

PU236 PHOTON ACER TENDL-2021 LIBRARY; T=0.K
Principal cross sections

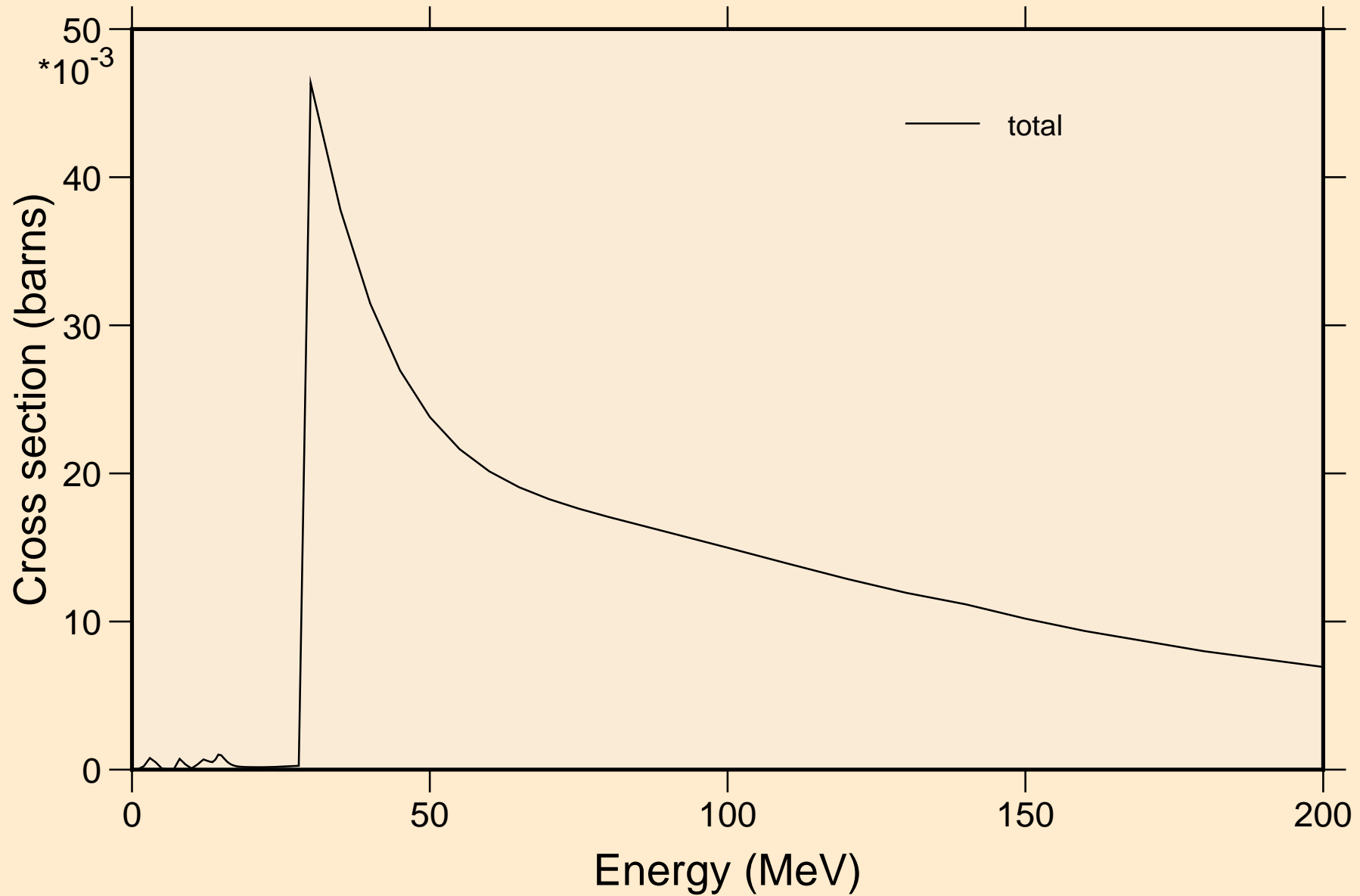

PU236 PHOTON ACER TENDL-2021 LIBRARY; T=0.K

Heating

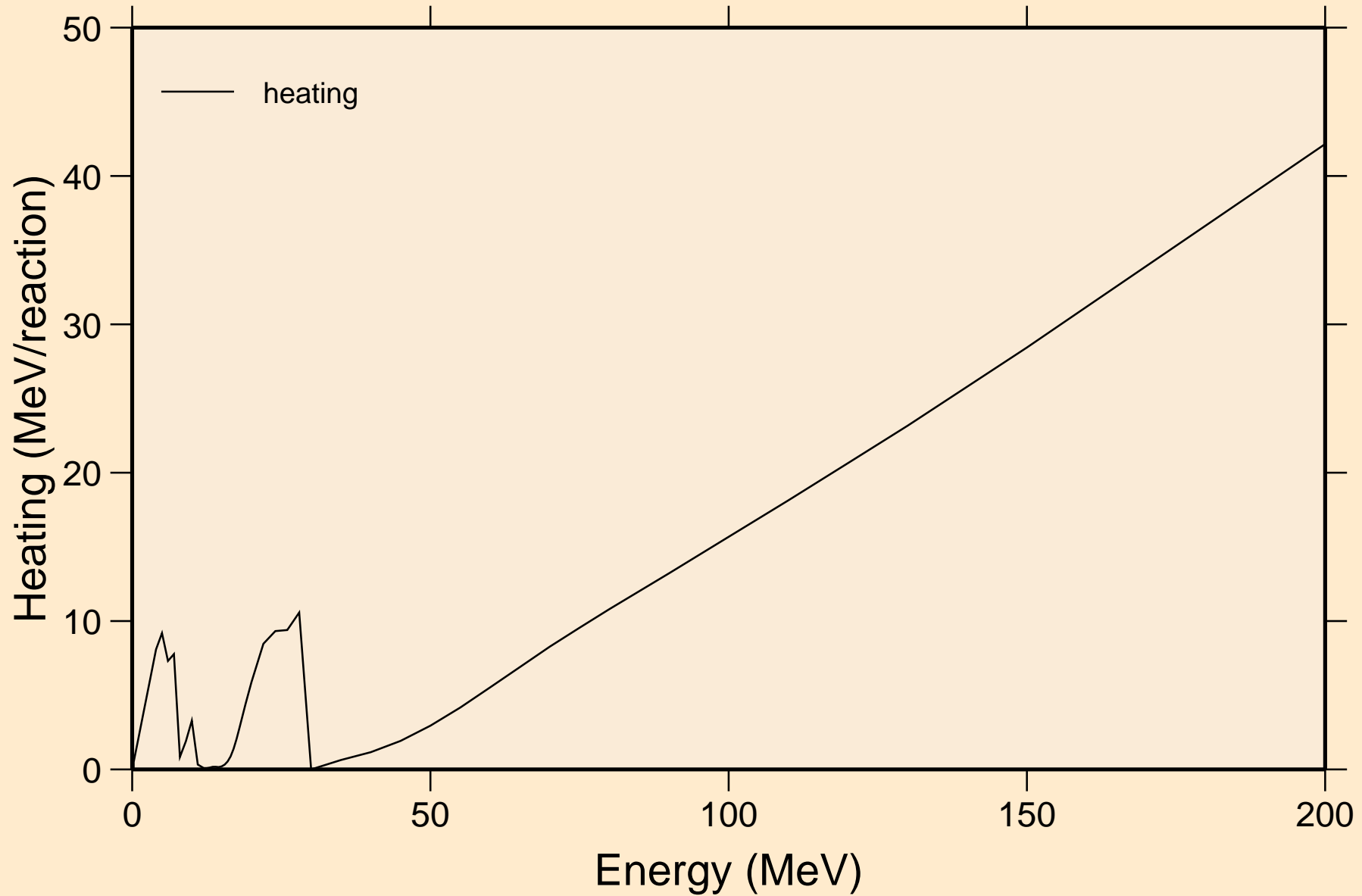

PU236 PHOTON ACER TENDL-2021 LIBRARY; T=0.K
Particle heating contributions

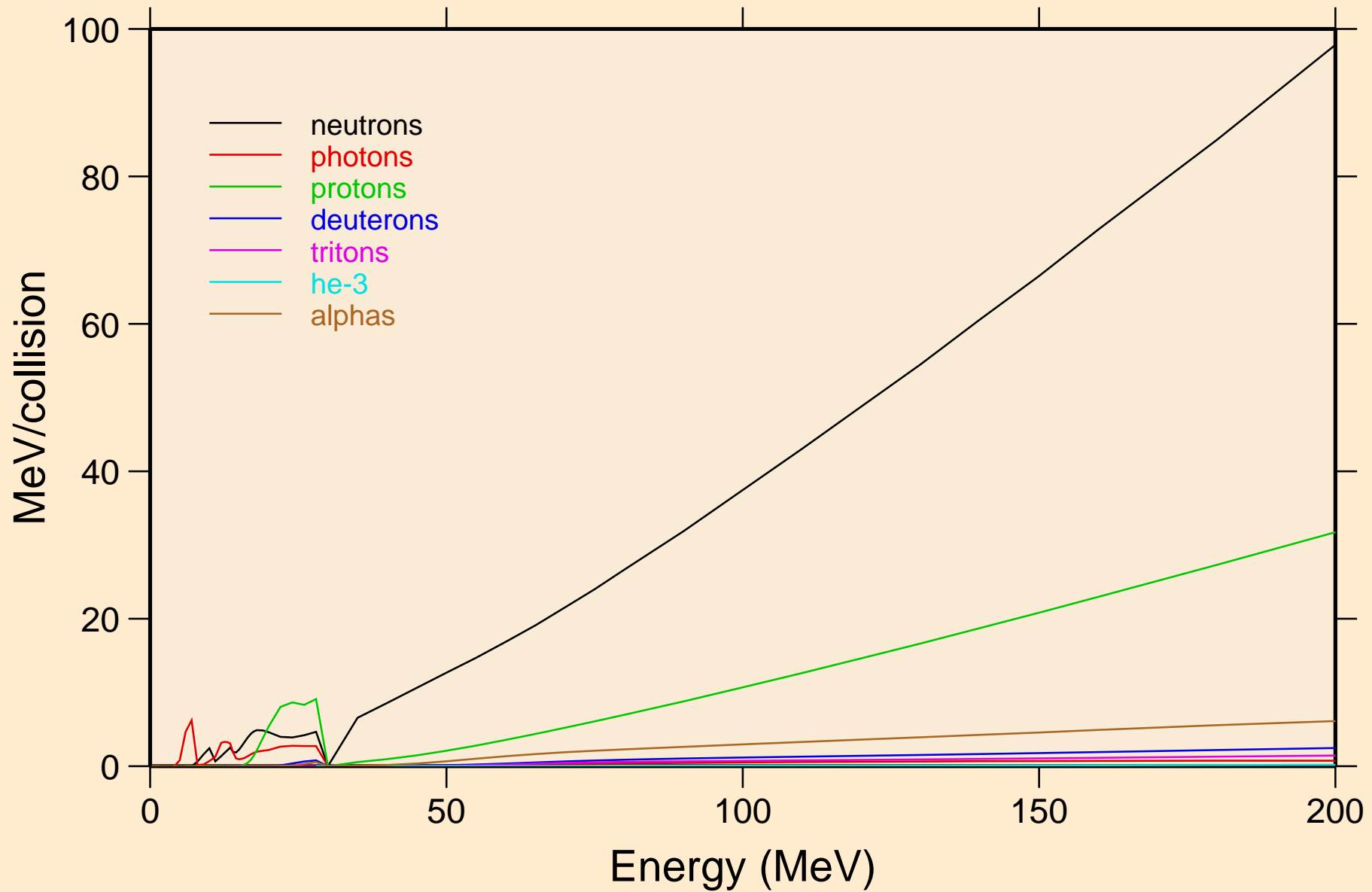

PU236 PHOTON ACER TENDL-2021 LIBRARY; T=0.K
Particle production cross sections

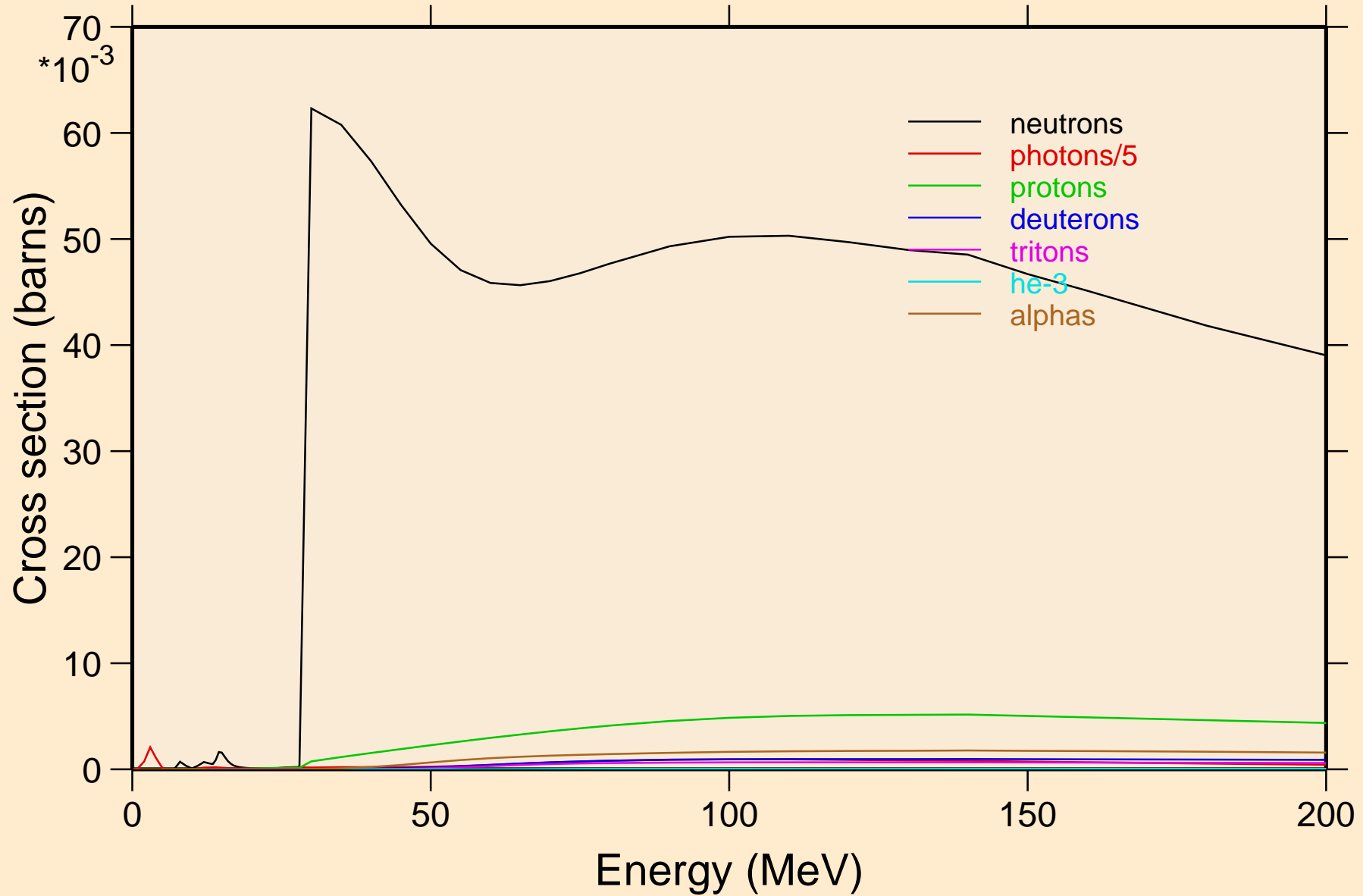

PU236 PHOTON ACER TENDL-2021 LIBRARY; T=0.K
neutrons from (g,x)

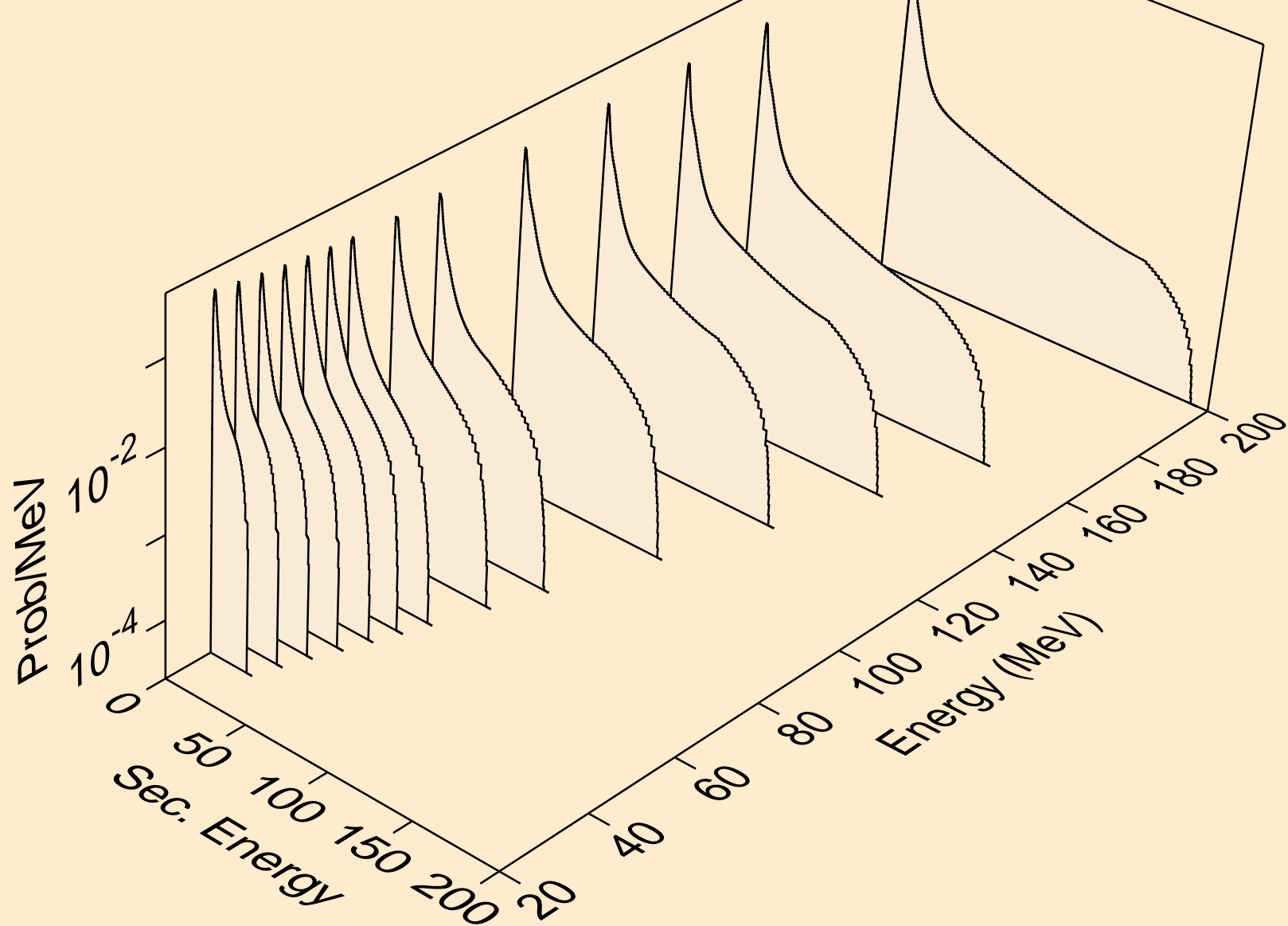

PU236 PHOTON ACER TENDL-2021 LIBRARY; T=0.K
neutrons from (g,2n)

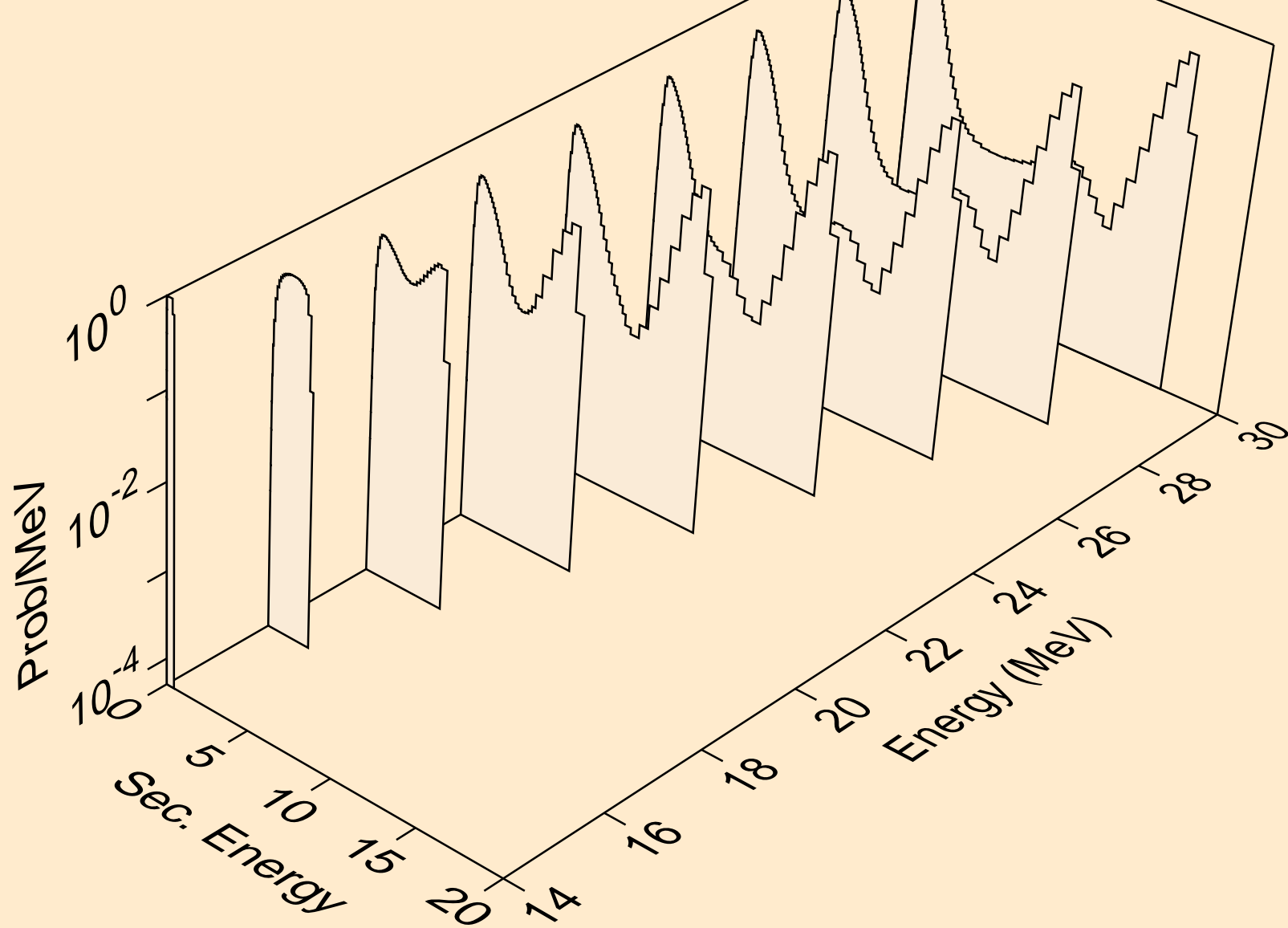

PU236 PHOTON ACER TENDL-2021 LIBRARY; T=0.K
neutrons from (g,3n)

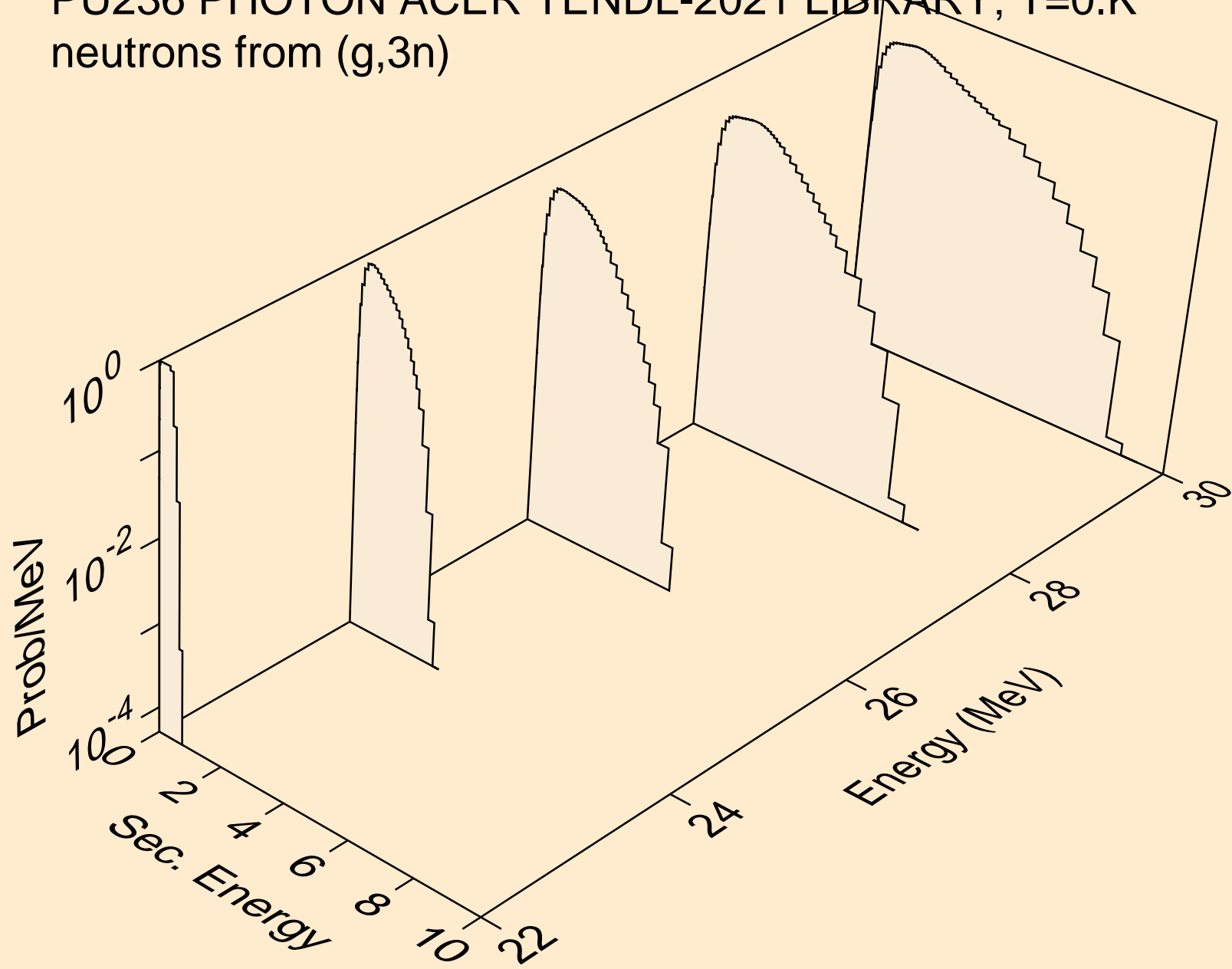

PU236 PHOTON ACER TENDL-2021 LIBRARY; T=0.K
neutrons from (g,n*)a

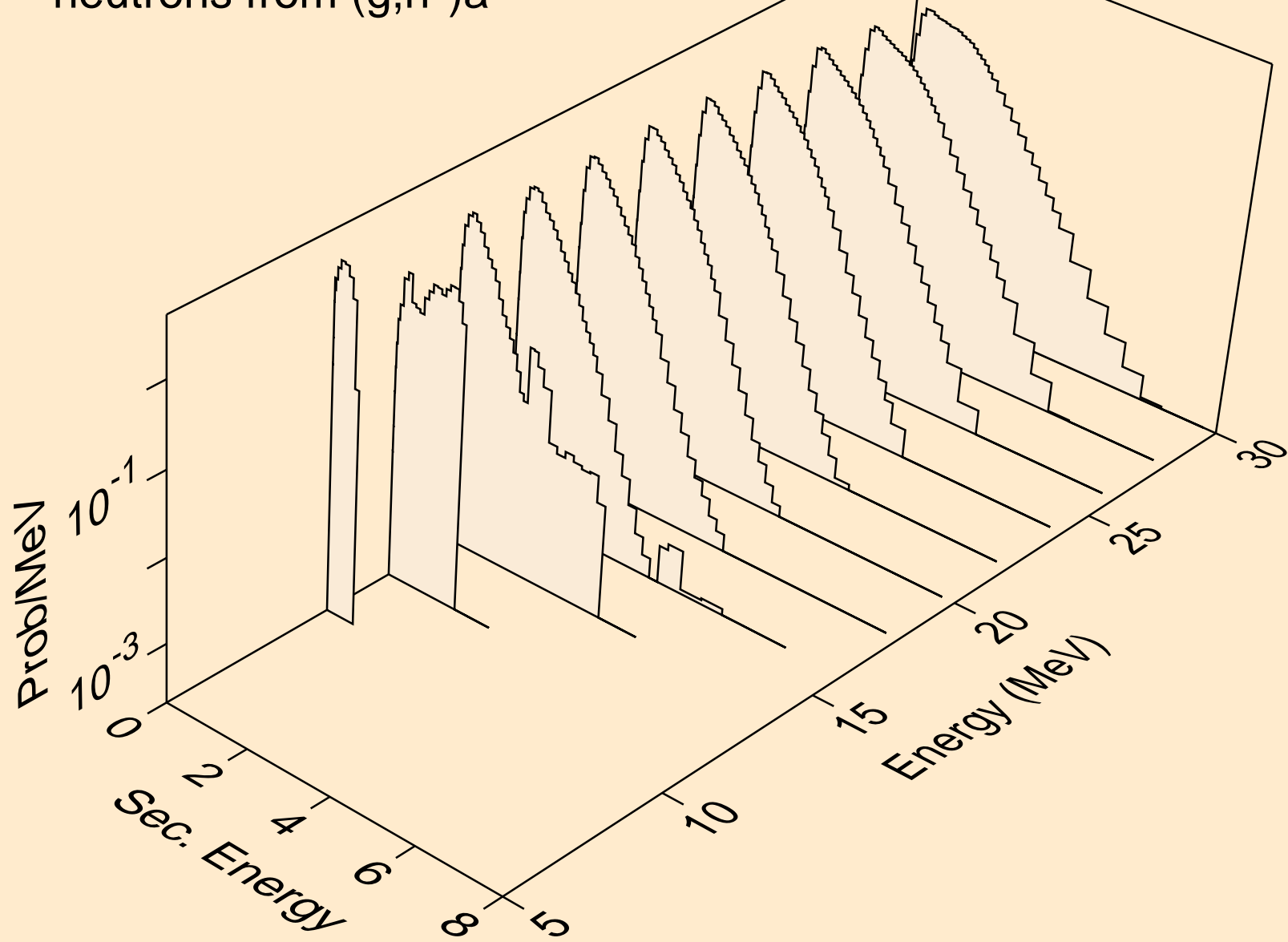

PU236 PHOTON ACER TENDL-2021 LIBRARY; T=0.K
neutrons from (g,2n)a

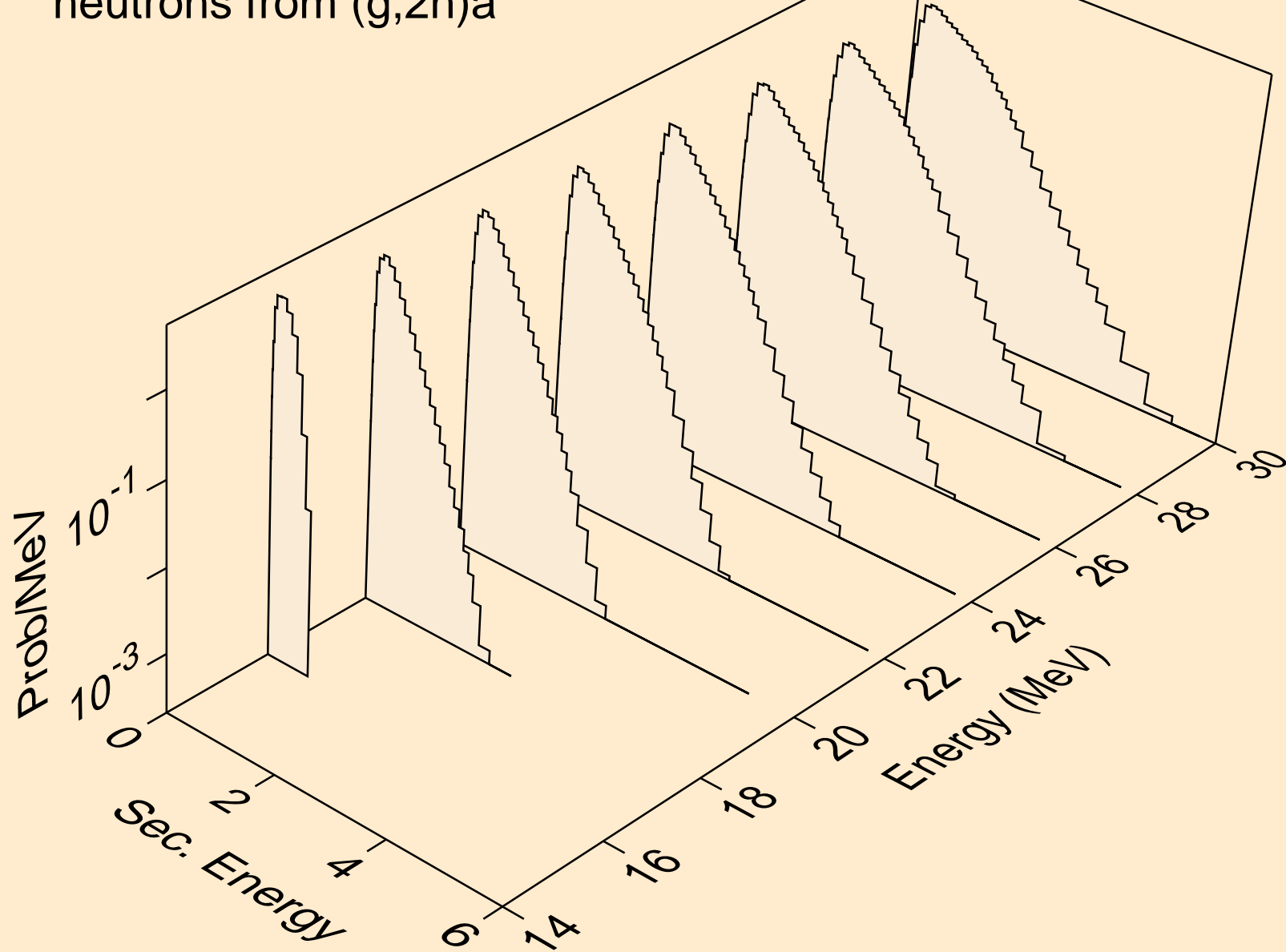

PU236 PHOTON ACER TENDL-2021 LIBRARY; T=0.K
neutrons from (g,n*)p

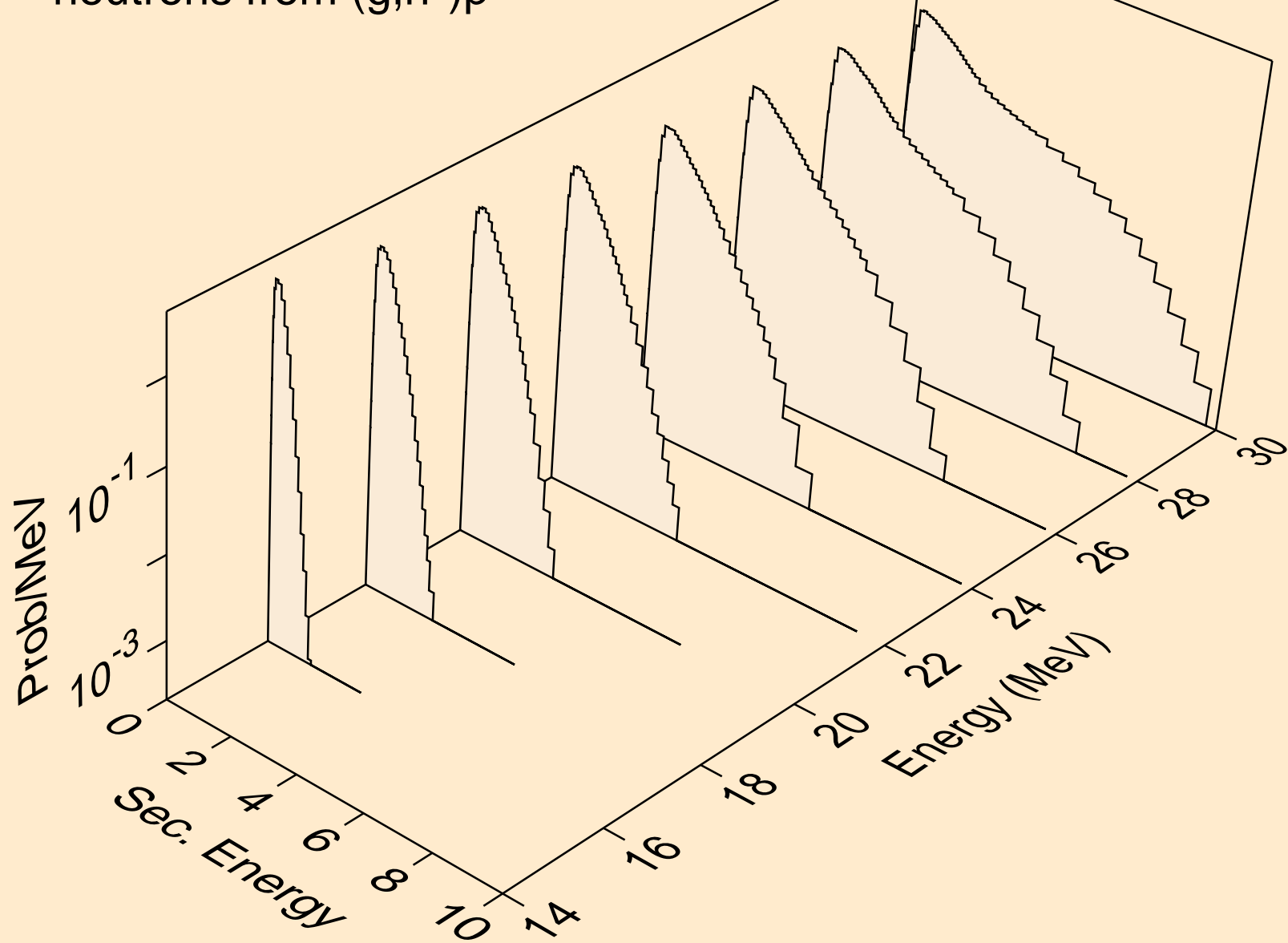

PU236 PHOTON ACER TENDL-2021 LIBRARY; T=0.K
neutrons from (g,n*)d

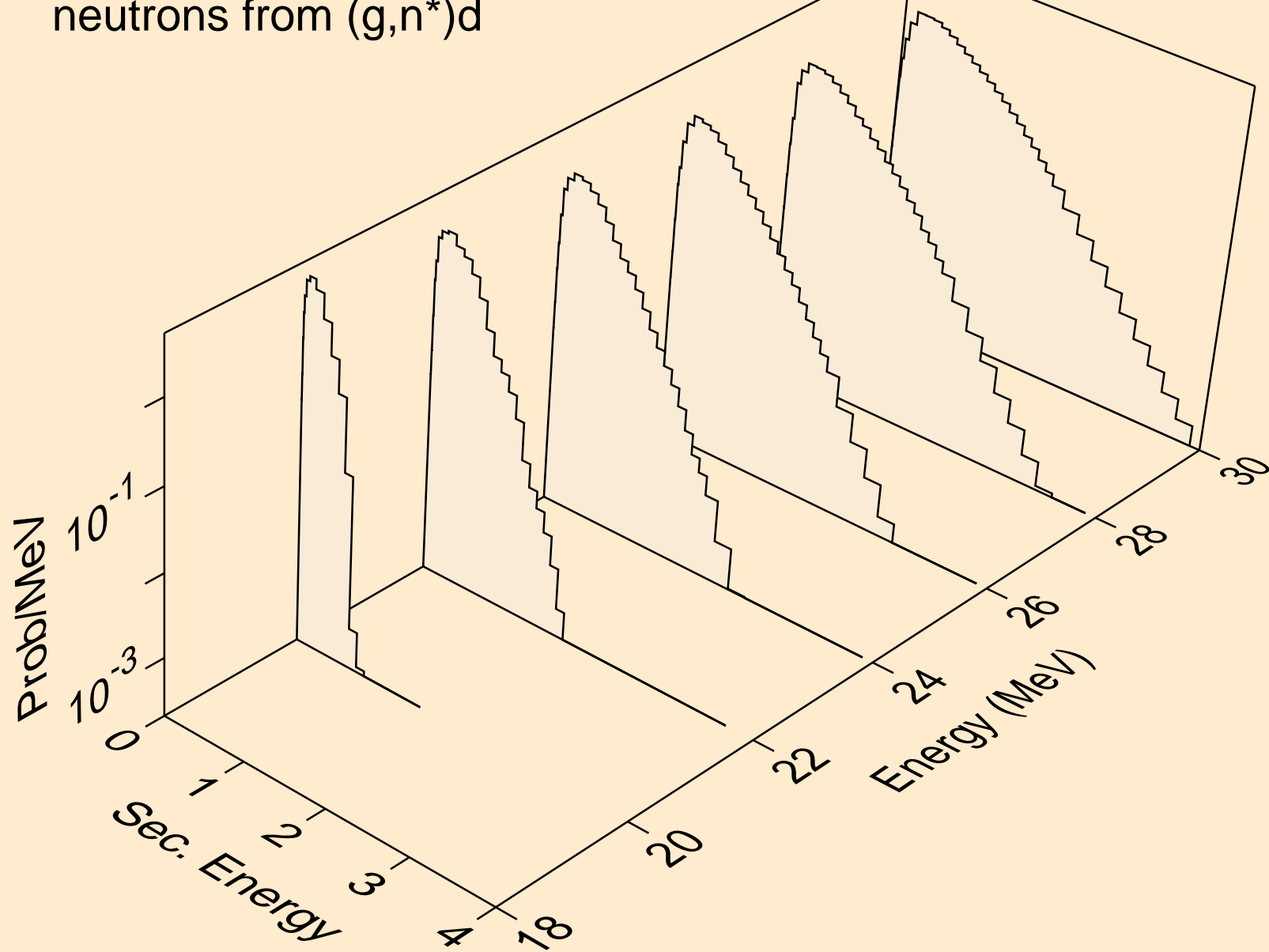

PU236 PHOTON ACER TENDL-2021 LIBRARY; T=0.K
neutrons from (g,n*)t

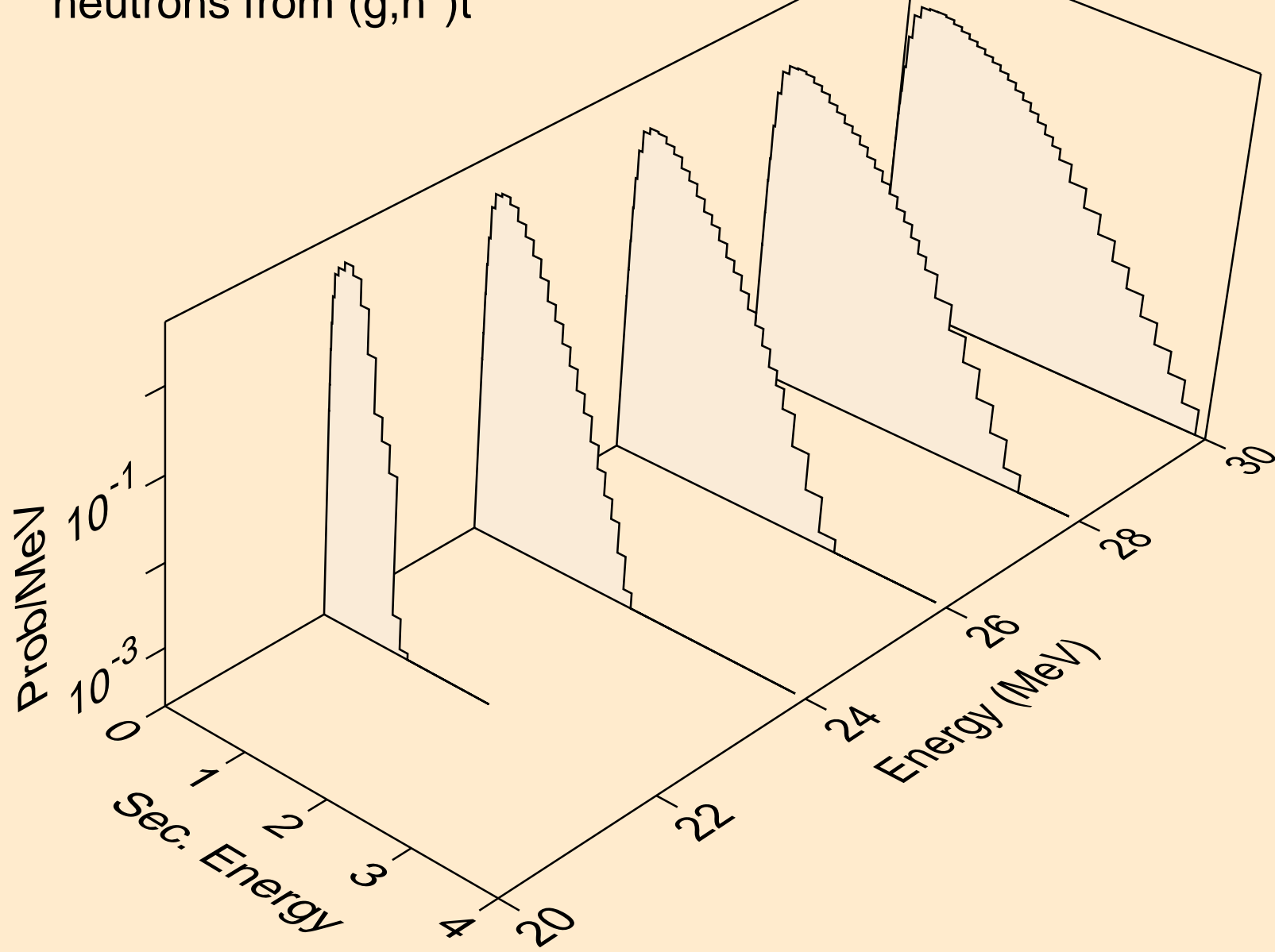

PU236 PHOTON ACER TENDL-2021 LIBRARY; T=0.K
neutrons from (g,4n)

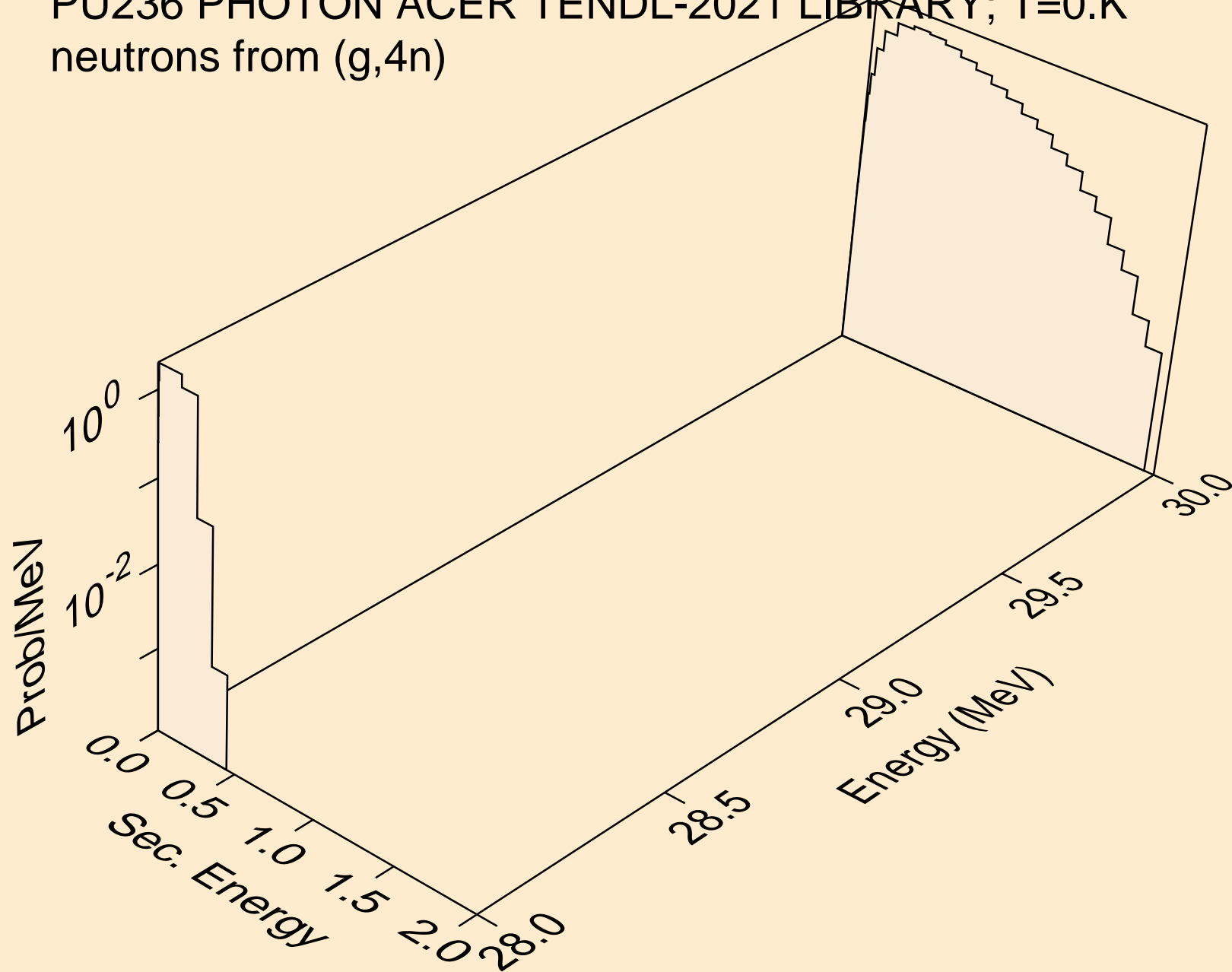

PU236 PHOTON ACER TENDL-2021 LIBRARY; T=0.K
neutrons from (g,2np)

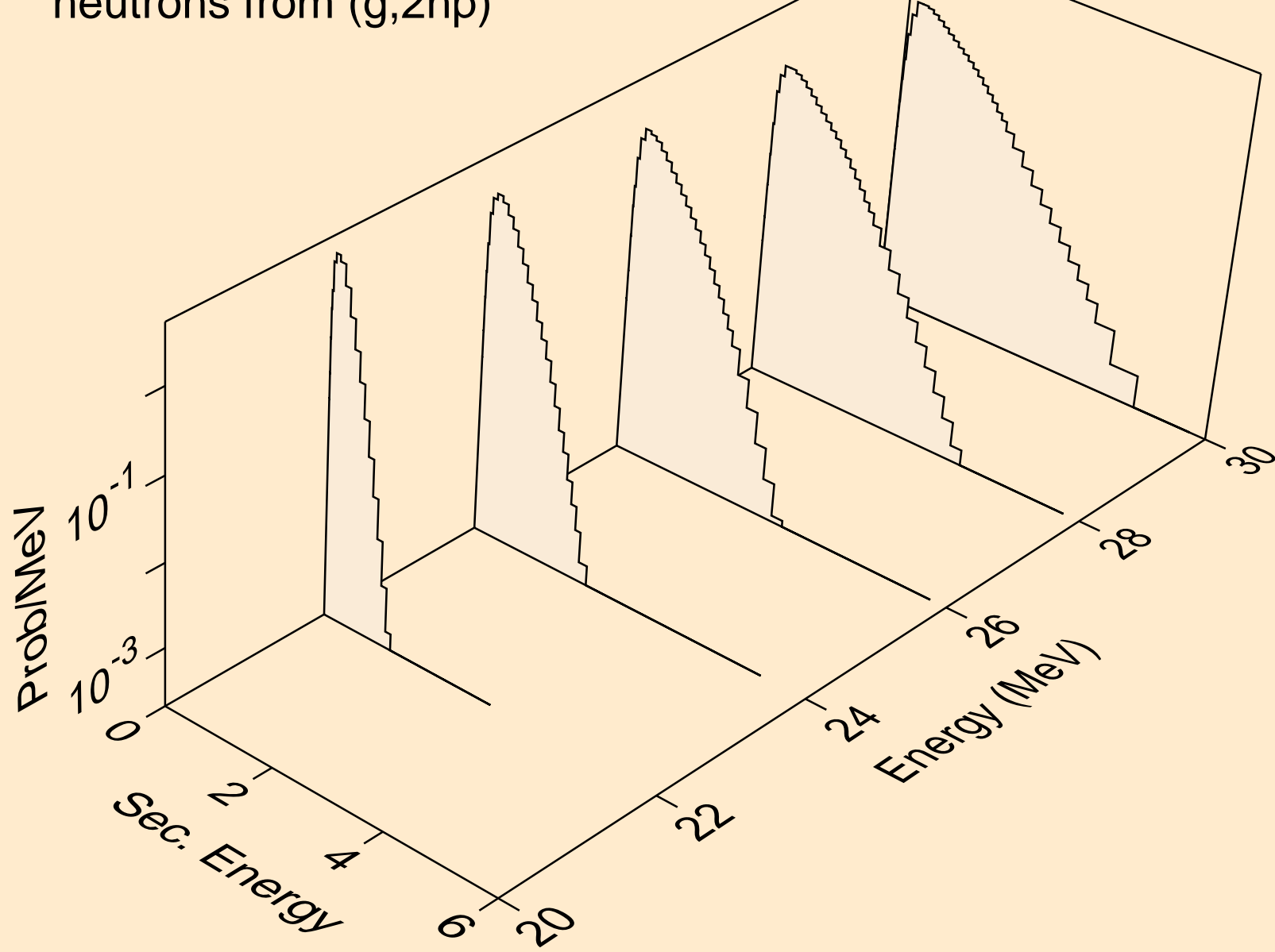

PU236 PHOTON ACER TENDL-2021 LIBRARY; T=0.K
angular distribution for (g,n*0) neutron

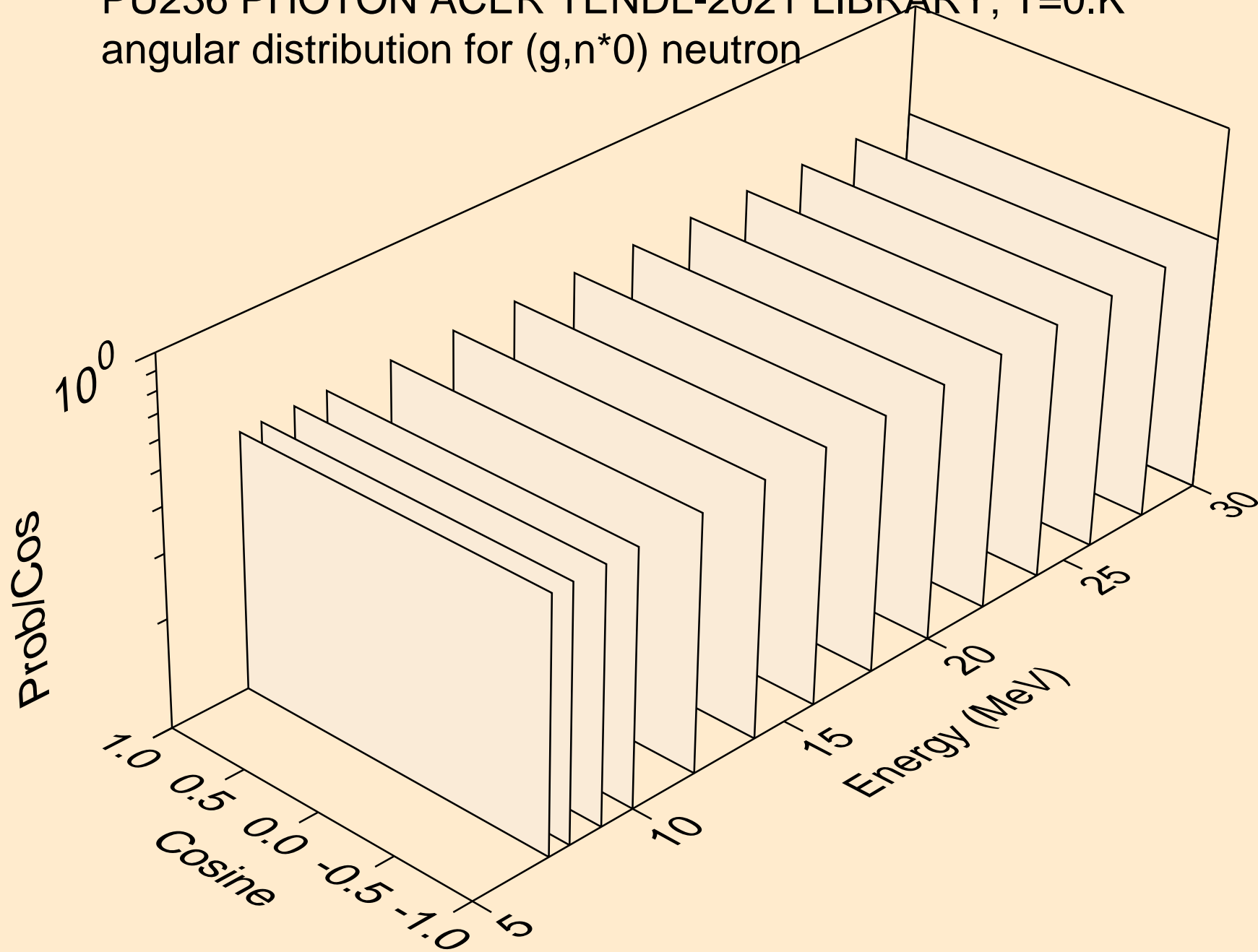

PU236 PHOTON ACER TENDL-2021 LIBRARY; T=0.K
angular distribution for (g,n*1) neutron

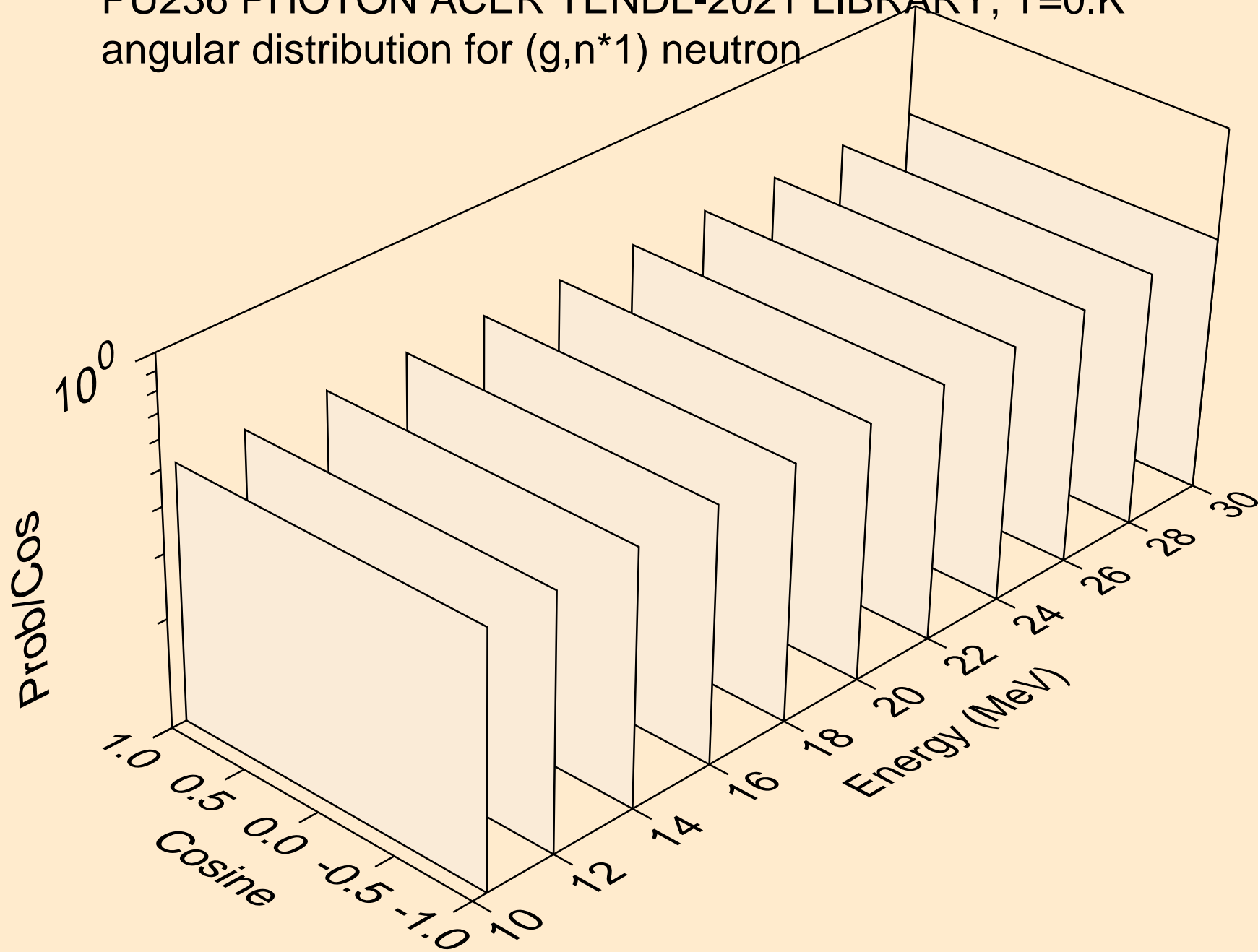

PU236 PHOTON ACER TENDL-2021 LIBRARY; T=0.K
neutrons from (g,n*c)

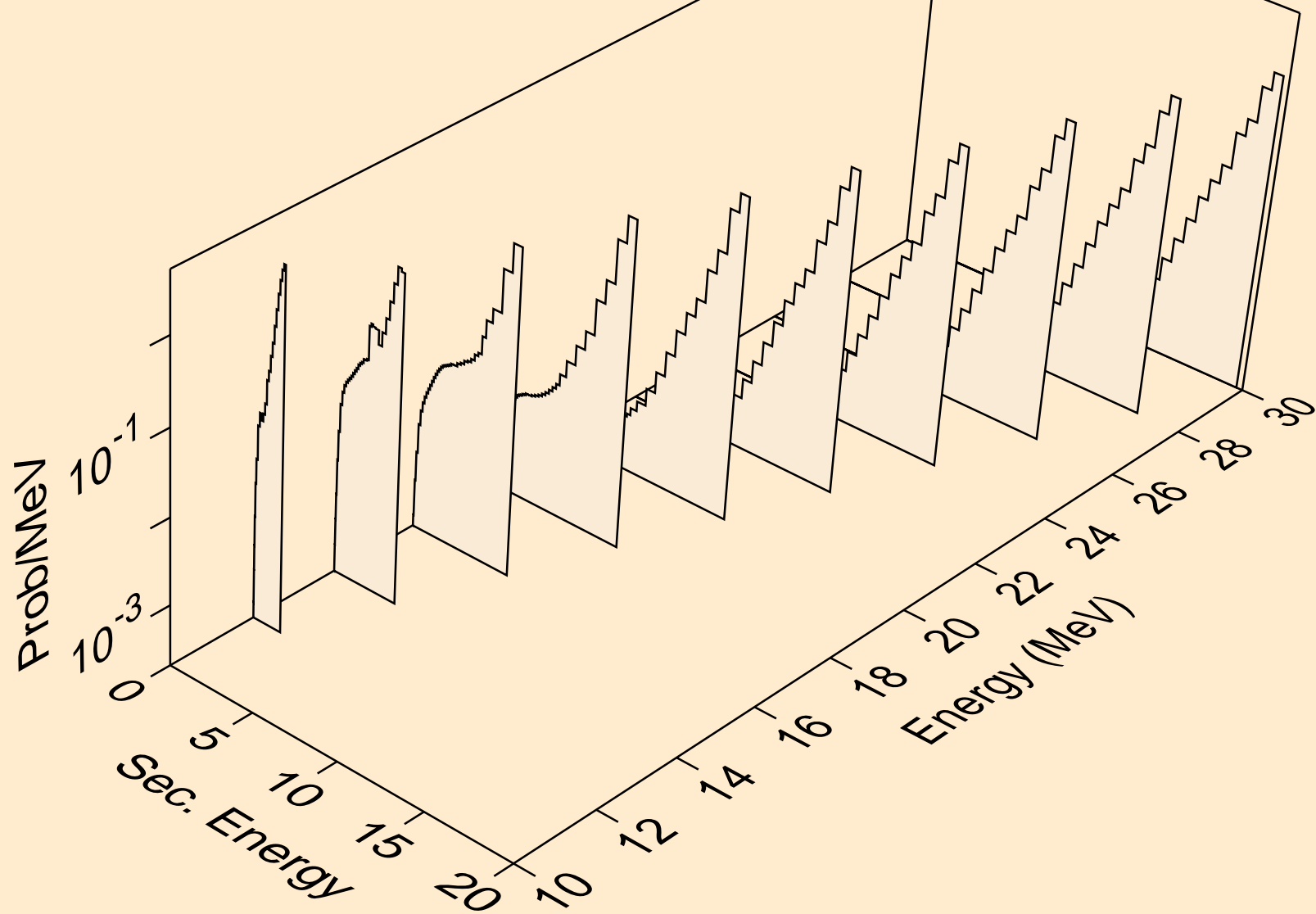

PU236 PHOTON ACER TENDL-2021 LIBRARY; T=0.K
photons from (g,x)

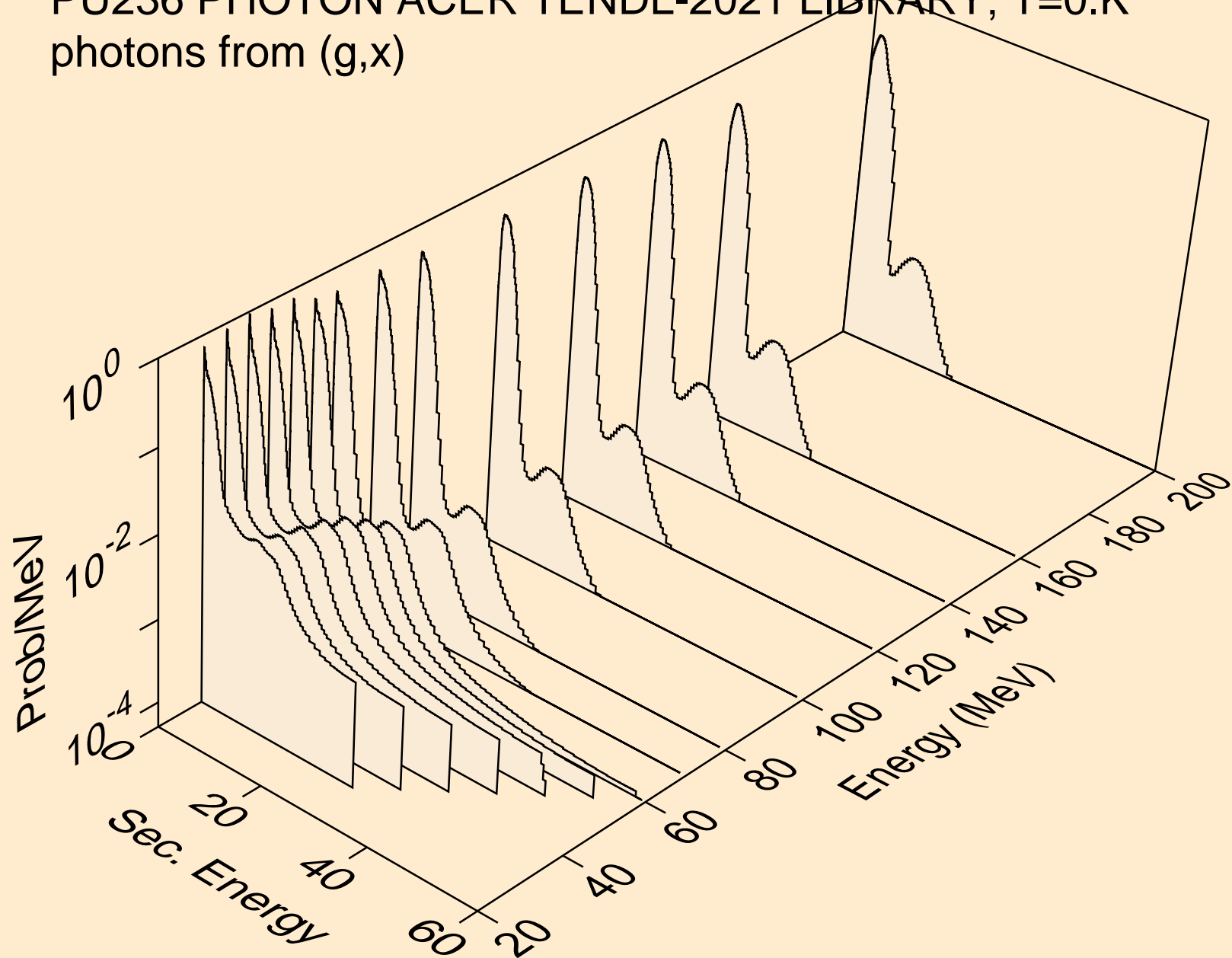

PU236 PHOTON ACER TENDL-2021 LIBRARY; T=0.K
photons from (g,2n)

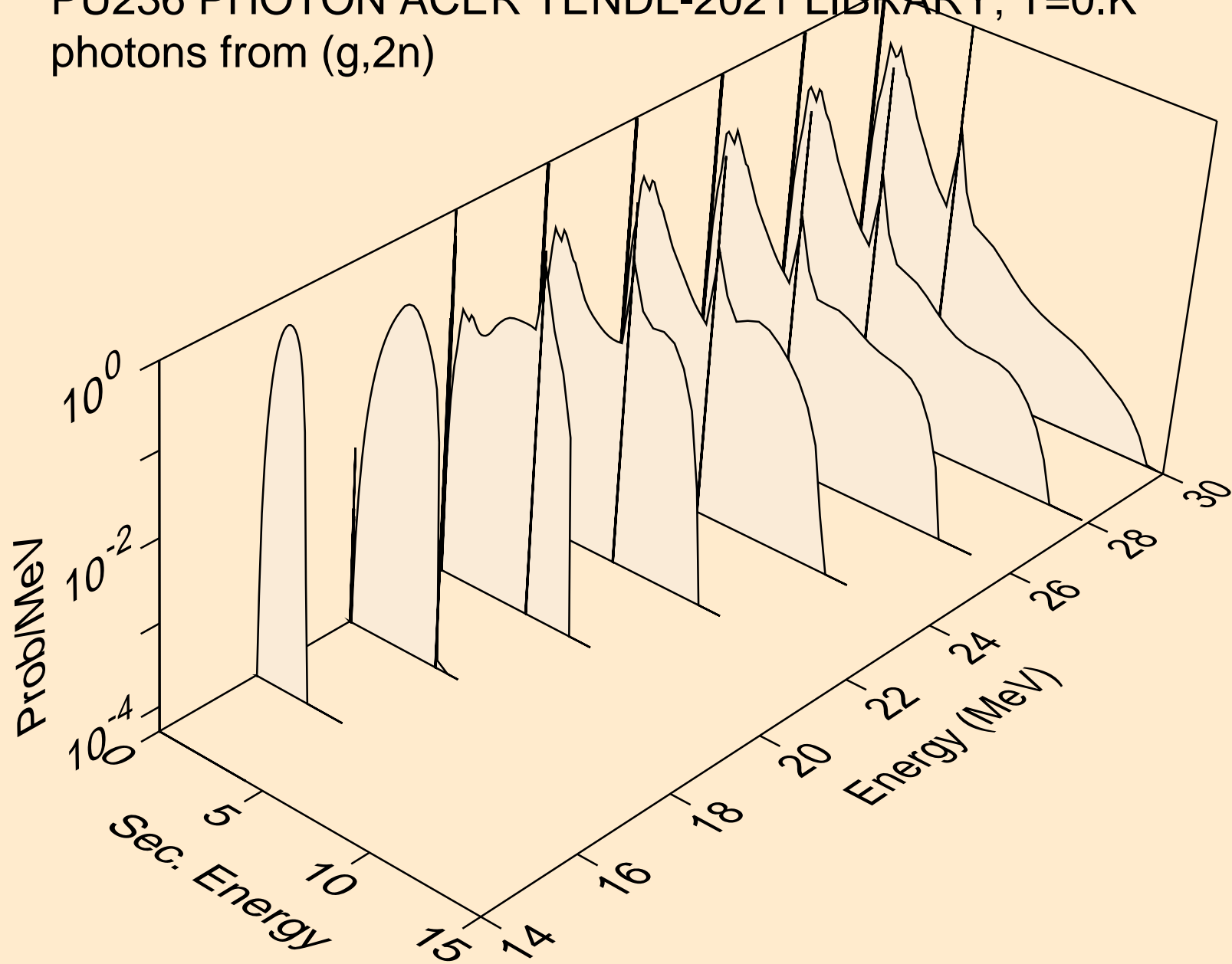

PU236 PHOTON ACER TENDL-2021 LIBRARY; T=0.K
photons from (g,3n)

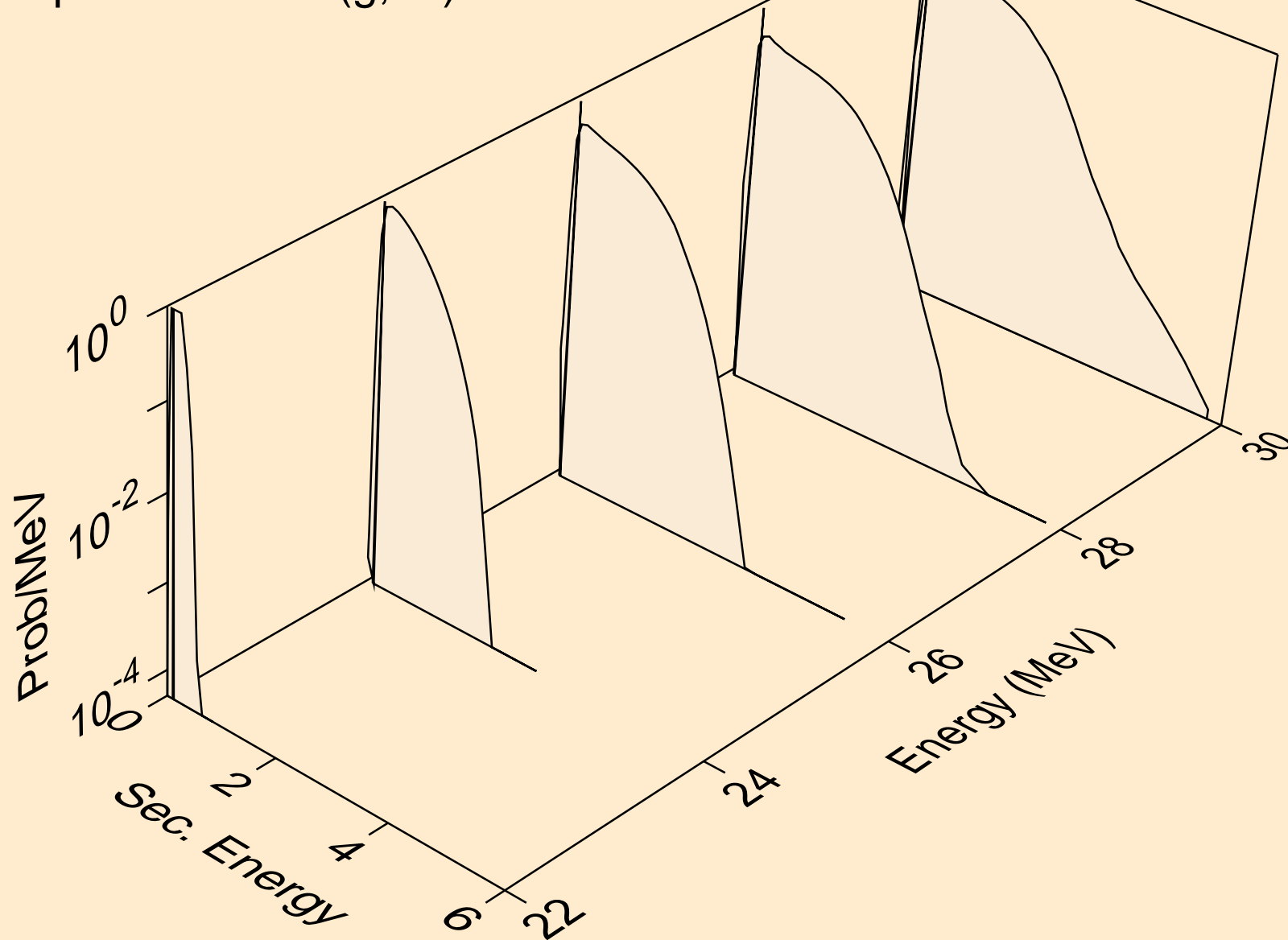

PU236 PHOTON ACER TENDL-2021 LIBRARY; T=0.K
photons from (g,n*)a

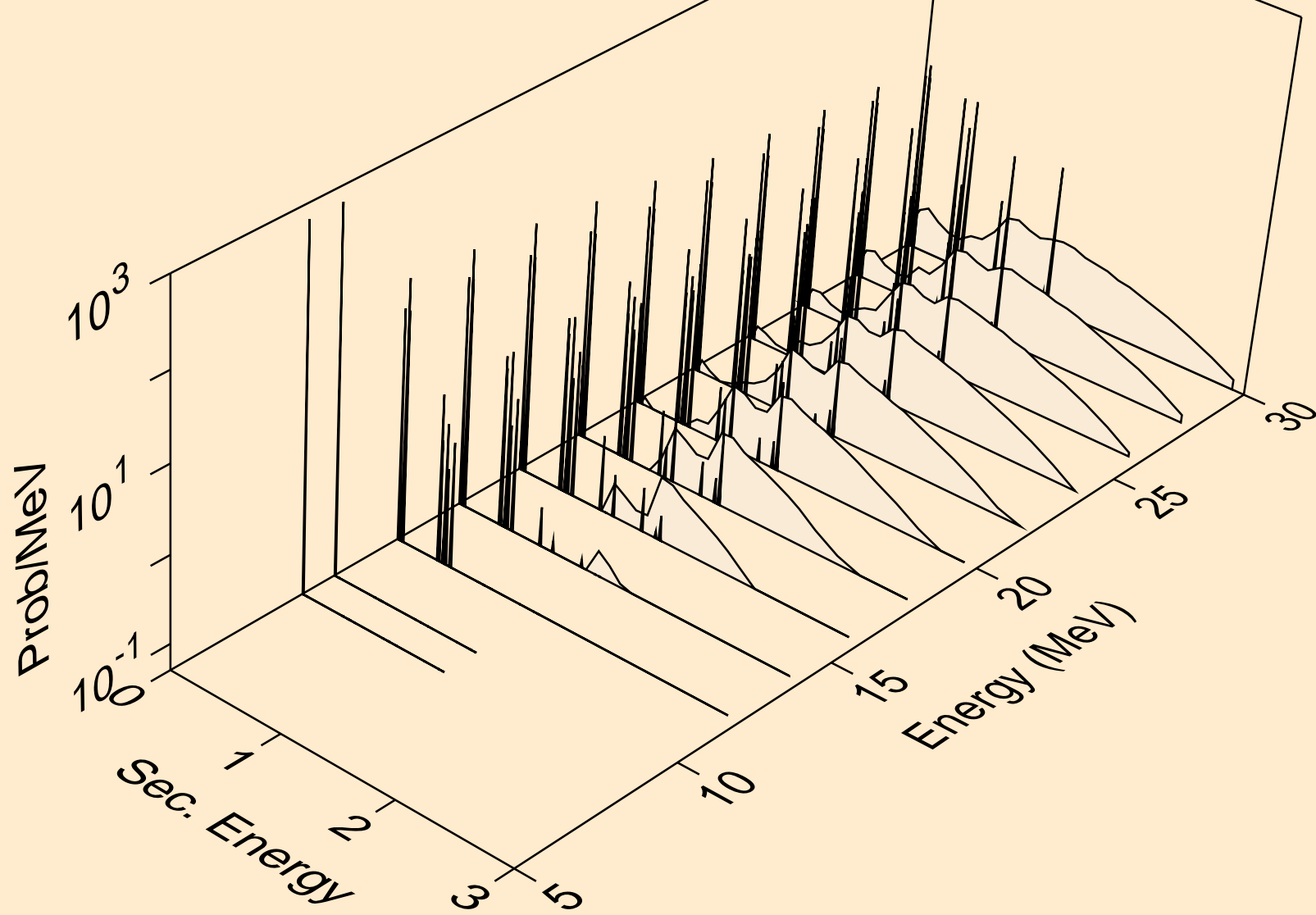

PU236 PHOTON ACER TENDL-2021 LIBRARY; T=0.K
photons from (g,2n)a

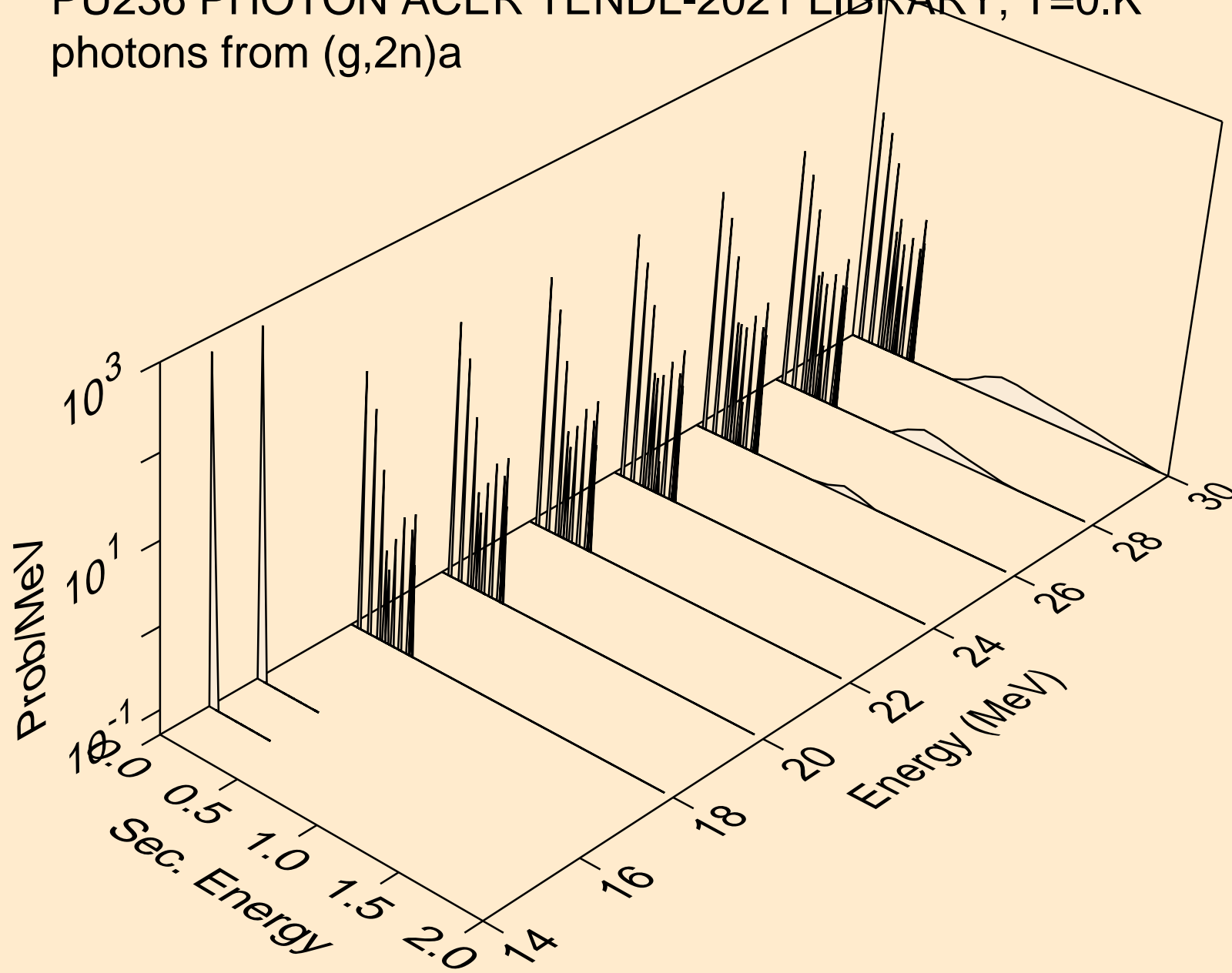

PU236 PHOTON ACER TENDL-2021 LIBRARY; T=0.K
photons from (g,n*)p

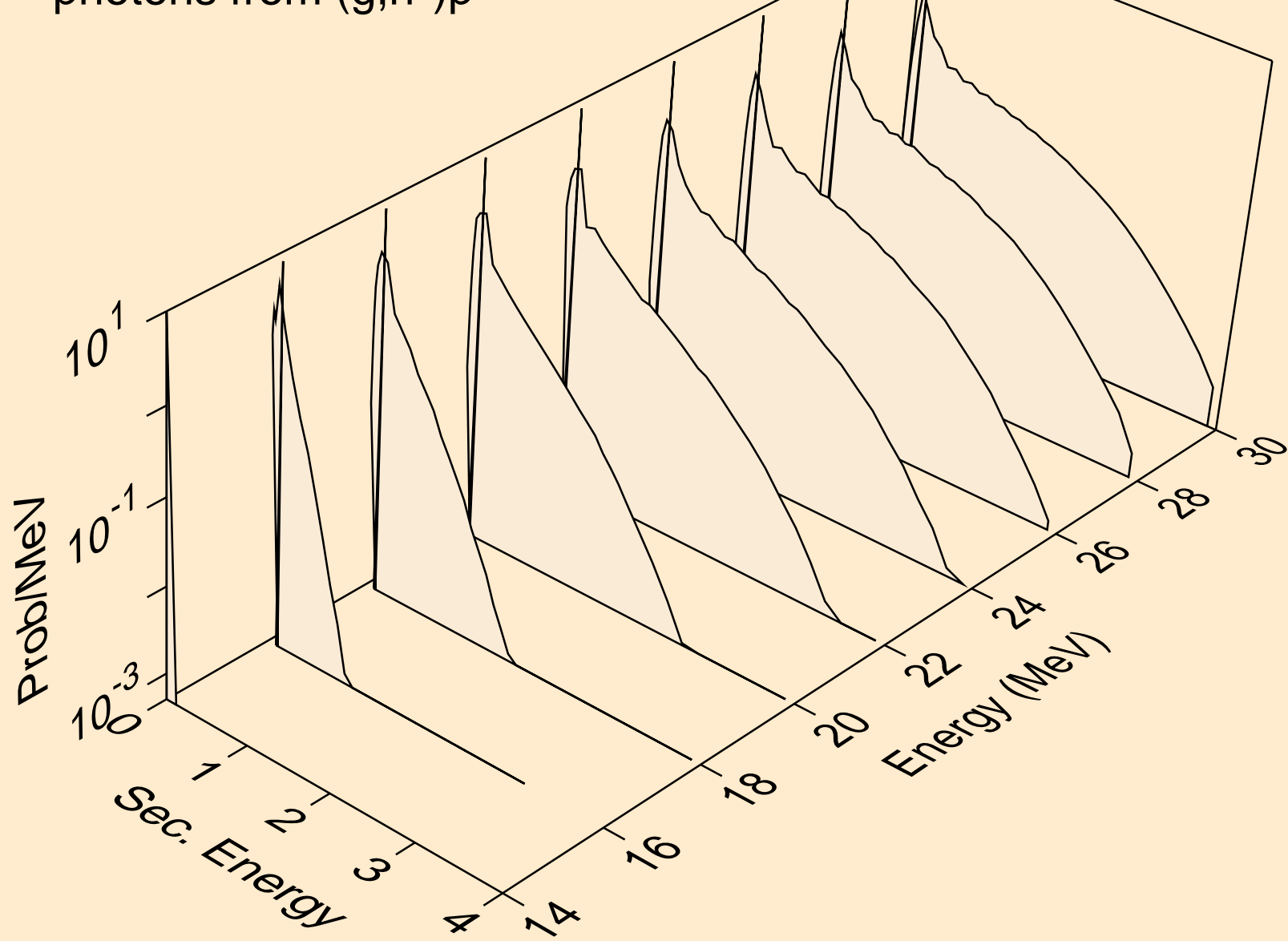

PU236 PHOTON ACER TENDL-2021 LIBRARY; T=0.K
photons from (g,n*)d

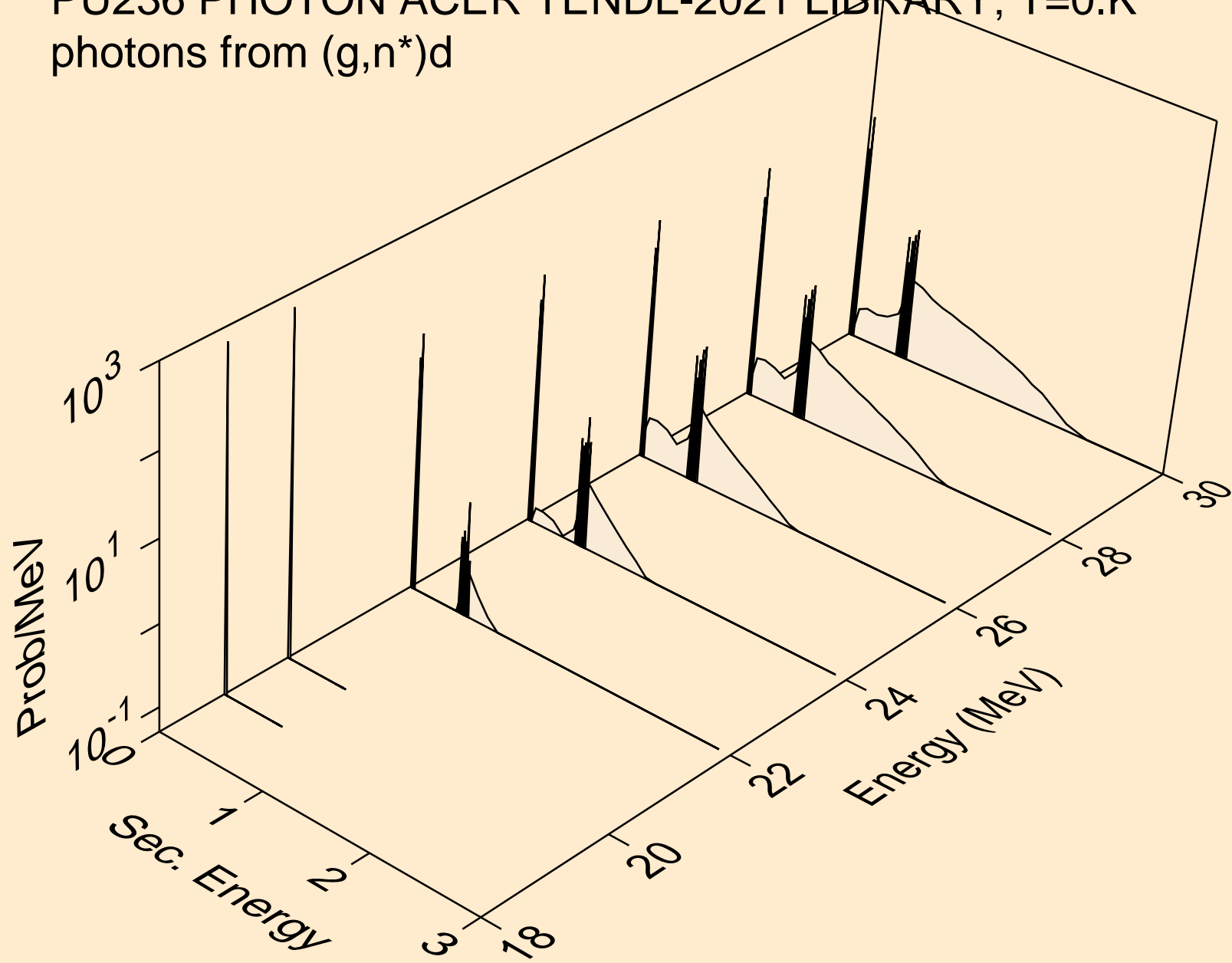

PU236 PHOTON ACER TENDL-2021 LIBRARY; T=0.K
photons from (g,n*)t

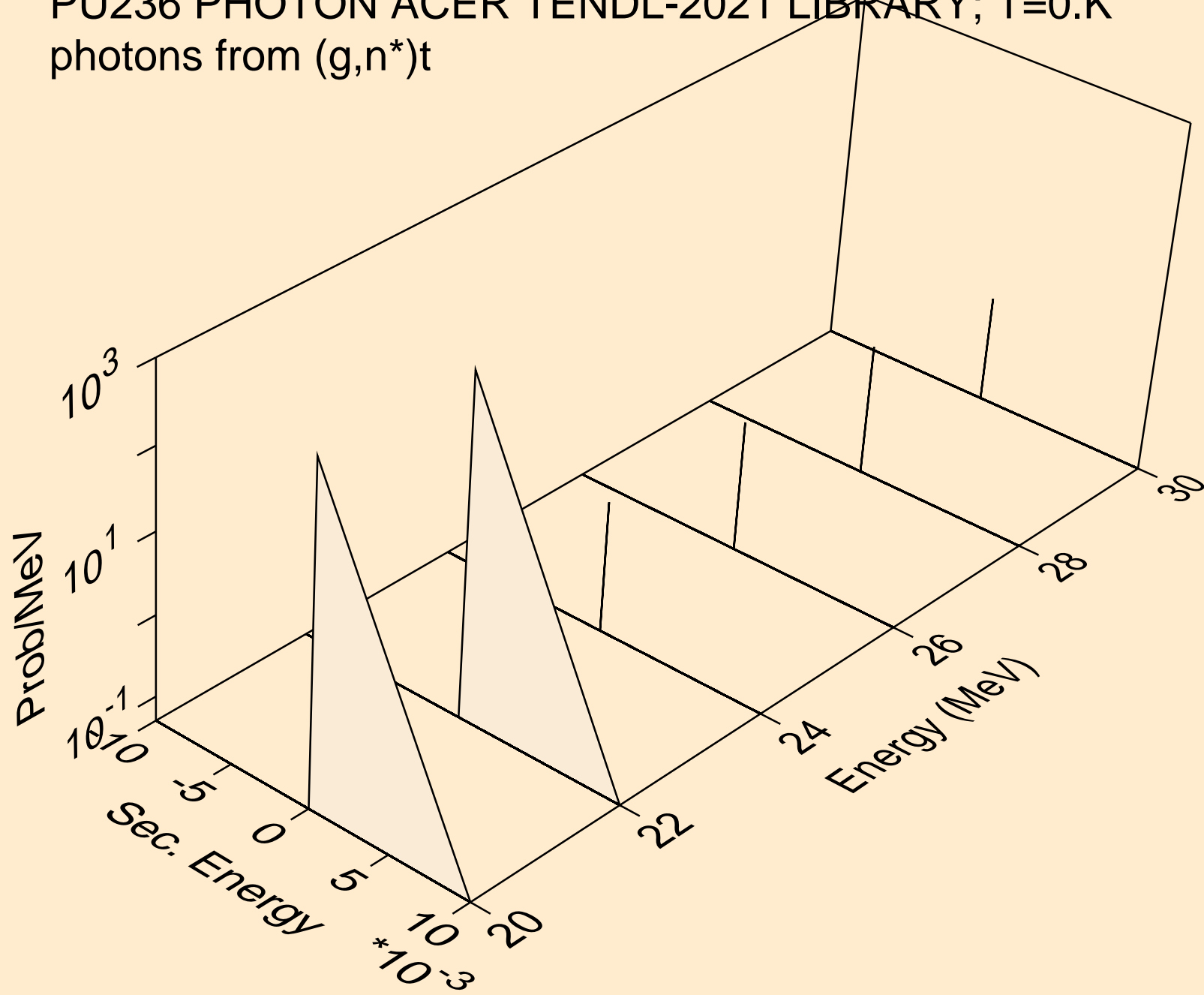

PU236 PHOTON ACER TENDL-2021 LIBRARY; T=0.K
photons from (g,4n)

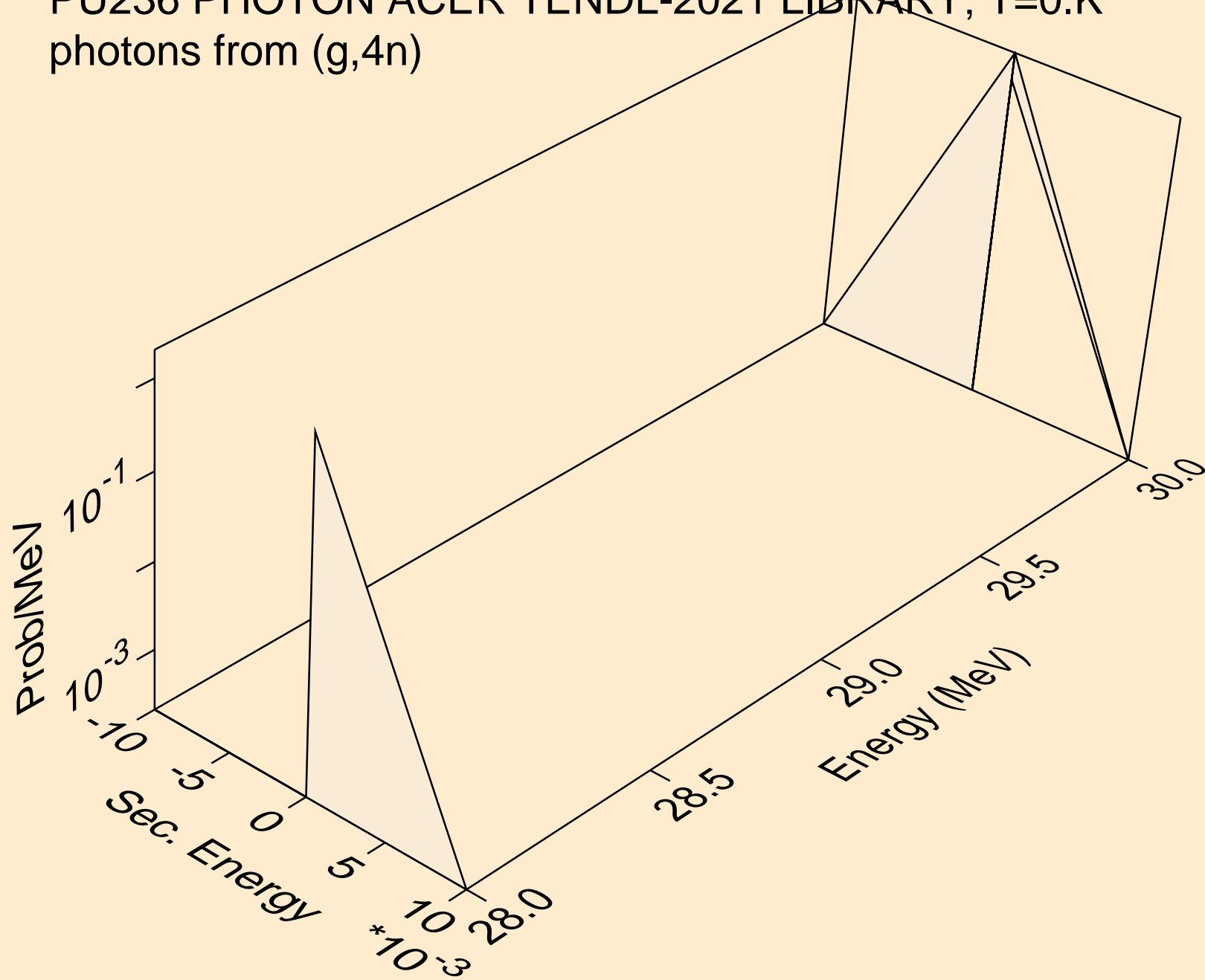

PU236 PHOTON ACER TENDL-2021 LIBRARY; T=0.K
photons from (g,2np)

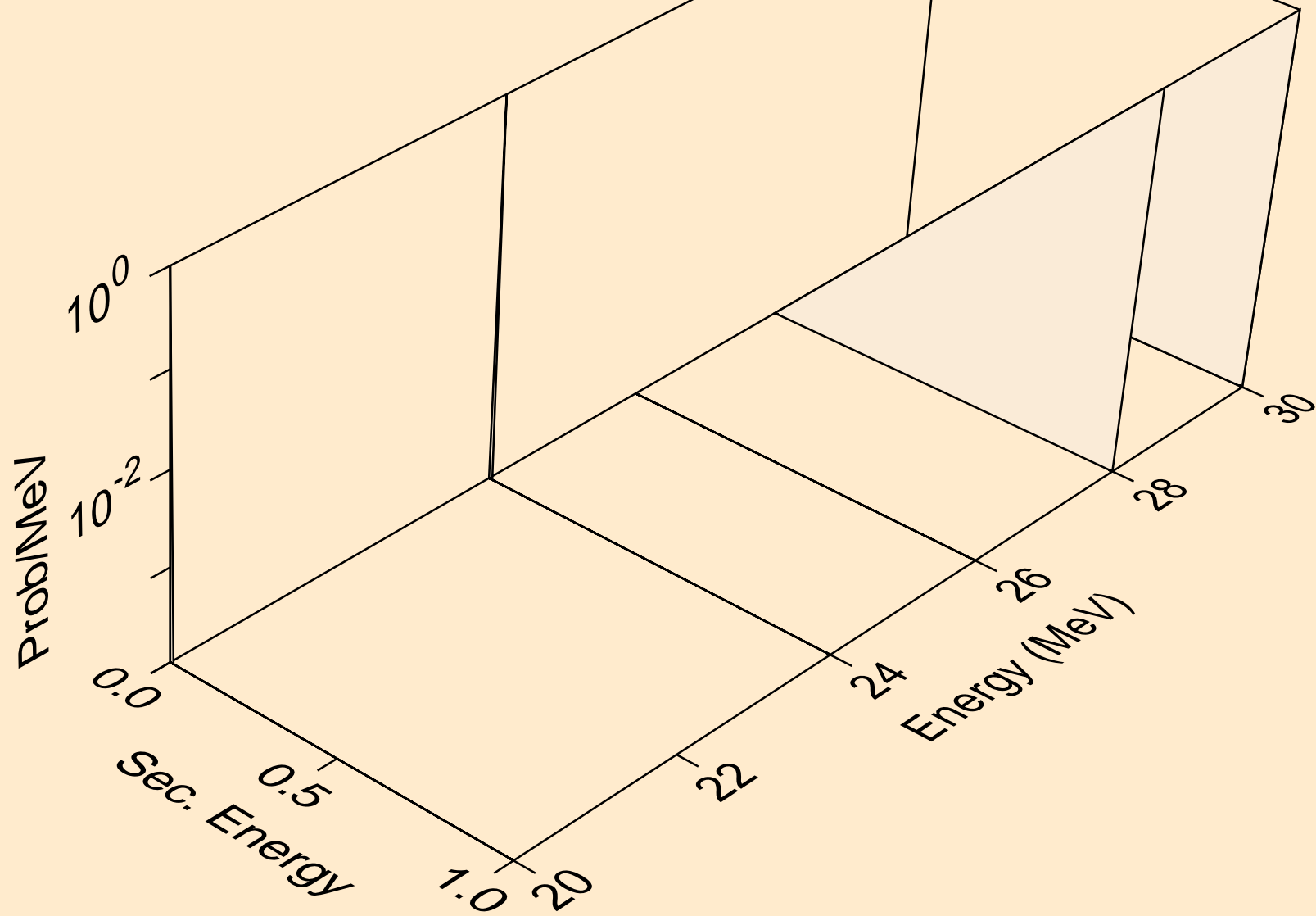

PU236 PHOTON ACER TENDL-2021 LIBRARY; T=0.K
photons from (g,n*c)

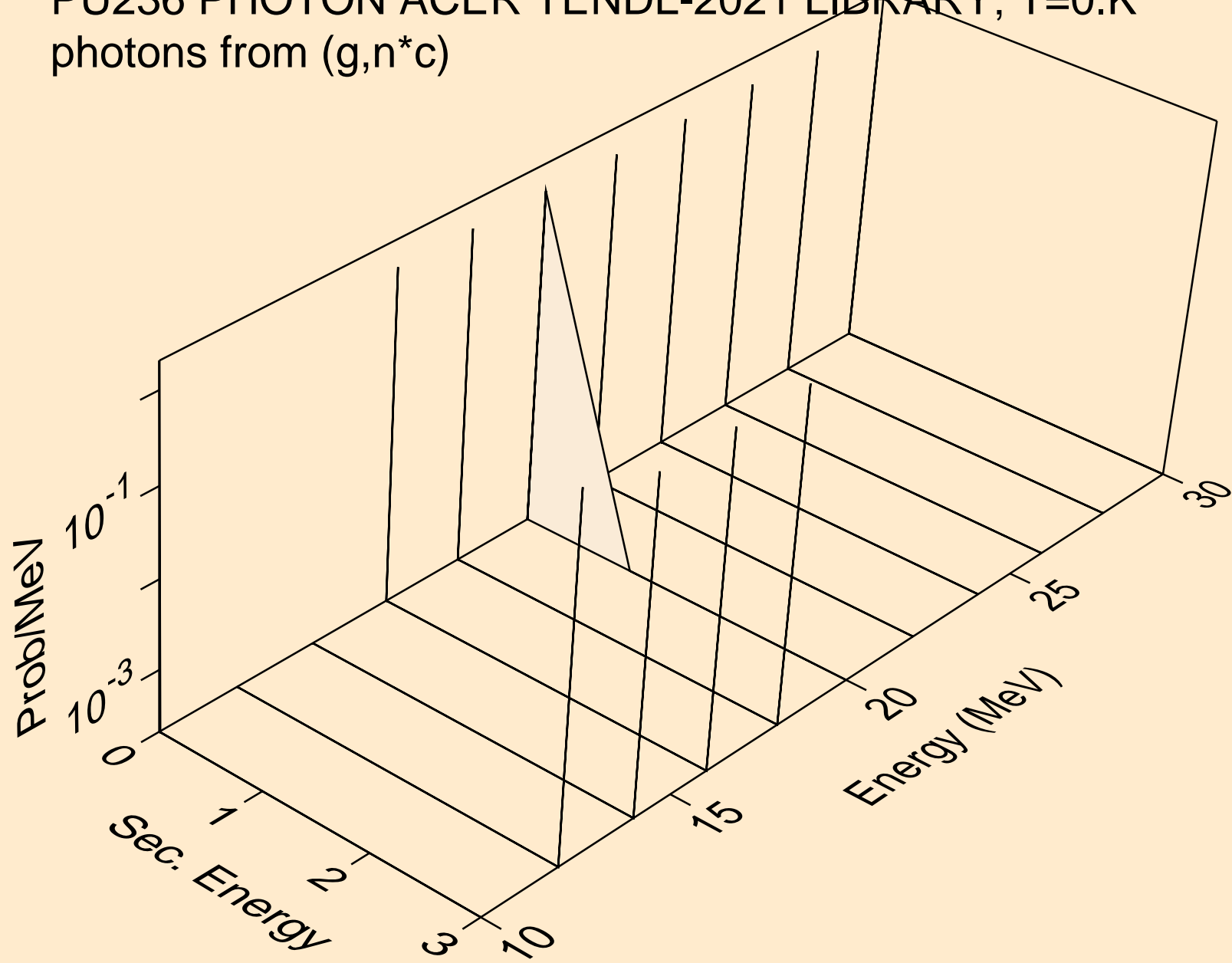

PU236 PHOTON ACER TENDL-2021 LIBRARY; T=0.K
photons from (g,gma)

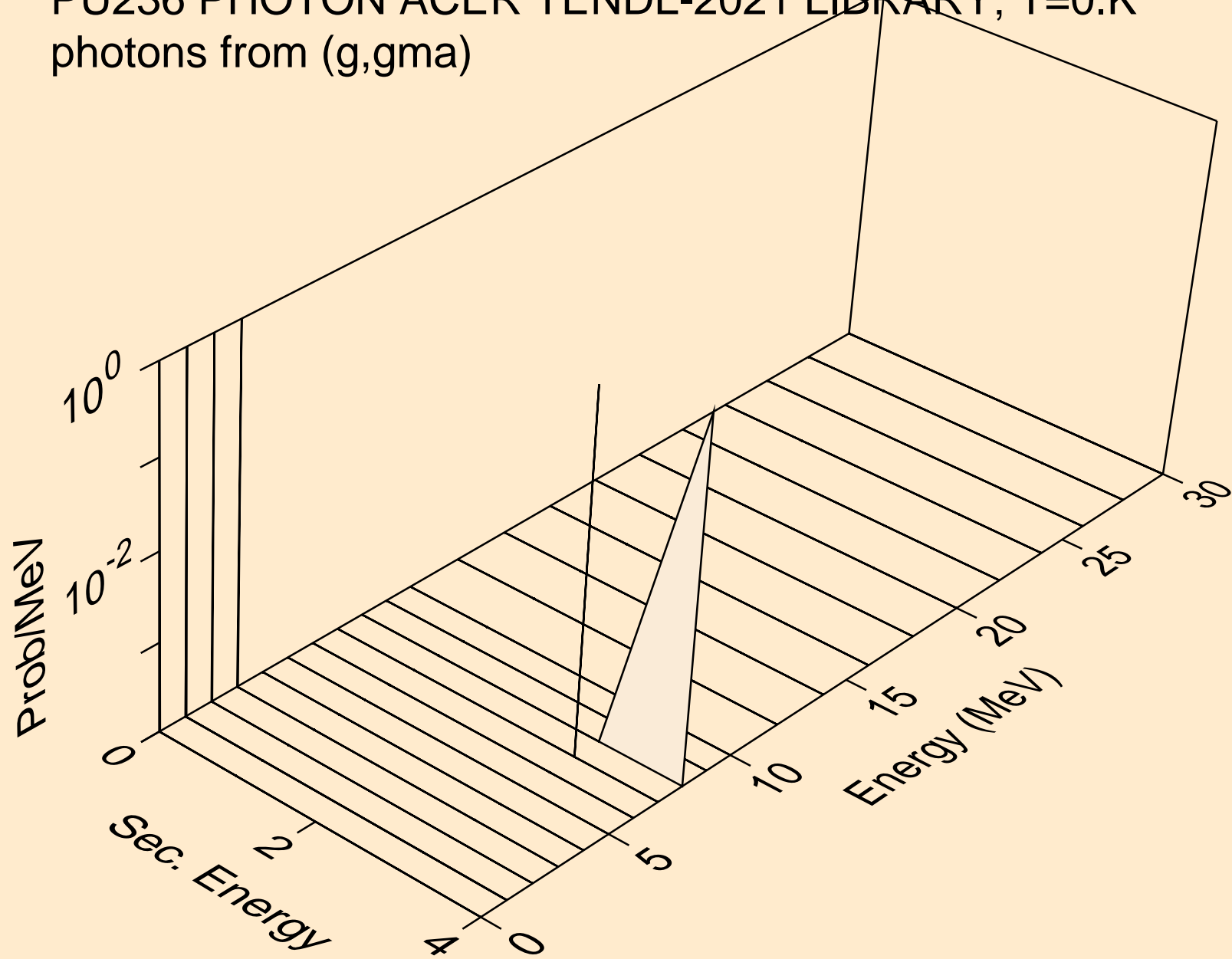

PU236 PHOTON ACER TENDL-2021 LIBRARY; T=0.K
photons from (g,p)

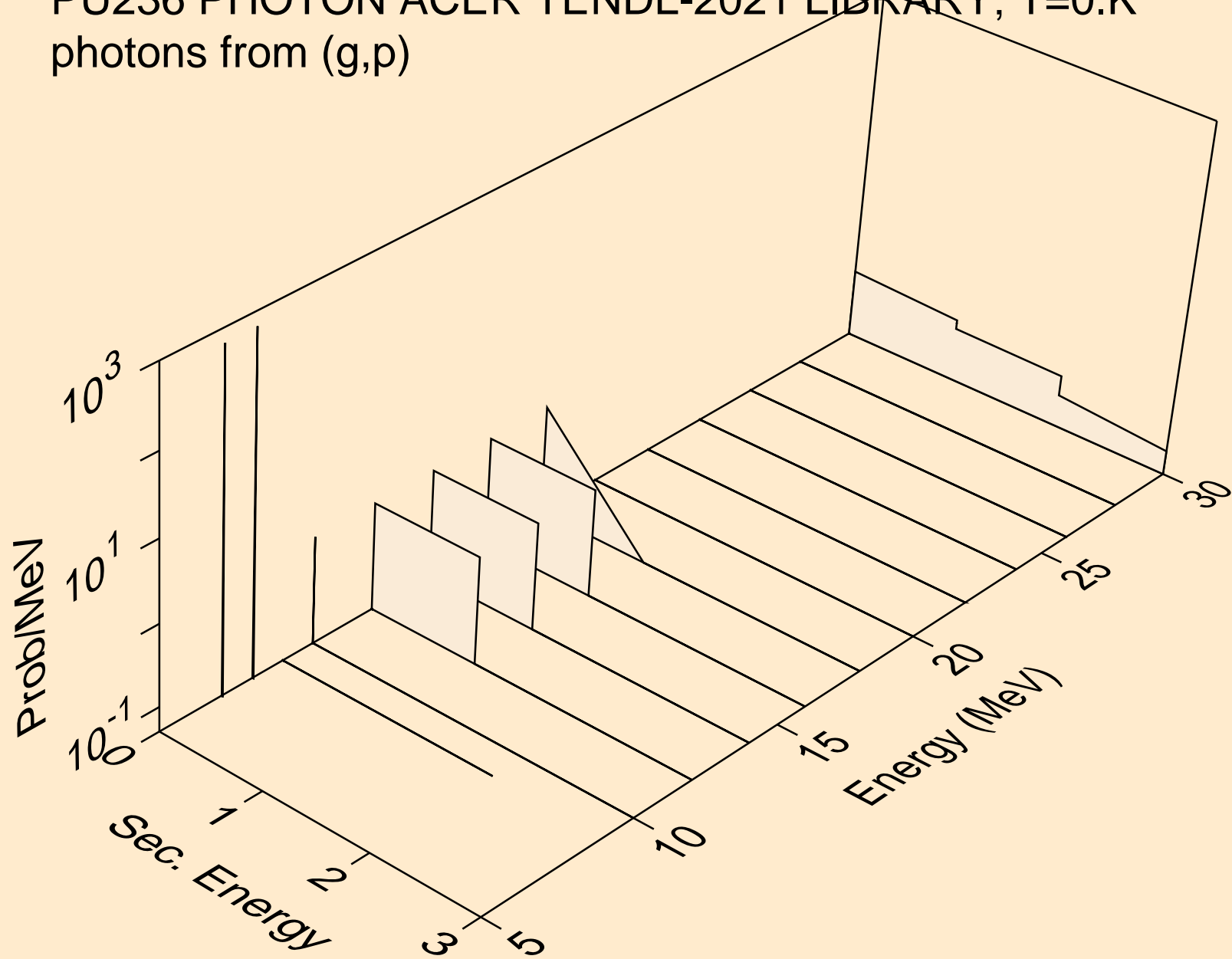

PU236 PHOTON ACER TENDL-2021 LIBRARY; T=0.K
photons from (g,d)

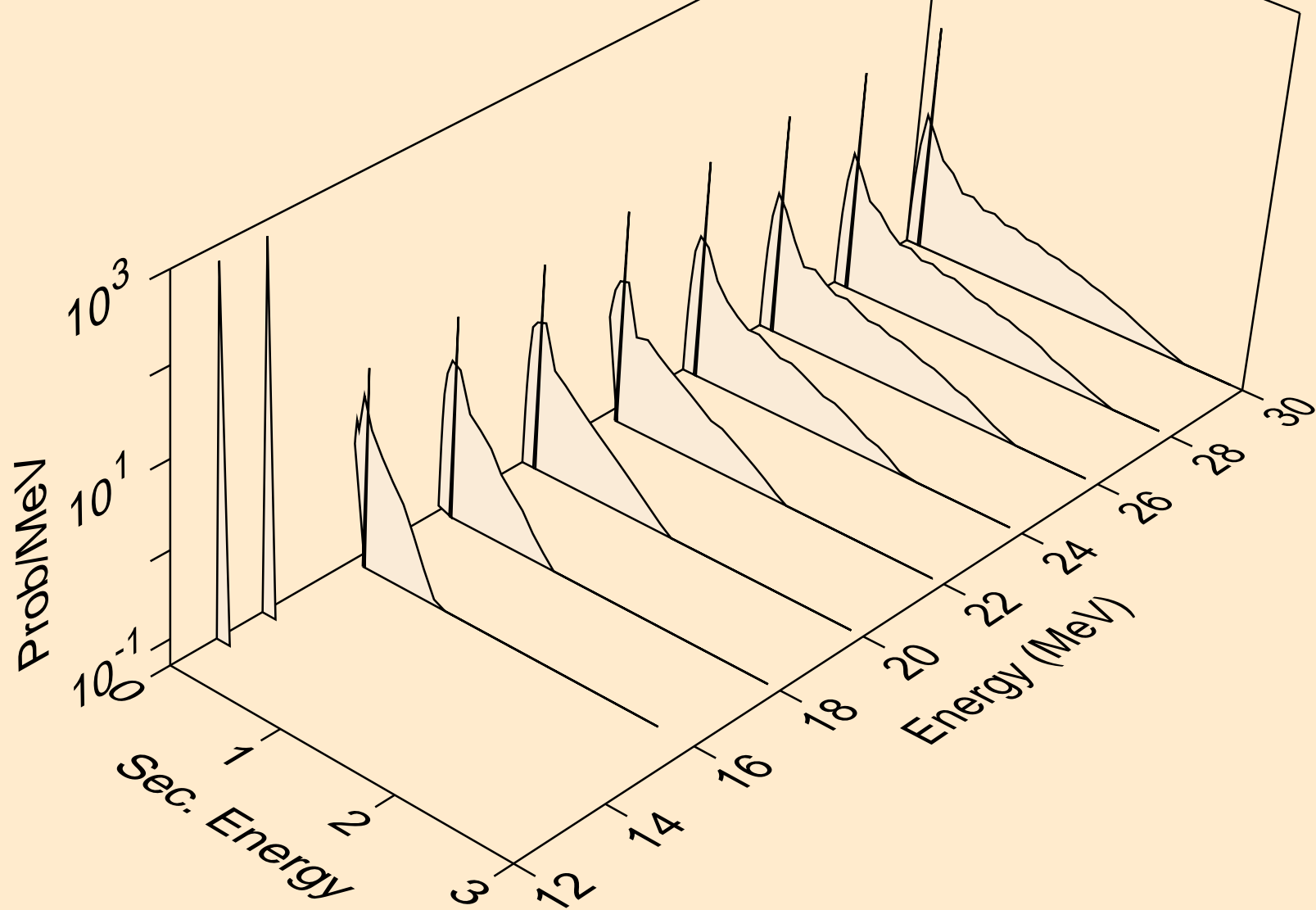

PU236 PHOTON ACER TENDL-2021 LIBRARY; T=0.K
photons from (g,t)

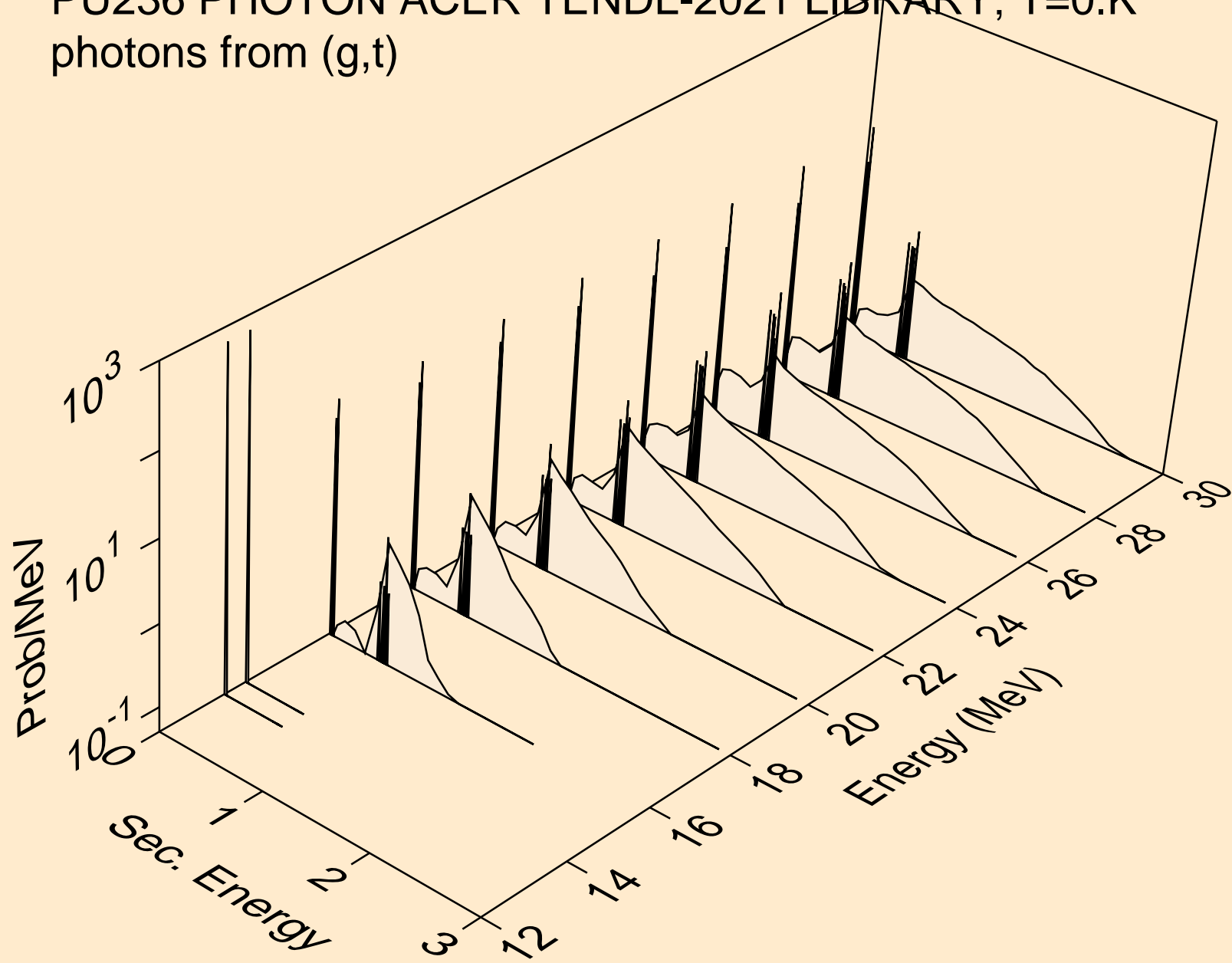

PU236 PHOTON ACER TENDL-2021 LIBRARY; T=0.K
protons from (g,x)

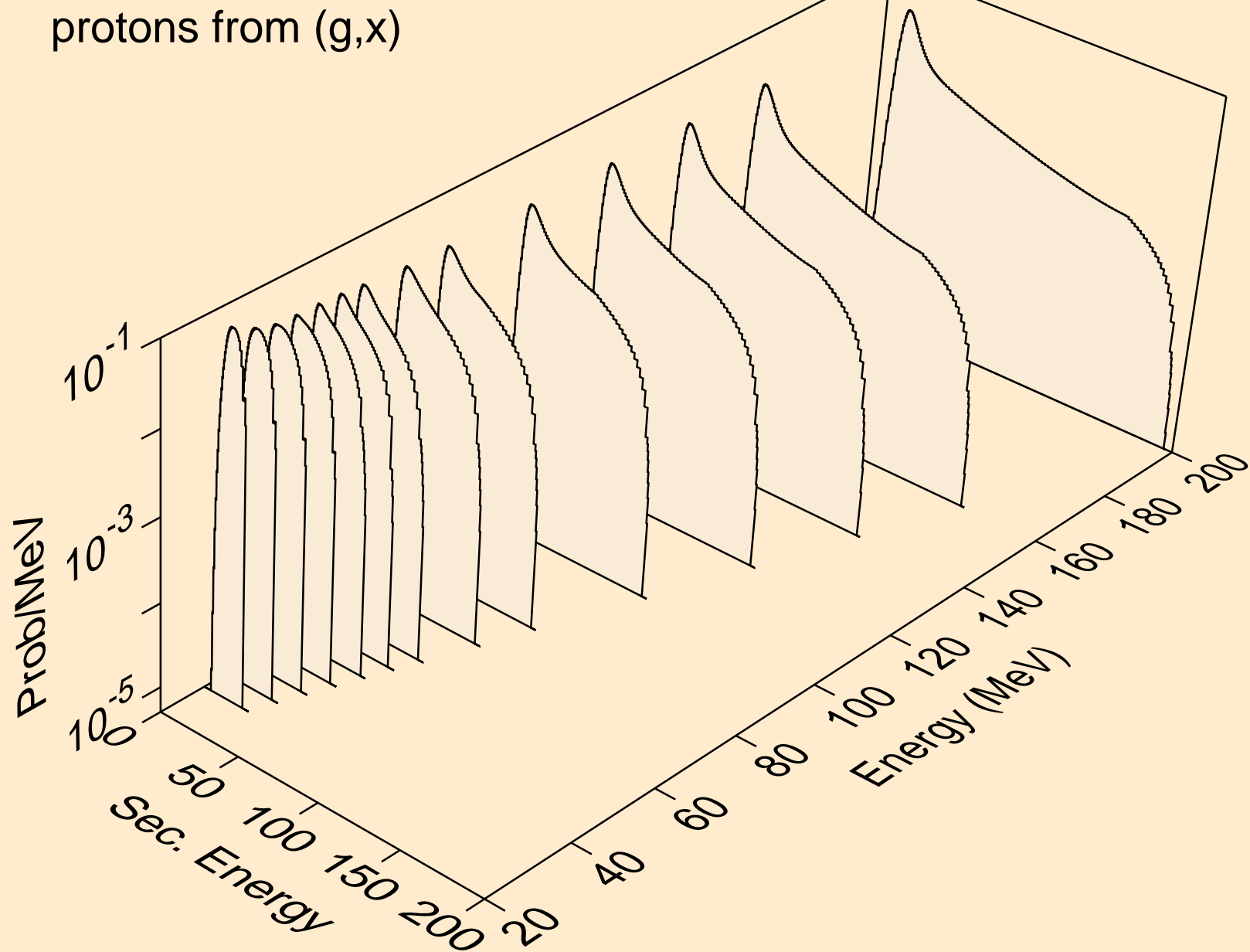

PU236 PHOTON ACER TENDL-2021 LIBRARY; T=0.K
protons from (g,n*)p

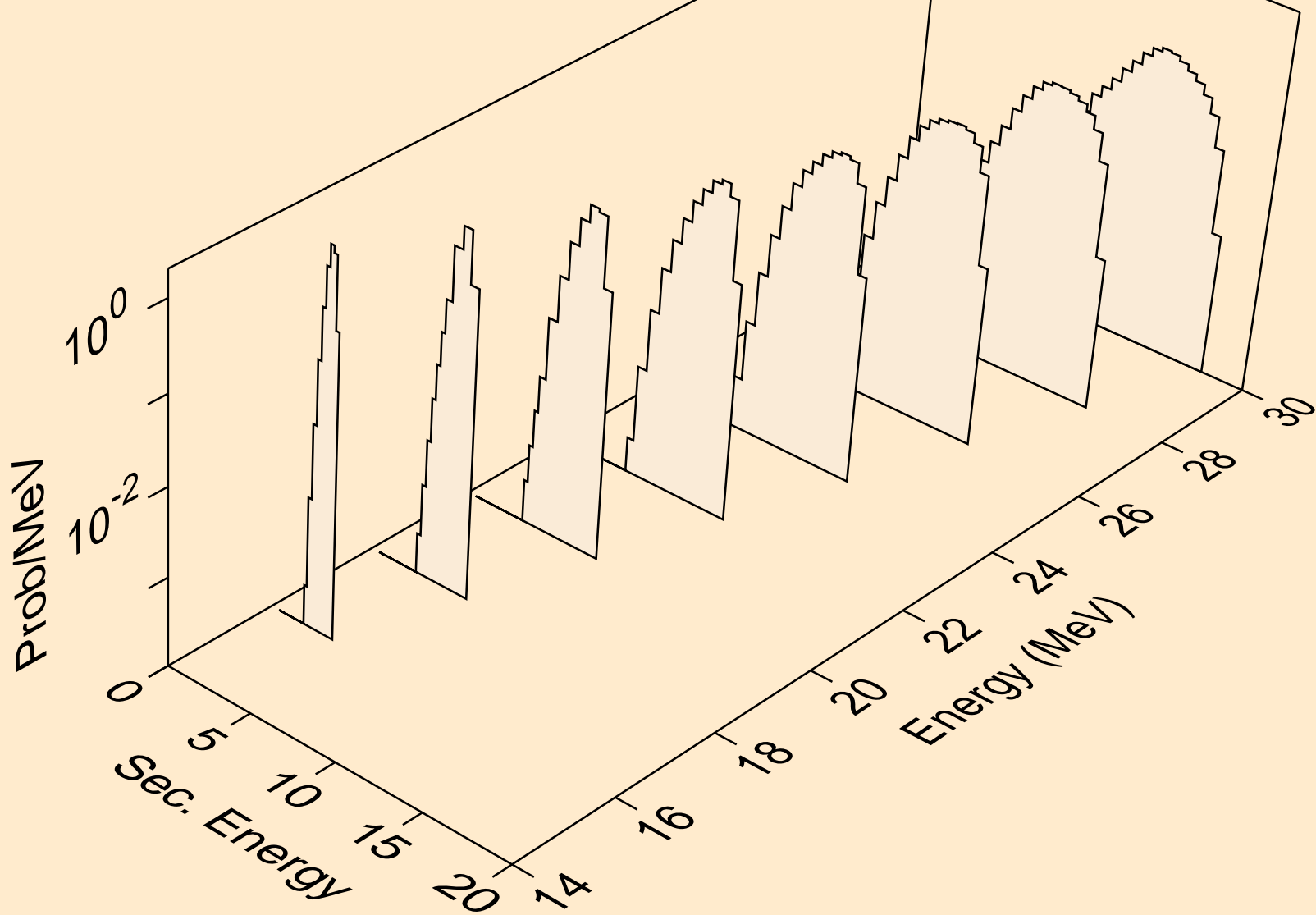

PU236 PHOTON ACER TENDL-2021 LIBRARY; T=0.K
protons from (g,2np)

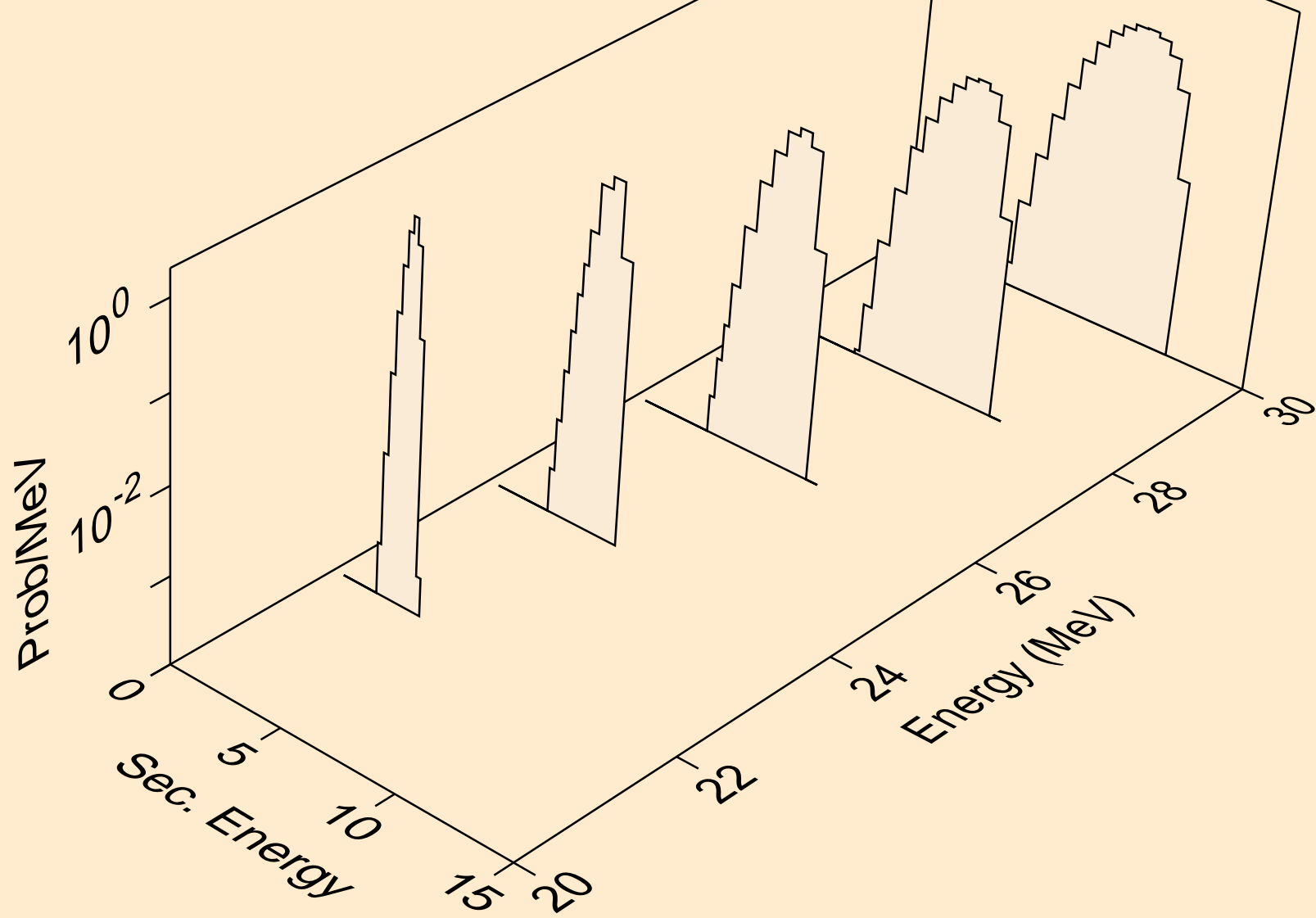

PU236 PHOTON ACER TENDL-2021 LIBRARY; T=0.K
protons from (g,p)

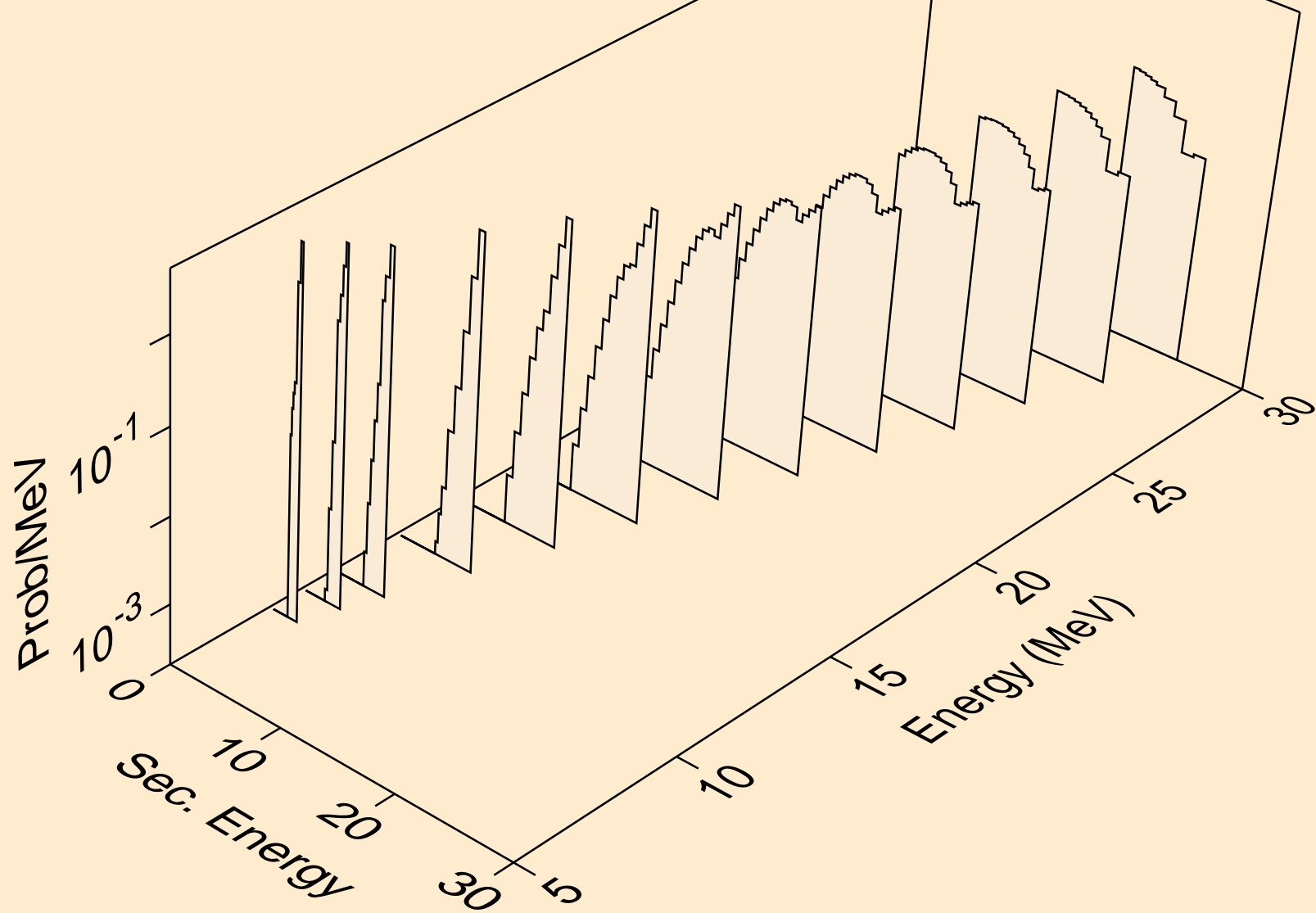

PU236 PHOTON ACER TENDL-2021 LIBRARY; T=0.K
deuterons from (g,x)

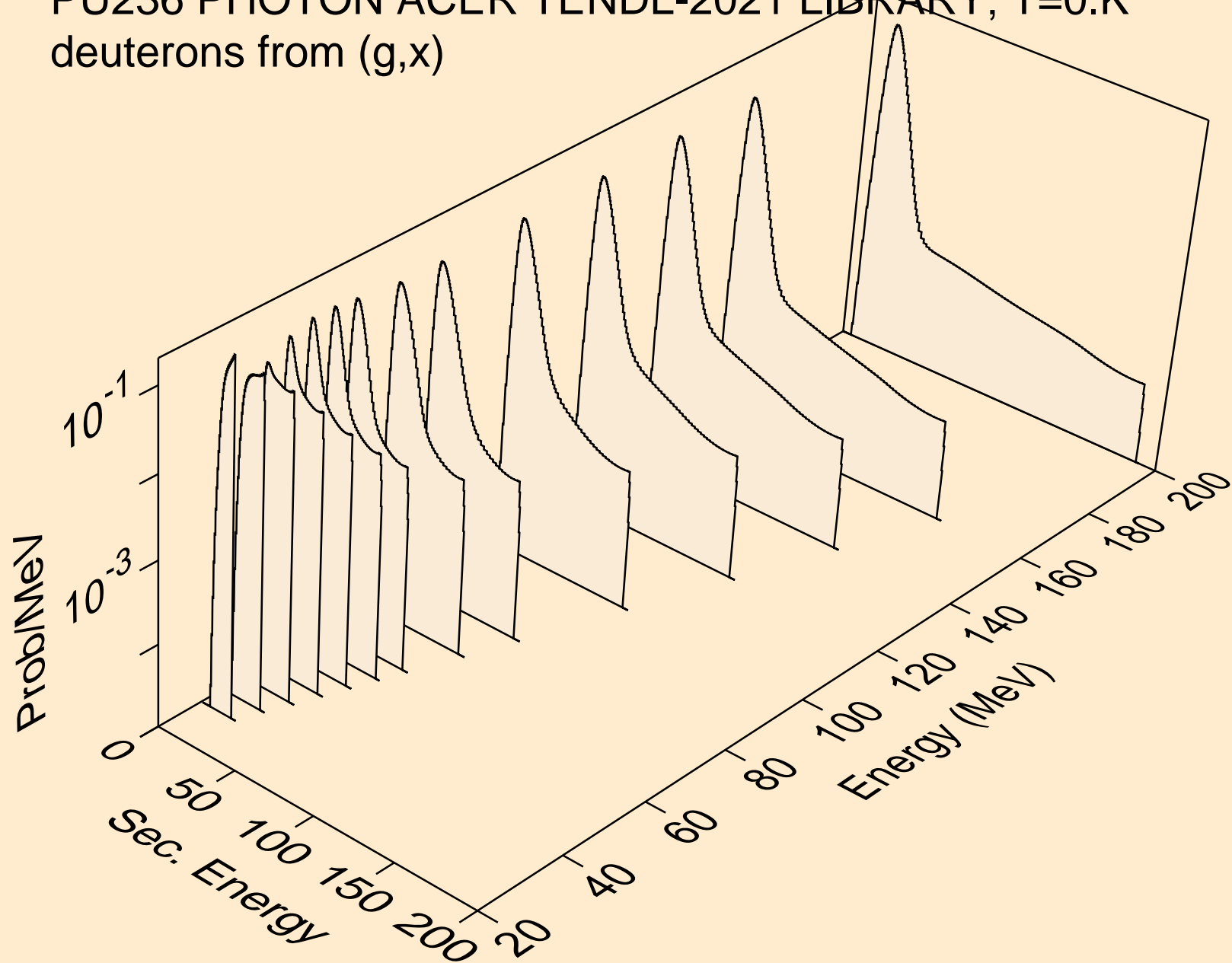

PU236 PHOTON ACER TENDL-2021 LIBRARY; T=0.K
deuterons from (g,n*)d

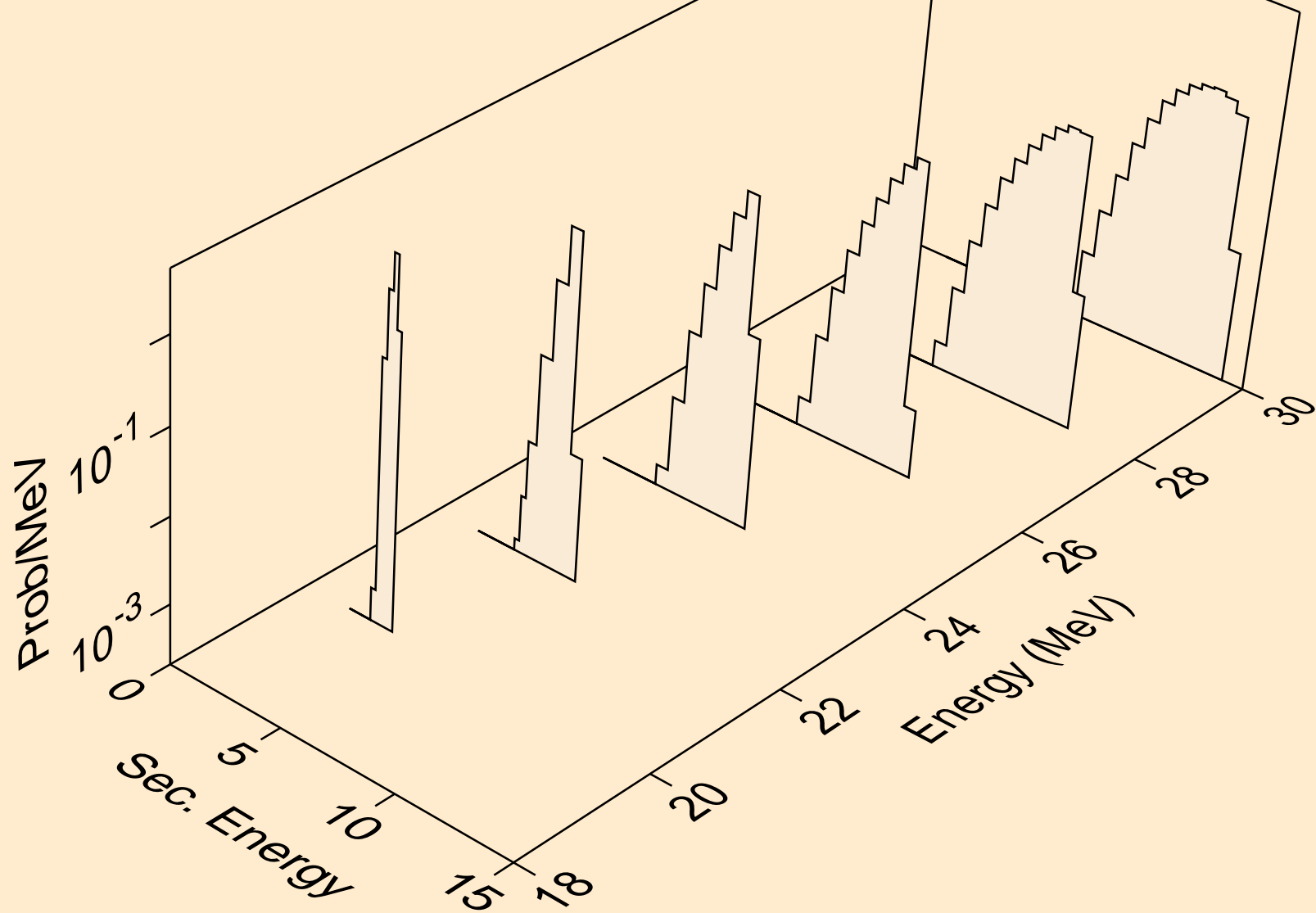

PU236 PHOTON ACER TENDL-2021 LIBRARY; T=0.K
deuterons from (g,d)

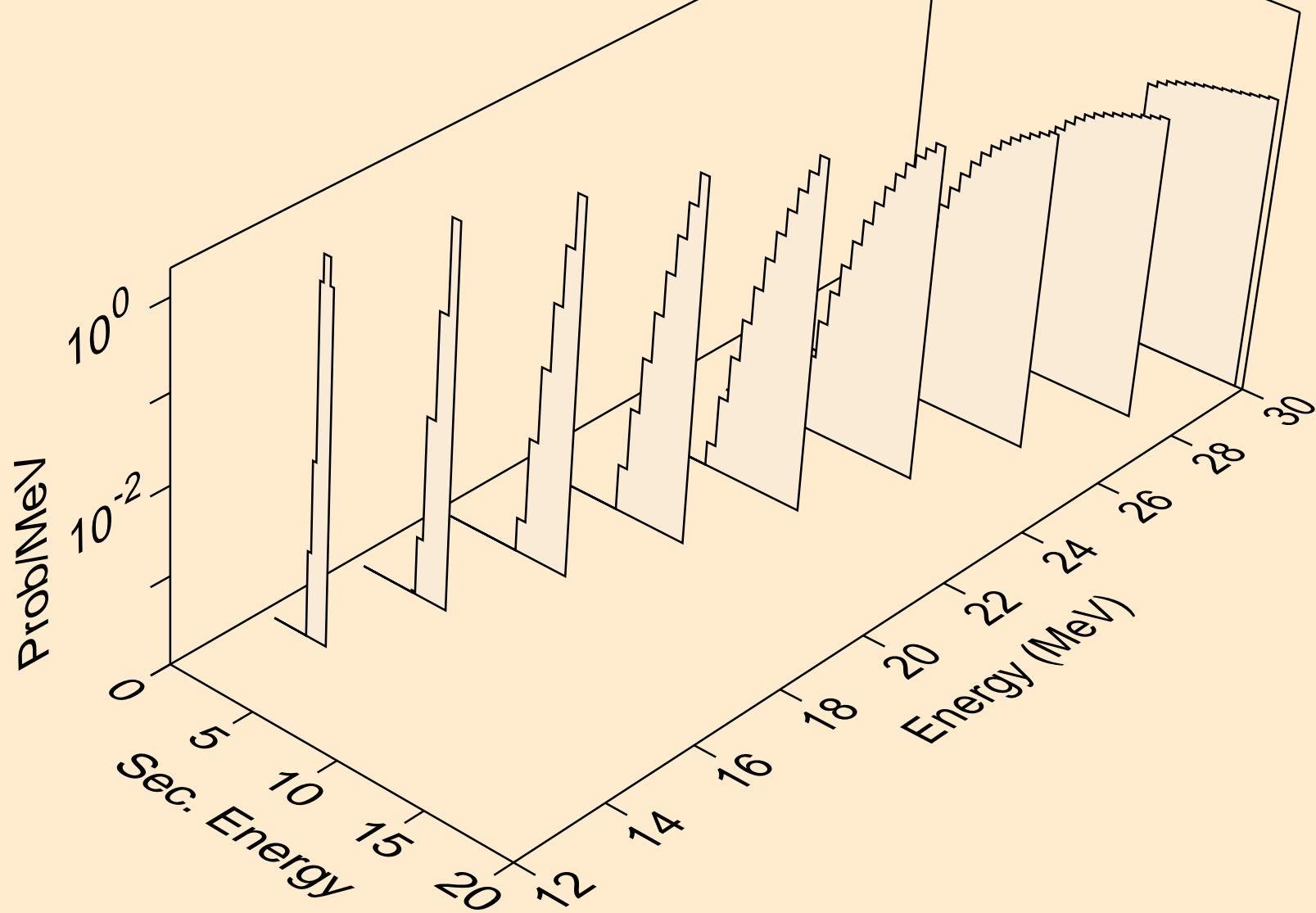

PU236 PHOTON ACER TENDL-2021 LIBRARY; T=0.K
tritons from (g,x)

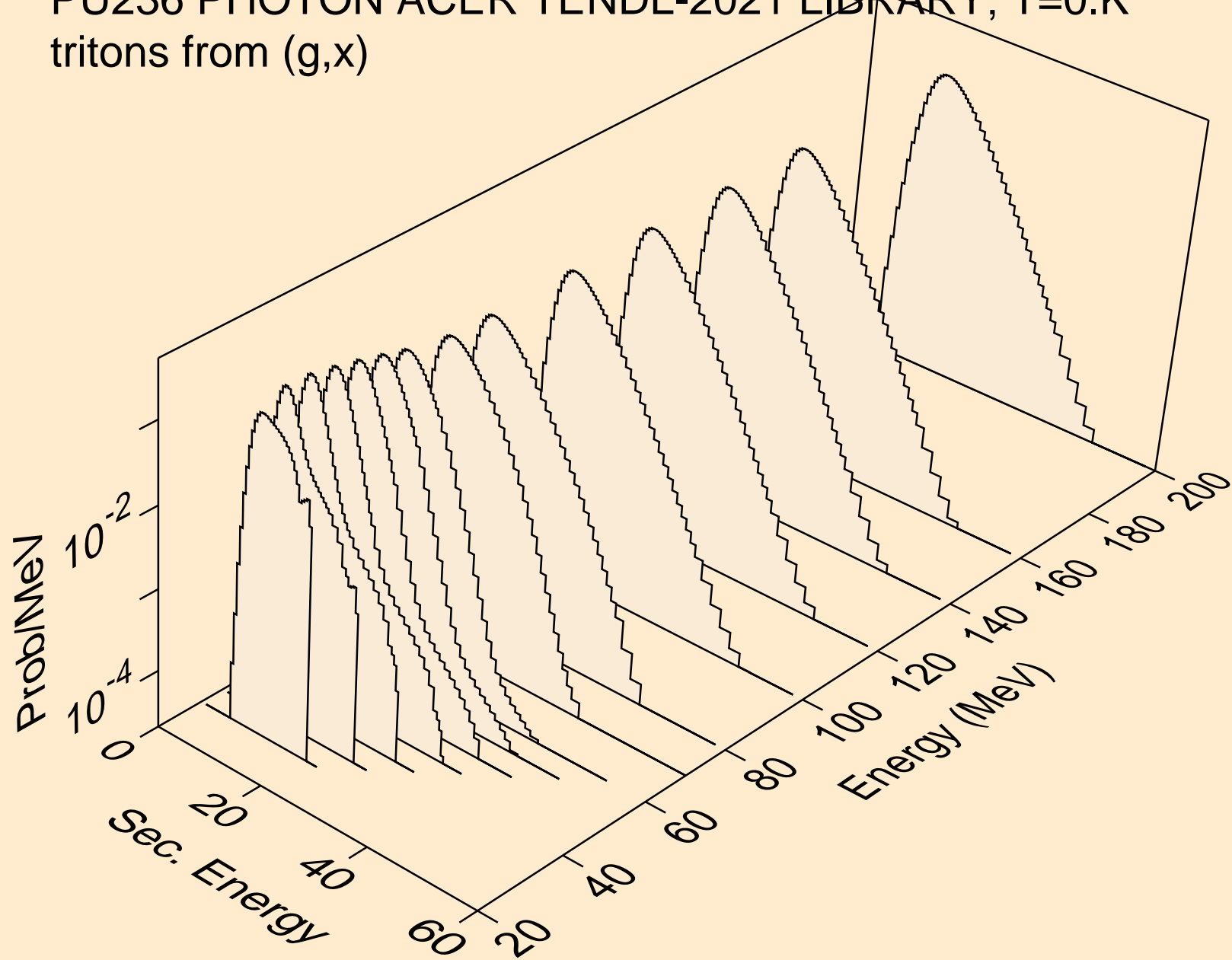

PU236 PHOTON ACER TENDL-2021 LIBRARY; T=0.K
tritons from (g,n*)t

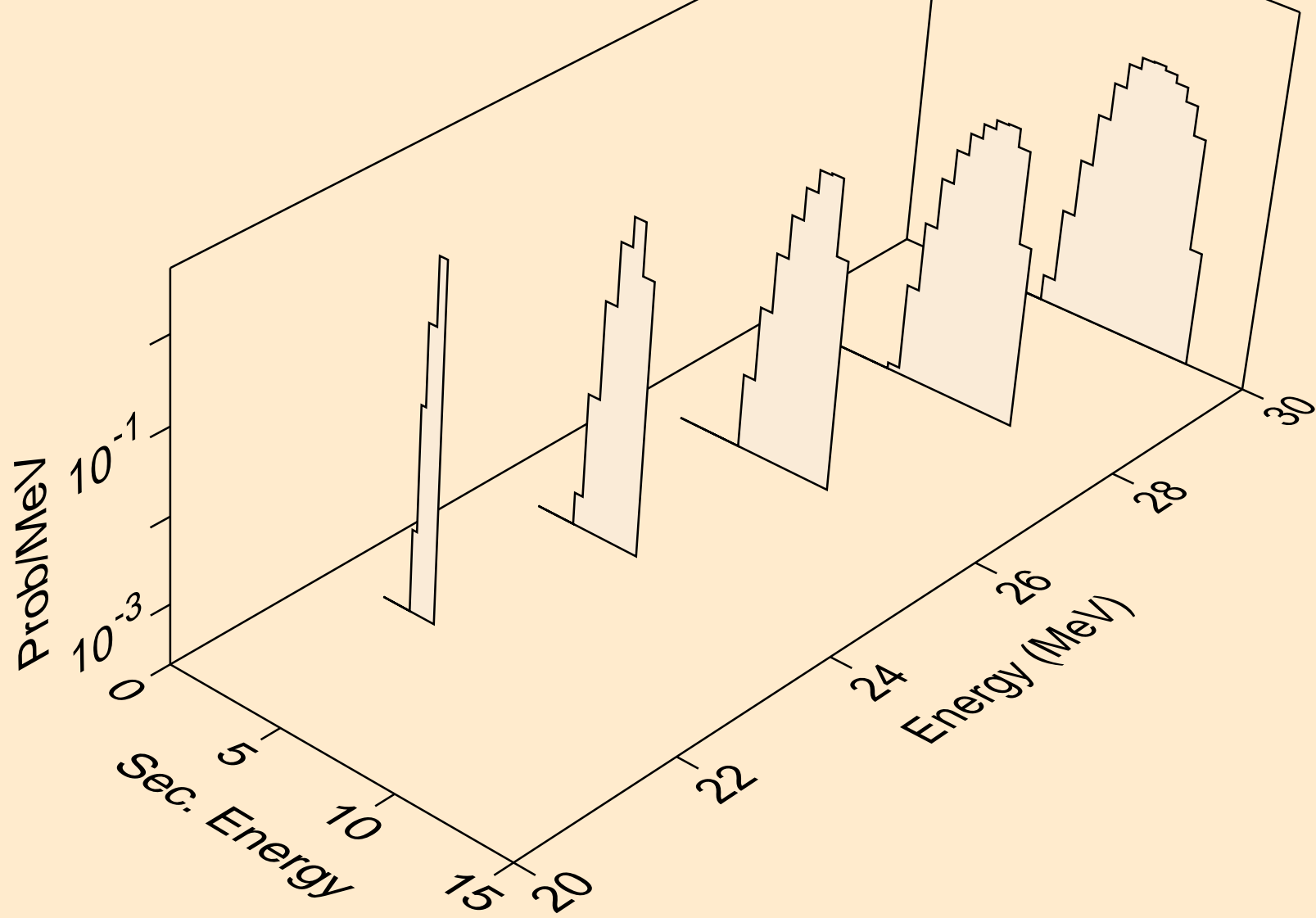

PU236 PHOTON ACER TENDL-2021 LIBRARY; T=0.K
tritons from (g,t)

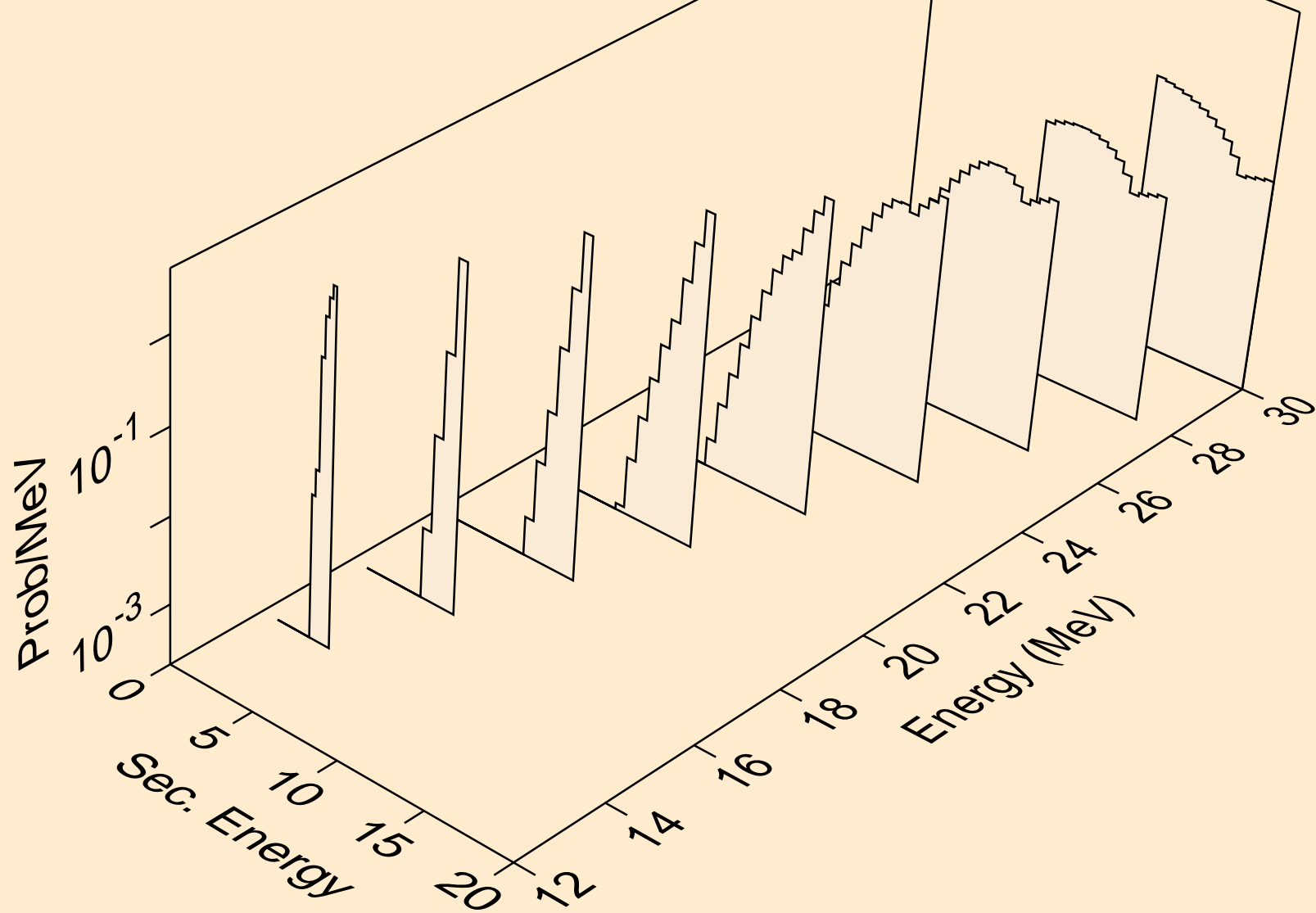

PU236 PHOTON ACER TENDL-2021 LIBRARY; T=0.K
he3s from (g,x)

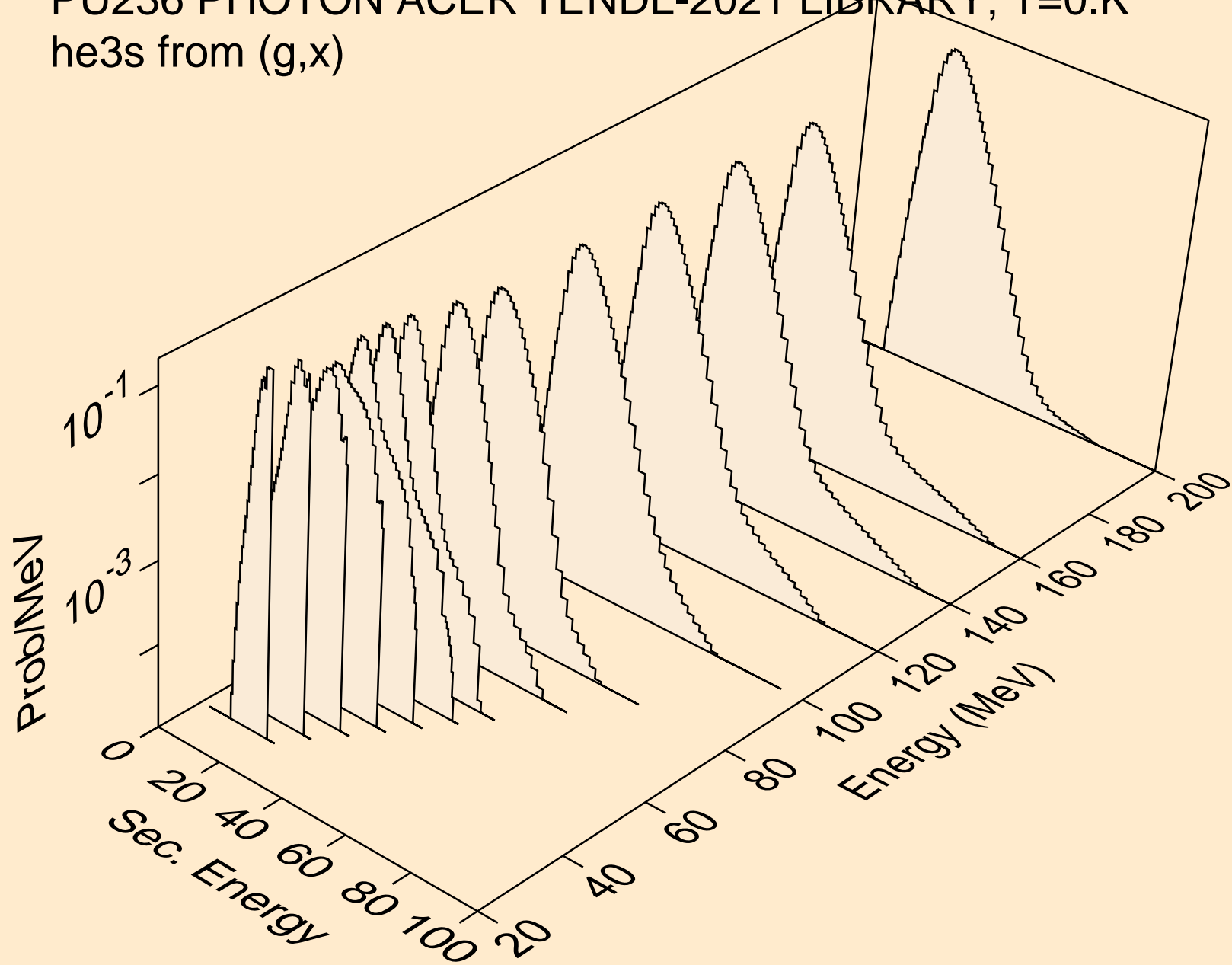

PU236 PHOTON ACER TENDL-2021 LIBRARY; T=0.K
alphas from (g,x)

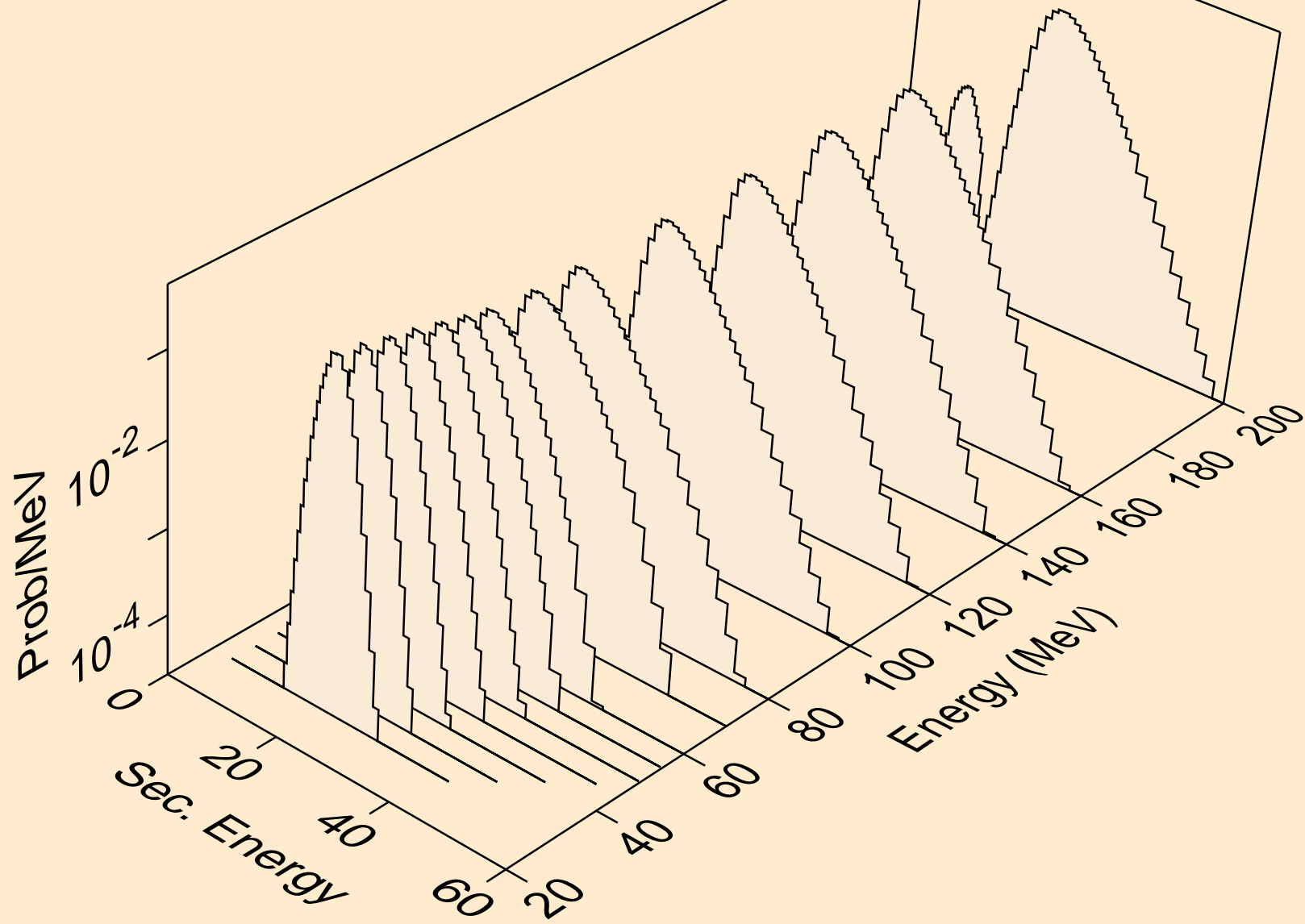

PU236 PHOTON ACER TENDL-2021 LIBRARY; T=0.K
alphas from (g,n*)a

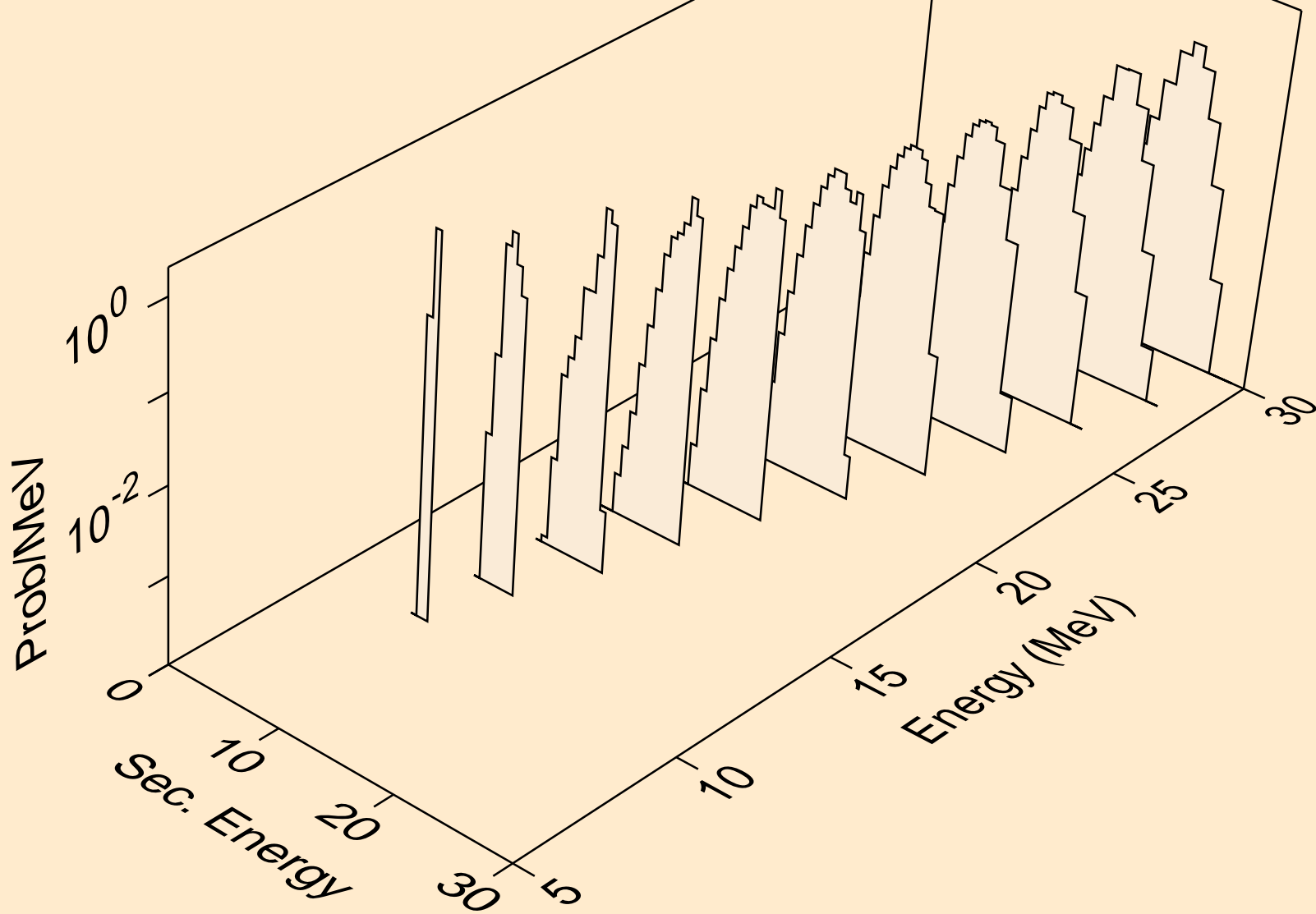

PU236 PHOTON ACER TENDL-2021 LIBRARY; T=0.K
alphas from (g,2n)a

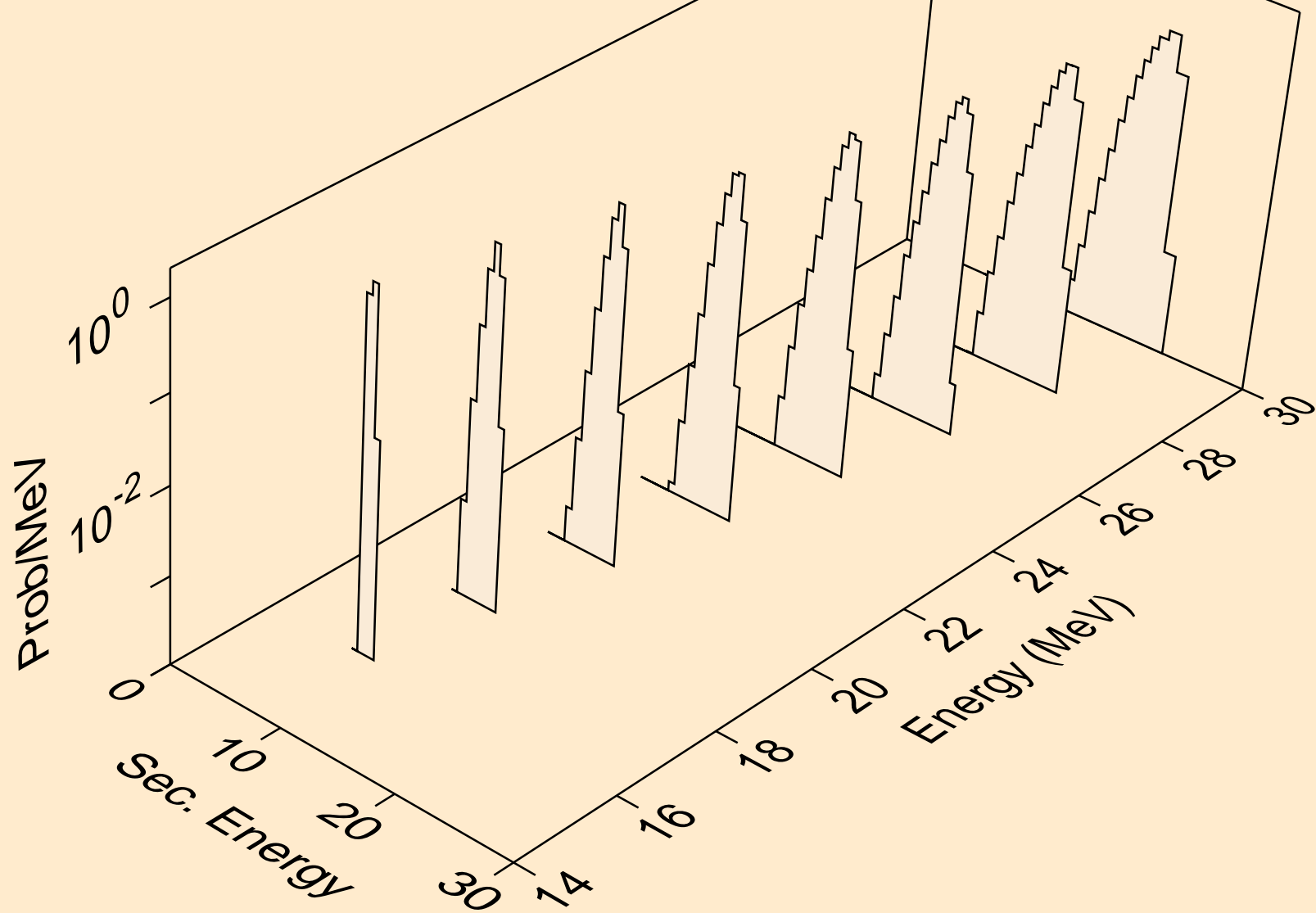

PU236 PHOTON ACER TENDL-2021 LIBRARY; T=0.K
alphas from (g,a)

