

RB081M PHOTON ACER TENDL-2021 LIBRARY; T=0.K  
Principal cross sections

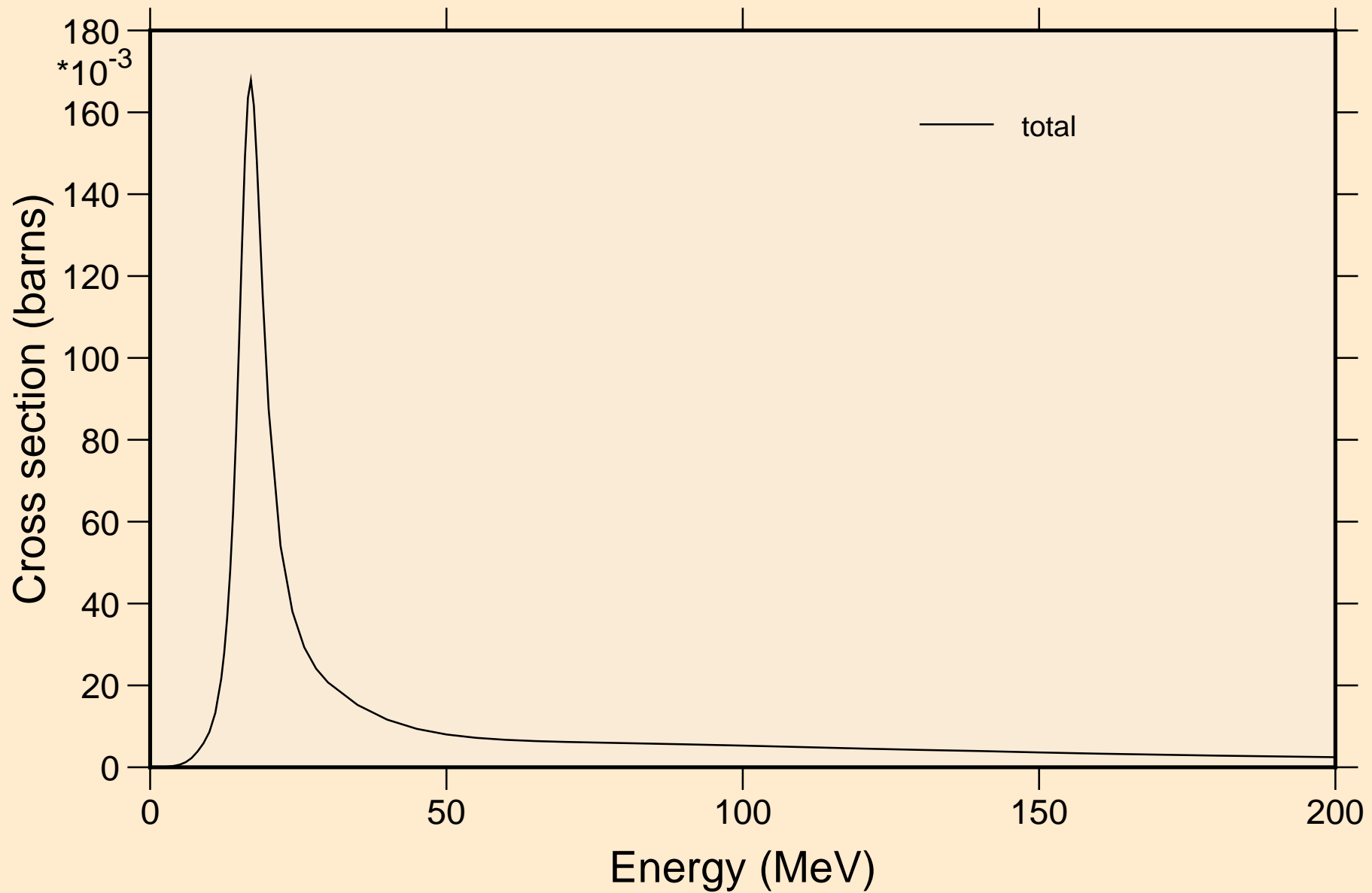

# RB081M PHOTON ACER TENDL-2021 LIBRARY; T=0.K

## Partial cross sections

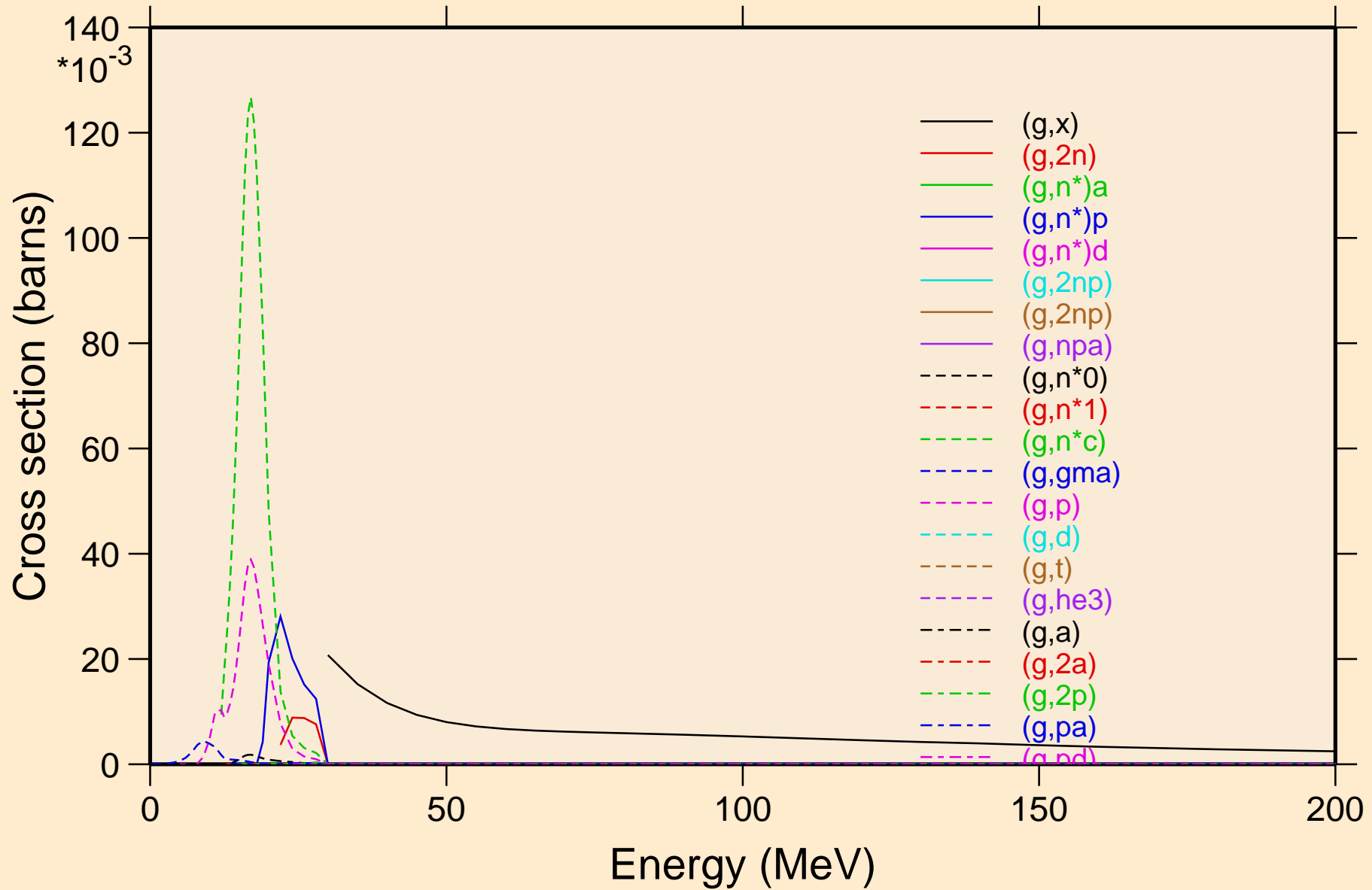

RB081M PHOTON ACER TENDL-2021 LIBRARY; T=0.K

Heating

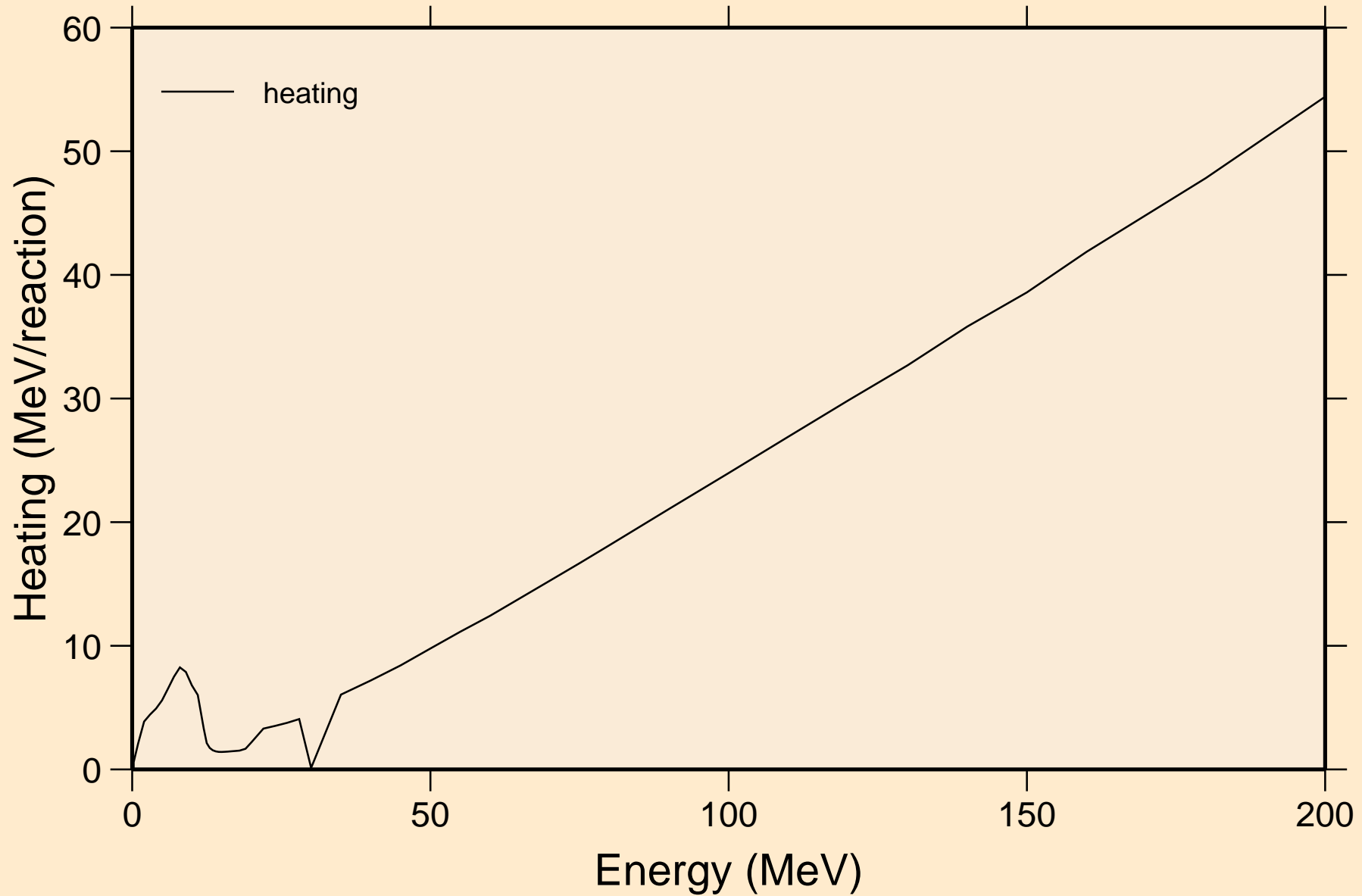

# RB081M PHOTON ACER TENDL-2021 LIBRARY; T=0.K

## Particle heating contributions

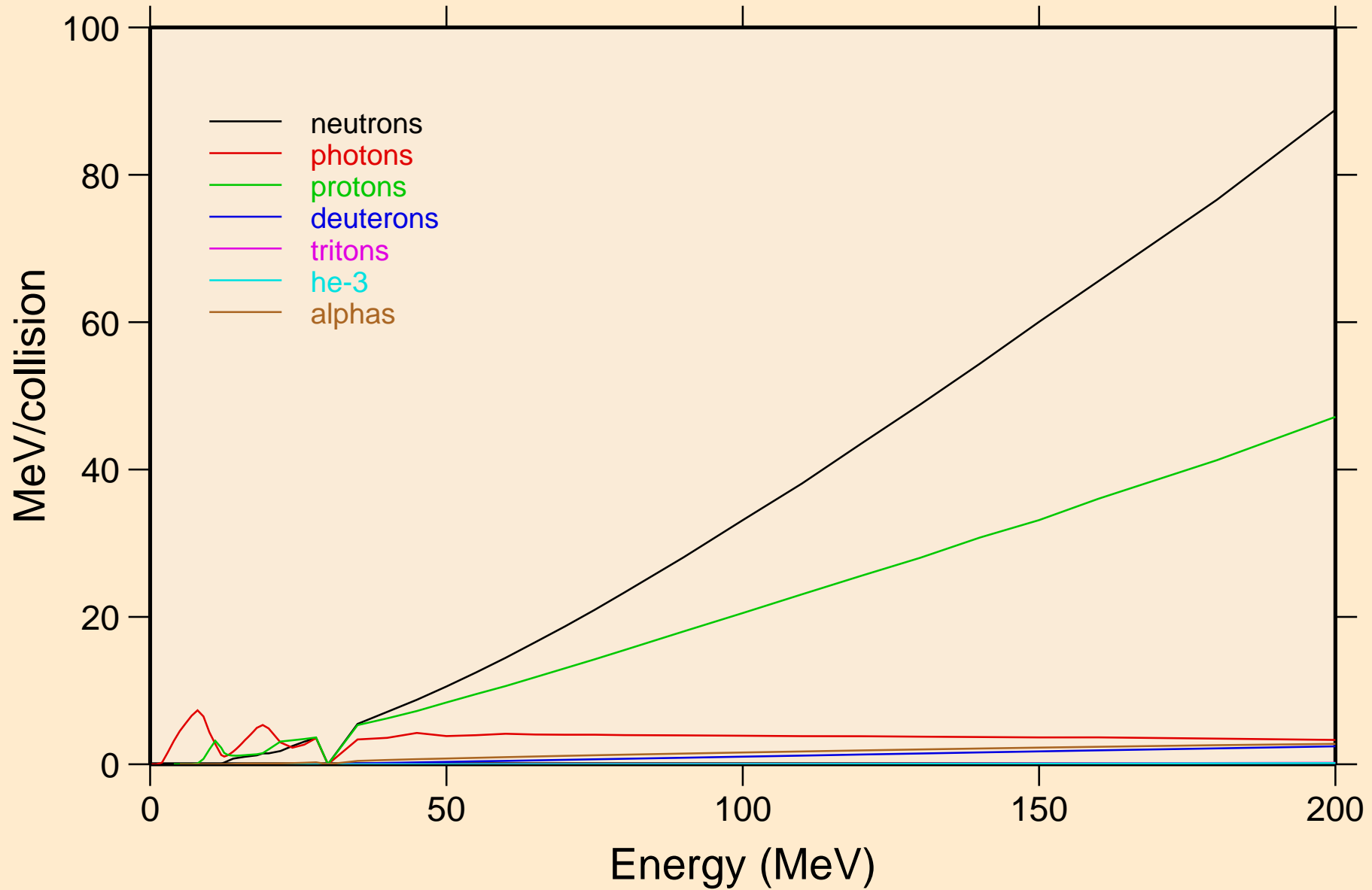

RB081M PHOTON ACER TENDL-2021 LIBRARY; T=0.K  
Particle production cross sections

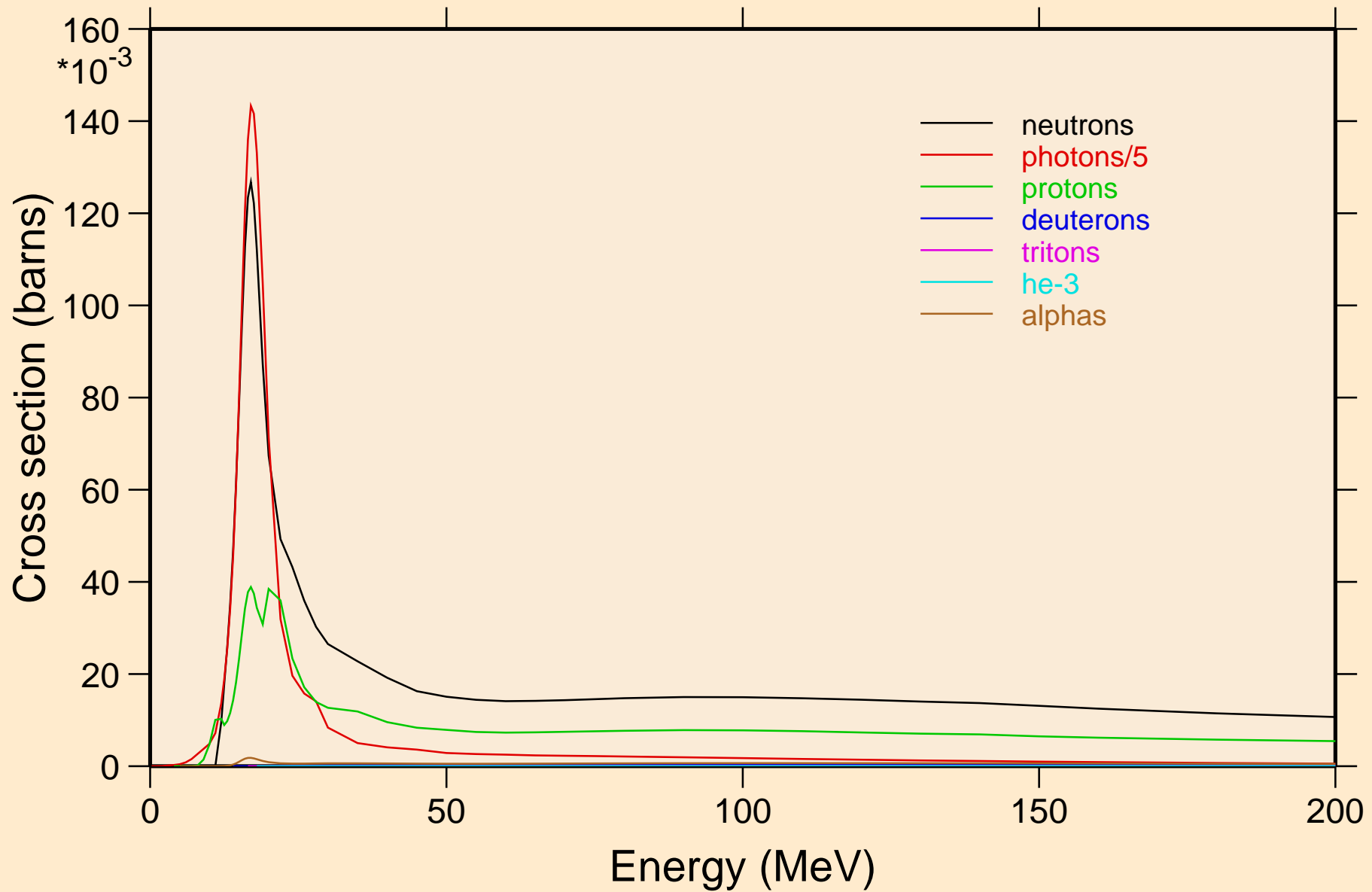

RB081M PHOTON ACER TENDL-2021 LIBRARY; T=0.K  
neutrons from (g,x)

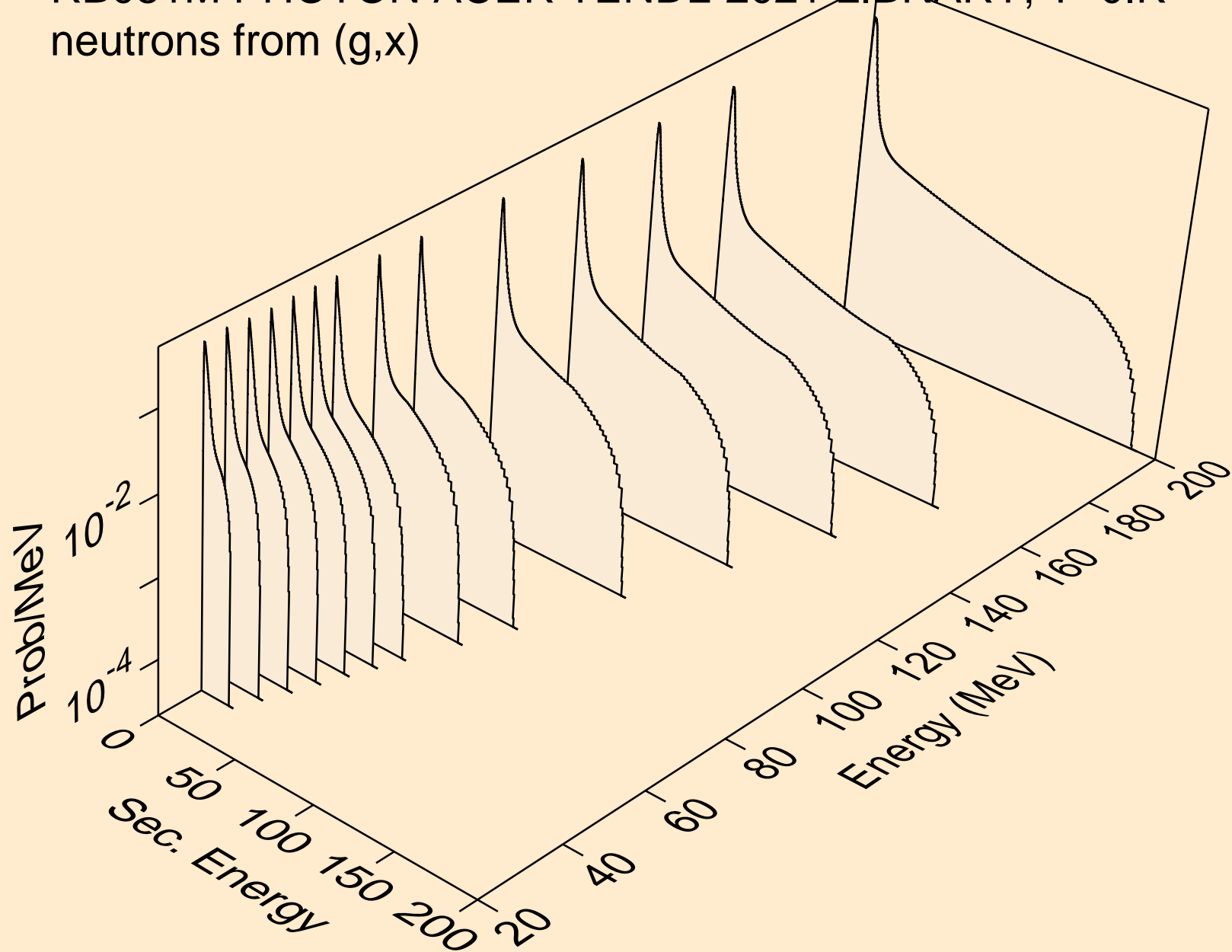

RB081M PHOTON ACER TENDL-2021 LIBRARY; T=0.K  
neutrons from (g,2n)

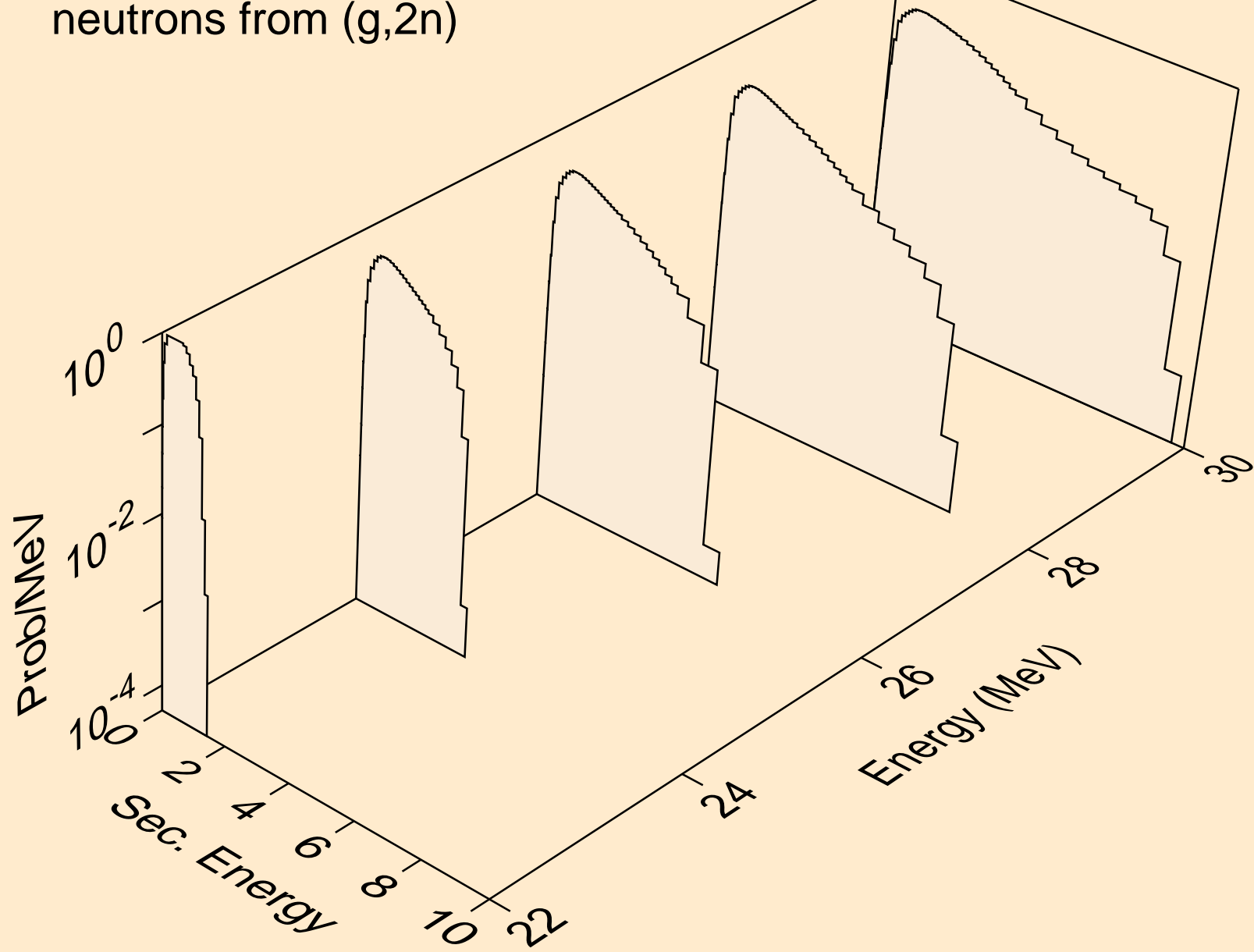

RB081M PHOTON ACER TENDL-2021 LIBRARY; T=0.K  
neutrons from (g,n\*)a

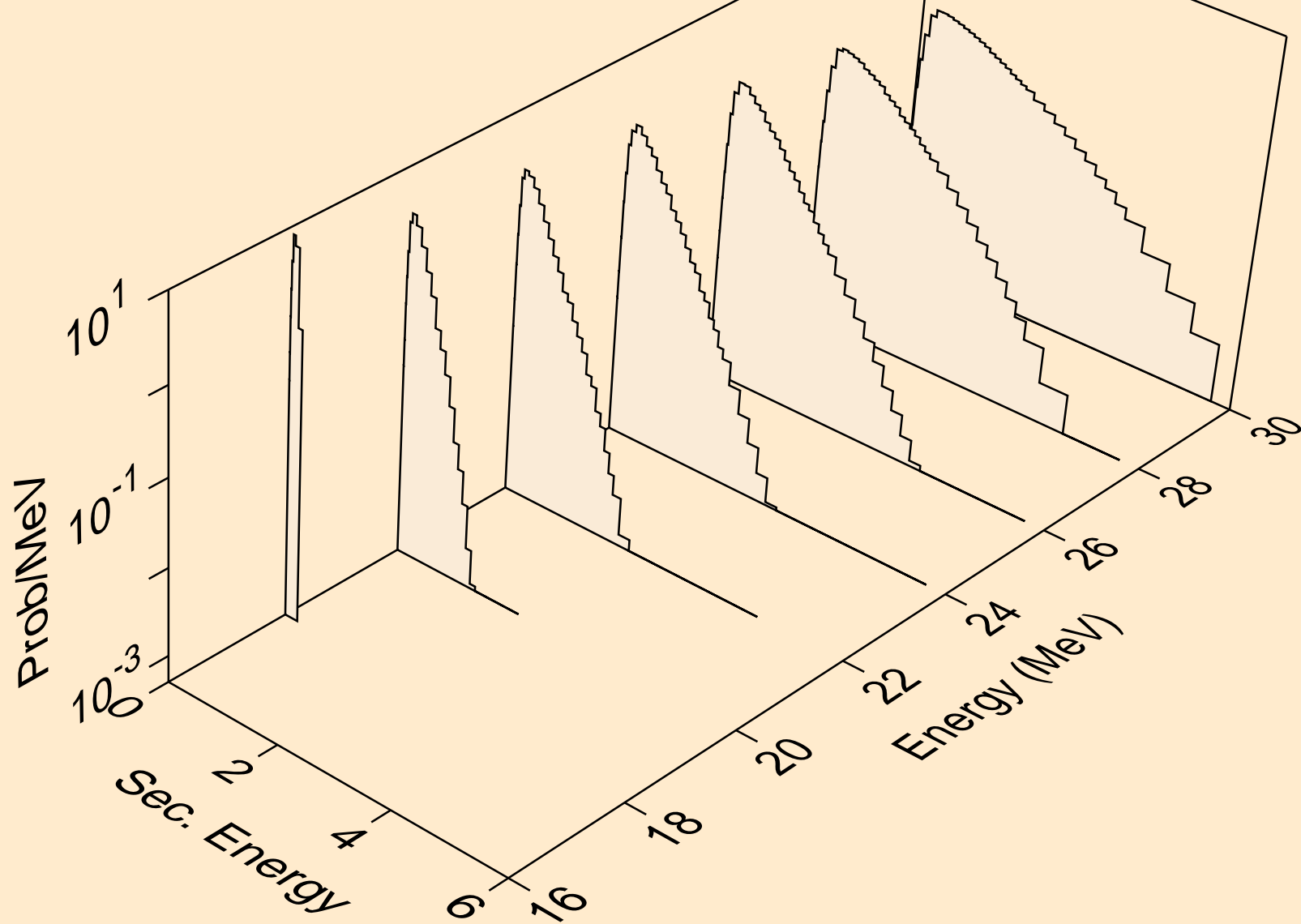



RB081M PHOTON ACER TENDL-2021 LIBRARY; T=0.K  
neutrons from (g,n\*)p

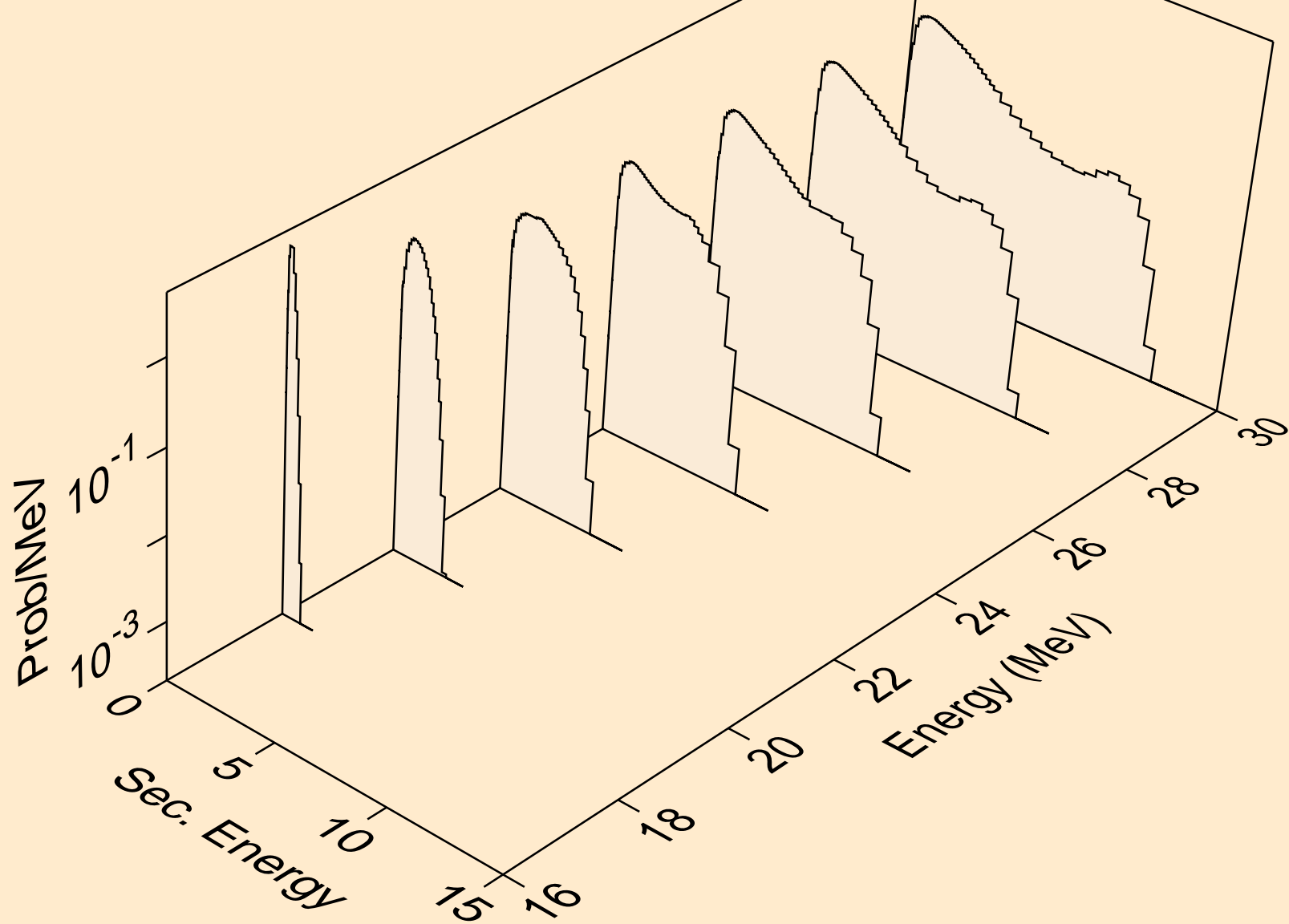

RB081M PHOTON ACER TENDL-2021 LIBRARY; T=0.K  
neutrons from (g,n\*)d

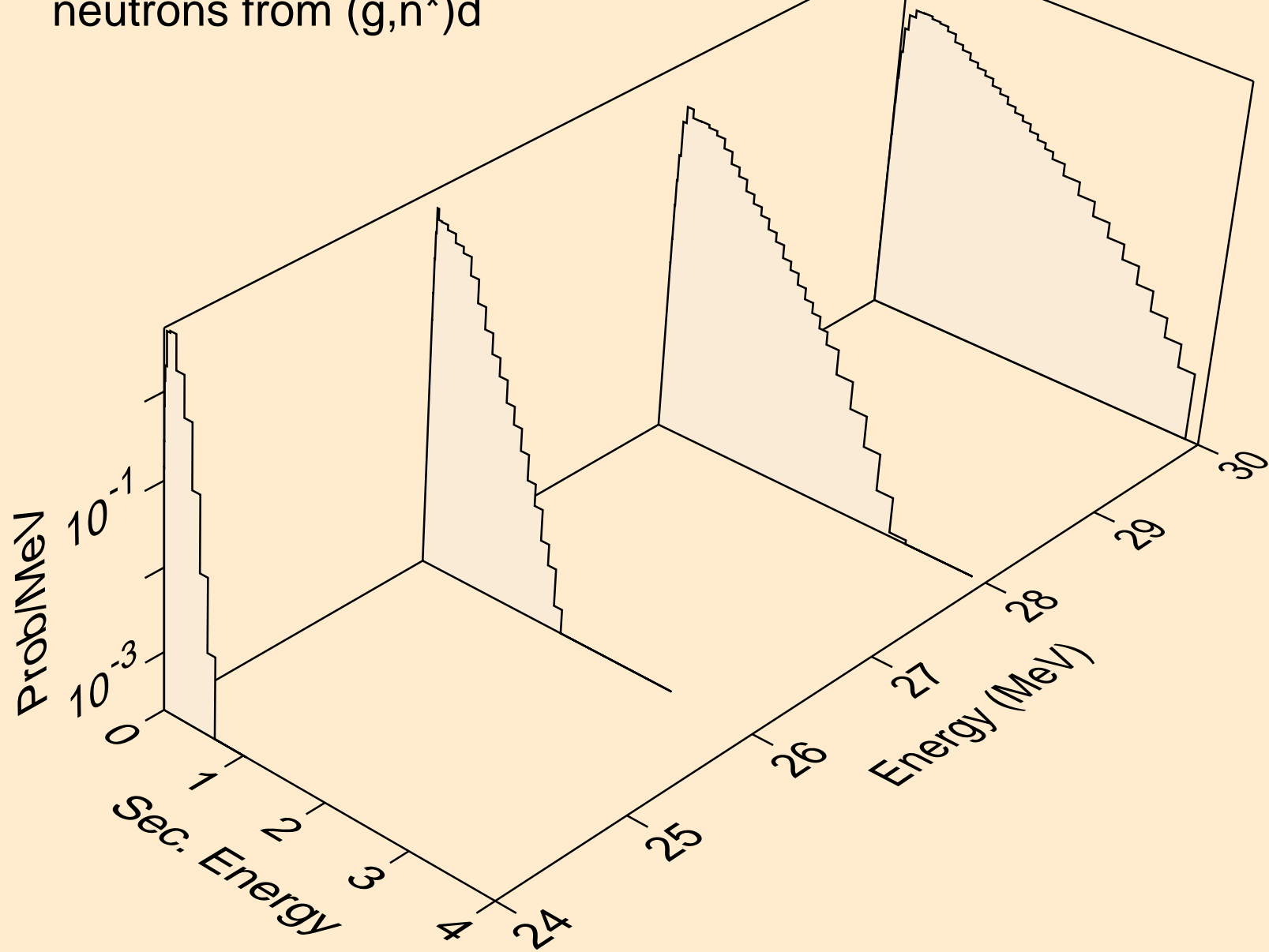

RB081M PHOTON ACER TENDL-2021 LIBRARY; T=0.K  
neutrons from (g,2np)

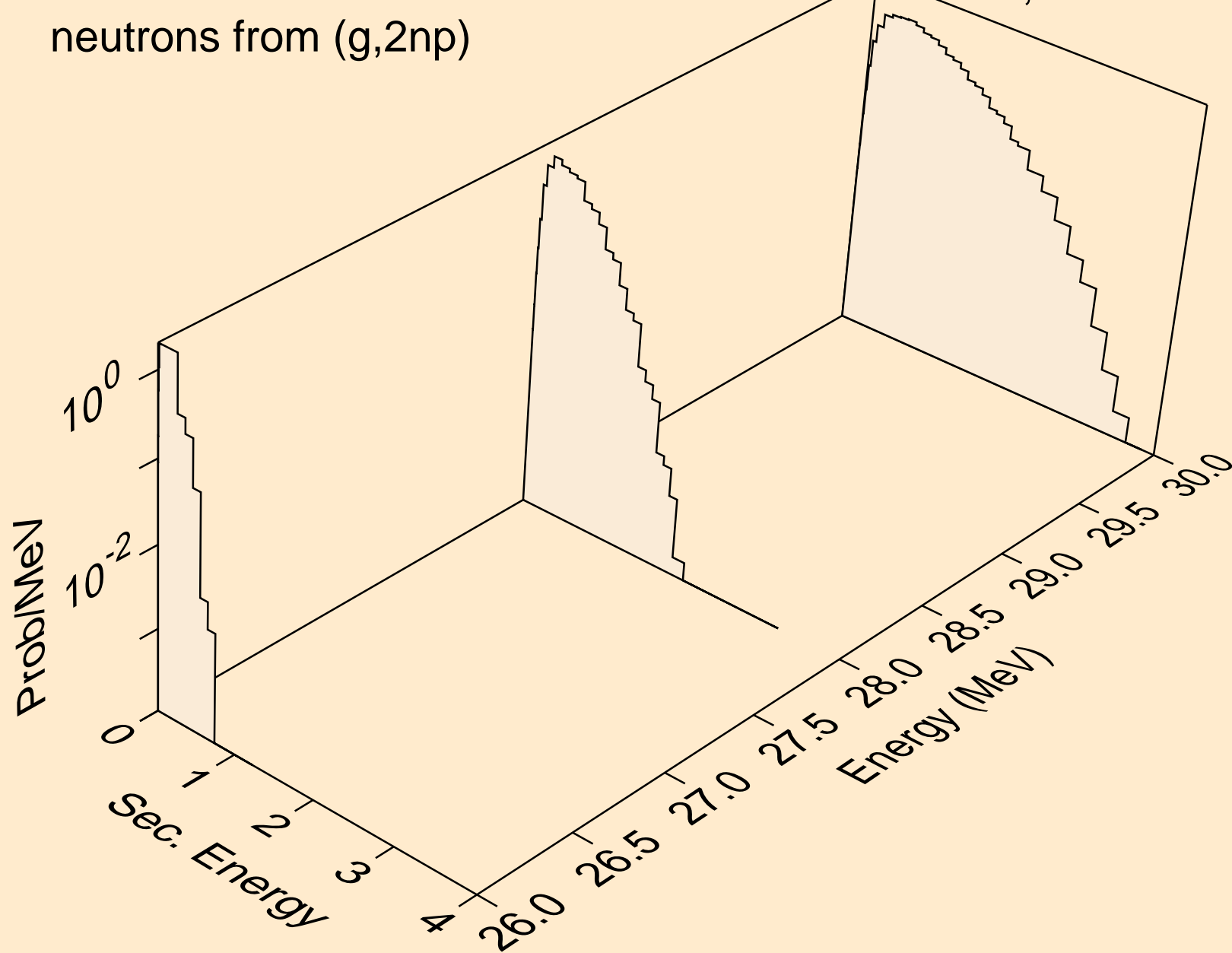

RB081M PHOTON ACER TENDL-2021 LIBRARY; T=0.K  
neutrons from (g,2np)

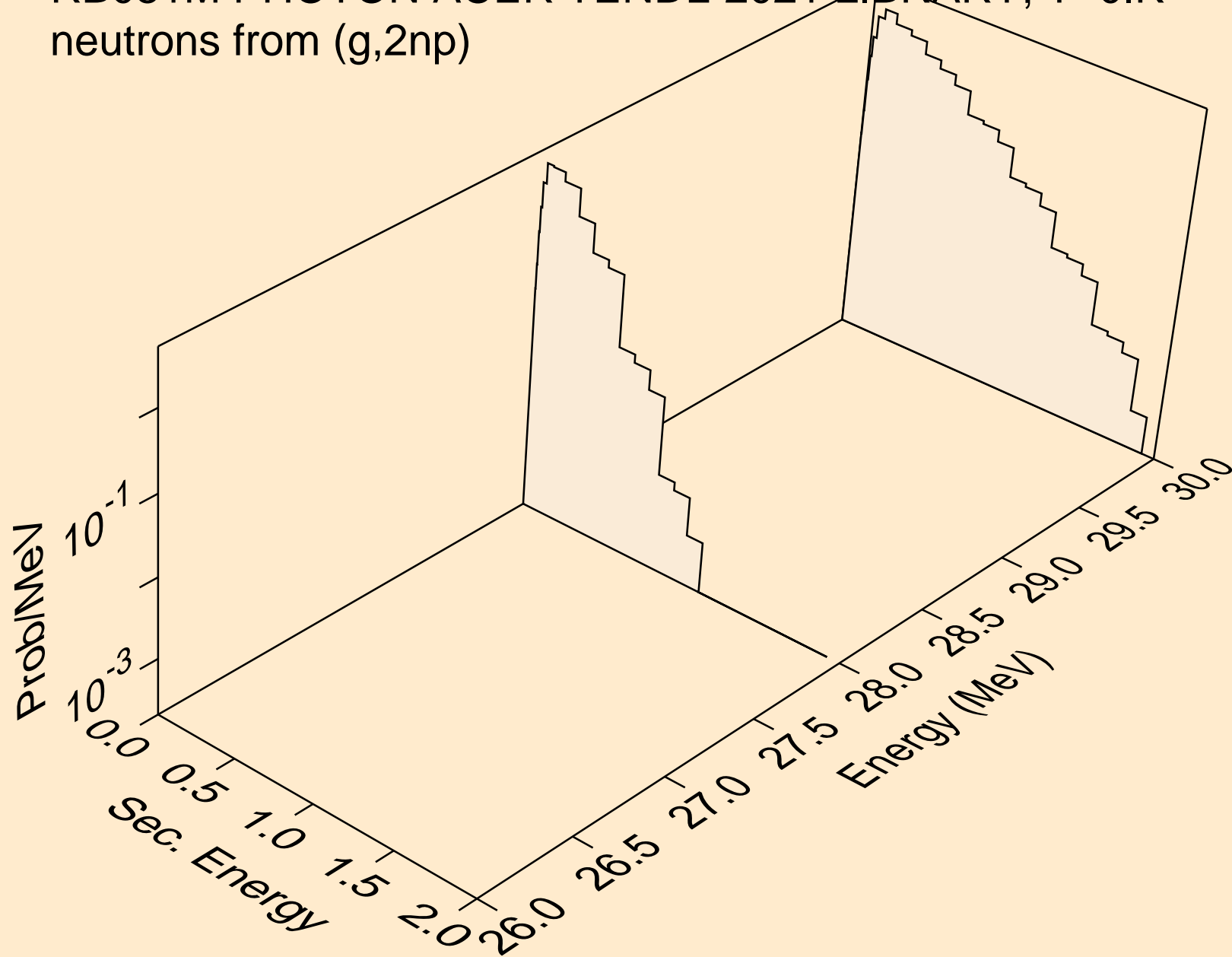

RB081M PHOTON ACER TENDL-2021 LIBRARY; T=0.K  
neutrons from (g,npa)

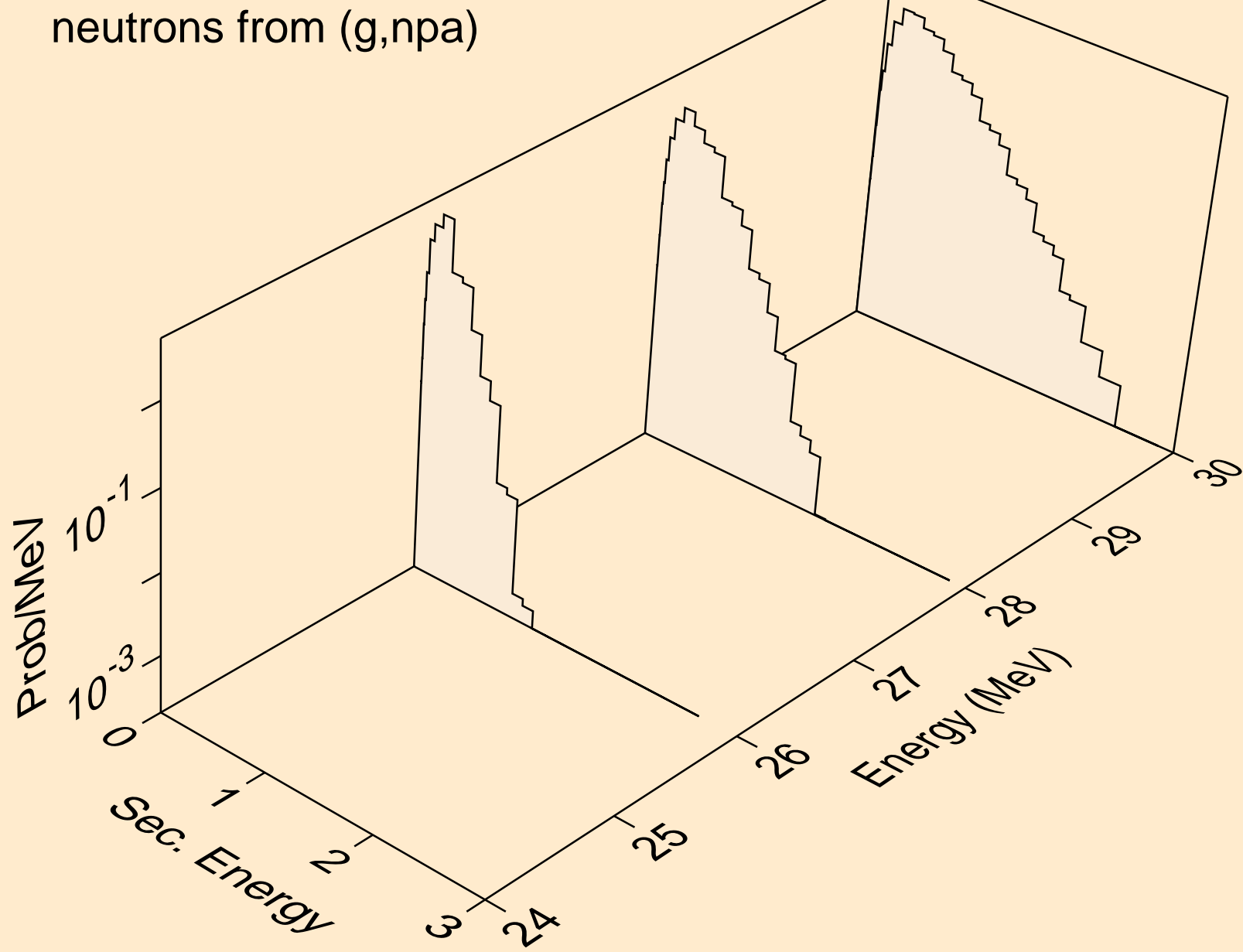

RB081M PHOTON ACER TENDL-2021 LIBRARY; T=0.K  
angular distribution for (g,n\*0) neutron

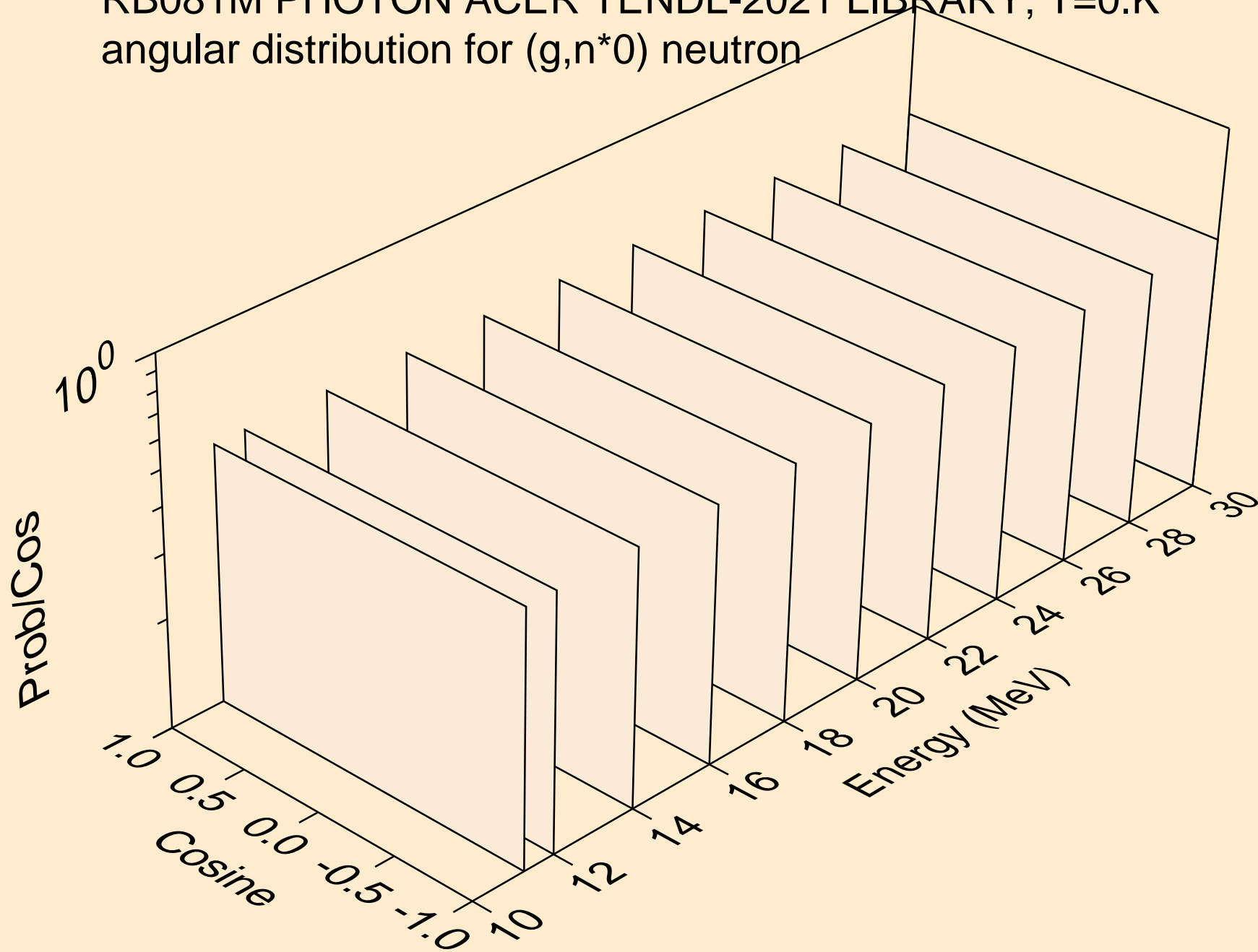

RB081M PHOTON ACER TENDL-2021 LIBRARY; T=0.K  
angular distribution for (g,n\*1) neutron

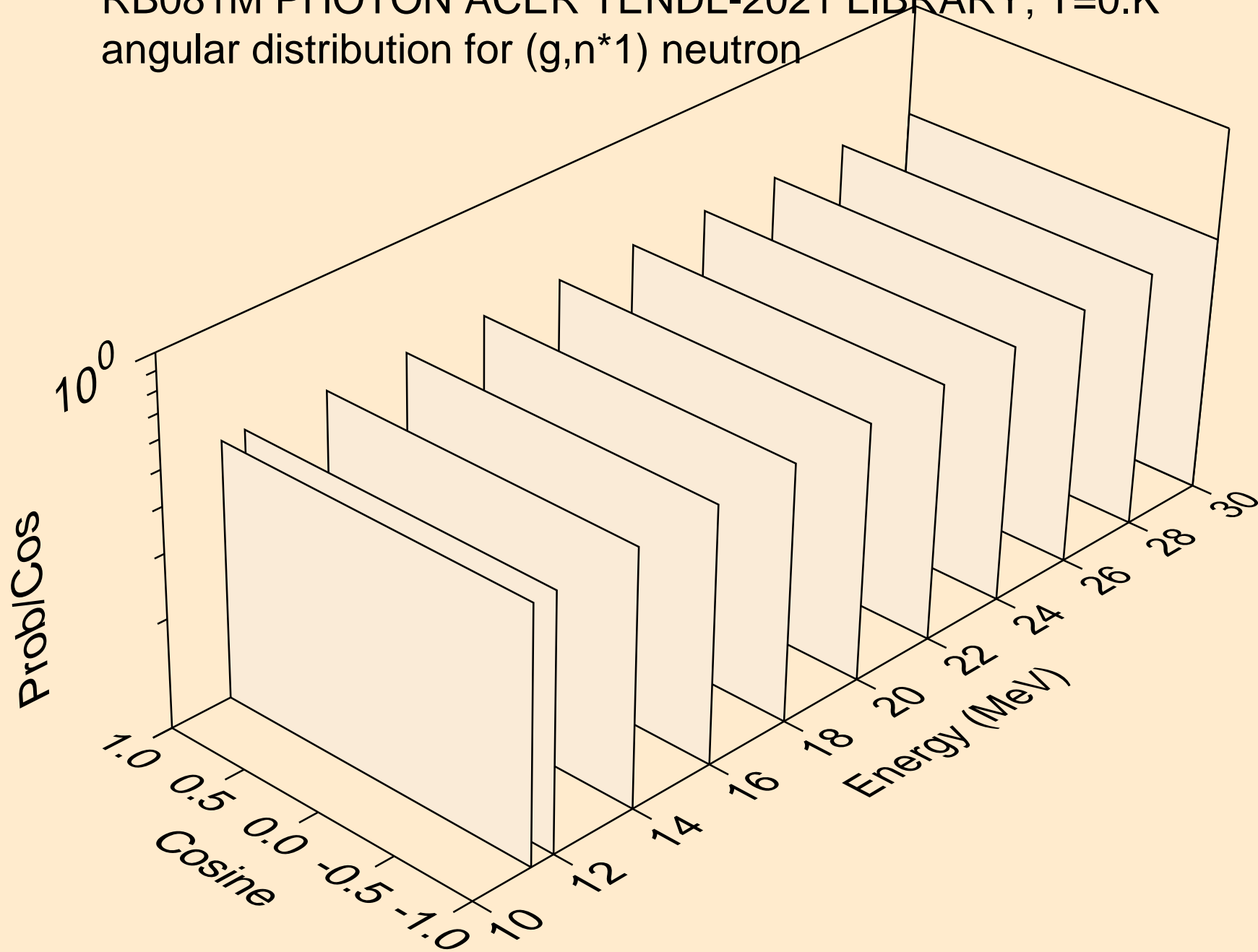

RB081M PHOTON ACER TENDL-2021 LIBRARY; T=0.K  
neutrons from (g,n\*c)

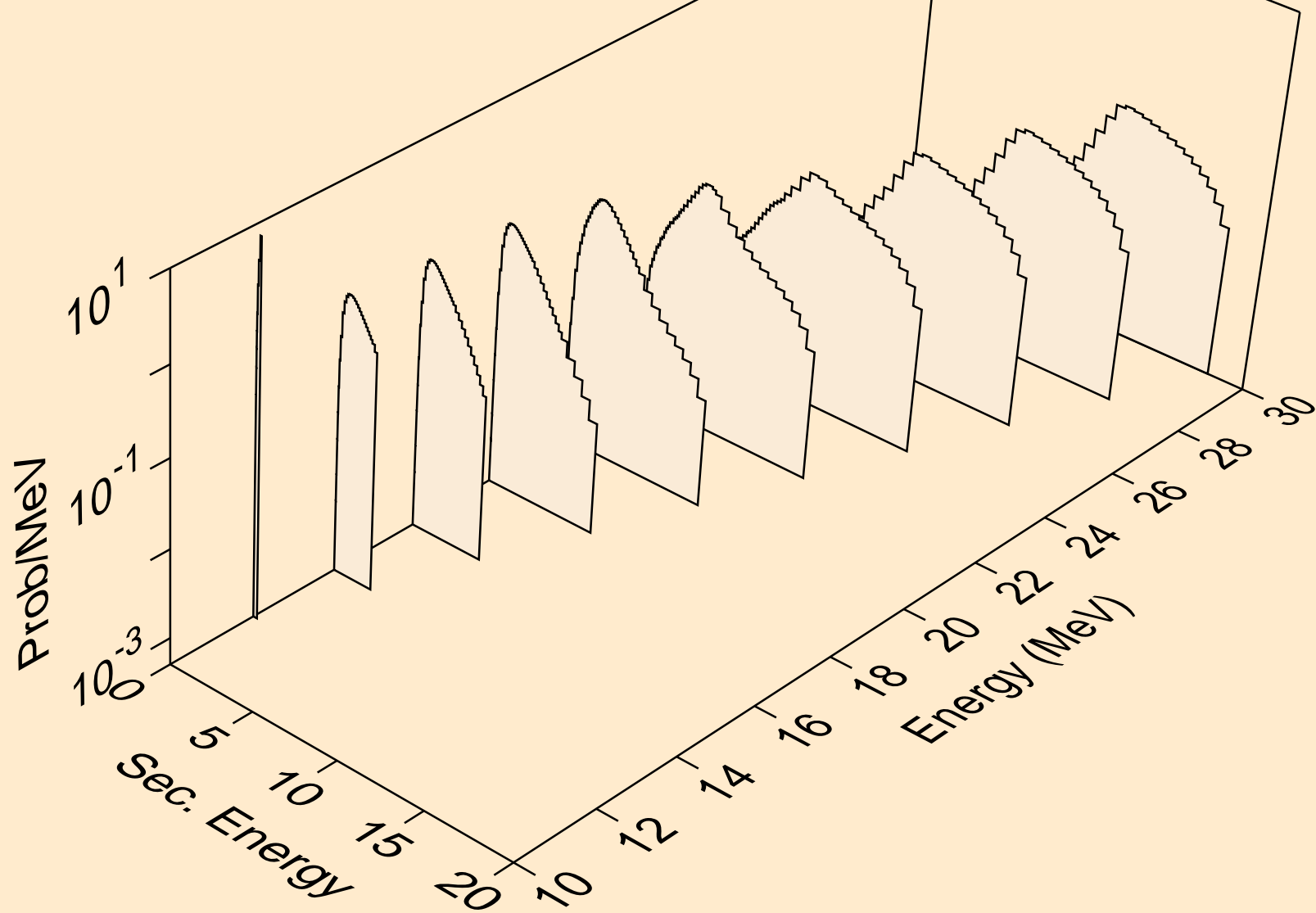



RB081M PHOTON ACER TENDL-2021 LIBRARY; T=0.K  
photons from (g,x)

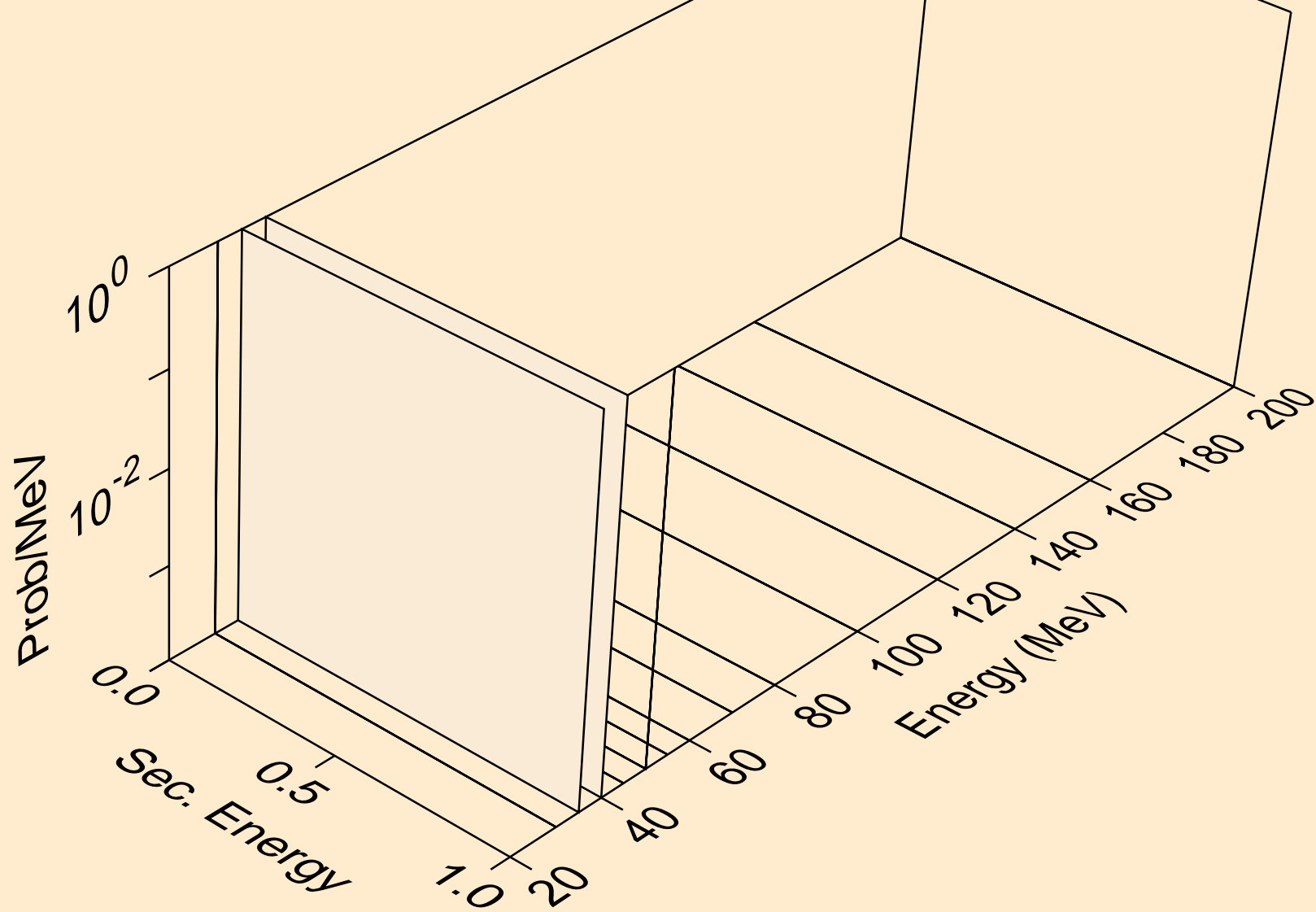

RB081M PHOTON ACER TENDL-2021 LIBRARY; T=0.K  
photons from (g,2n)

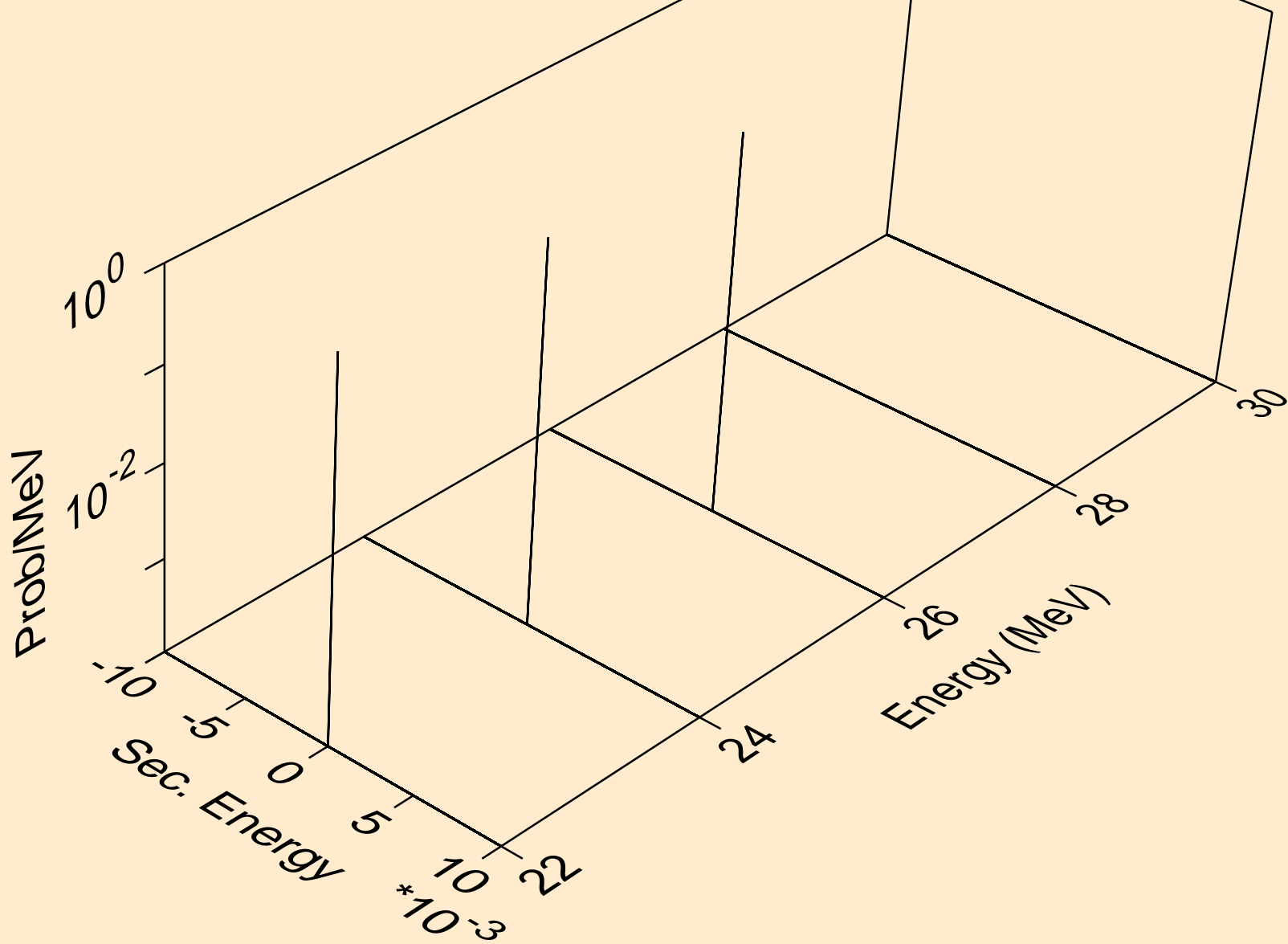

RB081M PHOTON ACER TENDL-2021 LIBRARY; T=0.K  
photons from (g,n\*)a

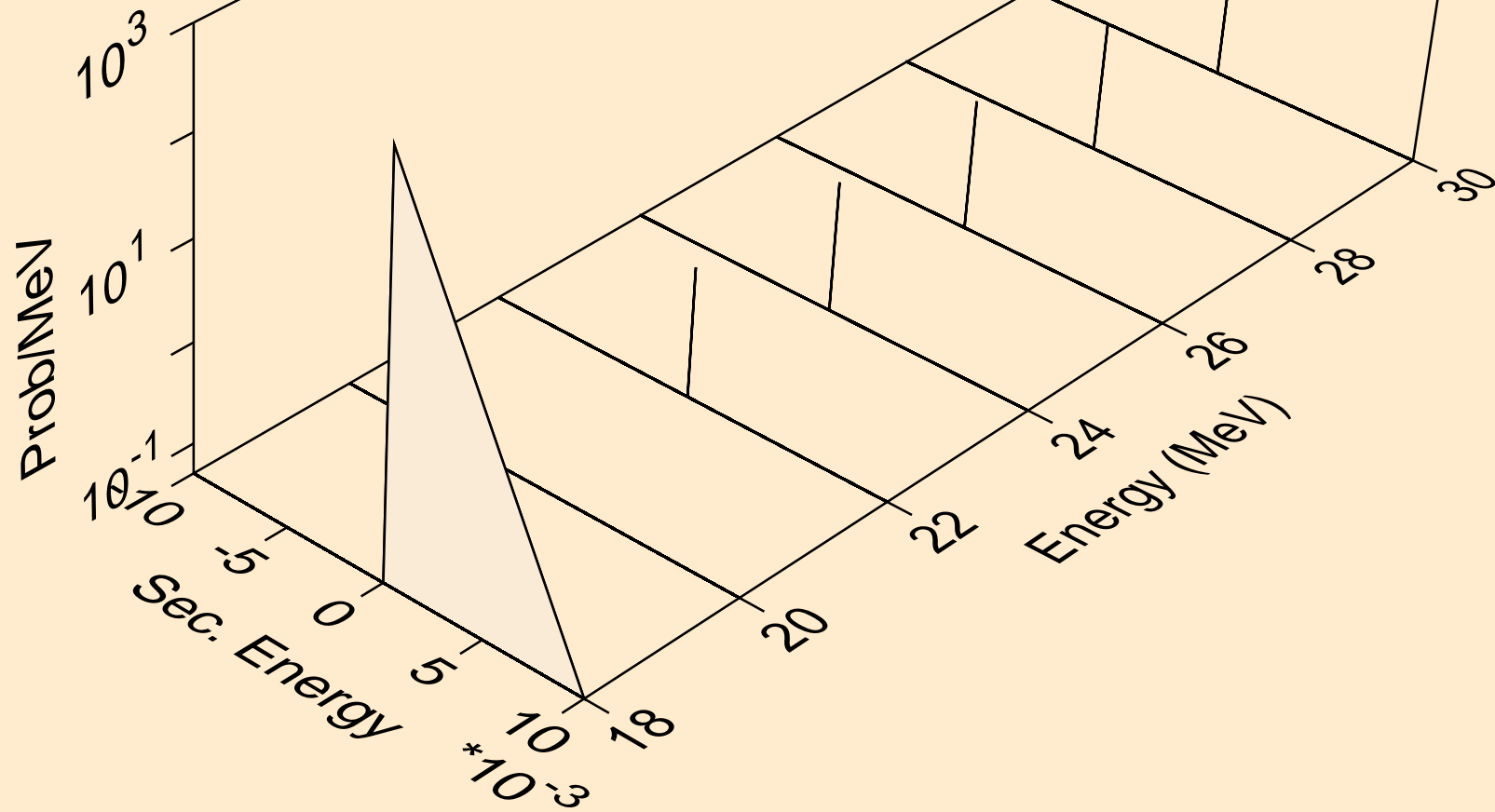

RB081M PHOTON ACER TENDL-2021 LIBRARY; T=0.K  
photons from (g,n\*)p

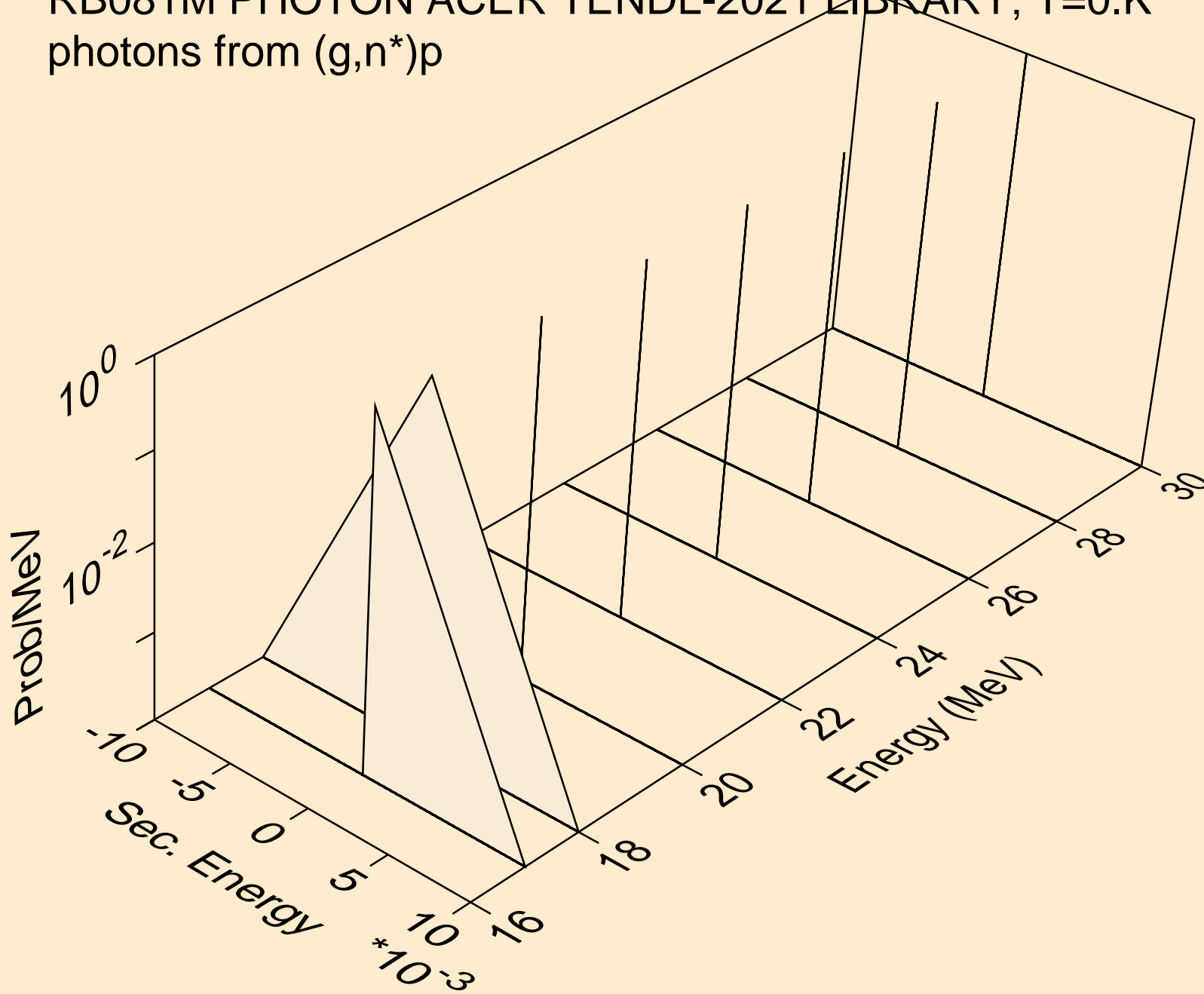

RB081M PHOTON ACER TENDL-2021 LIBRARY; T=0.K  
photons from (g,n\*)d

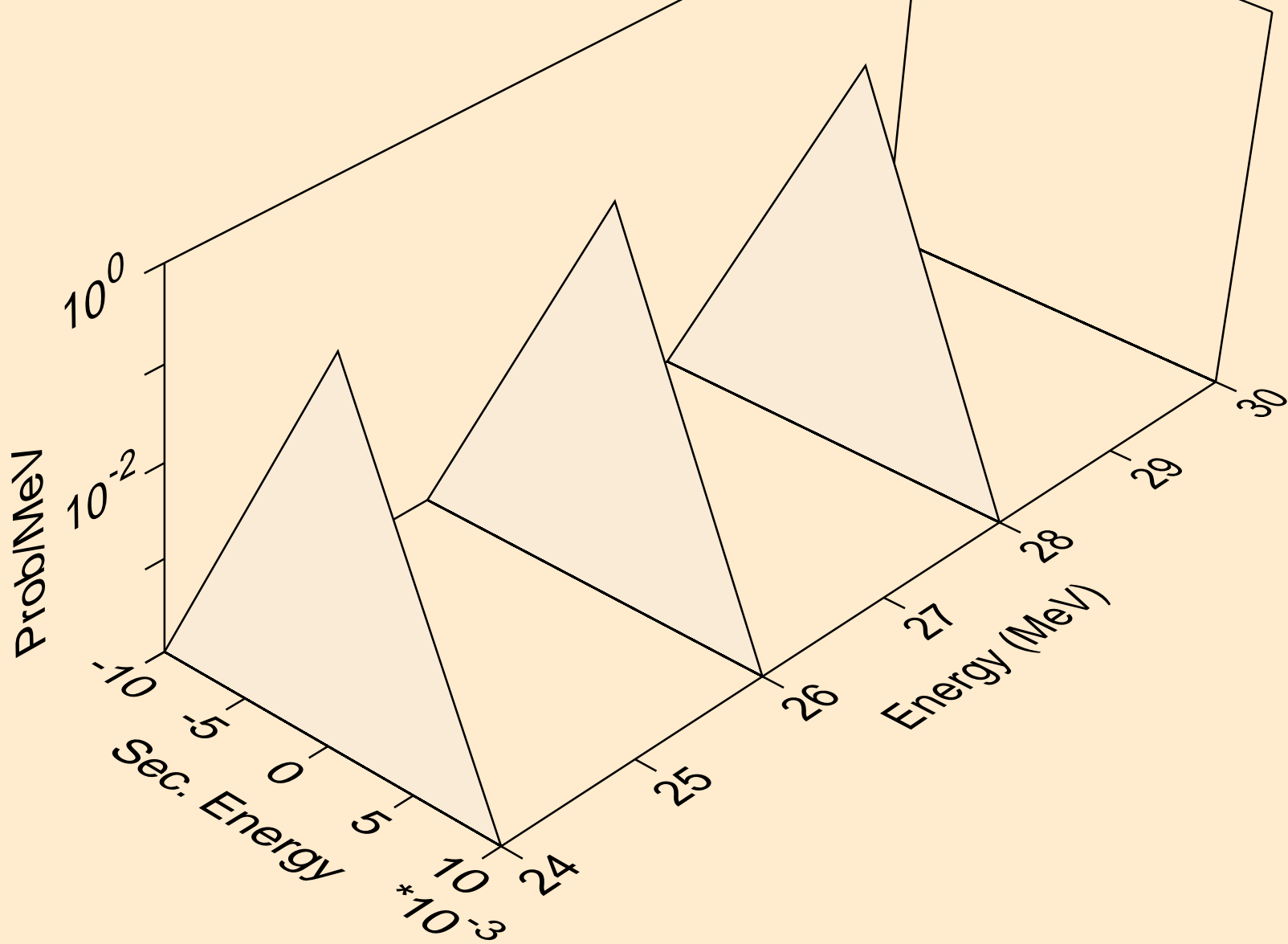

RB081M PHOTON ACER TENDL-2021 LIBRARY; T=0.K  
photons from (g,2np)

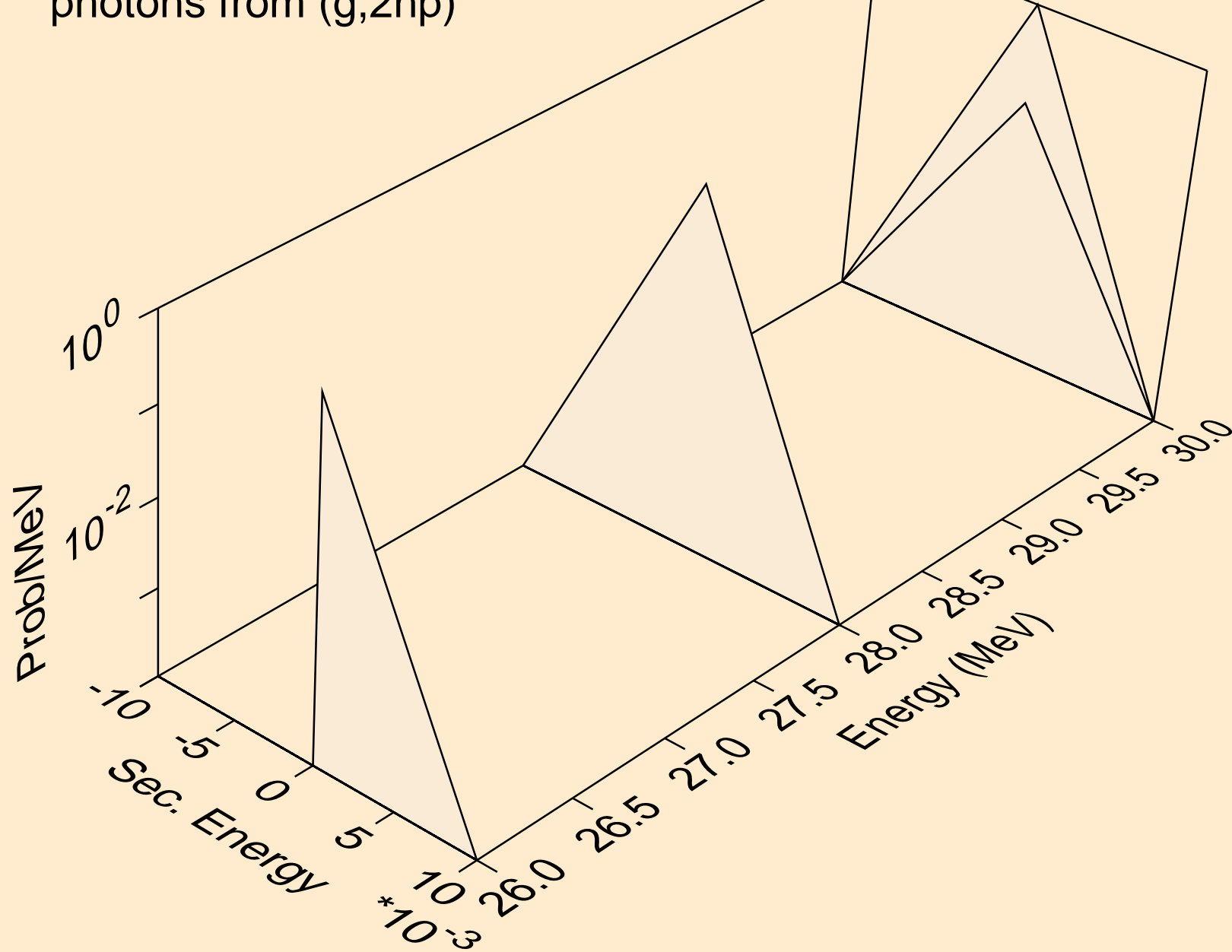

RB081M PHOTON ACER TENDL-2021 LIBRARY; T=0.K  
photons from (g,2np)

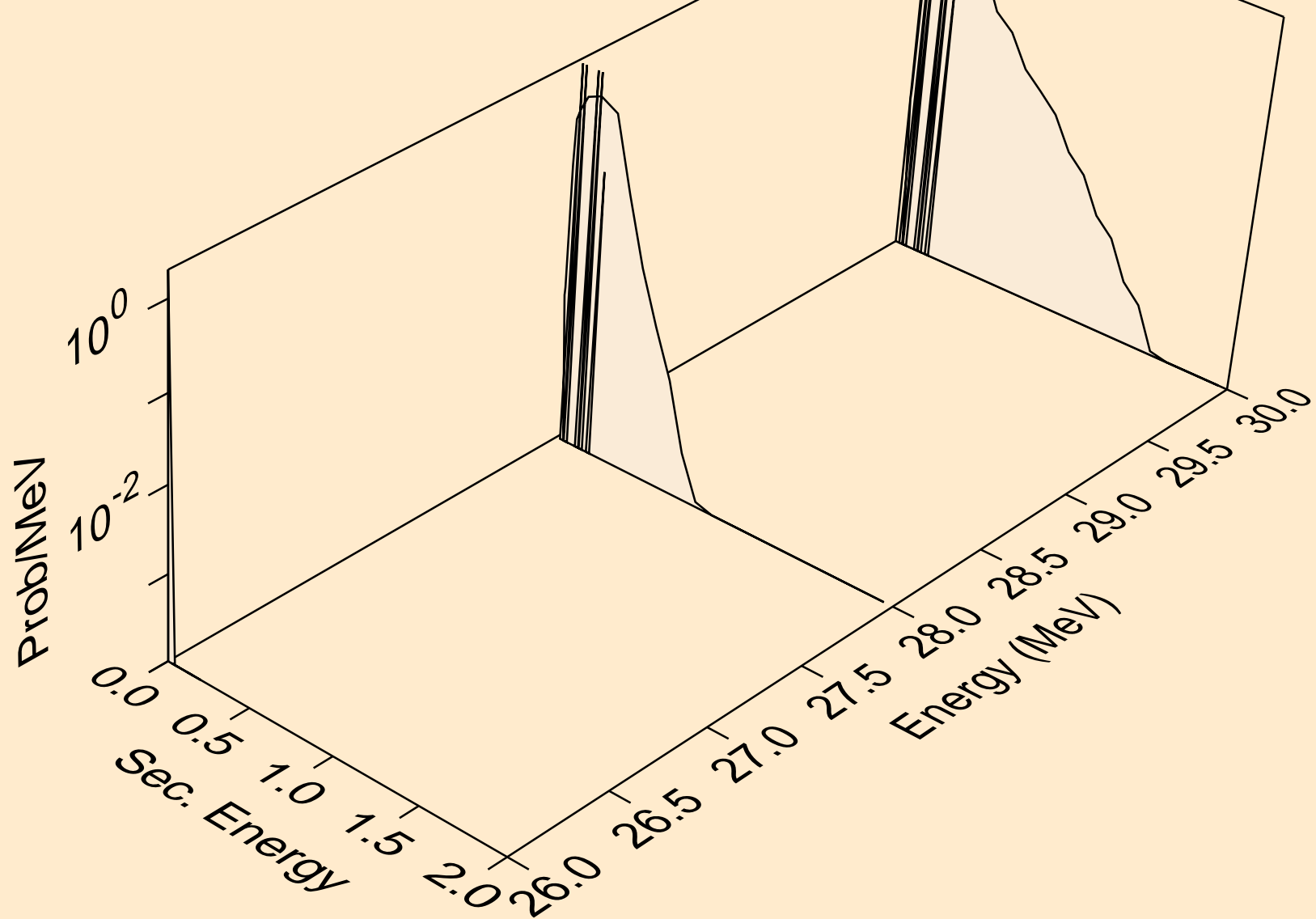

RB081M PHOTON ACER TENDL-2021 LIBRARY; T=0.K  
photons from (g,npa)

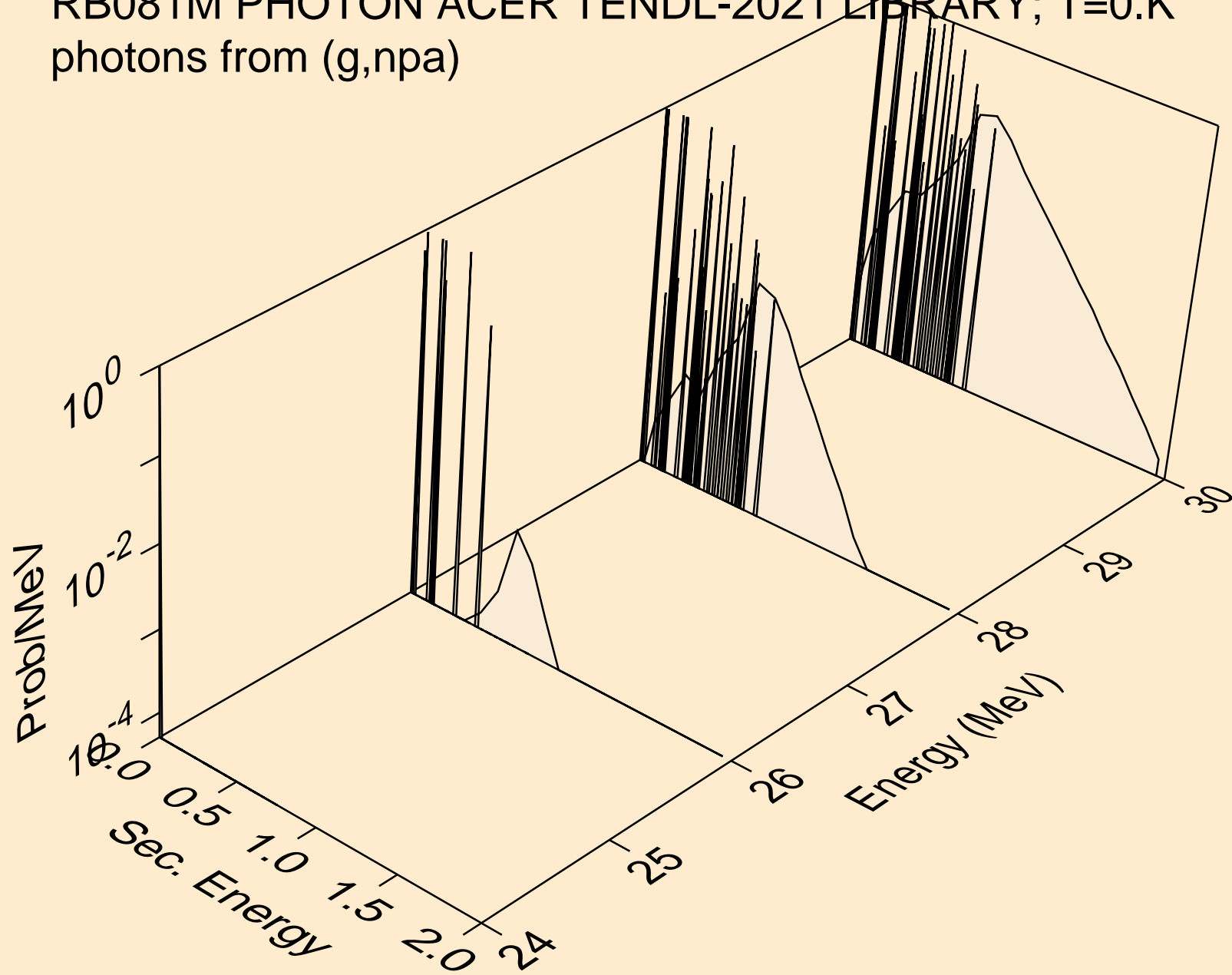



RB081M PHOTON ACER TENDL-2021 LIBRARY; T=0.K  
photons from (g,n\*c)

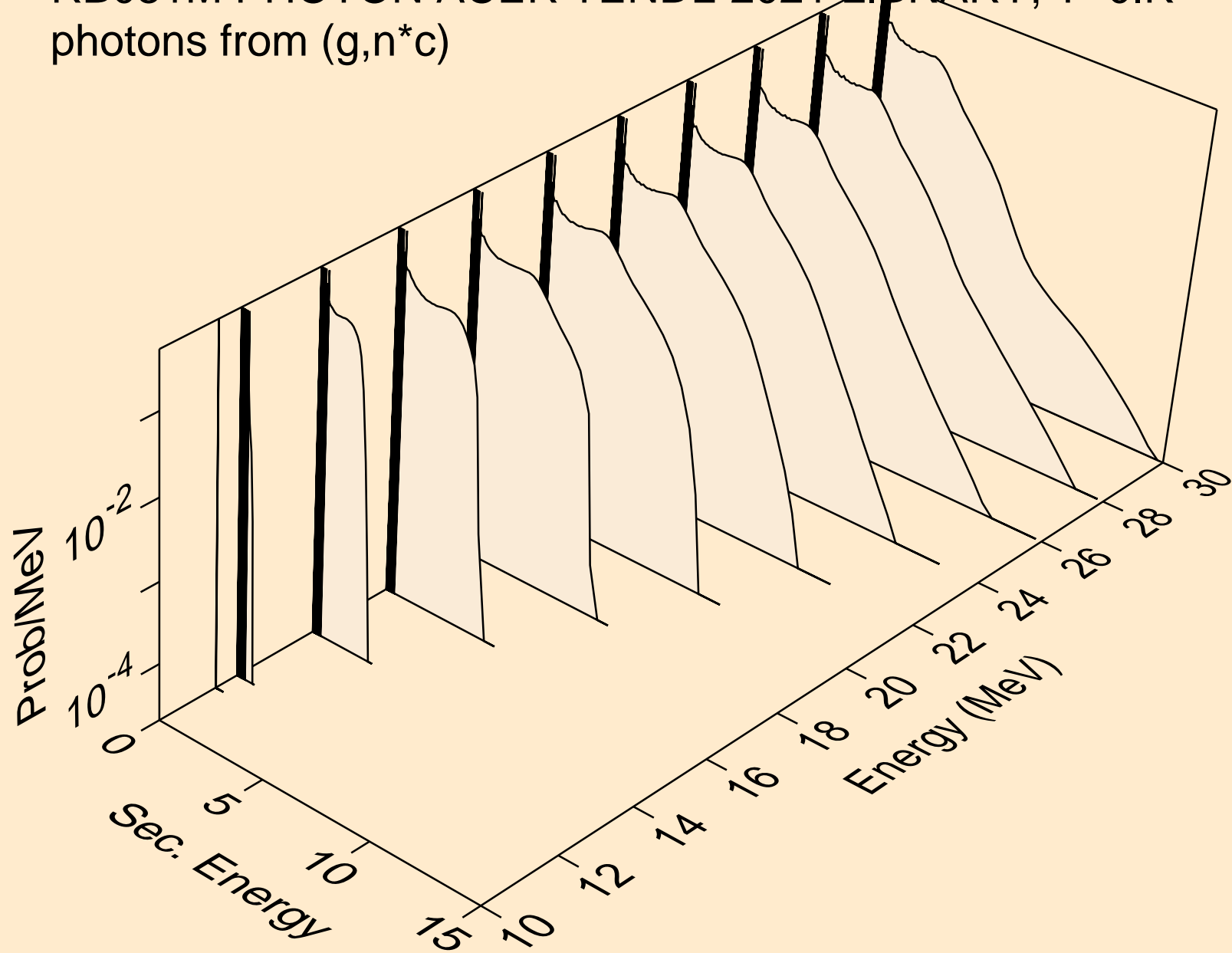

RB081M PHOTON ACER TENDL-2021 LIBRARY; T=0.K  
photons from (g,gma)

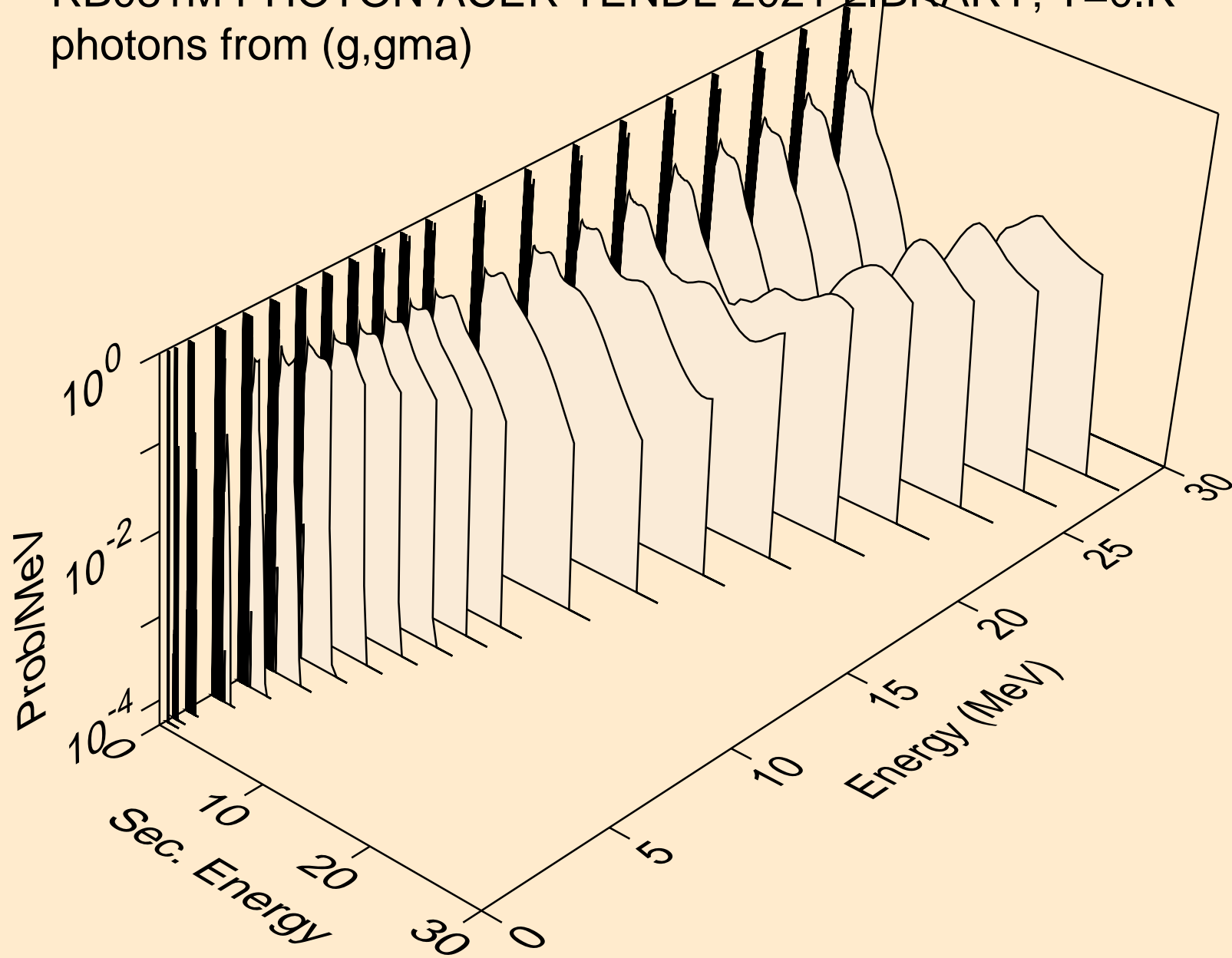

RB081M PHOTON ACER TENDL-2021 LIBRARY; T=0.K  
photons from (g,p)

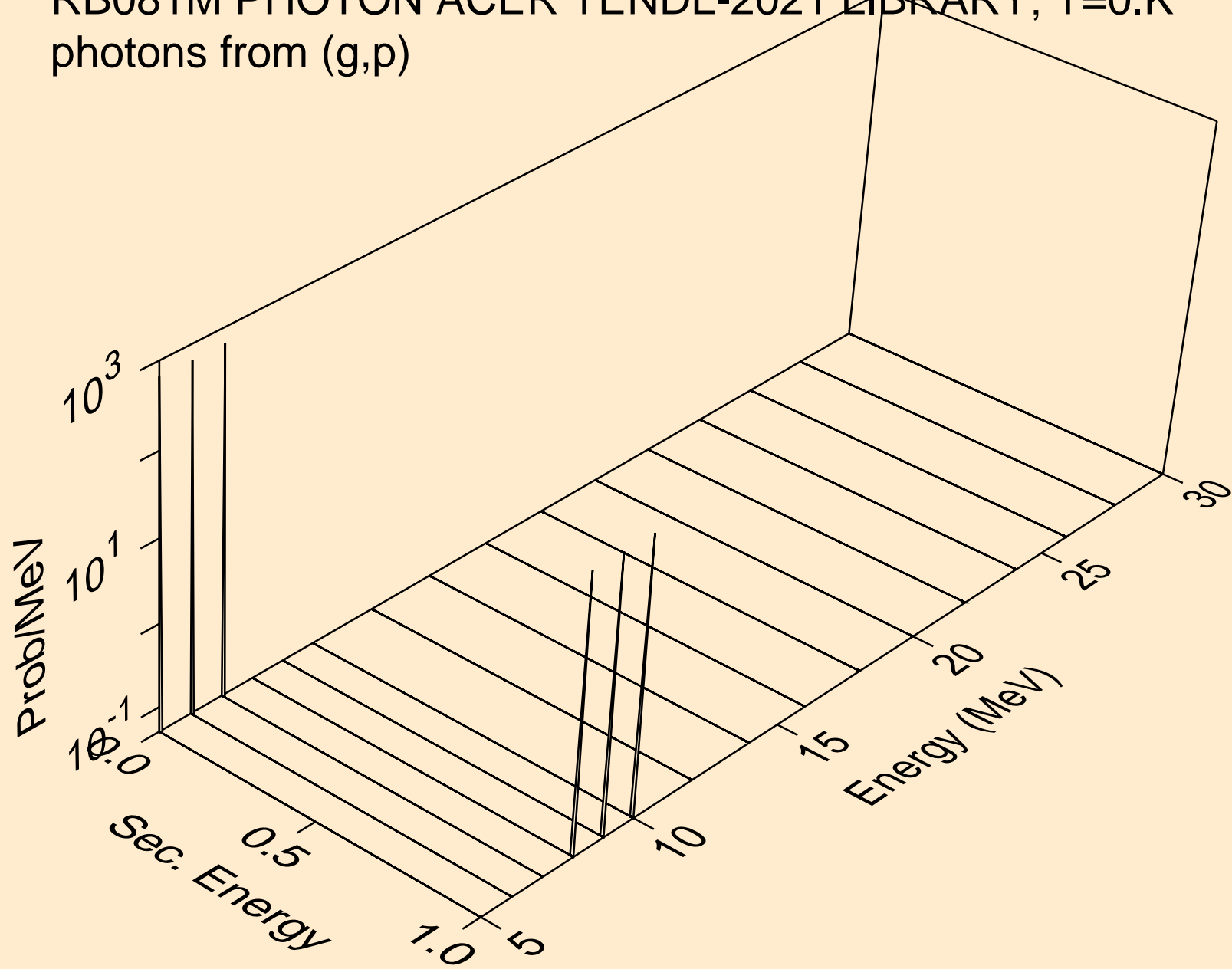

RB081M PHOTON ACER TENDL-2021 LIBRARY; T=0.K  
photons from (g,d)

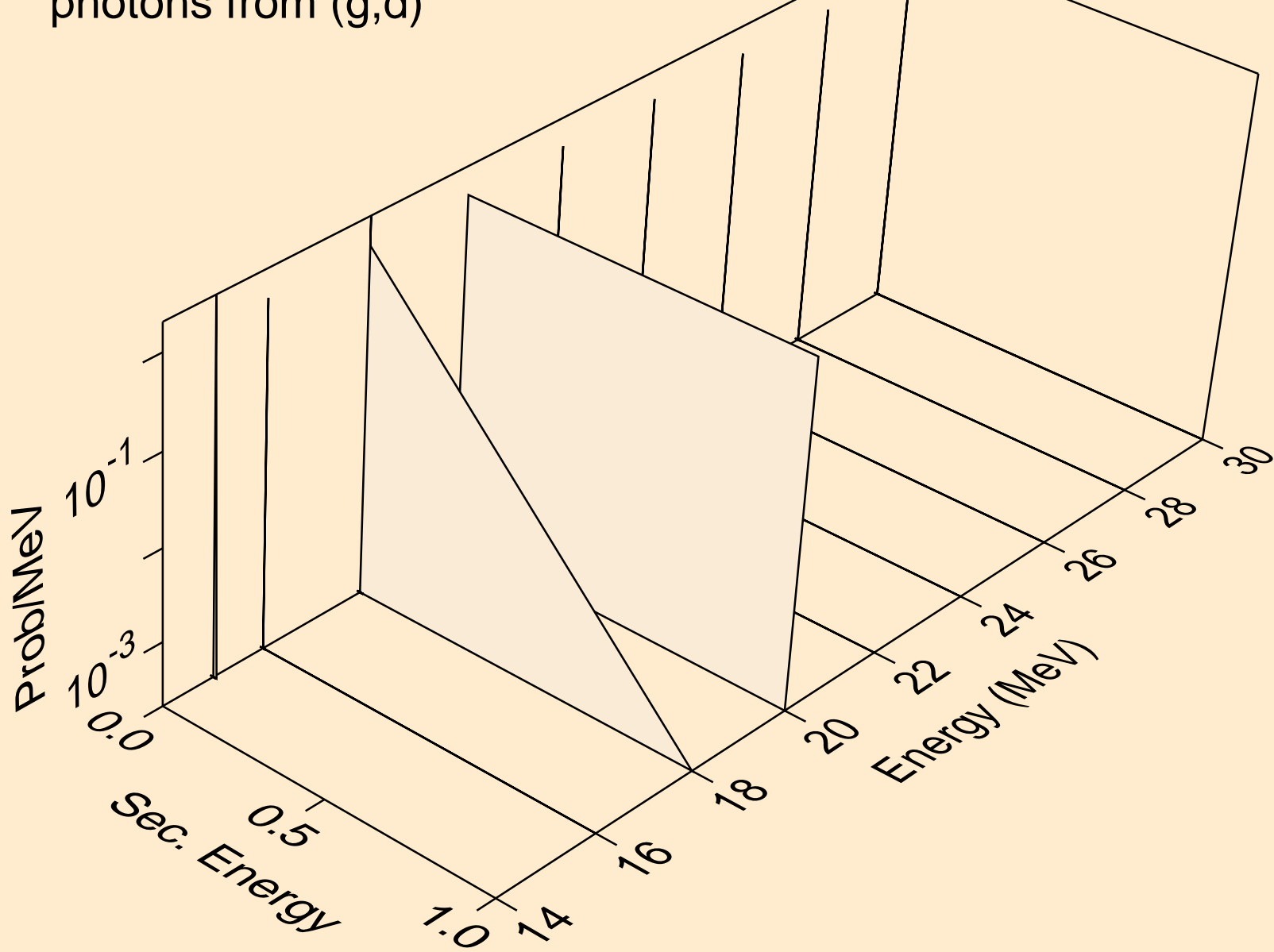

RB081M PHOTON ACER TENDL-2021 LIBRARY; T=0.K  
photons from (g,t)

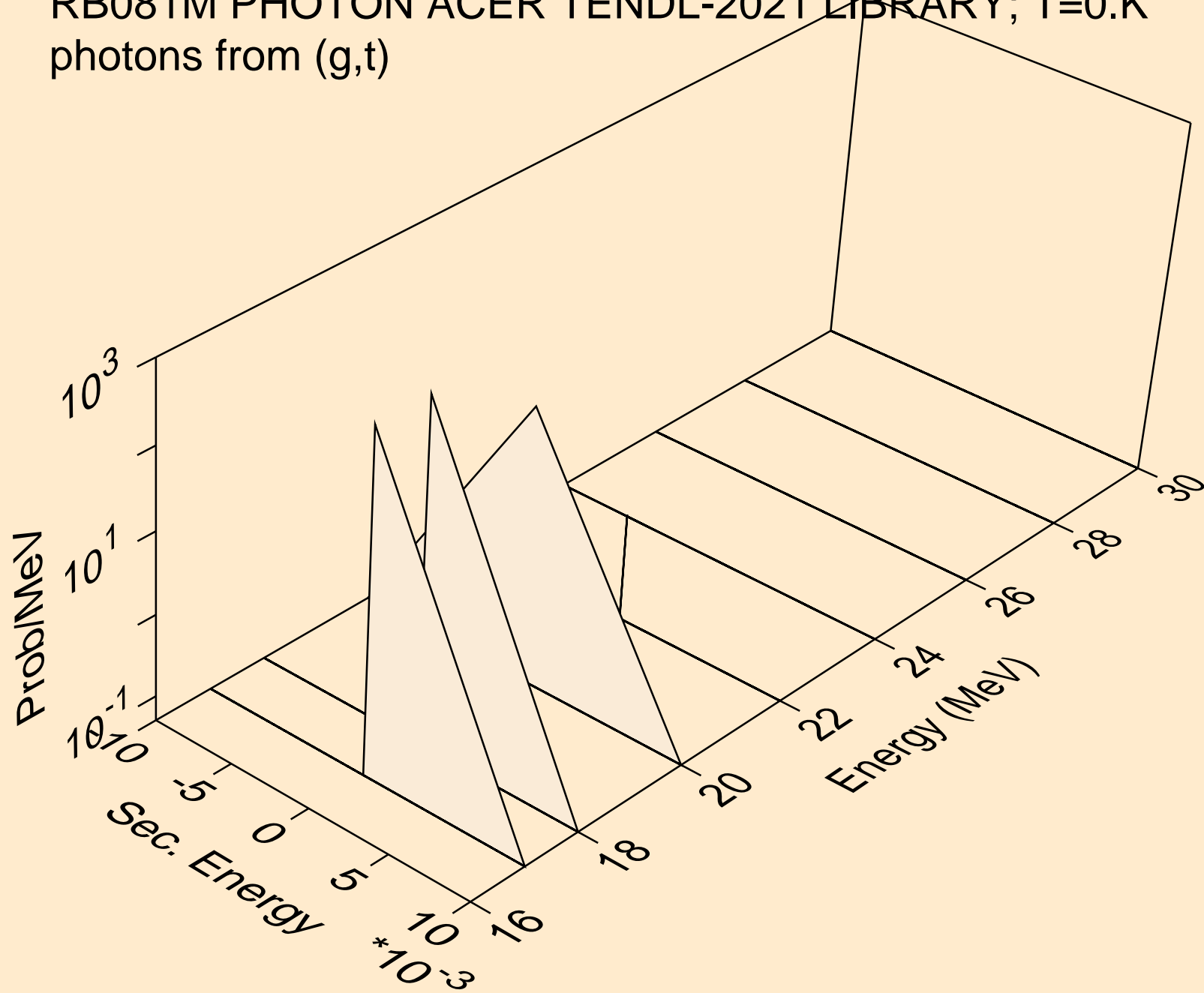

RB081M PHOTON ACER TENDL-2021 LIBRARY; T=0.K  
photons from (g,he3)

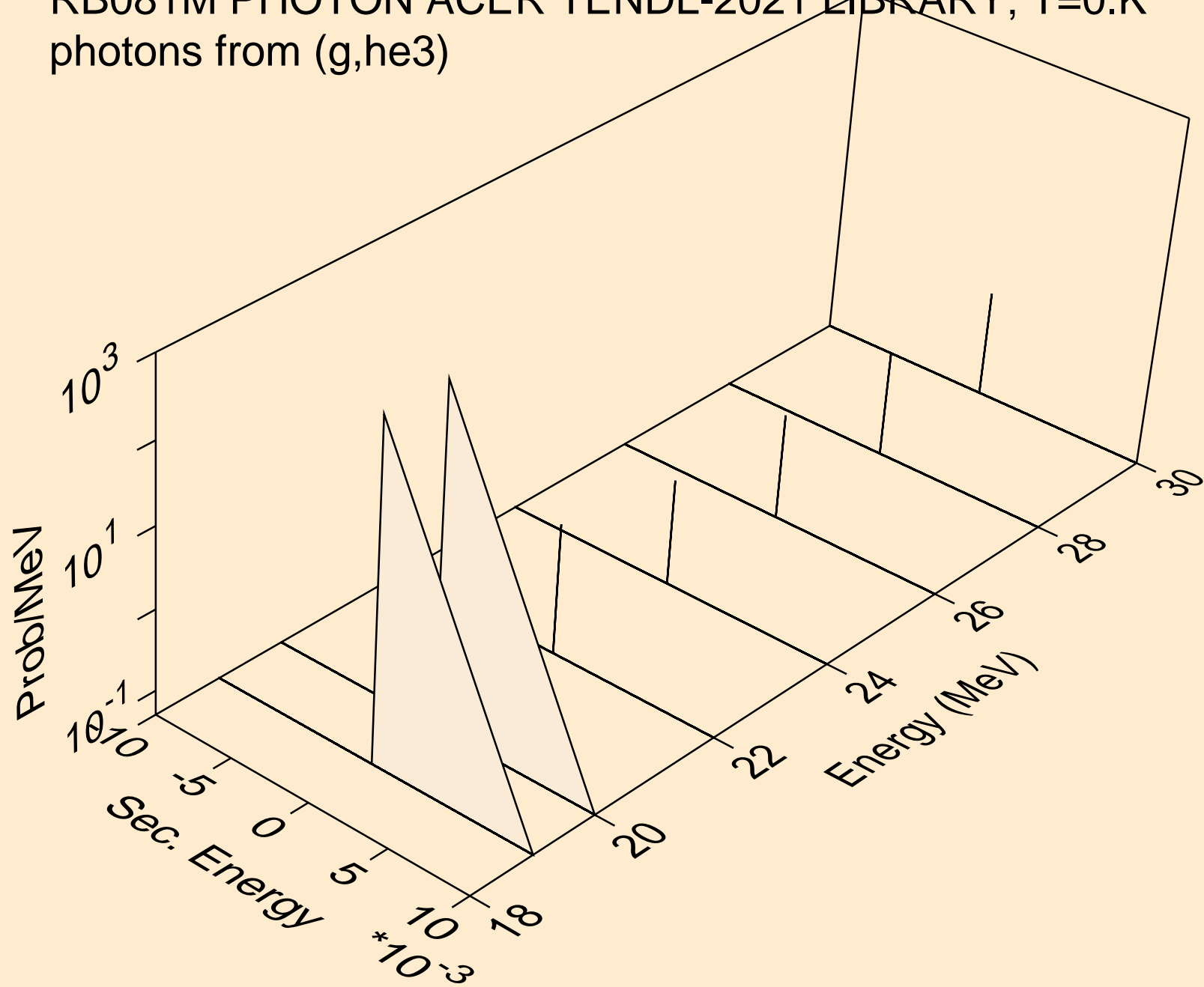

RB081M PHOTON ACER TENDL-2021 LIBRARY; T=0.K  
photons from (g,a)

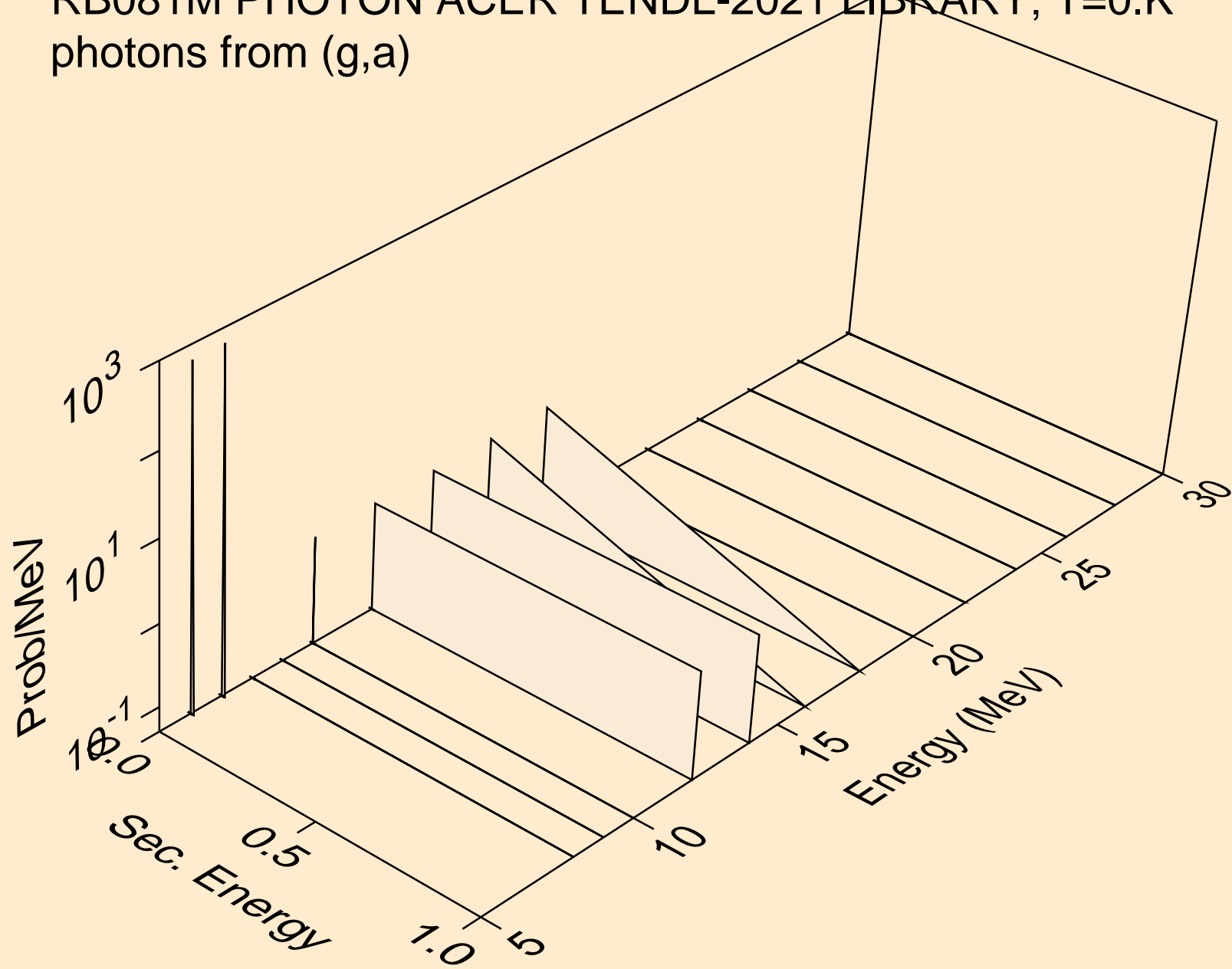

RB081M PHOTON ACER TENDL-2021 LIBRARY; T=0.K  
photons from (g,2a)

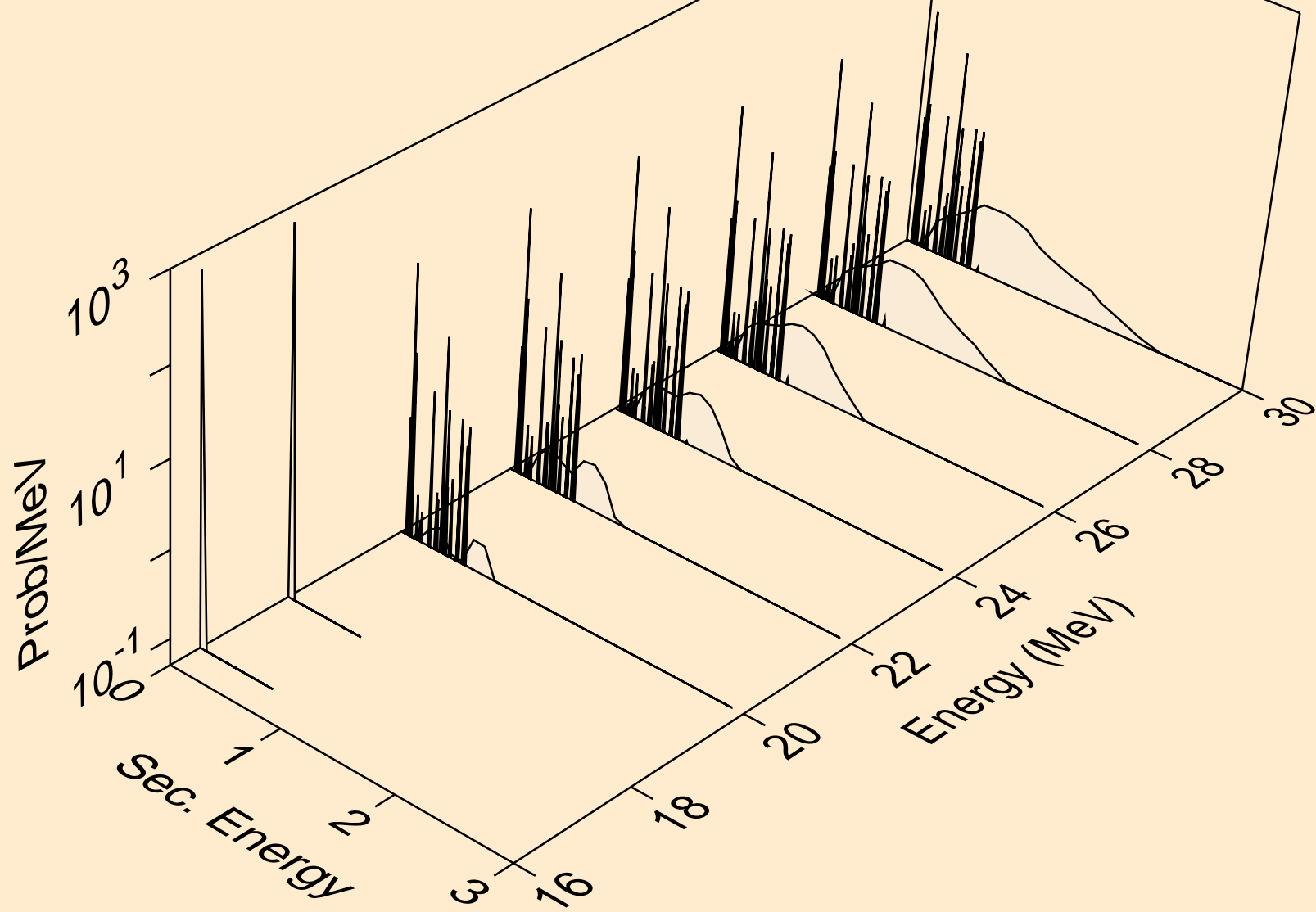



RB081M PHOTON ACER TENDL-2021 LIBRARY; T=0.K  
photons from (g,2p)

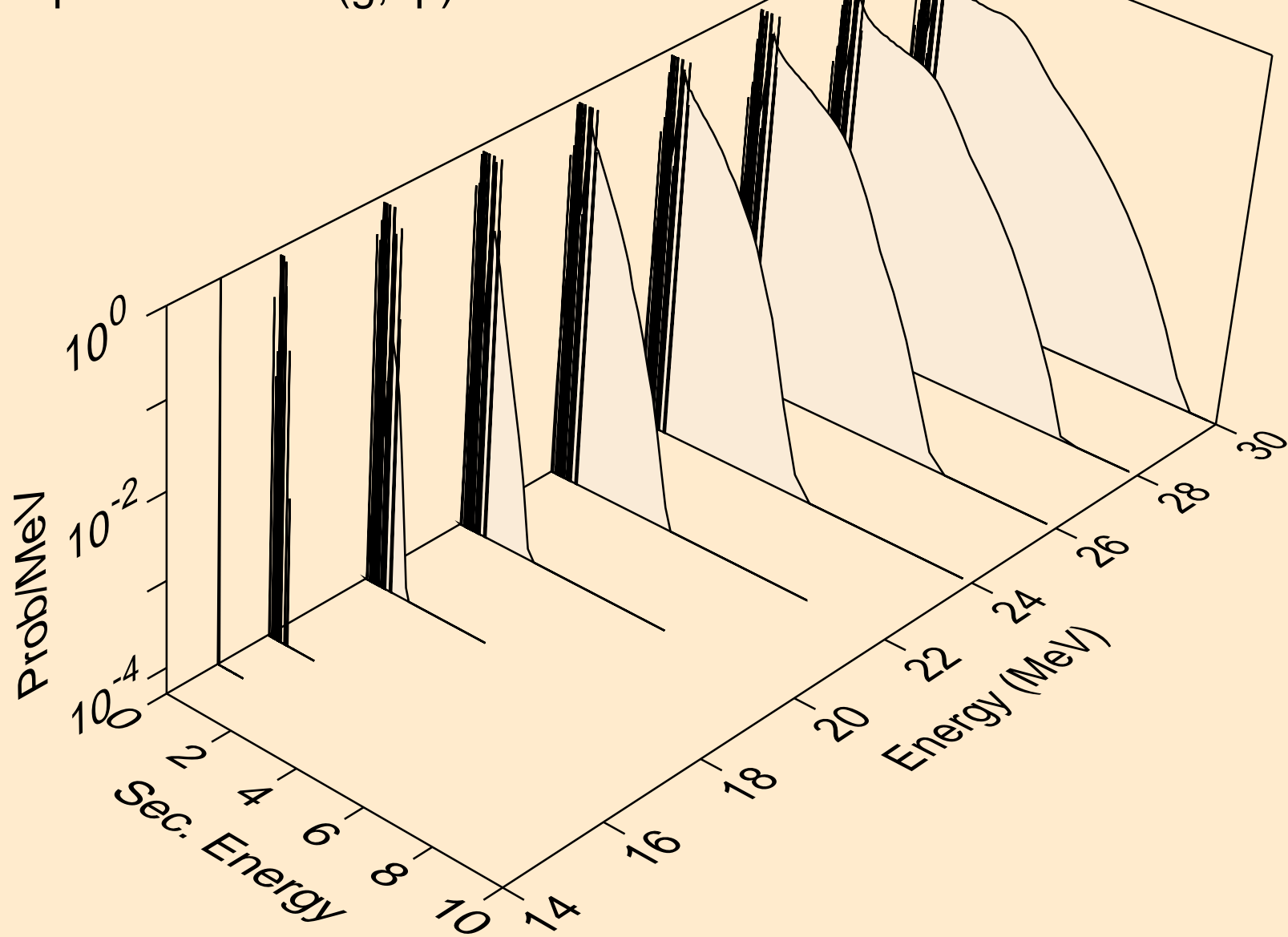

RB081M PHOTON ACER TENDL-2021 LIBRARY; T=0.K  
photons from (g,pa)

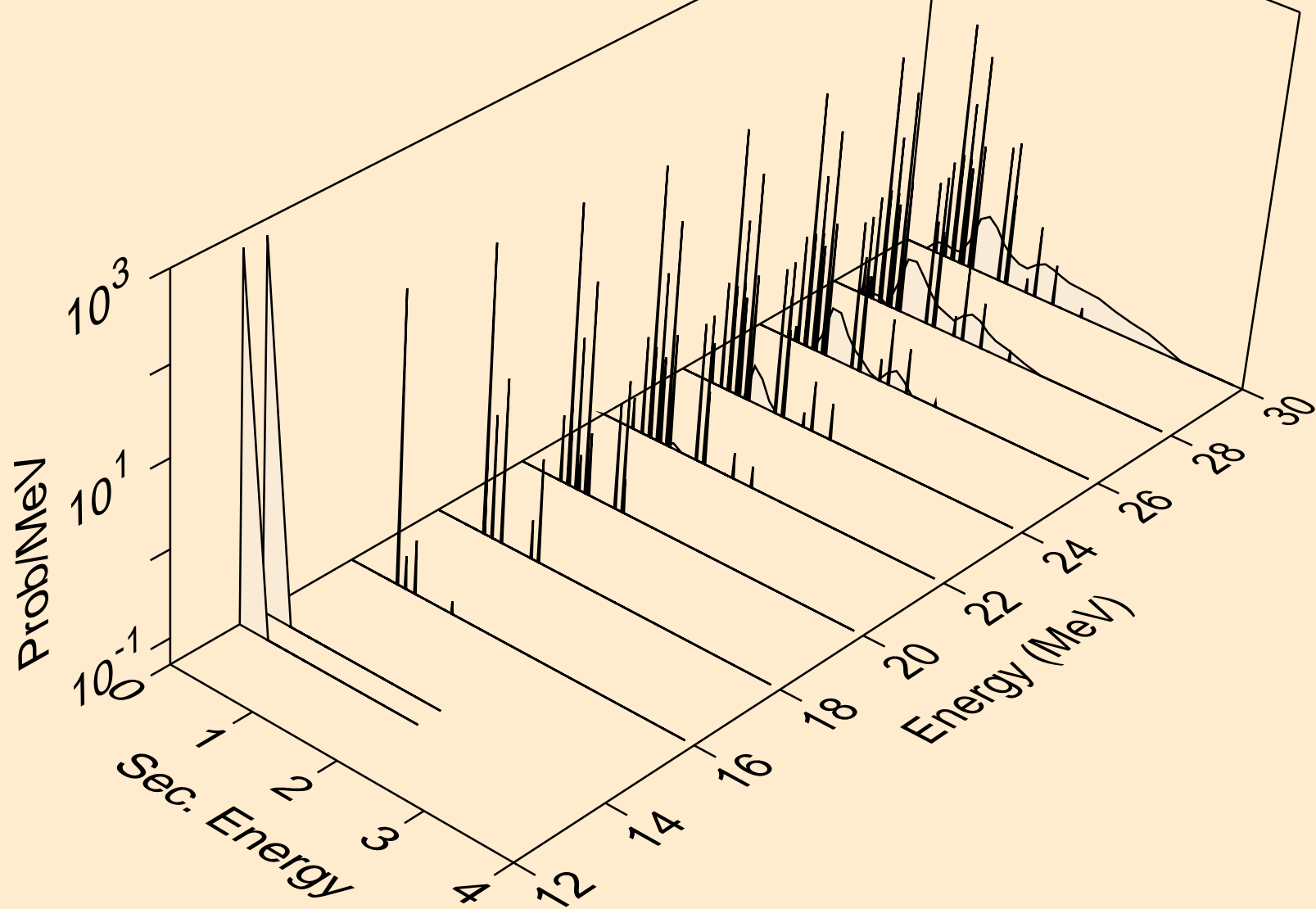

RB081M PHOTON ACER TENDL-2021 LIBRARY; T=0.K  
protons from (g,x)

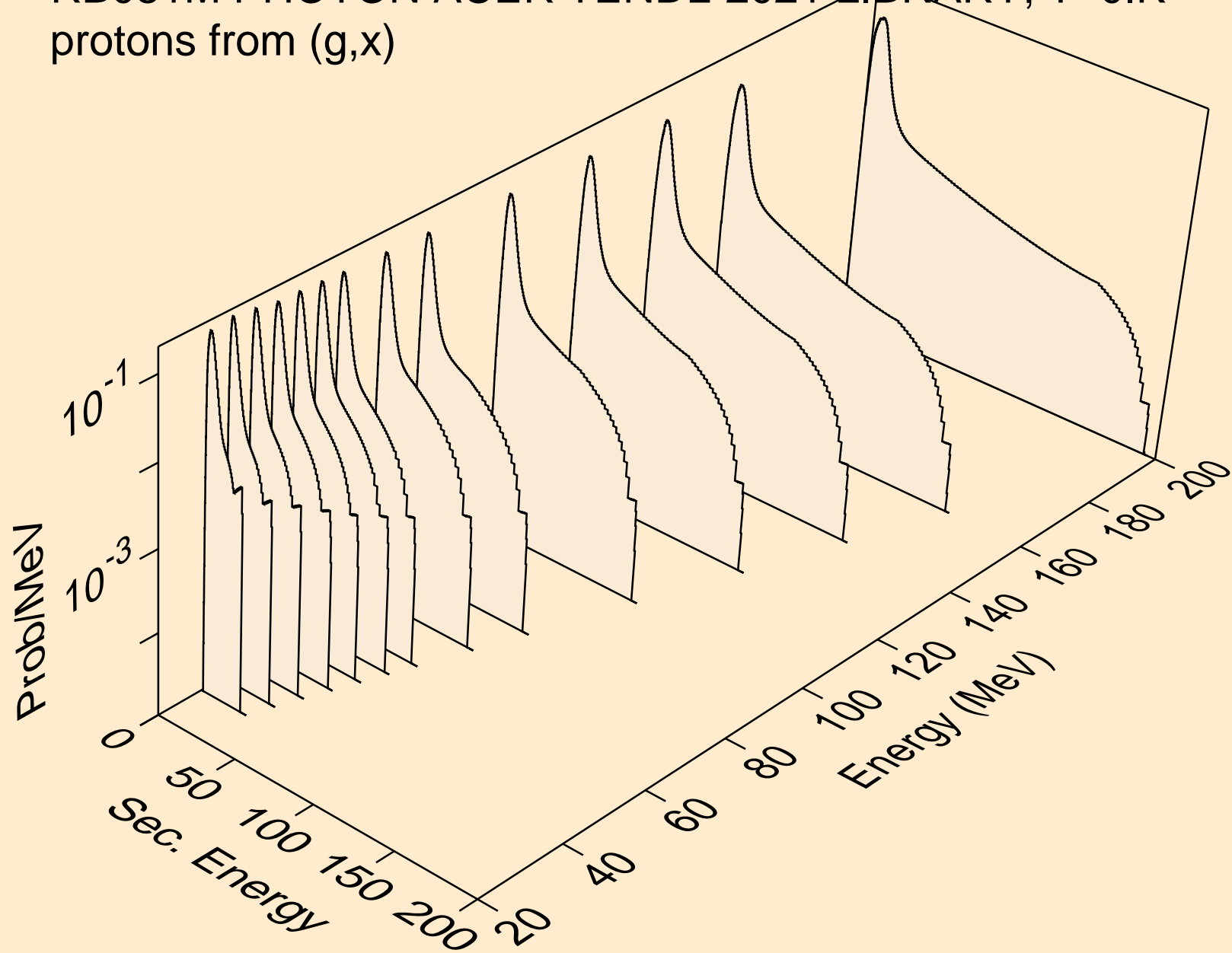

RB081M PHOTON ACER TENDL-2021 LIBRARY; T=0.K  
protons from (g,n\*)p

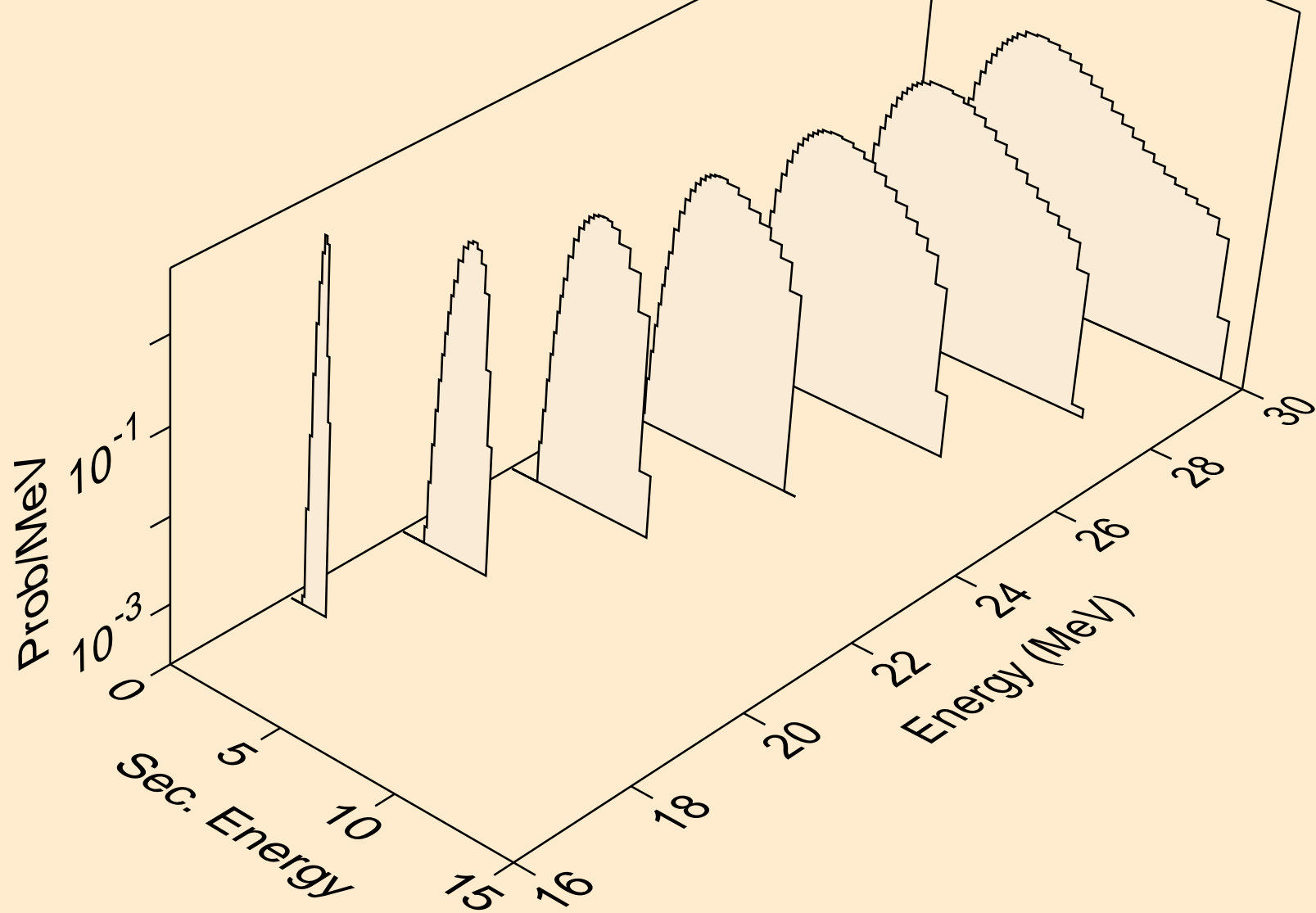

RB081M PHOTON ACER TENDL-2021 LIBRARY; T=0.K  
protons from (g,2np)

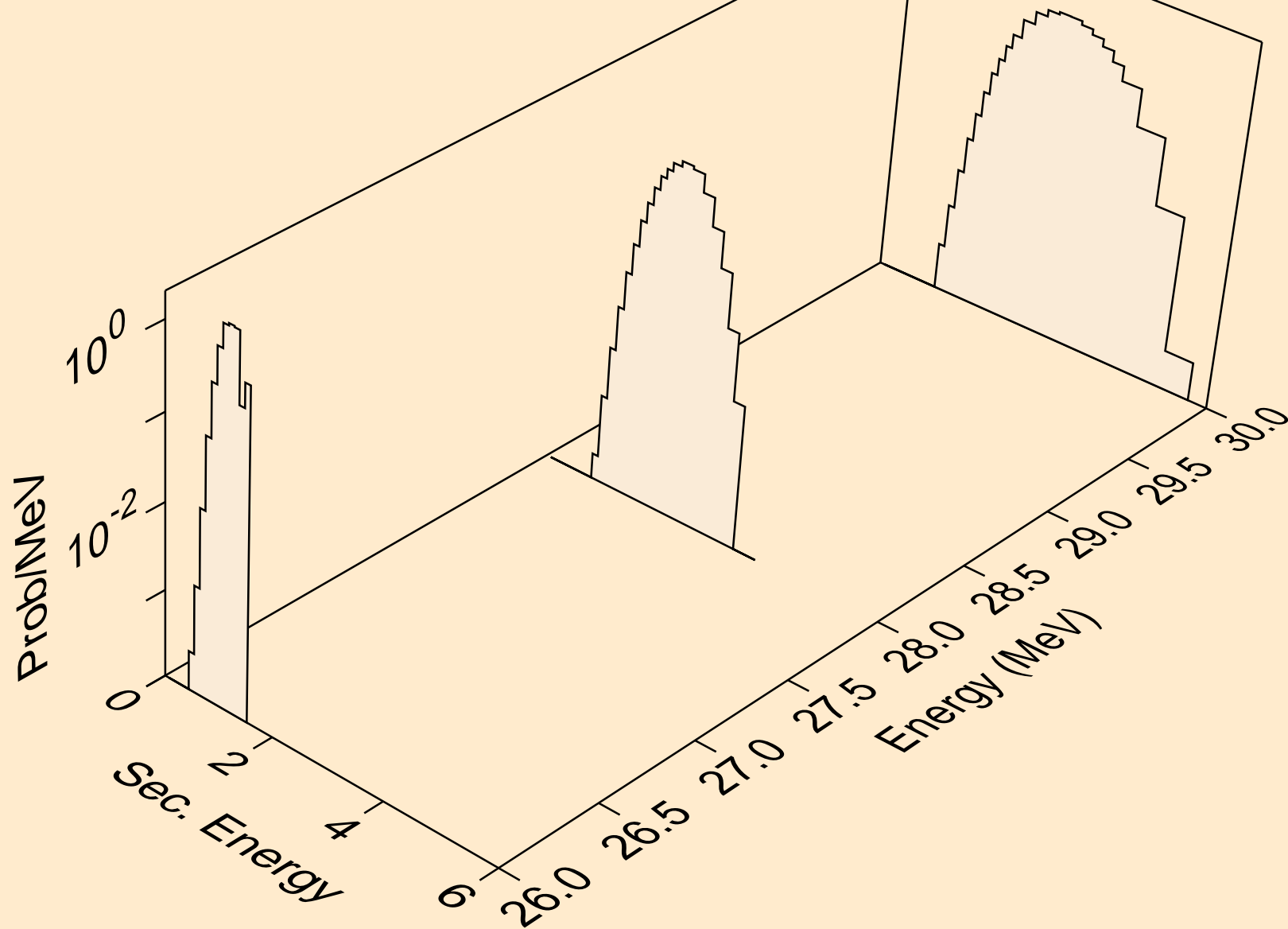

RB081M PHOTON ACER TENDL-2021 LIBRARY; T=0.K  
protons from (g,2np)

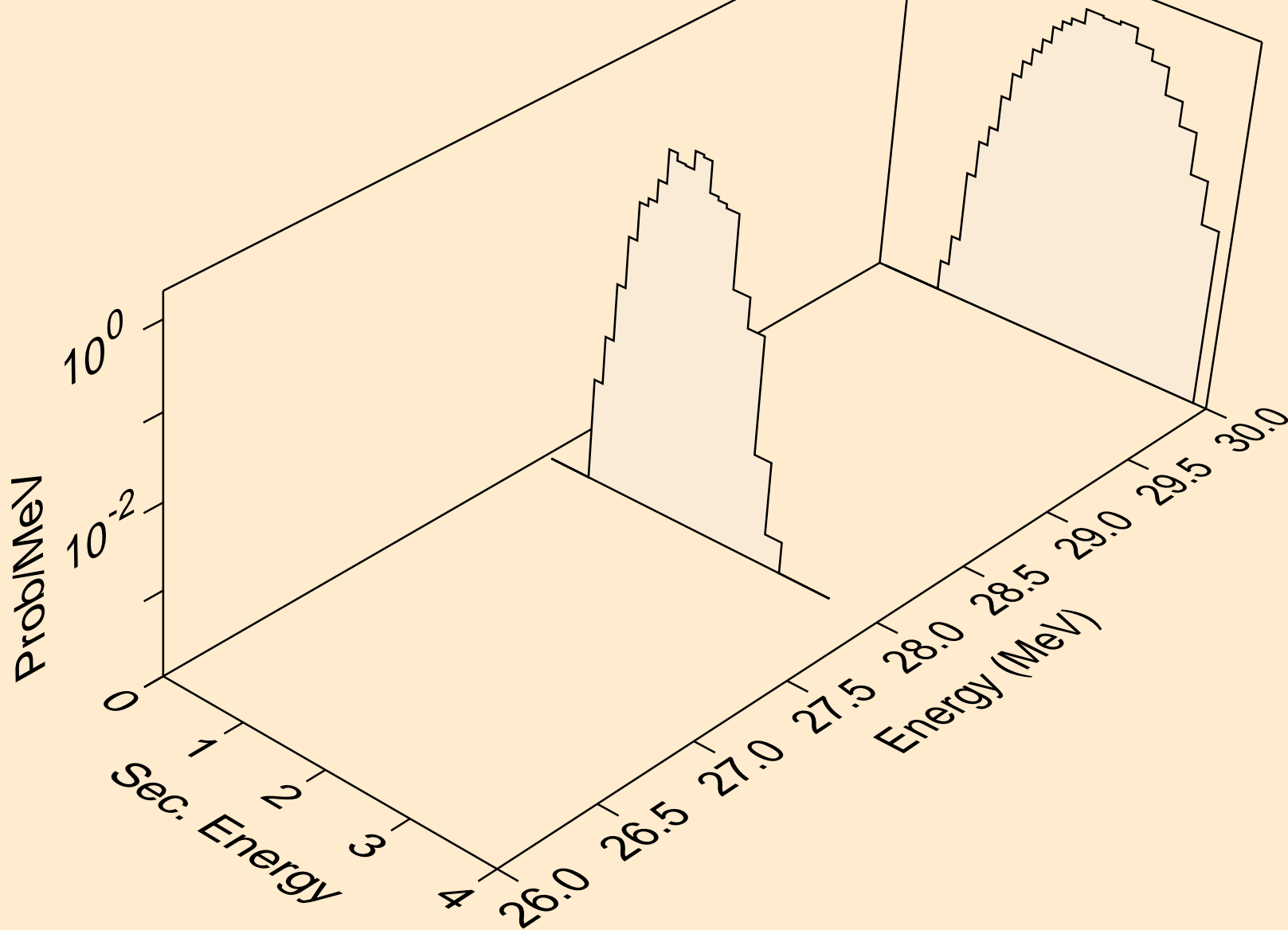

RB081M PHOTON ACER TENDL-2021 LIBRARY; T=0.K  
protons from (g,npa)

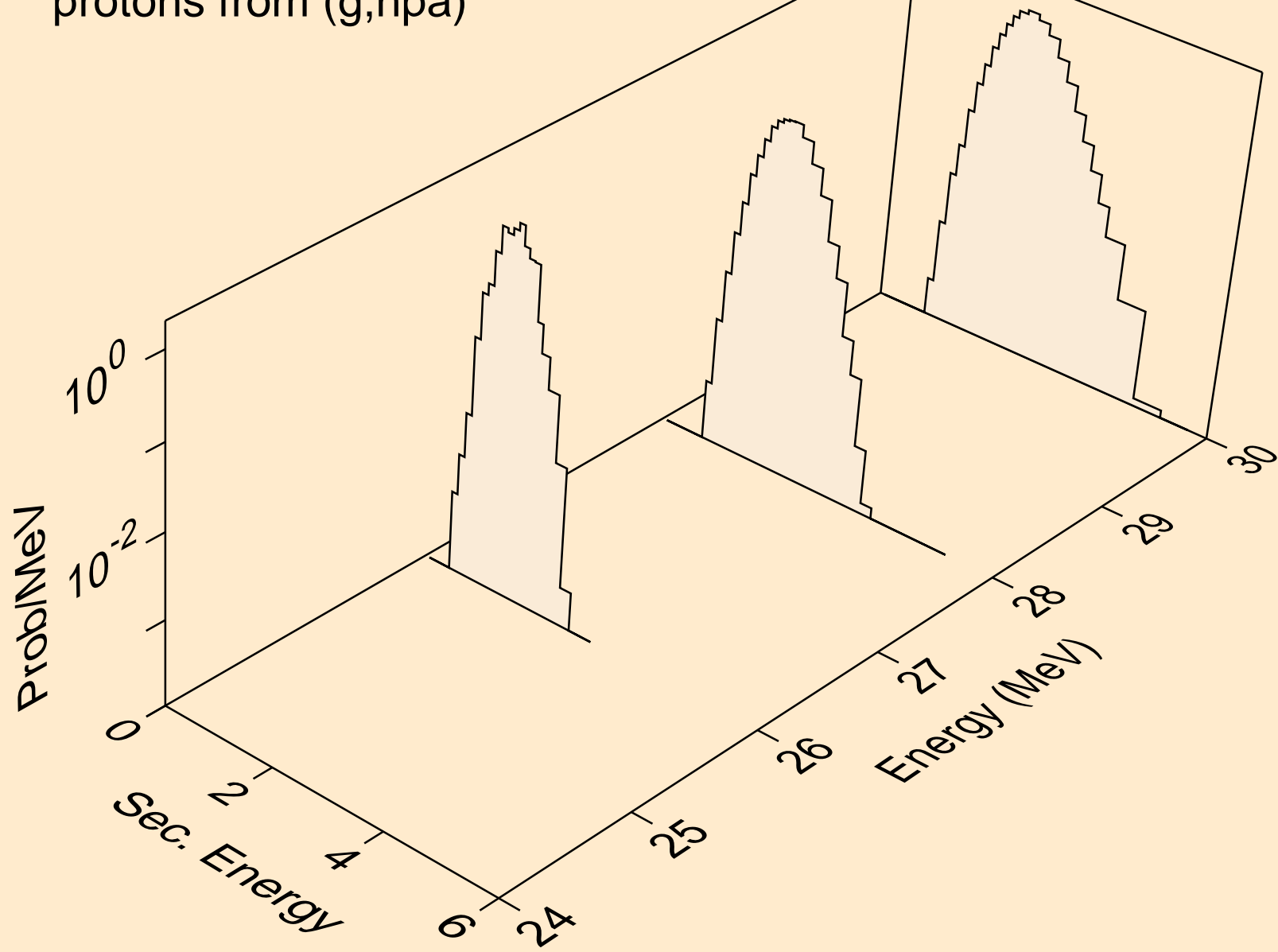

RB081M PHOTON ACER TENDL-2021 LIBRARY; T=0.K  
protons from (g,p)

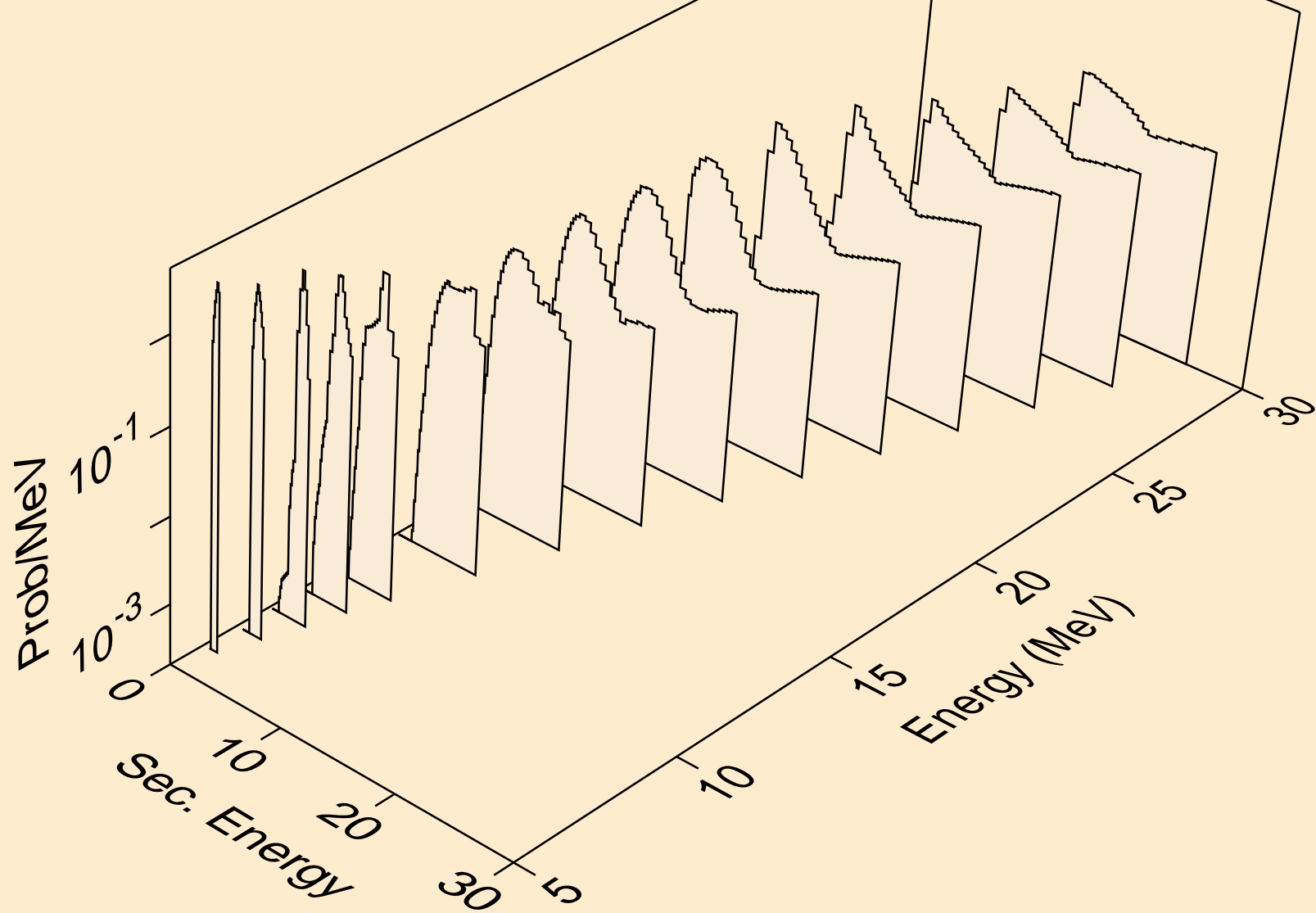



RB081M PHOTON ACER TENDL-2021 LIBRARY; T=0.K  
protons from (g,2p)

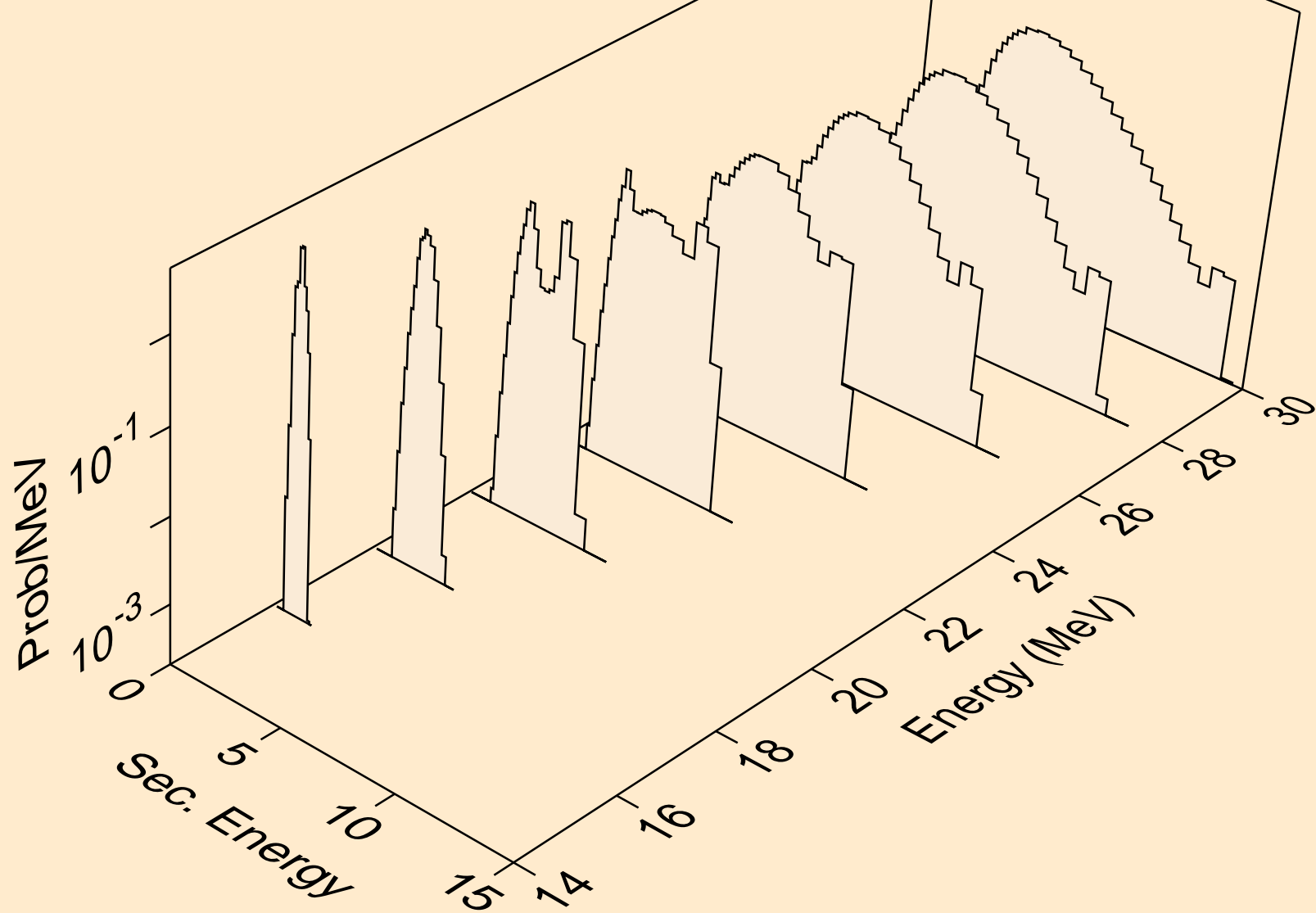

RB081M PHOTON ACER TENDL-2021 LIBRARY; T=0.K  
protons from (g,pa)

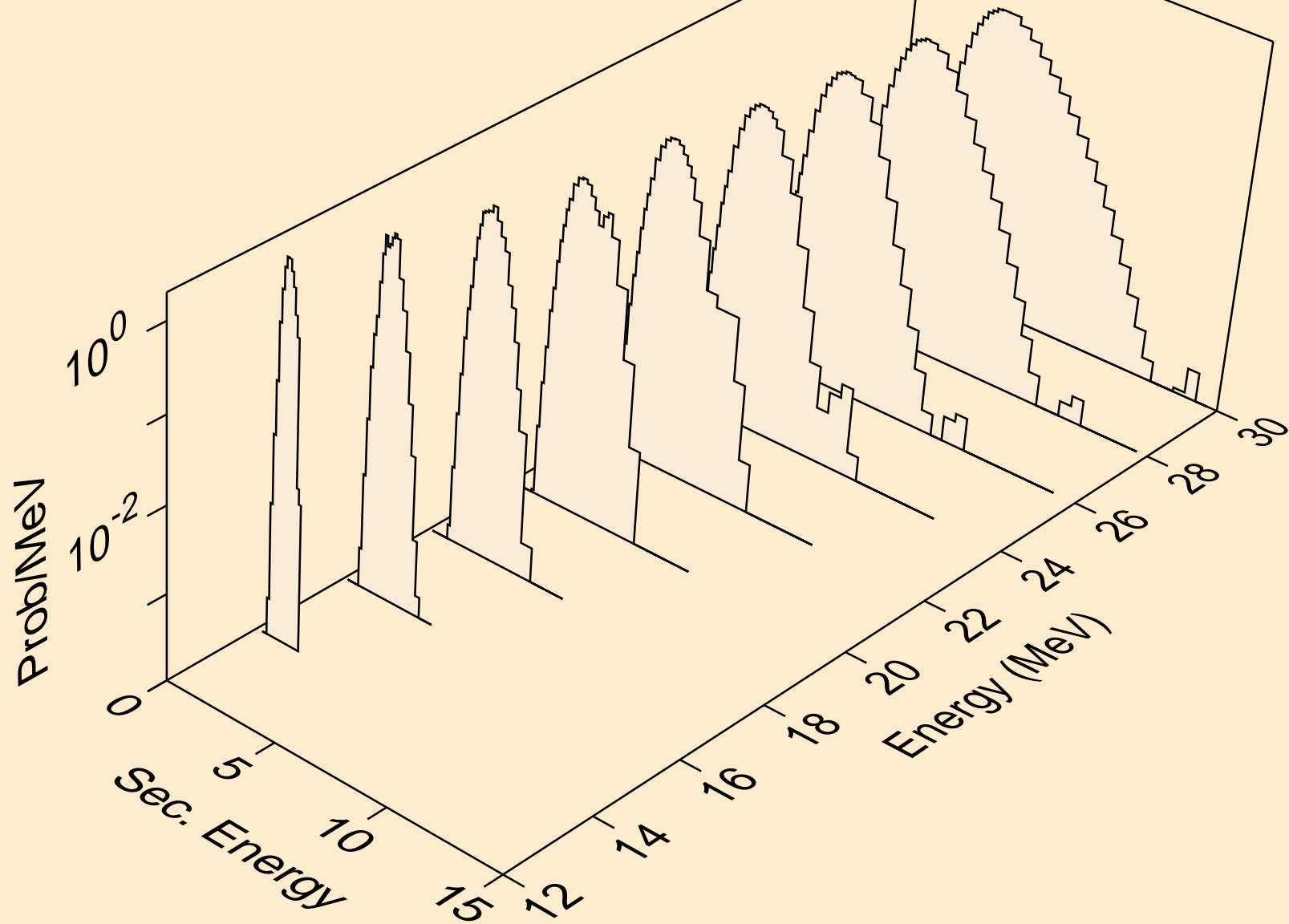

RB081M PHOTON ACER TENDL-2021 LIBRARY; T=0.K  
protons from (g,pd)

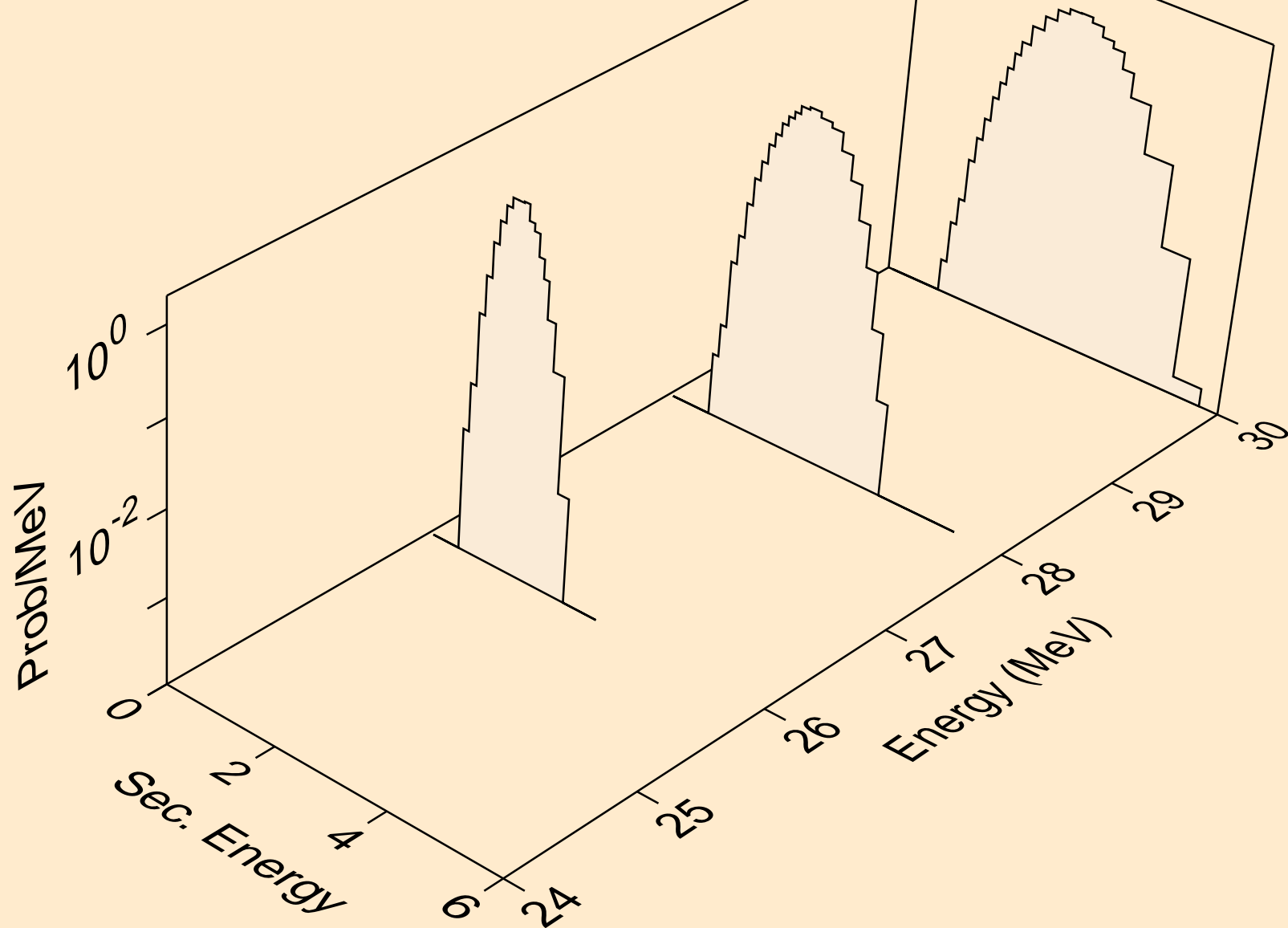

RB081M PHOTON ACER TENDL-2021 LIBRARY; T=0.K  
deuterons from (g,x)

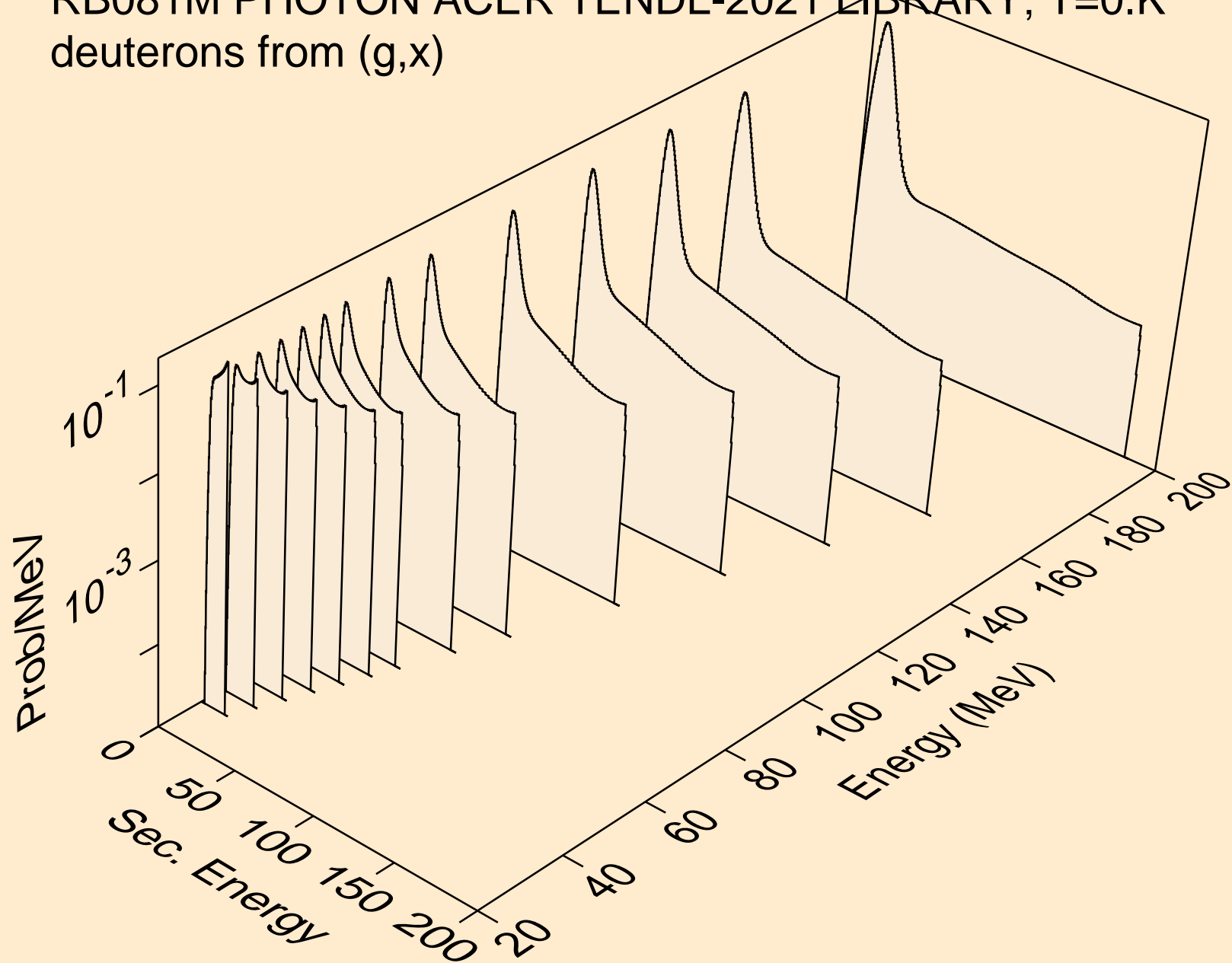

RB081M PHOTON ACER TENDL-2021 LIBRARY; T=0.K  
deuterons from (g,n\*)d

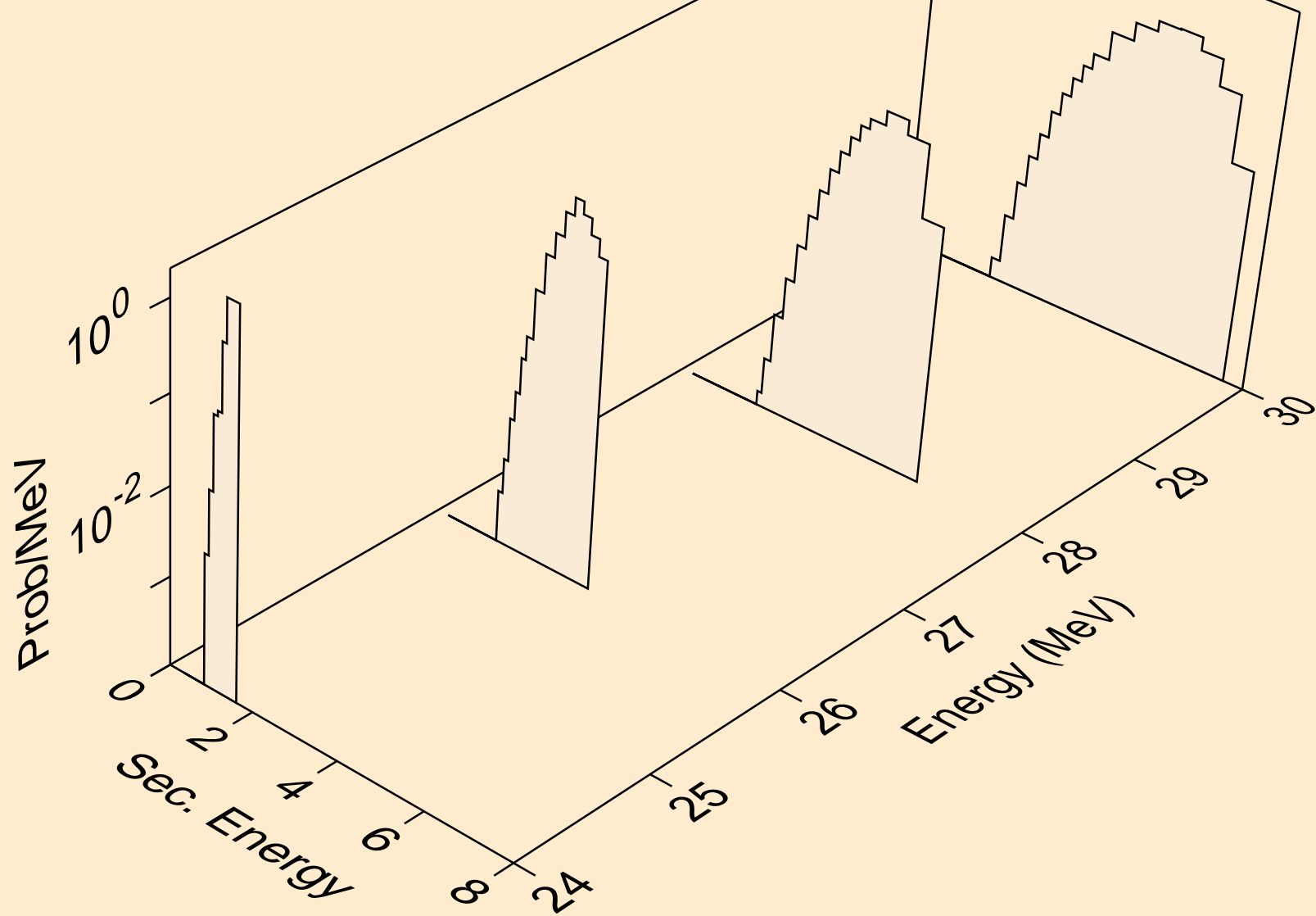

RB081M PHOTON ACER TENDL-2021 LIBRARY; T=0.K  
deuterons from (g,d)

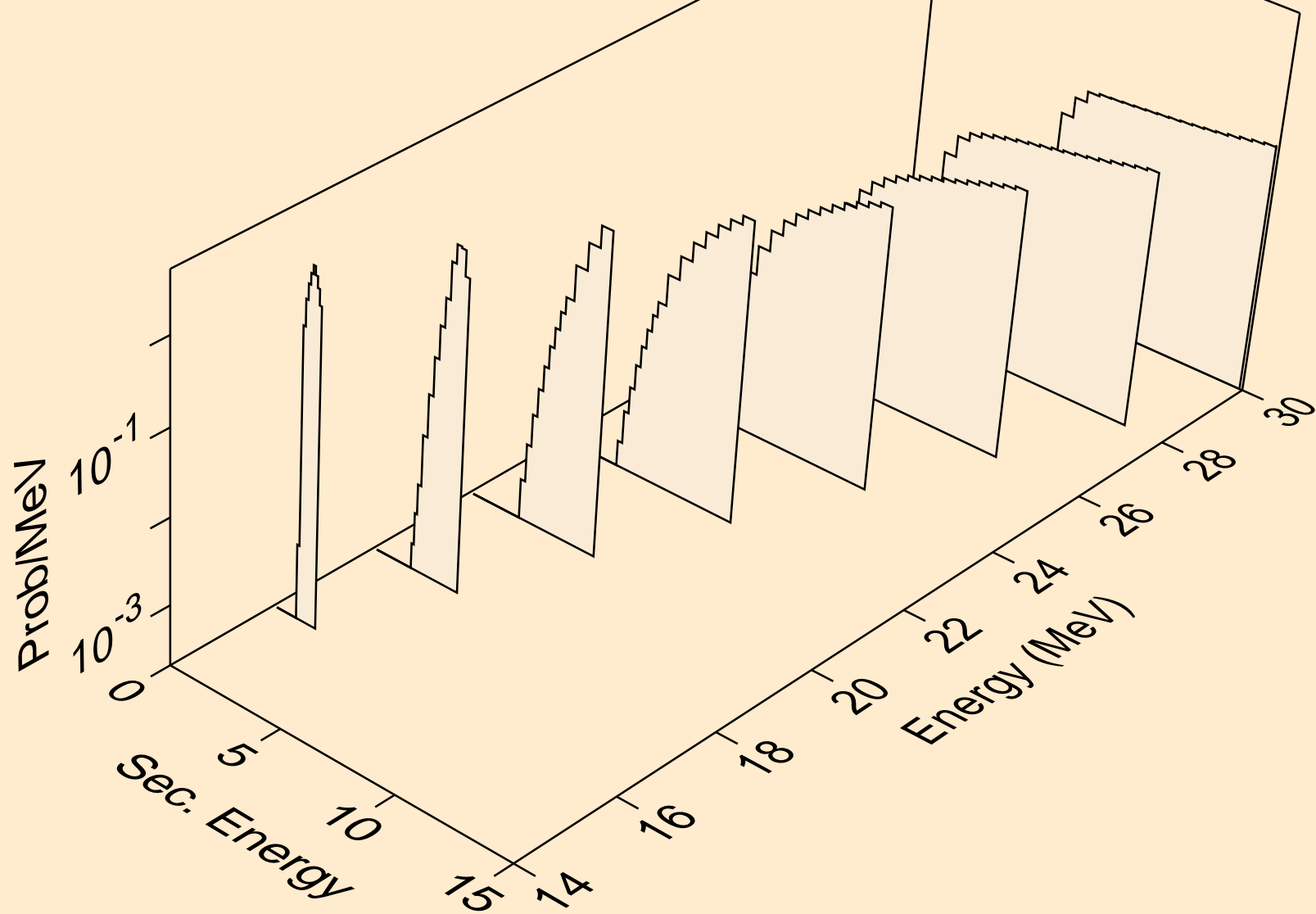

RB081M PHOTON ACER TENDL-2021 LIBRARY; T=0.K  
deuterons from (g,pd)

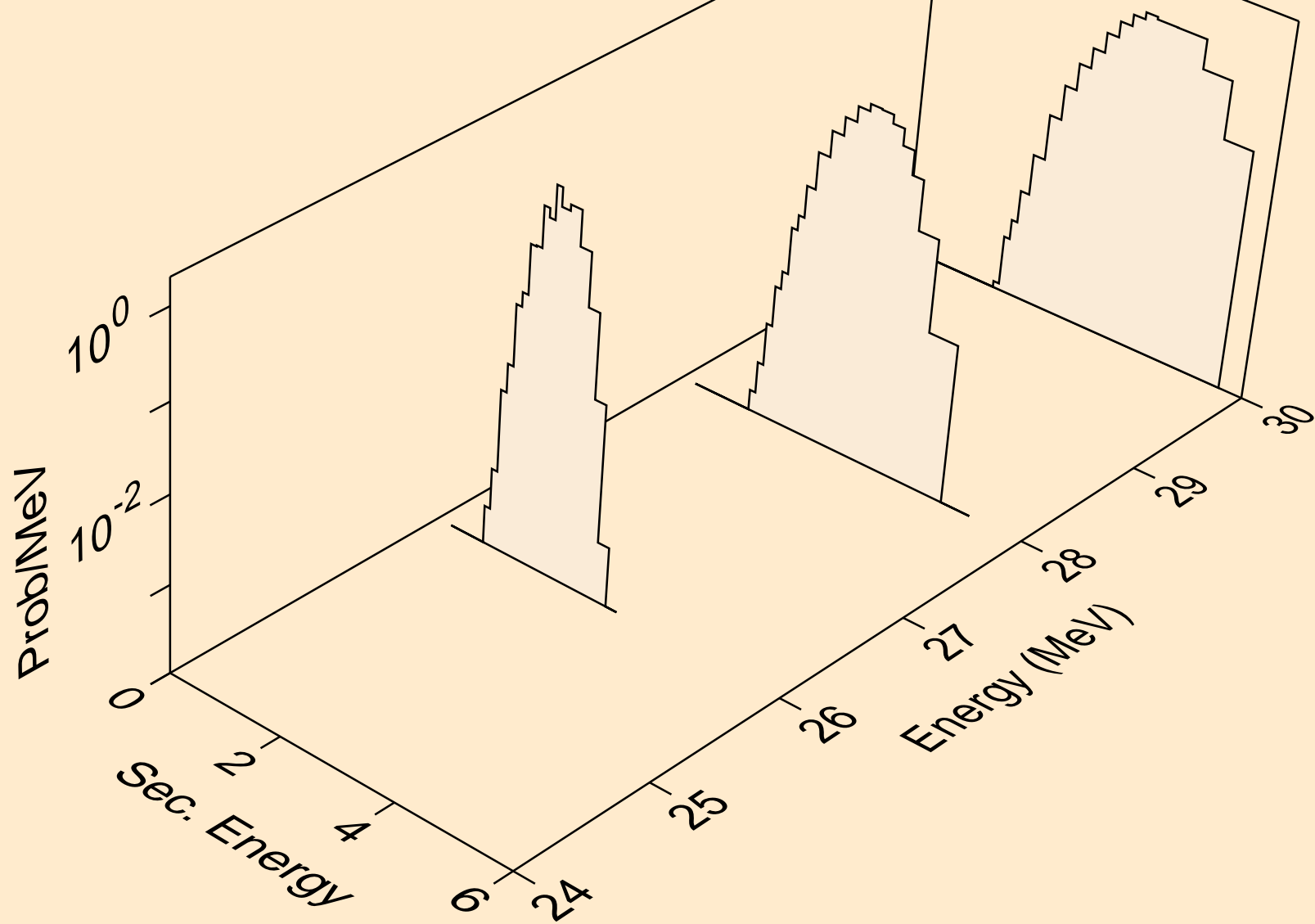

RB081M PHOTON ACER TENDL-2021 LIBRARY; T=0.K  
tritons from (g,x)

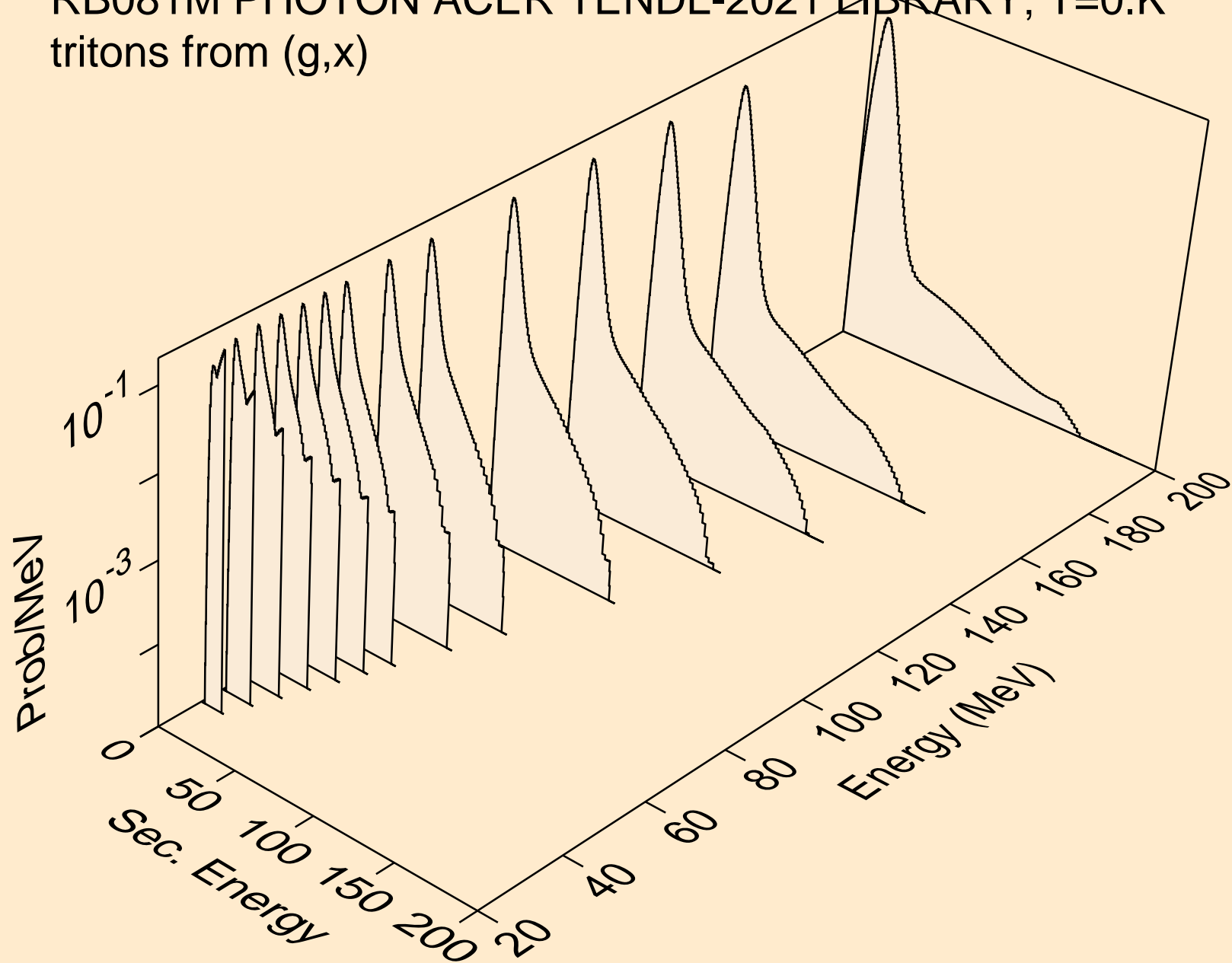



RB081M PHOTON ACER TENDL-2021 LIBRARY; T=0.K  
tritons from (g,t)

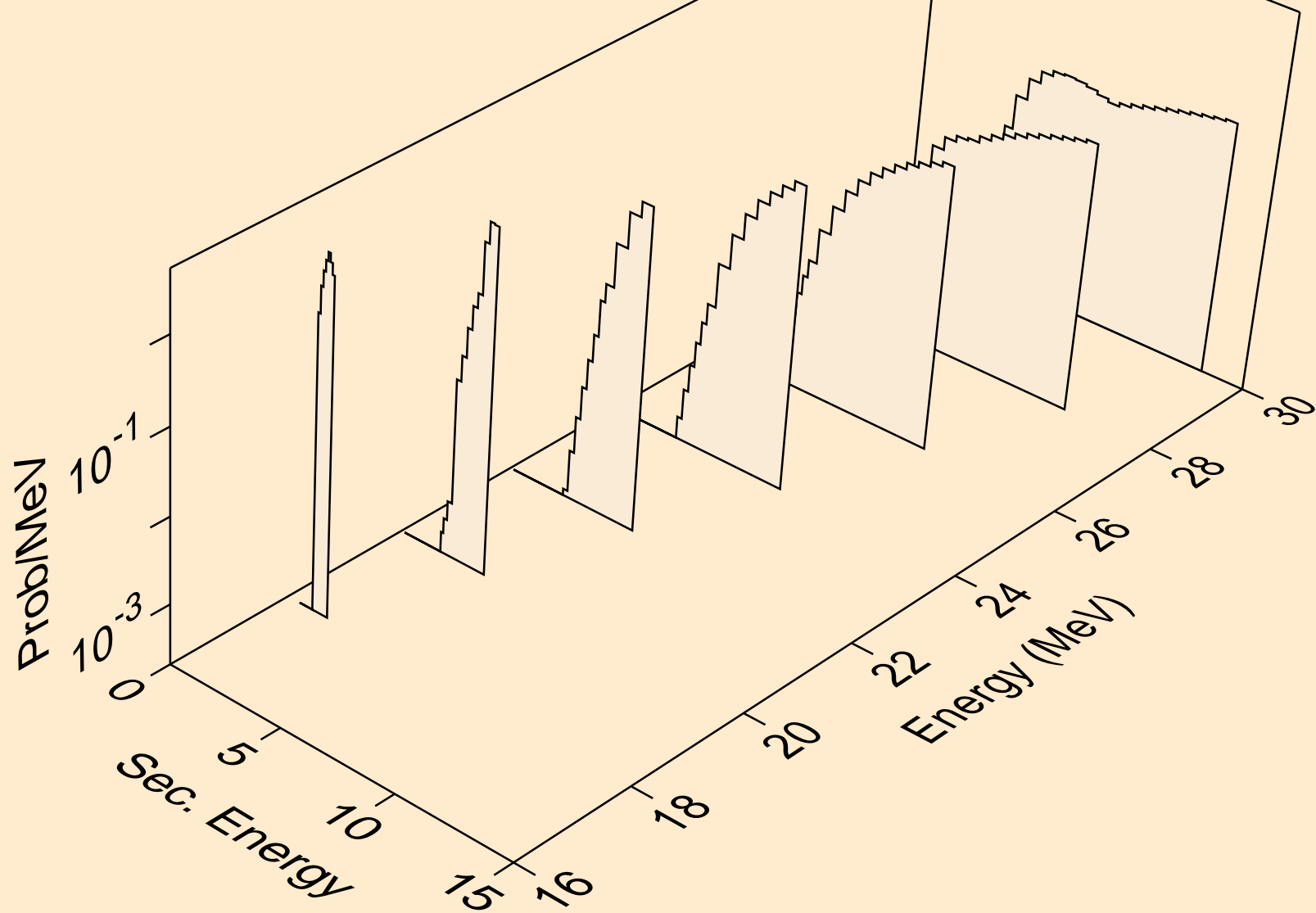

RB081M PHOTON ACER TENDL-2021 LIBRARY; T=0.K  
he3s from (g,x)

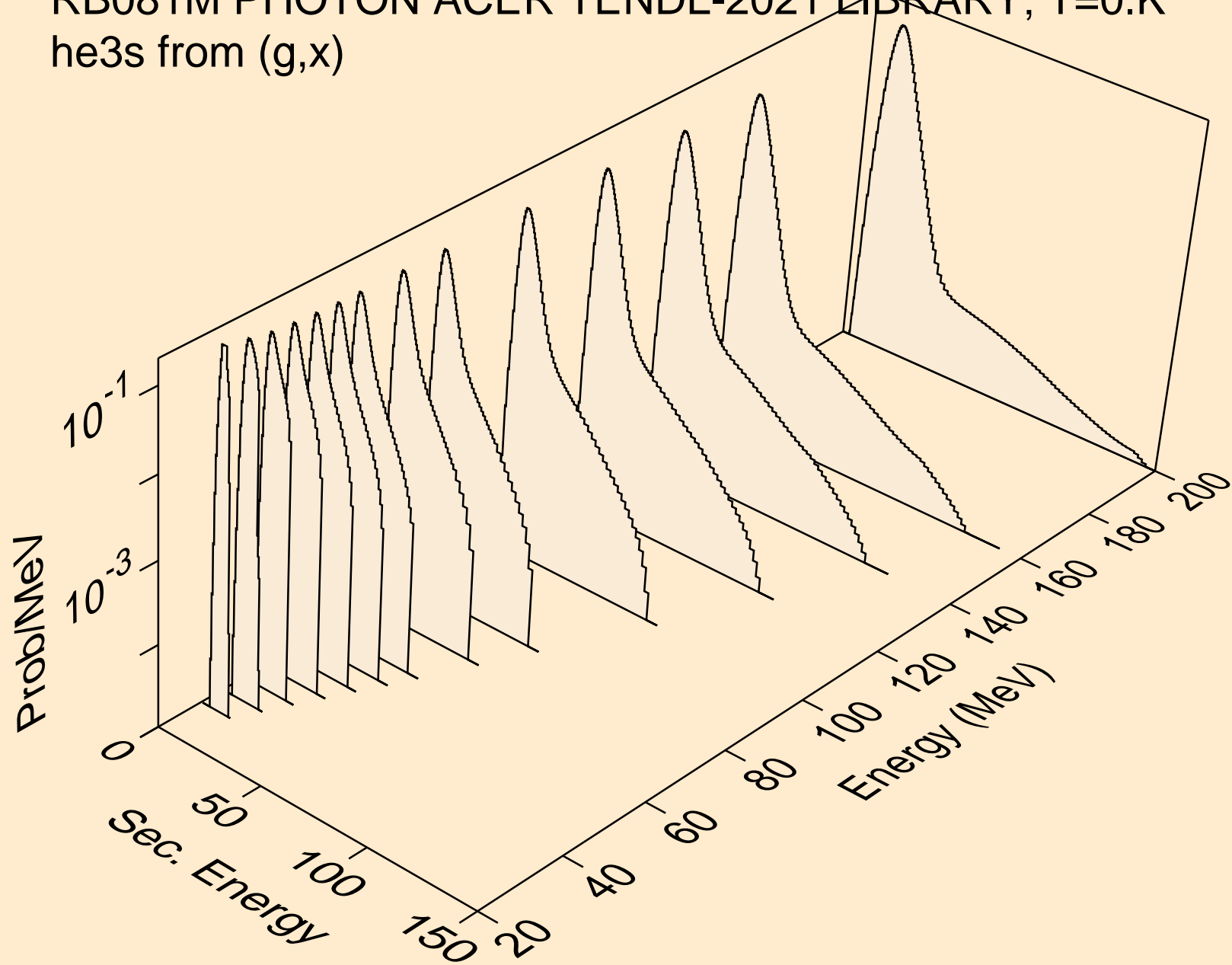

RB081M PHOTON ACER TENDL-2021 LIBRARY; T=0.K  
he3s from (g,he3)

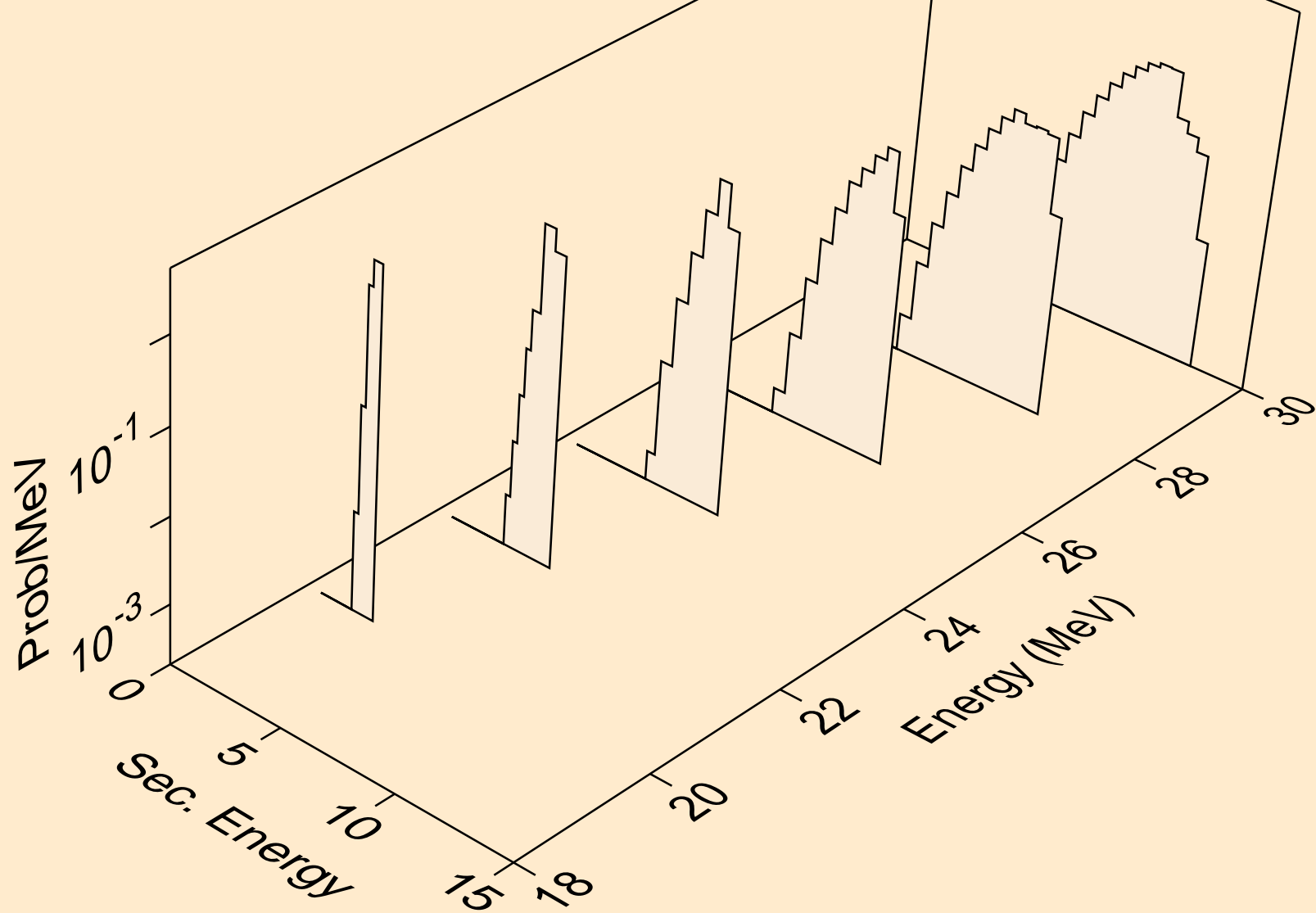

RB081M PHOTON ACER TENDL-2021 LIBRARY; T=0.K  
alphas from (g,x)

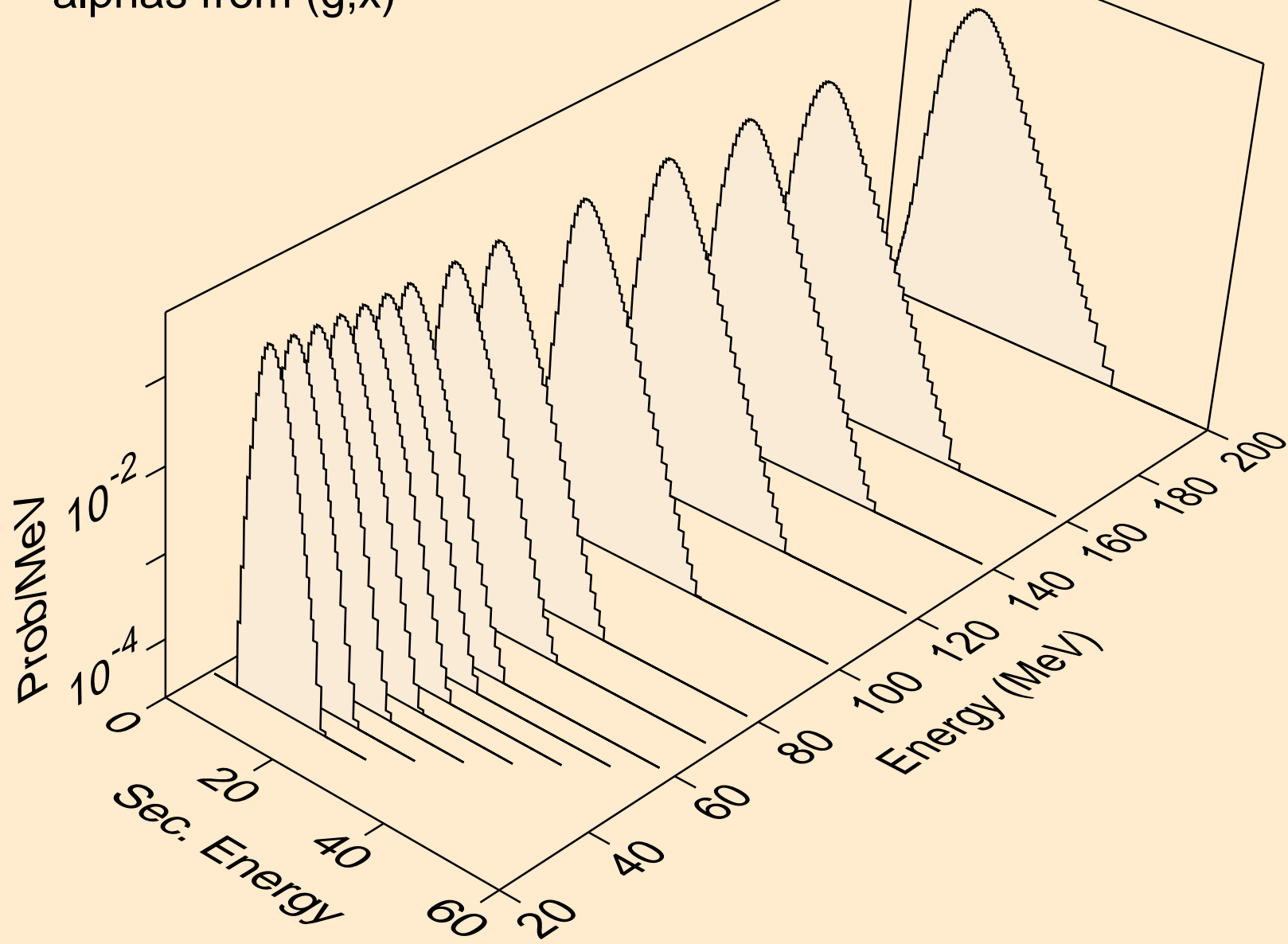

RB081M PHOTON ACER TENDL-2021 LIBRARY; T=0.K  
alphas from (g,n\*)a

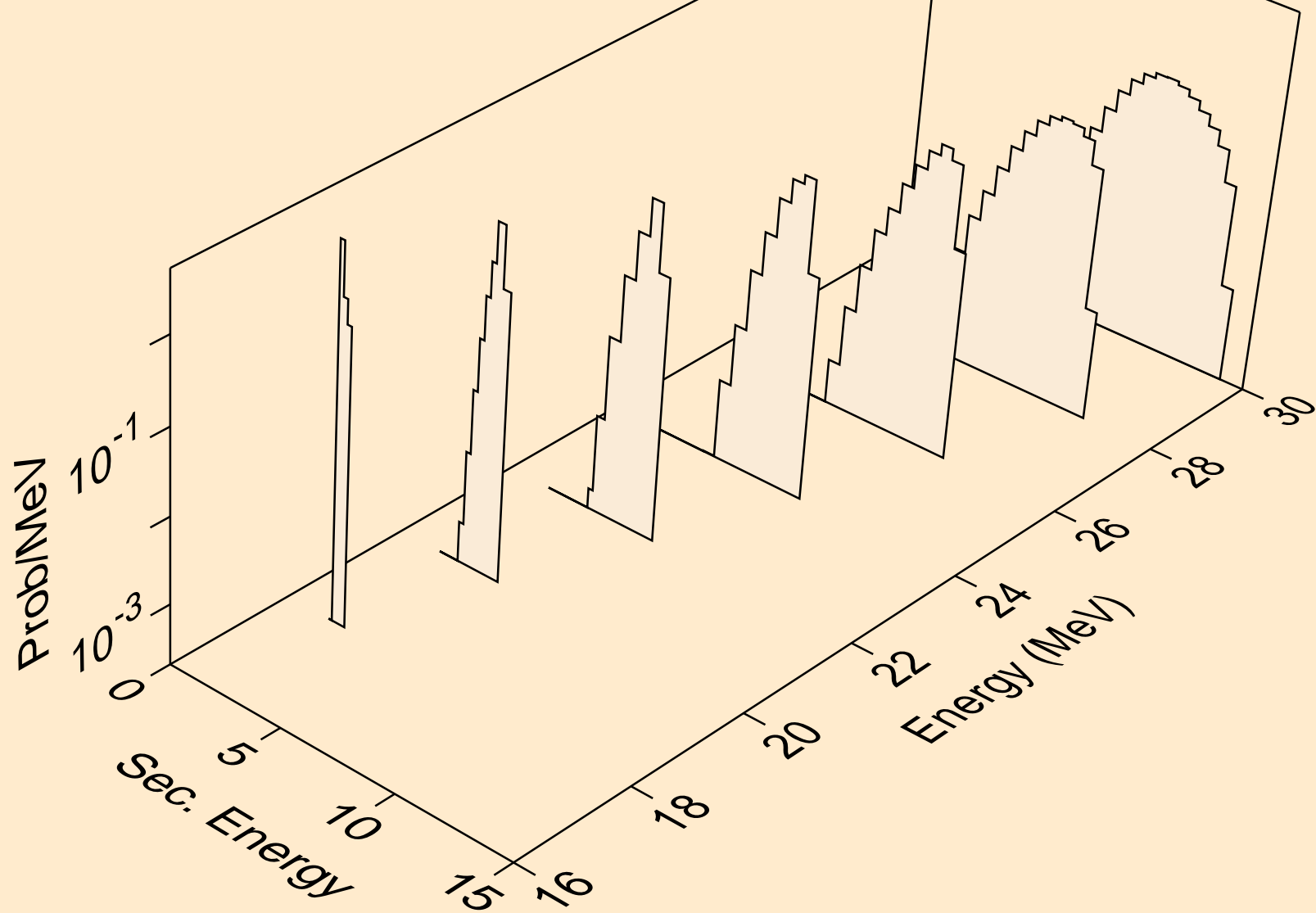

RB081M PHOTON ACER TENDL-2021 LIBRARY; T=0.K  
alphas from (g,npa)

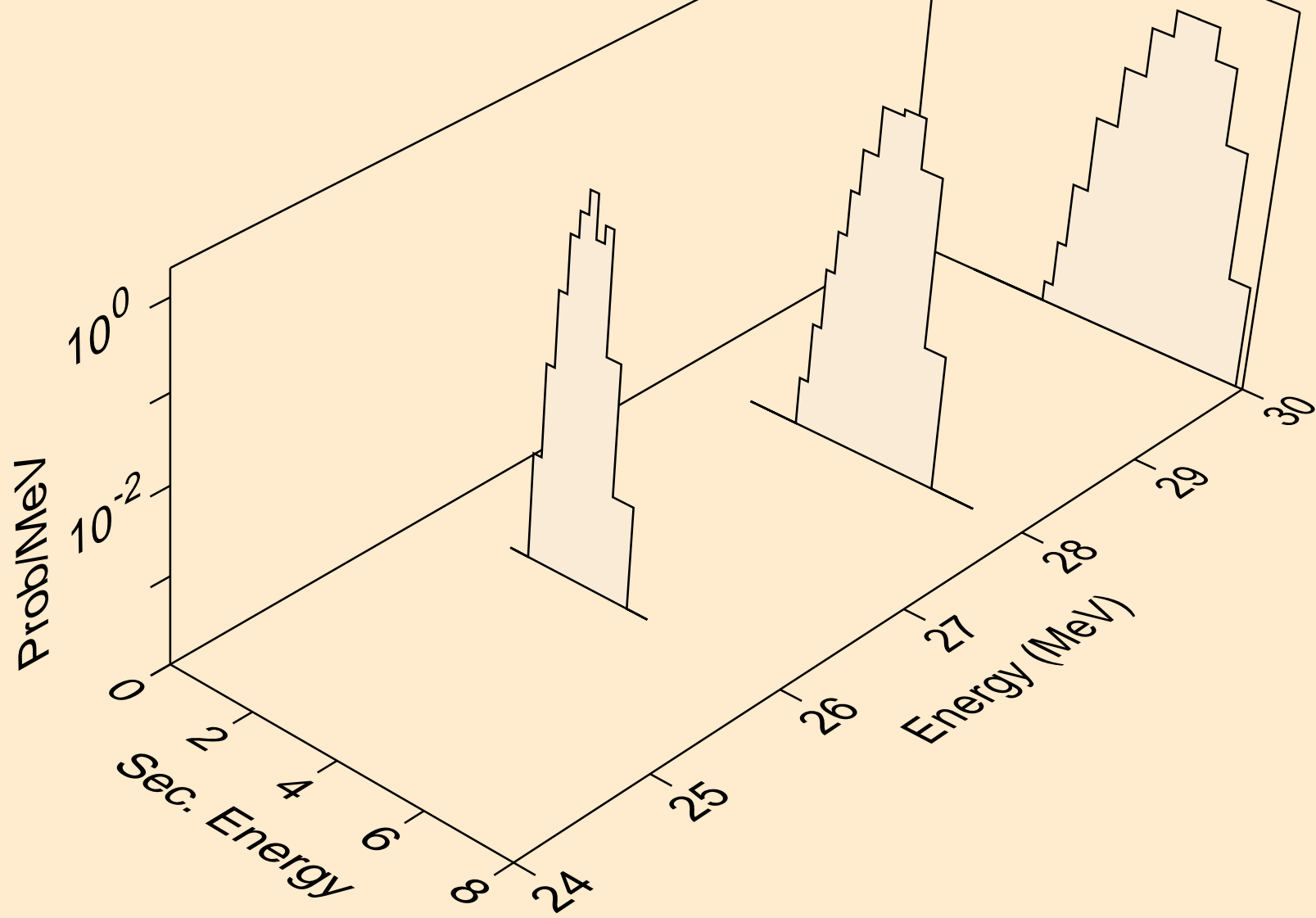

RB081M PHOTON ACER TENDL-2021 LIBRARY; T=0.K  
alphas from (g,a)

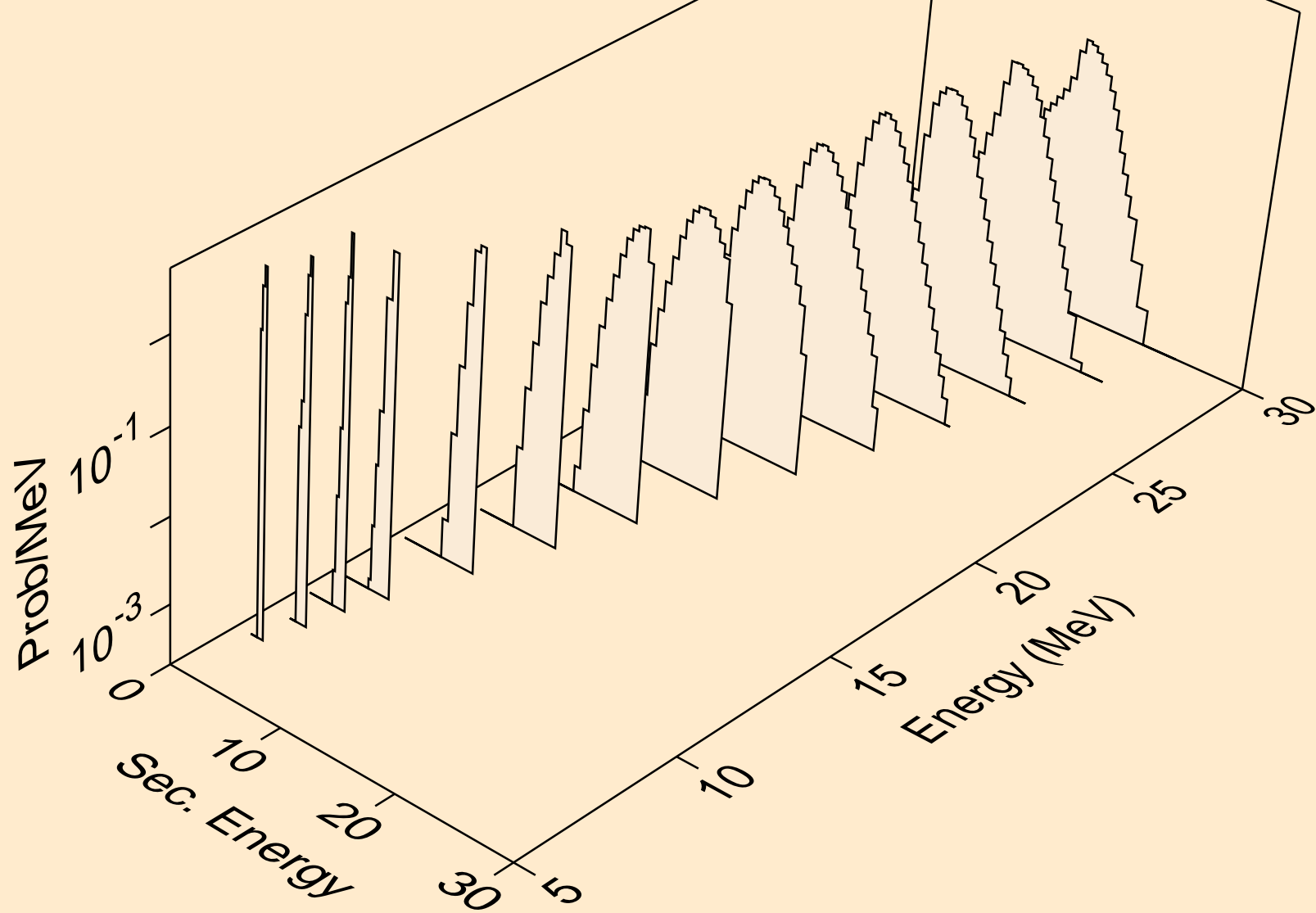

RB081M PHOTON ACER TENDL-2021 LIBRARY; T=0.K  
alphas from (g,2a)

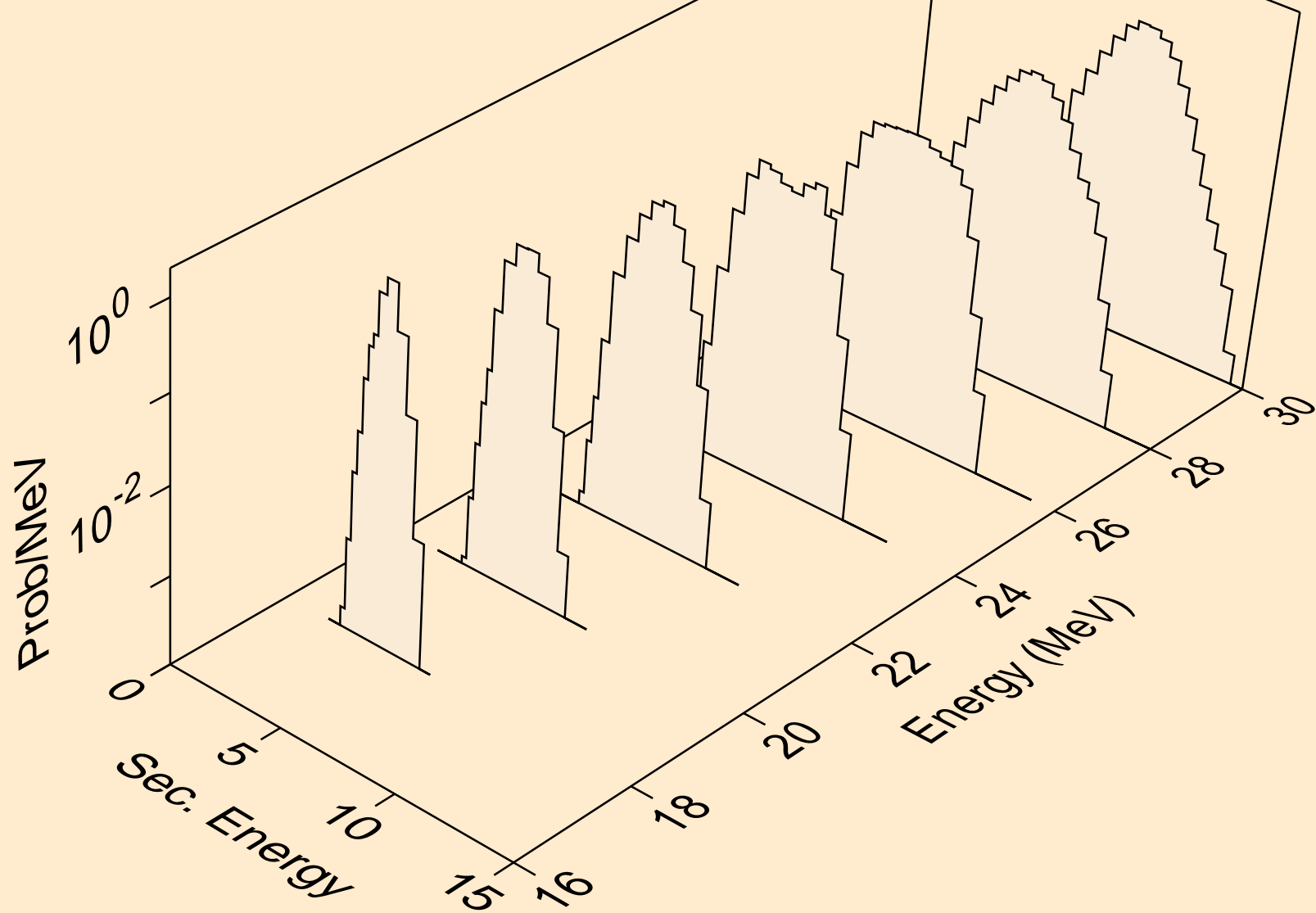



RB081M PHOTON ACER TENDL-2021 LIBRARY; T=0.K  
alphas from (g,pa)

