

SB105 PHOTON ACER TENDL-2021 LIBRARY; T=0.K

Principal cross sections

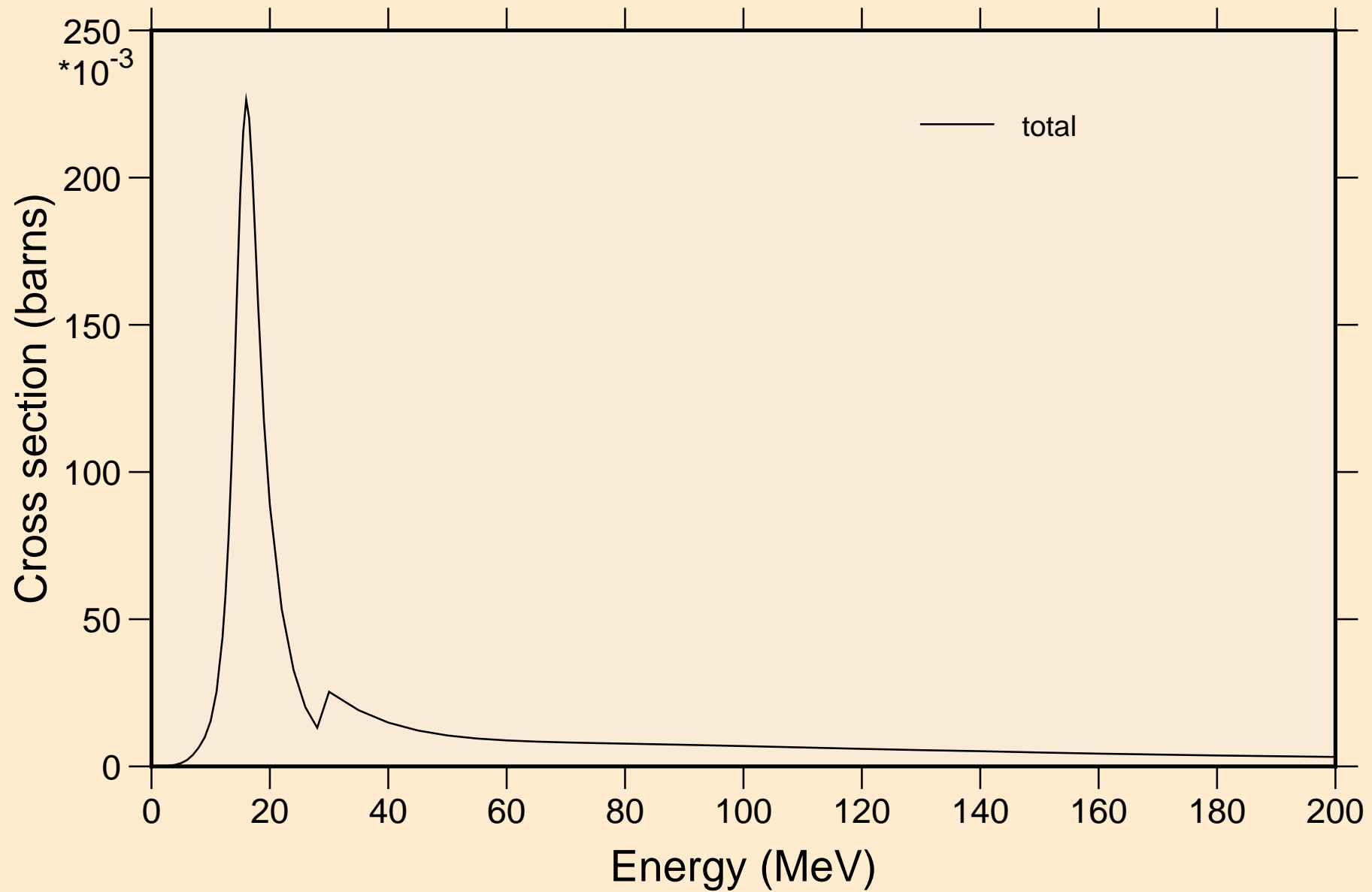

SB105 PHOTON ACER TENDL-2021 LIBRARY; T=0.K

Partial cross sections

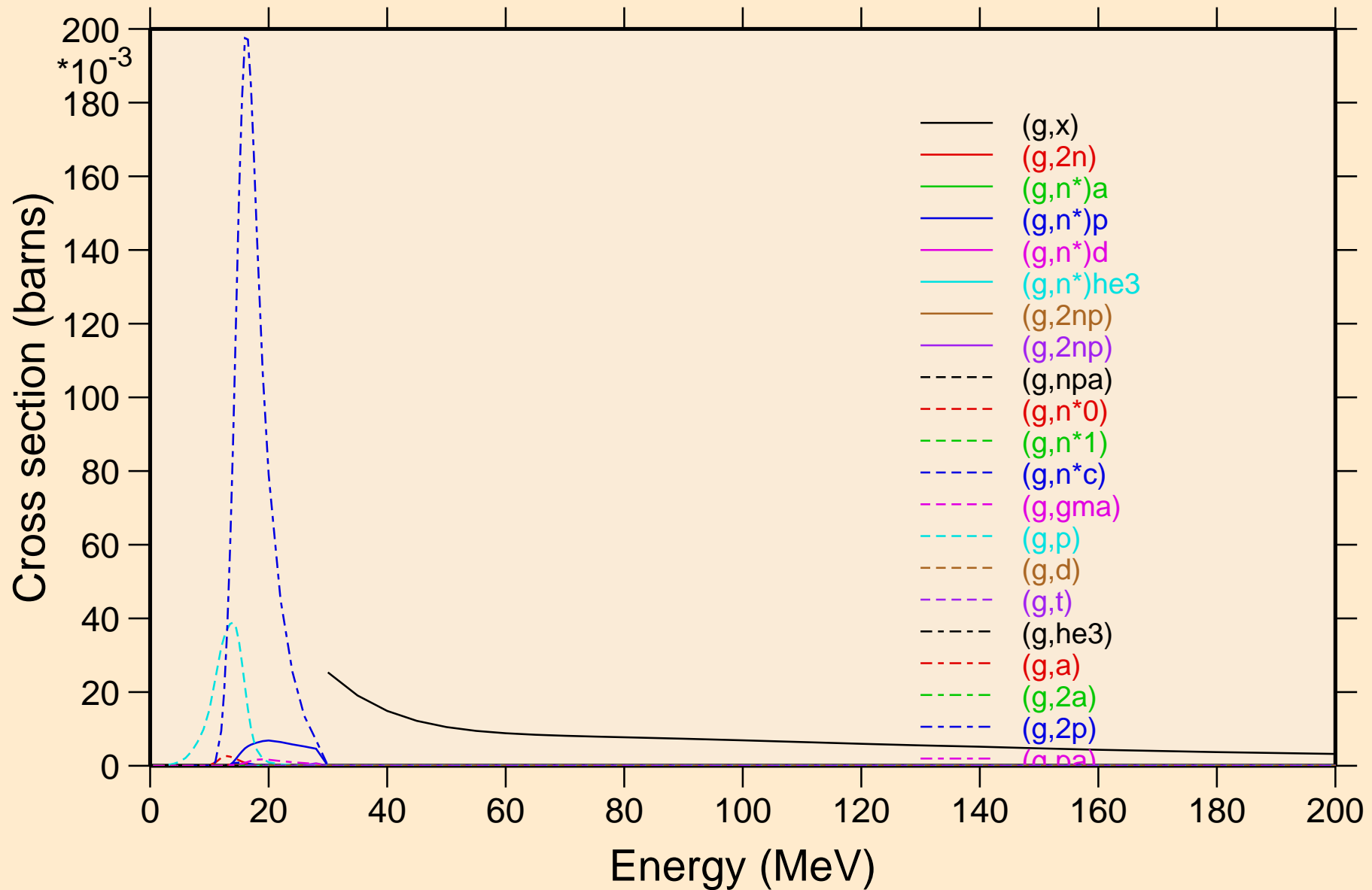

SB105 PHOTON ACER TENDL-2021 LIBRARY; T=0.K

Heating

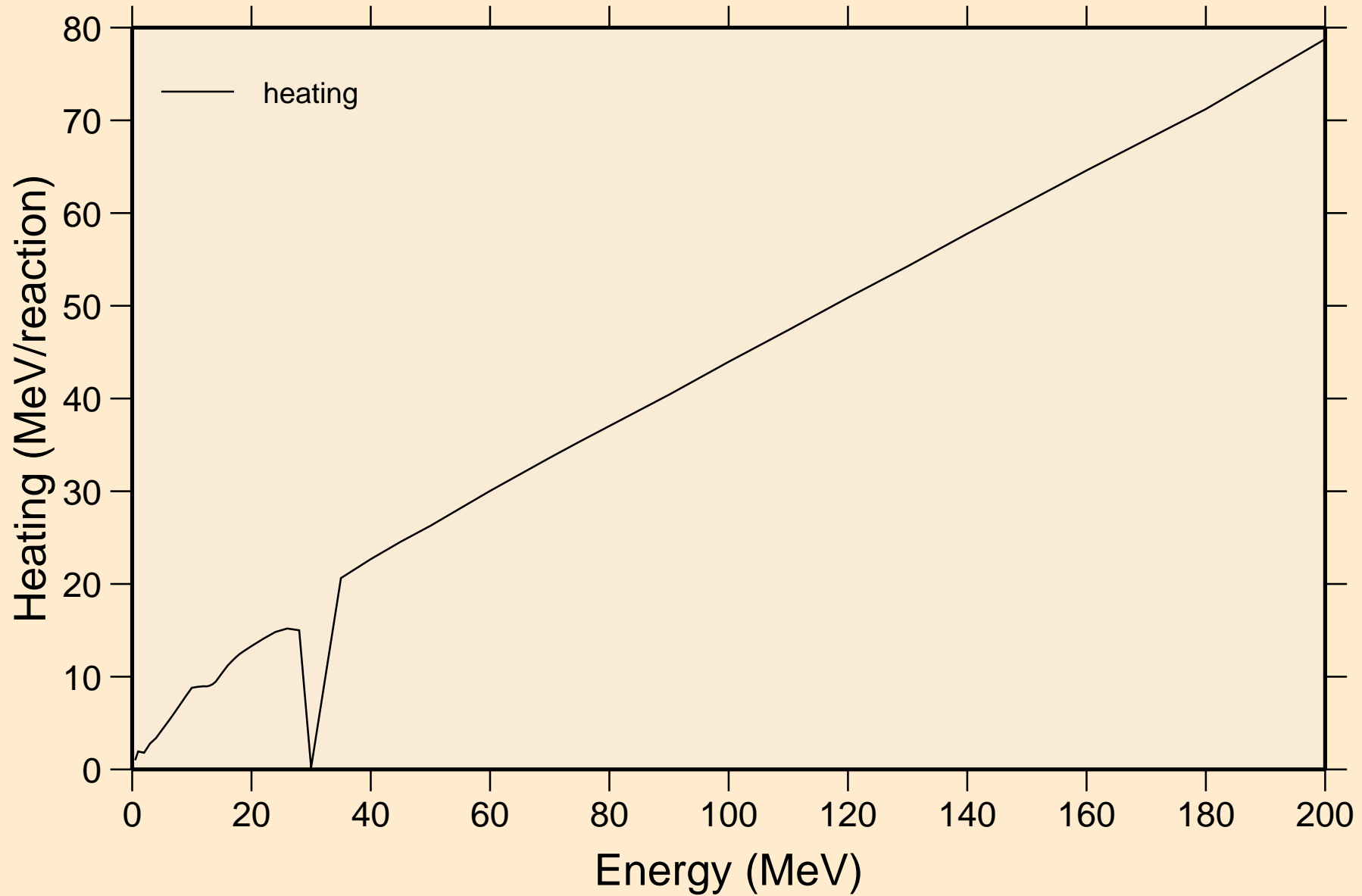

SB105 PHOTON ACER TENDL-2021 LIBRARY; T=0.K

Particle heating contributions

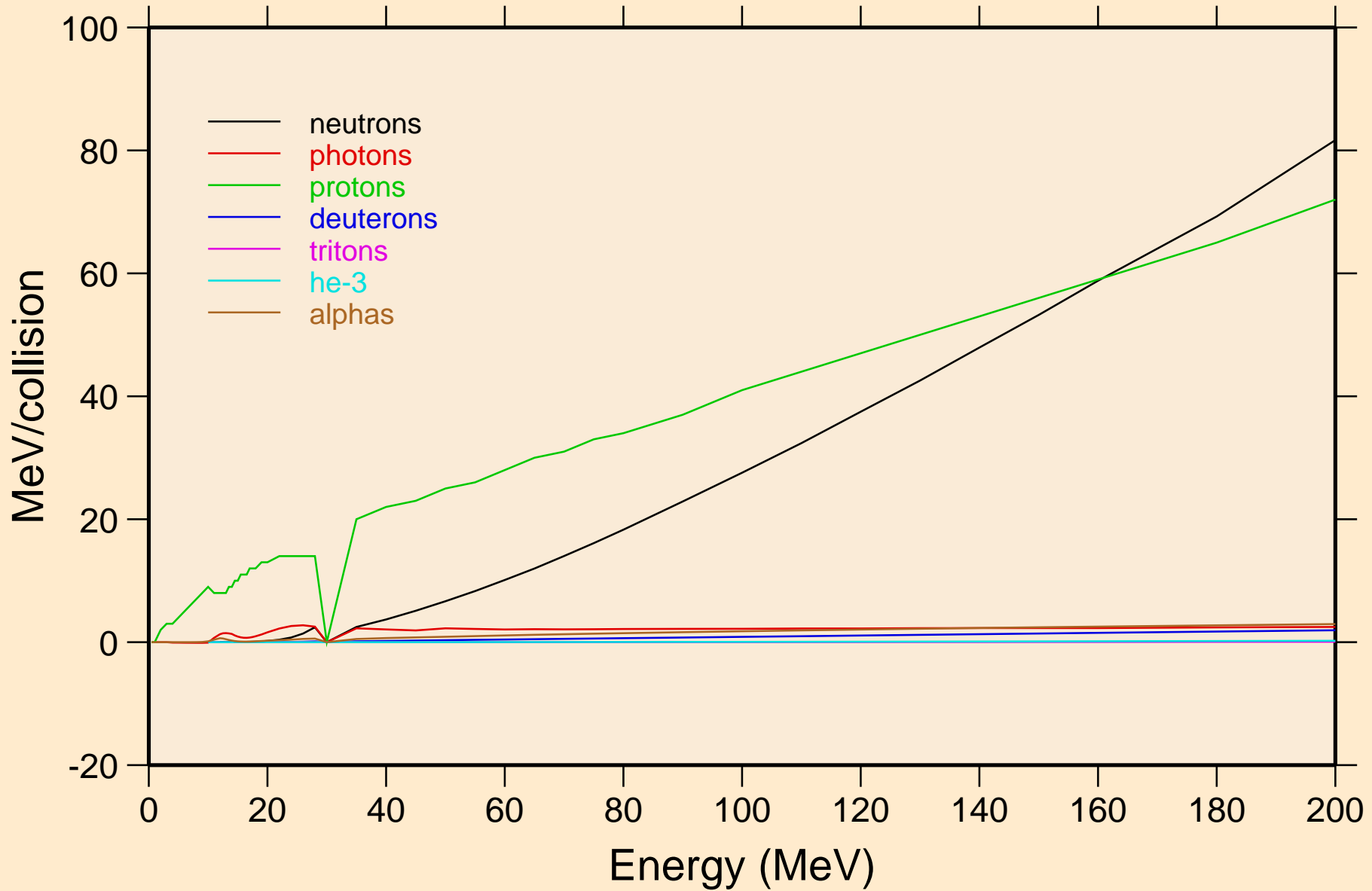

SB105 PHOTON ACER TENDL-2021 LIBRARY; T=0.K

Particle production cross sections

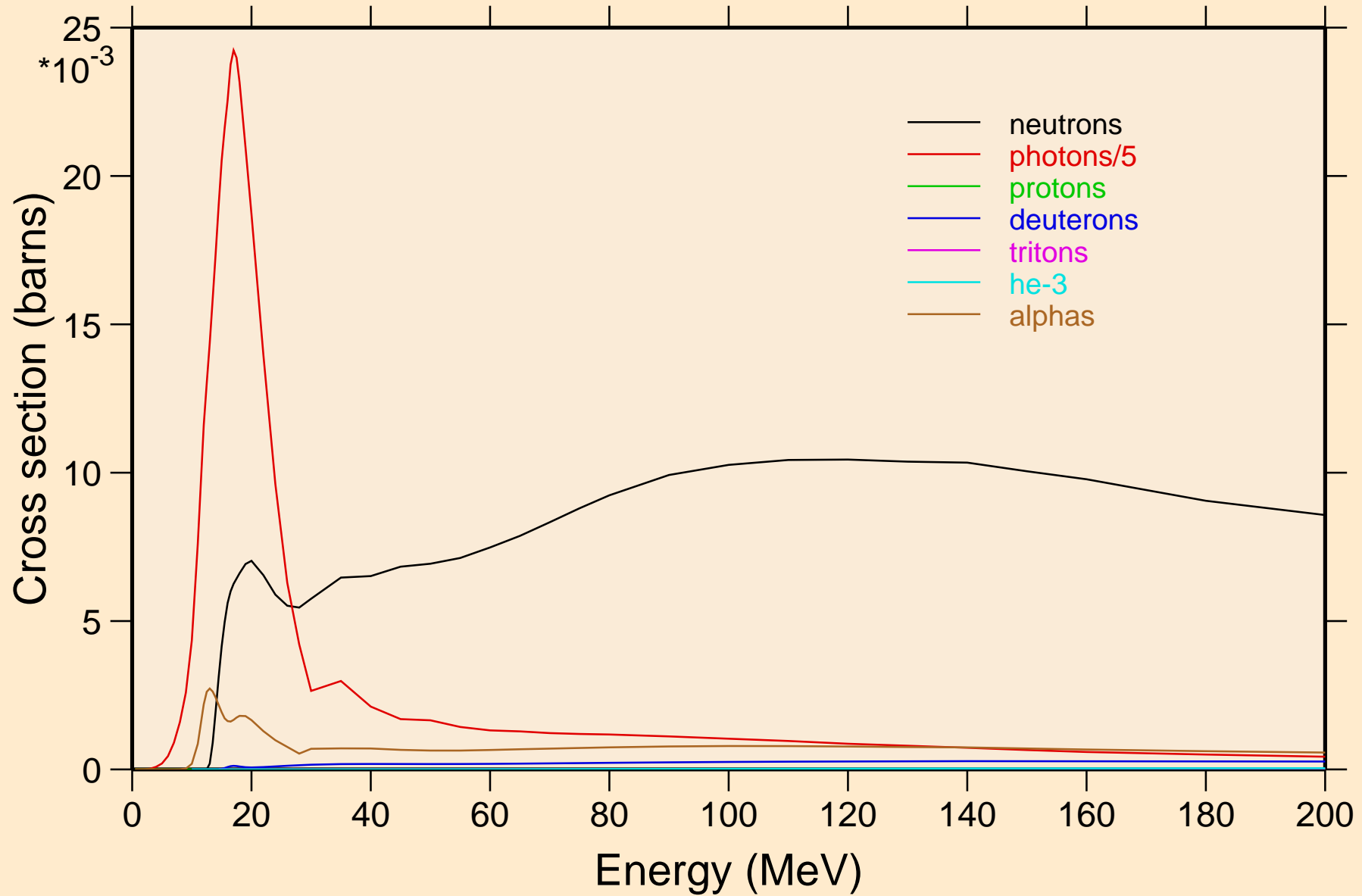

SB105 PHOTON ACER TENDL-2021 LIBRARY; T=0.K
neutrons from (g,x)

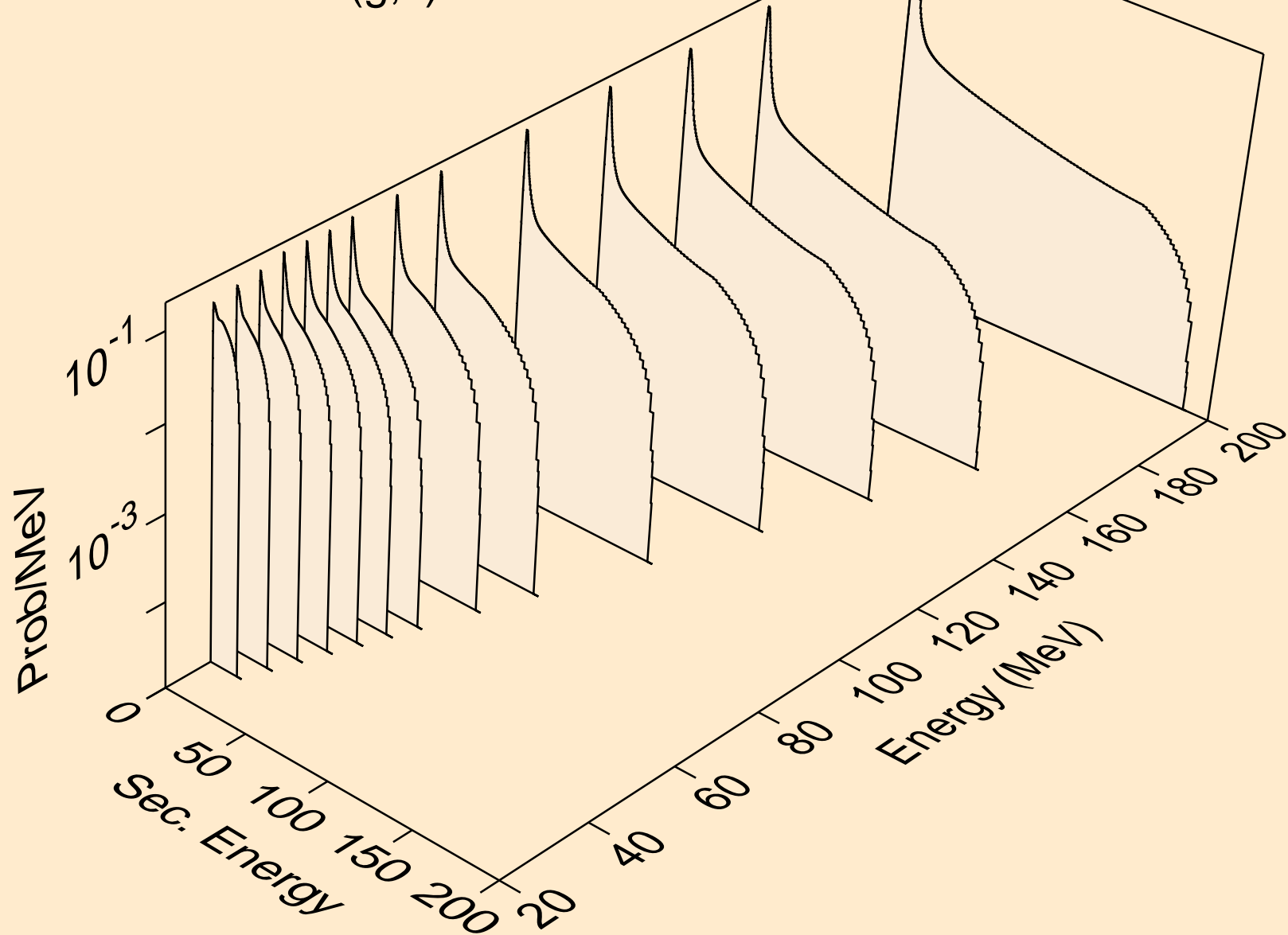

SB105 PHOTON ACER TENDL-2021 LIBRARY; T=0.K
neutrons from (g,2n)

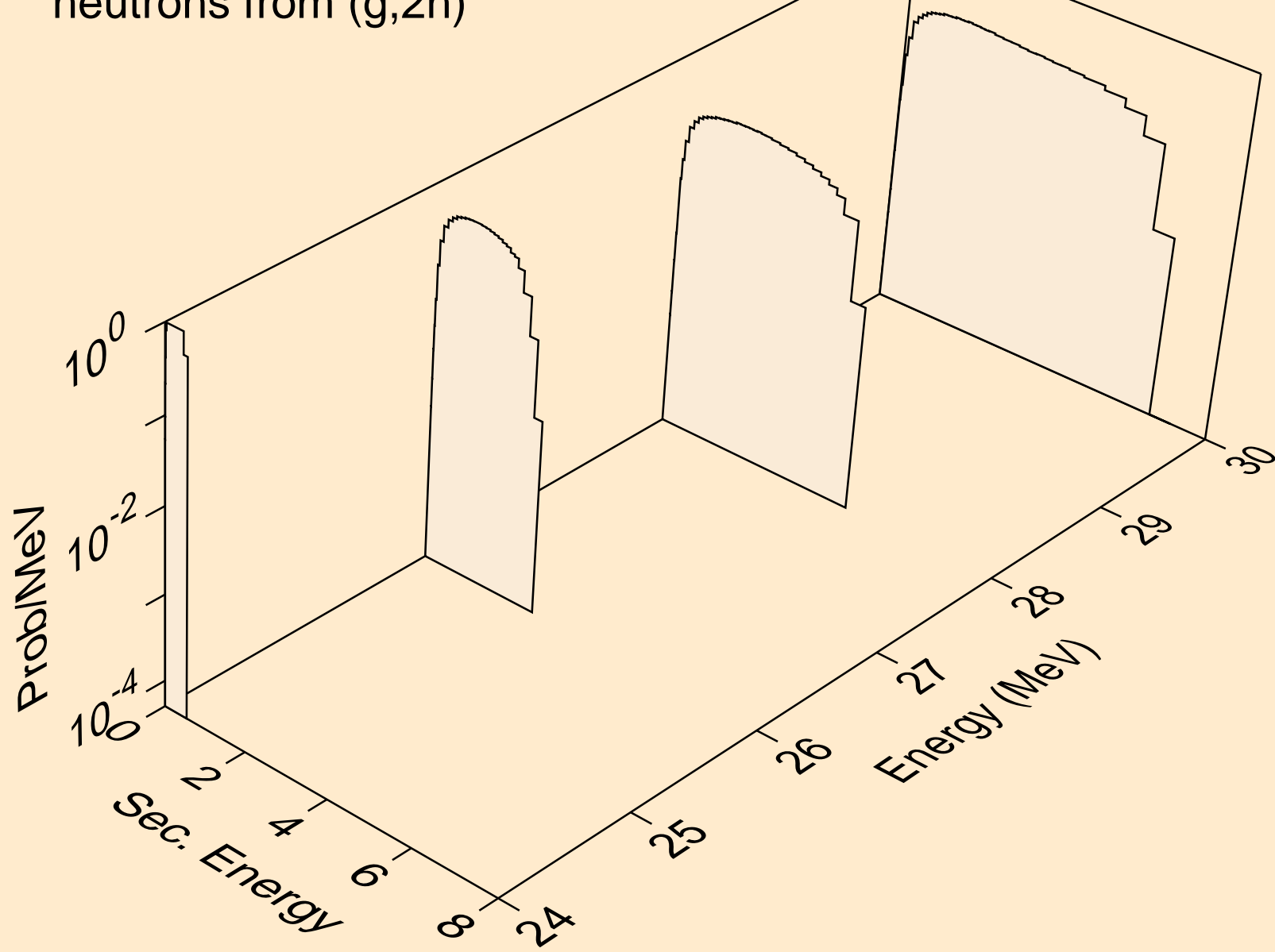

SB105 PHOTON ACER TENDL-2021 LIBRARY; T=0.K
neutrons from (g,n*)a

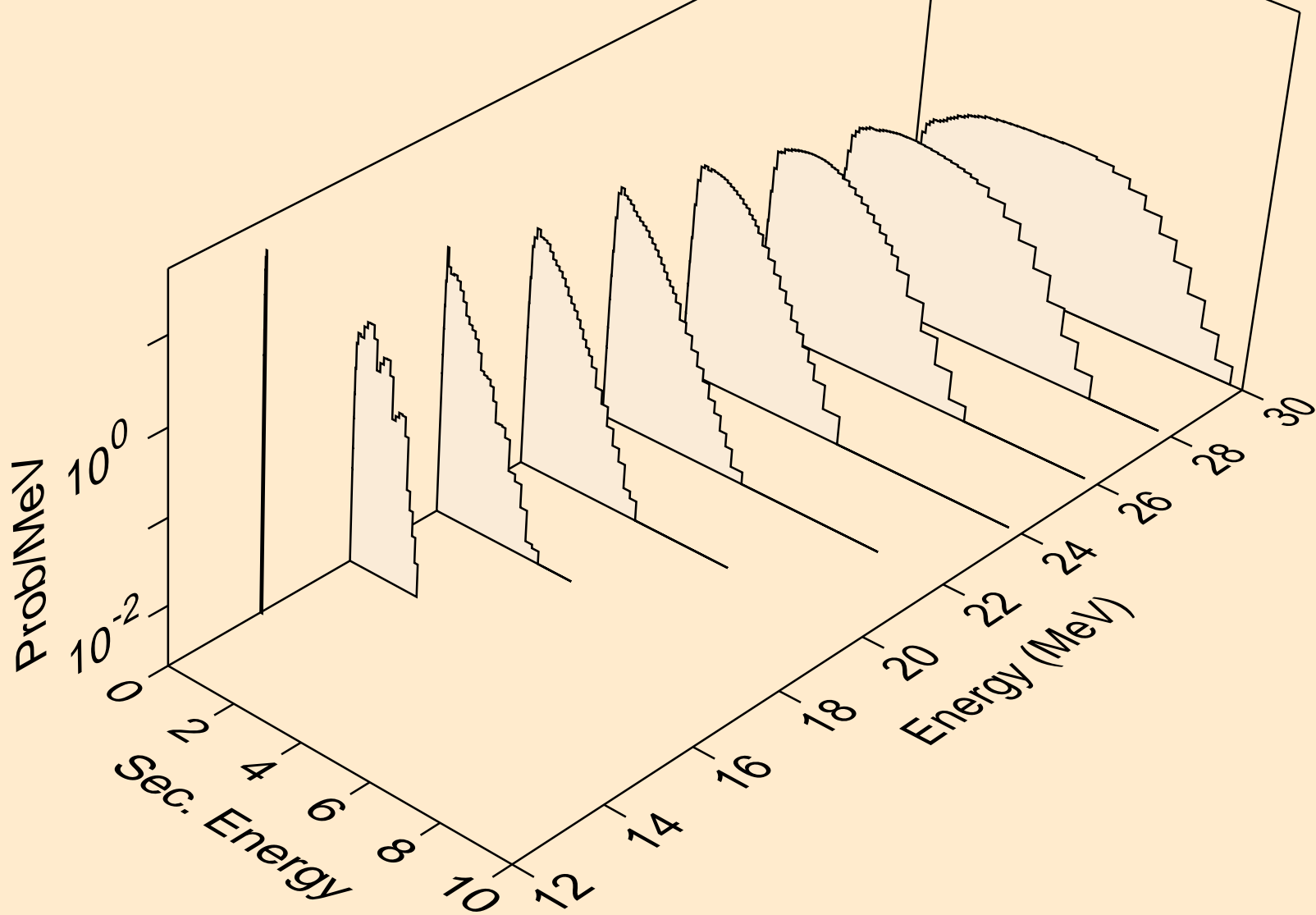

SB105 PHOTON ACER TENDL-2021 LIBRARY; T=0.K
neutrons from (g,n*)p

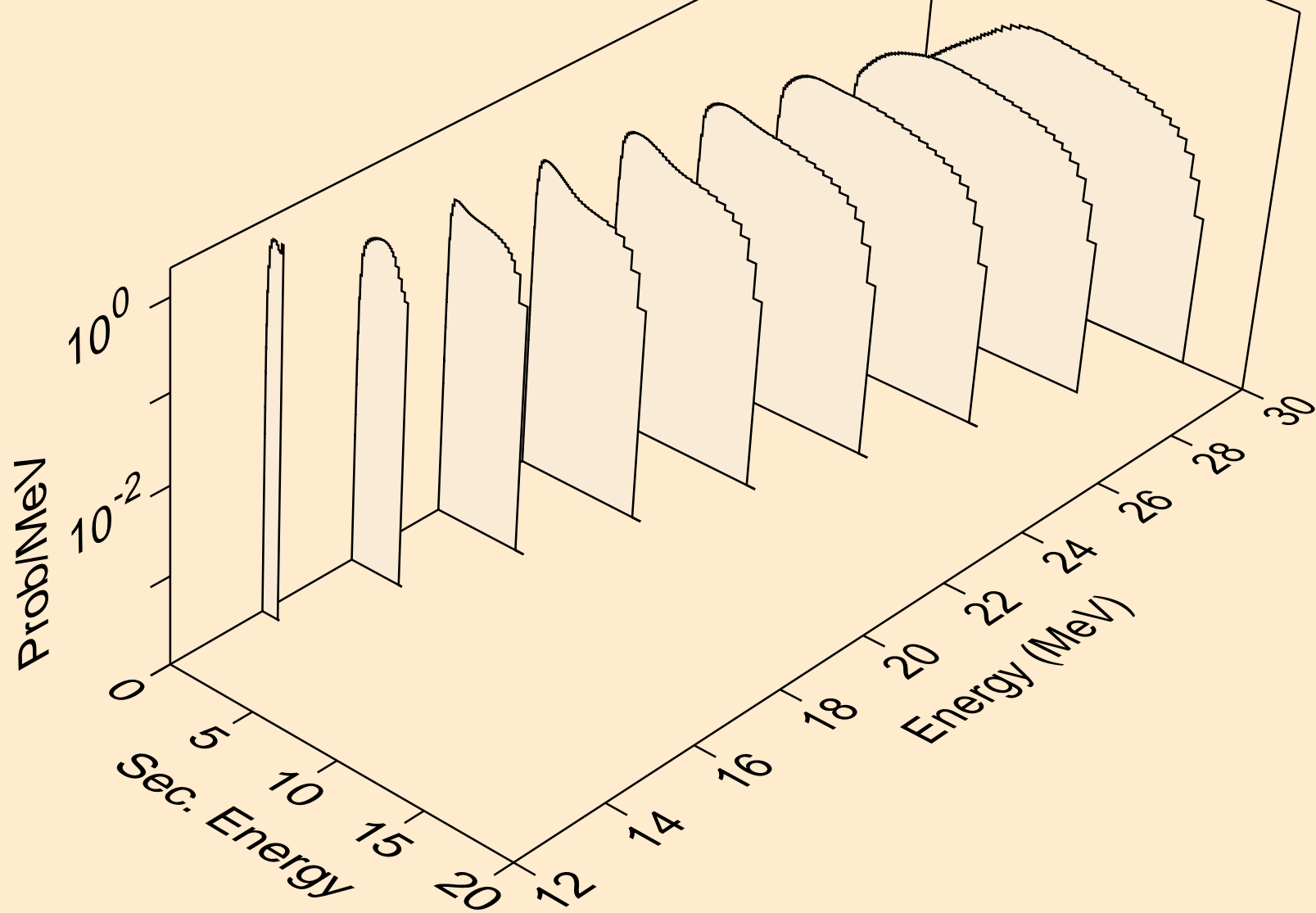

SB105 PHOTON ACER TENDL-2021 LIBRARY; T=0.K
neutrons from (g,n*)d

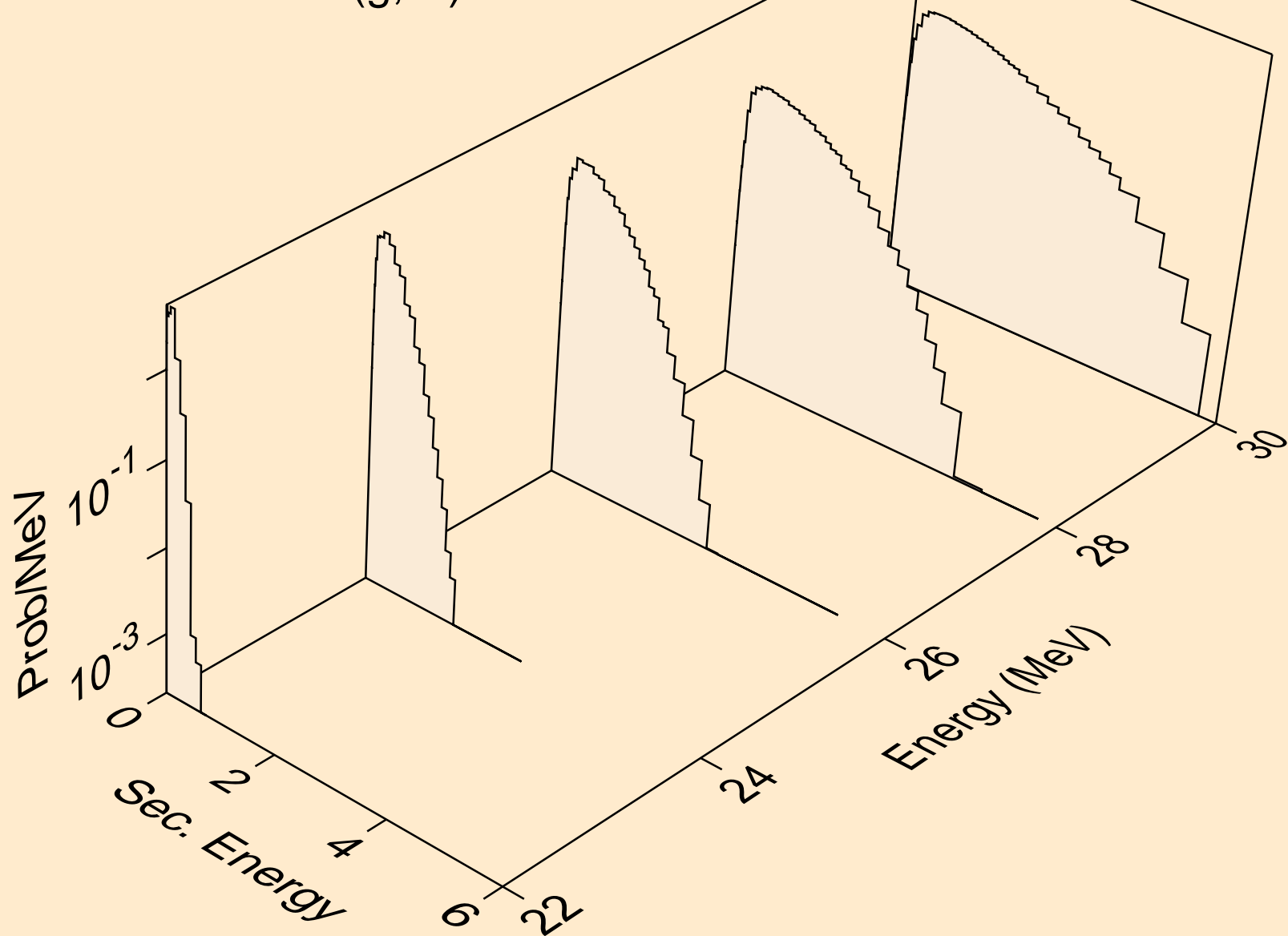

SB105 PHOTON ACER TENDL-2021 LIBRARY; T=0.K
neutrons from (g,n*)he3

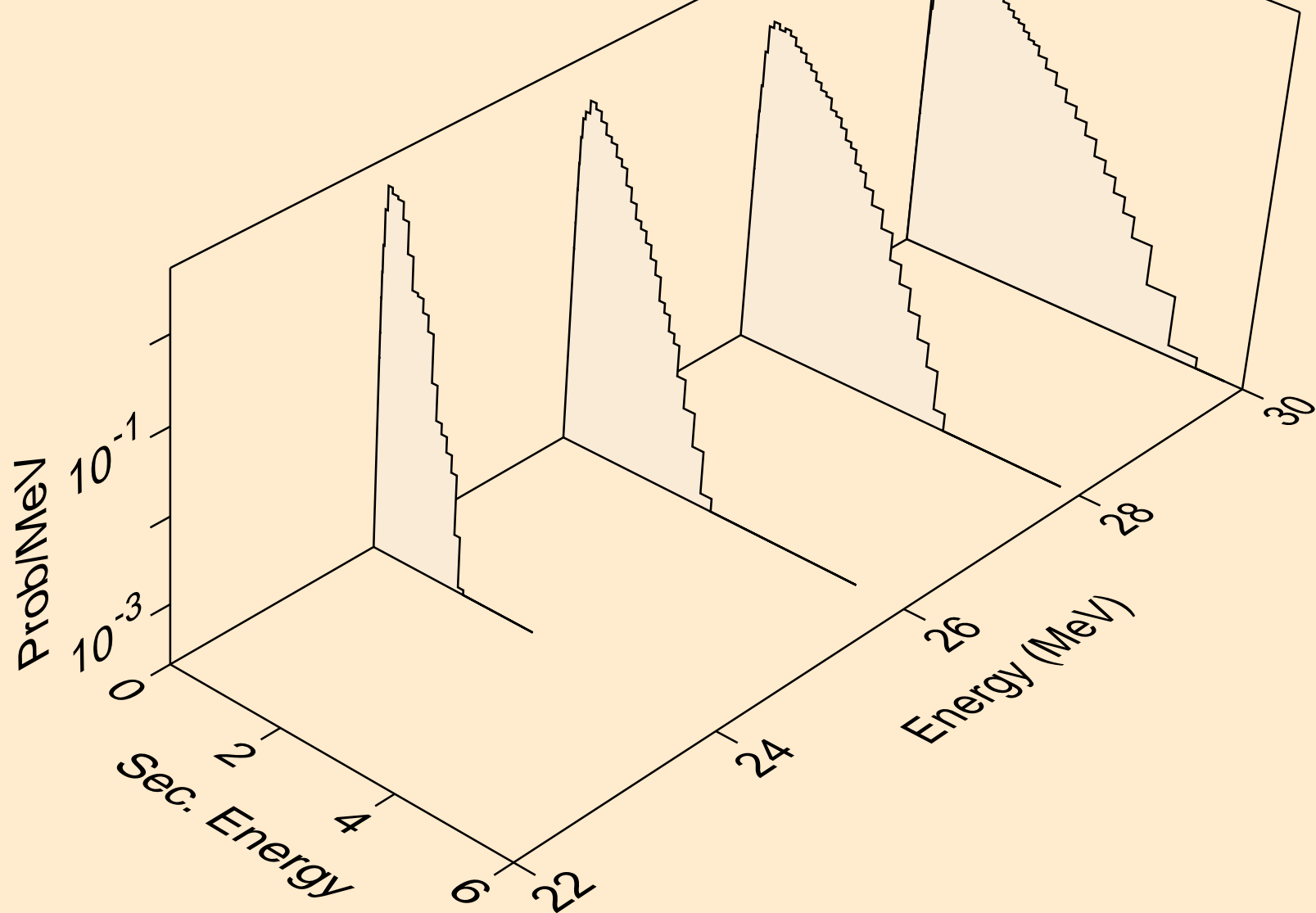

SB105 PHOTON ACER TENDL-2021 LIBRARY; T=0.K
neutrons from (g,2np)

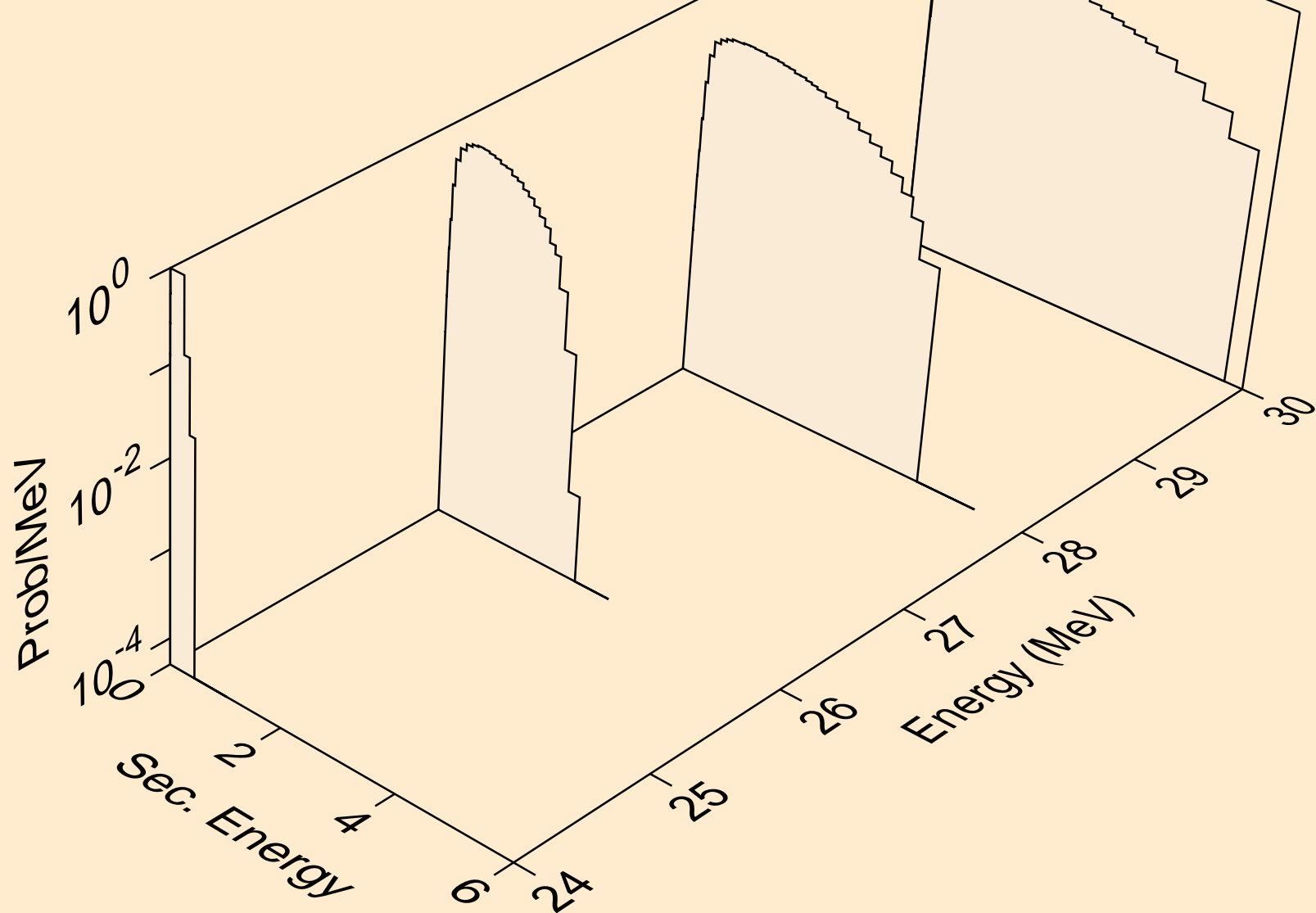

SB105 PHOTON ACER TENDL-2021 LIBRARY; T=0.K
neutrons from (g,2np)

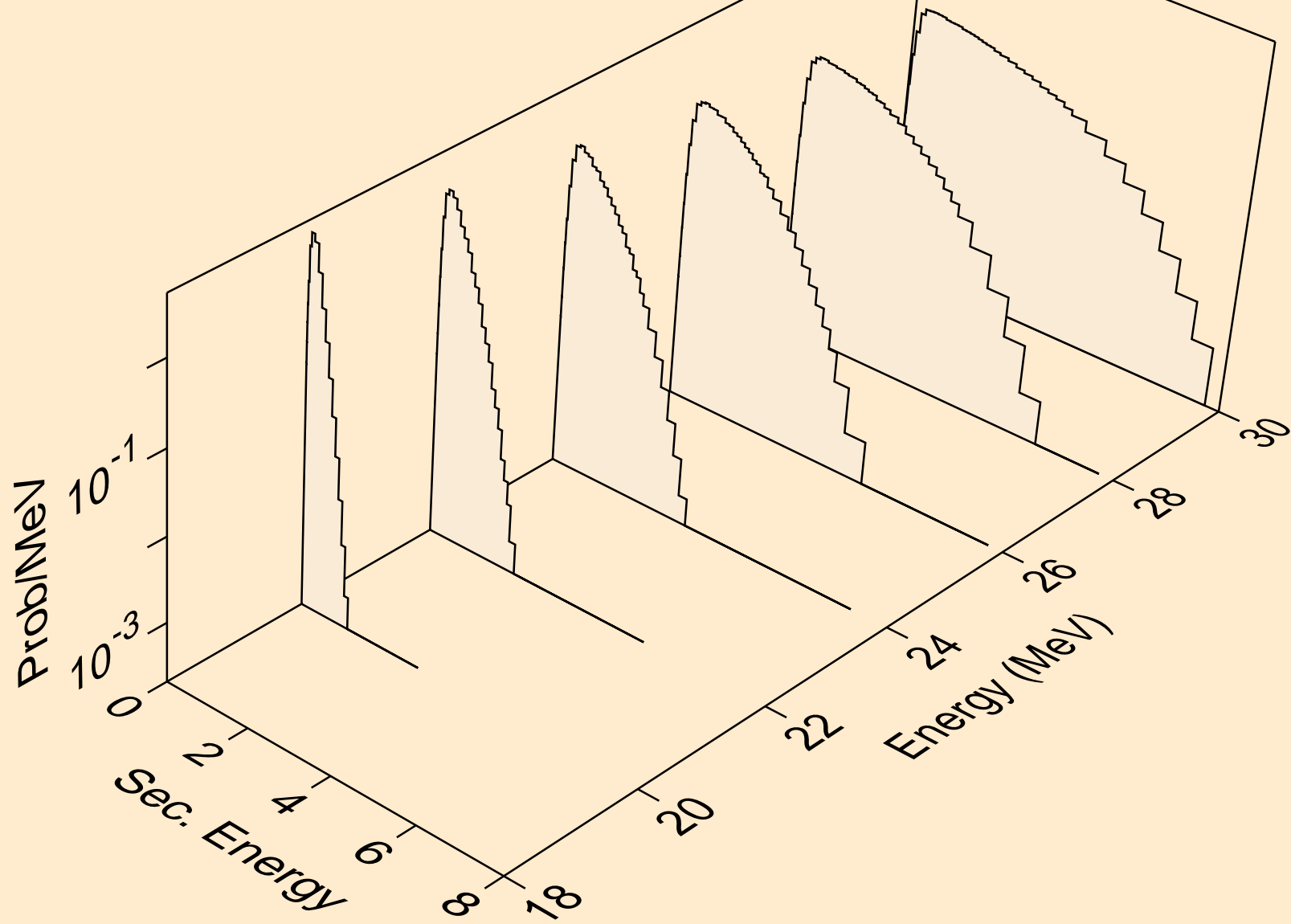

SB105 PHOTON ACER TENDL-2021 LIBRARY; T=0.K
neutrons from (g,npa)

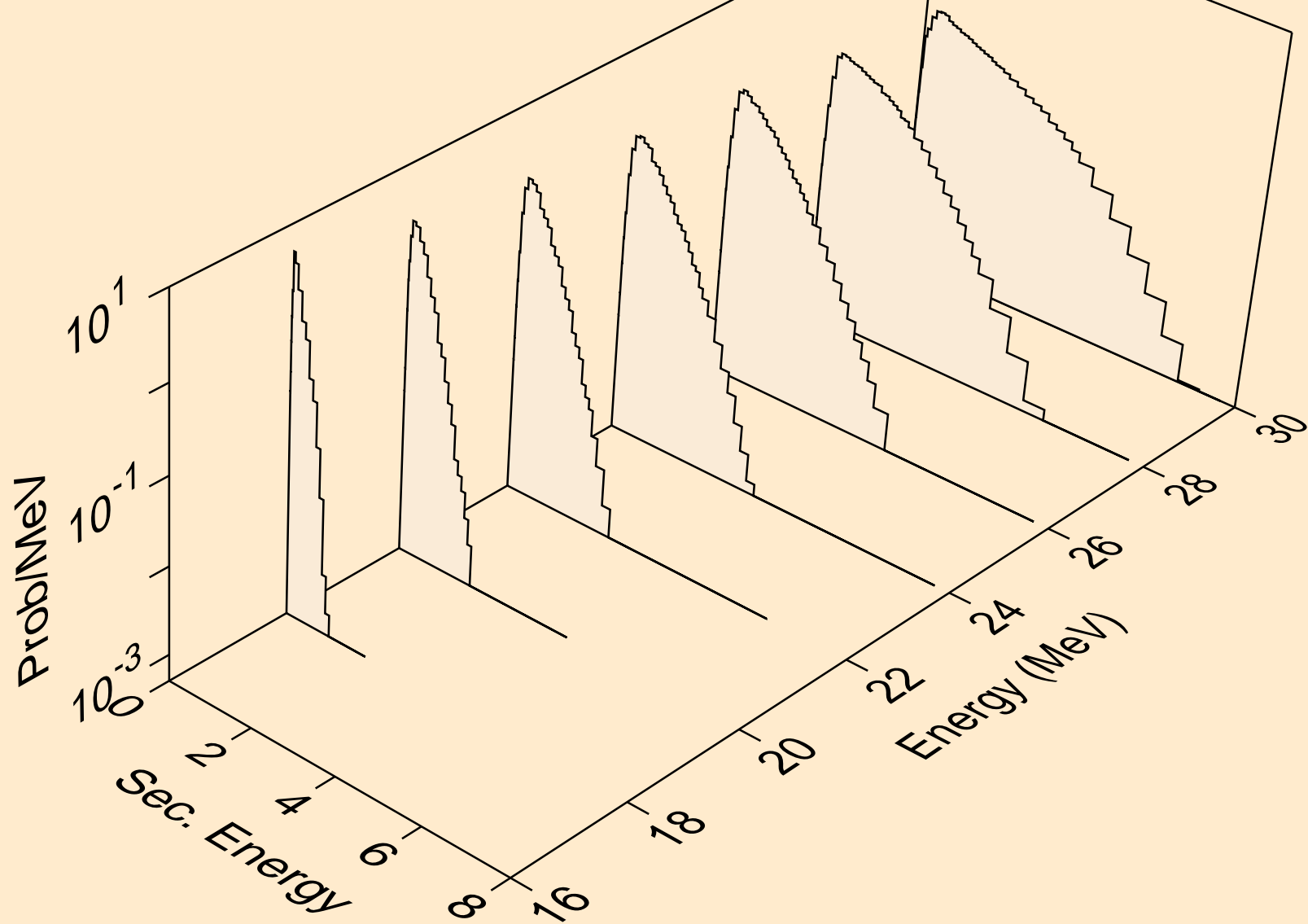

SB105 PHOTON ACER TENDL-2021 LIBRARY; T=0.K
angular distribution for (g,n*0) neutron

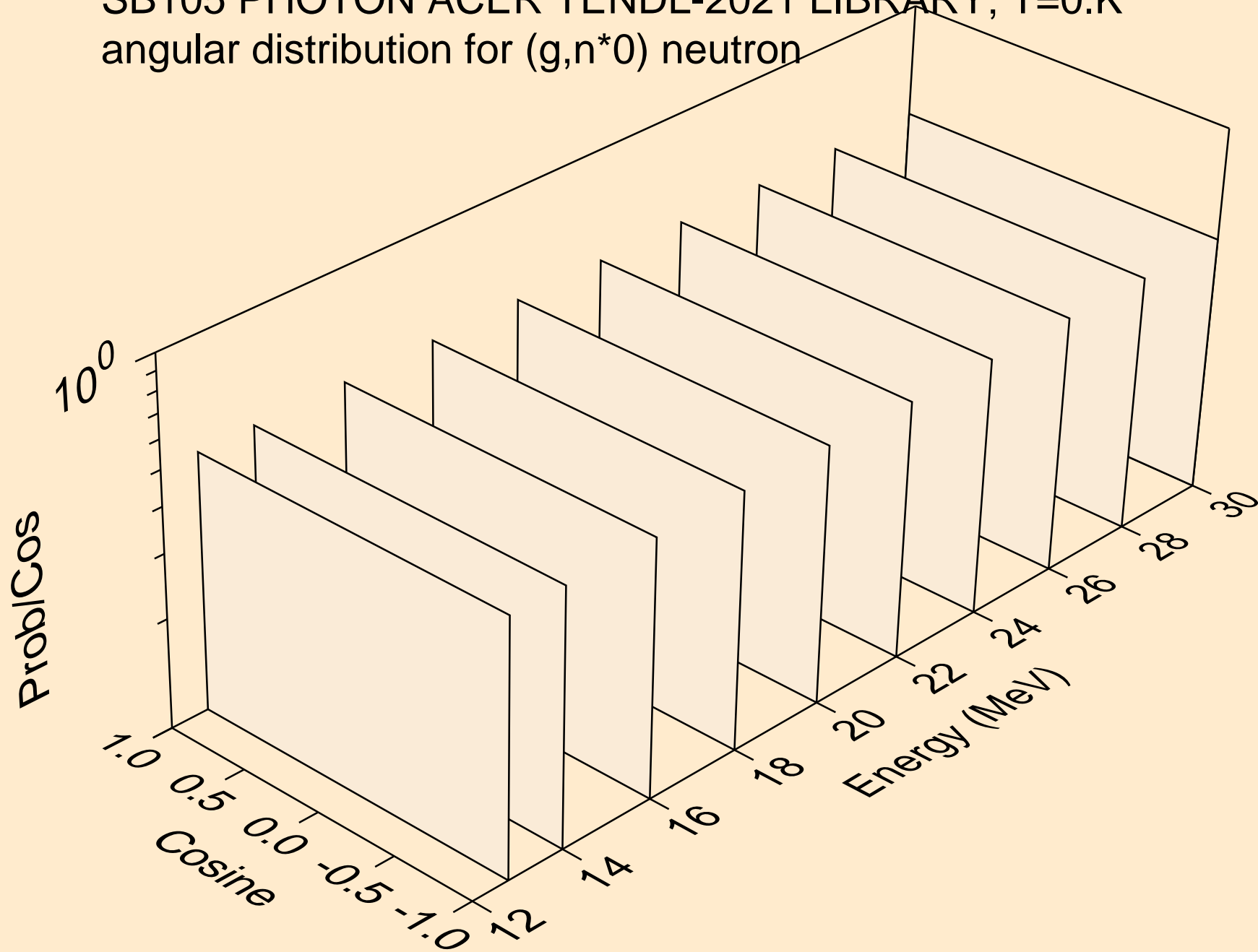

SB105 PHOTON ACER TENDL-2021 LIBRARY; T=0.K
angular distribution for (g,n*1) neutron

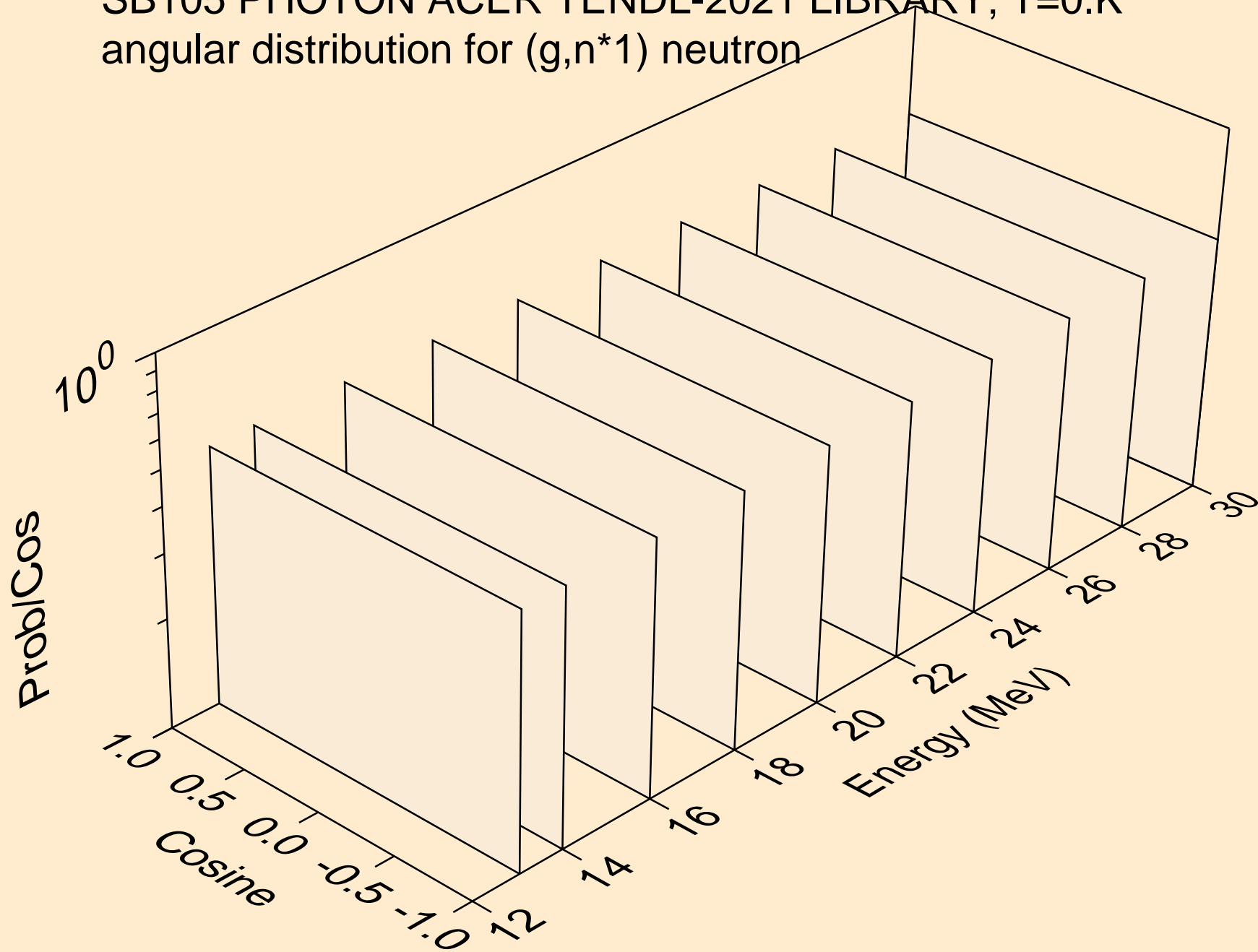

SB105 PHOTON ACER TENDL-2021 LIBRARY; T=0.K
neutrons from (g,n*c)

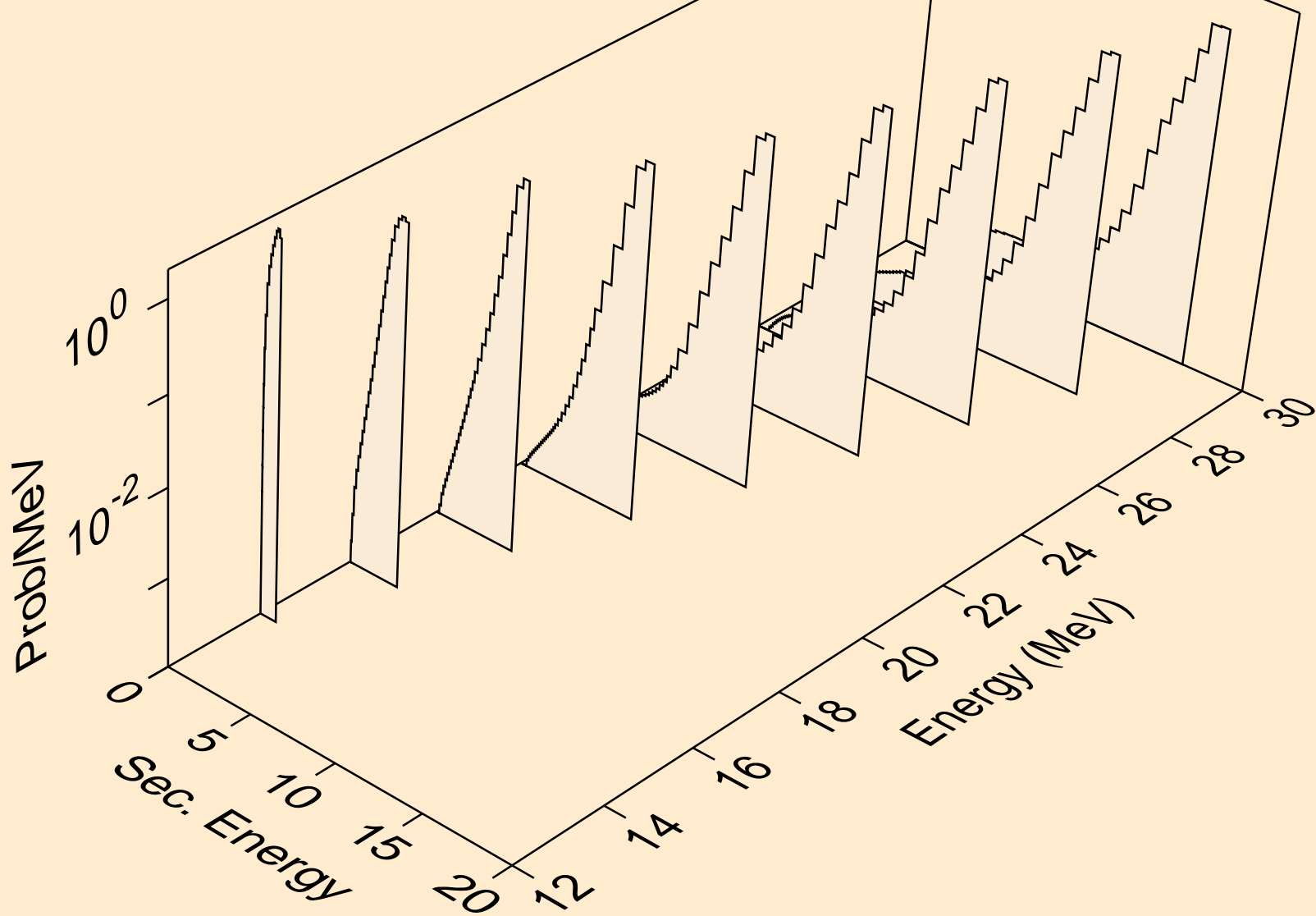

SB105 PHOTON ACER TENDL-2021 LIBRARY; T=0.K
photons from (g,x)

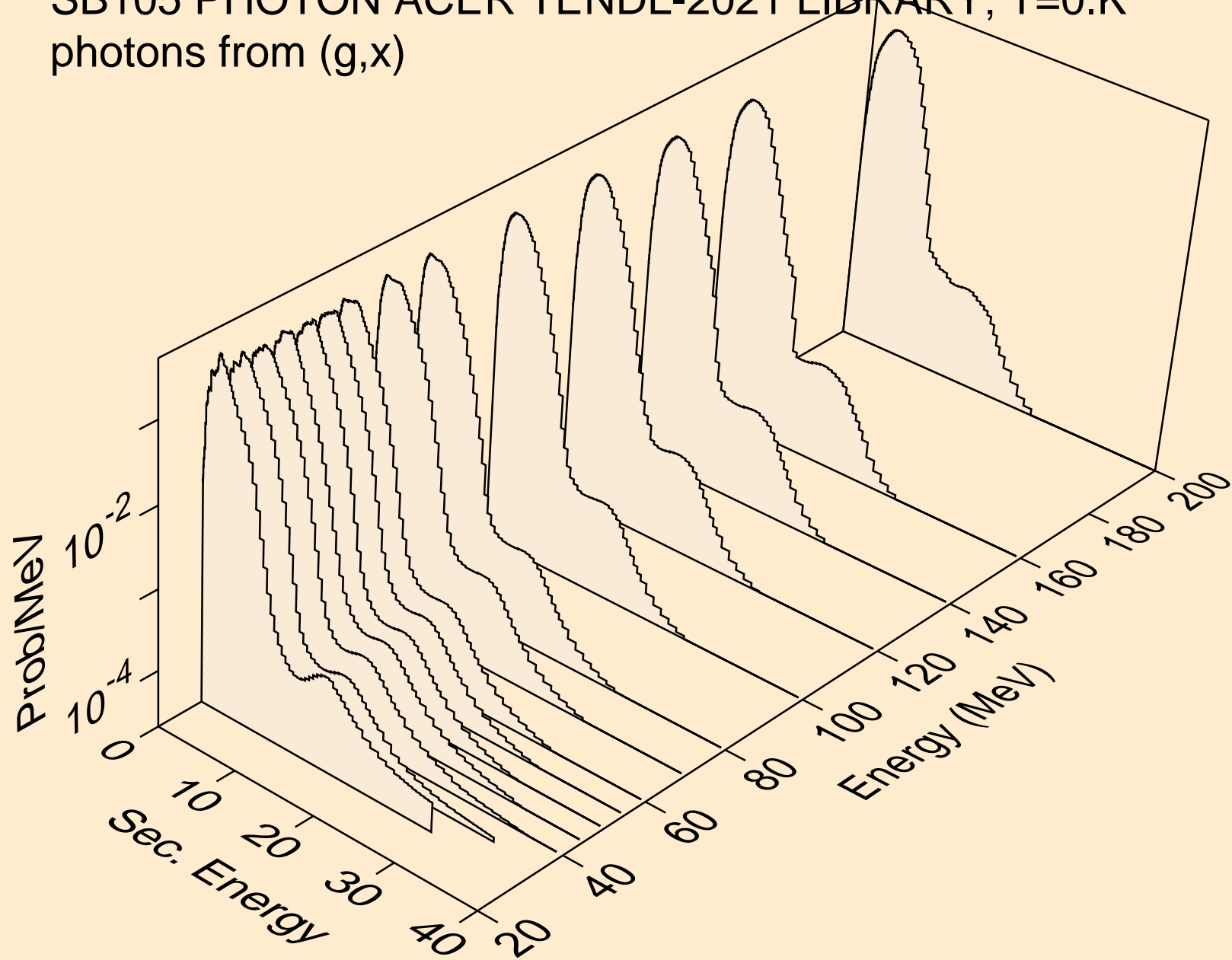

SB105 PHOTON ACER TENDL-2021 LIBRARY; T=0.K
photons from (g,2n)

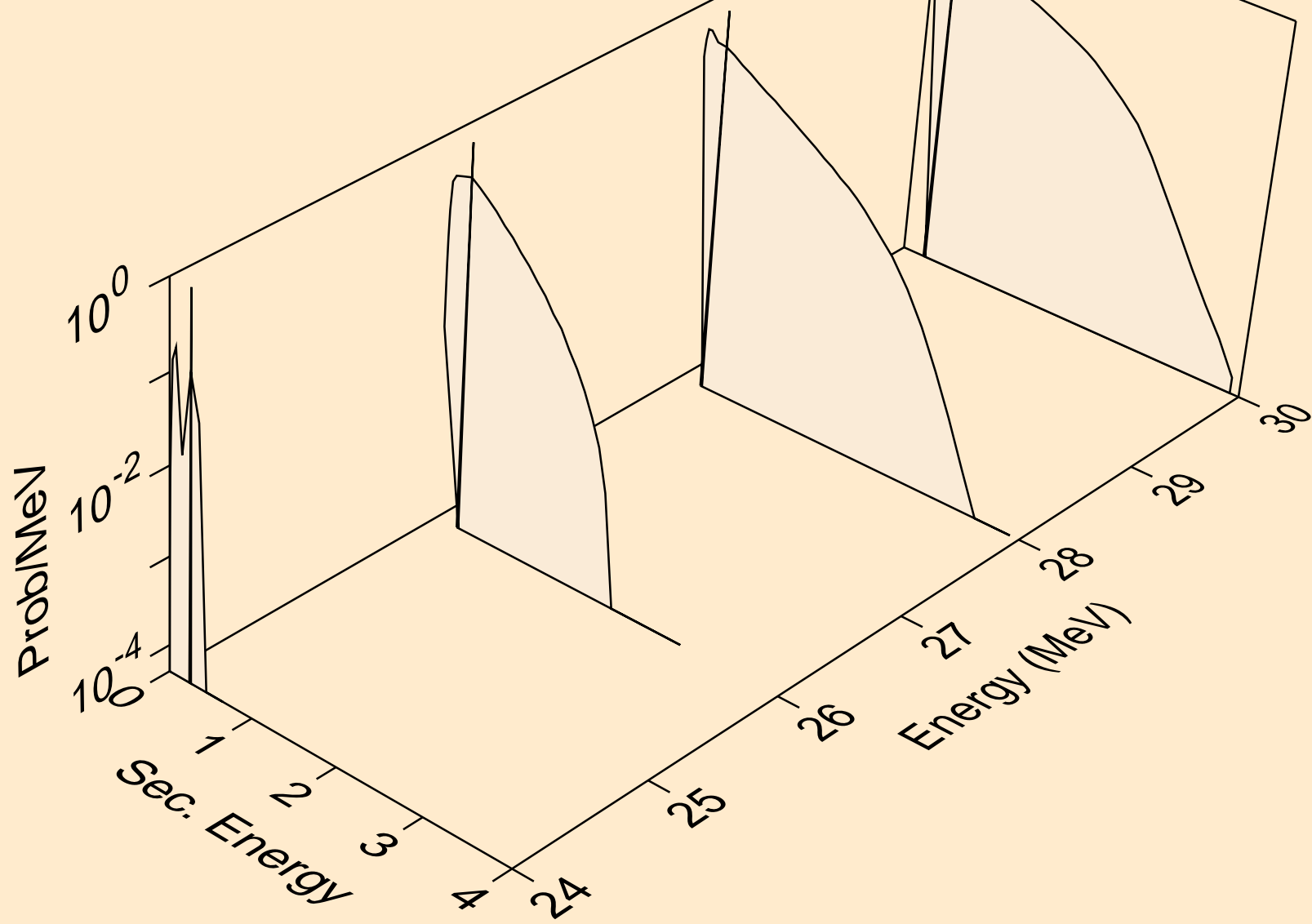

SB105 PHOTON ACER TENDL-2021 LIBRARY; T=0.K
photons from (g,n*)a

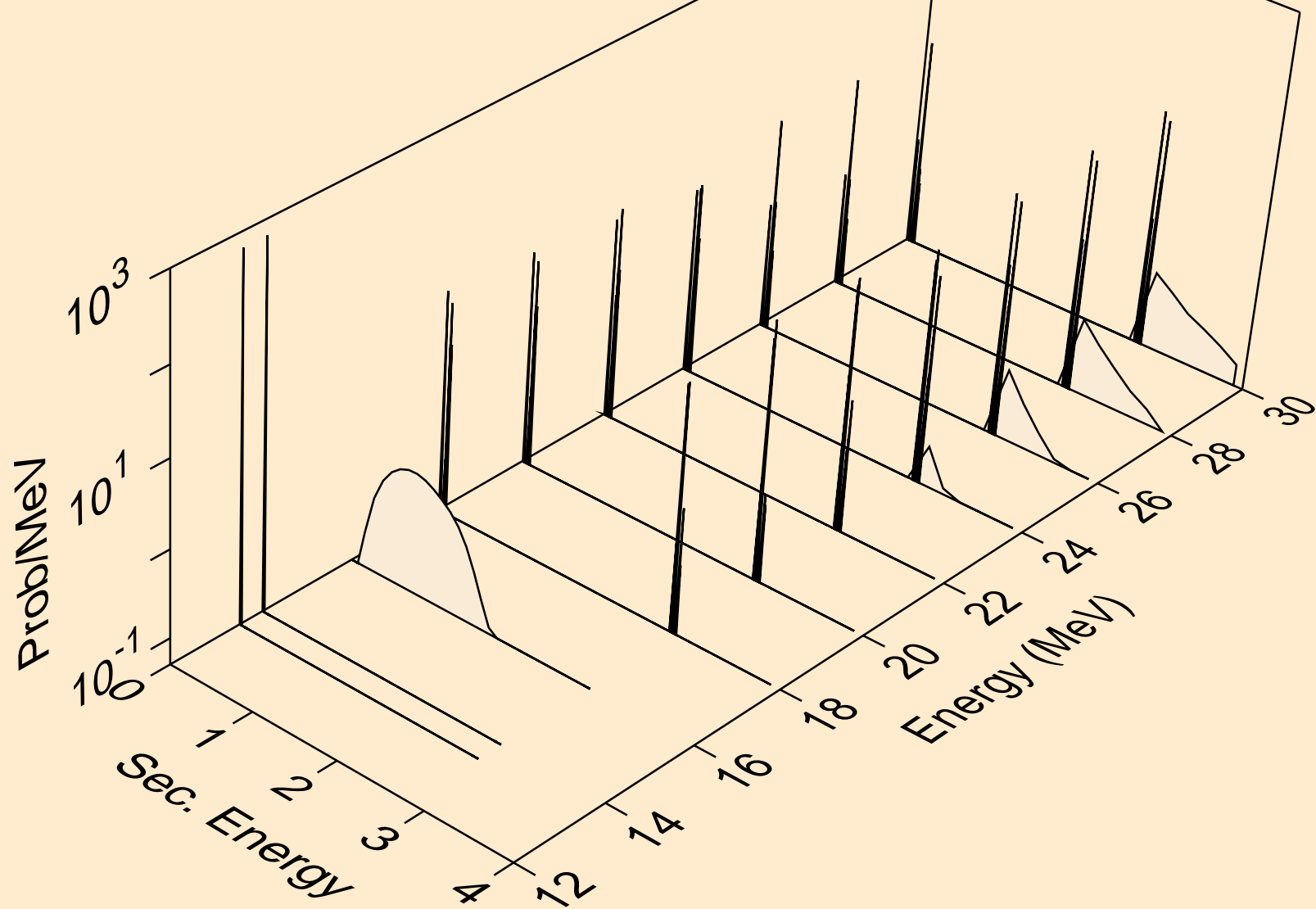

SB105 PHOTON ACER TENDL-2021 LIBRARY; T=0.K
photons from (g,n*)p

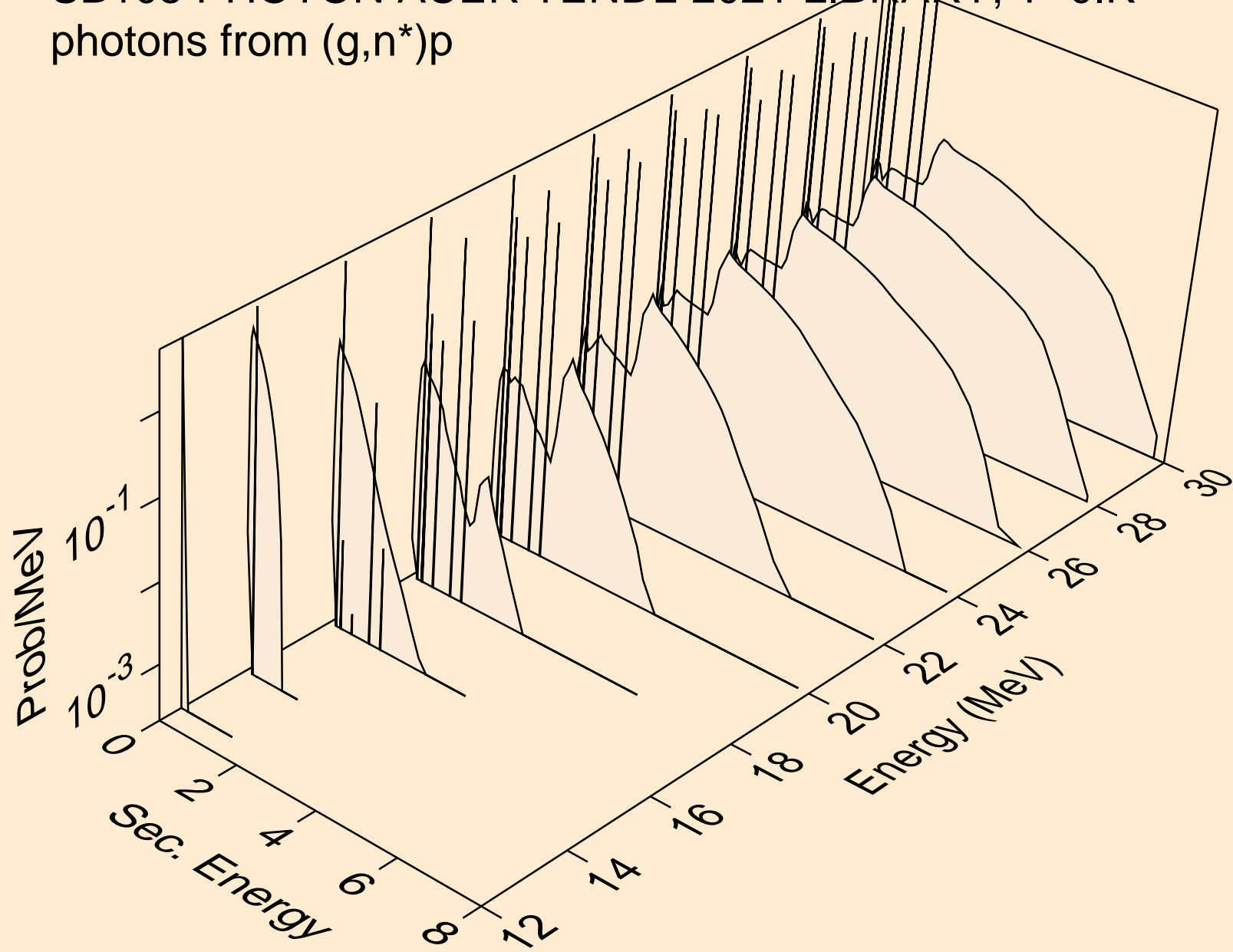

SB105 PHOTON ACER TENDL-2021 LIBRARY; T=0.K
photons from (g,n*)d

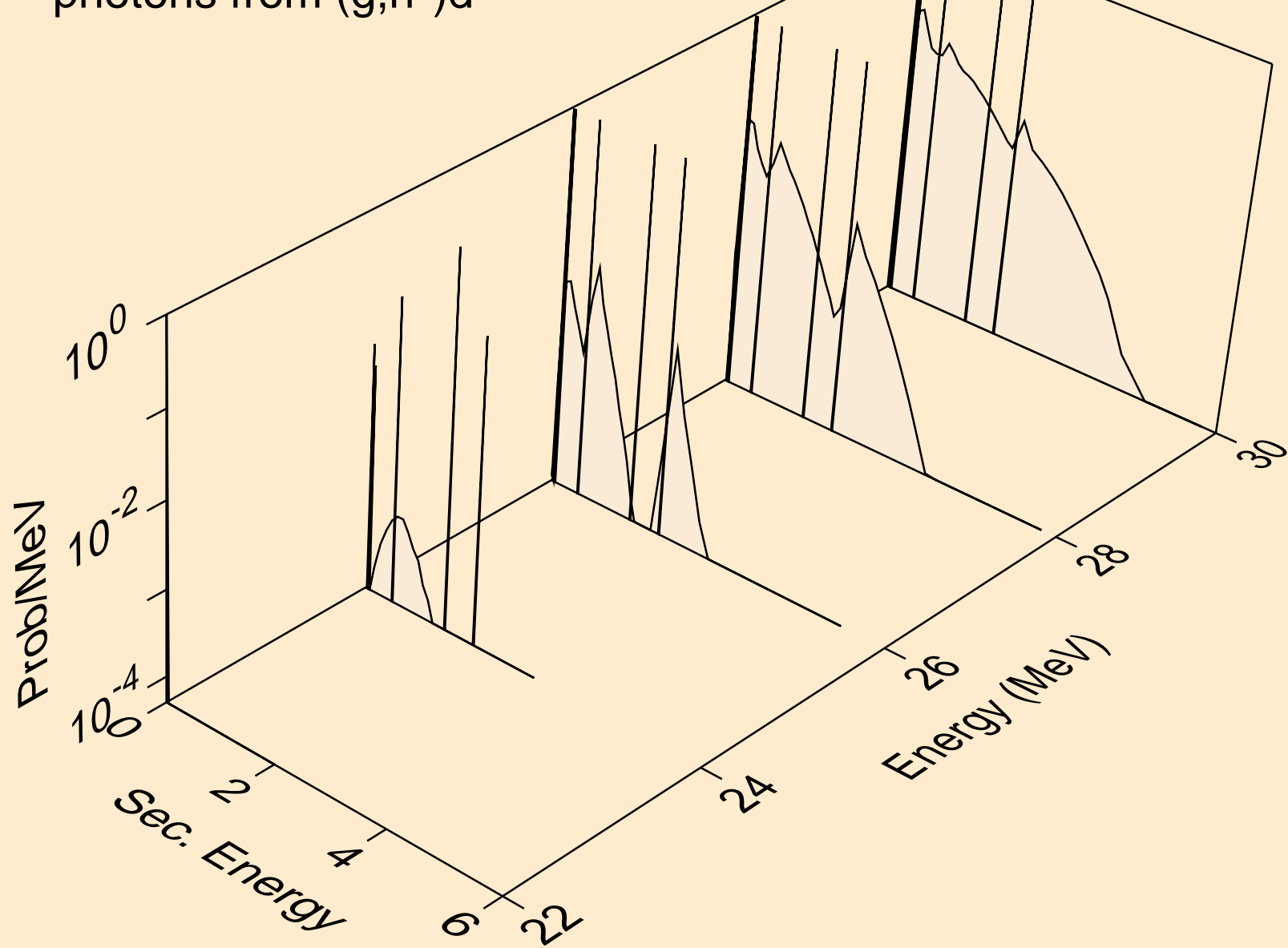

SB105 PHOTON ACER TENDL-2021 LIBRARY; T=0.K
photons from (g,n*)he3

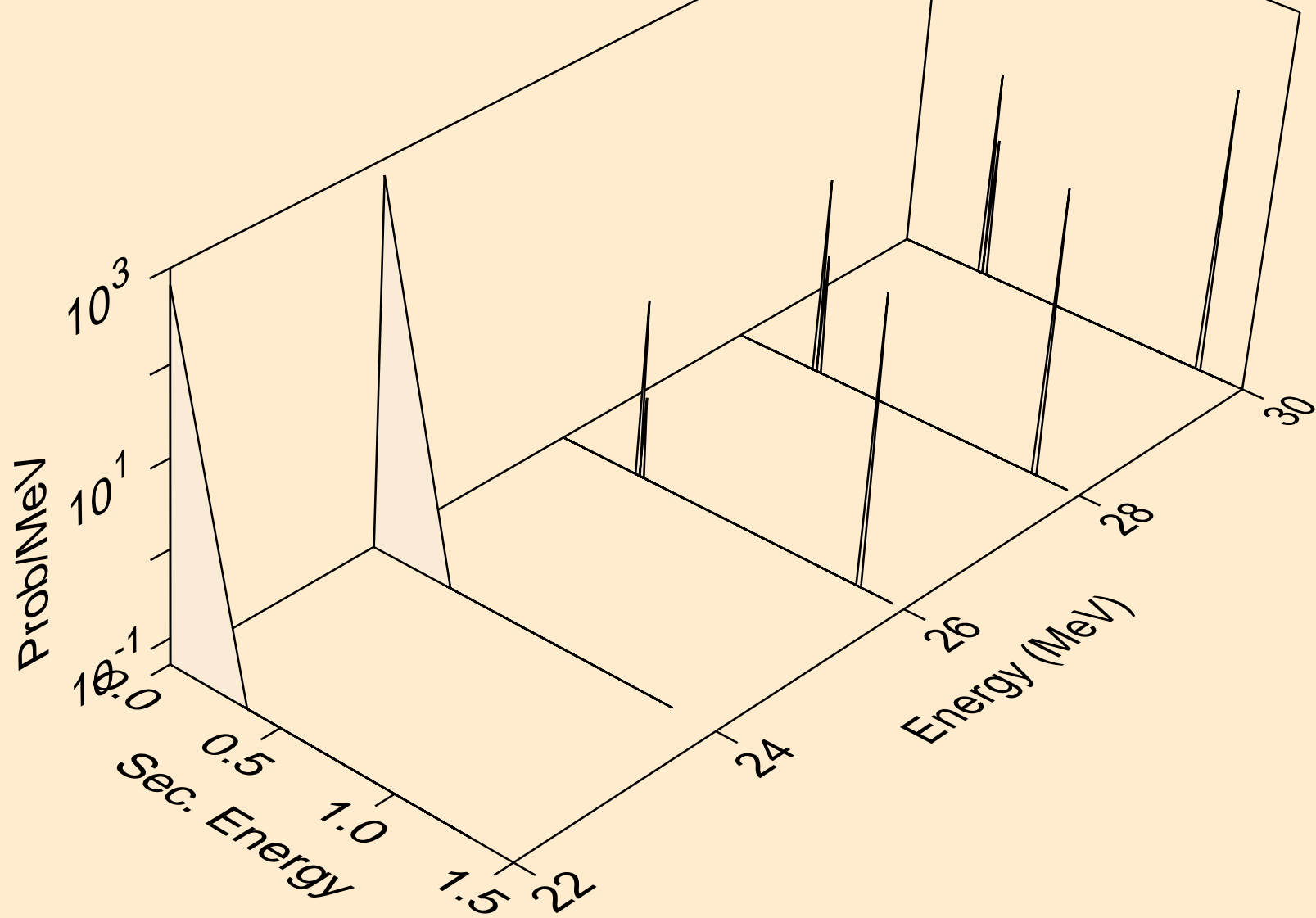

SB105 PHOTON ACER TENDL-2021 LIBRARY; T=0.K
photons from (g,2np)

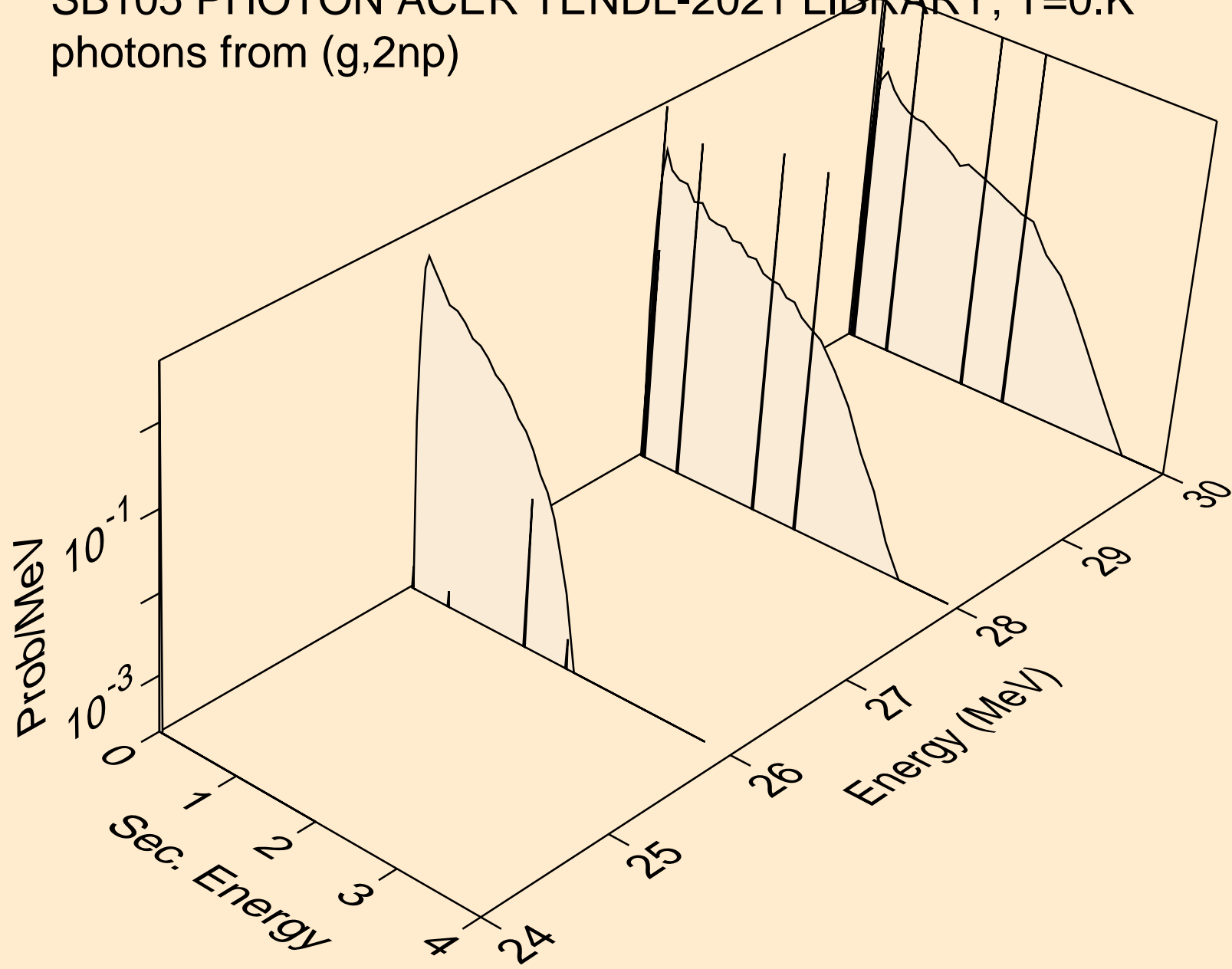

SB105 PHOTON ACER TENDL-2021 LIBRARY; T=0.K
photons from (g,2np)

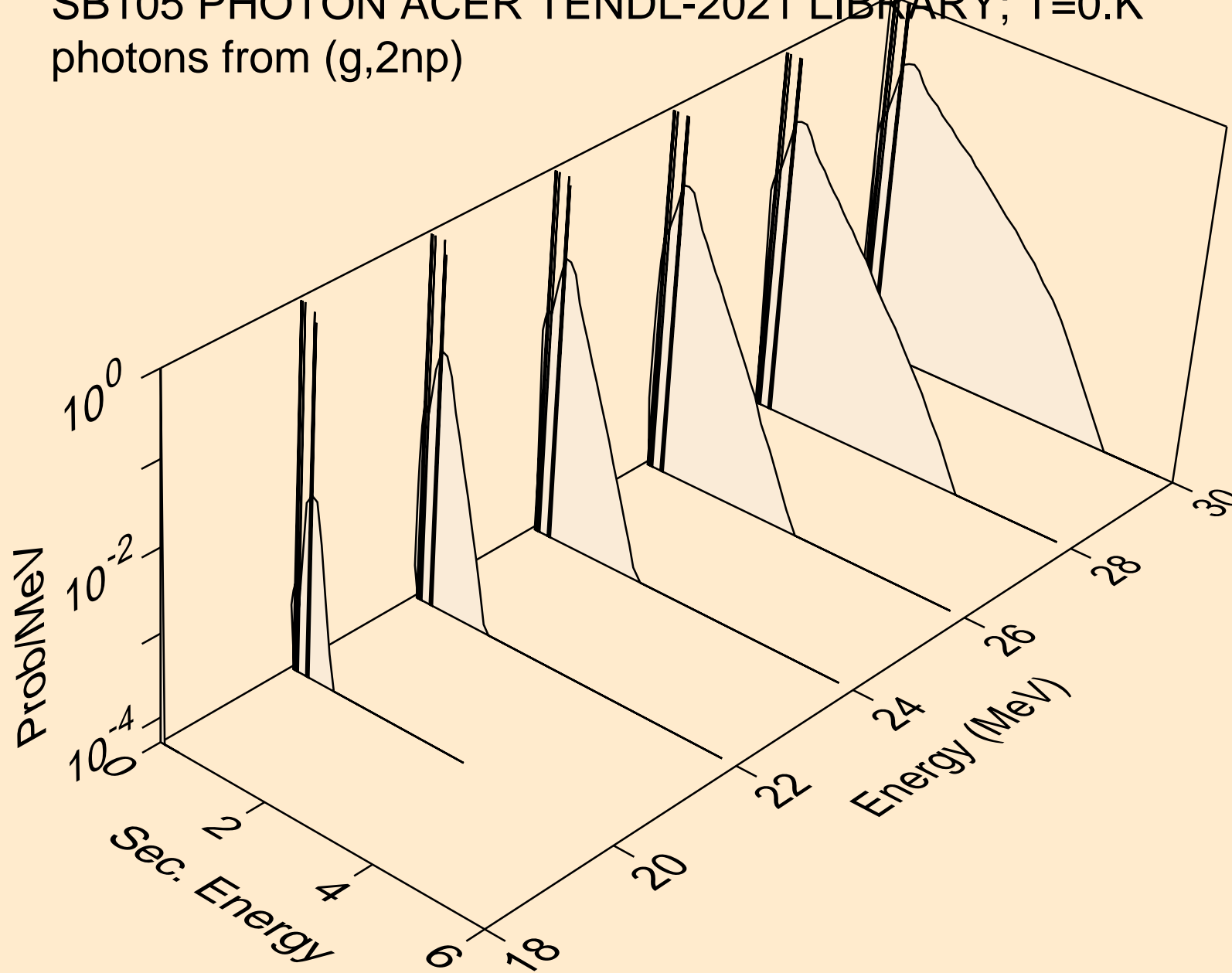

SB105 PHOTON ACER TENDL-2021 LIBRARY; T=0.K
photons from (g,npa)

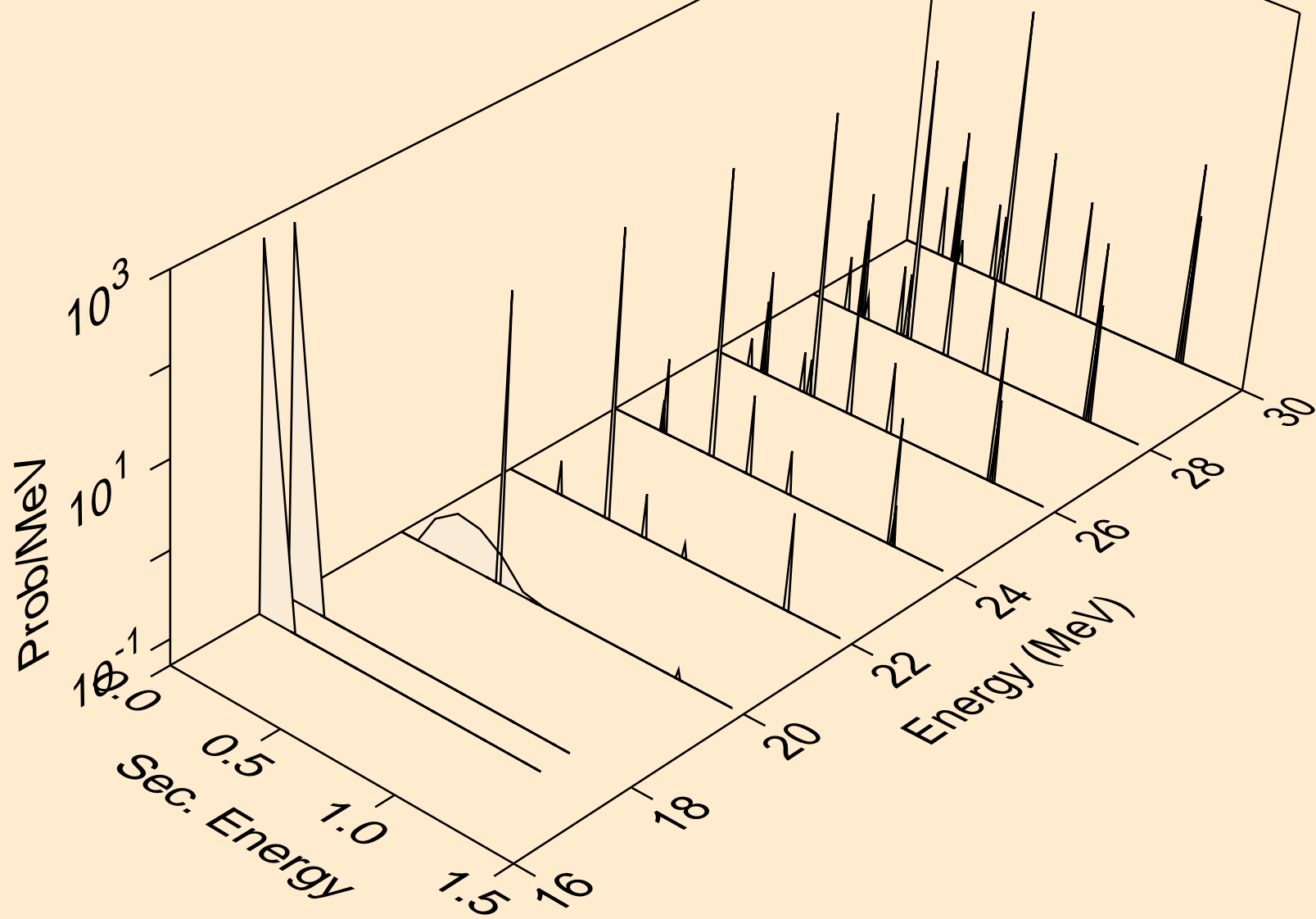

SB105 PHOTON ACER TENDL-2021 LIBRARY; T=0.K
photons from (g,n*c)

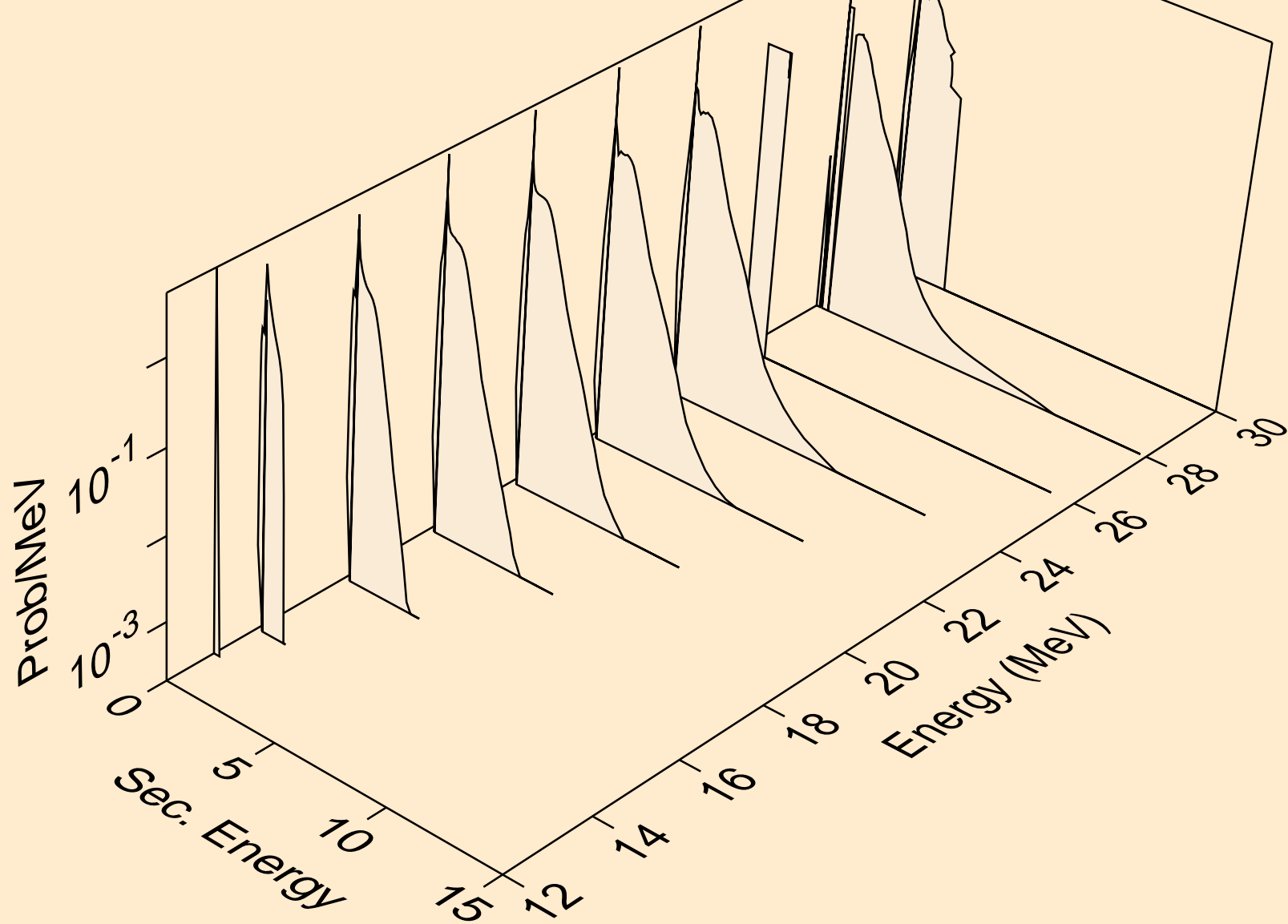

SB105 PHOTON ACER TENDL-2021 LIBRARY; T=0.K
photons from (g,gma)

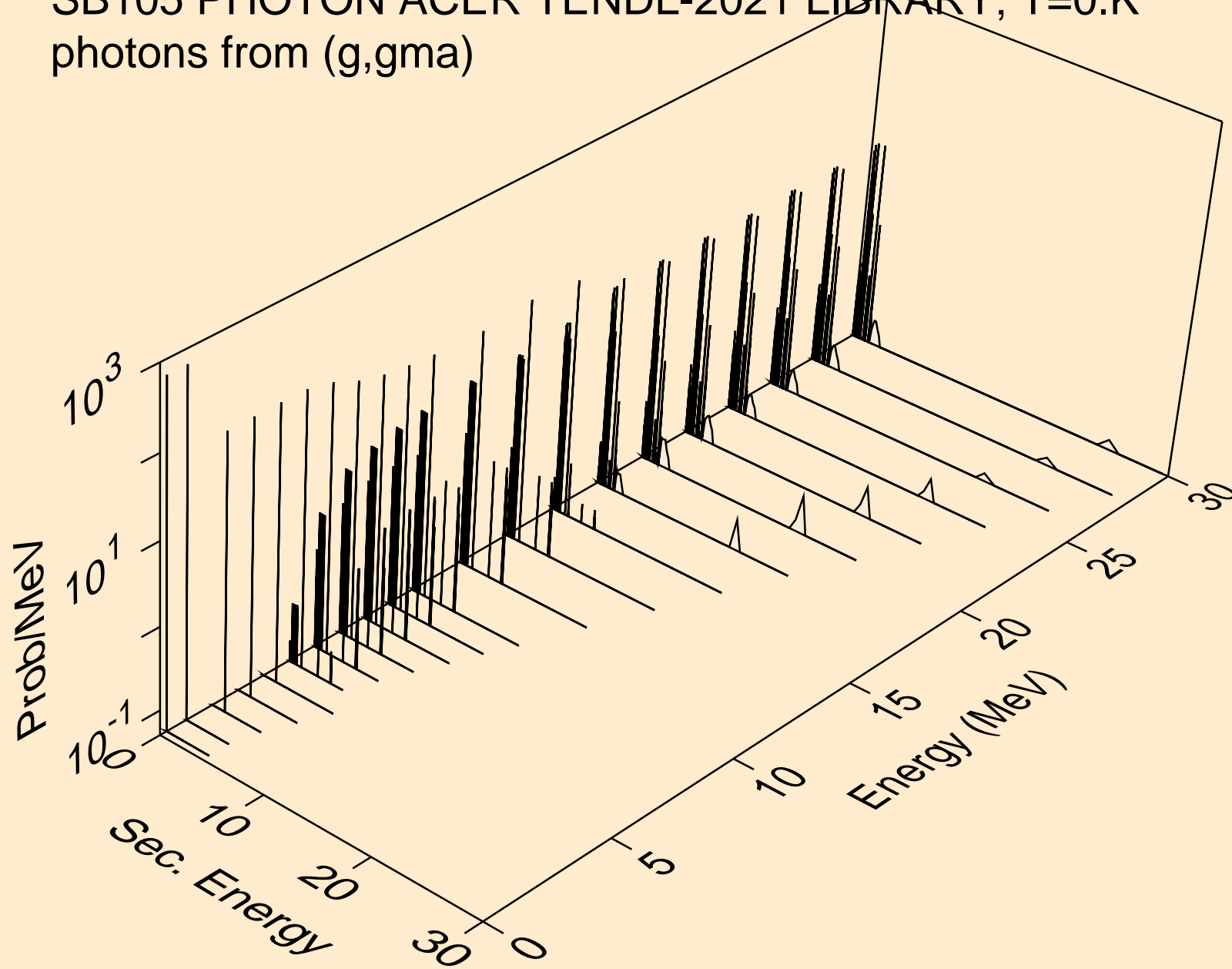

SB105 PHOTON ACER TENDL-2021 LIBRARY; T=0.K
photons from (g,p)

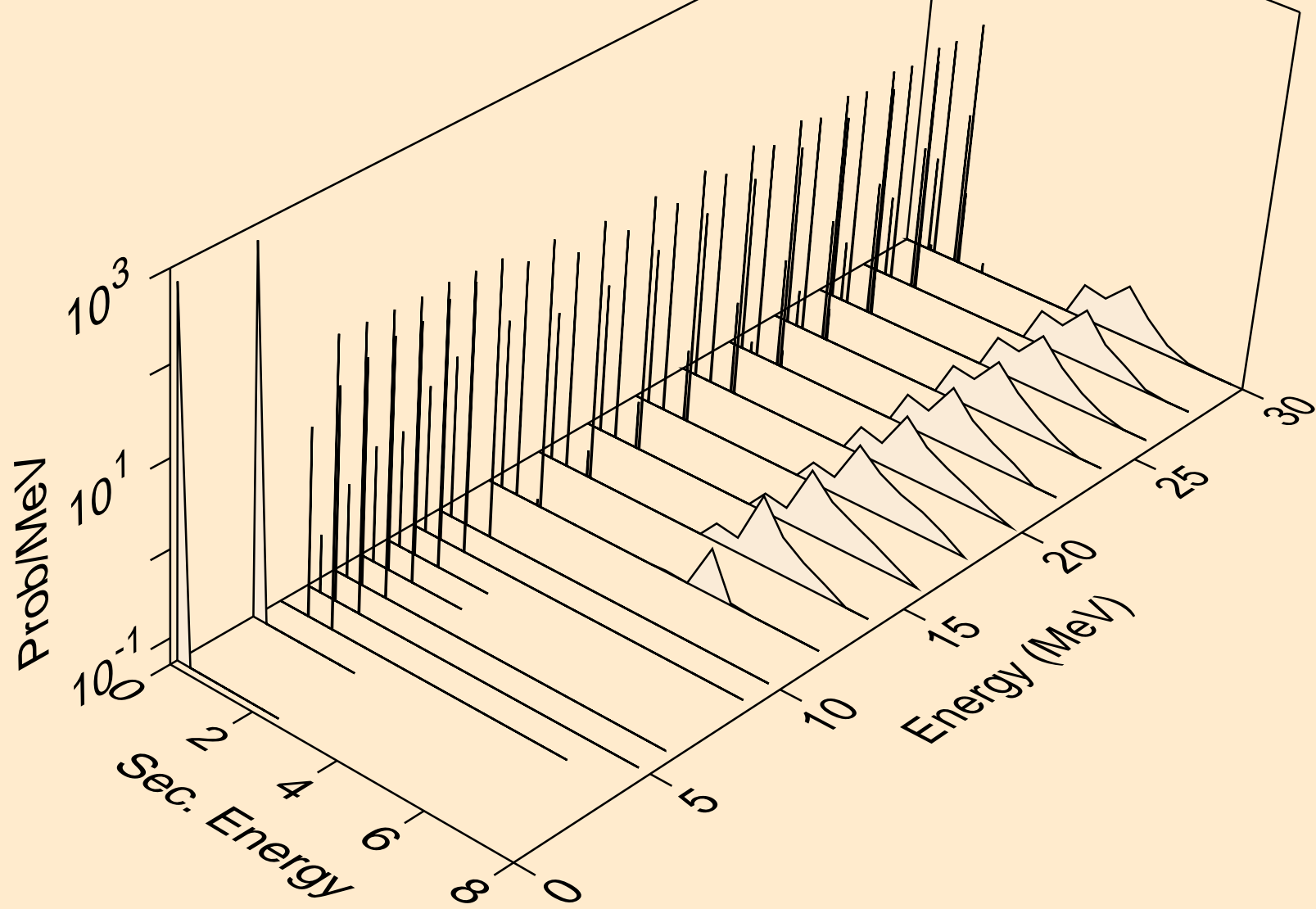

SB105 PHOTON ACER TENDL-2021 LIBRARY; T=0.K
photons from (g,d)

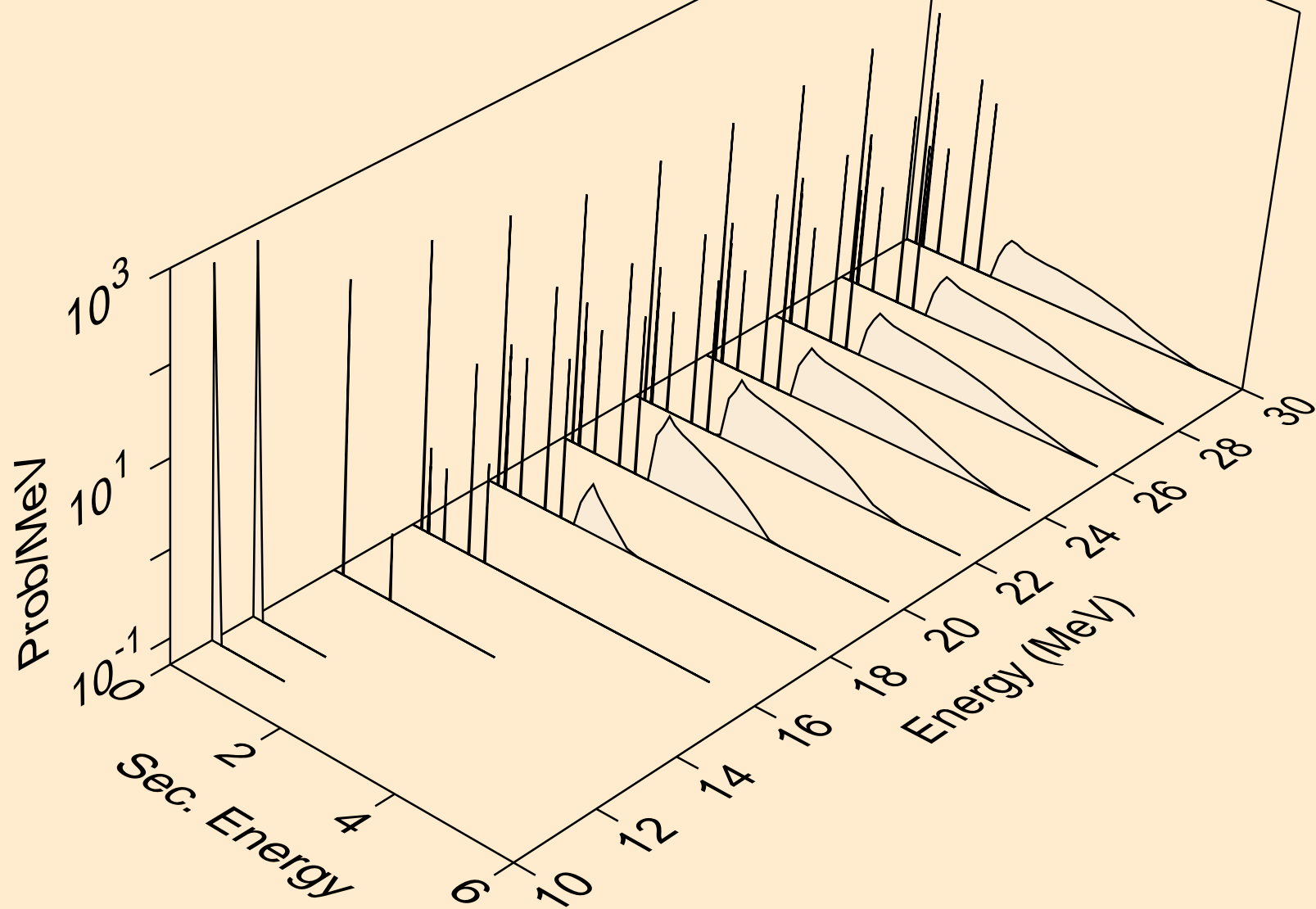

SB105 PHOTON ACER TENDL-2021 LIBRARY; T=0.K
photons from (g,t)

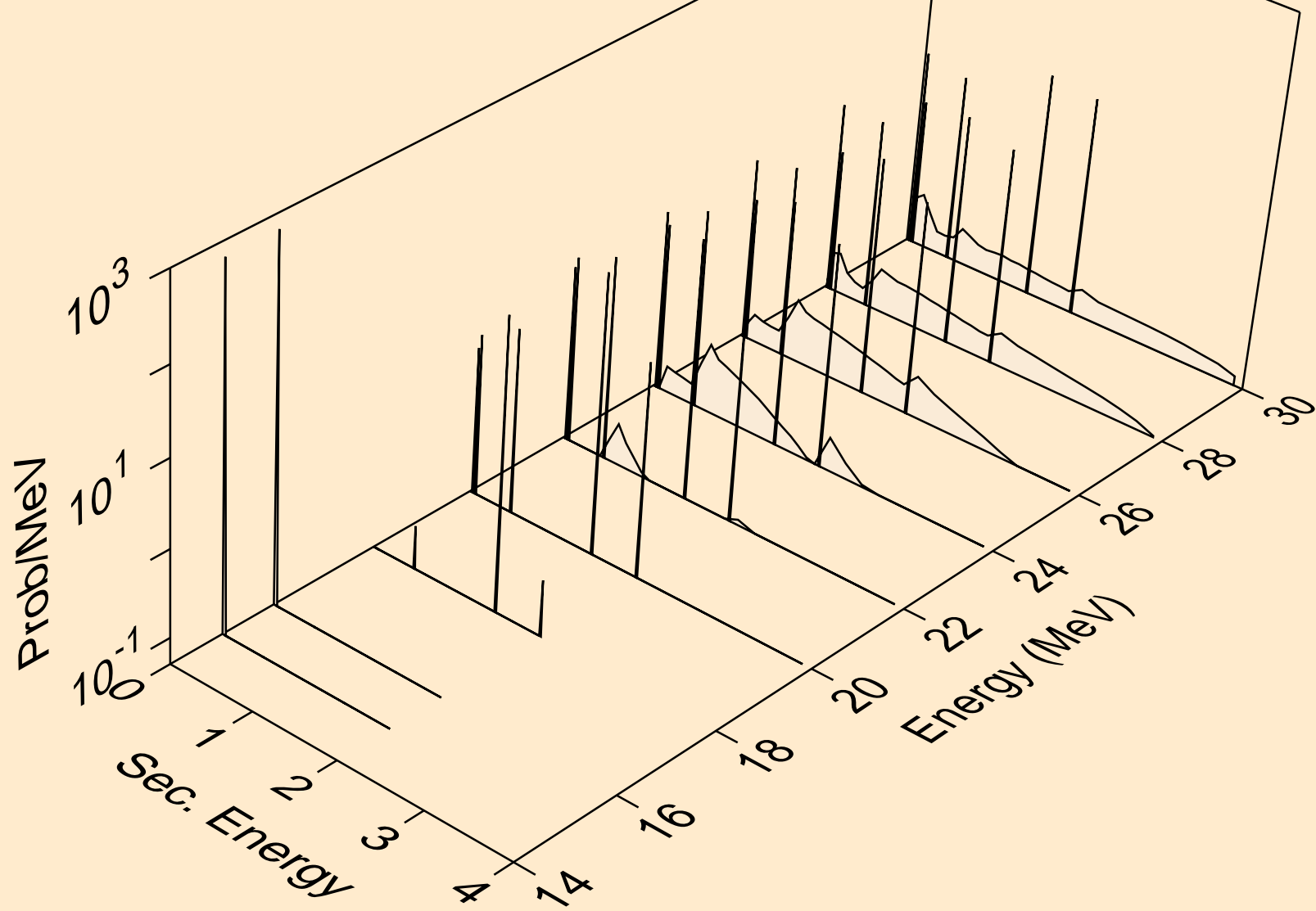

SB105 PHOTON ACER TENDL-2021 LIBRARY; T=0.K
photons from (g,he3)

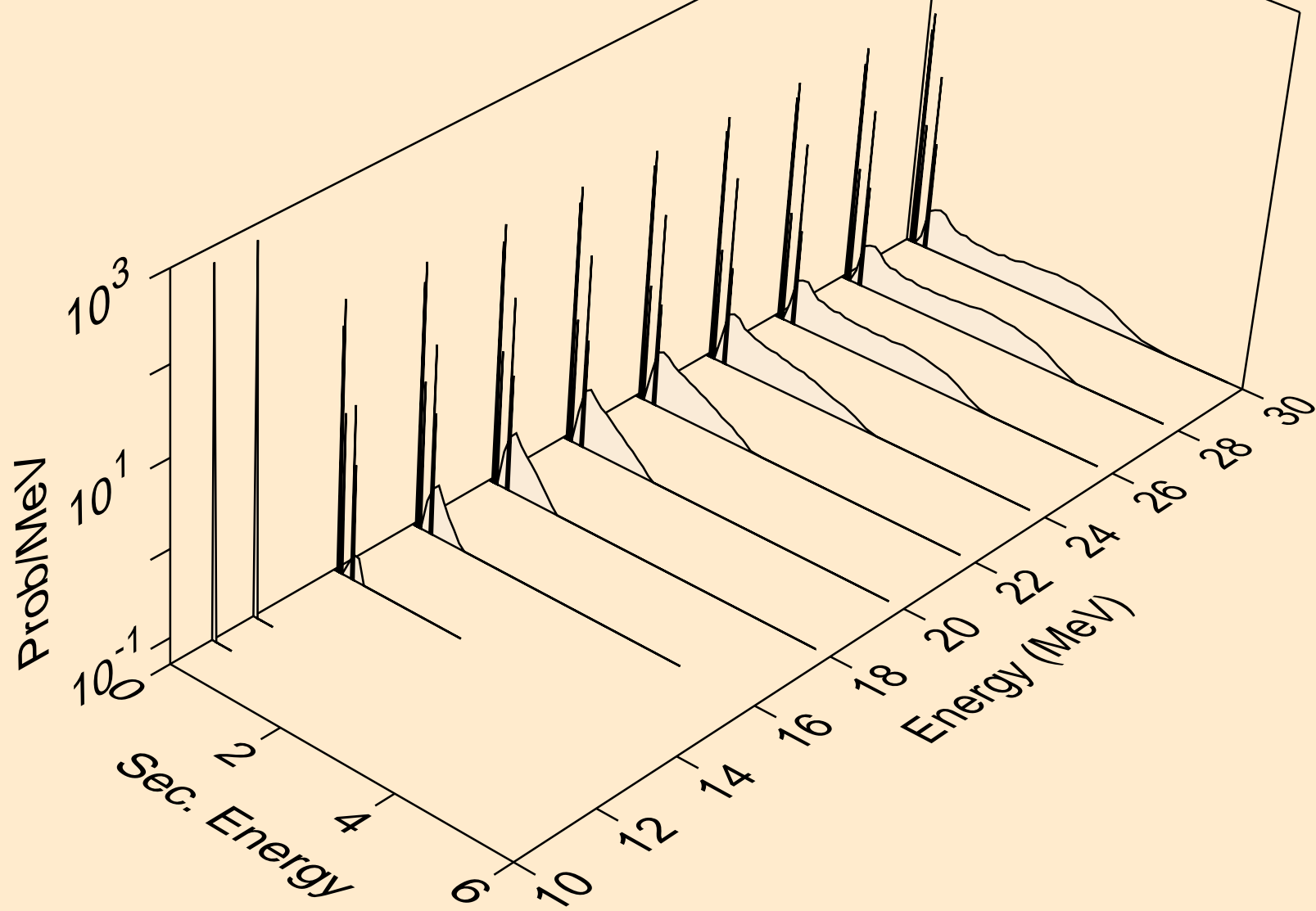

SB105 PHOTON ACER TENDL-2021 LIBRARY; T=0.K
photons from (g,a)

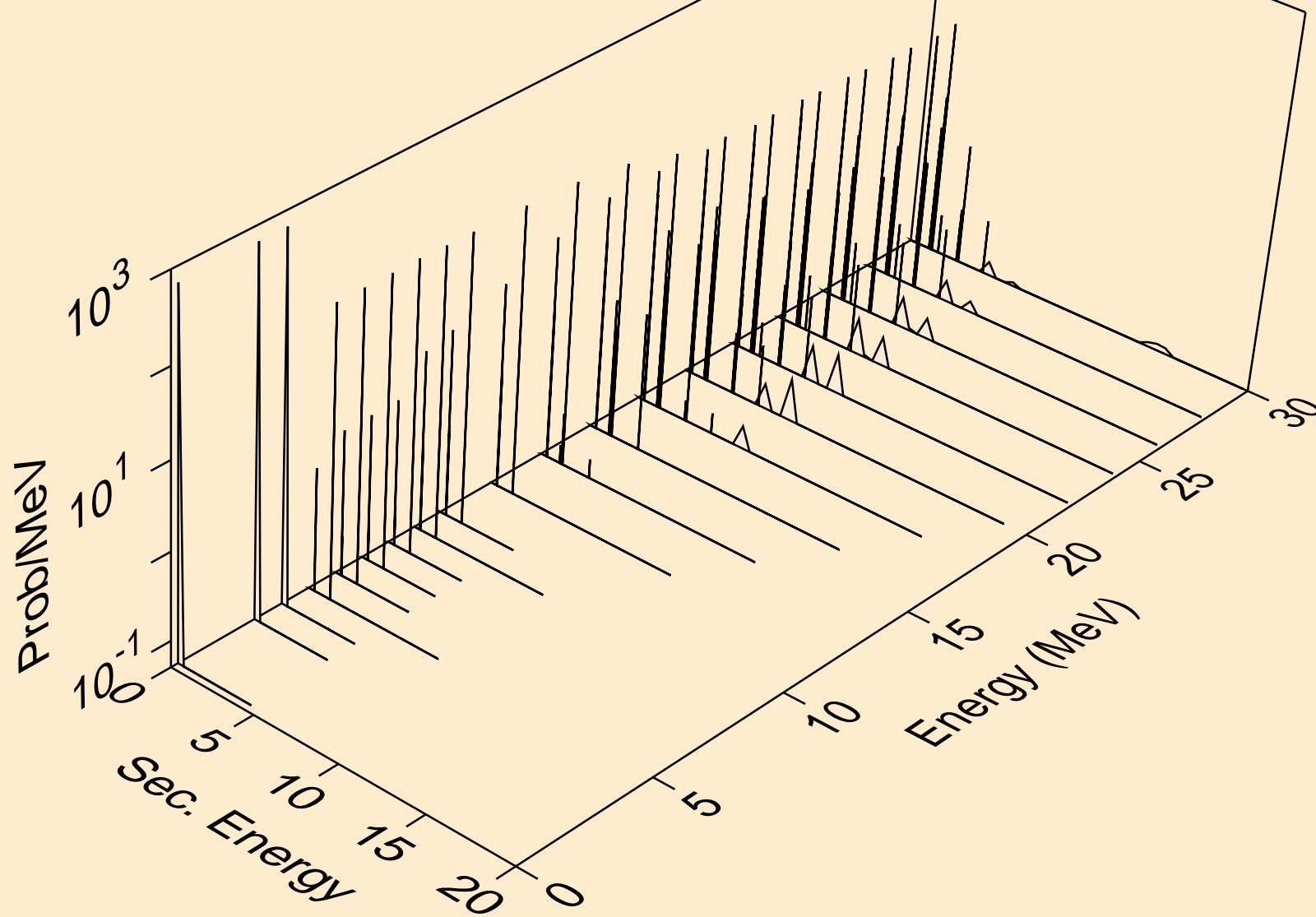

SB105 PHOTON ACER TENDL-2021 LIBRARY; T=0.K
photons from (g,2a)

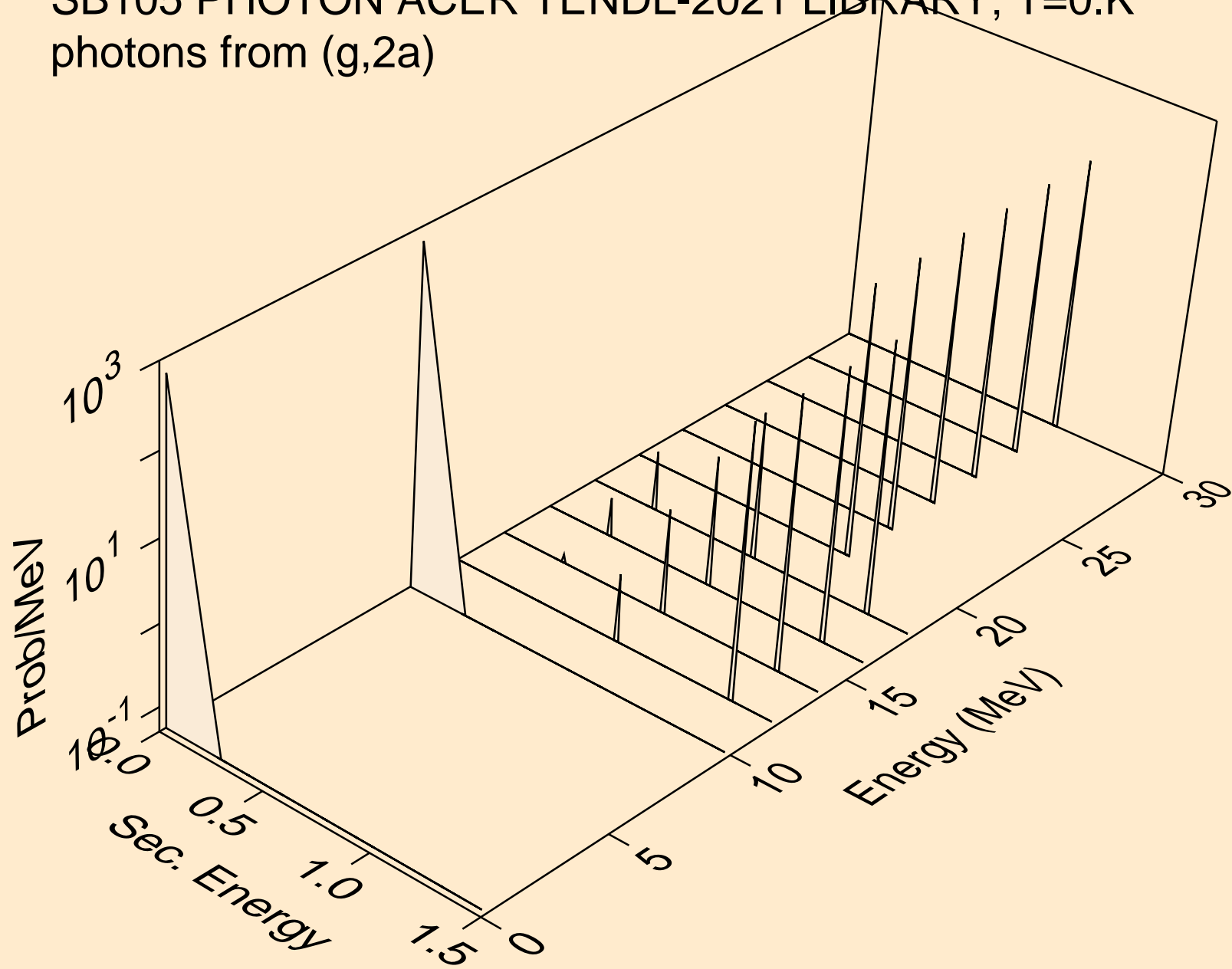

SB105 PHOTON ACER TENDL-2021 LIBRARY; T=0.K
photons from (g,2p)

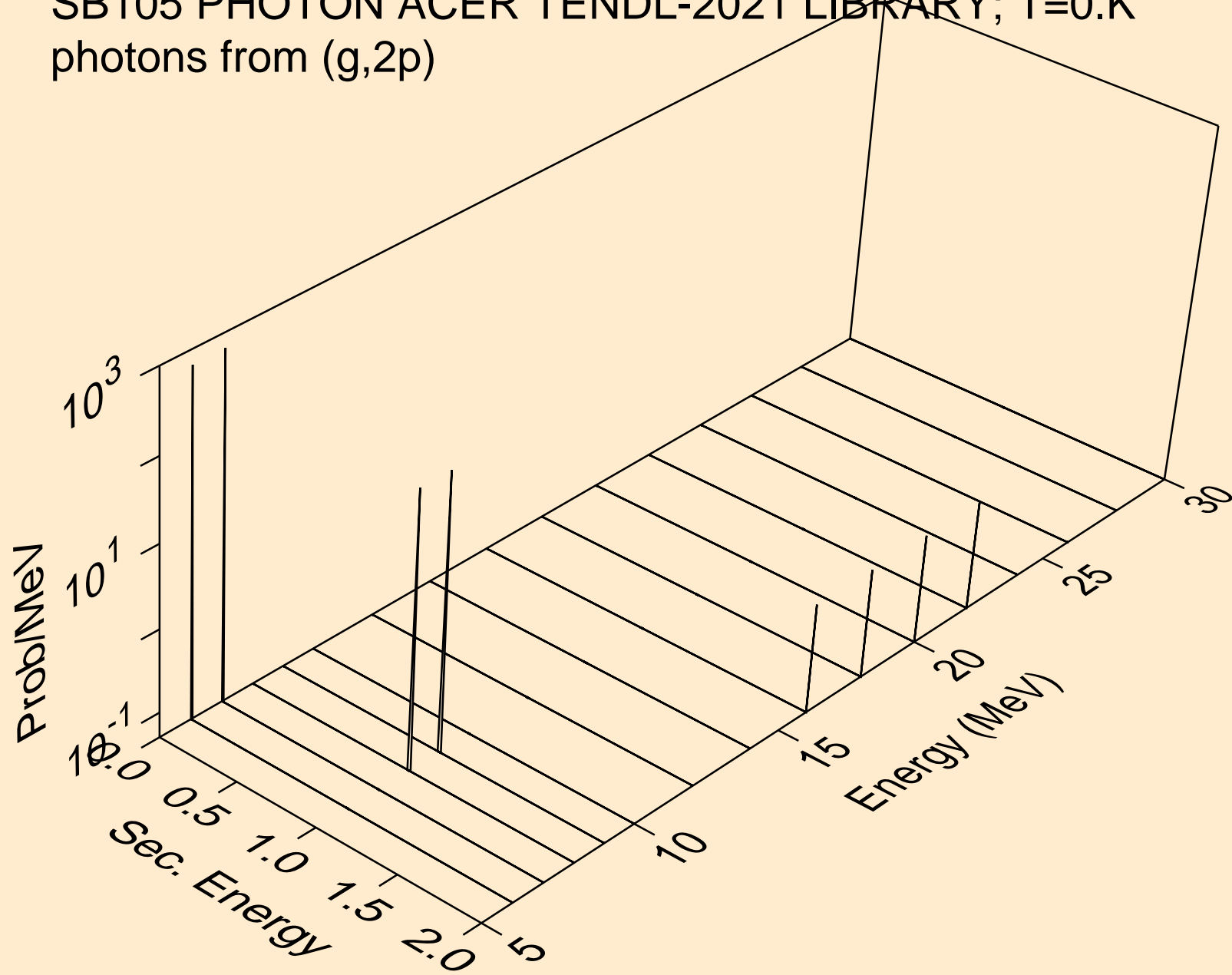

SB105 PHOTON ACER TENDL-2021 LIBRARY; T=0.K
photons from (g,pa)

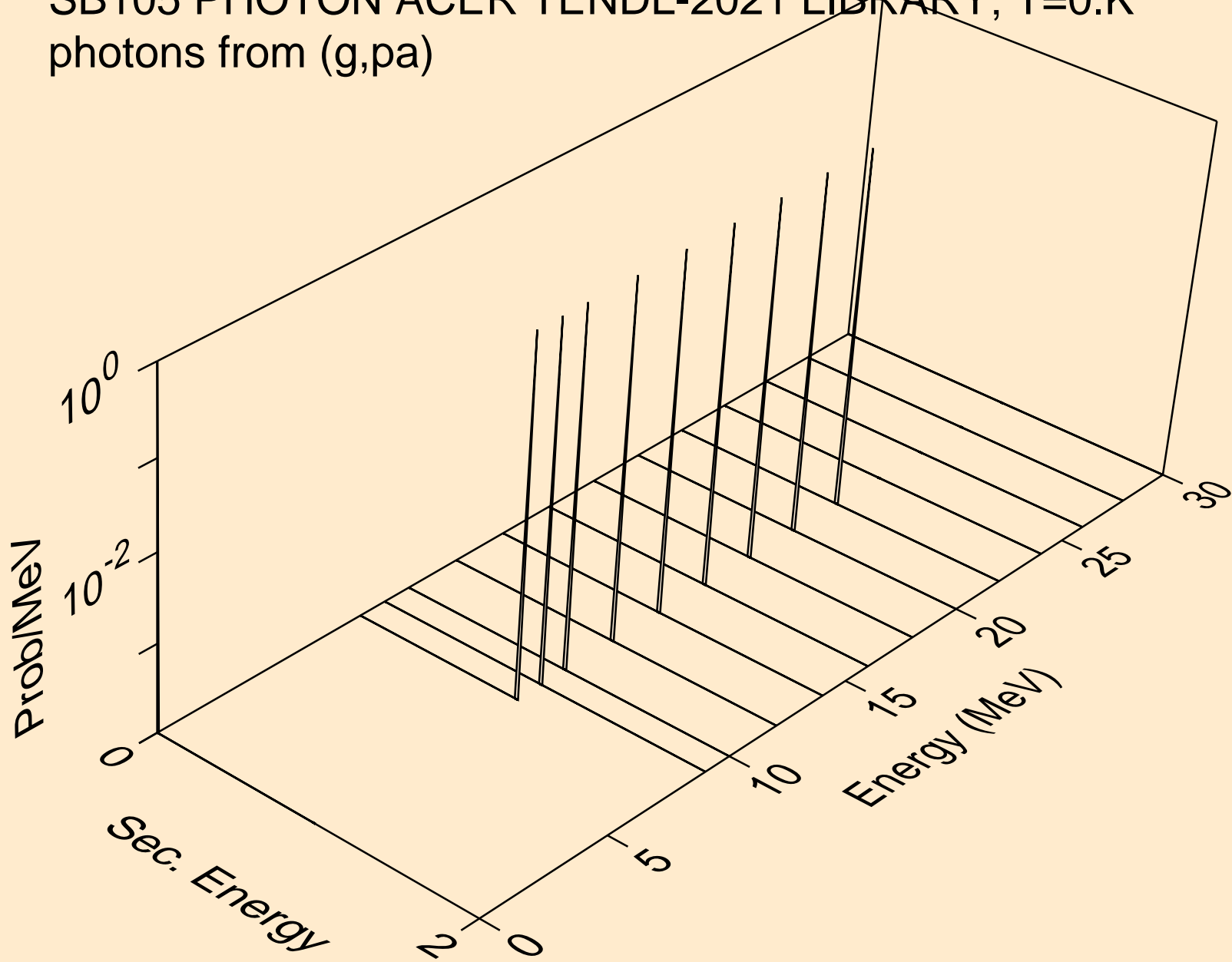

SB105 PHOTON ACER TENDL-2021 LIBRARY; T=0.K
photons from (g,pd)

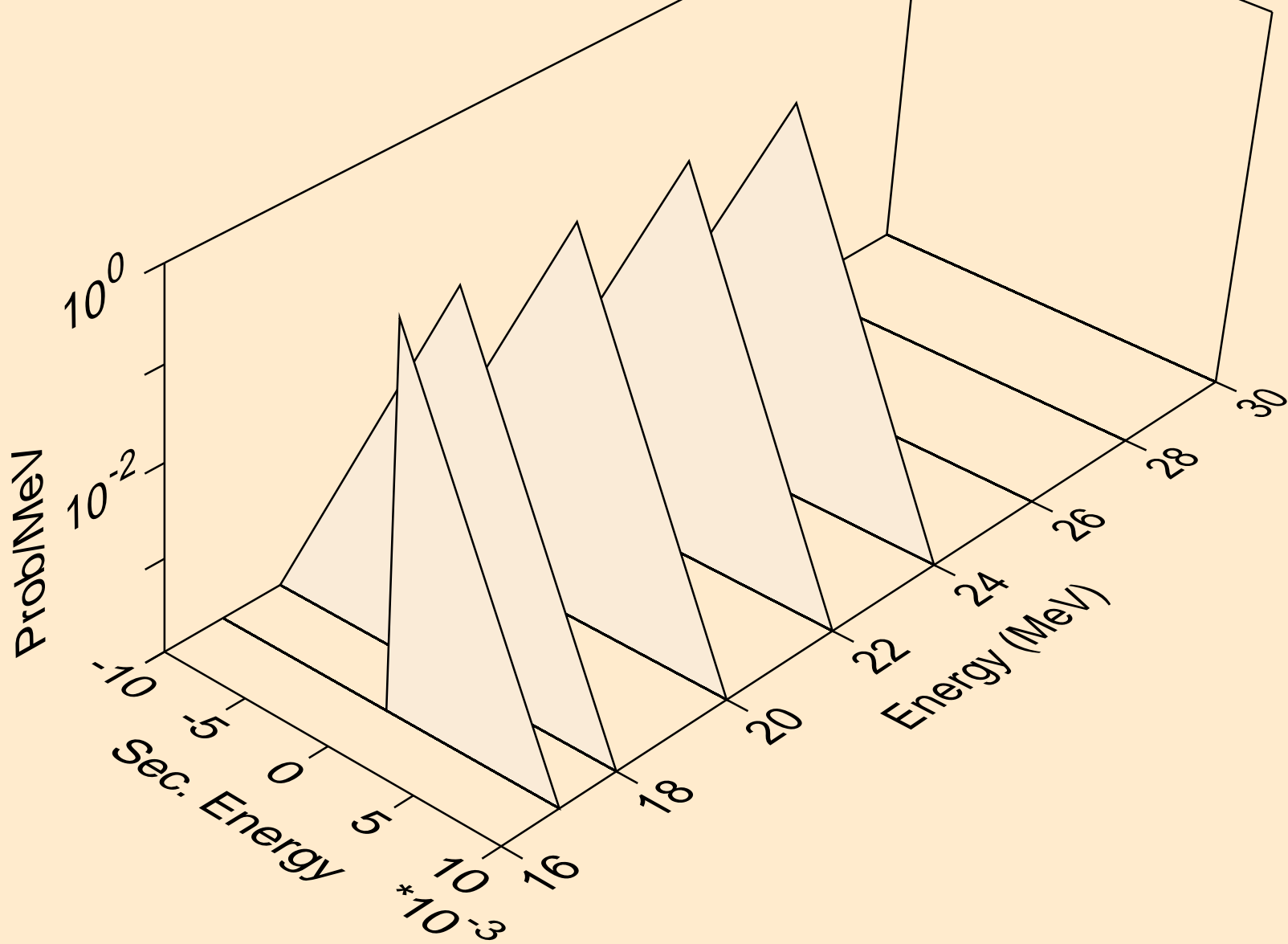

SB105 PHOTON ACER TENDL-2021 LIBRARY; T=0.K
photons from (g,pt)

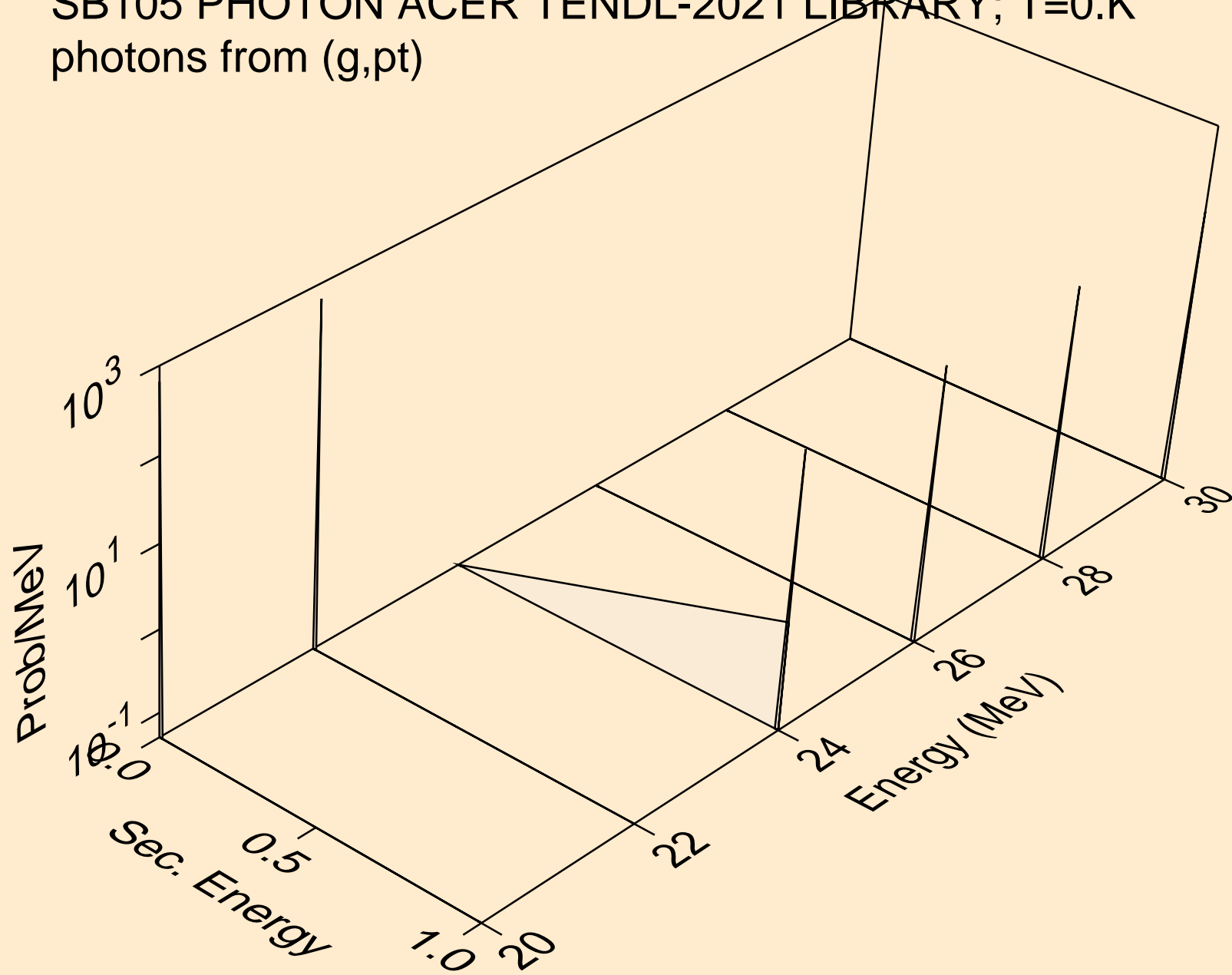

SB105 PHOTON ACER TENDL-2021 LIBRARY; T=0.K
protons from (g,n*)p

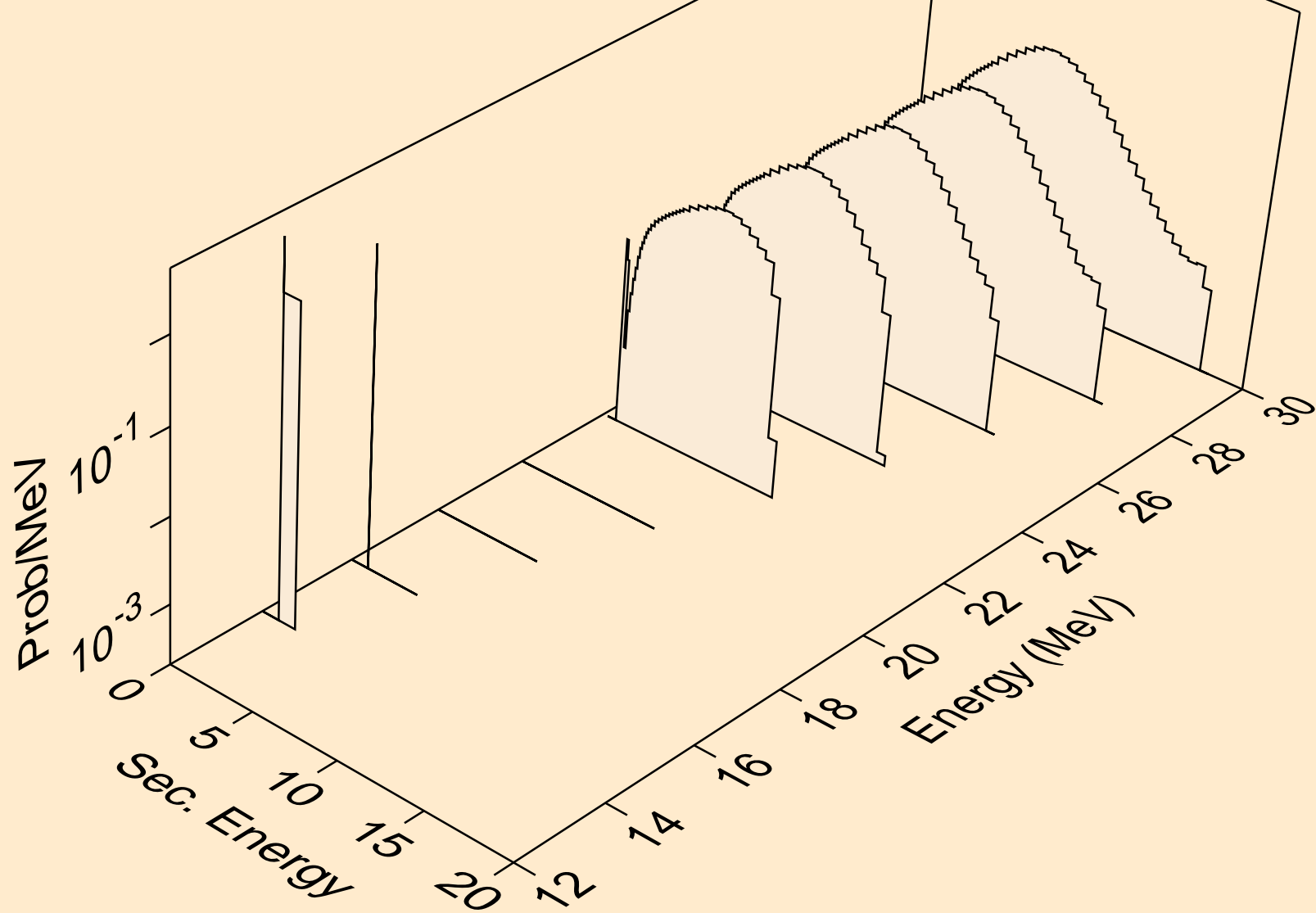

SB105 PHOTON ACER TENDL-2021 LIBRARY; T=0.K
protons from (g,2np)

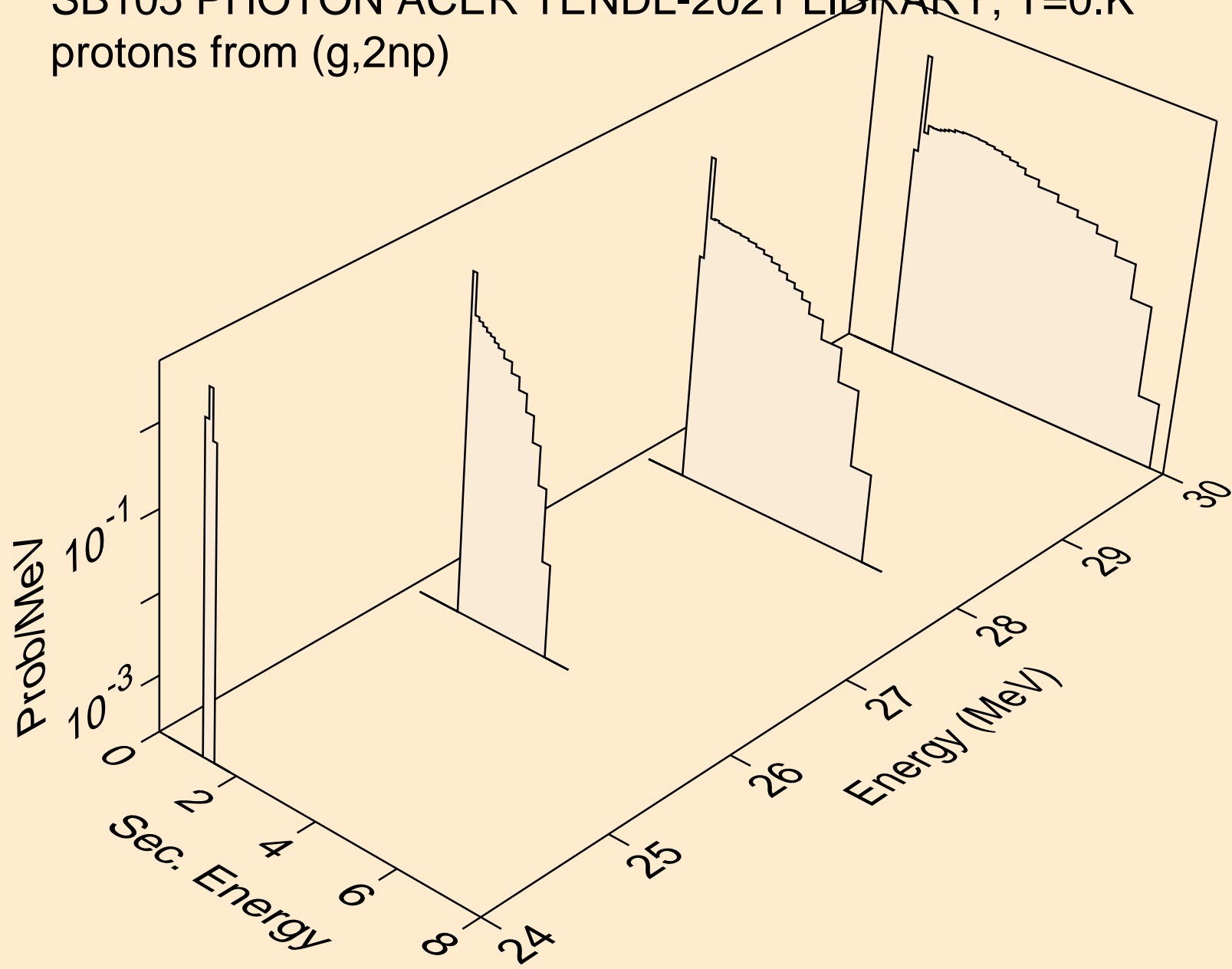

SB105 PHOTON ACER TENDL-2021 LIBRARY; T=0.K
protons from (g,2np)

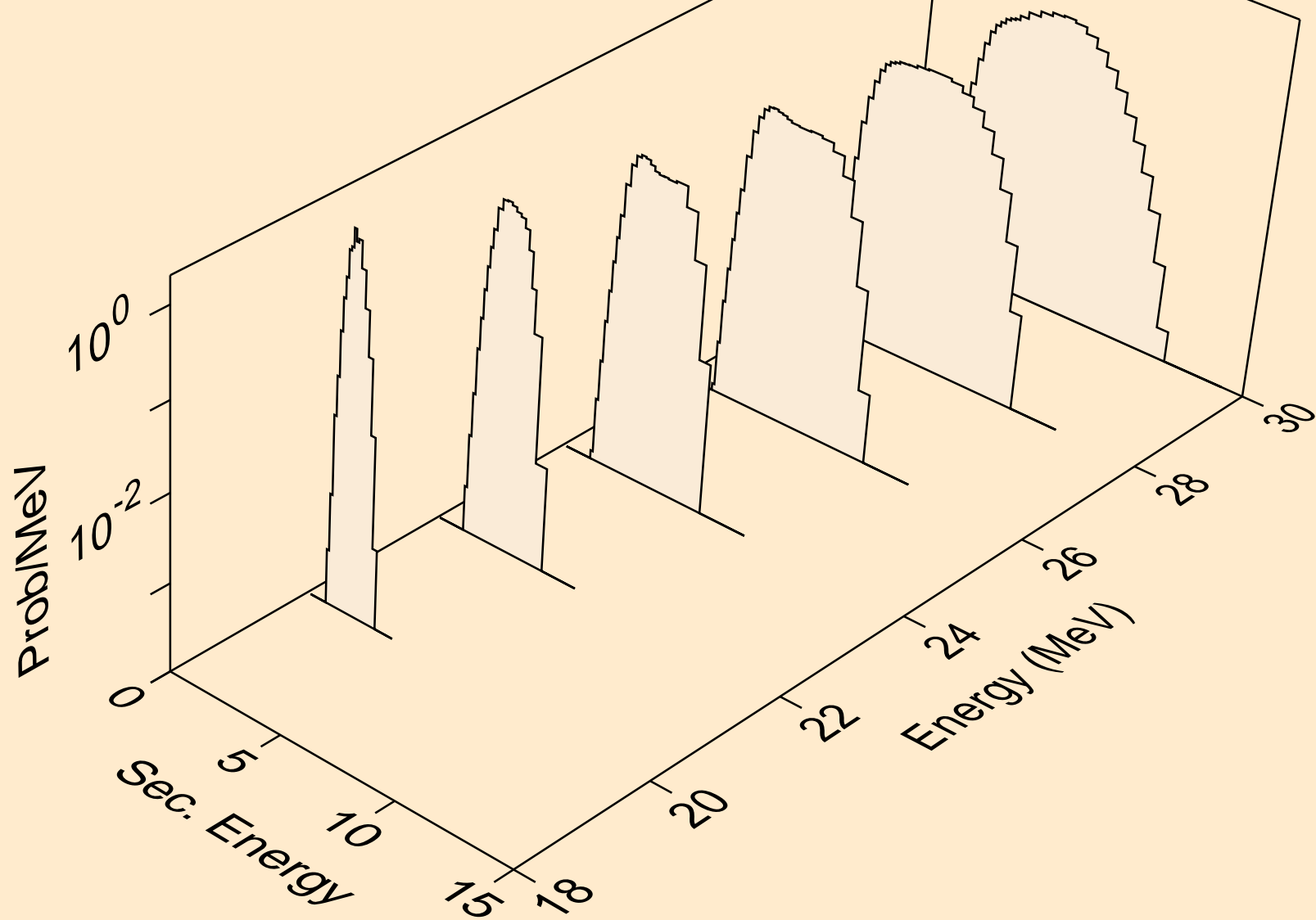

SB105 PHOTON ACER TENDL-2021 LIBRARY; T=0.K
protons from (g,npa)

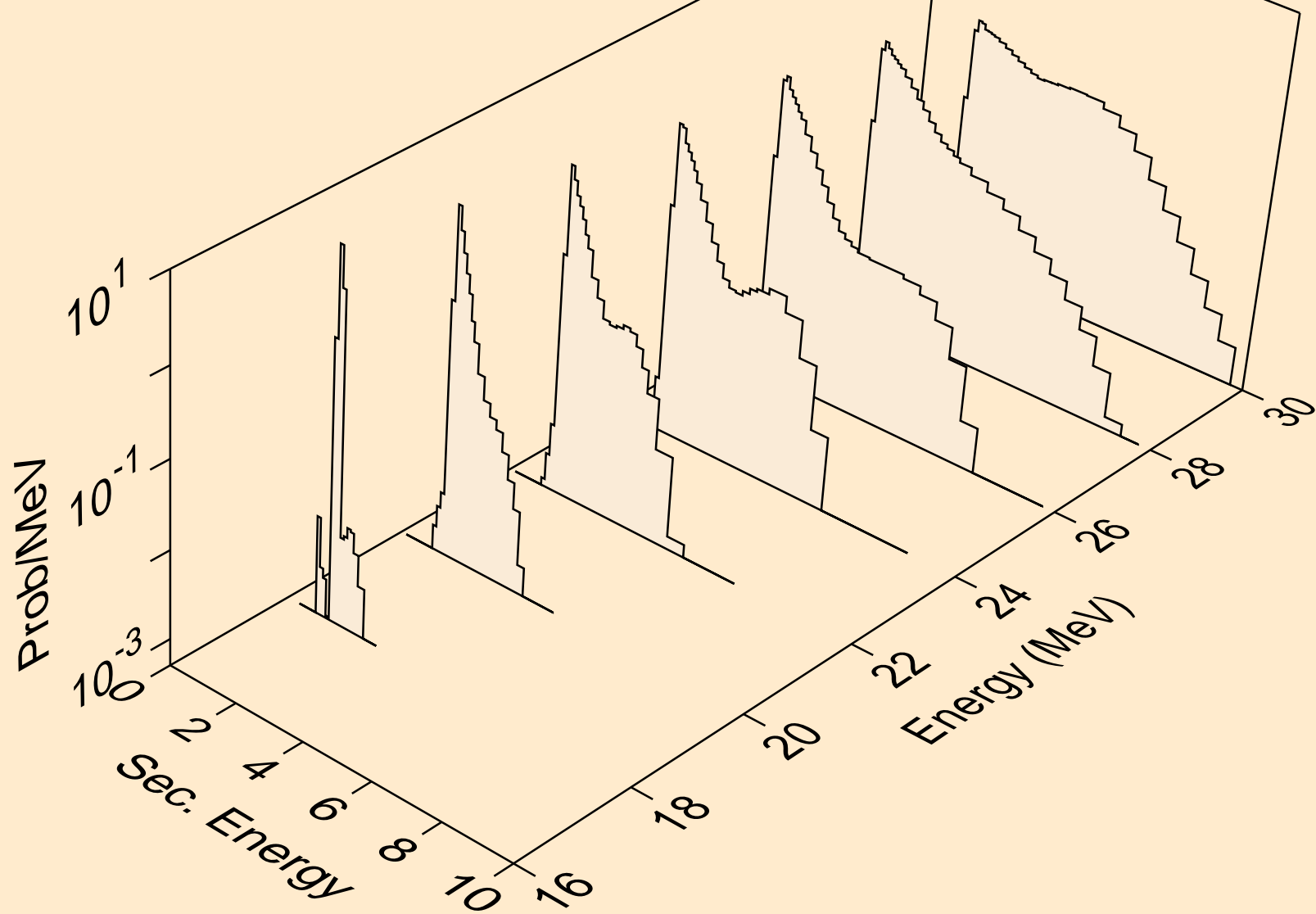

SB105 PHOTON ACER TENDL-2021 LIBRARY; T=0.K
protons from (g,p)

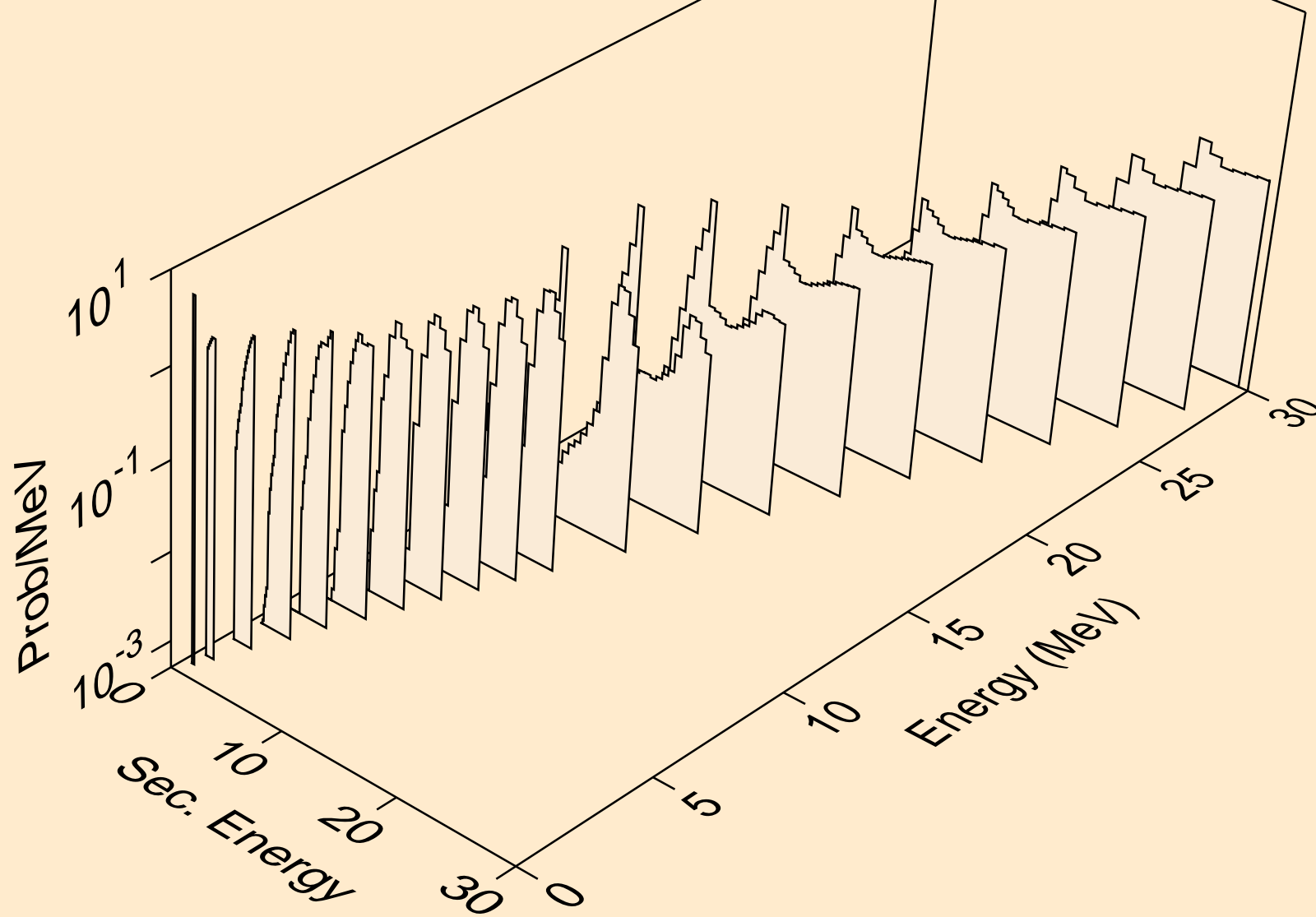

SB105 PHOTON ACER TENDL-2021 LIBRARY; T=0.K
protons from (g,2p)

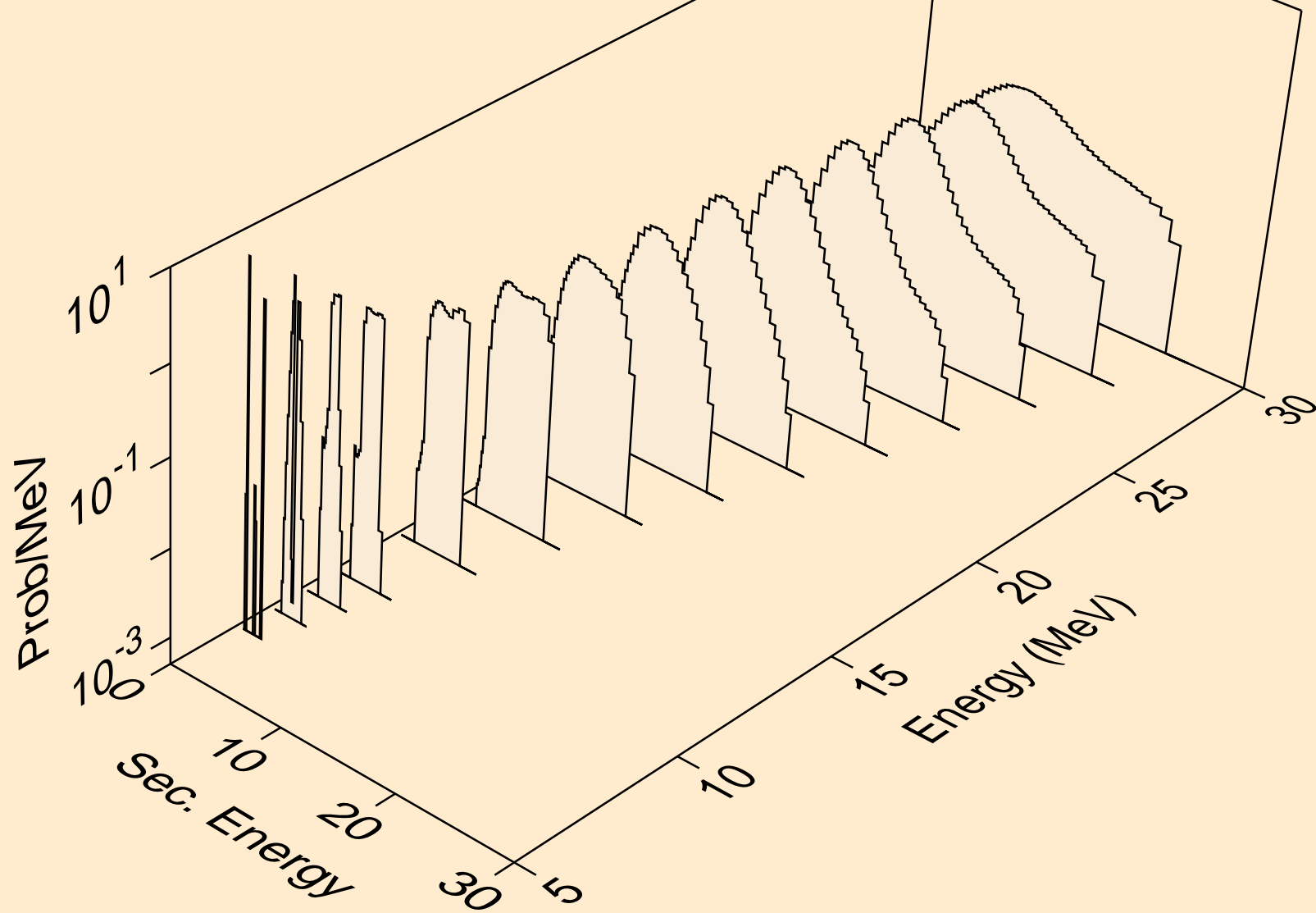

SB105 PHOTON ACER TENDL-2021 LIBRARY; T=0.K
protons from (g,pa)

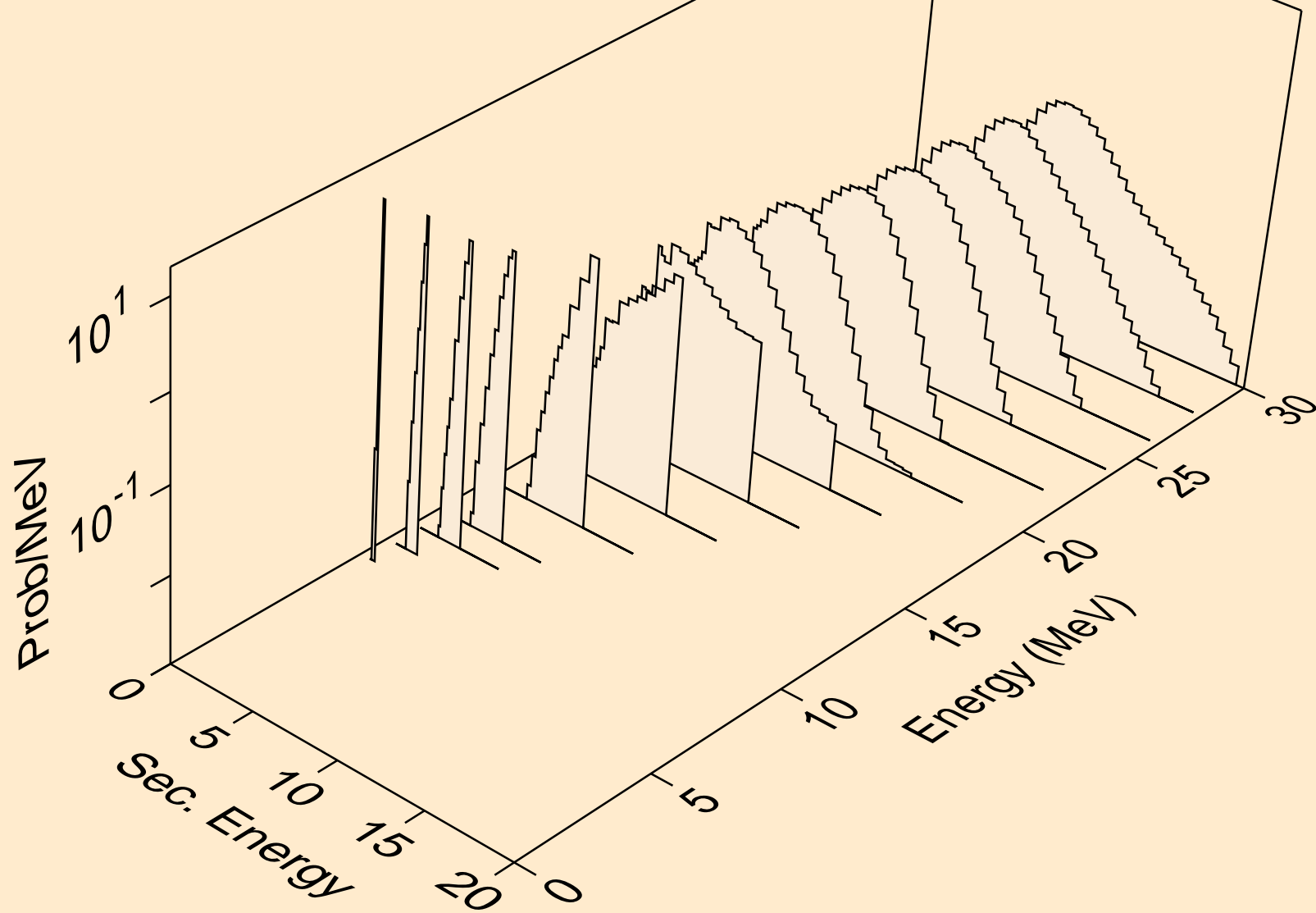

SB105 PHOTON ACER TENDL-2021 LIBRARY; T=0.K
protons from (g,pd)

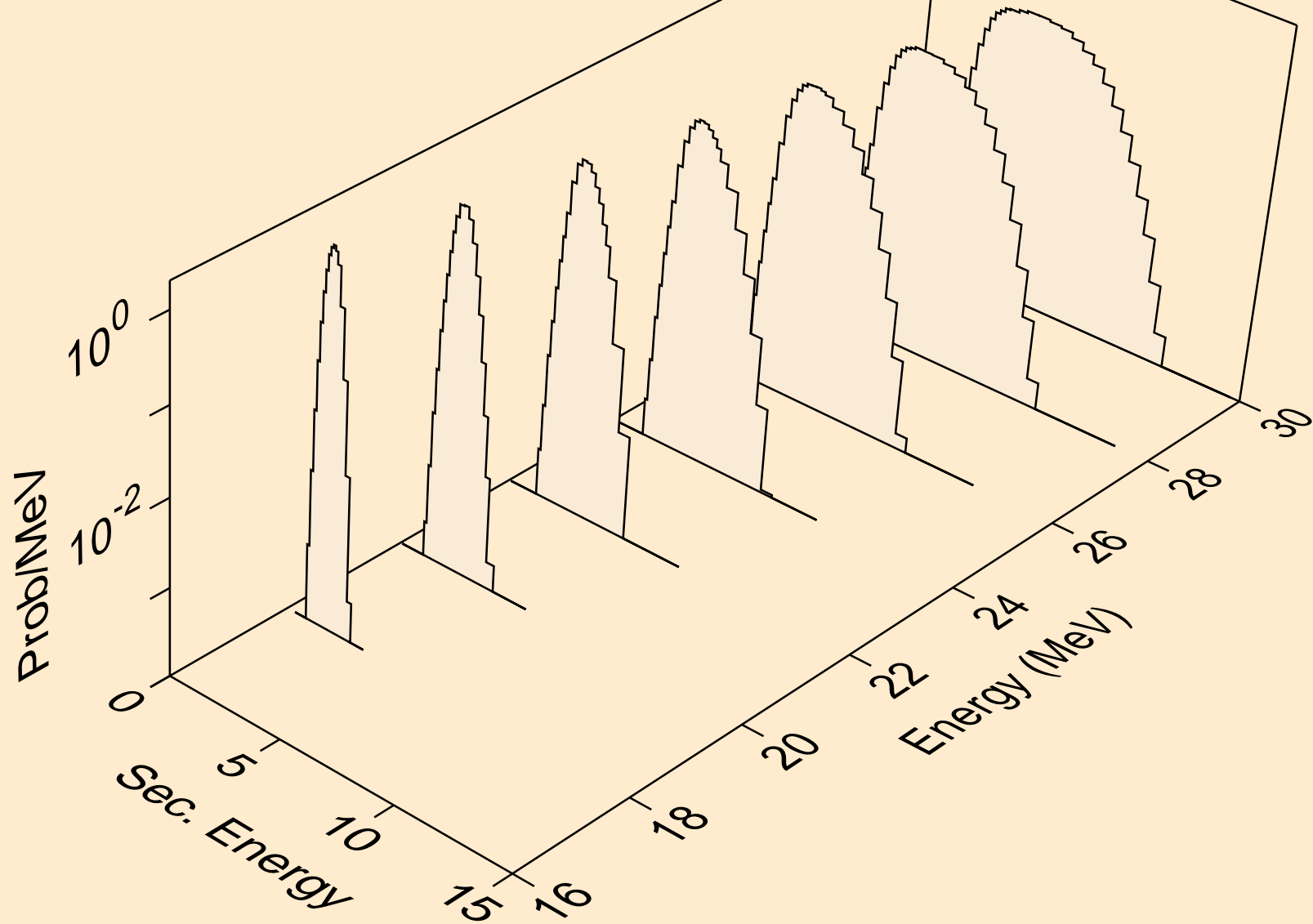

SB105 PHOTON ACER TENDL-2021 LIBRARY; T=0.K
protons from (g,pt)

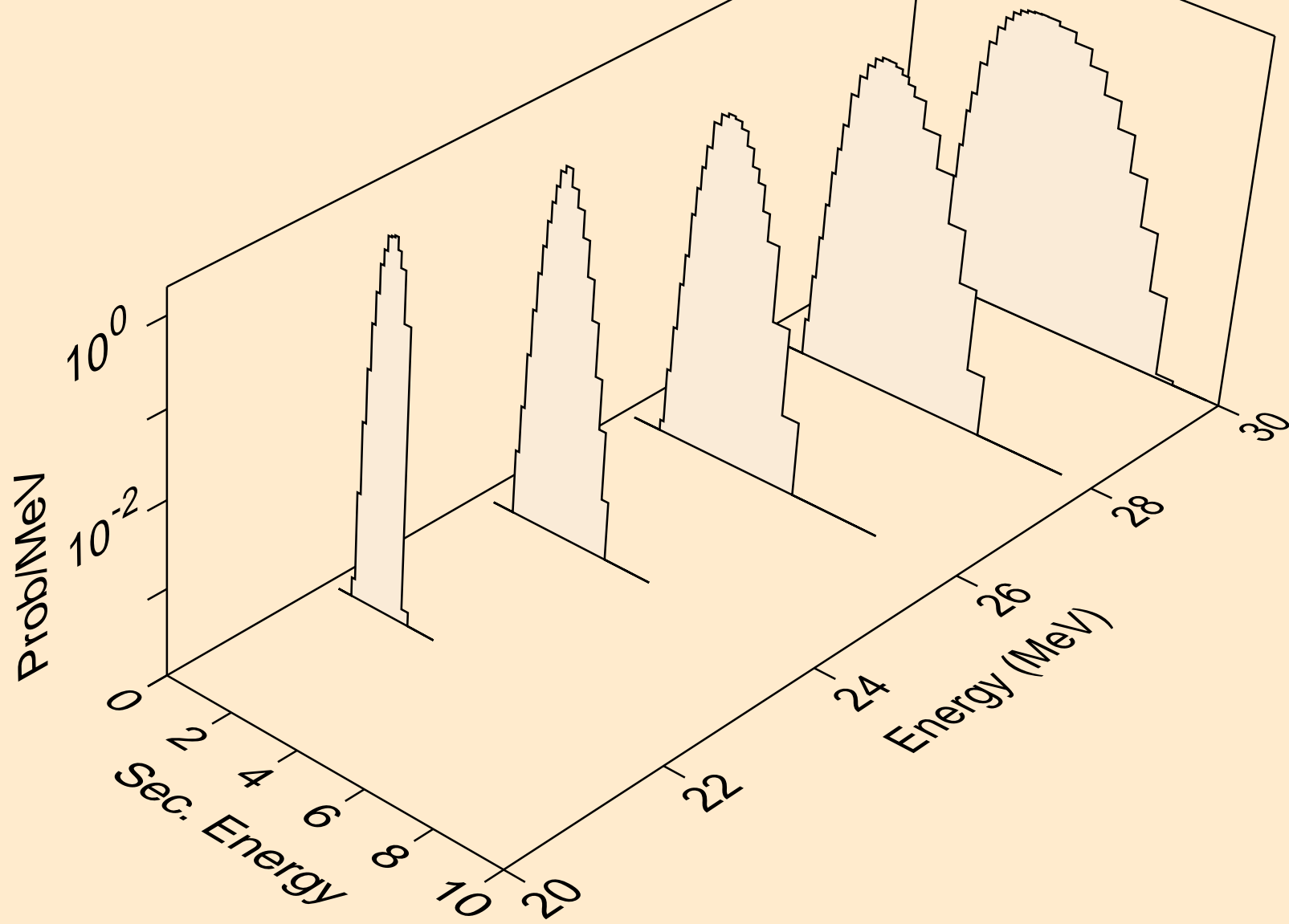

SB105 PHOTON ACER TENDL-2021 LIBRARY; T=0.K
deuterons from (g,x)

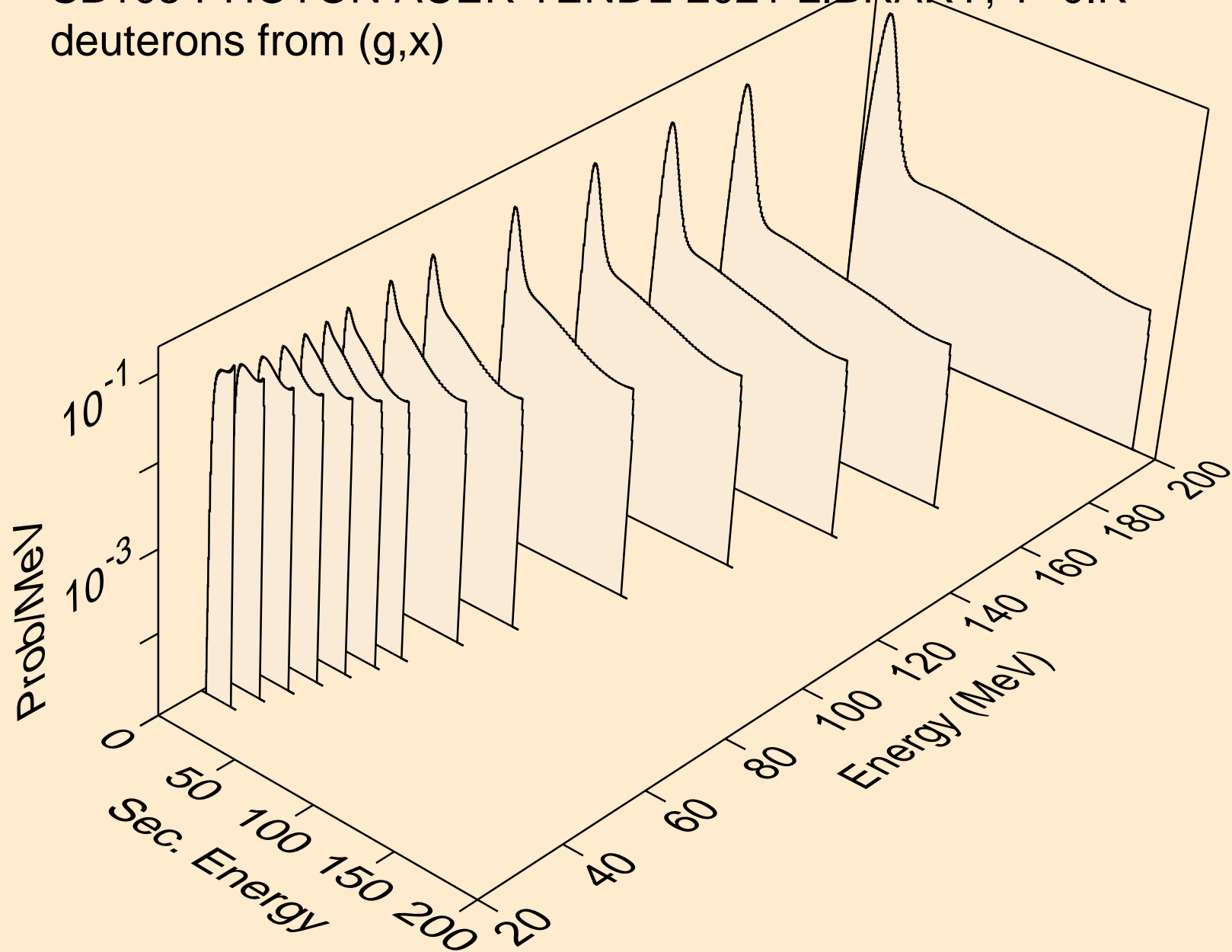

SB105 PHOTON ACER TENDL-2021 LIBRARY; T=0.K
deuterons from (g,n*)d

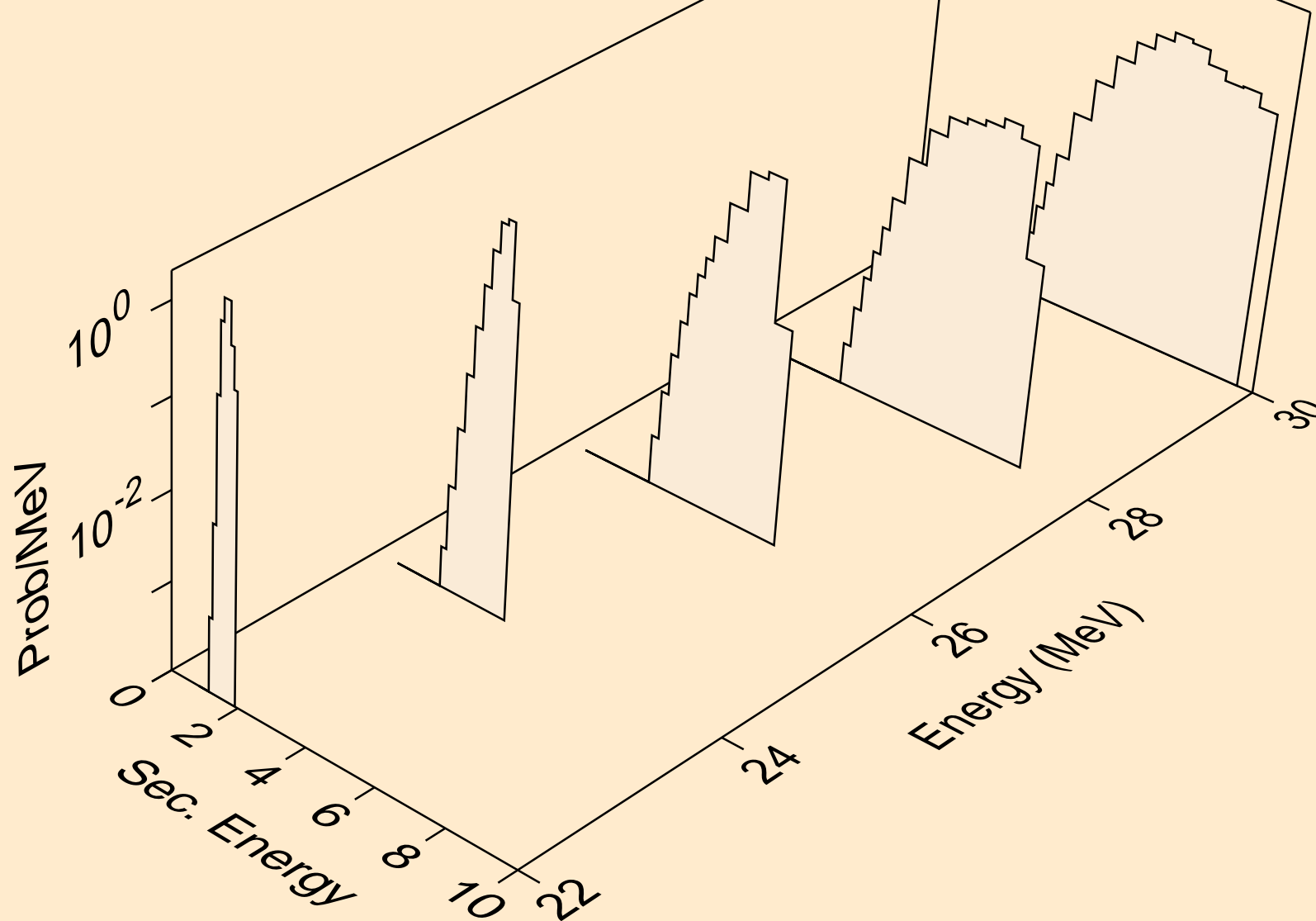

SB105 PHOTON ACER TENDL-2021 LIBRARY; T=0.K
deuterons from (g,d)

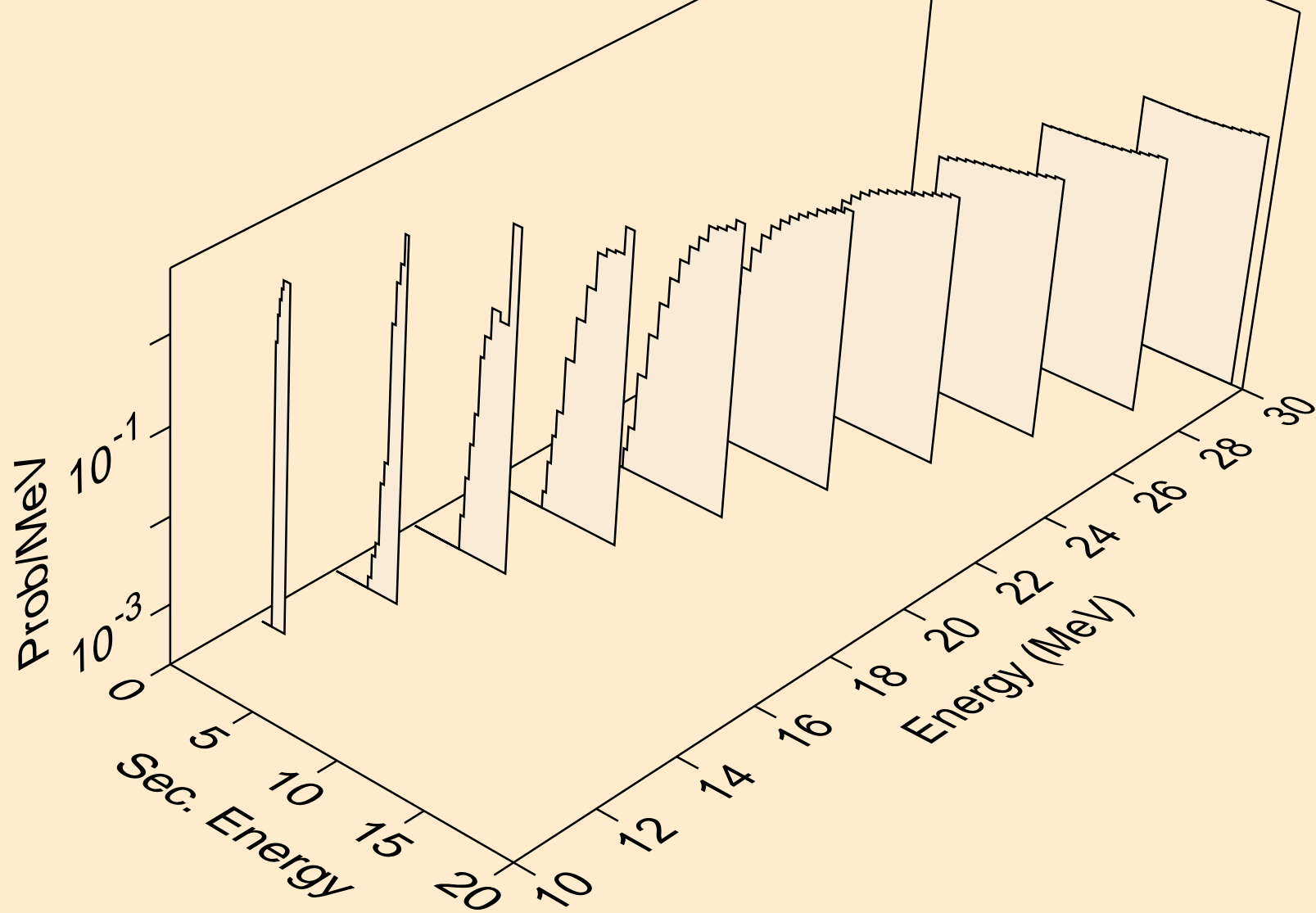

SB105 PHOTON ACER TENDL-2021 LIBRARY; T=0.K
deuterons from (g,pd)

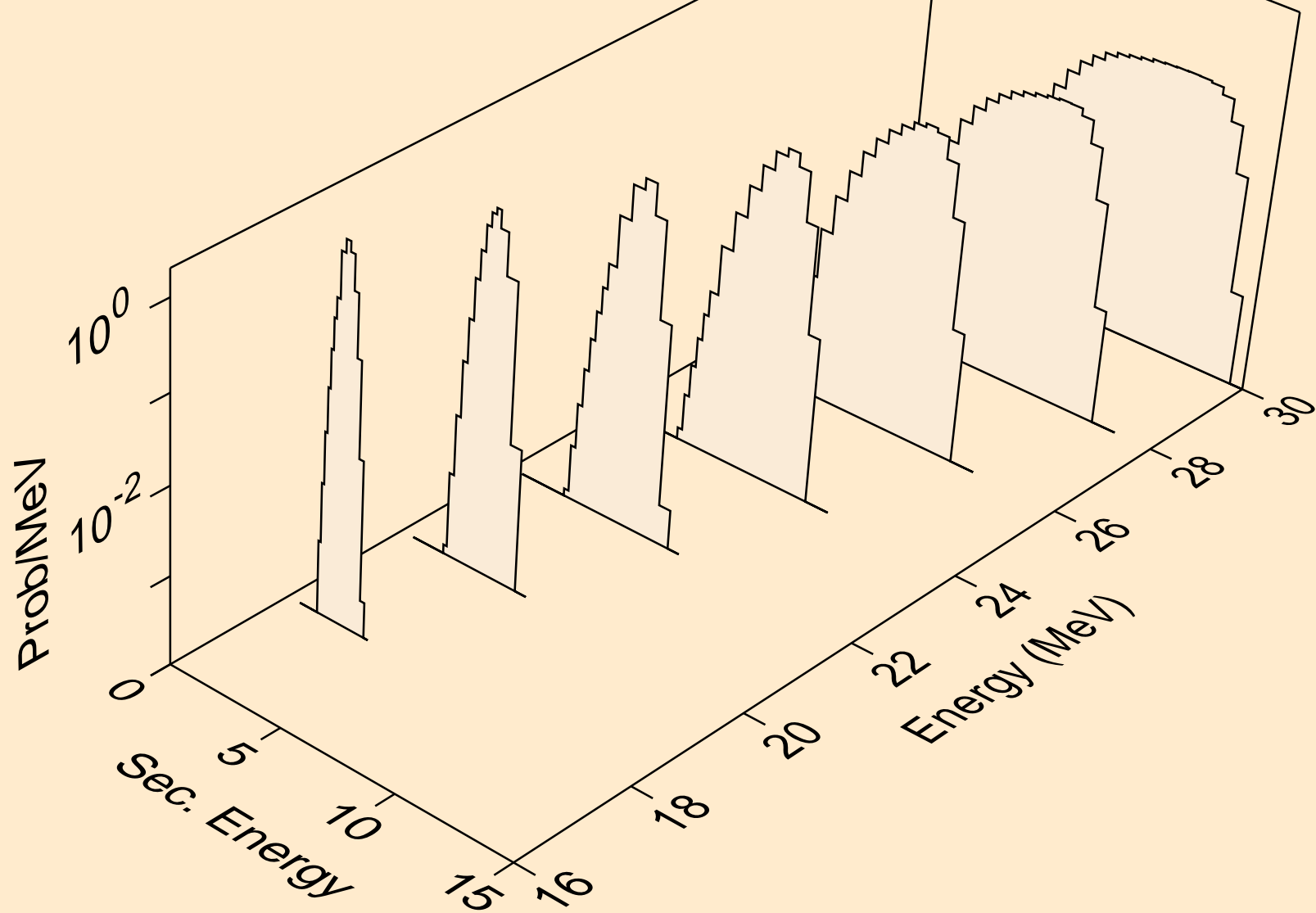

SB105 PHOTON ACER TENDL-2021 LIBRARY; T=0.K
deuterons from (g,da)

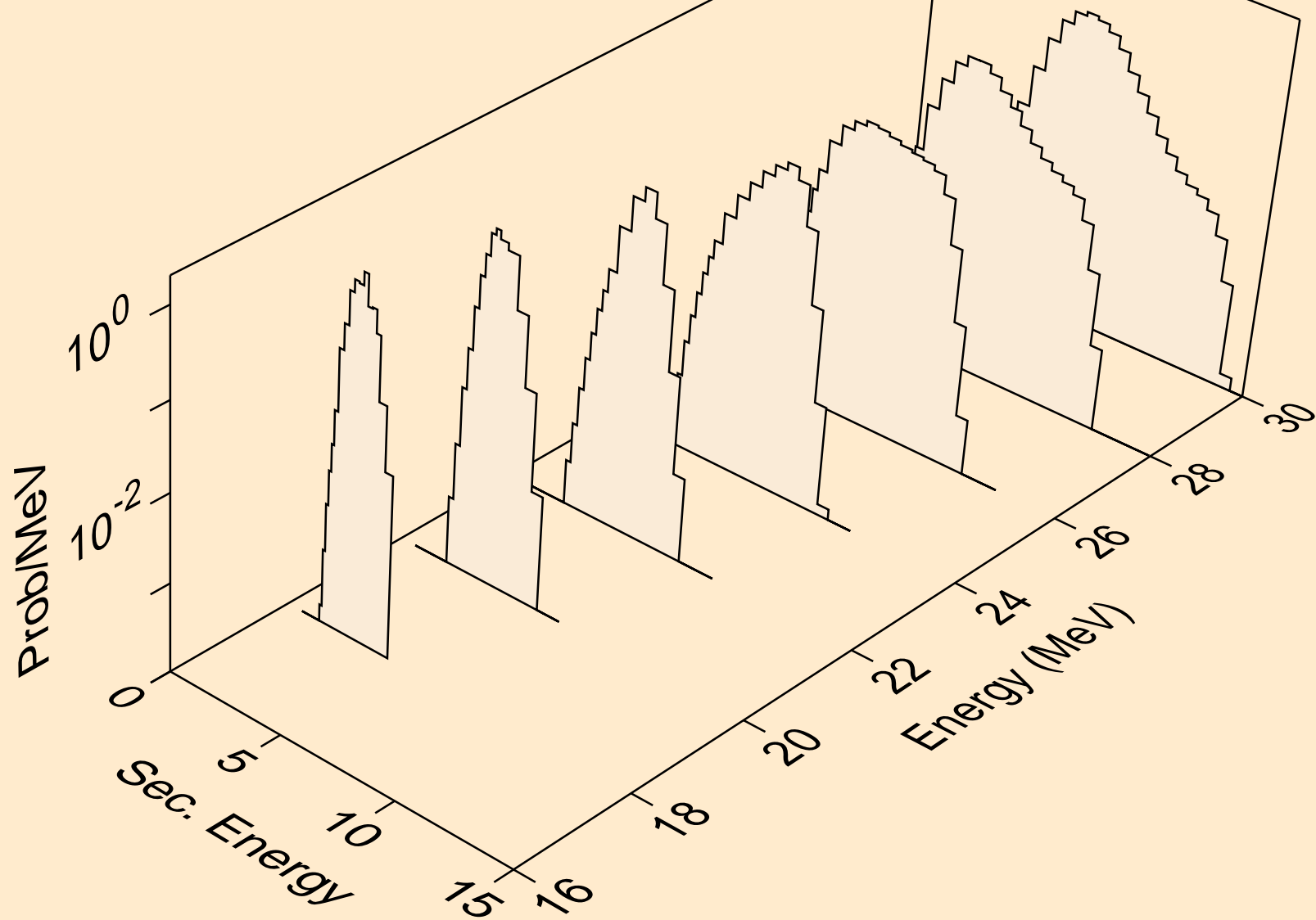

SB105 PHOTON ACER TENDL-2021 LIBRARY; T=0.K
tritons from (g,x)

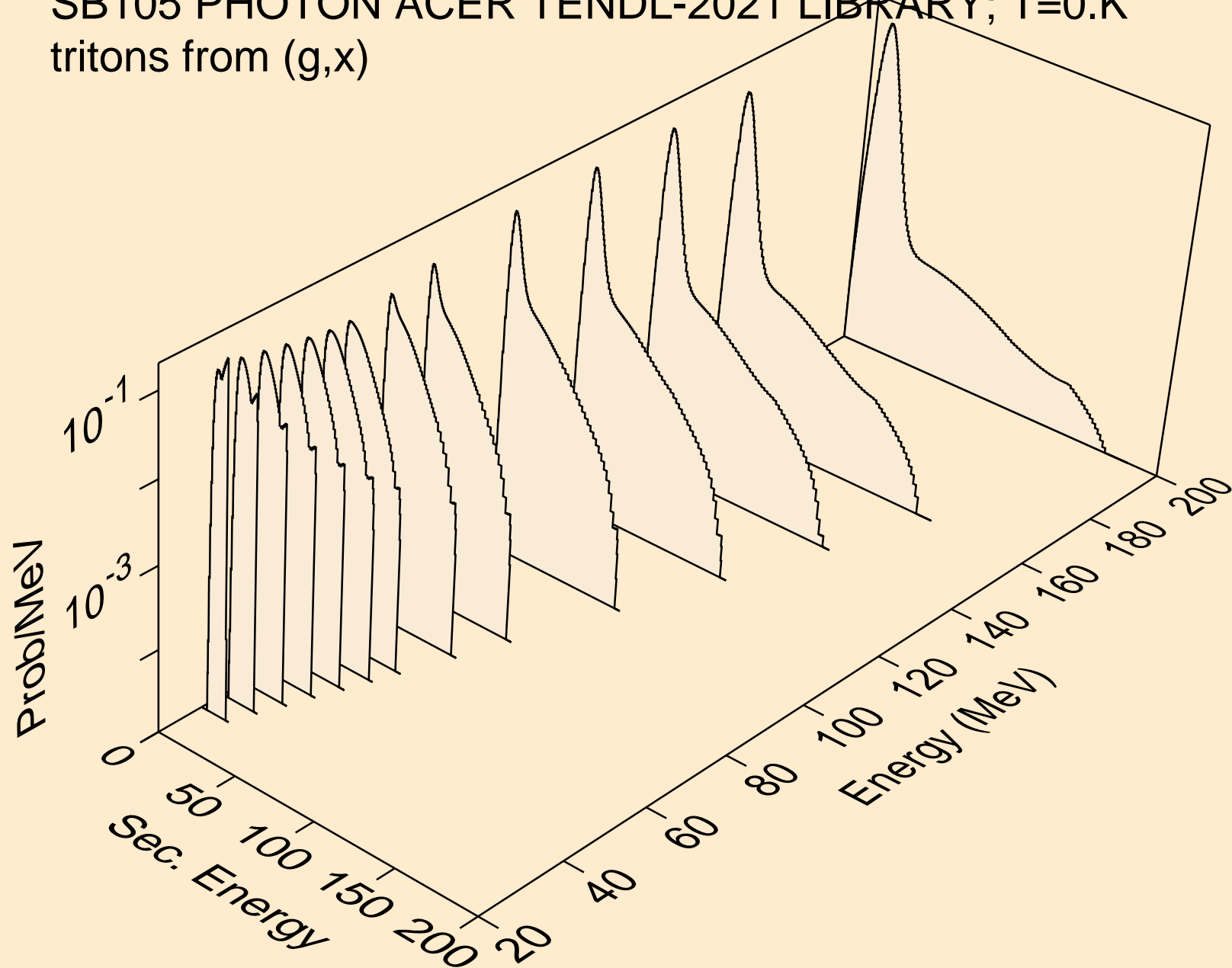

SB105 PHOTON ACER TENDL-2021 LIBRARY; T=0.K
tritons from (g,t)

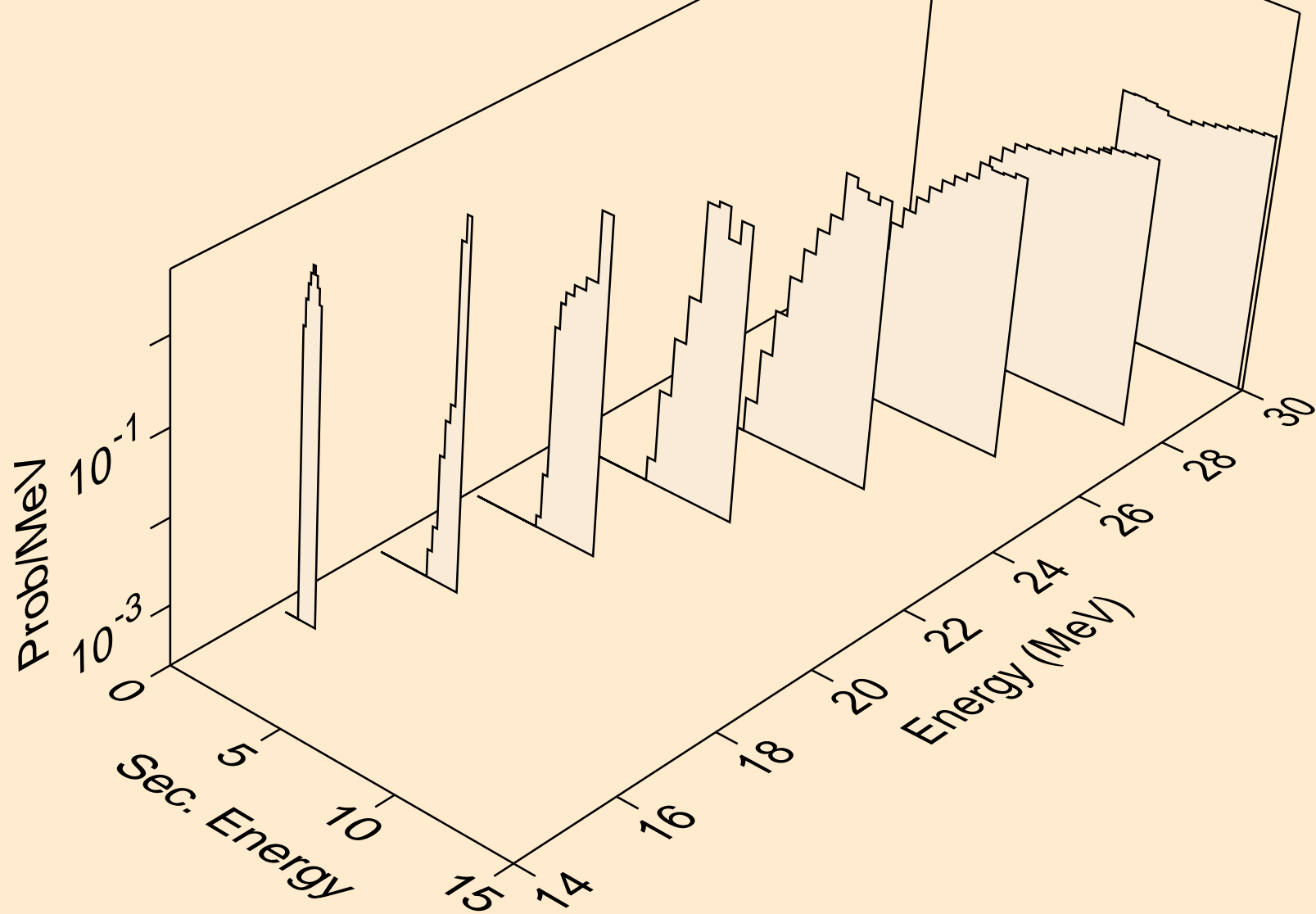

SB105 PHOTON ACER TENDL-2021 LIBRARY; T=0.K
tritons from (g,pt)

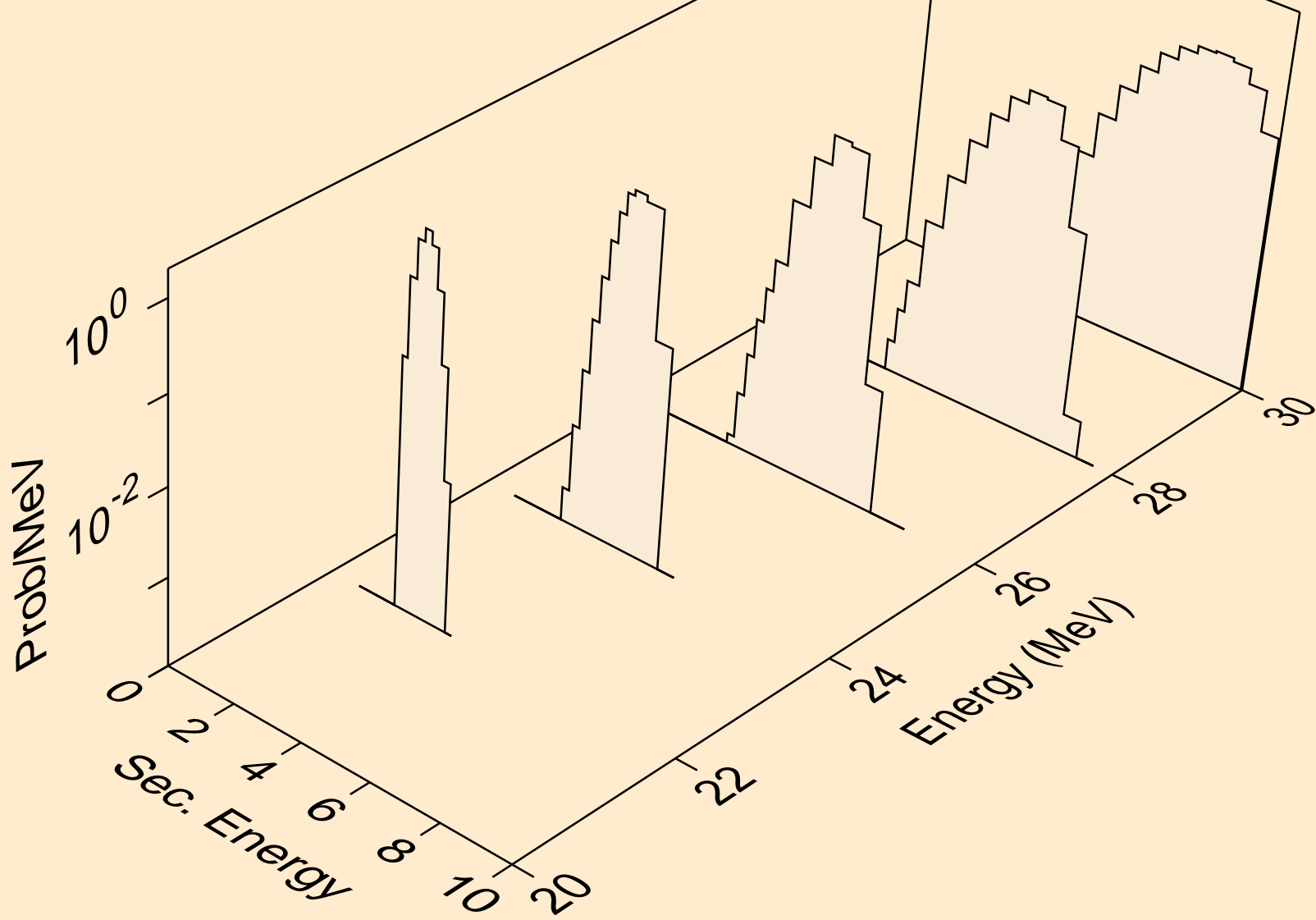

SB105 PHOTON ACER TENDL-2021 LIBRARY; T=0.K
he3s from (g,x)

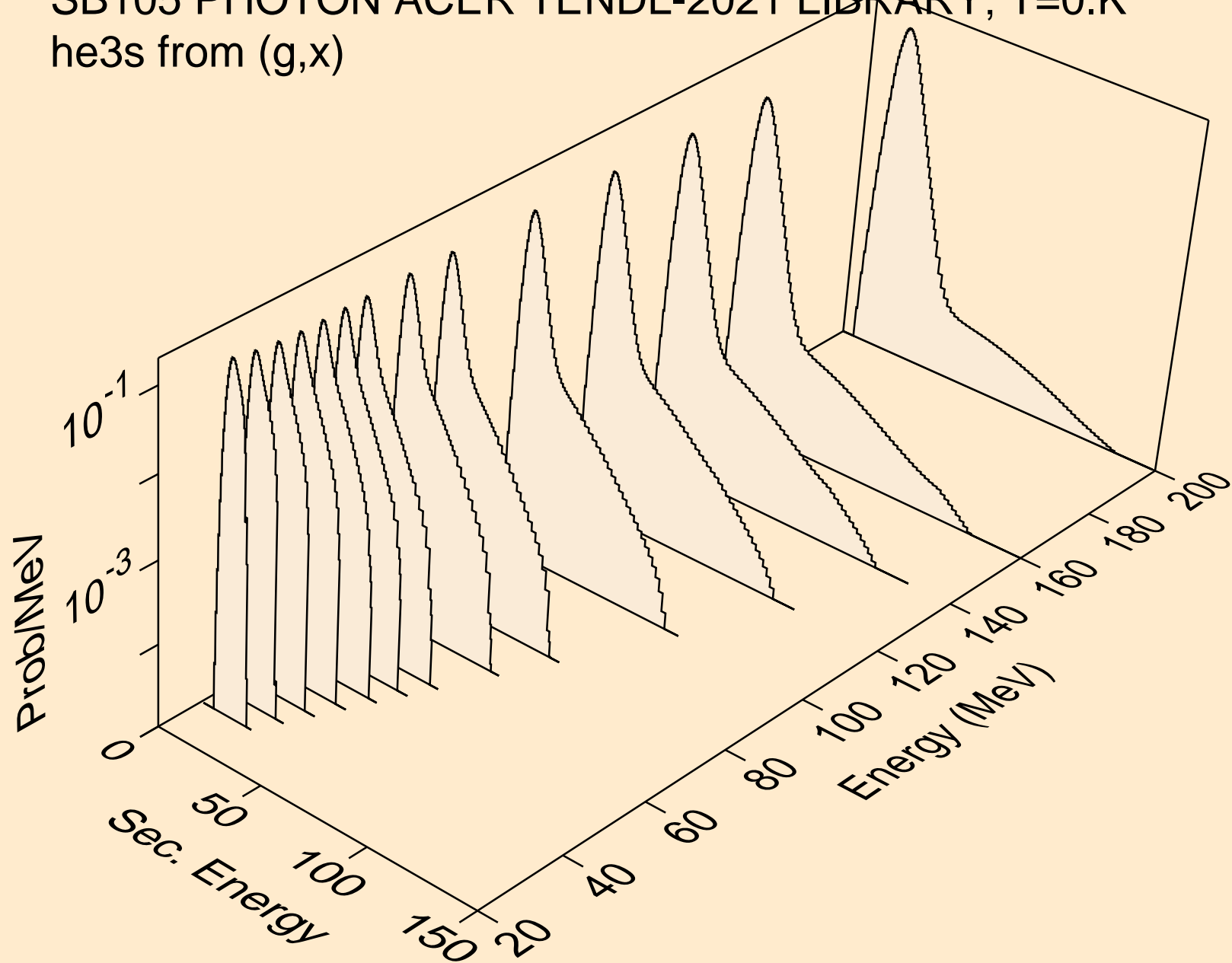

SB105 PHOTON ACER TENDL-2021 LIBRARY; T=0.K
he3s from (g,n*)he3

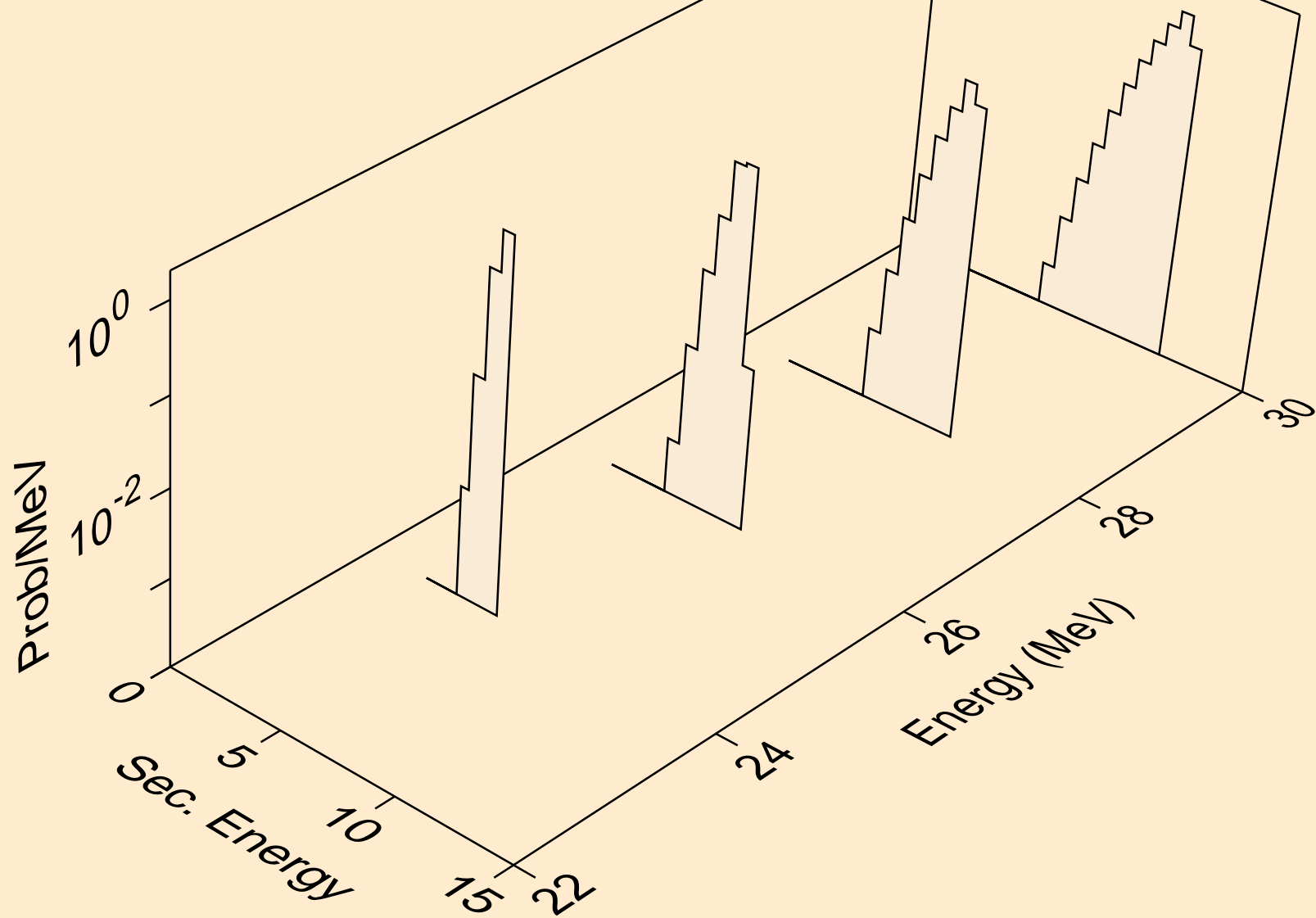

SB105 PHOTON ACER TENDL-2021 LIBRARY; T=0.K
he3s from (g,he3)

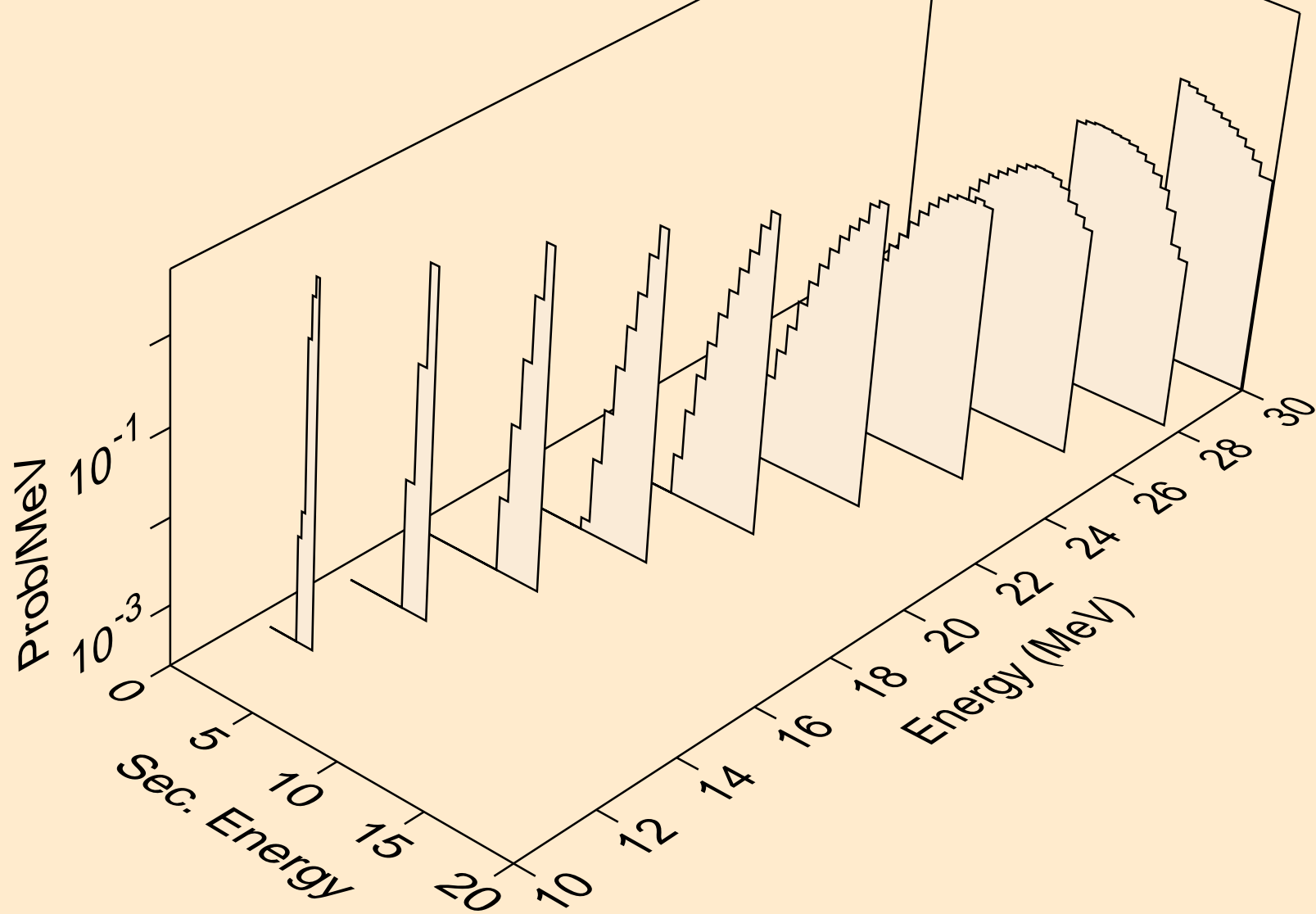

SB105 PHOTON ACER TENDL-2021 LIBRARY; T=0.K
alphas from (g,x)

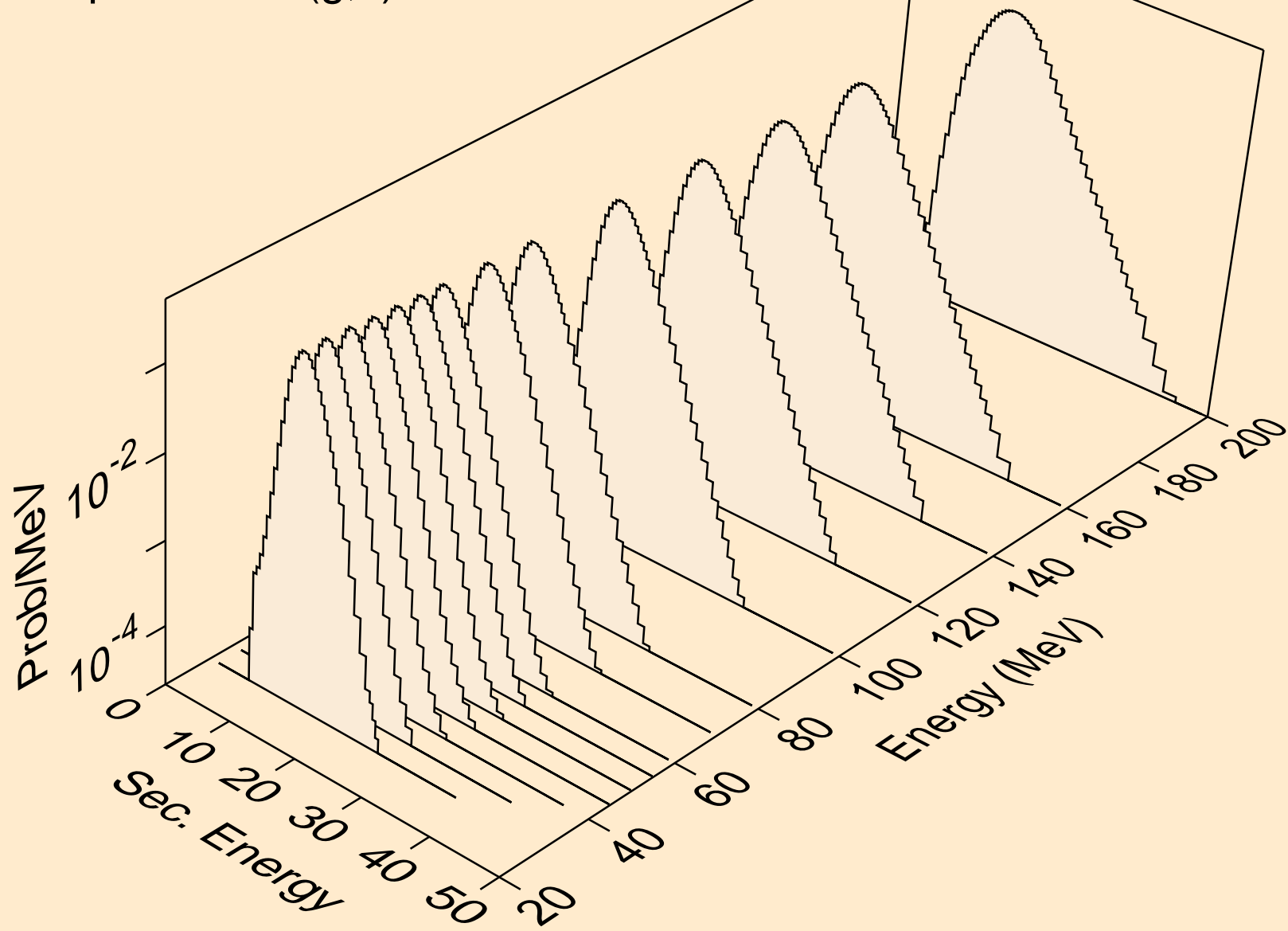

SB105 PHOTON ACER TENDL-2021 LIBRARY; T=0.K
alphas from (g,n*)a

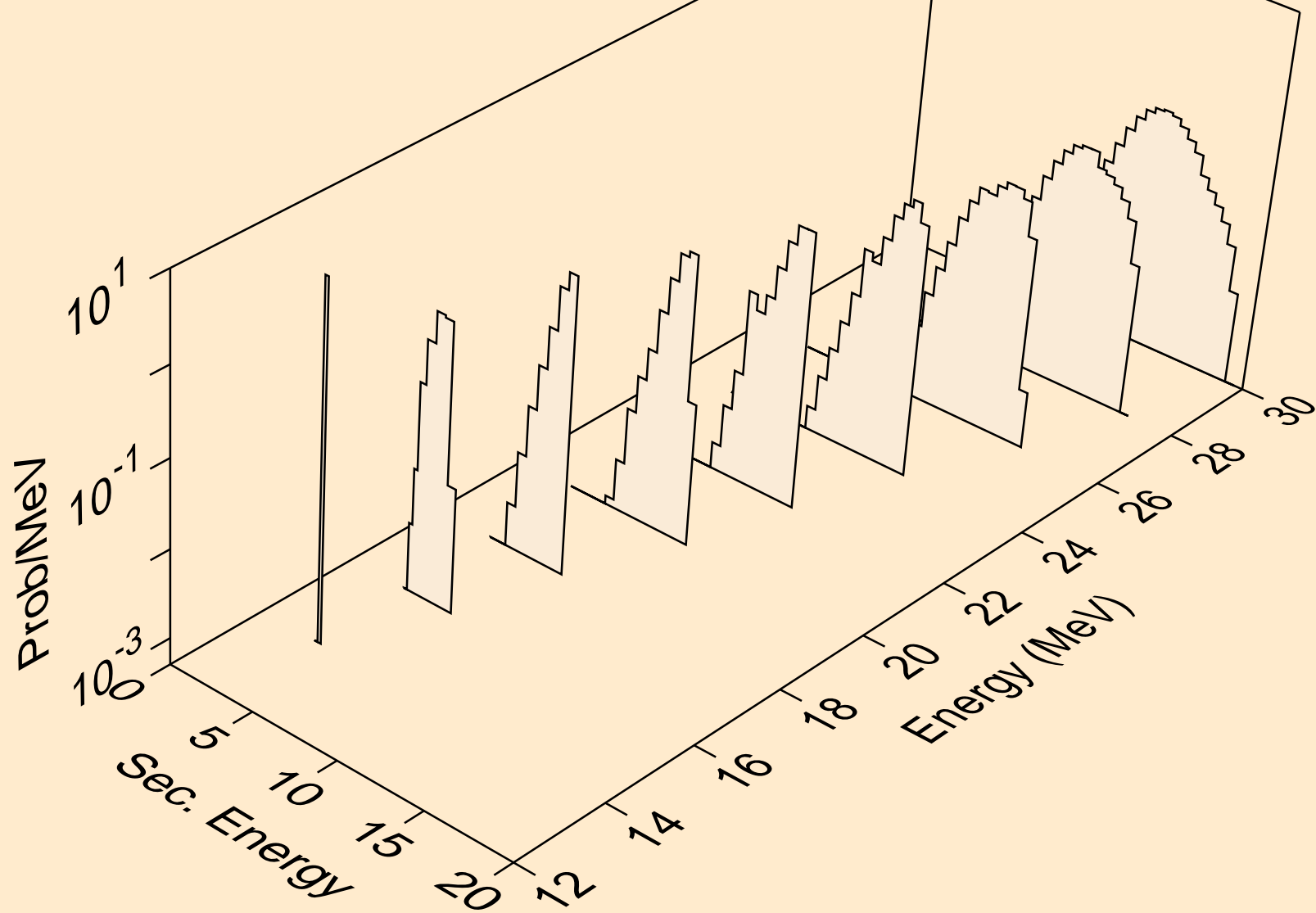

SB105 PHOTON ACER TENDL-2021 LIBRARY; T=0.K
alphas from (g,npa)

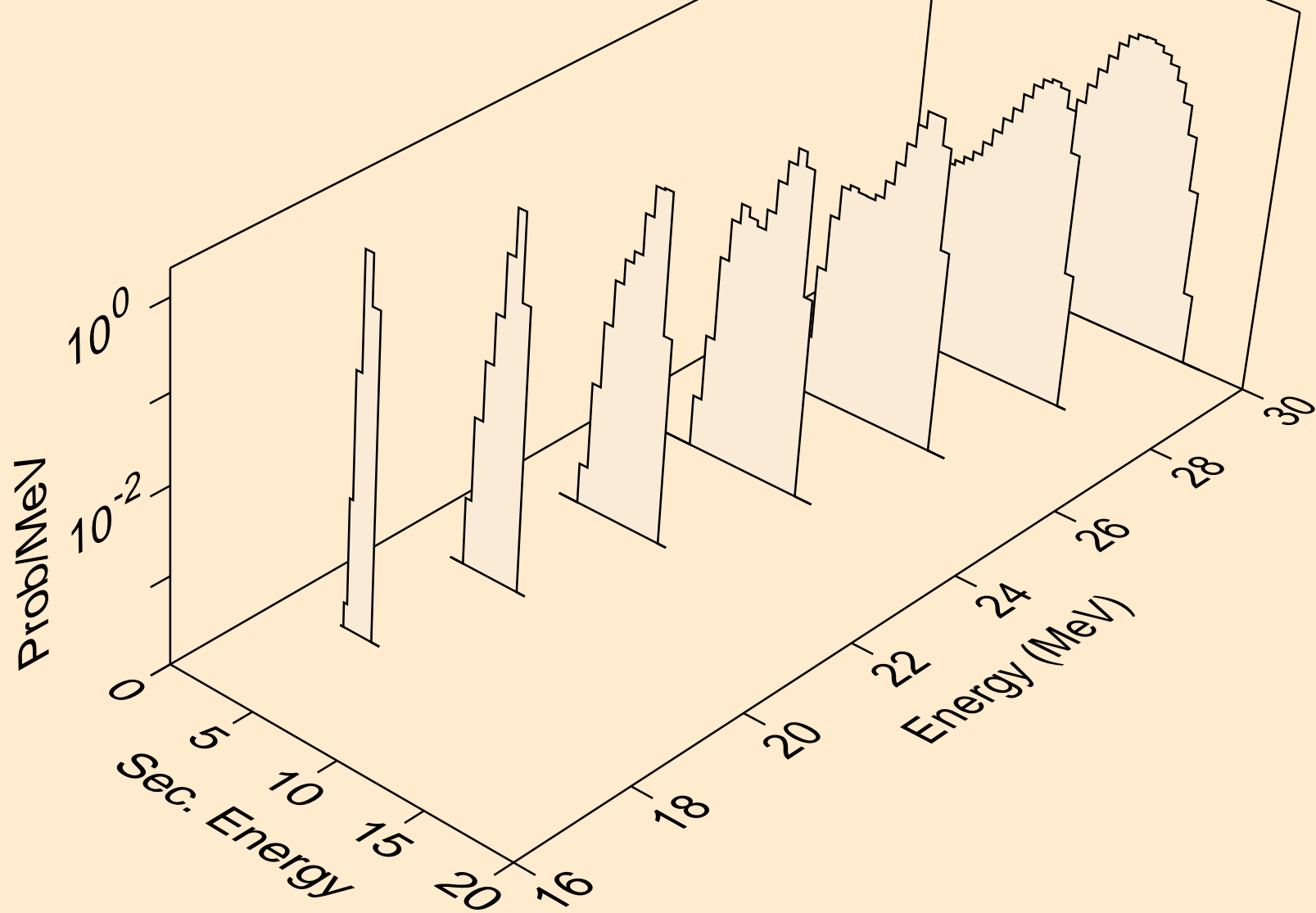

SB105 PHOTON ACER TENDL-2021 LIBRARY; T=0.K
alphas from (g,a)

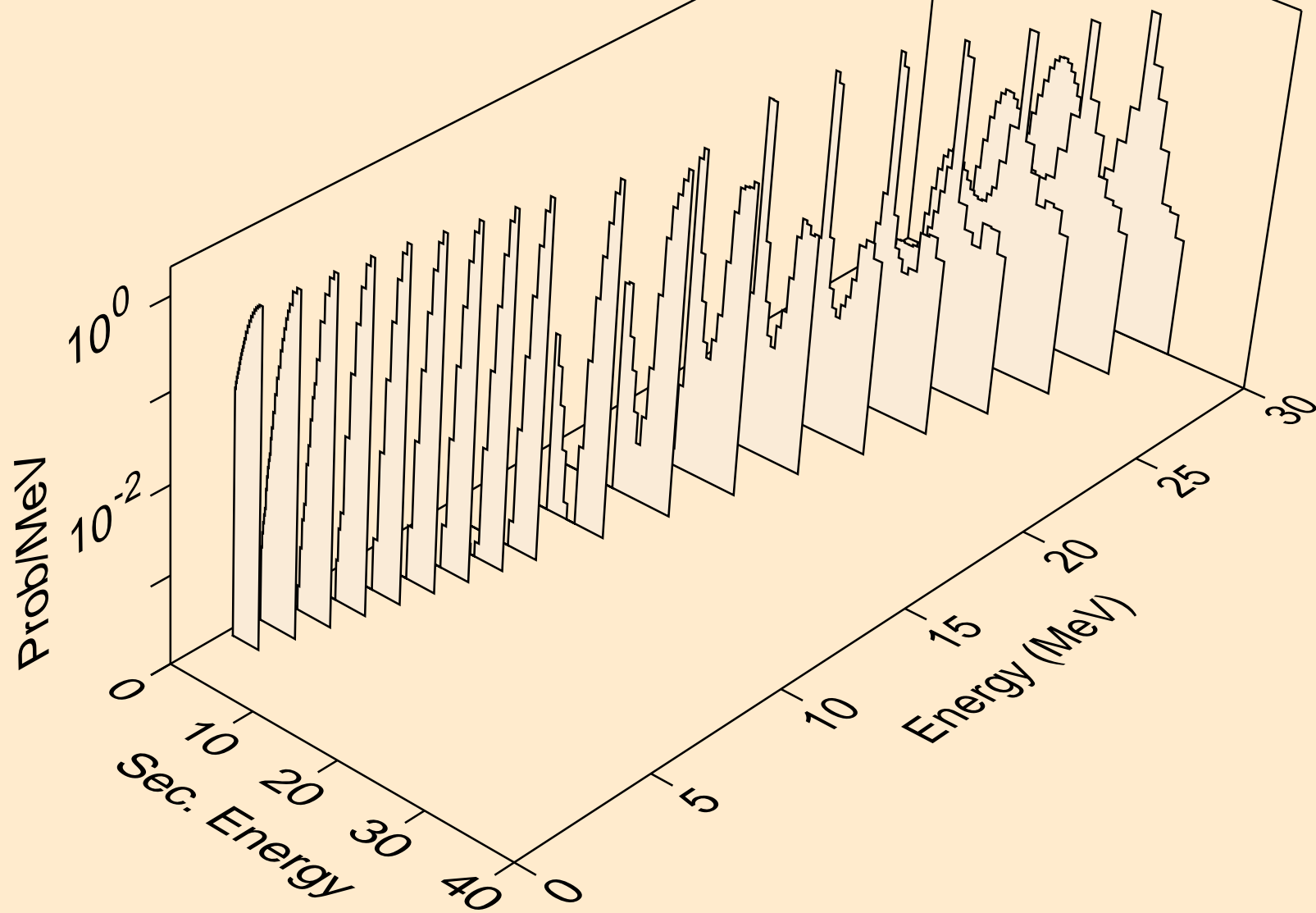

SB105 PHOTON ACER TENDL-2021 LIBRARY; T=0.K
alphas from (g,2a)

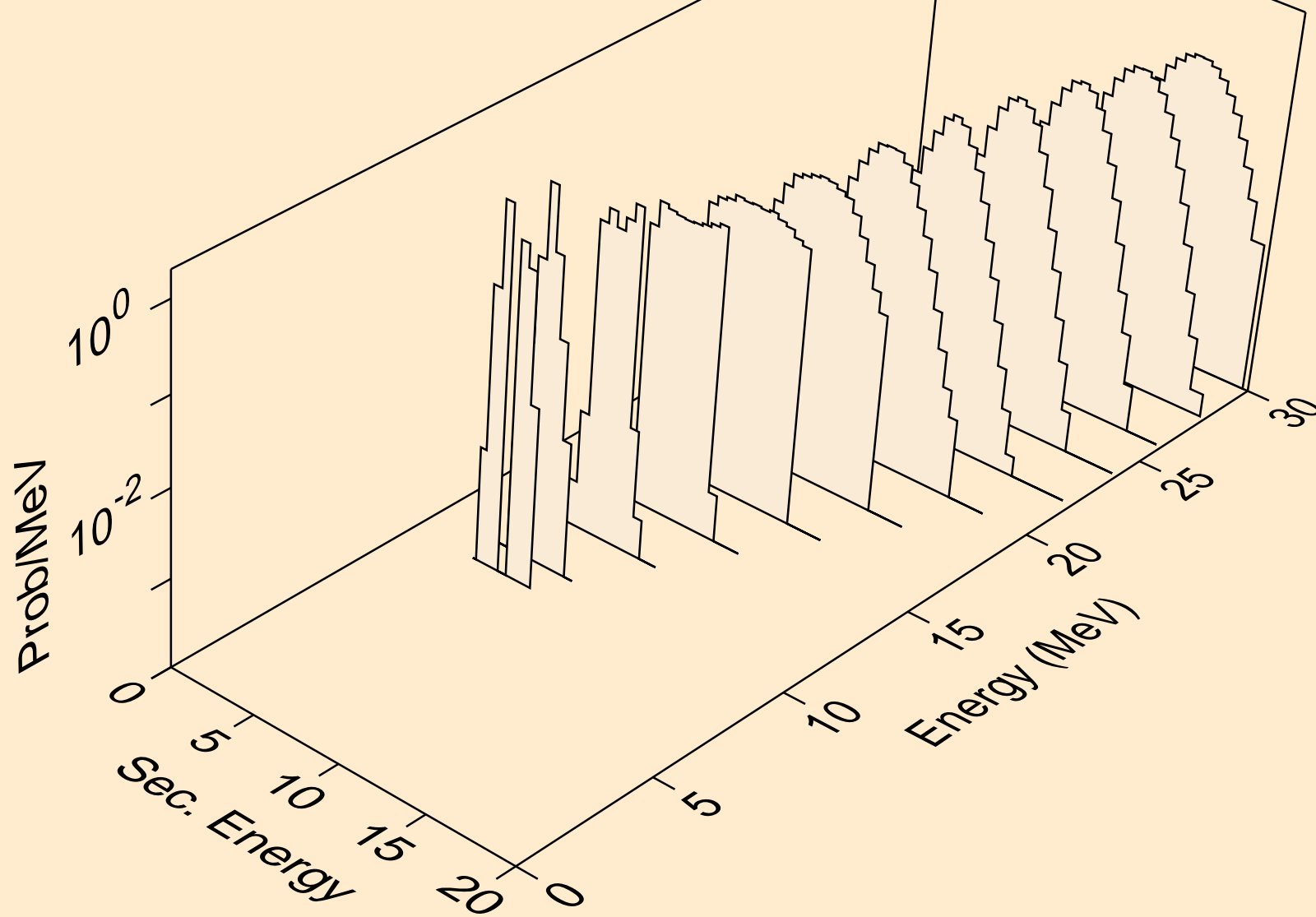

SB105 PHOTON ACER TENDL-2021 LIBRARY; T=0.K
alphas from (g,pa)

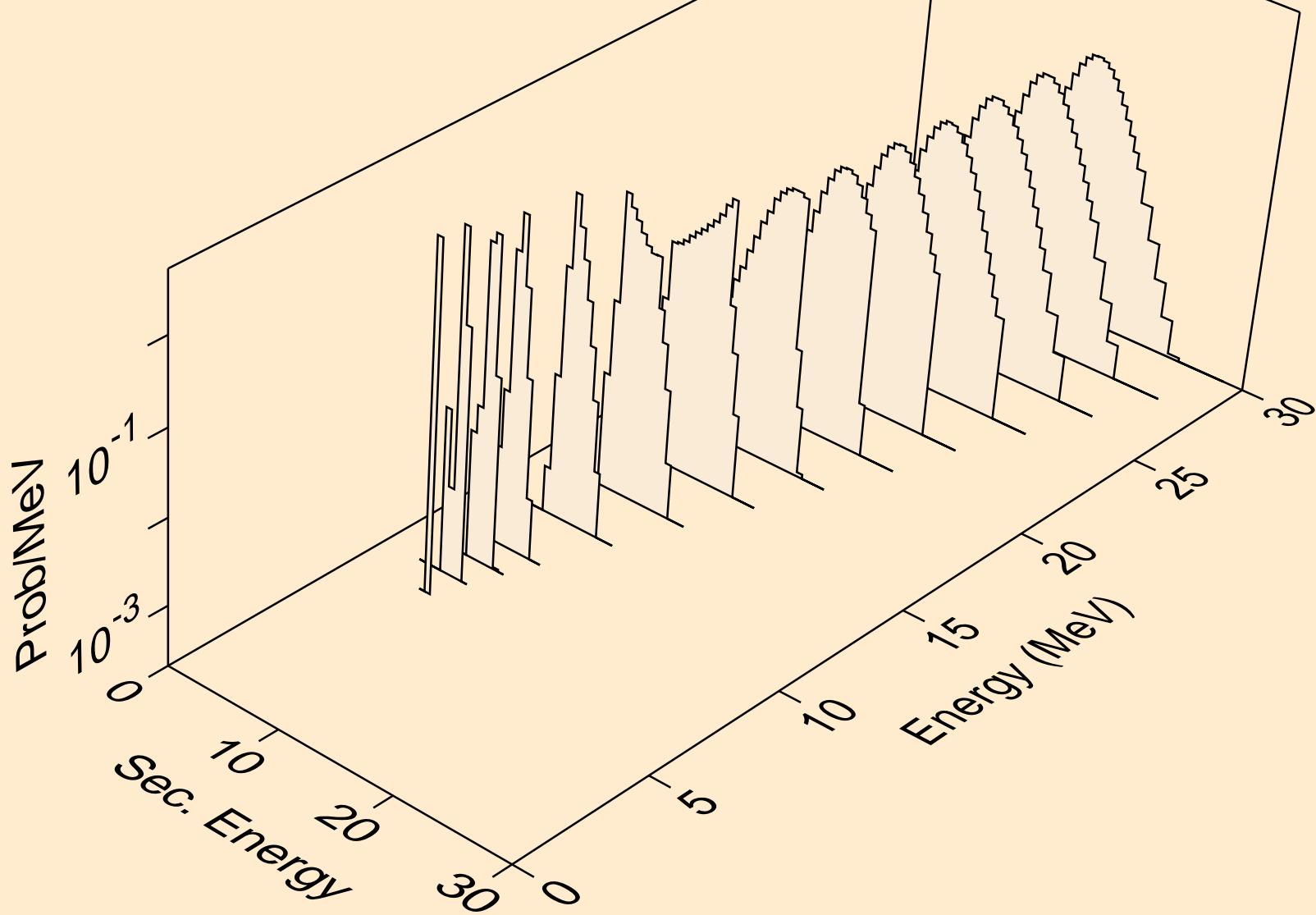

SB105 PHOTON ACER TENDL-2021 LIBRARY; T=0.K
alphas from (g,da)

