

SM131 PHOTON ACER TENDL-2021 LIBRARY; T=0.K
Principal cross sections

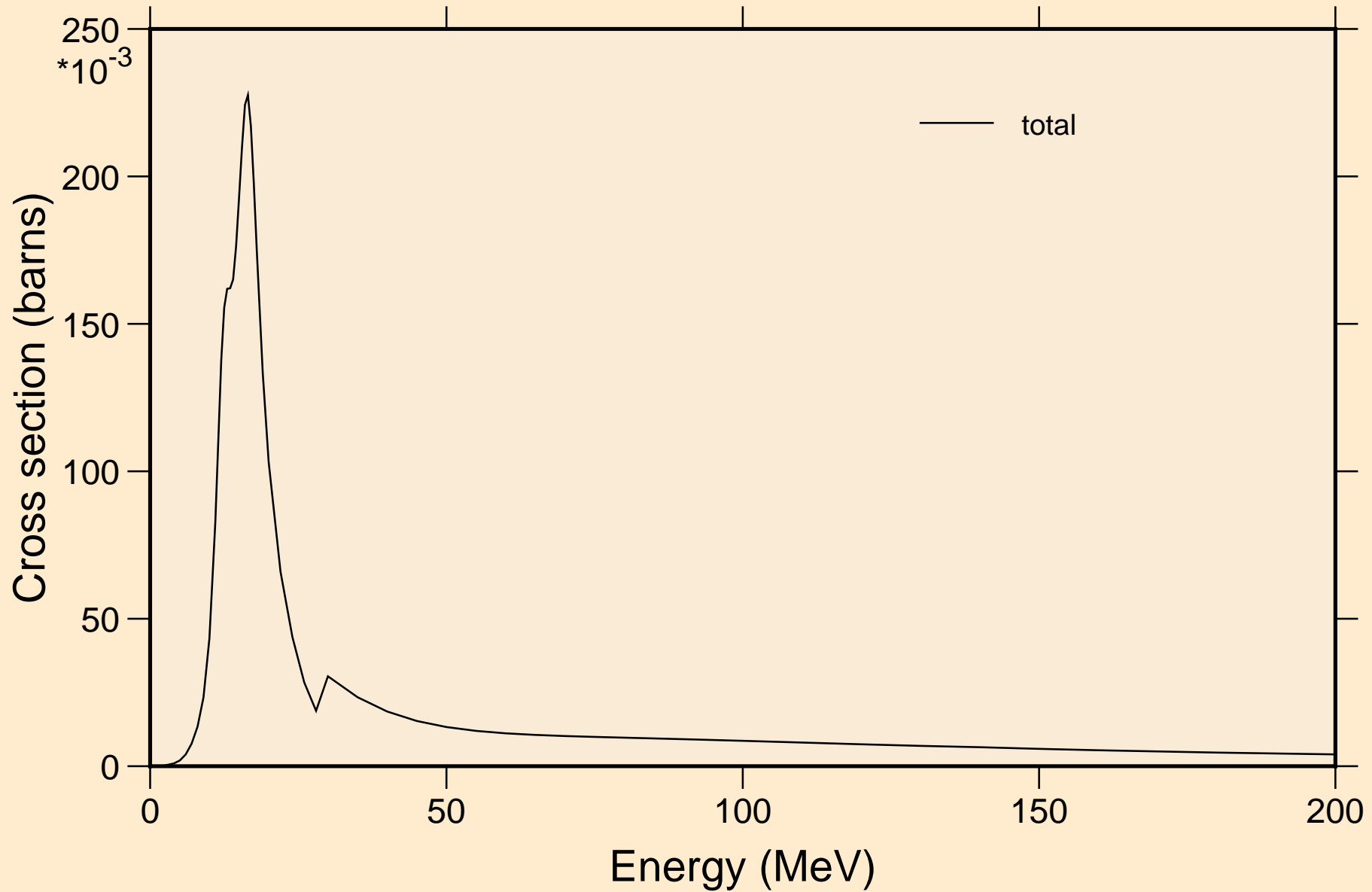

SM131 PHOTON ACER TENDL-2021 LIBRARY; T=0.K

Partial cross sections

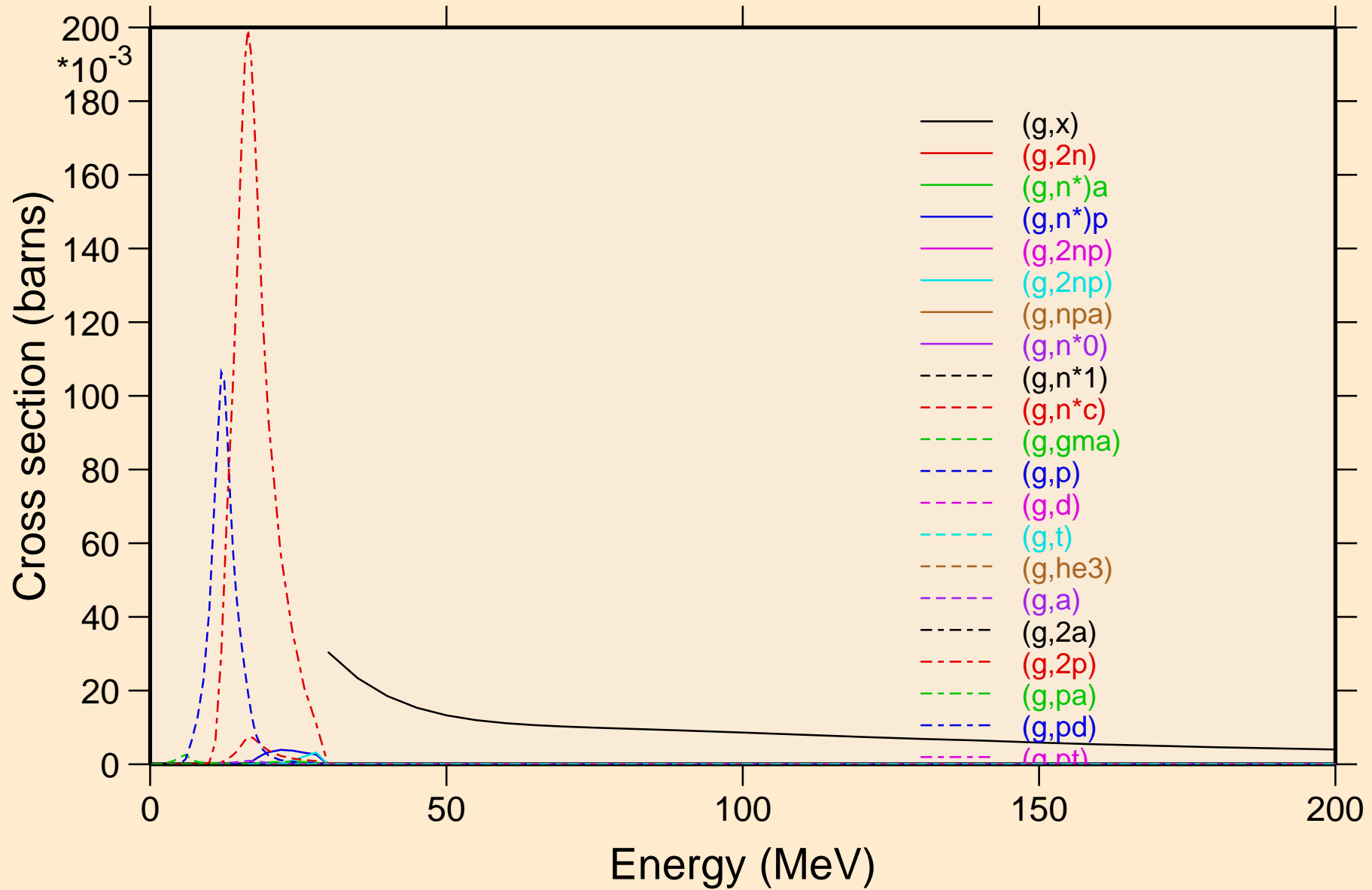

SM131 PHOTON ACER TENDL-2021 LIBRARY; T=0.K

Heating

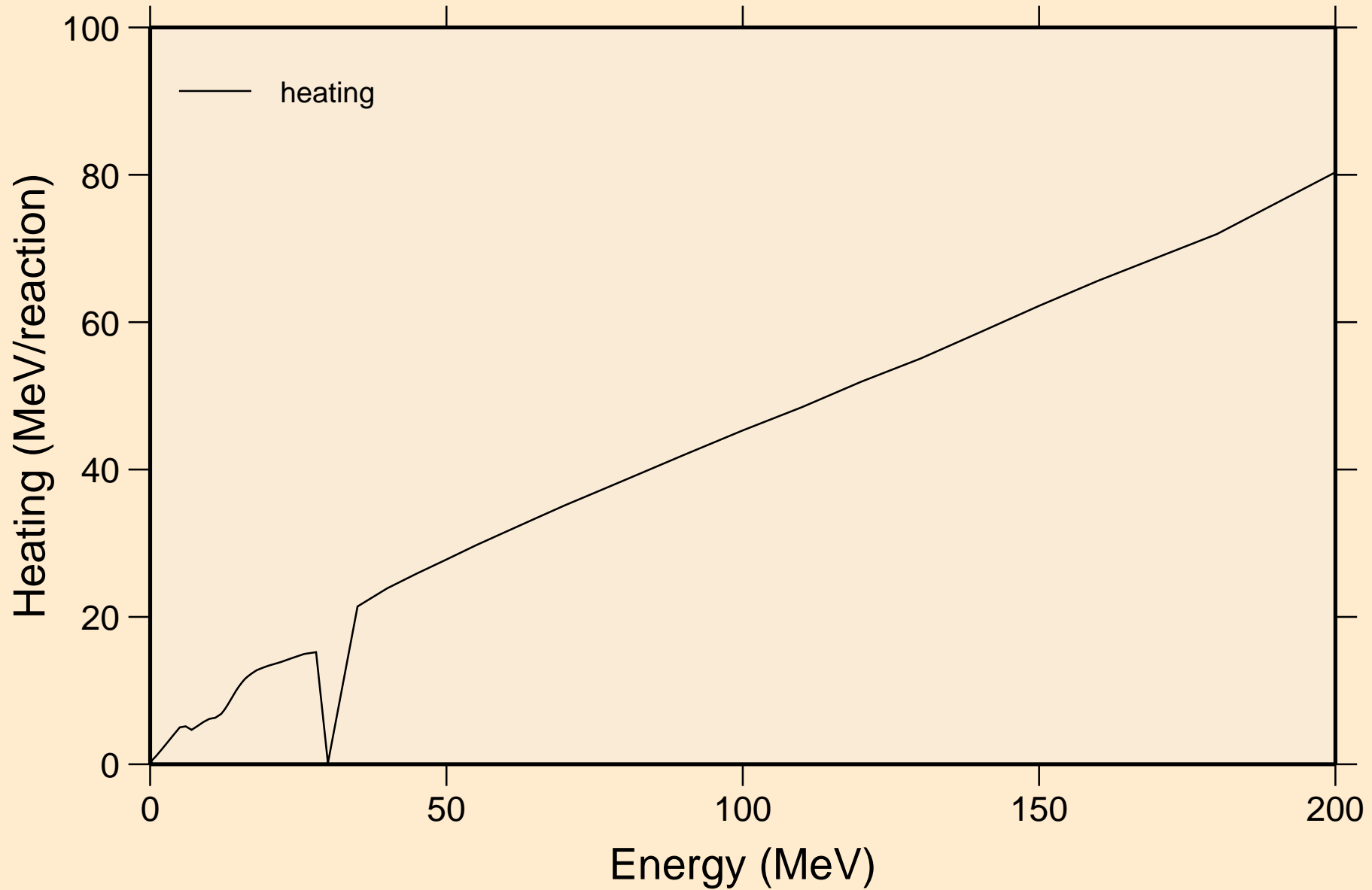

SM131 PHOTON ACER TENDL-2021 LIBRARY; T=0.K

Particle heating contributions

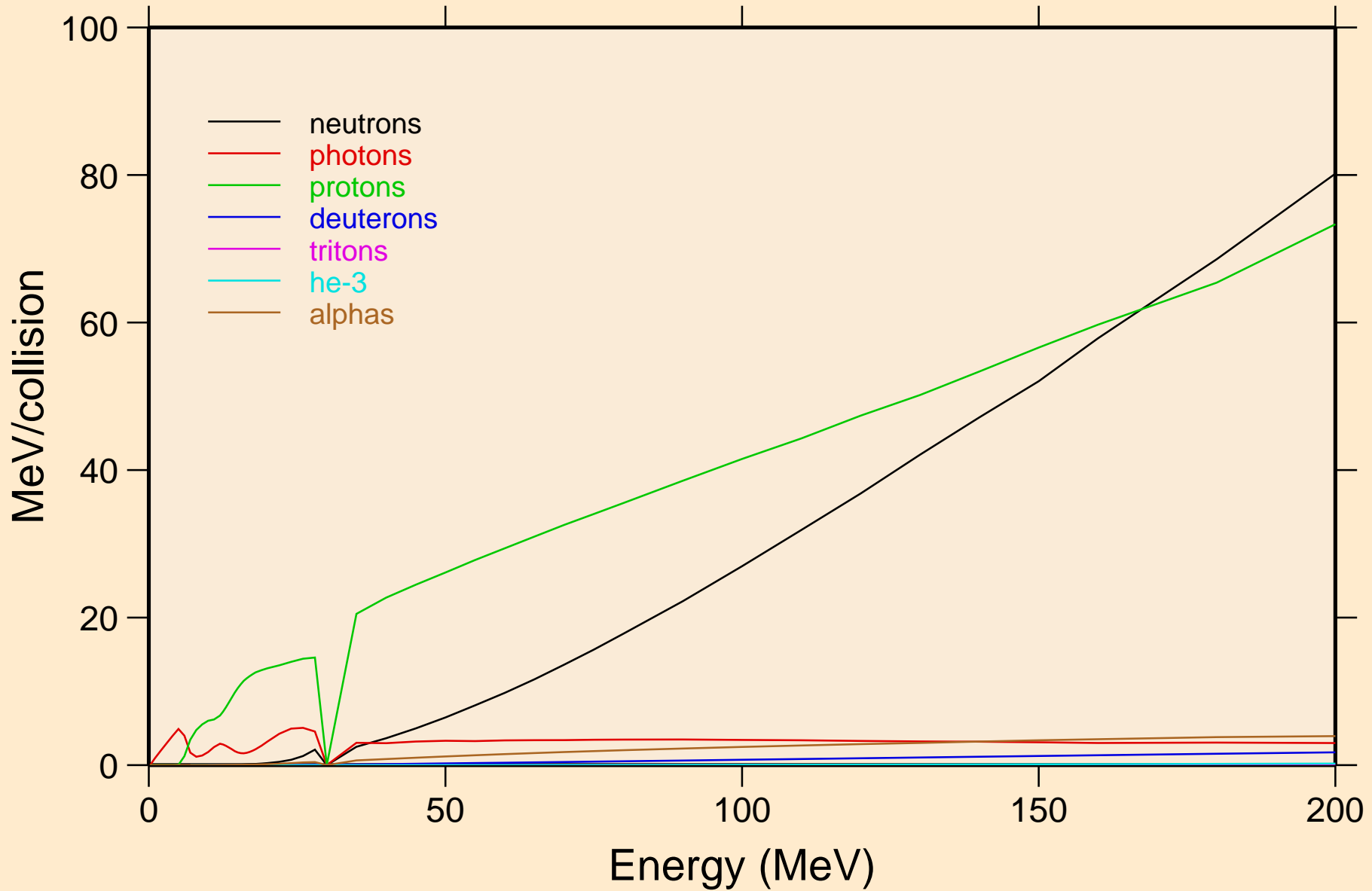

SM131 PHOTON ACER TENDL-2021 LIBRARY; T=0.K

Particle production cross sections

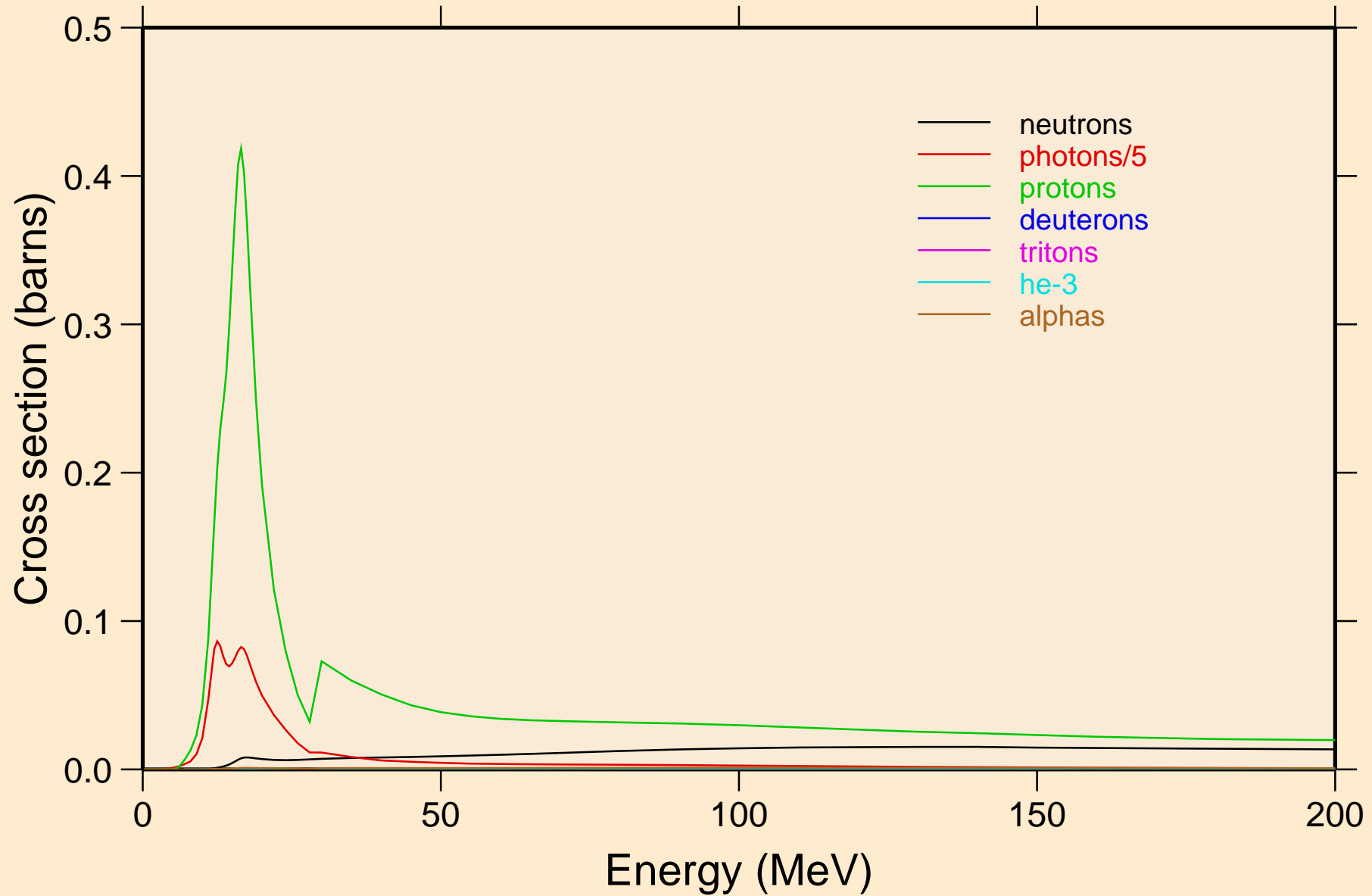

SM131 PHOTON ACER TENDL-2021 LIBRARY; T=0.K
neutrons from (g,x)

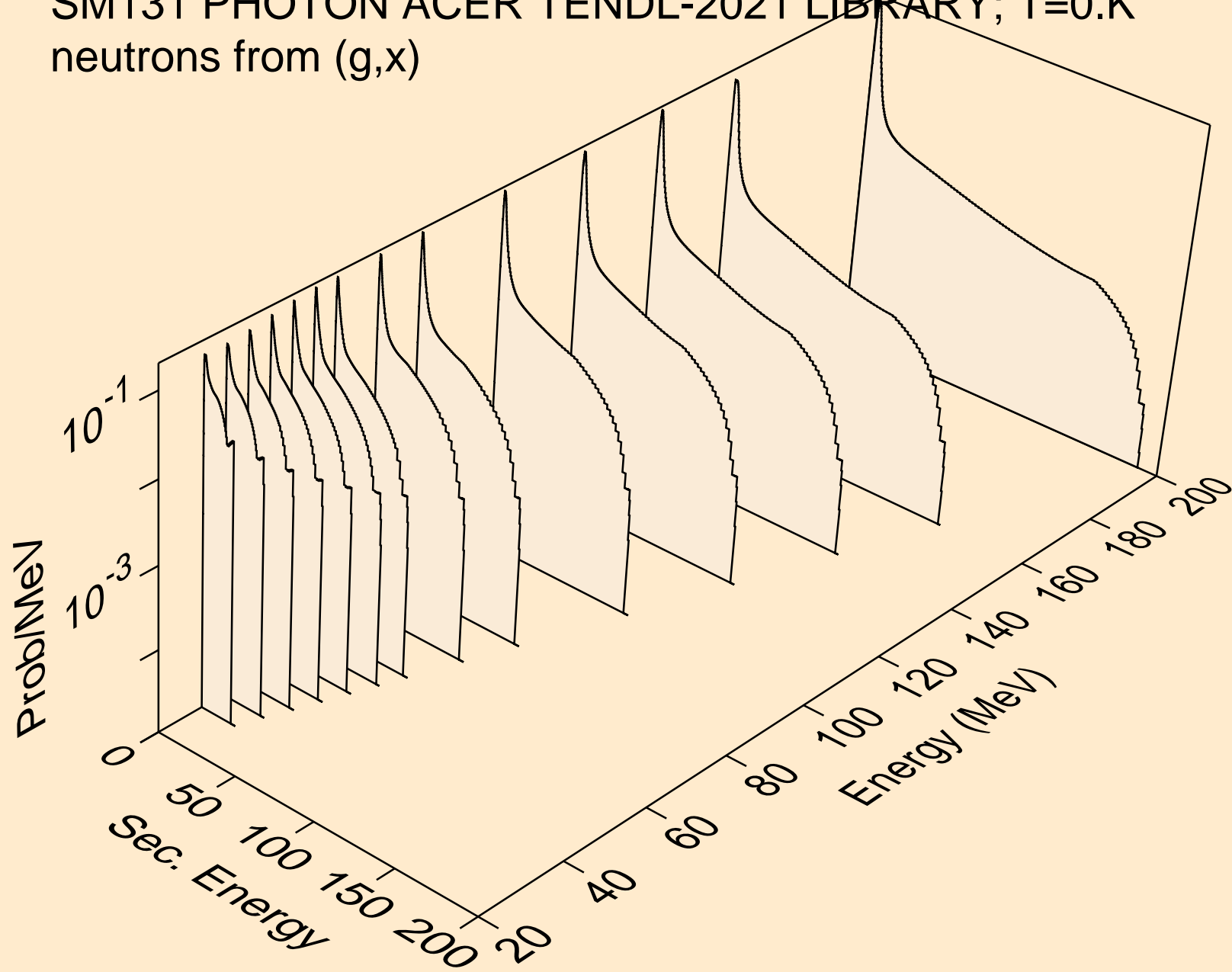

SM131 PHOTON ACER TENDL-2021 LIBRARY; T=0.K
neutrons from (g,2n)

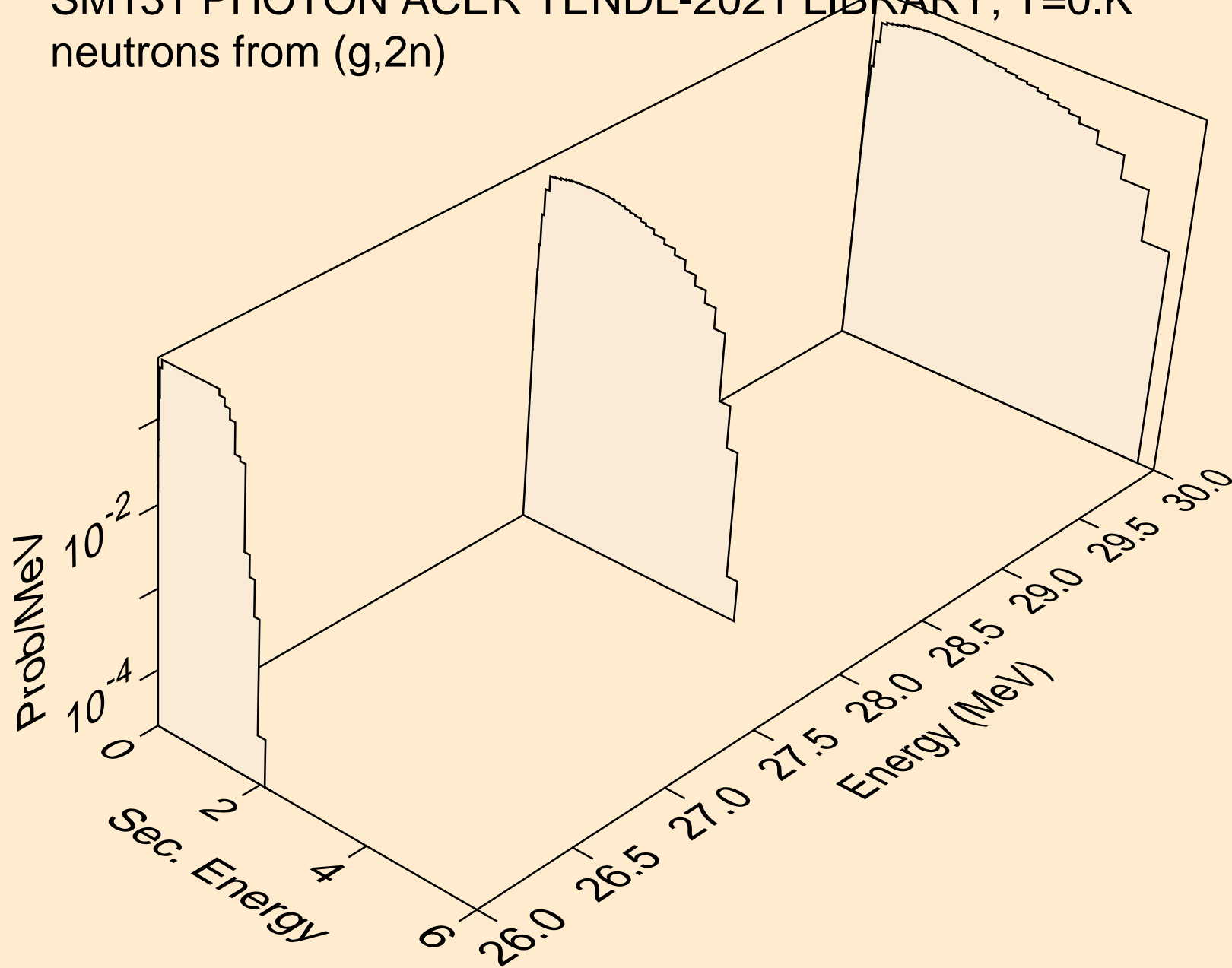

SM131 PHOTON ACER TENDL-2021 LIBRARY; T=0.K
neutrons from (g,n*)a

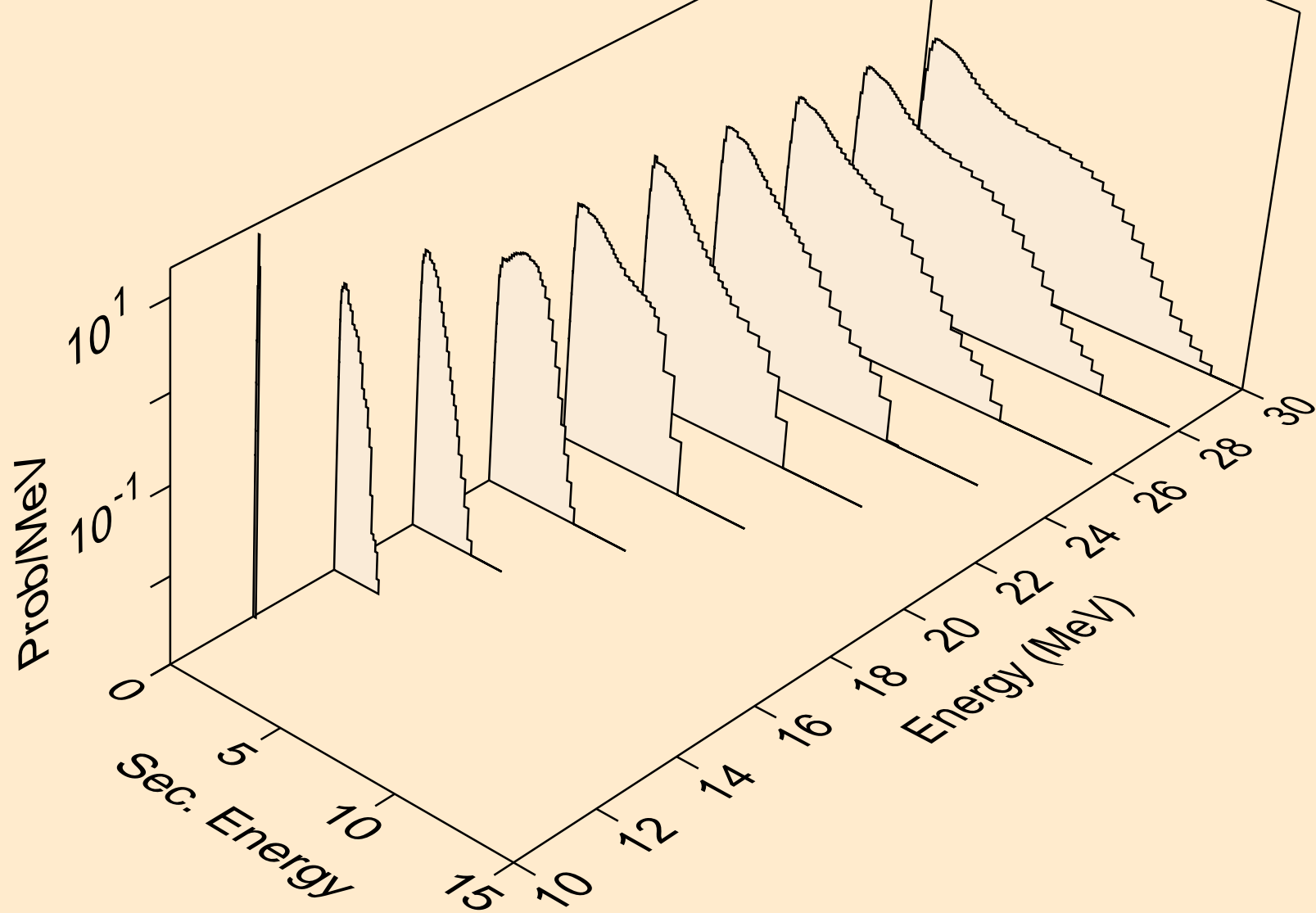

SM131 PHOTON ACER TENDL-2021 LIBRARY; T=0.K
neutrons from (g,n*)p

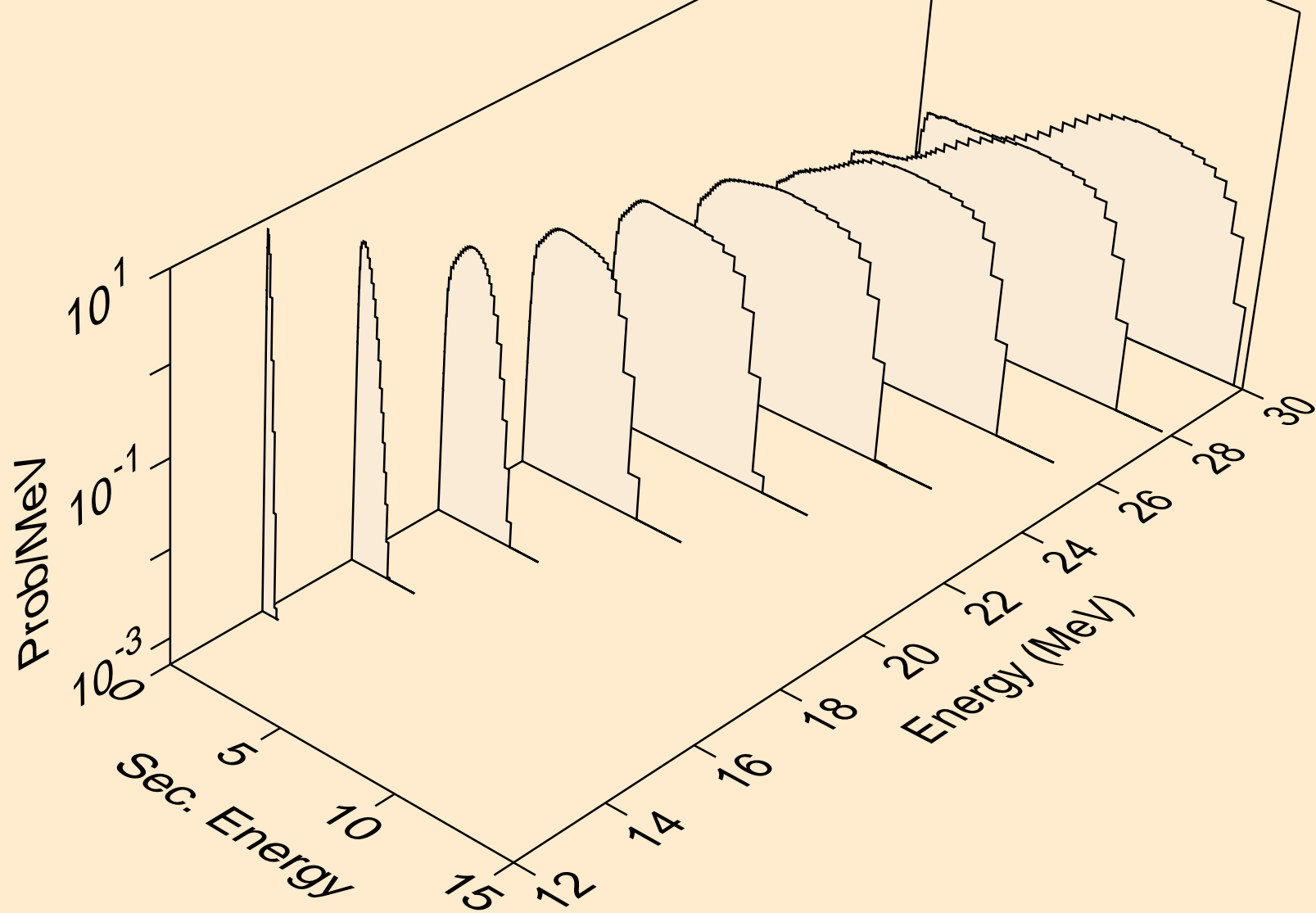

SM131 PHOTON ACER TENDL-2021 LIBRARY; T=0.K
neutrons from (g,2np)

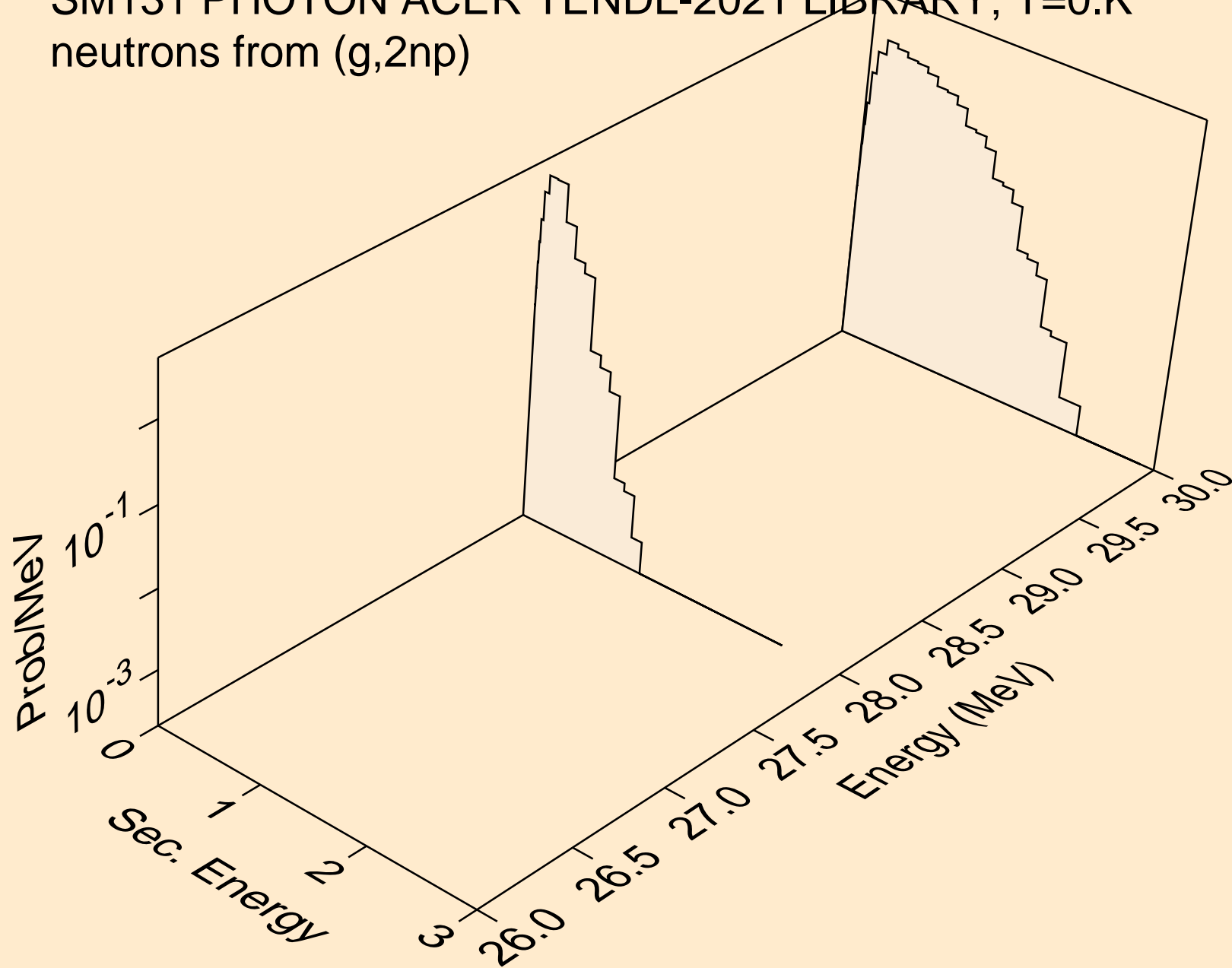

SM131 PHOTON ACER TENDL-2021 LIBRARY; T=0.K
neutrons from (g,2np)

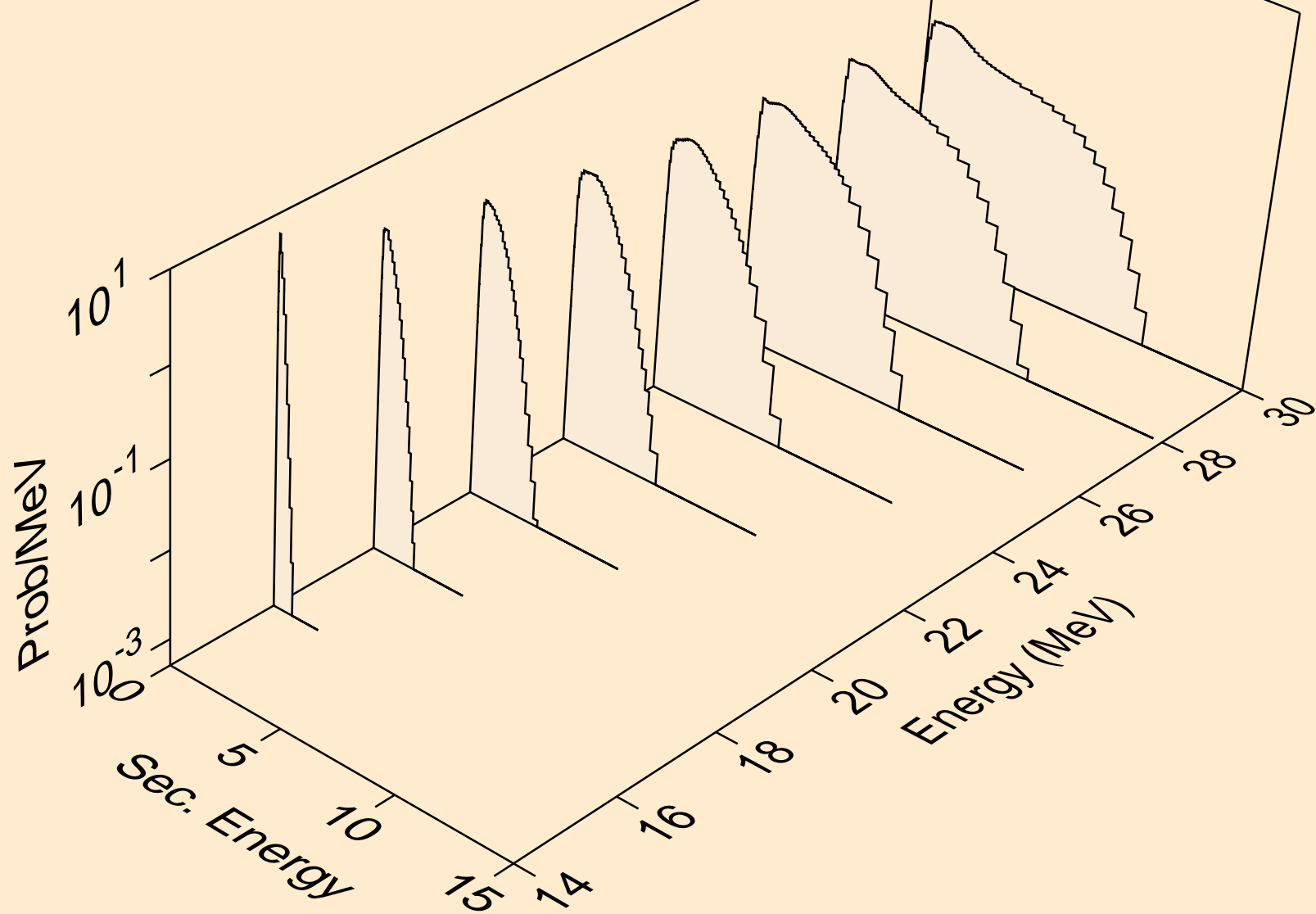

SM131 PHOTON ACER TENDL-2021 LIBRARY; T=0.K
neutrons from (g,npa)

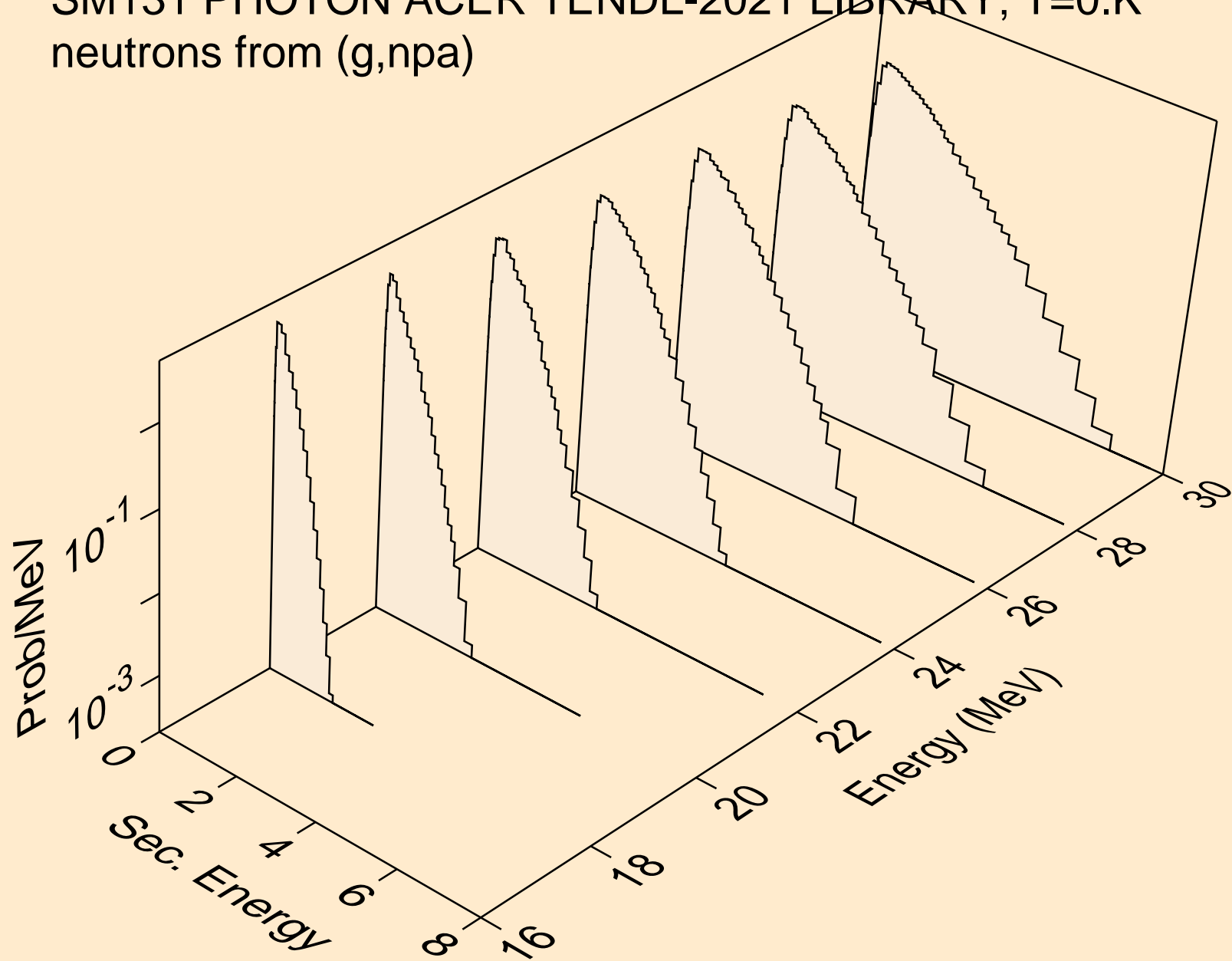

SM131 PHOTON ACER TENDL-2021 LIBRARY; T=0.K
angular distribution for (g,n*0) neutron

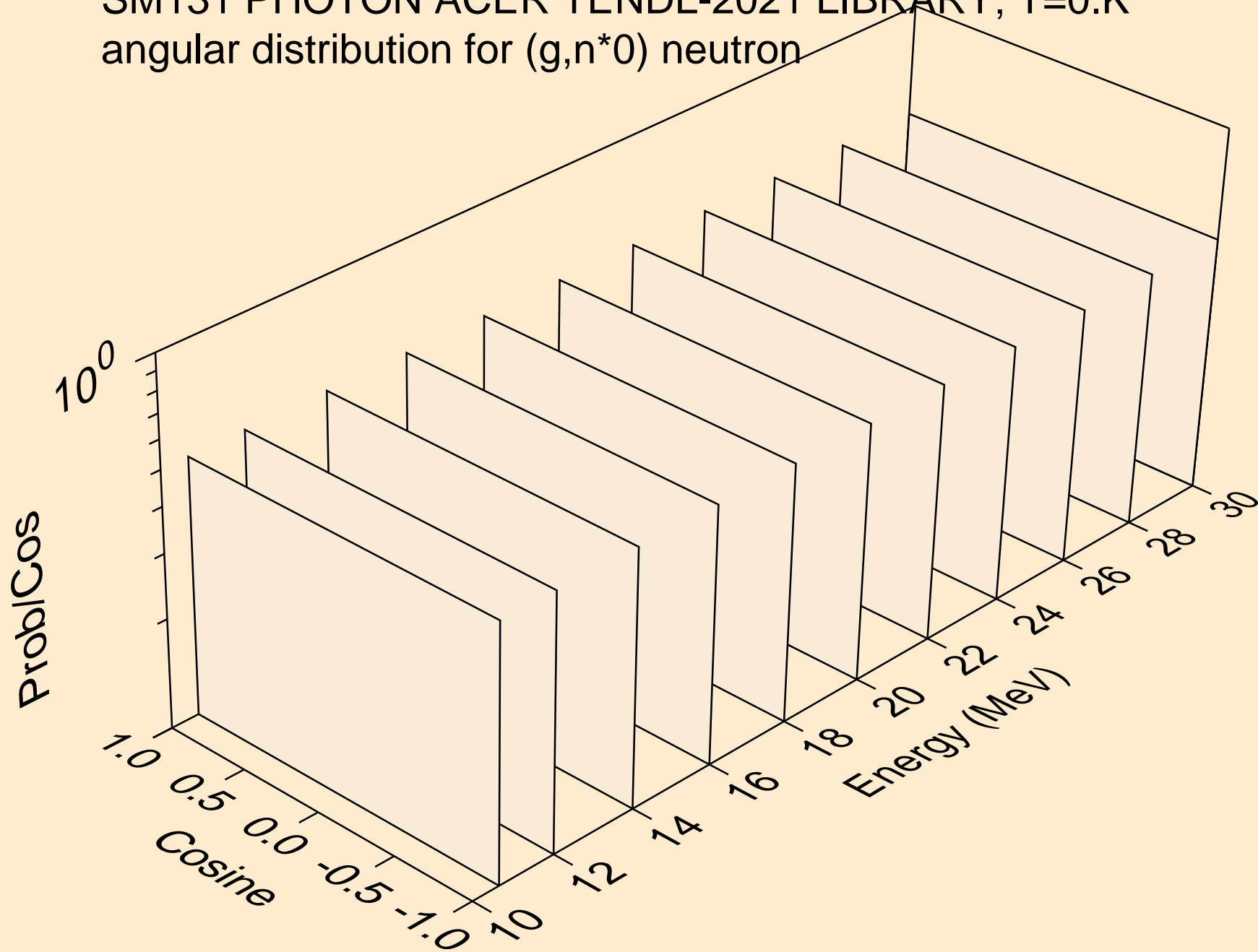

SM131 PHOTON ACER TENDL-2021 LIBRARY; T=0.K
angular distribution for (g,n*1) neutron

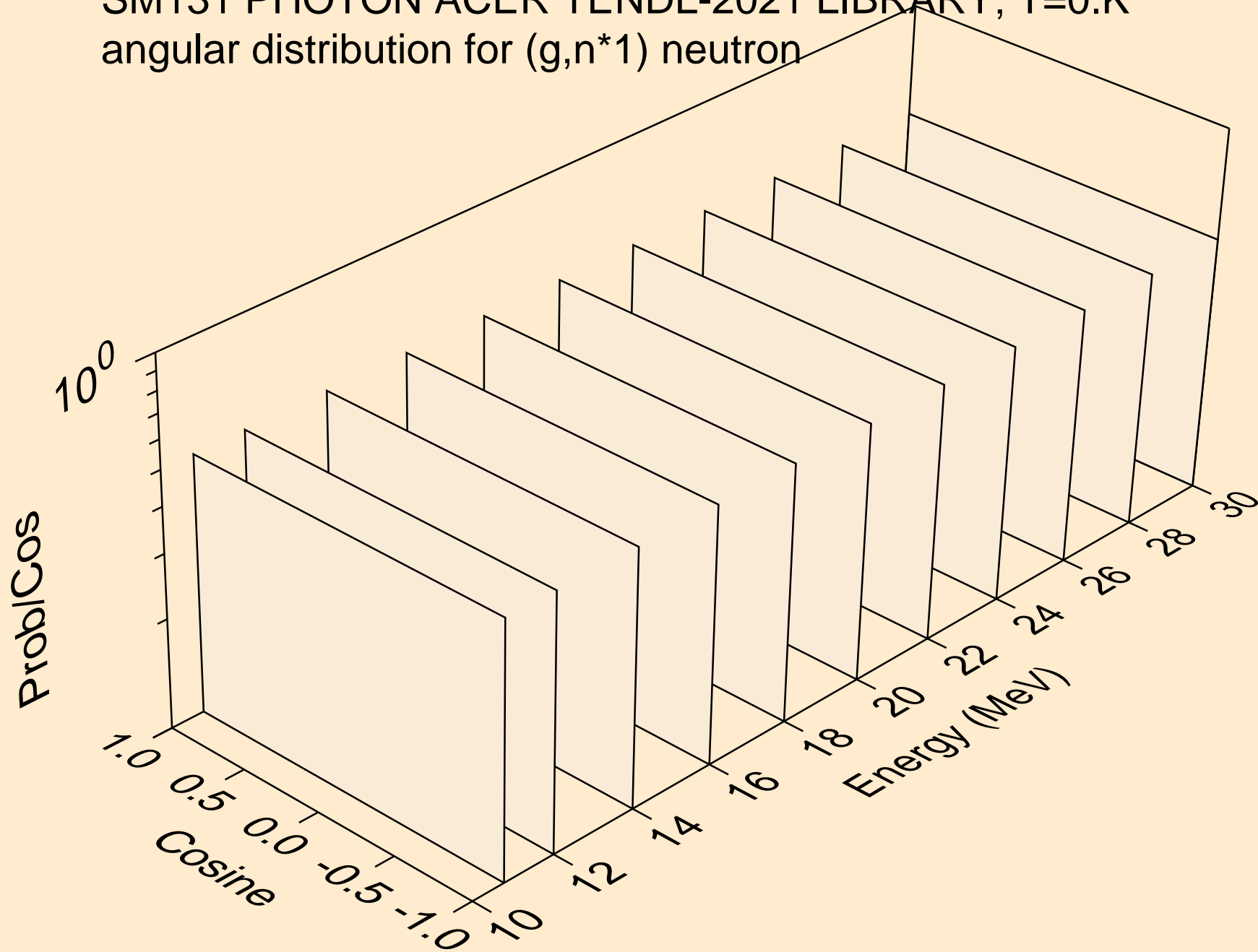

SM131 PHOTON ACER TENDL-2021 LIBRARY; T=0.K
neutrons from (g,n*c)

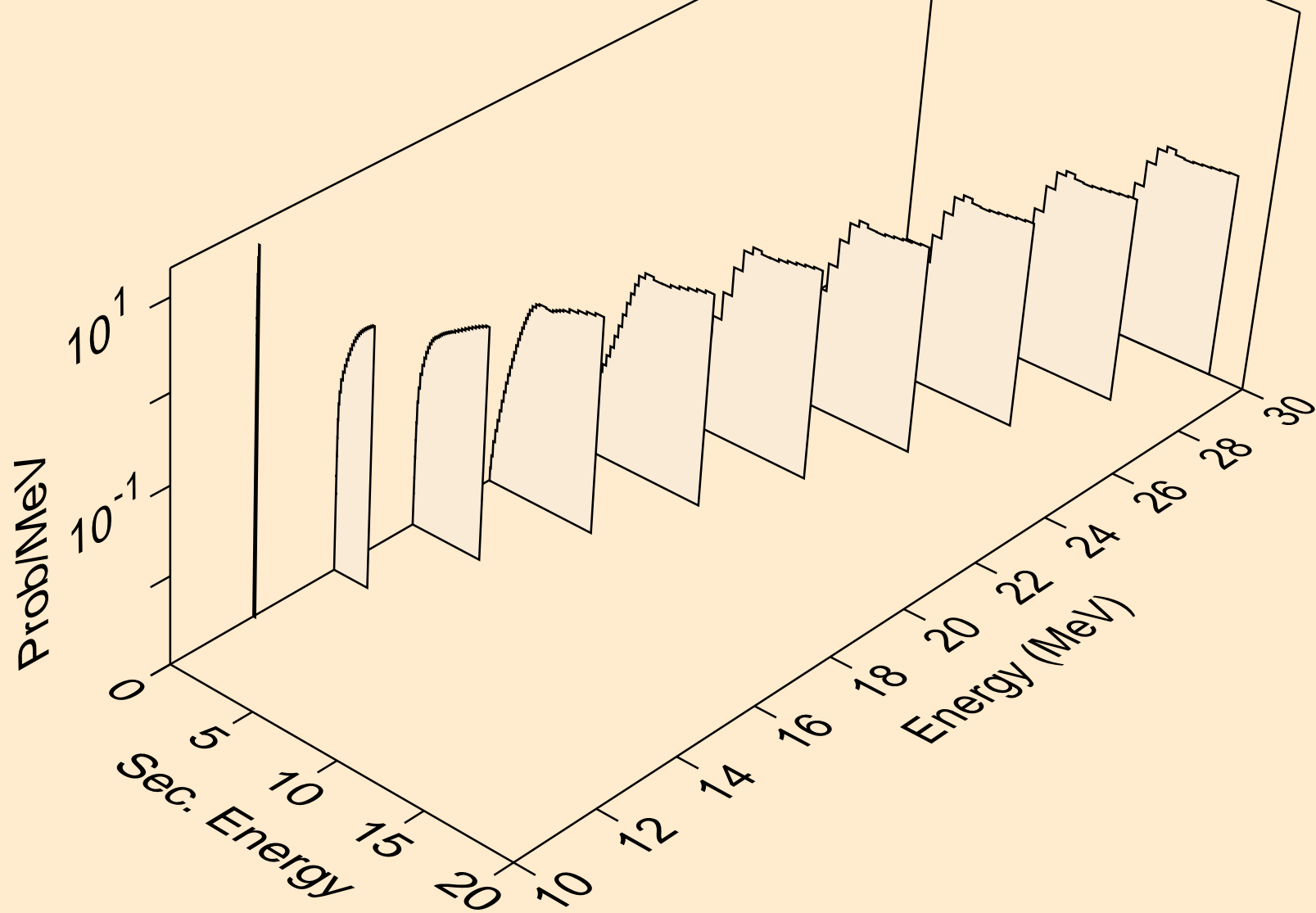

SM131 PHOTON ACER TENDL-2021 LIBRARY; T=0.K
photons from (g,x)

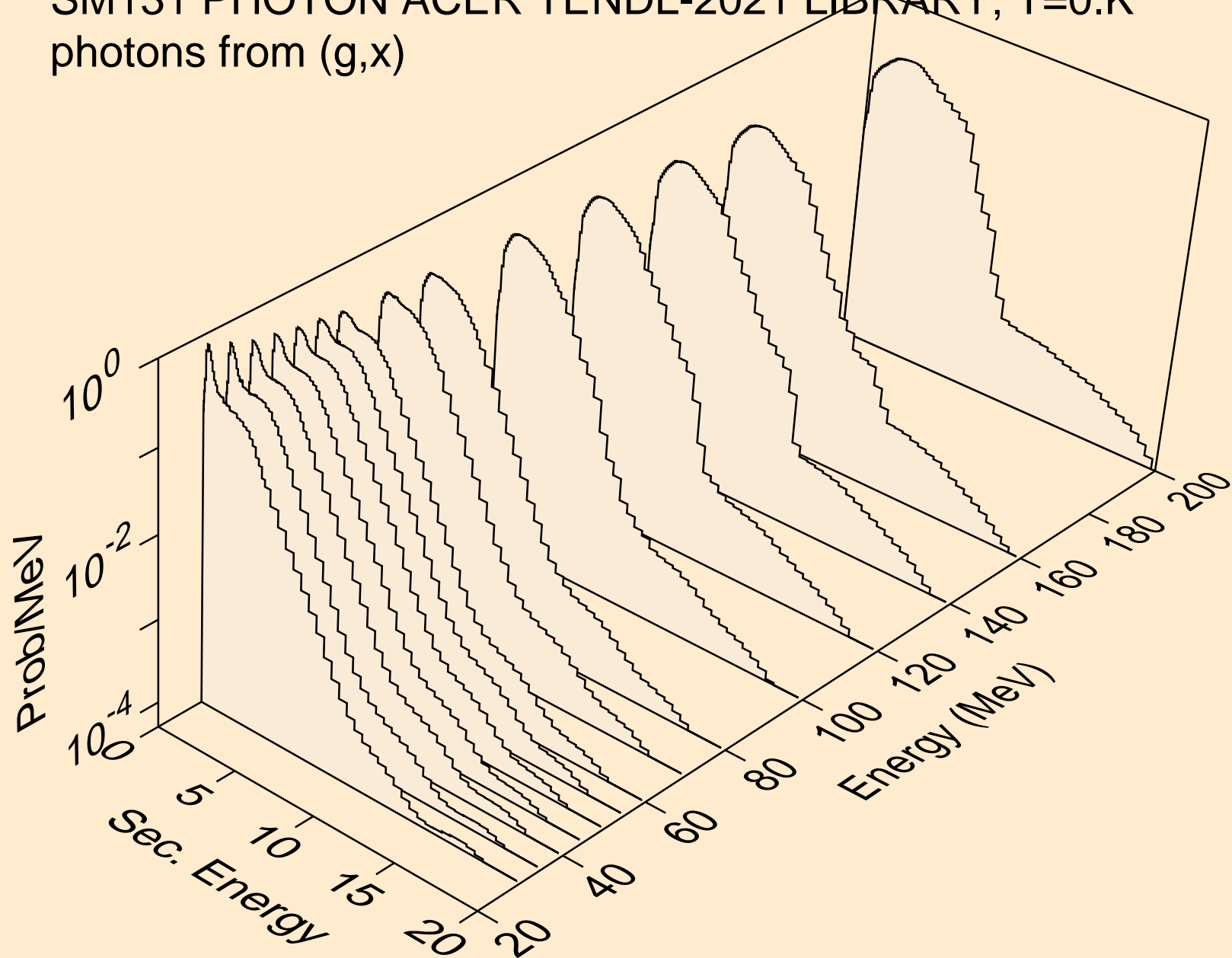

SM131 PHOTON ACER TENDL-2021 LIBRARY; T=0.K
photons from (g,2n)

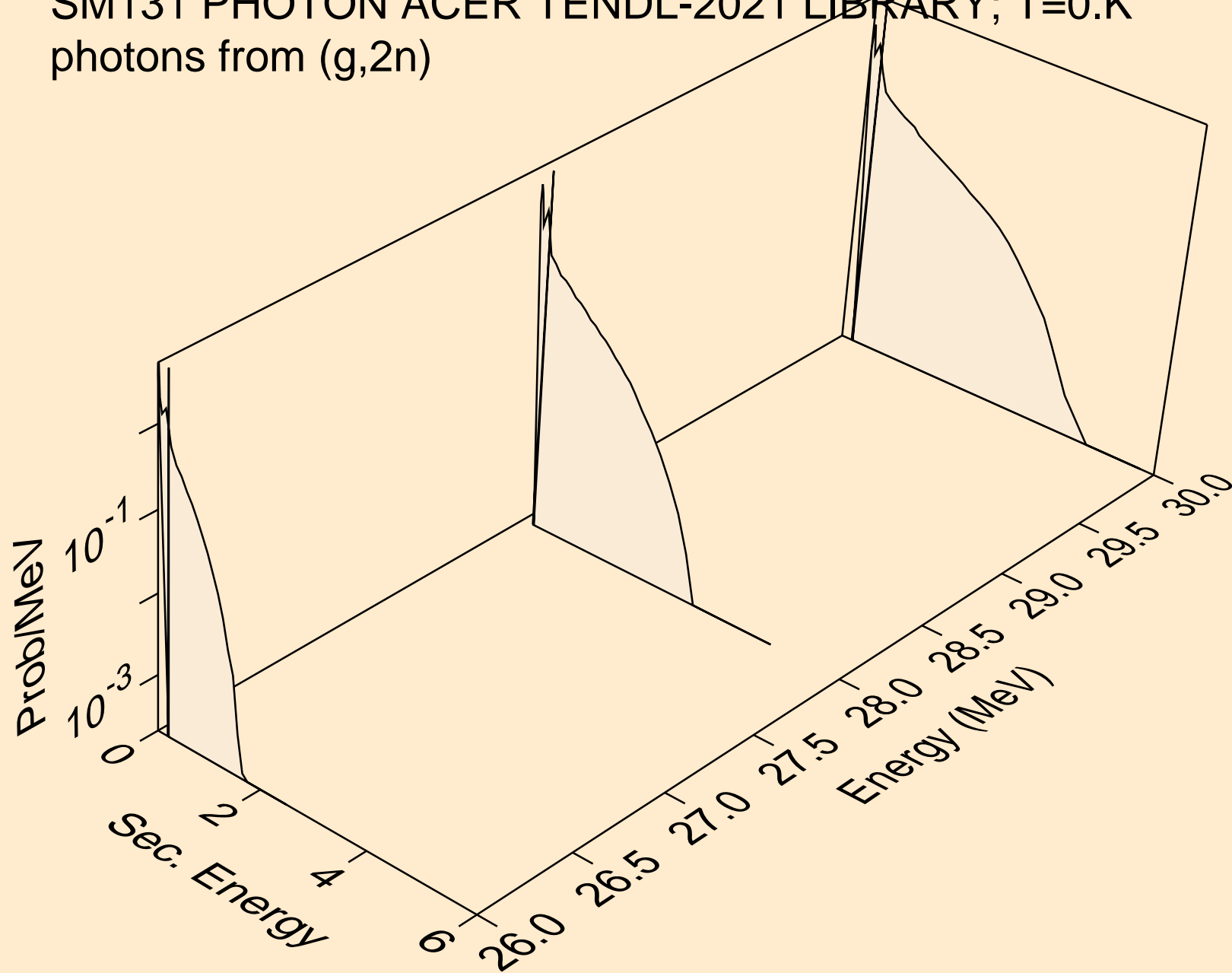

SM131 PHOTON ACER TENDL-2021 LIBRARY; T=0.K
photons from (g,n*)a

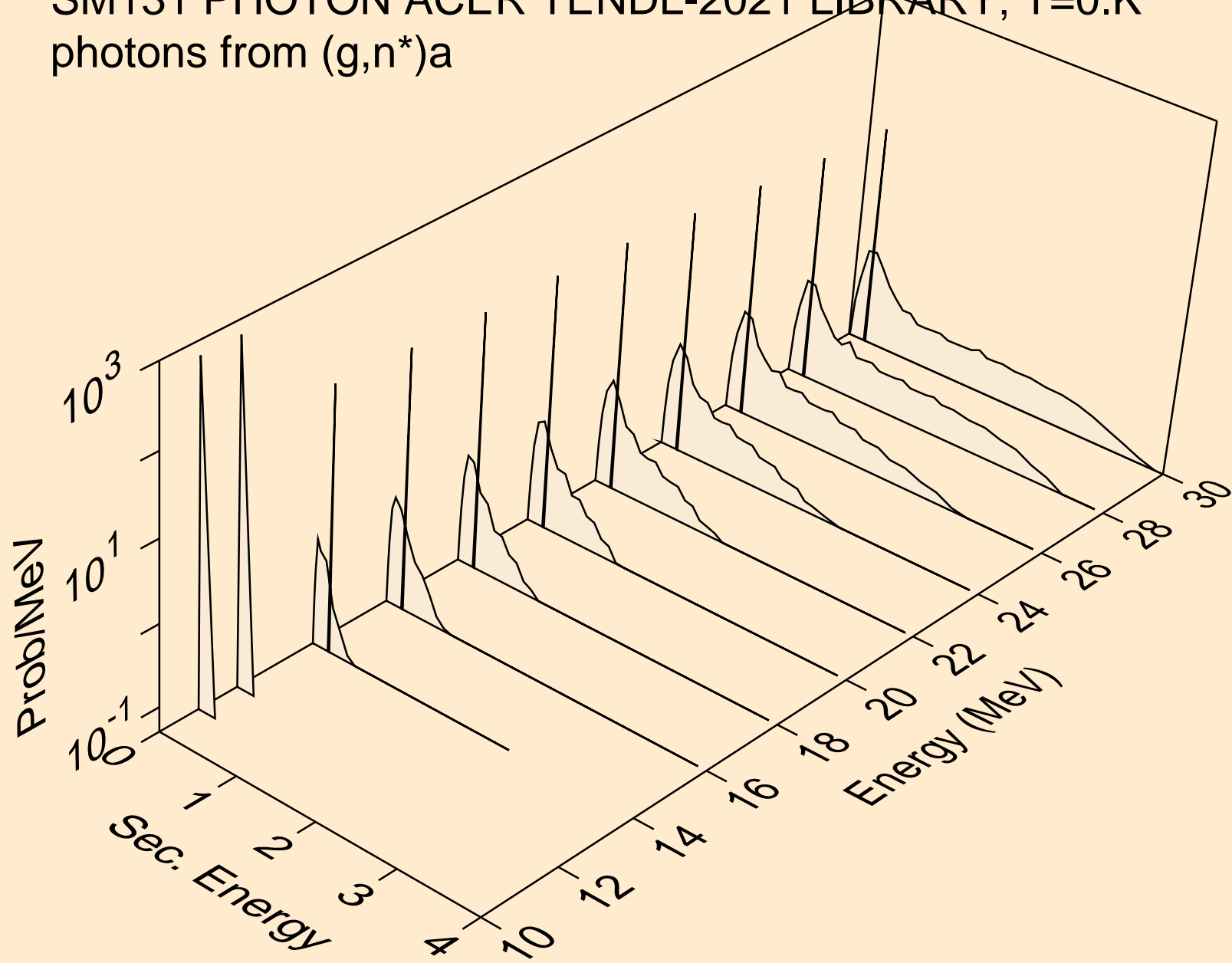

SM131 PHOTON ACER TENDL-2021 LIBRARY; T=0.K
photons from (g,n*)p

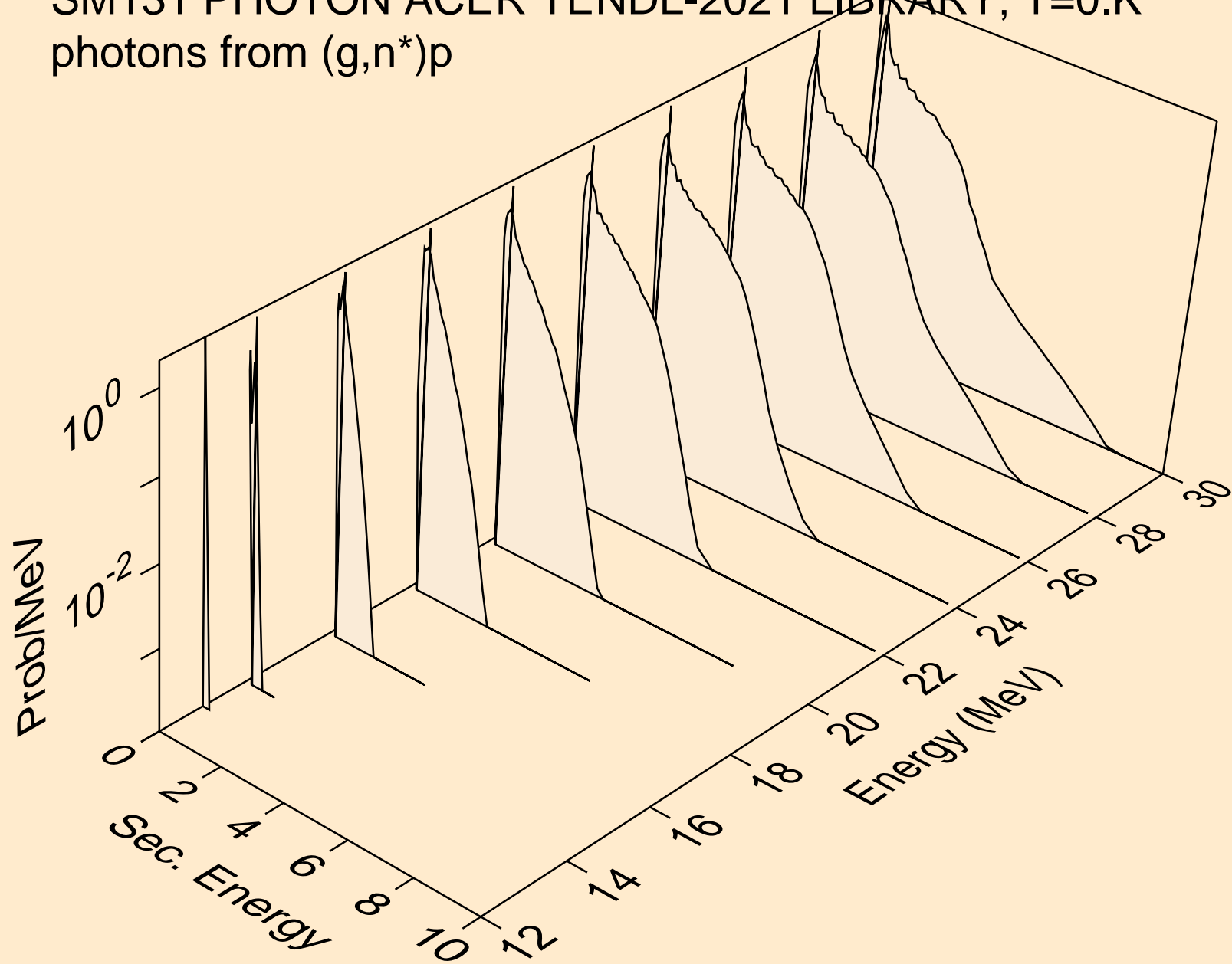

SM131 PHOTON ACER TENDL-2021 LIBRARY; T=0.K
photons from (g,2np)

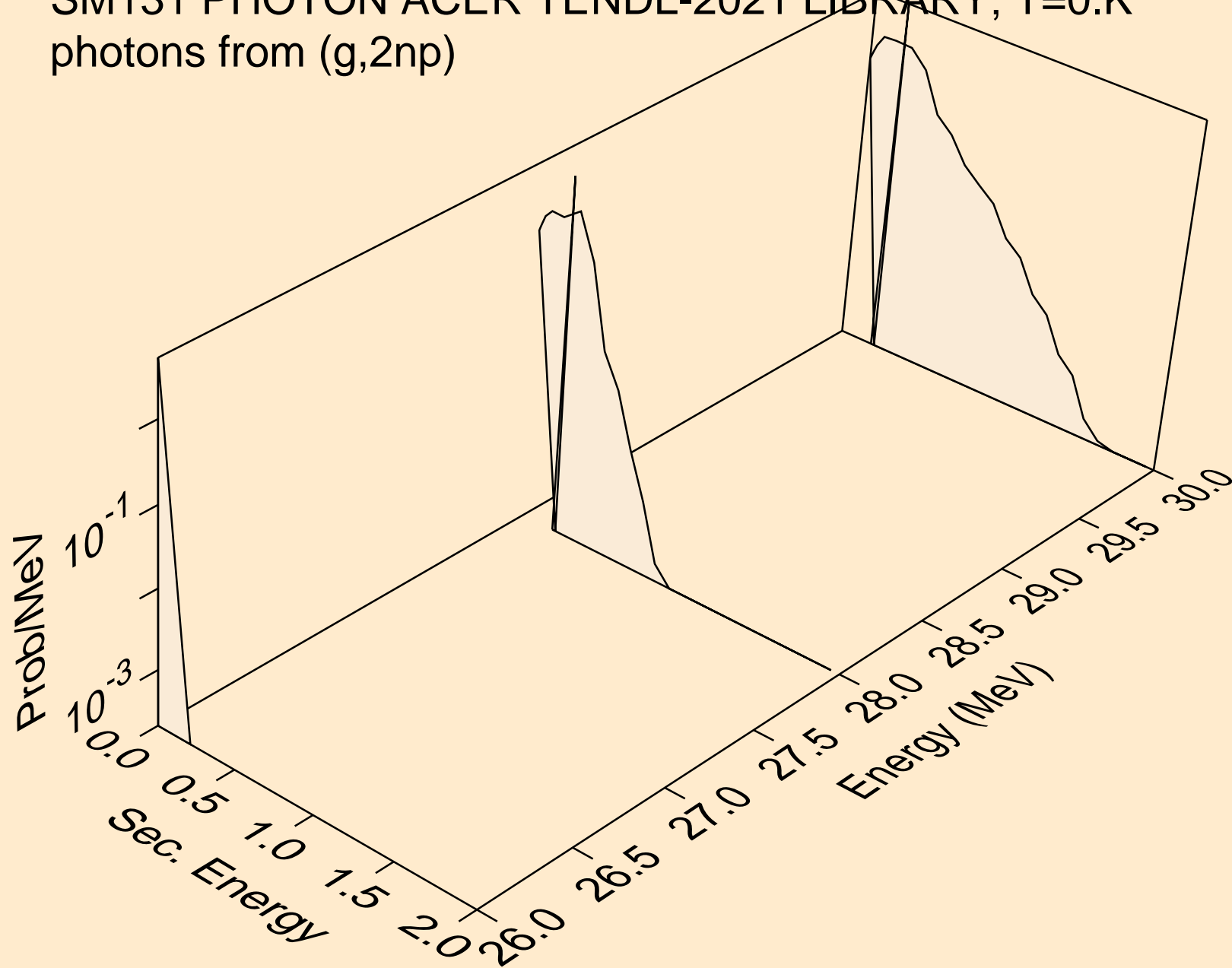

SM131 PHOTON ACER TENDL-2021 LIBRARY; T=0.K
photons from (g,2np)

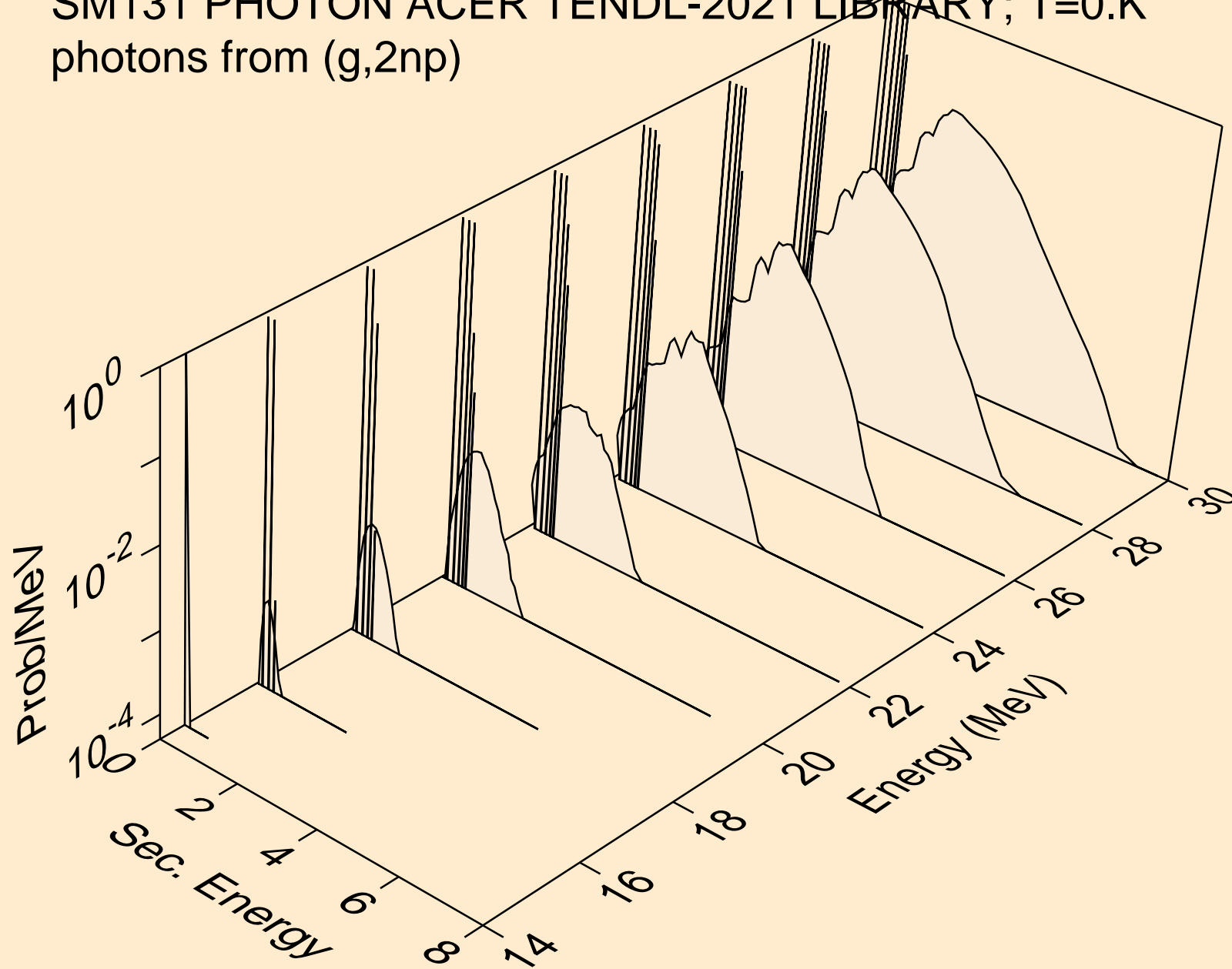

SM131 PHOTON ACER TENDL-2021 LIBRARY; T=0.K
photons from (g,npa)

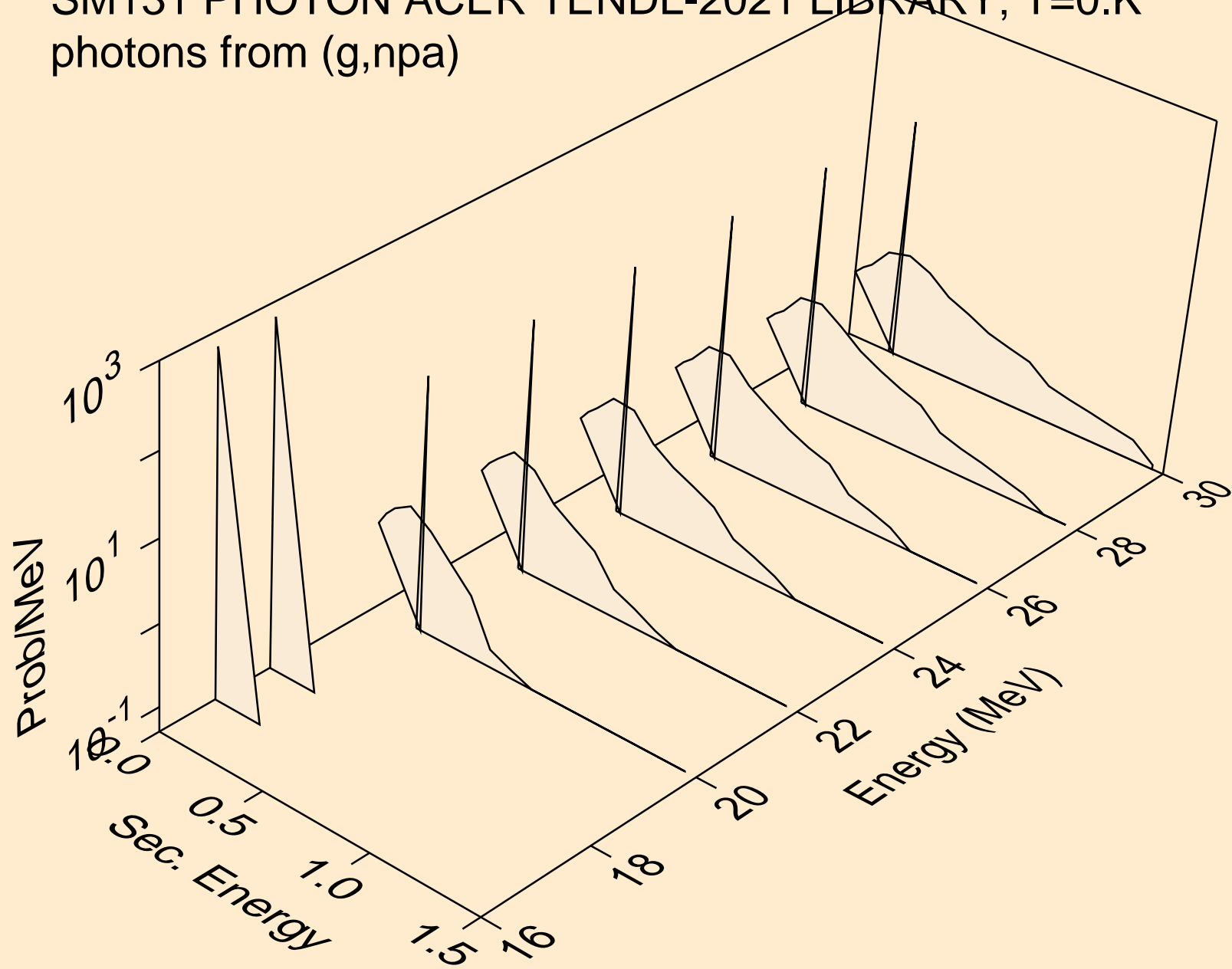

SM131 PHOTON ACER TENDL-2021 LIBRARY; T=0.K
photons from (g,n*c)

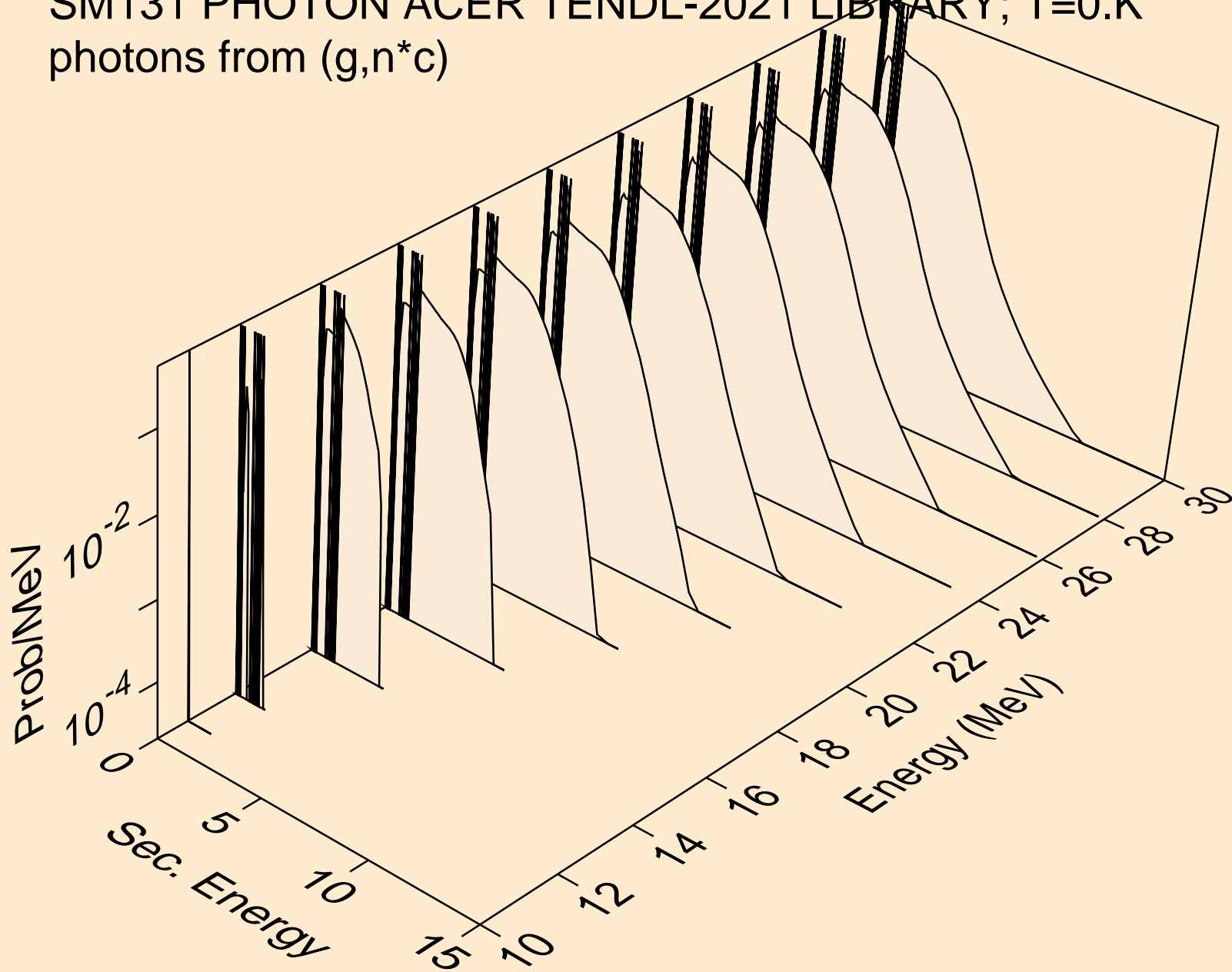

SM131 PHOTON ACER TENDL-2021 LIBRARY; T=0.K
photons from (g,gma)

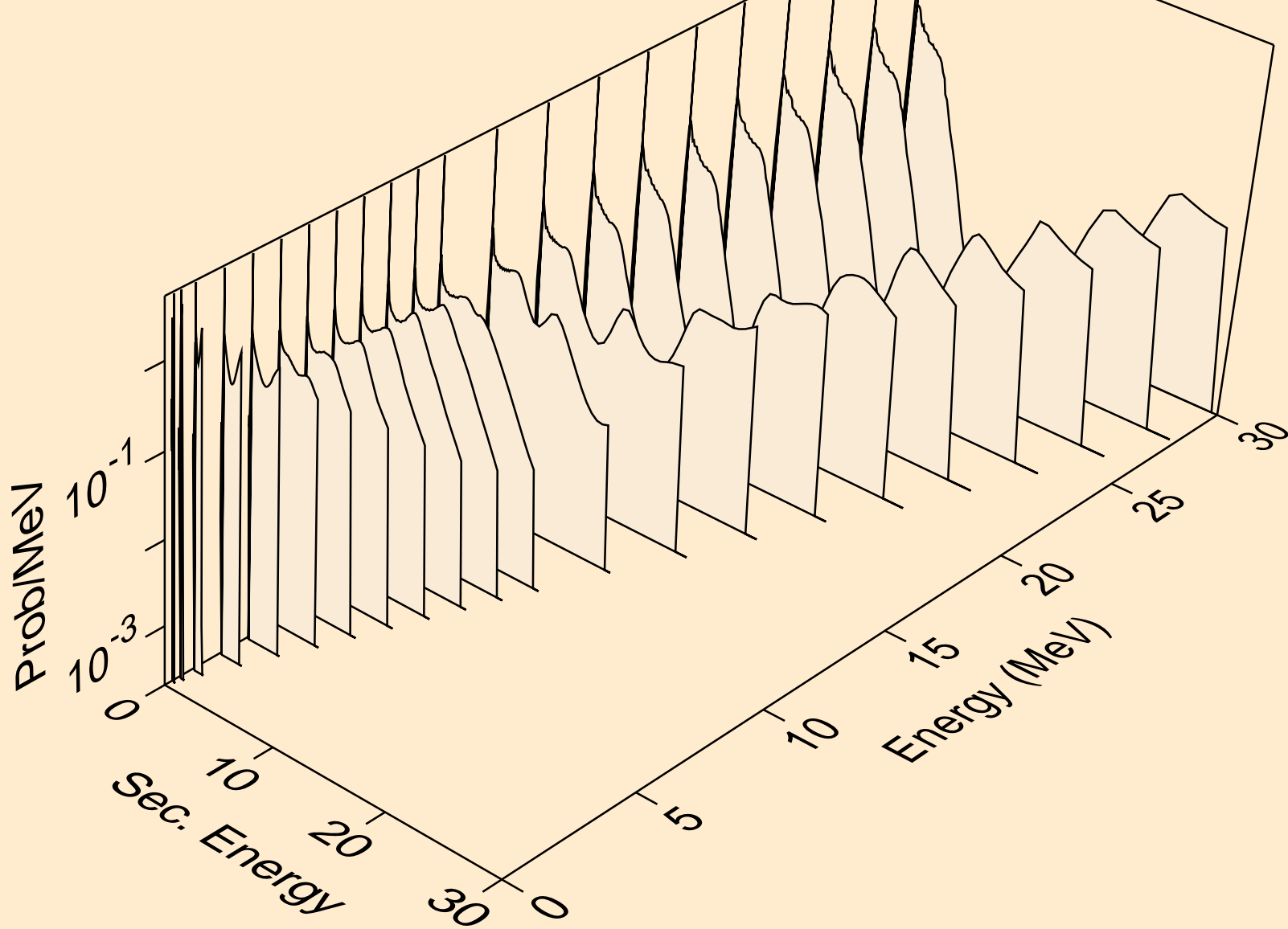

SM131 PHOTON ACER TENDL-2021 LIBRARY; T=0.K
photons from (g,p)

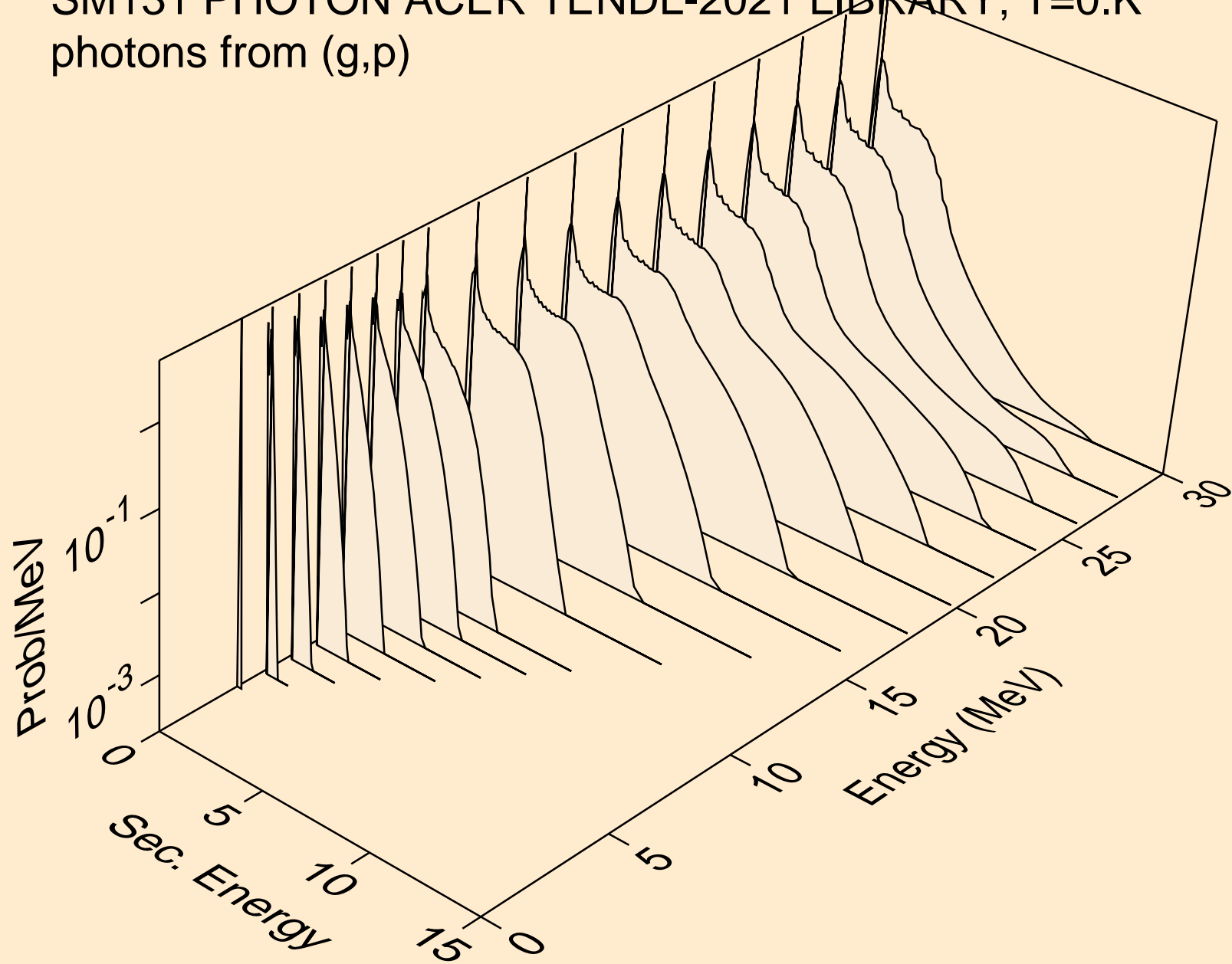

SM131 PHOTON ACER TENDL-2021 LIBRARY; T=0.K
photons from (g,d)

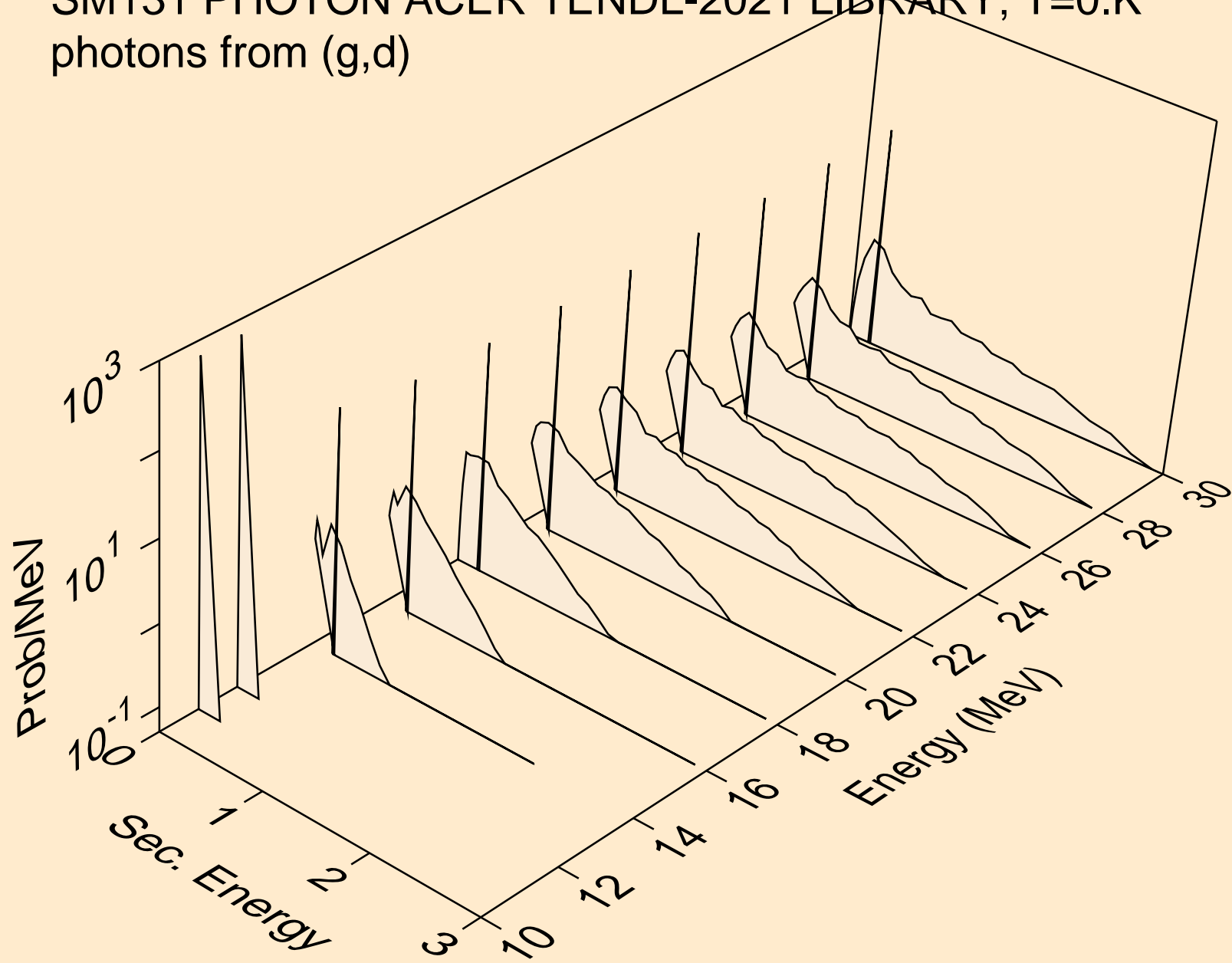

SM131 PHOTON ACER TENDL-2021 LIBRARY; T=0.K
photons from (g,t)

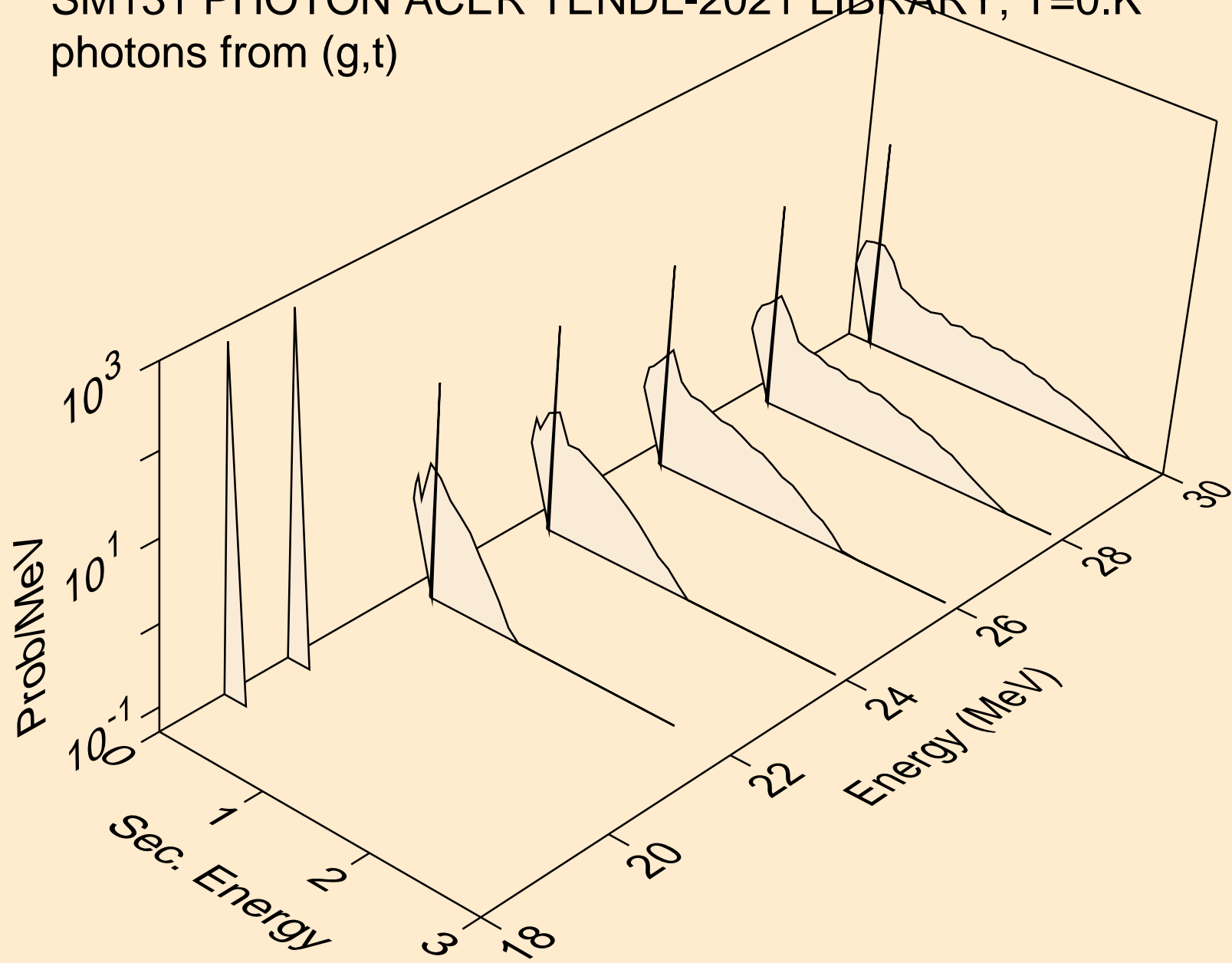

SM131 PHOTON ACER TENDL-2021 LIBRARY; T=0.K
photons from (g,he3)

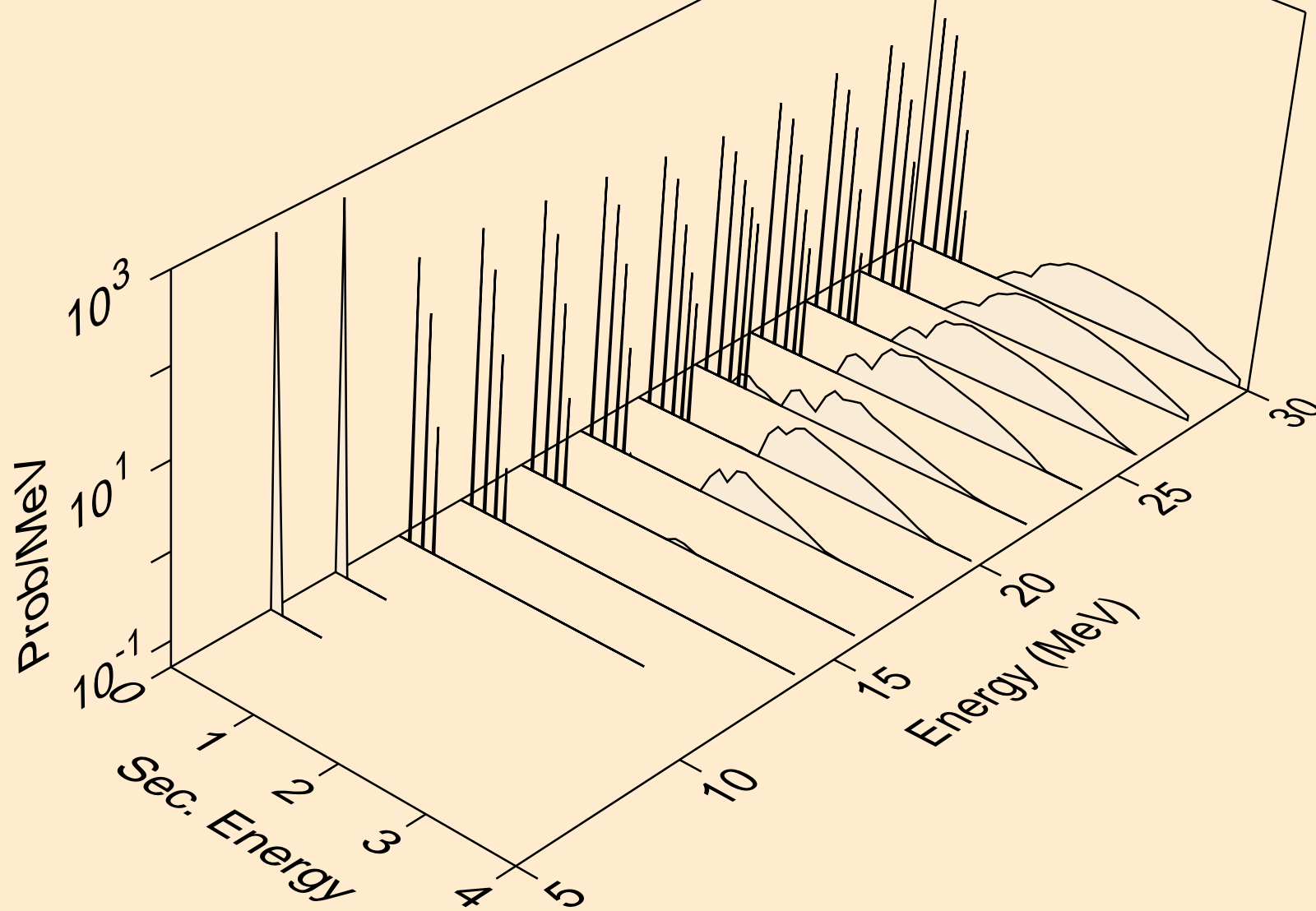

SM131 PHOTON ACER TENDL-2021 LIBRARY; T=0.K
photons from (g,a)

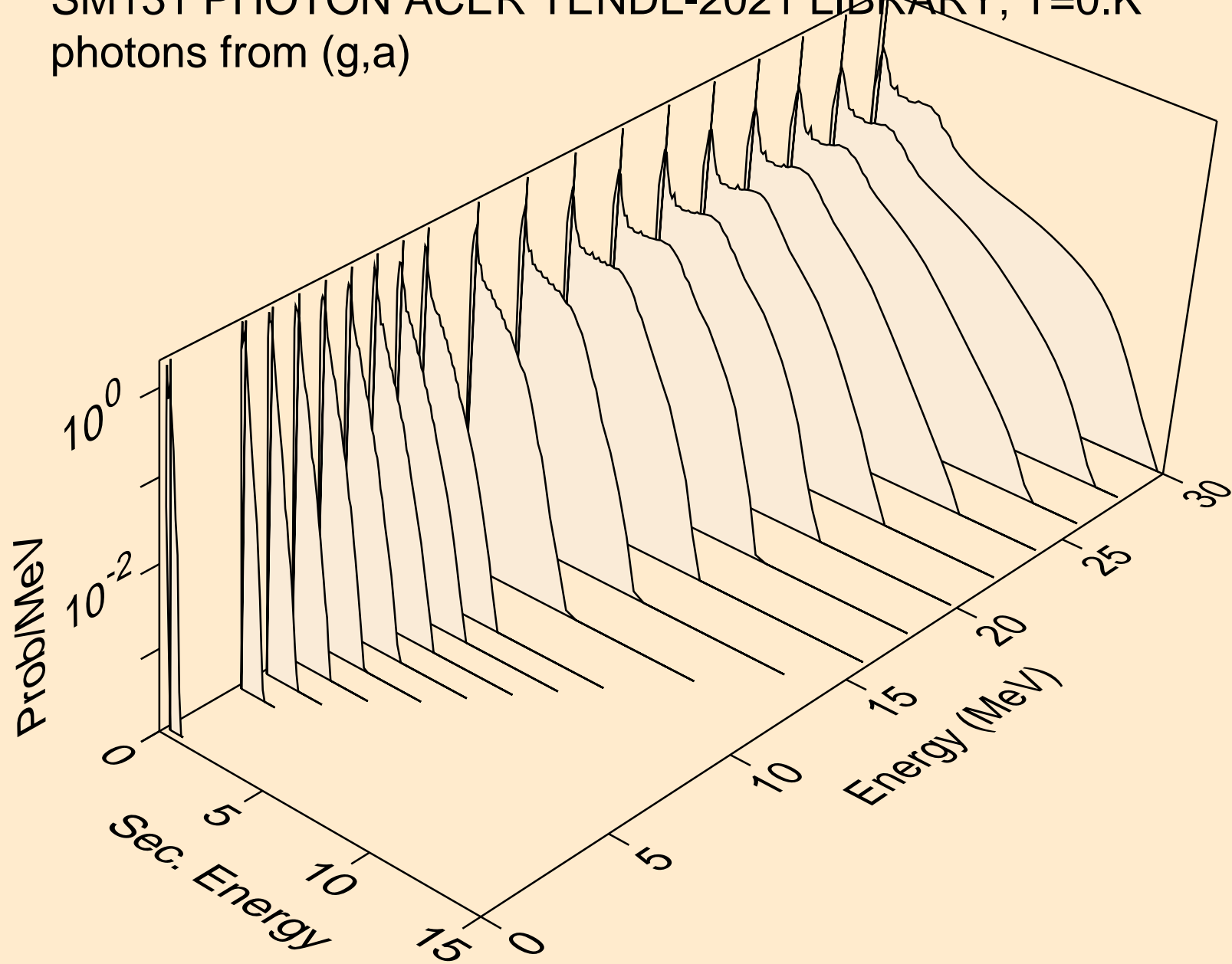

SM131 PHOTON ACER TENDL-2021 LIBRARY; T=0.K
photons from (g,2a)

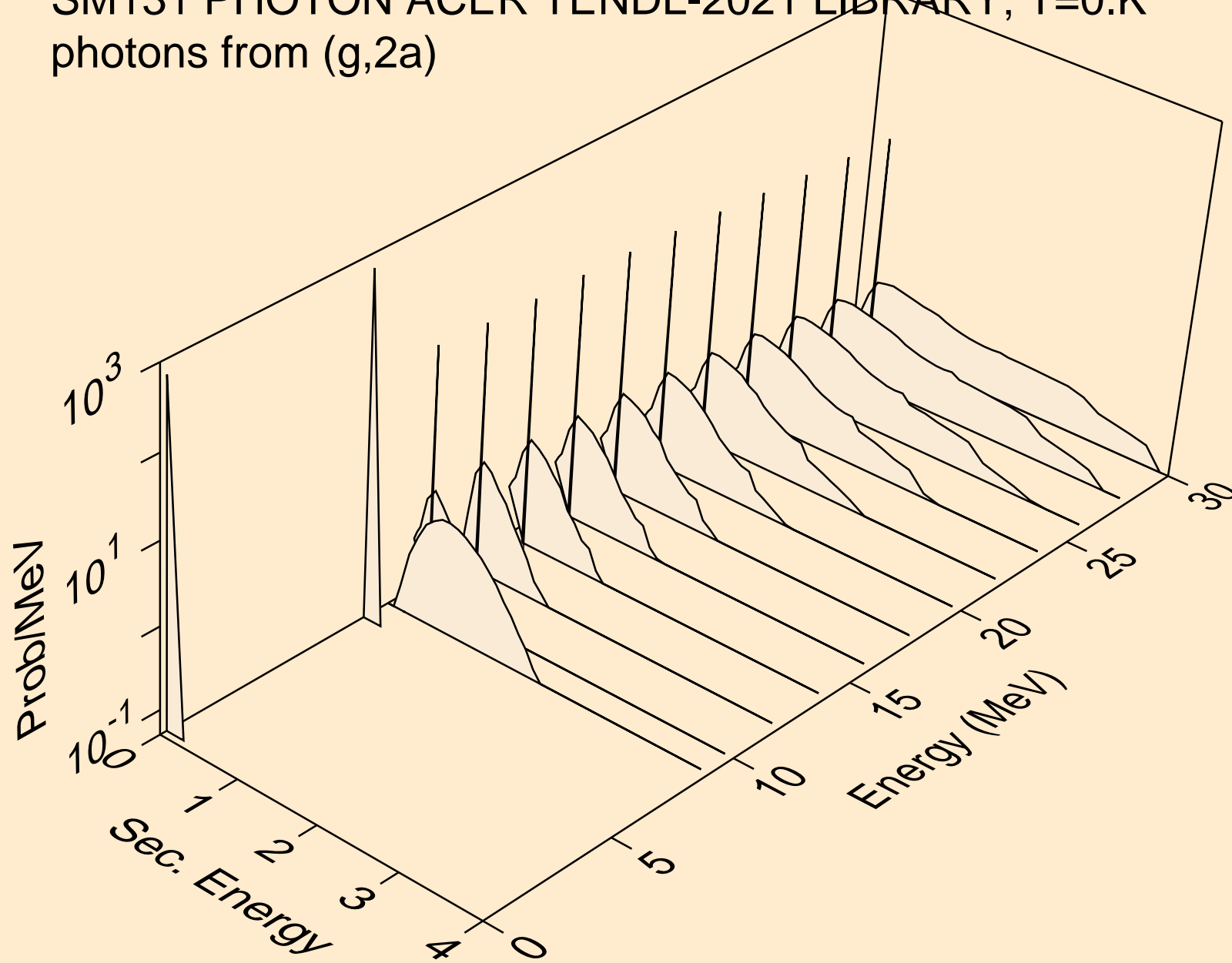

SM131 PHOTON ACER TENDL-2021 LIBRARY; T=0.K
photons from (g,2p)

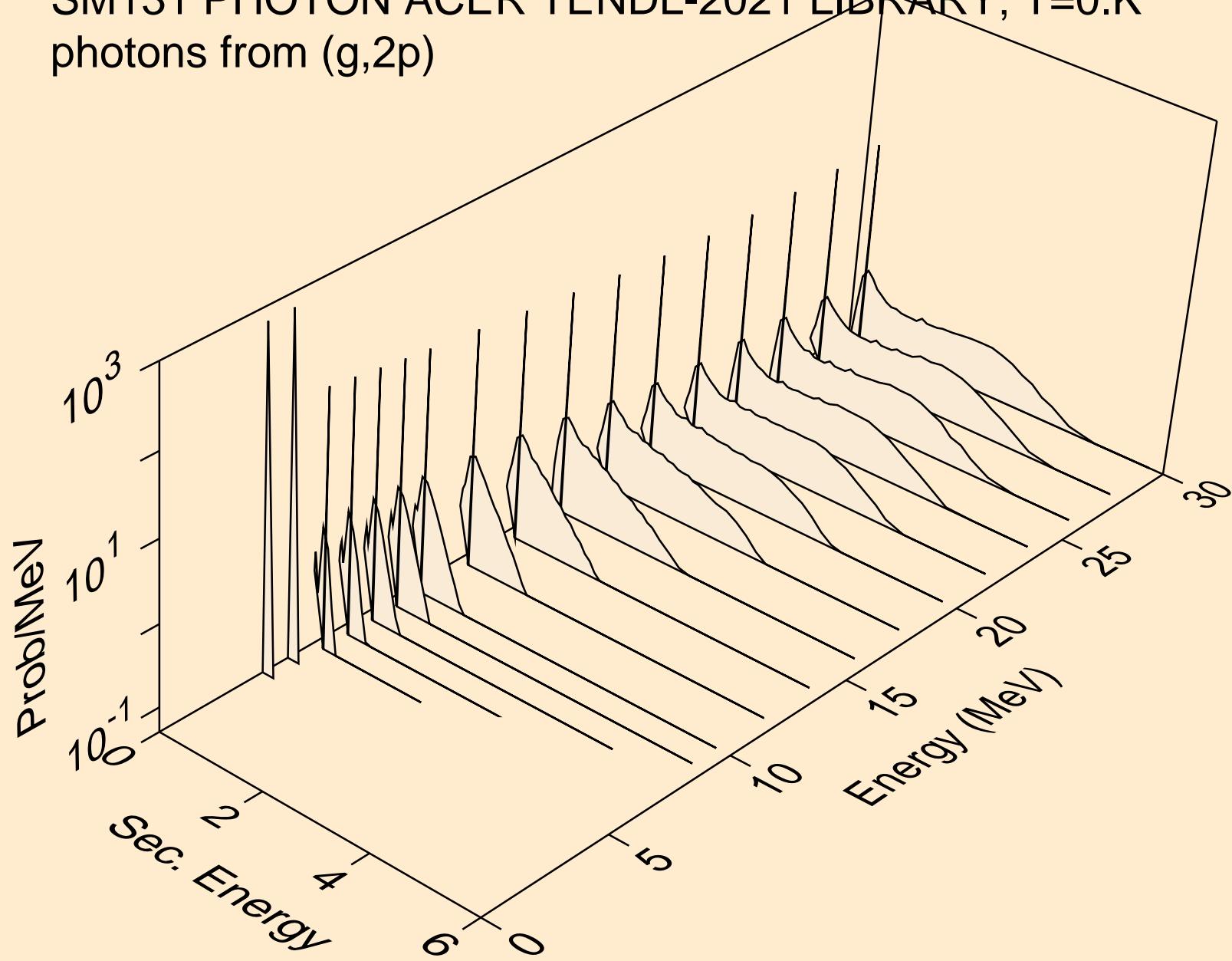

SM131 PHOTON ACER TENDL-2021 LIBRARY; T=0.K
photons from (g,pa)

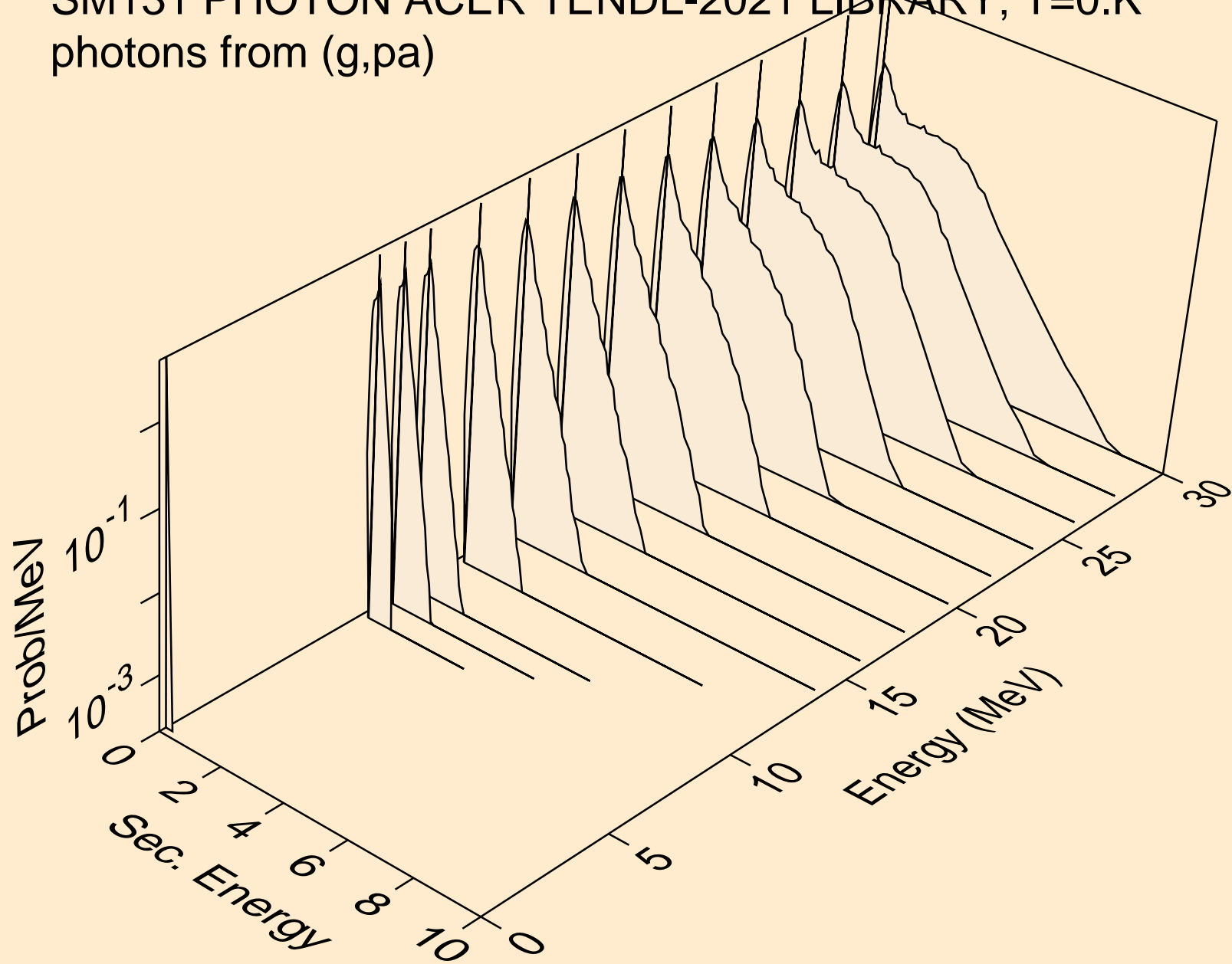

SM131 PHOTON ACER TENDL-2021 LIBRARY; T=0.K
photons from (g,pd)

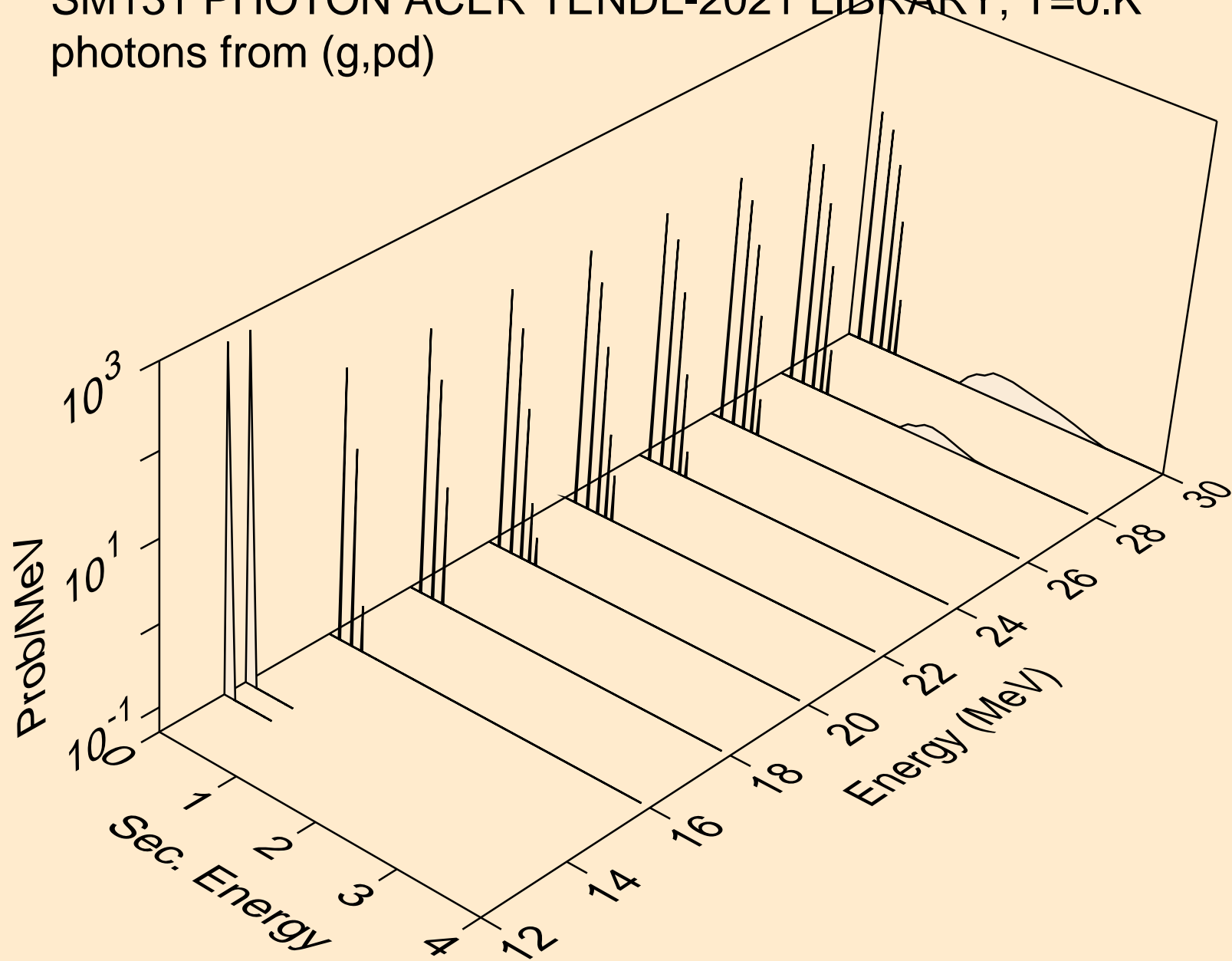

SM131 PHOTON ACER TENDL-2021 LIBRARY; T=0.K
photons from (g,pt)

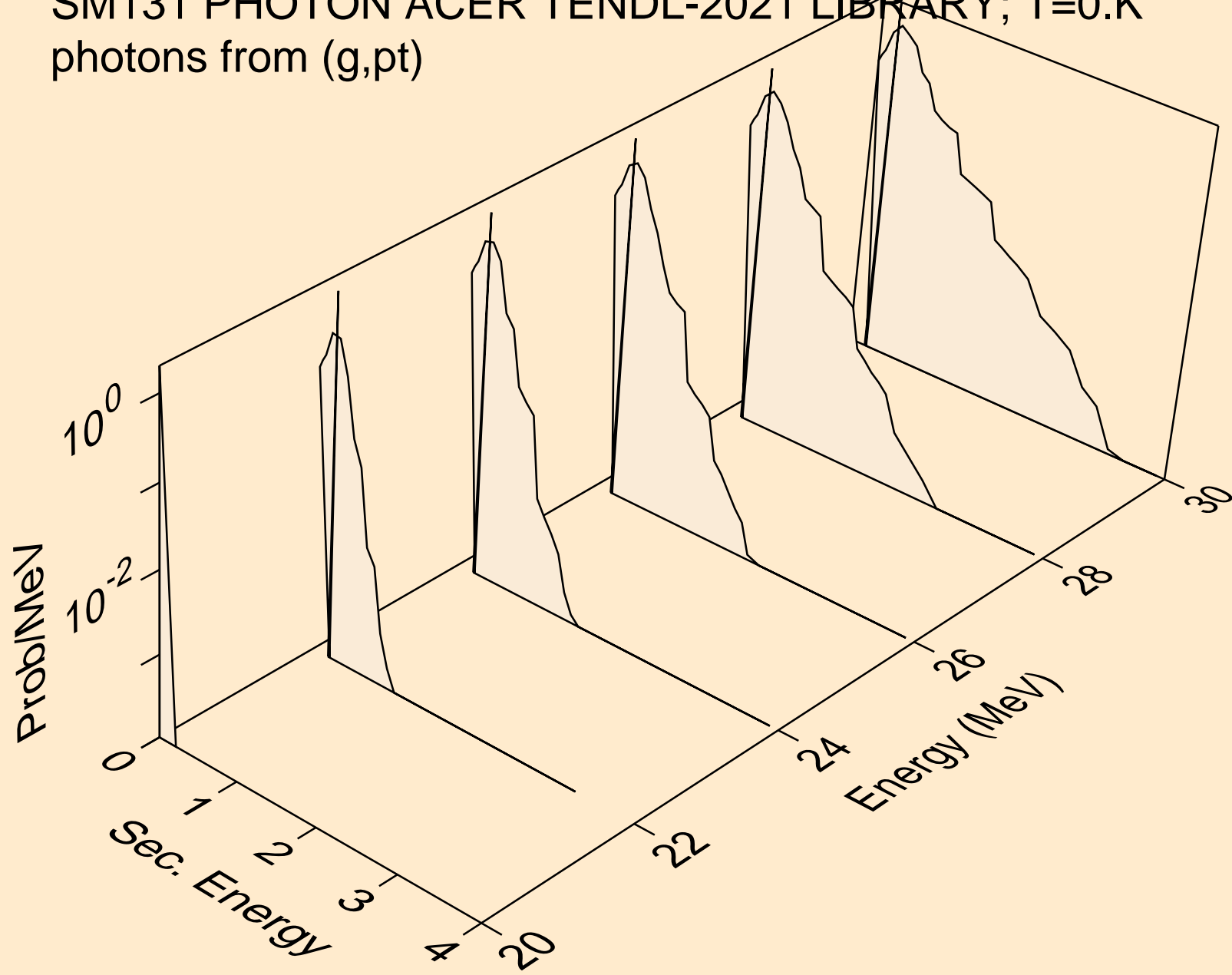

SM131 PHOTON ACER TENDL-2021 LIBRARY; T=0.K
protons from (g,x)

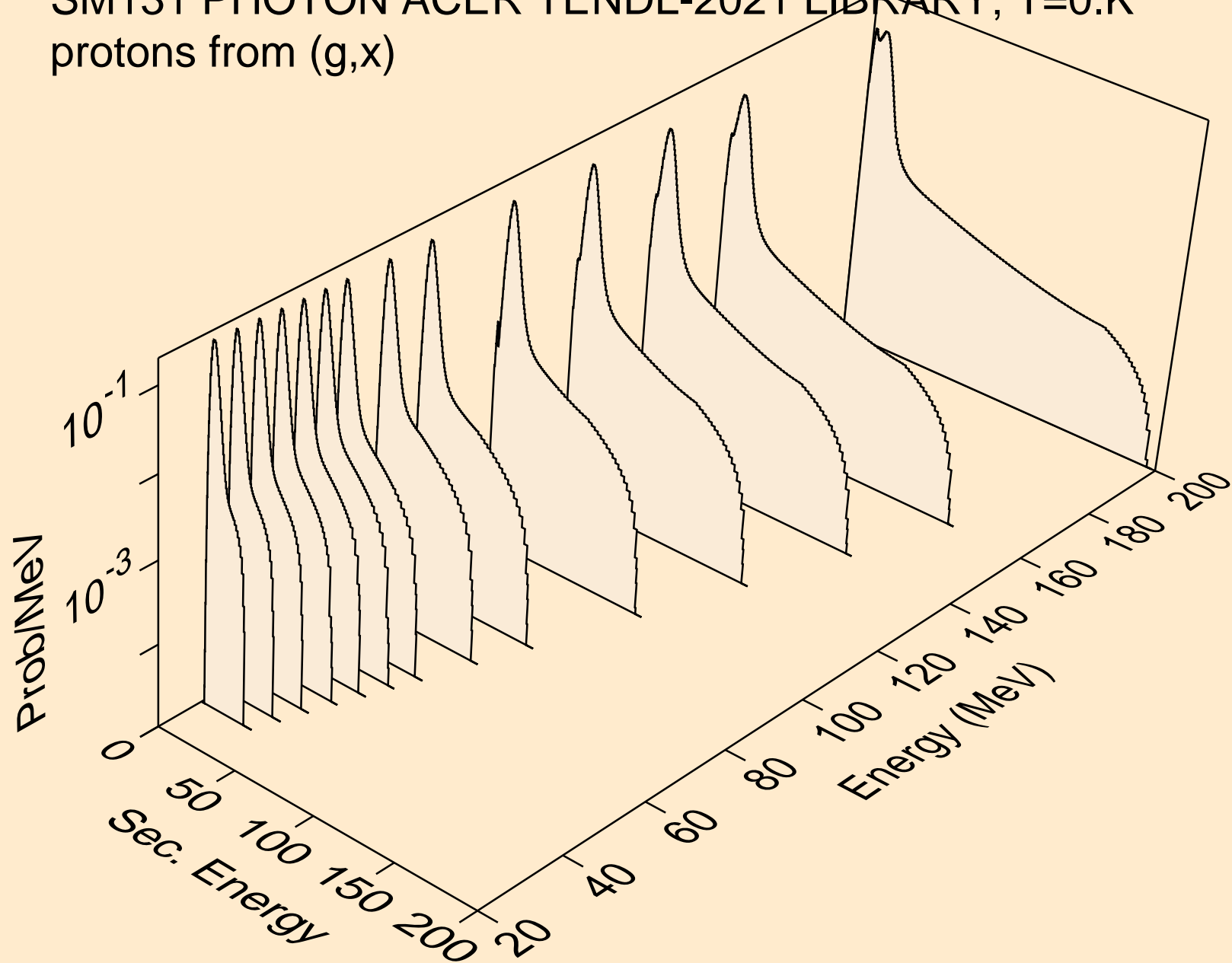

SM131 PHOTON ACER TENDL-2021 LIBRARY; T=0.K
protons from (g,n*)p

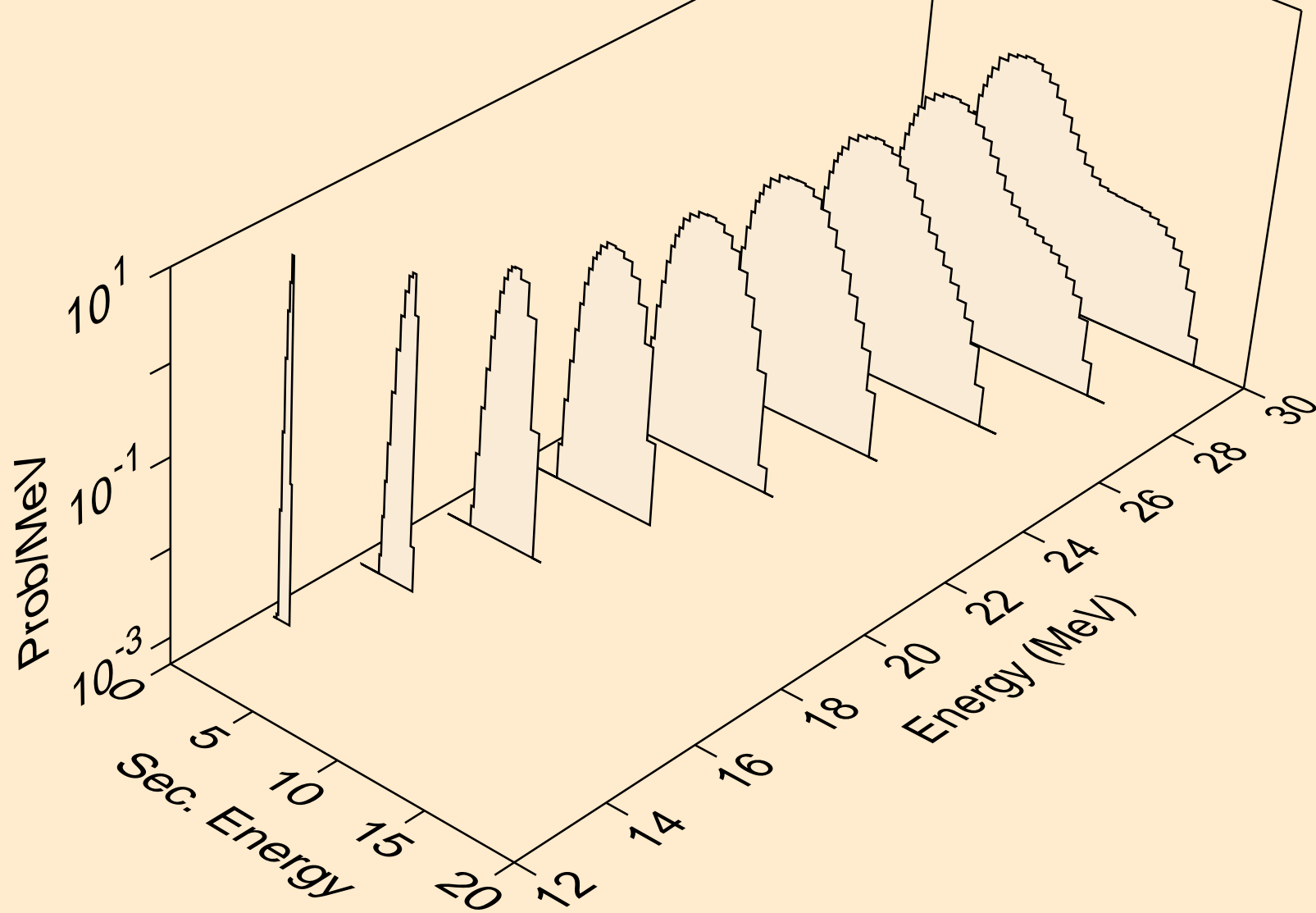

SM131 PHOTON ACER TENDL-2021 LIBRARY; T=0.K
protons from (g,2np)

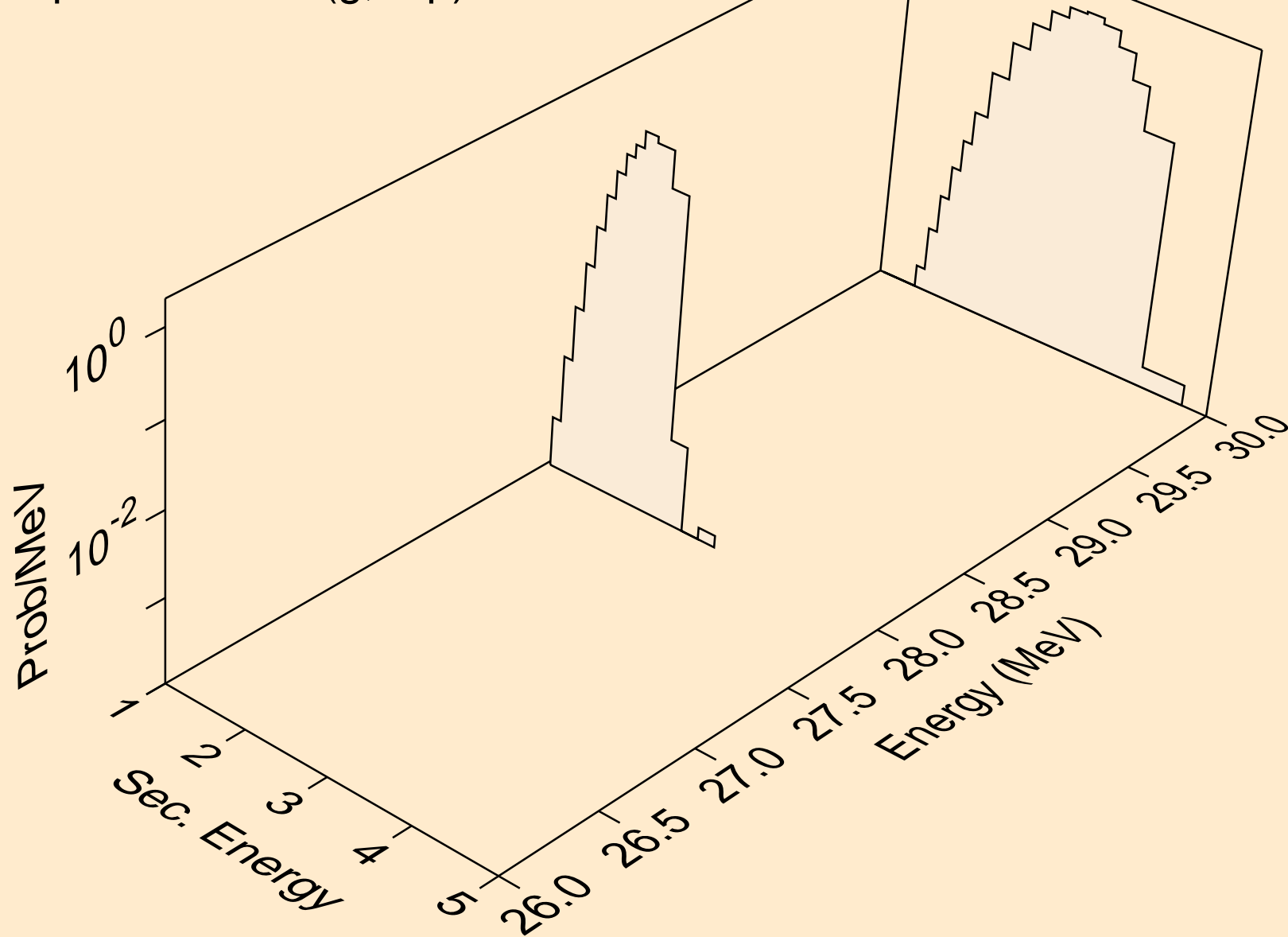

SM131 PHOTON ACER TENDL-2021 LIBRARY; T=0.K
protons from (g,2np)

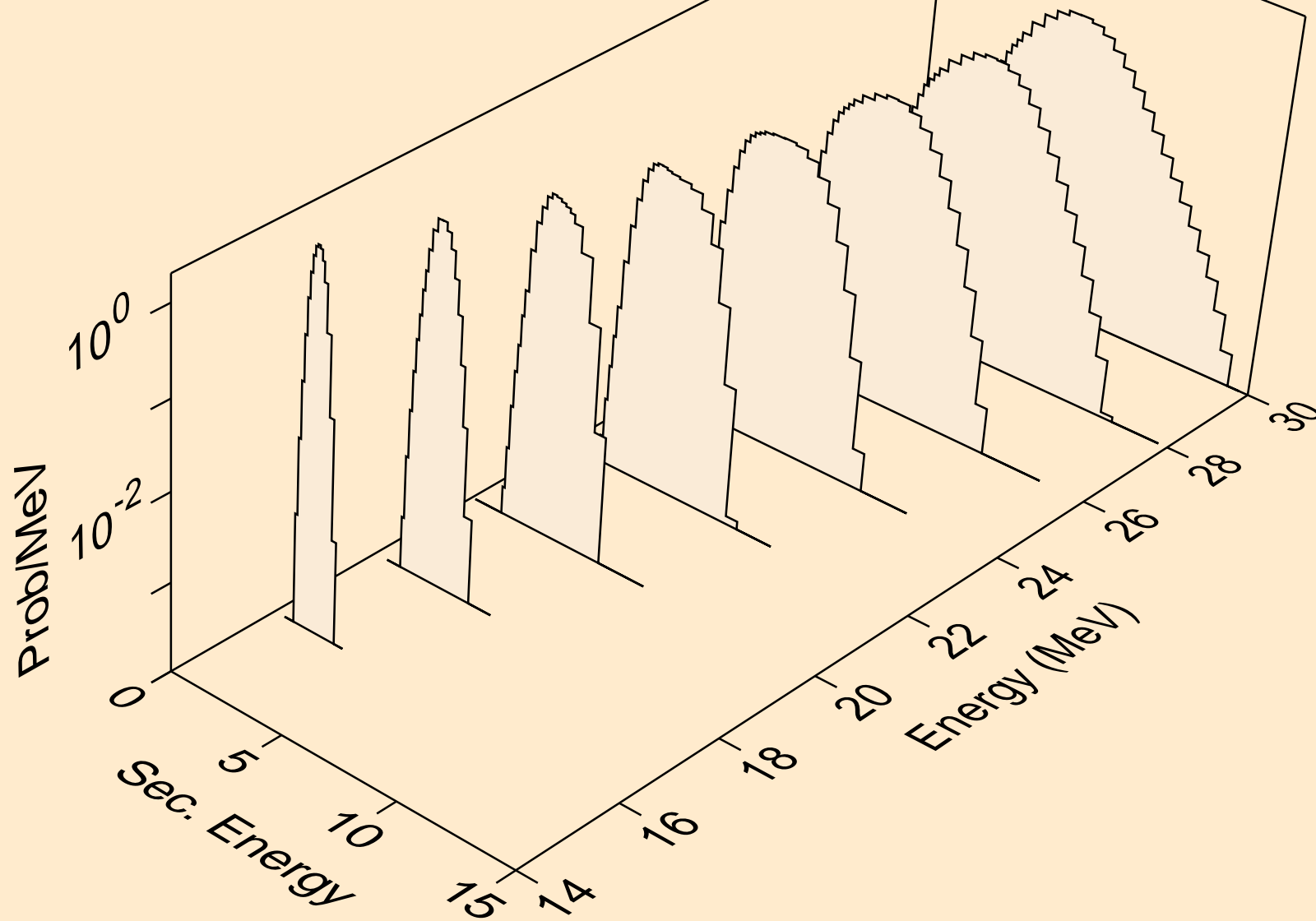

SM131 PHOTON ACER TENDL-2021 LIBRARY; T=0.K
protons from (g,npa)

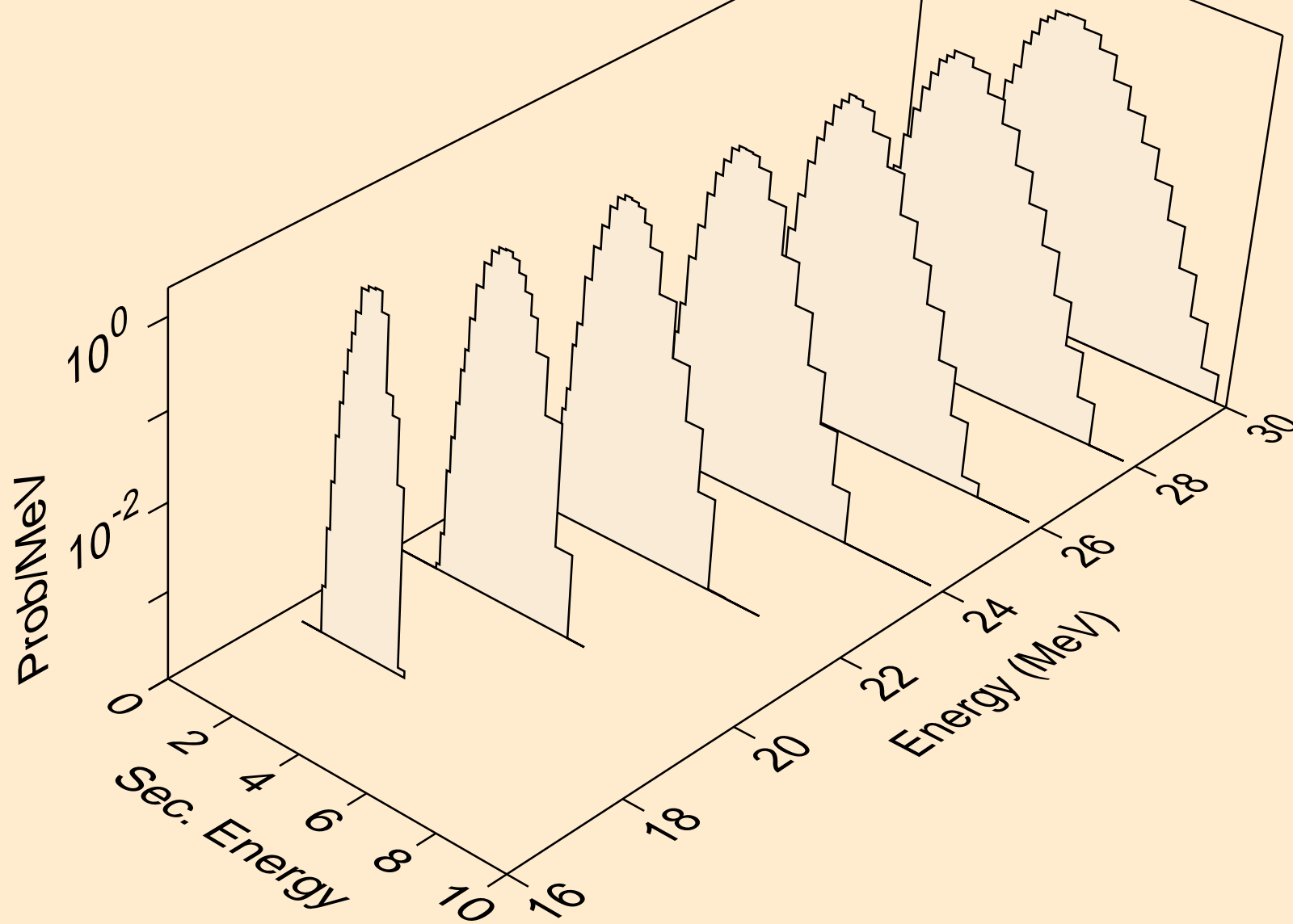

SM131 PHOTON ACER TENDL-2021 LIBRARY; T=0.K
protons from (g,p)

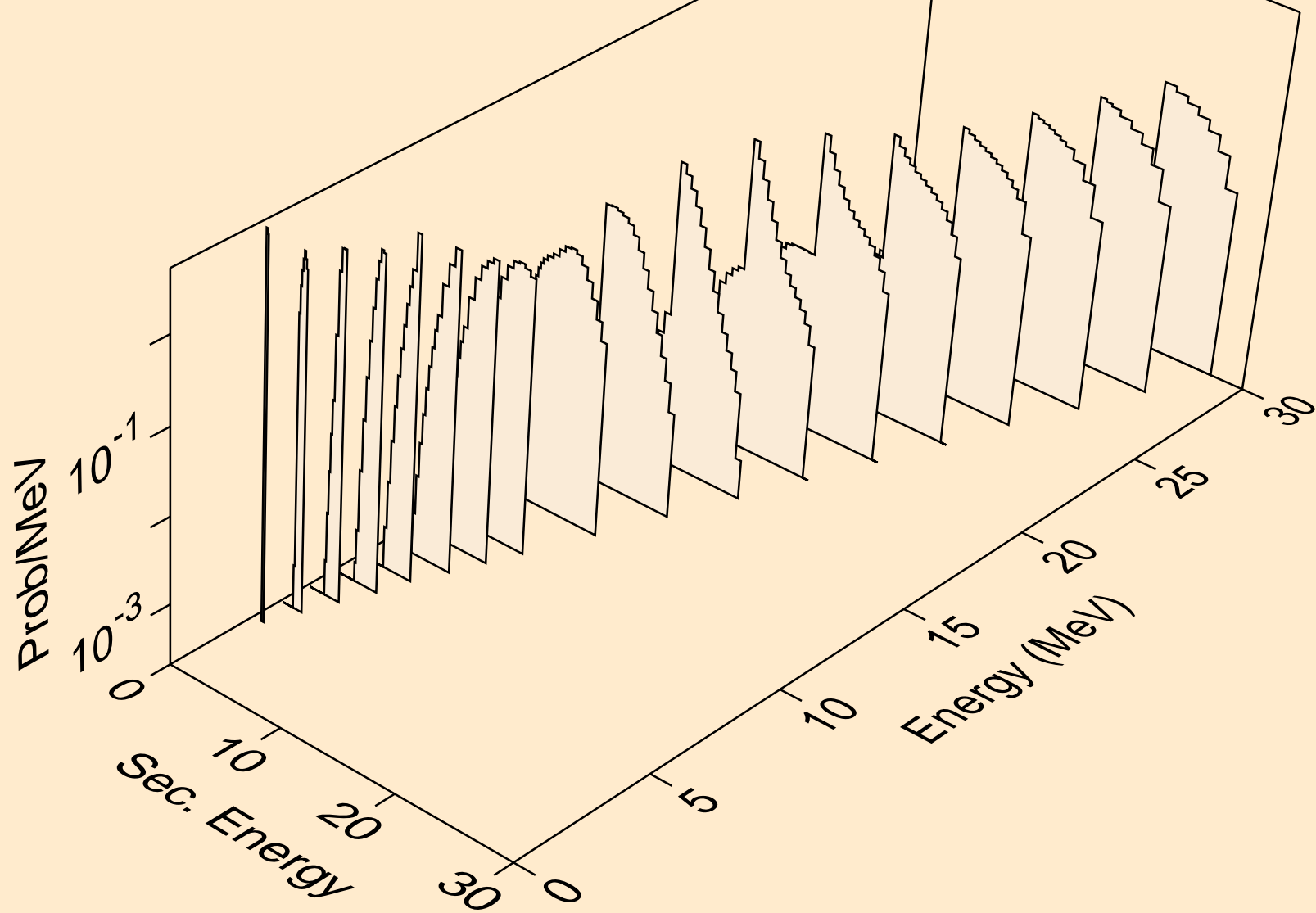

SM131 PHOTON ACER TENDL-2021 LIBRARY; T=0.K
protons from (g,2p)

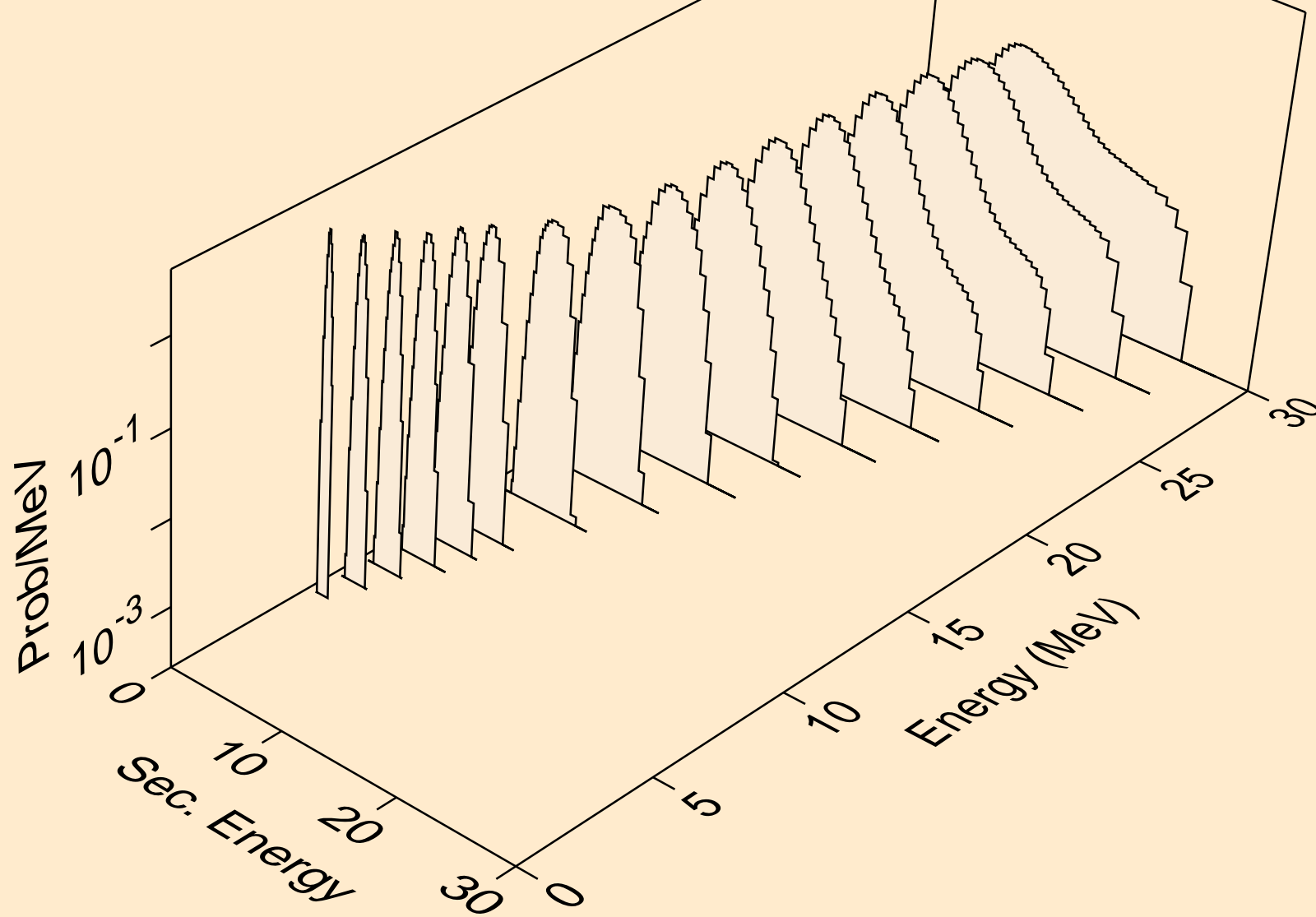

SM131 PHOTON ACER TENDL-2021 LIBRARY; T=0.K
protons from (g,pa)

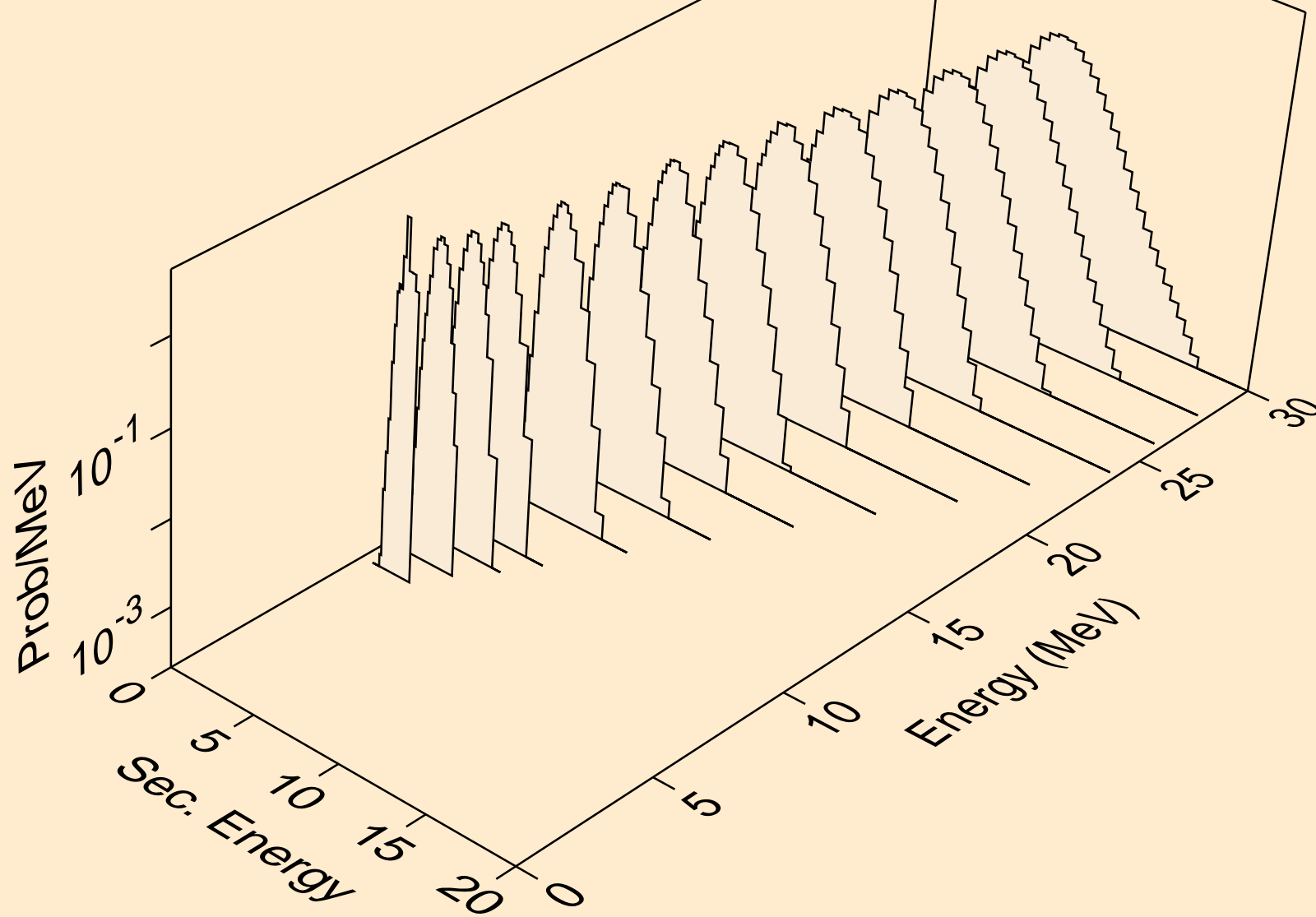

SM131 PHOTON ACER TENDL-2021 LIBRARY; T=0.K
protons from (g,pd)

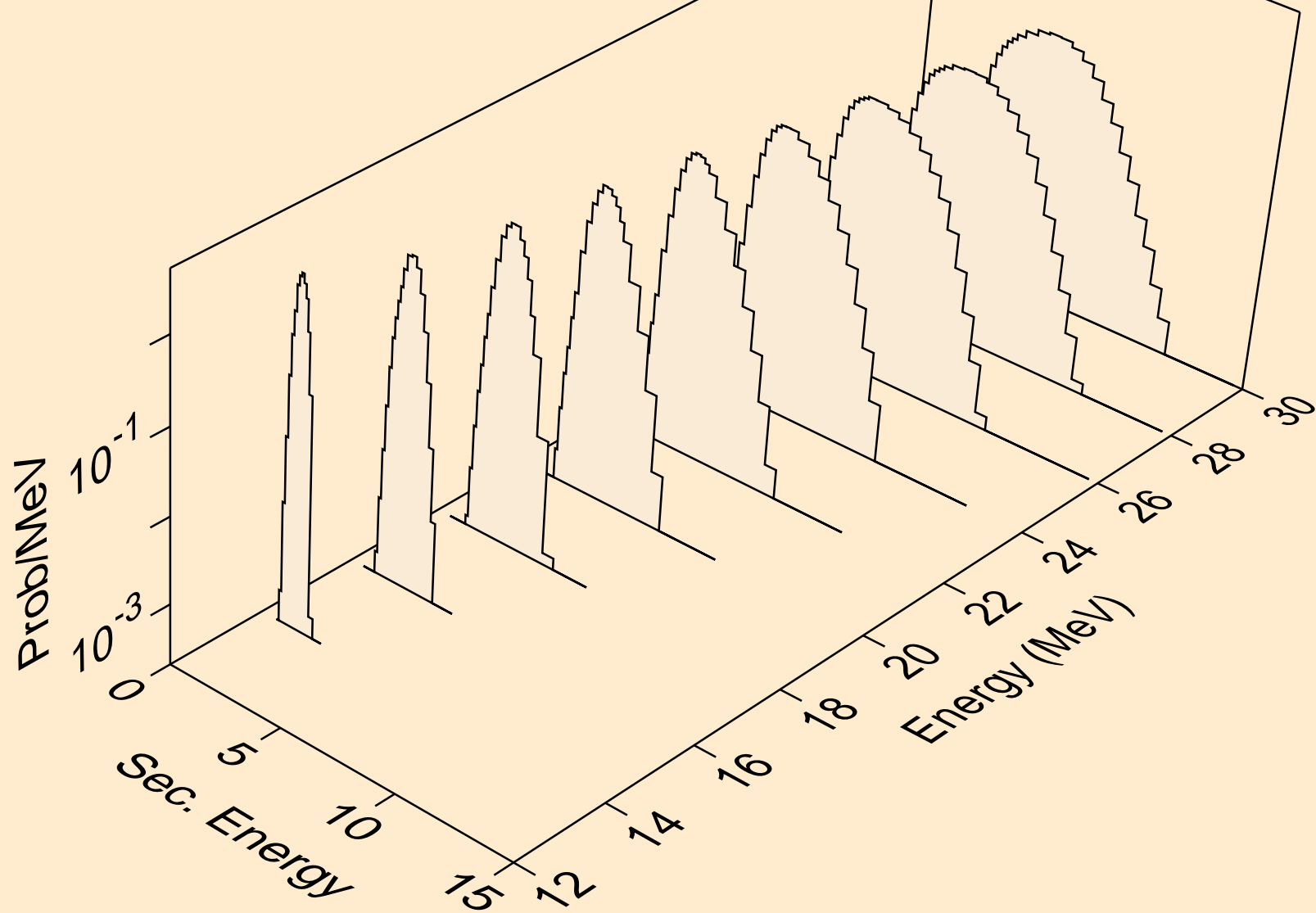

SM131 PHOTON ACER TENDL-2021 LIBRARY; T=0.K
protons from (g,pt)

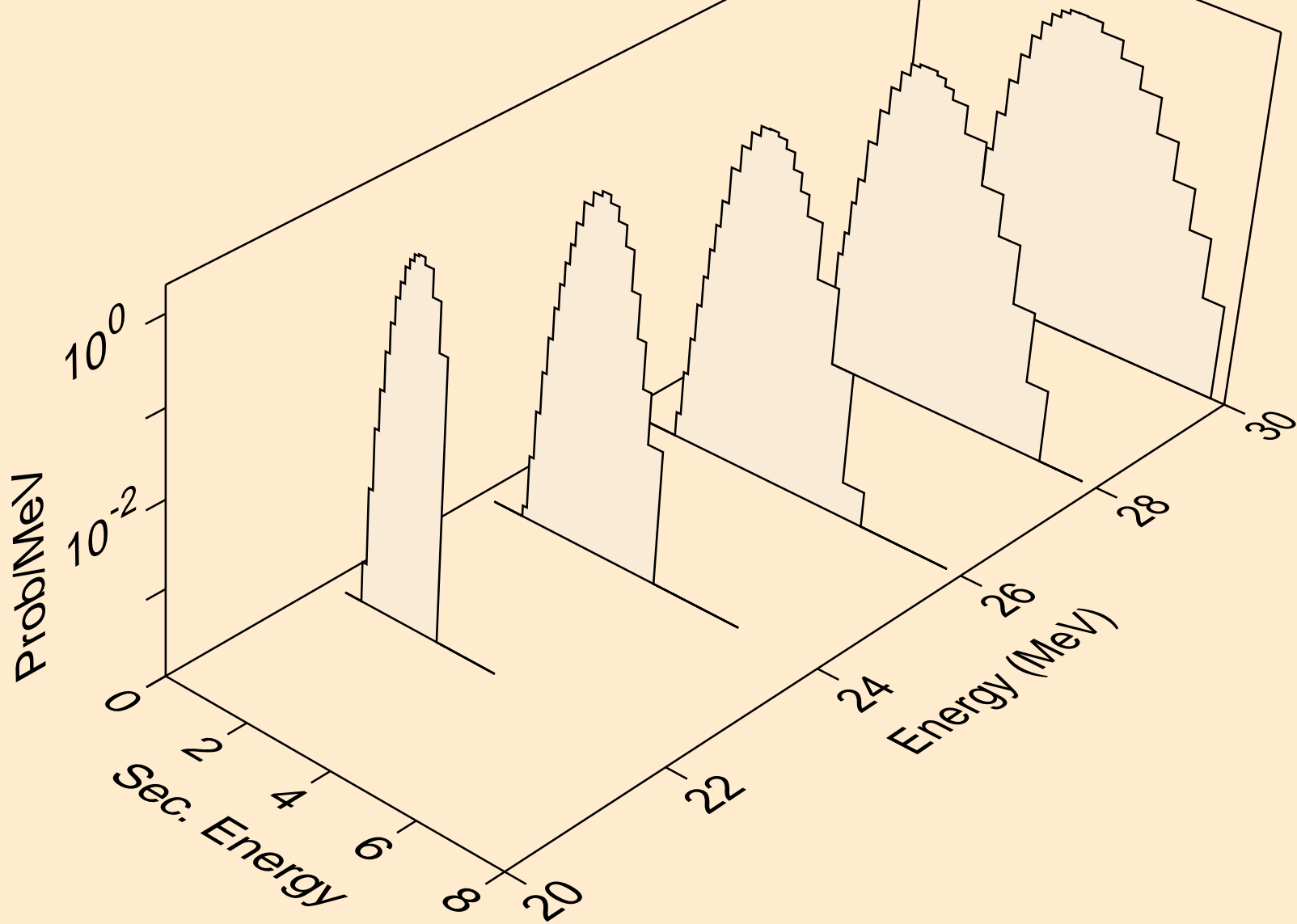

SM131 PHOTON ACER TENDL-2021 LIBRARY; T=0.K
deuterons from (g,x)

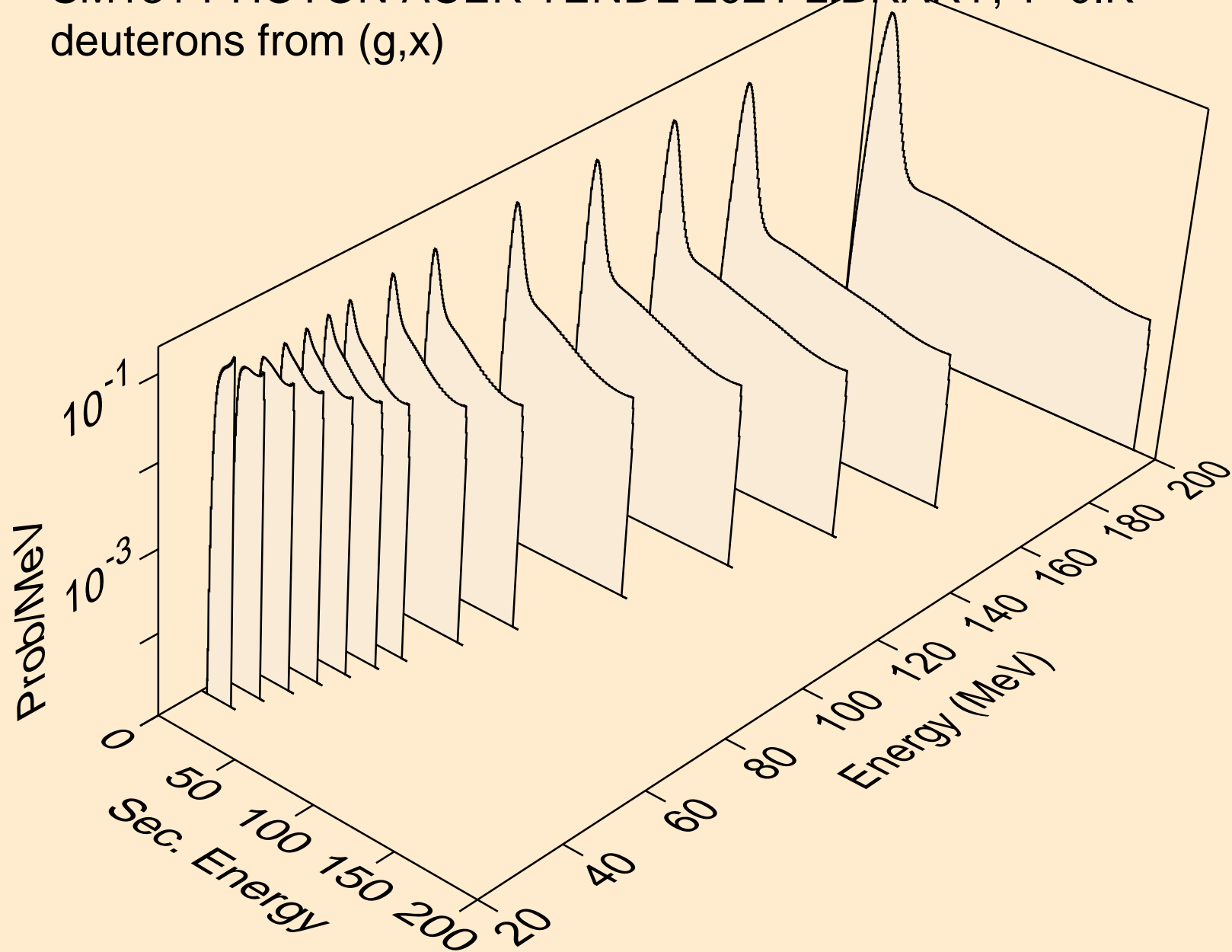

SM131 PHOTON ACER TENDL-2021 LIBRARY; T=0.K
deuterons from (g,d)

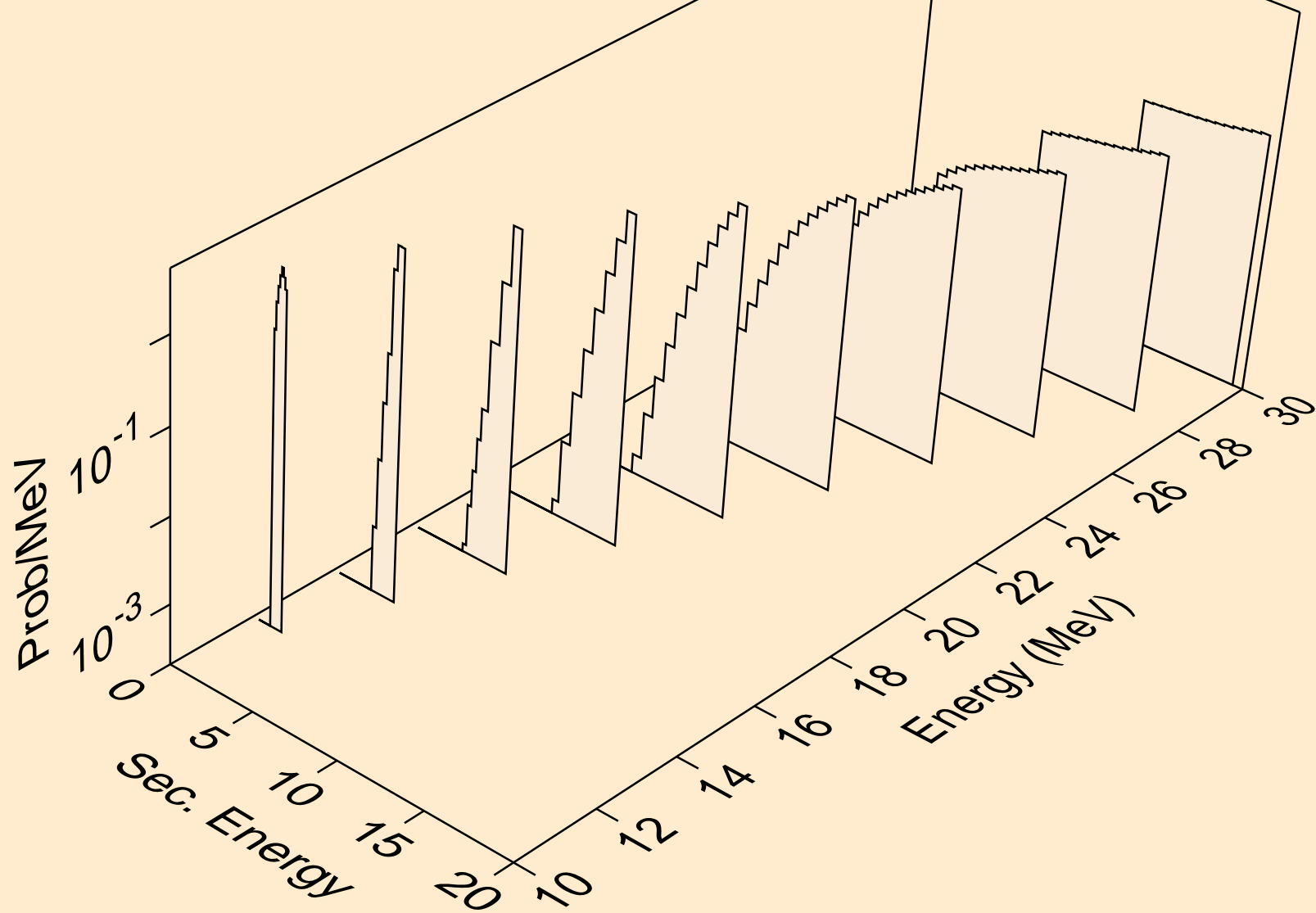

SM131 PHOTON ACER TENDL-2021 LIBRARY; T=0.K
deuterons from (g,pd)

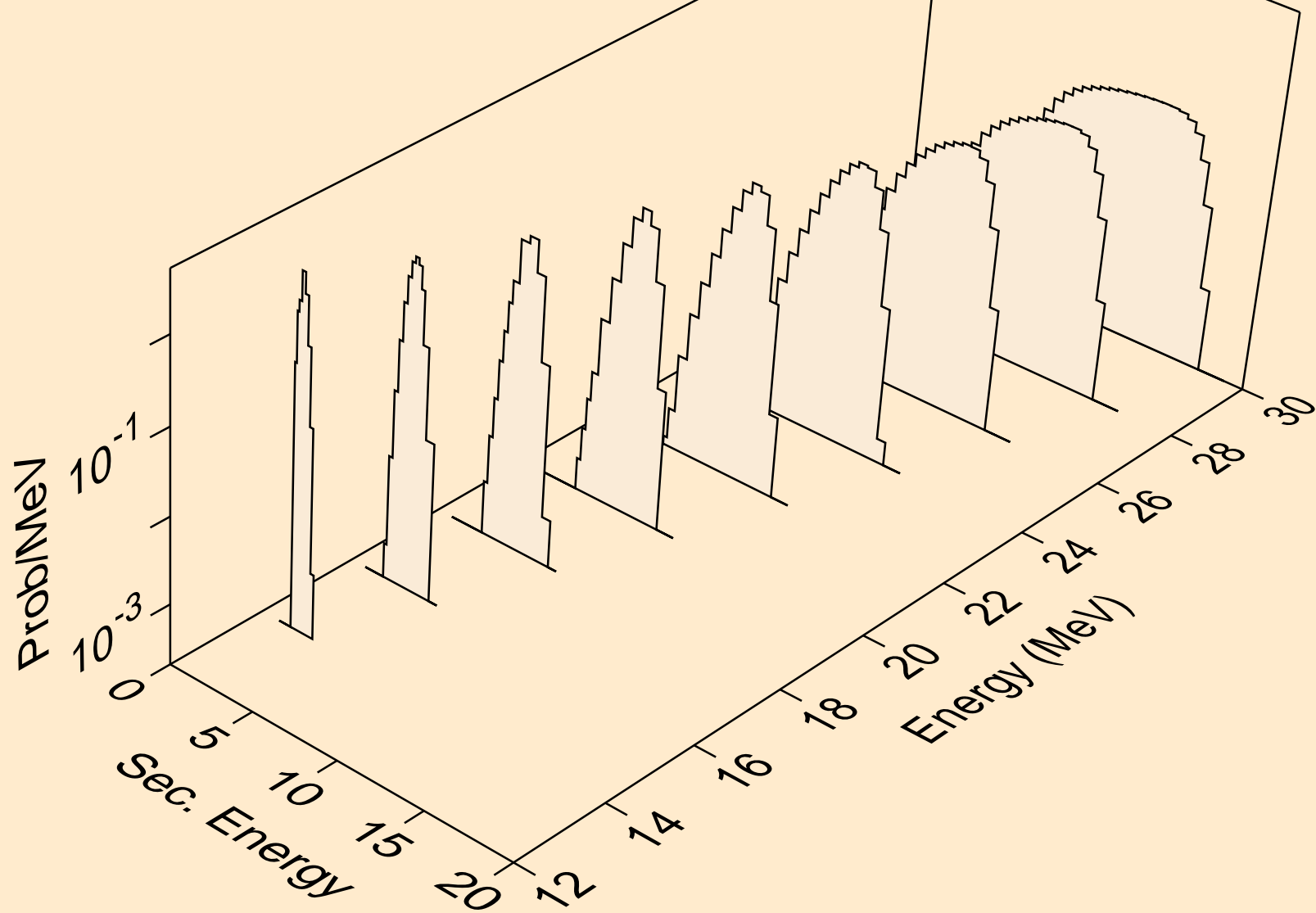

SM131 PHOTON ACER TENDL-2021 LIBRARY; T=0.K
deuterons from (g,da)

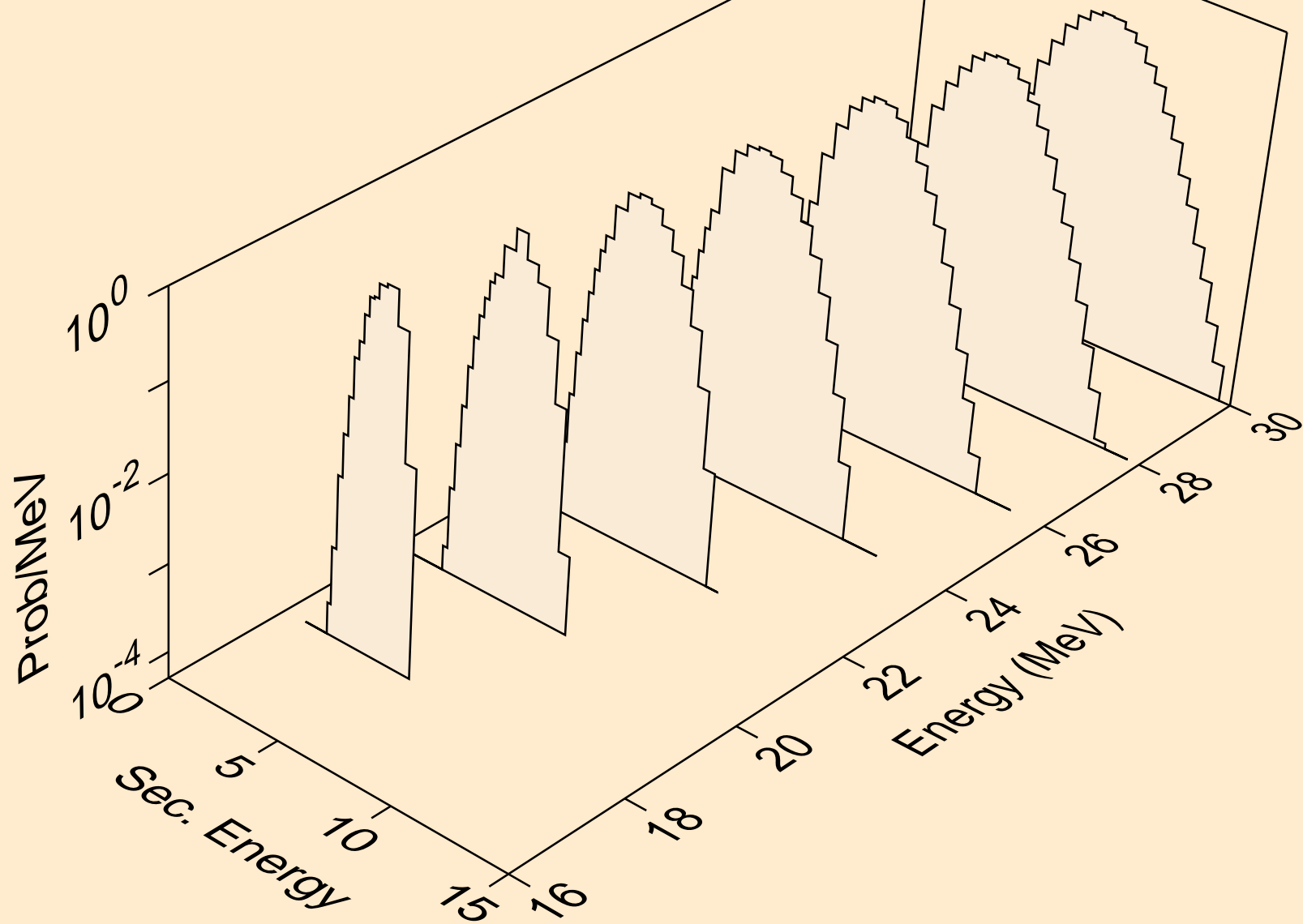

SM131 PHOTON ACER TENDL-2021 LIBRARY; T=0.K
tritons from (g,x)

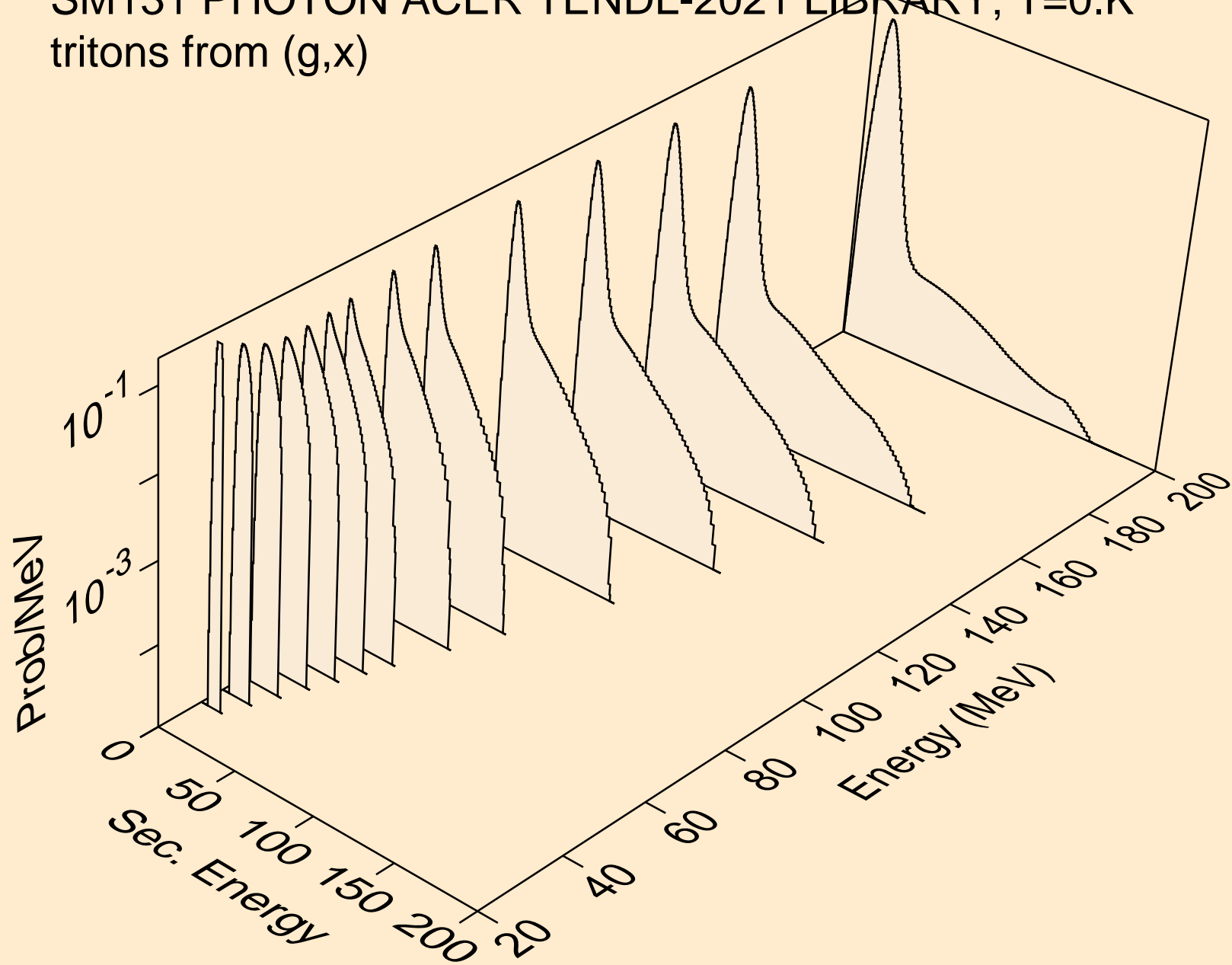

SM131 PHOTON ACER TENDL-2021 LIBRARY; T=0.K
tritons from (g,t)

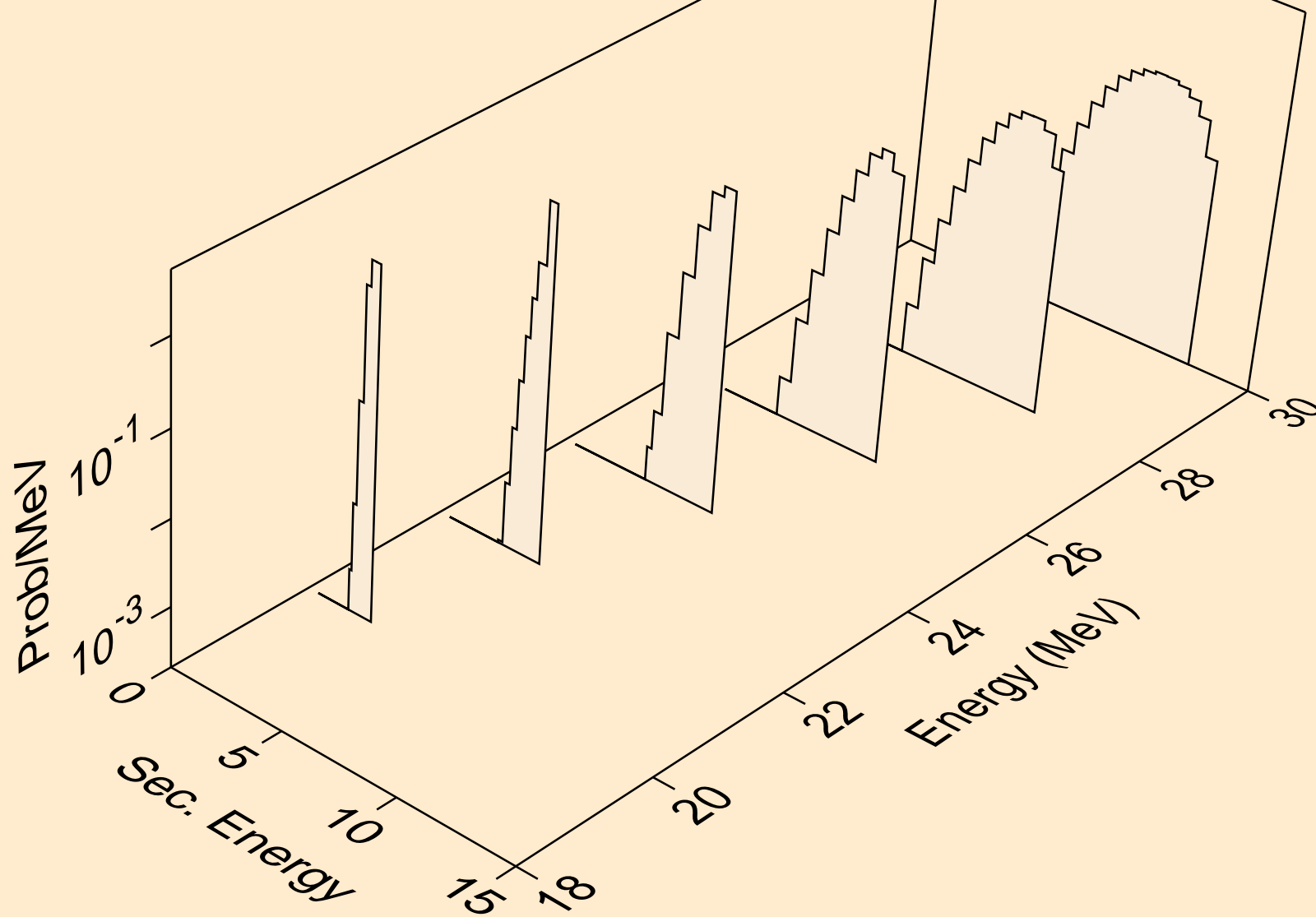

SM131 PHOTON ACER TENDL-2021 LIBRARY; T=0.K
tritons from (g,pt)

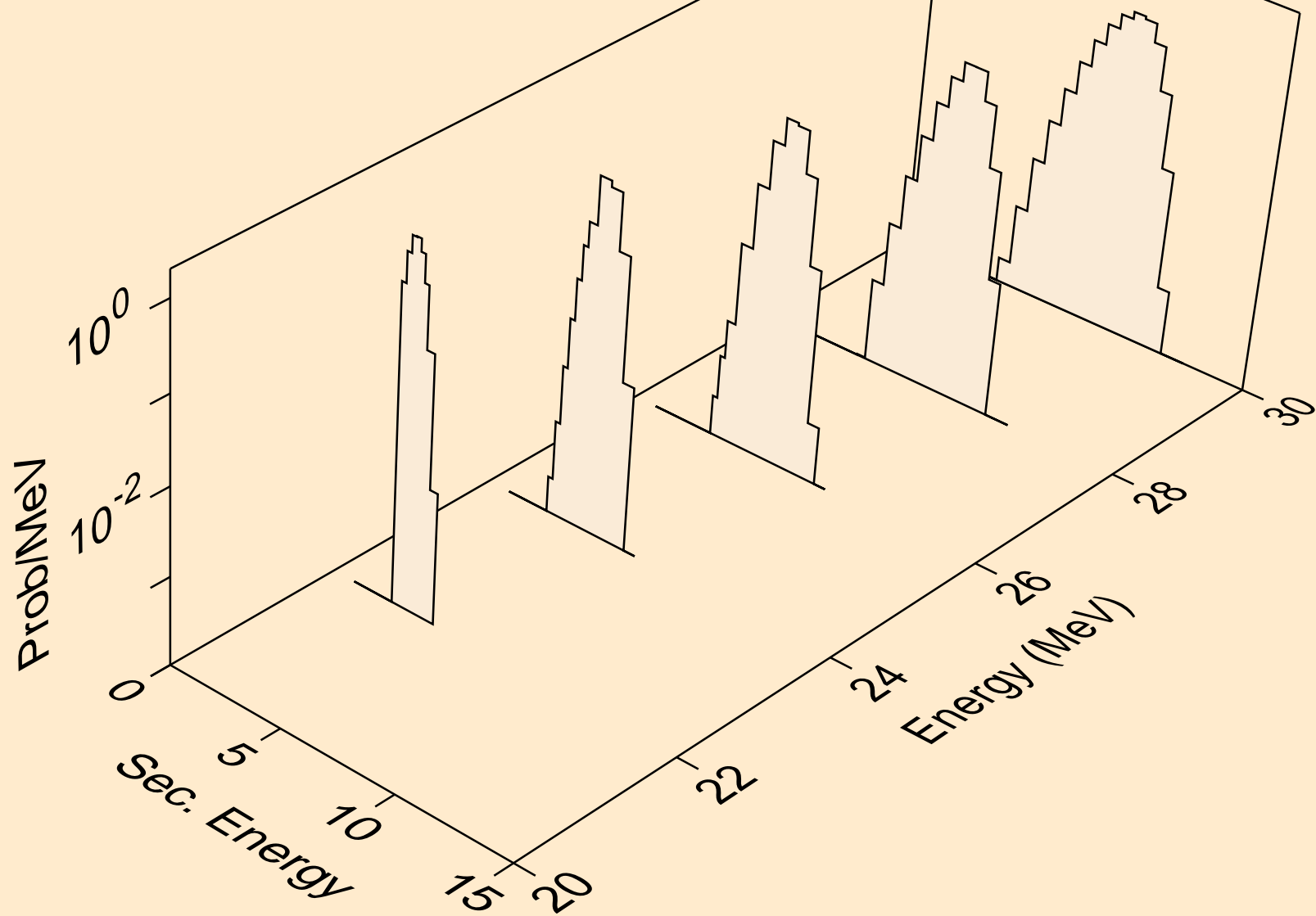

SM131 PHOTON ACER TENDL-2021 LIBRARY; T=0.K
he3s from (g,x)

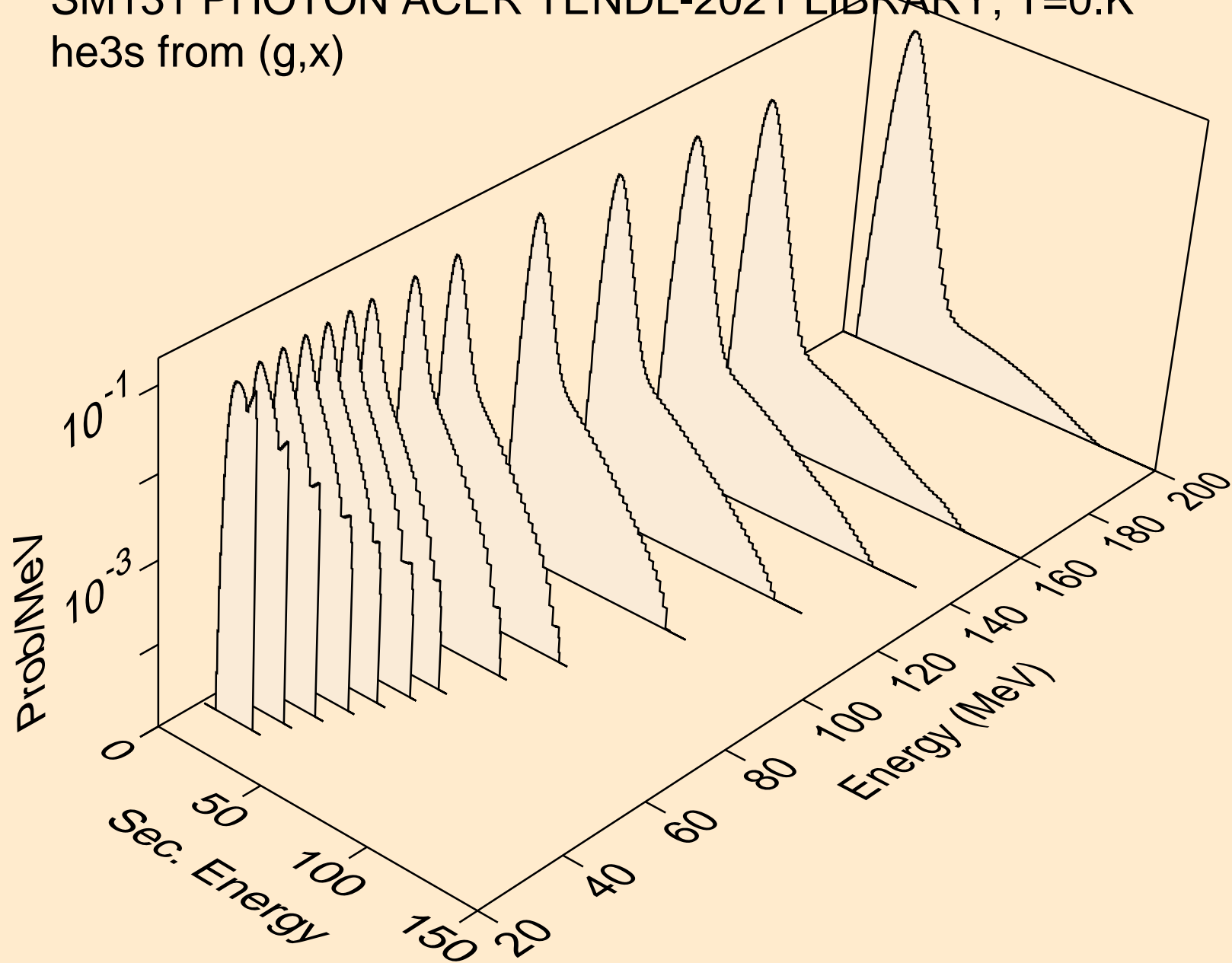

SM131 PHOTON ACER TENDL-2021 LIBRARY; T=0.K
he3s from (g,he3)

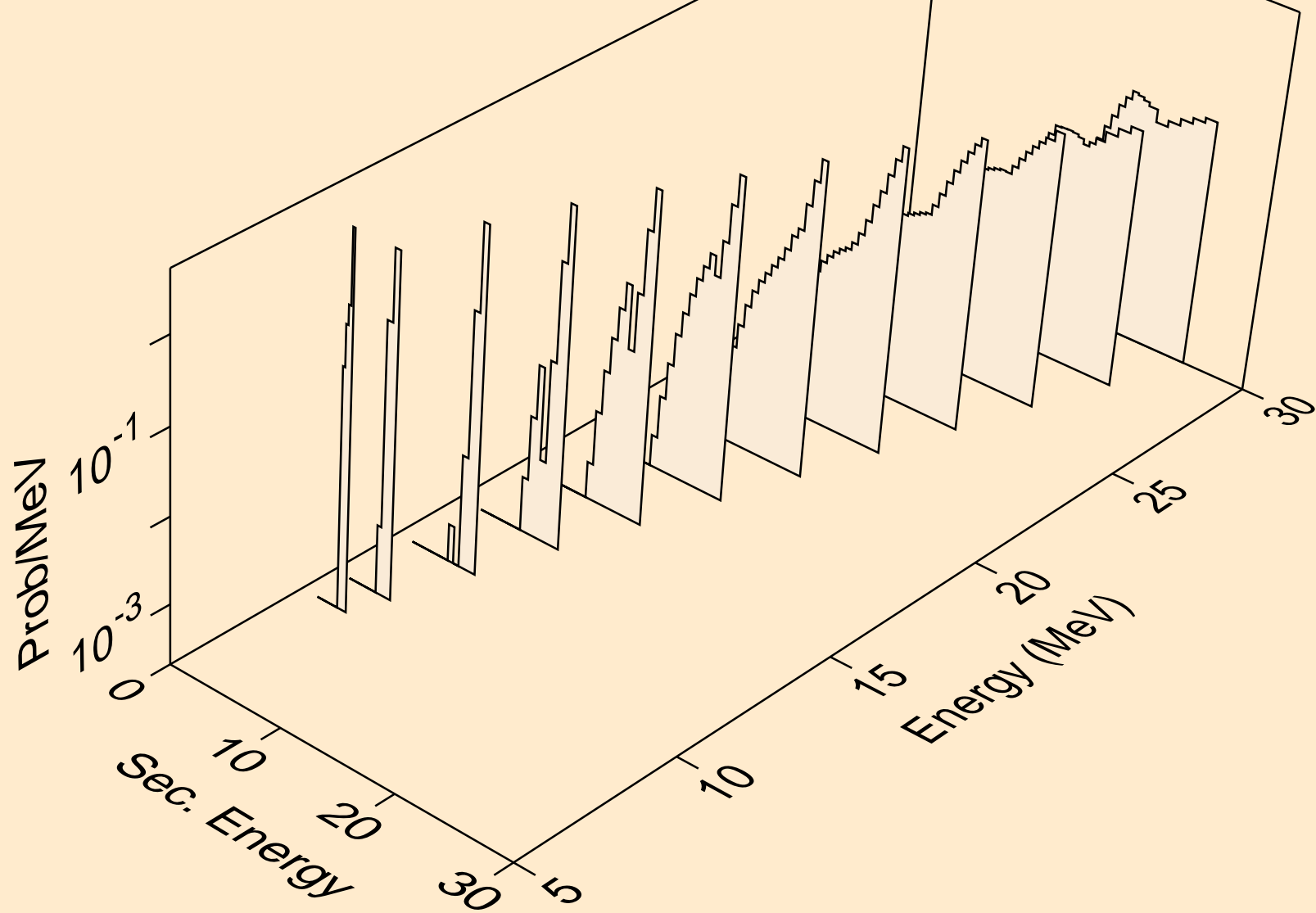

SM131 PHOTON ACER TENDL-2021 LIBRARY; T=0.K
alphas from (g,x)

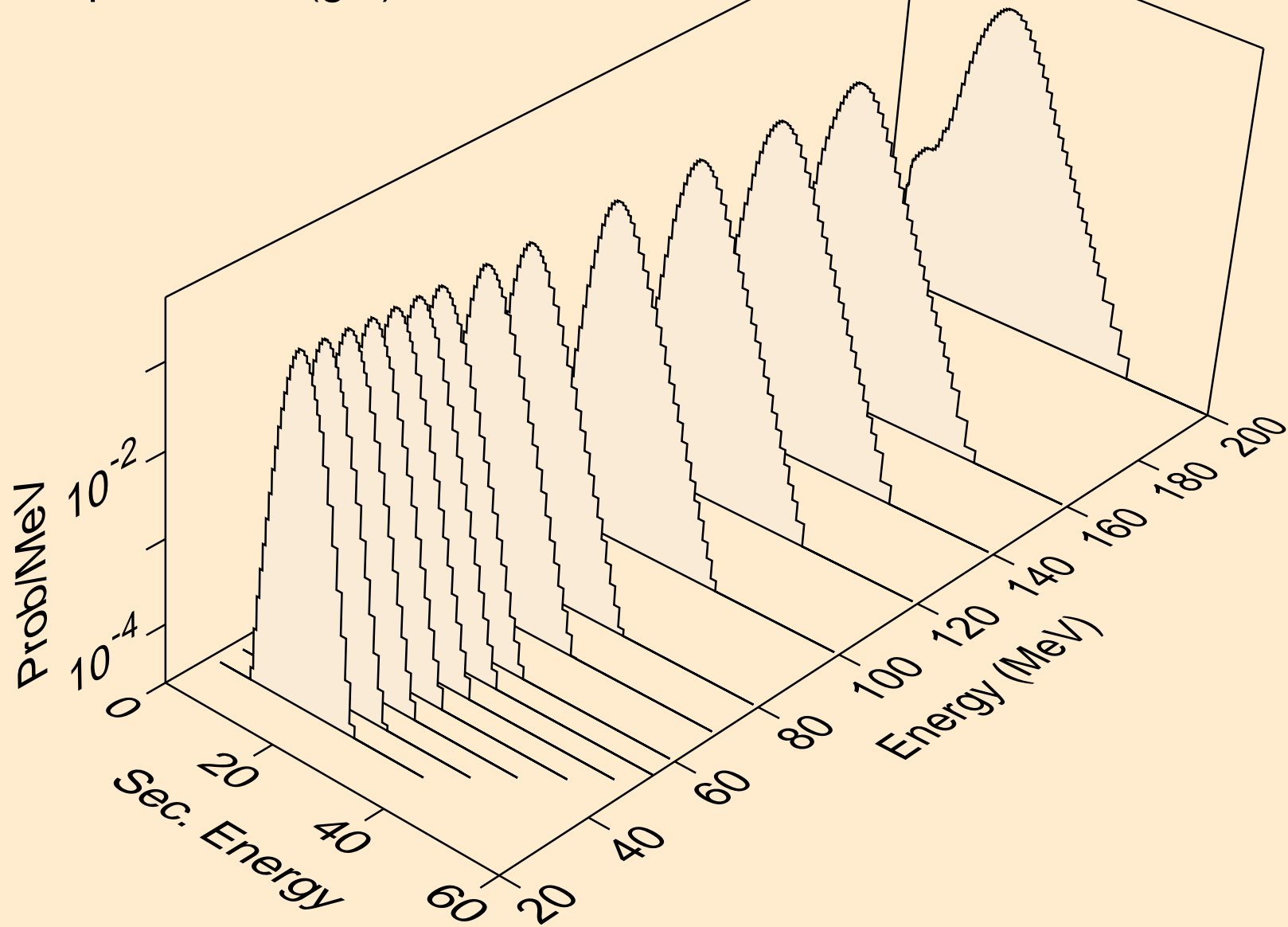

SM131 PHOTON ACER TENDL-2021 LIBRARY; T=0.K
alphas from (g,n*)a

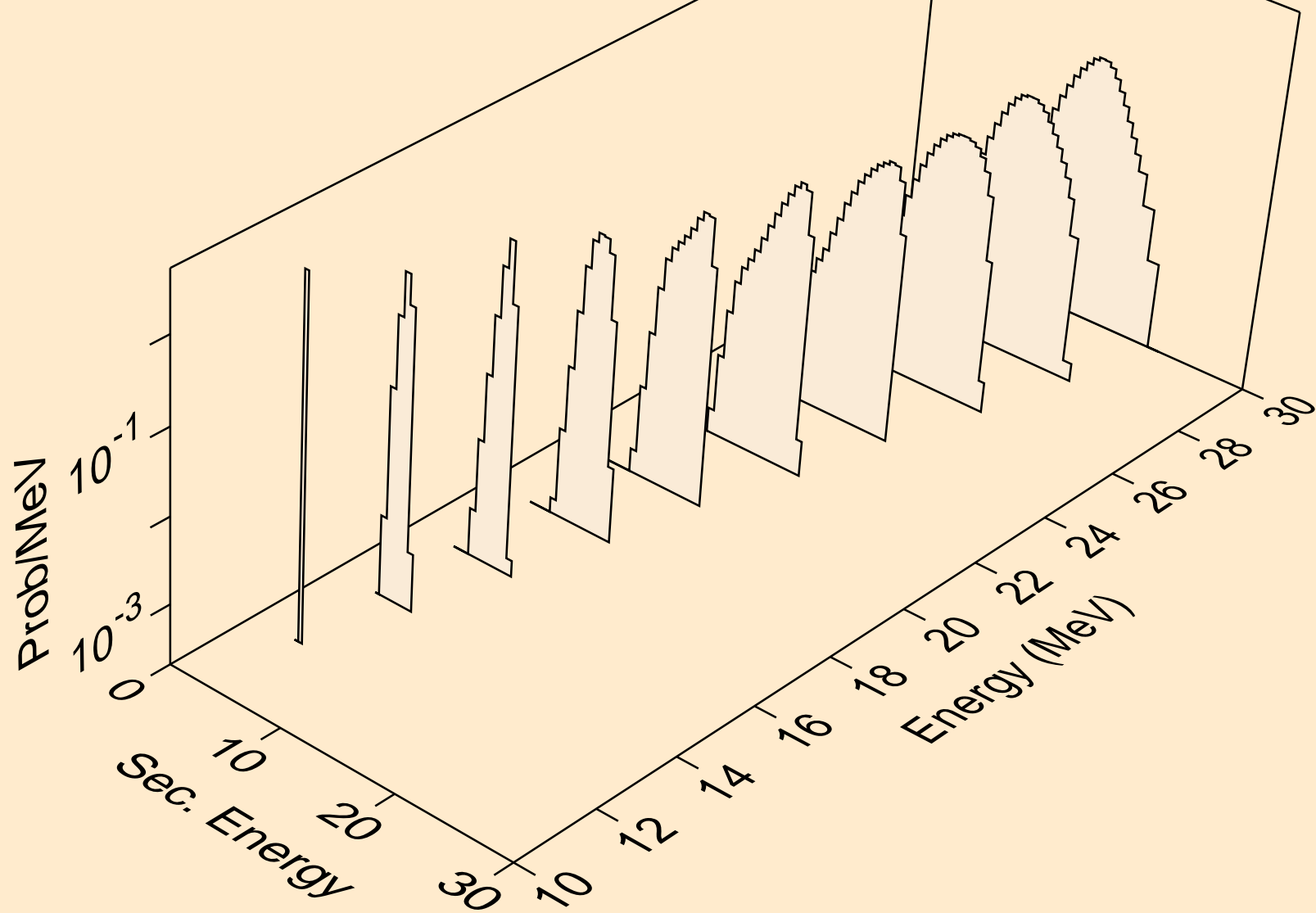

SM131 PHOTON ACER TENDL-2021 LIBRARY; T=0.K
alphas from (g,npa)

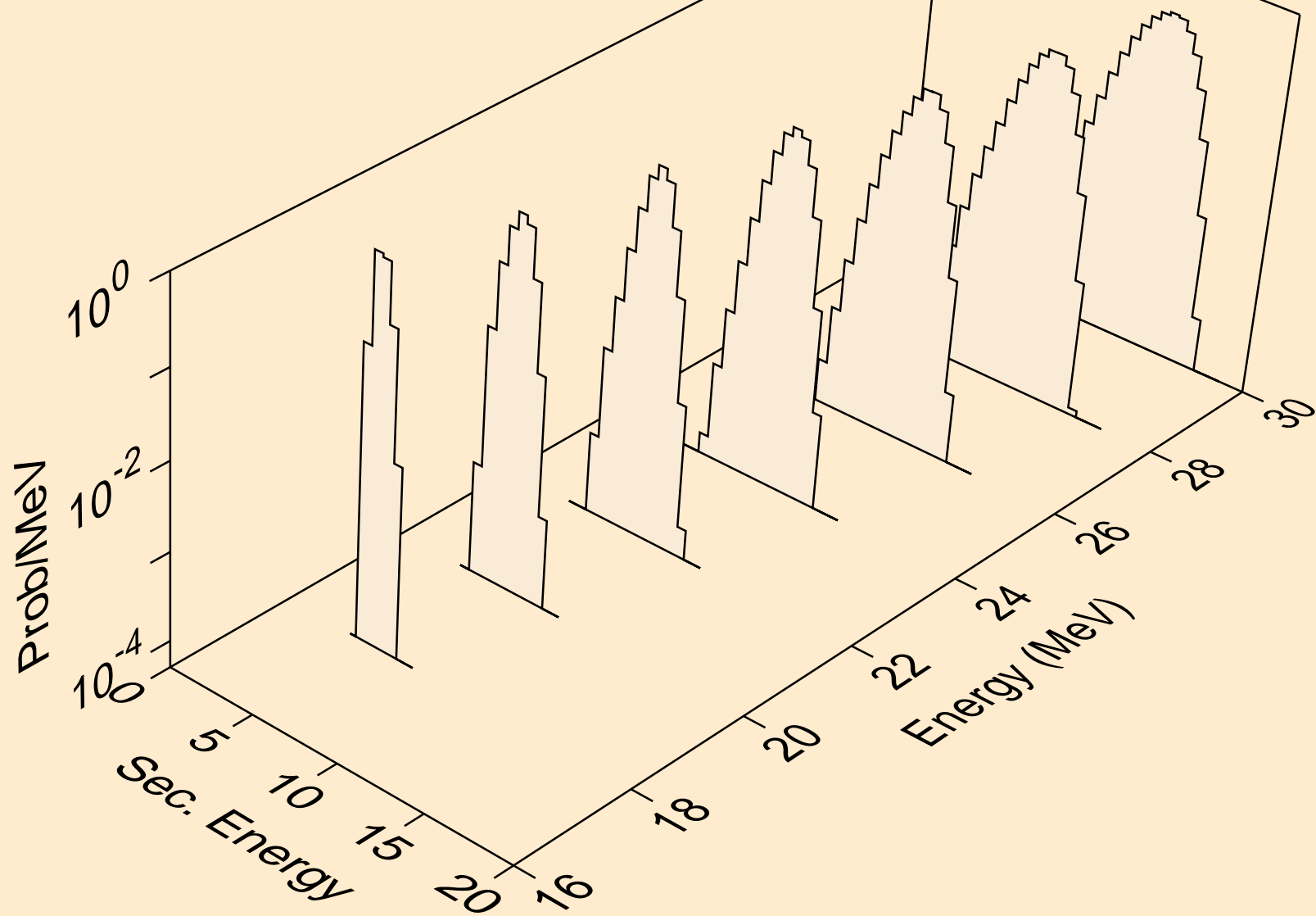

SM131 PHOTON ACER TENDL-2021 LIBRARY; T=0.K
alphas from (g,a)

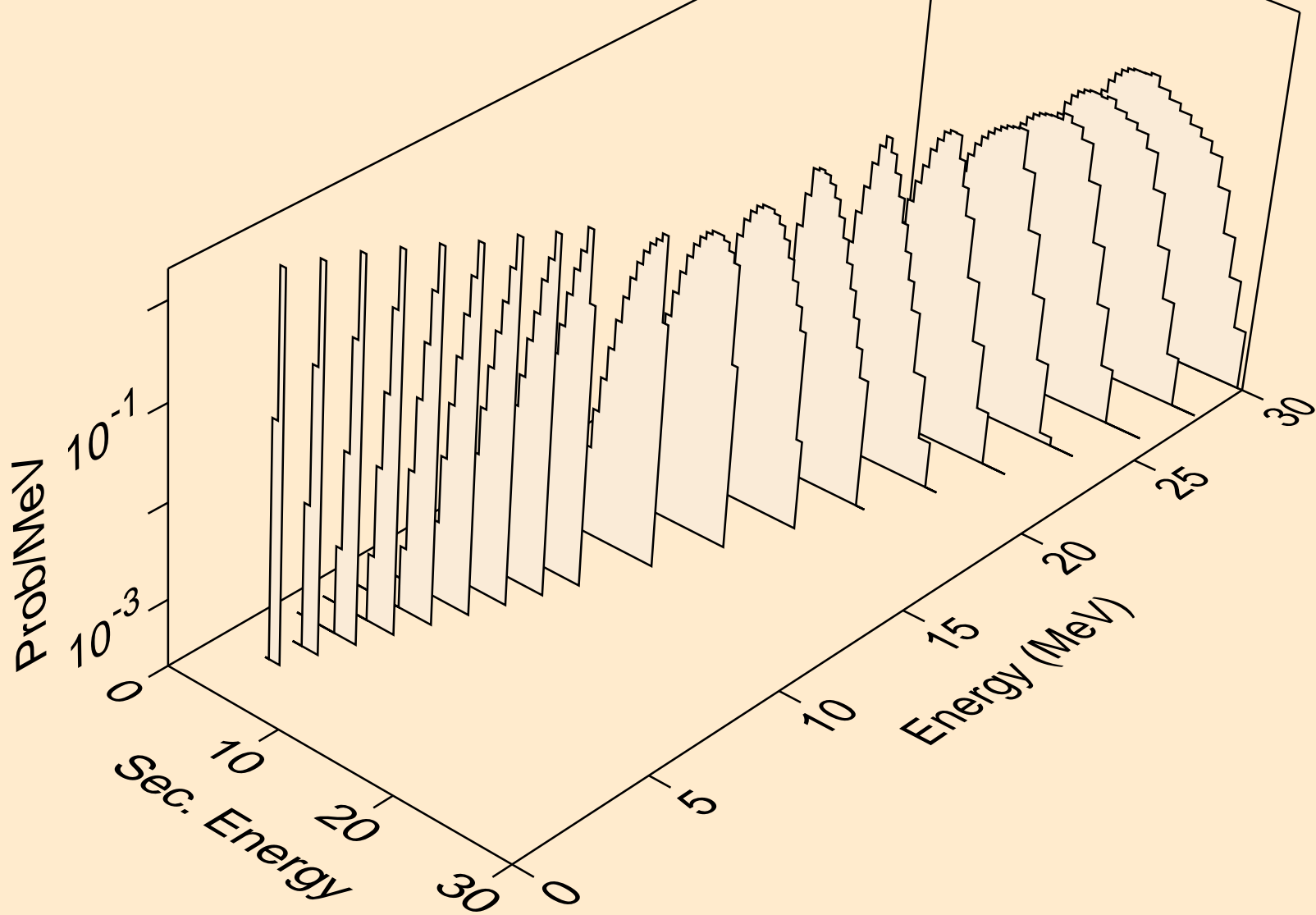

SM131 PHOTON ACER TENDL-2021 LIBRARY; T=0.K
alphas from (g,2a)

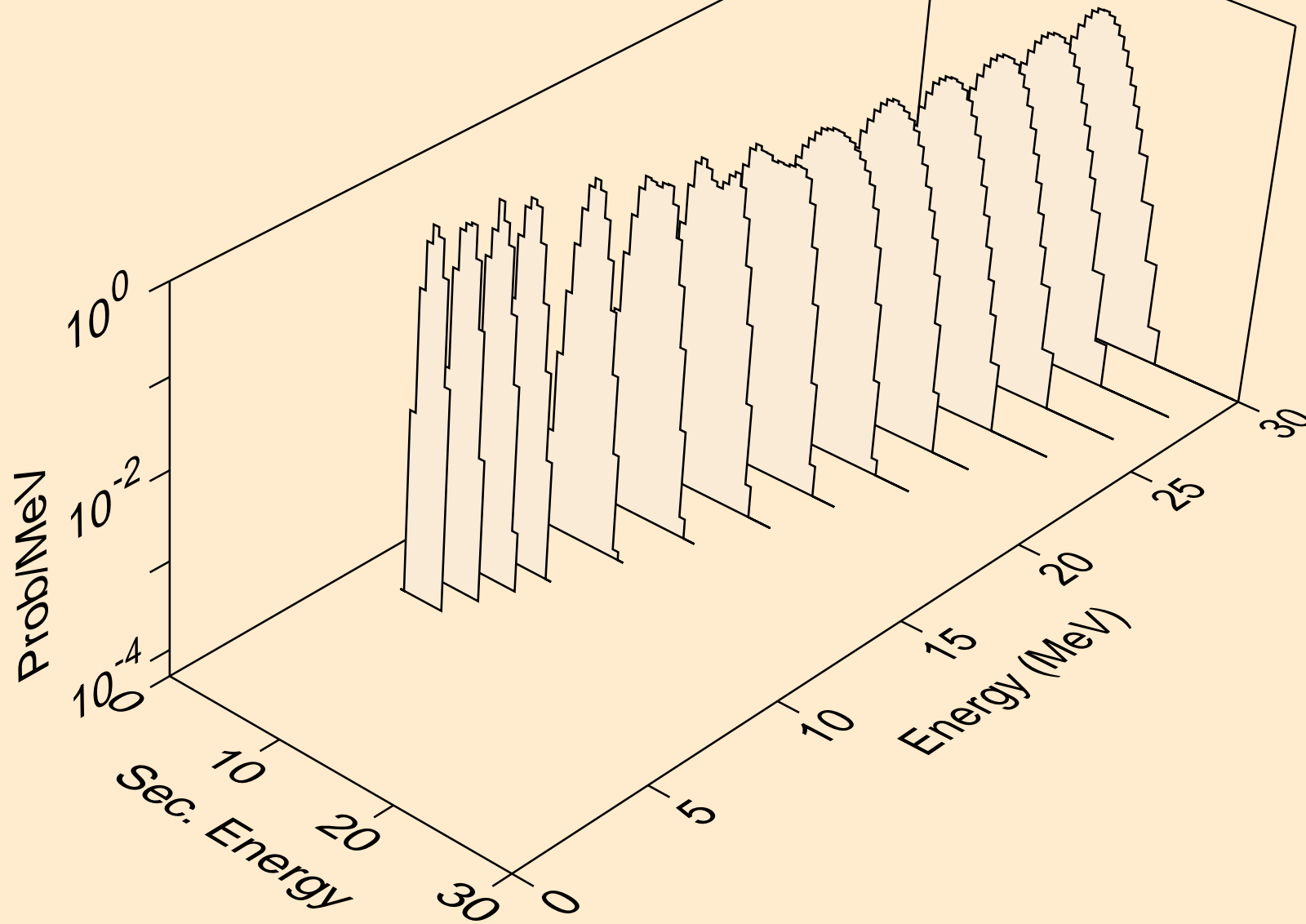

SM131 PHOTON ACER TENDL-2021 LIBRARY; T=0.K
alphas from (g,pa)

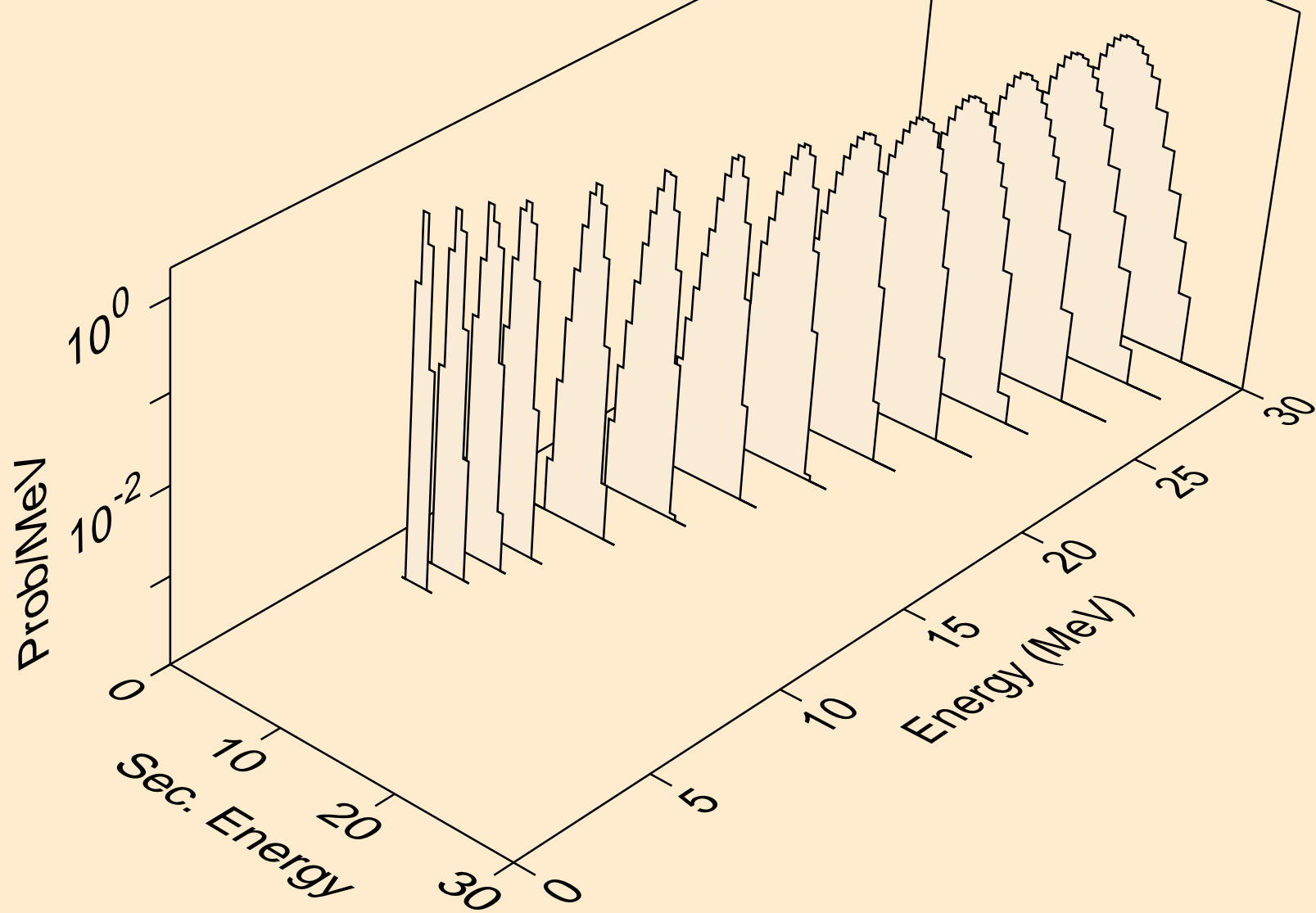

SM131 PHOTON ACER TENDL-2021 LIBRARY; T=0.K
alphas from (g,da)

