

AC228 HELION ACER TENDL-2021 LIBRARY; T=0.K  
Principal cross sections

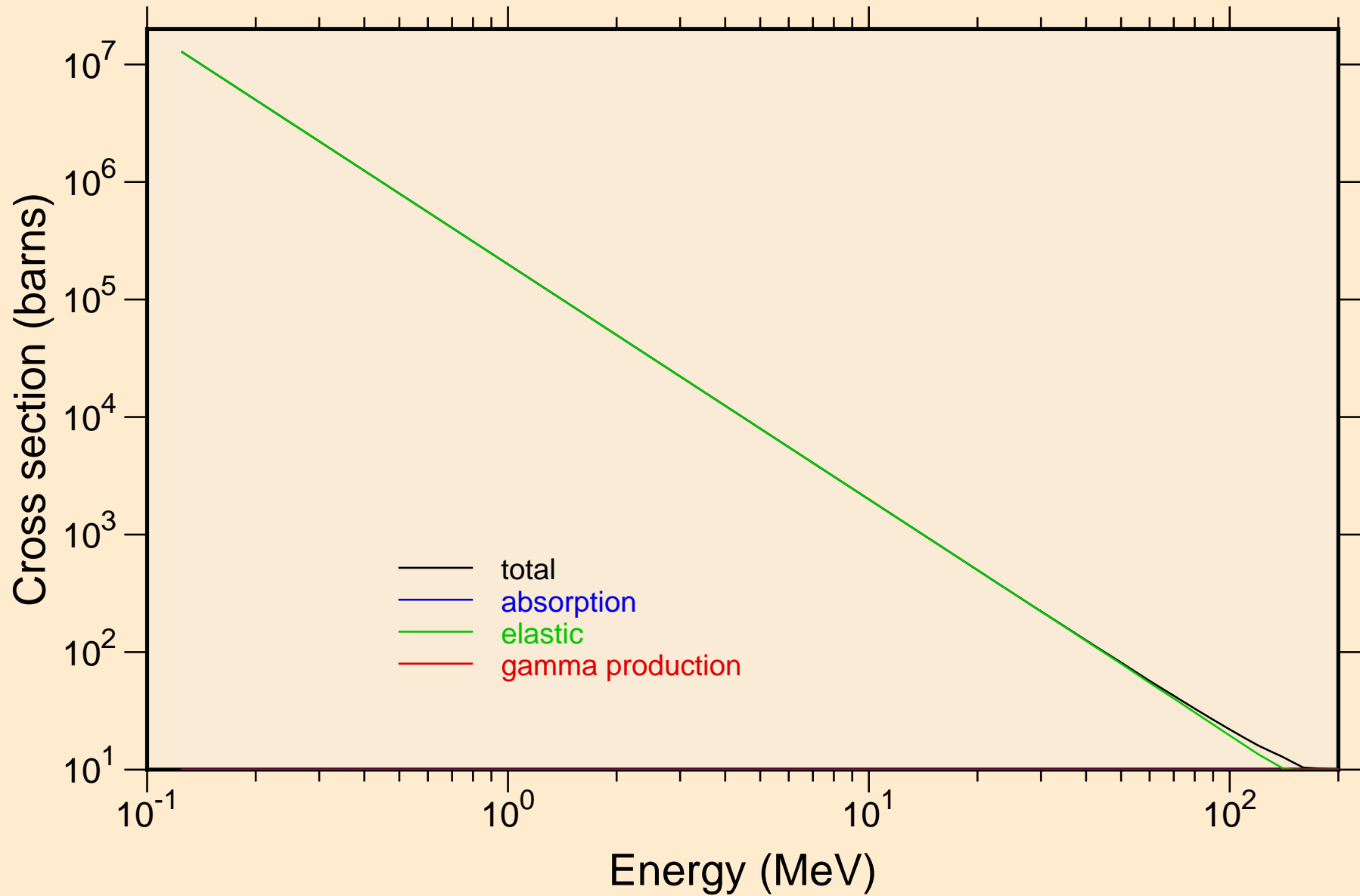

AC228 HELION ACER TENDL-2021 LIBRARY; T=0.K  
Heating

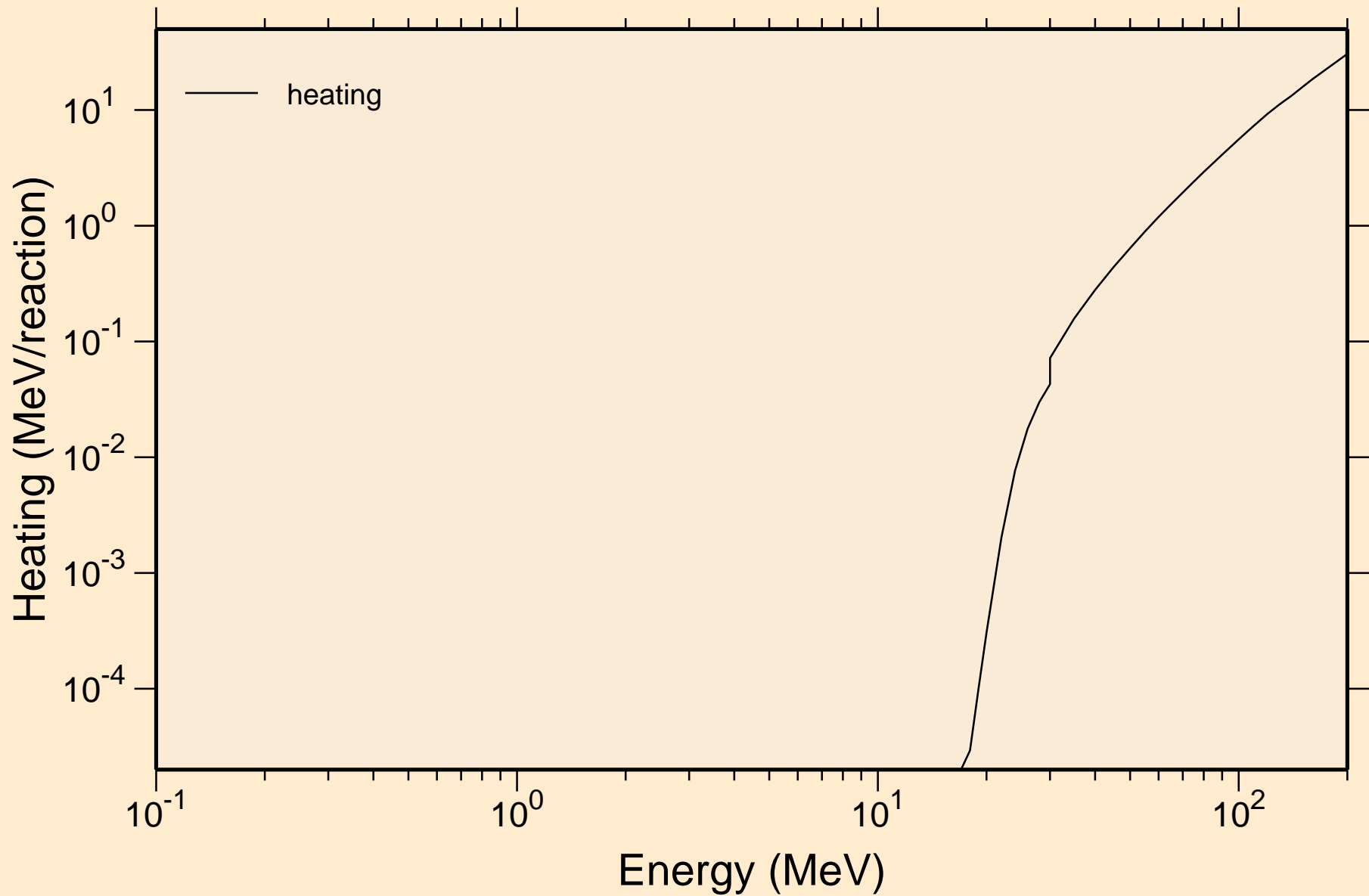

# AC228 HELION ACER TENDL-2021 LIBRARY; T=0.K

## Principal cross sections

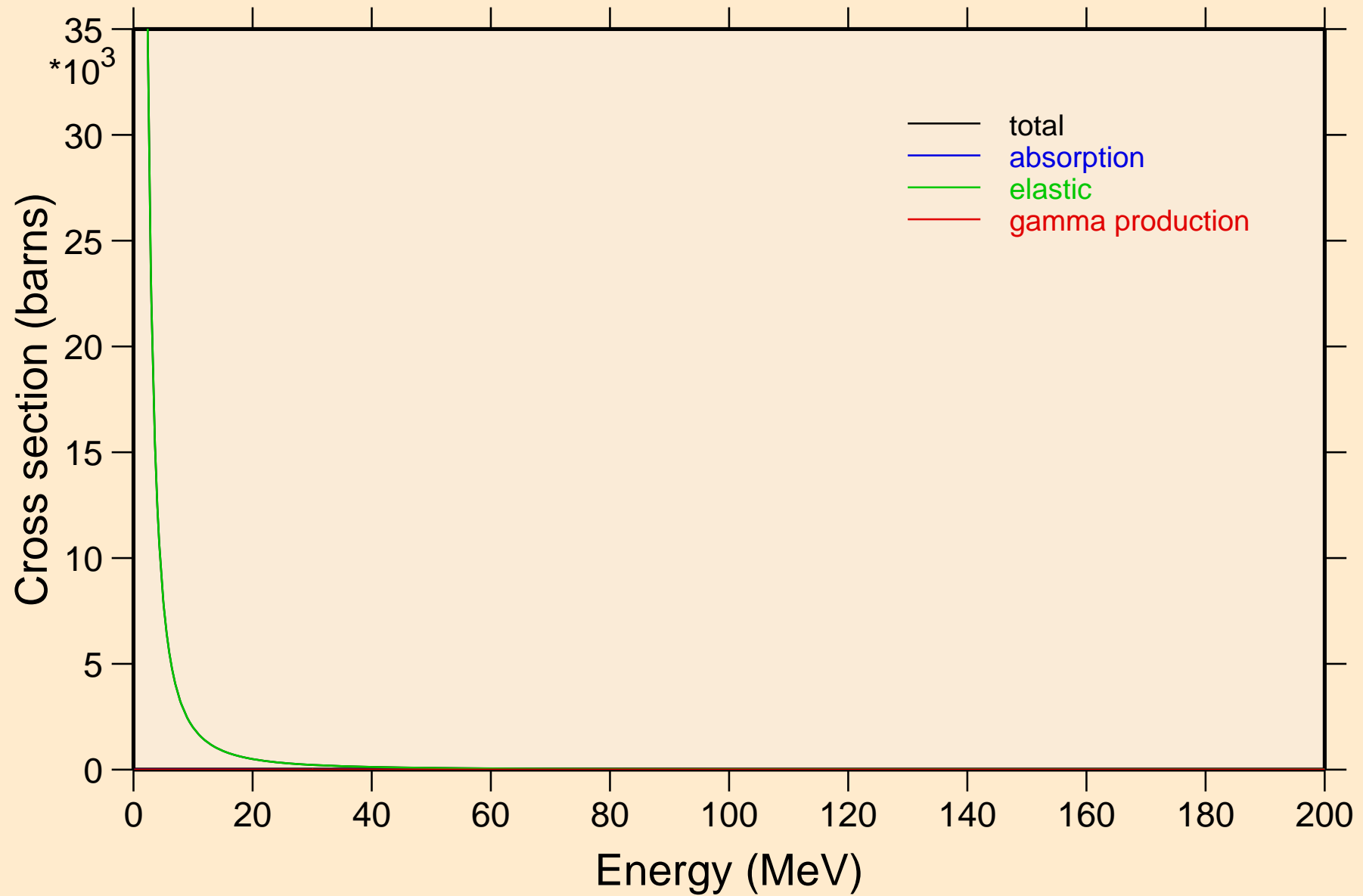

AC228 HELION ACER TENDL-2021 LIBRARY; T=0.K

Heating

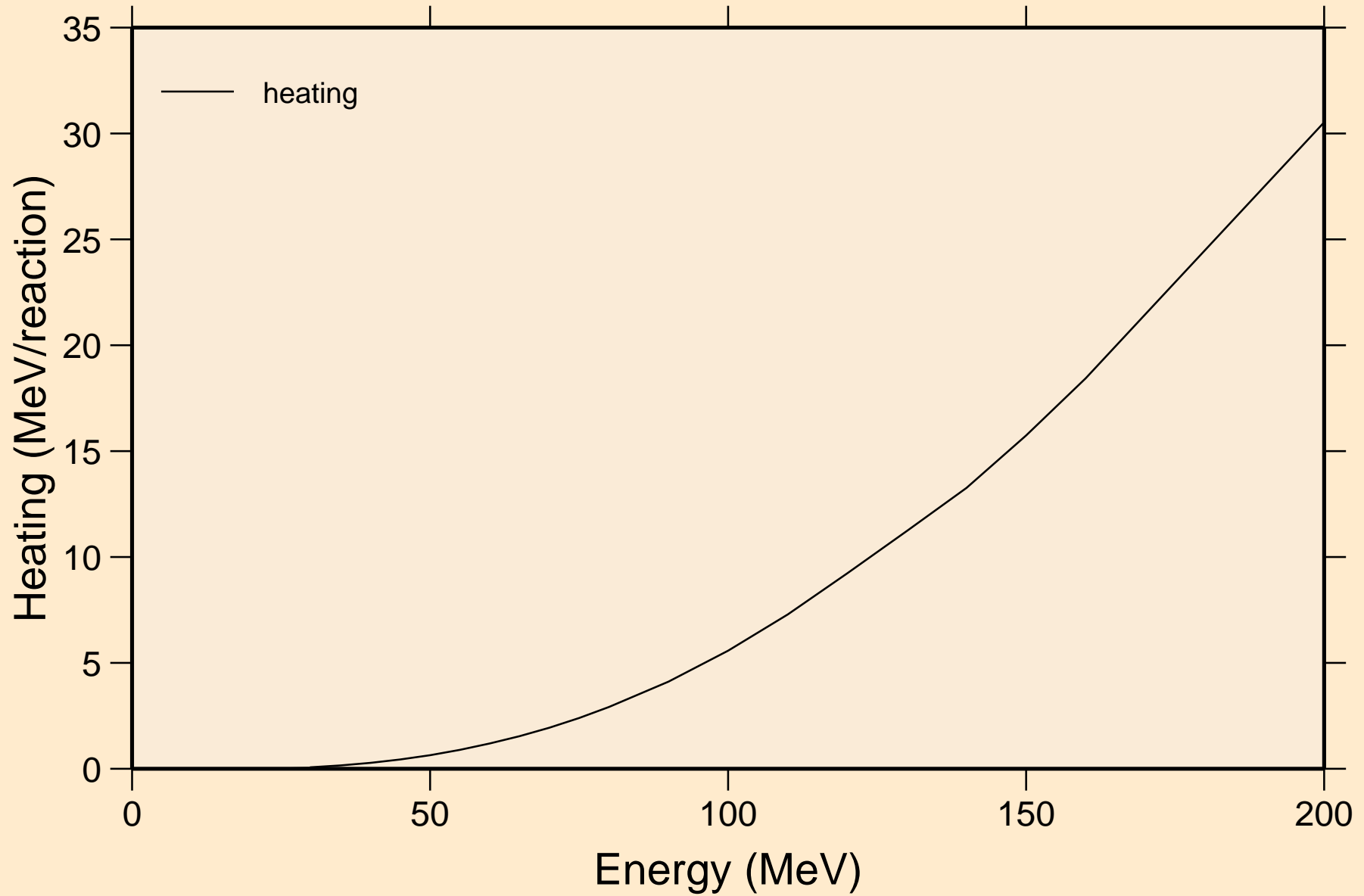

AC228 HELION ACER TENDL-2021 LIBRARY; T=0.K  
Threshold reactions

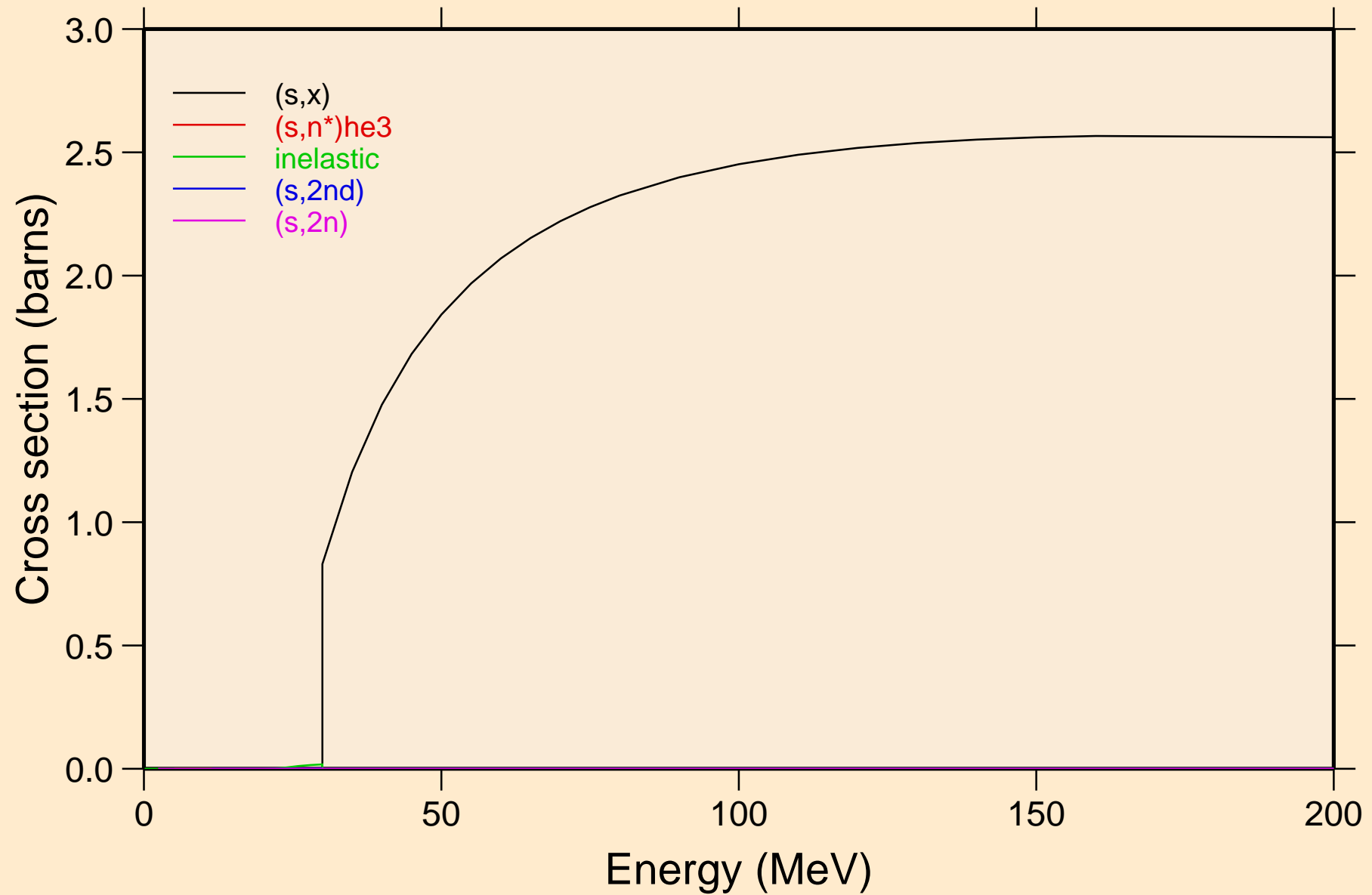

AC228 HELION ACER TENDL-2021 LIBRARY; T=0.K  
Threshold reactions

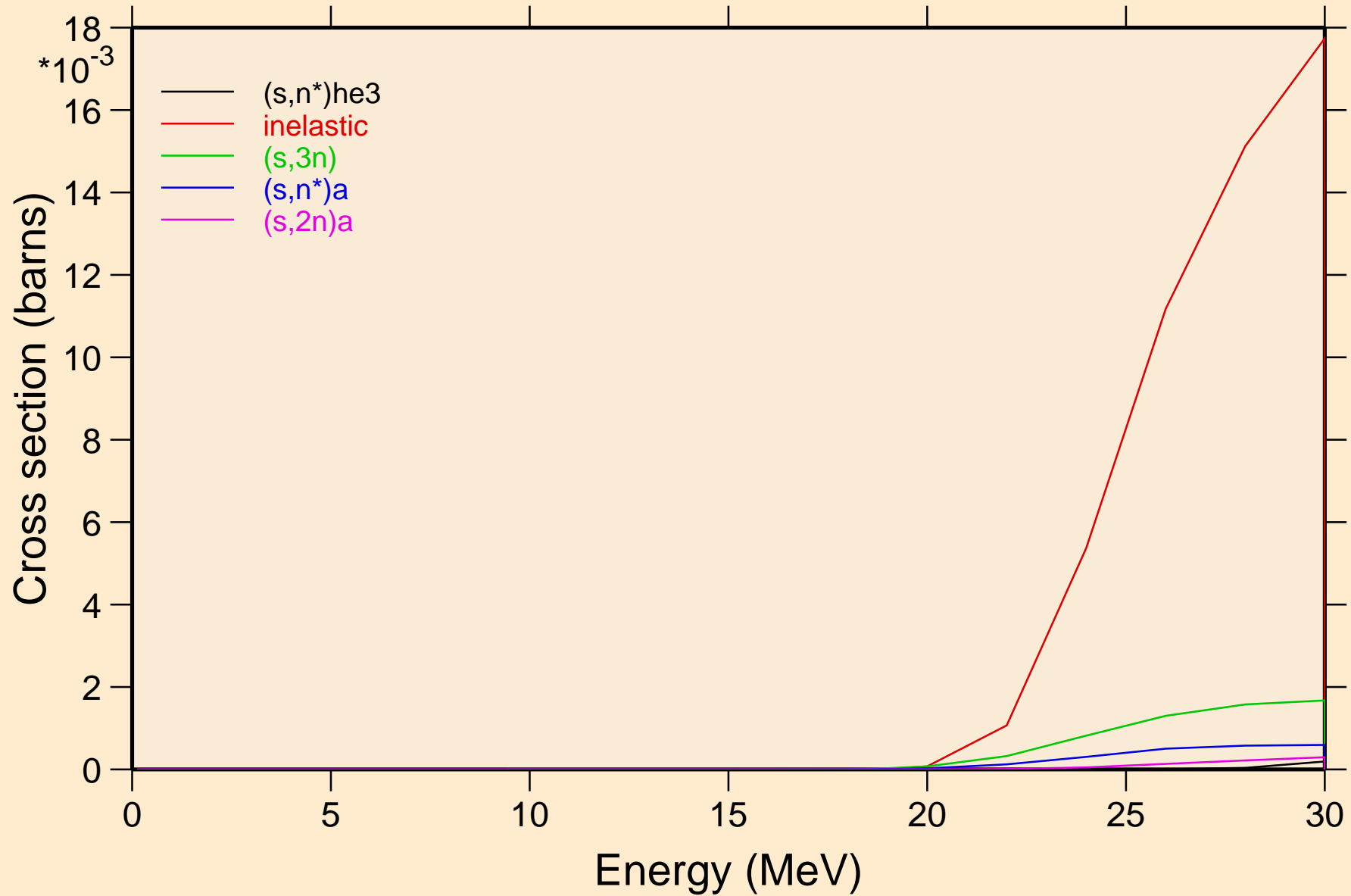

AC228 HELION ACER TENDL-2021 LIBRARY; T=0.K  
Threshold reactions

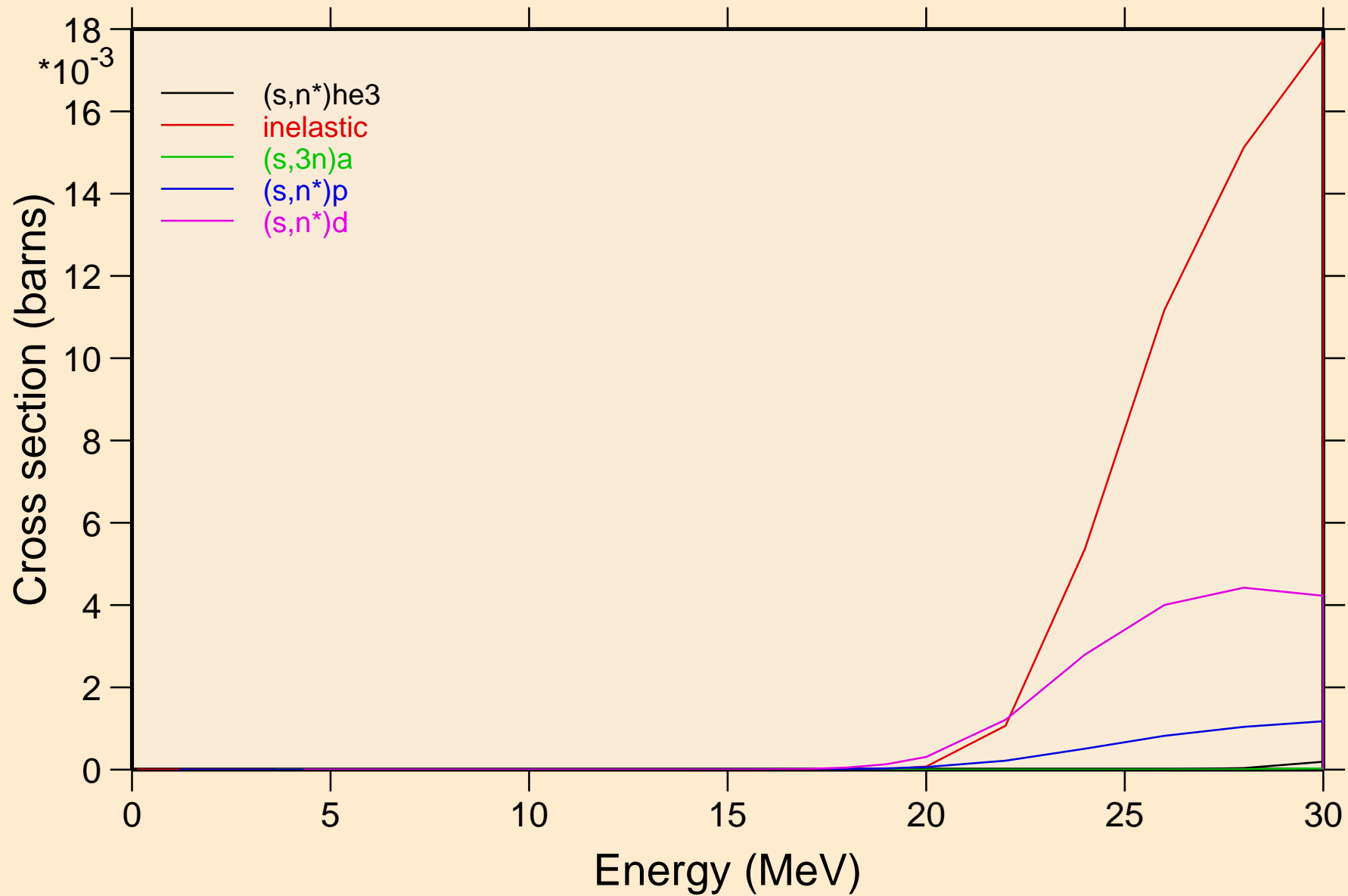

AC228 HELION ACER TENDL-2021 LIBRARY; T=0.K  
Threshold reactions

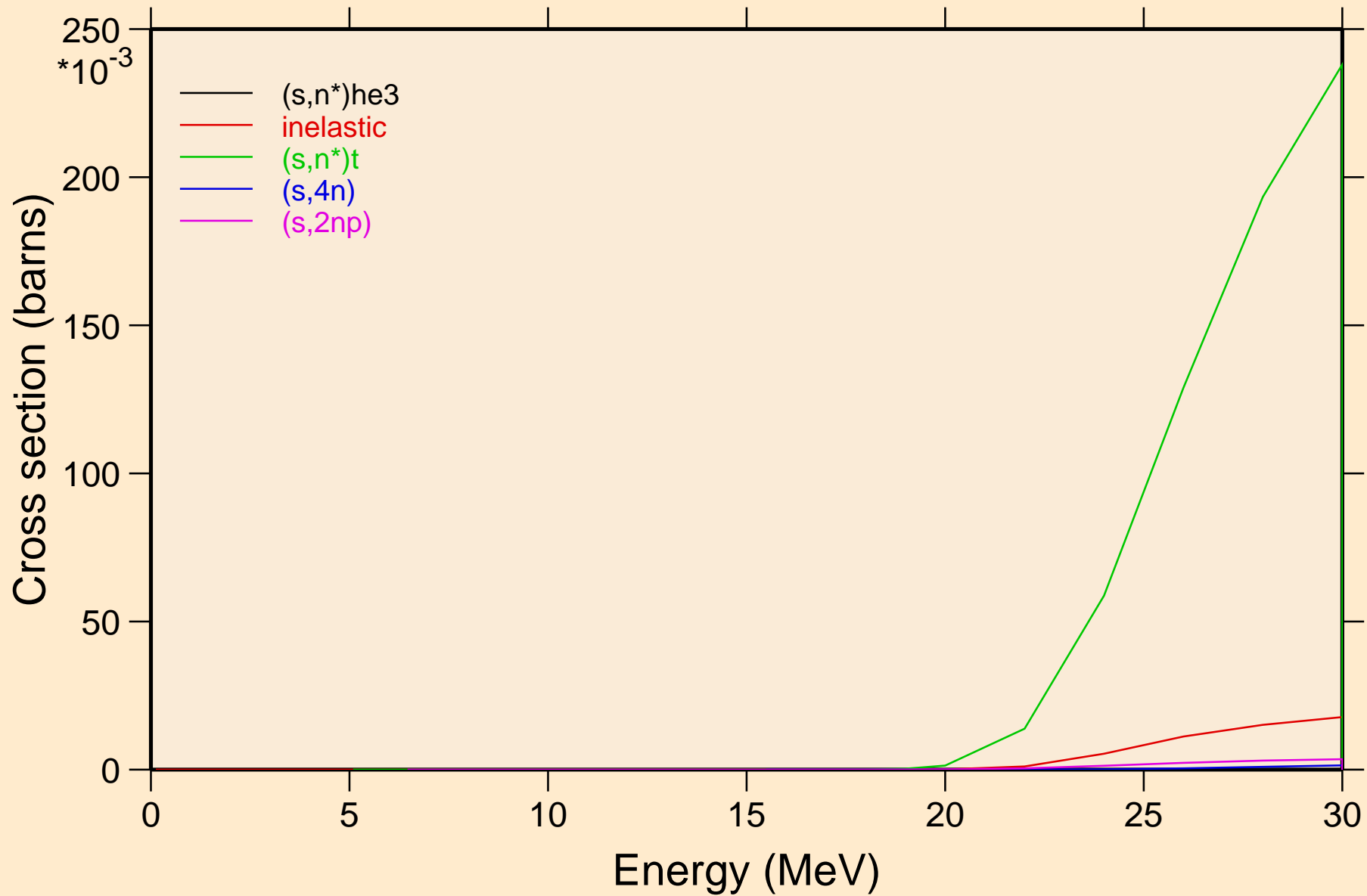



AC228 HELION ACER TENDL-2021 LIBRARY; T=0.K  
Threshold reactions

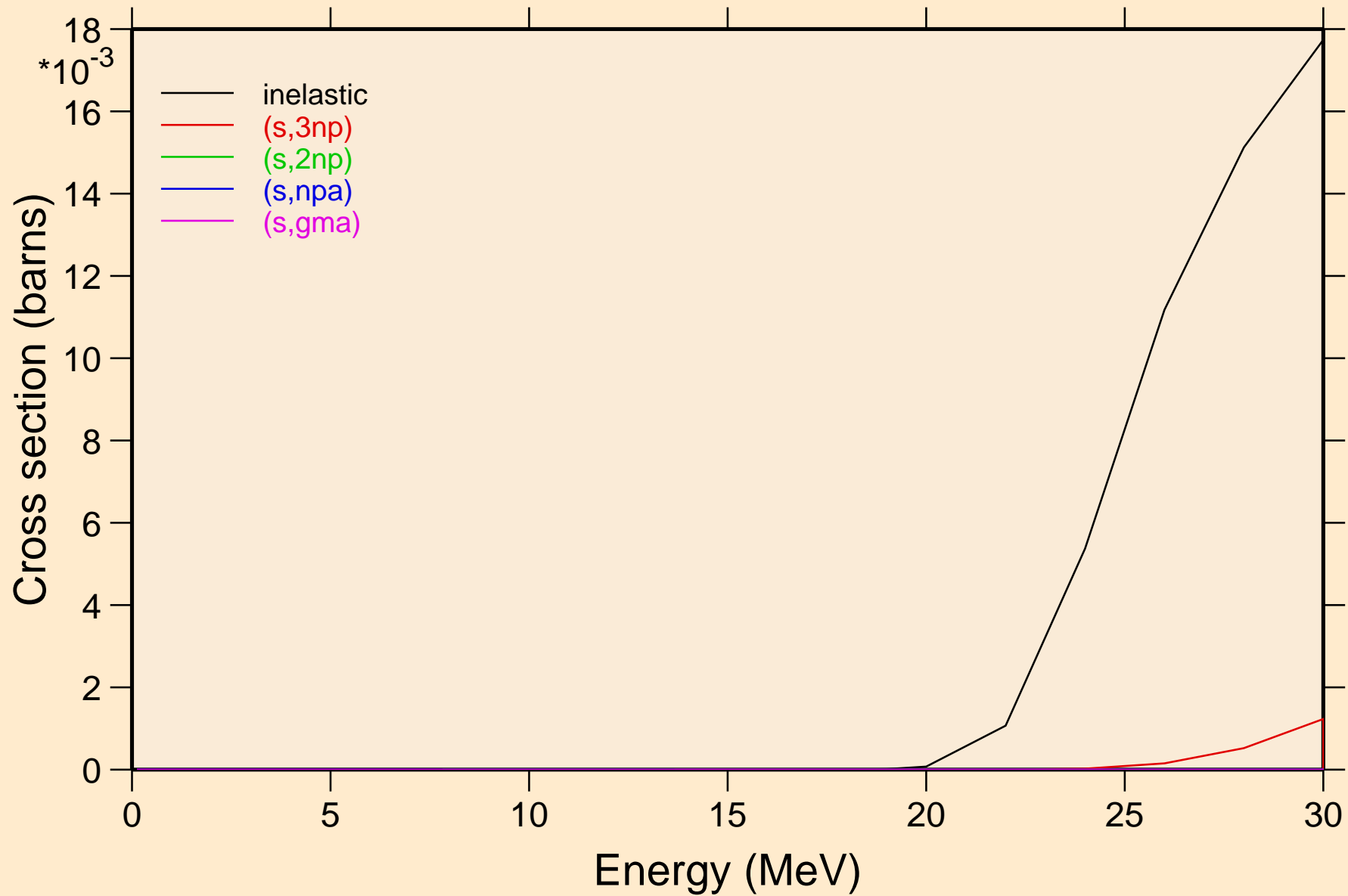

AC228 HELION ACER TENDL-2021 LIBRARY; T=0.K  
Threshold reactions

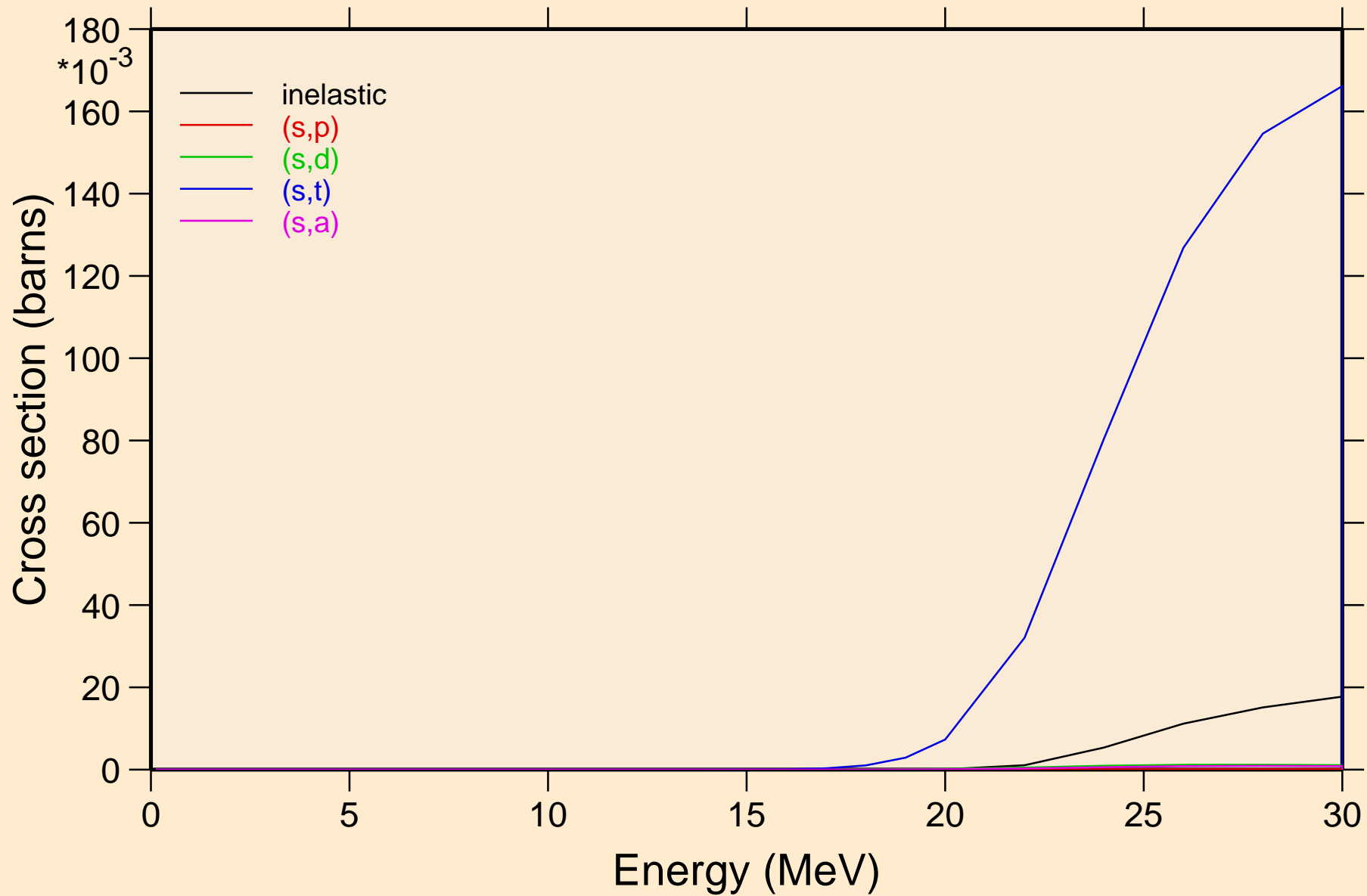

AC228 HELION ACER TENDL-2021 LIBRARY; T=0.K  
Threshold reactions

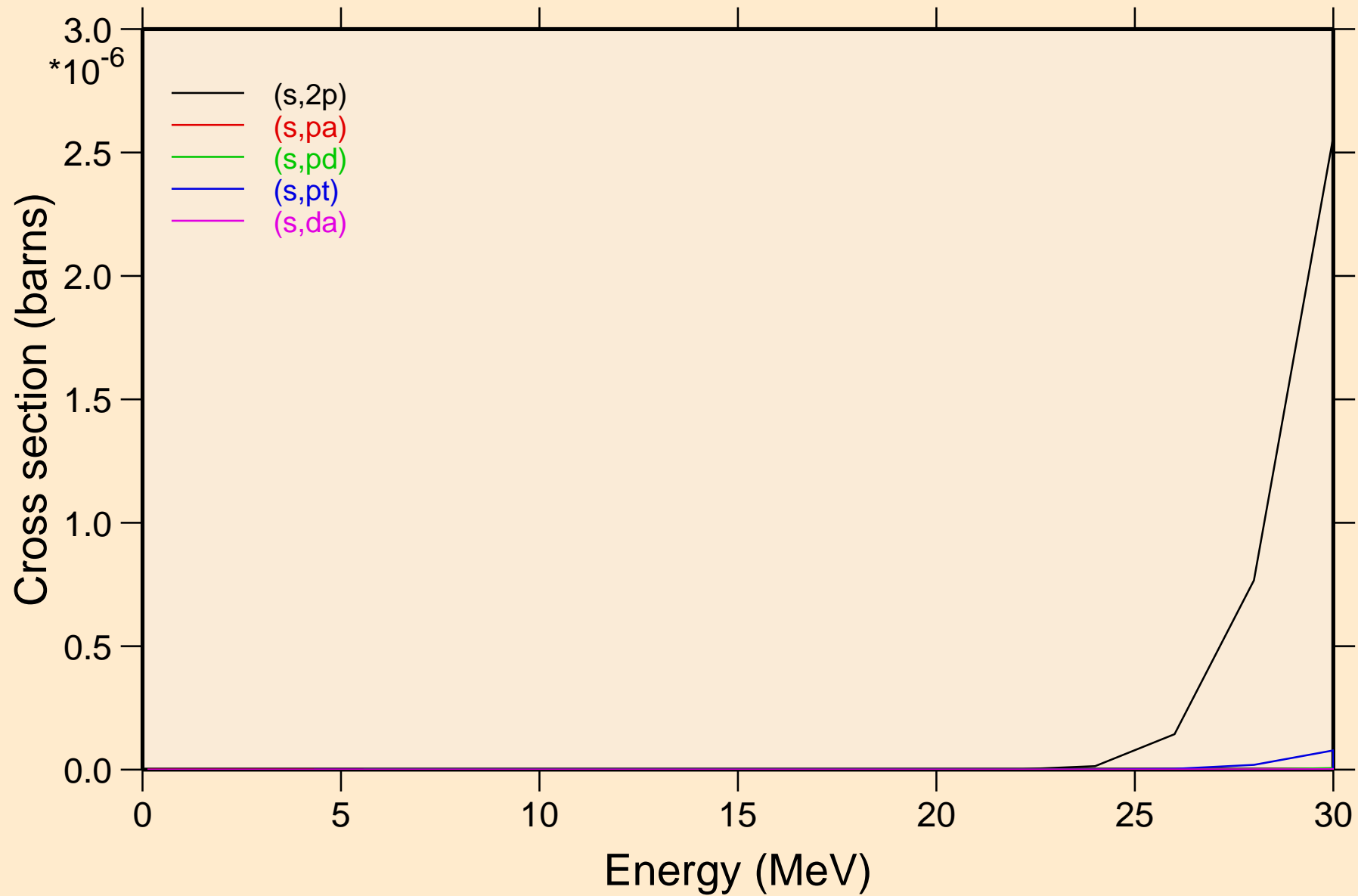

AC228 HELION ACER TENDL-2021 LIBRARY; T=0.K  
angular distribution for elastic

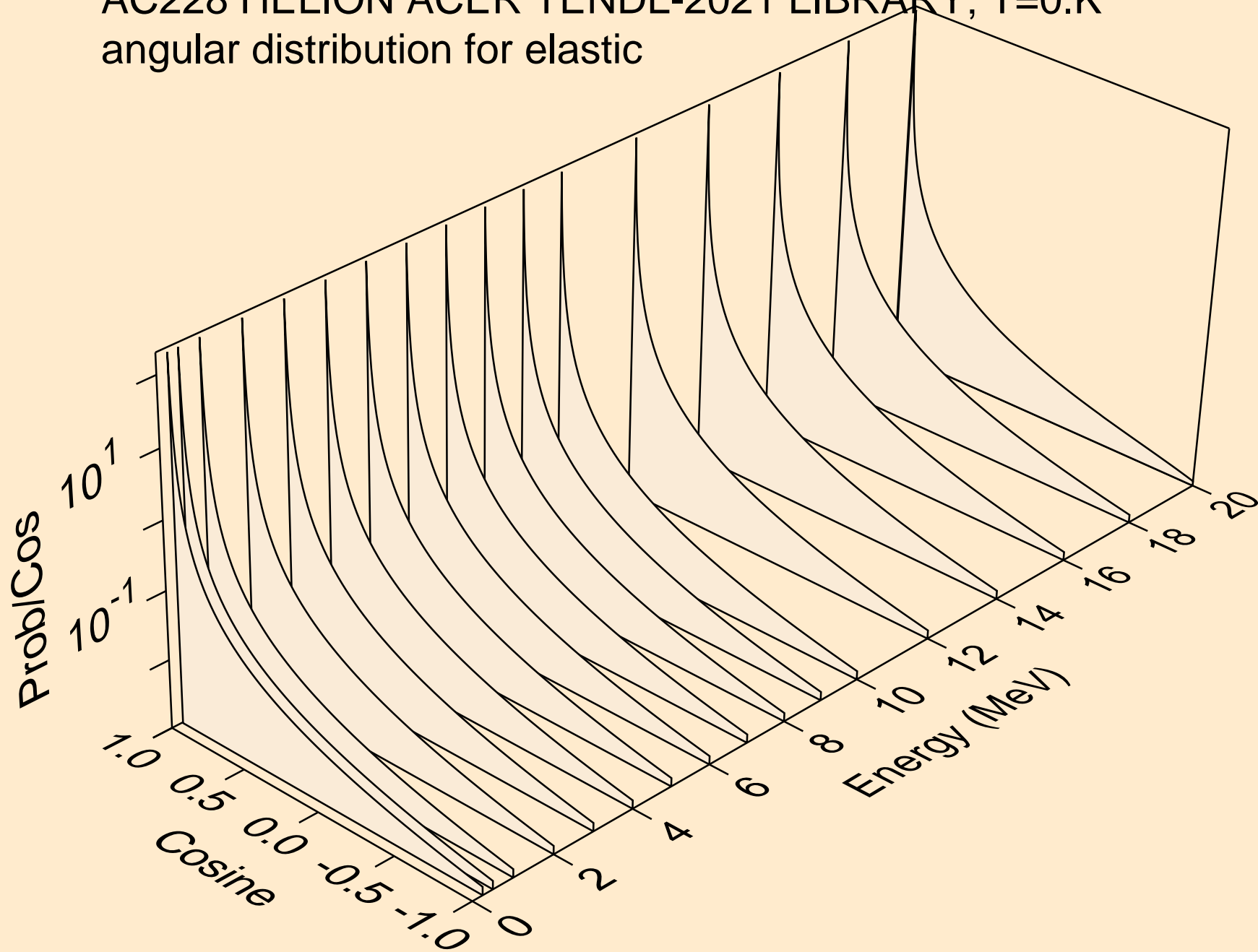

AC228 HELION ACER TENDL-2021 LIBRARY; T=0.K  
angular distribution for elastic

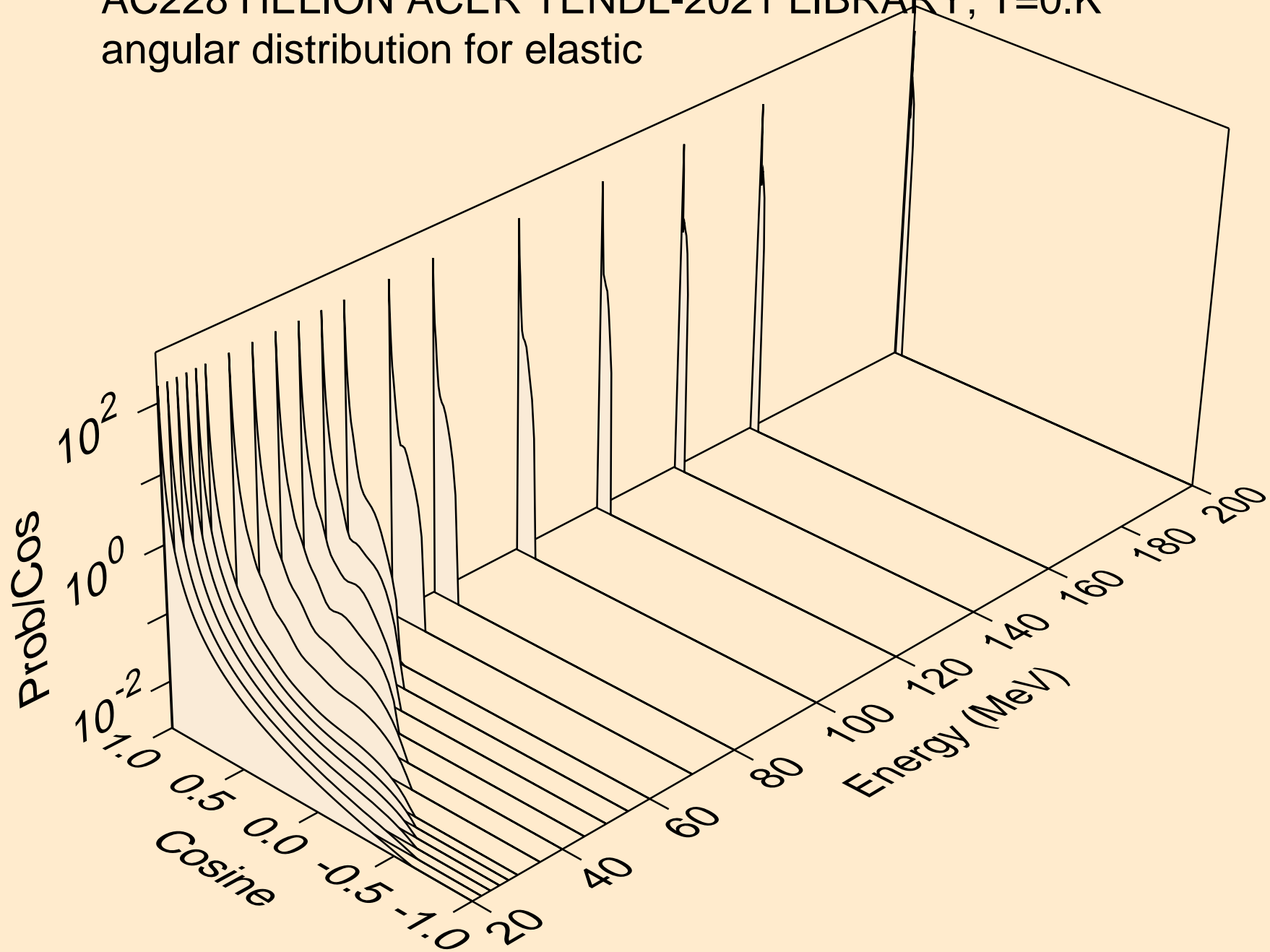

AC228 HELION ACER TENDL-2021 LIBRARY; T=0.K  
He-3 emission for (s,x)

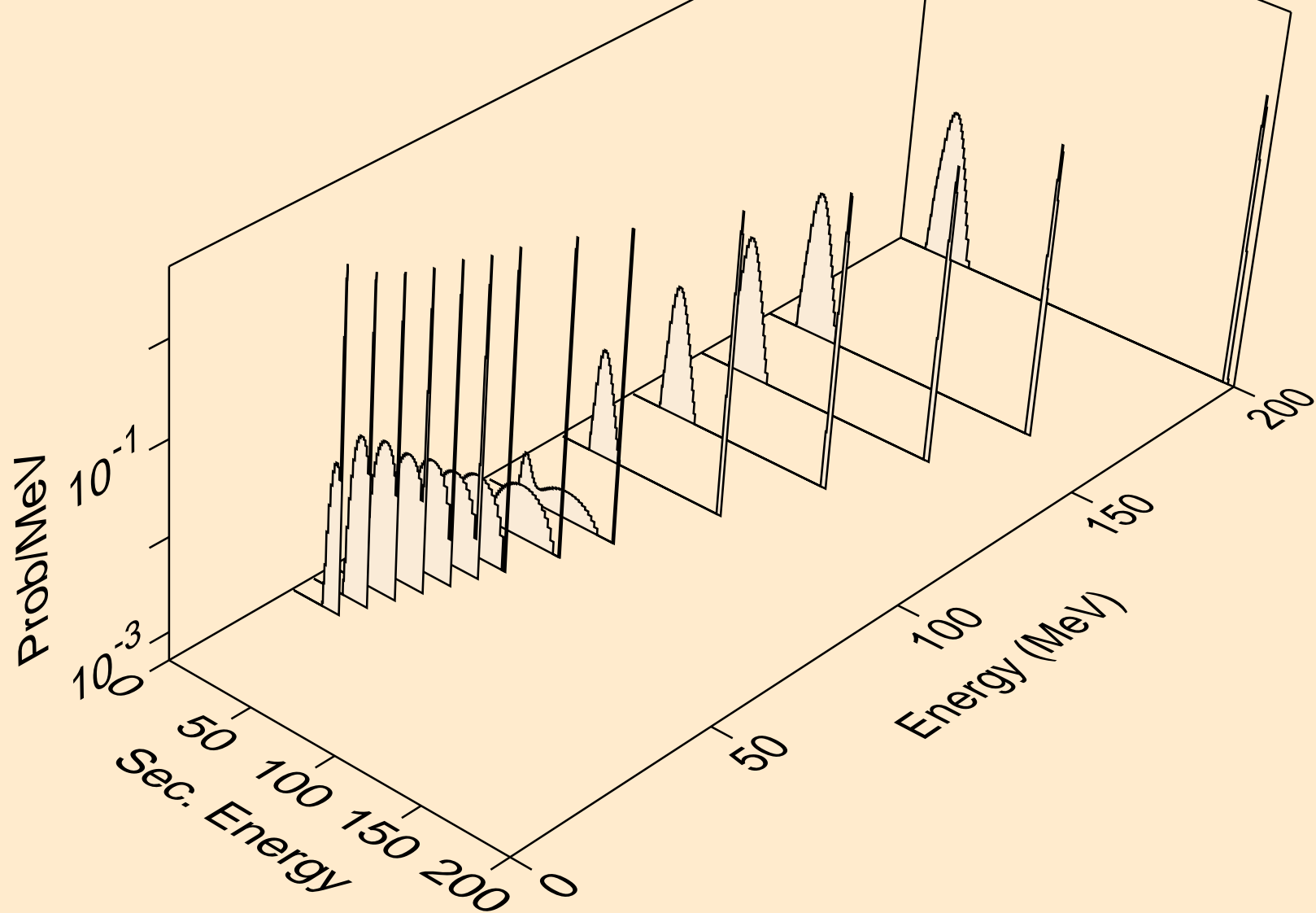

AC228 HELION ACER TENDL-2021 LIBRARY; T=0.K  
He-3 emission for (s,n\*)he3

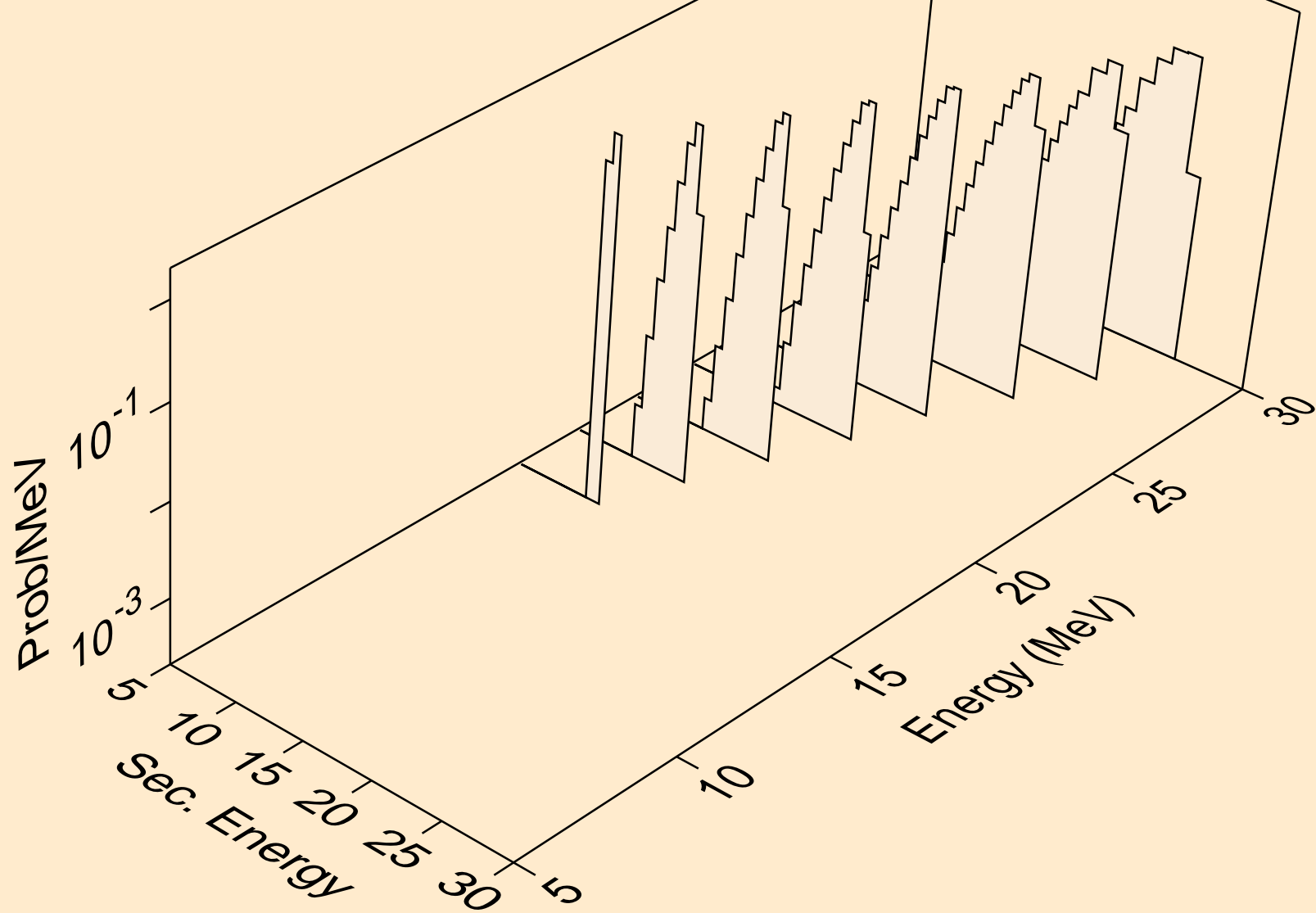

AC228 HELION ACER TENDL-2021 LIBRARY; T=0.K  
He-3 emission for inelastic

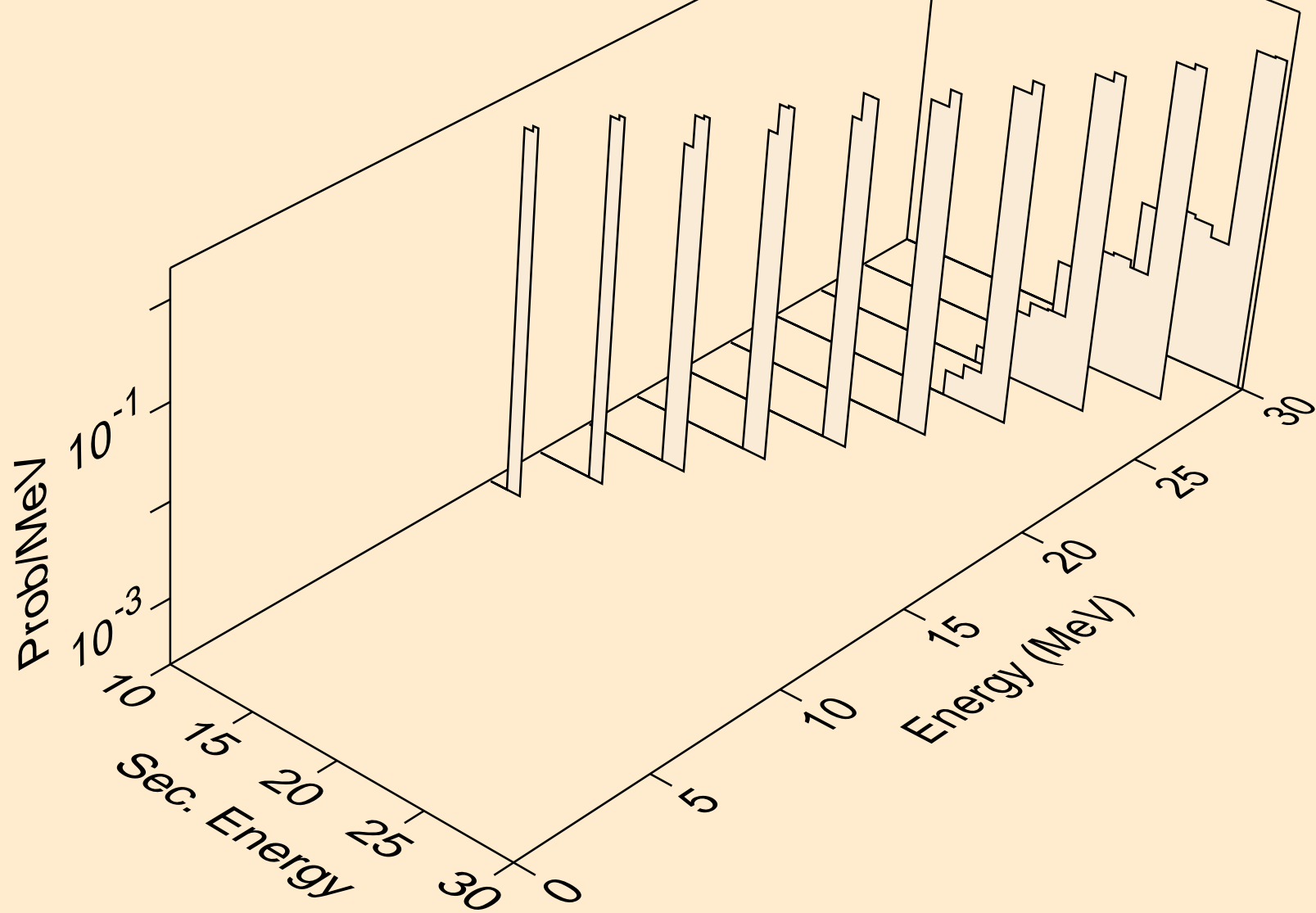



AC228 HELION ACER TENDL-2021 LIBRARY; T=0.K  
Photon emission for (z,n)

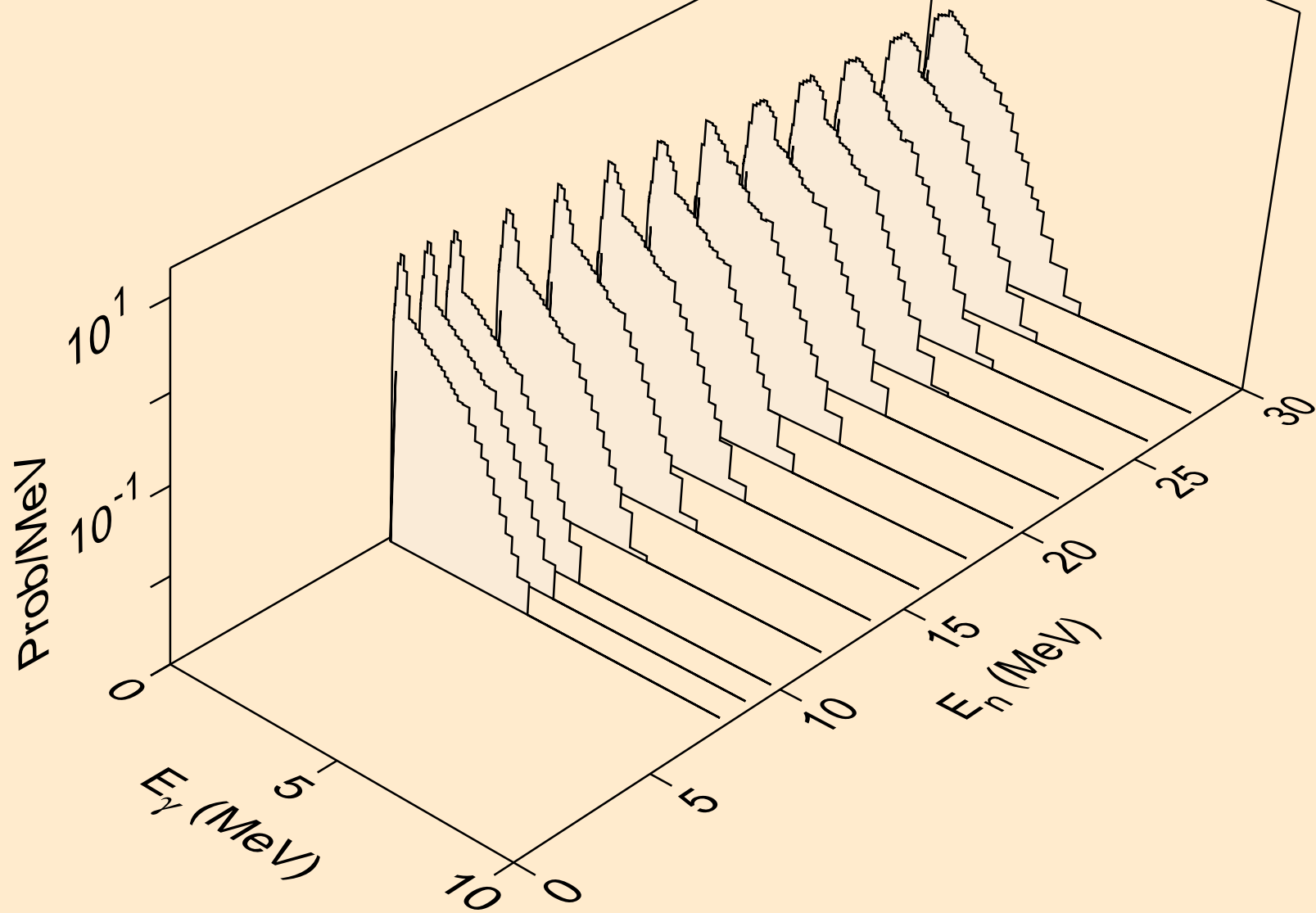

AC228 HELION ACER TENDL-2021 LIBRARY; T=0.K  
Photon emission for (n,x)

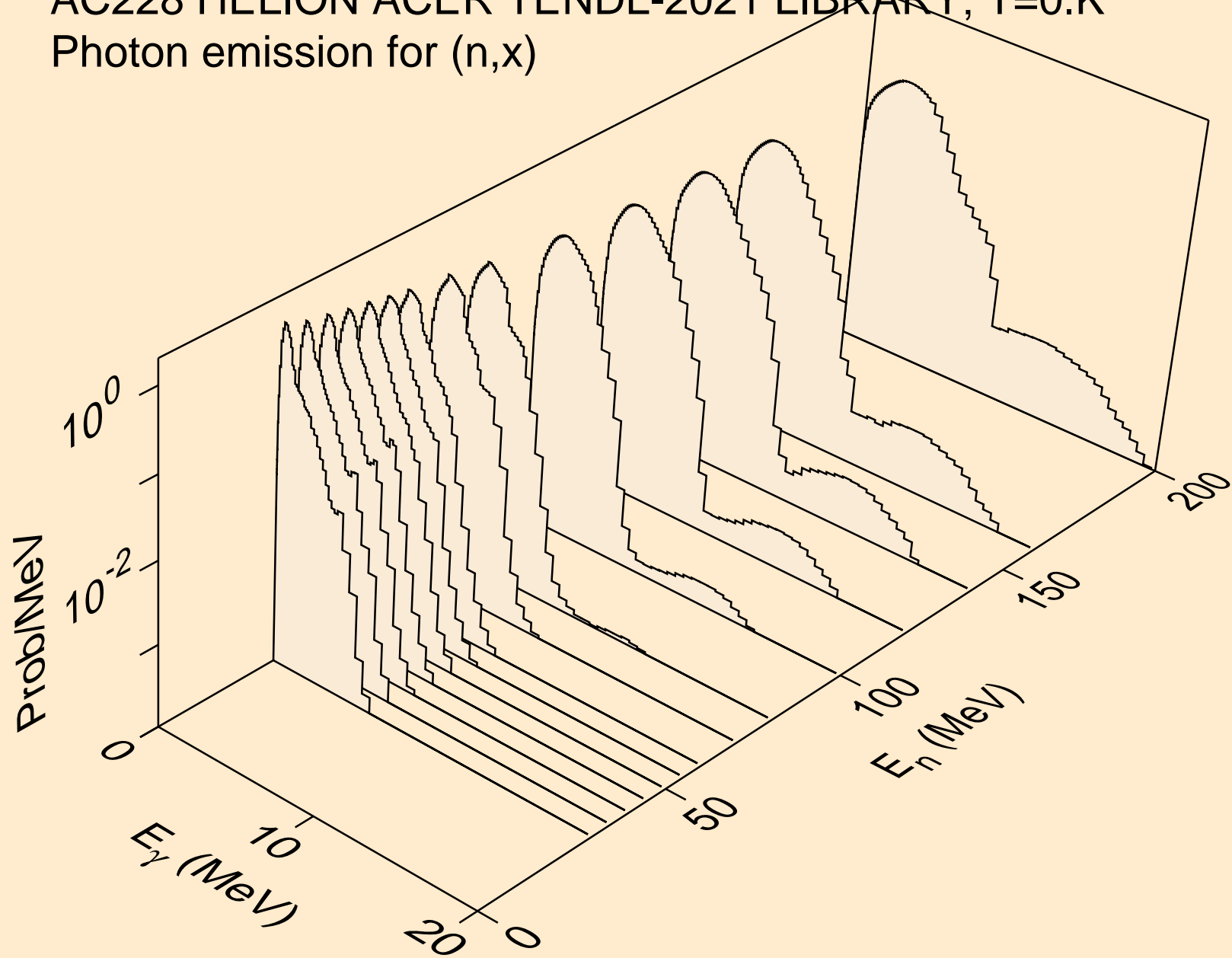

AC228 HELION ACER TENDL-2021 LIBRARY; T=0.K  
Photon emission for (n,2nd)

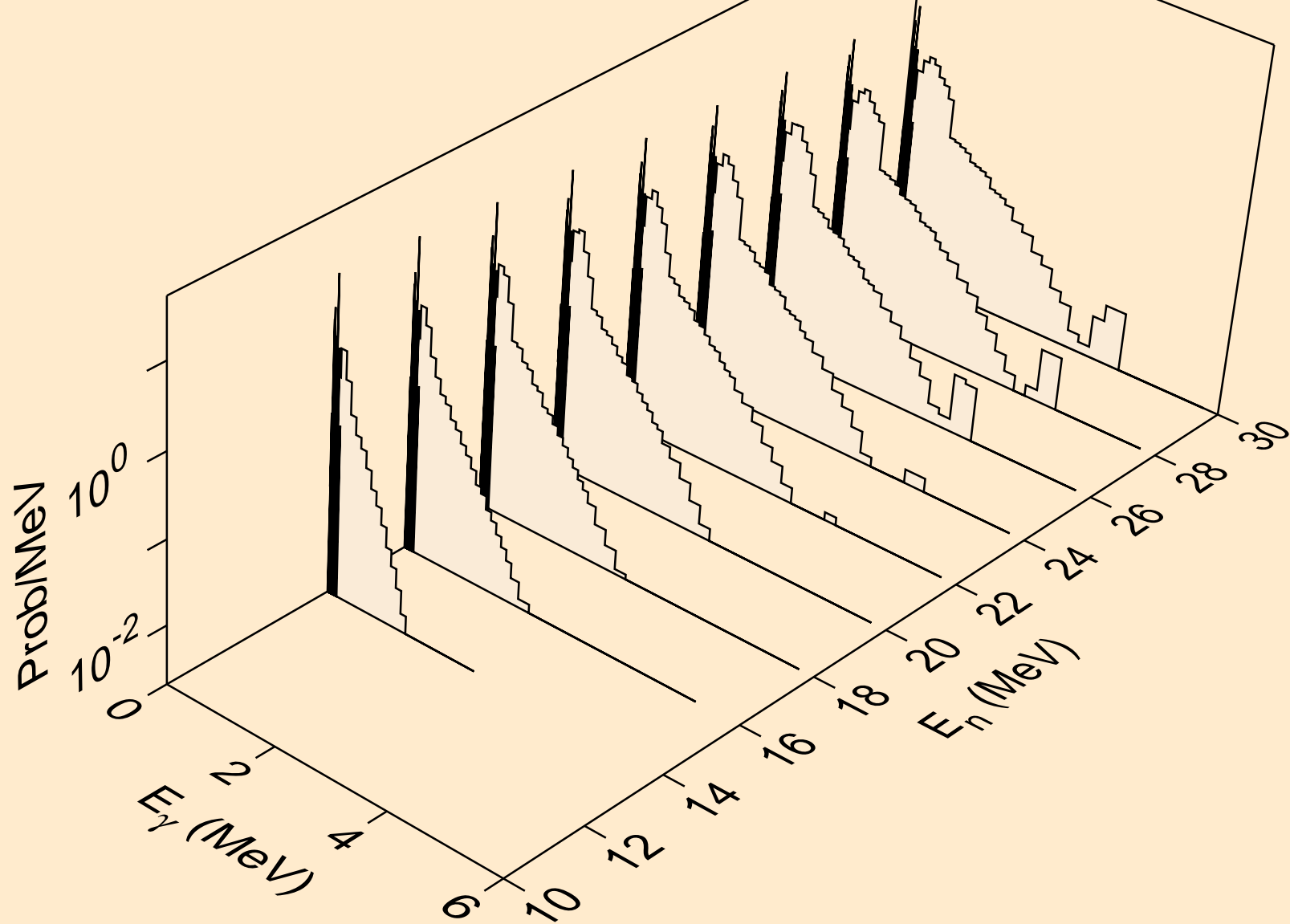

AC228 HELION ACER TENDL-2021 LIBRARY; T=0.K  
Photon emission for (n,2n)

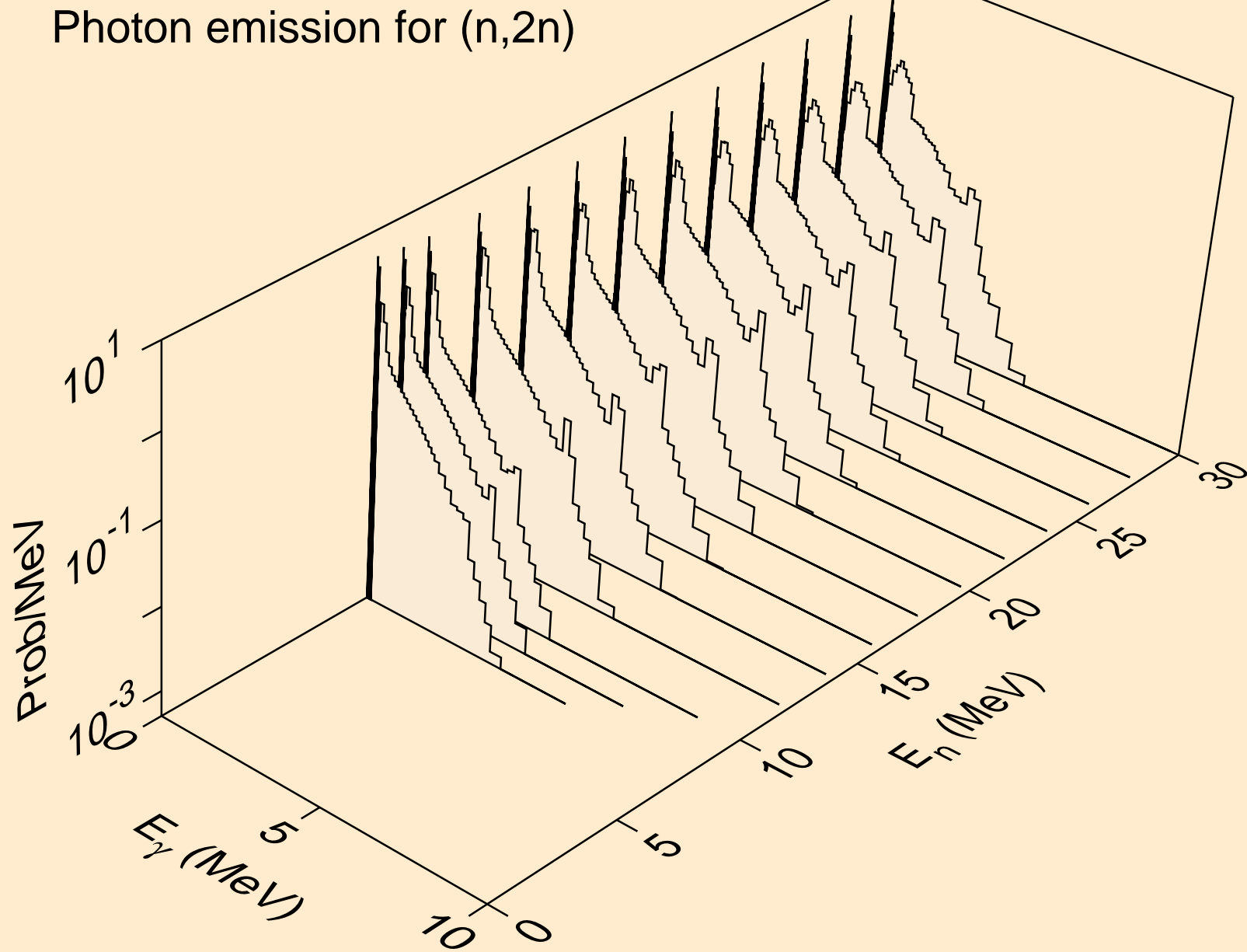

AC228 HELION ACER TENDL-2021 LIBRARY; T=0.K  
Photon emission for (n,3n)

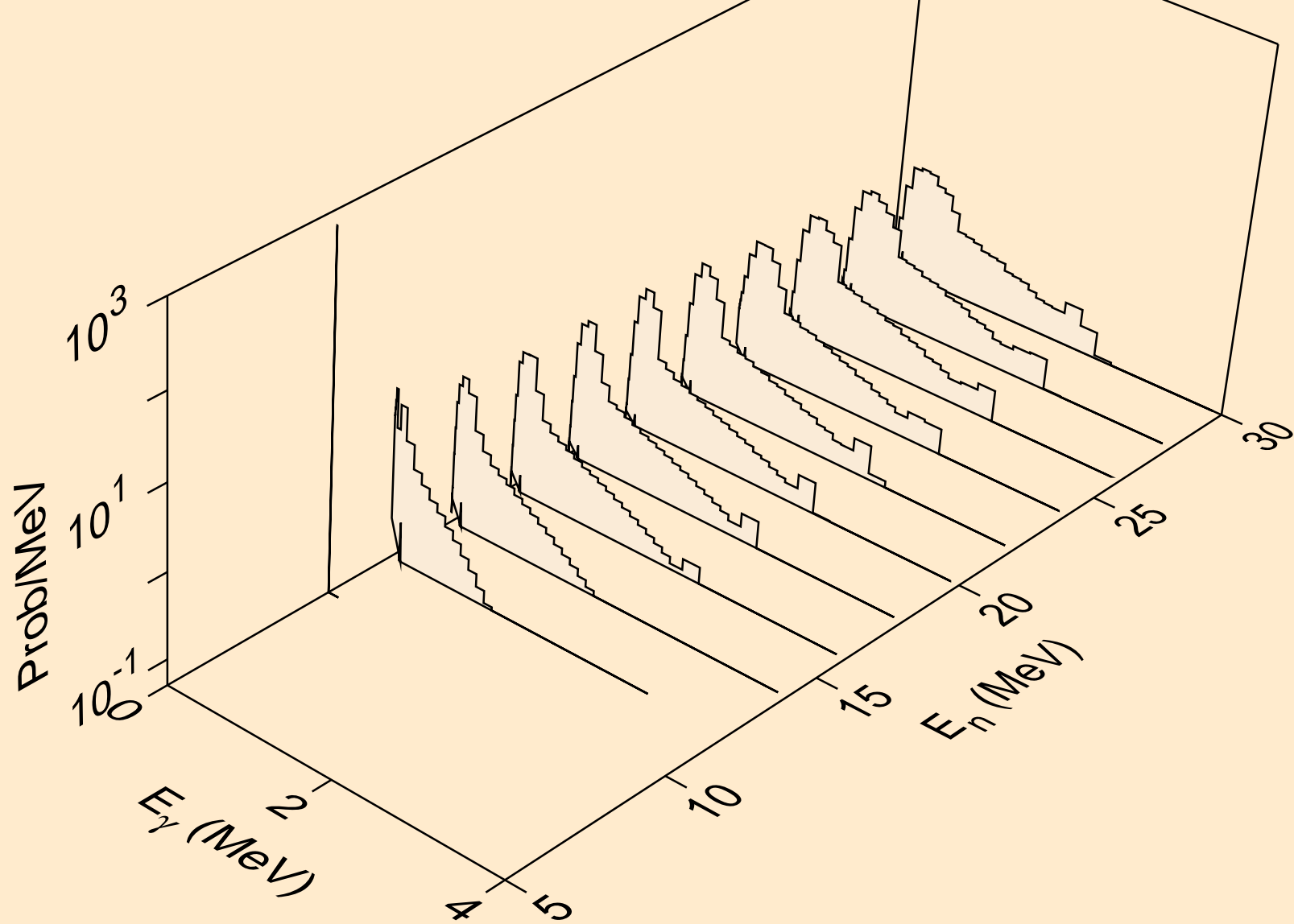

AC228 HELION ACER TENDL-2021 LIBRARY; T=0.K  
Photon emission for (n,n\*)a

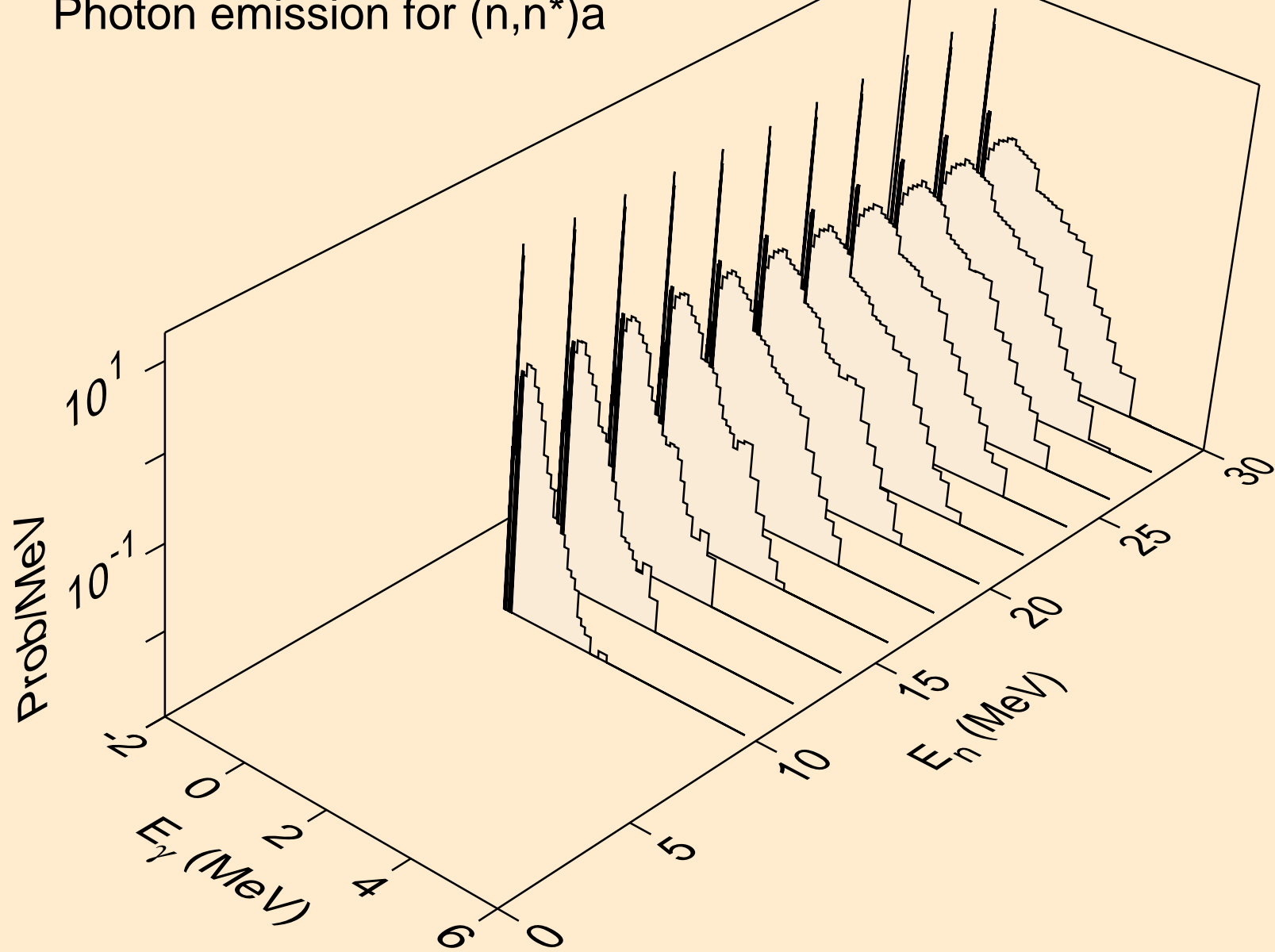

AC228 HELION ACER TENDL-2021 LIBRARY; T=0.K  
Photon emission for (n,2n)a

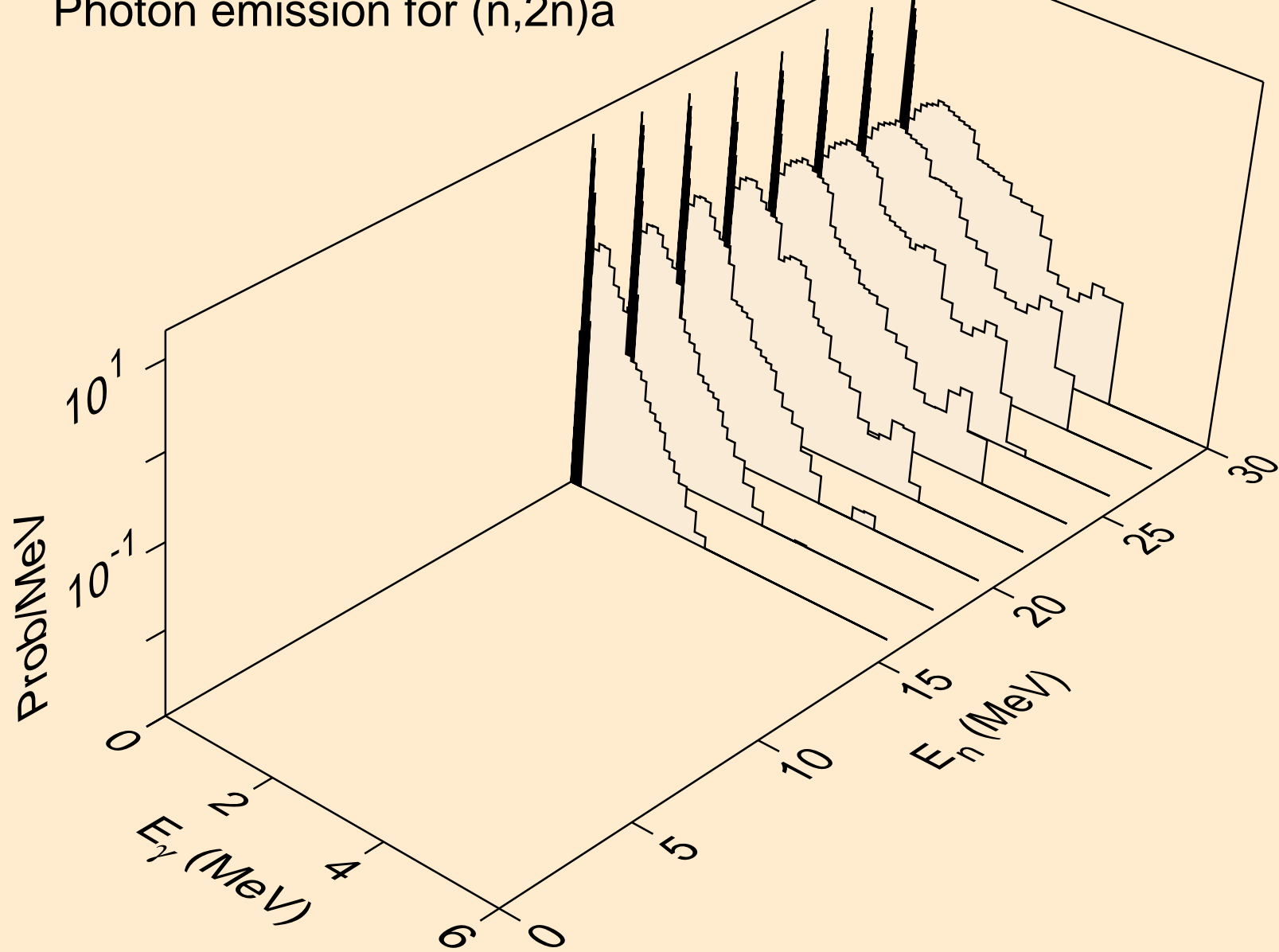

AC228 HELION ACER TENDL-2021 LIBRARY; T=0.K  
Photon emission for (n,3n)a

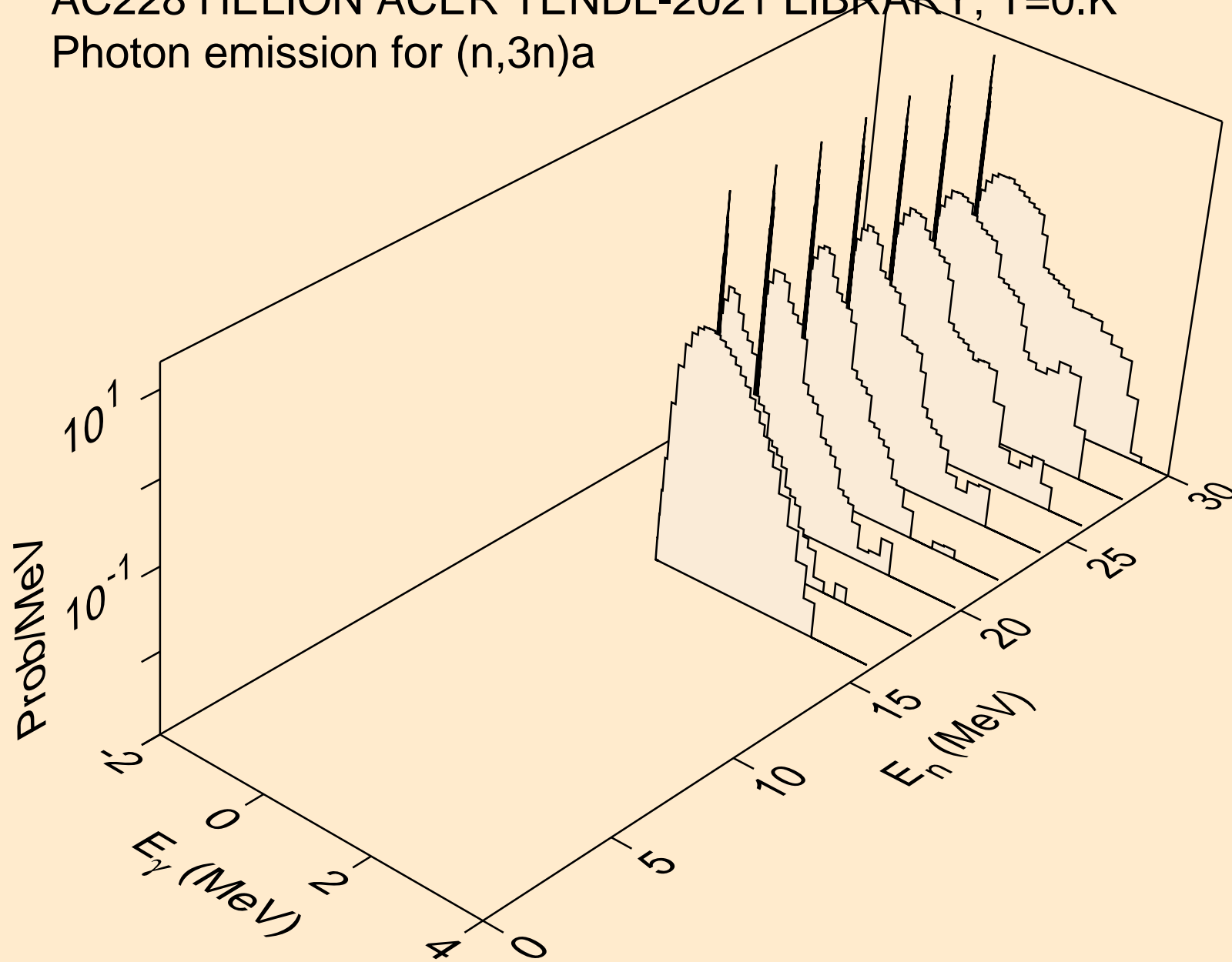



AC228 HELION ACER TENDL-2021 LIBRARY; T=0.K  
Photon emission for (n,n\*)p

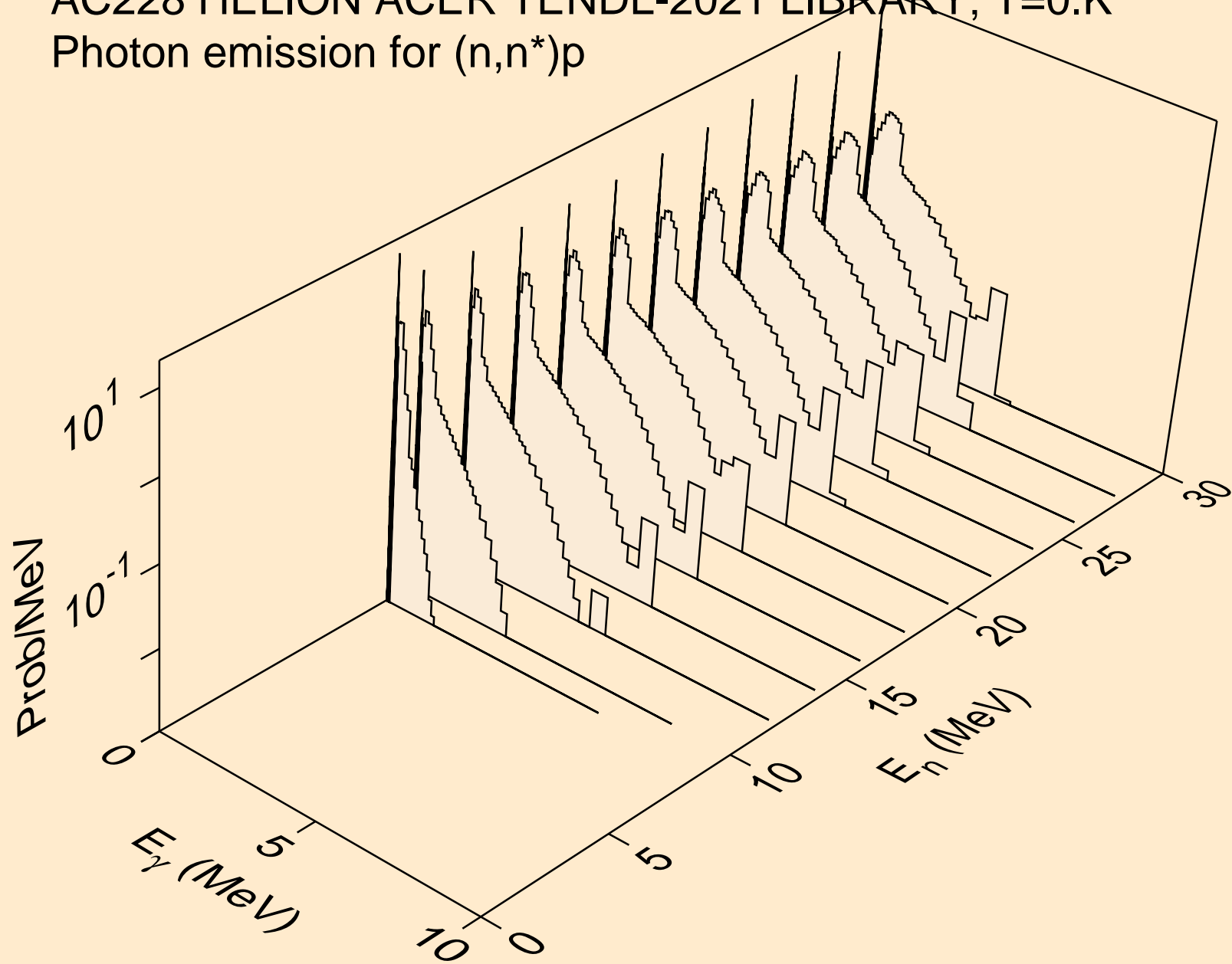

AC228 HELION ACER TENDL-2021 LIBRARY; T=0.K  
Photon emission for (n,n\*)d

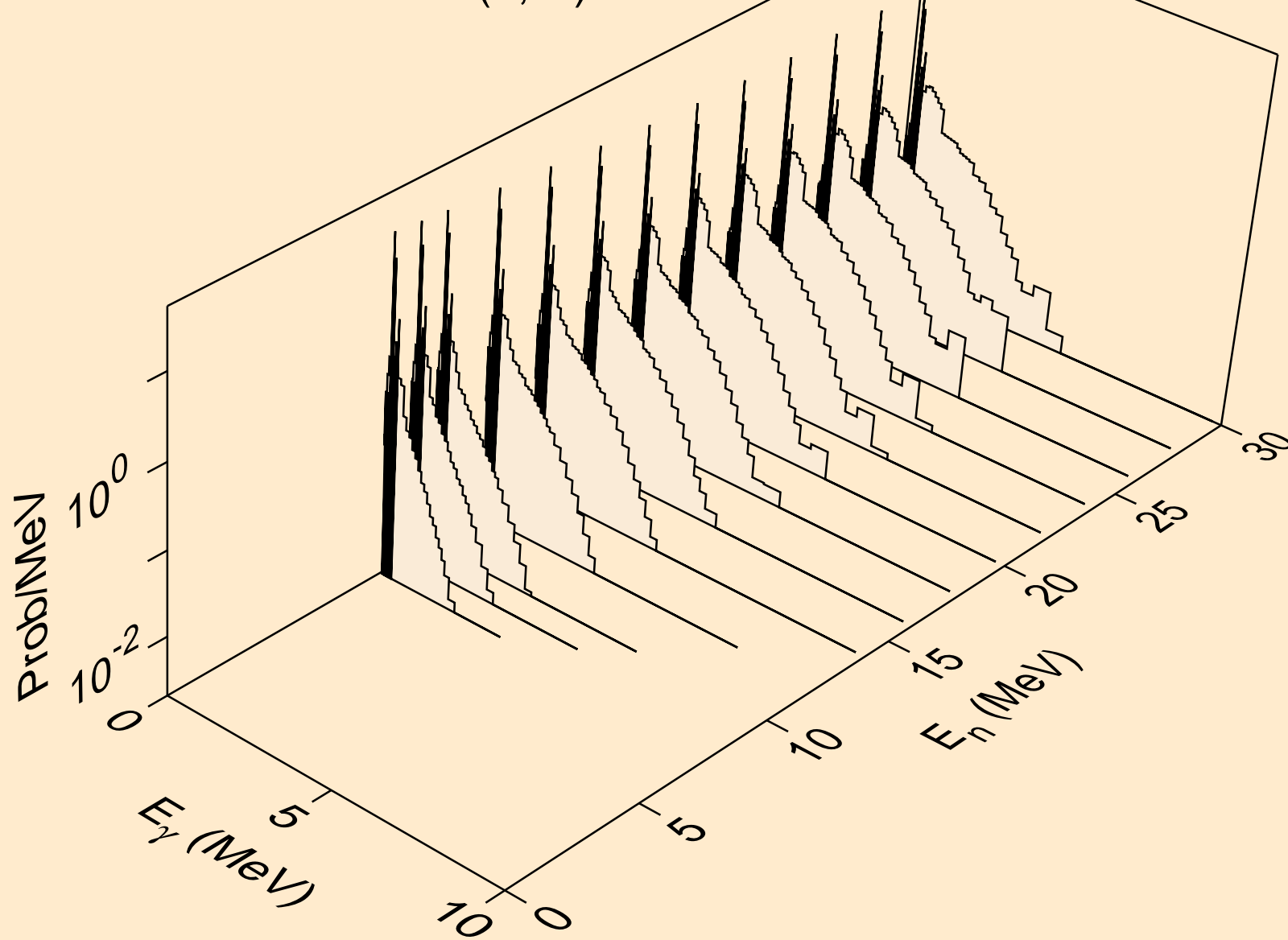

AC228 HELION ACER TENDL-2021 LIBRARY; T=0.K  
Photon emission for (n,n\*)t

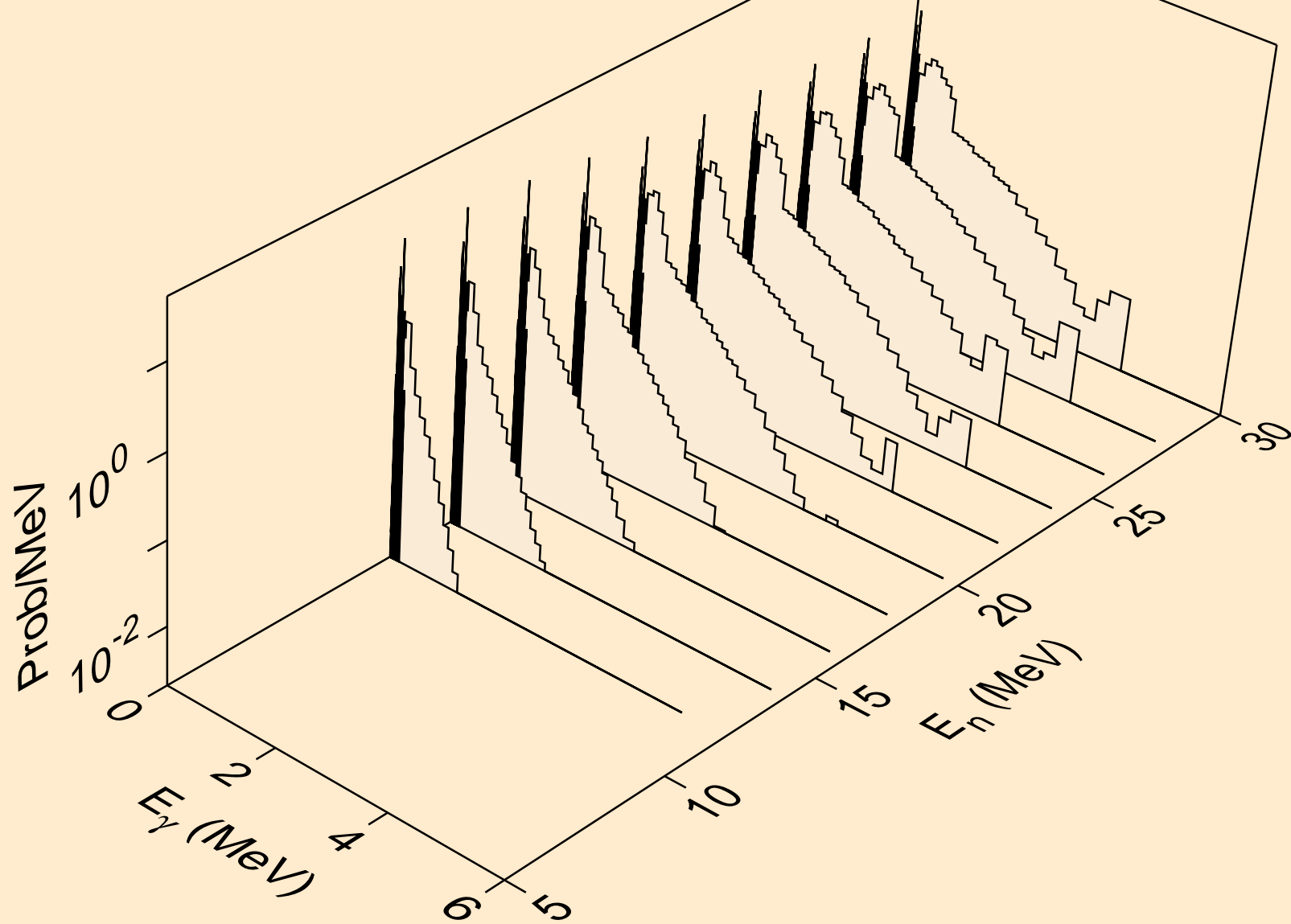

AC228 HELION ACER TENDL-2021 LIBRARY; T=0.K  
Photon emission for (n,n\*)he3

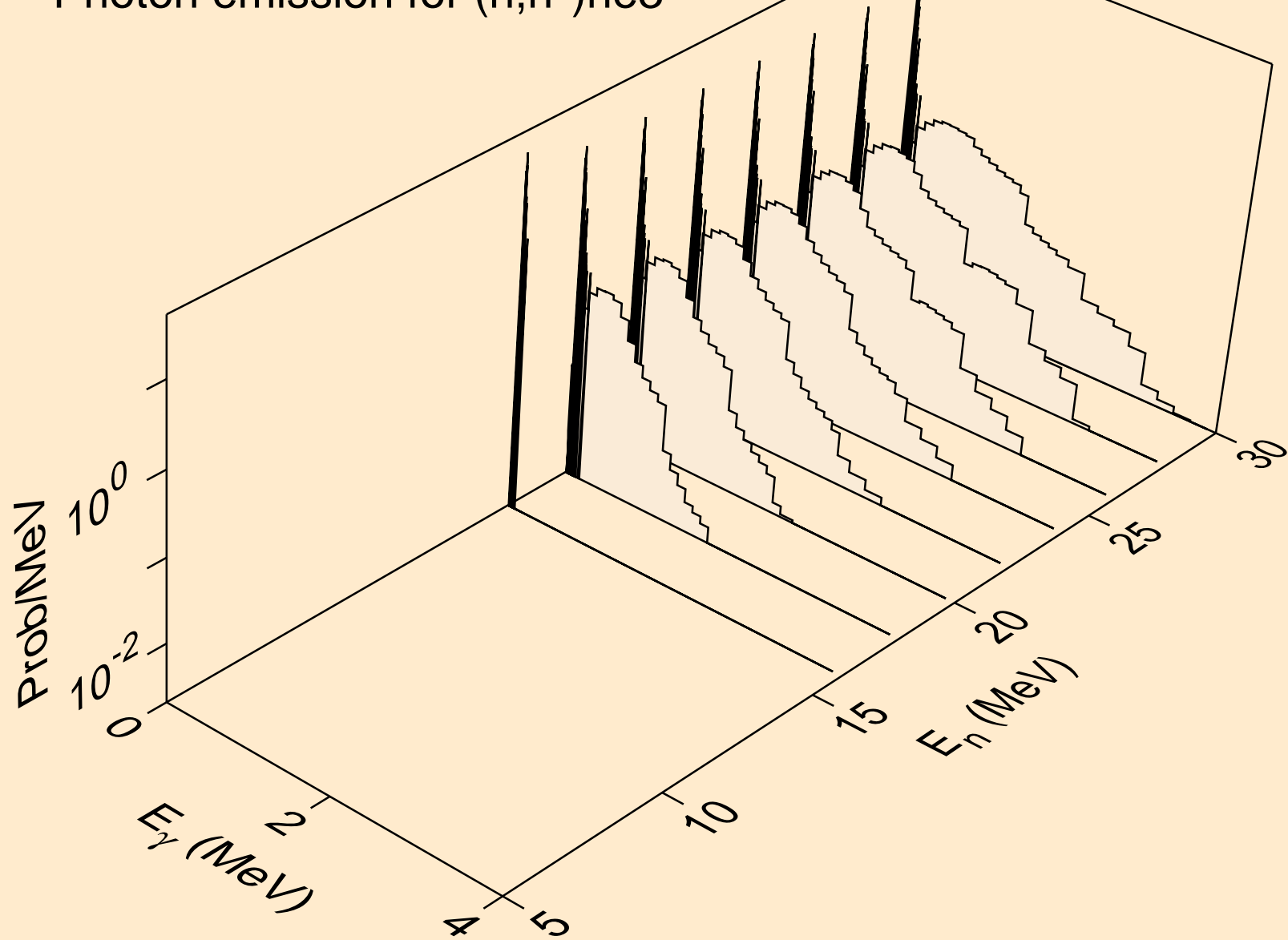

AC228 HELION ACER TENDL-2021 LIBRARY; T=0.K  
Photon emission for (n,4n)

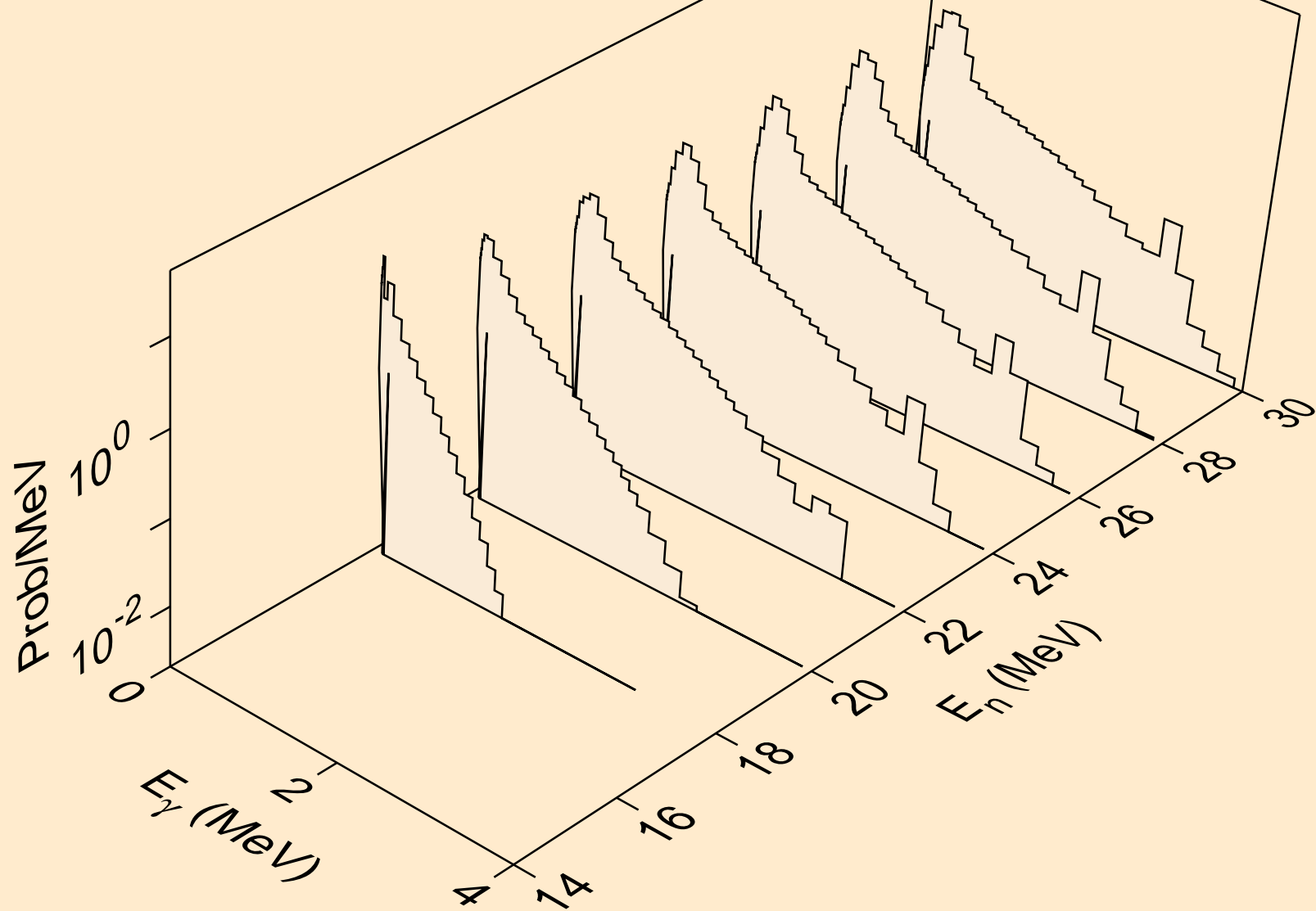

AC228 HELION ACER TENDL-2021 LIBRARY; T=0.K  
Photon emission for (n,2np)

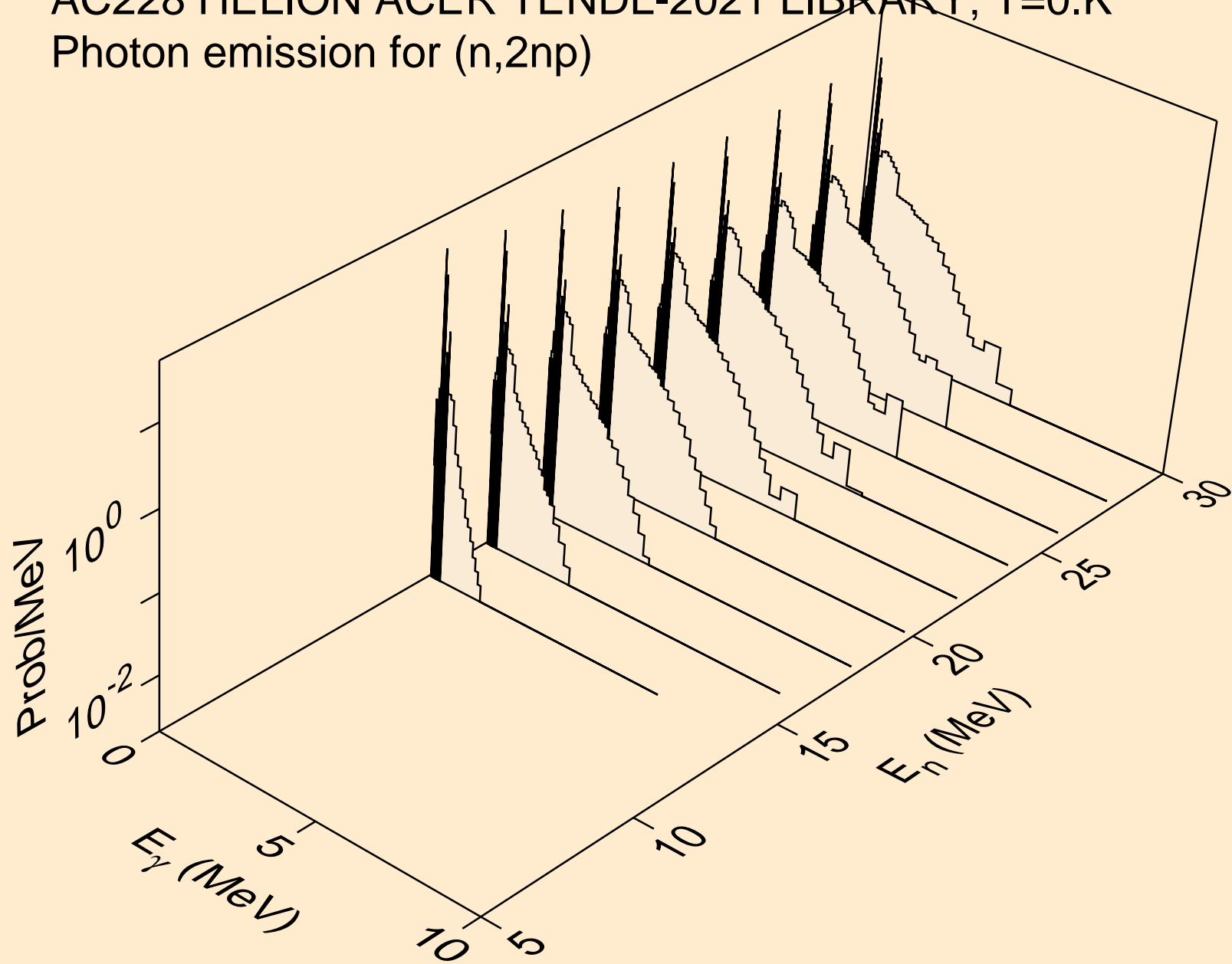

AC228 HELION ACER TENDL-2021 LIBRARY; T=0.K  
Photon emission for (n,3np)

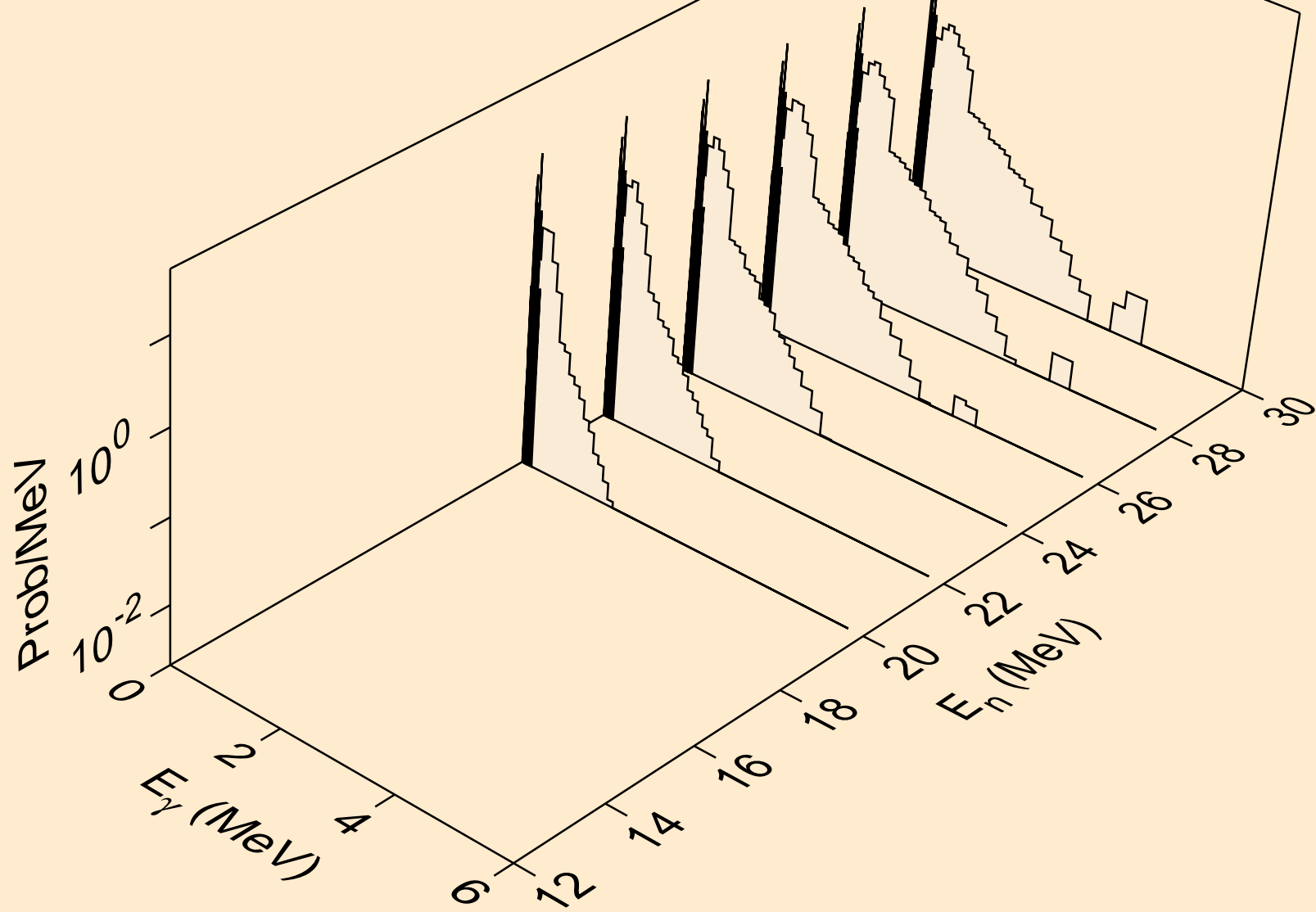

AC228 HELION ACER TENDL-2021 LIBRARY; T=0.K  
Photon emission for (n,2np)

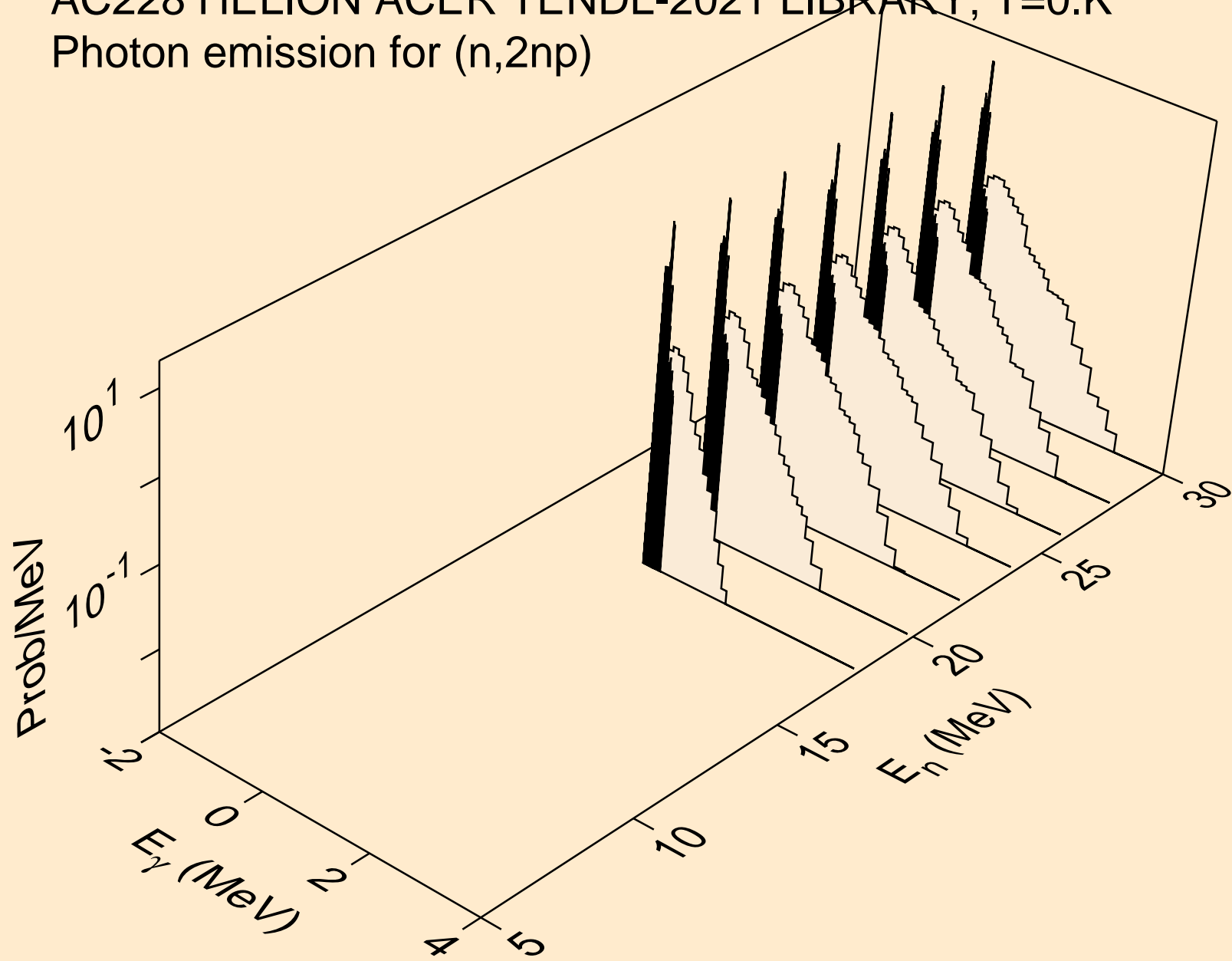



AC228 HELION ACER TENDL-2021 LIBRARY; T=0.K  
Photon emission for (n,npa)

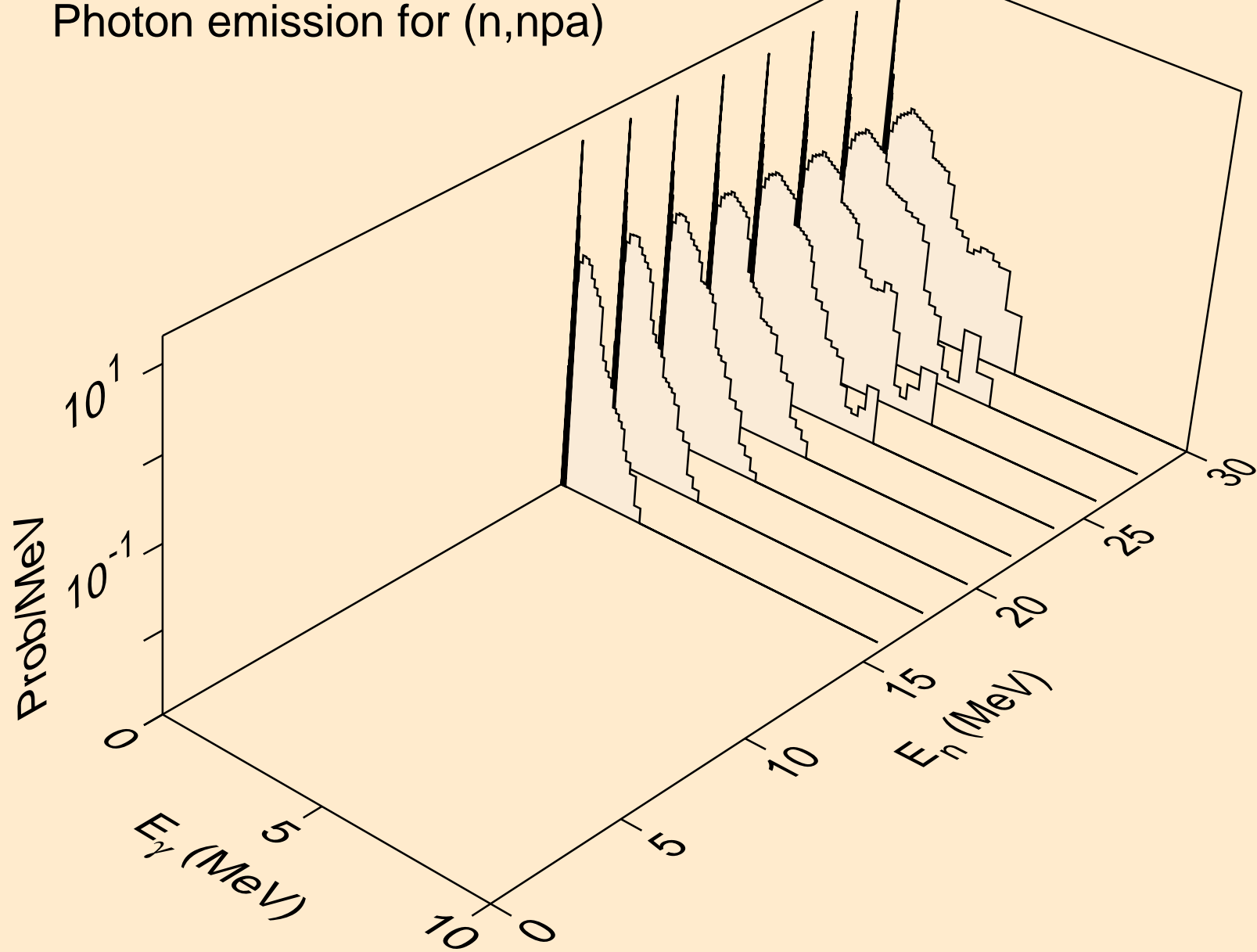

AC228 HELION ACER TENDL-2021 LIBRARY; T=0.K  
Photon emission for (n,gma)

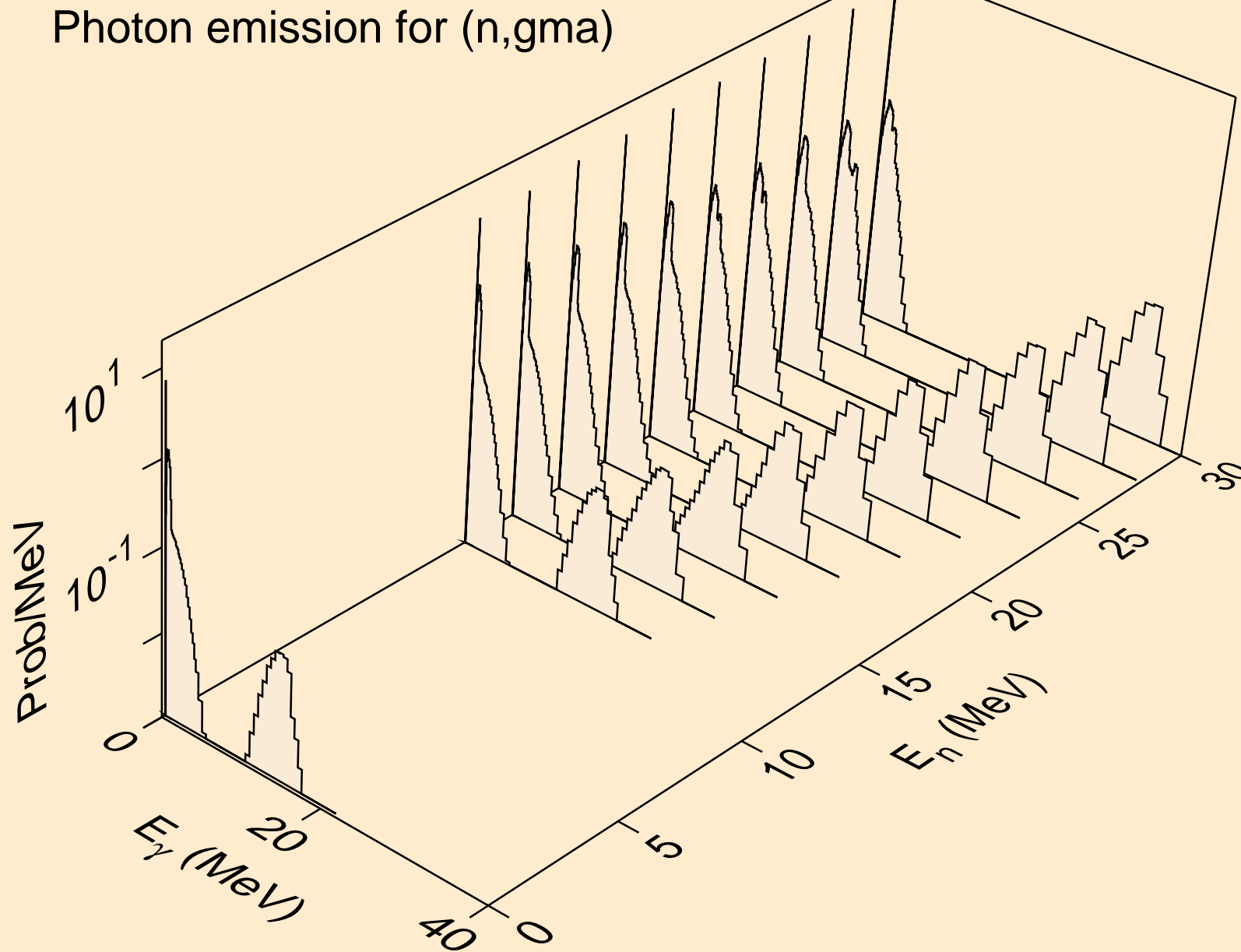

AC228 HELION ACER TENDL-2021 LIBRARY; T=0.K  
Photon emission for (n,p)

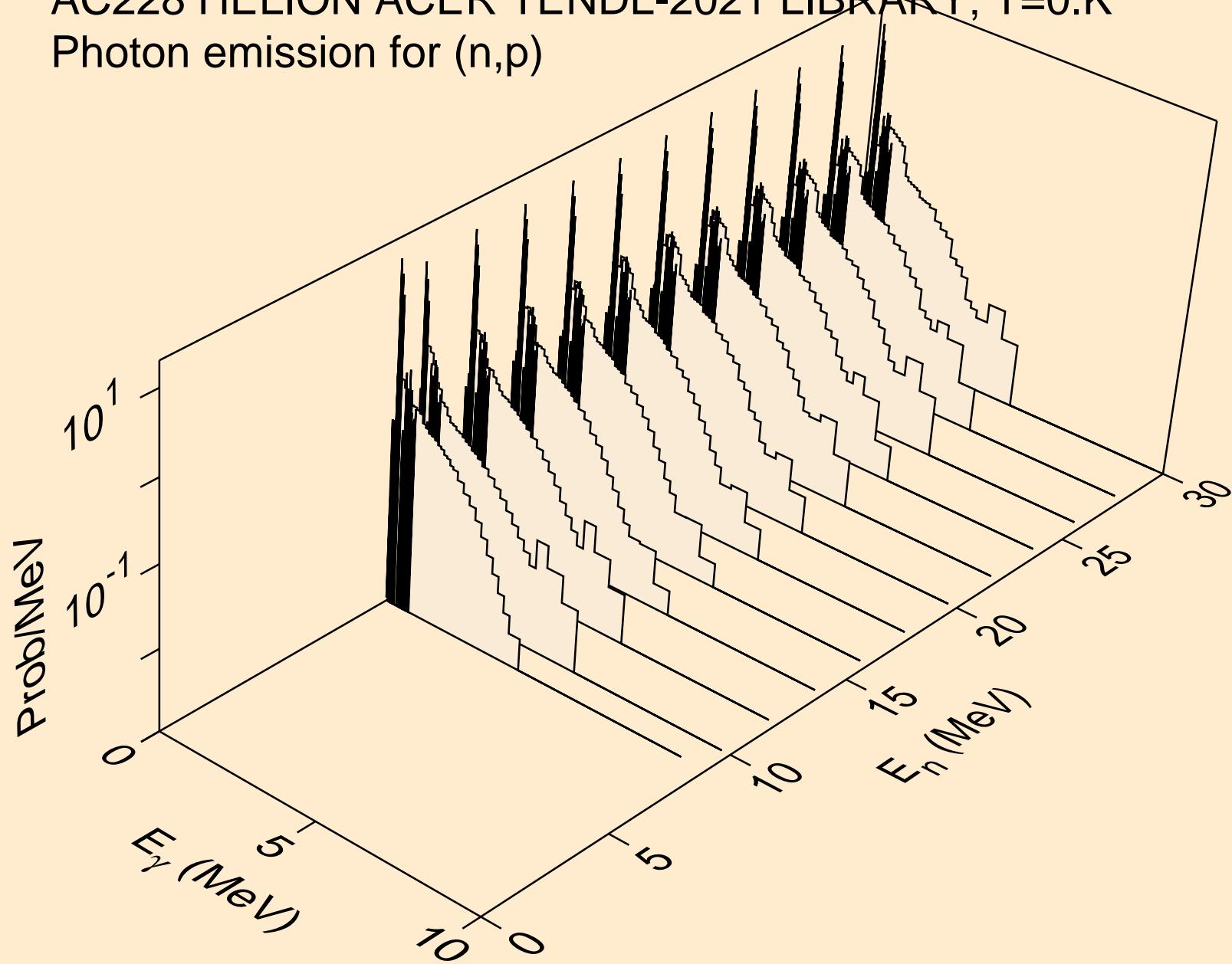

AC228 HELION ACER TENDL-2021 LIBRARY; T=0.K  
Photon emission for (n,d)

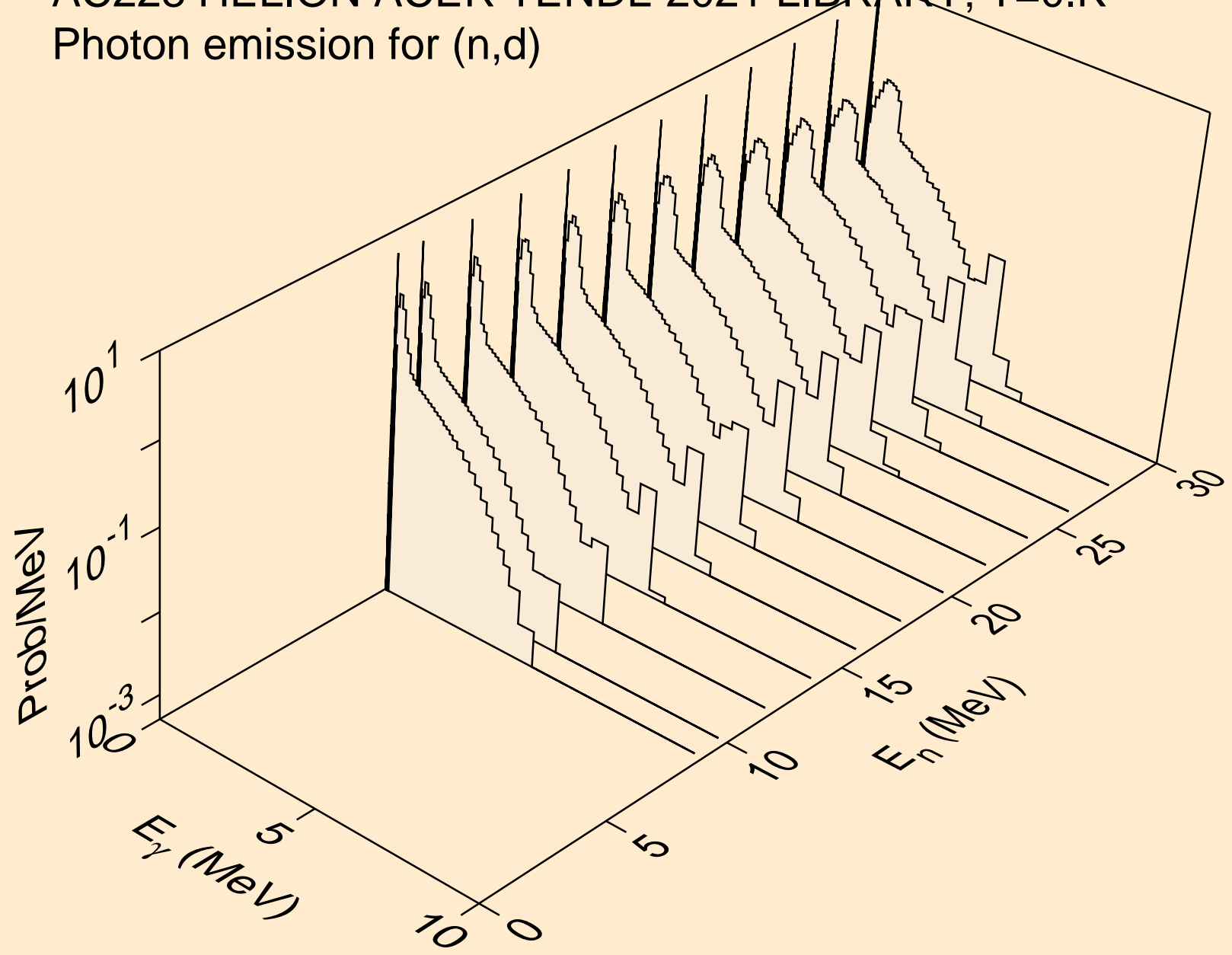

AC228 HELION ACER TENDL-2021 LIBRARY; T=0.K  
Photon emission for (n,t)

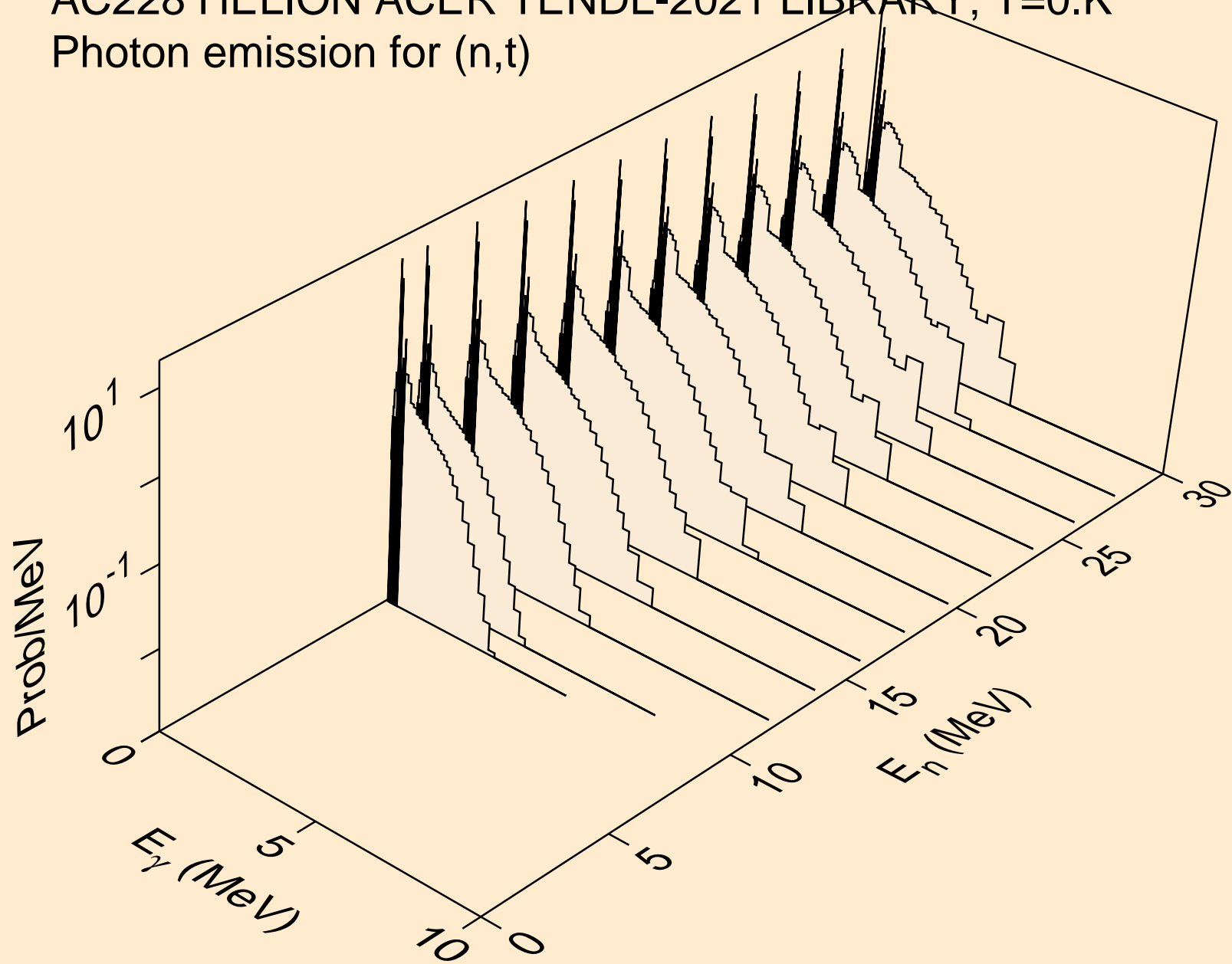

AC228 HELION ACER TENDL-2021 LIBRARY; T=0.K  
Photon emission for inelastic

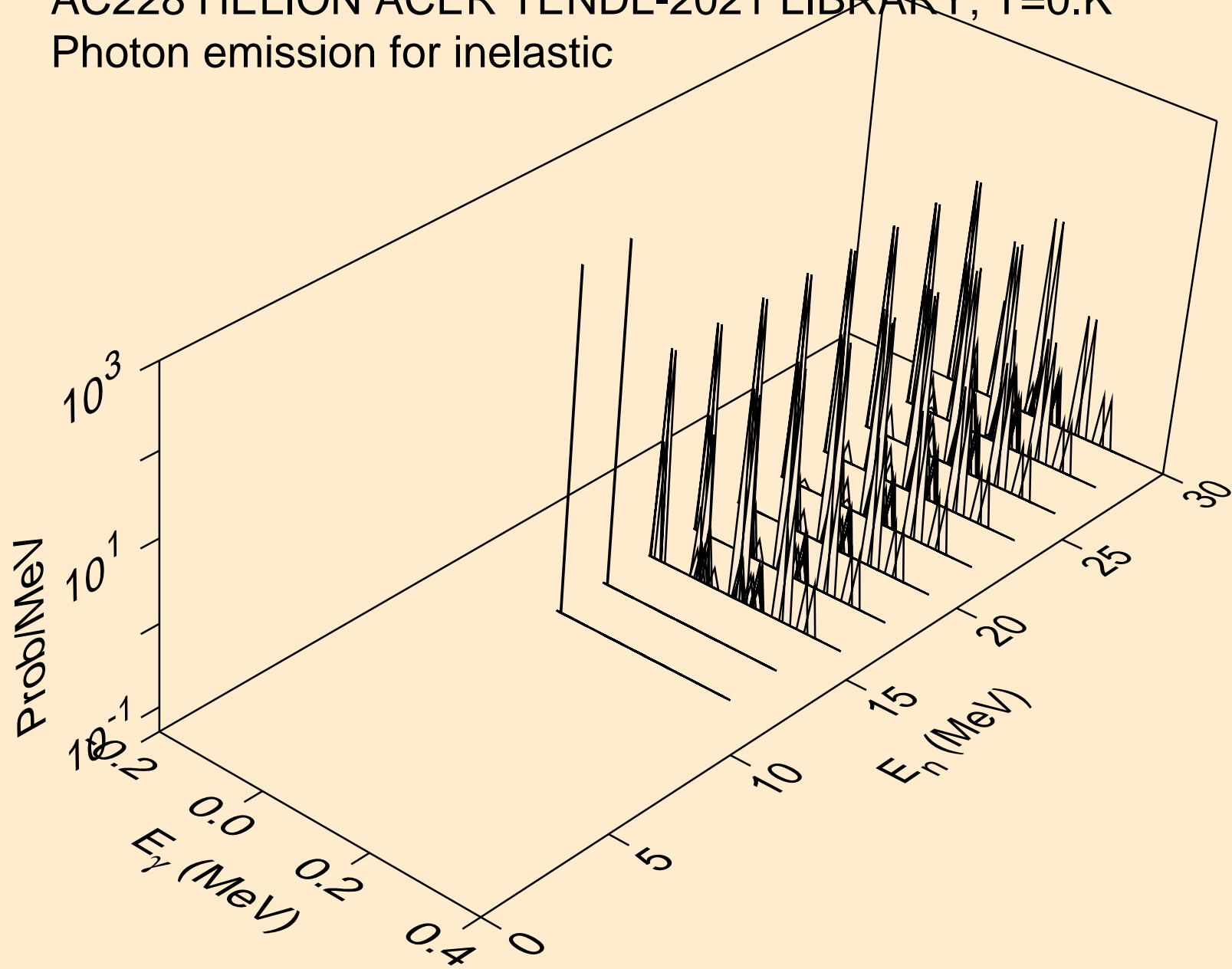

AC228 HELION ACER TENDL-2021 LIBRARY; T=0.K  
Photon emission for (n,a)

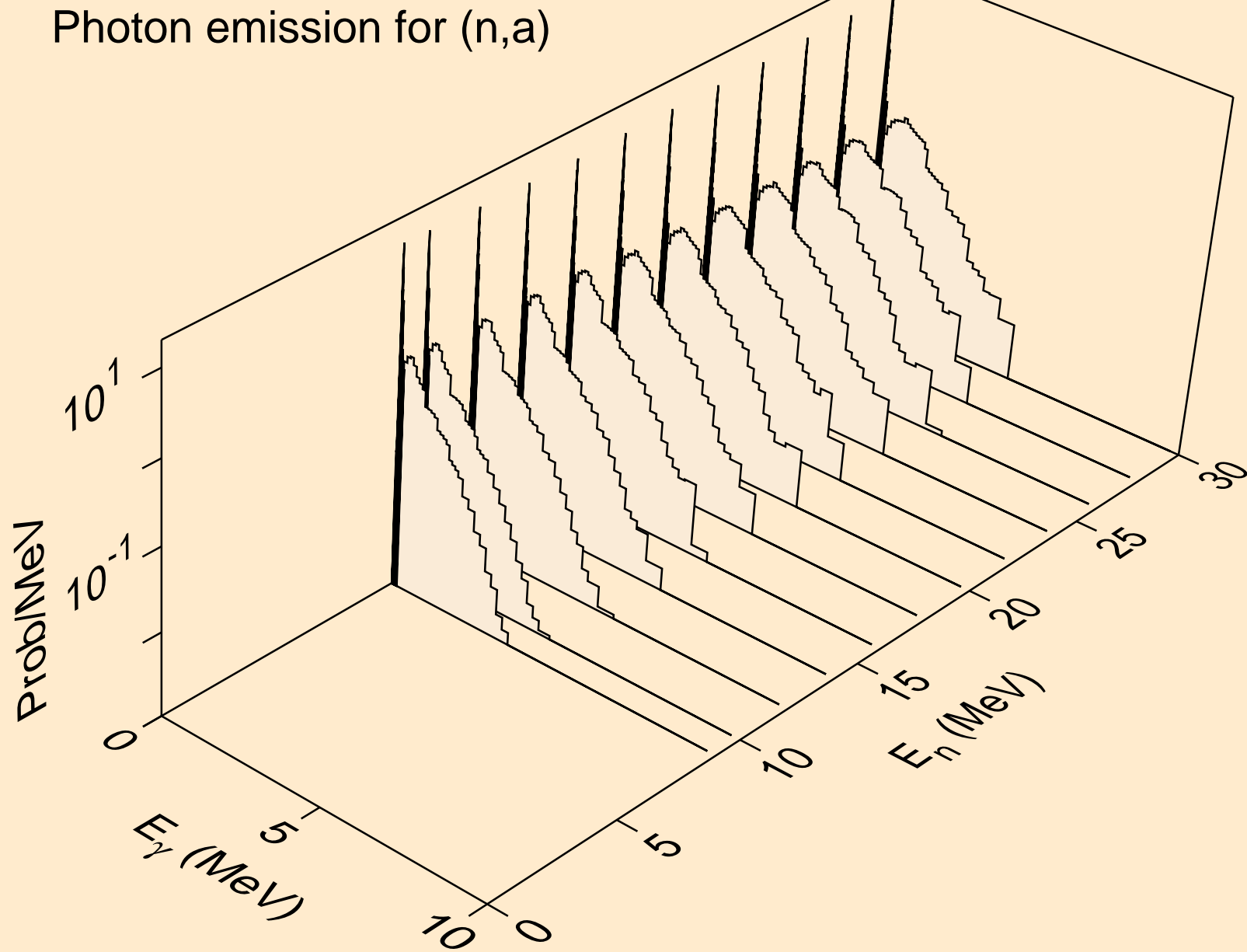

AC228 HELION ACER TENDL-2021 LIBRARY; T=0.K  
Photon emission for (n,2p)

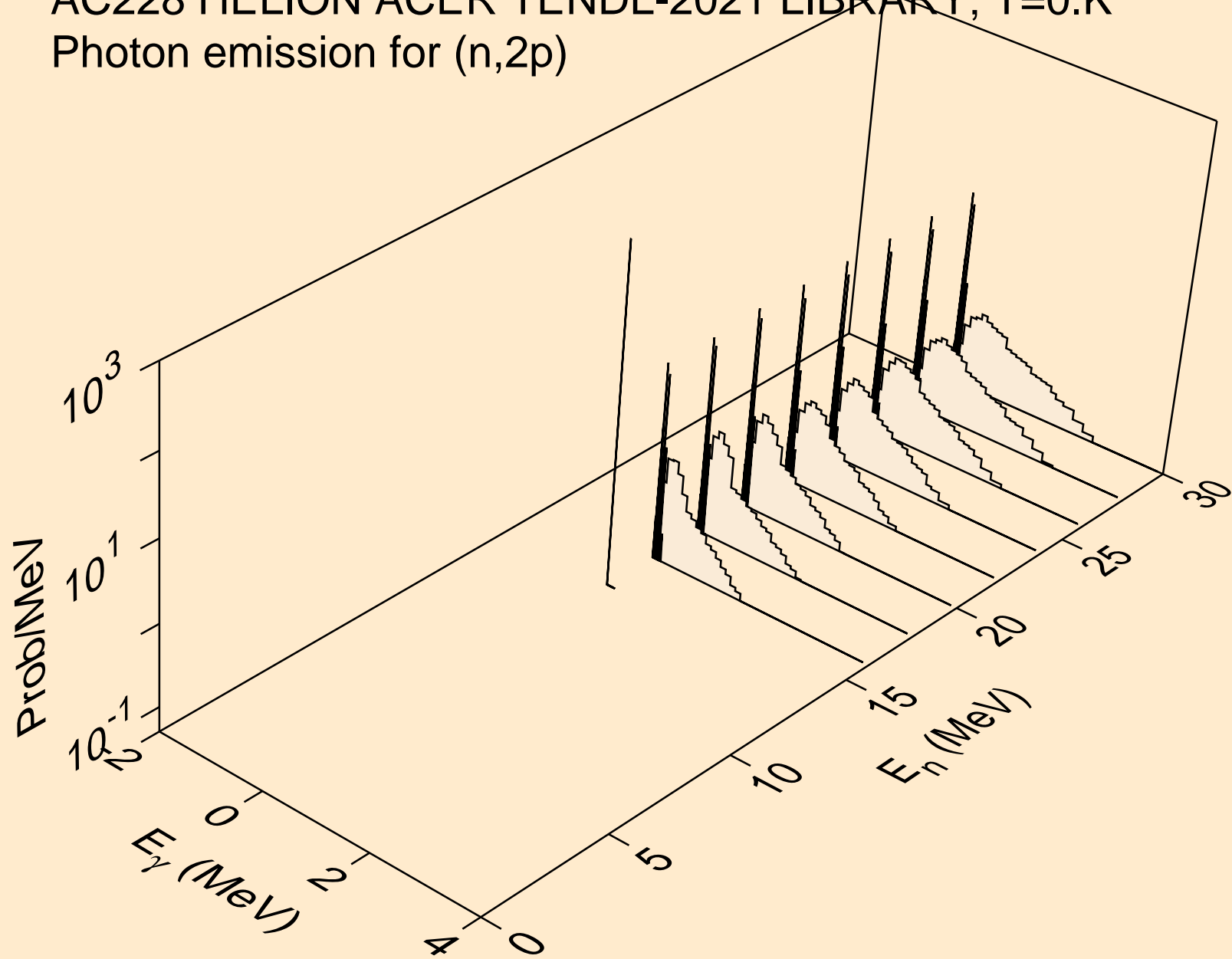



AC228 HELION ACER TENDL-2021 LIBRARY; T=0.K  
Photon emission for (n,pa)

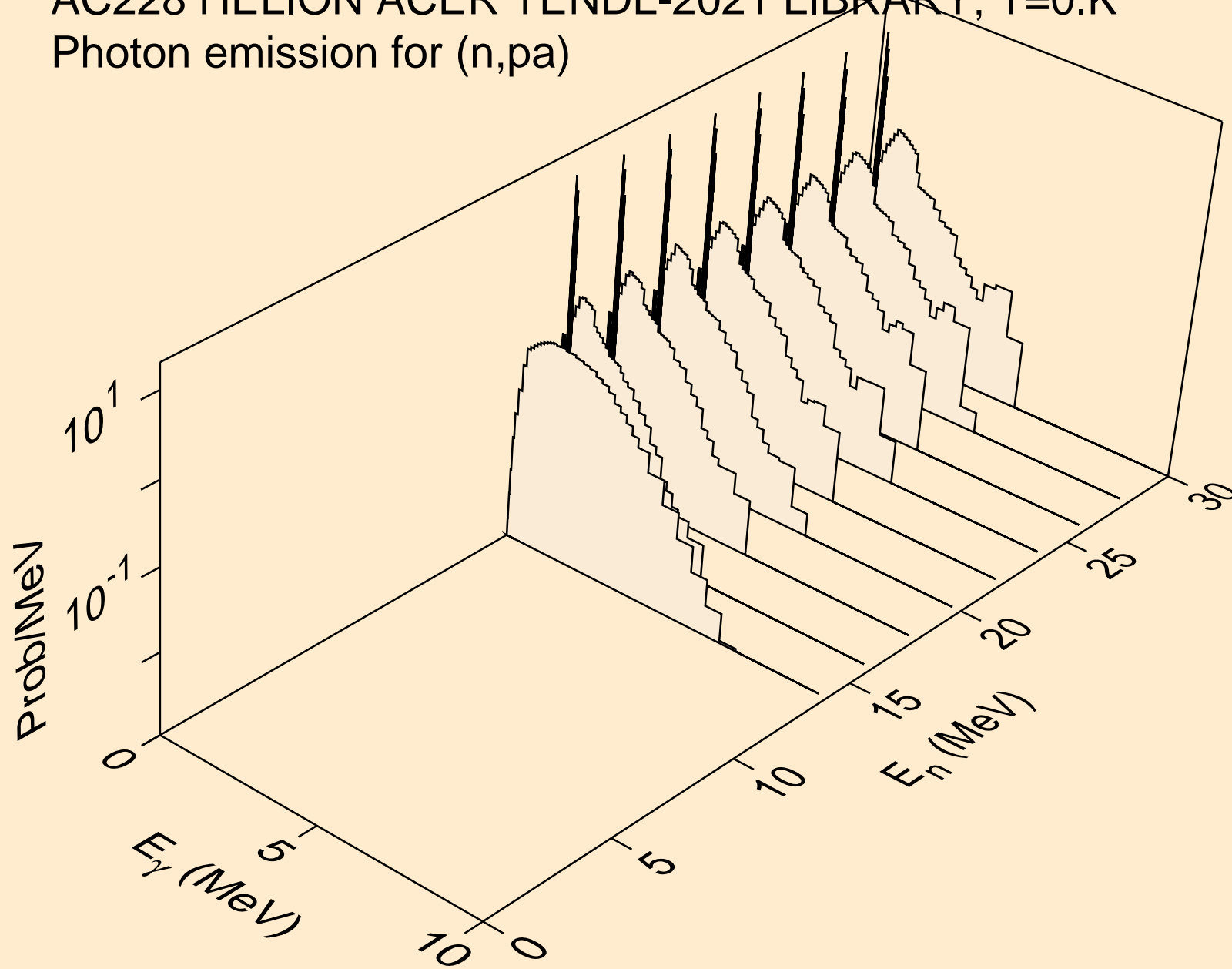

AC228 HELION ACER TENDL-2021 LIBRARY; T=0.K  
Photon emission for (n,pd)

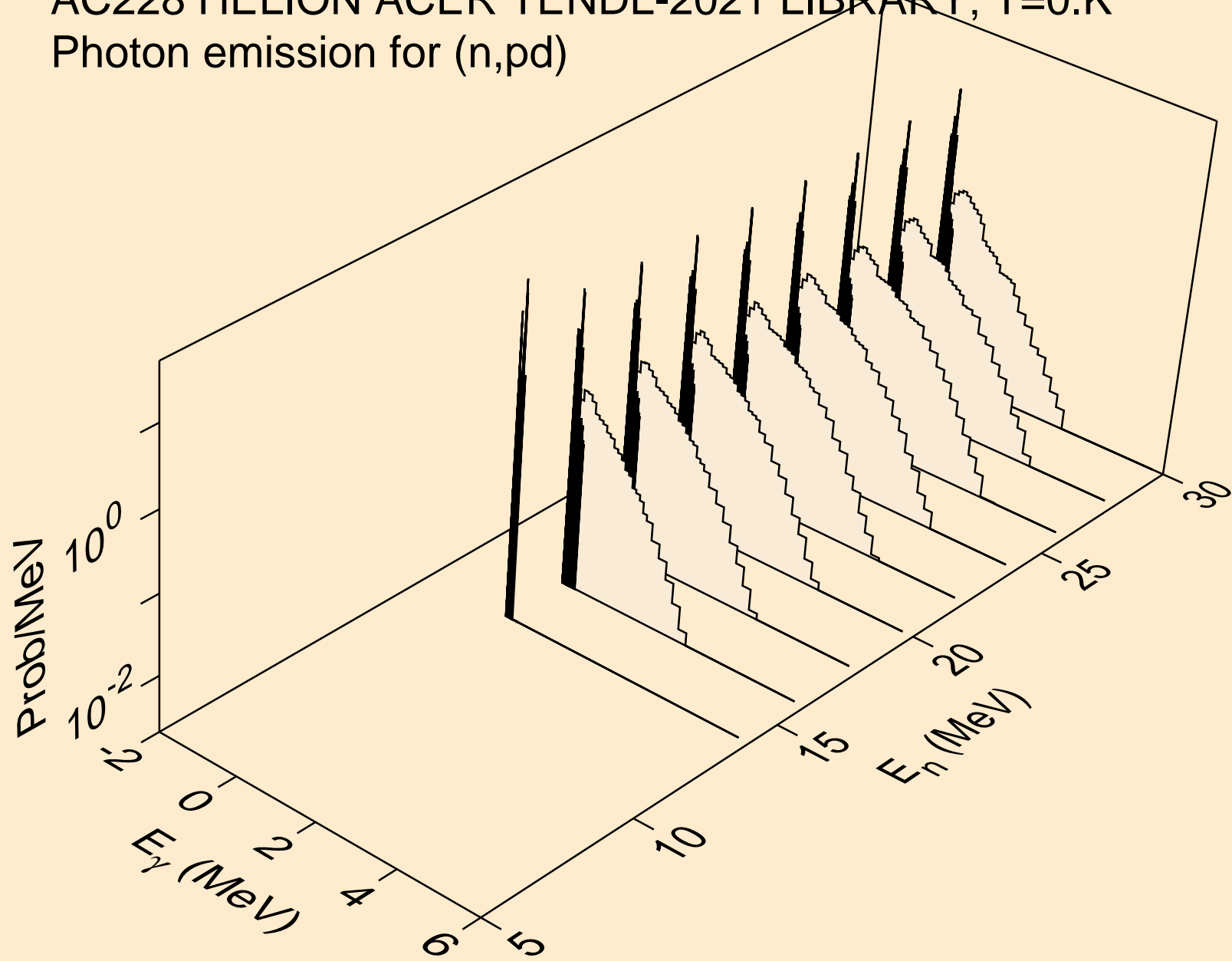

AC228 HELION ACER TENDL-2021 LIBRARY; T=0.K  
Photon emission for (n,pt)

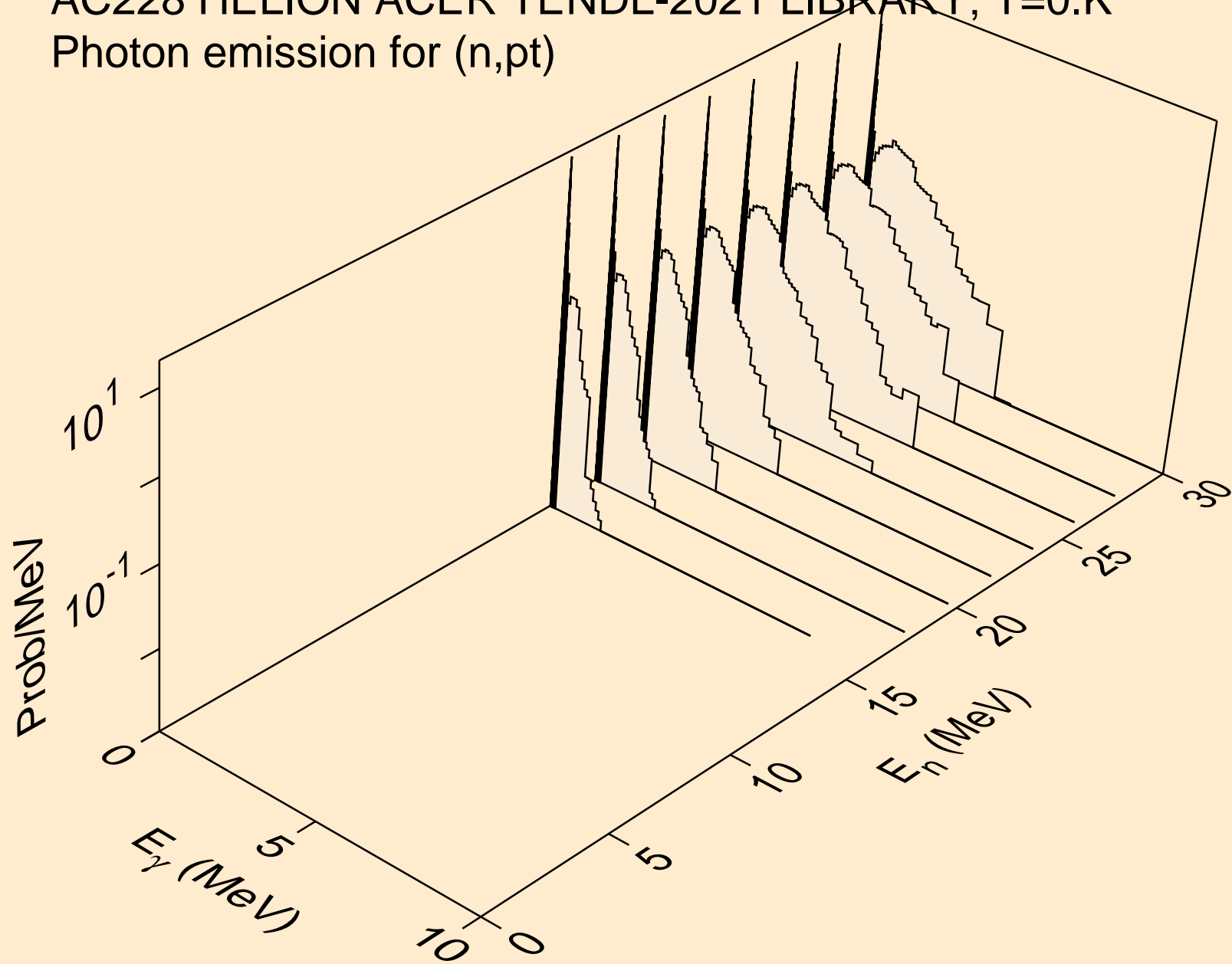

AC228 HELION ACER TENDL-2021 LIBRARY; T=0.K  
Photon emission for (n,da)

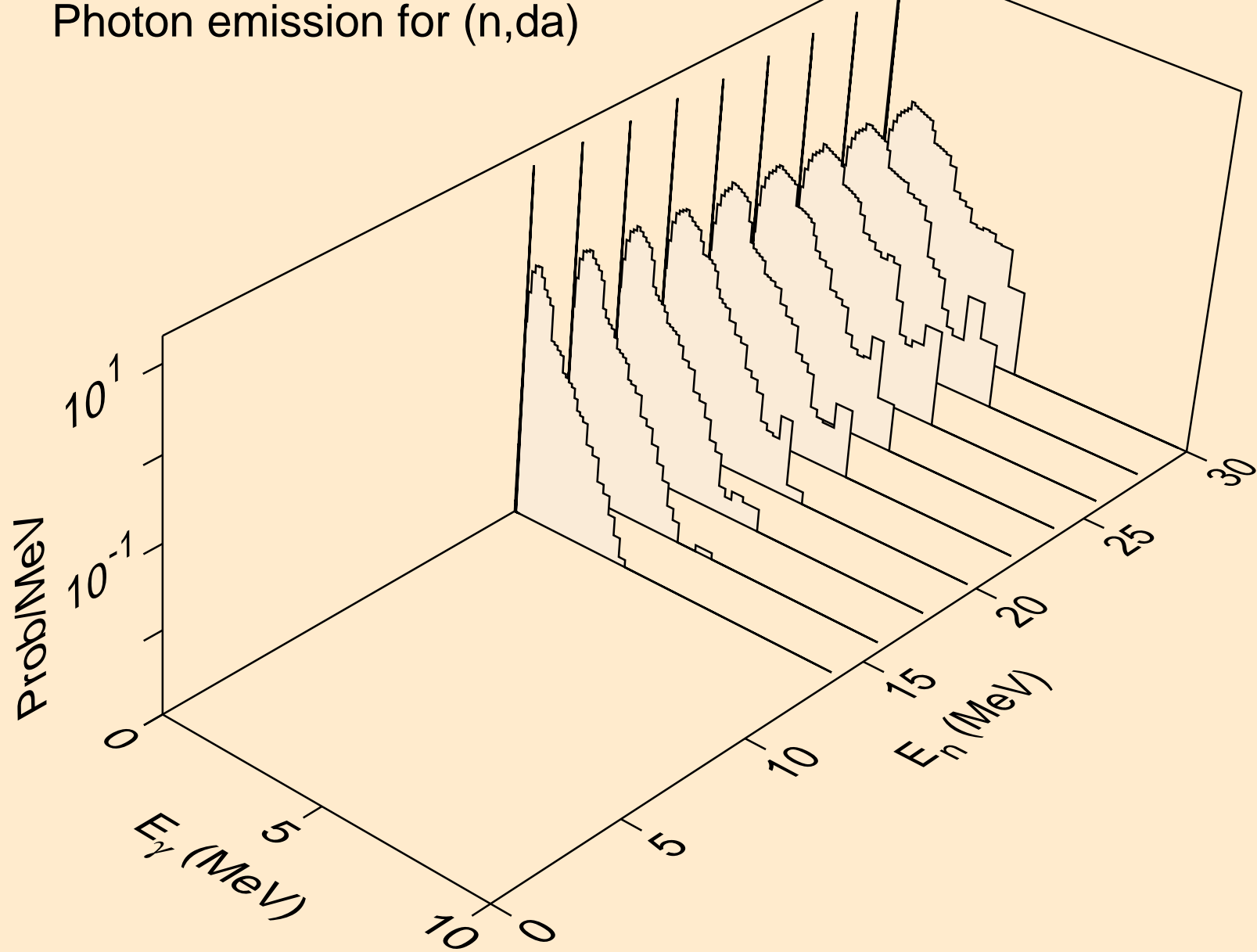

AC228 HELION ACER TENDL-2021 LIBRARY; T=0.K  
Particle heating contributions

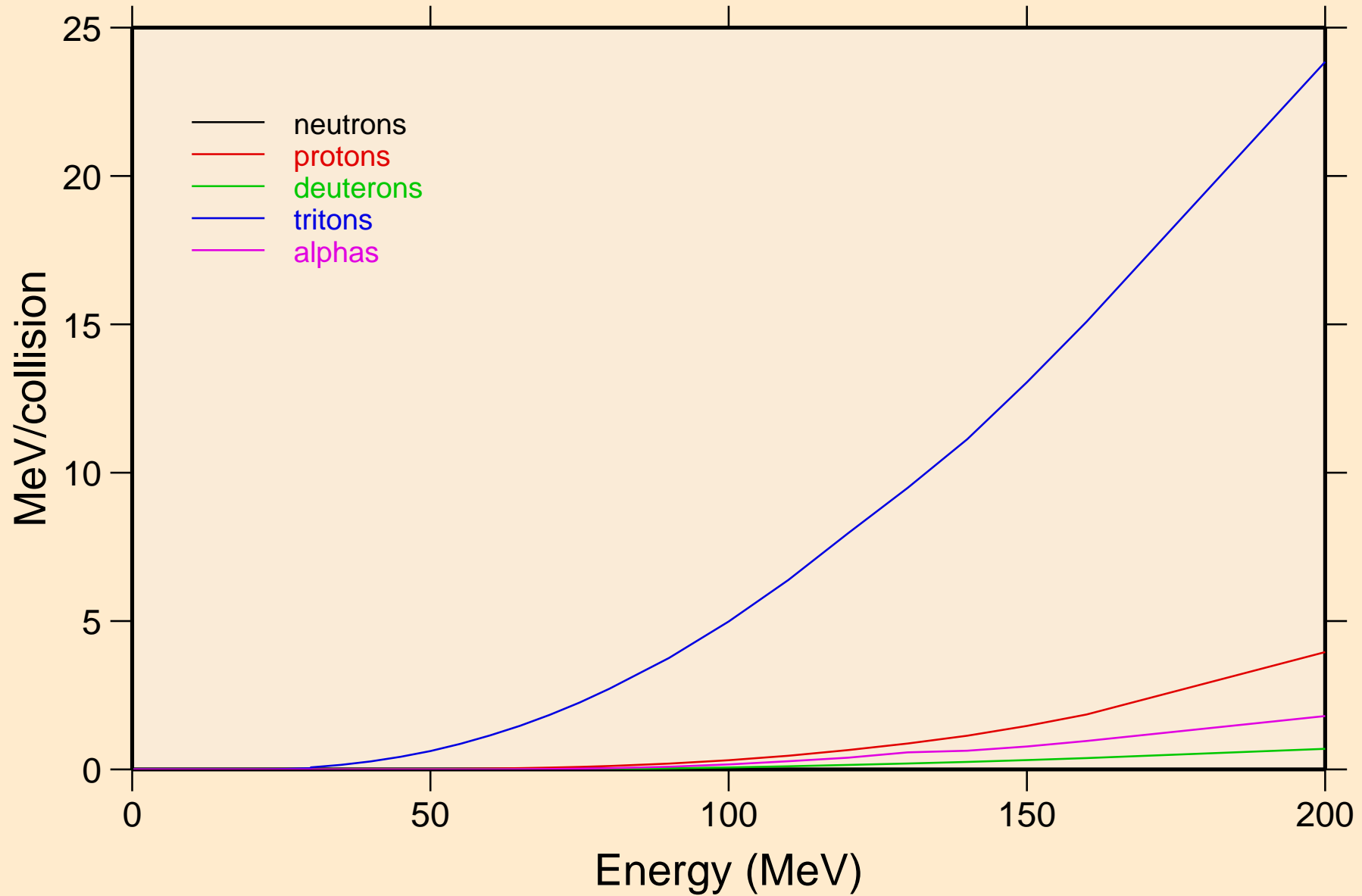

AC228 HELION ACER TENDL-2021 LIBRARY; T=0.K  
Recoil Heating

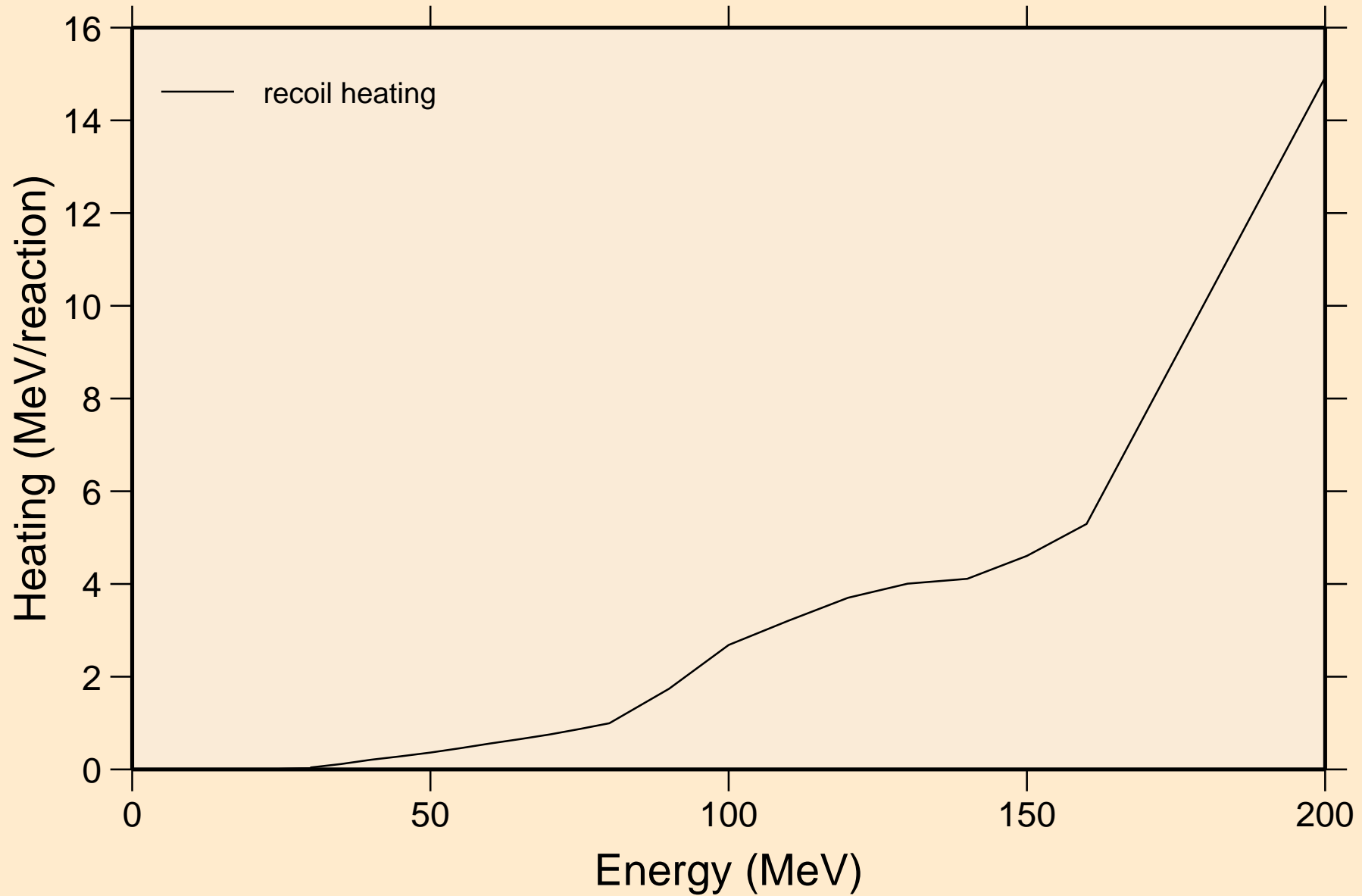

AC228 HELION ACER TENDL-2021 LIBRARY; T=0.K  
Particle production cross sections

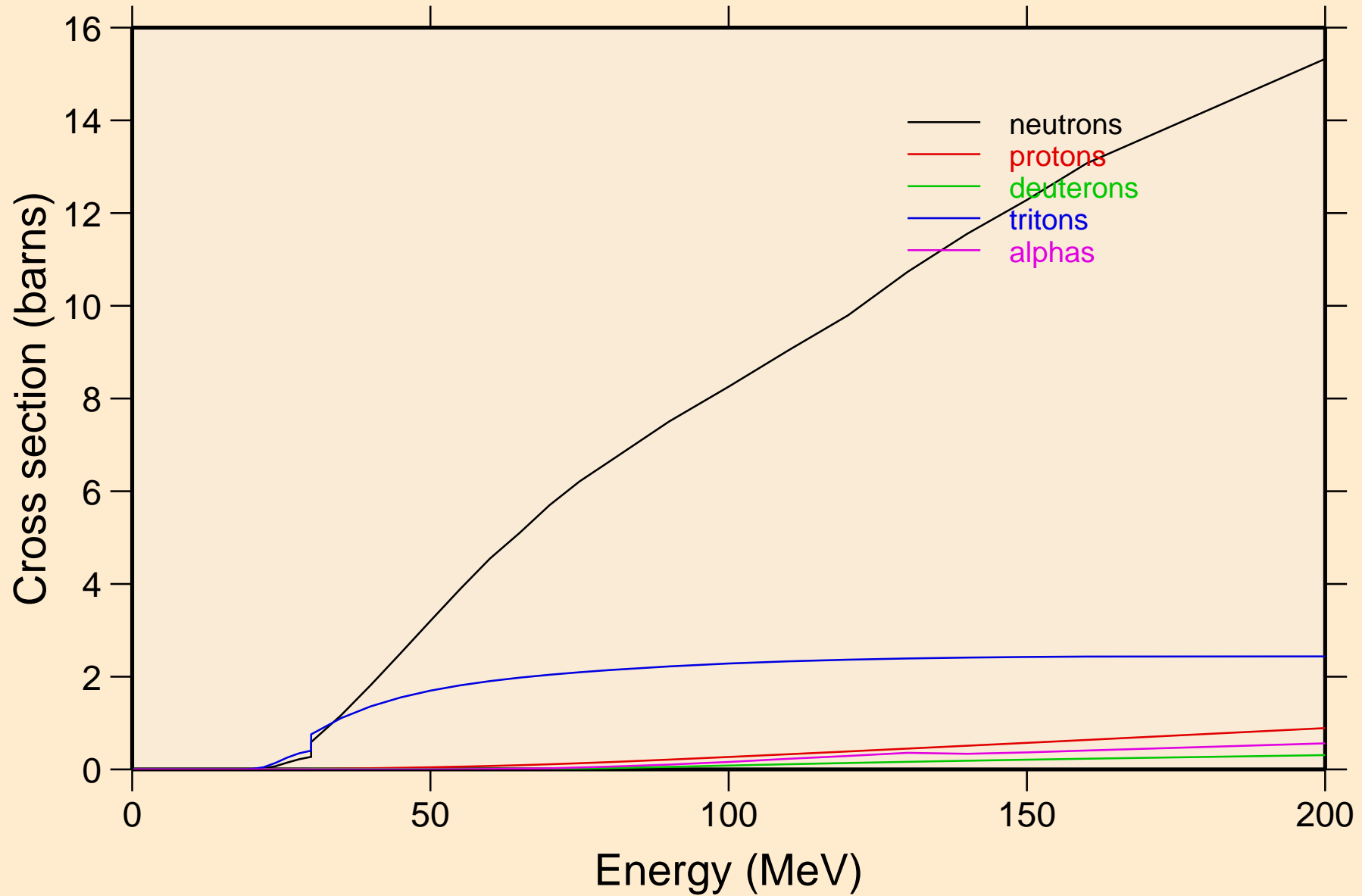

AC228 HELION ACER TENDL-2021 LIBRARY; T=0.K  
neutrons from (s,n)

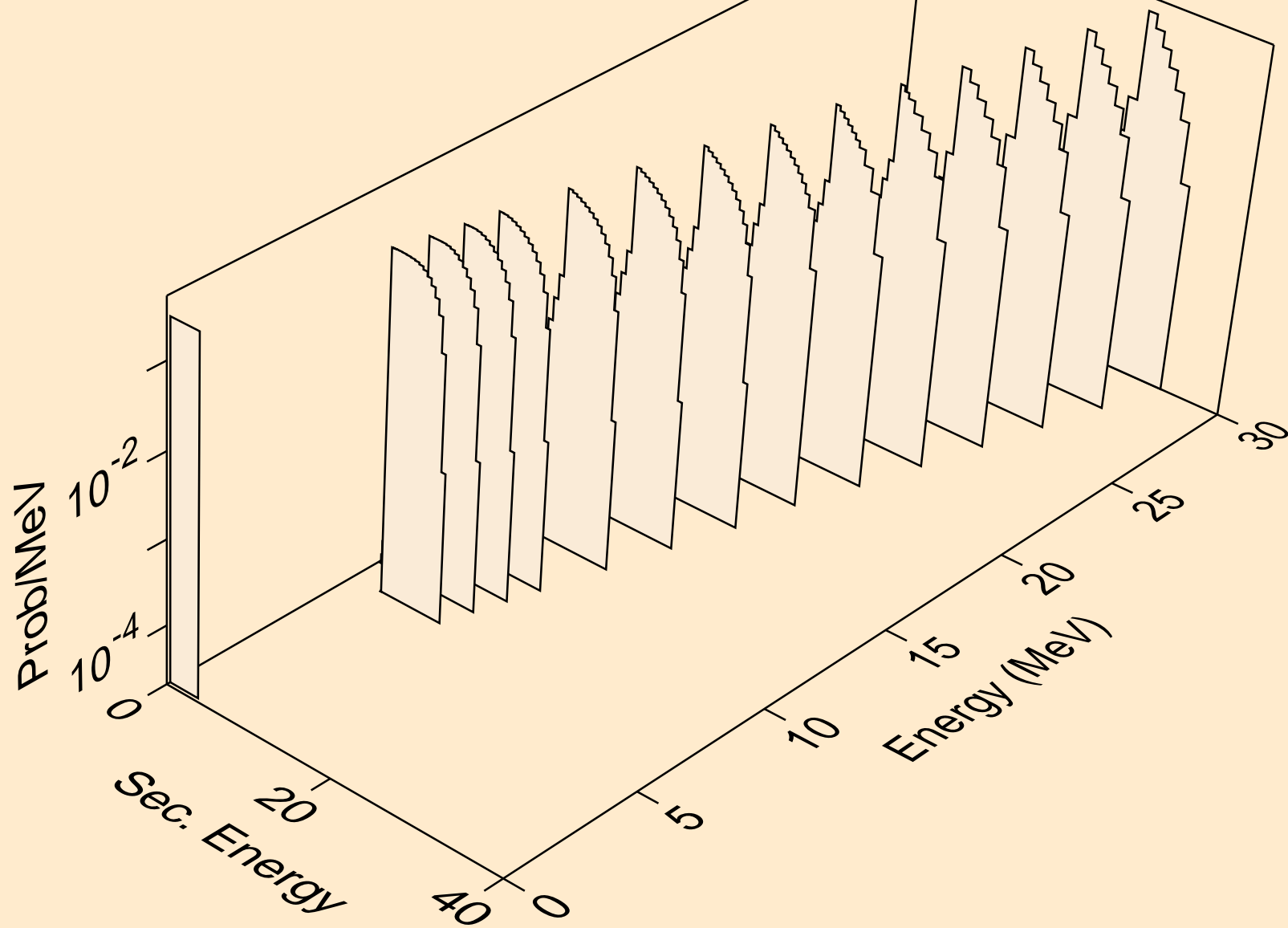



AC228 HELION ACER TENDL-2021 LIBRARY; T=0.K  
neutrons from (s,x)

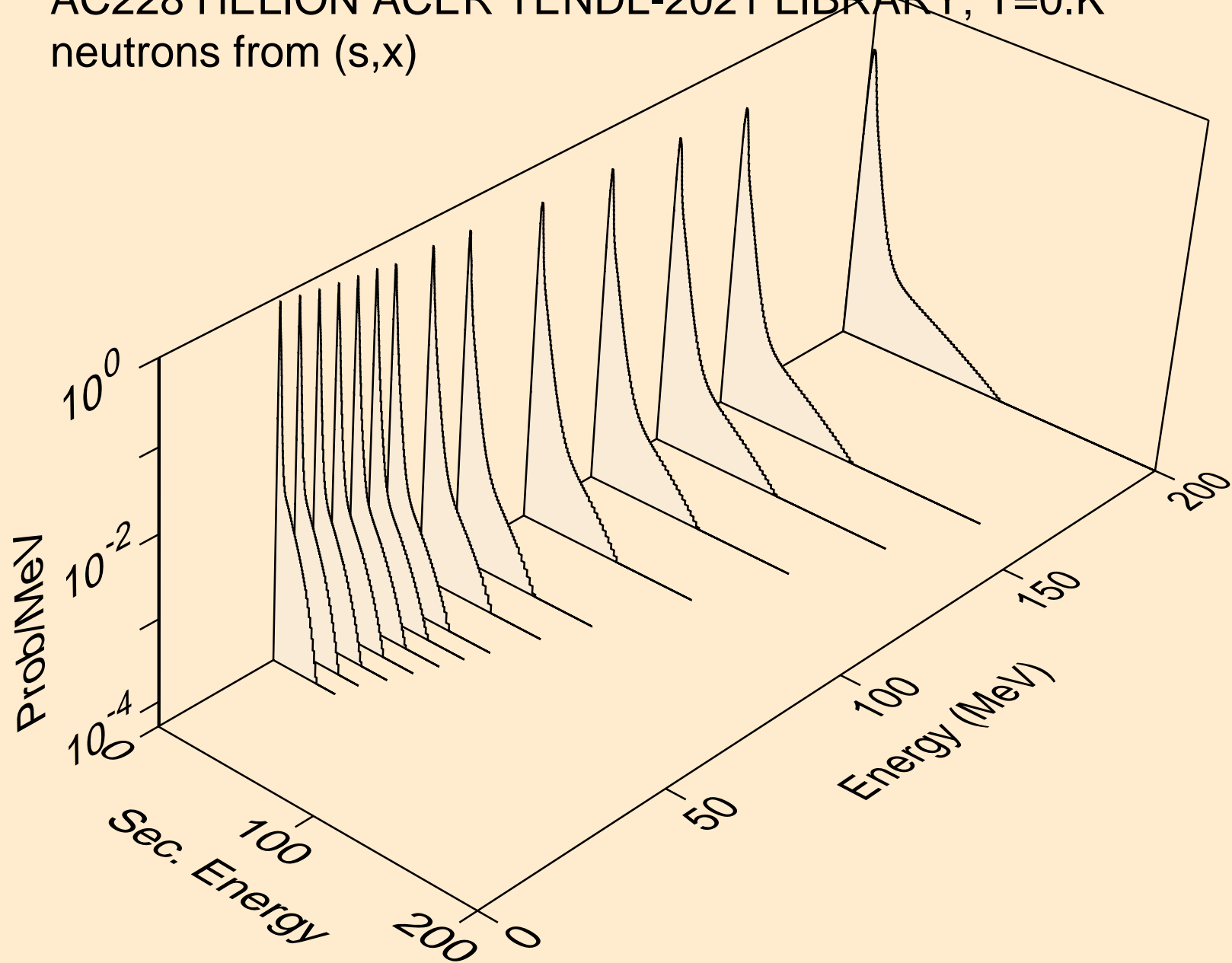

AC228 HELION ACER TENDL-2021 LIBRARY; T=0.K  
neutrons from (s,2nd)

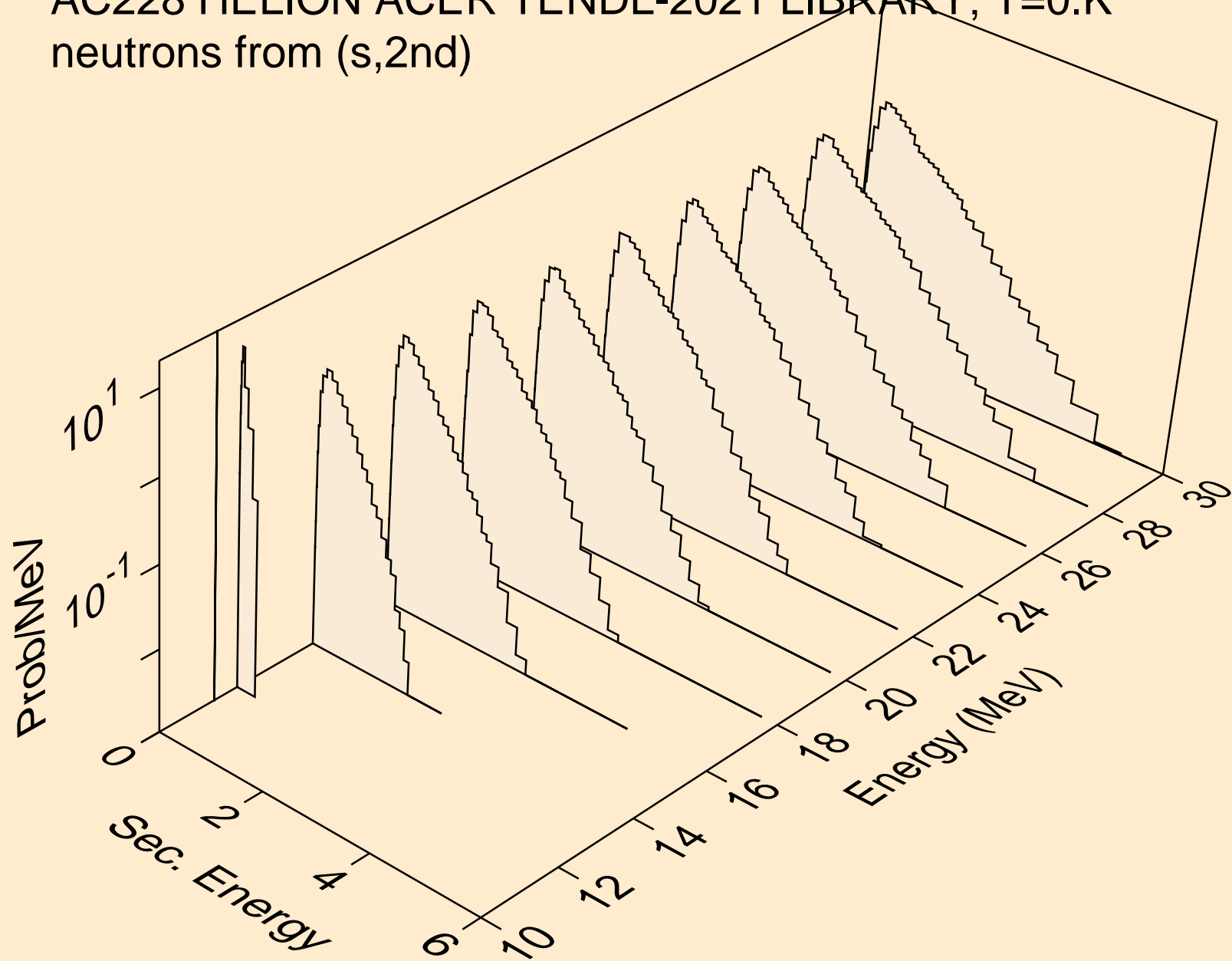

AC228 HELION ACER TENDL-2021 LIBRARY; T=0.K  
neutrons from (s,2n)

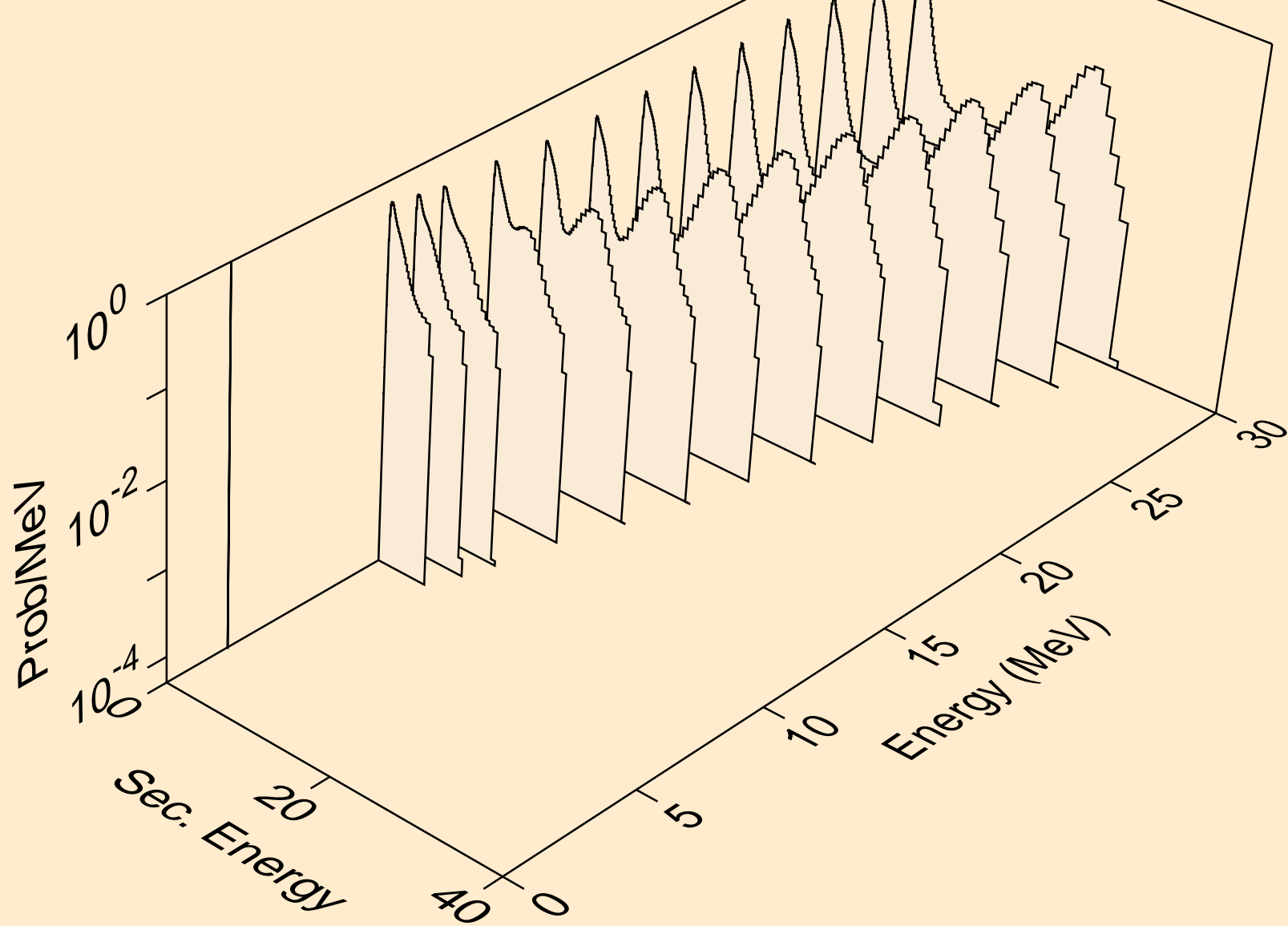

AC228 HELION ACER TENDL-2021 LIBRARY; T=0.K  
neutrons from (s,3n)

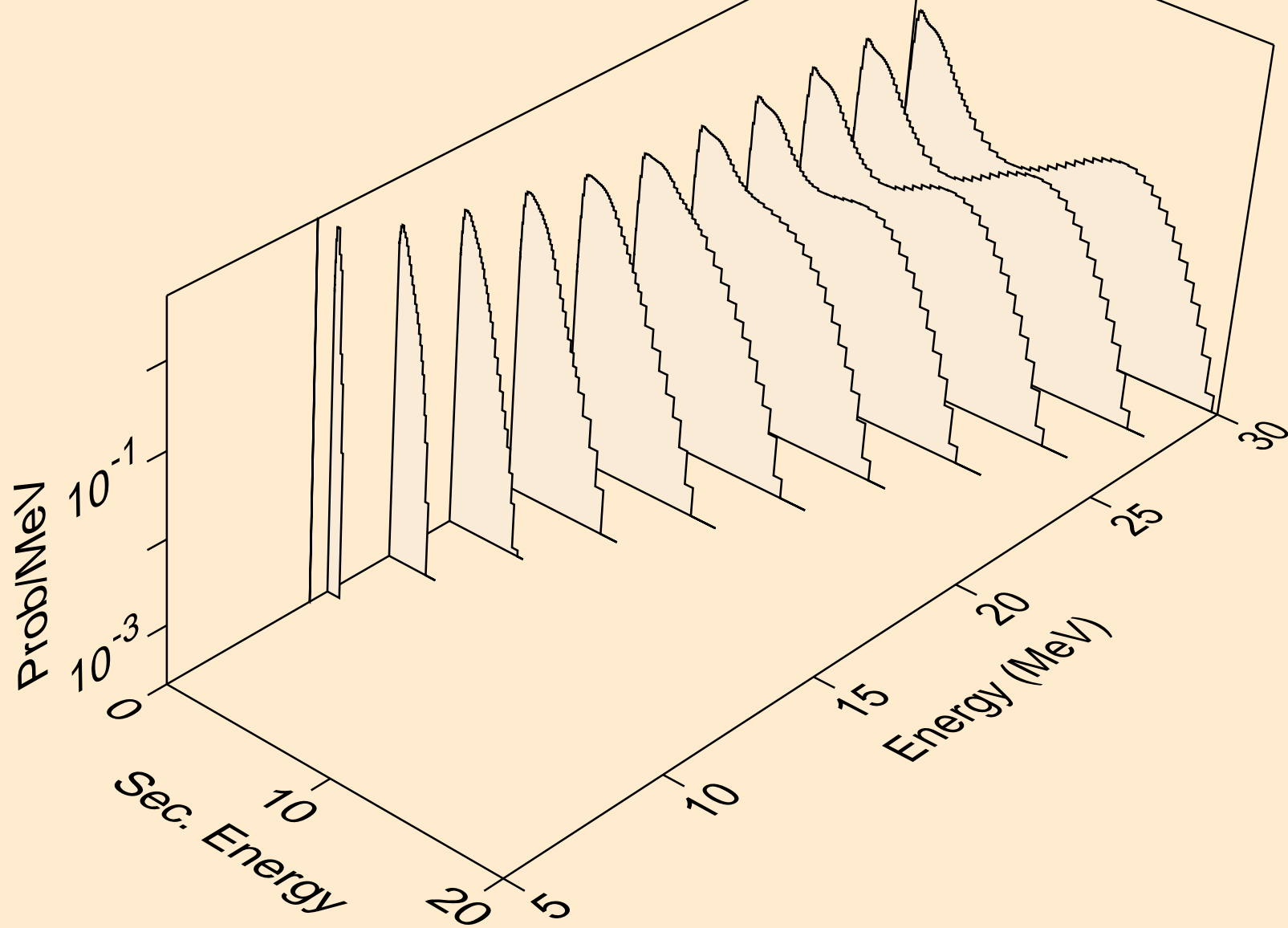

AC228 HELION ACER TENDL-2021 LIBRARY; T=0.K  
neutrons from (s,n\*)a

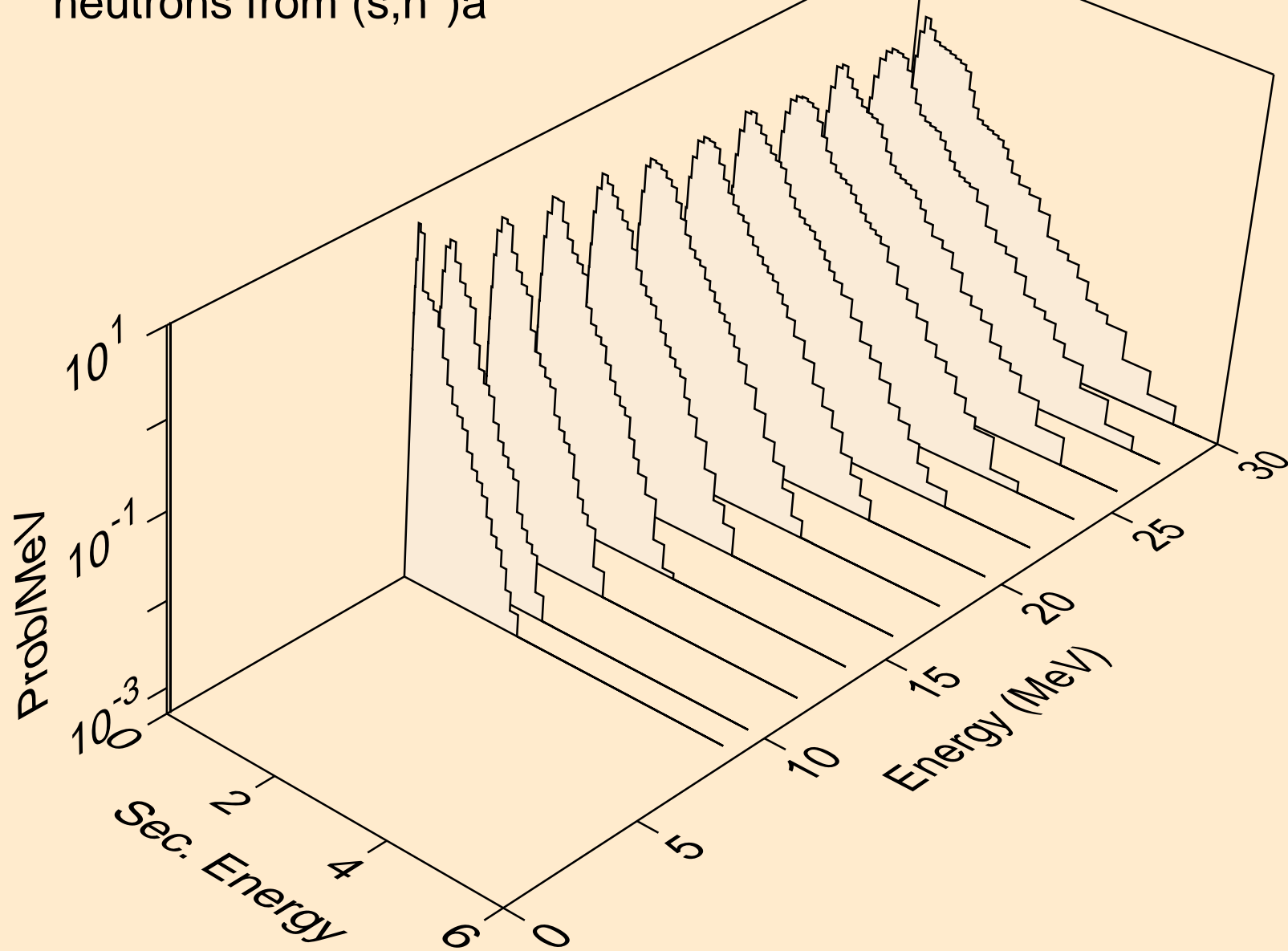

AC228 HELION ACER TENDL-2021 LIBRARY; T=0.K  
neutrons from (s,2n)a

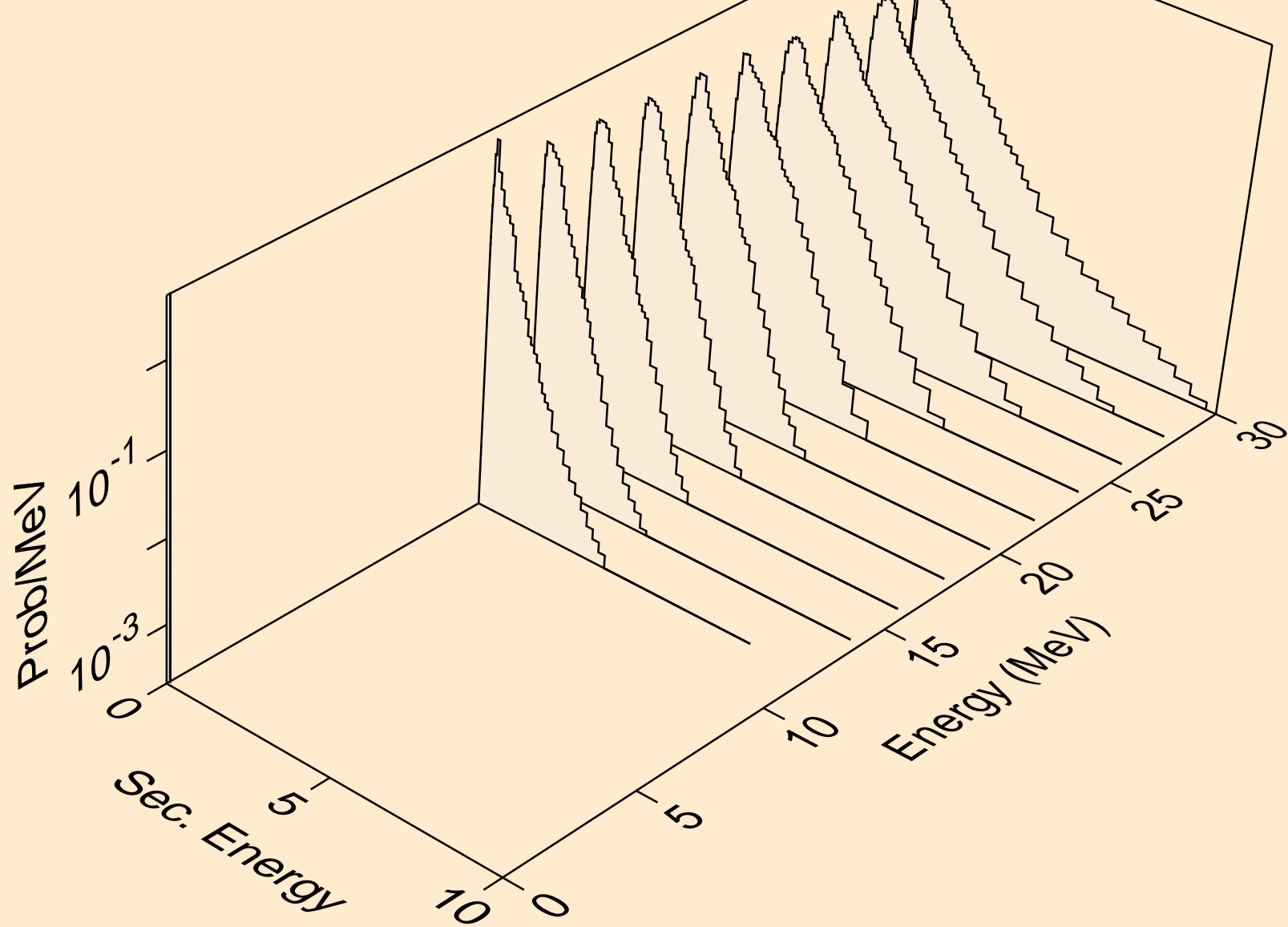

AC228 HELION ACER TENDL-2021 LIBRARY; T=0.K  
neutrons from (s,3n)a

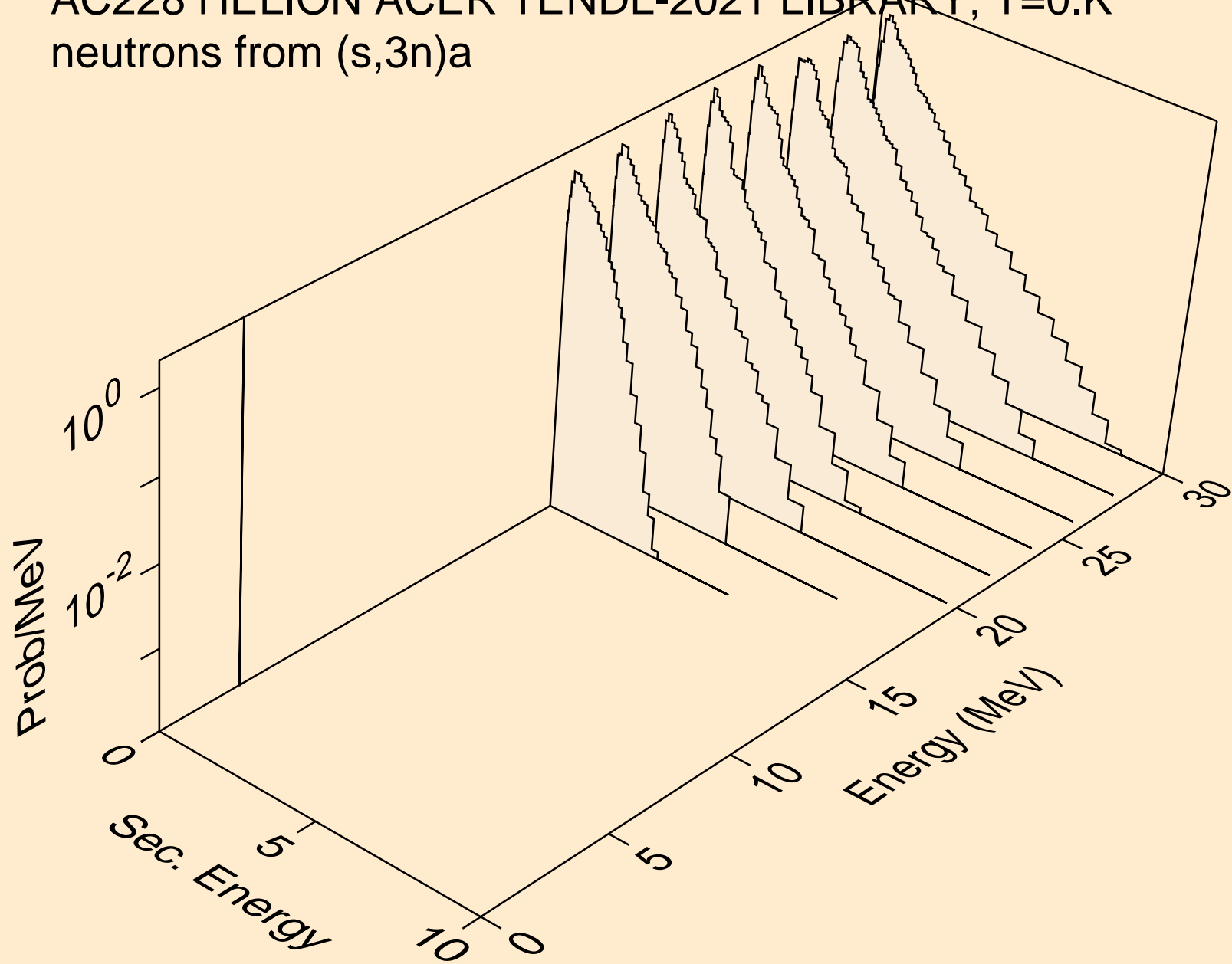

AC228 HELION ACER TENDL-2021 LIBRARY; T=0.K  
neutrons from (s,n\*)p

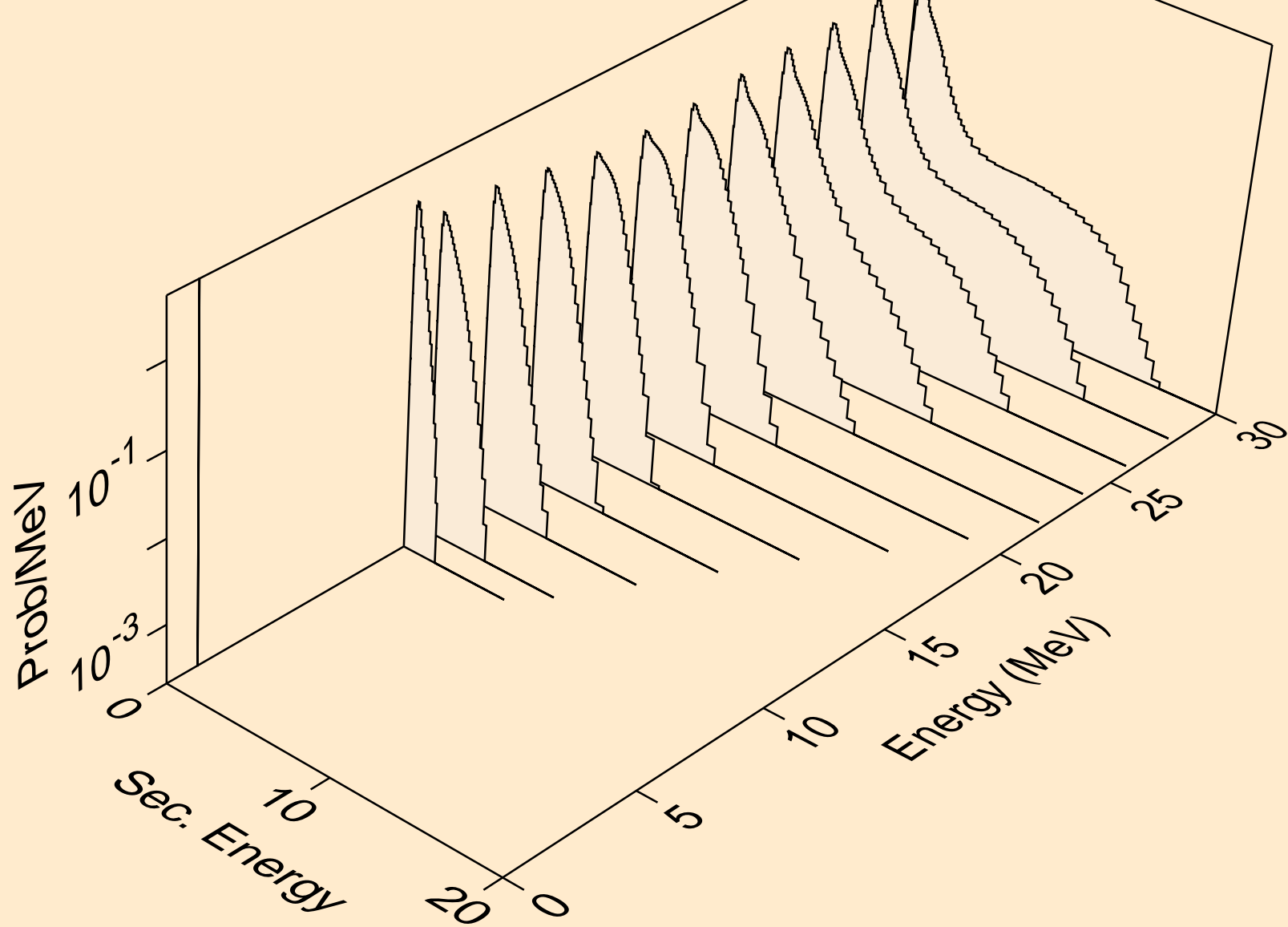



AC228 HELION ACER TENDL-2021 LIBRARY; T=0.K  
neutrons from (s,n\*)d

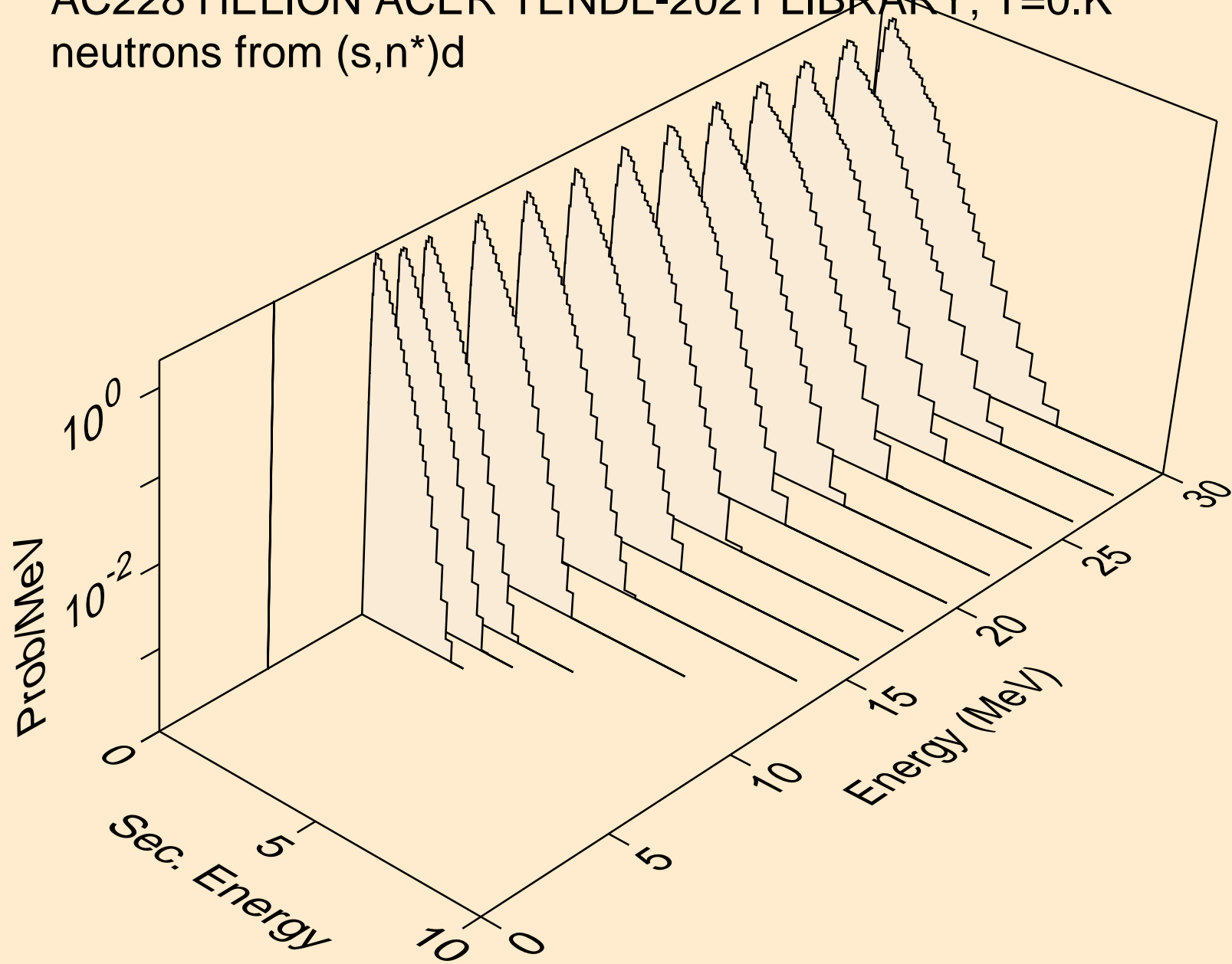

AC228 HELION ACER TENDL-2021 LIBRARY; T=0.K  
neutrons from (s,n\*)t

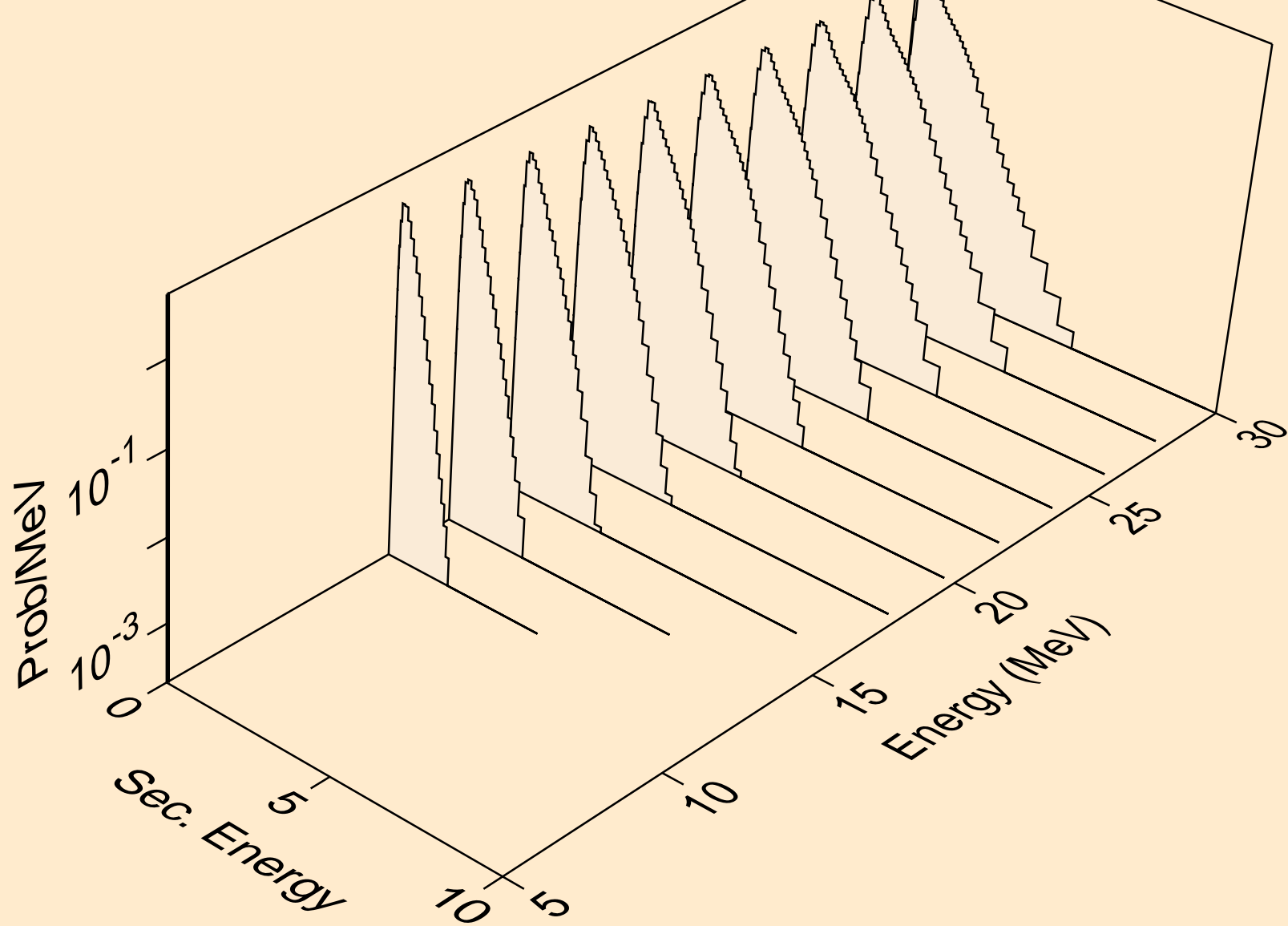

AC228 HELION ACER TENDL-2021 LIBRARY; T=0.K  
neutrons from (s,n\*)he3

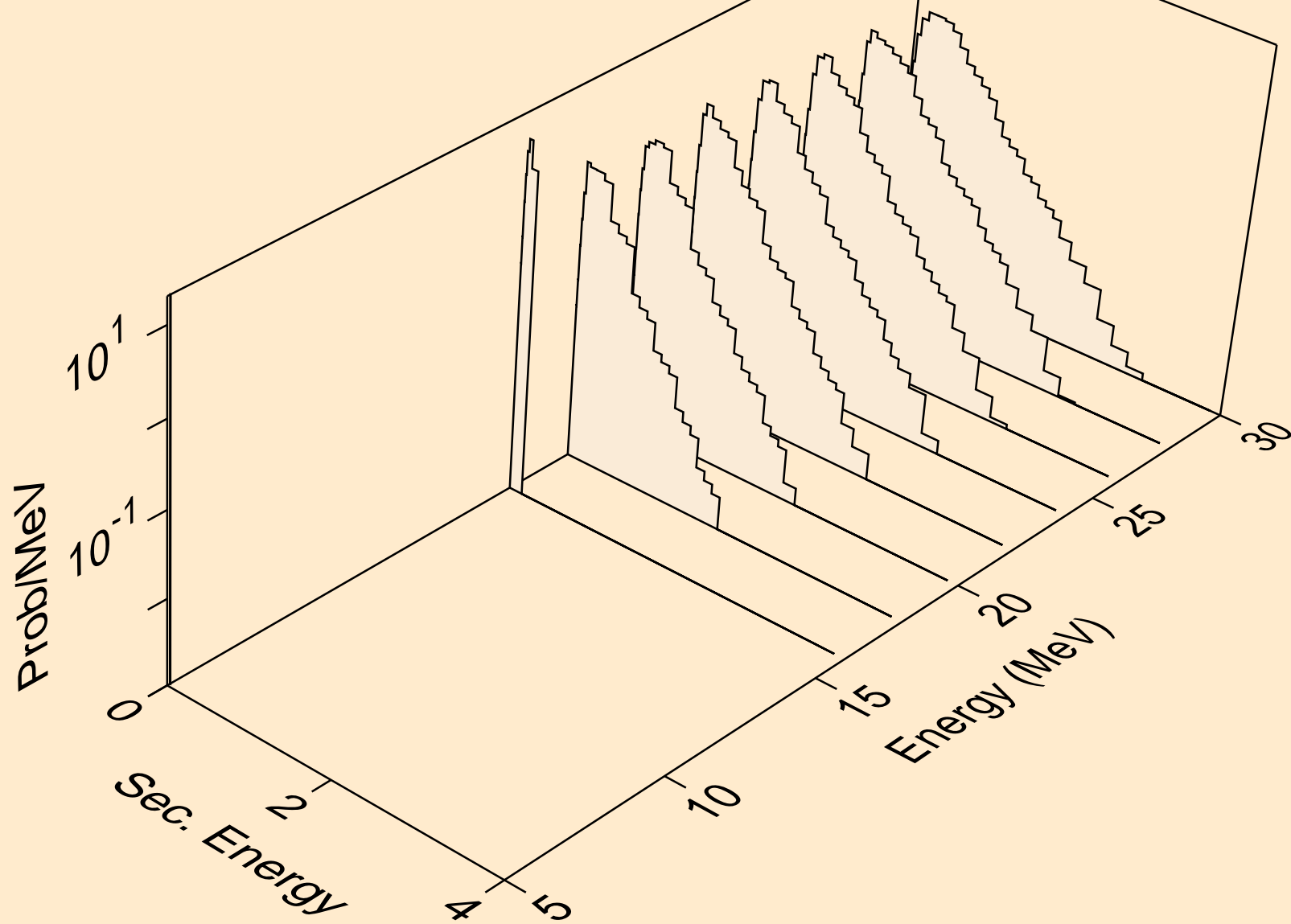

AC228 HELION ACER TENDL-2021 LIBRARY; T=0.K  
neutrons from (s,4n)

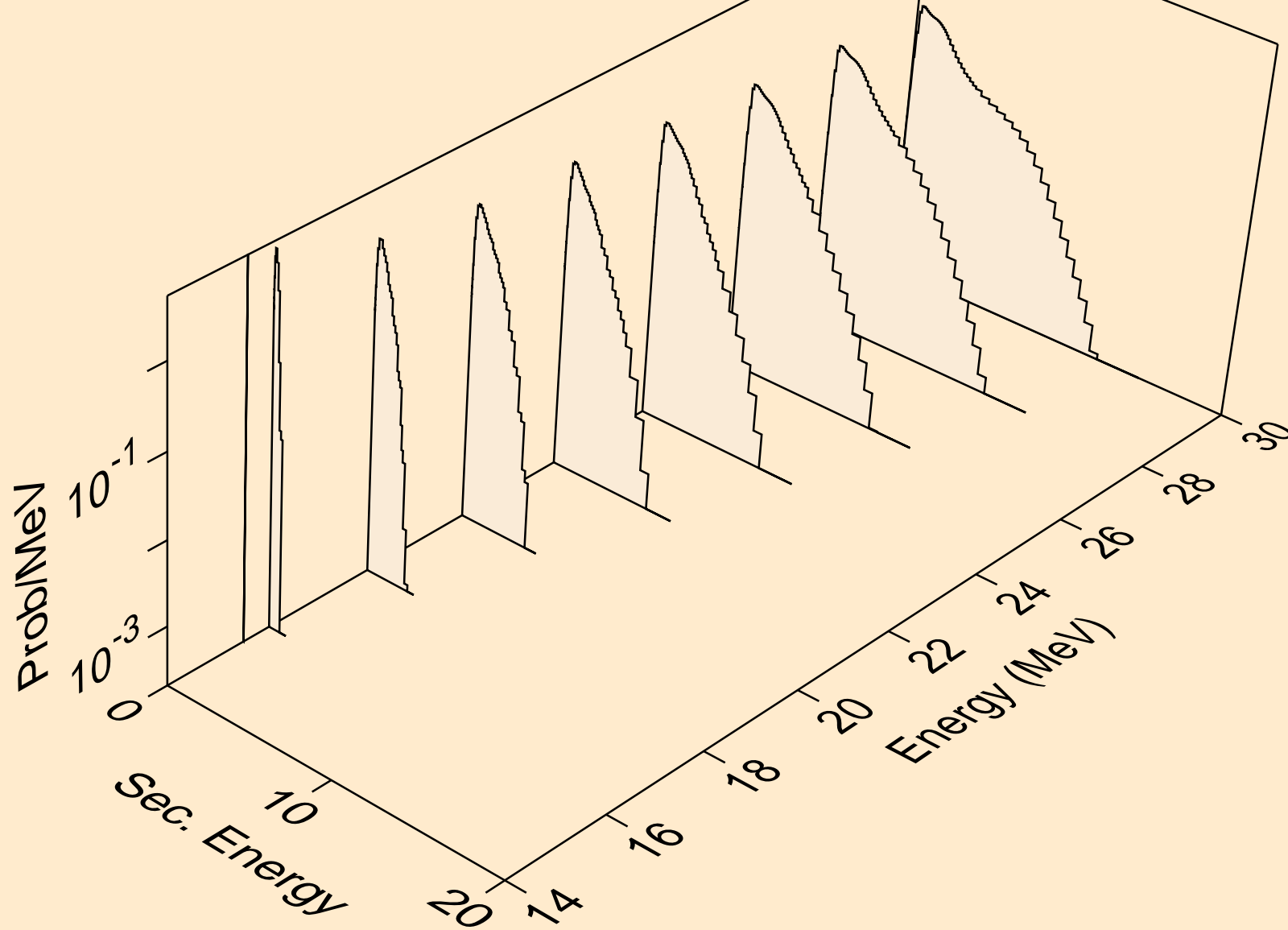

AC228 HELION ACER TENDL-2021 LIBRARY; T=0.K  
neutrons from (s,2np)

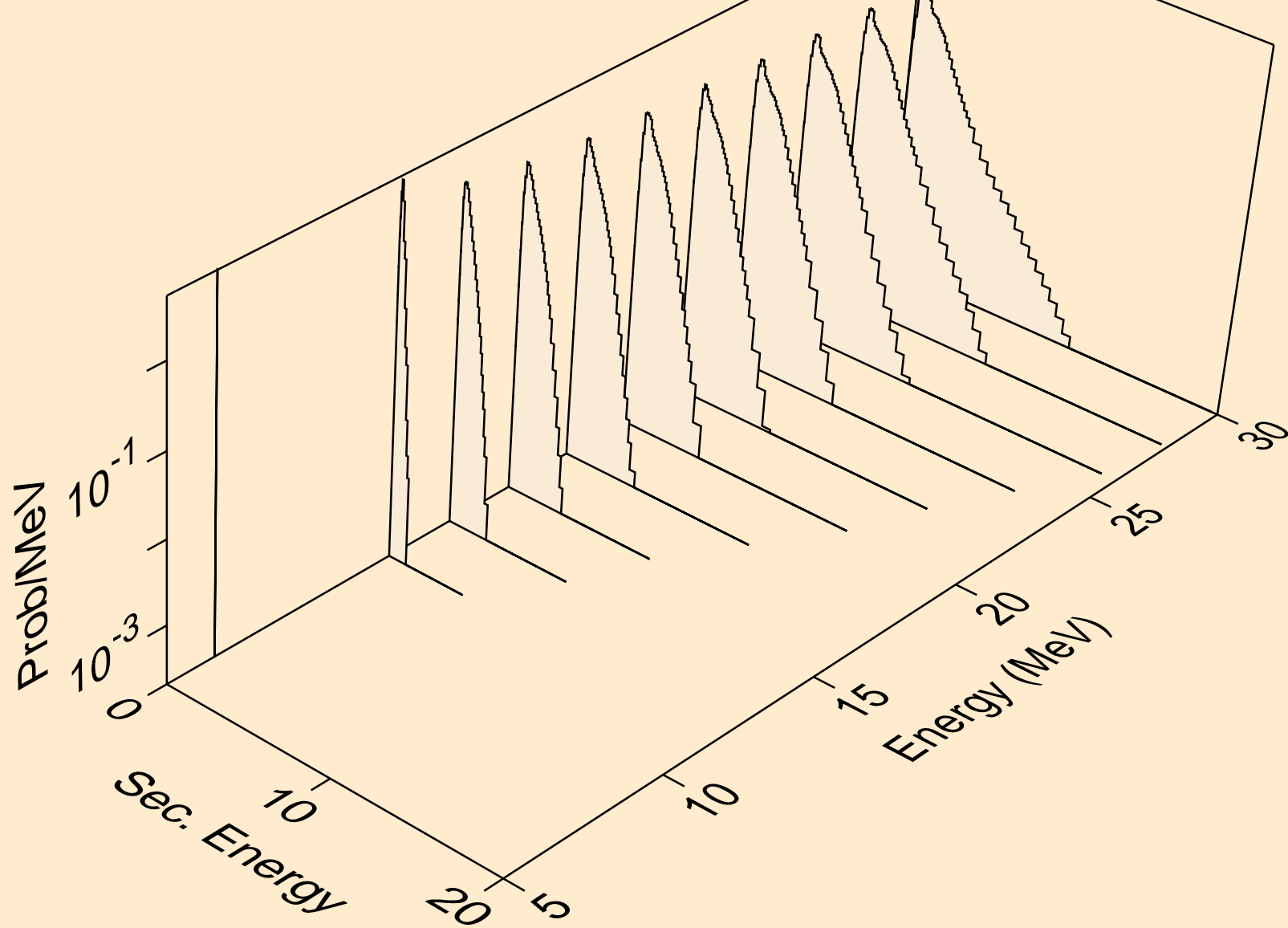

AC228 HELION ACER TENDL-2021 LIBRARY; T=0.K  
neutrons from (s,3np)

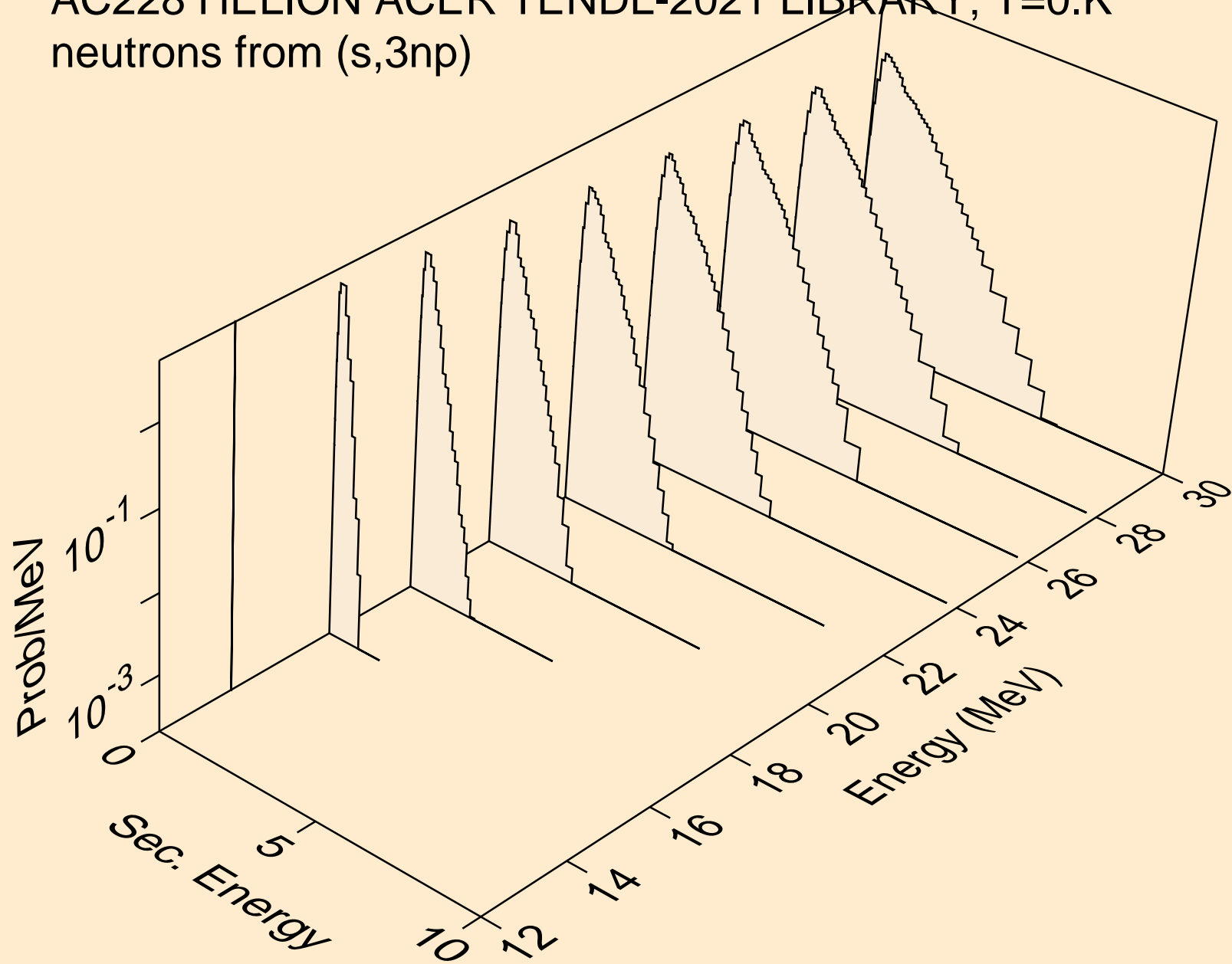

AC228 HELION ACER TENDL-2021 LIBRARY; T=0.K  
neutrons from (s,2np)

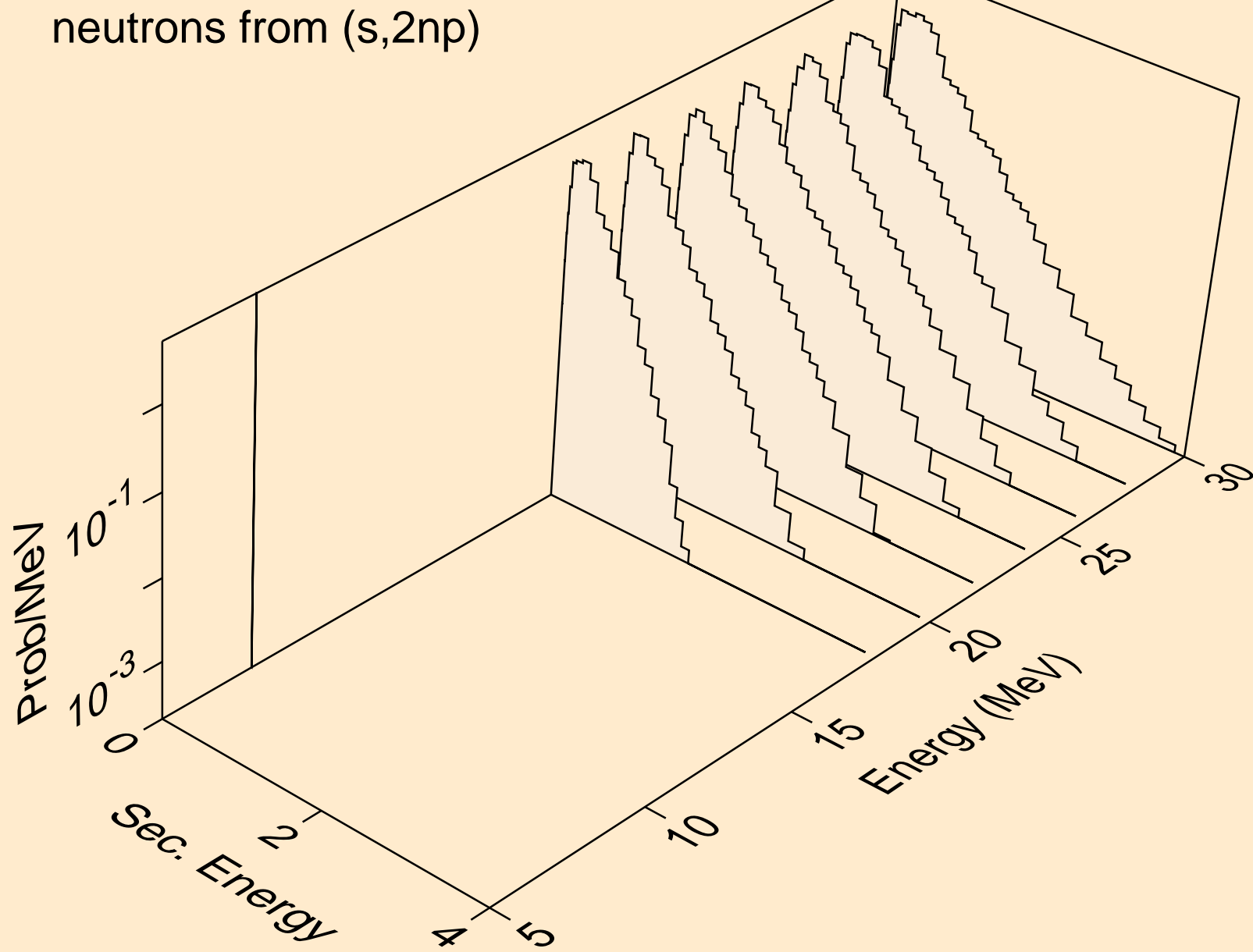

AC228 HELION ACER TENDL-2021 LIBRARY; T=0.K  
neutrons from (s,npa)

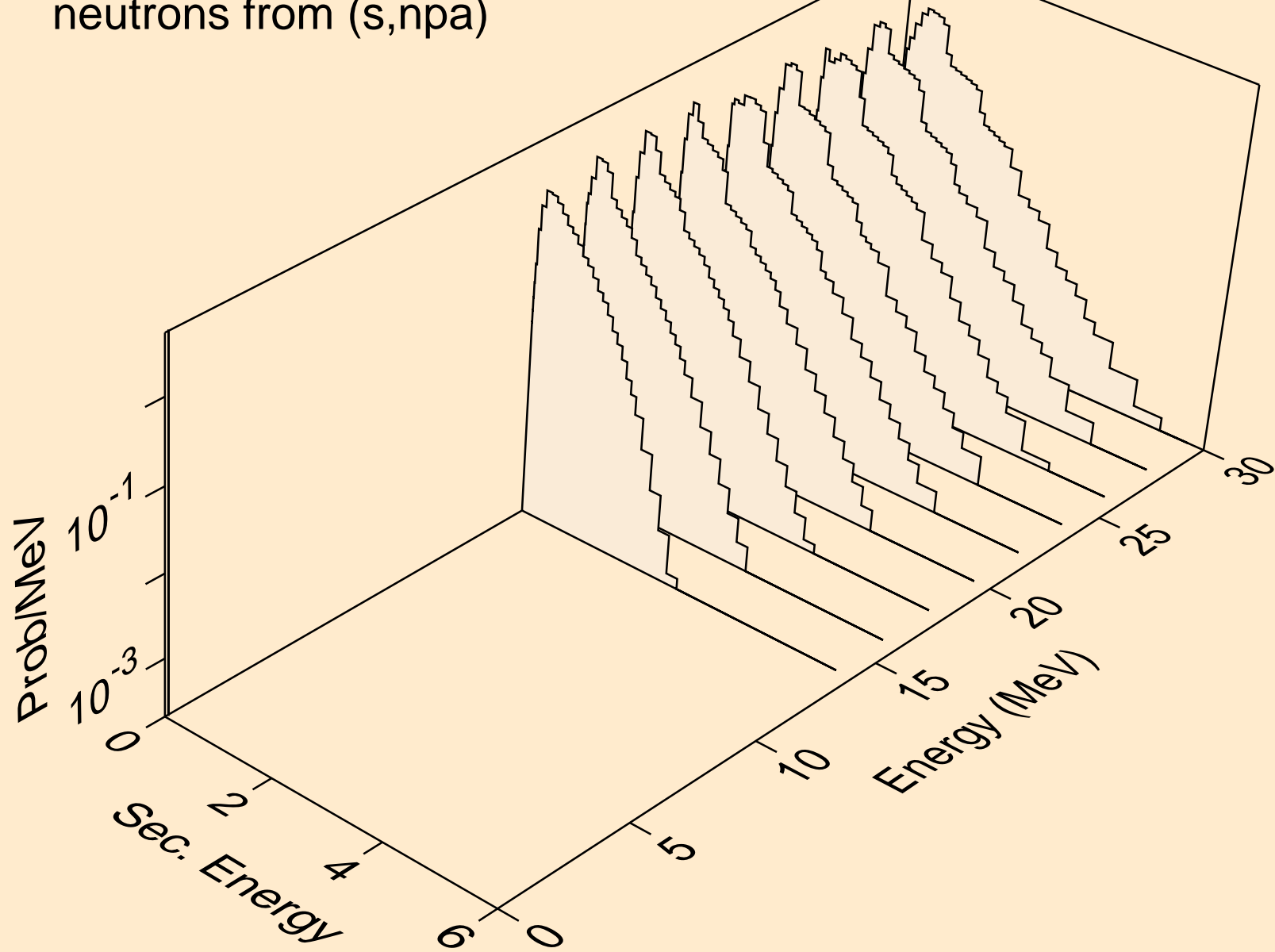



AC228 HELION ACER TENDL-2021 LIBRARY; T=0.K  
protons from (s,x)

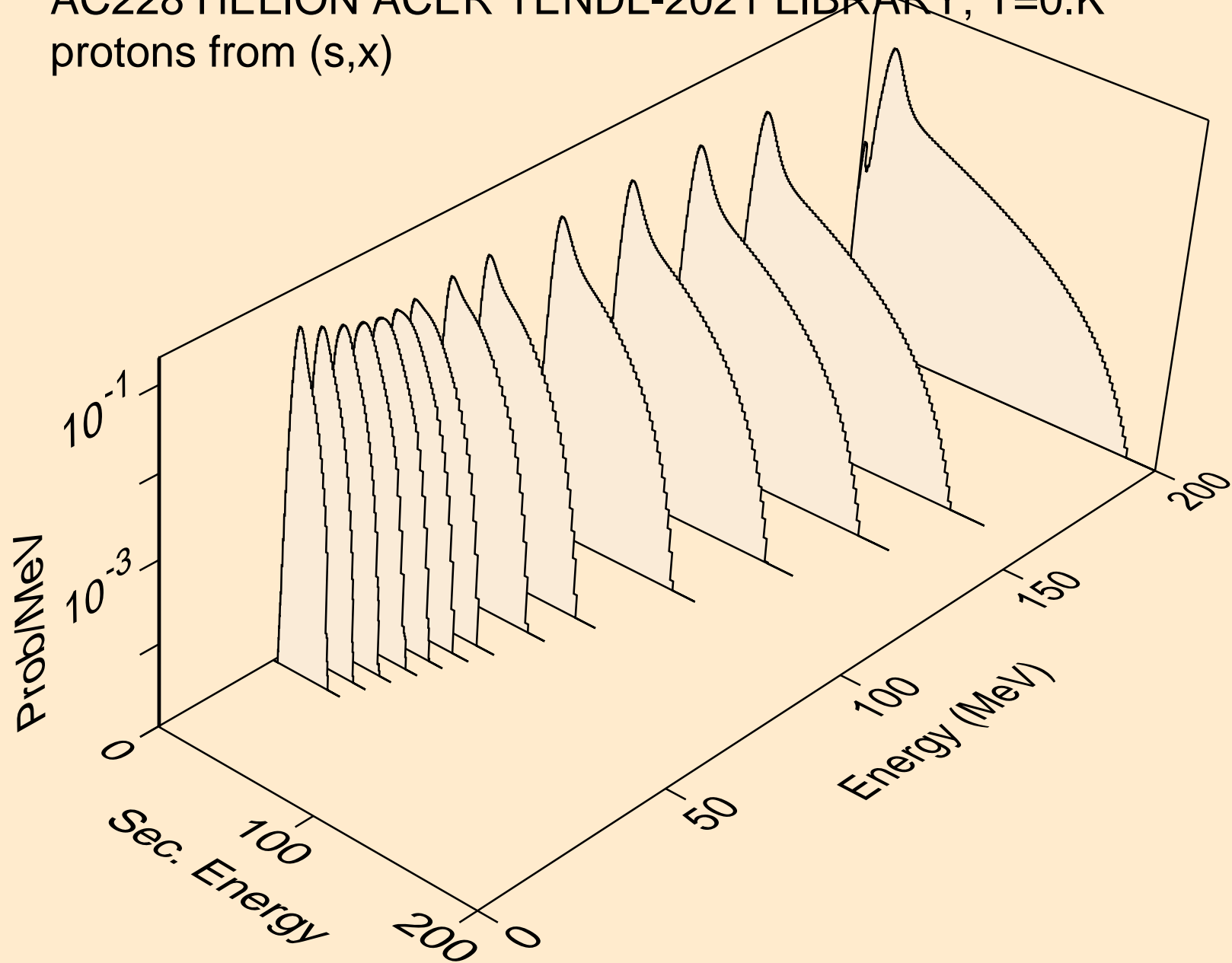

AC228 HELION ACER TENDL-2021 LIBRARY; T=0.K  
protons from (s,n\*)p

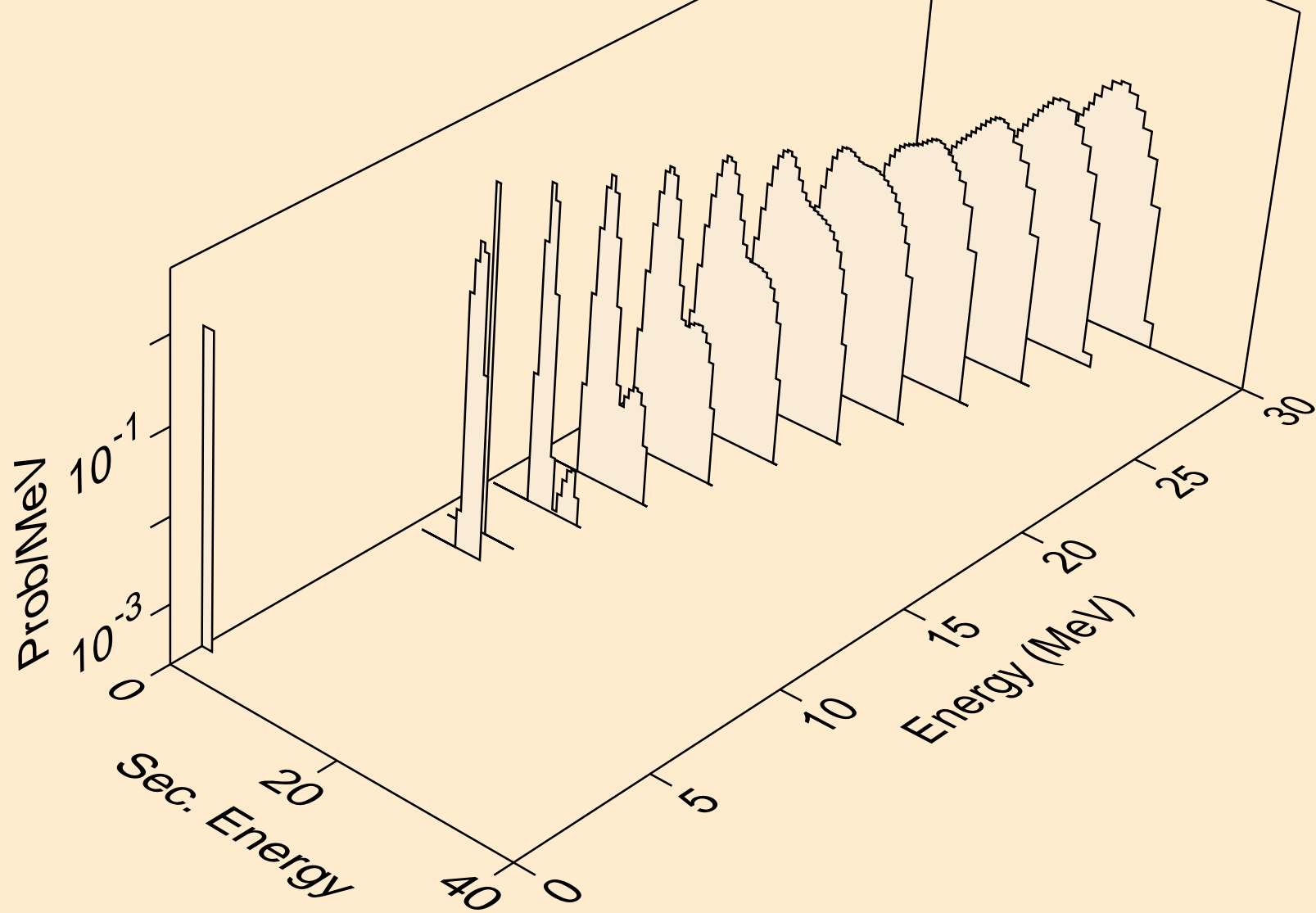

AC228 HELION ACER TENDL-2021 LIBRARY; T=0.K  
protons from (s,2np)

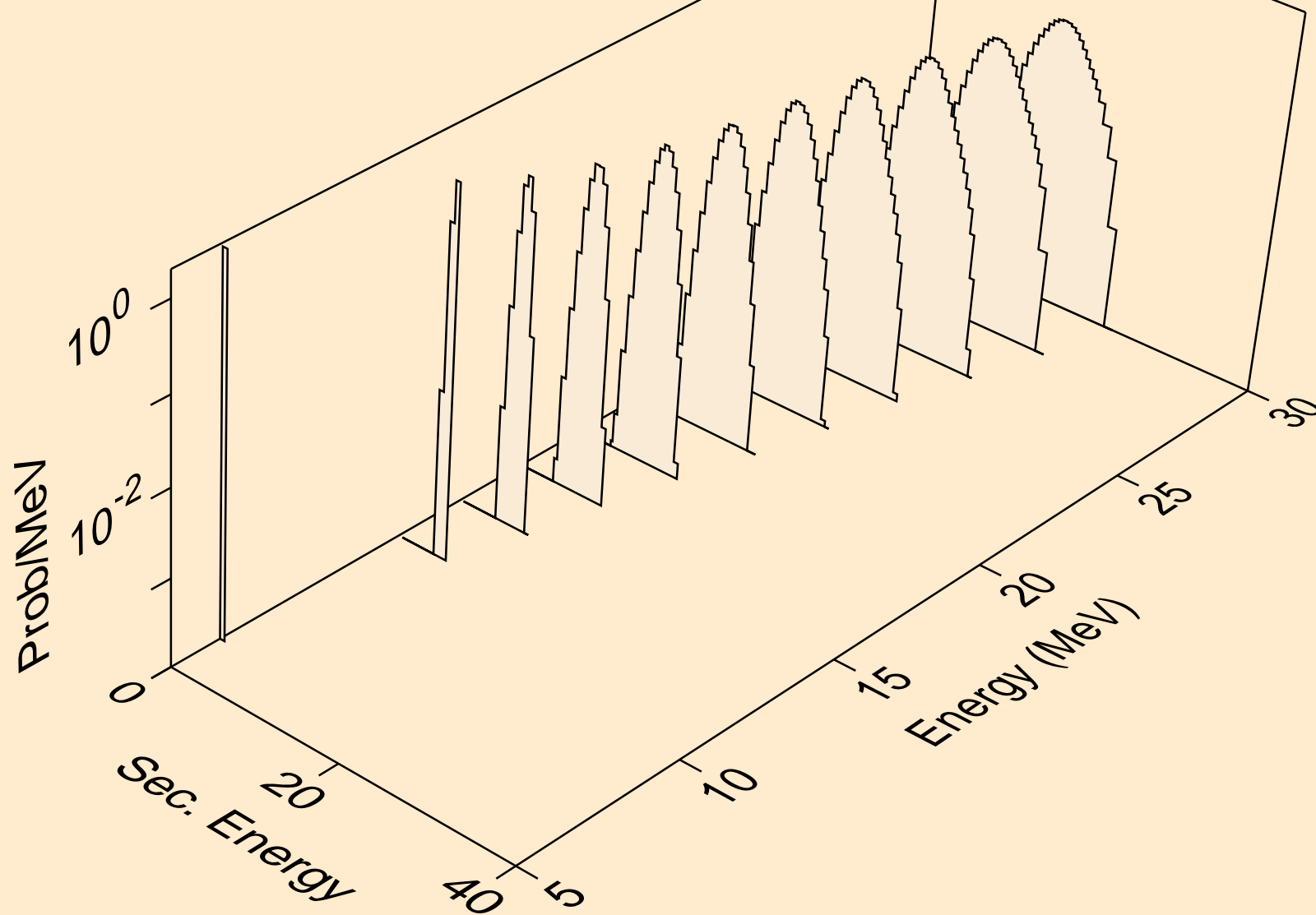

AC228 HELION ACER TENDL-2021 LIBRARY; T=0.K  
protons from (s,3np)

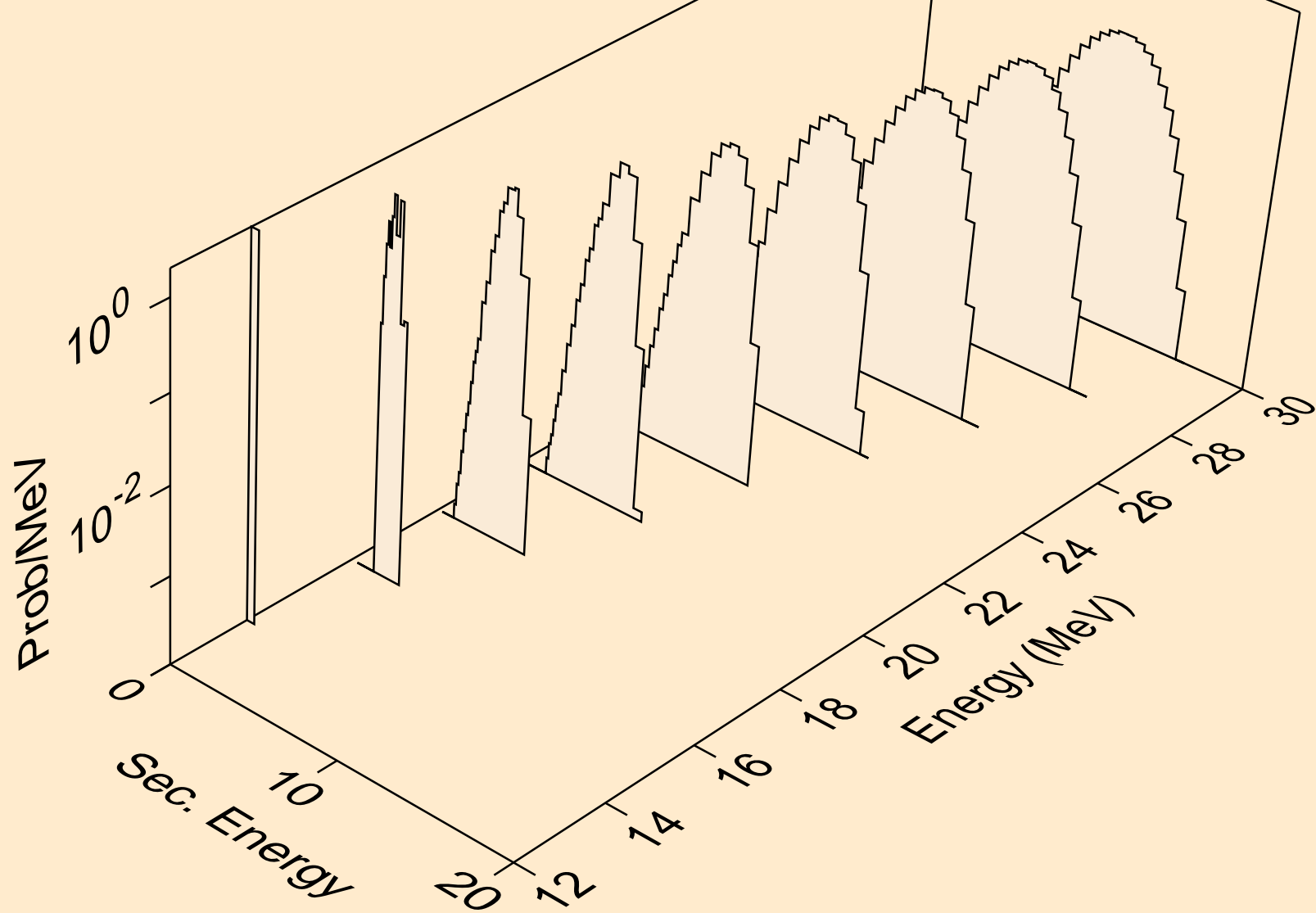

AC228 HELION ACER TENDL-2021 LIBRARY; T=0.K  
protons from (s,2np)

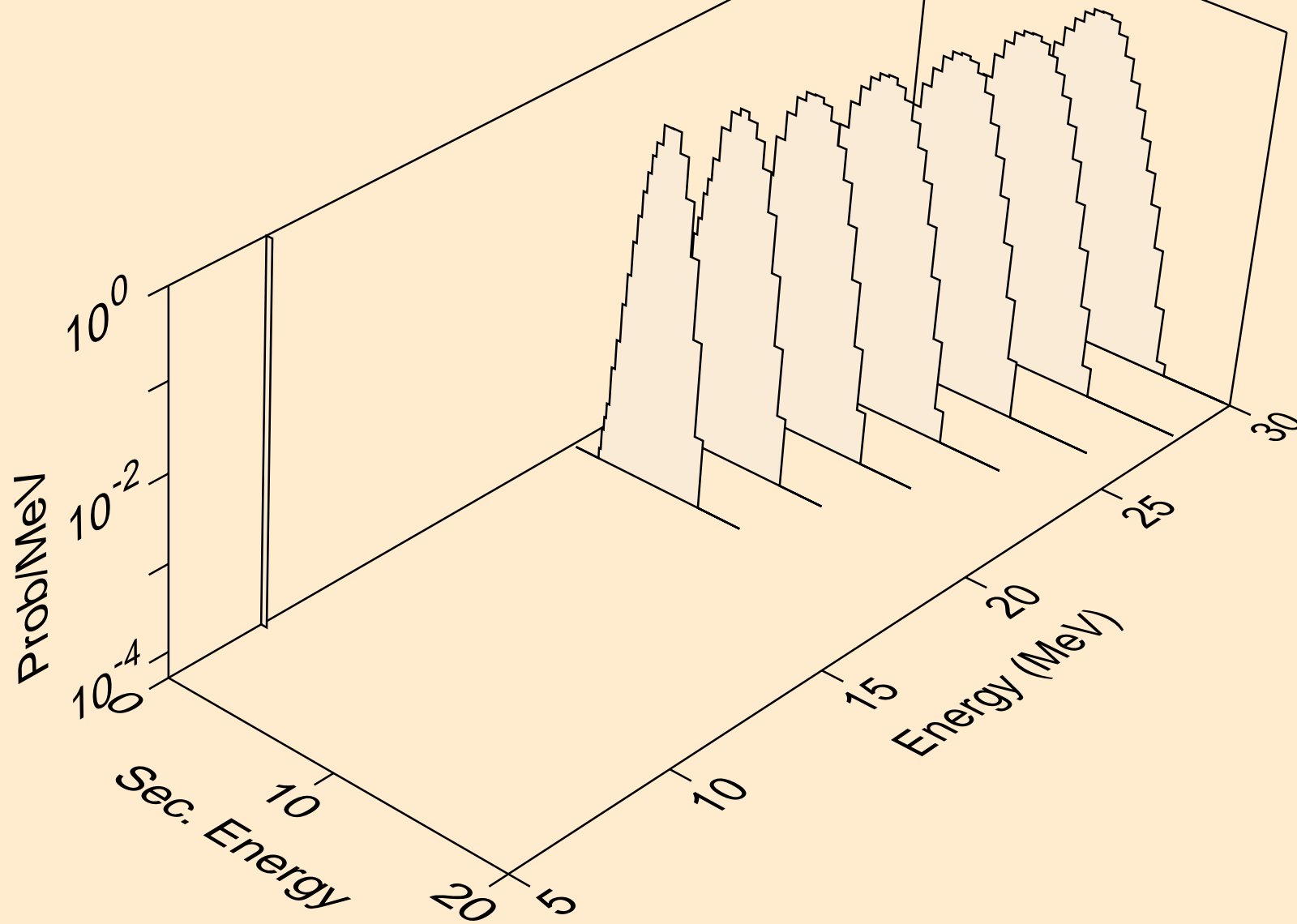

AC228 HELION ACER TENDL-2021 LIBRARY; T=0.K  
protons from (s,npa)

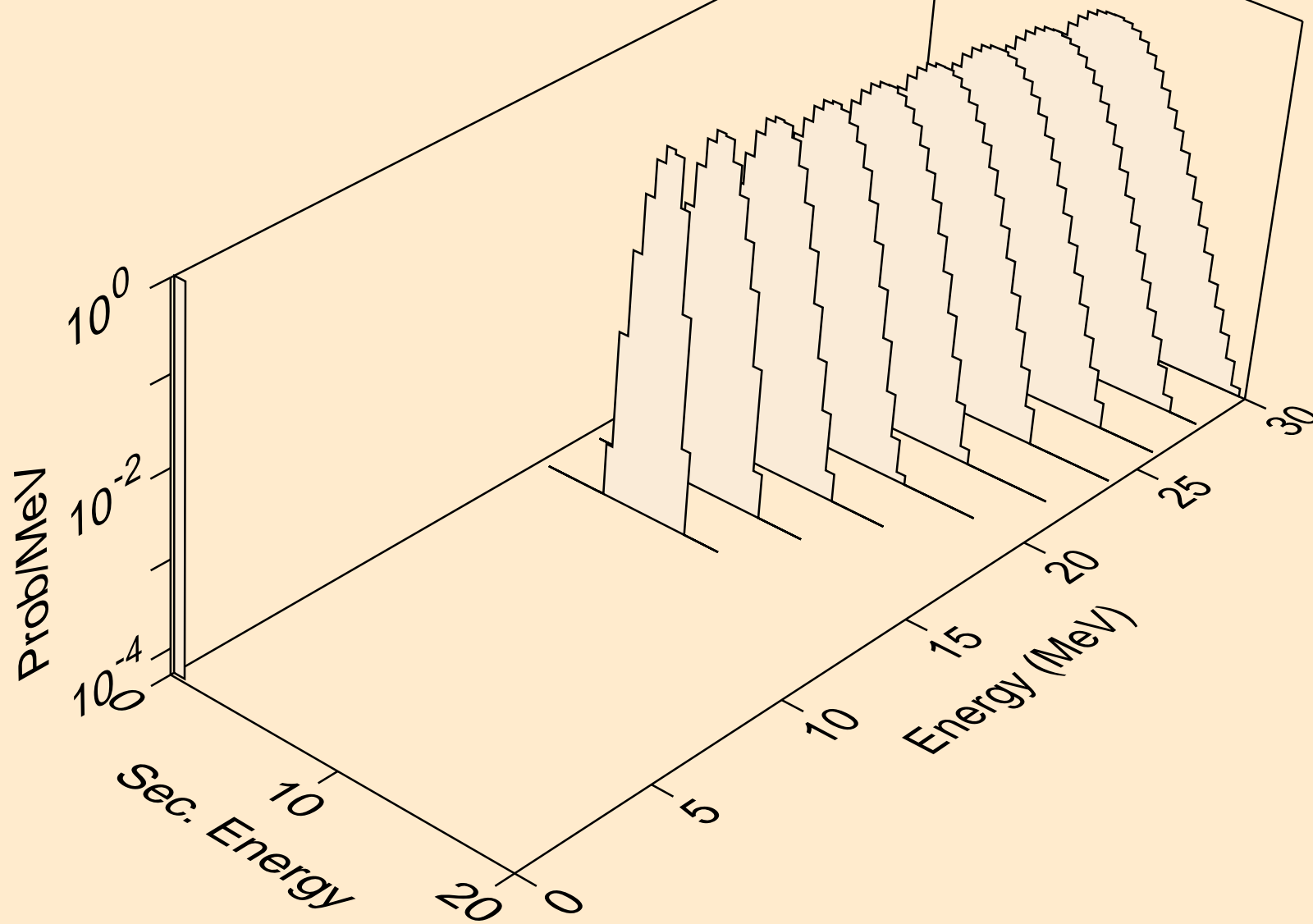

AC228 HELION ACER TENDL-2021 LIBRARY; T=0.K  
protons from (s,p)

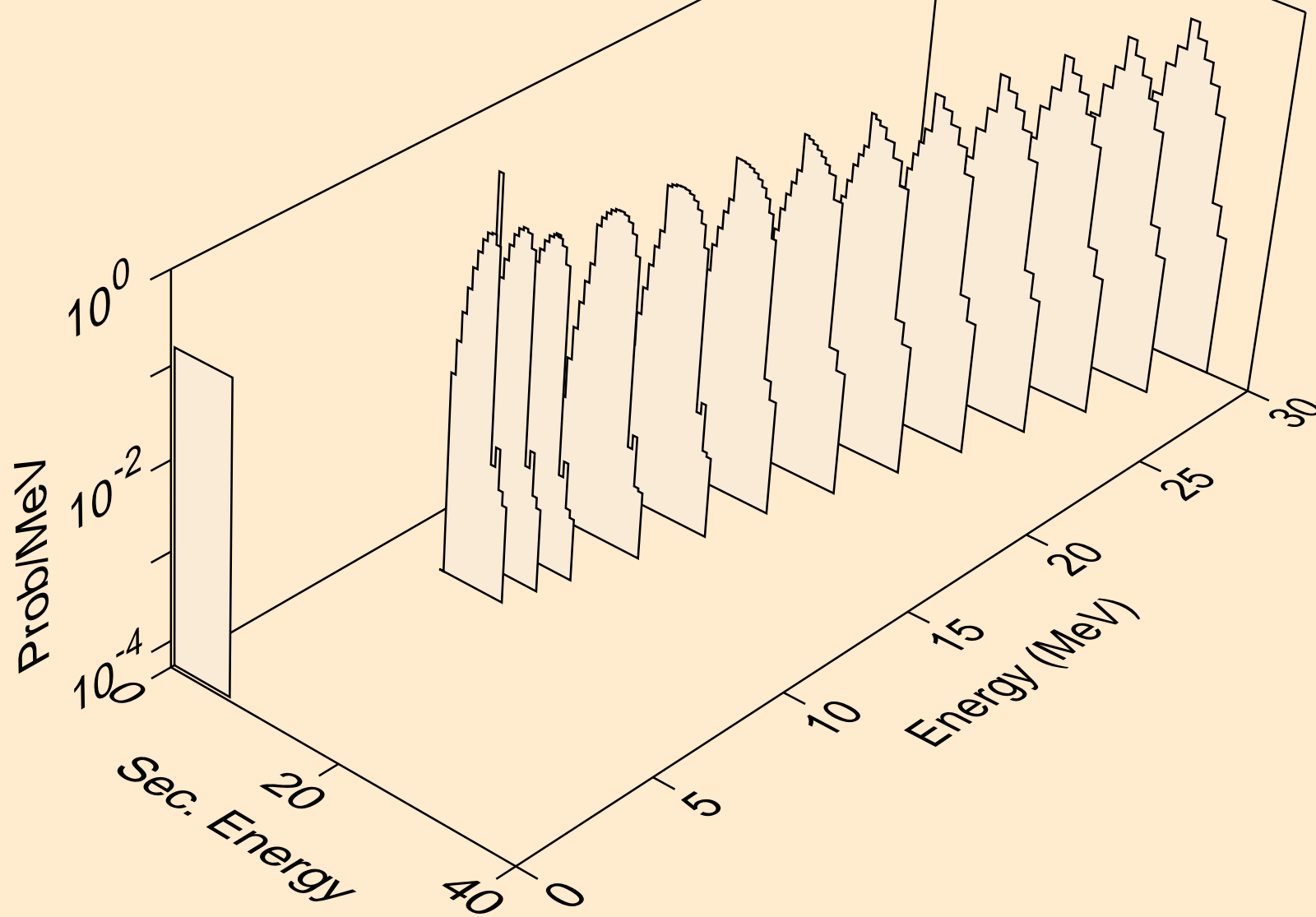

AC228 HELION ACER TENDL-2021 LIBRARY; T=0.K  
protons from (s,2p)

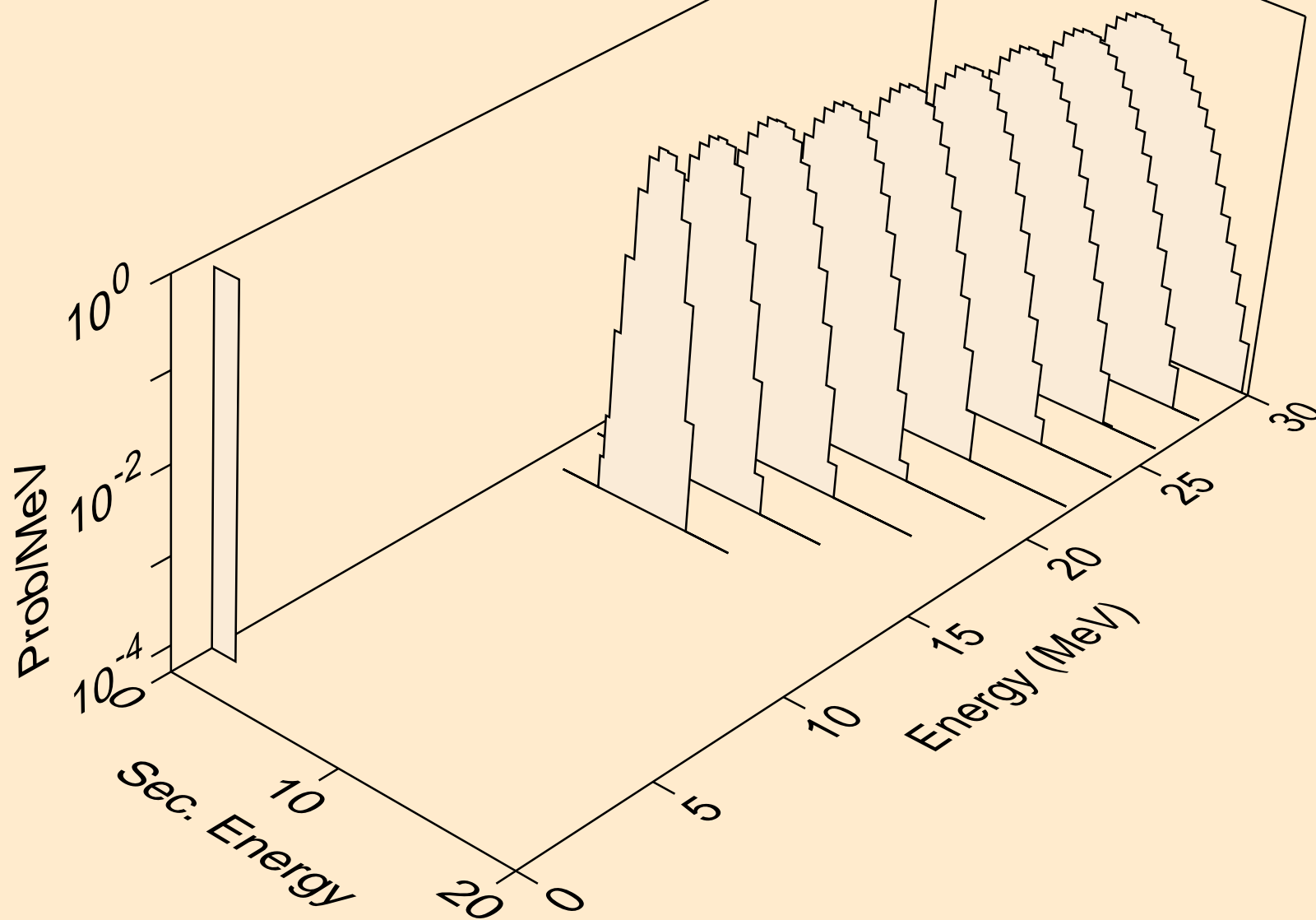



AC228 HELION ACER TENDL-2021 LIBRARY; T=0.K  
protons from (s,pa)

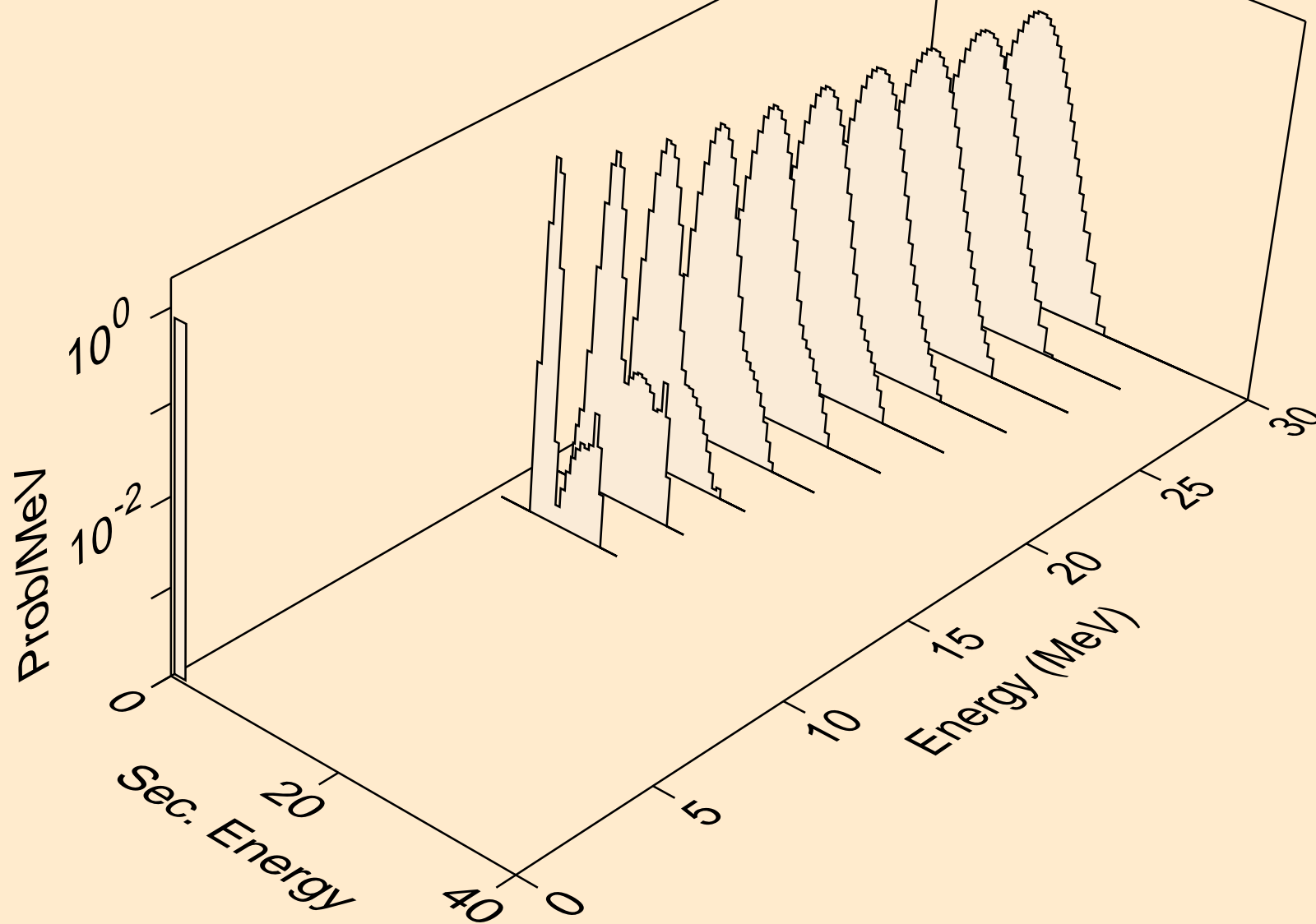

AC228 HELION ACER TENDL-2021 LIBRARY; T=0.K  
protons from (s,pd)

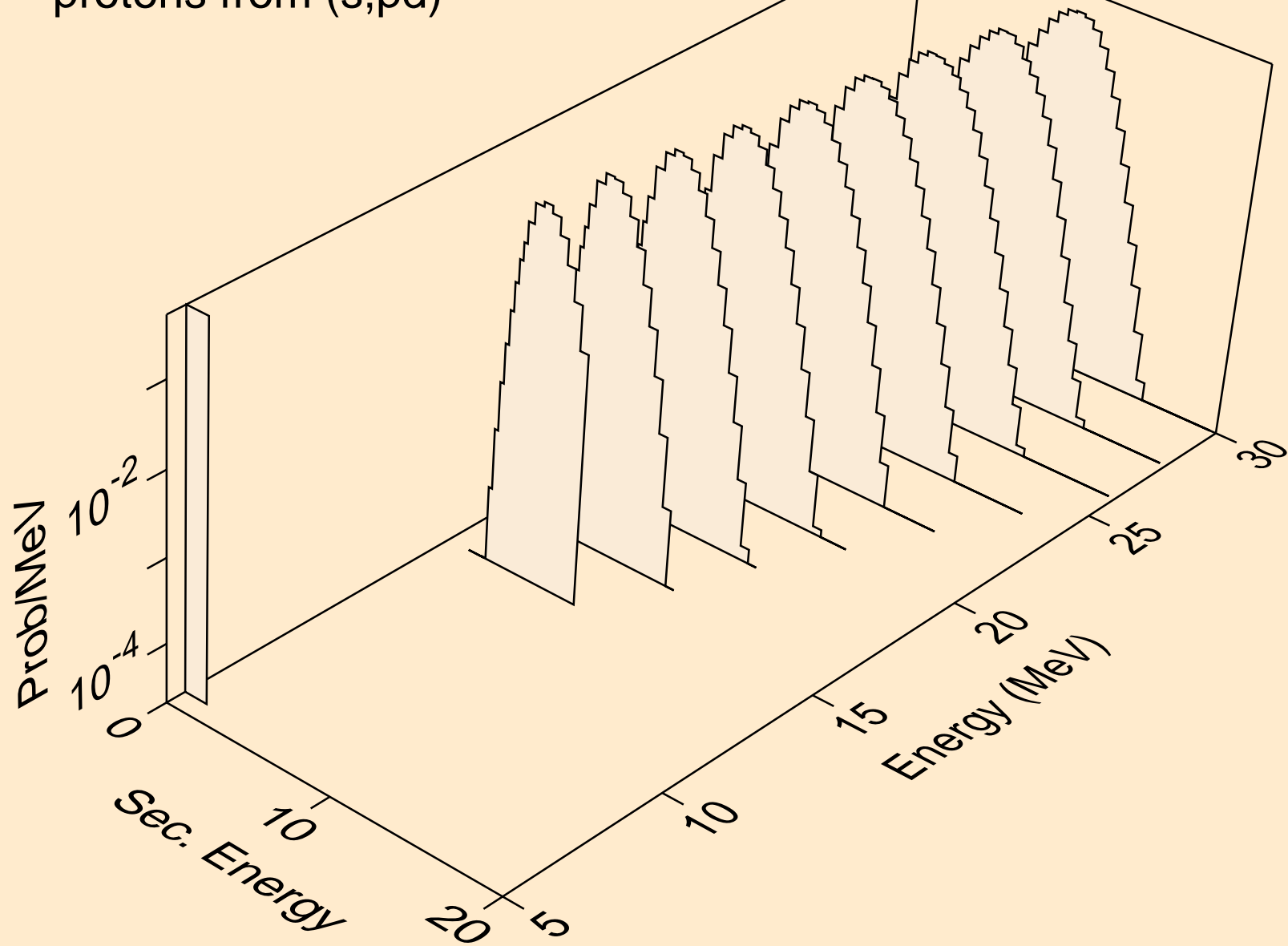

AC228 HELION ACER TENDL-2021 LIBRARY; T=0.K  
protons from (s,pt)

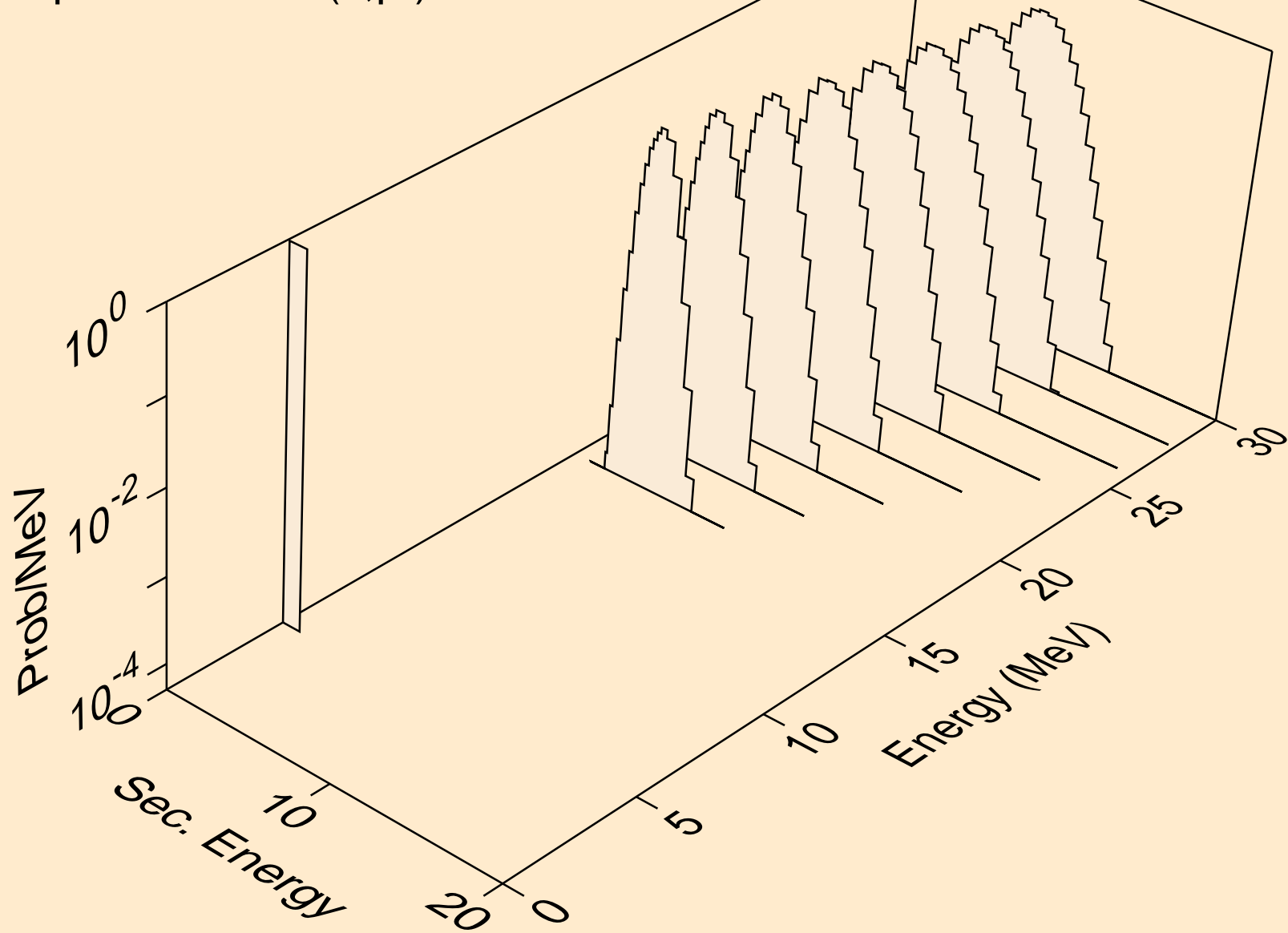

AC228 HELION ACER TENDL-2021 LIBRARY; T=0.K  
deuterons from (s,x)

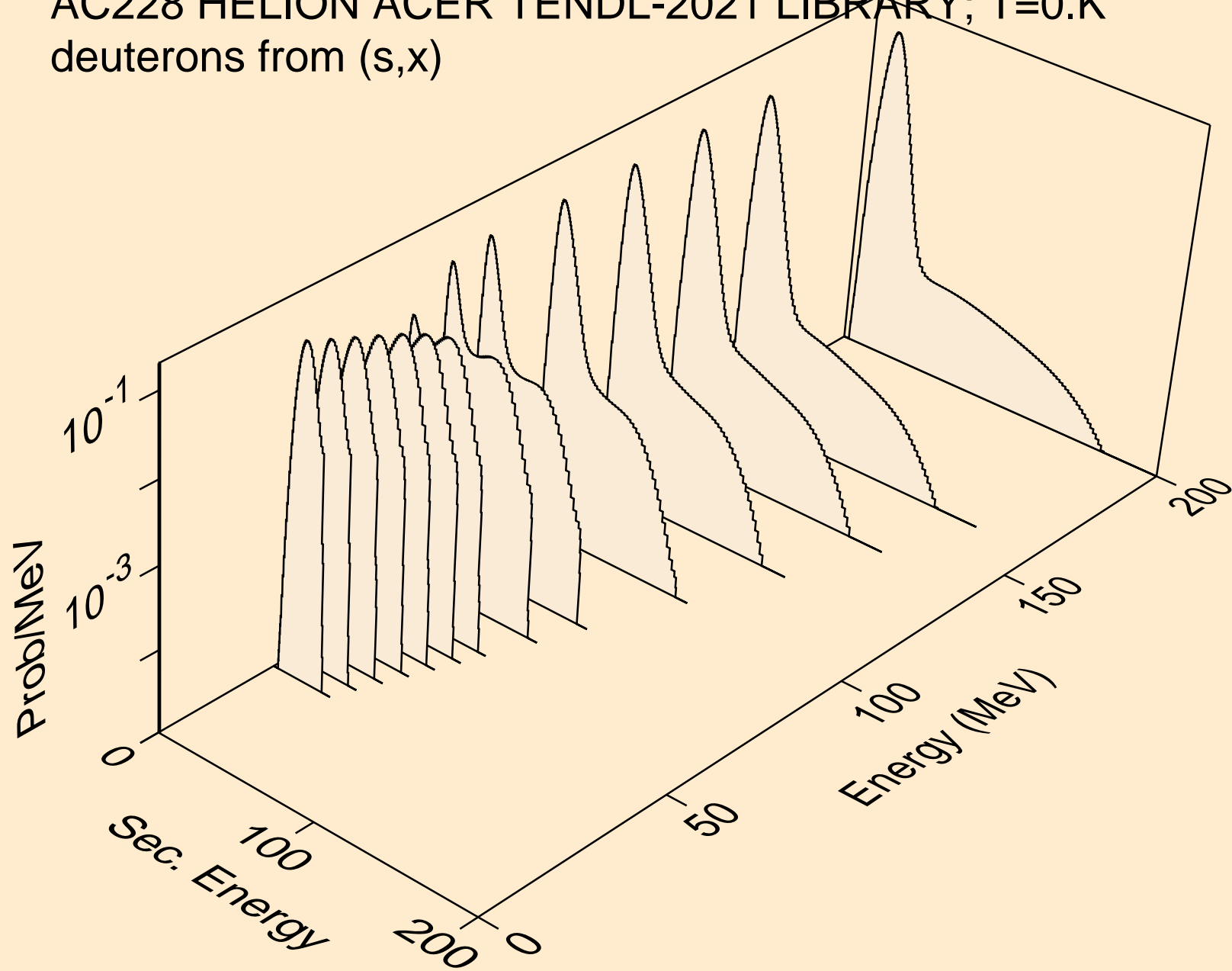

AC228 HELION ACER TENDL-2021 LIBRARY; T=0.K  
deuterons from (s,2nd)

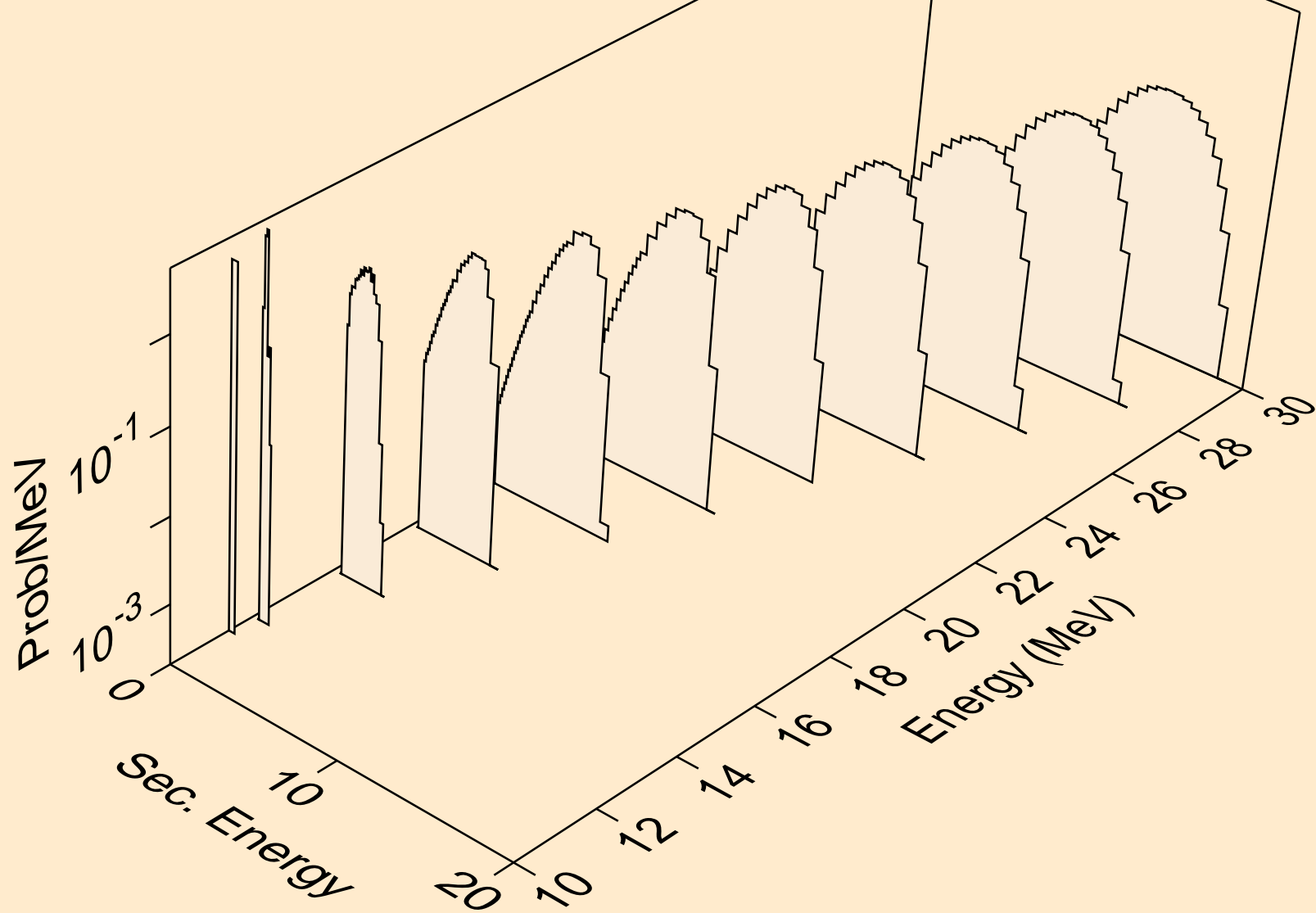

AC228 HELION ACER TENDL-2021 LIBRARY; T=0.K  
deuterons from (s,n\*)d

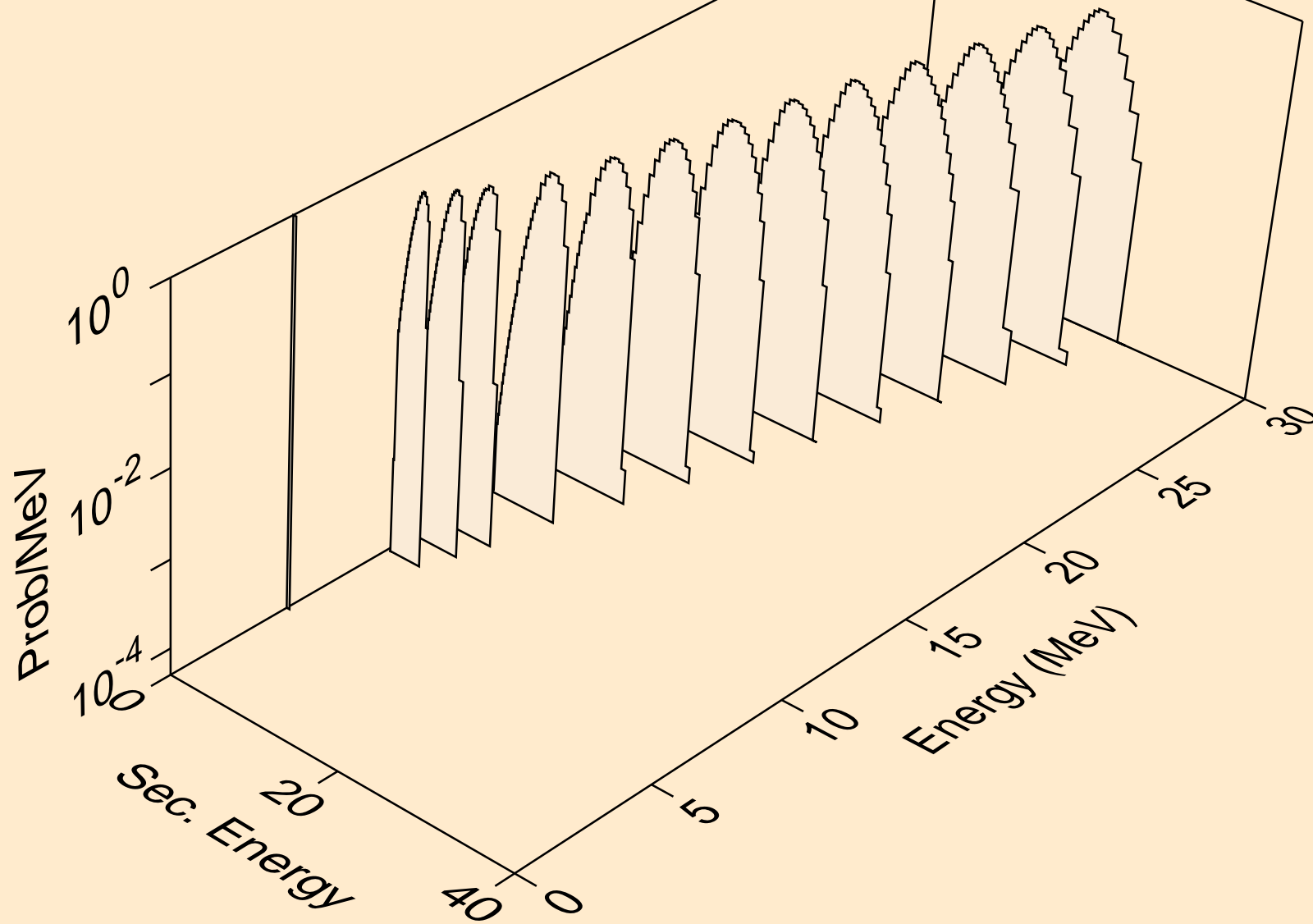

AC228 HELION ACER TENDL-2021 LIBRARY; T=0.K  
deuterons from (s,d)

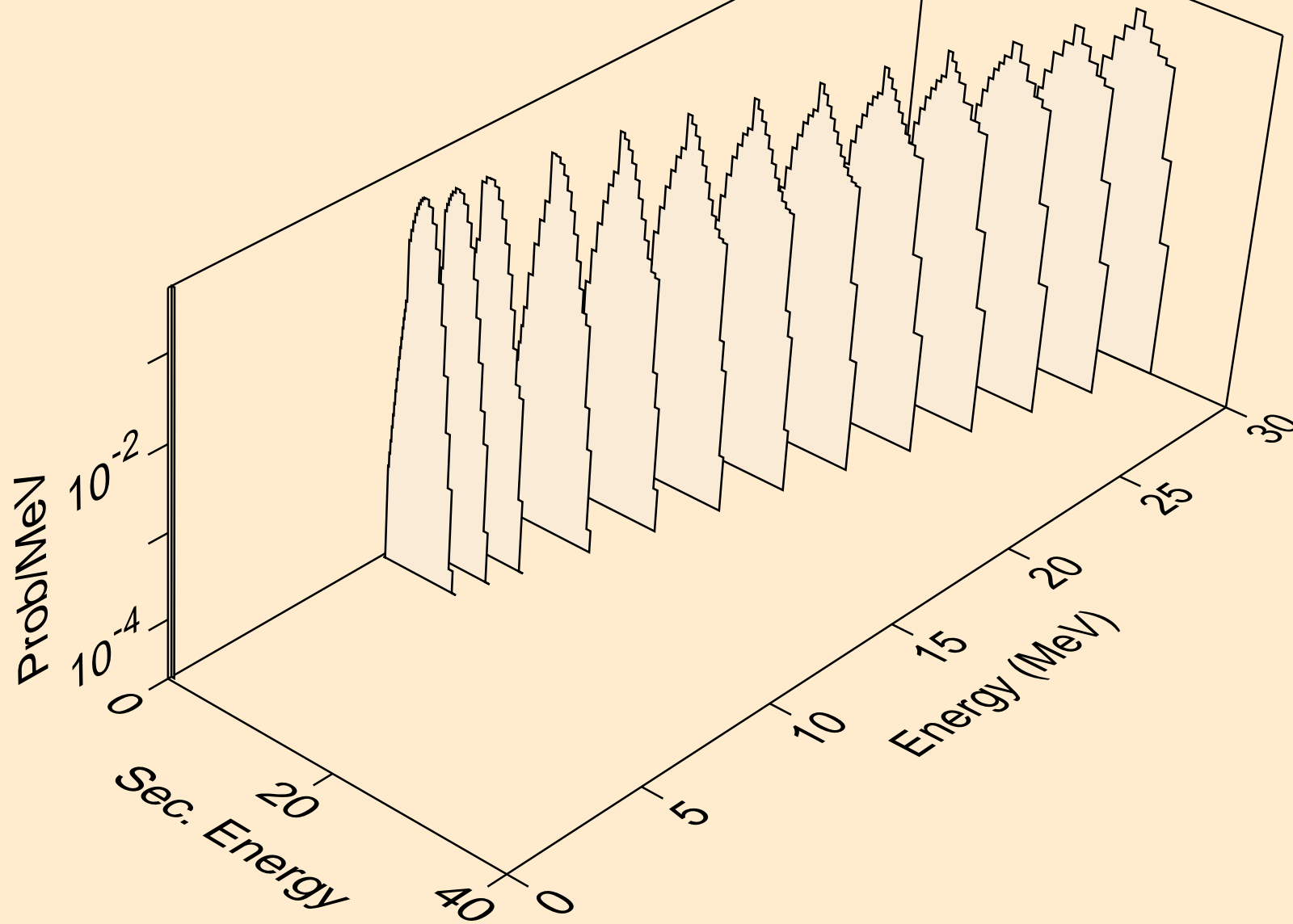

AC228 HELION ACER TENDL-2021 LIBRARY; T=0.K  
deuterons from (s,pd)

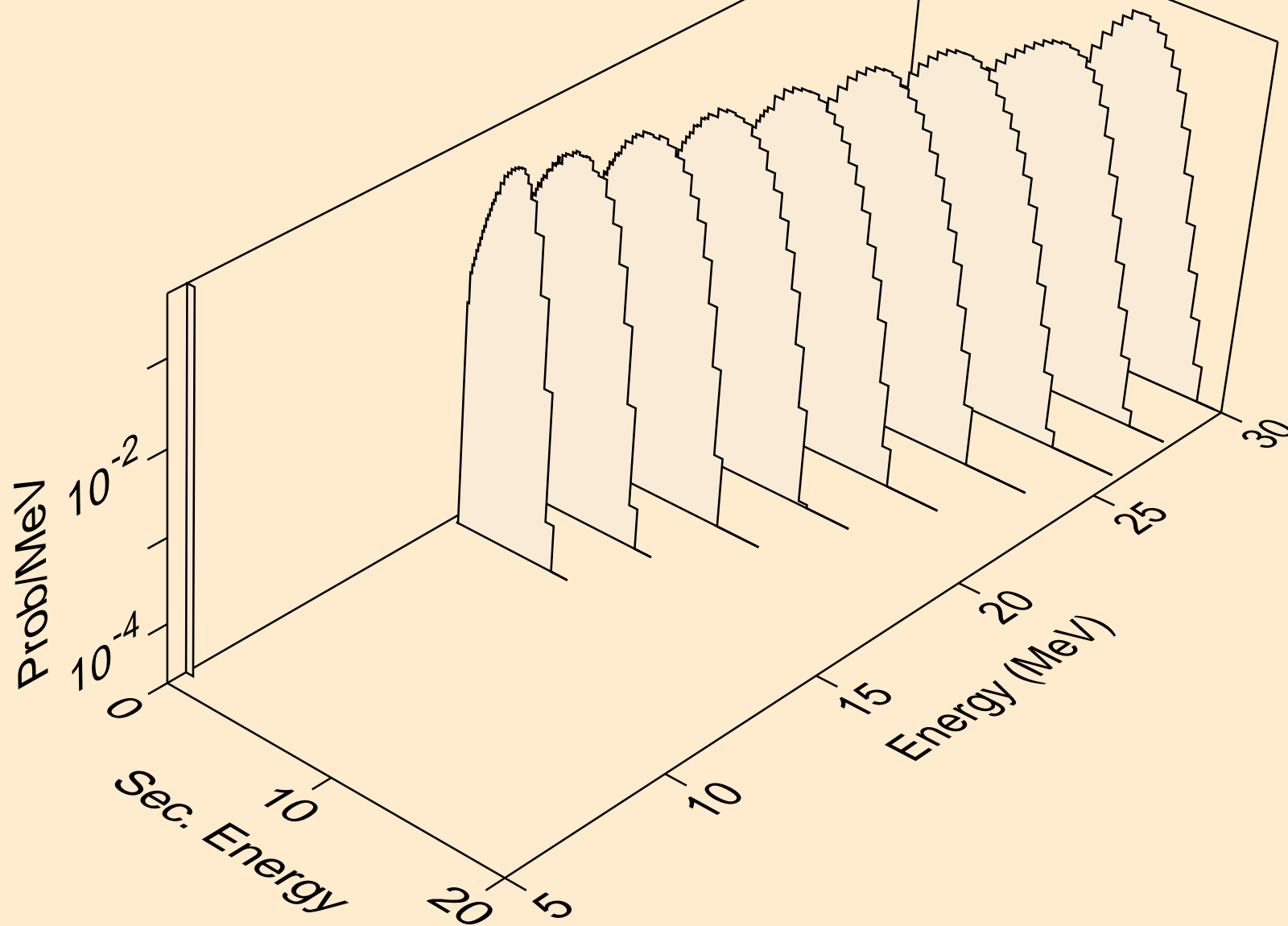



AC228 HELION ACER TENDL-2021 LIBRARY; T=0.K  
deuterons from (s,da)

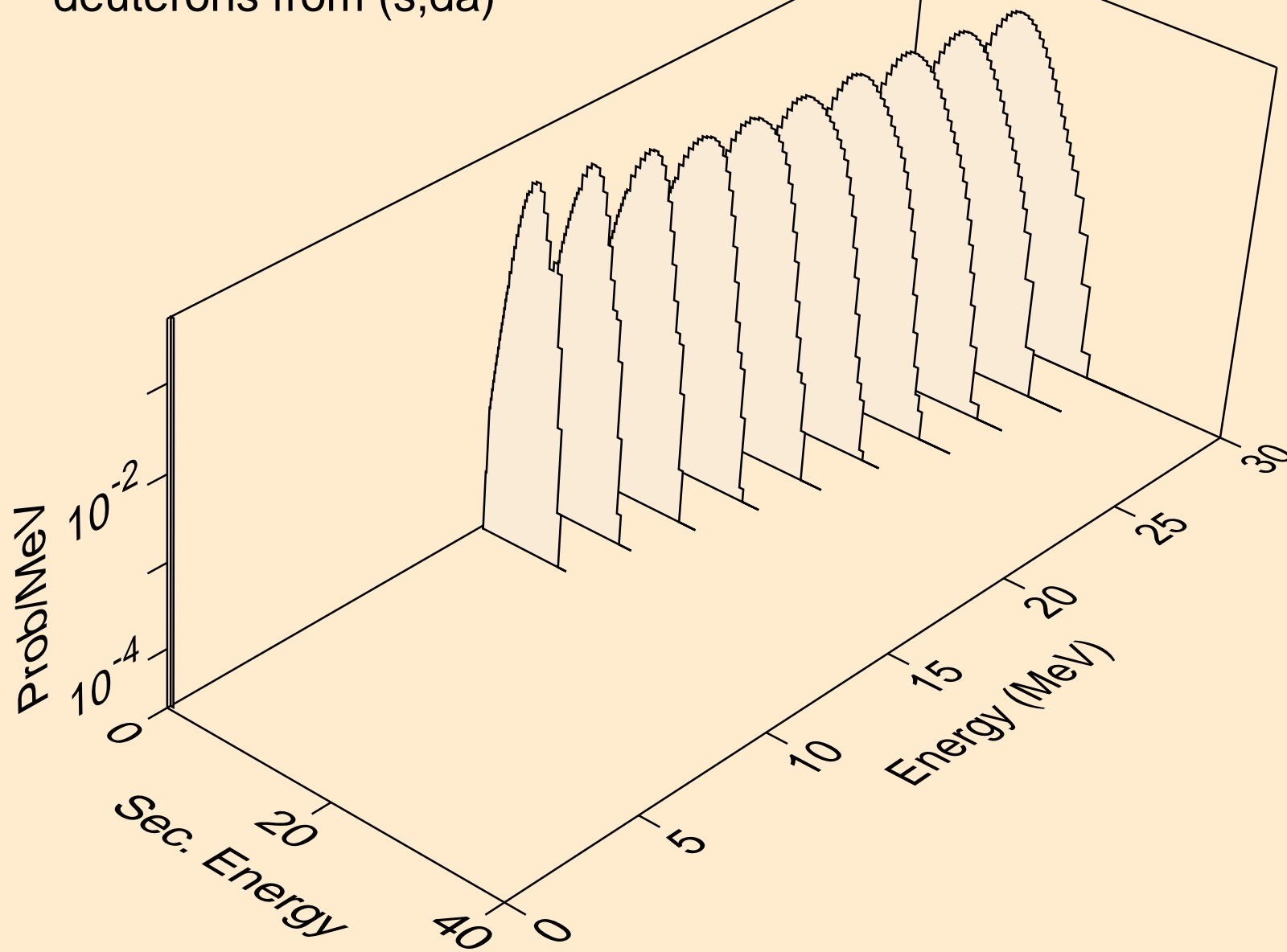

AC228 HELION ACER TENDL-2021 LIBRARY; T=0.K  
tritons from (s,x)

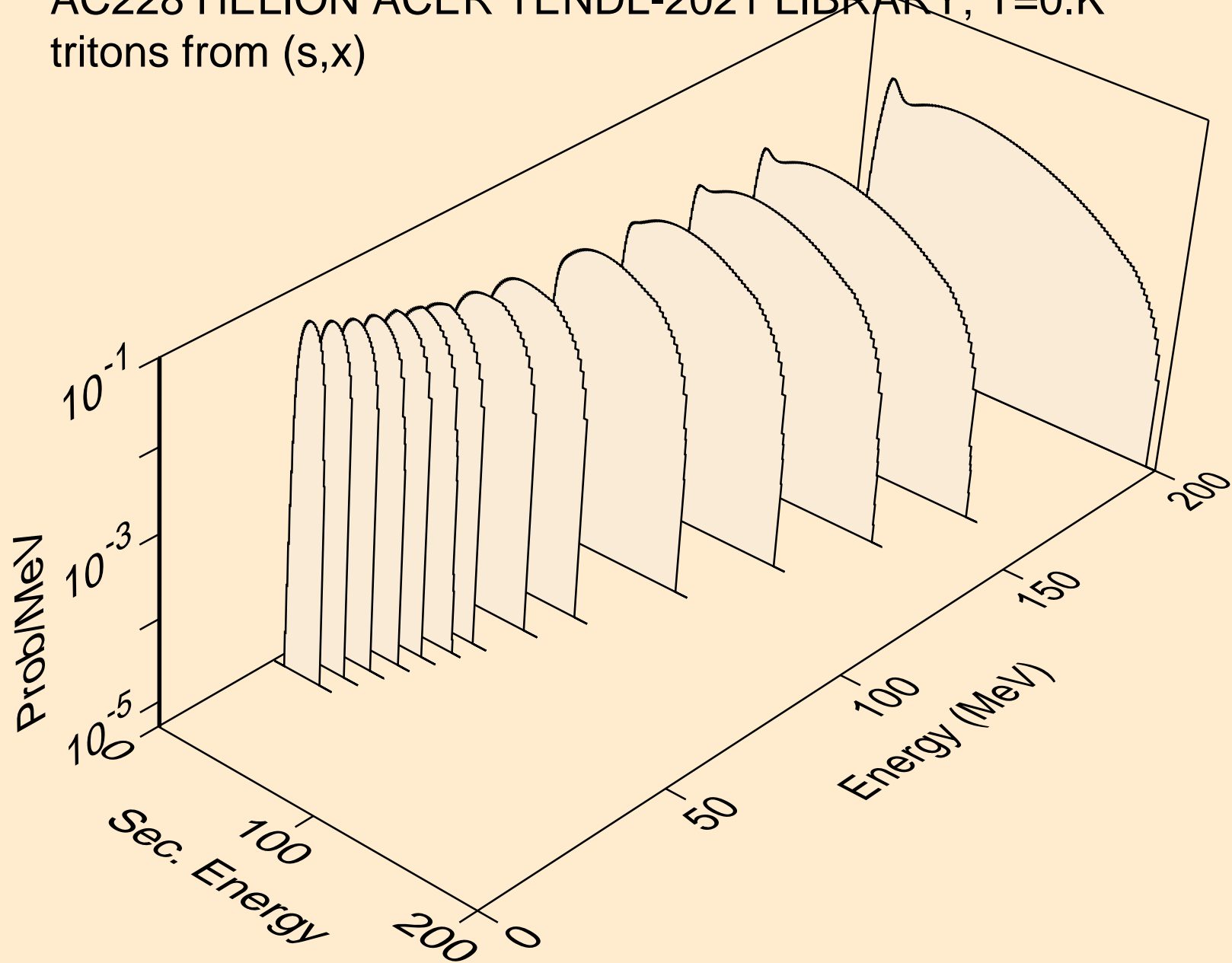

AC228 HELION ACER TENDL-2021 LIBRARY; T=0.K  
tritons from (s,n\*)t

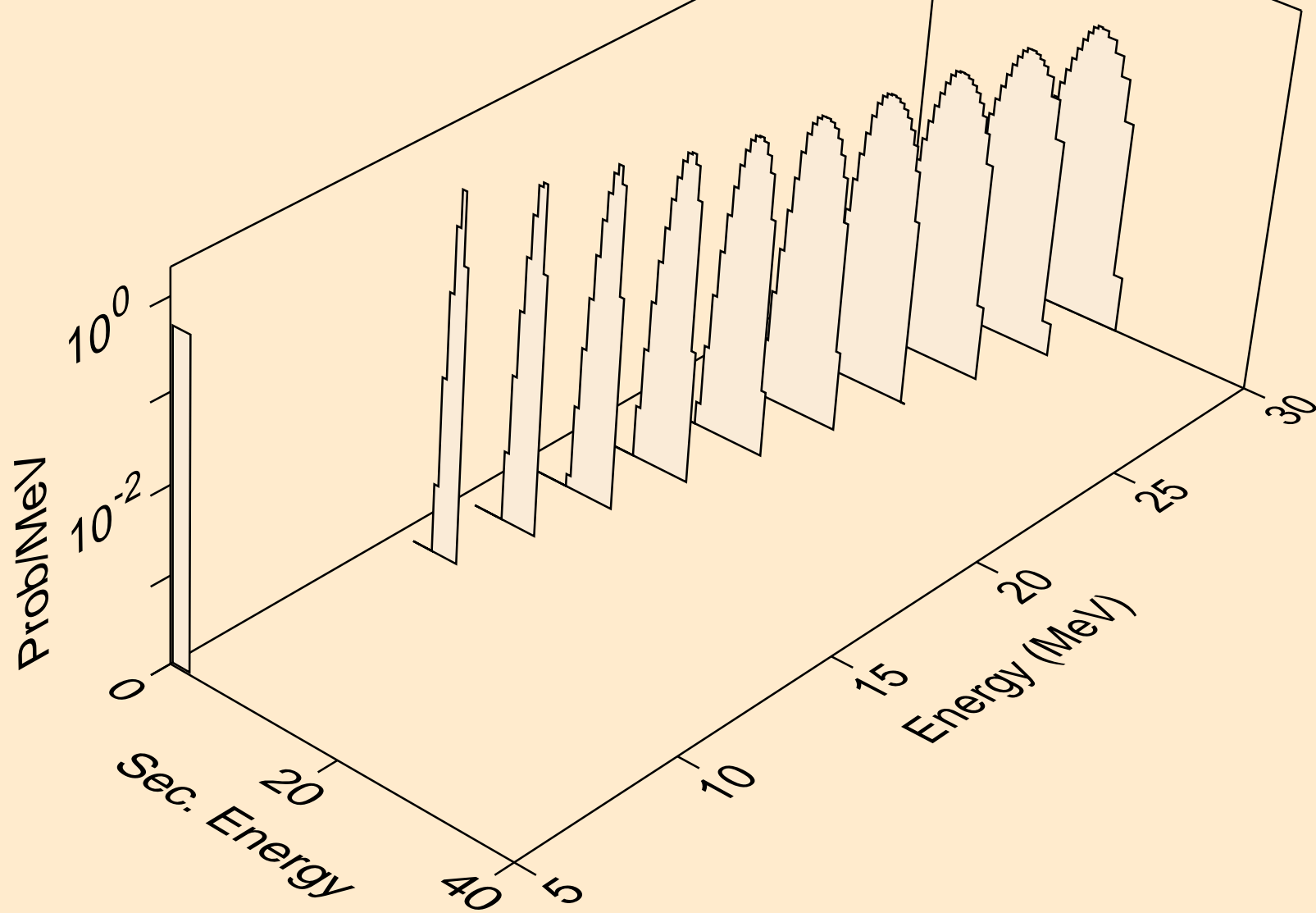

AC228 HELION ACER TENDL-2021 LIBRARY; T=0.K  
tritons from (s,t)

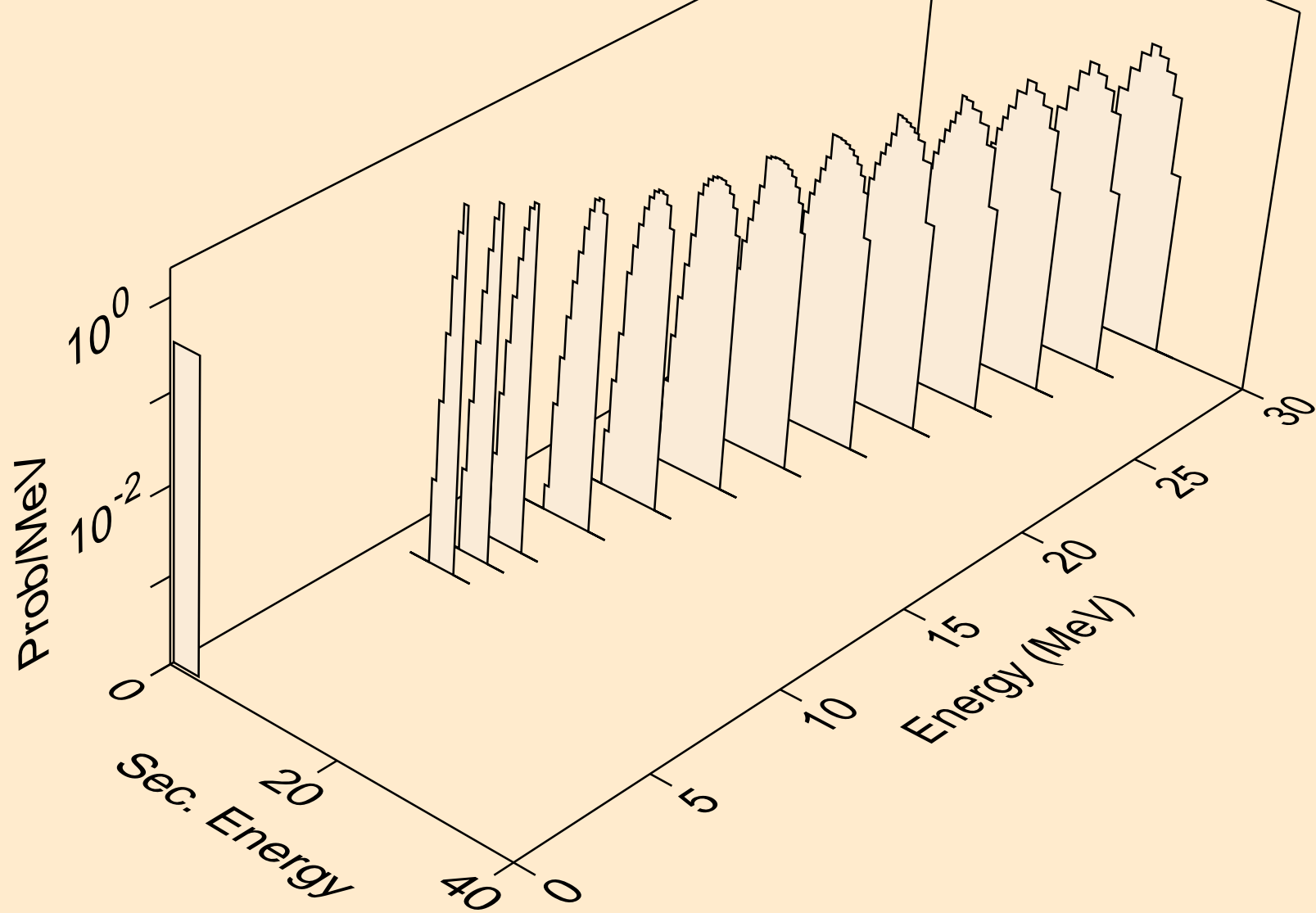

AC228 HELION ACER TENDL-2021 LIBRARY; T=0.K  
tritons from (s,pt)

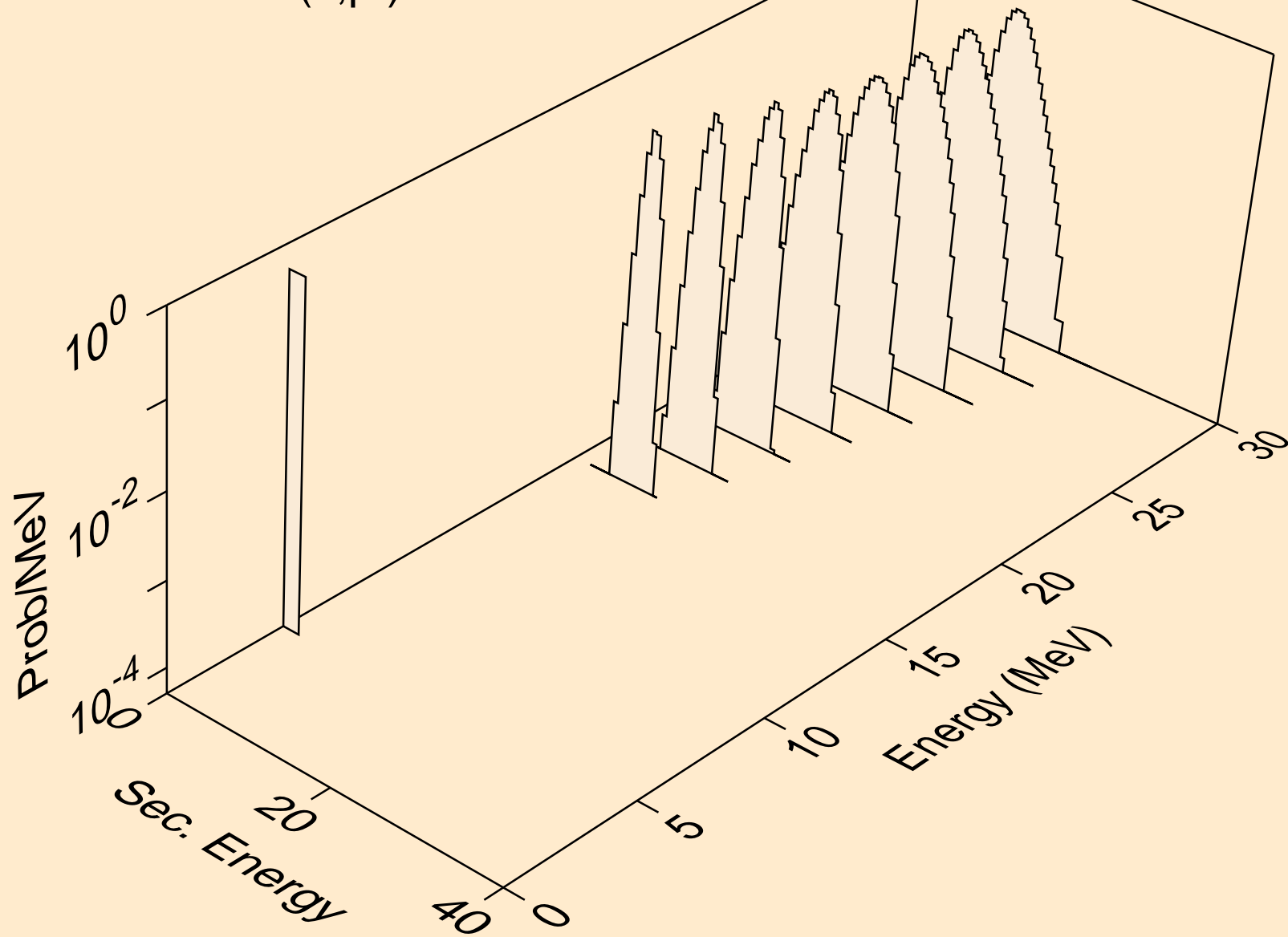

AC228 HELION ACER TENDL-2021 LIBRARY; T=0.K  
alphas from (s,x)

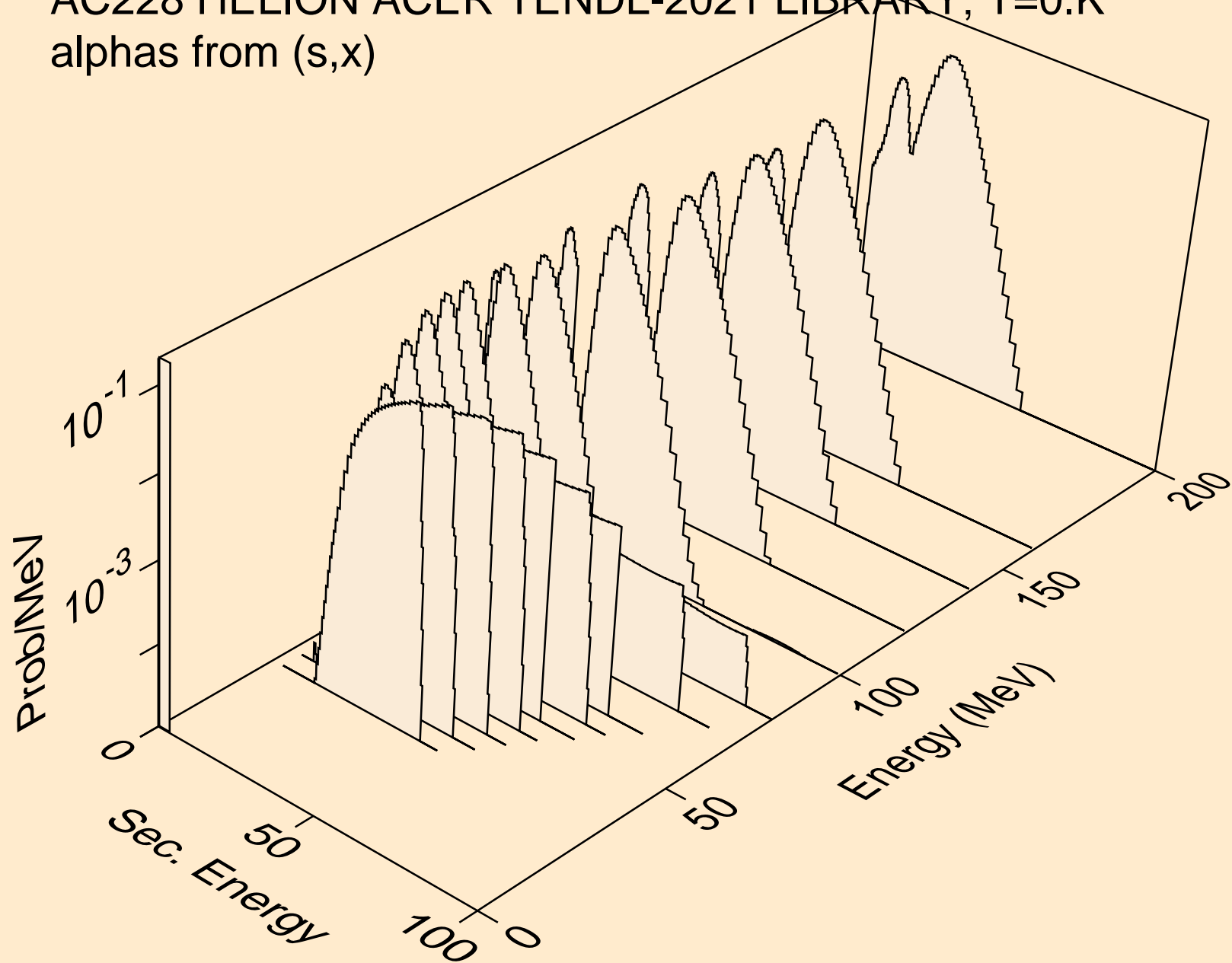

AC228 HELION ACER TENDL-2021 LIBRARY; T=0.K  
alphas from (s,n\*)a

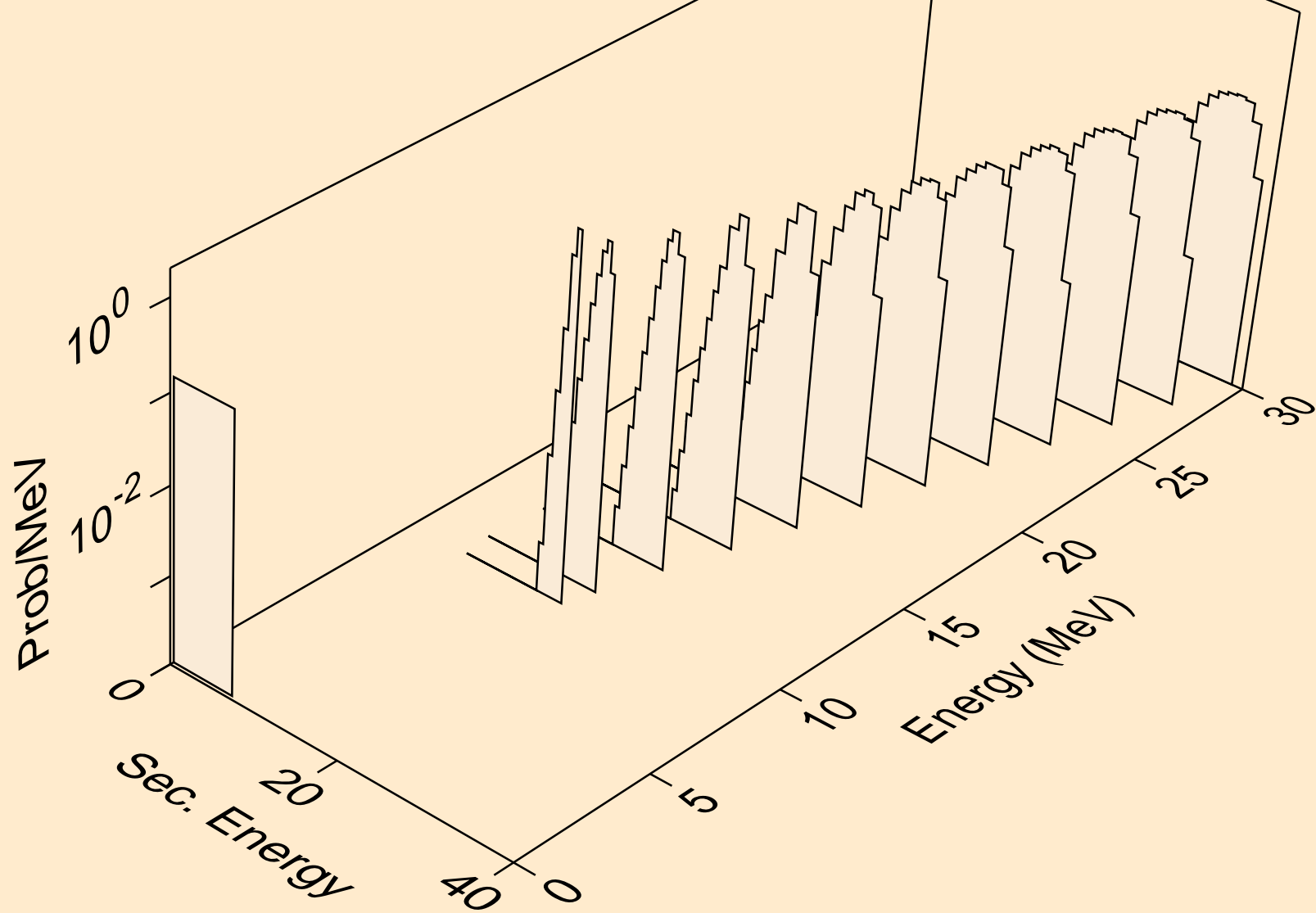

AC228 HELION ACER TENDL-2021 LIBRARY; T=0.K  
alphas from (s,2n)a

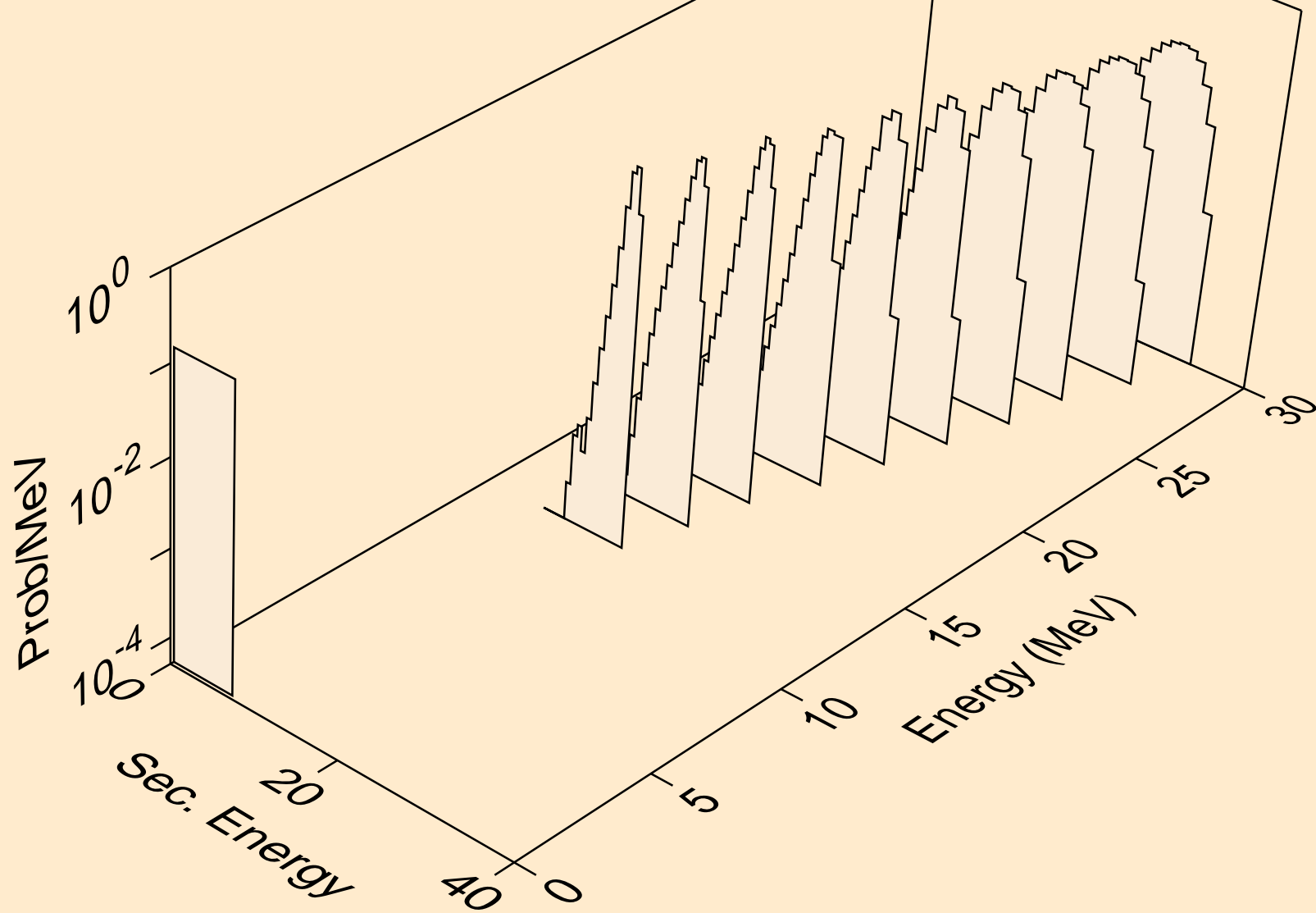



AC228 HELION ACER TENDL-2021 LIBRARY; T=0.K  
alphas from (s,3n)a

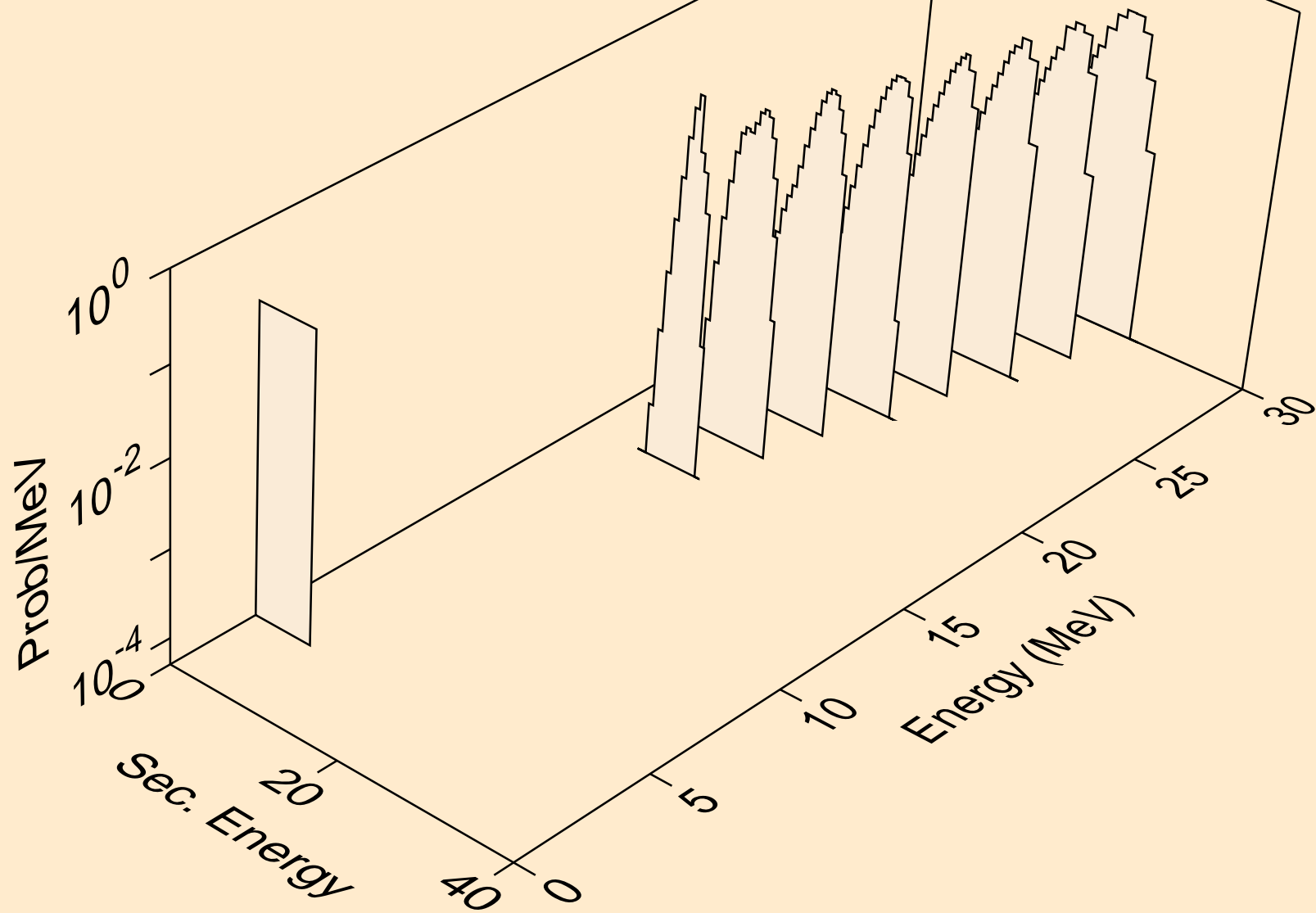

AC228 HELION ACER TENDL-2021 LIBRARY; T=0.K  
alphas from (s,npa)

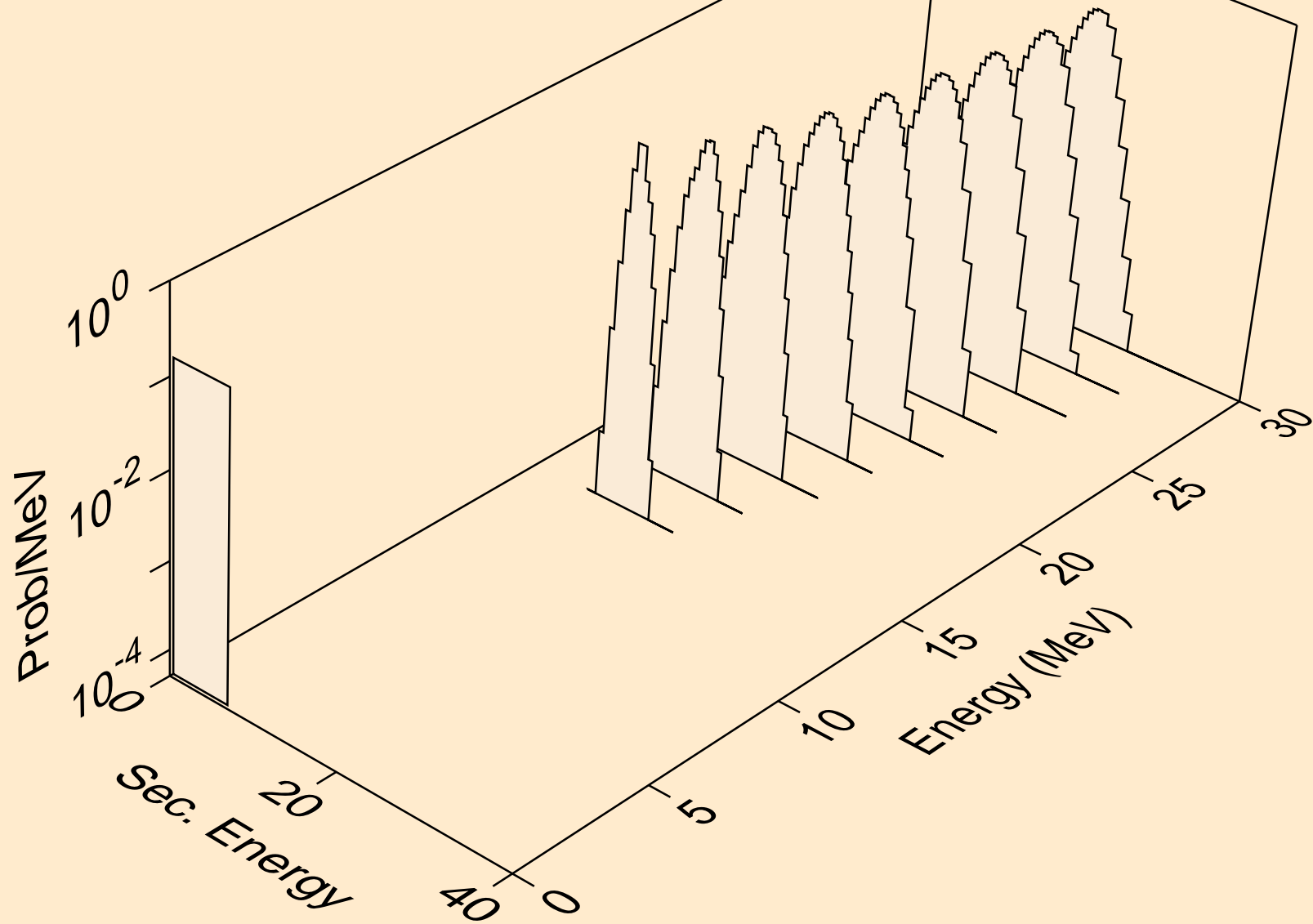

AC228 HELION ACER TENDL-2021 LIBRARY; T=0.K  
alphas from (s,a)

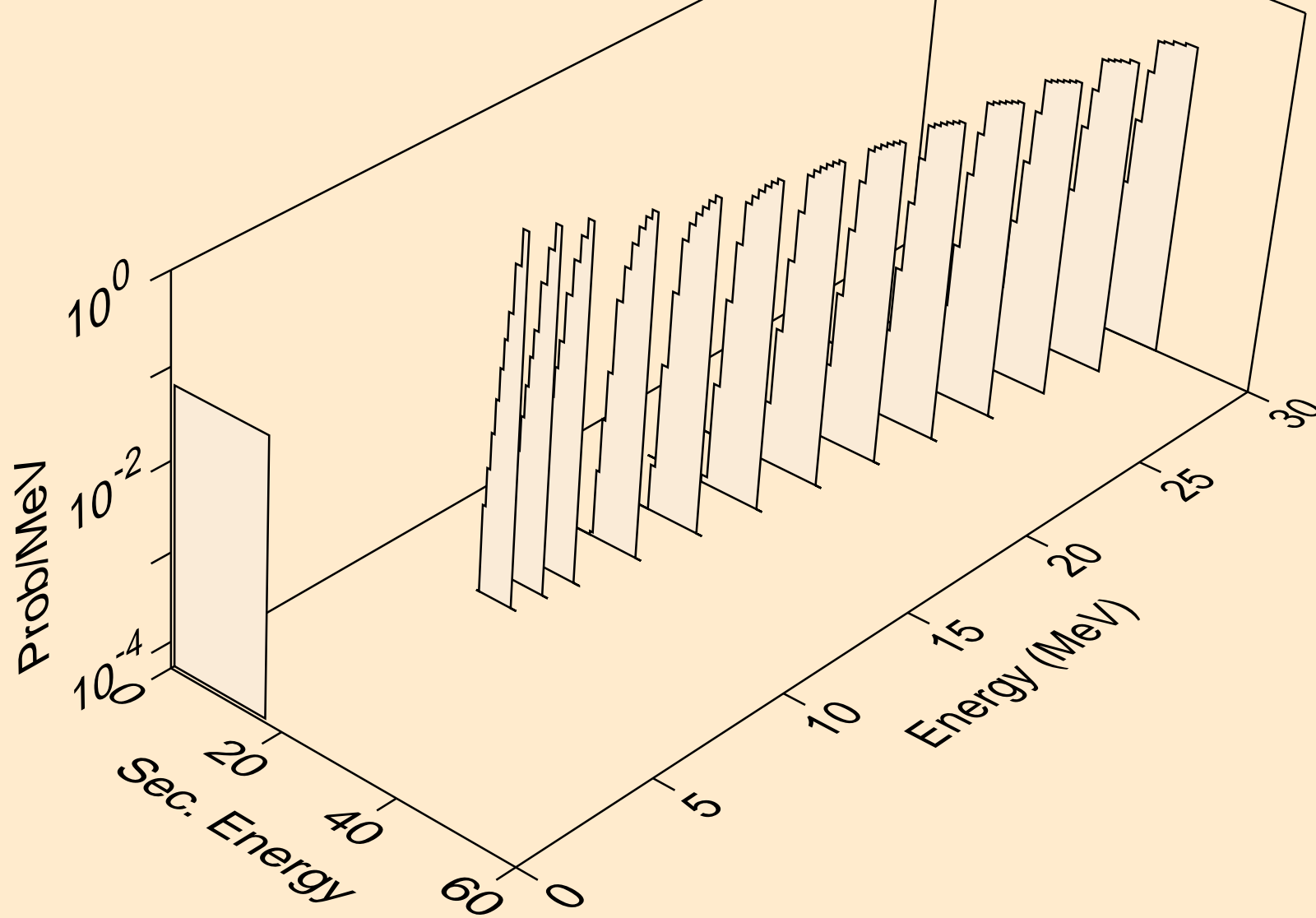

AC228 HELION ACER TENDL-2021 LIBRARY; T=0.K  
alphas from (s,pa)

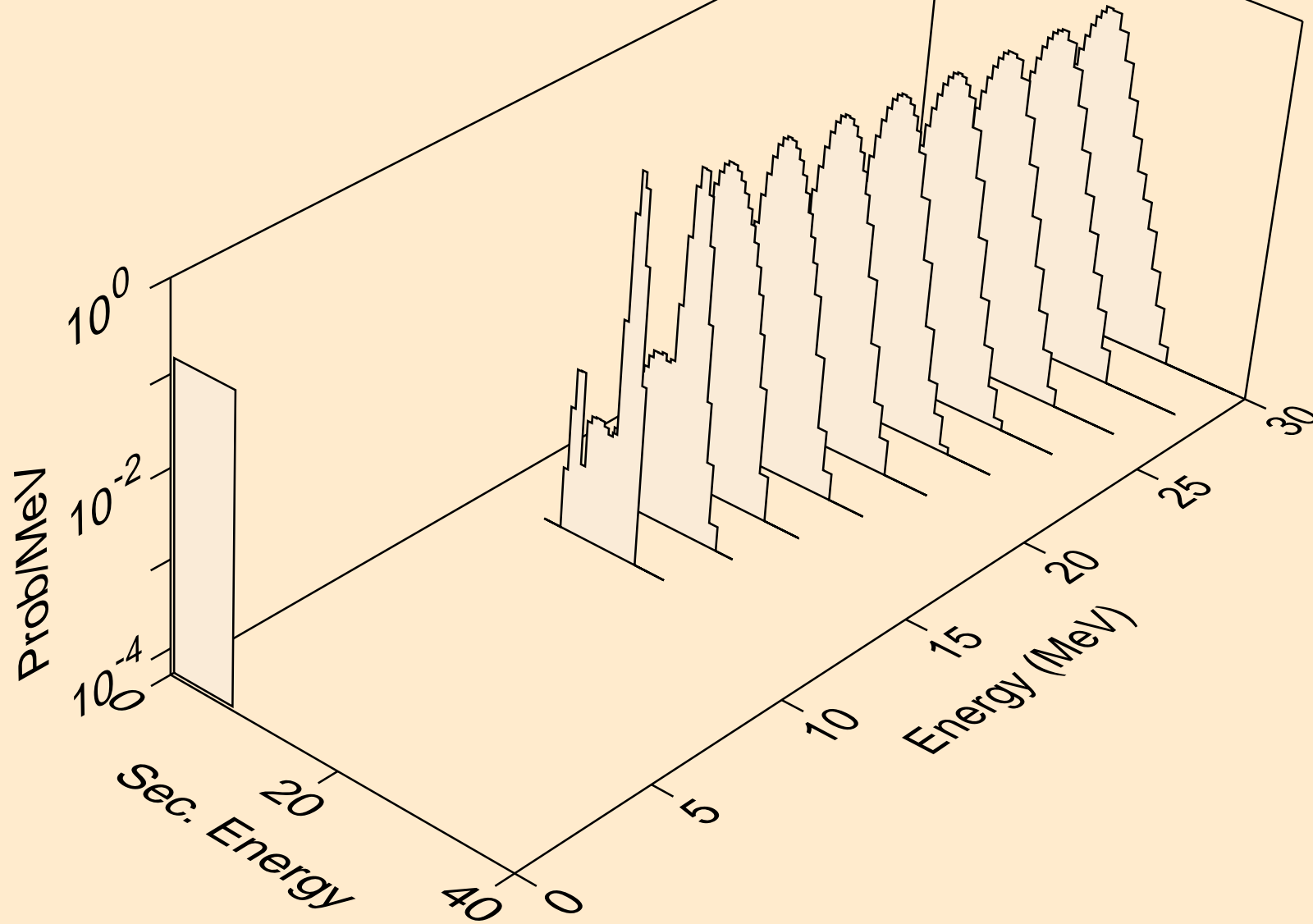

AC228 HELION ACER TENDL-2021 LIBRARY; T=0.K  
alphas from (s,da)

