

AM232 HELION ACER TENDL-2021 LIBRARY; T=0.K
Principal cross sections

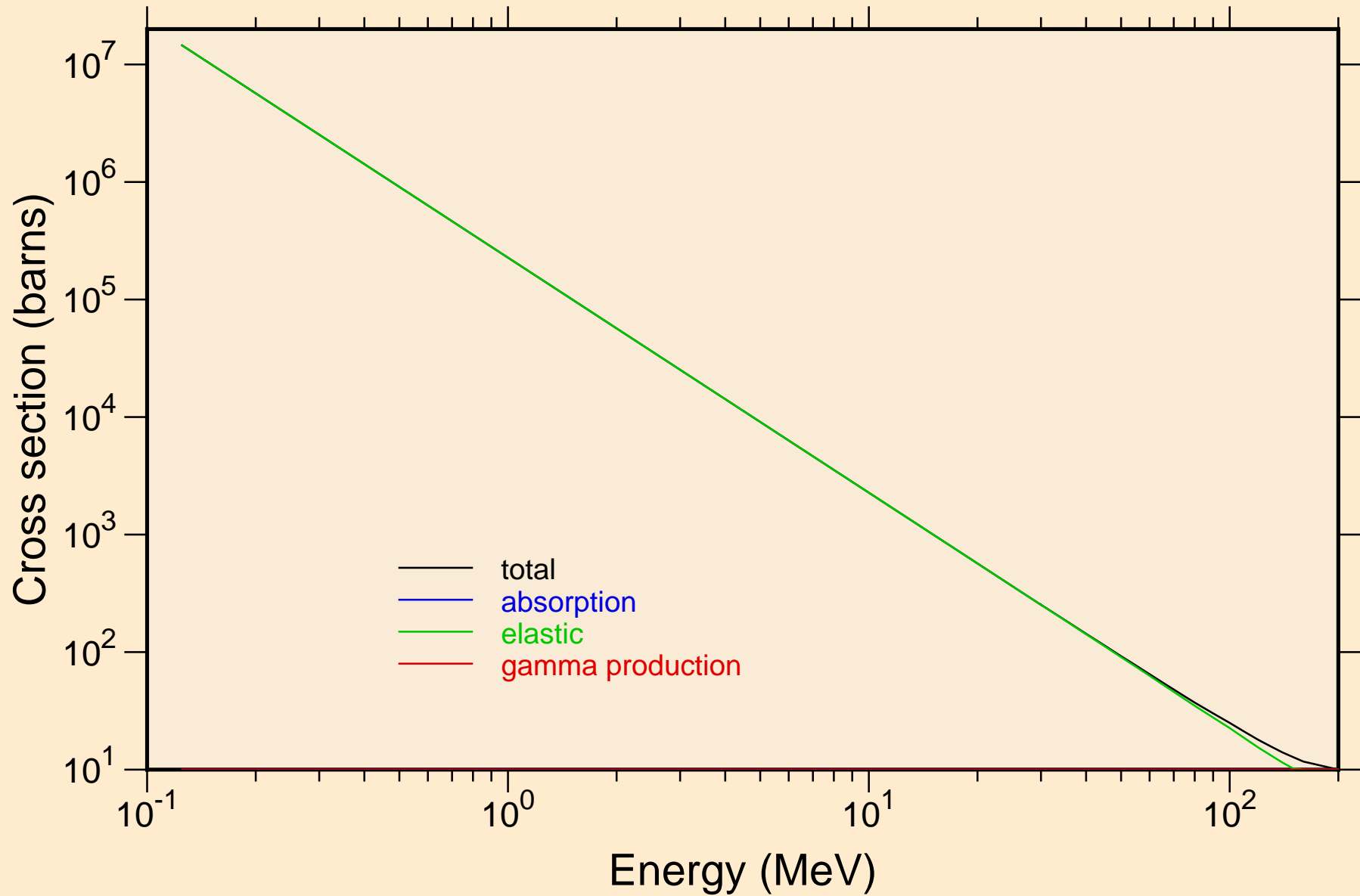

AM232 HELION ACER TENDL-2021 LIBRARY; T=0.K

Heating

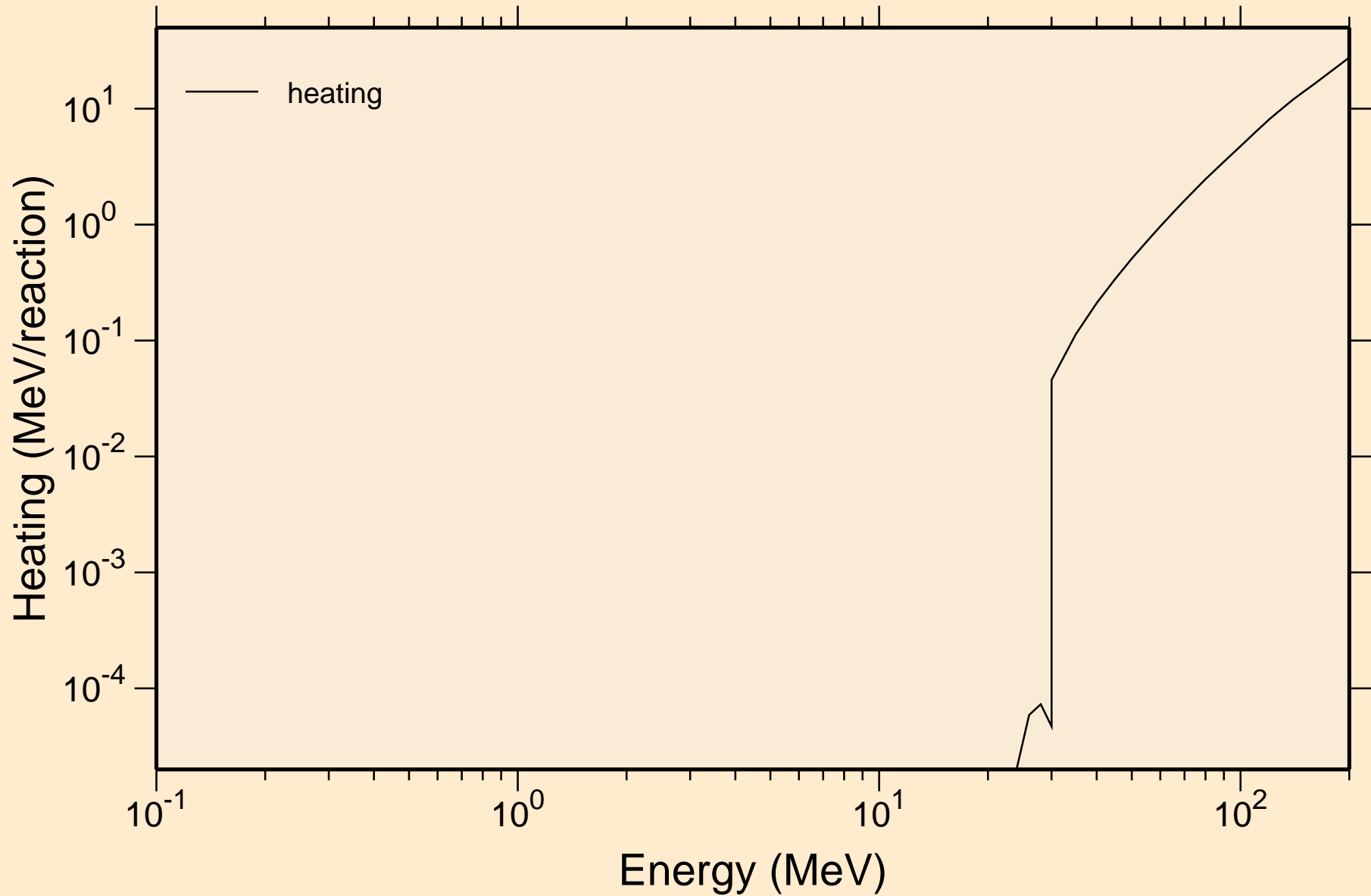

AM232 HELION ACER TENDL-2021 LIBRARY; T=0.K

Principal cross sections

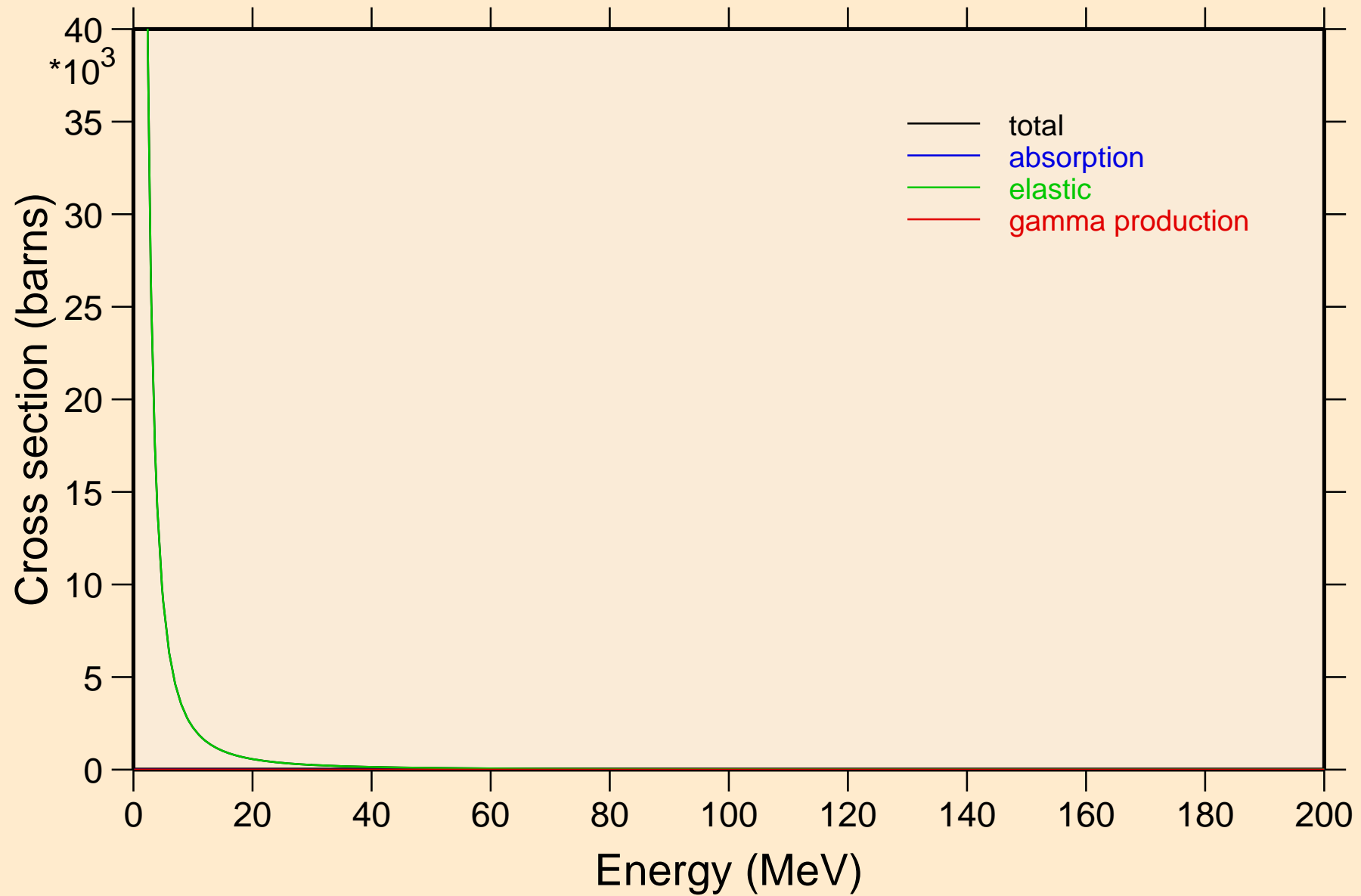

AM232 HELION ACER TENDL-2021 LIBRARY; T=0.K

Heating

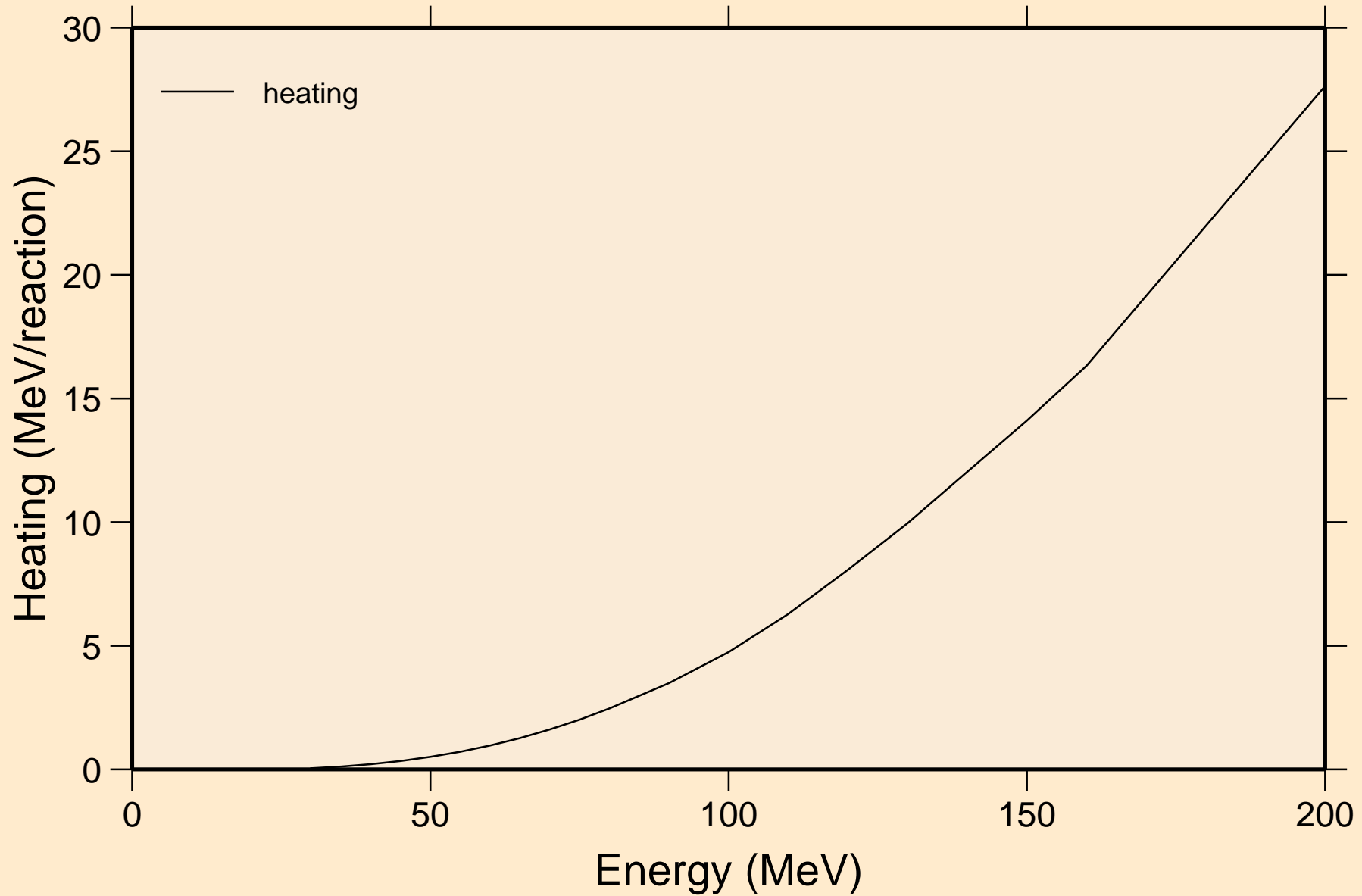

AM232 HELION ACER TENDL-2021 LIBRARY; T=0.K
Threshold reactions

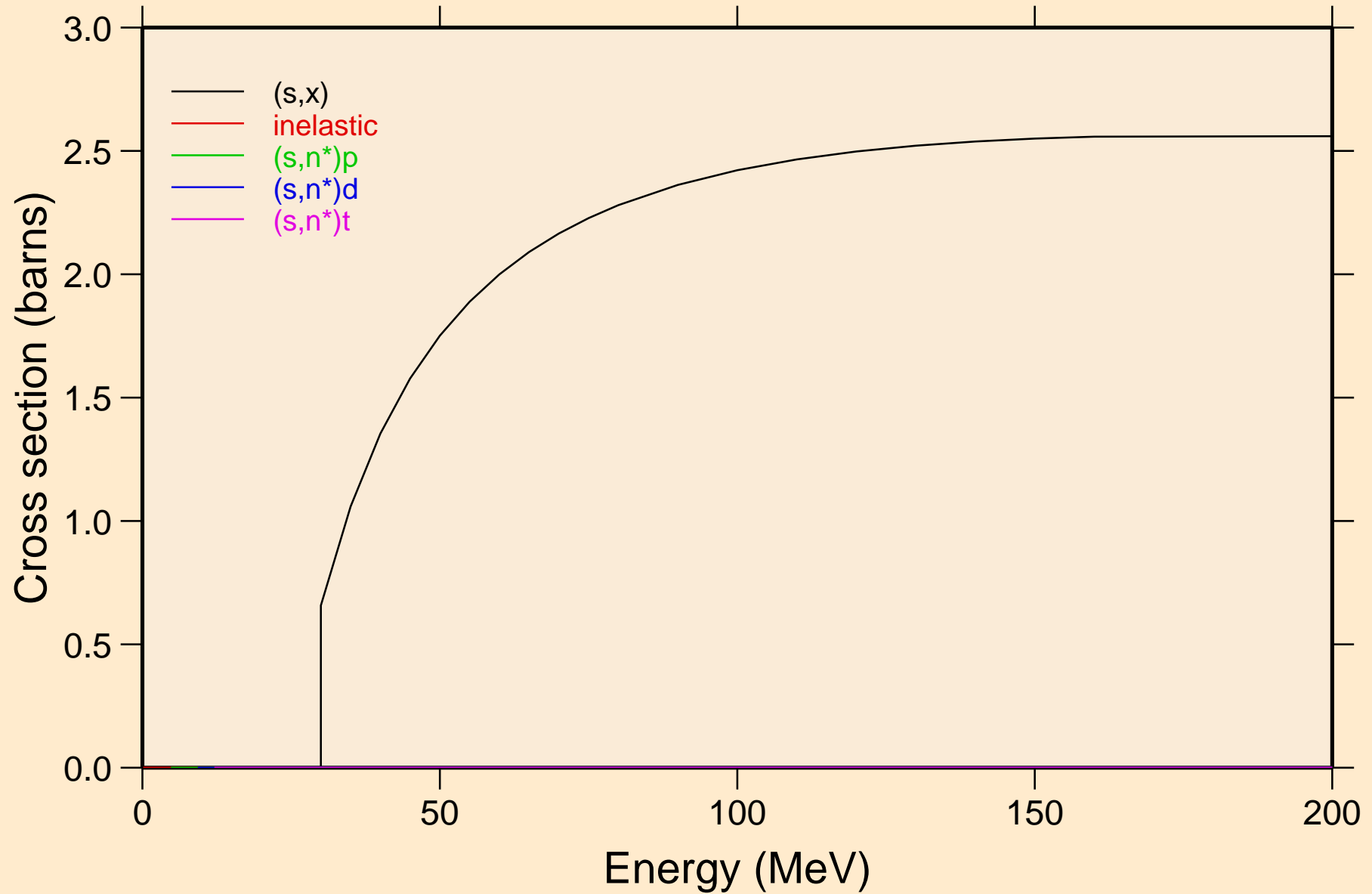

AM232 HELION ACER TENDL-2021 LIBRARY; T=0.K
Threshold reactions

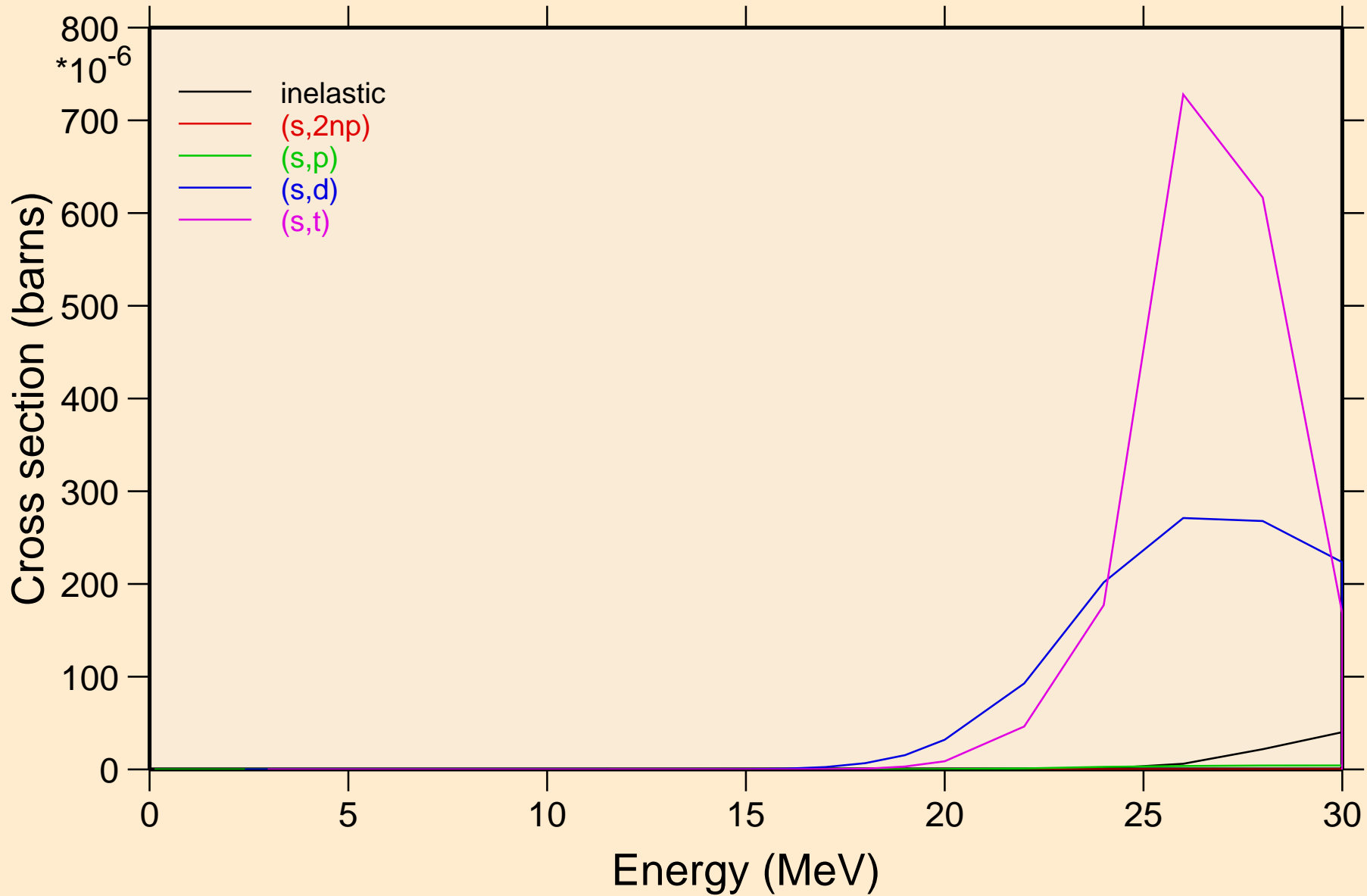

AM232 HELION ACER TENDL-2021 LIBRARY; T=0.K
Threshold reactions

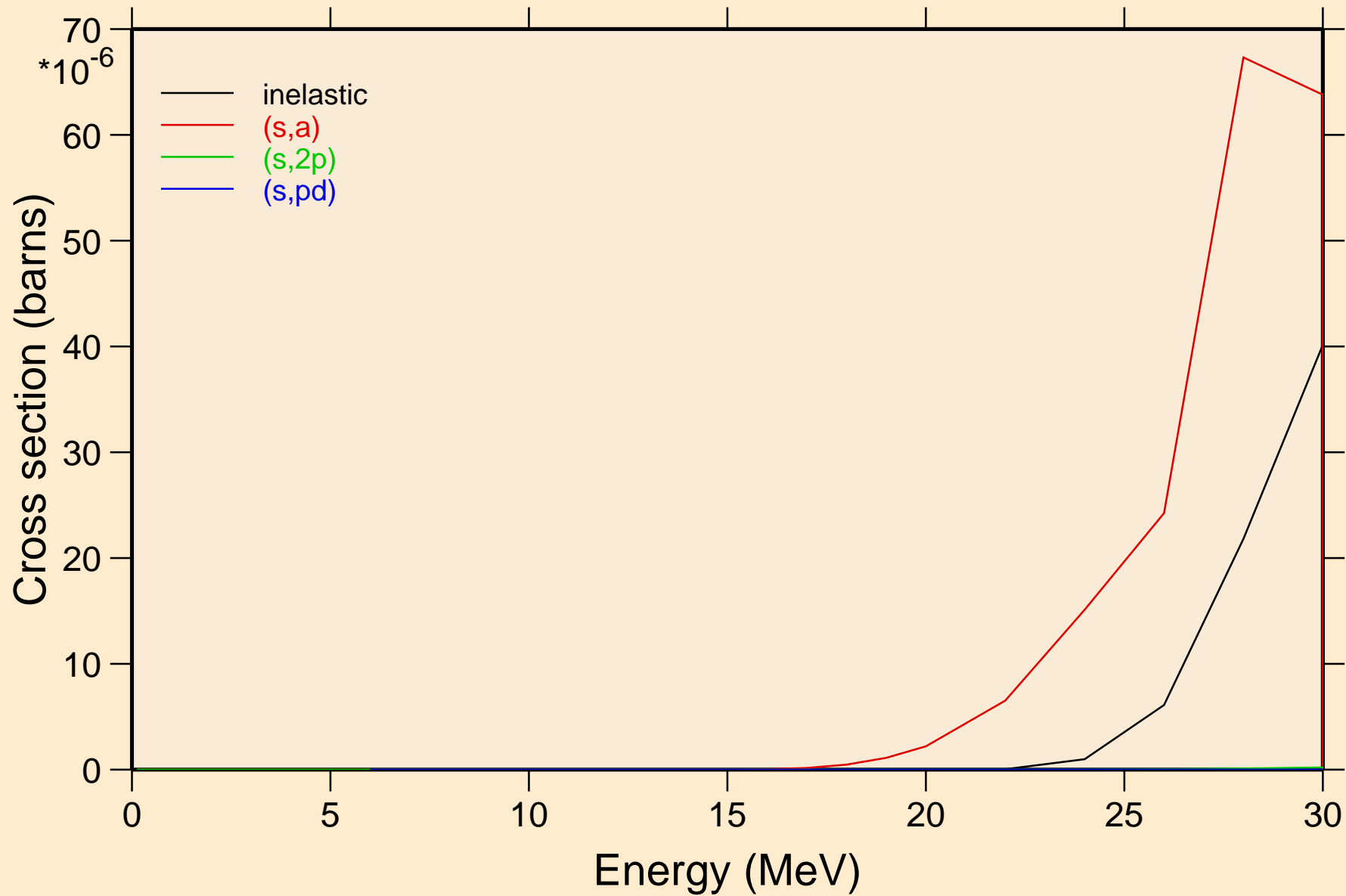

AM232 HELION ACER TENDL-2021 LIBRARY; T=0.K
angular distribution for elastic

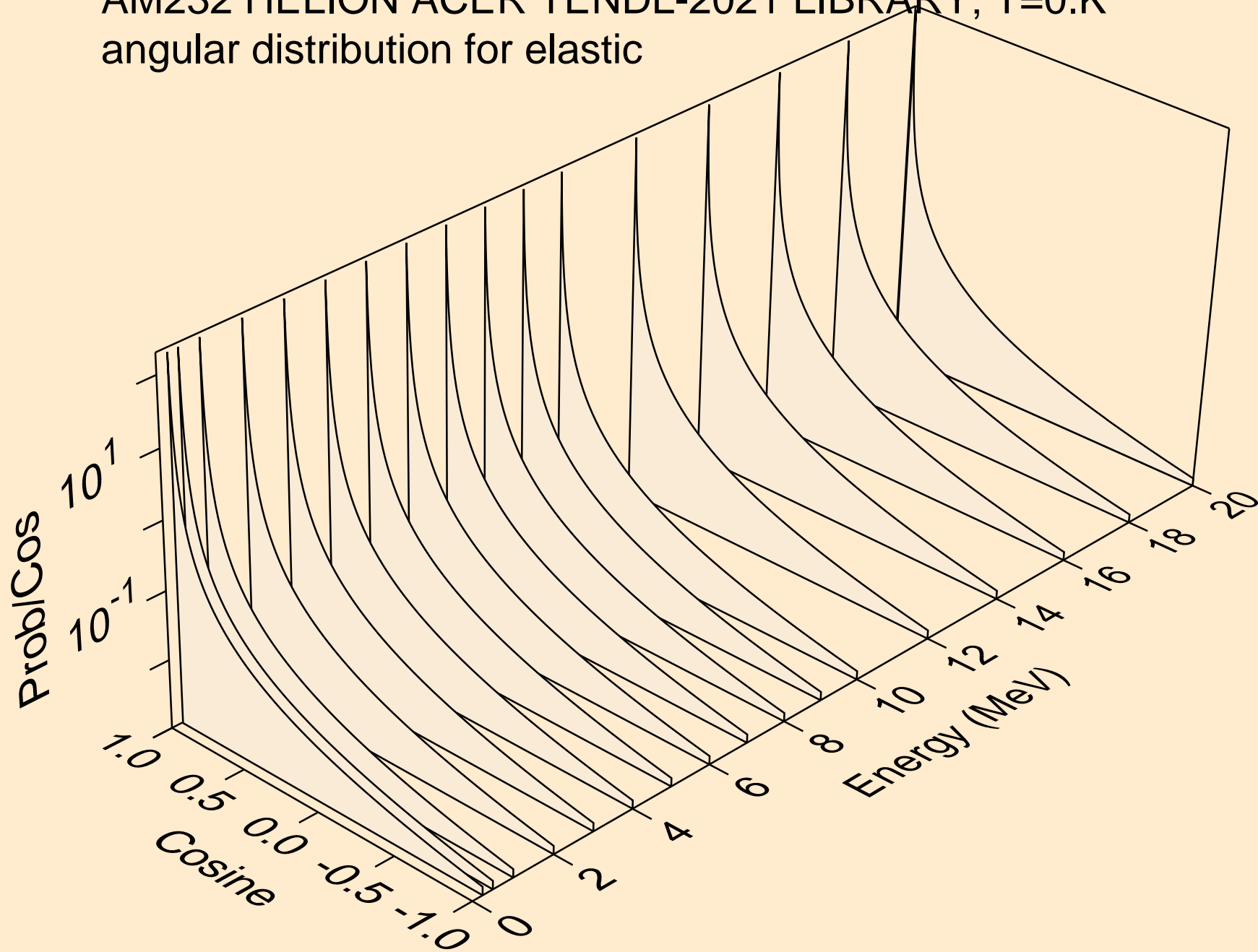

AM232 HELION ACER TENDL-2021 LIBRARY; T=0.K
angular distribution for elastic

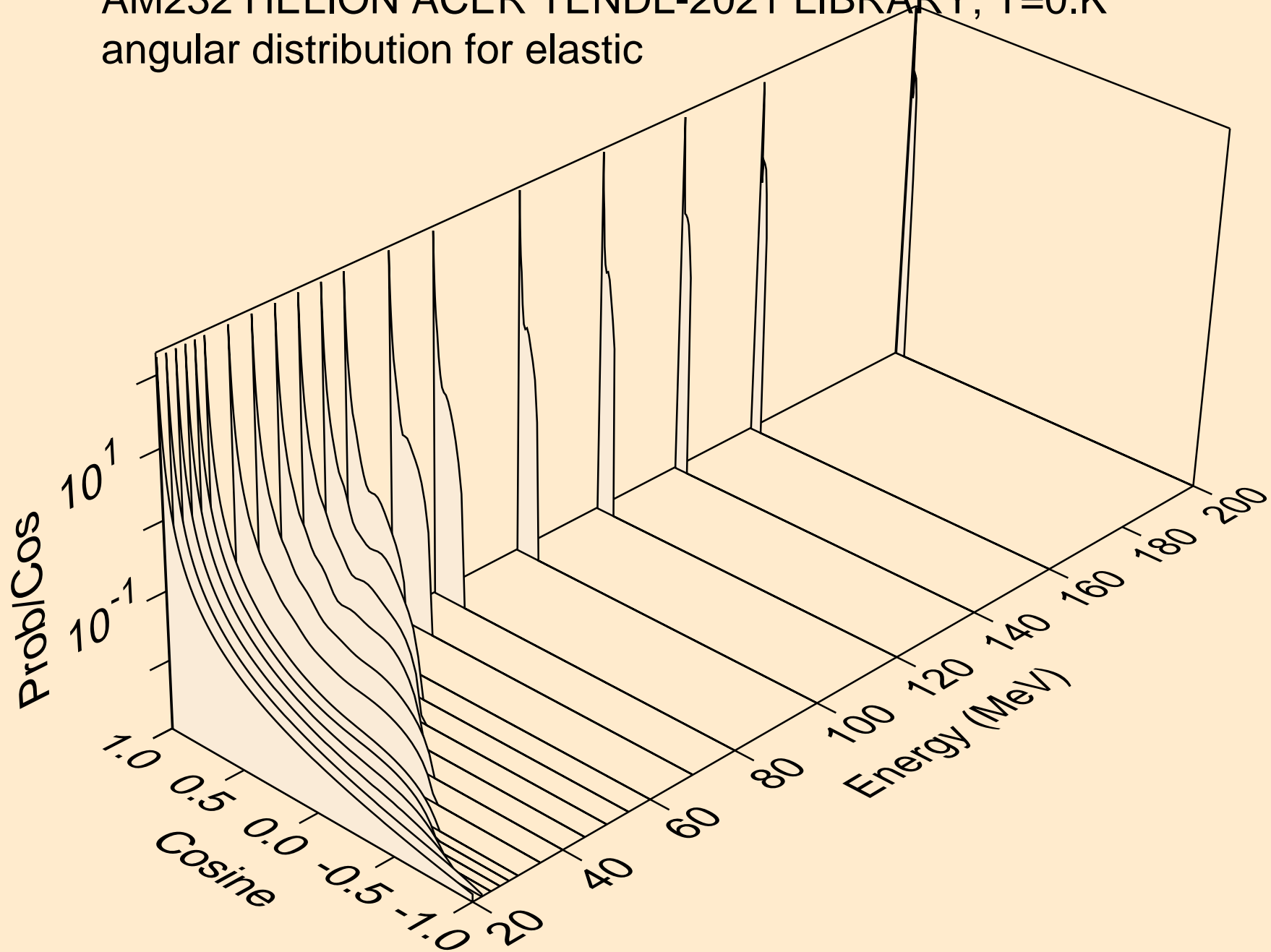

AM232 HELION ACER TENDL-2021 LIBRARY; T=0.K
He-3 emission for (s,x)

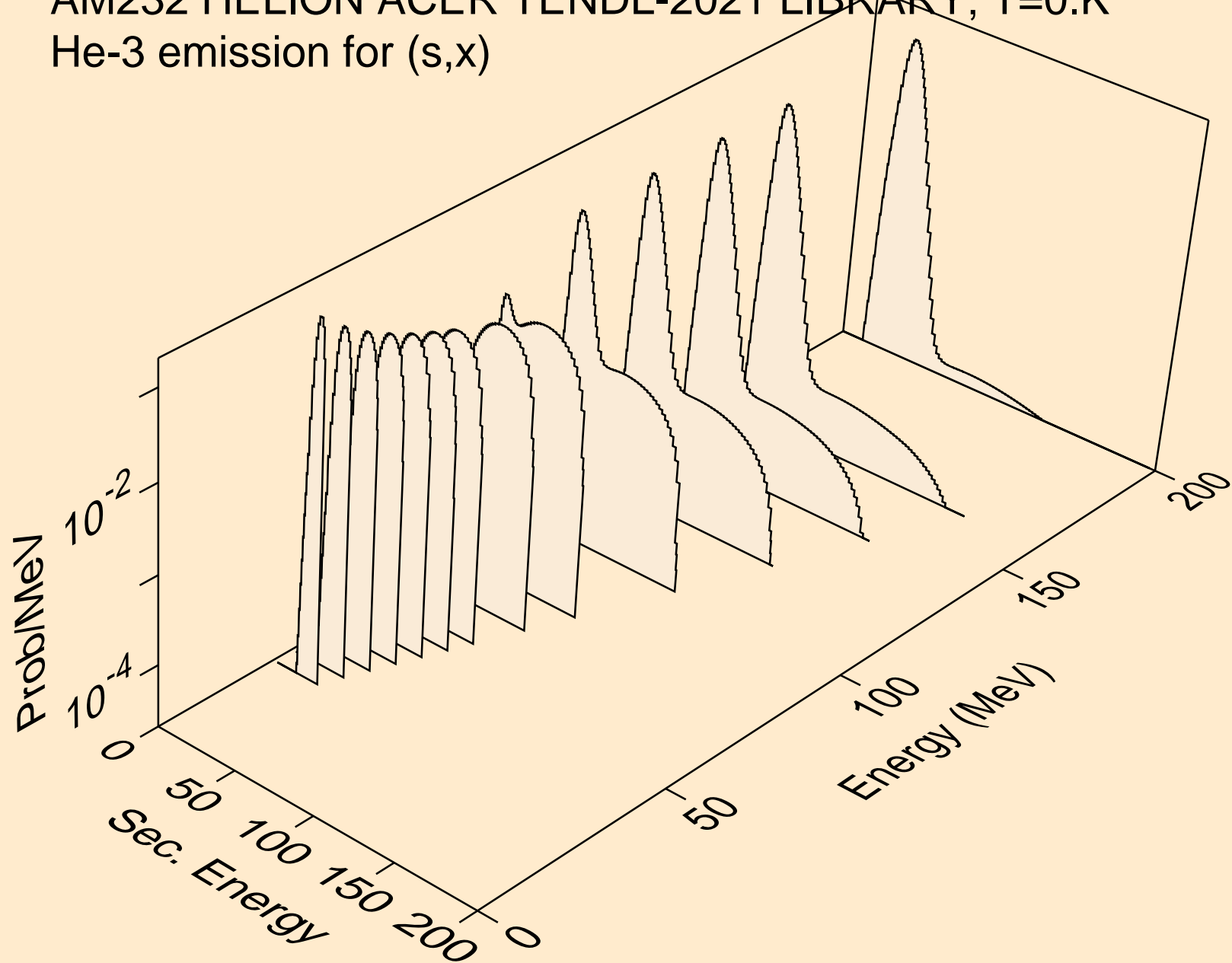

AM232 HELION ACER TENDL-2021 LIBRARY; T=0.K
He-3 emission for inelastic

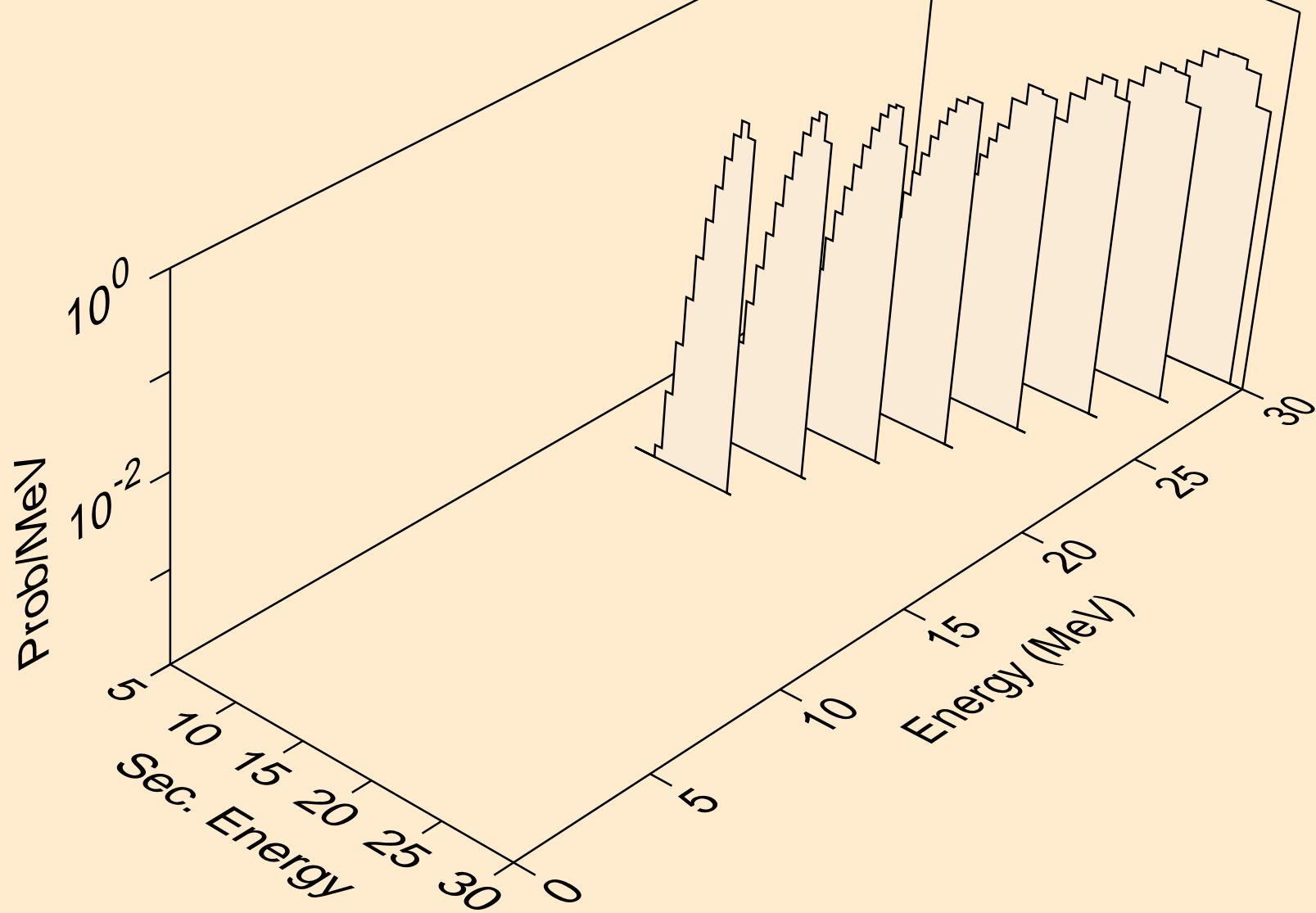

AM232 HELION ACER TENDL-2021 LIBRARY; T=0.K
Photon emission for (z,n)

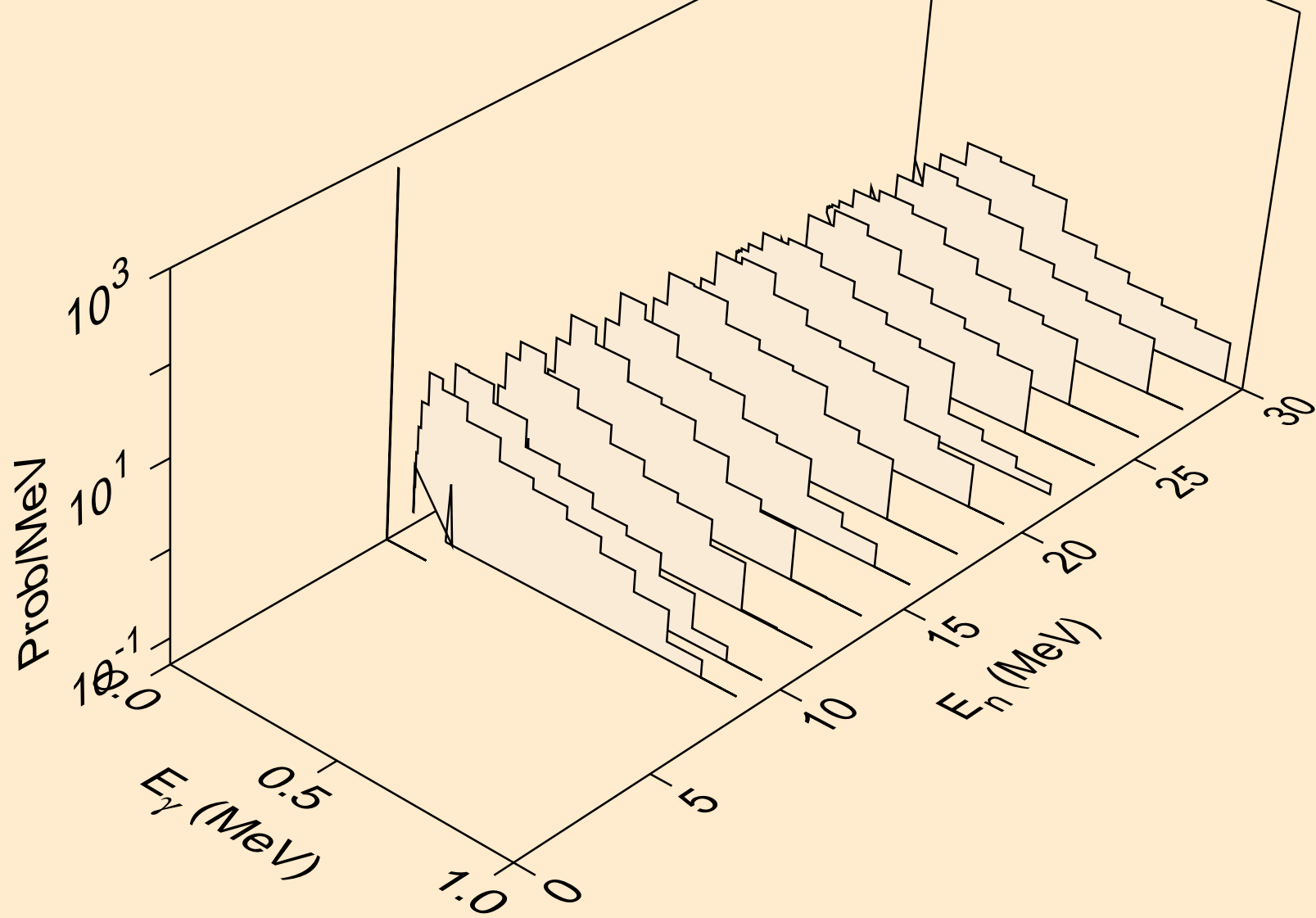

AM232 HELION ACER TENDL-2021 LIBRARY; T=0.K
Photon emission for (n,x)

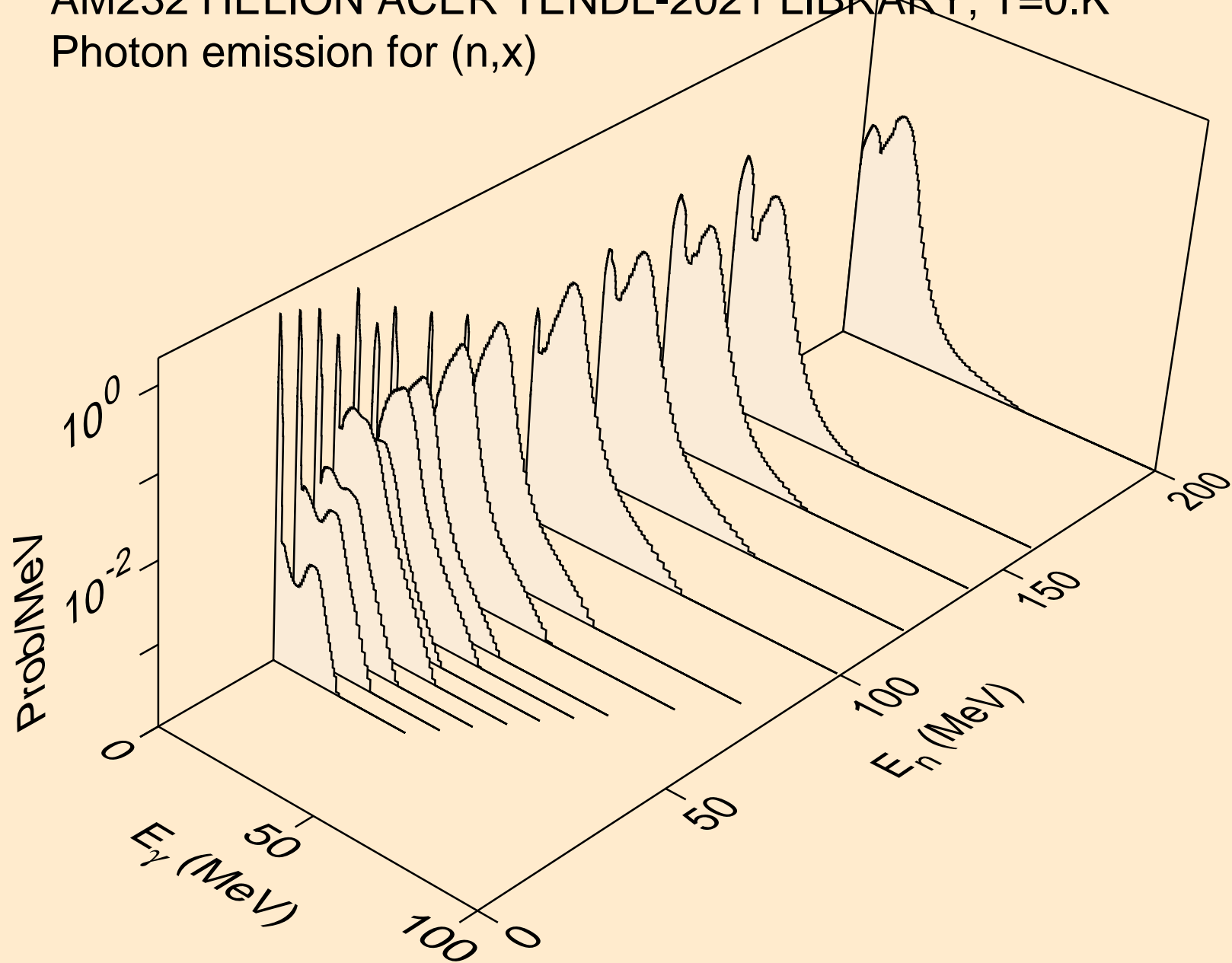

AM232 HELION ACER TENDL-2021 LIBRARY; T=0.K
Photon emission for (n,n*)p

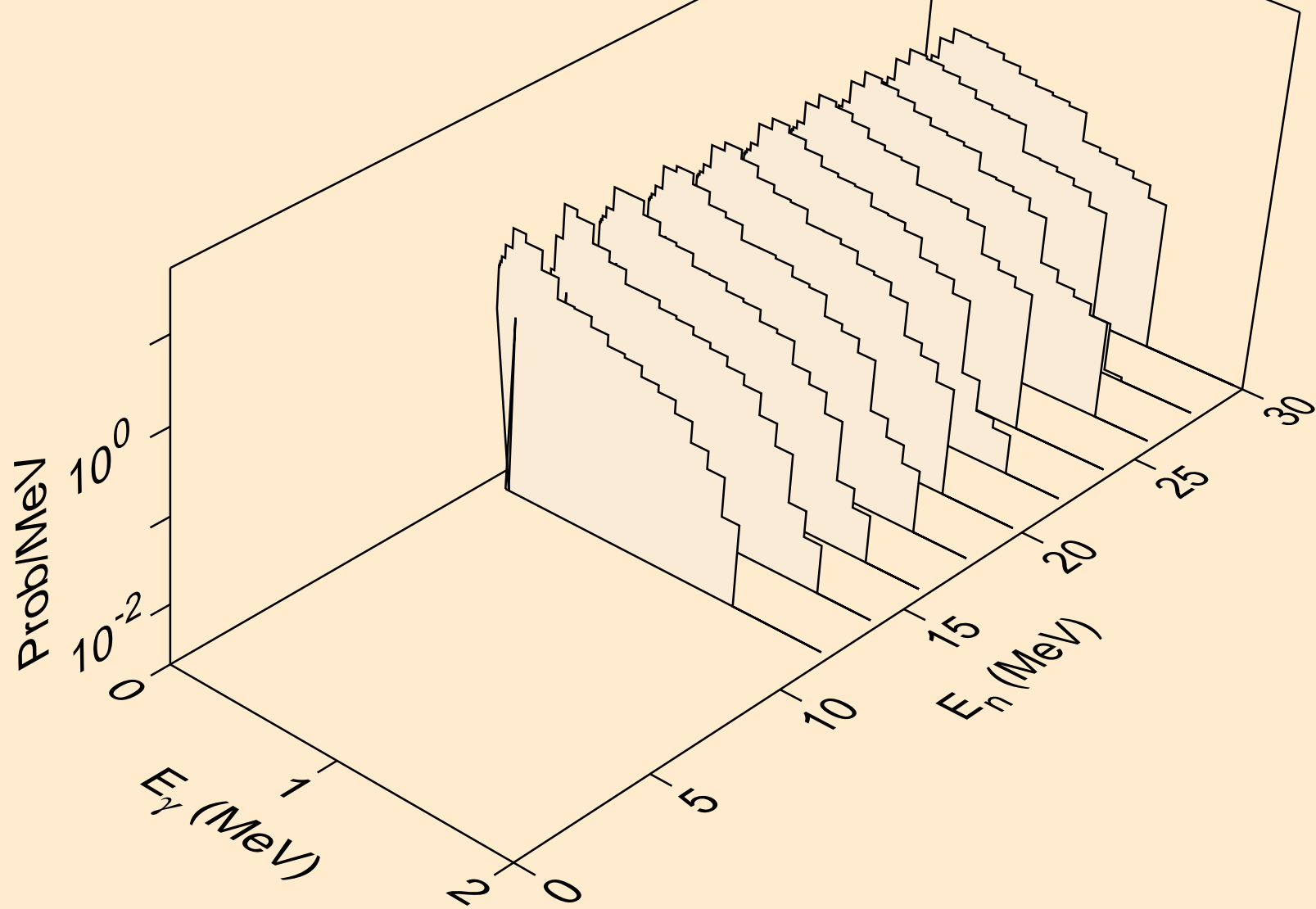

AM232 HELION ACER TENDL-2021 LIBRARY; T=0.K
Photon emission for (n,n*)d

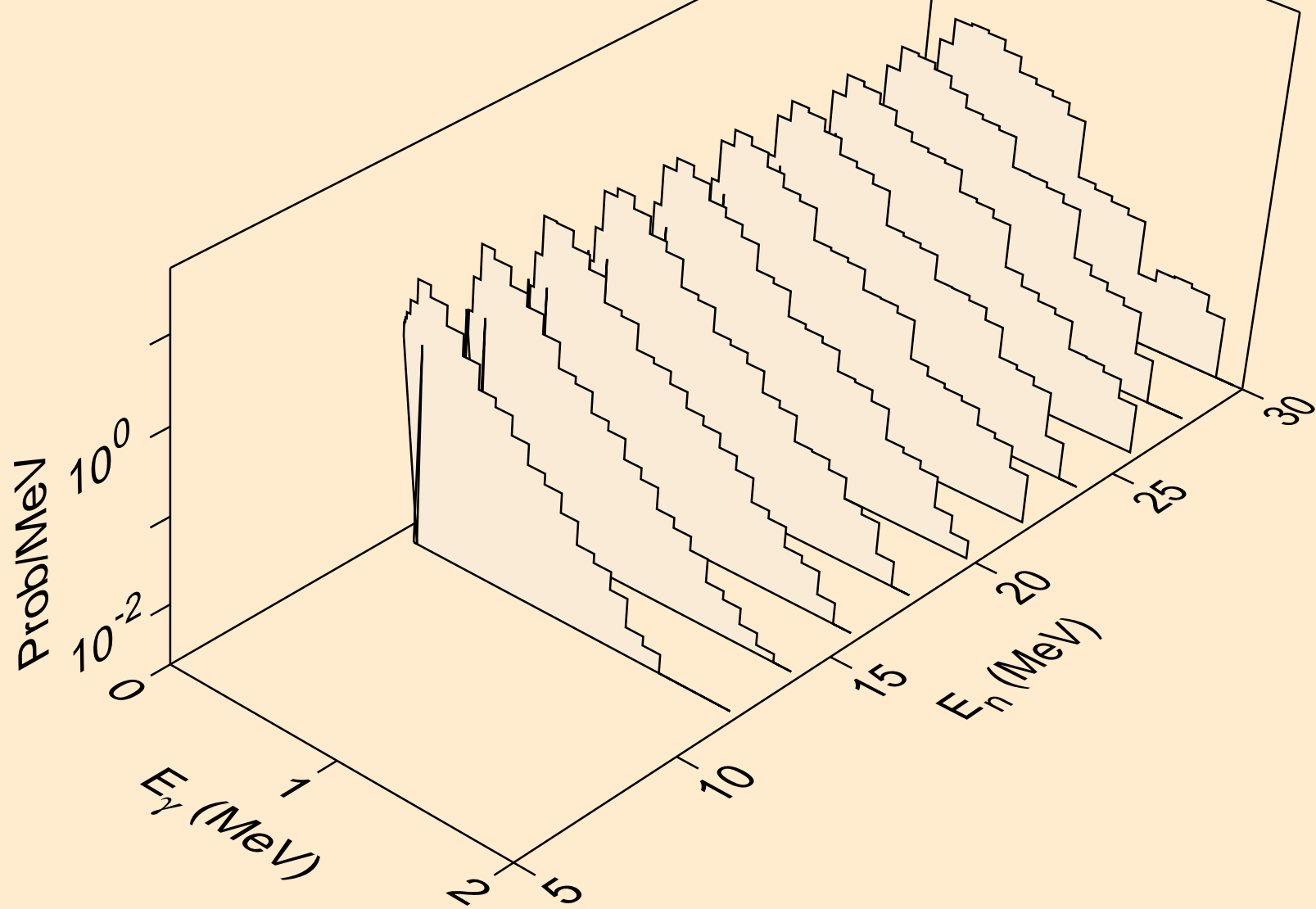

AM232 HELION ACER TENDL-2021 LIBRARY; T=0.K
Photon emission for (n,n*)t

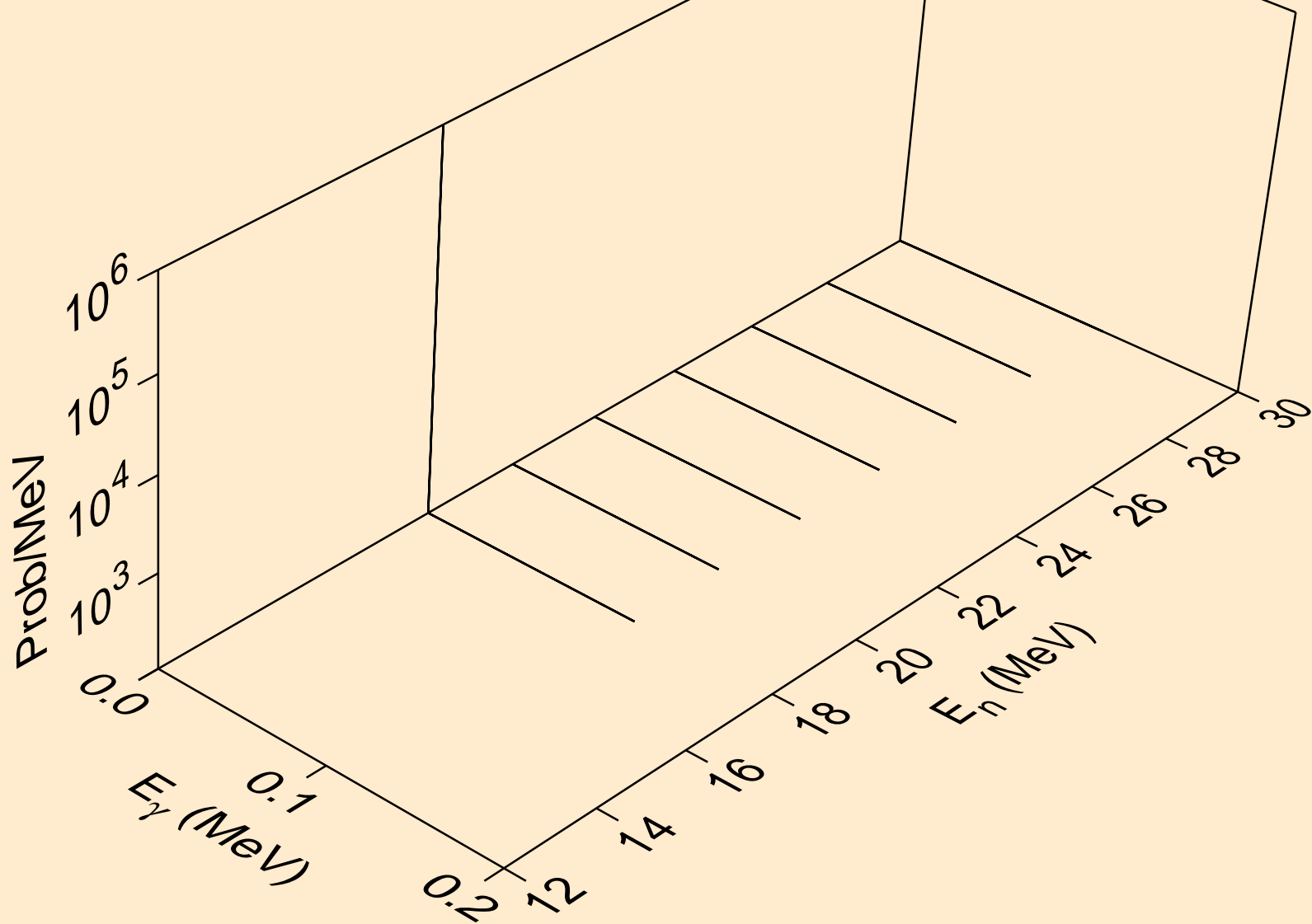

AM232 HELION ACER TENDL-2021 LIBRARY; T=0.K
Photon emission for (n,2np)

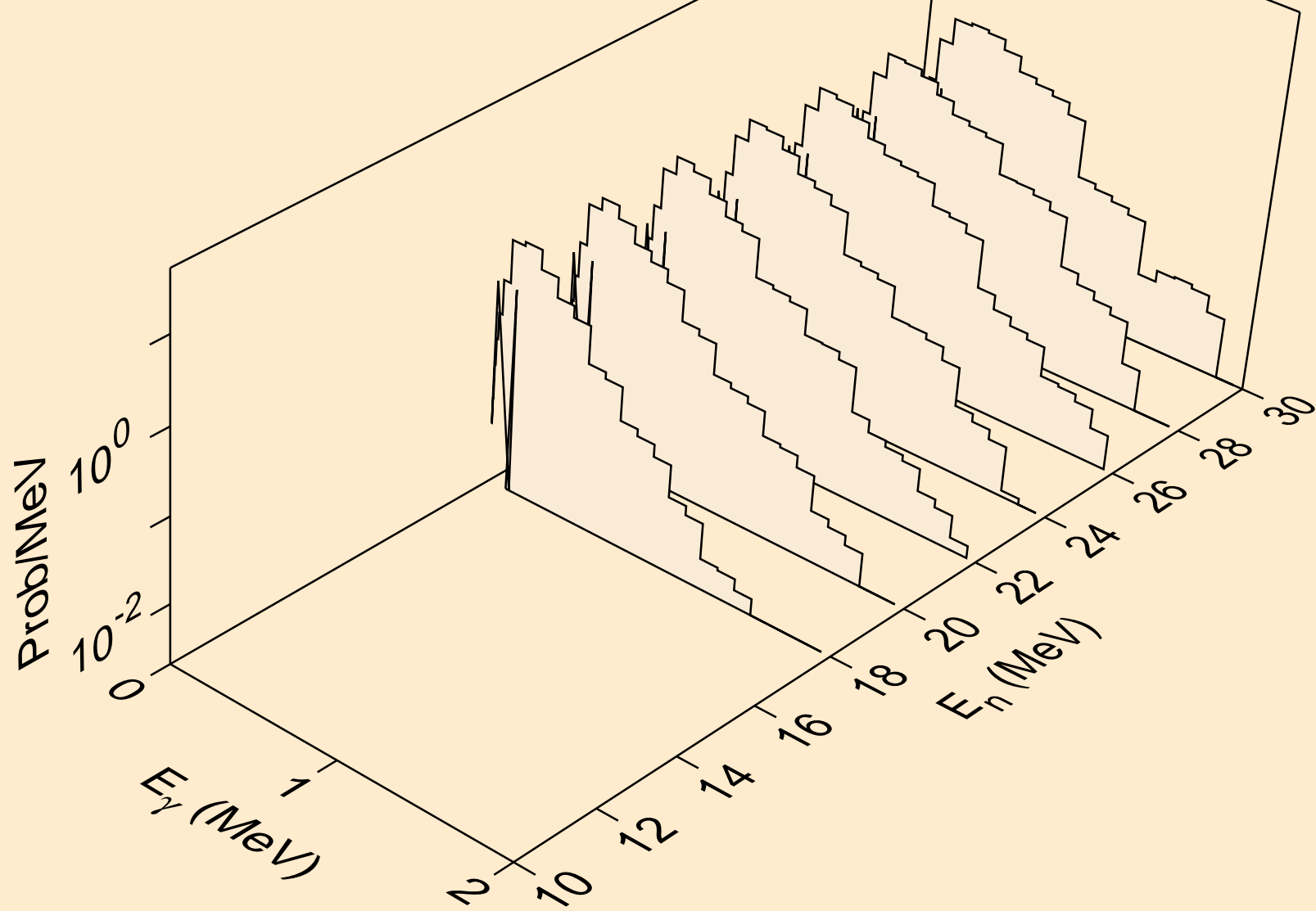

AM232 HELION ACER TENDL-2021 LIBRARY; T=0.K
Photon emission for (n,p)

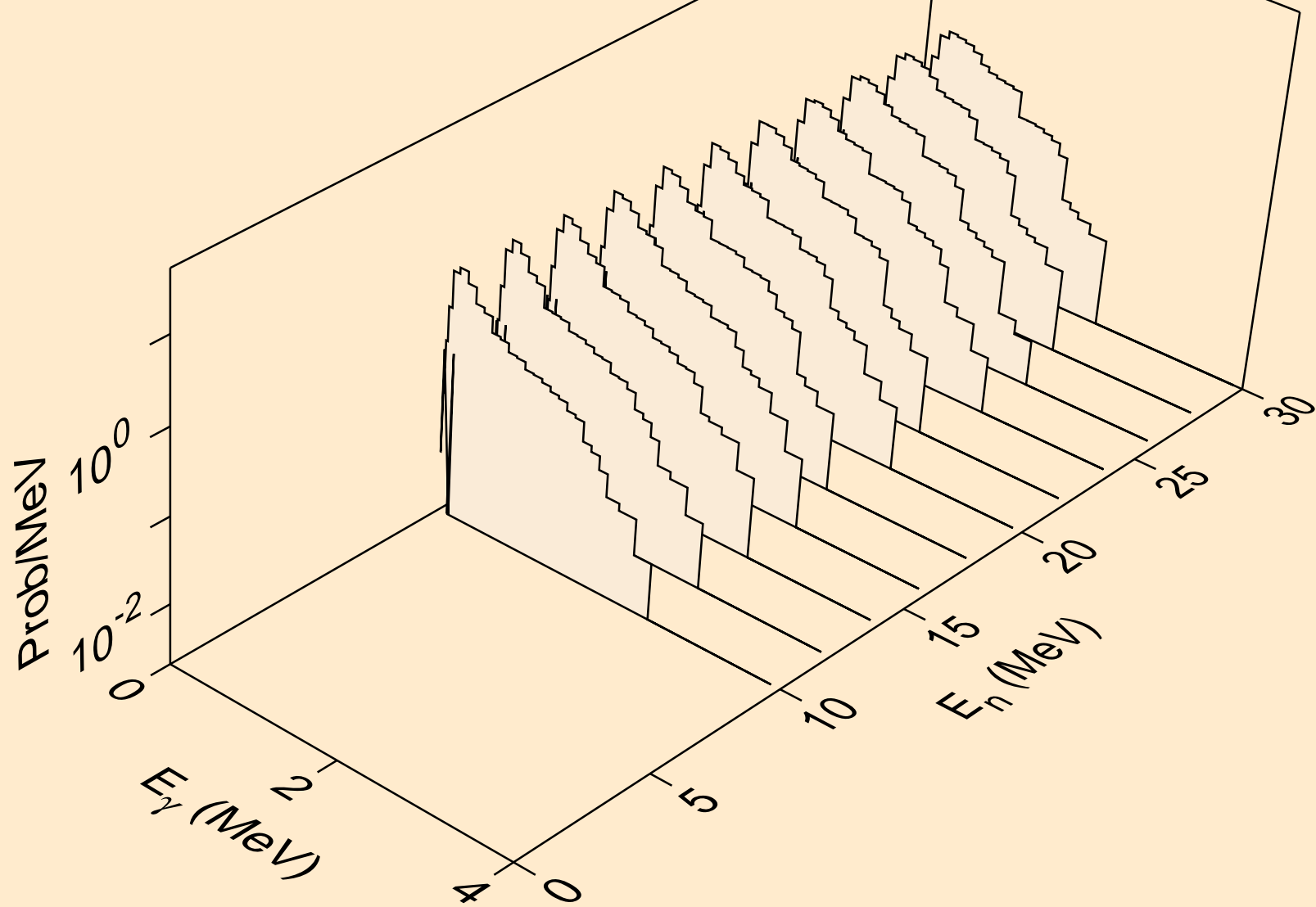

AM232 HELION ACER TENDL-2021 LIBRARY; T=0.K
Photon emission for (n,d)

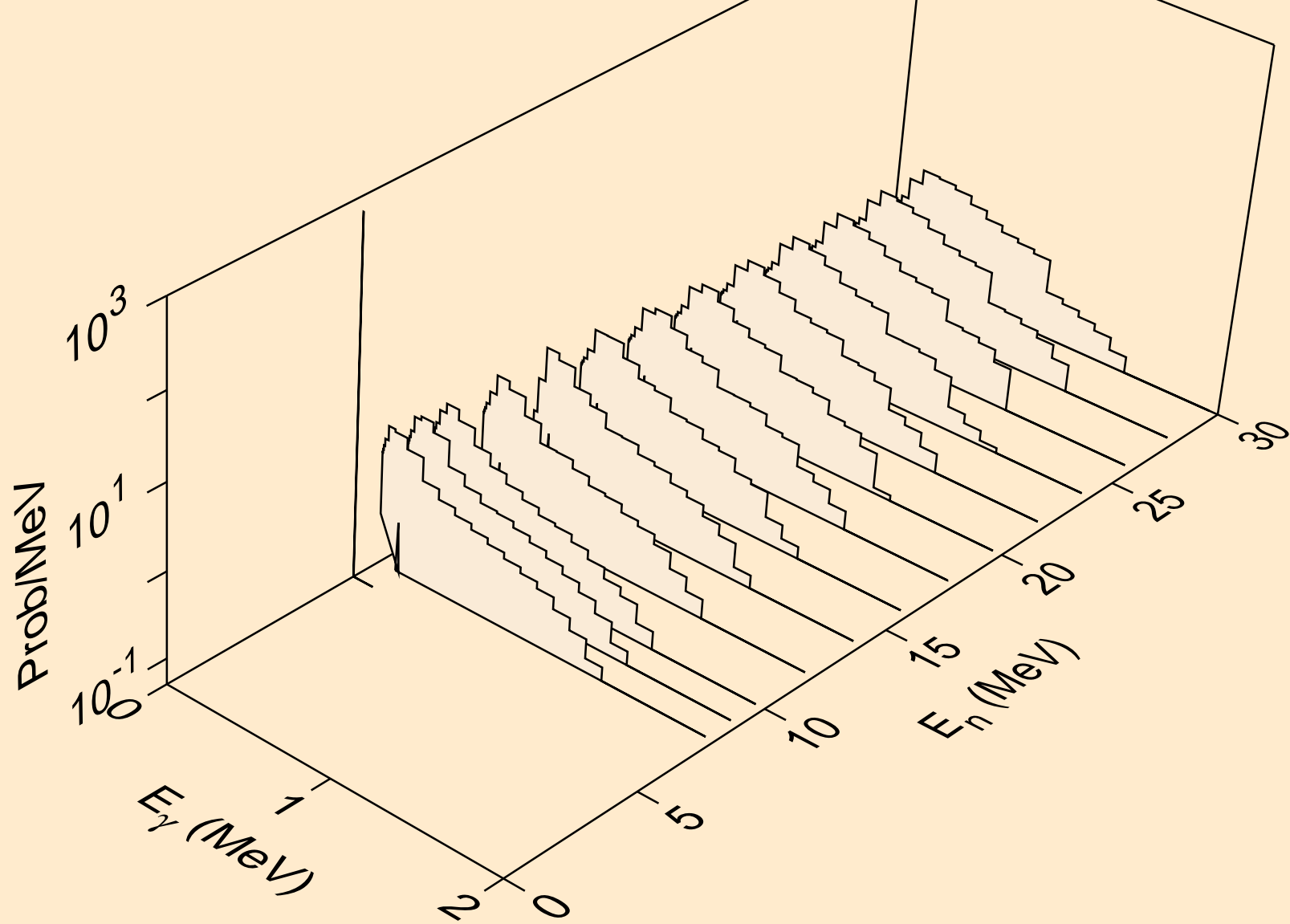

AM232 HELION ACER TENDL-2021 LIBRARY; T=0.K
Photon emission for (n,t)

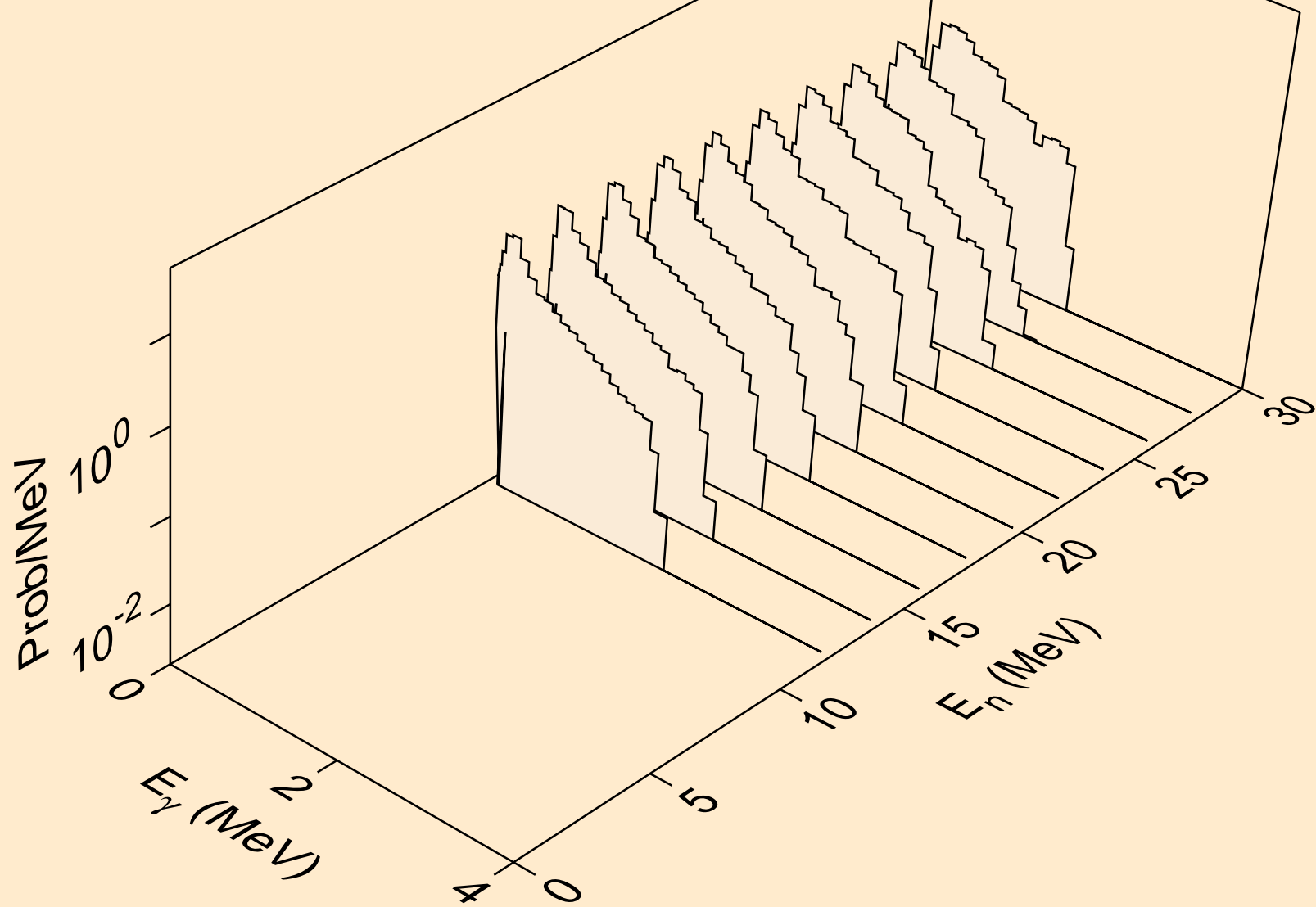

AM232 HELION ACER TENDL-2021 LIBRARY; T=0.K
Photon emission for inelastic

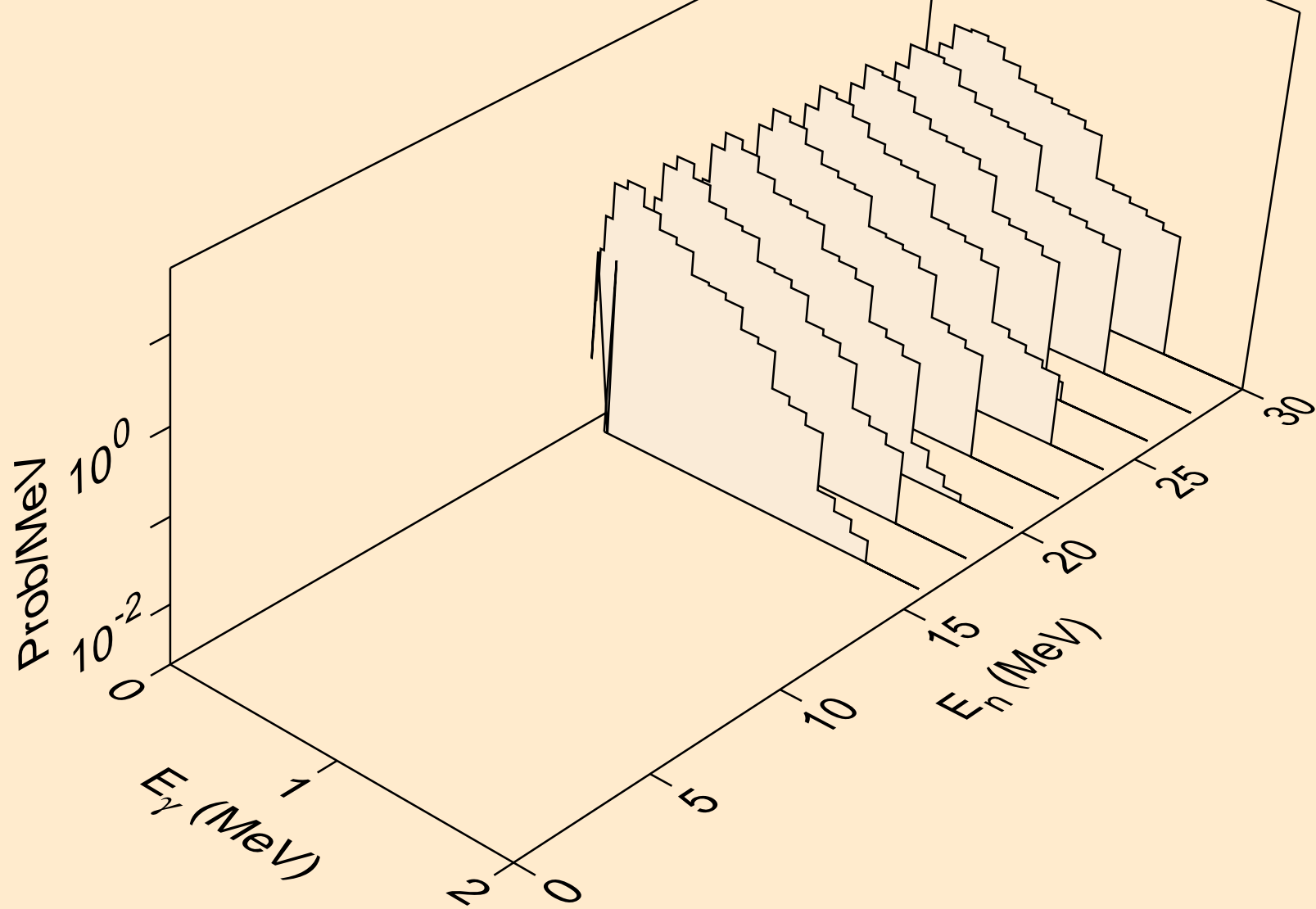

AM232 HELION ACER TENDL-2021 LIBRARY; T=0.K
Photon emission for (n,a)

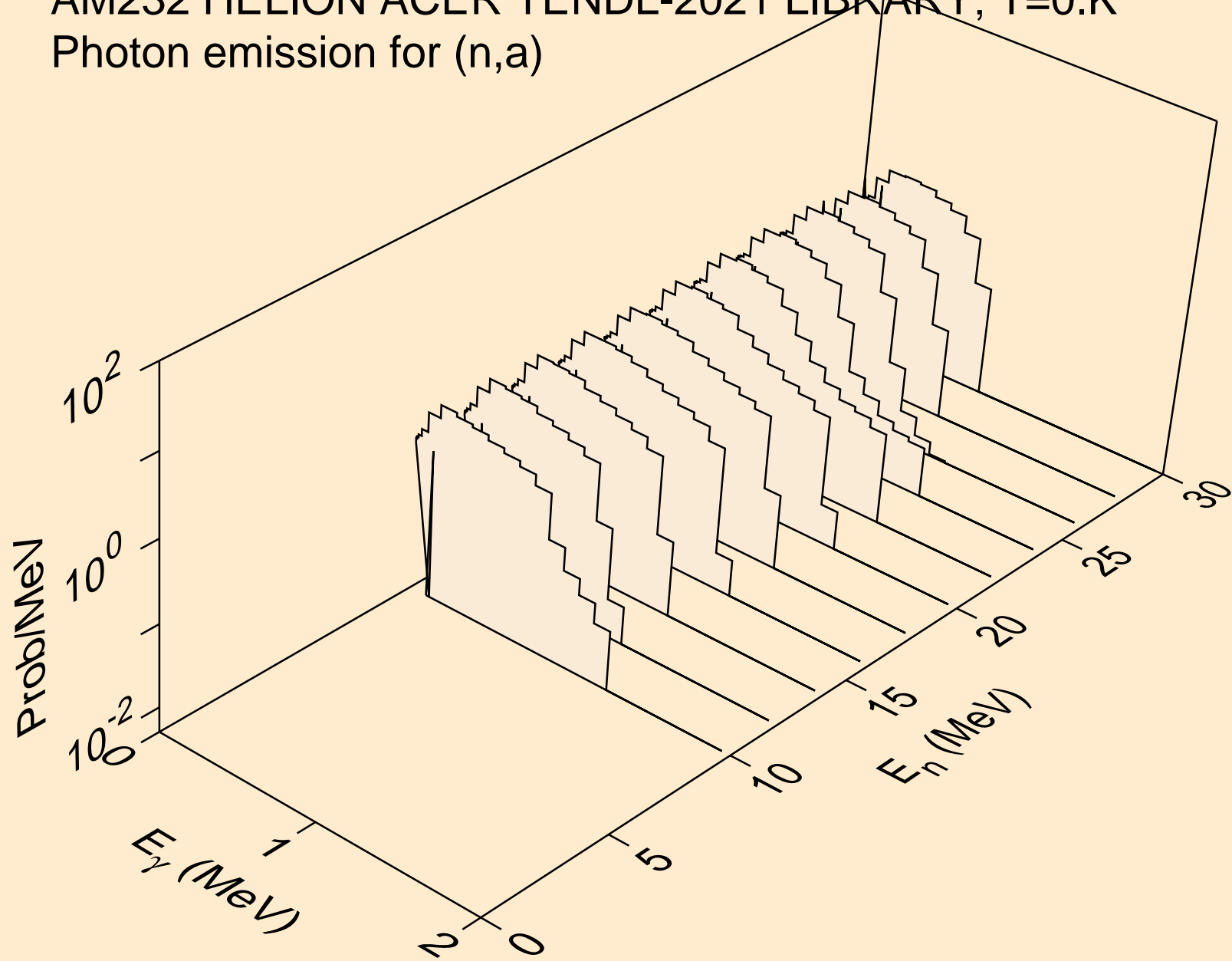

AM232 HELION ACER TENDL-2021 LIBRARY; T=0.K
Photon emission for (n,2p)

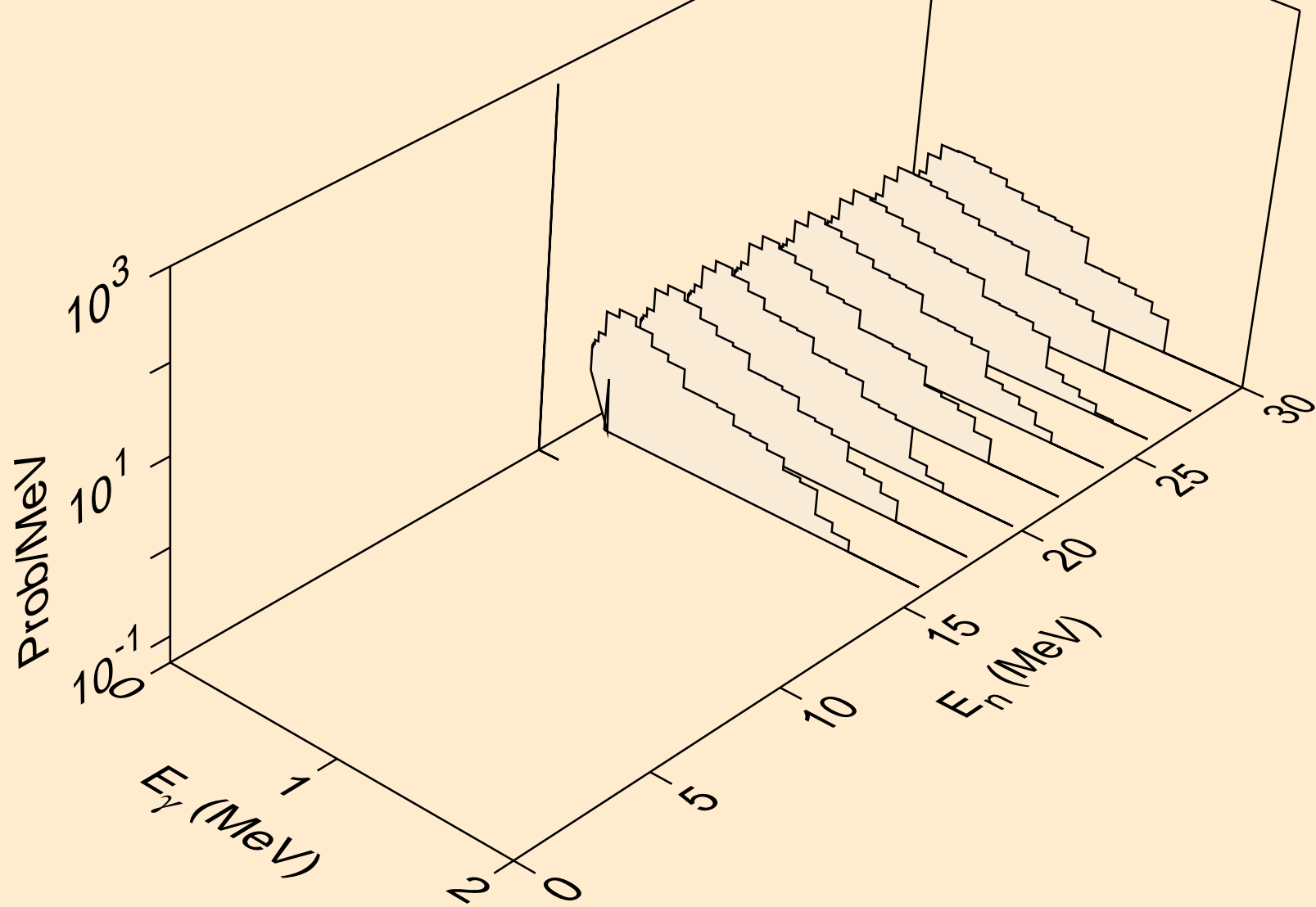

AM232 HELION ACER TENDL-2021 LIBRARY; T=0.K
Photon emission for (n,pd)

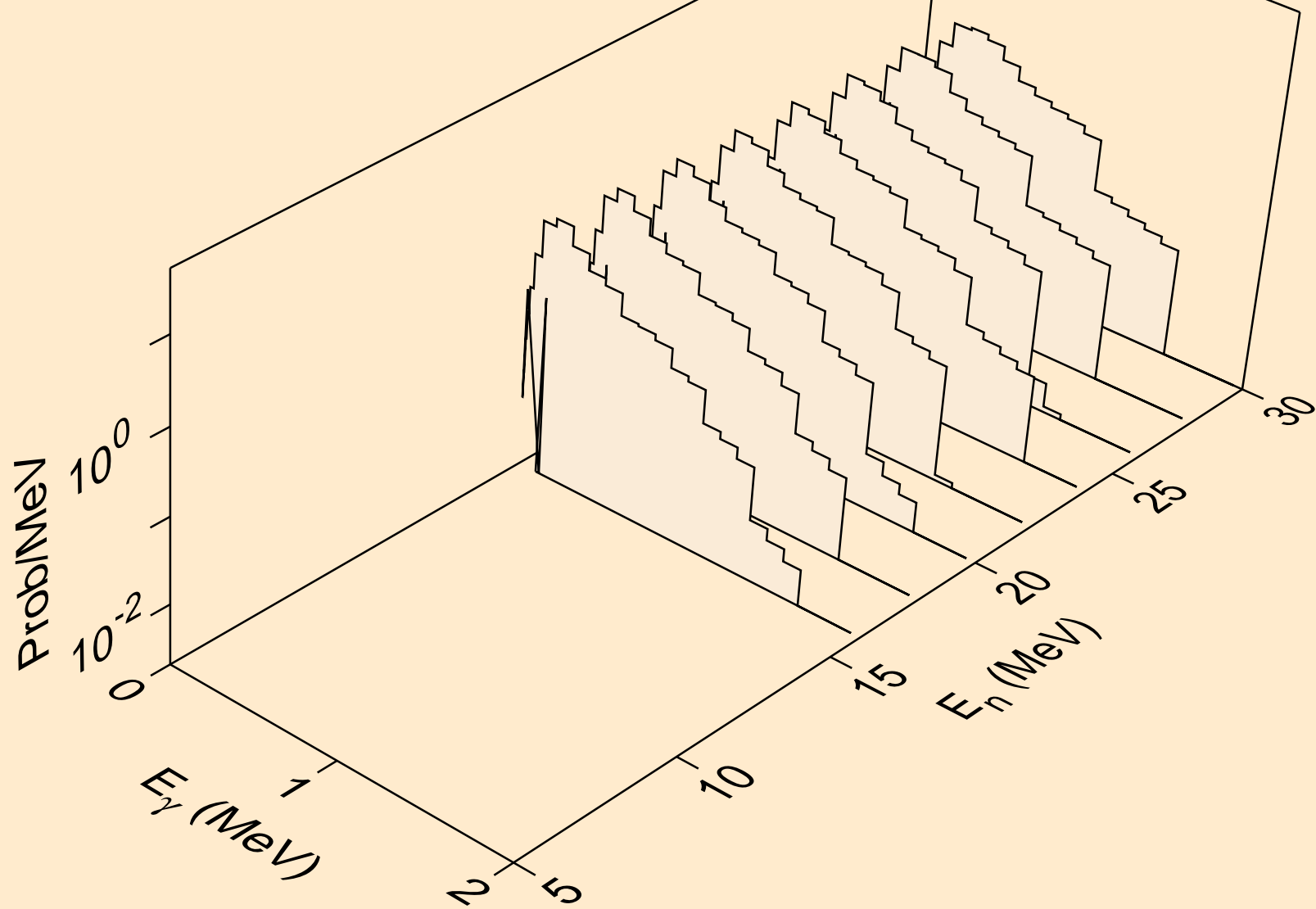

AM232 HELION ACER TENDL-2021 LIBRARY; T=0.K
Particle heating contributions

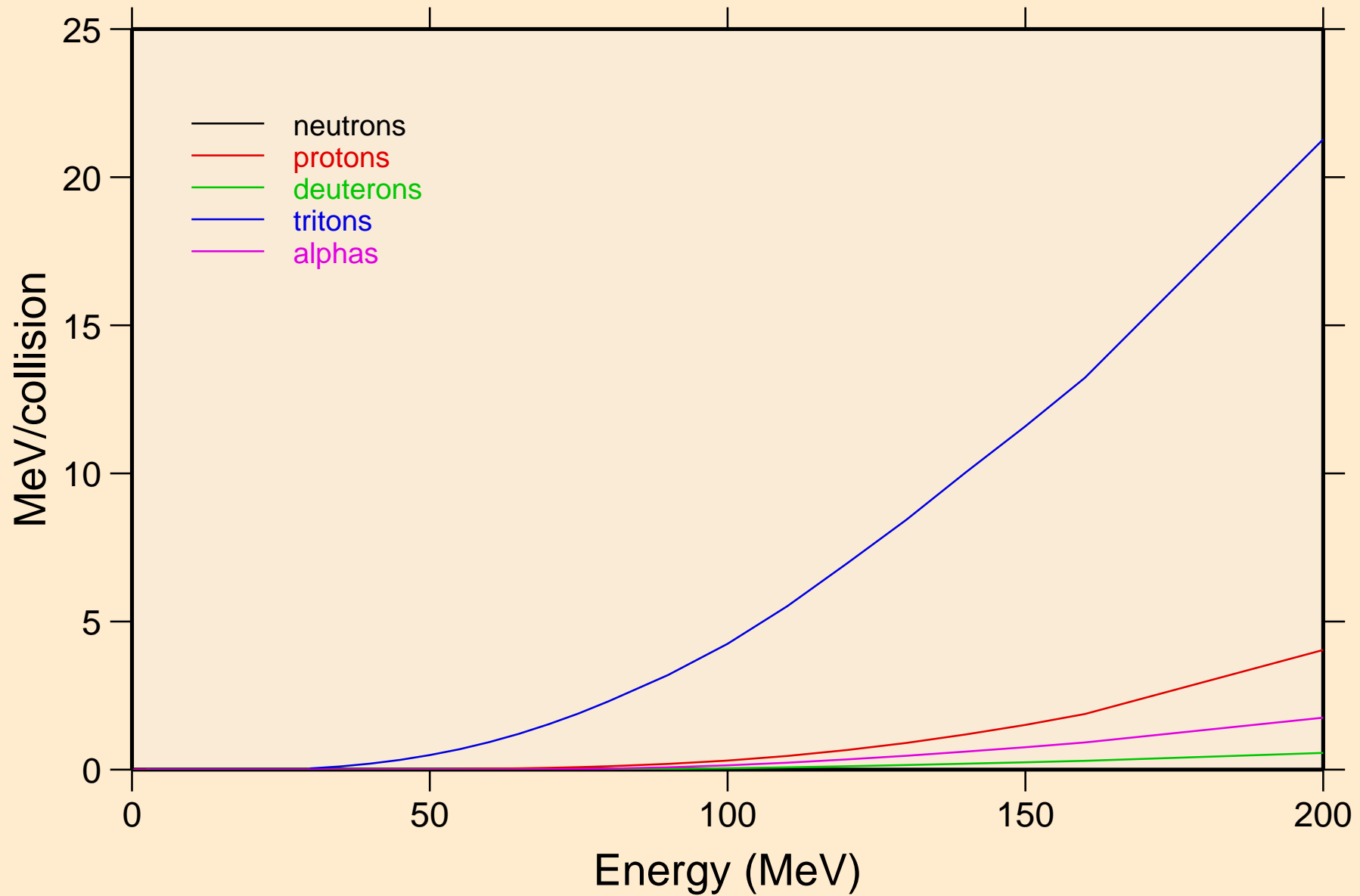

AM232 HELION ACER TENDL-2021 LIBRARY; T=0.K
Recoil Heating

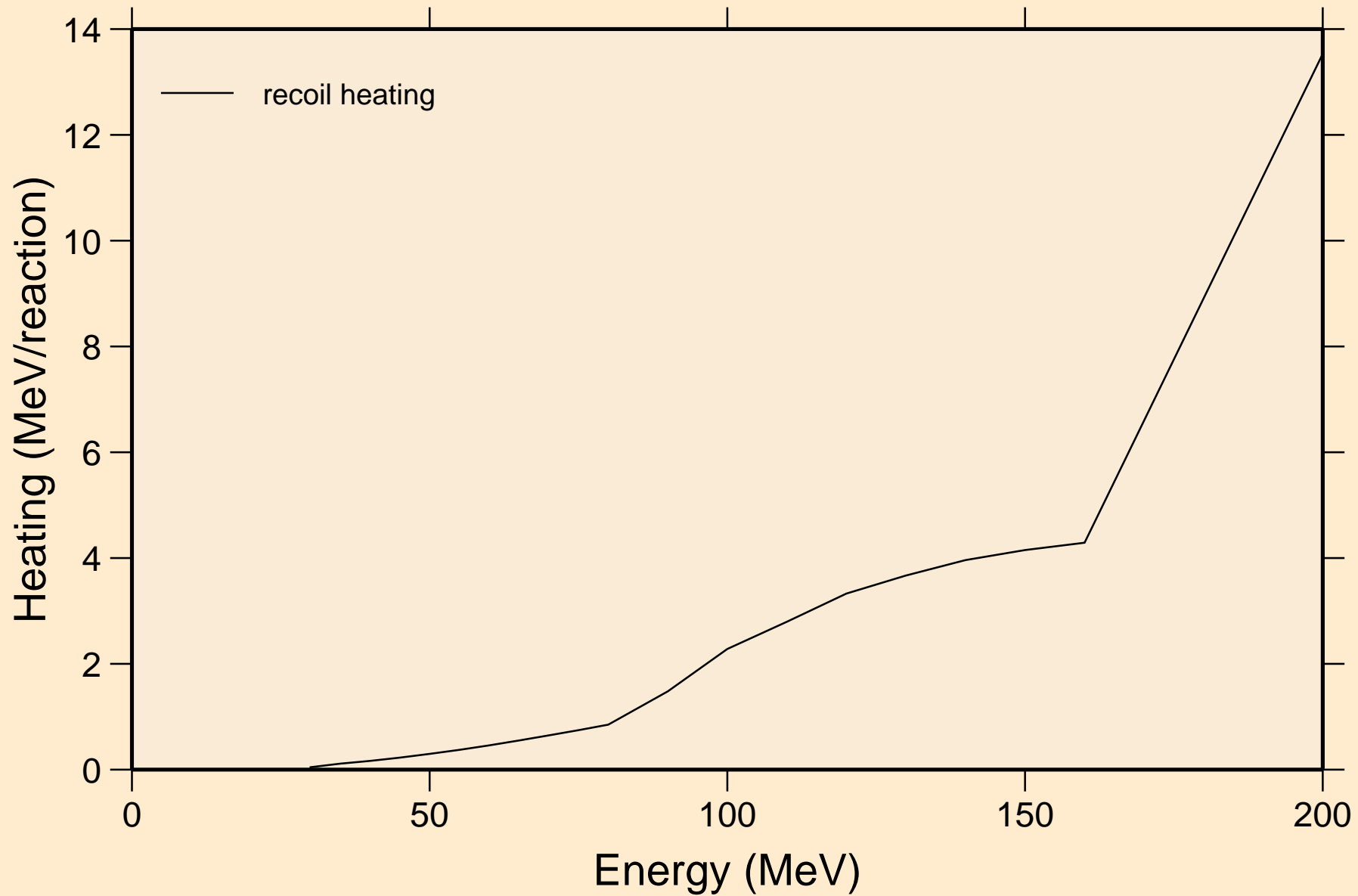

AM232 HELION ACER TENDL-2021 LIBRARY; T=0.K
Particle production cross sections

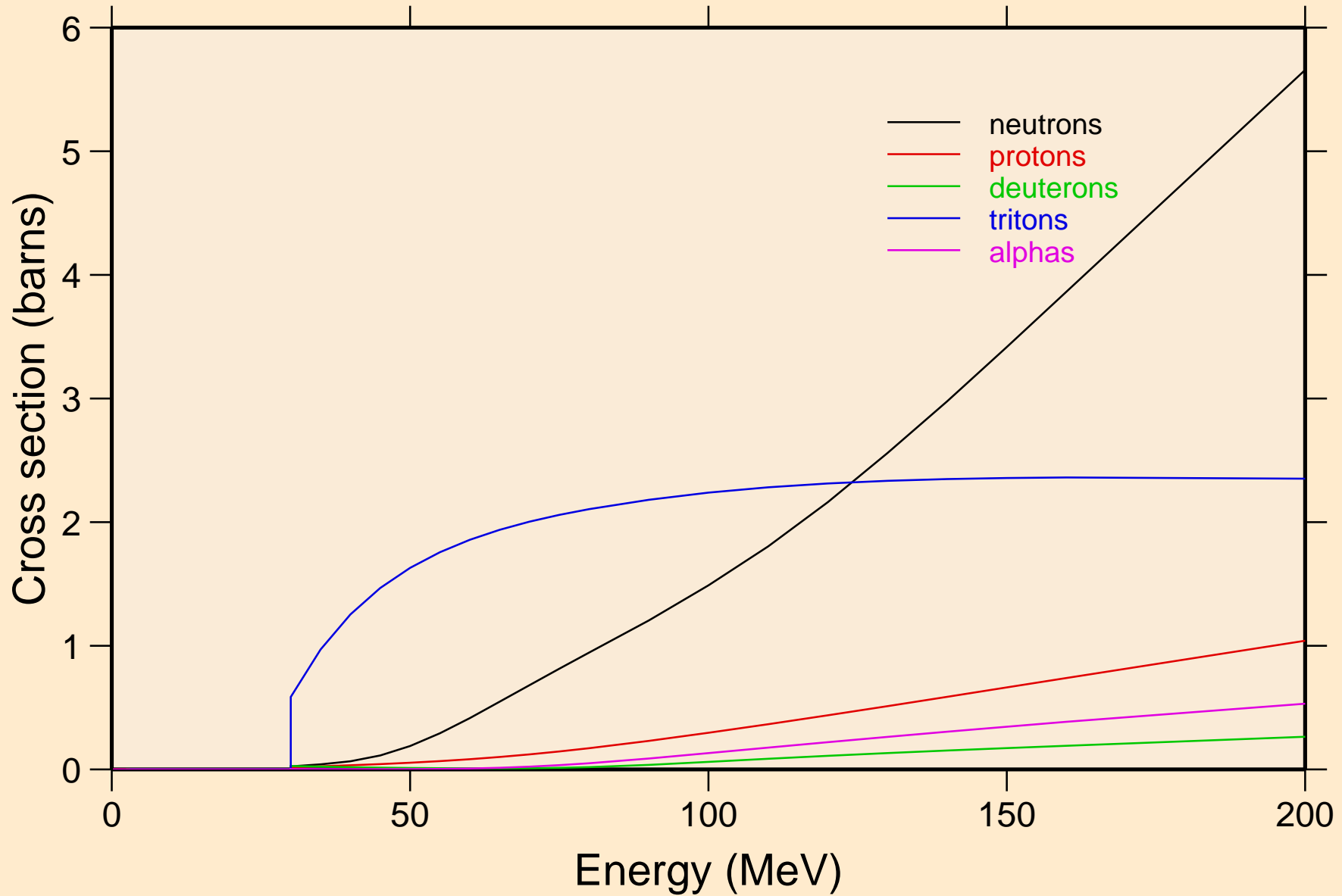

AM232 HELION ACER TENDL-2021 LIBRARY; T=0.K
neutrons from (s,n)

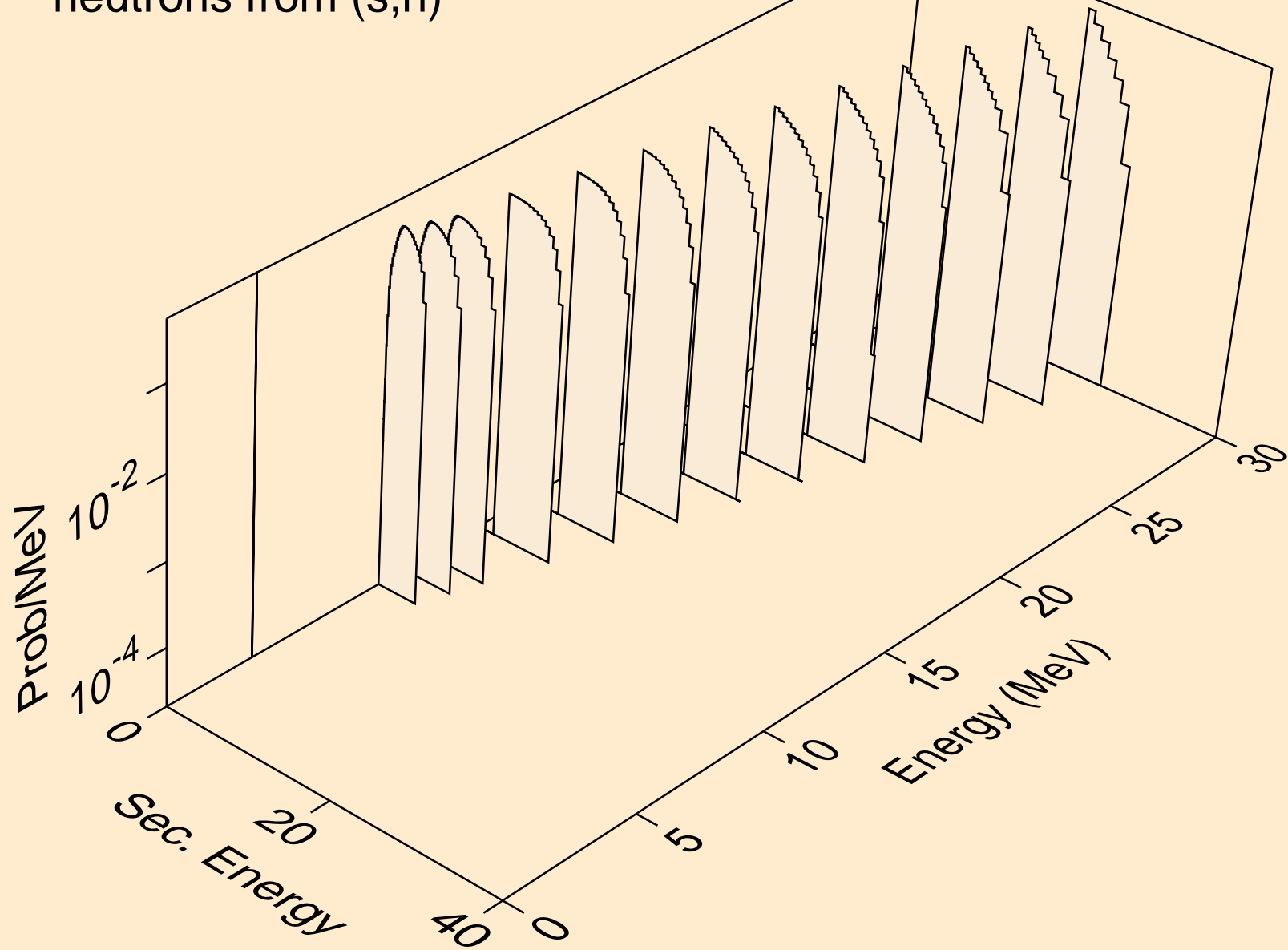

AM232 HELION ACER TENDL-2021 LIBRARY; T=0.K
neutrons from (s,x)

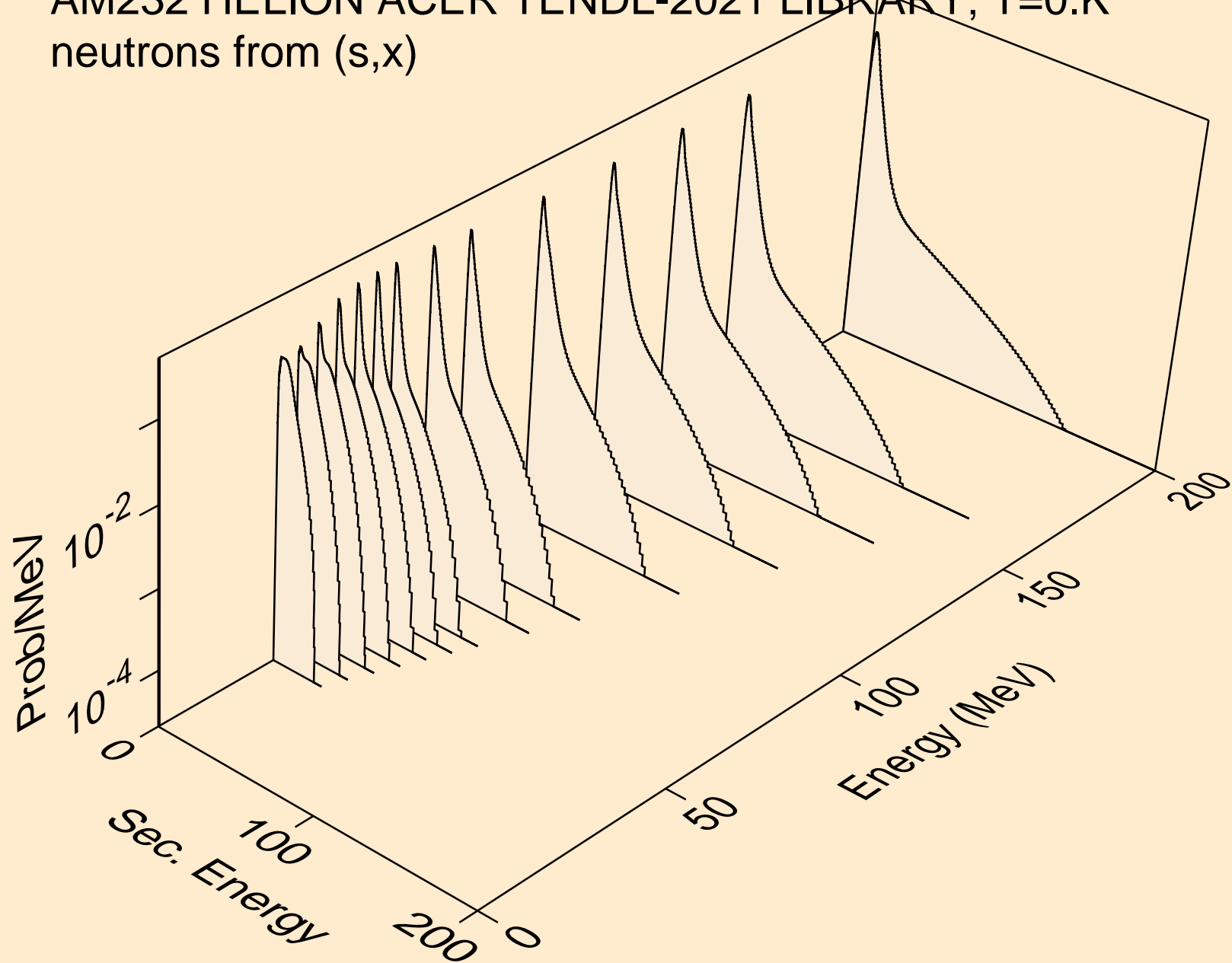

AM232 HELION ACER TENDL-2021 LIBRARY; T=0.K
neutrons from (s,n*)p

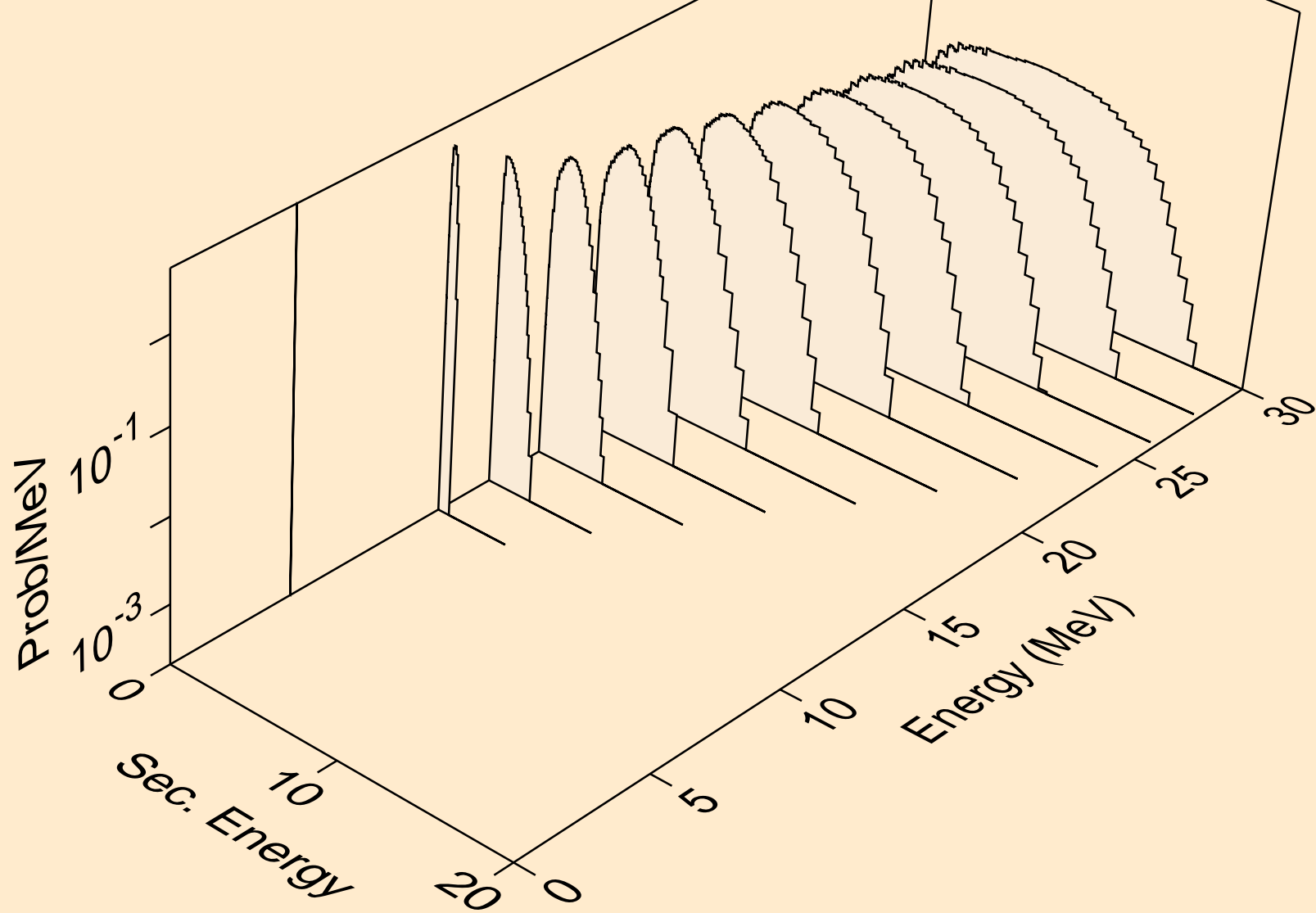

AM232 HELION ACER TENDL-2021 LIBRARY; T=0.K
neutrons from (s,n*)d

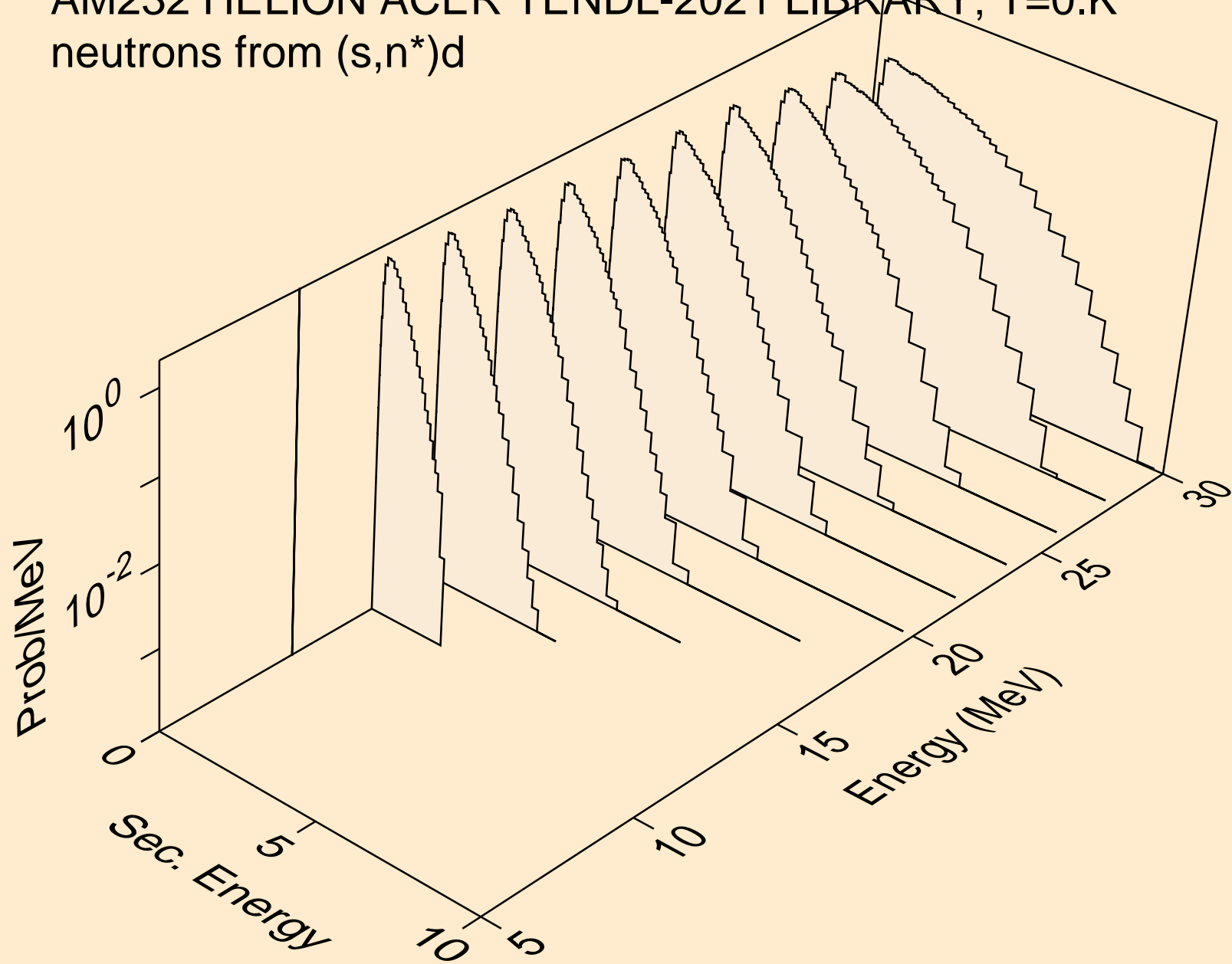

AM232 HELION ACER TENDL-2021 LIBRARY; T=0.K
neutrons from (s,n*)t

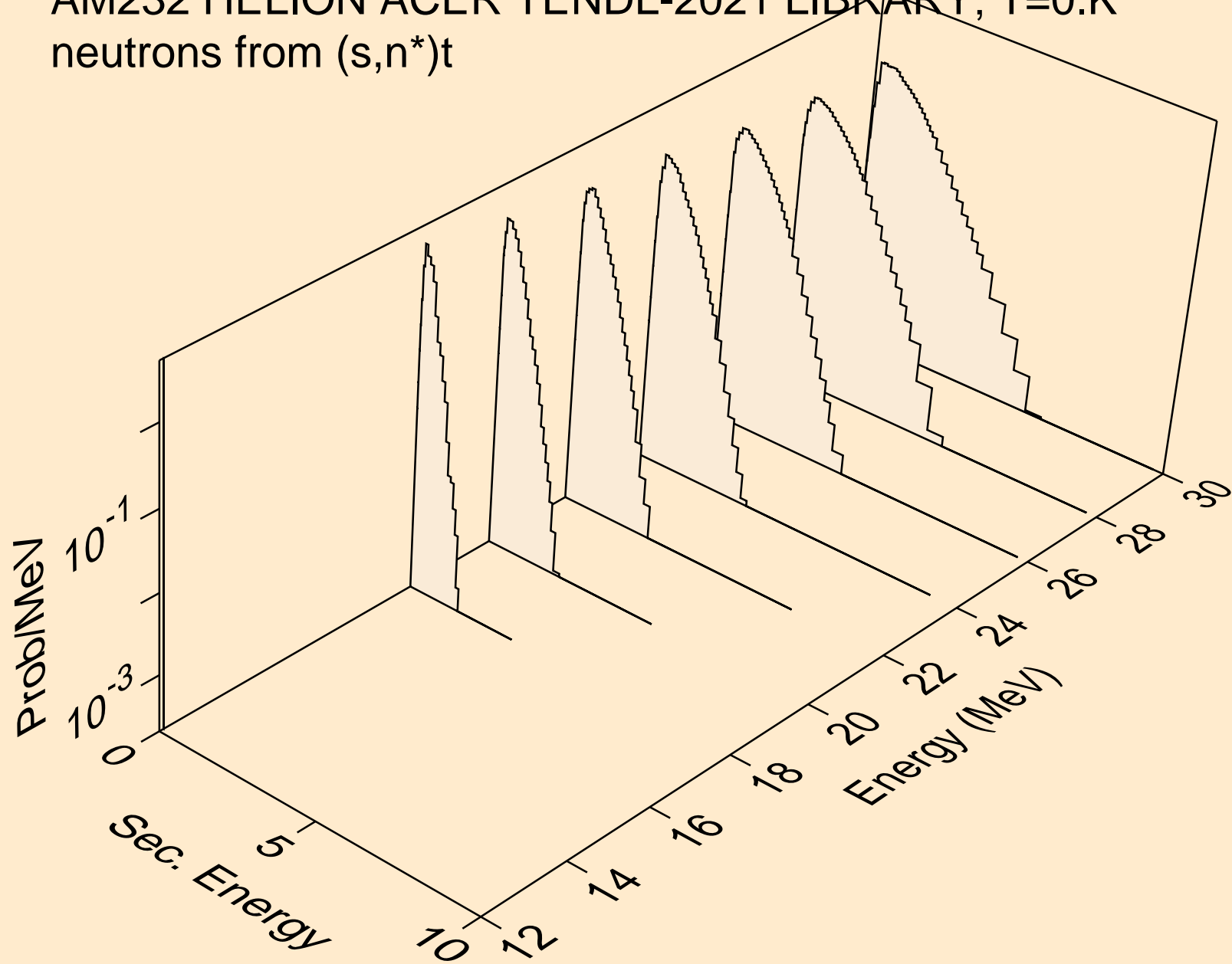

AM232 HELION ACER TENDL-2021 LIBRARY; T=0.K
neutrons from (s,2np)

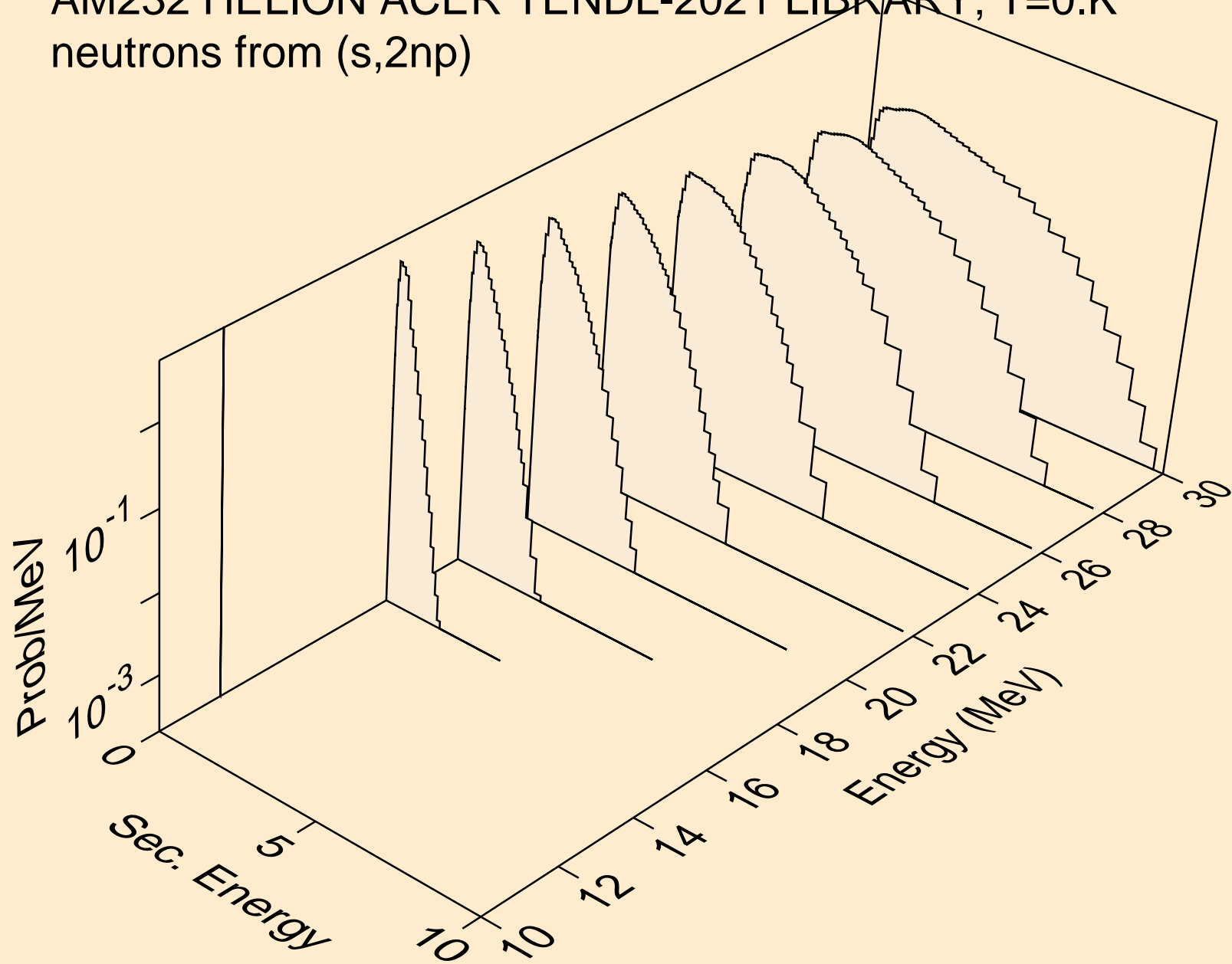

AM232 HELION ACER TENDL-2021 LIBRARY; T=0.K
protons from (s,x)

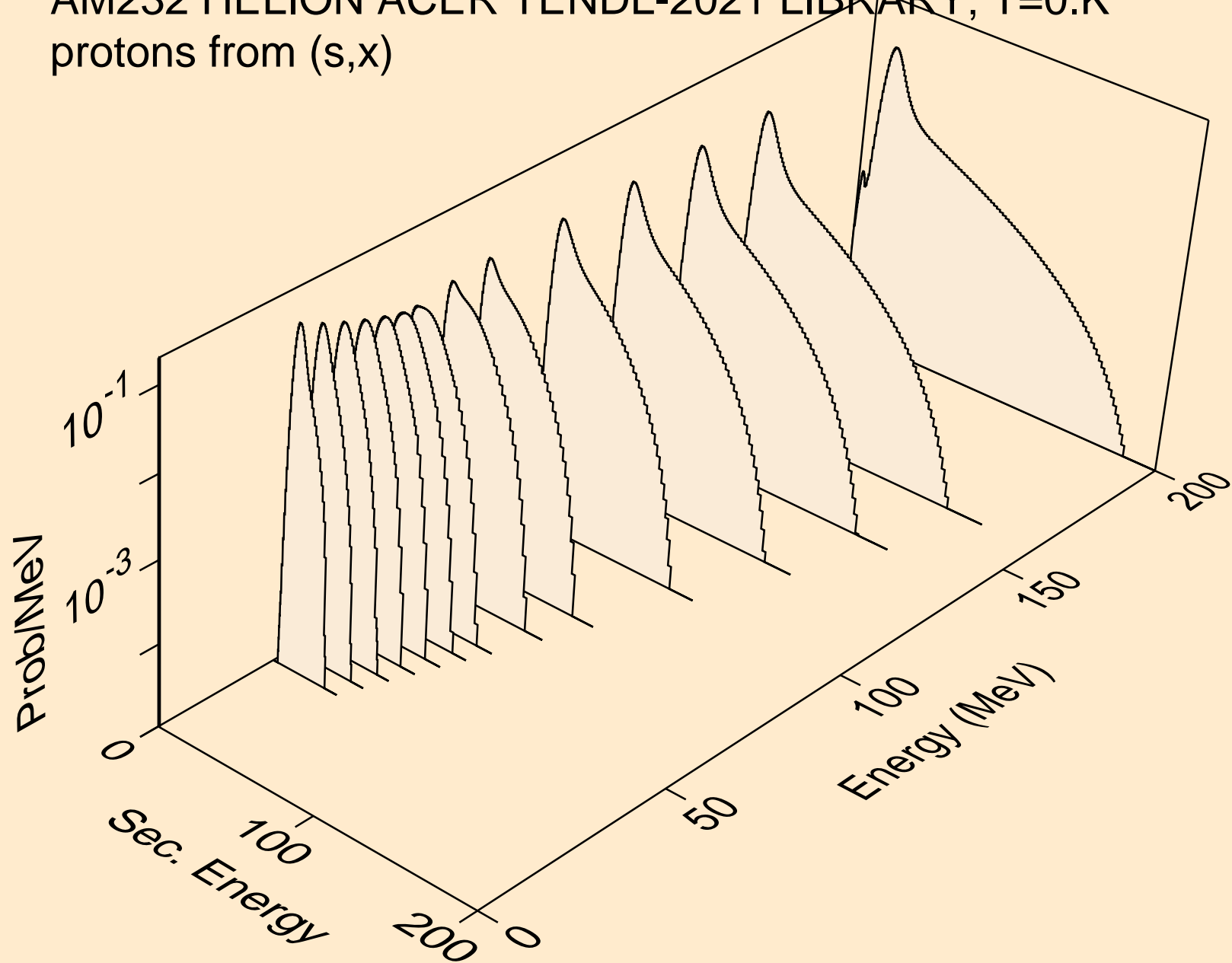

AM232 HELION ACER TENDL-2021 LIBRARY; T=0.K
protons from (s,n*)p

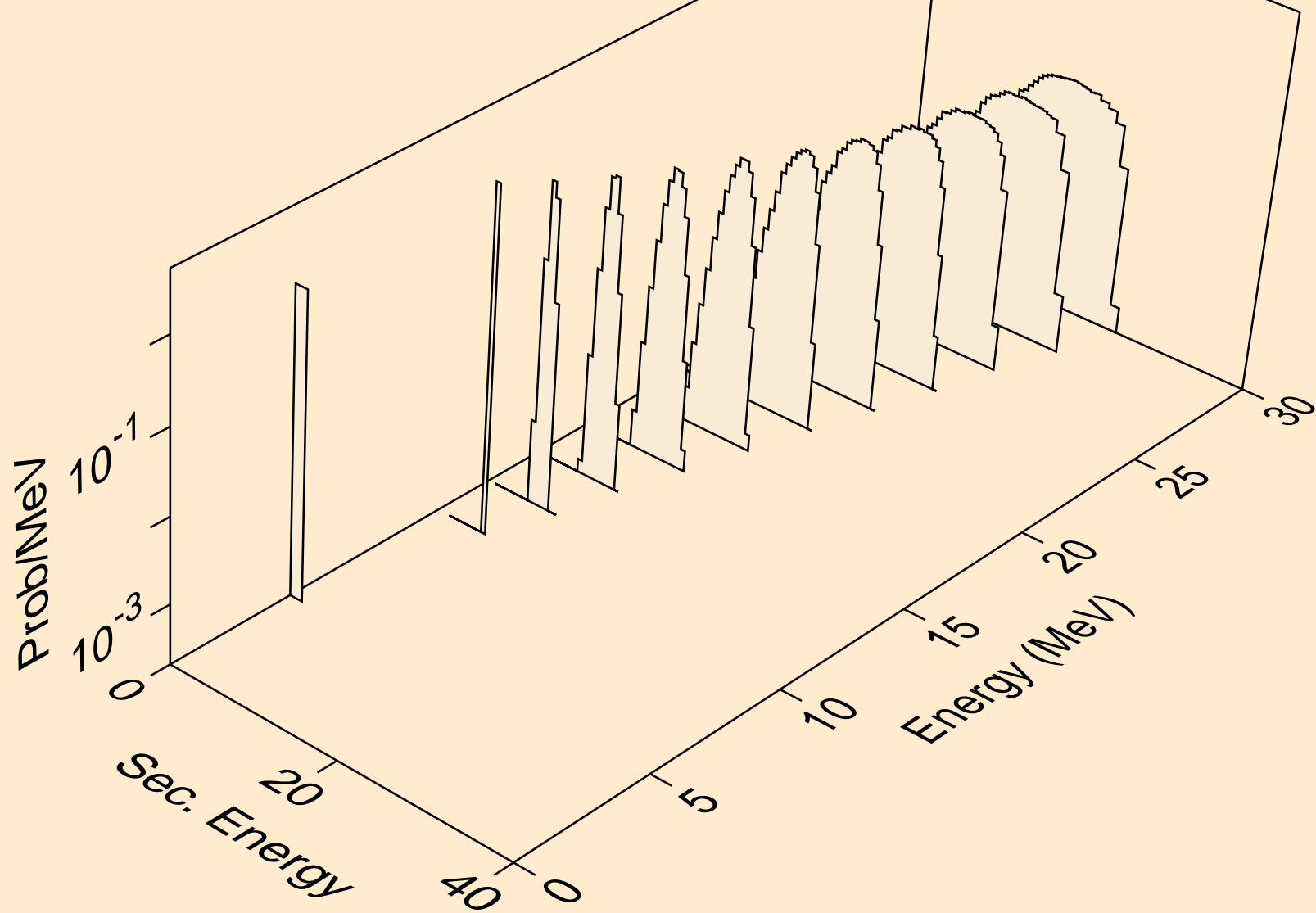

AM232 HELION ACER TENDL-2021 LIBRARY; T=0.K
protons from (s,2np)

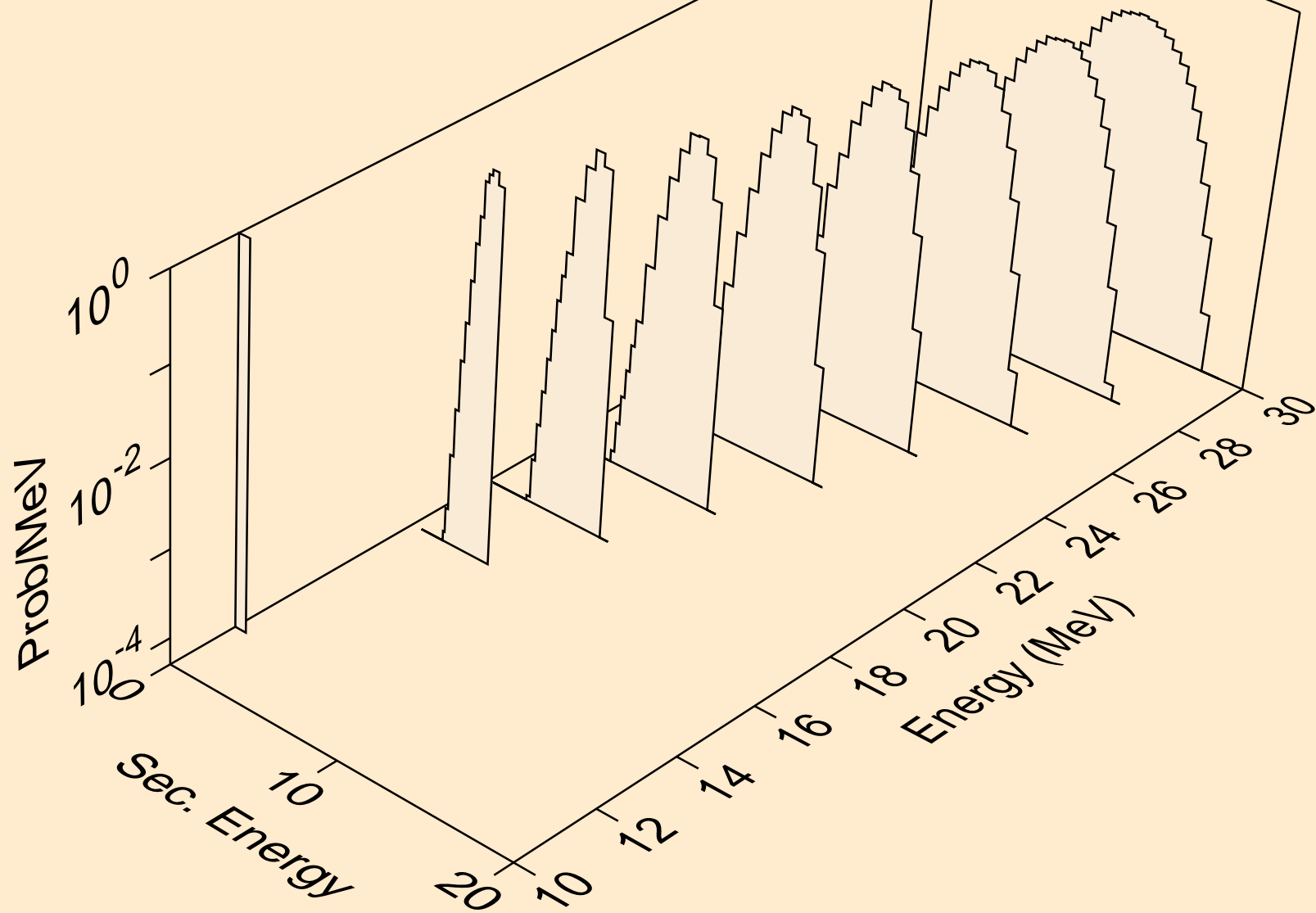

AM232 HELION ACER TENDL-2021 LIBRARY; T=0.K
protons from (s,p)

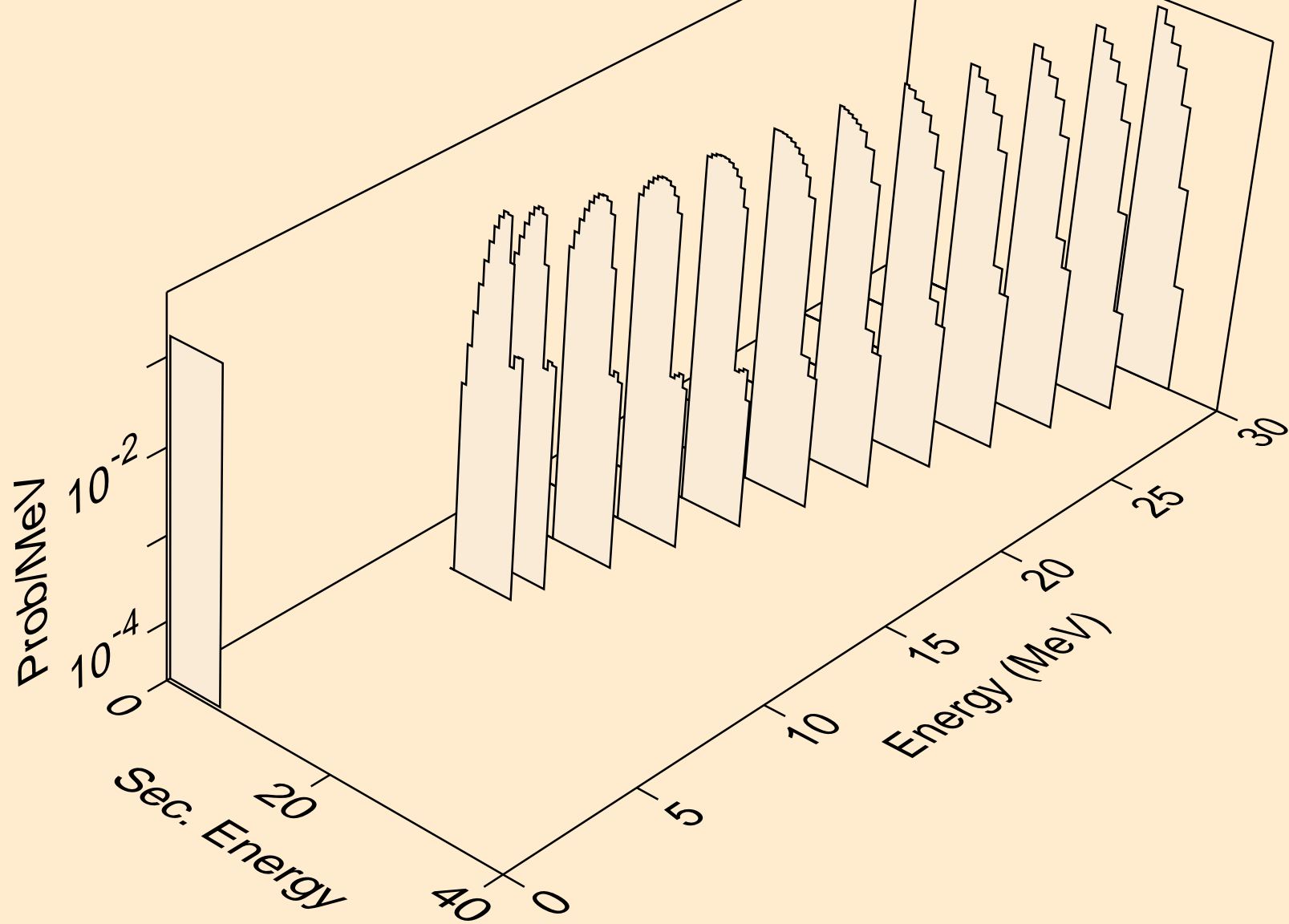

AM232 HELION ACER TENDL-2021 LIBRARY; T=0.K
protons from (s,2p)

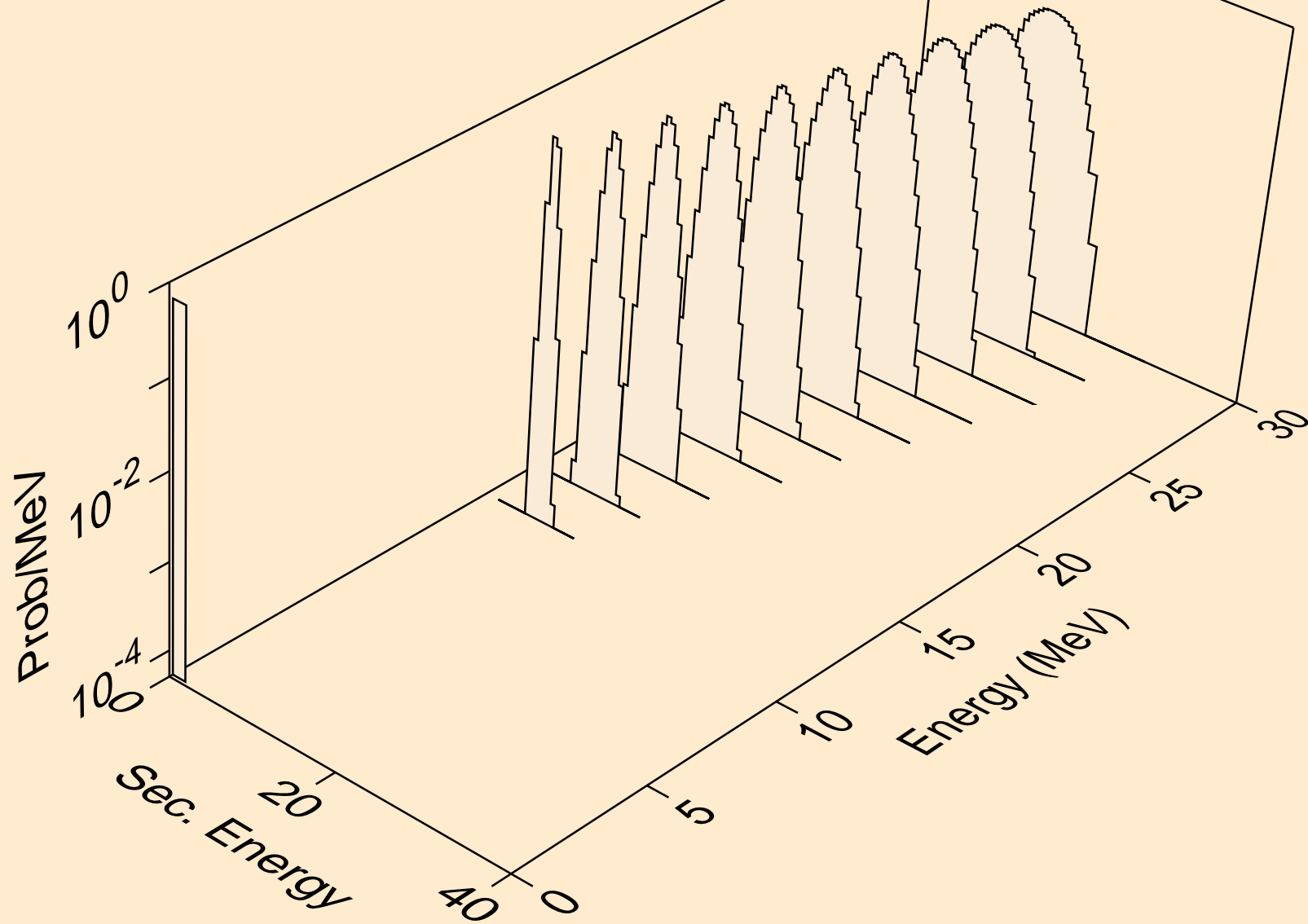

AM232 HELION ACER TENDL-2021 LIBRARY; T=0.K
protons from (s,pd)

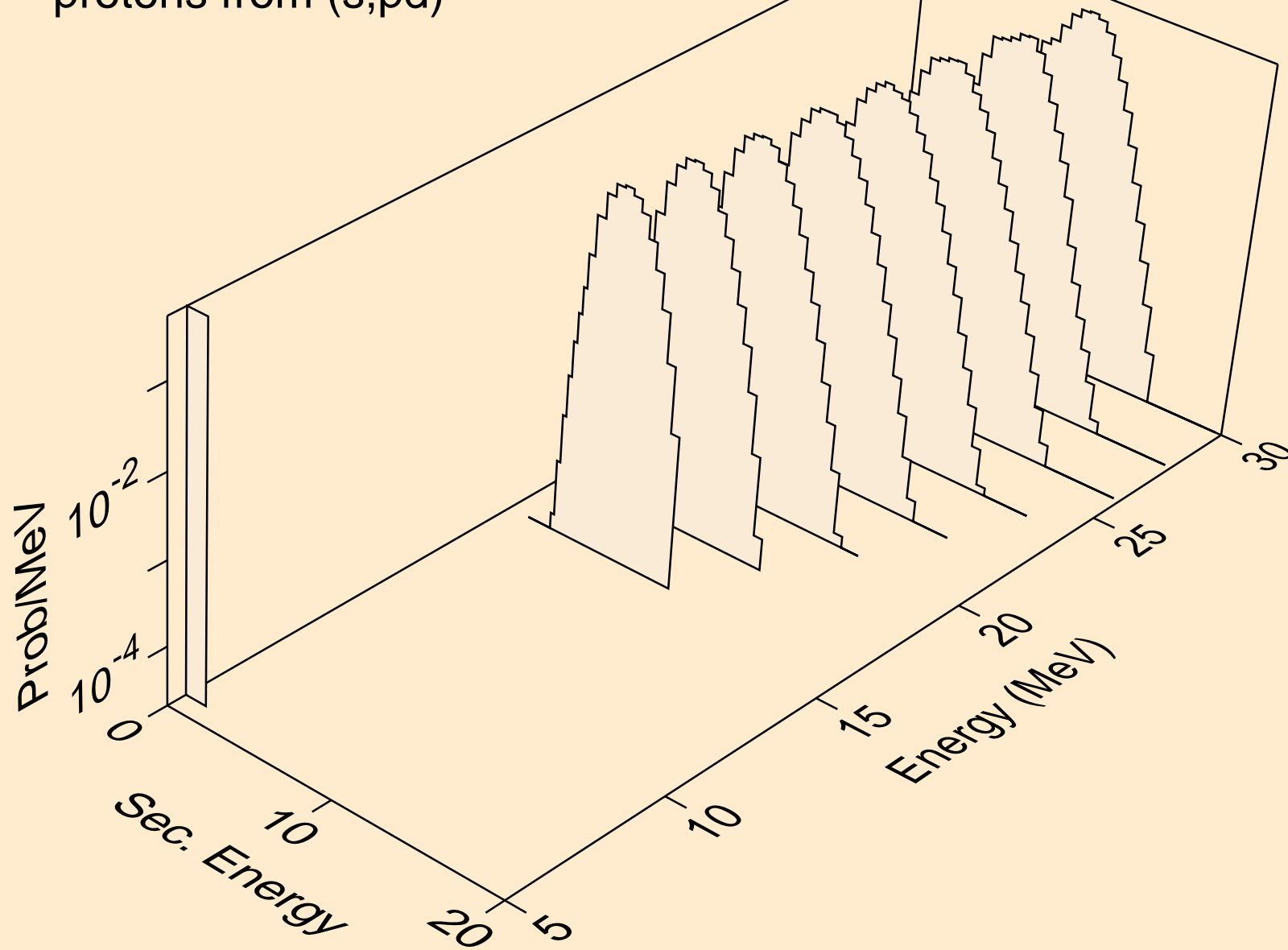

AM232 HELION ACER TENDL-2021 LIBRARY; T=0.K
deuterons from (s,x)

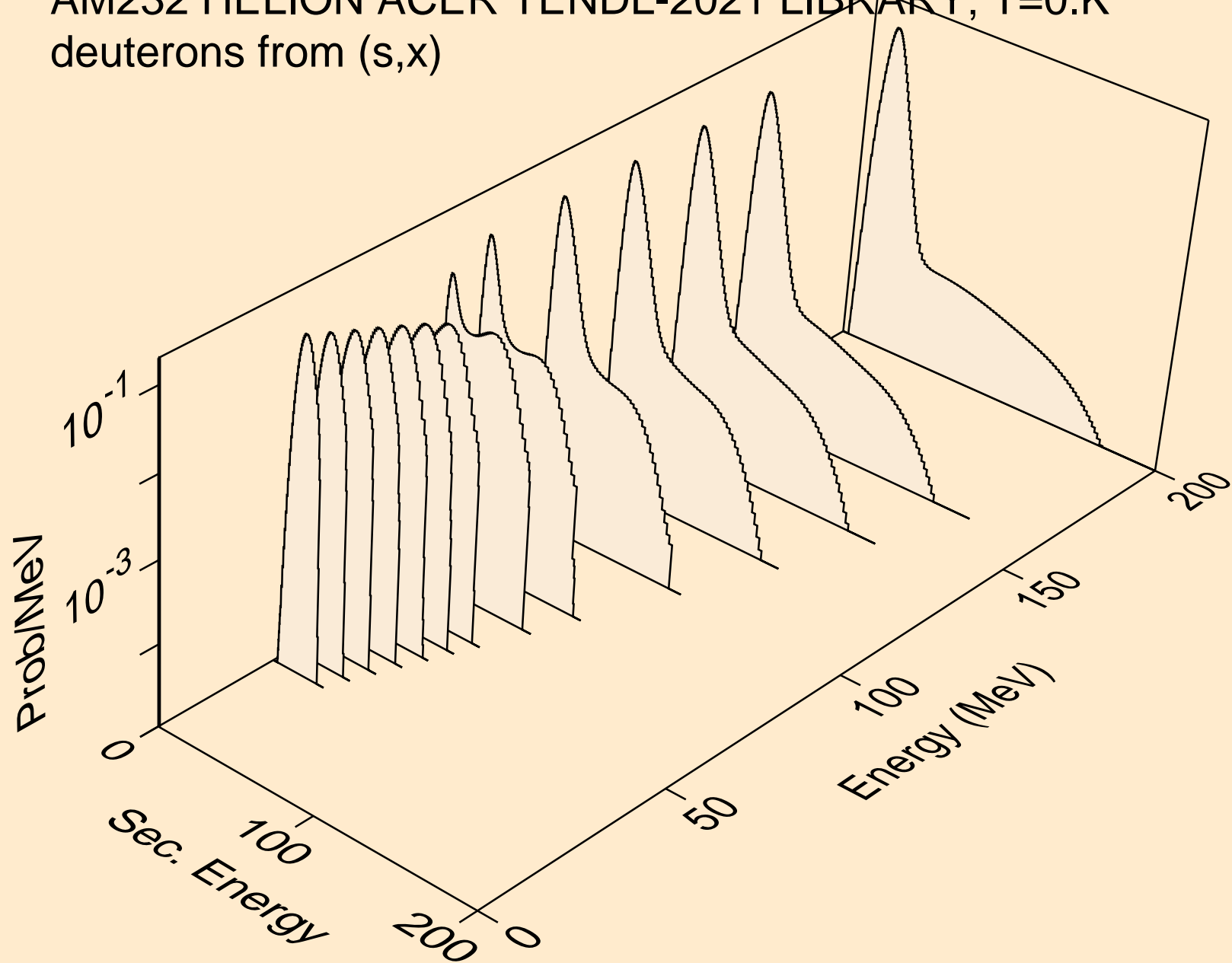

AM232 HELION ACER TENDL-2021 LIBRARY; T=0.K
deuterons from (s,n*)d

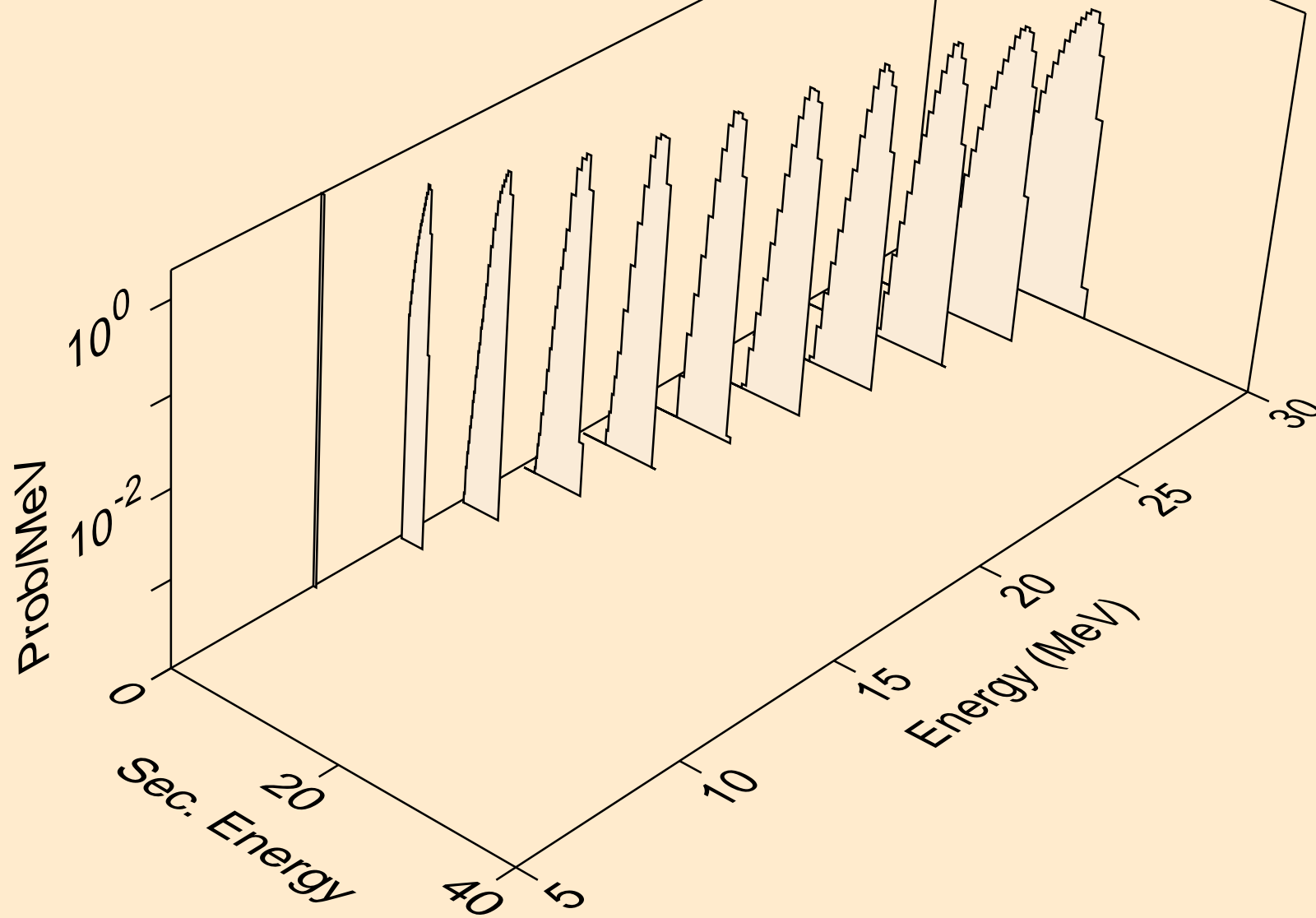

AM232 HELION ACER TENDL-2021 LIBRARY; T=0.K
deuterons from (s,d)

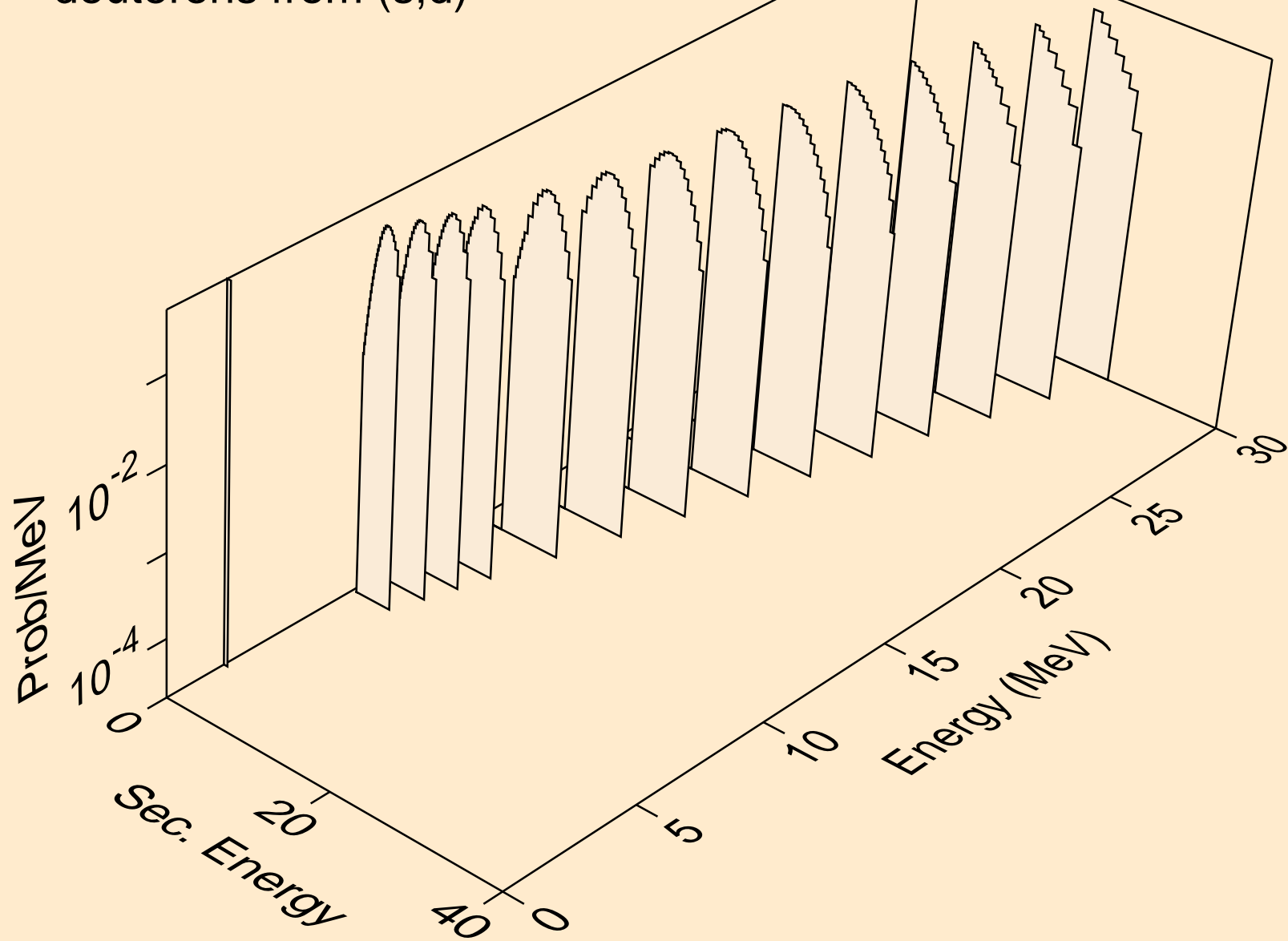

AM232 HELION ACER TENDL-2021 LIBRARY; T=0.K
deuterons from (s,pd)

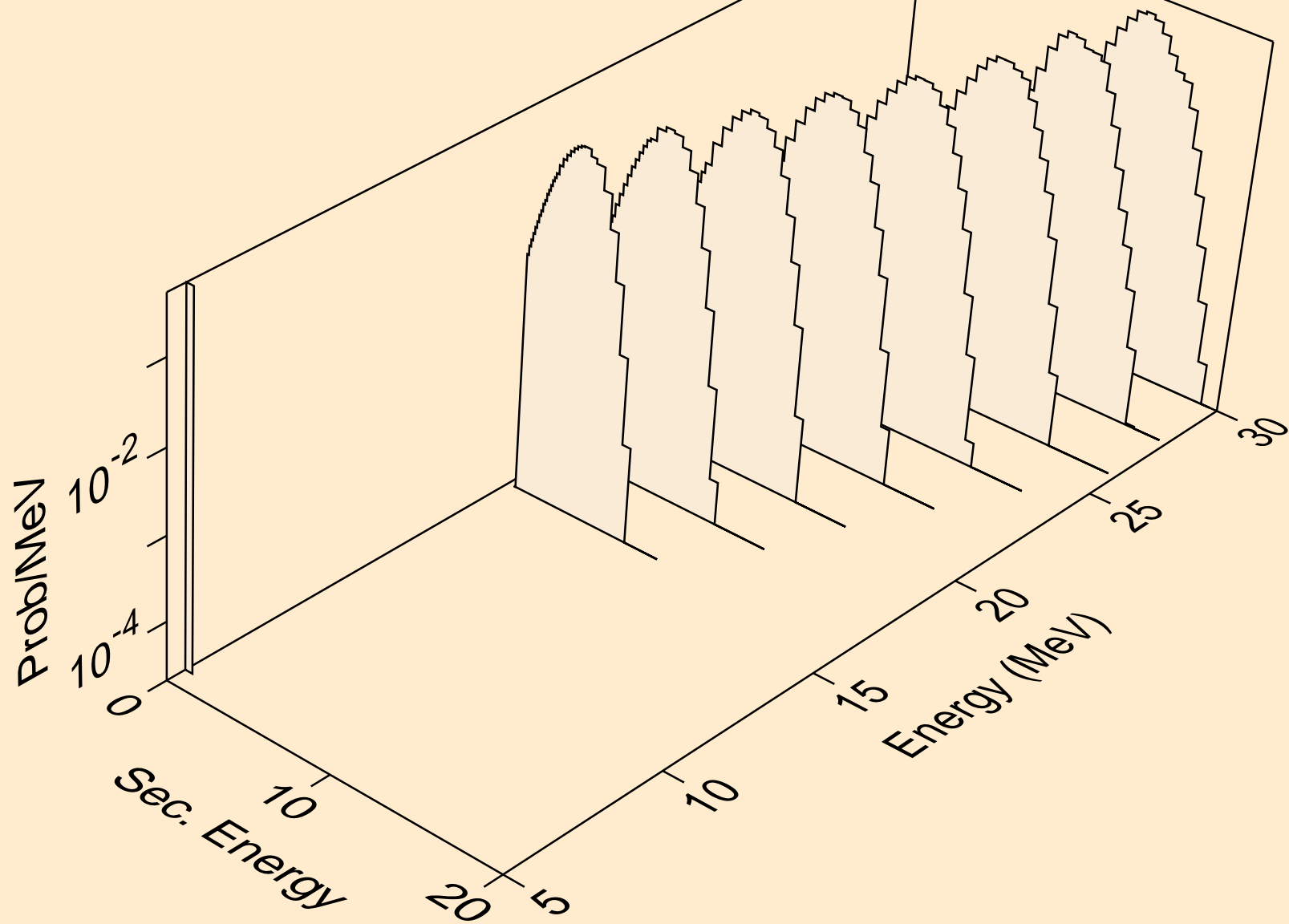

AM232 HELION ACER TENDL-2021 LIBRARY; T=0.K
tritons from (s,x)

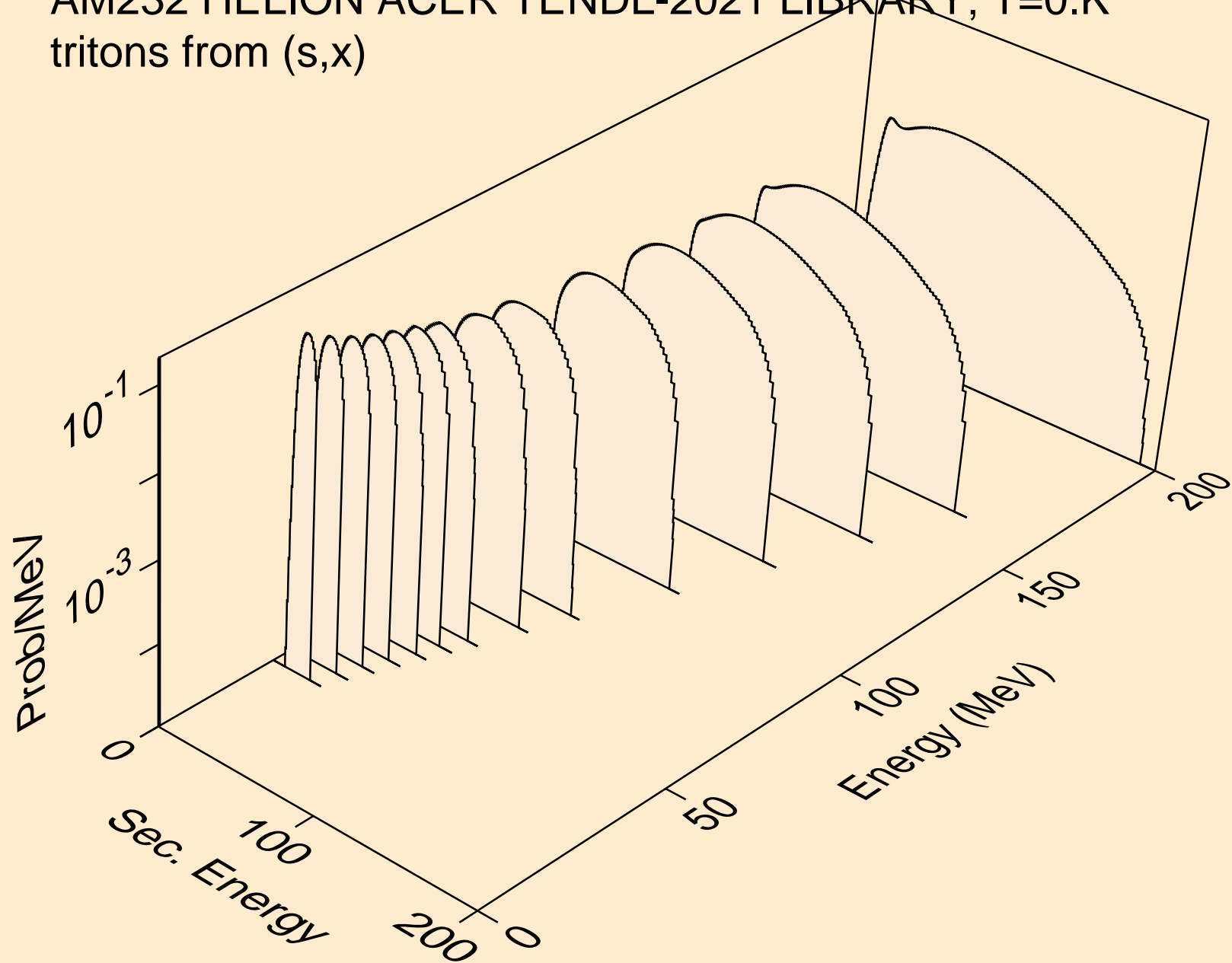

AM232 HELION ACER TENDL-2021 LIBRARY; T=0.K
tritons from (s,n*)t

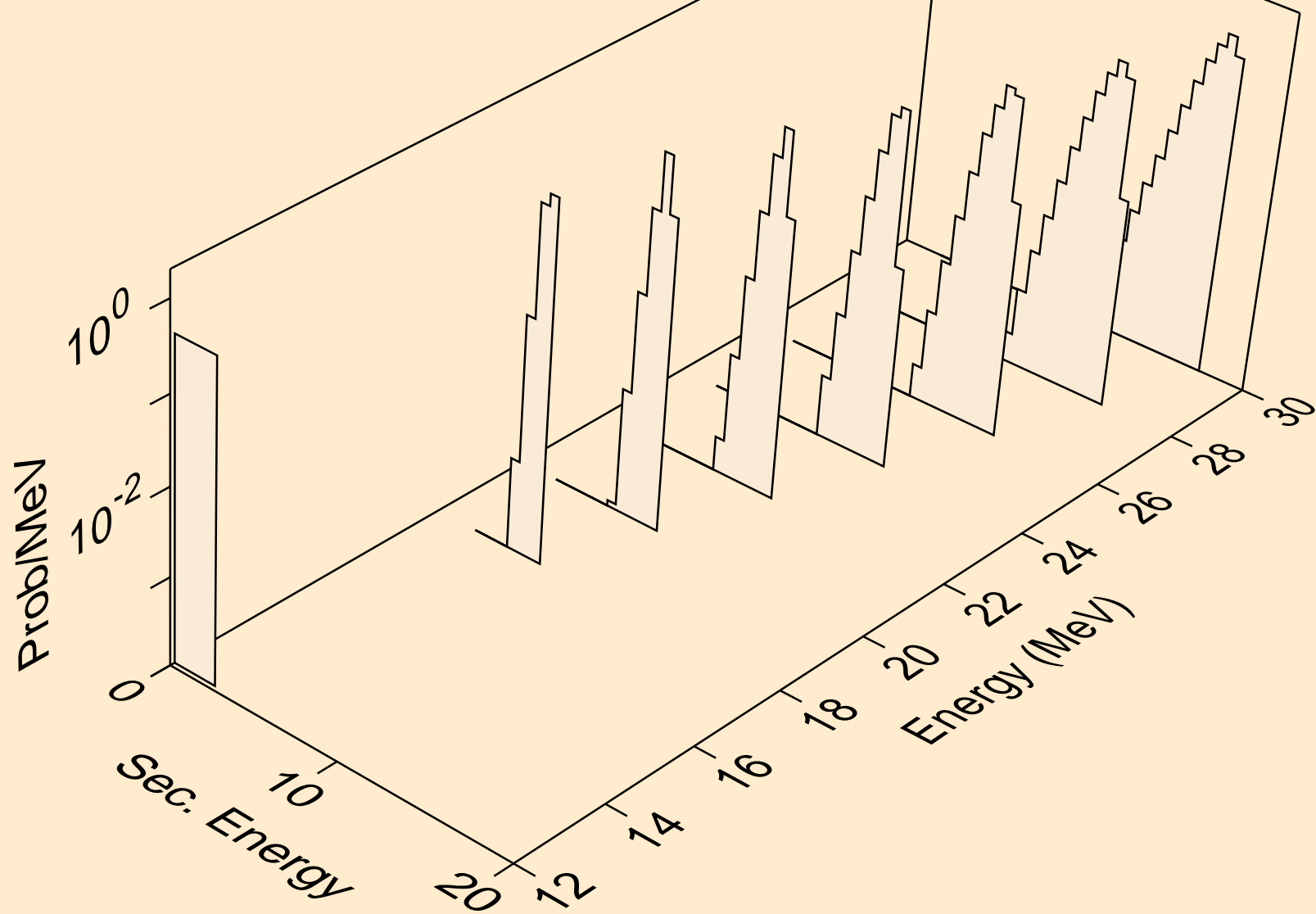

AM232 HELION ACER TENDL-2021 LIBRARY; T=0.K
tritons from (s,t)

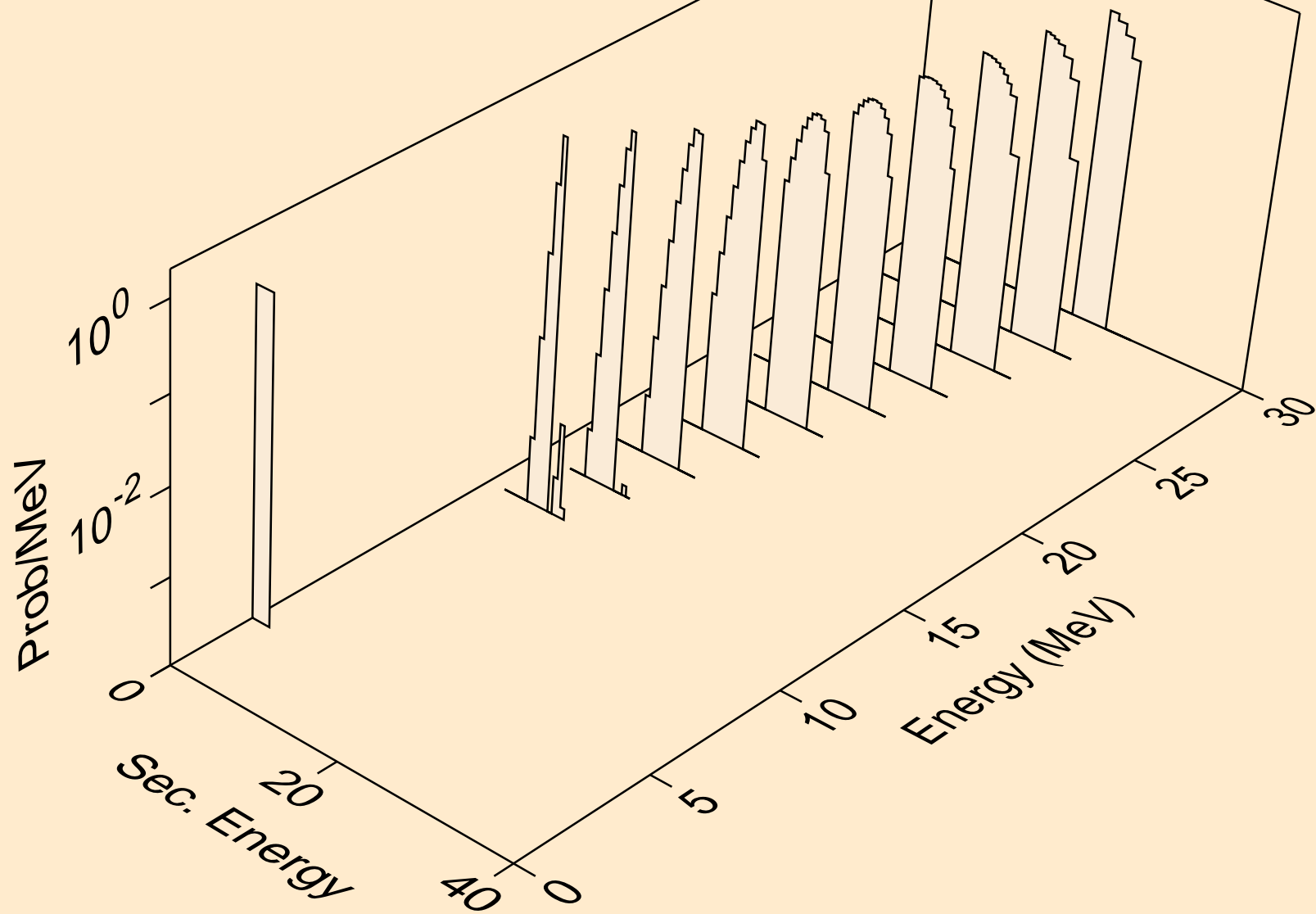

AM232 HELION ACER TENDL-2021 LIBRARY; T=0.K
alphas from (s,x)

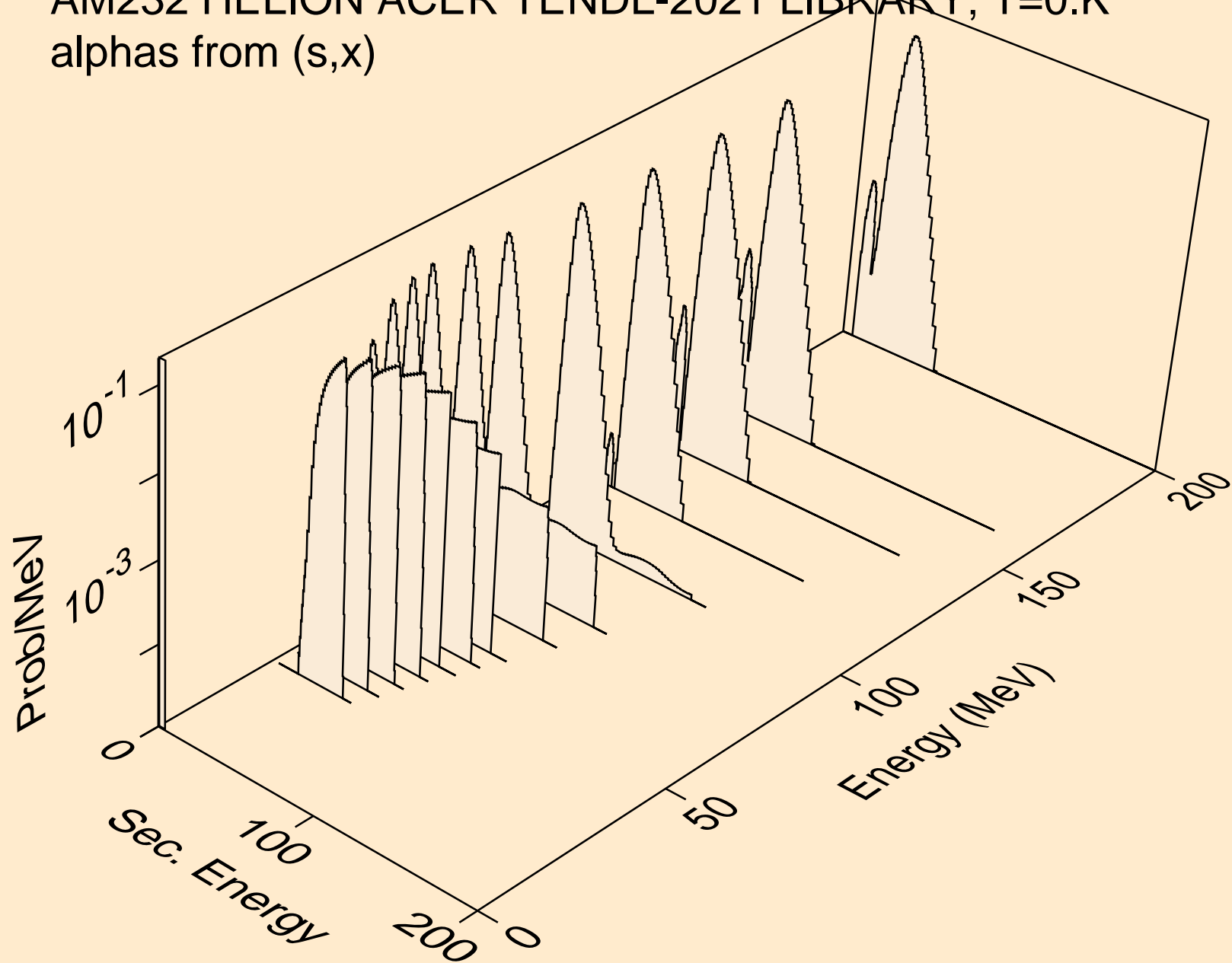

AM232 HELION ACER TENDL-2021 LIBRARY; T=0.K
alphas from (s,a)

