

AM234 HELION ACER TENDL-2021 LIBRARY; T=0.K  
Principal cross sections

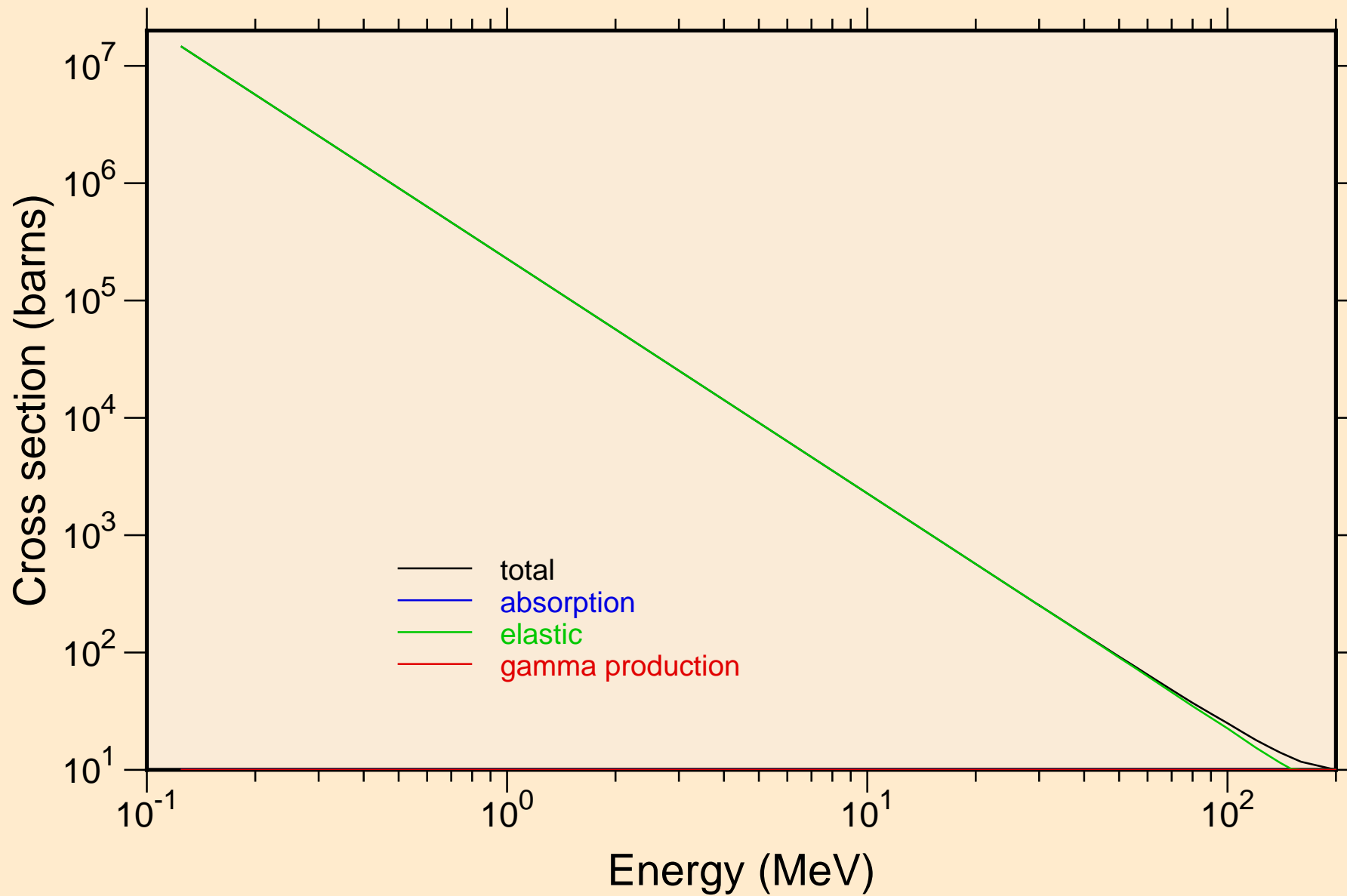

AM234 HELION ACER TENDL-2021 LIBRARY; T=0.K

Heating

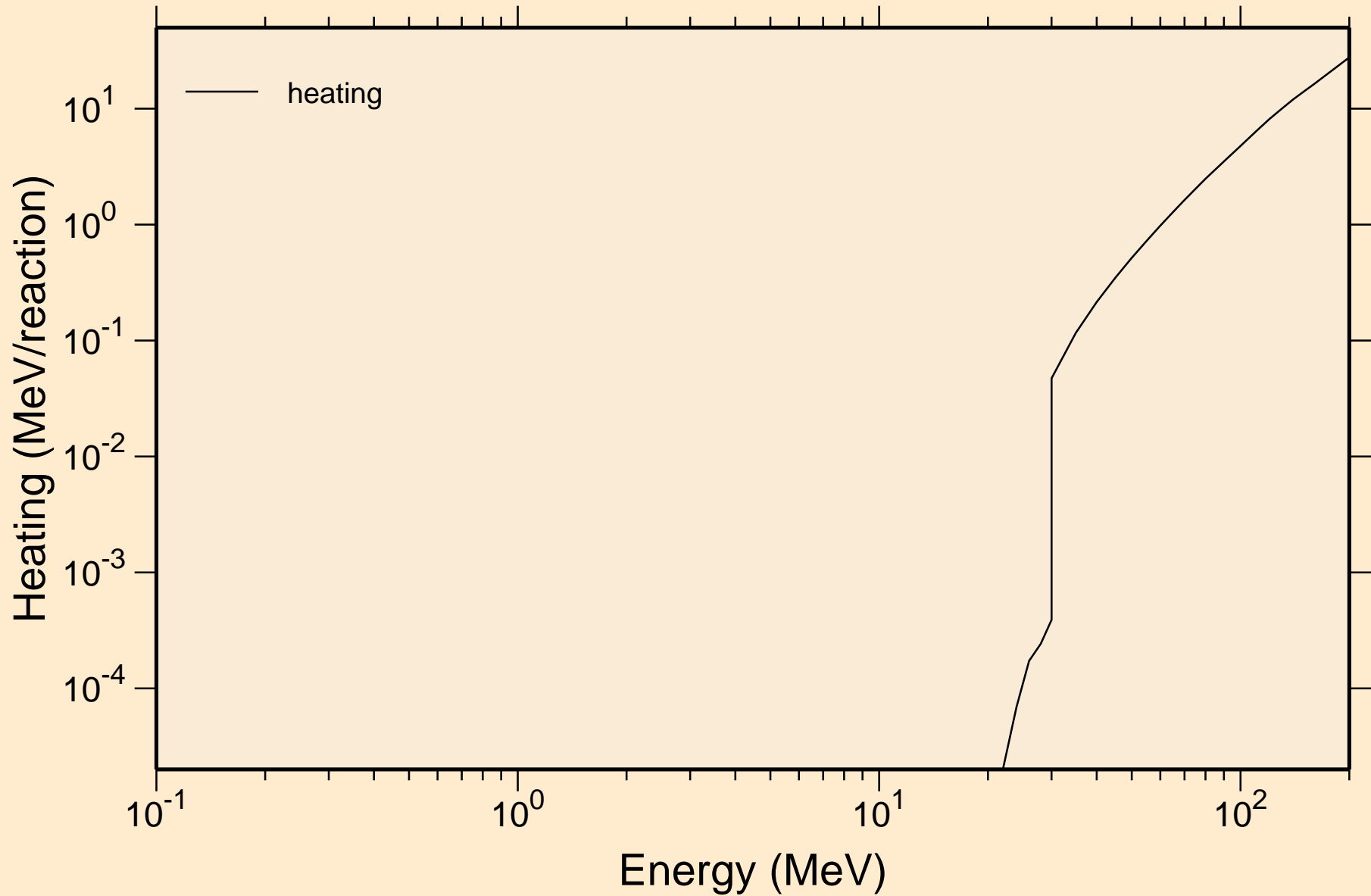

# AM234 HELION ACER TENDL-2021 LIBRARY; T=0.K

## Principal cross sections

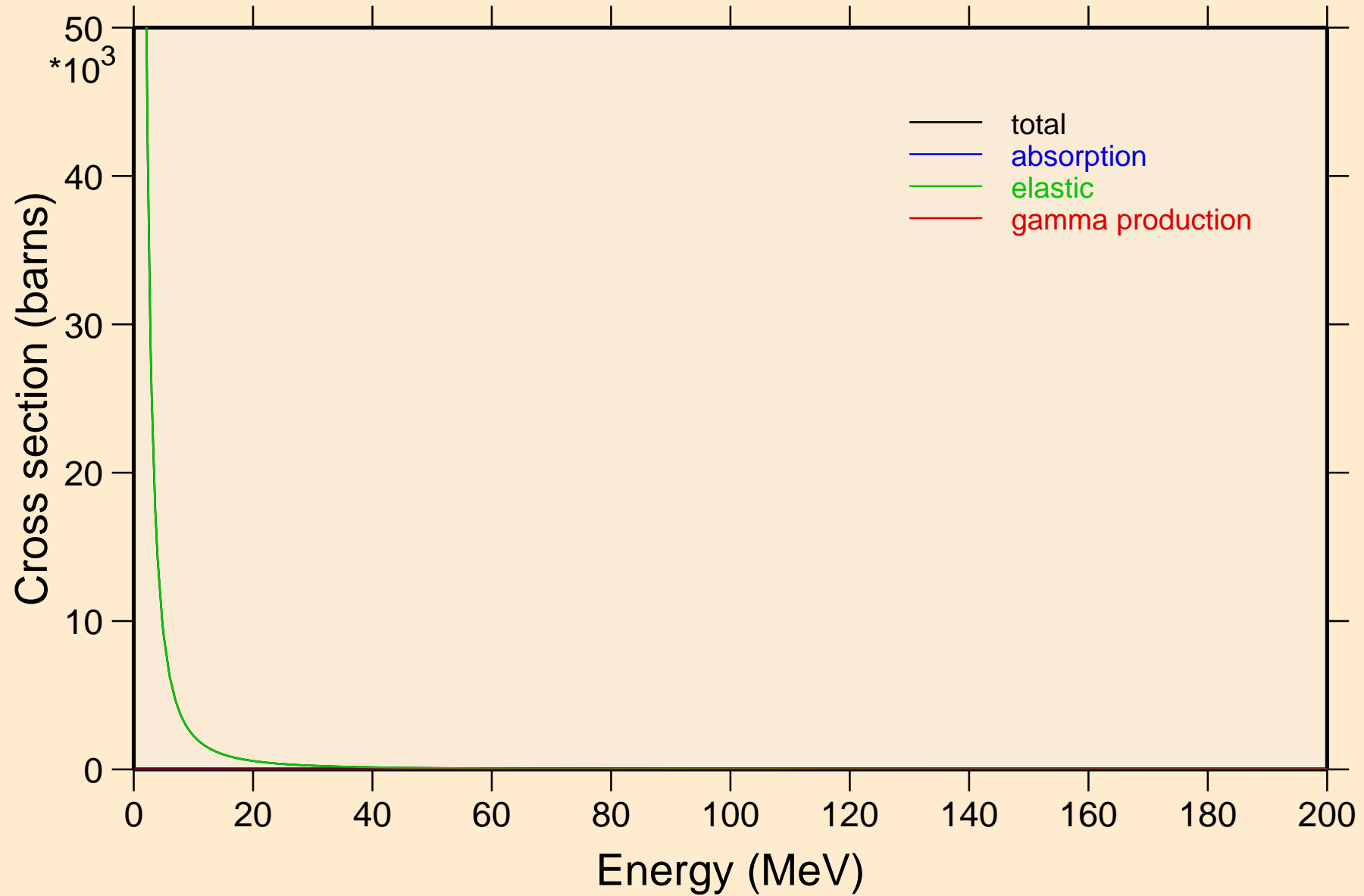

AM234 HELION ACER TENDL-2021 LIBRARY; T=0.K

Heating

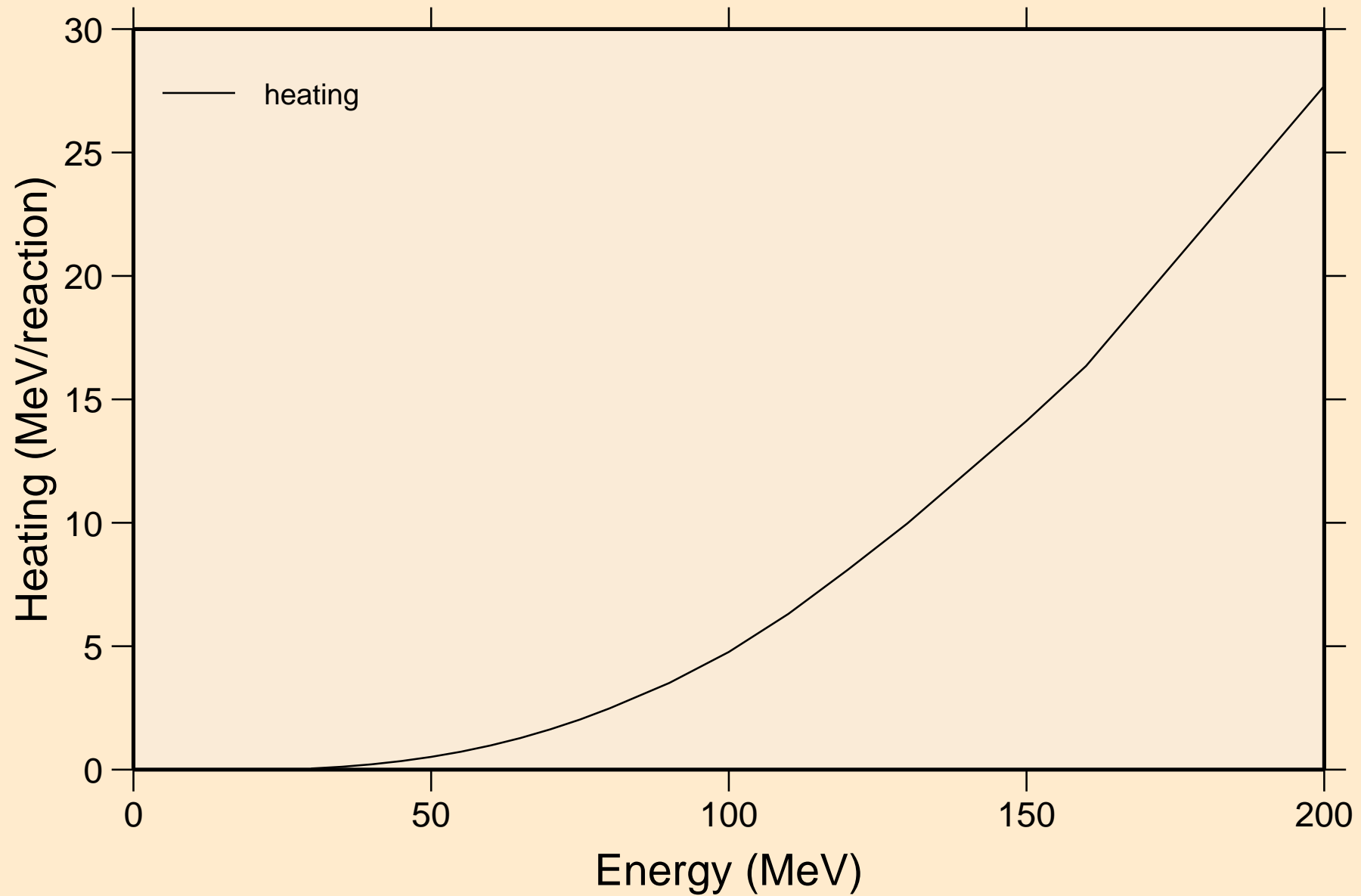

AM234 HELION ACER TENDL-2021 LIBRARY; T=0.K  
Threshold reactions

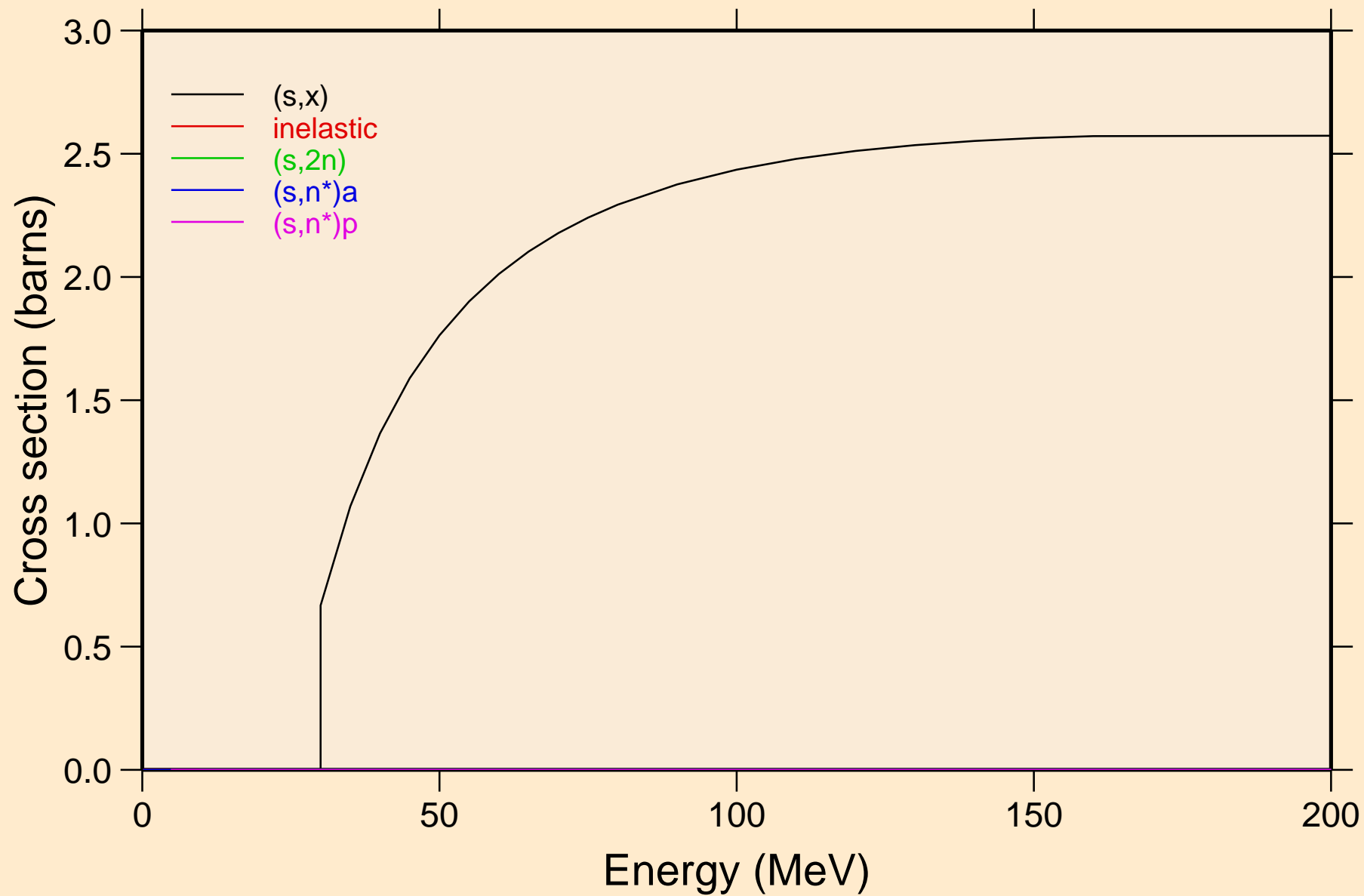

AM234 HELION ACER TENDL-2021 LIBRARY; T=0.K  
Threshold reactions

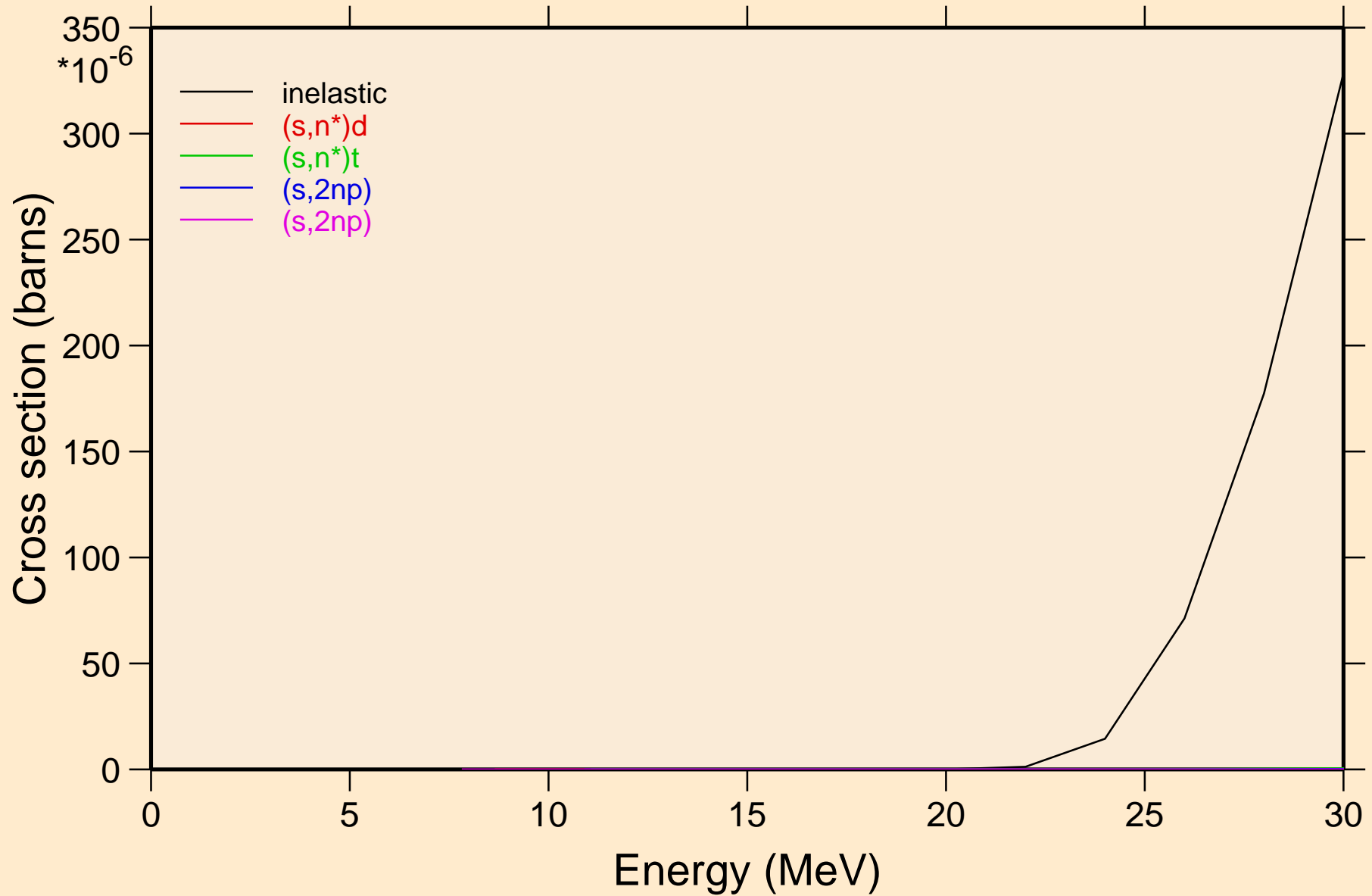

# AM234 HELION ACER TENDL-2021 LIBRARY; T=0.K

## Threshold reactions

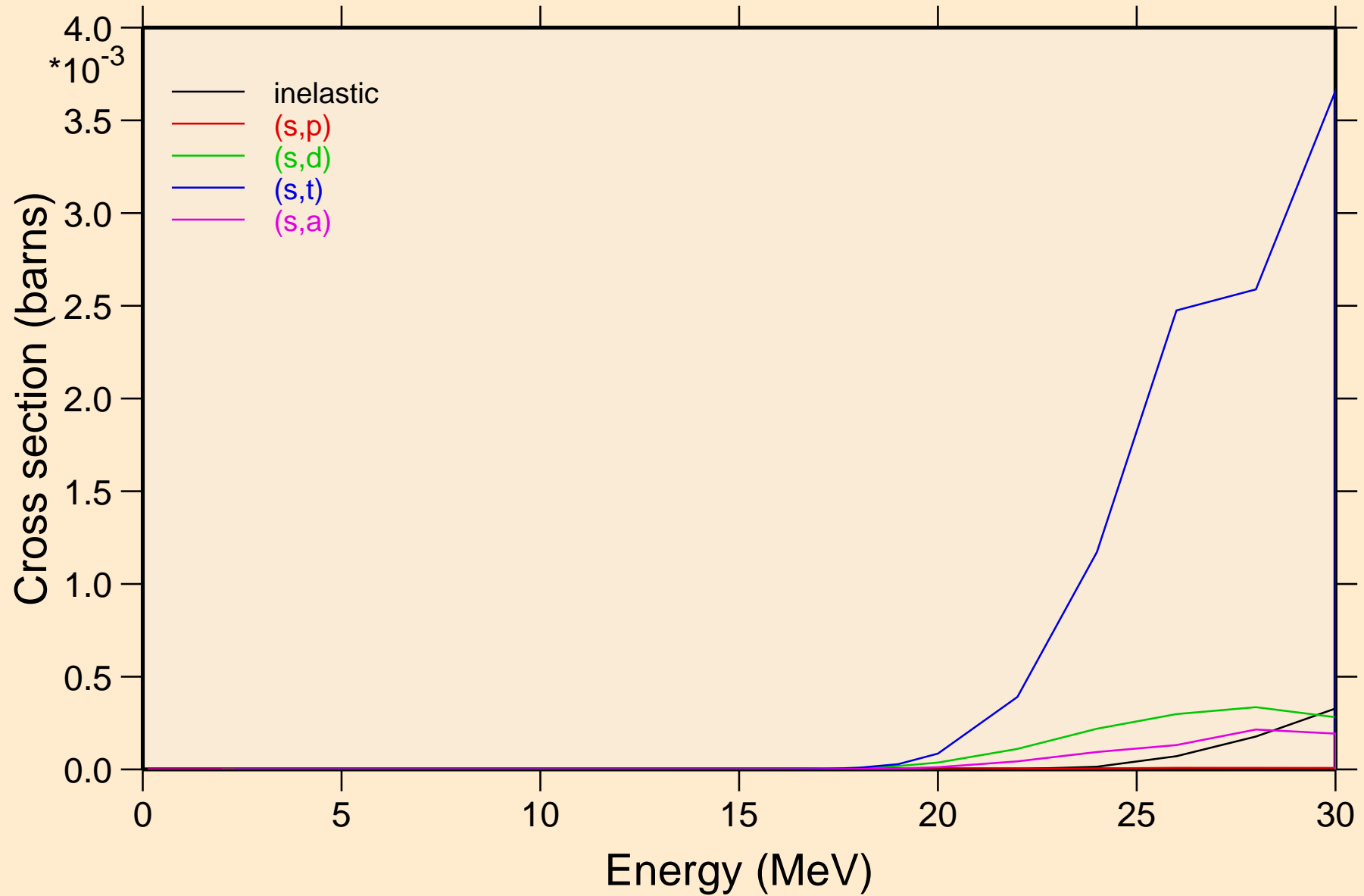

AM234 HELION ACER TENDL-2021 LIBRARY; T=0.K  
Threshold reactions

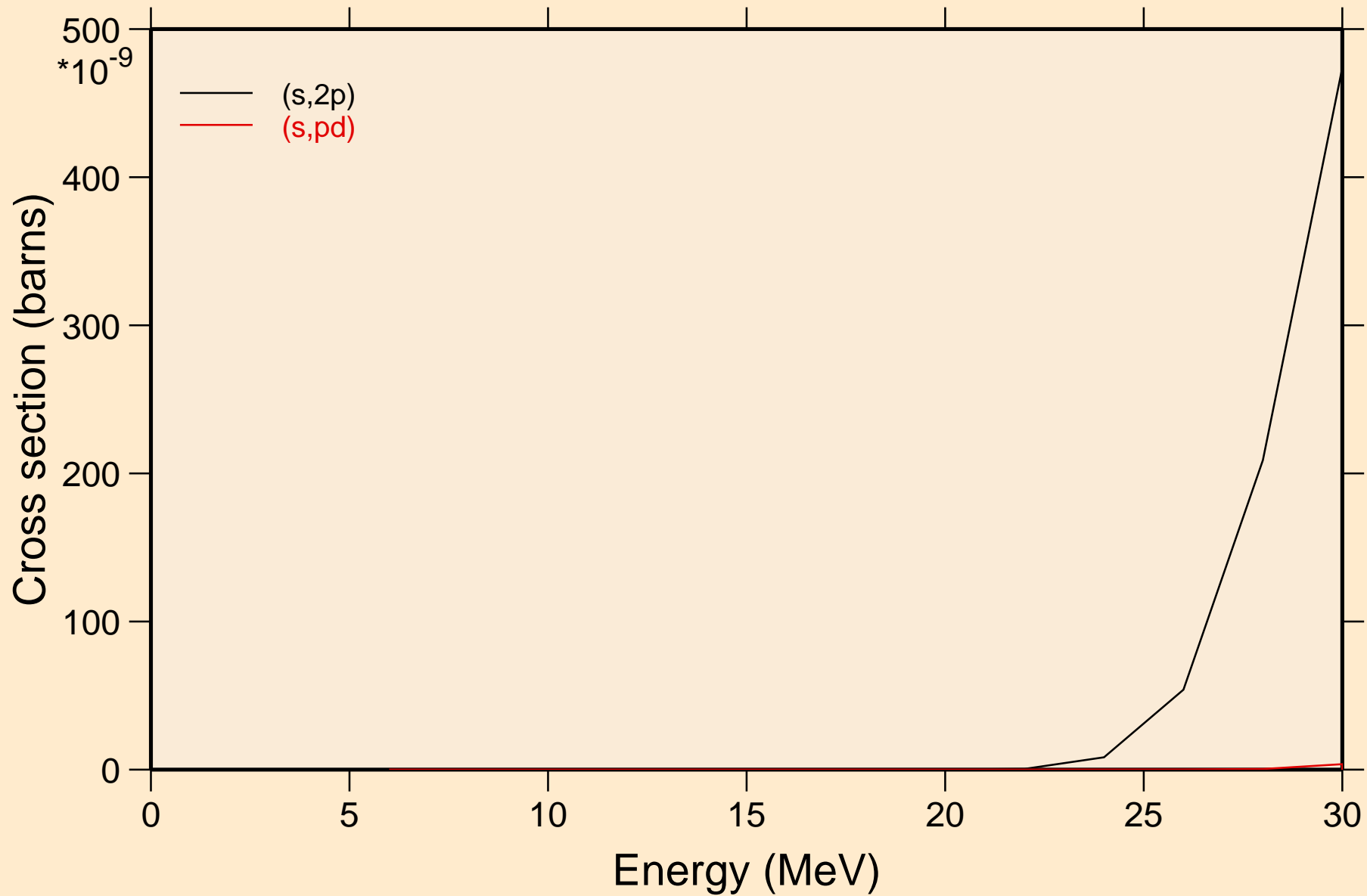



AM234 HELION ACER TENDL-2021 LIBRARY; T=0.K  
angular distribution for elastic

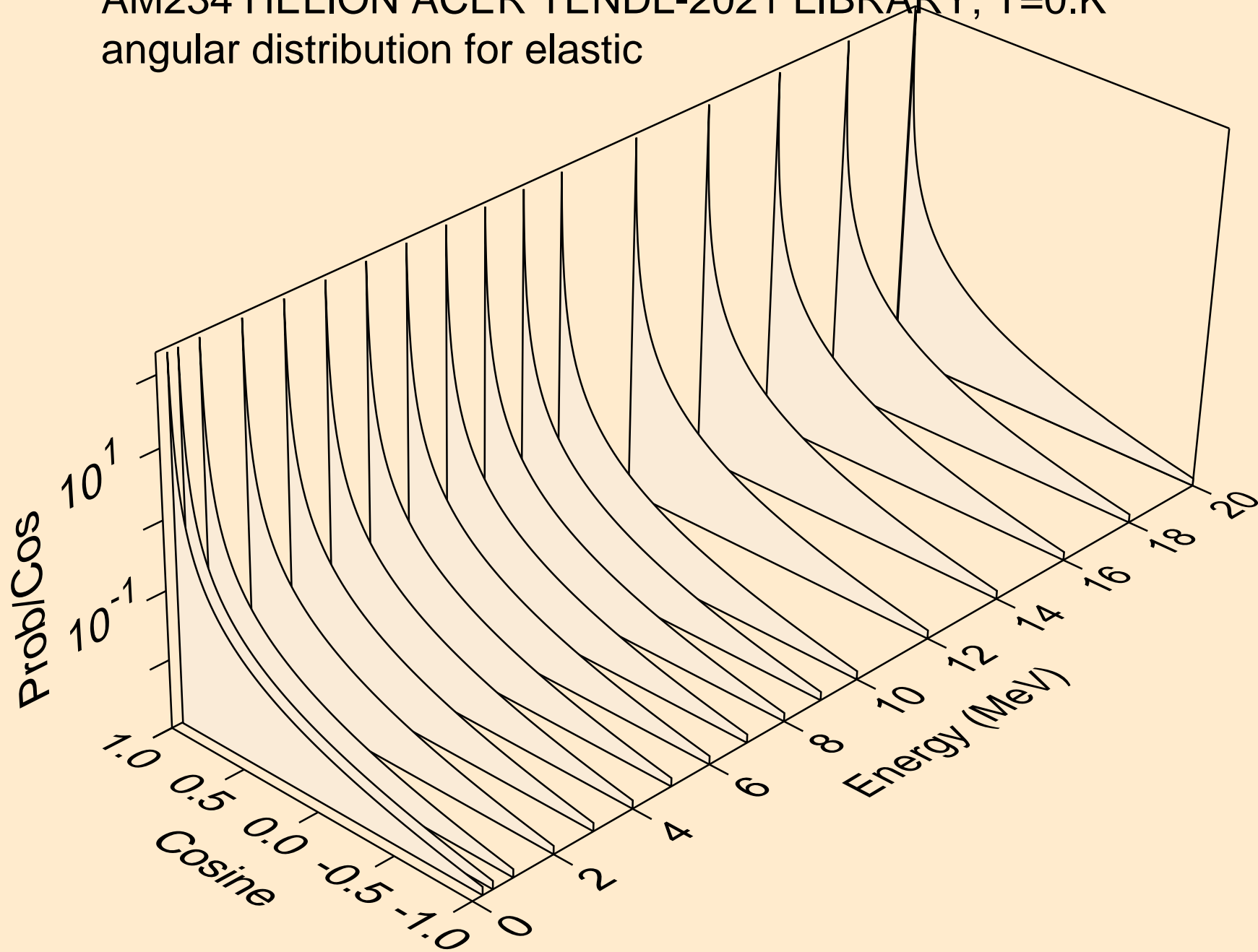

AM234 HELION ACER TENDL-2021 LIBRARY; T=0.K  
angular distribution for elastic

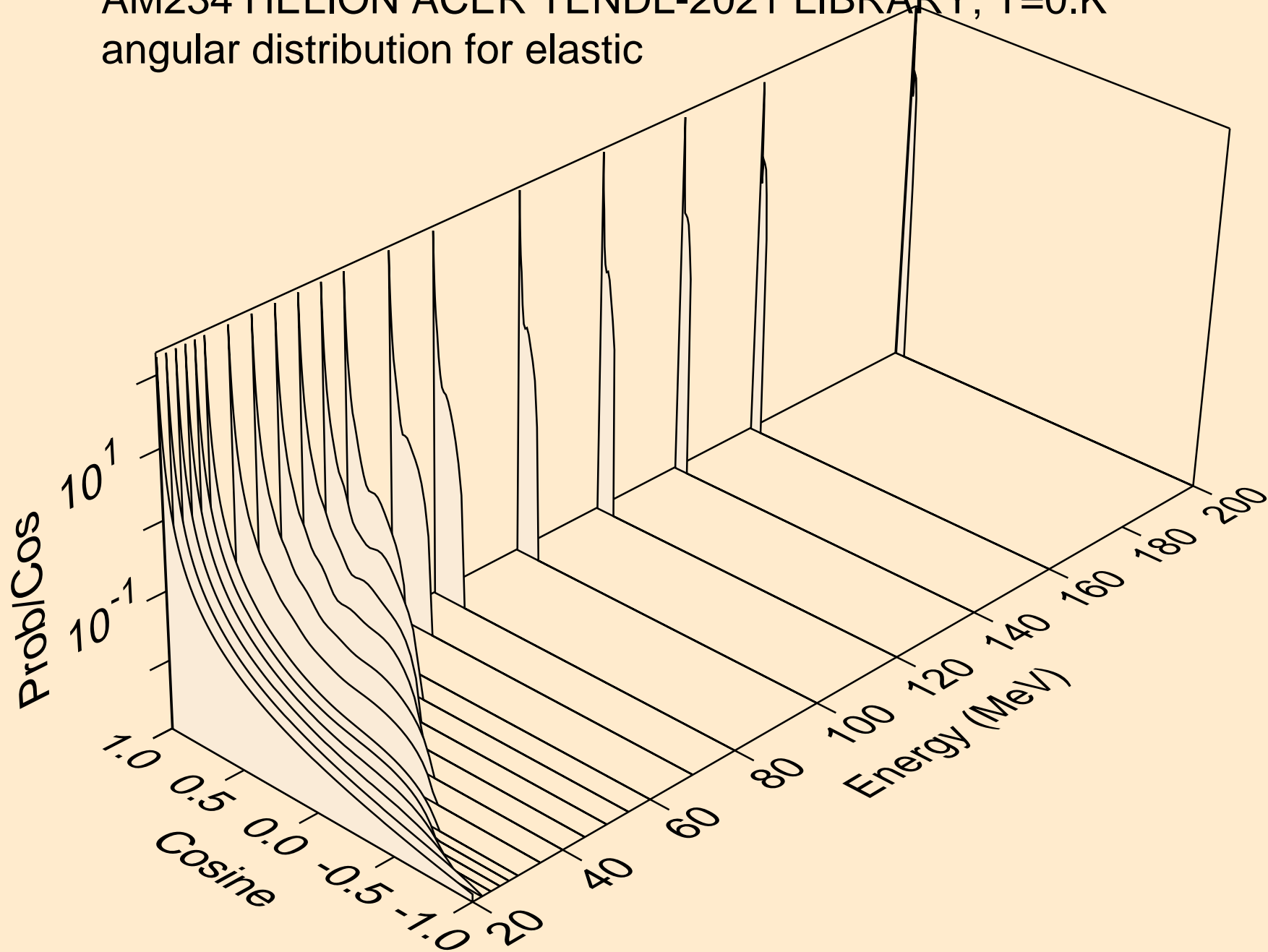

AM234 HELION ACER TENDL-2021 LIBRARY; T=0.K  
He-3 emission for (s,x)

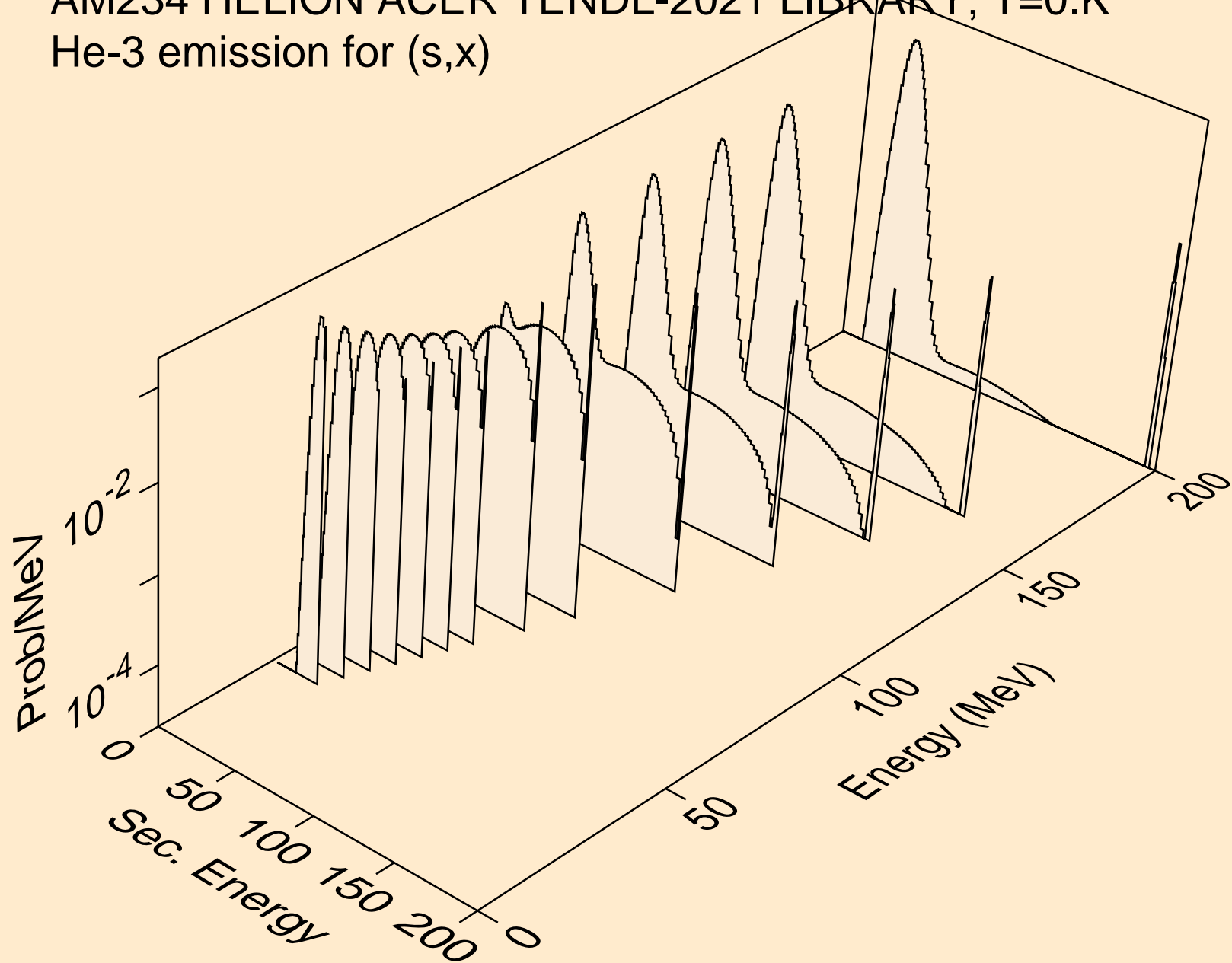

AM234 HELION ACER TENDL-2021 LIBRARY; T=0.K  
He-3 emission for inelastic

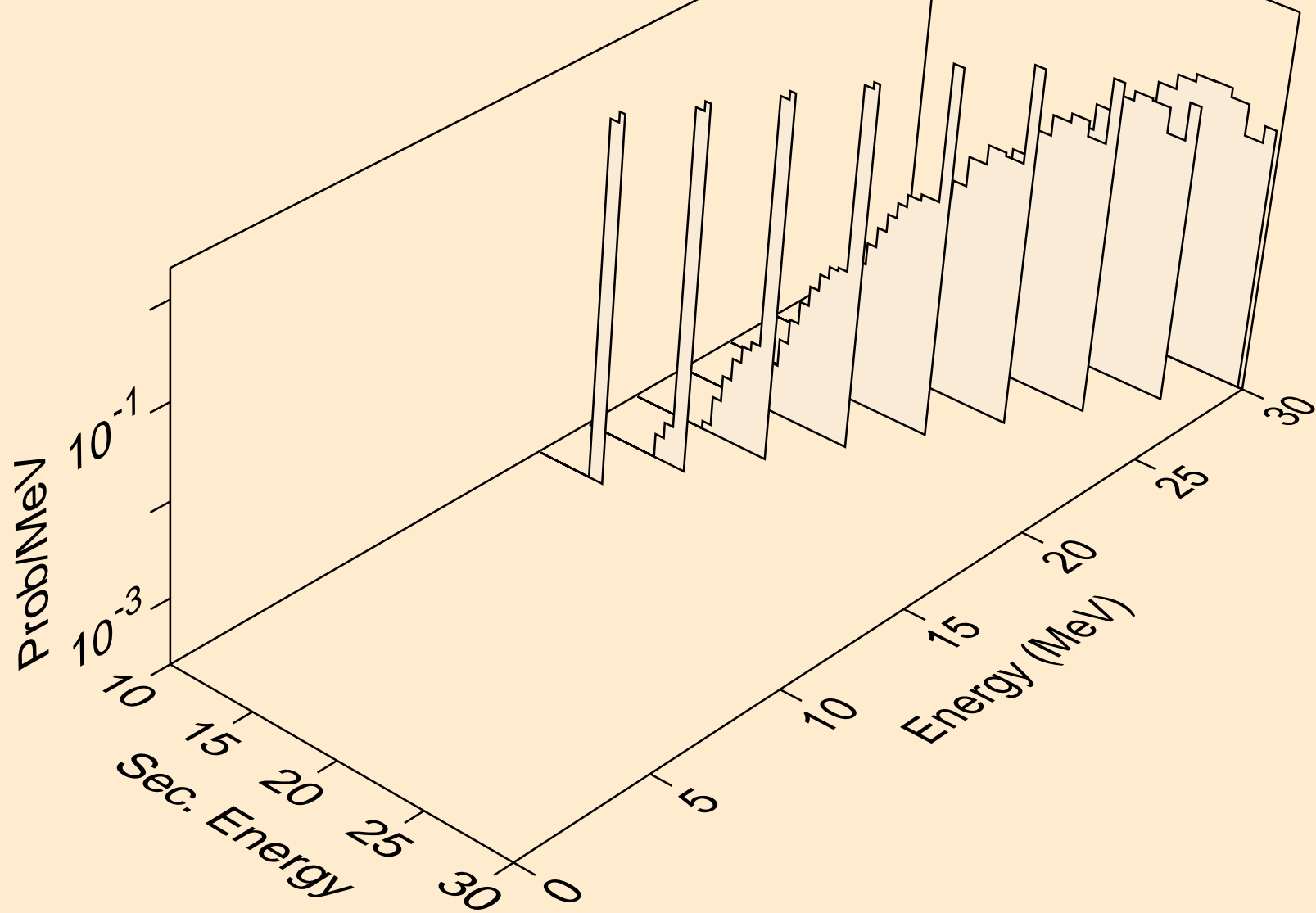

AM234 HELION ACER TENDL-2021 LIBRARY; T=0.K  
Photon emission for (z,n)

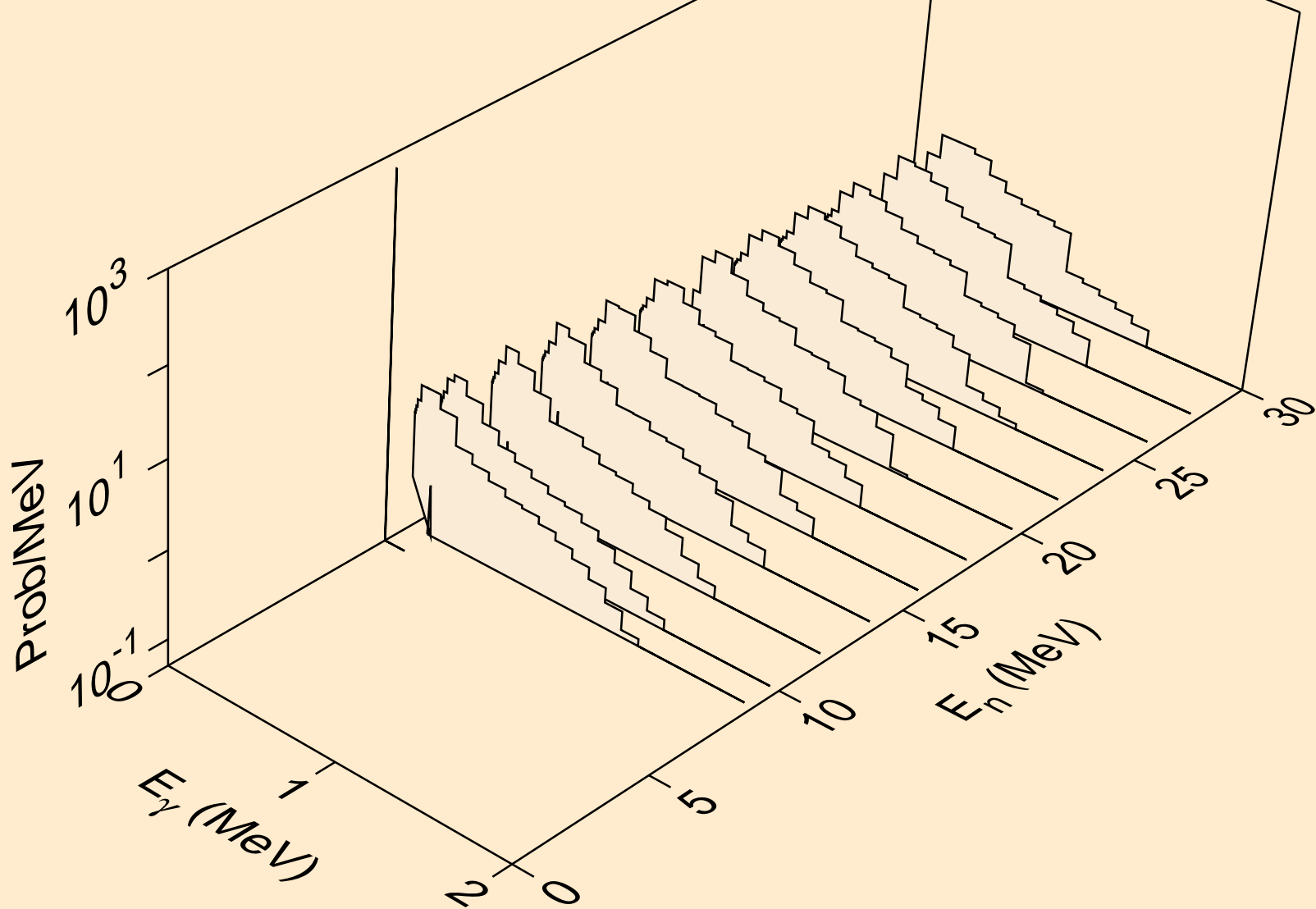

AM234 HELION ACER TENDL-2021 LIBRARY; T=0.K  
Photon emission for (n,x)

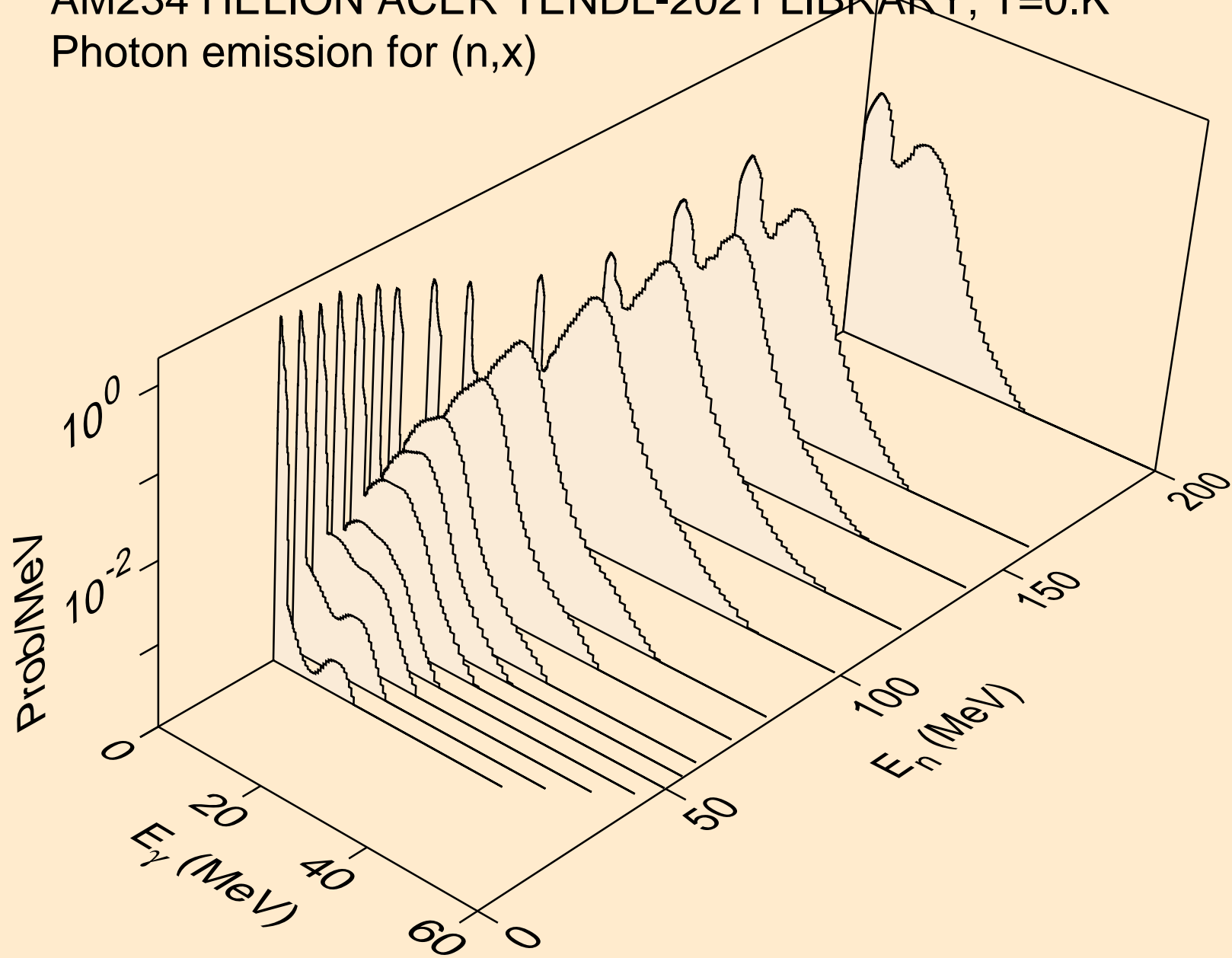

AM234 HELION ACER TENDL-2021 LIBRARY; T=0.K  
Photon emission for (n,2n)

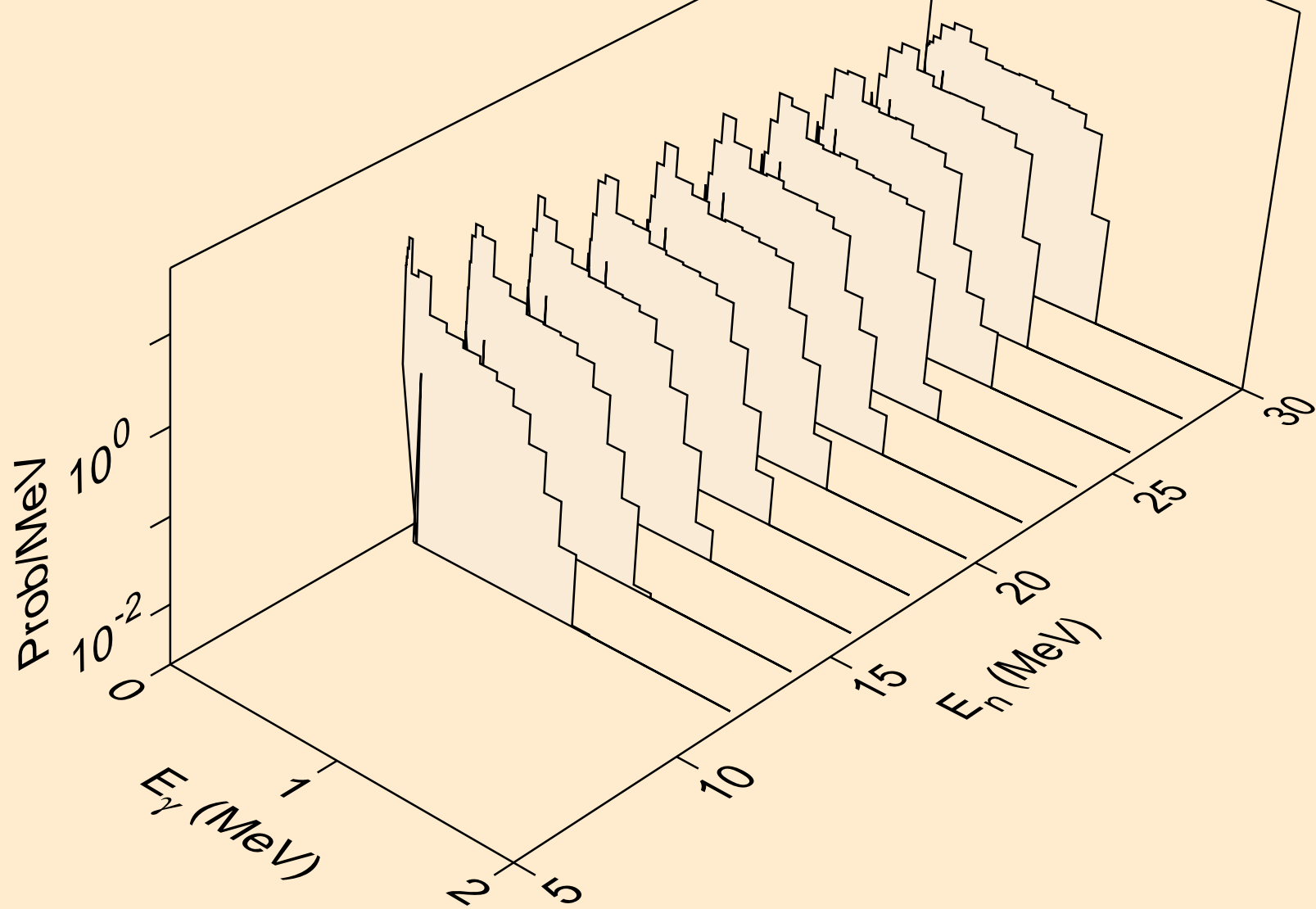

AM234 HELION ACER TENDL-2021 LIBRARY; T=0.K  
Photon emission for (n,n\*)a

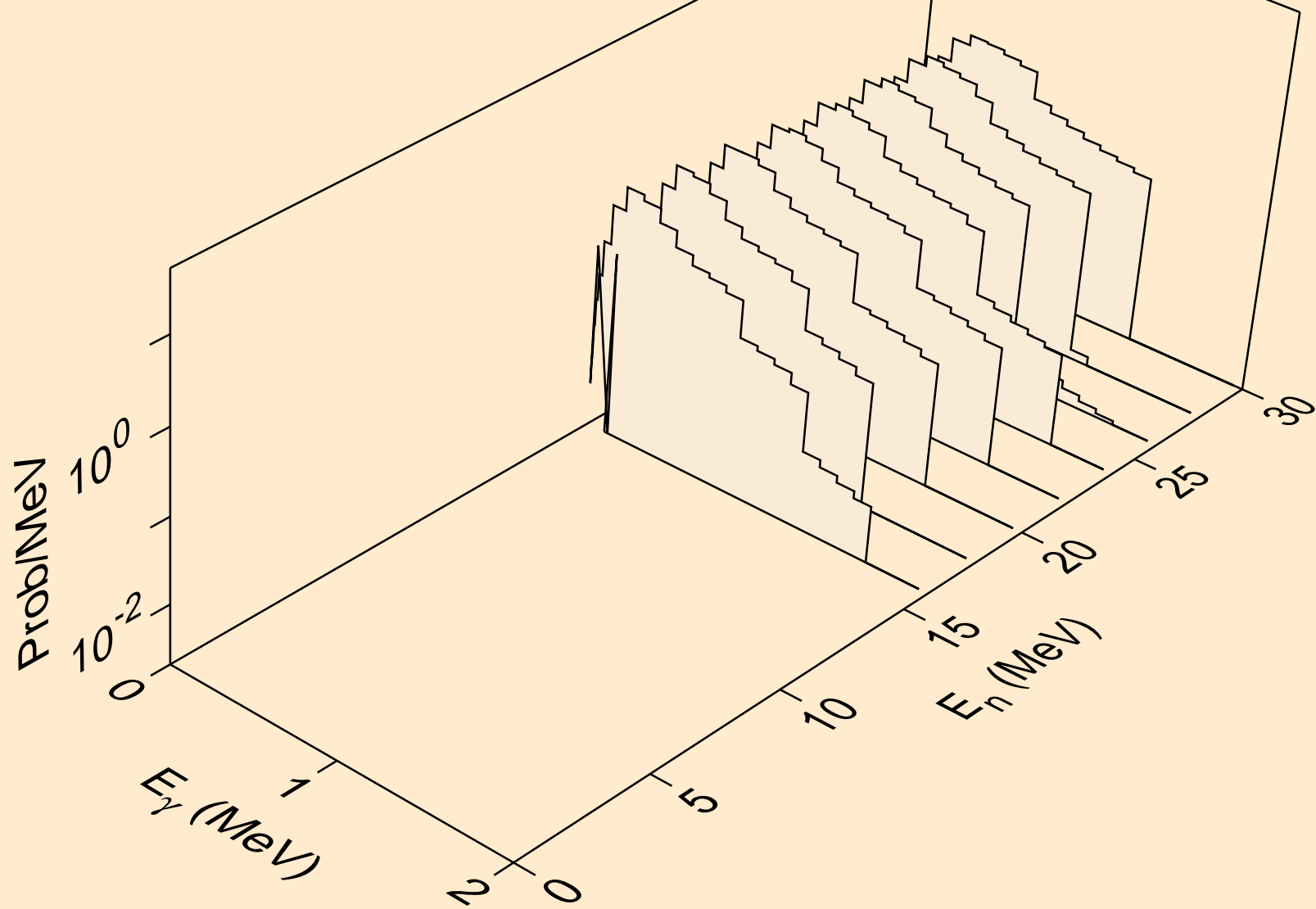



AM234 HELION ACER TENDL-2021 LIBRARY; T=0.K  
Photon emission for (n,n\*)p

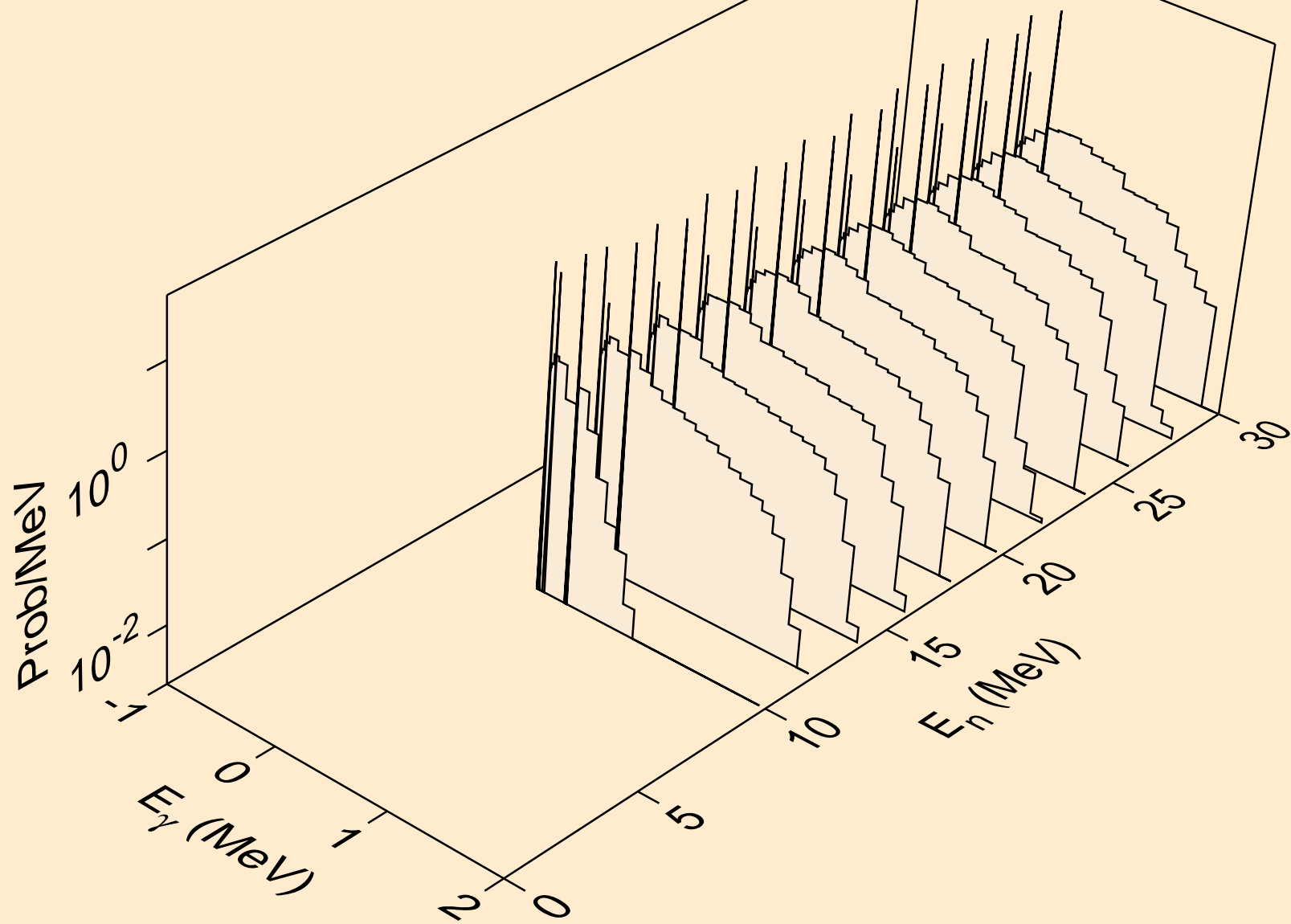

AM234 HELION ACER TENDL-2021 LIBRARY; T=0.K  
Photon emission for (n,n\*)d

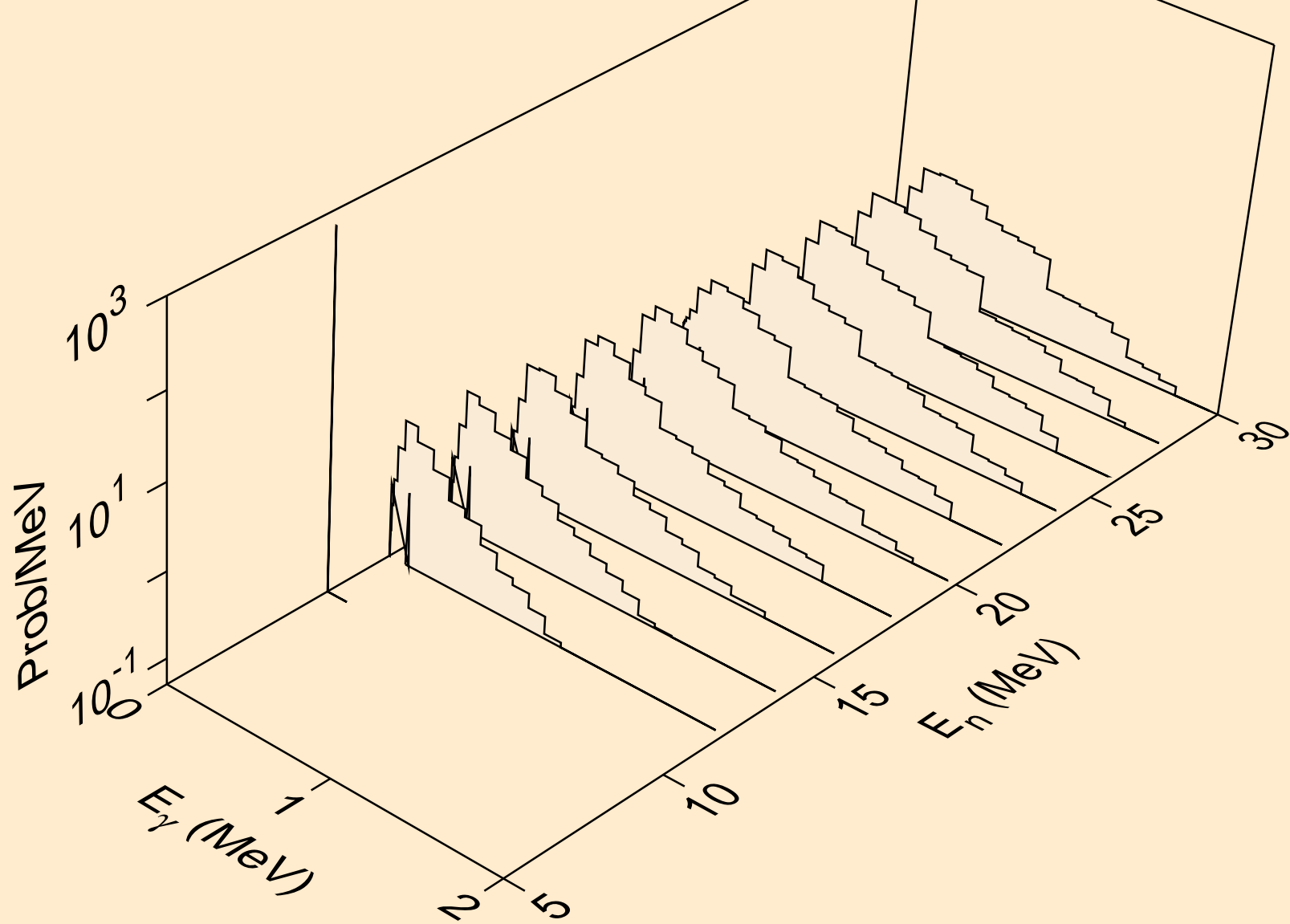

AM234 HELION ACER TENDL-2021 LIBRARY; T=0.K  
Photon emission for (n,n\*)t

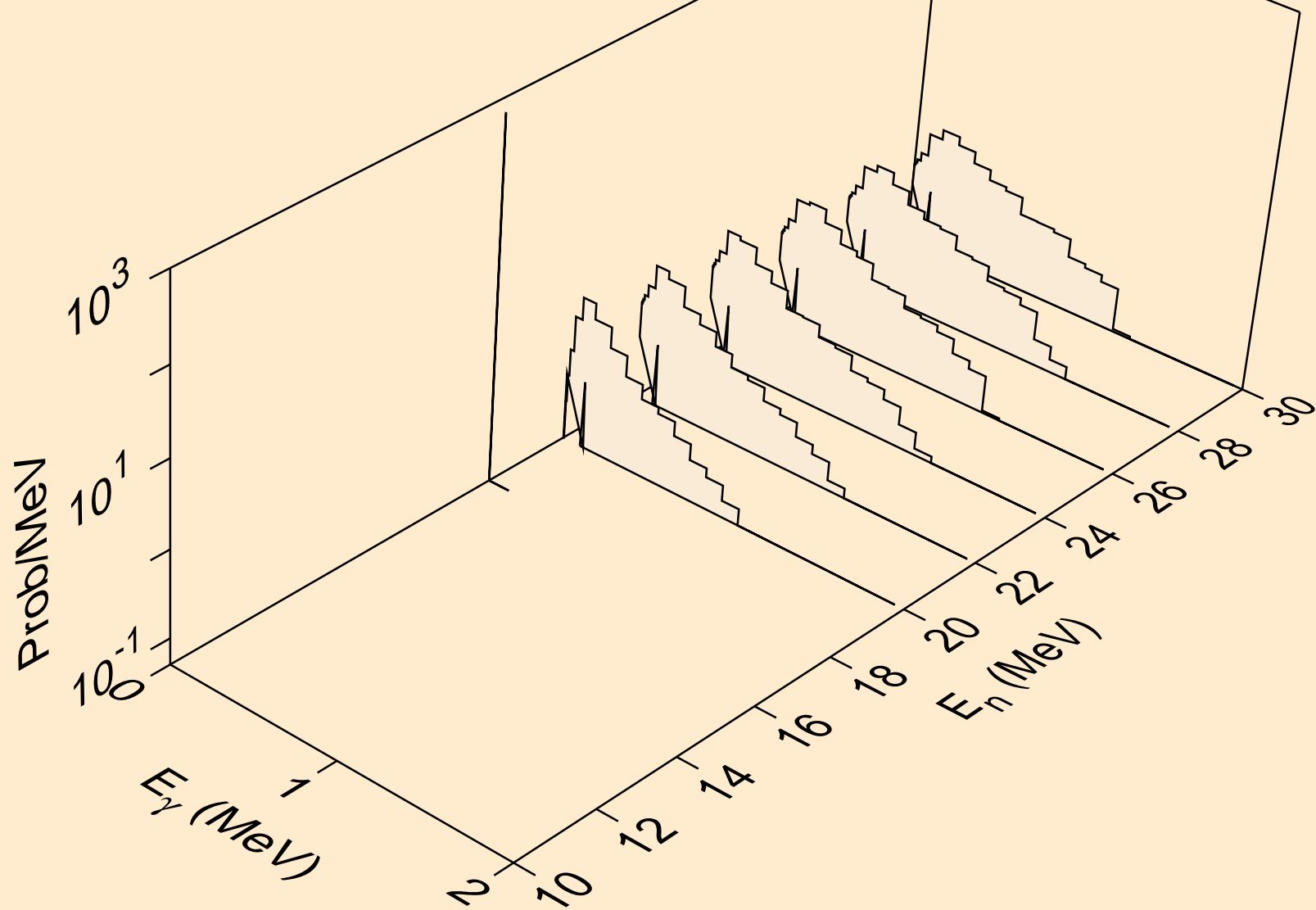

AM234 HELION ACER TENDL-2021 LIBRARY; T=0.K  
Photon emission for (n,2np)

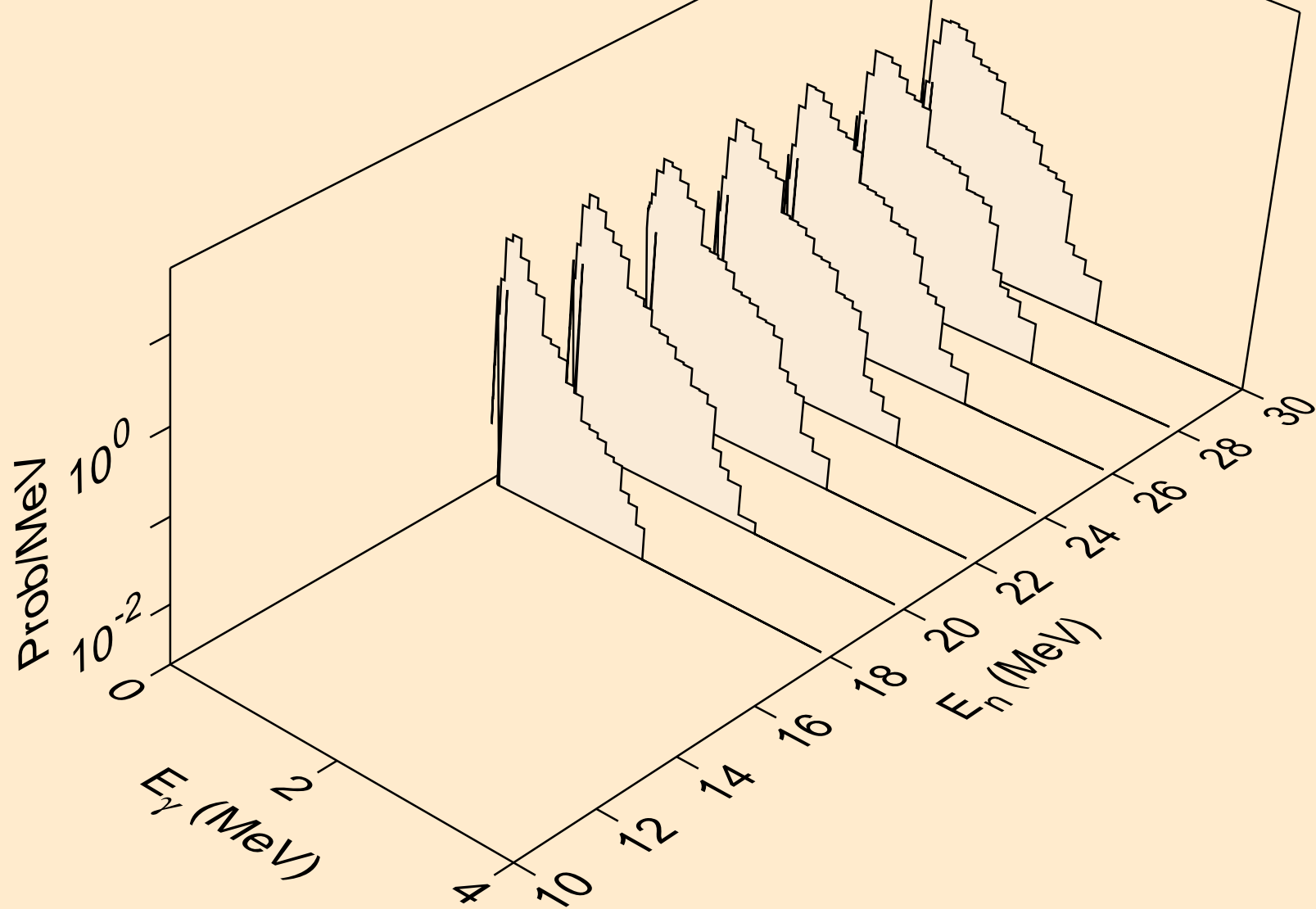

AM234 HELION ACER TENDL-2021 LIBRARY; T=0.K  
Photon emission for (n,2np)

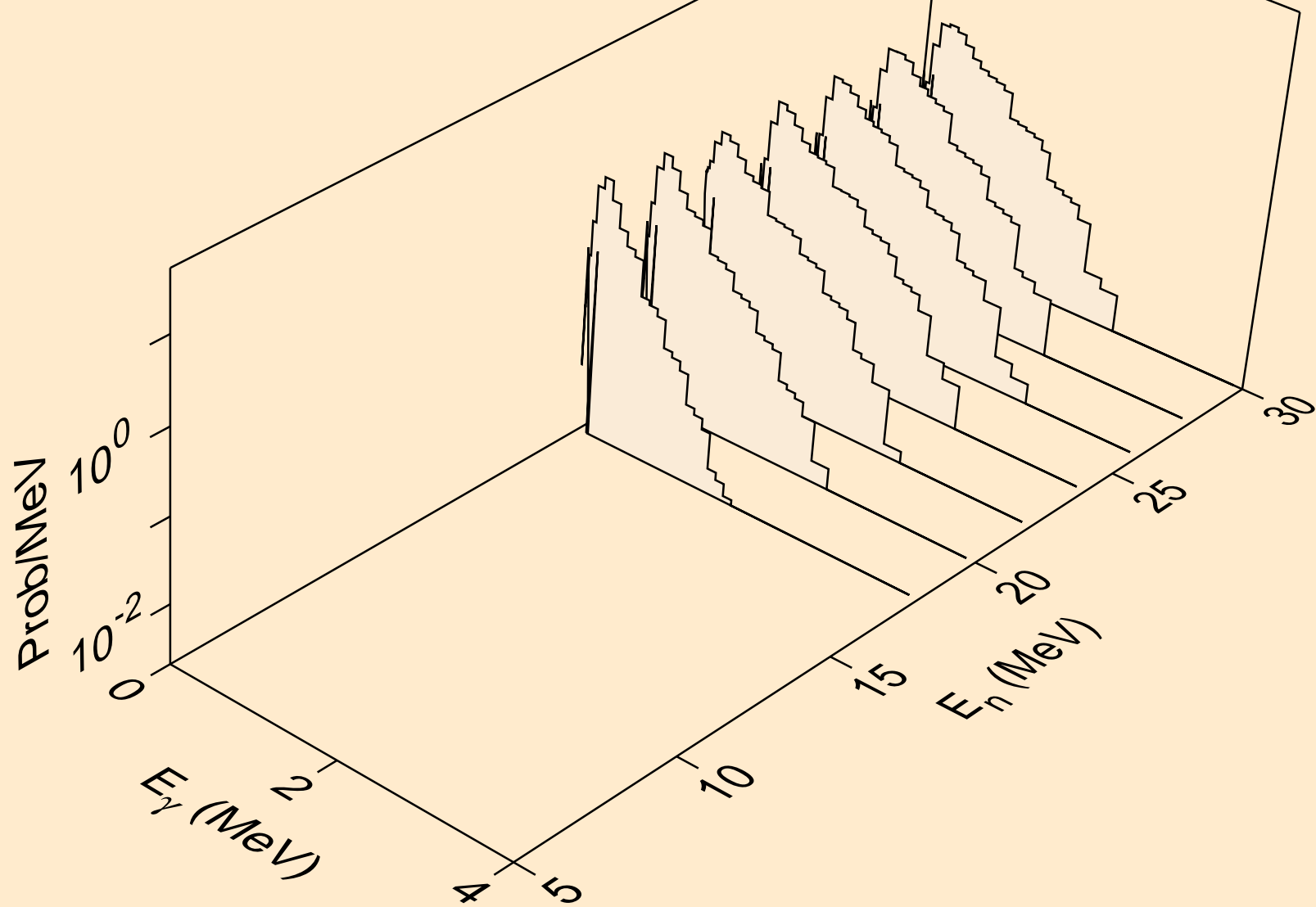

AM234 HELION ACER TENDL-2021 LIBRARY; T=0.K  
Photon emission for (n,p)

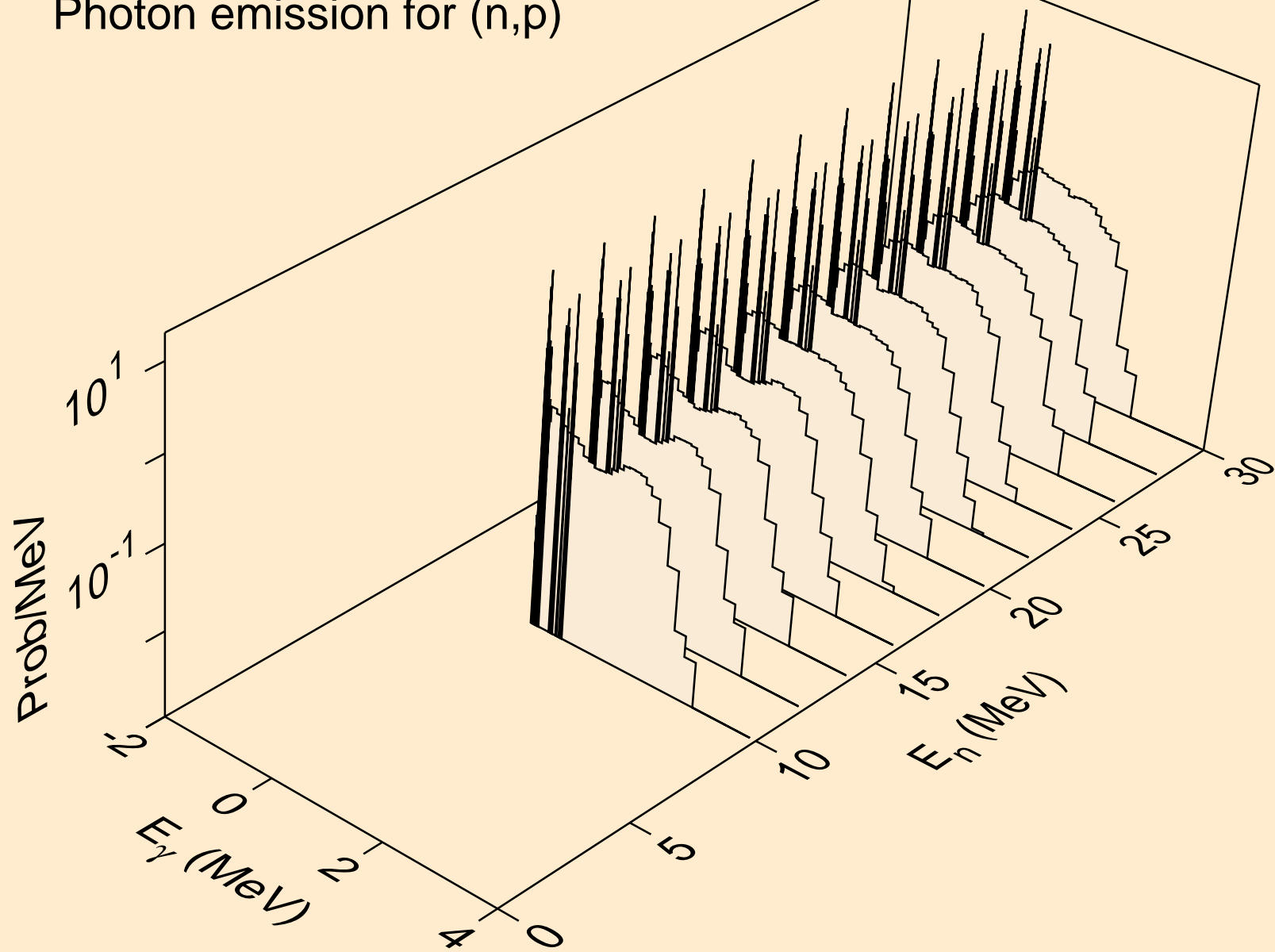

AM234 HELION ACER TENDL-2021 LIBRARY; T=0.K  
Photon emission for (n,d)

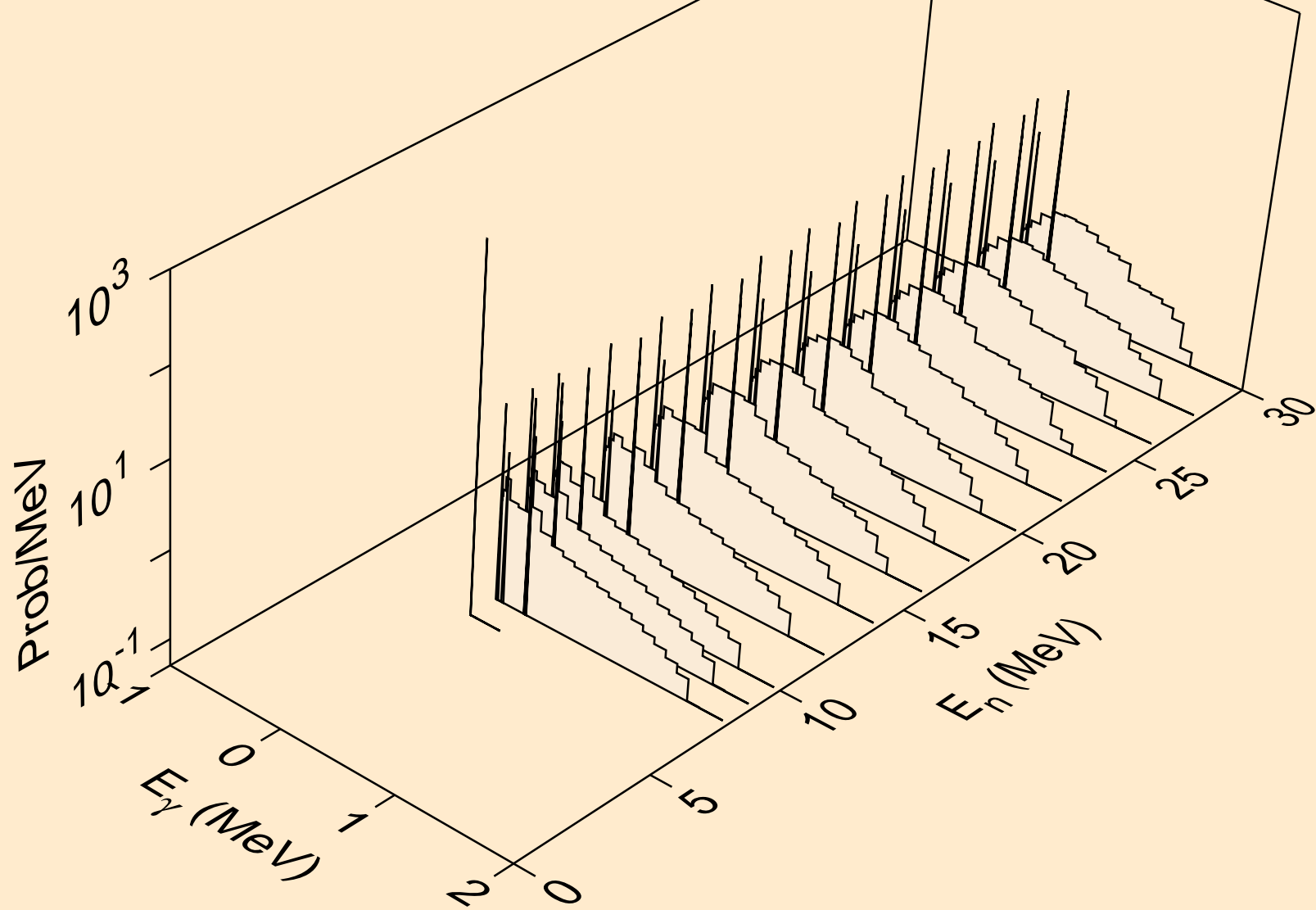

AM234 HELION ACER TENDL-2021 LIBRARY; T=0.K  
Photon emission for (n,t)

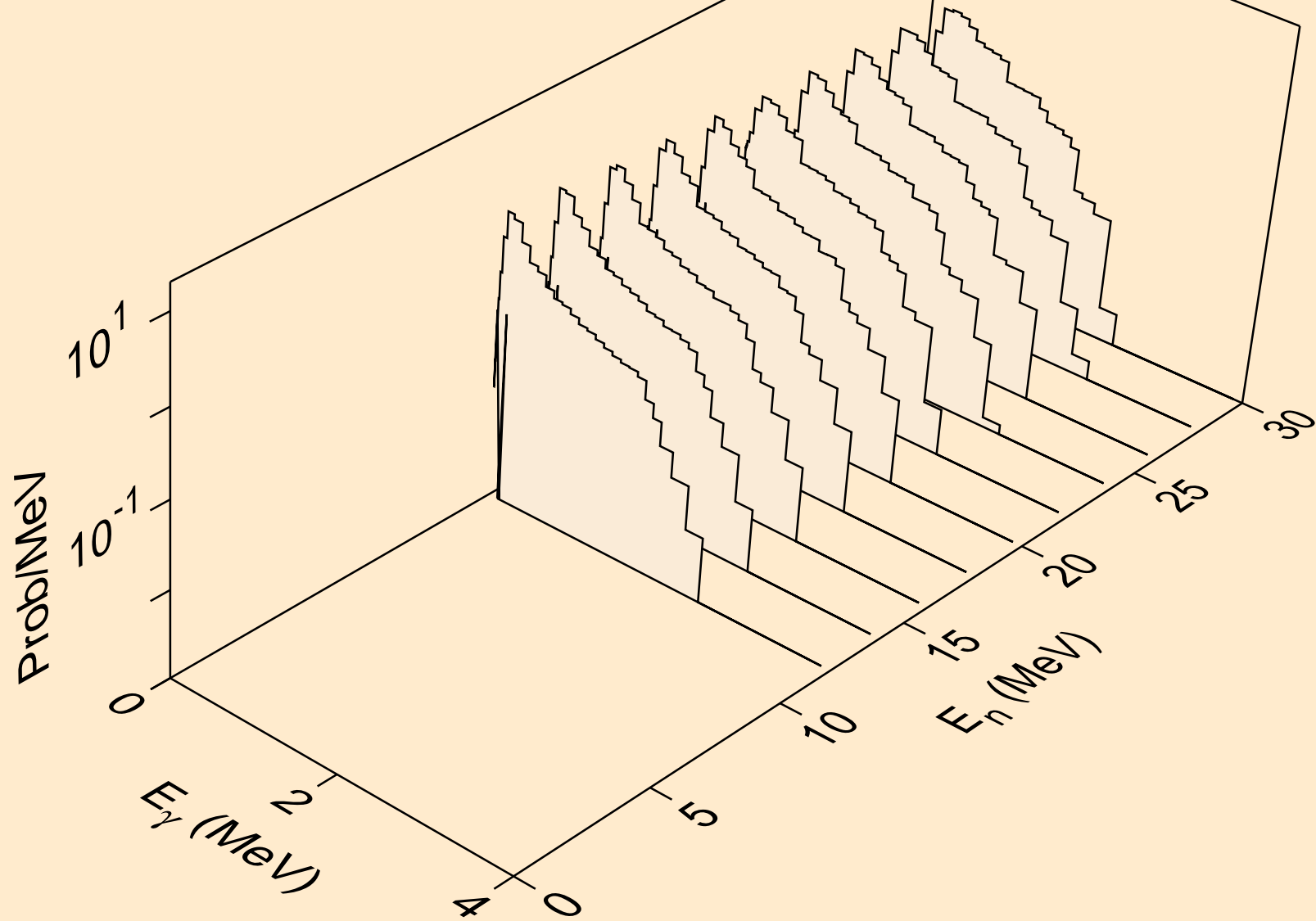



AM234 HELION ACER TENDL-2021 LIBRARY; T=0.K  
Photon emission for inelastic

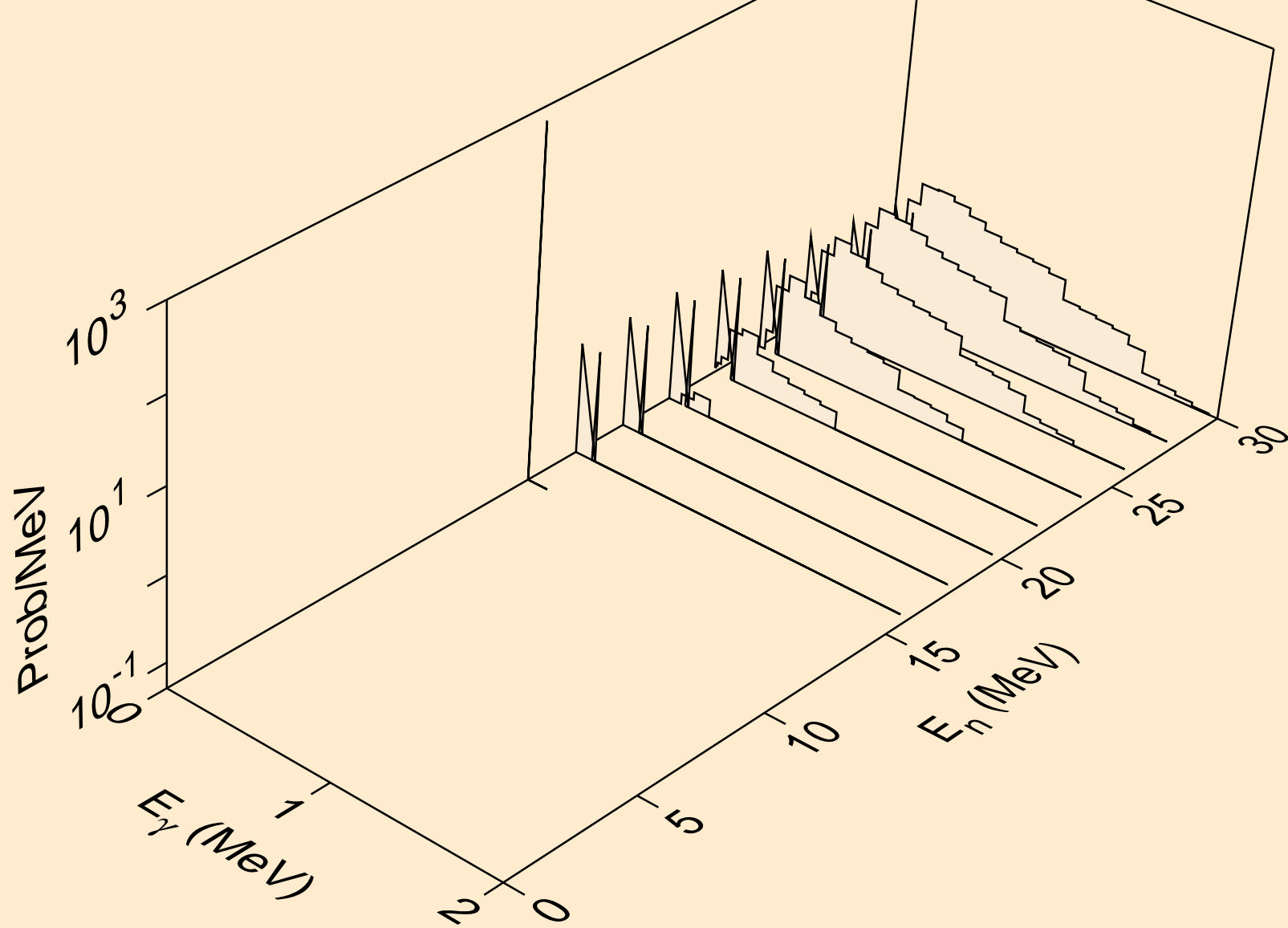

AM234 HELION ACER TENDL-2021 LIBRARY; T=0.K  
Photon emission for (n,a)

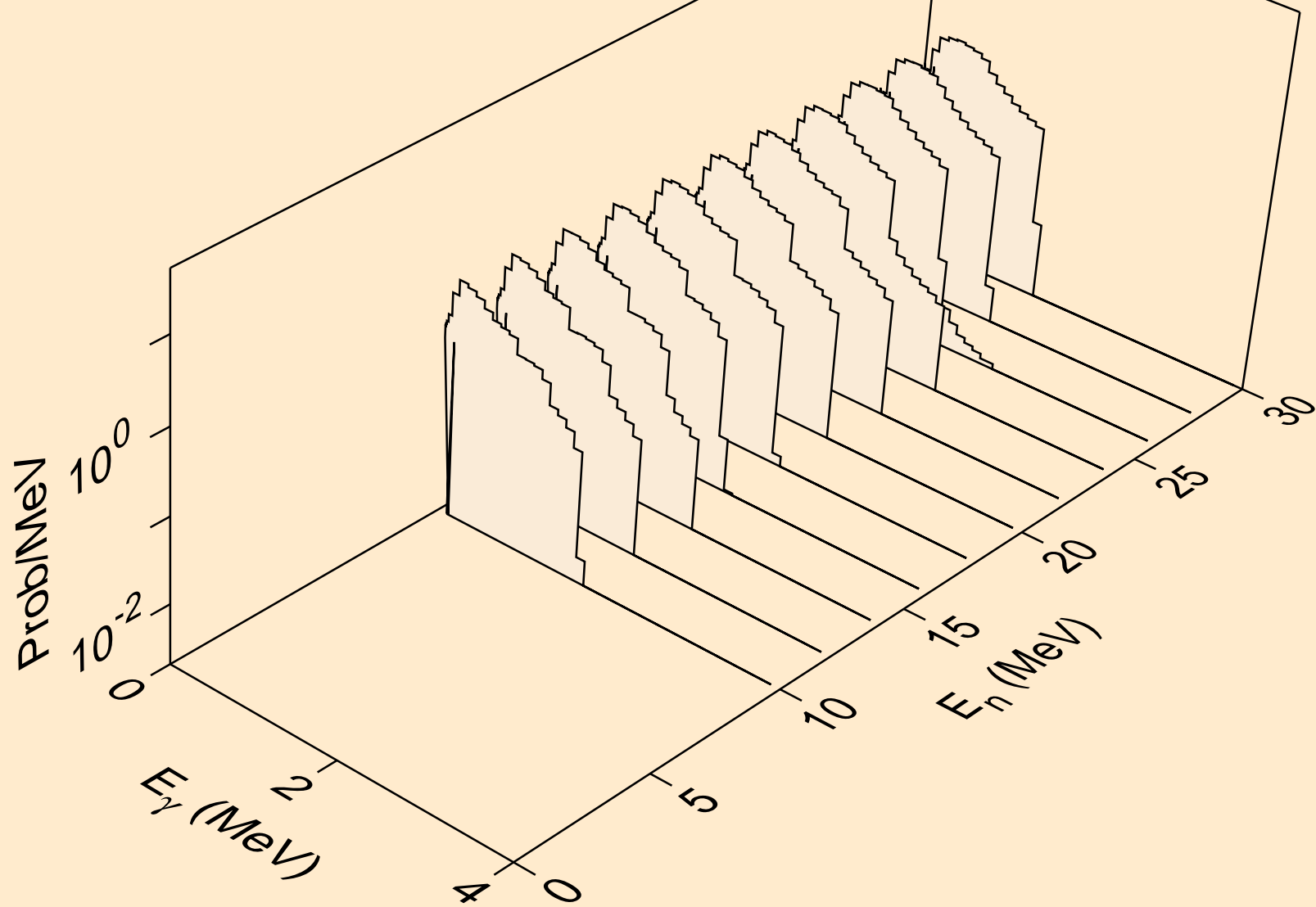

AM234 HELION ACER TENDL-2021 LIBRARY; T=0.K  
Photon emission for (n,2p)

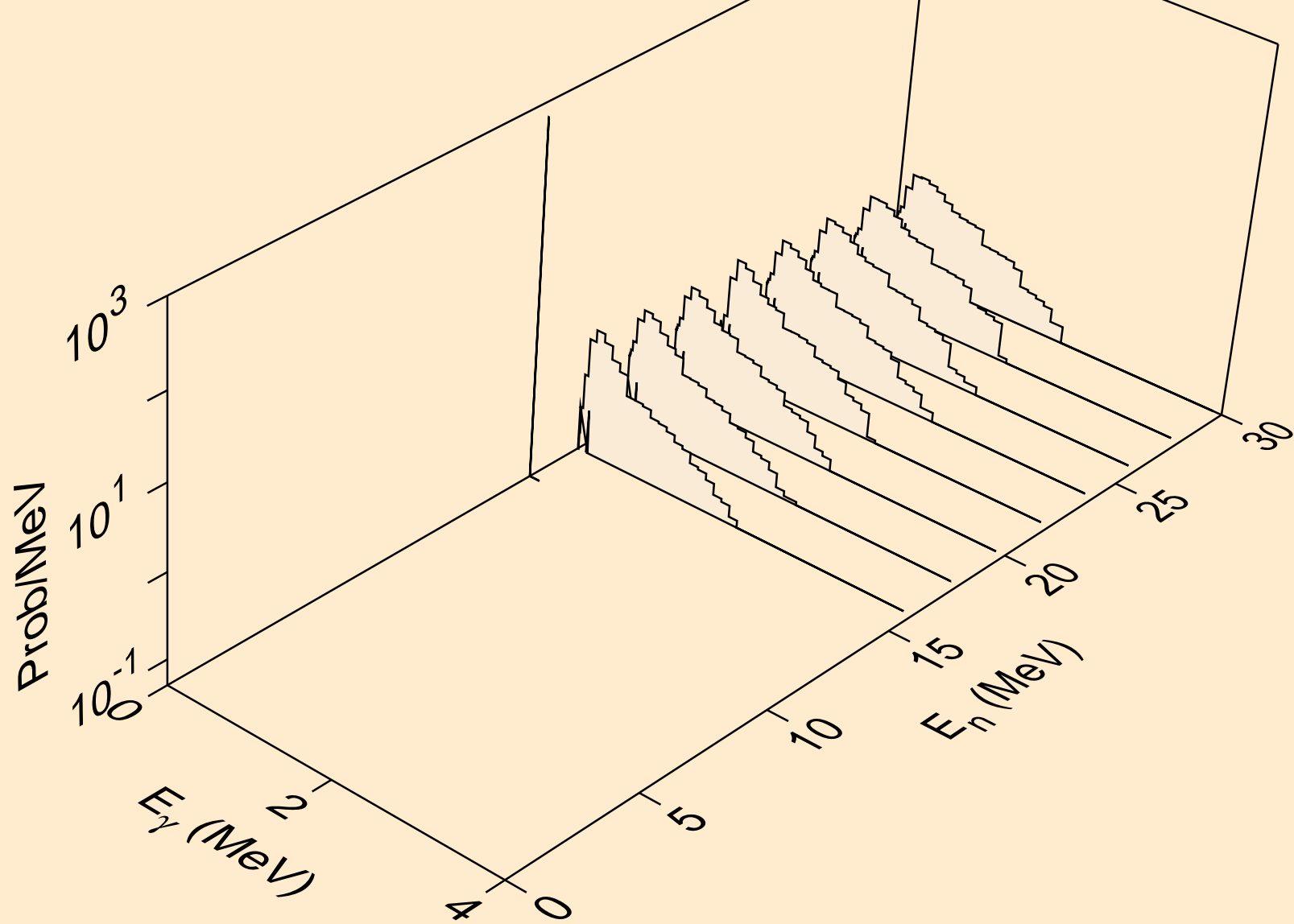

AM234 HELION ACER TENDL-2021 LIBRARY; T=0.K  
Photon emission for (n,pd)

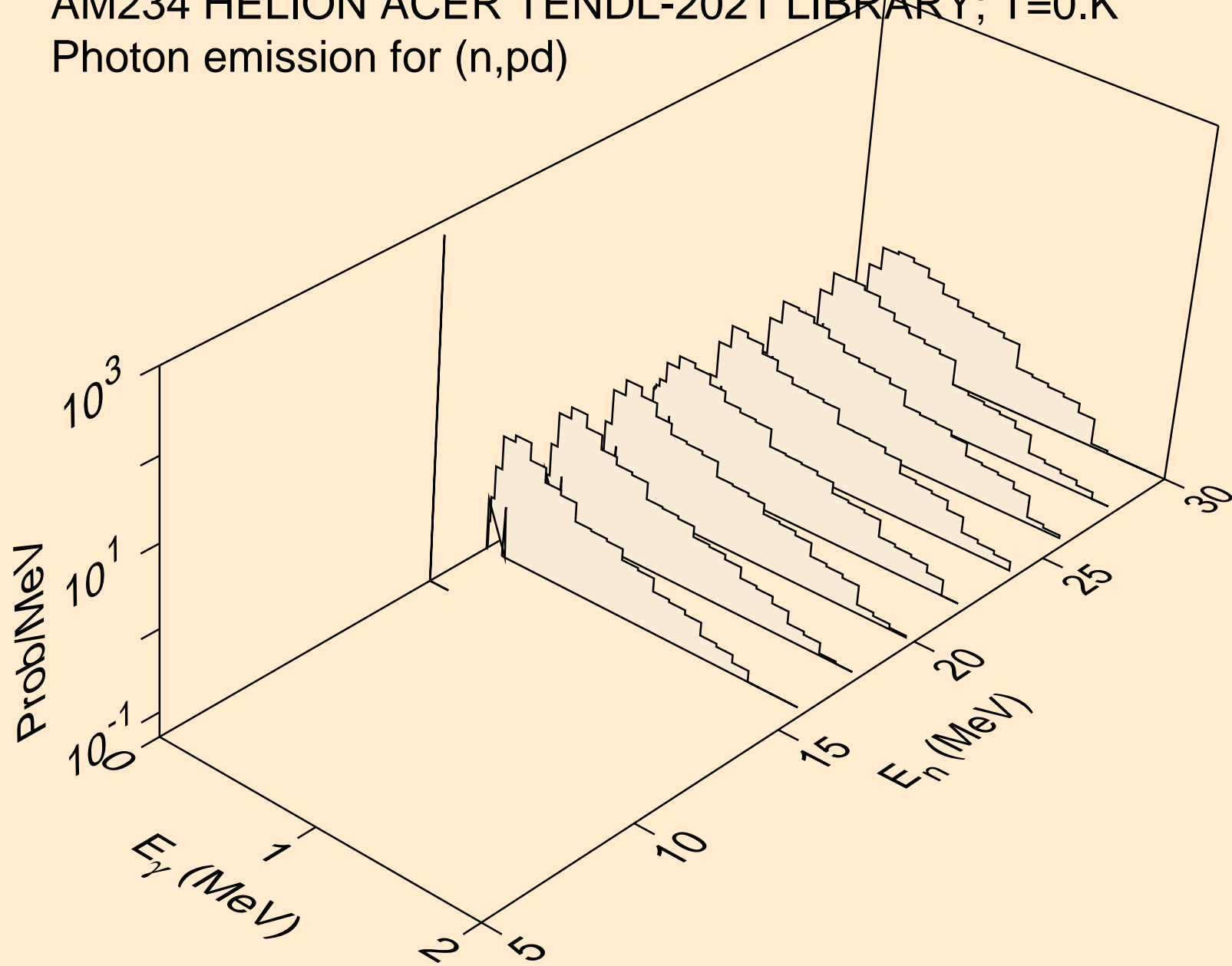

AM234 HELION ACER TENDL-2021 LIBRARY; T=0.K  
Particle heating contributions

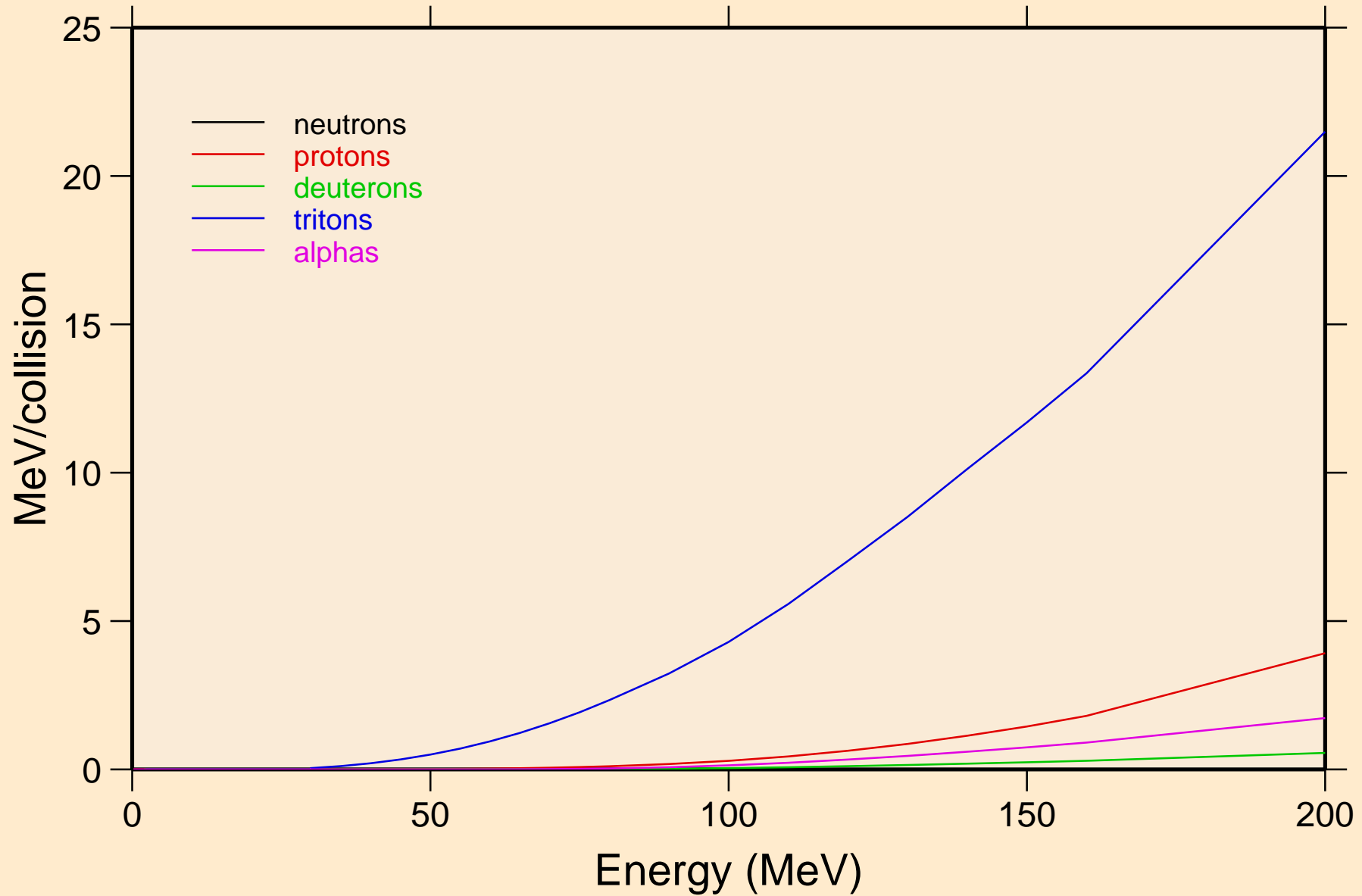

AM234 HELION ACER TENDL-2021 LIBRARY; T=0.K  
Recoil Heating

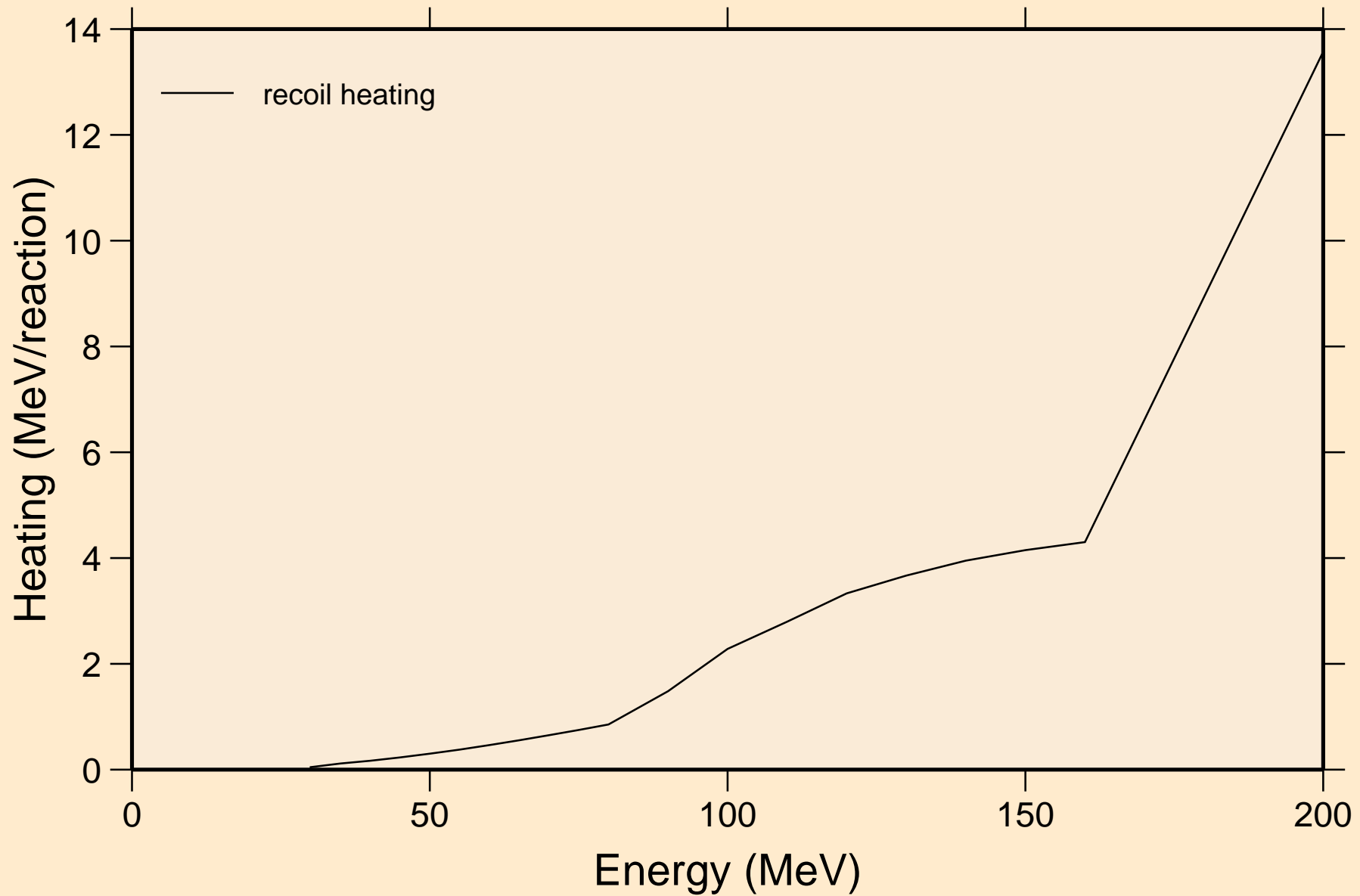

AM234 HELION ACER TENDL-2021 LIBRARY; T=0.K  
Particle production cross sections

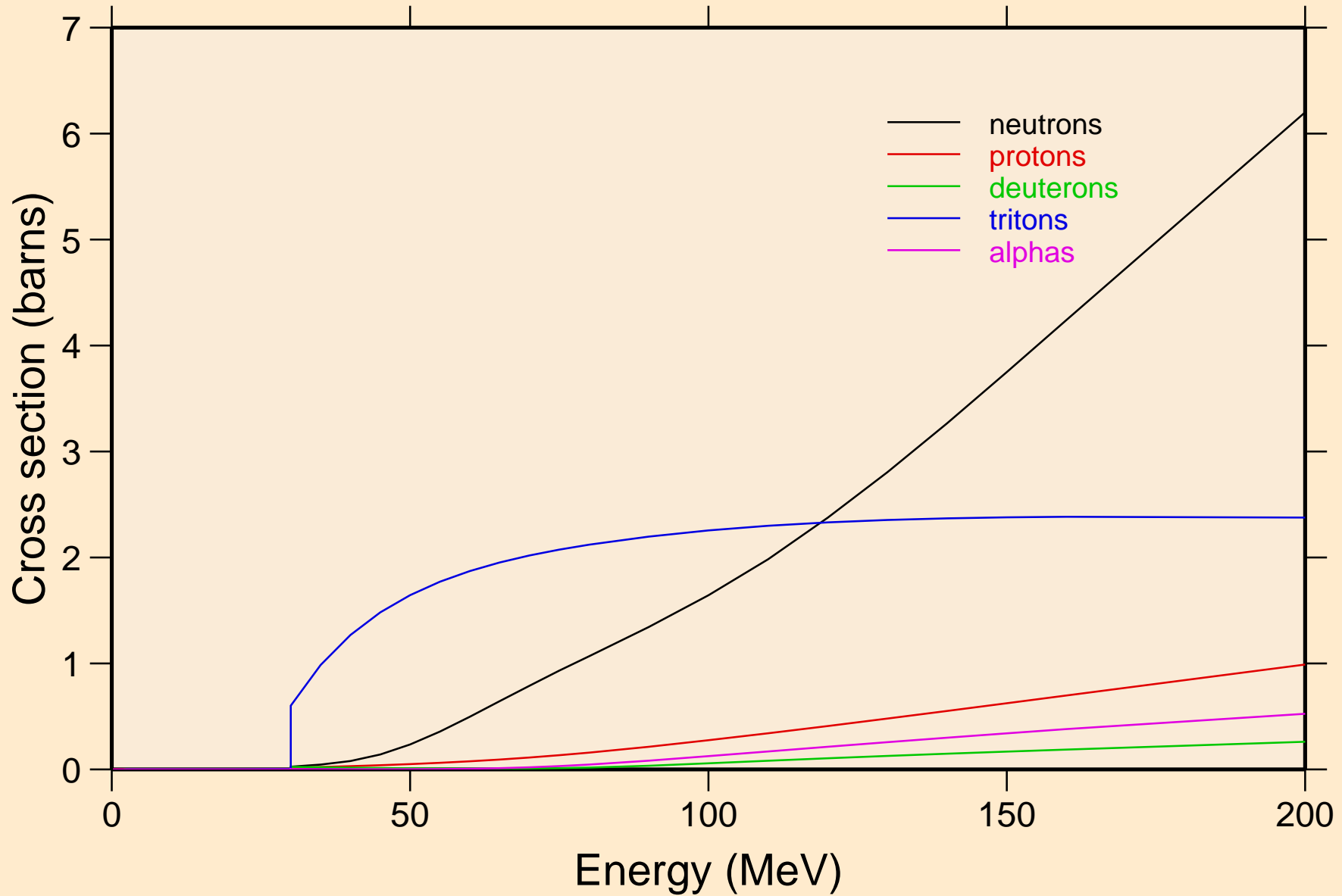

AM234 HELION ACER TENDL-2021 LIBRARY; T=0.K  
neutrons from (s,n)

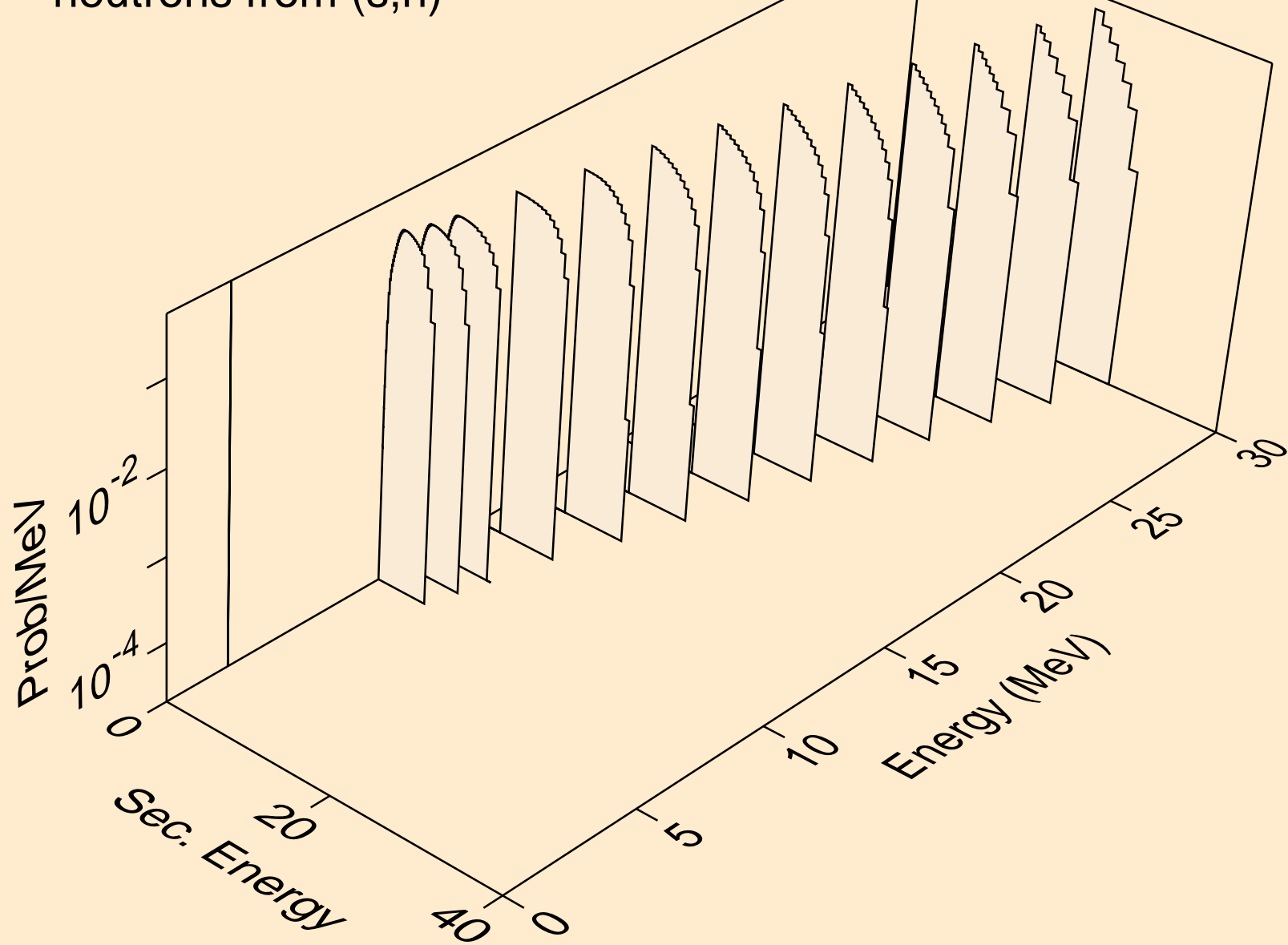



AM234 HELION ACER TENDL-2021 LIBRARY; T=0.K  
neutrons from (s,x)

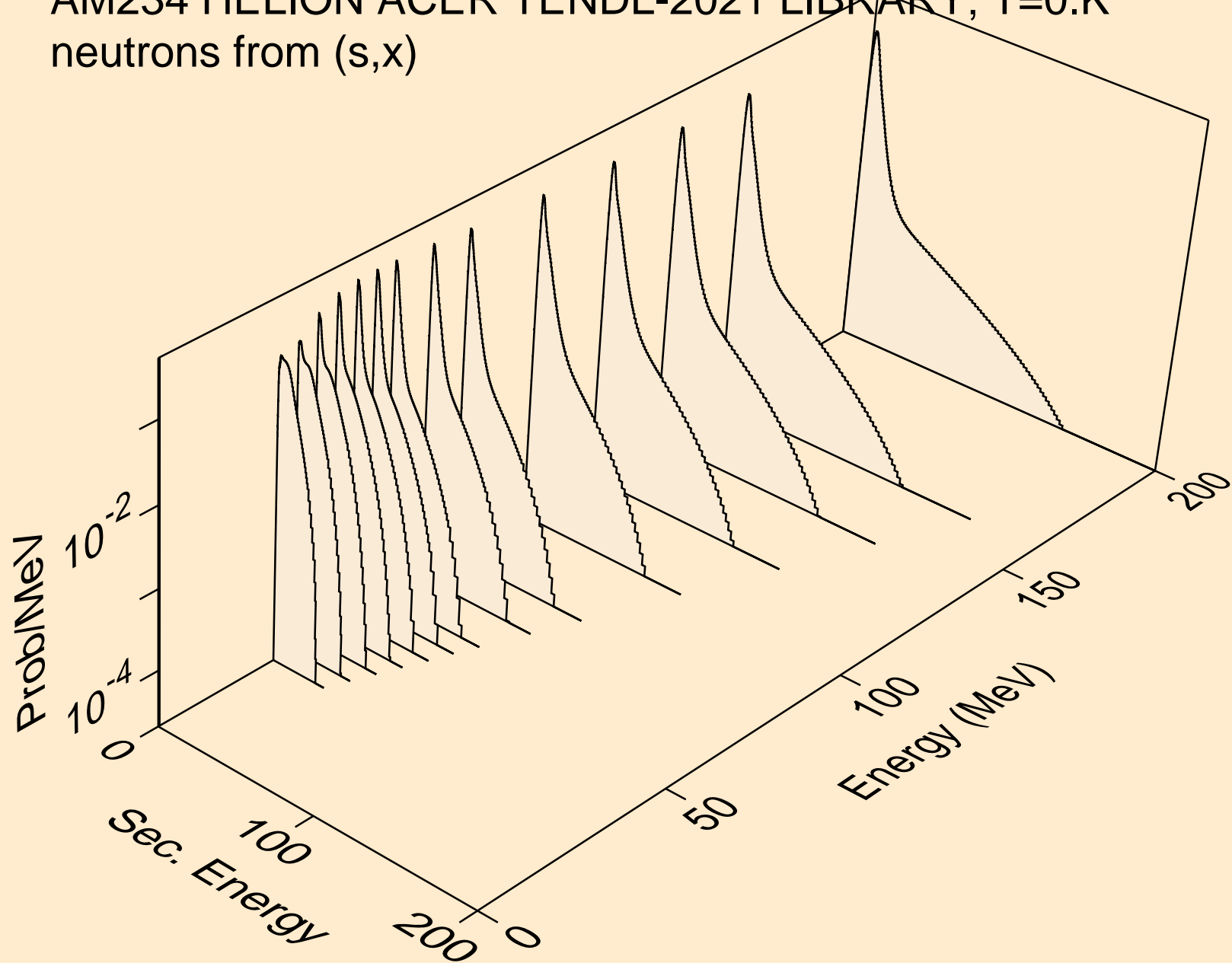

AM234 HELION ACER TENDL-2021 LIBRARY; T=0.K  
neutrons from (s,2n)

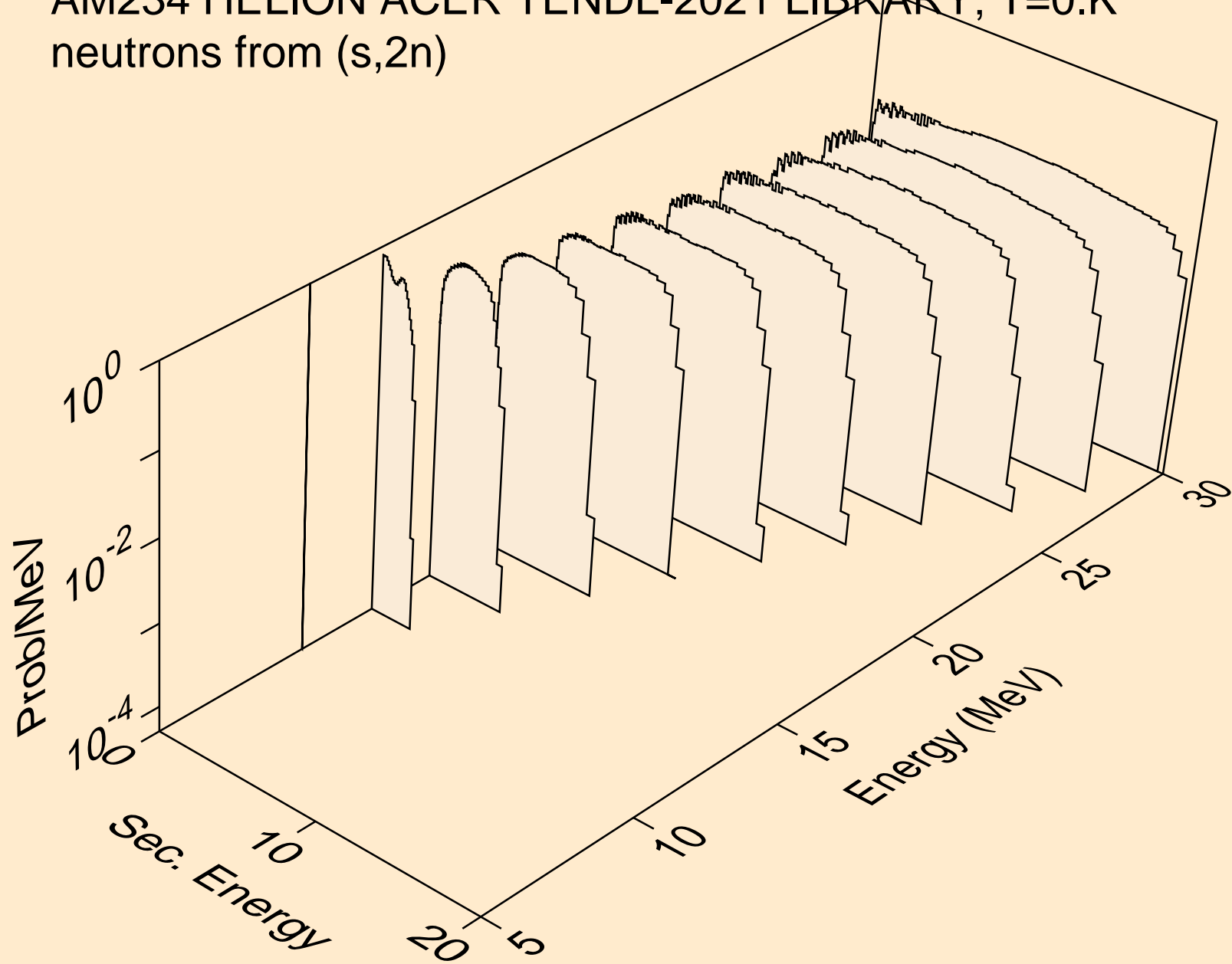

AM234 HELION ACER TENDL-2021 LIBRARY; T=0.K  
neutrons from (s,n\*)a

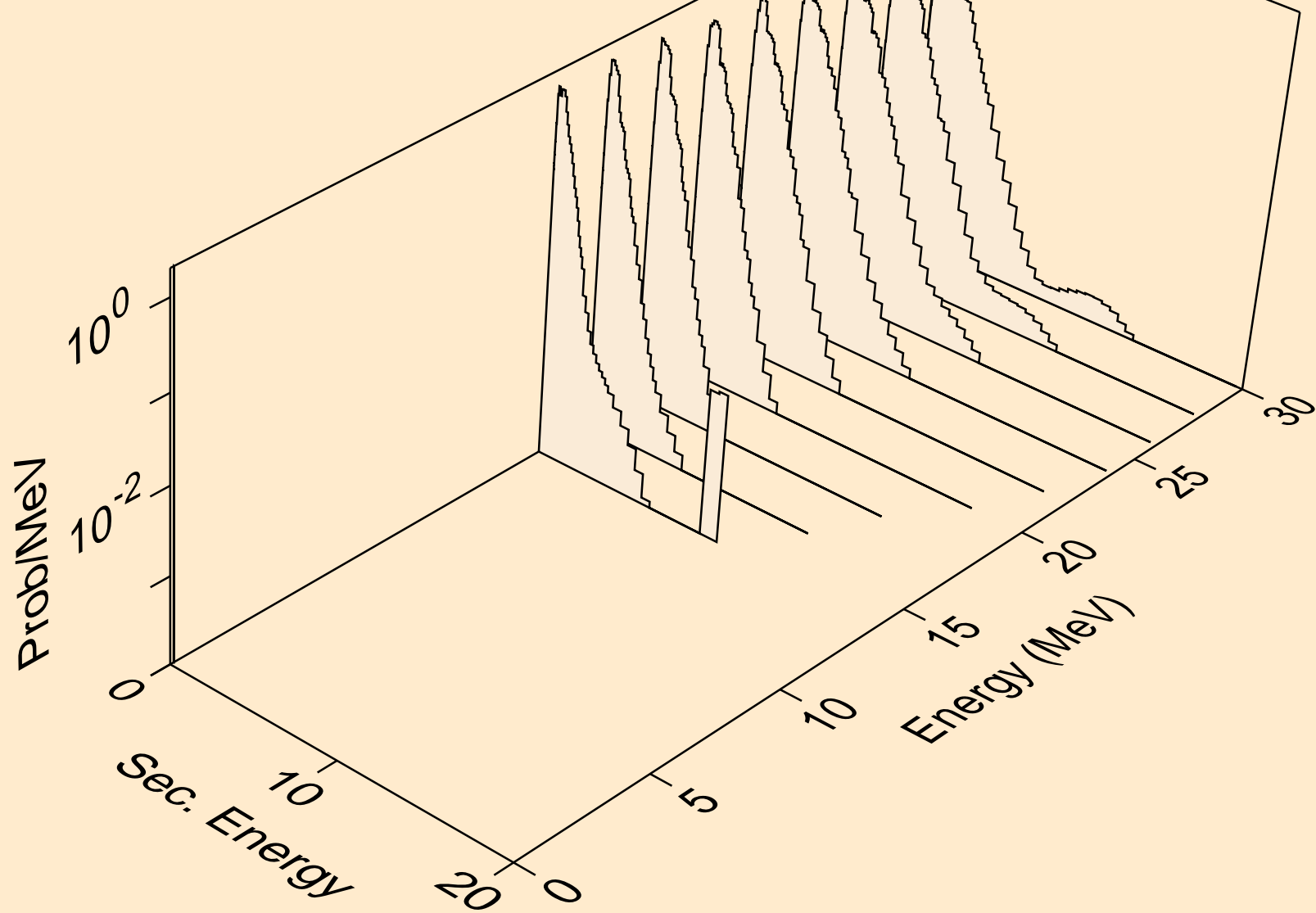

AM234 HELION ACER TENDL-2021 LIBRARY; T=0.K  
neutrons from (s,n\*)p

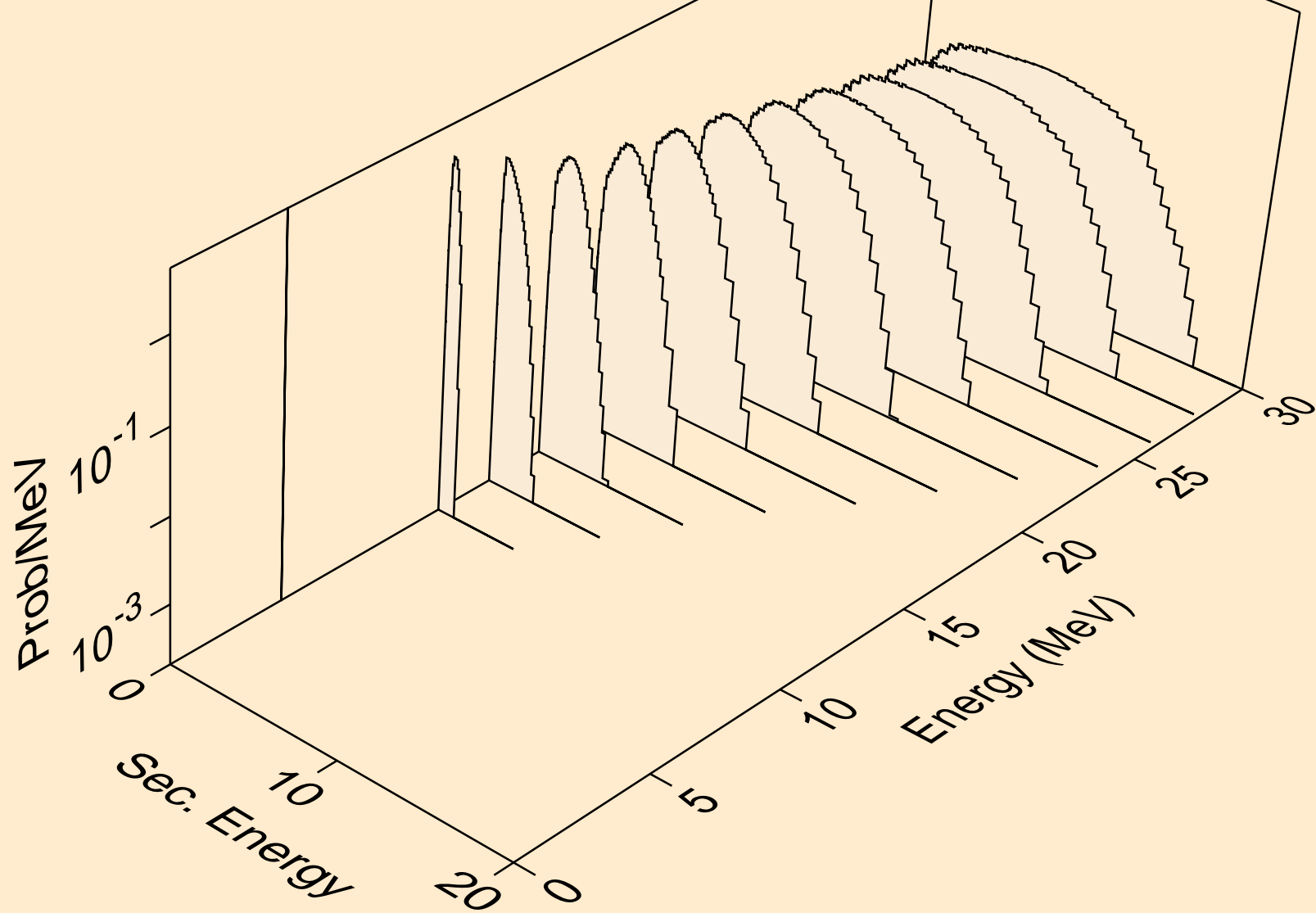

AM234 HELION ACER TENDL-2021 LIBRARY; T=0.K  
neutrons from (s,n\*)d

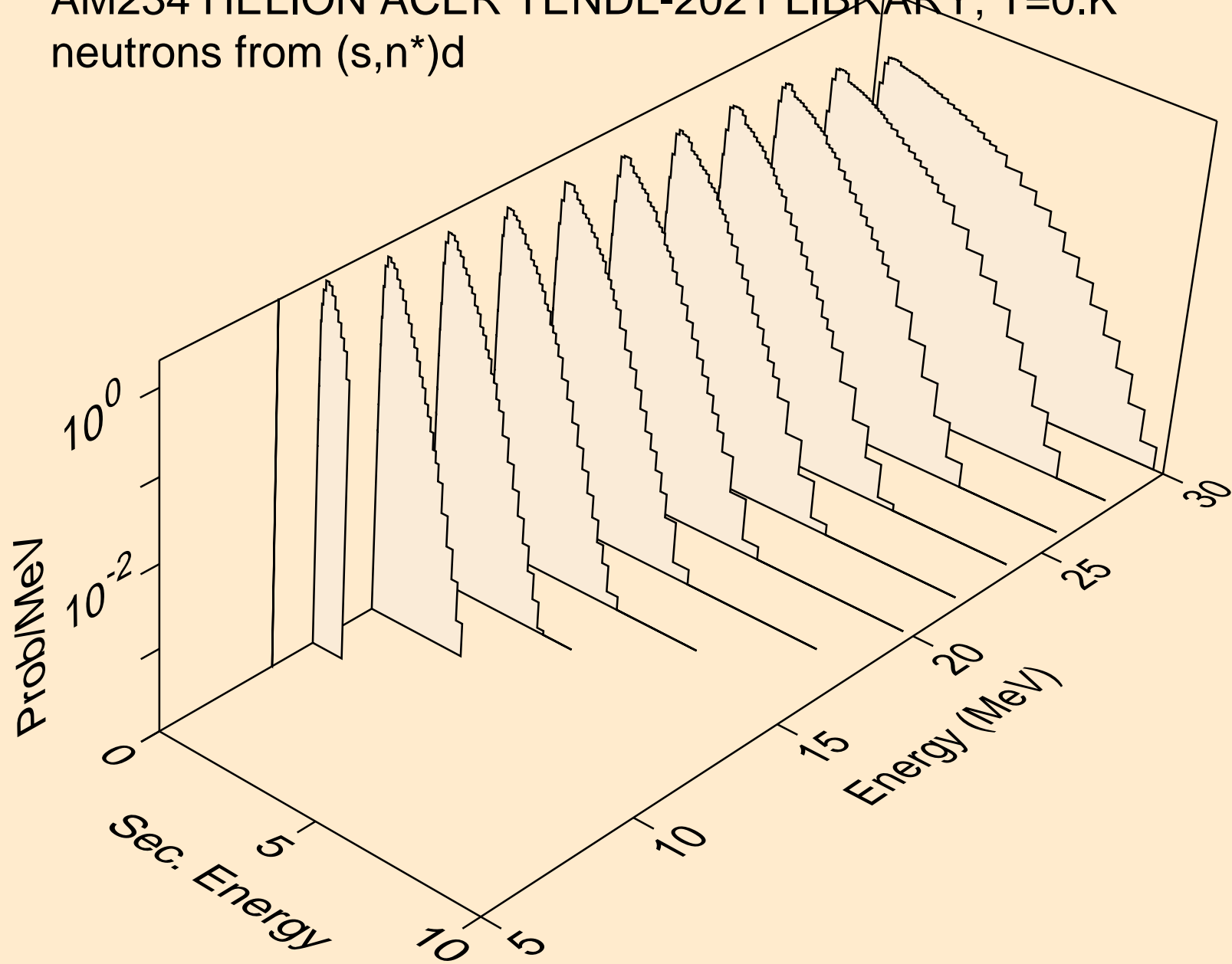

AM234 HELION ACER TENDL-2021 LIBRARY; T=0.K  
neutrons from (s,n\*)t

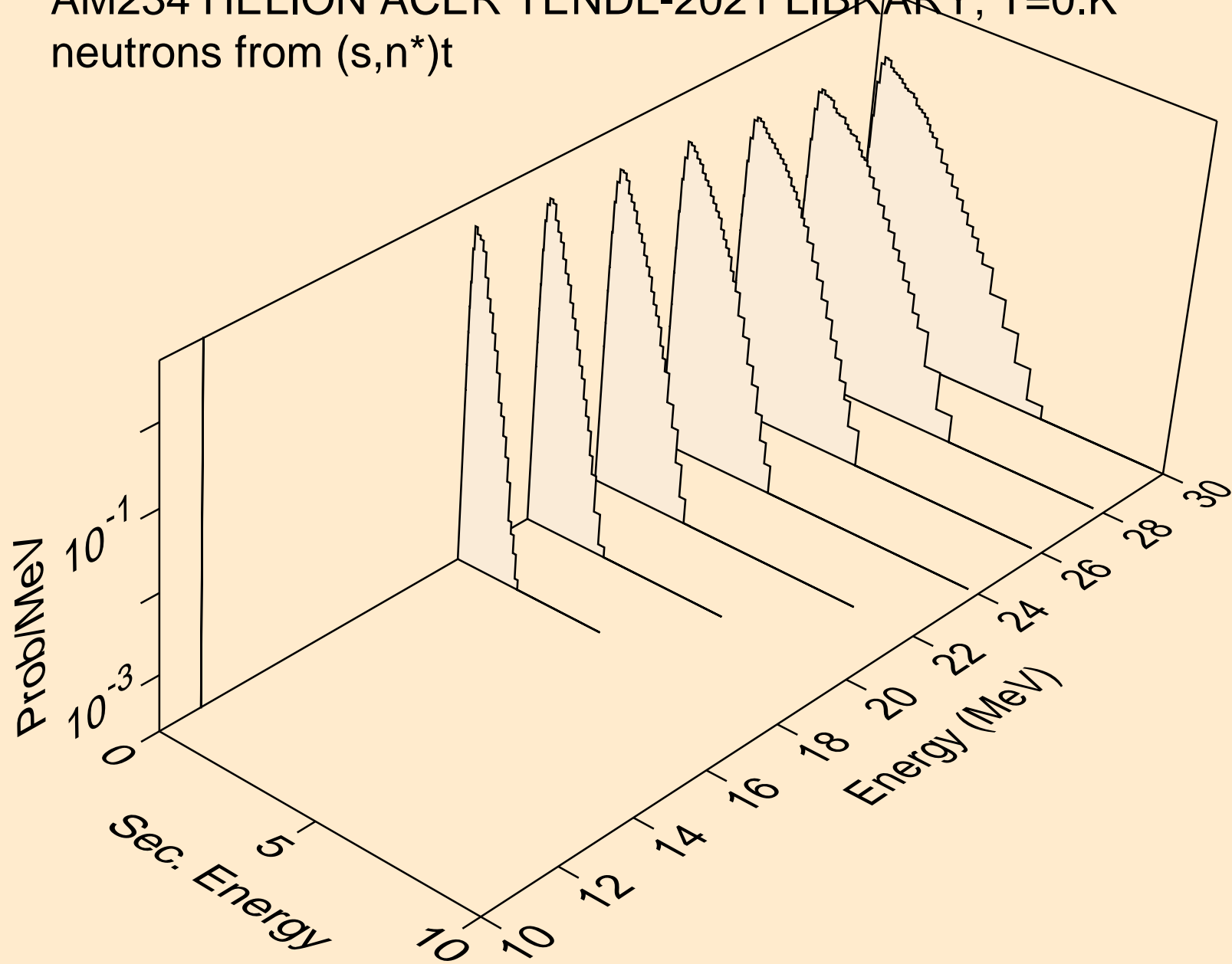

AM234 HELION ACER TENDL-2021 LIBRARY; T=0.K  
neutrons from (s,2np)

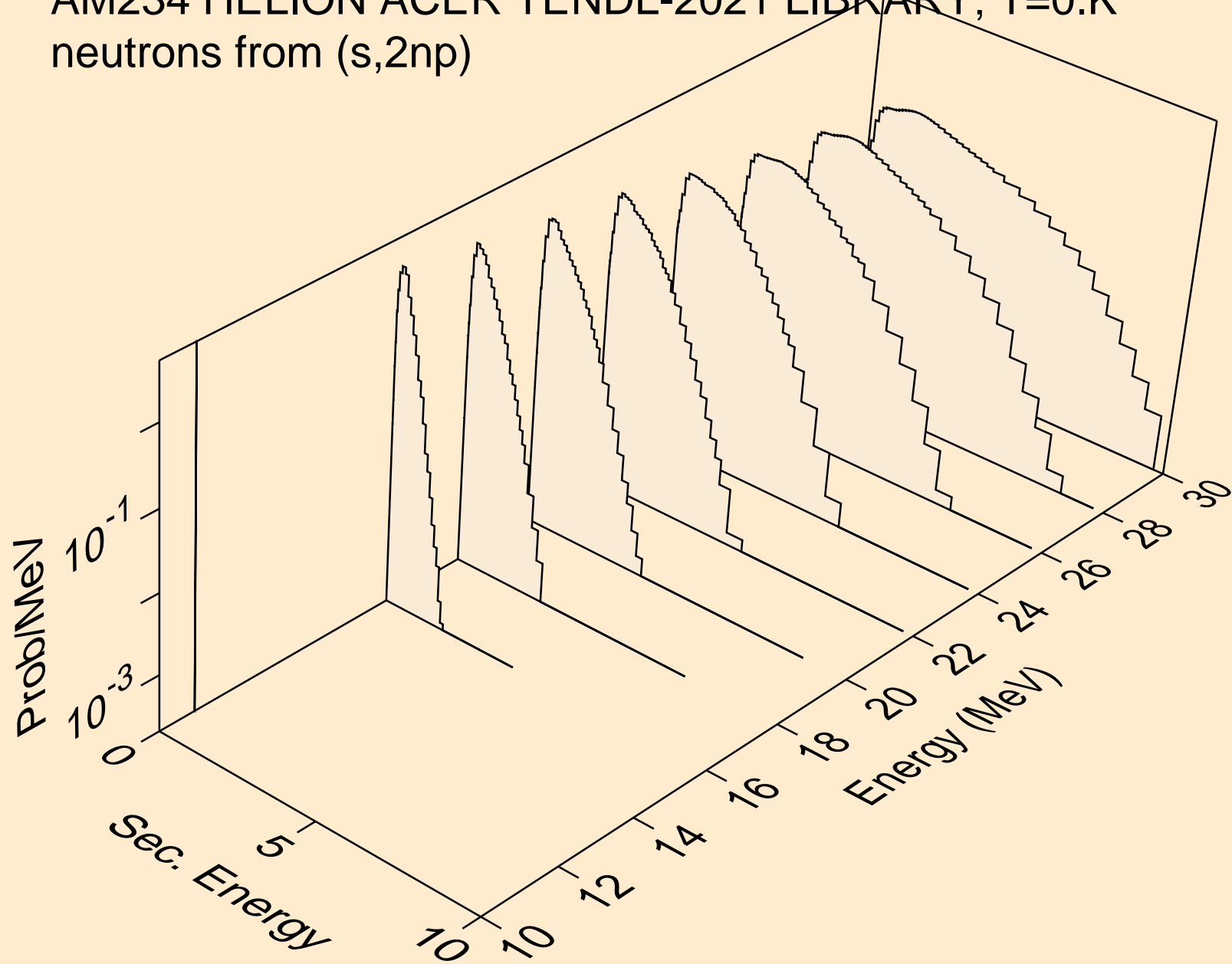

AM234 HELION ACER TENDL-2021 LIBRARY; T=0.K  
neutrons from (s,2np)

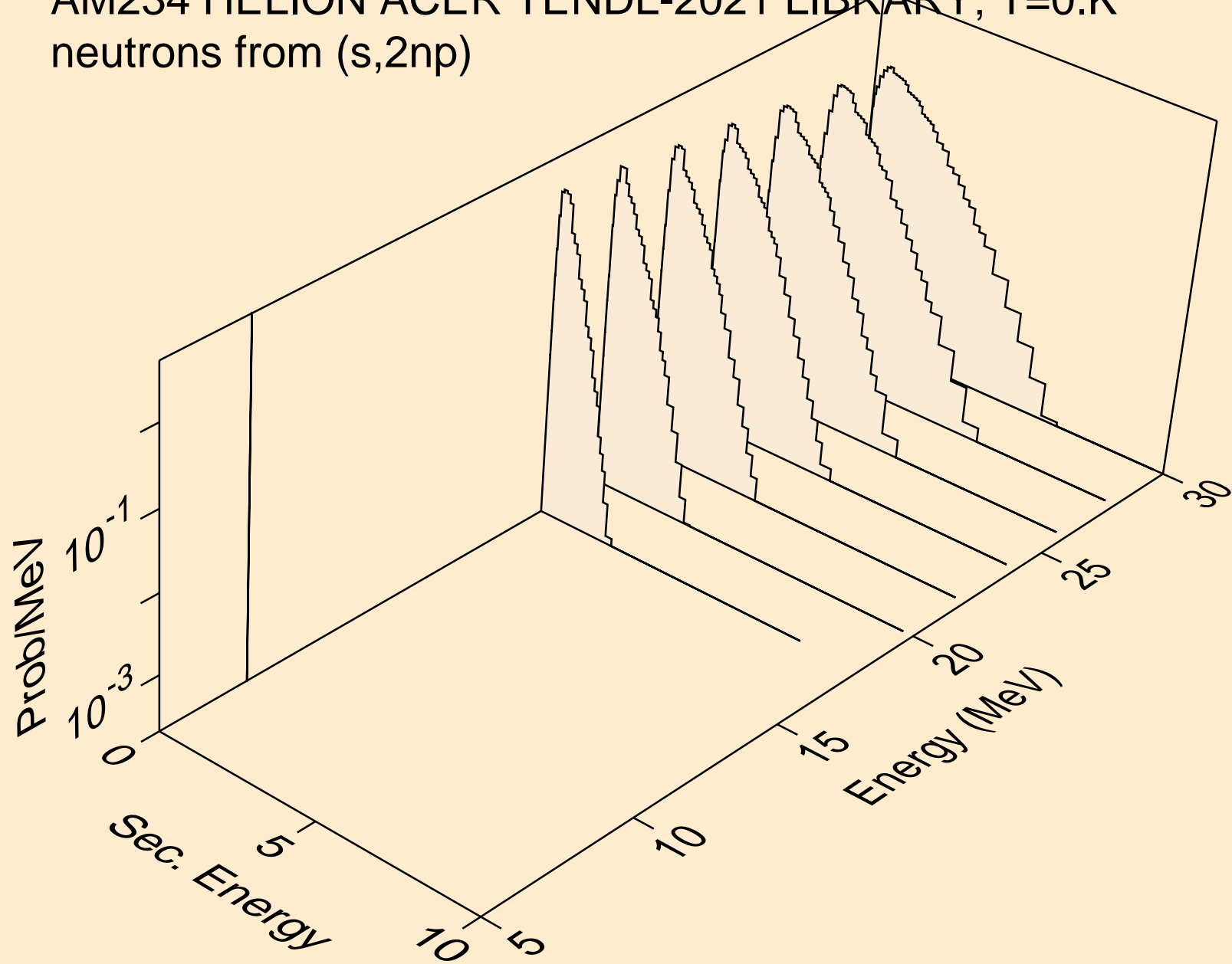



AM234 HELION ACER TENDL-2021 LIBRARY; T=0.K  
protons from (s,x)

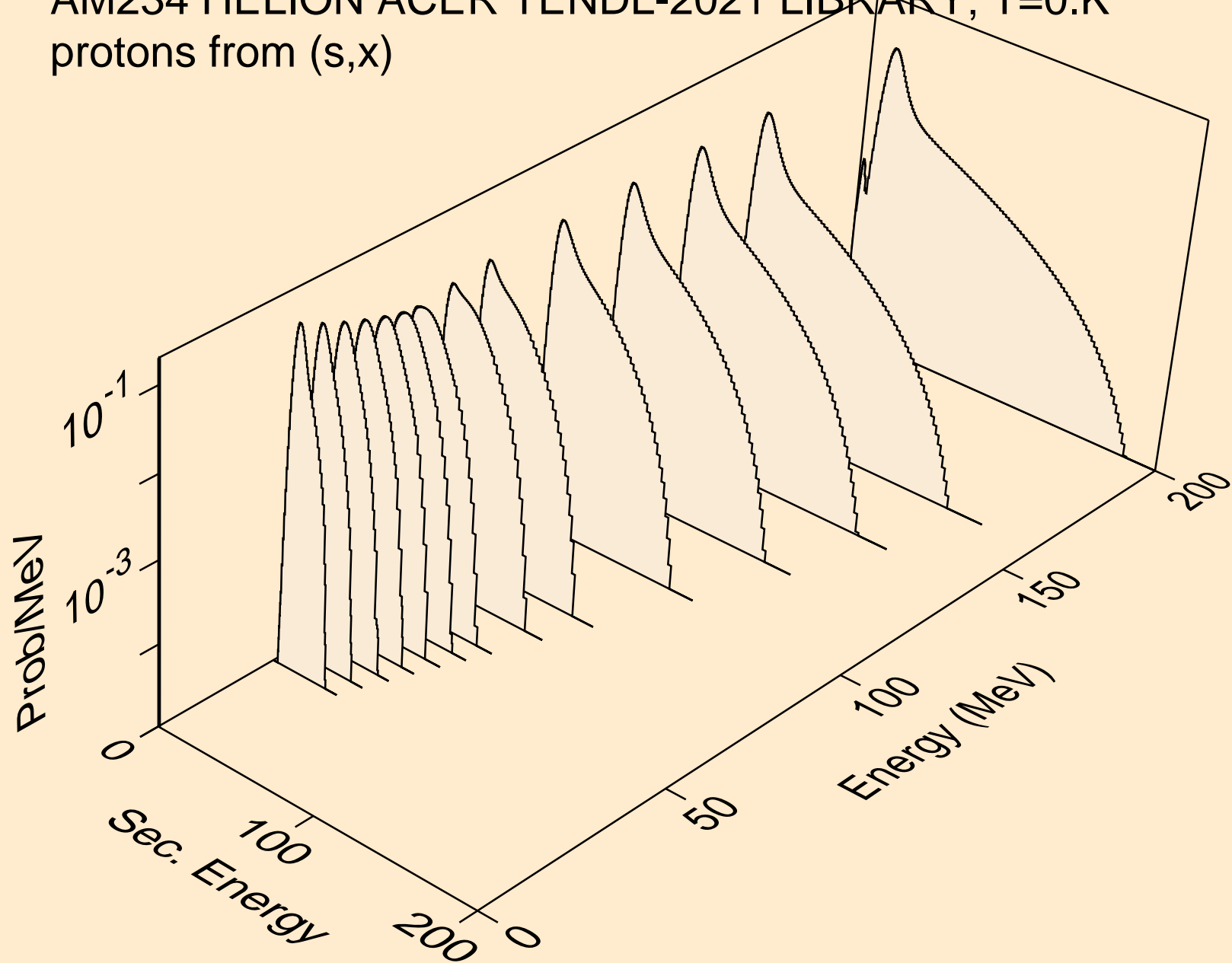

AM234 HELION ACER TENDL-2021 LIBRARY; T=0.K  
protons from (s,n\*)p

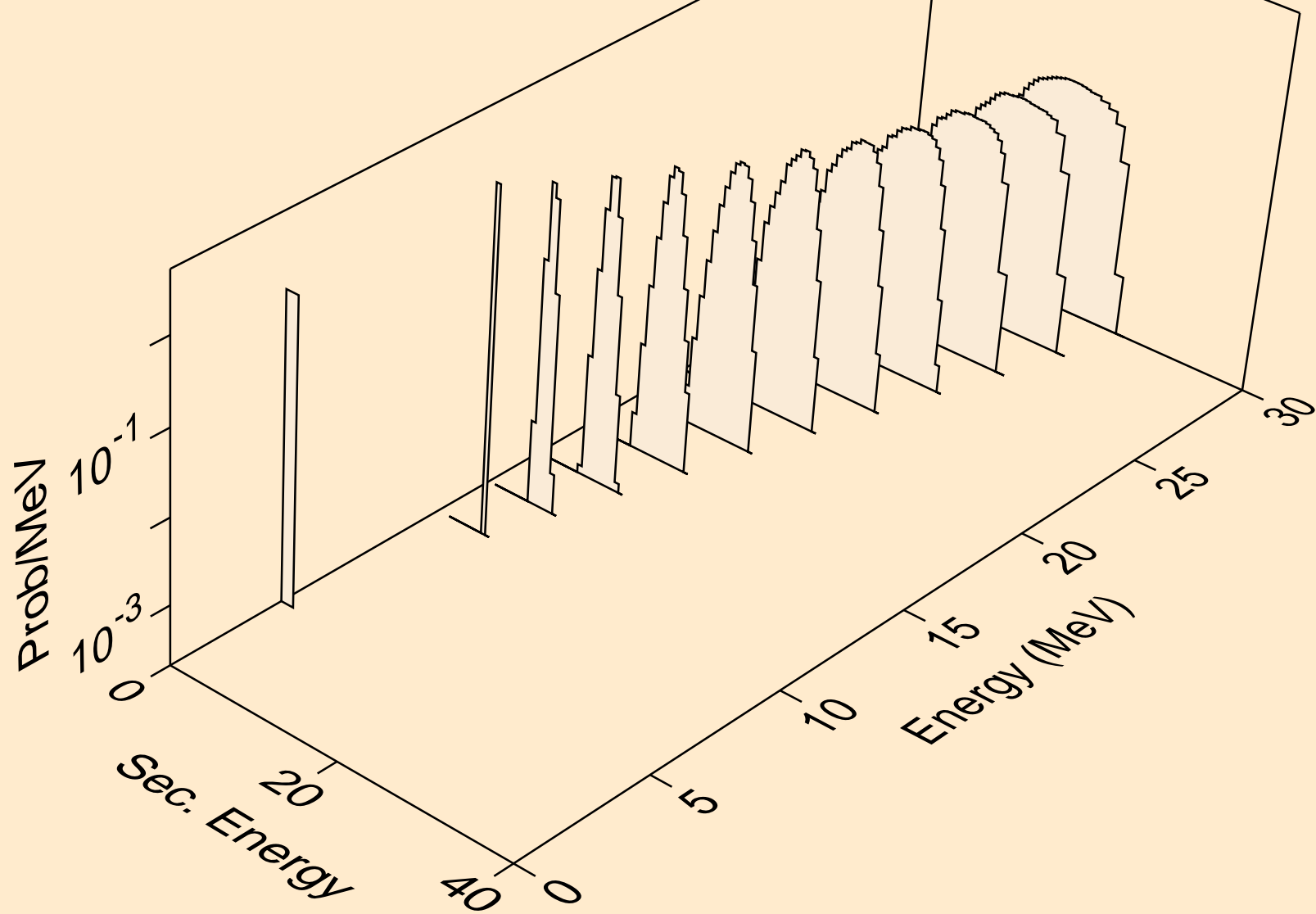

AM234 HELION ACER TENDL-2021 LIBRARY; T=0.K  
protons from (s,2np)

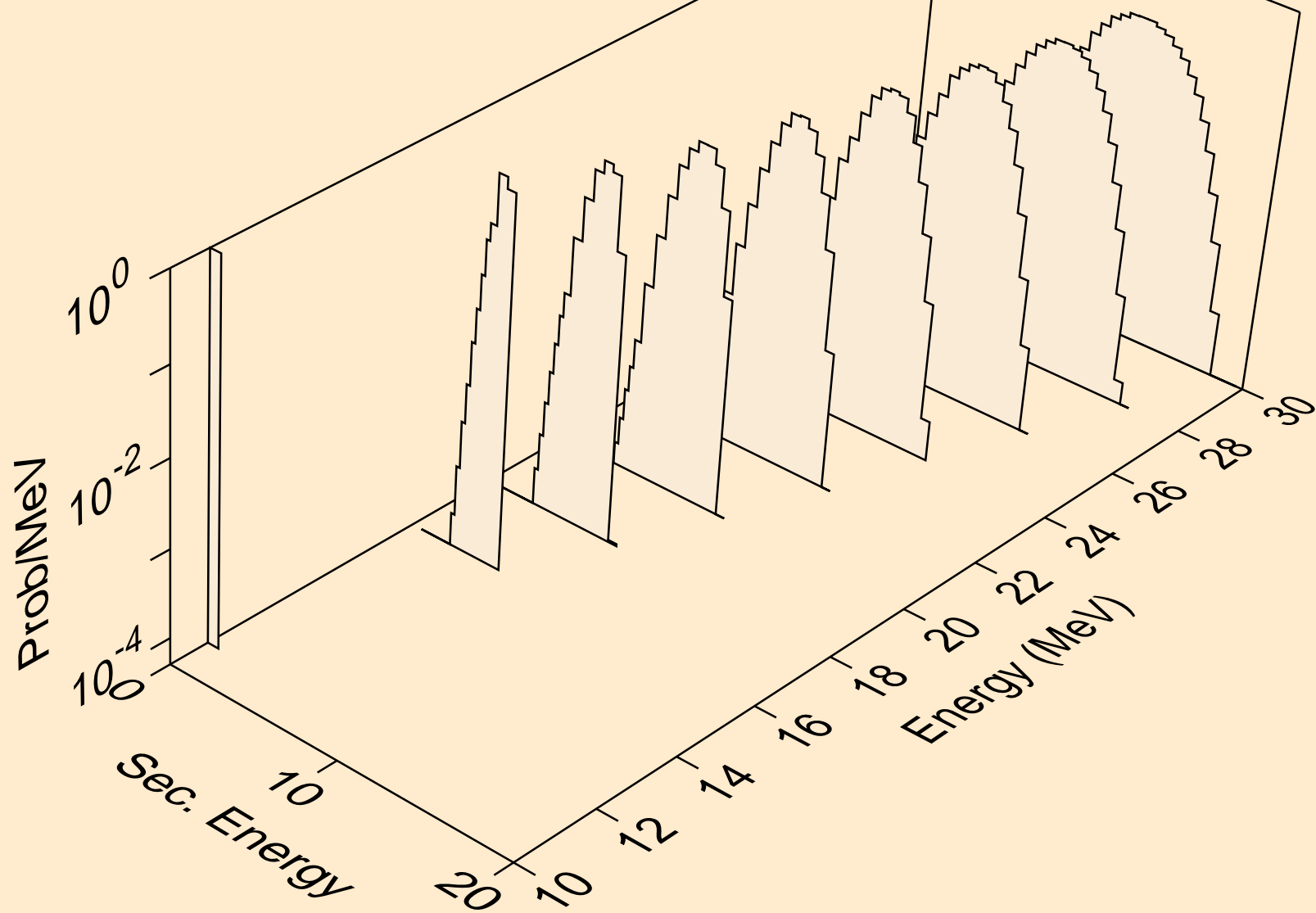

AM234 HELION ACER TENDL-2021 LIBRARY; T=0.K  
protons from (s,2np)

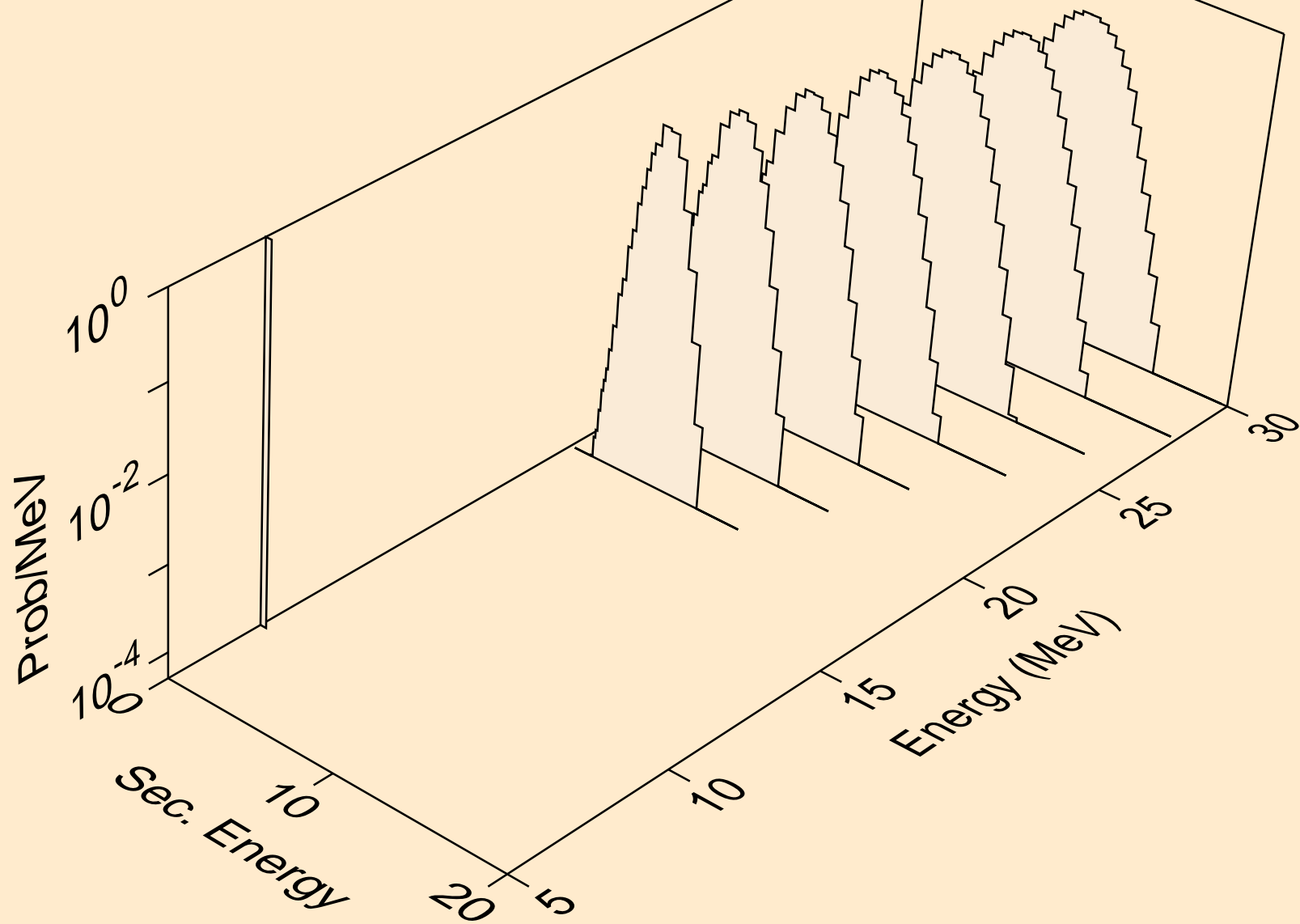

AM234 HELION ACER TENDL-2021 LIBRARY; T=0.K  
protons from (s,p)

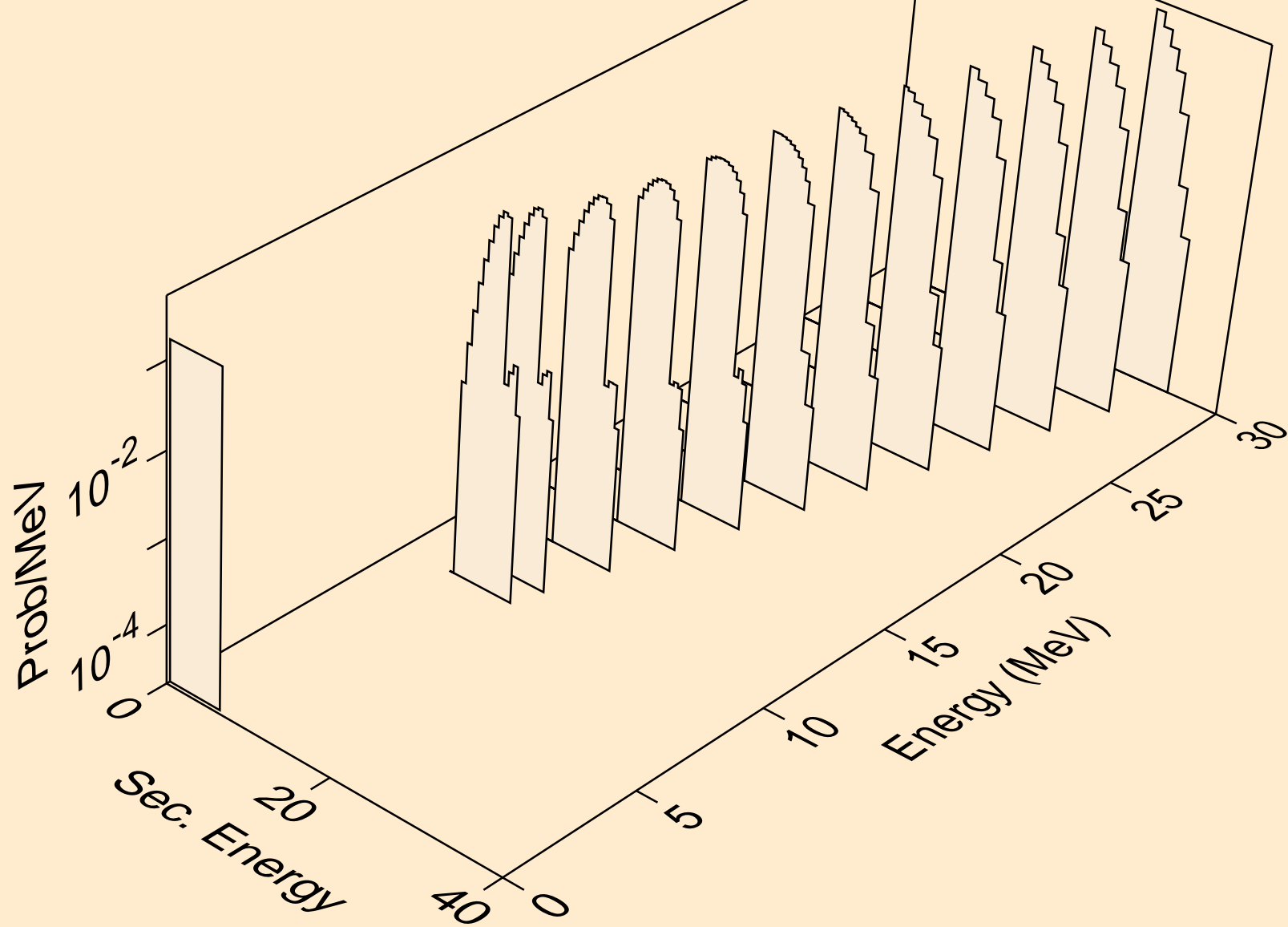

AM234 HELION ACER TENDL-2021 LIBRARY; T=0.K  
protons from (s,2p)

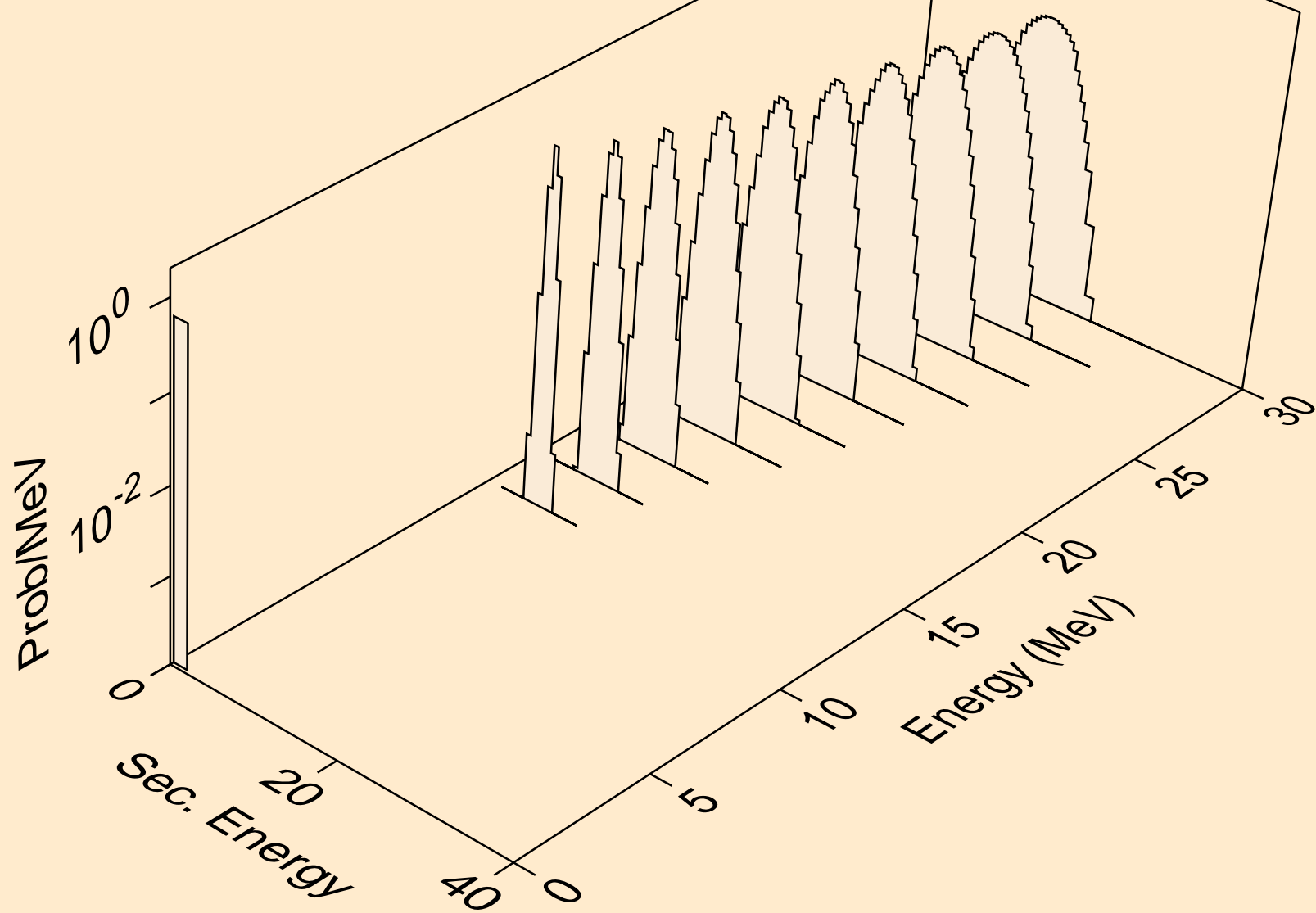

AM234 HELION ACER TENDL-2021 LIBRARY; T=0.K  
protons from (s,pd)

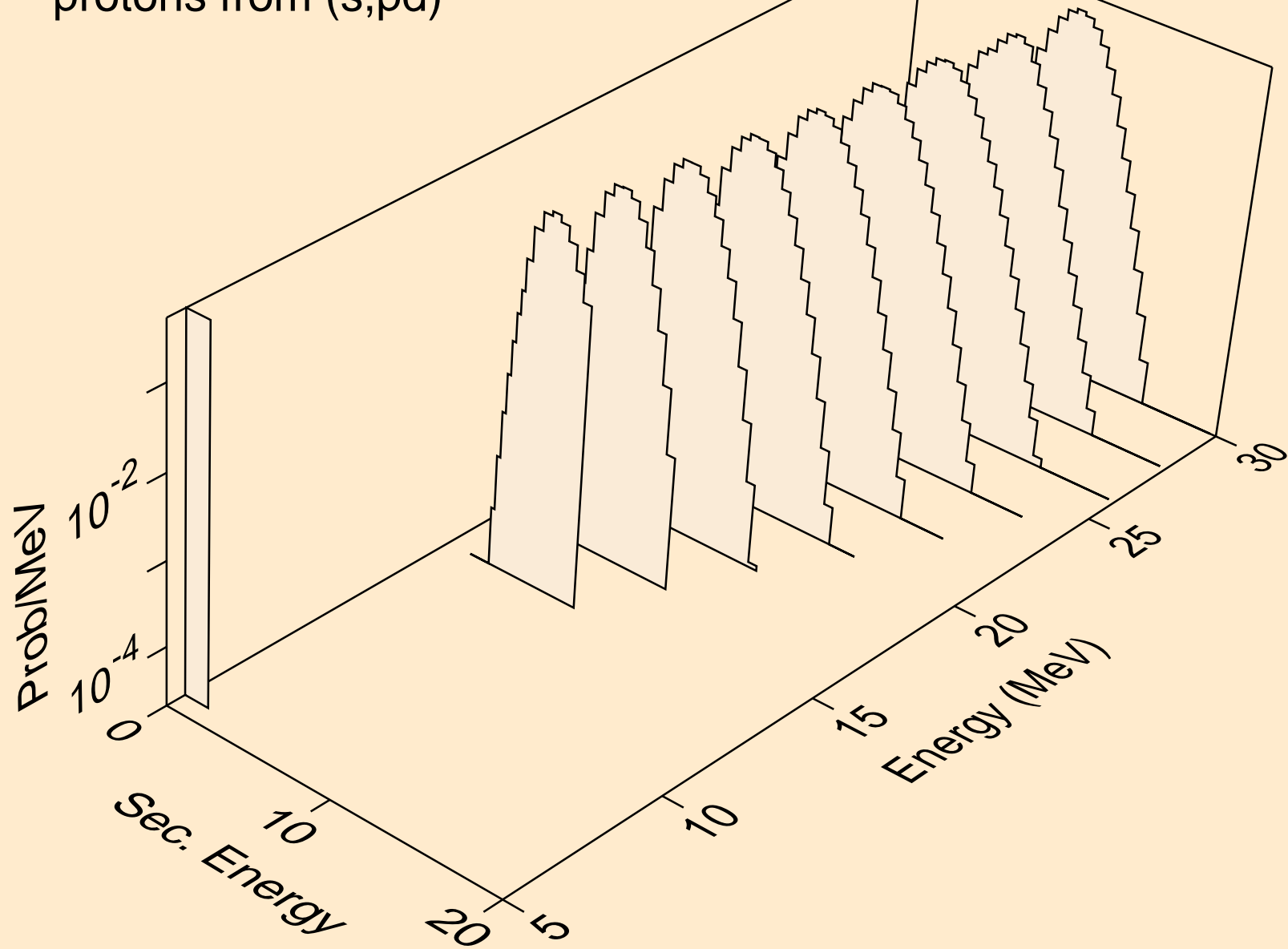

AM234 HELION ACER TENDL-2021 LIBRARY; T=0.K  
deuterons from (s,x)

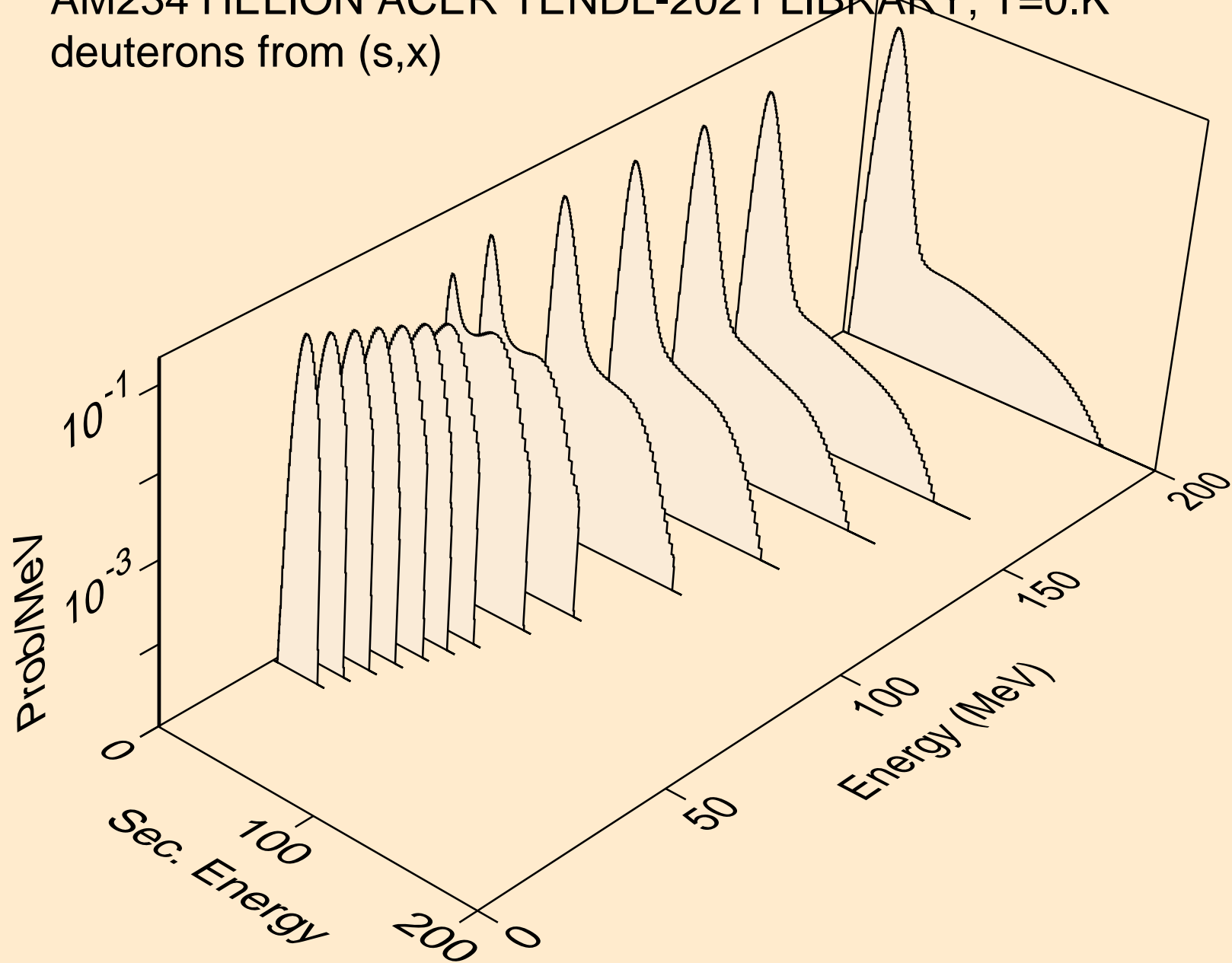



AM234 HELION ACER TENDL-2021 LIBRARY; T=0.K  
deuterons from (s,n\*)d

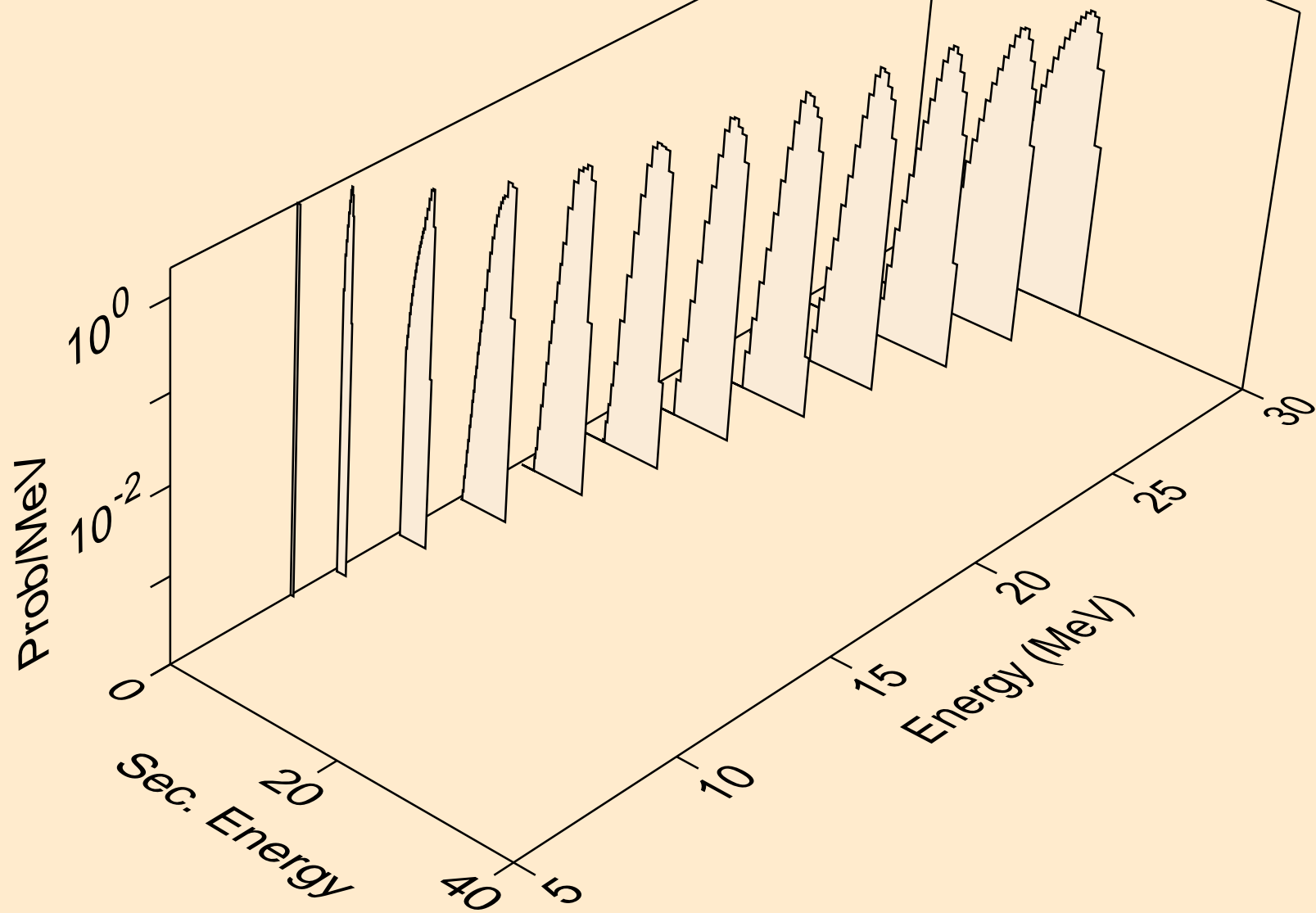

AM234 HELION ACER TENDL-2021 LIBRARY; T=0.K  
deuterons from (s,d)

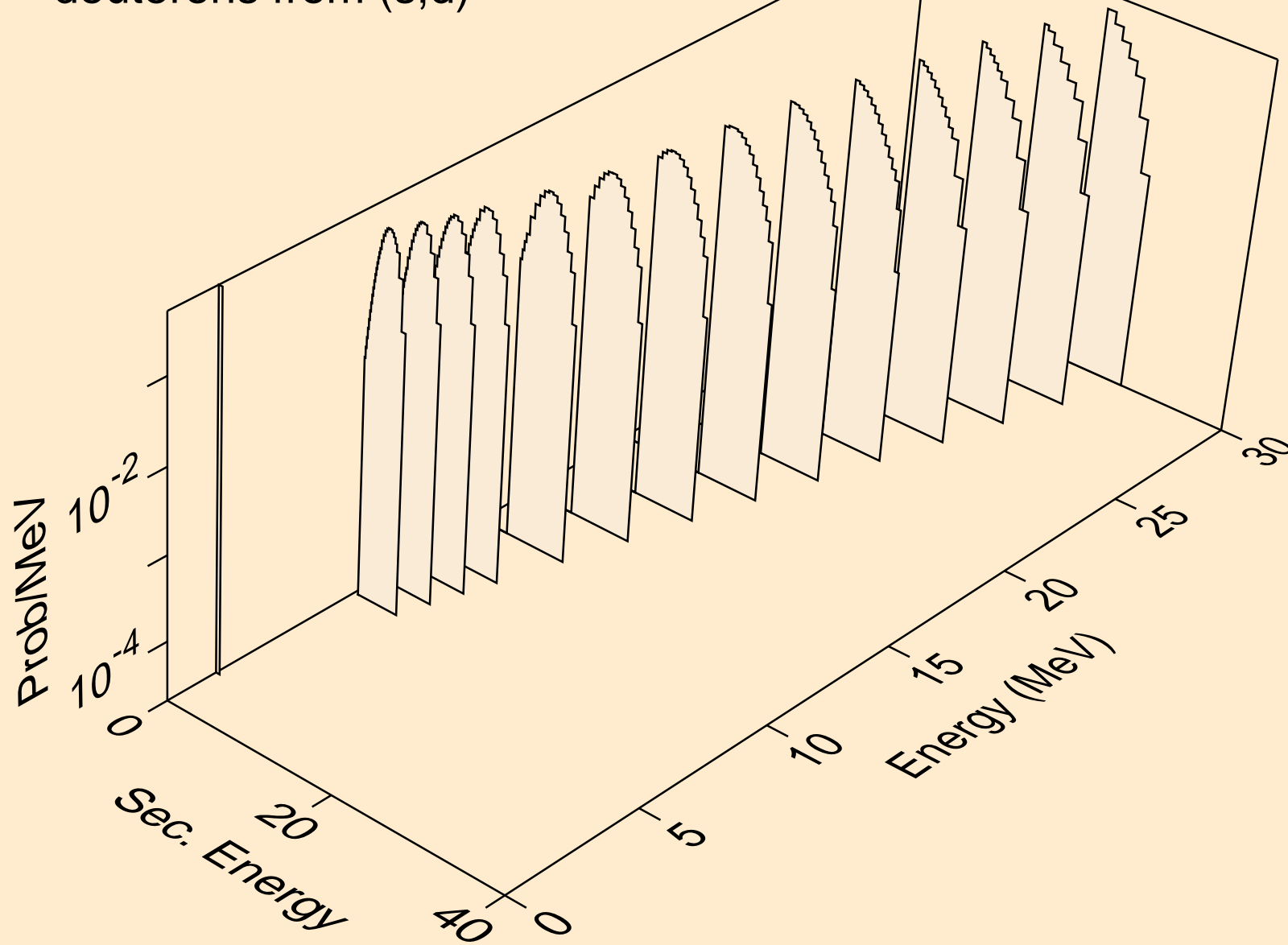

AM234 HELION ACER TENDL-2021 LIBRARY; T=0.K  
deuterons from (s,pd)

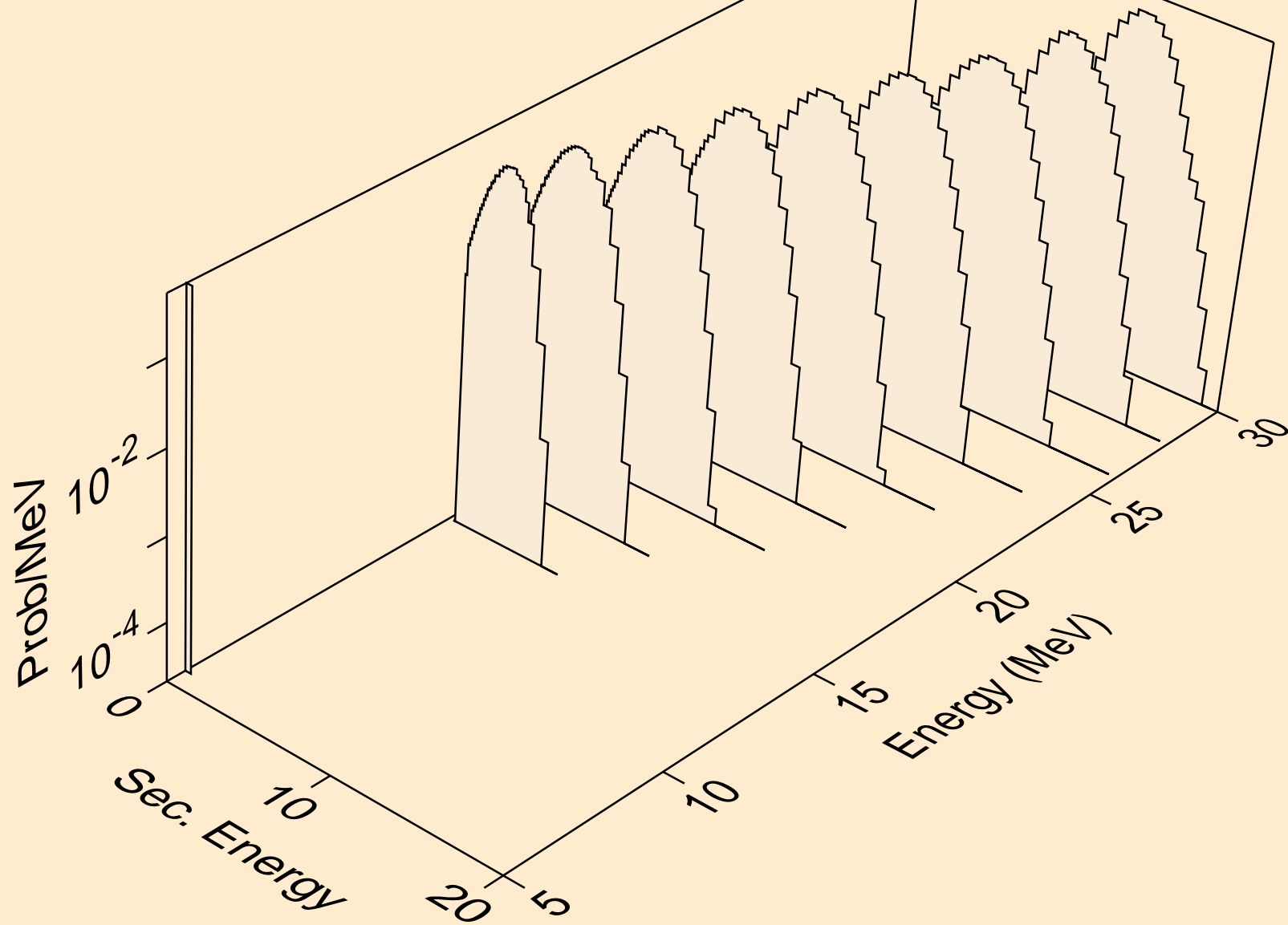

AM234 HELION ACER TENDL-2021 LIBRARY; T=0.K  
tritons from (s,x)

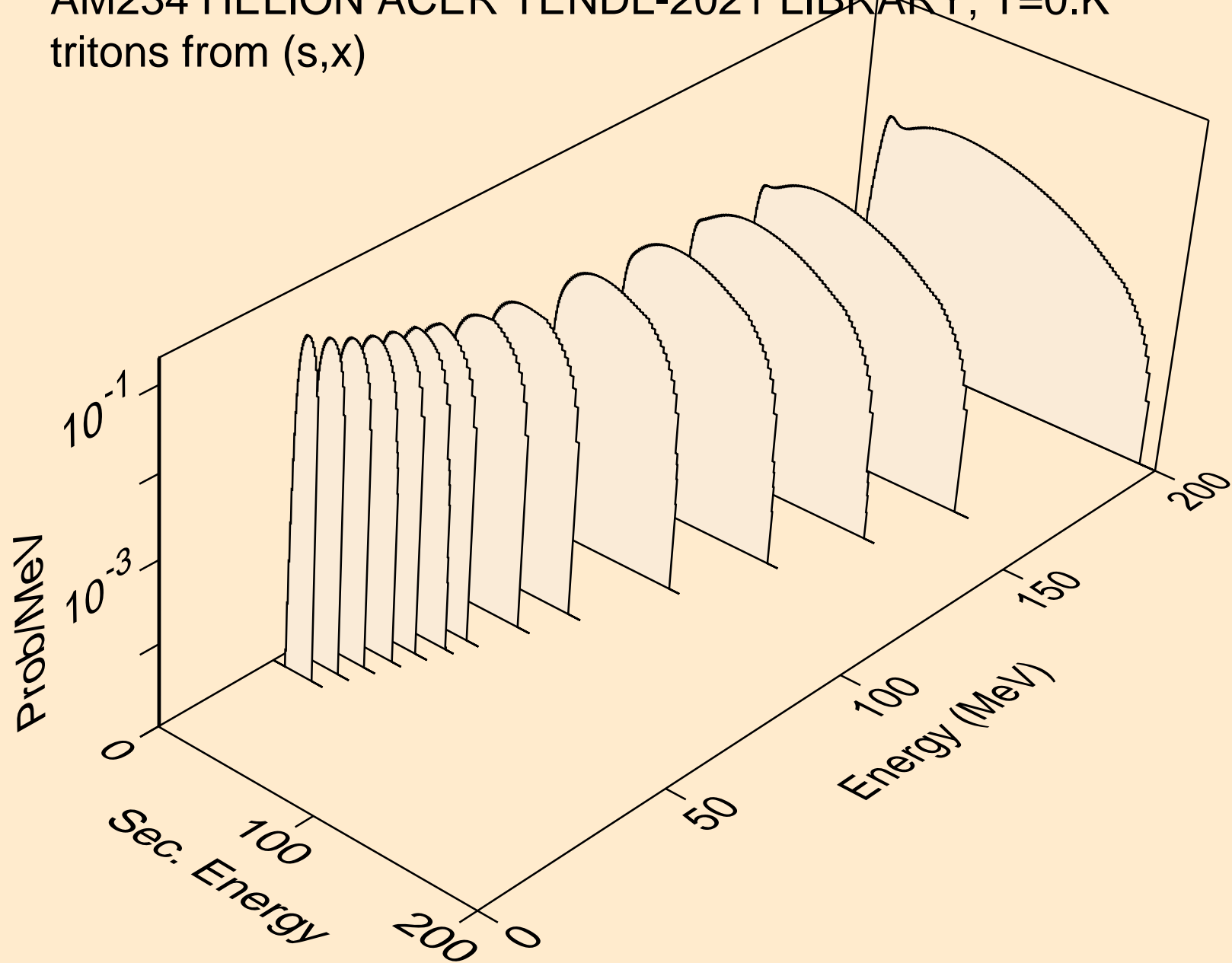

AM234 HELION ACER TENDL-2021 LIBRARY; T=0.K  
tritons from (s,n\*)t

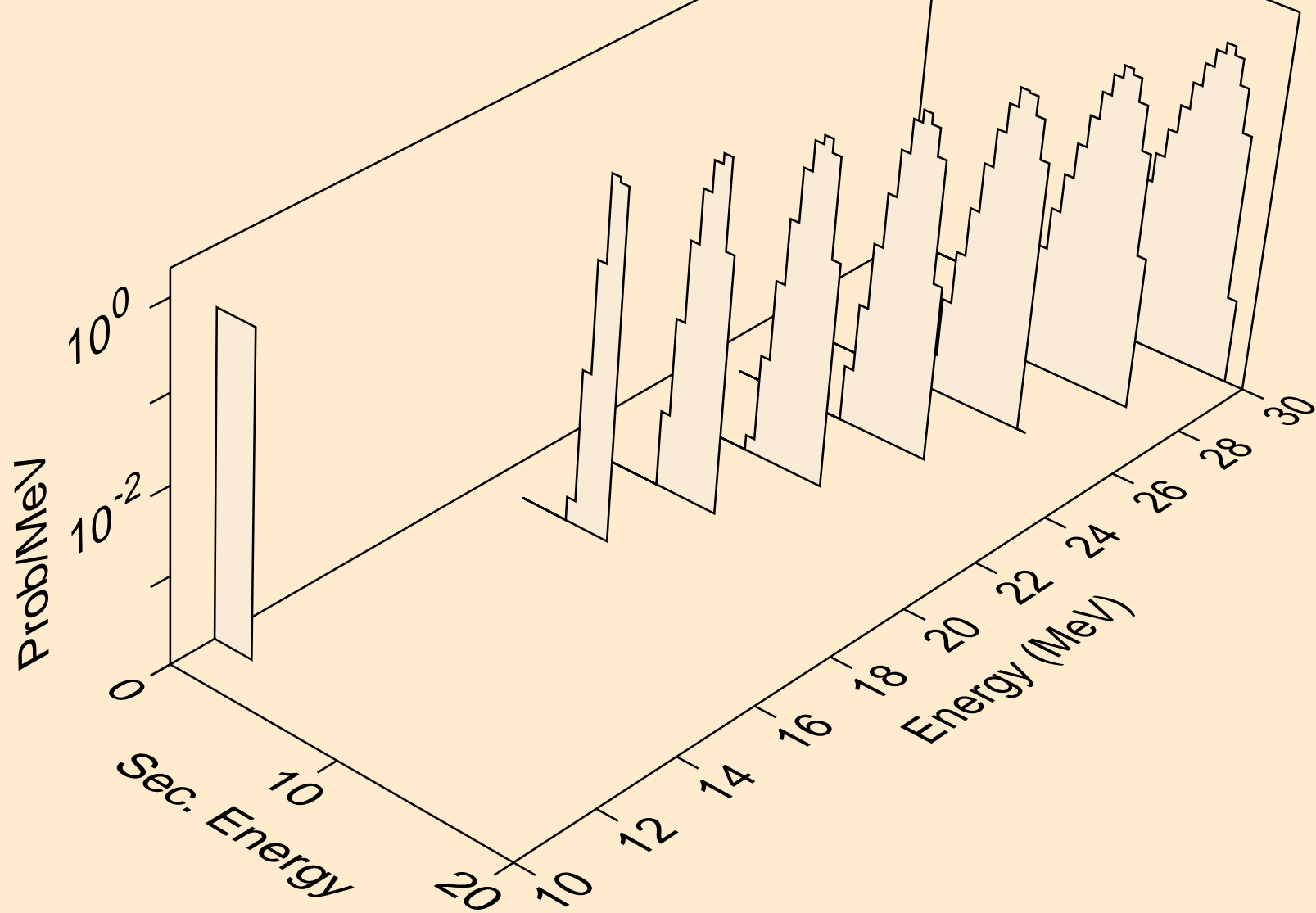

AM234 HELION ACER TENDL-2021 LIBRARY; T=0.K  
tritons from (s,t)

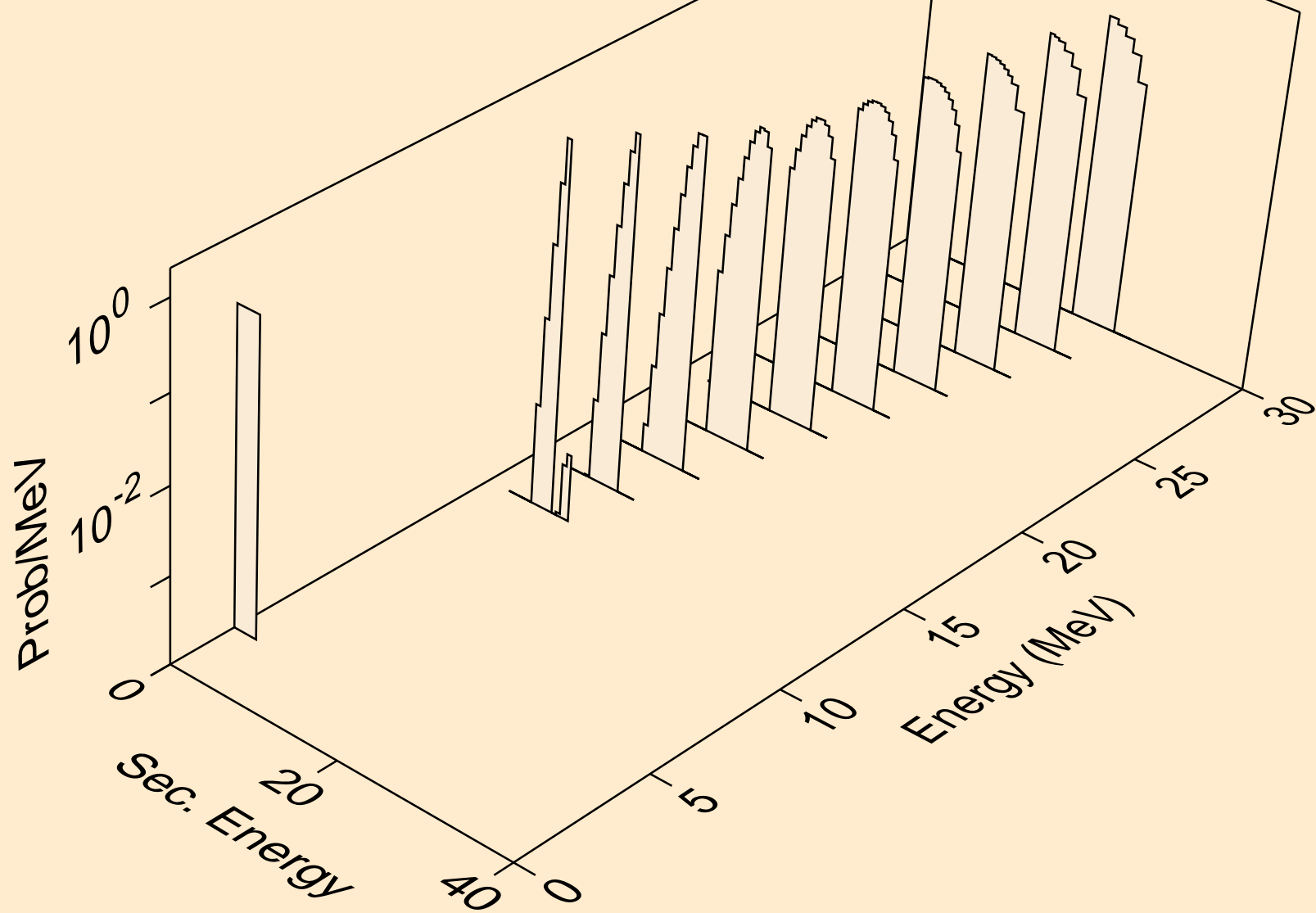

AM234 HELION ACER TENDL-2021 LIBRARY; T=0.K  
alphas from (s,x)

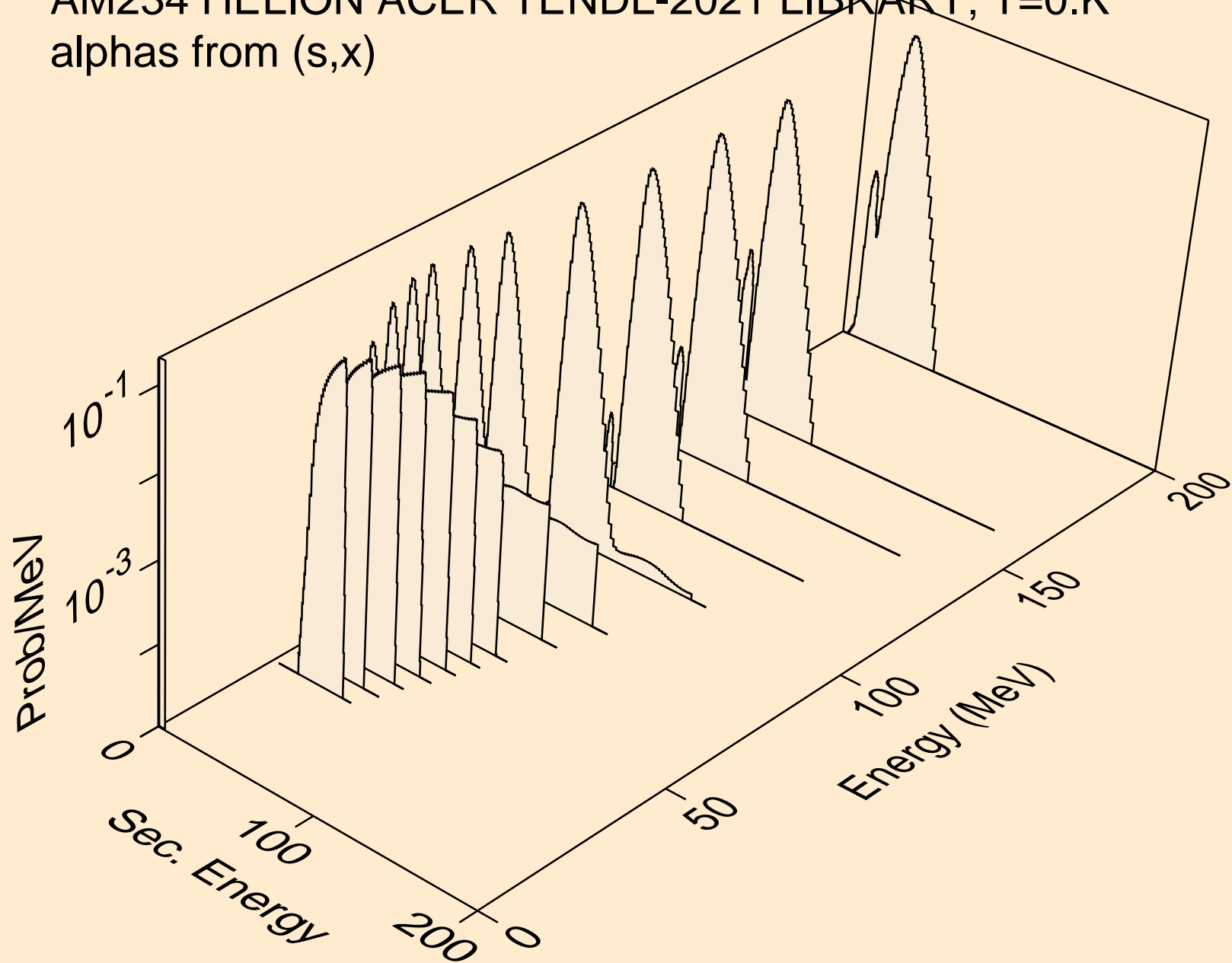

AM234 HELION ACER TENDL-2021 LIBRARY; T=0.K  
alphas from (s,n\*)a

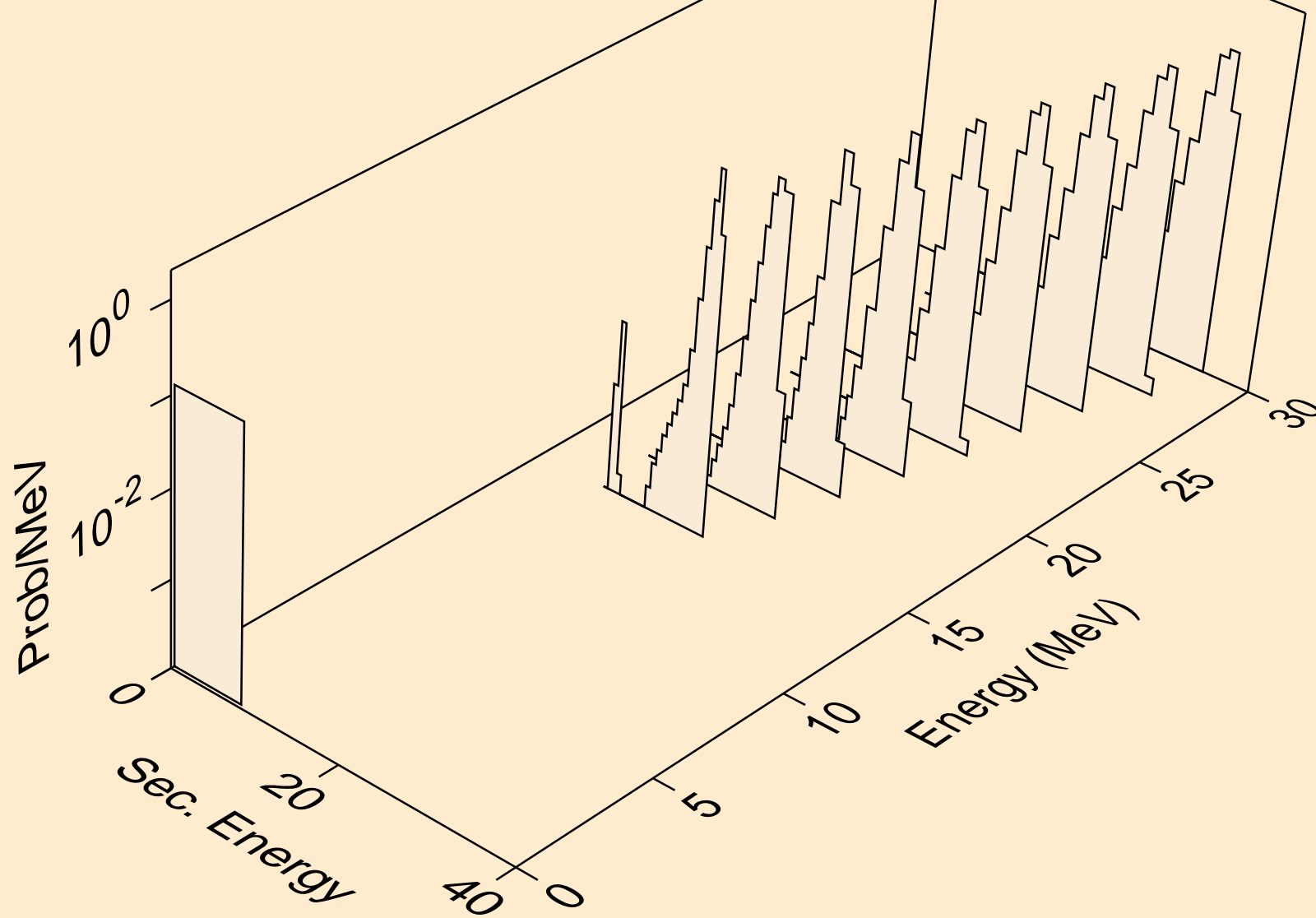



AM234 HELION ACER TENDL-2021 LIBRARY; T=0.K  
alphas from (s,a)

