

AT203 HELION ACER TENDL-2021 LIBRARY; T=0.K  
Principal cross sections

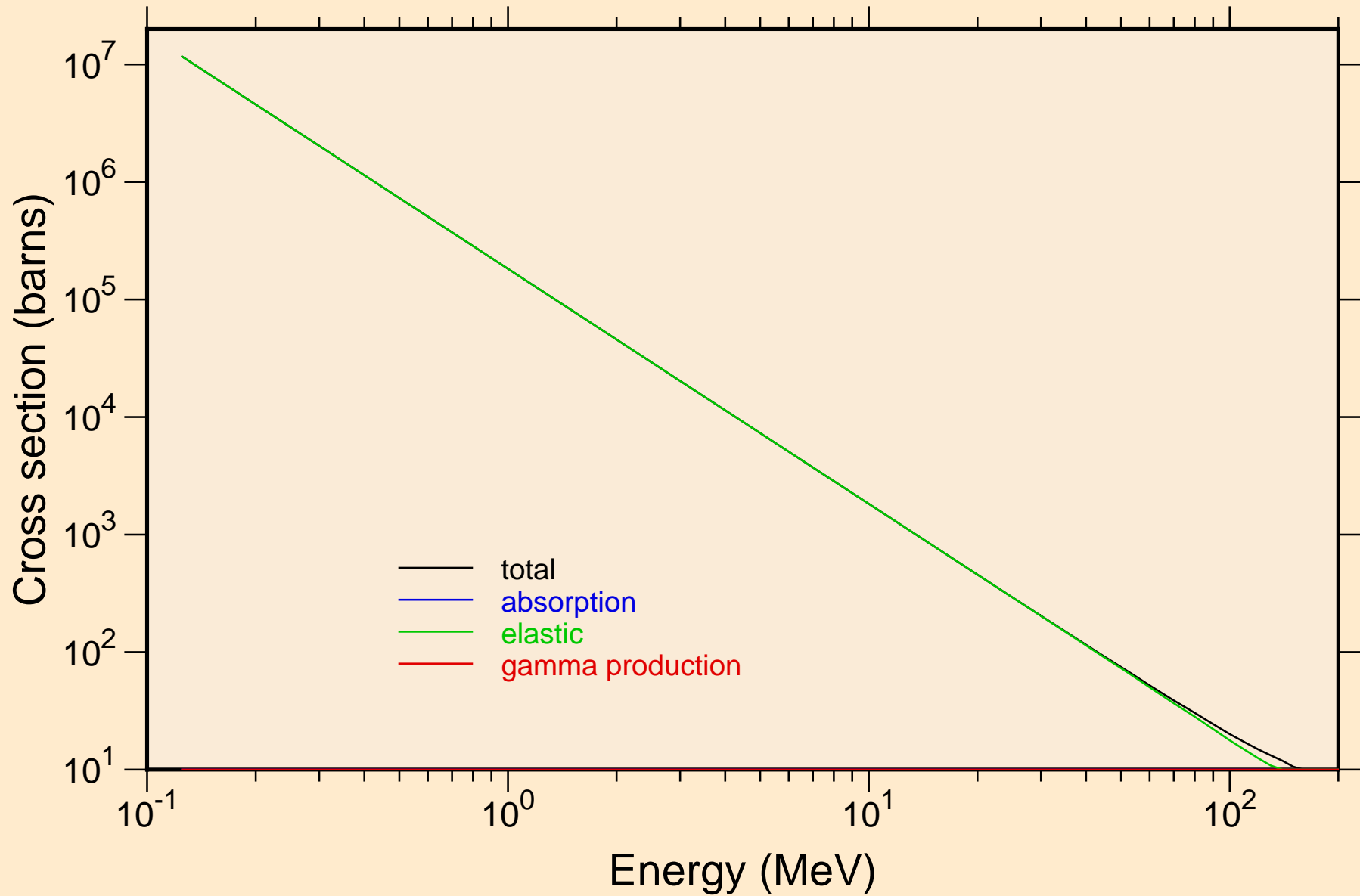

AT203 HELION ACER TENDL-2021 LIBRARY; T=0.K

Heating

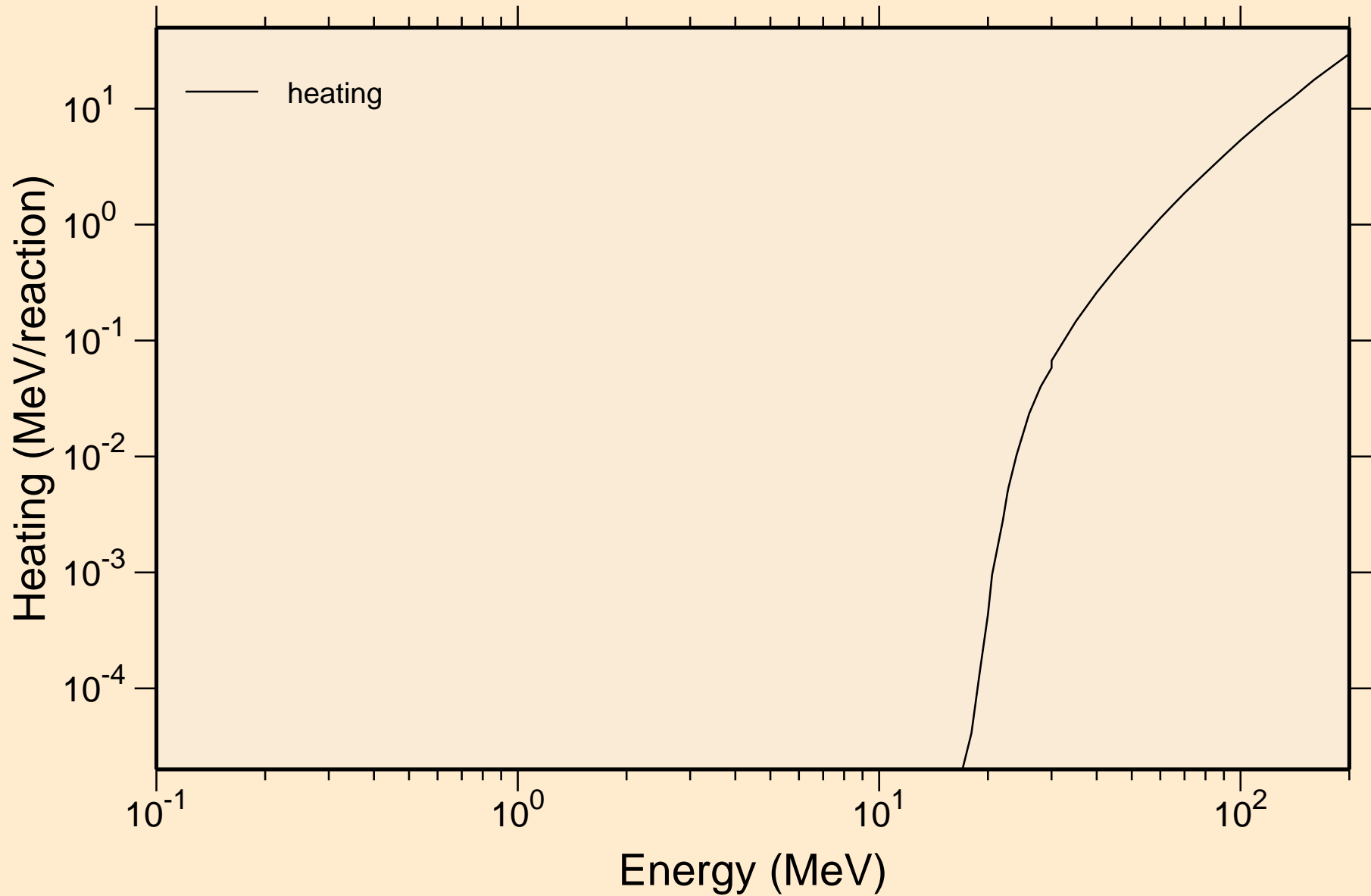

# AT203 HELION ACER TENDL-2021 LIBRARY; T=0.K

## Principal cross sections

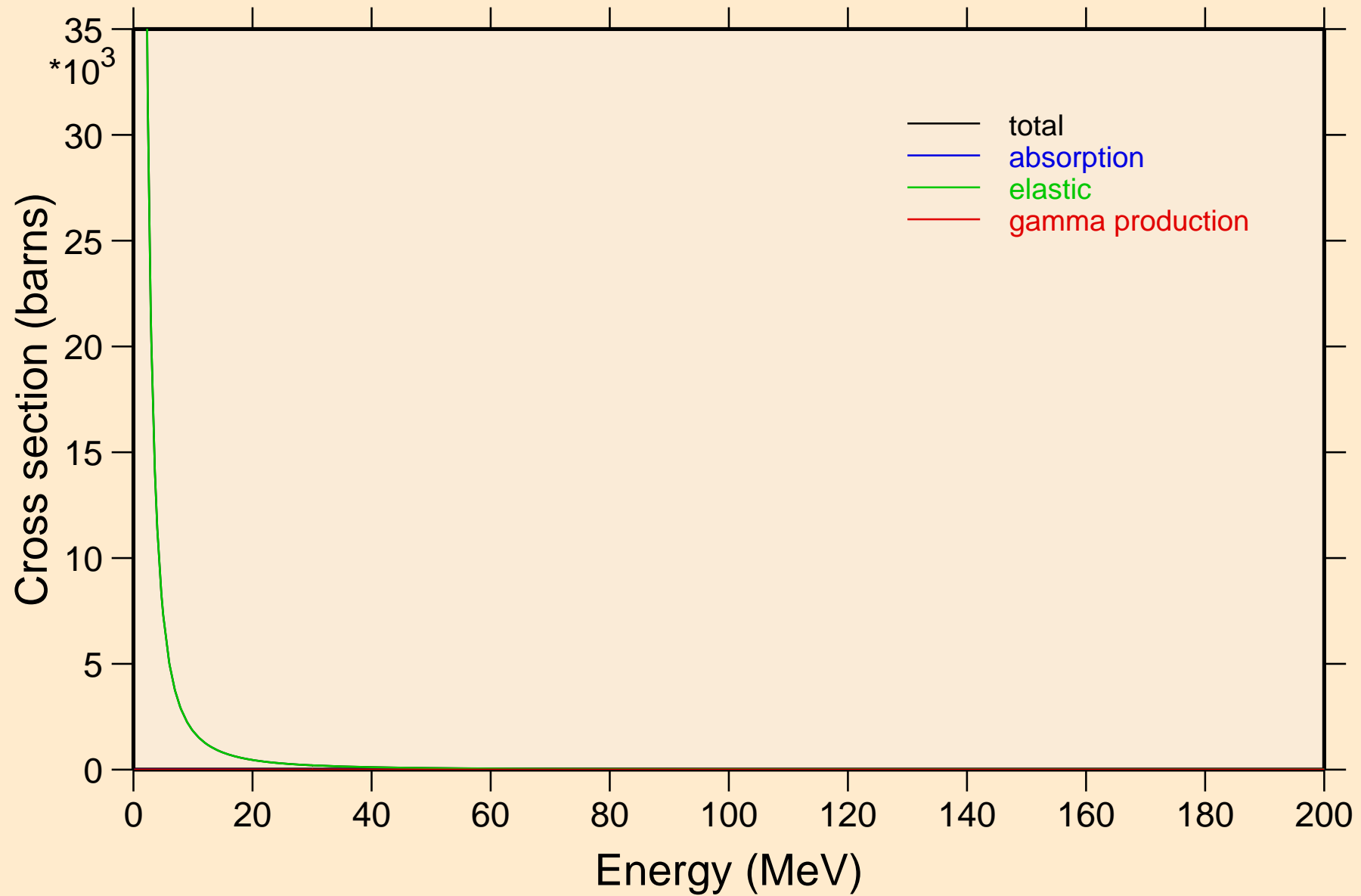

AT203 HELION ACER TENDL-2021 LIBRARY; T=0.K

Heating

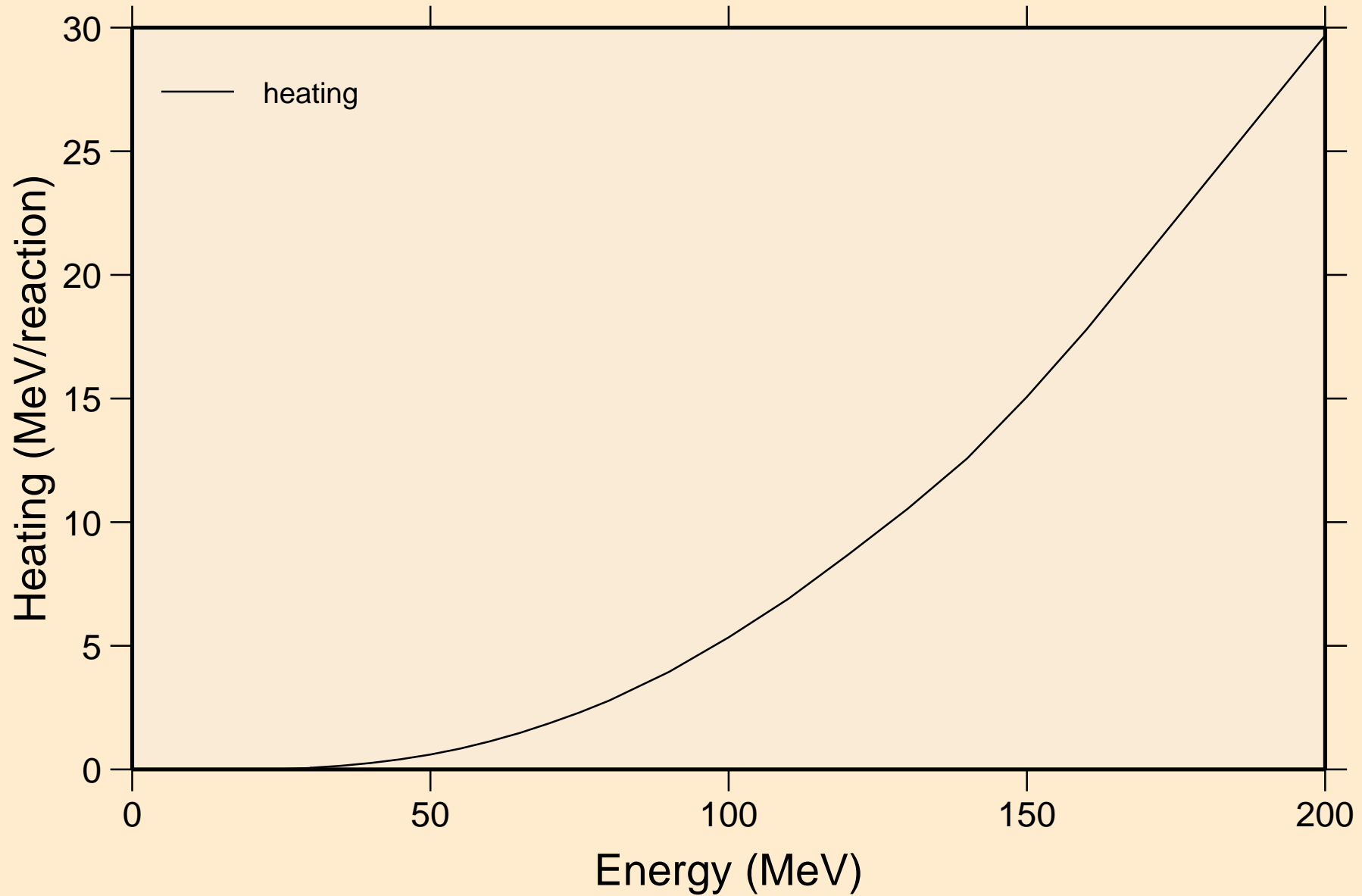

AT203 HELION ACER TENDL-2021 LIBRARY; T=0.K  
Threshold reactions

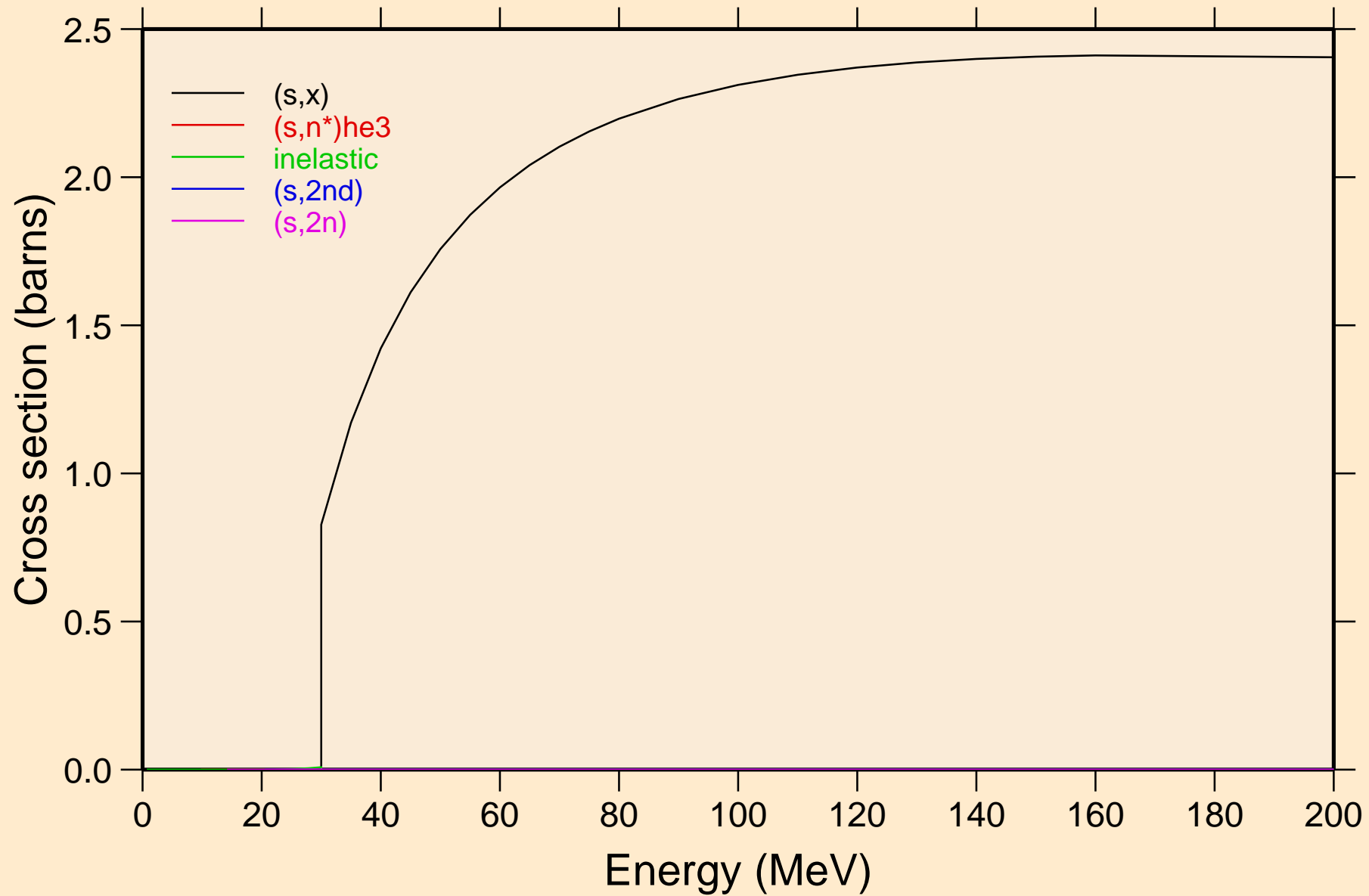

AT203 HELION ACER TENDL-2021 LIBRARY; T=0.K  
Threshold reactions

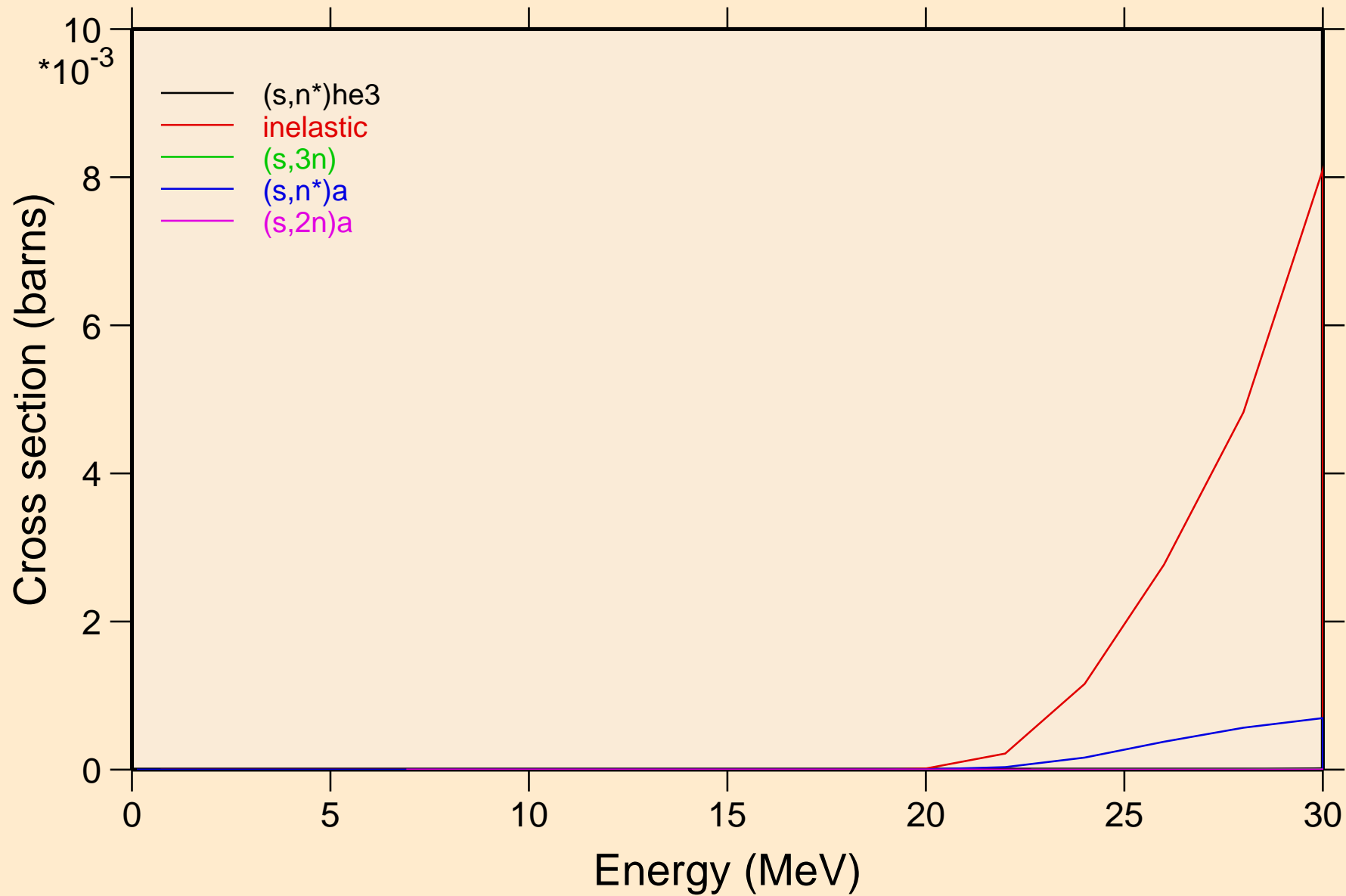

AT203 HELION ACER TENDL-2021 LIBRARY; T=0.K  
Threshold reactions

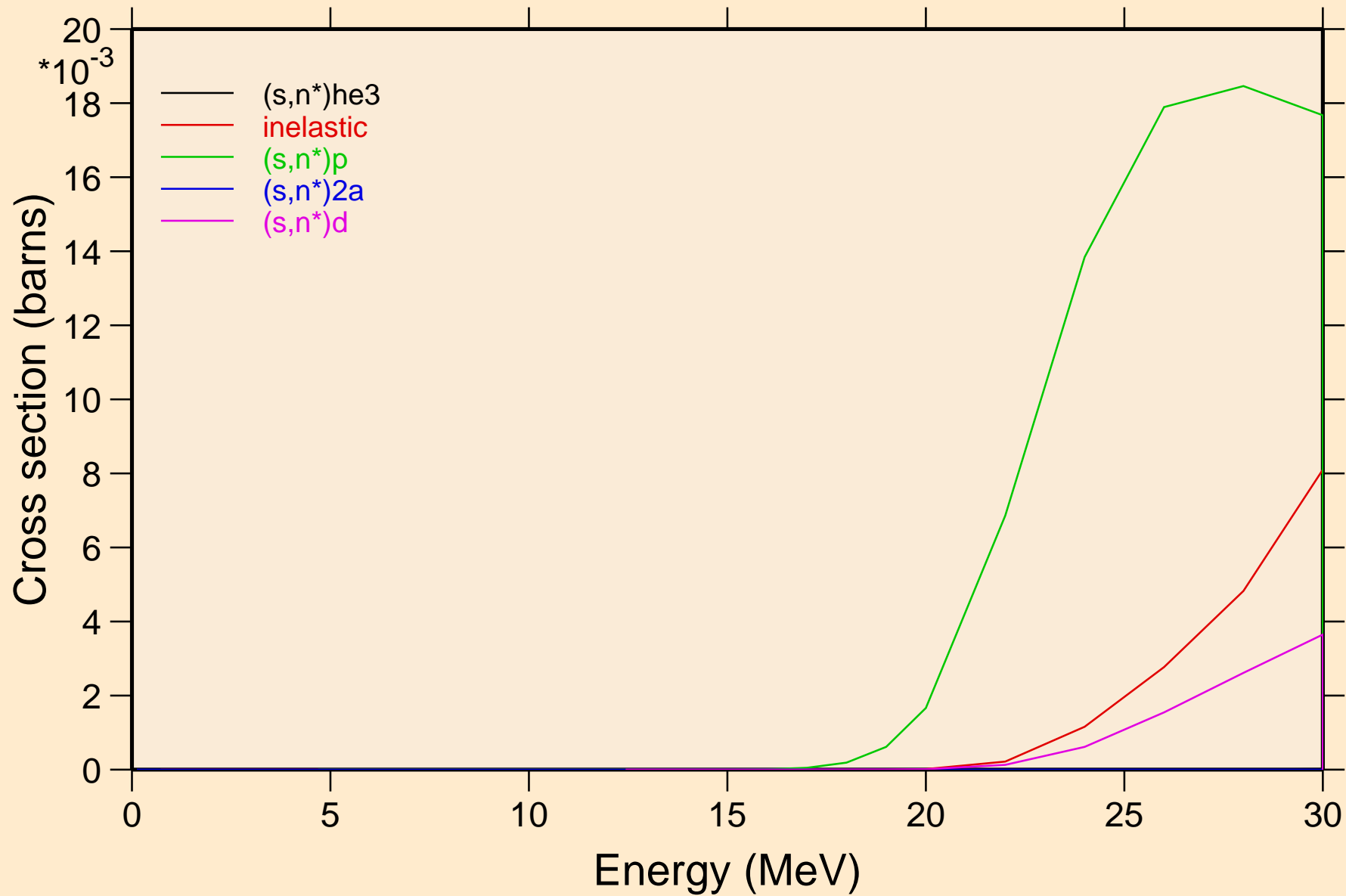

AT203 HELION ACER TENDL-2021 LIBRARY; T=0.K  
Threshold reactions

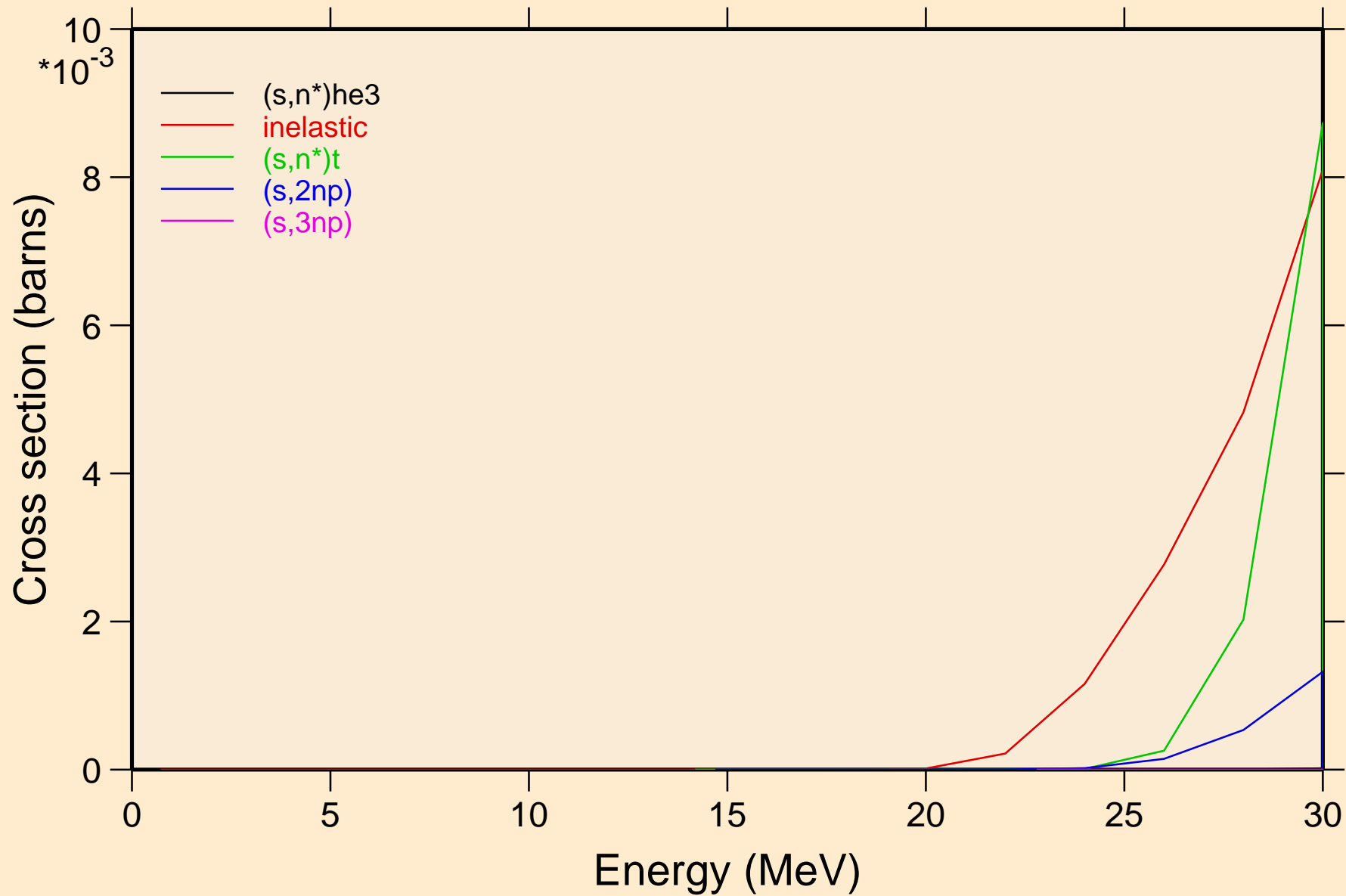



AT203 HELION ACER TENDL-2021 LIBRARY; T=0.K  
Threshold reactions

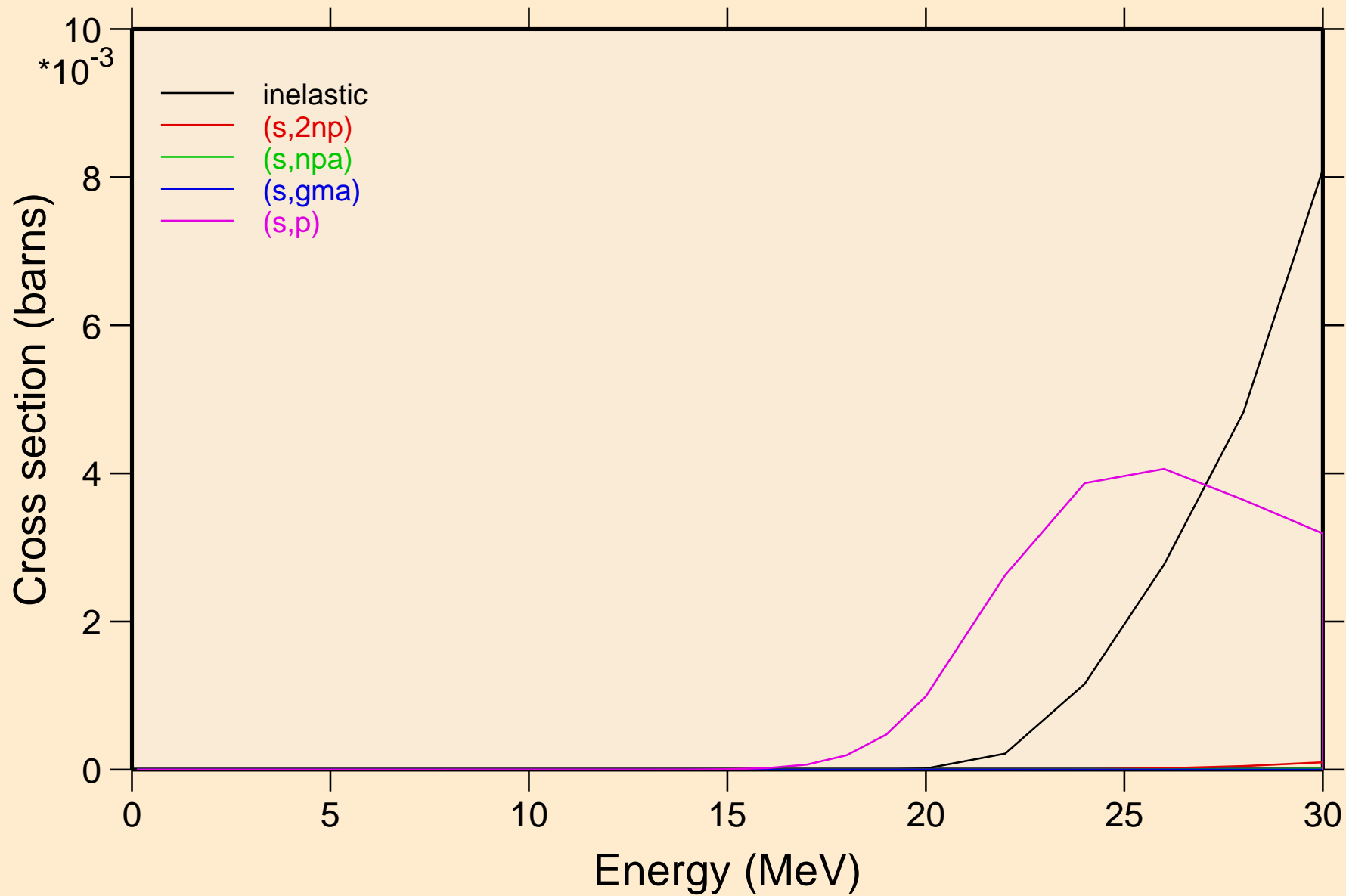

AT203 HELION ACER TENDL-2021 LIBRARY; T=0.K  
Threshold reactions

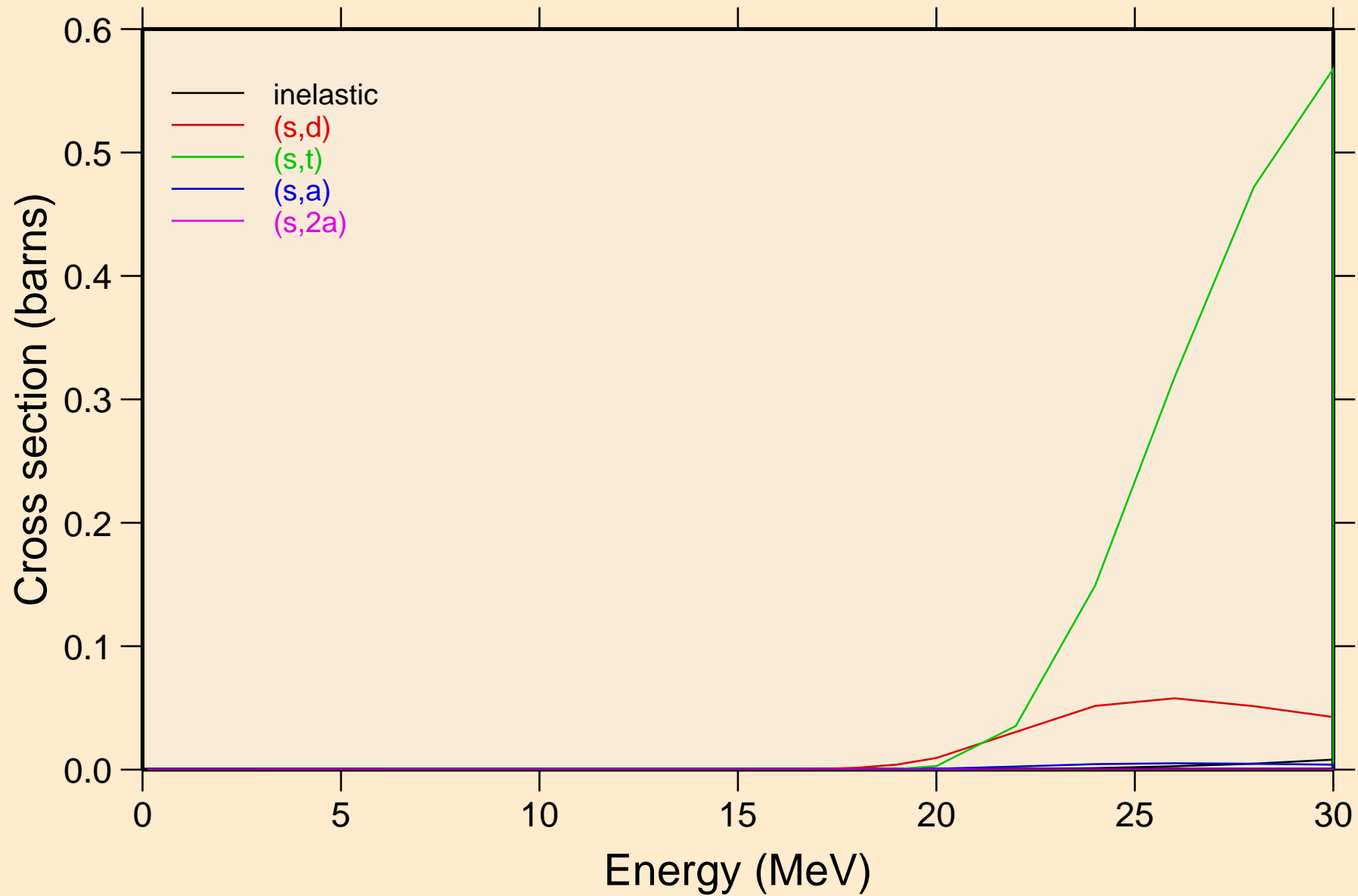

AT203 HELION ACER TENDL-2021 LIBRARY; T=0.K  
Threshold reactions

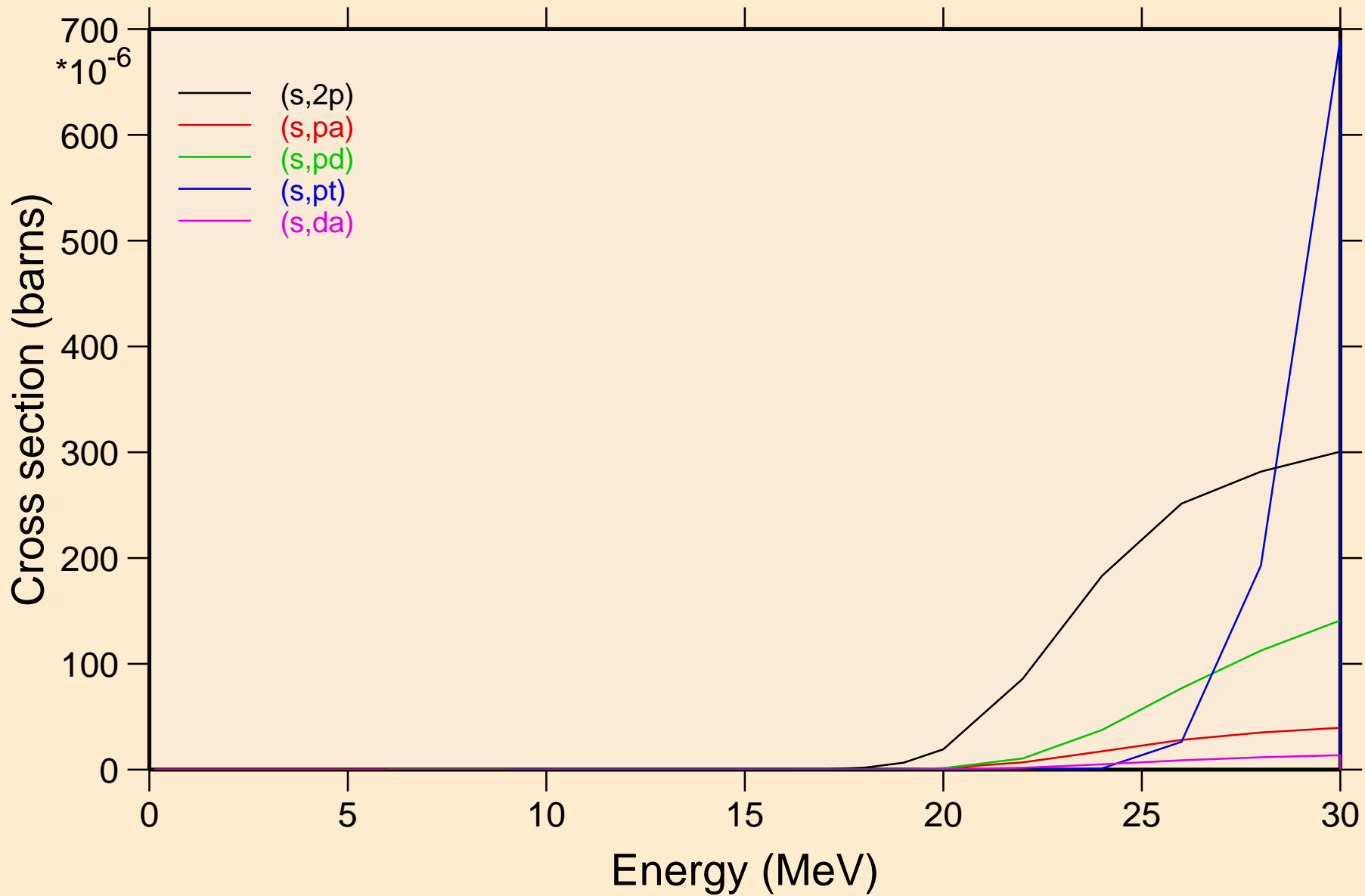

AT203 HELION ACER TENDL-2021 LIBRARY; T=0.K  
angular distribution for elastic

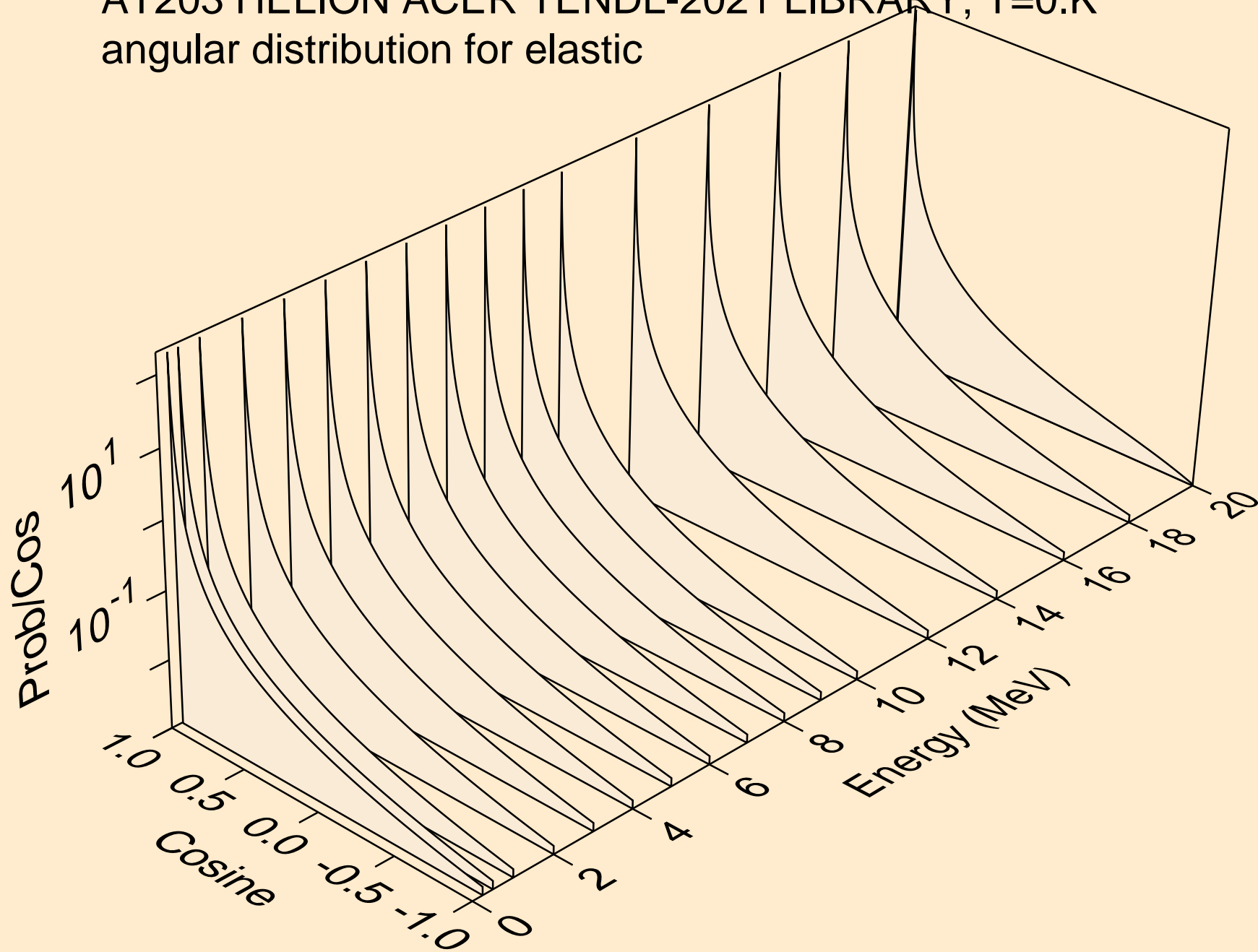

AT203 HELION ACER TENDL-2021 LIBRARY; T=0.K  
angular distribution for elastic

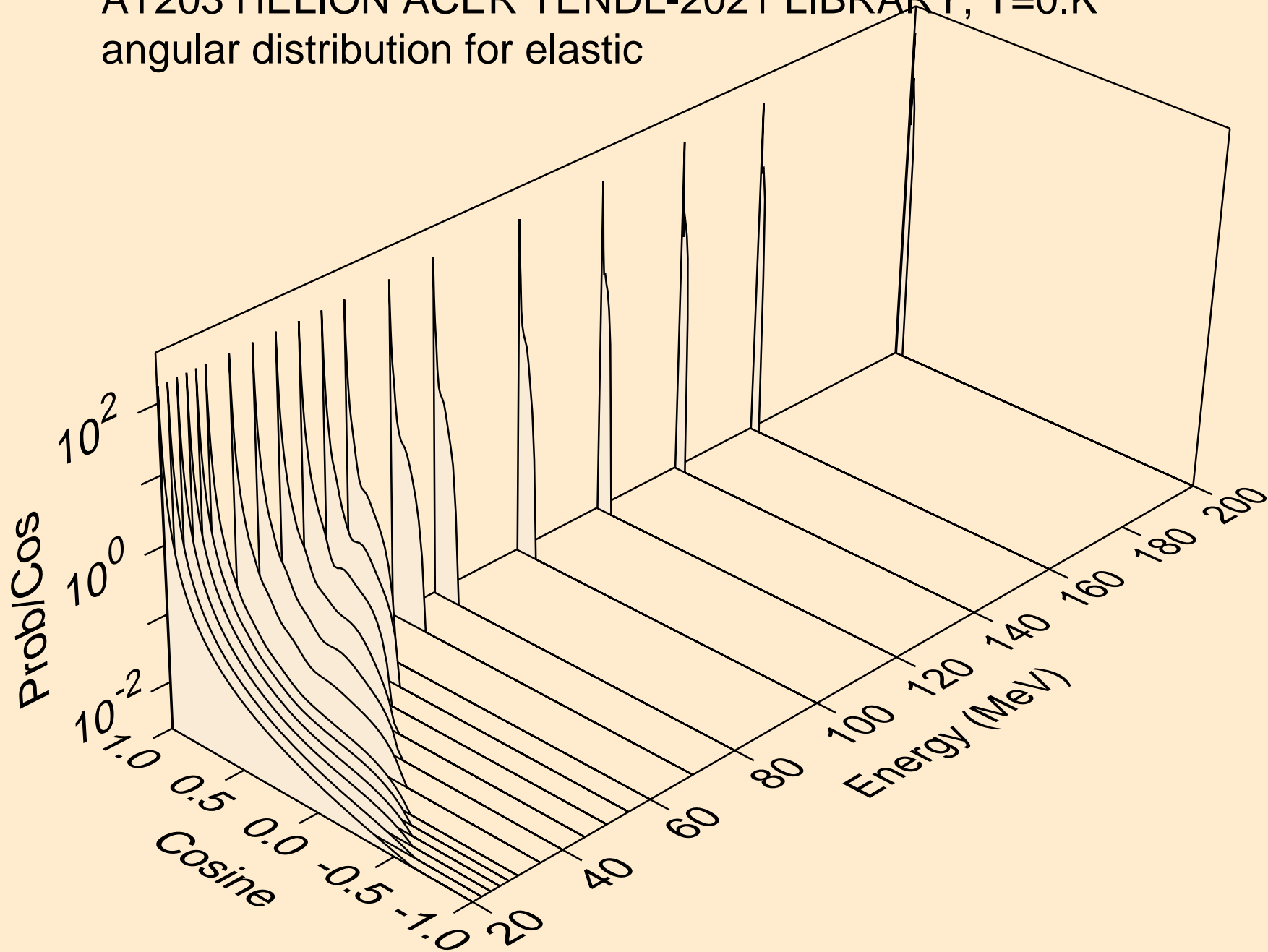

AT203 HELION ACER TENDL-2021 LIBRARY; T=0.K  
He-3 emission for (s,x)

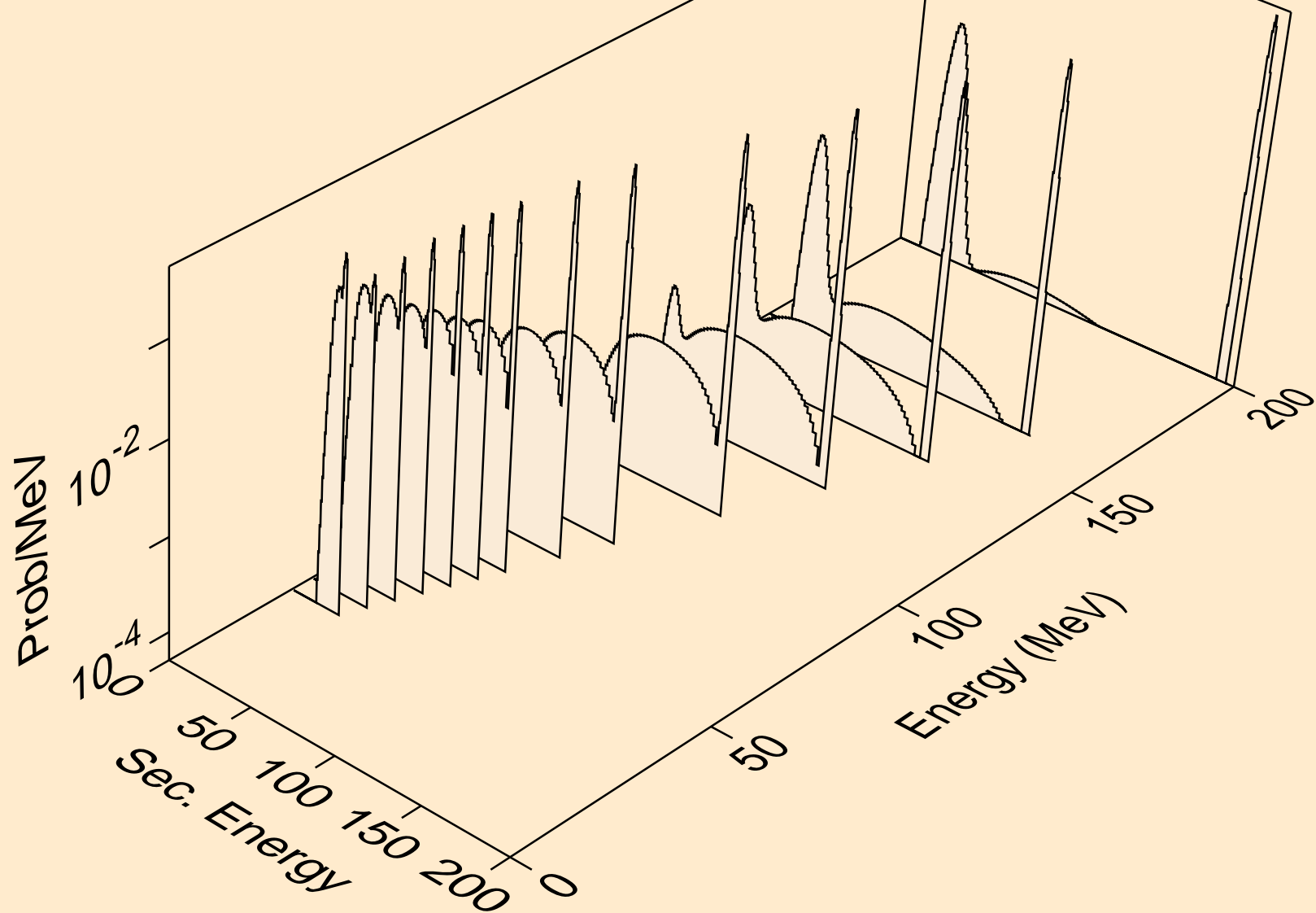

AT203 HELION ACER TENDL-2021 LIBRARY; T=0.K  
He-3 emission for (s,n\*)he3

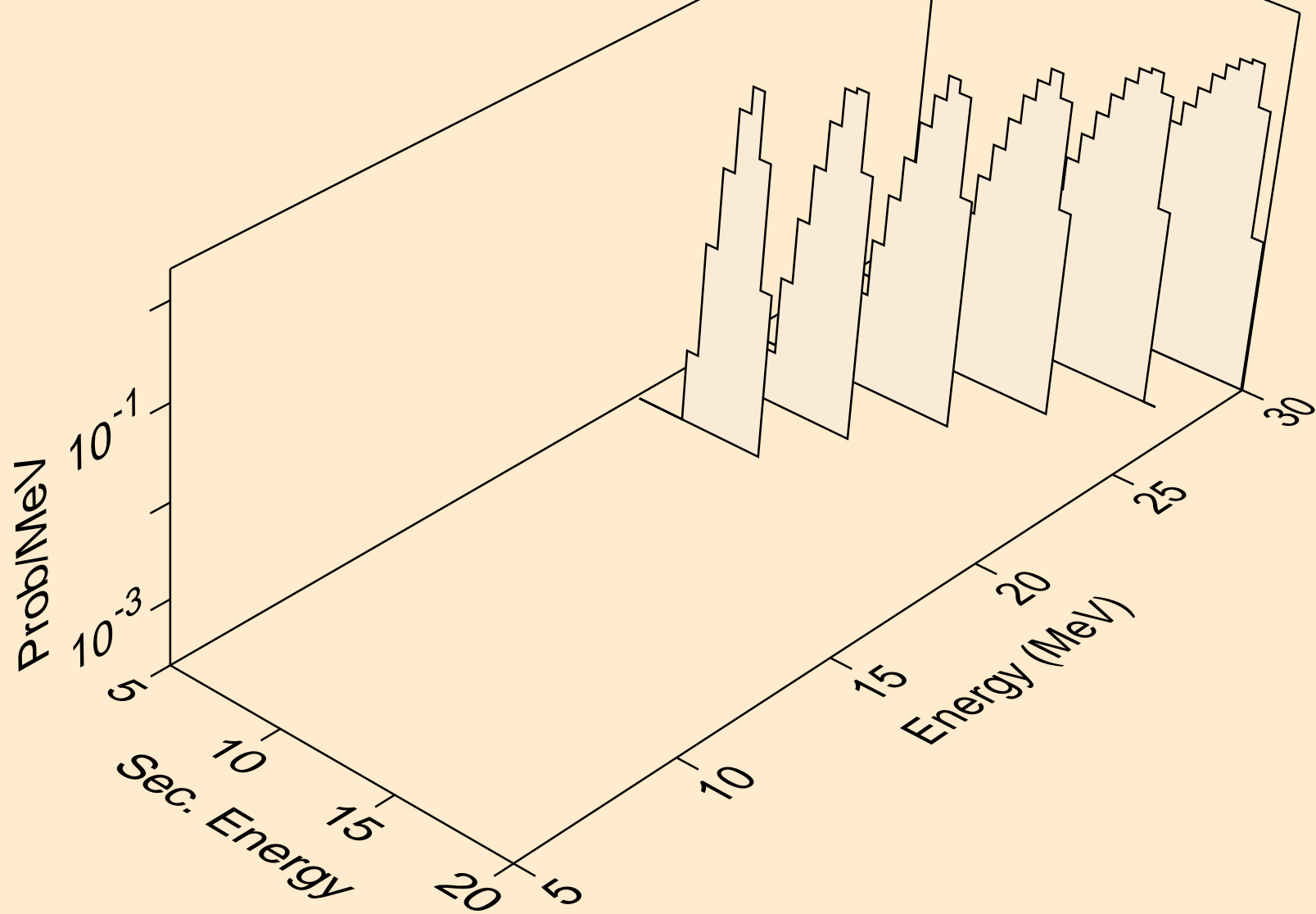

AT203 HELION ACER TENDL-2021 LIBRARY; T=0.K  
He-3 emission for inelastic

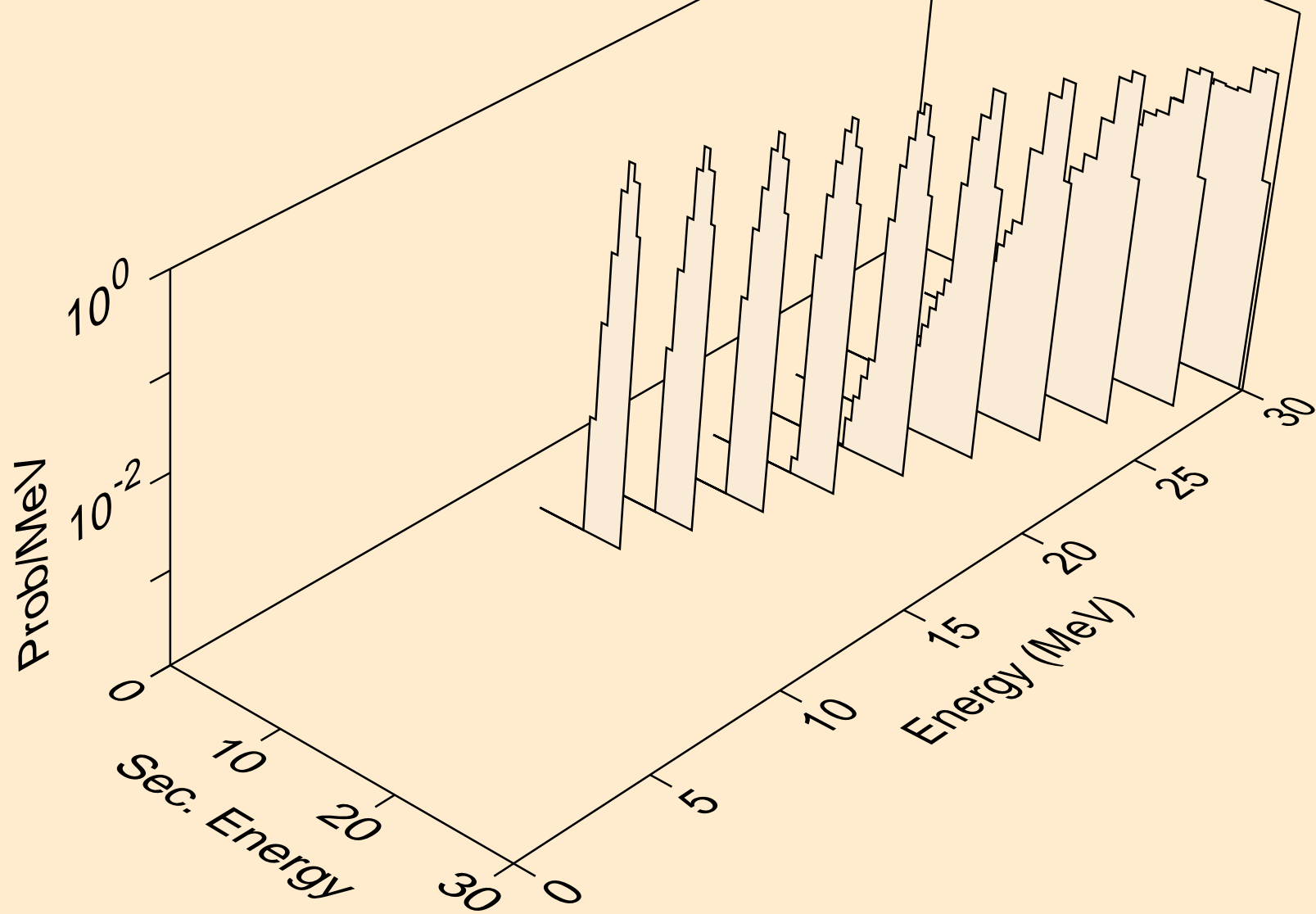



AT203 HELION ACER TENDL-2021 LIBRARY; T=0.K  
Photon emission for (z,n)

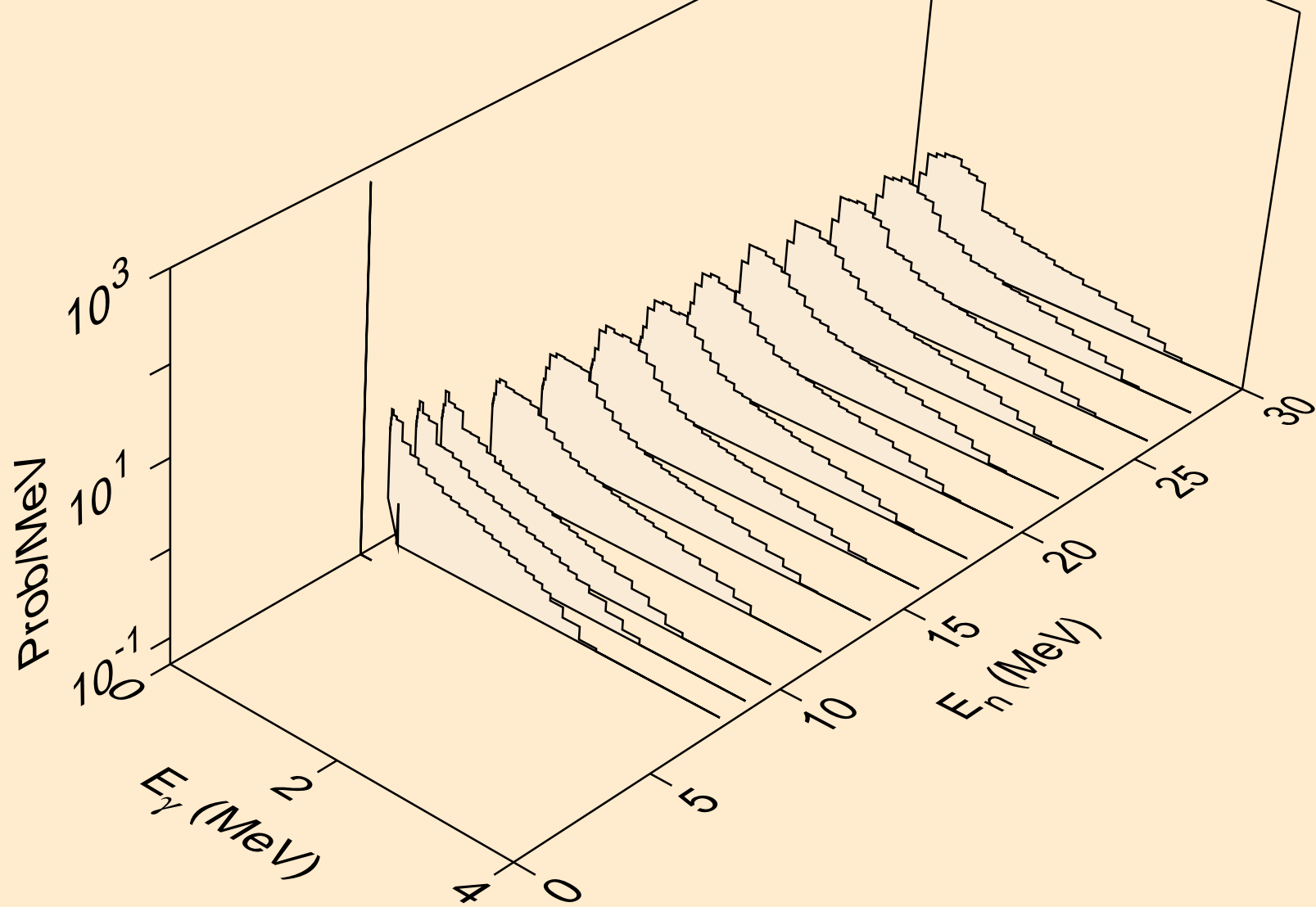

AT203 HELION ACER TENDL-2021 LIBRARY; T=0.K  
Photon emission for (n,x)

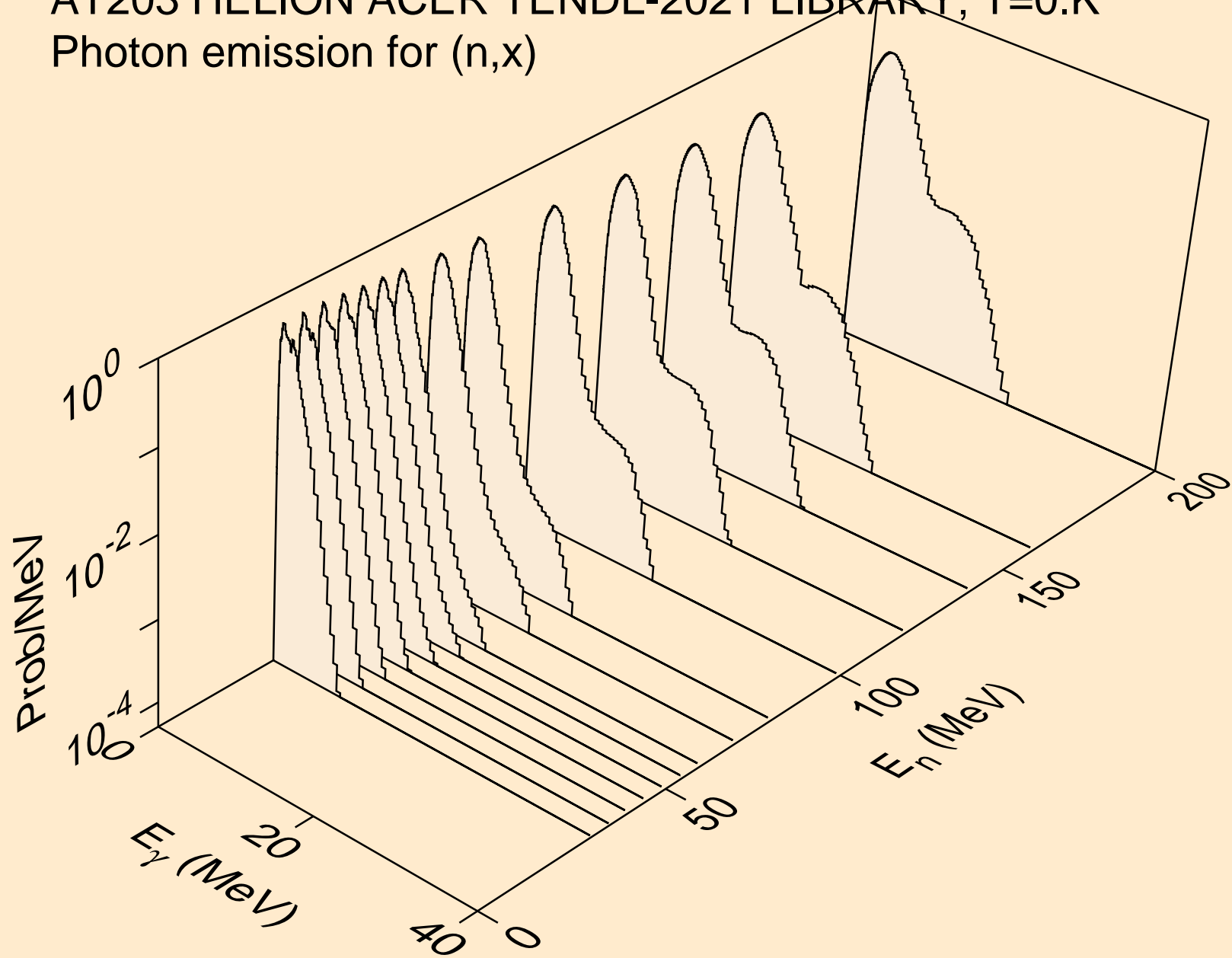

AT203 HELION ACER TENDL-2021 LIBRARY; T=0.K  
Photon emission for (n,2nd)

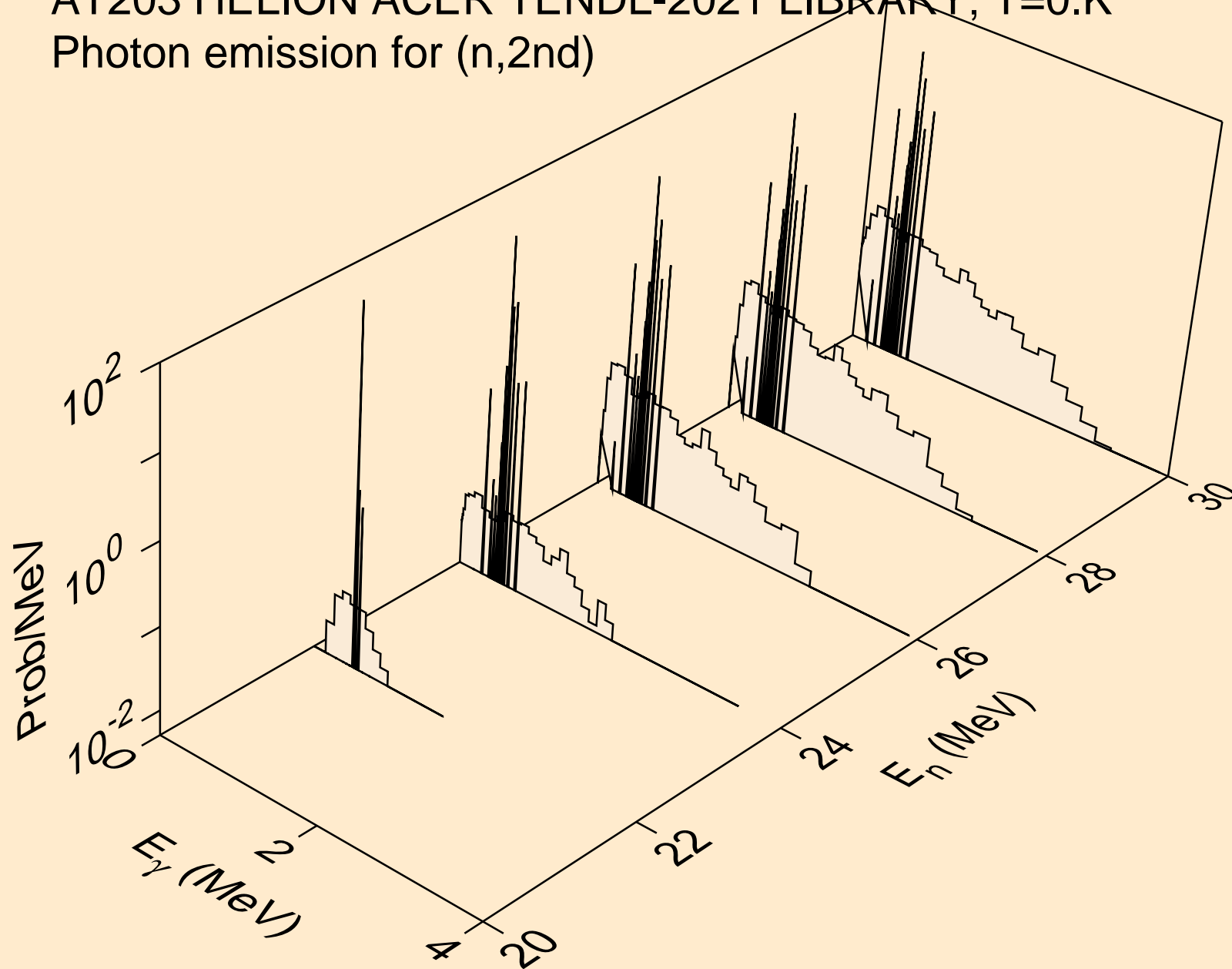

AT203 HELION ACER TENDL-2021 LIBRARY; T=0.K  
Photon emission for (n,2n)

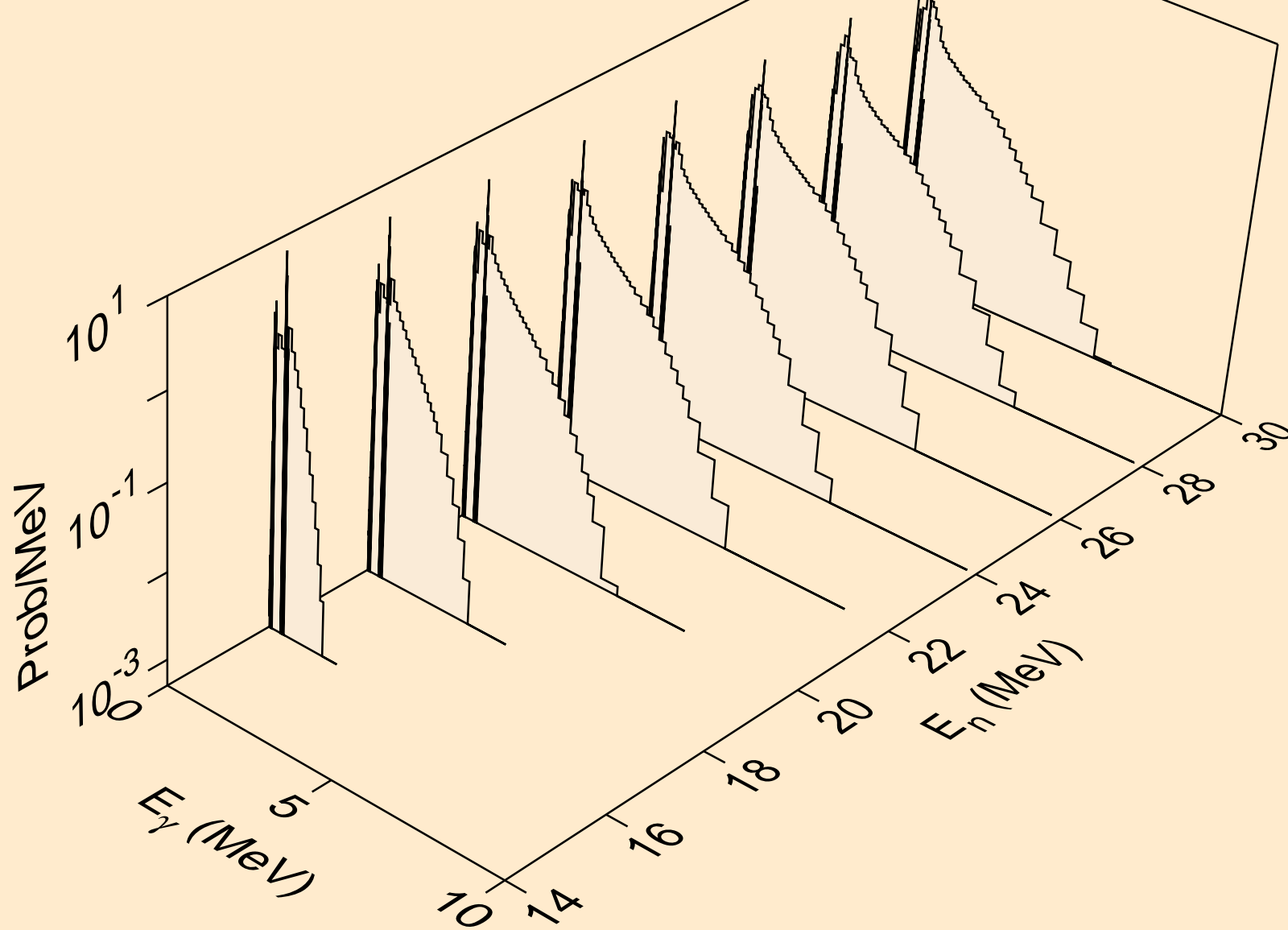

AT203 HELION ACER TENDL-2021 LIBRARY; T=0.K  
Photon emission for (n,3n)

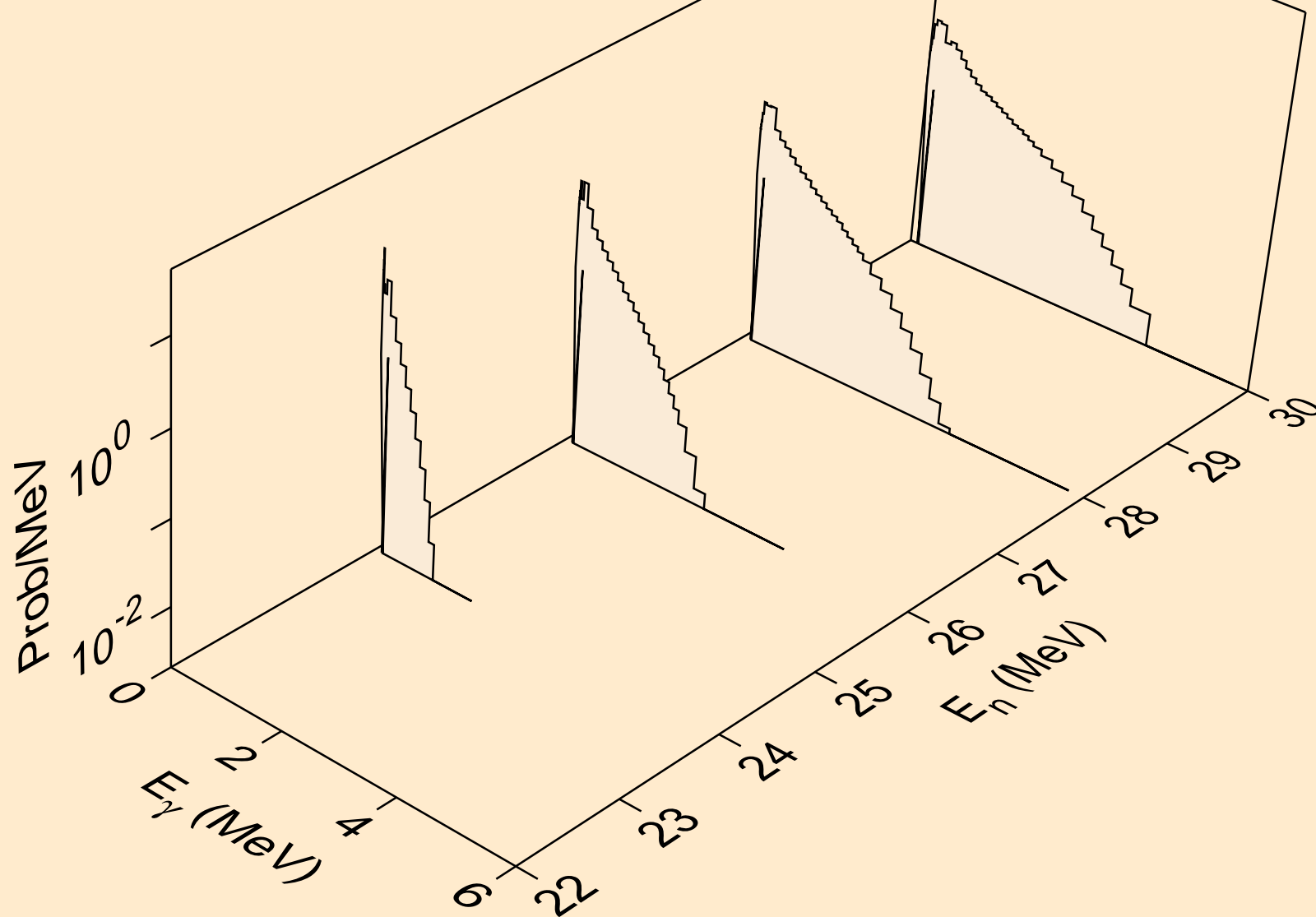

AT203 HELION ACER TENDL-2021 LIBRARY; T=0.K  
Photon emission for (n,n\*)a

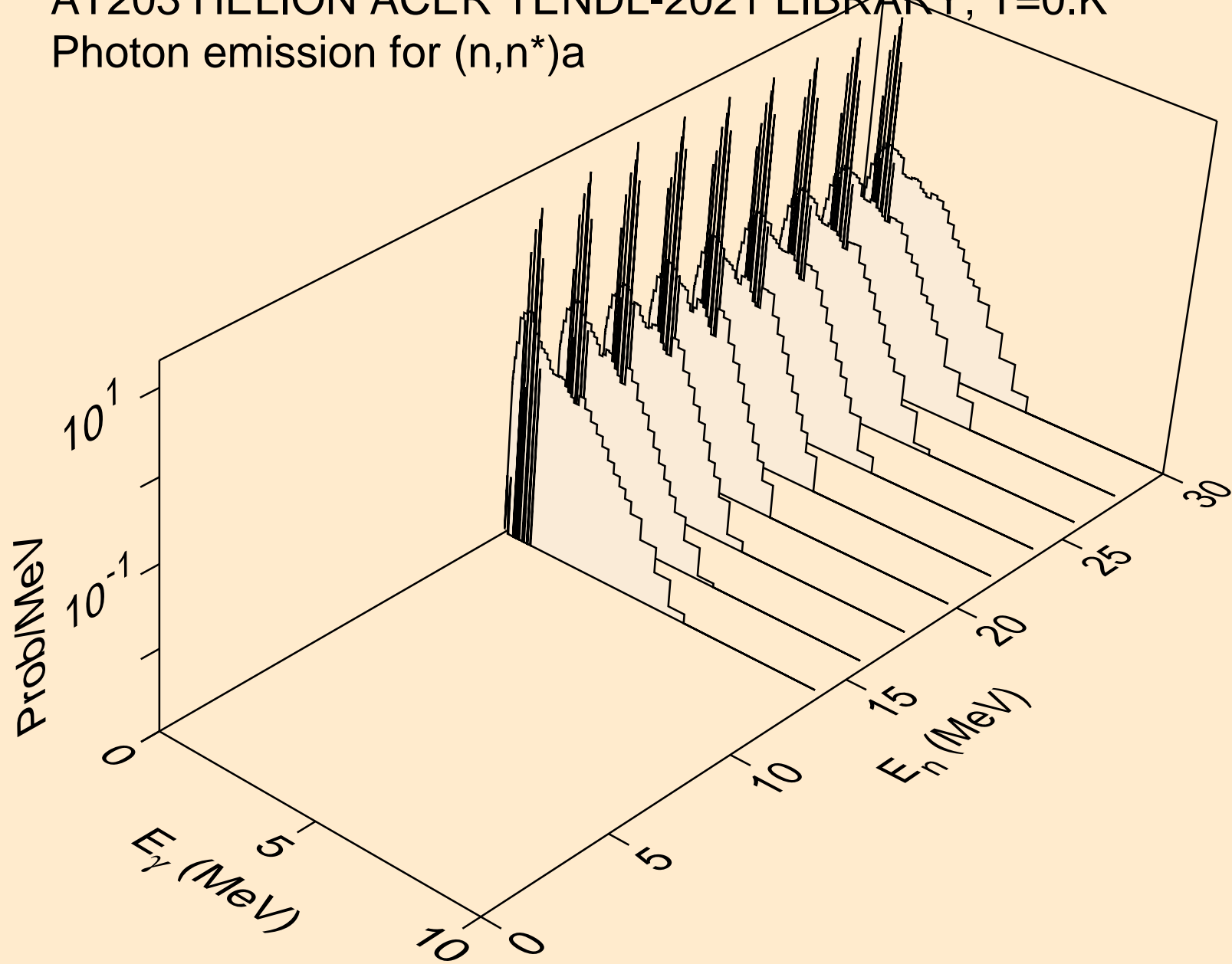

AT203 HELION ACER TENDL-2021 LIBRARY; T=0.K  
Photon emission for (n,2n)a

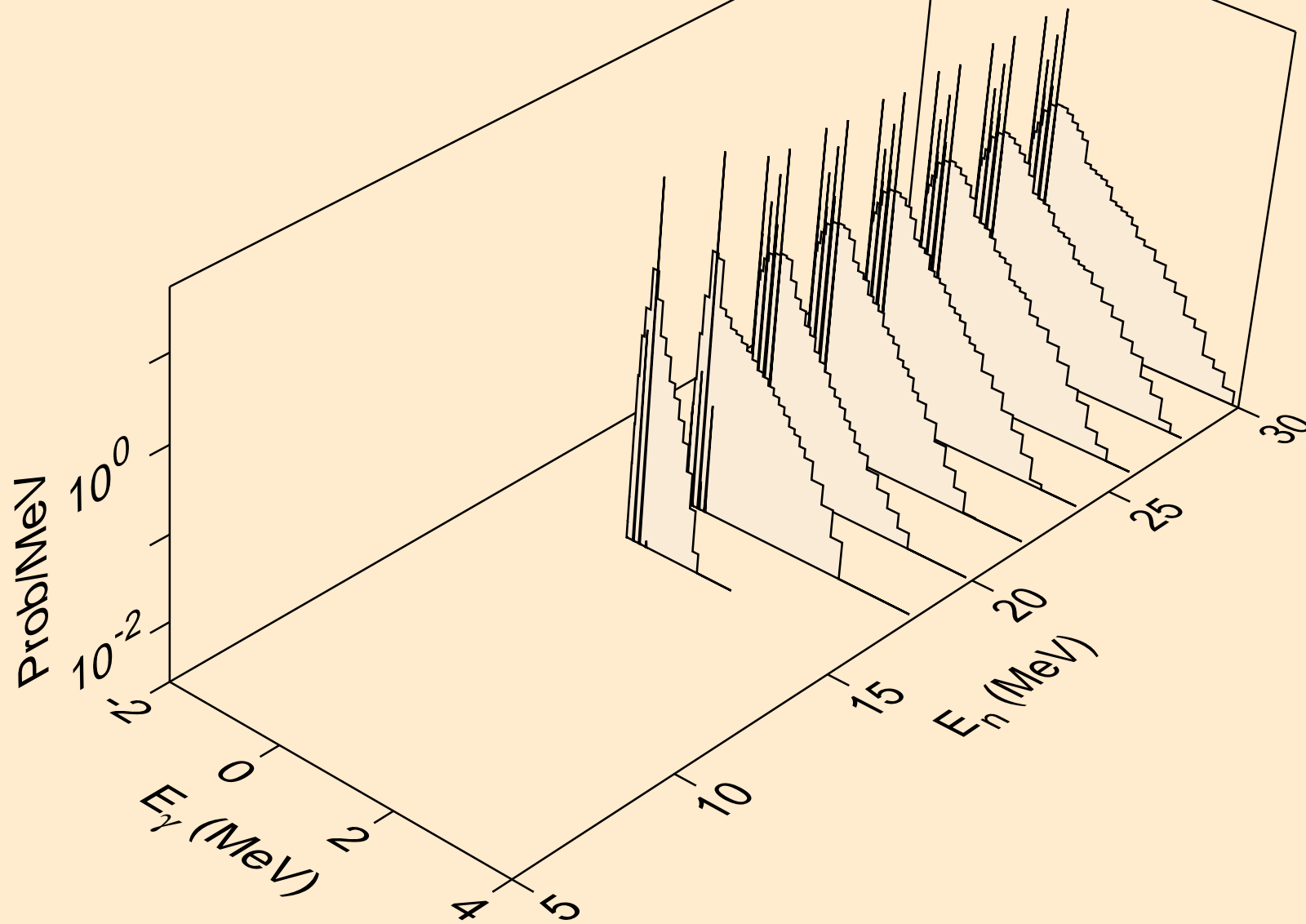

AT203 HELION ACER TENDL-2021 LIBRARY; T=0.K  
Photon emission for (n,n\*)p

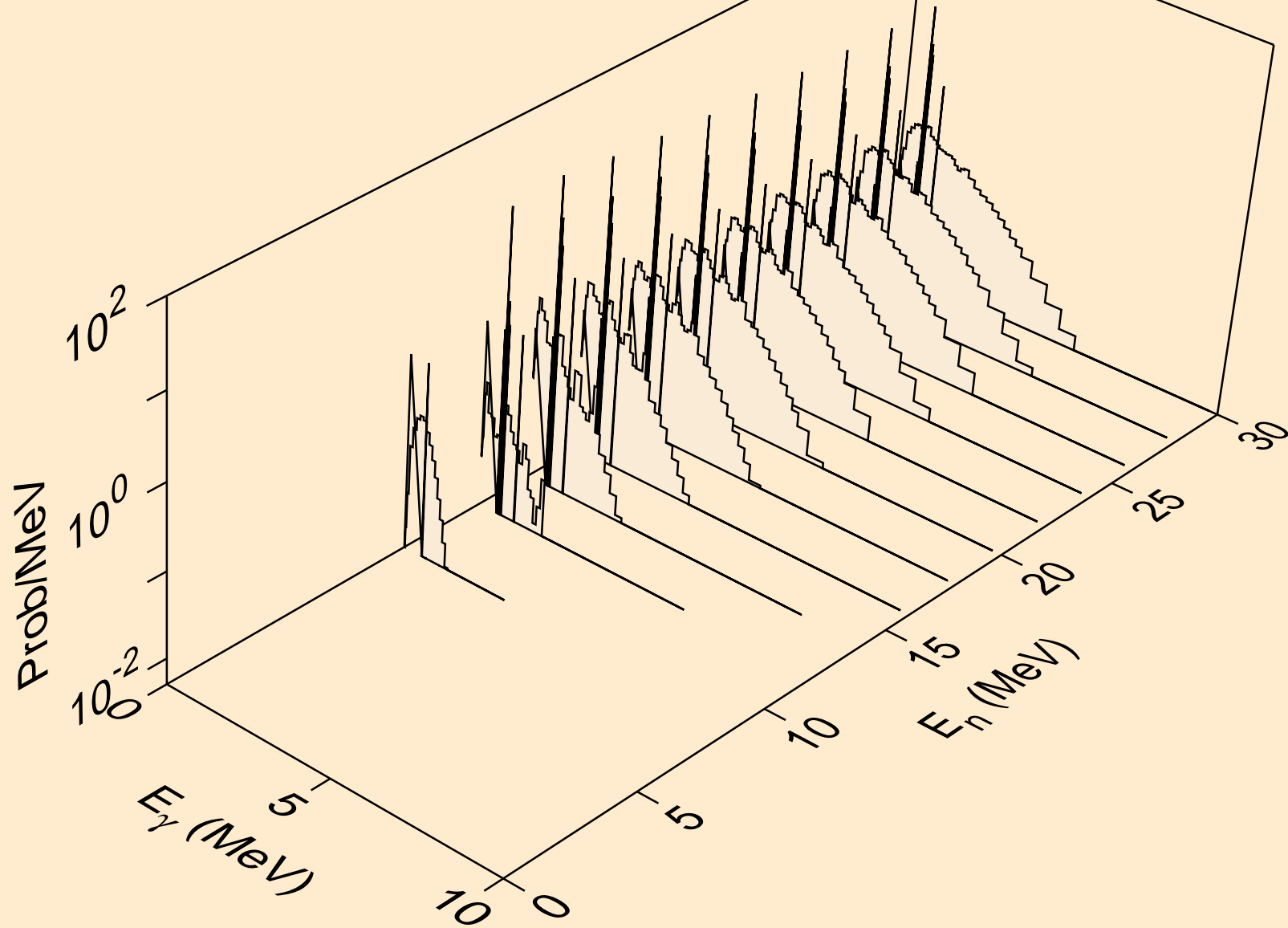



AT203 HELION ACER TENDL-2021 LIBRARY; T=0.K  
Photon emission for (n,n\*)2a

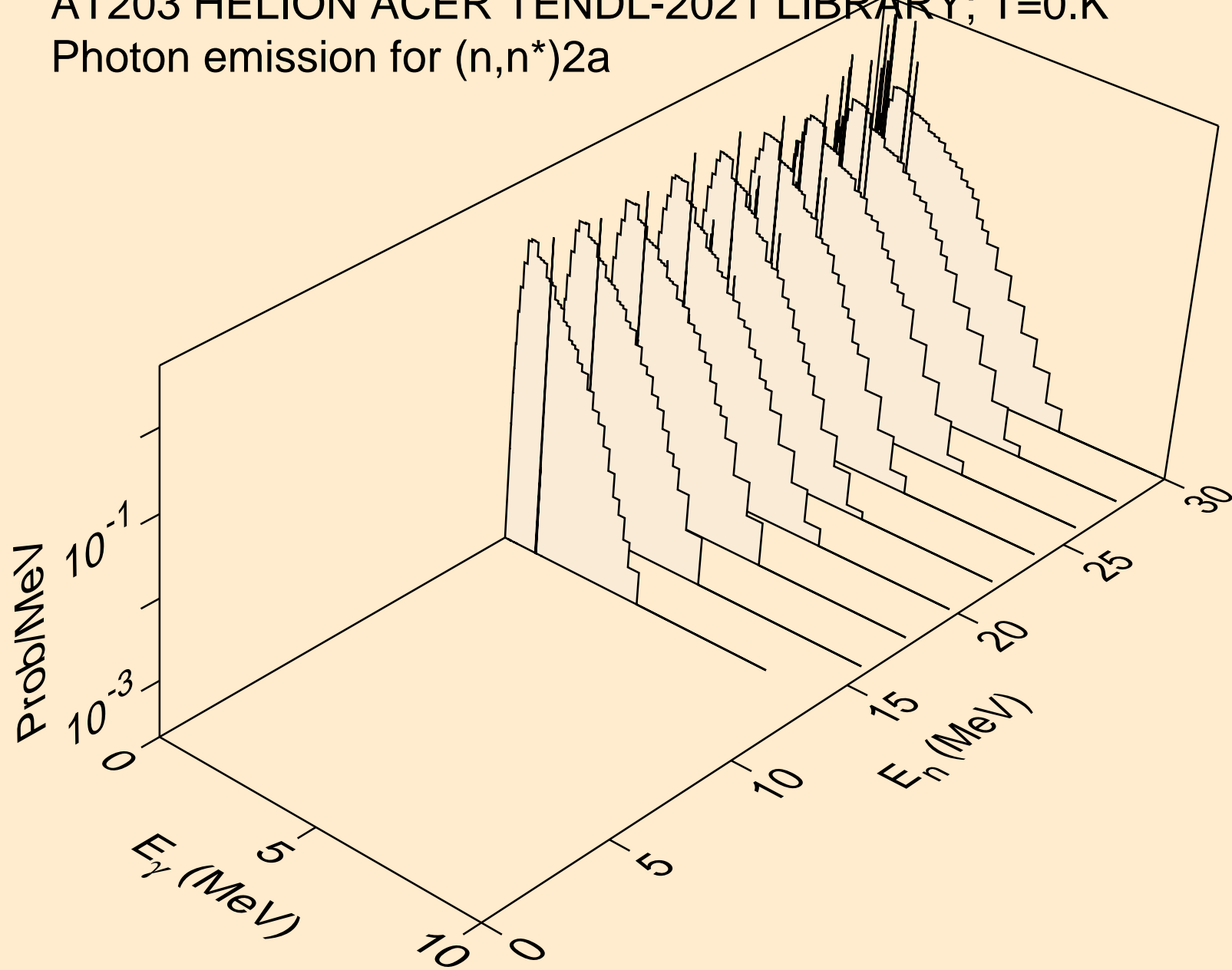

AT203 HELION ACER TENDL-2021 LIBRARY; T=0.K  
Photon emission for (n,n\*)d

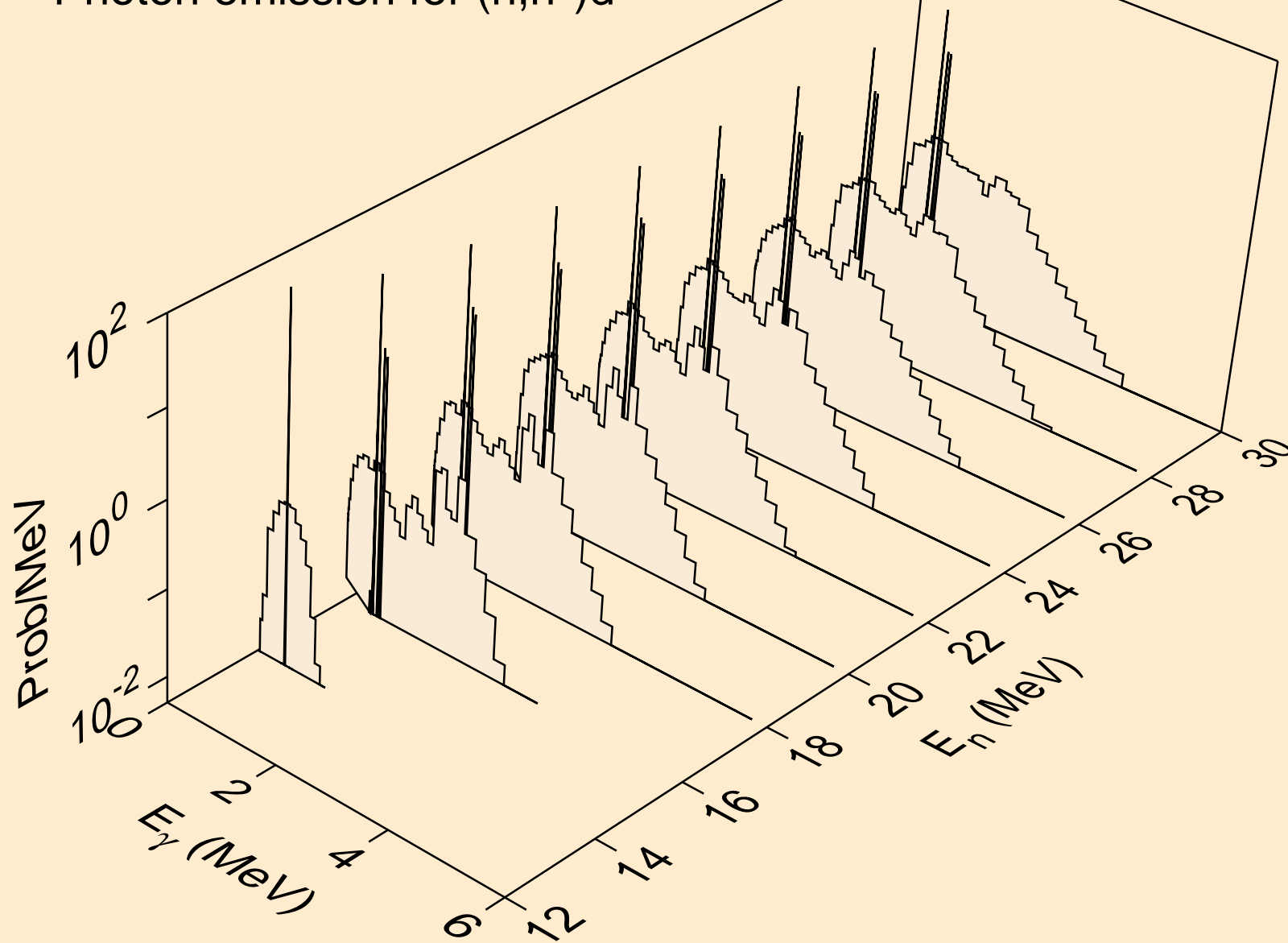

AT203 HELION ACER TENDL-2021 LIBRARY; T=0.K  
Photon emission for (n,n\*)t

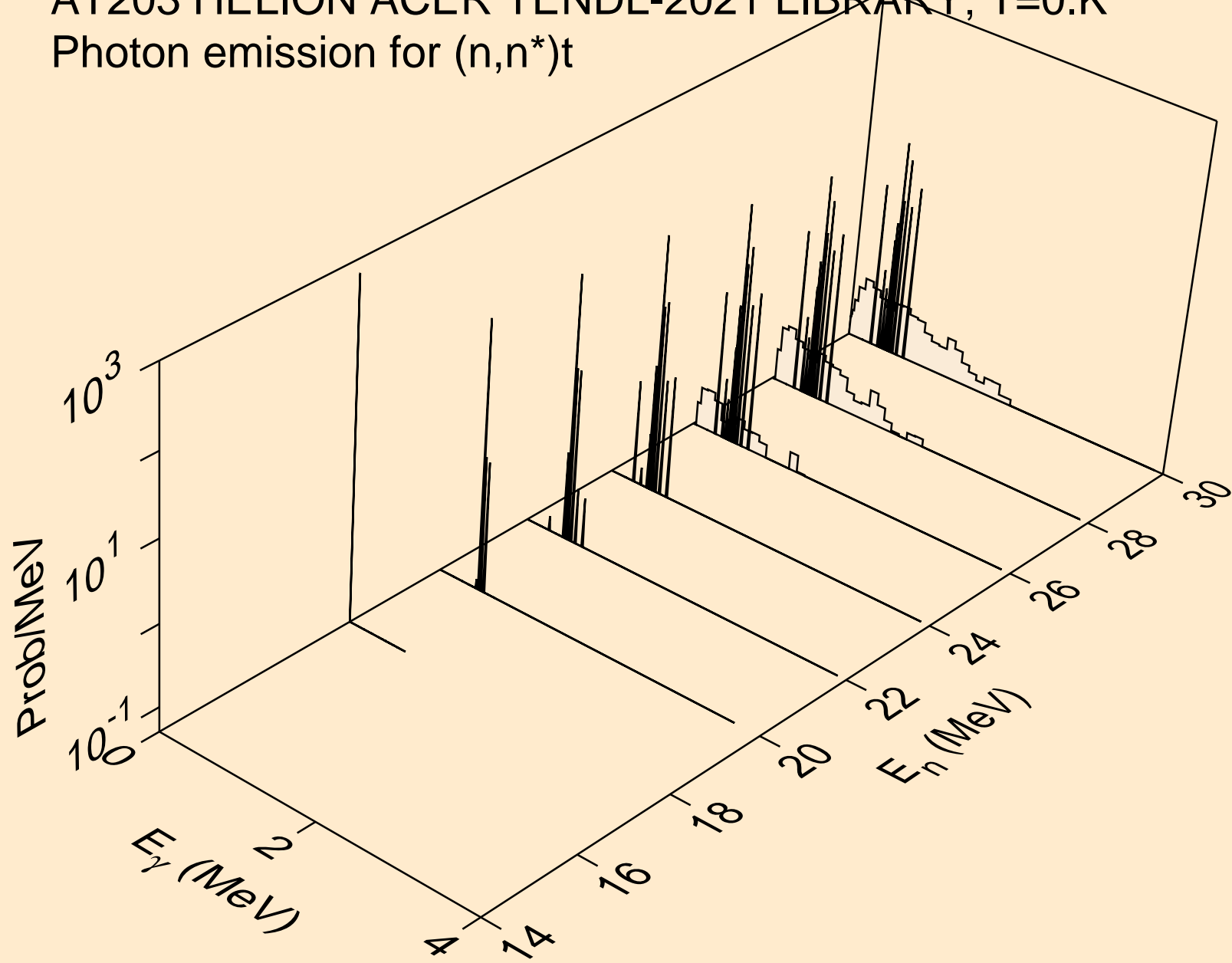

AT203 HELION ACER TENDL-2021 LIBRARY; T=0.K  
Photon emission for (n,n\*)he3

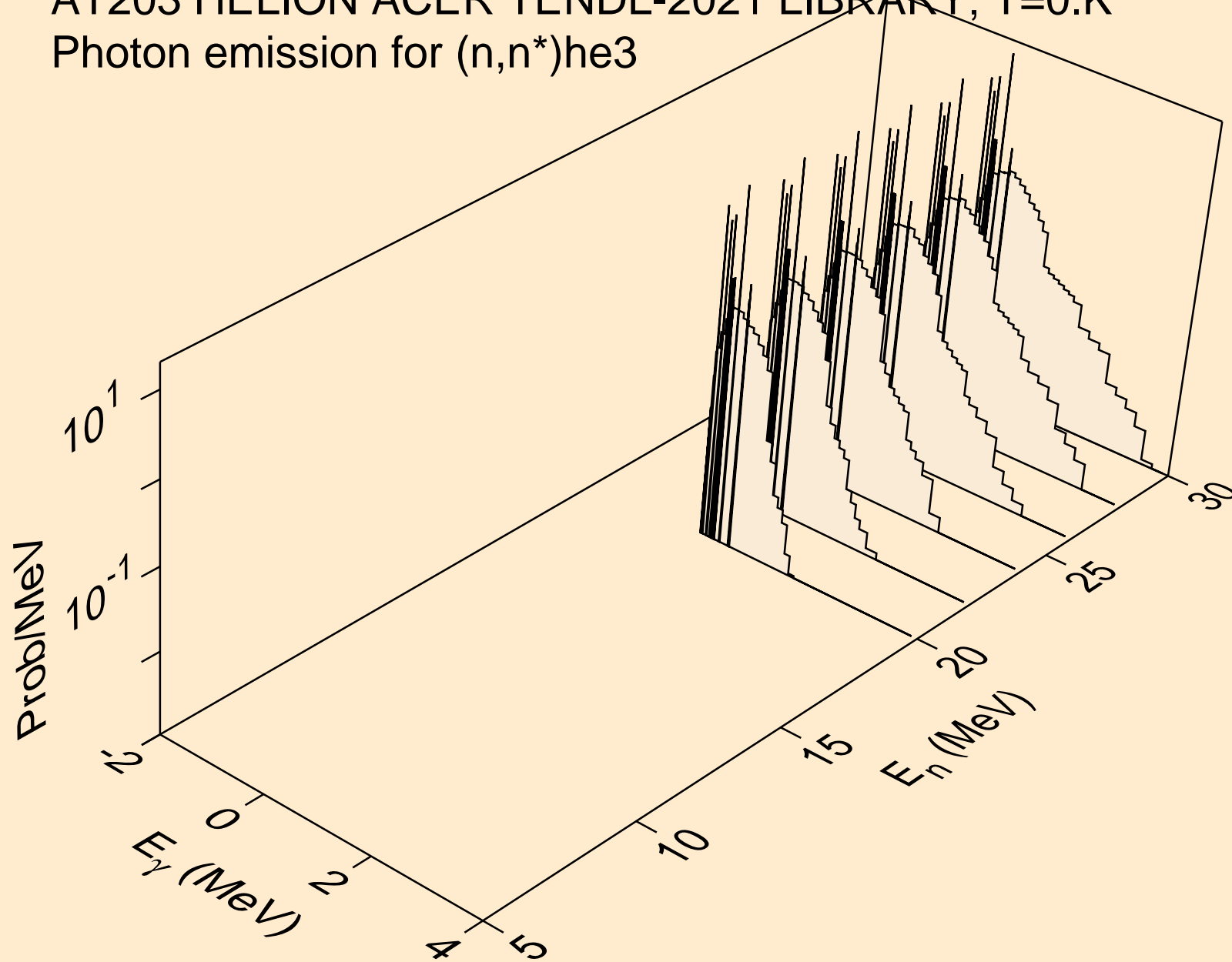

AT203 HELION ACER TENDL-2021 LIBRARY; T=0.K  
Photon emission for (n,2np)

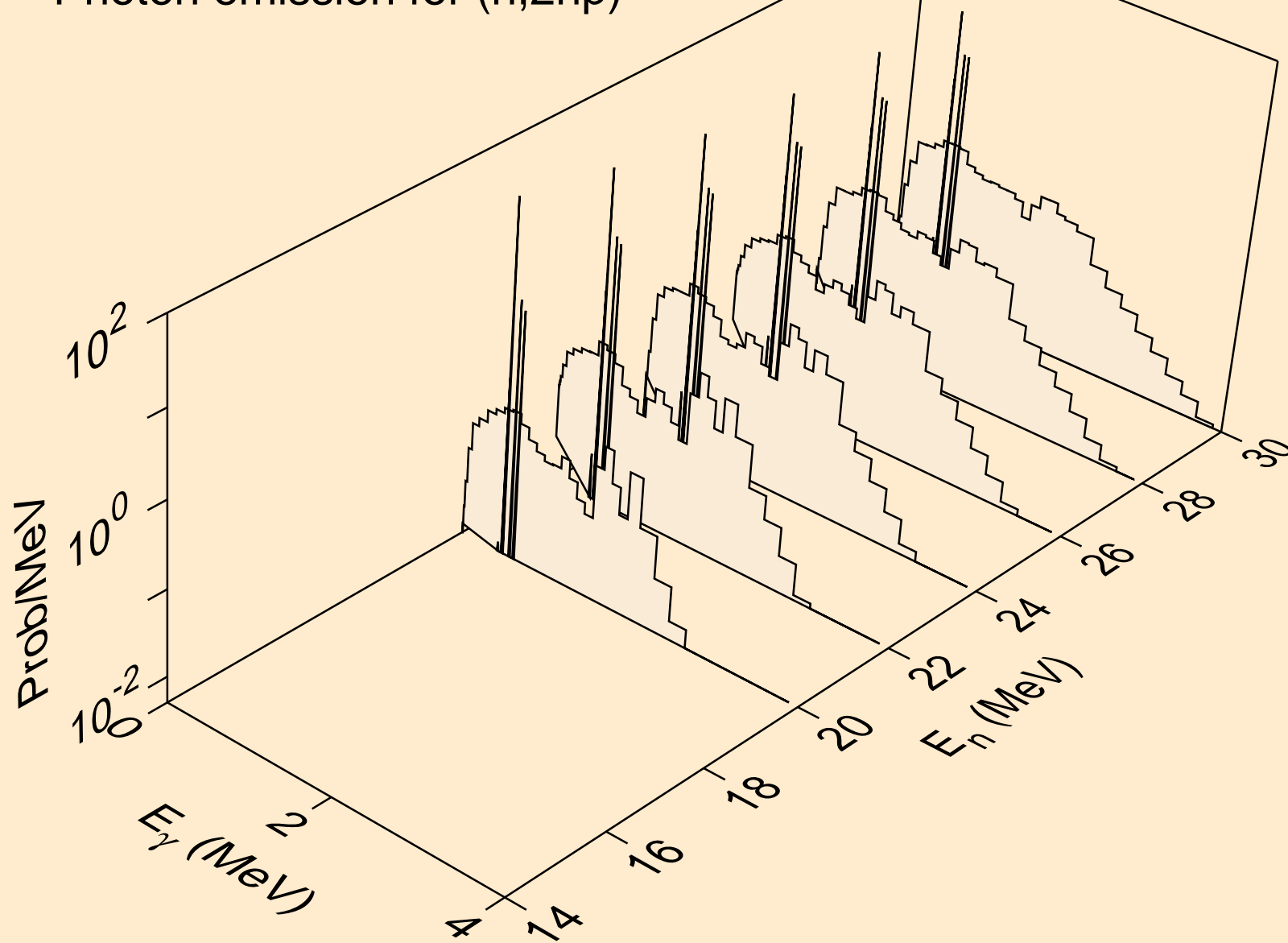

AT203 HELION ACER TENDL-2021 LIBRARY; T=0.K  
Photon emission for (n,3np)

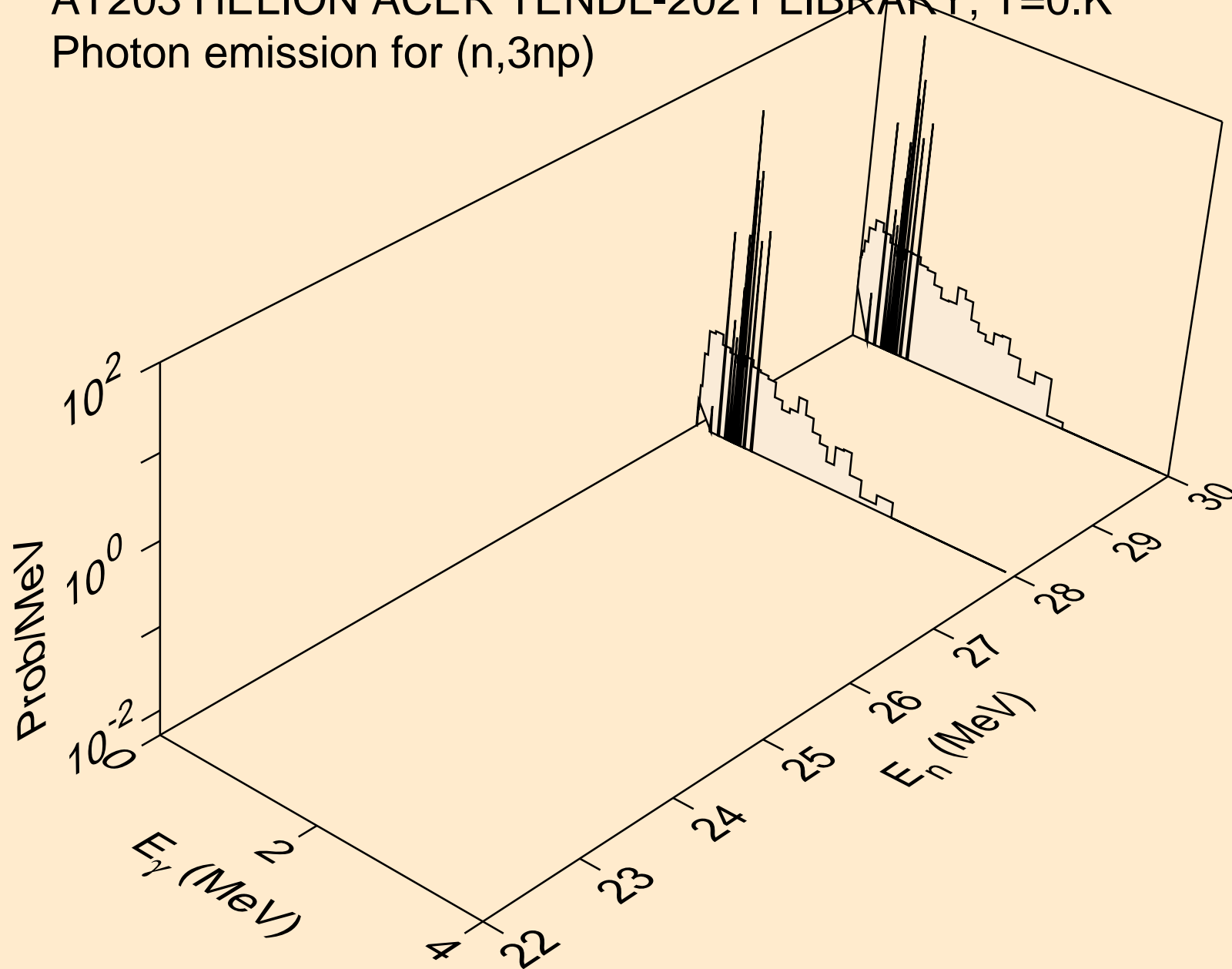

AT203 HELION ACER TENDL-2021 LIBRARY; T=0.K  
Photon emission for (n,2np)

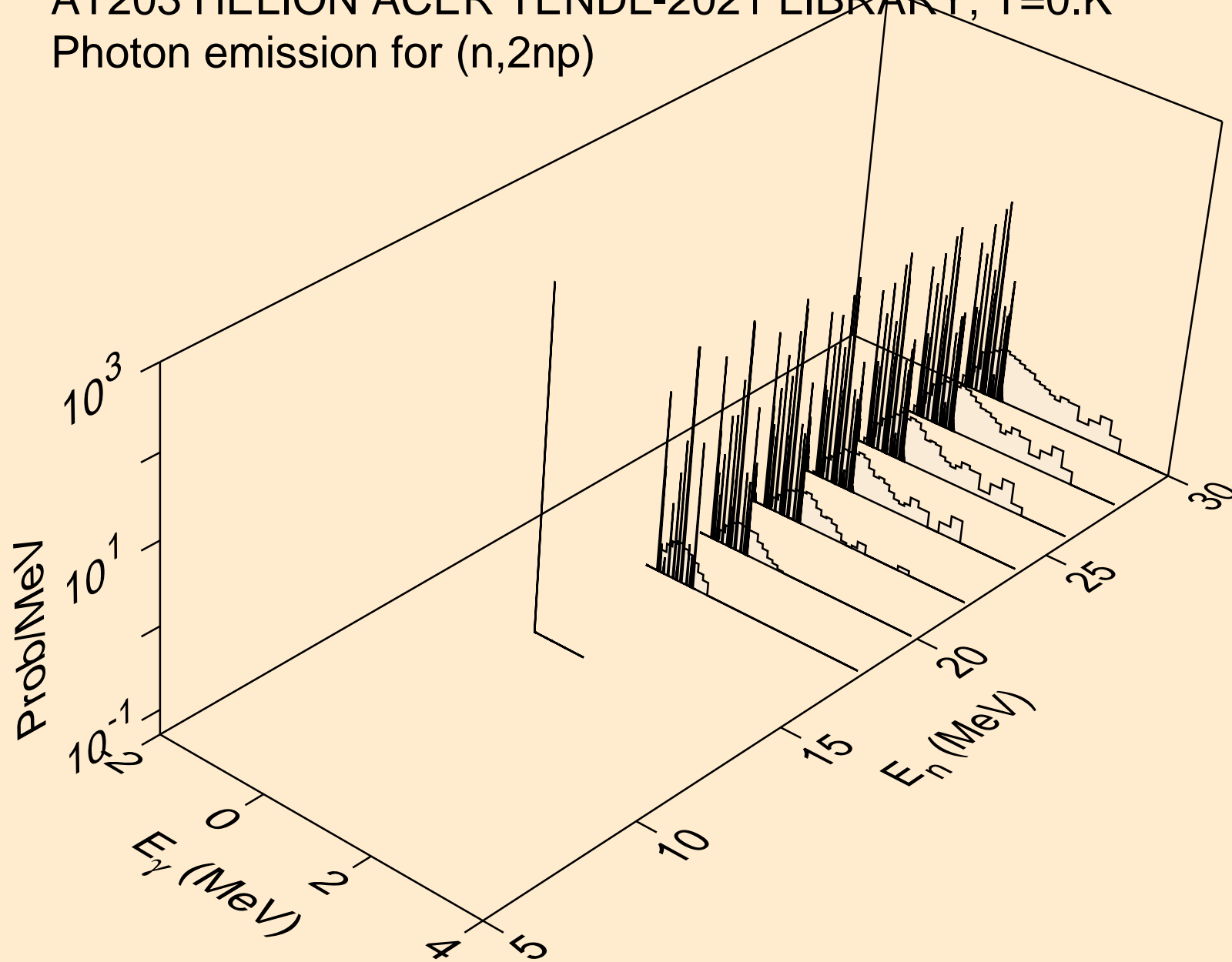

AT203 HELION ACER TENDL-2021 LIBRARY; T=0.K  
Photon emission for (n,npa)

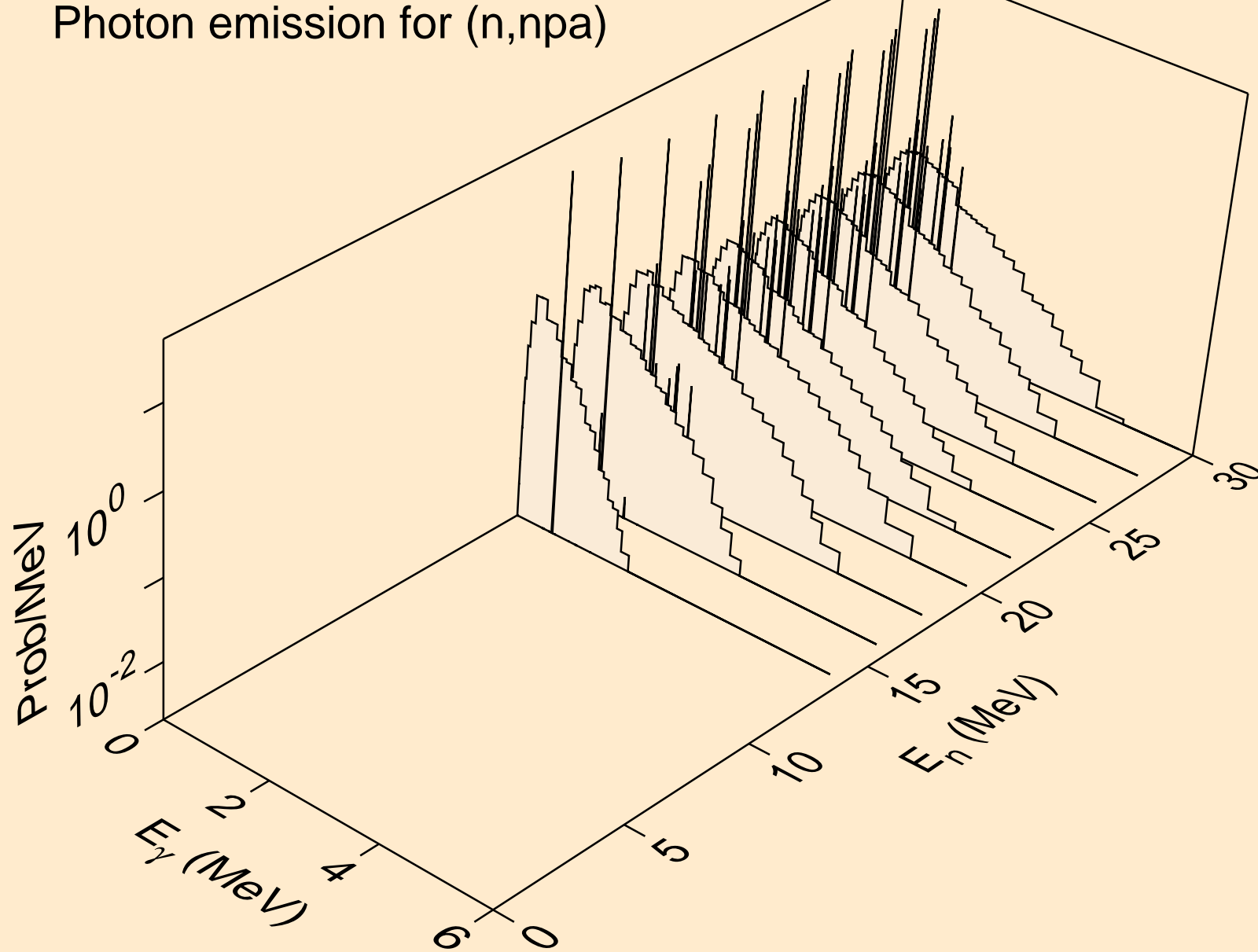



AT203 HELION ACER TENDL-2021 LIBRARY; T=0.K  
Photon emission for (n,gma)

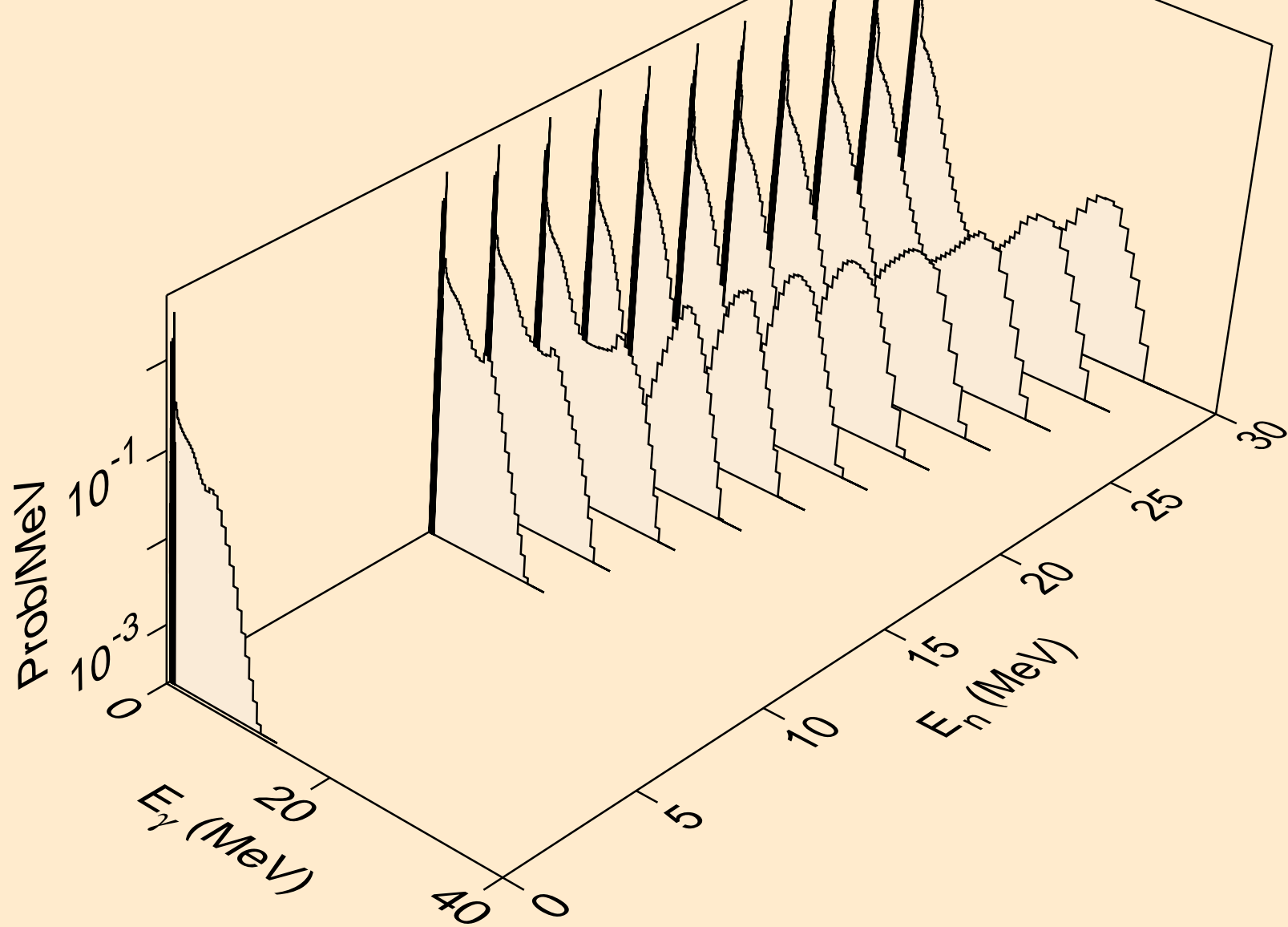

AT203 HELION ACER TENDL-2021 LIBRARY; T=0.K  
Photon emission for (n,p)

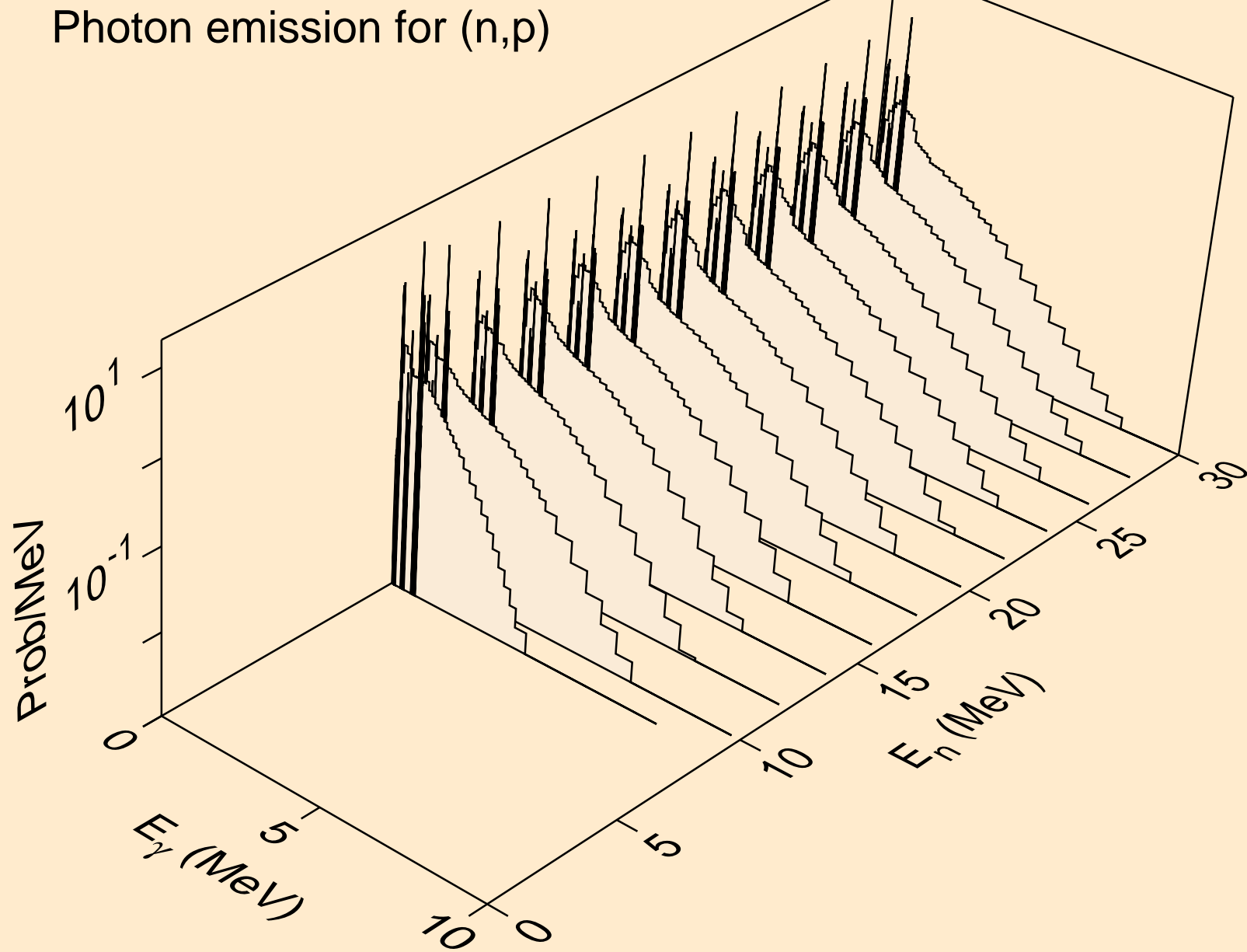

AT203 HELION ACER TENDL-2021 LIBRARY; T=0.K  
Photon emission for (n,d)

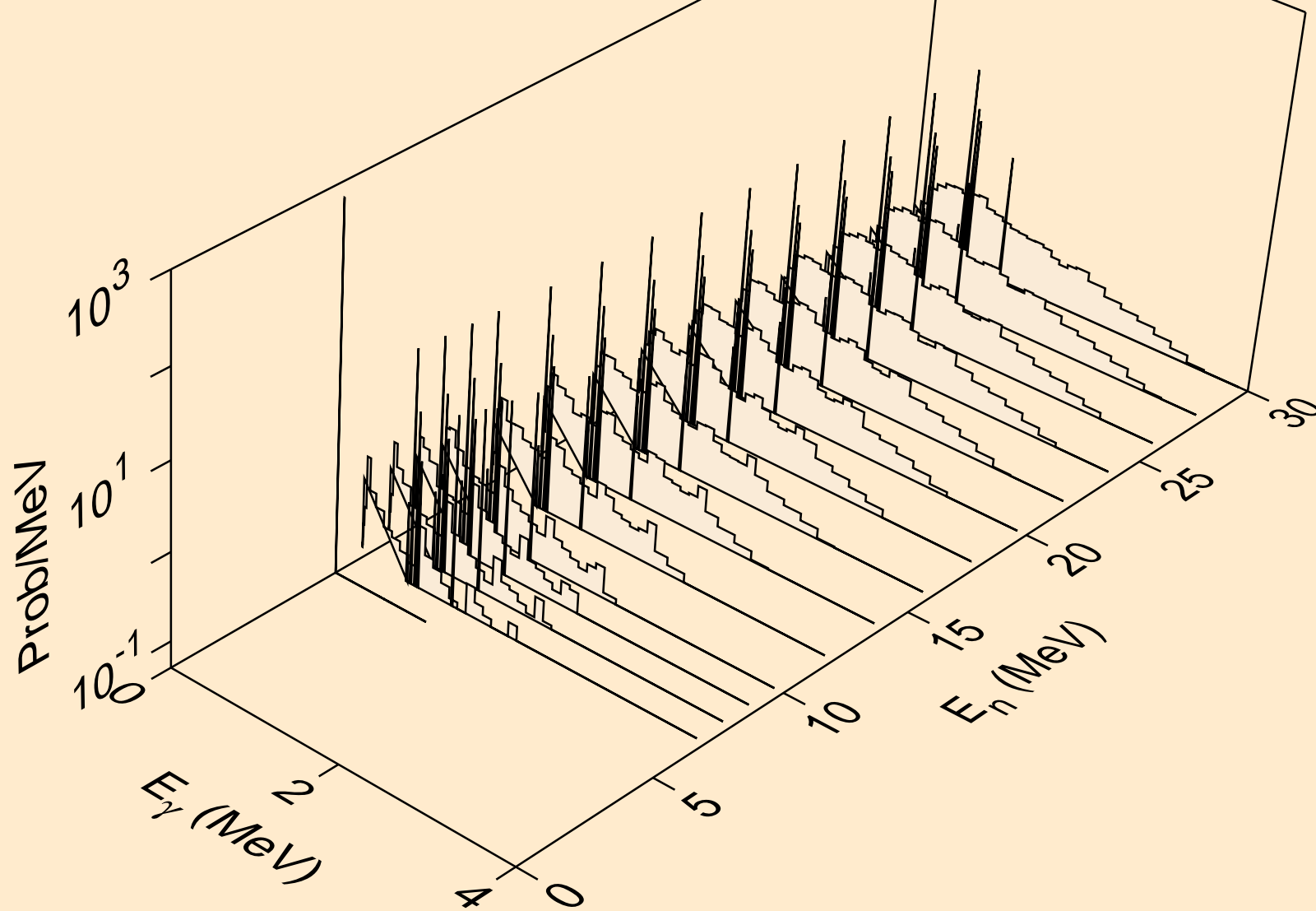

AT203 HELION ACER TENDL-2021 LIBRARY; T=0.K  
Photon emission for (n,t)

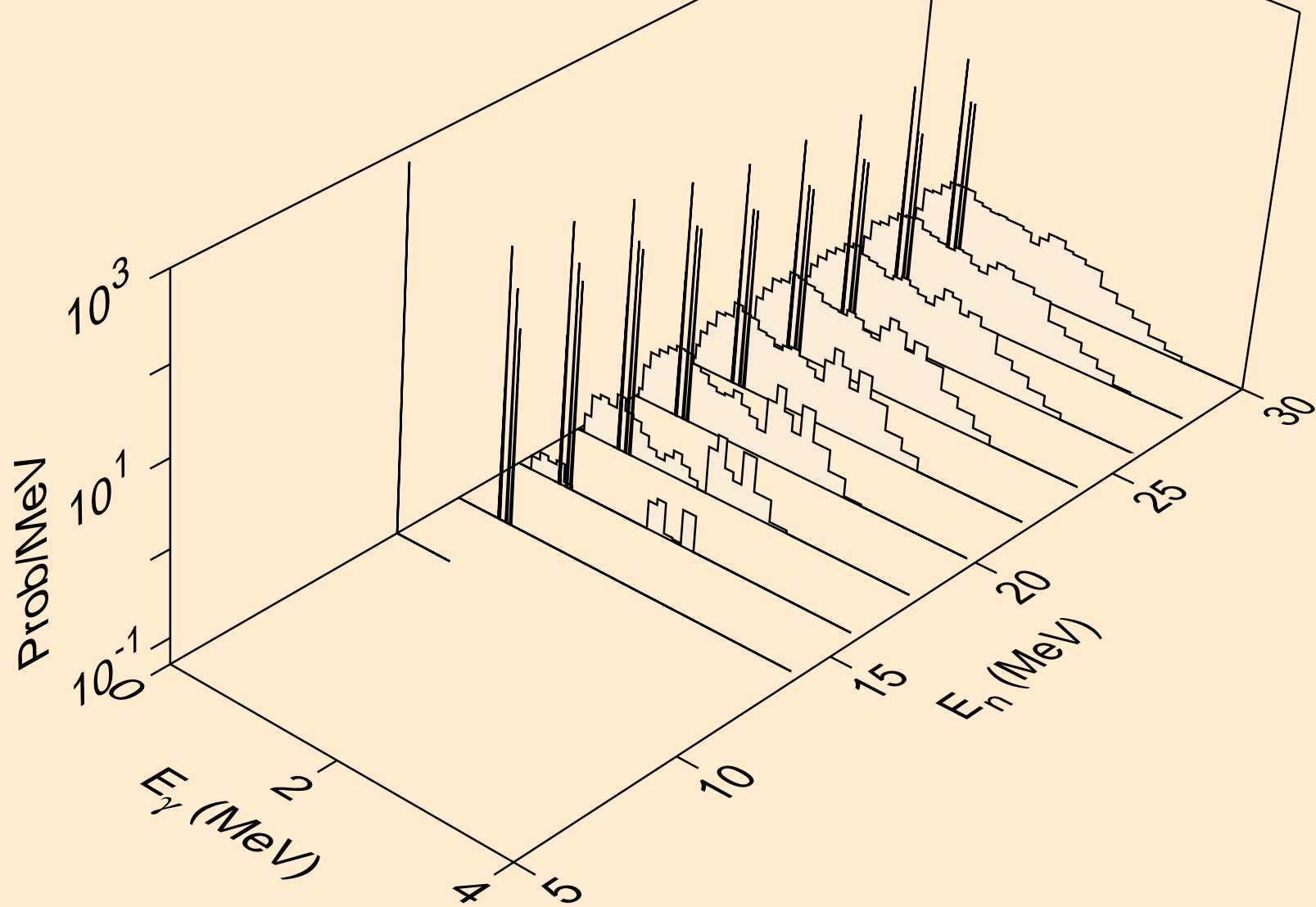

AT203 HELION ACER TENDL-2021 LIBRARY; T=0.K  
Photon emission for inelastic

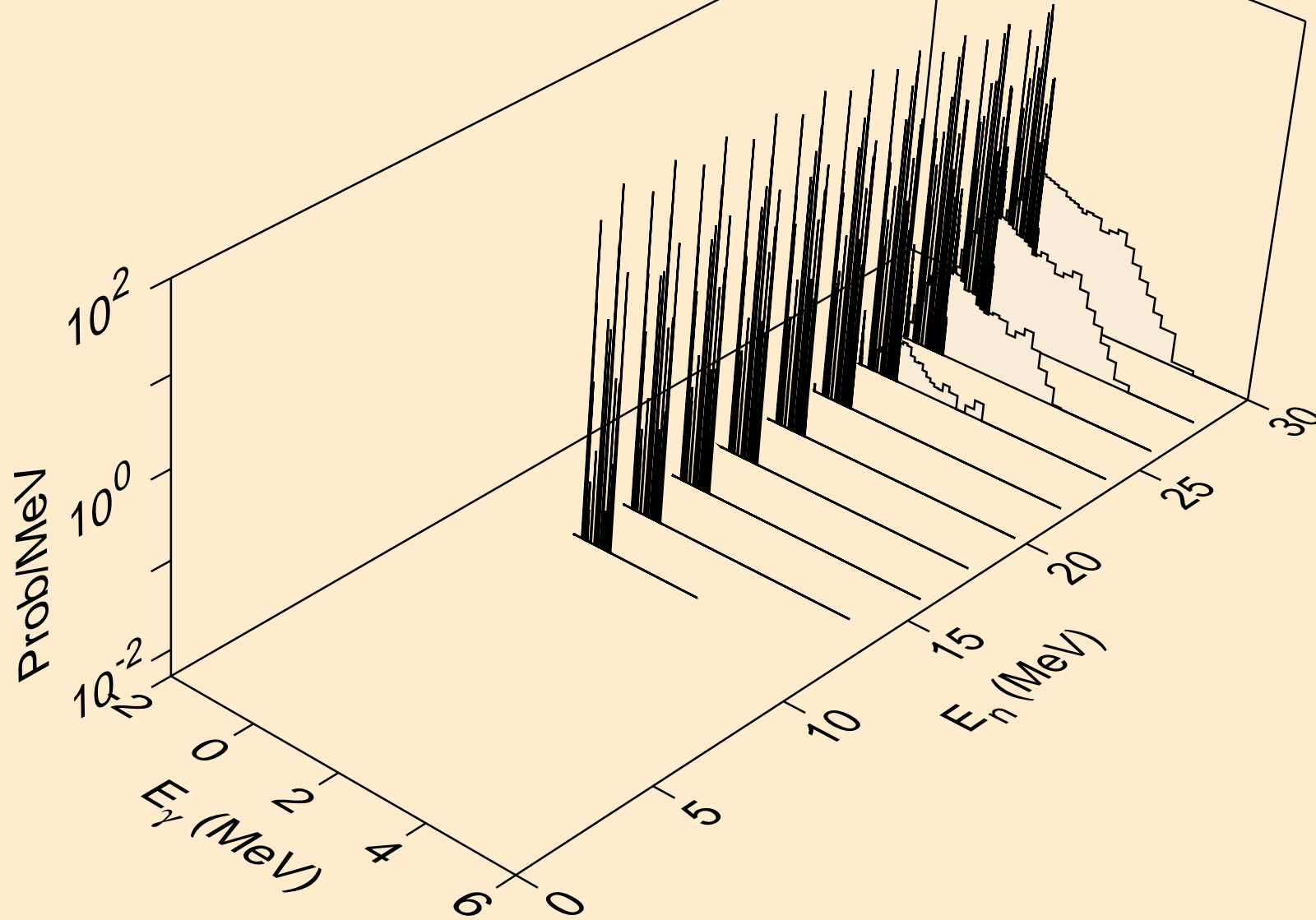

AT203 HELION ACER TENDL-2021 LIBRARY; T=0.K  
Photon emission for (n,a)

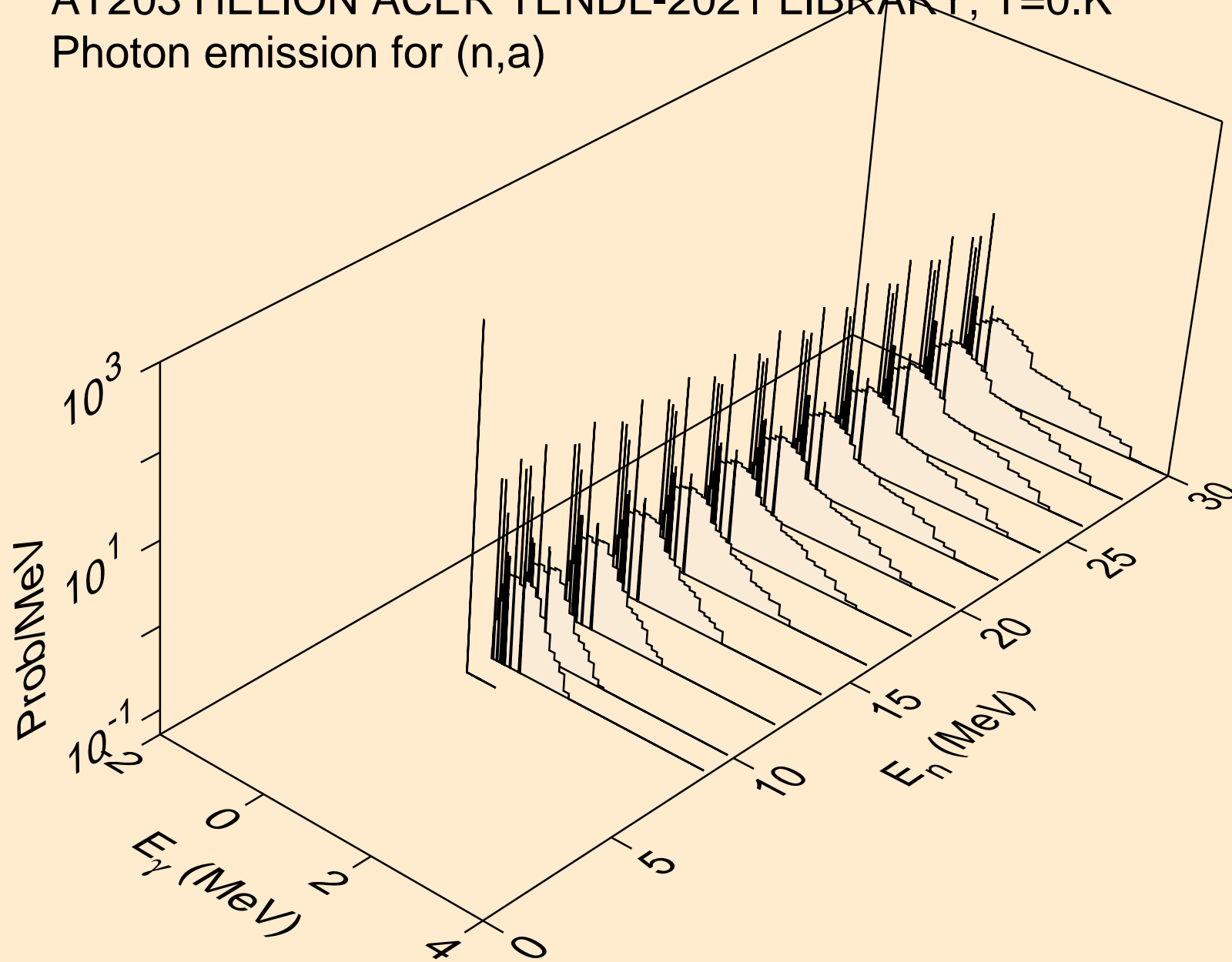

AT203 HELION ACER TENDL-2021 LIBRARY; T=0.K  
Photon emission for (n,2a)

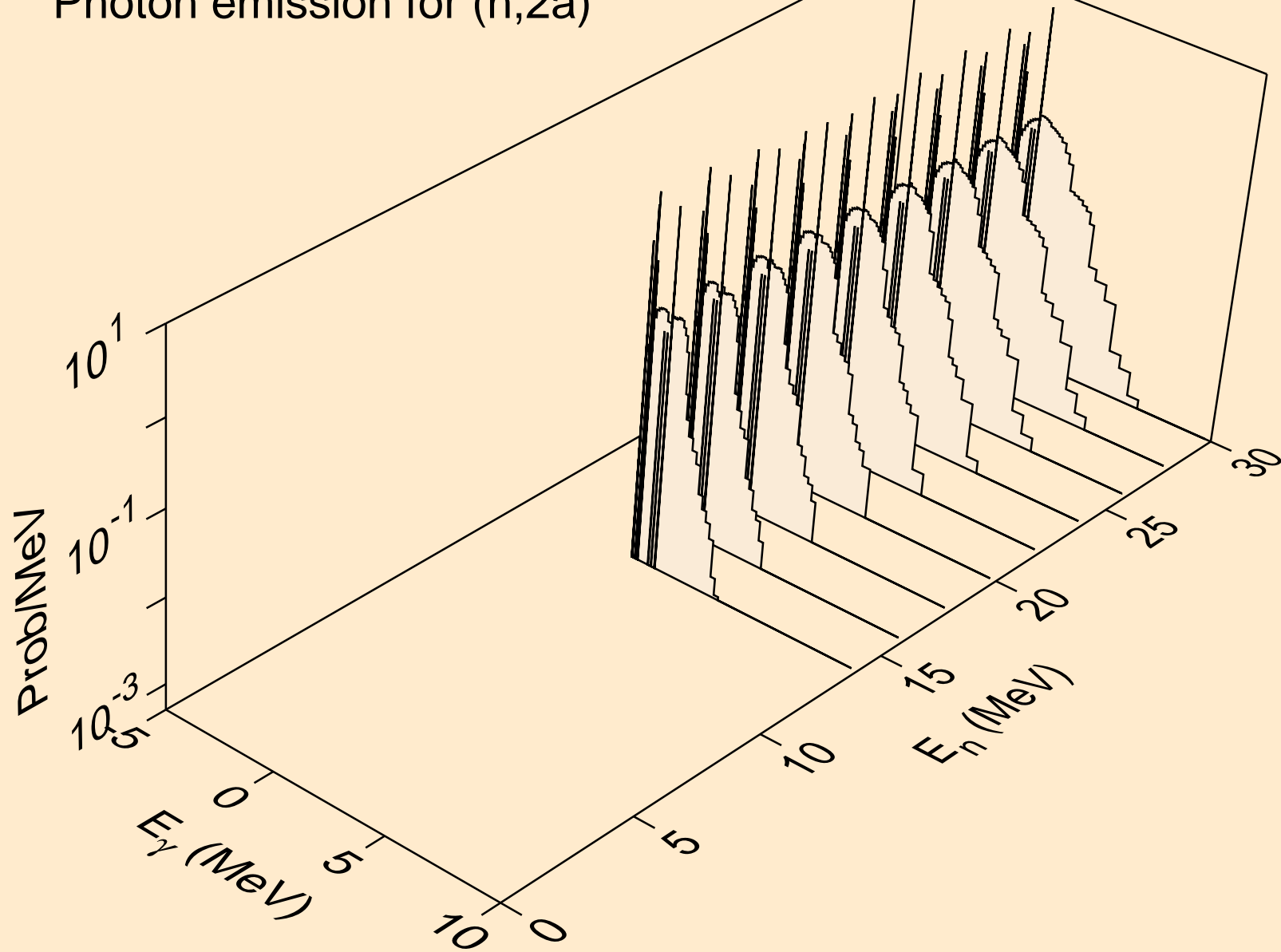

AT203 HELION ACER TENDL-2021 LIBRARY; T=0.K  
Photon emission for (n,2p)

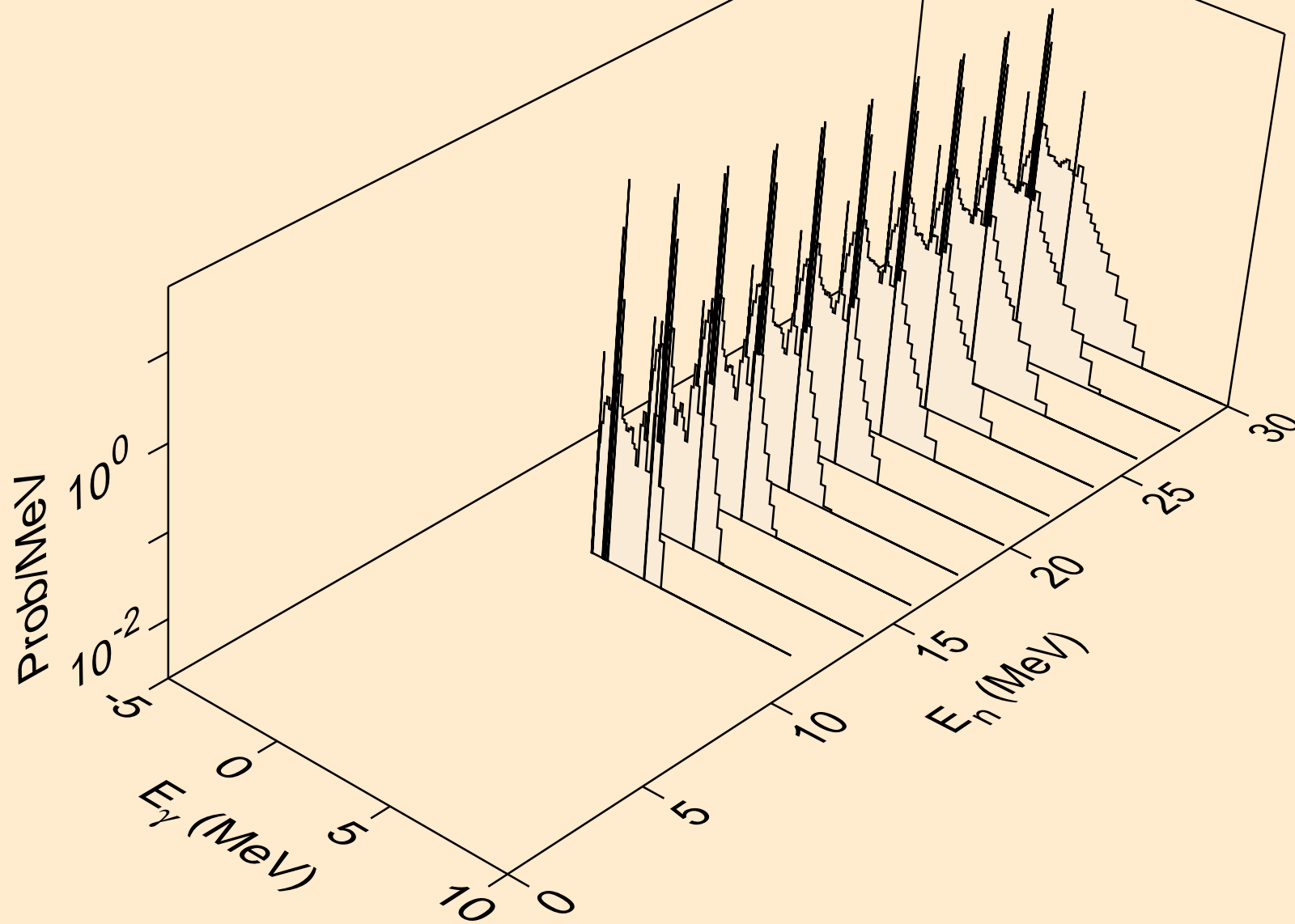



AT203 HELION ACER TENDL-2021 LIBRARY; T=0.K  
Photon emission for (n,p $\alpha$ )

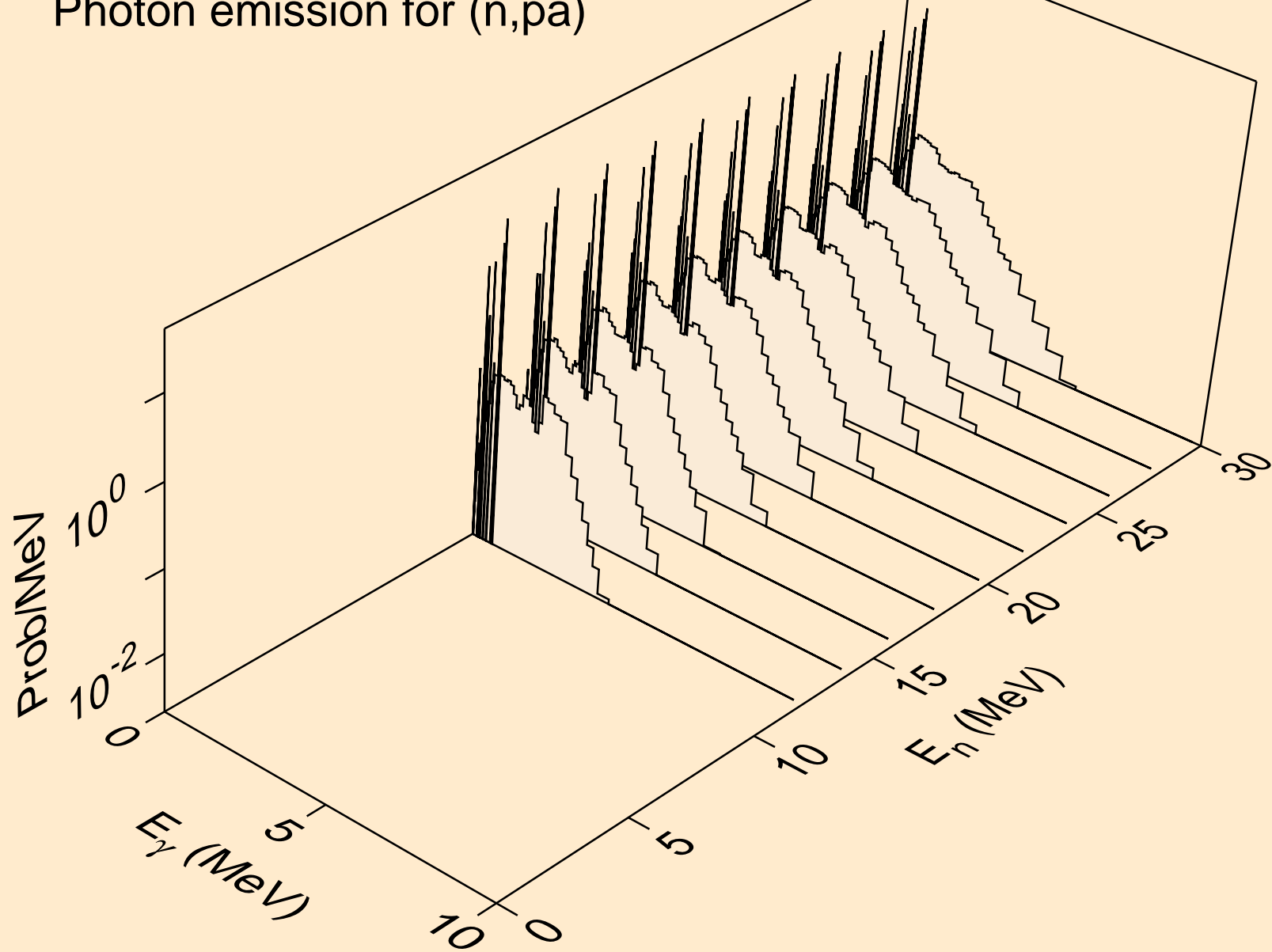

AT203 HELION ACER TENDL-2021 LIBRARY; T=0.K  
Photon emission for (n,pd)

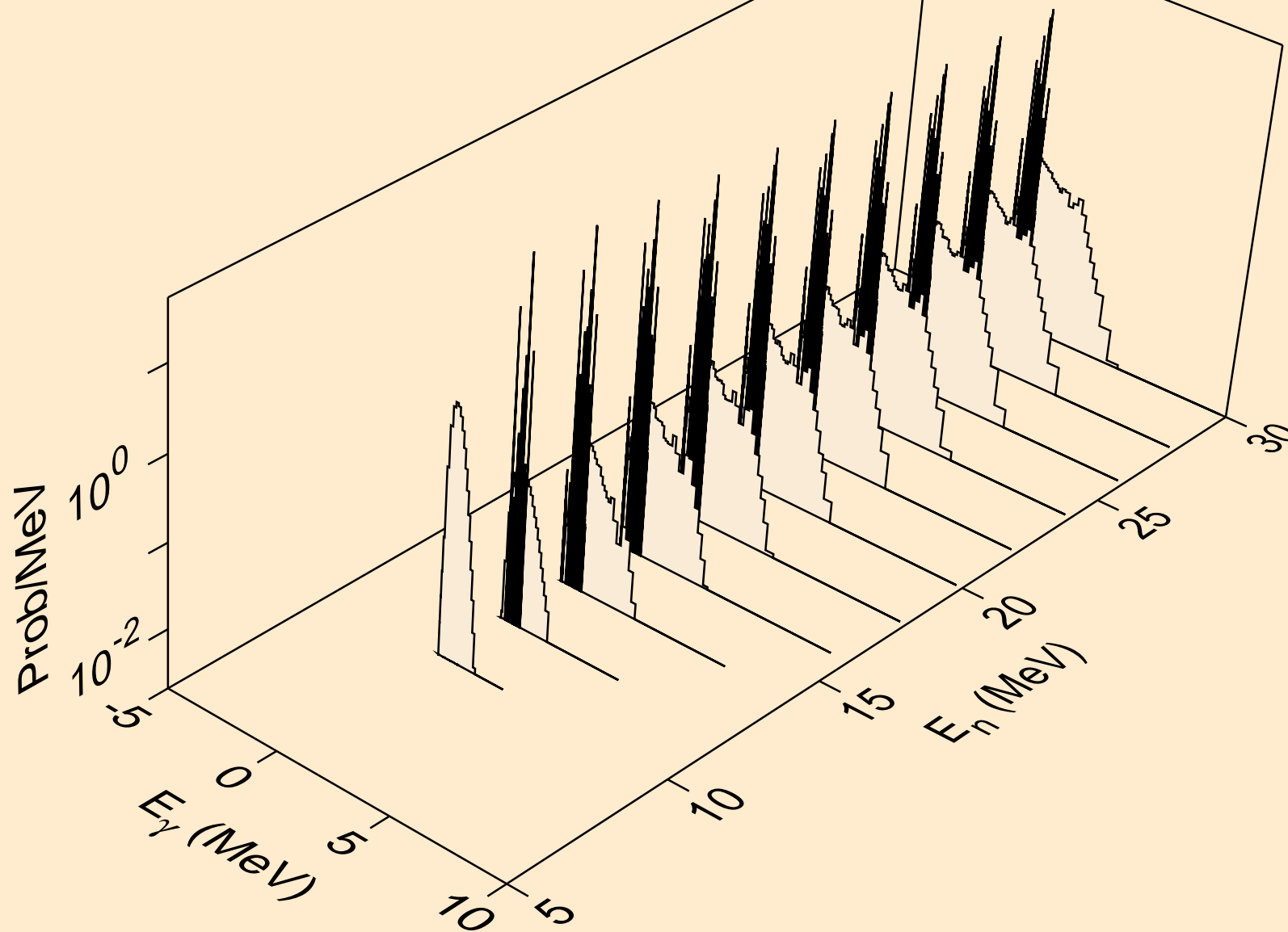

AT203 HELION ACER TENDL-2021 LIBRARY; T=0.K  
Photon emission for (n,pt)

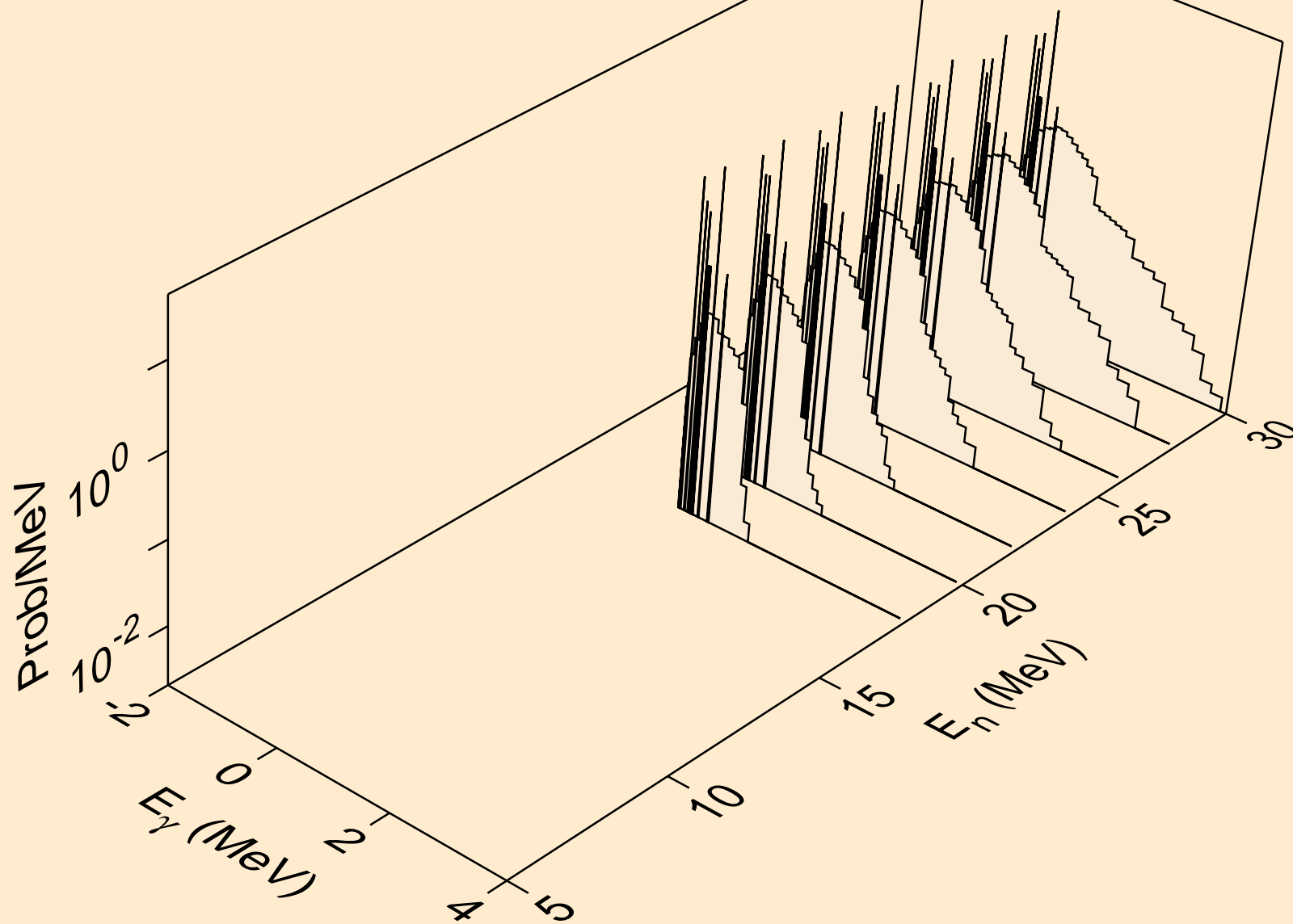

AT203 HELION ACER TENDL-2021 LIBRARY; T=0.K  
Photon emission for (n,da)

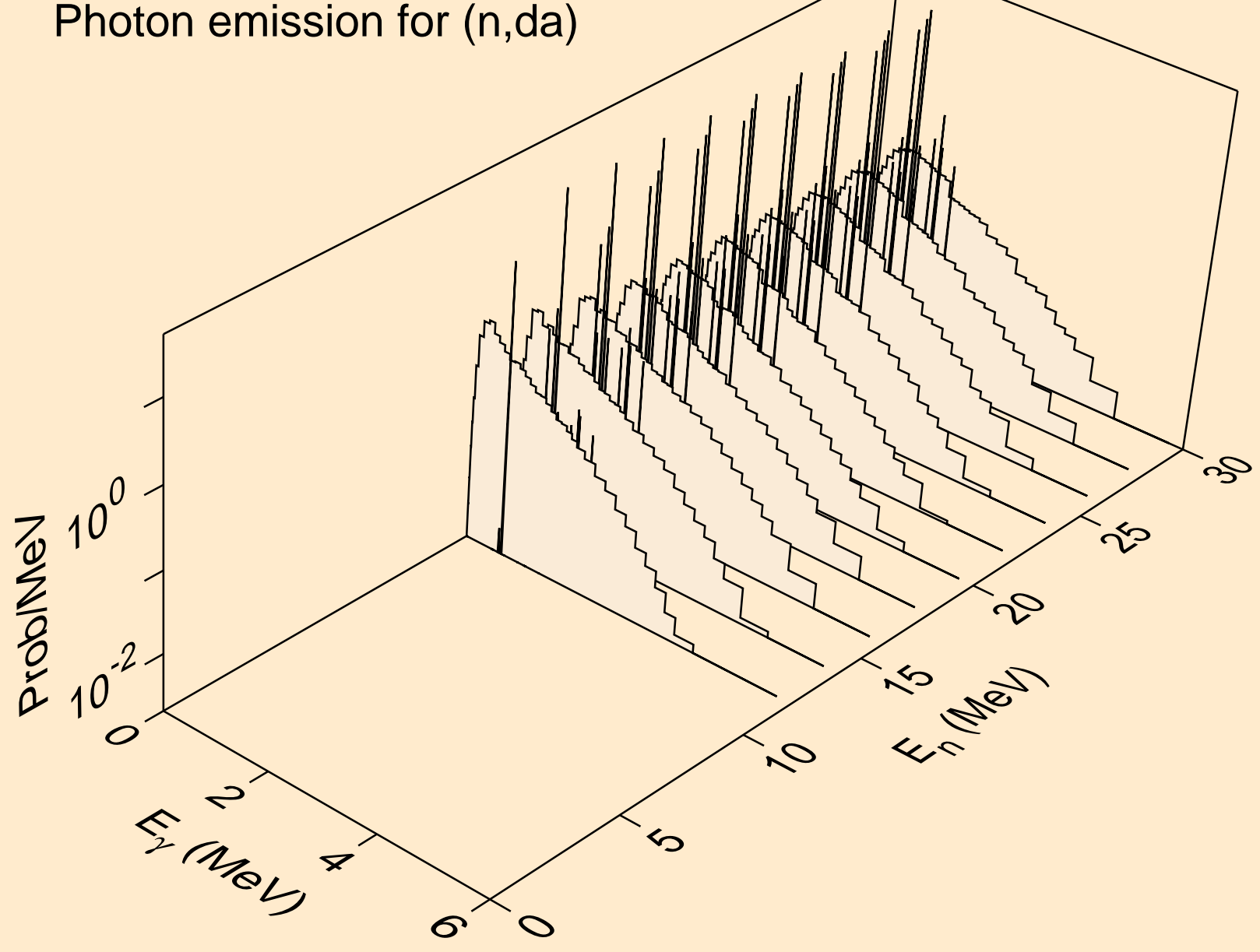

AT203 HELION ACER TENDL-2021 LIBRARY; T=0.K  
Particle heating contributions

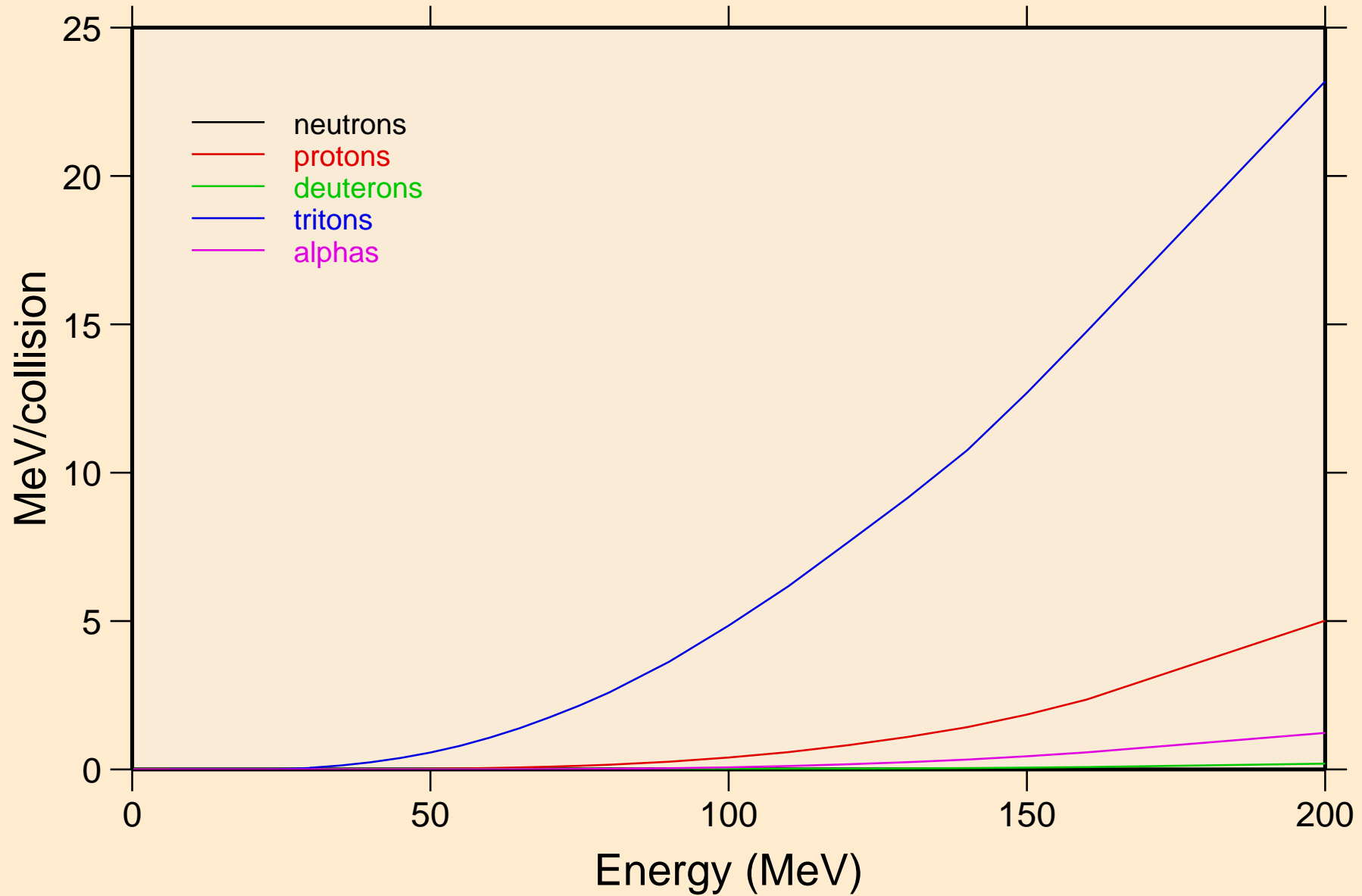

AT203 HELION ACER TENDL-2021 LIBRARY; T=0.K  
Recoil Heating

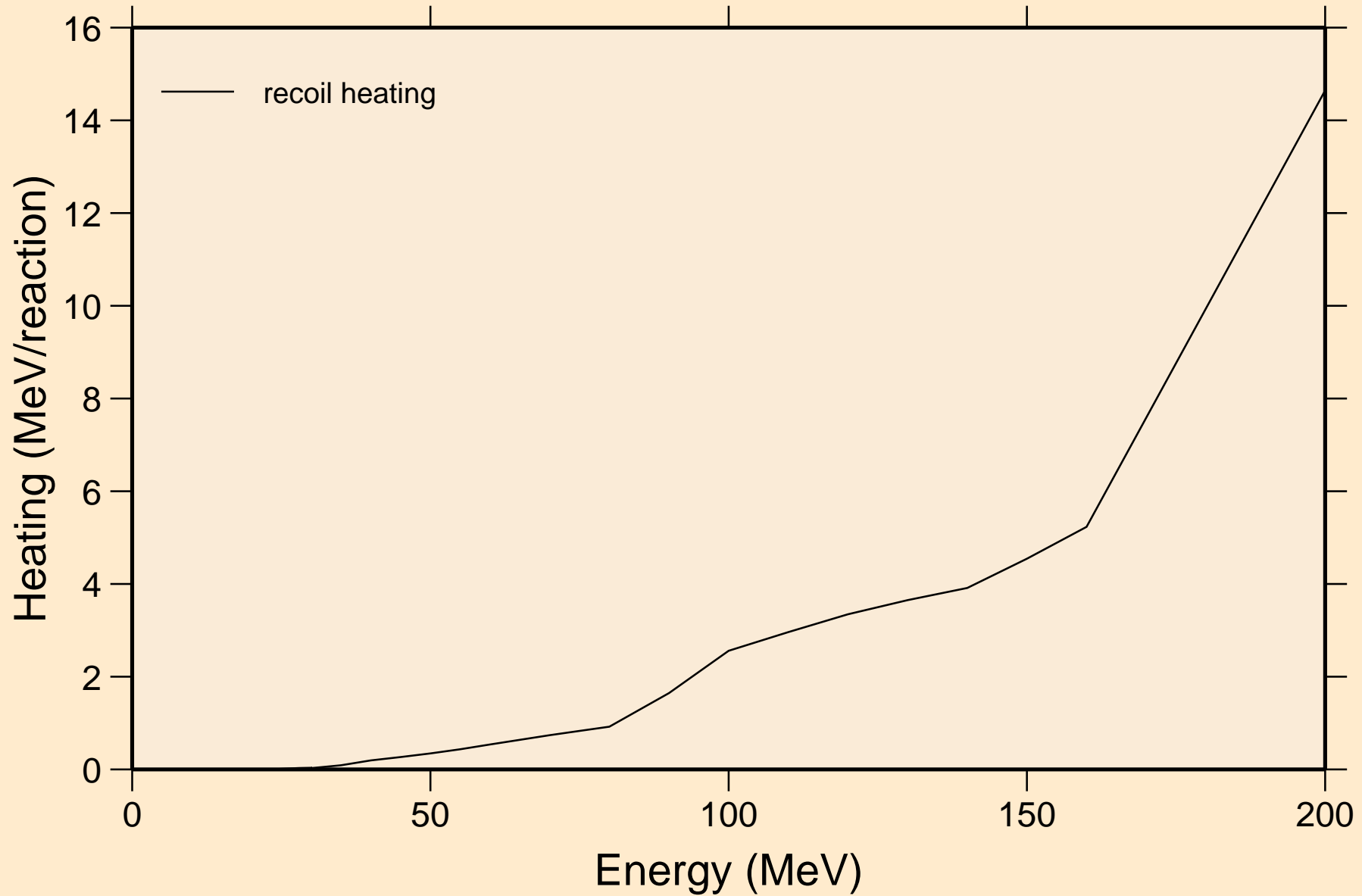

AT203 HELION ACER TENDL-2021 LIBRARY; T=0.K  
Particle production cross sections

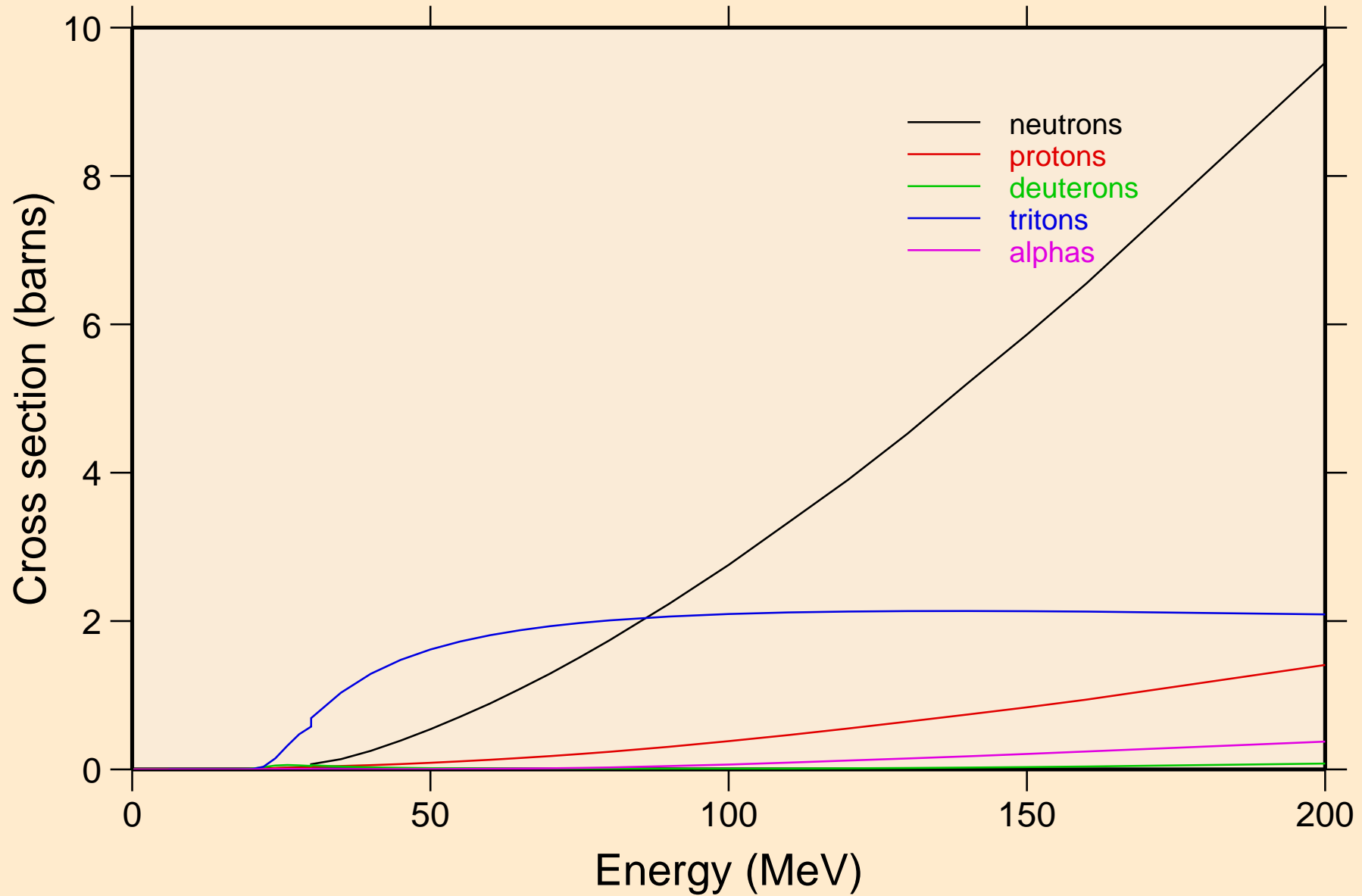

AT203 HELION ACER TENDL-2021 LIBRARY; T=0.K  
neutrons from (s,n)

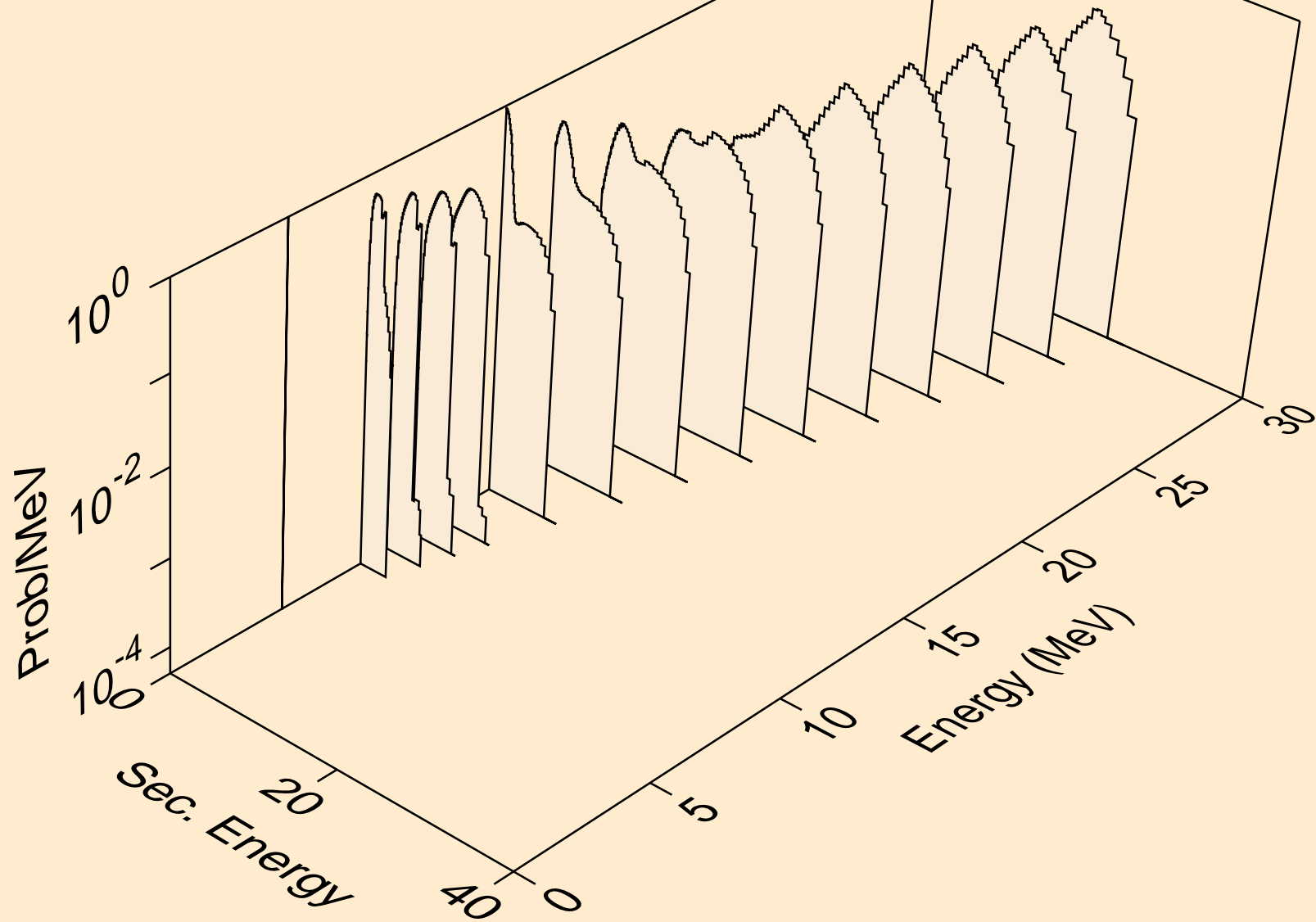



AT203 HELION ACER TENDL-2021 LIBRARY; T=0.K  
neutrons from (s,x)

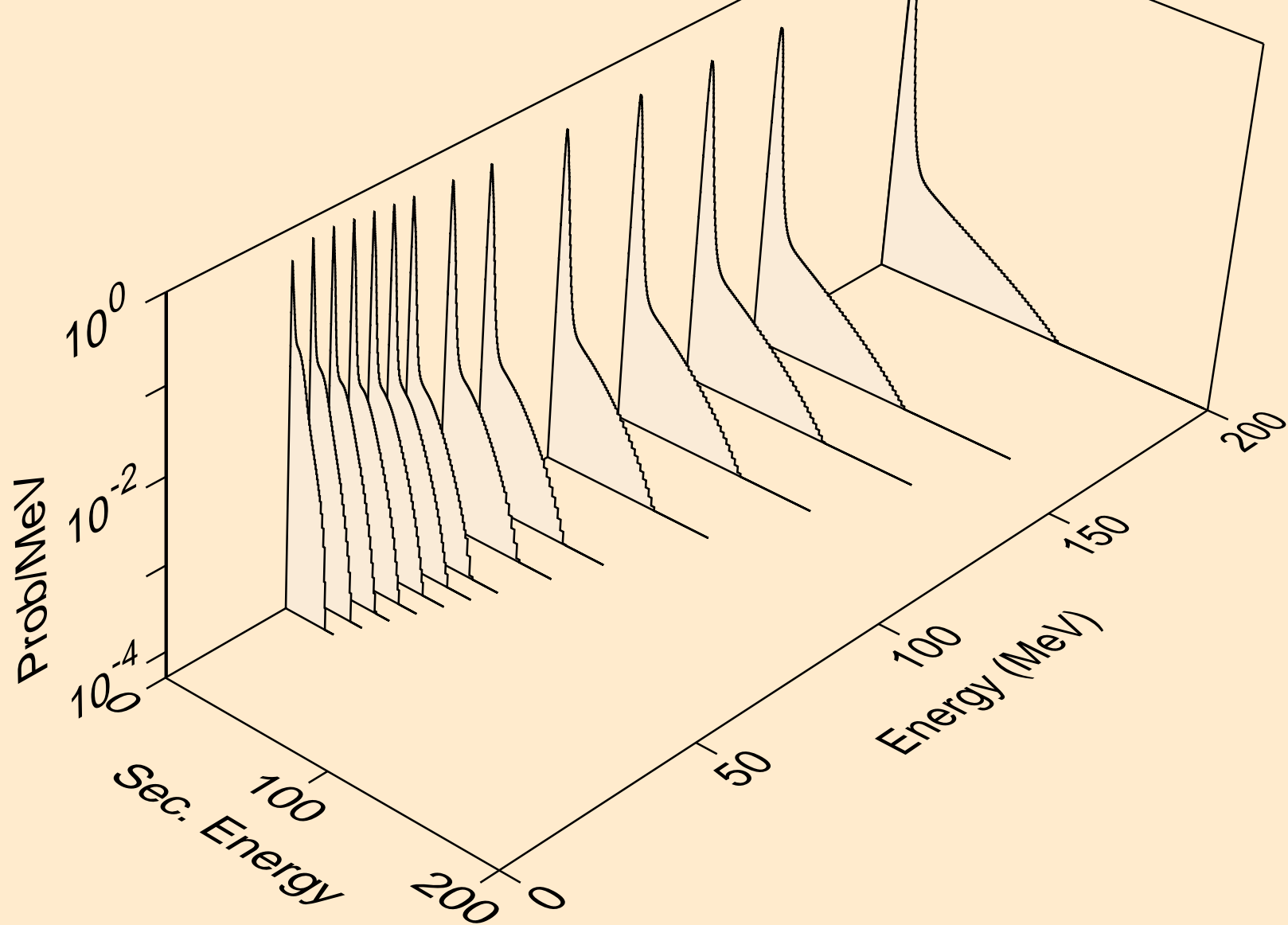

AT203 HELION ACER TENDL-2021 LIBRARY; T=0.K  
neutrons from (s,2nd)

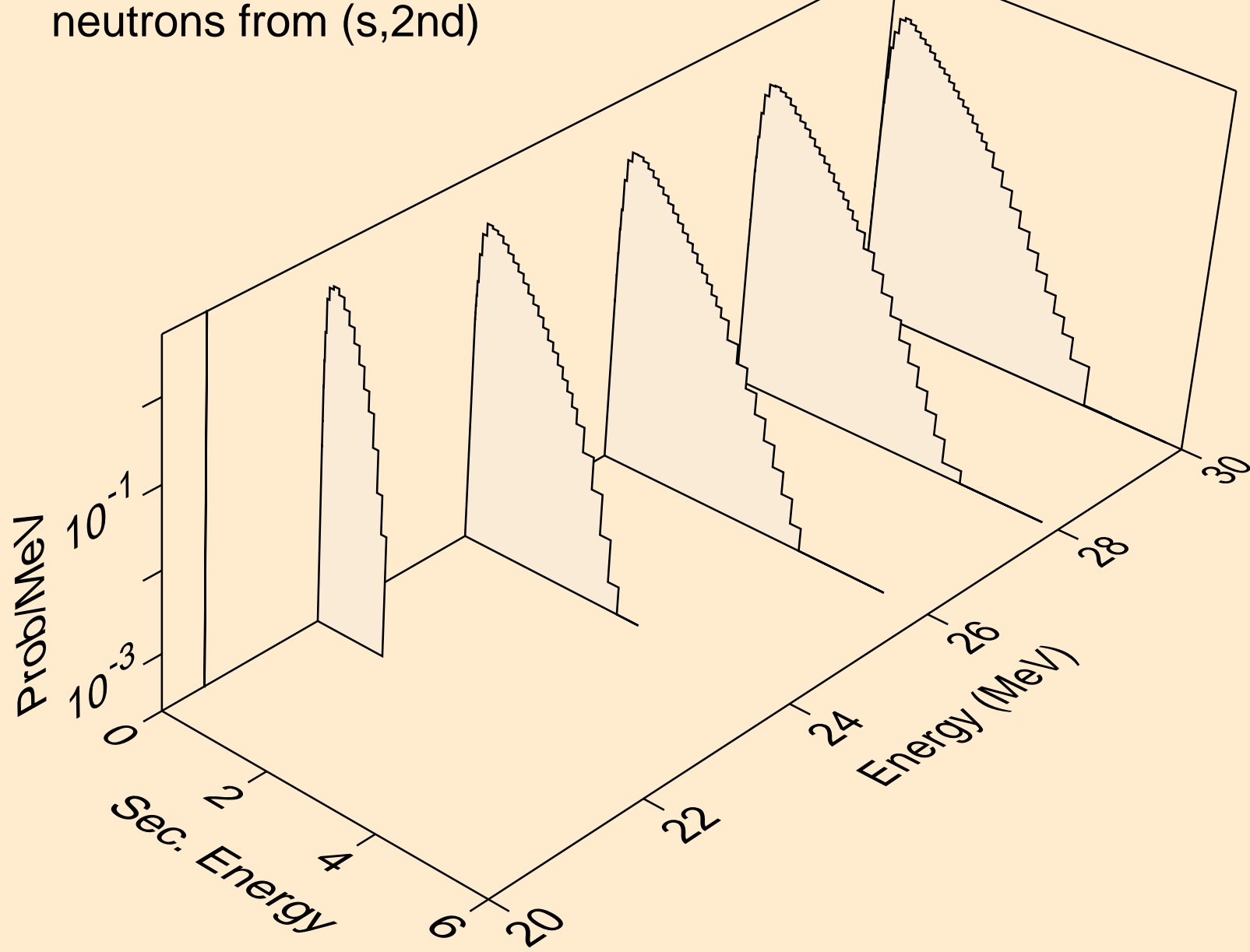

AT203 HELION ACER TENDL-2021 LIBRARY; T=0.K  
neutrons from (s,2n)

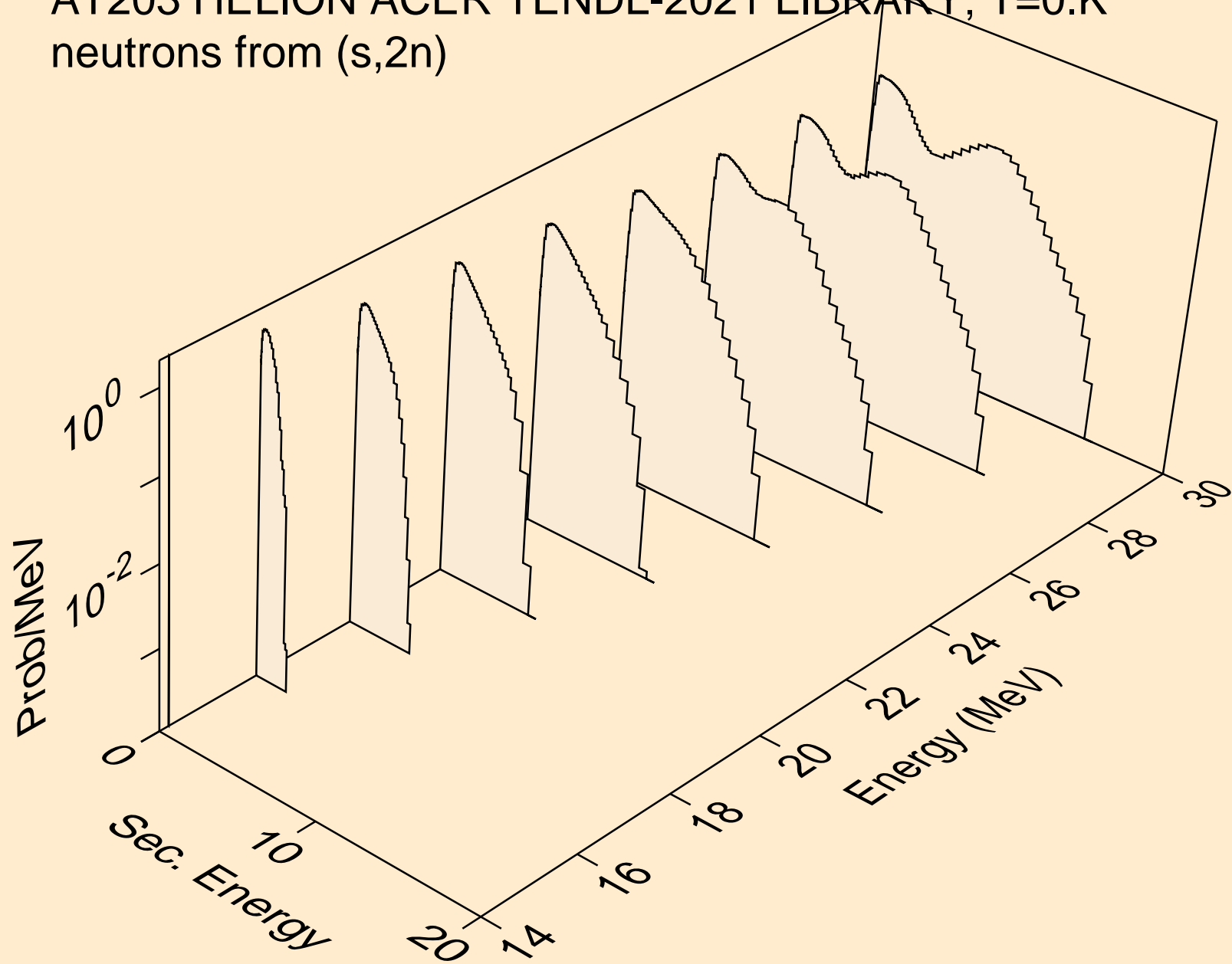

AT203 HELION ACER TENDL-2021 LIBRARY; T=0.K  
neutrons from (s,3n)

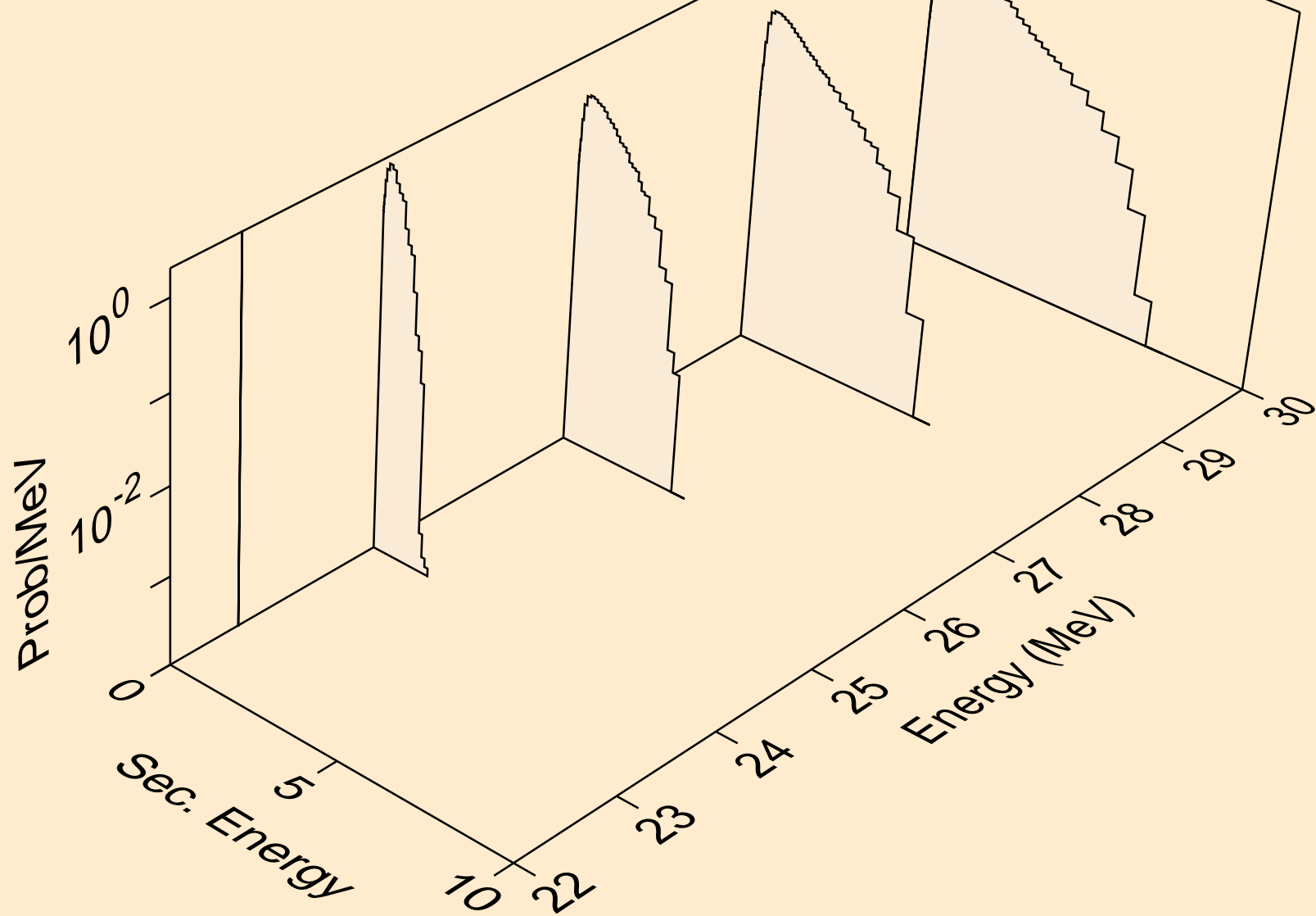

AT203 HELION ACER TENDL-2021 LIBRARY; T=0.K  
neutrons from (s,n\*)a

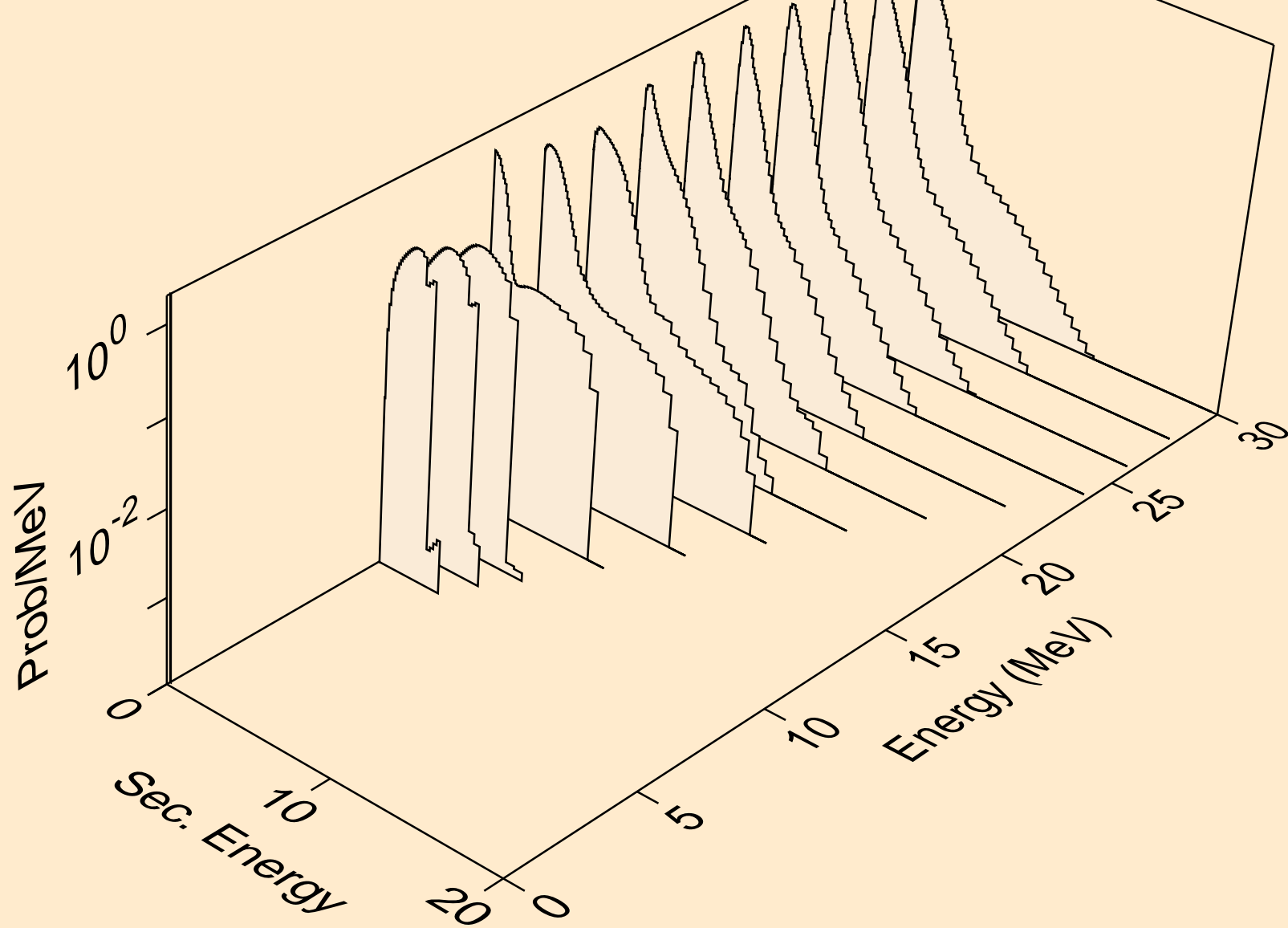

AT203 HELION ACER TENDL-2021 LIBRARY; T=0.K  
neutrons from (s,2n)a

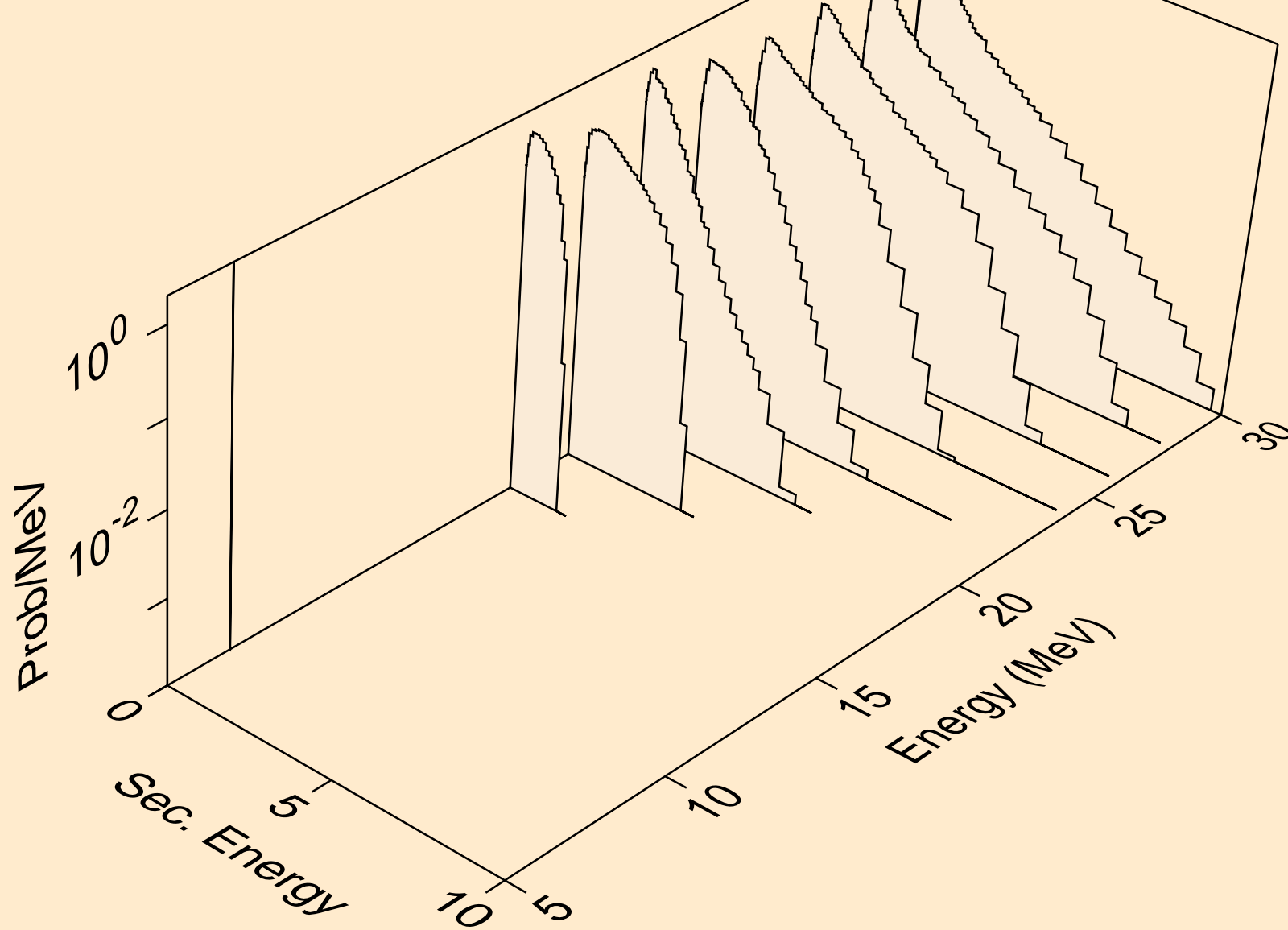

AT203 HELION ACER TENDL-2021 LIBRARY; T=0.K  
neutrons from (s,n\*)p

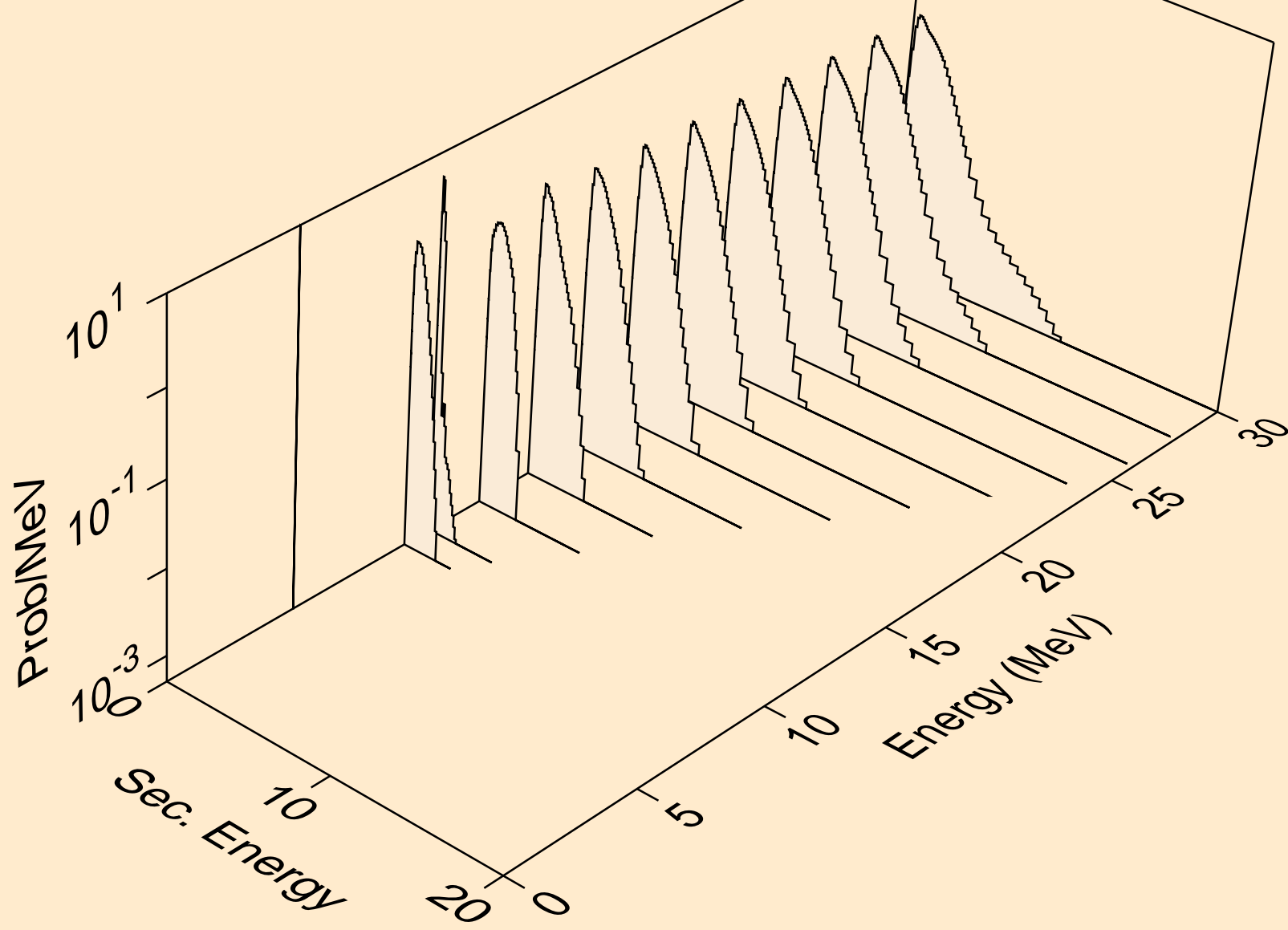

AT203 HELION ACER TENDL-2021 LIBRARY; T=0.K  
neutrons from (s,n\*)2a

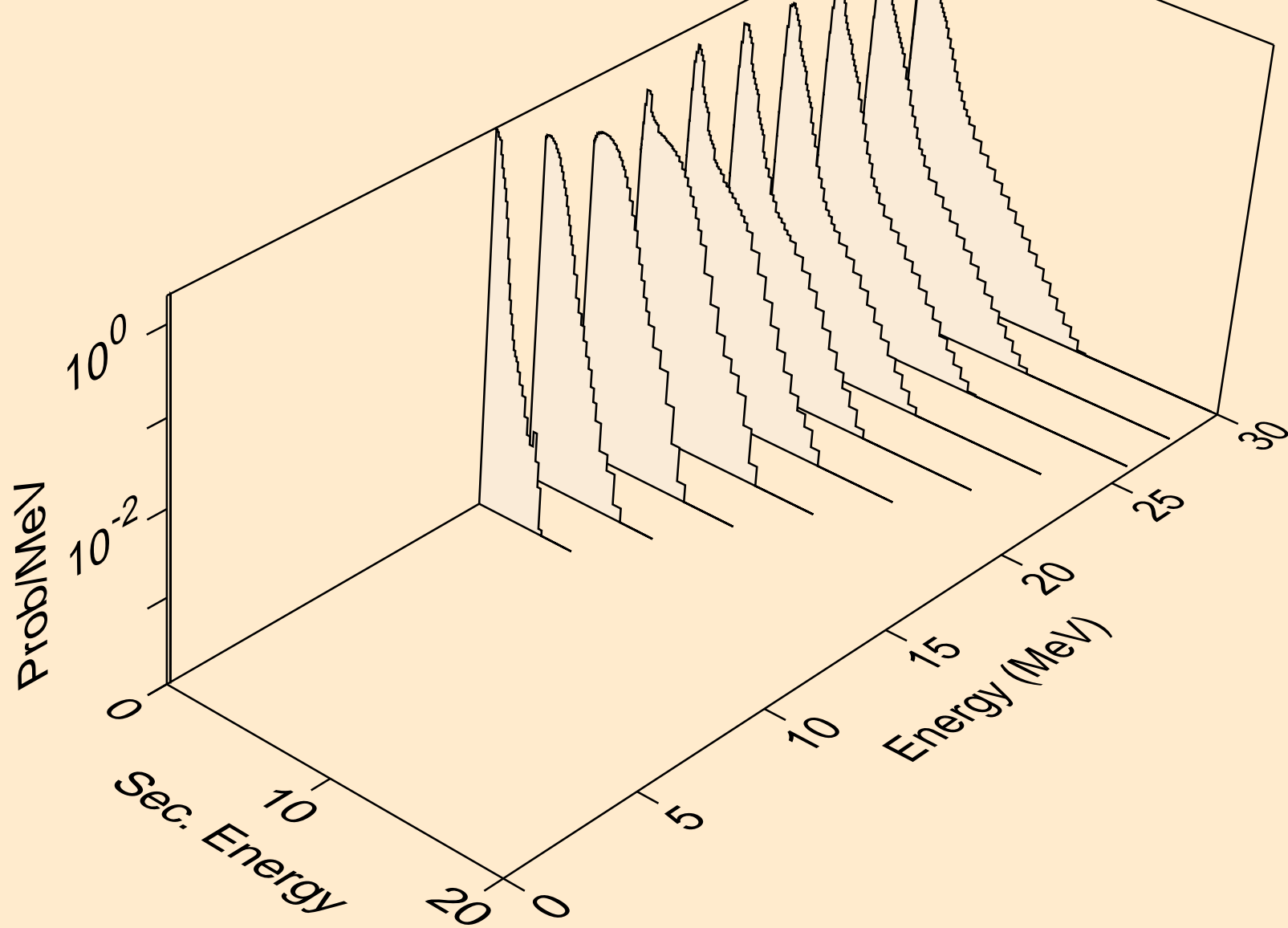



AT203 HELION ACER TENDL-2021 LIBRARY; T=0.K  
neutrons from (s,n\*)d

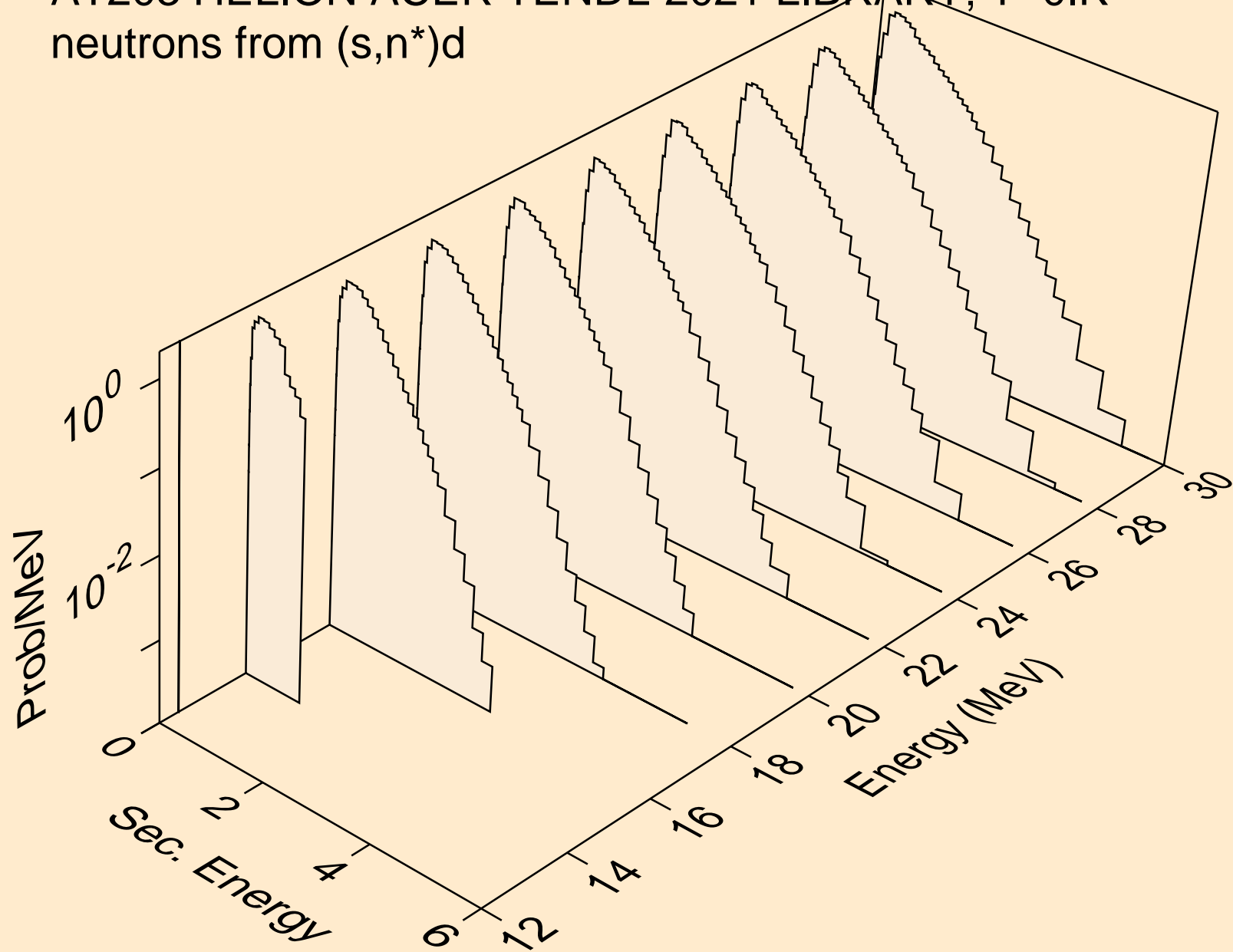

AT203 HELION ACER TENDL-2021 LIBRARY; T=0.K  
neutrons from (s,n\*)t

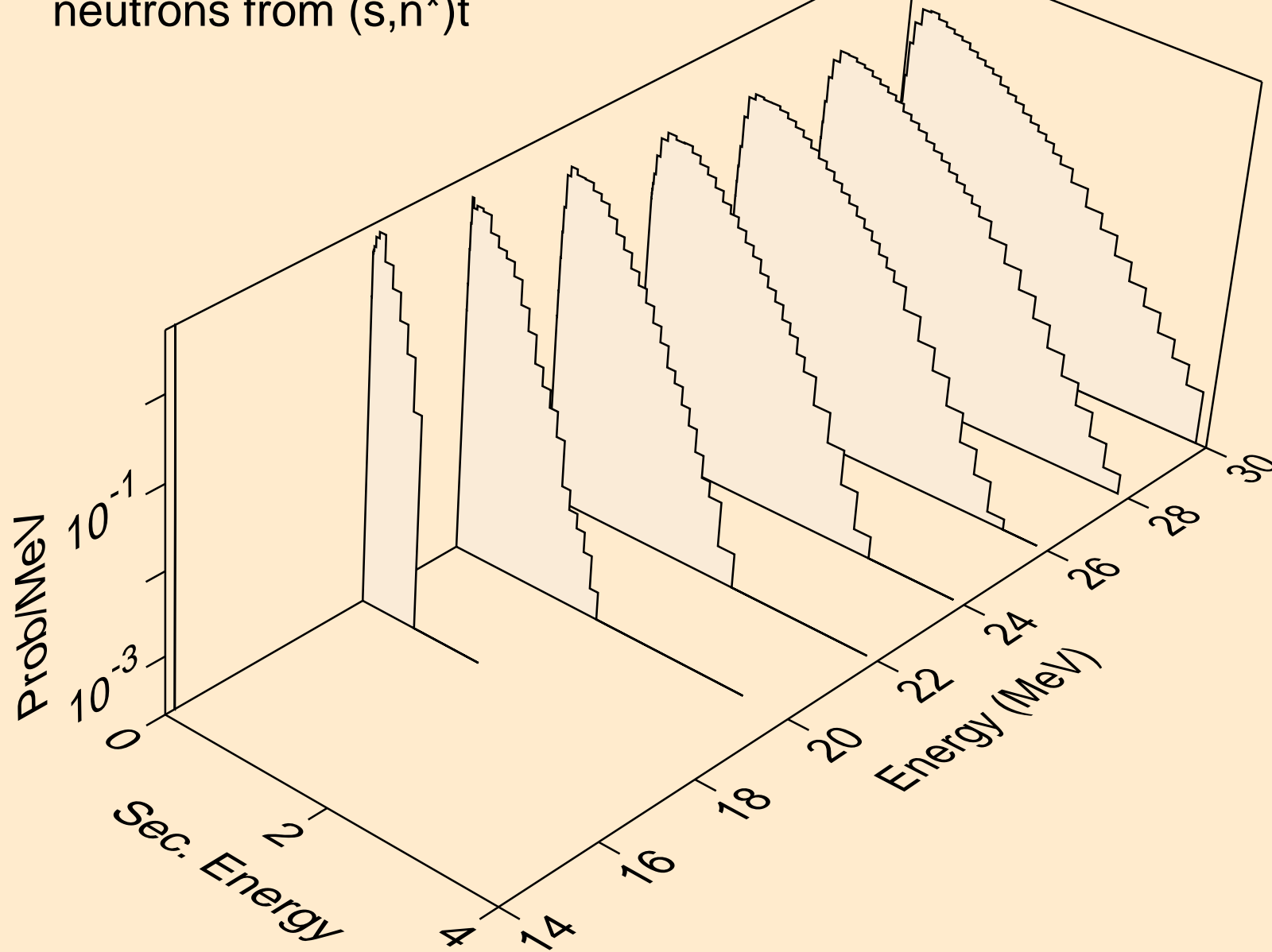

AT203 HELION ACER TENDL-2021 LIBRARY; T=0.K  
neutrons from (s,n\*)he3

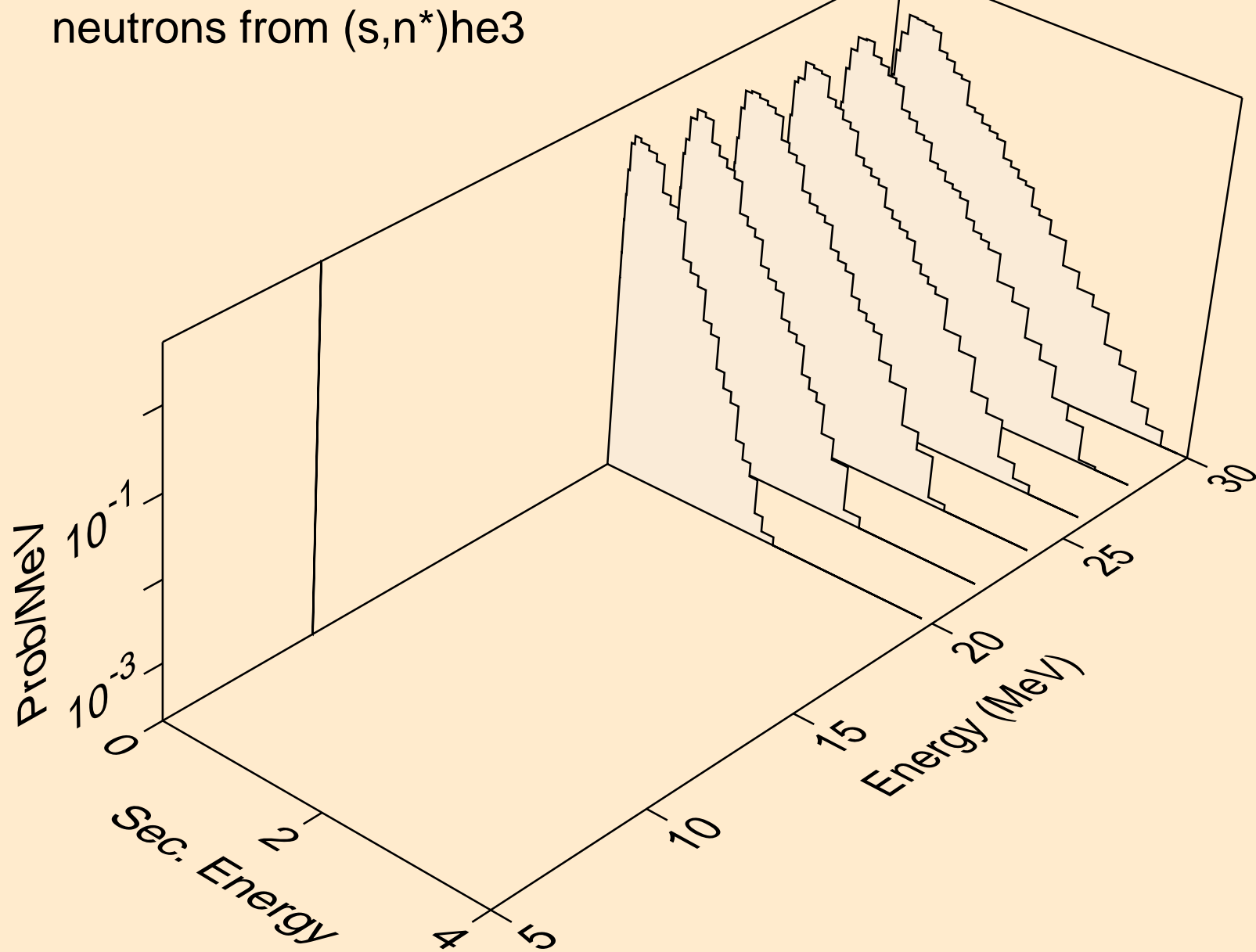

AT203 HELION ACER TENDL-2021 LIBRARY; T=0.K  
neutrons from (s,2np)

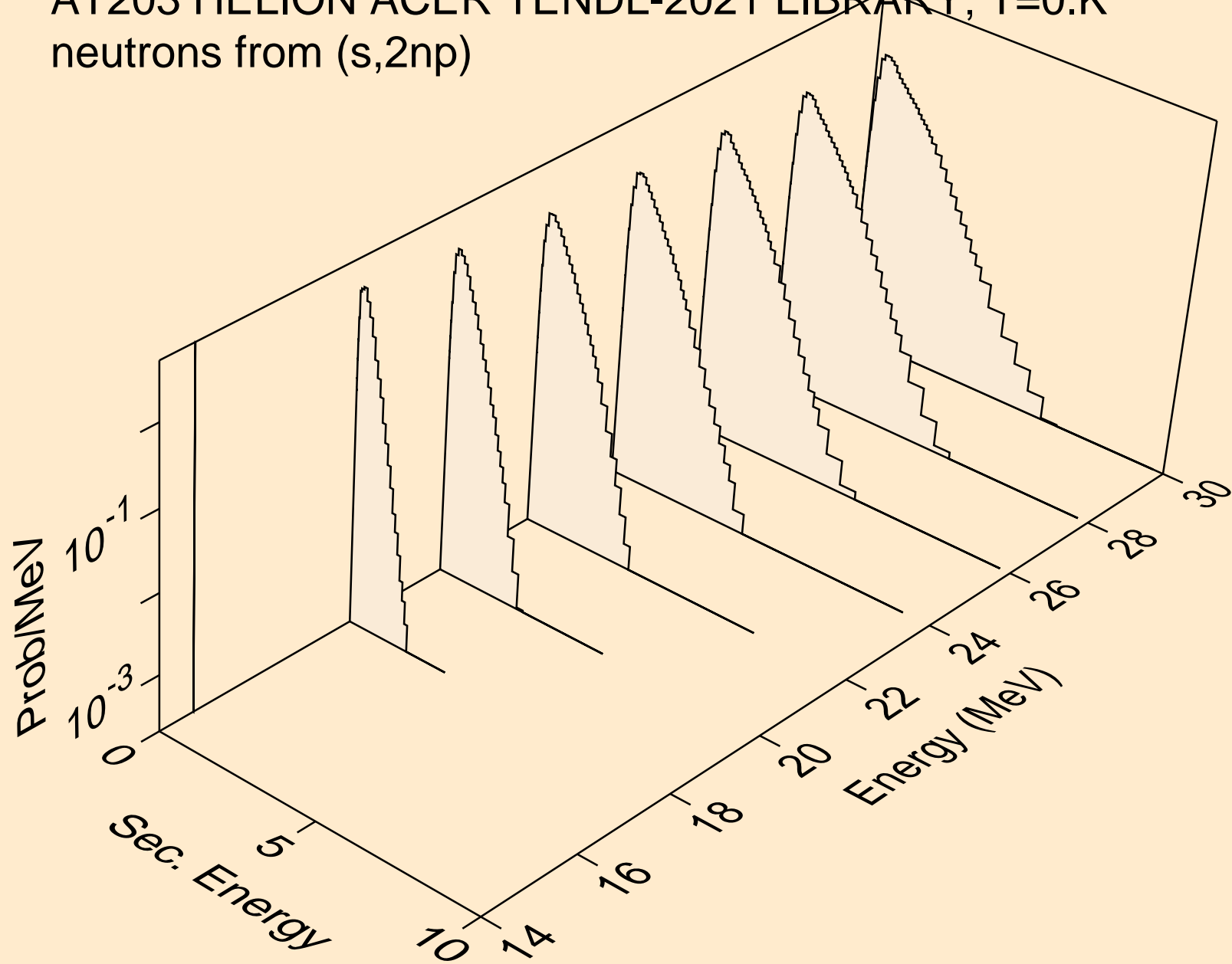

AT203 HELION ACER TENDL-2021 LIBRARY; T=0.K  
neutrons from (s,3np)

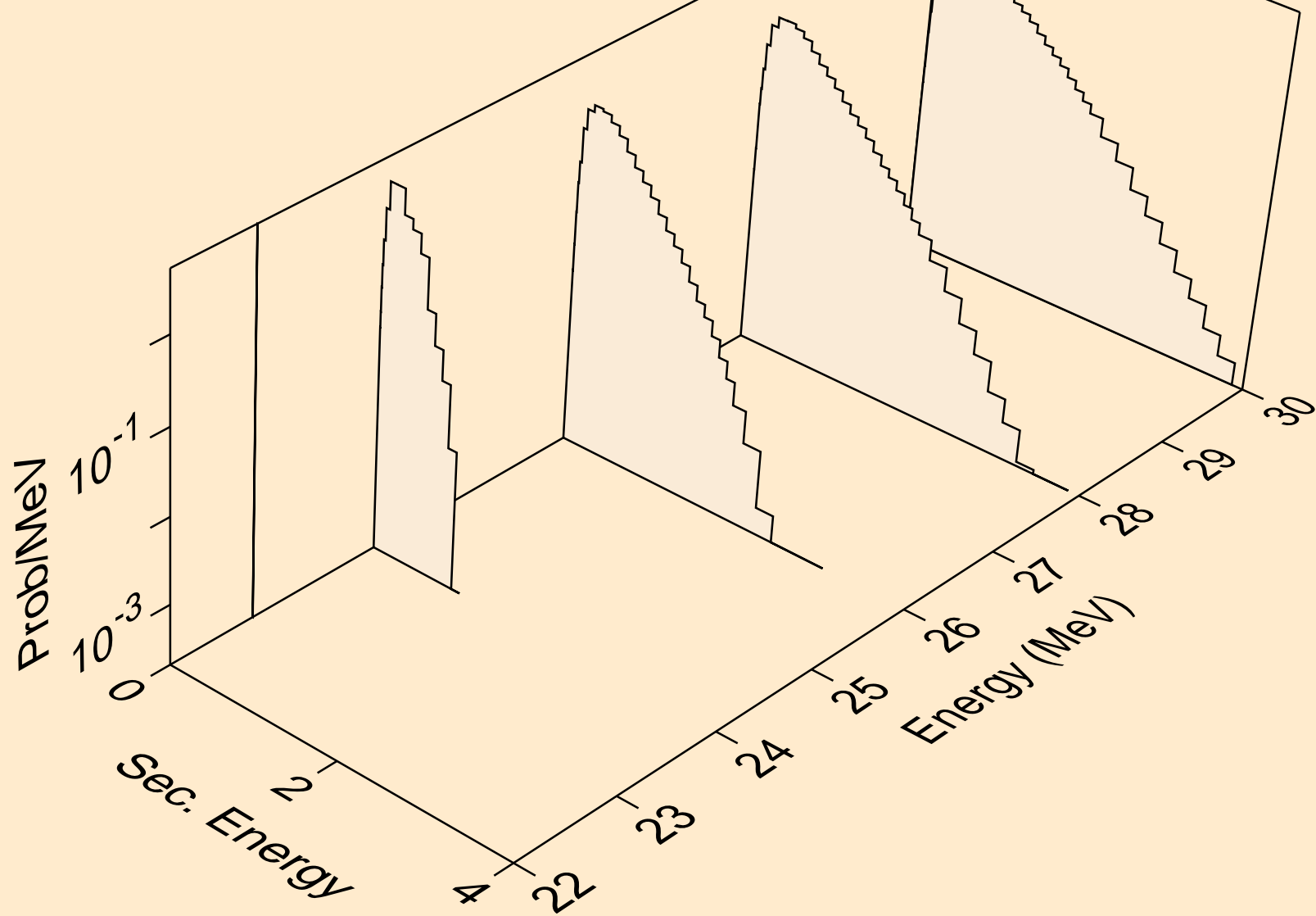

AT203 HELION ACER TENDL-2021 LIBRARY; T=0.K  
neutrons from (s,2np)

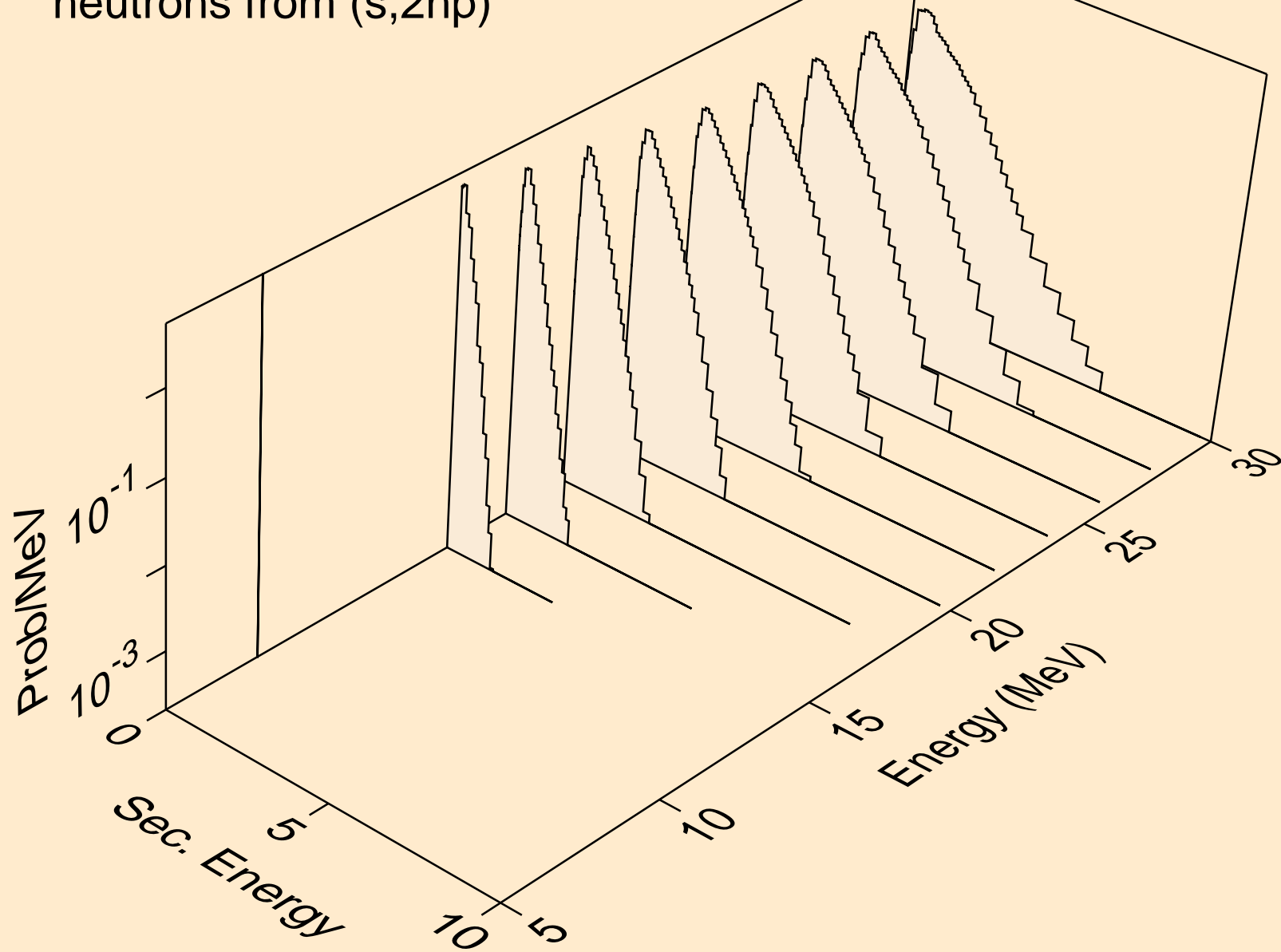

AT203 HELION ACER TENDL-2021 LIBRARY; T=0.K  
neutrons from (s,npa)

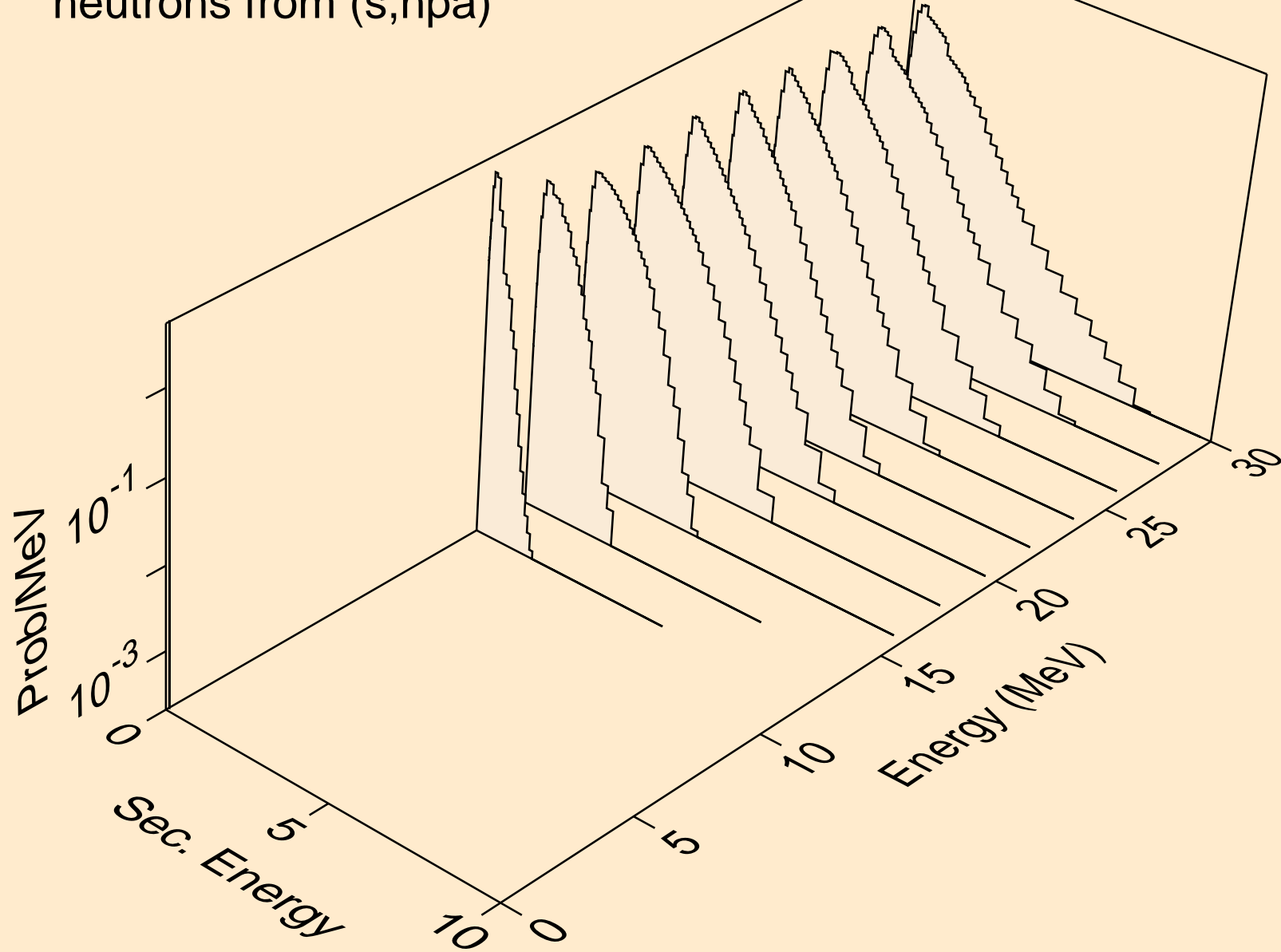

AT203 HELION ACER TENDL-2021 LIBRARY; T=0.K  
protons from (s,x)

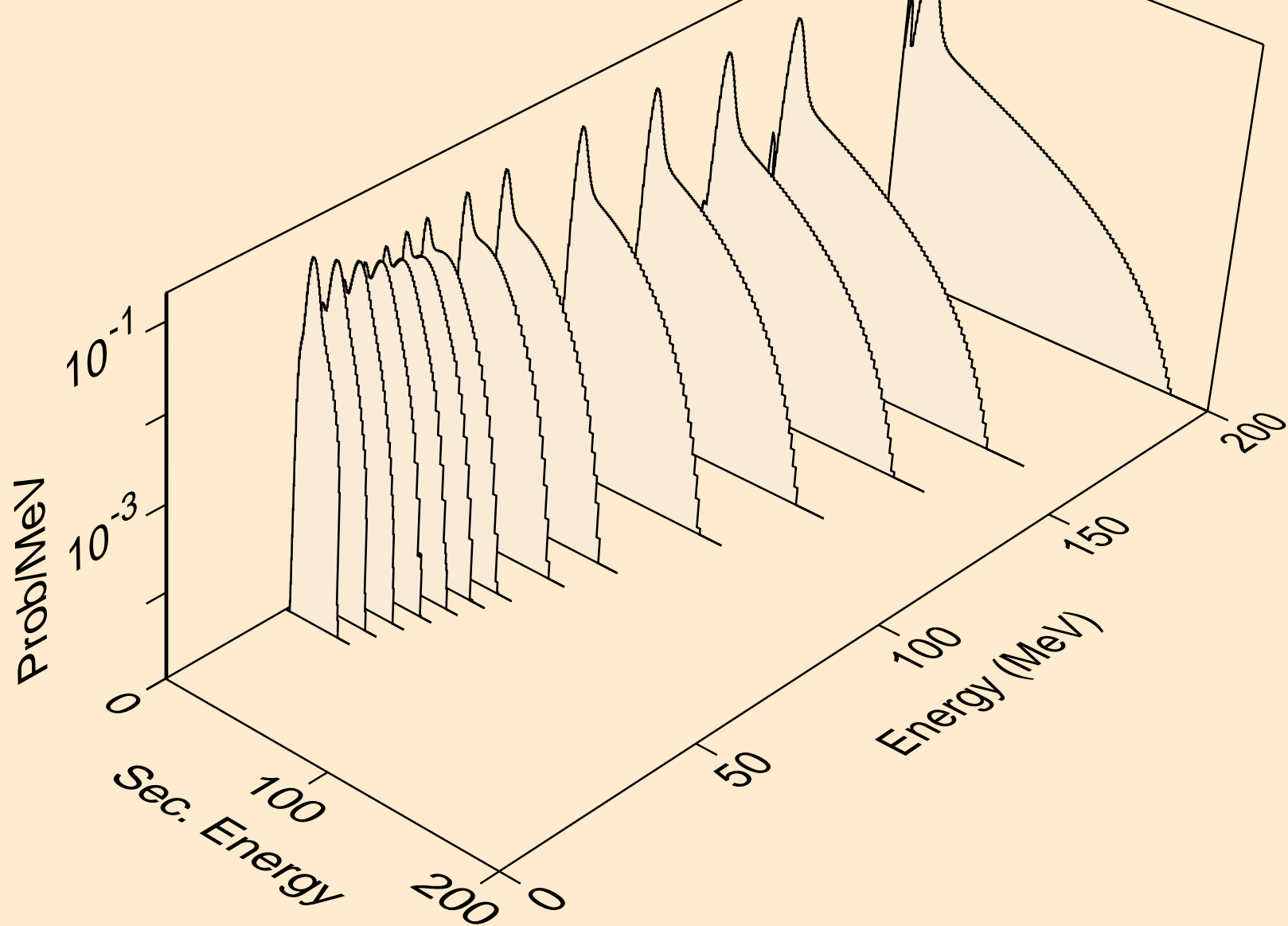



AT203 HELION ACER TENDL-2021 LIBRARY; T=0.K  
protons from (s,n\*)p

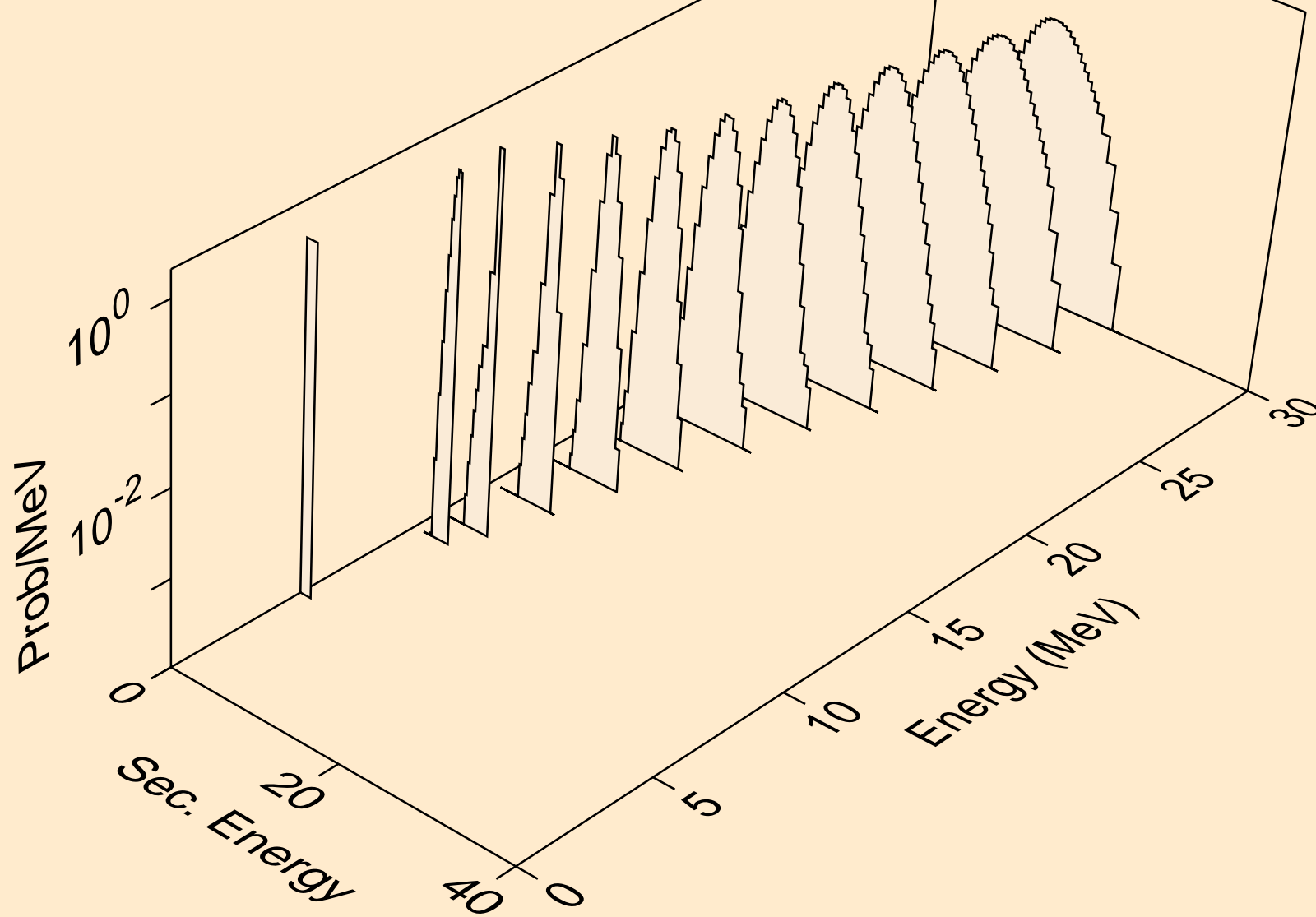

AT203 HELION ACER TENDL-2021 LIBRARY; T=0.K  
protons from (s,2np)

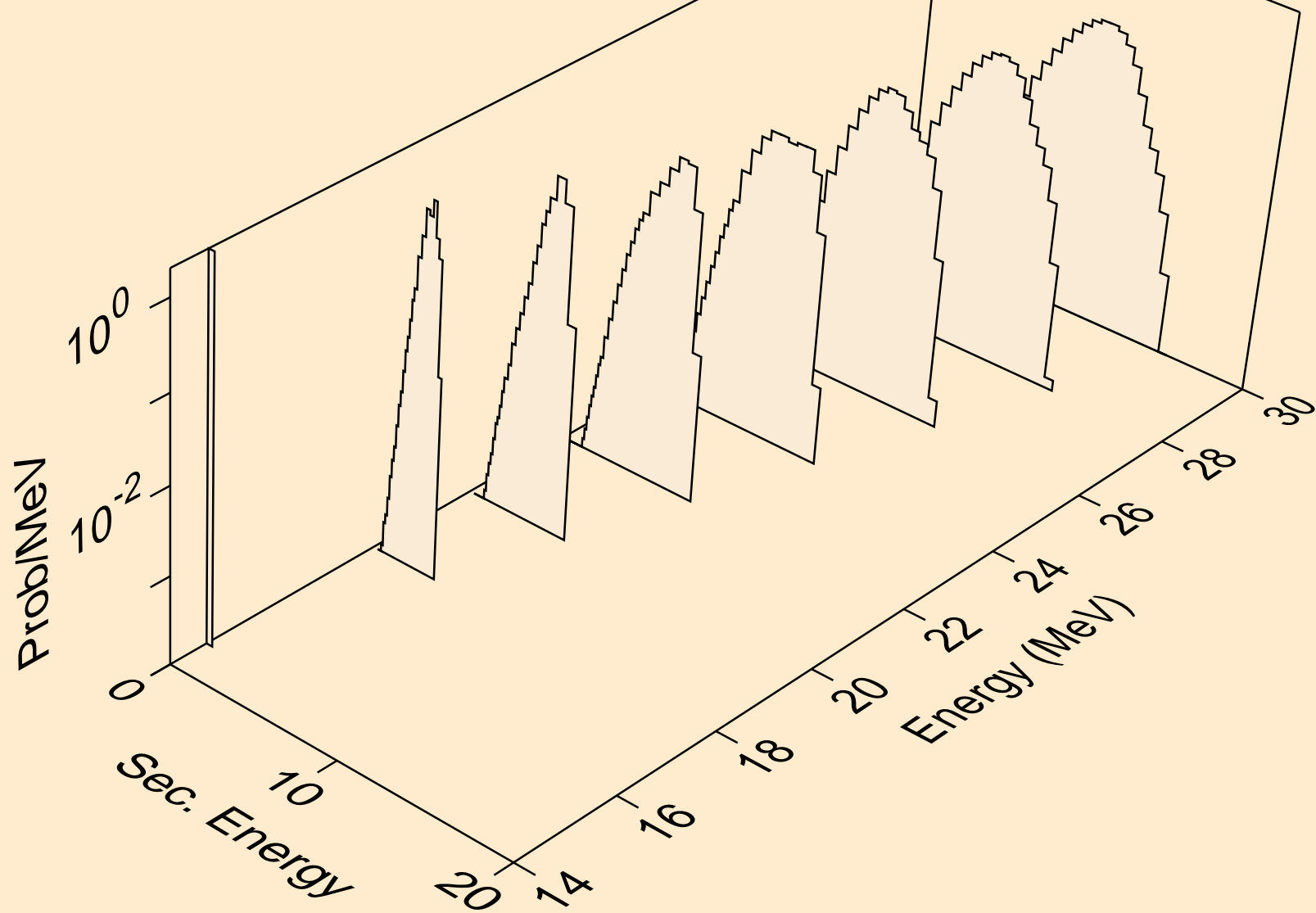

AT203 HELION ACER TENDL-2021 LIBRARY; T=0.K  
protons from (s,3np)

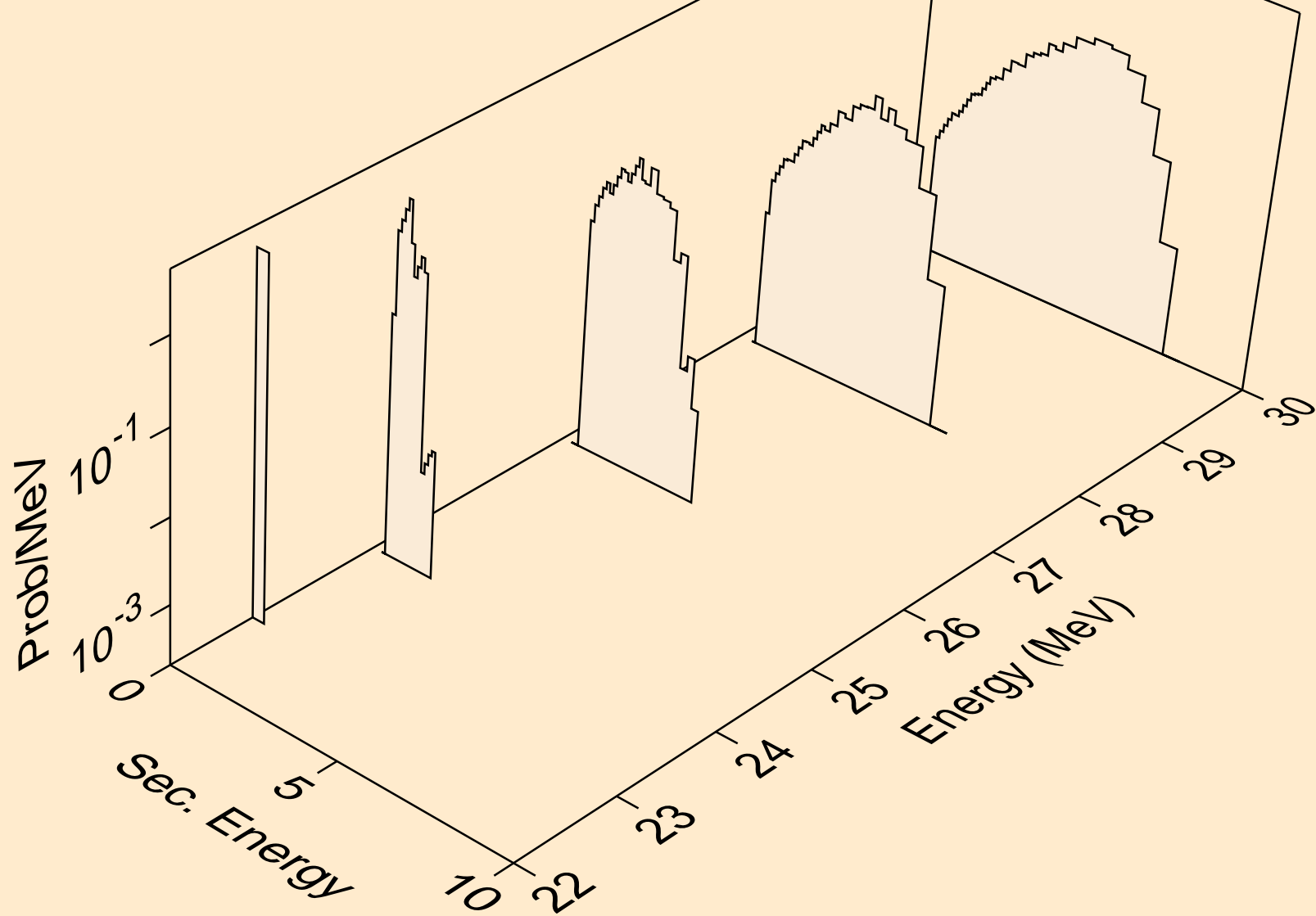

AT203 HELION ACER TENDL-2021 LIBRARY; T=0.K  
protons from (s,2np)

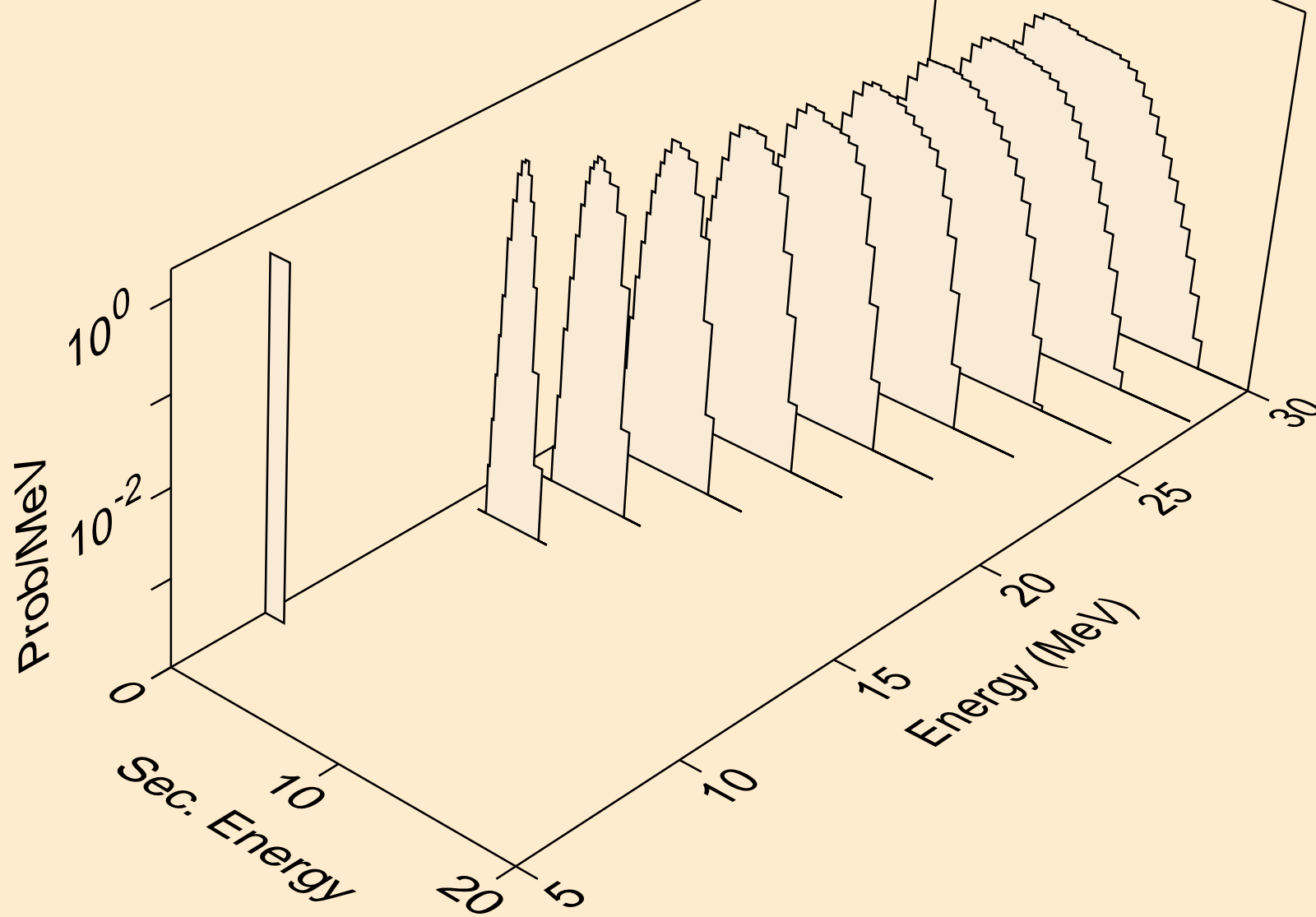

AT203 HELION ACER TENDL-2021 LIBRARY; T=0.K  
protons from (s,npa)

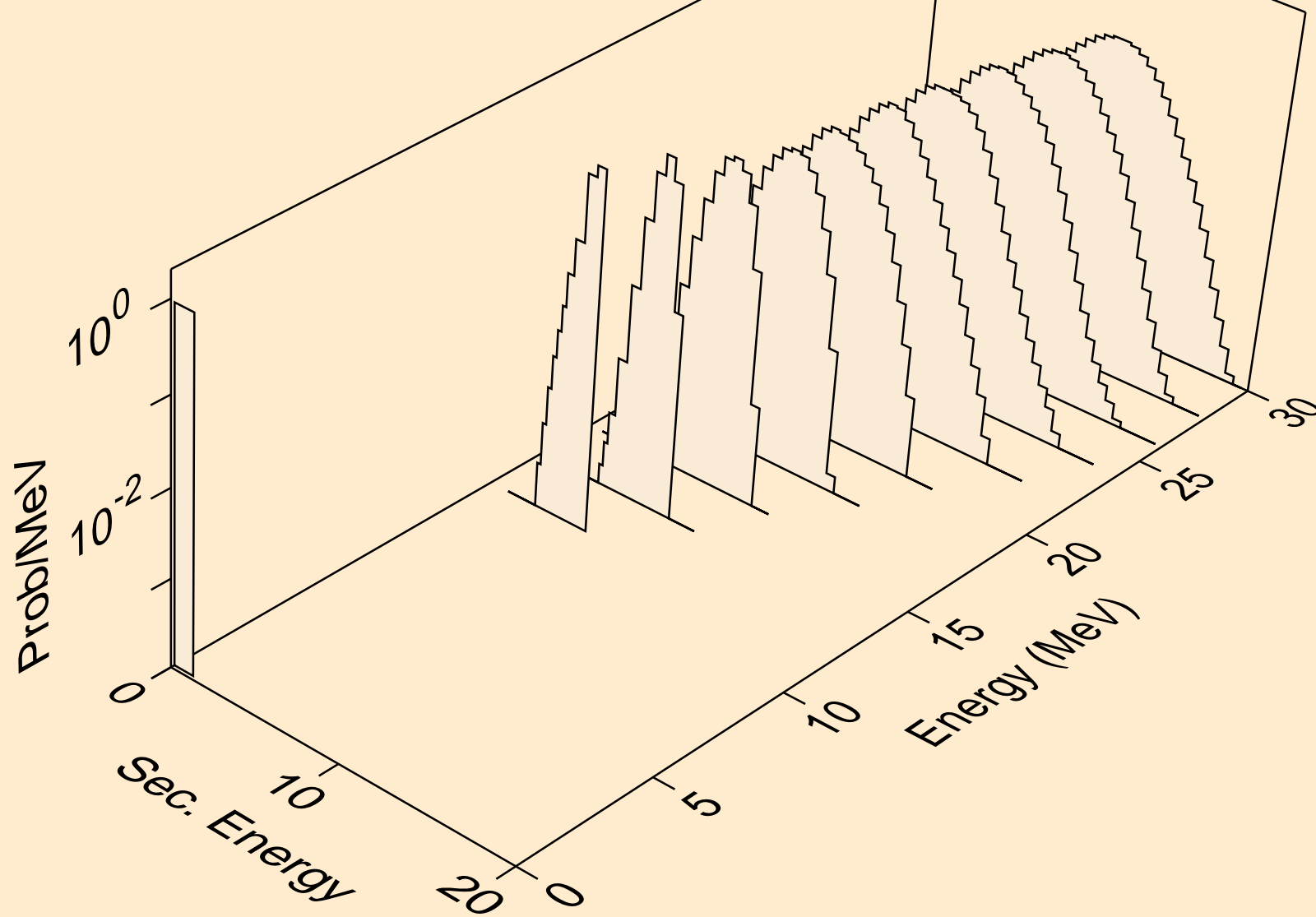

AT203 HELION ACER TENDL-2021 LIBRARY; T=0.K  
protons from (s,p)

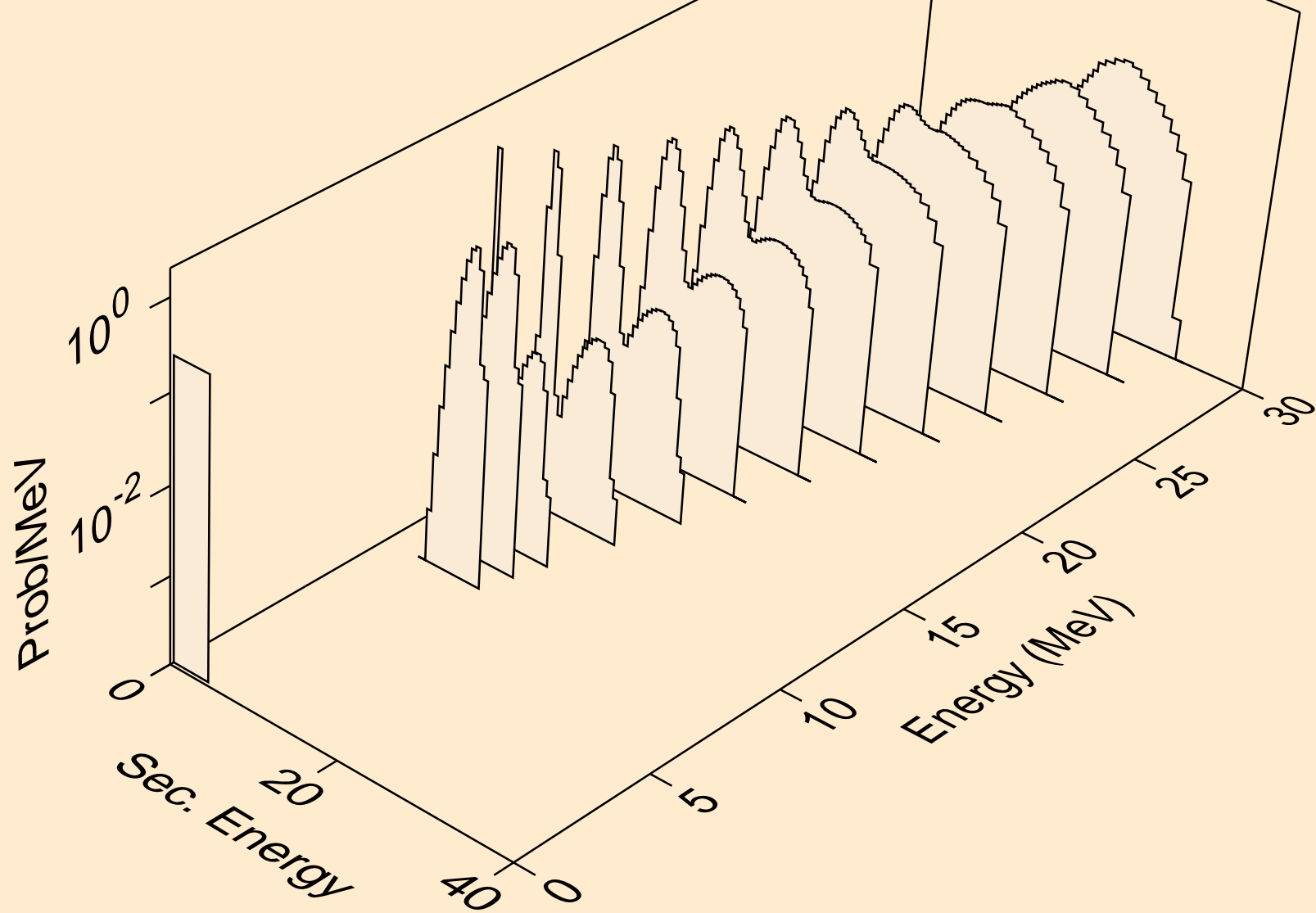

AT203 HELION ACER TENDL-2021 LIBRARY; T=0.K  
protons from (s,2p)

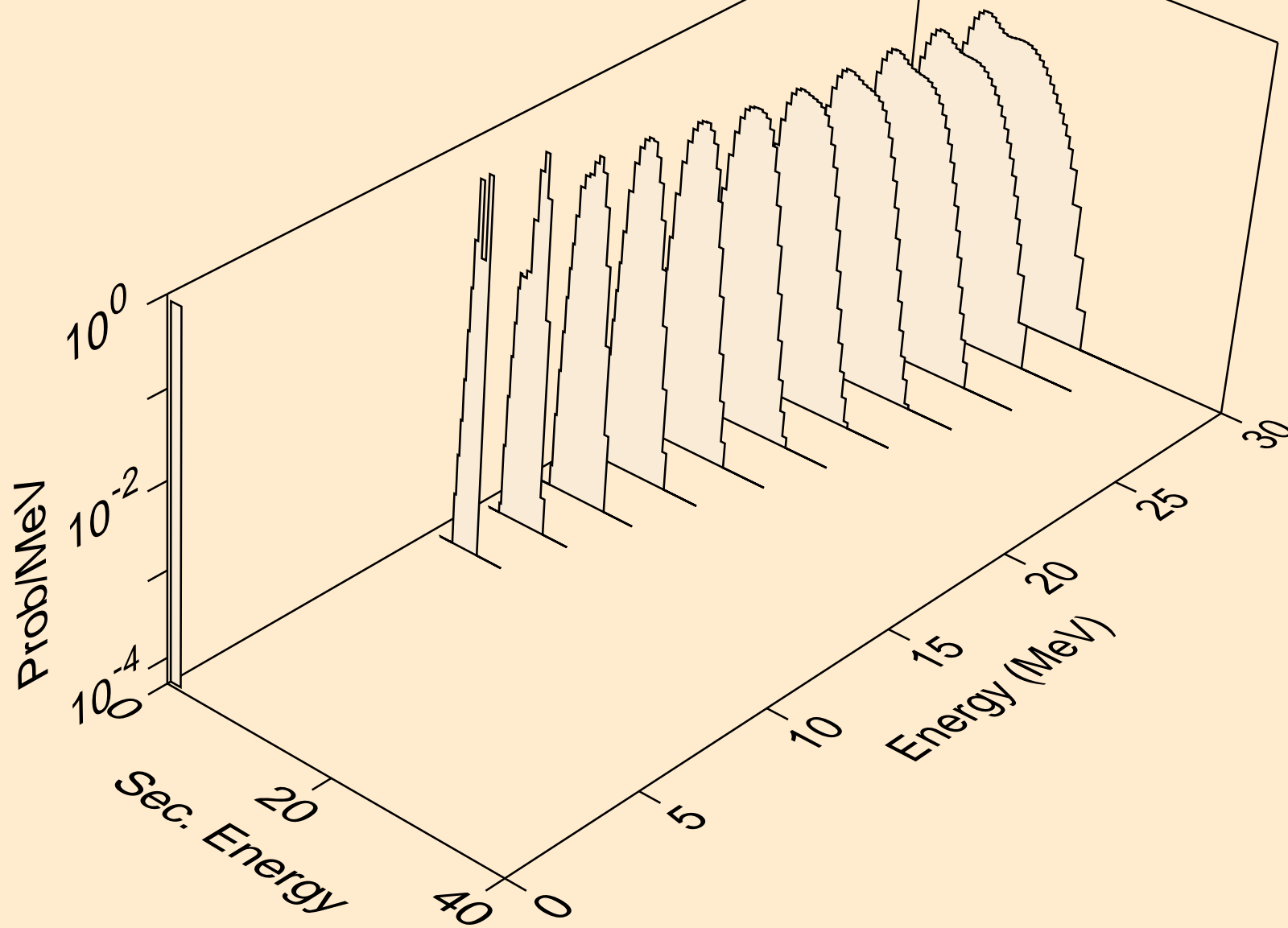

AT203 HELION ACER TENDL-2021 LIBRARY; T=0.K  
protons from (s,pa)

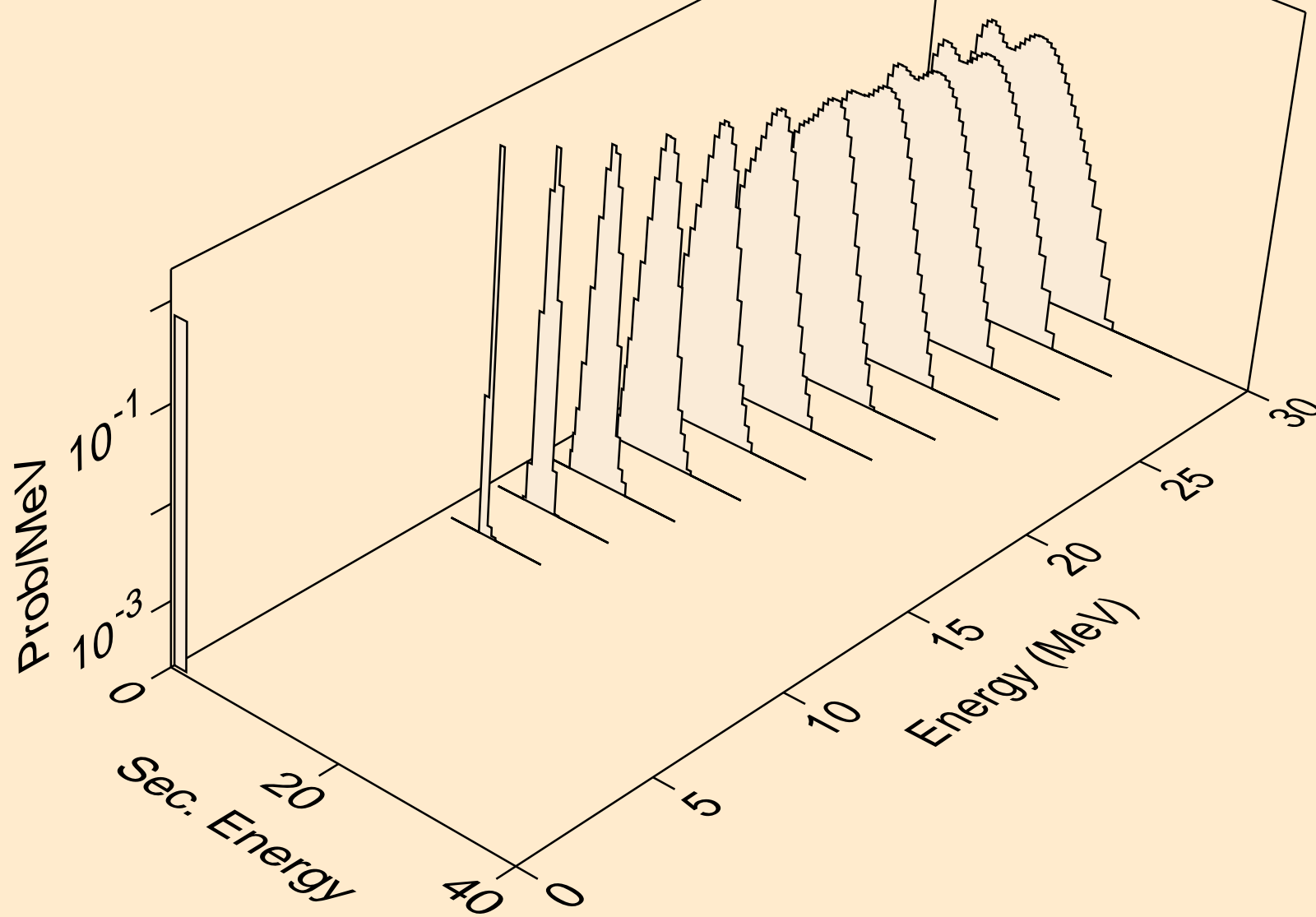



AT203 HELION ACER TENDL-2021 LIBRARY; T=0.K  
protons from (s,pd)

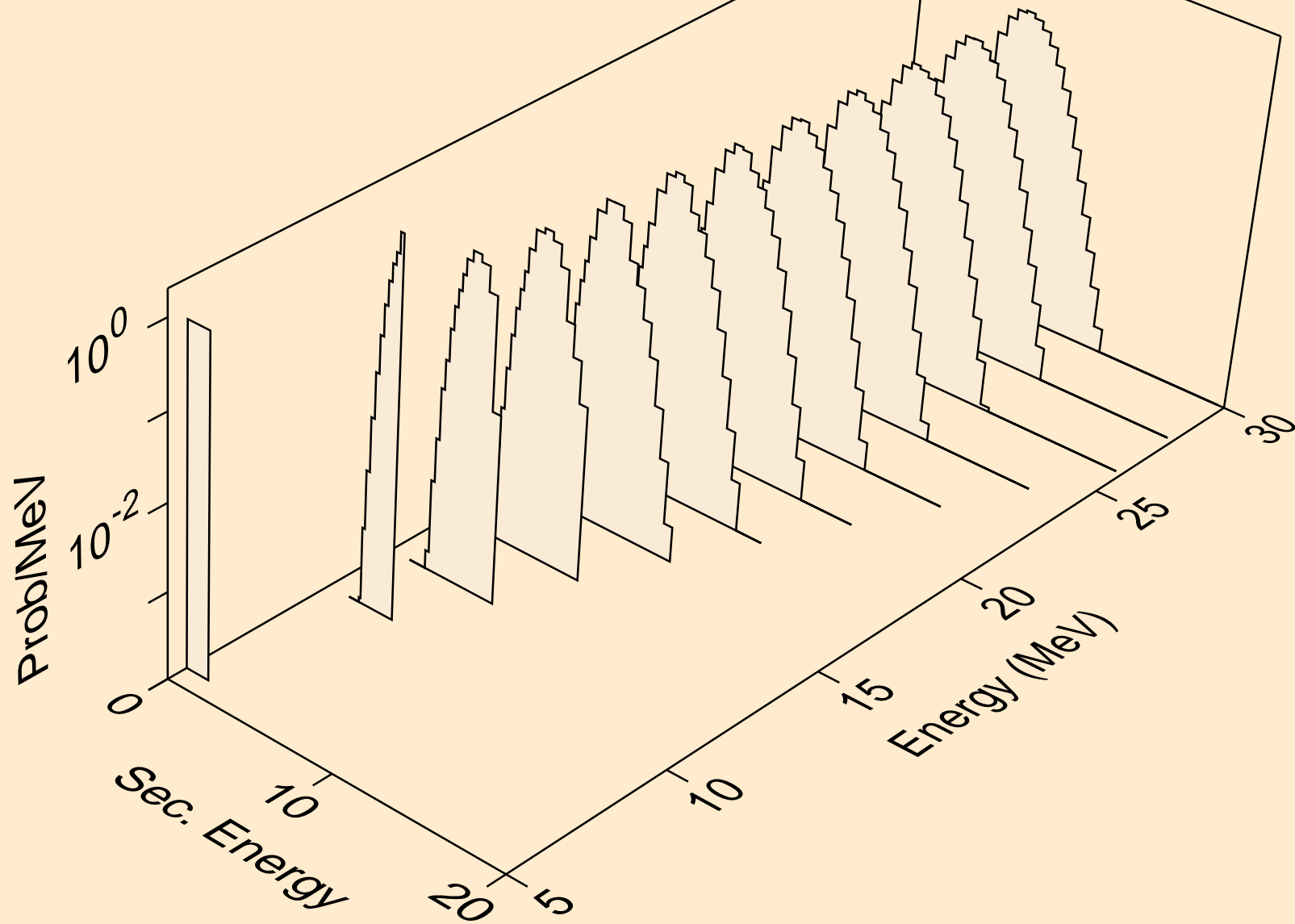

AT203 HELION ACER TENDL-2021 LIBRARY; T=0.K  
protons from (s,pt)

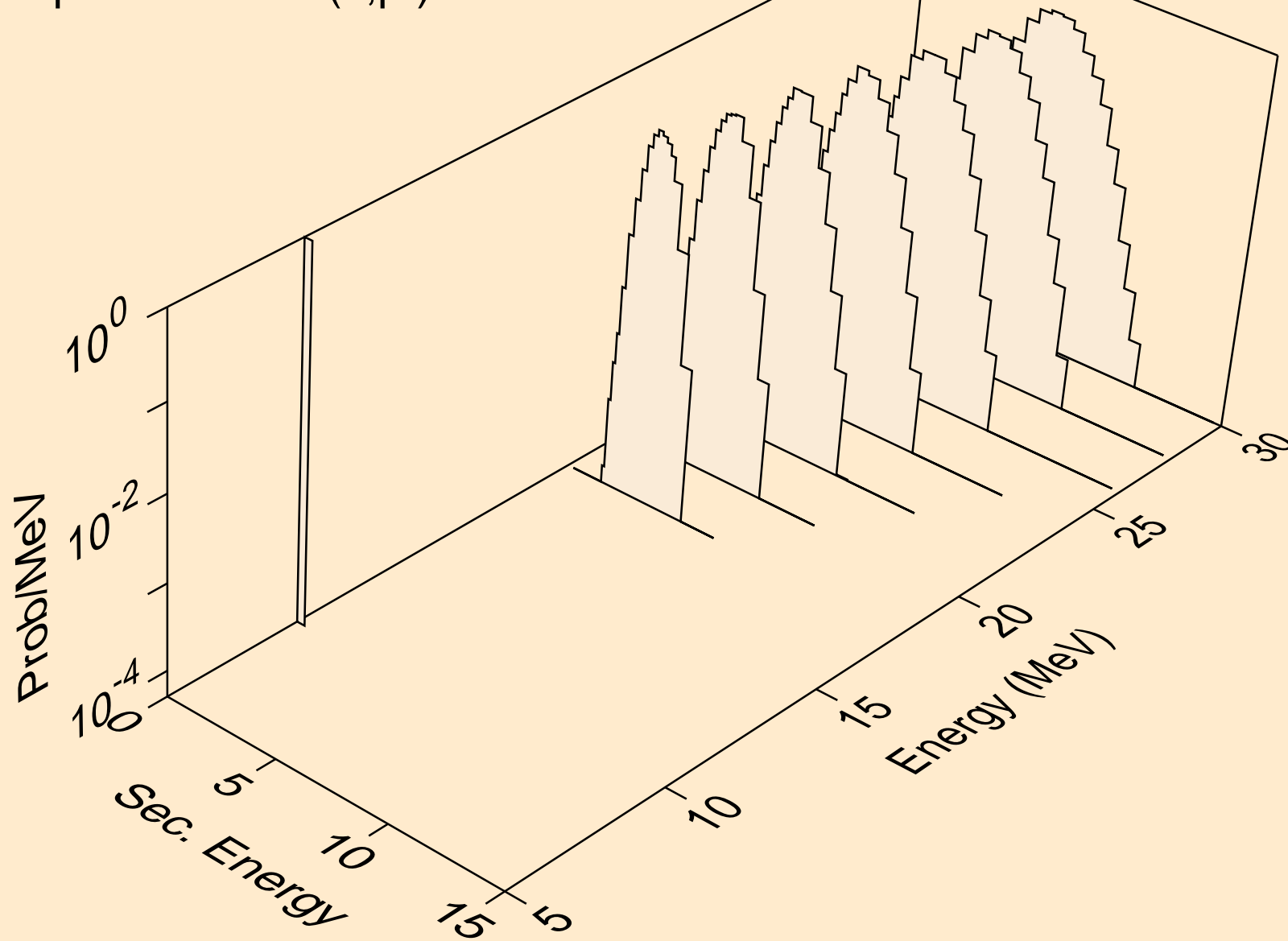

AT203 HELION ACER TENDL-2021 LIBRARY; T=0.K  
deuterons from (s,x)

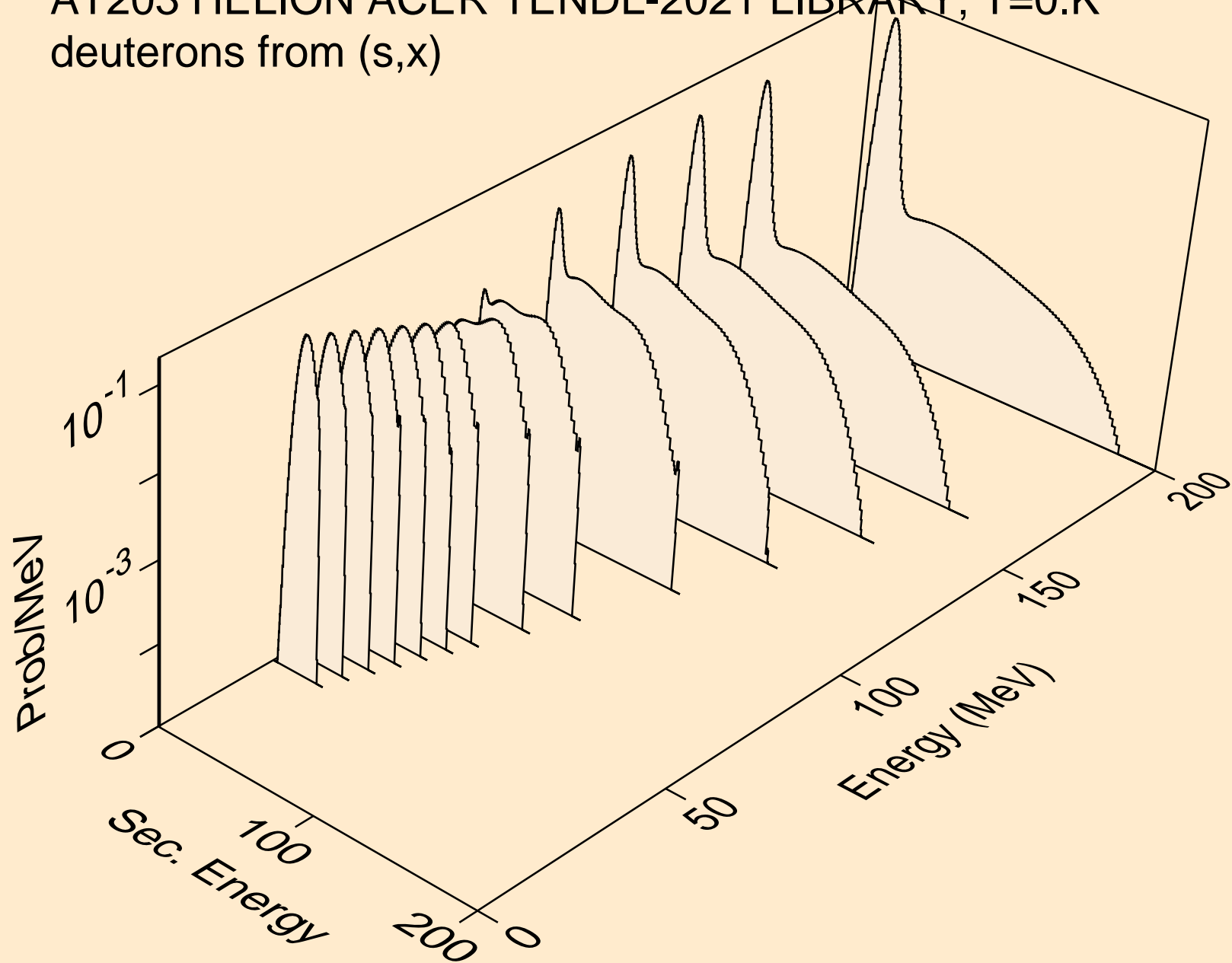

AT203 HELION ACER TENDL-2021 LIBRARY; T=0.K  
deuterons from (s,2nd)

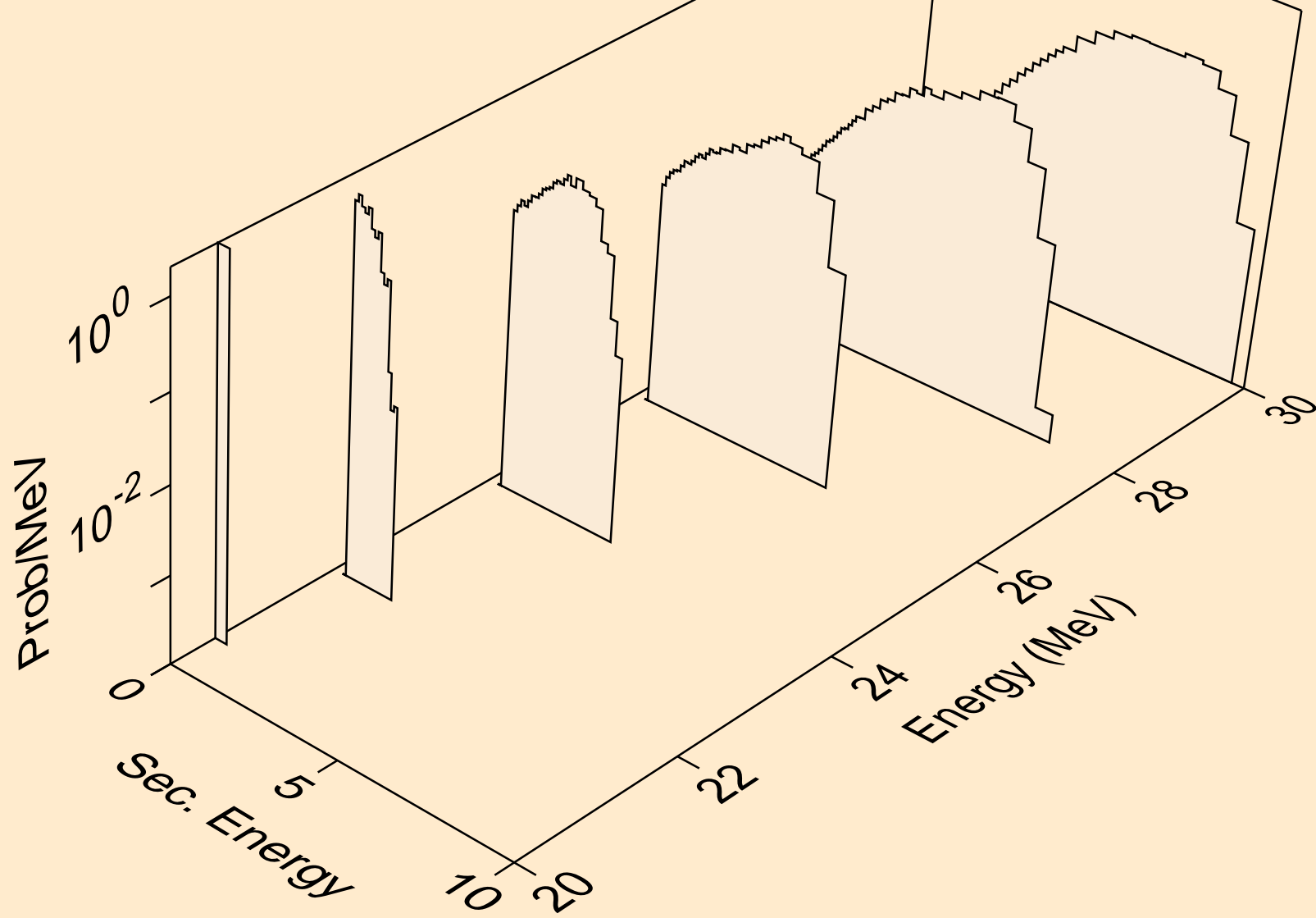

AT203 HELION ACER TENDL-2021 LIBRARY; T=0.K  
deuterons from (s,n\*)d

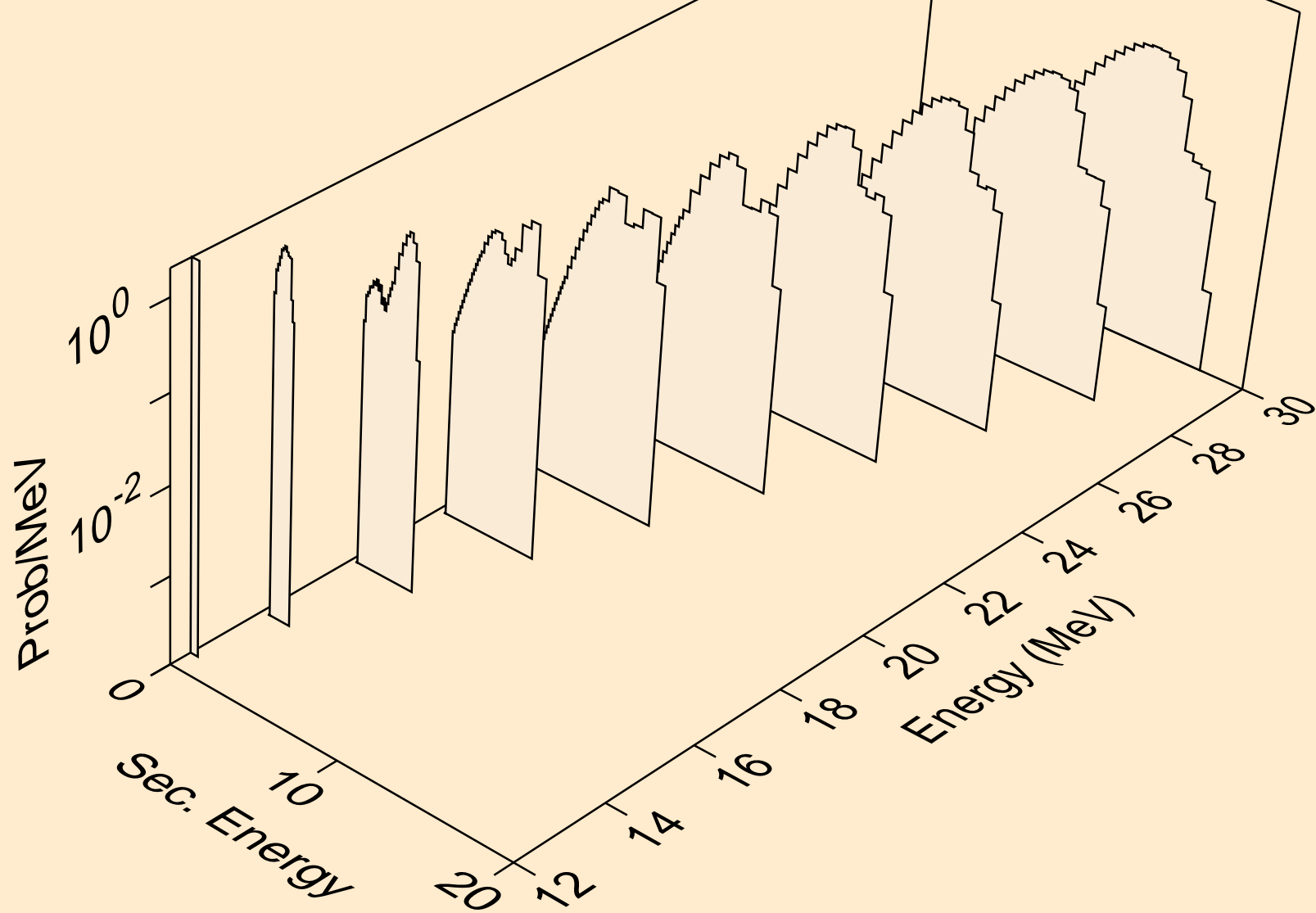

AT203 HELION ACER TENDL-2021 LIBRARY; T=0.K  
deuterons from (s,d)

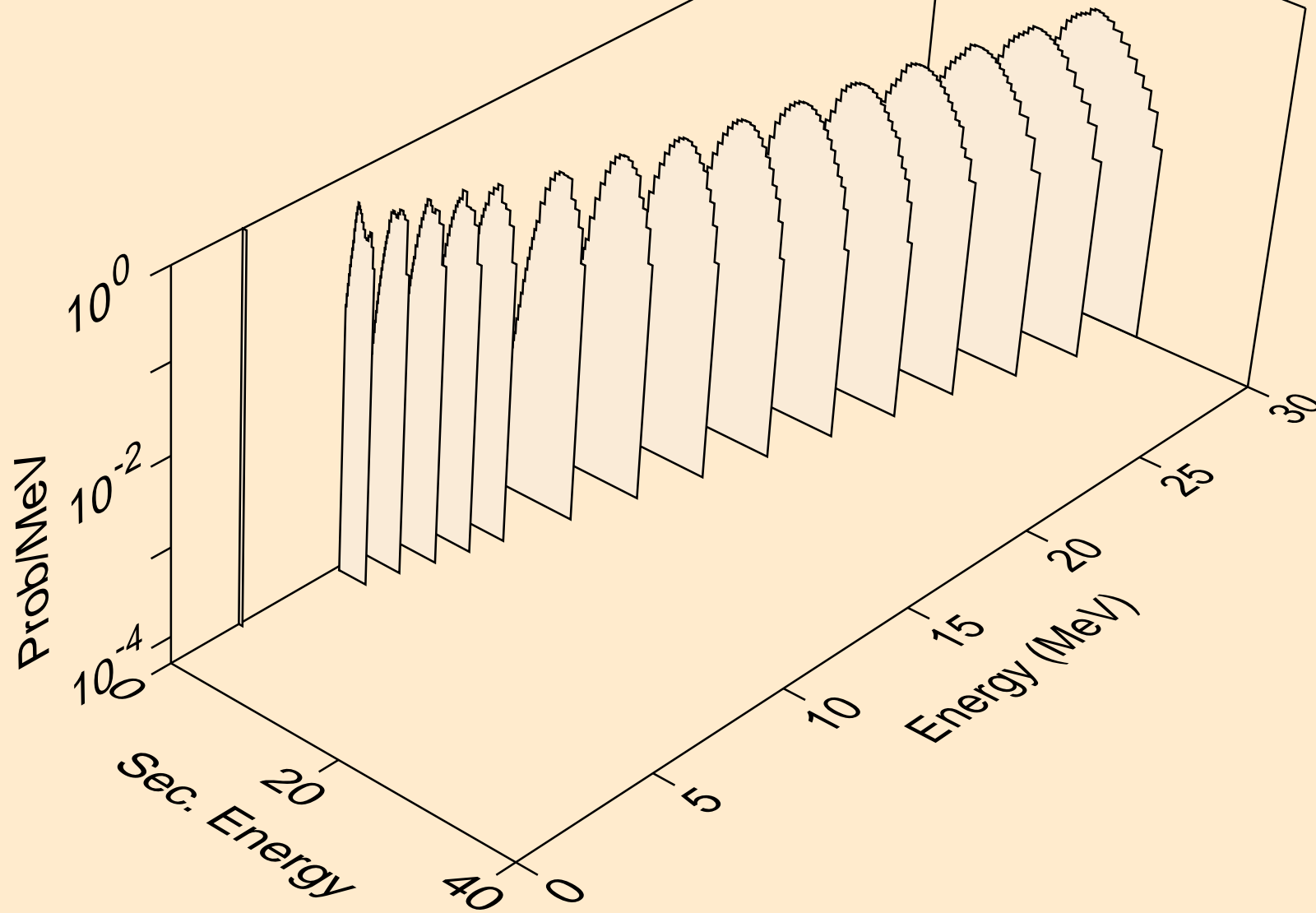

AT203 HELION ACER TENDL-2021 LIBRARY; T=0.K  
deuterons from (s,pd)

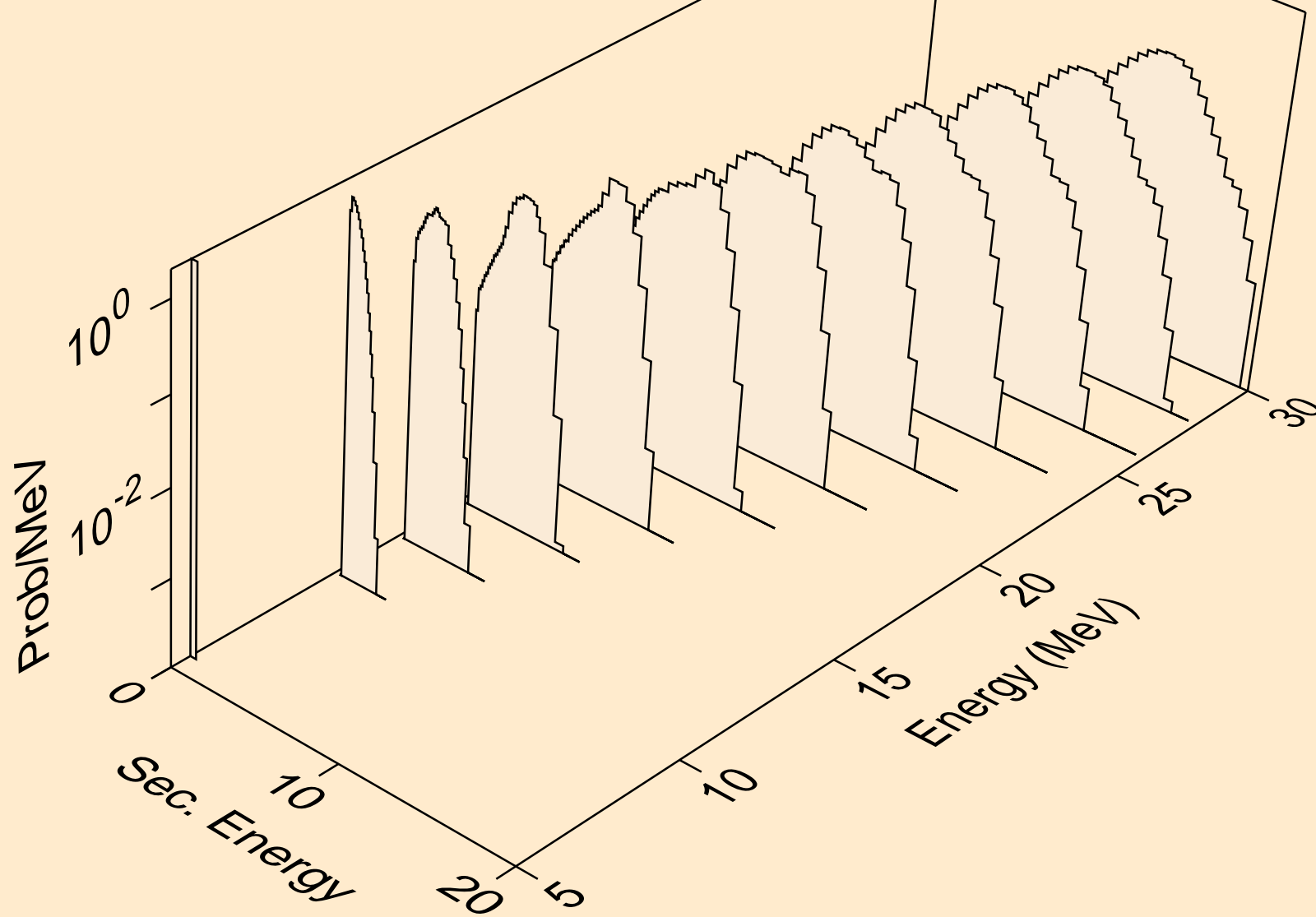

AT203 HELION ACER TENDL-2021 LIBRARY; T=0.K  
deuterons from (s,da)

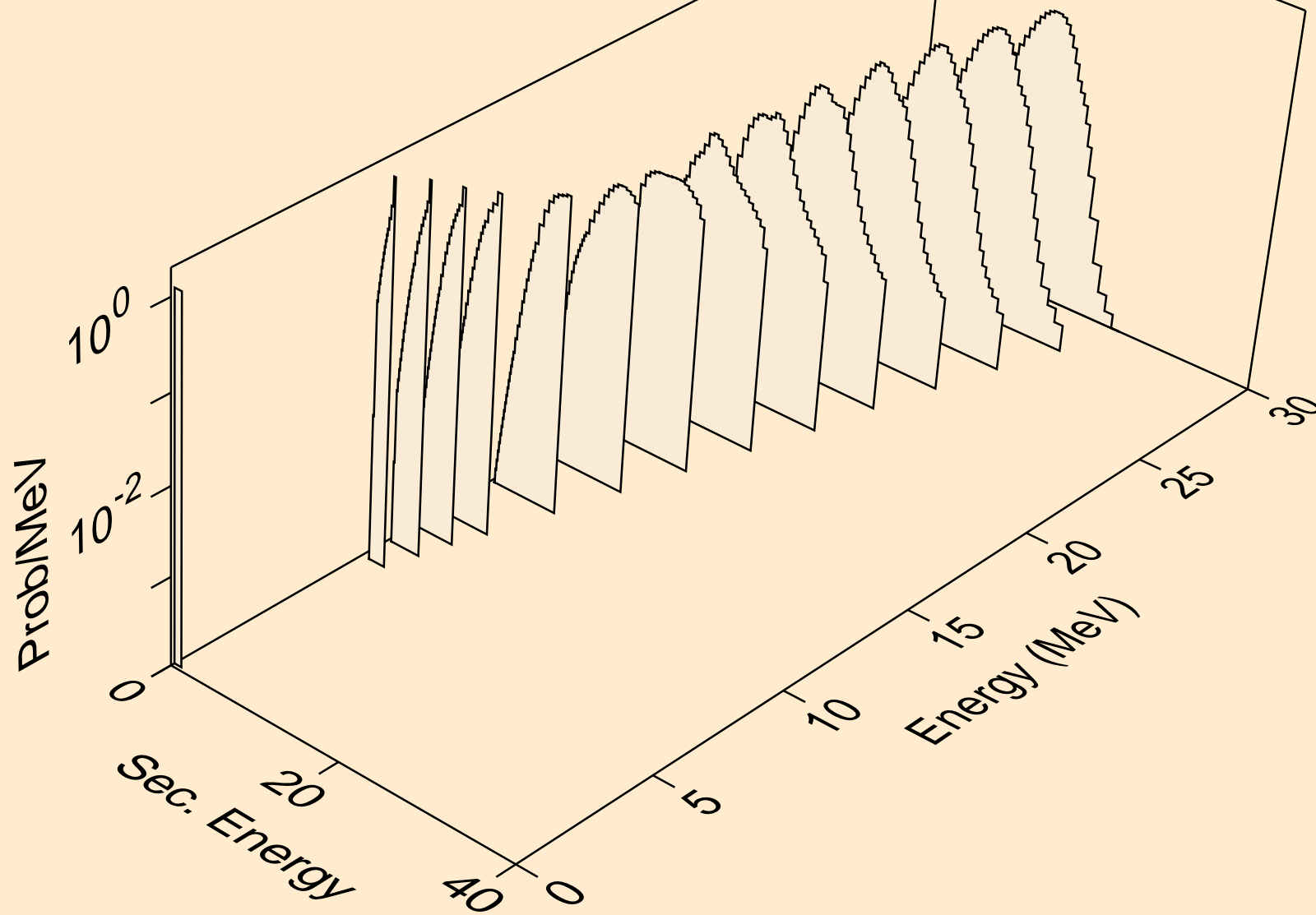



AT203 HELION ACER TENDL-2021 LIBRARY; T=0.K  
tritons from (s,x)

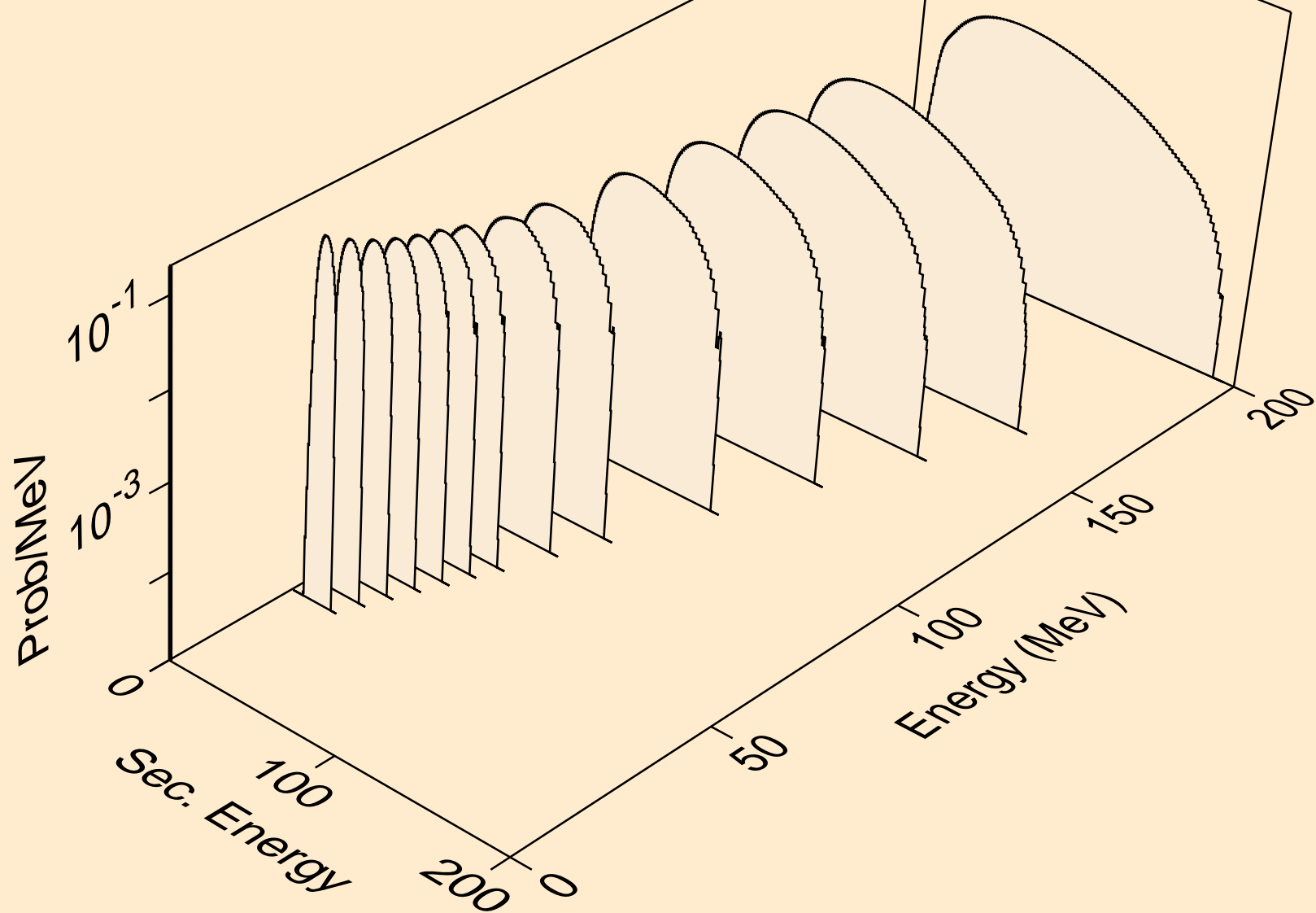

AT203 HELION ACER TENDL-2021 LIBRARY; T=0.K  
tritons from (s,n\*)t

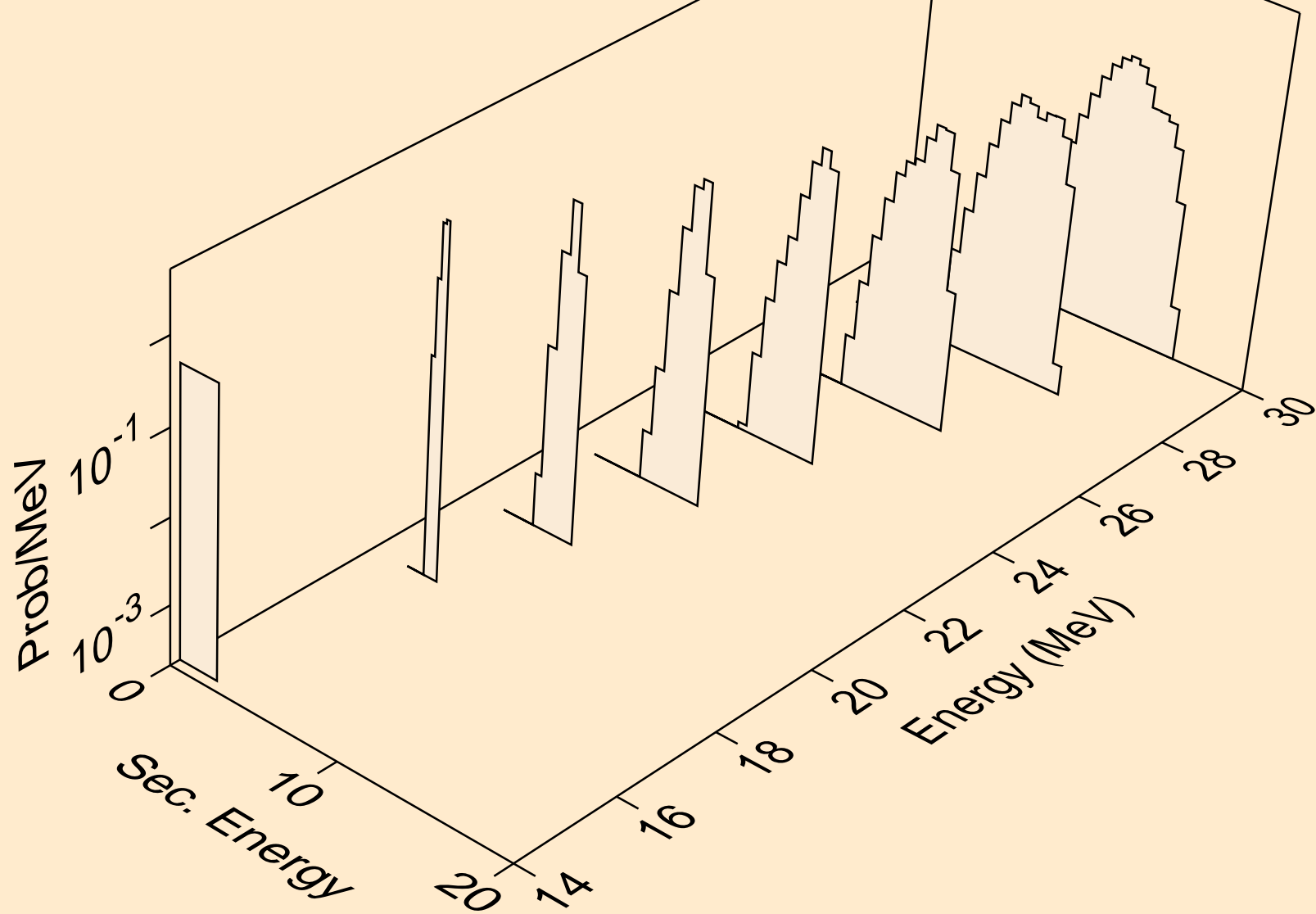

AT203 HELION ACER TENDL-2021 LIBRARY; T=0.K  
tritons from (s,t)

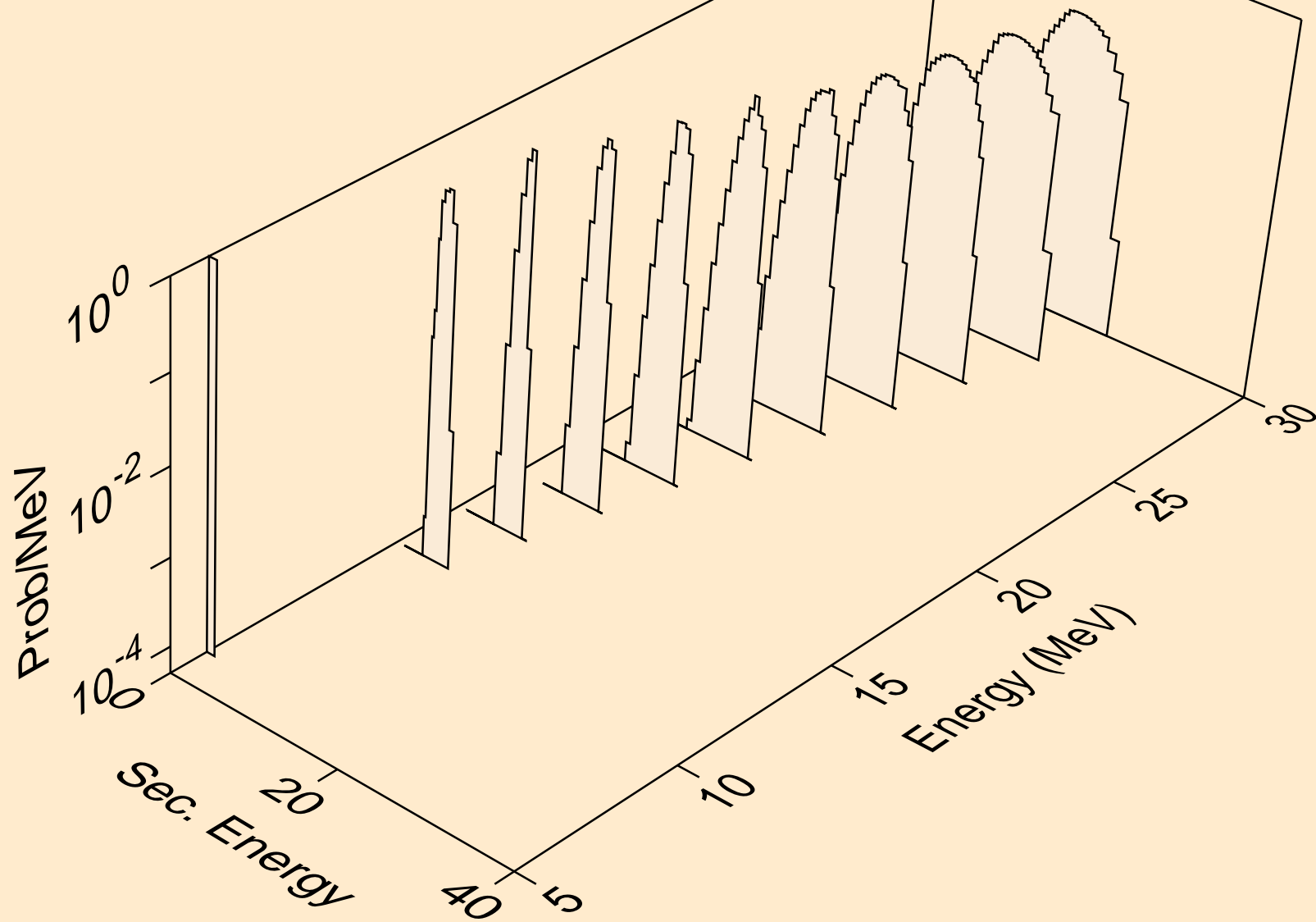

AT203 HELION ACER TENDL-2021 LIBRARY; T=0.K  
tritons from (s,pt)

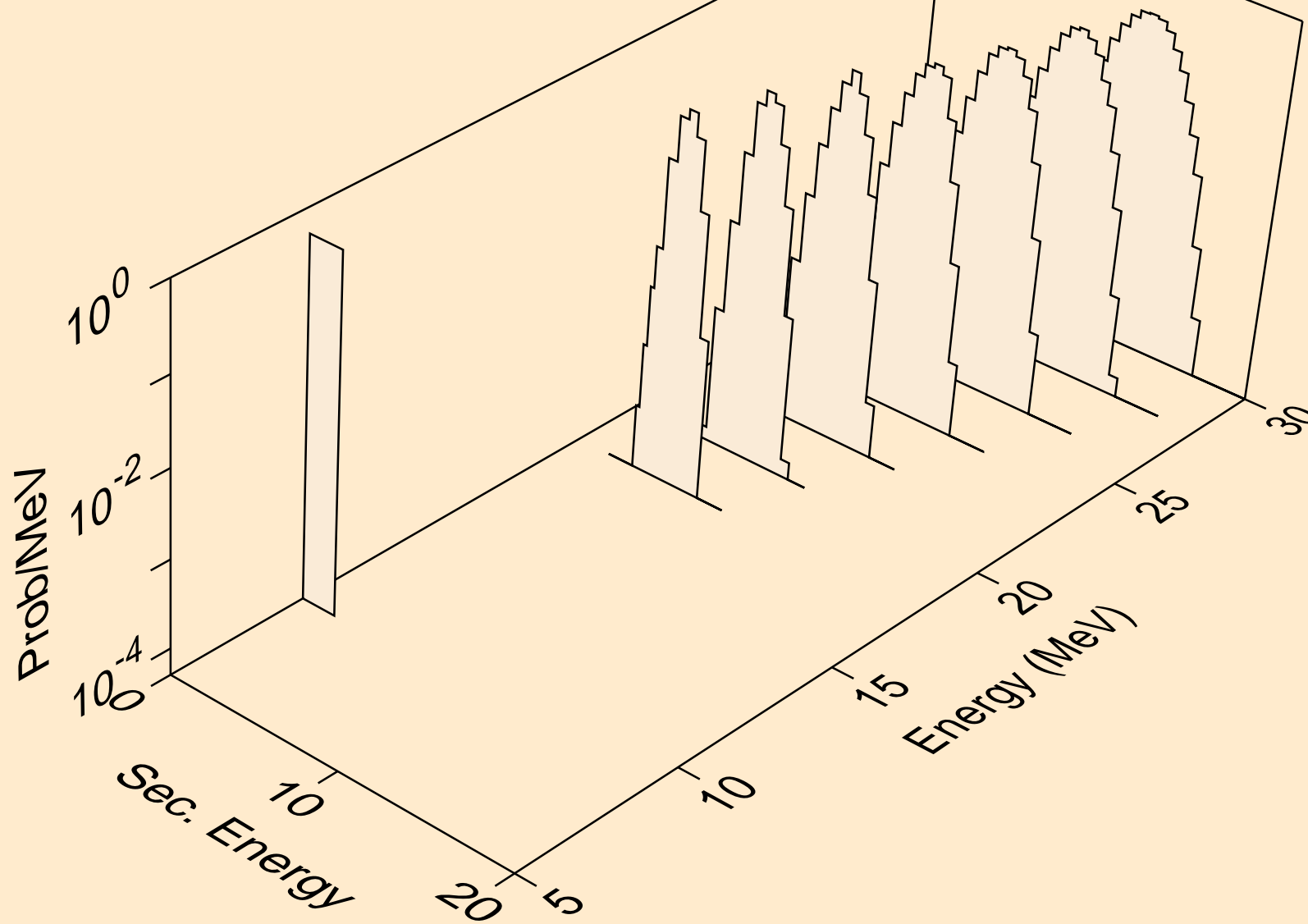

AT203 HELION ACER TENDL-2021 LIBRARY; T=0.K  
alphas from (s,x)

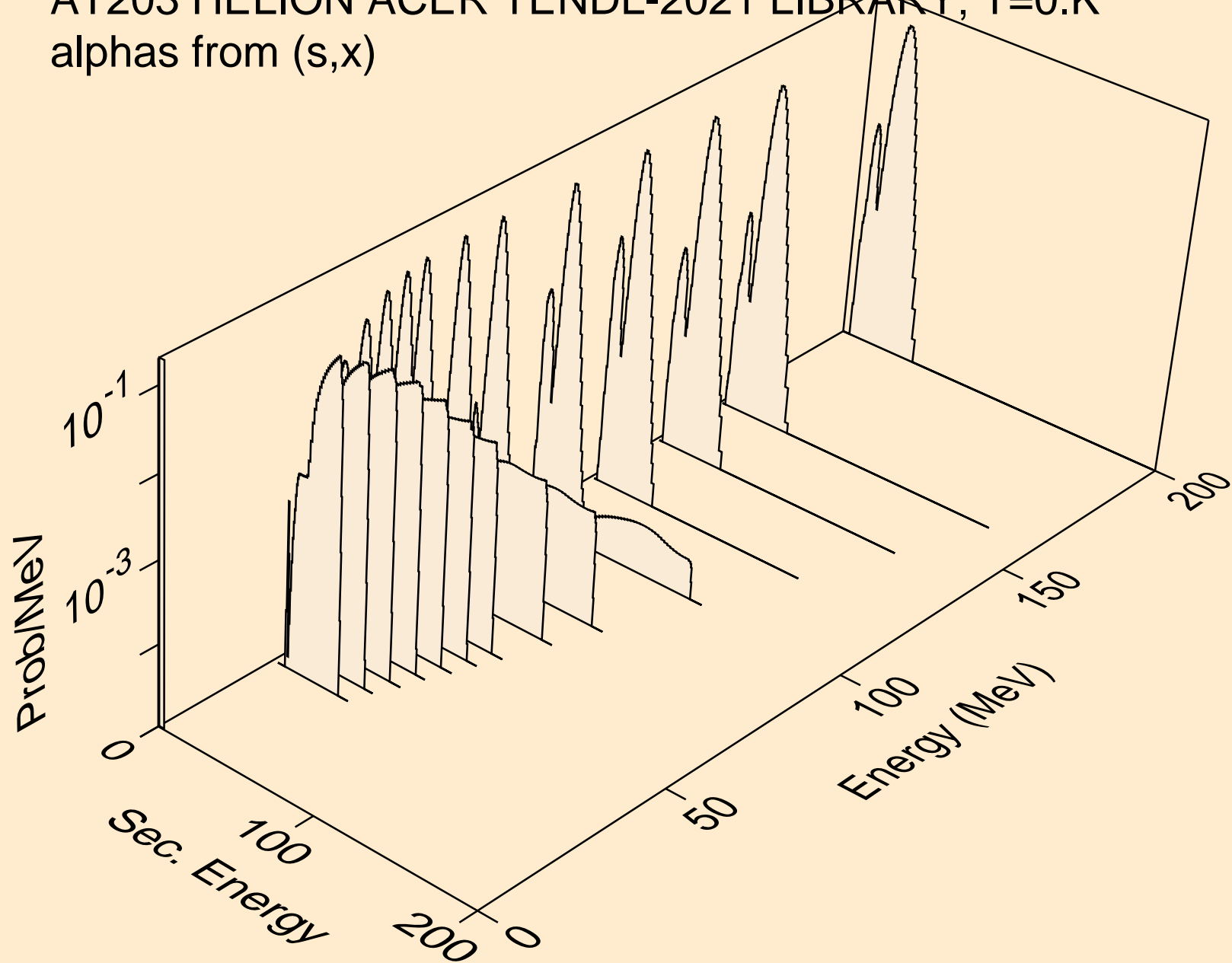

AT203 HELION ACER TENDL-2021 LIBRARY; T=0.K  
alphas from (s,n\*)a

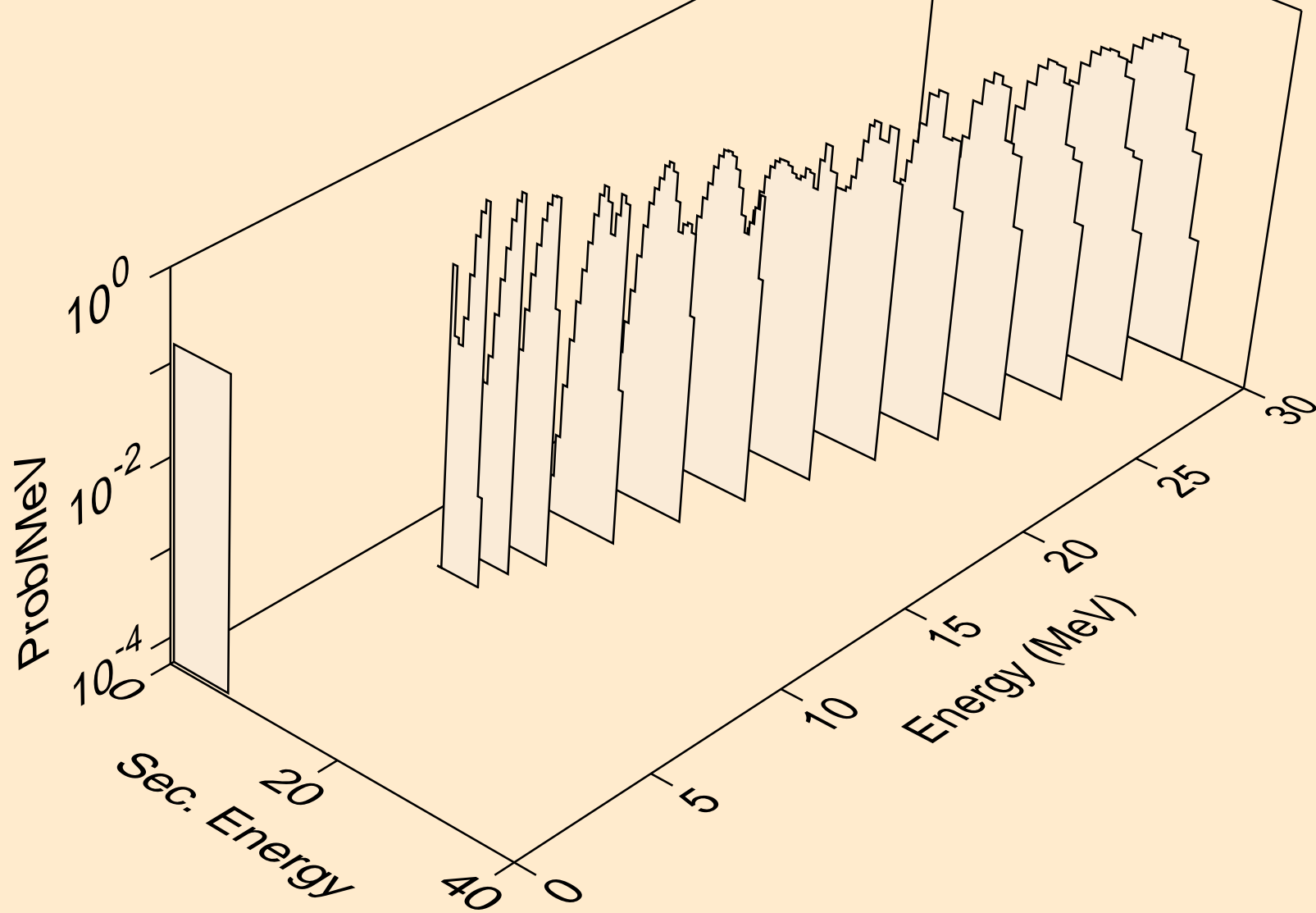

AT203 HELION ACER TENDL-2021 LIBRARY; T=0.K  
alphas from (s,2n)a

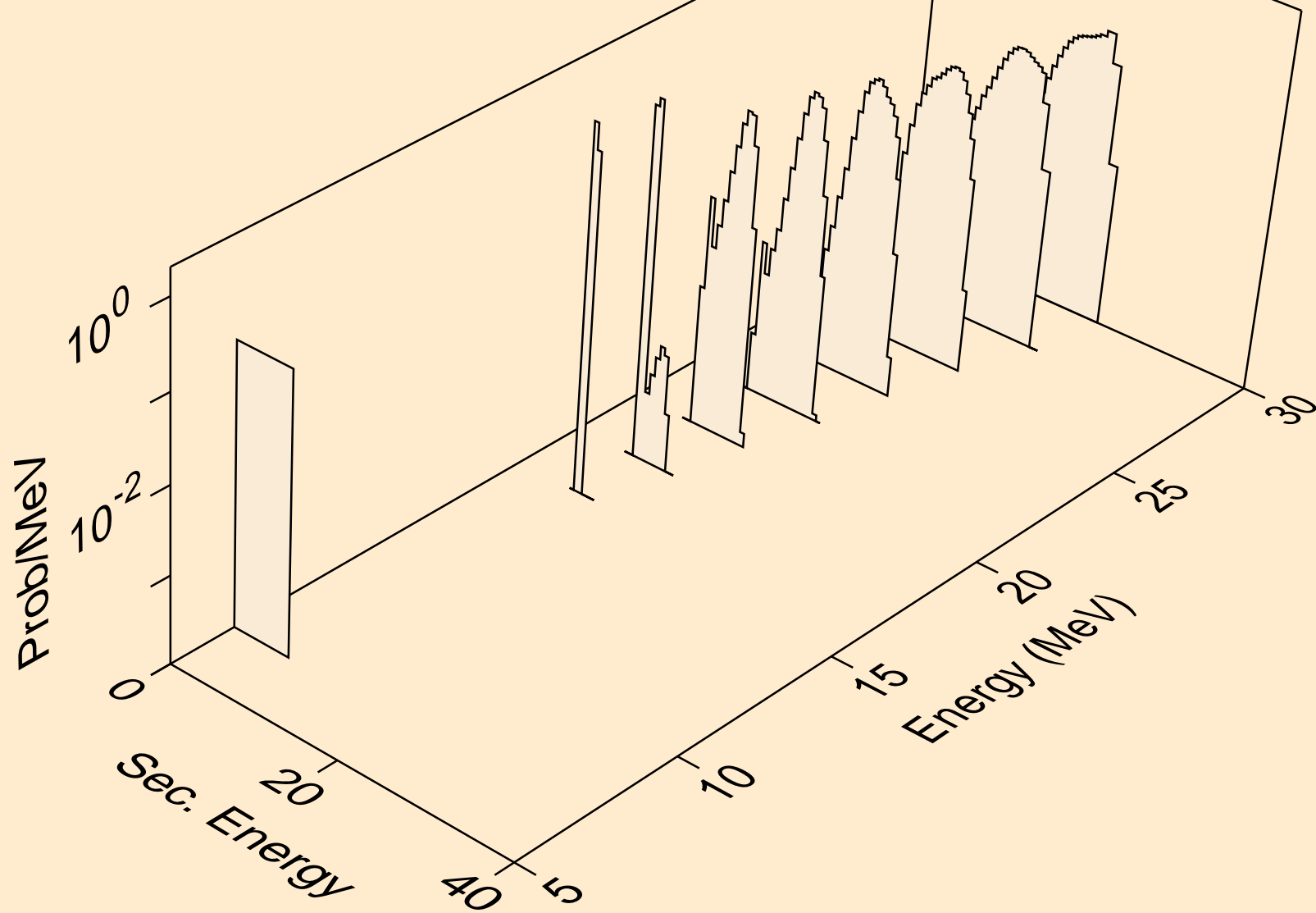

AT203 HELION ACER TENDL-2021 LIBRARY; T=0.K  
alphas from (s,n\*)2a

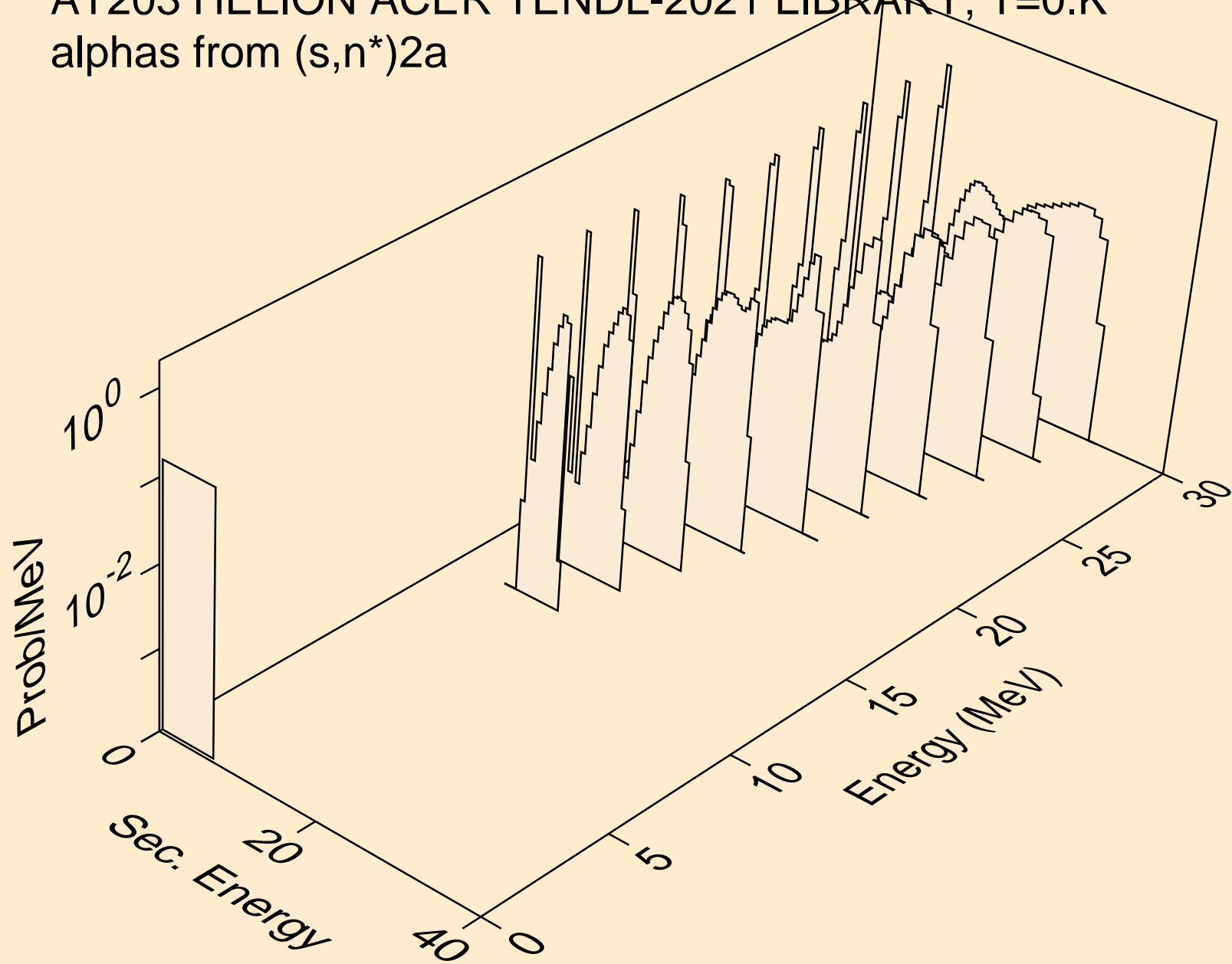



AT203 HELION ACER TENDL-2021 LIBRARY; T=0.K  
alphas from (s,npa)

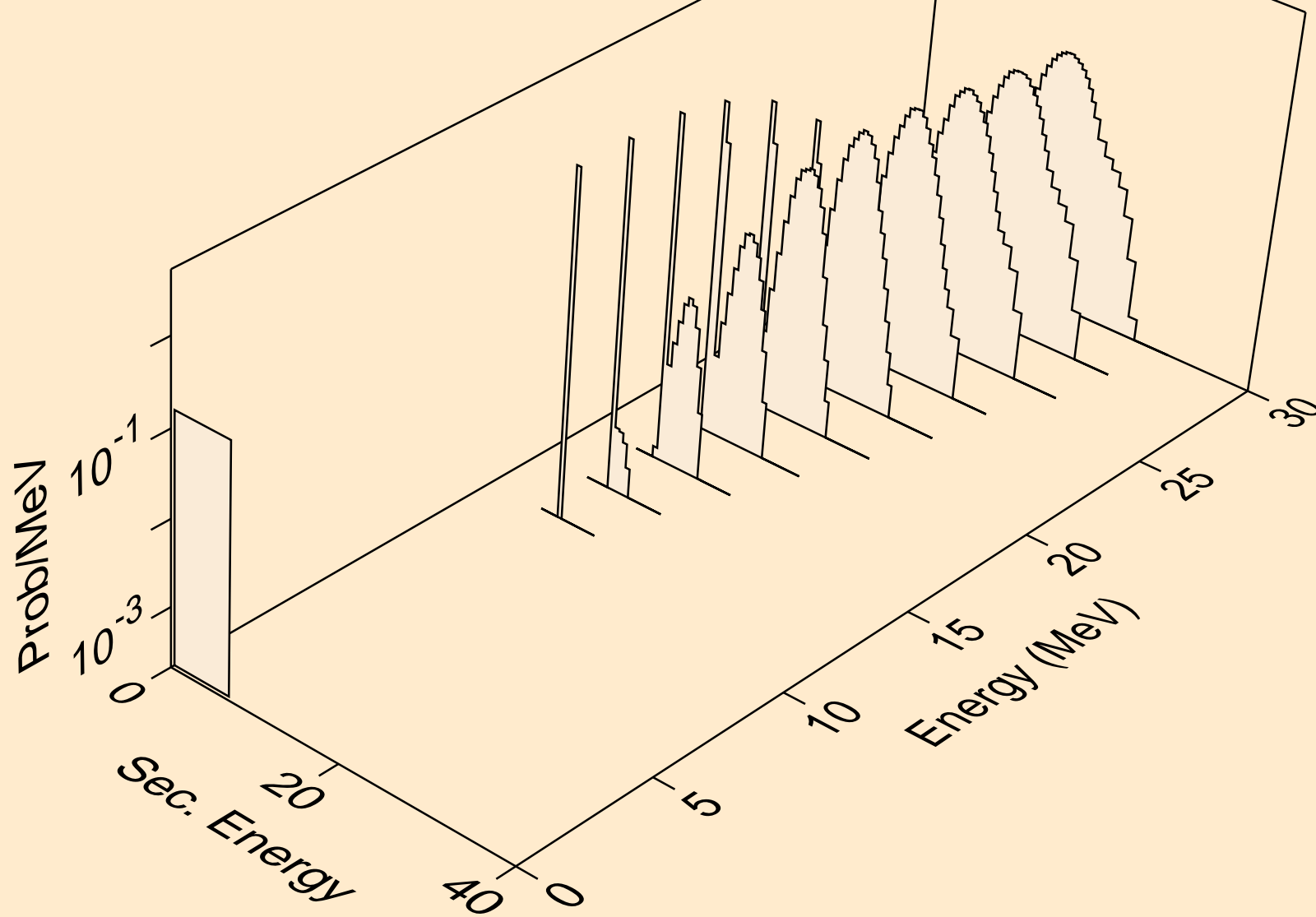

AT203 HELION ACER TENDL-2021 LIBRARY; T=0.K  
alphas from (s,a)

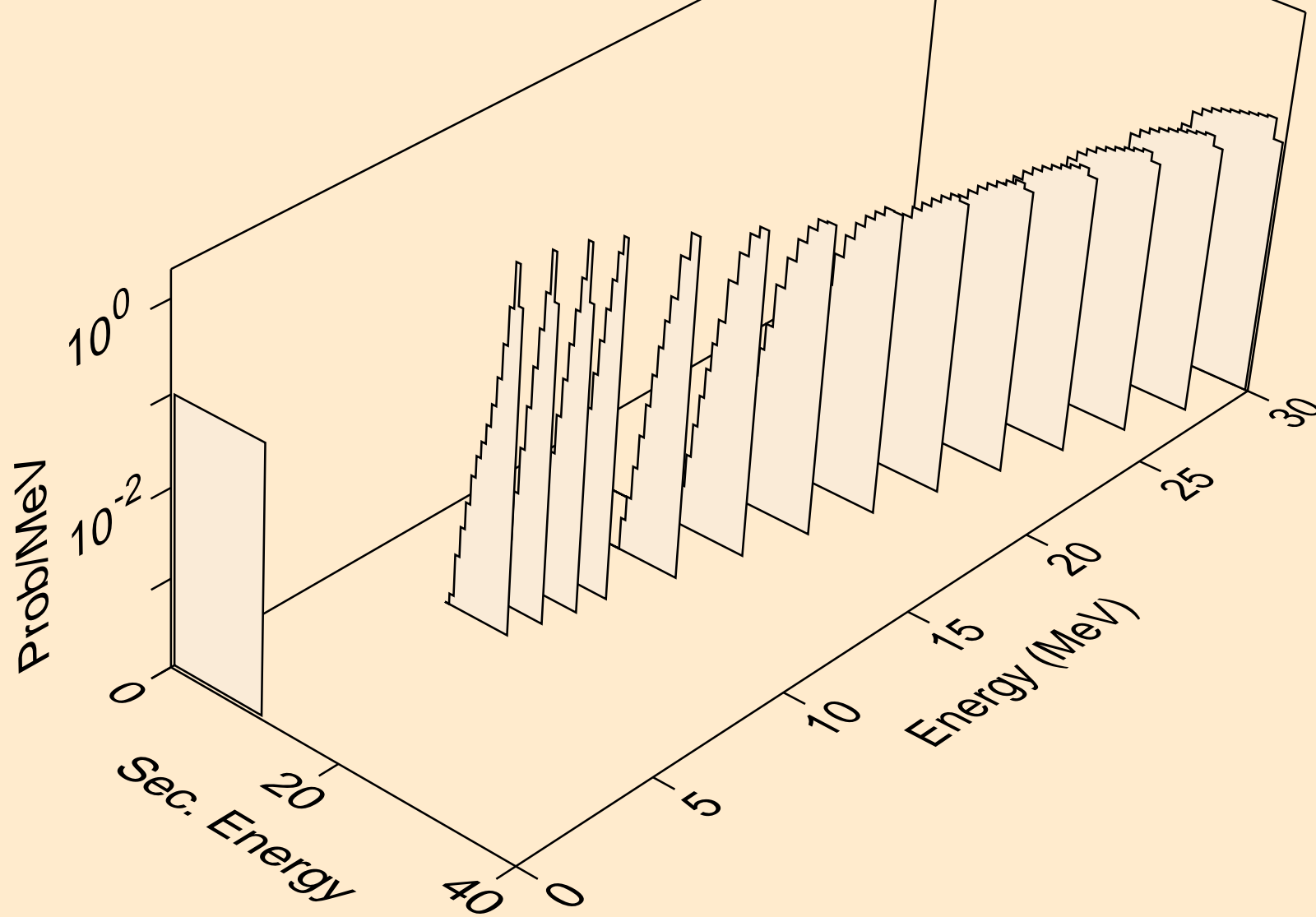

AT203 HELION ACER TENDL-2021 LIBRARY; T=0.K  
alphas from (s,2a)

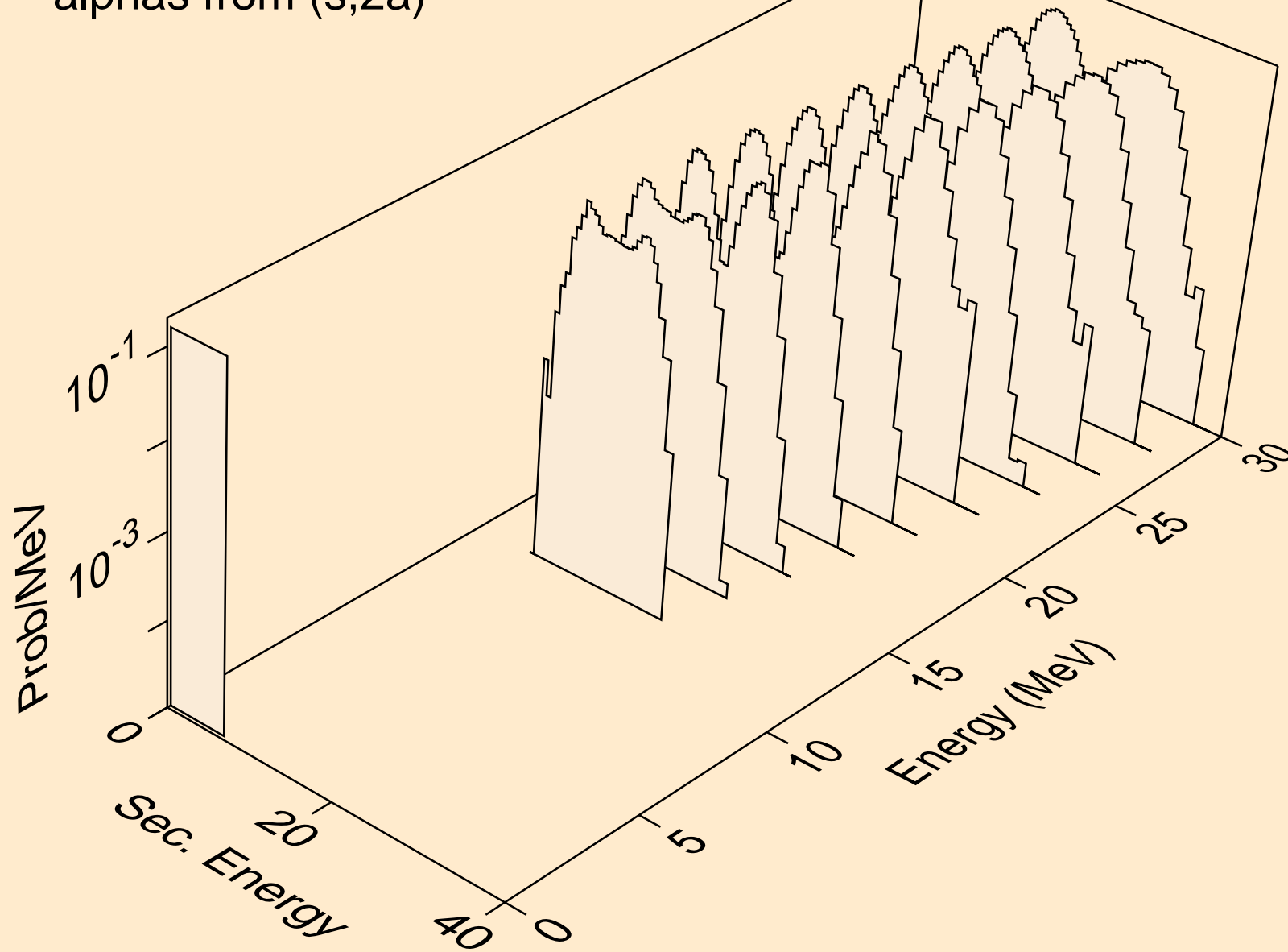

AT203 HELION ACER TENDL-2021 LIBRARY; T=0.K  
alphas from (s,pa)

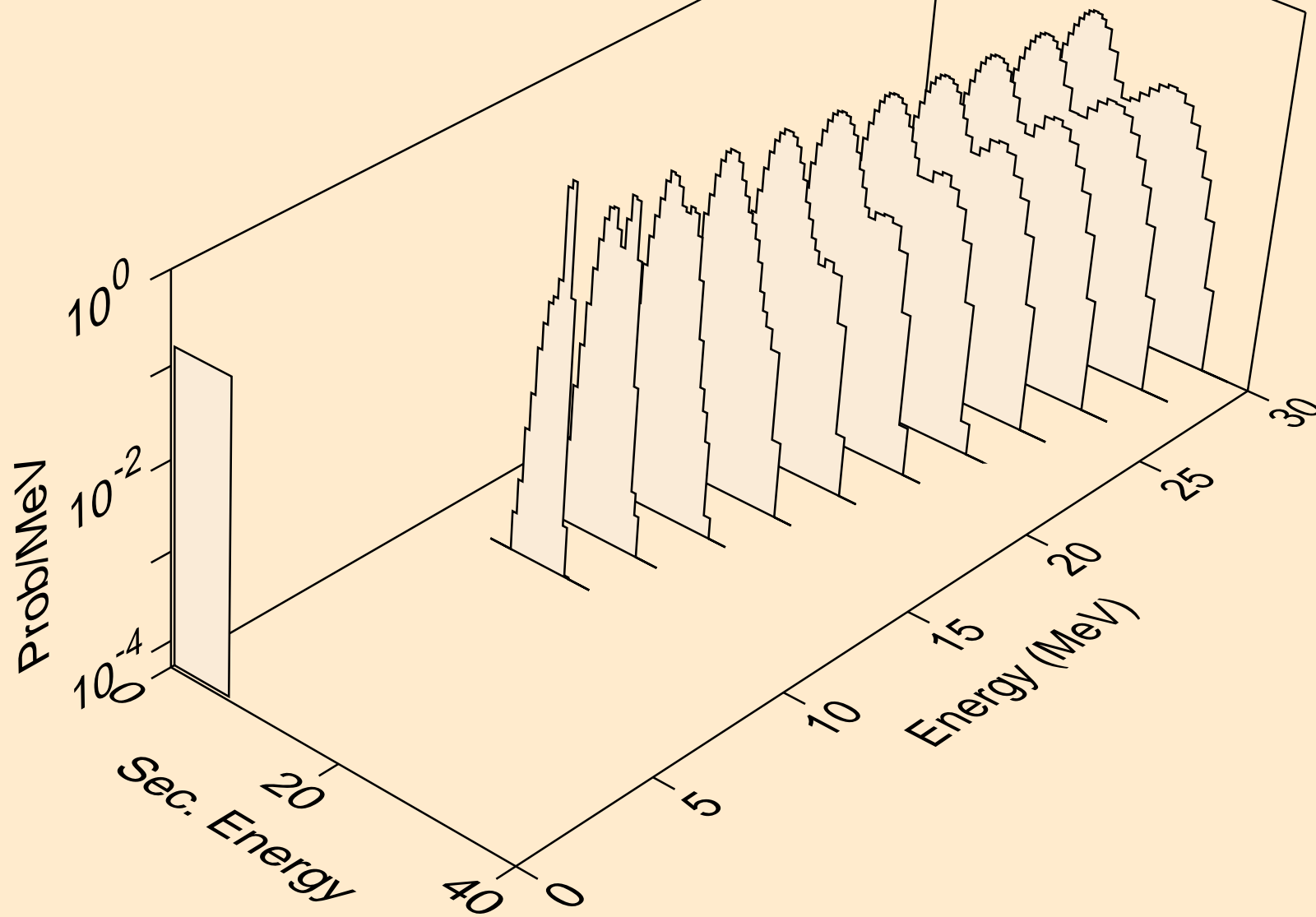

AT203 HELION ACER TENDL-2021 LIBRARY; T=0.K  
alphas from (s,da)

