

AU182 HELION ACER TENDL-2021 LIBRARY; T=0.K  
Principal cross sections

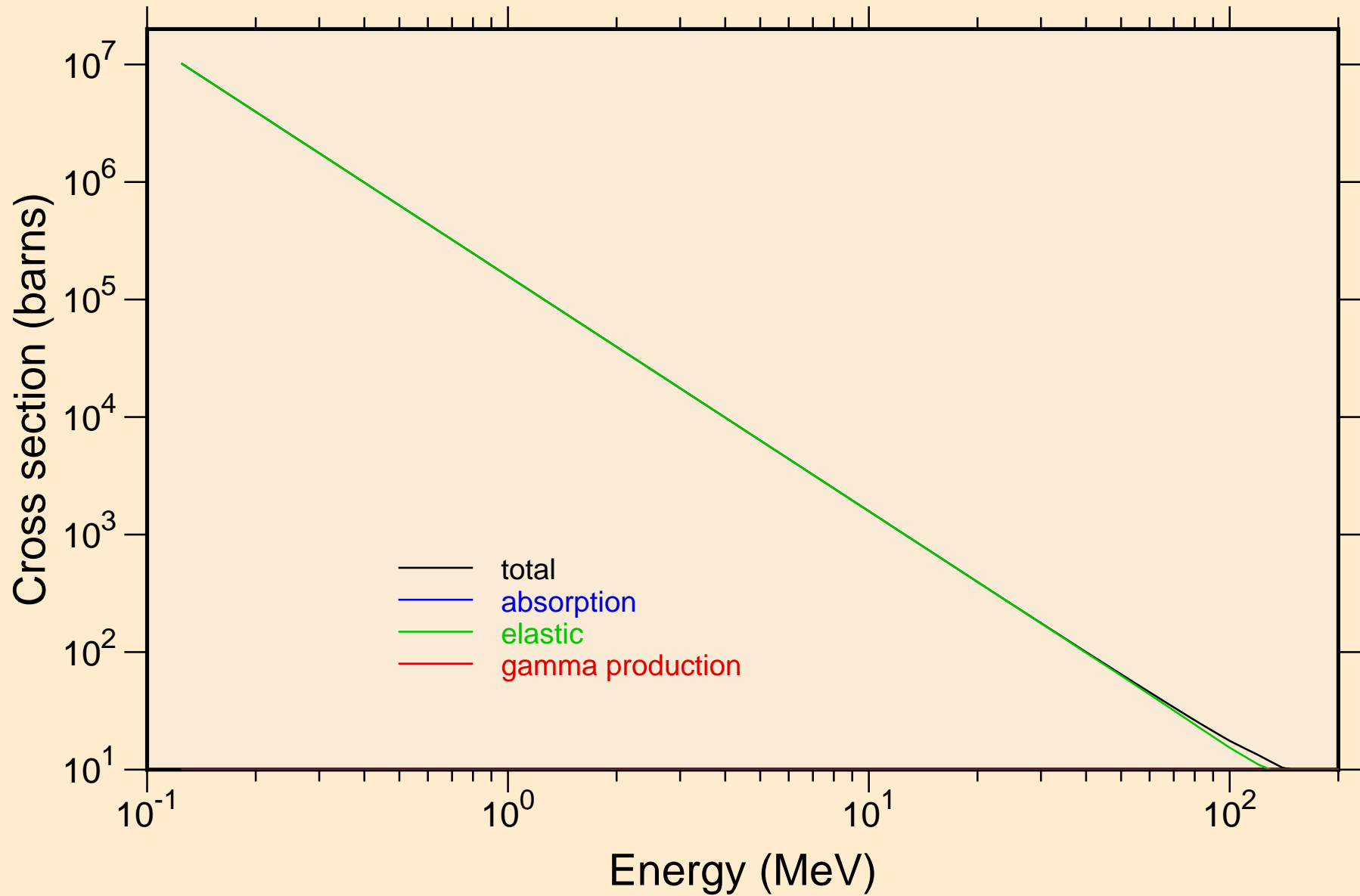

AU182 HELION ACER TENDL-2021 LIBRARY; T=0.K

Heating

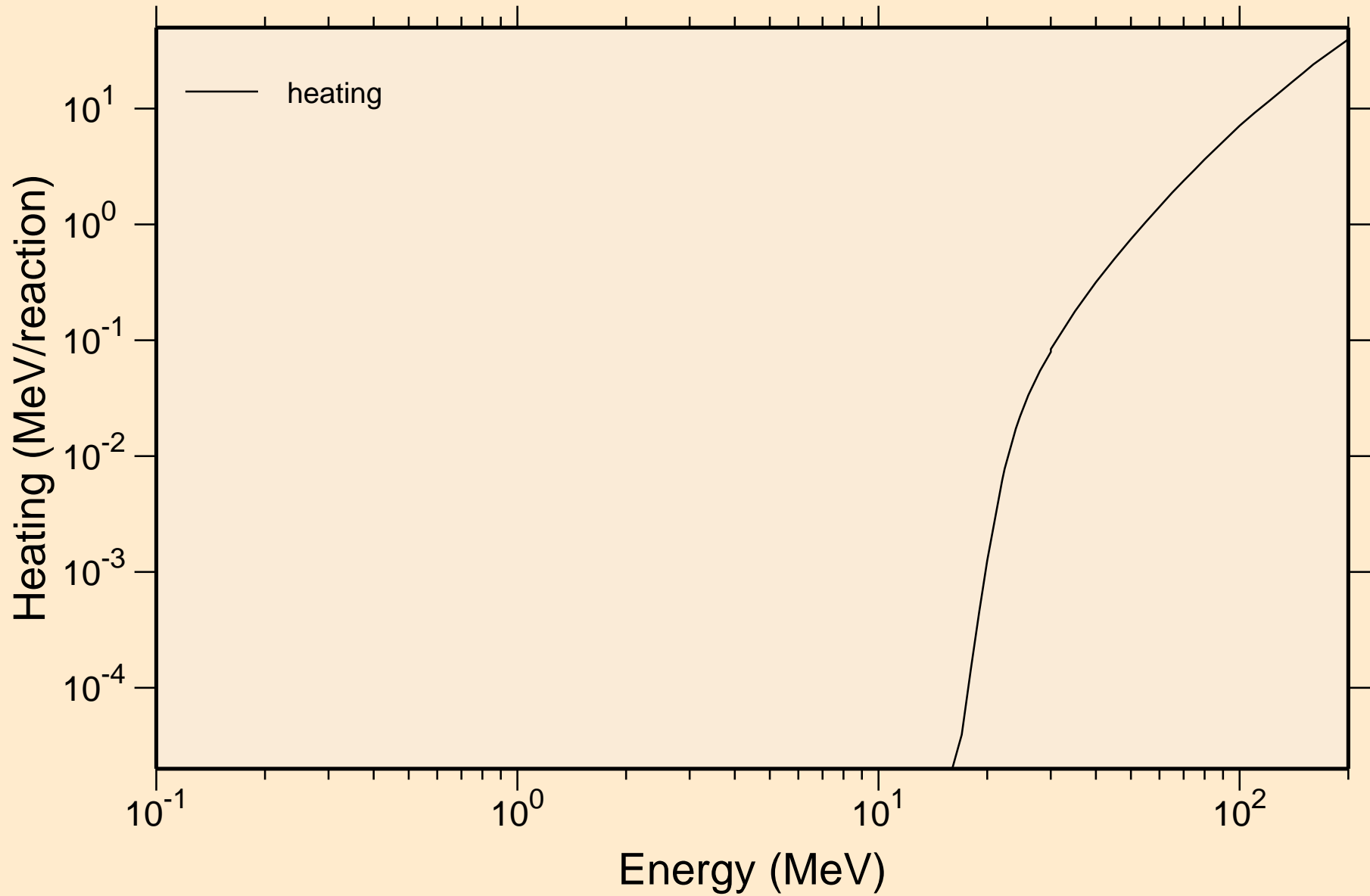

# AU182 HELION ACER TENDL-2021 LIBRARY; T=0.K

## Principal cross sections

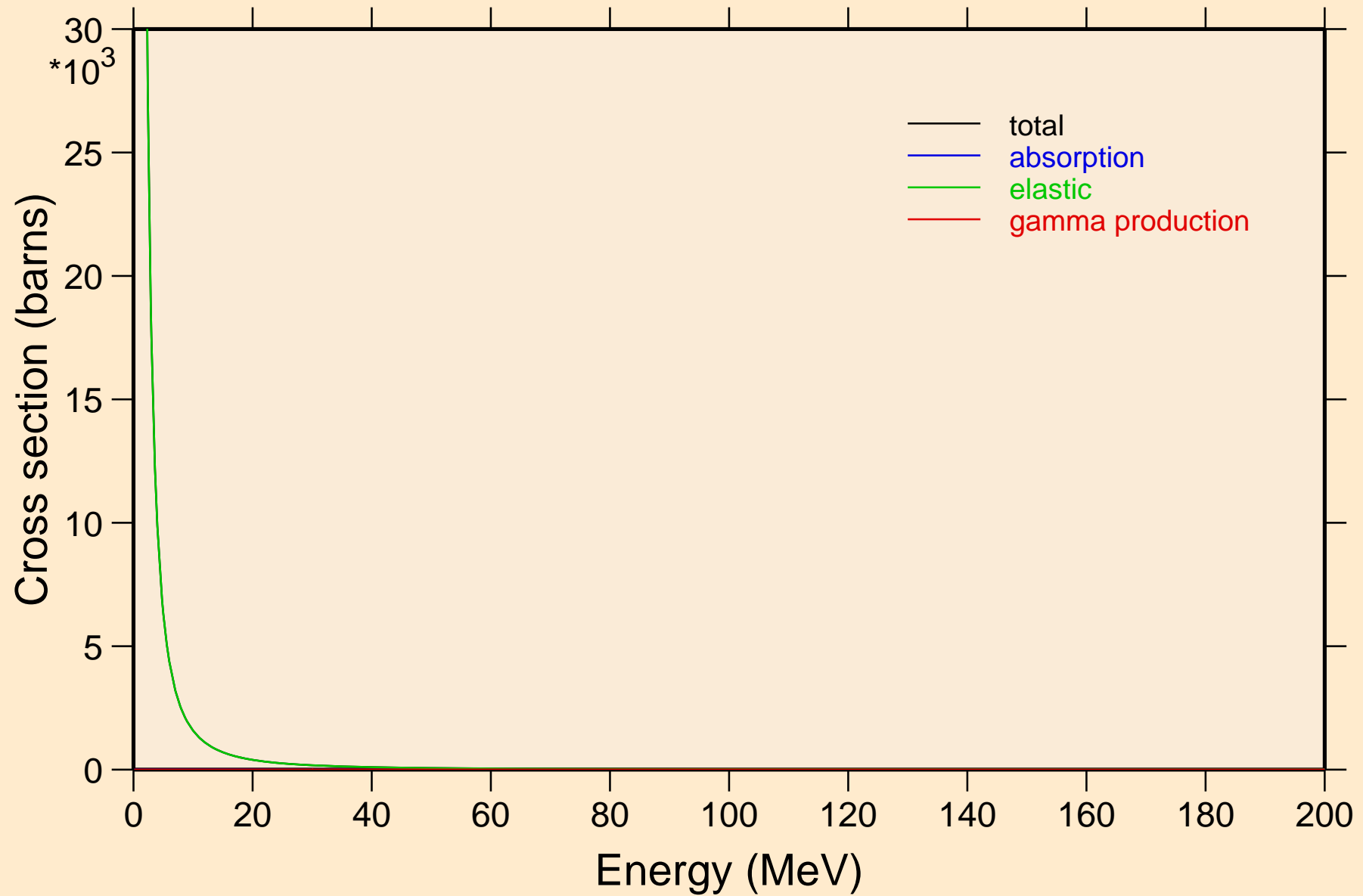

AU182 HELION ACER TENDL-2021 LIBRARY; T=0.K

Heating

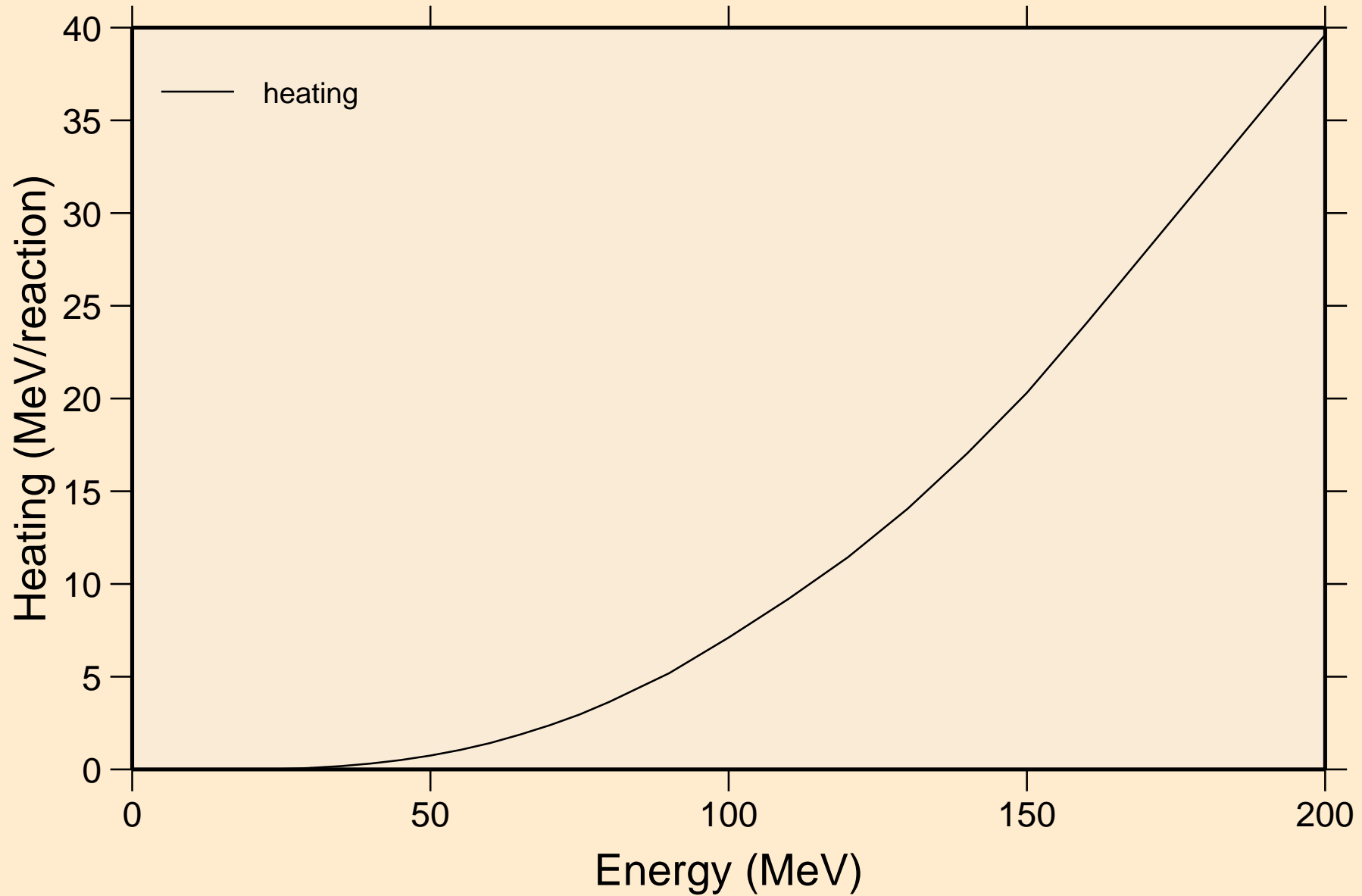

AU182 HELION ACER TENDL-2021 LIBRARY; T=0.K  
Threshold reactions

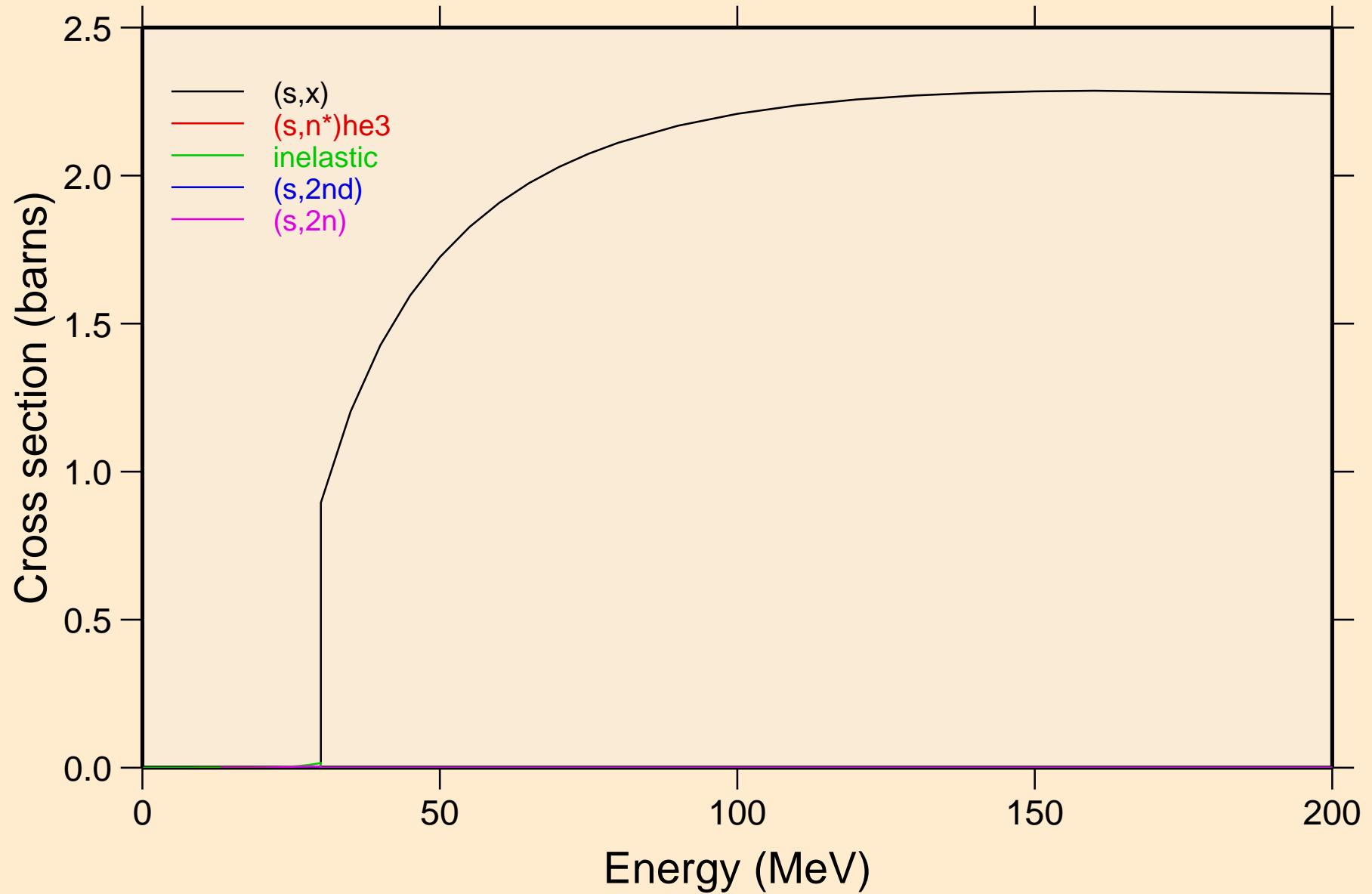

AU182 HELION ACER TENDL-2021 LIBRARY; T=0.K  
Threshold reactions

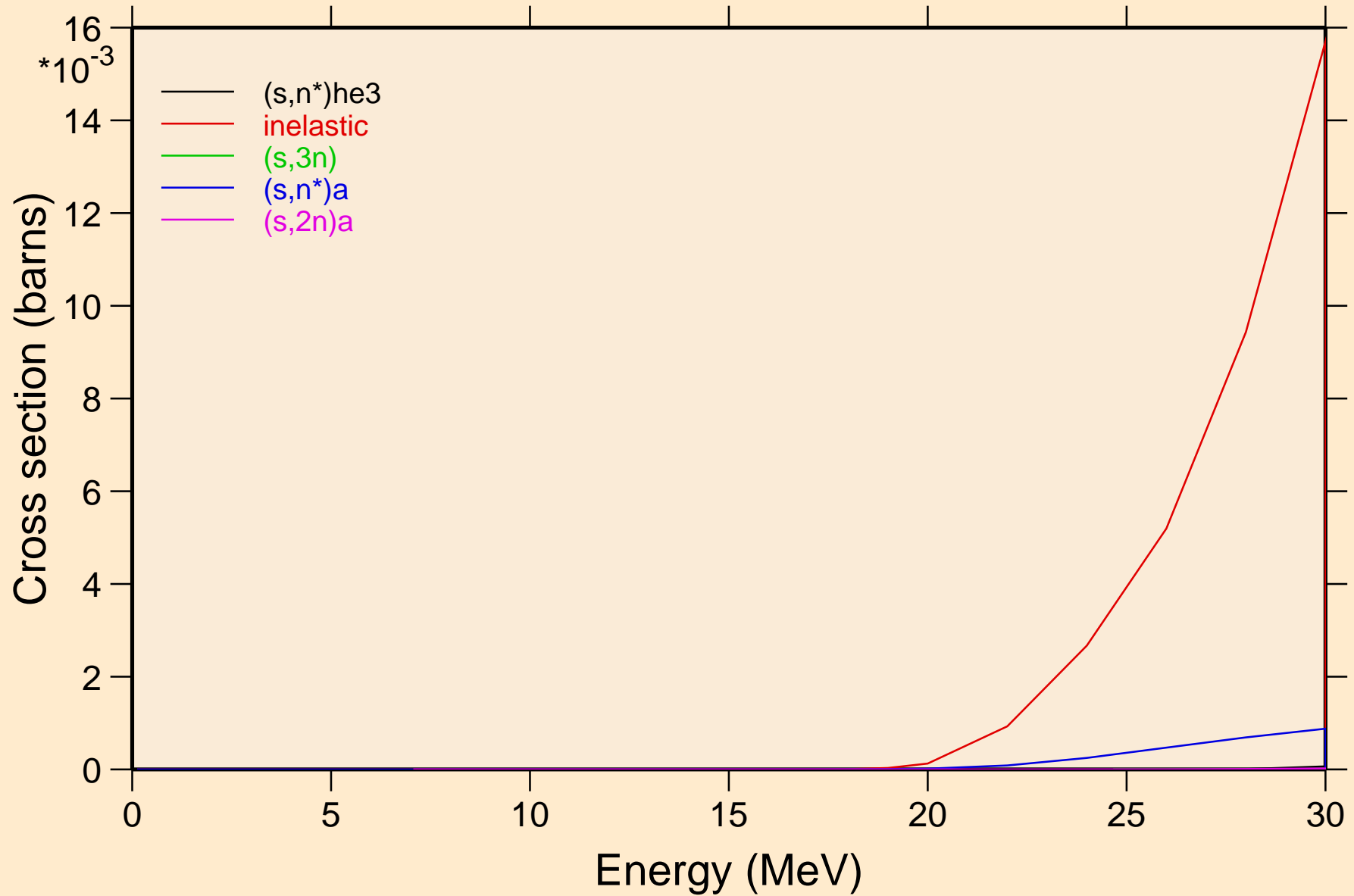

AU182 HELION ACER TENDL-2021 LIBRARY; T=0.K  
Threshold reactions

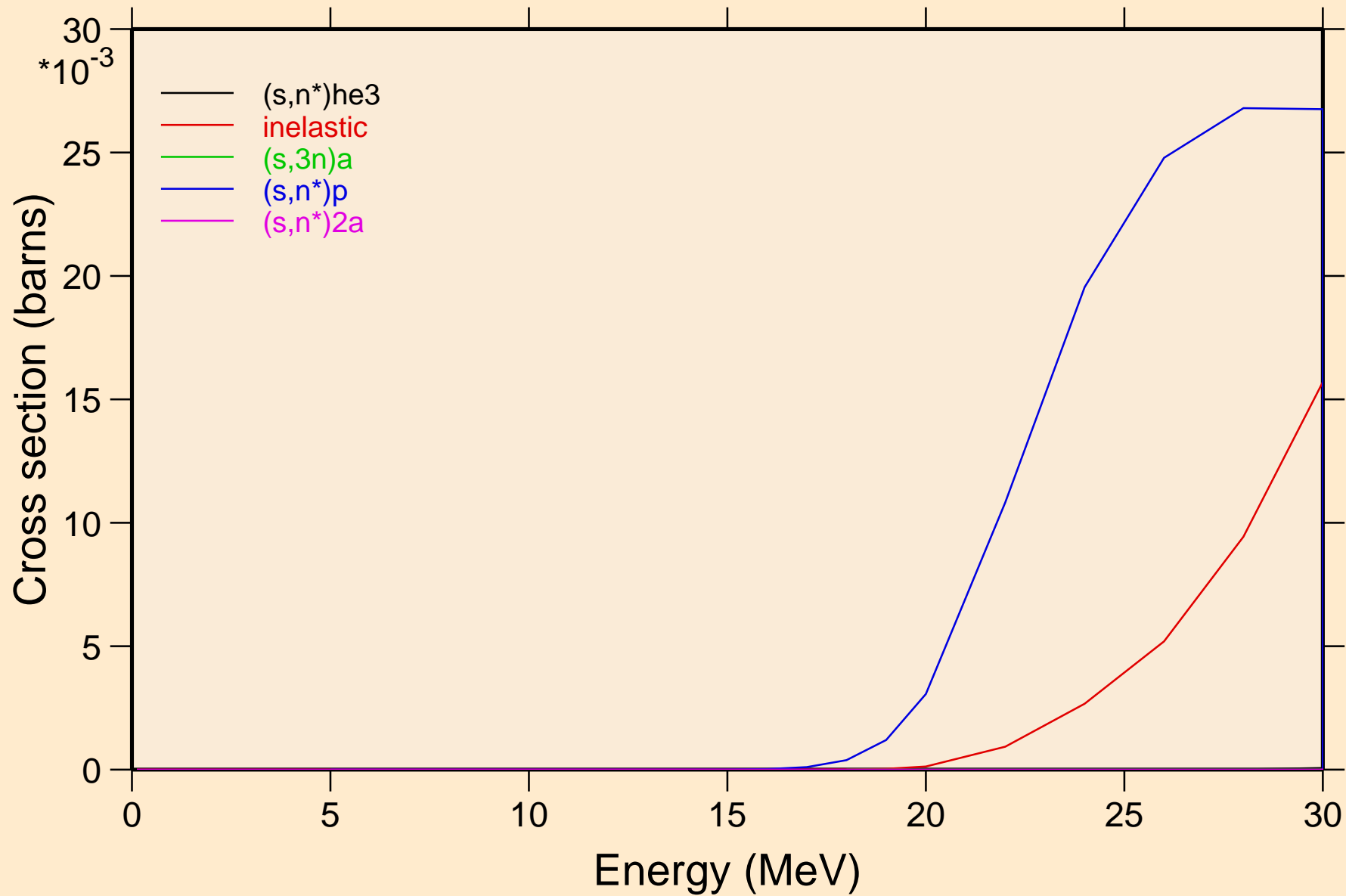

AU182 HELION ACER TENDL-2021 LIBRARY; T=0.K  
Threshold reactions

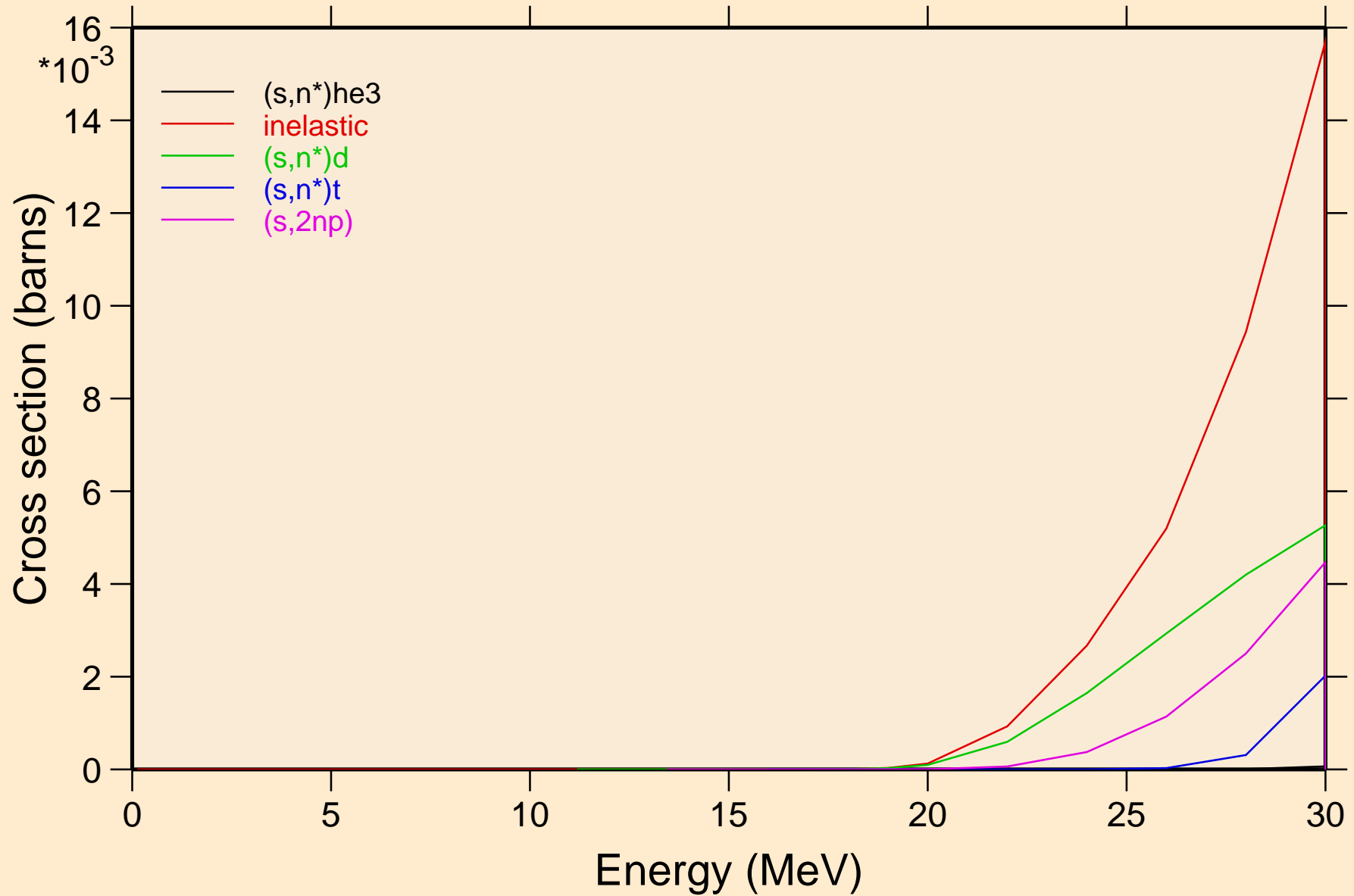



AU182 HELION ACER TENDL-2021 LIBRARY; T=0.K  
Threshold reactions

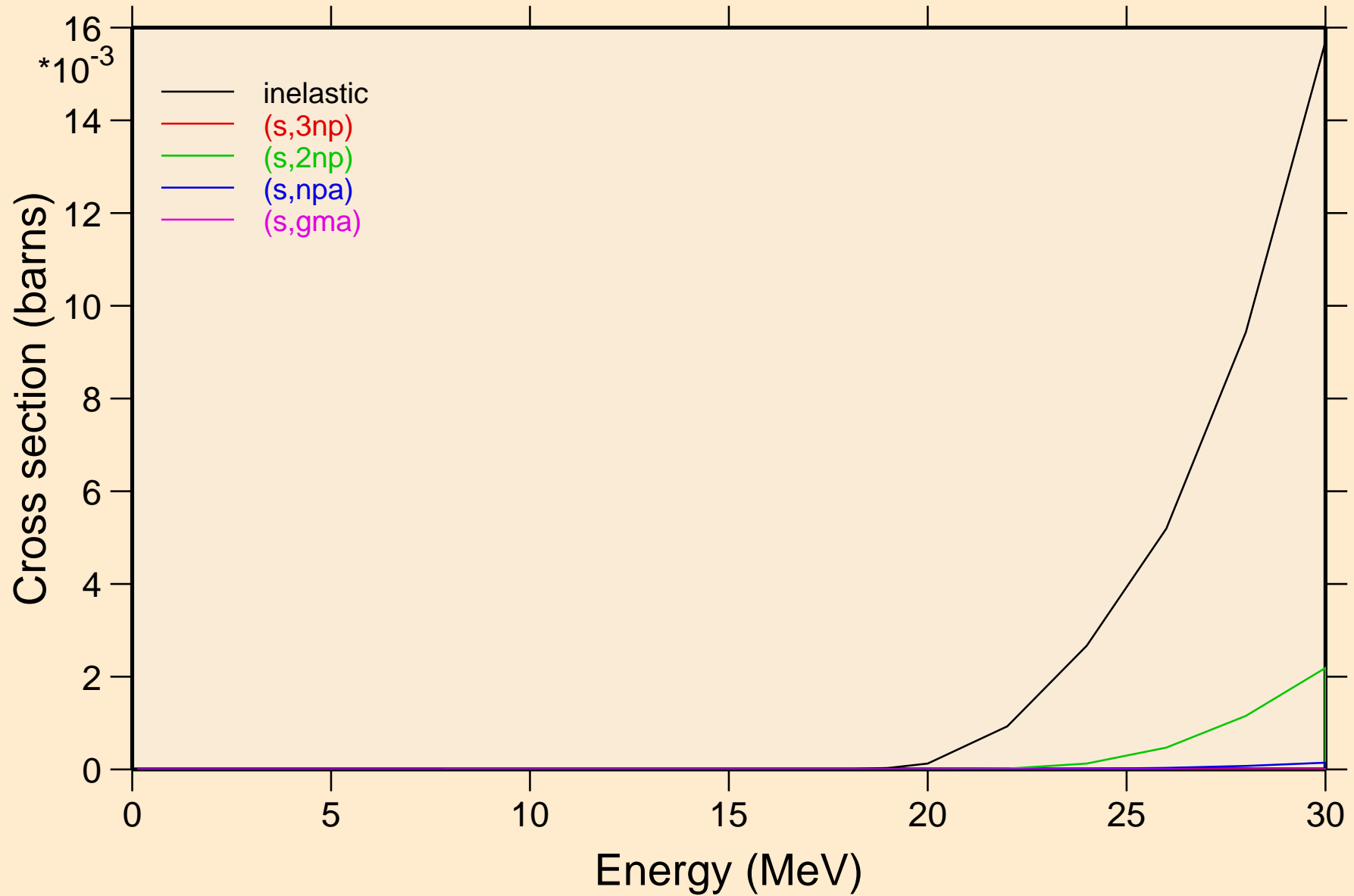

AU182 HELION ACER TENDL-2021 LIBRARY; T=0.K  
Threshold reactions

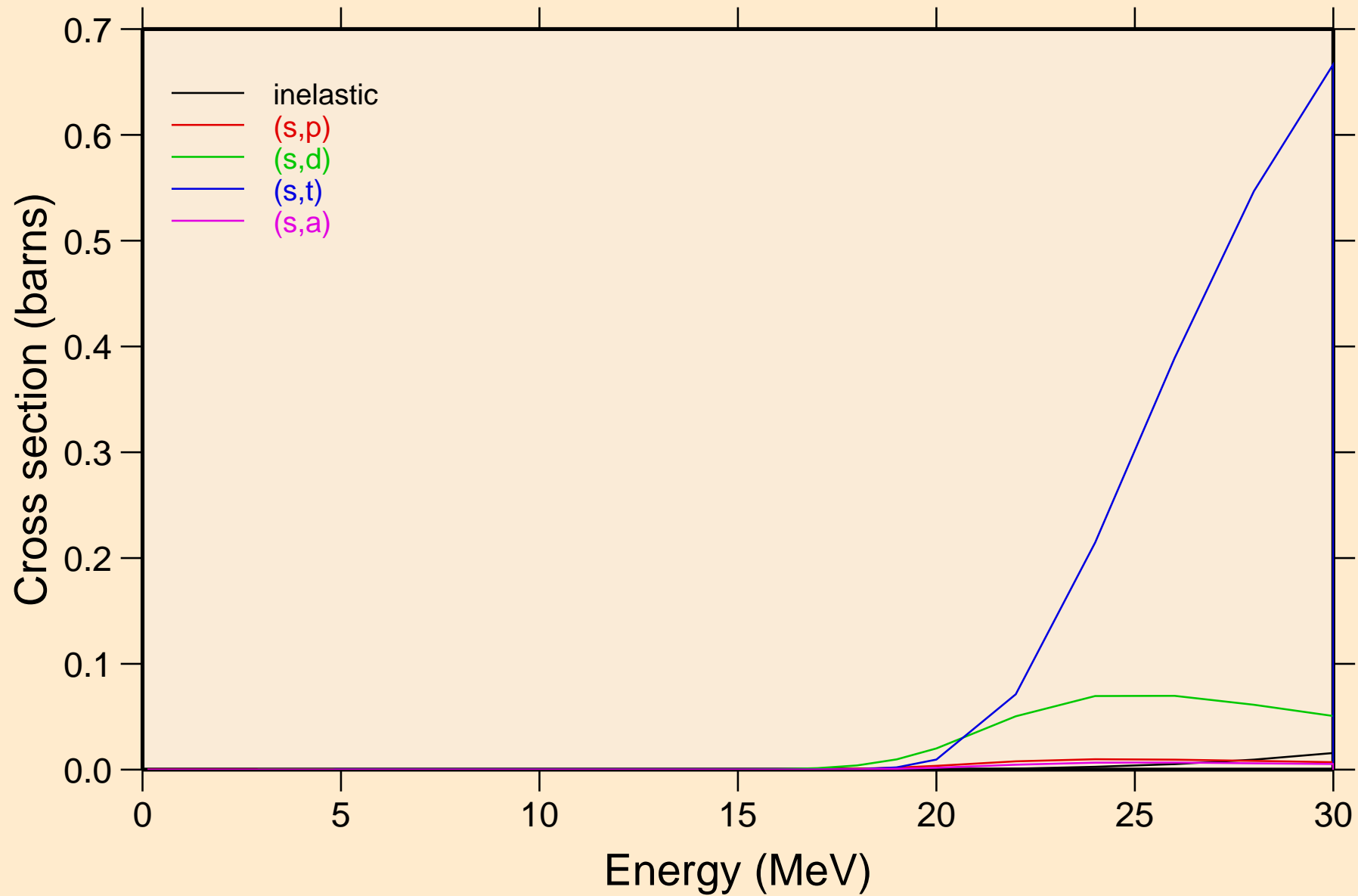

AU182 HELION ACER TENDL-2021 LIBRARY; T=0.K  
Threshold reactions

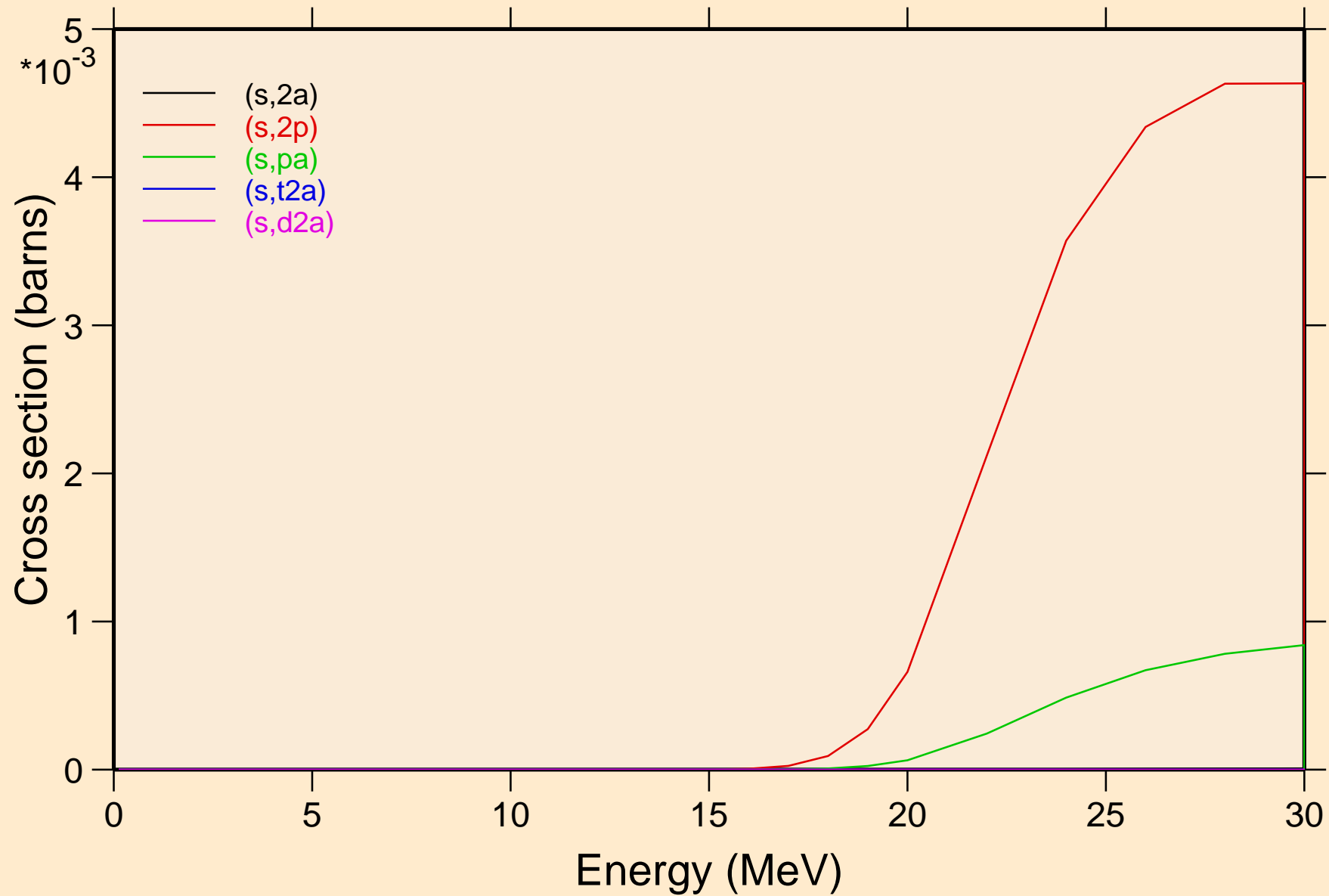

AU182 HELION ACER TENDL-2021 LIBRARY; T=0.K  
Threshold reactions

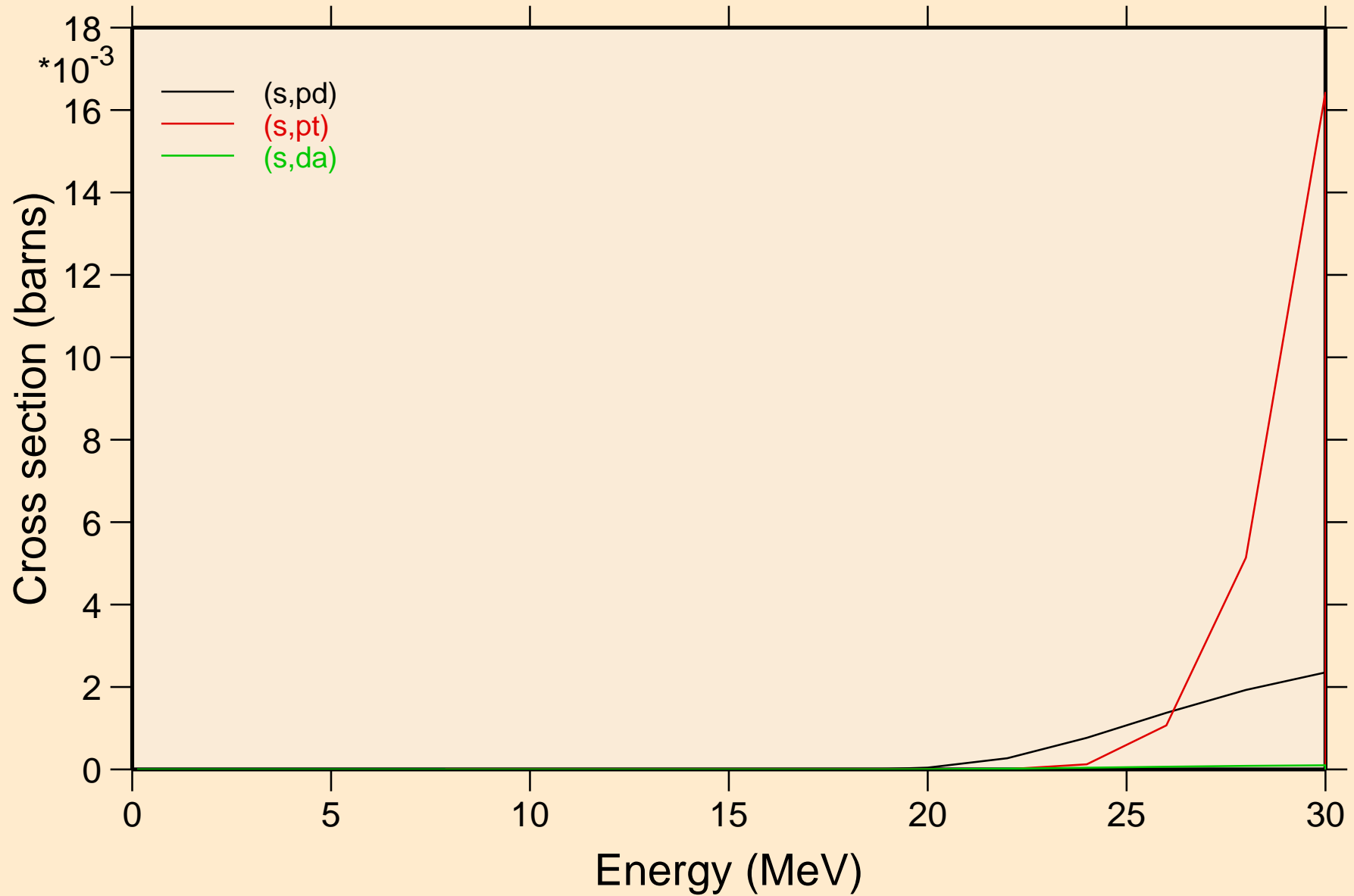

AU182 HELION ACER TENDL-2021 LIBRARY; T=0.K  
angular distribution for elastic

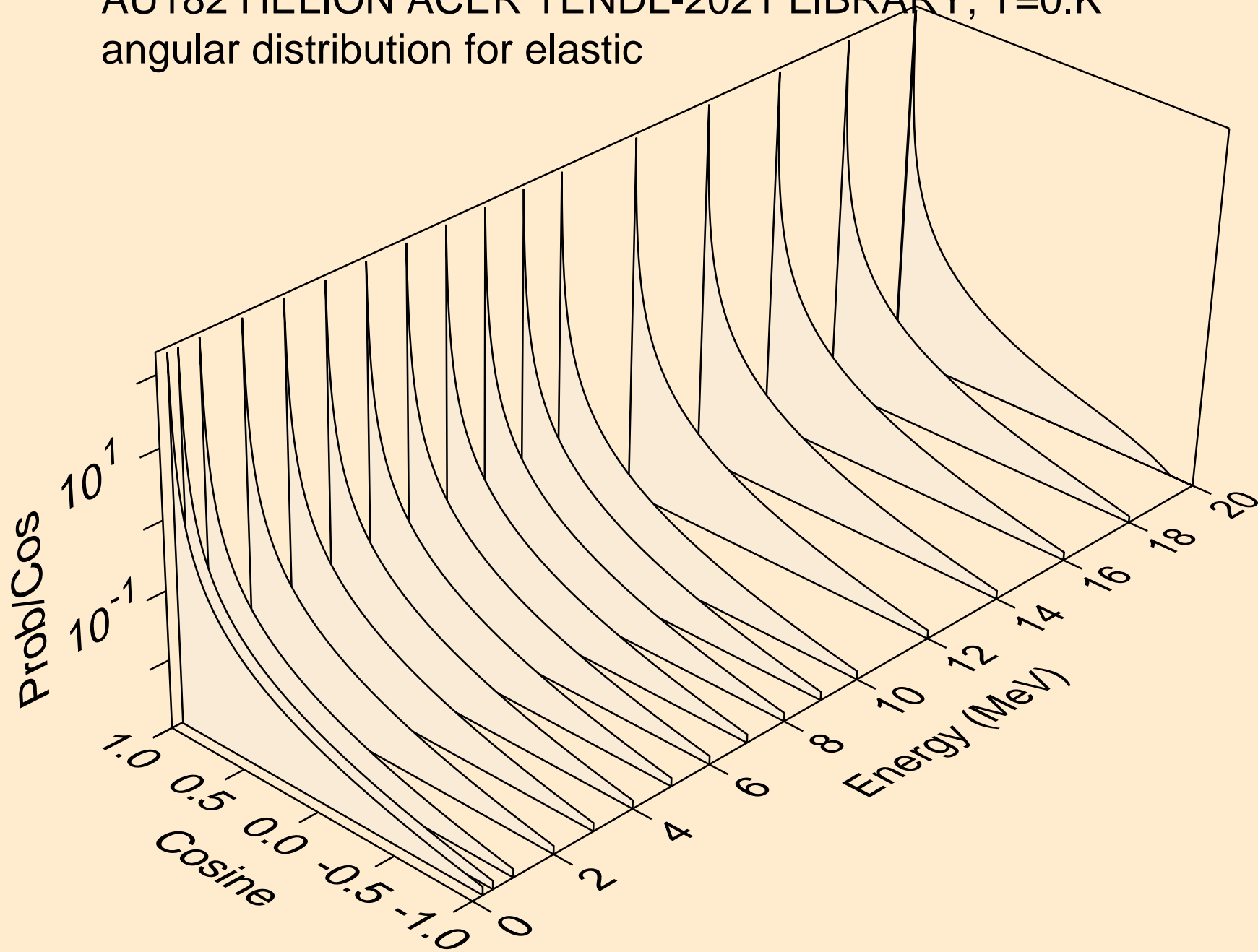

AU182 HELION ACER TENDL-2021 LIBRARY; T=0.K  
angular distribution for elastic

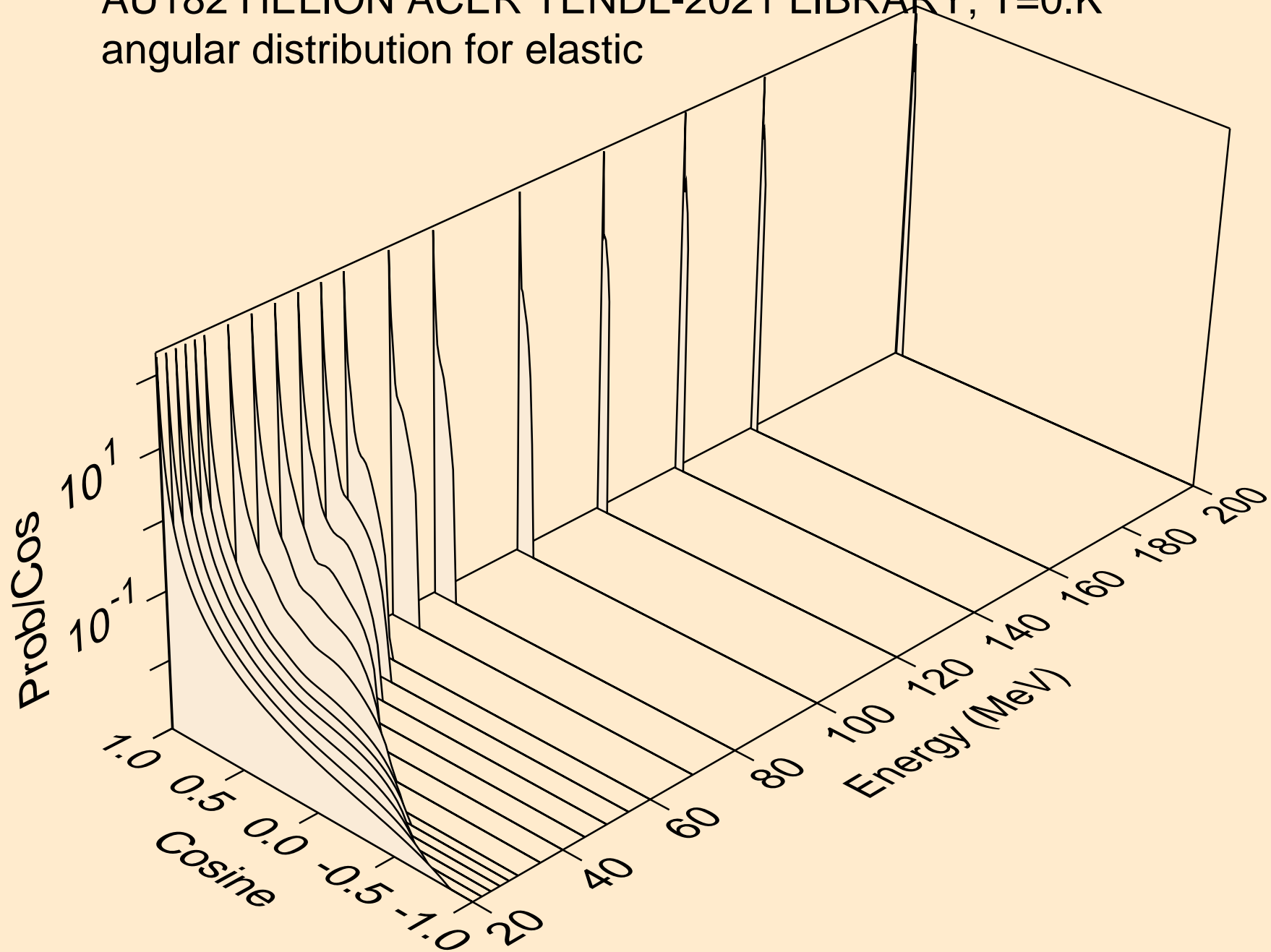

AU182 HELION ACER TENDL-2021 LIBRARY; T=0.K  
He-3 emission for (s,x)

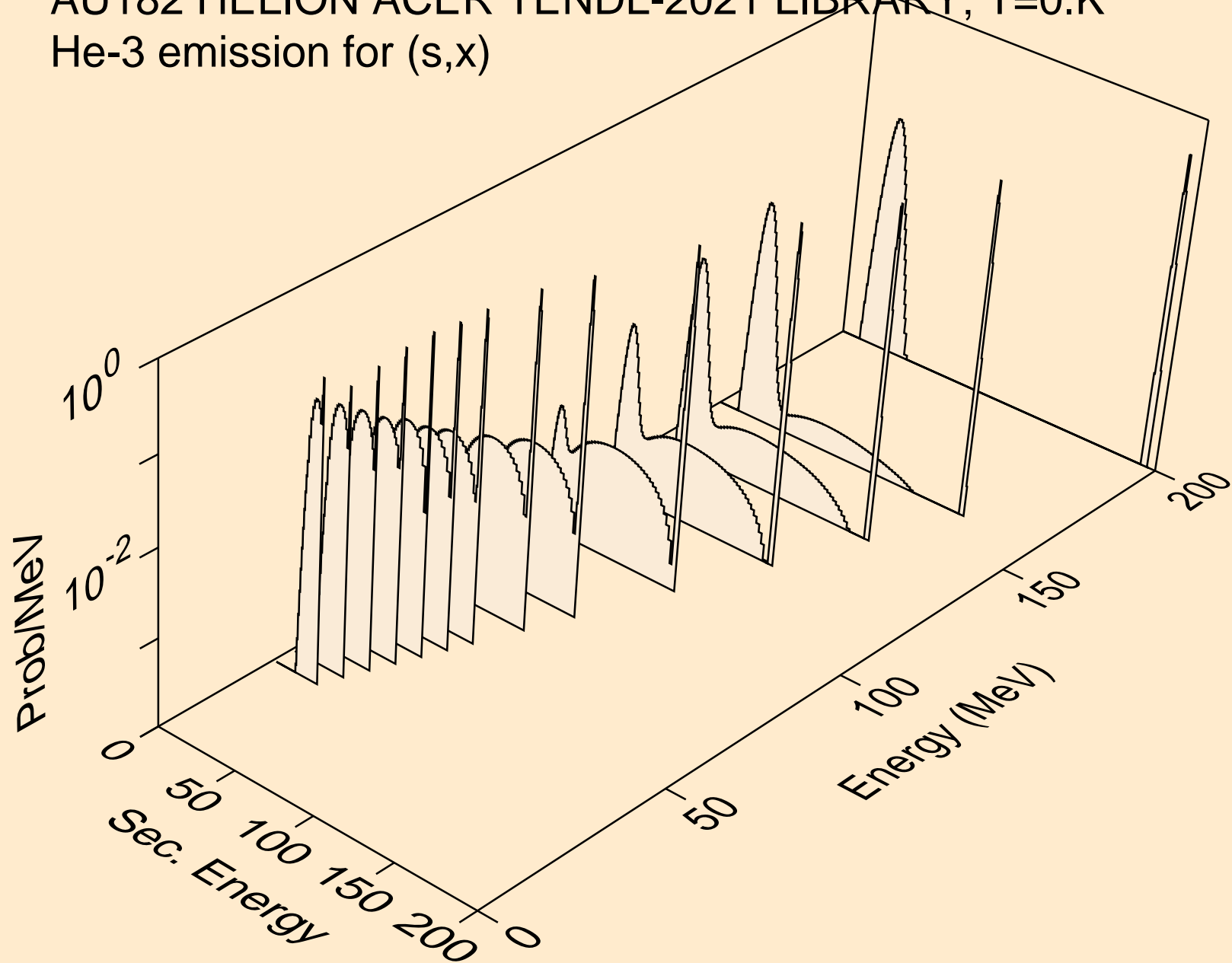

AU182 HELION ACER TENDL-2021 LIBRARY; T=0.K  
He-3 emission for (s,n\*)he3

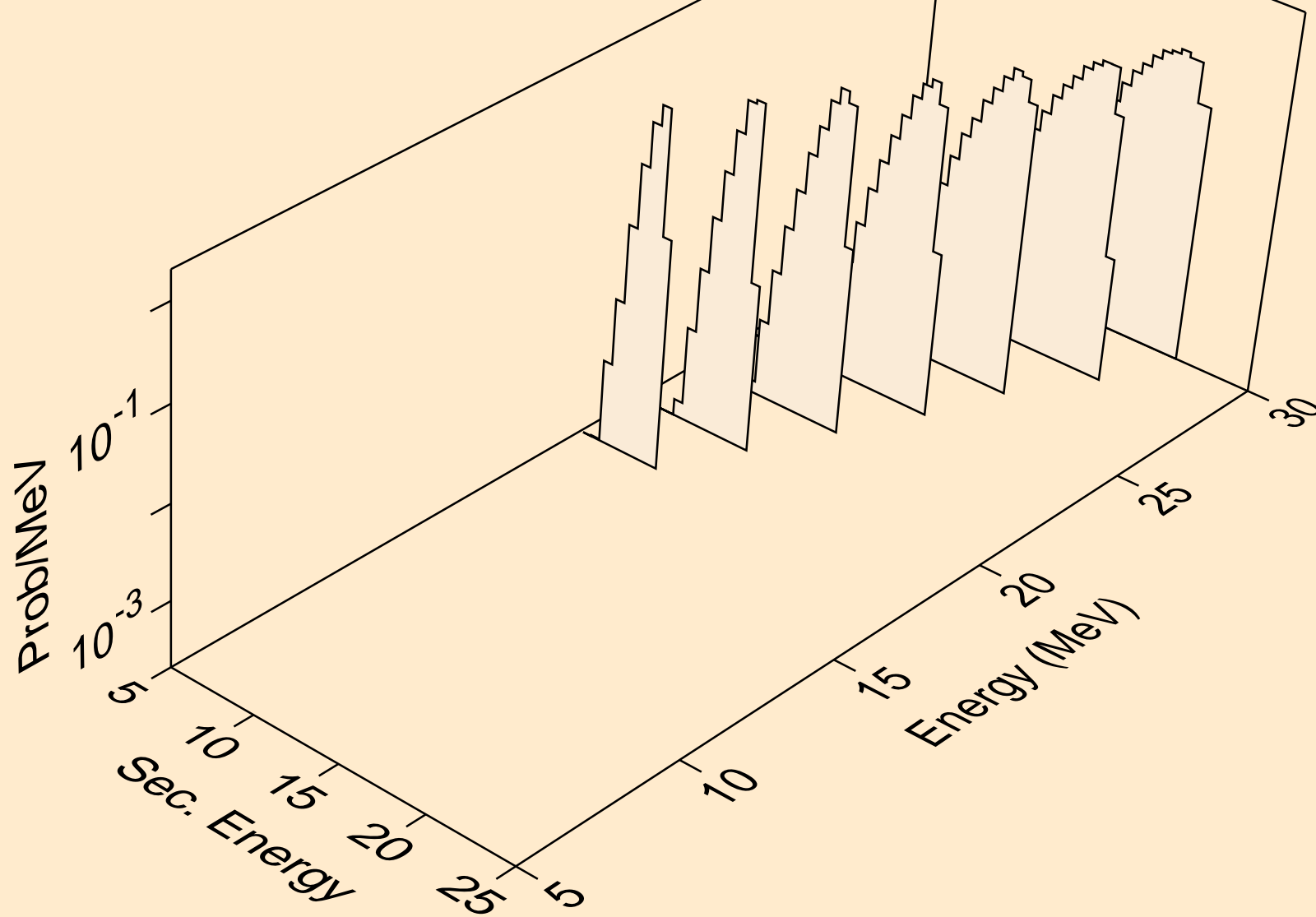



AU182 HELION ACER TENDL-2021 LIBRARY; T=0.K  
He-3 emission for inelastic

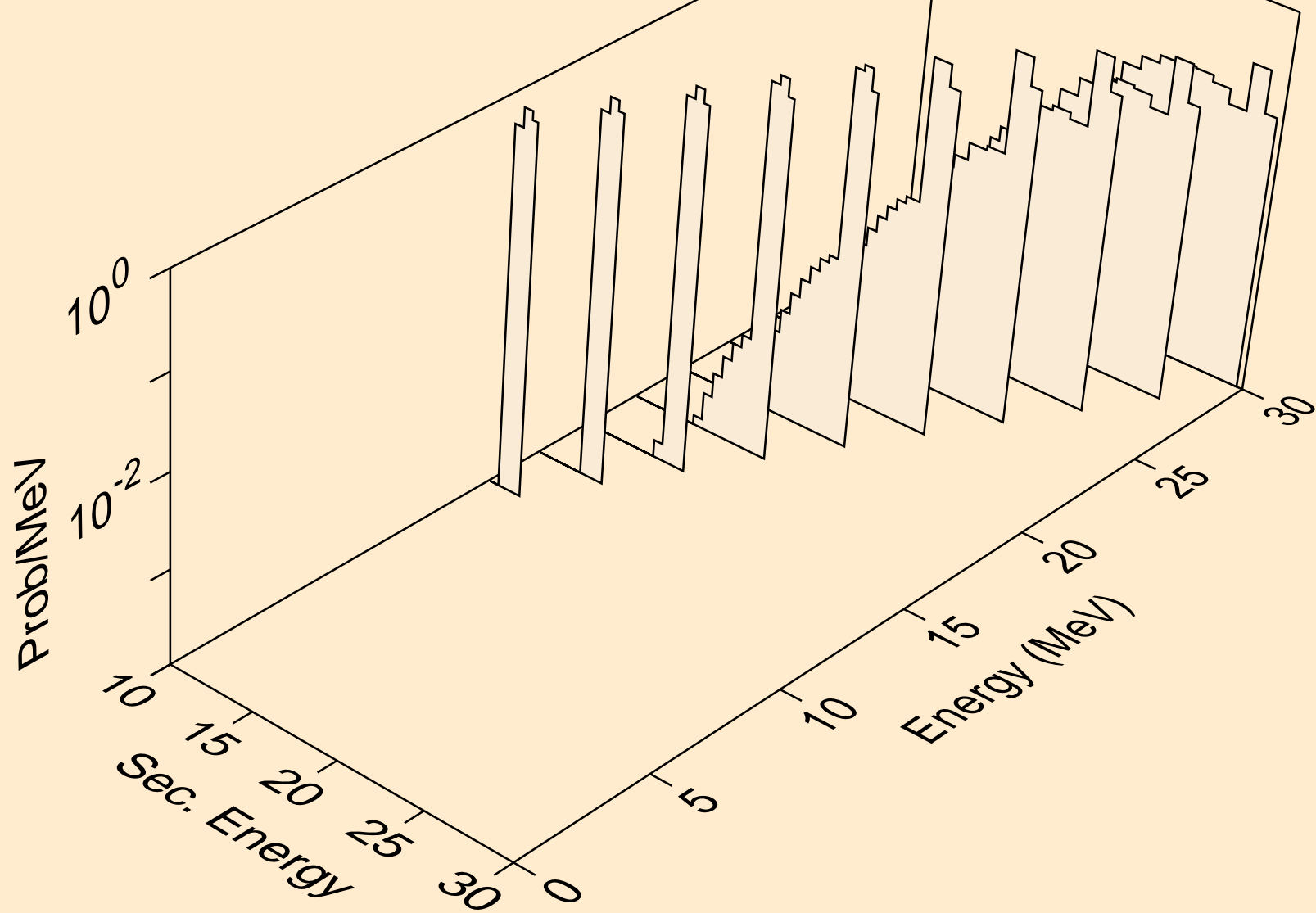

AU182 HELION ACER TENDL-2021 LIBRARY; T=0.K  
Photon emission for (z,n)

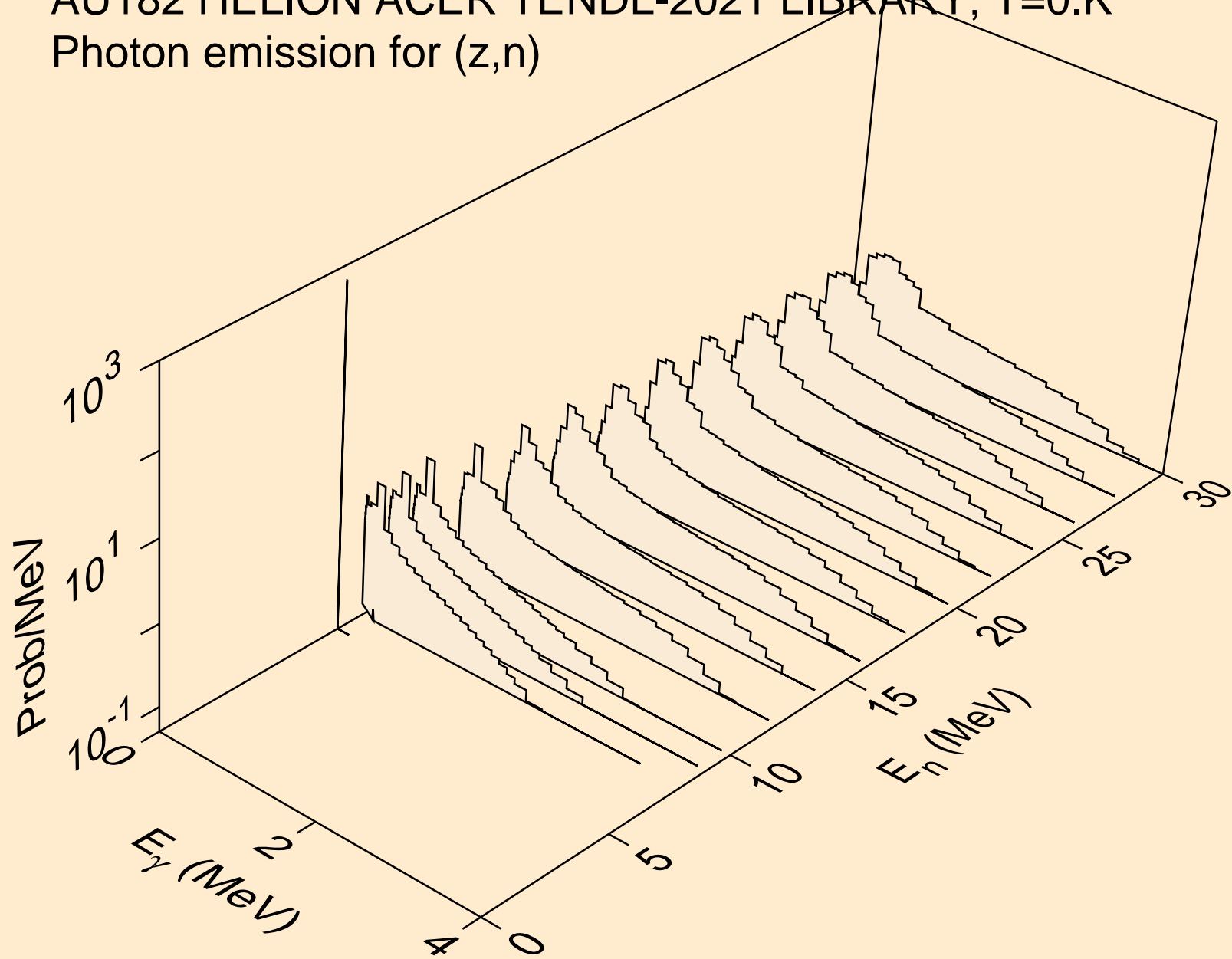

AU182 HELION ACER TENDL-2021 LIBRARY; T=0.K  
Photon emission for (n,x)

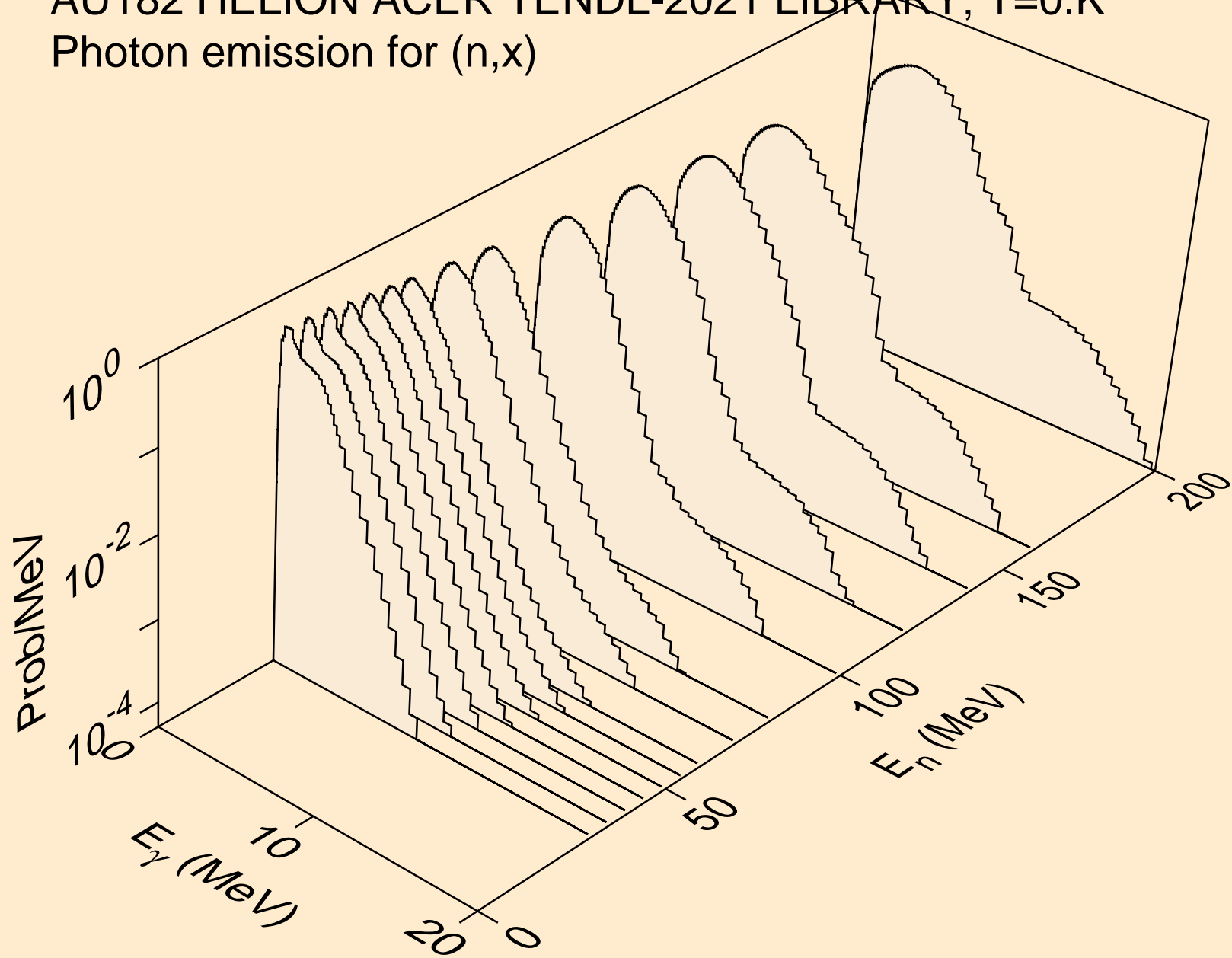

AU182 HELION ACER TENDL-2021 LIBRARY; T=0.K  
Photon emission for (n,2nd)

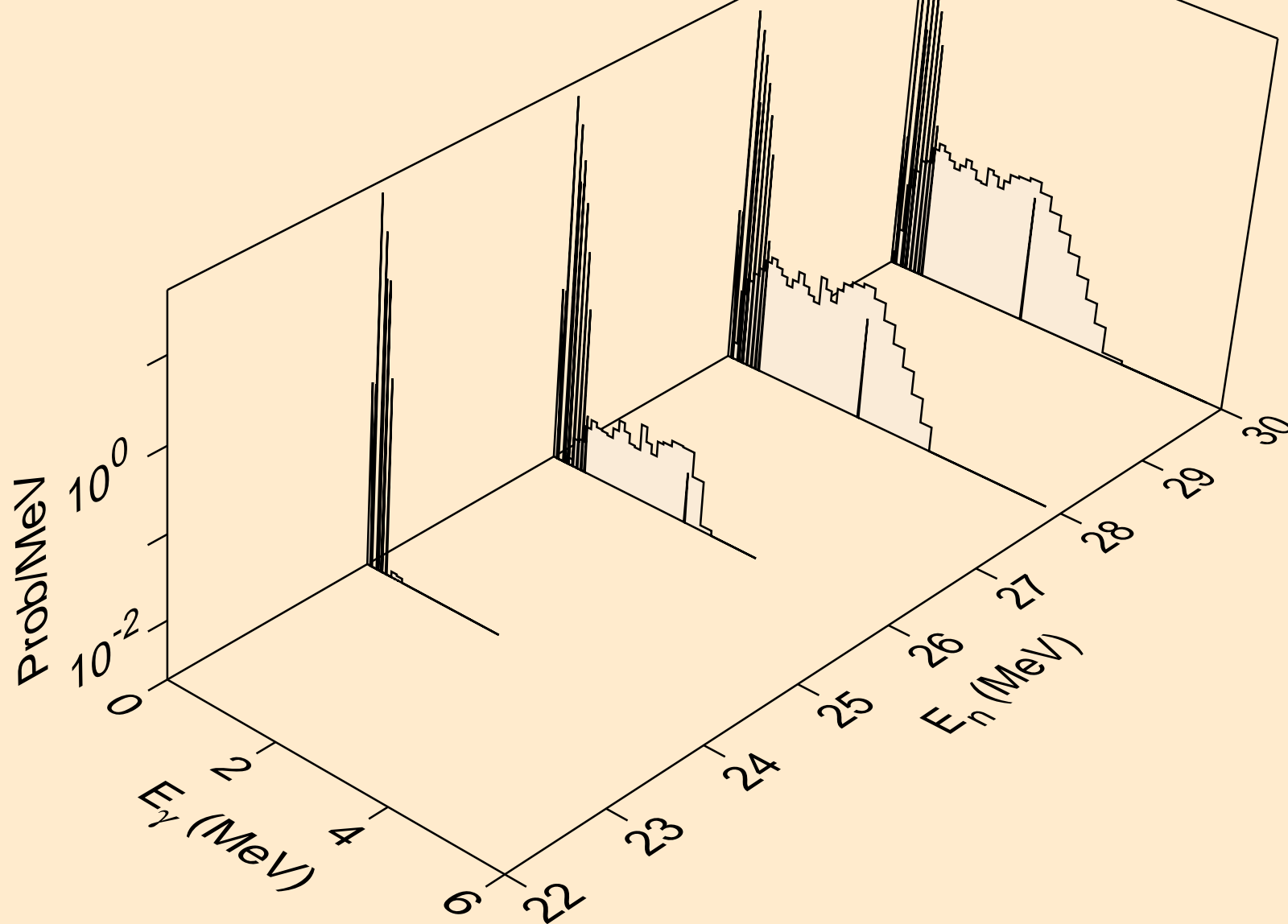

AU182 HELION ACER TENDL-2021 LIBRARY; T=0.K  
Photon emission for (n,2n)

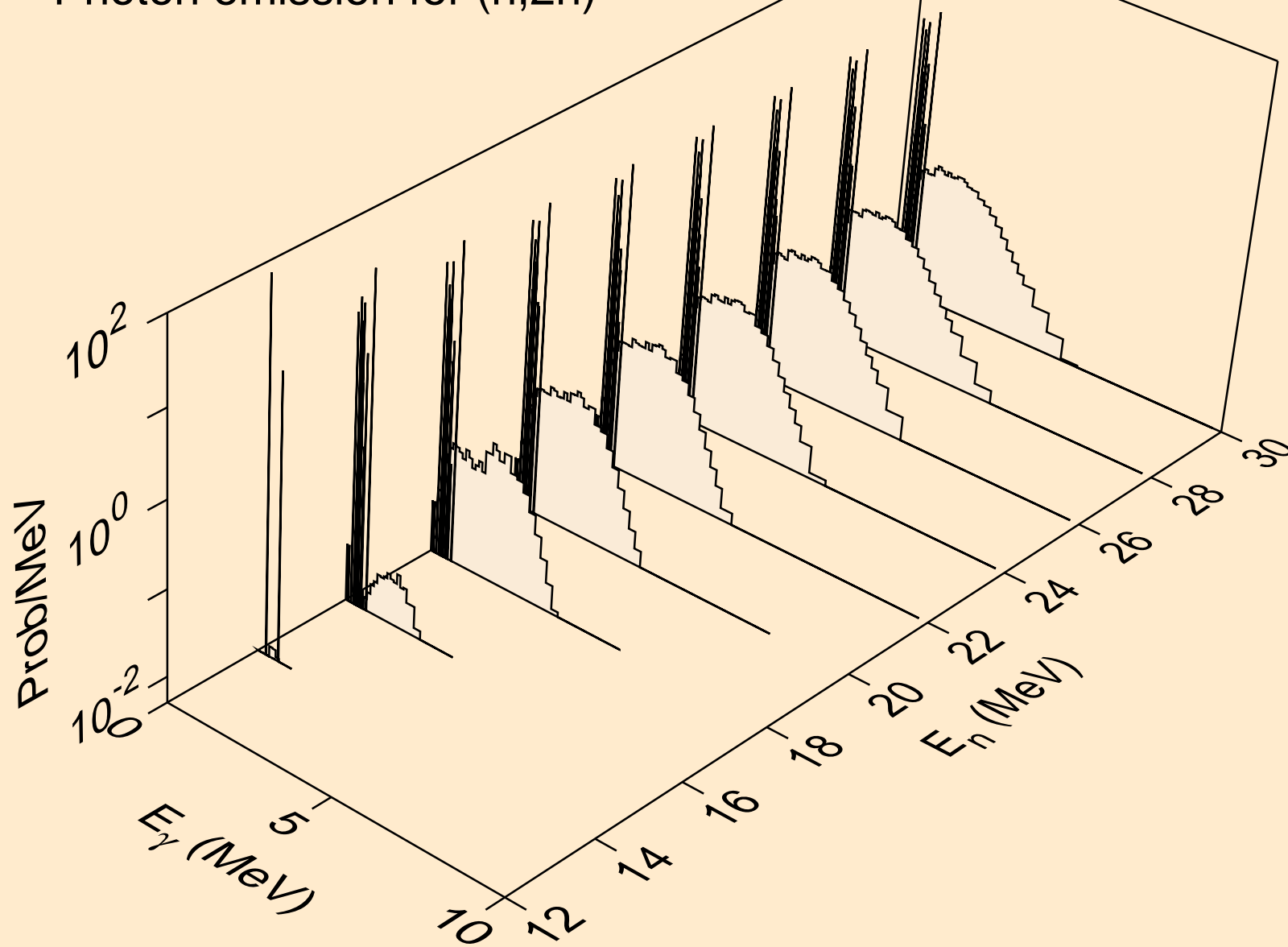

AU182 HELION ACER TENDL-2021 LIBRARY; T=0.K  
Photon emission for (n,3n)

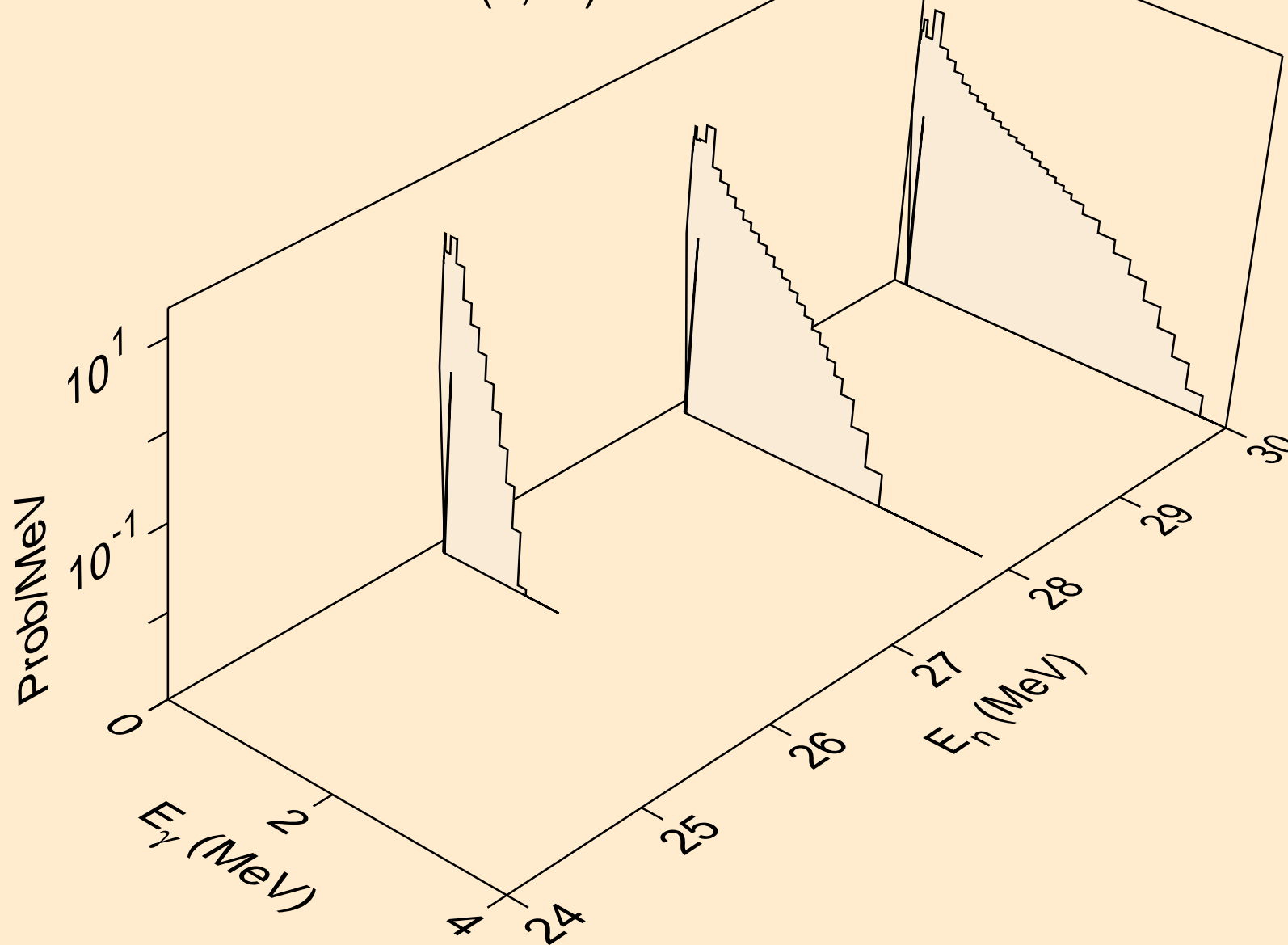

AU182 HELION ACER TENDL-2021 LIBRARY; T=0.K  
Photon emission for (n,n\*)a

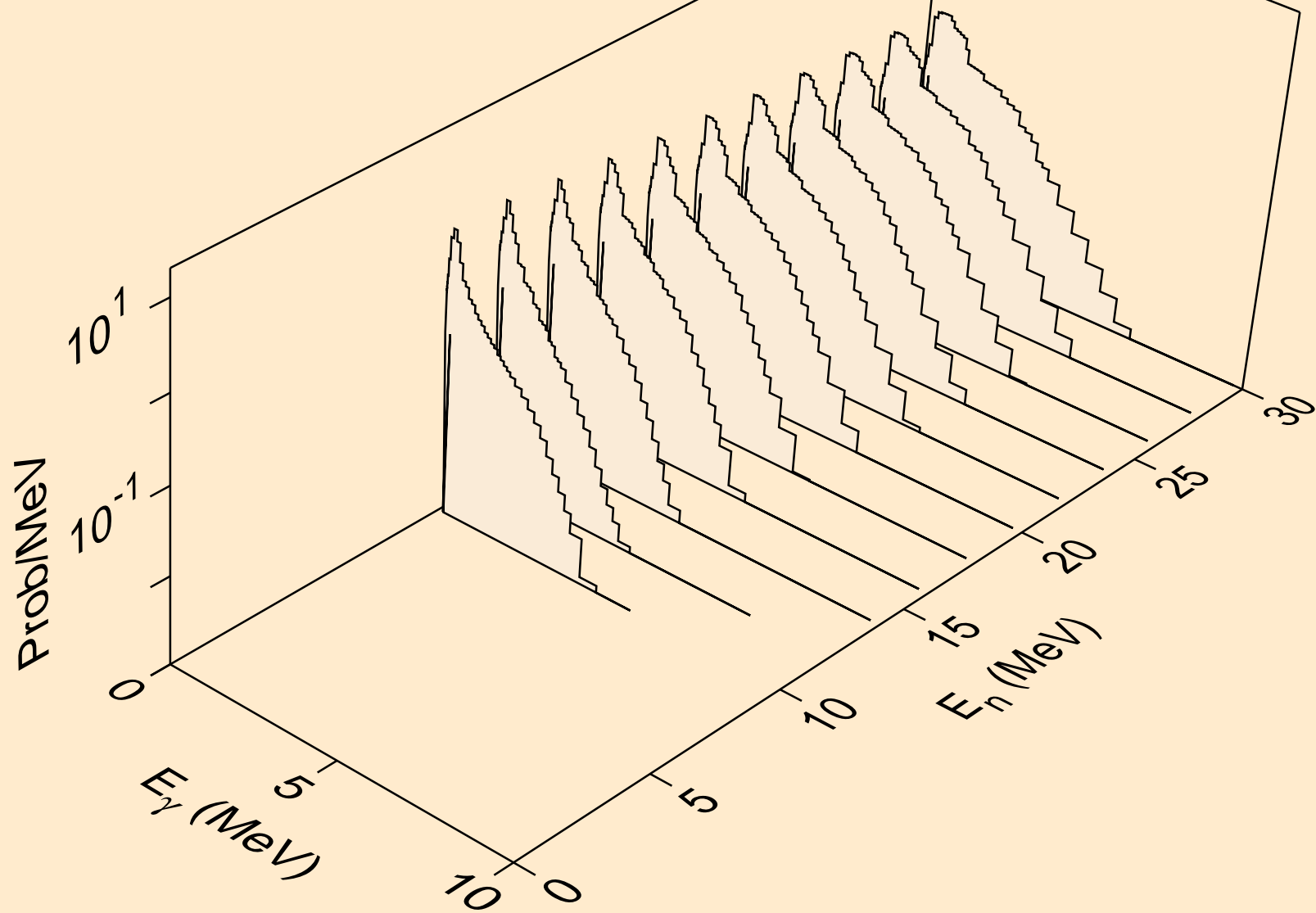

AU182 HELION ACER TENDL-2021 LIBRARY; T=0.K  
Photon emission for (n,2n)a

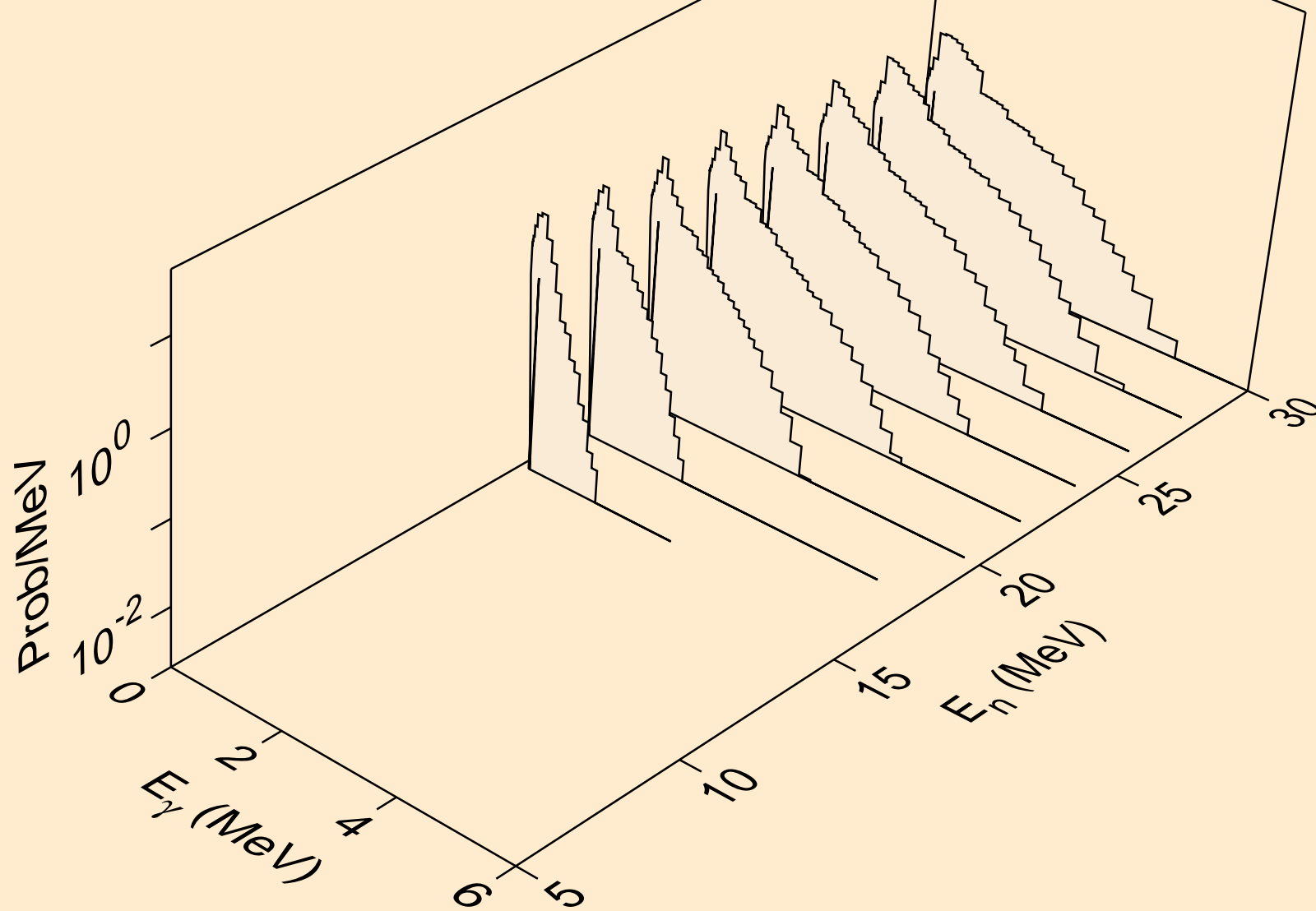



AU182 HELION ACER TENDL-2021 LIBRARY; T=0.K  
Photon emission for (n,3n)a

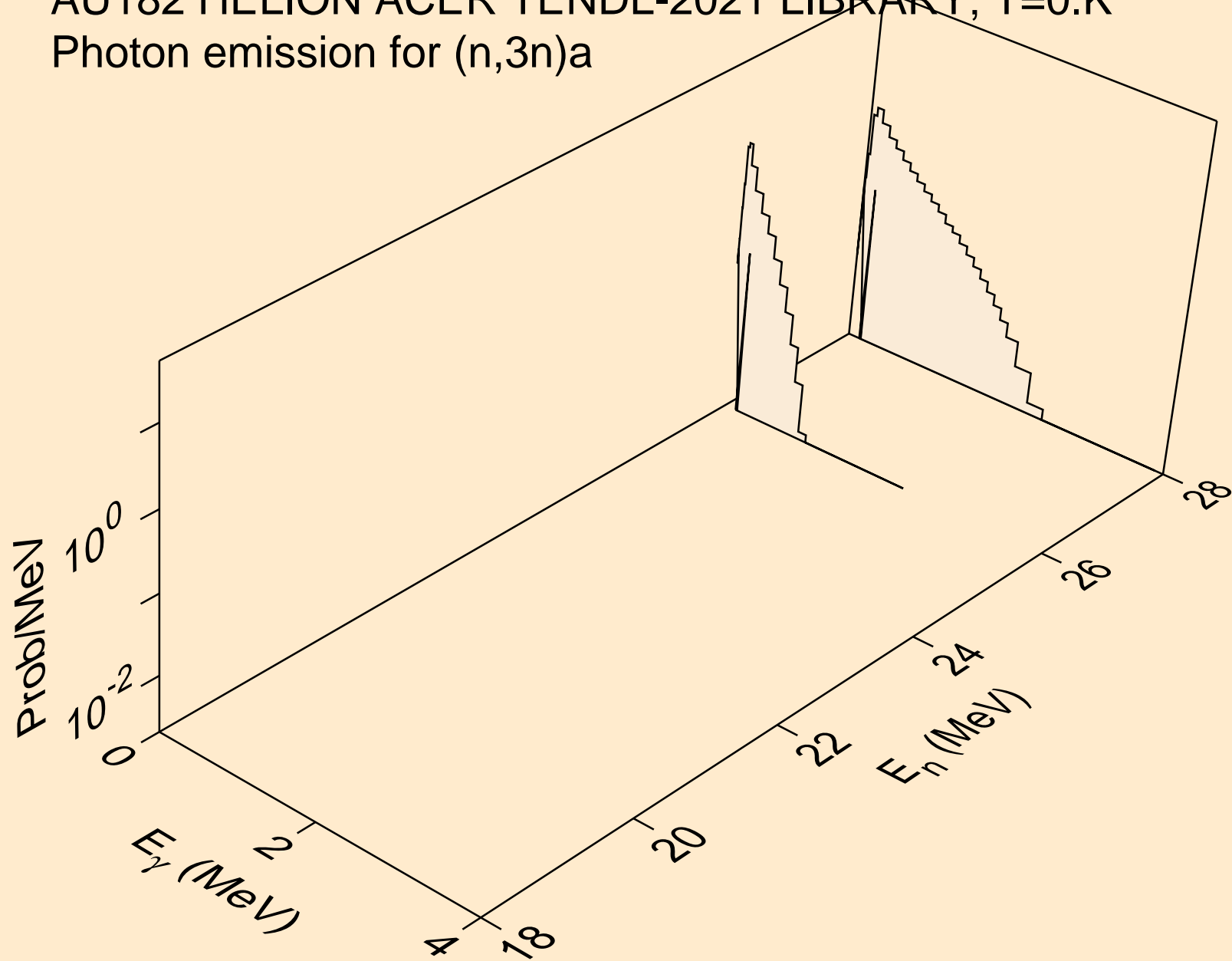

AU182 HELION ACER TENDL-2021 LIBRARY; T=0.K  
Photon emission for (n,n\*)p

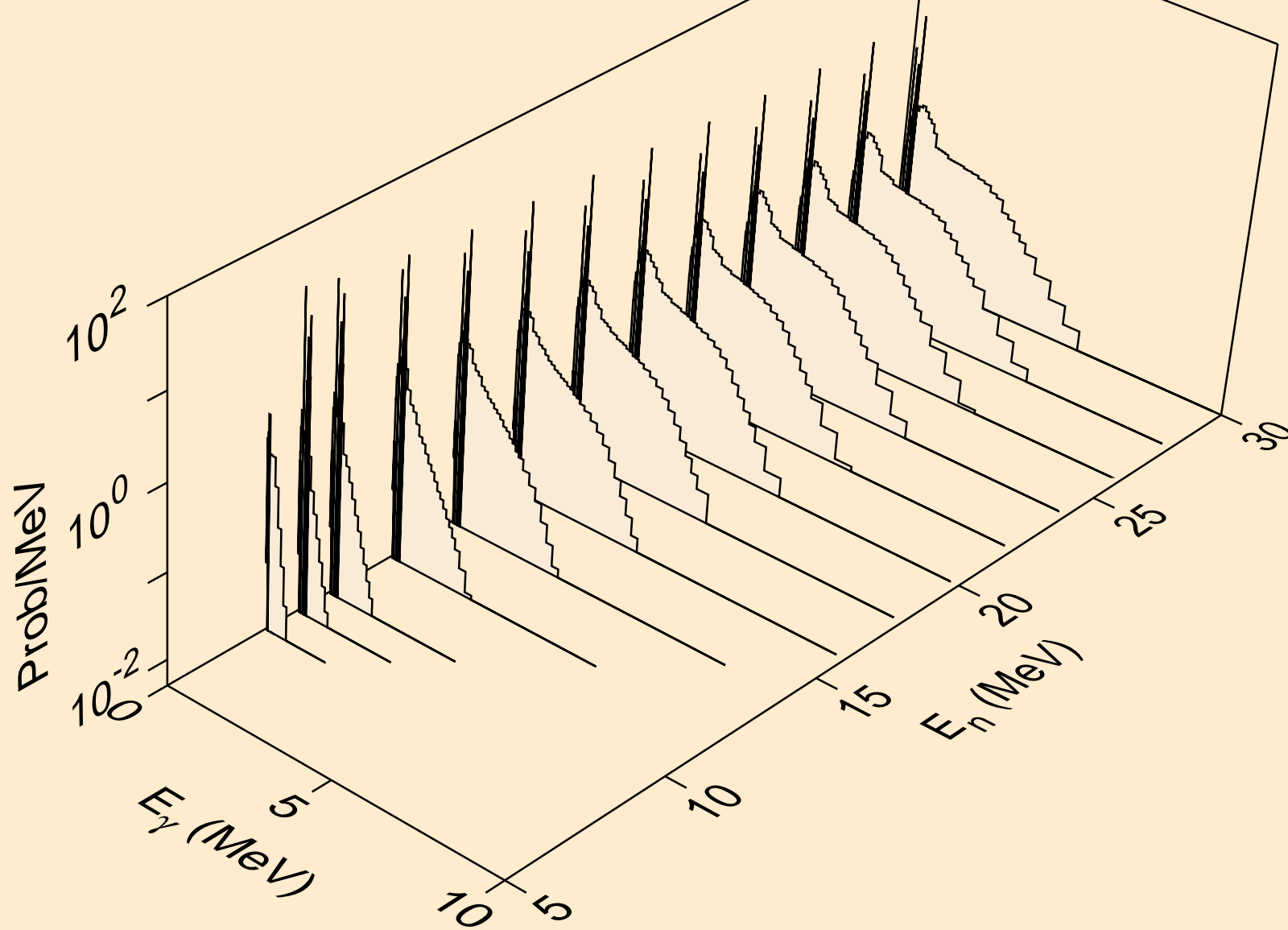

AU182 HELION ACER TENDL-2021 LIBRARY; T=0.K  
Photon emission for (n,n\*)2a

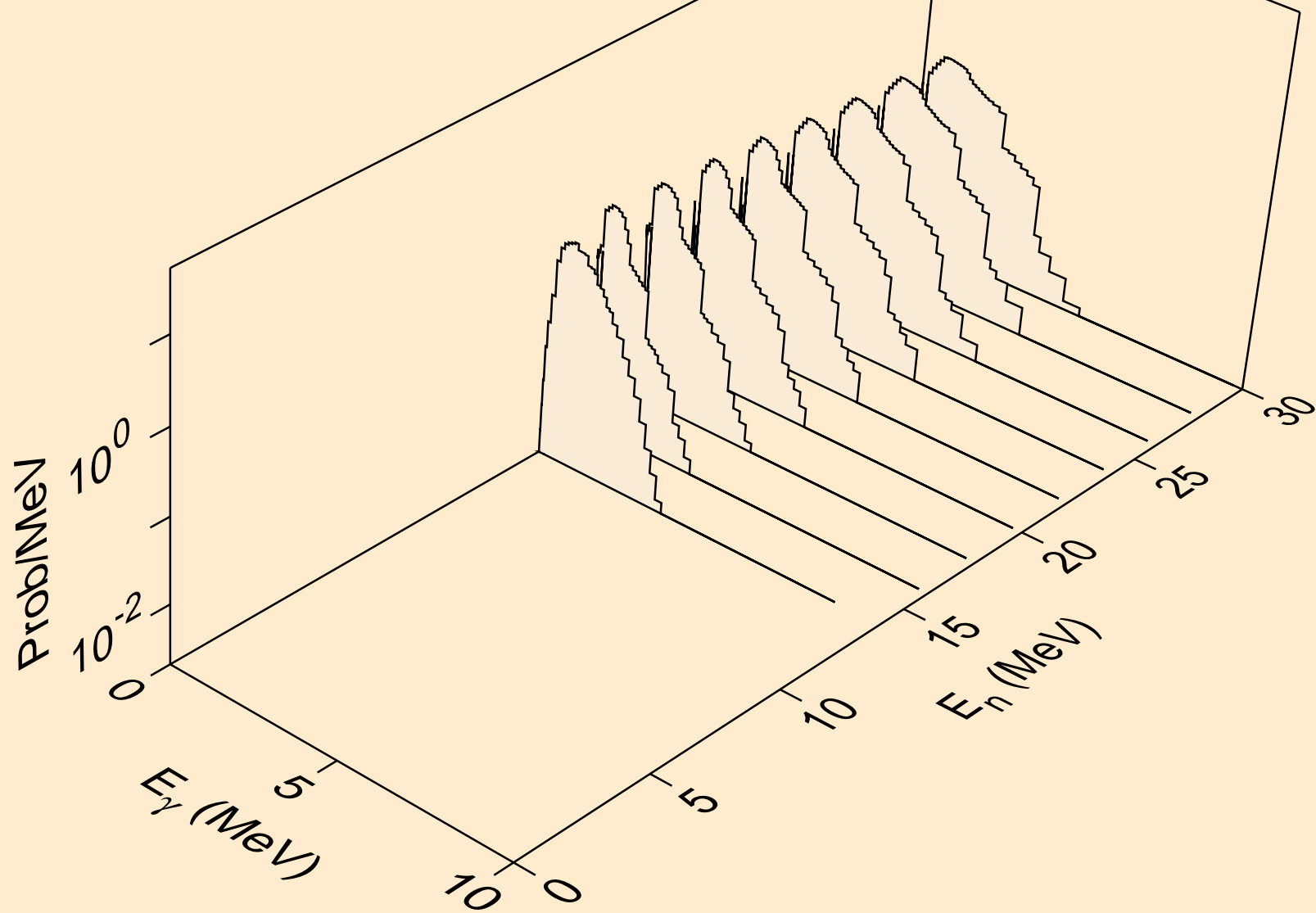

AU182 HELION ACER TENDL-2021 LIBRARY; T=0.K  
Photon emission for (n,n\*)d

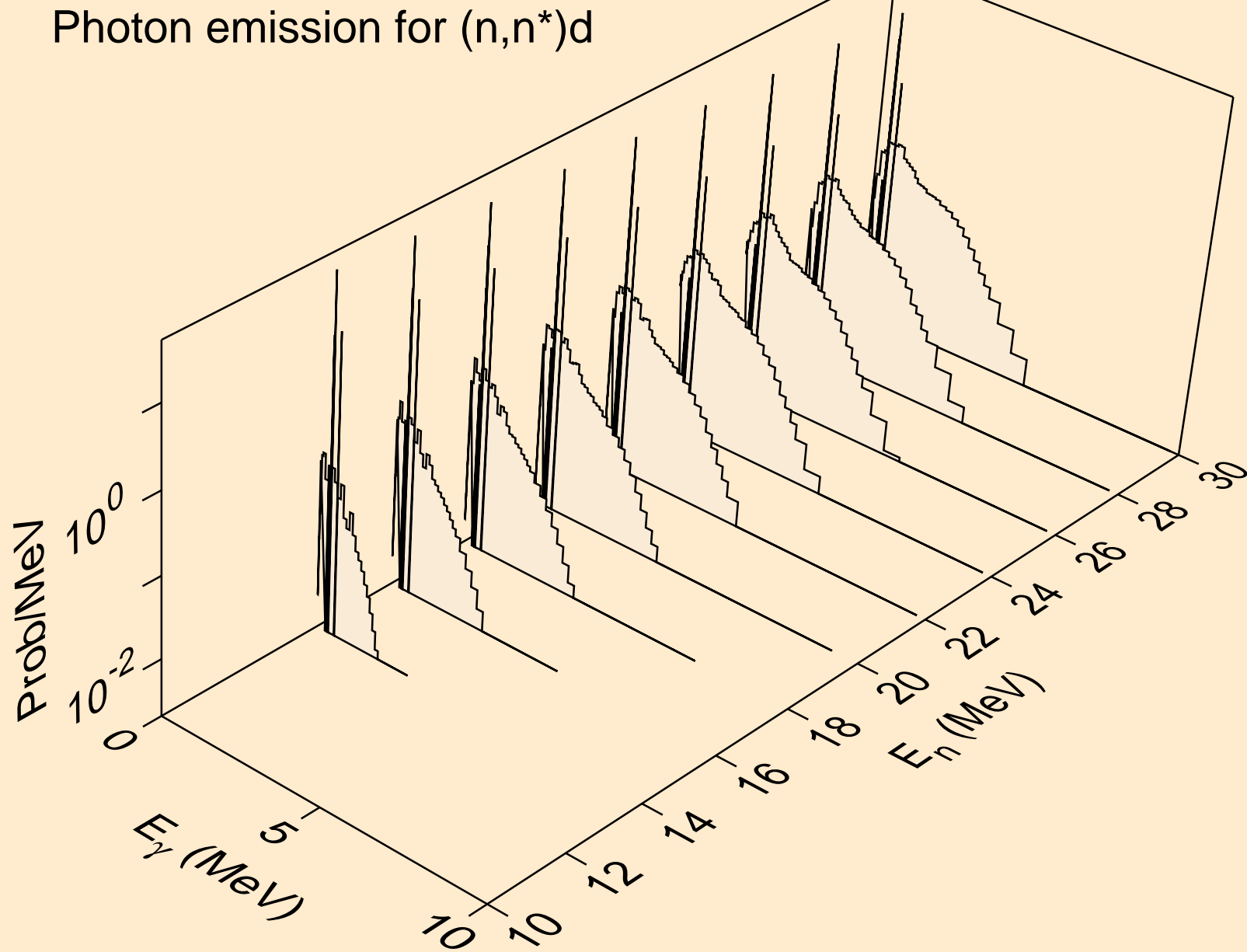

AU182 HELION ACER TENDL-2021 LIBRARY; T=0.K  
Photon emission for (n,n\*)t

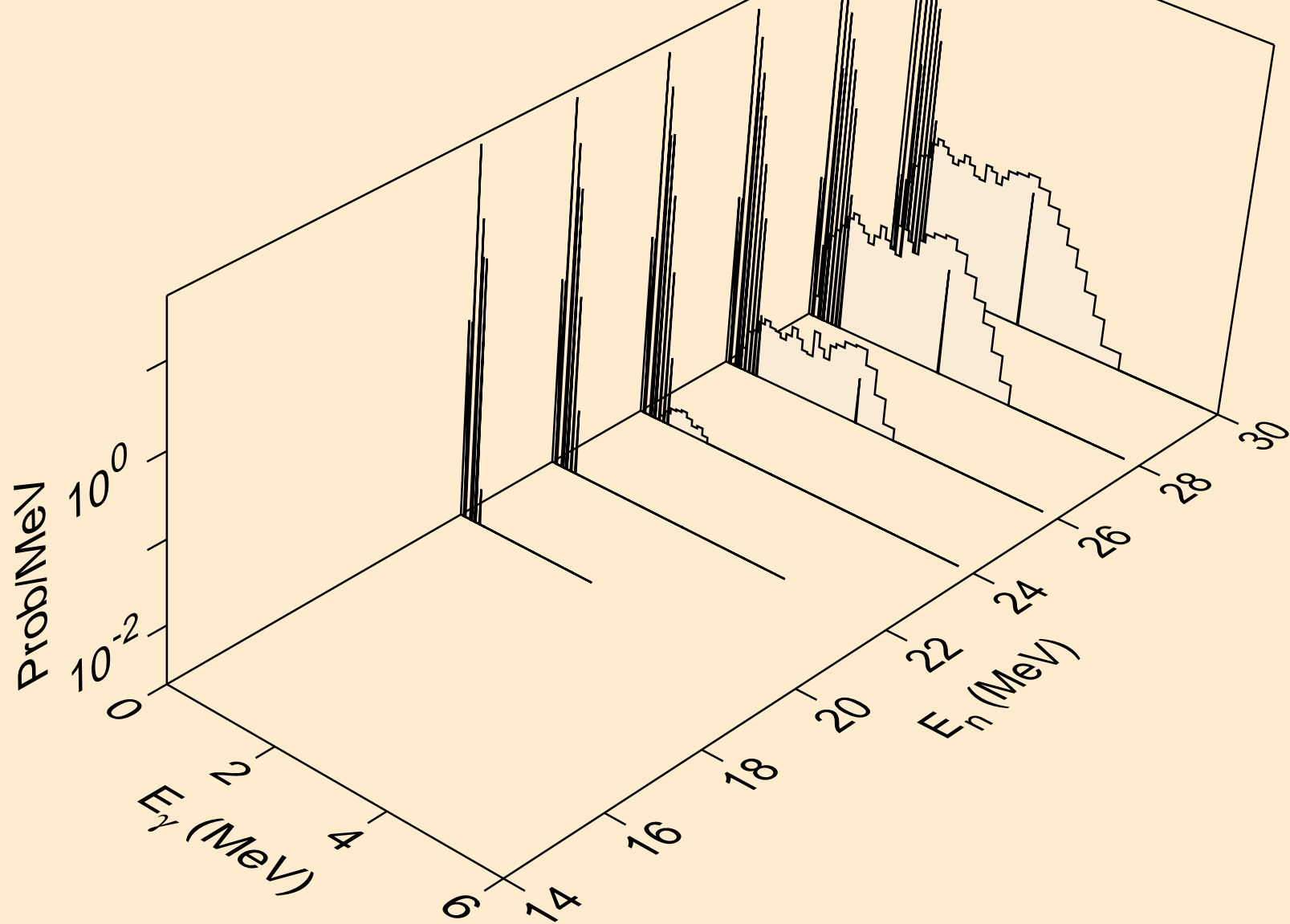

AU182 HELION ACER TENDL-2021 LIBRARY; T=0.K  
Photon emission for (n,n\*)he3

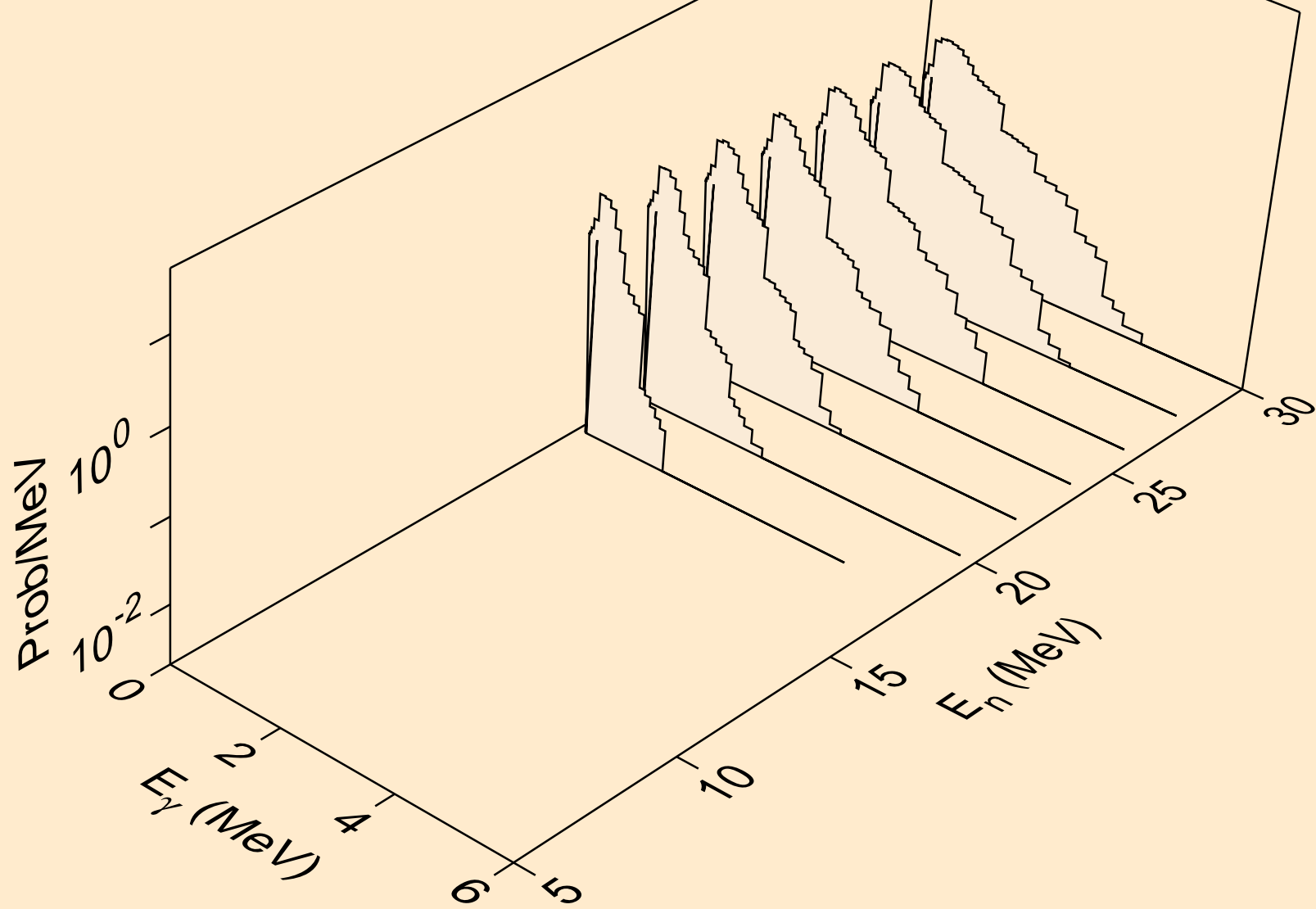

AU182 HELION ACER TENDL-2021 LIBRARY; T=0.K  
Photon emission for (n,2np)

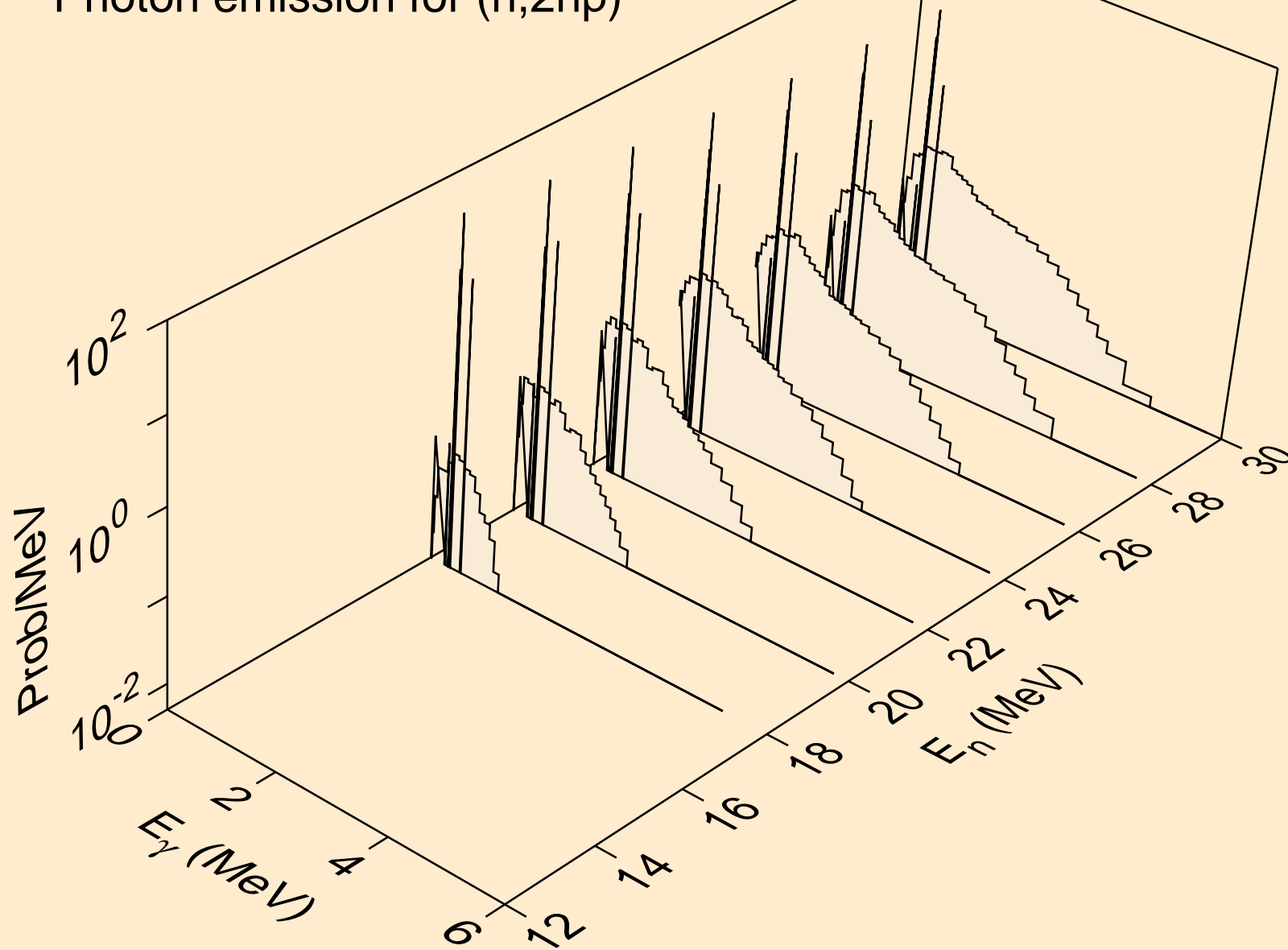

AU182 HELION ACER TENDL-2021 LIBRARY; T=0.K  
Photon emission for (n,3np)

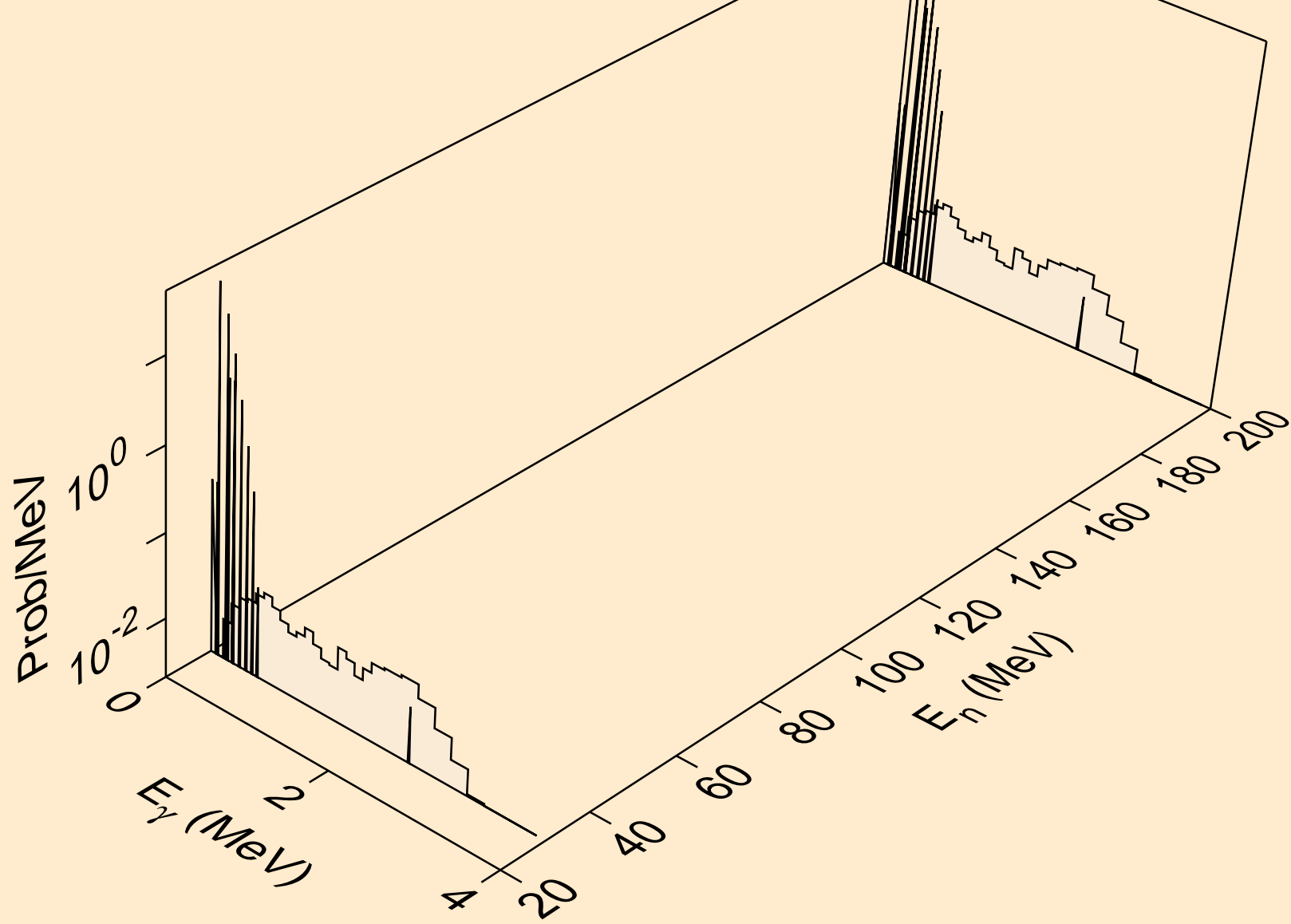



AU182 HELION ACER TENDL-2021 LIBRARY; T=0.K  
Photon emission for (n,2np)

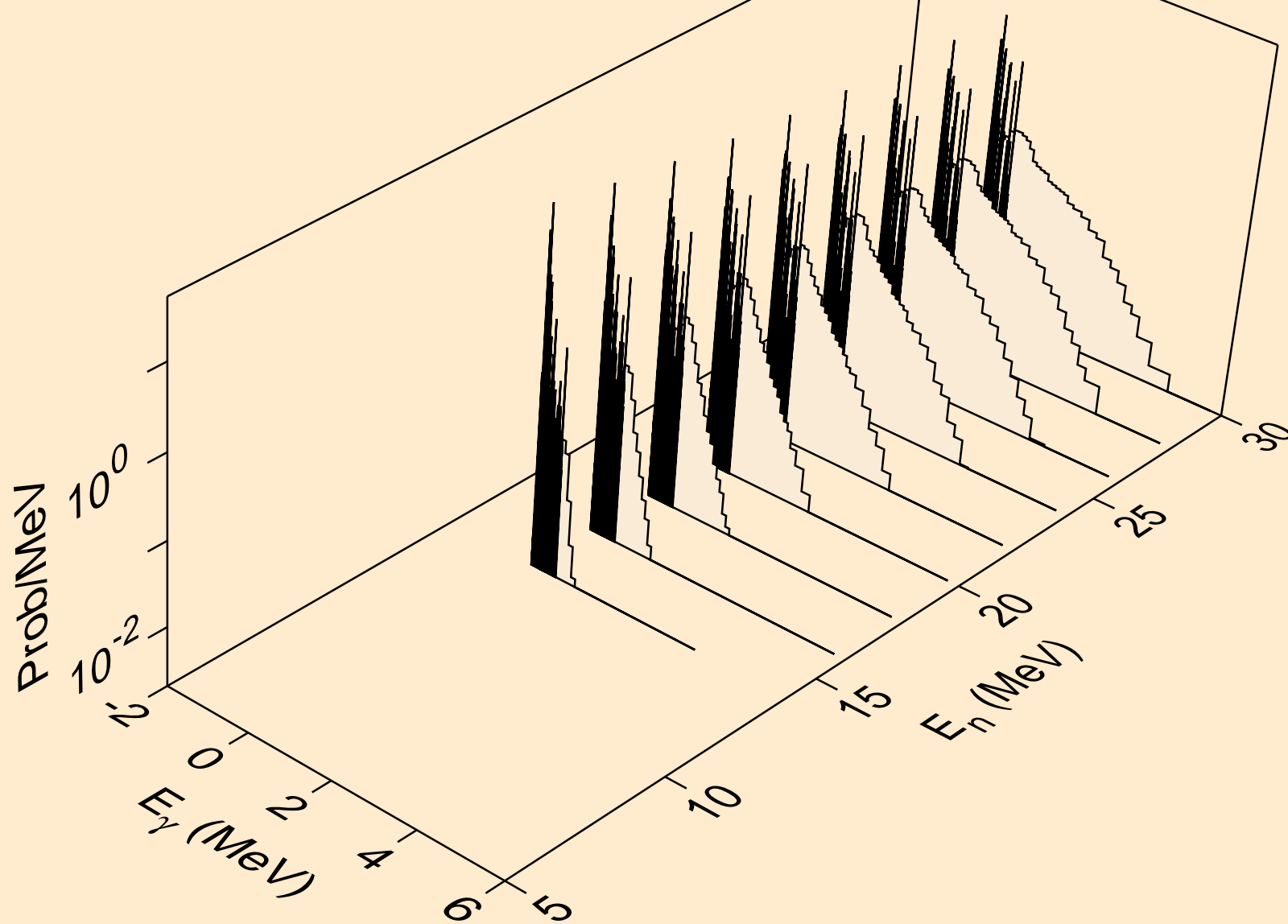

AU182 HELION ACER TENDL-2021 LIBRARY; T=0.K  
Photon emission for (n,npa)

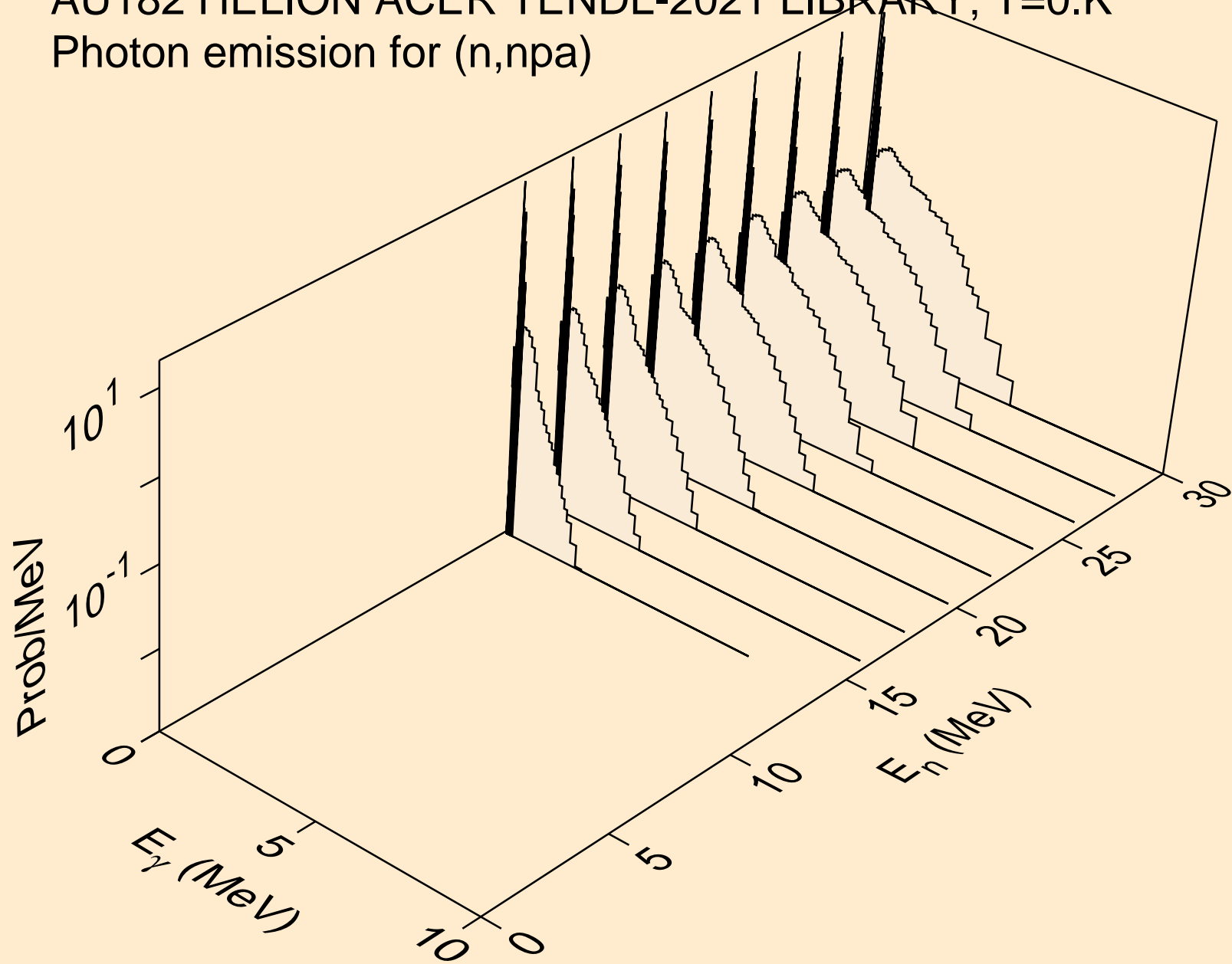

AU182 HELION ACER TENDL-2021 LIBRARY; T=0.K  
Photon emission for (n,gma)

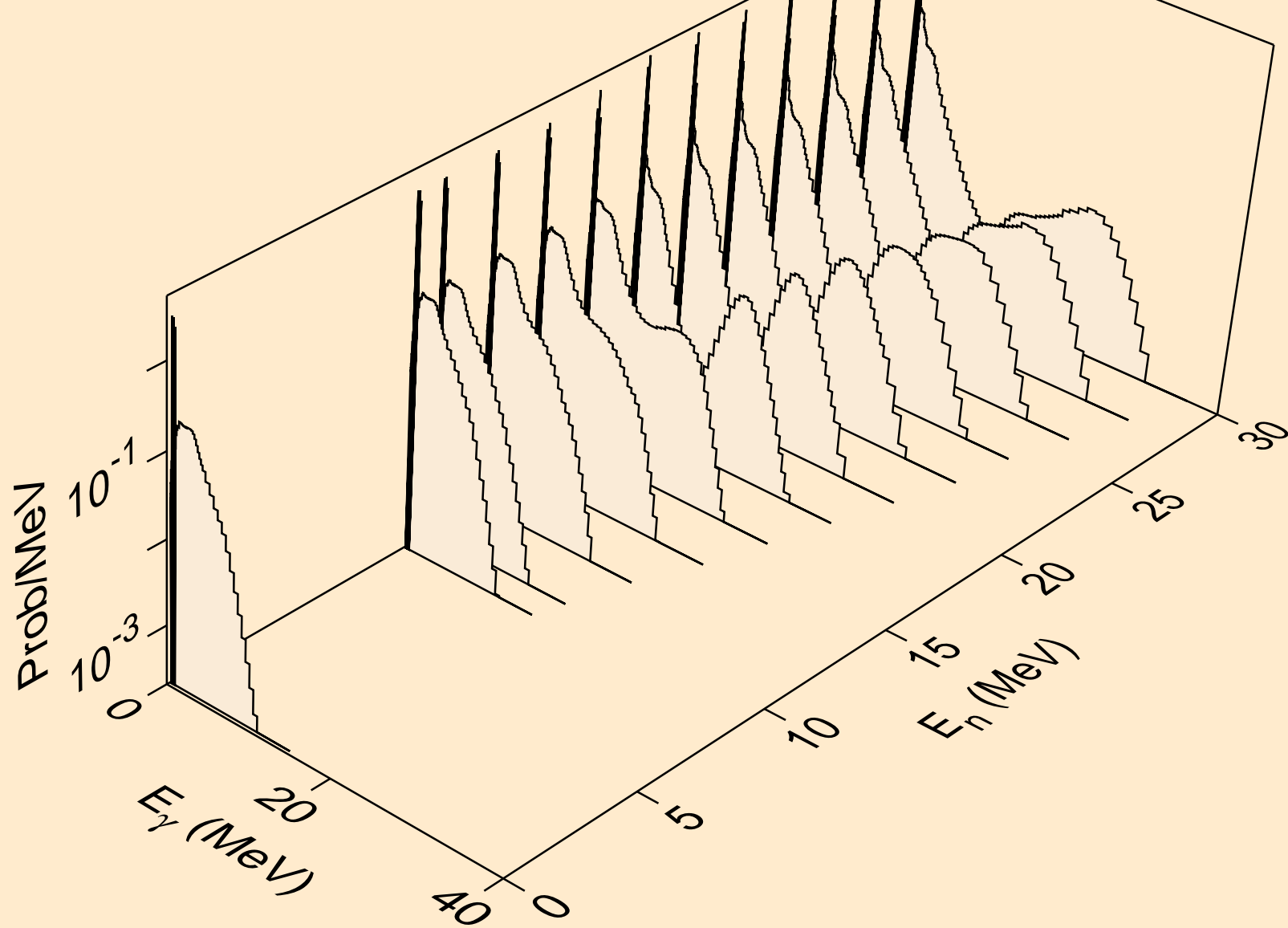

AU182 HELION ACER TENDL-2021 LIBRARY; T=0.K  
Photon emission for (n,p)

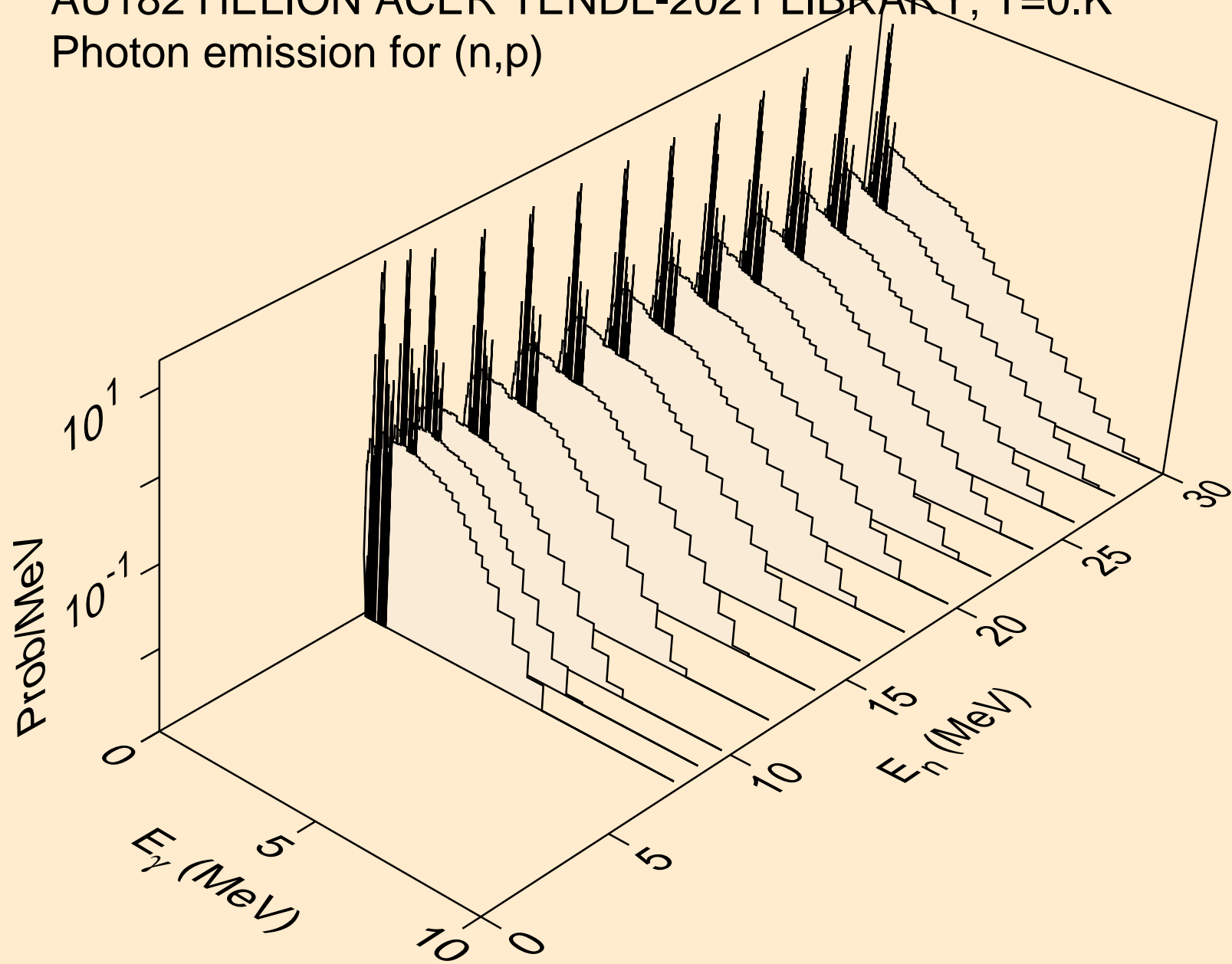

AU182 HELION ACER TENDL-2021 LIBRARY; T=0.K  
Photon emission for (n,d)

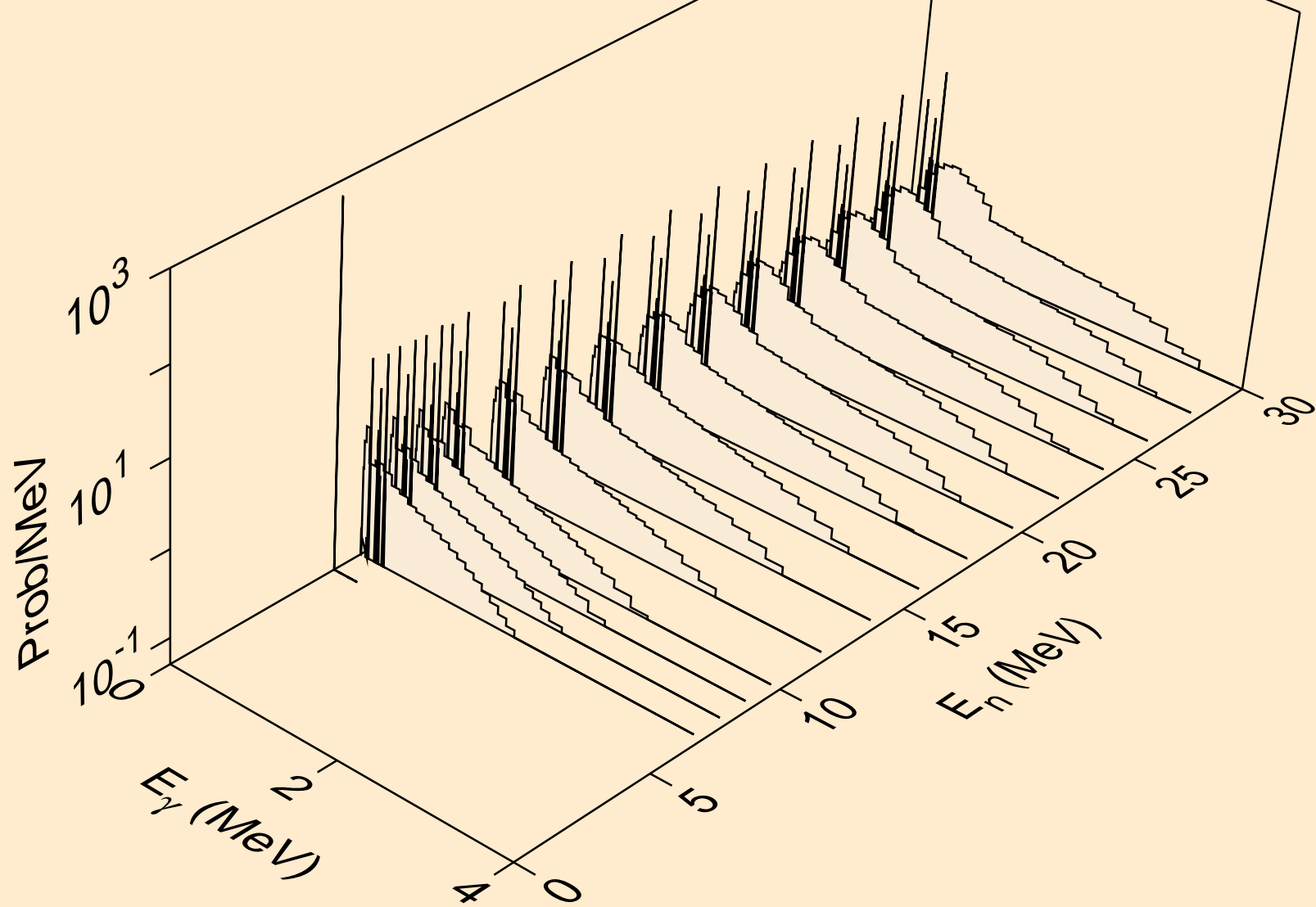

AU182 HELION ACER TENDL-2021 LIBRARY; T=0.K  
Photon emission for (n,t)

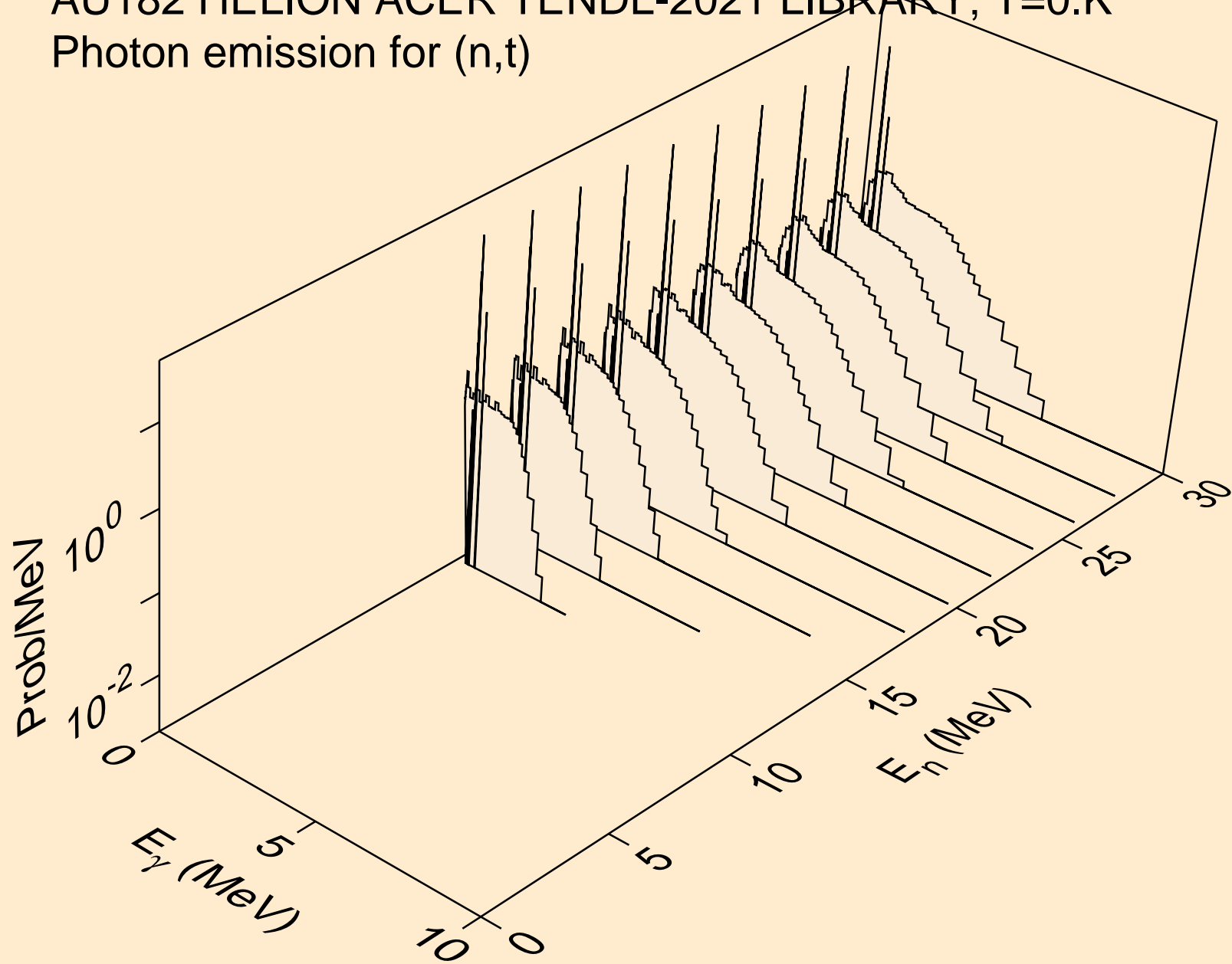

AU182 HELION ACER TENDL-2021 LIBRARY; T=0.K  
Photon emission for inelastic

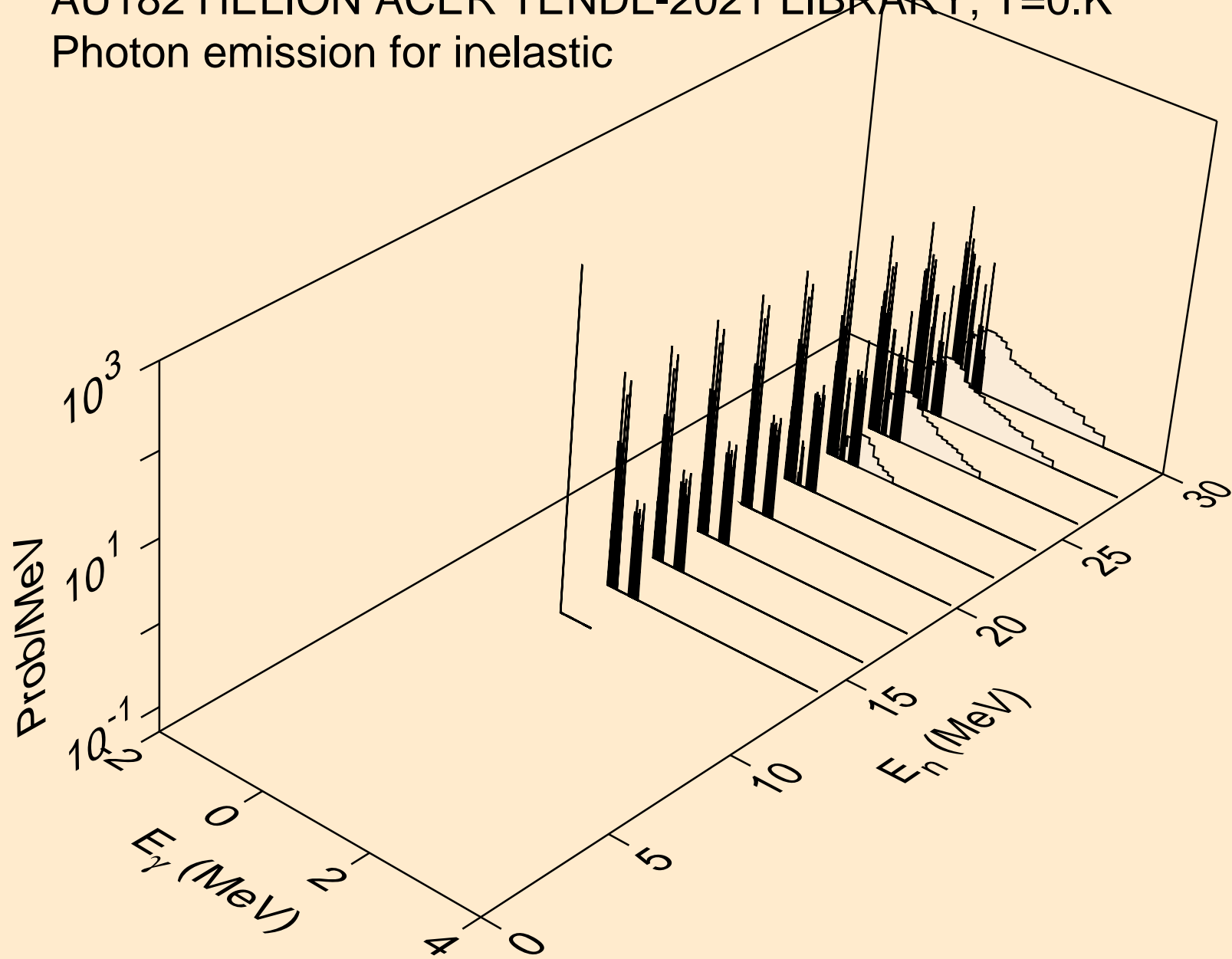

AU182 HELION ACER TENDL-2021 LIBRARY; T=0.K  
Photon emission for (n,a)

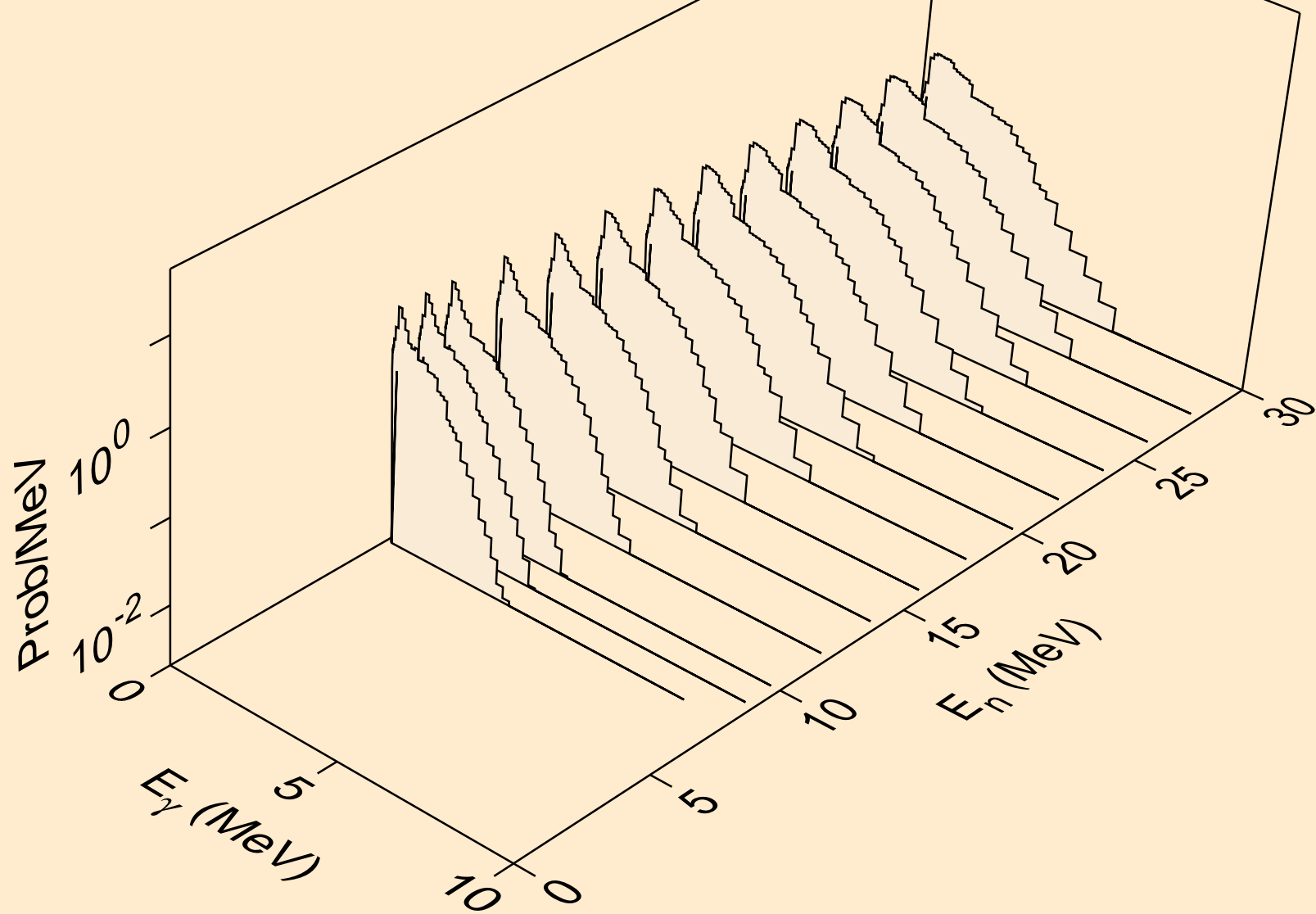



AU182 HELION ACER TENDL-2021 LIBRARY; T=0.K  
Photon emission for (n,2a)

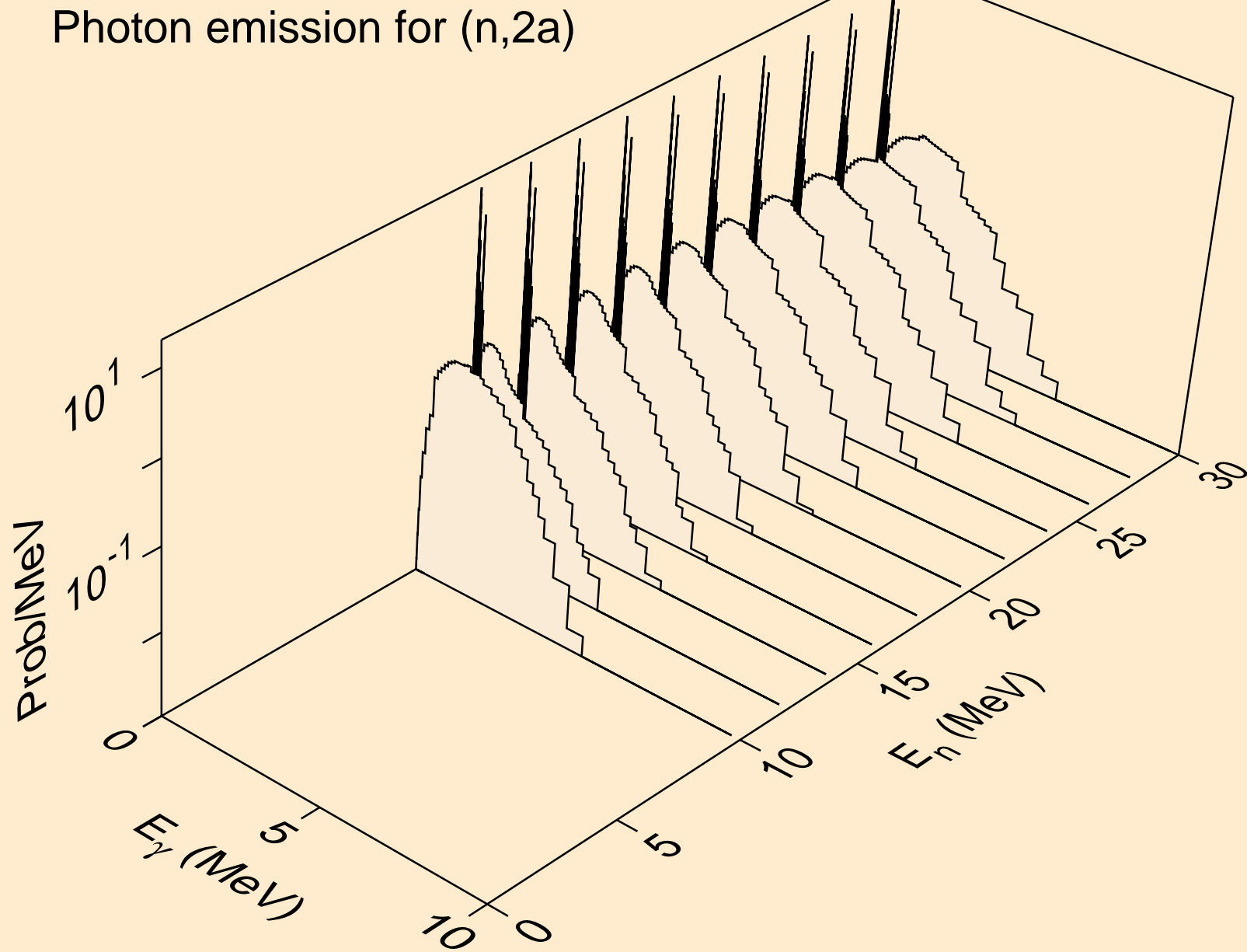

AU182 HELION ACER TENDL-2021 LIBRARY; T=0.K  
Photon emission for (n,2p)

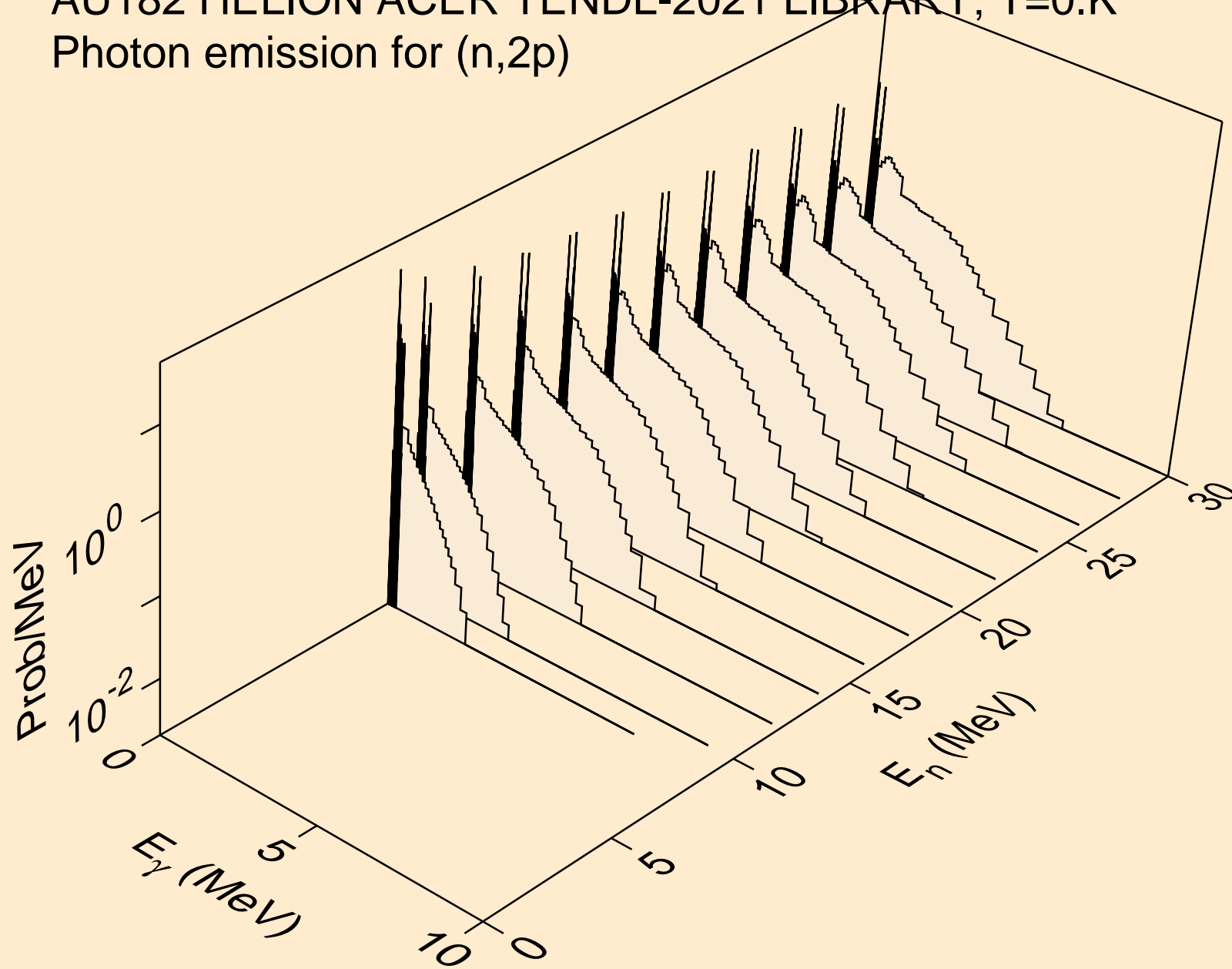

AU182 HELION ACER TENDL-2021 LIBRARY; T=0.K  
Photon emission for (n,pa)

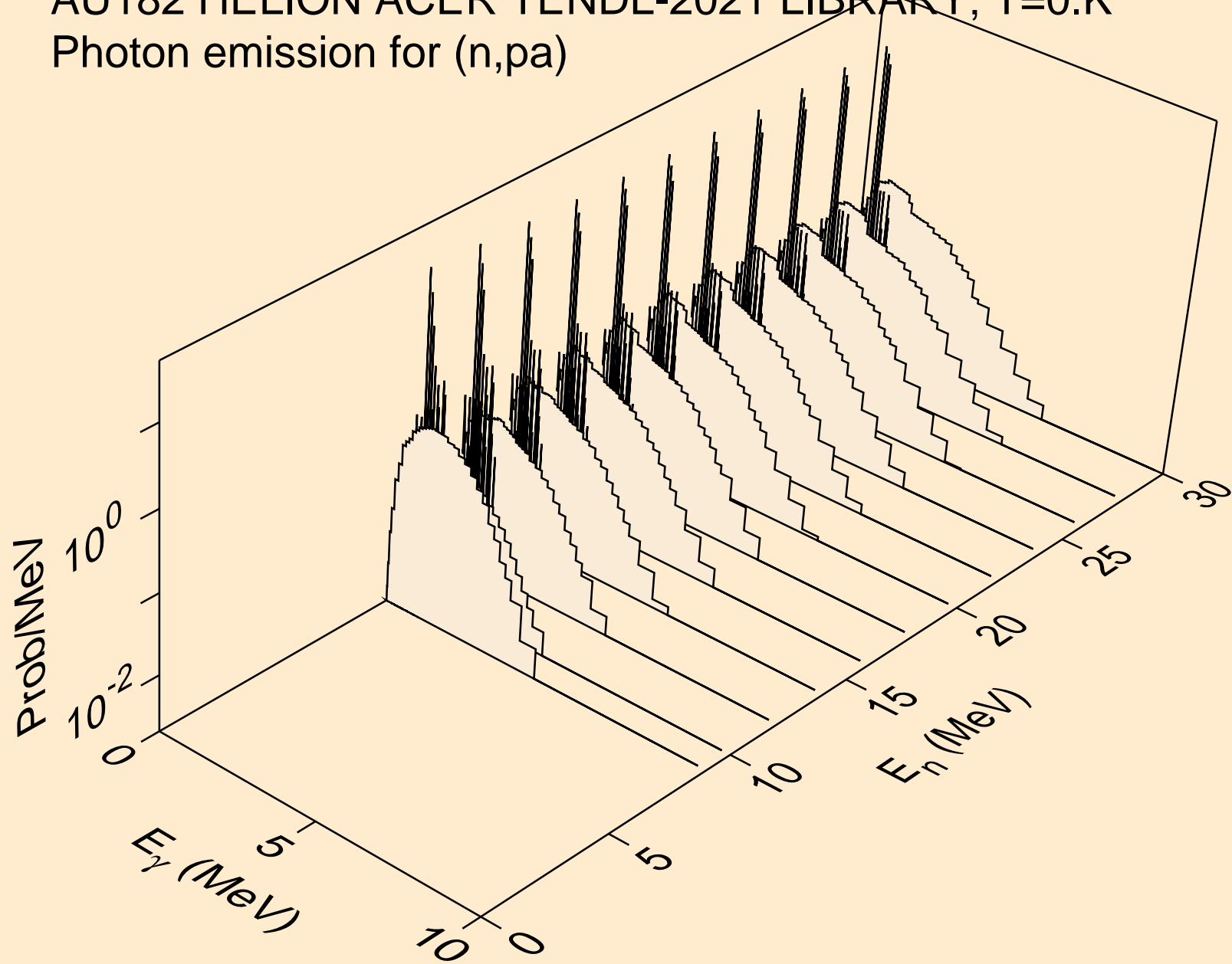

AU182 HELION ACER TENDL-2021 LIBRARY; T=0.K  
Photon emission for (n,t2a)

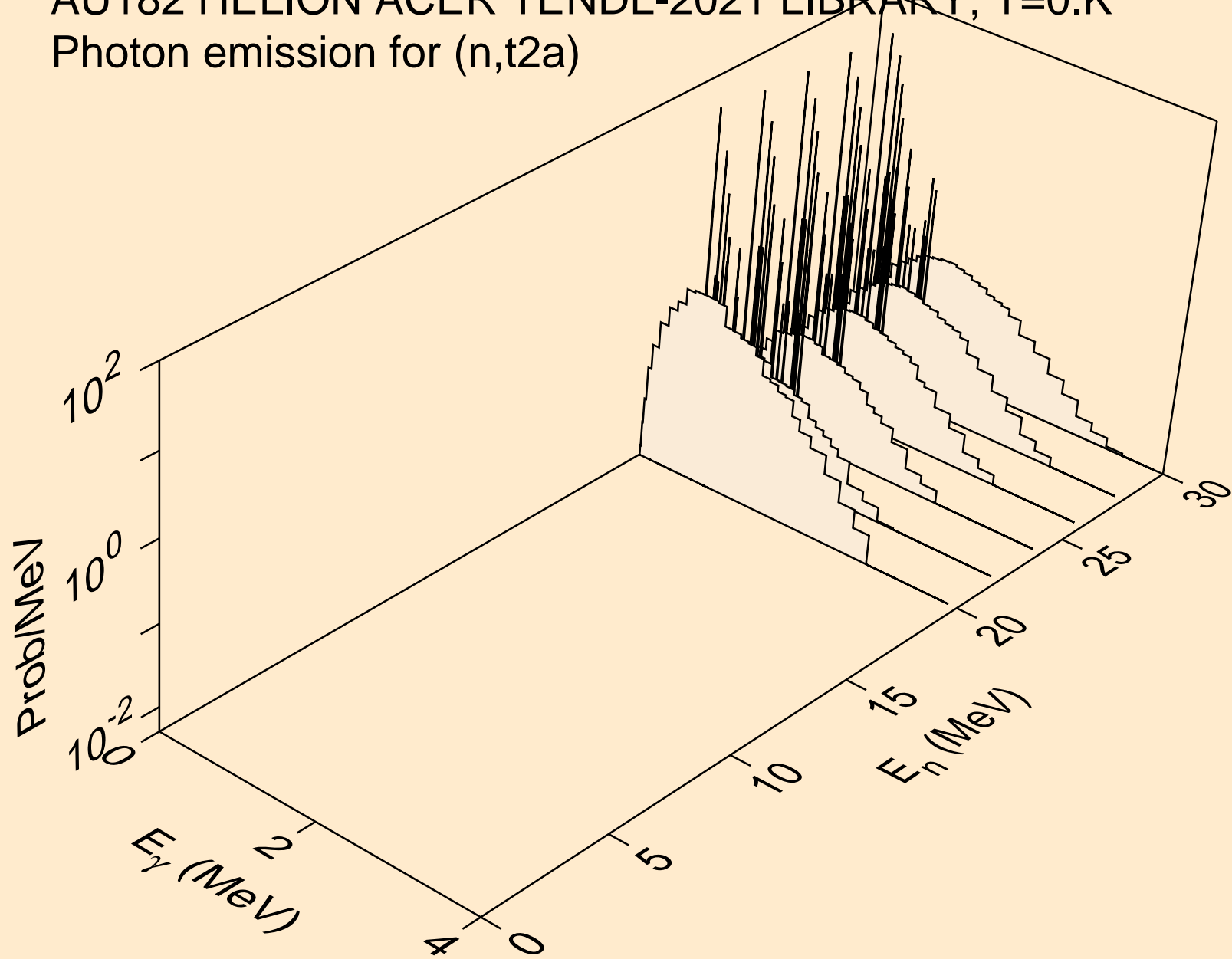

AU182 HELION ACER TENDL-2021 LIBRARY; T=0.K  
Photon emission for (n,d2a)

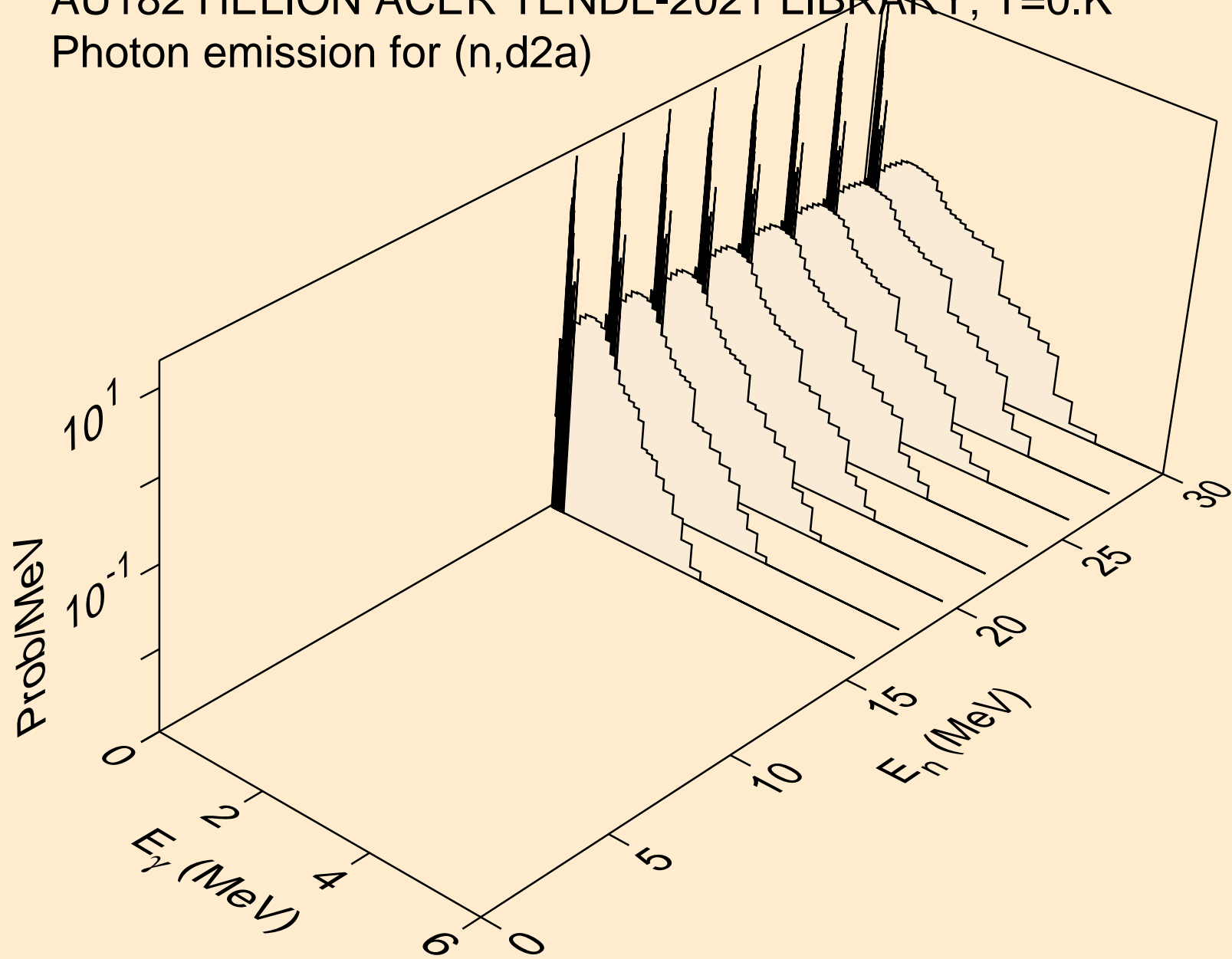

AU182 HELION ACER TENDL-2021 LIBRARY; T=0.K  
Photon emission for (n,pd)

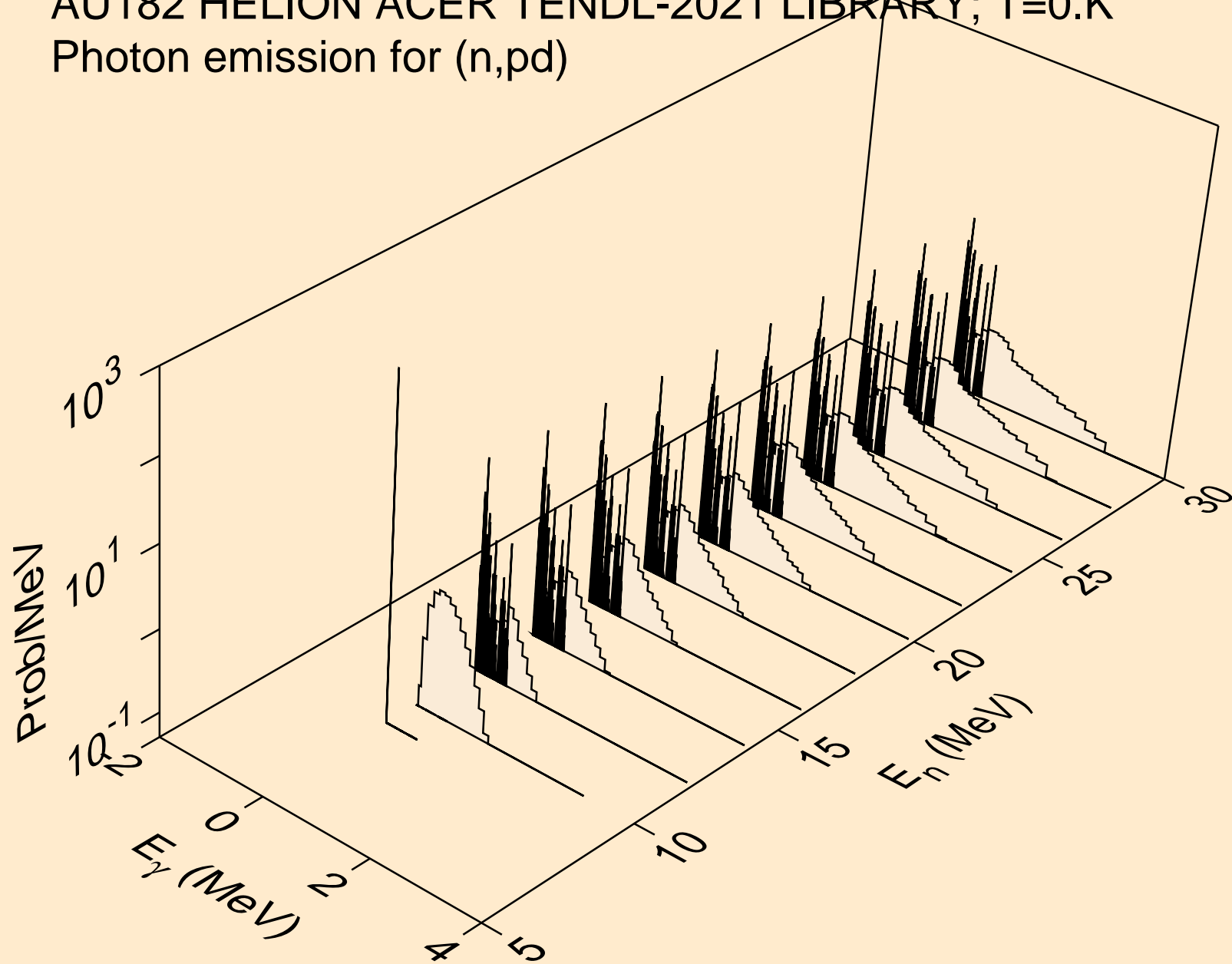

AU182 HELION ACER TENDL-2021 LIBRARY; T=0.K  
Photon emission for (n,pt)

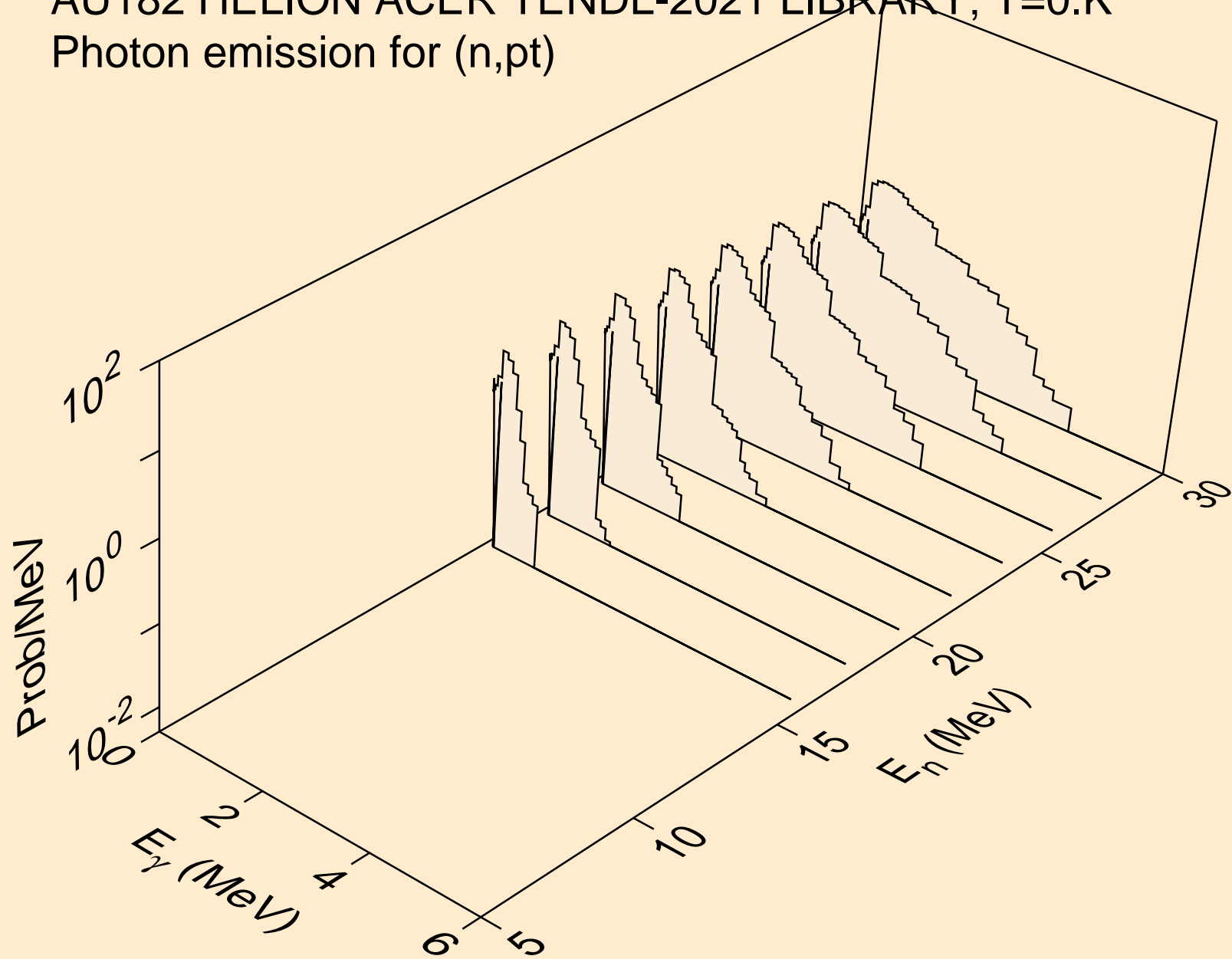

AU182 HELION ACER TENDL-2021 LIBRARY; T=0.K  
Photon emission for (n,da)

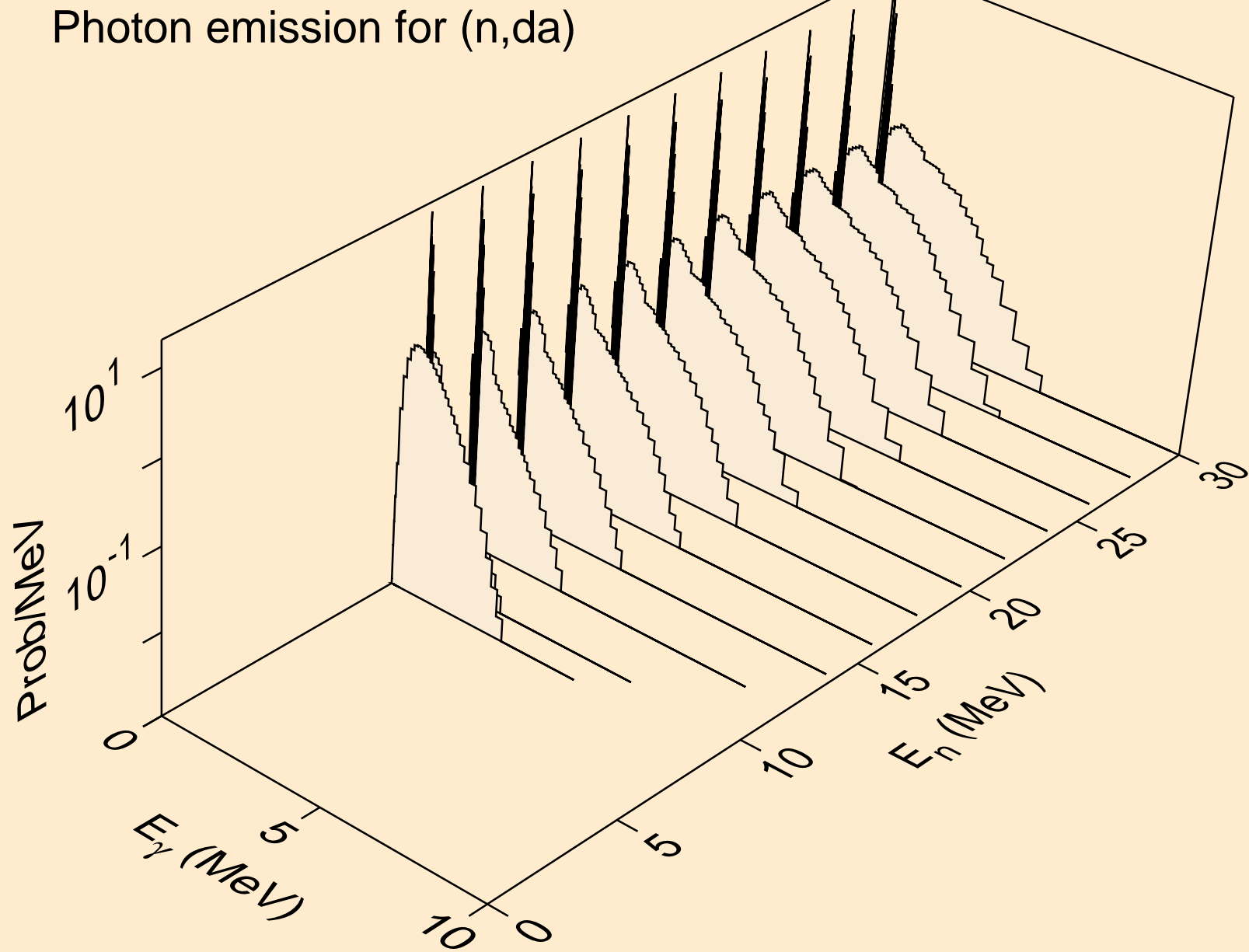



AU182 HELION ACER TENDL-2021 LIBRARY; T=0.K  
Particle heating contributions

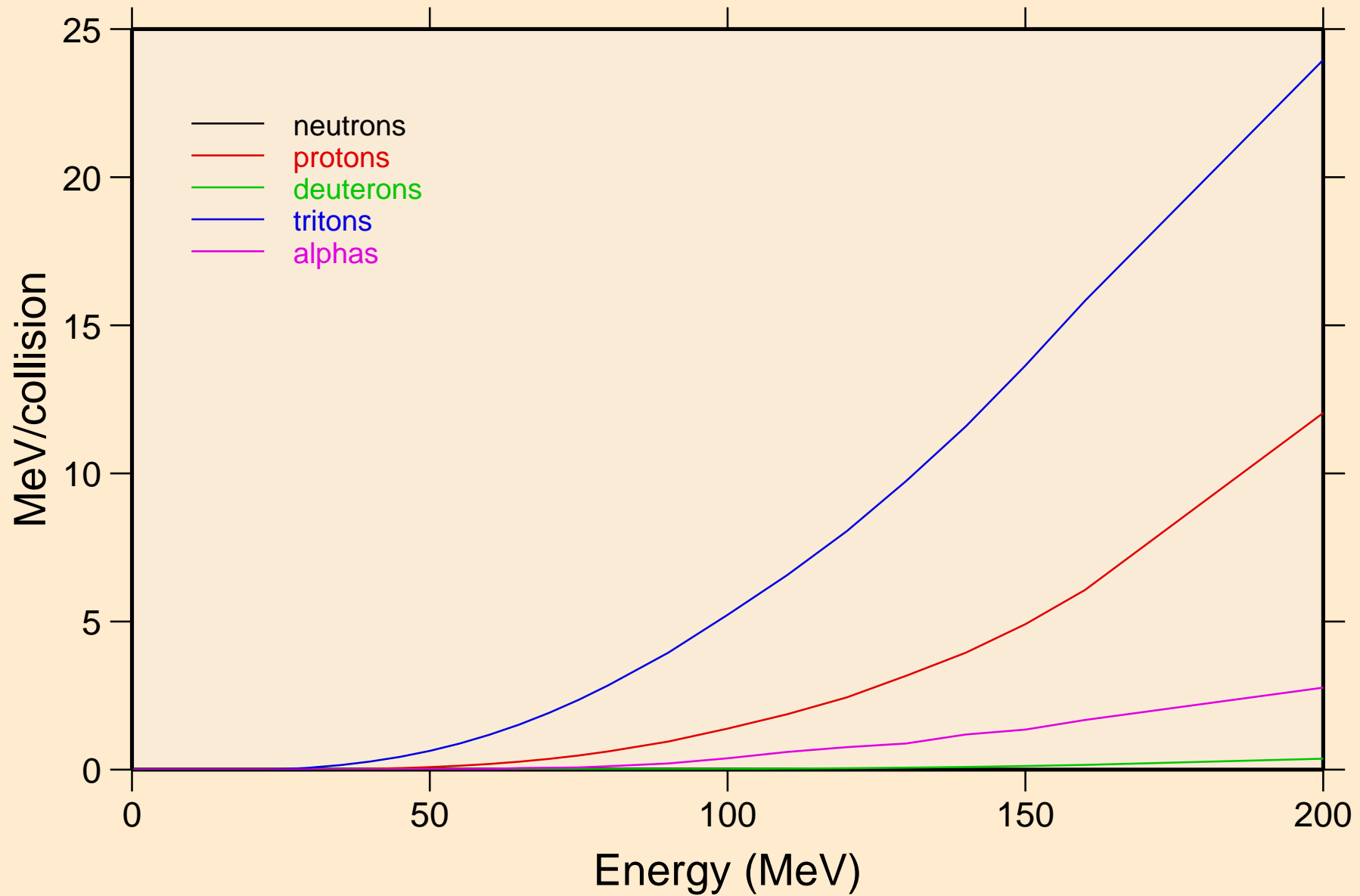

AU182 HELION ACER TENDL-2021 LIBRARY; T=0.K  
Recoil Heating

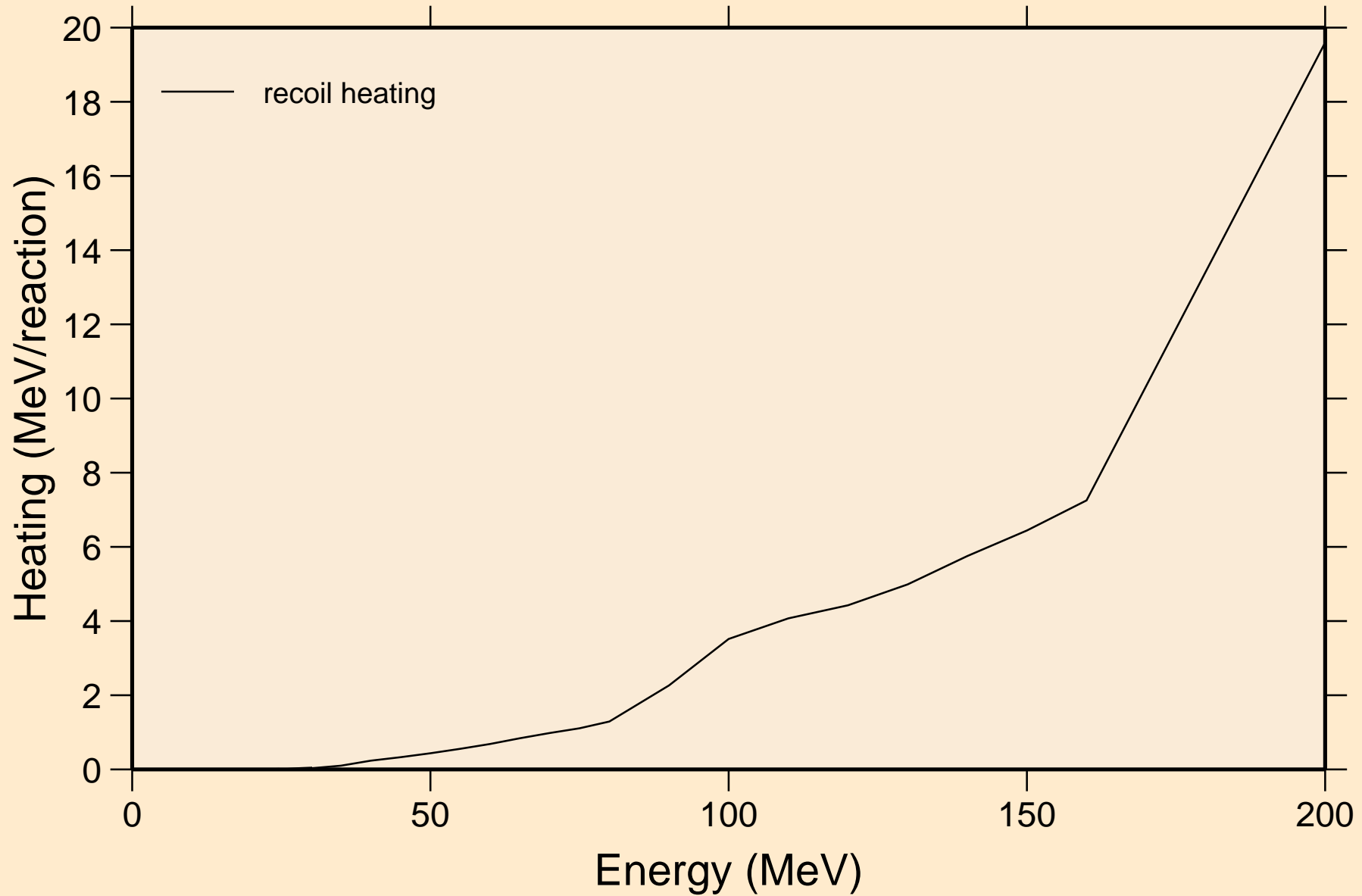

AU182 HELION ACER TENDL-2021 LIBRARY; T=0.K  
Particle production cross sections

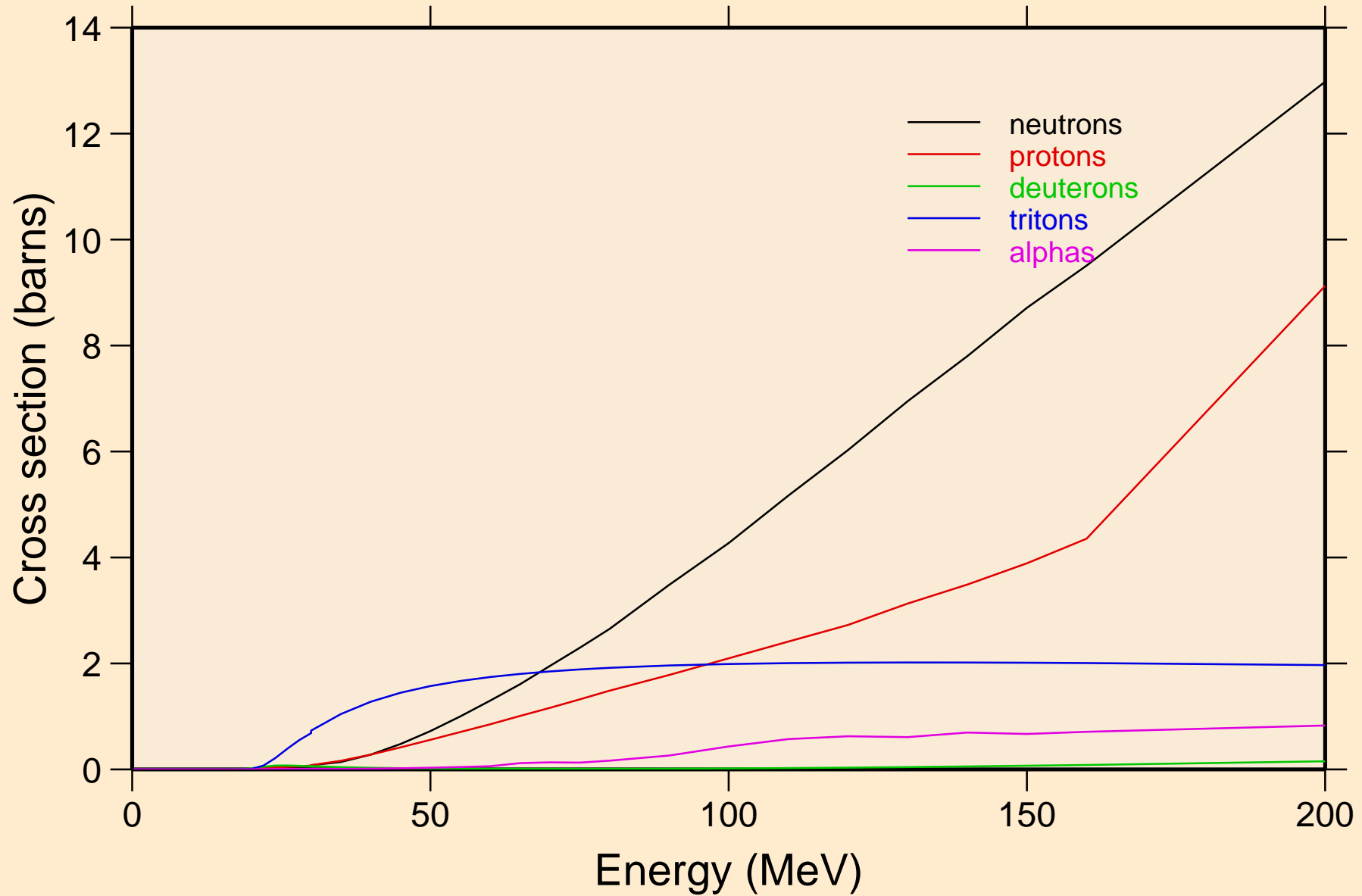

AU182 HELION ACER TENDL-2021 LIBRARY; T=0.K  
neutrons from (s,n)

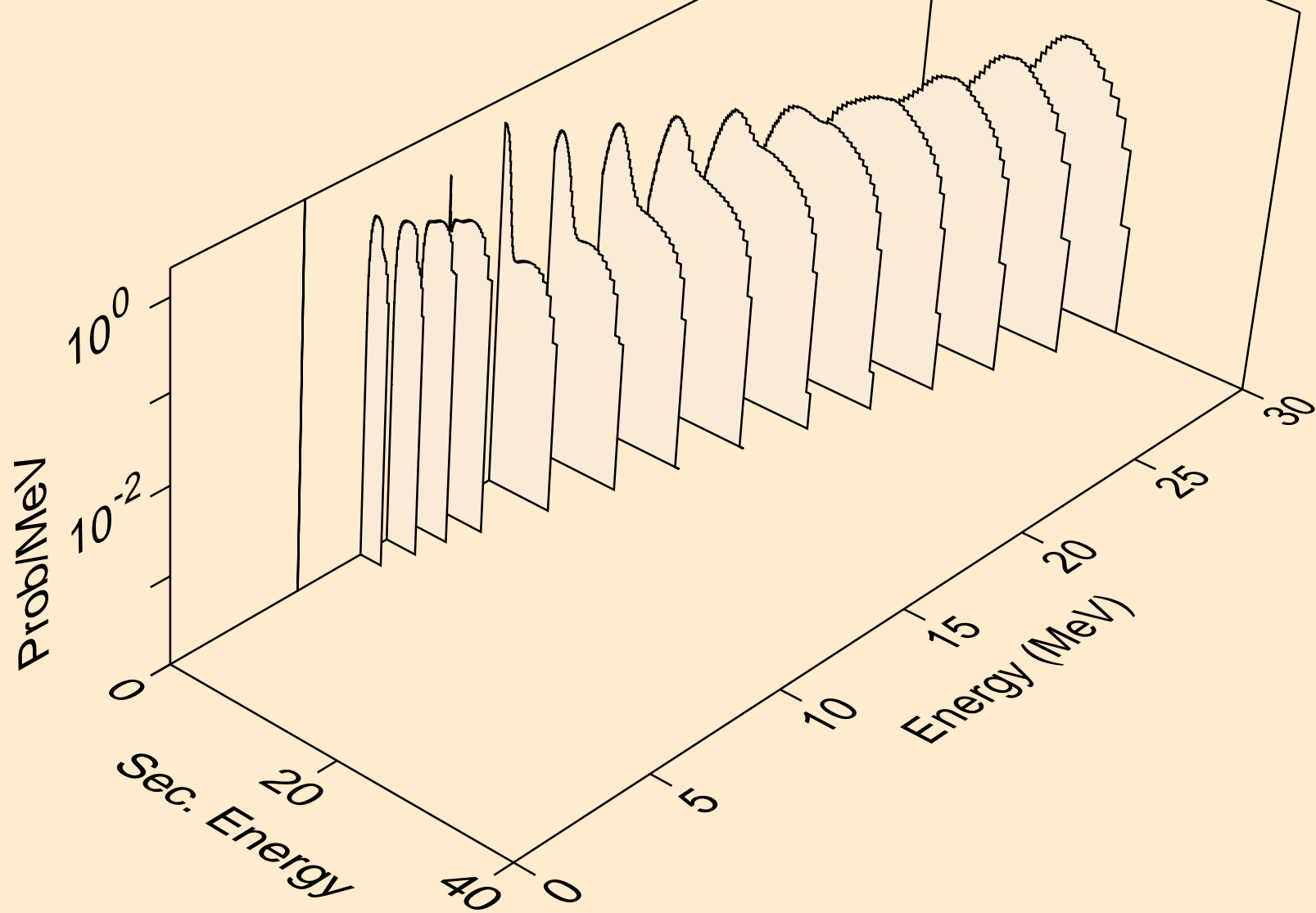

AU182 HELION ACER TENDL-2021 LIBRARY; T=0.K  
neutrons from (s,x)

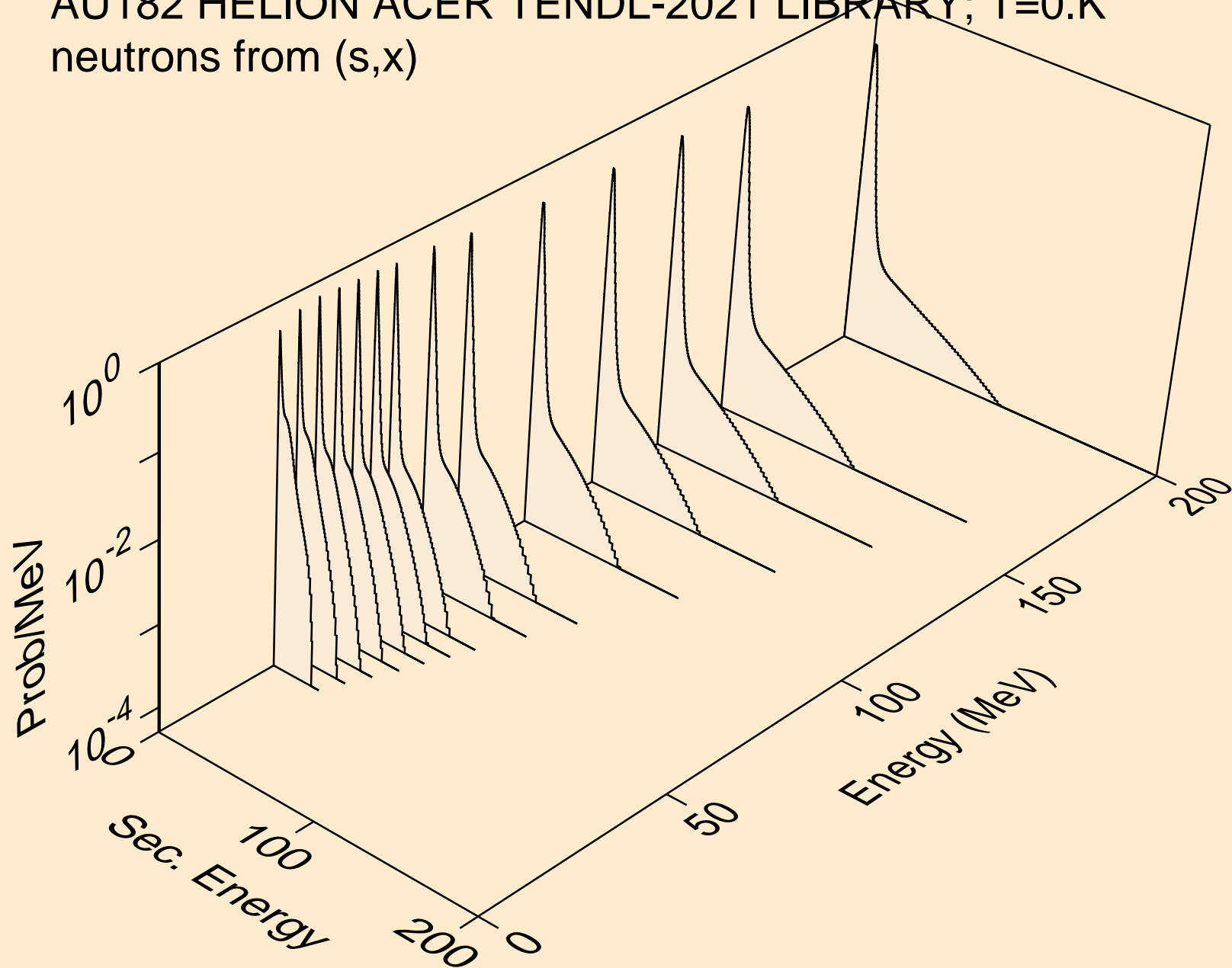

AU182 HELION ACER TENDL-2021 LIBRARY; T=0.K  
neutrons from (s,2nd)

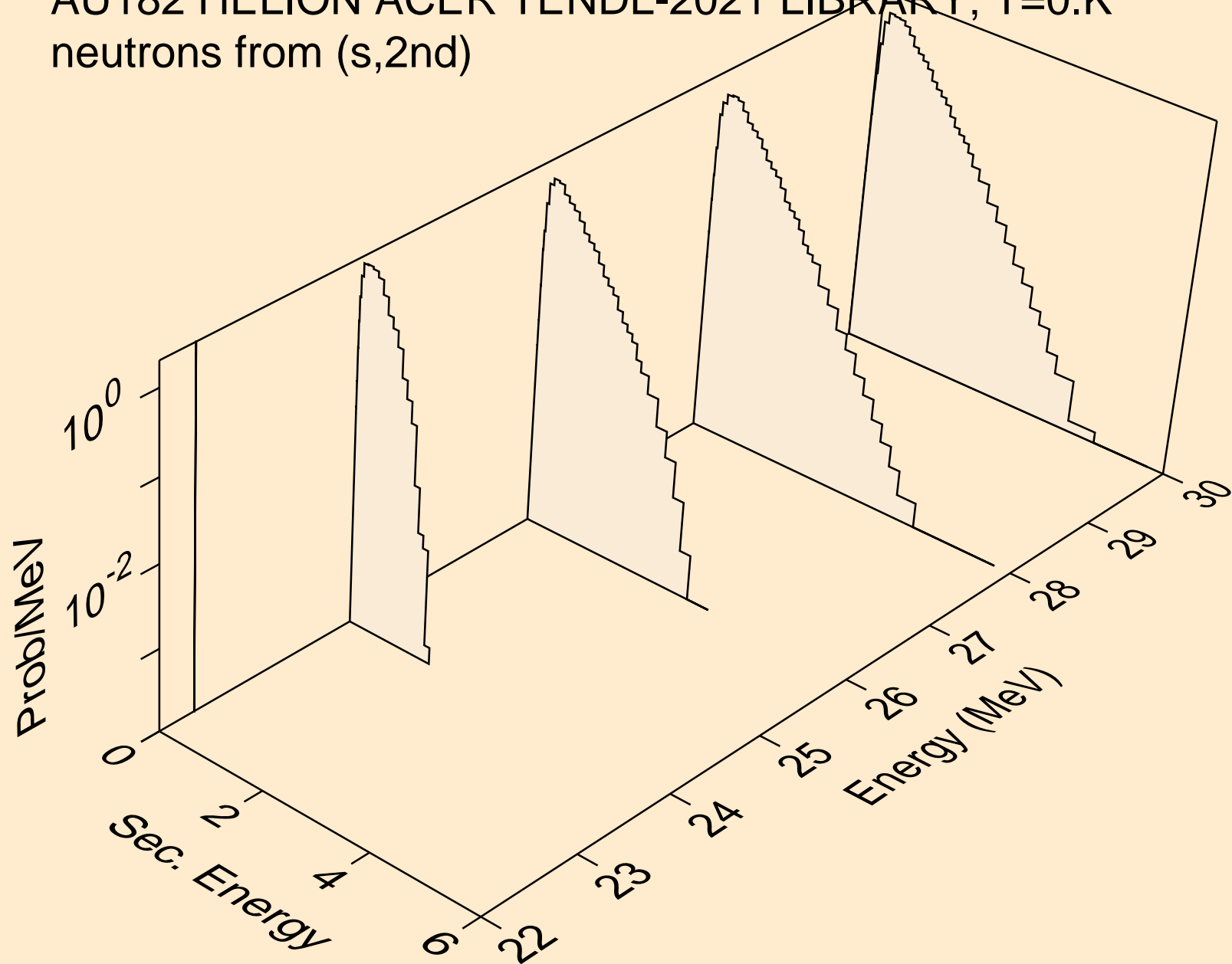

AU182 HELION ACER TENDL-2021 LIBRARY; T=0.K  
neutrons from (s,2n)

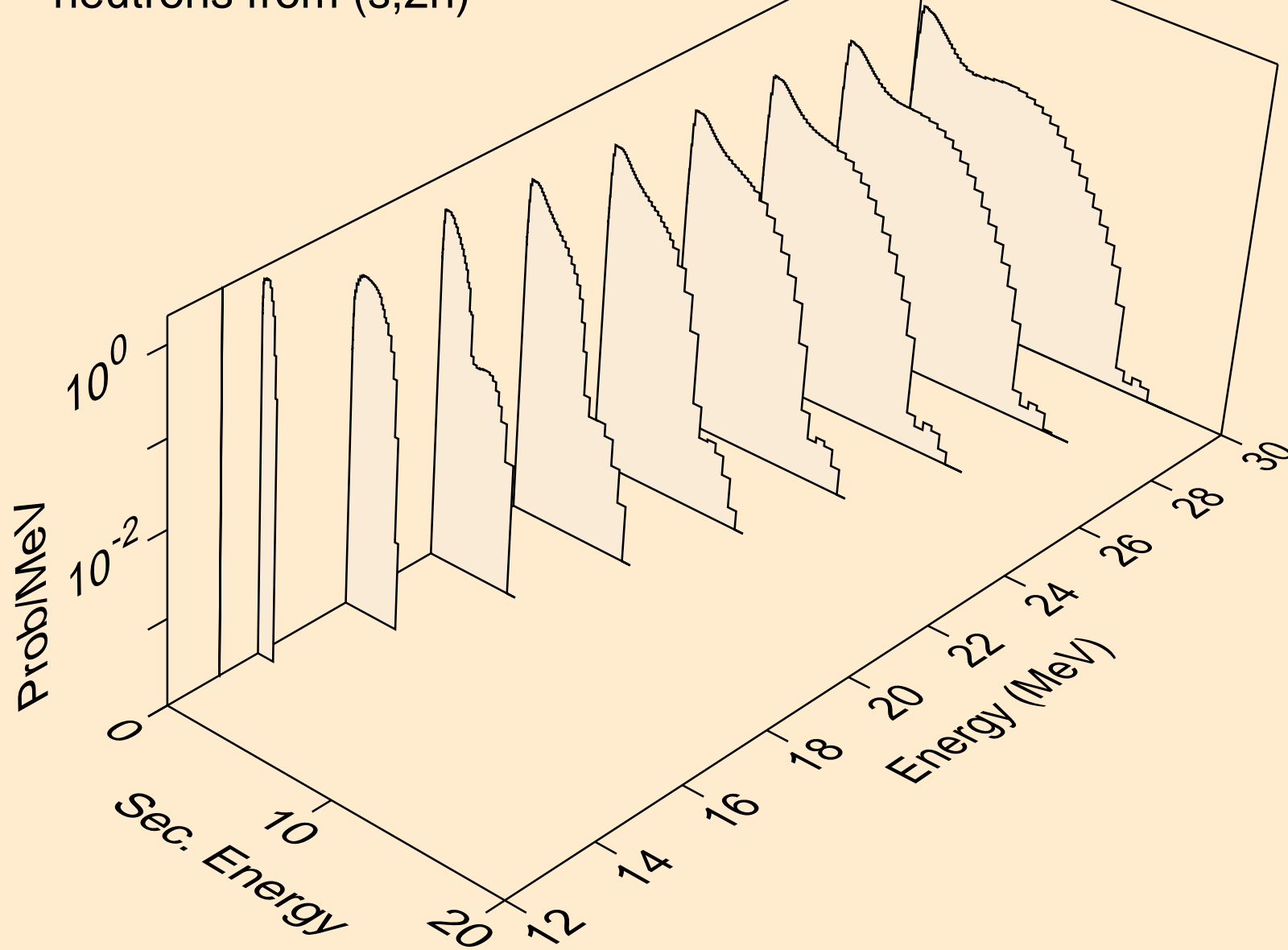

AU182 HELION ACER TENDL-2021 LIBRARY; T=0.K  
neutrons from (s,3n)

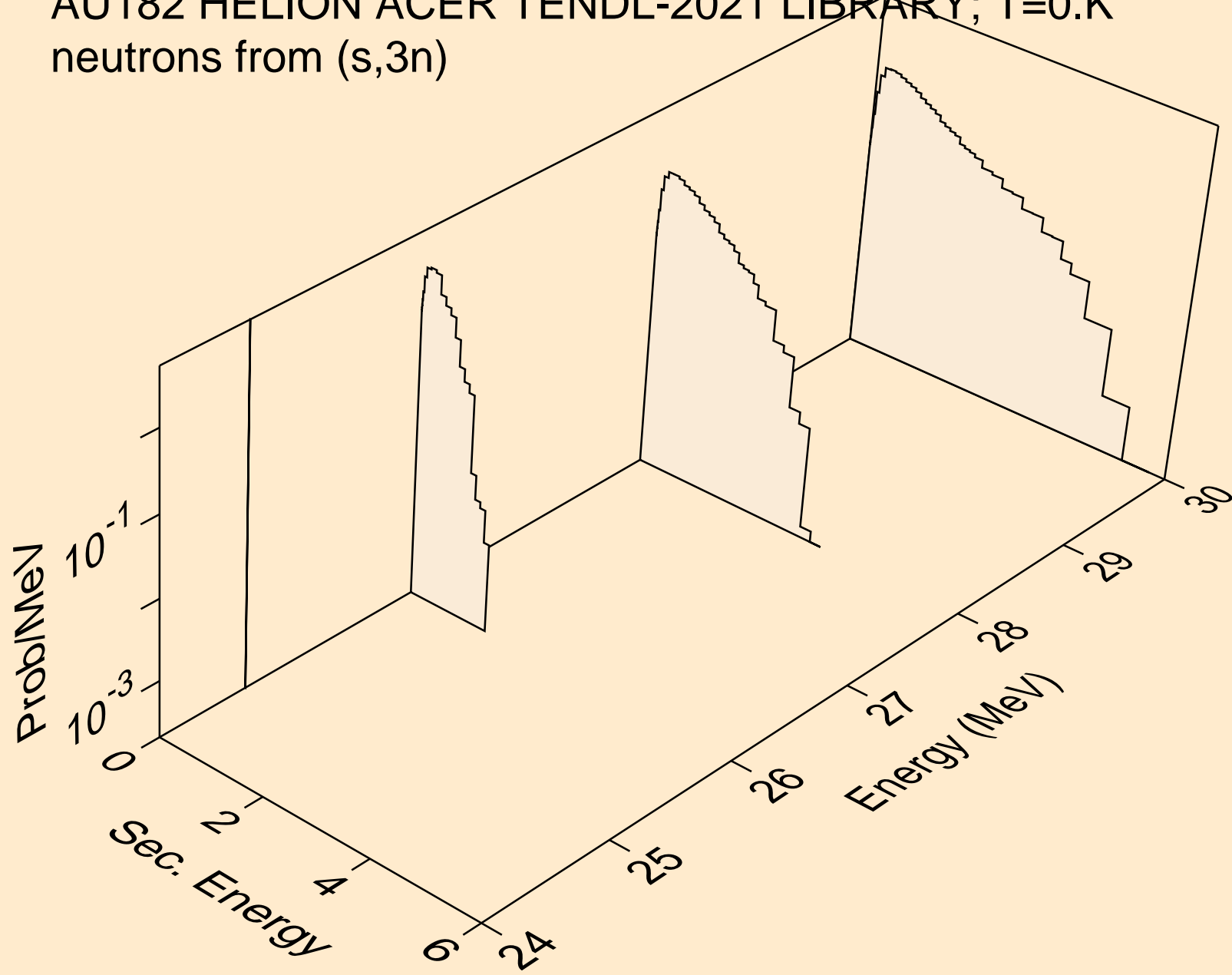



AU182 HELION ACER TENDL-2021 LIBRARY; T=0.K  
neutrons from (s,n\*)a

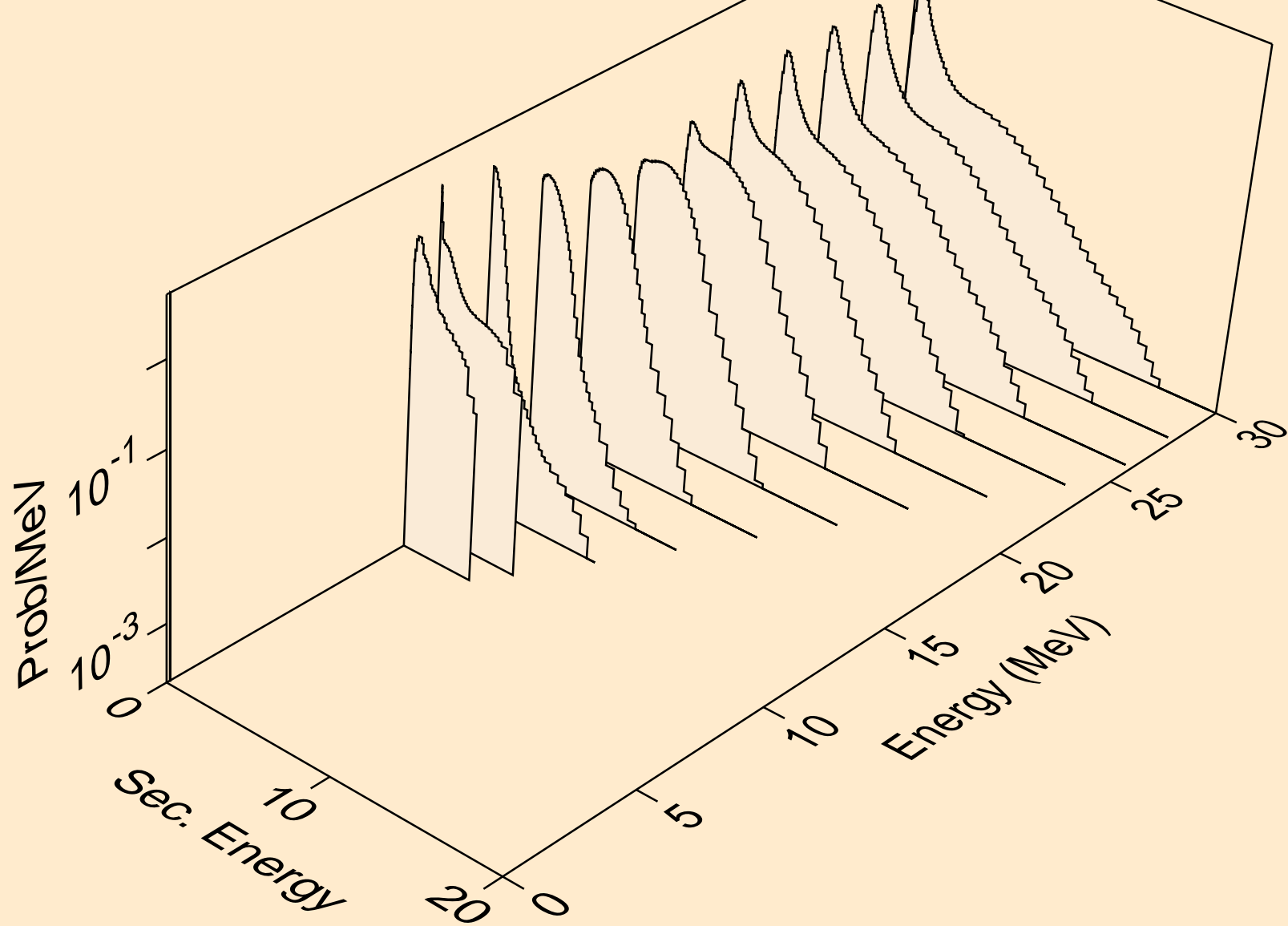

AU182 HELION ACER TENDL-2021 LIBRARY; T=0.K  
neutrons from (s,2n)a

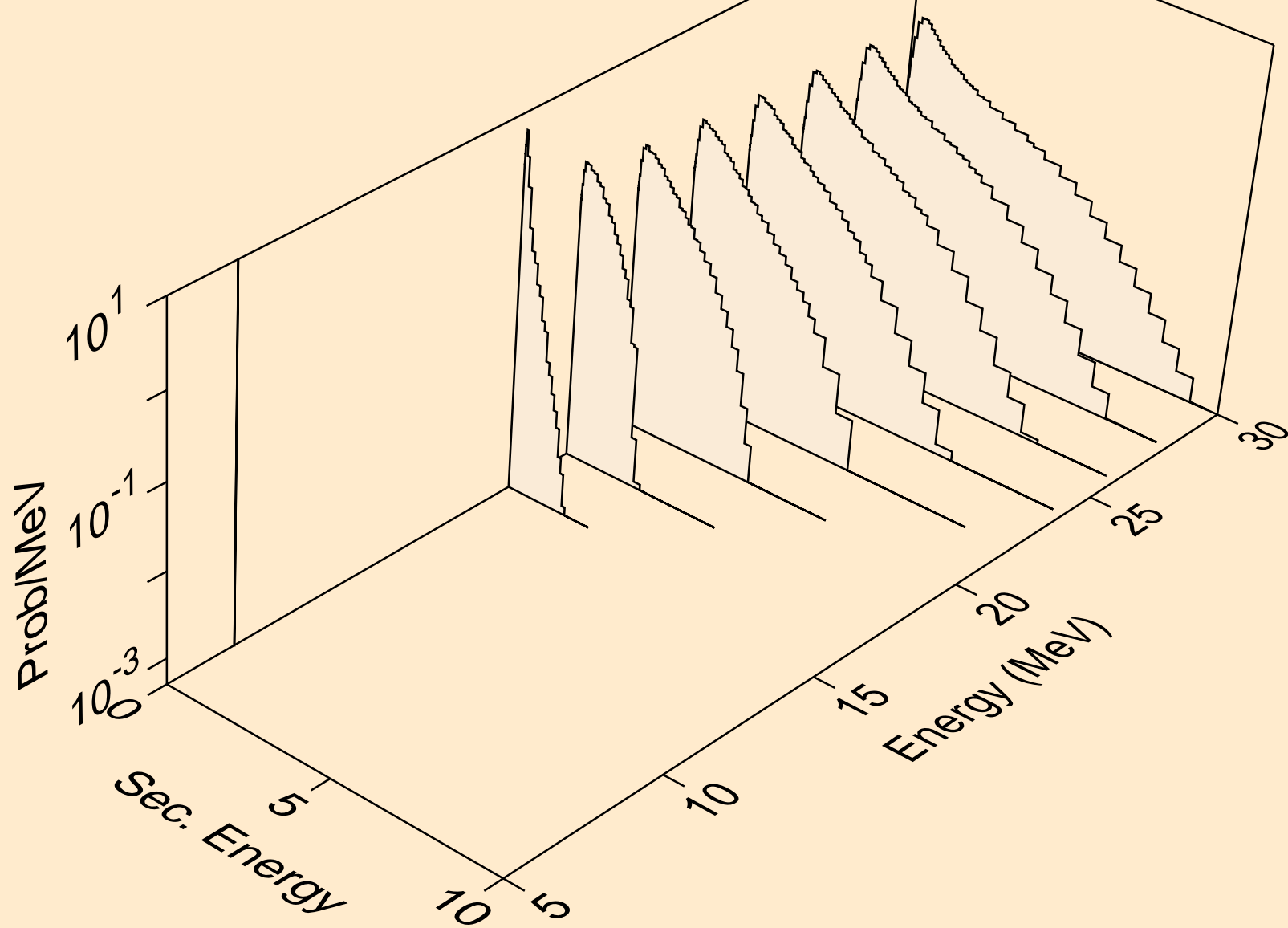

AU182 HELION ACER TENDL-2021 LIBRARY; T=0.K  
neutrons from (s,3n)a

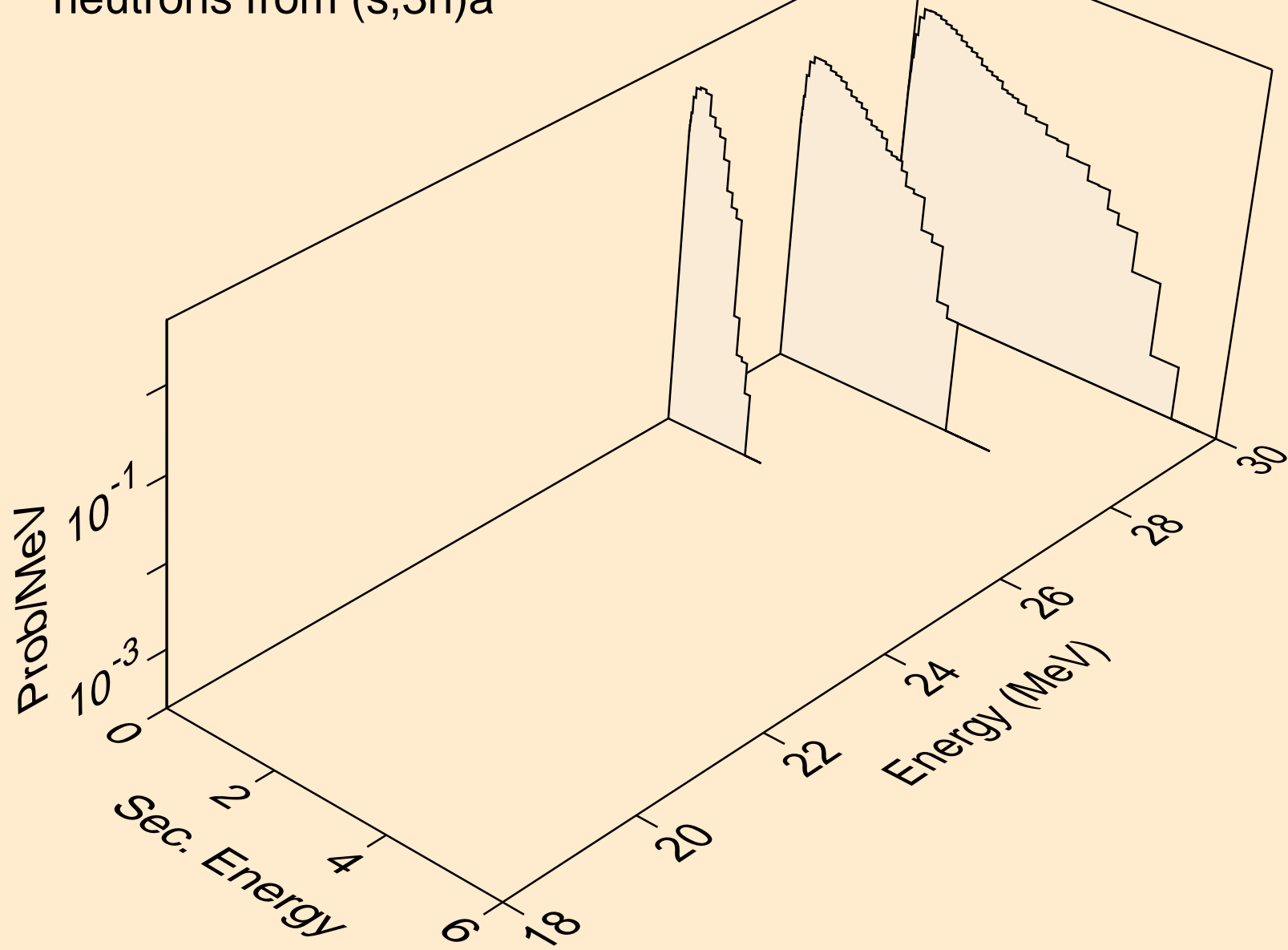

AU182 HELION ACER TENDL-2021 LIBRARY; T=0.K  
neutrons from (s,n\*)p

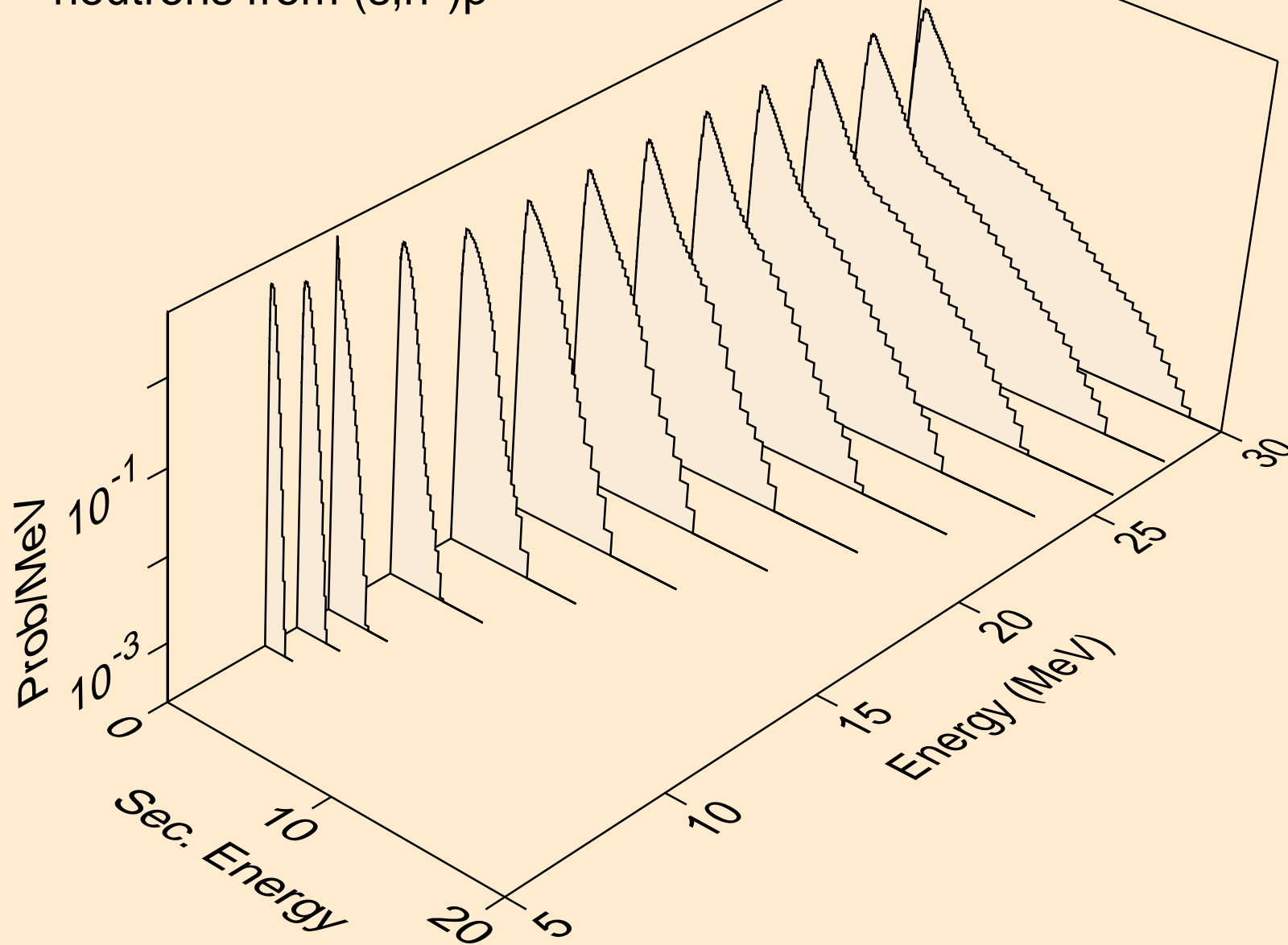

AU182 HELION ACER TENDL-2021 LIBRARY; T=0.K  
neutrons from (s,n\*)2a

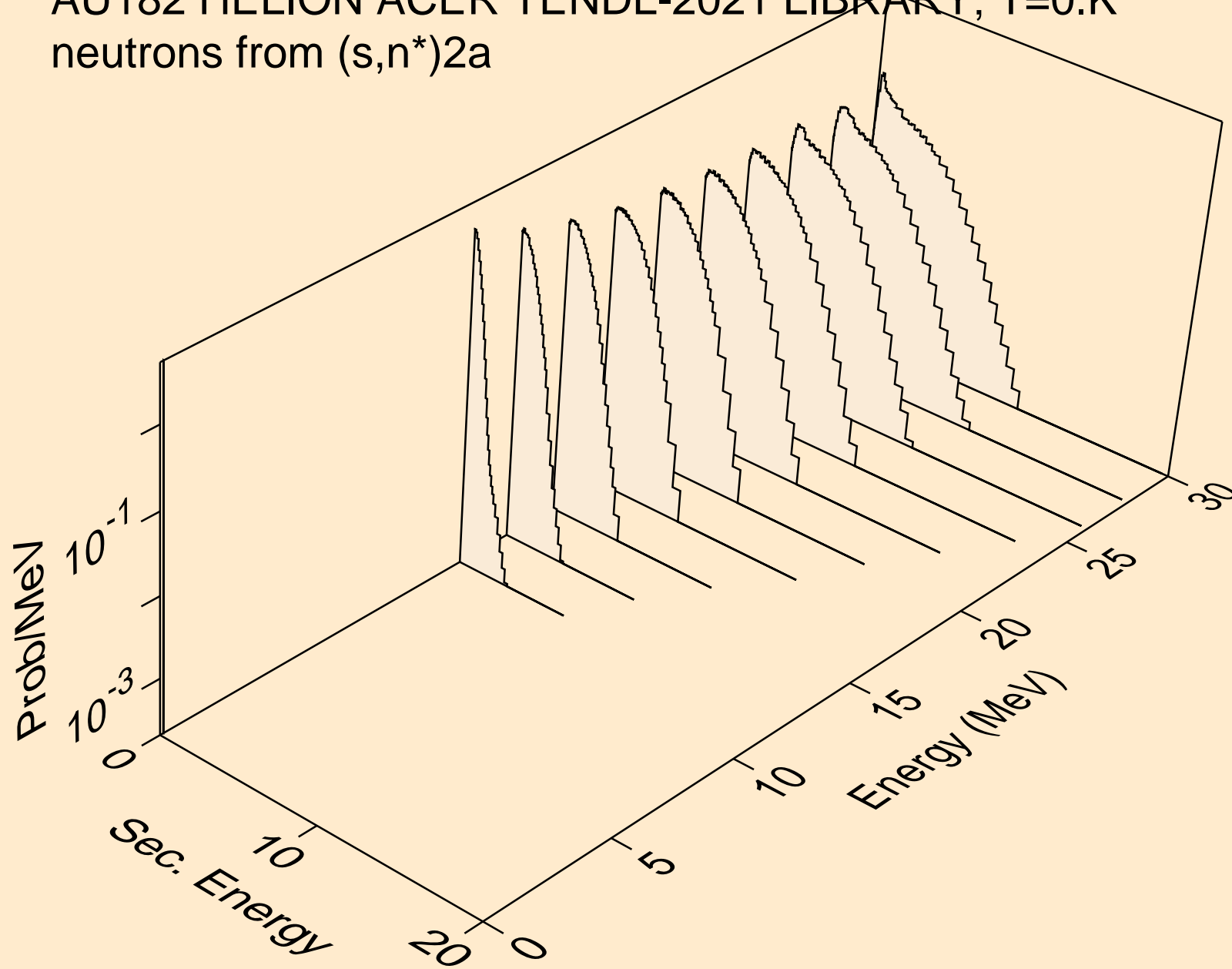

AU182 HELION ACER TENDL-2021 LIBRARY; T=0.K  
neutrons from (s,n\*)d

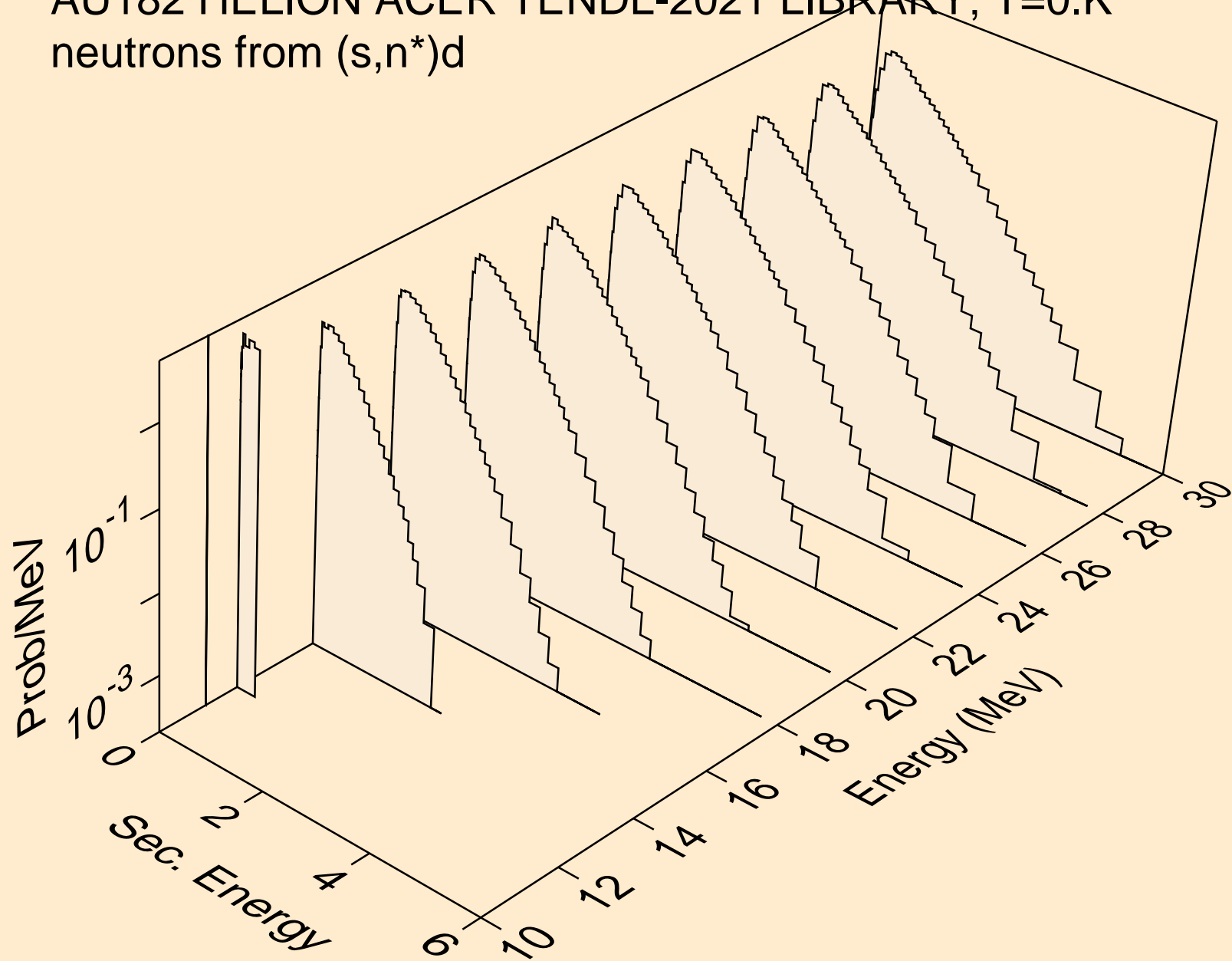

AU182 HELION ACER TENDL-2021 LIBRARY; T=0.K  
neutrons from (s,n\*)t

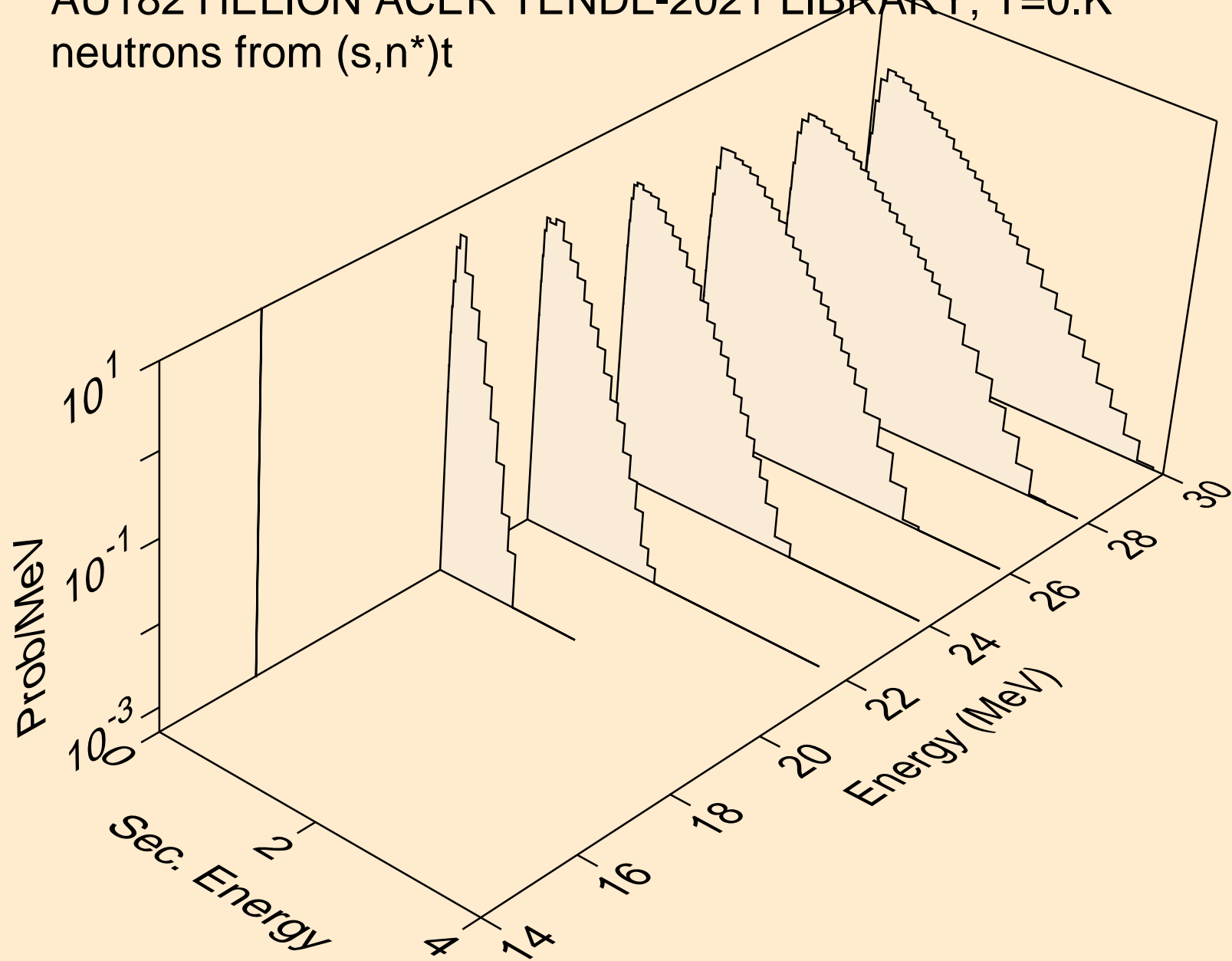

AU182 HELION ACER TENDL-2021 LIBRARY; T=0.K  
neutrons from (s,n\*)he3

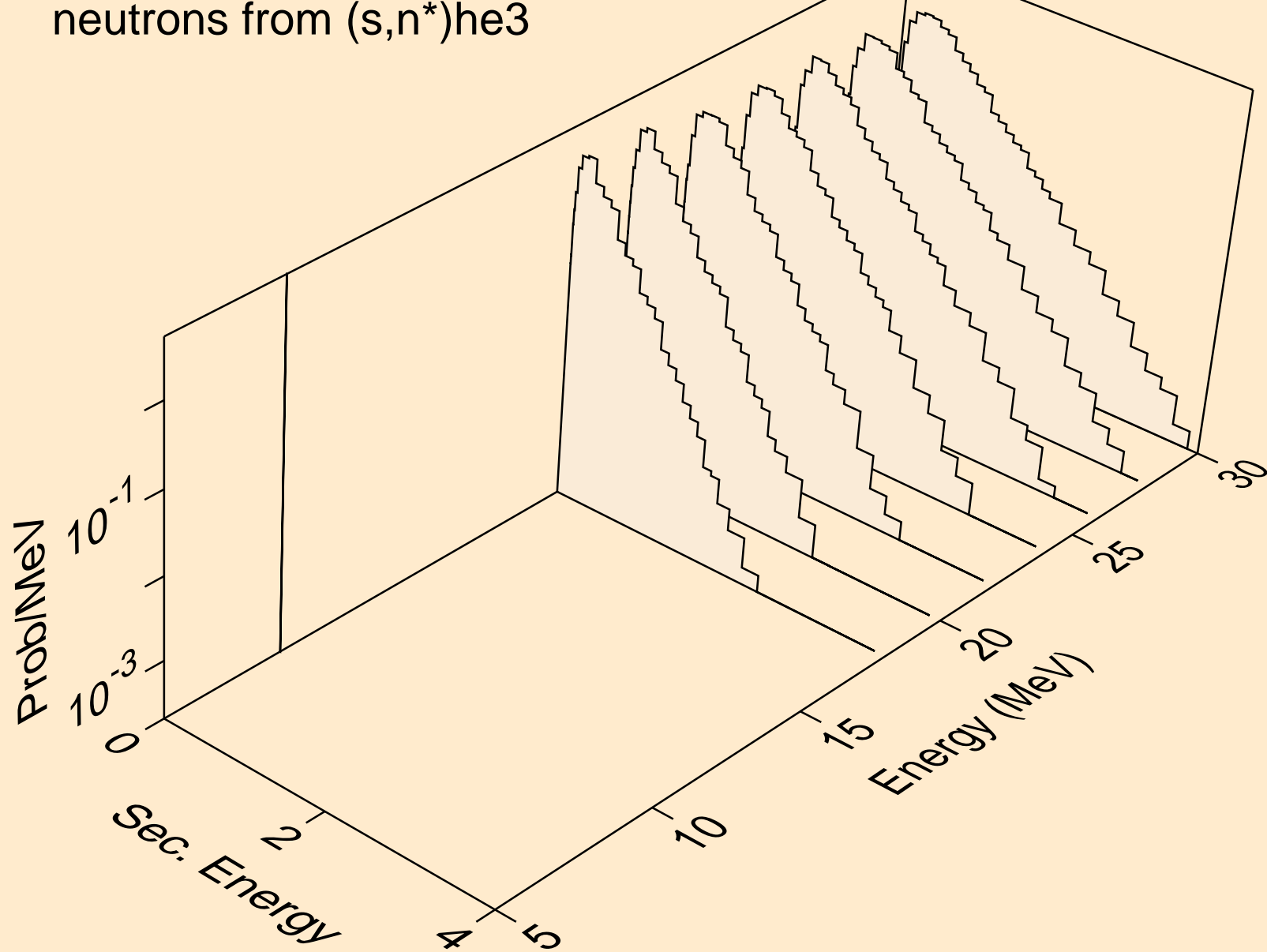



AU182 HELION ACER TENDL-2021 LIBRARY; T=0.K  
neutrons from (s,2np)

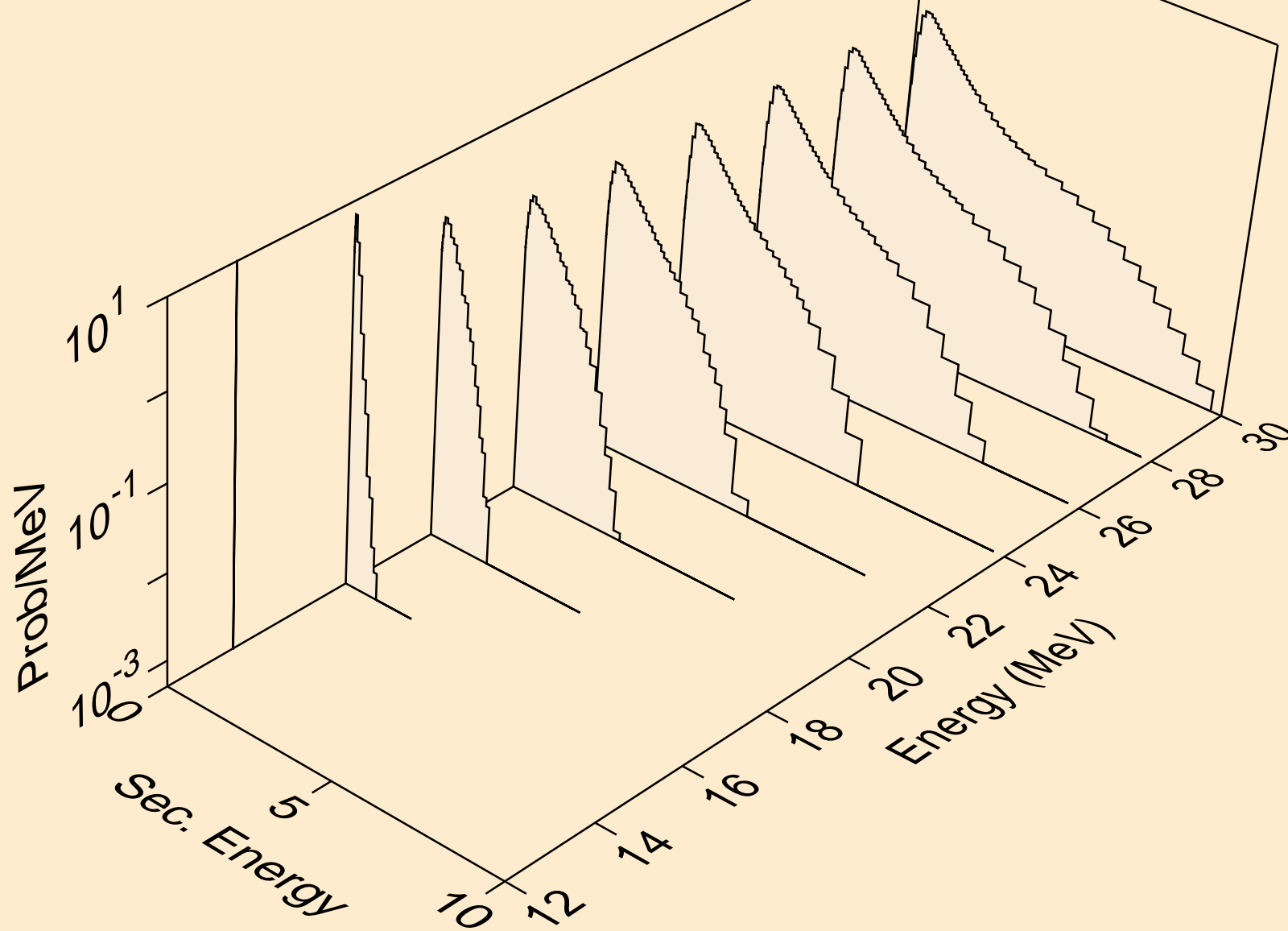

AU182 HELION ACER TENDL-2021 LIBRARY; T=0.K  
neutrons from (s,3np)

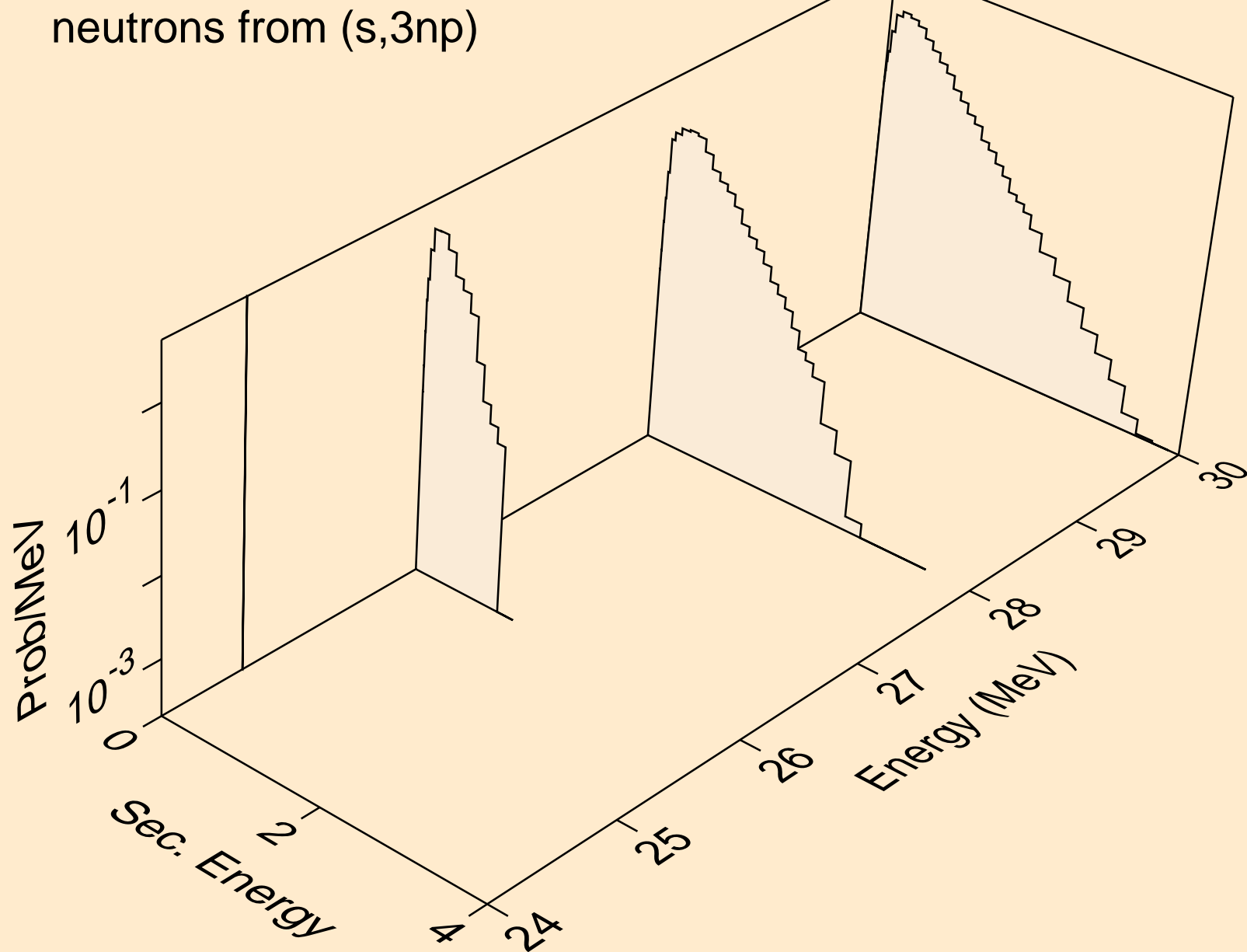

AU182 HELION ACER TENDL-2021 LIBRARY; T=0.K  
neutrons from (s,2np)

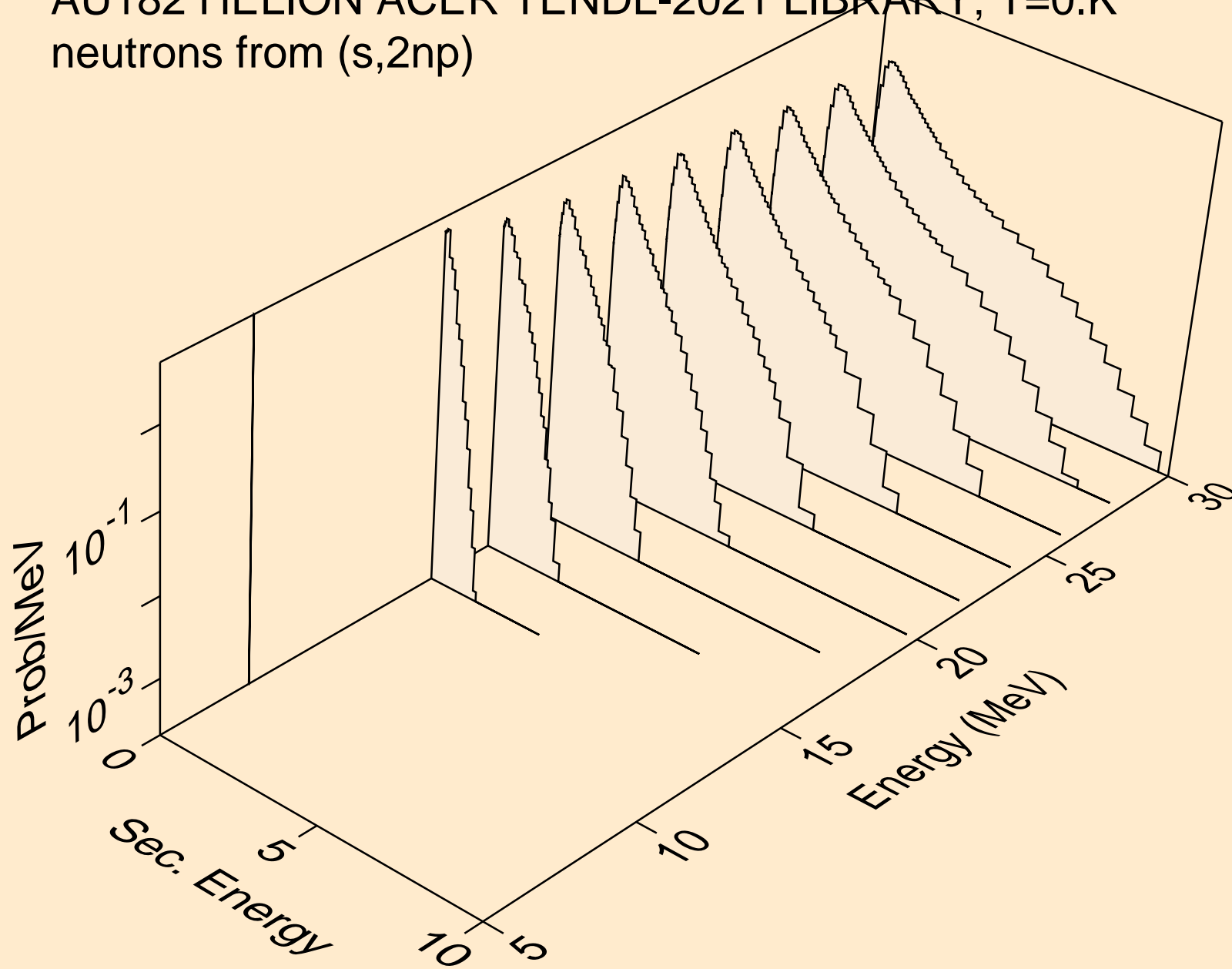

AU182 HELION ACER TENDL-2021 LIBRARY; T=0.K  
neutrons from (s,npa)

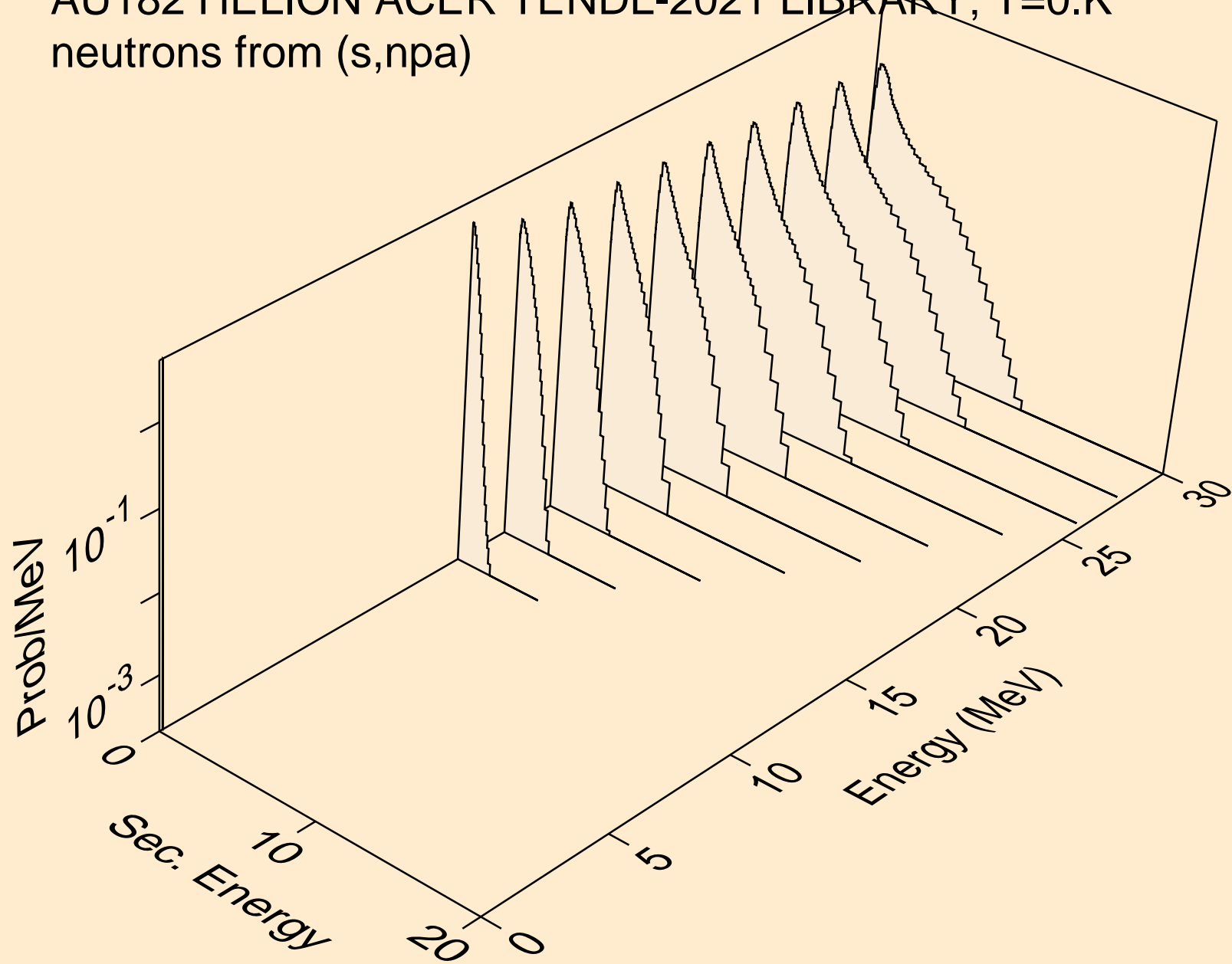

AU182 HELION ACER TENDL-2021 LIBRARY; T=0.K  
protons from (s,x)

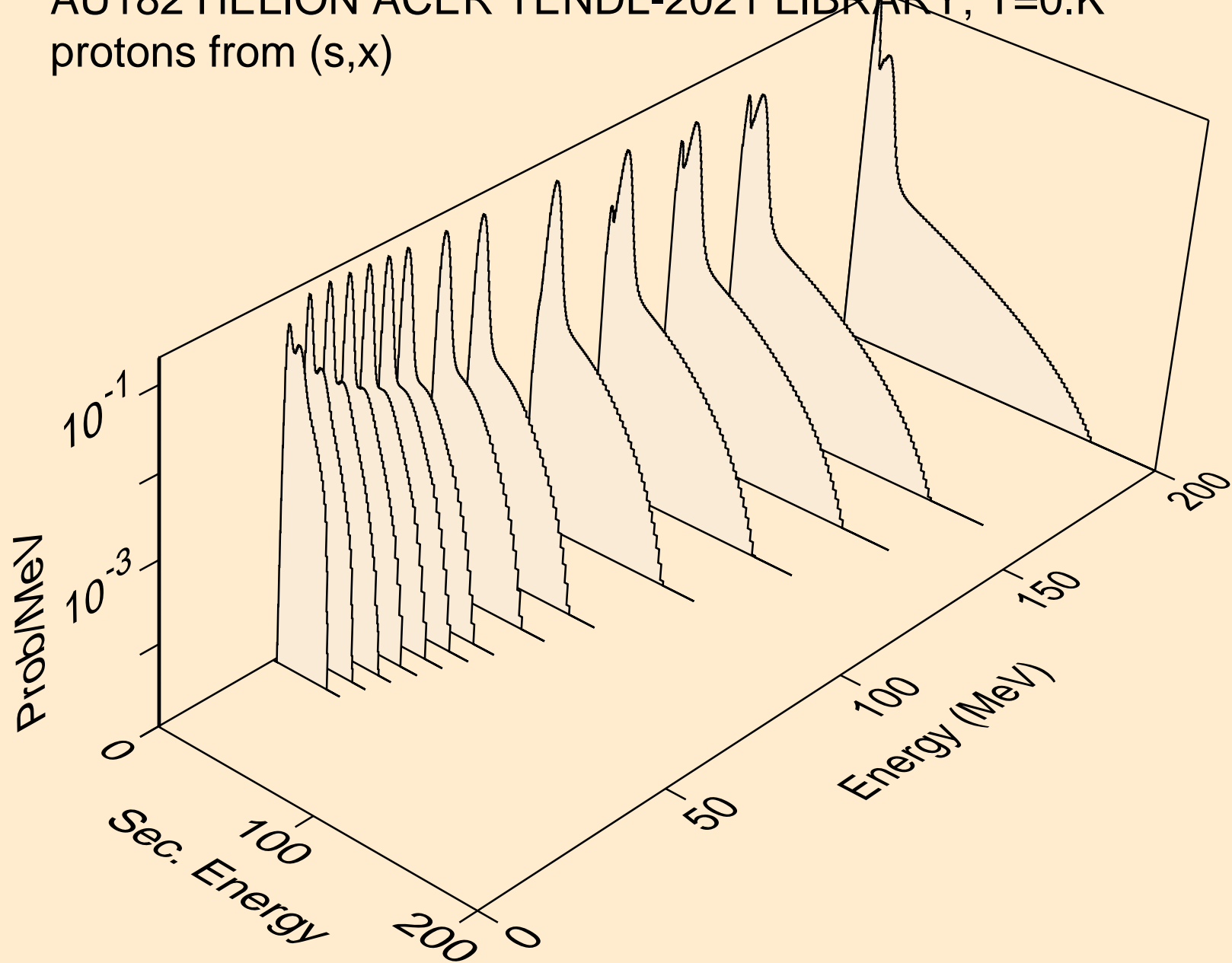

AU182 HELION ACER TENDL-2021 LIBRARY; T=0.K  
protons from (s,n\*)p

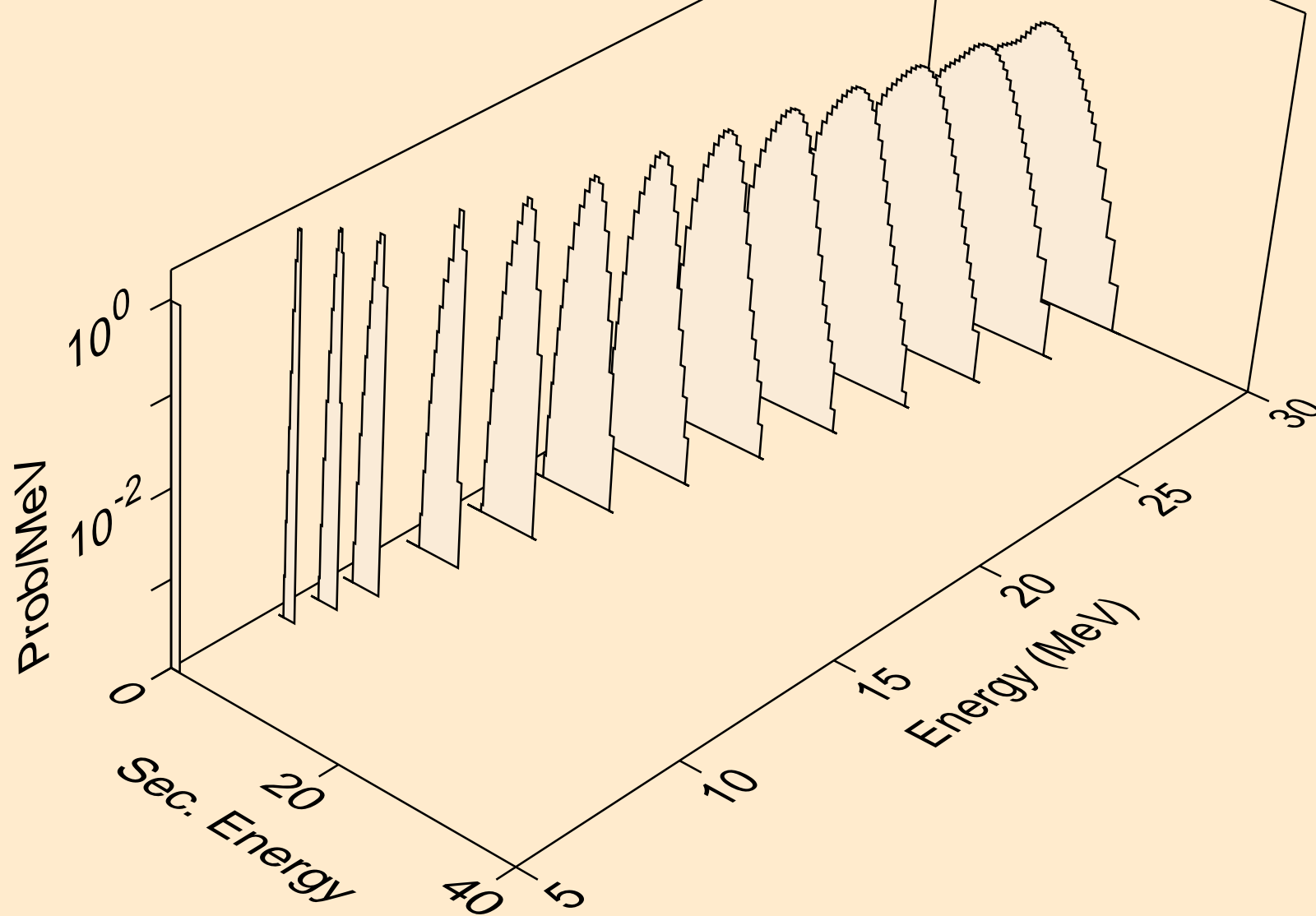

AU182 HELION ACER TENDL-2021 LIBRARY; T=0.K  
protons from (s,2np)

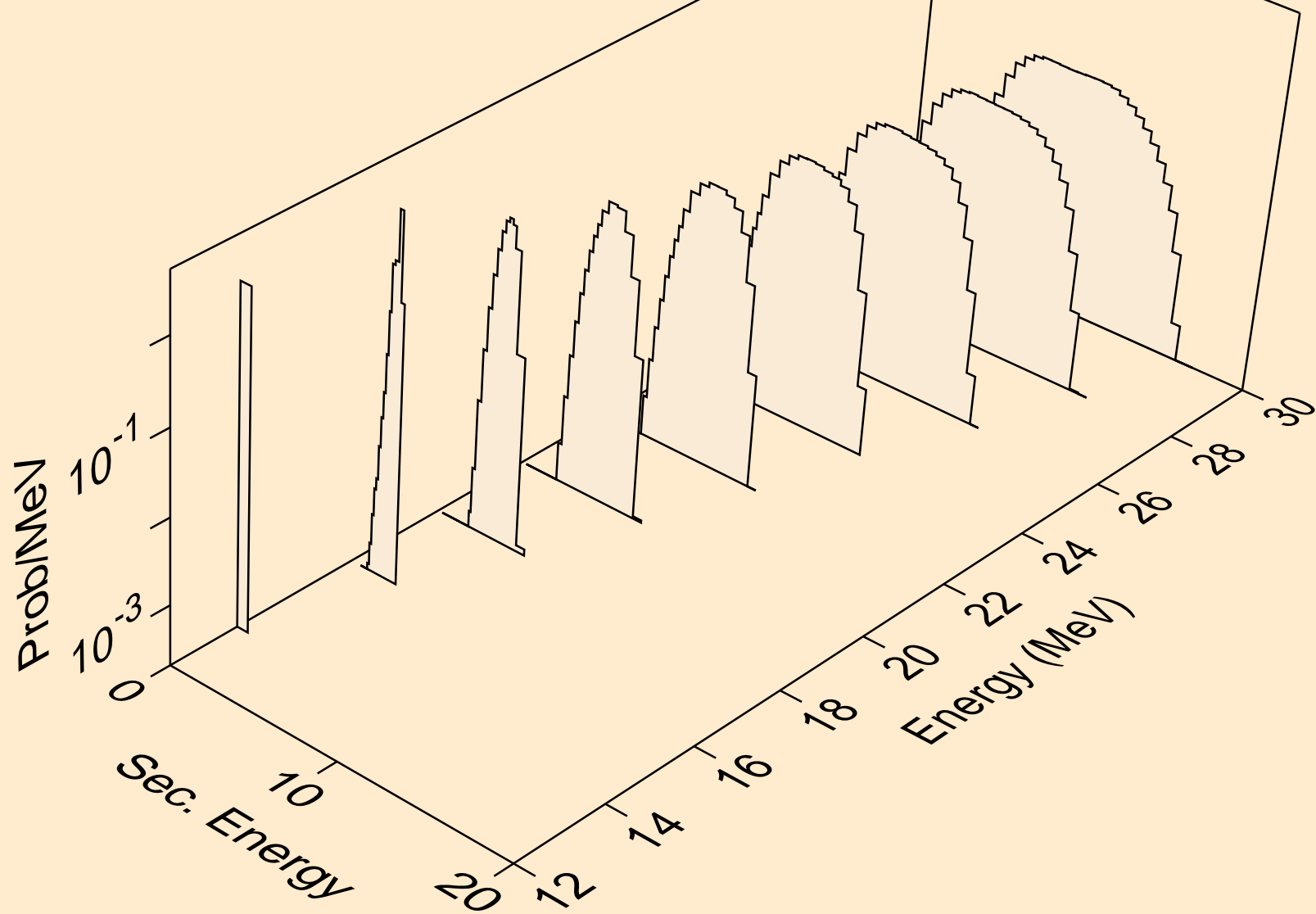

AU182 HELION ACER TENDL-2021 LIBRARY; T=0.K  
protons from (s,3np)

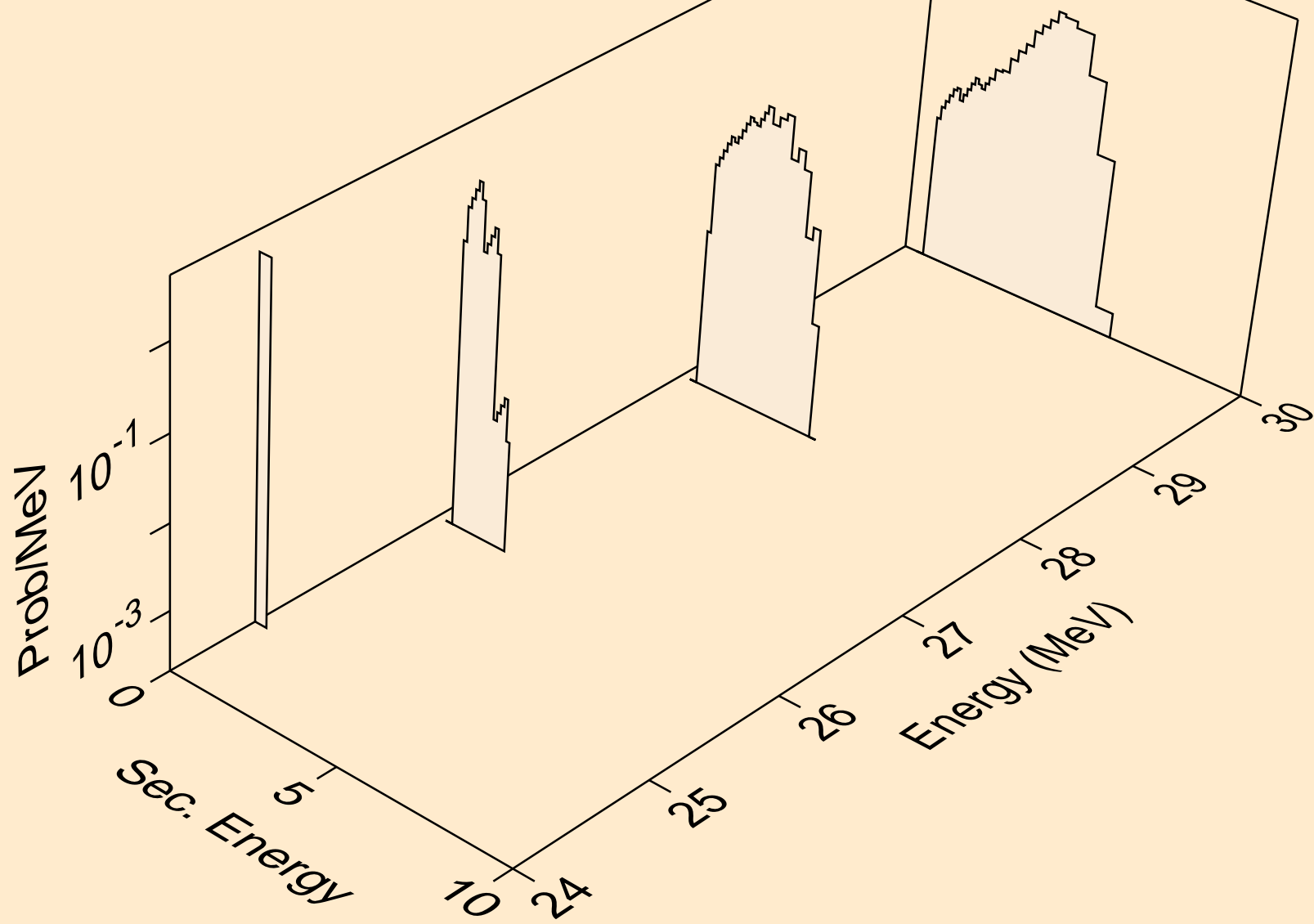



AU182 HELION ACER TENDL-2021 LIBRARY; T=0.K  
protons from (s,2np)

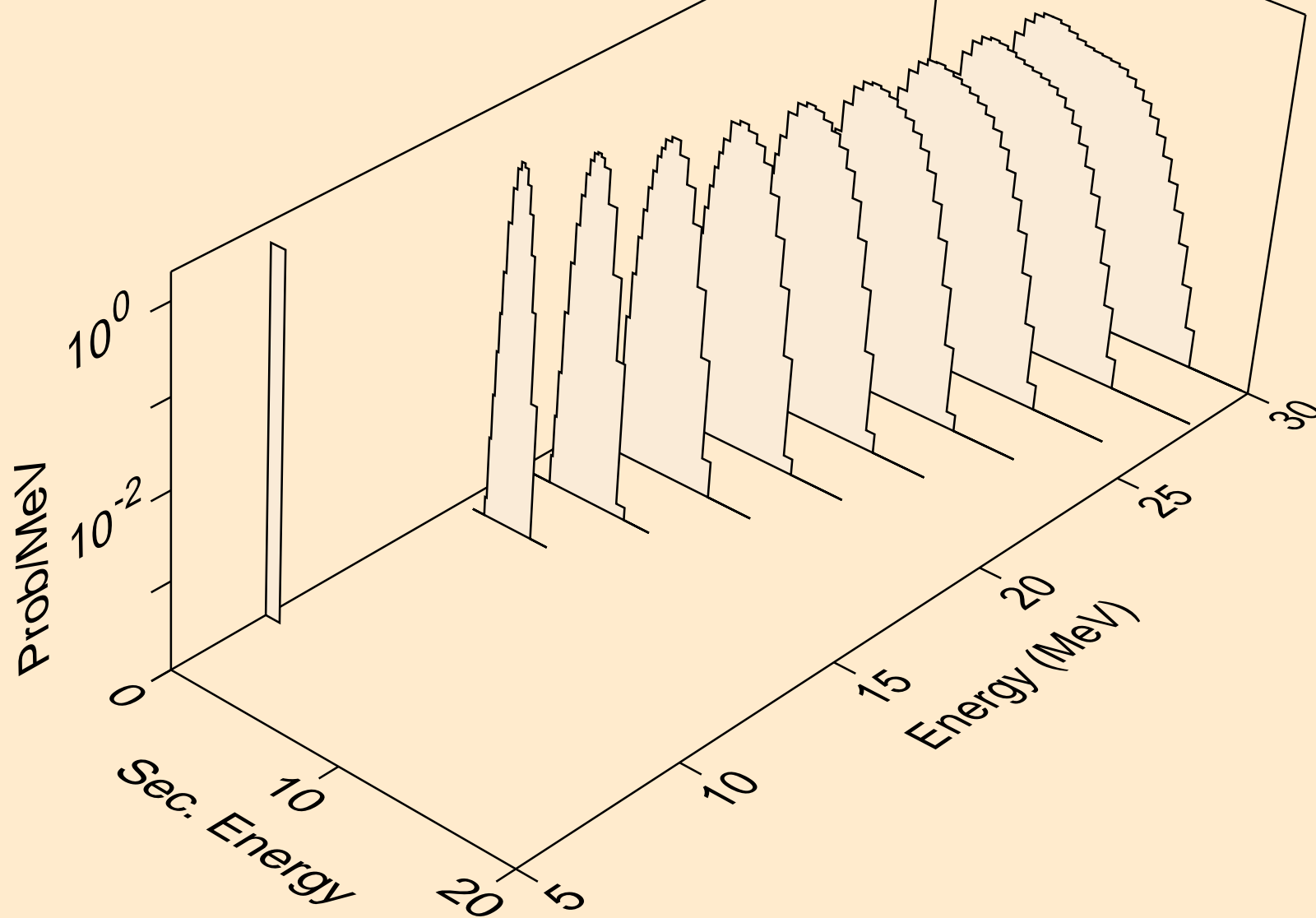

AU182 HELION ACER TENDL-2021 LIBRARY; T=0.K  
protons from (s,npa)

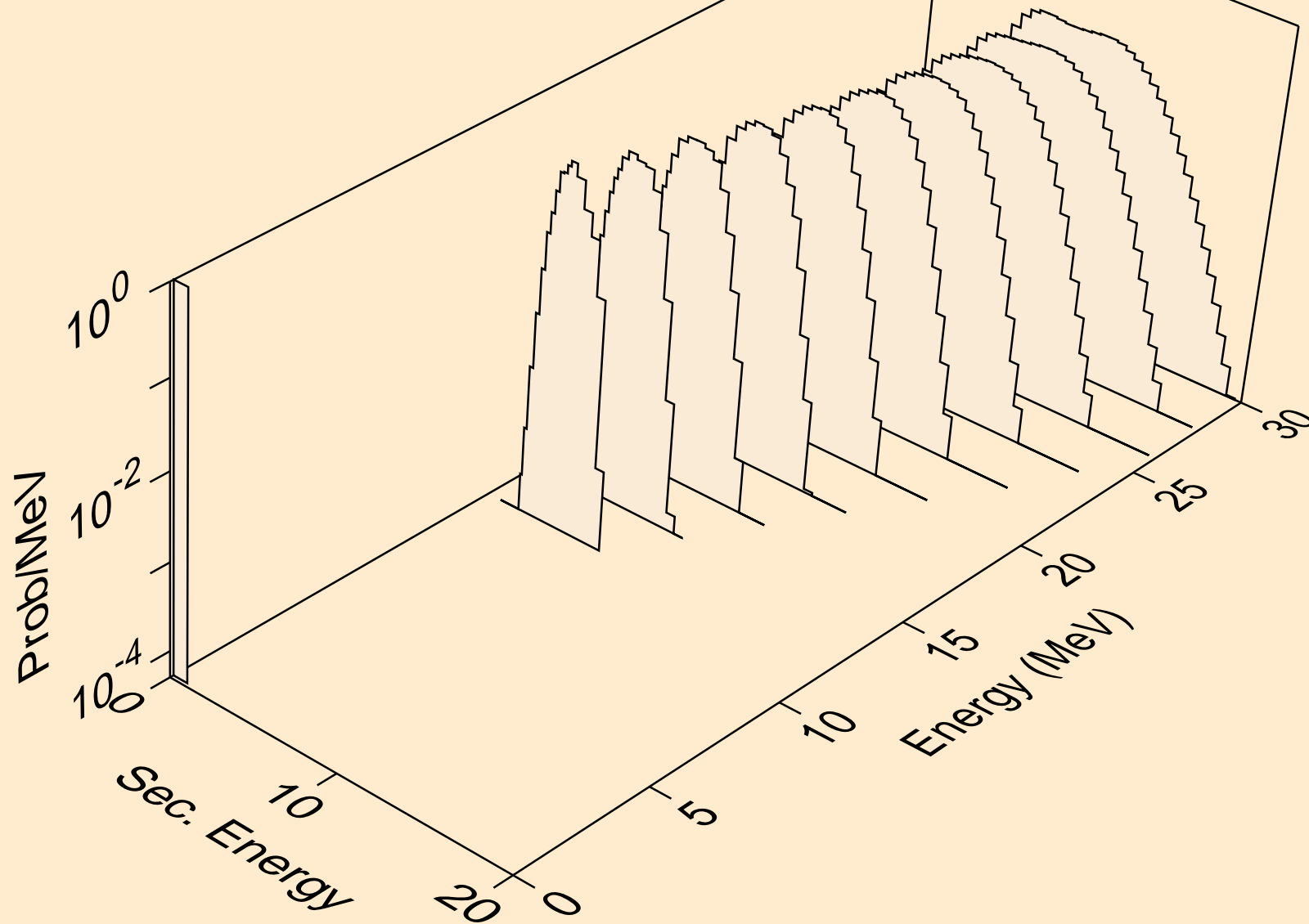

AU182 HELION ACER TENDL-2021 LIBRARY; T=0.K  
protons from (s,p)

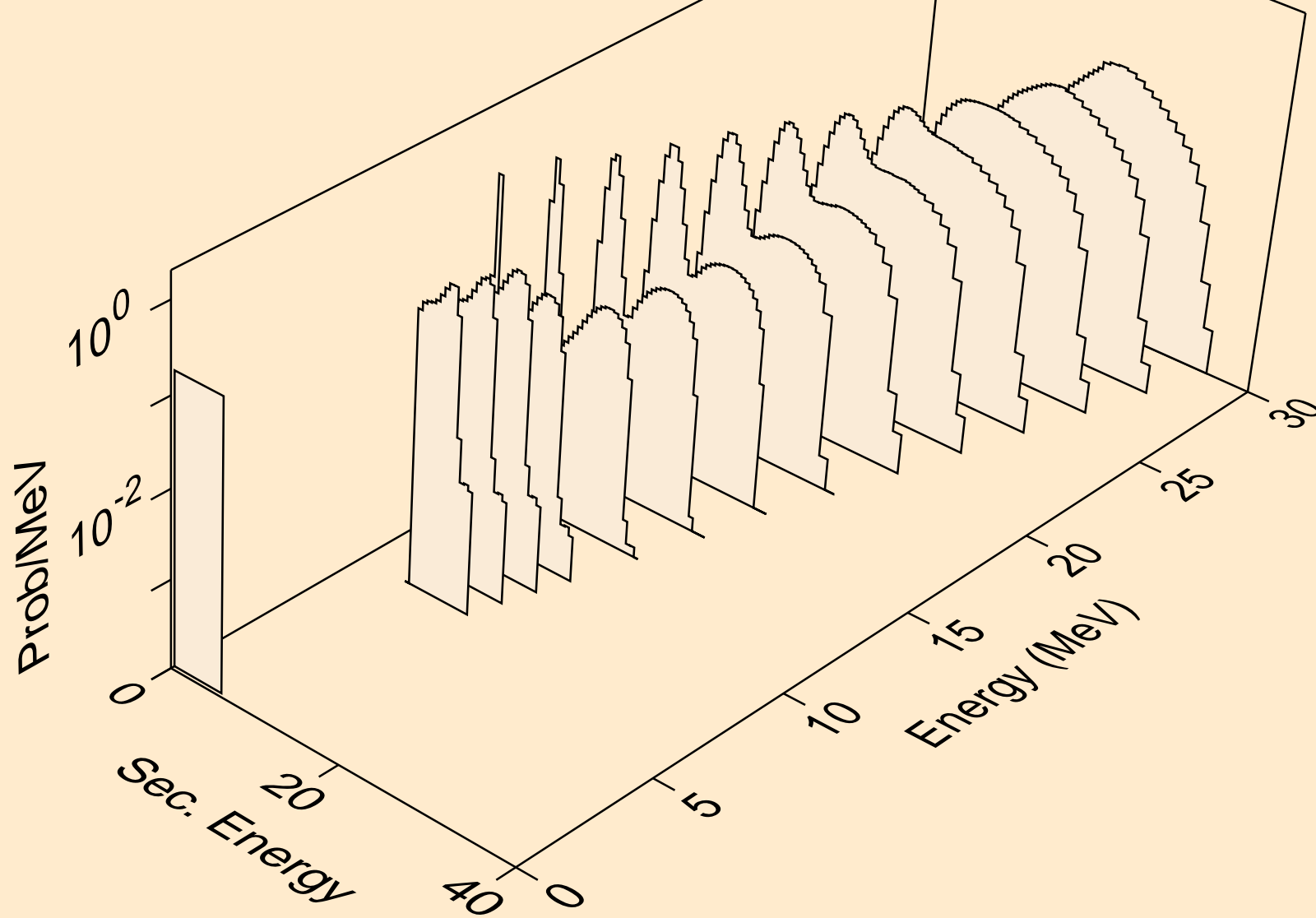

AU182 HELION ACER TENDL-2021 LIBRARY; T=0.K  
protons from (s,2p)

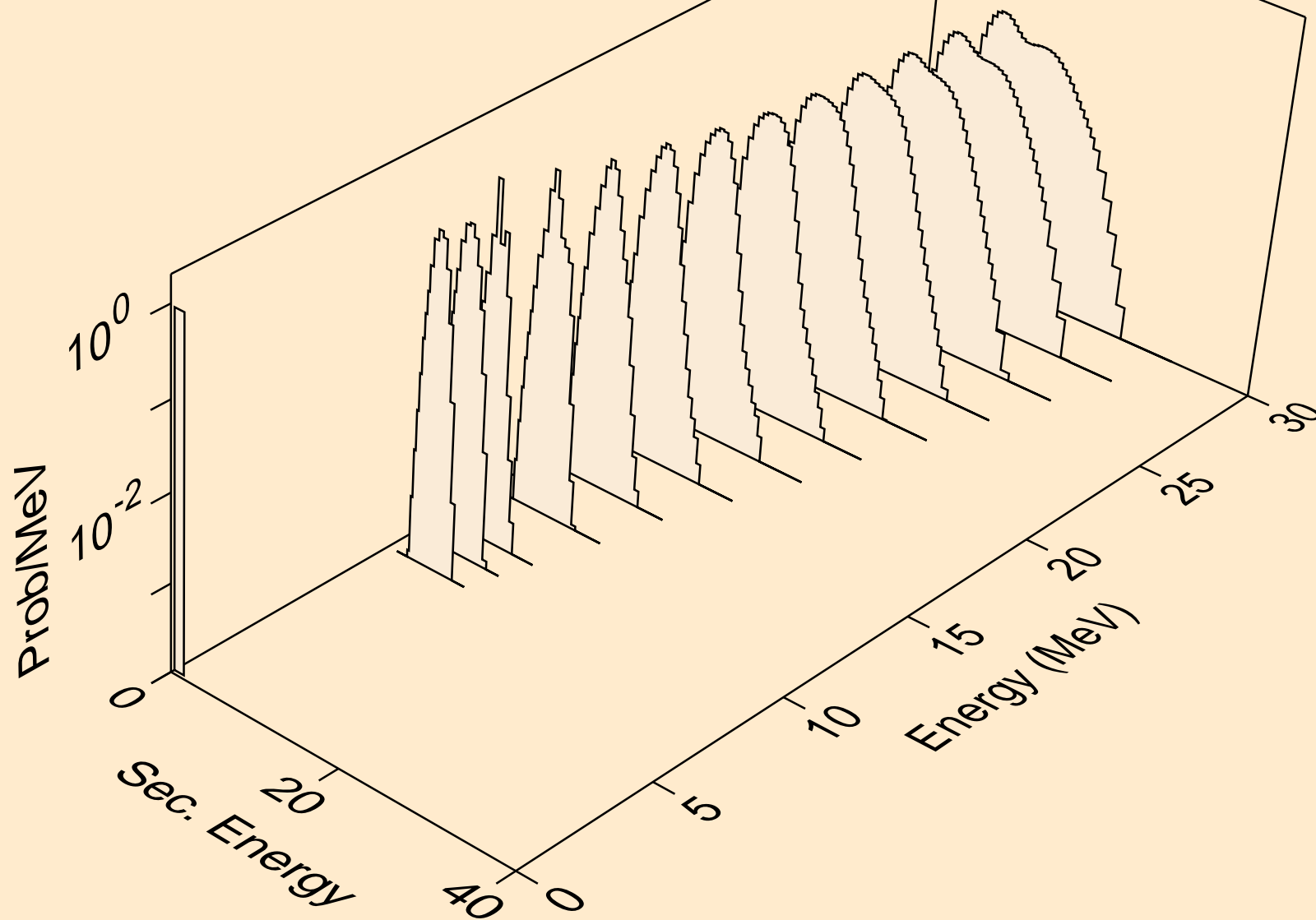

AU182 HELION ACER TENDL-2021 LIBRARY; T=0.K  
protons from (s,pa)

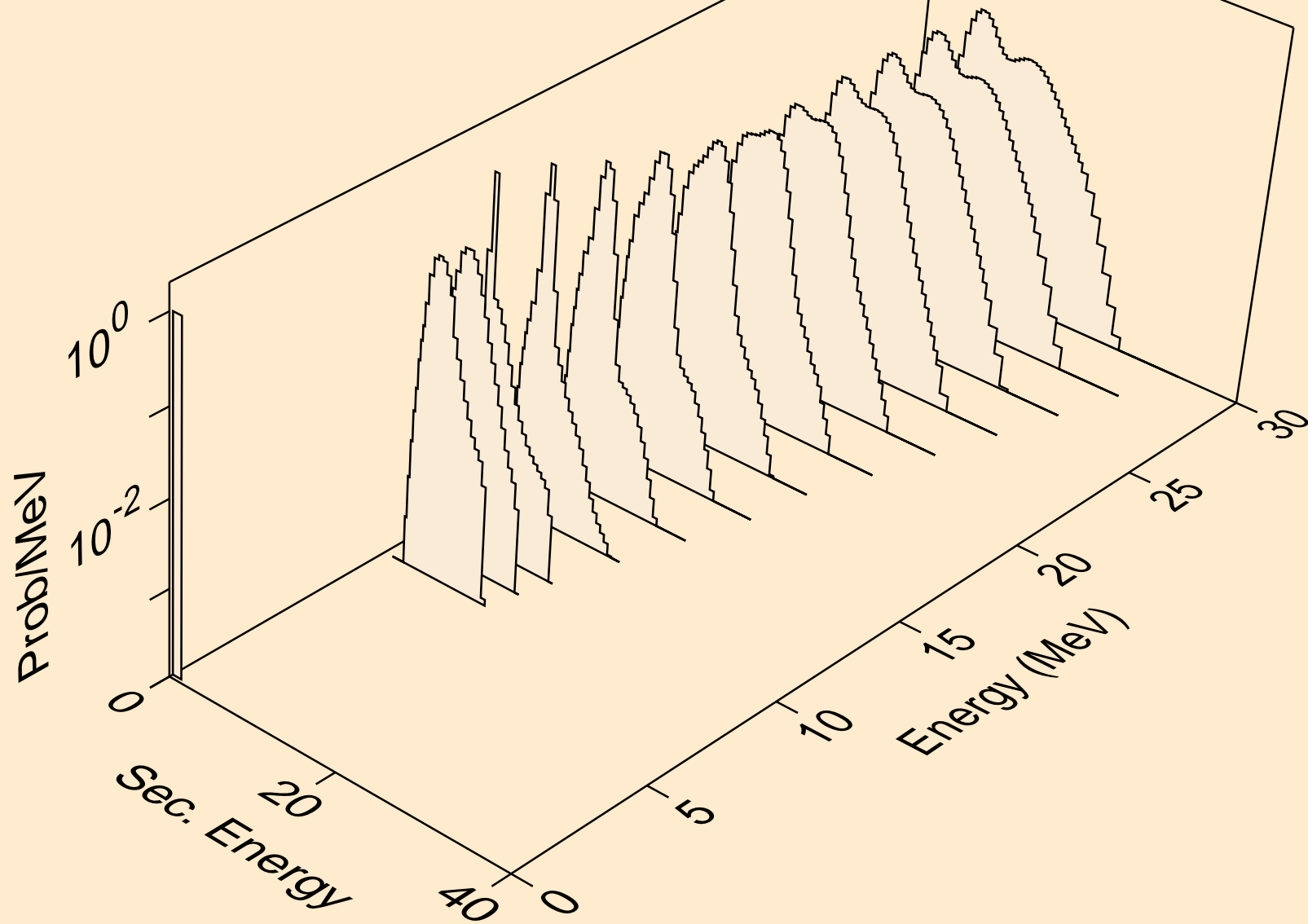

AU182 HELION ACER TENDL-2021 LIBRARY; T=0.K  
protons from (s,pd)

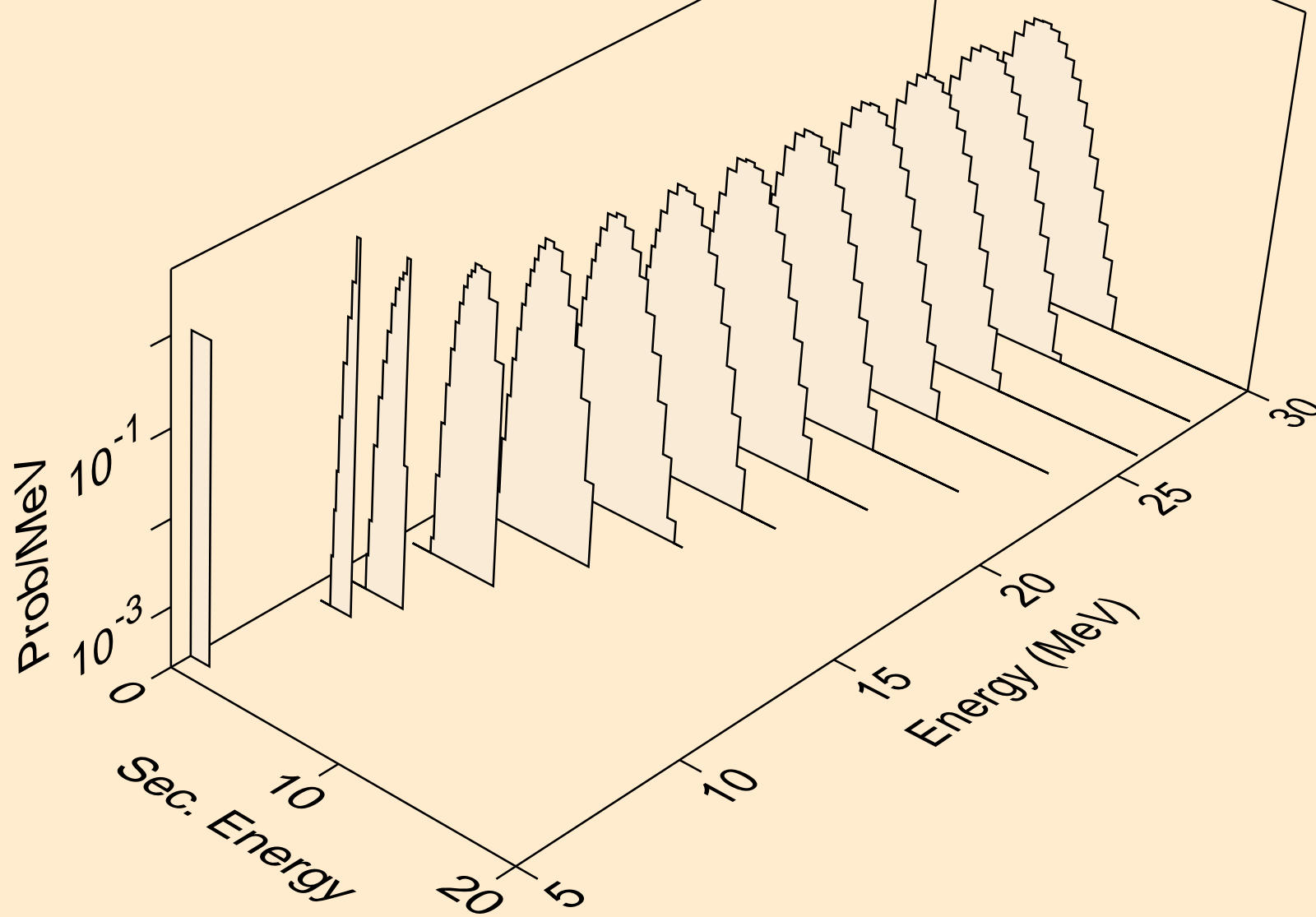

AU182 HELION ACER TENDL-2021 LIBRARY; T=0.K  
protons from (s,pt)

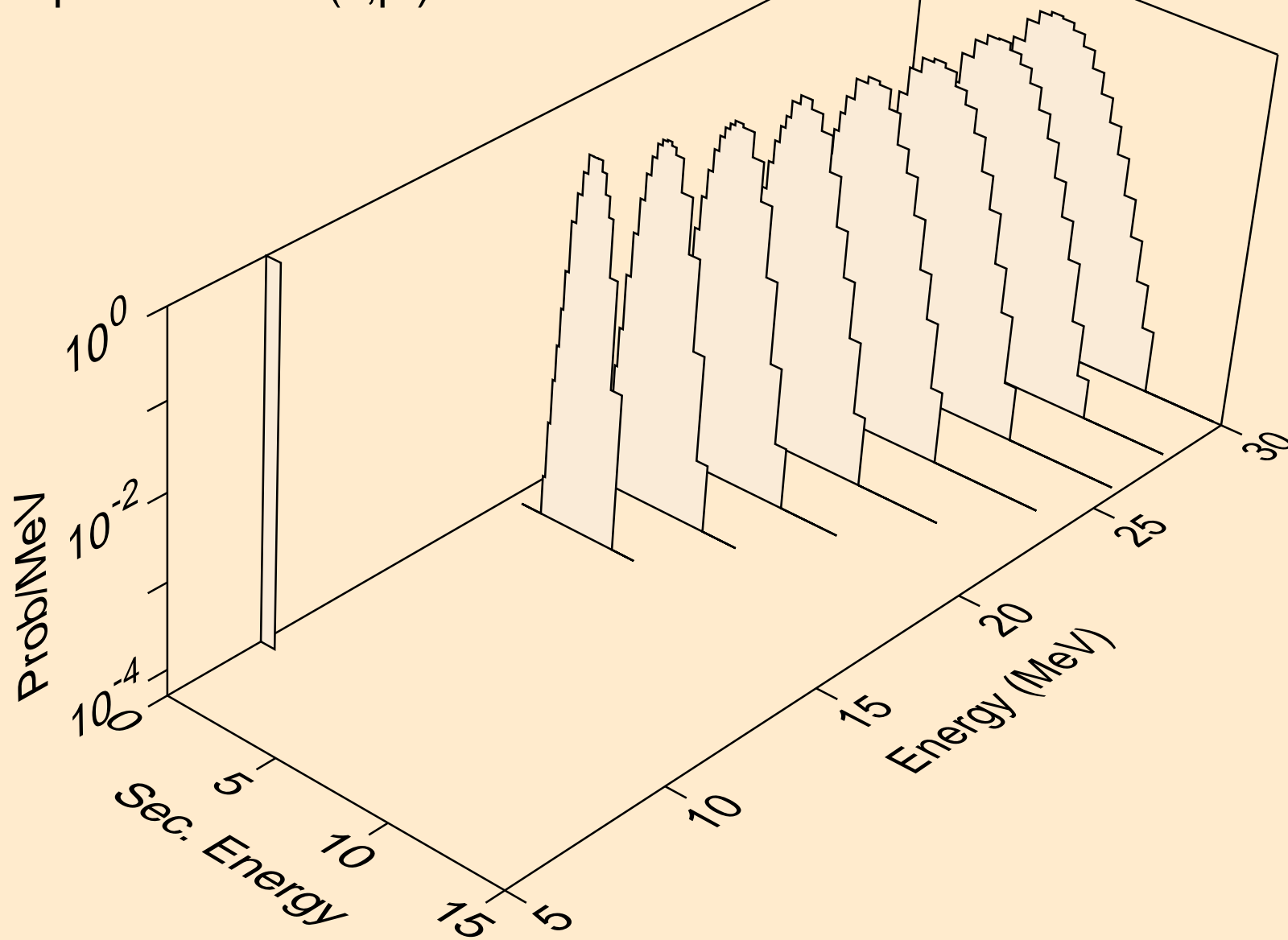

AU182 HELION ACER TENDL-2021 LIBRARY; T=0.K  
deuterons from (s,x)

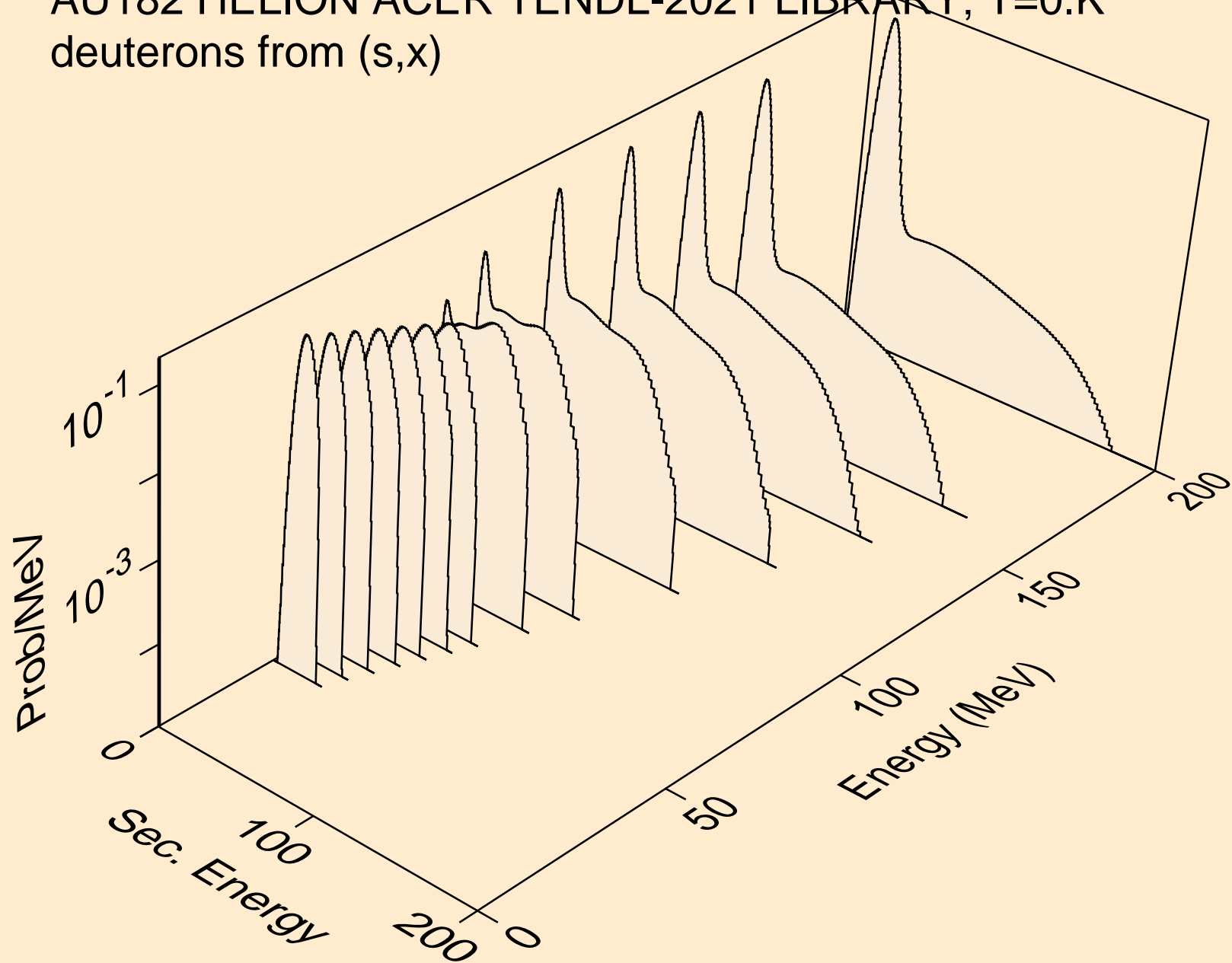



AU182 HELION ACER TENDL-2021 LIBRARY; T=0.K  
deuterons from (s,2nd)

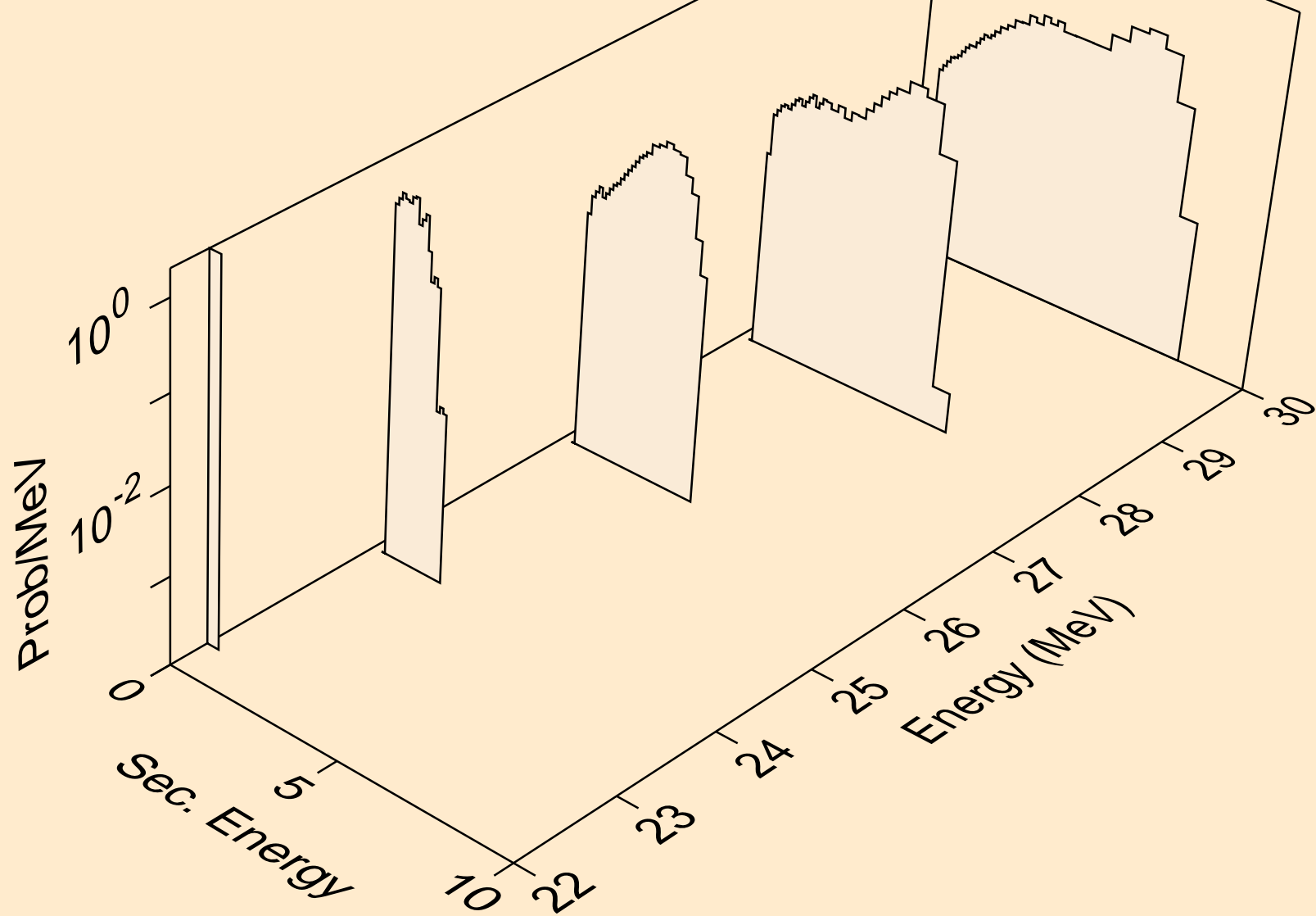

AU182 HELION ACER TENDL-2021 LIBRARY; T=0.K  
deuterons from (s,n\*)d

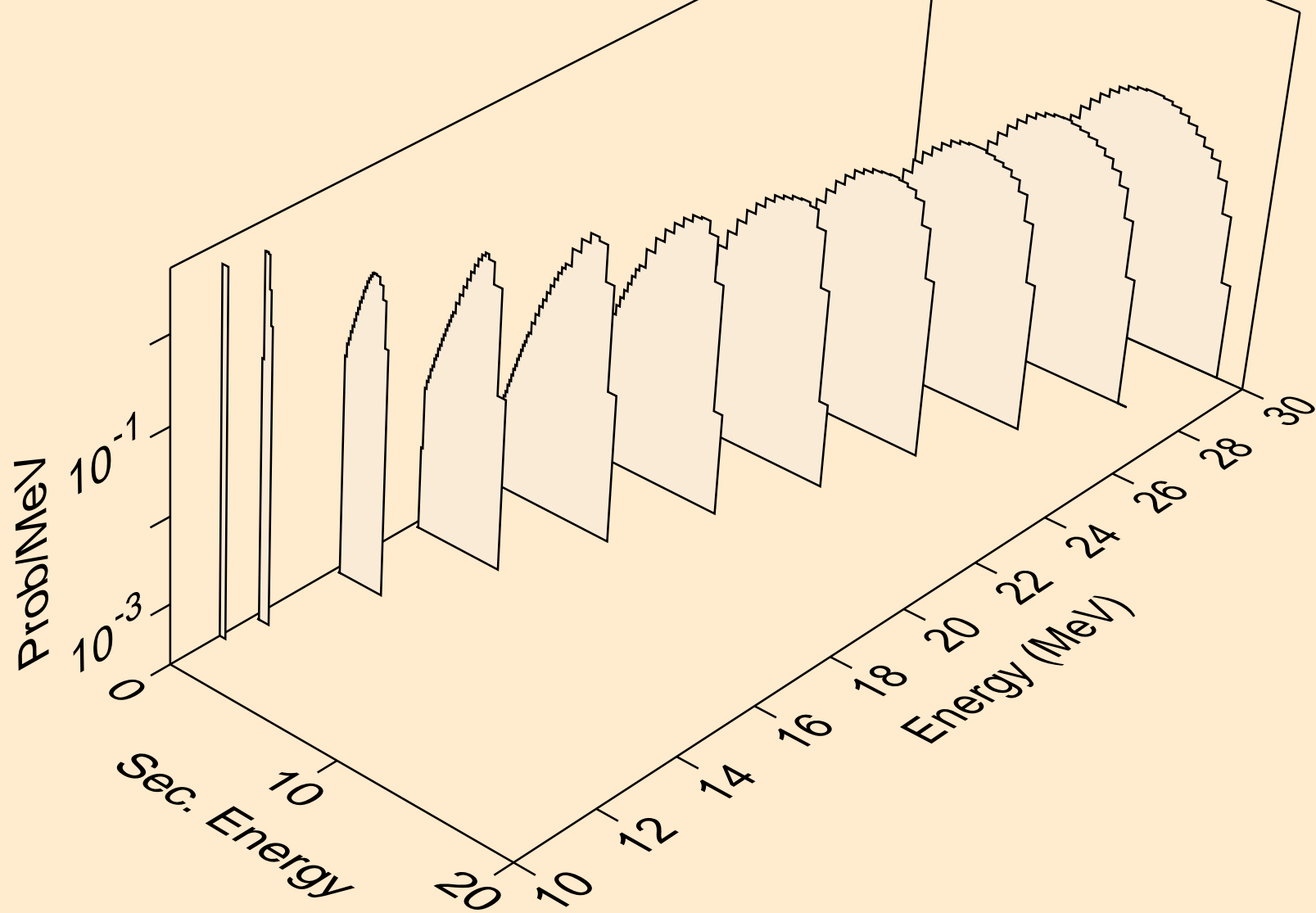

AU182 HELION ACER TENDL-2021 LIBRARY; T=0.K  
deuterons from (s,d)

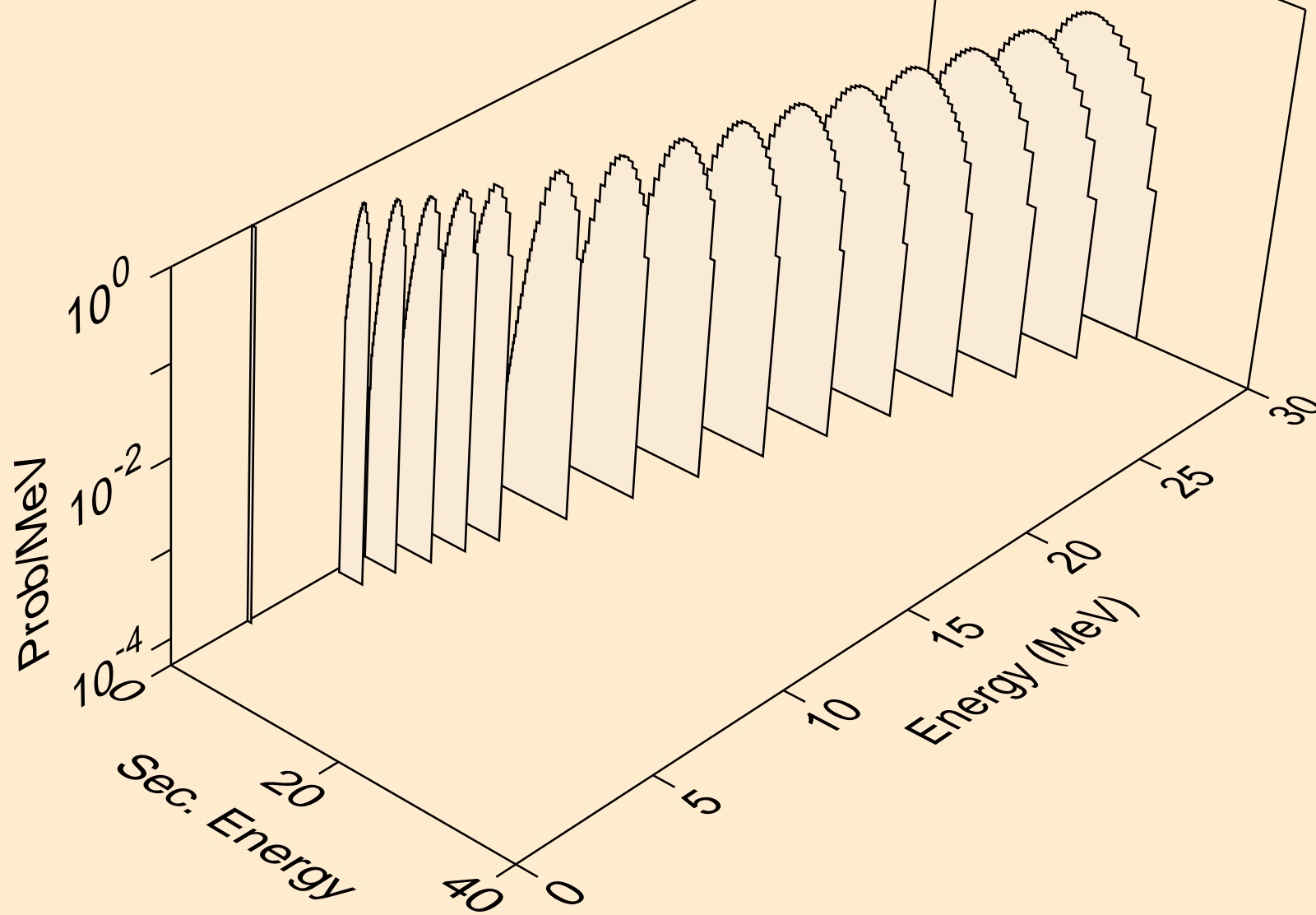

AU182 HELION ACER TENDL-2021 LIBRARY; T=0.K  
deuterons from (s,d2a)

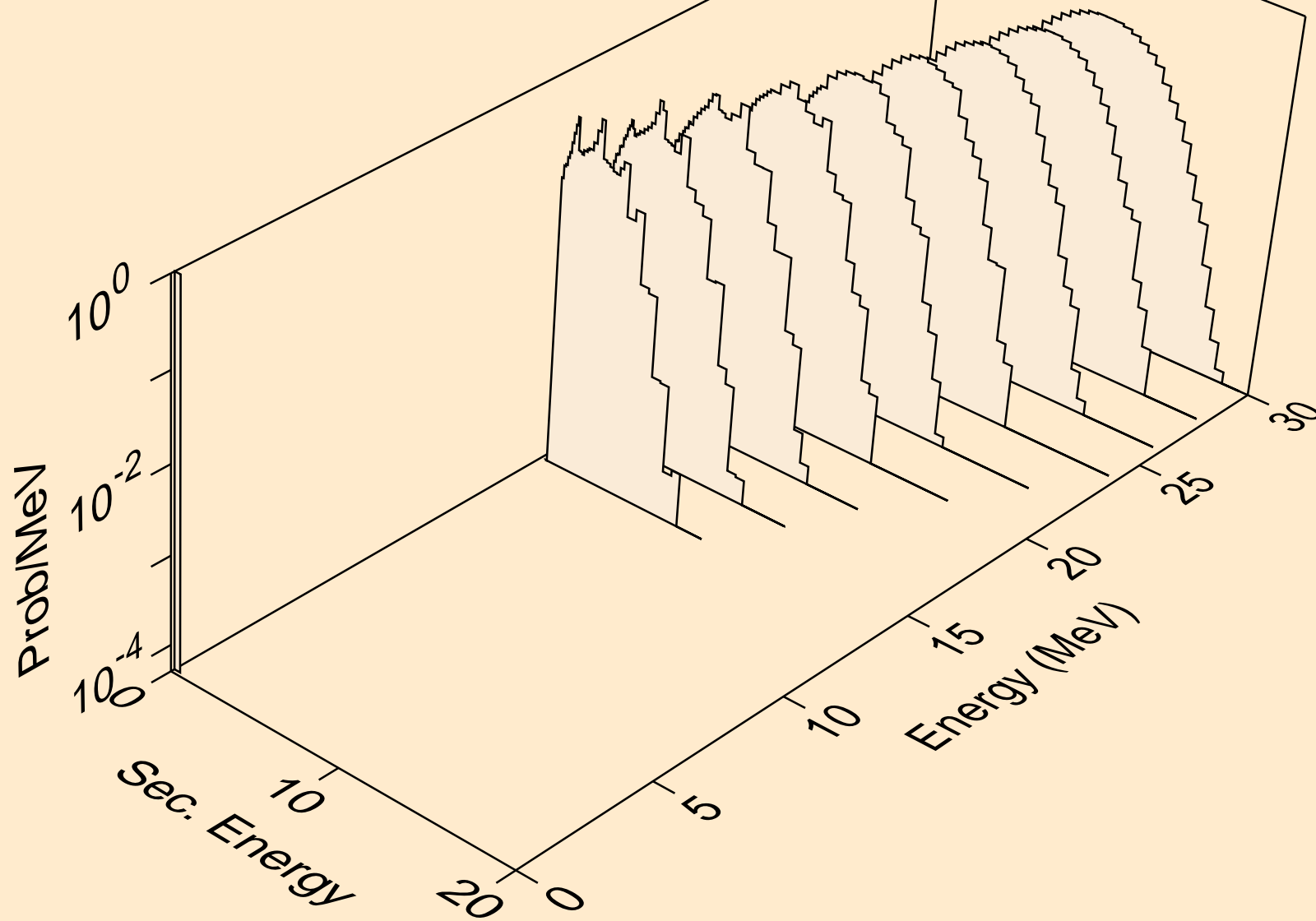

AU182 HELION ACER TENDL-2021 LIBRARY; T=0.K  
deuterons from (s,pd)

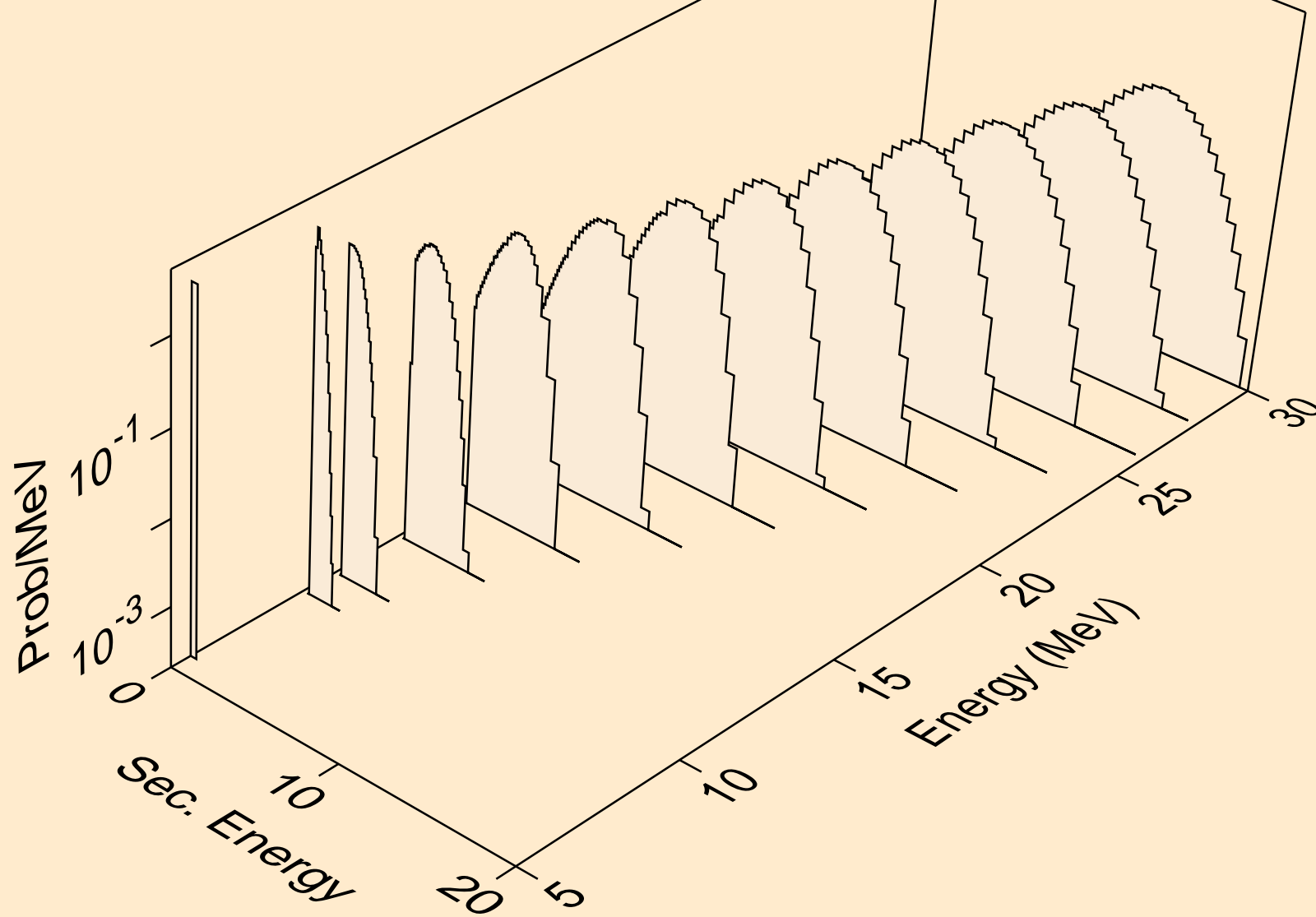

AU182 HELION ACER TENDL-2021 LIBRARY; T=0.K  
deuterons from (s,da)

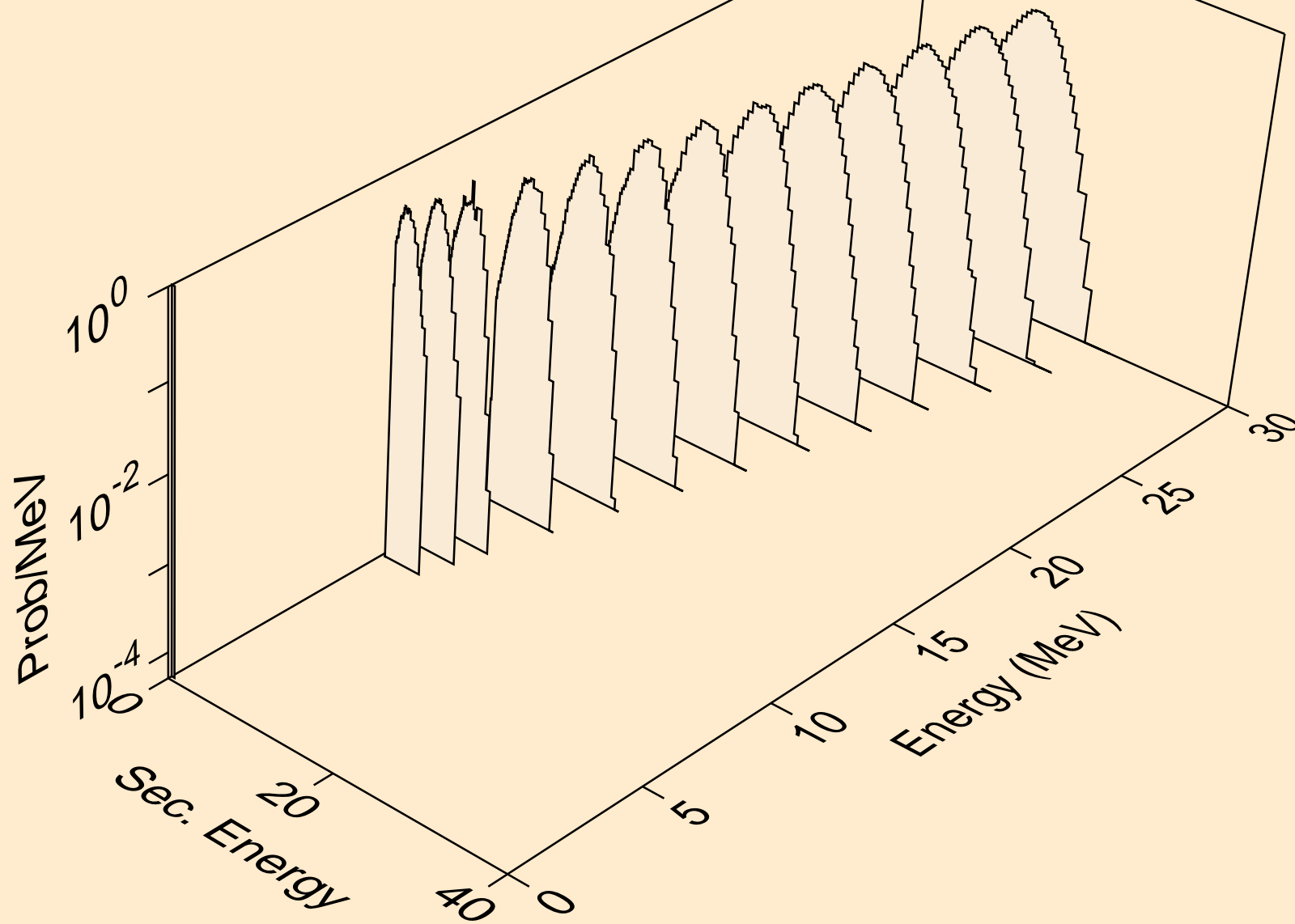

AU182 HELION ACER TENDL-2021 LIBRARY; T=0.K  
tritons from (s,x)

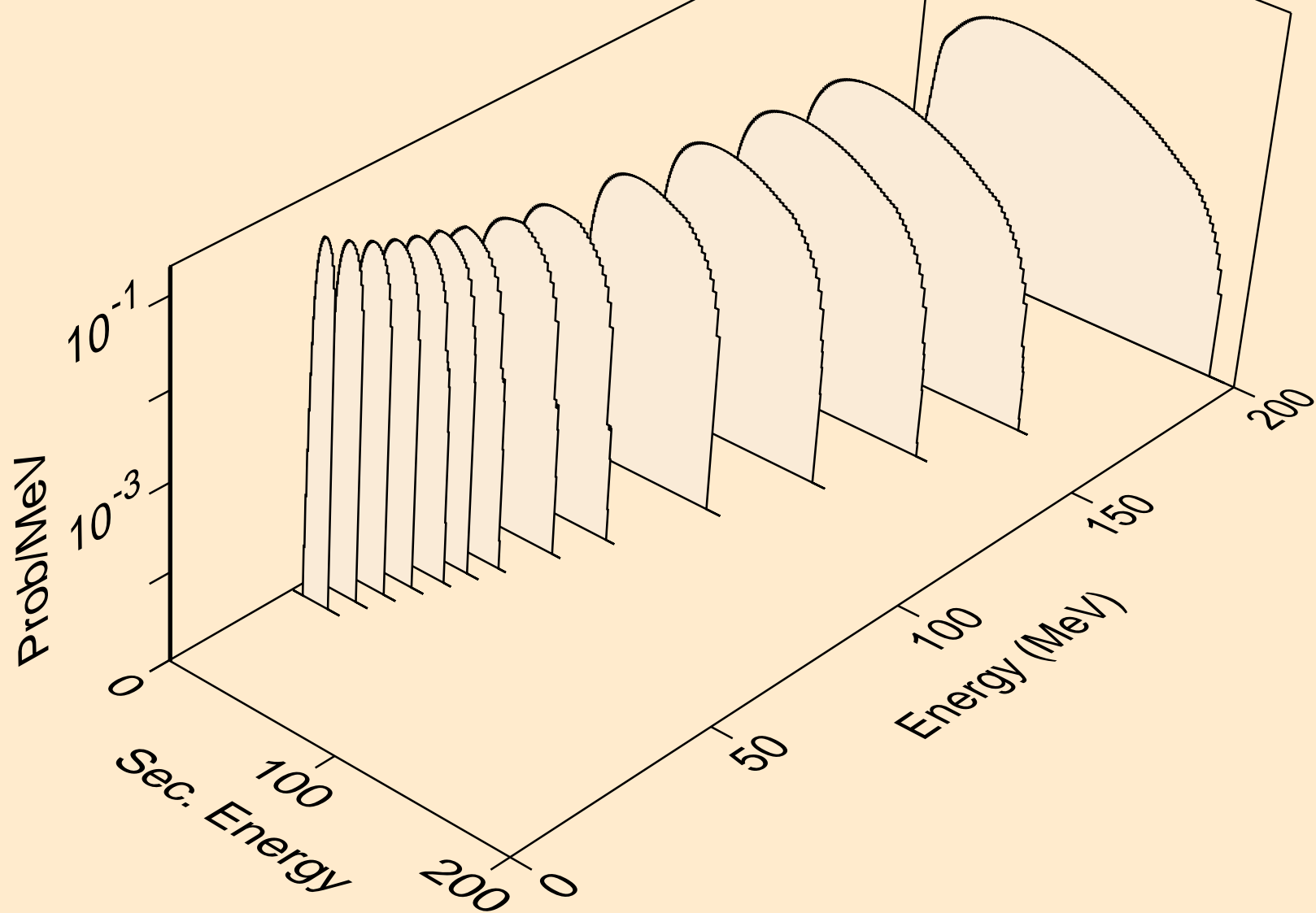

AU182 HELION ACER TENDL-2021 LIBRARY; T=0.K  
tritons from (s,n\*)t

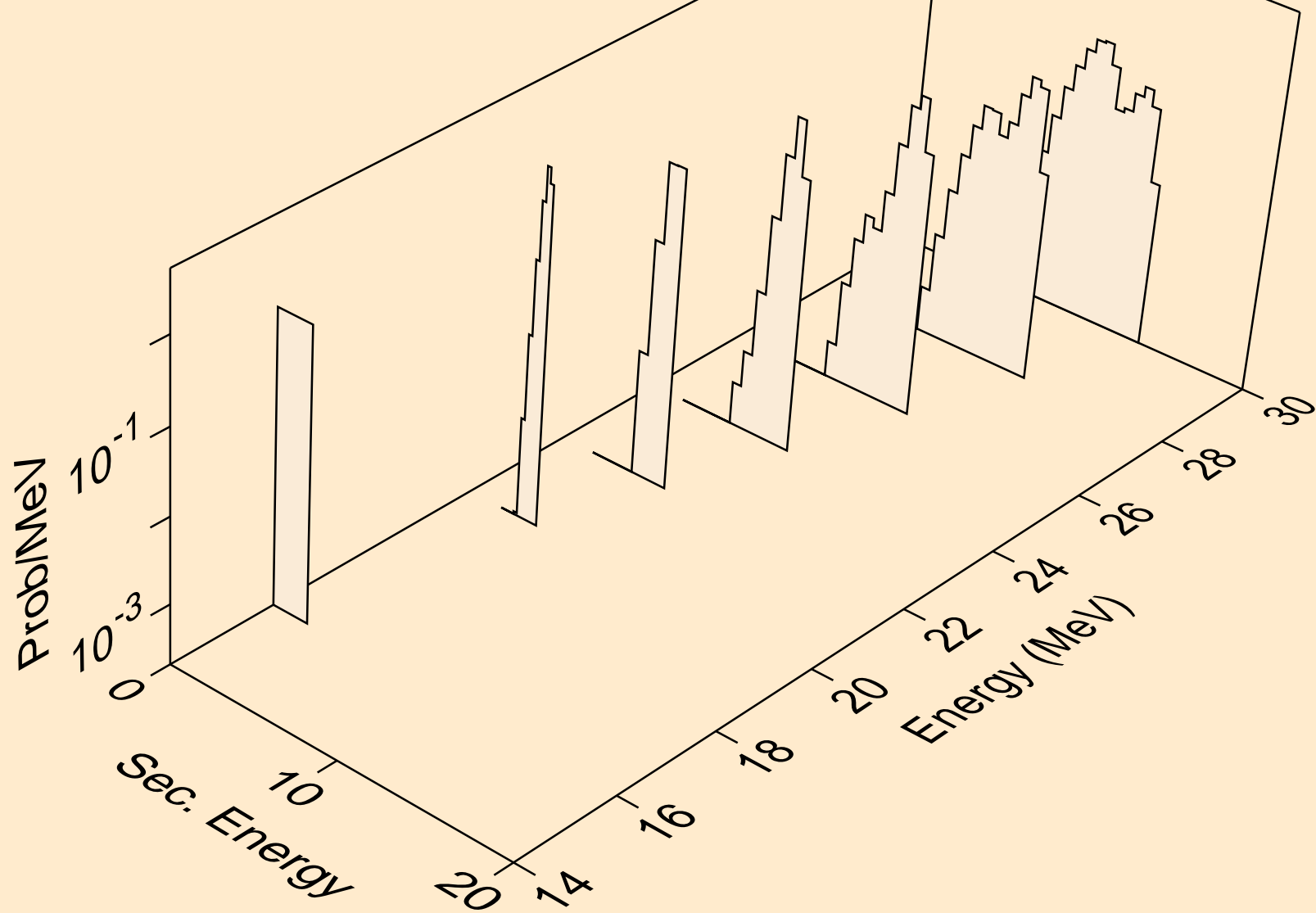



AU182 HELION ACER TENDL-2021 LIBRARY; T=0.K  
tritons from (s,t)

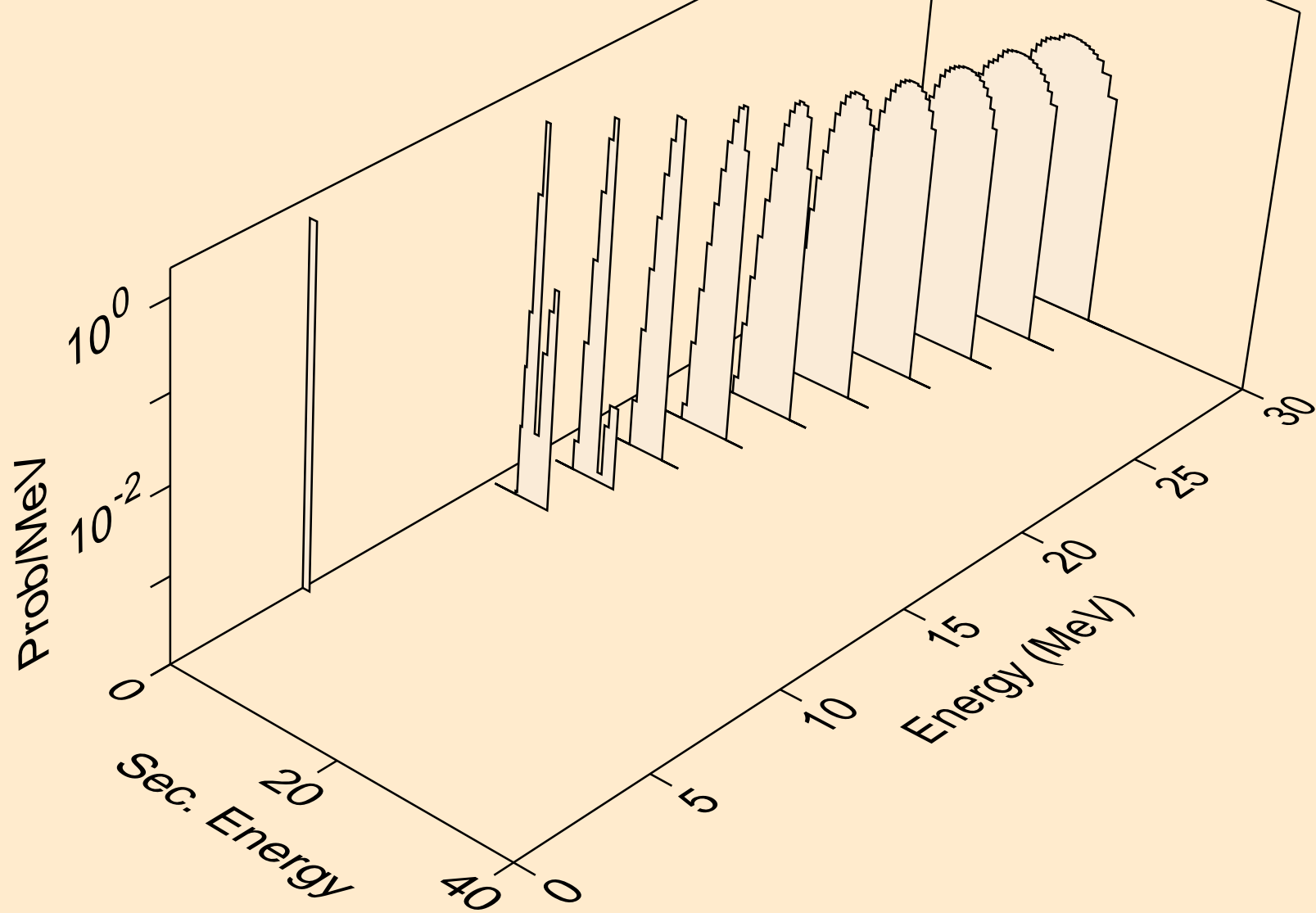

AU182 HELION ACER TENDL-2021 LIBRARY; T=0.K  
tritons from (s,t2a)

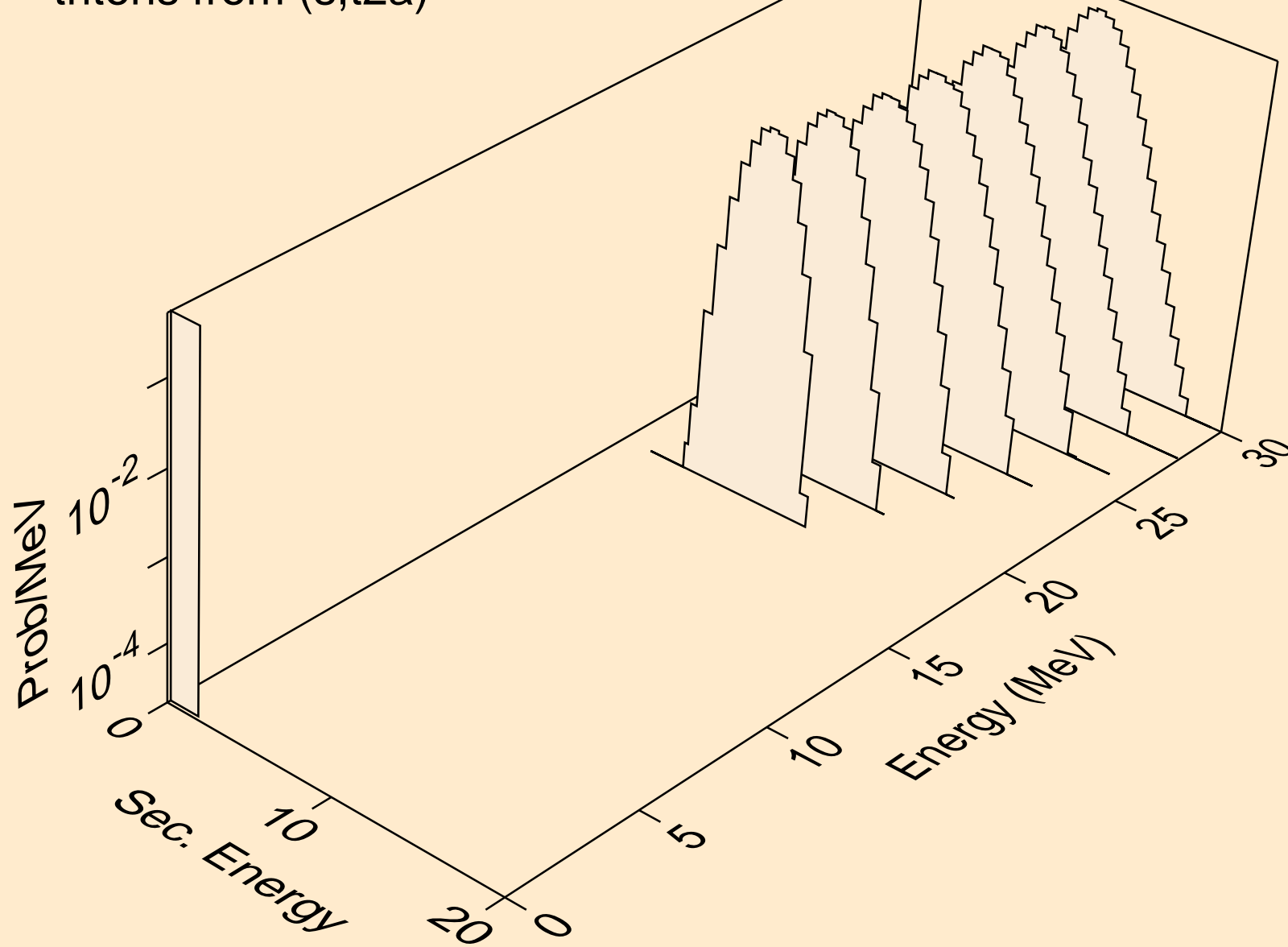

AU182 HELION ACER TENDL-2021 LIBRARY; T=0.K  
tritons from (s,pt)

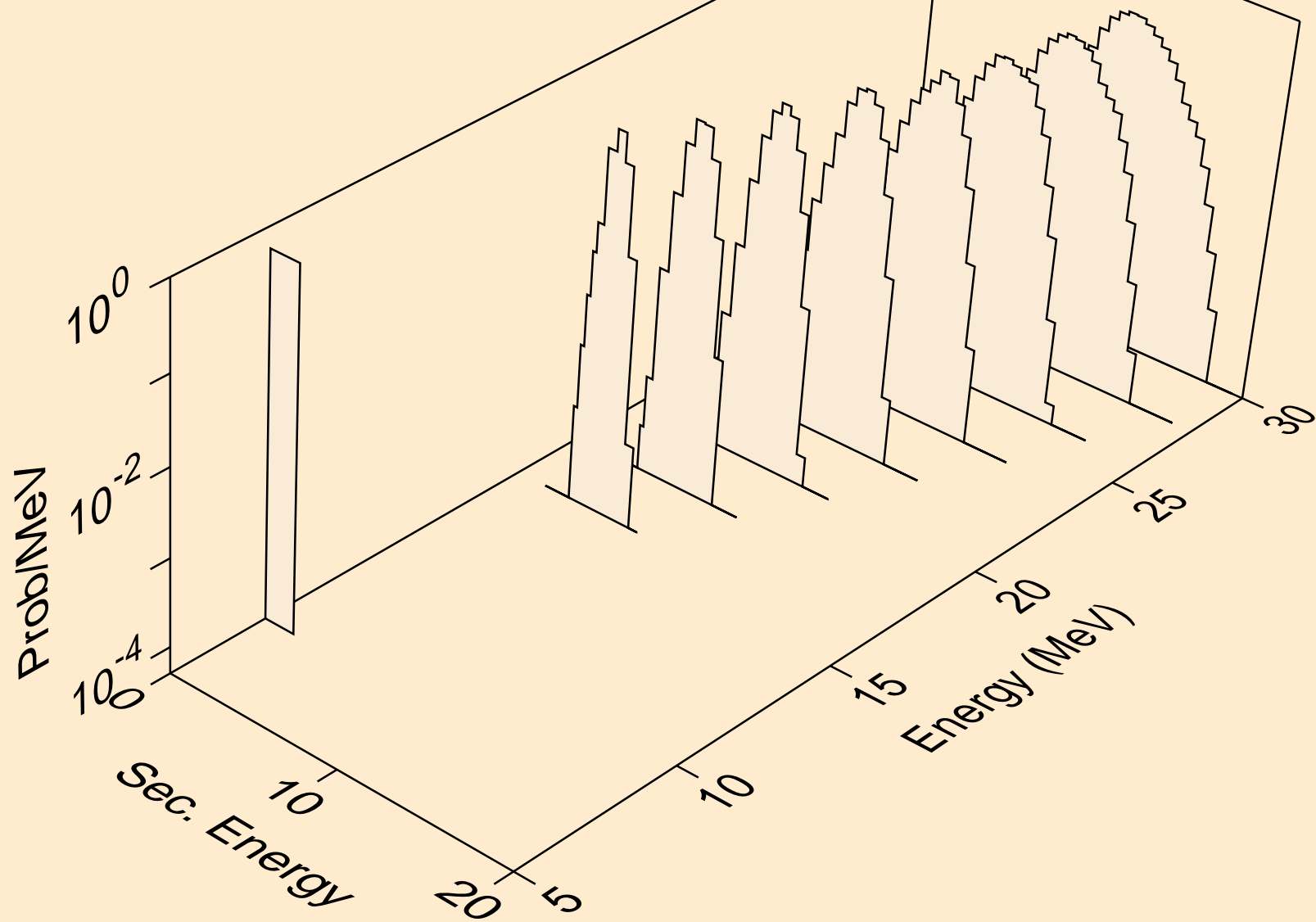

AU182 HELION ACER TENDL-2021 LIBRARY; T=0.K  
alphas from (s,x)

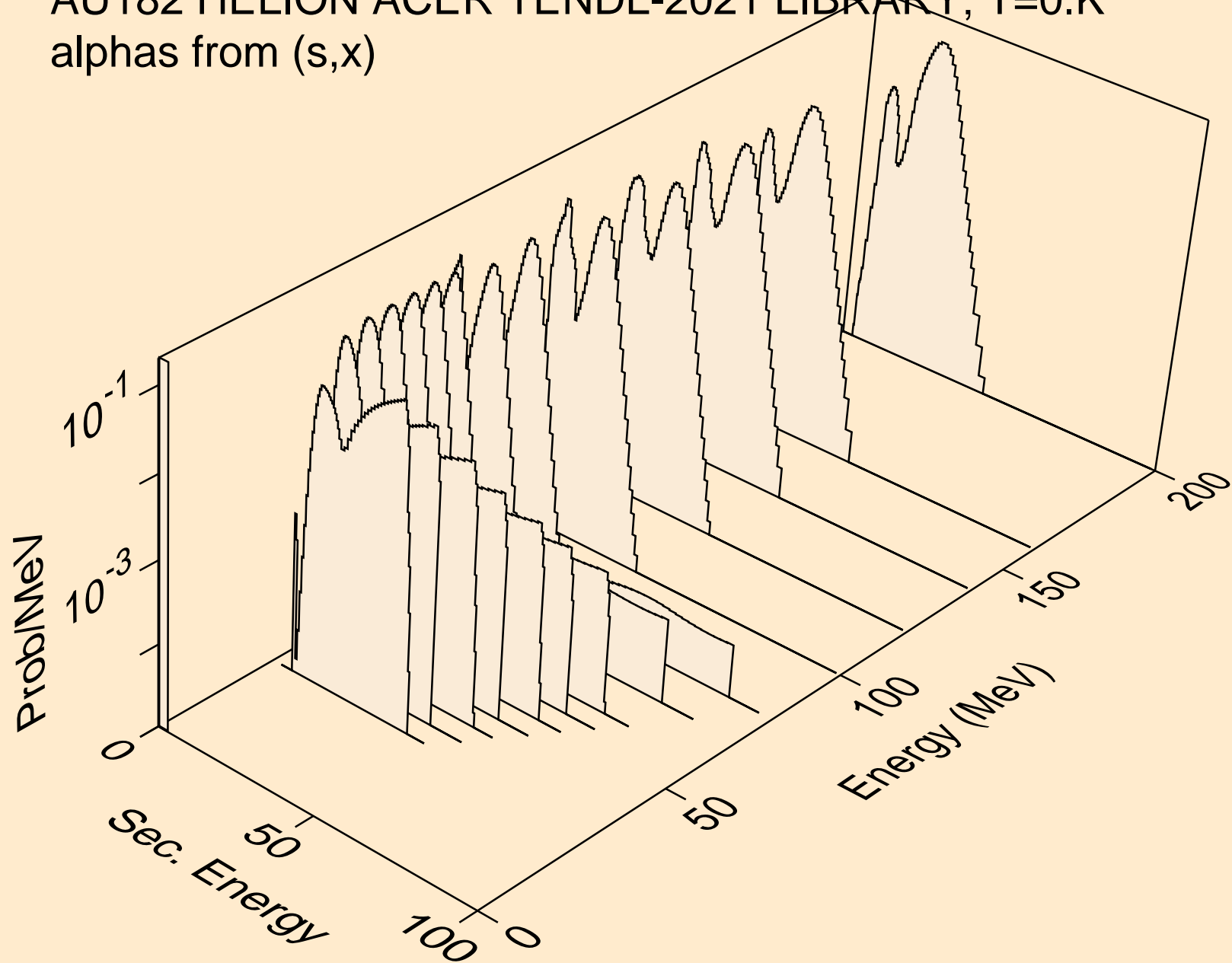

AU182 HELION ACER TENDL-2021 LIBRARY; T=0.K  
alphas from (s,n\*)a

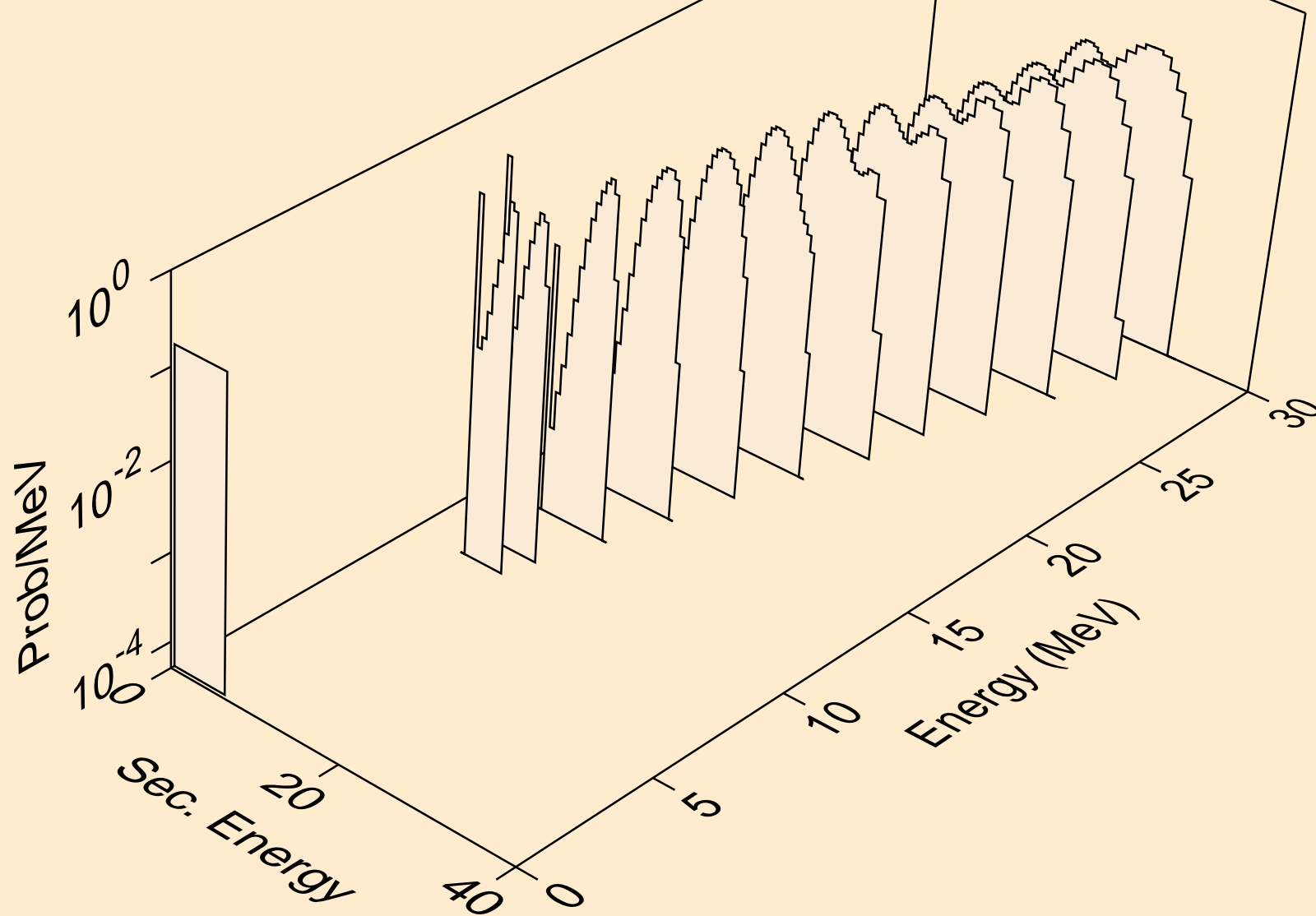

AU182 HELION ACER TENDL-2021 LIBRARY; T=0.K  
alphas from (s,2n)a

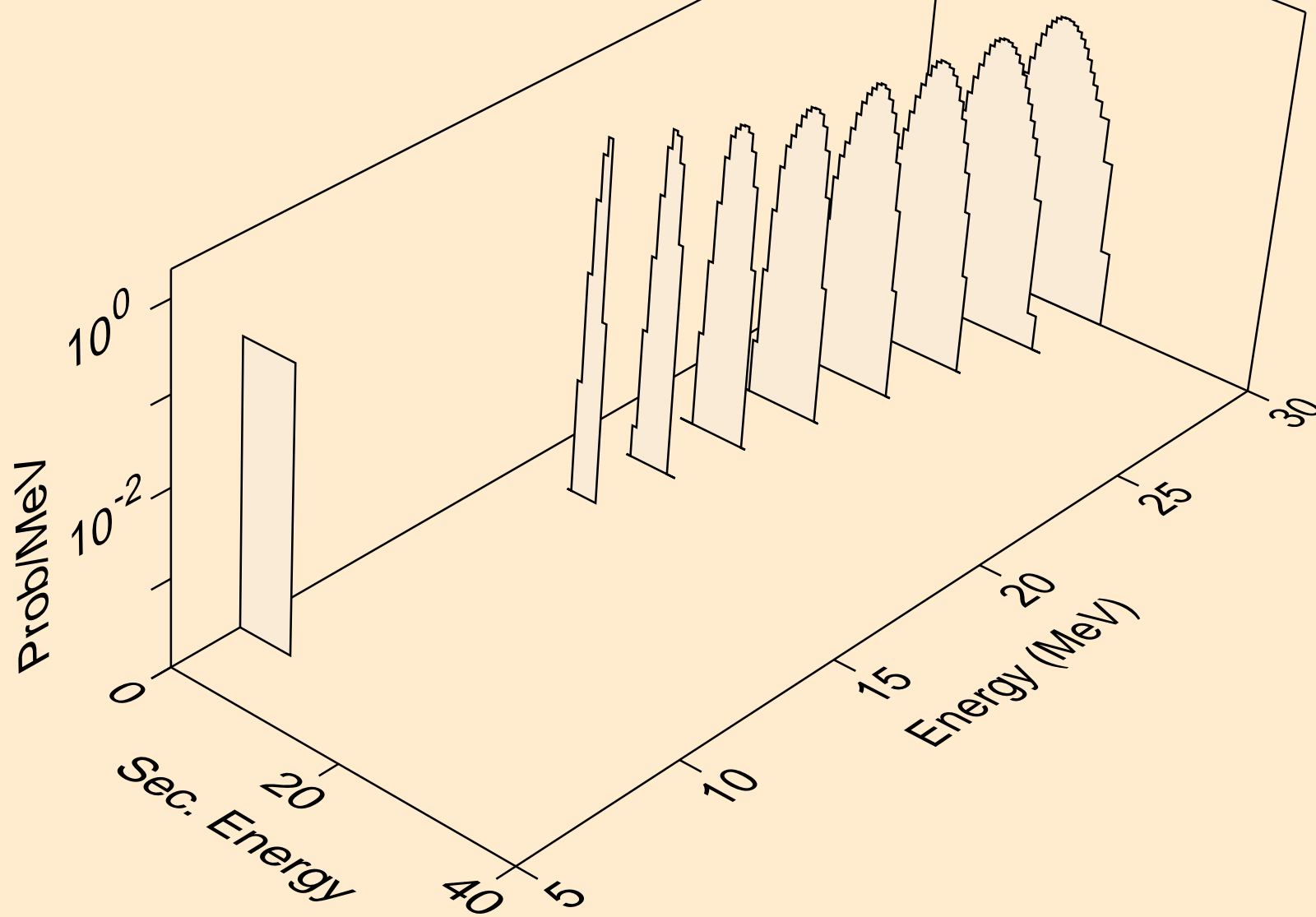

AU182 HELION ACER TENDL-2021 LIBRARY; T=0.K  
alphas from (s,3n)a

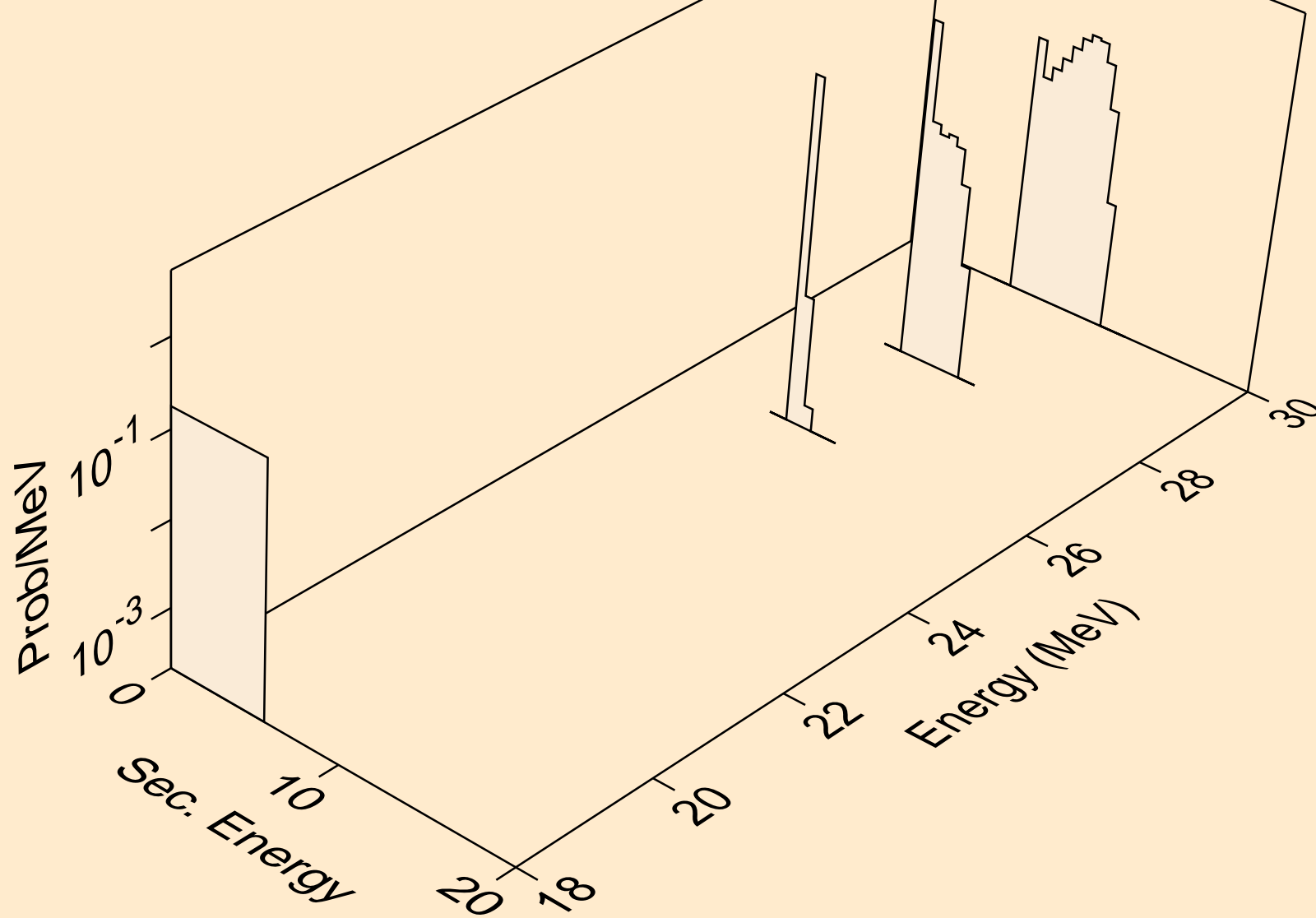

AU182 HELION ACER TENDL-2021 LIBRARY; T=0.K  
alphas from (s,n\*)2a

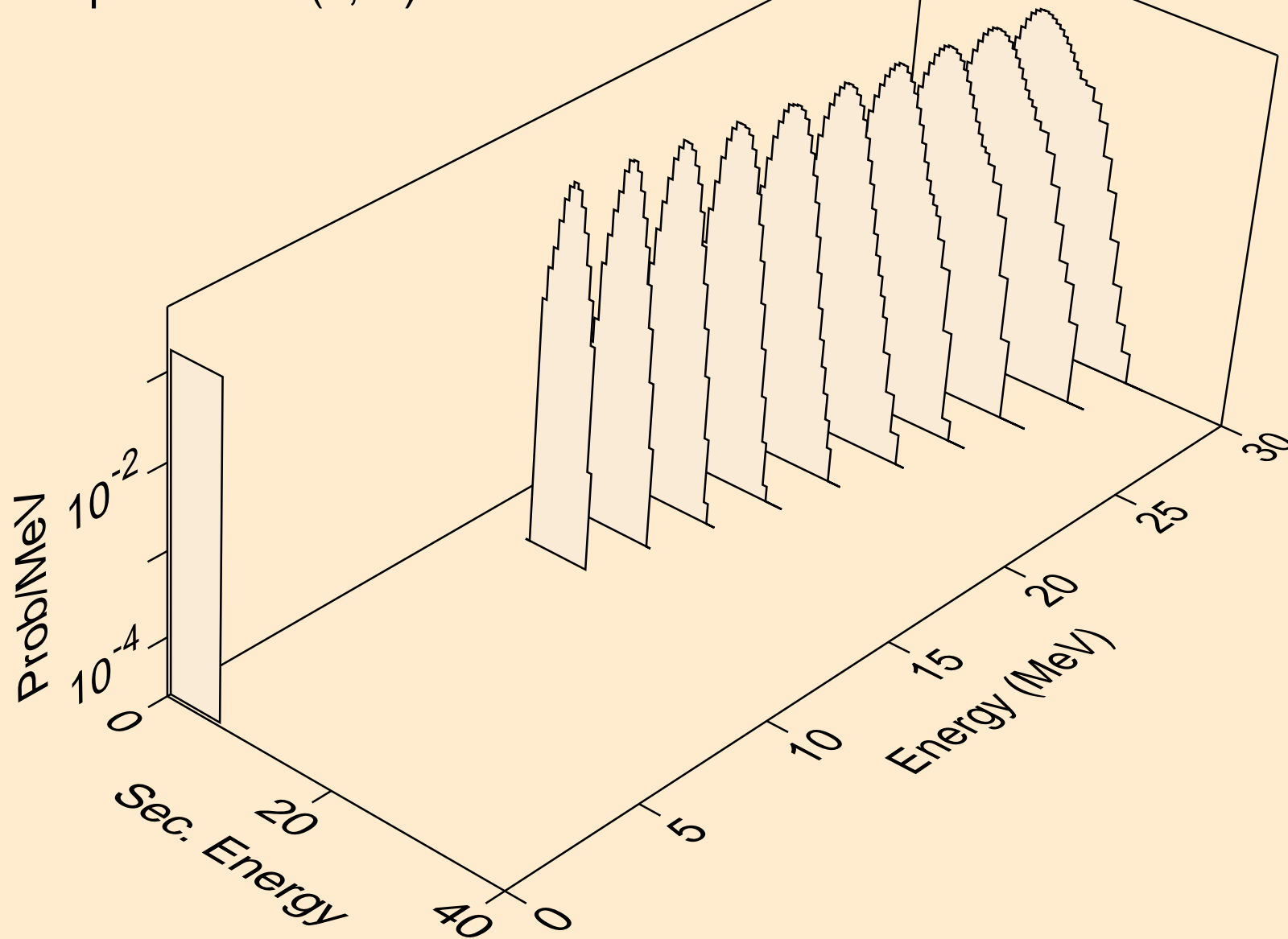



AU182 HELION ACER TENDL-2021 LIBRARY; T=0.K  
alphas from (s,npa)

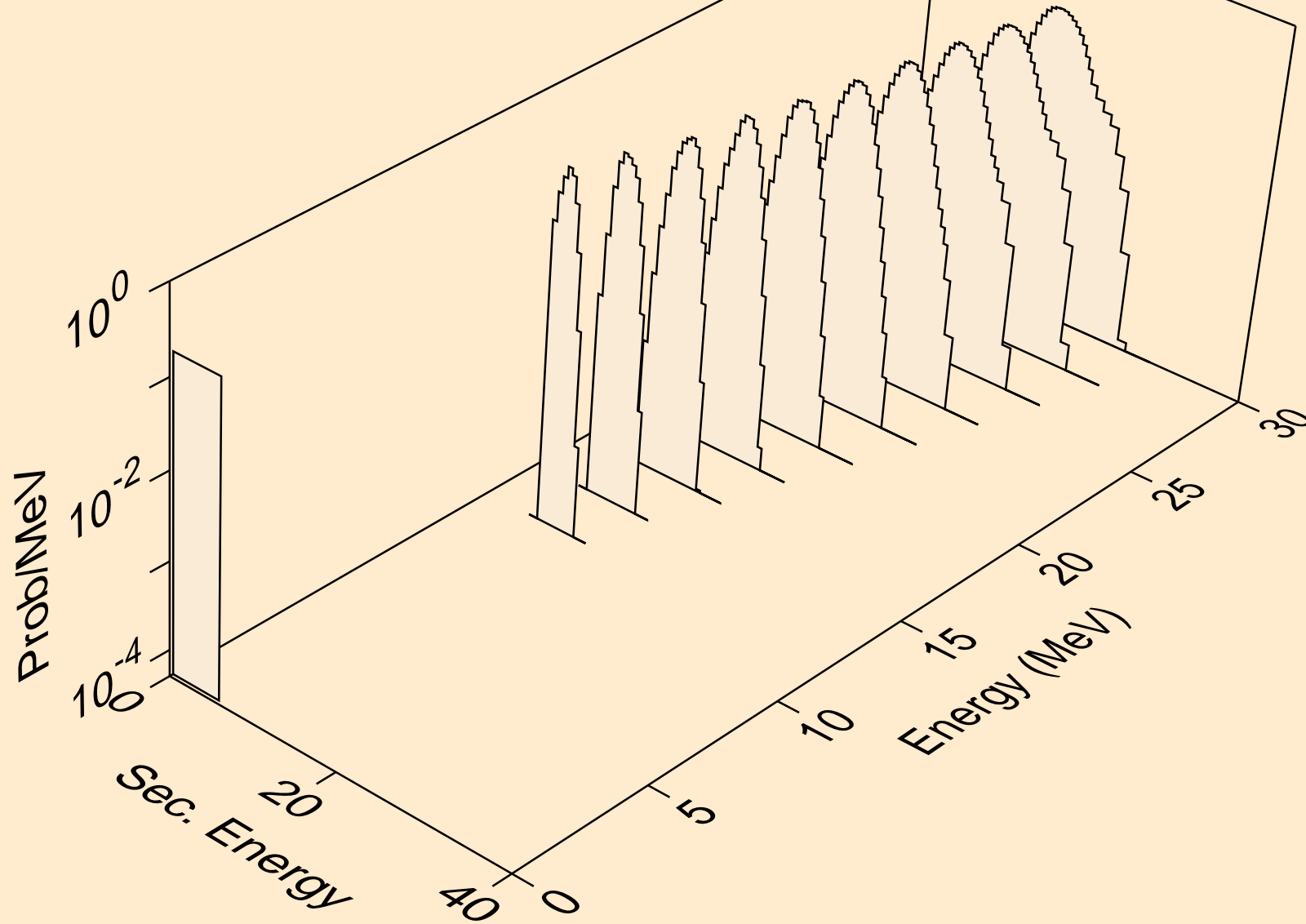

AU182 HELION ACER TENDL-2021 LIBRARY; T=0.K  
alphas from (s,a)

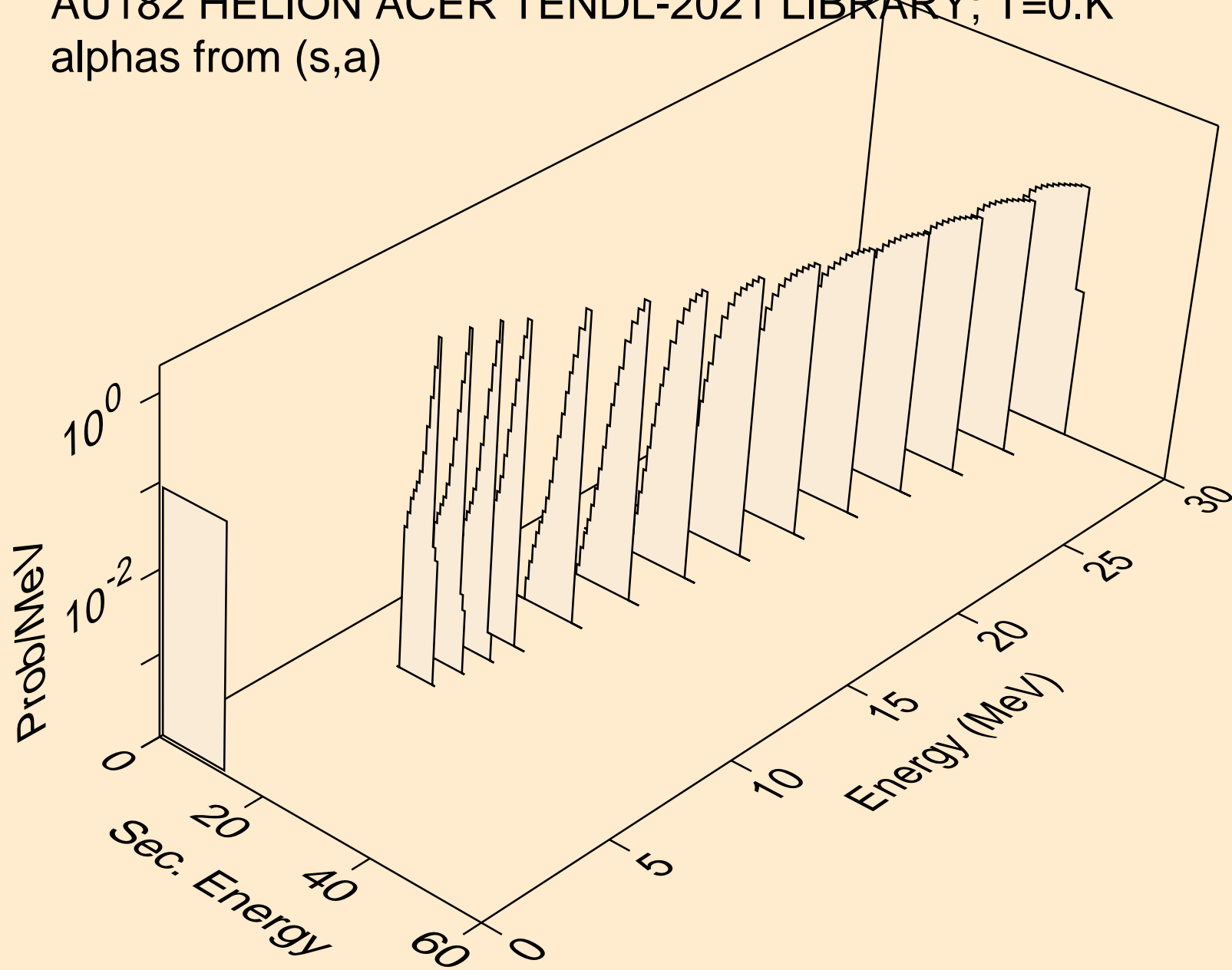

AU182 HELION ACER TENDL-2021 LIBRARY; T=0.K  
alphas from (s,2a)

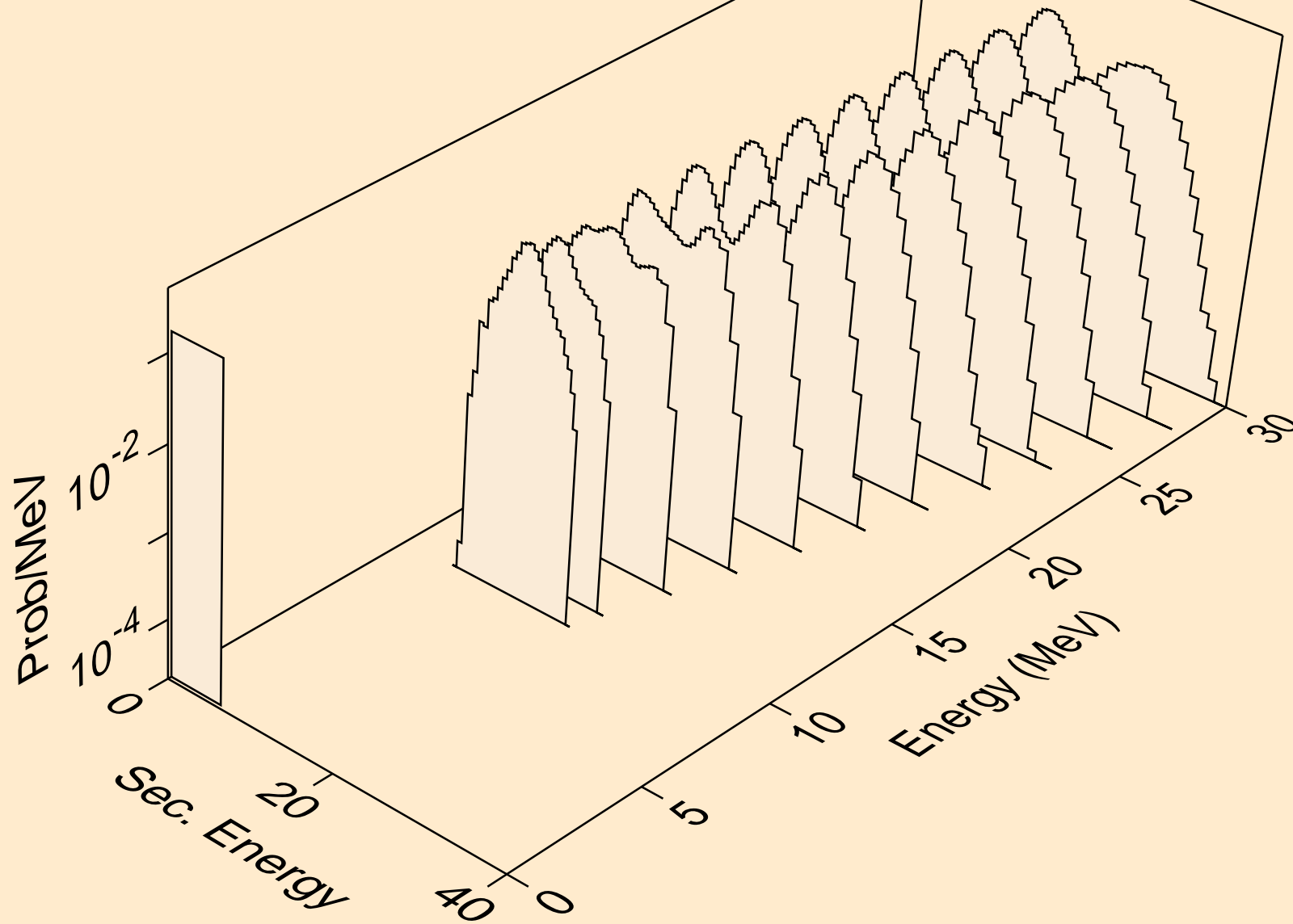

AU182 HELION ACER TENDL-2021 LIBRARY; T=0.K  
alphas from (s,pa)

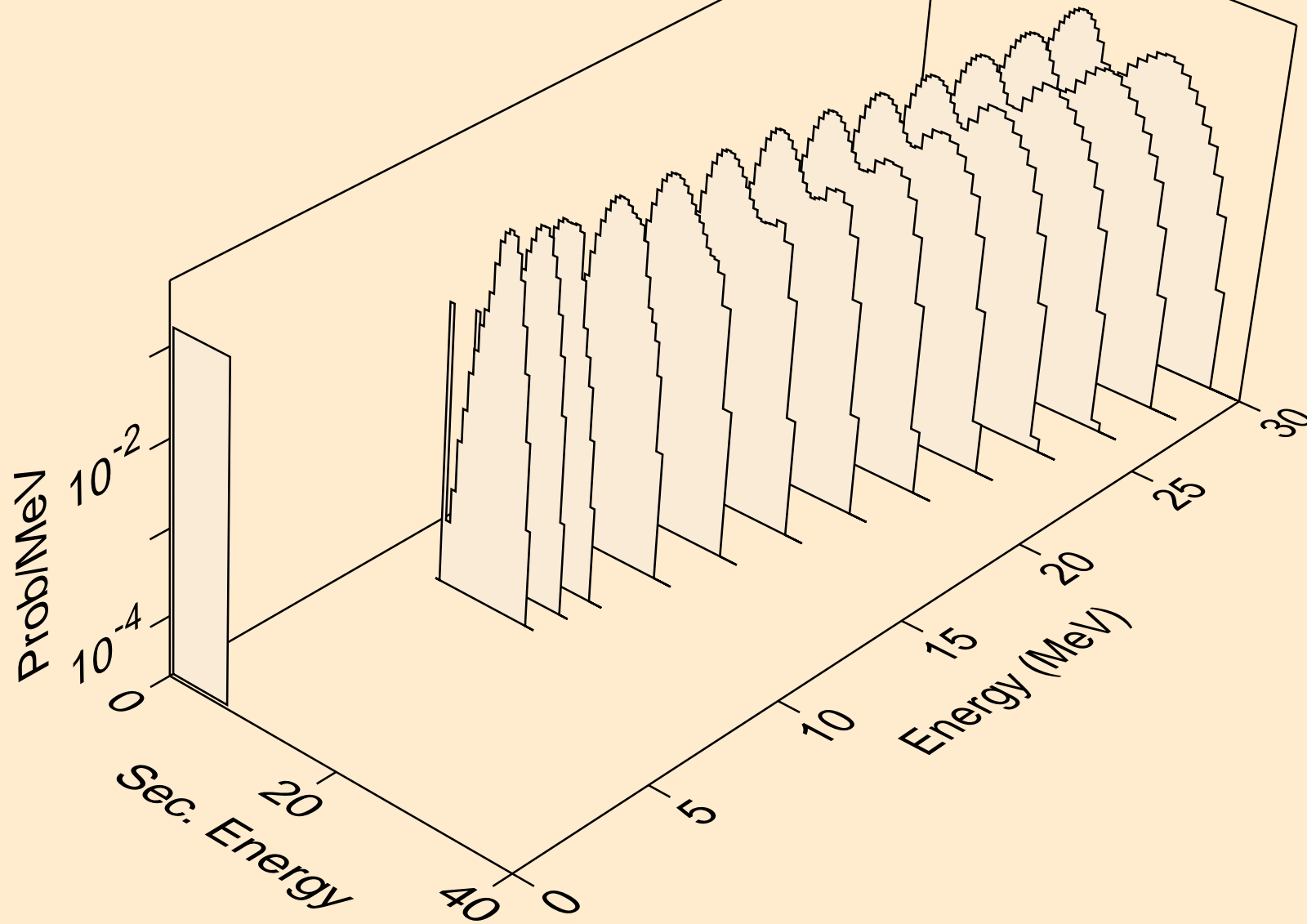

AU182 HELION ACER TENDL-2021 LIBRARY; T=0.K  
alphas from (s,t2a)

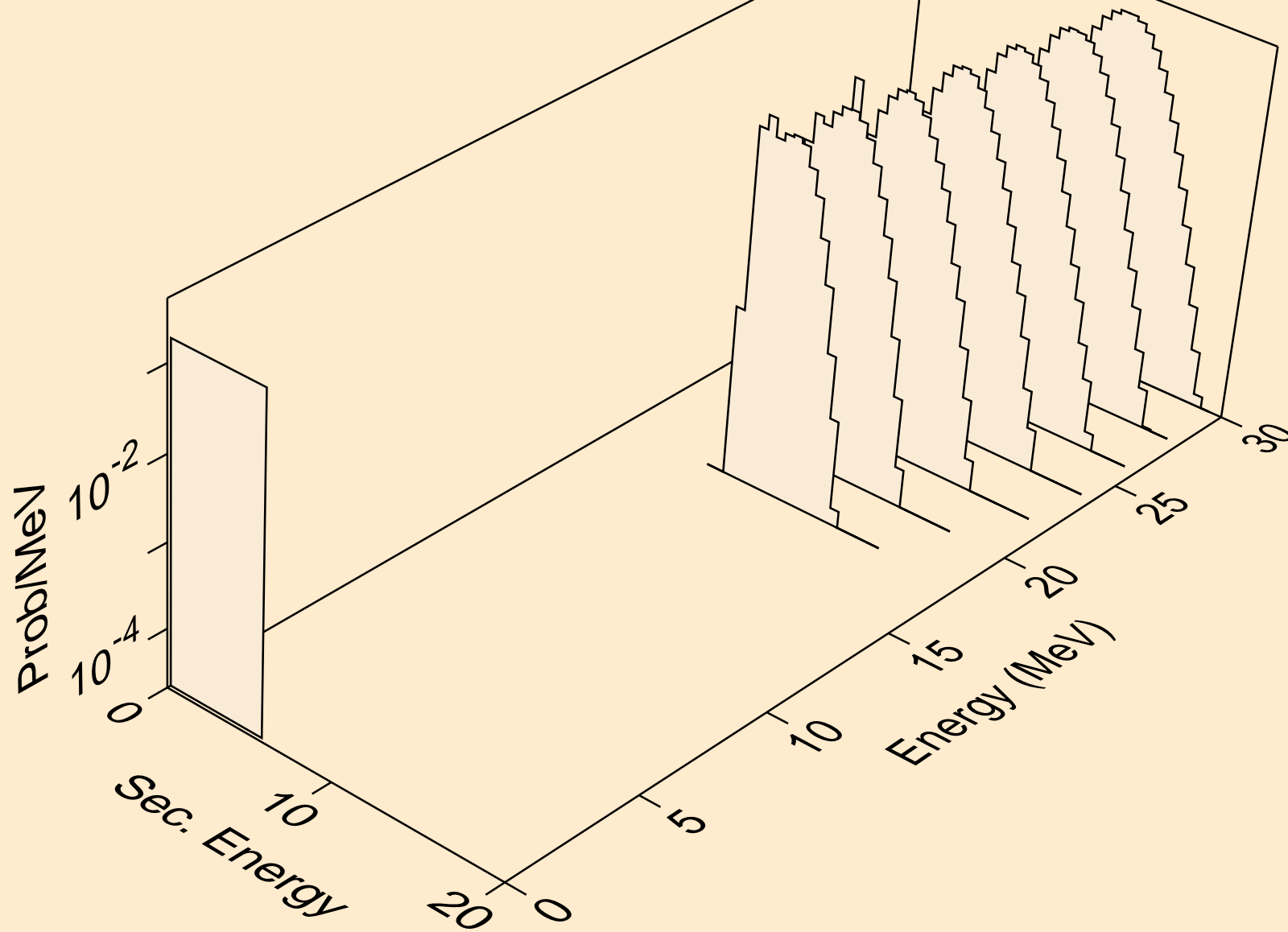

AU182 HELION ACER TENDL-2021 LIBRARY; T=0.K  
alphas from (s,d2a)

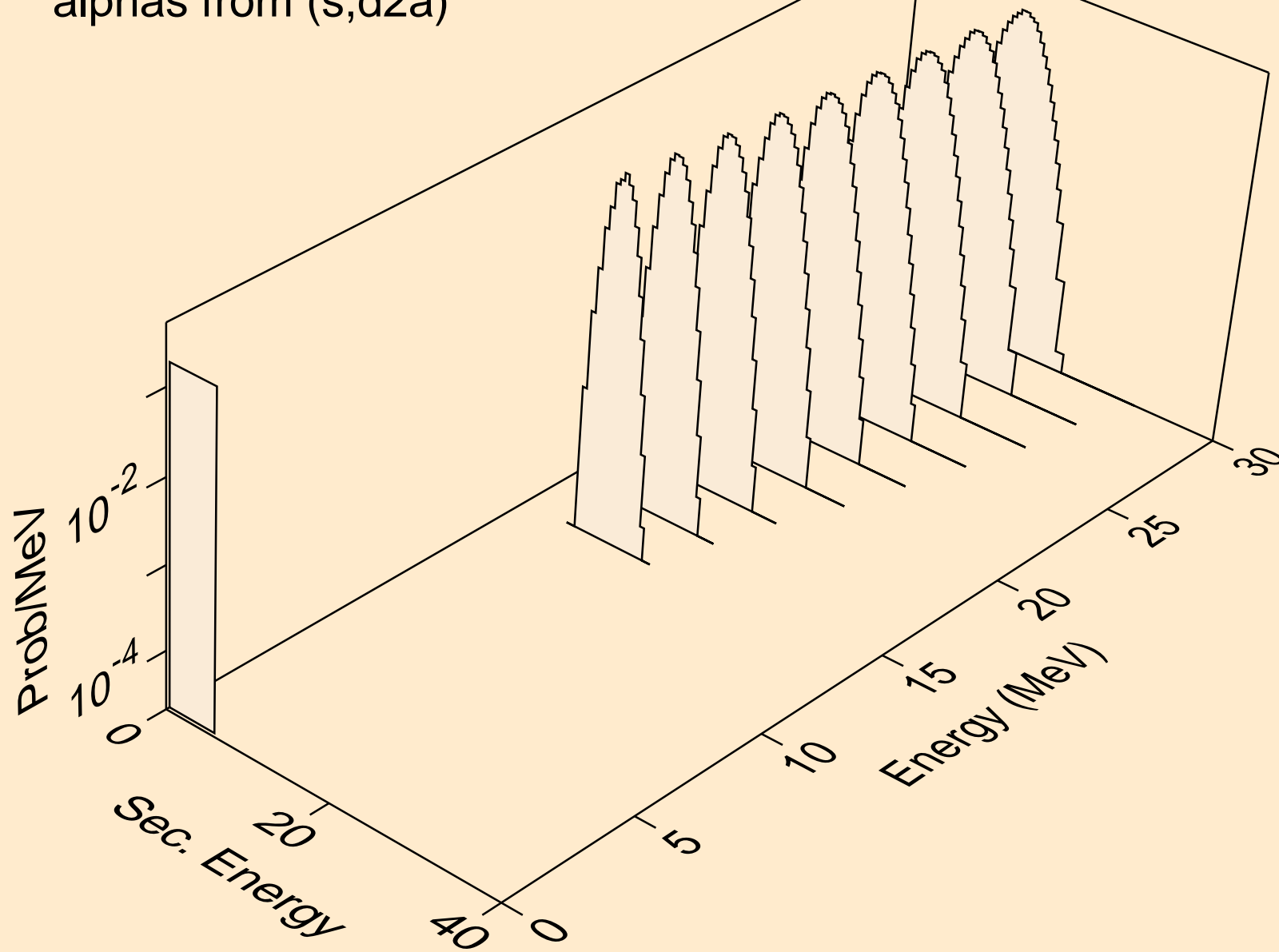

AU182 HELION ACER TENDL-2021 LIBRARY; T=0.K  
alphas from (s,da)

