

AU206 HELION ACER TENDL-2021 LIBRARY; T=0.K  
Principal cross sections

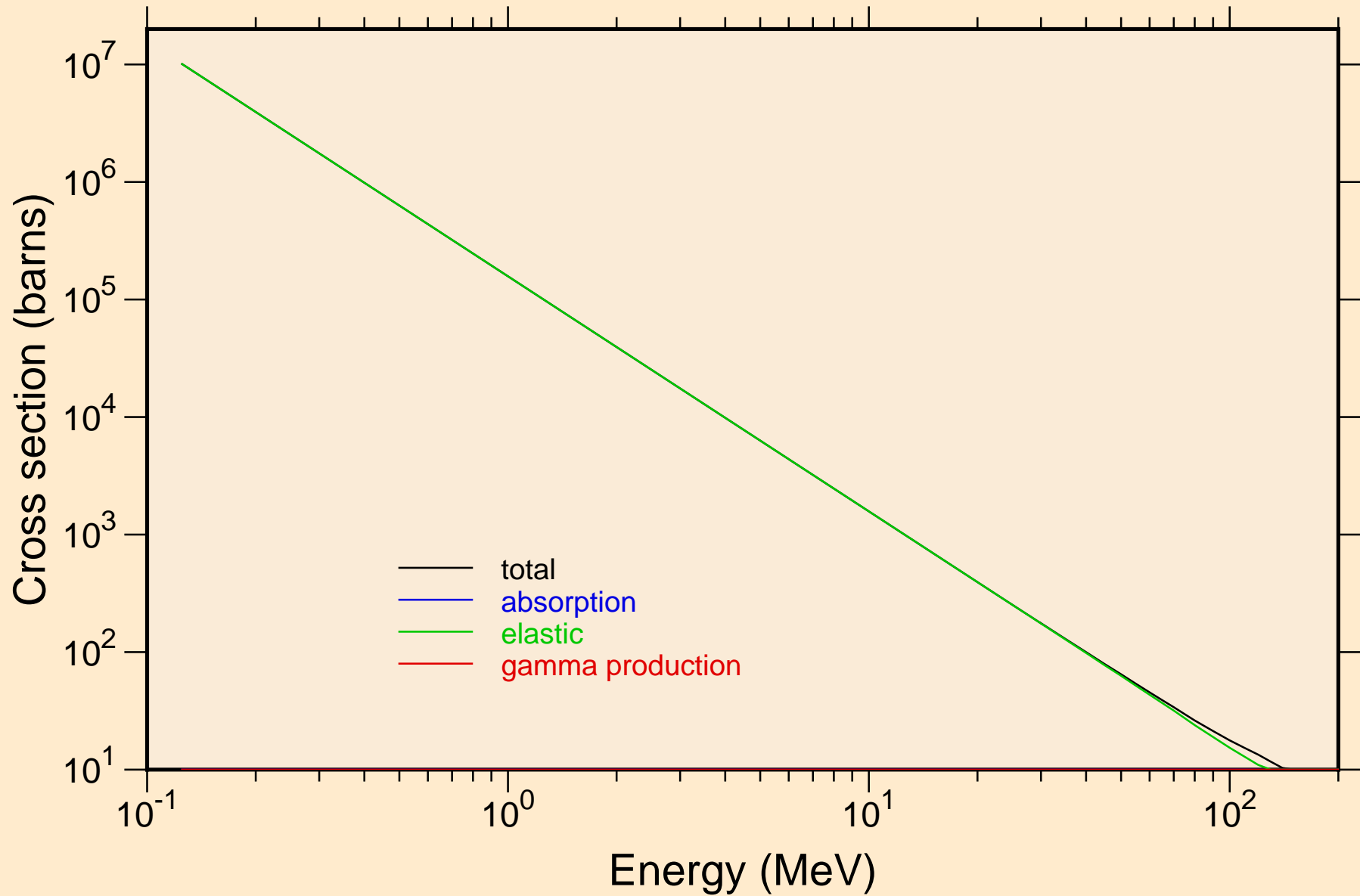

AU206 HELION ACER TENDL-2021 LIBRARY; T=0.K

Heating

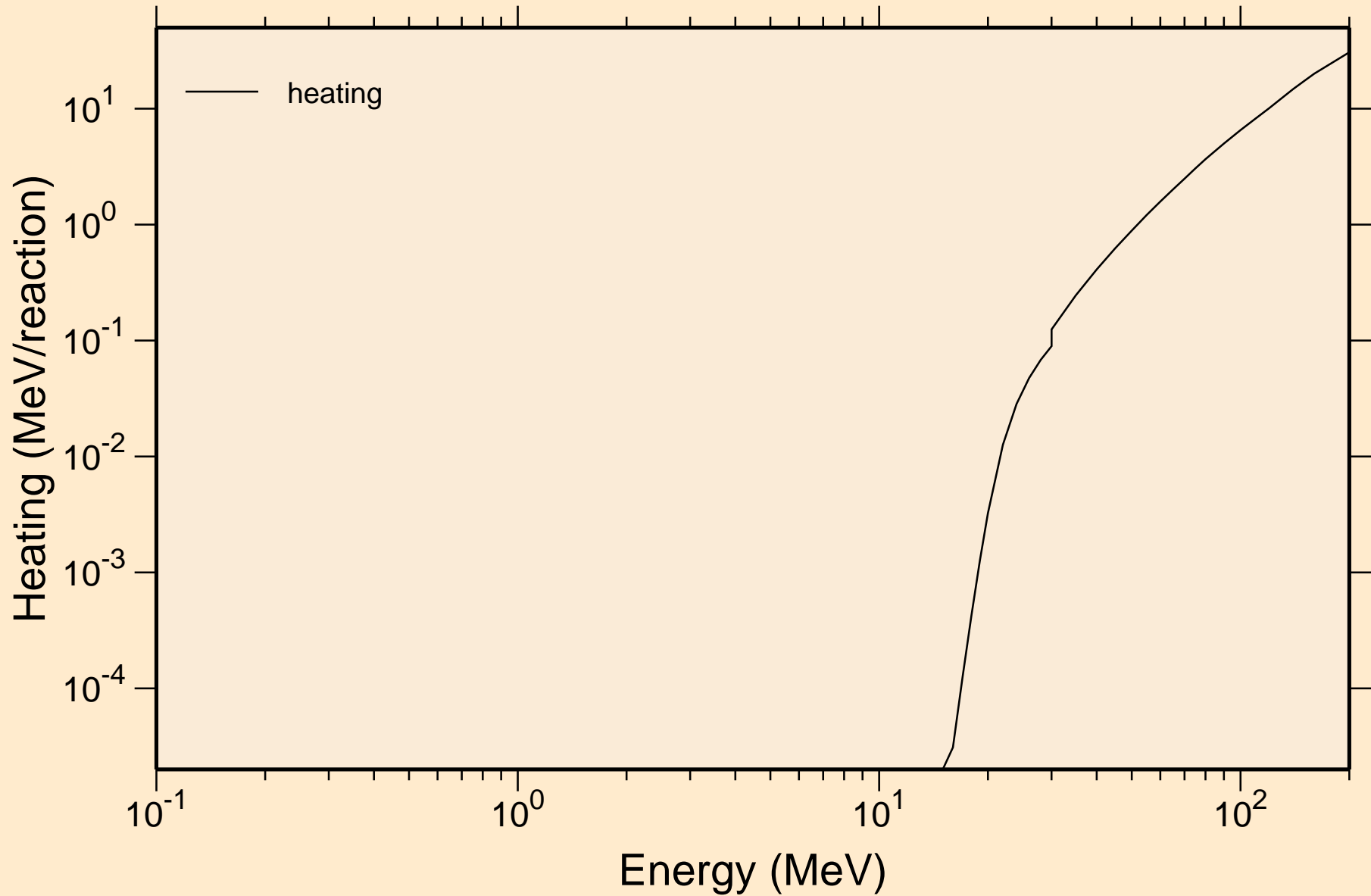

# AU206 HELION ACER TENDL-2021 LIBRARY; T=0.K

## Principal cross sections

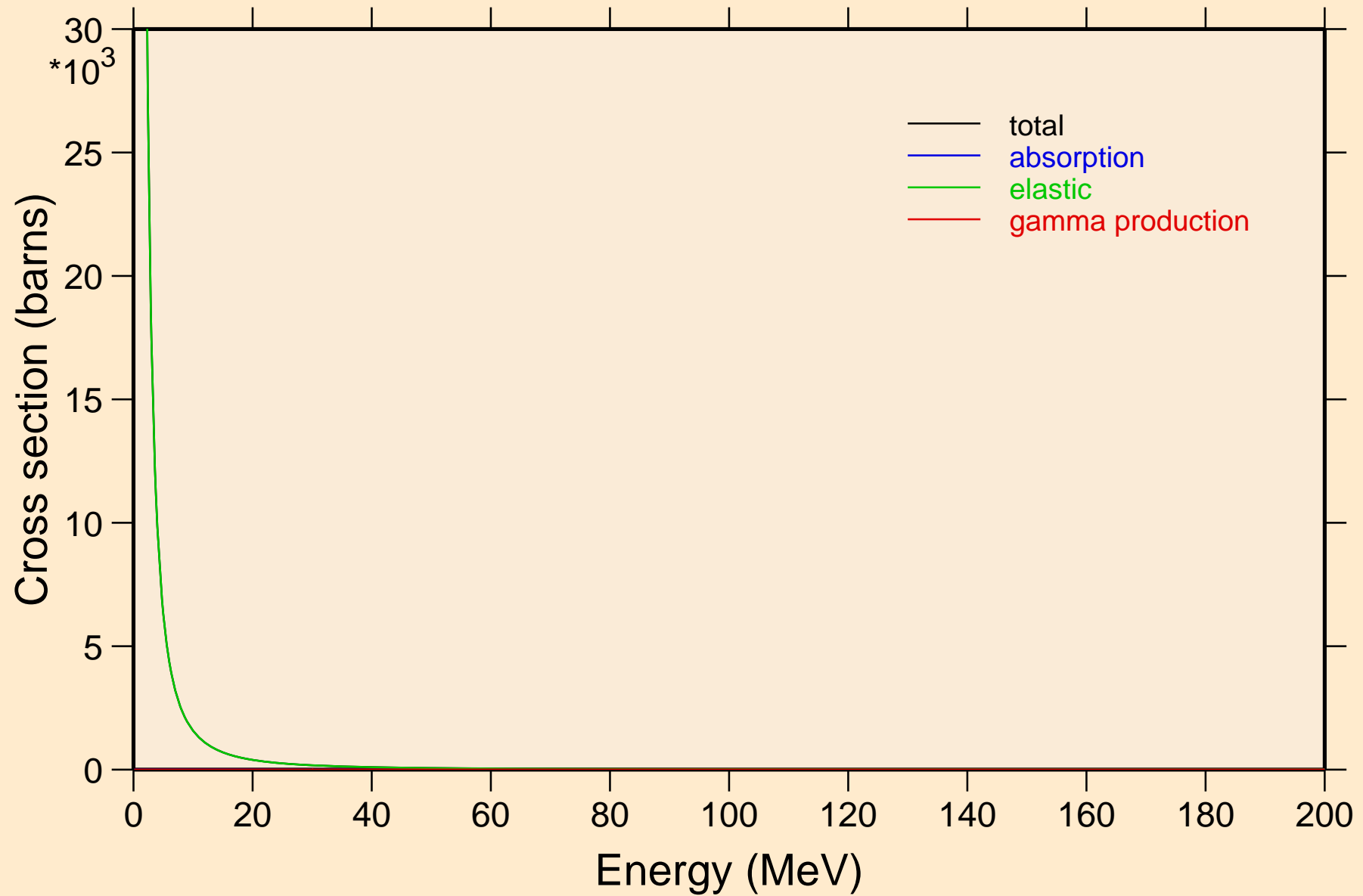

AU206 HELION ACER TENDL-2021 LIBRARY; T=0.K

Heating

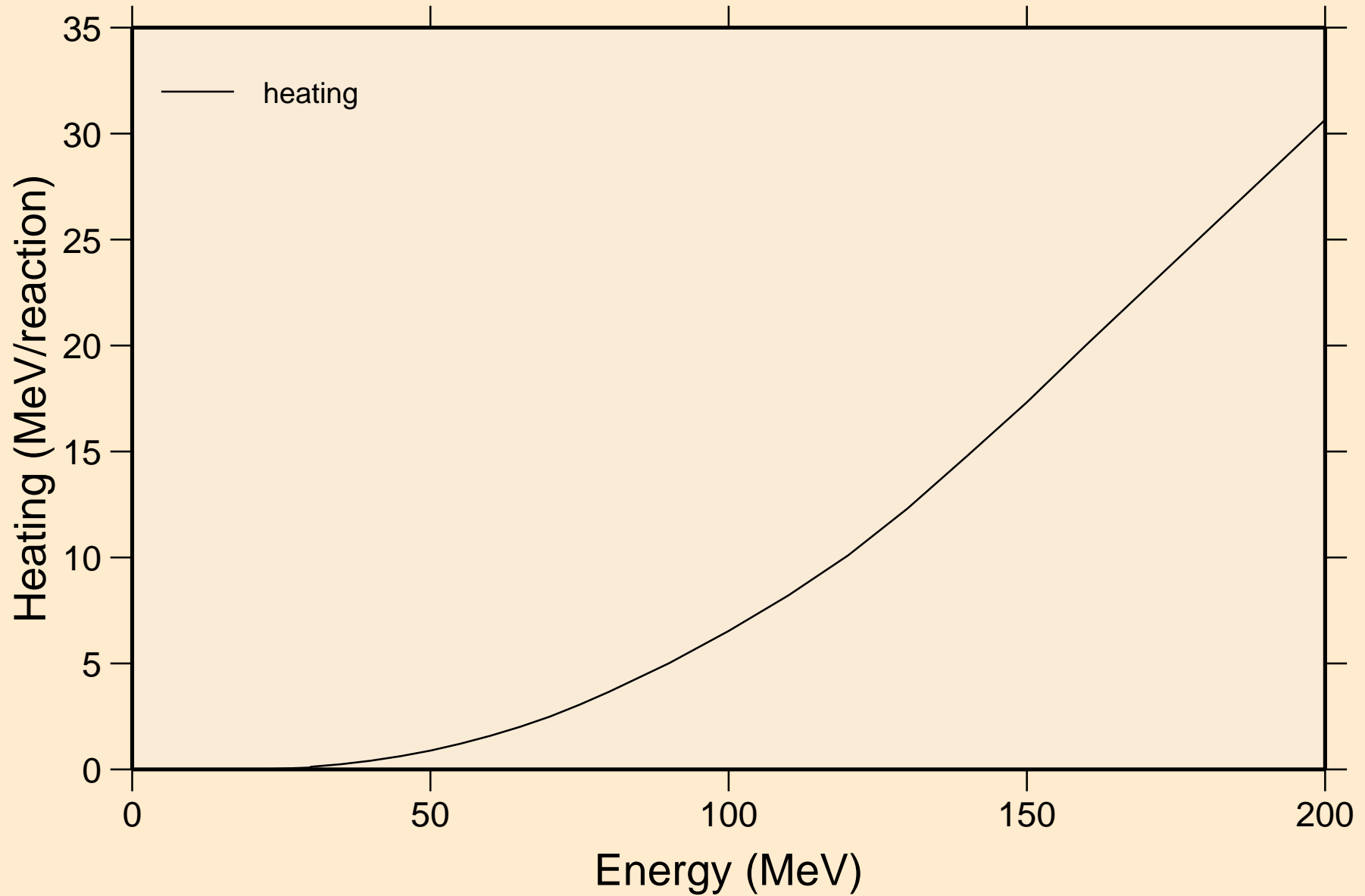

AU206 HELION ACER TENDL-2021 LIBRARY; T=0.K  
Threshold reactions

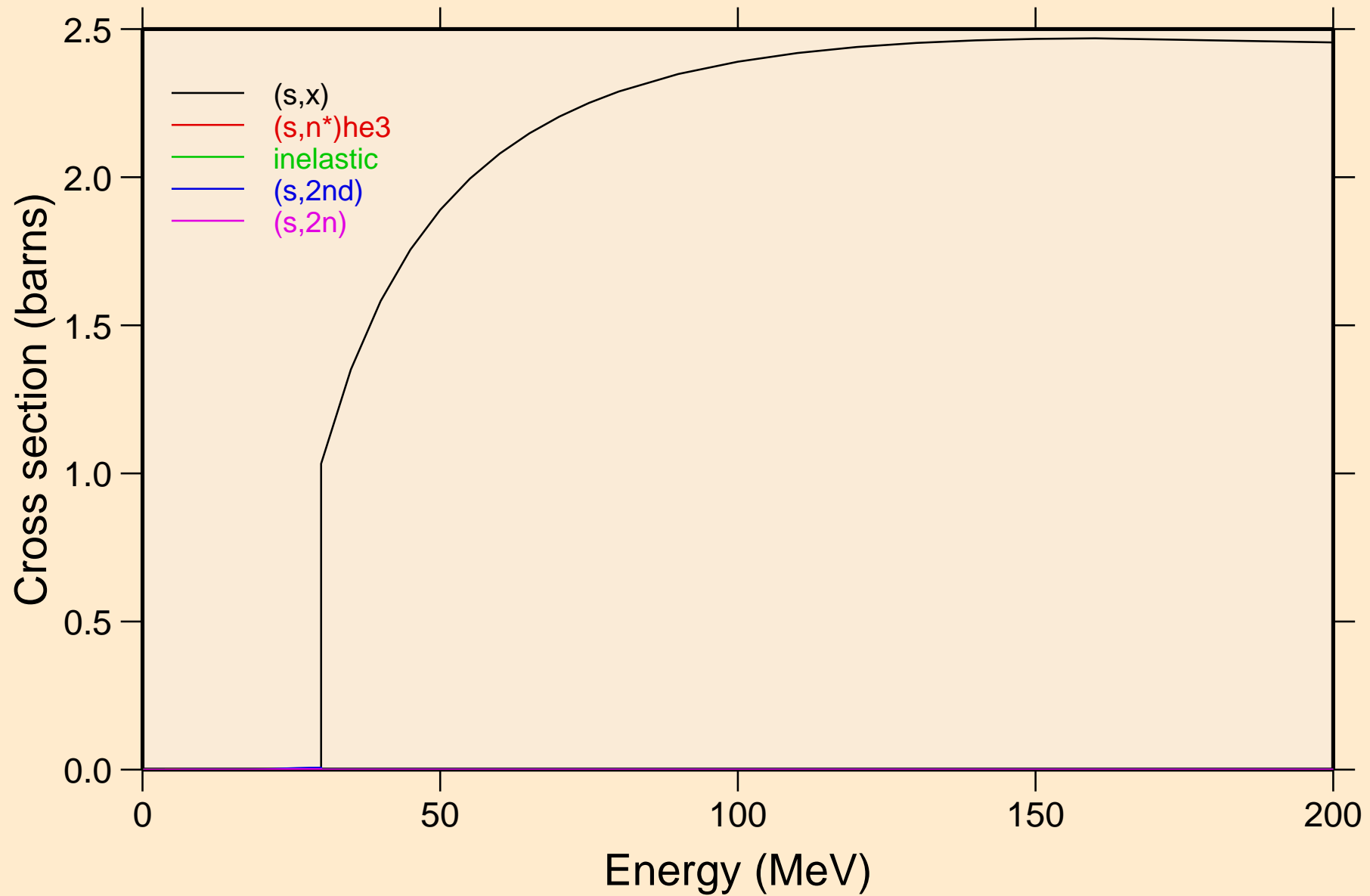

AU206 HELION ACER TENDL-2021 LIBRARY; T=0.K  
Threshold reactions

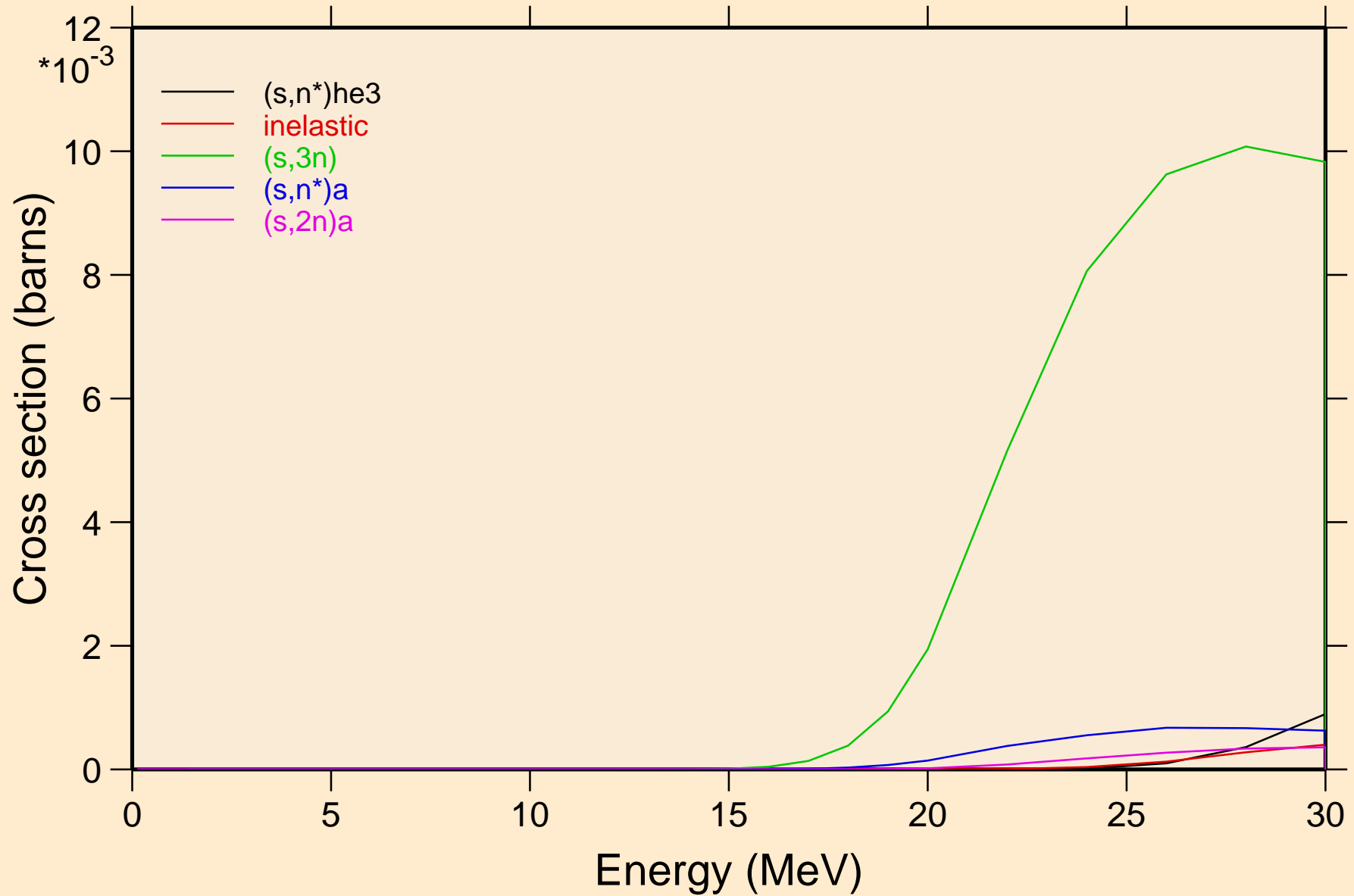

AU206 HELION ACER TENDL-2021 LIBRARY; T=0.K  
Threshold reactions

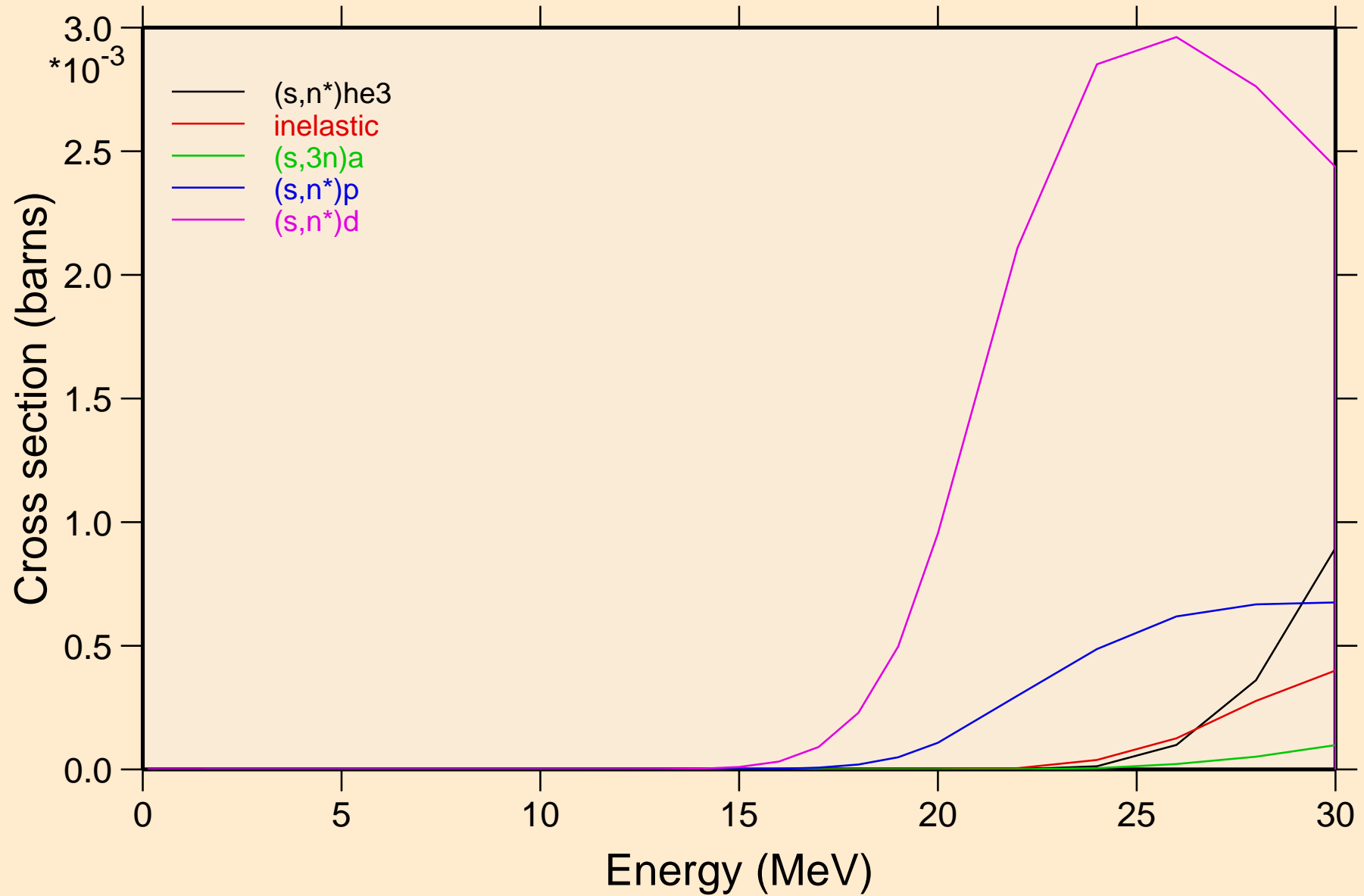

AU206 HELION ACER TENDL-2021 LIBRARY; T=0.K  
Threshold reactions

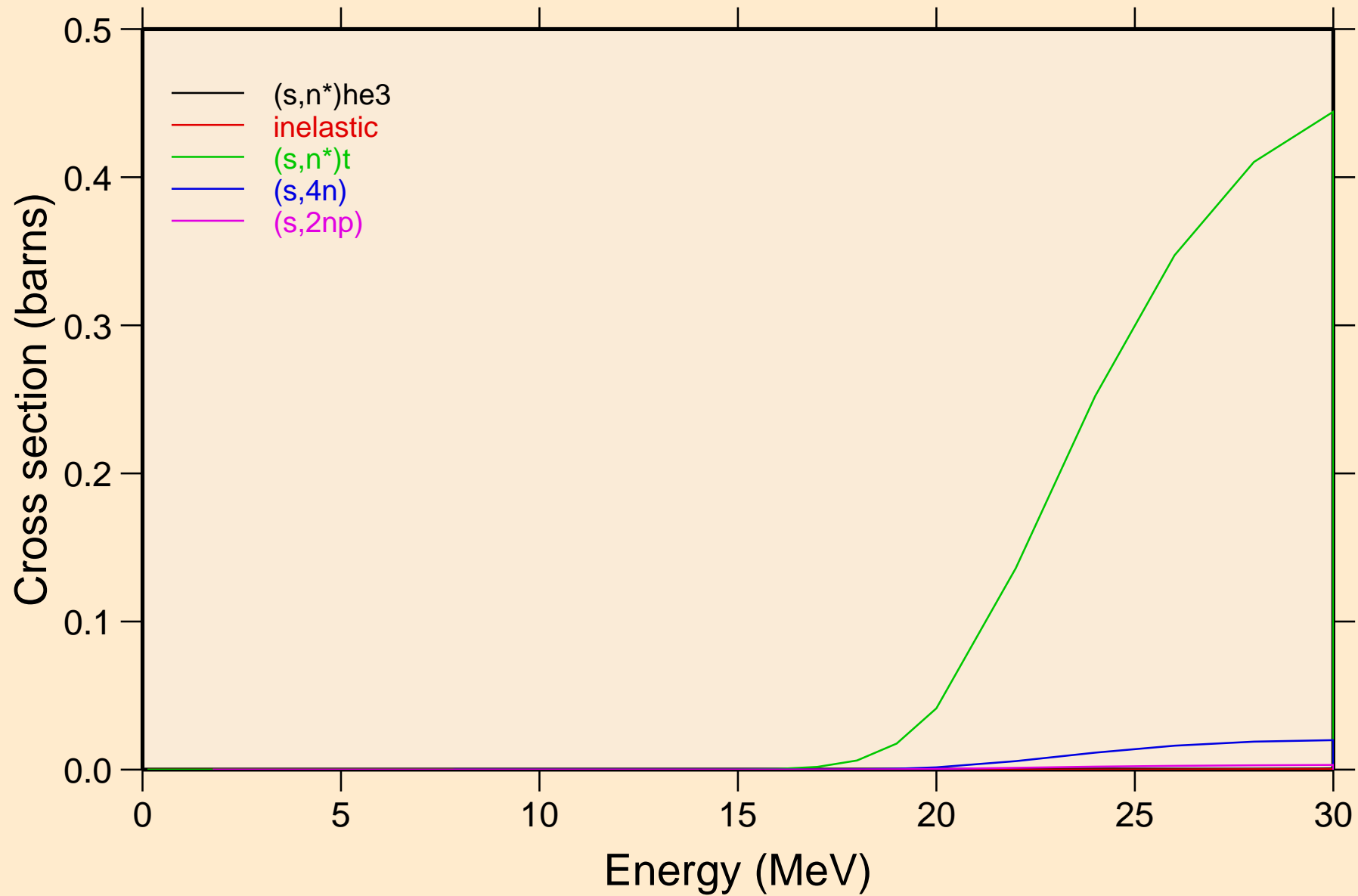



AU206 HELION ACER TENDL-2021 LIBRARY; T=0.K  
Threshold reactions

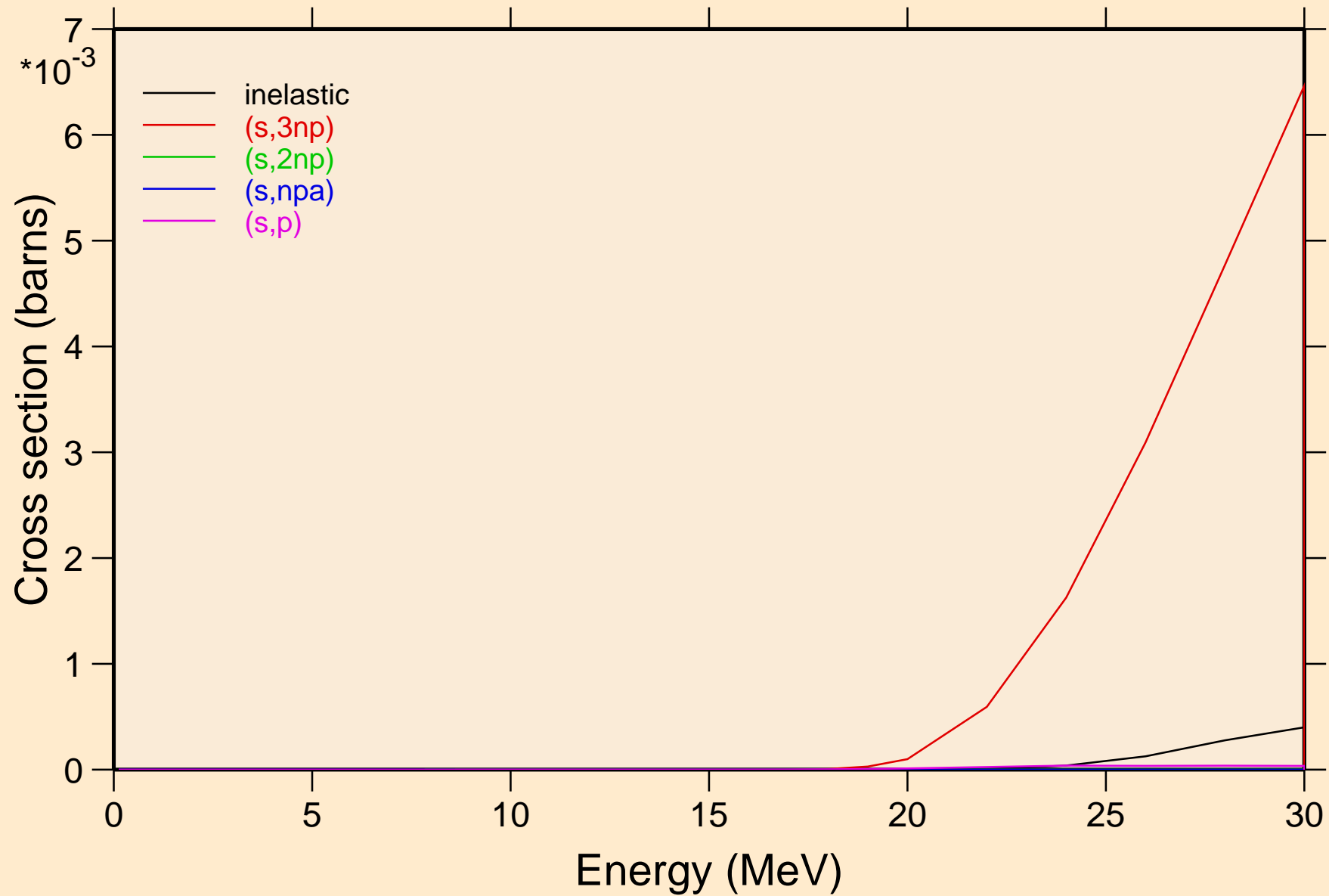

AU206 HELION ACER TENDL-2021 LIBRARY; T=0.K  
Threshold reactions

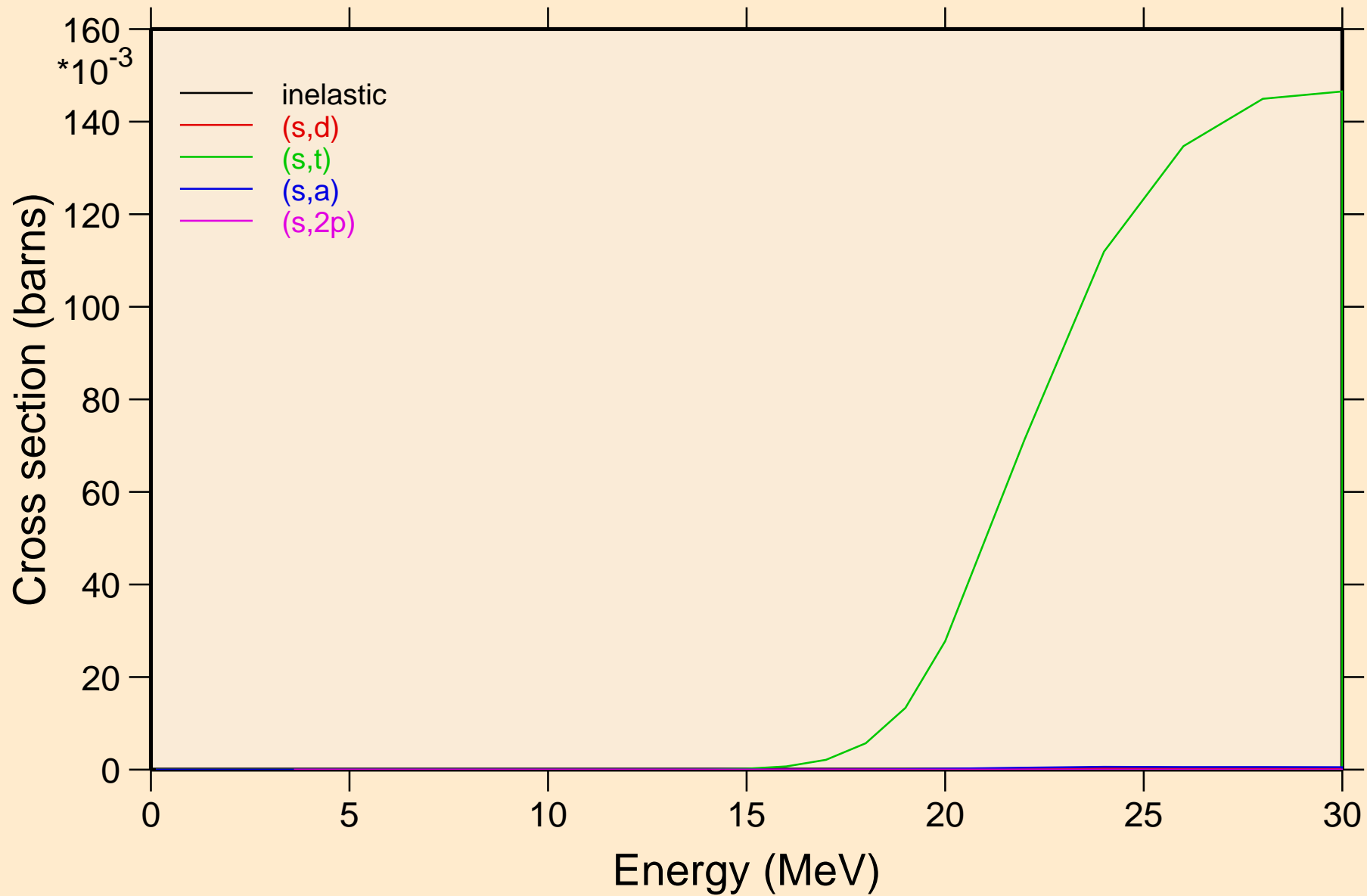

AU206 HELION ACER TENDL-2021 LIBRARY; T=0.K  
Threshold reactions

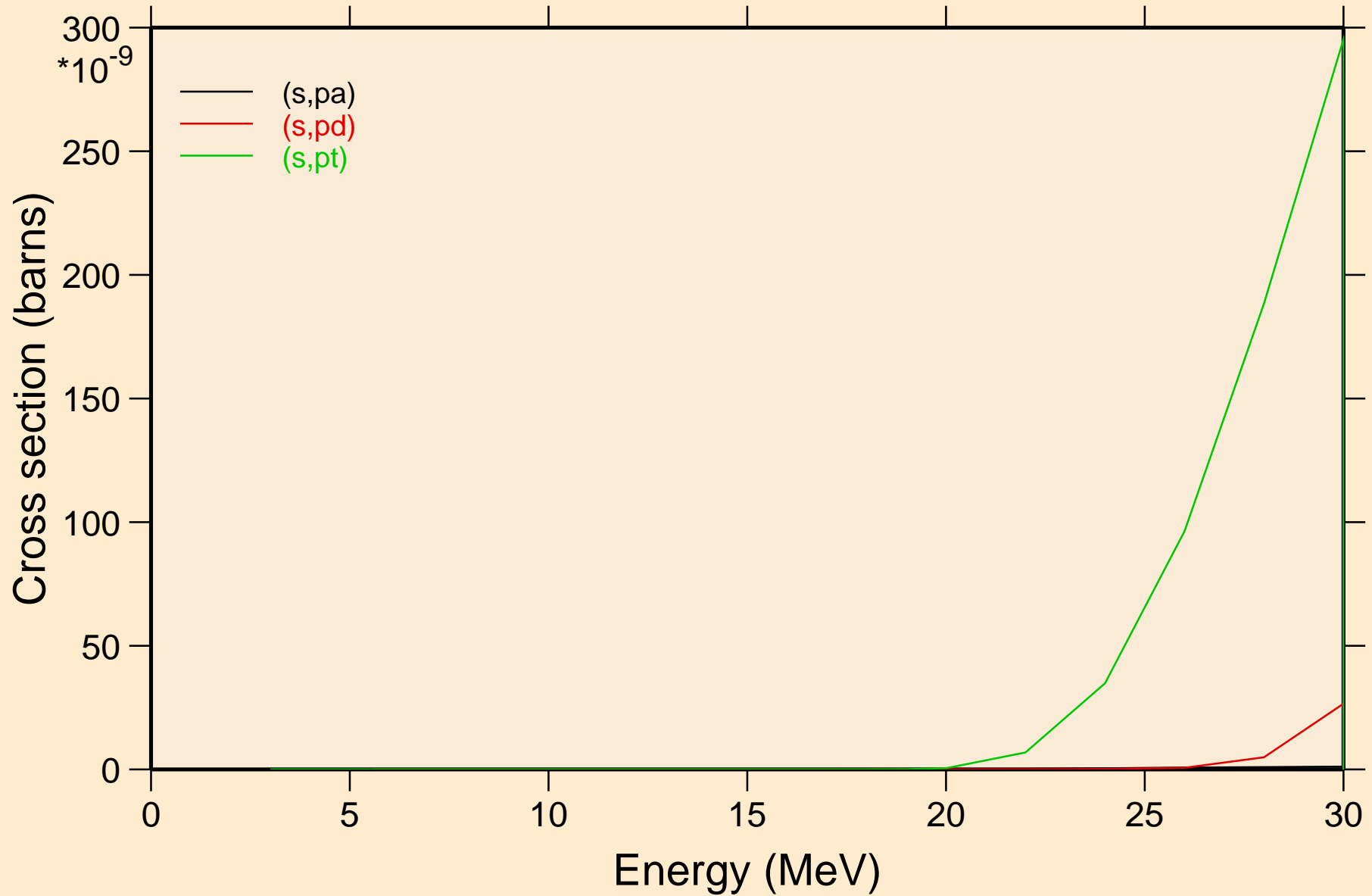

AU206 HELION ACER TENDL-2021 LIBRARY; T=0.K  
angular distribution for elastic

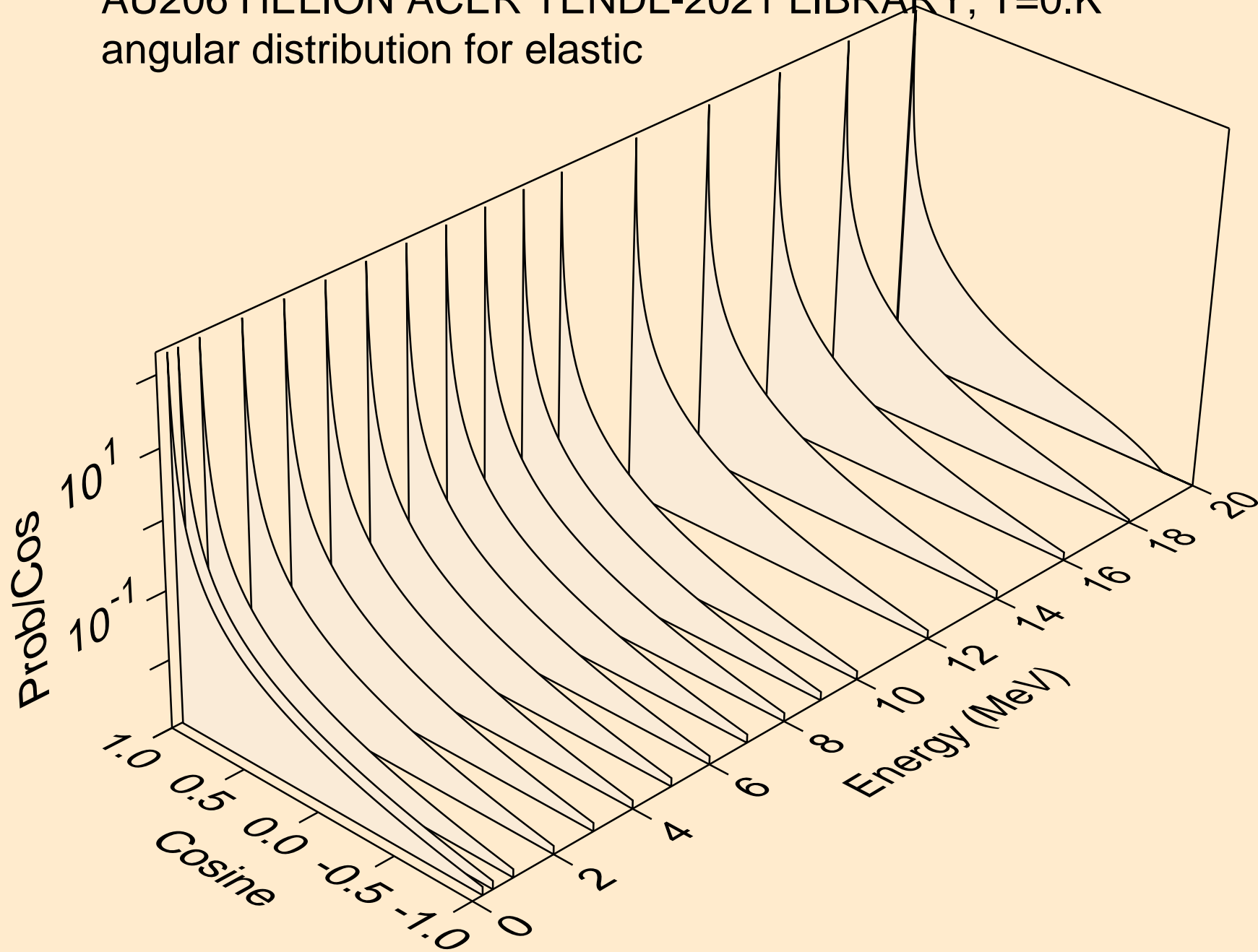

AU206 HELION ACER TENDL-2021 LIBRARY; T=0.K  
angular distribution for elastic

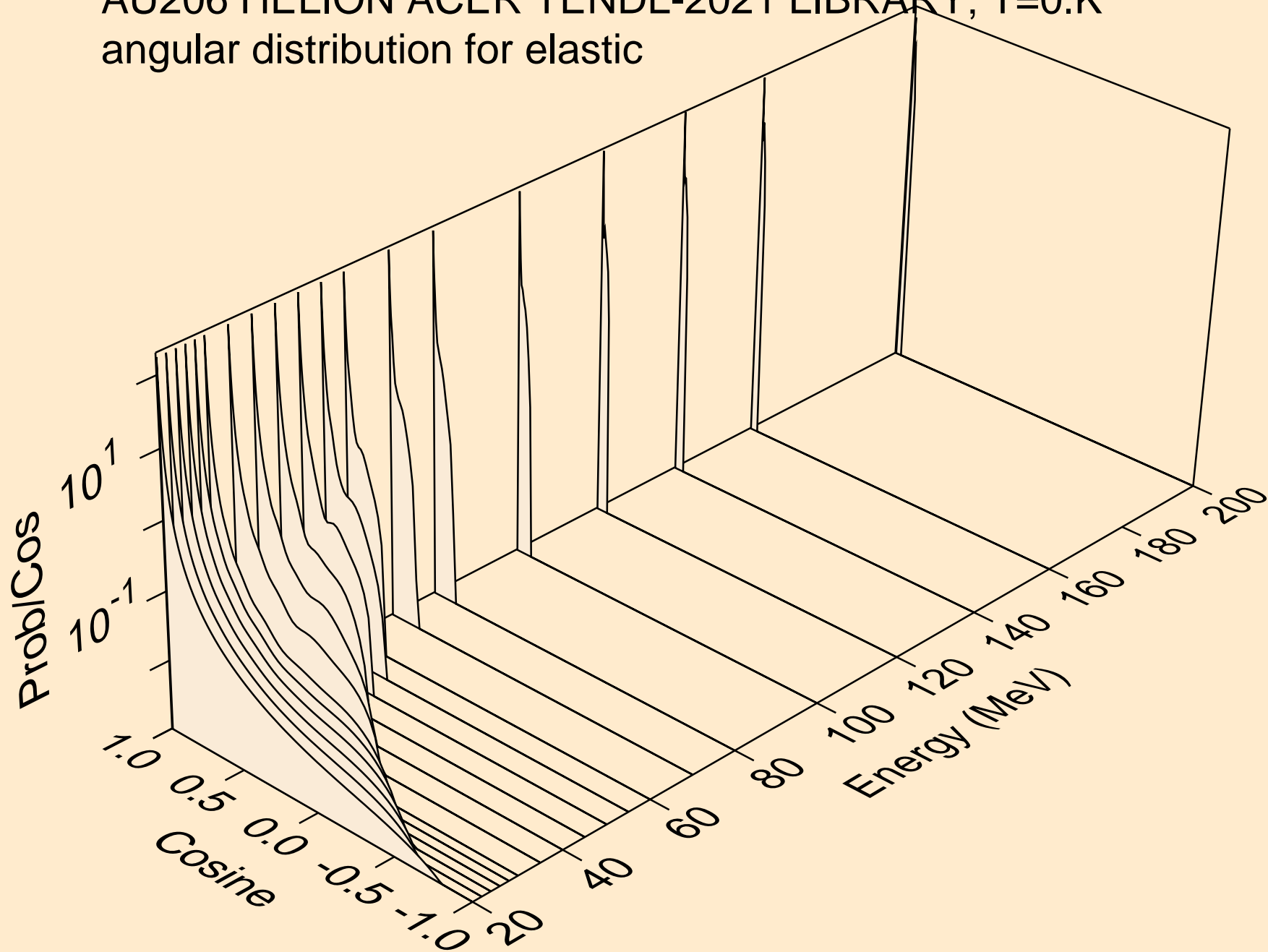

AU206 HELION ACER TENDL-2021 LIBRARY; T=0.K  
He-3 emission for (s,x)

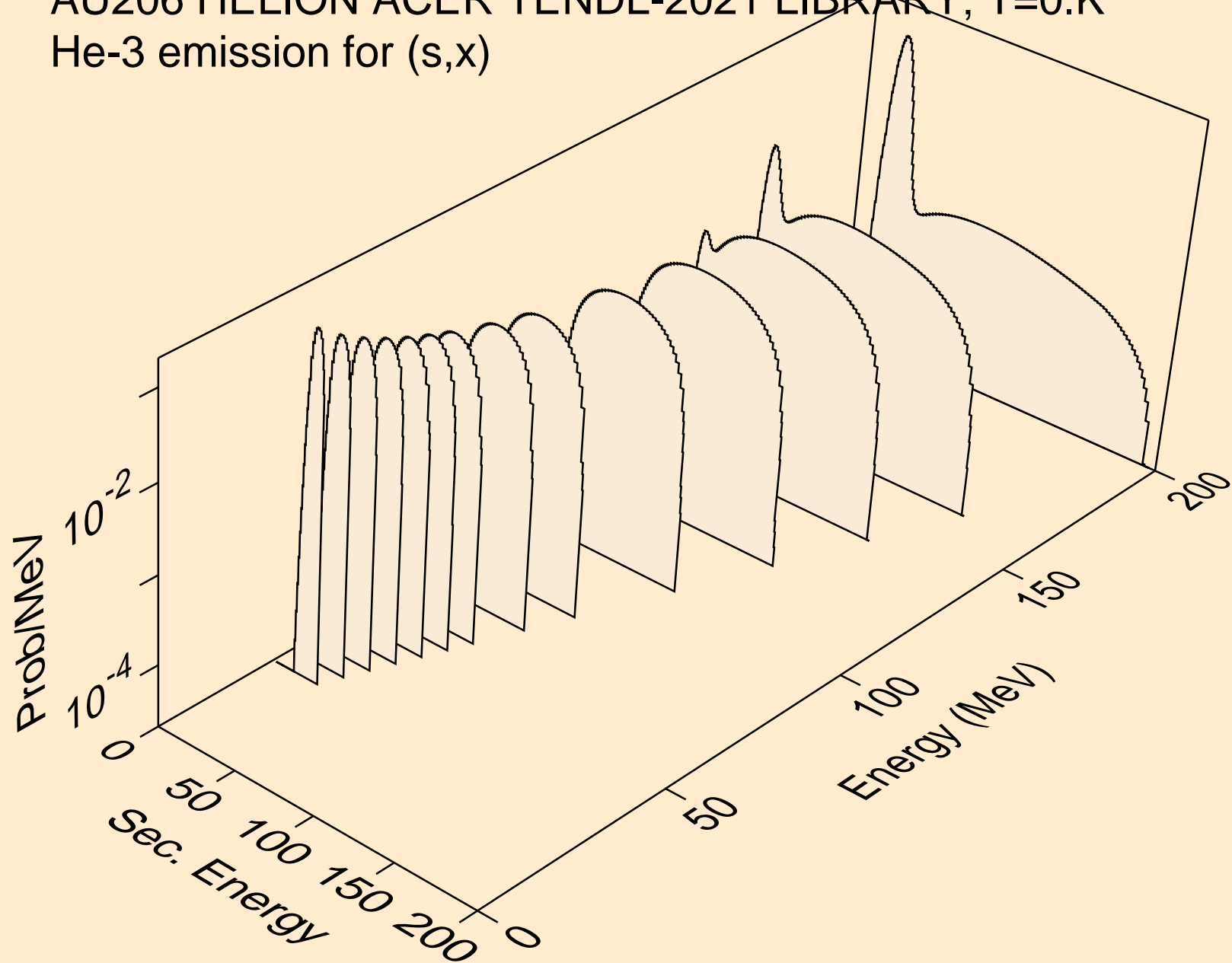

AU206 HELION ACER TENDL-2021 LIBRARY; T=0.K  
He-3 emission for (s,n\*)he3

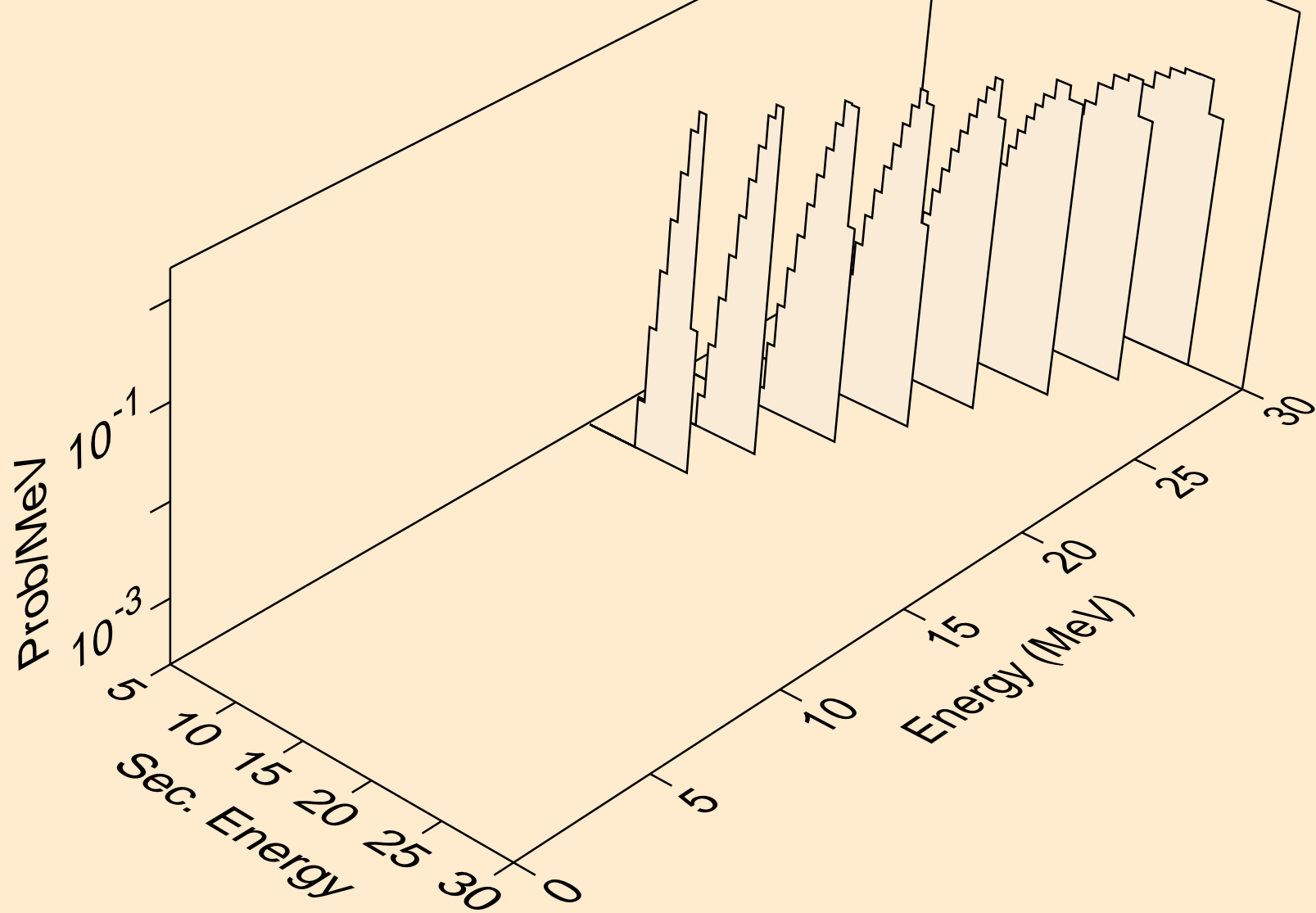

AU206 HELION ACER TENDL-2021 LIBRARY; T=0.K  
He-3 emission for inelastic

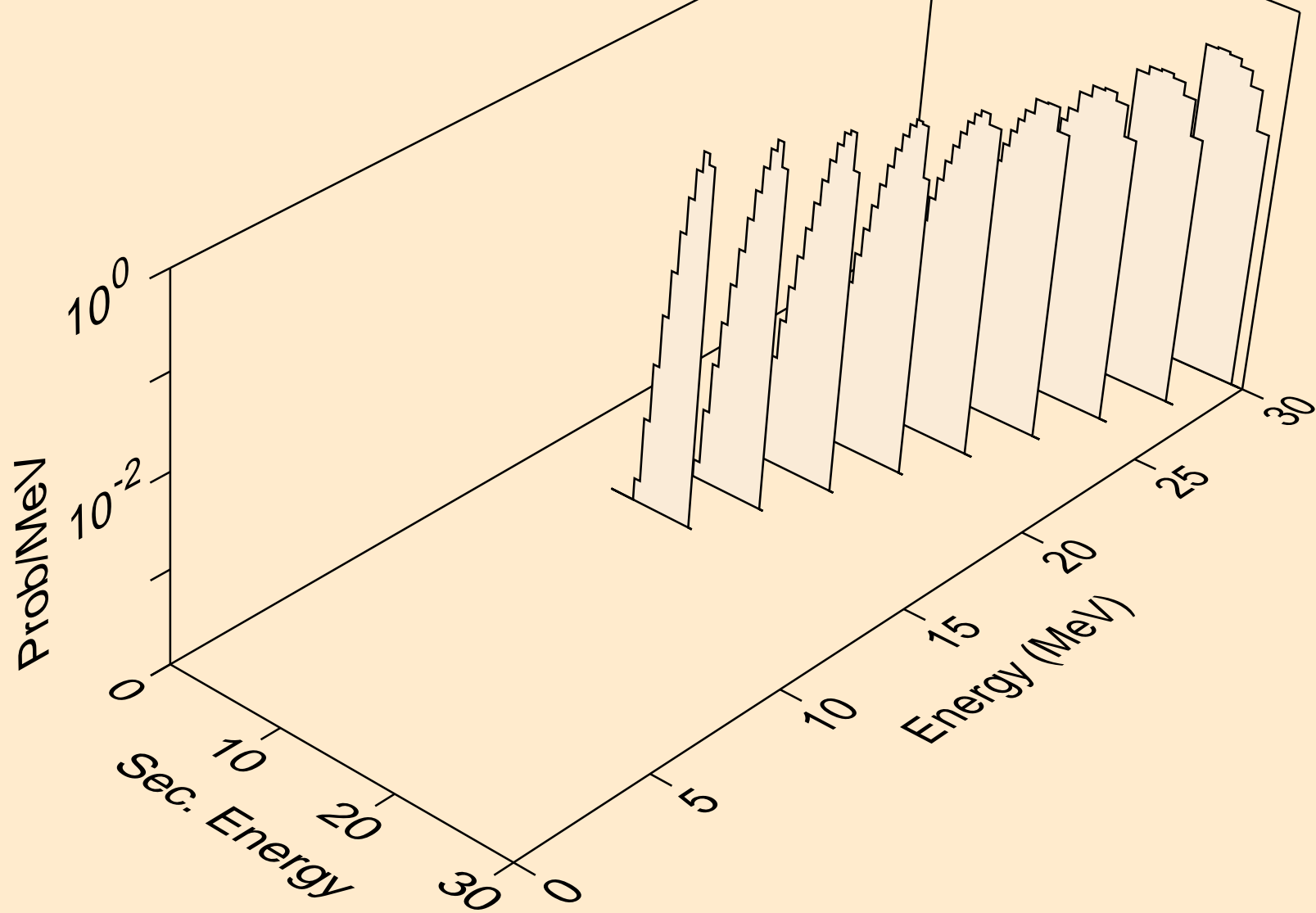



AU206 HELION ACER TENDL-2021 LIBRARY; T=0.K  
Photon emission for (z,n)

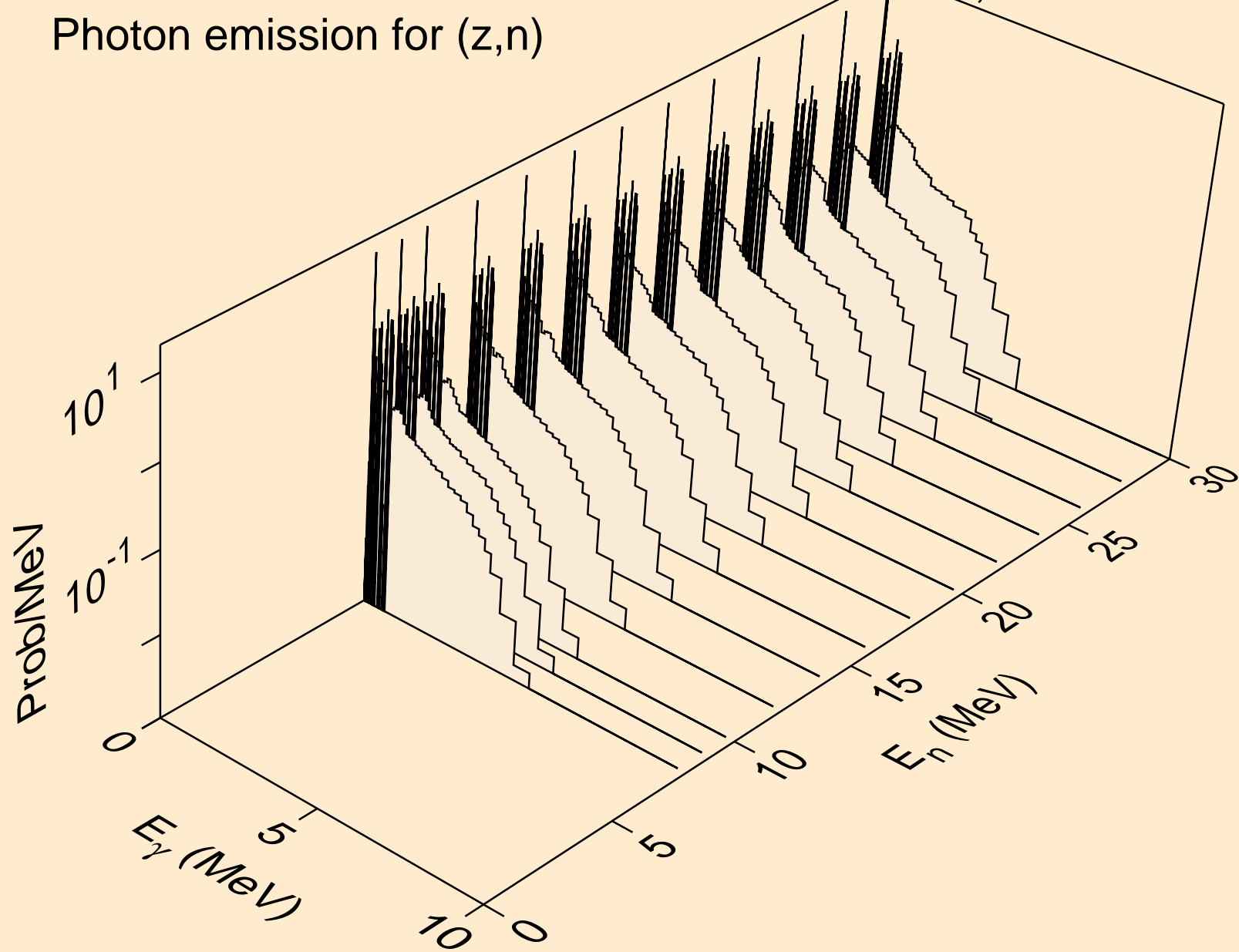

AU206 HELION ACER TENDL-2021 LIBRARY; T=0.K  
Photon emission for (n,x)

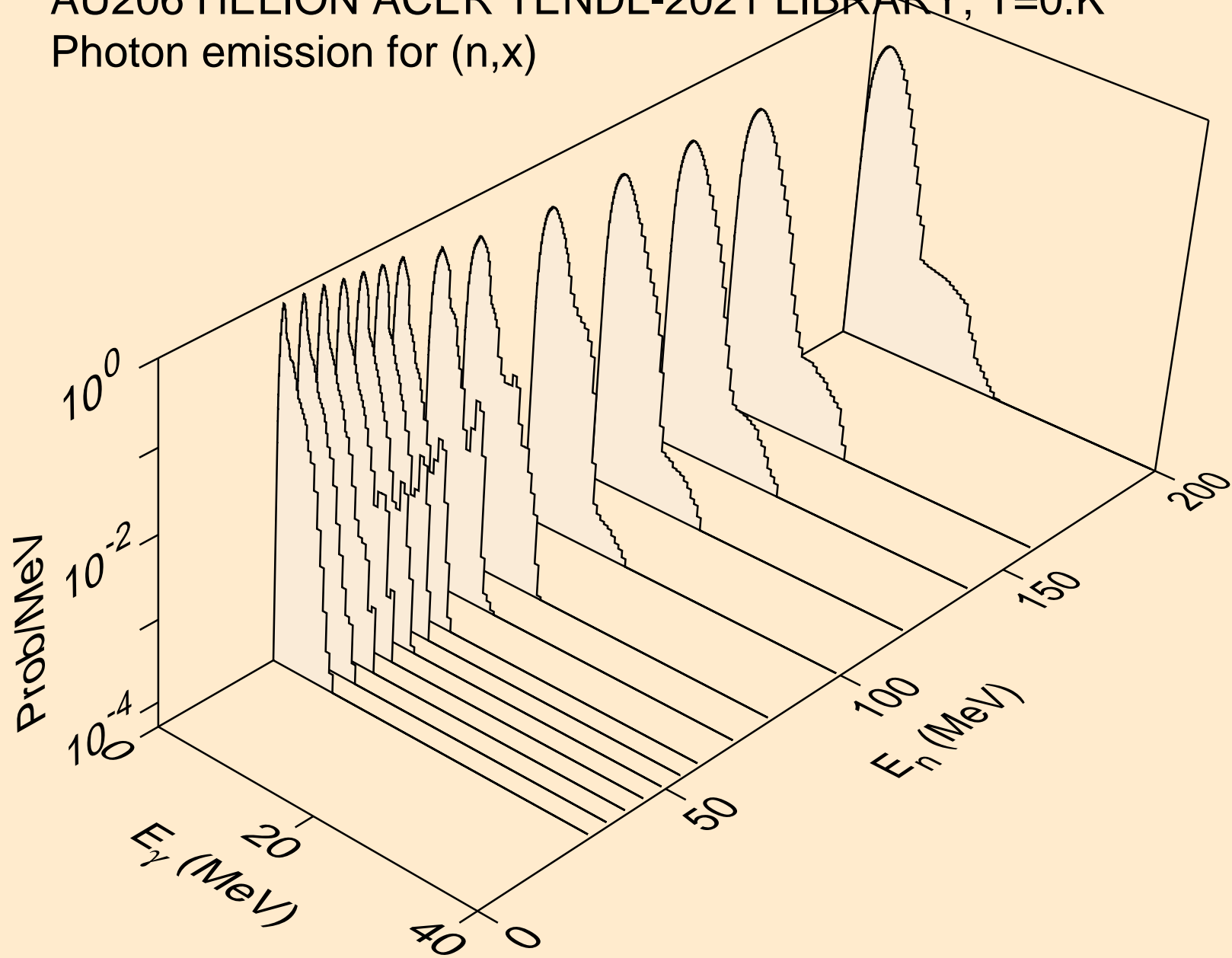

AU206 HELION ACER TENDL-2021 LIBRARY; T=0.K  
Photon emission for (n,2nd)

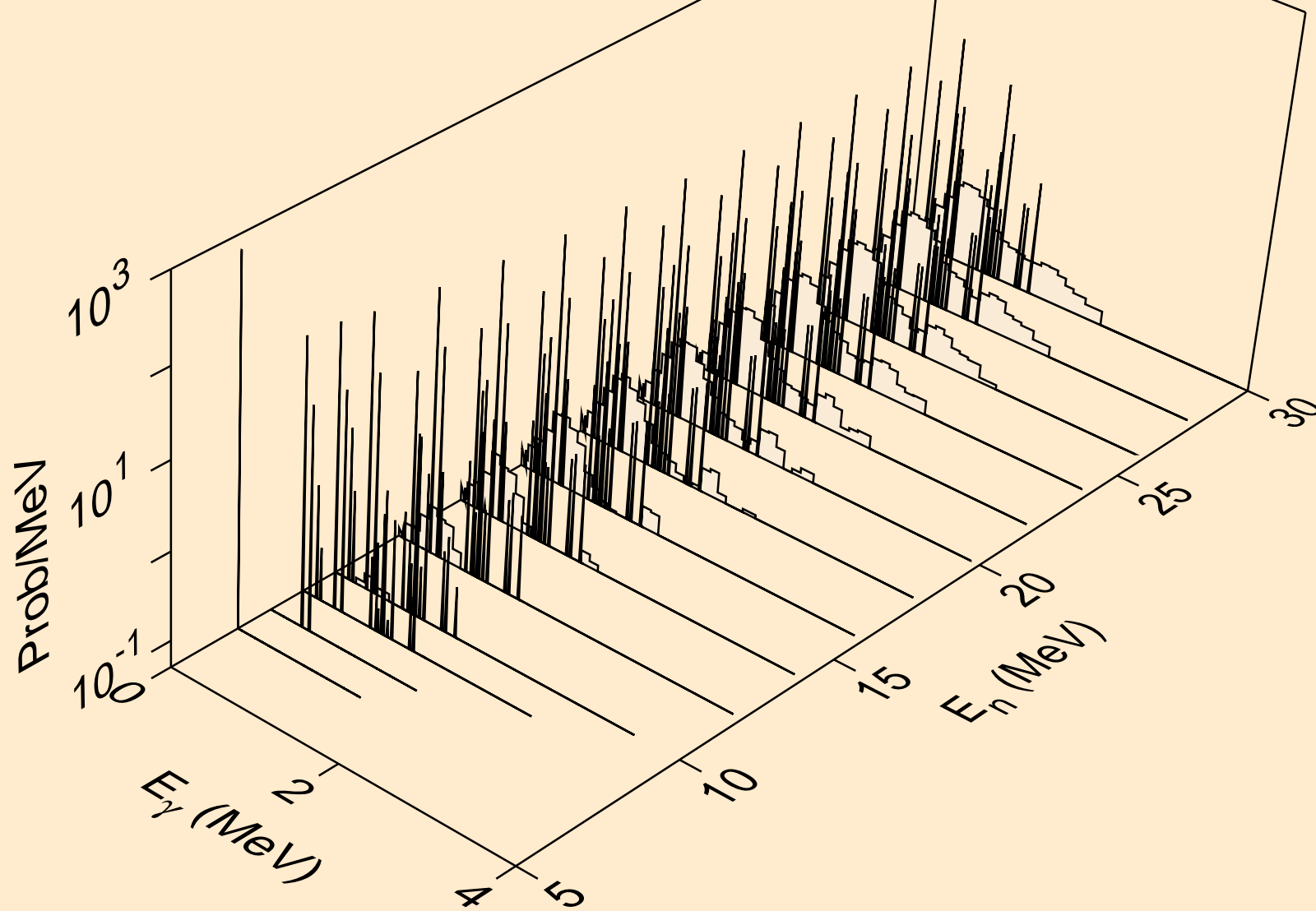

AU206 HELION ACER TENDL-2021 LIBRARY; T=0.K  
Photon emission for (n,2n)

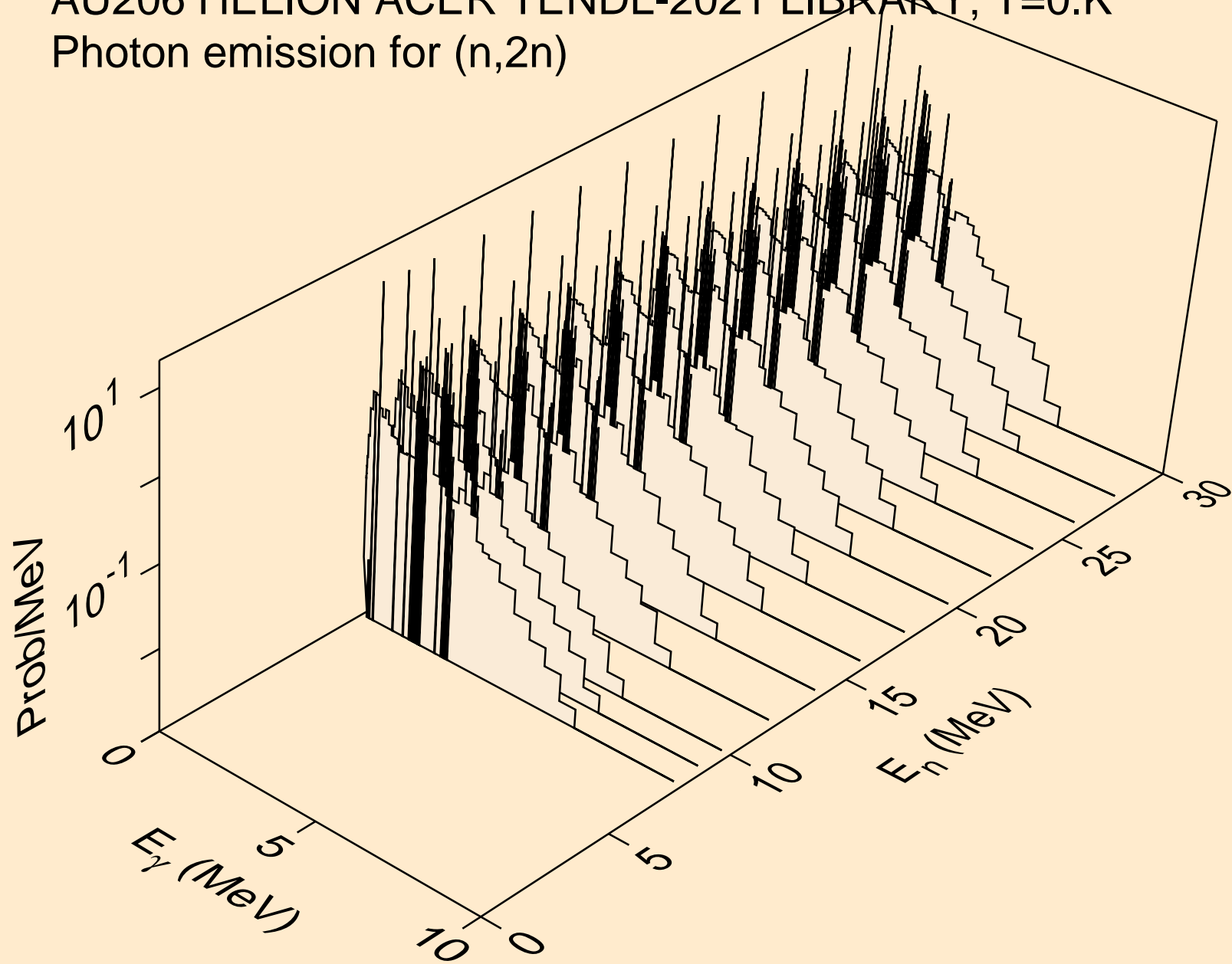

AU206 HELION ACER TENDL-2021 LIBRARY; T=0.K  
Photon emission for (n,3n)

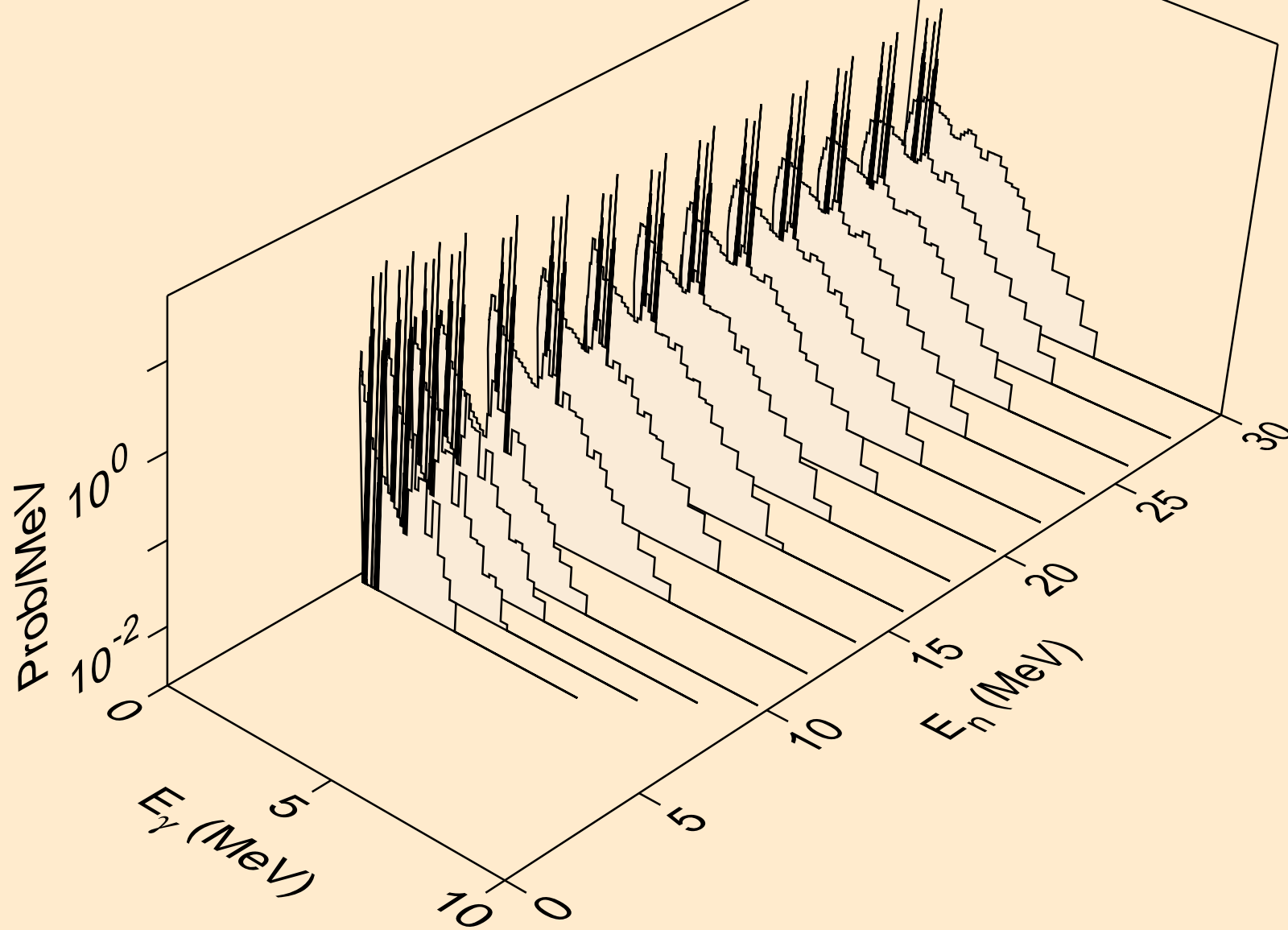

AU206 HELION ACER TENDL-2021 LIBRARY; T=0.K  
Photon emission for (n,n\*)a

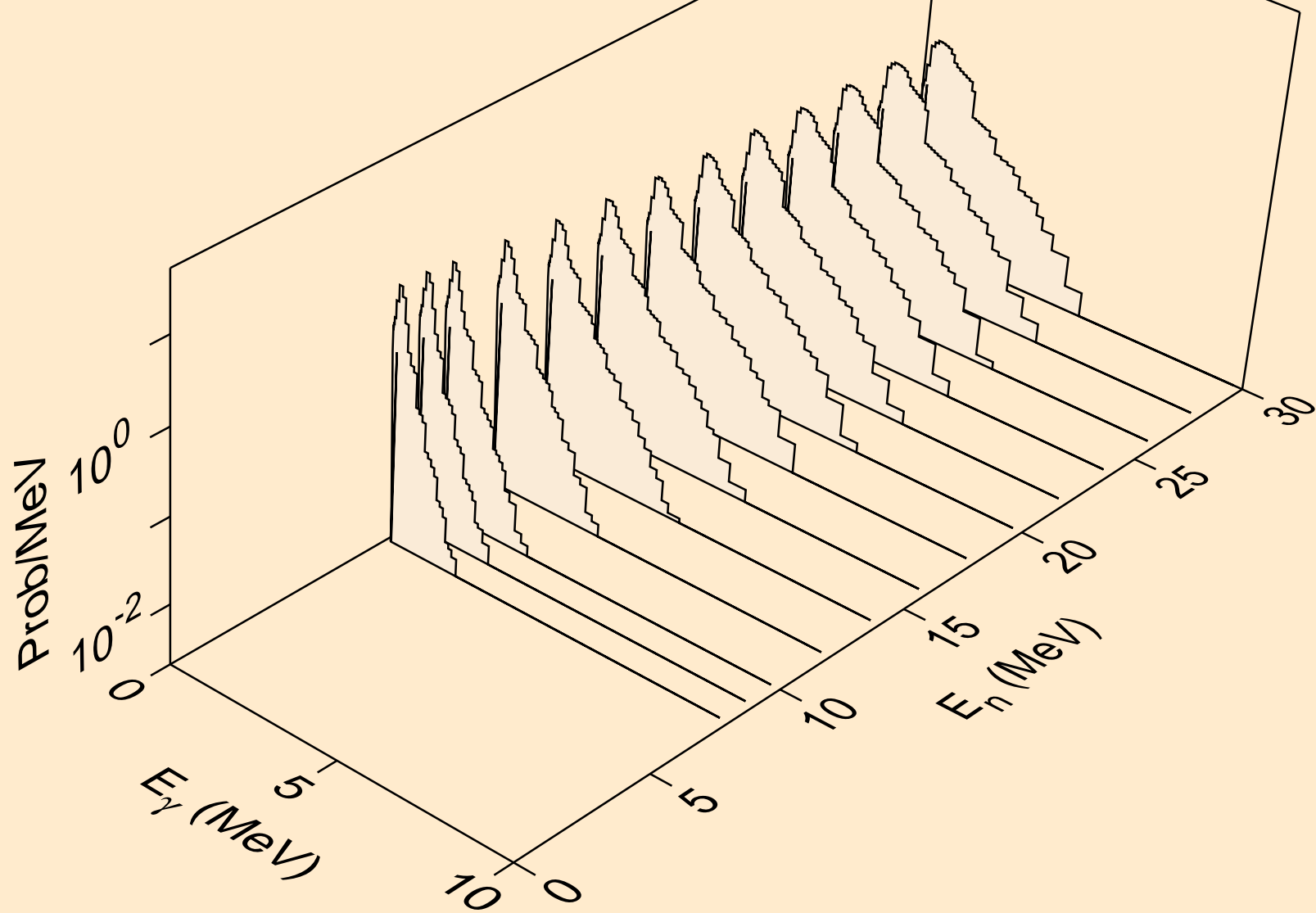

AU206 HELION ACER TENDL-2021 LIBRARY; T=0.K  
Photon emission for (n,2n)a

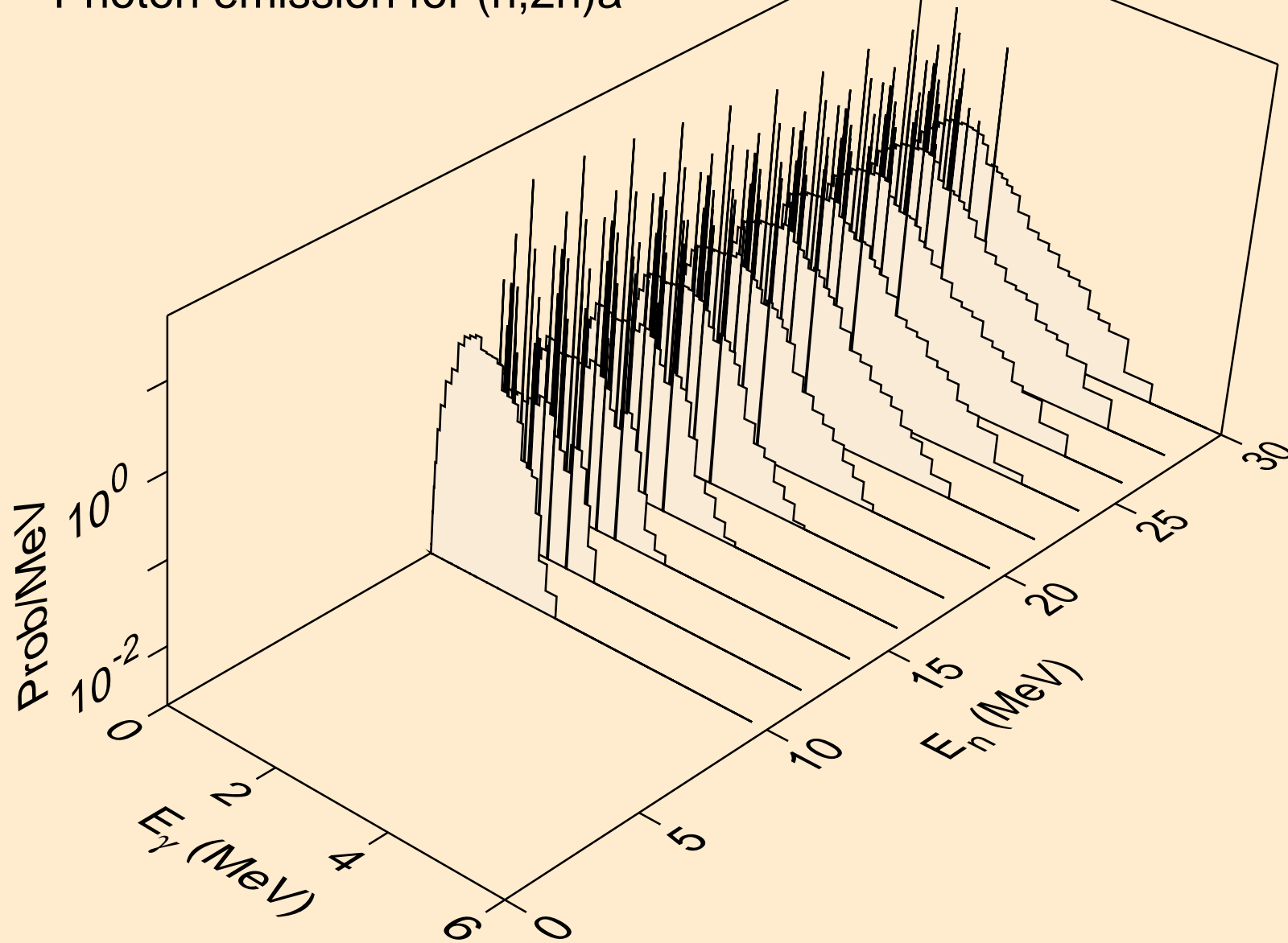

AU206 HELION ACER TENDL-2021 LIBRARY; T=0.K  
Photon emission for (n,3n)a

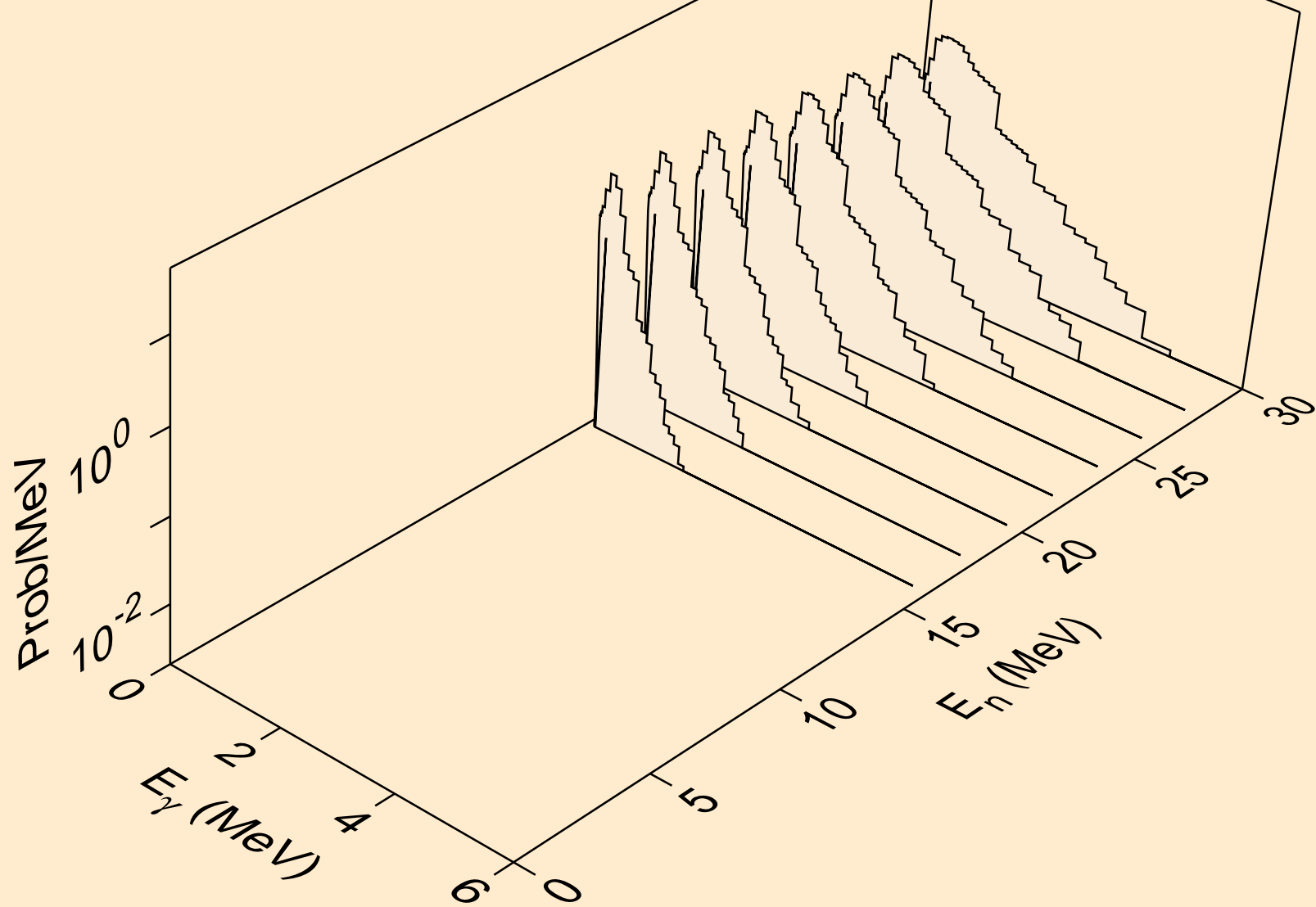



AU206 HELION ACER TENDL-2021 LIBRARY; T=0.K  
Photon emission for (n,n\*)p

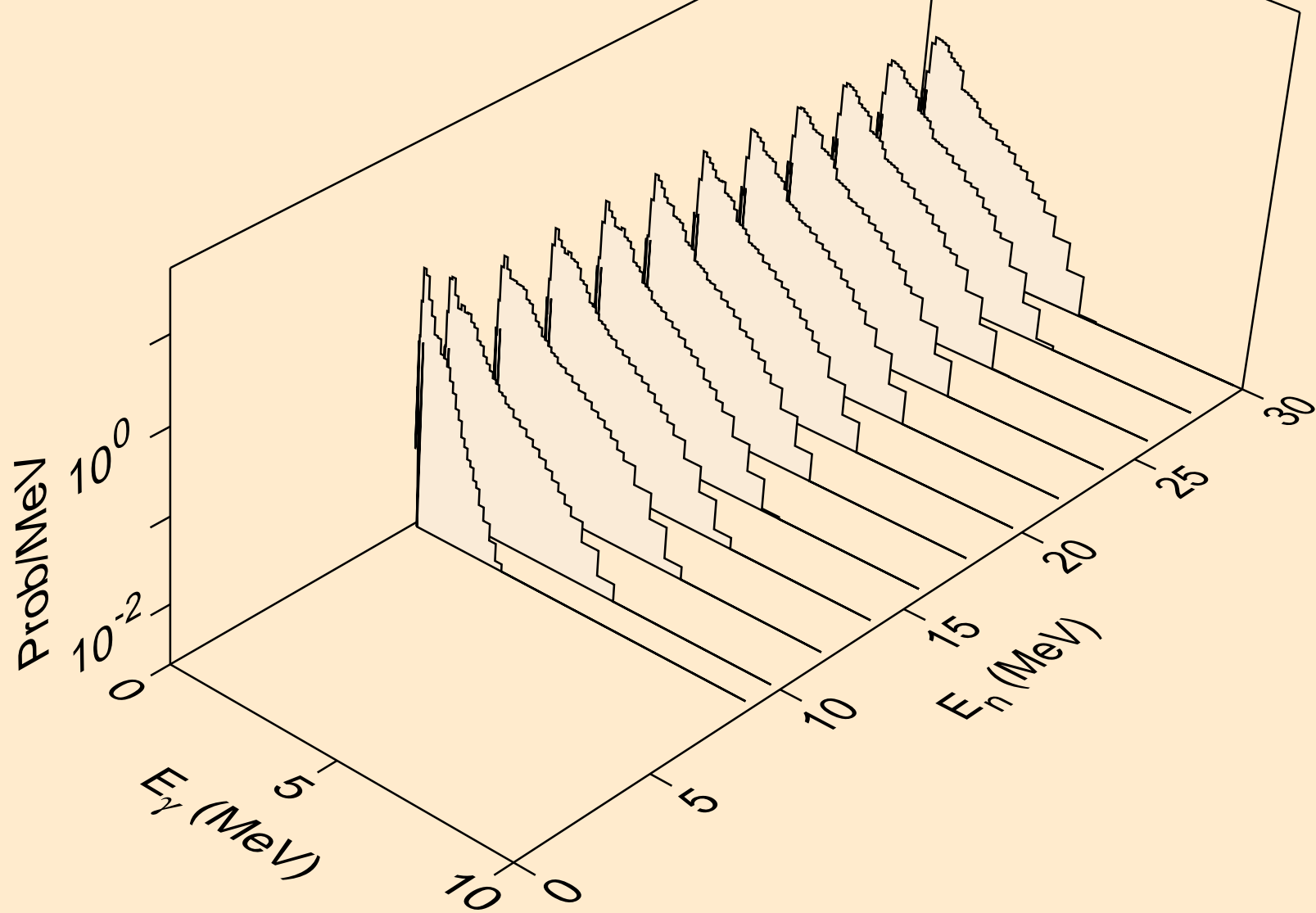

AU206 HELION ACER TENDL-2021 LIBRARY; T=0.K  
Photon emission for (n,n\*)d

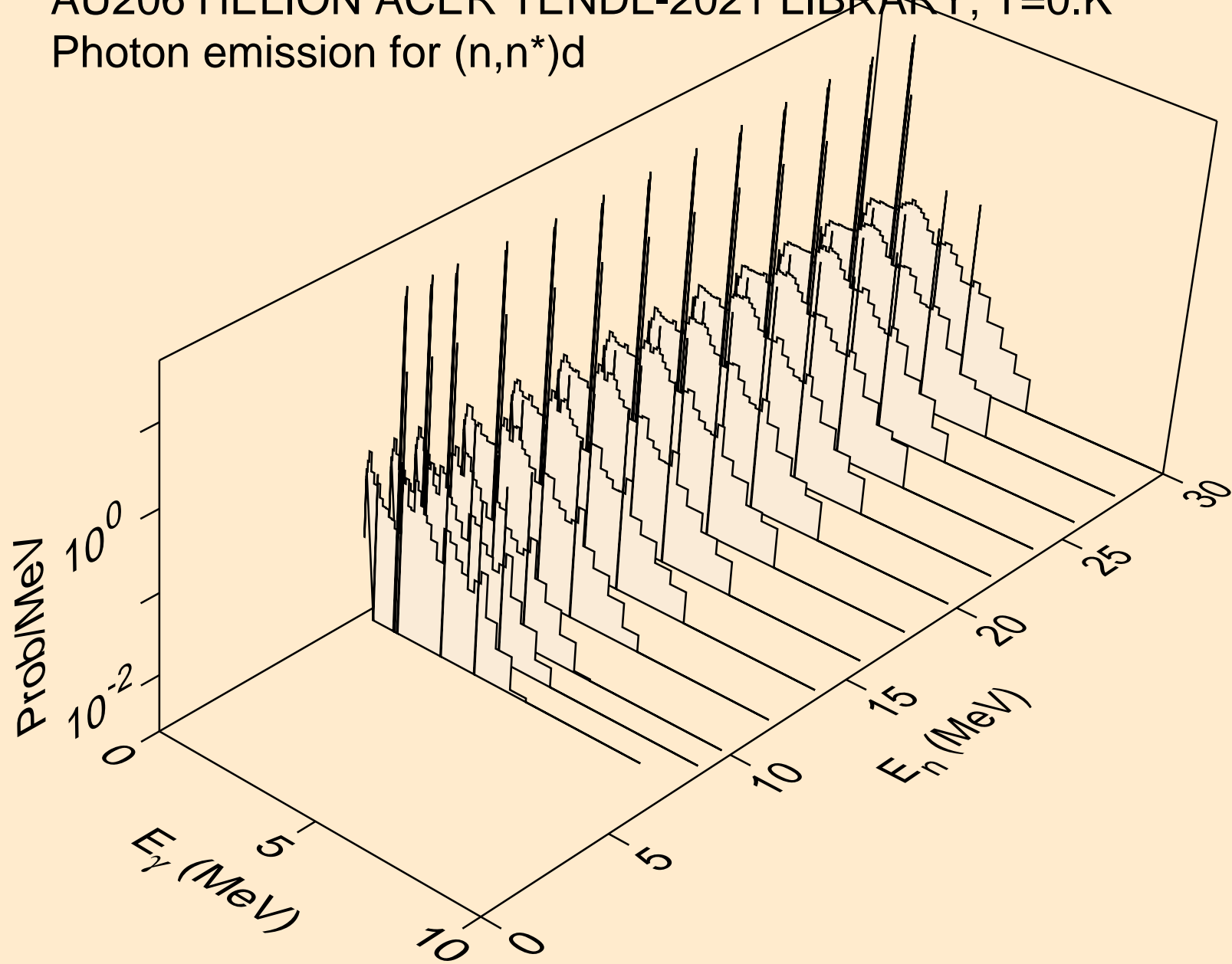

AU206 HELION ACER TENDL-2021 LIBRARY; T=0.K  
Photon emission for (n,n\*)t

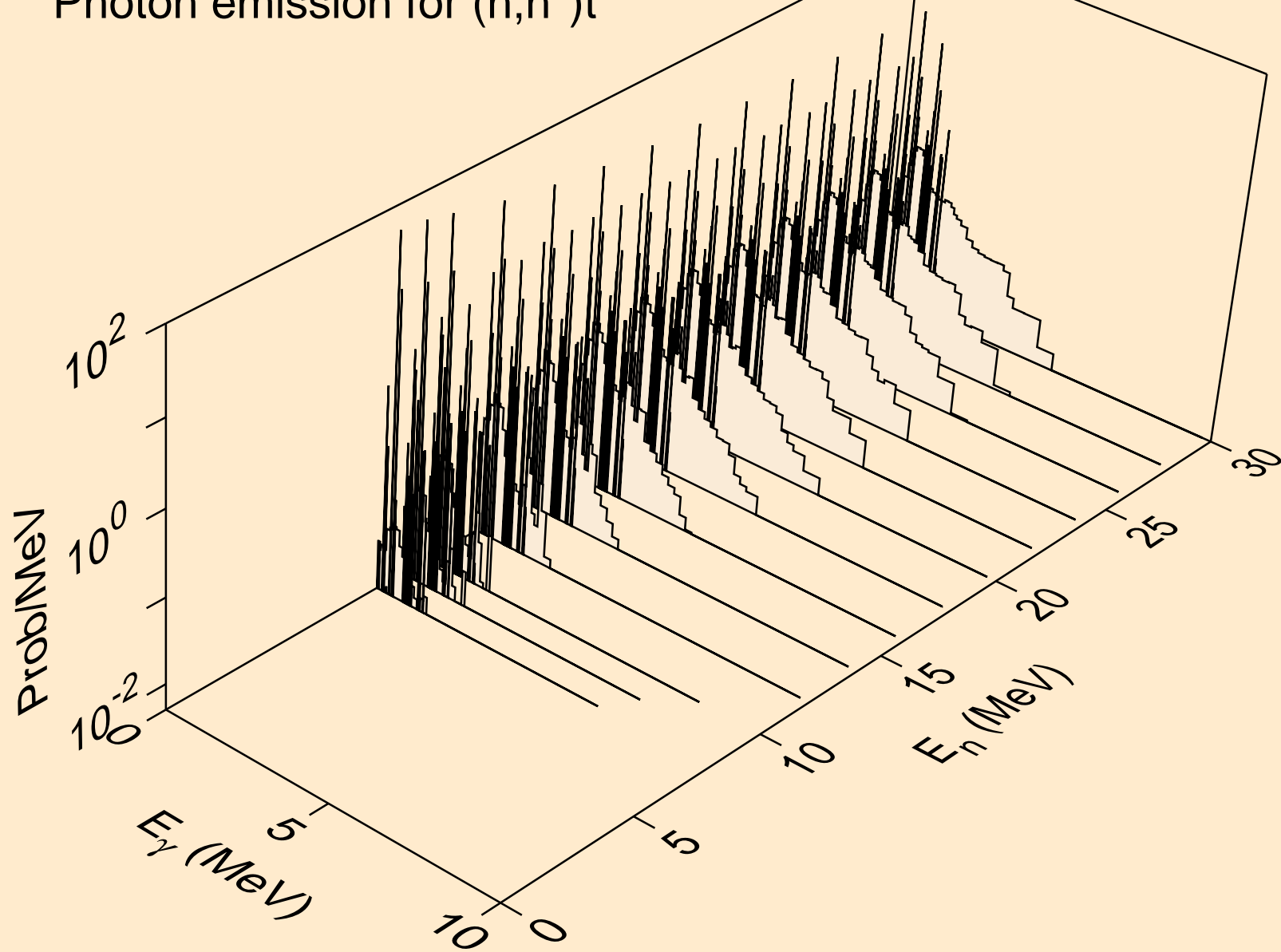

AU206 HELION ACER TENDL-2021 LIBRARY; T=0.K  
Photon emission for (n,n\*)he3

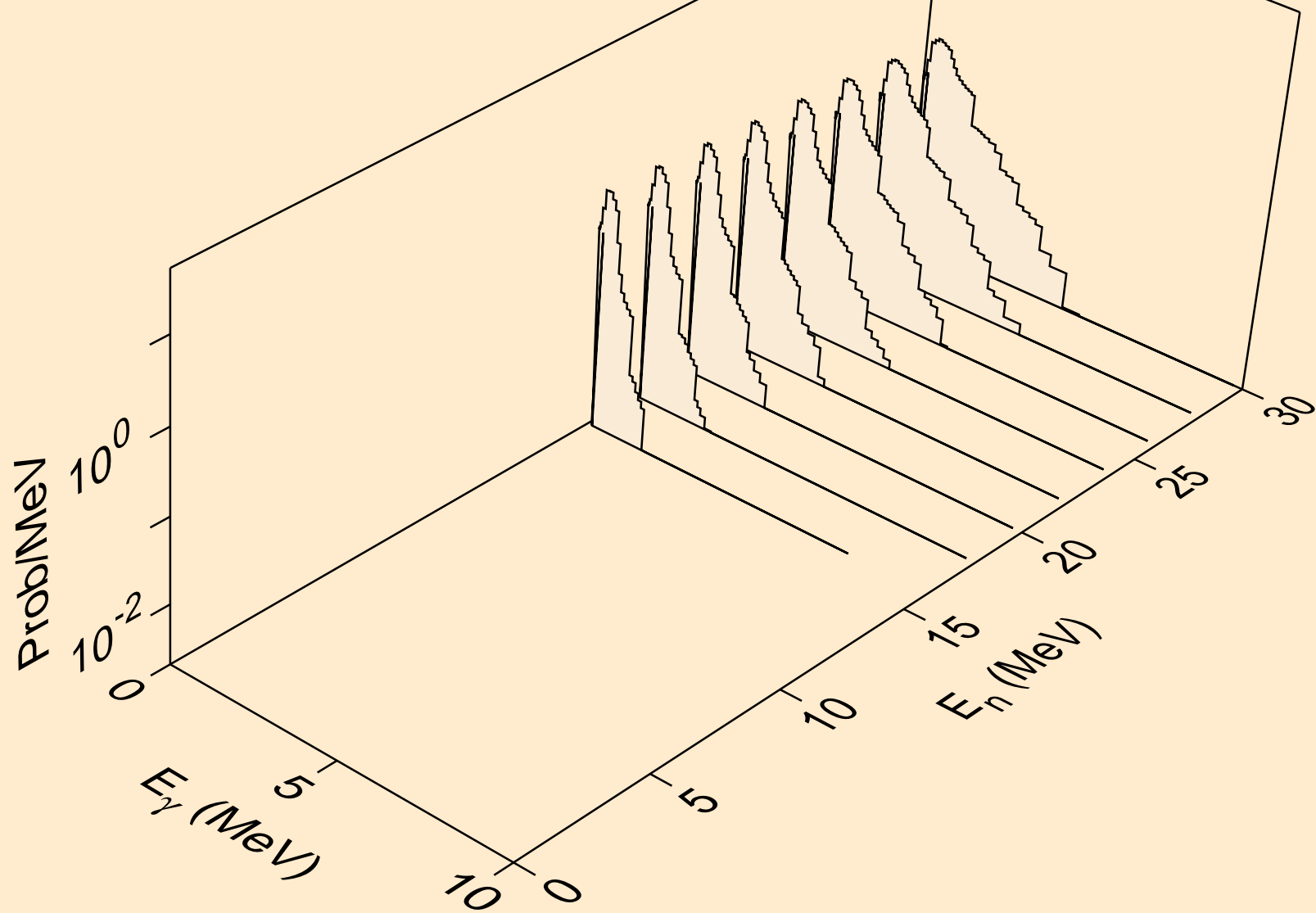

AU206 HELION ACER TENDL-2021 LIBRARY; T=0.K  
Photon emission for (n,4n)

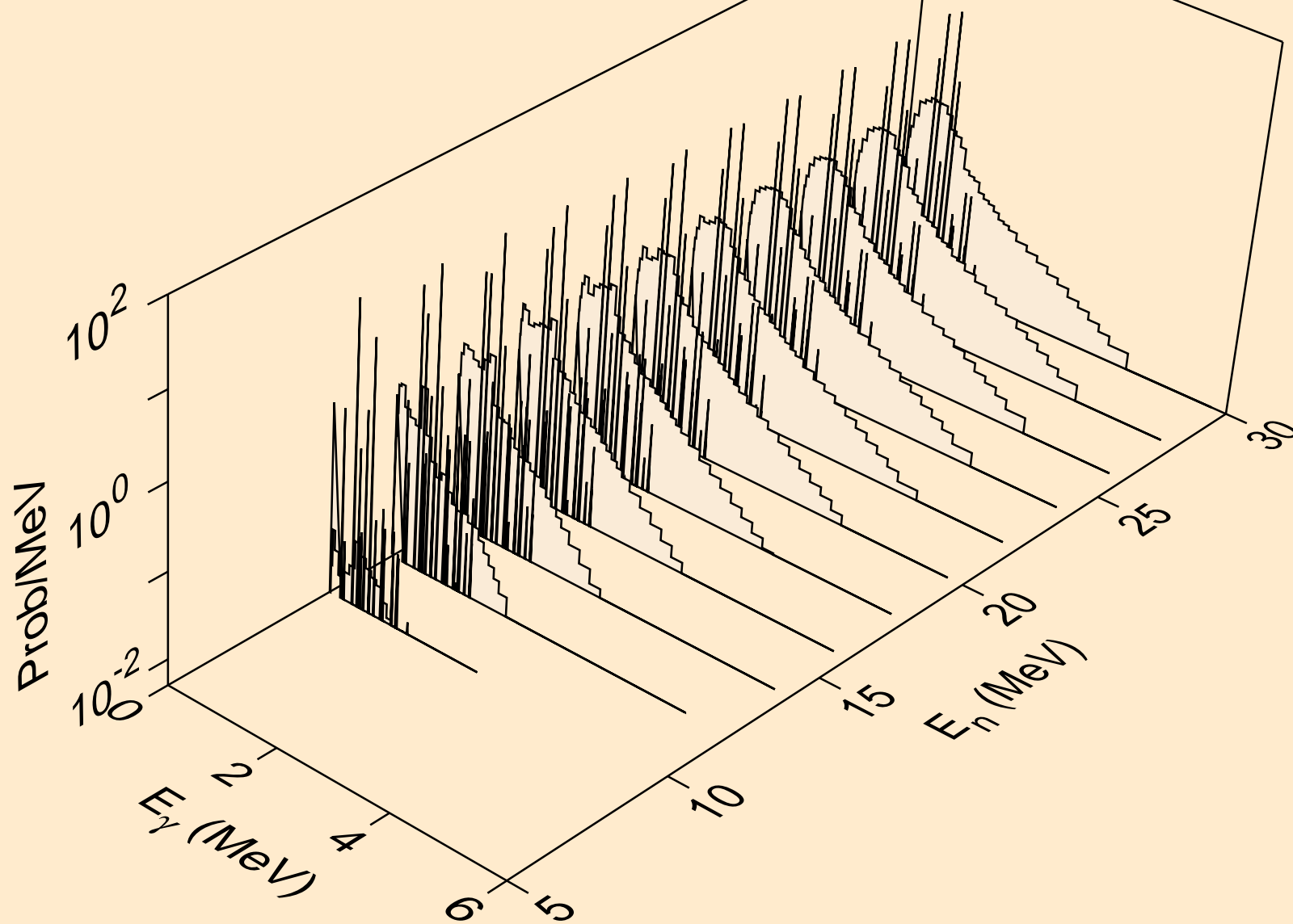

AU206 HELION ACER TENDL-2021 LIBRARY; T=0.K  
Photon emission for (n,2np)

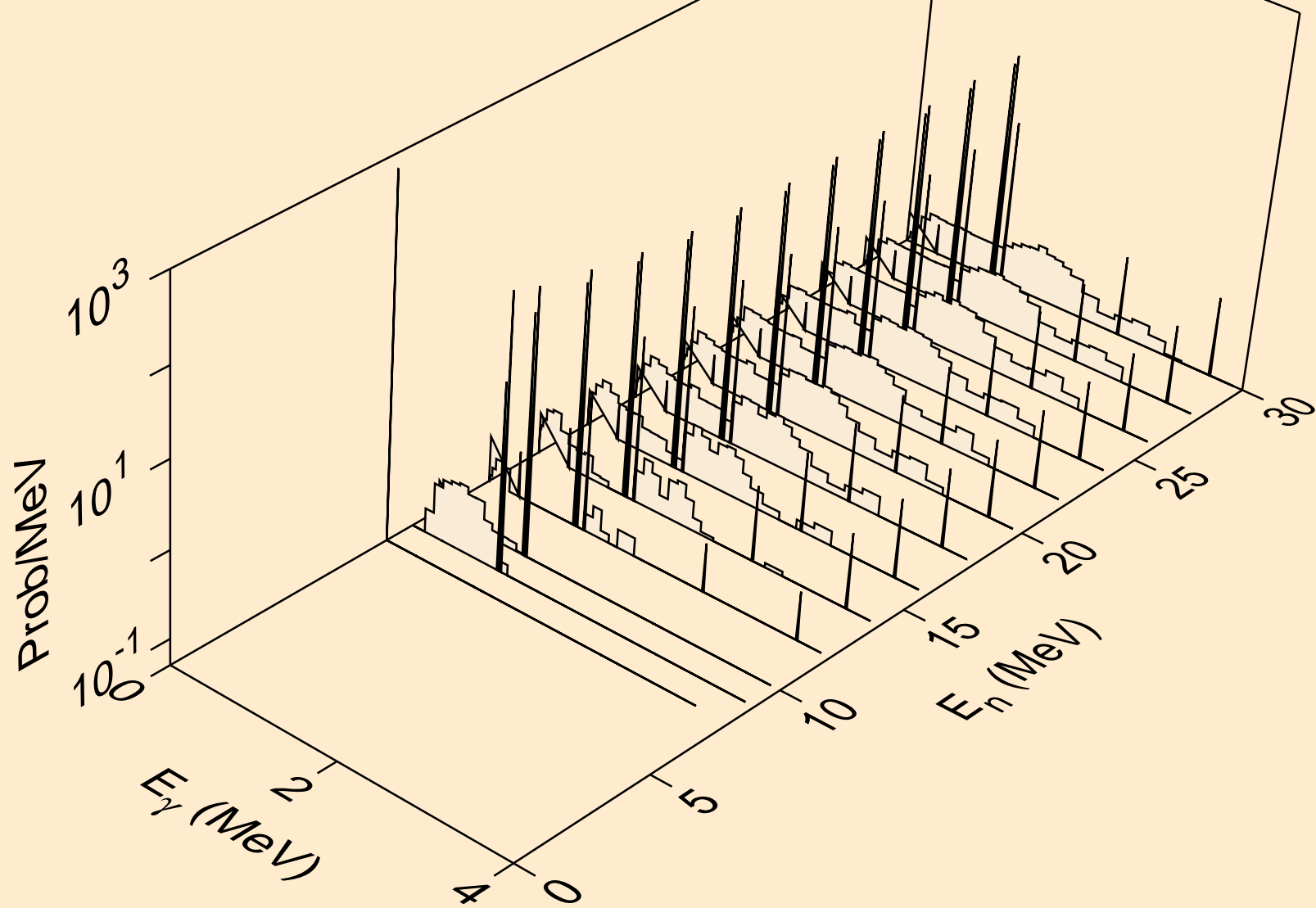

AU206 HELION ACER TENDL-2021 LIBRARY; T=0.K  
Photon emission for (n,3np)

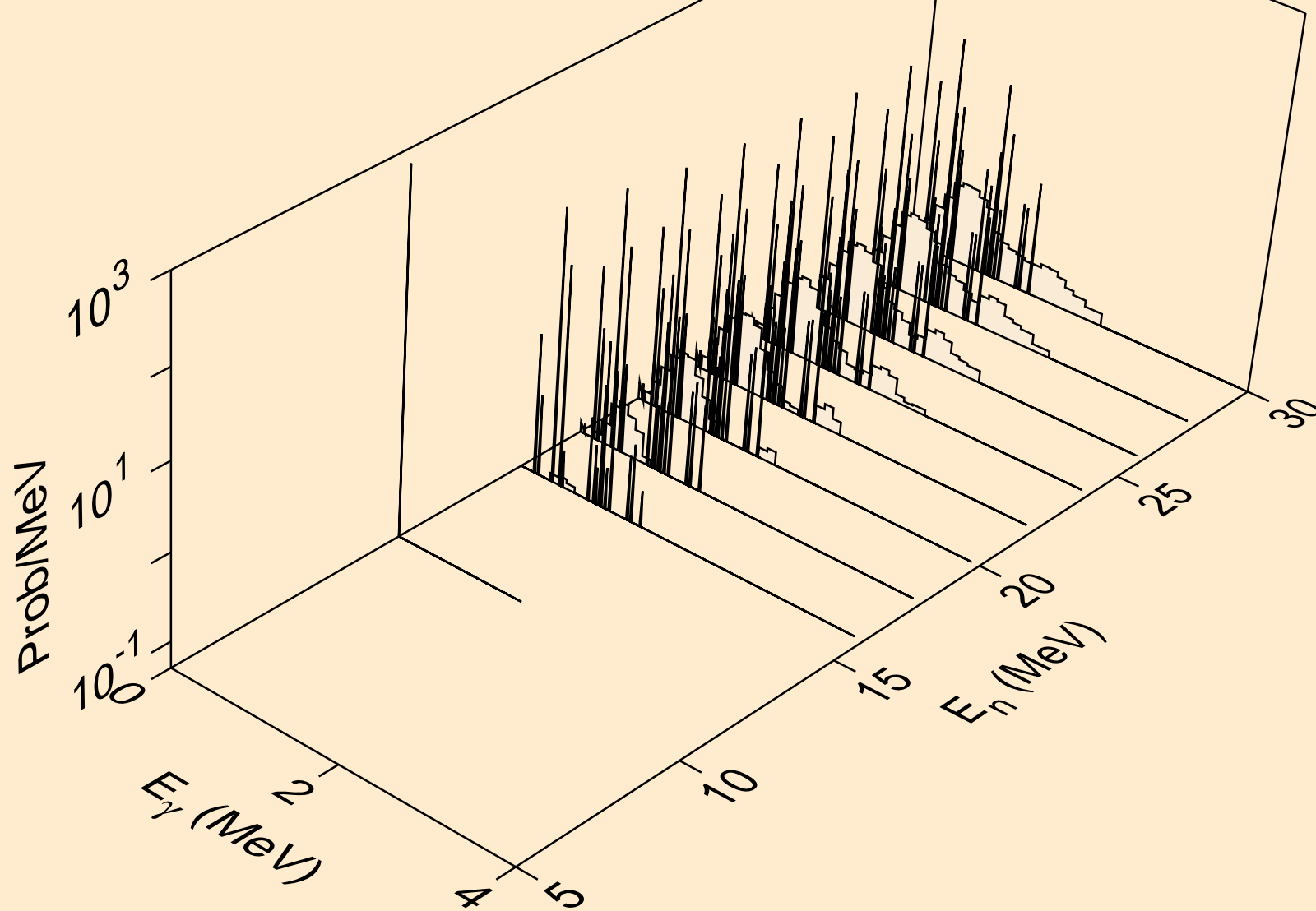

AU206 HELION ACER TENDL-2021 LIBRARY; T=0.K  
Photon emission for (n,2np)

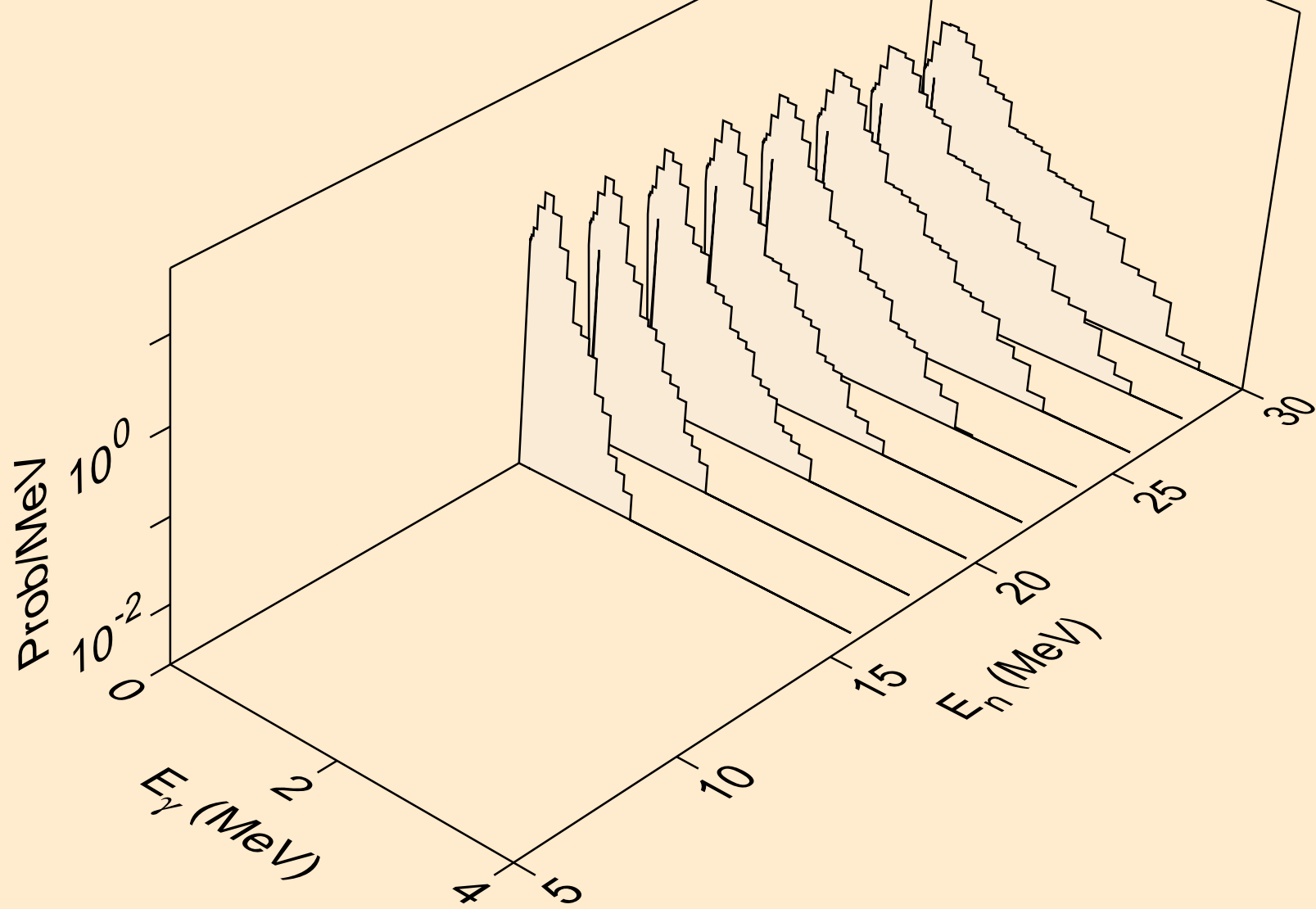



AU206 HELION ACER TENDL-2021 LIBRARY; T=0.K  
Photon emission for (n,npa)

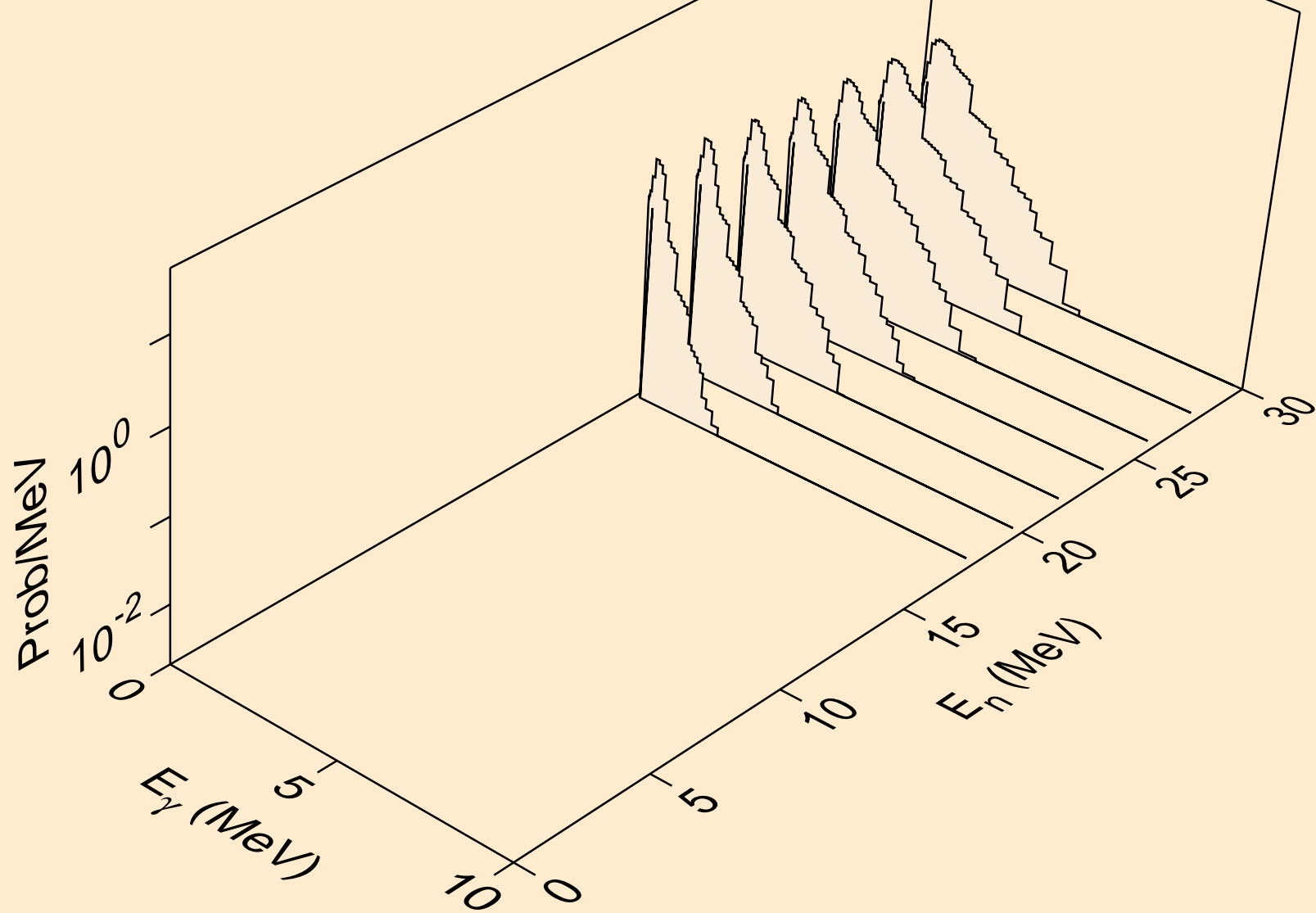

AU206 HELION ACER TENDL-2021 LIBRARY; T=0.K  
Photon emission for (n,p)

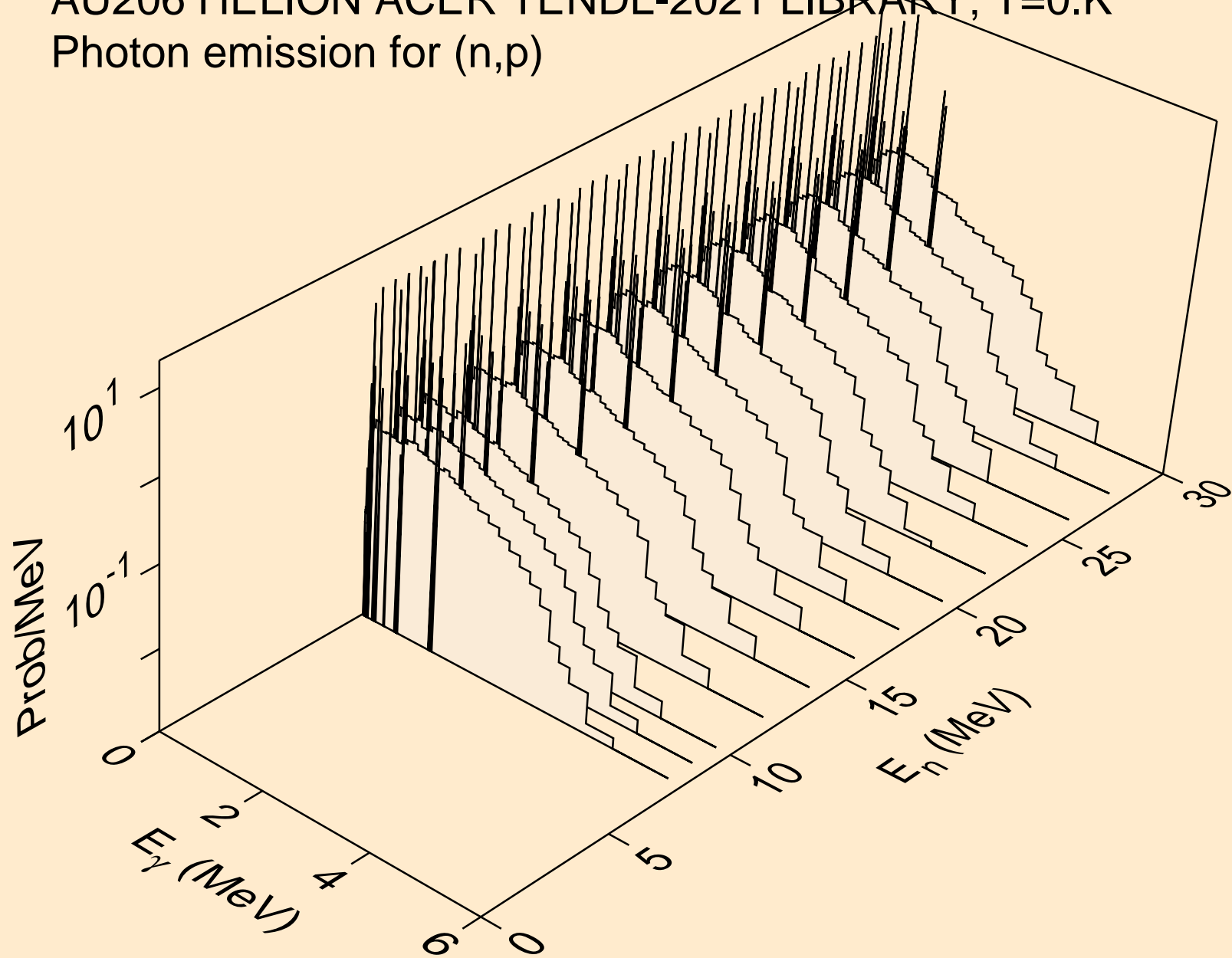

AU206 HELION ACER TENDL-2021 LIBRARY; T=0.K  
Photon emission for (n,d)

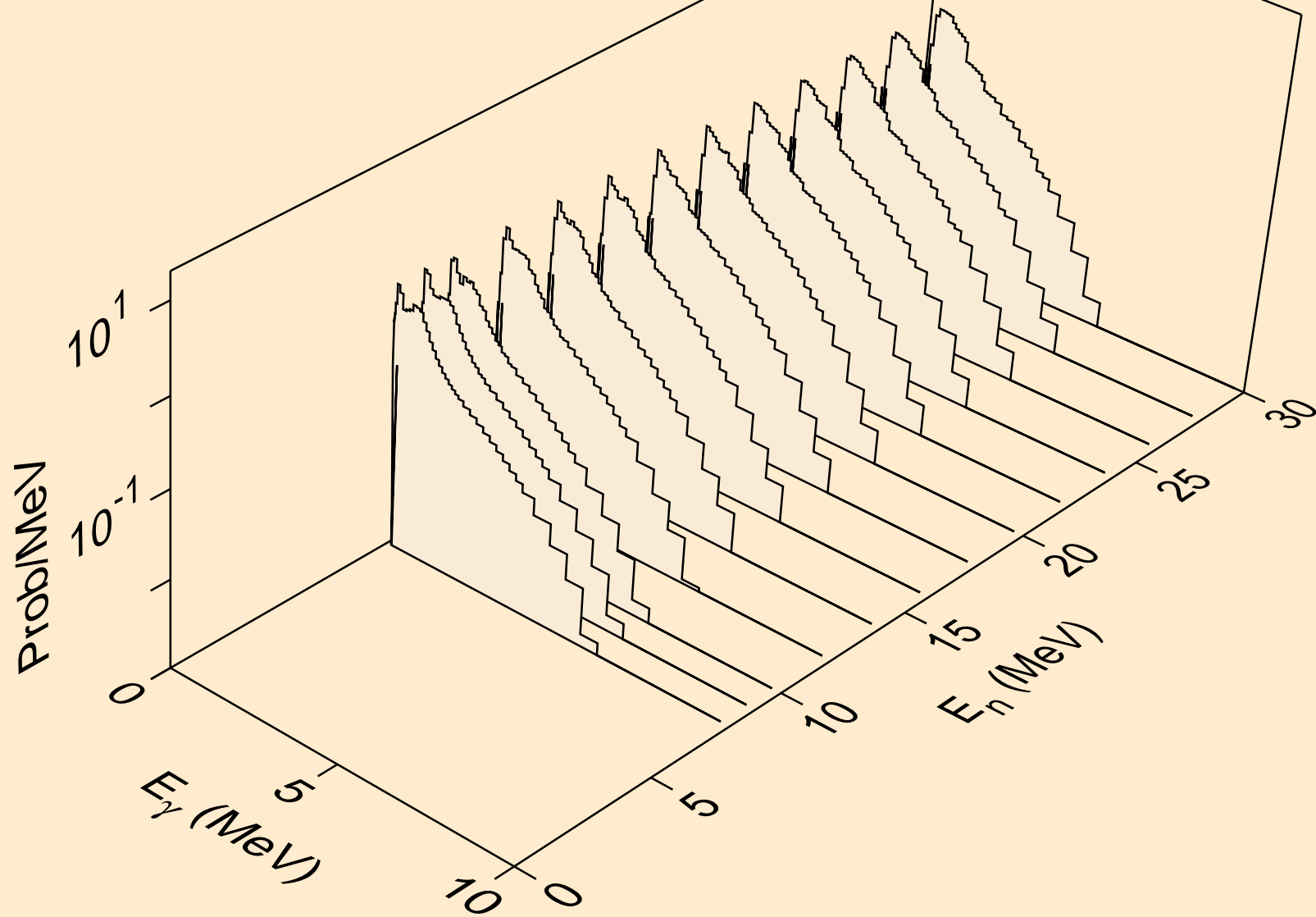

AU206 HELION ACER TENDL-2021 LIBRARY; T=0.K  
Photon emission for (n,t)

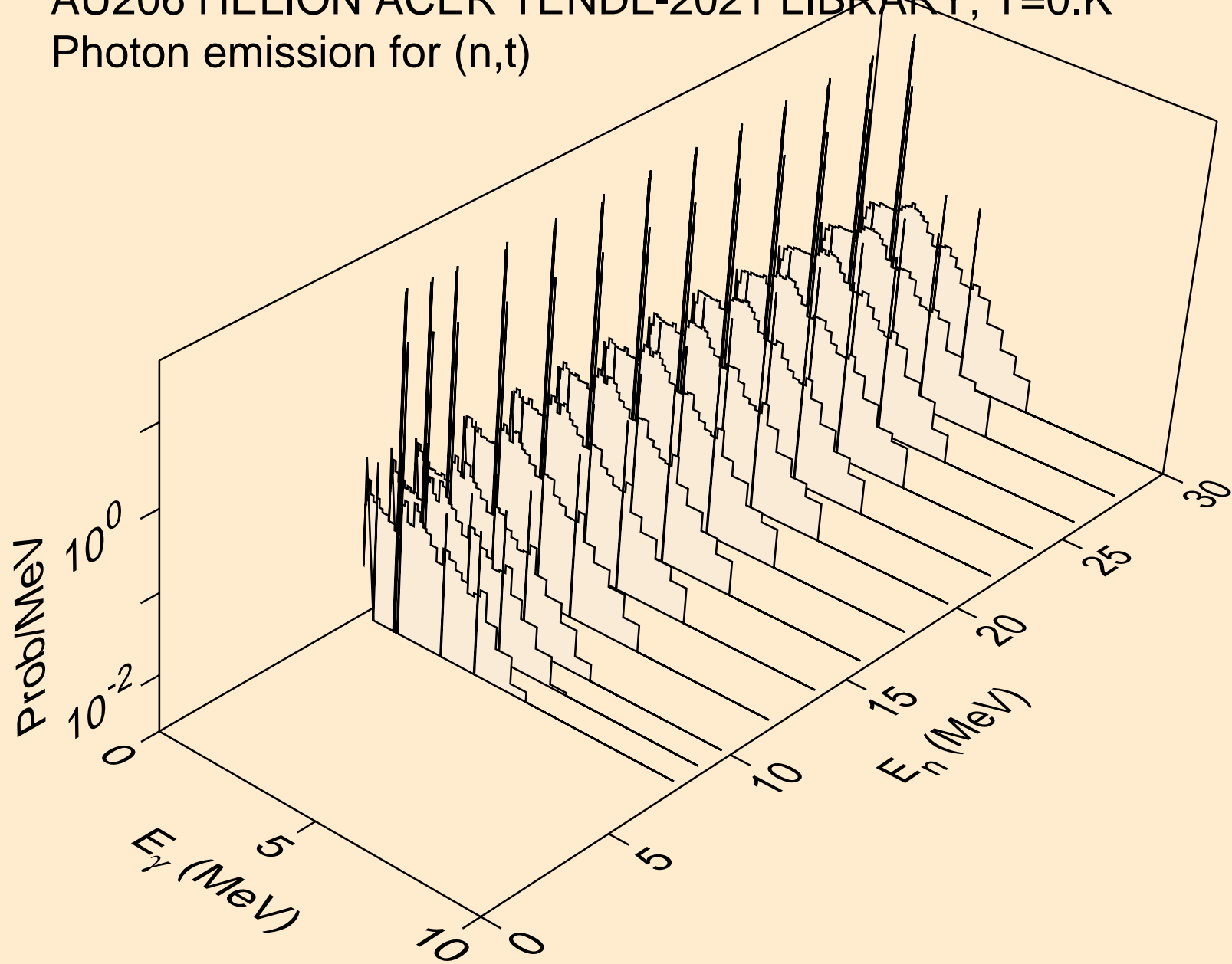

AU206 HELION ACER TENDL-2021 LIBRARY; T=0.K  
Photon emission for inelastic

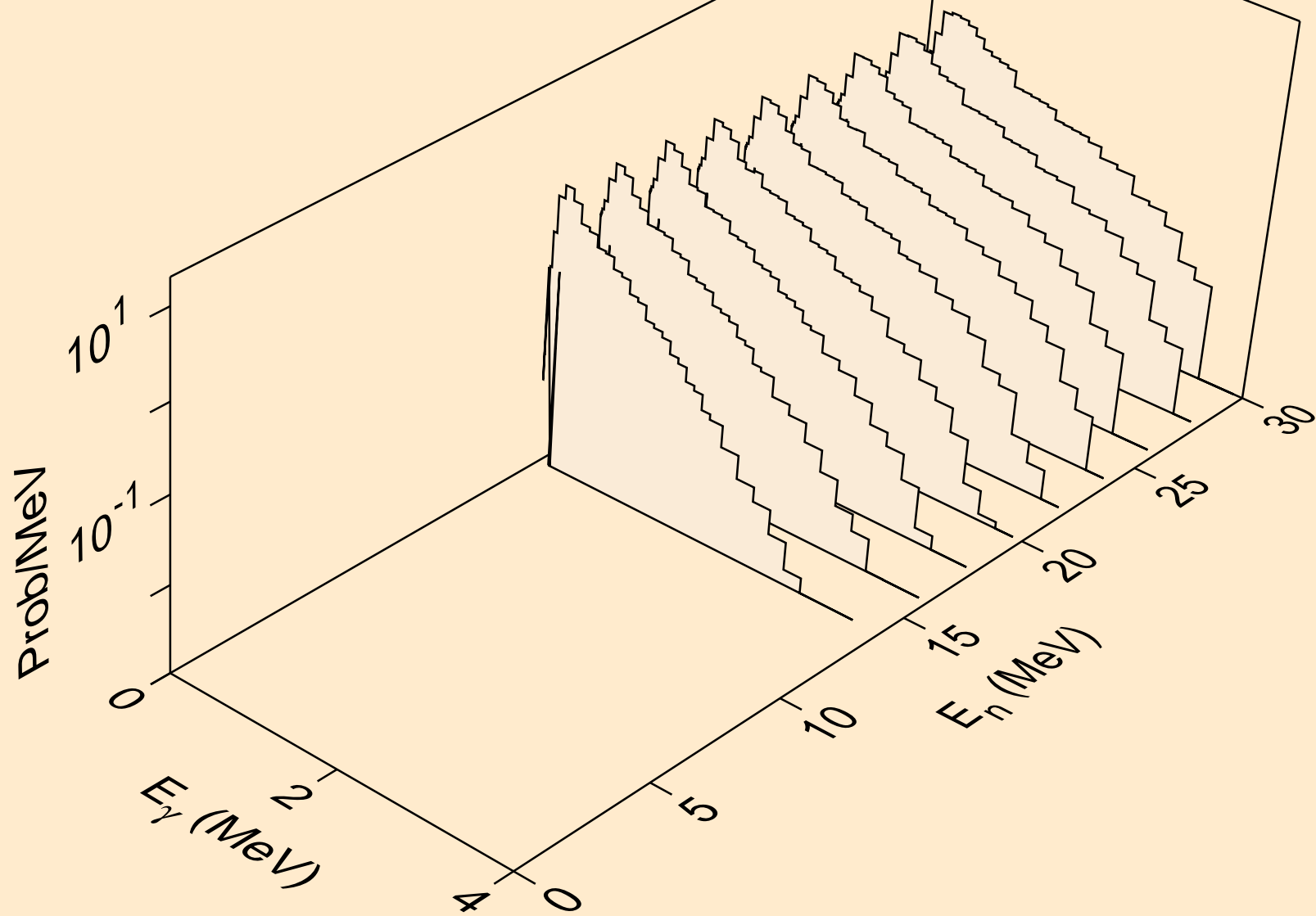

AU206 HELION ACER TENDL-2021 LIBRARY; T=0.K  
Photon emission for (n,a)

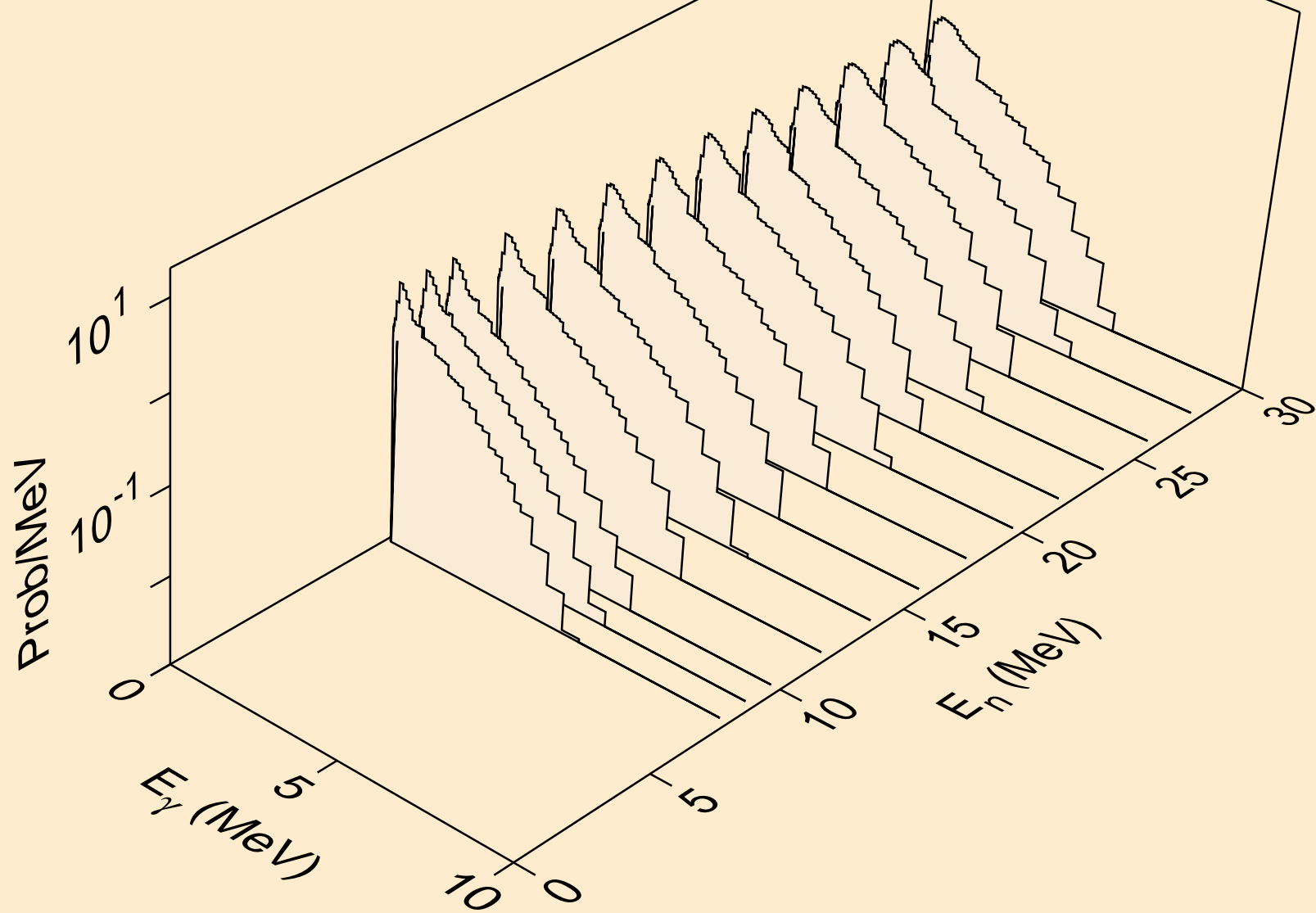

AU206 HELION ACER TENDL-2021 LIBRARY; T=0.K  
Photon emission for (n,2p)

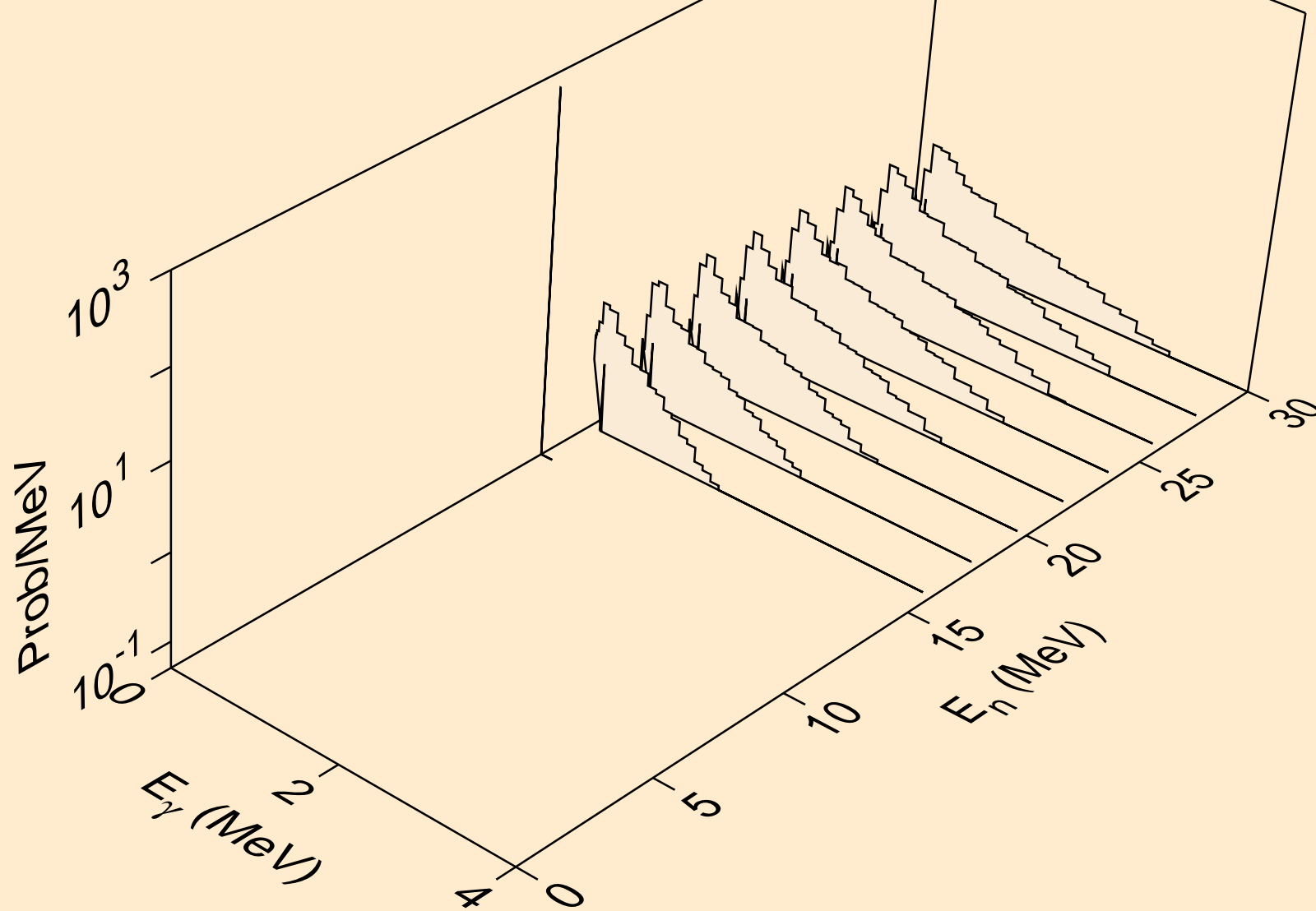

AU206 HELION ACER TENDL-2021 LIBRARY; T=0.K  
Photon emission for (n,pa)

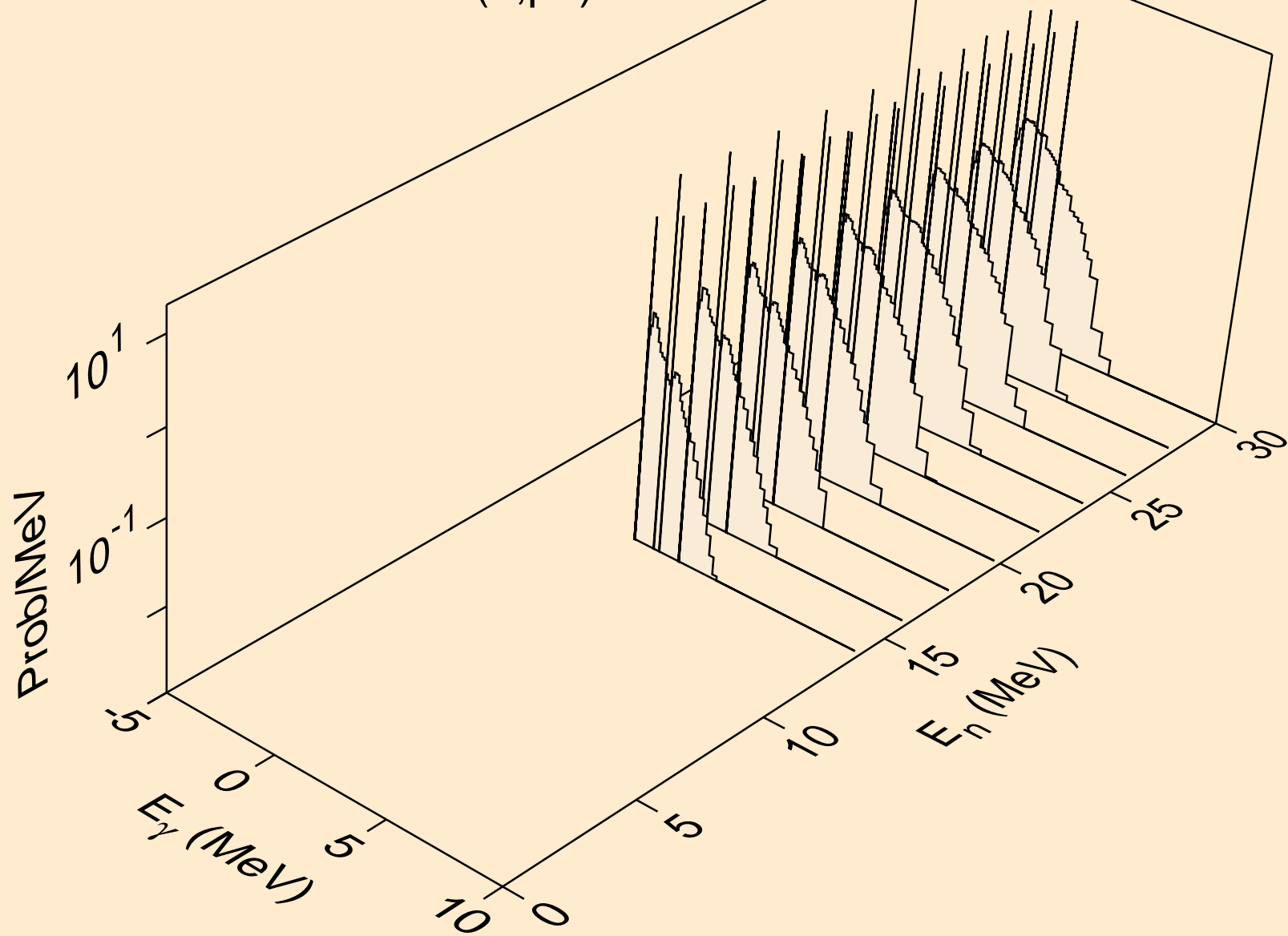



AU206 HELION ACER TENDL-2021 LIBRARY; T=0.K  
Photon emission for (n,pd)

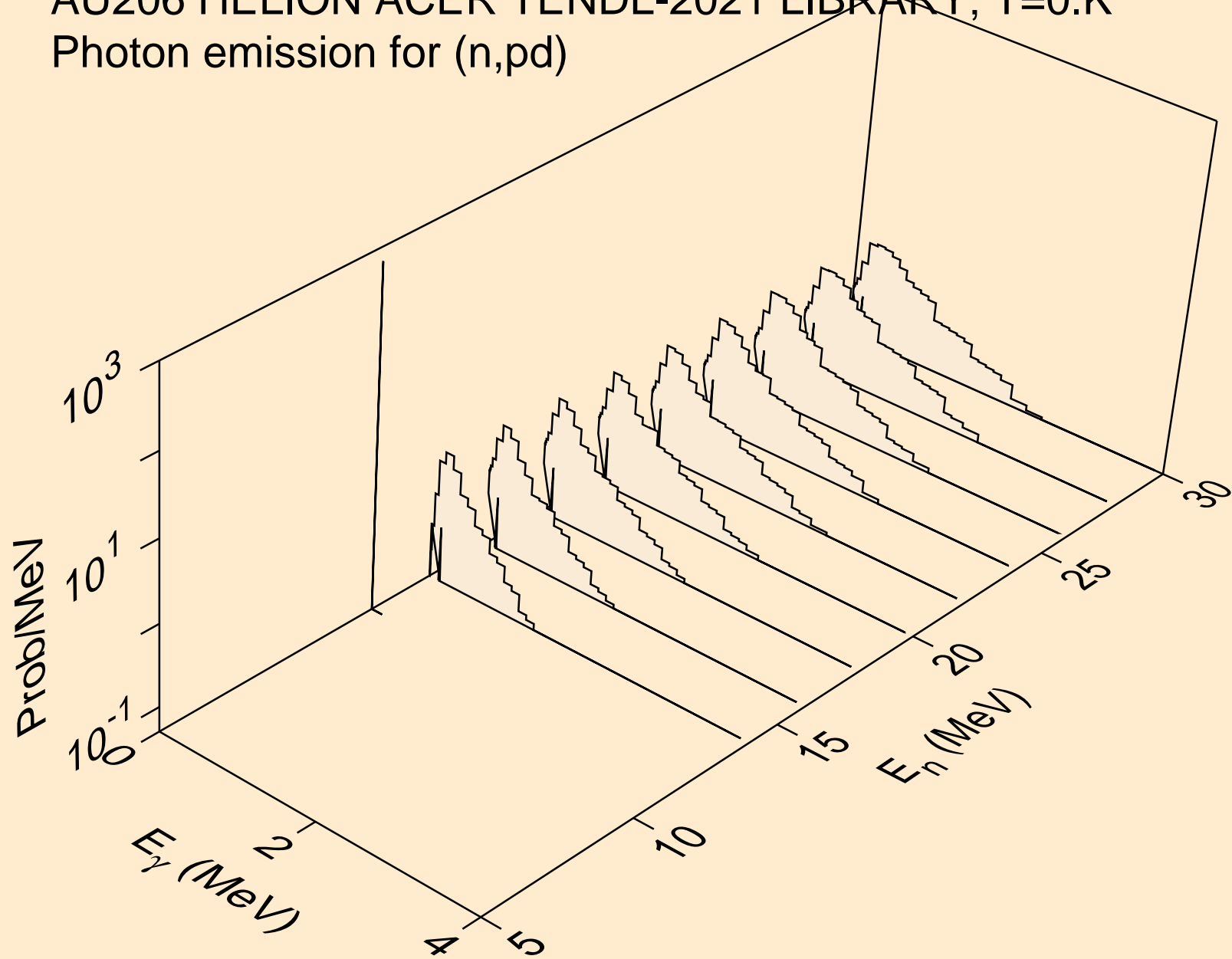

AU206 HELION ACER TENDL-2021 LIBRARY; T=0.K  
Photon emission for (n,pt)

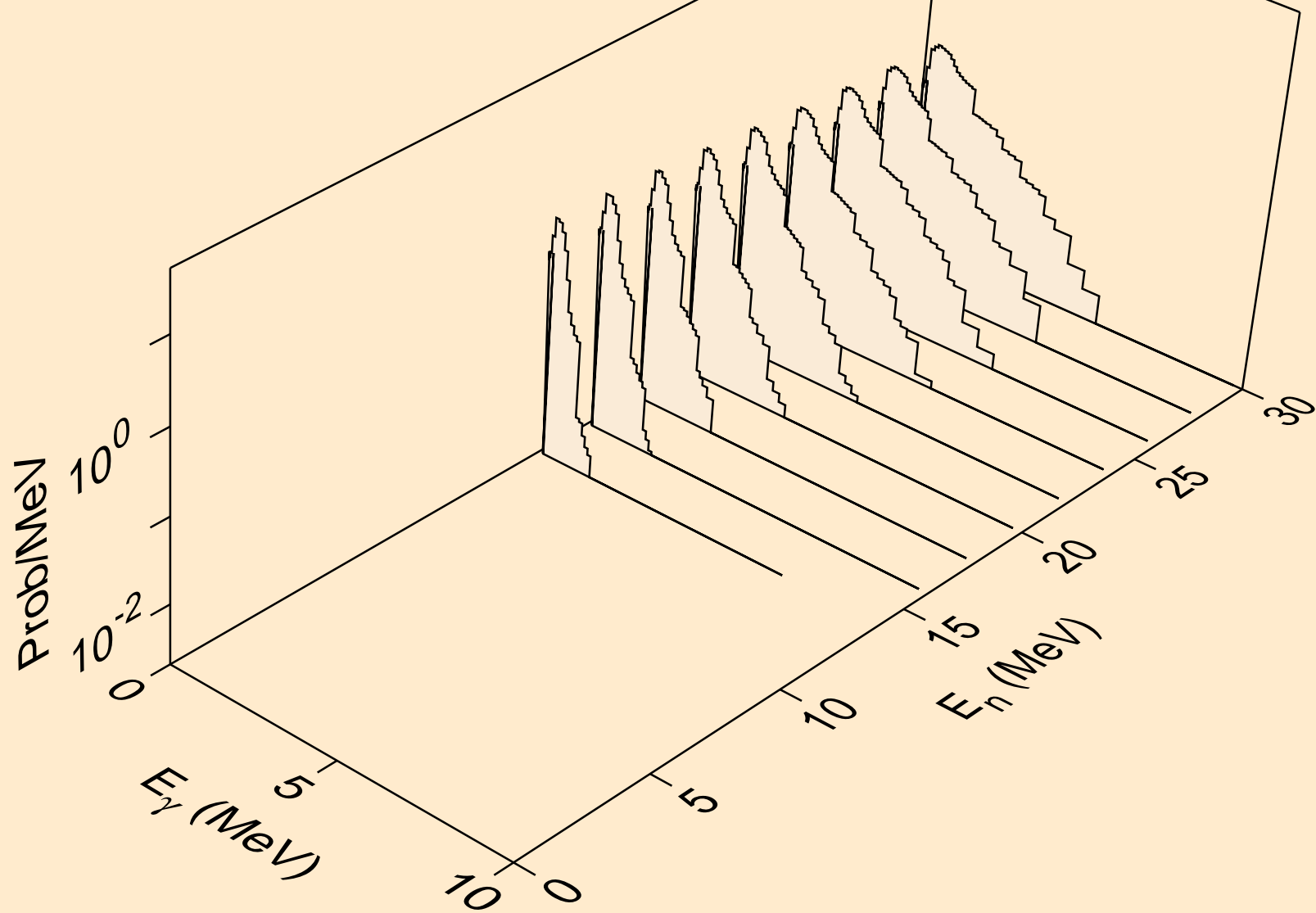

AU206 HELION ACER TENDL-2021 LIBRARY; T=0.K  
Particle heating contributions

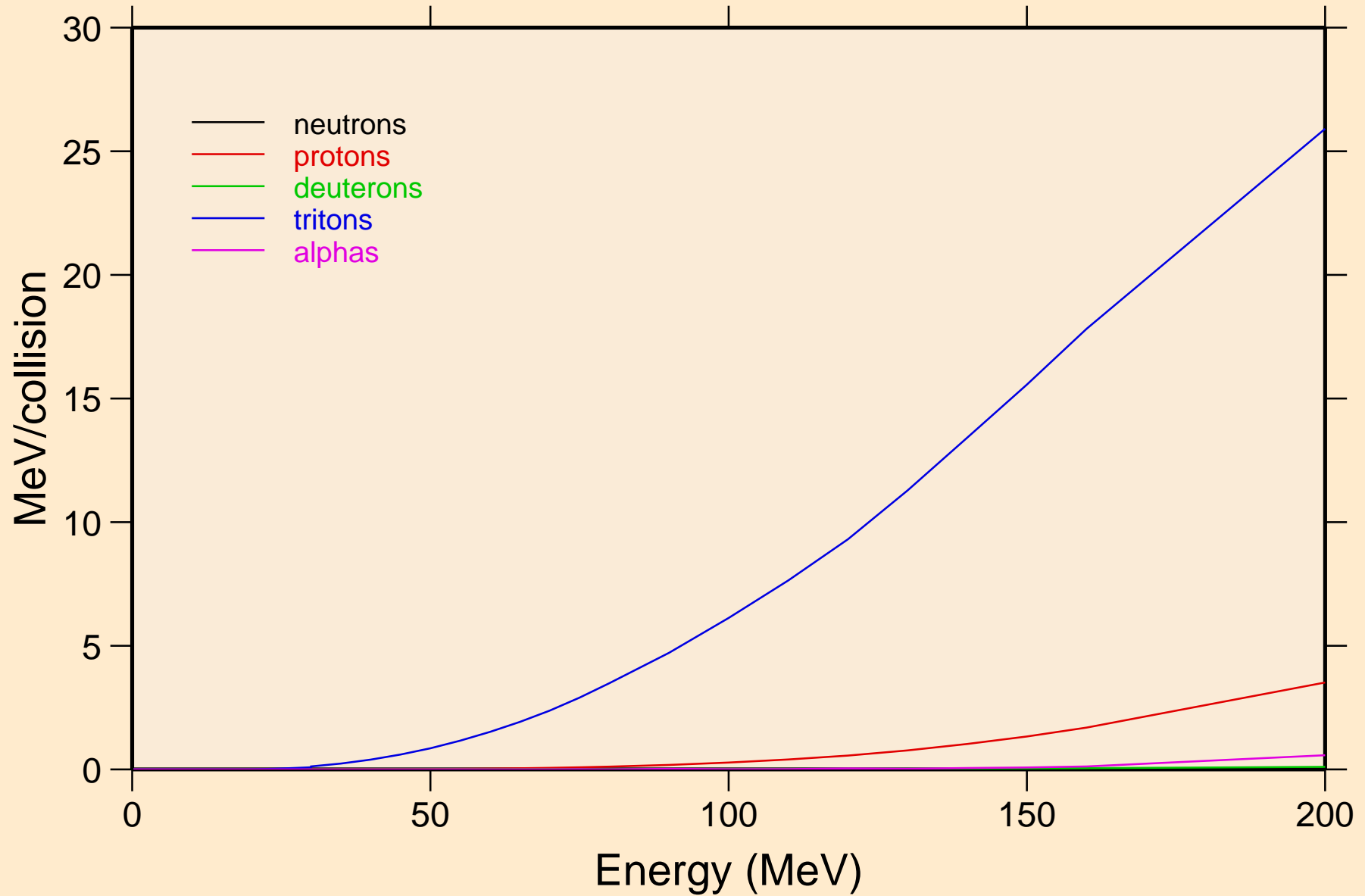

AU206 HELION ACER TENDL-2021 LIBRARY; T=0.K  
Recoil Heating

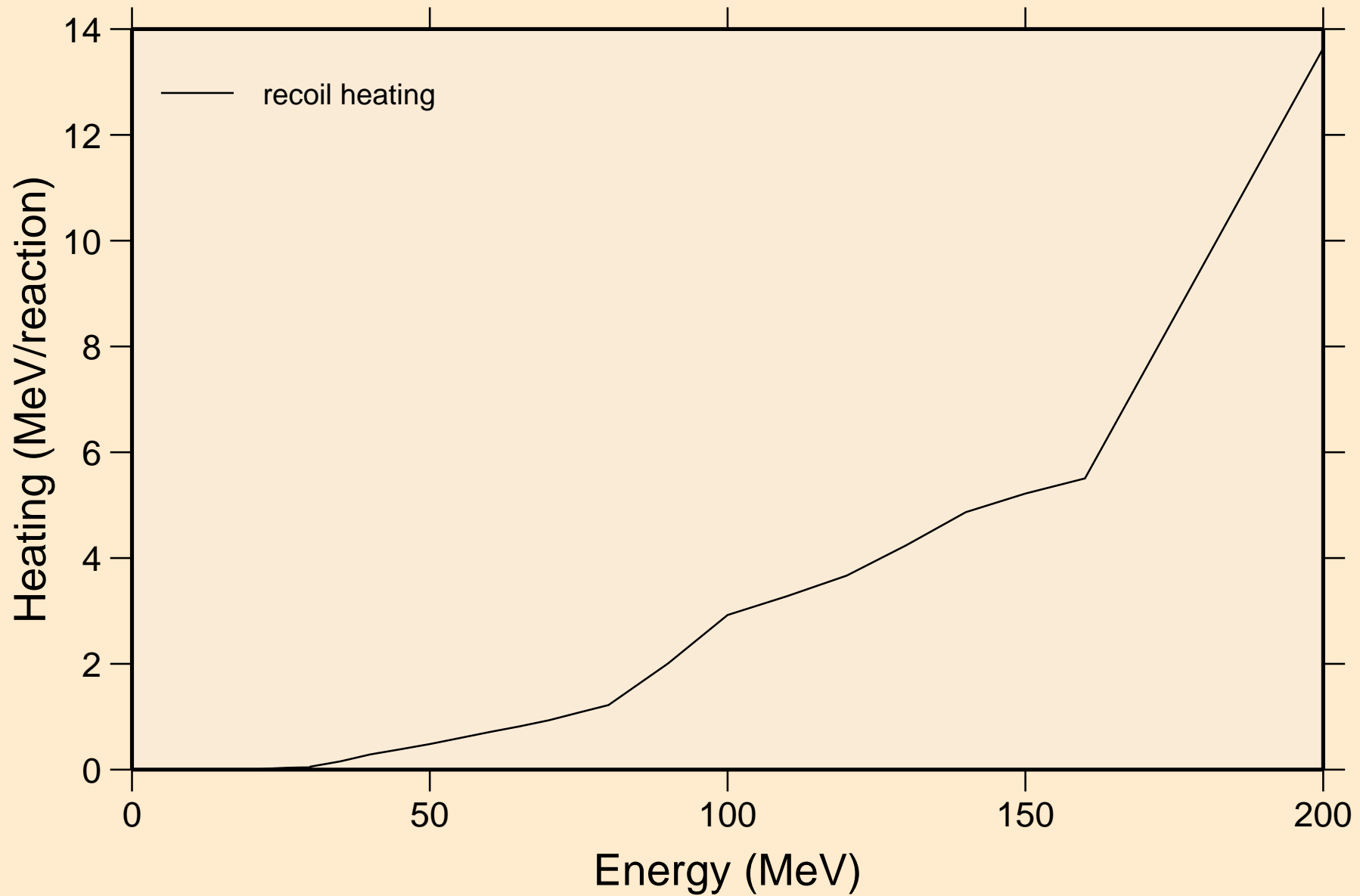

AU206 HELION ACER TENDL-2021 LIBRARY; T=0.K  
Particle production cross sections

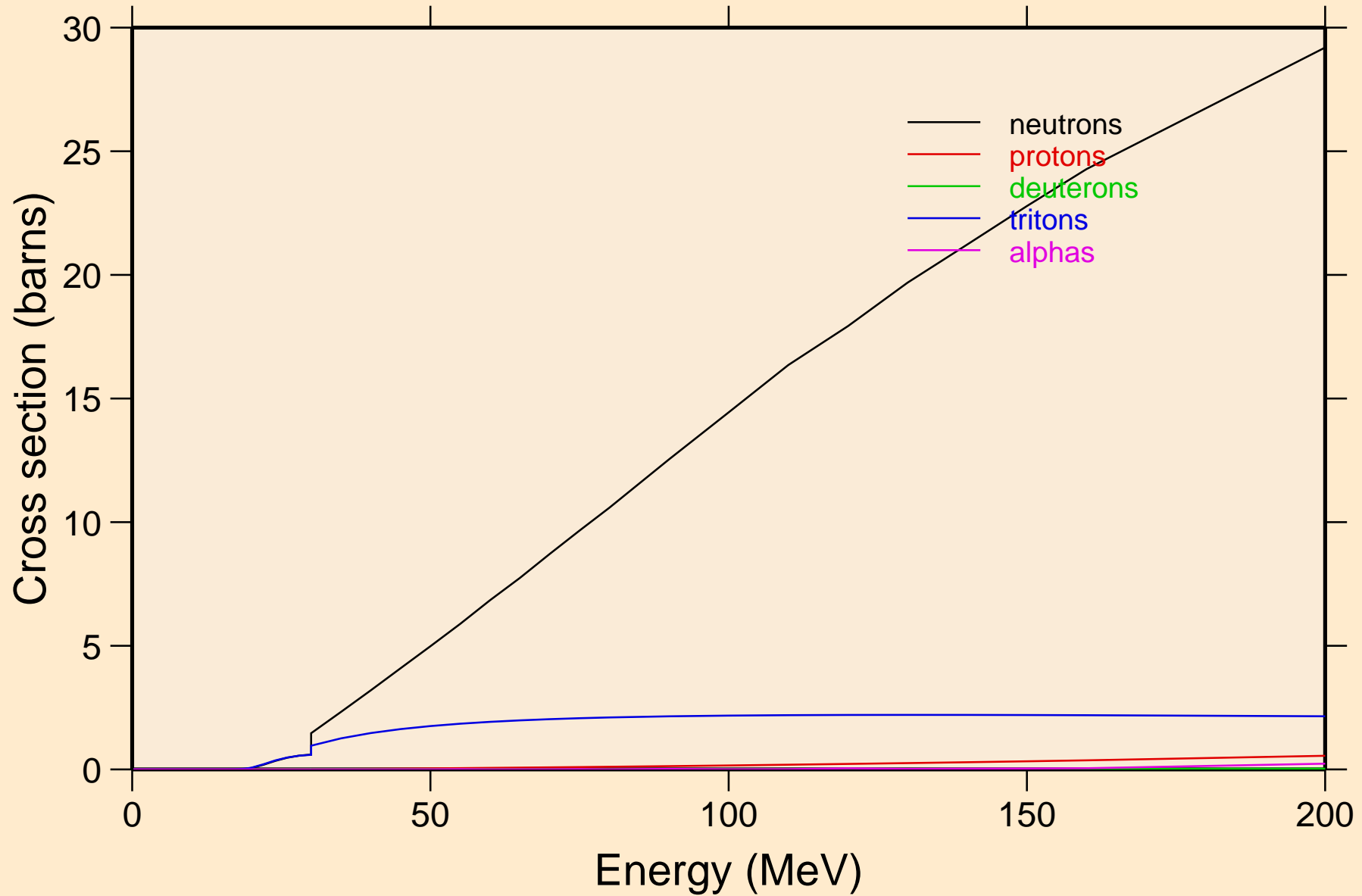

AU206 HELION ACER TENDL-2021 LIBRARY; T=0.K  
neutrons from (s,n)

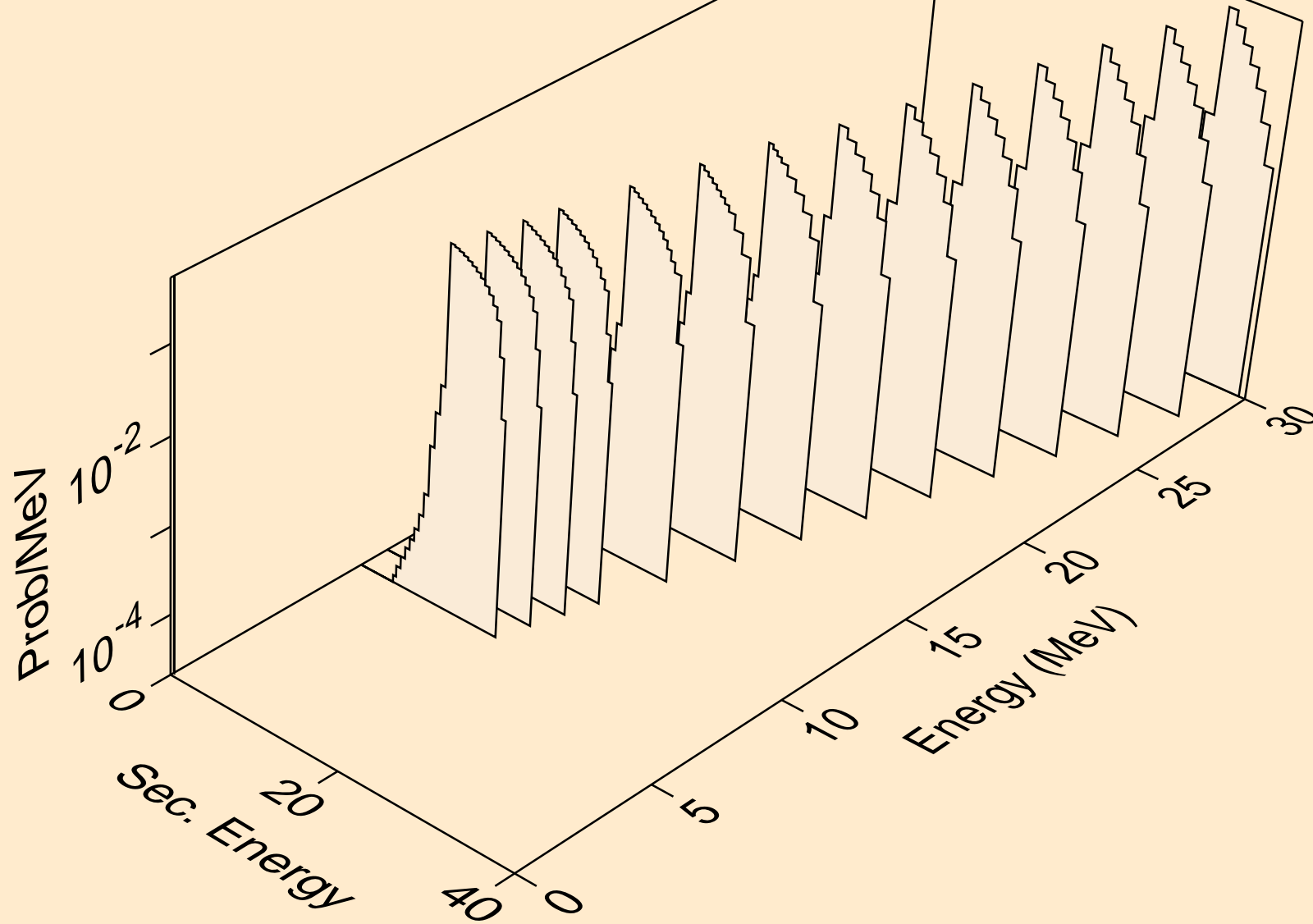

AU206 HELION ACER TENDL-2021 LIBRARY; T=0.K  
neutrons from (s,x)

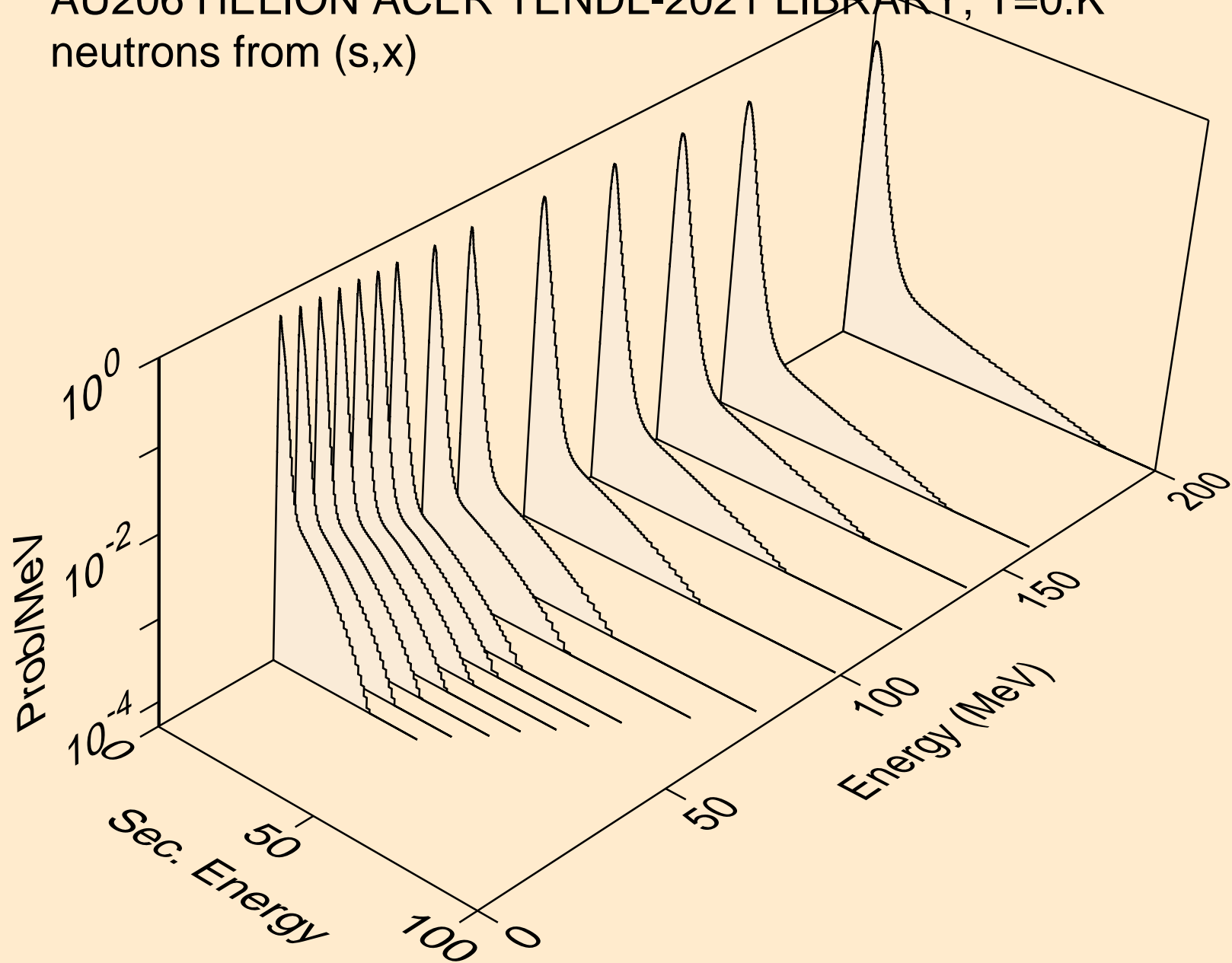

AU206 HELION ACER TENDL-2021 LIBRARY; T=0.K  
neutrons from (s,2nd)

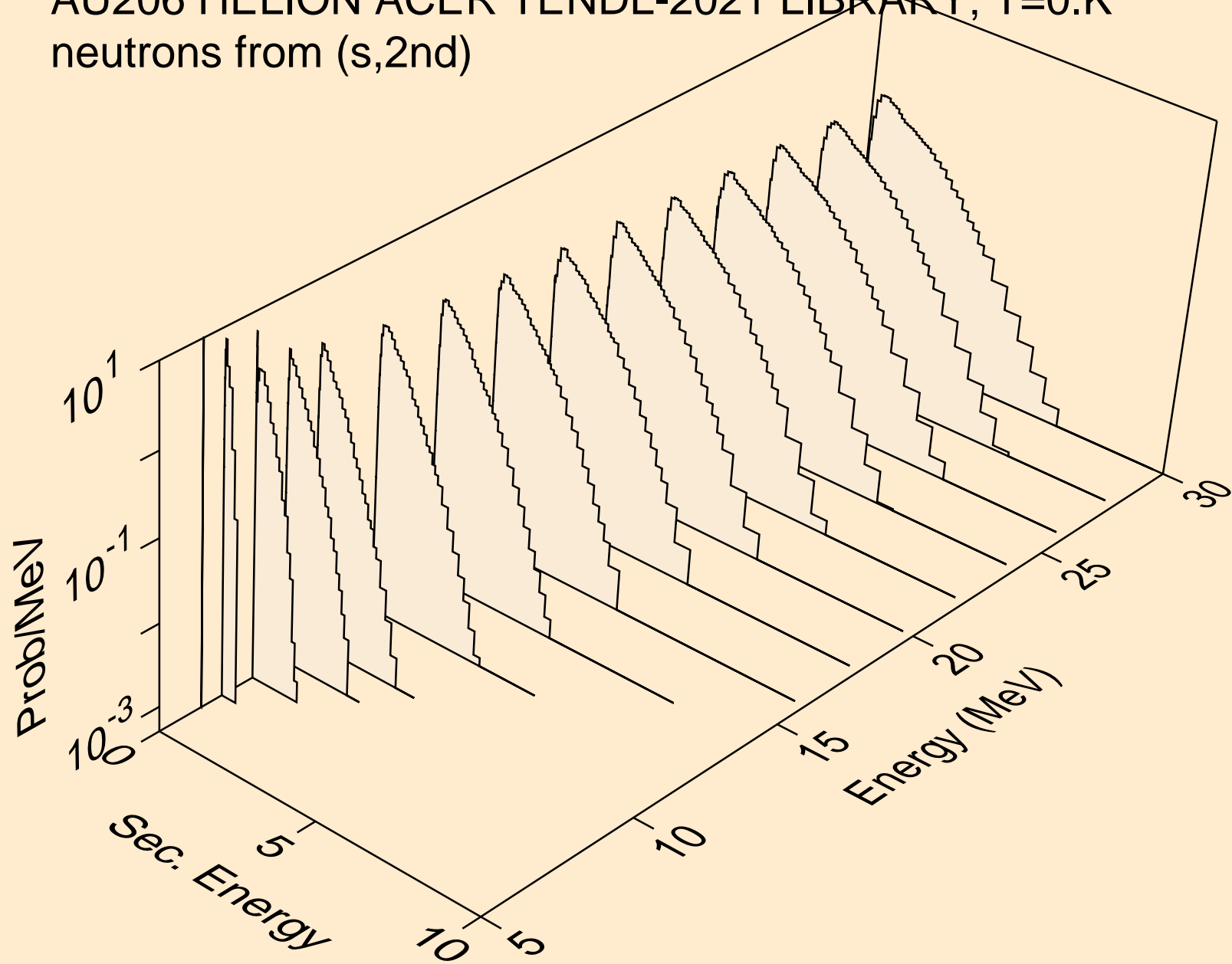



AU206 HELION ACER TENDL-2021 LIBRARY; T=0.K  
neutrons from (s,2n)

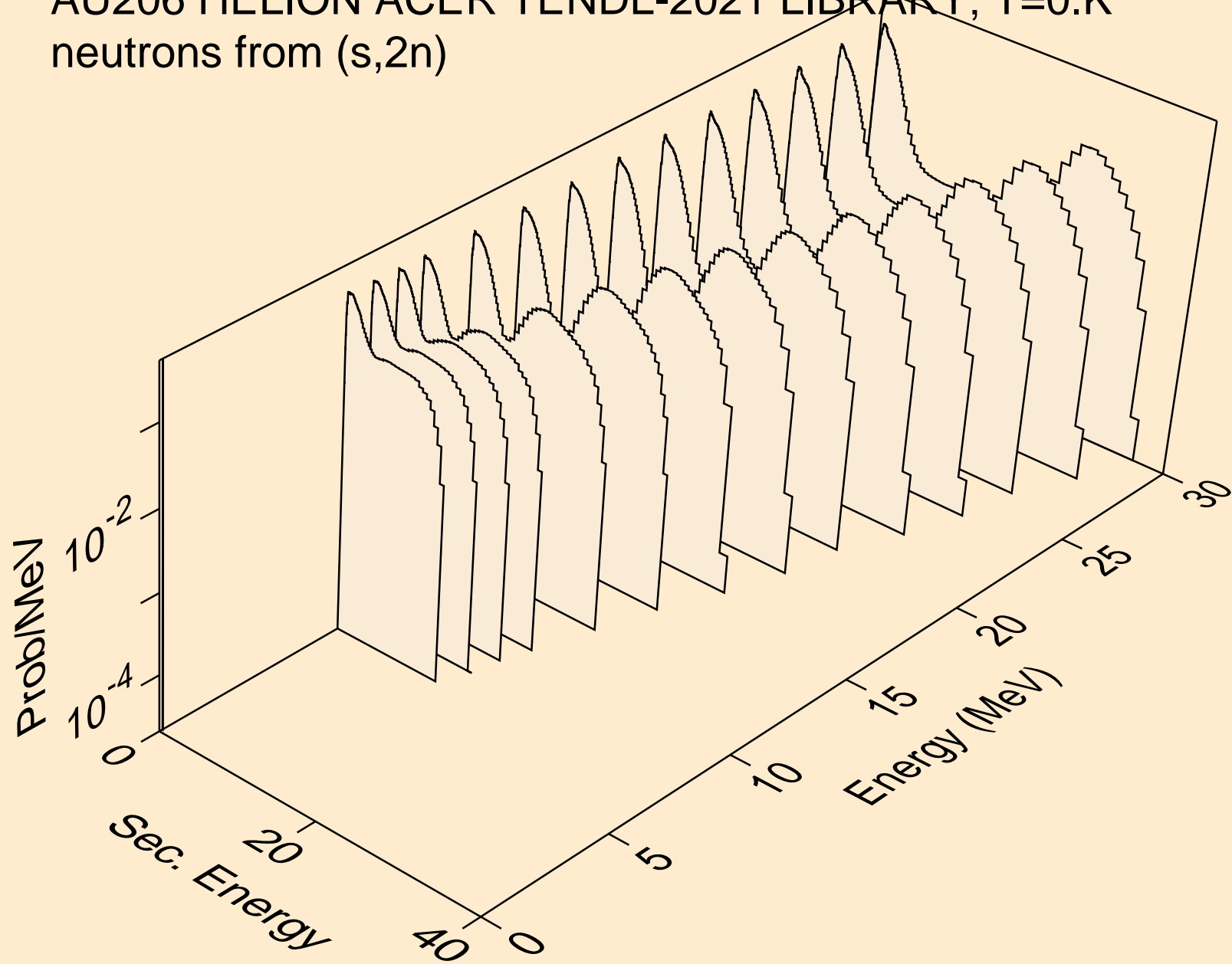

AU206 HELION ACER TENDL-2021 LIBRARY; T=0.K  
neutrons from (s,3n)

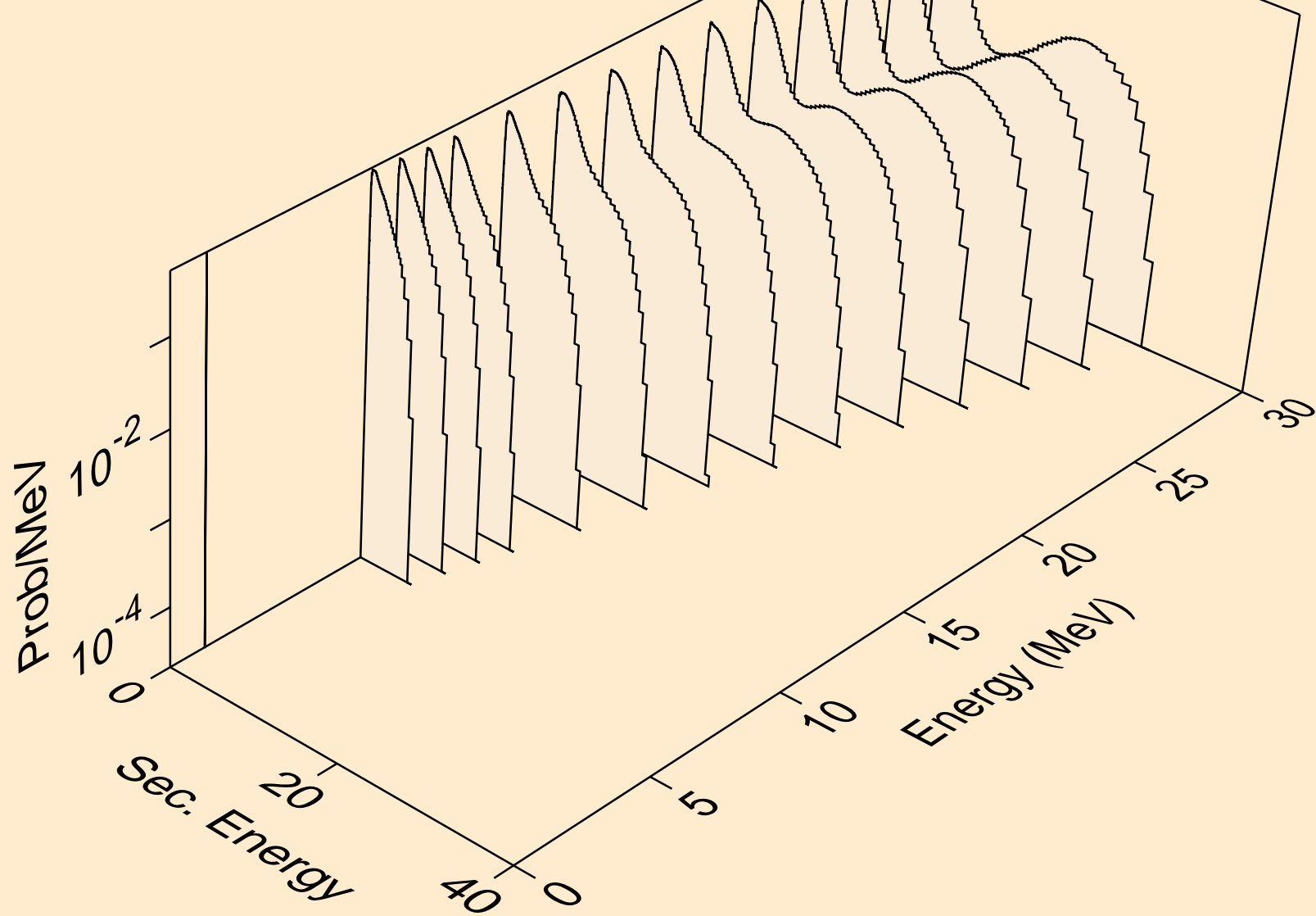

AU206 HELION ACER TENDL-2021 LIBRARY; T=0.K  
neutrons from (s,n\*)a

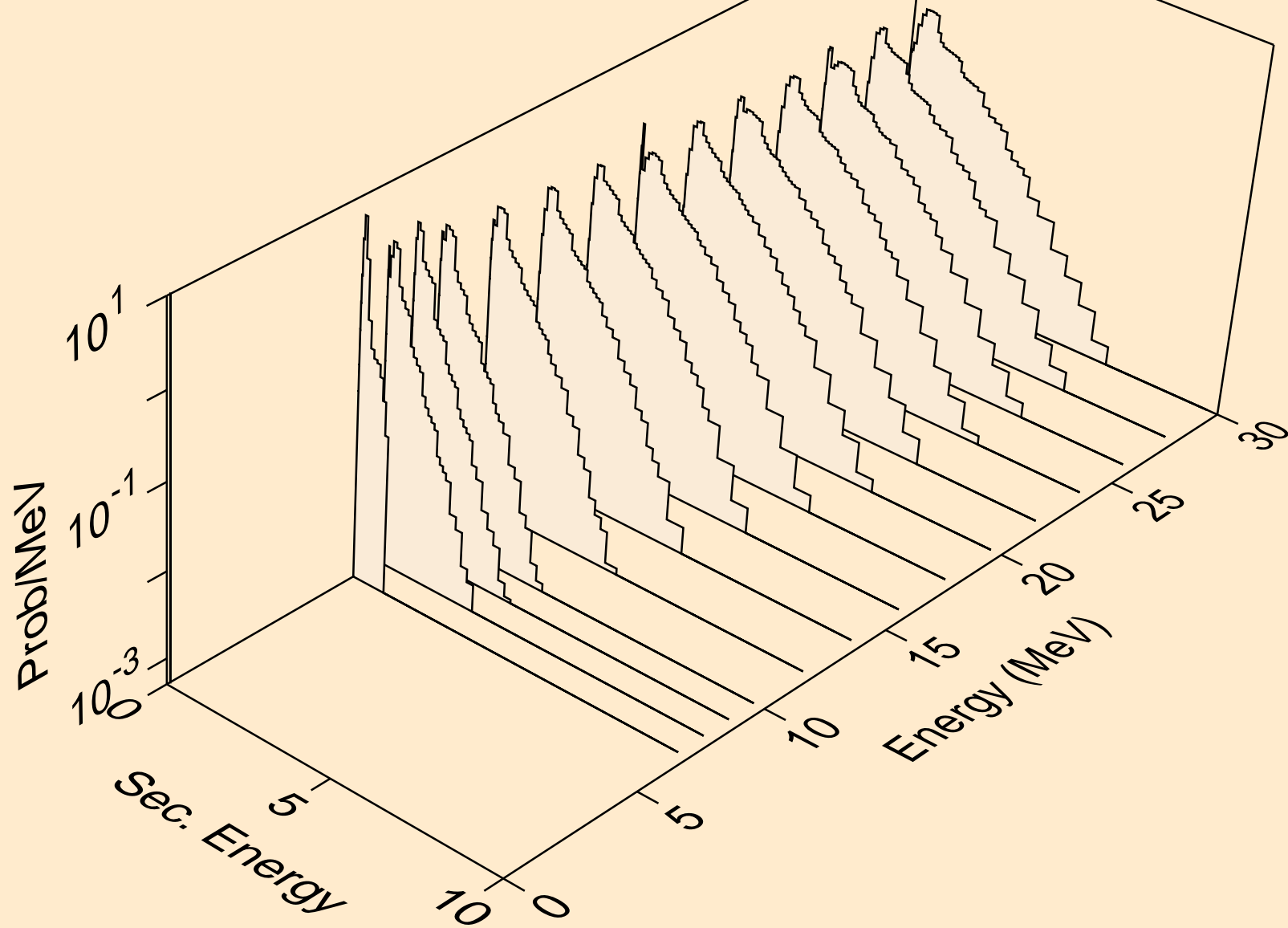

AU206 HELION ACER TENDL-2021 LIBRARY; T=0.K  
neutrons from (s,2n)a

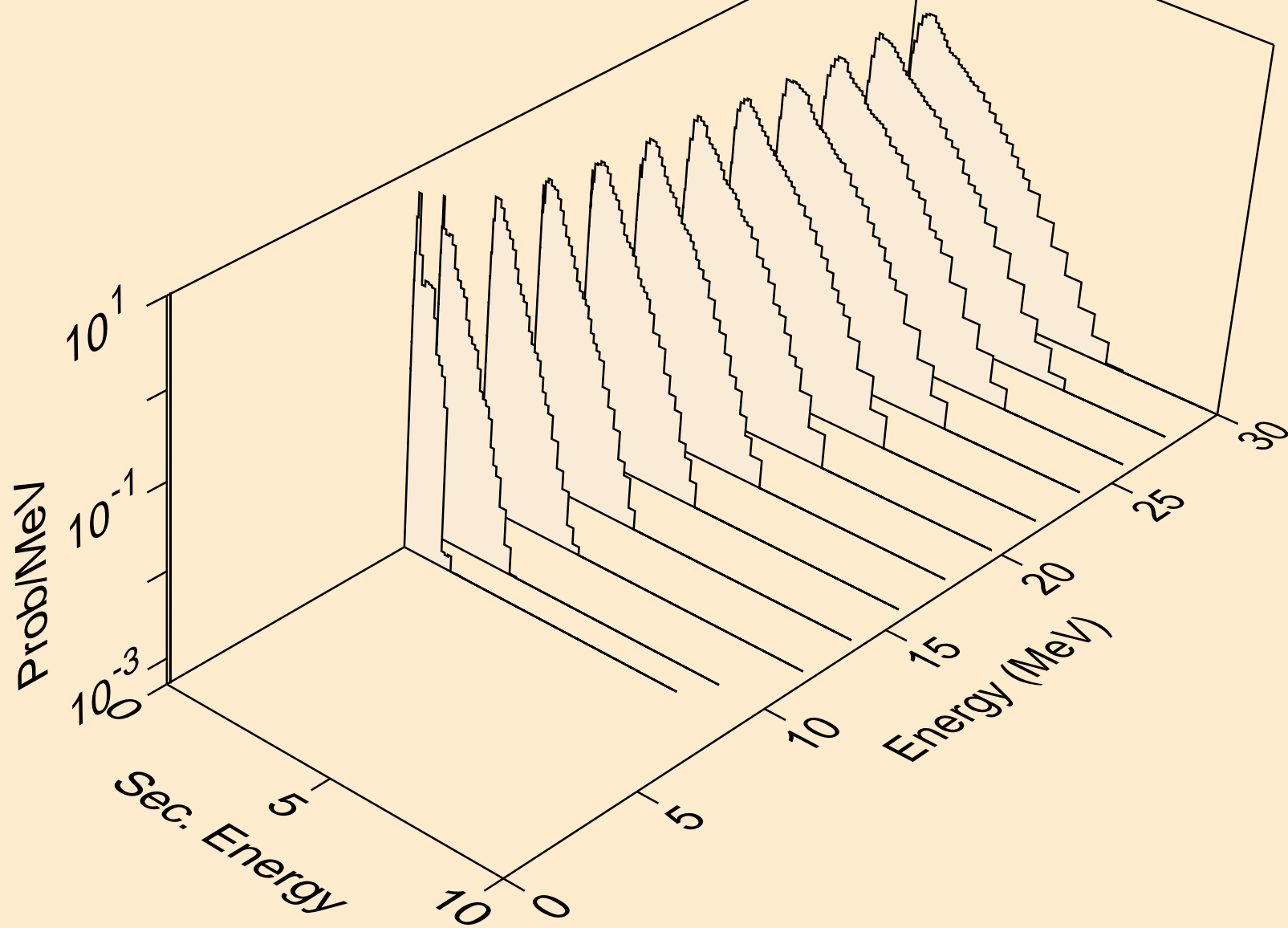

AU206 HELION ACER TENDL-2021 LIBRARY; T=0.K  
neutrons from (s,3n)a

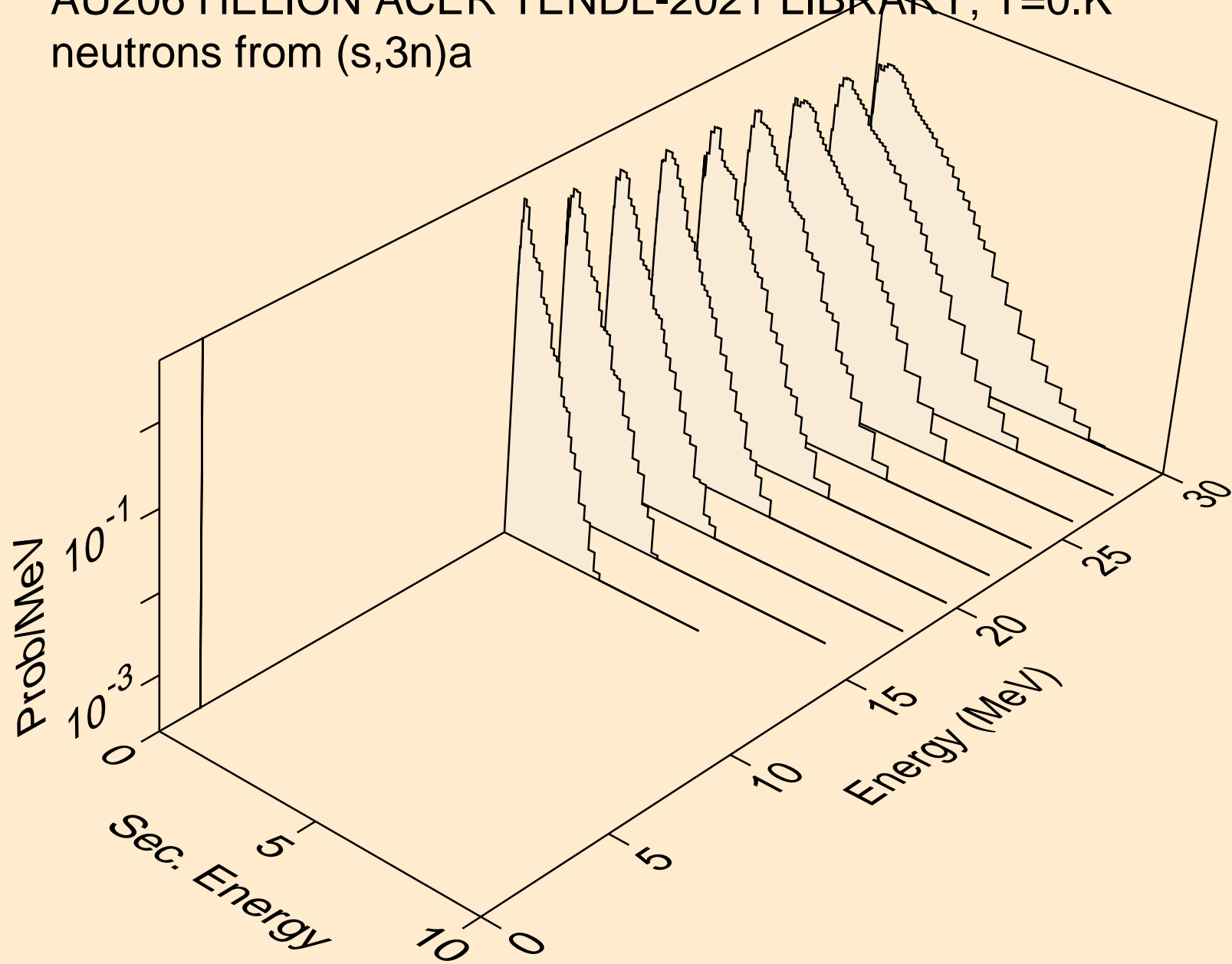

AU206 HELION ACER TENDL-2021 LIBRARY; T=0.K  
neutrons from (s,n\*)p

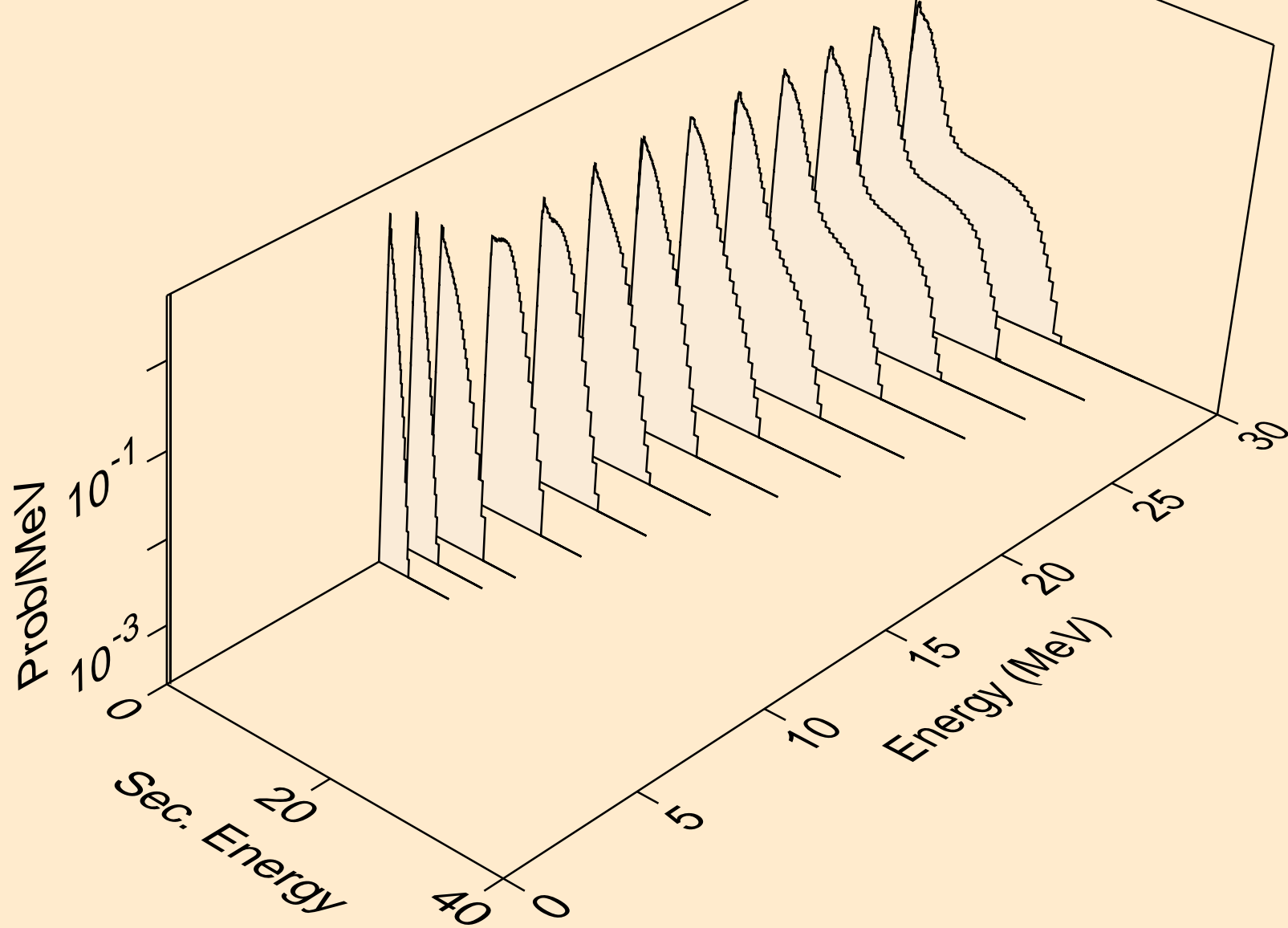

AU206 HELION ACER TENDL-2021 LIBRARY; T=0.K  
neutrons from (s,n\*)d

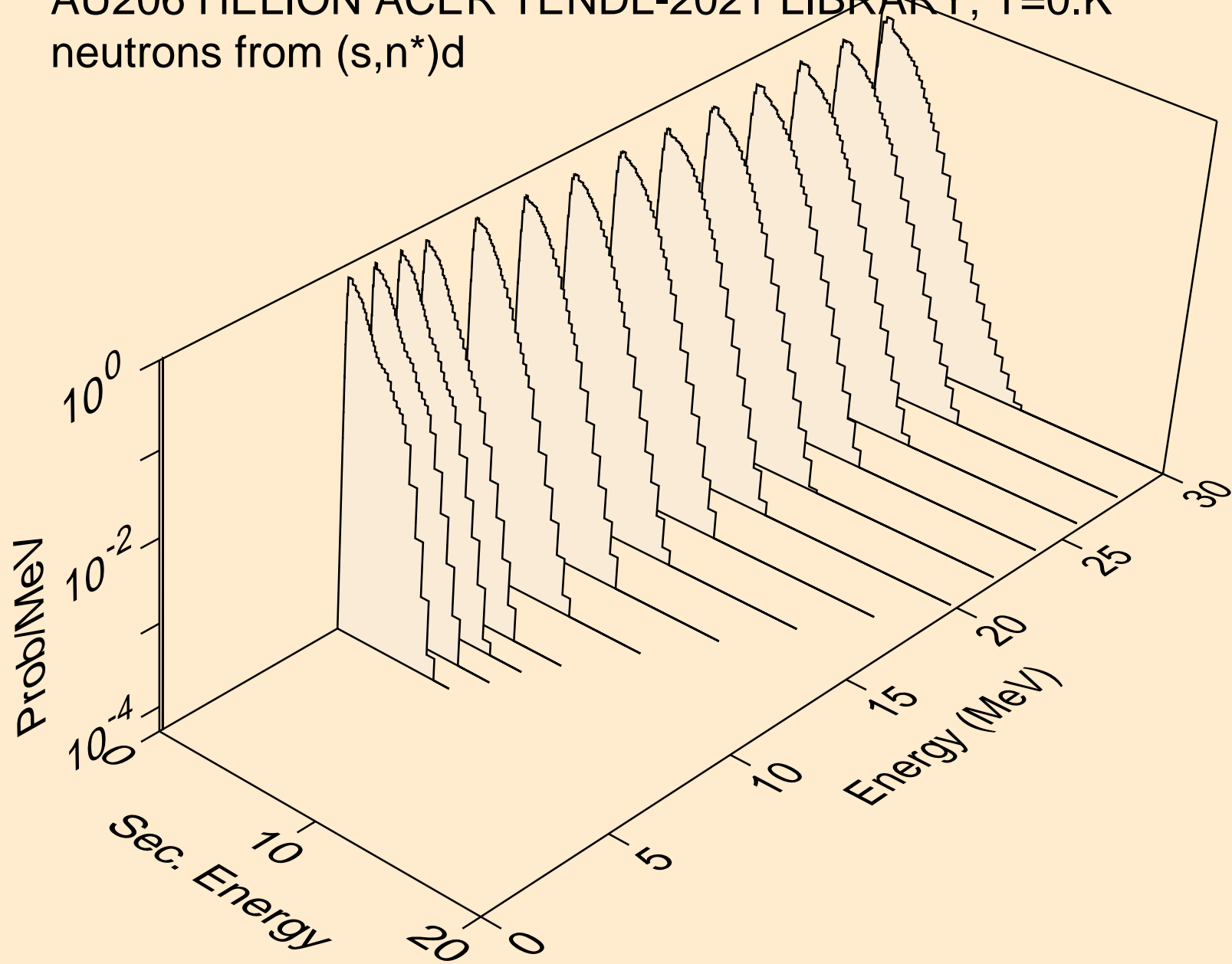

AU206 HELION ACER TENDL-2021 LIBRARY; T=0.K  
neutrons from (s,n\*)t

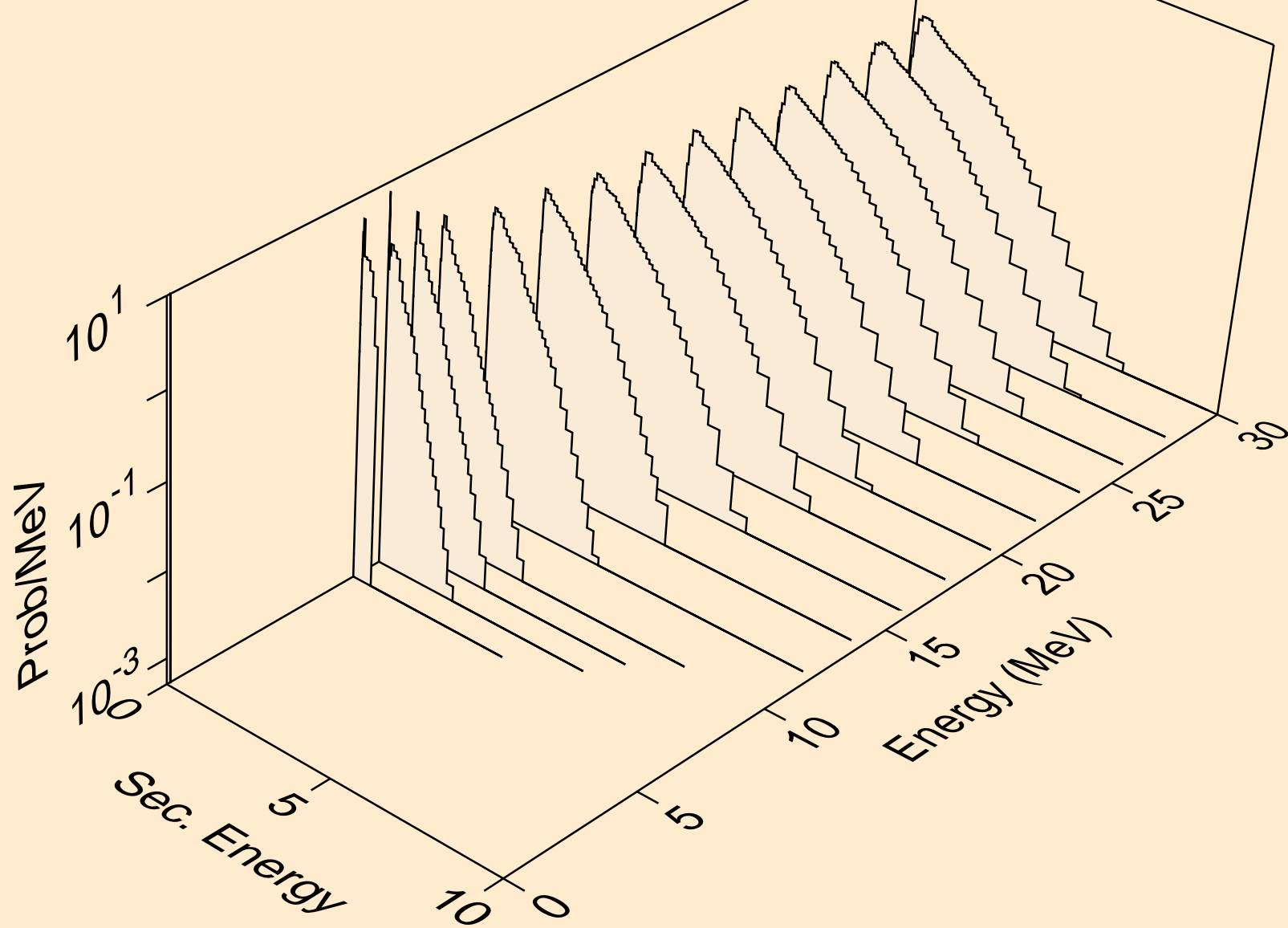



AU206 HELION ACER TENDL-2021 LIBRARY; T=0.K  
neutrons from (s,n\*)he3

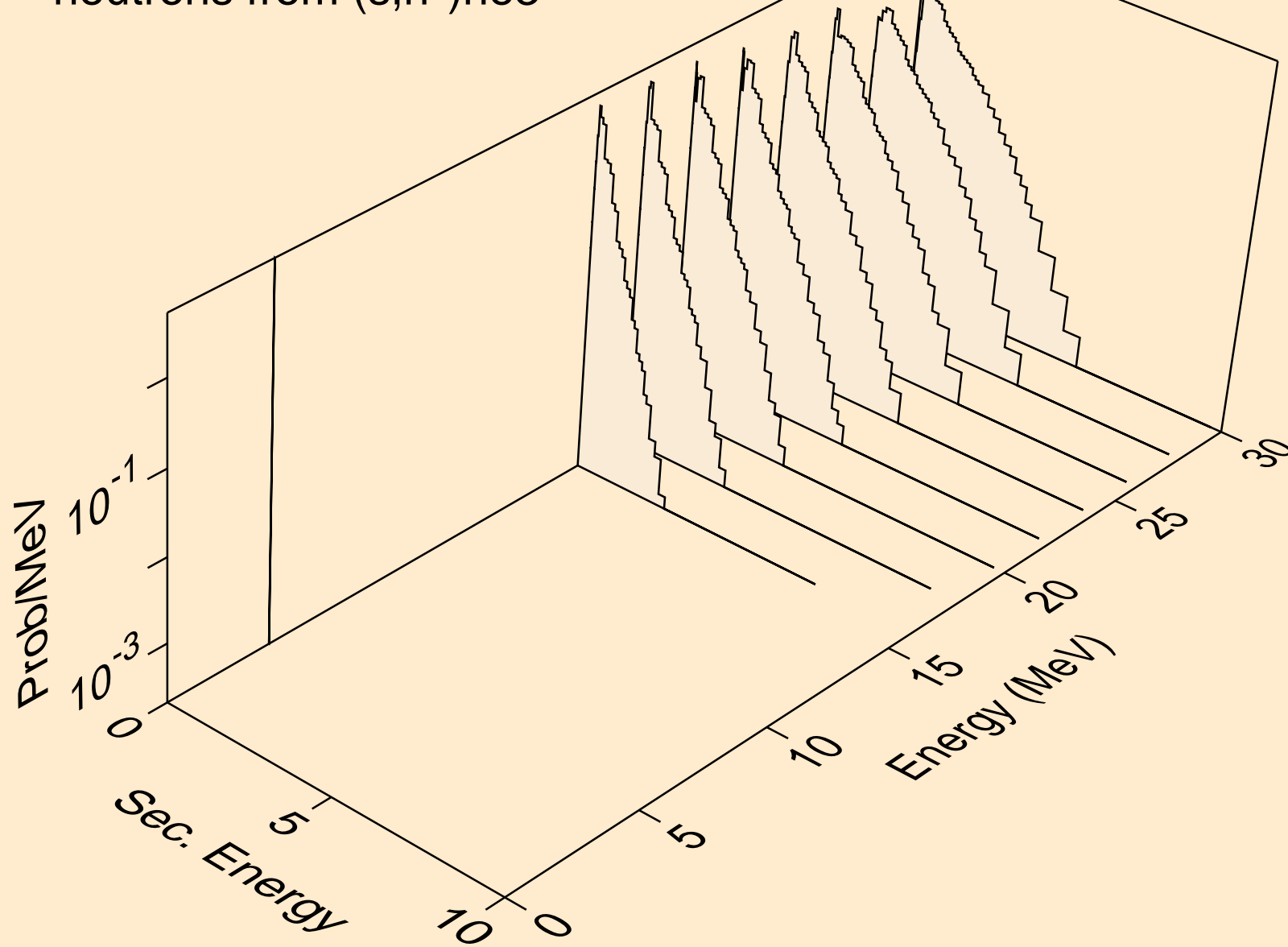

AU206 HELION ACER TENDL-2021 LIBRARY; T=0.K  
neutrons from (s,4n)

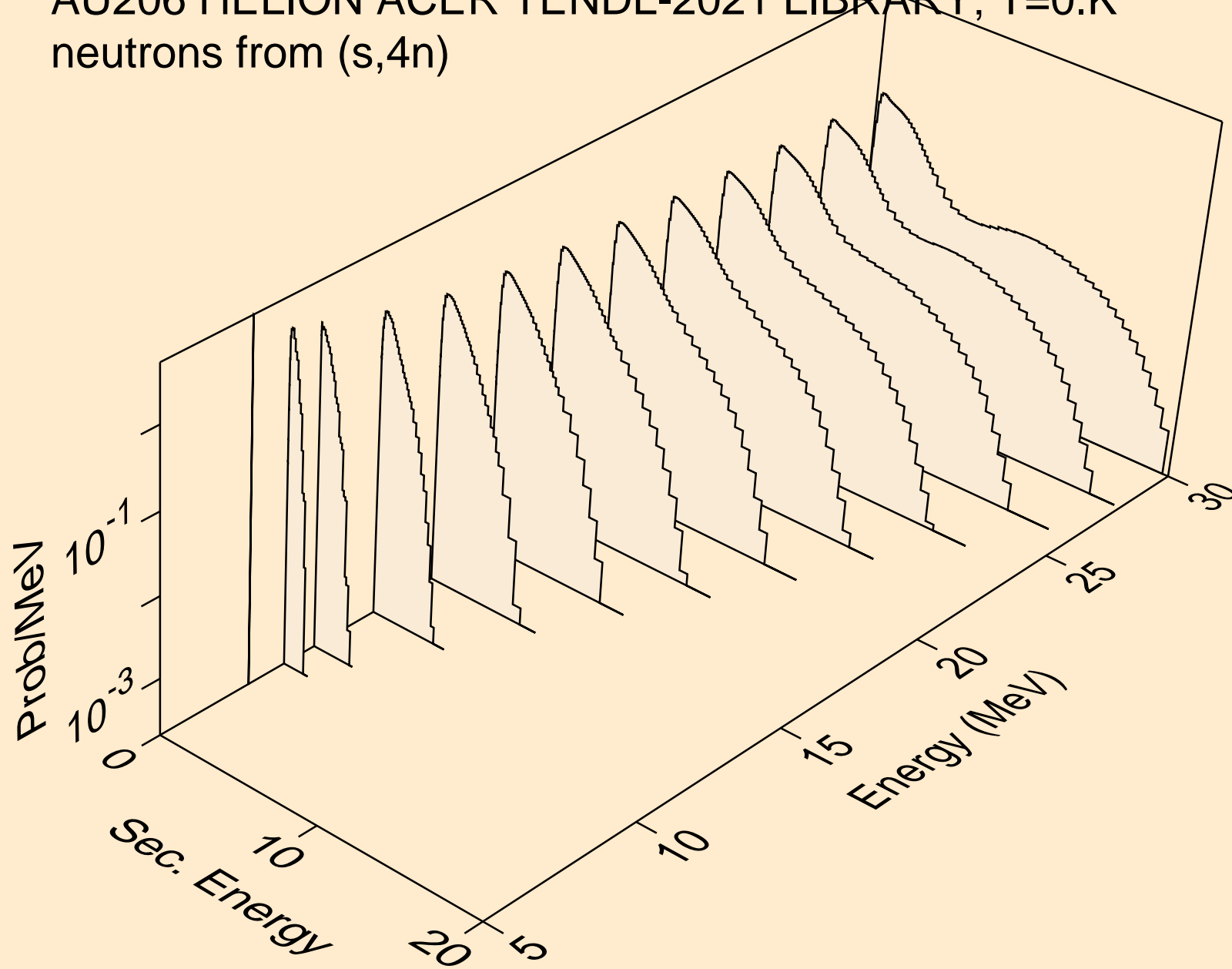

AU206 HELION ACER TENDL-2021 LIBRARY; T=0.K  
neutrons from (s,2np)

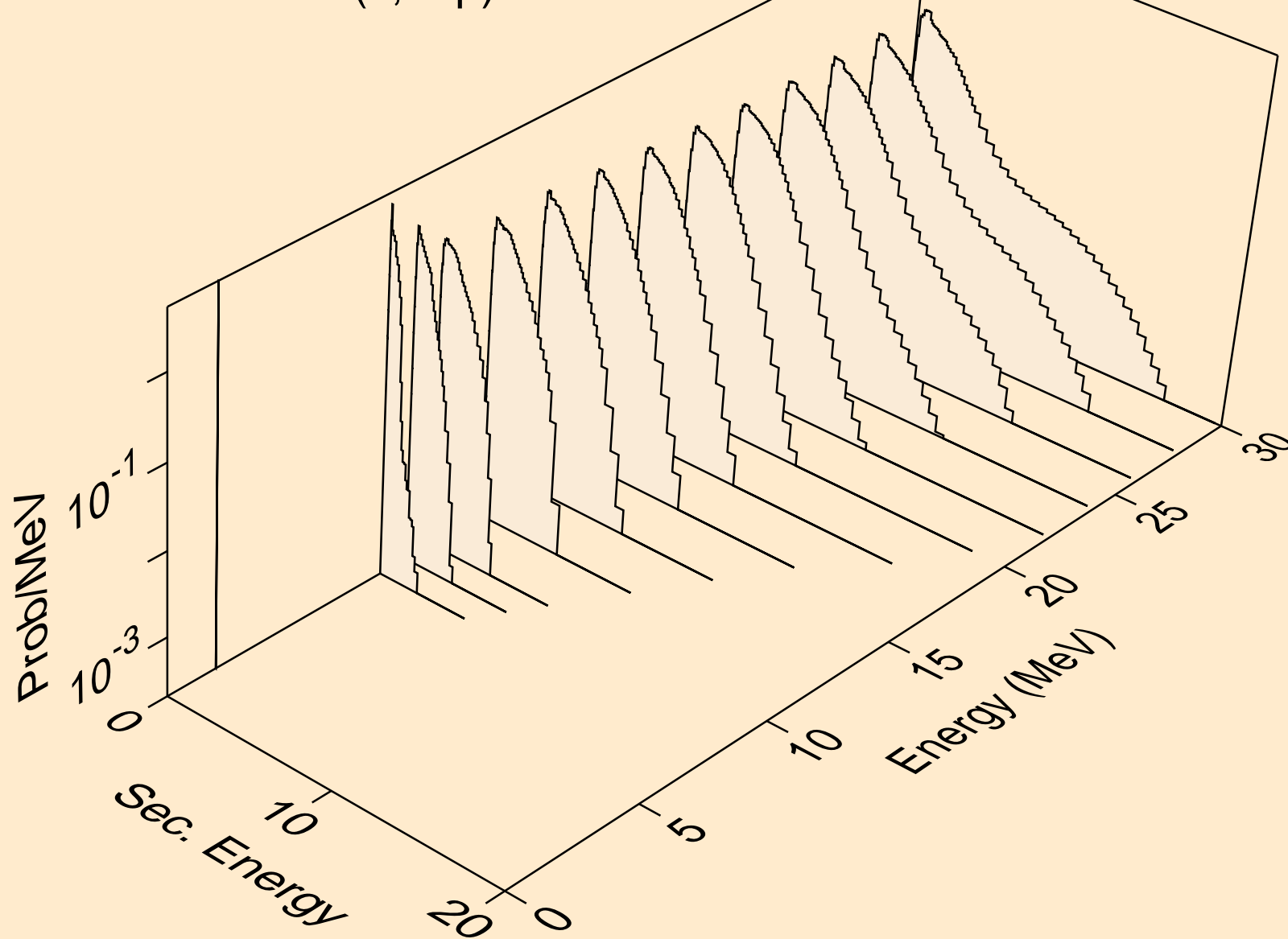

AU206 HELION ACER TENDL-2021 LIBRARY; T=0.K  
neutrons from (s,3np)

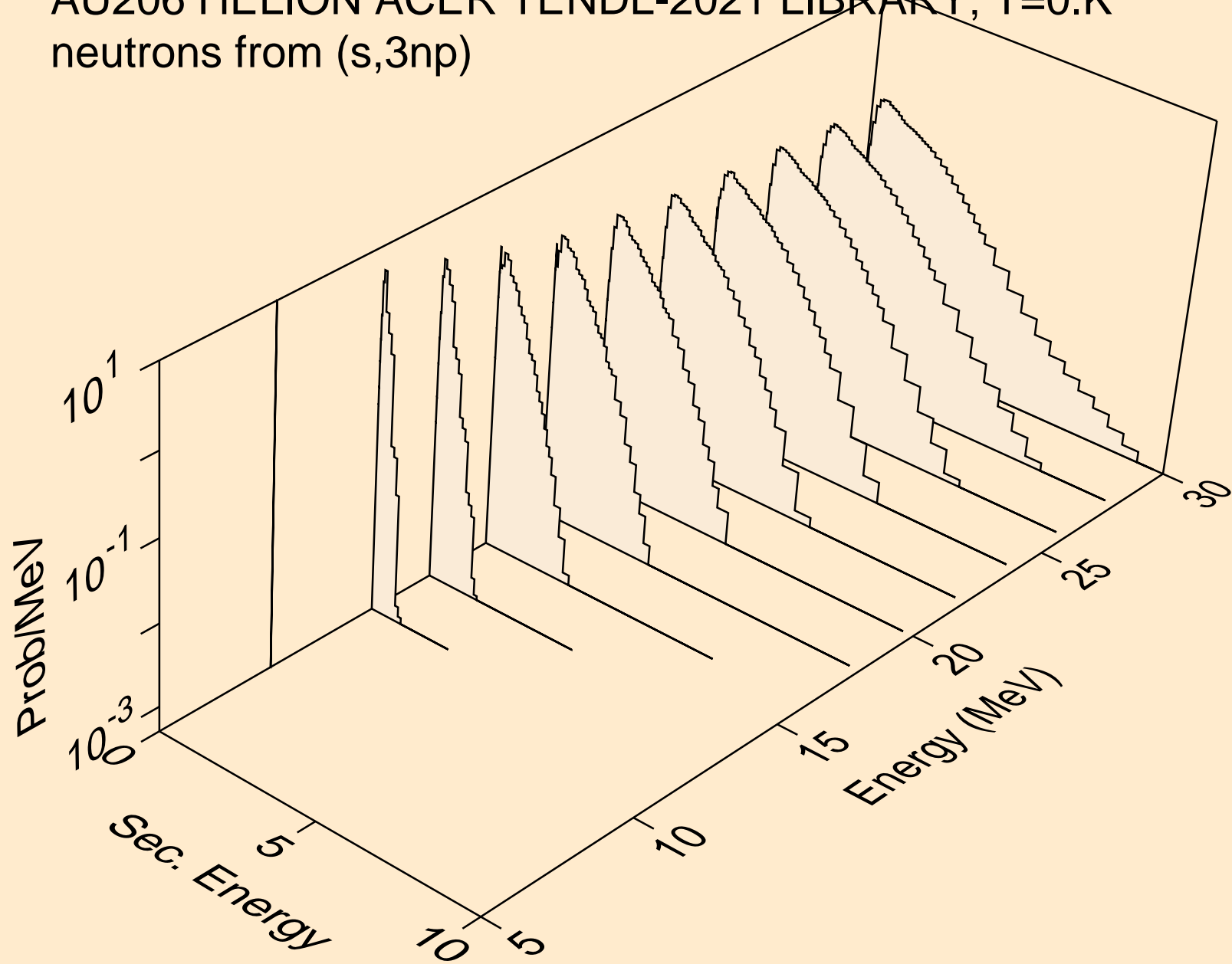

AU206 HELION ACER TENDL-2021 LIBRARY; T=0.K  
neutrons from (s,2np)

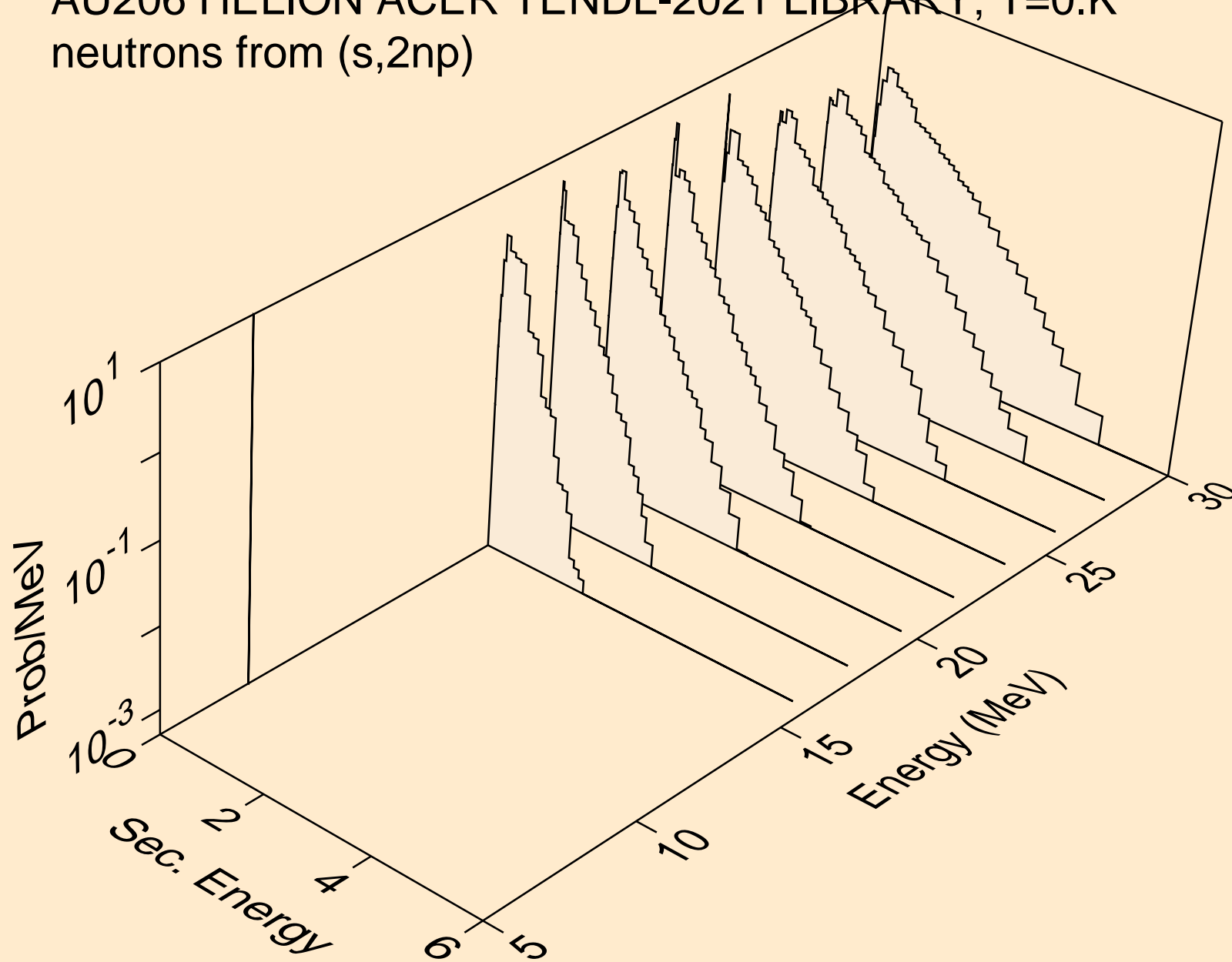

AU206 HELION ACER TENDL-2021 LIBRARY; T=0.K  
neutrons from (s,npa)

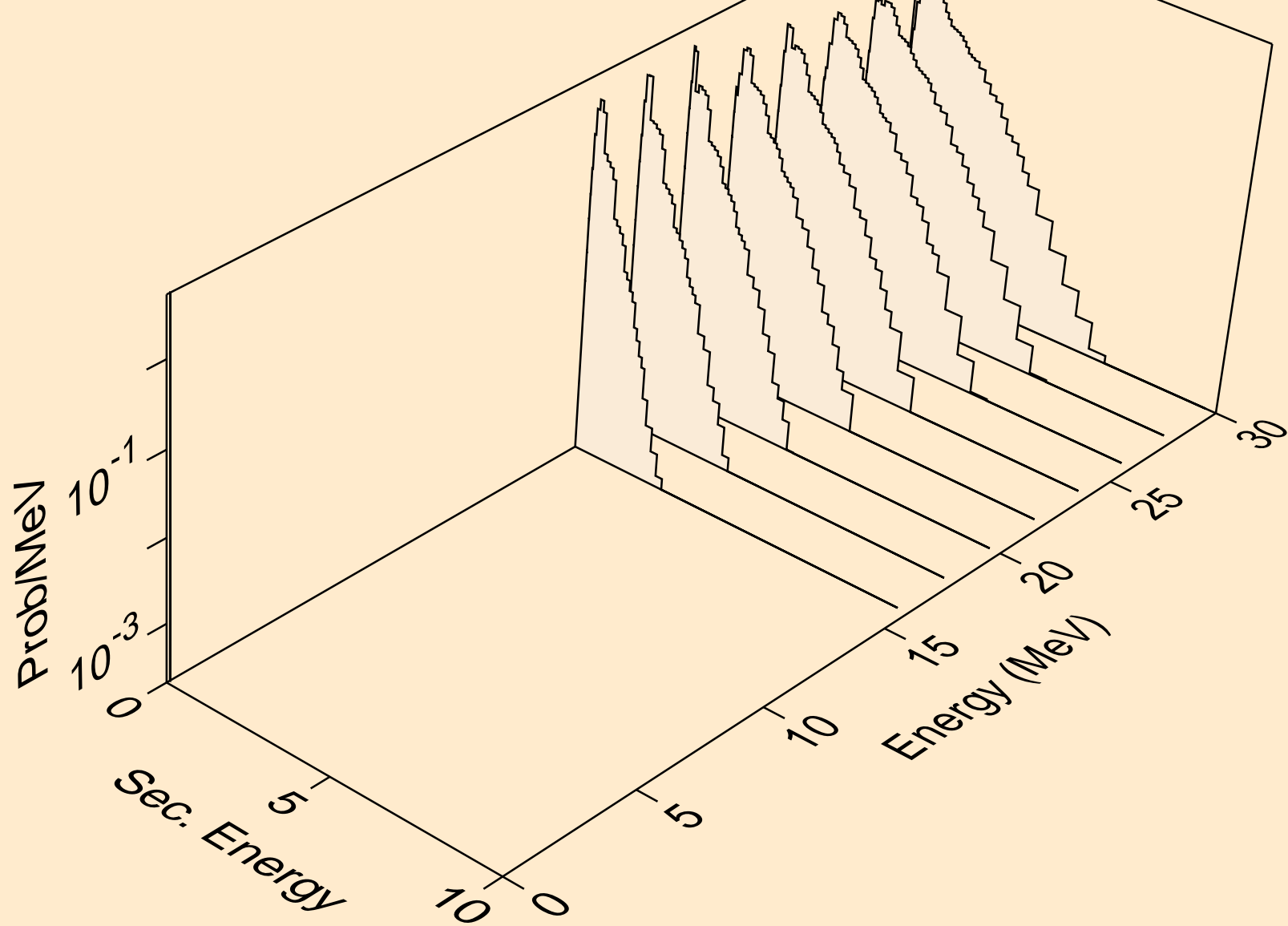

AU206 HELION ACER TENDL-2021 LIBRARY; T=0.K  
protons from (s,x)

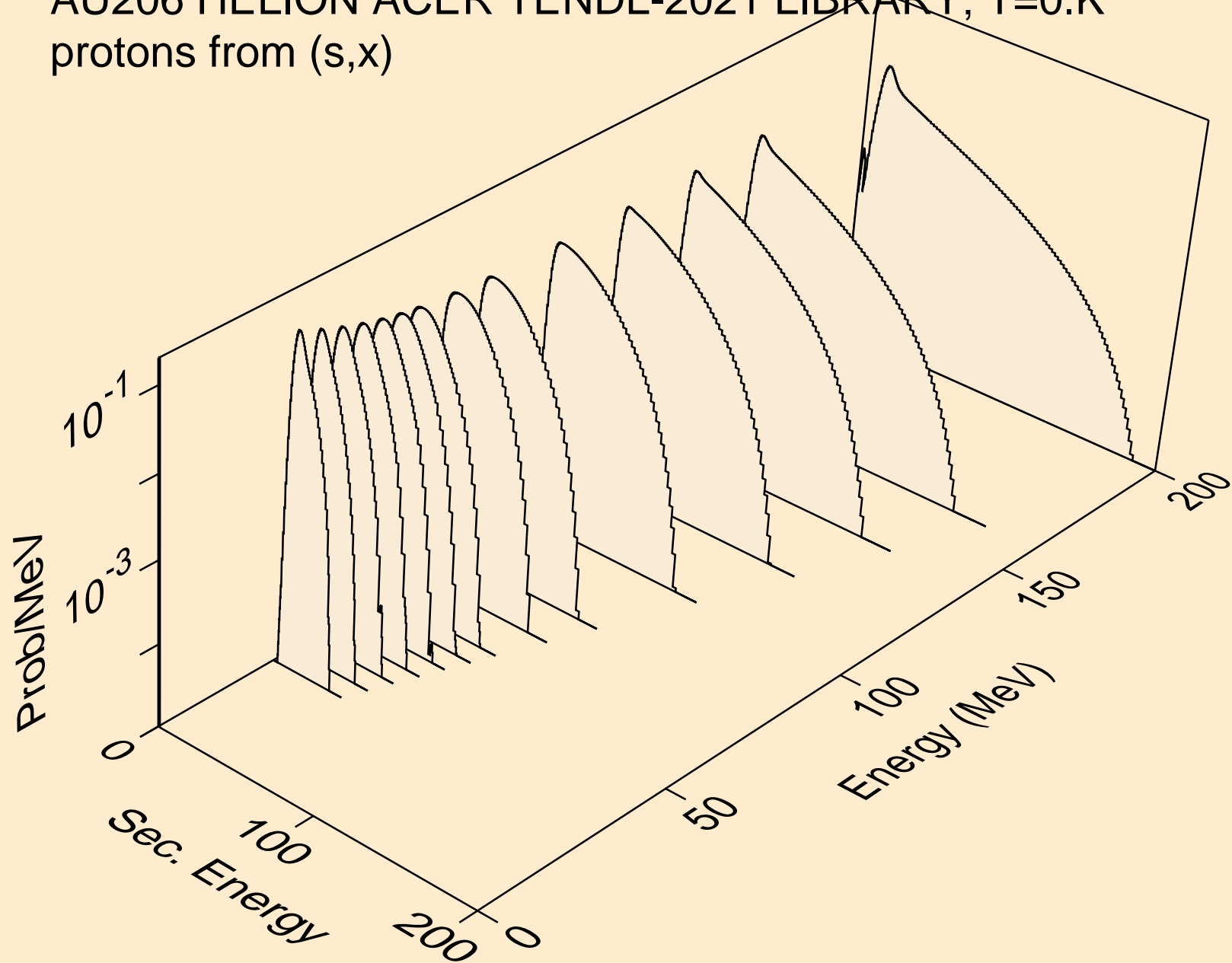

AU206 HELION ACER TENDL-2021 LIBRARY; T=0.K  
protons from (s,n\*)p

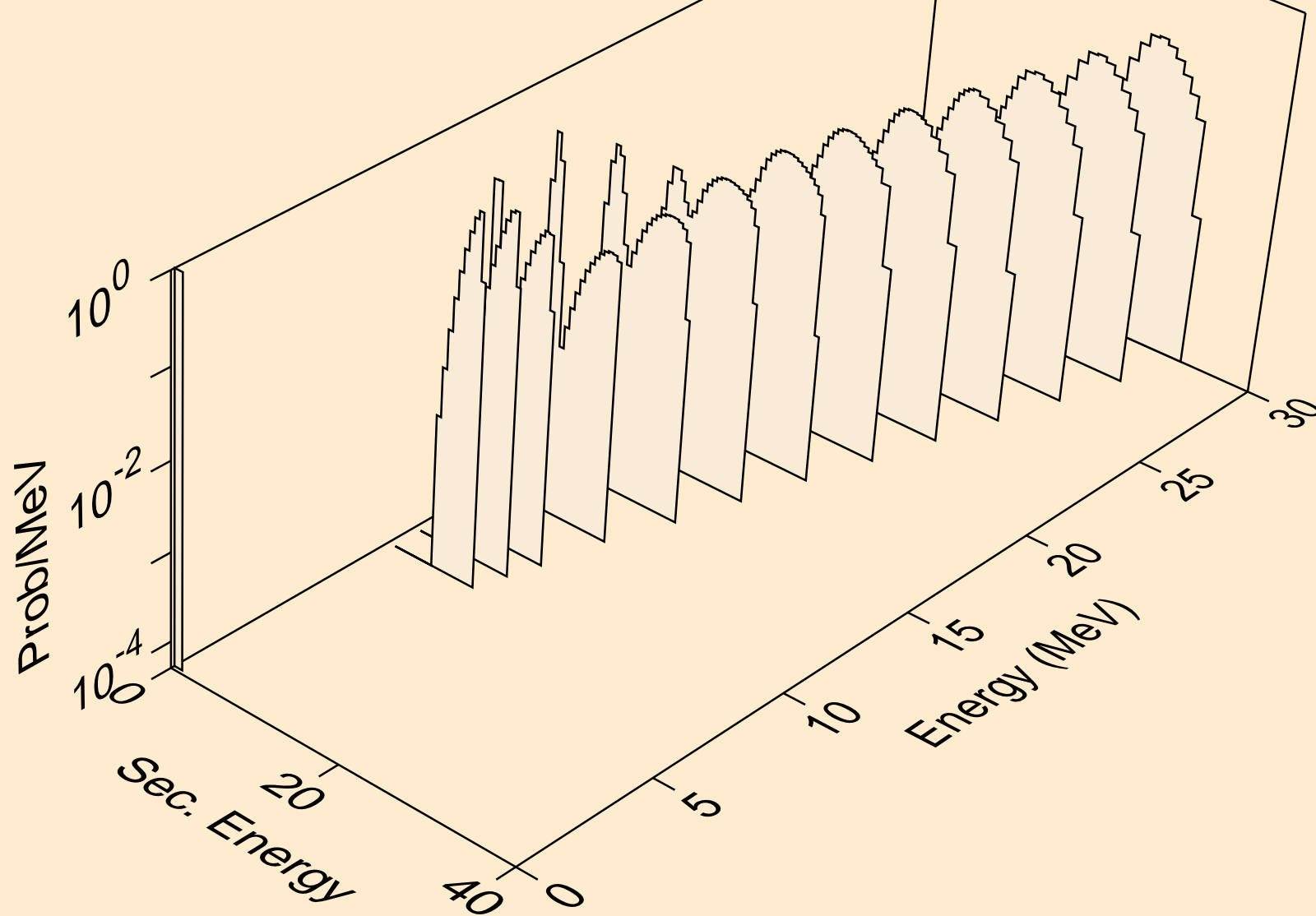



AU206 HELION ACER TENDL-2021 LIBRARY; T=0.K  
protons from (s,2np)

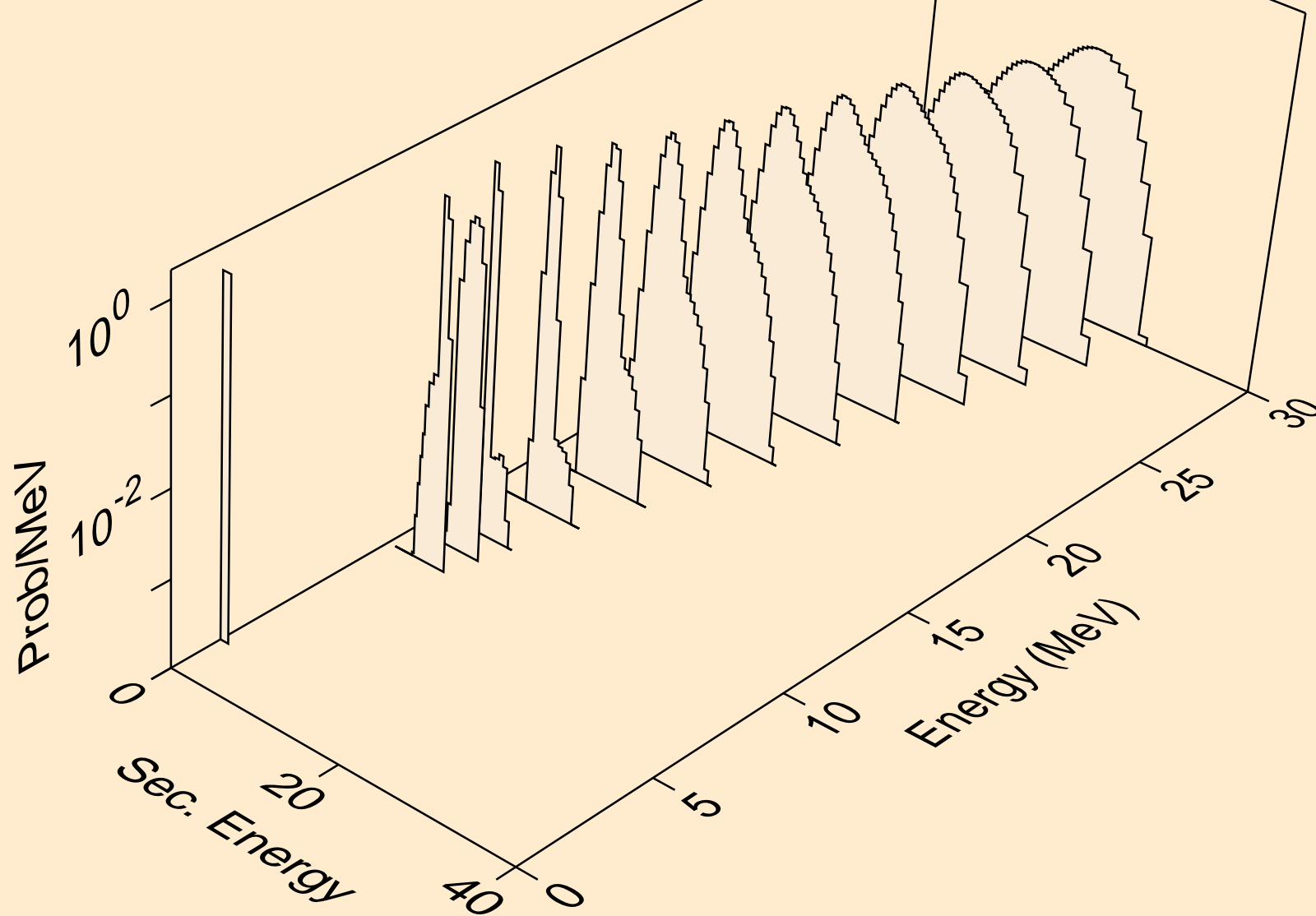

AU206 HELION ACER TENDL-2021 LIBRARY; T=0.K  
protons from (s,3np)

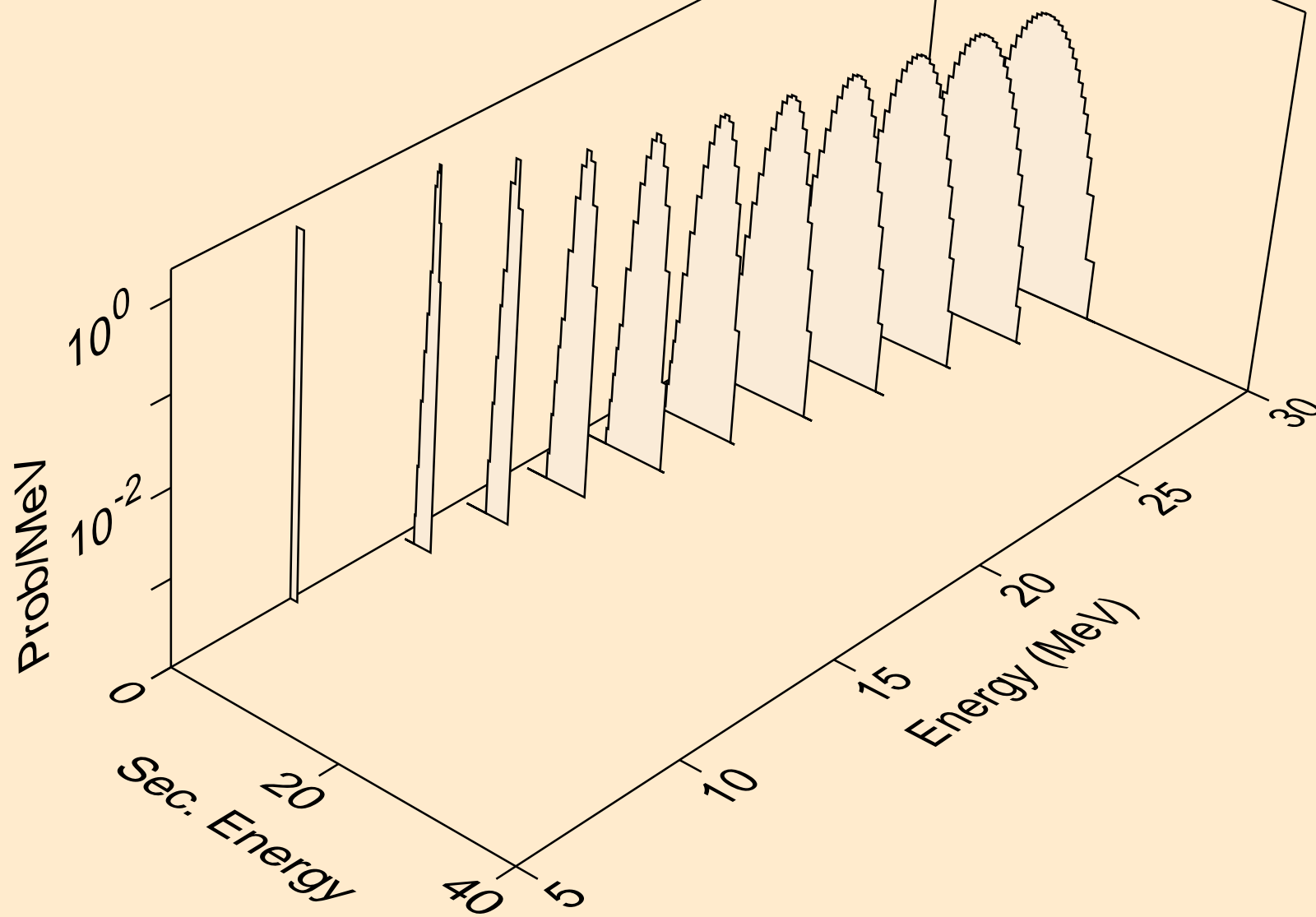

AU206 HELION ACER TENDL-2021 LIBRARY; T=0.K  
protons from (s,2np)

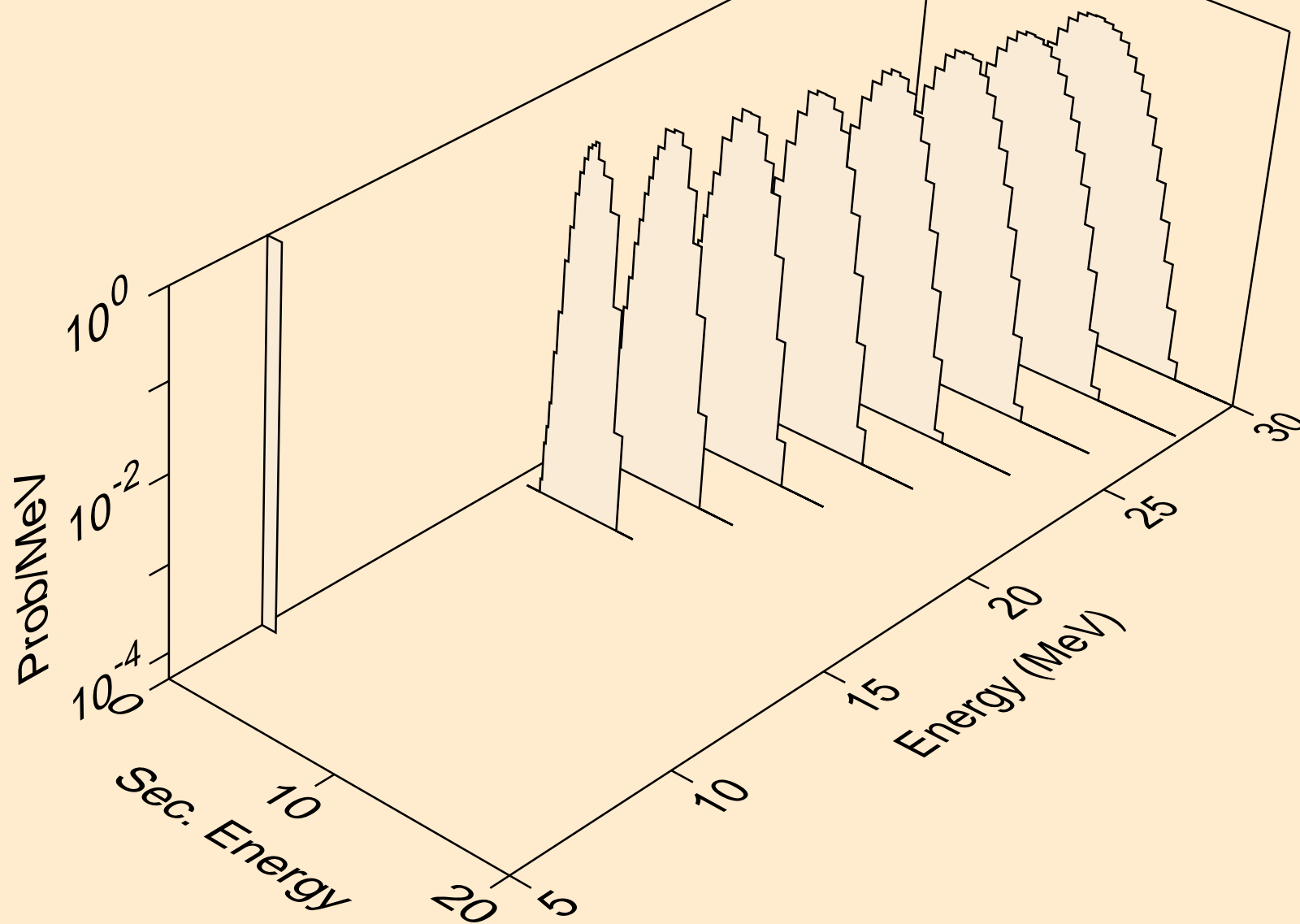

AU206 HELION ACER TENDL-2021 LIBRARY; T=0.K  
protons from (s,npa)

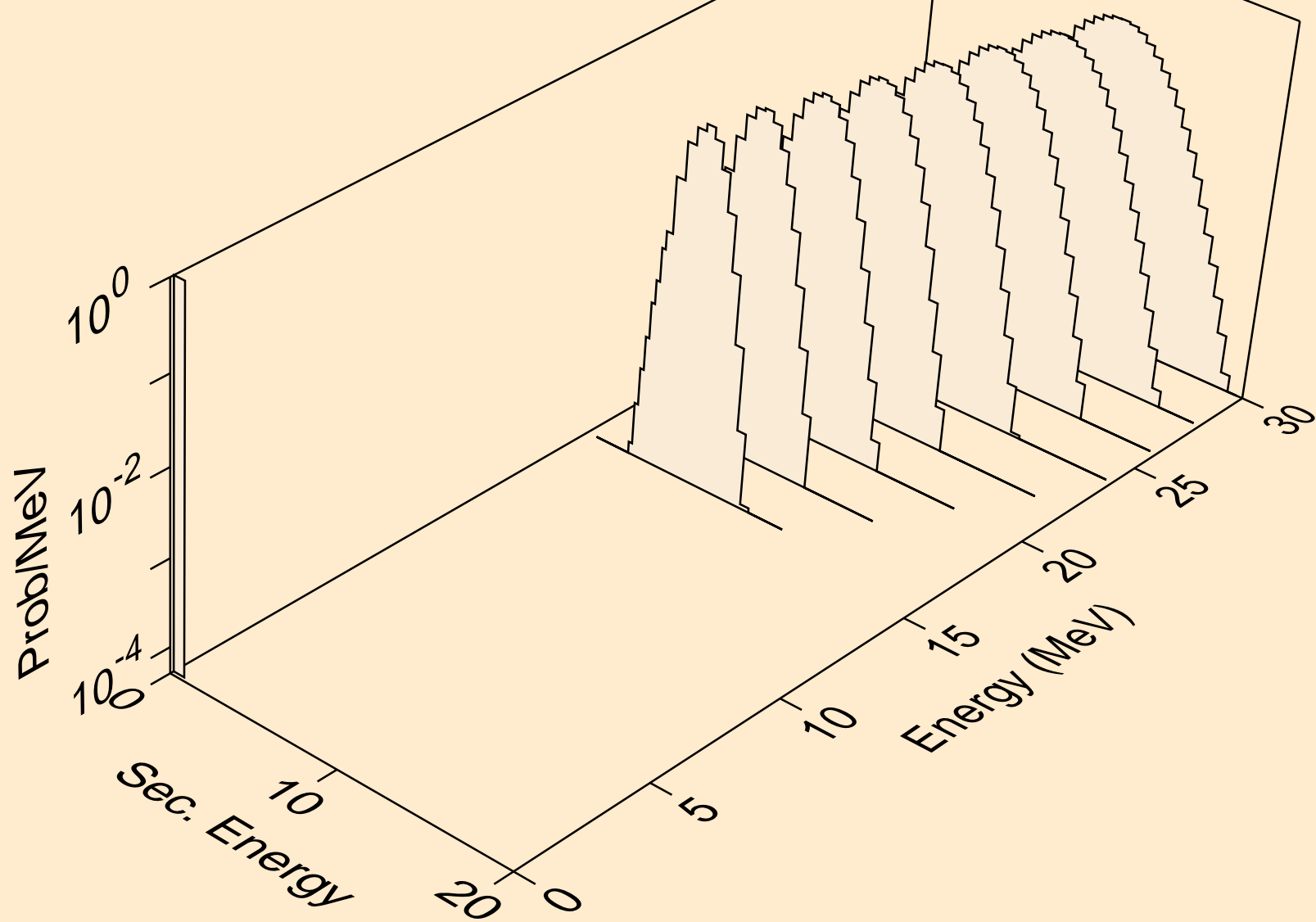

AU206 HELION ACER TENDL-2021 LIBRARY; T=0.K  
protons from (s,p)

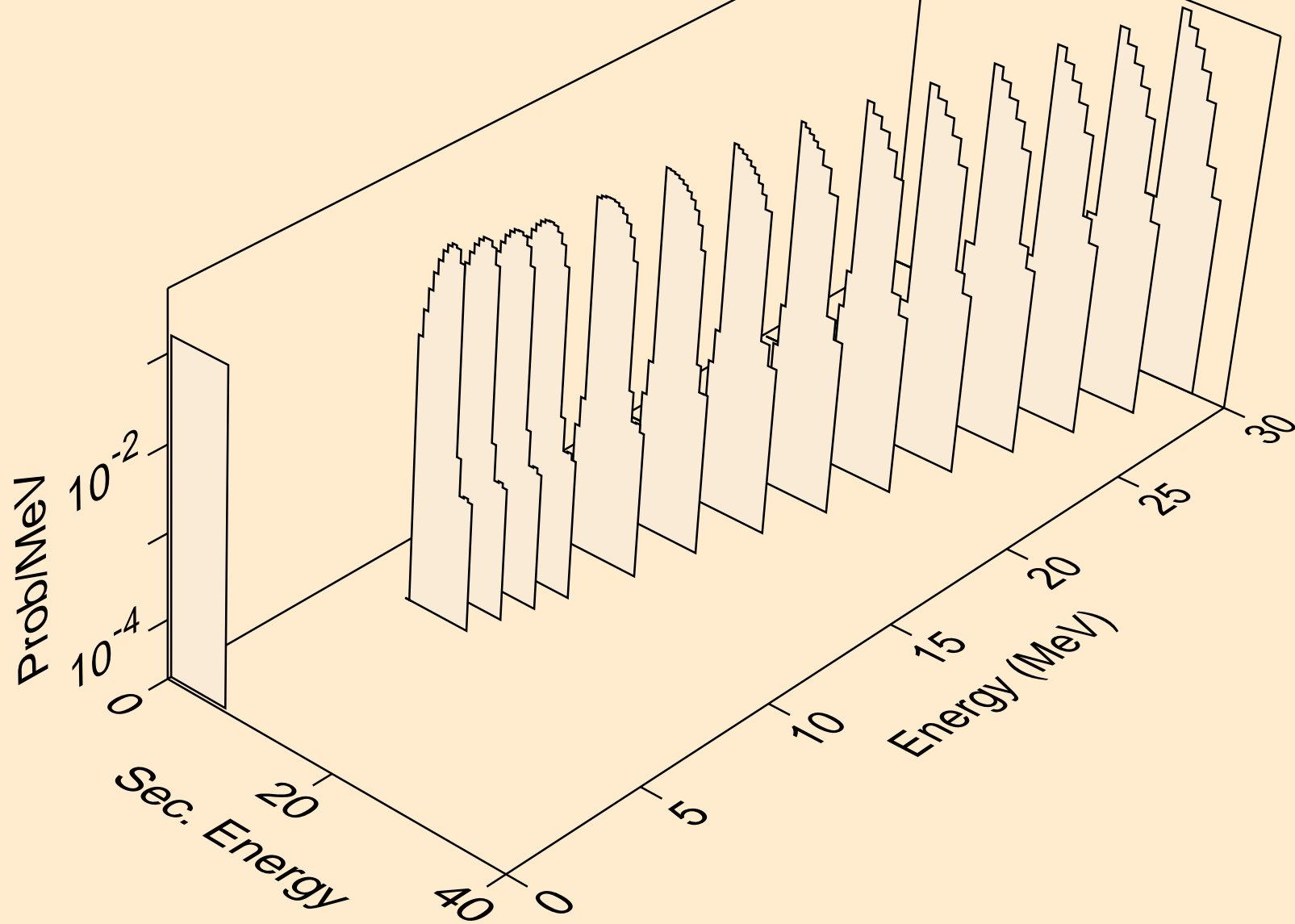

AU206 HELION ACER TENDL-2021 LIBRARY; T=0.K  
protons from (s,2p)

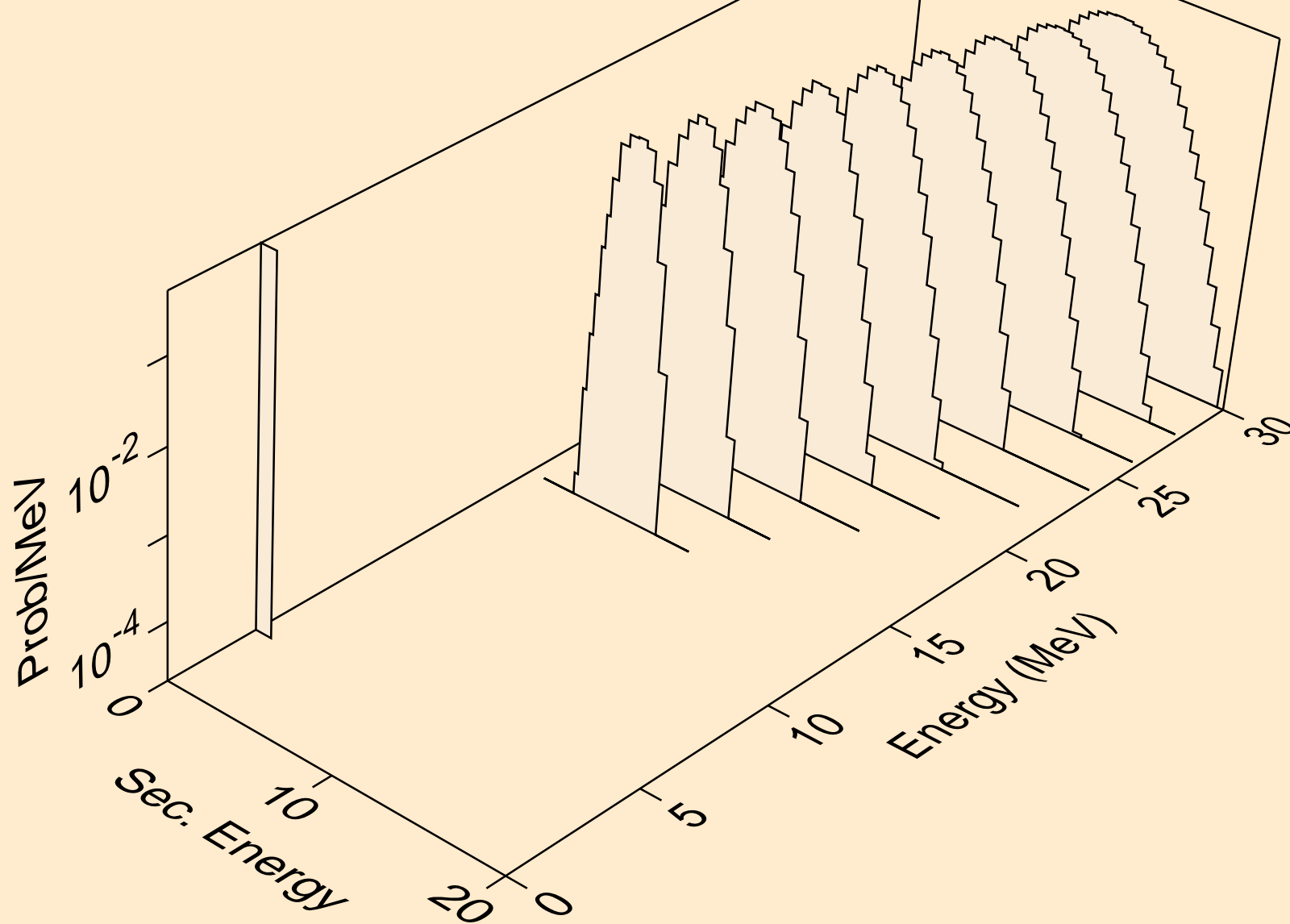

AU206 HELION ACER TENDL-2021 LIBRARY; T=0.K  
protons from (s,pa)

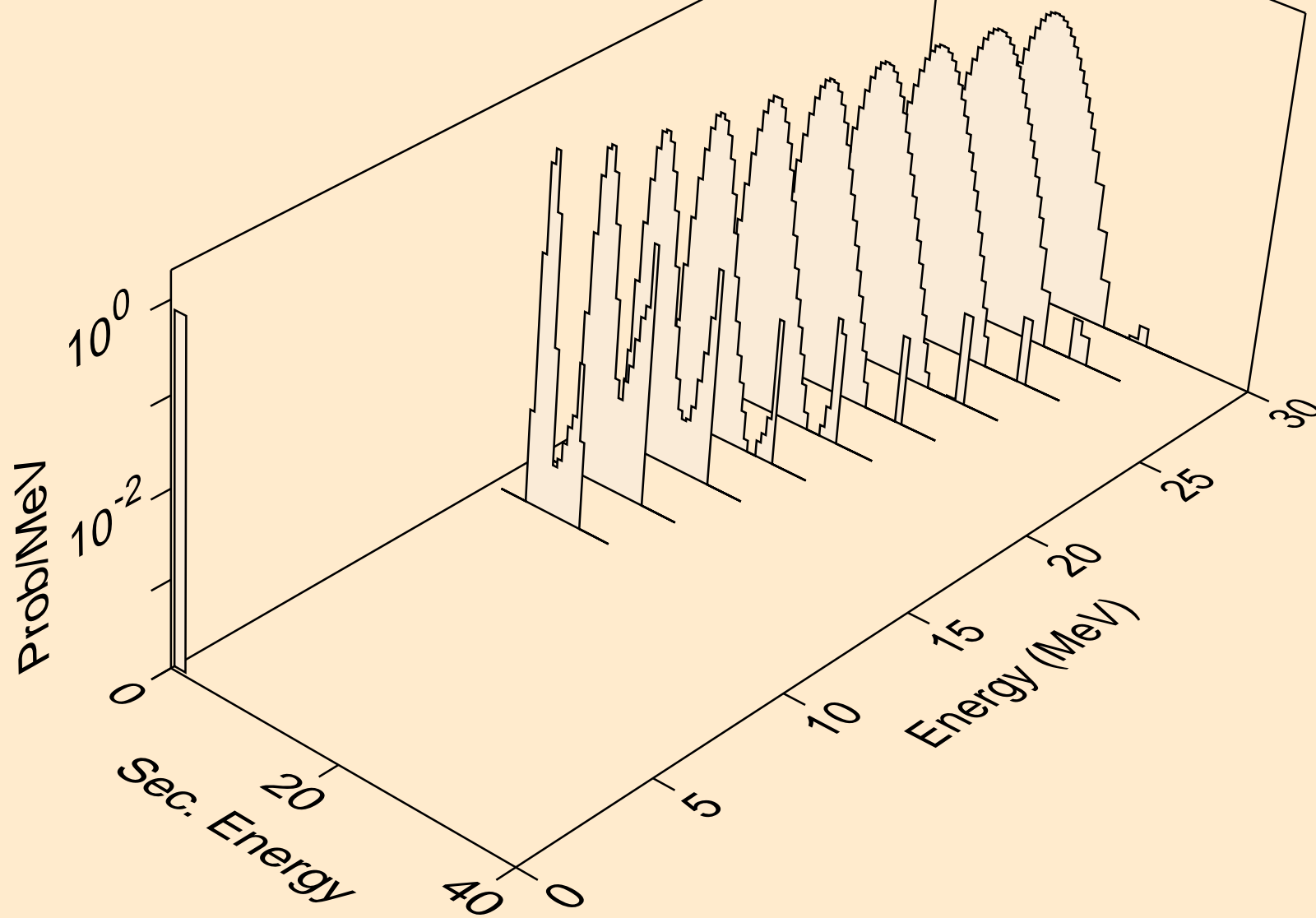

AU206 HELION ACER TENDL-2021 LIBRARY; T=0.K  
protons from (s,pd)

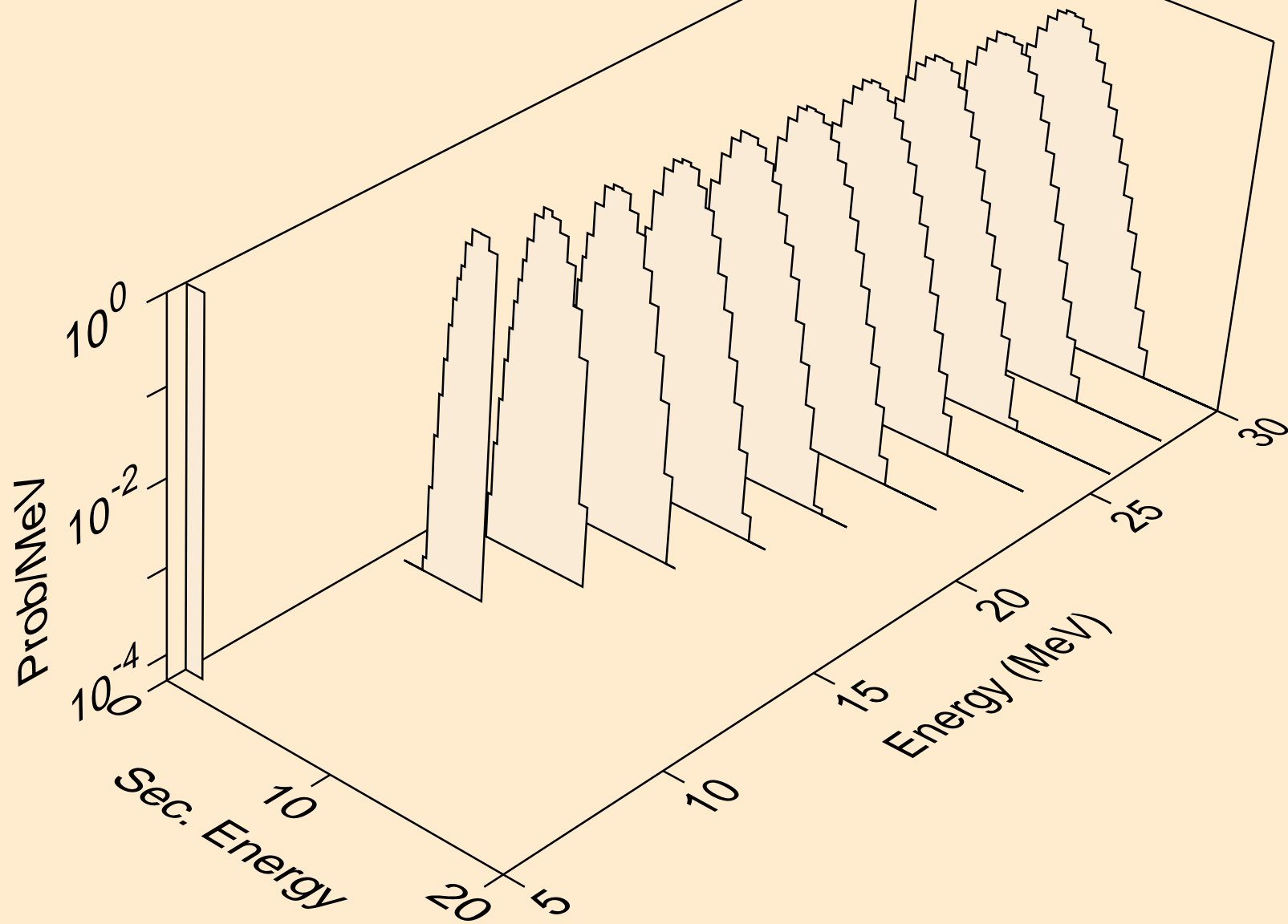



AU206 HELION ACER TENDL-2021 LIBRARY; T=0.K  
protons from (s,pt)

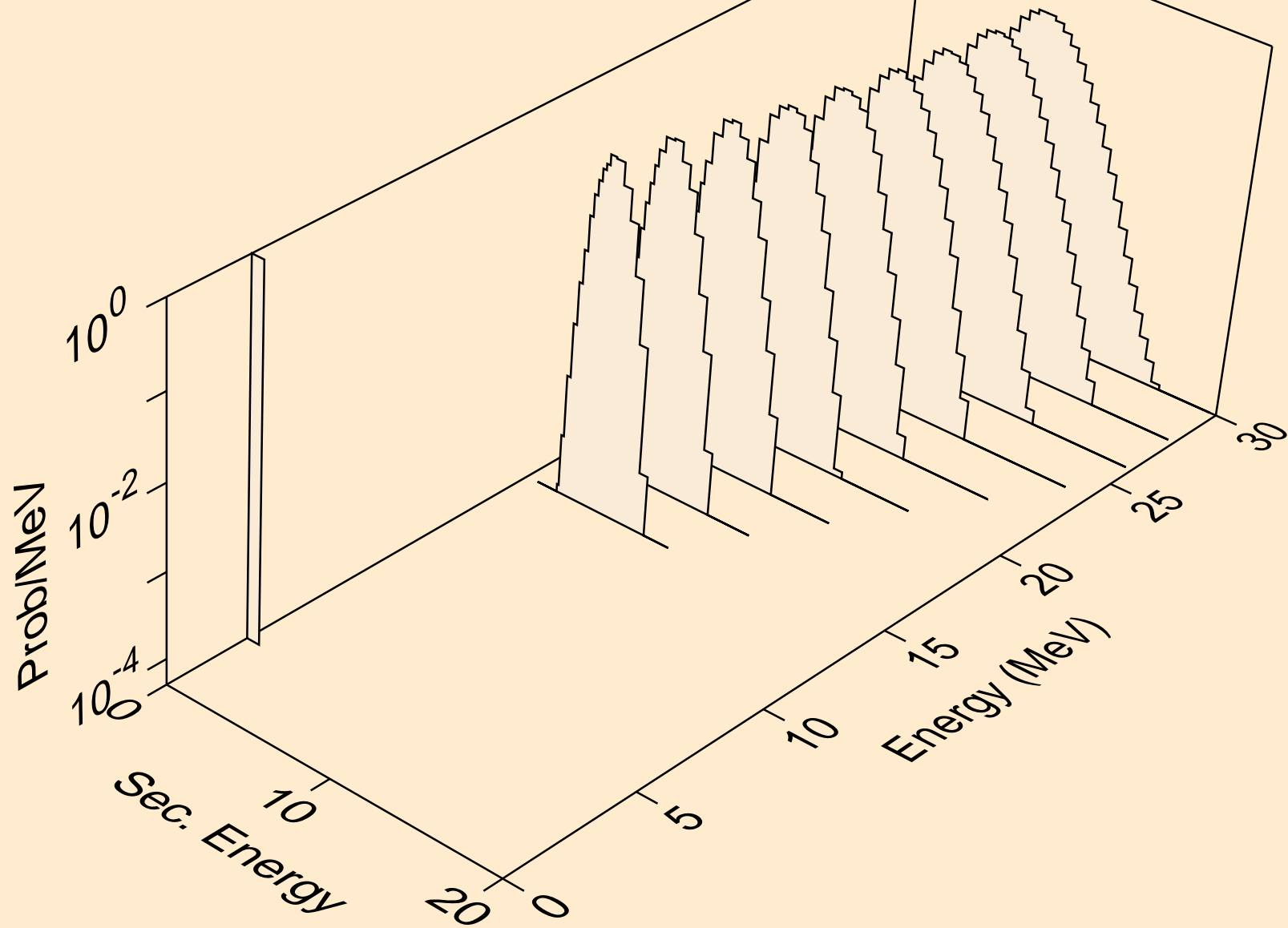

AU206 HELION ACER TENDL-2021 LIBRARY; T=0.K  
deuterons from (s,x)

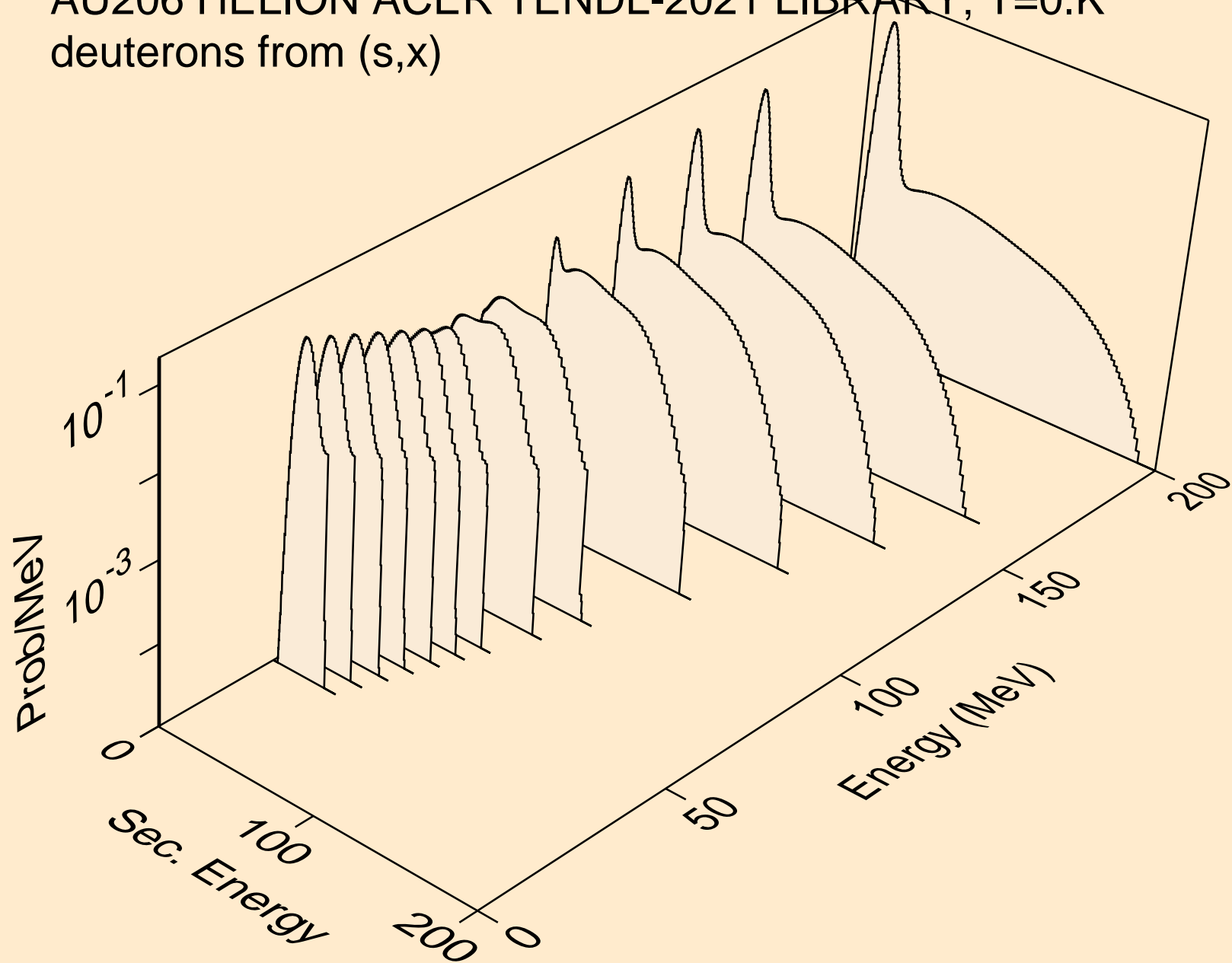

AU206 HELION ACER TENDL-2021 LIBRARY; T=0.K  
deuterons from (s,2nd)

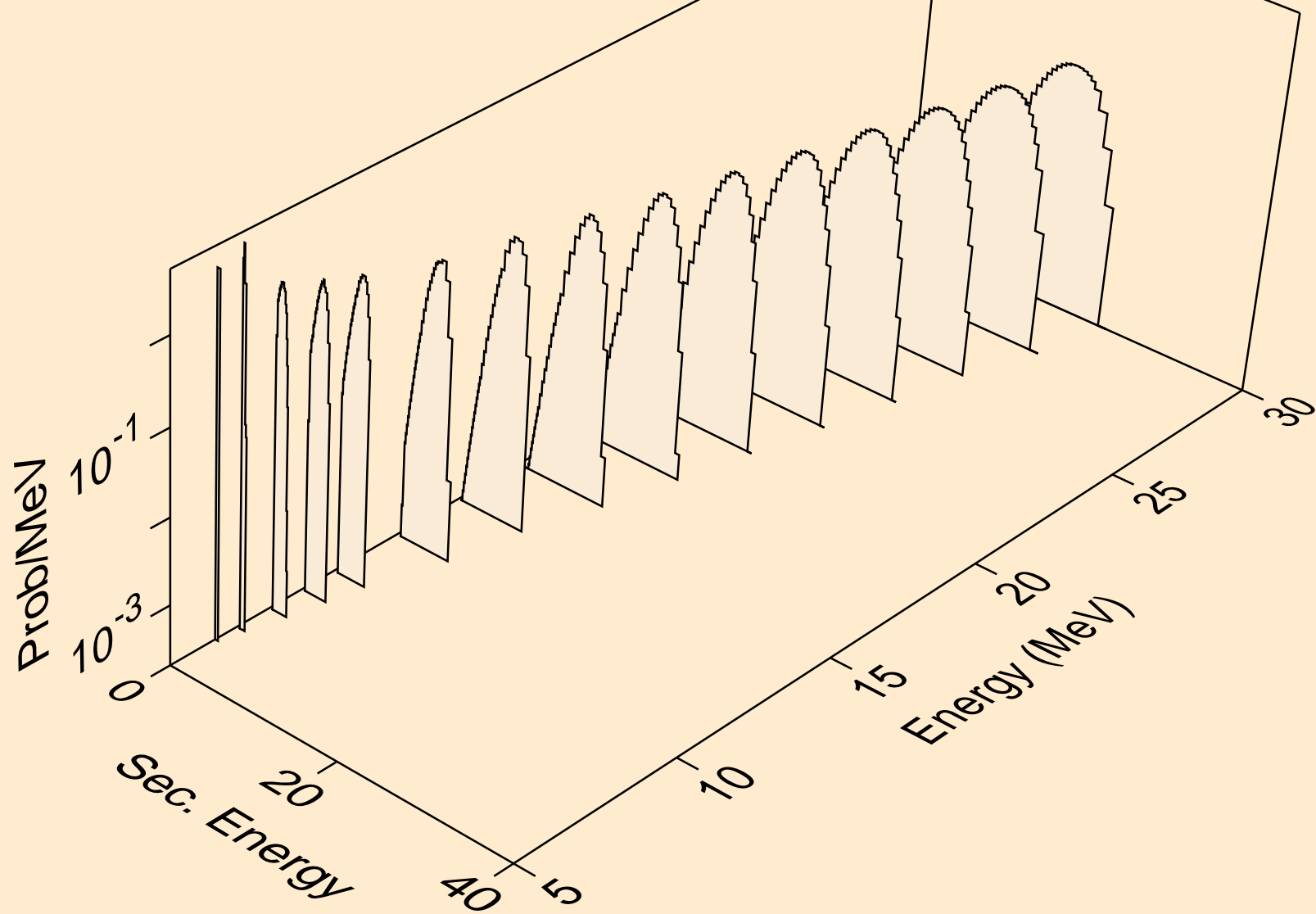

AU206 HELION ACER TENDL-2021 LIBRARY; T=0.K  
deuterons from (s,n\*)d

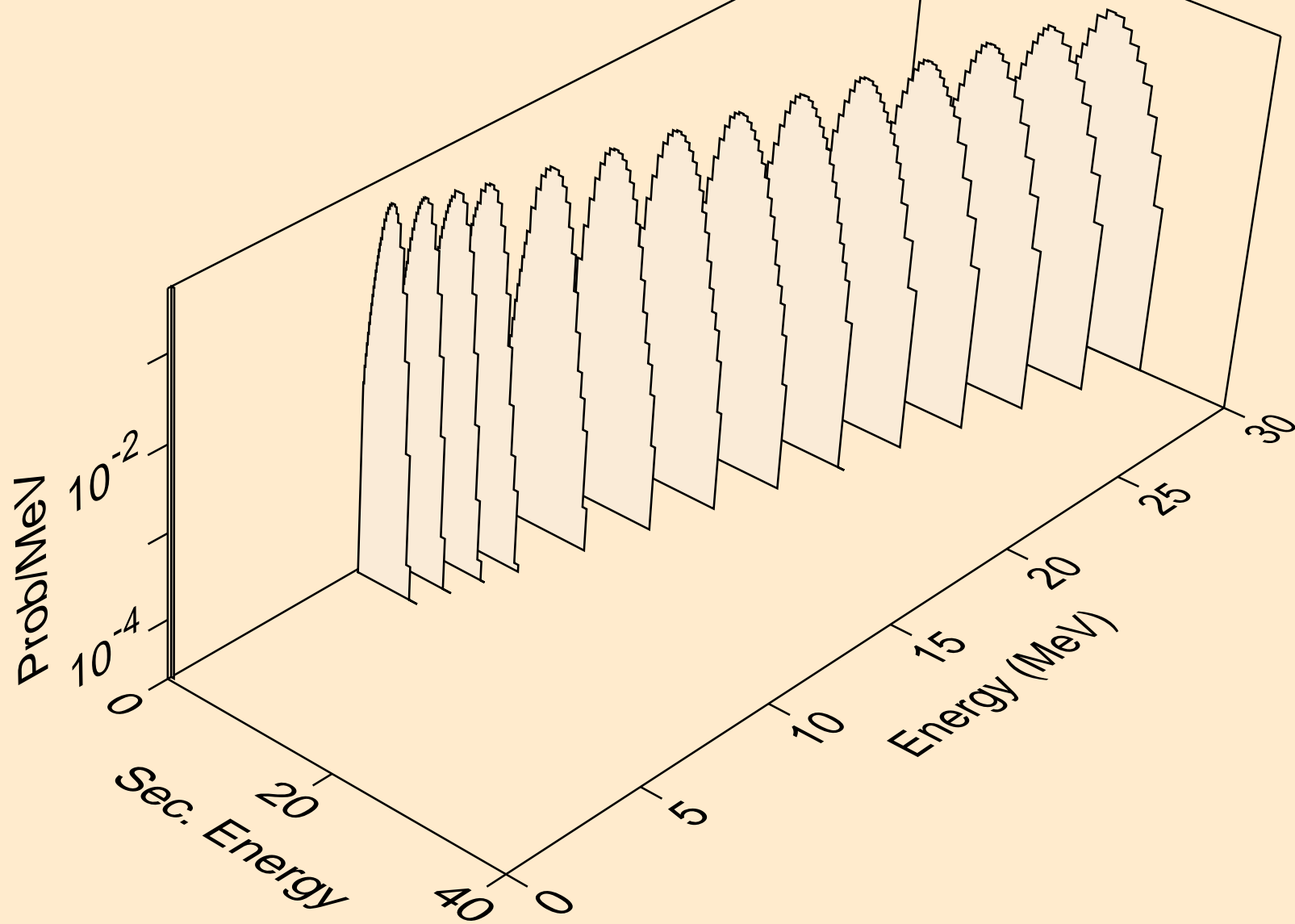

AU206 HELION ACER TENDL-2021 LIBRARY; T=0.K  
deuterons from (s,d)

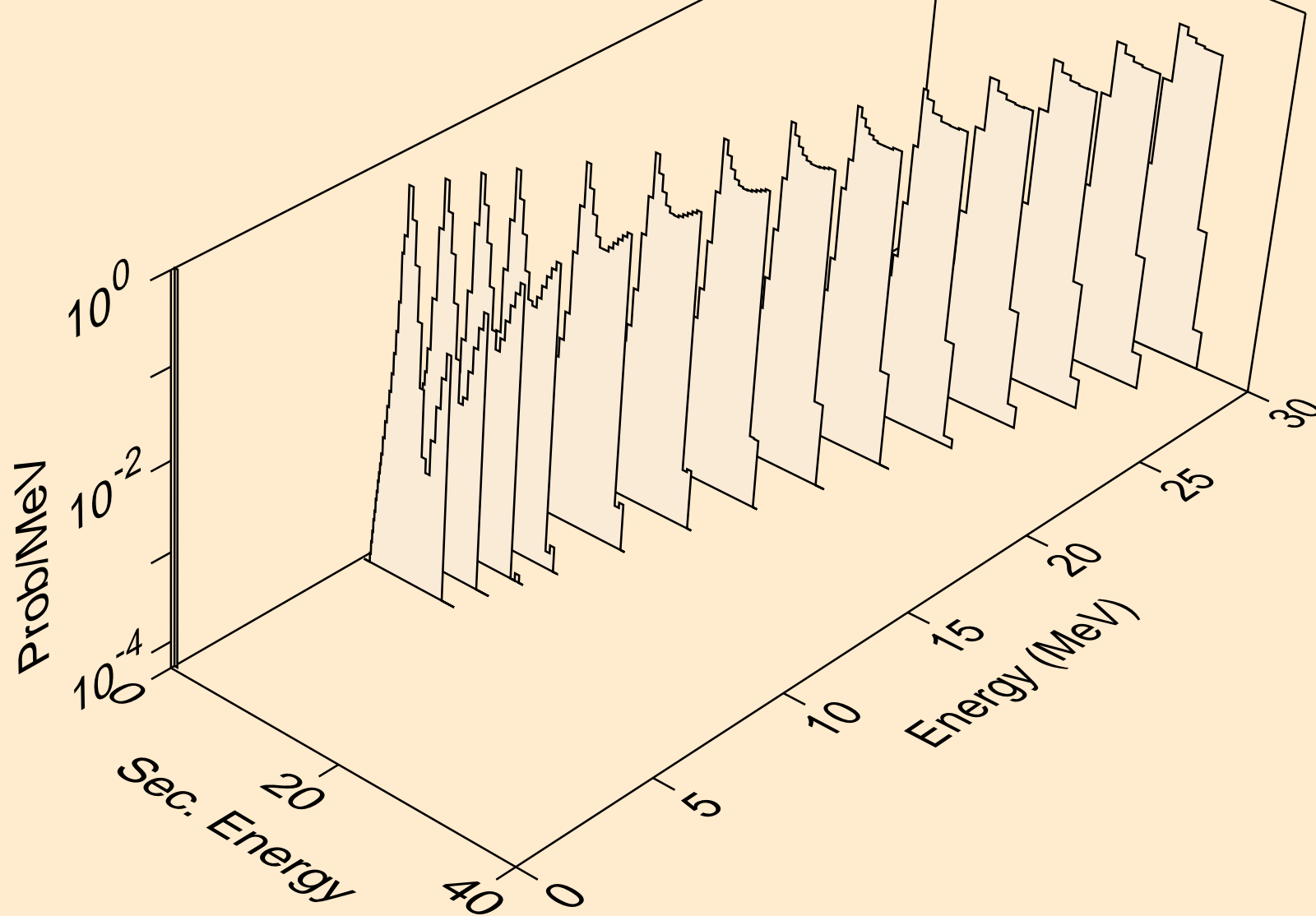

AU206 HELION ACER TENDL-2021 LIBRARY; T=0.K  
deuterons from (s,pd)

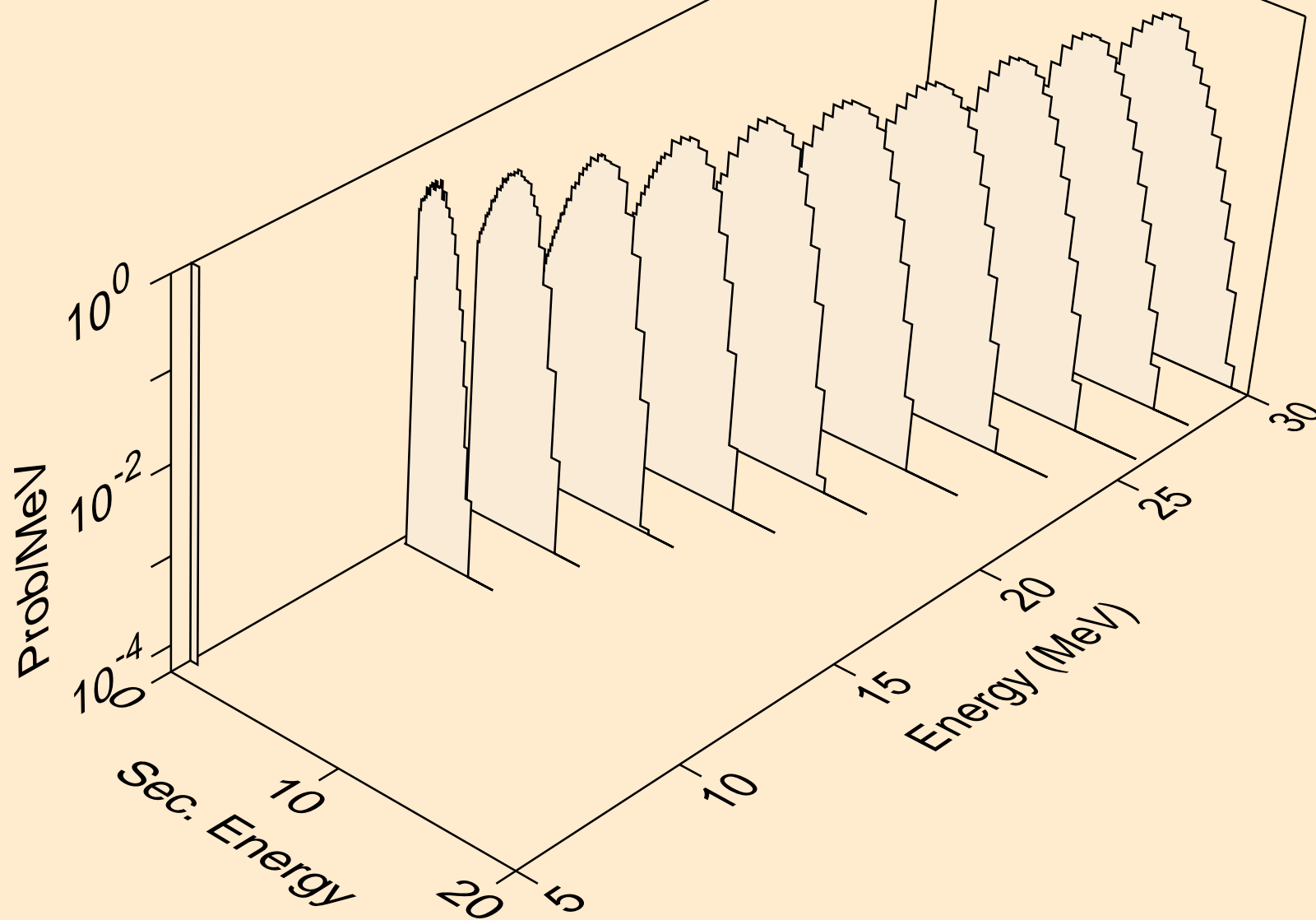

AU206 HELION ACER TENDL-2021 LIBRARY; T=0.K  
tritons from (s,x)

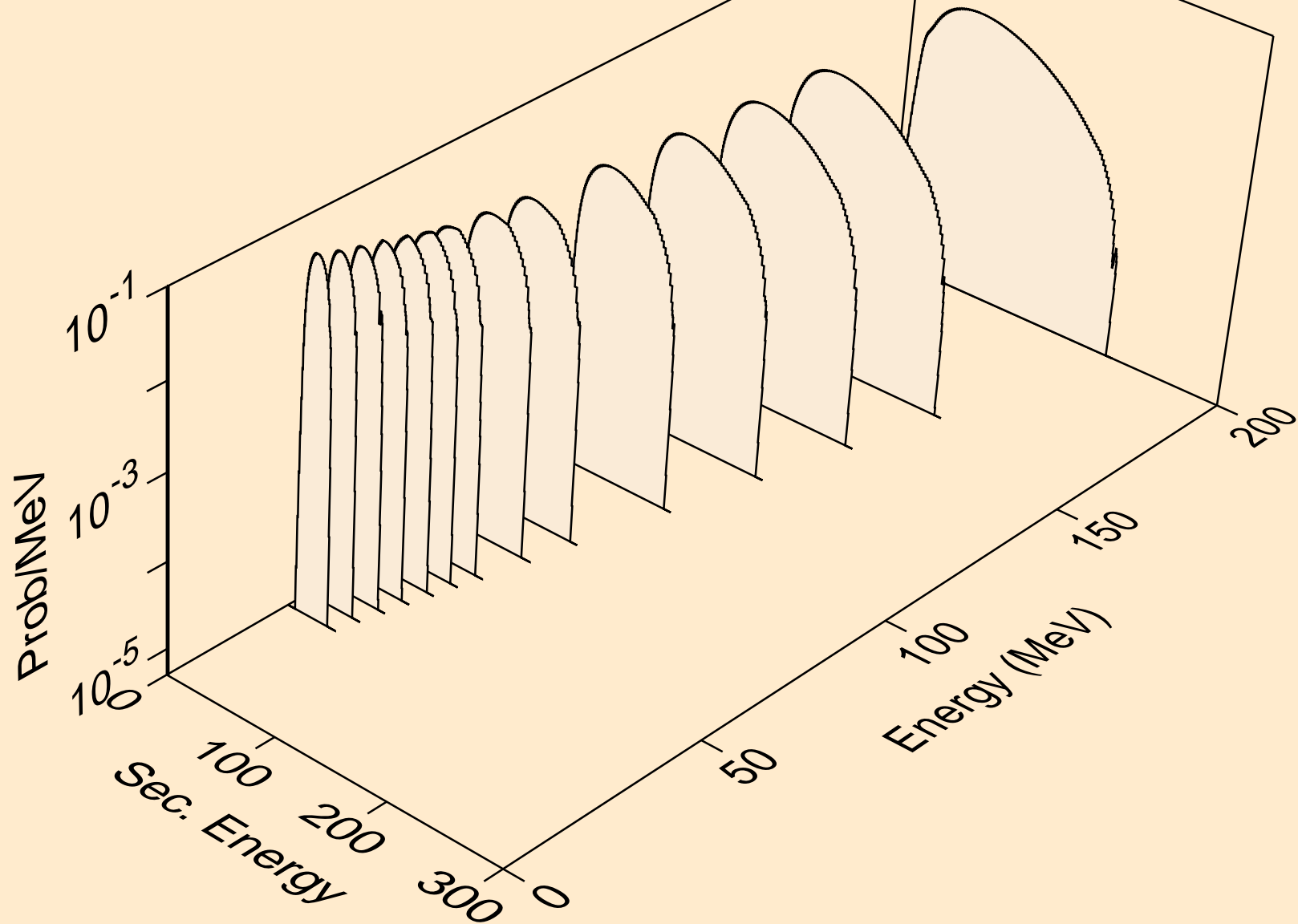

AU206 HELION ACER TENDL-2021 LIBRARY; T=0.K  
tritons from (s,n\*)t

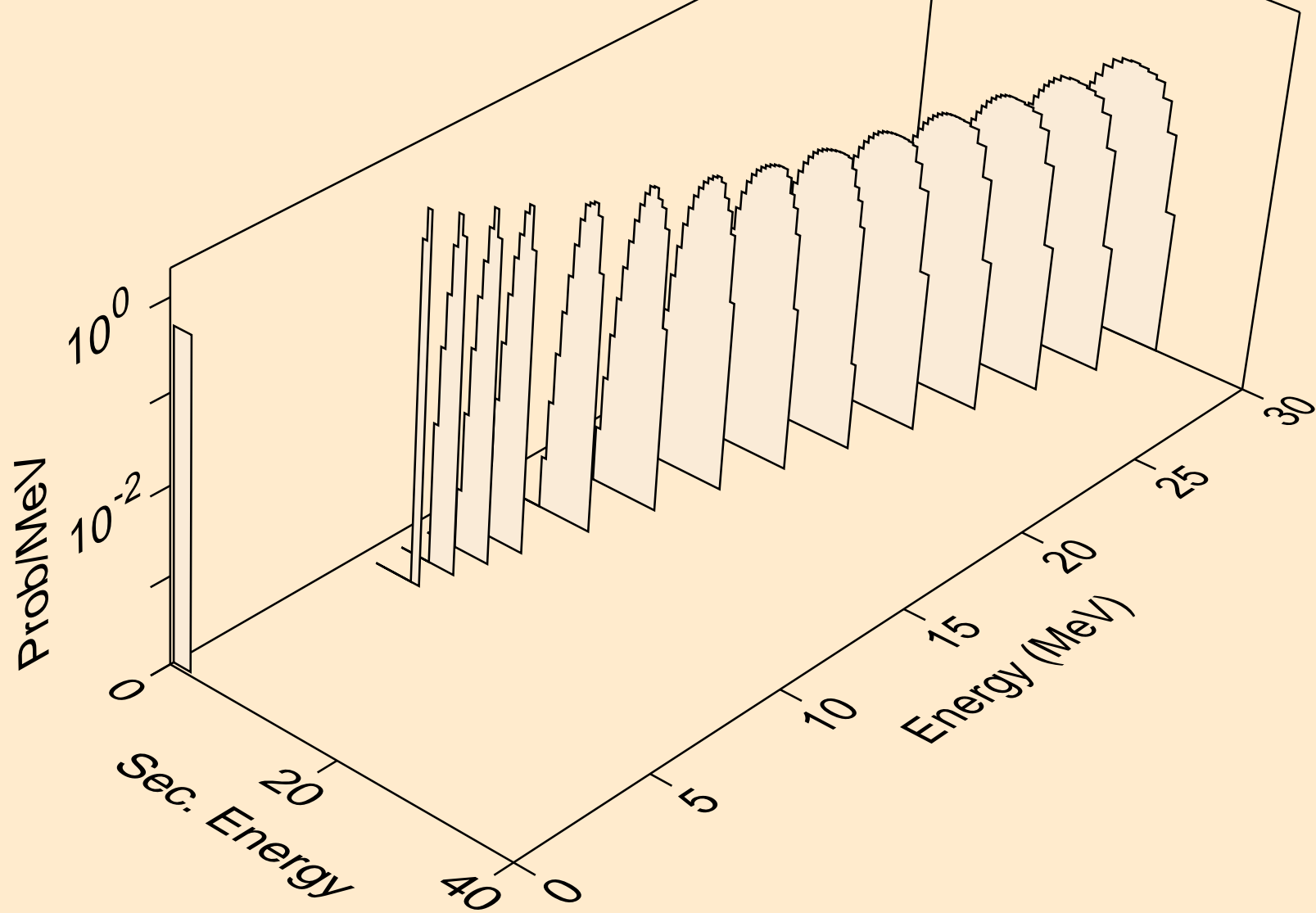



AU206 HELION ACER TENDL-2021 LIBRARY; T=0.K  
tritons from (s,t)

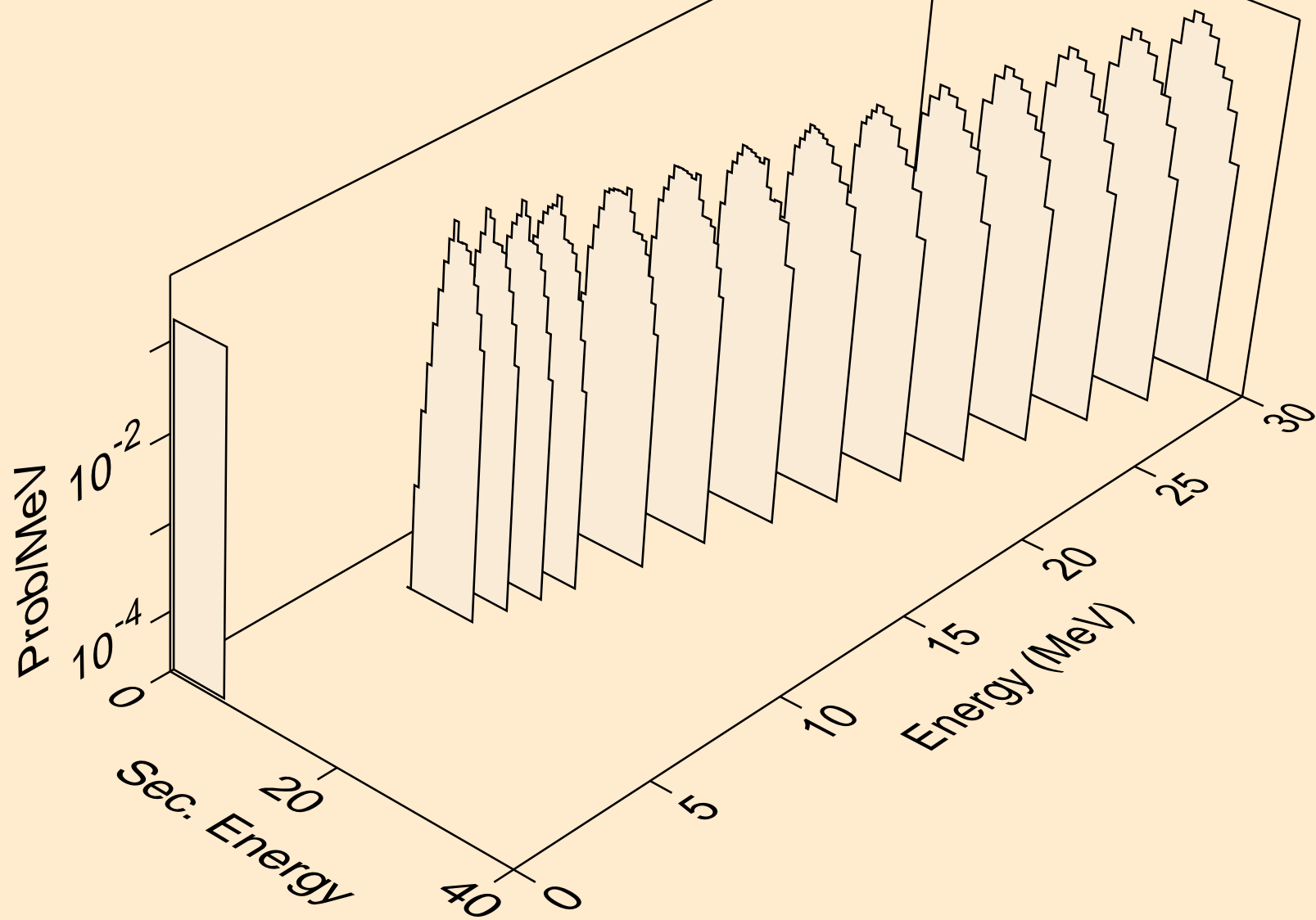

AU206 HELION ACER TENDL-2021 LIBRARY; T=0.K  
tritons from (s,pt)

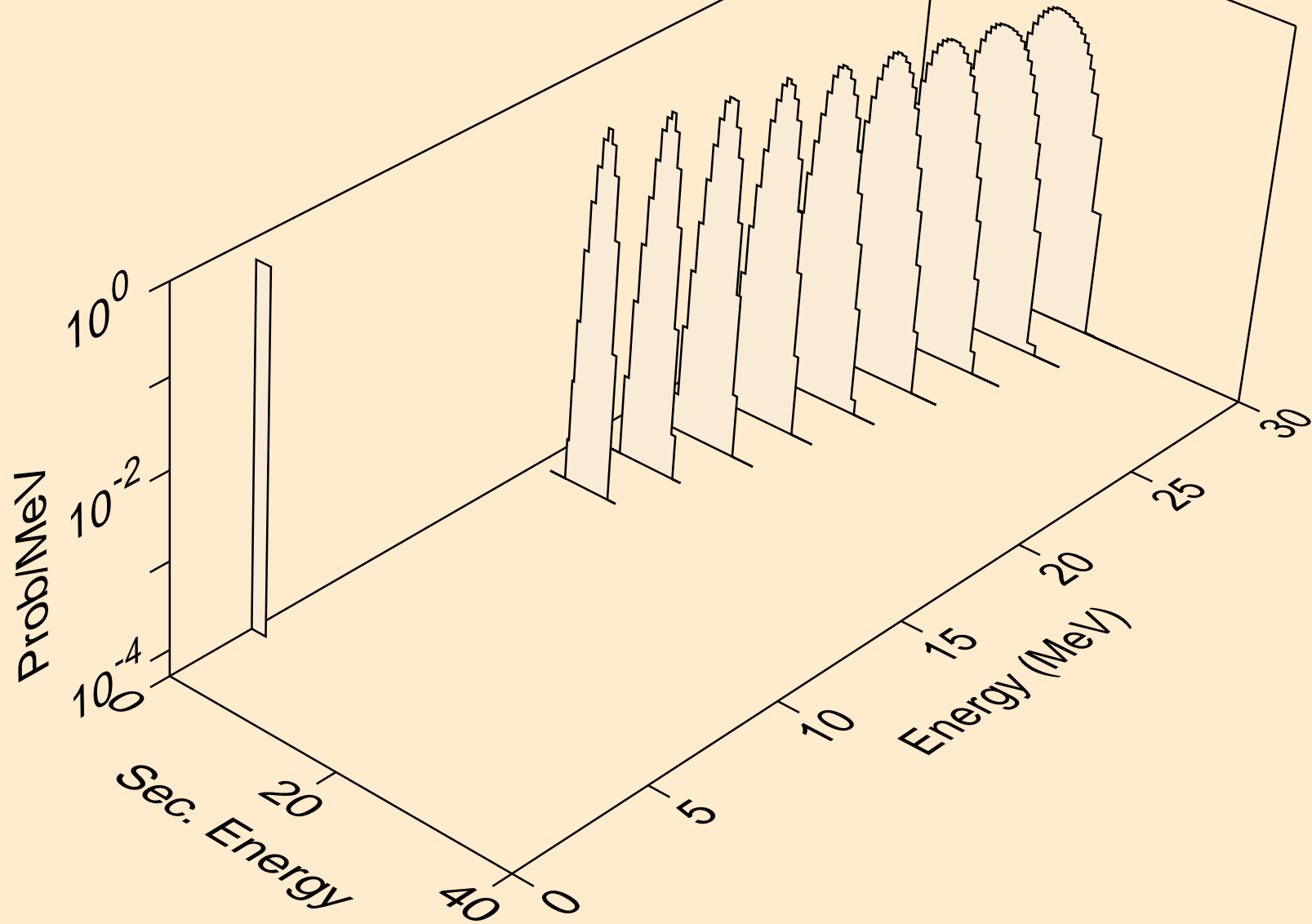

AU206 HELION ACER TENDL-2021 LIBRARY; T=0.K  
alphas from (s,x)

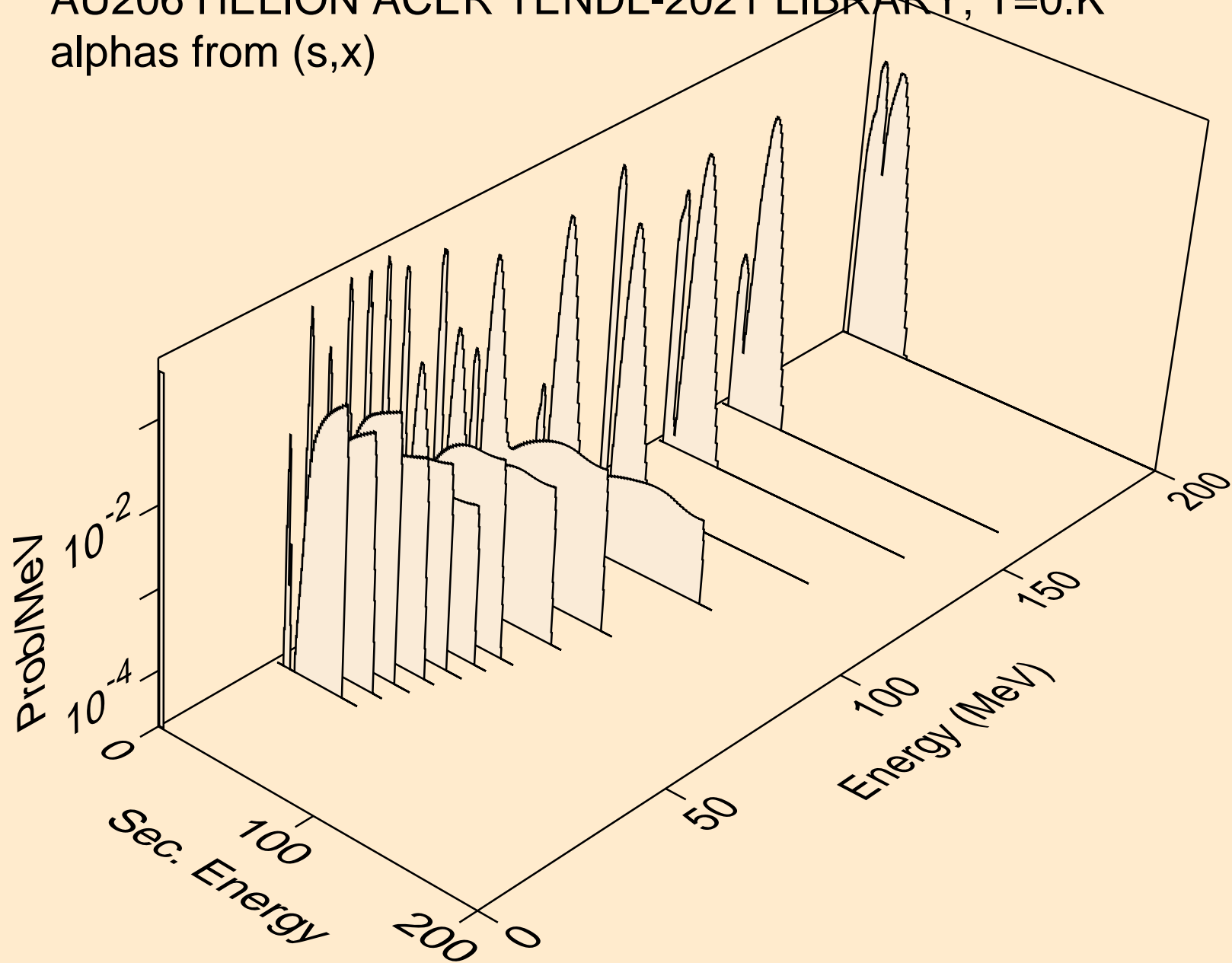

AU206 HELION ACER TENDL-2021 LIBRARY; T=0.K  
alphas from (s,n\*)a

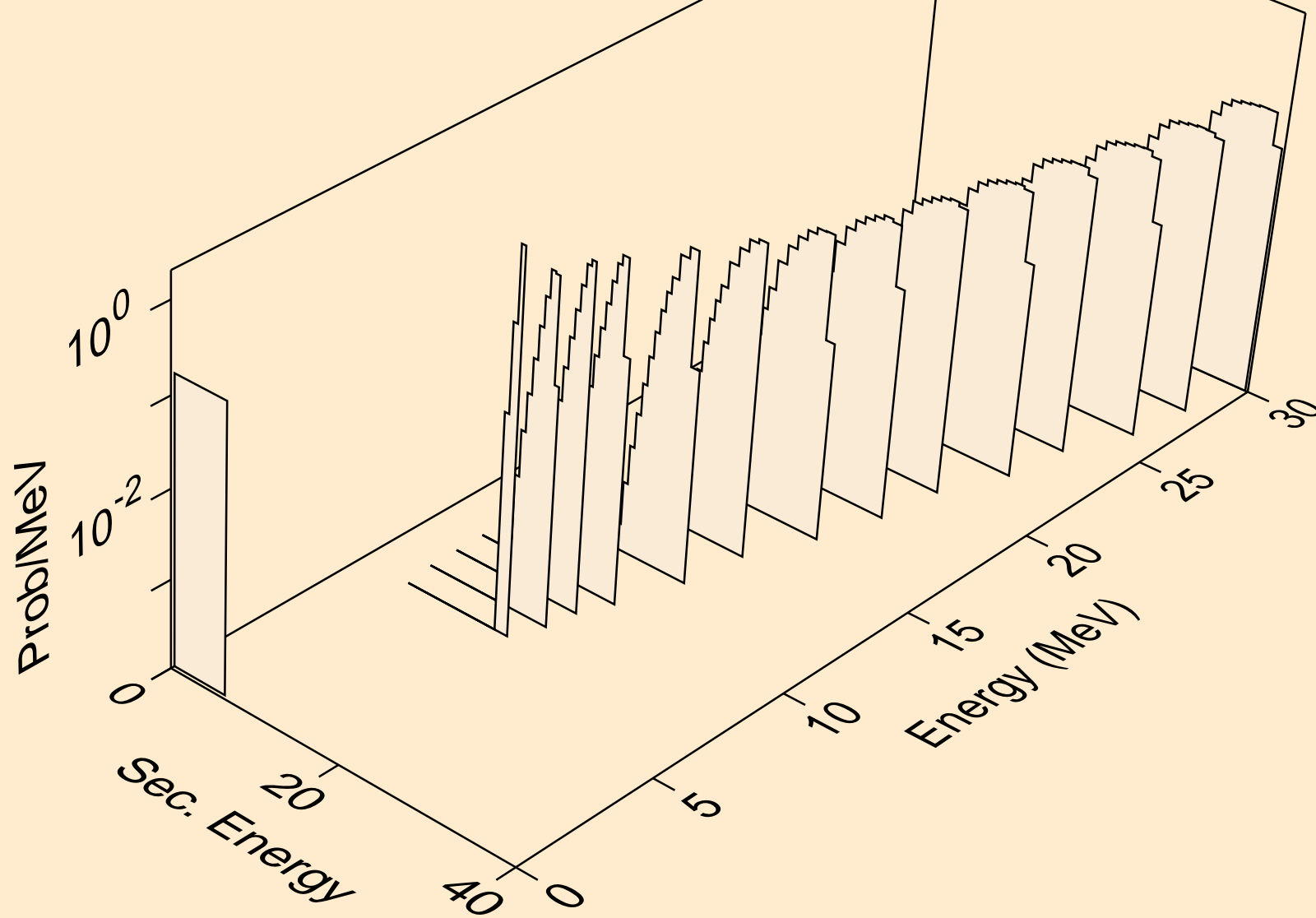

AU206 HELION ACER TENDL-2021 LIBRARY; T=0.K  
alphas from (s,2n)a

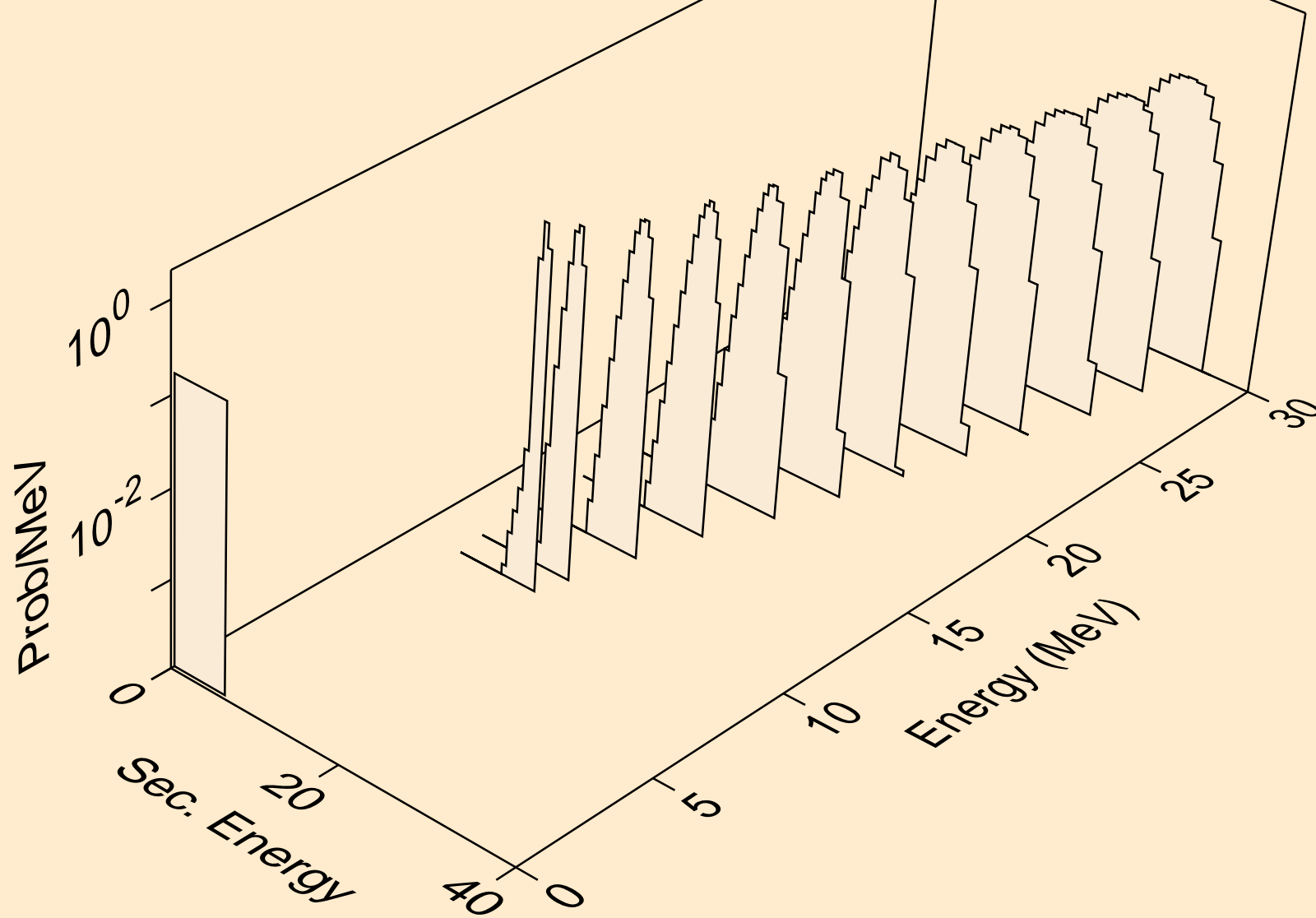

AU206 HELION ACER TENDL-2021 LIBRARY; T=0.K  
alphas from (s,3n)a

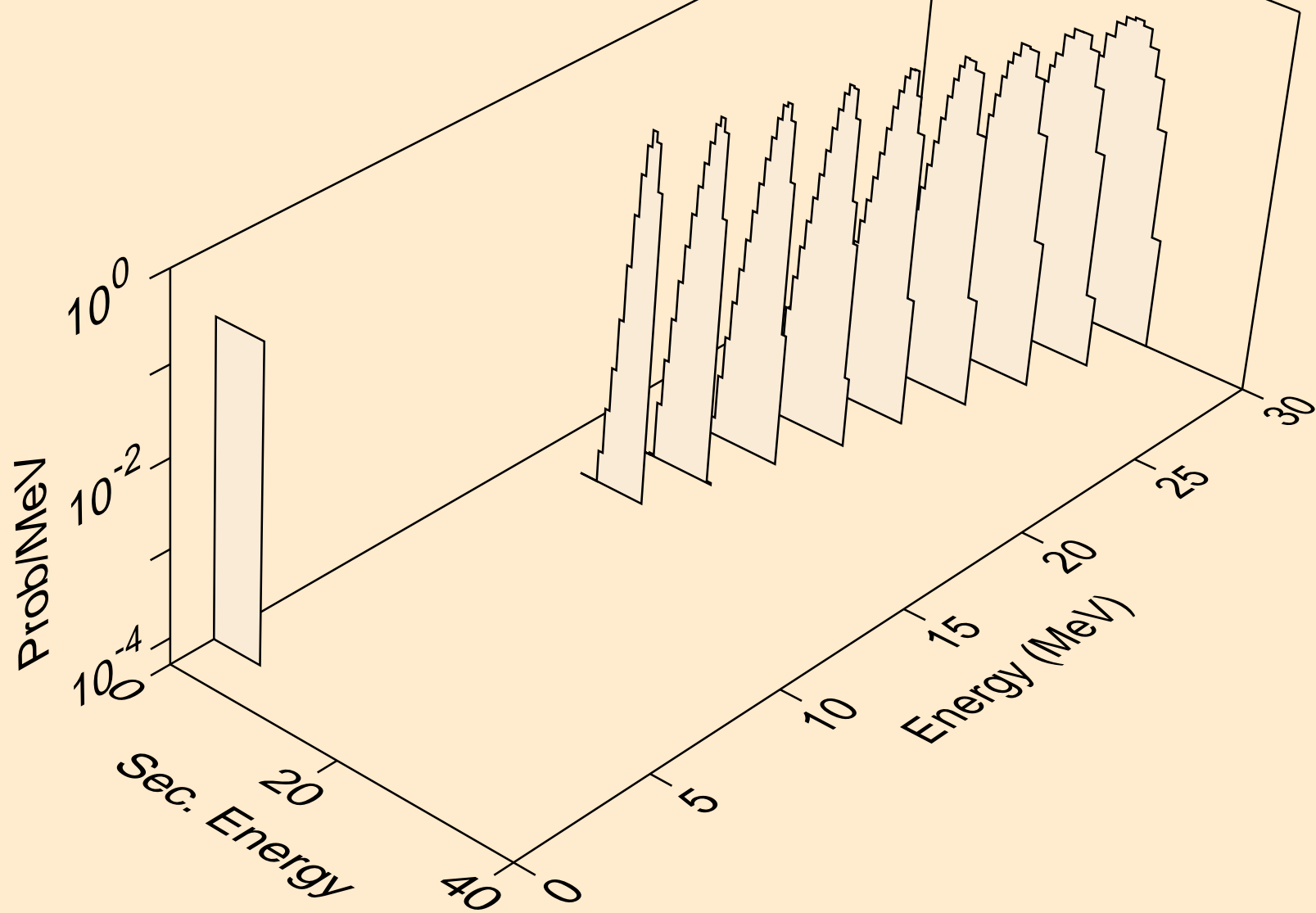

AU206 HELION ACER TENDL-2021 LIBRARY; T=0.K  
alphas from (s,npa)

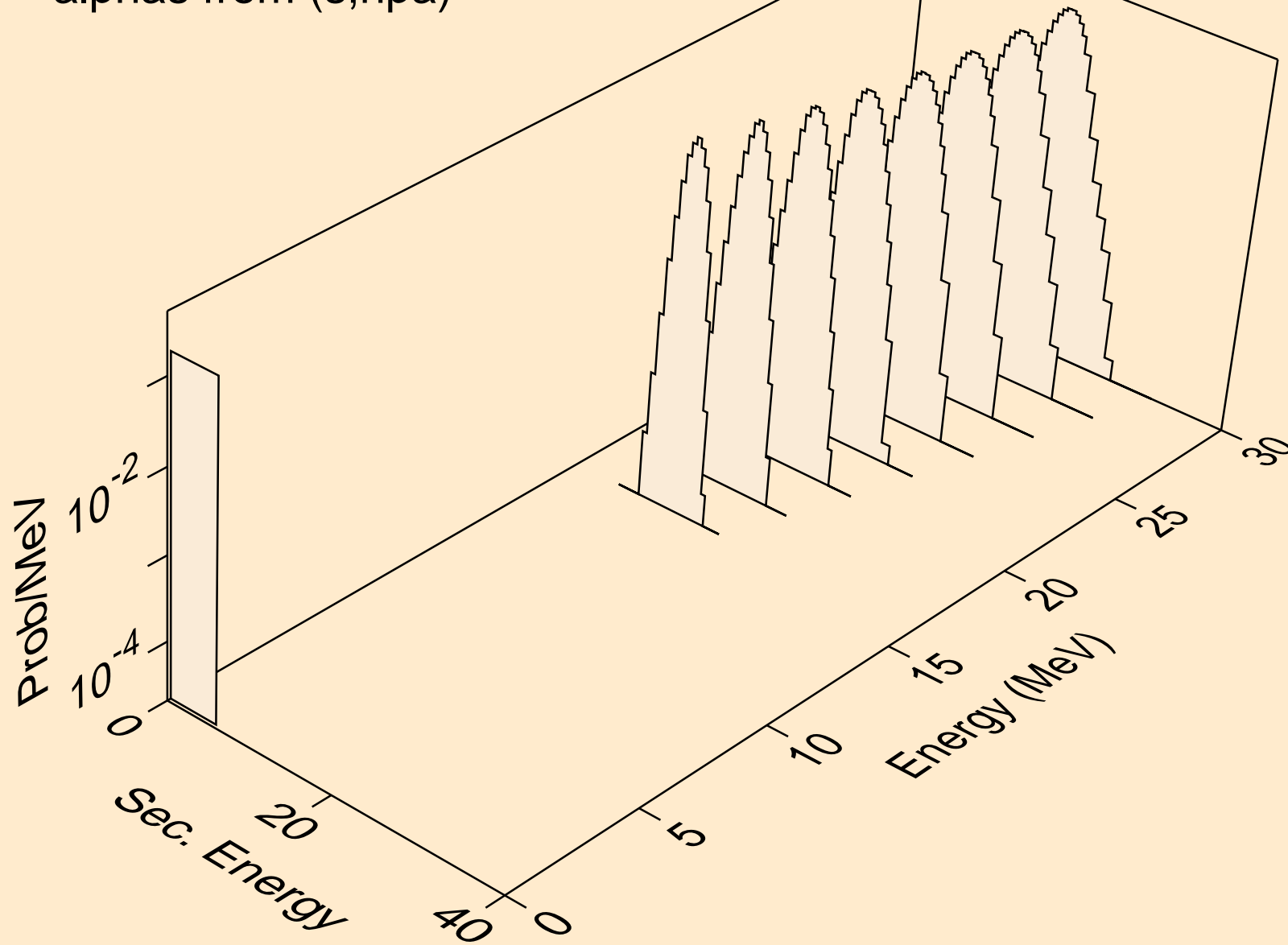

AU206 HELION ACER TENDL-2021 LIBRARY; T=0.K  
alphas from (s,a)

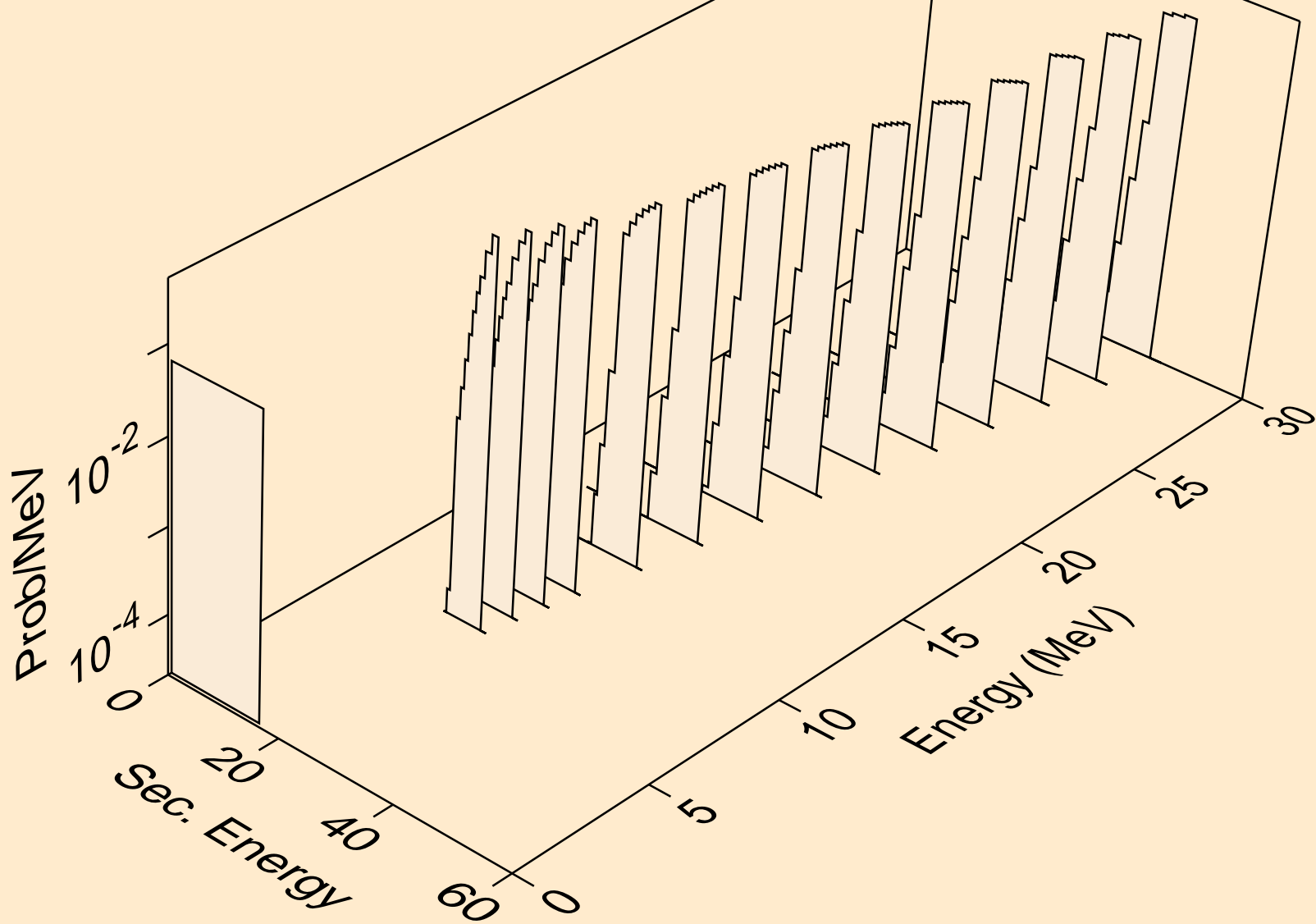



AU206 HELION ACER TENDL-2021 LIBRARY; T=0.K  
alphas from (s,pa)

