

# BA116 HELION ACER TENDL-2021 LIBRARY; T=0.K

## Principal cross sections

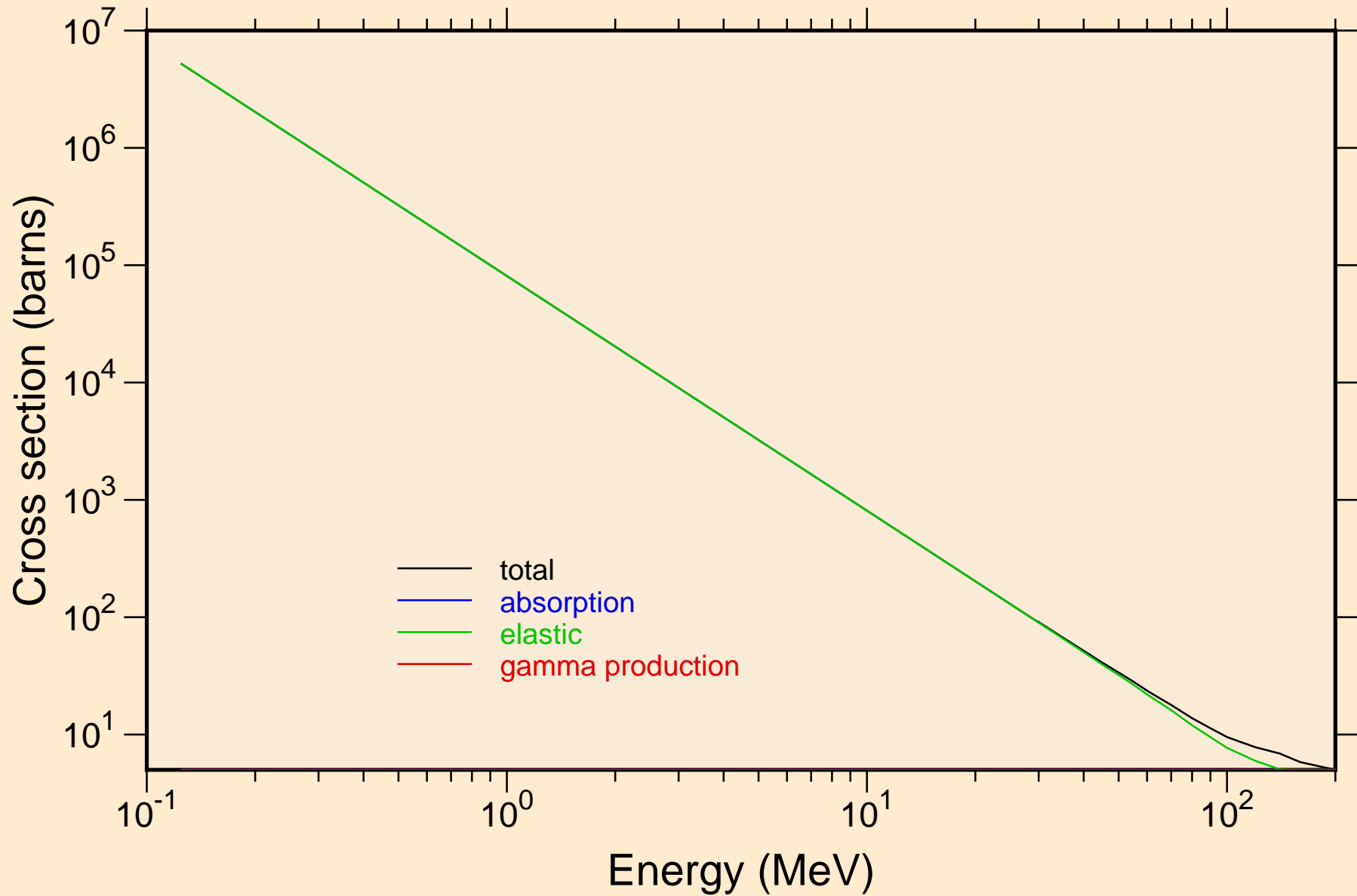

BA116 HELION ACER TENDL-2021 LIBRARY; T=0.K

Heating

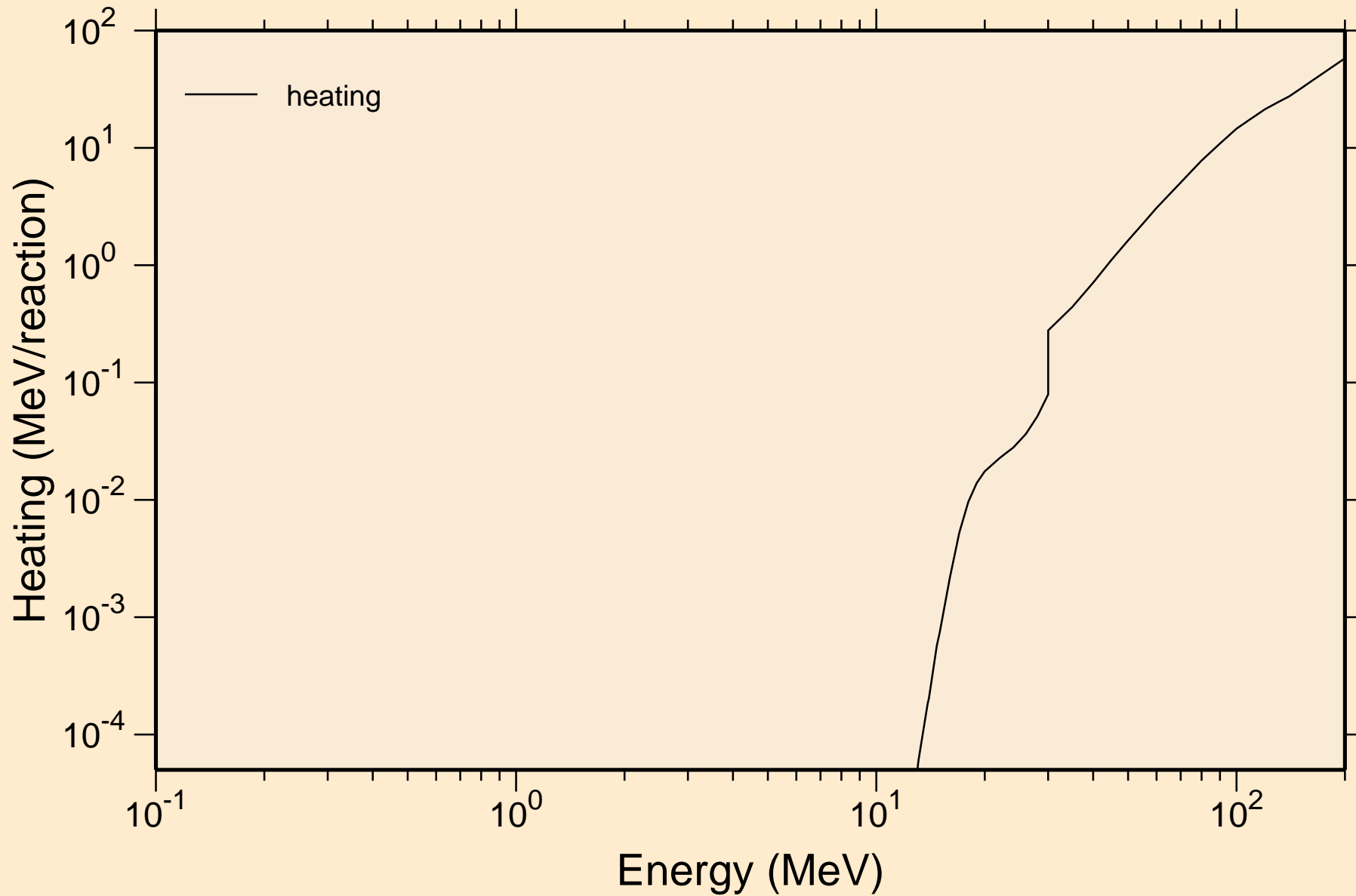

# BA116 HELION ACER TENDL-2021 LIBRARY; T=0.K

## Principal cross sections

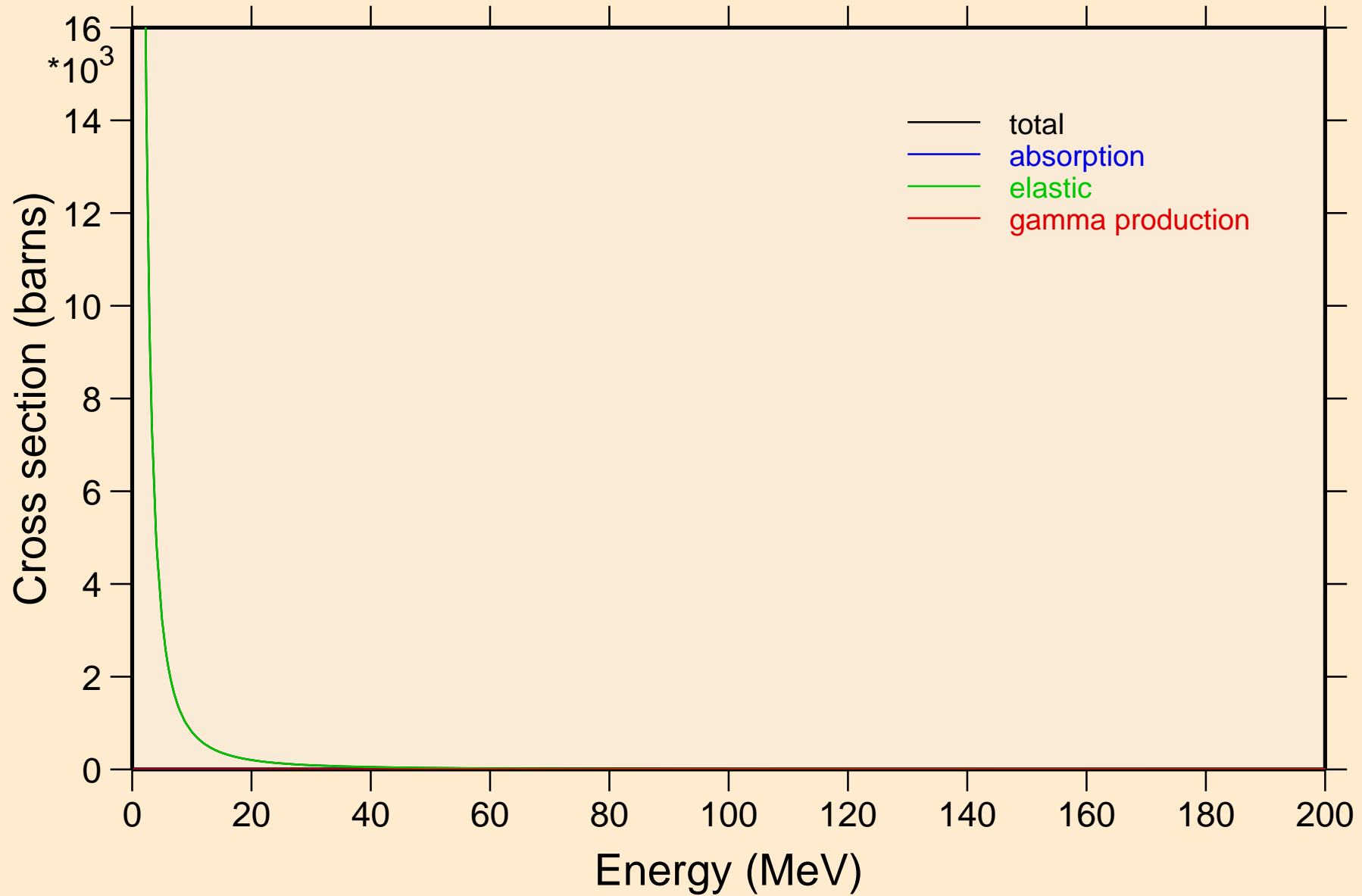

BA116 HELION ACER TENDL-2021 LIBRARY; T=0.K

Heating

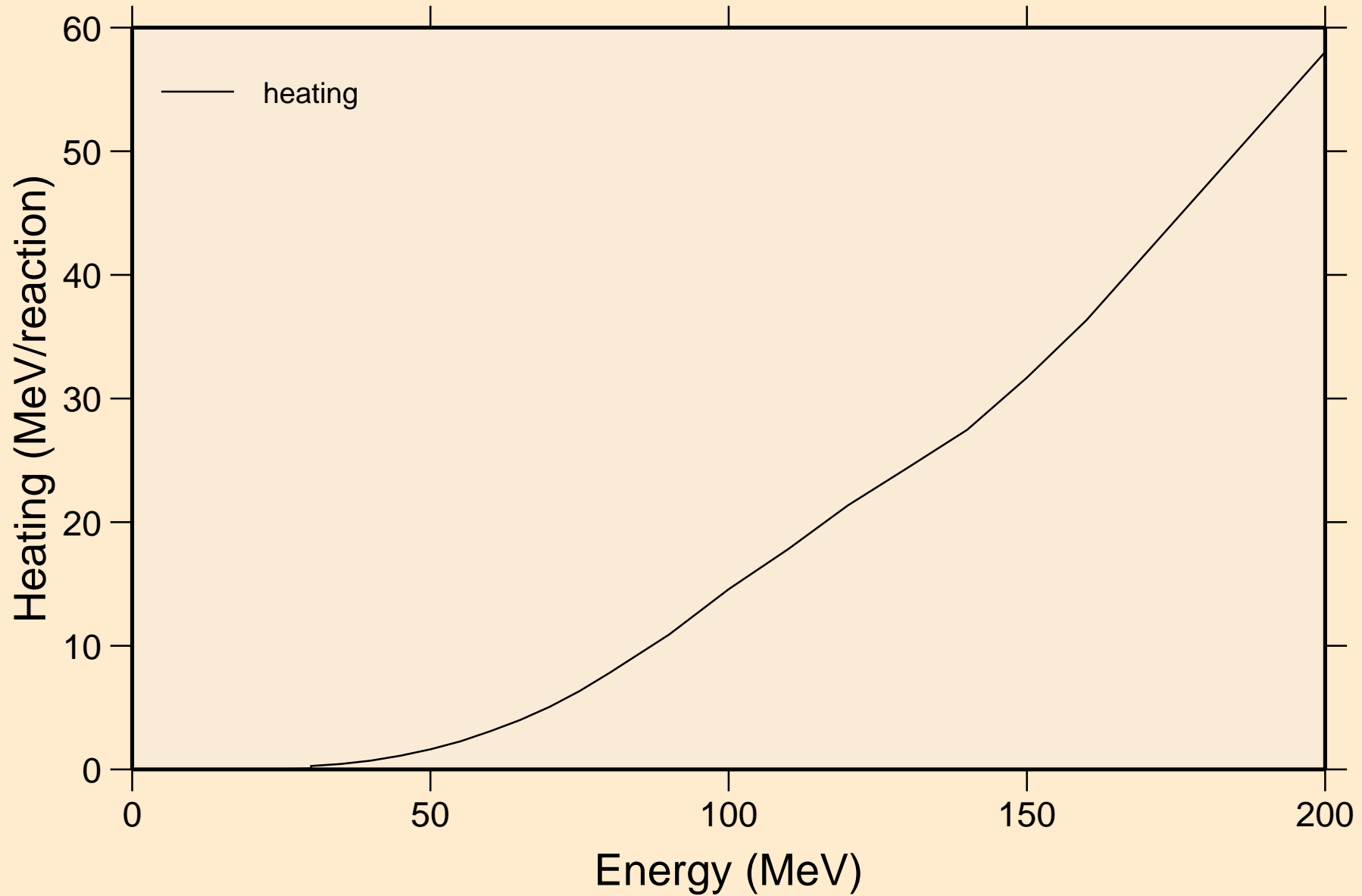

BA116 HELION ACER TENDL-2021 LIBRARY; T=0.K  
Threshold reactions

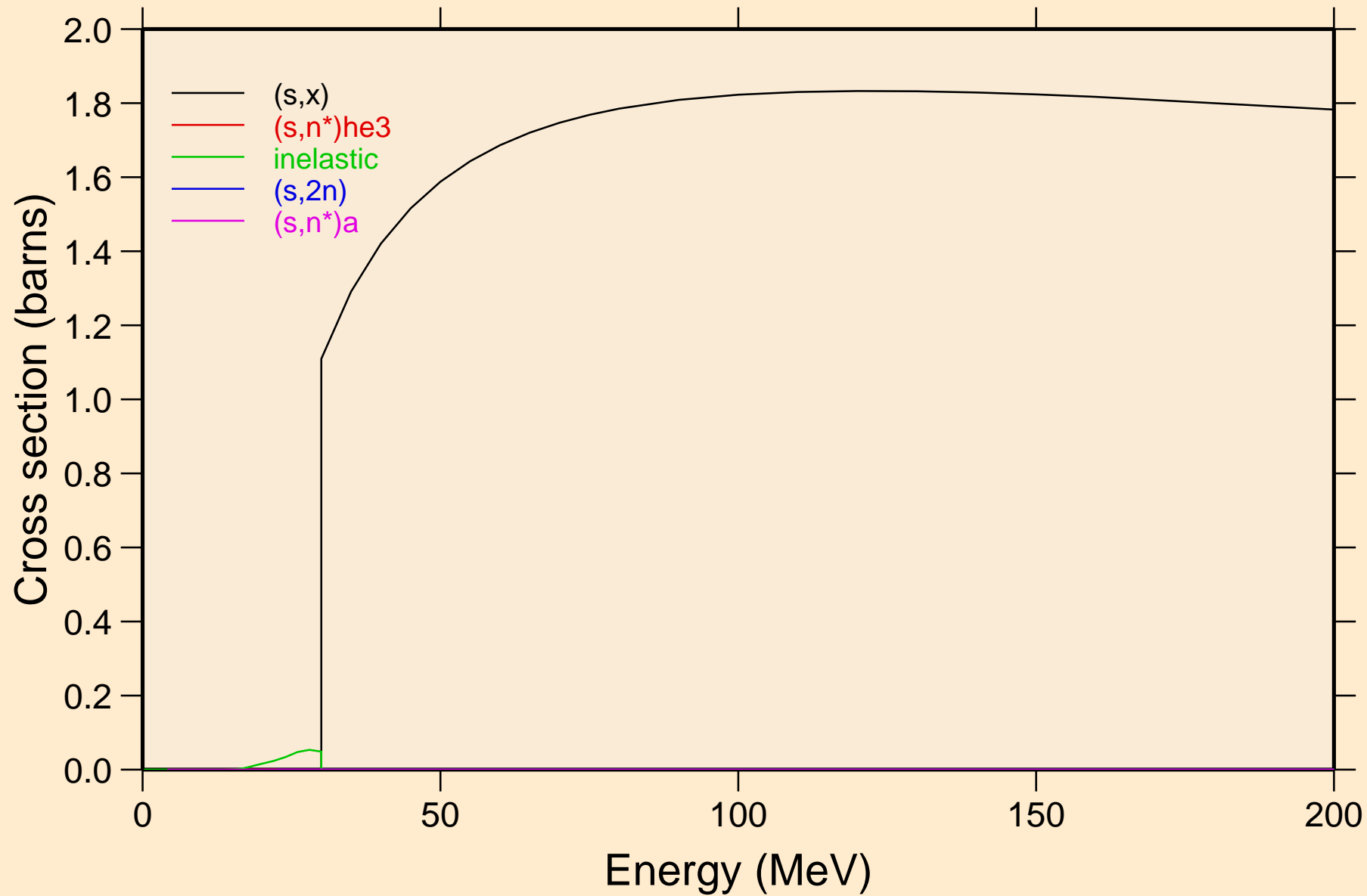

BA116 HELION ACER TENDL-2021 LIBRARY; T=0.K  
Threshold reactions

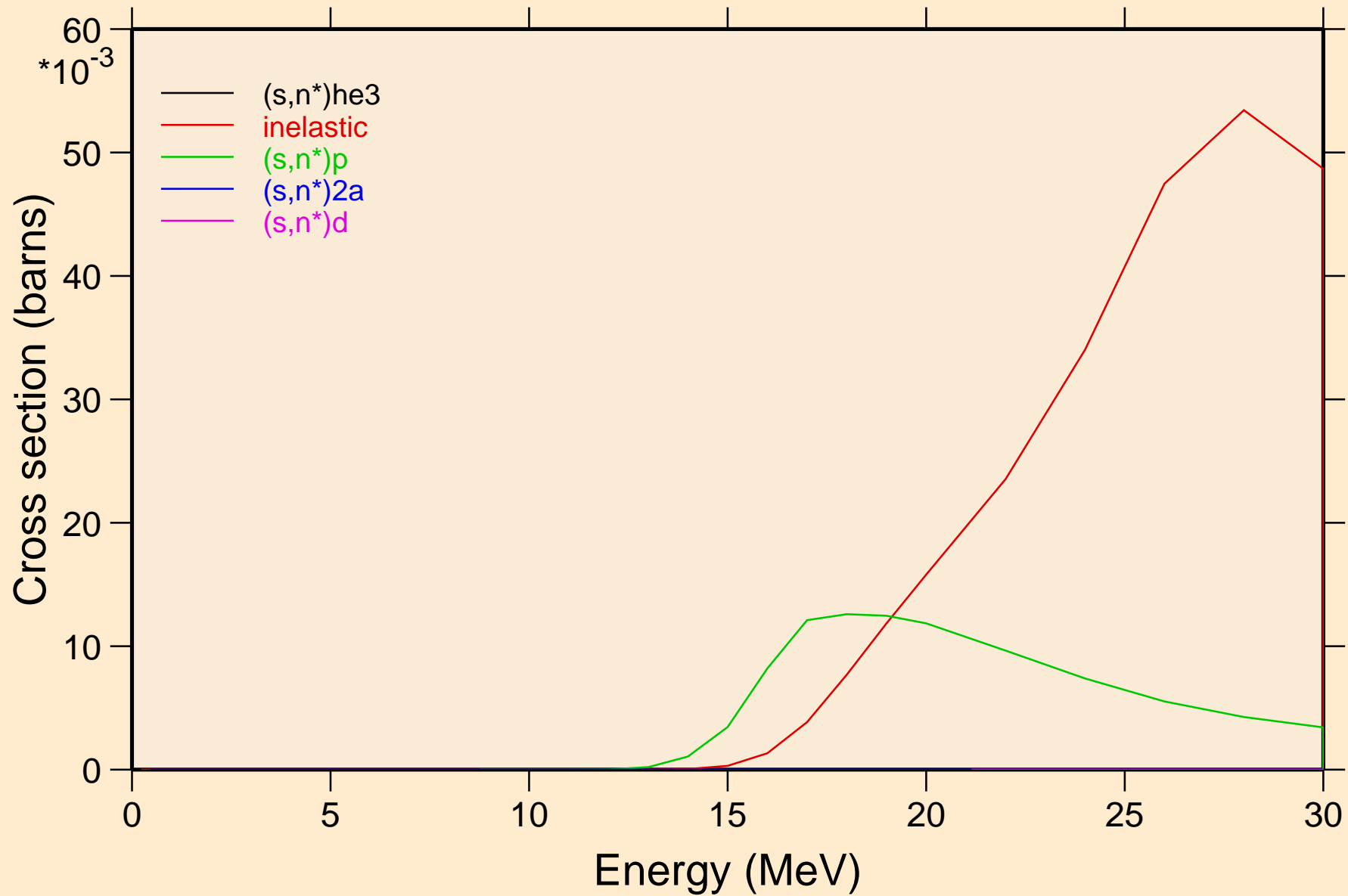

BA116 HELION ACER TENDL-2021 LIBRARY; T=0.K  
Threshold reactions

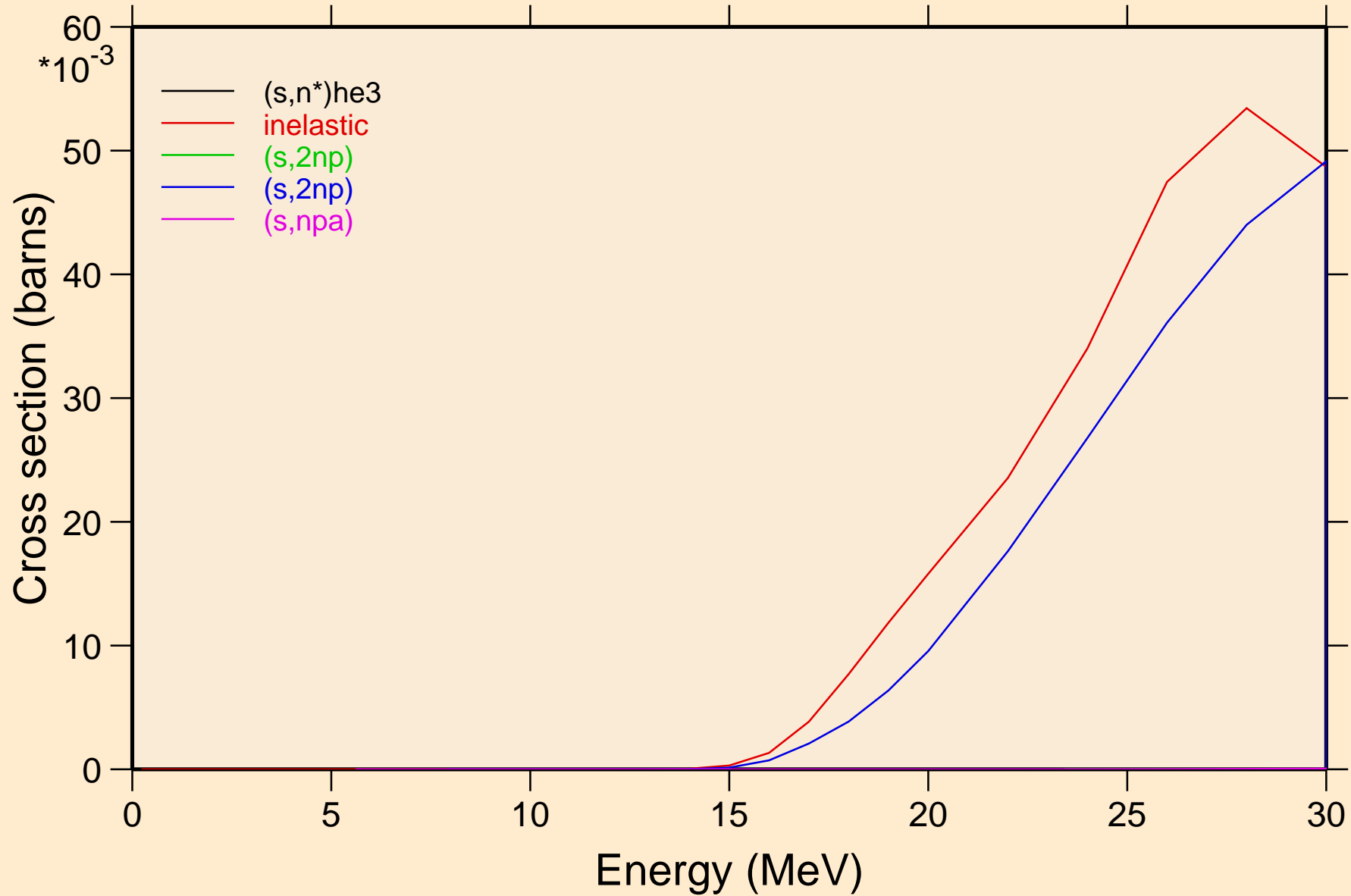

BA116 HELION ACER TENDL-2021 LIBRARY; T=0.K  
Threshold reactions

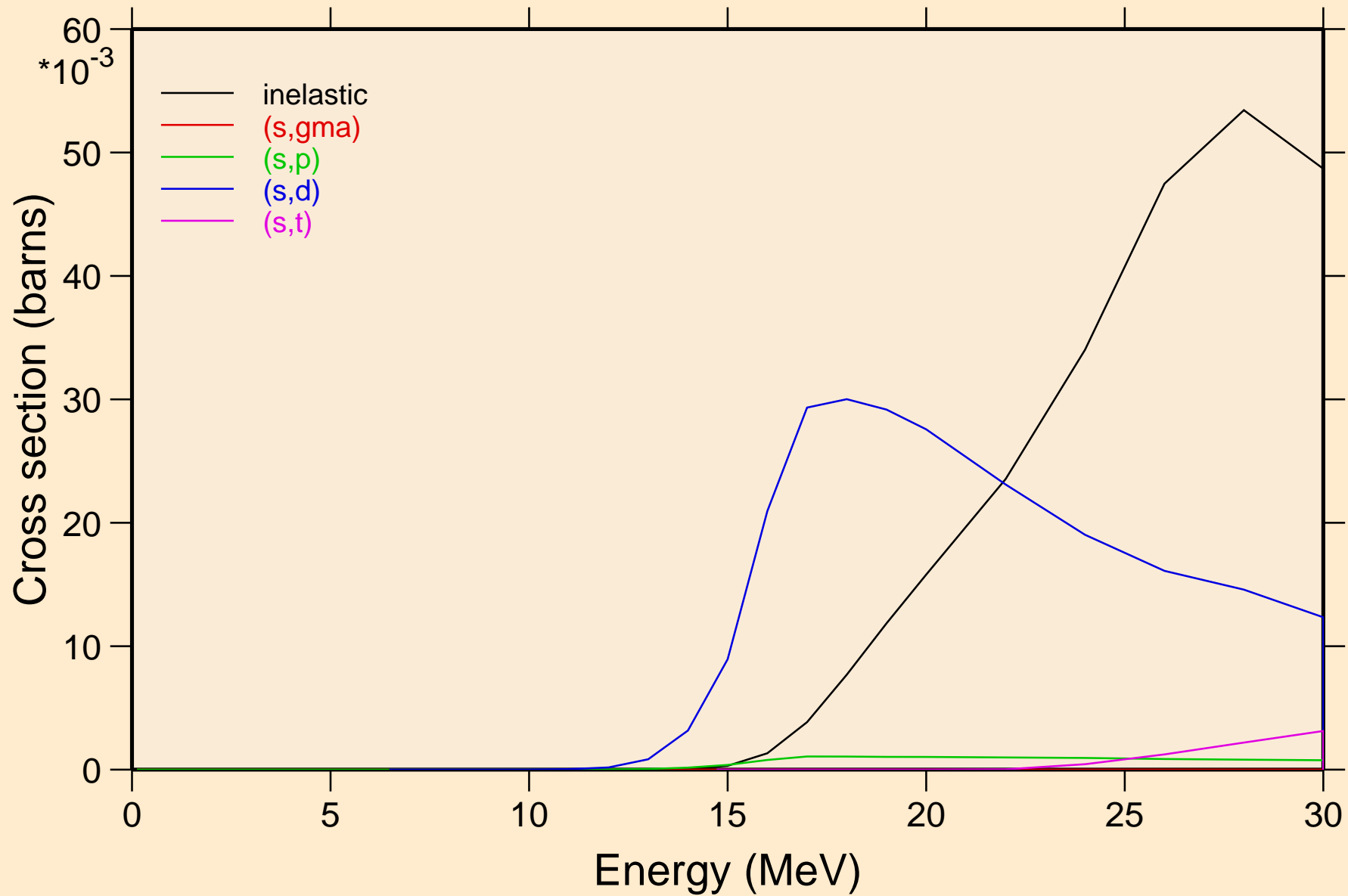



BA116 HELION ACER TENDL-2021 LIBRARY; T=0.K  
Threshold reactions

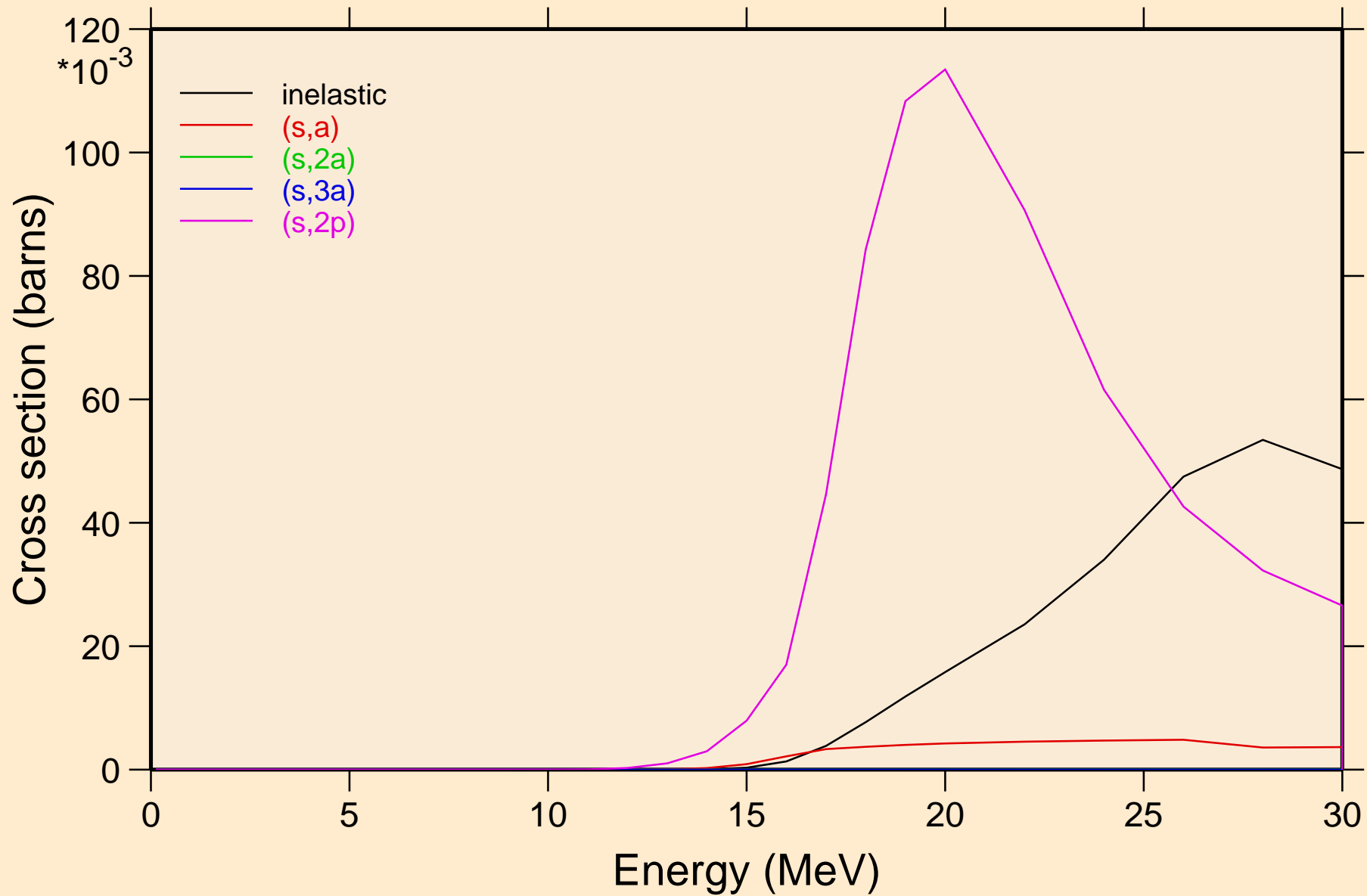

BA116 HELION ACER TENDL-2021 LIBRARY; T=0.K  
Threshold reactions

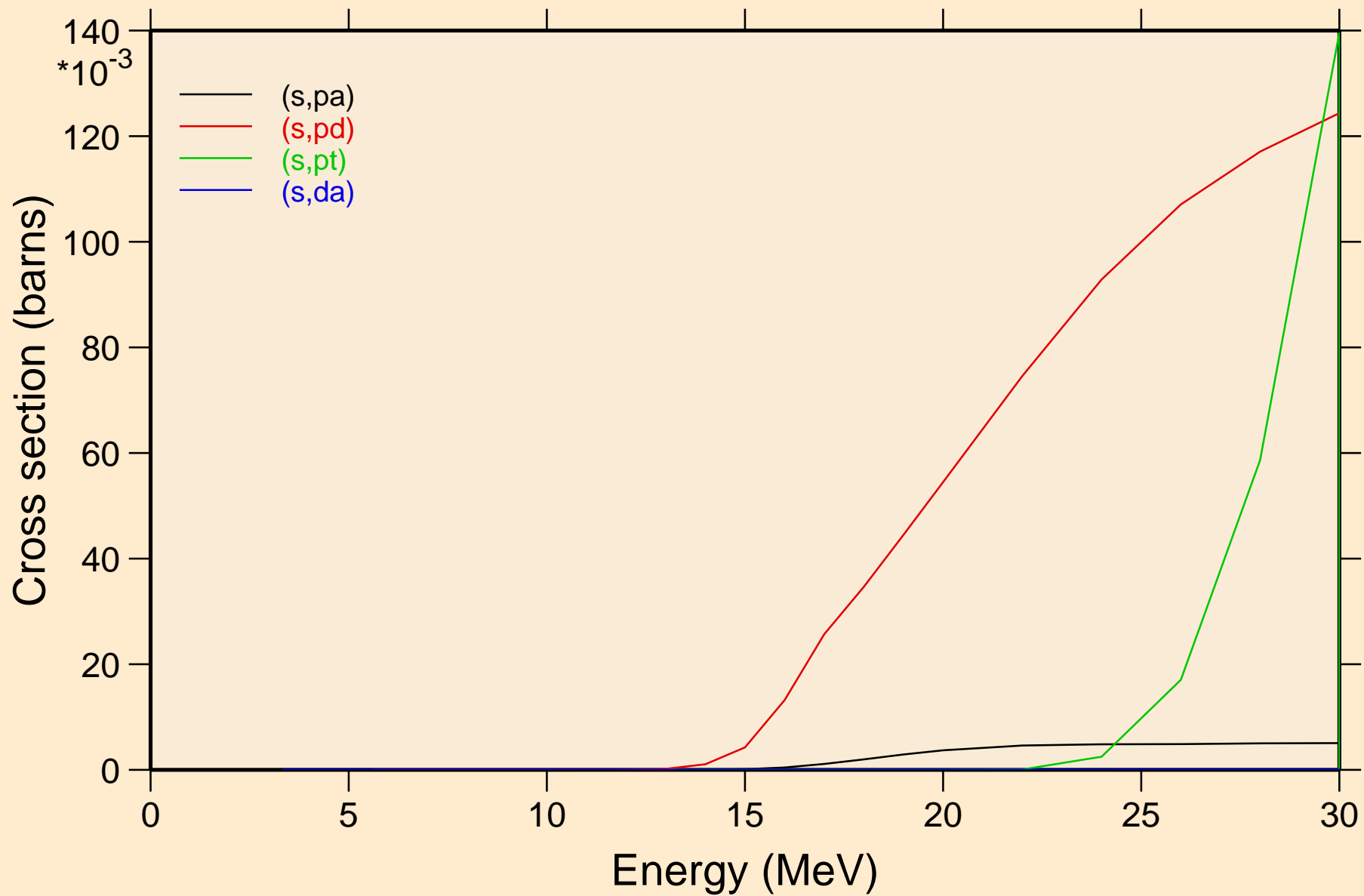

BA116 HELION ACER TENDL-2021 LIBRARY; T=0.K  
angular distribution for elastic

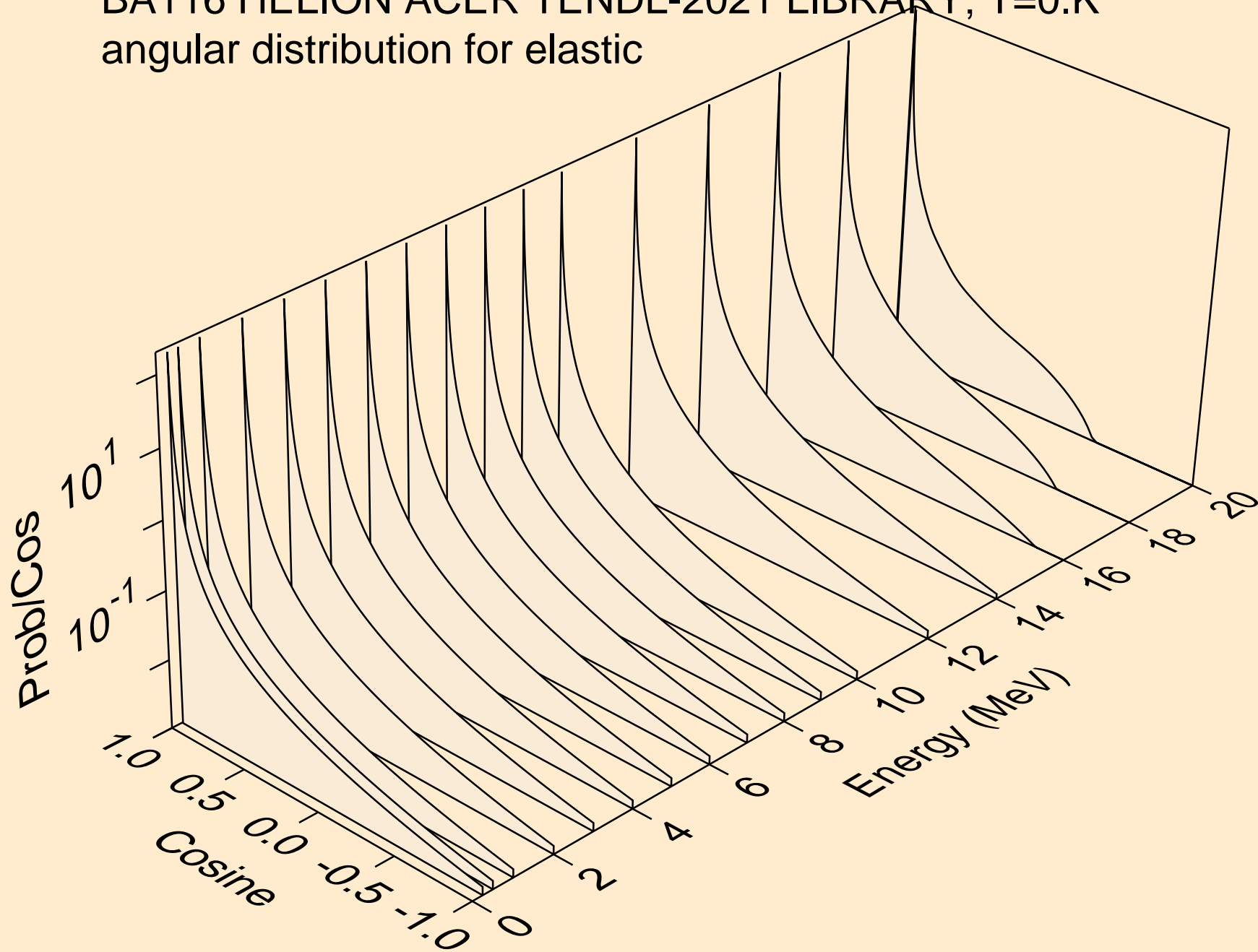

BA116 HELION ACER TENDL-2021 LIBRARY; T=0.K  
angular distribution for elastic

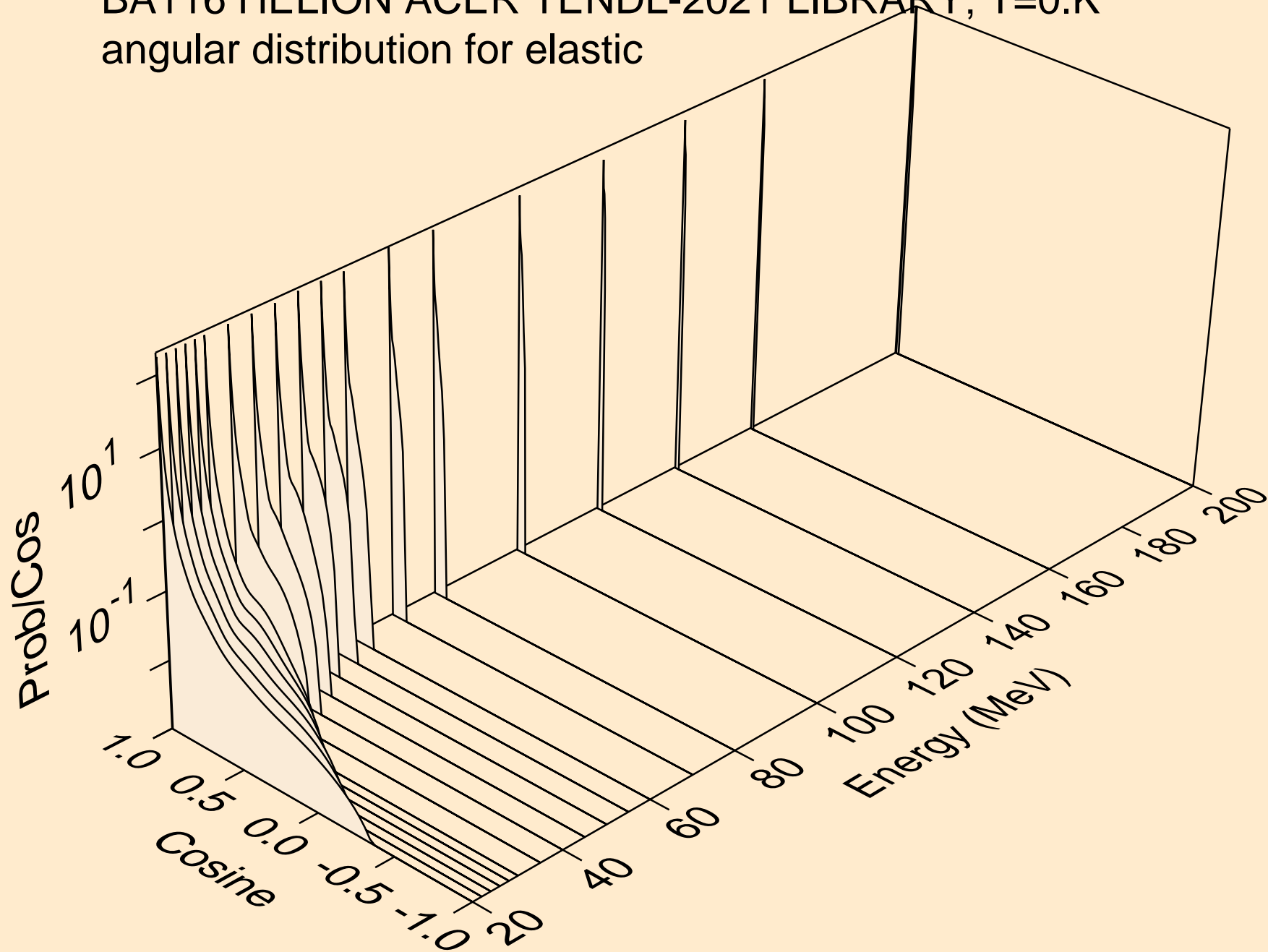

BA116 HELION ACER TENDL-2021 LIBRARY; T=0.K  
He-3 emission for (s,x)

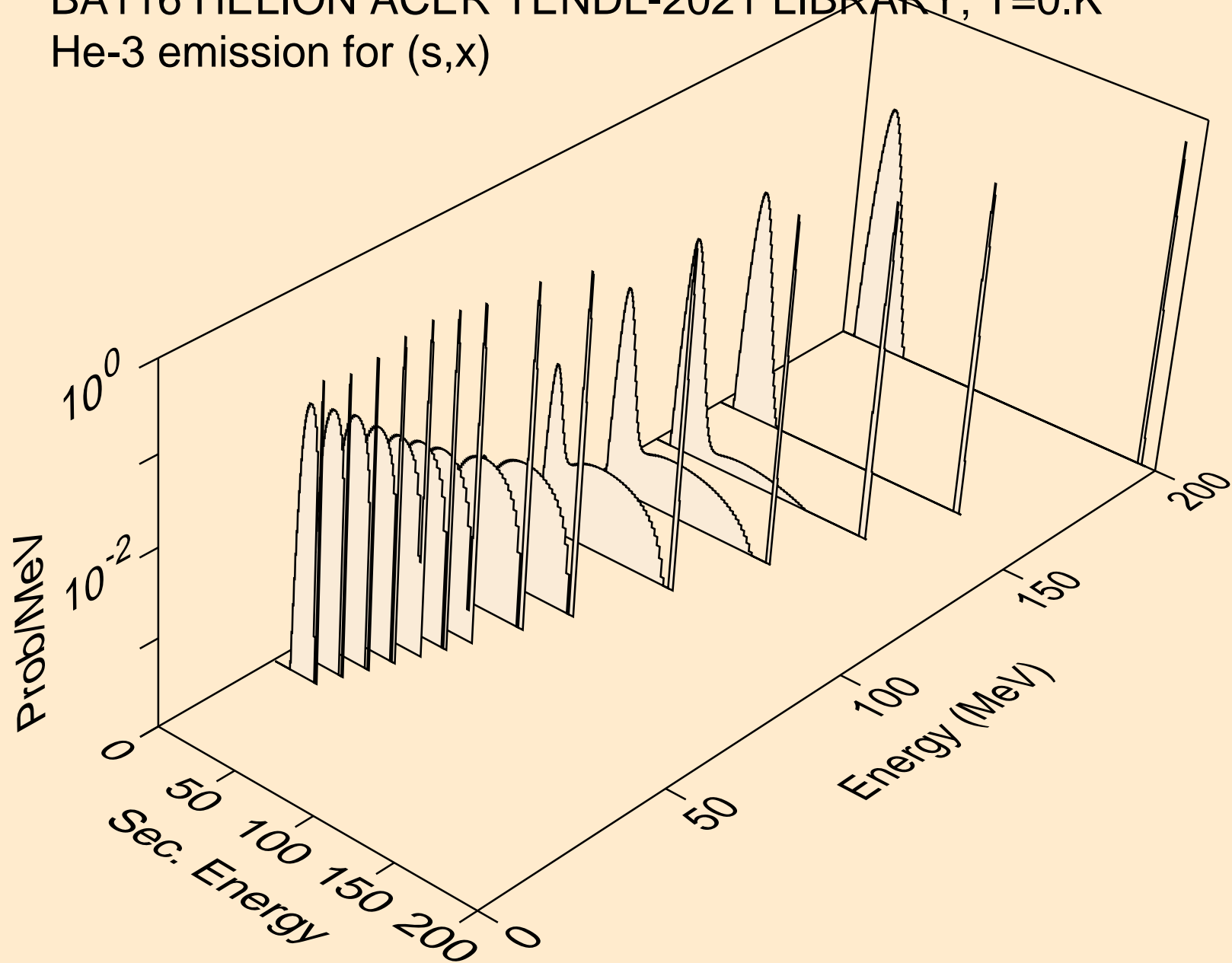

BA116 HELION ACER TENDL-2021 LIBRARY; T=0.K  
He-3 emission for (s,n\*)he3

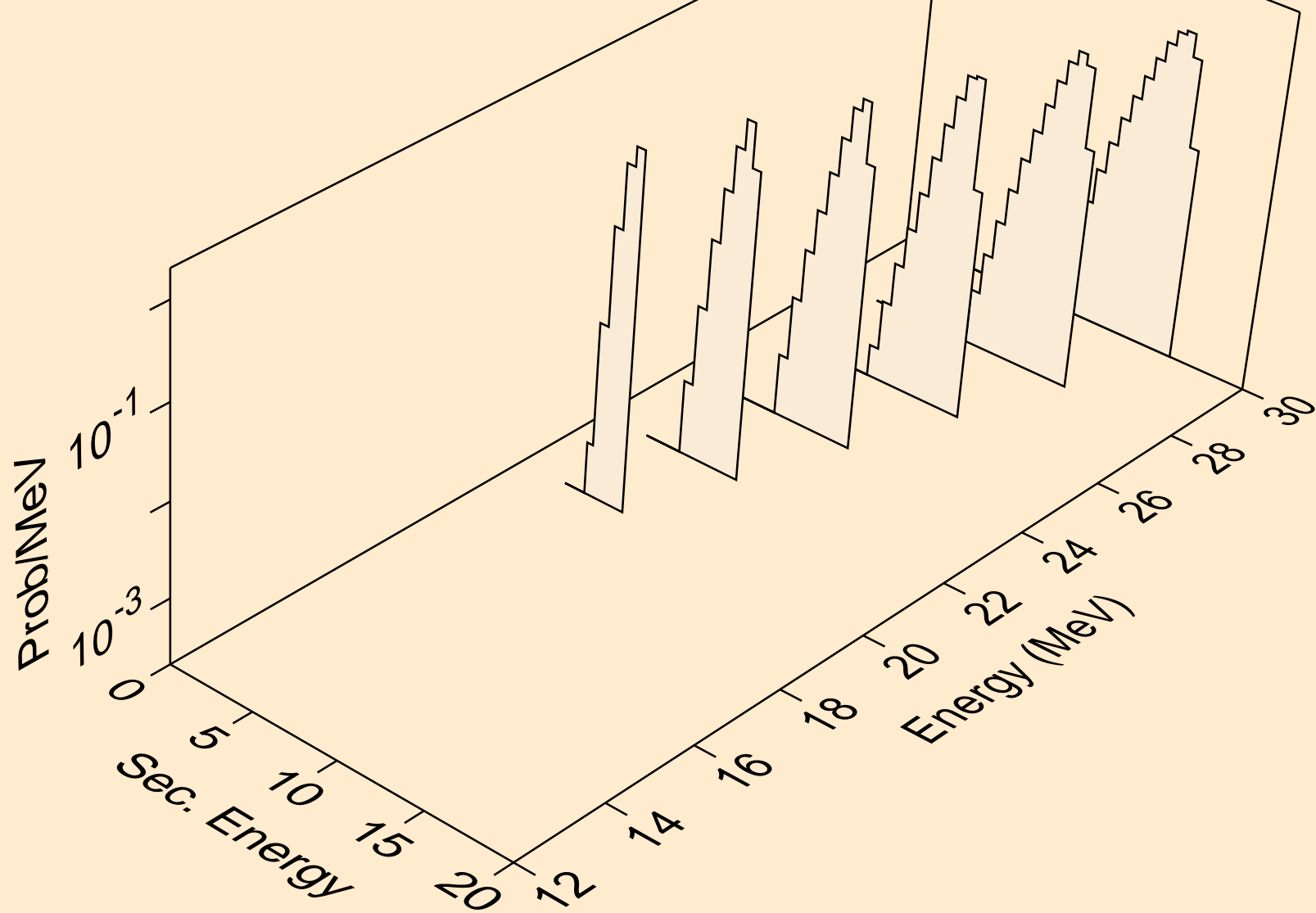

BA116 HELION ACER TENDL-2021 LIBRARY; T=0.K  
He-3 emission for inelastic

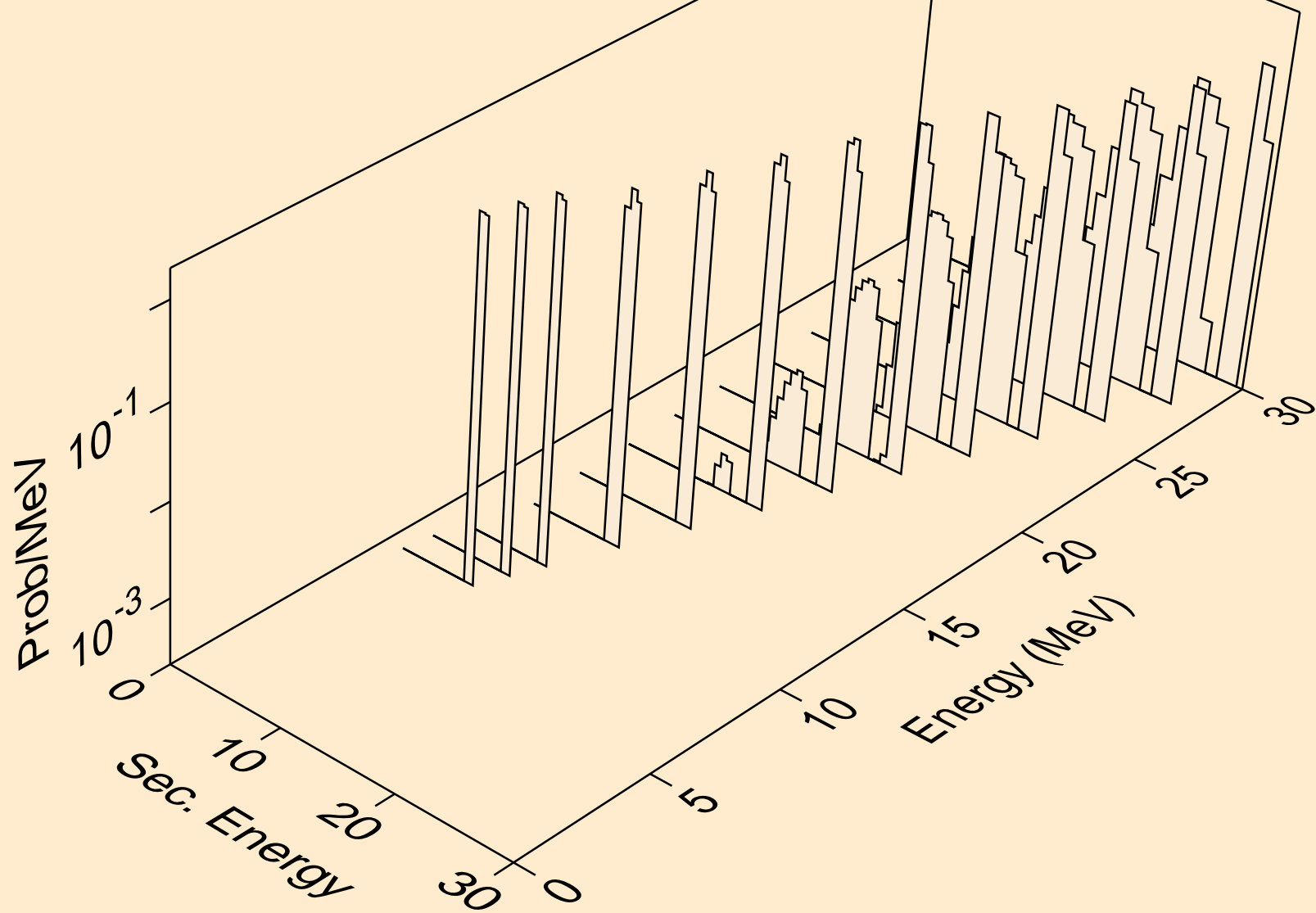

BA116 HELION ACER TENDL-2021 LIBRARY; T=0.K  
Photon emission for (z,n)

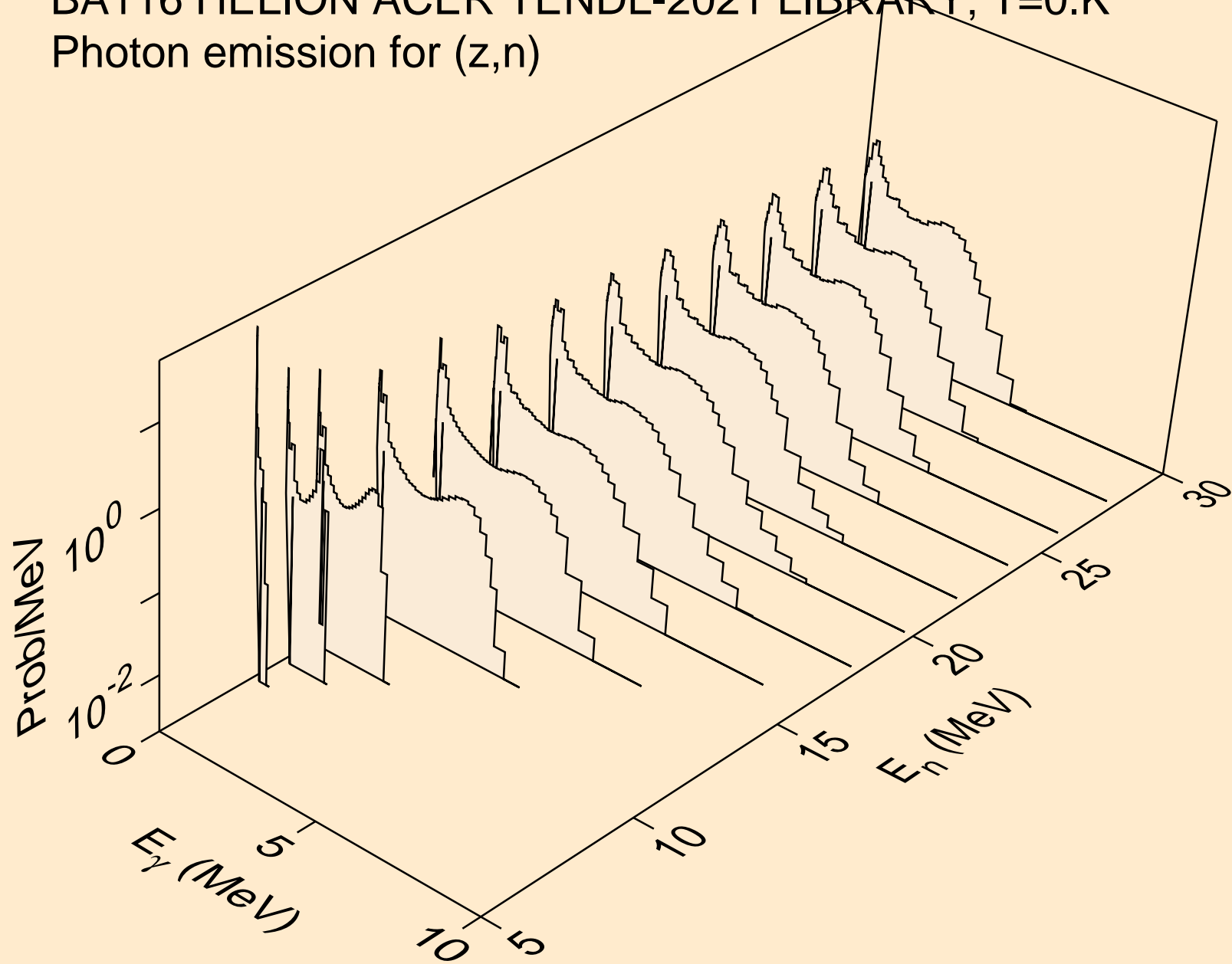



BA116 HELION ACER TENDL-2021 LIBRARY; T=0.K  
Photon emission for (n,x)

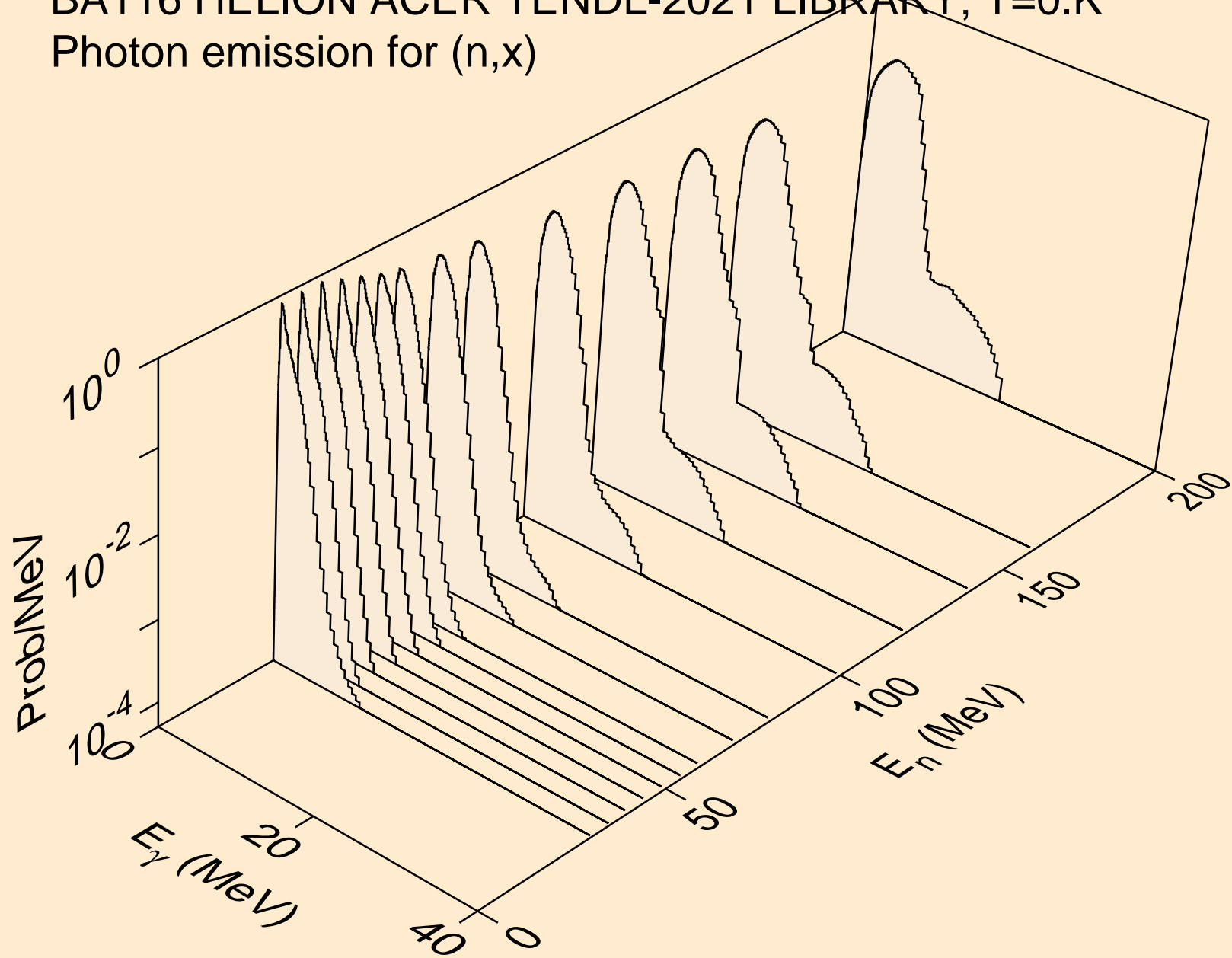

BA116 HELION ACER TENDL-2021 LIBRARY; T=0.K  
Photon emission for (n,2n)

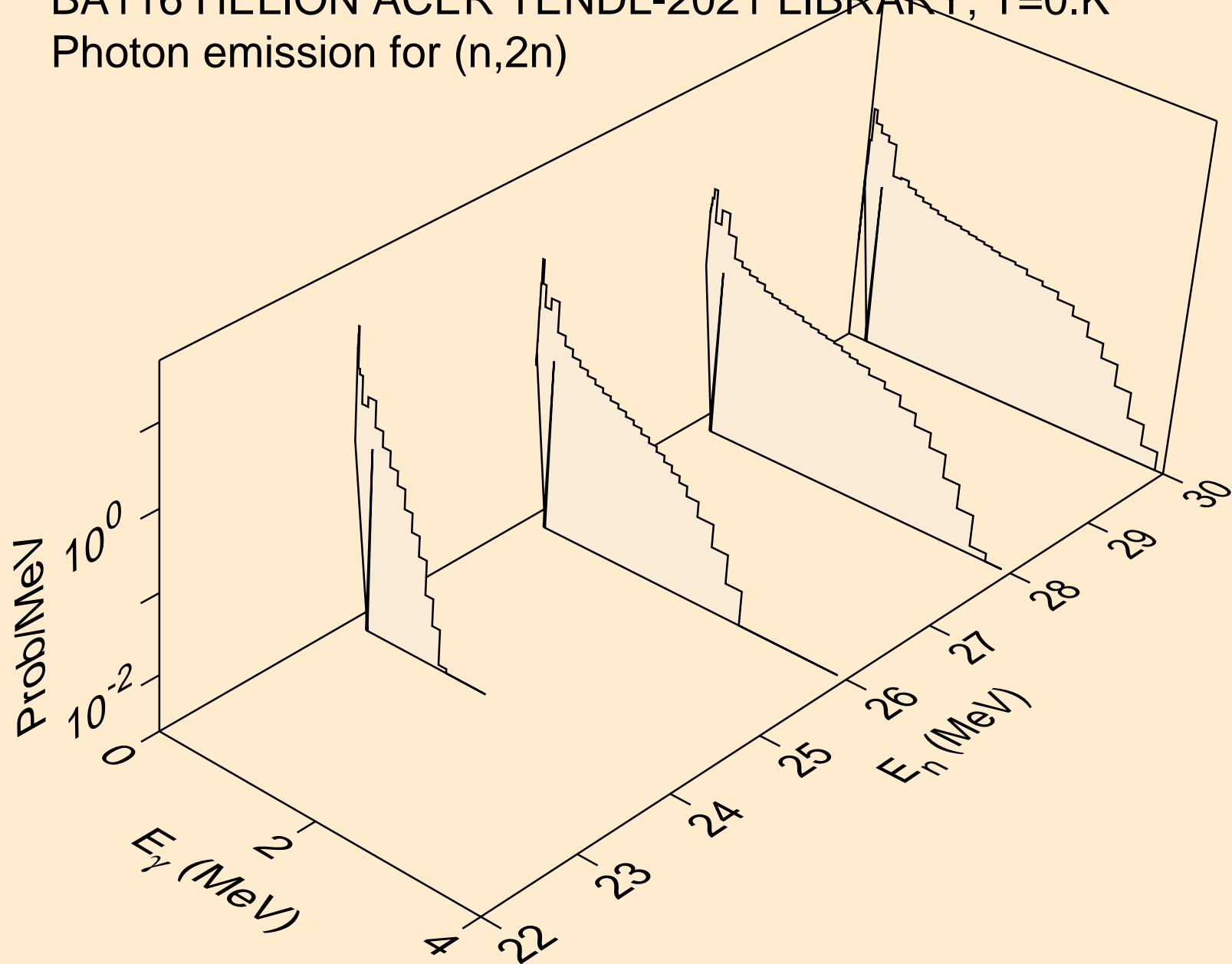

BA116 HELION ACER TENDL-2021 LIBRARY; T=0.K  
Photon emission for (n,n\*)a

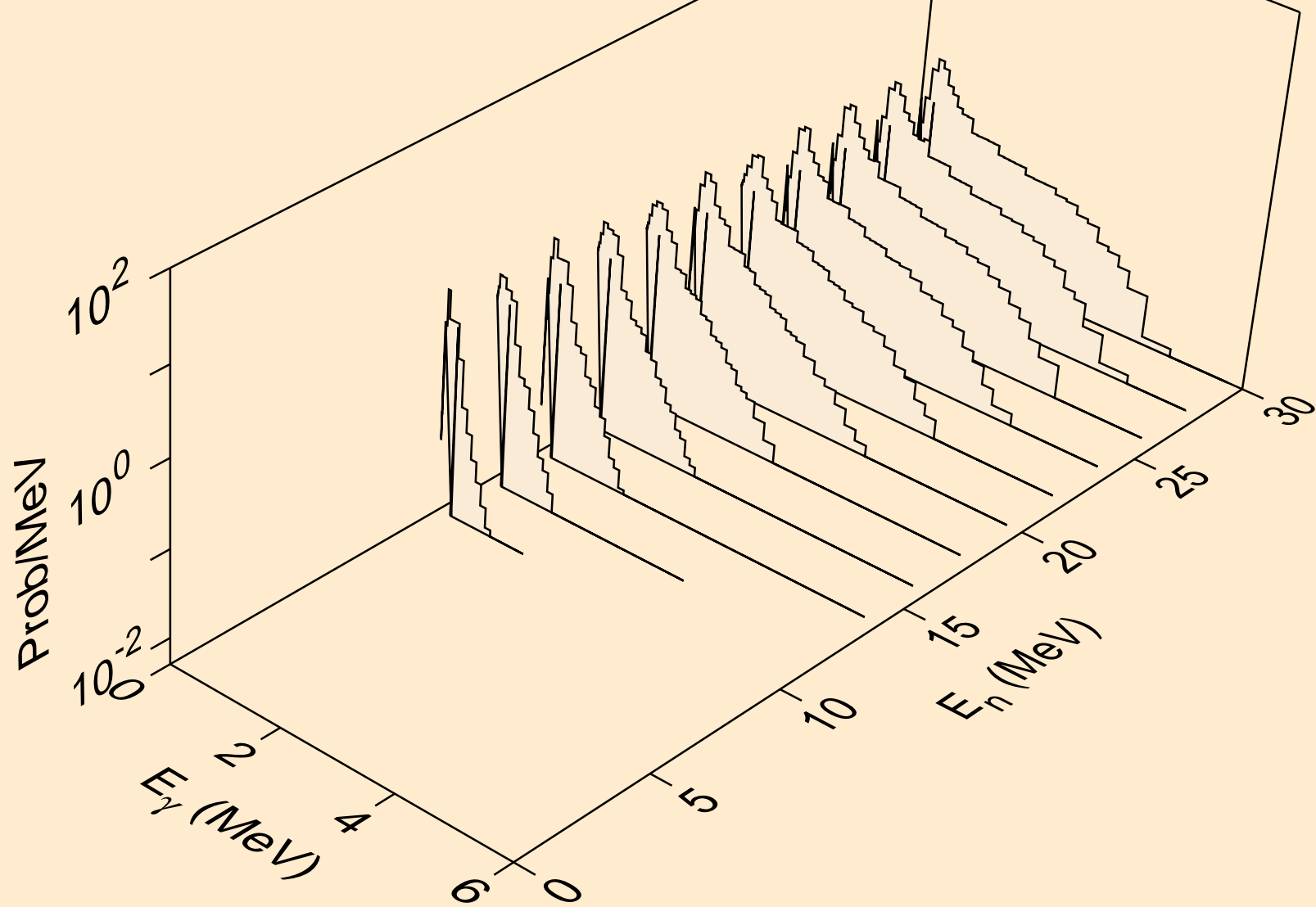

BA116 HELION ACER TENDL-2021 LIBRARY; T=0.K  
Photon emission for (n,n\*)p

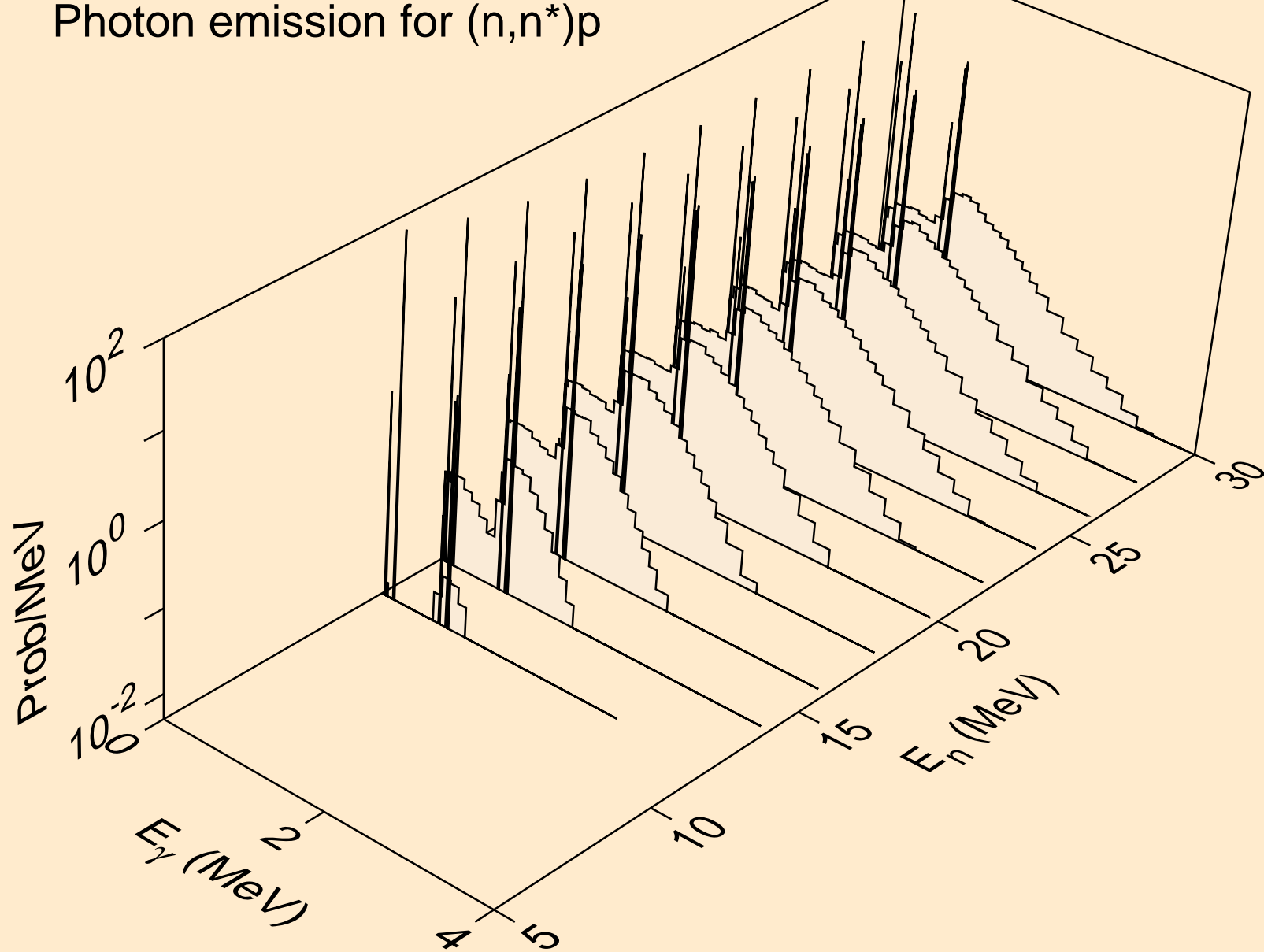

BA116 HELION ACER TENDL-2021 LIBRARY; T=0.K  
Photon emission for (n,n\*)2a

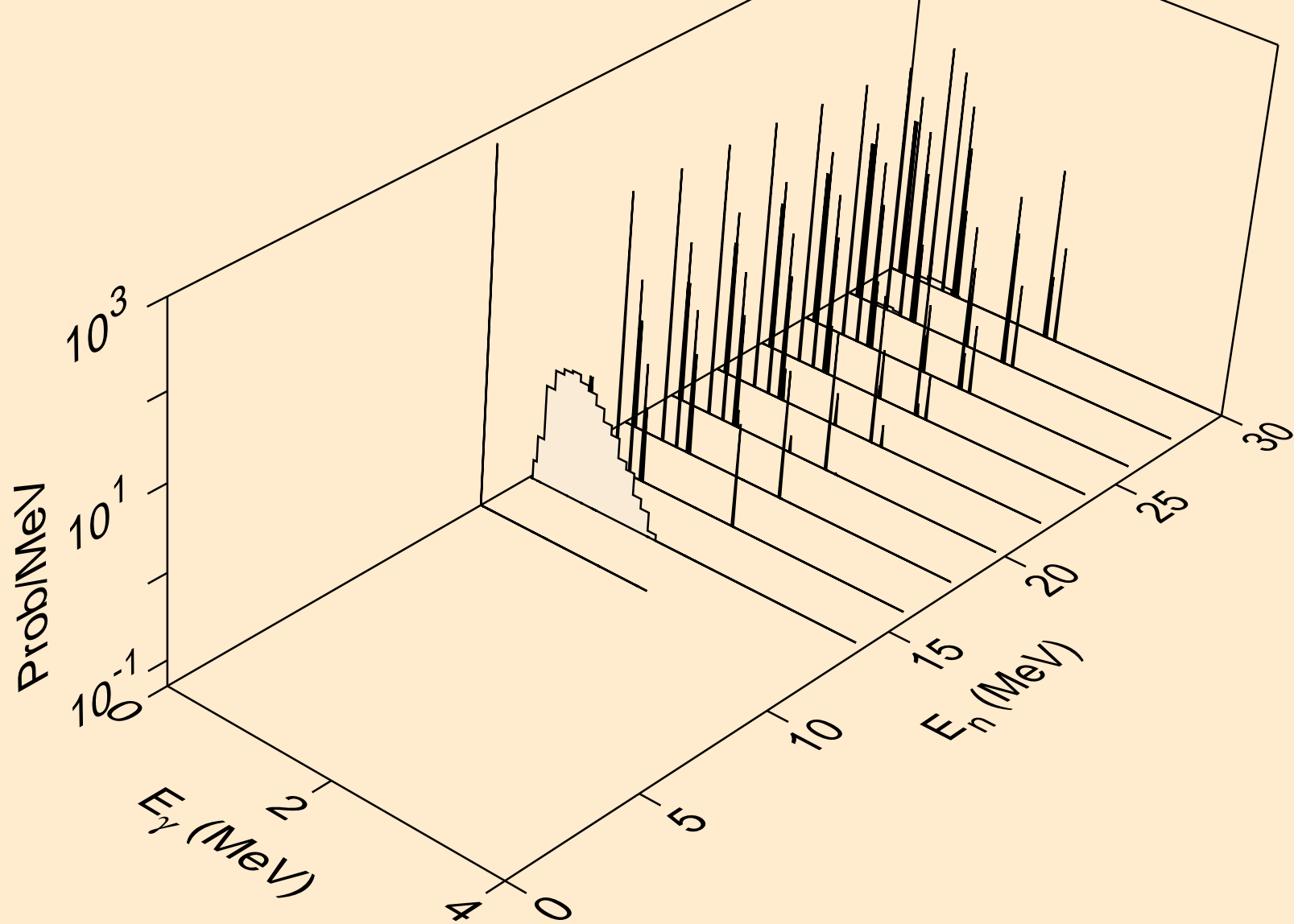

BA116 HELION ACER TENDL-2021 LIBRARY; T=0.K  
Photon emission for (n,n\*)d

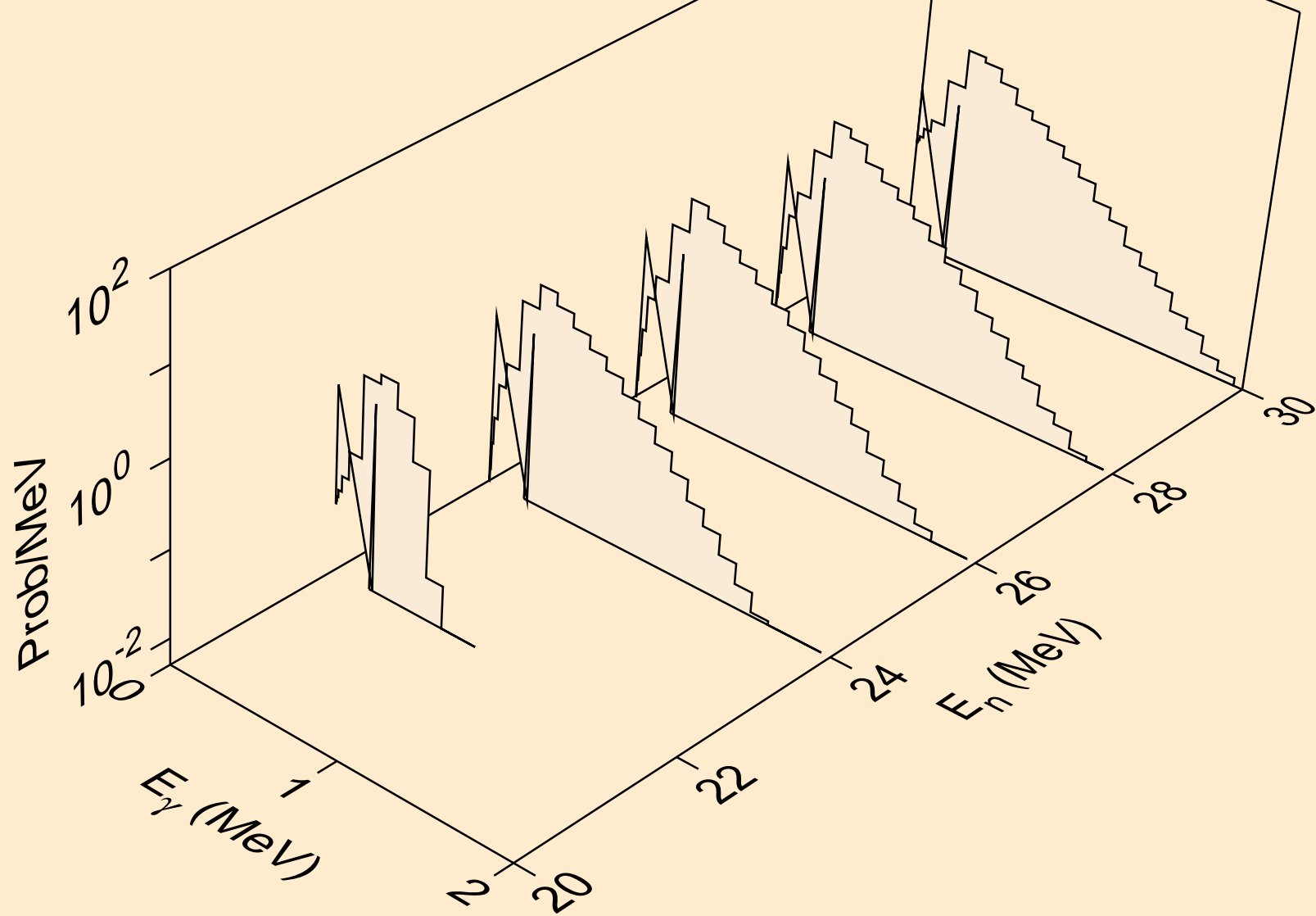

BA116 HELION ACER TENDL-2021 LIBRARY; T=0.K  
Photon emission for (n,n\*)he3

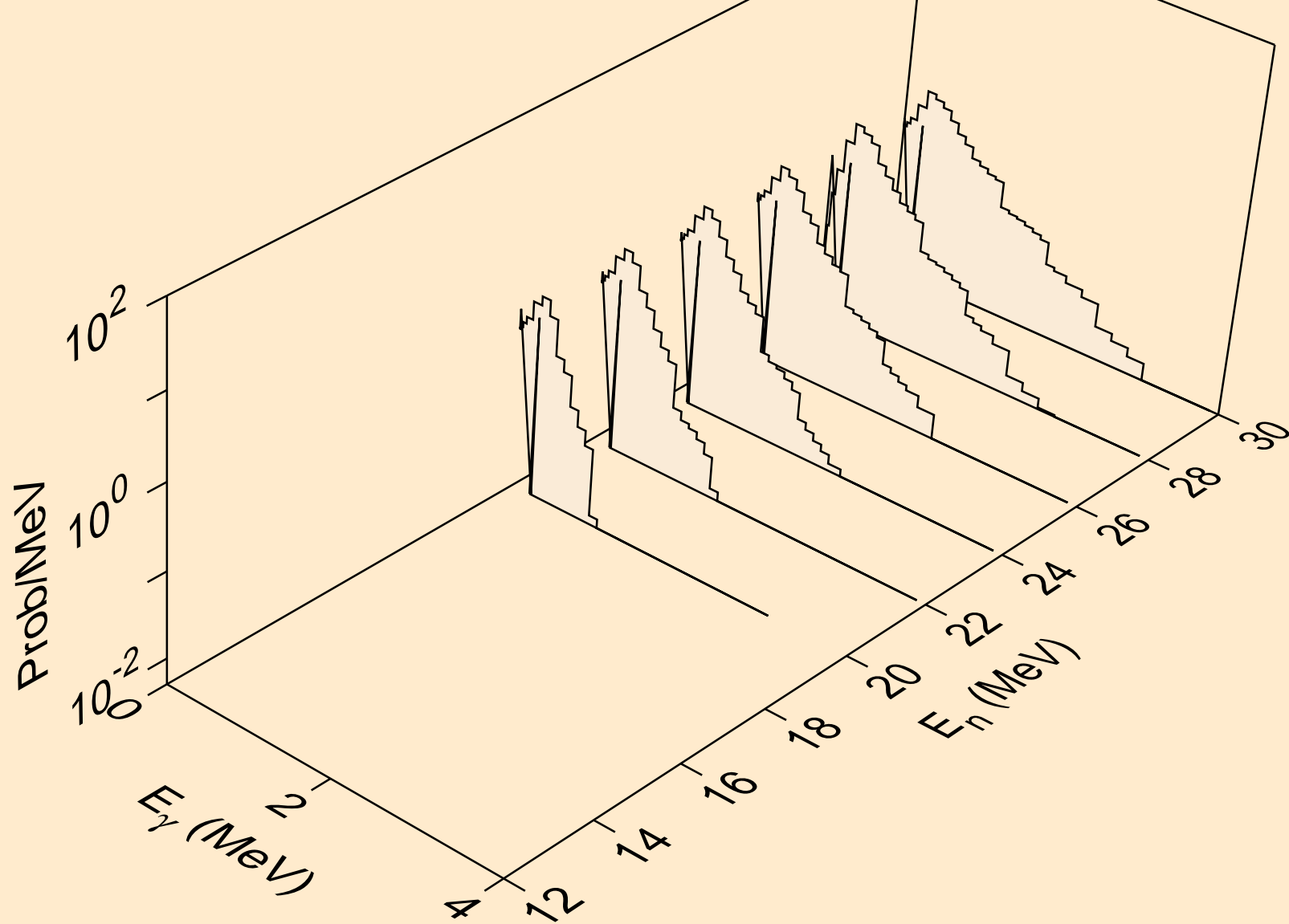

BA116 HELION ACER TENDL-2021 LIBRARY; T=0.K  
Photon emission for (n,2np)

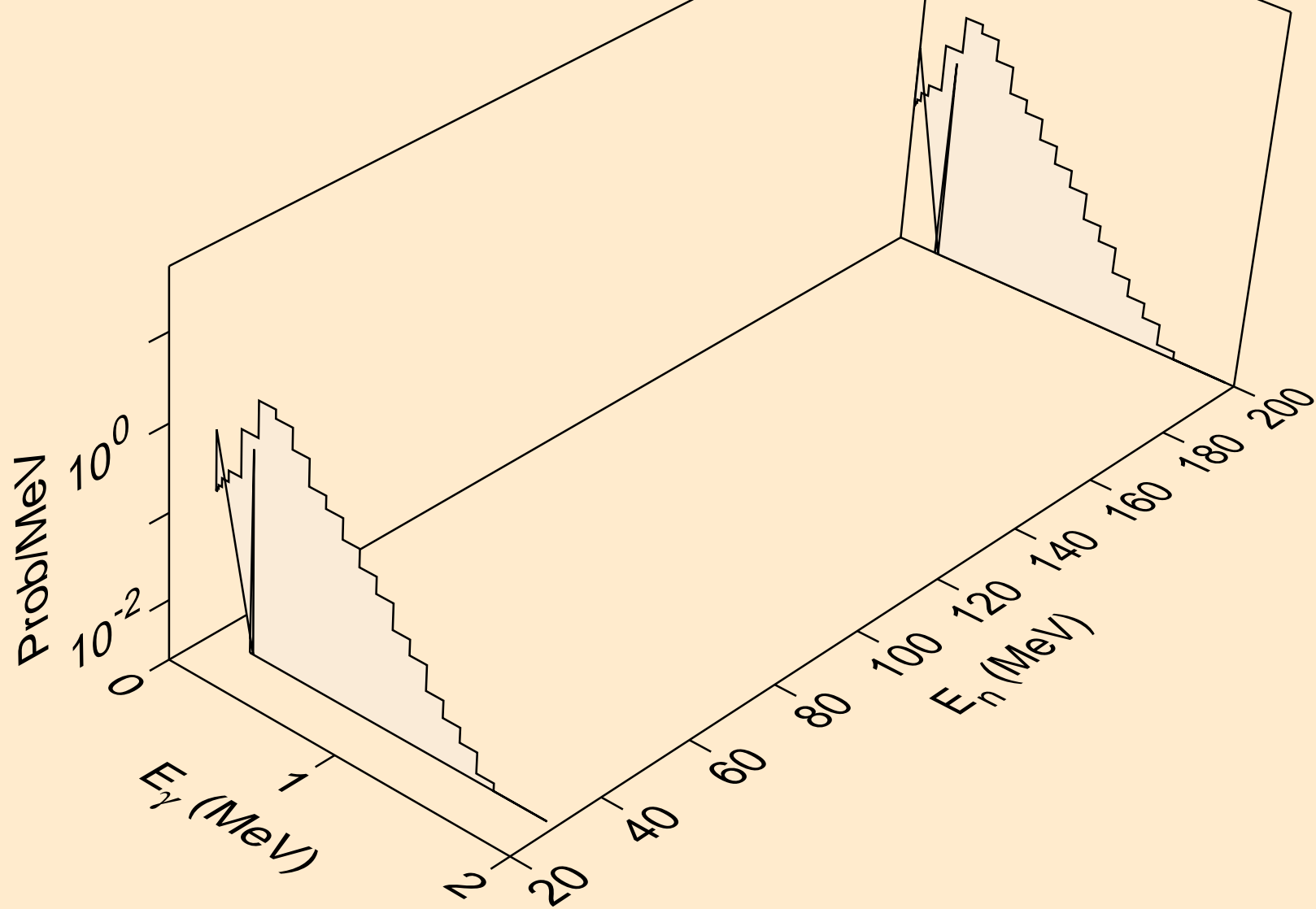



BA116 HELION ACER TENDL-2021 LIBRARY; T=0.K  
Photon emission for (n,2np)

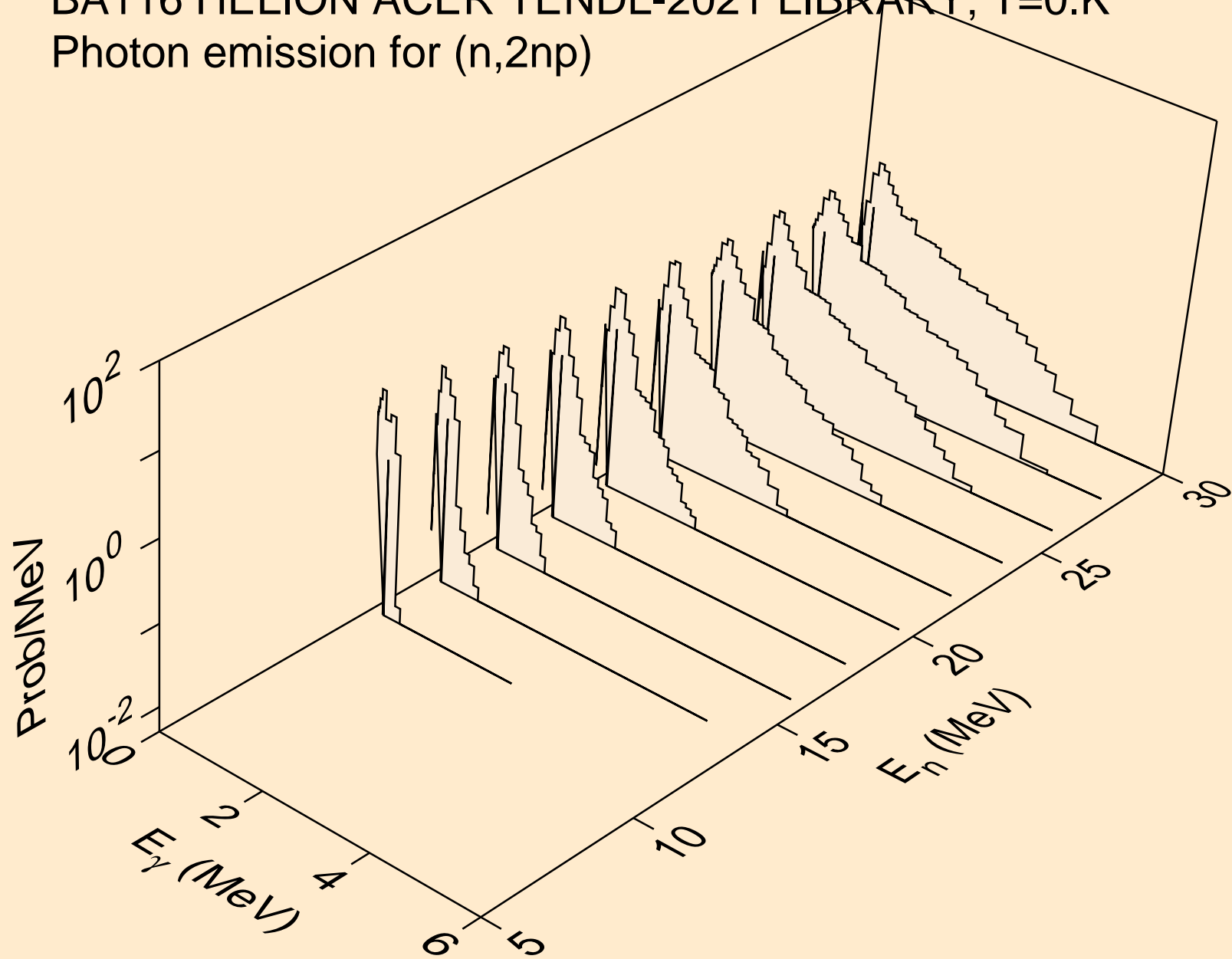

BA116 HELION ACER TENDL-2021 LIBRARY; T=0.K  
Photon emission for (n,npa)

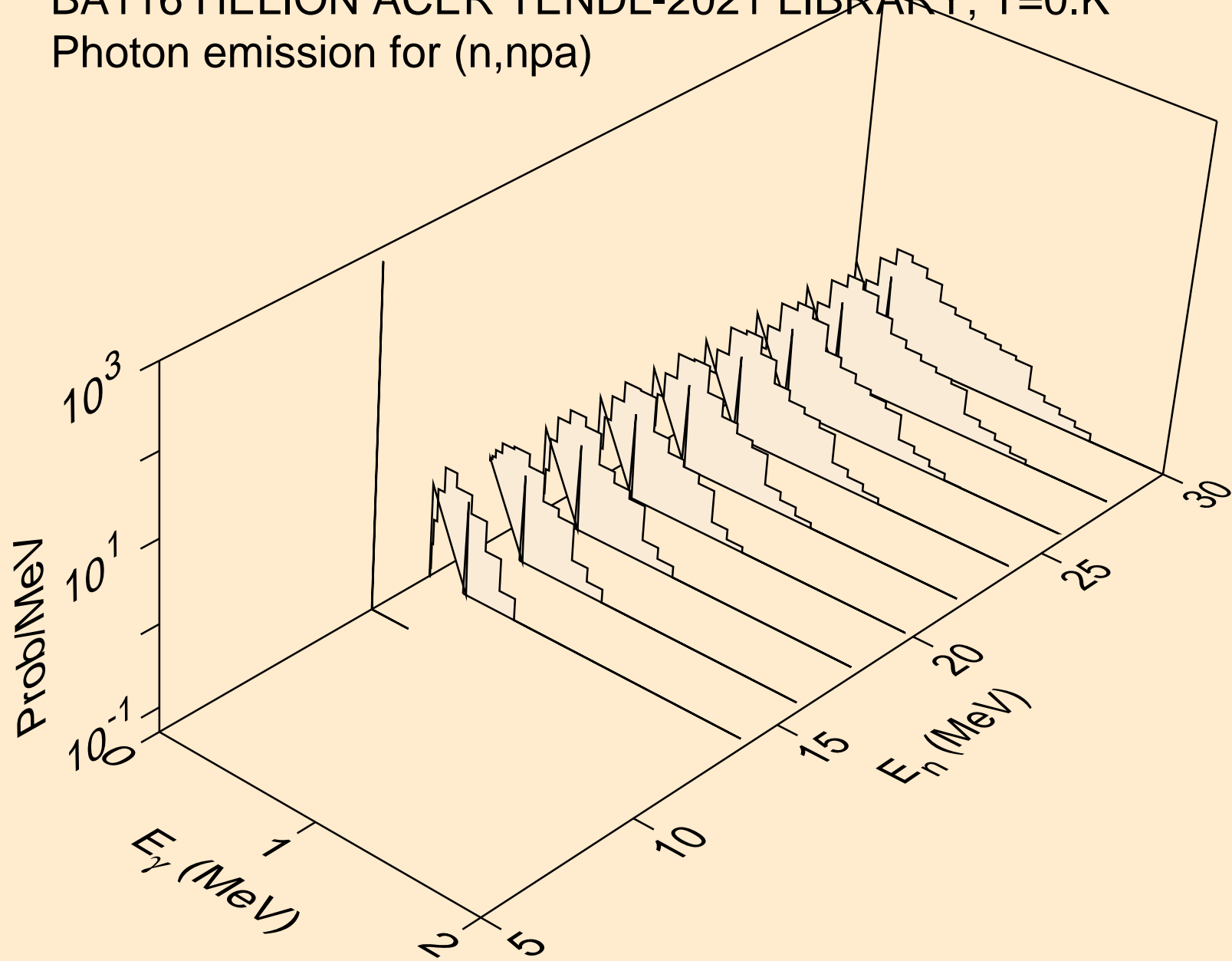

BA116 HELION ACER TENDL-2021 LIBRARY; T=0.K  
Photon emission for (n,gma)

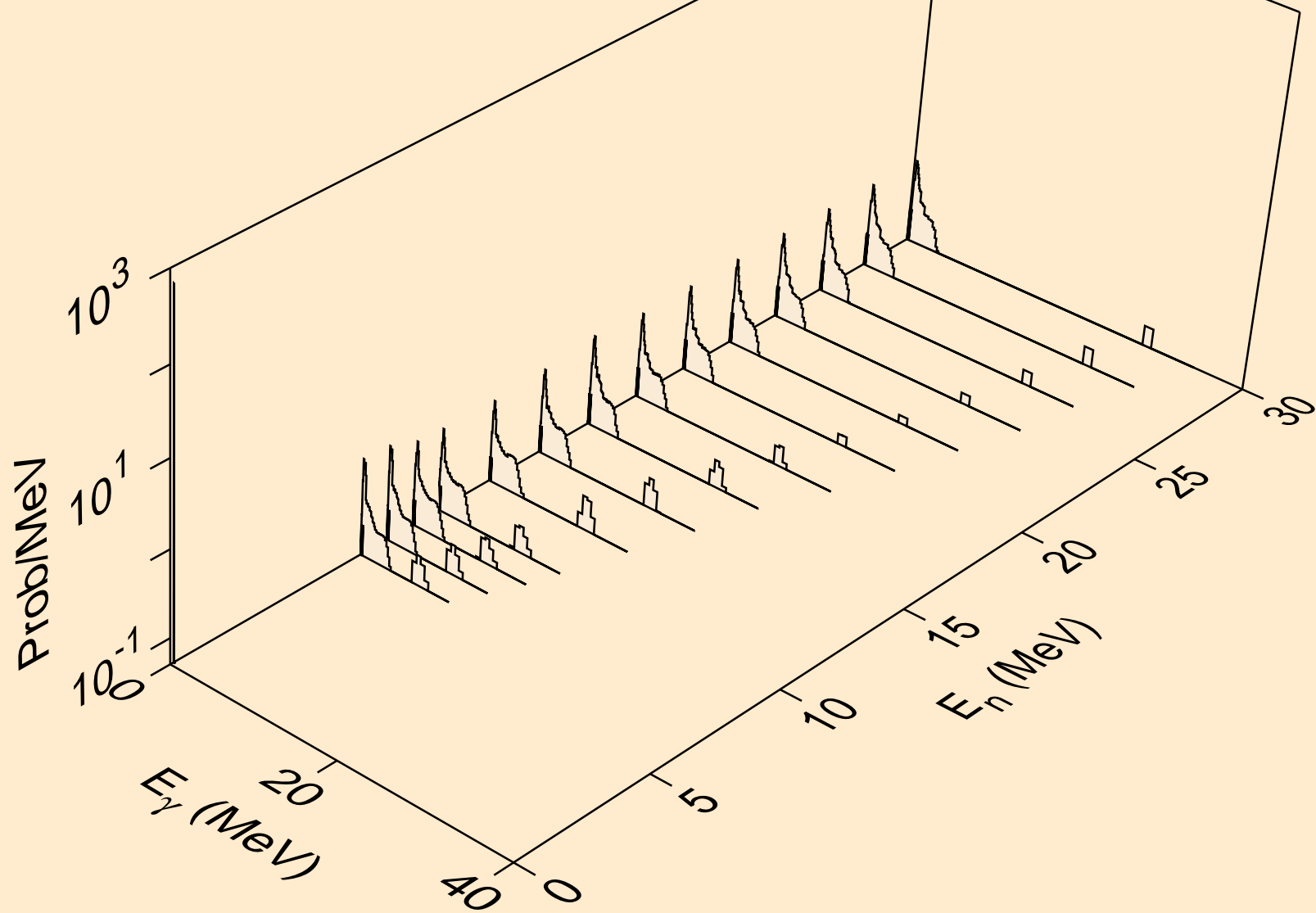

BA116 HELION ACER TENDL-2021 LIBRARY; T=0.K  
Photon emission for (n,p)

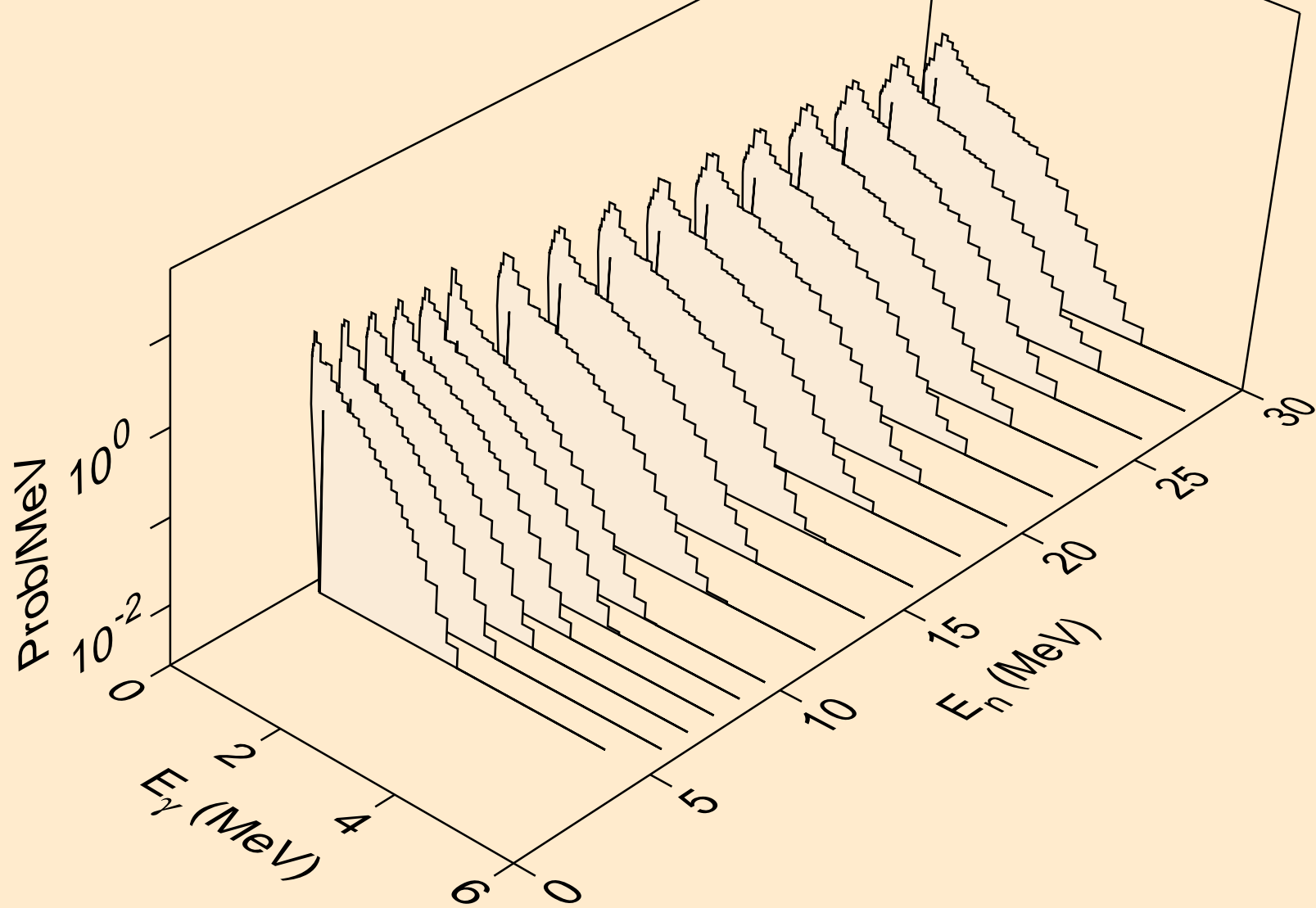

BA116 HELION ACER TENDL-2021 LIBRARY; T=0.K  
Photon emission for (n,d)

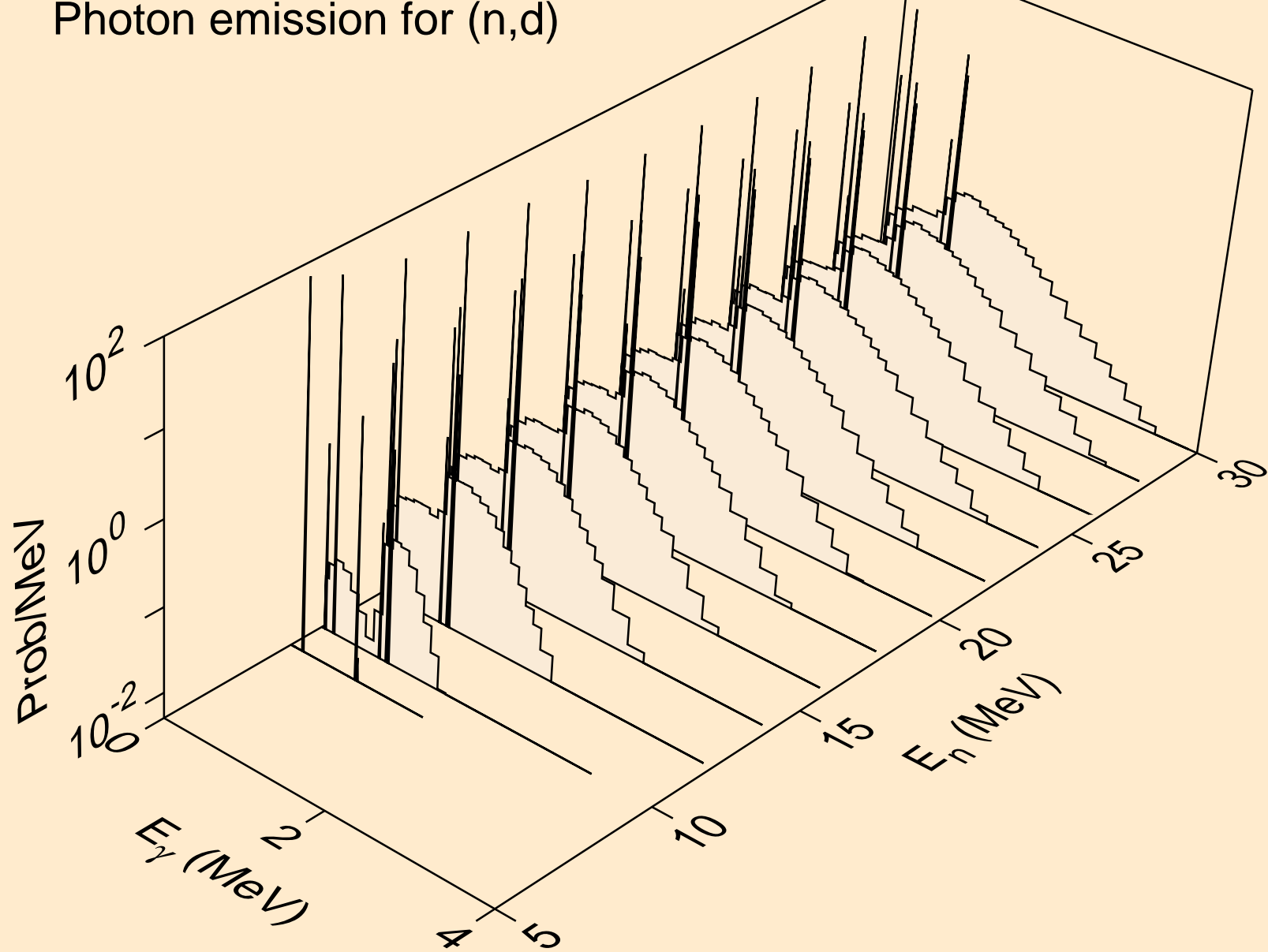

BA116 HELION ACER TENDL-2021 LIBRARY; T=0.K  
Photon emission for (n,t)

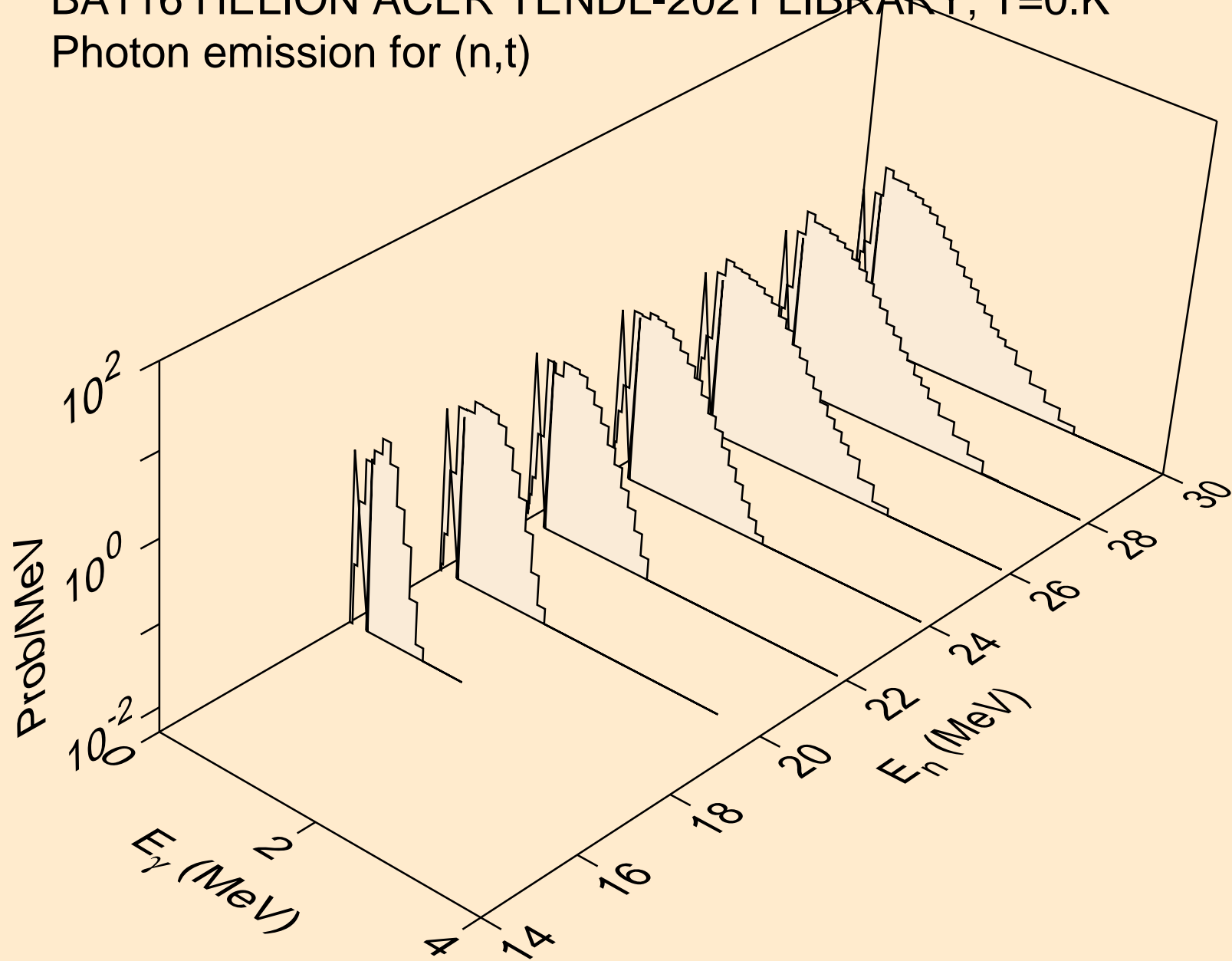

BA116 HELION ACER TENDL-2021 LIBRARY; T=0.K  
Photon emission for inelastic

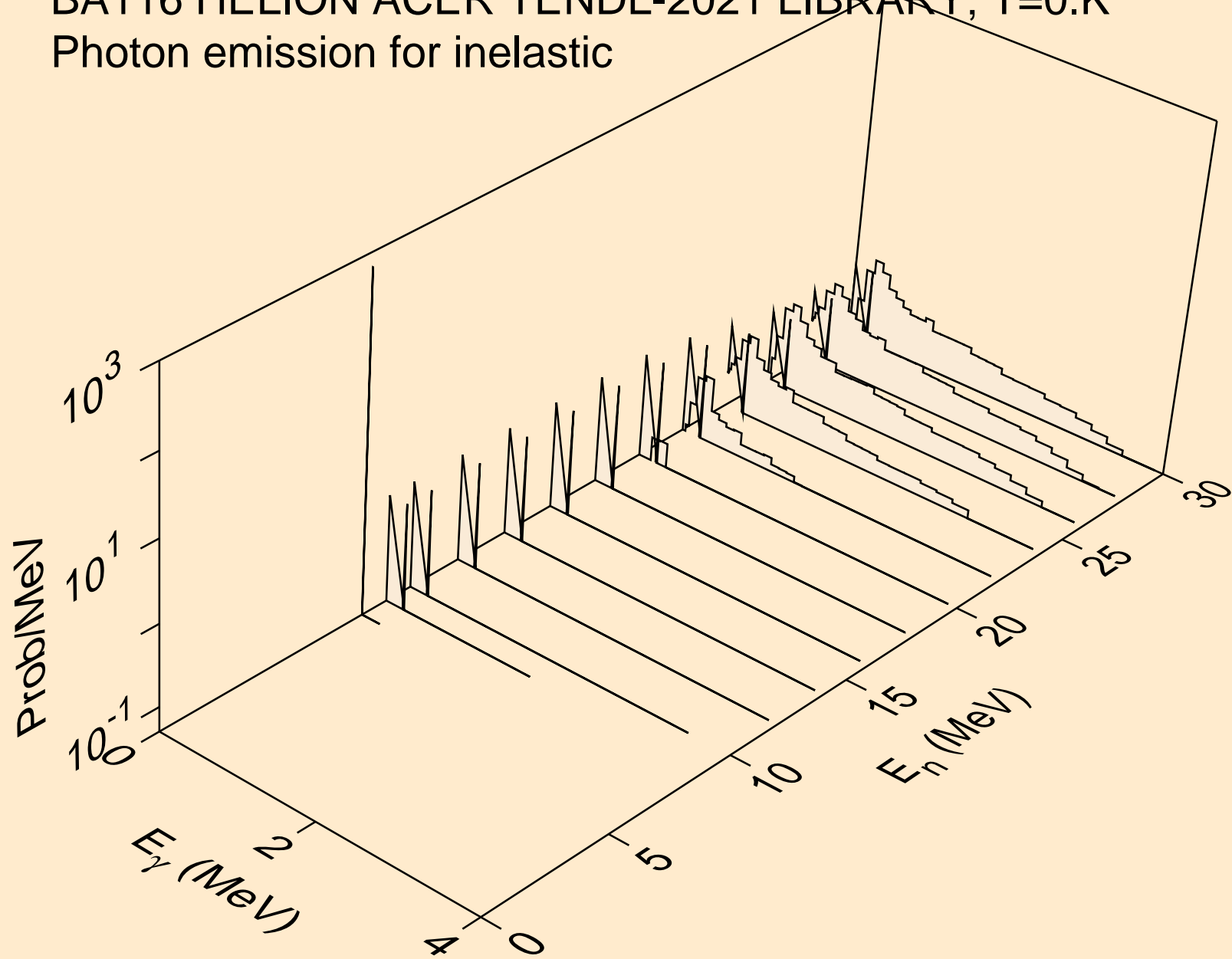

BA116 HELION ACER TENDL-2021 LIBRARY; T=0.K  
Photon emission for (n,a)

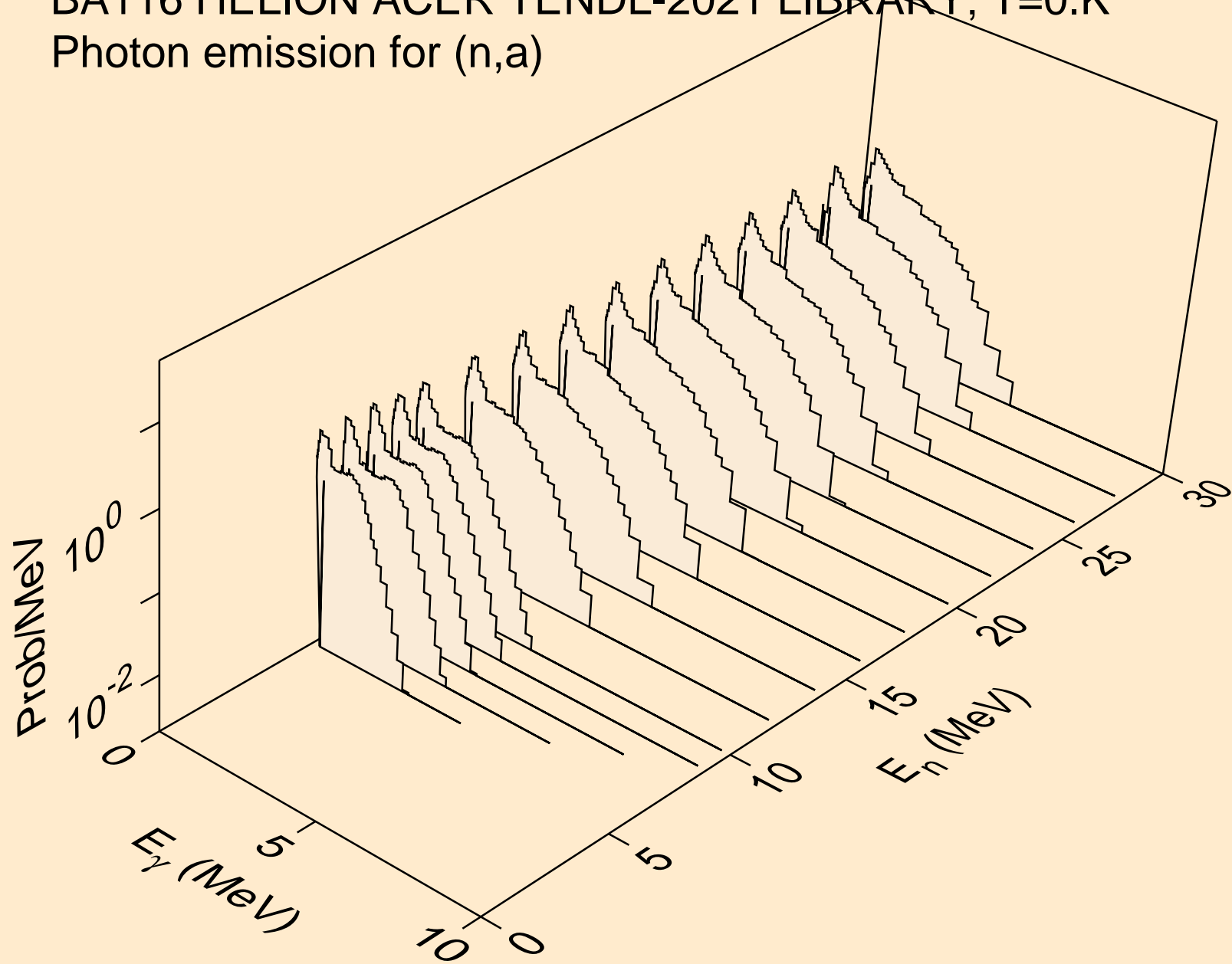



BA116 HELION ACER TENDL-2021 LIBRARY; T=0.K  
Photon emission for (n,2a)

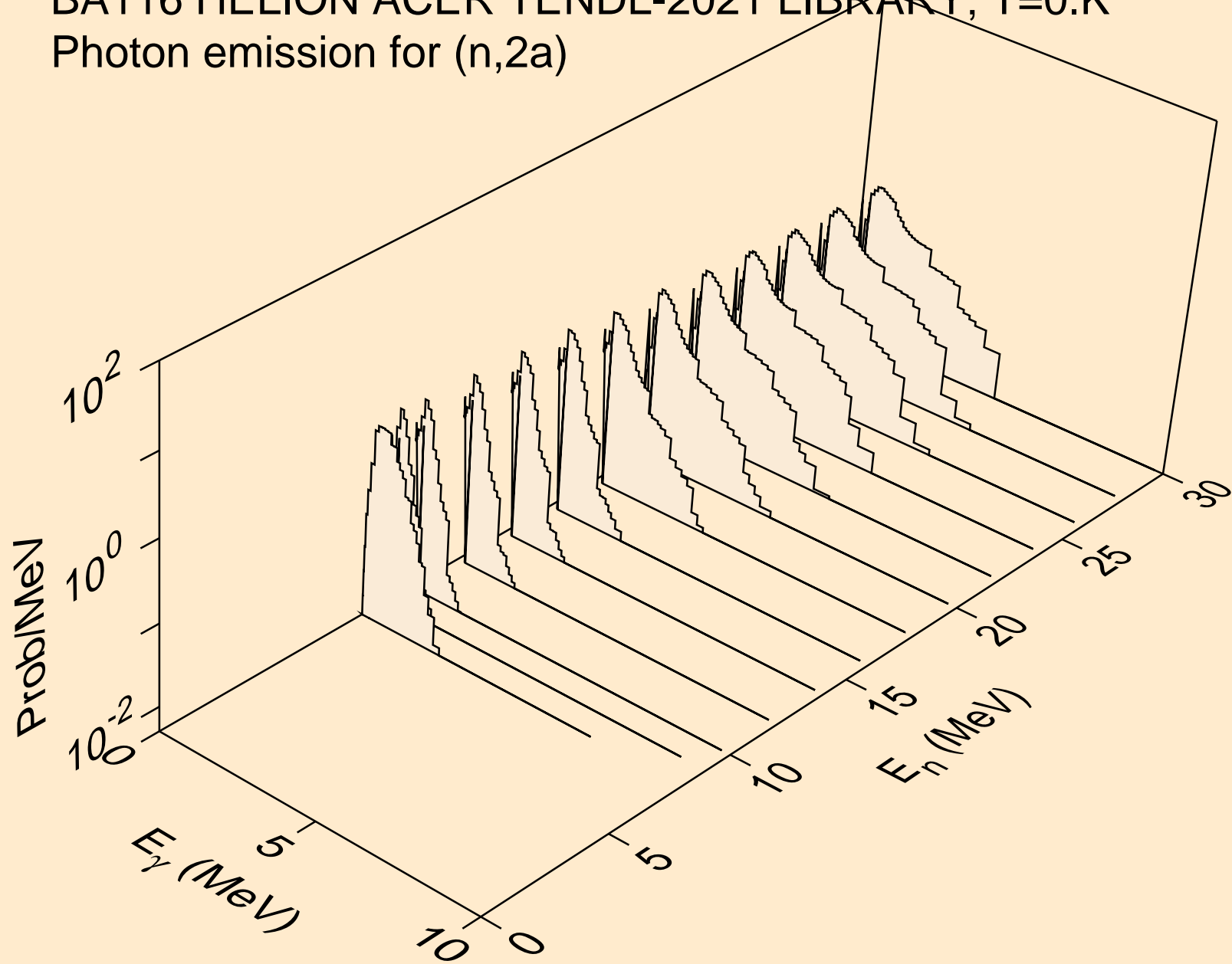

BA116 HELION ACER TENDL-2021 LIBRARY; T=0.K  
Photon emission for (n,3a)

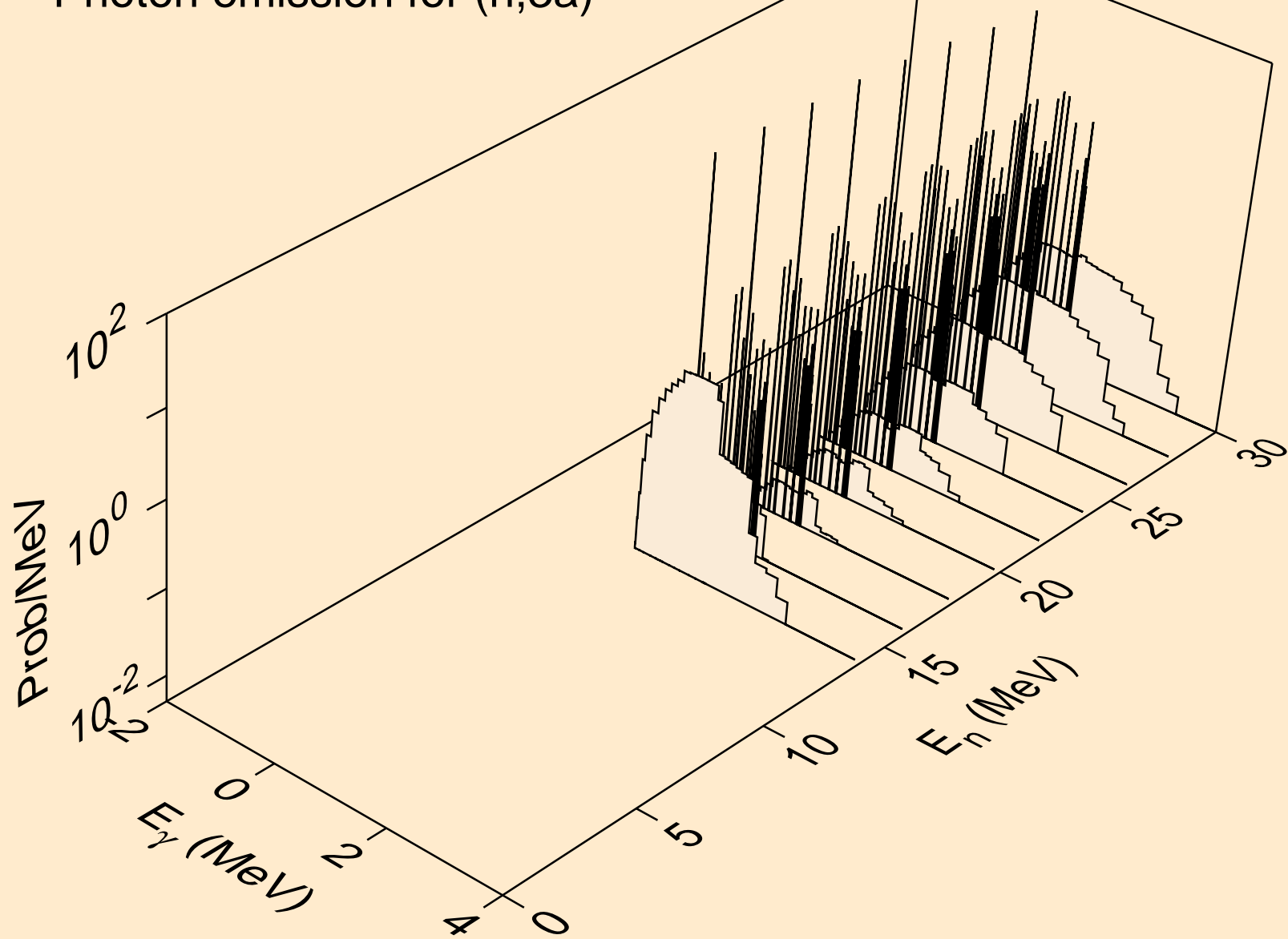

BA116 HELION ACER TENDL-2021 LIBRARY; T=0.K  
Photon emission for (n,2p)

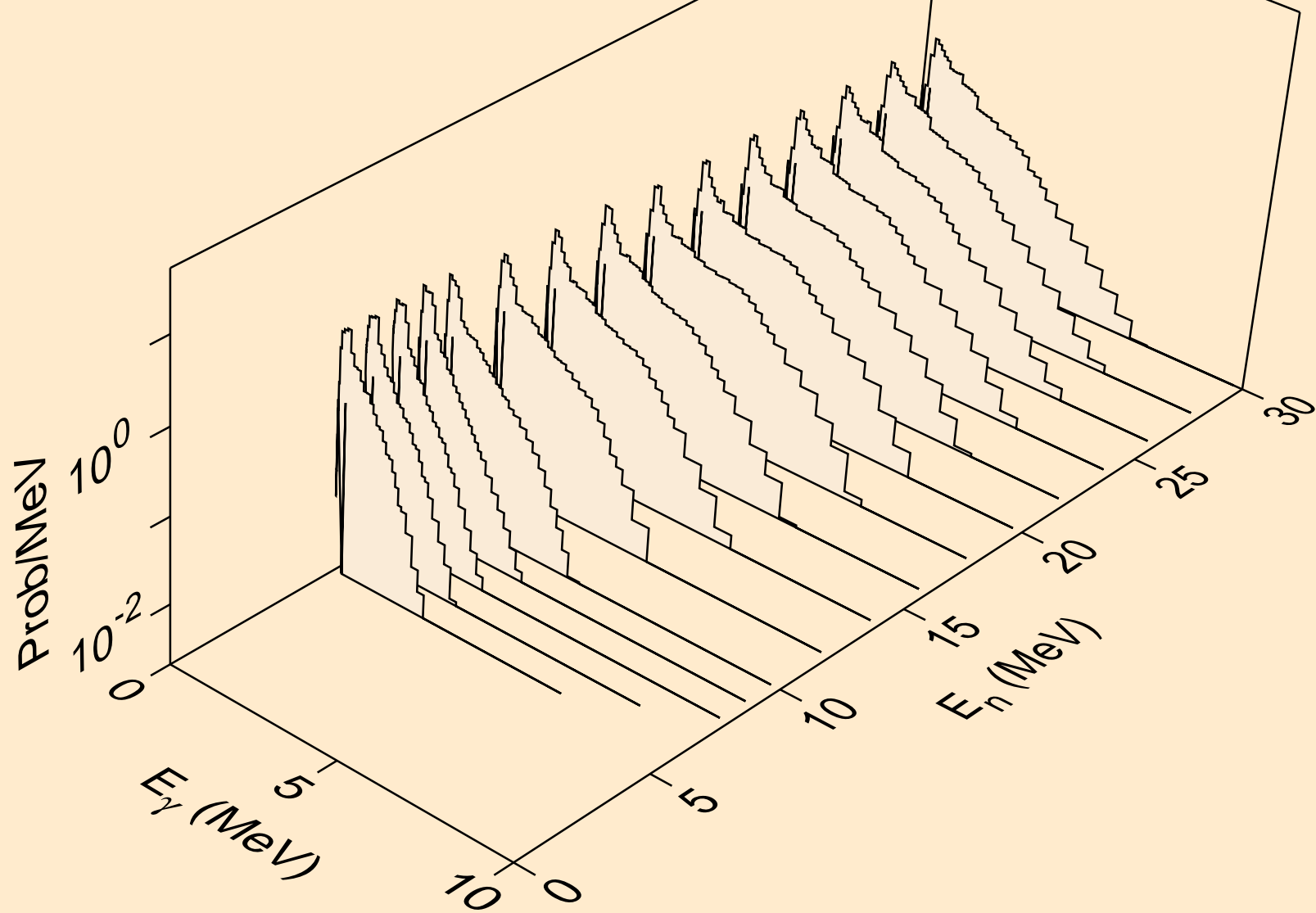

BA116 HELION ACER TENDL-2021 LIBRARY; T=0.K  
Photon emission for (n,pa)

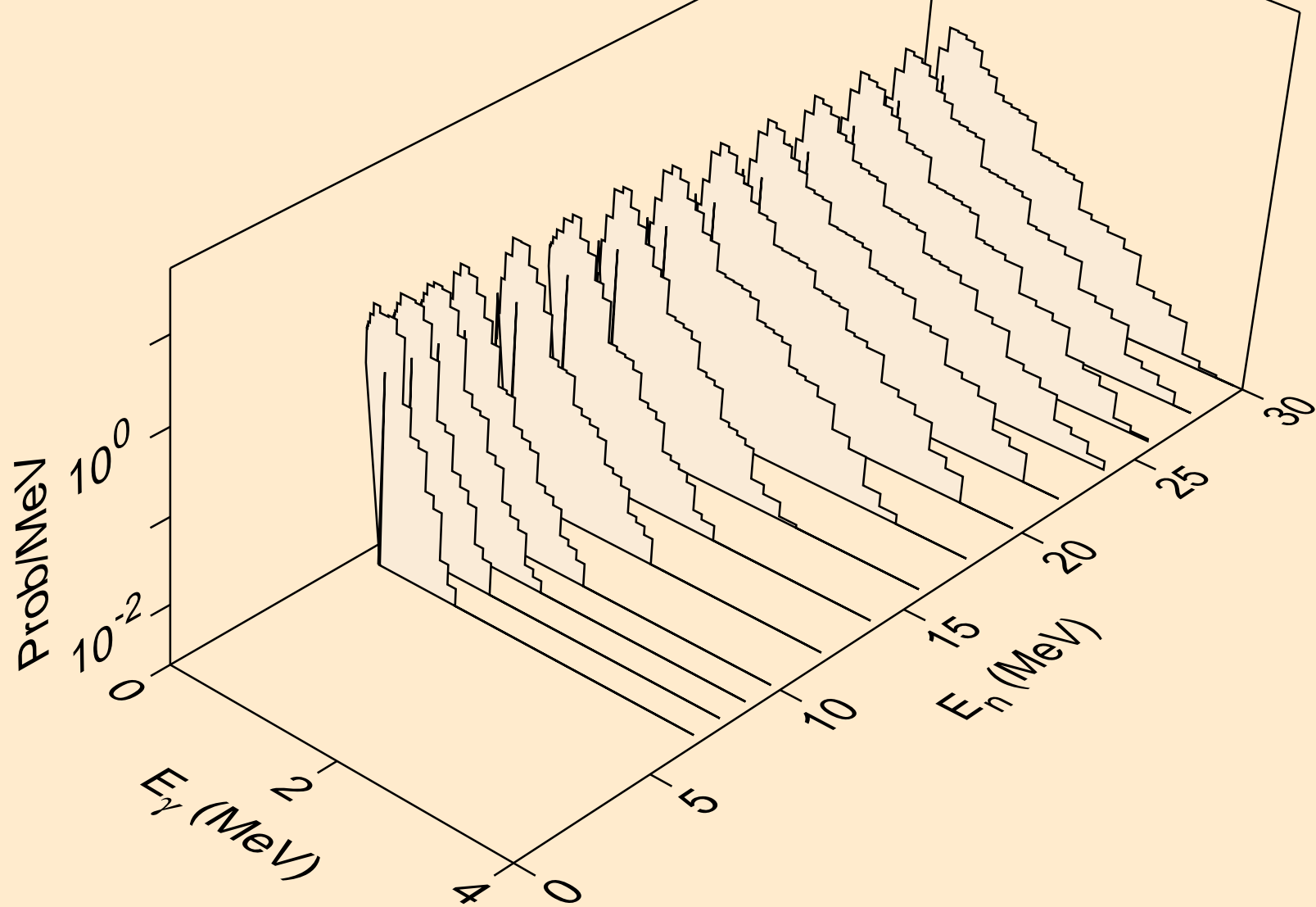

BA116 HELION ACER TENDL-2021 LIBRARY; T=0.K  
Photon emission for (n,pd)

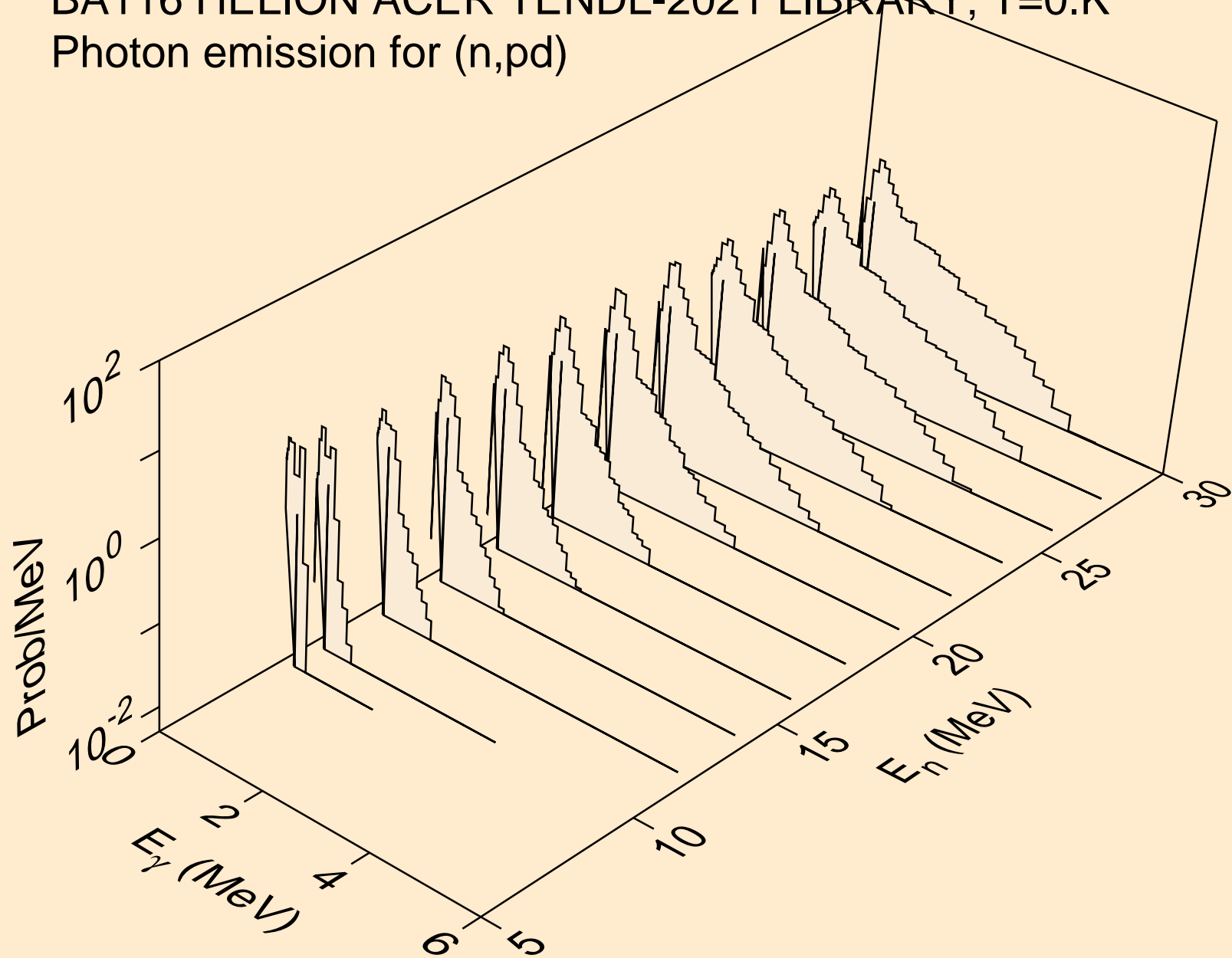

BA116 HELION ACER TENDL-2021 LIBRARY; T=0.K  
Photon emission for (n,pt)

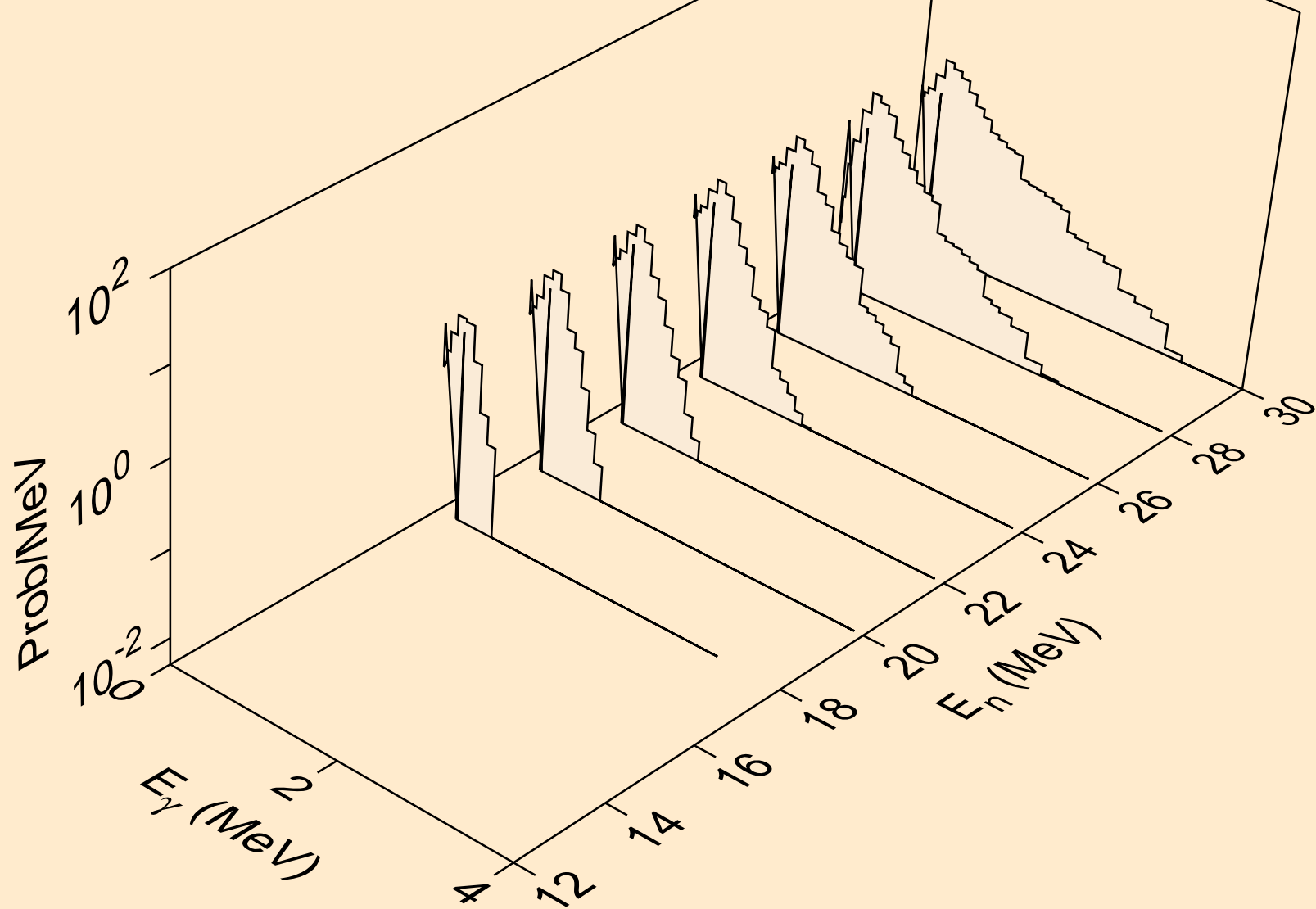

BA116 HELION ACER TENDL-2021 LIBRARY; T=0.K  
Photon emission for (n,da)

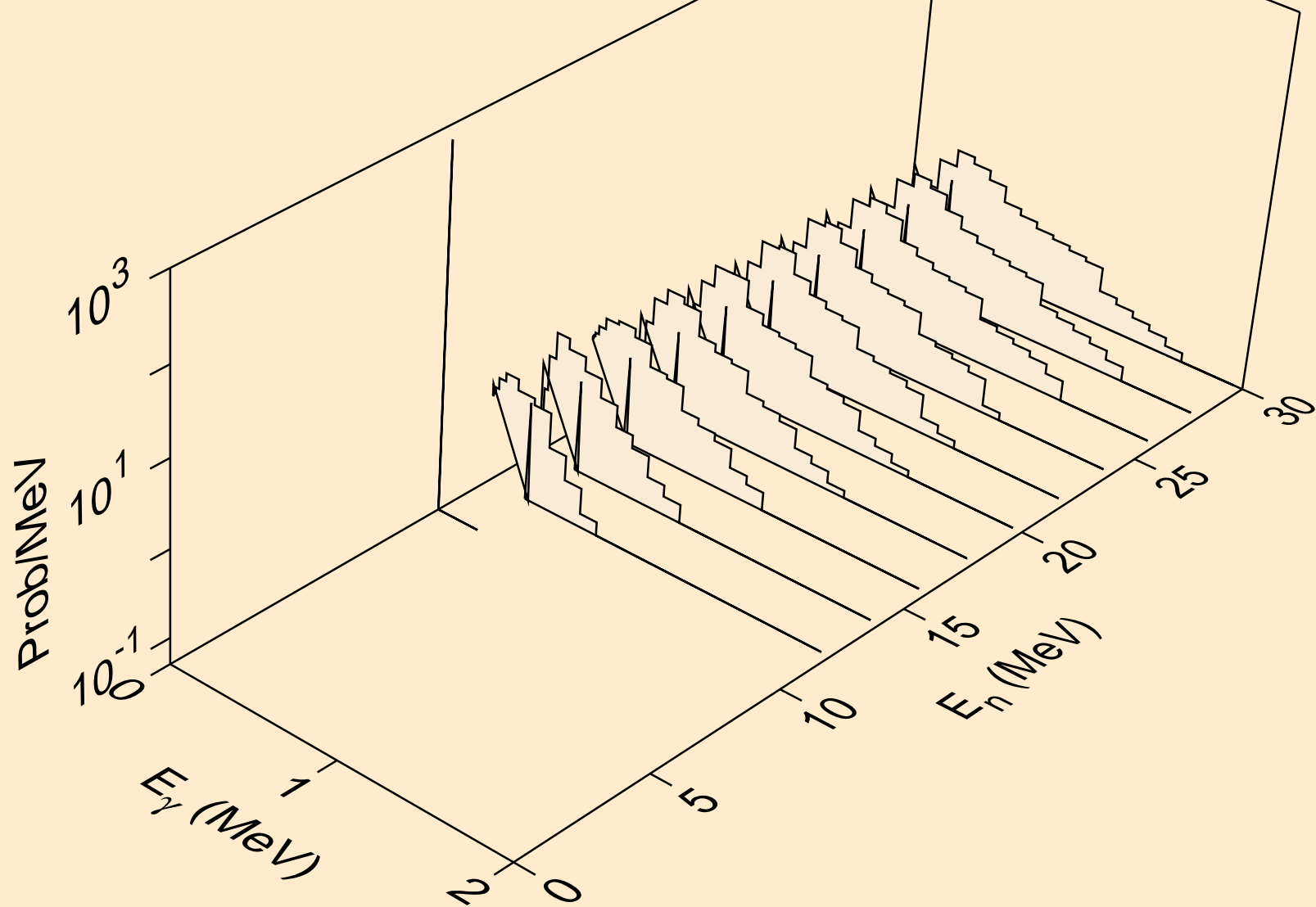

BA116 HELION ACER TENDL-2021 LIBRARY; T=0.K  
Particle heating contributions

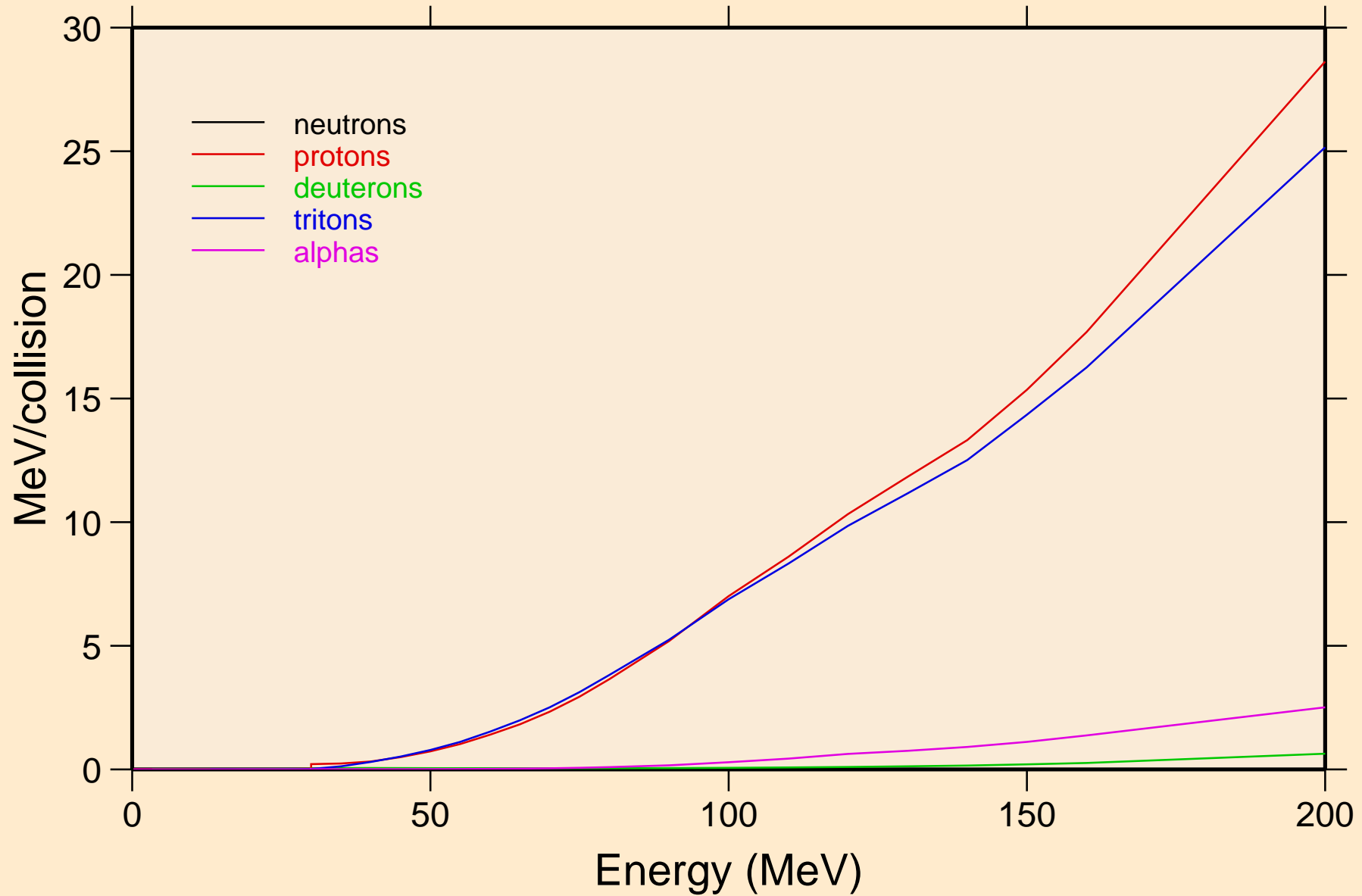



BA116 HELION ACER TENDL-2021 LIBRARY; T=0.K  
Recoil Heating

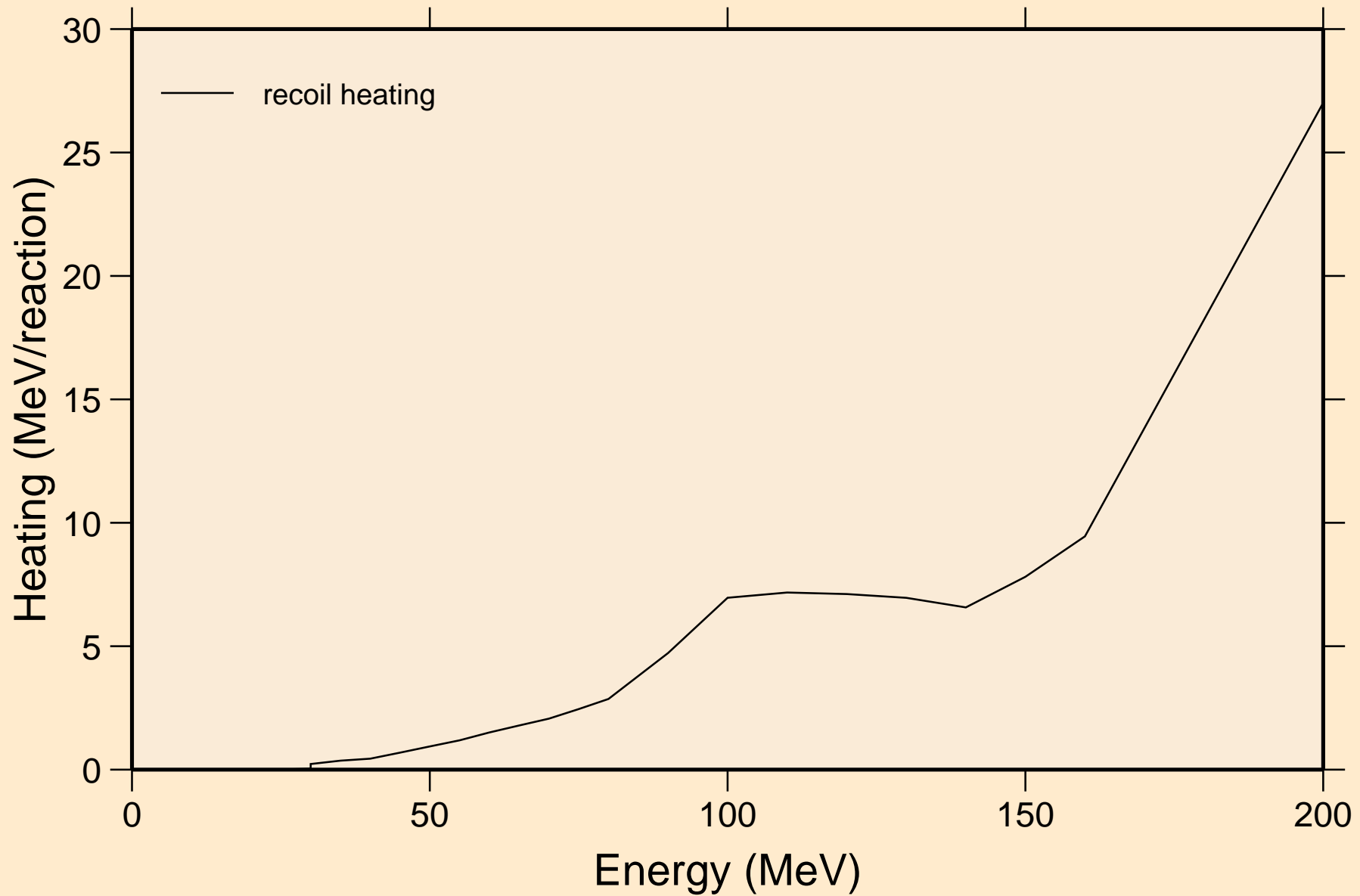

BA116 HELION ACER TENDL-2021 LIBRARY; T=0.K  
Particle production cross sections

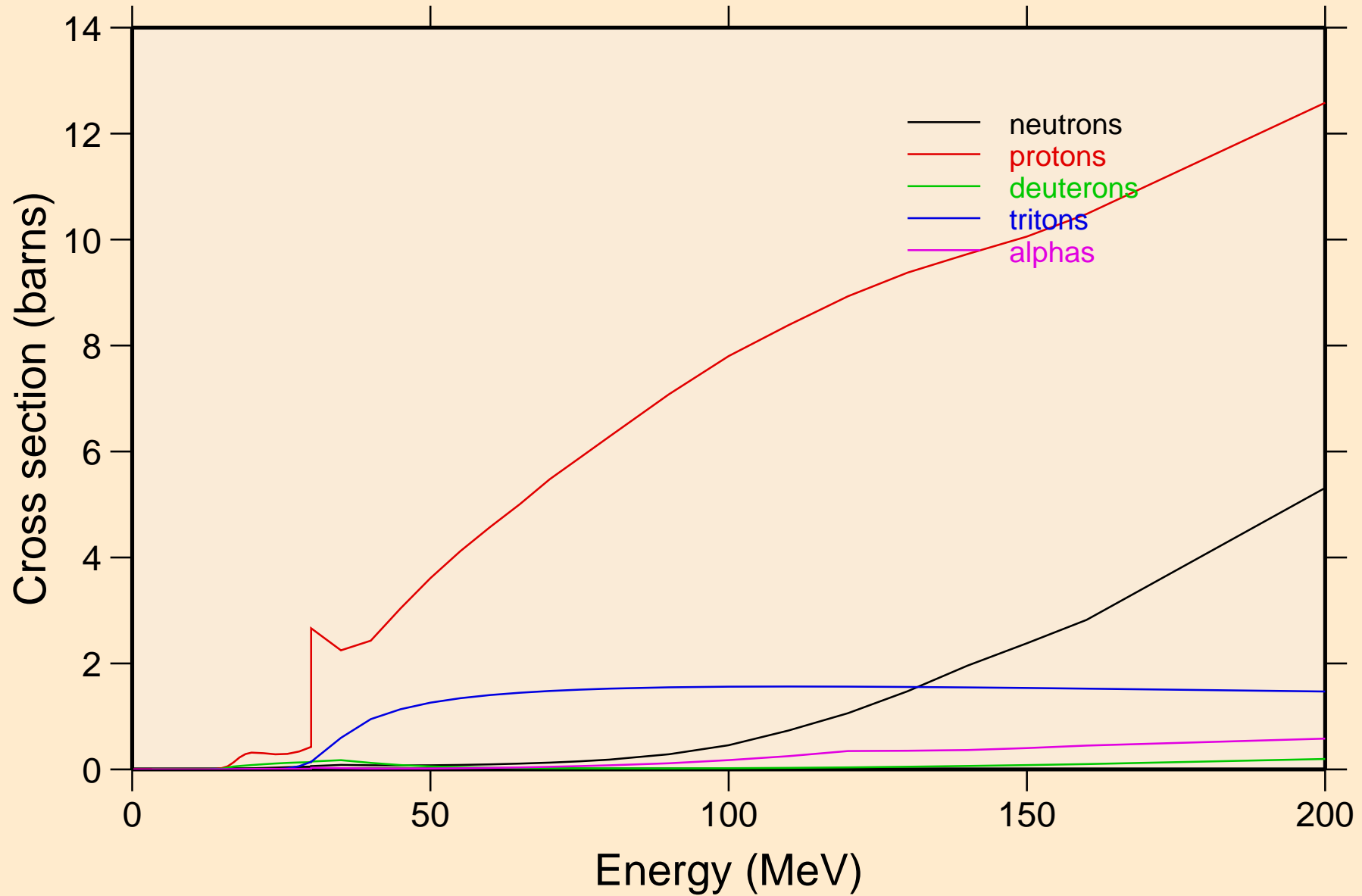

BA116 HELION ACER TENDL-2021 LIBRARY; T=0.K  
neutrons from (s,n)

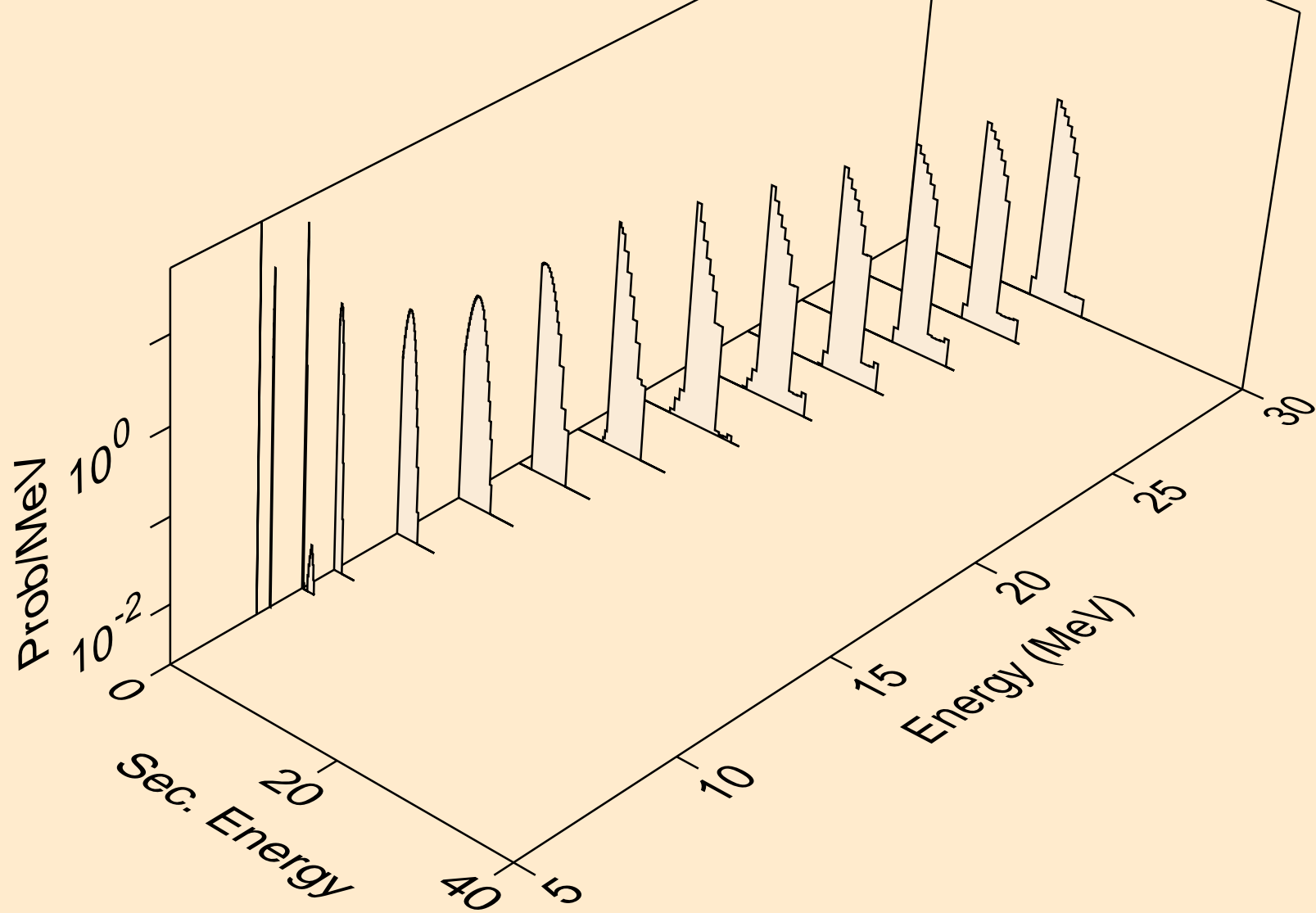

BA116 HELION ACER TENDL-2021 LIBRARY; T=0.K  
neutrons from (s,x)

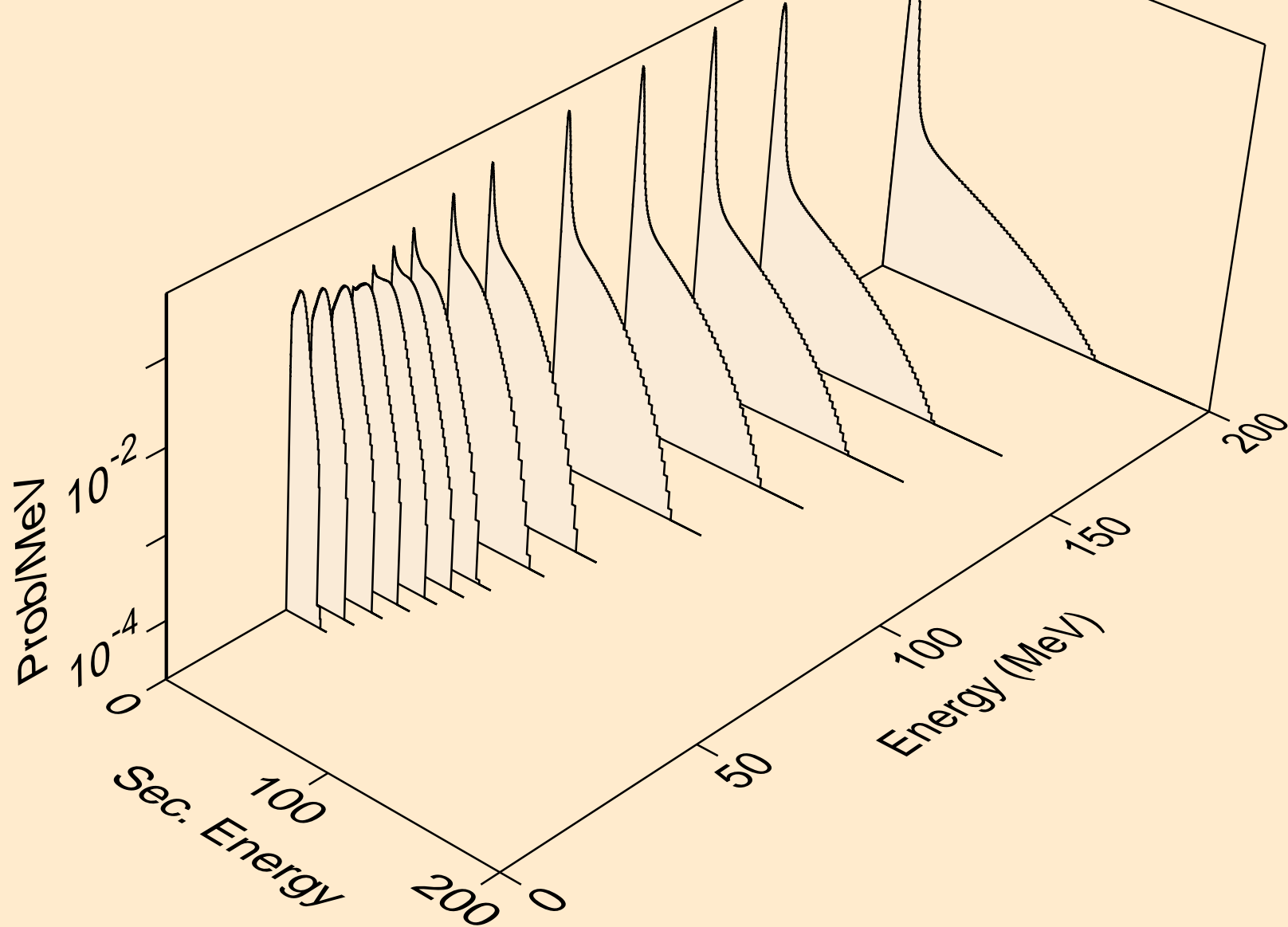

BA116 HELION ACER TENDL-2021 LIBRARY; T=0.K  
neutrons from (s,2n)

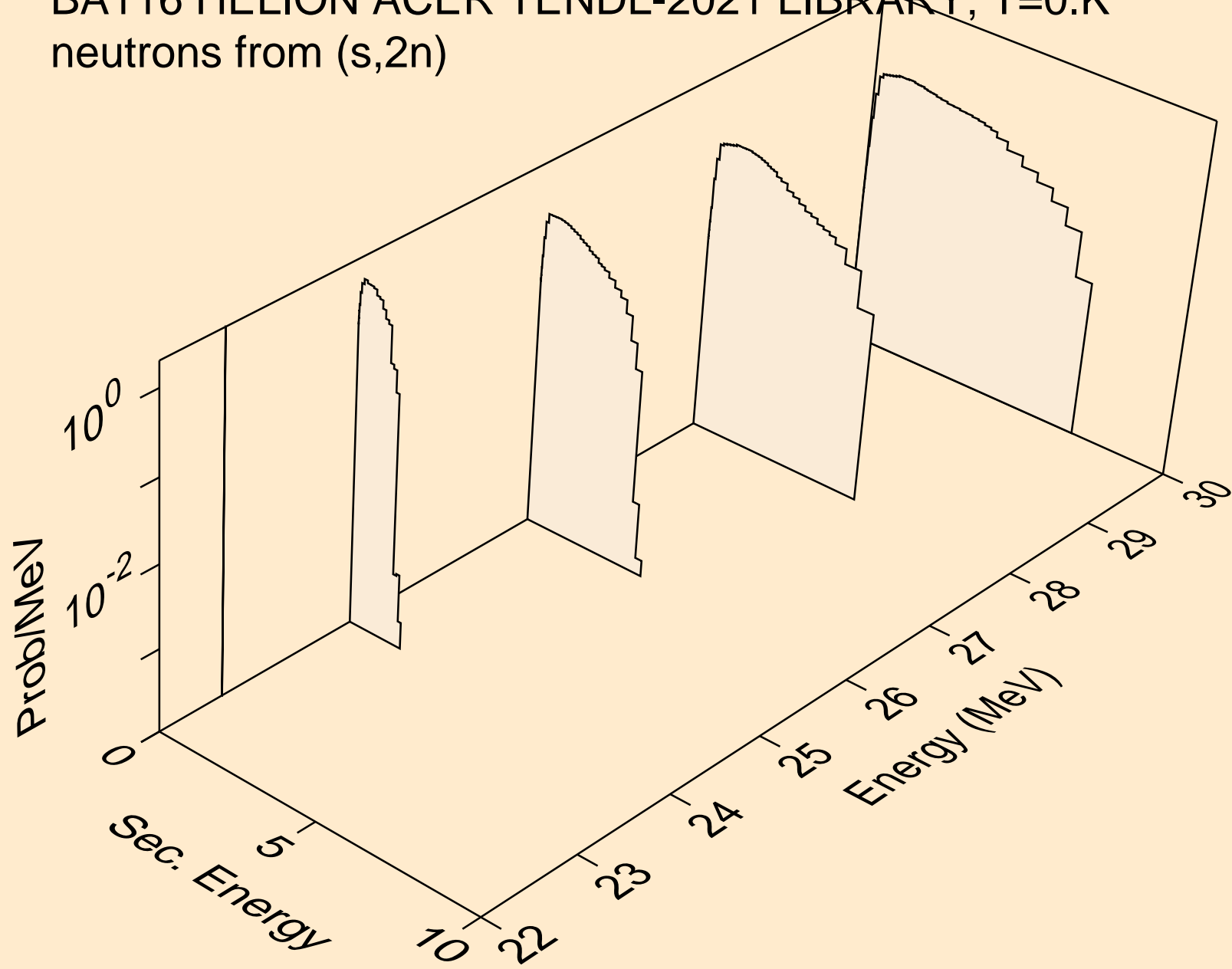

BA116 HELION ACER TENDL-2021 LIBRARY; T=0.K  
neutrons from (s,n\*)a

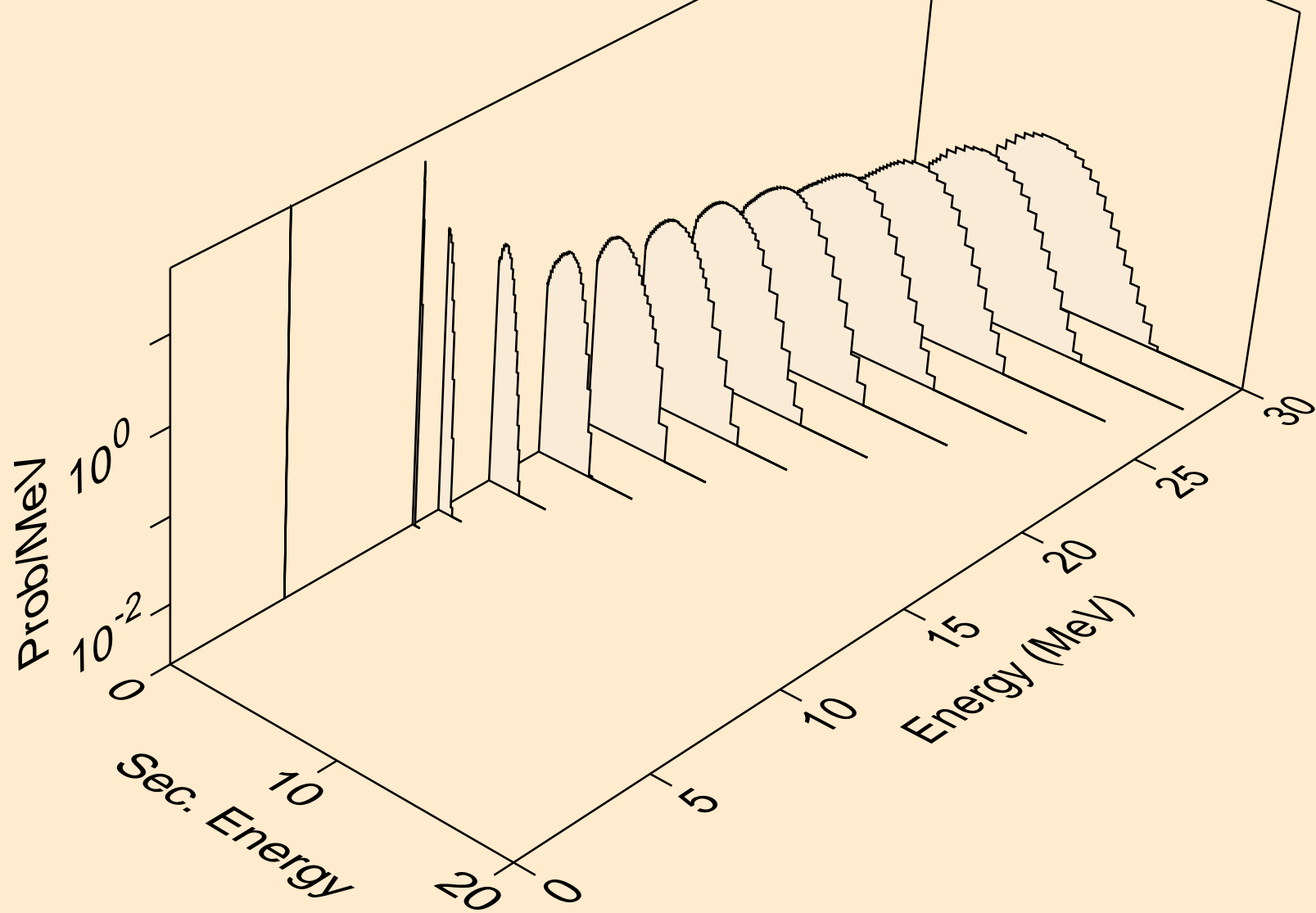

BA116 HELION ACER TENDL-2021 LIBRARY; T=0.K  
neutrons from (s,n\*)p

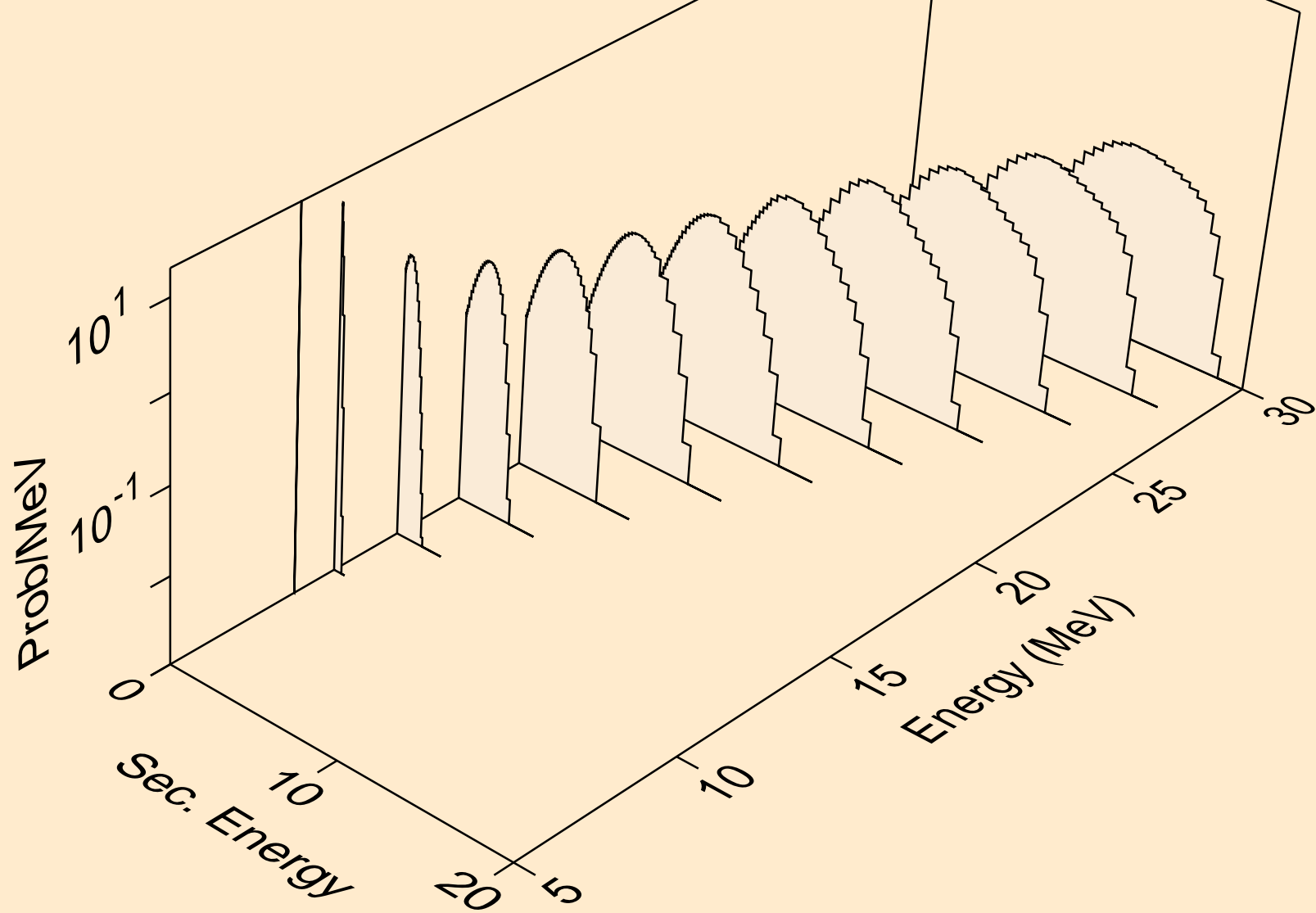

BA116 HELION ACER TENDL-2021 LIBRARY; T=0.K  
neutrons from (s,n\*)2a

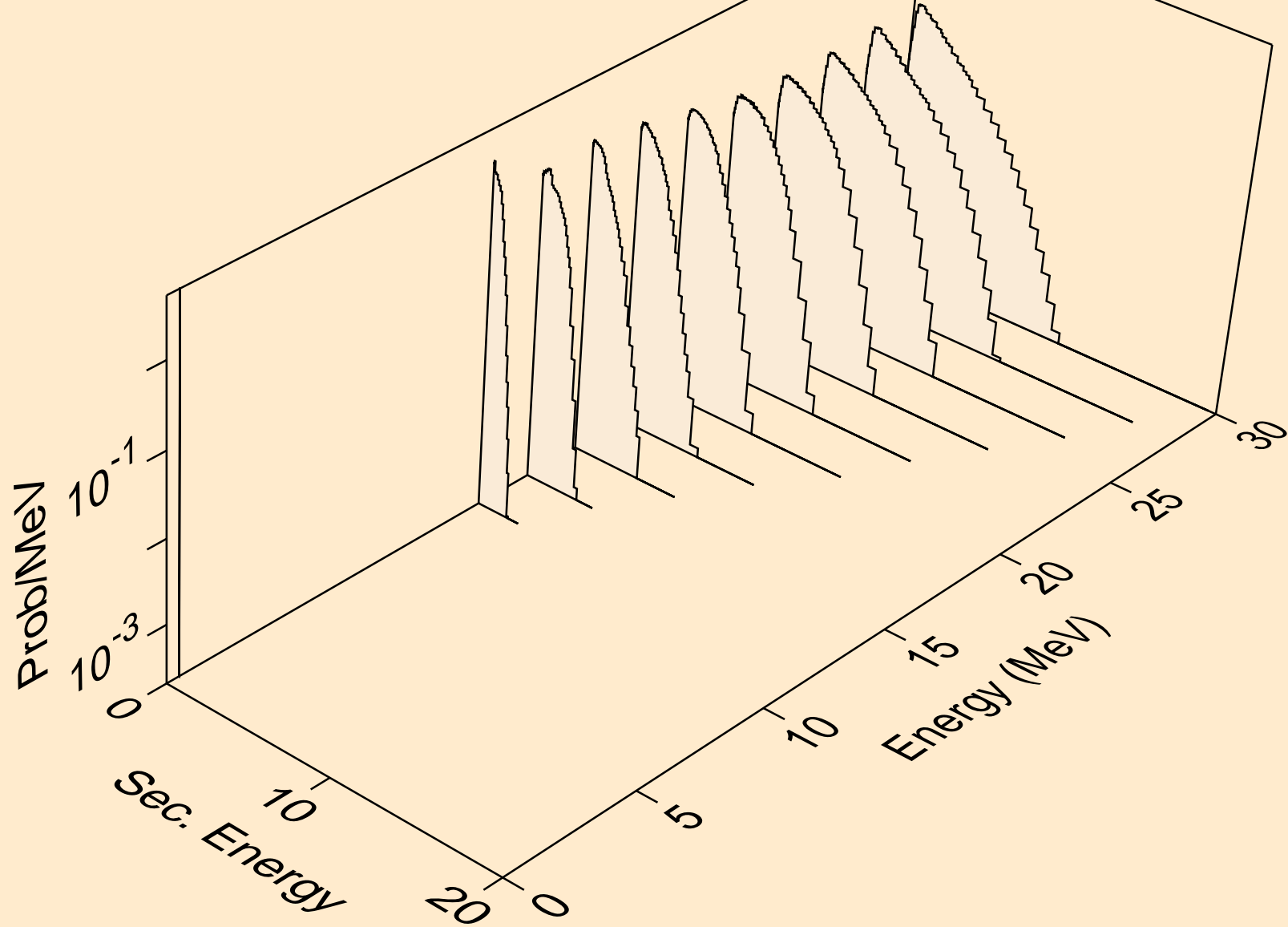



BA116 HELION ACER TENDL-2021 LIBRARY; T=0.K  
neutrons from (s,n\*)d

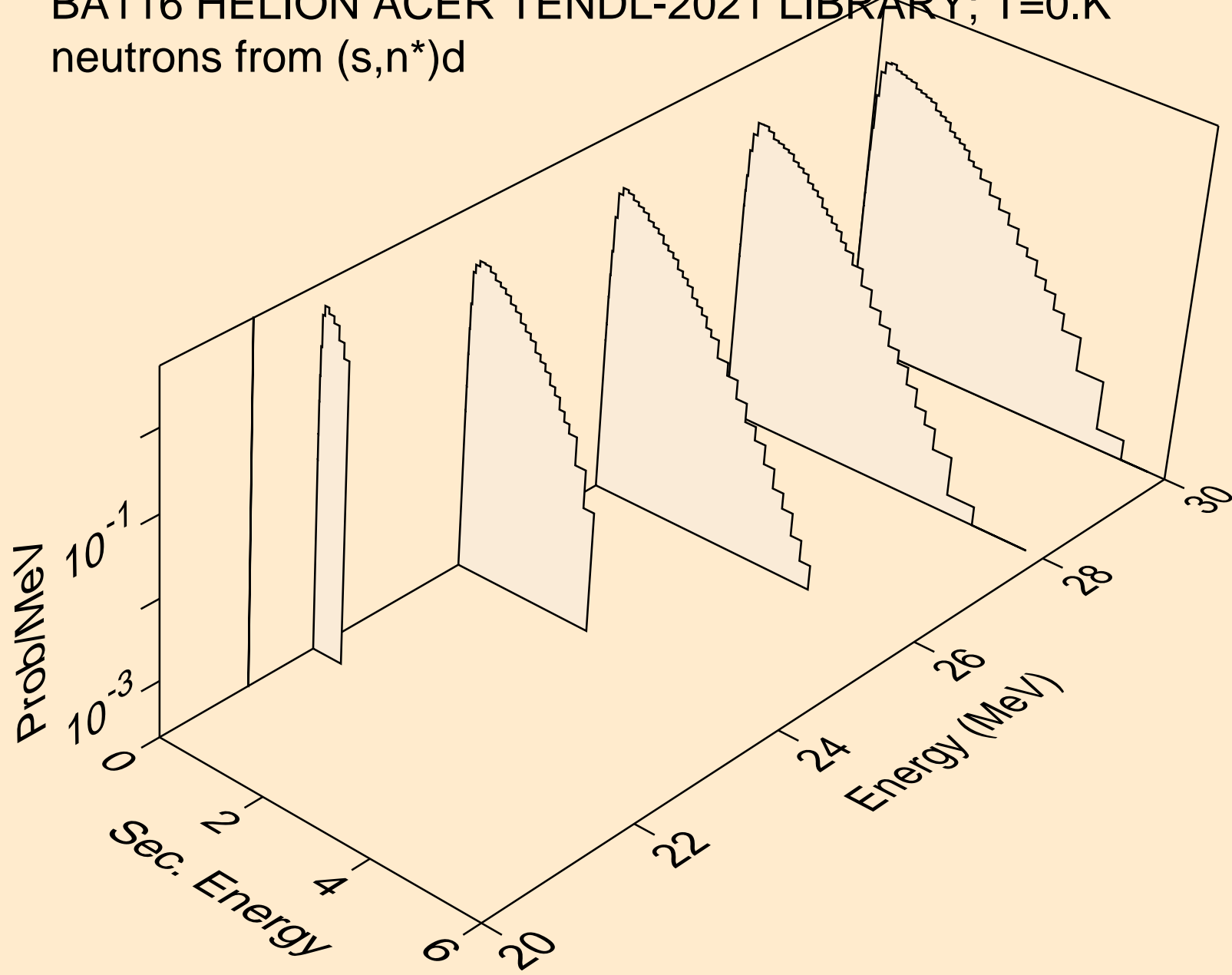

BA116 HELION ACER TENDL-2021 LIBRARY; T=0.K  
neutrons from (s,n\*)he3

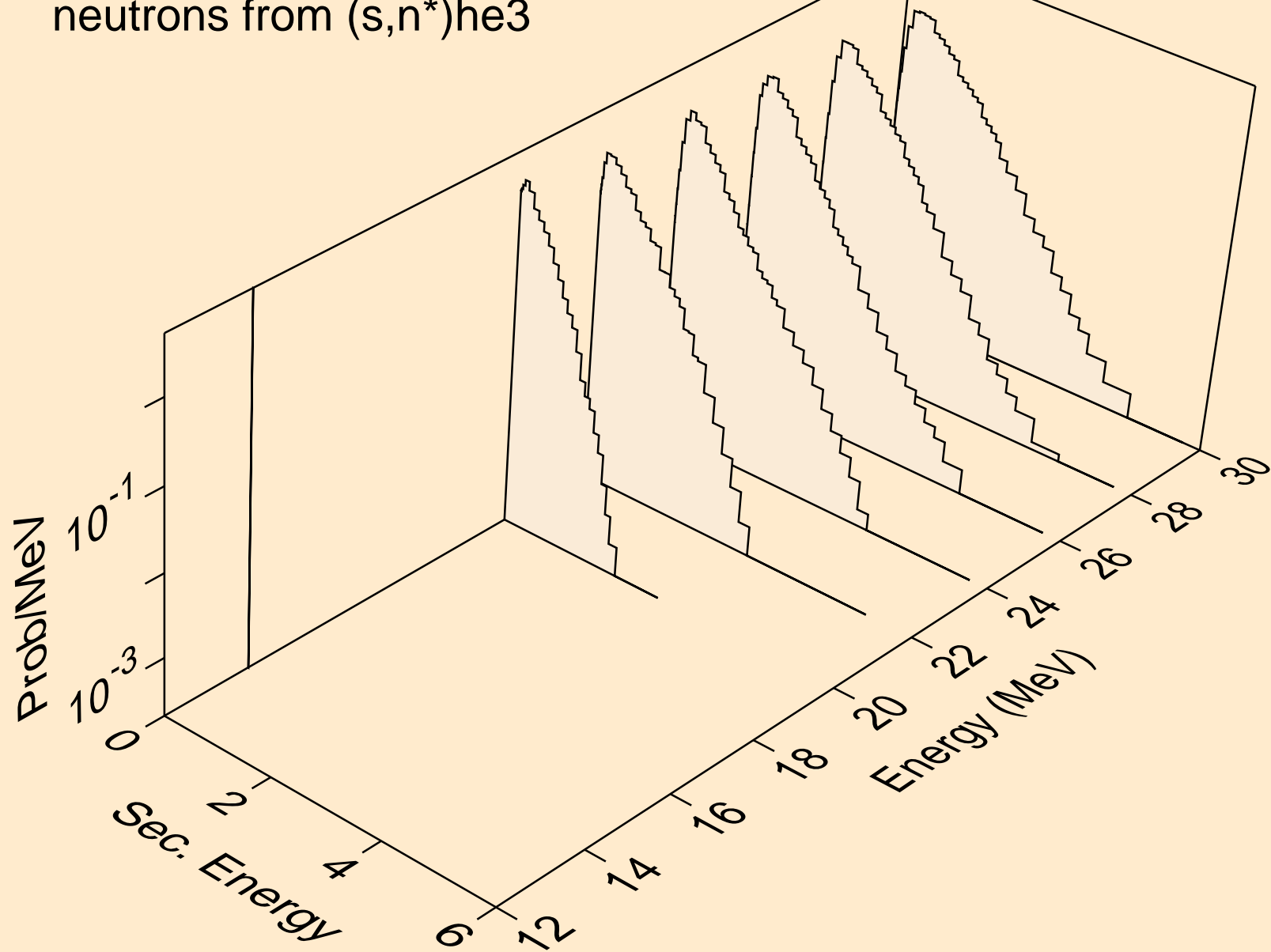

BA116 HELION ACER TENDL-2021 LIBRARY; T=0.K  
neutrons from (s,2np)

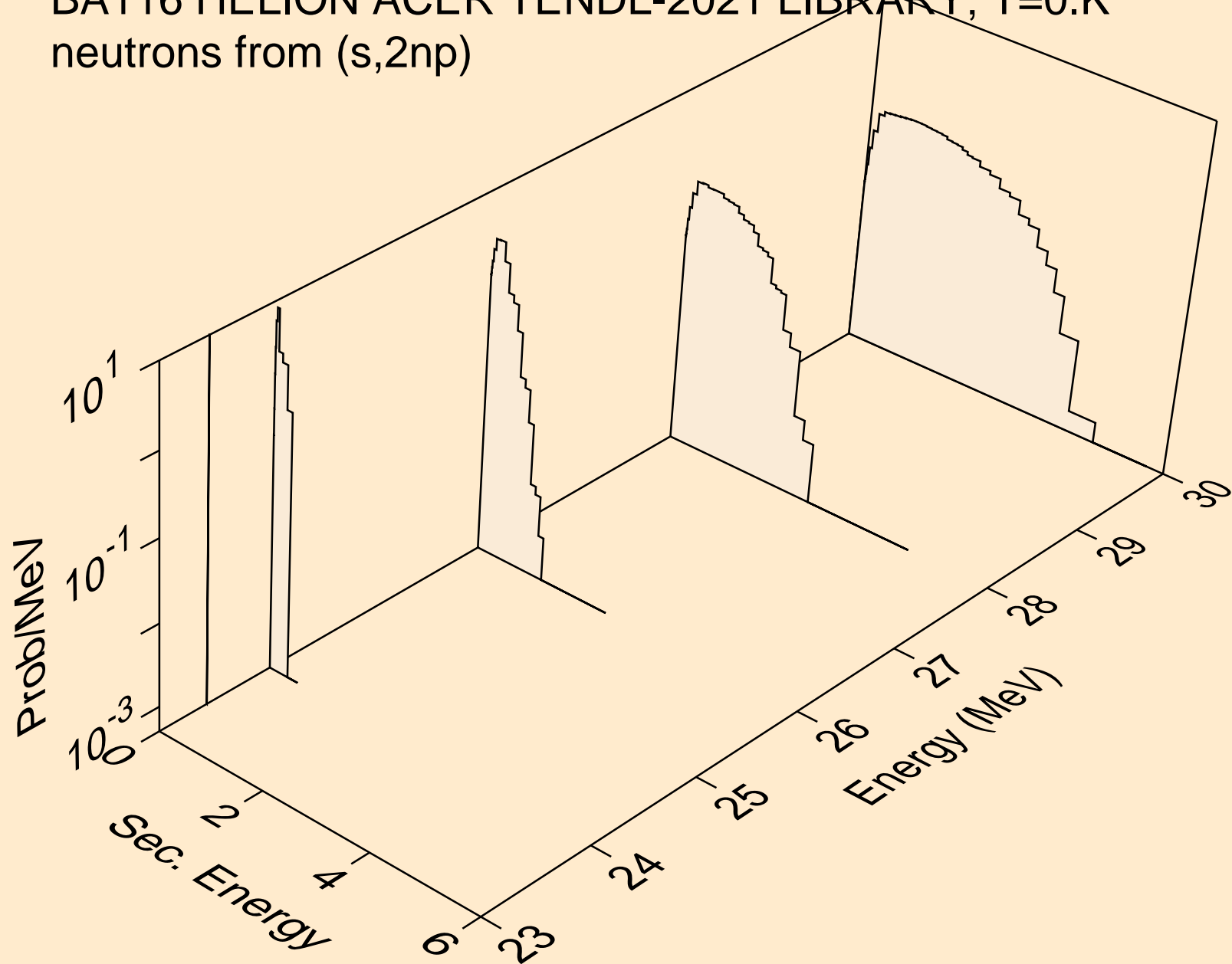

BA116 HELION ACER TENDL-2021 LIBRARY; T=0.K  
neutrons from (s,2np)

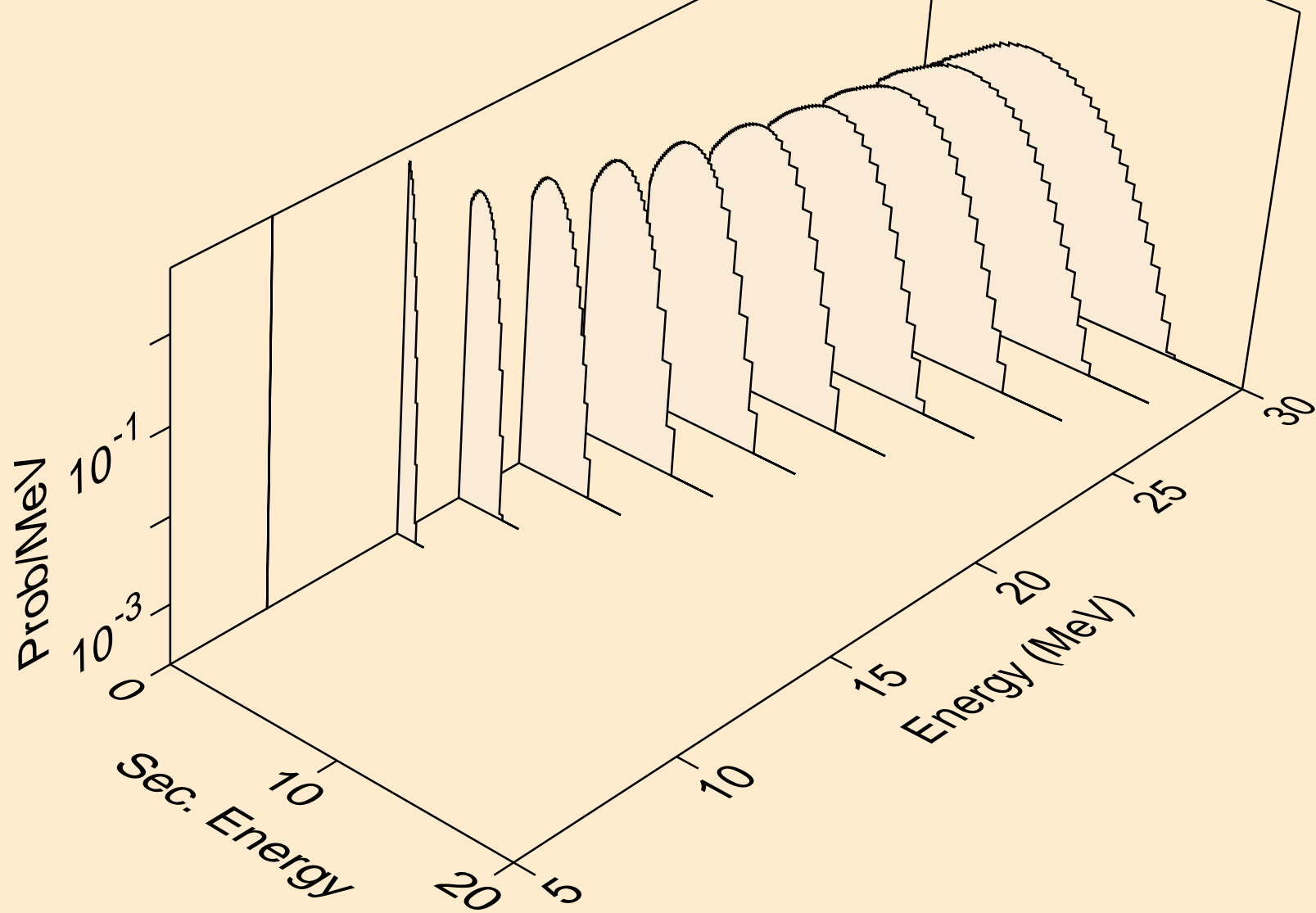

BA116 HELION ACER TENDL-2021 LIBRARY; T=0.K  
neutrons from (s,npa)

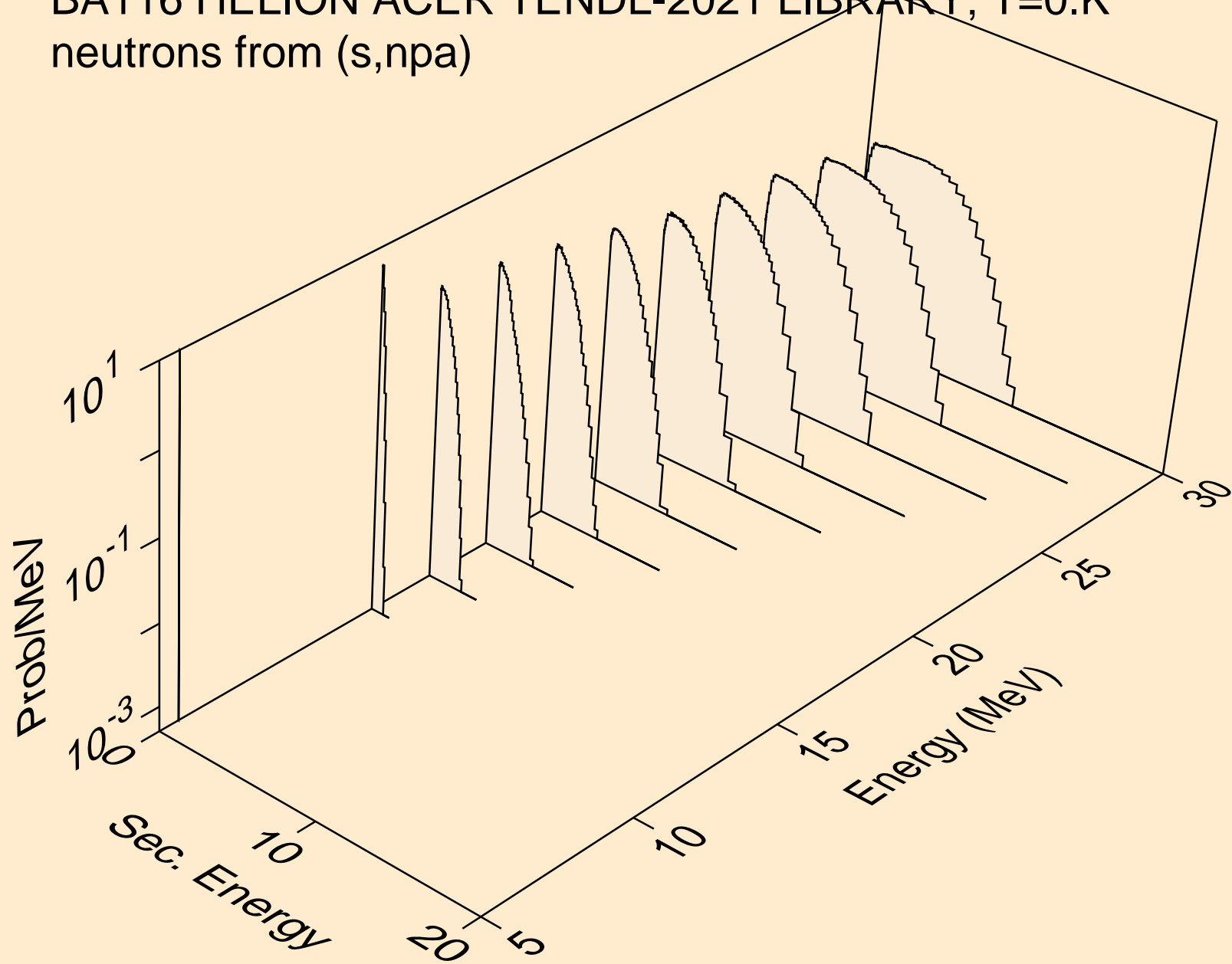

BA116 HELION ACER TENDL-2021 LIBRARY; T=0.K  
protons from (s,x)

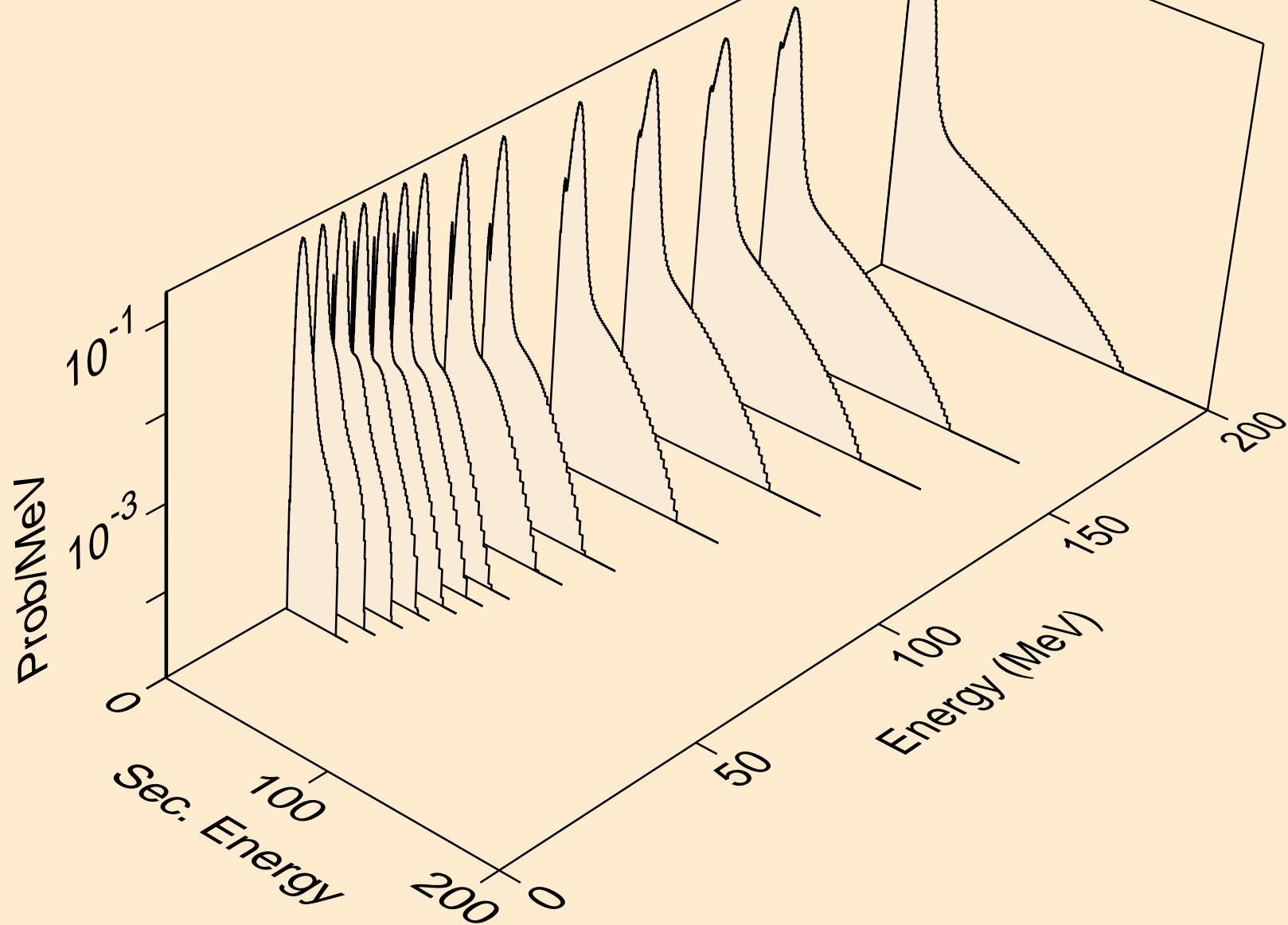

BA116 HELION ACER TENDL-2021 LIBRARY; T=0.K  
protons from (s,n\*)p

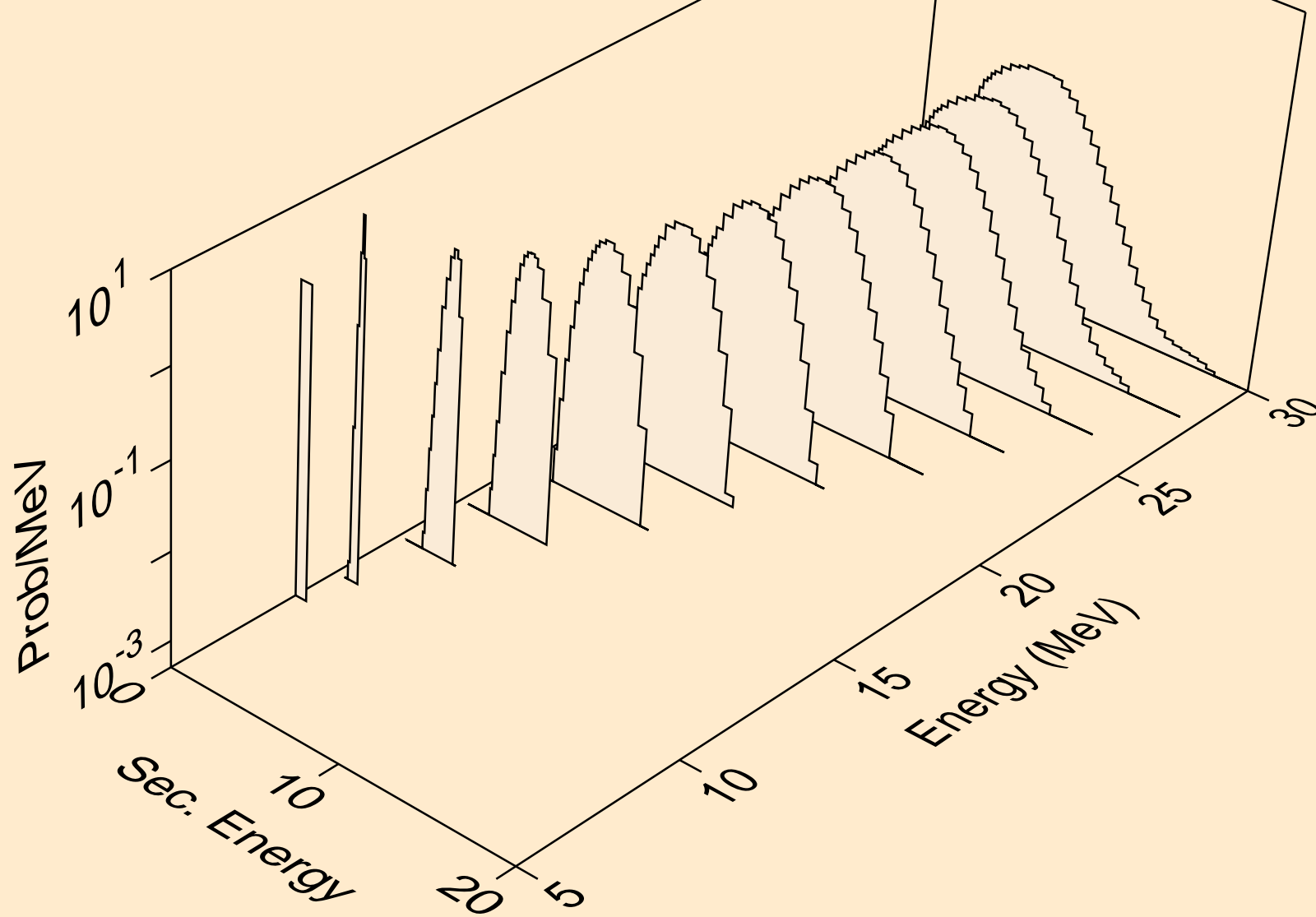

BA116 HELION ACER TENDL-2021 LIBRARY; T=0.K  
protons from (s,2np)

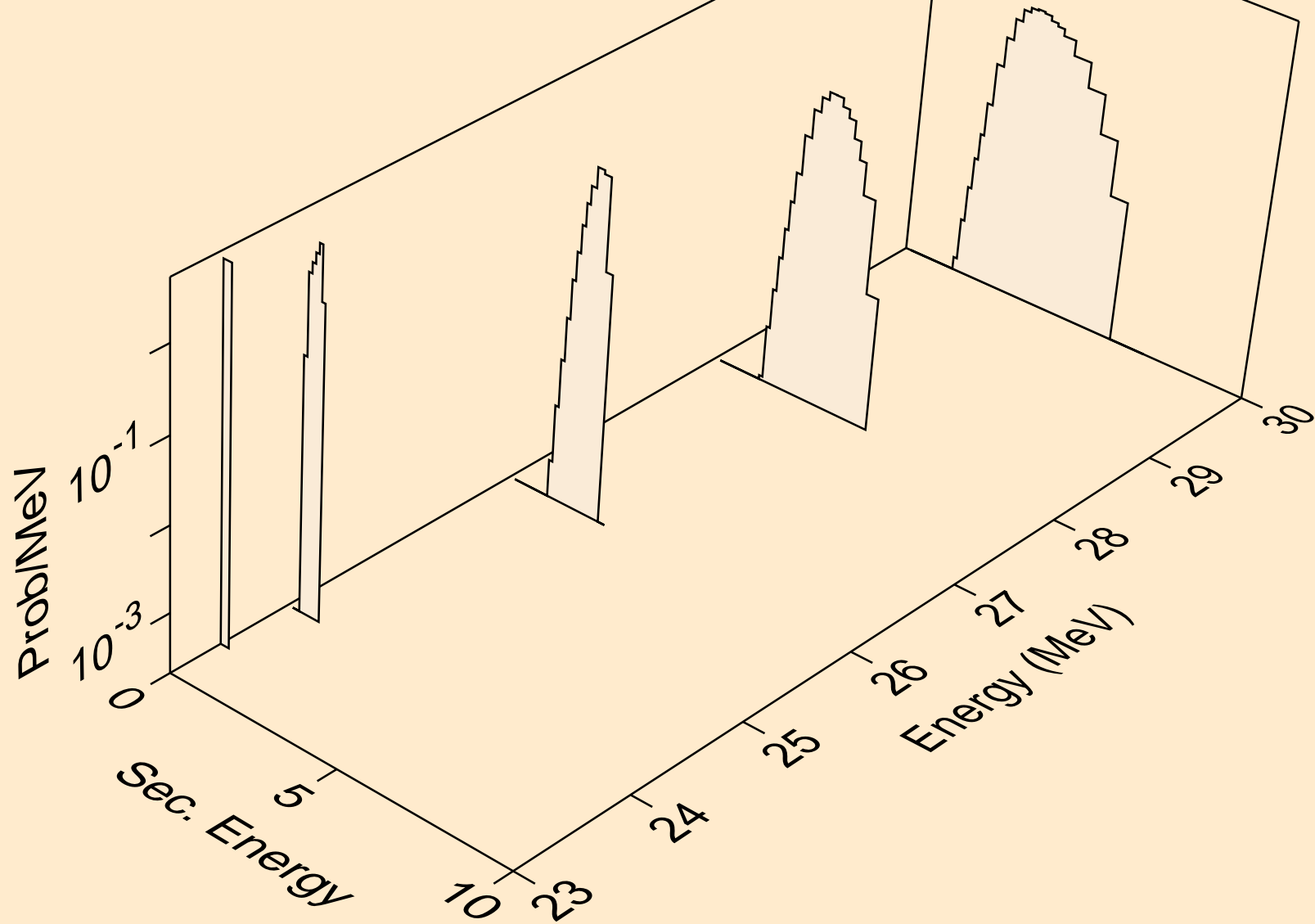



BA116 HELION ACER TENDL-2021 LIBRARY; T=0.K  
protons from (s,2np)

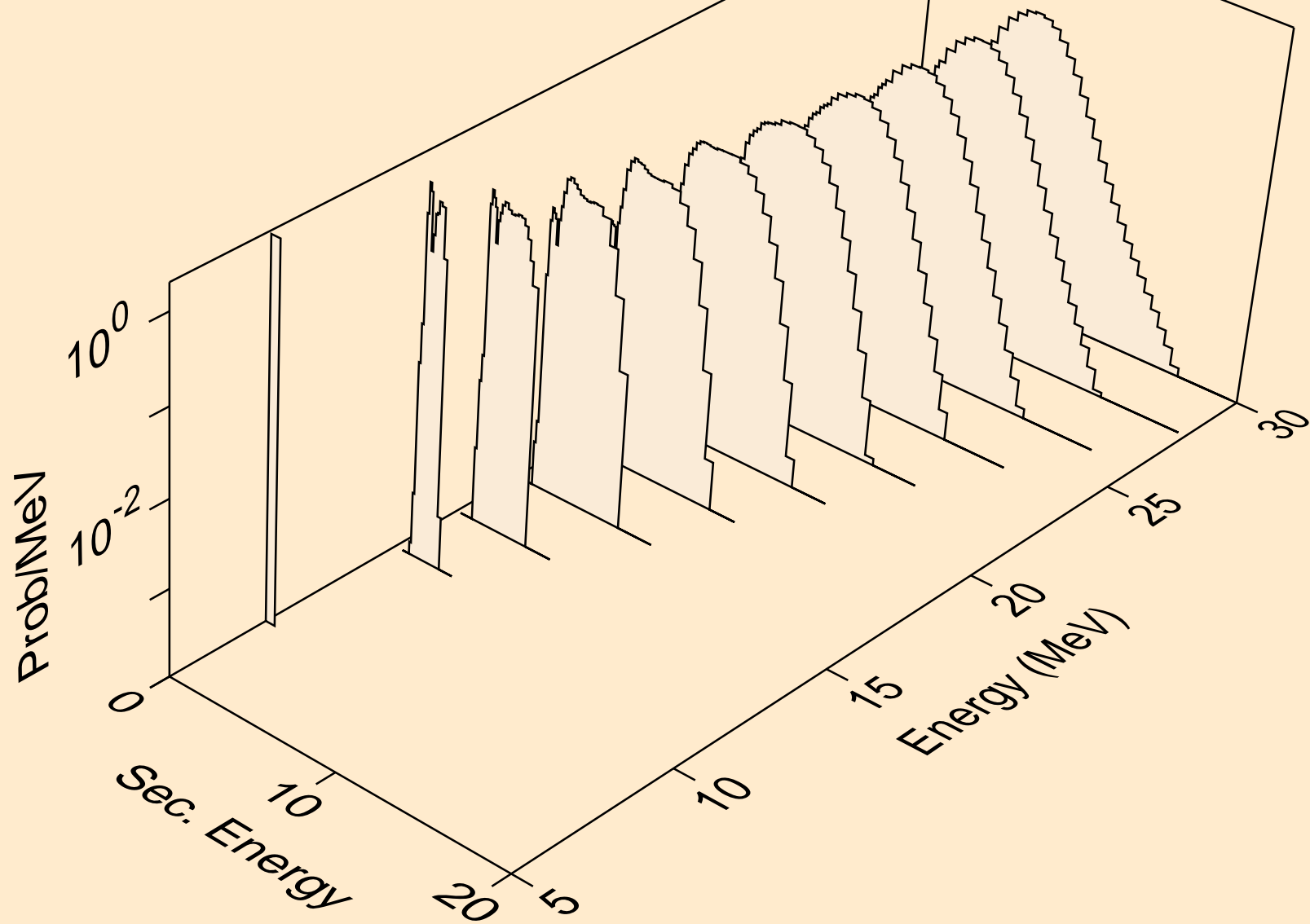

BA116 HELION ACER TENDL-2021 LIBRARY; T=0.K  
protons from (s,npa)

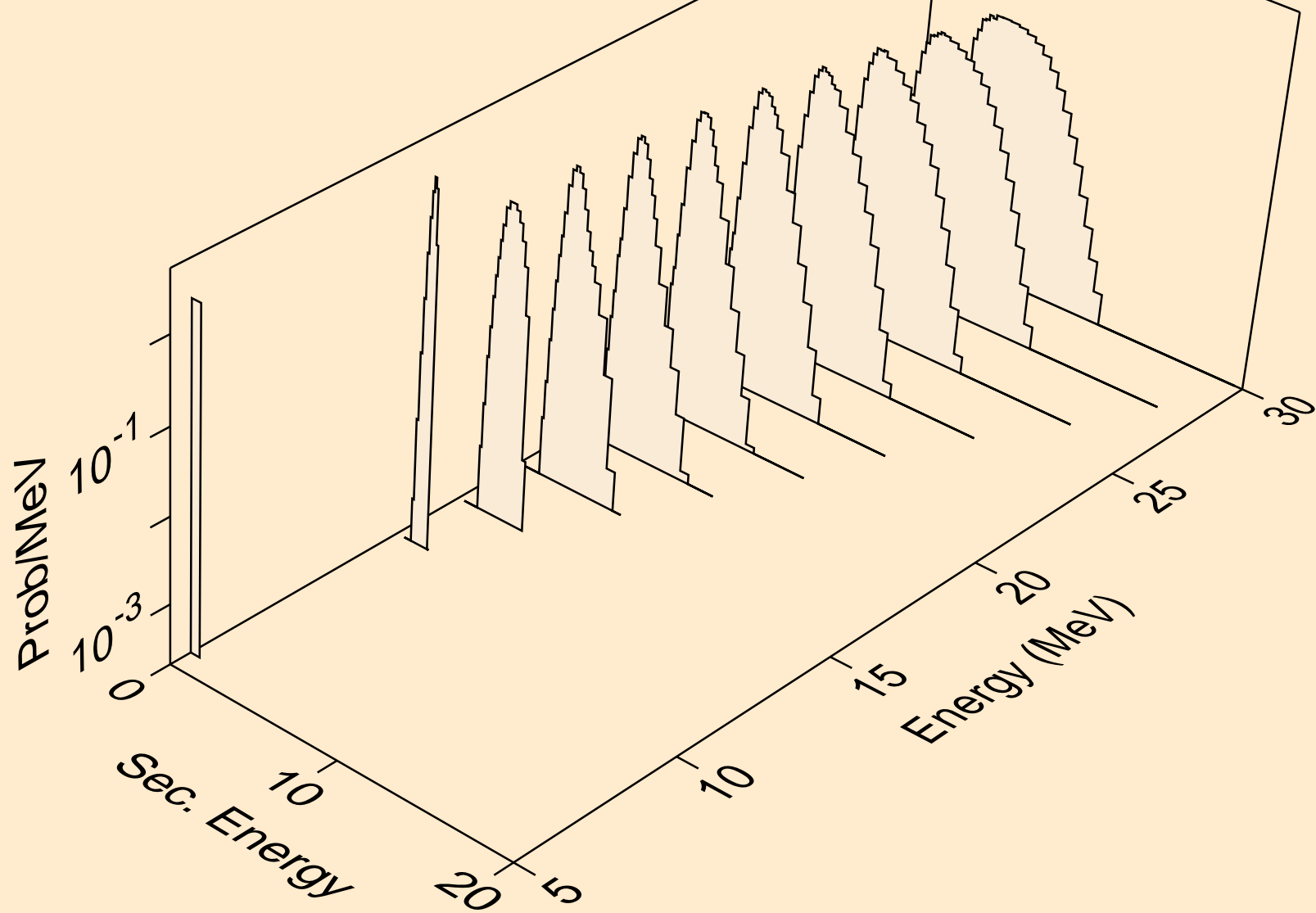

BA116 HELION ACER TENDL-2021 LIBRARY; T=0.K  
protons from (s,p)

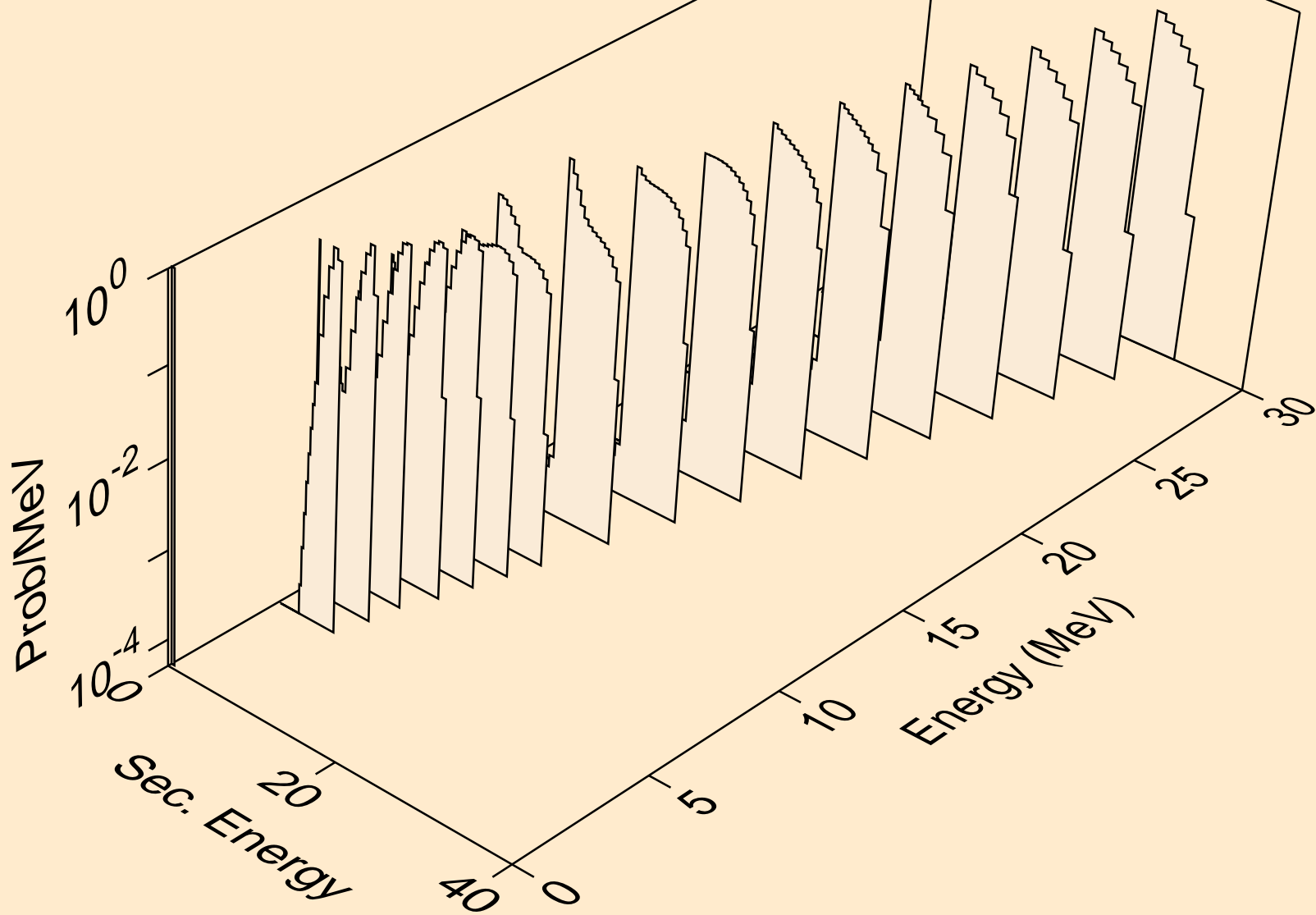

BA116 HELION ACER TENDL-2021 LIBRARY; T=0.K  
protons from (s,2p)

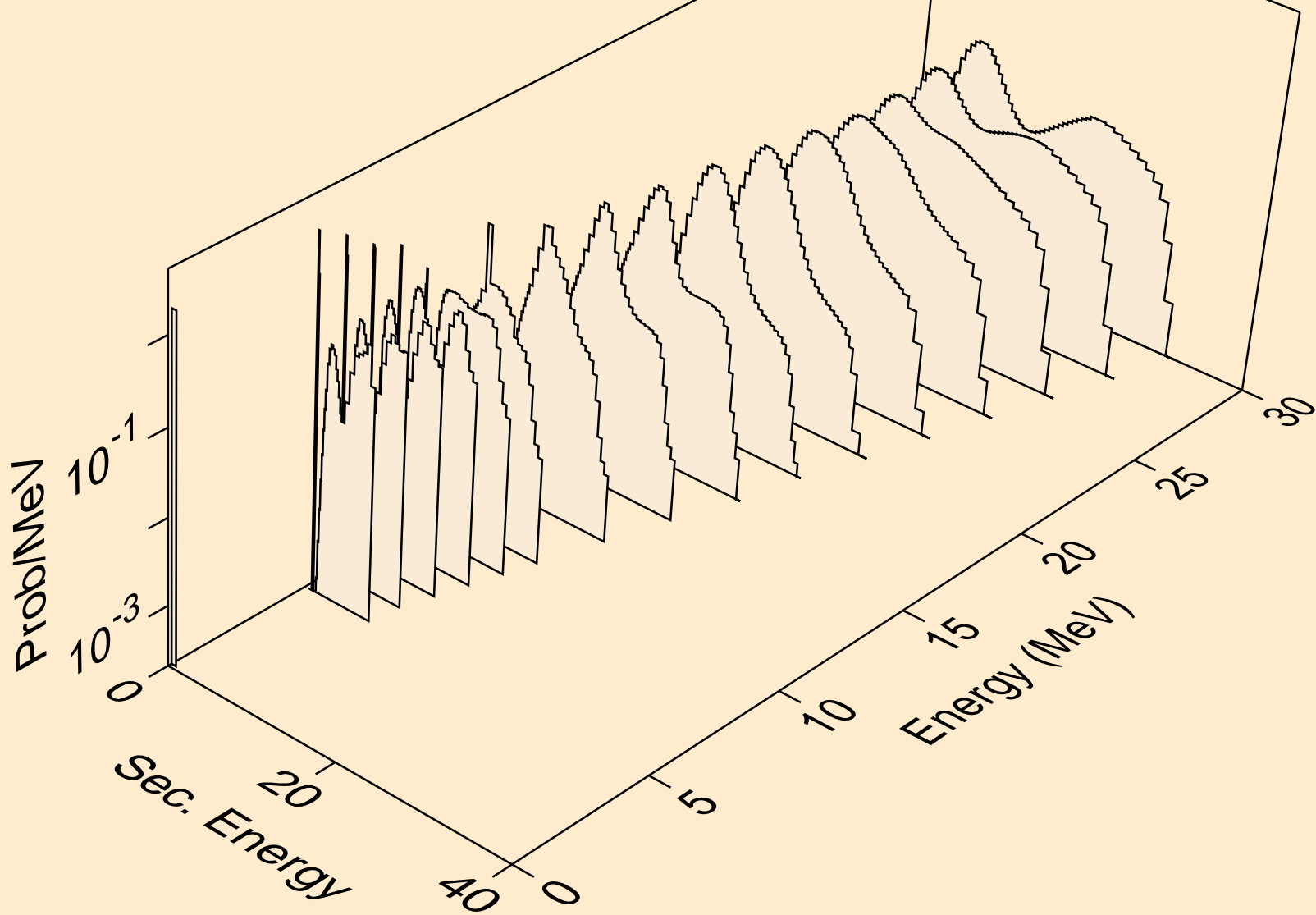

BA116 HELION ACER TENDL-2021 LIBRARY; T=0.K  
protons from (s,pa)

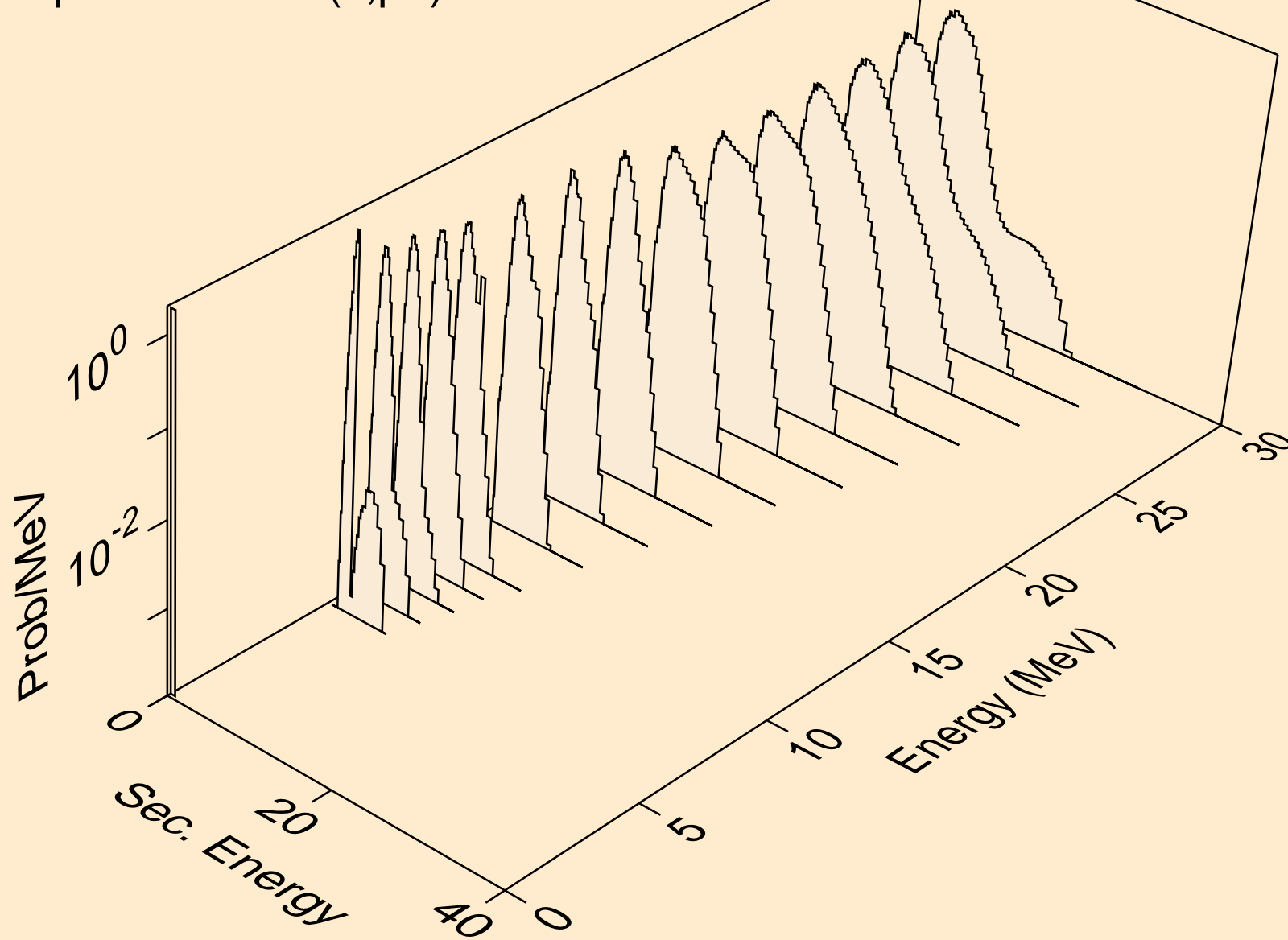

BA116 HELION ACER TENDL-2021 LIBRARY; T=0.K  
protons from (s,pd)

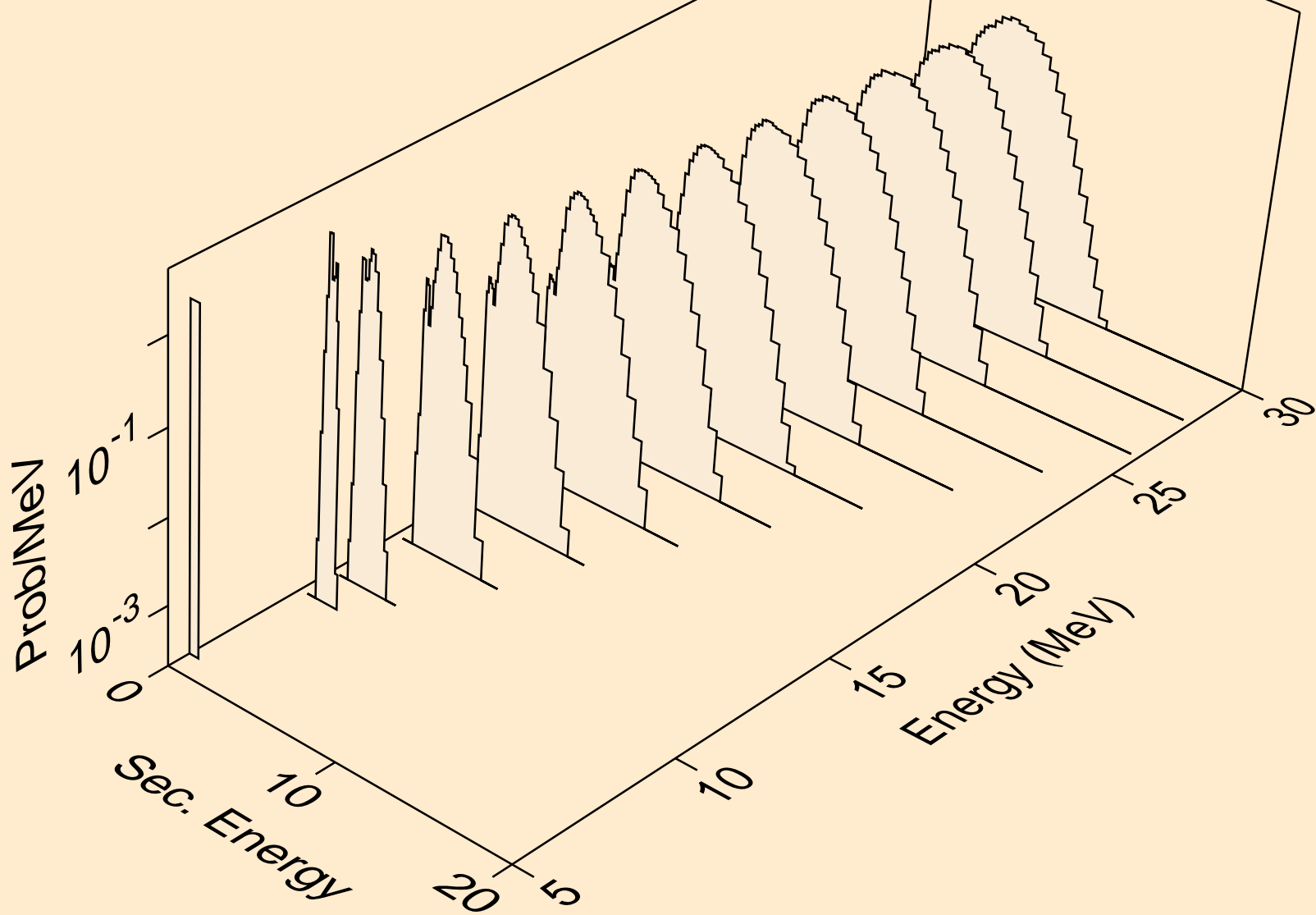

BA116 HELION ACER TENDL-2021 LIBRARY; T=0.K  
protons from (s,pt)

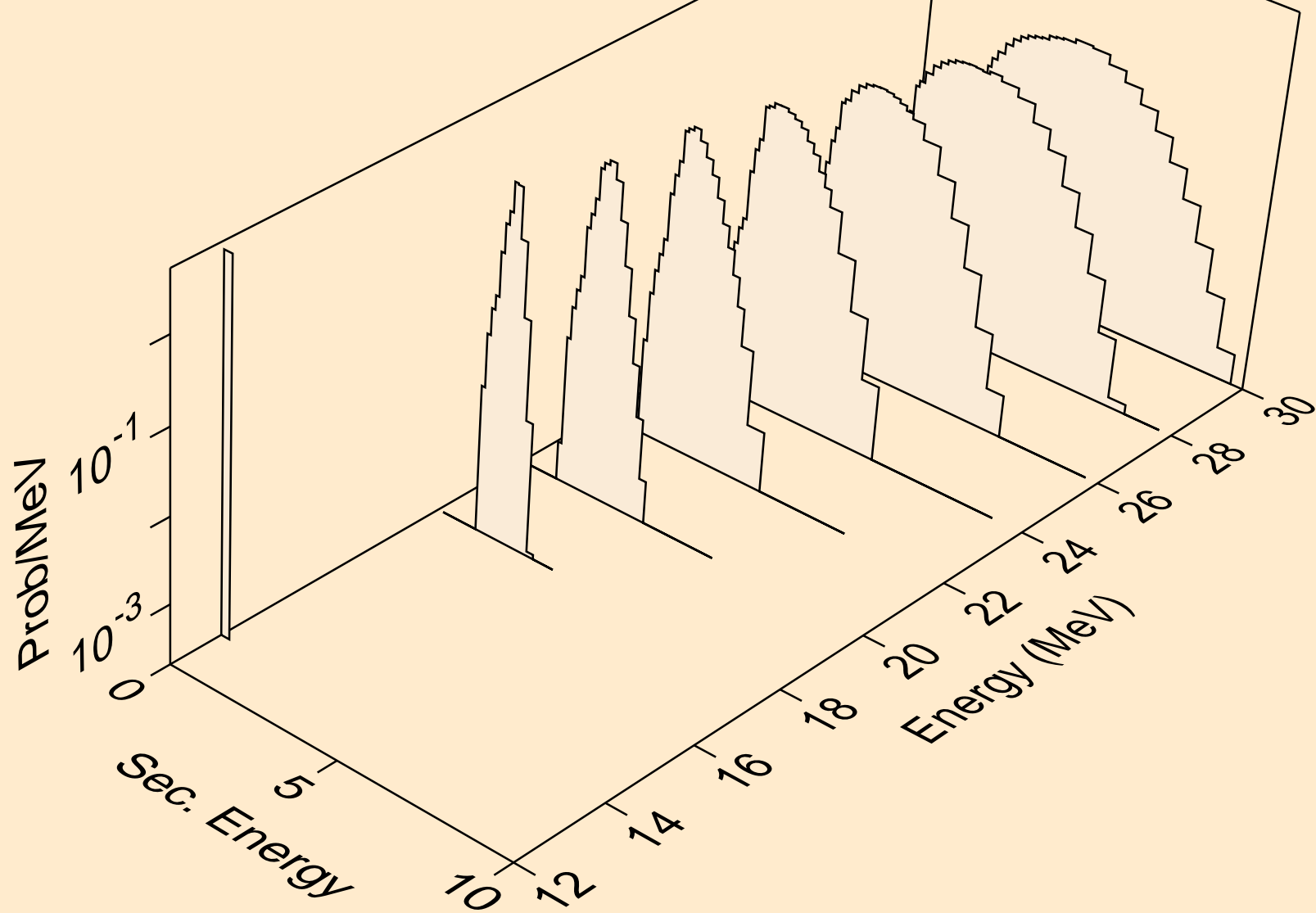

BA116 HELION ACER TENDL-2021 LIBRARY; T=0.K  
deuterons from (s,x)

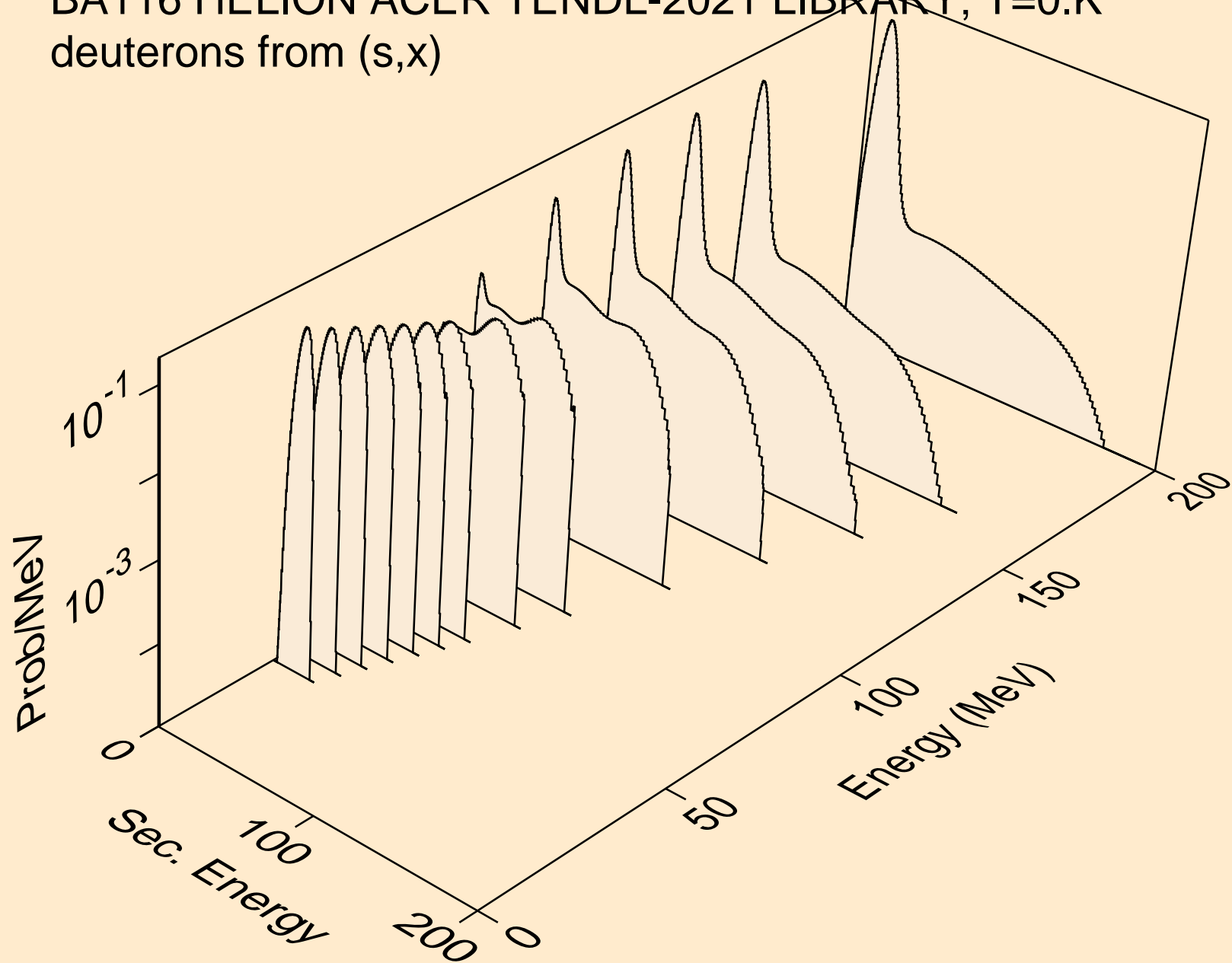



BA116 HELION ACER TENDL-2021 LIBRARY; T=0.K  
deuterons from (s,n\*)d

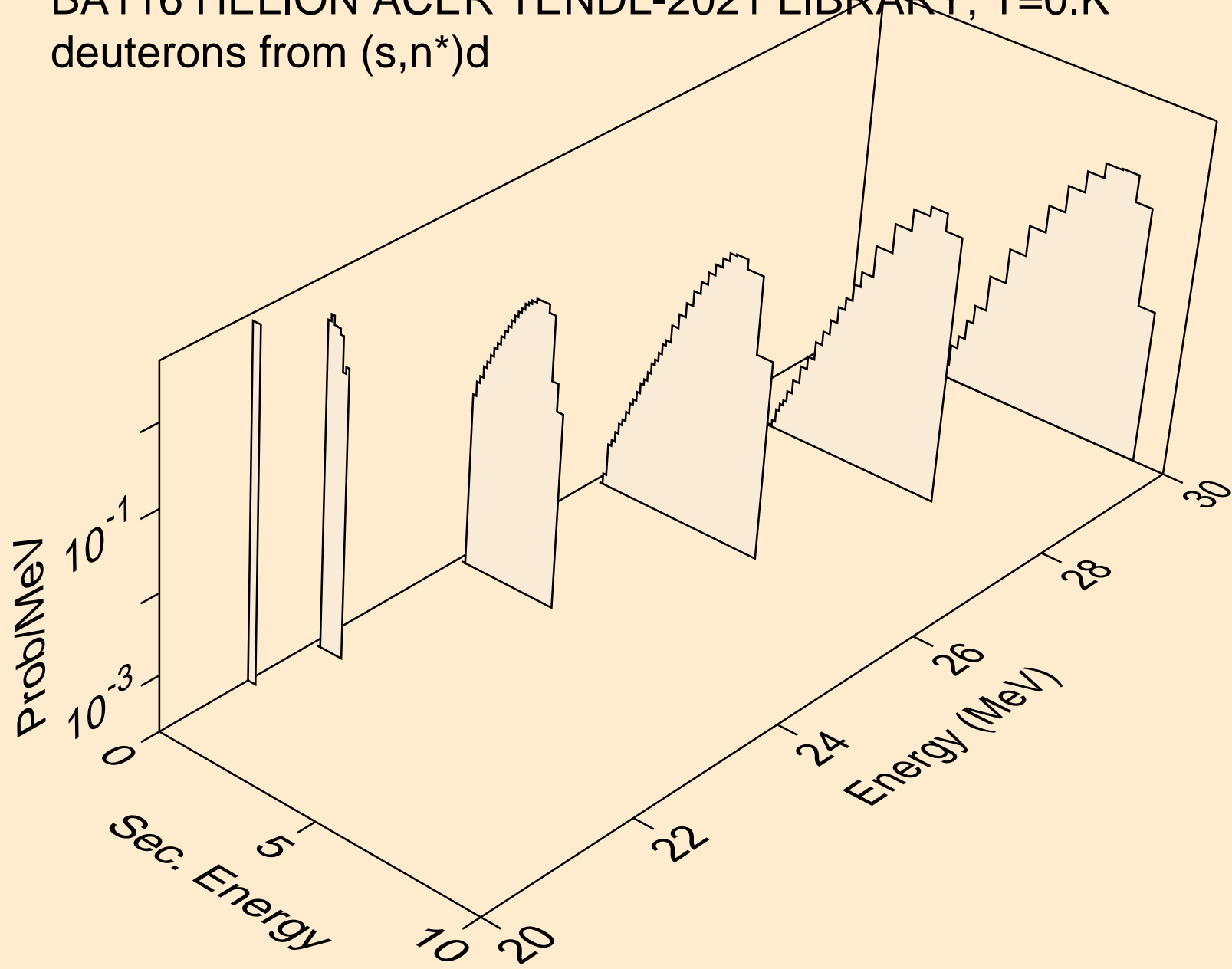

BA116 HELION ACER TENDL-2021 LIBRARY; T=0.K  
deuterons from (s,d)

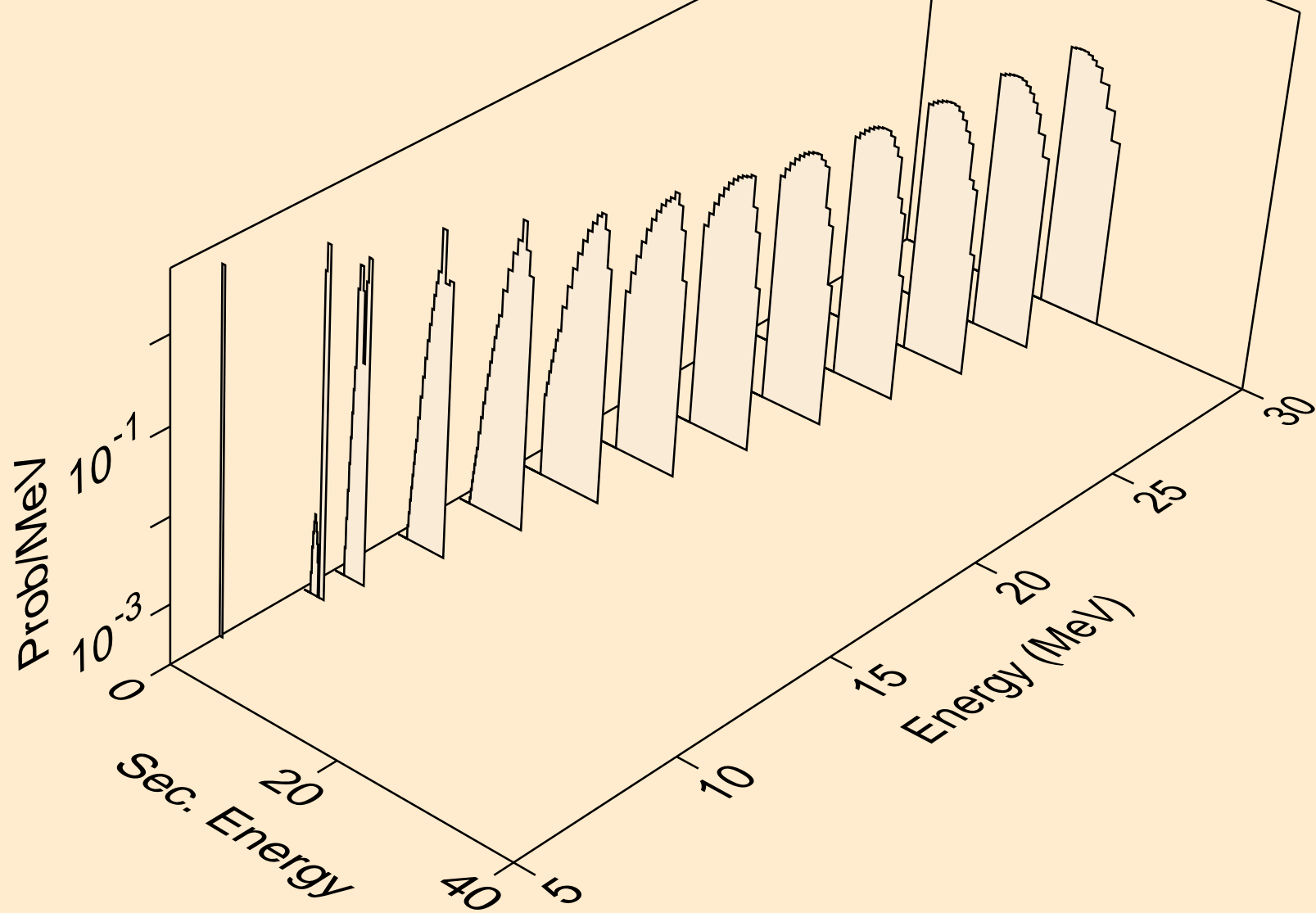

BA116 HELION ACER TENDL-2021 LIBRARY; T=0.K  
deuterons from (s,pd)

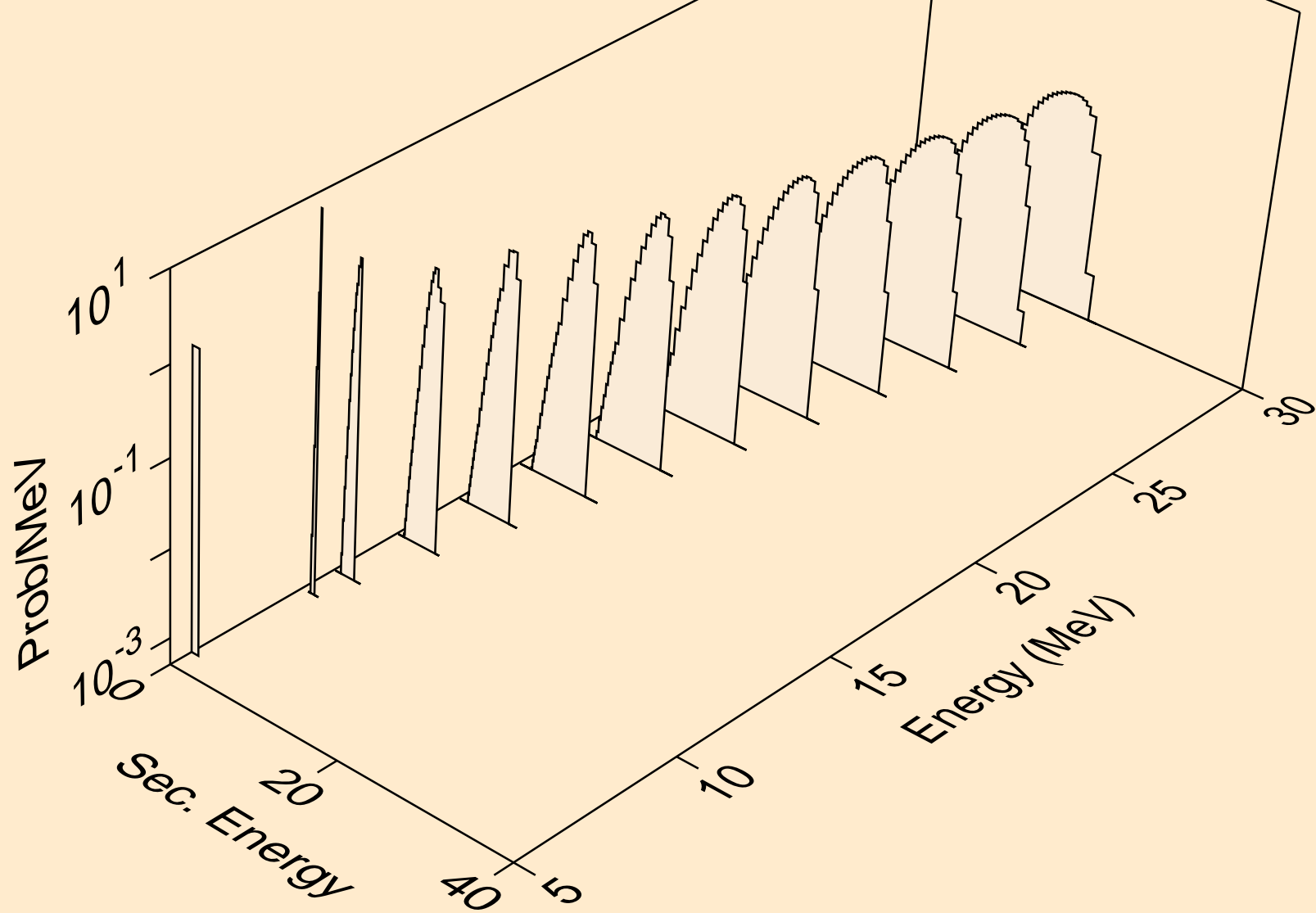

BA116 HELION ACER TENDL-2021 LIBRARY; T=0.K  
deuterons from (s,da)

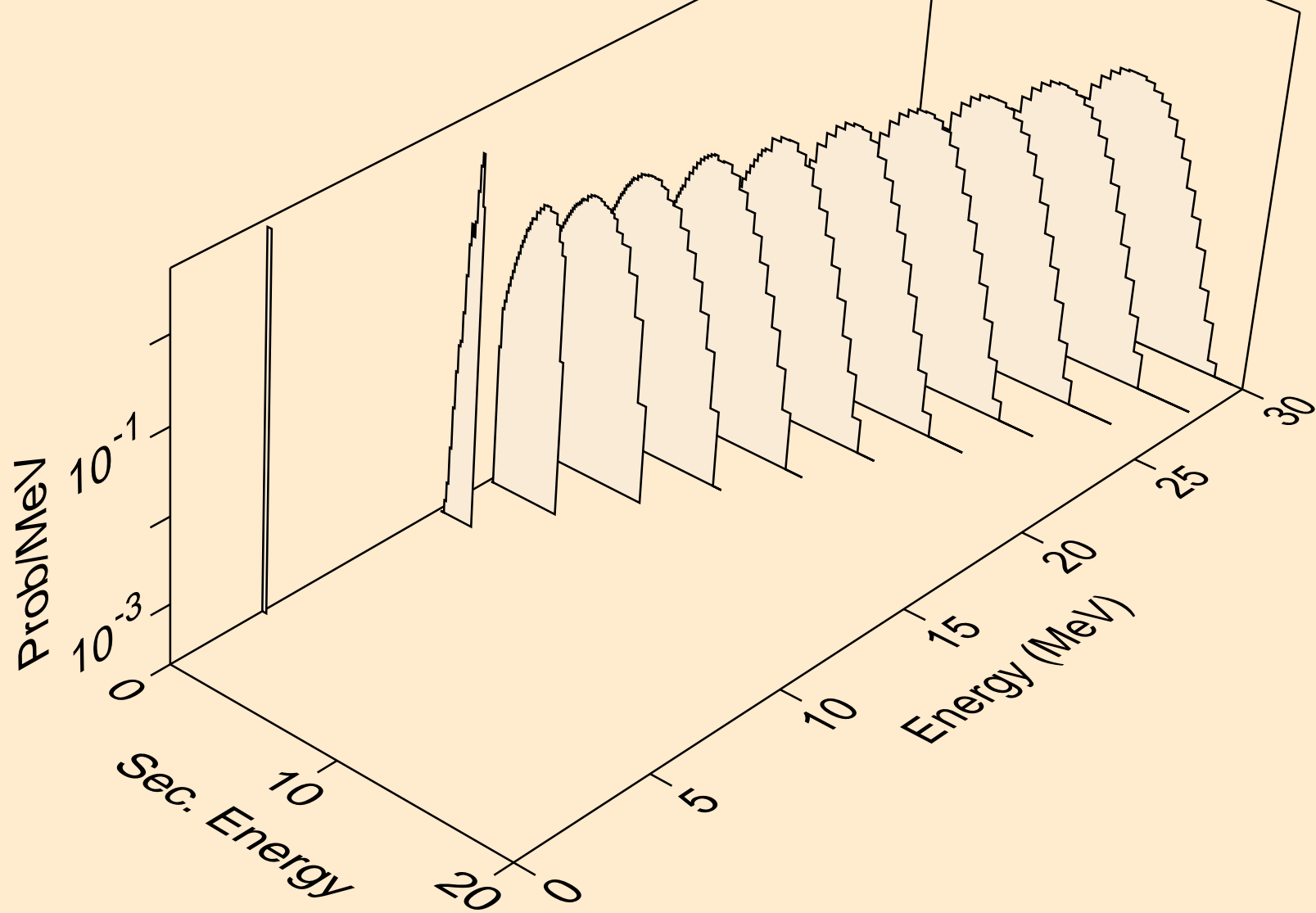

BA116 HELION ACER TENDL-2021 LIBRARY; T=0.K  
tritons from (s,x)

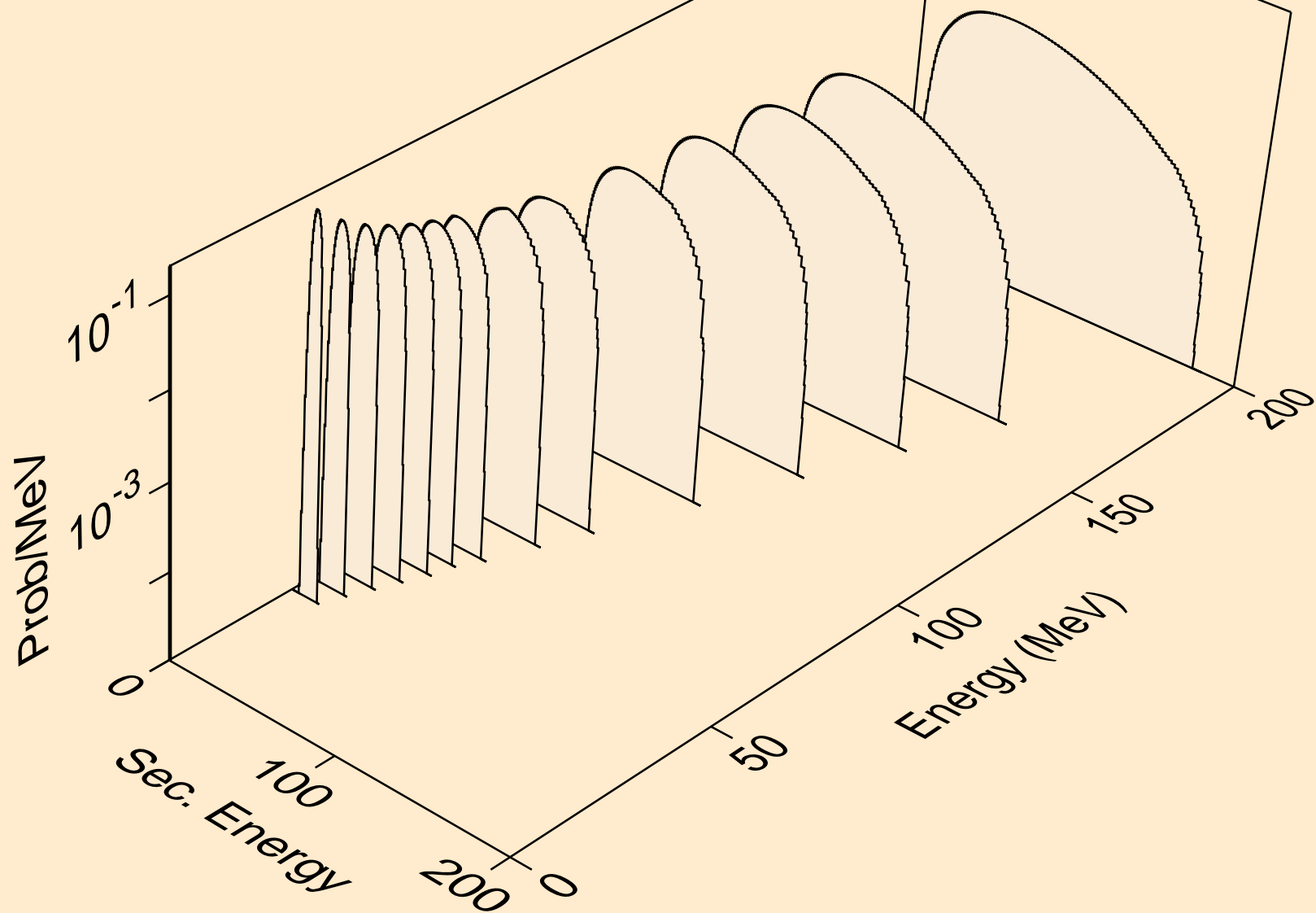

BA116 HELION ACER TENDL-2021 LIBRARY; T=0.K  
tritons from (s,t)

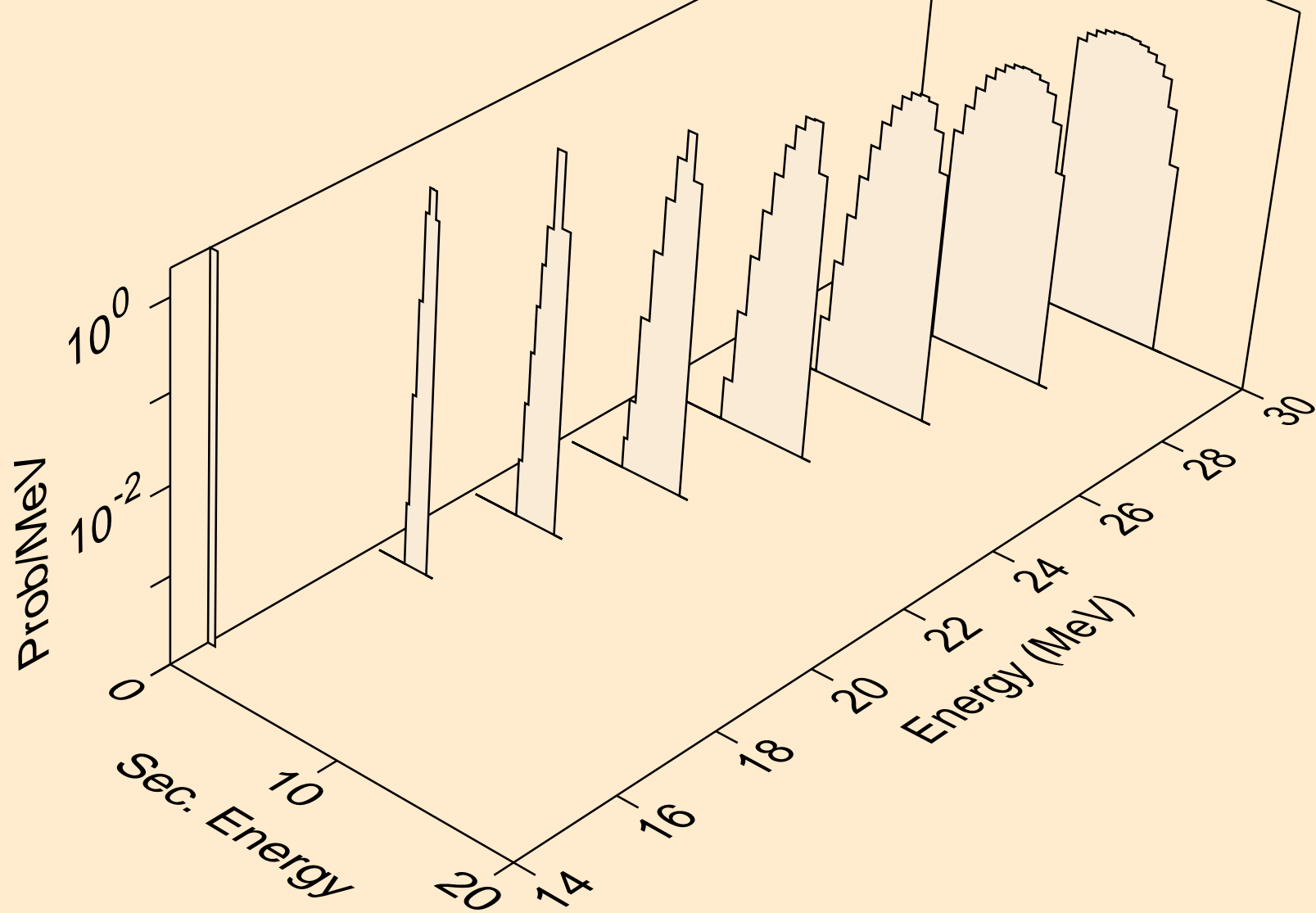

BA116 HELION ACER TENDL-2021 LIBRARY; T=0.K  
tritons from (s,pt)

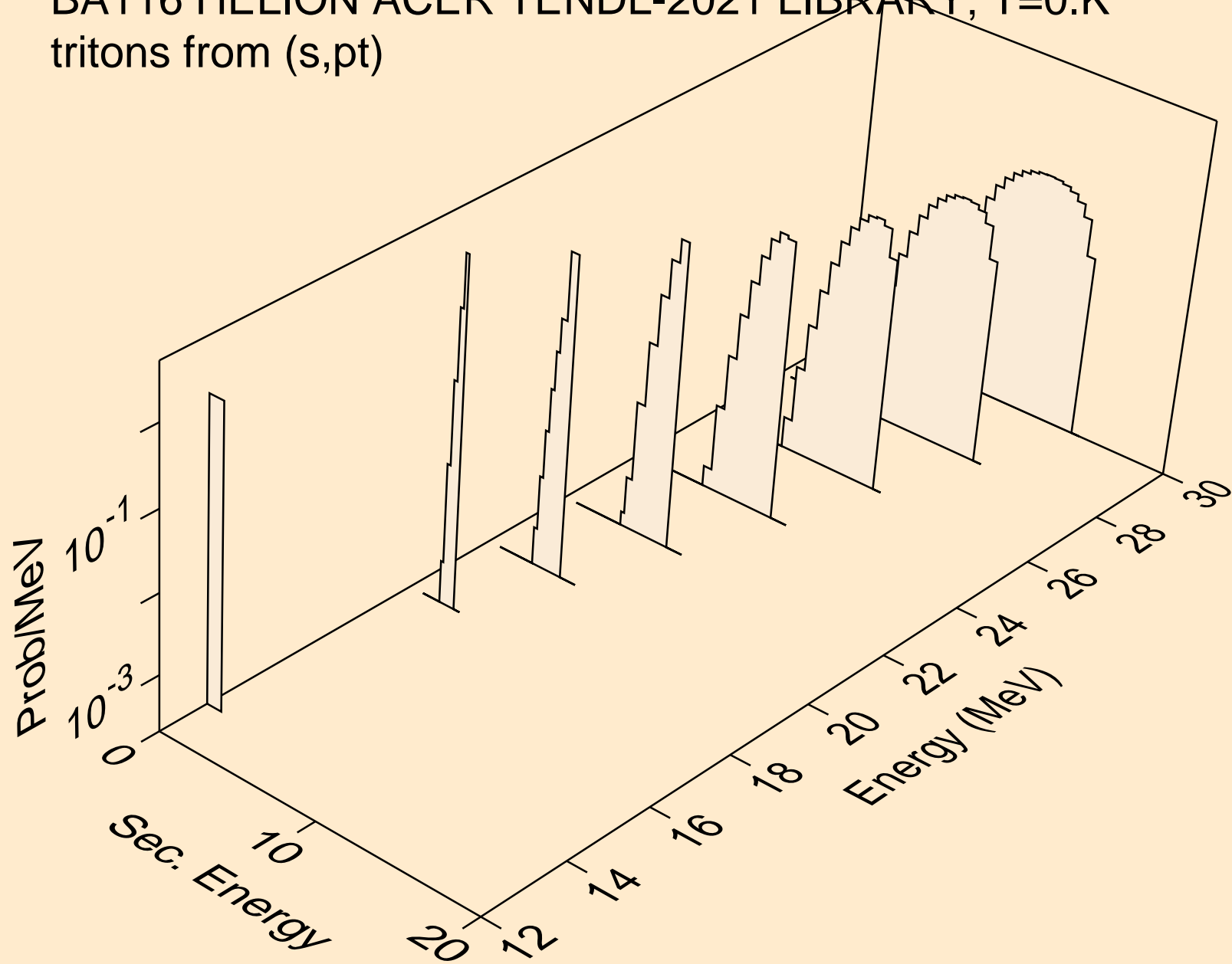

BA116 HELION ACER TENDL-2021 LIBRARY; T=0.K  
alphas from (s,x)

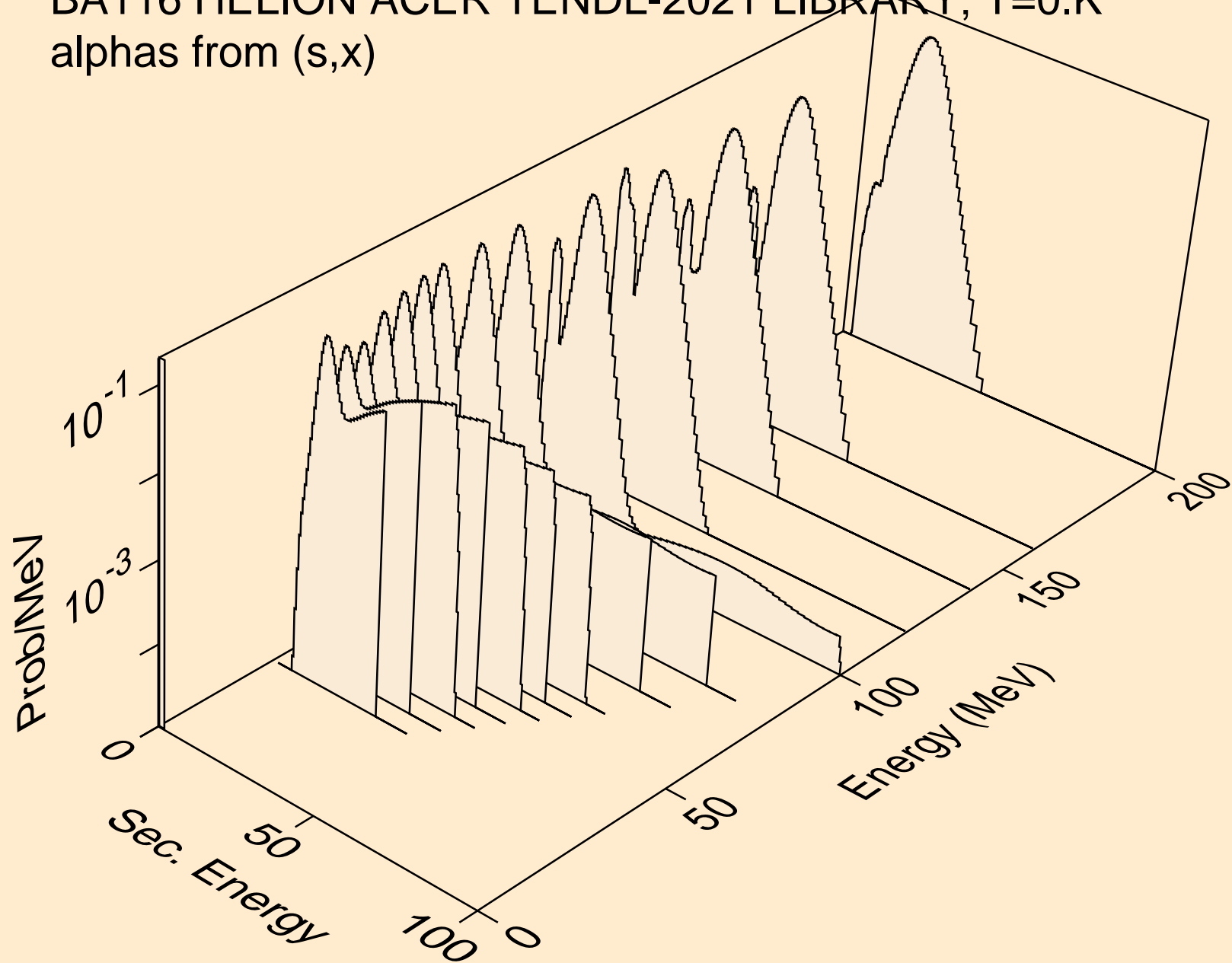



BA116 HELION ACER TENDL-2021 LIBRARY; T=0.K  
alphas from (s,n\*)a

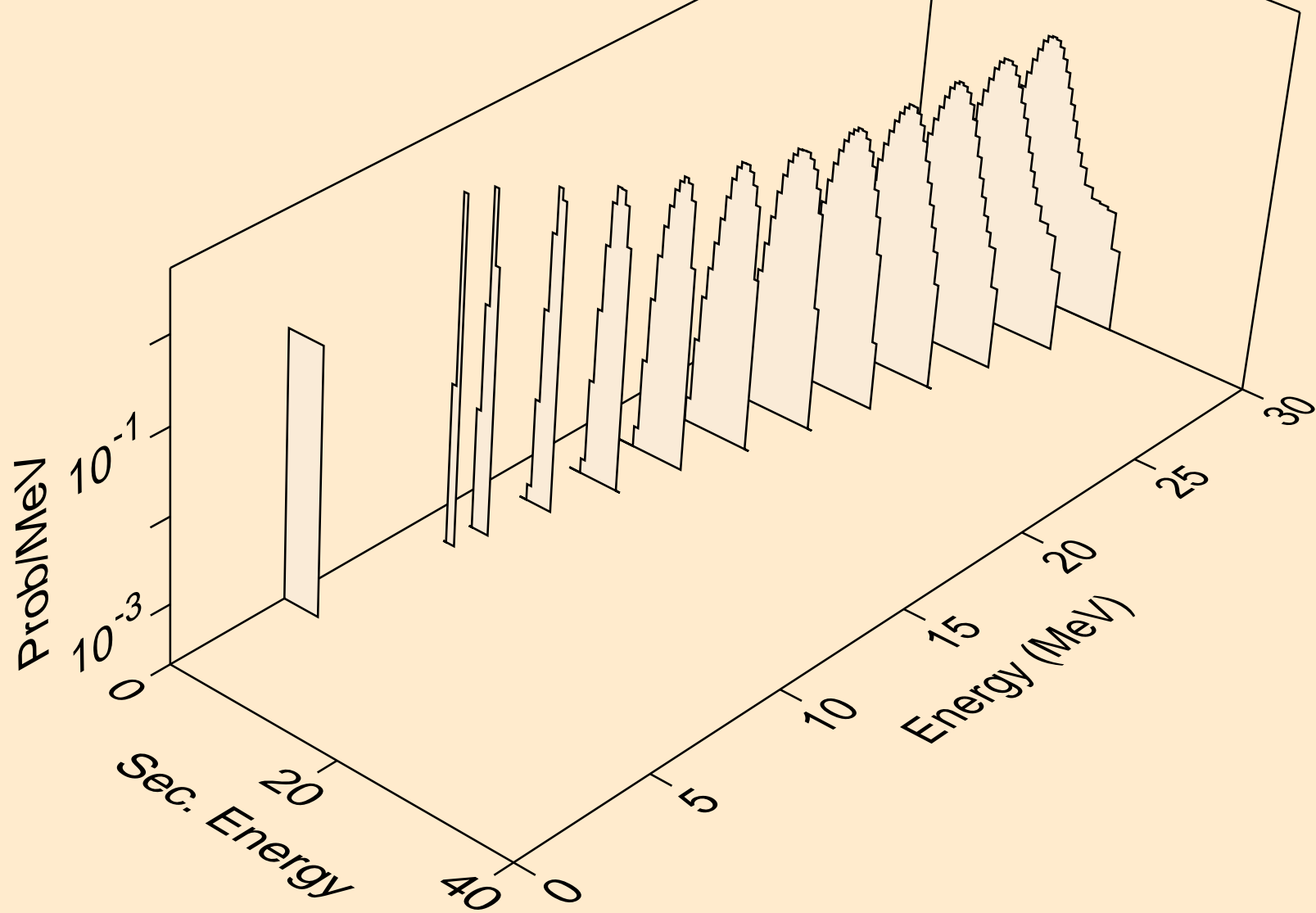

BA116 HELION ACER TENDL-2021 LIBRARY; T=0.K  
alphas from (s,n\*)2a

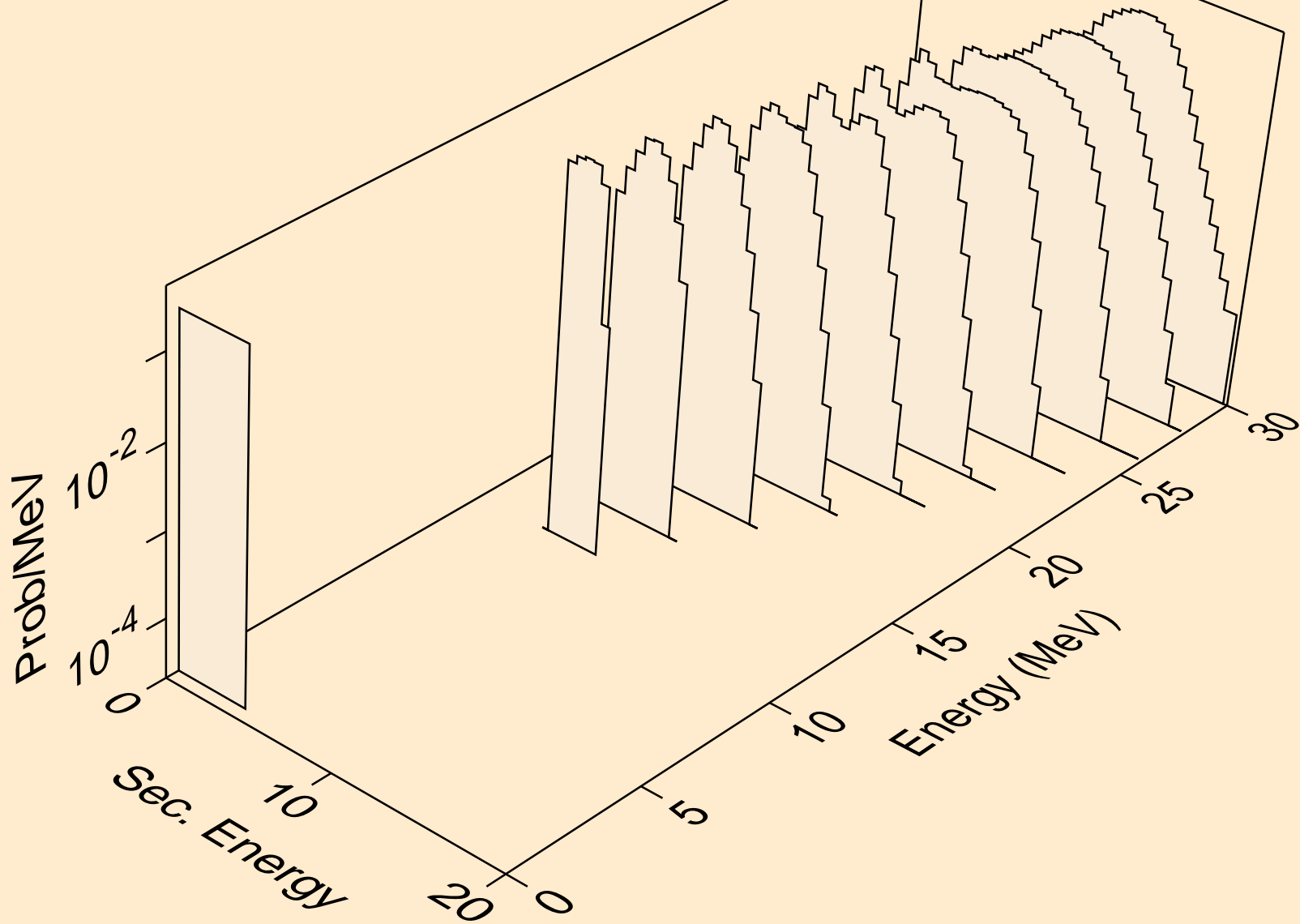

BA116 HELION ACER TENDL-2021 LIBRARY; T=0.K  
alphas from (s,npa)

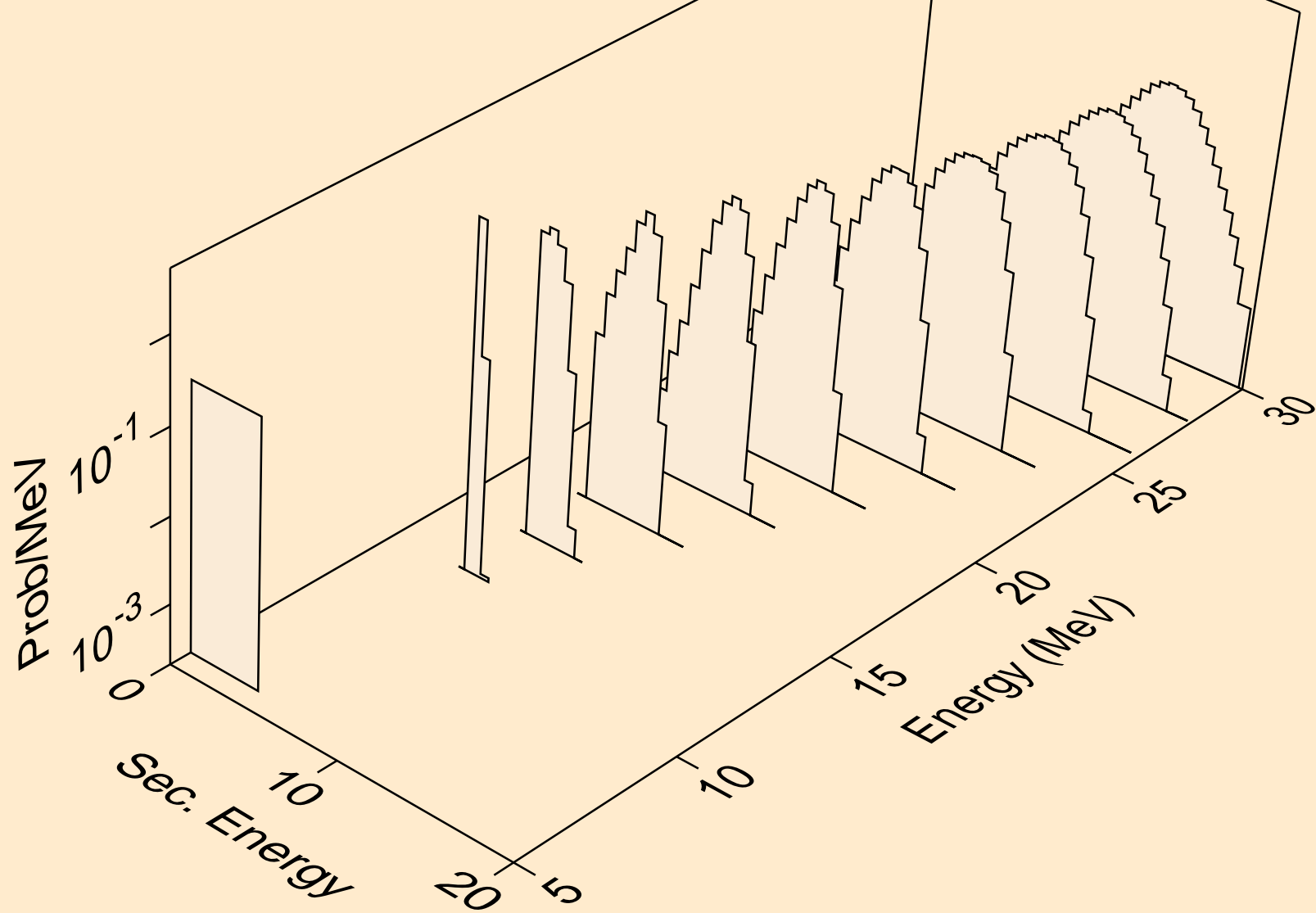

BA116 HELION ACER TENDL-2021 LIBRARY; T=0.K  
alphas from (s,a)

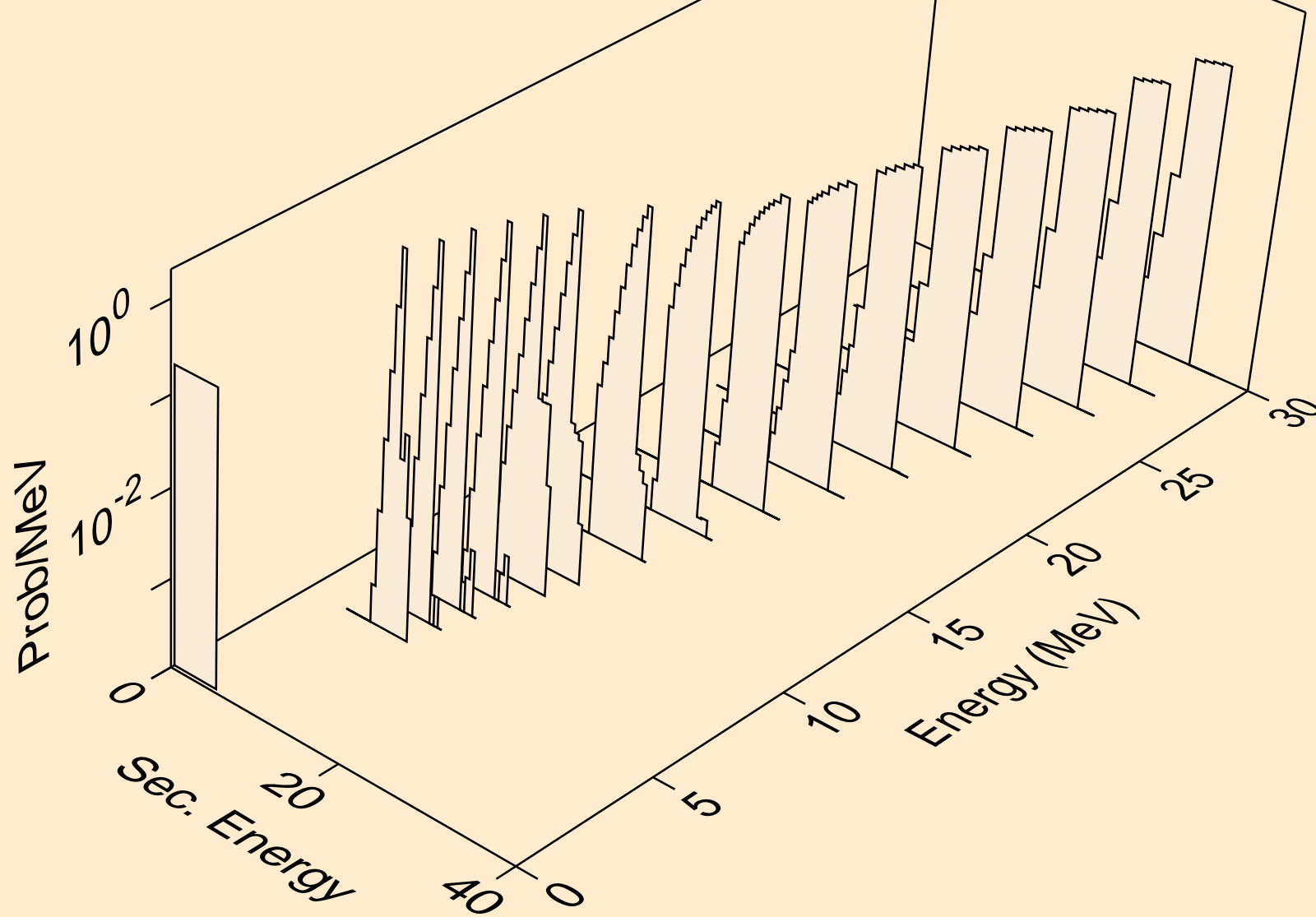

BA116 HELION ACER TENDL-2021 LIBRARY; T=0.K  
alphas from (s,2a)

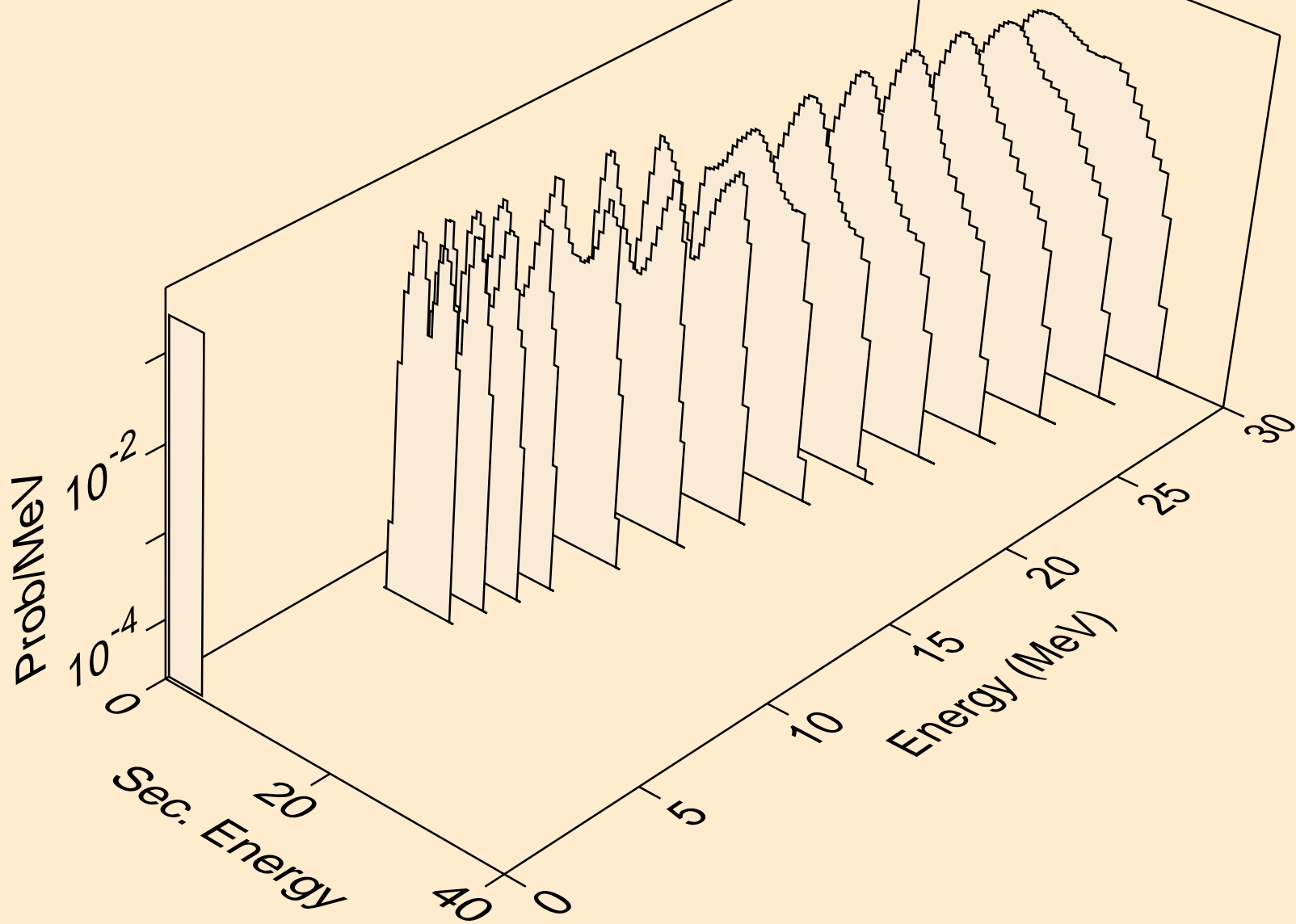

BA116 HELION ACER TENDL-2021 LIBRARY; T=0.K  
alphas from (s,3a)

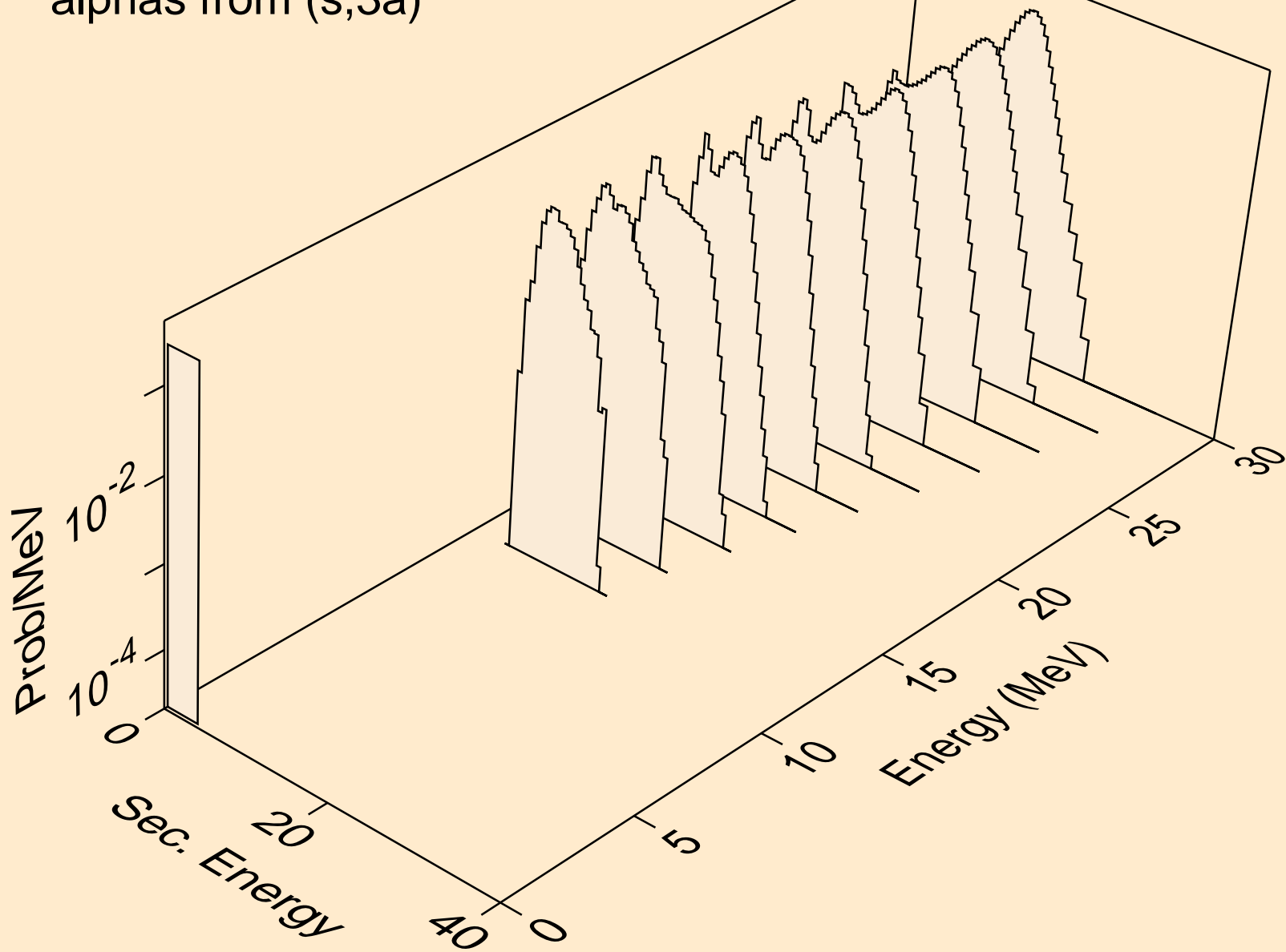

BA116 HELION ACER TENDL-2021 LIBRARY; T=0.K  
alphas from (s,pa)

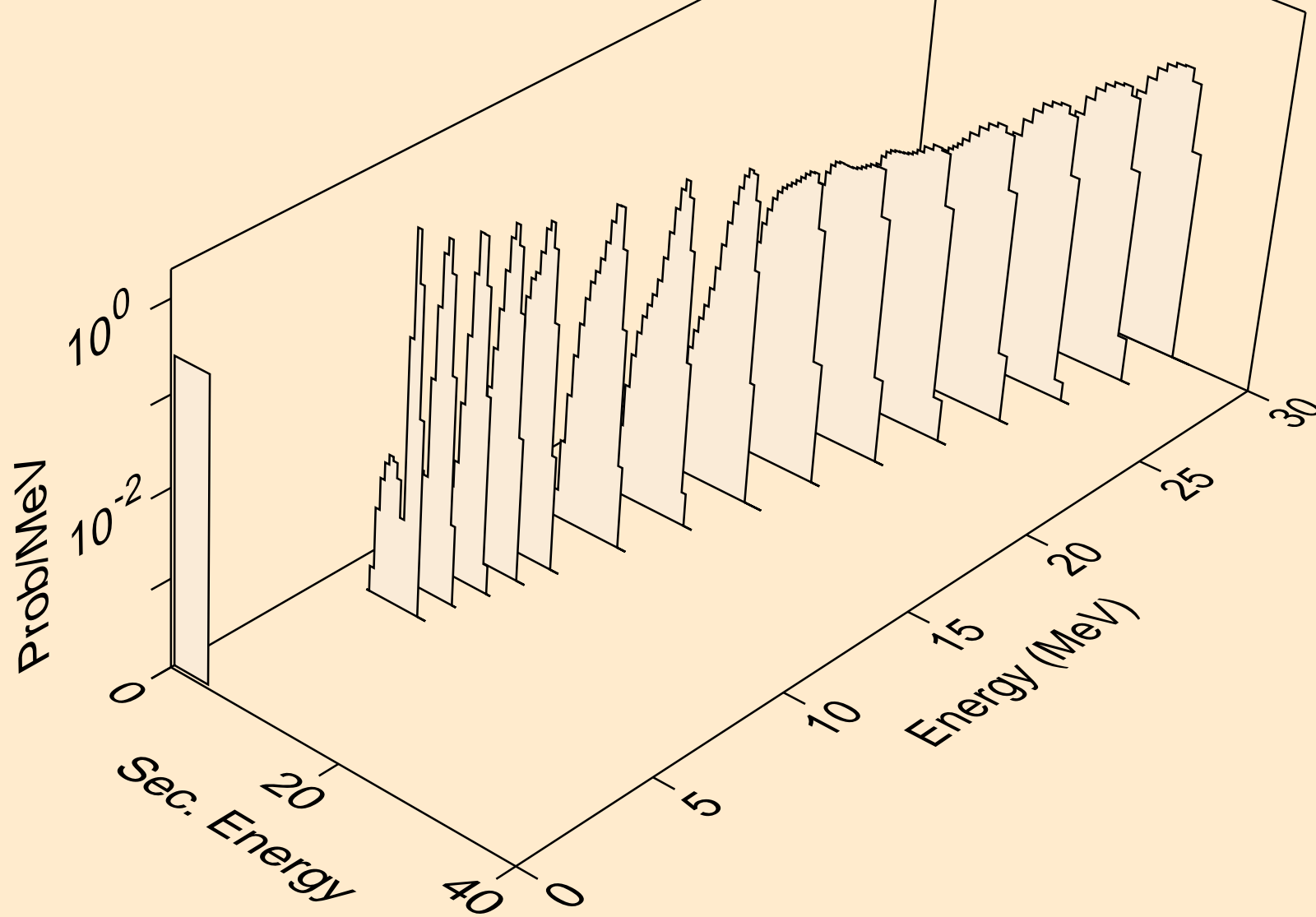

BA116 HELION ACER TENDL-2021 LIBRARY; T=0.K  
alphas from (s,da)

