

BH265 HELION ACER TENDL-2021 LIBRARY; T=0.K
Principal cross sections

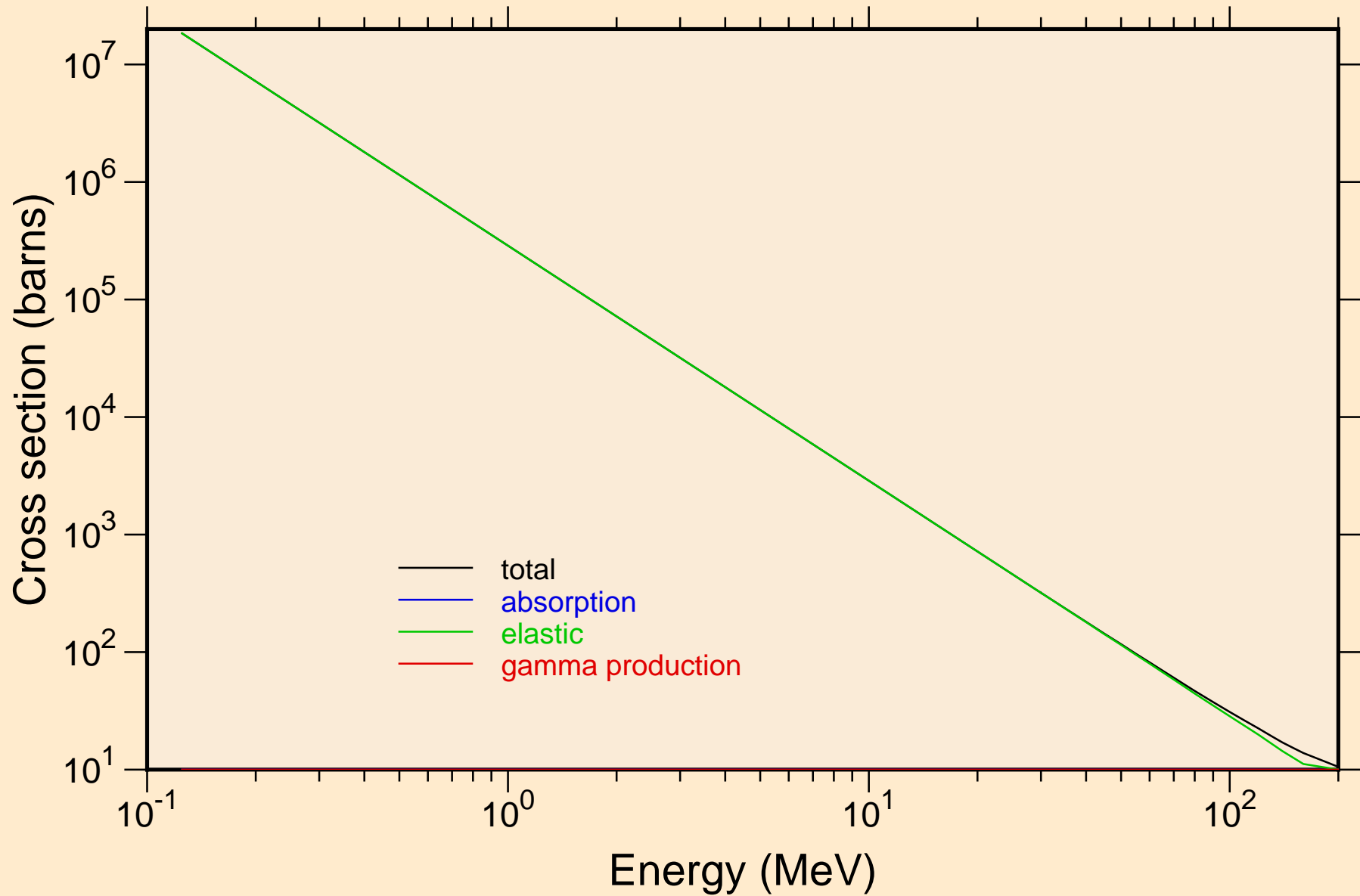

BH265 HELION ACER TENDL-2021 LIBRARY; T=0.K
Heating

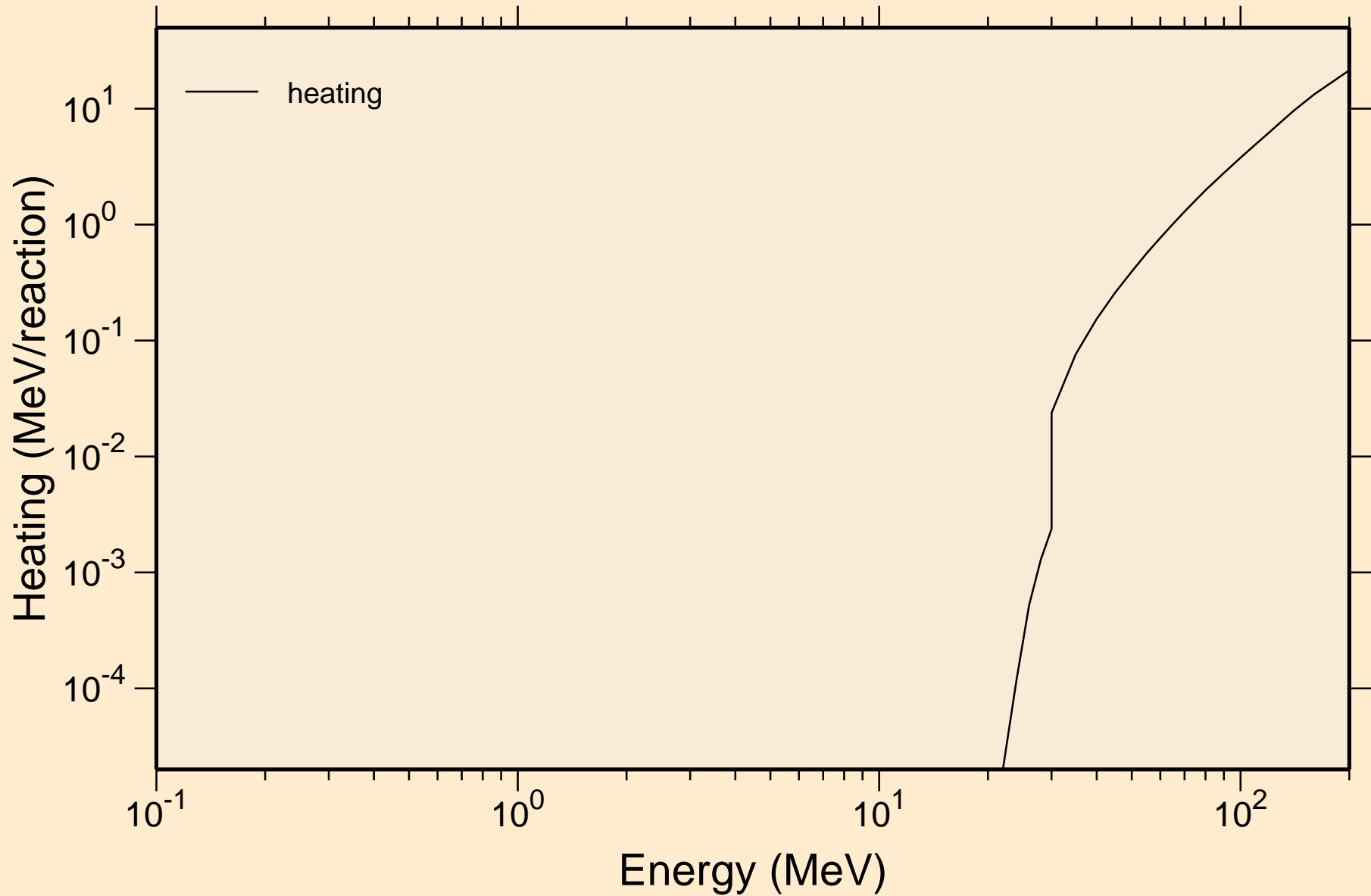

BH265 HELION ACER TENDL-2021 LIBRARY; T=0.K

Principal cross sections

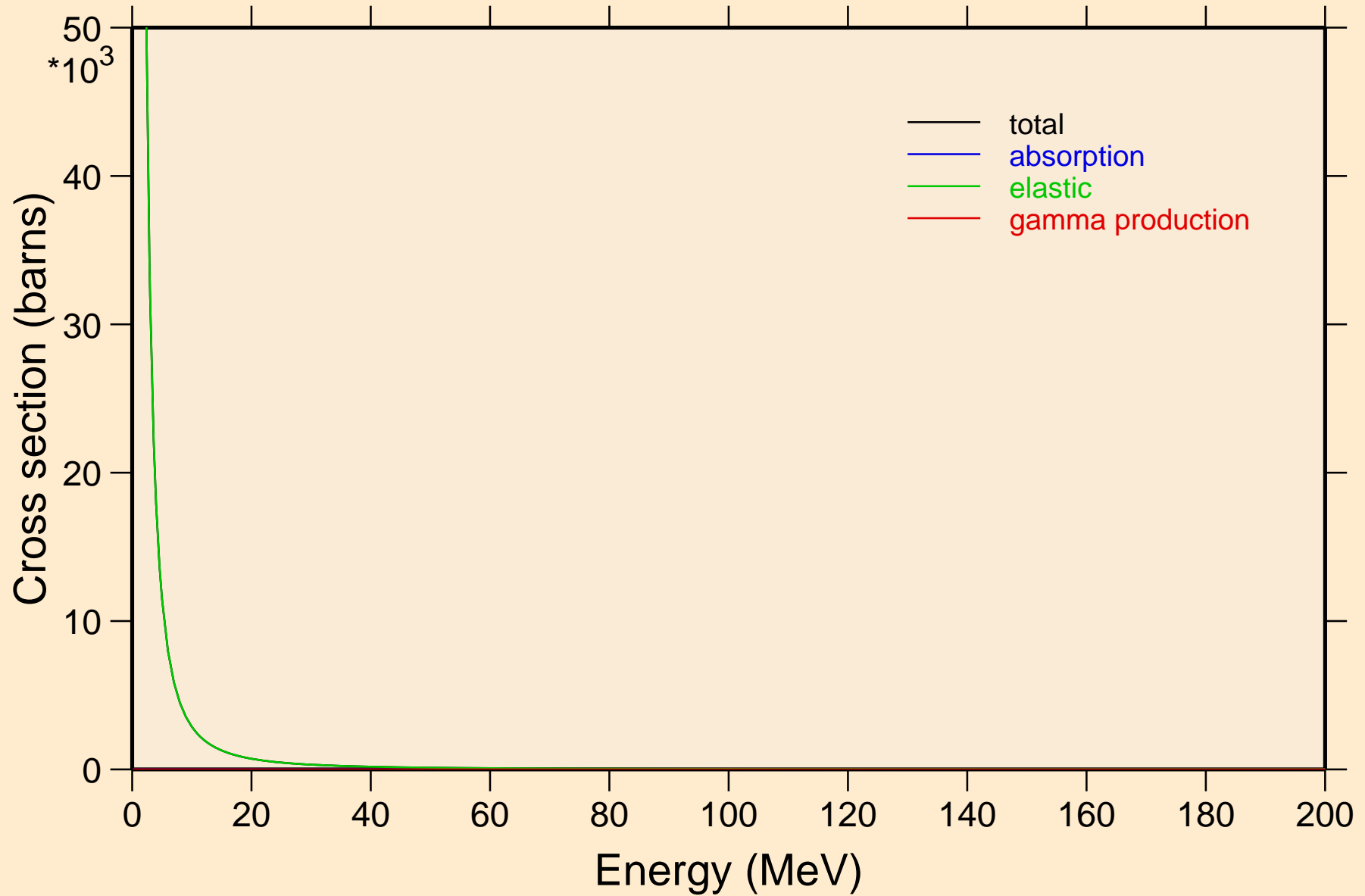

BH265 HELION ACER TENDL-2021 LIBRARY; T=0.K

Heating

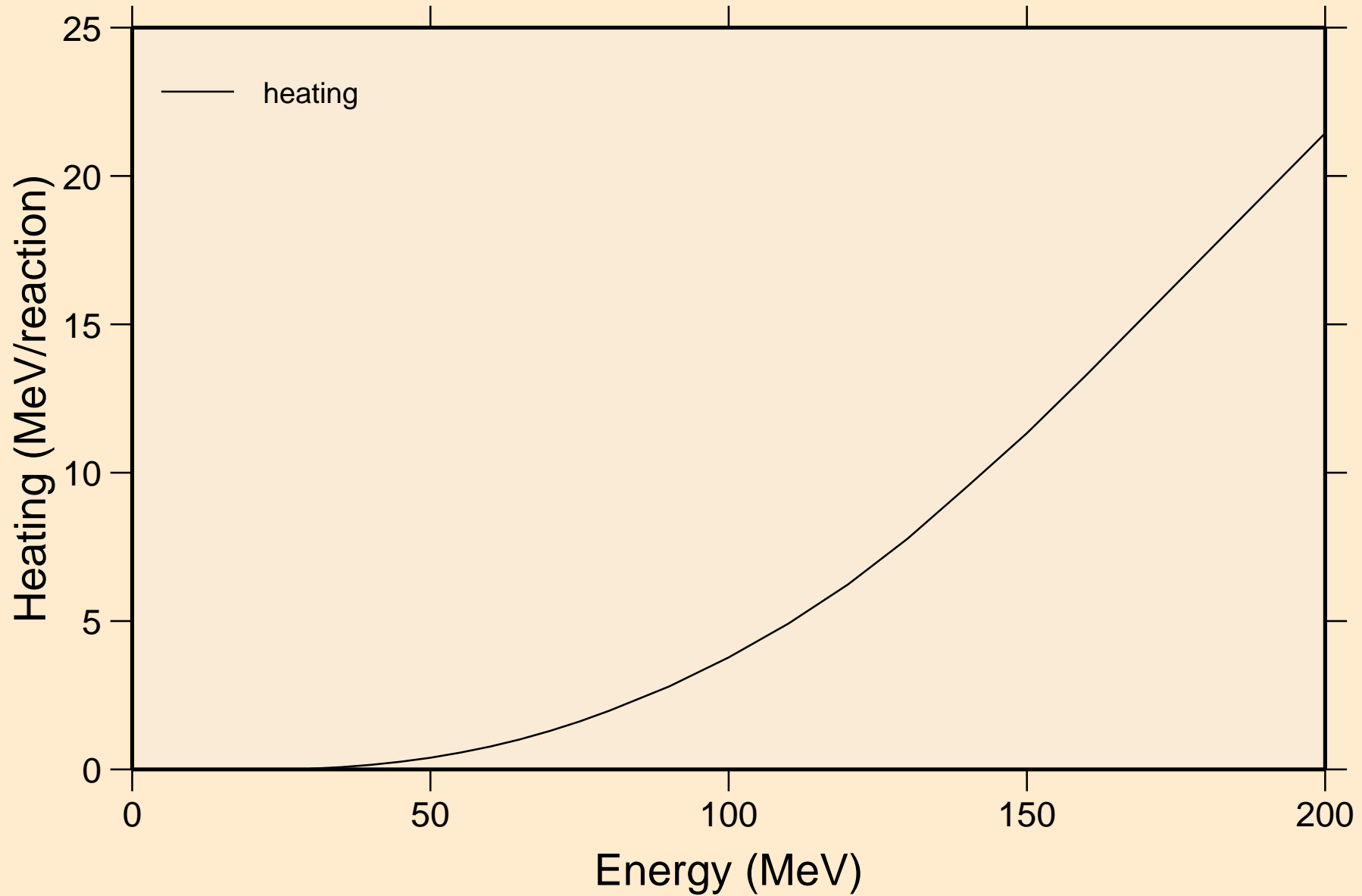

BH265 HELION ACER TENDL-2021 LIBRARY; T=0.K
Threshold reactions

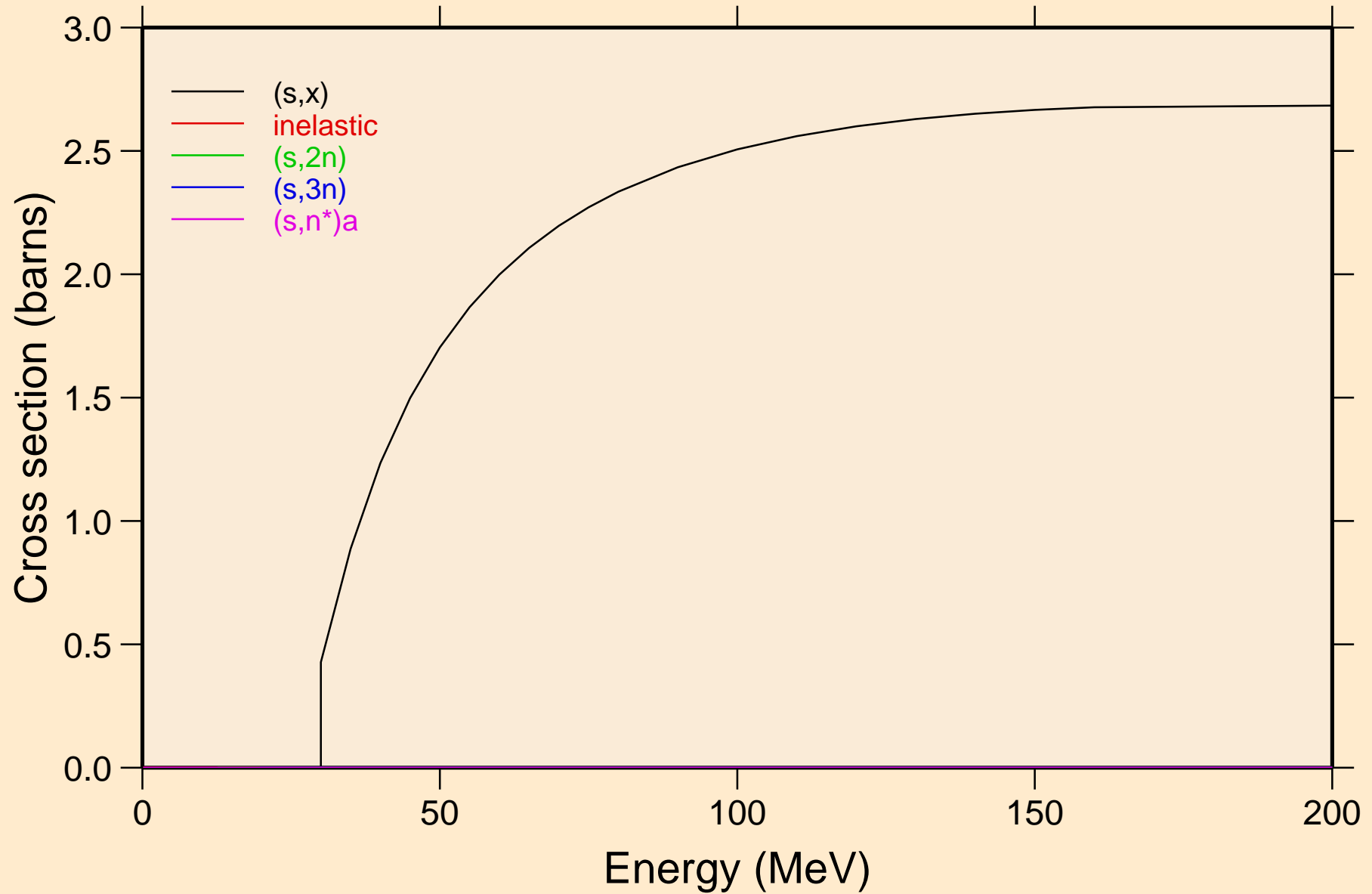

BH265 HELION ACER TENDL-2021 LIBRARY; T=0.K
Threshold reactions

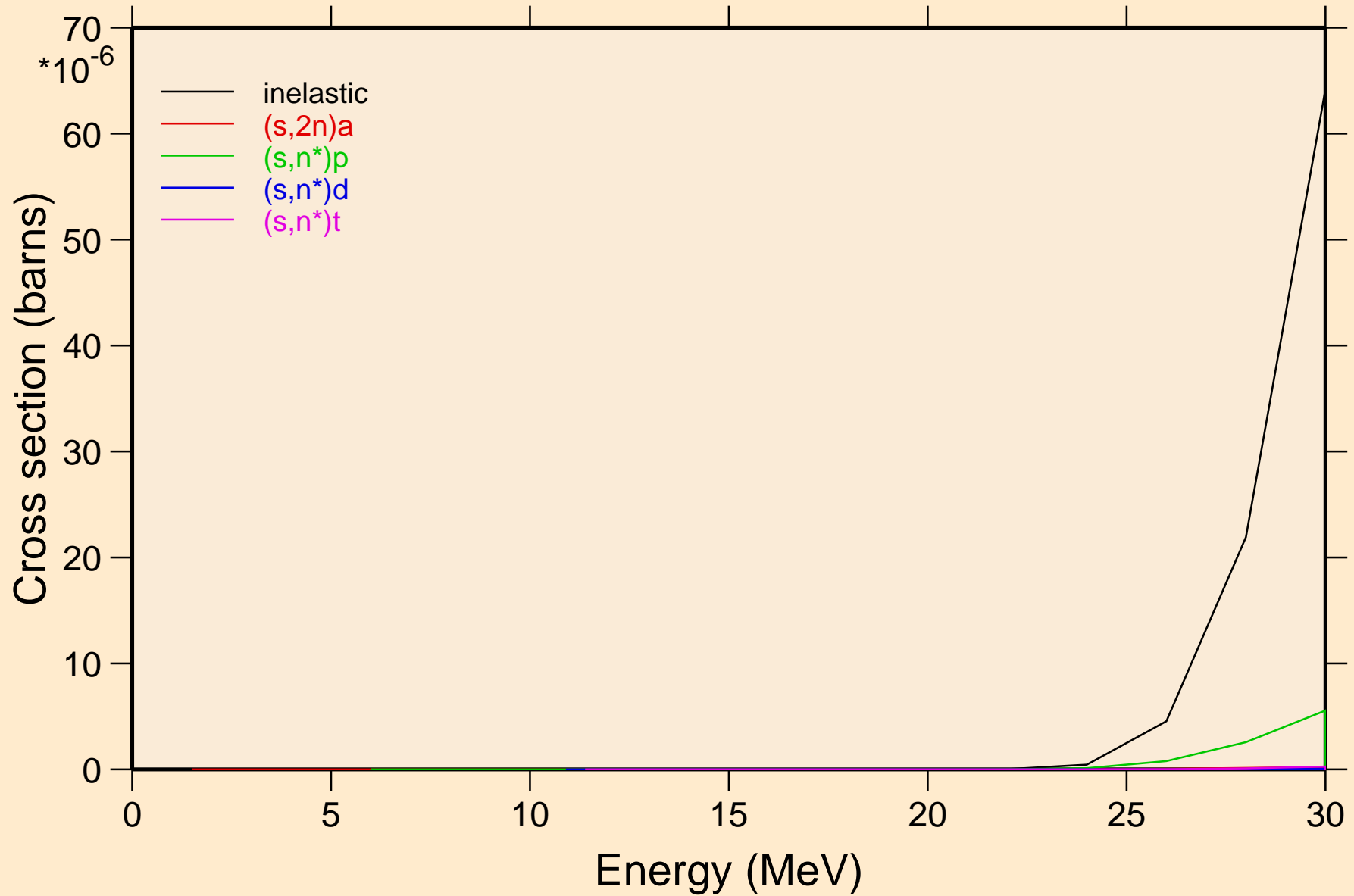

BH265 HELION ACER TENDL-2021 LIBRARY; T=0.K
Threshold reactions

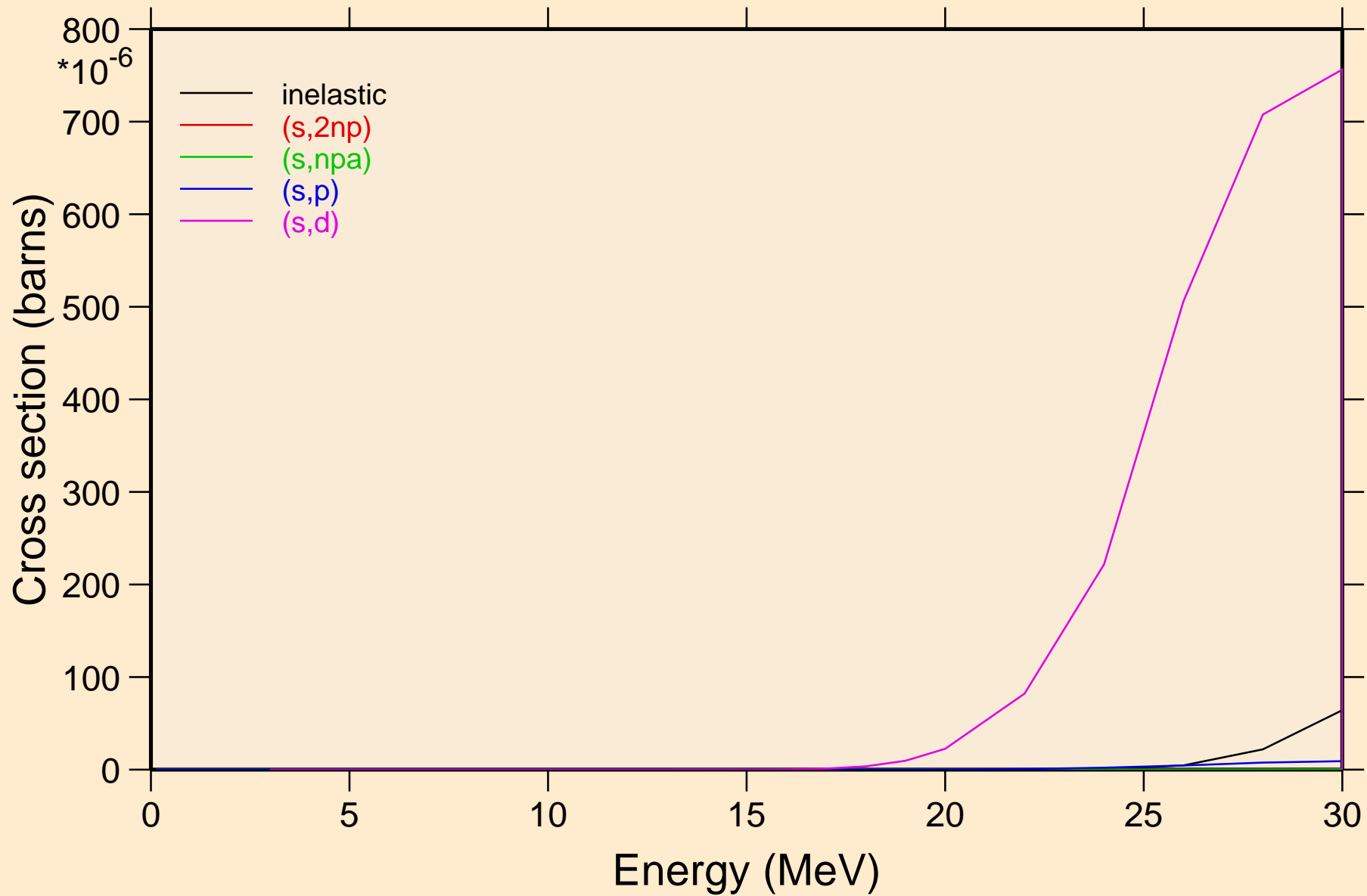

BH265 HELION ACER TENDL-2021 LIBRARY; T=0.K
Threshold reactions

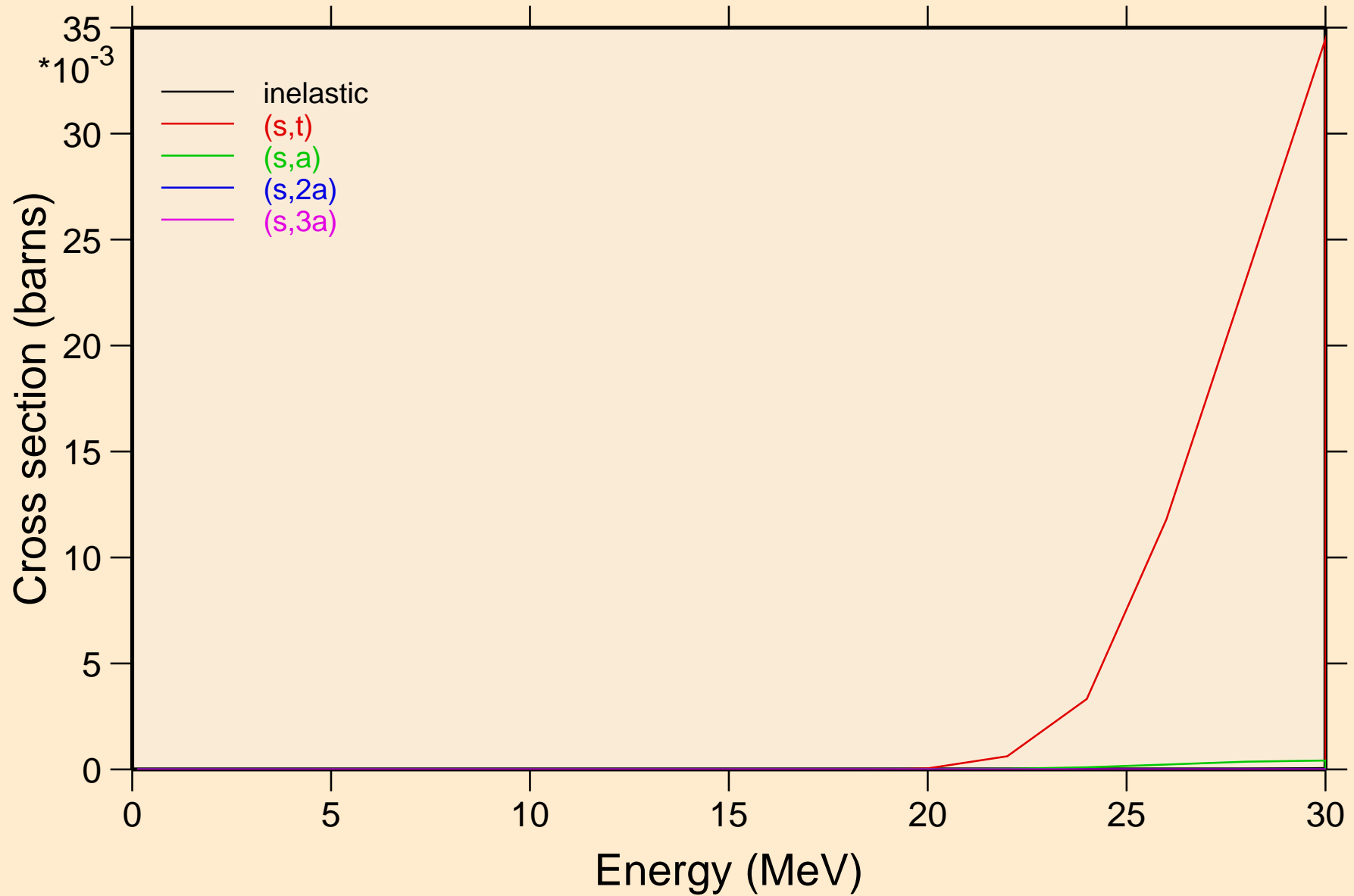

BH265 HELION ACER TENDL-2021 LIBRARY; T=0.K
Threshold reactions

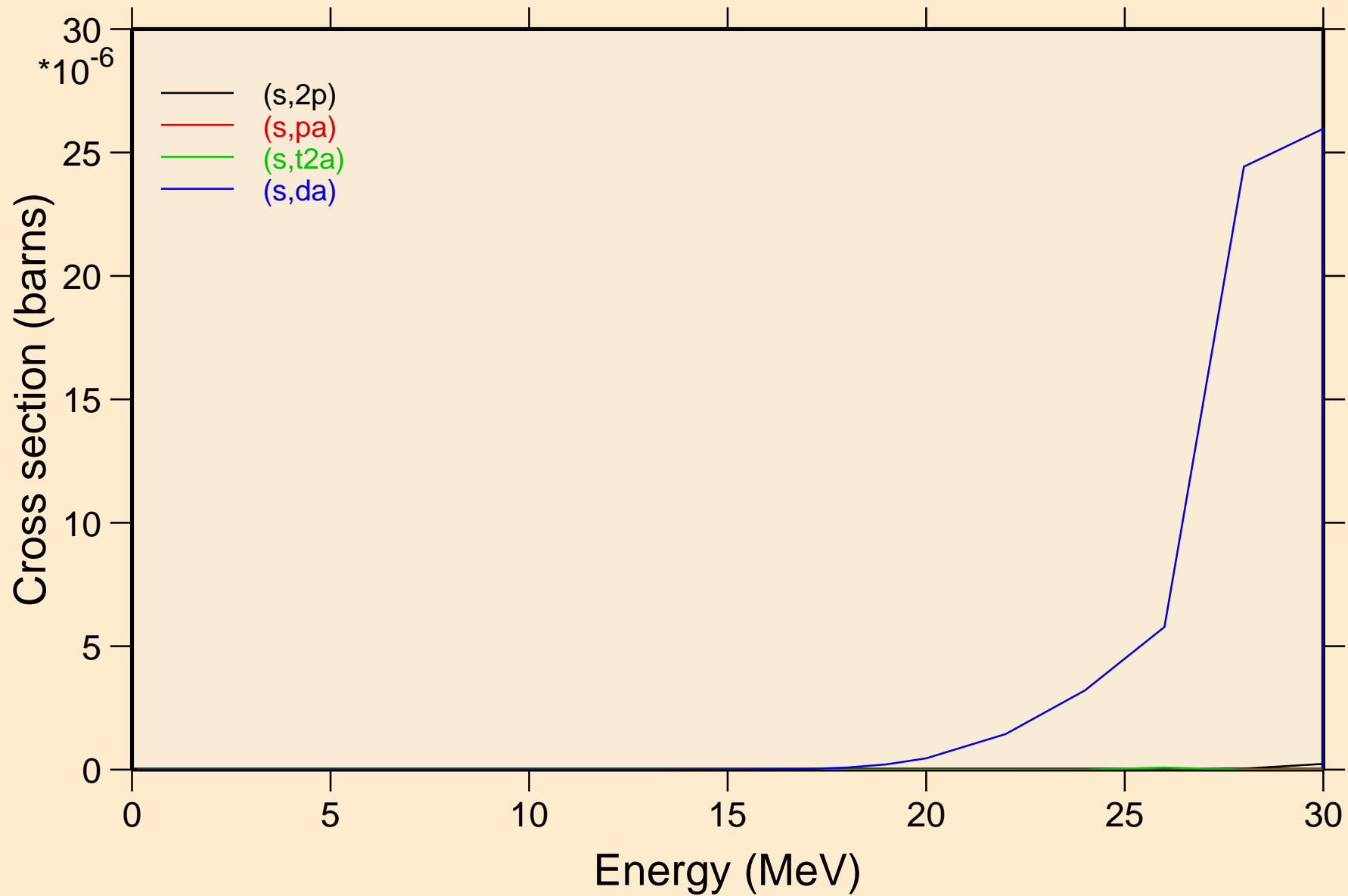

BH265 HELION ACER TENDL-2021 LIBRARY; T=0.K
angular distribution for elastic

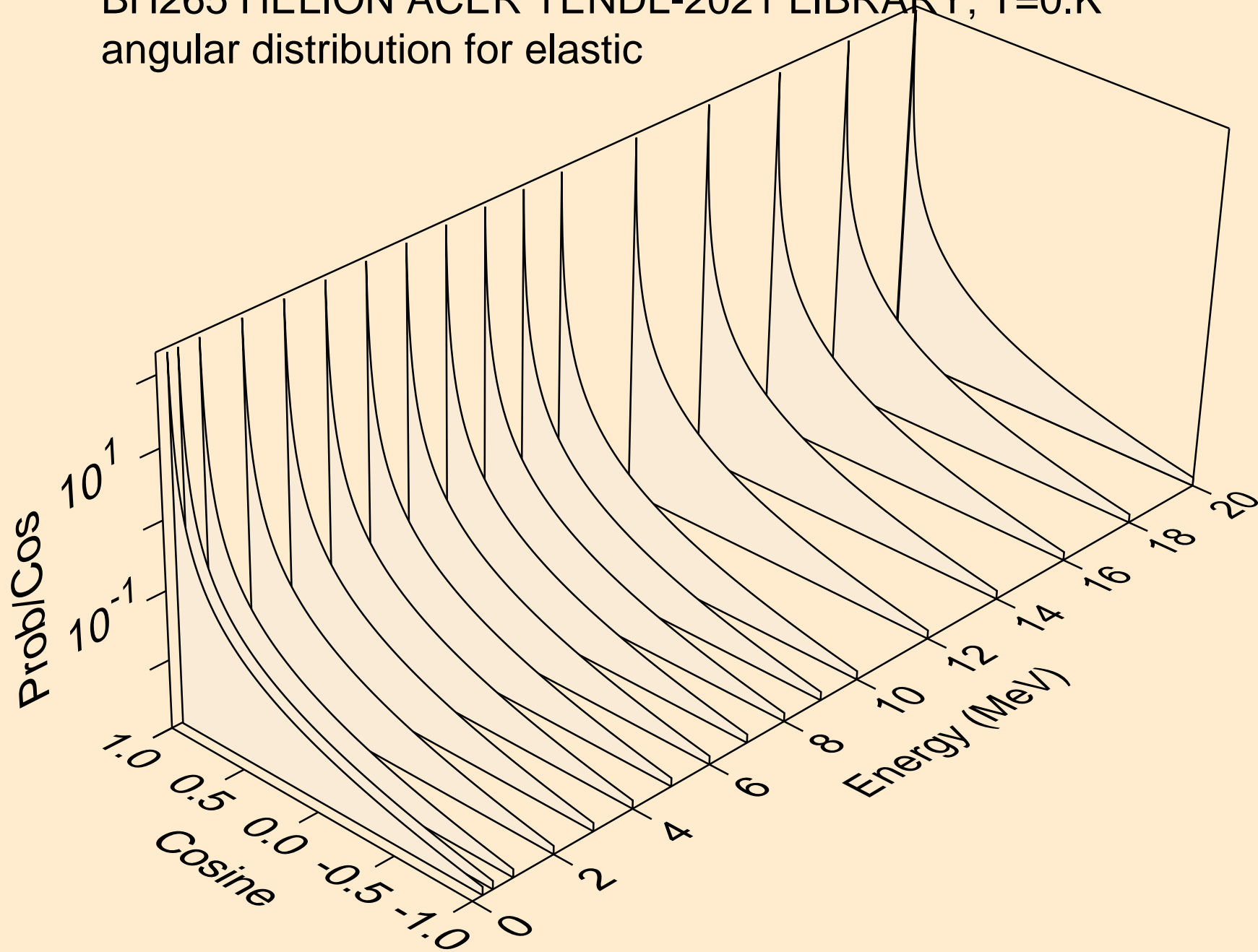

BH265 HELION ACER TENDL-2021 LIBRARY; T=0.K
angular distribution for elastic

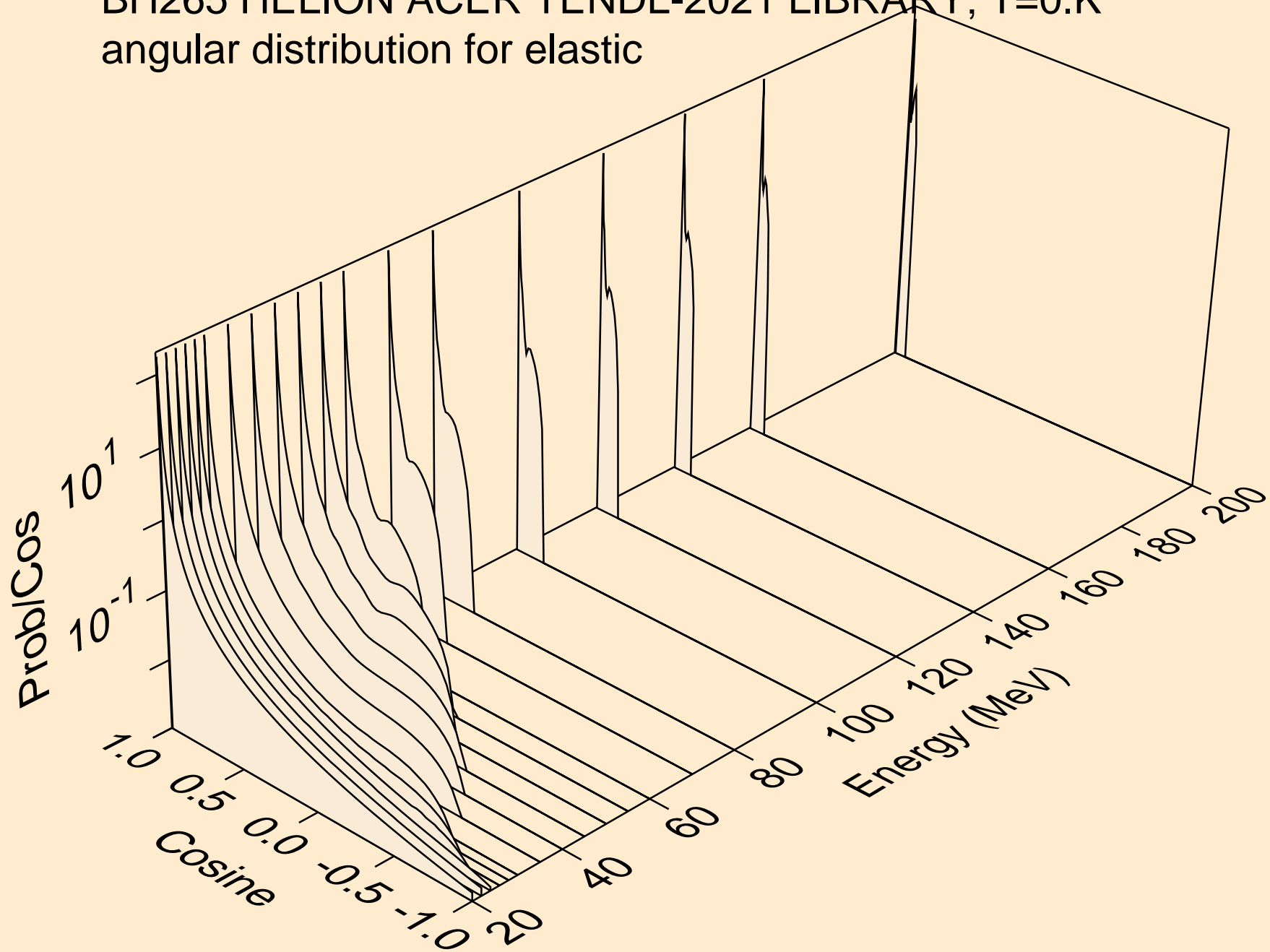

BH265 HELION ACER TENDL-2021 LIBRARY; T=0.K
He-3 emission for (s,x)

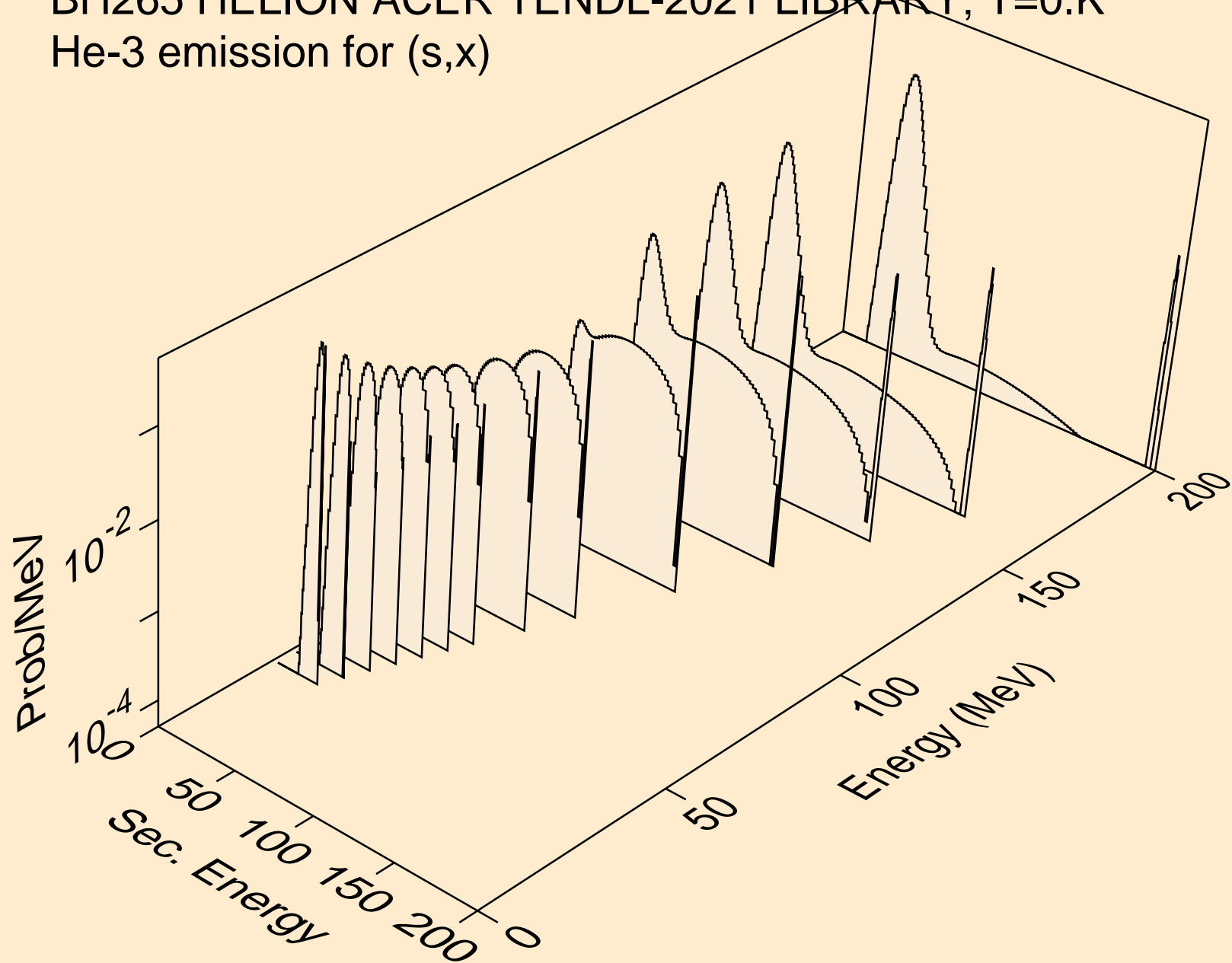

BH265 HELION ACER TENDL-2021 LIBRARY; T=0.K
He-3 emission for inelastic

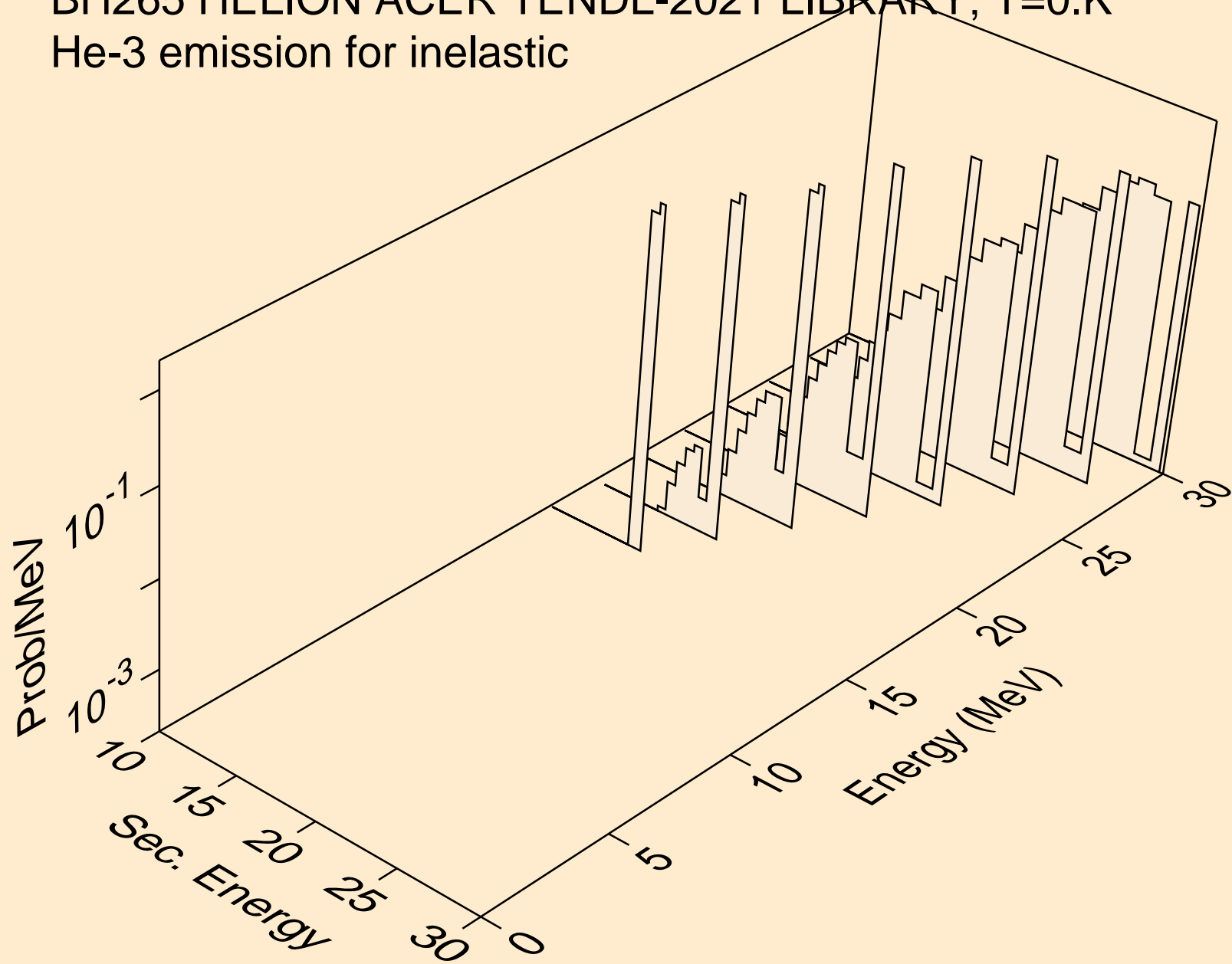

BH265 HELION ACER TENDL-2021 LIBRARY; T=0.K
Photon emission for (z,n)

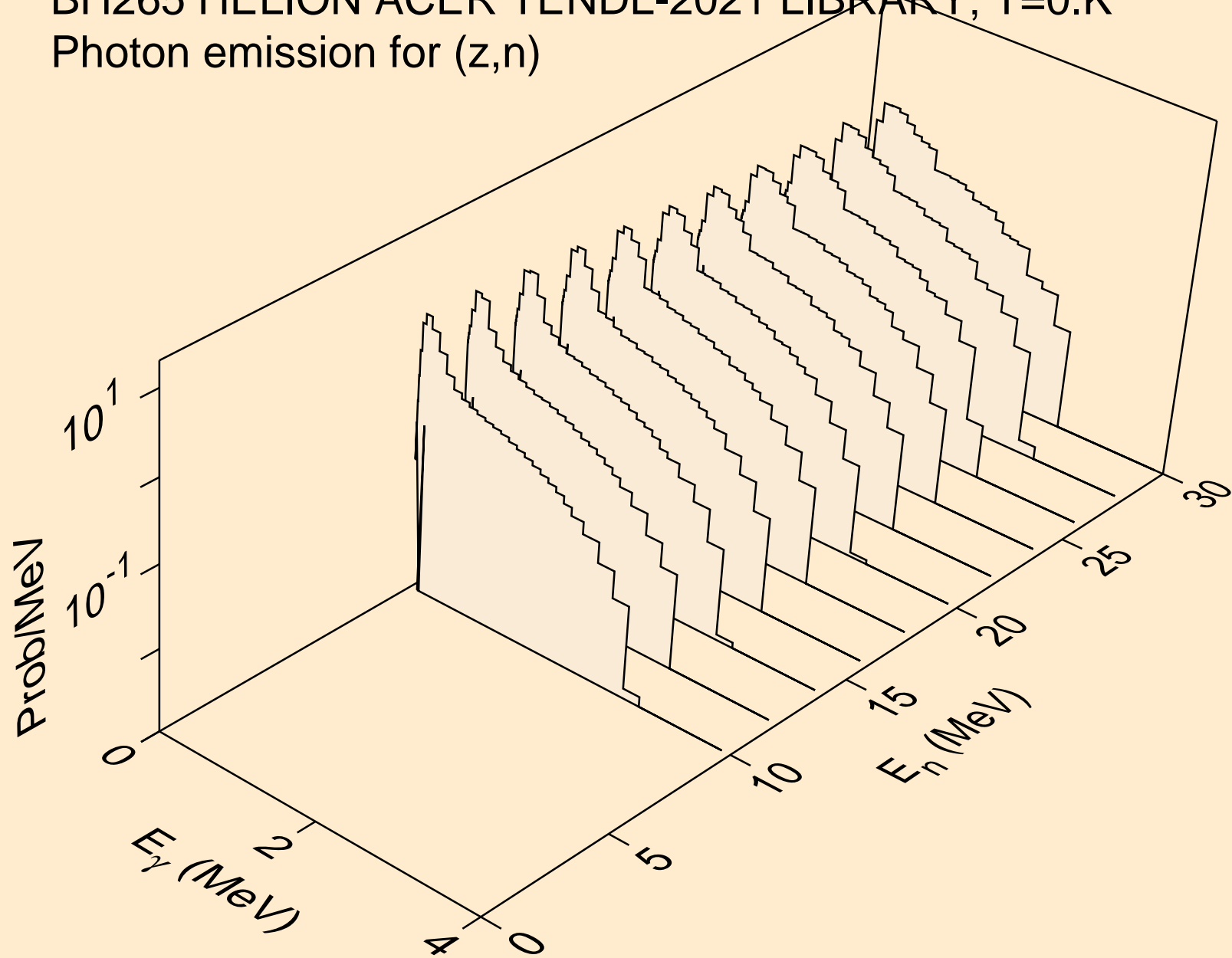

BH265 HELION ACER TENDL-2021 LIBRARY; T=0.K
Photon emission for (n,x)

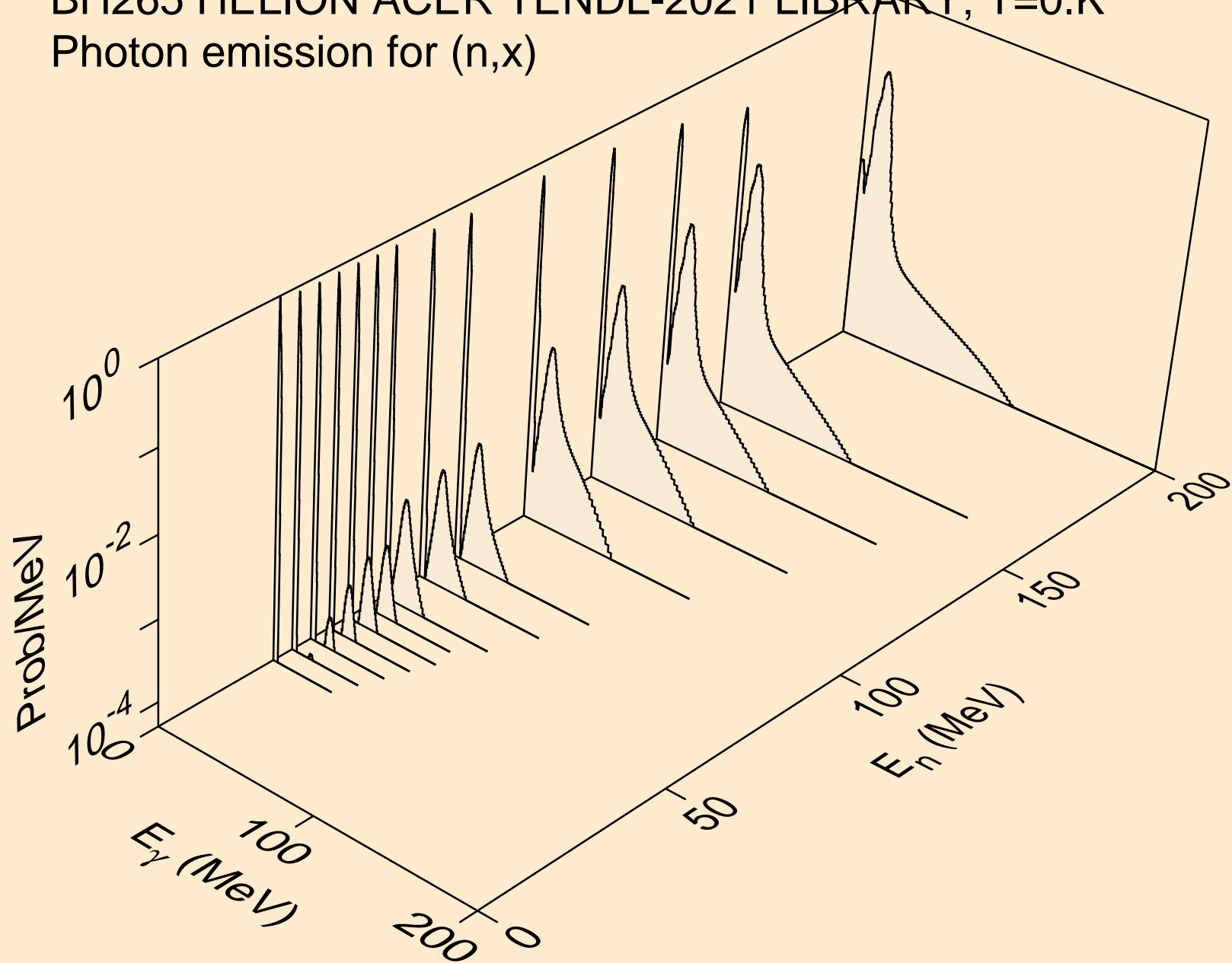

BH265 HELION ACER TENDL-2021 LIBRARY; T=0.K
Photon emission for (n,2n)

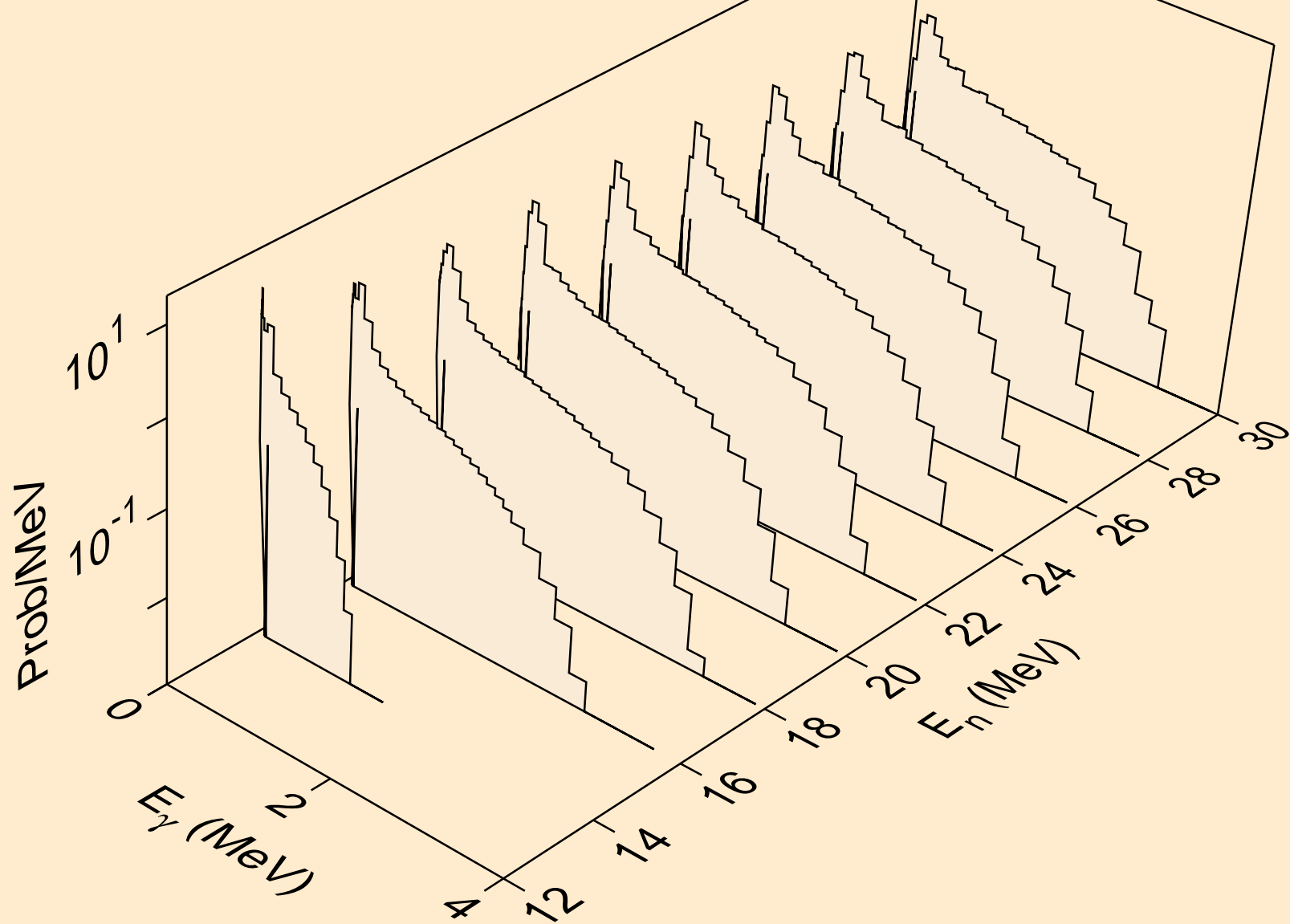

BH265 HELION ACER TENDL-2021 LIBRARY; T=0.K
Photon emission for (n,3n)

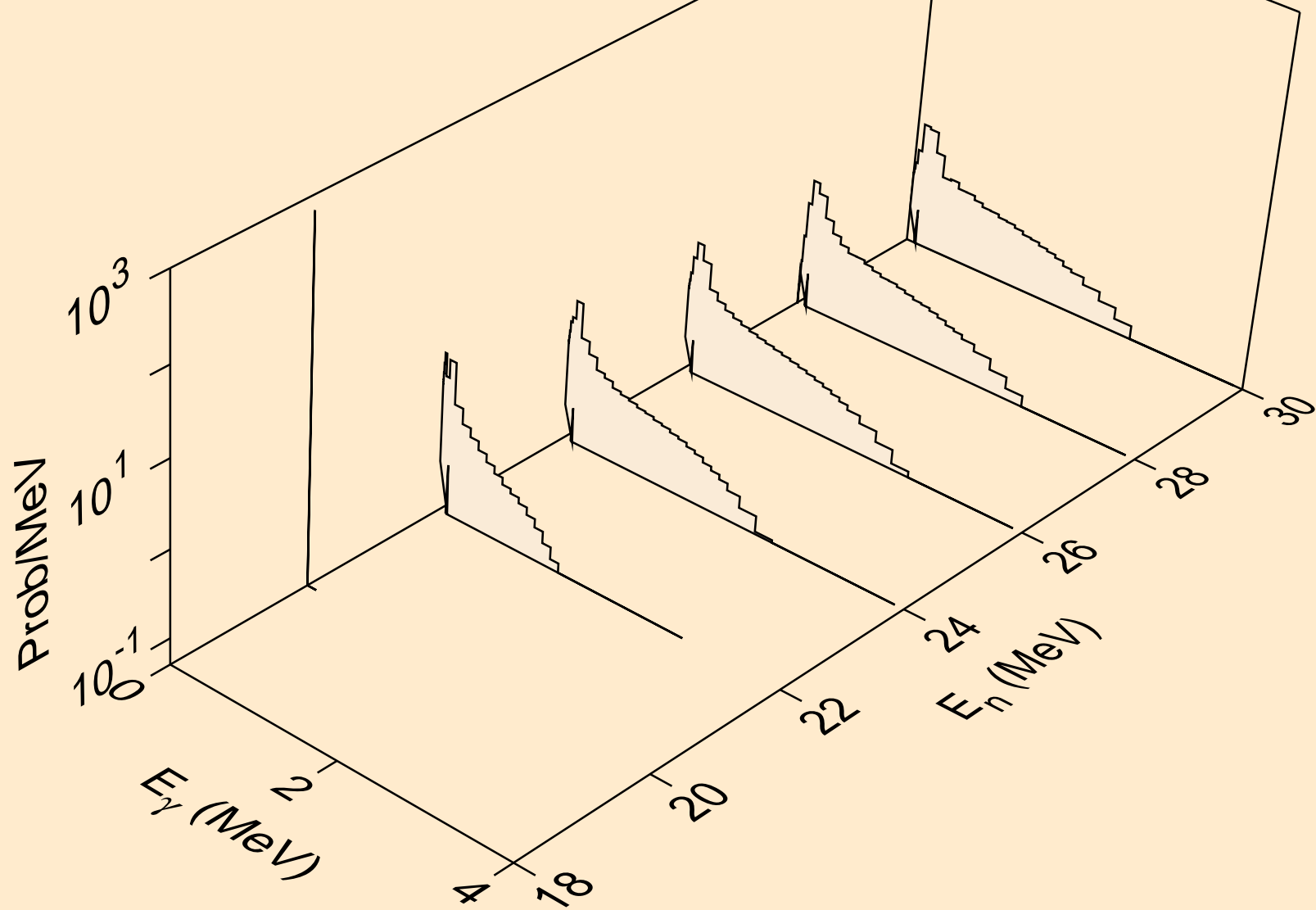

BH265 HELION ACER TENDL-2021 LIBRARY; T=0.K
Photon emission for (n,n*)a

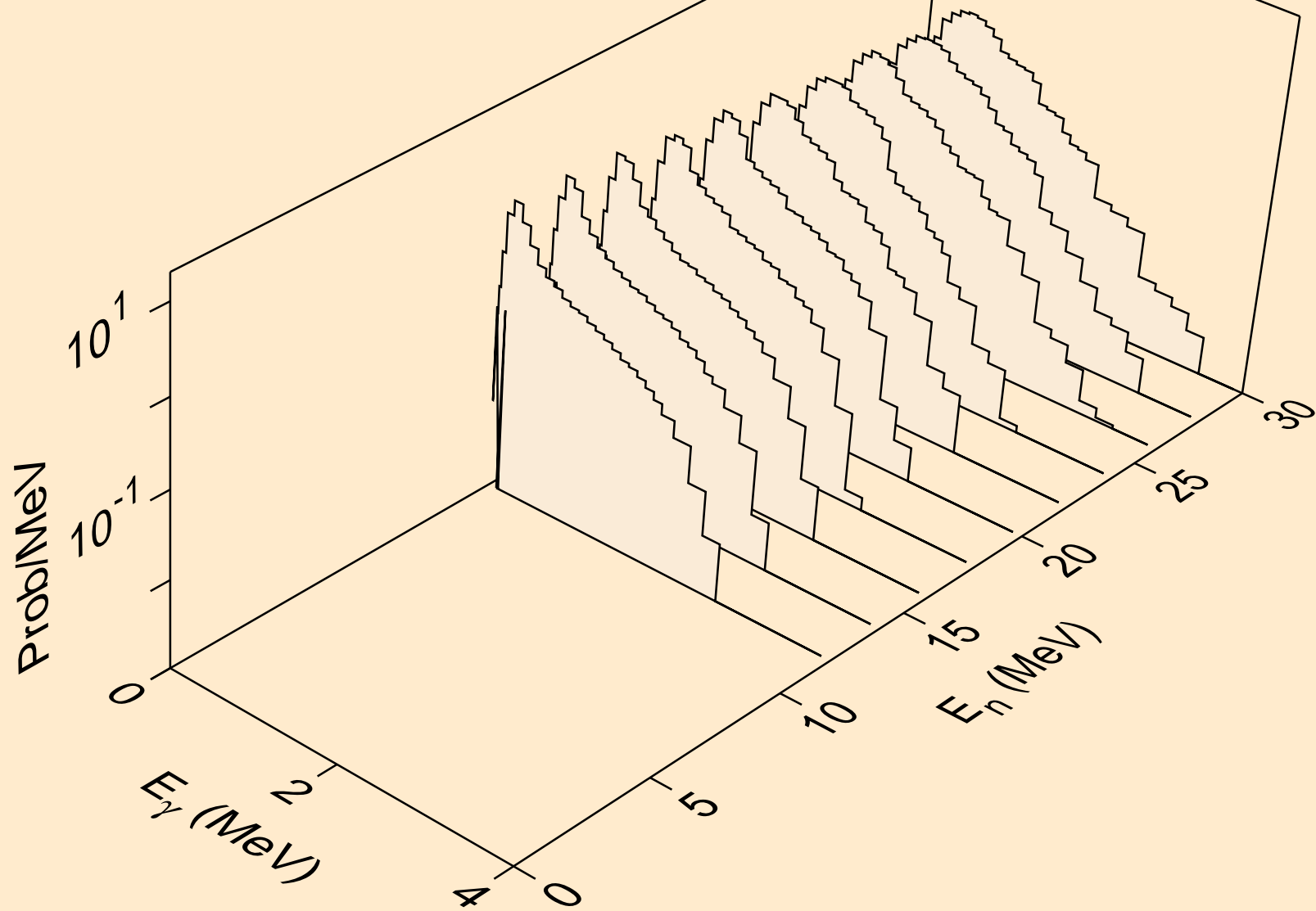

BH265 HELION ACER TENDL-2021 LIBRARY; T=0.K
Photon emission for (n,2n)a

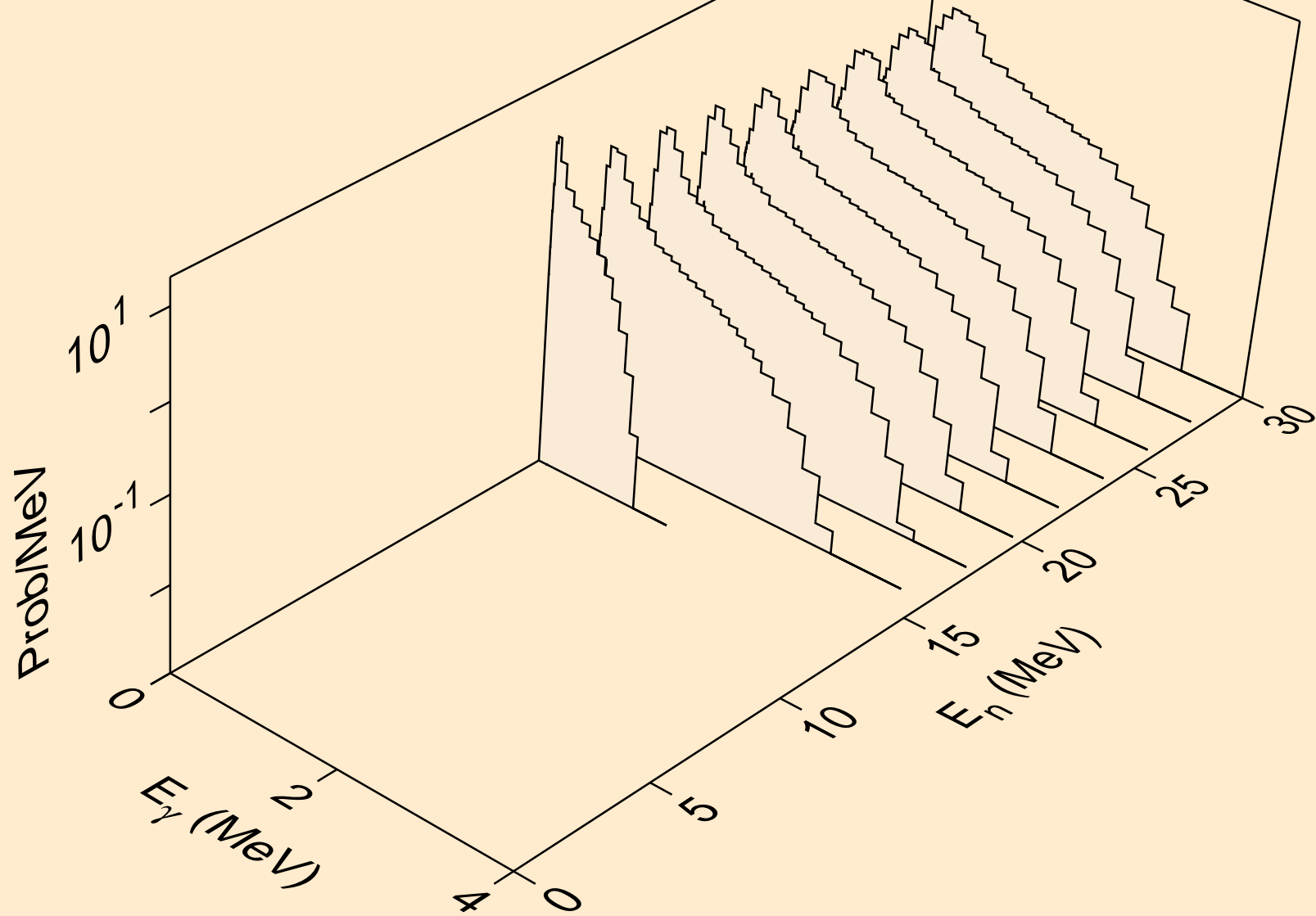

BH265 HELION ACER TENDL-2021 LIBRARY; T=0.K
Photon emission for (n,n*)p

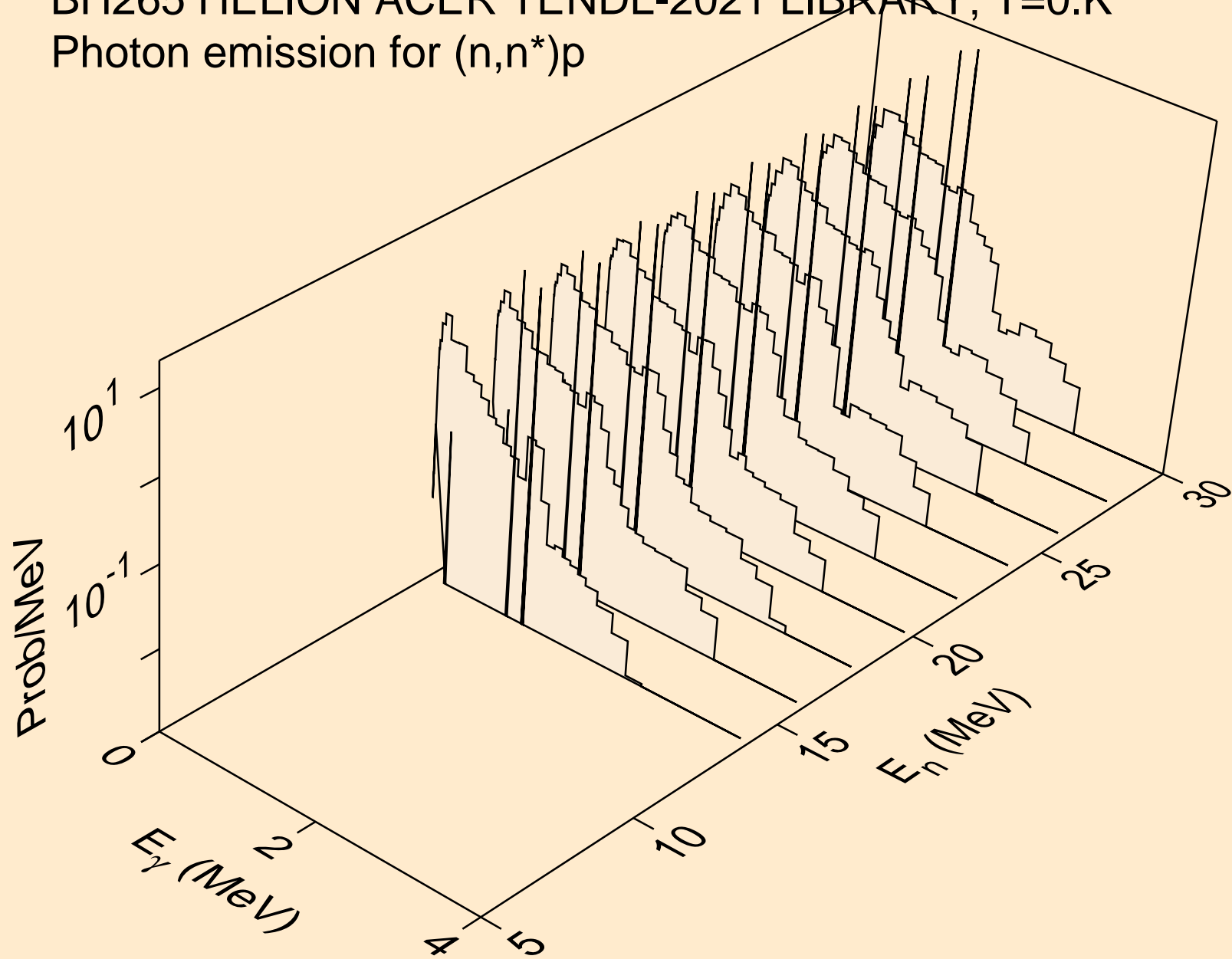

BH265 HELION ACER TENDL-2021 LIBRARY; T=0.K
Photon emission for (n,n*)d

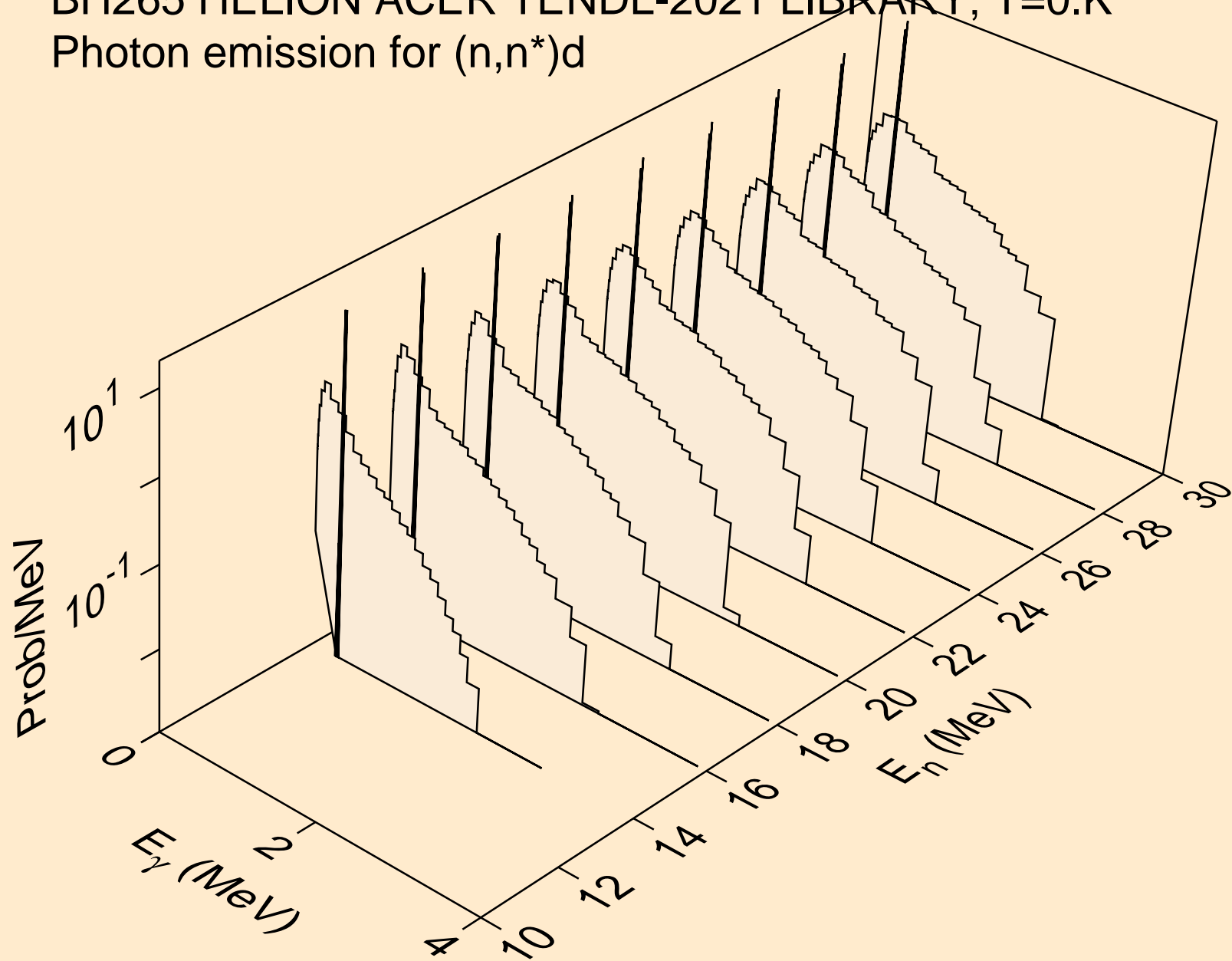

BH265 HELION ACER TENDL-2021 LIBRARY; T=0.K
Photon emission for (n,n*)t

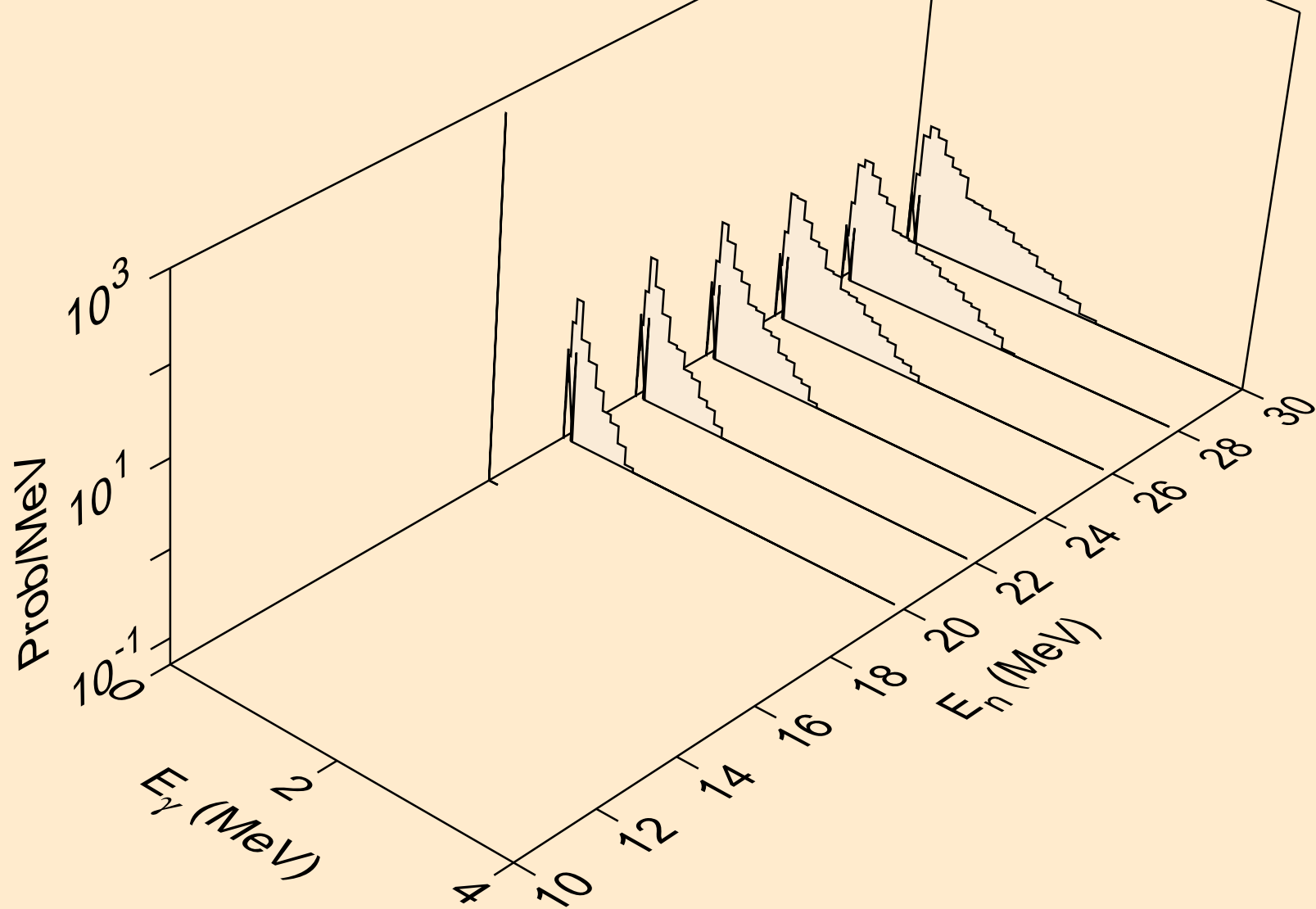

BH265 HELION ACER TENDL-2021 LIBRARY; T=0.K
Photon emission for (n,2np)

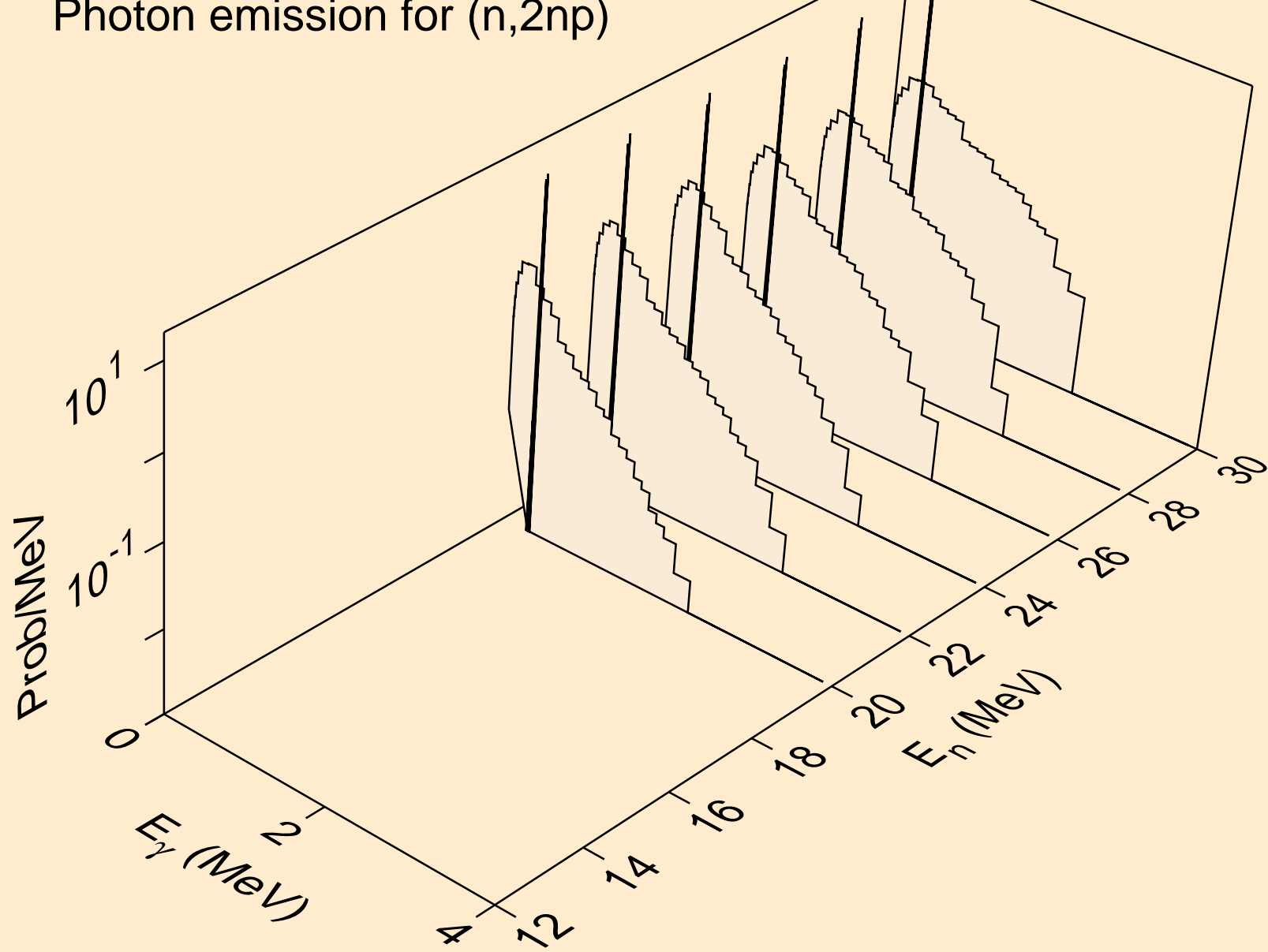

BH265 HELION ACER TENDL-2021 LIBRARY; T=0.K
Photon emission for (n,npa)

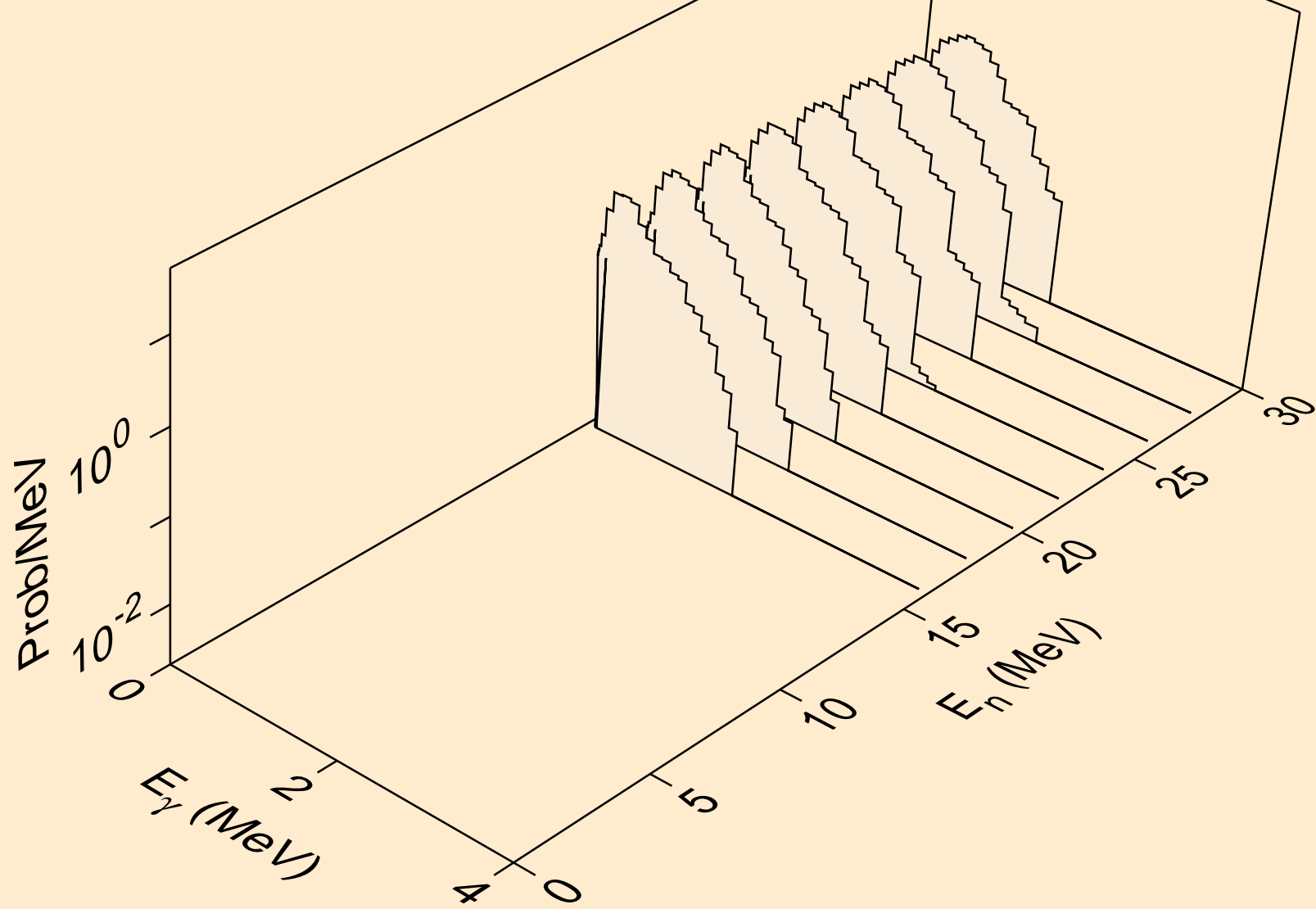

BH265 HELION ACER TENDL-2021 LIBRARY; T=0.K
Photon emission for (n,p)

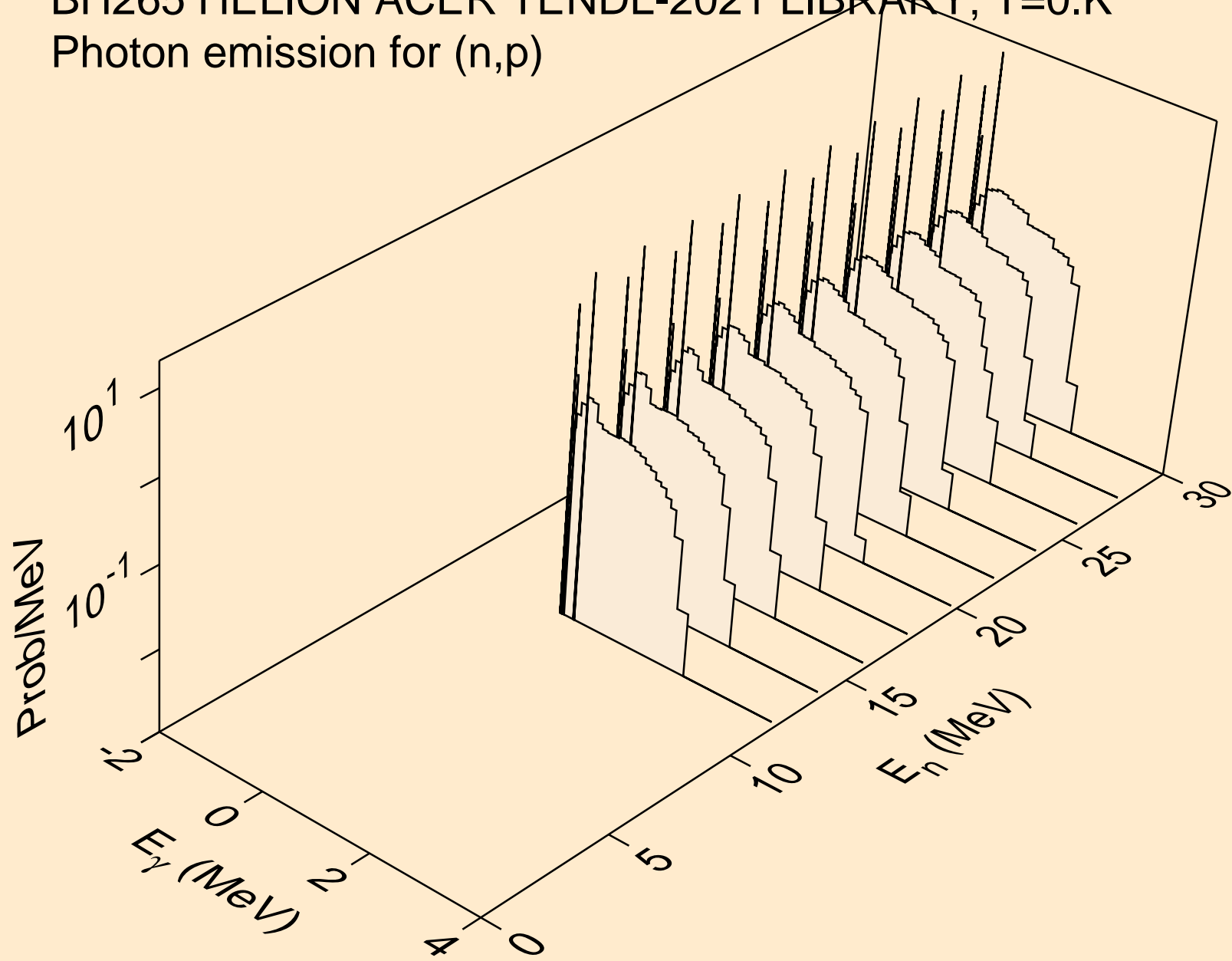

BH265 HELION ACER TENDL-2021 LIBRARY; T=0.K
Photon emission for (n,d)

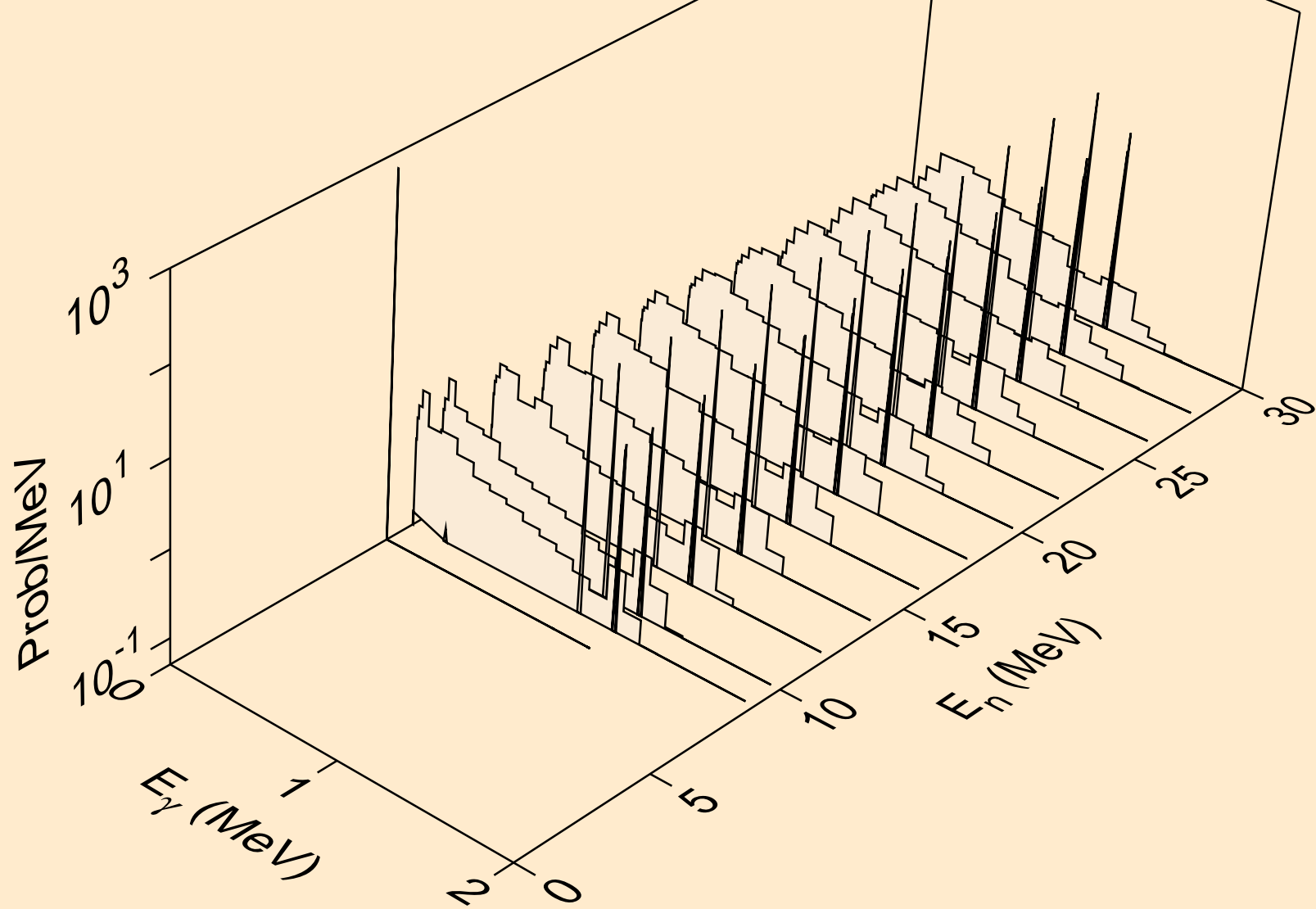

BH265 HELION ACER TENDL-2021 LIBRARY; T=0.K
Photon emission for (n,t)

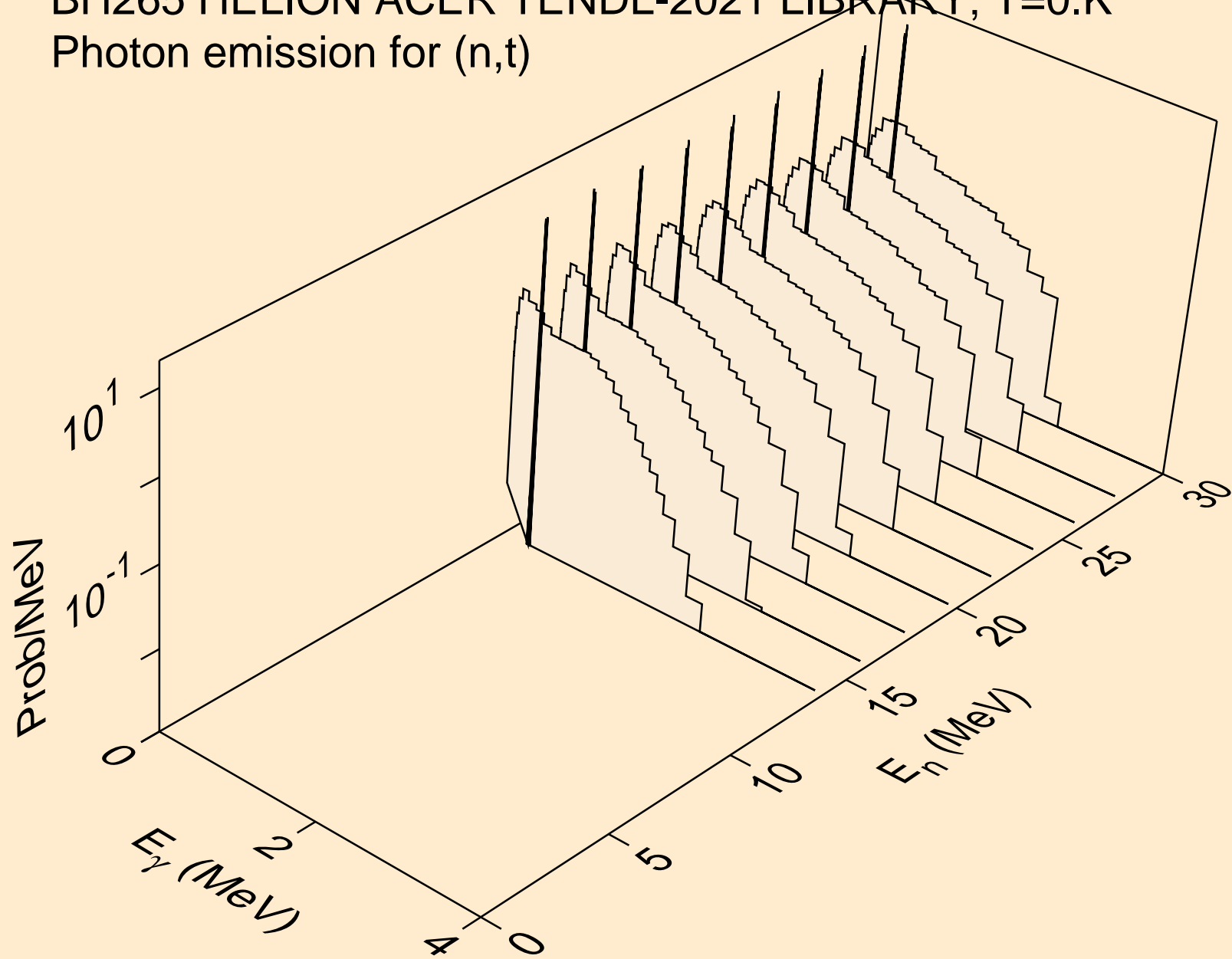

BH265 HELION ACER TENDL-2021 LIBRARY; T=0.K
Photon emission for inelastic

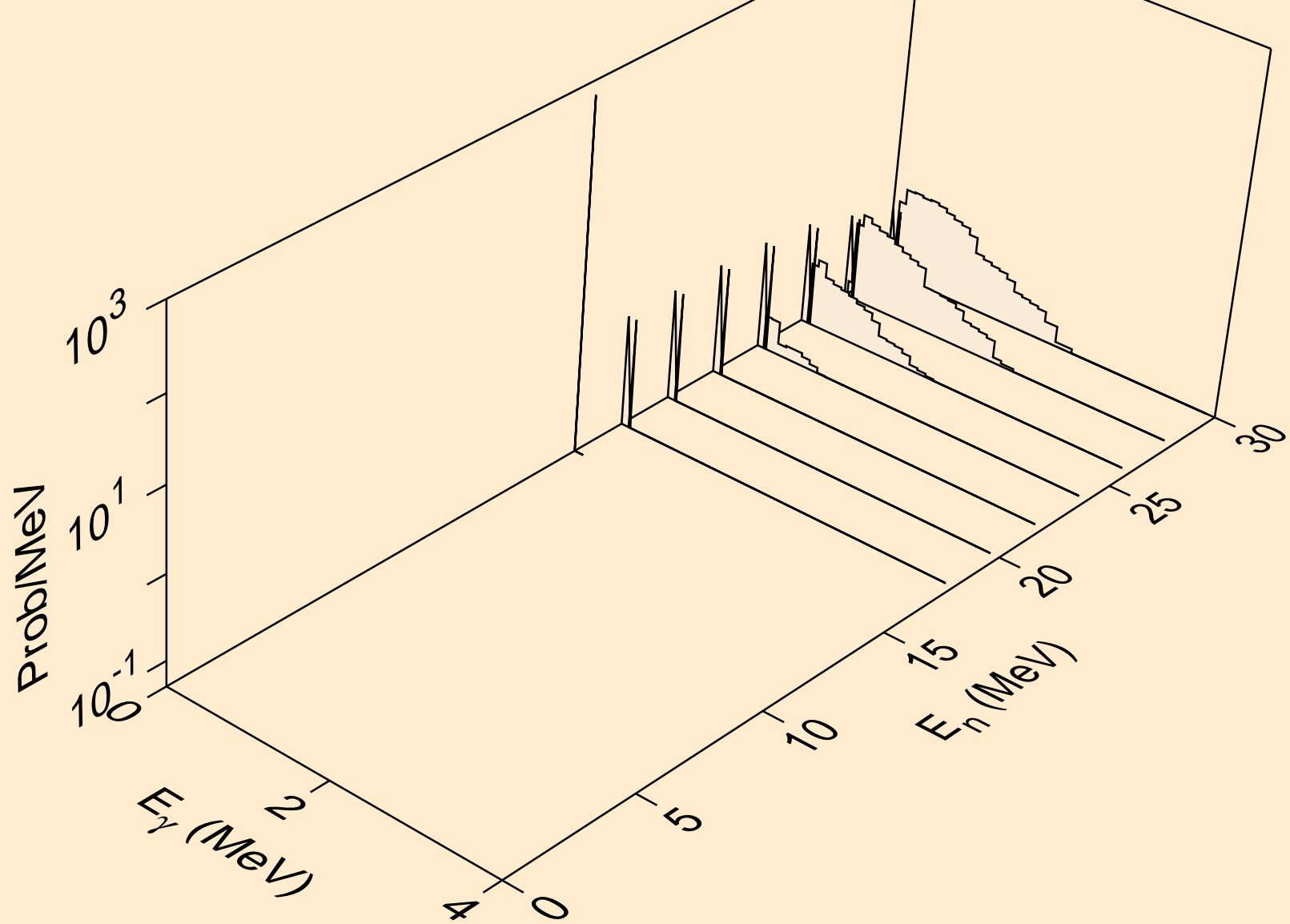

BH265 HELION ACER TENDL-2021 LIBRARY; T=0.K
Photon emission for (n,a)

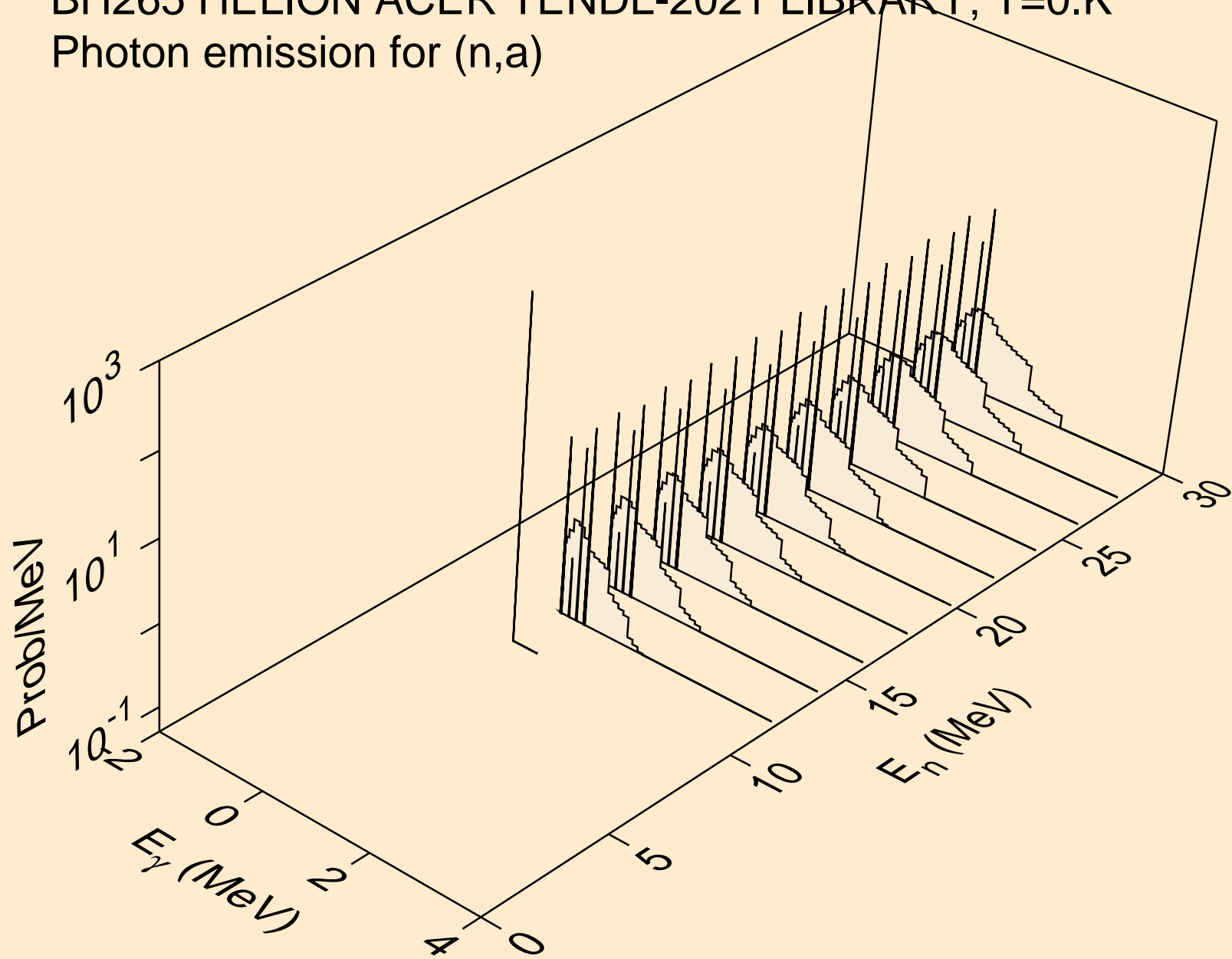

BH265 HELION ACER TENDL-2021 LIBRARY; T=0.K
Photon emission for (n,2a)

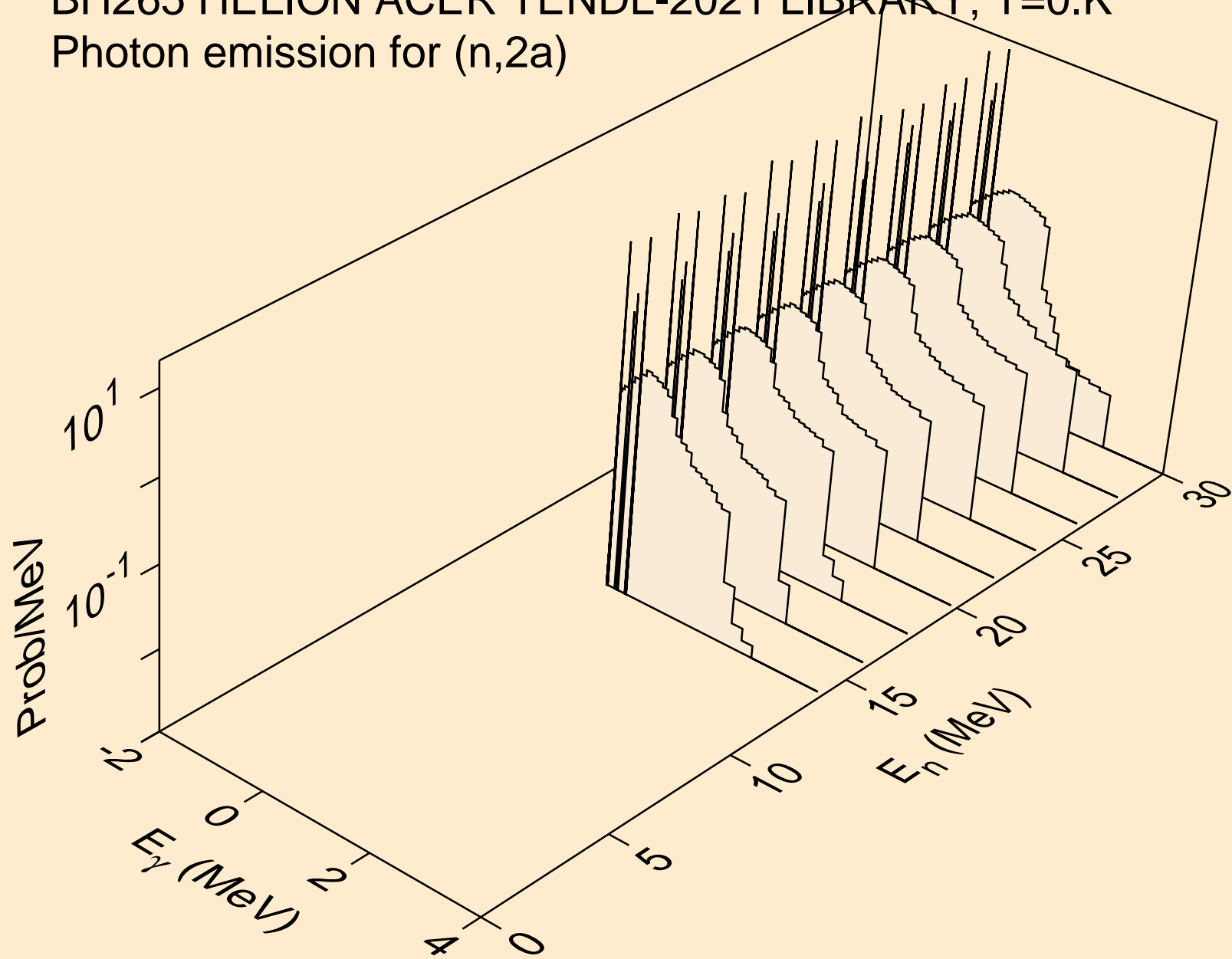

BH265 HELION ACER TENDL-2021 LIBRARY; T=0.K
Photon emission for (n,3a)

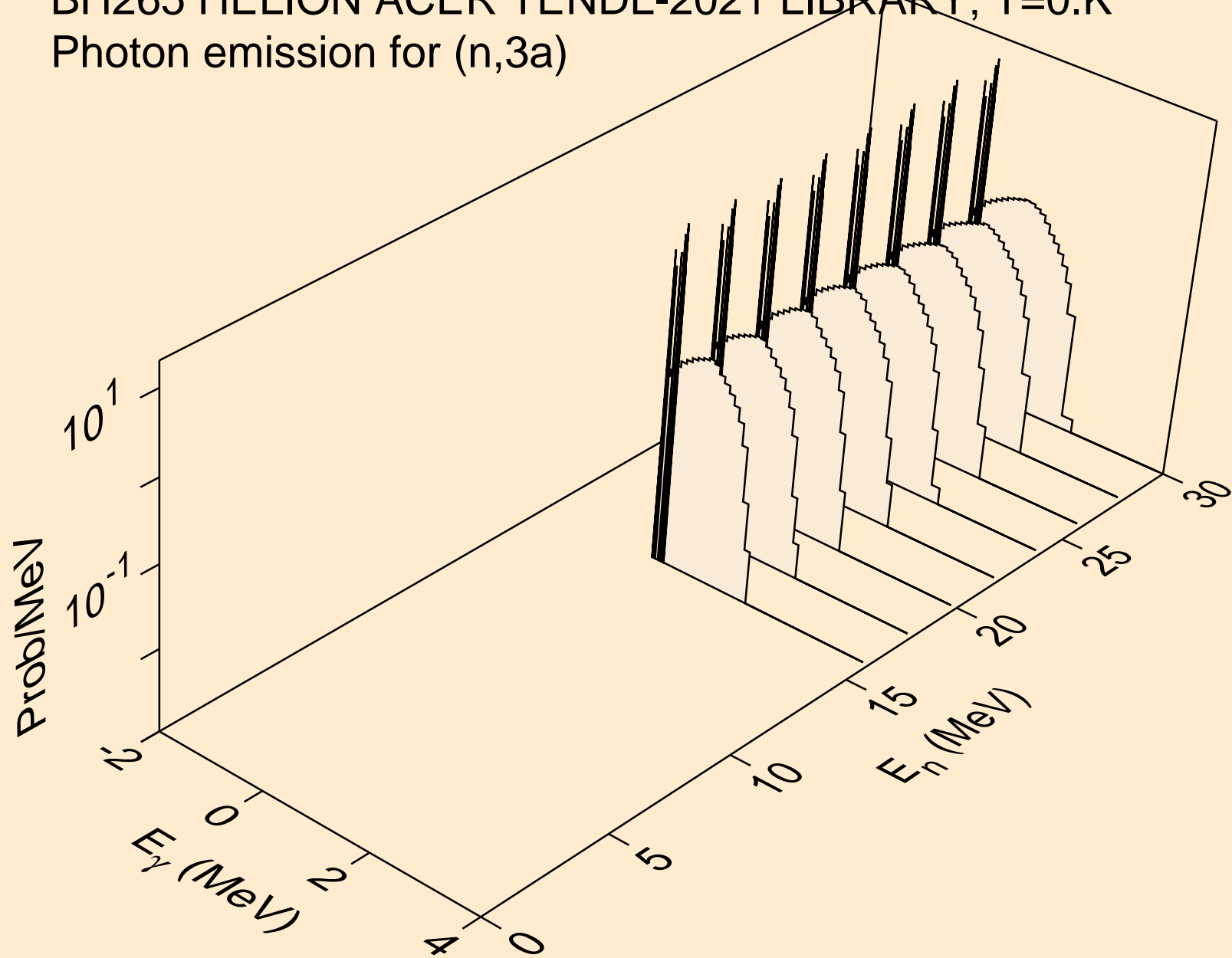

BH265 HELION ACER TENDL-2021 LIBRARY; T=0.K
Photon emission for (n,2p)

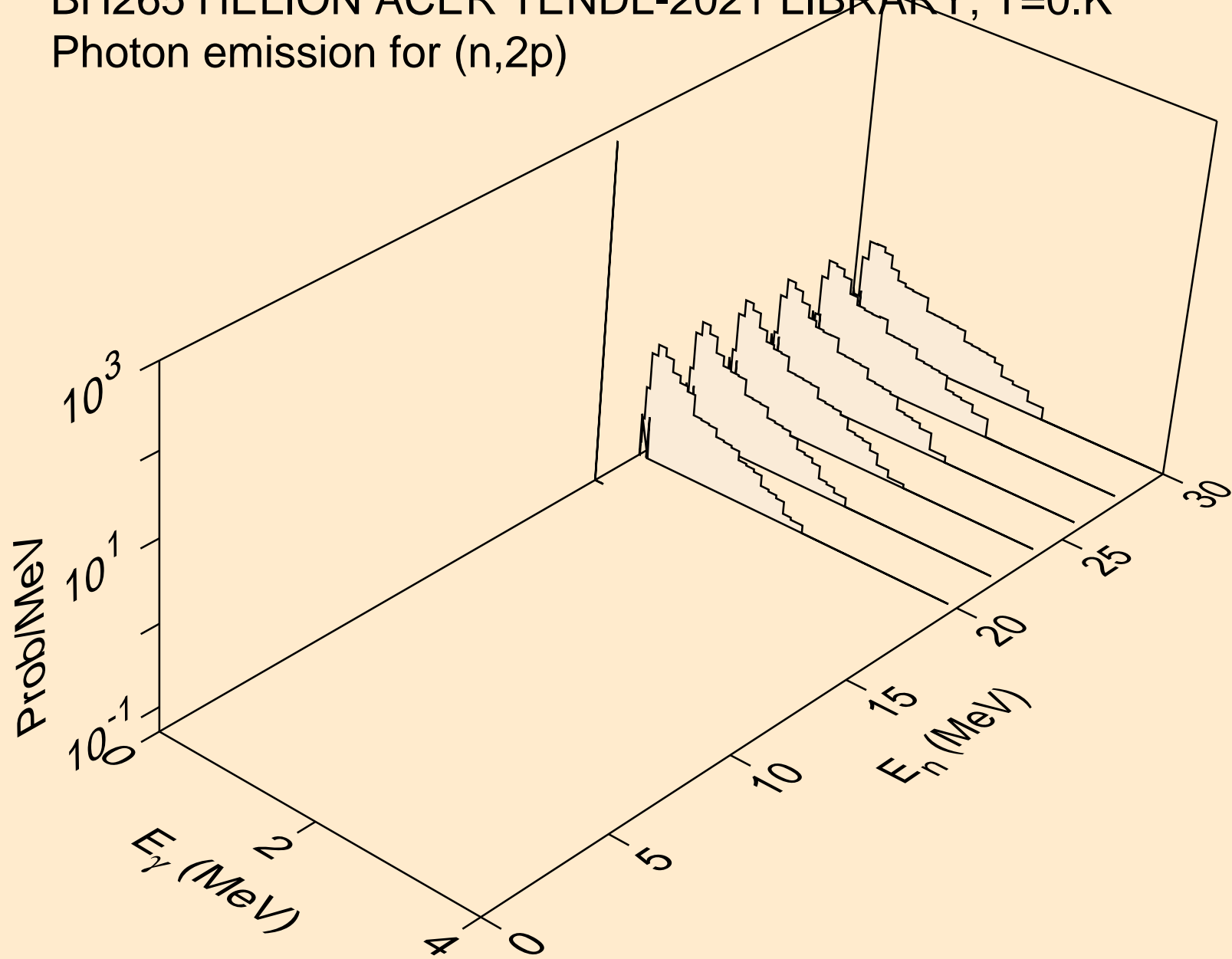

BH265 HELION ACER TENDL-2021 LIBRARY; T=0.K
Photon emission for (n,pa)

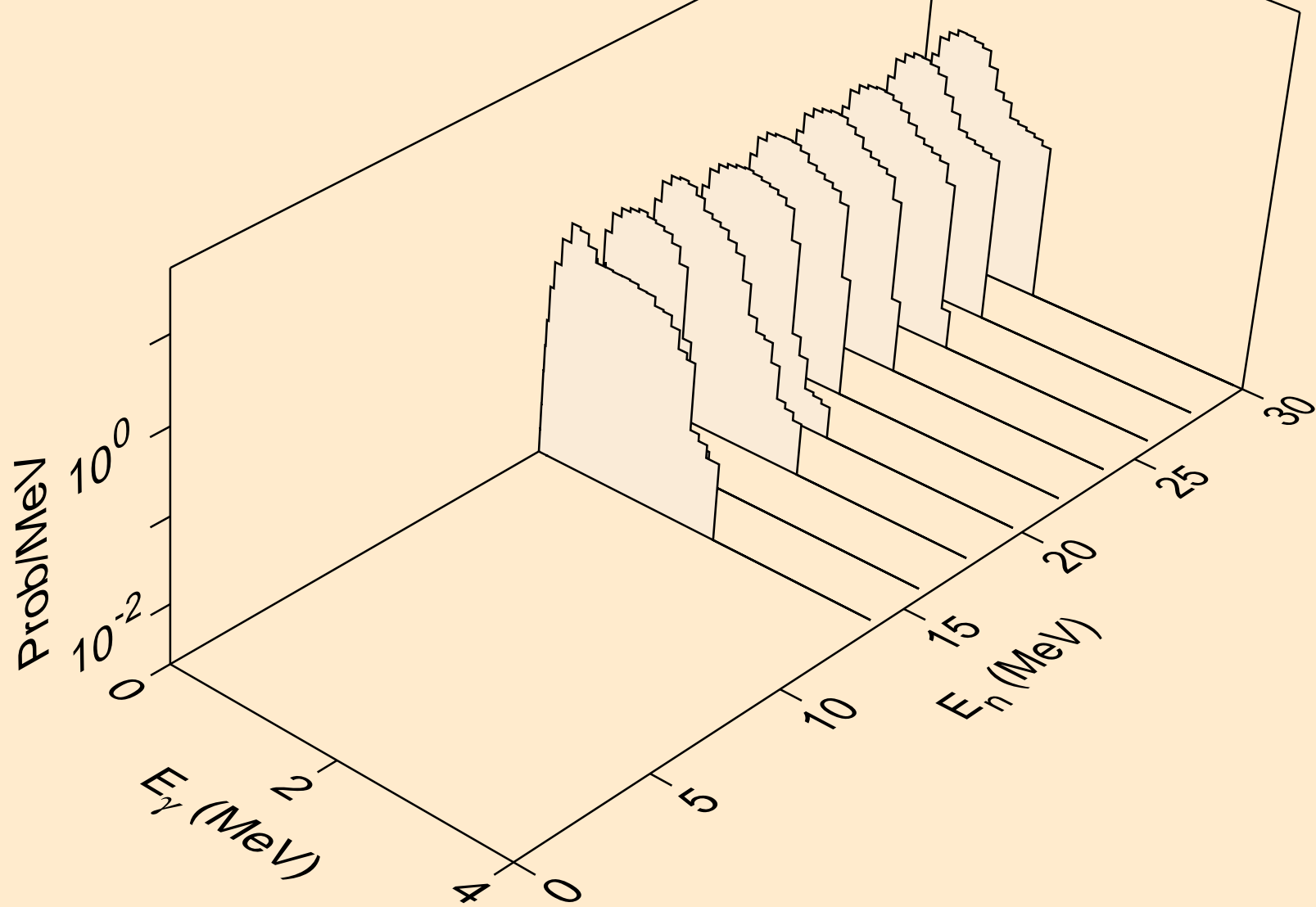

BH265 HELION ACER TENDL-2021 LIBRARY; T=0.K
Photon emission for (n,t2a)

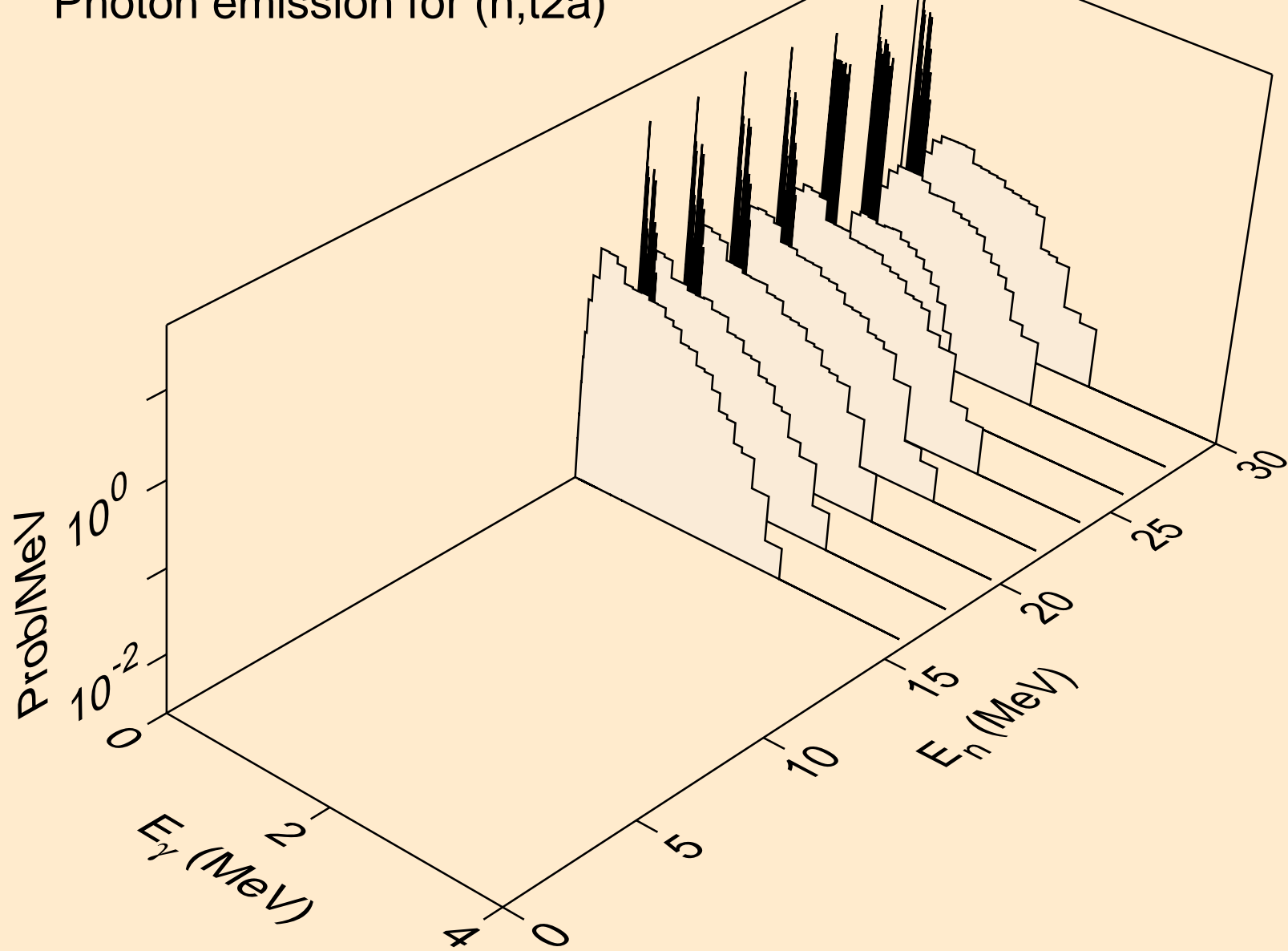

BH265 HELION ACER TENDL-2021 LIBRARY; T=0.K
Photon emission for (n,da)

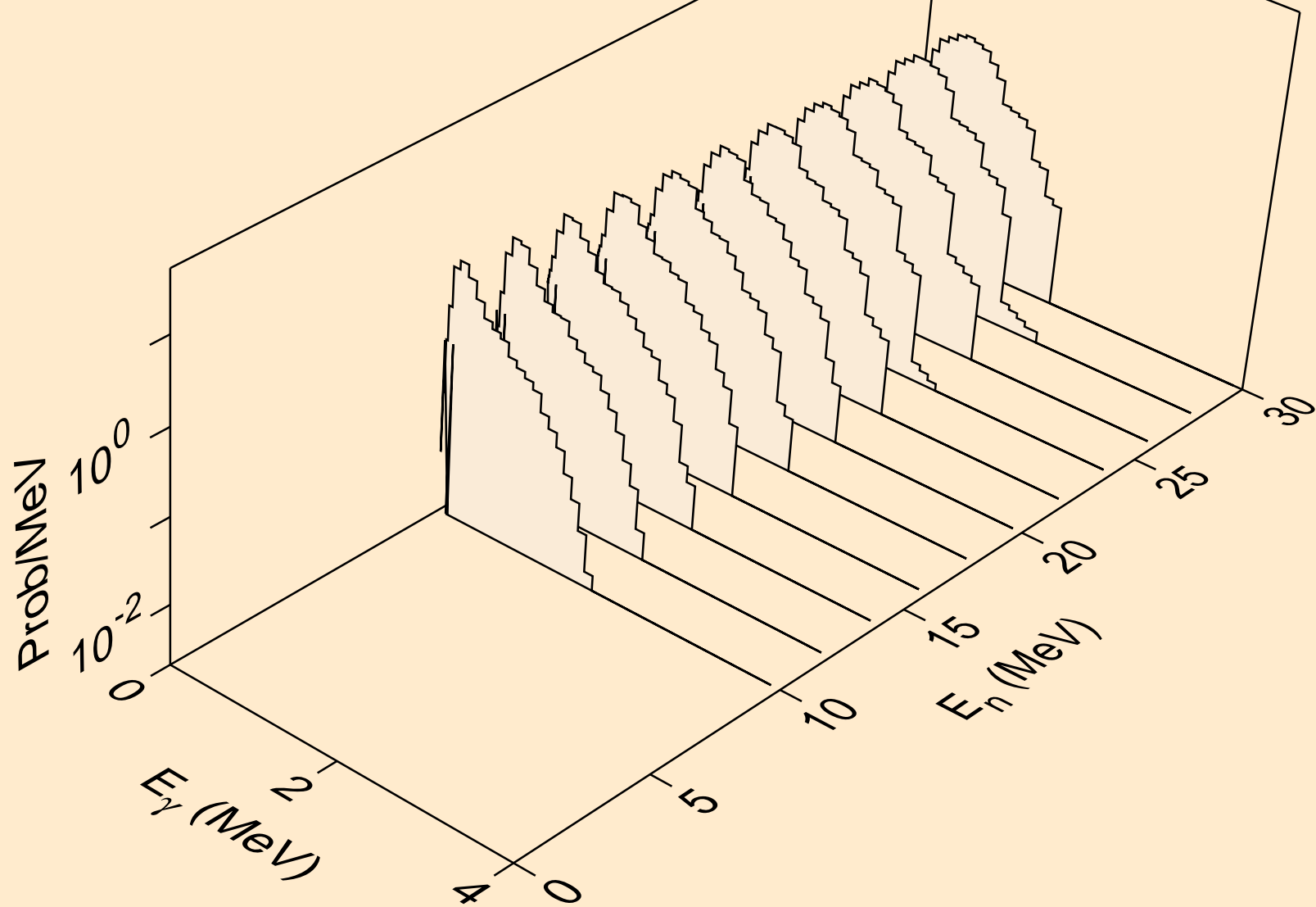

BH265 HELION ACER TENDL-2021 LIBRARY; T=0.K
Particle heating contributions

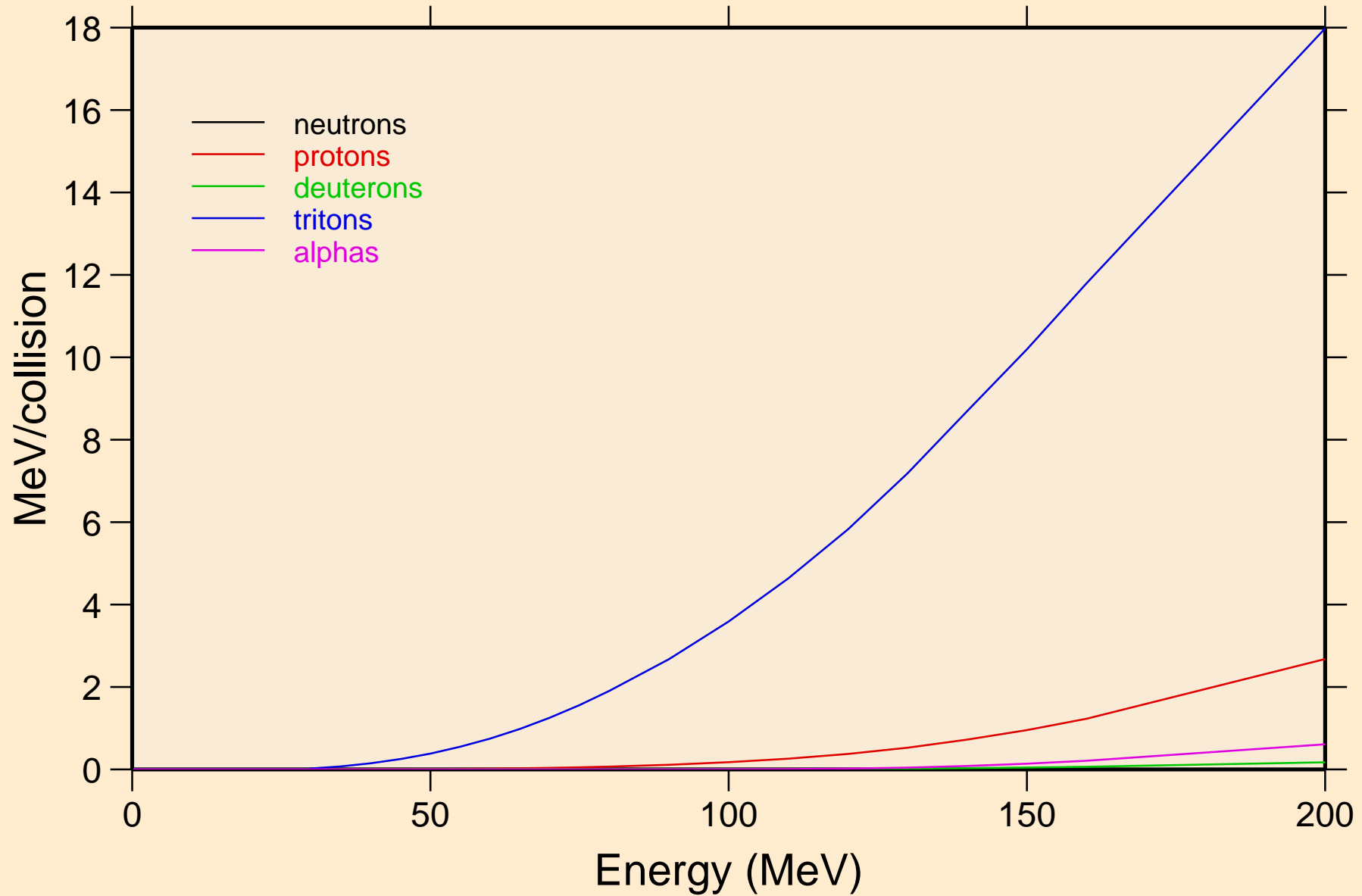

BH265 HELION ACER TENDL-2021 LIBRARY; T=0.K
Recoil Heating

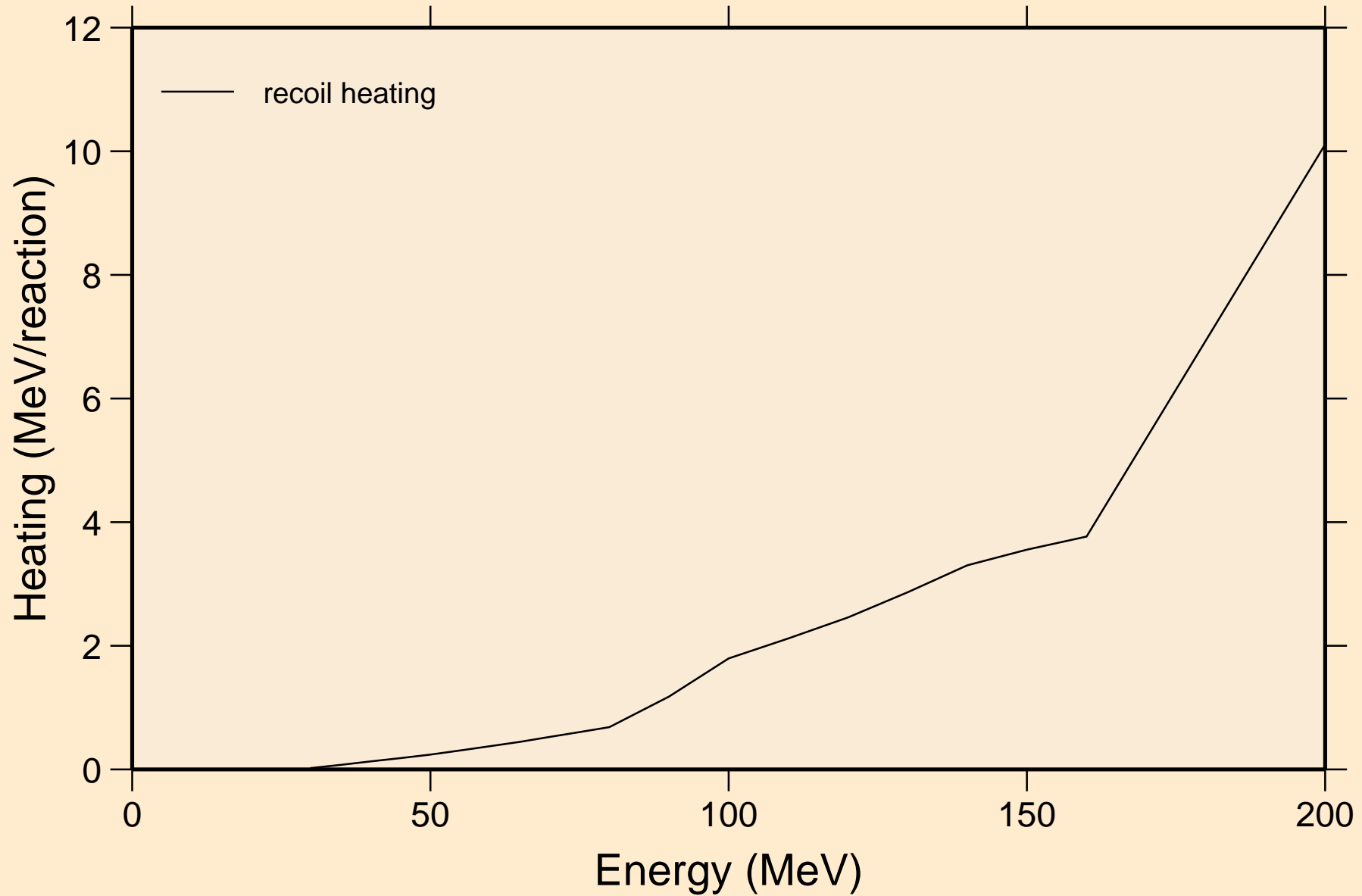

BH265 HELION ACER TENDL-2021 LIBRARY; T=0.K
Particle production cross sections

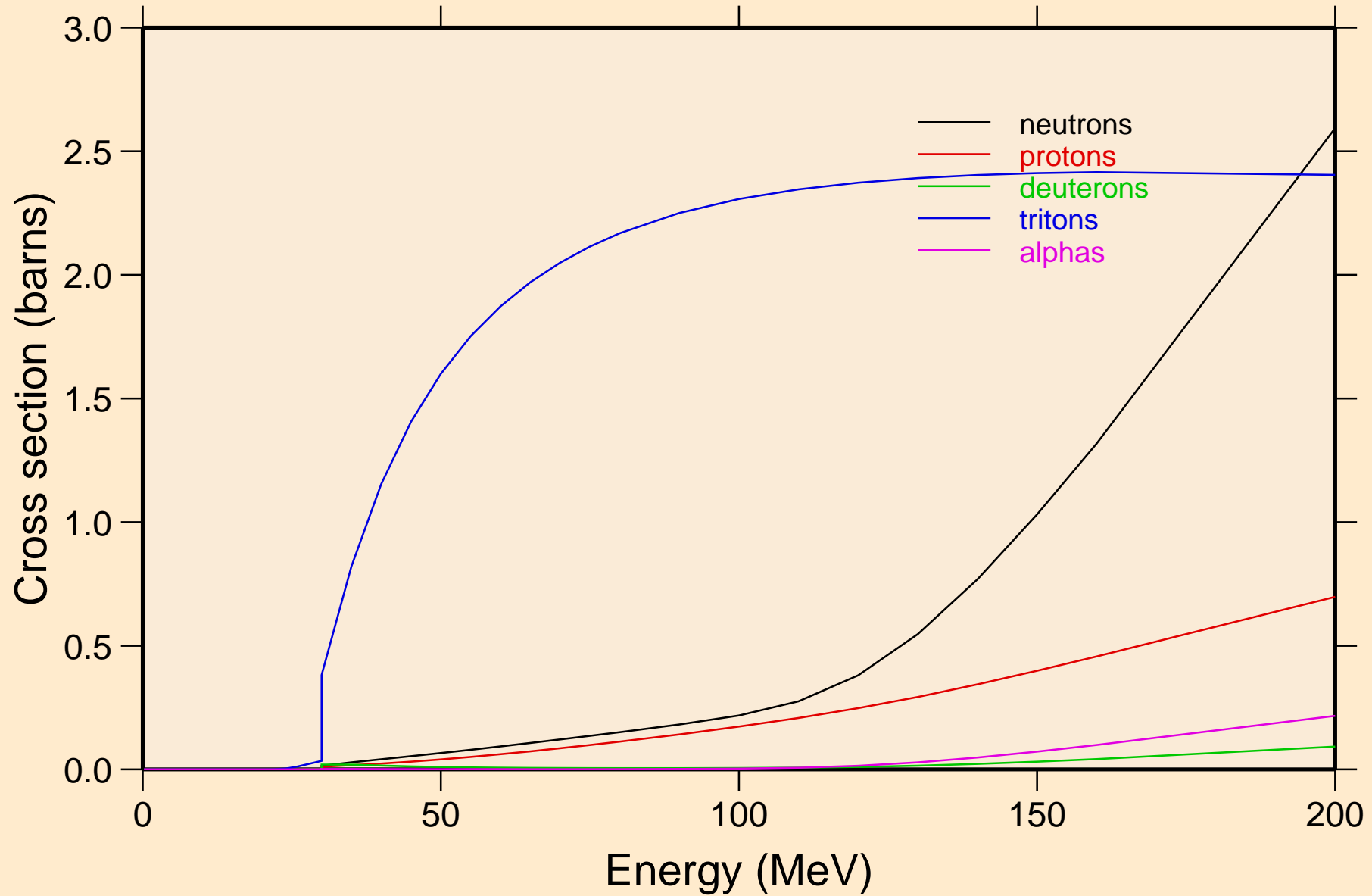

BH265 HELION ACER TENDL-2021 LIBRARY; T=0.K
neutrons from (s,n)

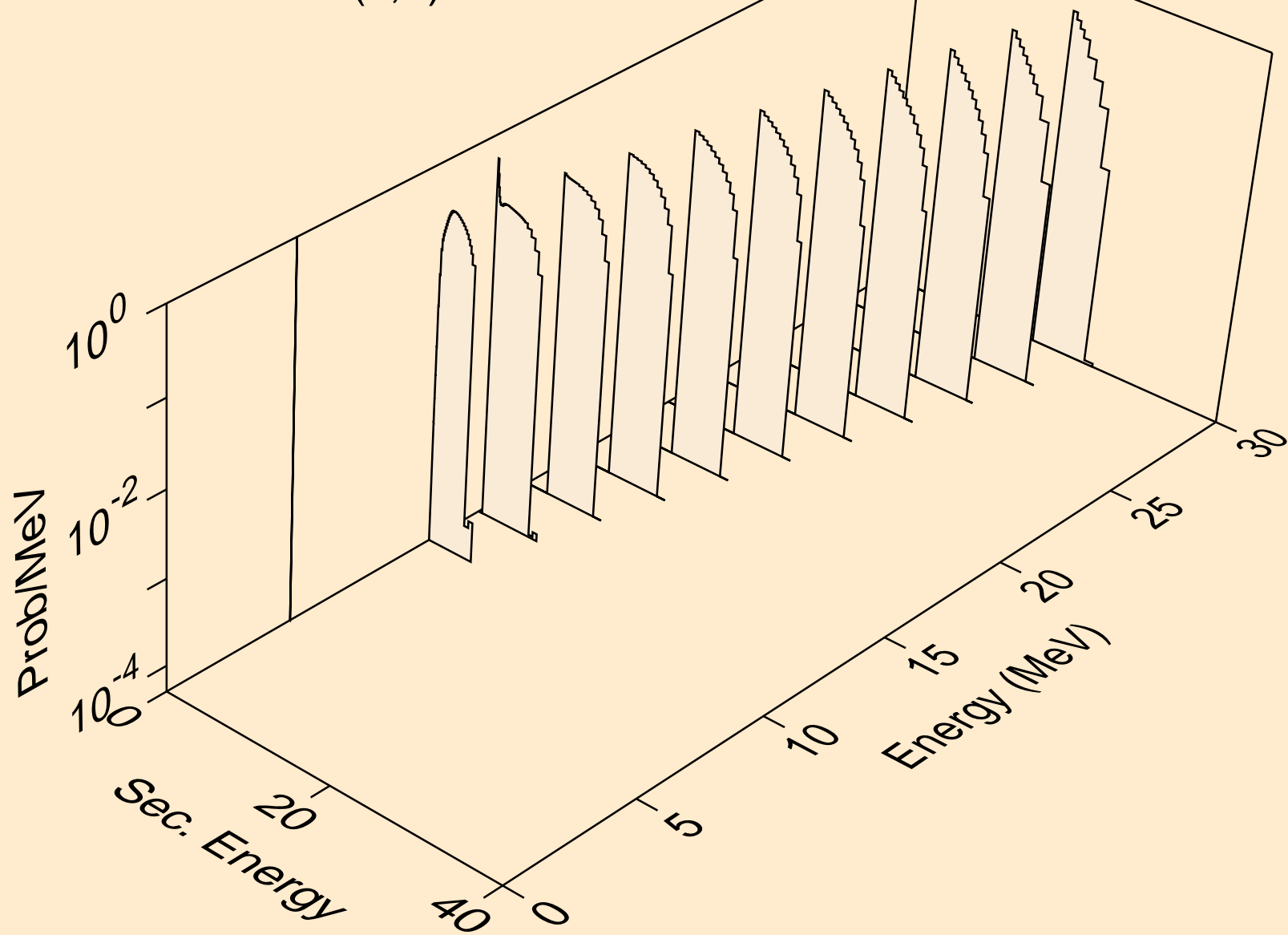

BH265 HELION ACER TENDL-2021 LIBRARY; T=0.K
neutrons from (s,x)

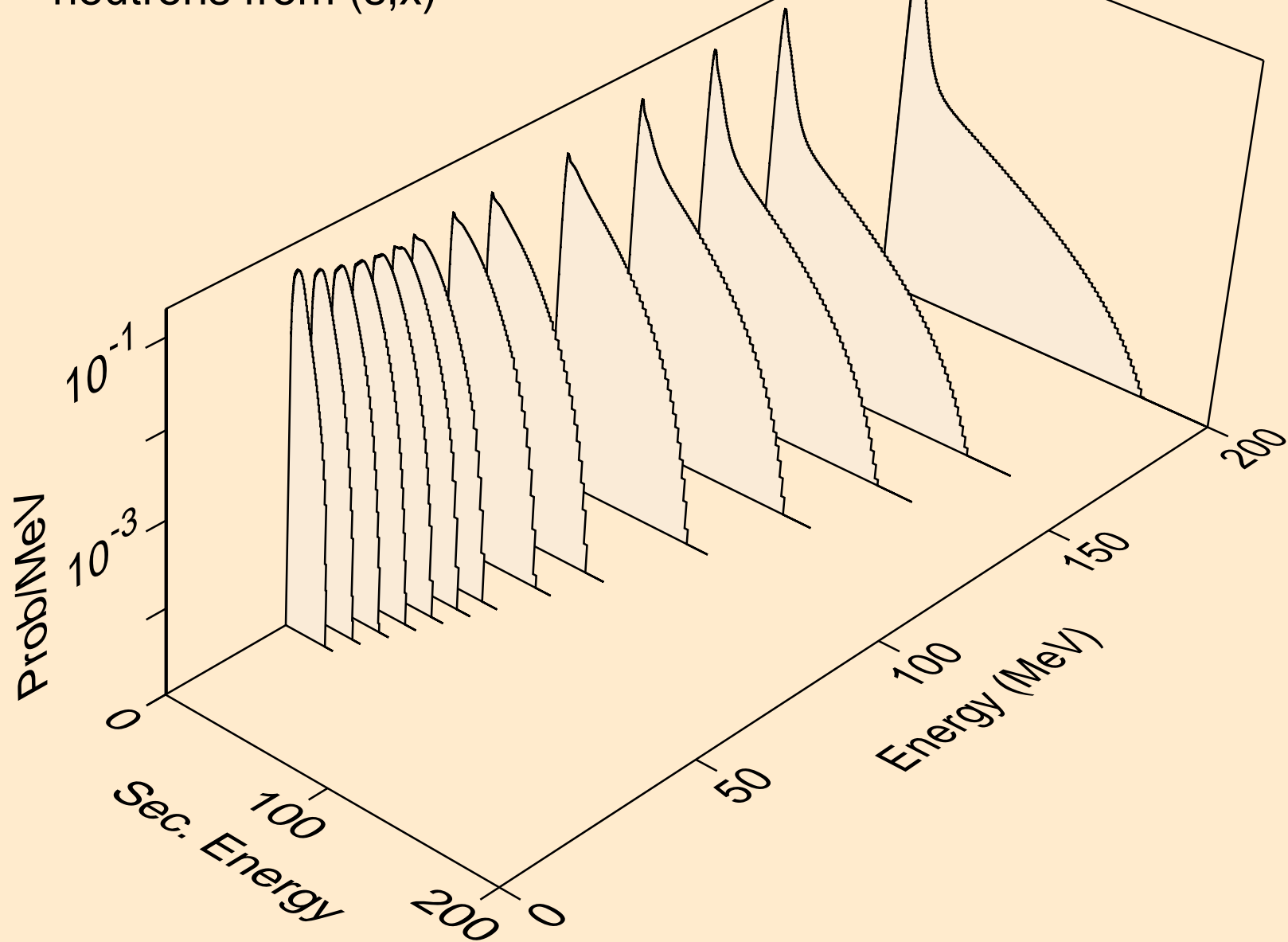

BH265 HELION ACER TENDL-2021 LIBRARY; T=0.K
neutrons from (s,2n)

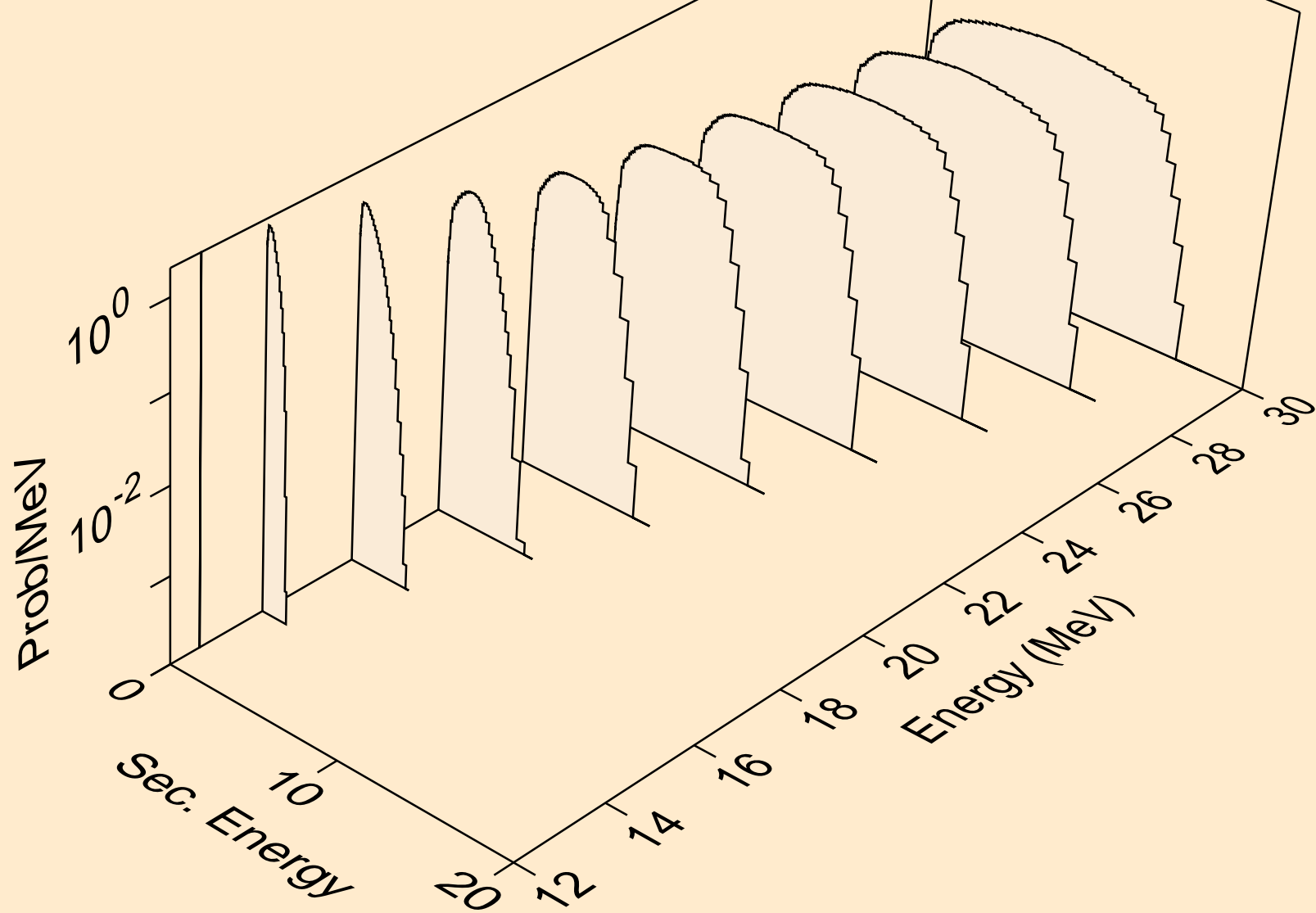

BH265 HELION ACER TENDL-2021 LIBRARY; T=0.K
neutrons from (s,3n)

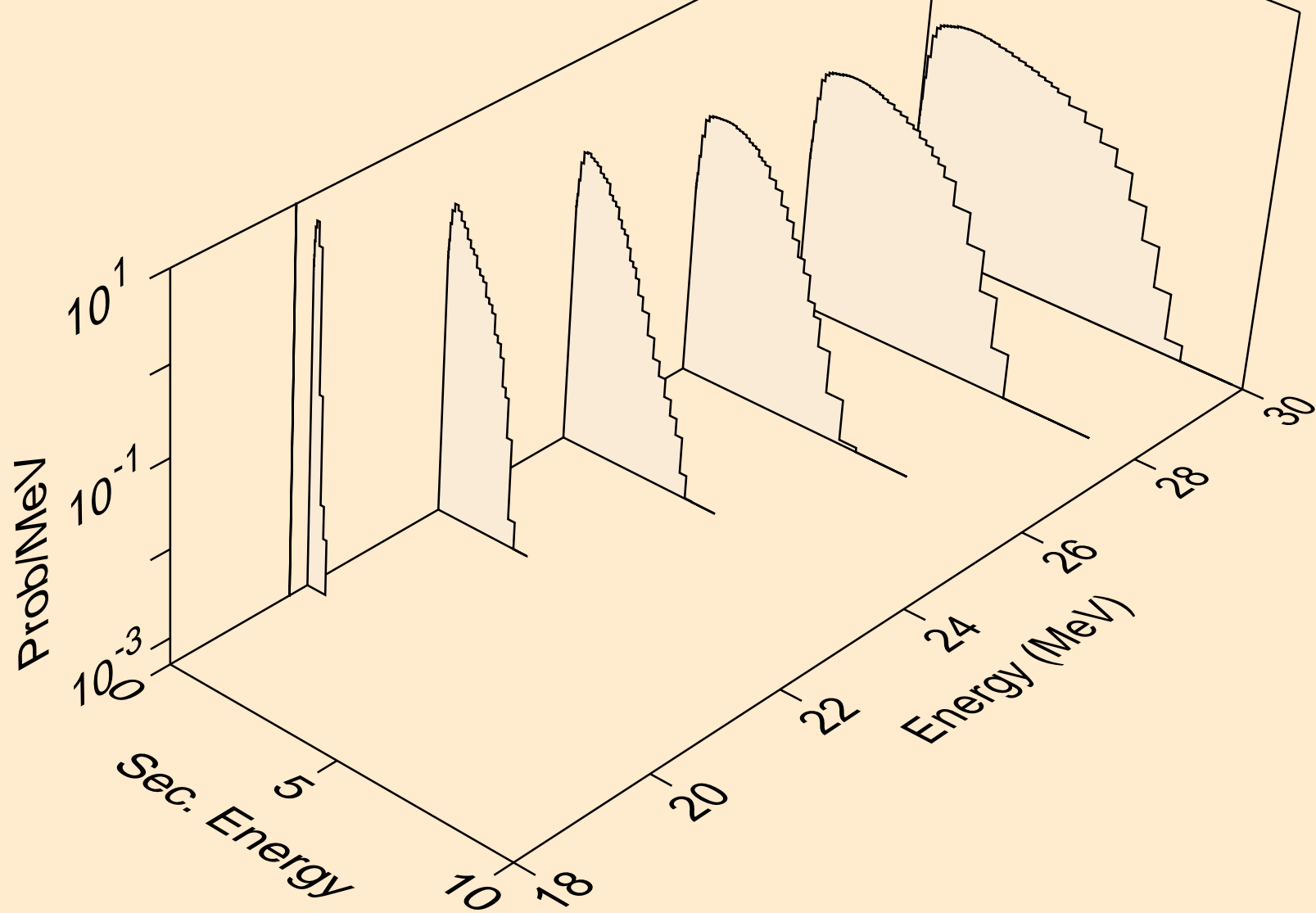

BH265 HELION ACER TENDL-2021 LIBRARY; T=0.K
neutrons from (s,n*)a

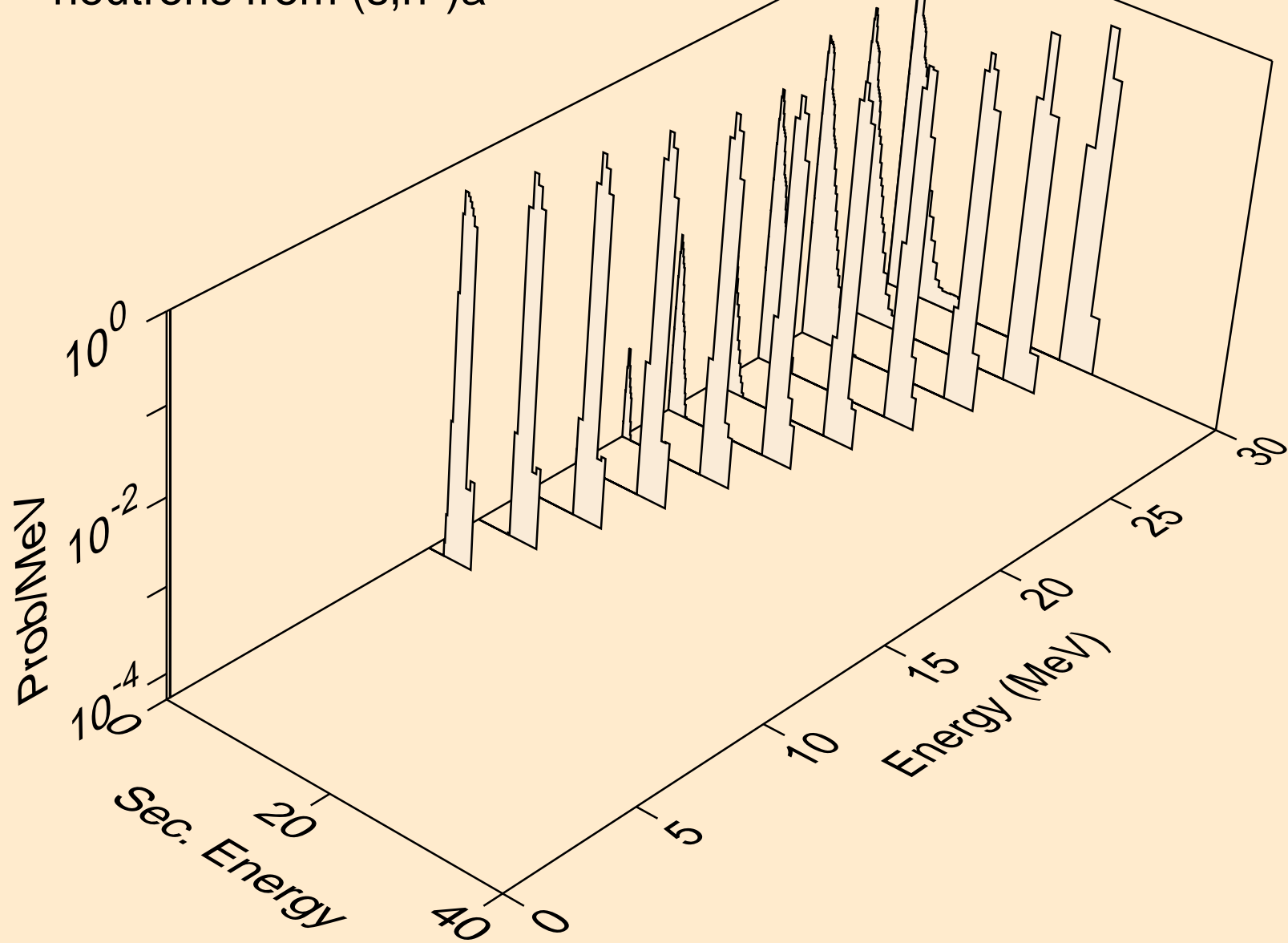

BH265 HELION ACER TENDL-2021 LIBRARY; T=0.K
neutrons from (s,2n)a

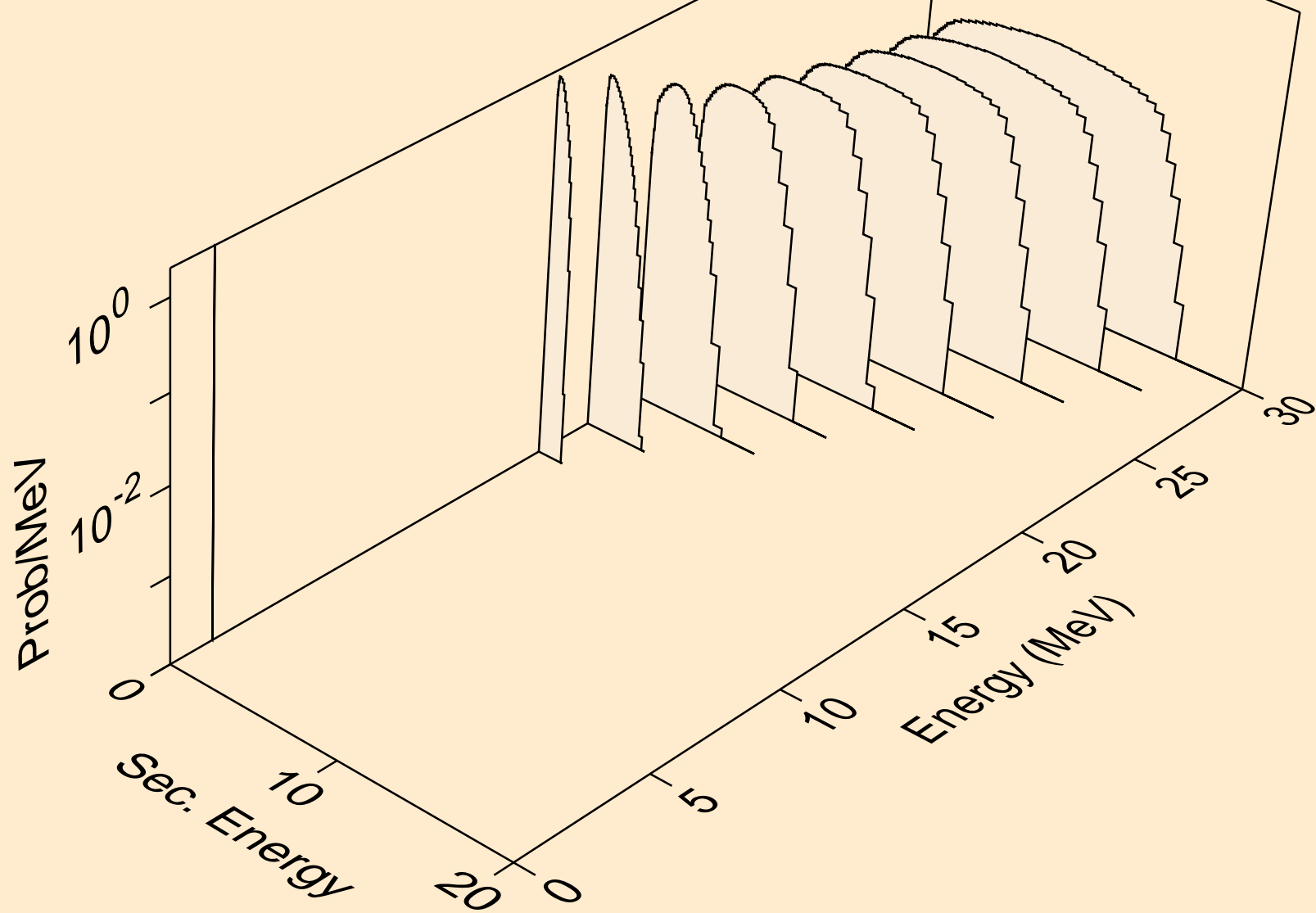

BH265 HELION ACER TENDL-2021 LIBRARY; T=0.K
neutrons from (s,n*)p

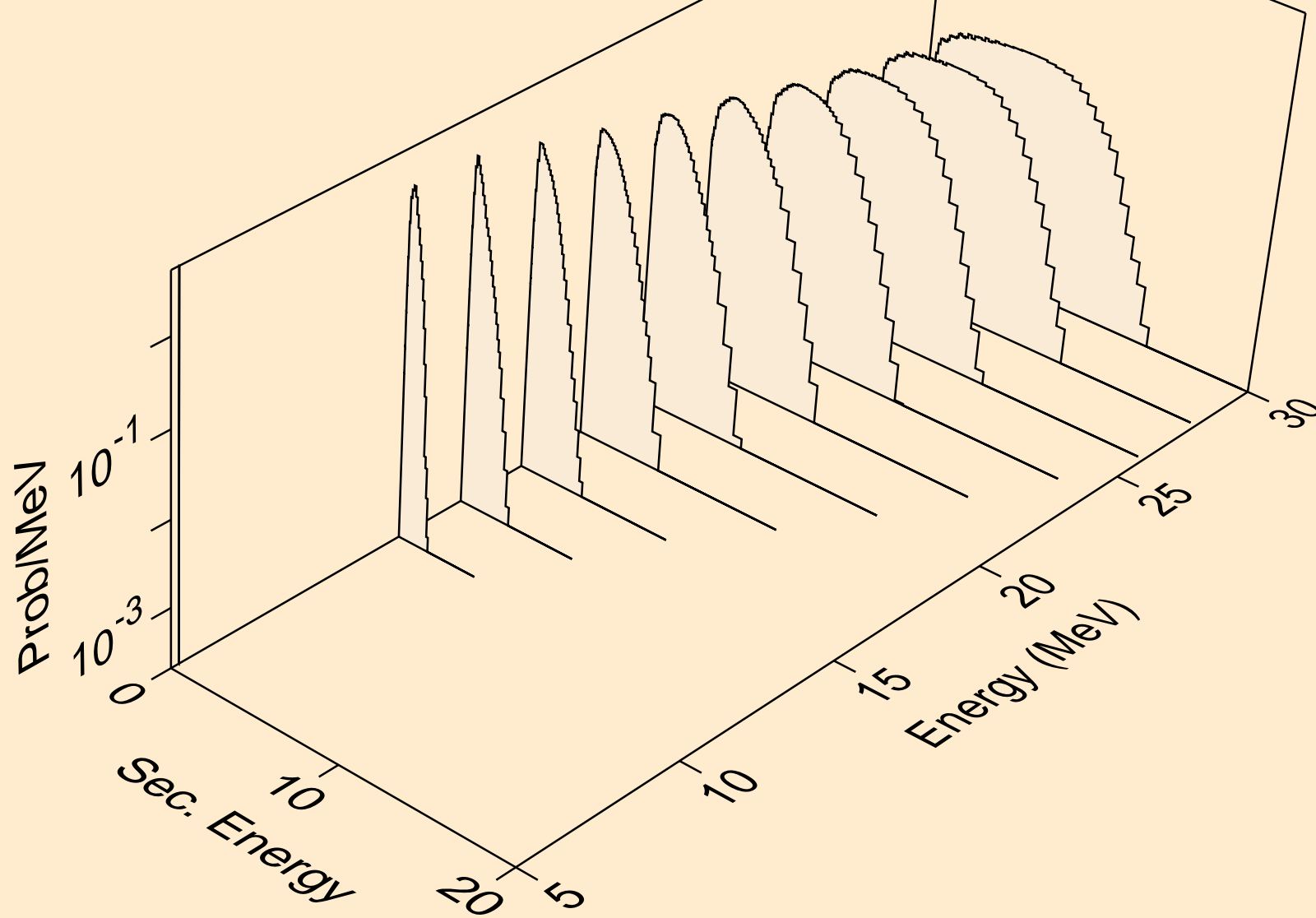

BH265 HELION ACER TENDL-2021 LIBRARY; T=0.K
neutrons from (s,n*)d

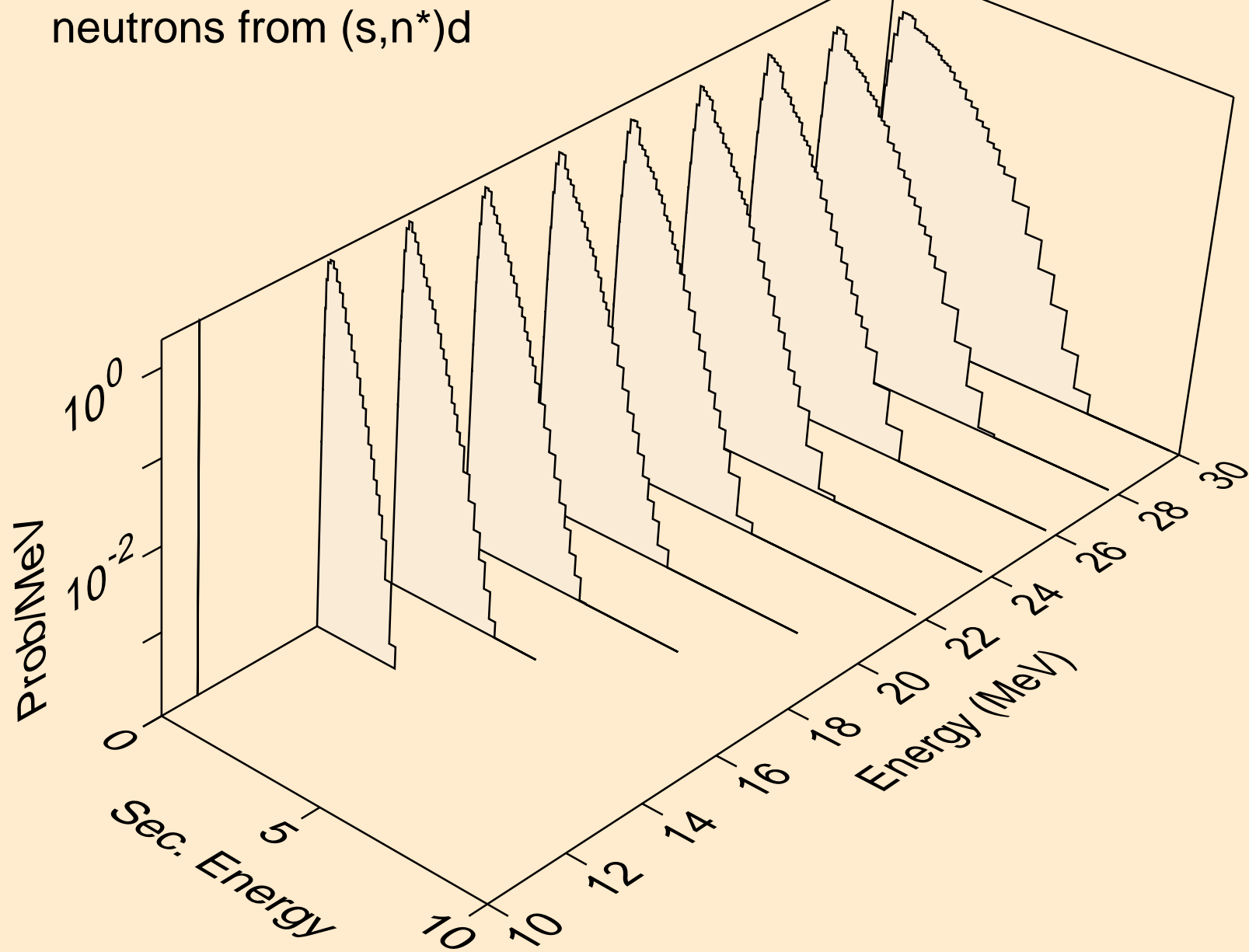

BH265 HELION ACER TENDL-2021 LIBRARY; T=0.K
neutrons from (s,n*)t

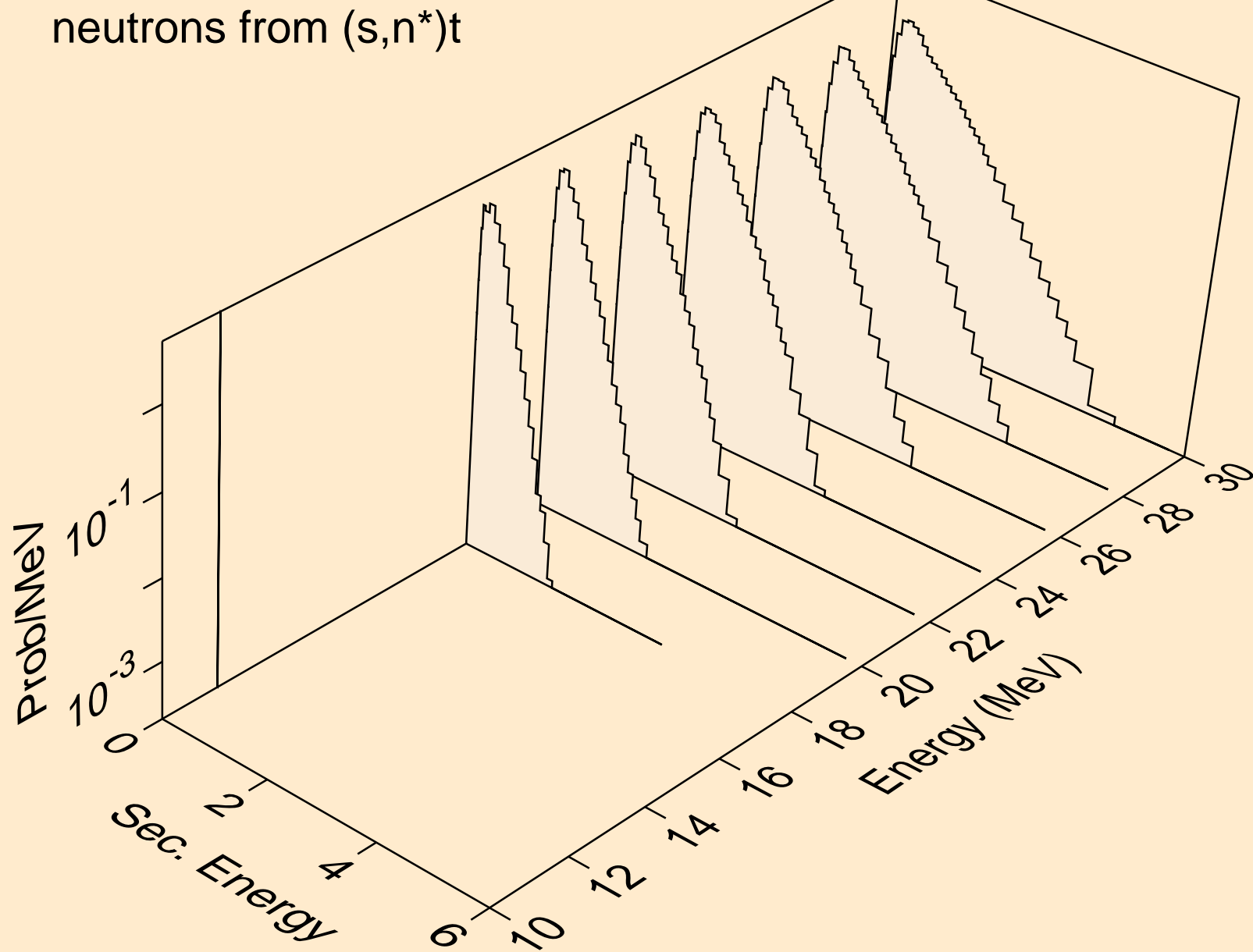

BH265 HELION ACER TENDL-2021 LIBRARY; T=0.K
neutrons from (s,2np)

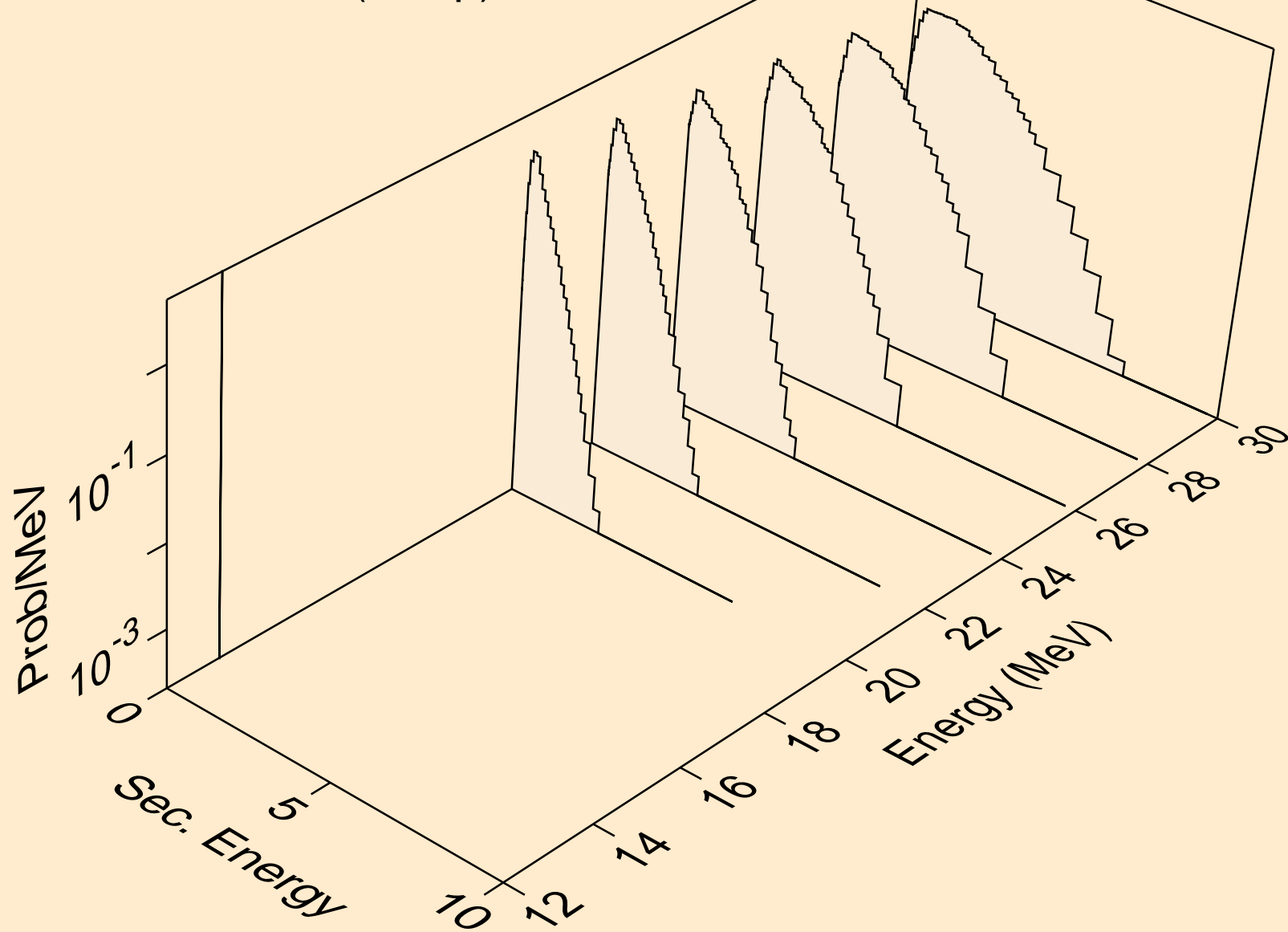

BH265 HELION ACER TENDL-2021 LIBRARY; T=0.K
neutrons from (s,npa)

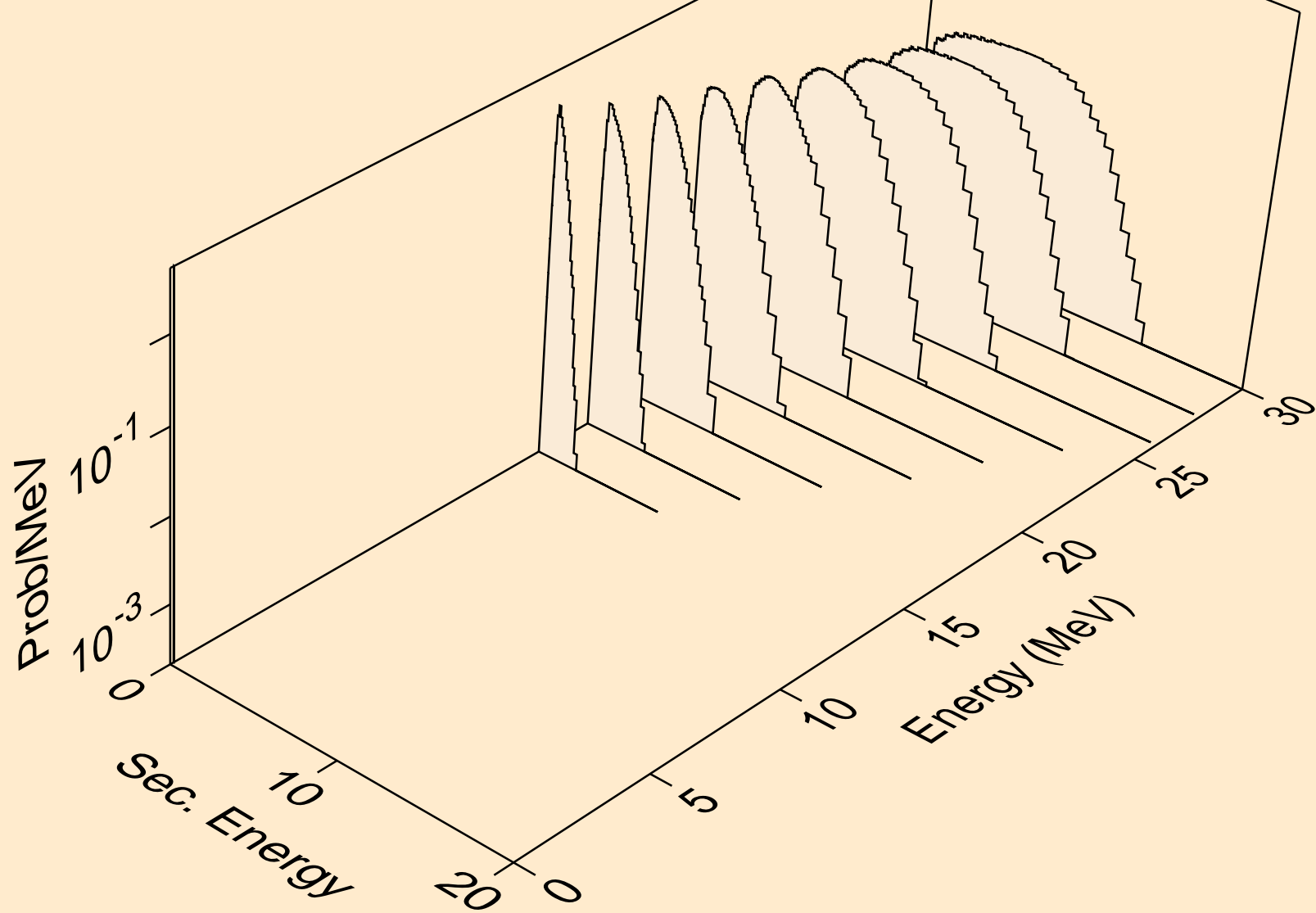

BH265 HELION ACER TENDL-2021 LIBRARY; T=0.K
protons from (s,x)

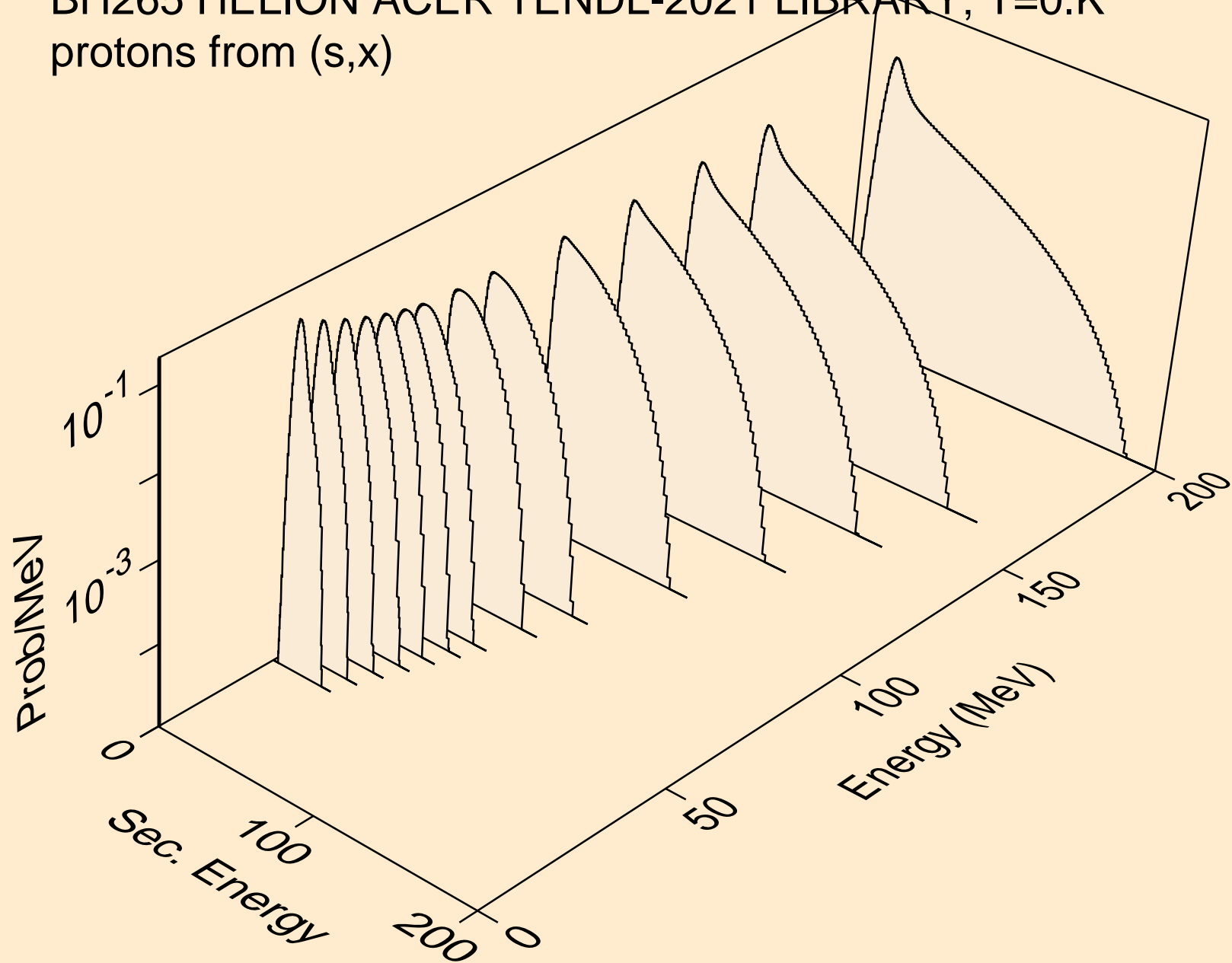

BH265 HELION ACER TENDL-2021 LIBRARY; T=0.K
protons from (s,n*)p

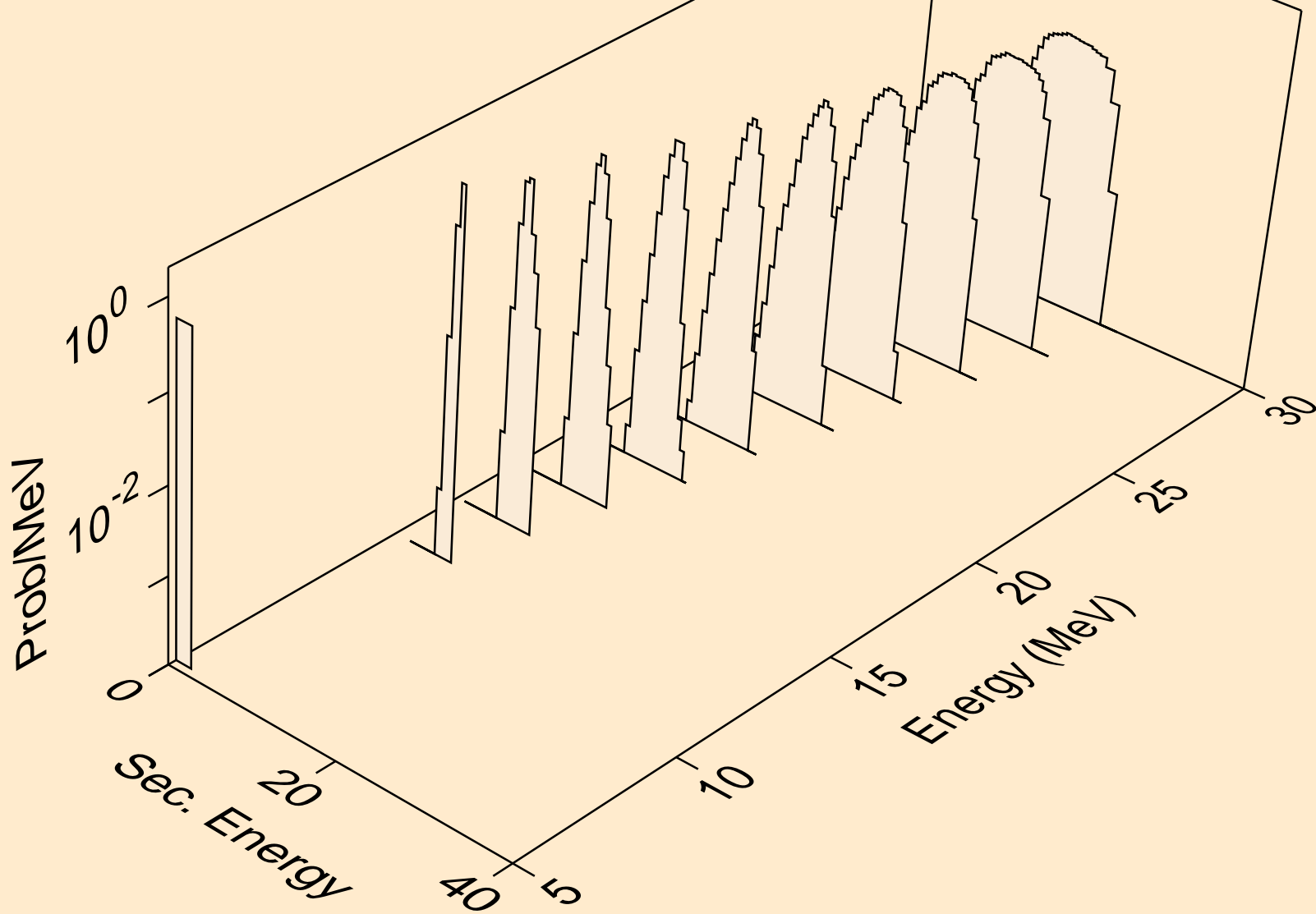

BH265 HELION ACER TENDL-2021 LIBRARY; T=0.K
protons from (s,2np)

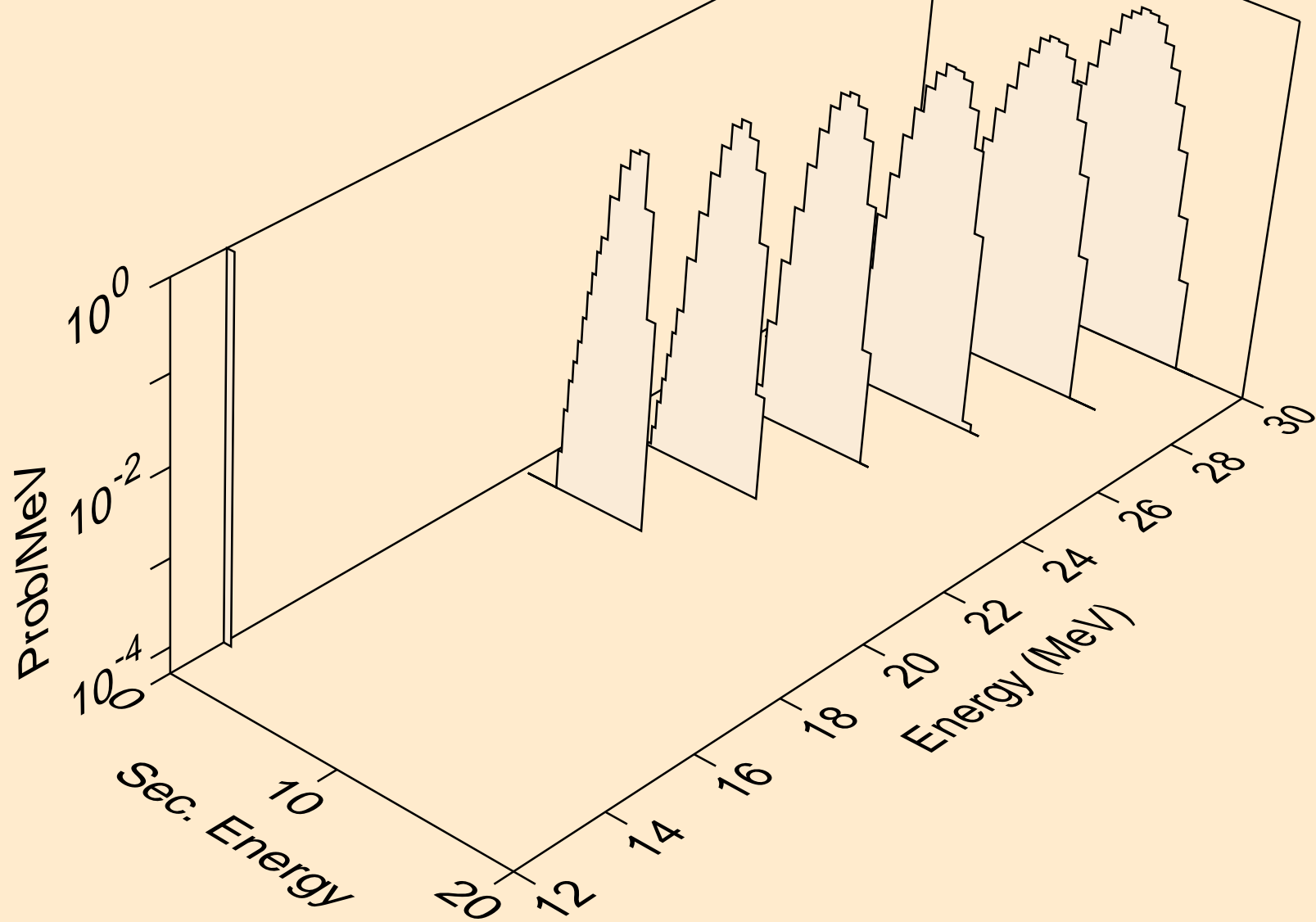

BH265 HELION ACER TENDL-2021 LIBRARY; T=0.K
protons from (s,npa)

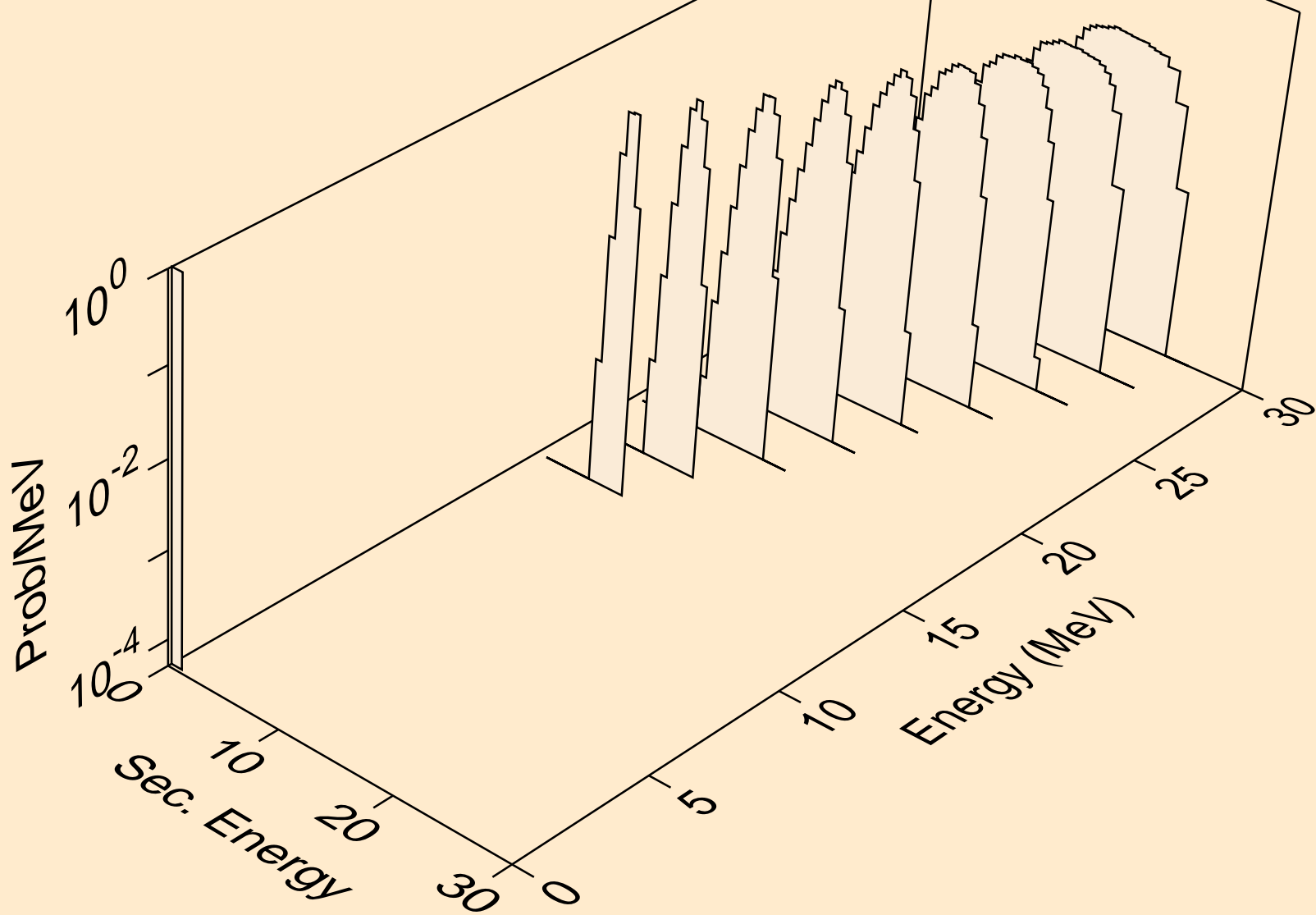

BH265 HELION ACER TENDL-2021 LIBRARY; T=0.K
protons from (s,p)

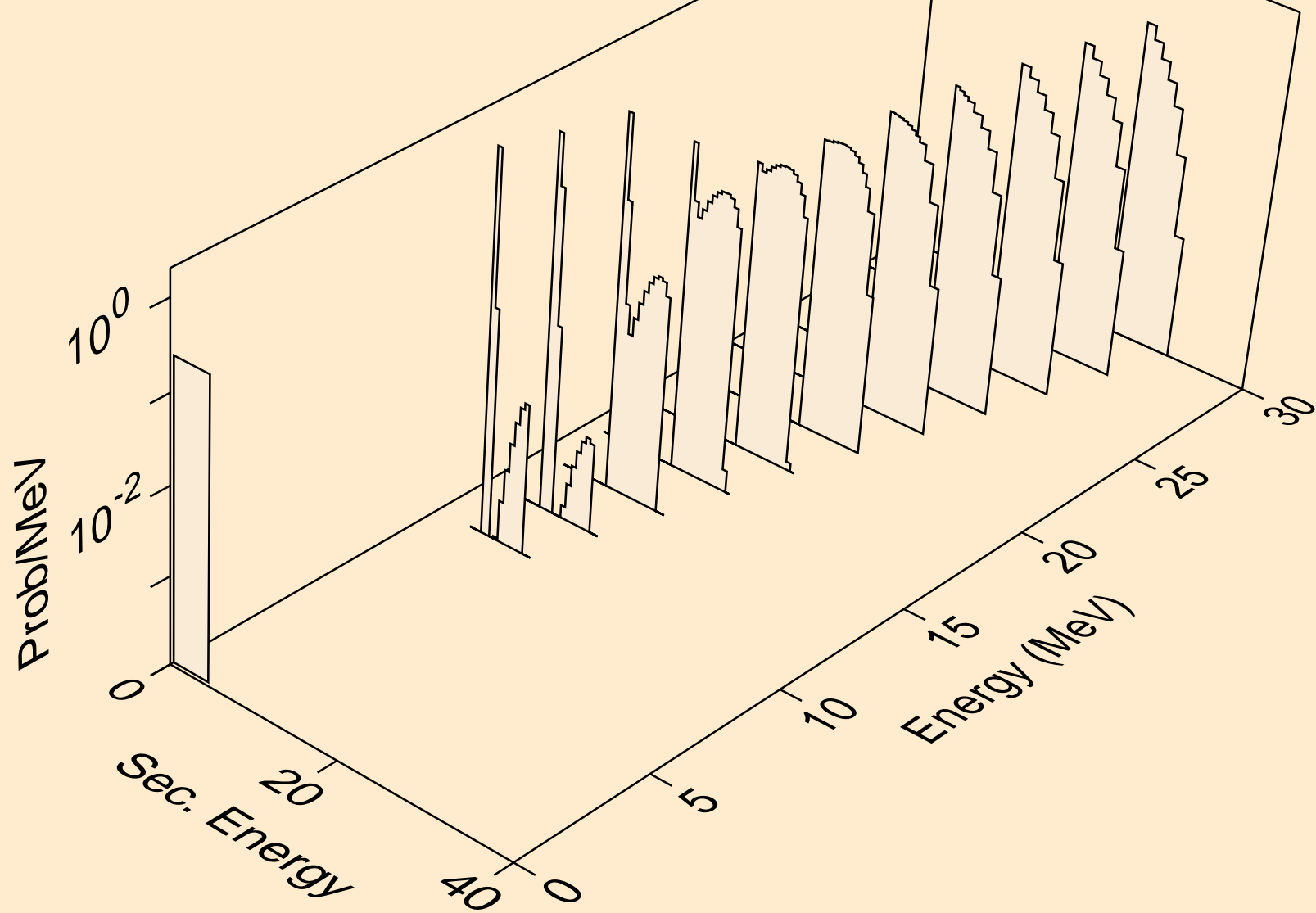

BH265 HELION ACER TENDL-2021 LIBRARY; T=0.K
protons from (s,2p)

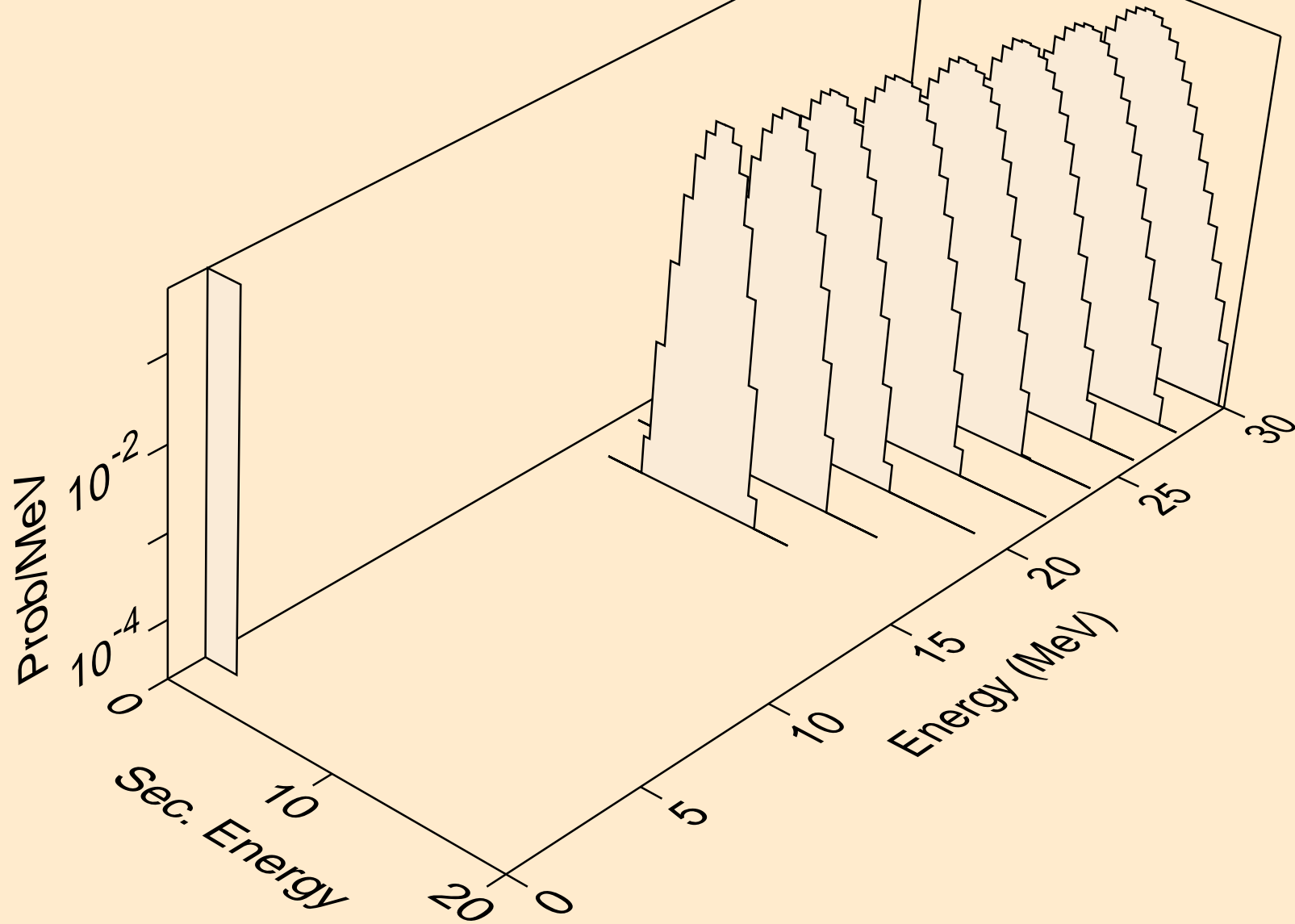

BH265 HELION ACER TENDL-2021 LIBRARY; T=0.K
protons from (s,pa)

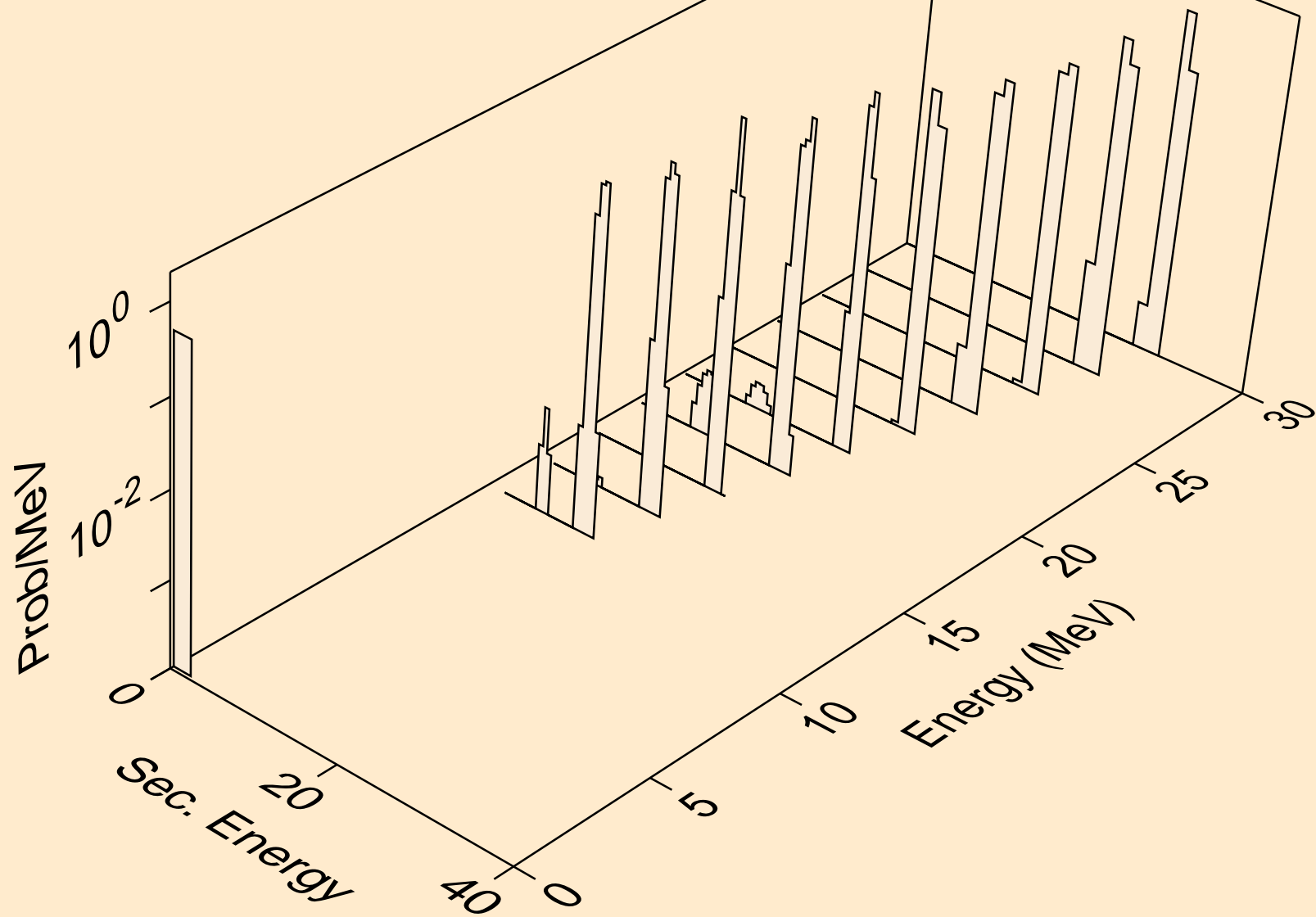

BH265 HELION ACER TENDL-2021 LIBRARY; T=0.K
deuterons from (s,x)

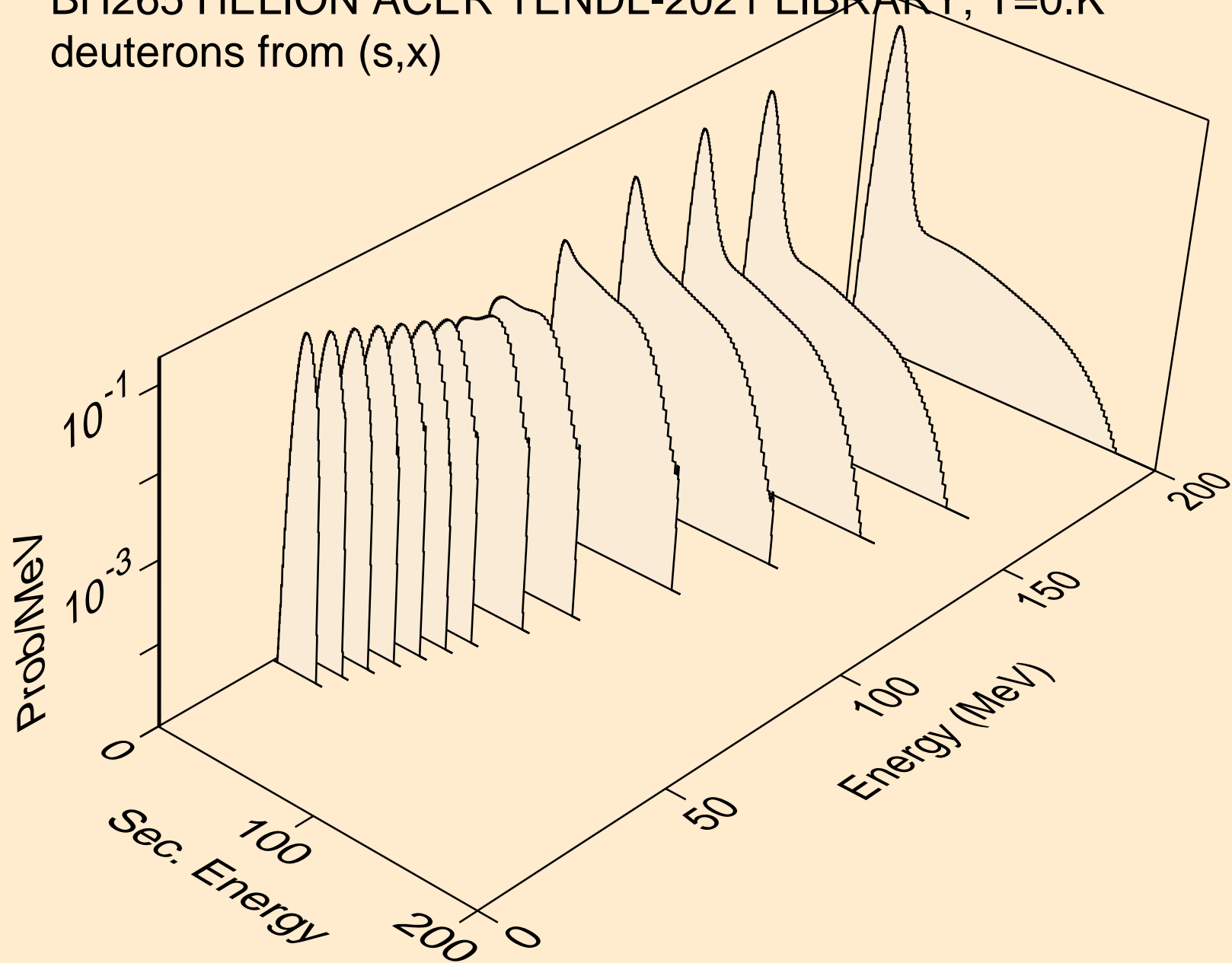

BH265 HELION ACER TENDL-2021 LIBRARY; T=0.K
deuterons from (s,n*)d

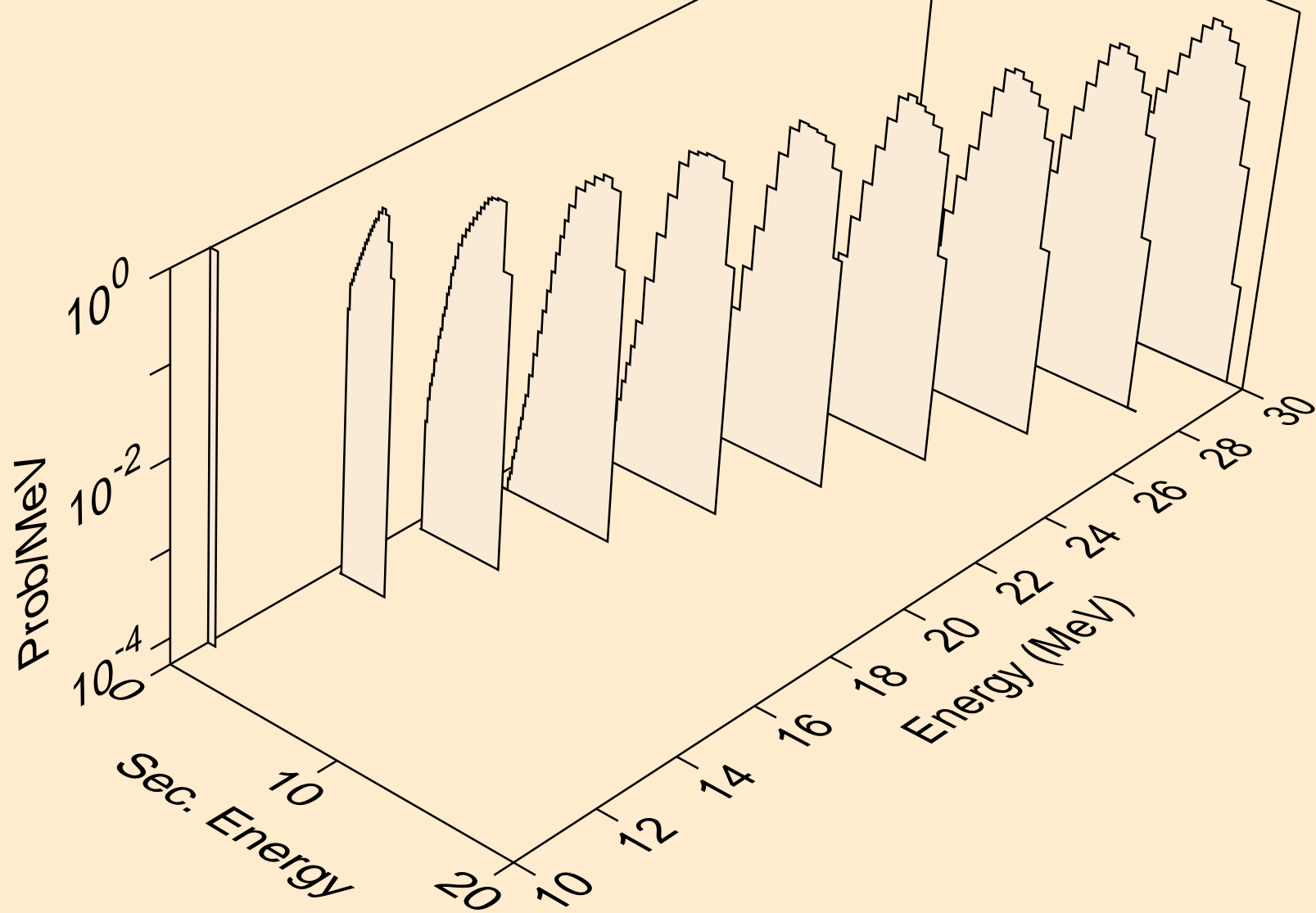

BH265 HELION ACER TENDL-2021 LIBRARY; T=0.K
deuterons from (s,d)

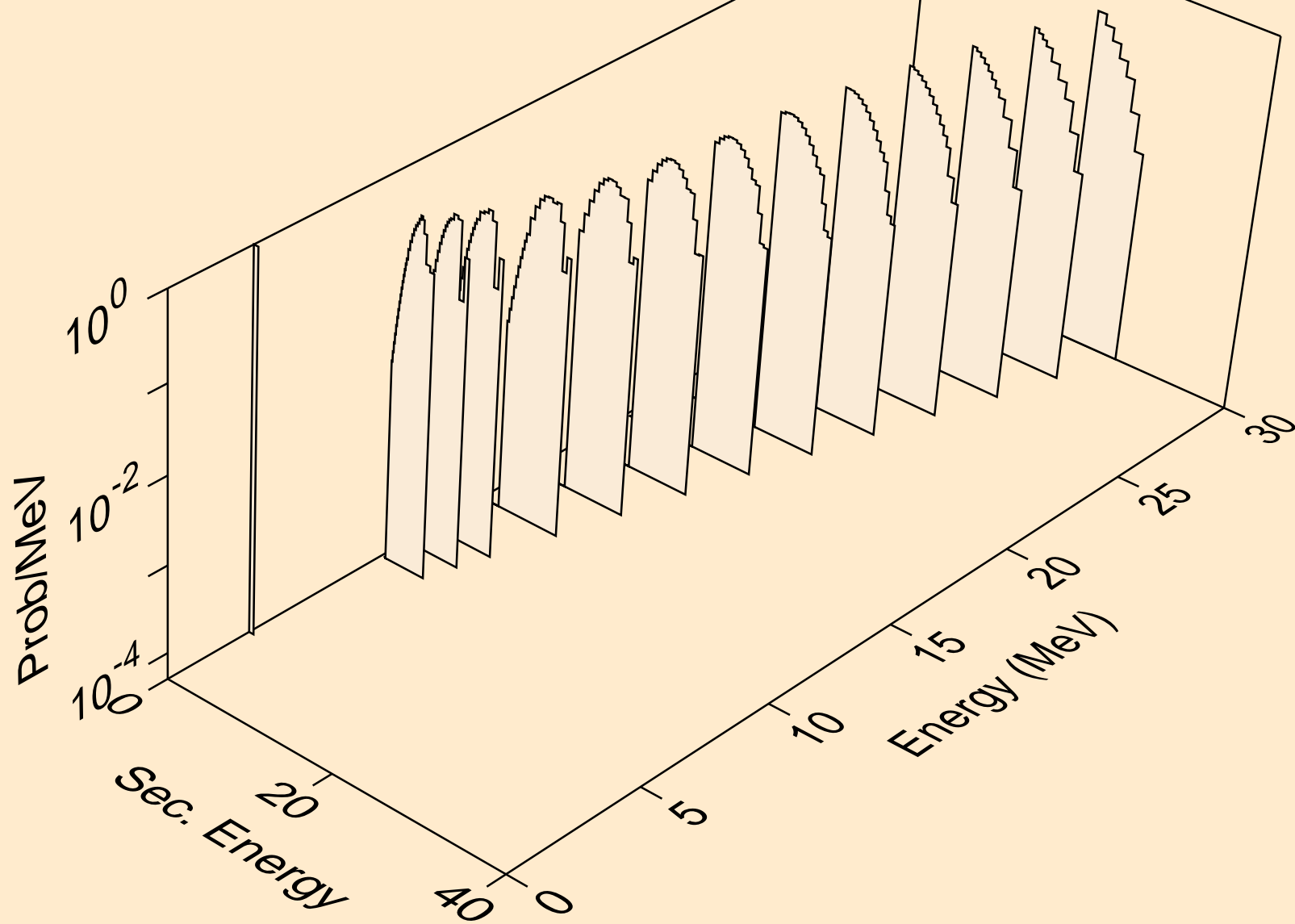

BH265 HELION ACER TENDL-2021 LIBRARY; T=0.K
deuterons from (s,da)

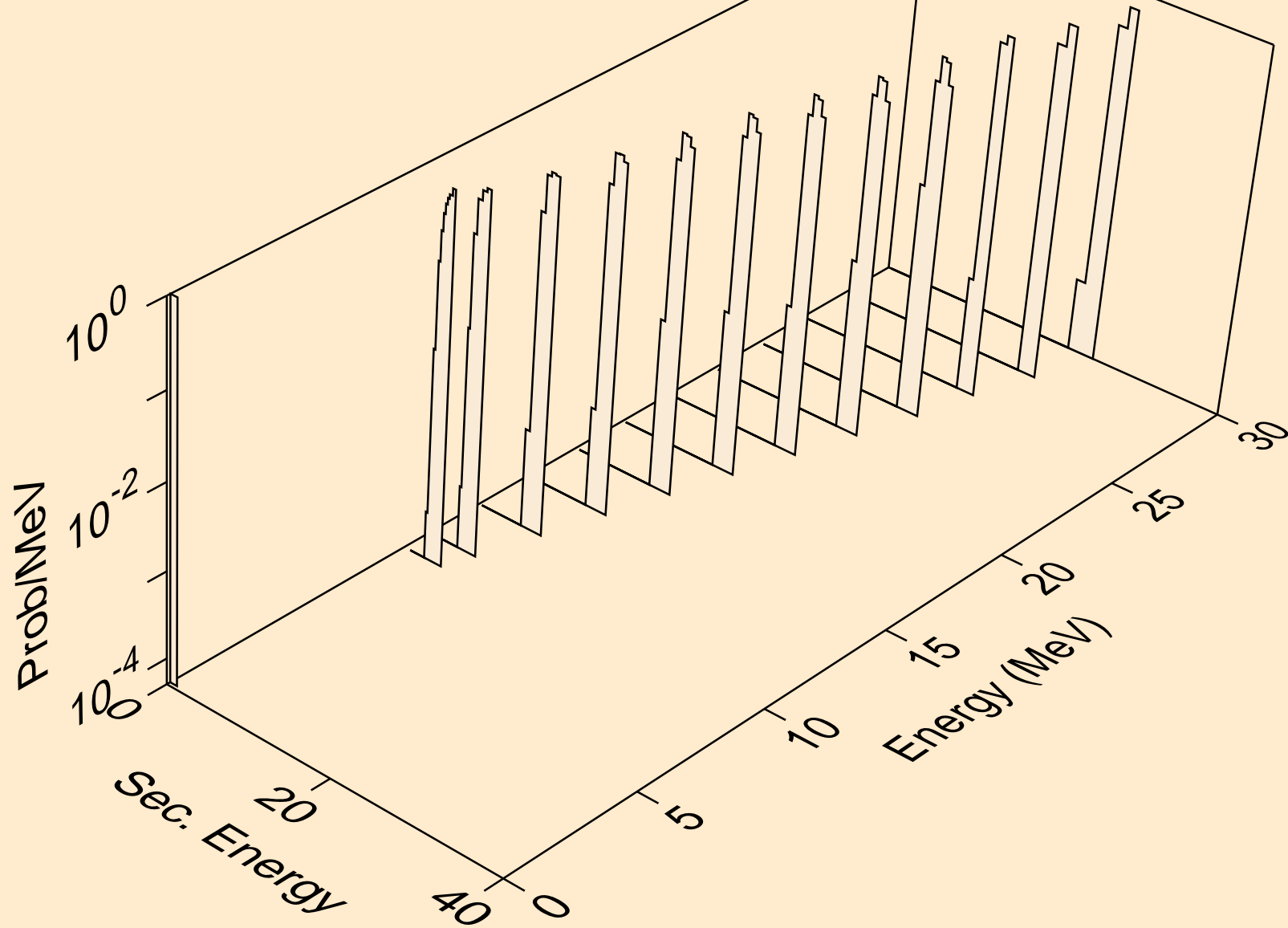

BH265 HELION ACER TENDL-2021 LIBRARY; T=0.K
tritons from (s,x)

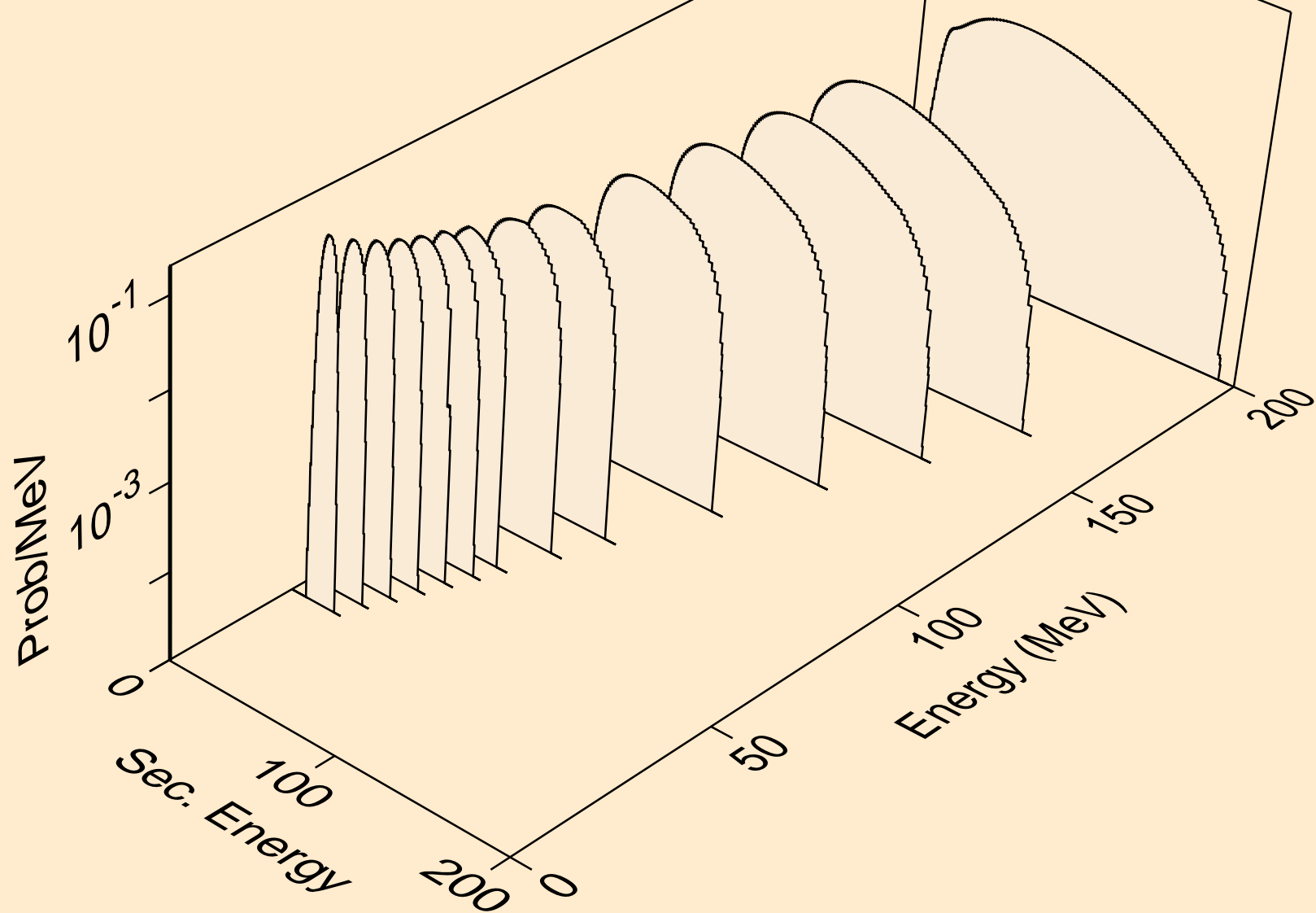

BH265 HELION ACER TENDL-2021 LIBRARY; T=0.K
tritons from (s,n*)t

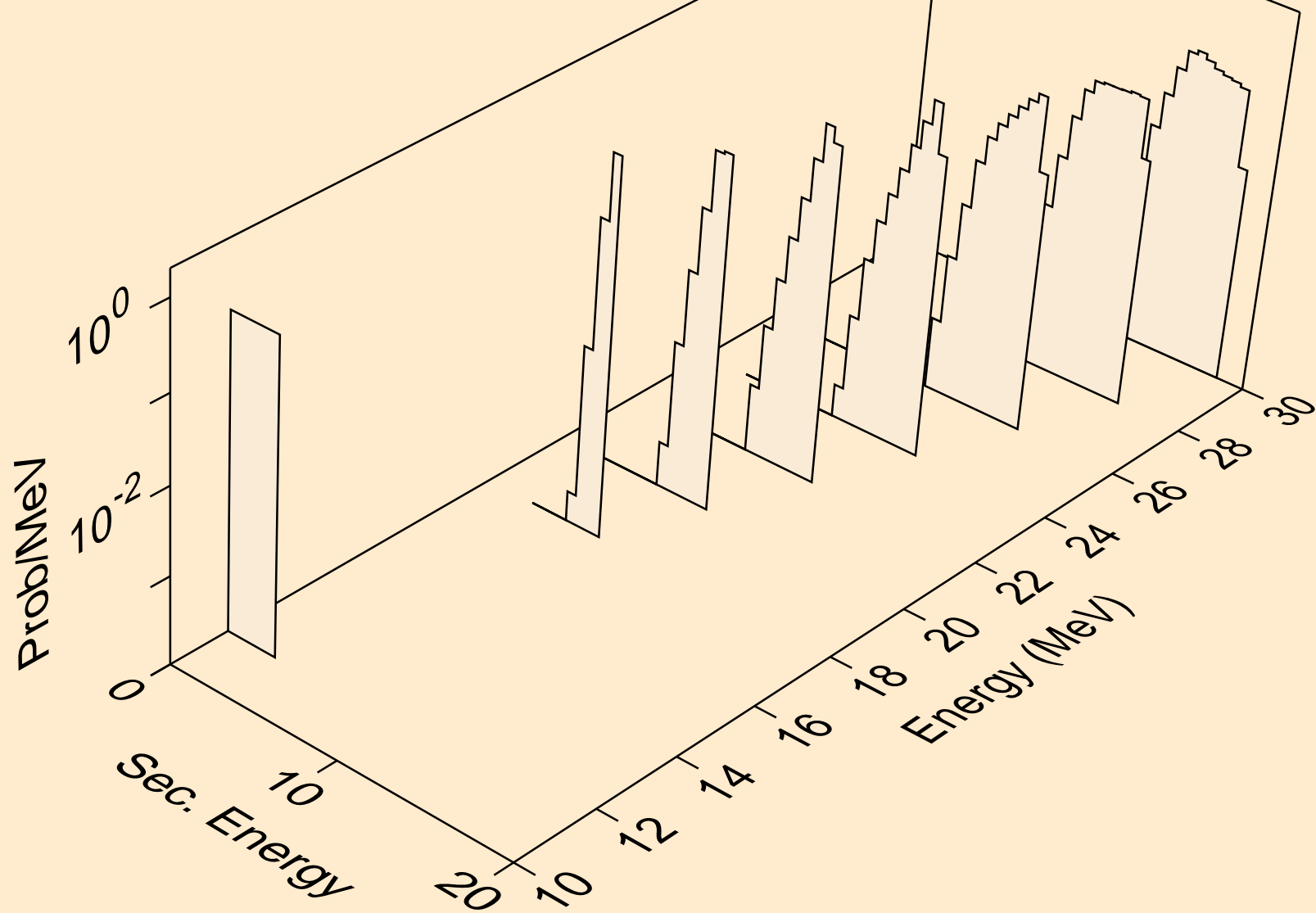

BH265 HELION ACER TENDL-2021 LIBRARY; T=0.K
tritons from (s,t)

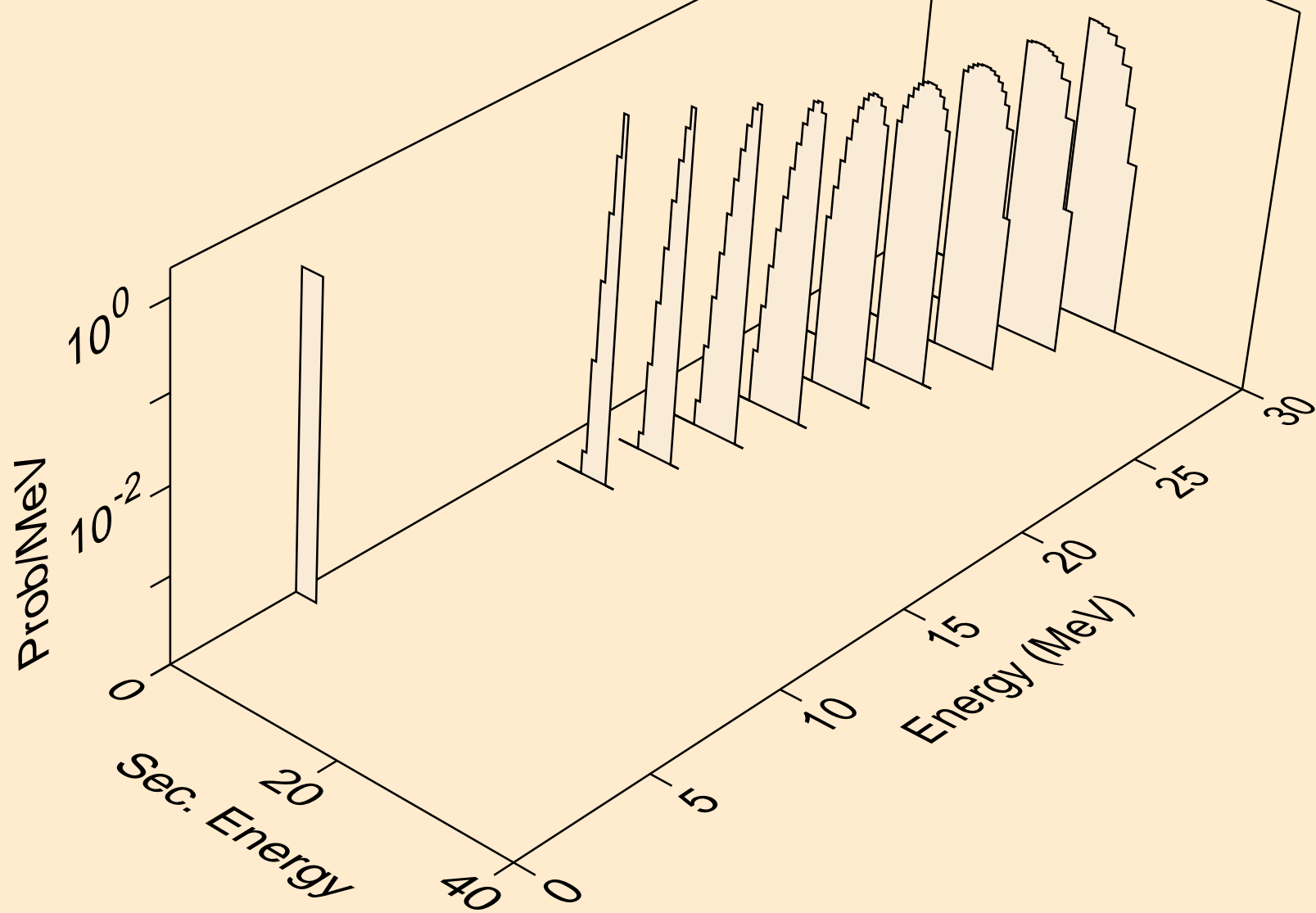

BH265 HELION ACER TENDL-2021 LIBRARY; T=0.K
tritons from (s,t2a)

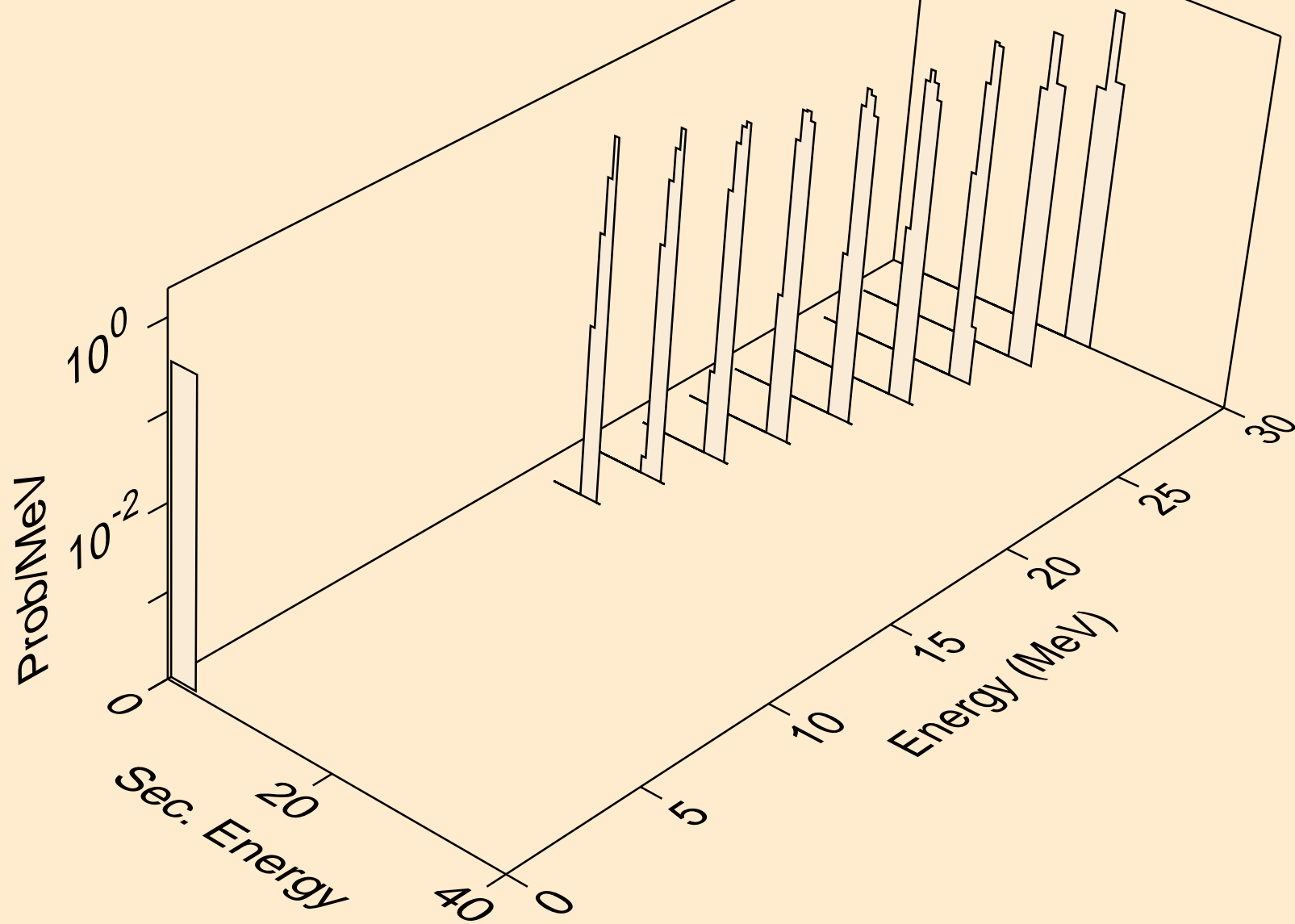

BH265 HELION ACER TENDL-2021 LIBRARY; T=0.K
alphas from (s,x)

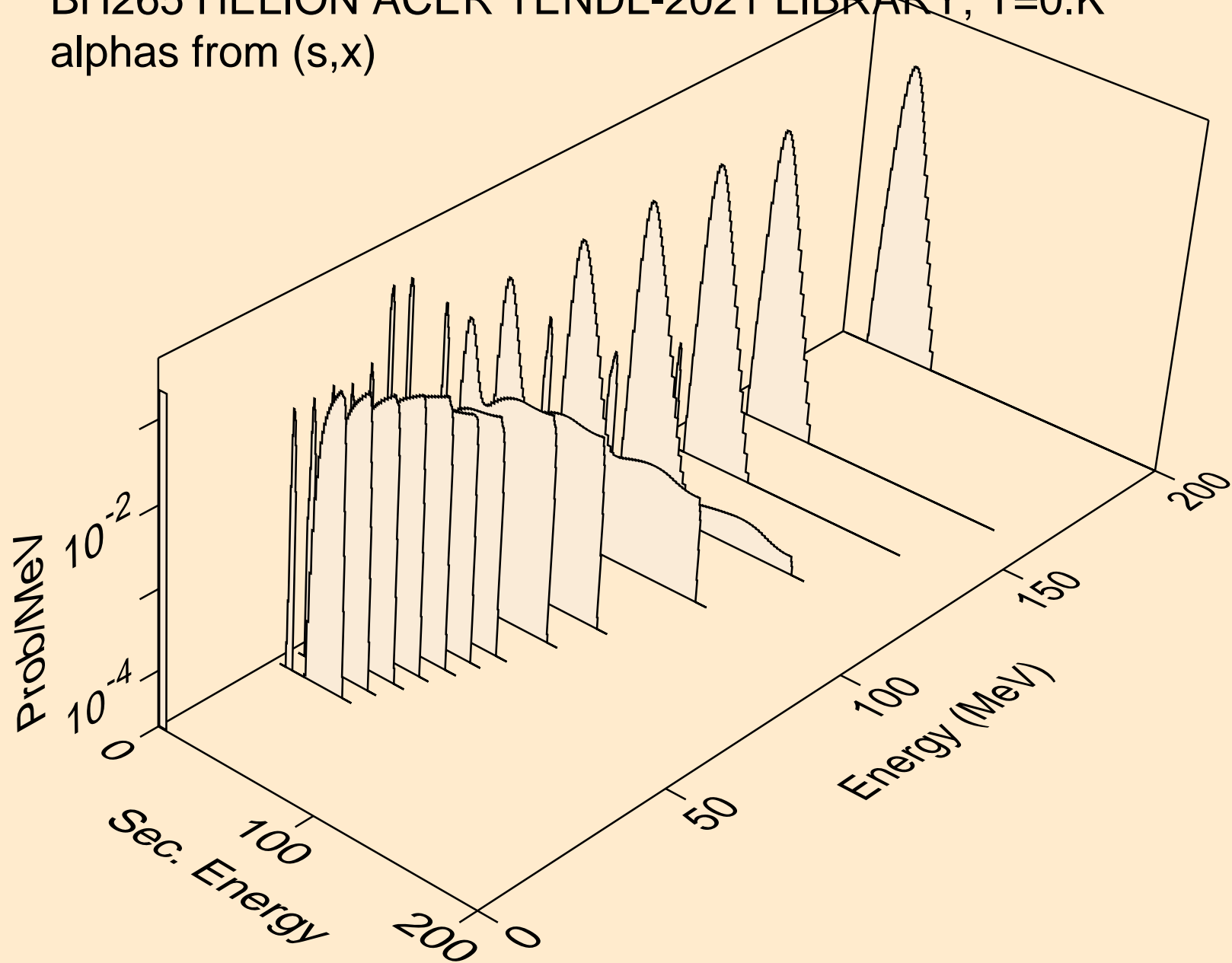

BH265 HELION ACER TENDL-2021 LIBRARY; T=0.K
alphas from (s,n*)a

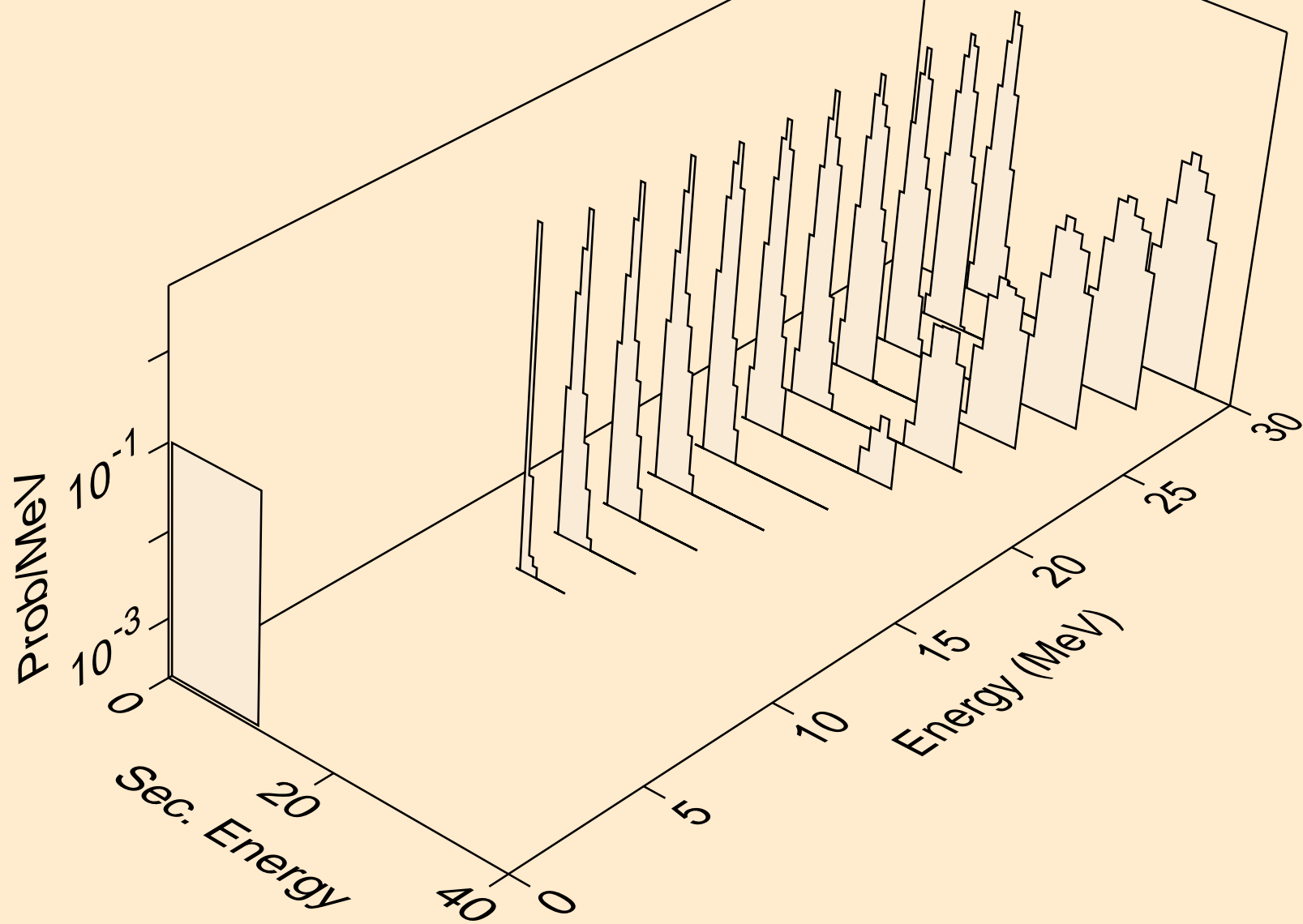

BH265 HELION ACER TENDL-2021 LIBRARY; T=0.K
alphas from (s,2n)a

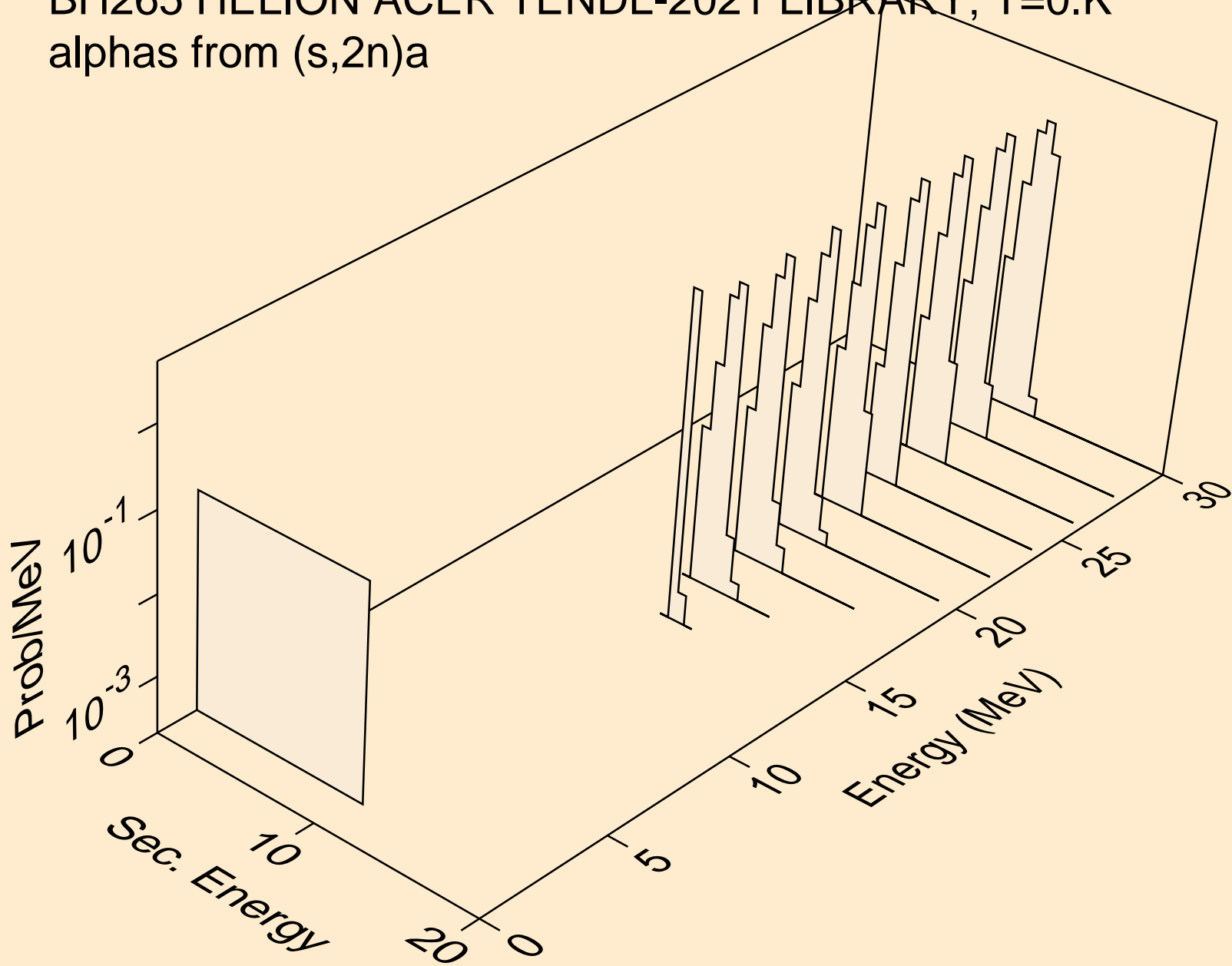

BH265 HELION ACER TENDL-2021 LIBRARY; T=0.K
alphas from (s,npa)

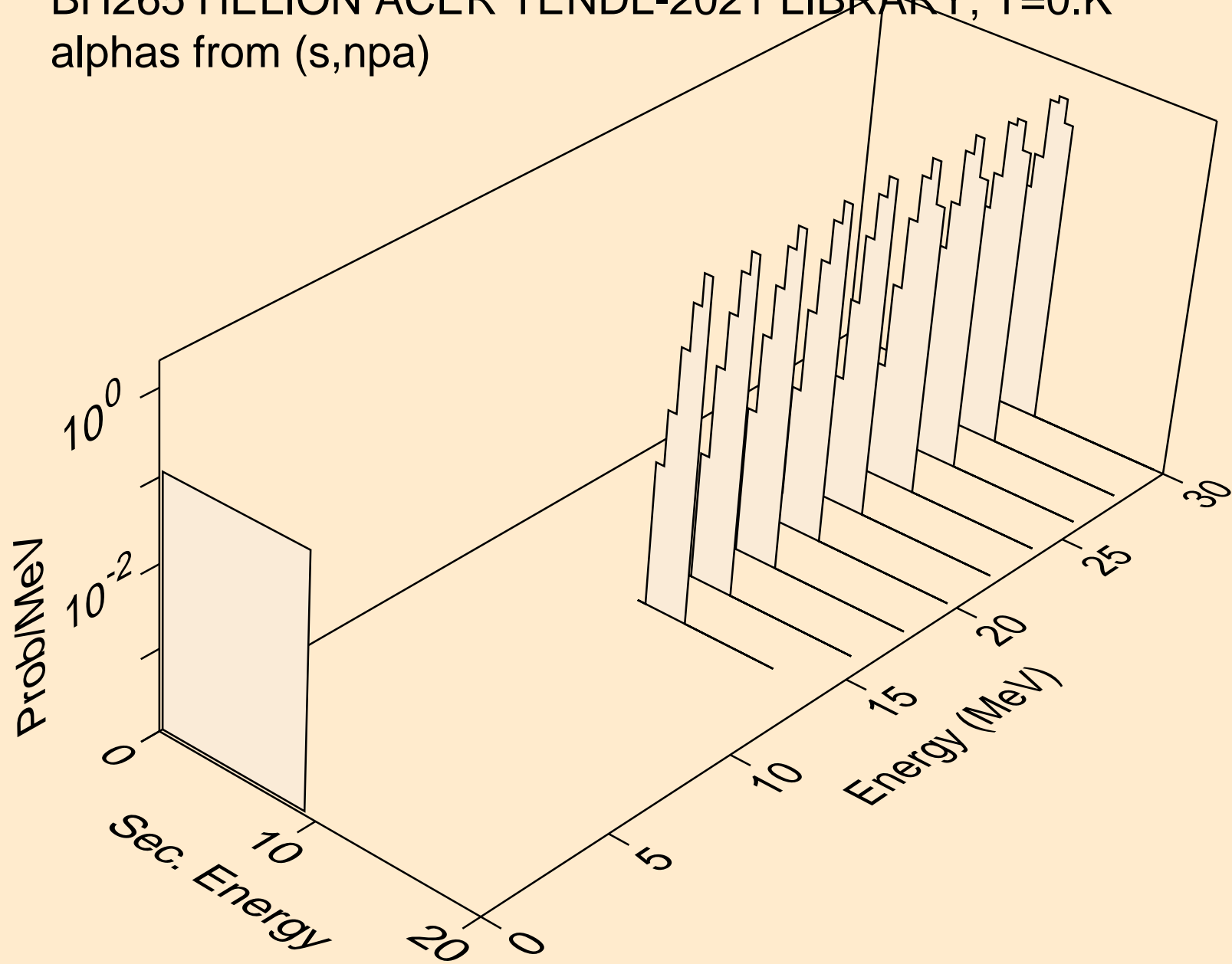

BH265 HELION ACER TENDL-2021 LIBRARY; T=0.K
alphas from (s,a)

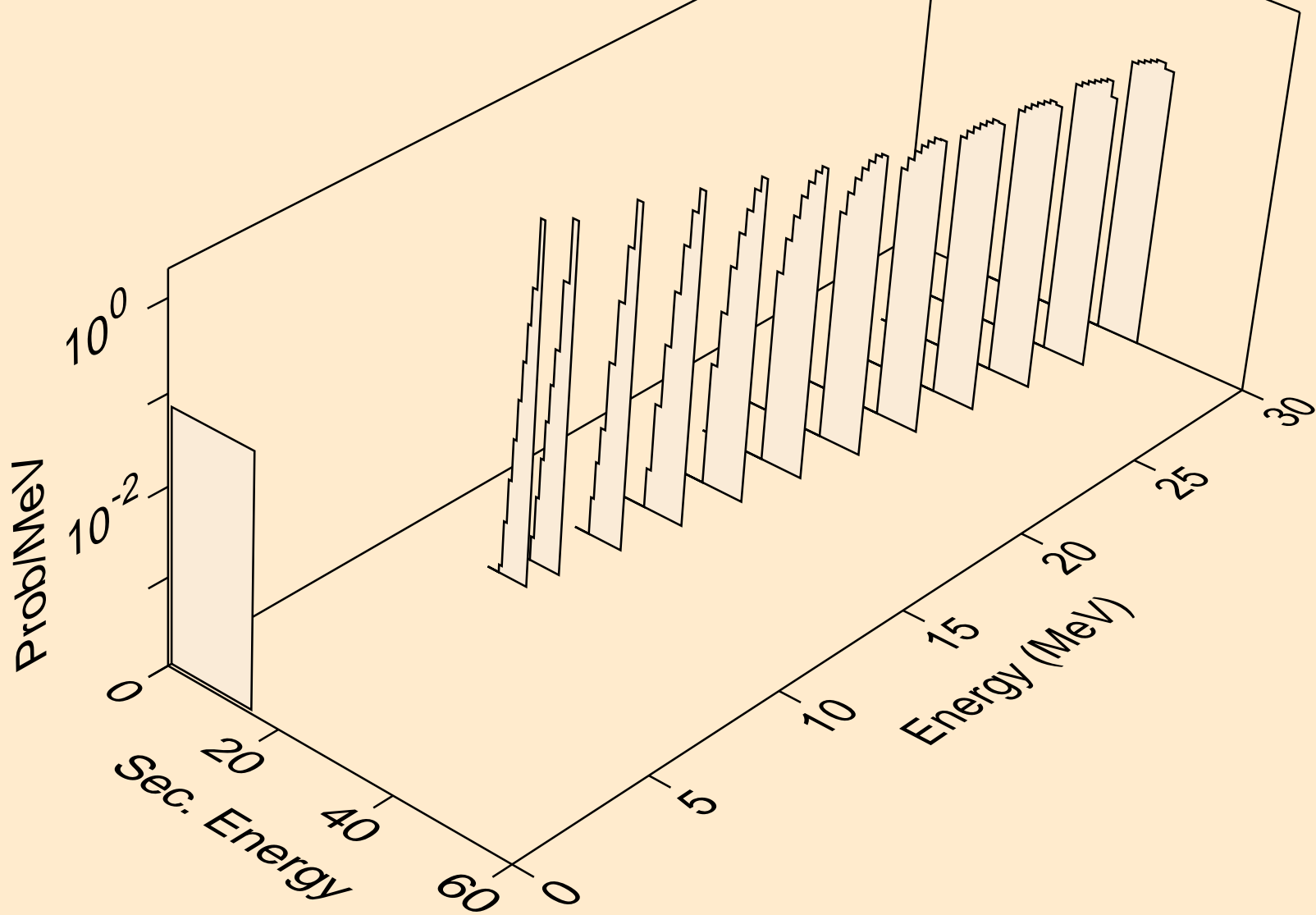

BH265 HELION ACER TENDL-2021 LIBRARY; T=0.K
alphas from (s,2a)

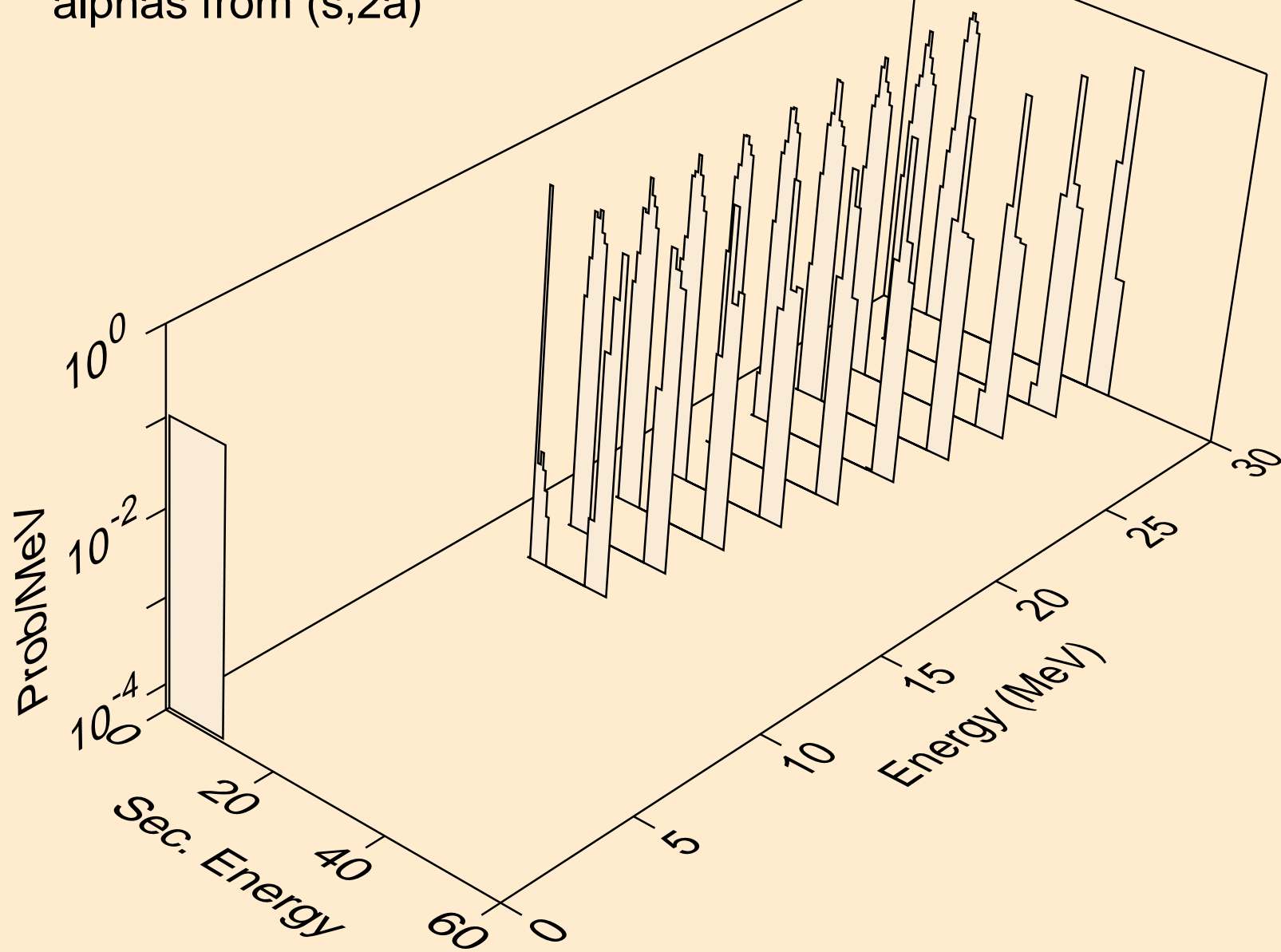

BH265 HELION ACER TENDL-2021 LIBRARY; T=0.K
alphas from (s,3a)

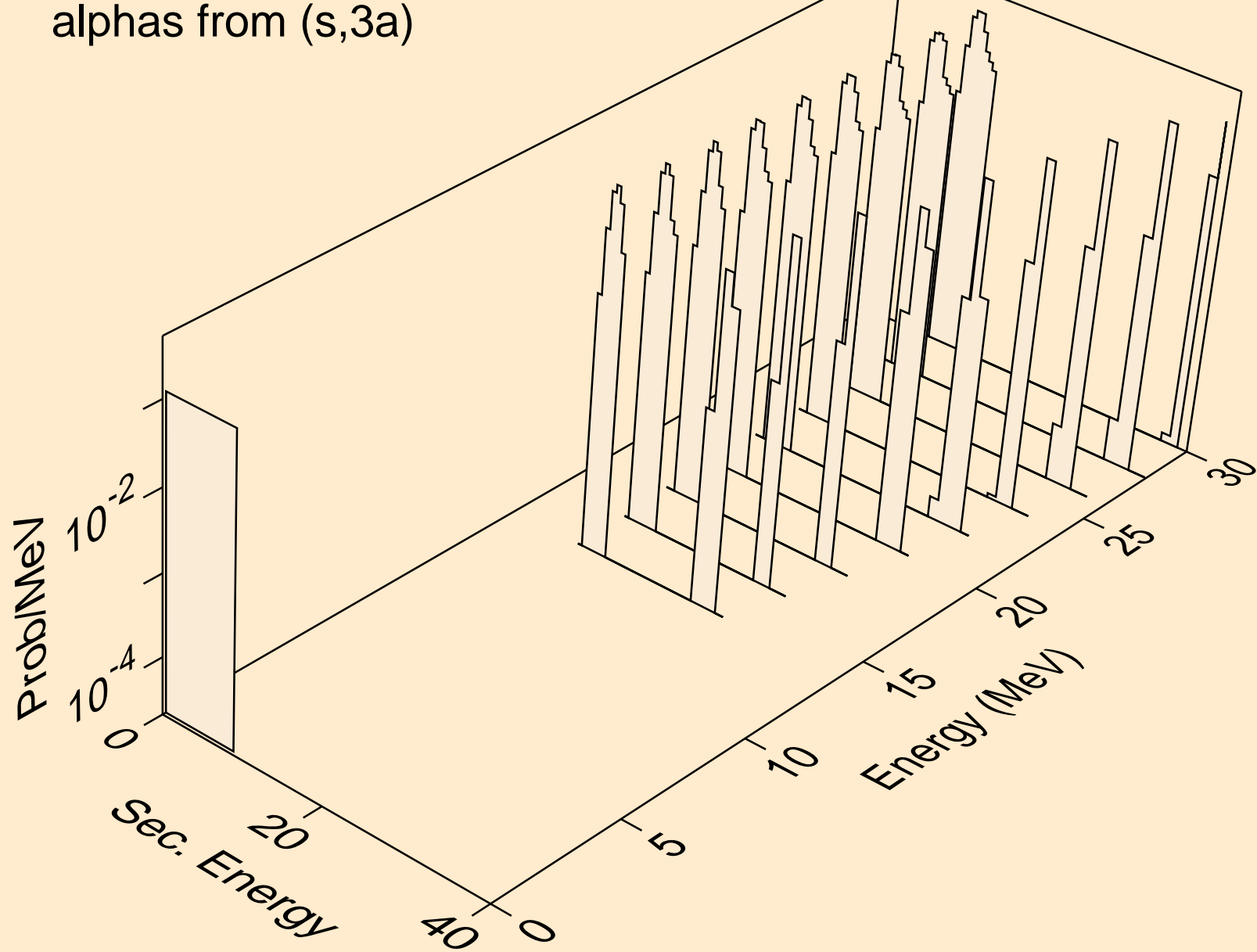

BH265 HELION ACER TENDL-2021 LIBRARY; T=0.K
alphas from (s,pa)

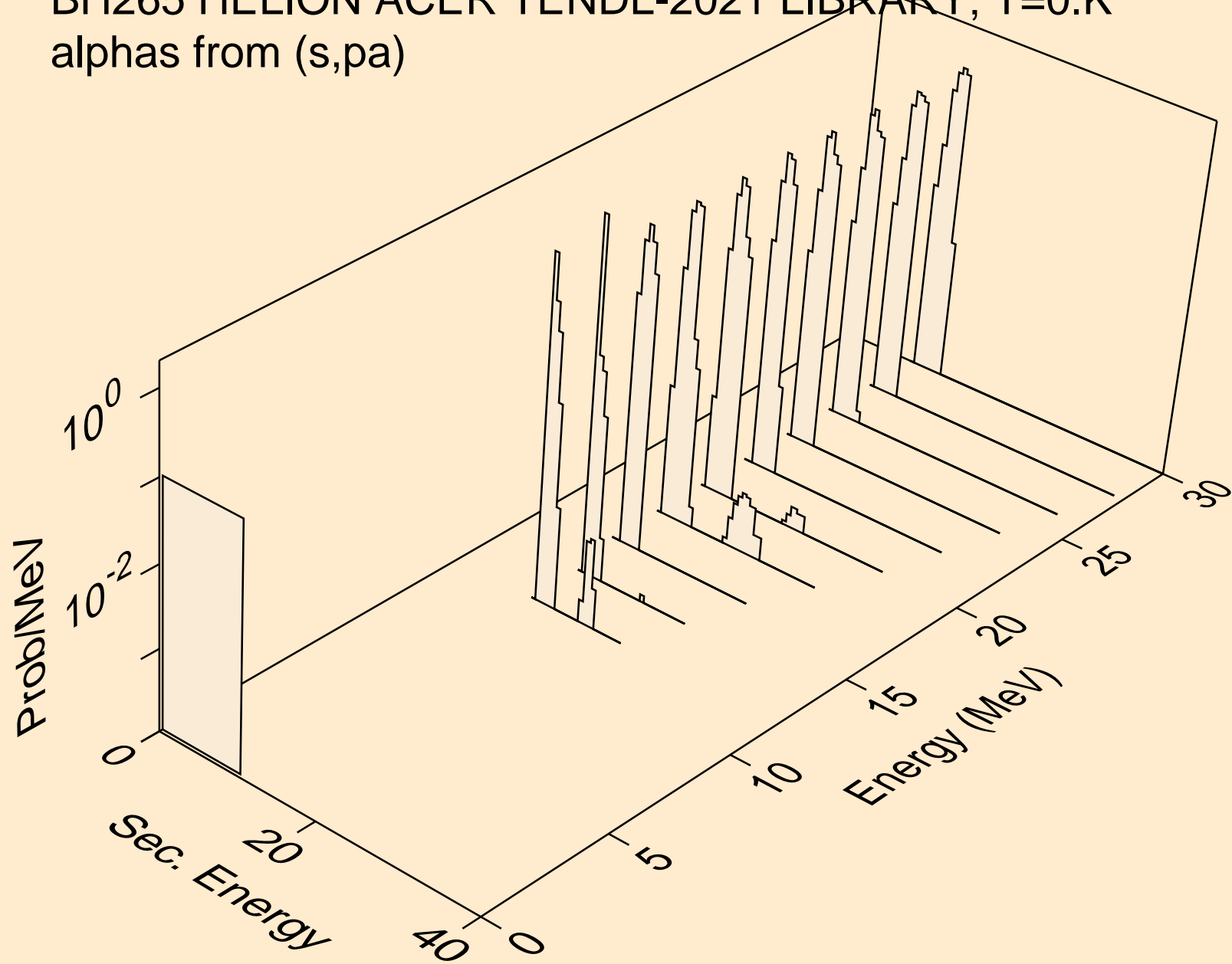

BH265 HELION ACER TENDL-2021 LIBRARY; T=0.K
alphas from (s,t2a)

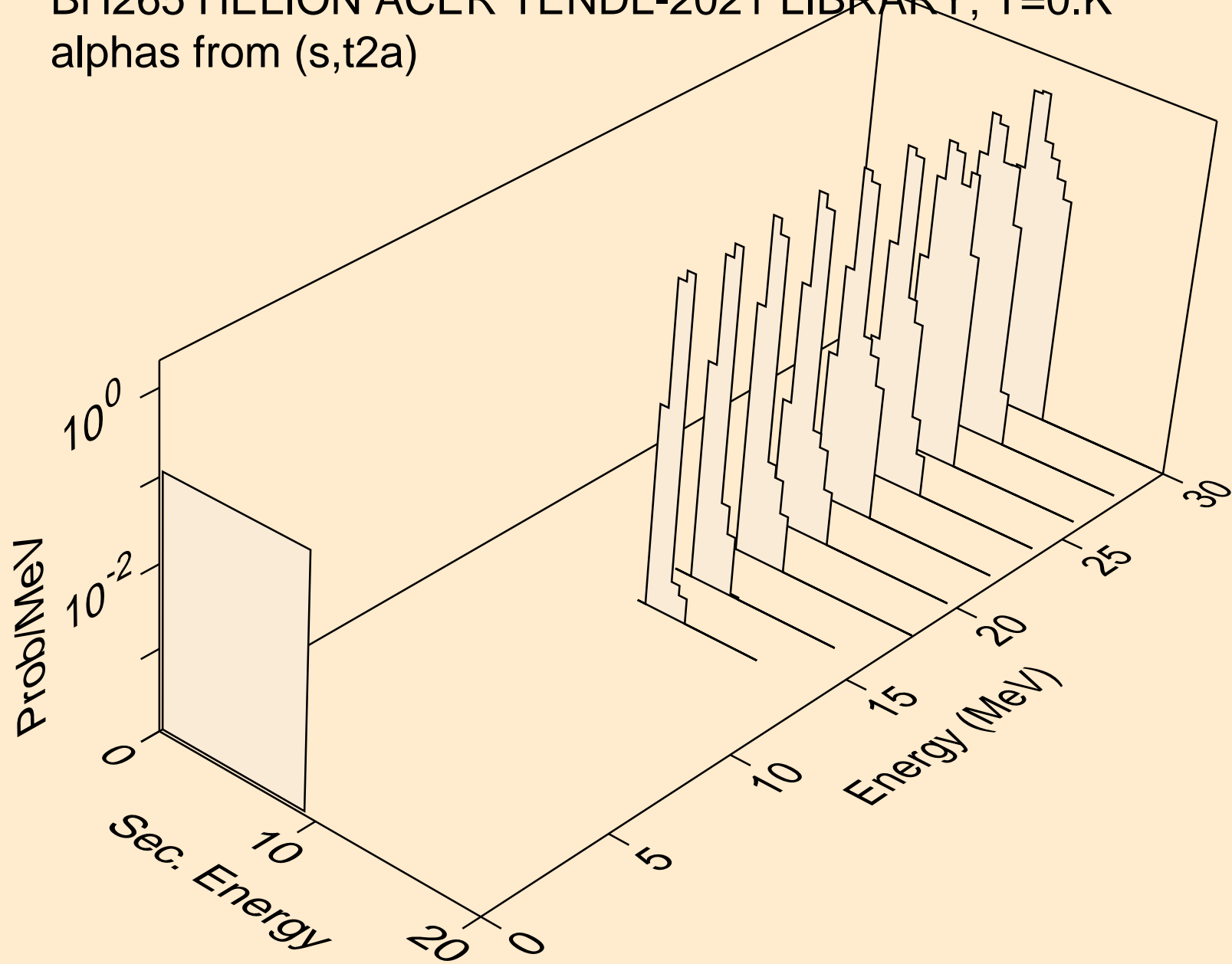

BH265 HELION ACER TENDL-2021 LIBRARY; T=0.K
alphas from (s,da)

