

BI222 HELION ACER TENDL-2021 LIBRARY; T=0.K  
Principal cross sections

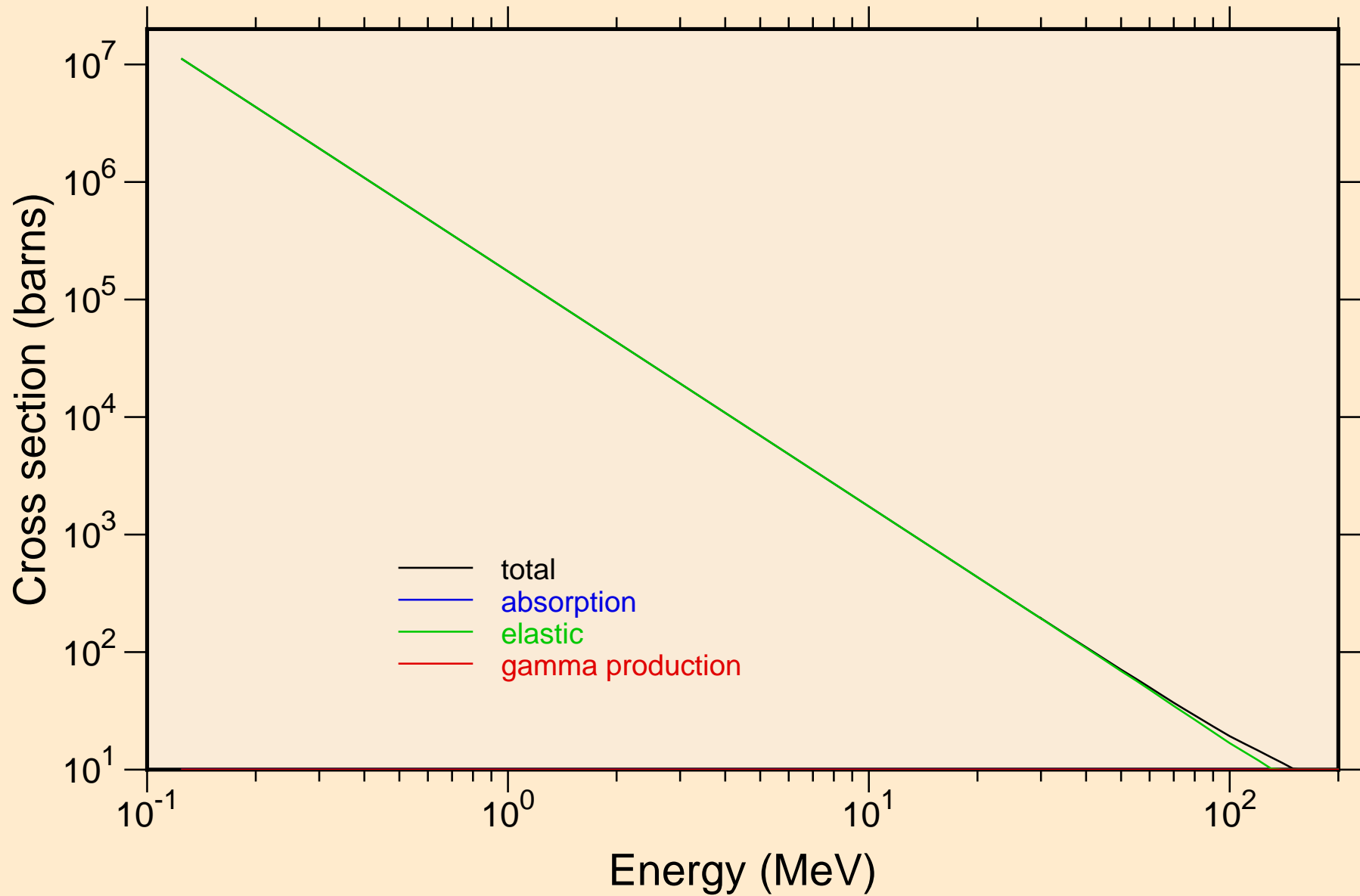

BI222 HELION ACER TENDL-2021 LIBRARY; T=0.K

Heating

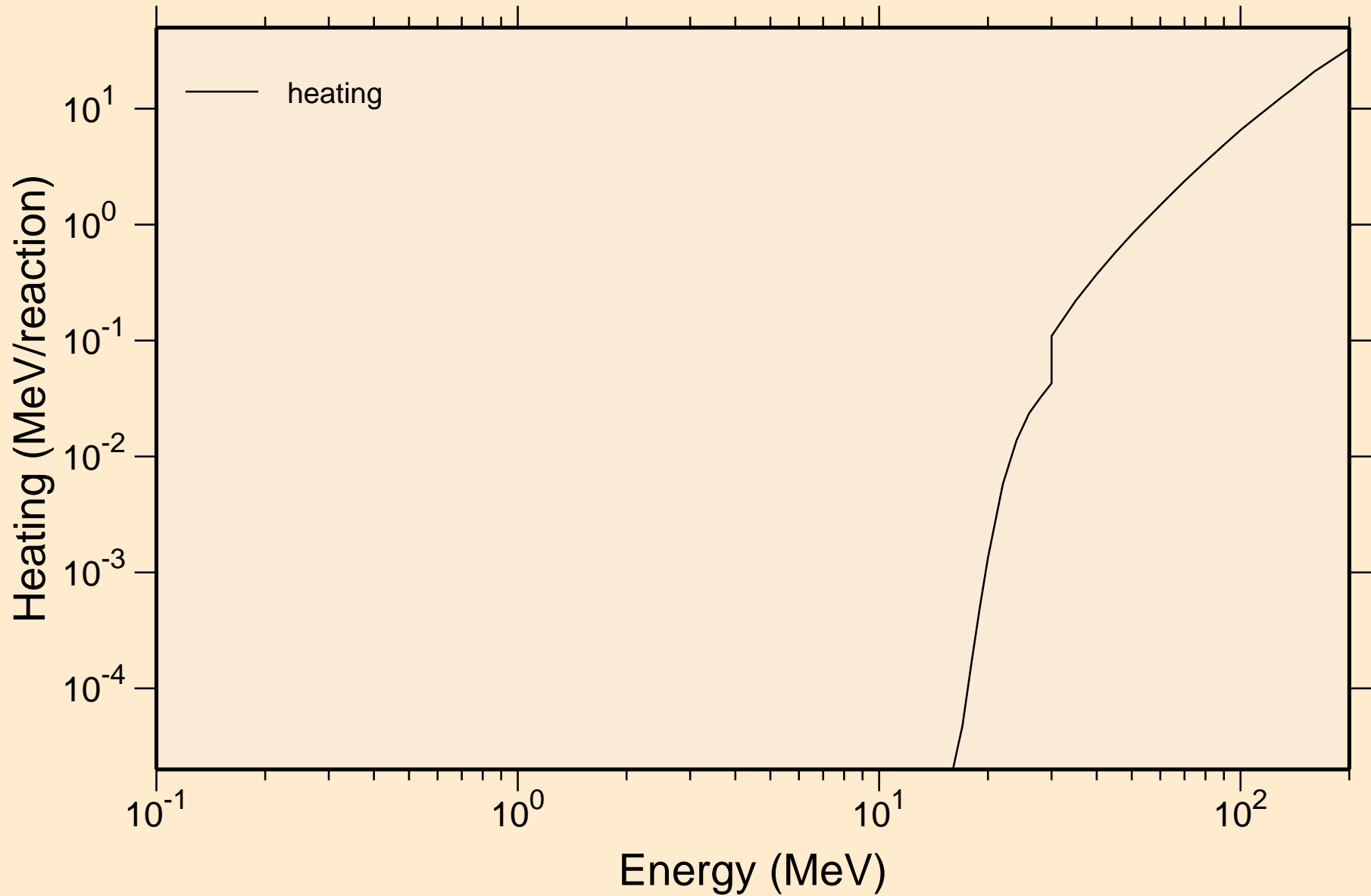

# BI222 HELION ACER TENDL-2021 LIBRARY; T=0.K

## Principal cross sections

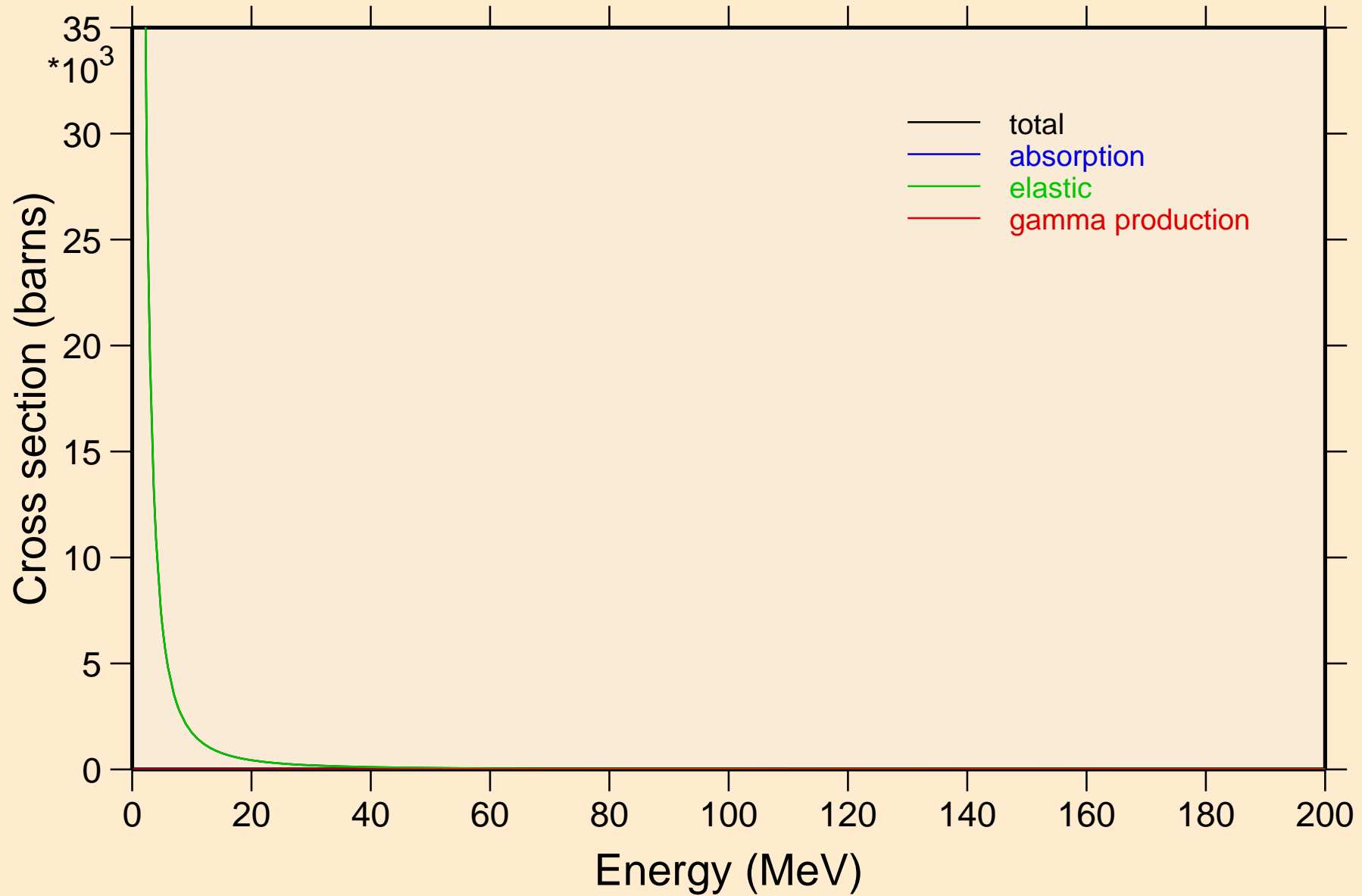

BI222 HELION ACER TENDL-2021 LIBRARY; T=0.K

Heating

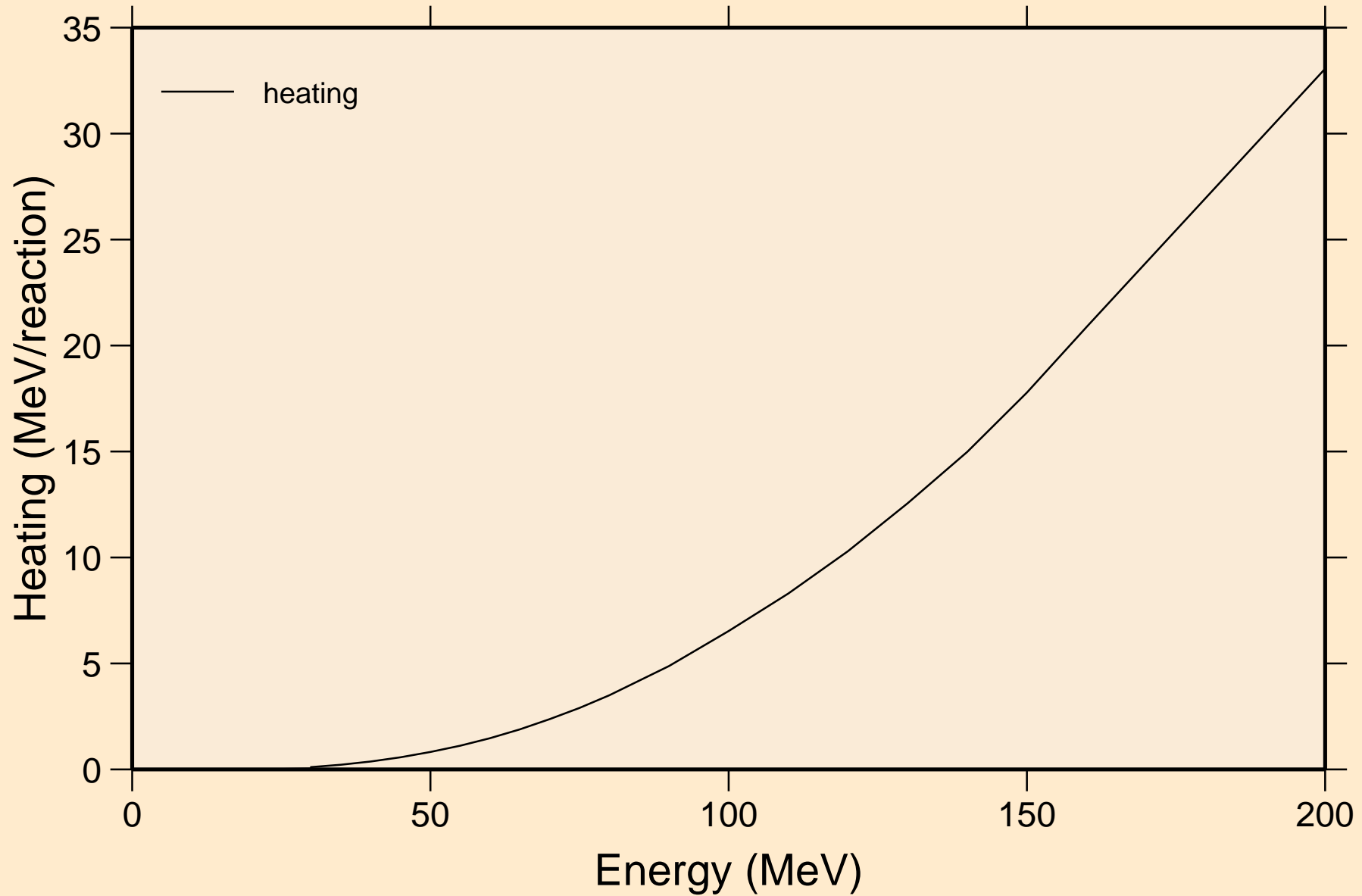

BI222 HELION ACER TENDL-2021 LIBRARY; T=0.K  
Threshold reactions

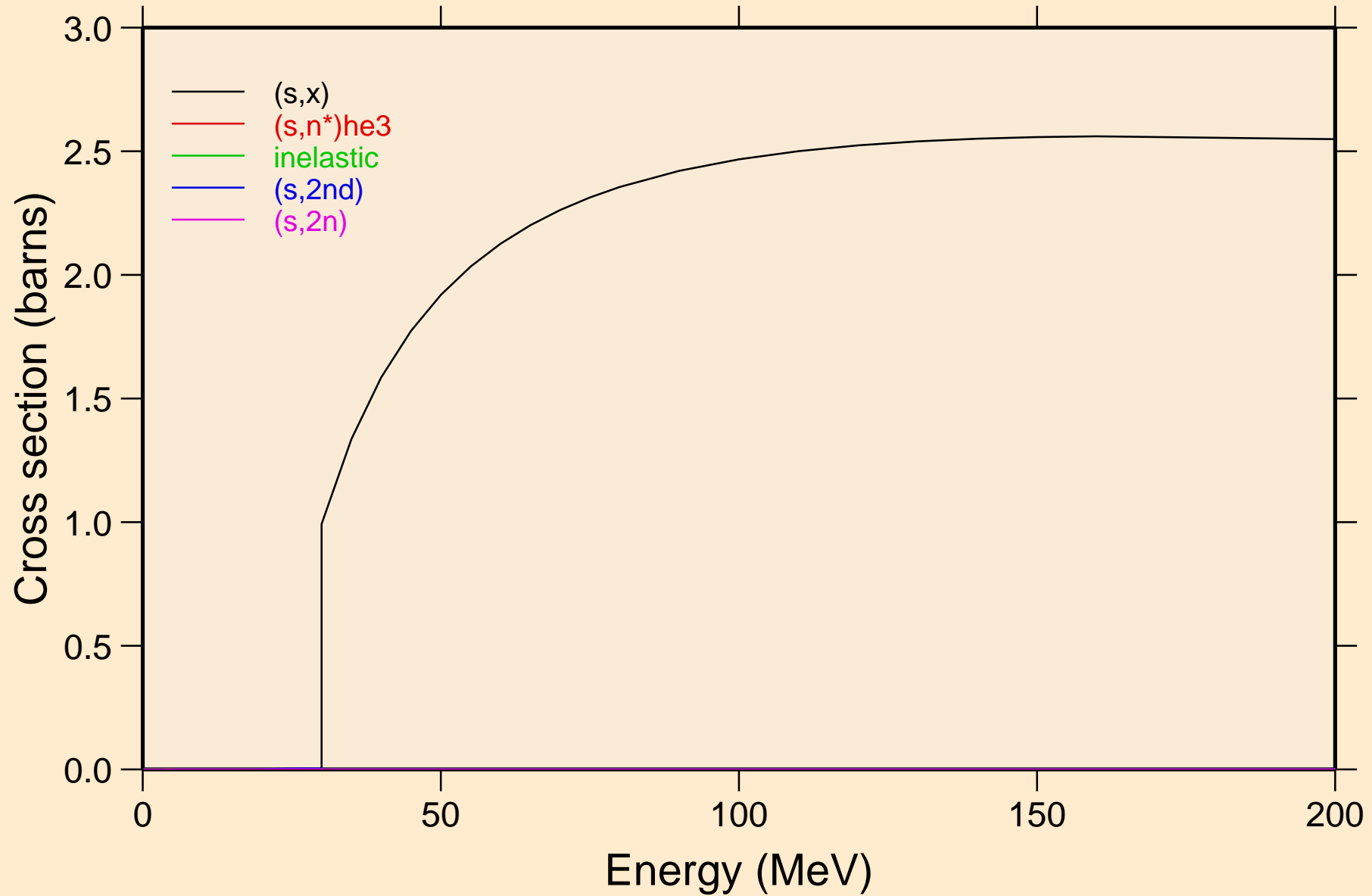

BI222 HELION ACER TENDL-2021 LIBRARY; T=0.K  
Threshold reactions

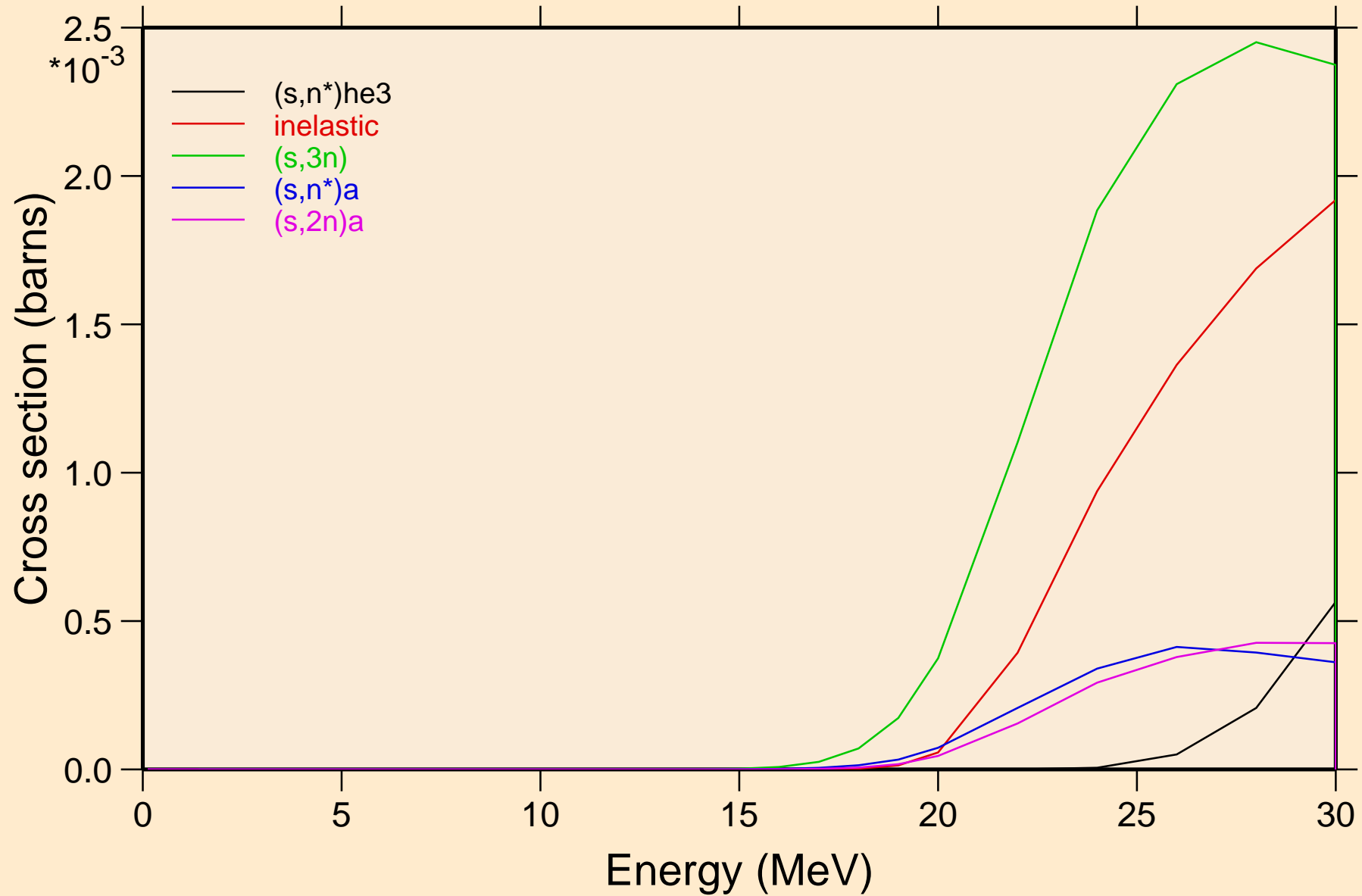

BI222 HELION ACER TENDL-2021 LIBRARY; T=0.K  
Threshold reactions

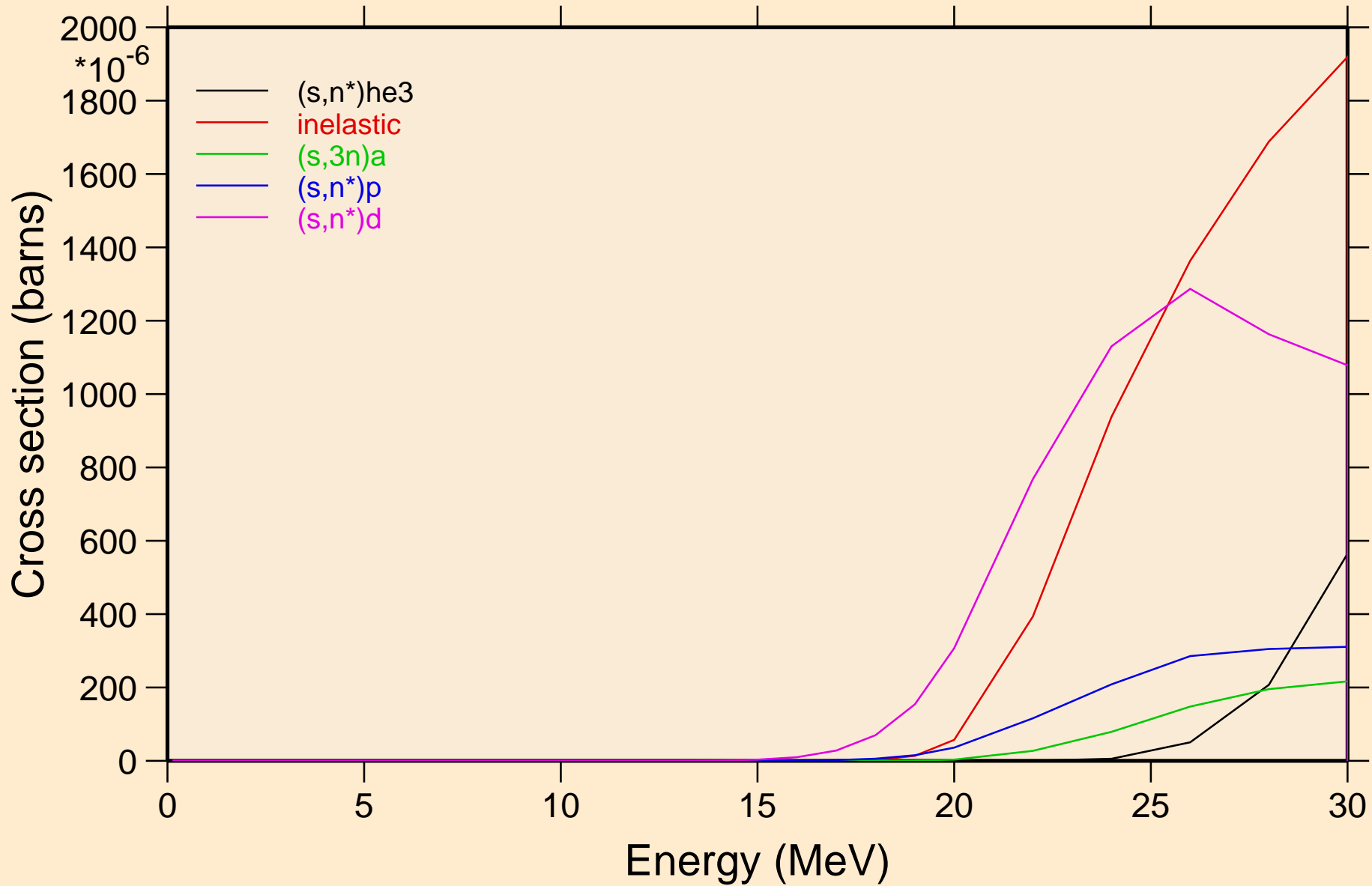

BI222 HELION ACER TENDL-2021 LIBRARY; T=0.K  
Threshold reactions

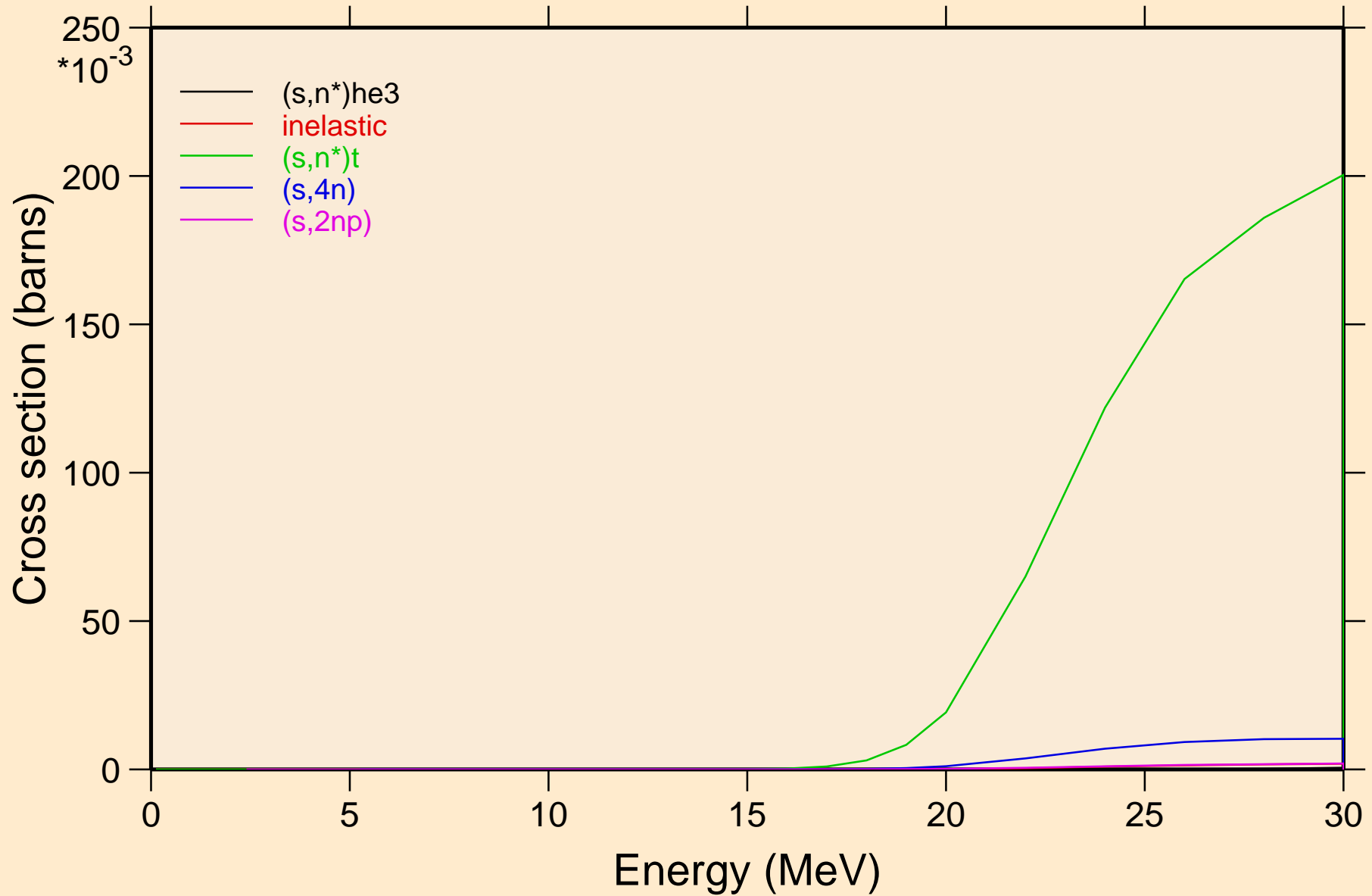



BI222 HELION ACER TENDL-2021 LIBRARY; T=0.K  
Threshold reactions

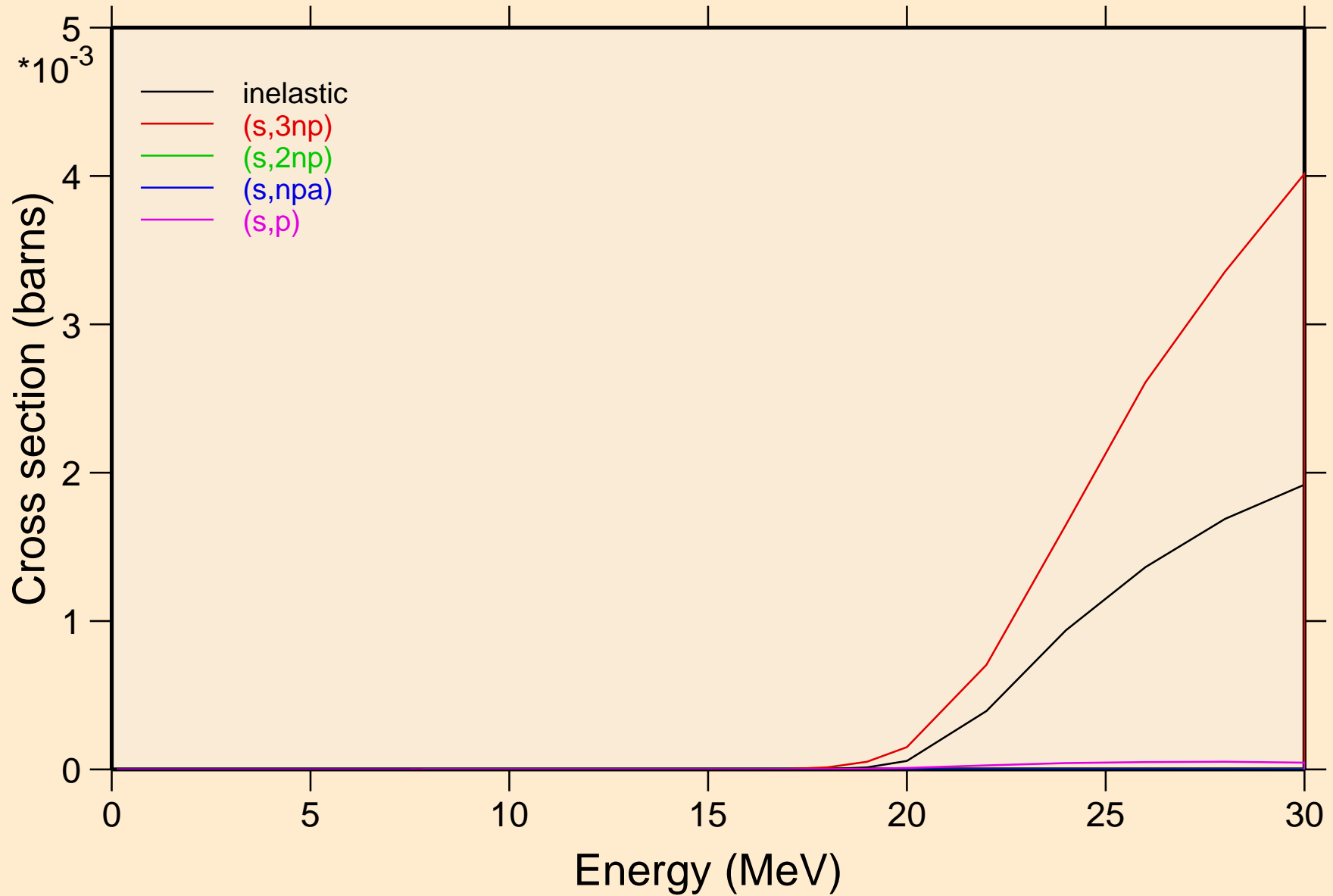

BI222 HELION ACER TENDL-2021 LIBRARY; T=0.K  
Threshold reactions

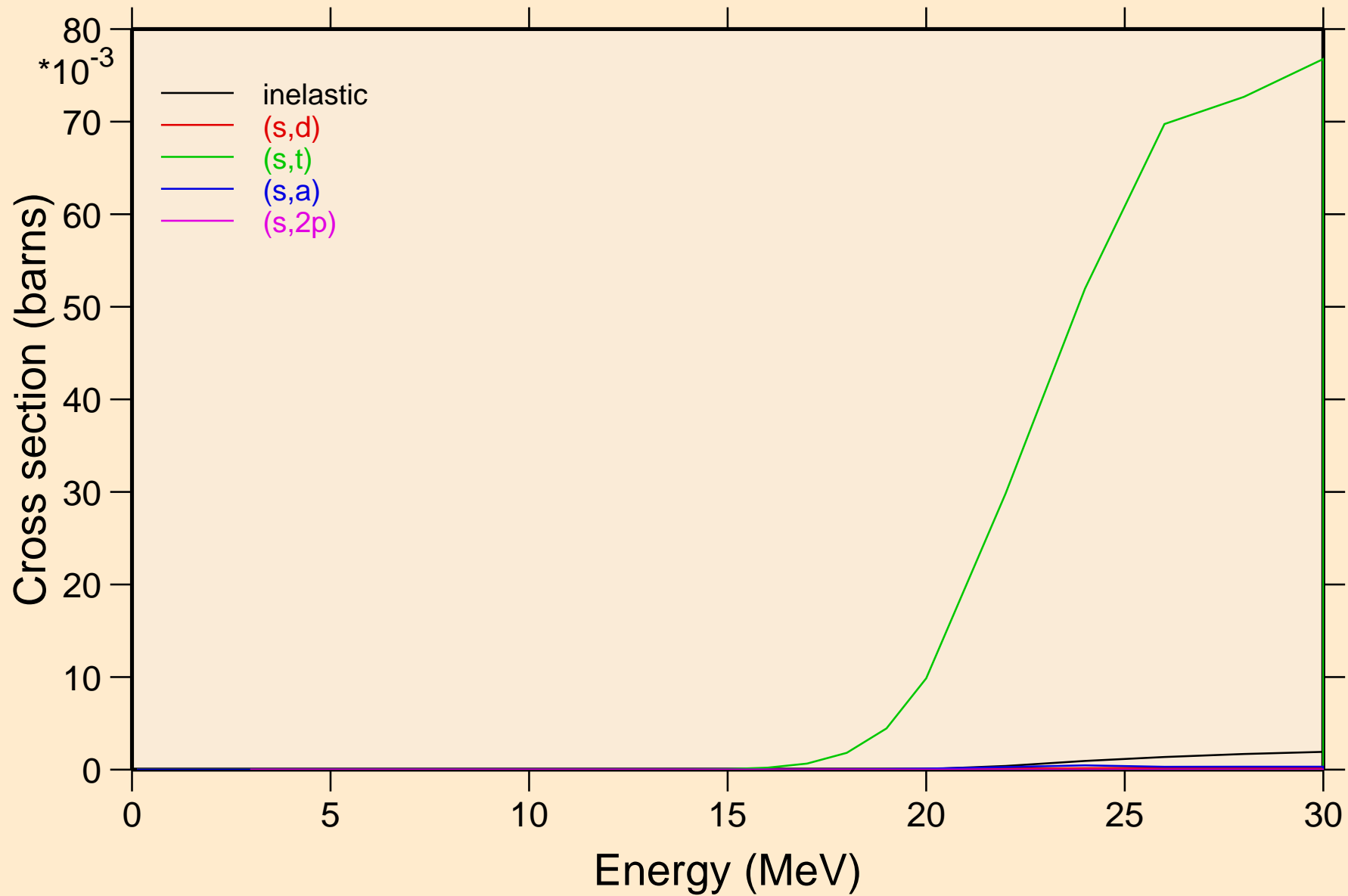

BI222 HELION ACER TENDL-2021 LIBRARY; T=0.K  
Threshold reactions

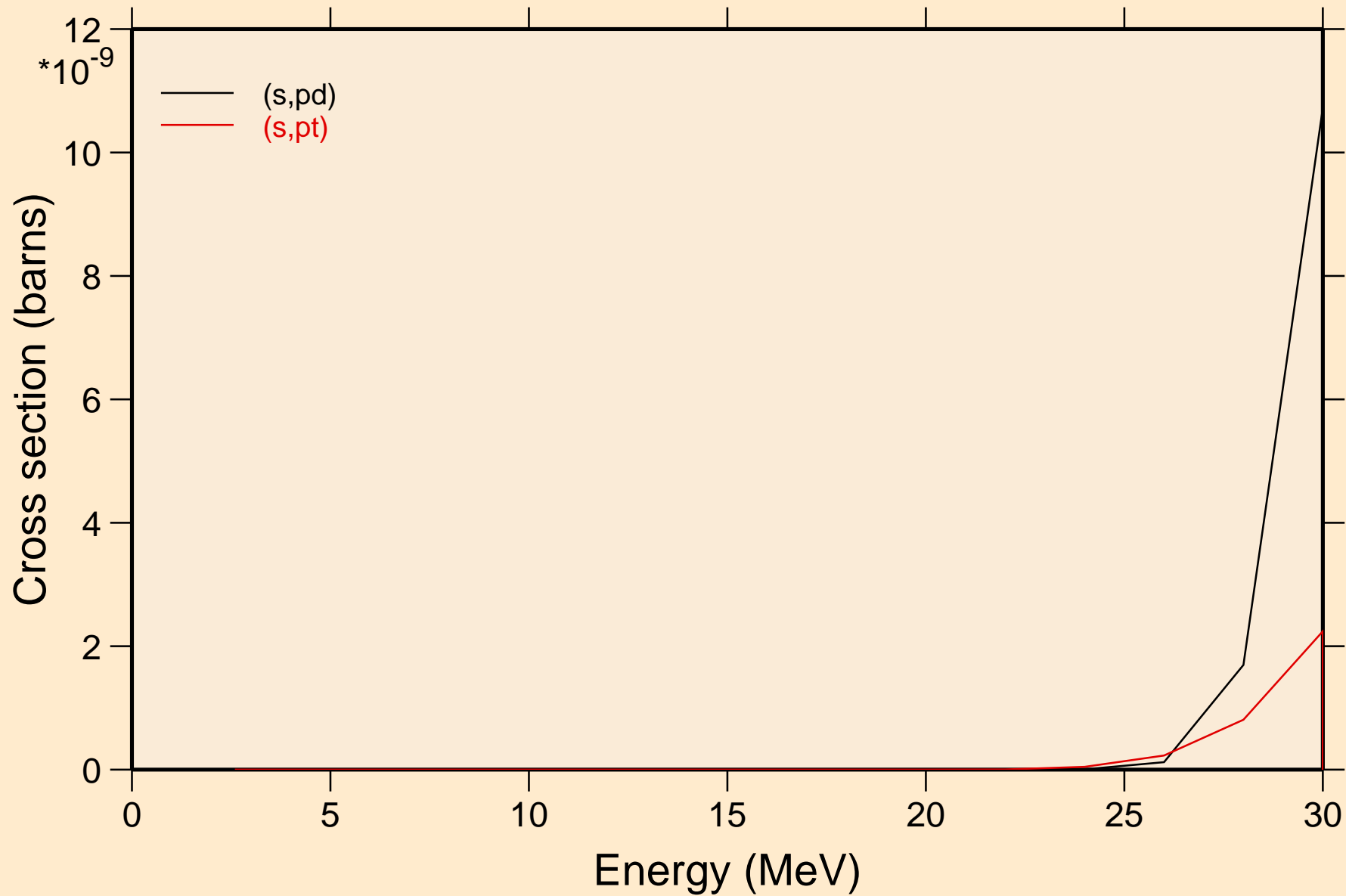

BI222 HELION ACER TENDL-2021 LIBRARY; T=0.K  
angular distribution for elastic

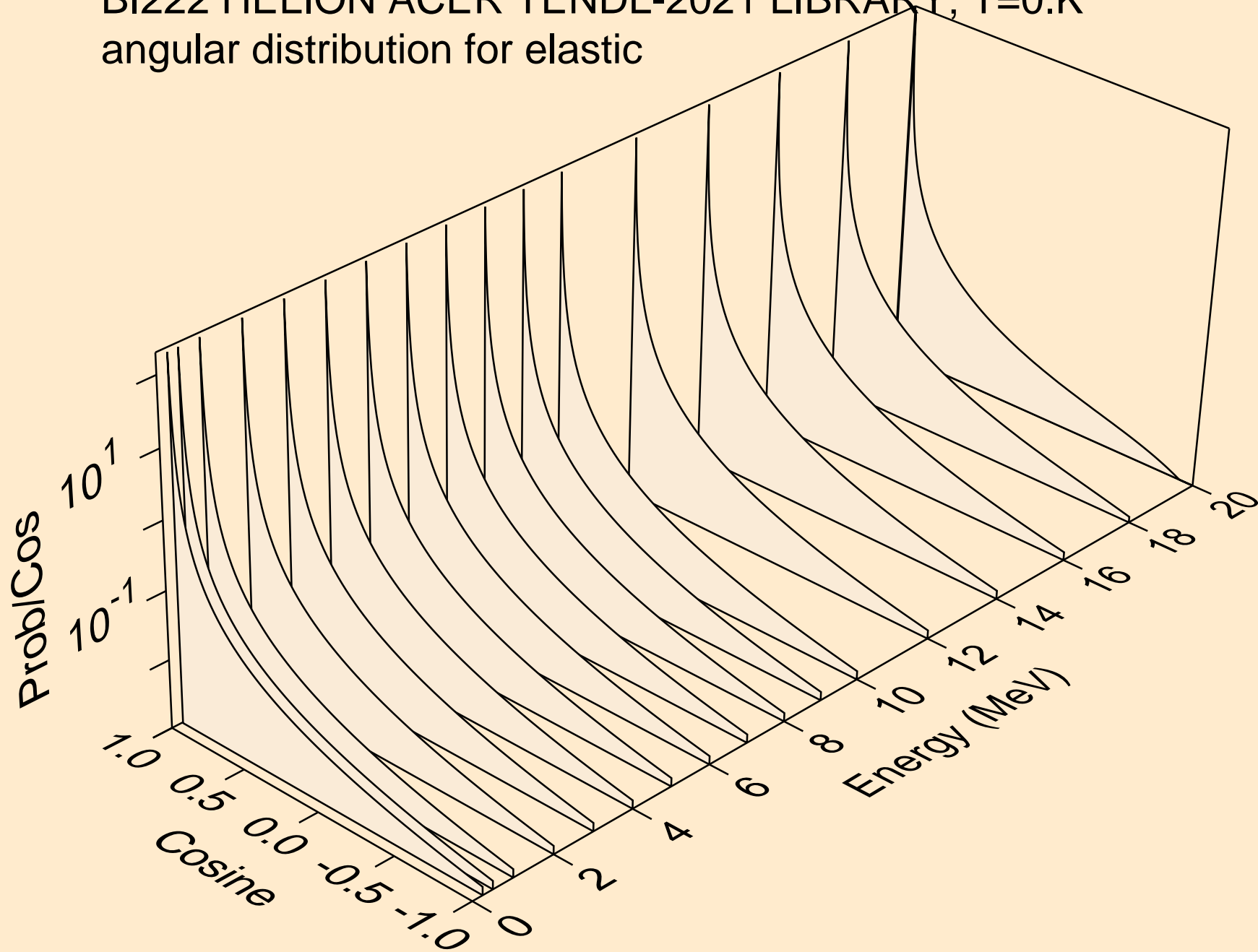

BI222 HELION ACER TENDL-2021 LIBRARY; T=0.K  
angular distribution for elastic

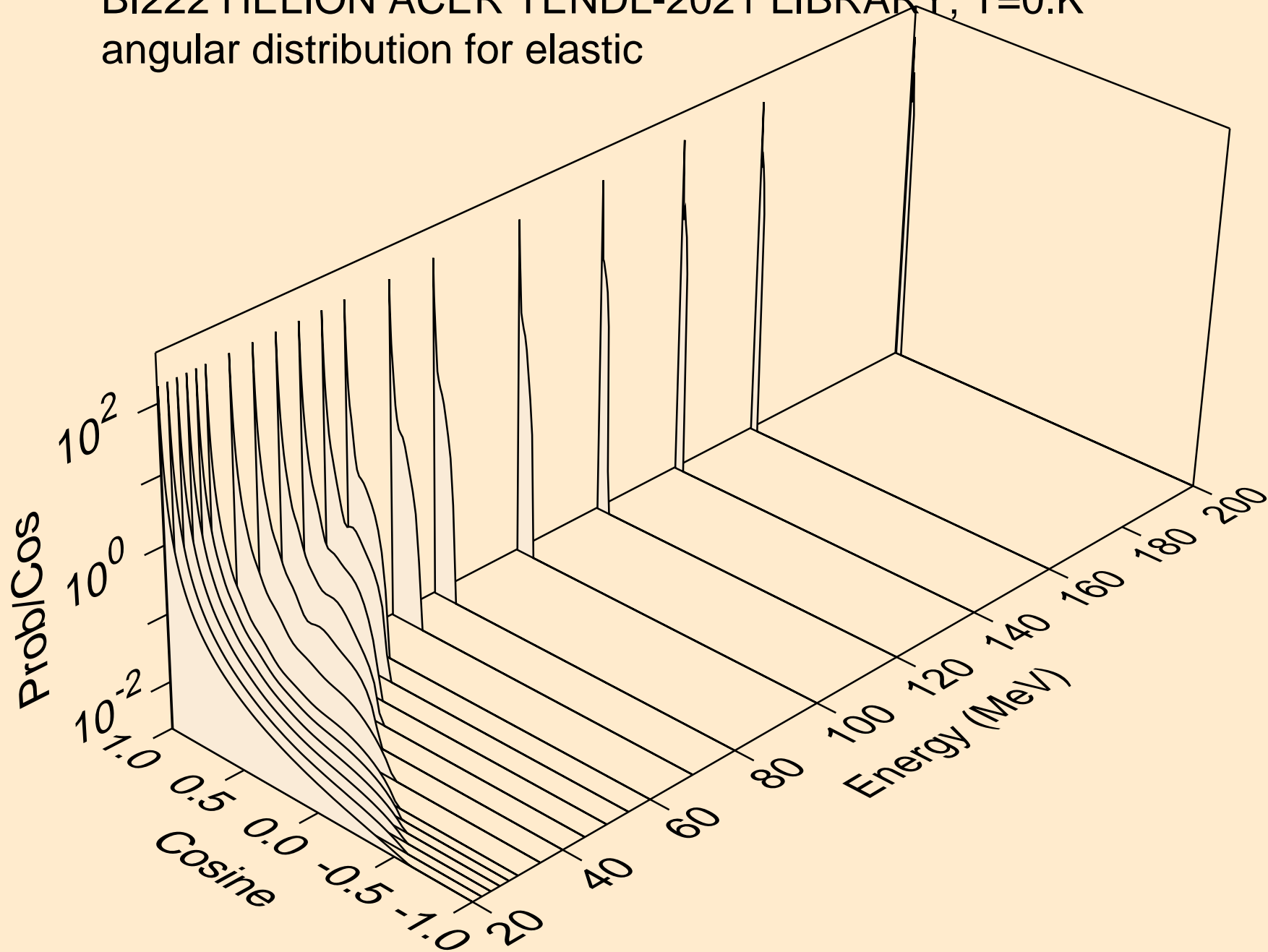

BI222 HELION ACER TENDL-2021 LIBRARY; T=0.K  
He-3 emission for (s,x)

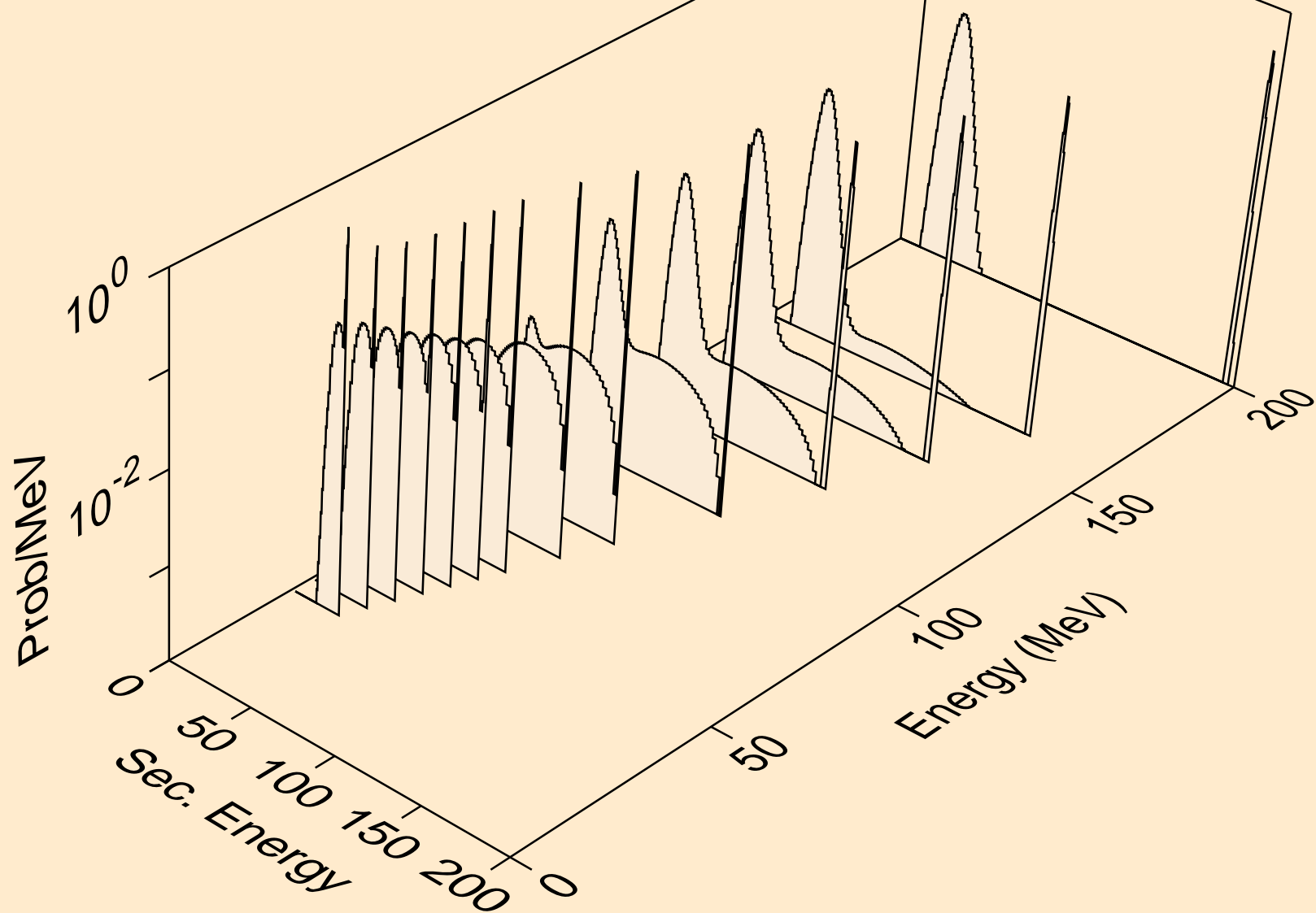

BI222 HELION ACER TENDL-2021 LIBRARY; T=0.K  
He-3 emission for (s,n\*)he3

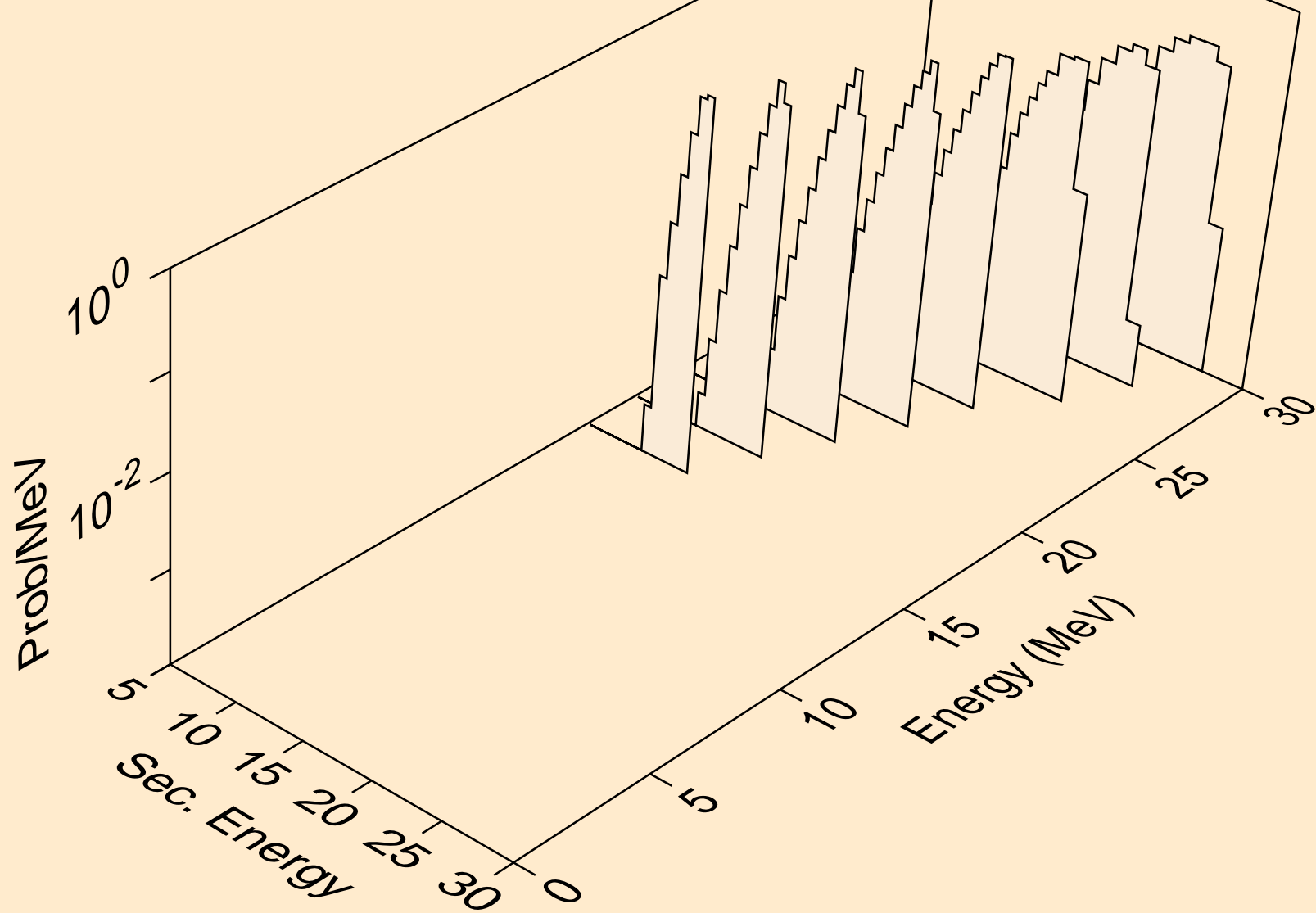

BI222 HELION ACER TENDL-2021 LIBRARY; T=0.K  
He-3 emission for inelastic

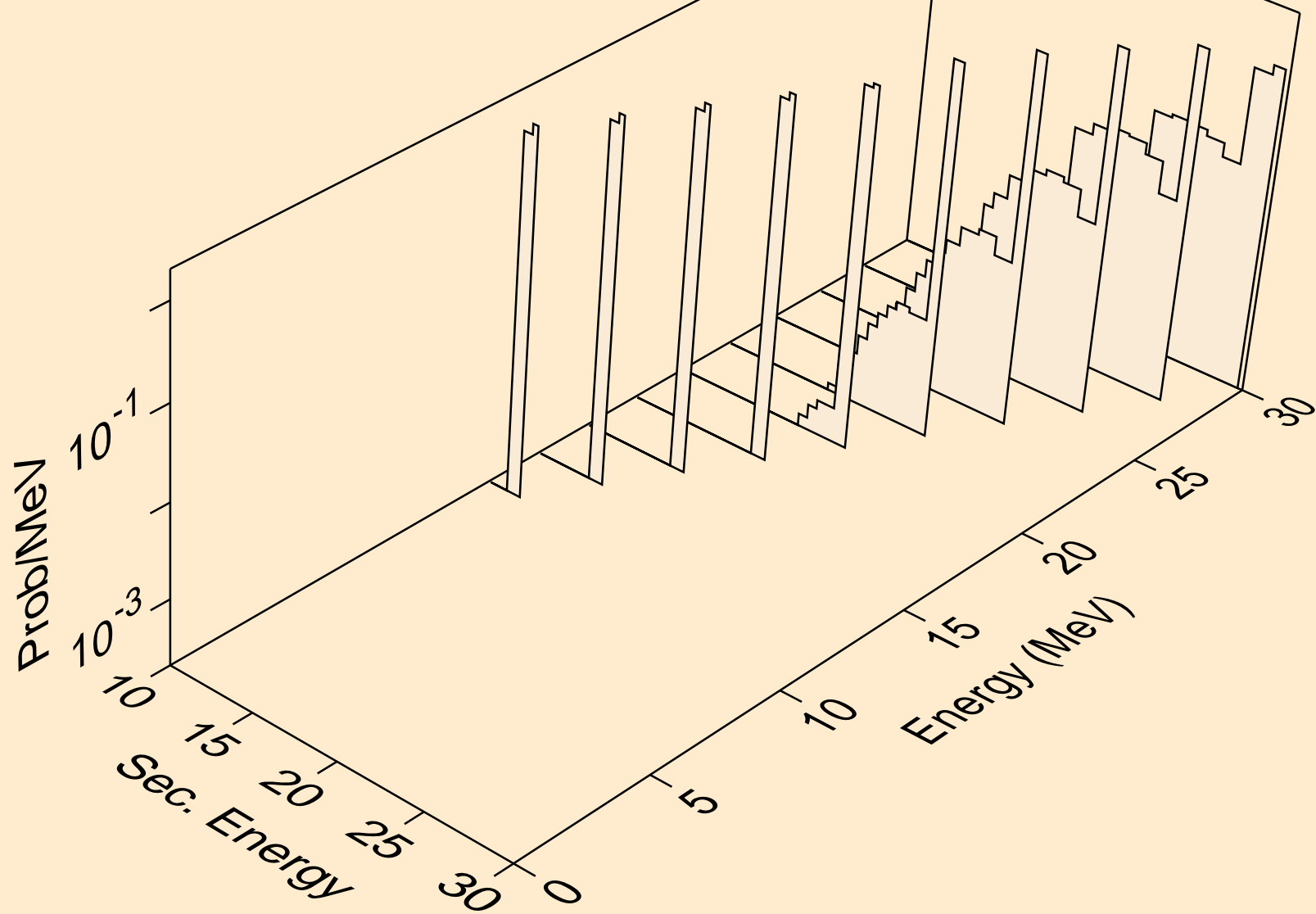



BI222 HELION ACER TENDL-2021 LIBRARY; T=0.K  
Photon emission for (z,n)

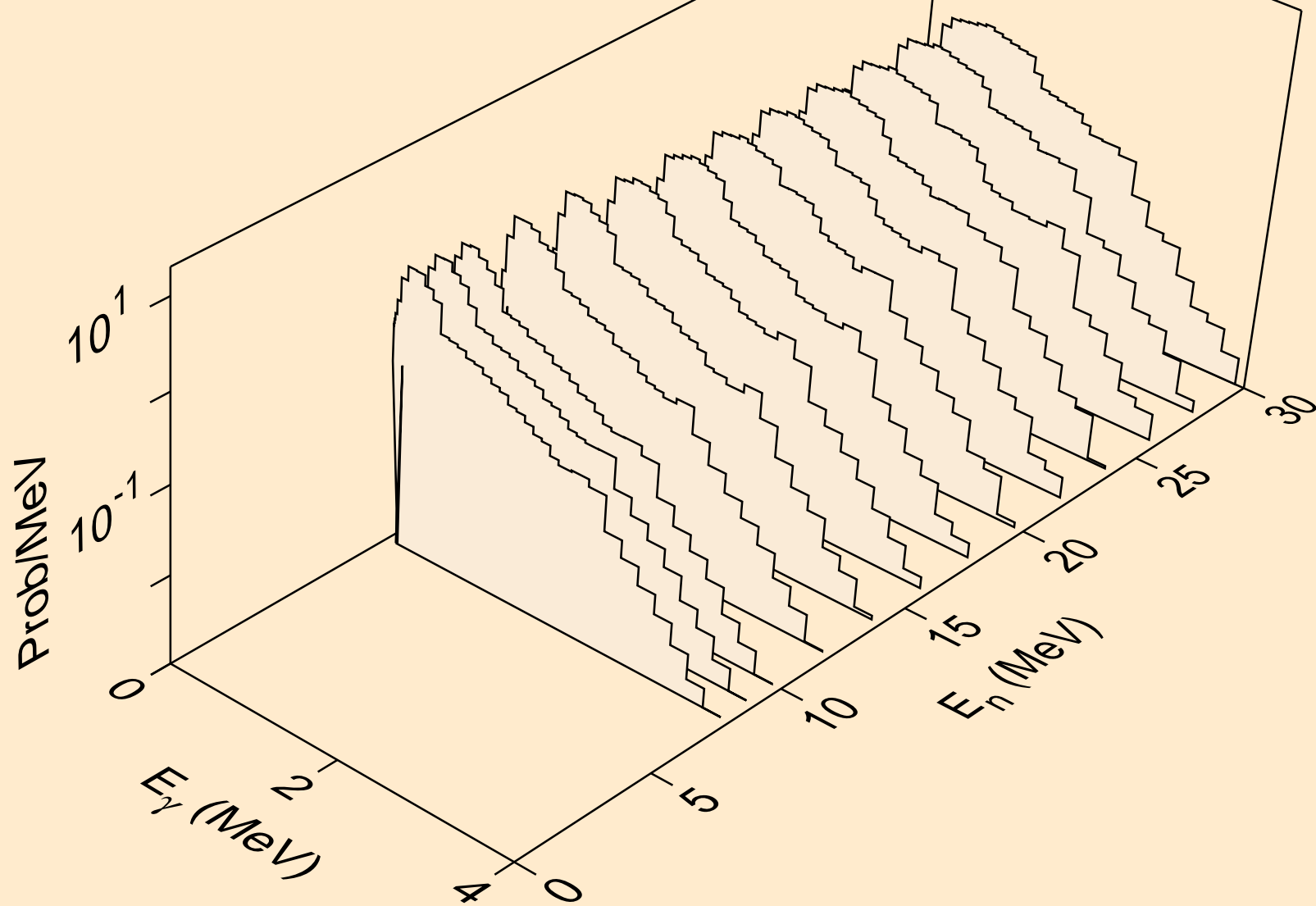

BI222 HELION ACER TENDL-2021 LIBRARY; T=0.K  
Photon emission for (n,x)

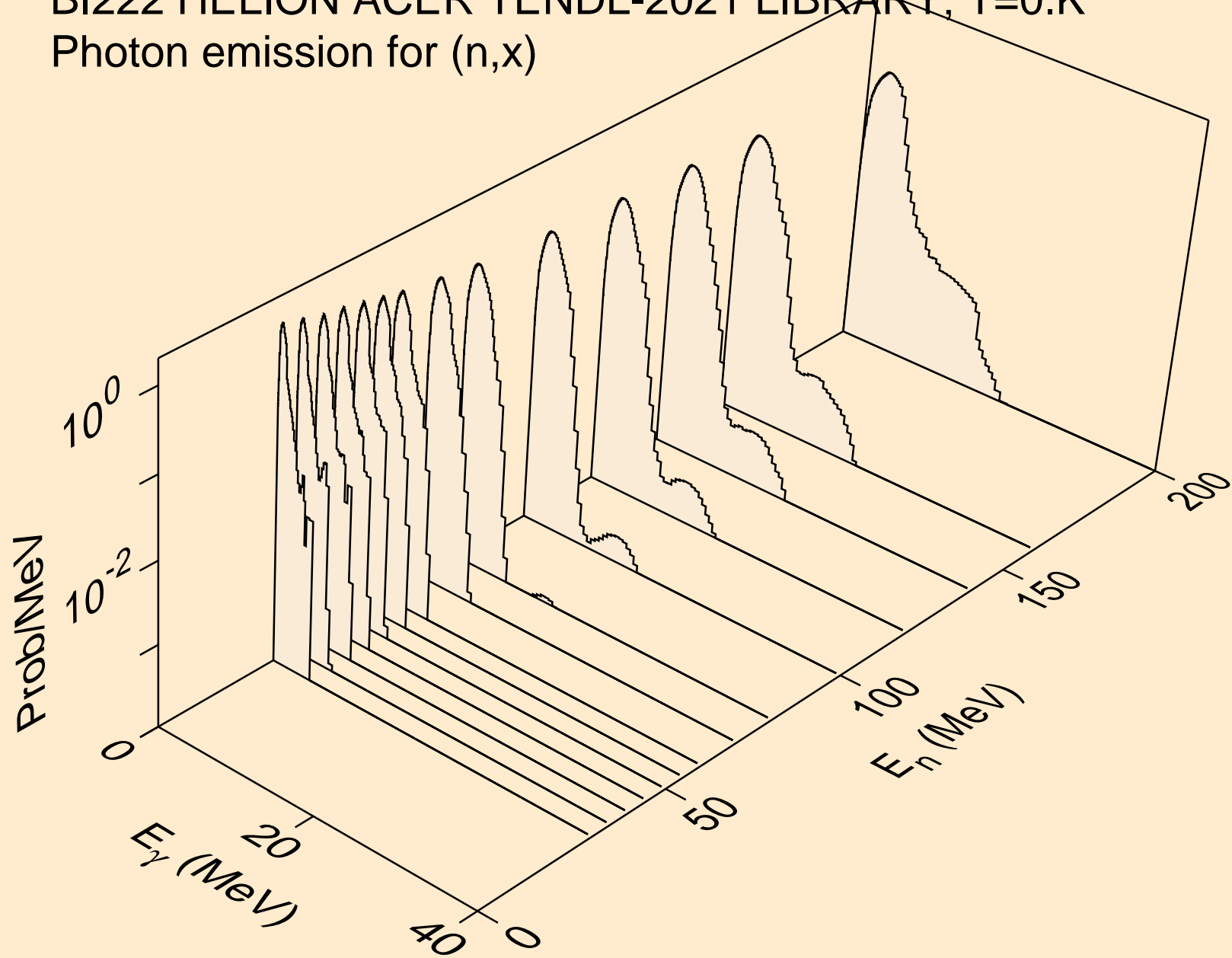

BI222 HELION ACER TENDL-2021 LIBRARY; T=0.K  
Photon emission for (n,2nd)

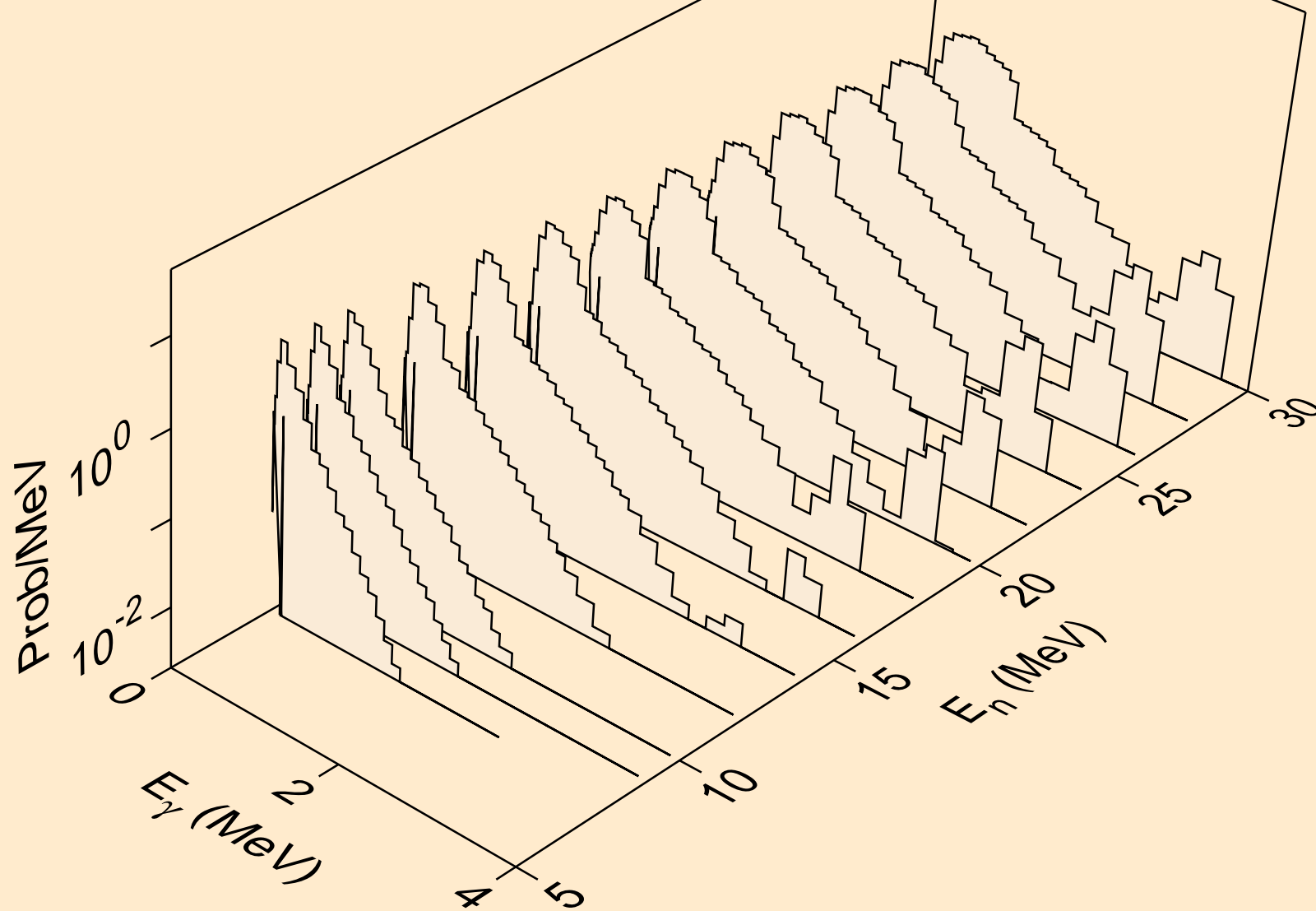

BI222 HELION ACER TENDL-2021 LIBRARY; T=0.K  
Photon emission for (n,2n)

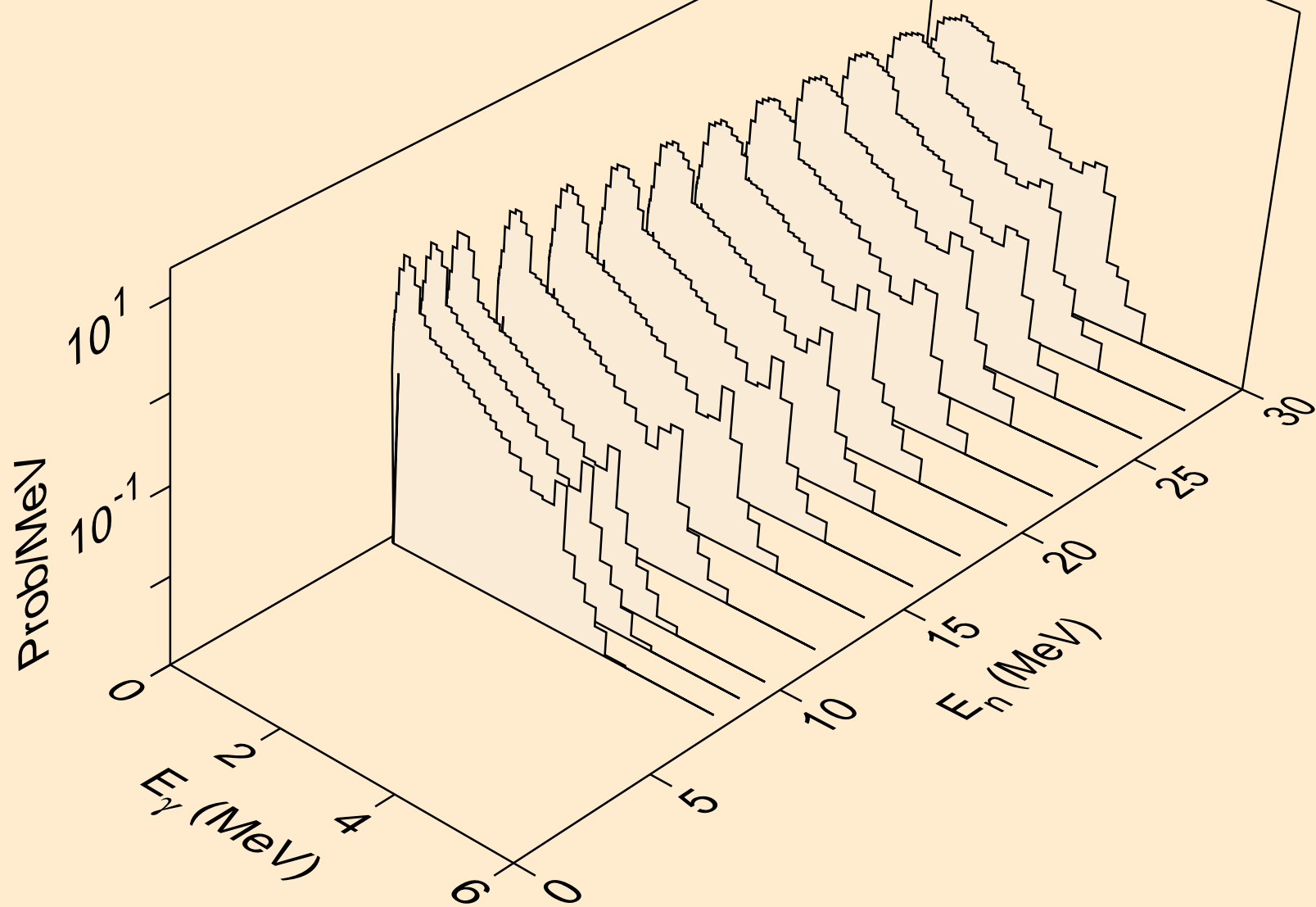

BI222 HELION ACER TENDL-2021 LIBRARY; T=0.K  
Photon emission for (n,3n)

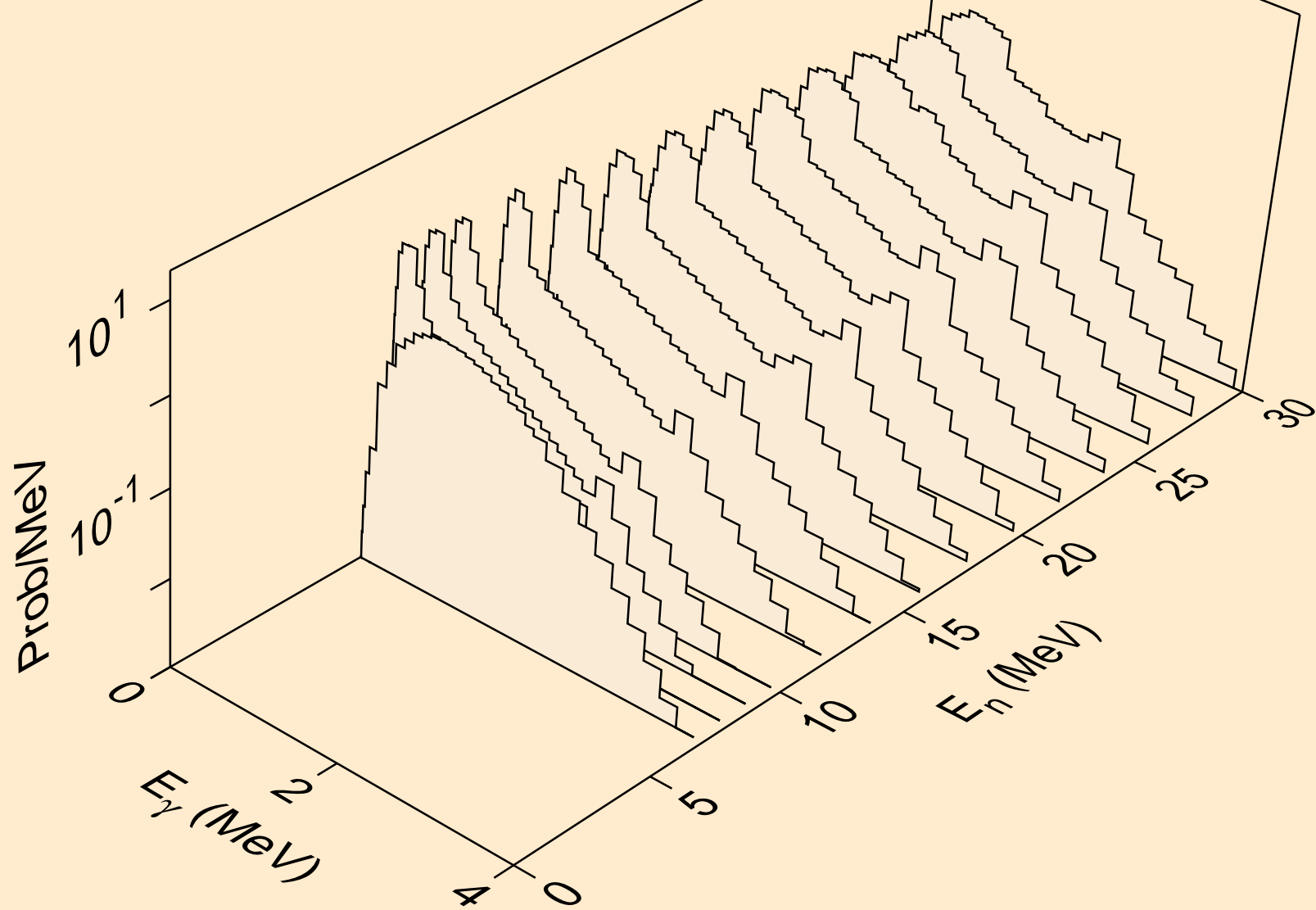

BI222 HELION ACER TENDL-2021 LIBRARY; T=0.K  
Photon emission for (n,n\*)a

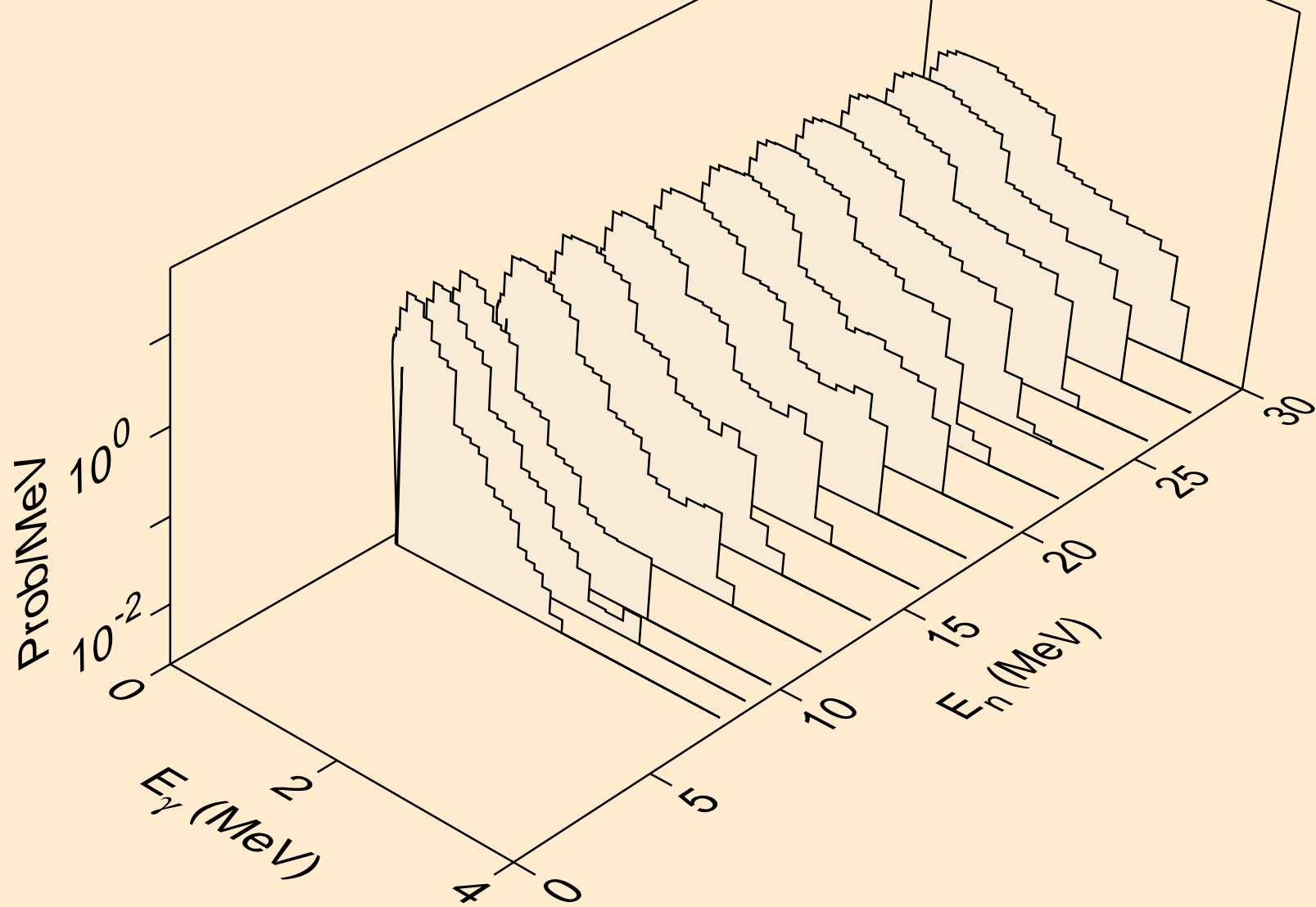

BI222 HELION ACER TENDL-2021 LIBRARY; T=0.K  
Photon emission for (n,2n)a

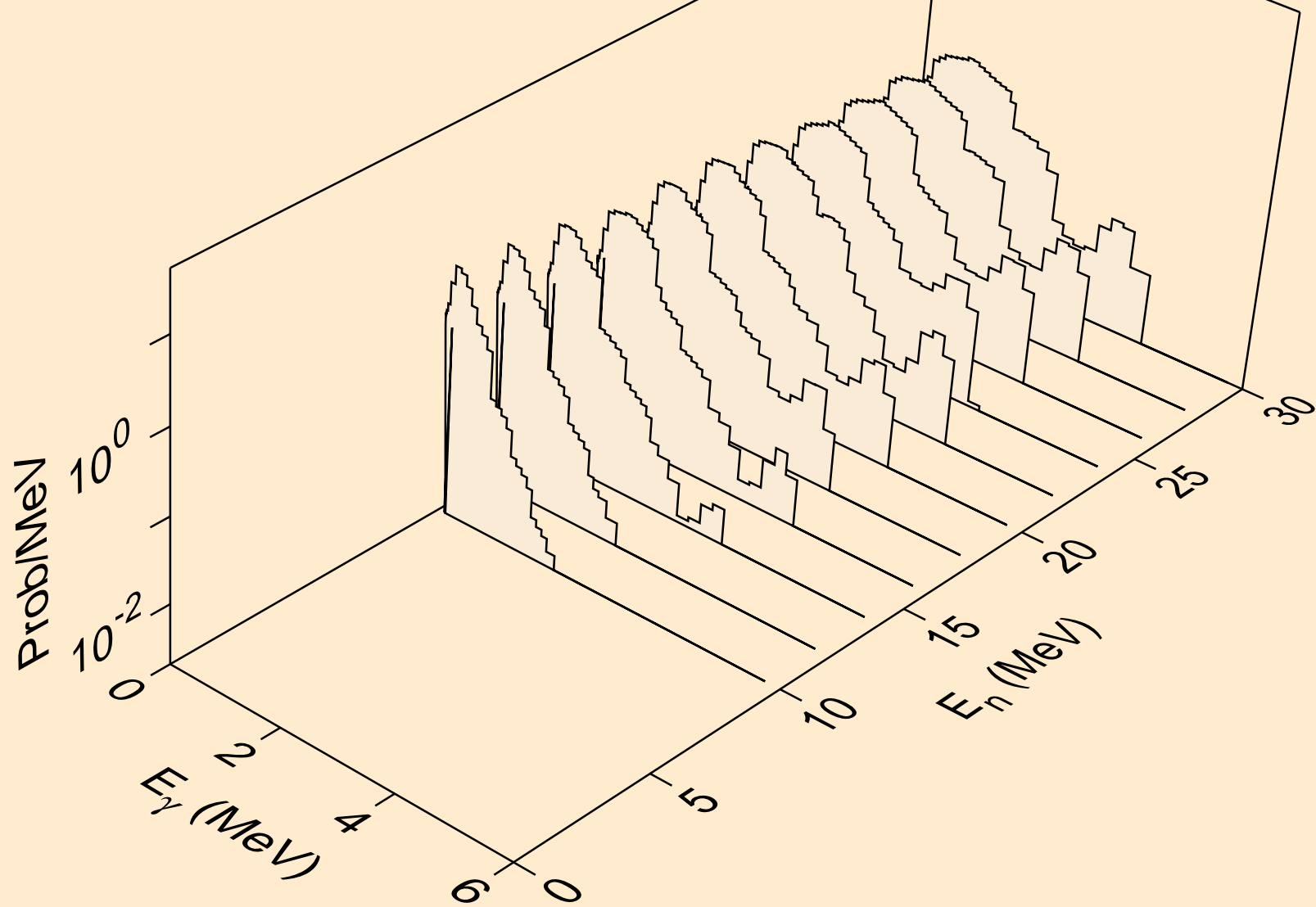

BI222 HELION ACER TENDL-2021 LIBRARY; T=0.K  
Photon emission for (n,3n)a

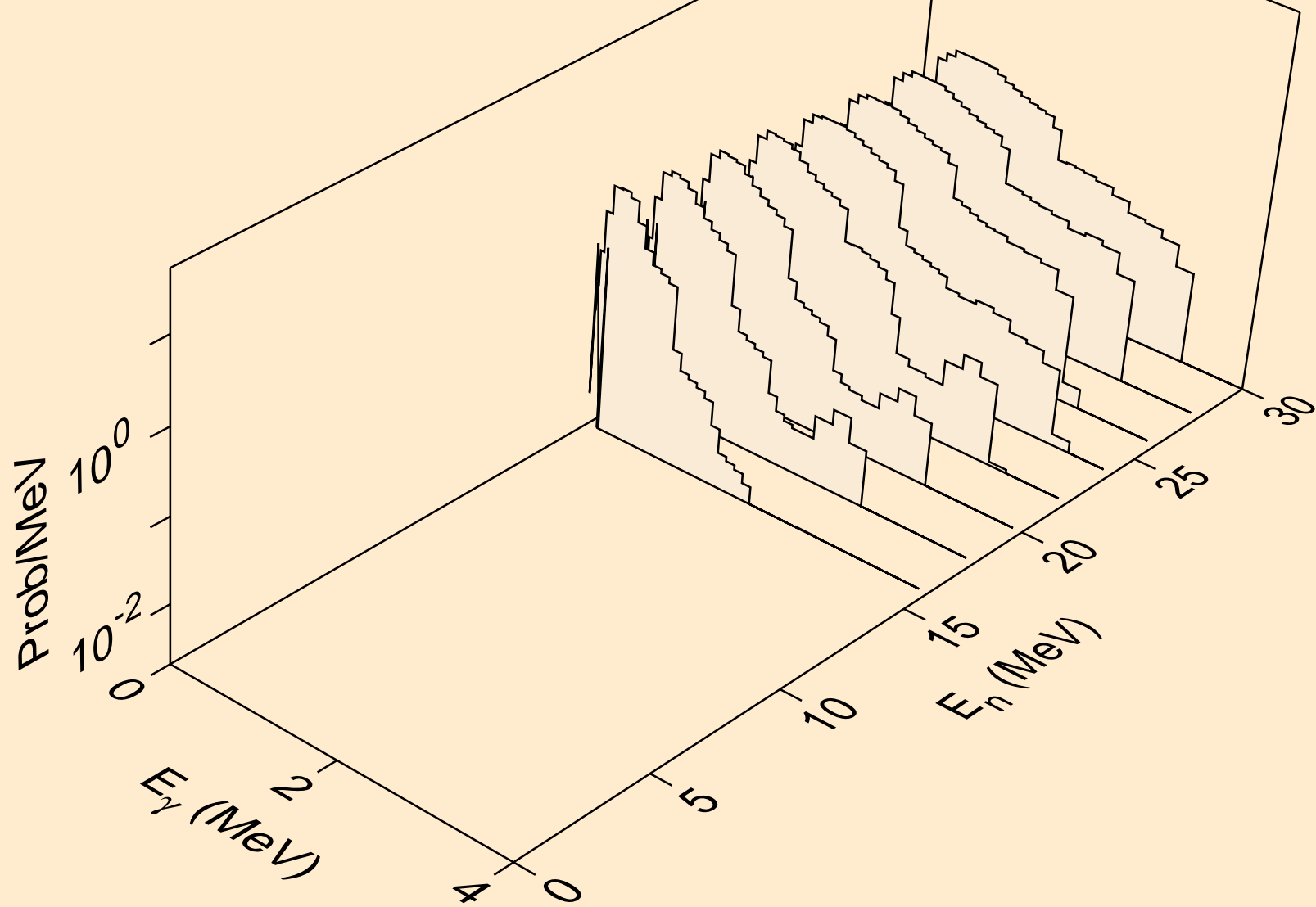



BI222 HELION ACER TENDL-2021 LIBRARY; T=0.K  
Photon emission for (n,n\*)p

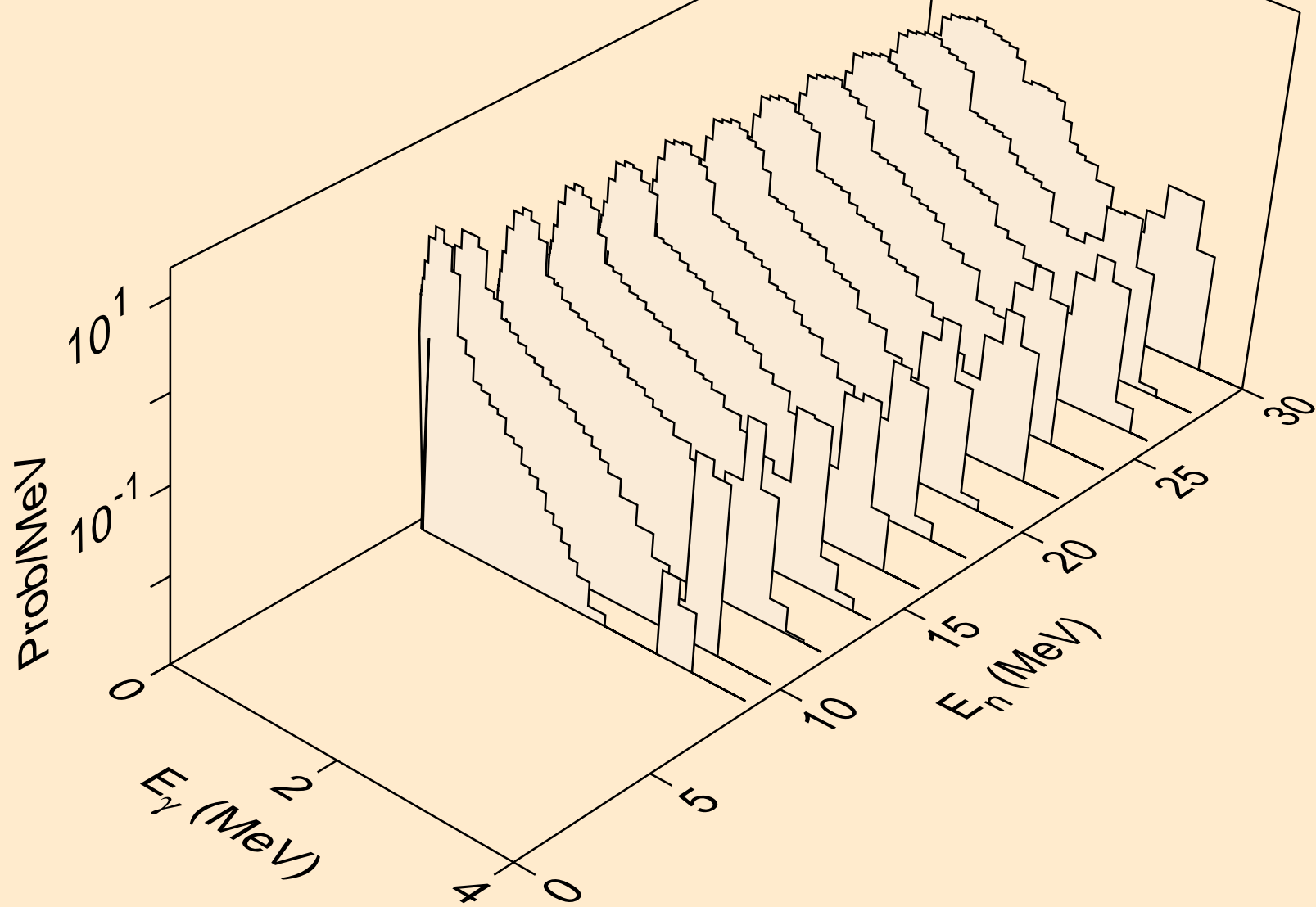

BI222 HELION ACER TENDL-2021 LIBRARY; T=0.K  
Photon emission for (n,n\*)d

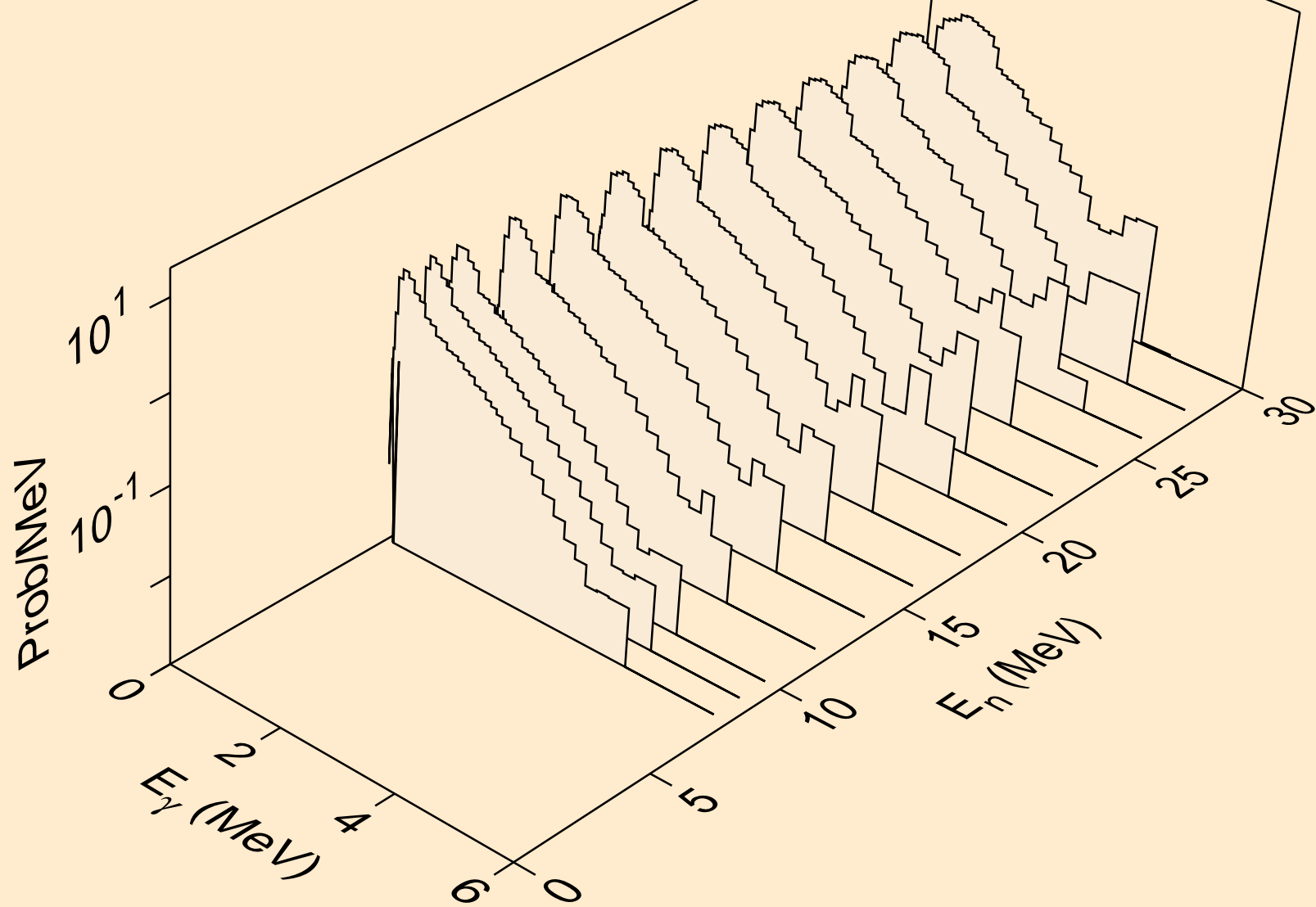

BI222 HELION ACER TENDL-2021 LIBRARY; T=0.K  
Photon emission for (n,n\*)t

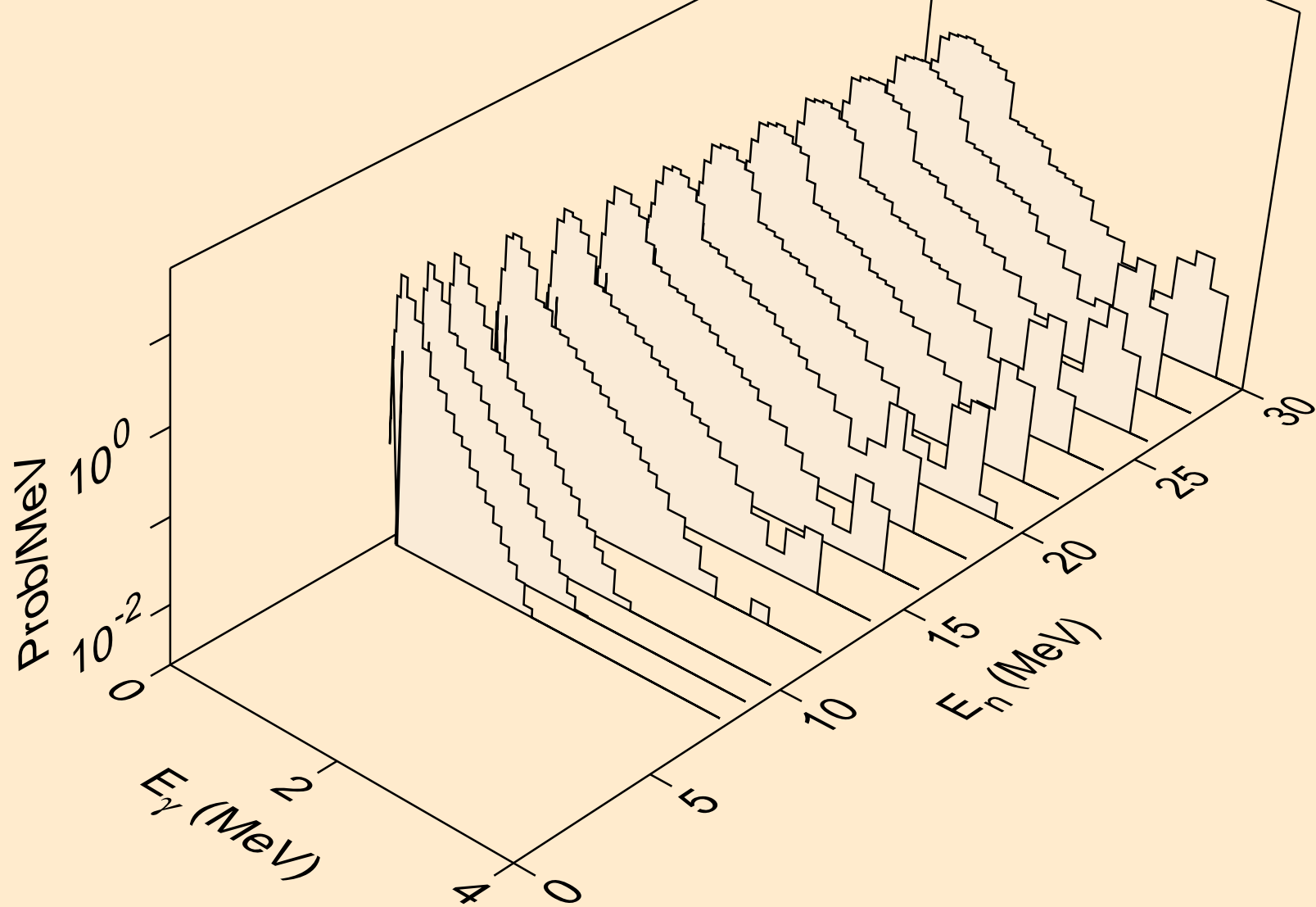

BI222 HELION ACER TENDL-2021 LIBRARY; T=0.K  
Photon emission for (n,n\*)he3

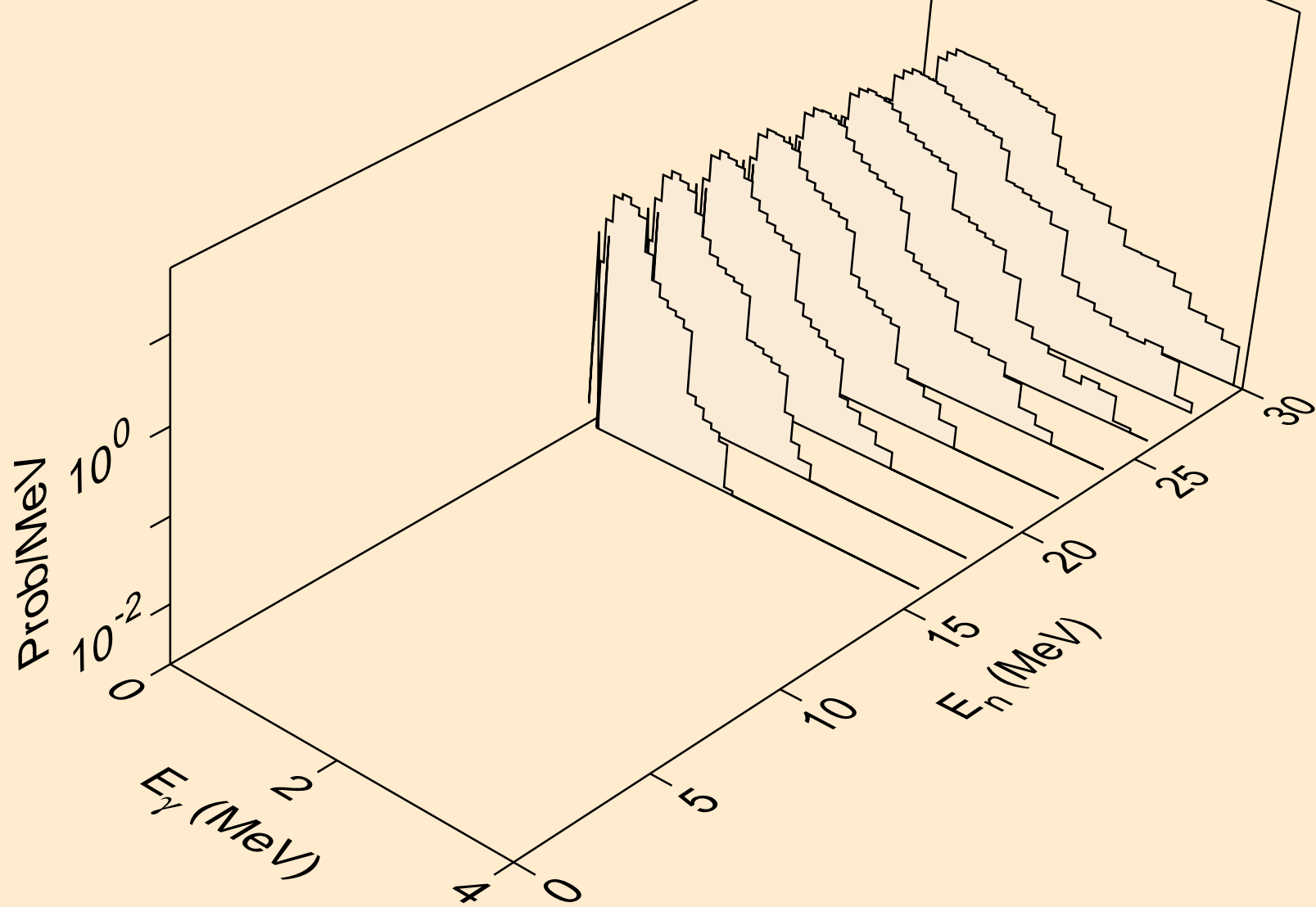

BI222 HELION ACER TENDL-2021 LIBRARY; T=0.K  
Photon emission for (n,4n)

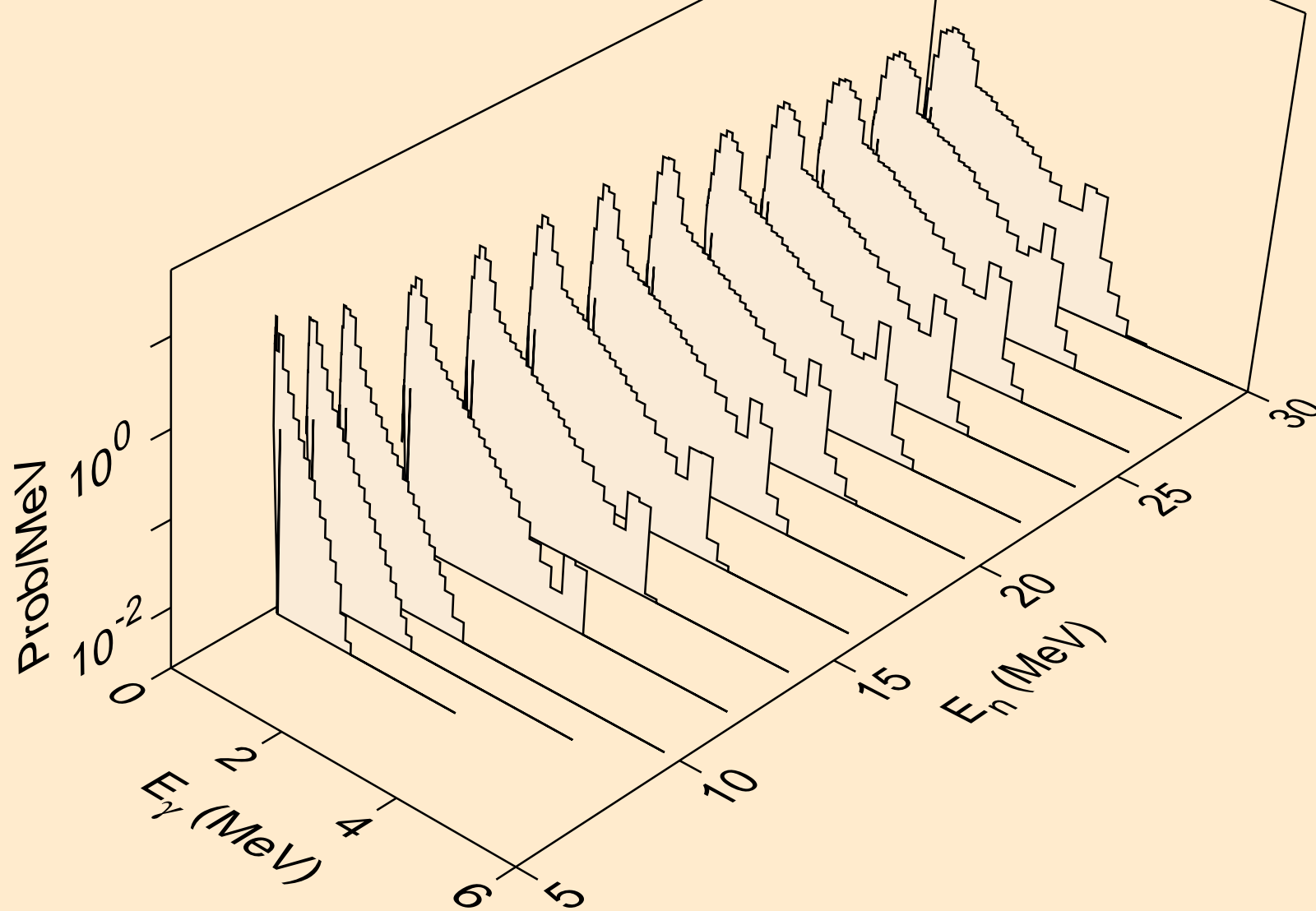

BI222 HELION ACER TENDL-2021 LIBRARY; T=0.K  
Photon emission for (n,2np)

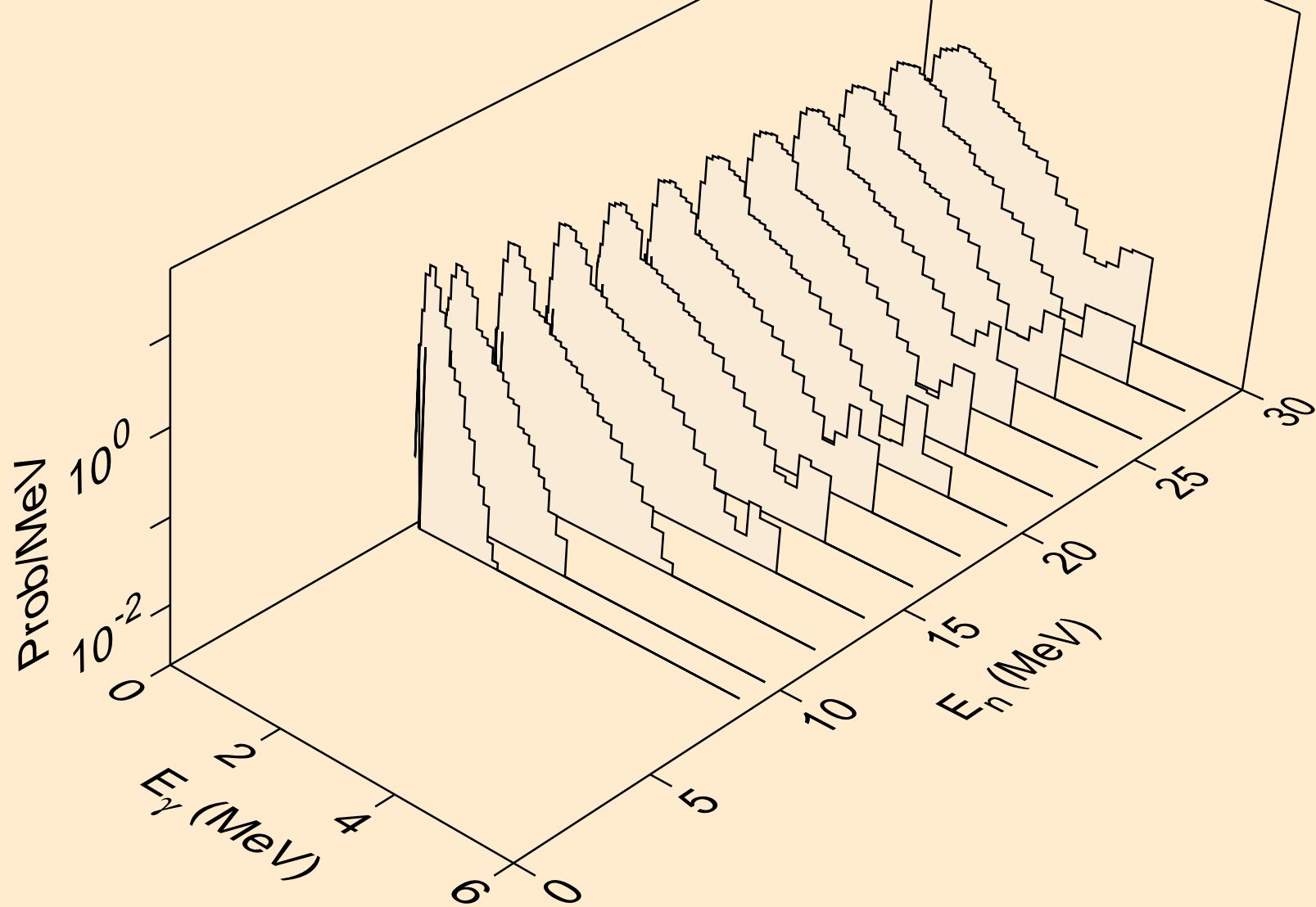

BI222 HELION ACER TENDL-2021 LIBRARY; T=0.K  
Photon emission for (n,3np)

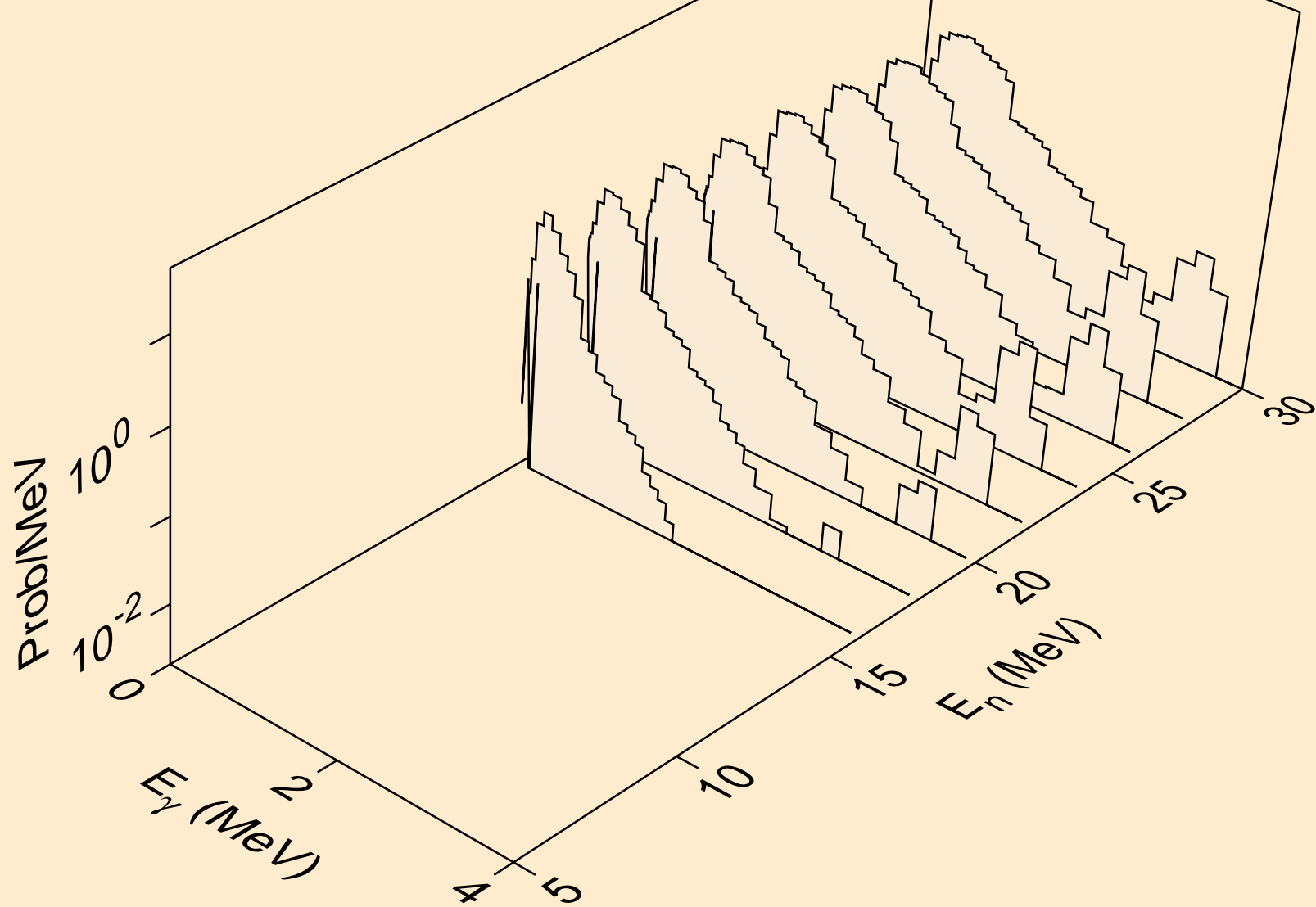

BI222 HELION ACER TENDL-2021 LIBRARY; T=0.K  
Photon emission for (n,2np)

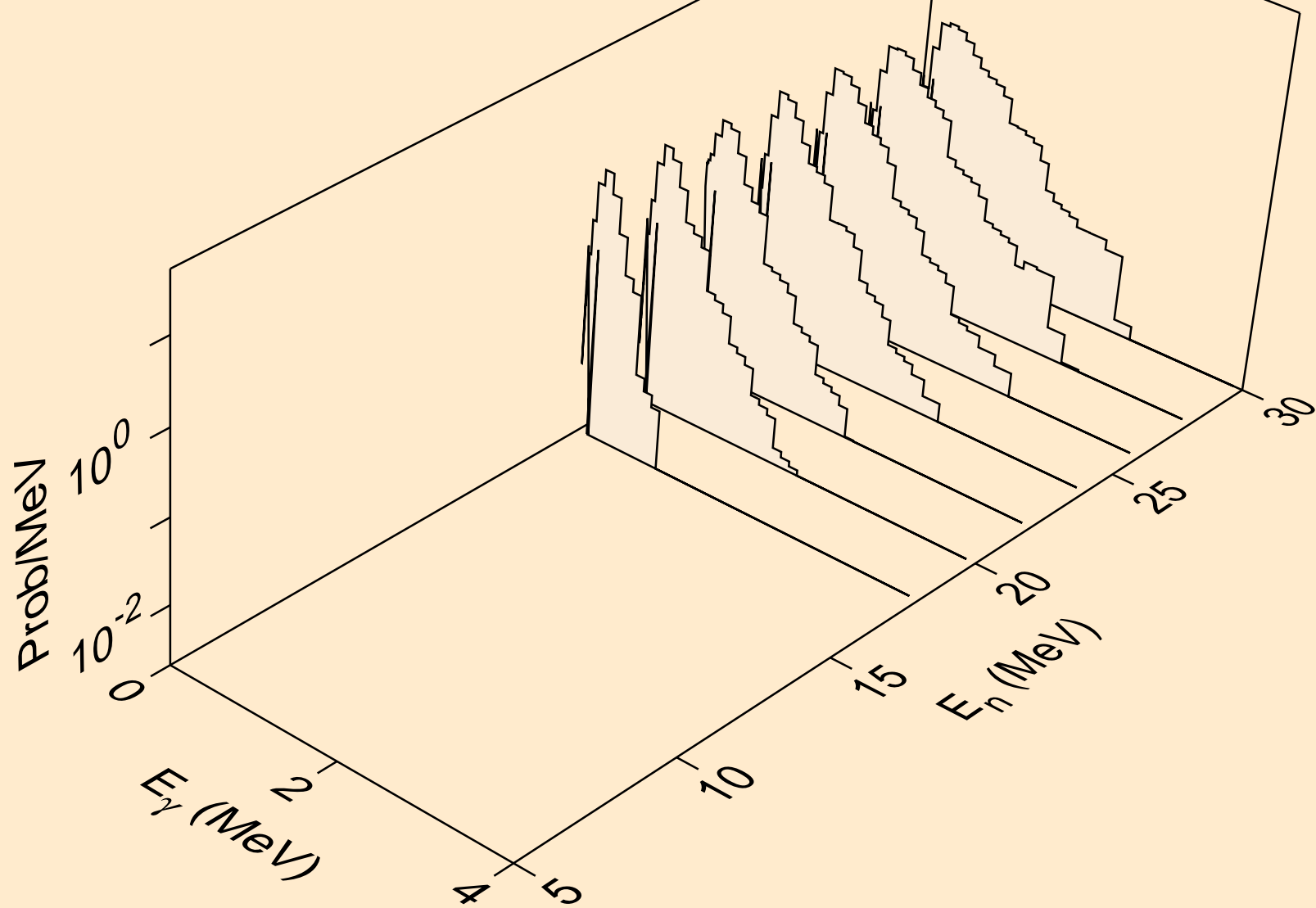



BI222 HELION ACER TENDL-2021 LIBRARY; T=0.K  
Photon emission for (n,npa)

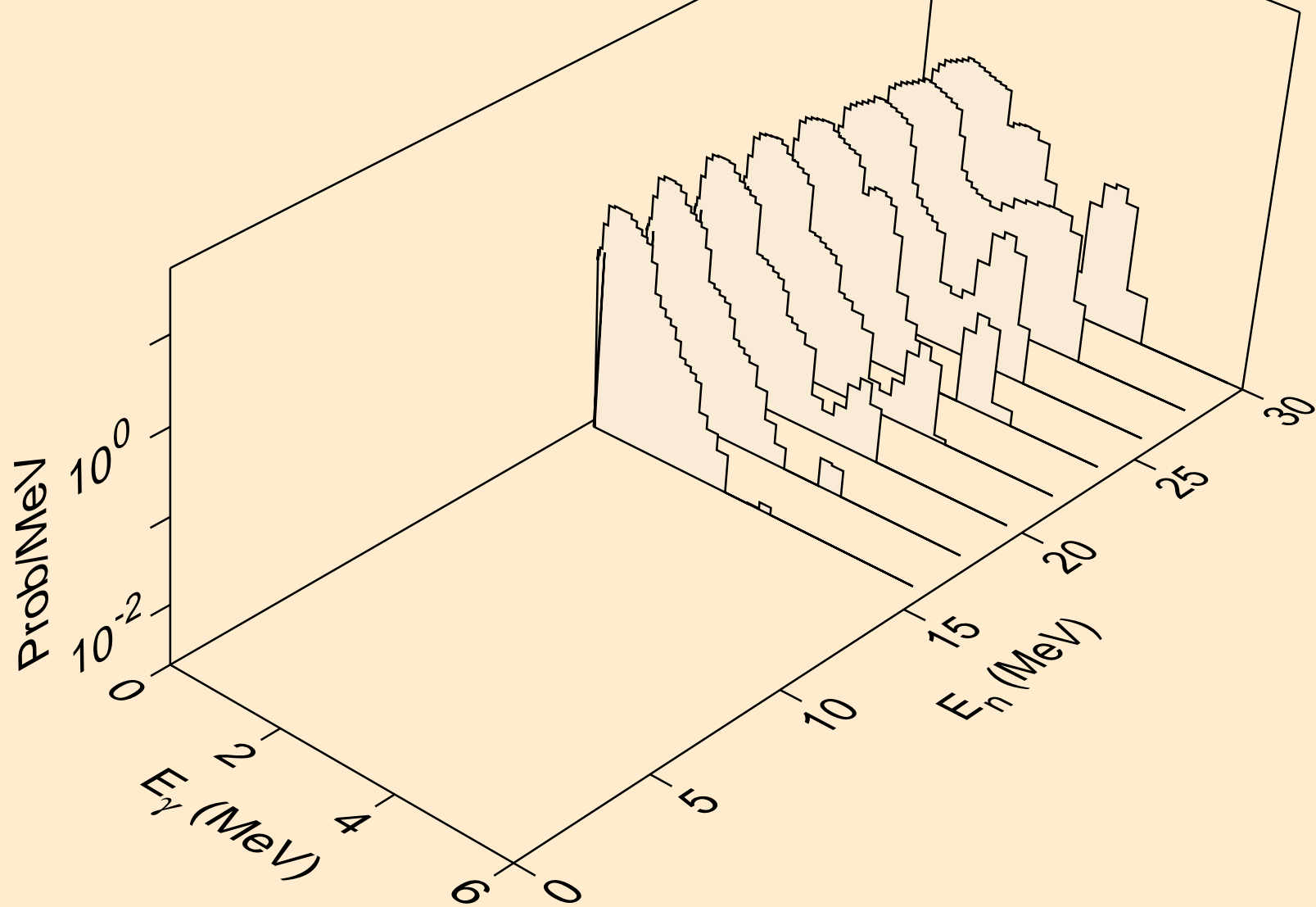

BI222 HELION ACER TENDL-2021 LIBRARY; T=0.K  
Photon emission for (n,p)

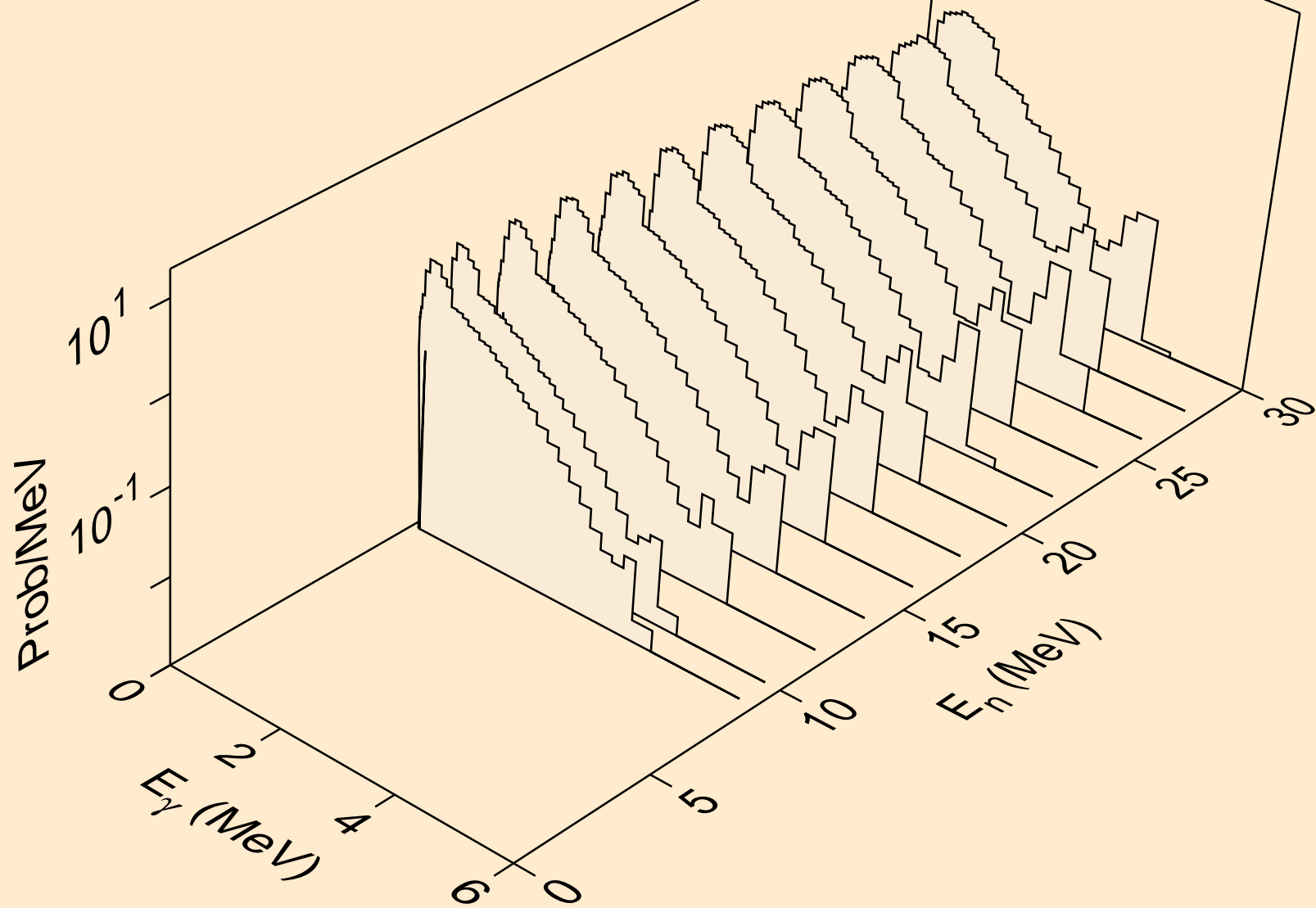

BI222 HELION ACER TENDL-2021 LIBRARY; T=0.K  
Photon emission for (n,d)

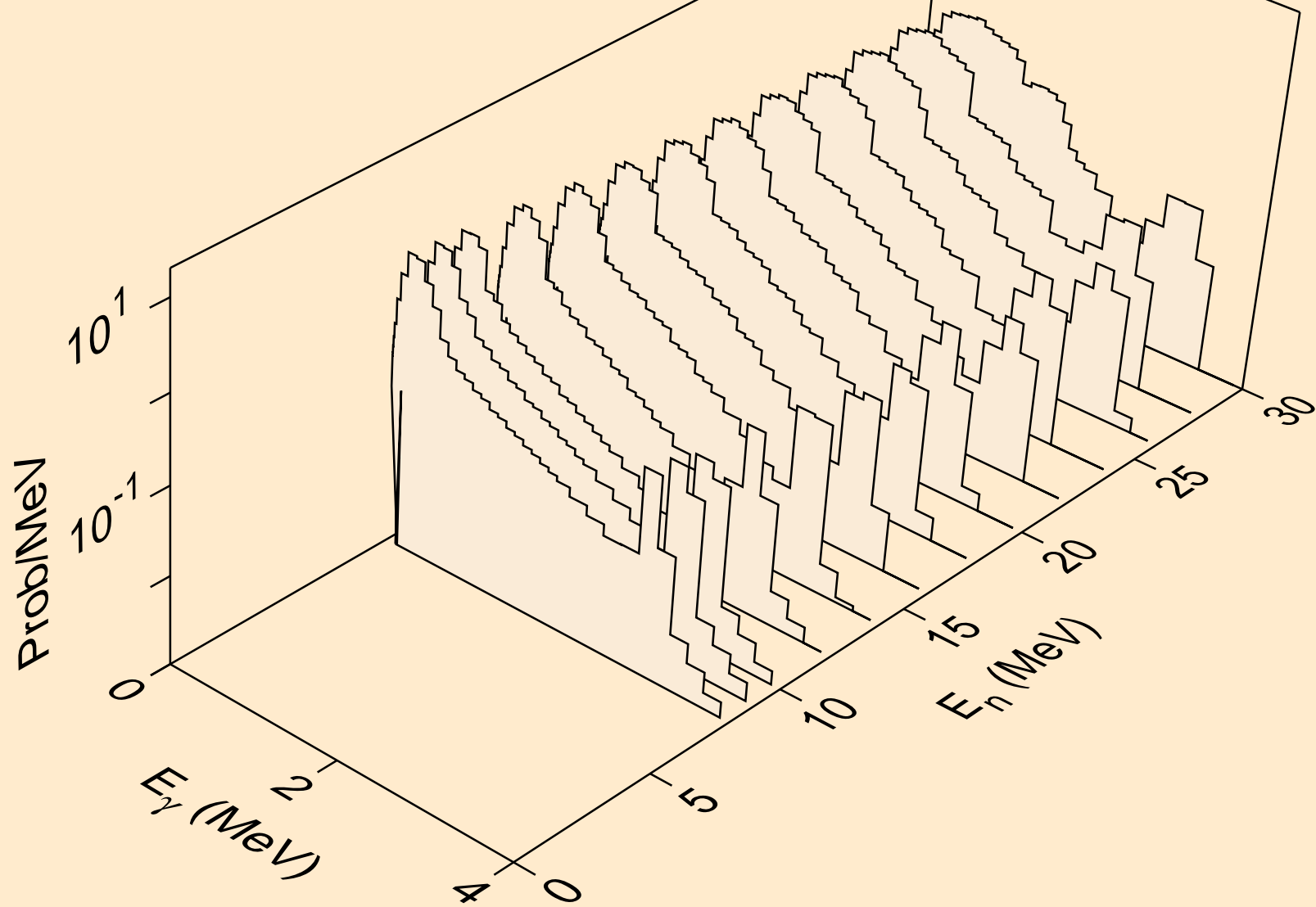

BI222 HELION ACER TENDL-2021 LIBRARY; T=0.K  
Photon emission for (n,t)

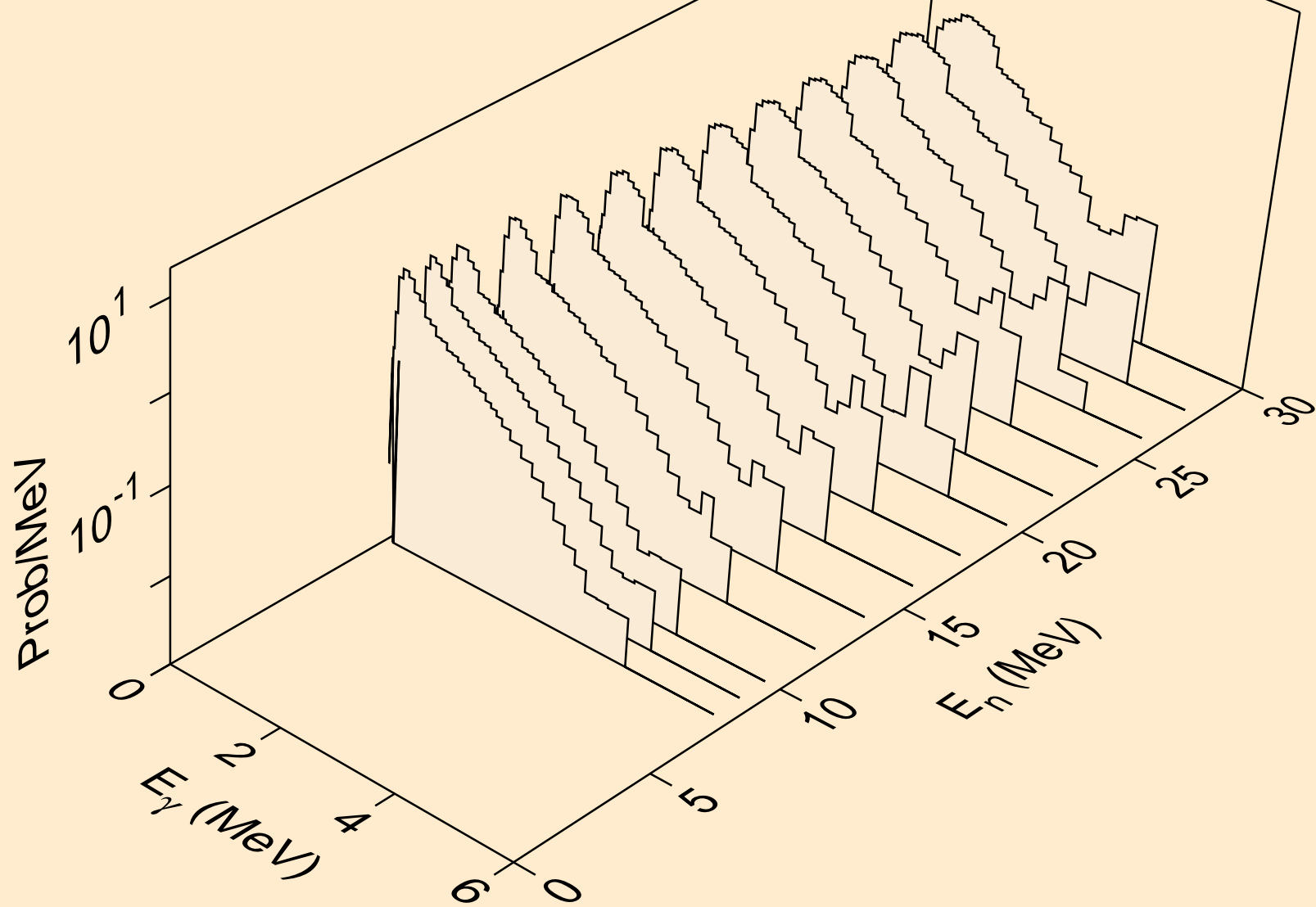

BI222 HELION ACER TENDL-2021 LIBRARY; T=0.K  
Photon emission for inelastic

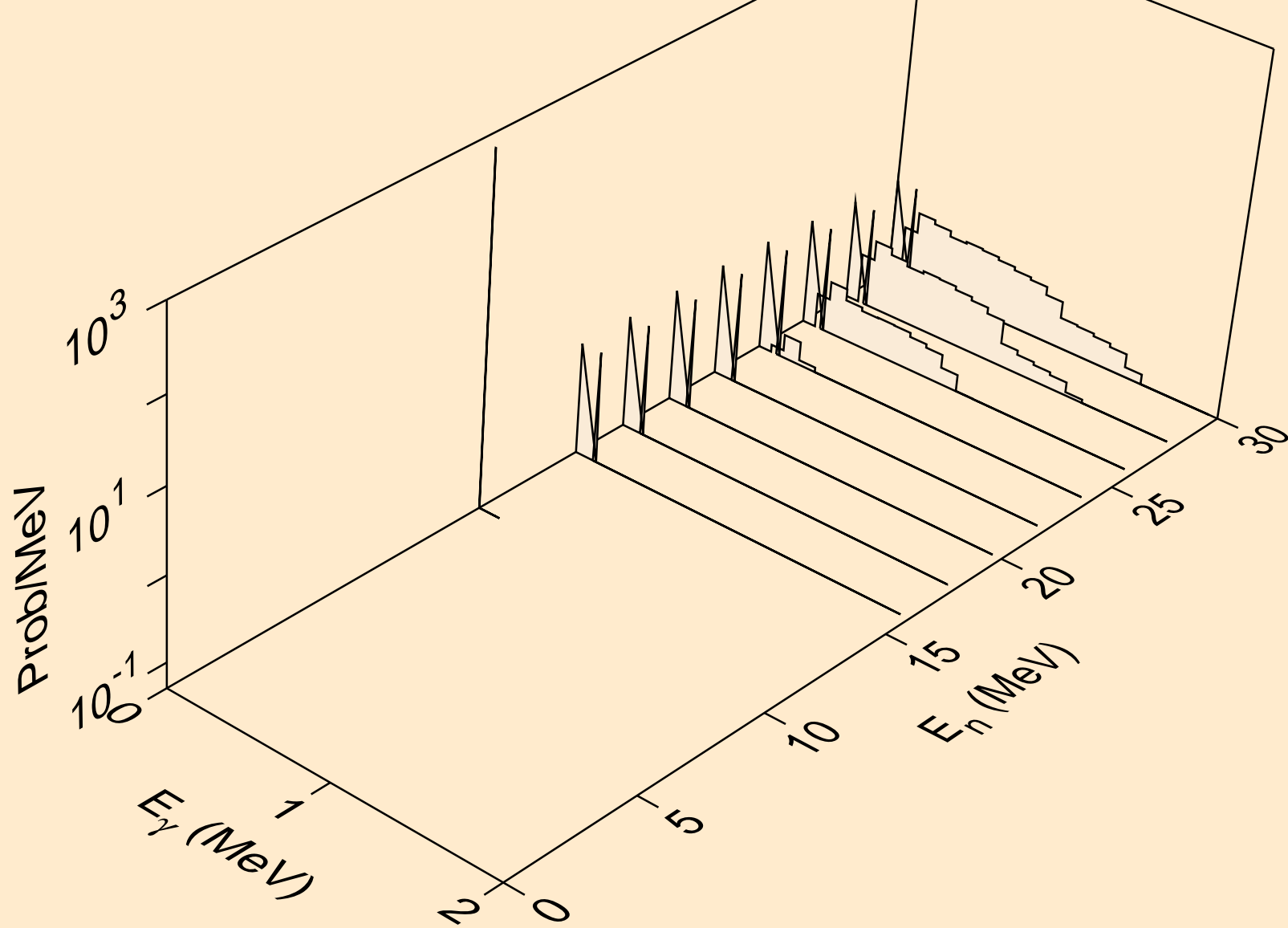

BI222 HELION ACER TENDL-2021 LIBRARY; T=0.K  
Photon emission for (n,a)

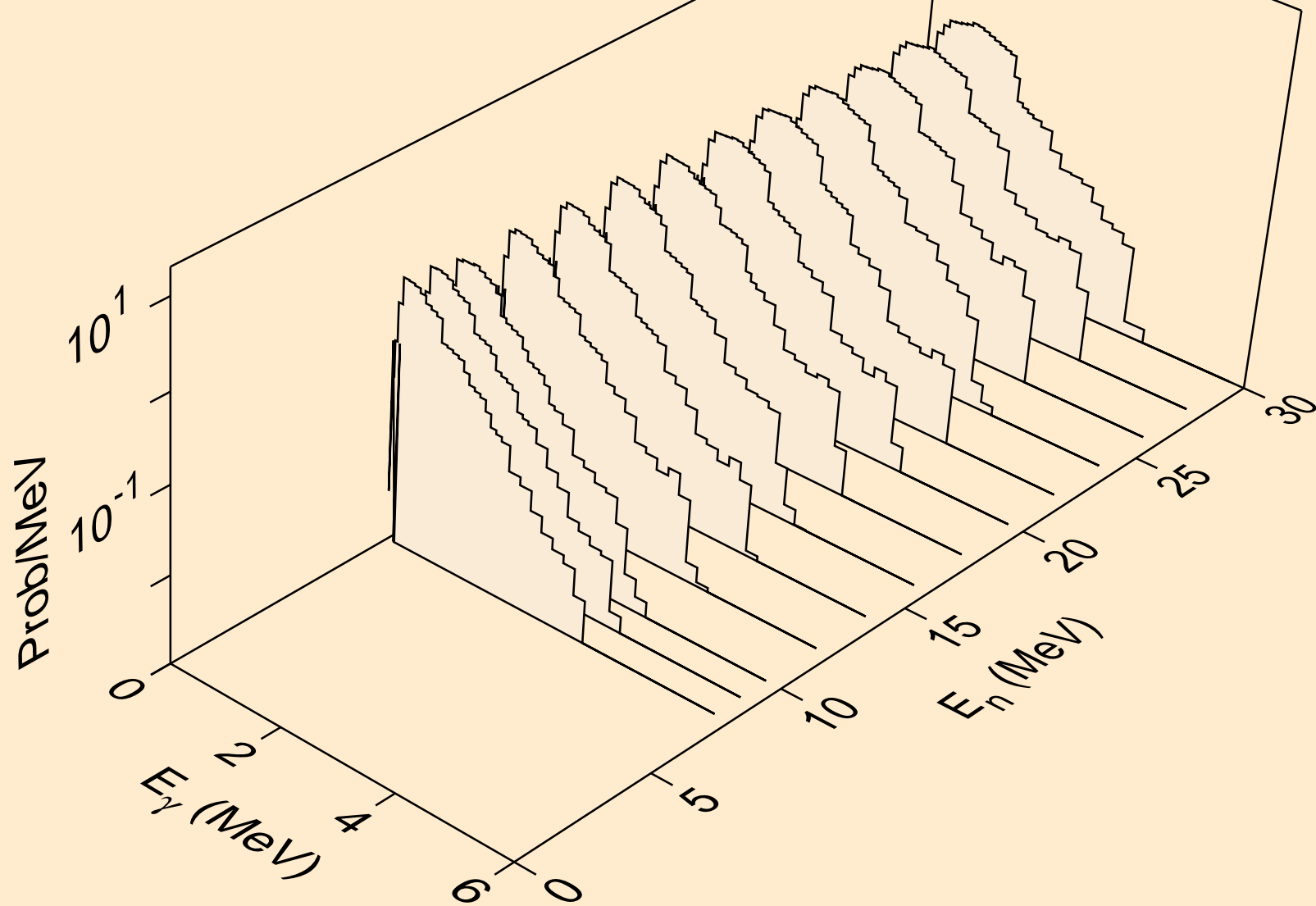

BI222 HELION ACER TENDL-2021 LIBRARY; T=0.K  
Photon emission for (n,2p)

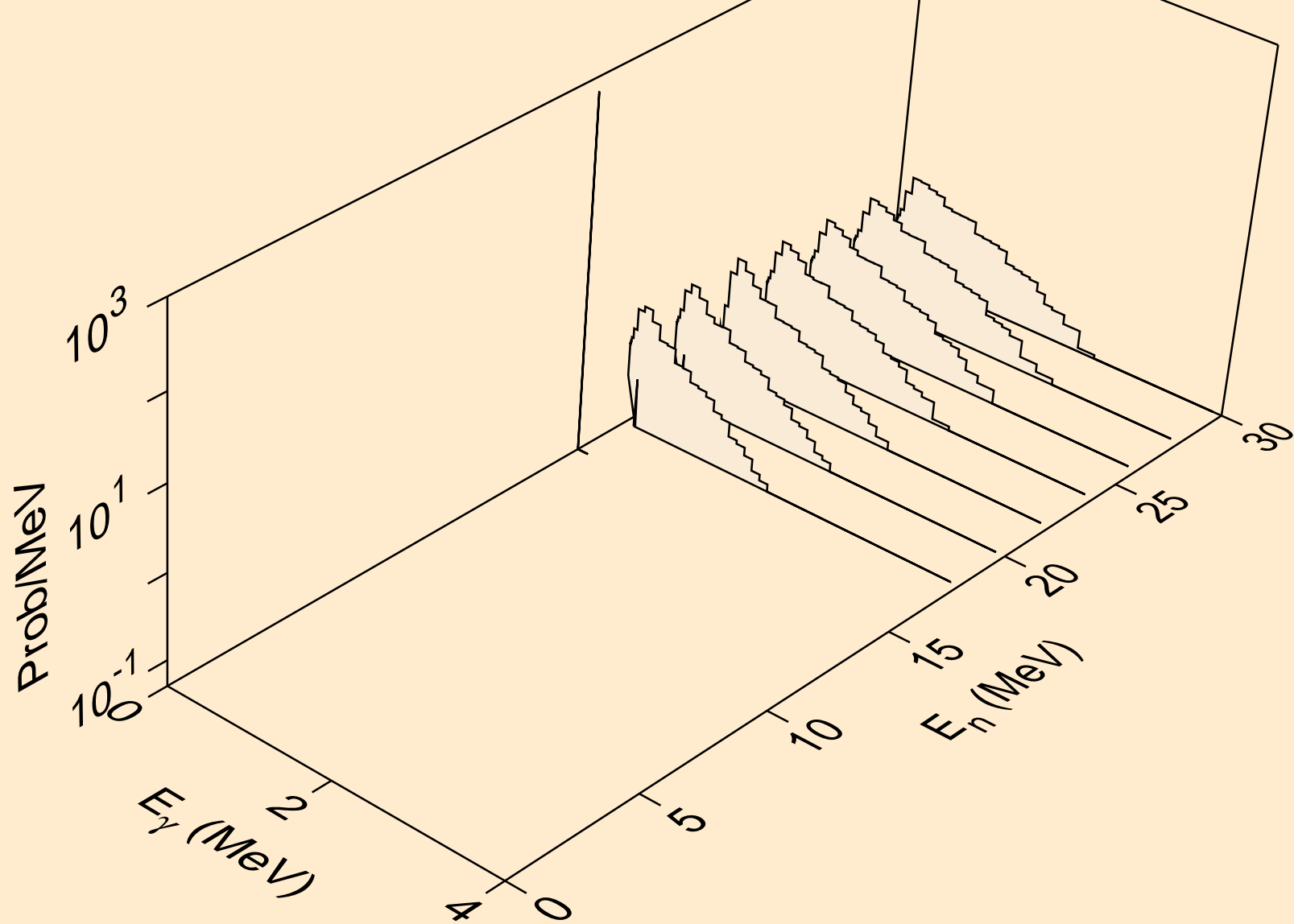

BI222 HELION ACER TENDL-2021 LIBRARY; T=0.K  
Photon emission for (n,pd)

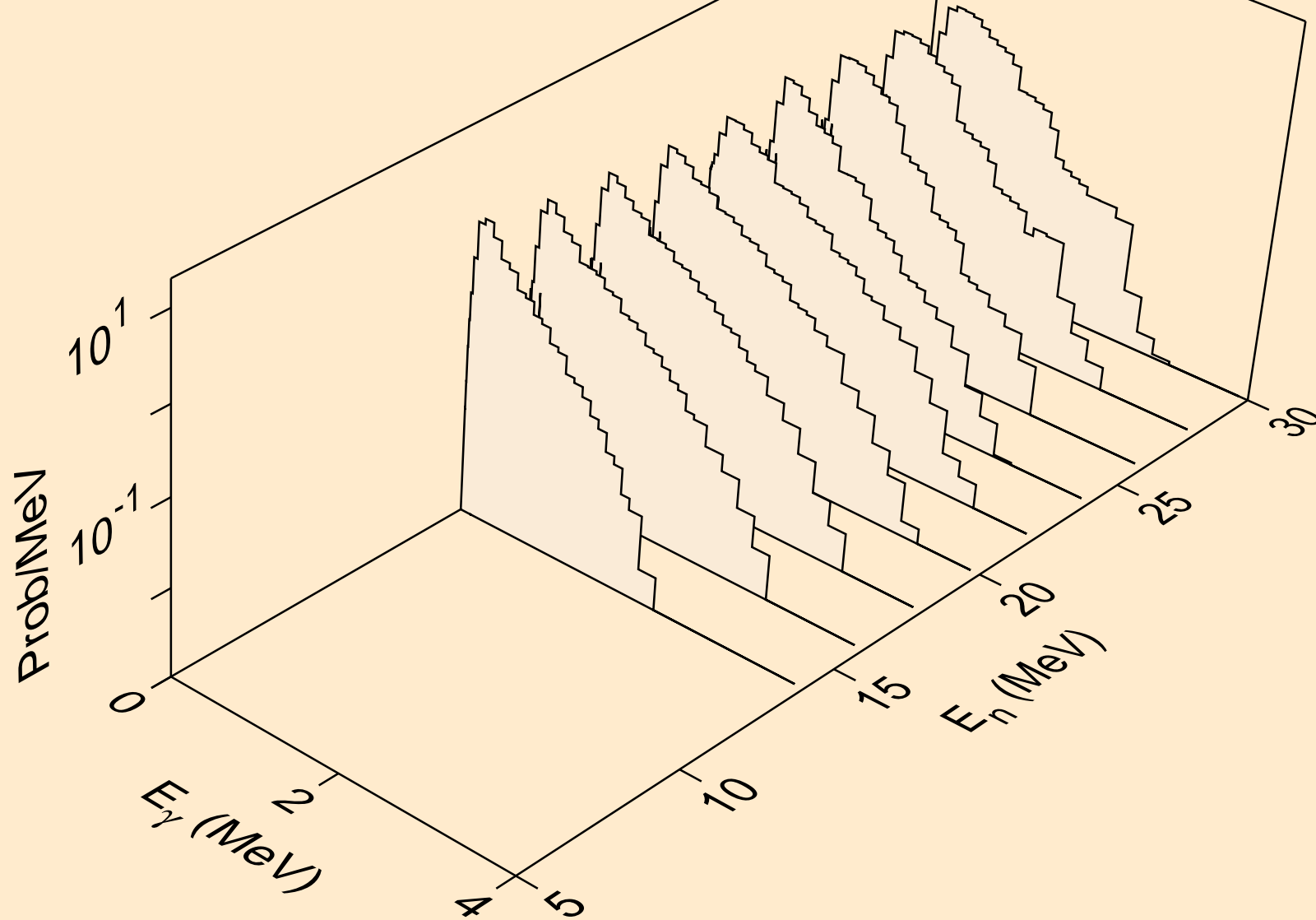



BI222 HELION ACER TENDL-2021 LIBRARY; T=0.K  
Photon emission for (n,pt)

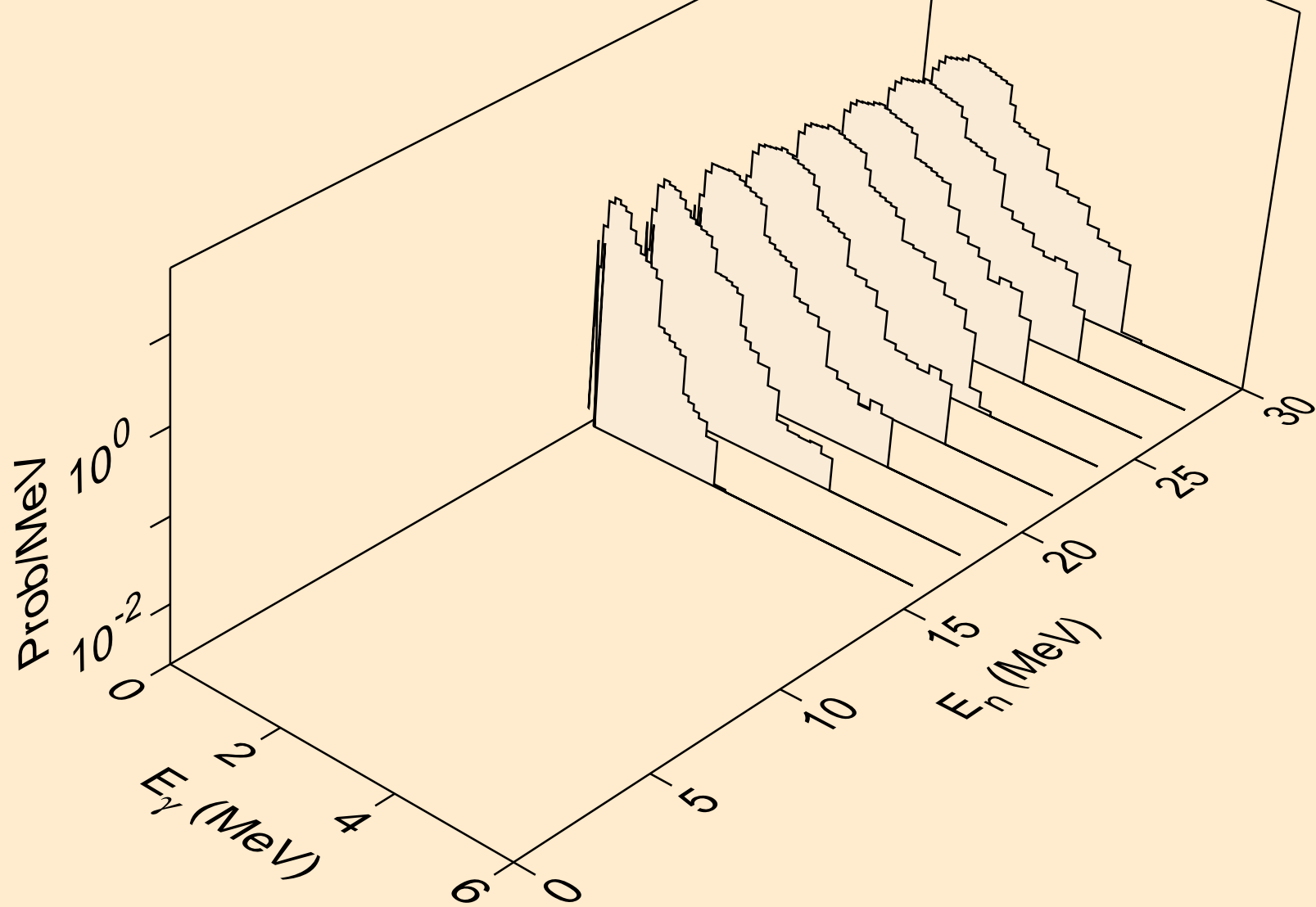

BI222 HELION ACER TENDL-2021 LIBRARY; T=0.K  
Particle heating contributions

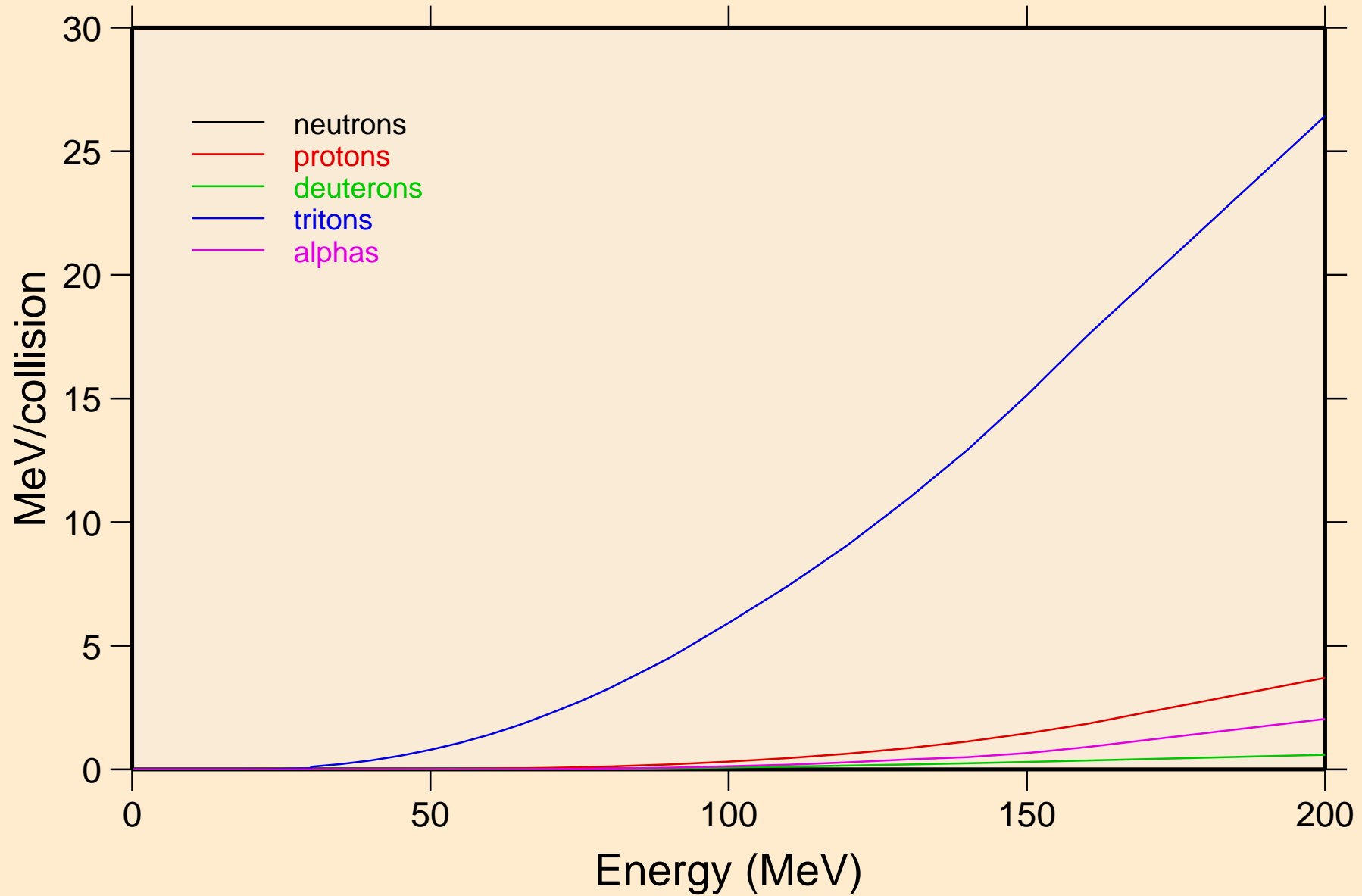

BI222 HELION ACER TENDL-2021 LIBRARY; T=0.K

Recoil Heating

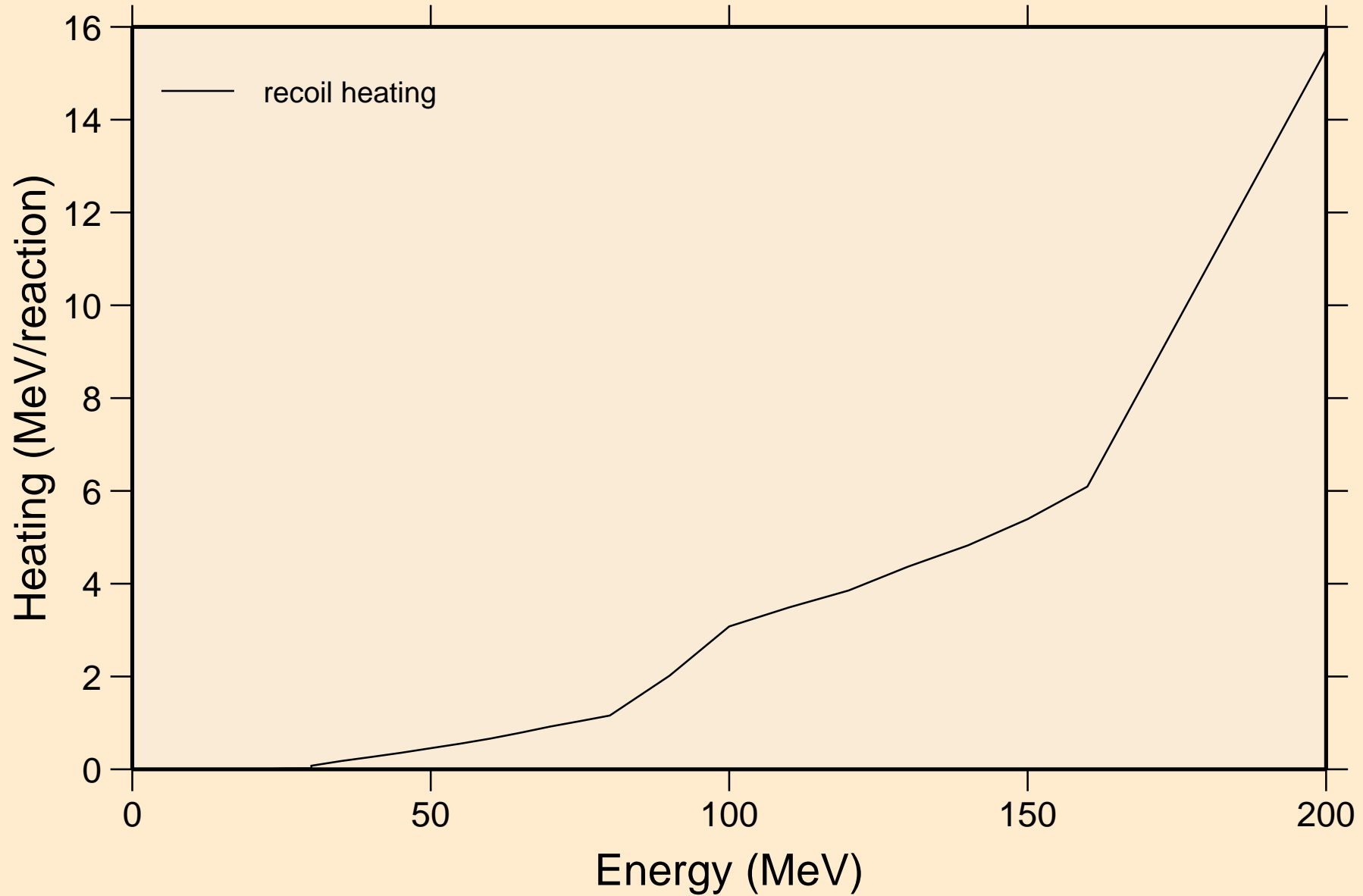

BI222 HELION ACER TENDL-2021 LIBRARY; T=0.K  
Particle production cross sections

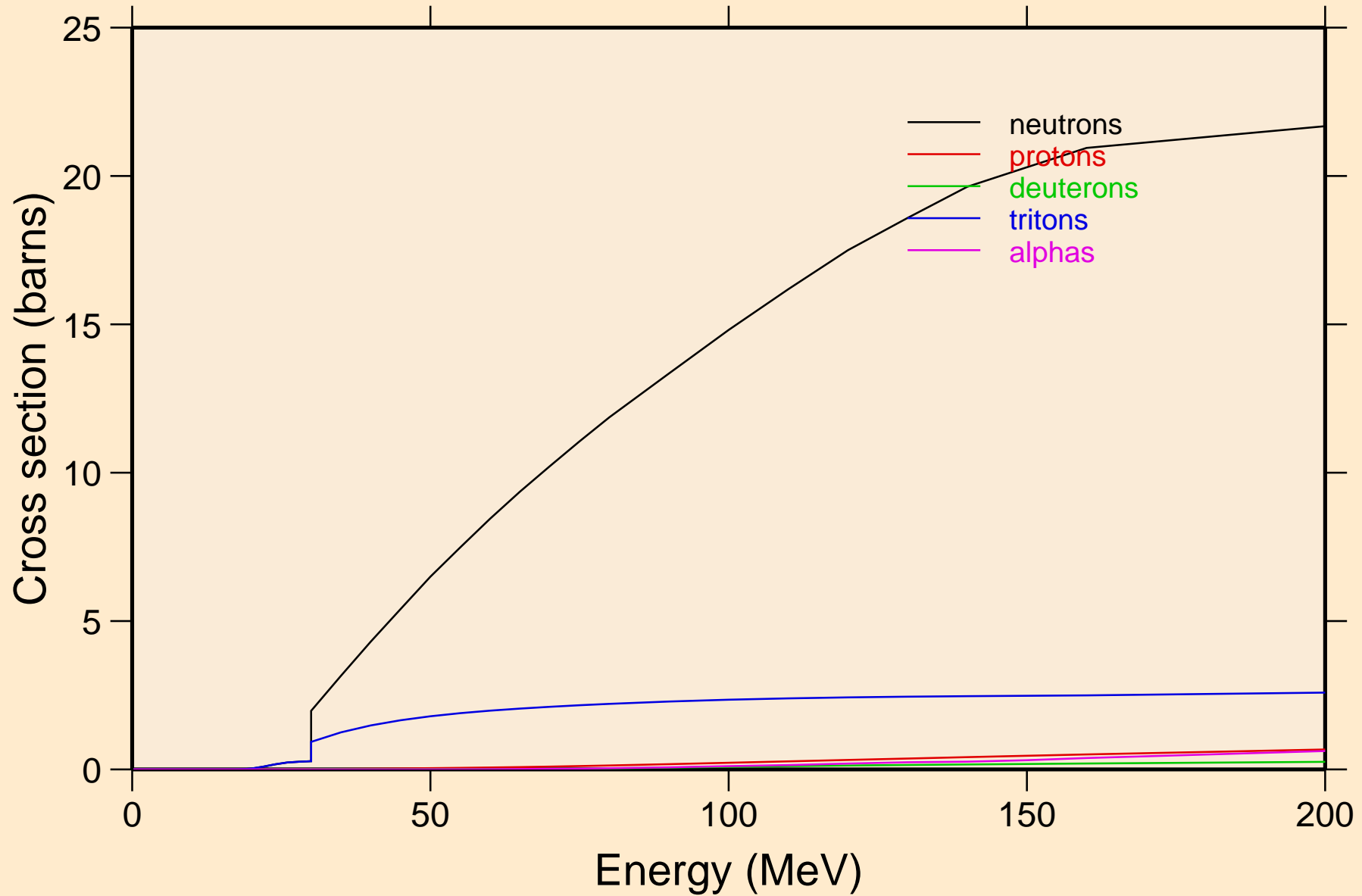

BI222 HELION ACER TENDL-2021 LIBRARY; T=0.K  
neutrons from (s,n)

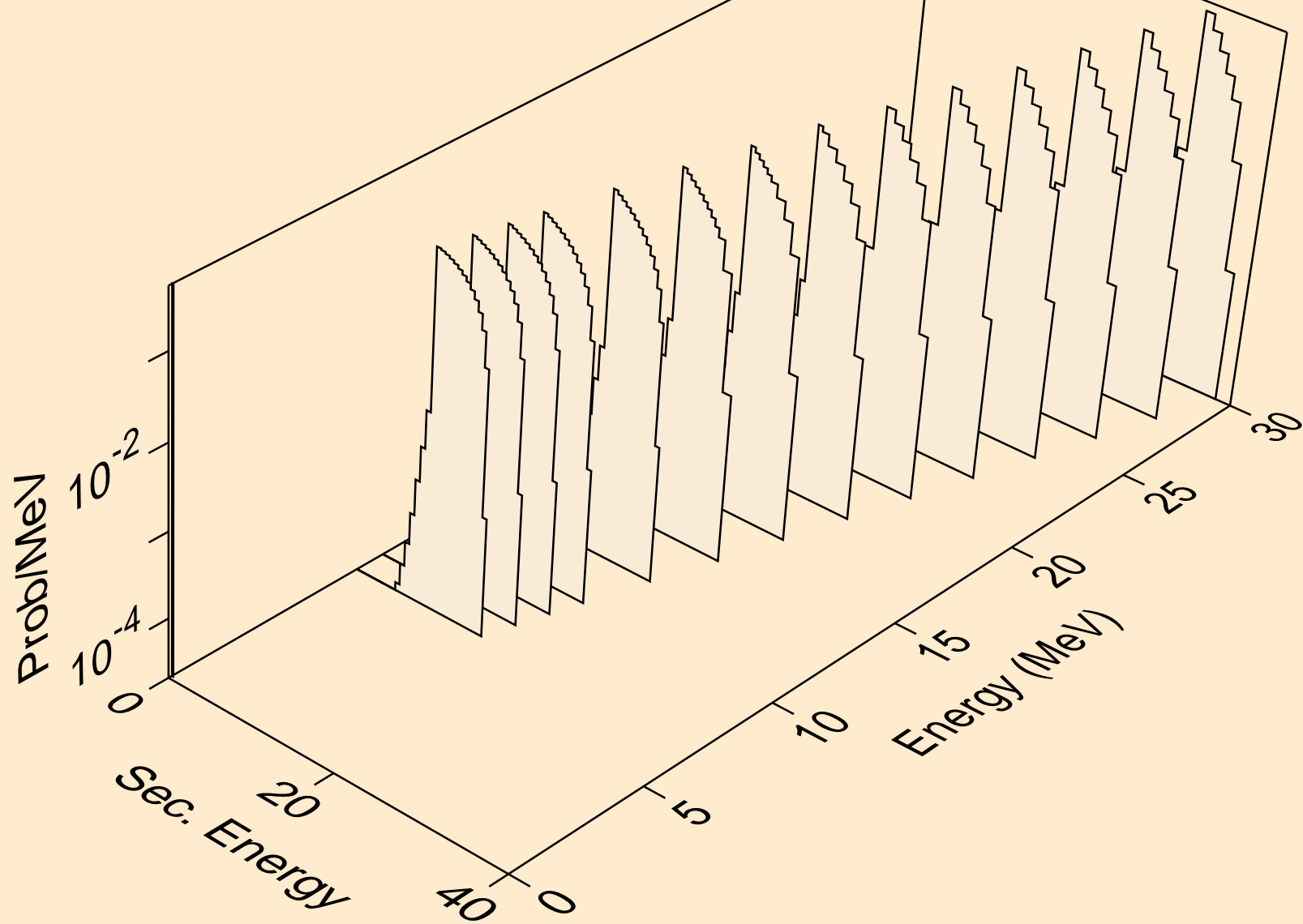

BI222 HELION ACER TENDL-2021 LIBRARY; T=0.K  
neutrons from (s,x)

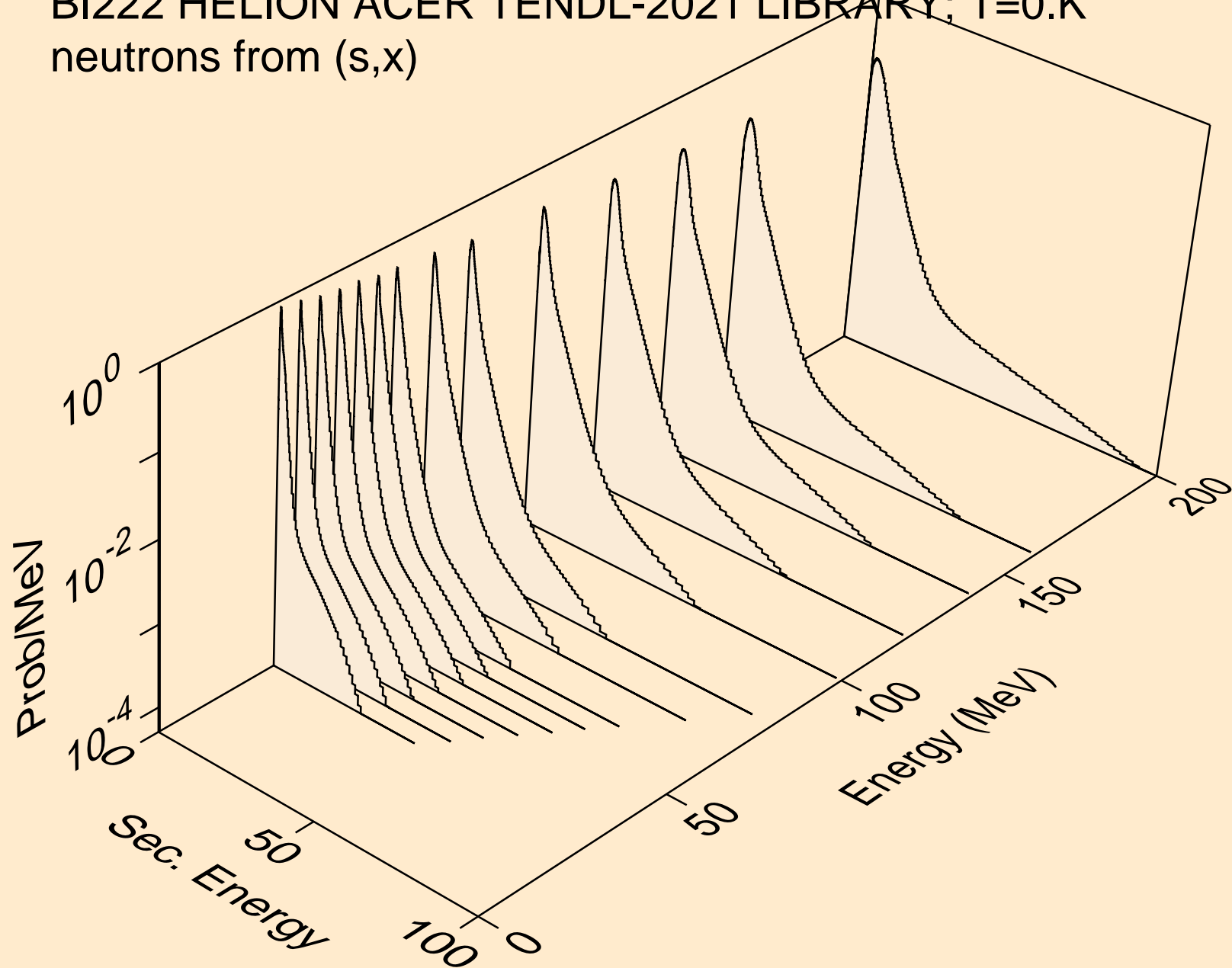

BI222 HELION ACER TENDL-2021 LIBRARY; T=0.K  
neutrons from (s,2nd)

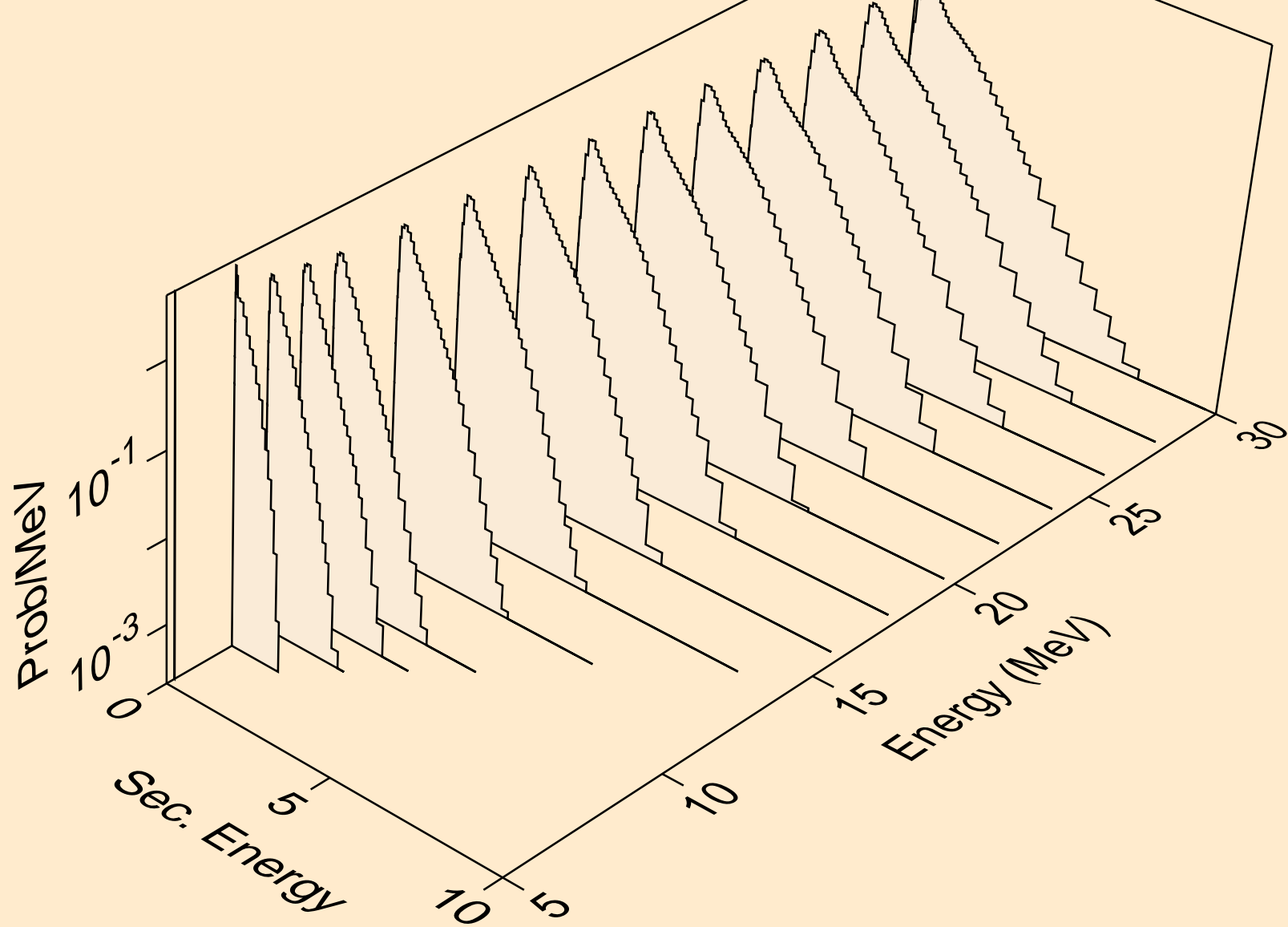

BI222 HELION ACER TENDL-2021 LIBRARY; T=0.K  
neutrons from (s,2n)

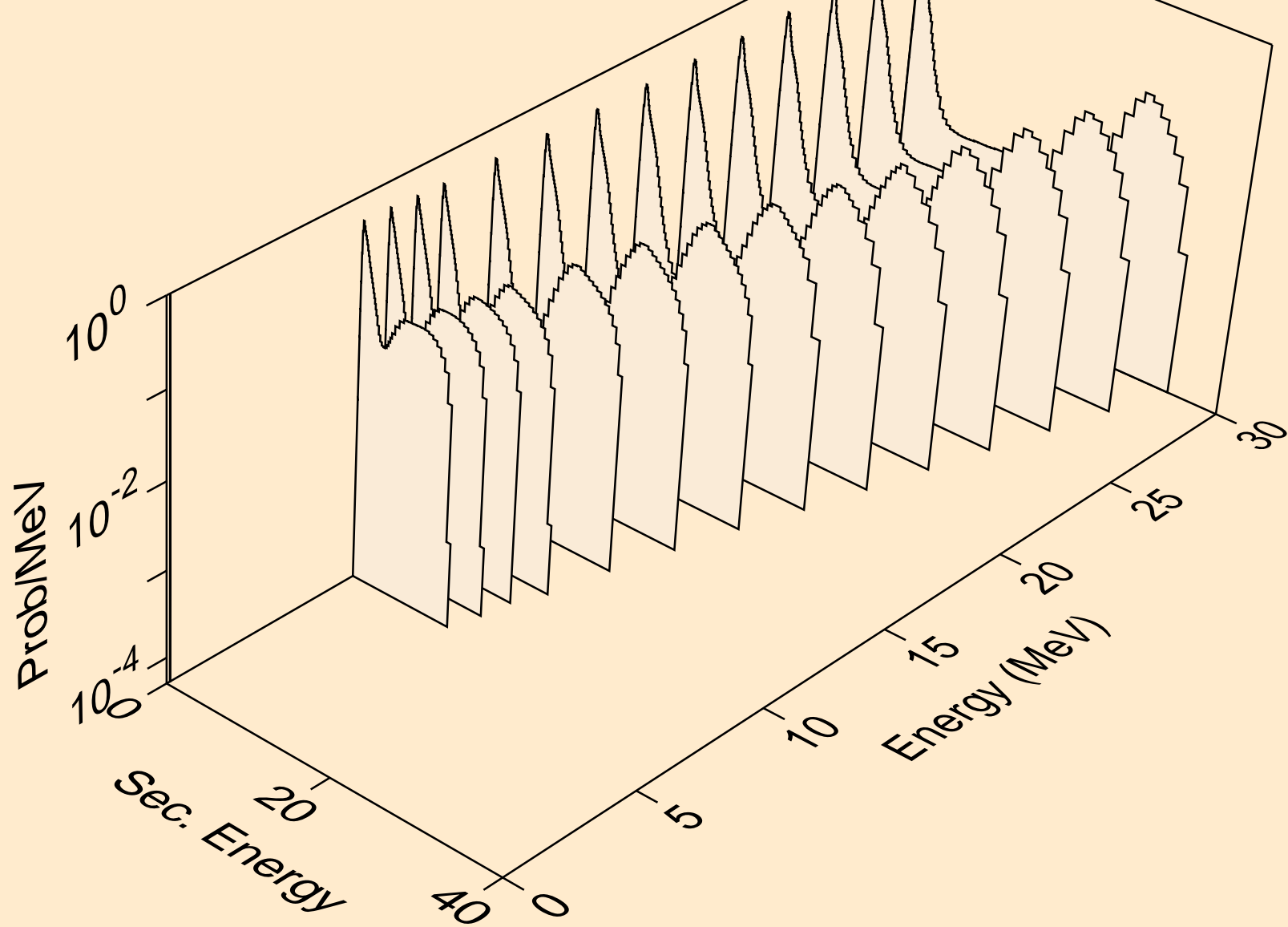



BI222 HELION ACER TENDL-2021 LIBRARY; T=0.K  
neutrons from (s,3n)

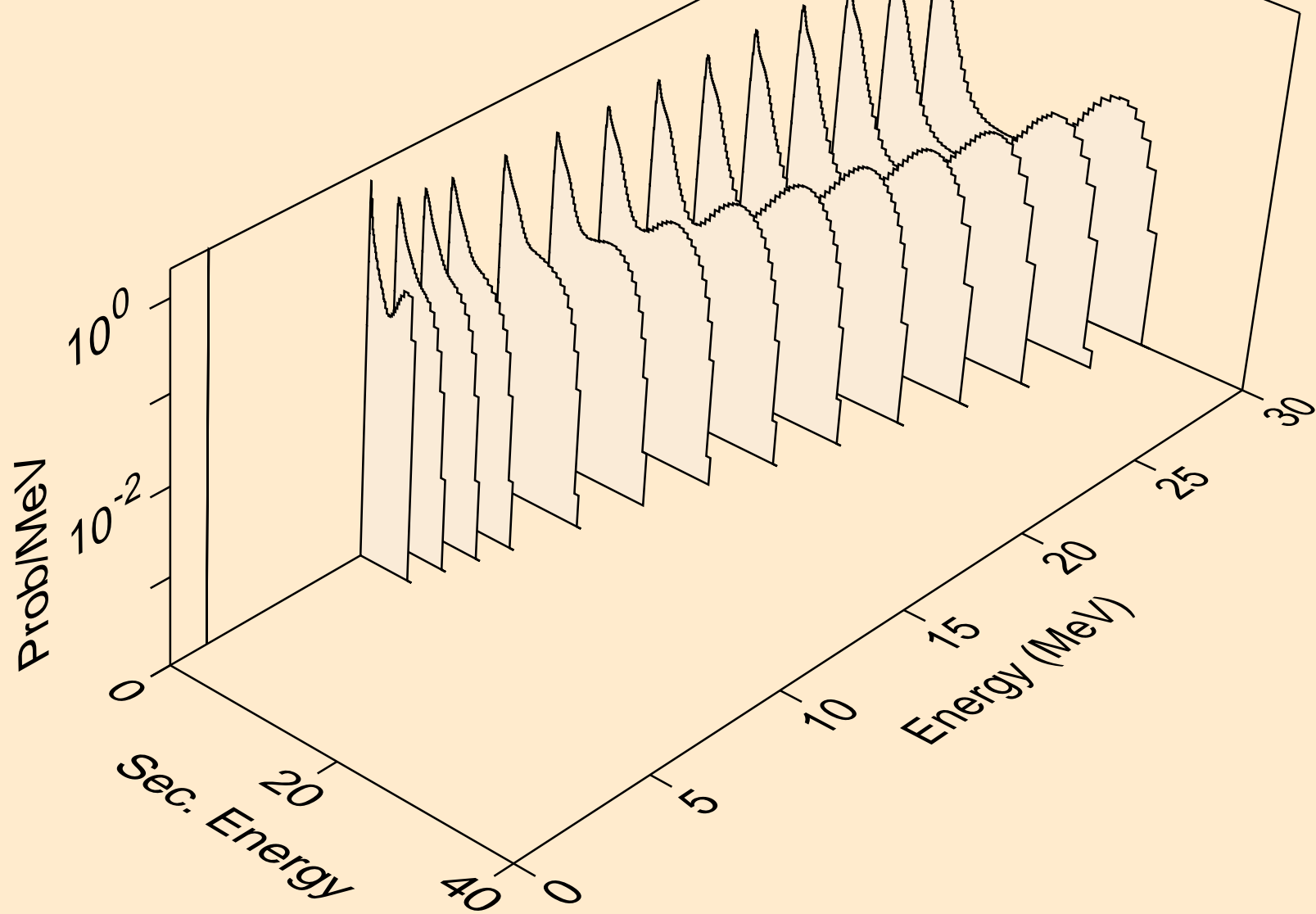

BI222 HELION ACER TENDL-2021 LIBRARY; T=0.K  
neutrons from (s,n\*)a

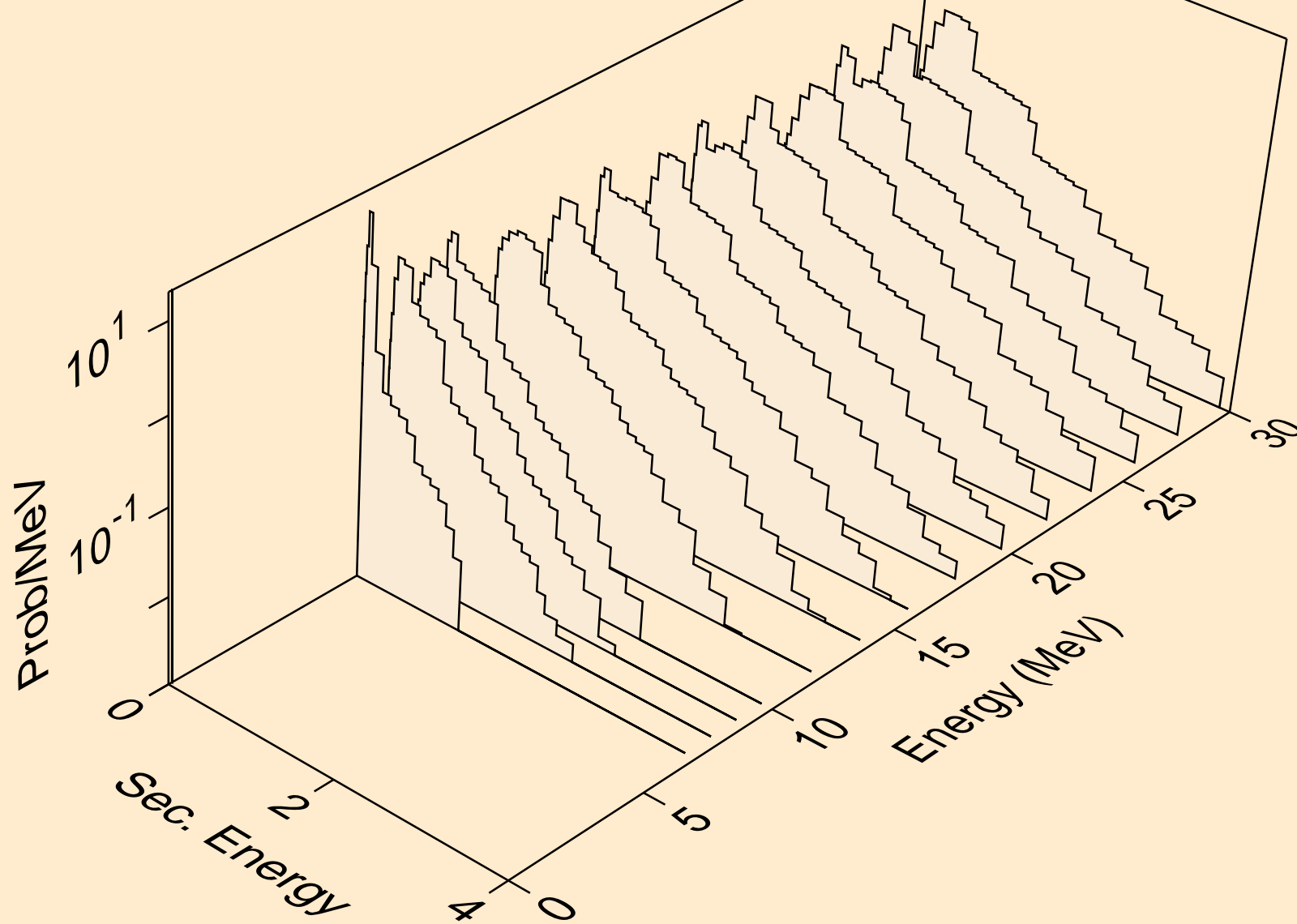

BI222 HELION ACER TENDL-2021 LIBRARY; T=0.K  
neutrons from (s,2n)a

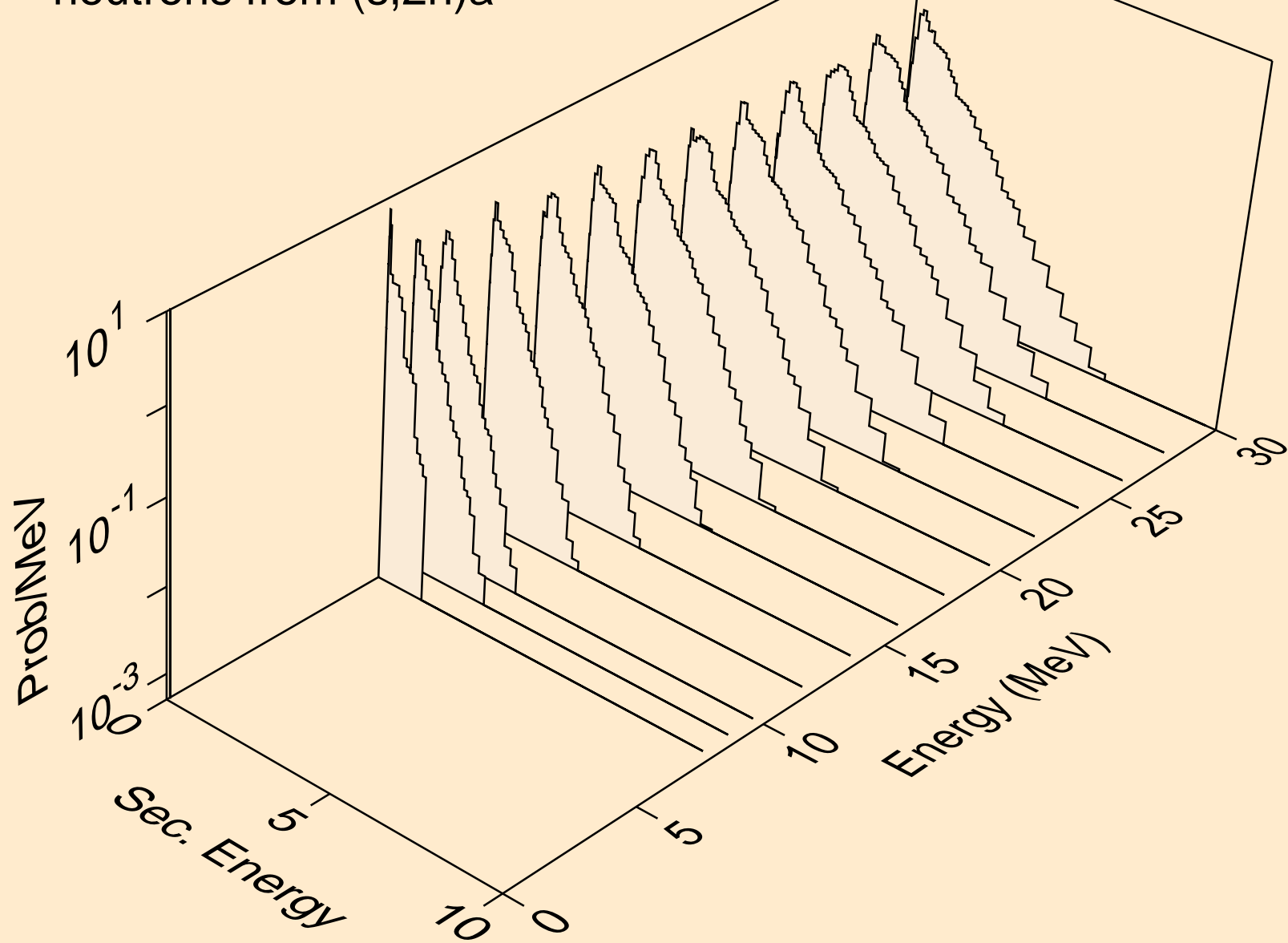

BI222 HELION ACER TENDL-2021 LIBRARY; T=0.K  
neutrons from (s,3n)a

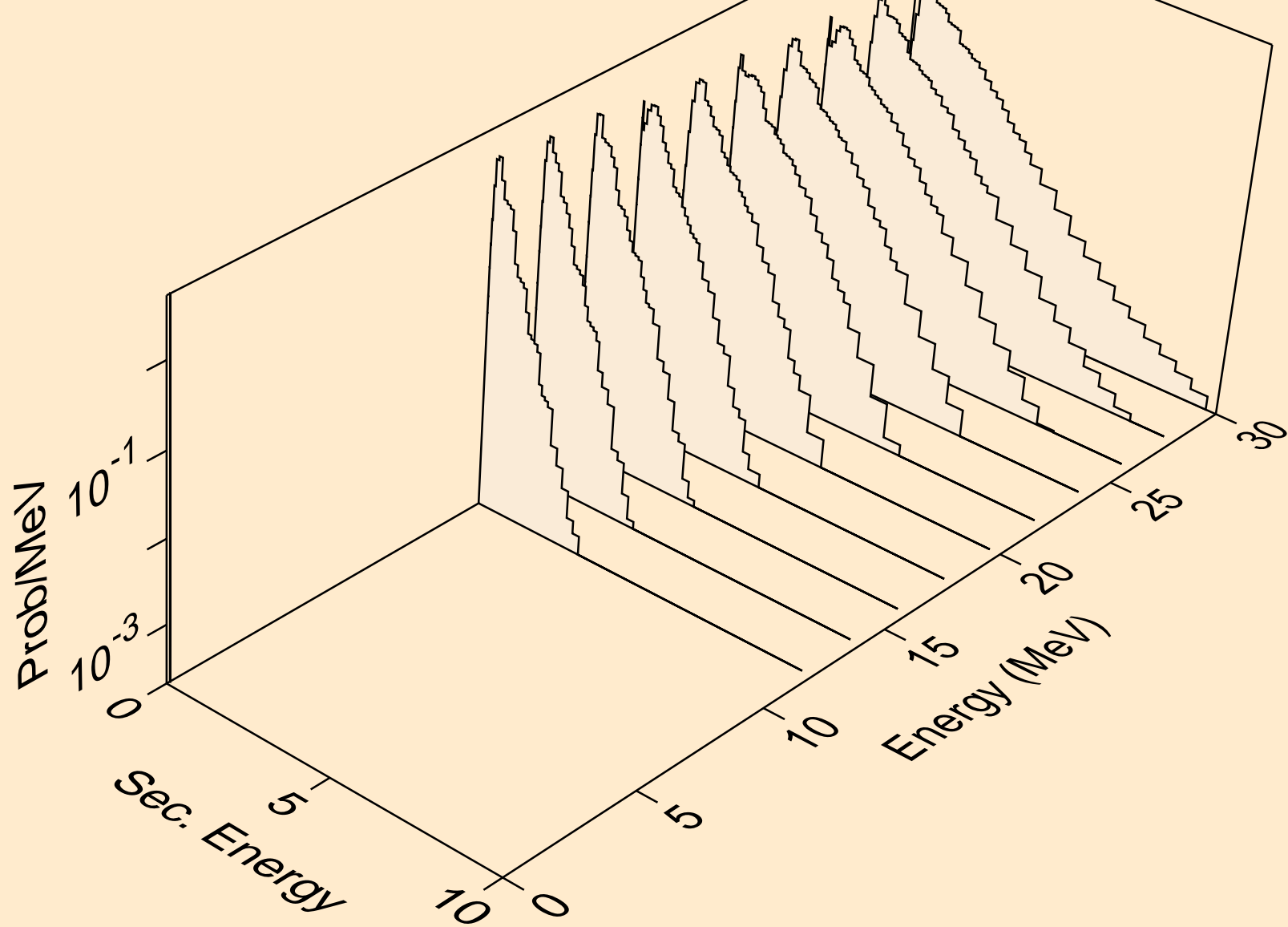

BI222 HELION ACER TENDL-2021 LIBRARY; T=0.K  
neutrons from (s,n\*)p

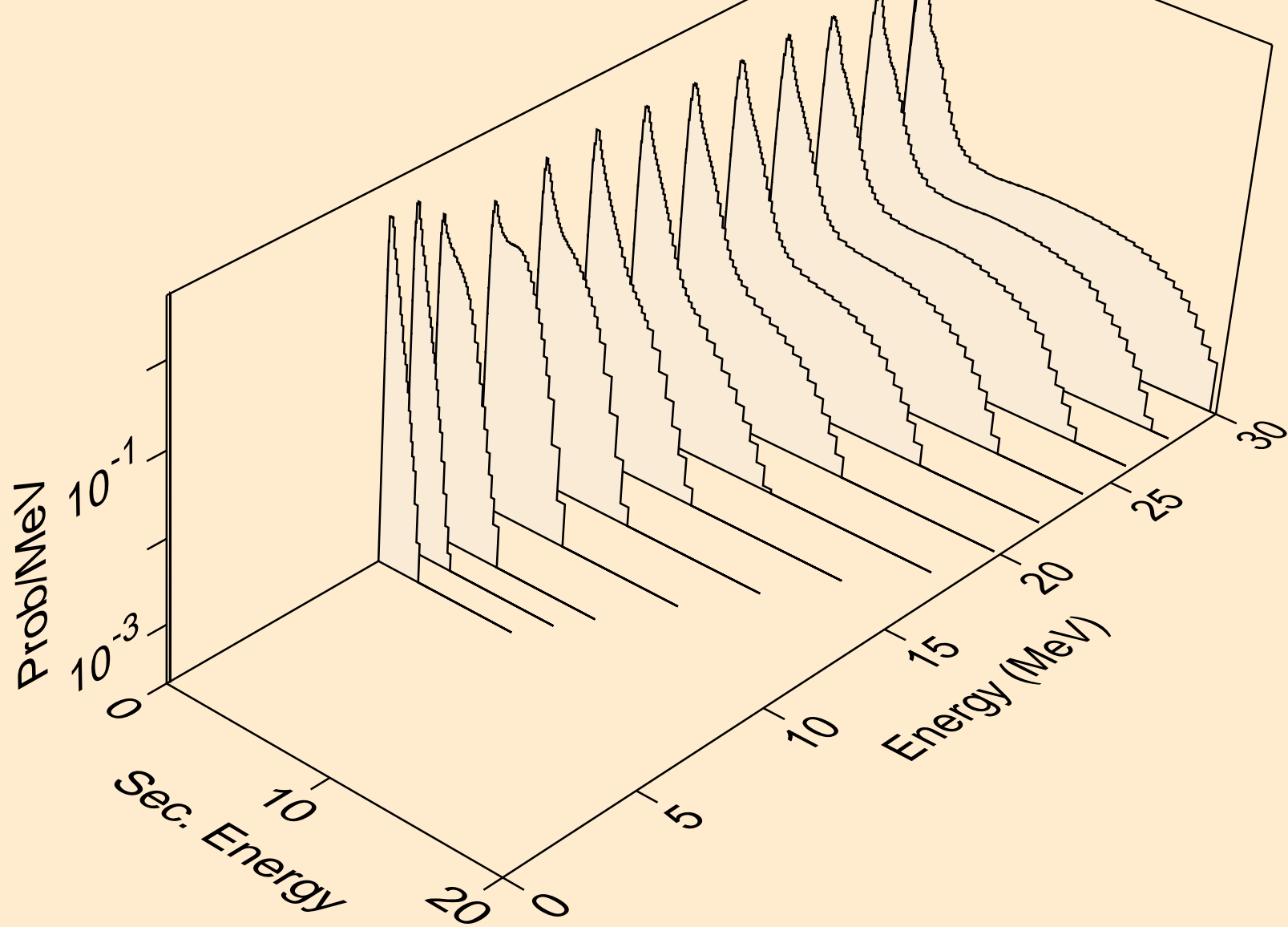

BI222 HELION ACER TENDL-2021 LIBRARY; T=0.K  
neutrons from (s,n\*)d

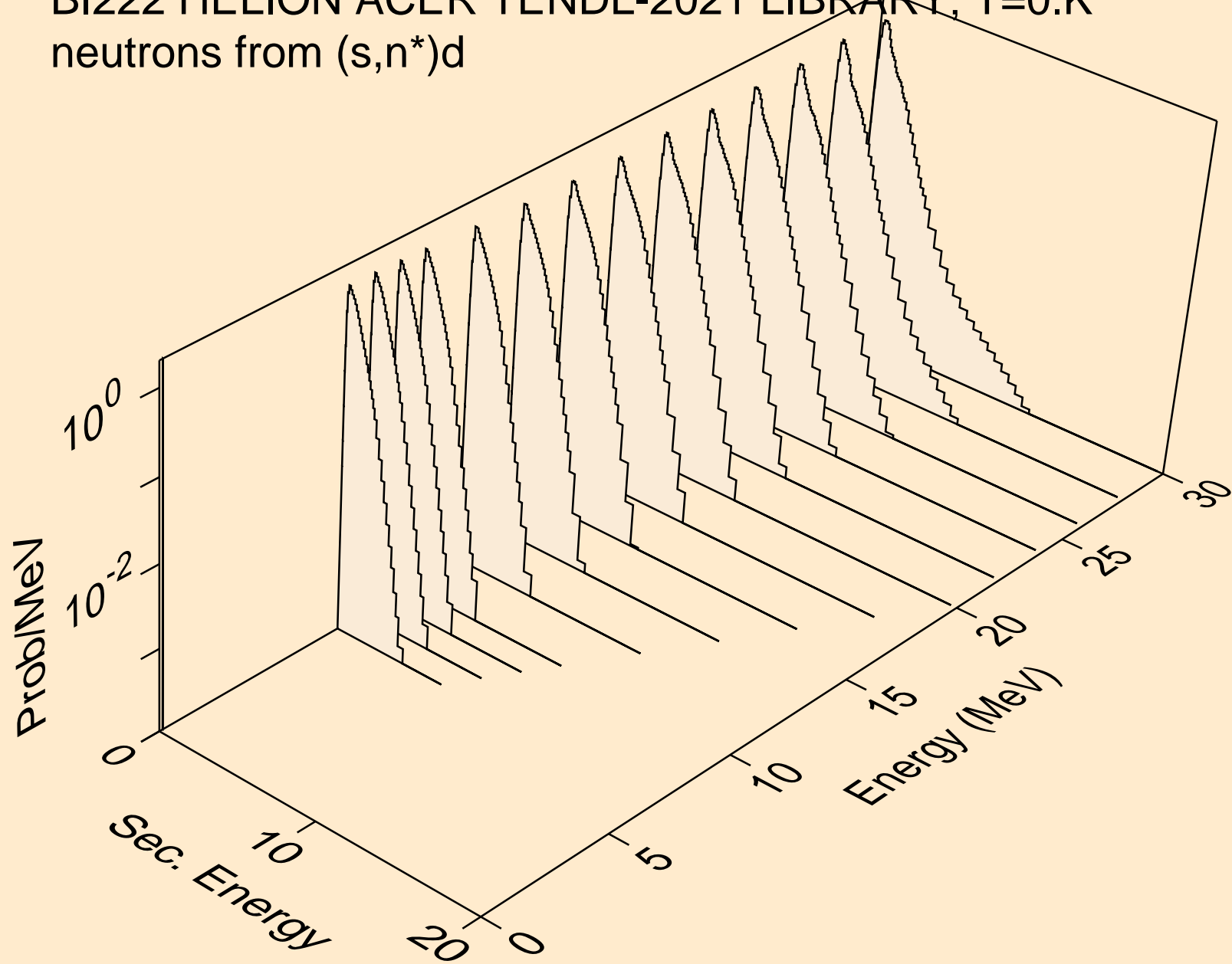

BI222 HELION ACER TENDL-2021 LIBRARY; T=0.K  
neutrons from (s,n\*)t

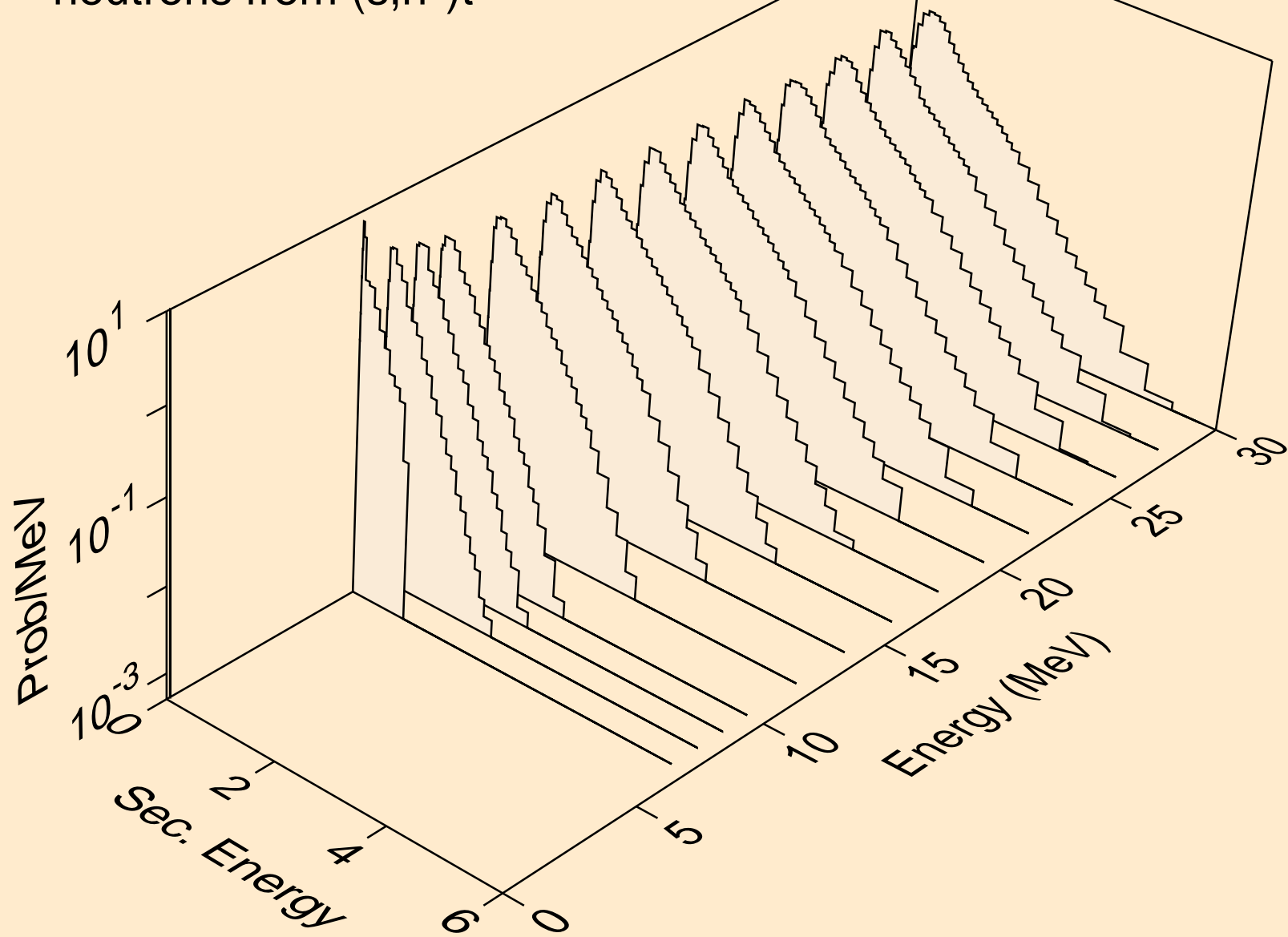

BI222 HELION ACER TENDL-2021 LIBRARY; T=0.K  
neutrons from (s,n\*)he3

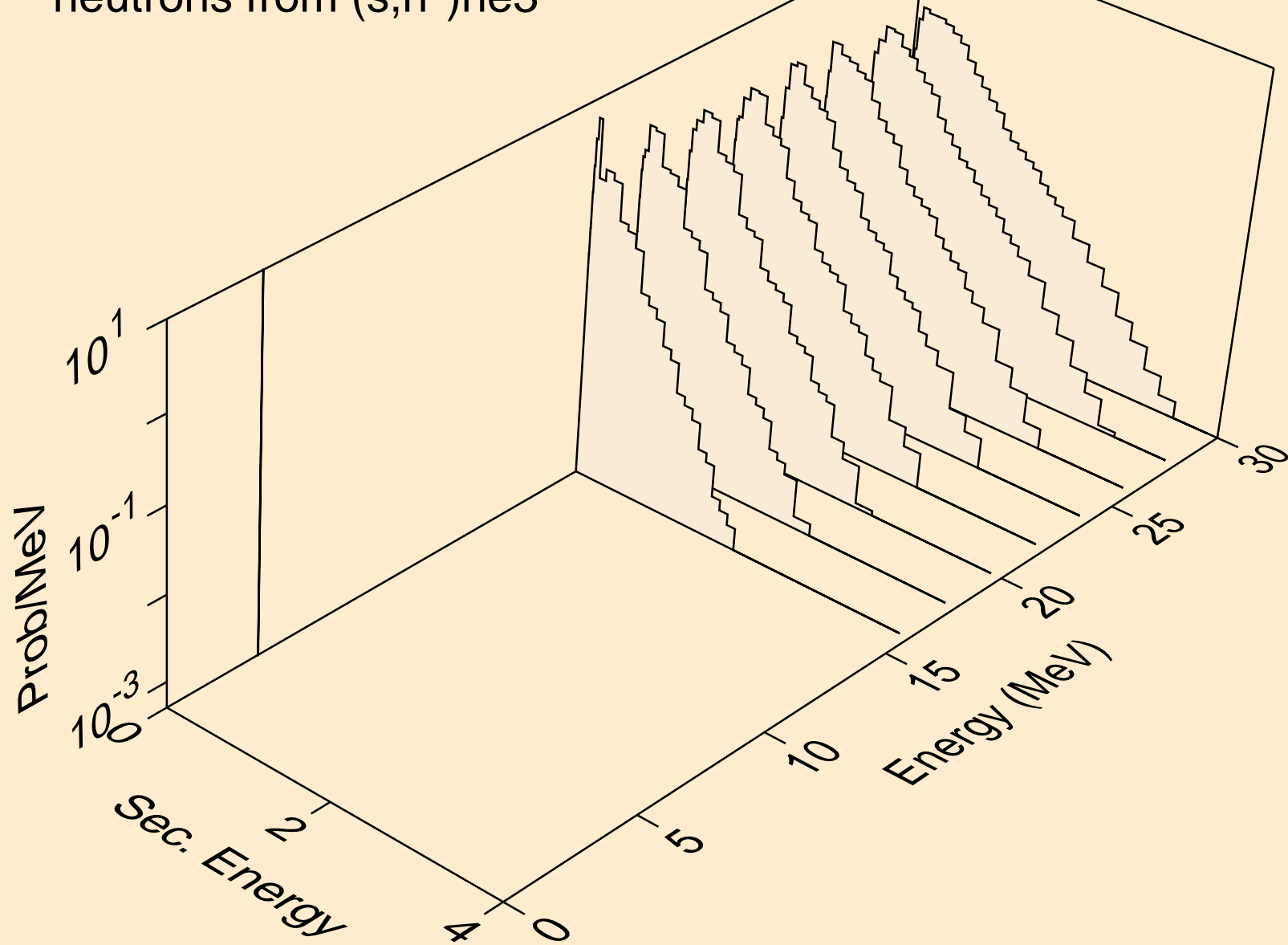



BI222 HELION ACER TENDL-2021 LIBRARY; T=0.K  
neutrons from (s,4n)

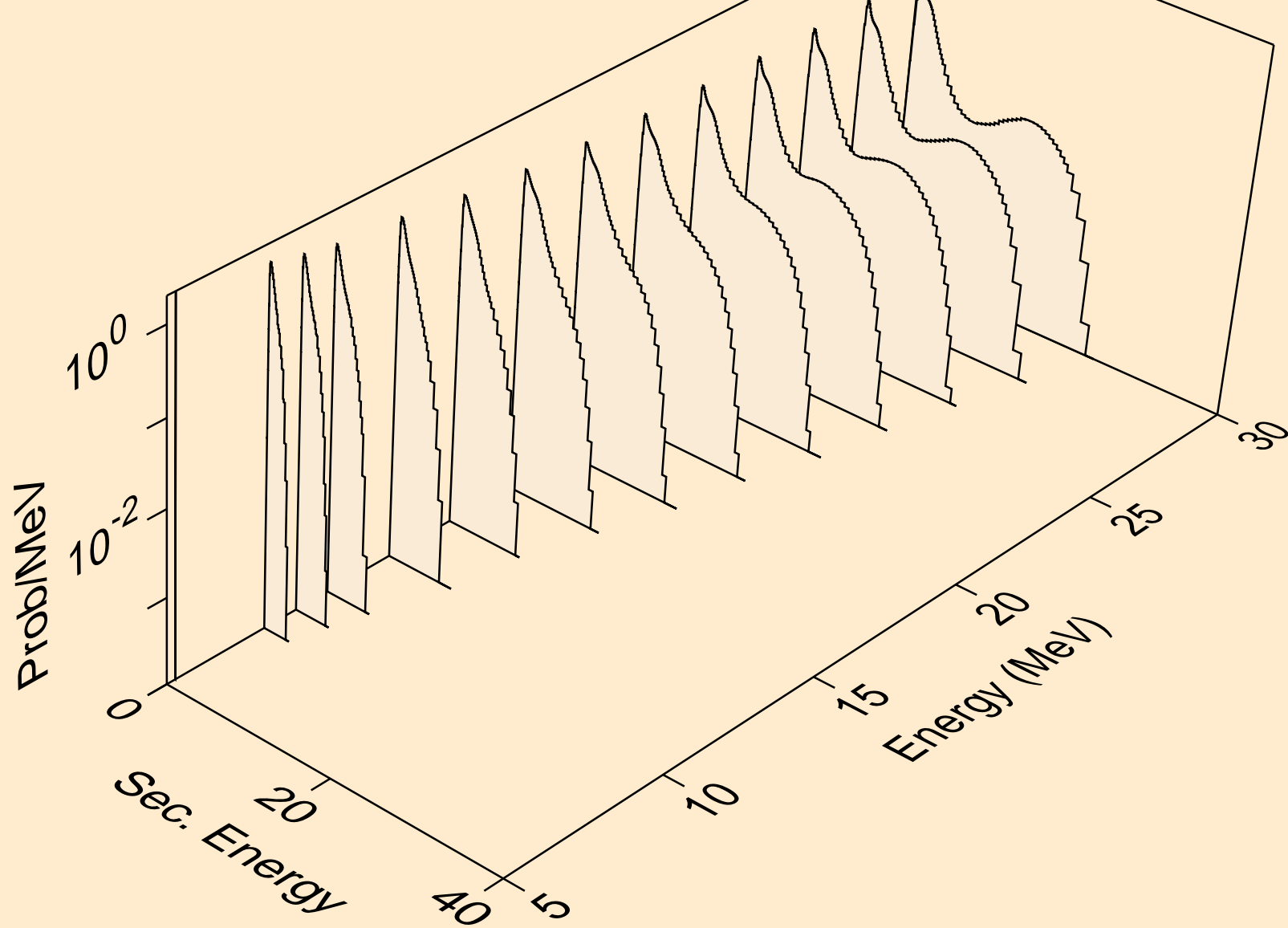

BI222 HELION ACER TENDL-2021 LIBRARY; T=0.K  
neutrons from (s,2np)

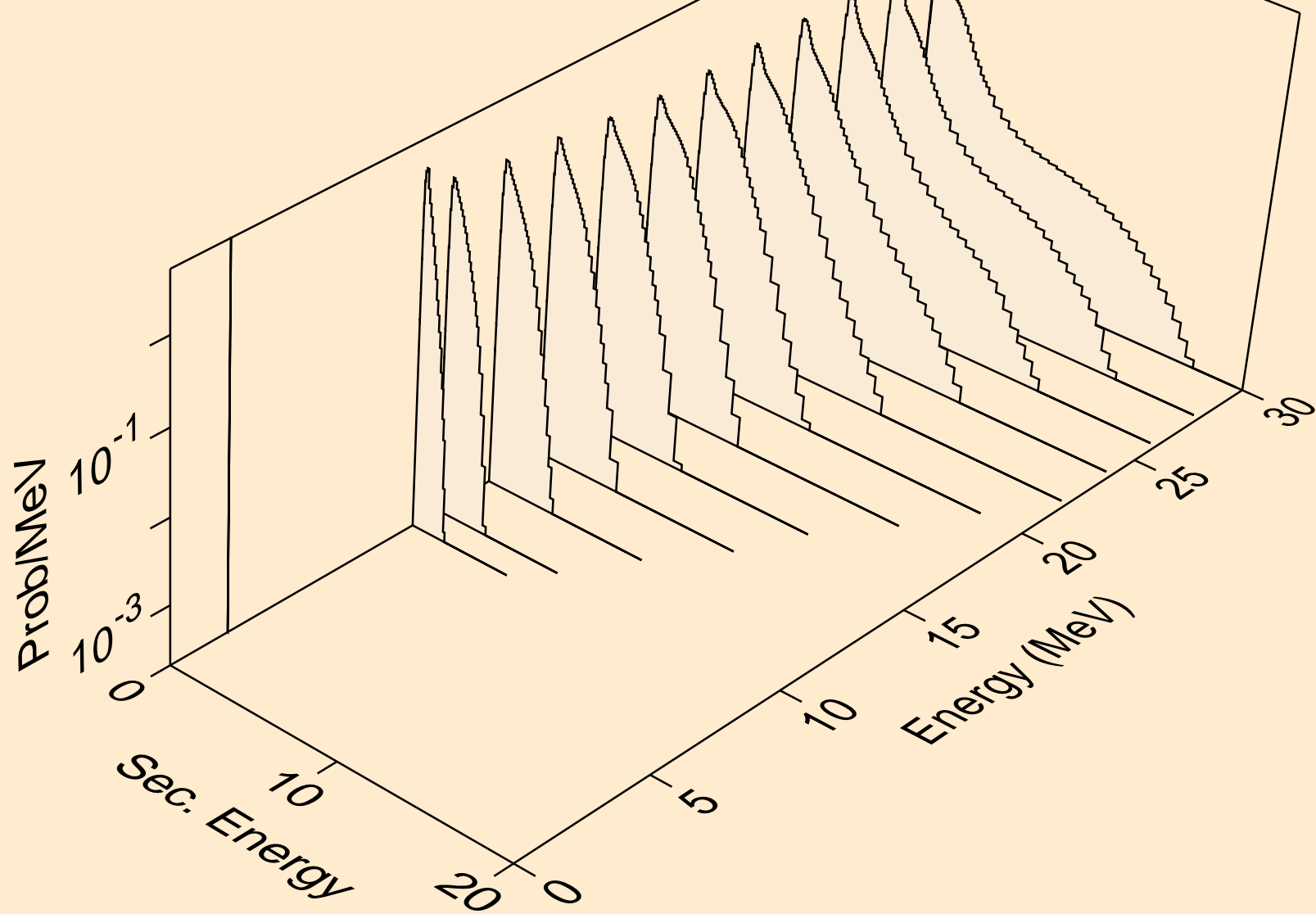

BI222 HELION ACER TENDL-2021 LIBRARY; T=0.K  
neutrons from (s,3np)

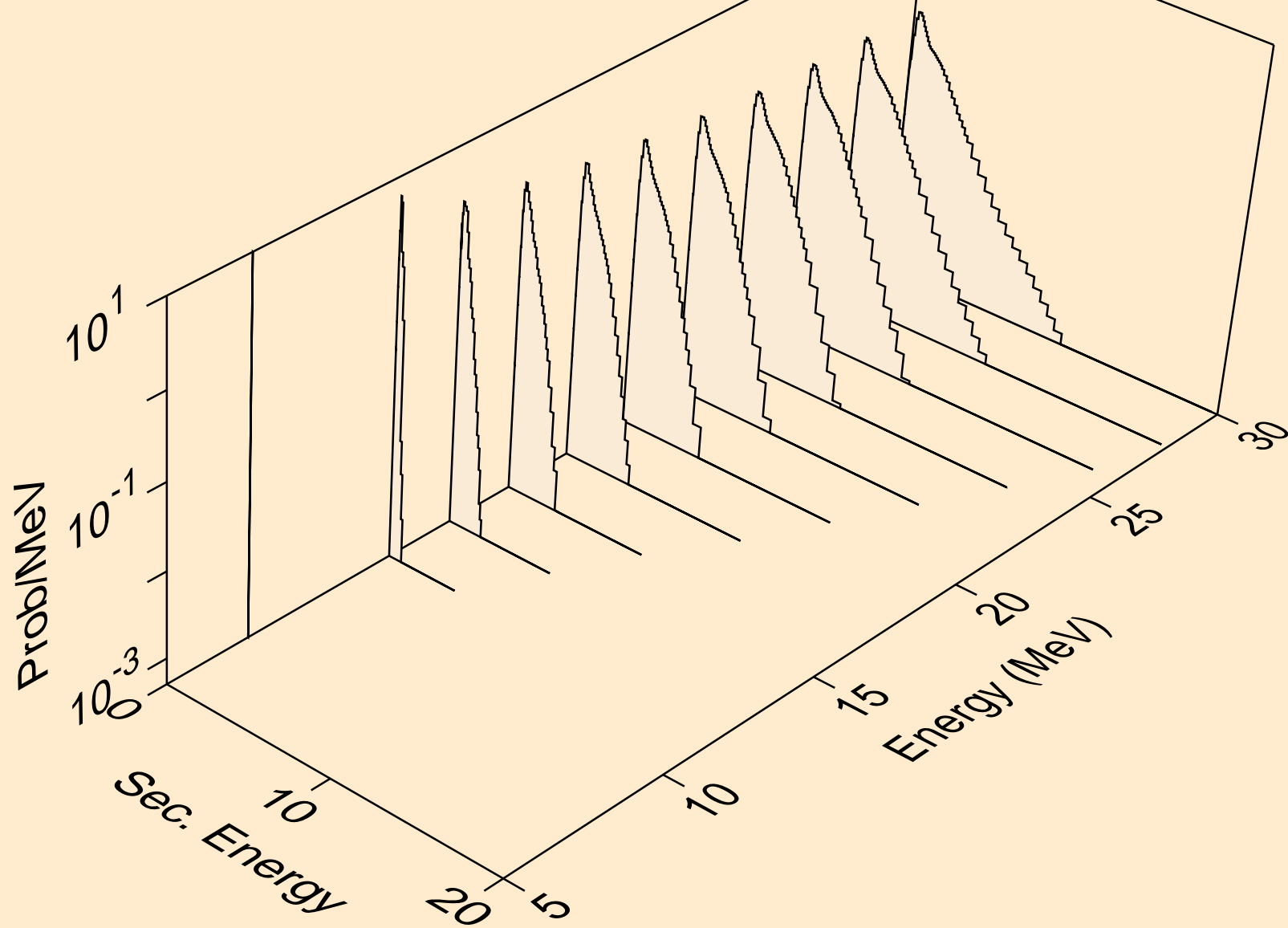

BI222 HELION ACER TENDL-2021 LIBRARY; T=0.K  
neutrons from (s,2np)

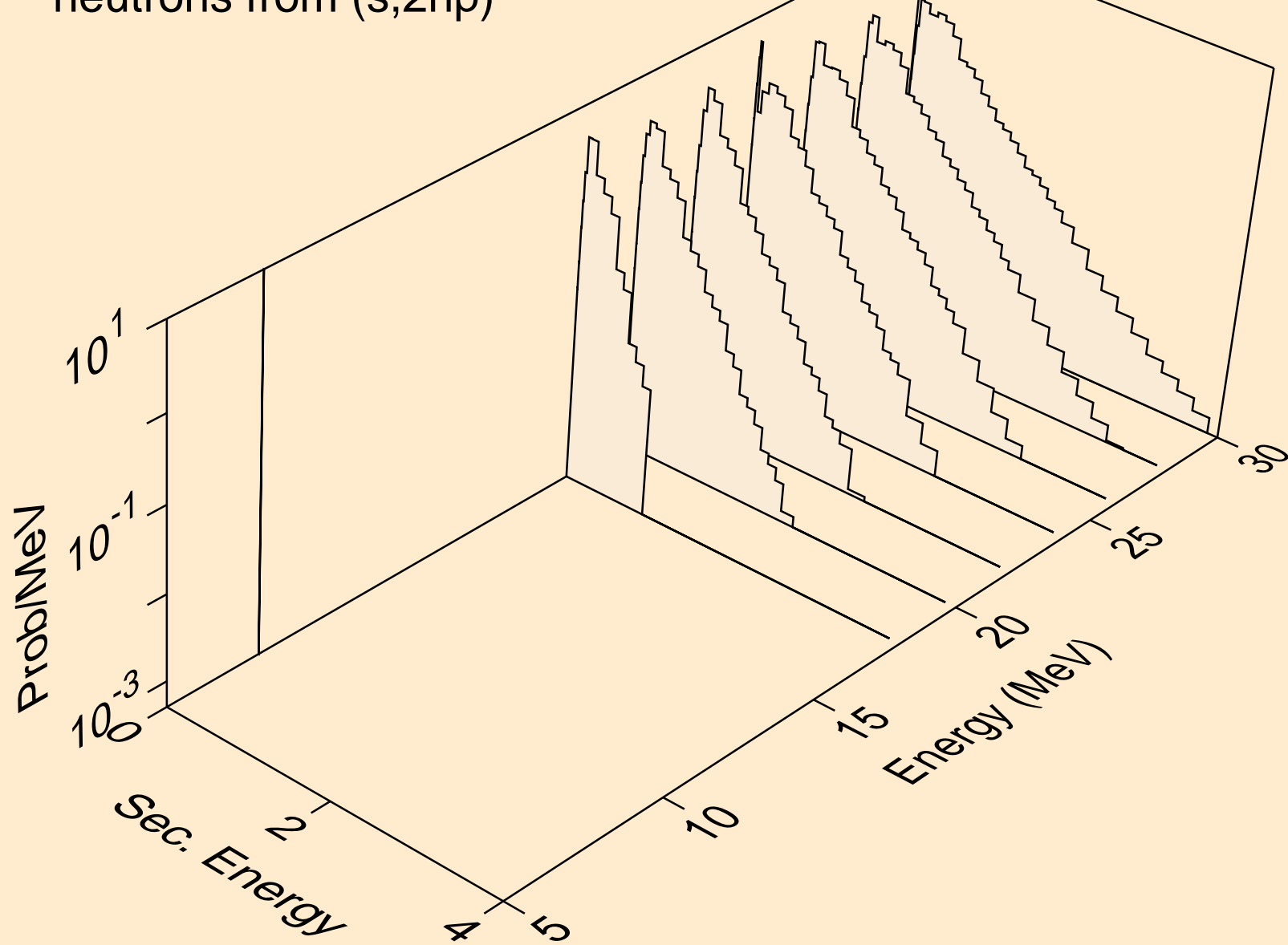

BI222 HELION ACER TENDL-2021 LIBRARY; T=0.K  
neutrons from (s,npa)

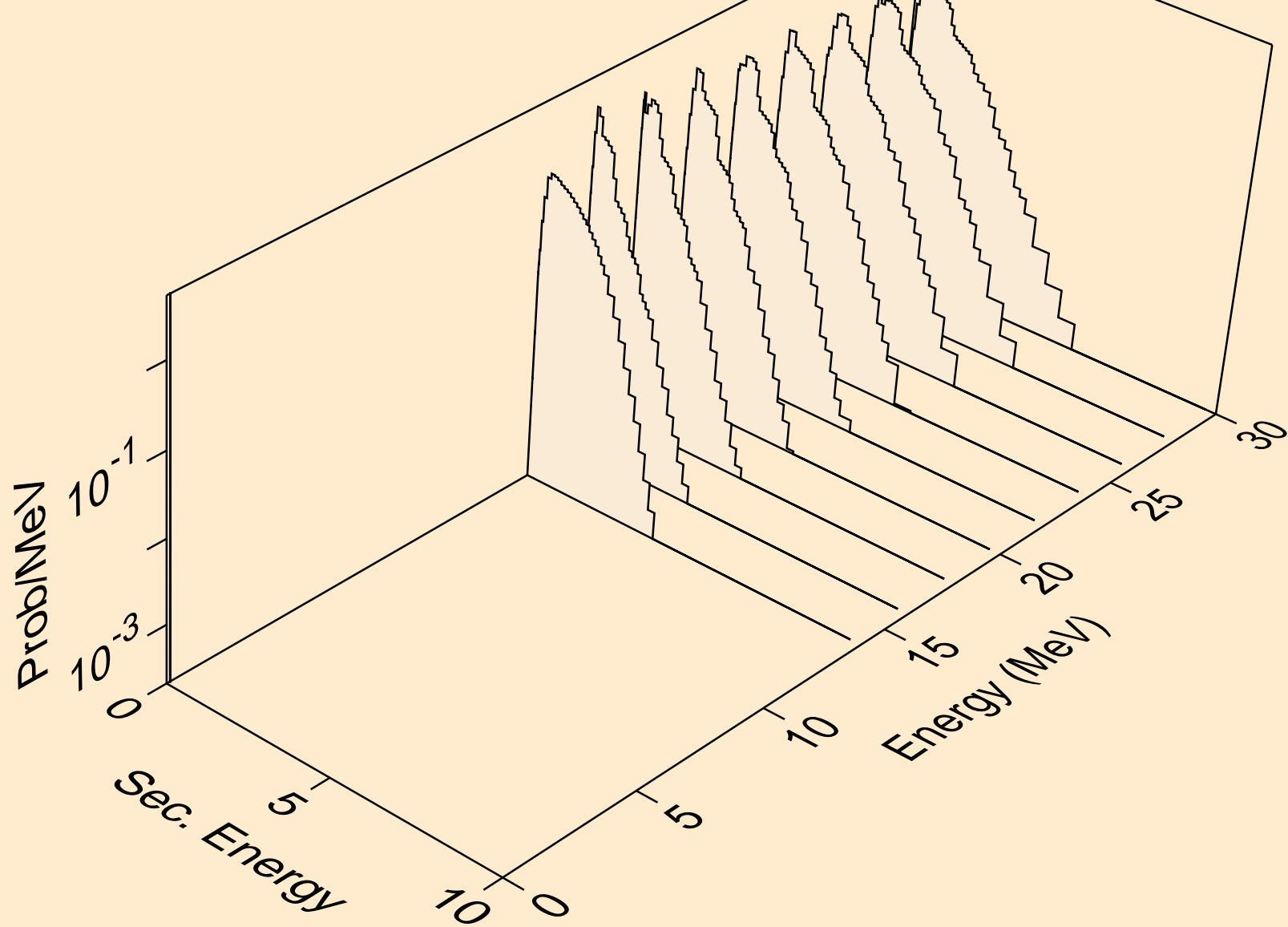

BI222 HELION ACER TENDL-2021 LIBRARY; T=0.K  
protons from (s,x)

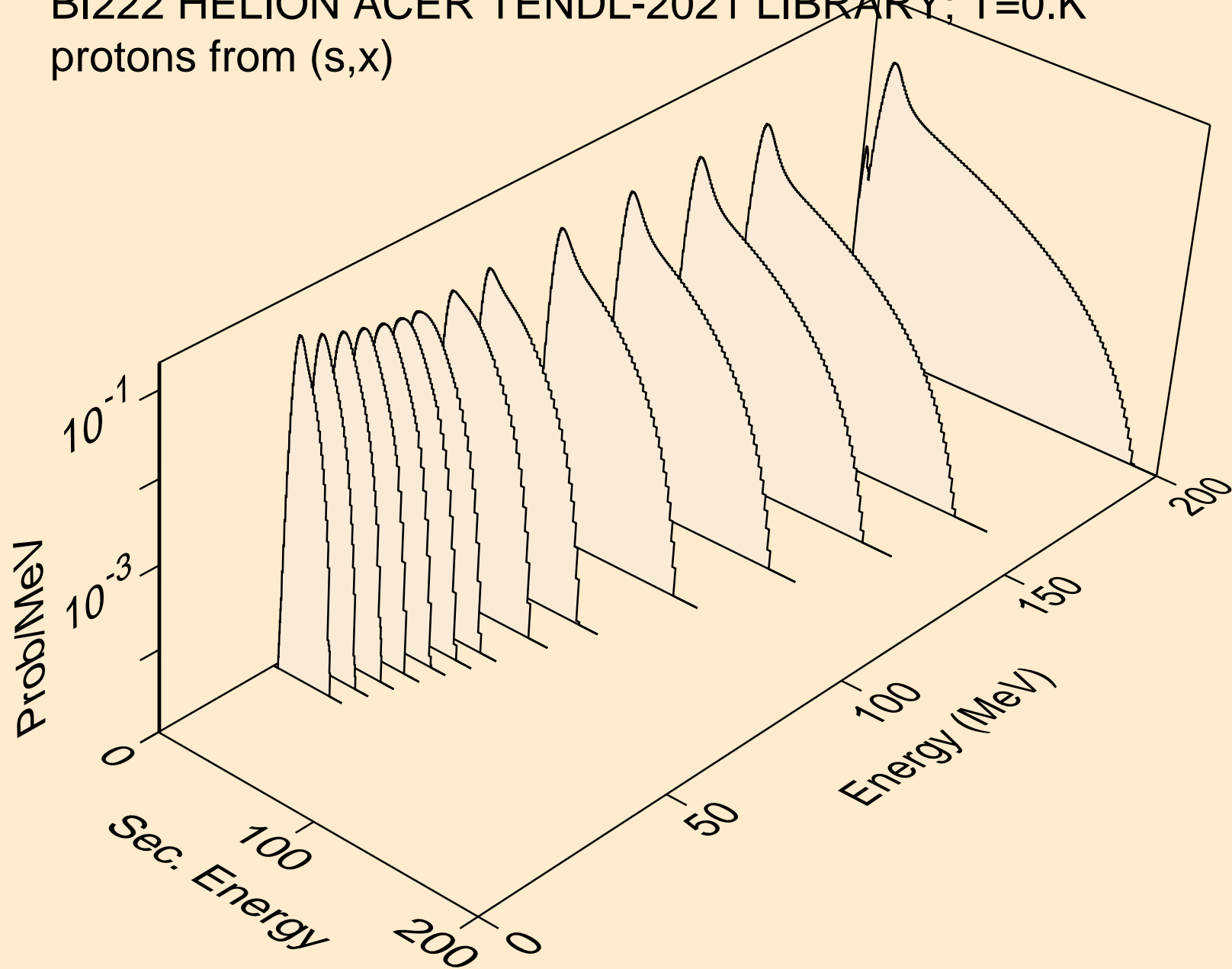

BI222 HELION ACER TENDL-2021 LIBRARY; T=0.K  
protons from (s,n\*)p

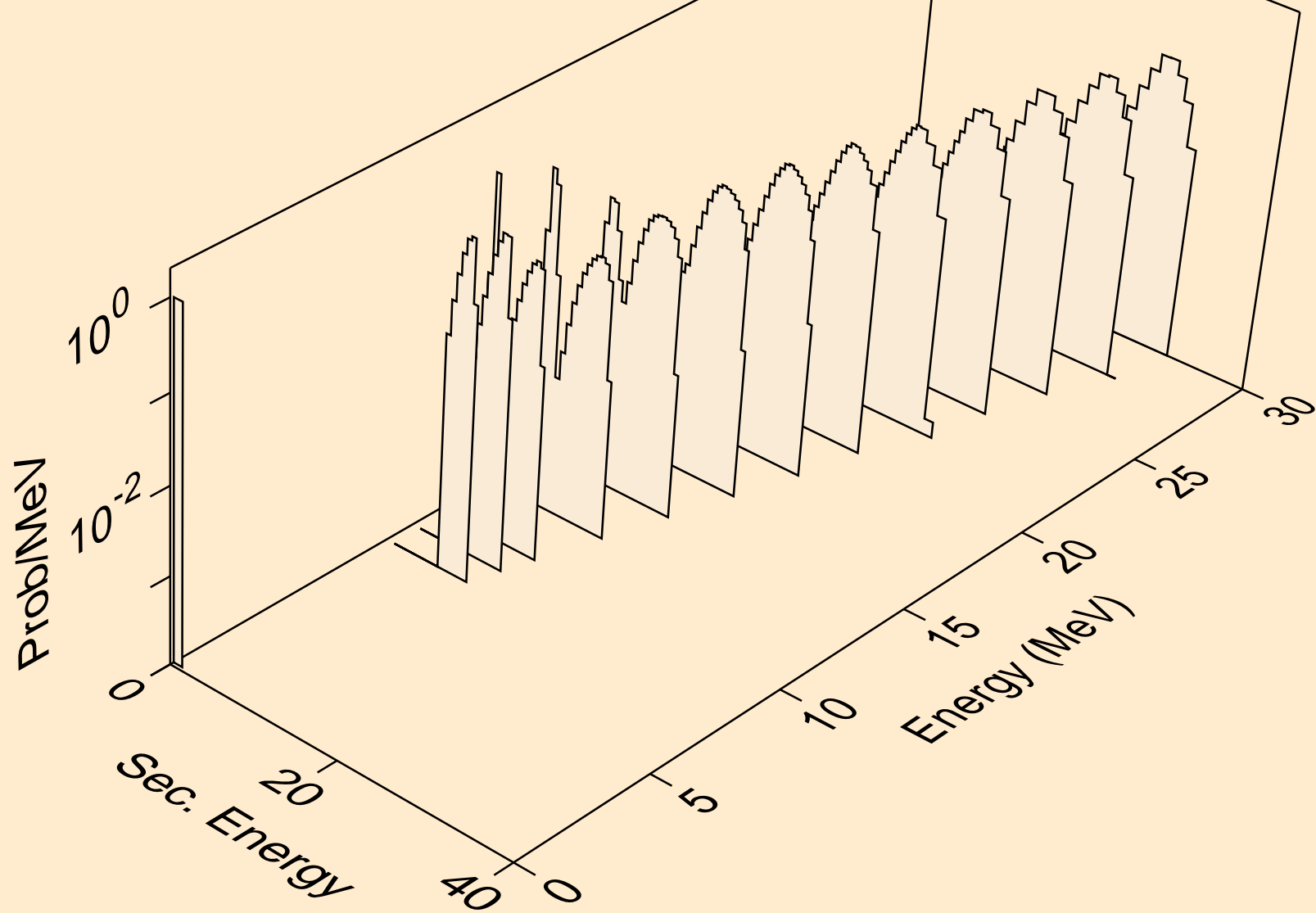

BI222 HELION ACER TENDL-2021 LIBRARY; T=0.K  
protons from (s,2np)

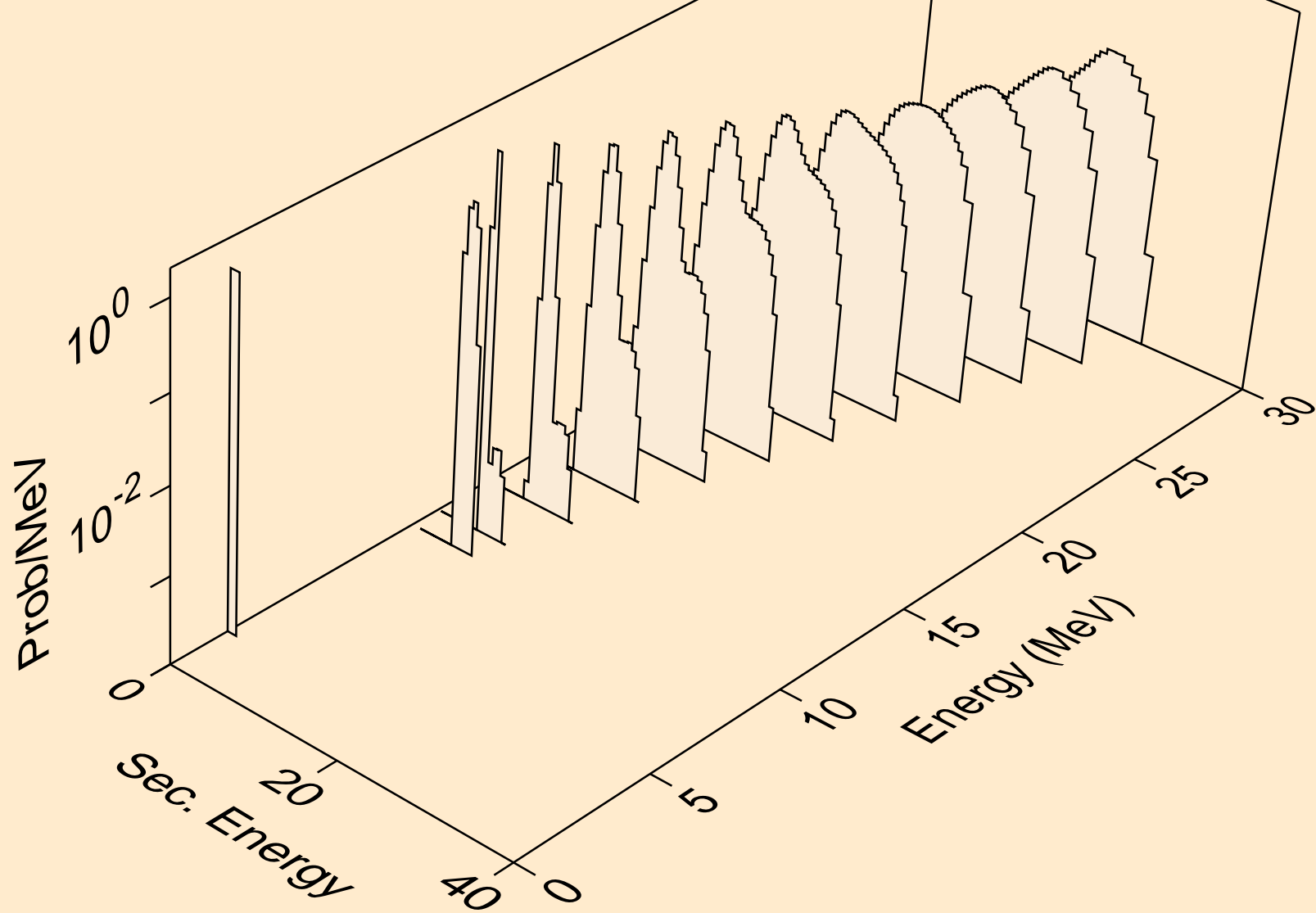



BI222 HELION ACER TENDL-2021 LIBRARY; T=0.K  
protons from (s,3np)

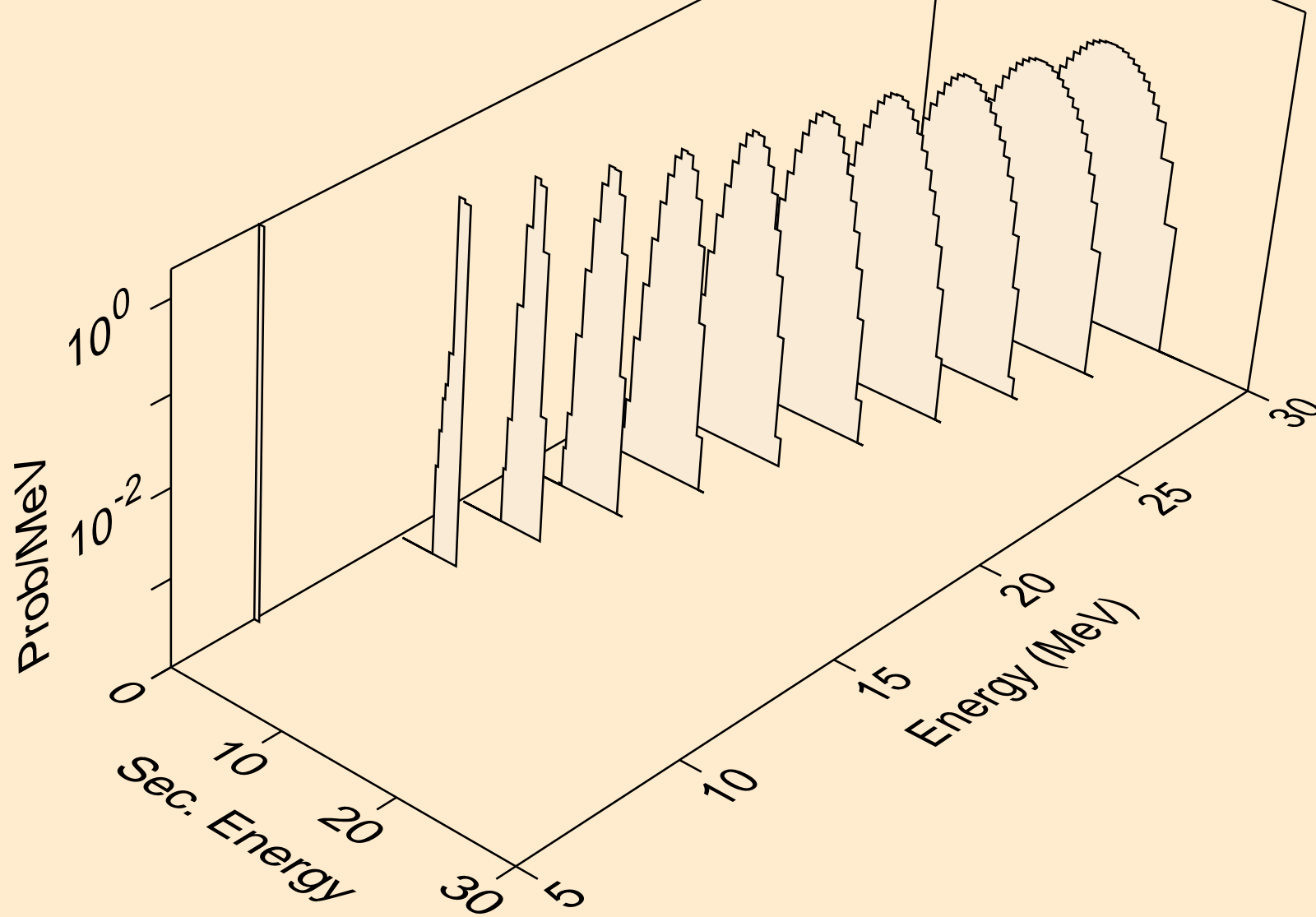

BI222 HELION ACER TENDL-2021 LIBRARY; T=0.K  
protons from (s,2np)

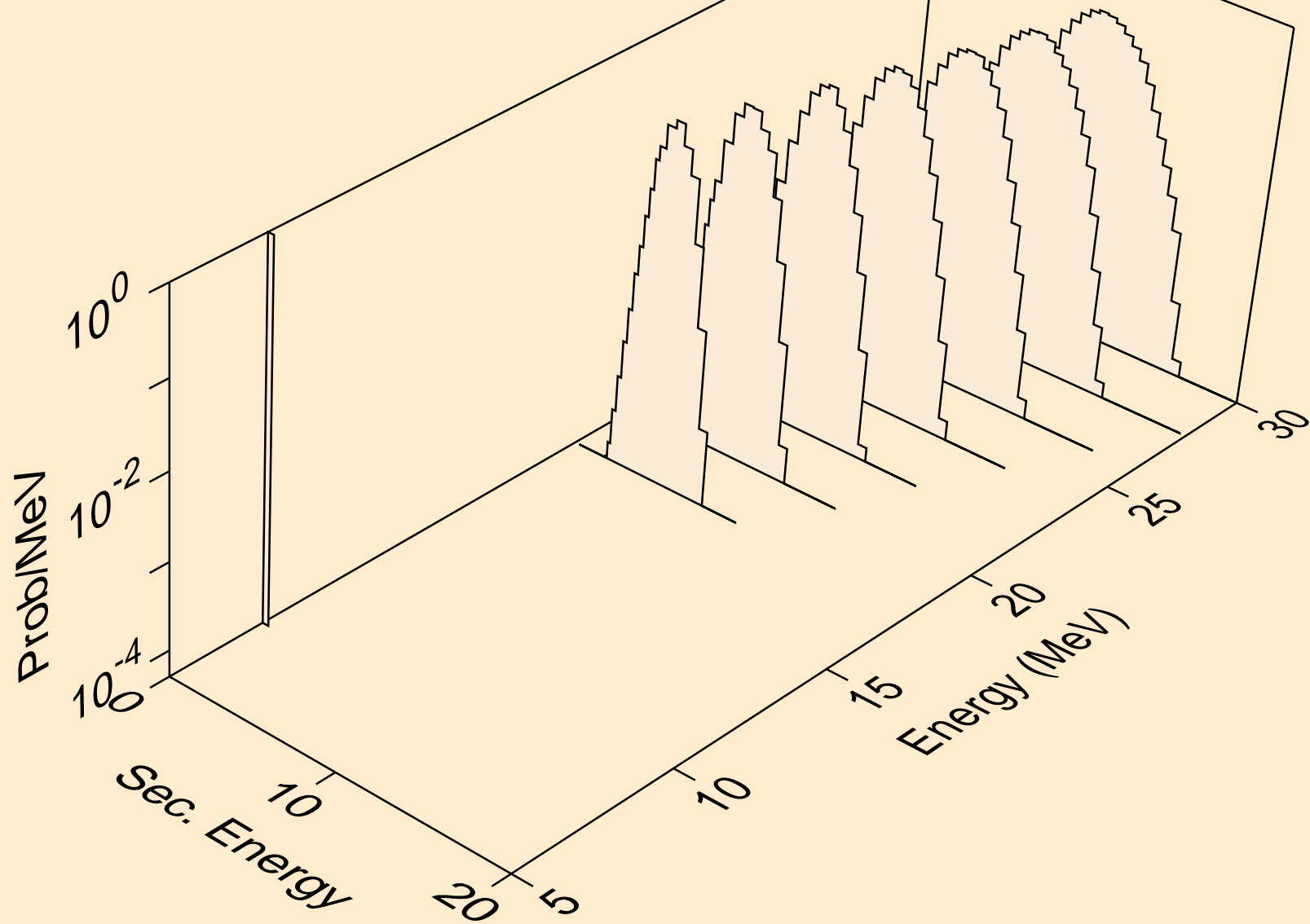

BI222 HELION ACER TENDL-2021 LIBRARY; T=0.K  
protons from (s,npa)

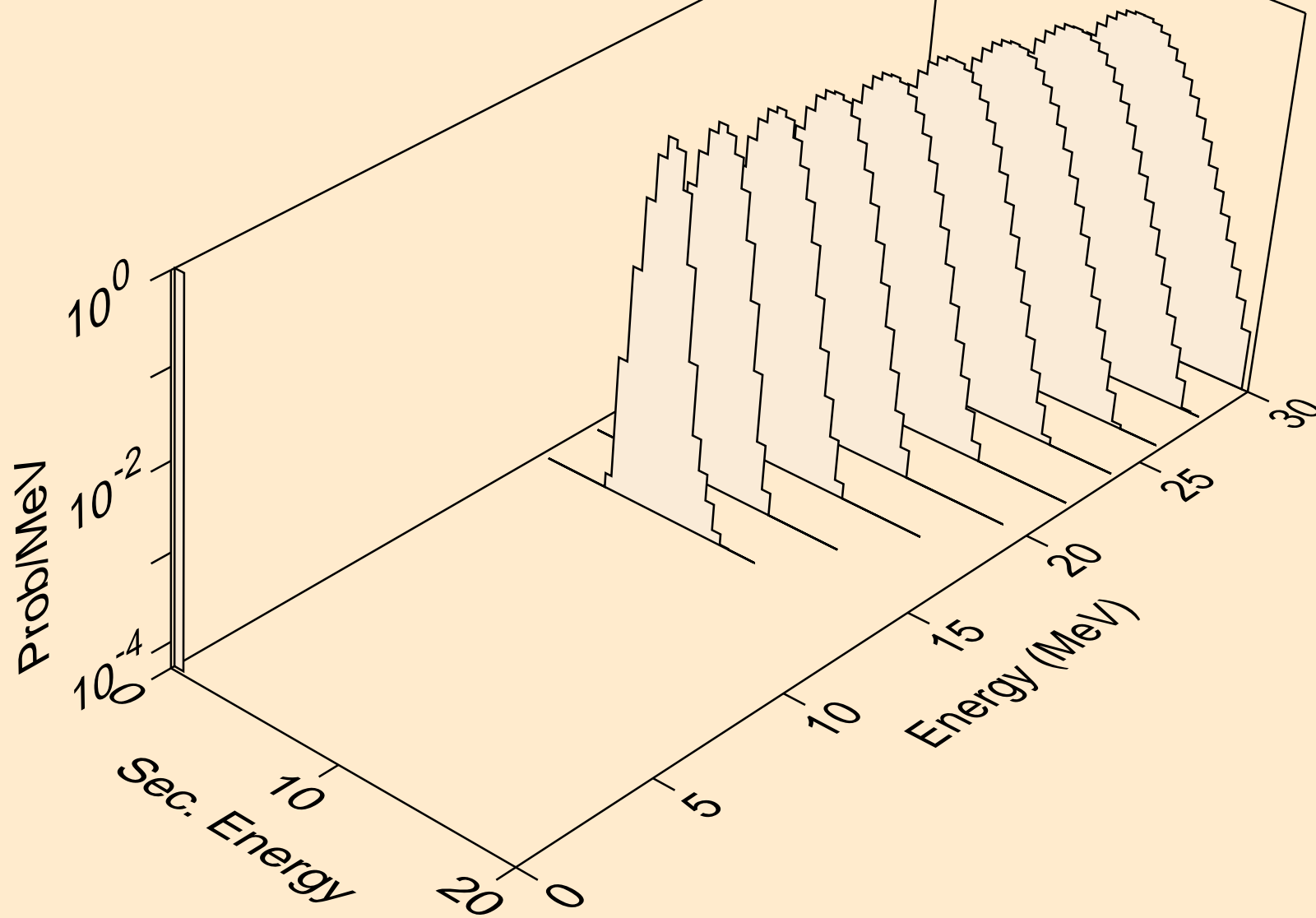

BI222 HELION ACER TENDL-2021 LIBRARY; T=0.K  
protons from (s,p)

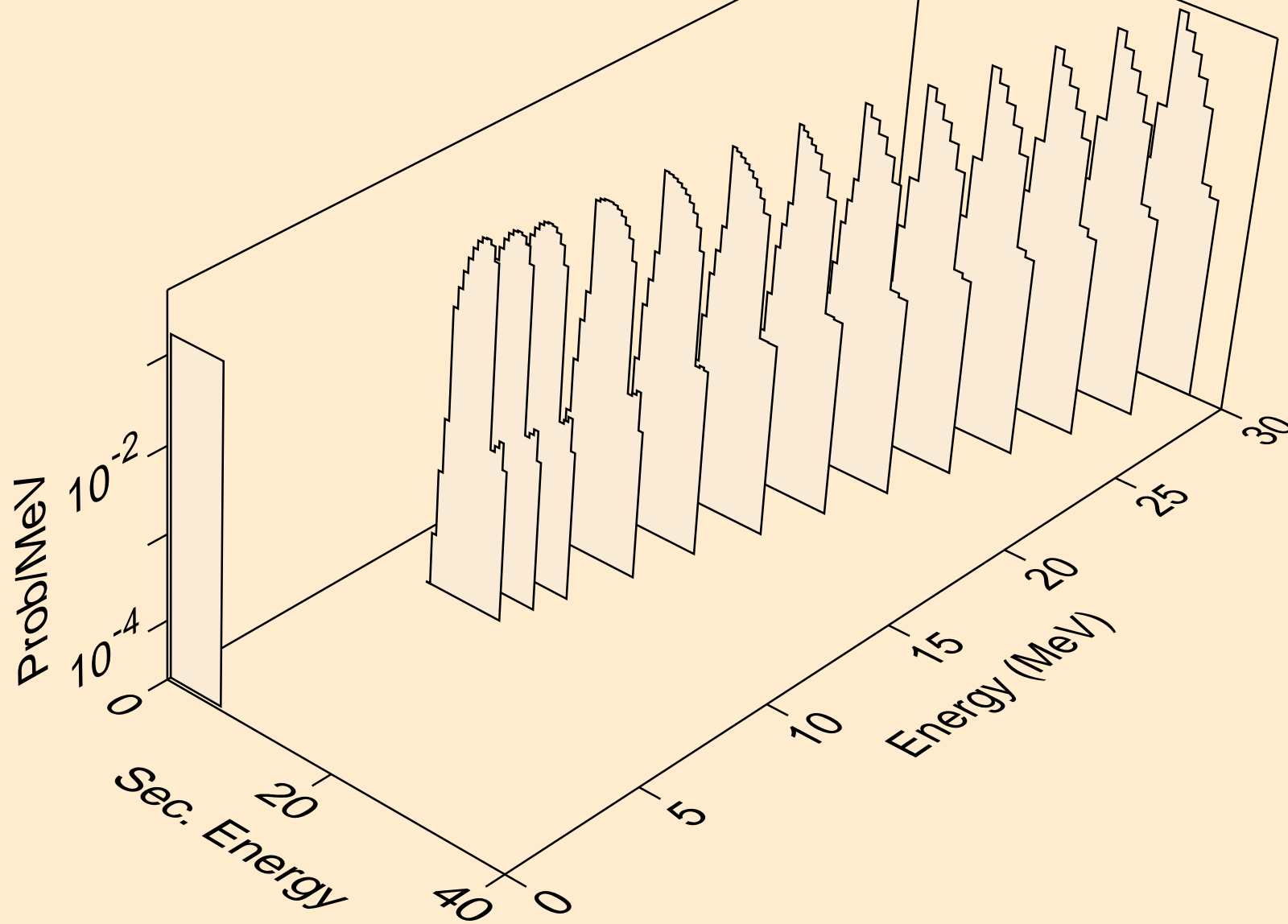

BI222 HELION ACER TENDL-2021 LIBRARY; T=0.K  
protons from (s,2p)

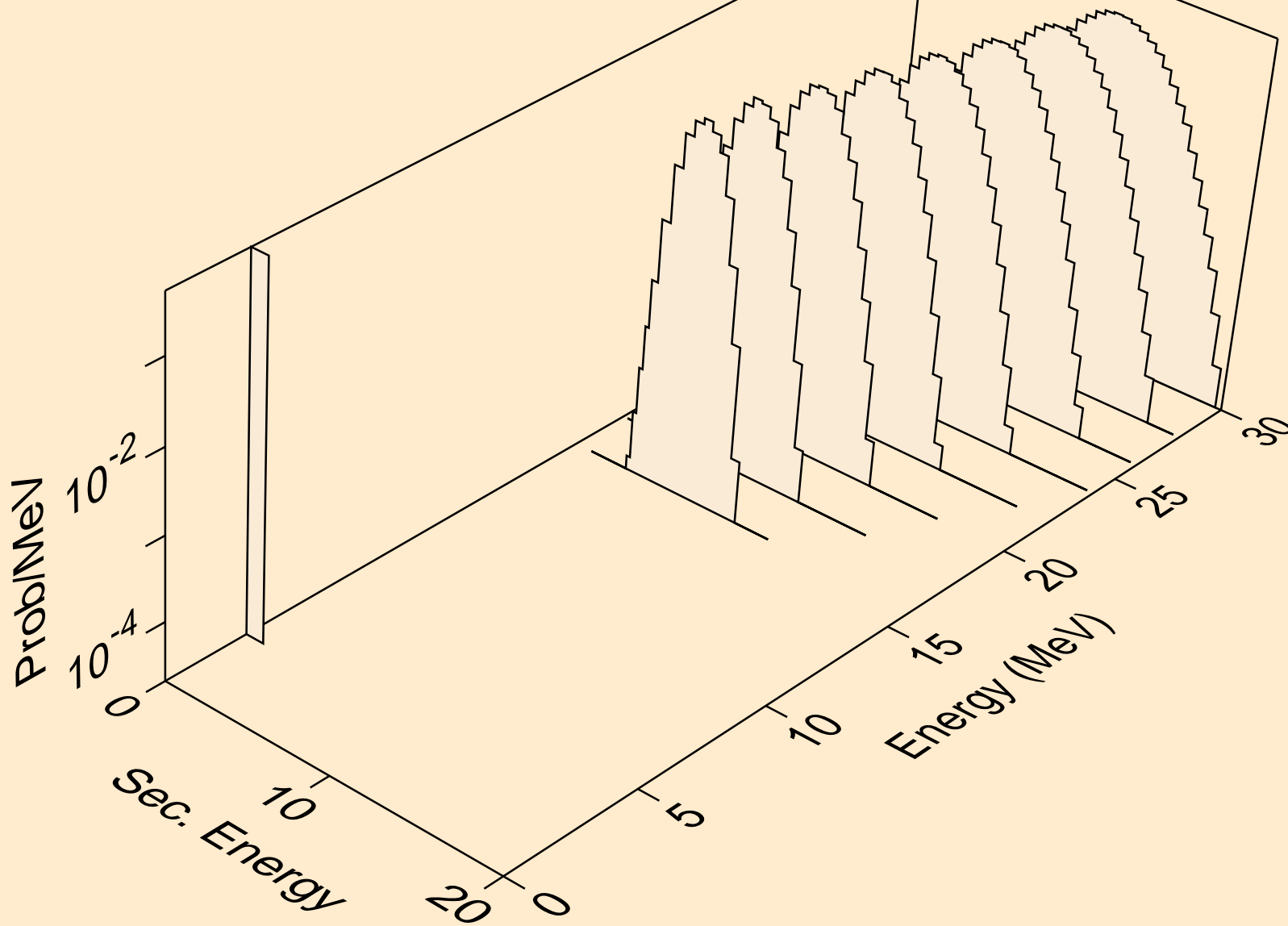

BI222 HELION ACER TENDL-2021 LIBRARY; T=0.K  
protons from (s,pd)

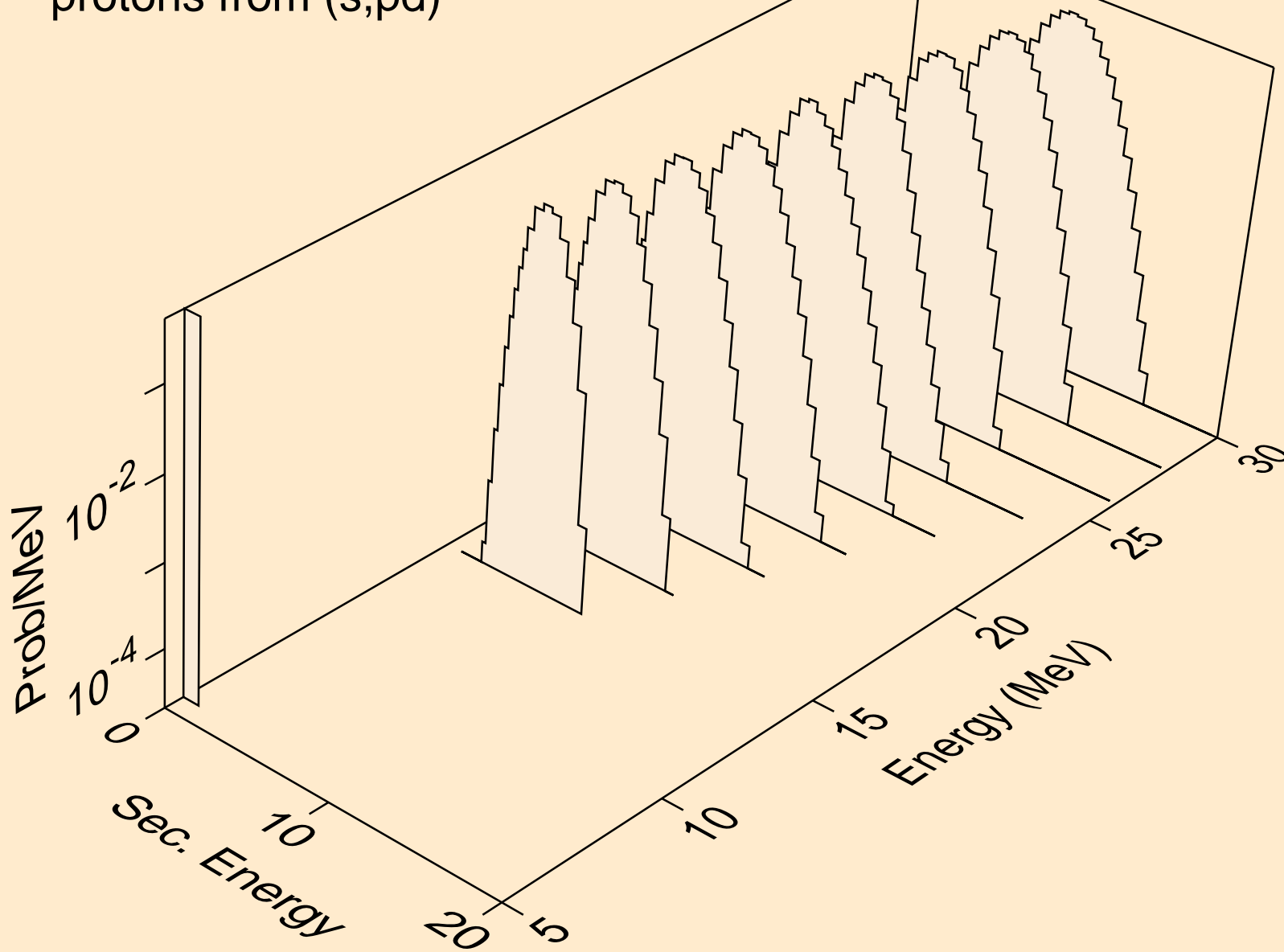

BI222 HELION ACER TENDL-2021 LIBRARY; T=0.K  
protons from (s,pt)

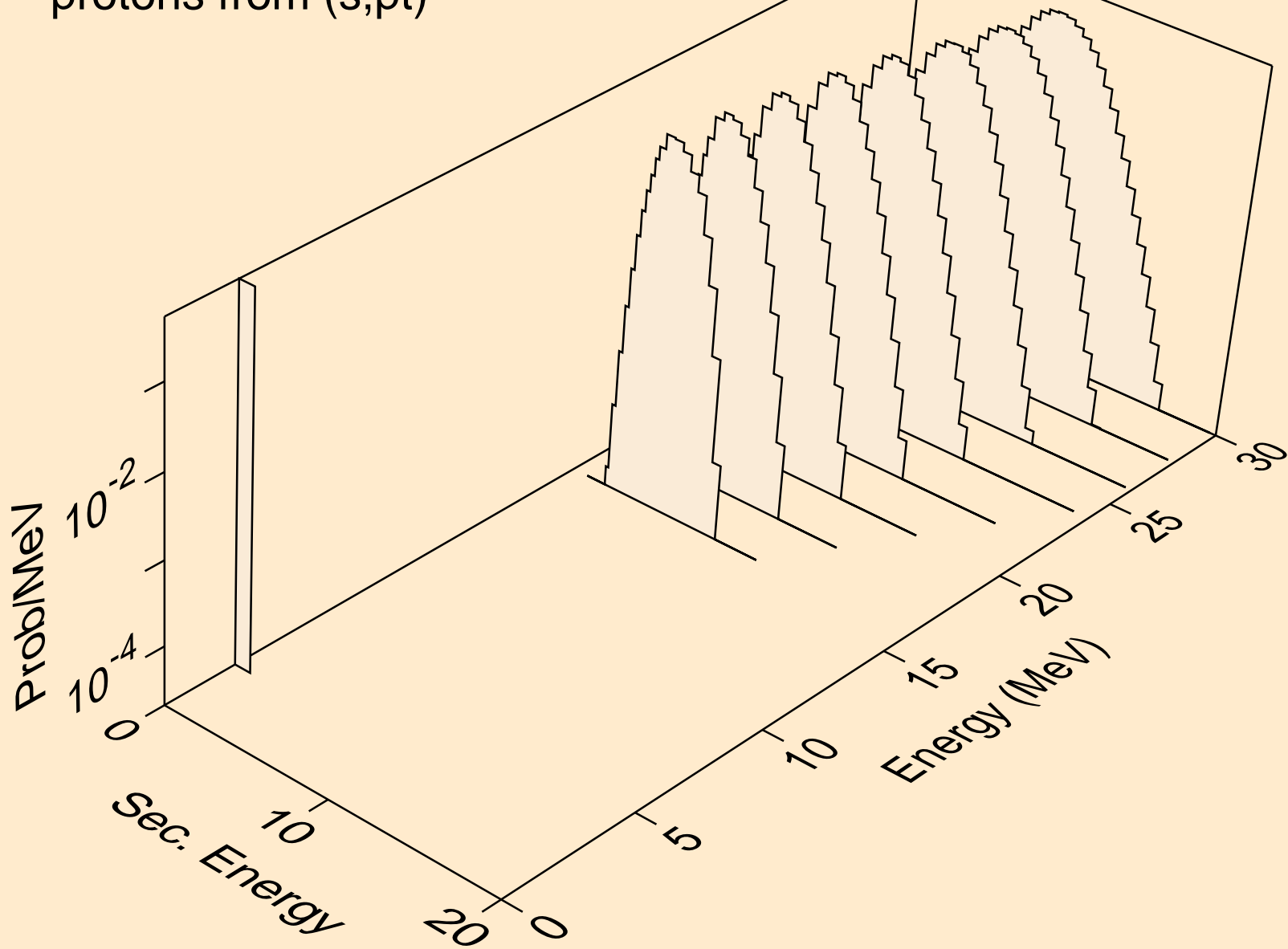

BI222 HELION ACER TENDL-2021 LIBRARY; T=0.K  
deuterons from (s,x)

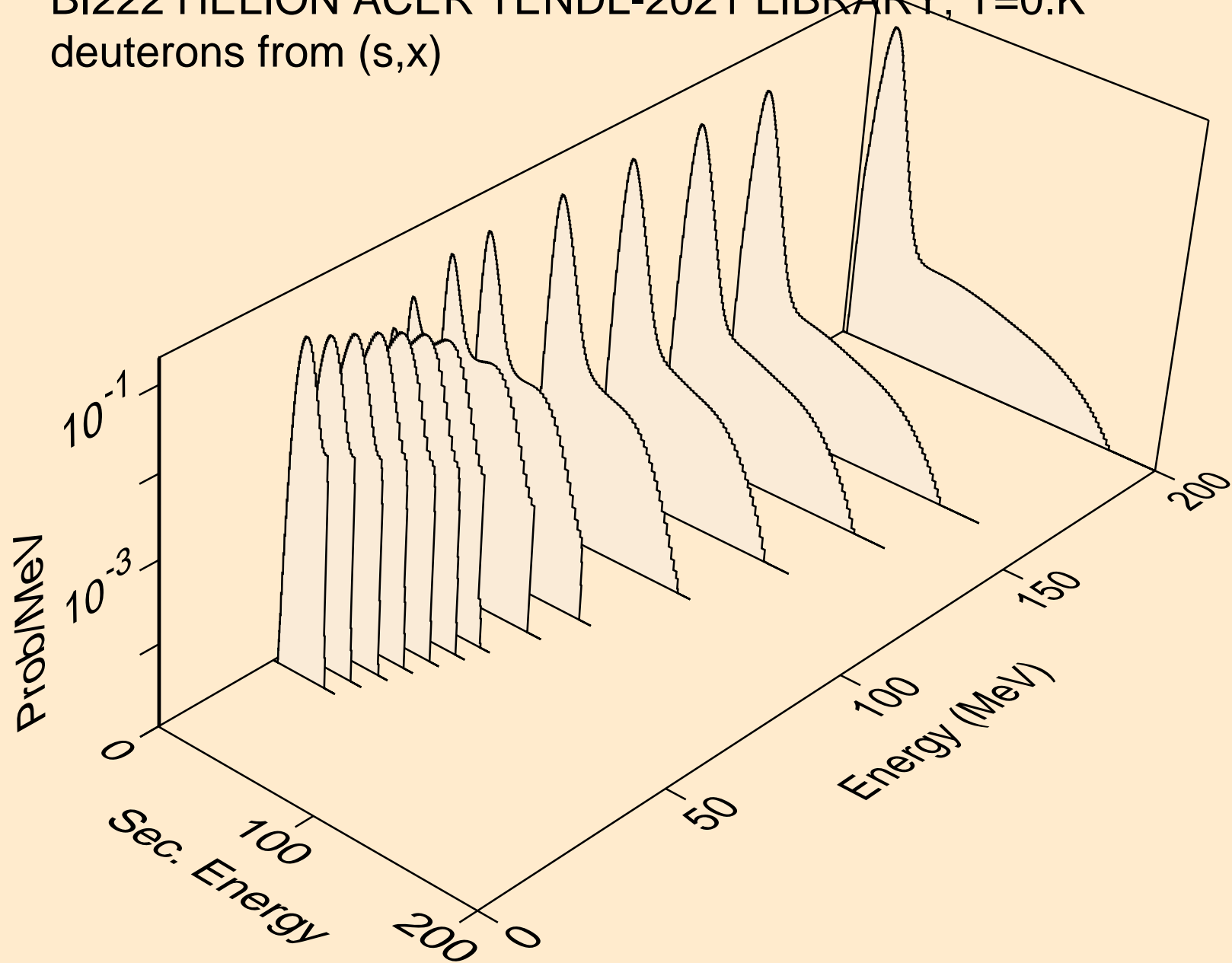



BI222 HELION ACER TENDL-2021 LIBRARY; T=0.K  
deuterons from (s,2nd)

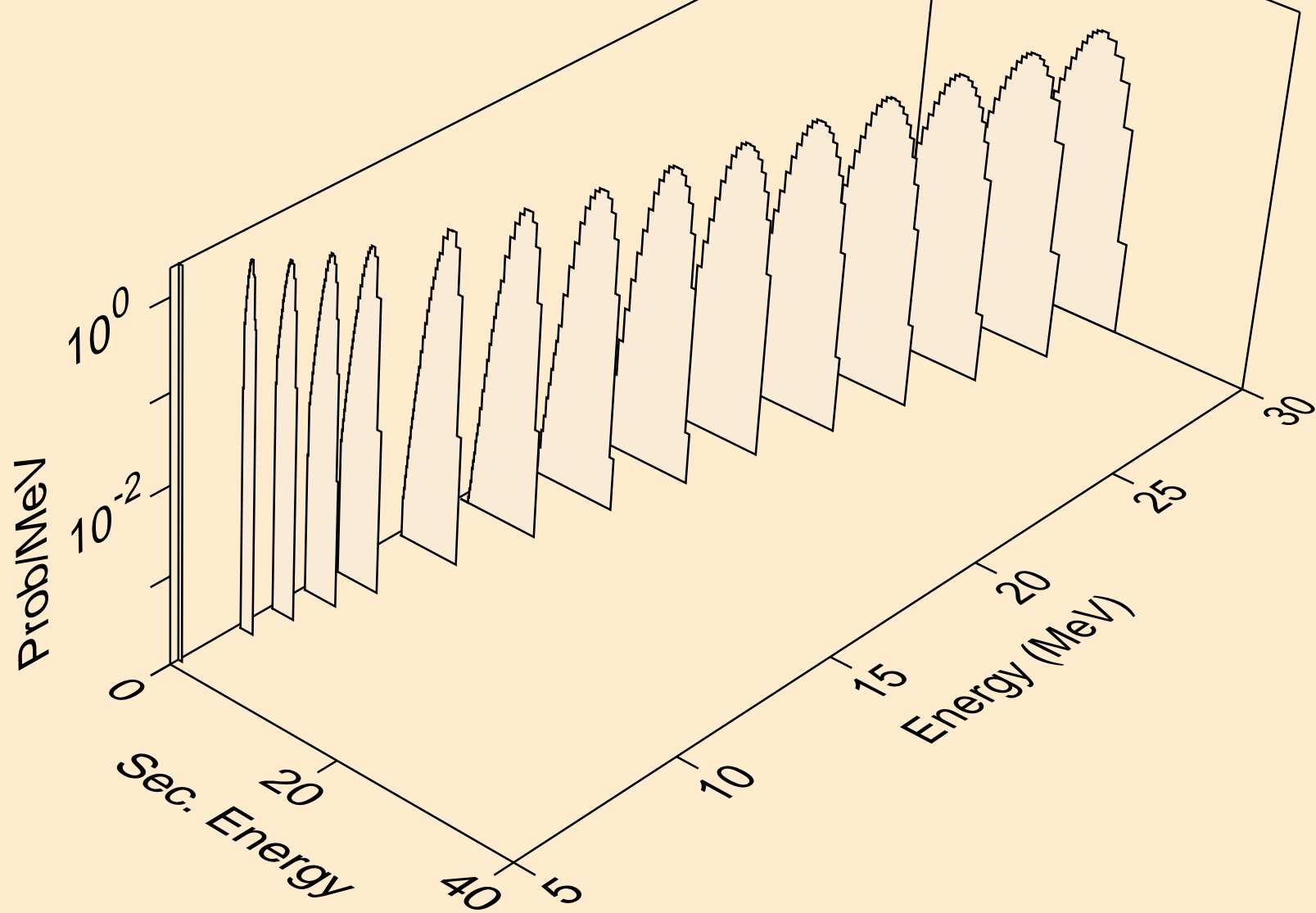

BI222 HELION ACER TENDL-2021 LIBRARY; T=0.K  
deuterons from (s,n\*)d

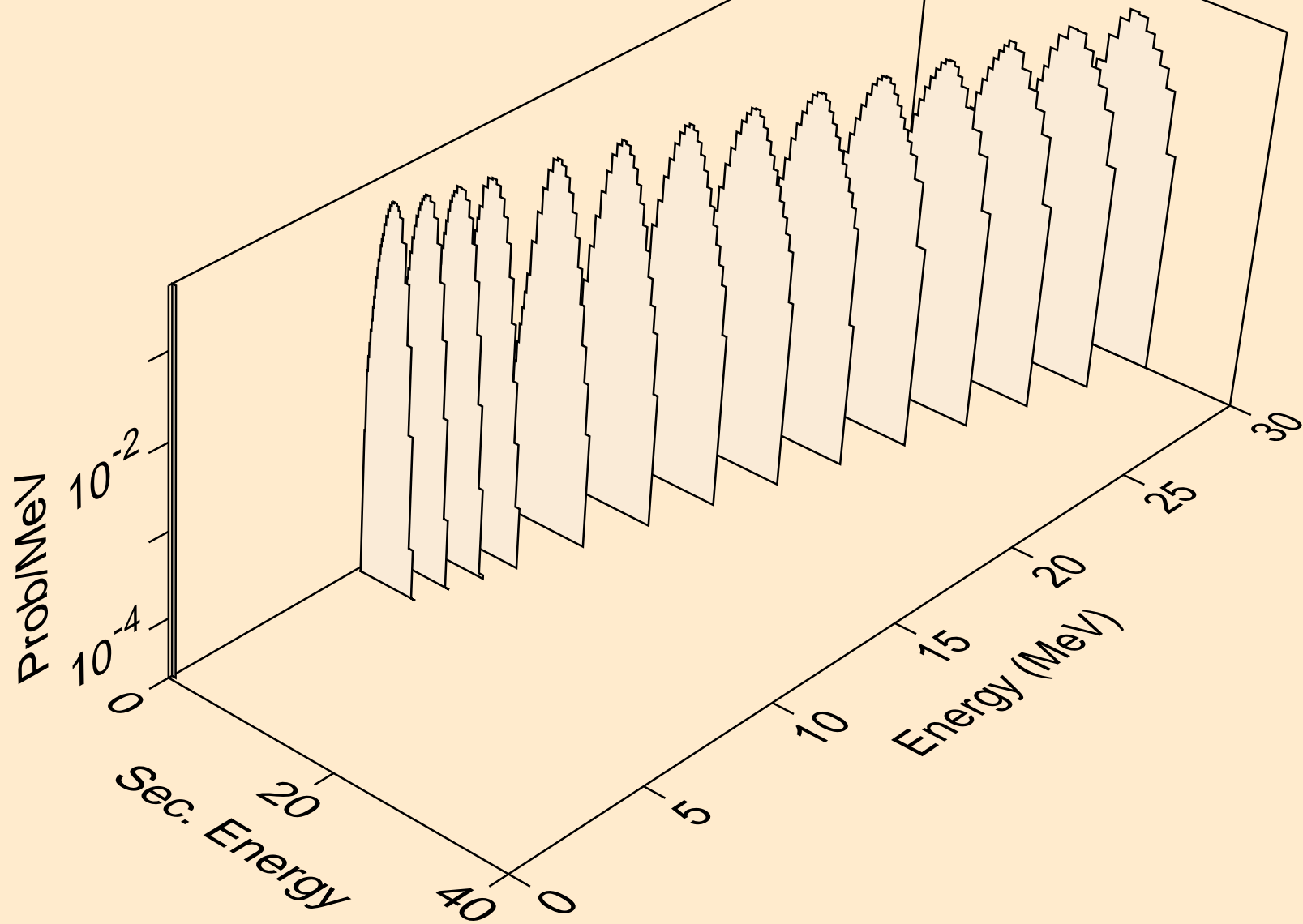

BI222 HELION ACER TENDL-2021 LIBRARY; T=0.K  
deuterons from (s,d)

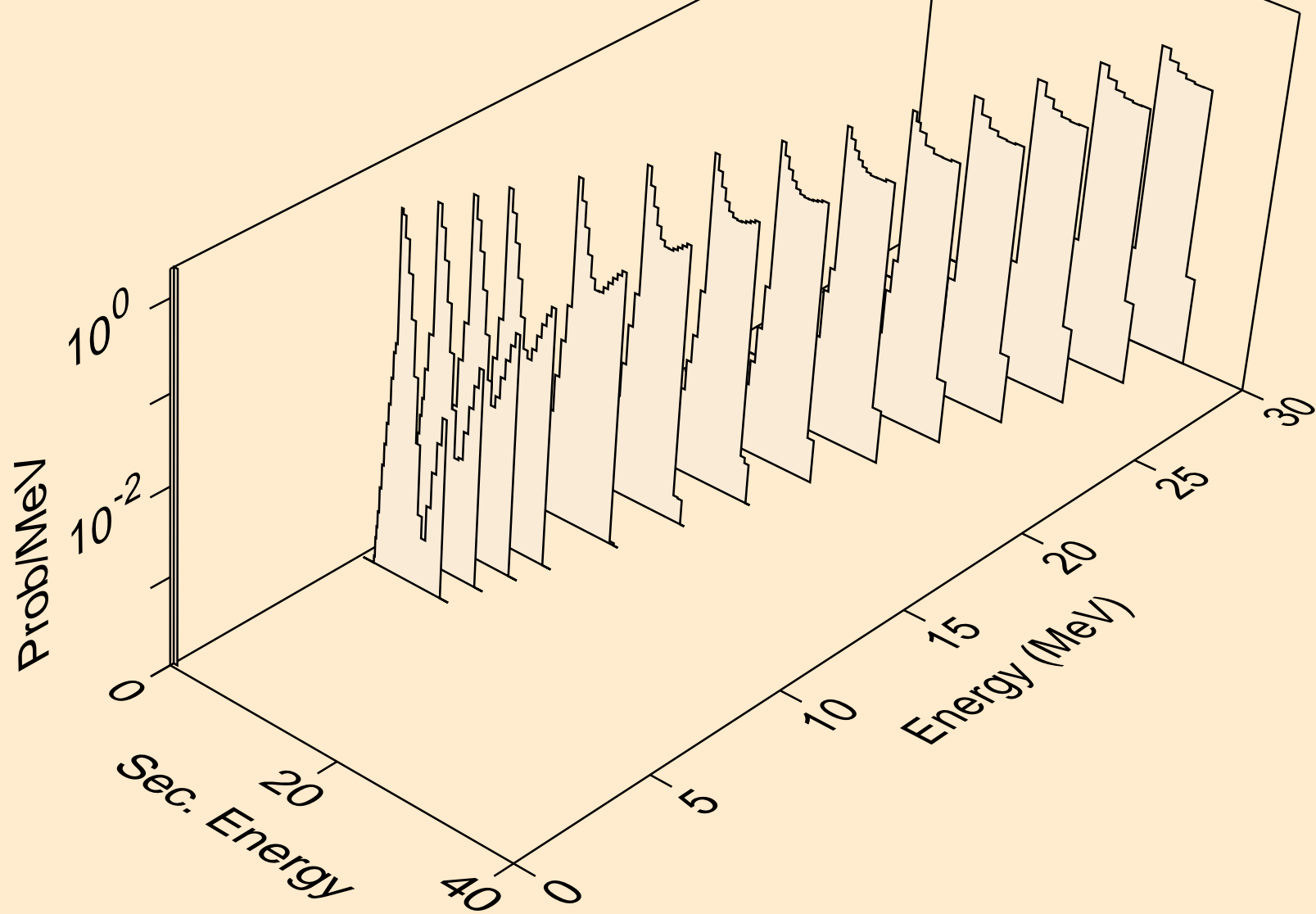

BI222 HELION ACER TENDL-2021 LIBRARY; T=0.K  
deuterons from (s,pd)

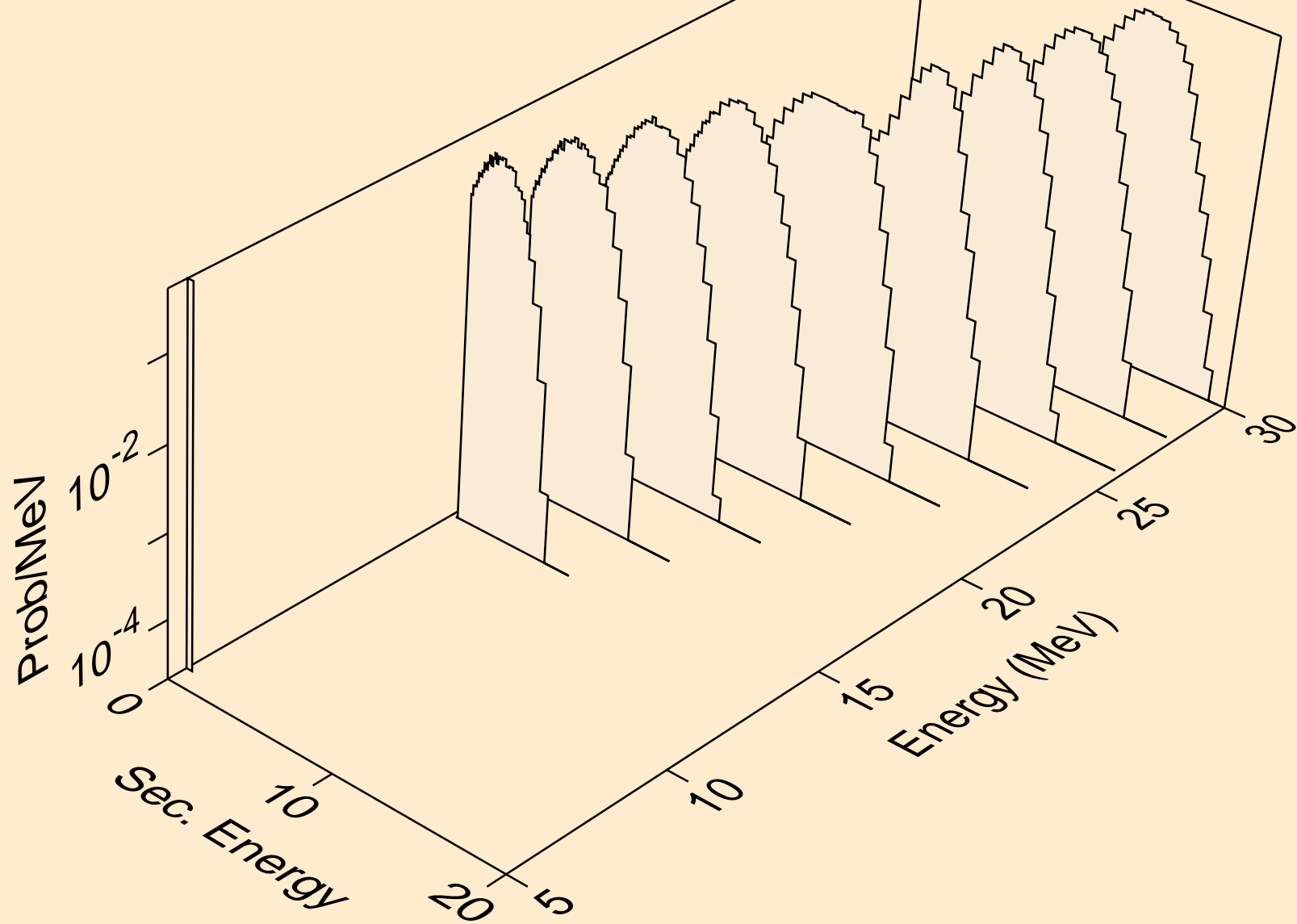

BI222 HELION ACER TENDL-2021 LIBRARY; T=0.K  
tritons from (s,x)

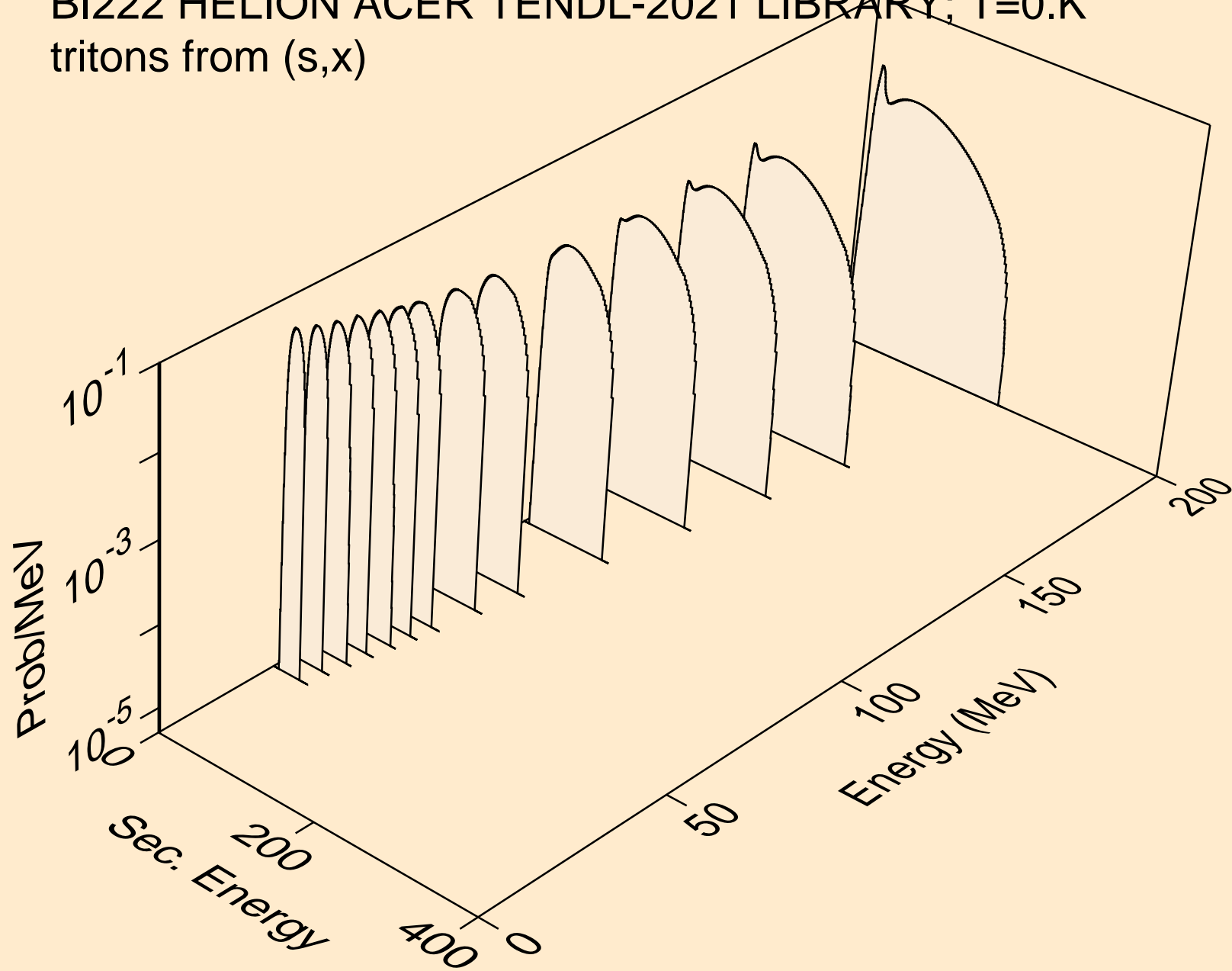

BI222 HELION ACER TENDL-2021 LIBRARY; T=0.K  
tritons from (s,n\*)t

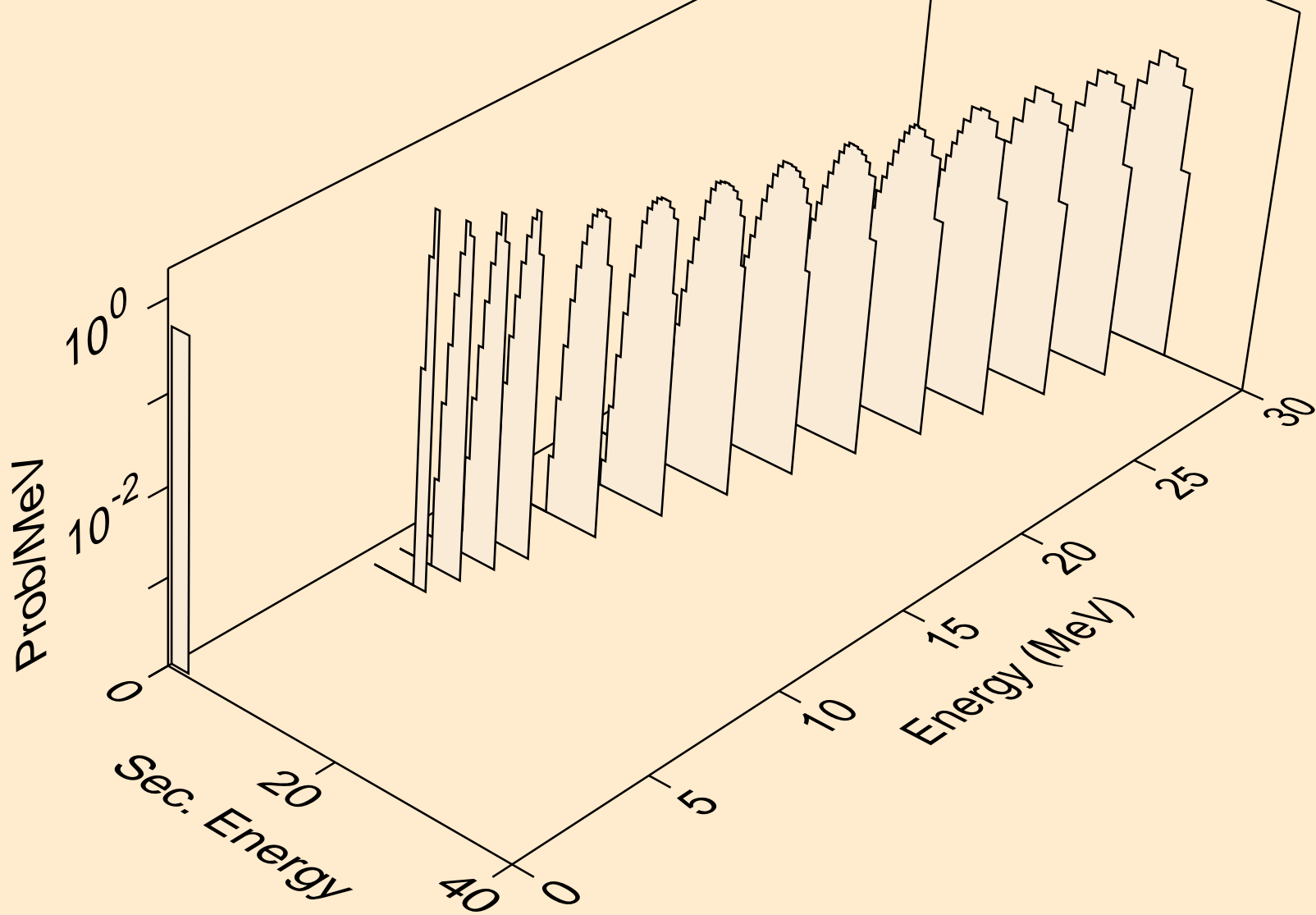

BI222 HELION ACER TENDL-2021 LIBRARY; T=0.K  
tritons from (s,t)

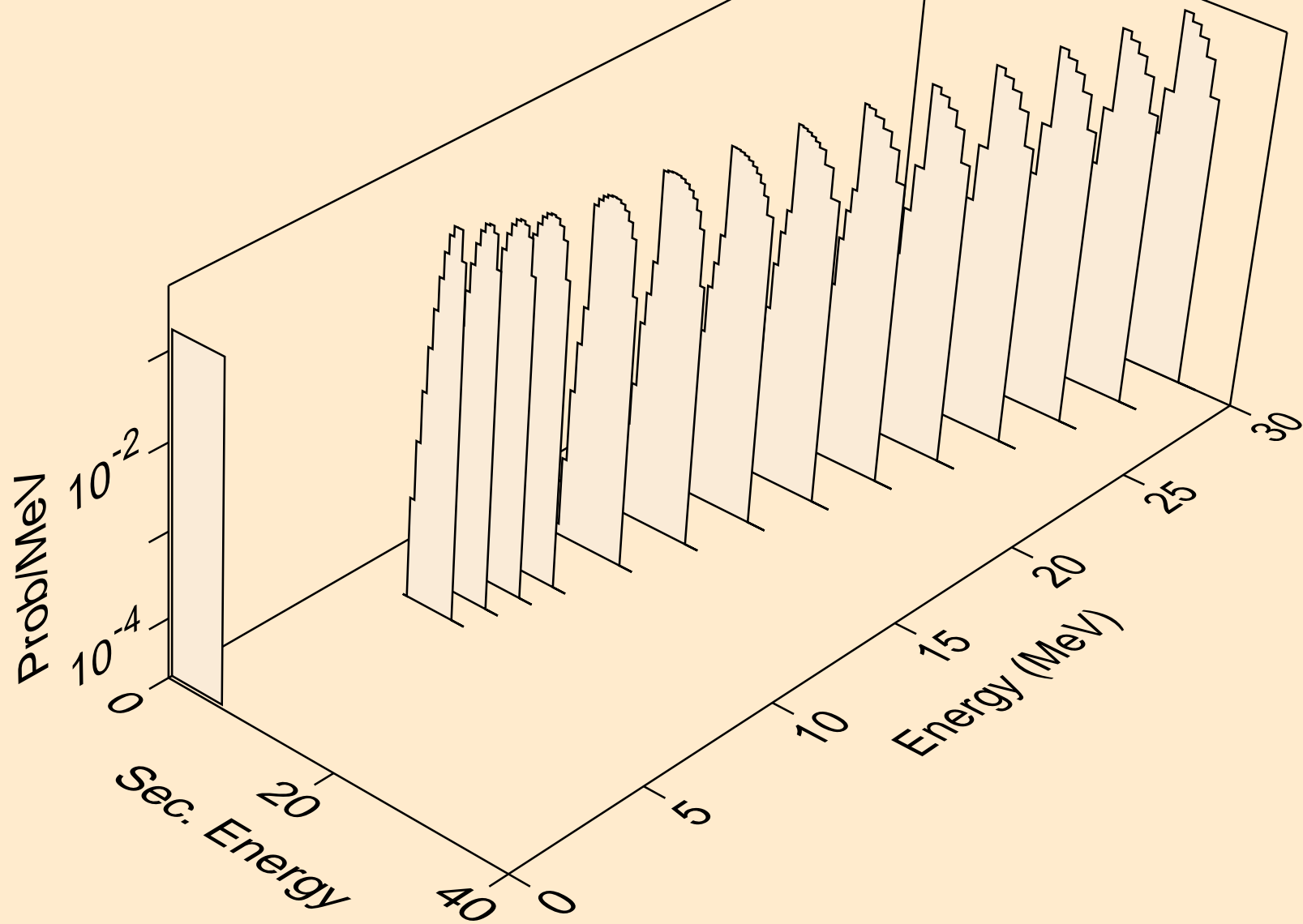

BI222 HELION ACER TENDL-2021 LIBRARY; T=0.K  
tritons from (s,pt)

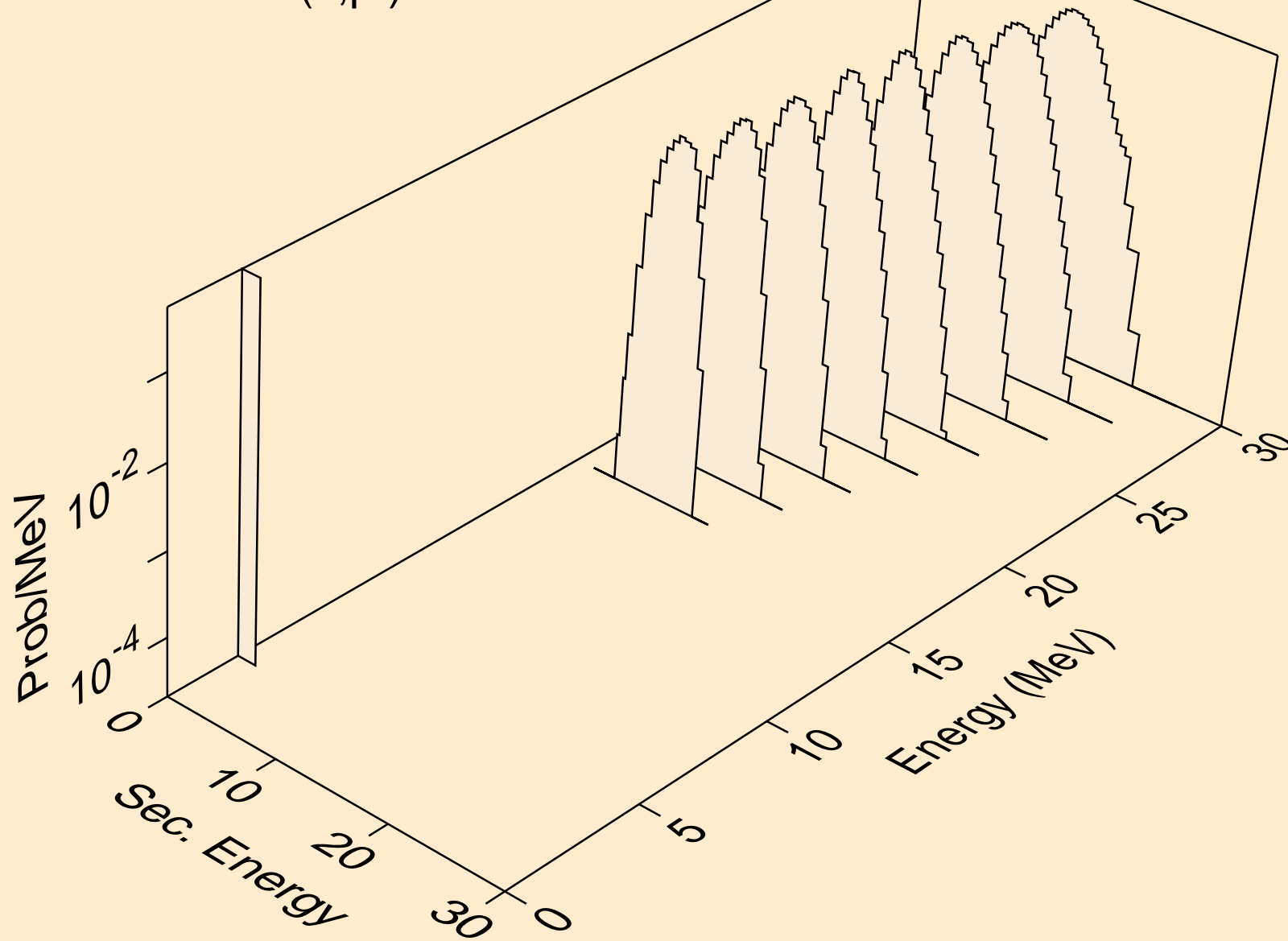



BI222 HELION ACER TENDL-2021 LIBRARY; T=0.K  
alphas from (s,x)

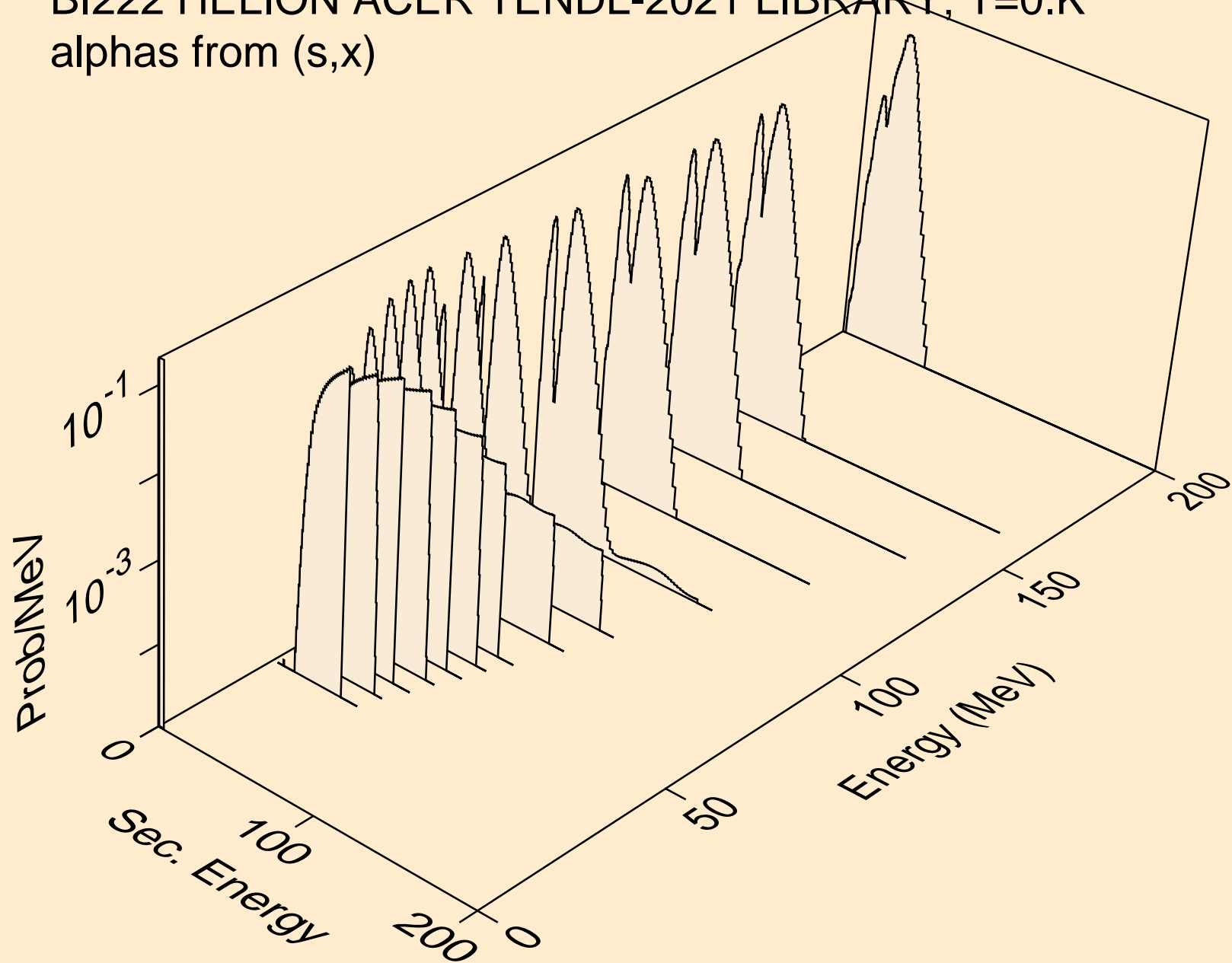

BI222 HELION ACER TENDL-2021 LIBRARY; T=0.K  
alphas from (s,n\*)a

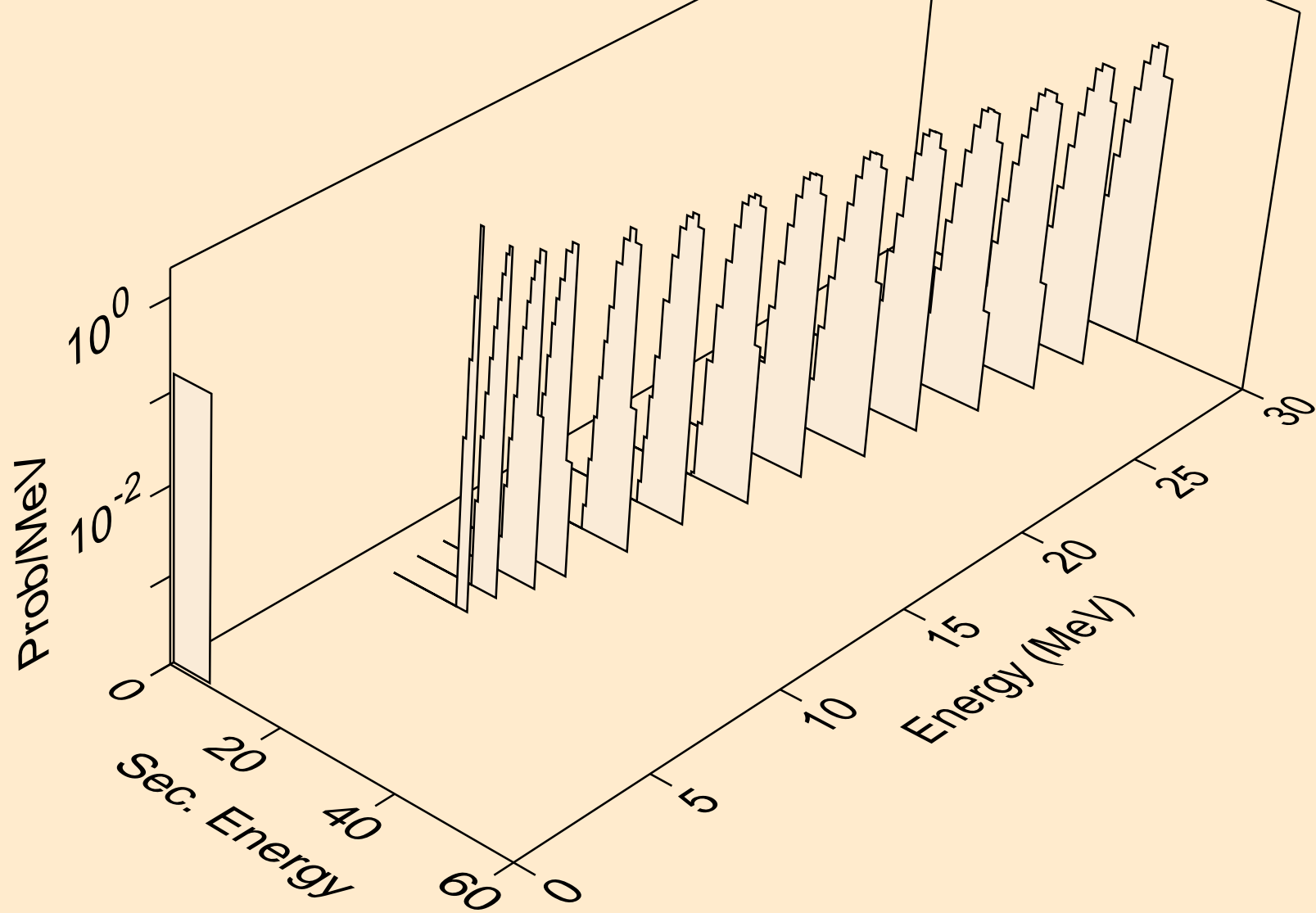

BI222 HELION ACER TENDL-2021 LIBRARY; T=0.K  
alphas from (s,2n)a

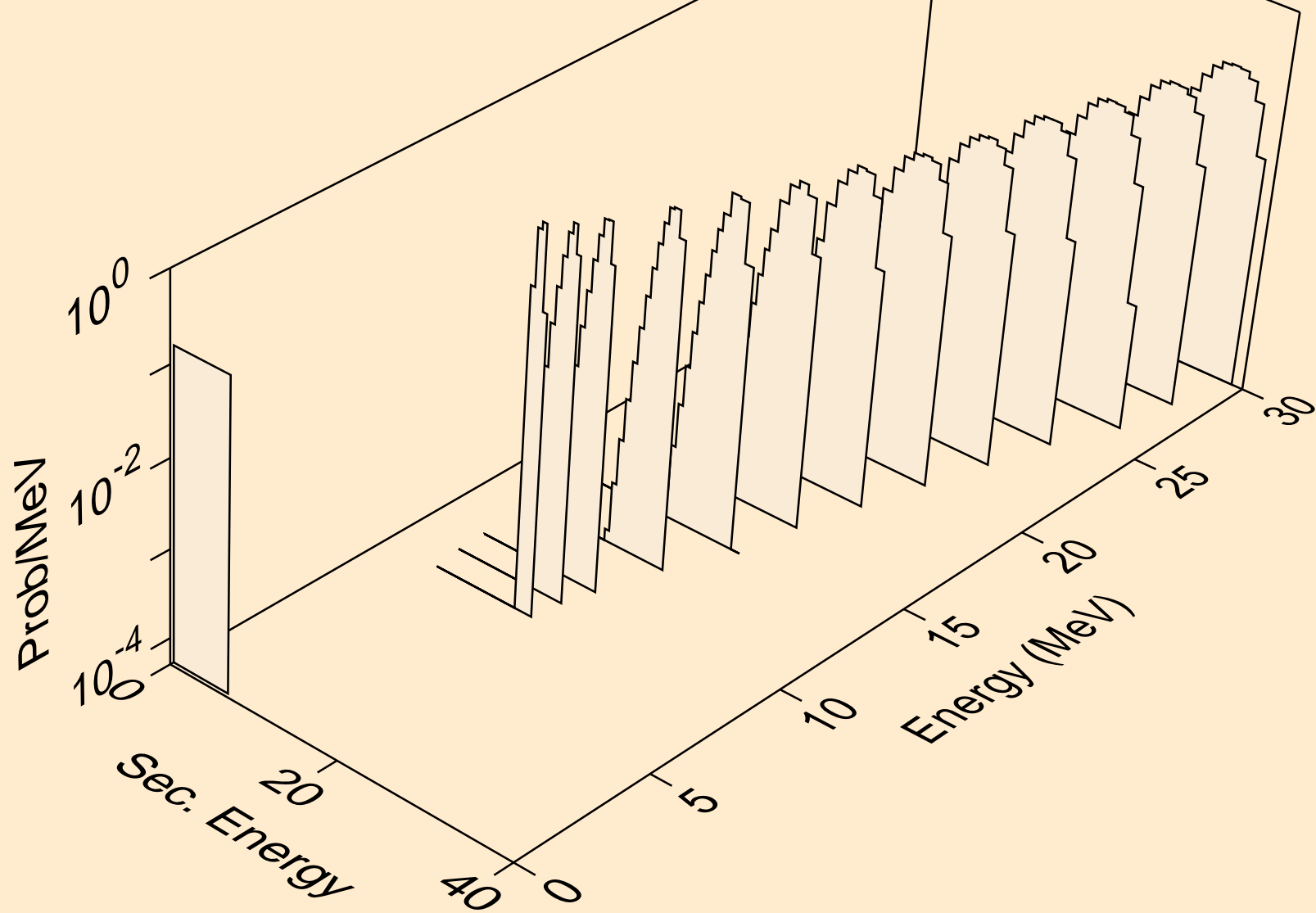

BI222 HELION ACER TENDL-2021 LIBRARY; T=0.K  
alphas from (s,3n)a

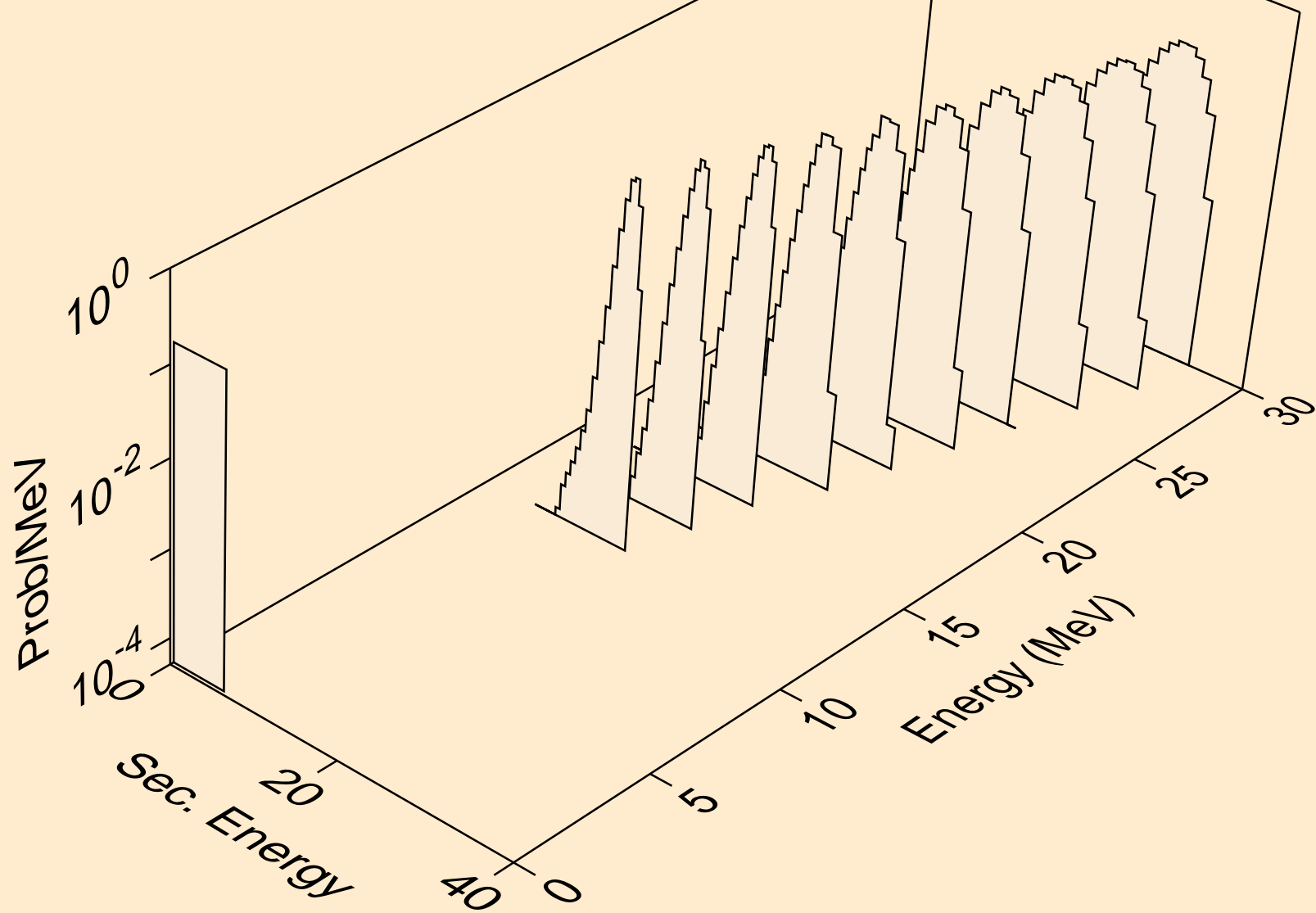

BI222 HELION ACER TENDL-2021 LIBRARY; T=0.K  
alphas from (s,npa)

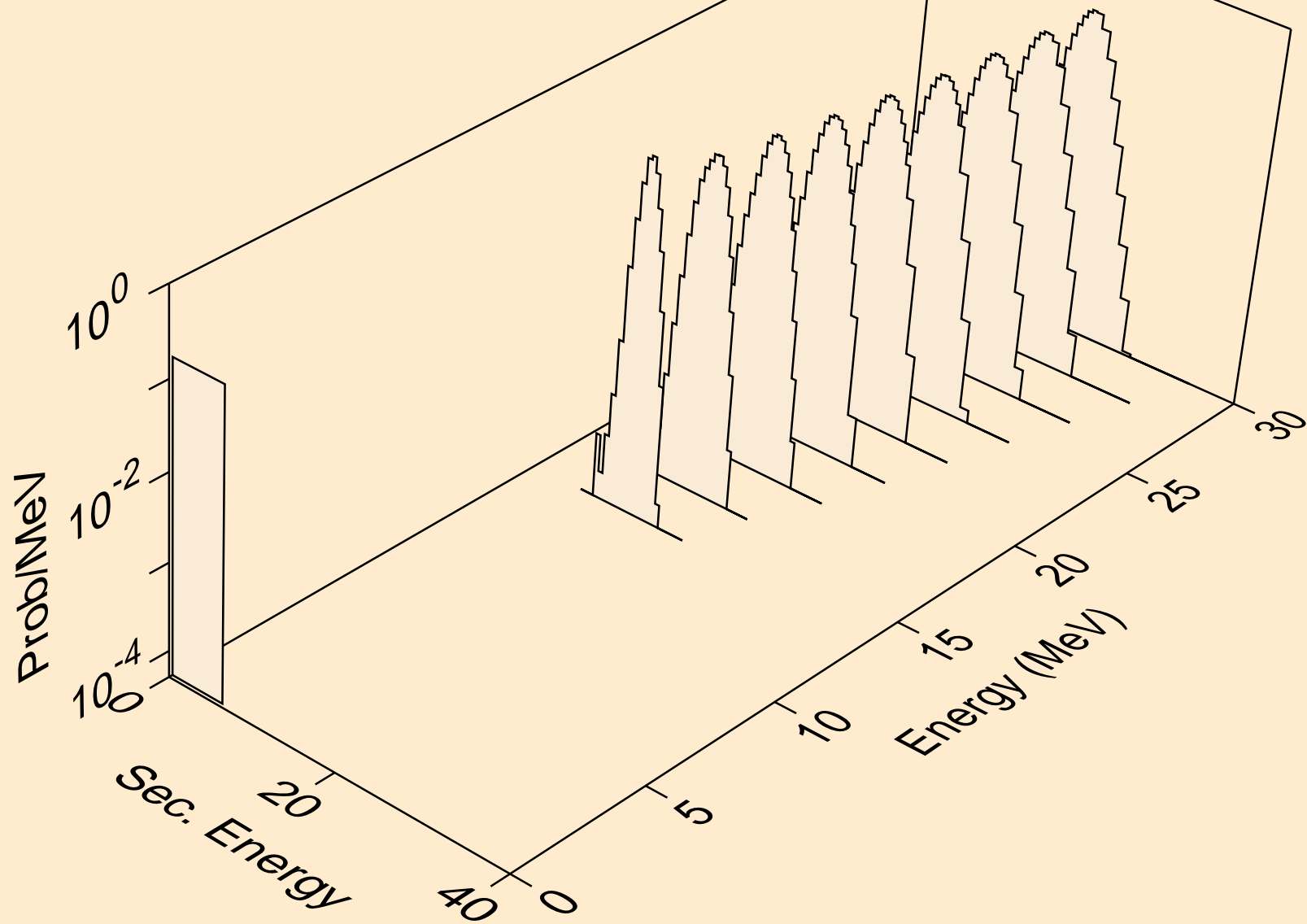

BI222 HELION ACER TENDL-2021 LIBRARY; T=0.K  
alphas from (s,a)

