

CD124 HELION ACER TENDL-2021 LIBRARY; T=0.K

Principal cross sections

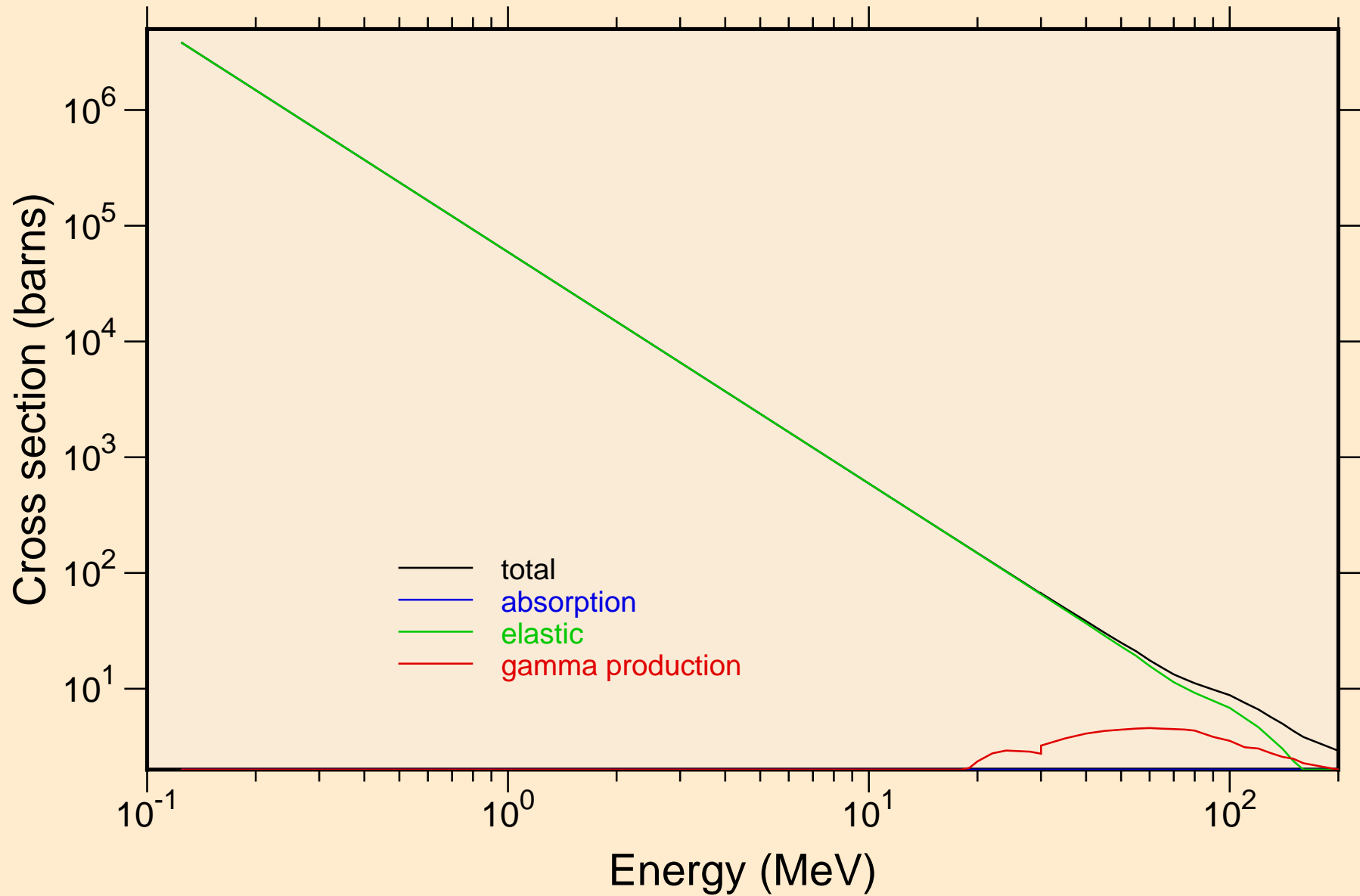

CD124 HELION ACER TENDL-2021 LIBRARY; T=0.K

Heating

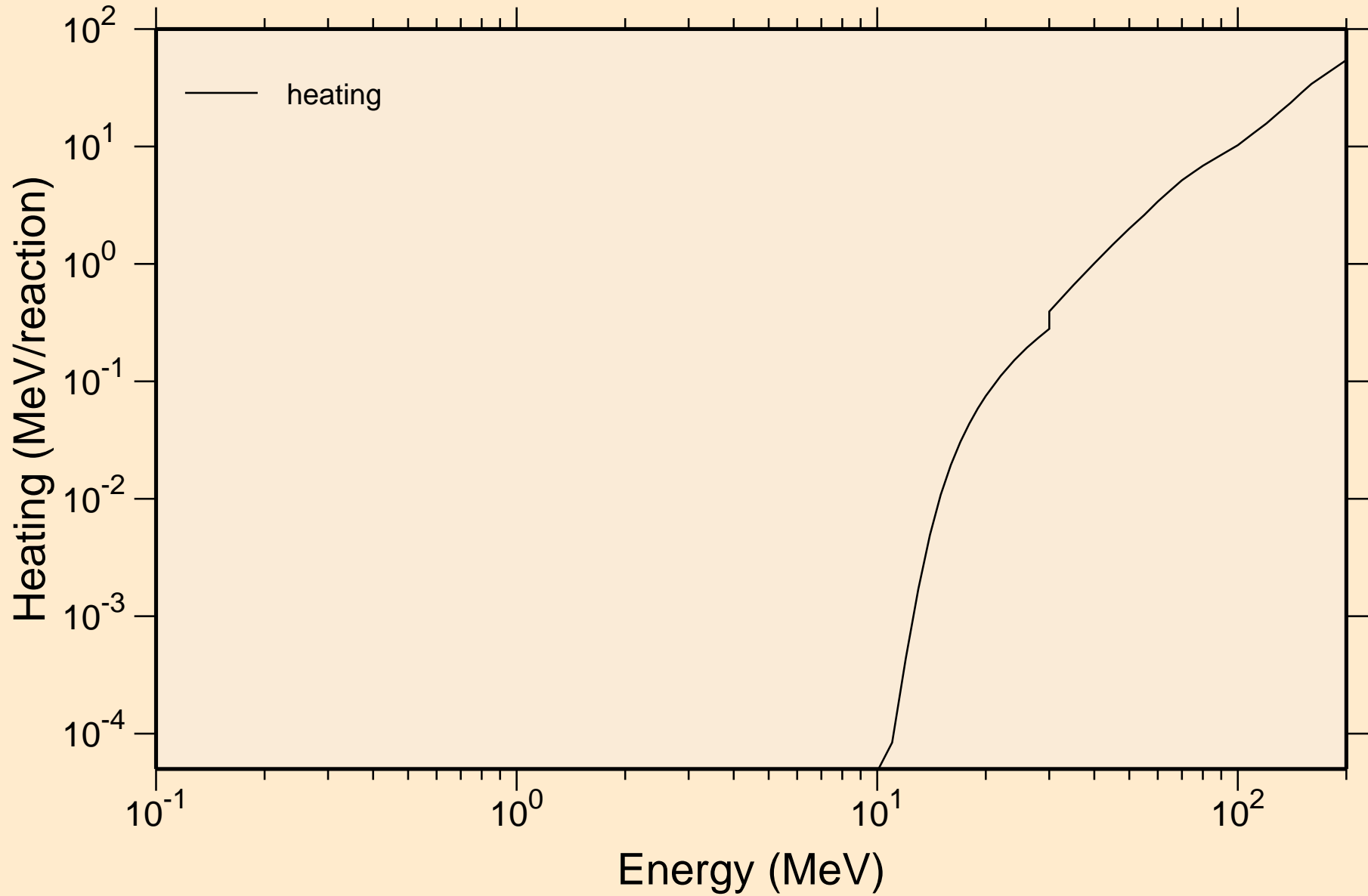

CD124 HELION ACER TENDL-2021 LIBRARY; T=0.K

Principal cross sections

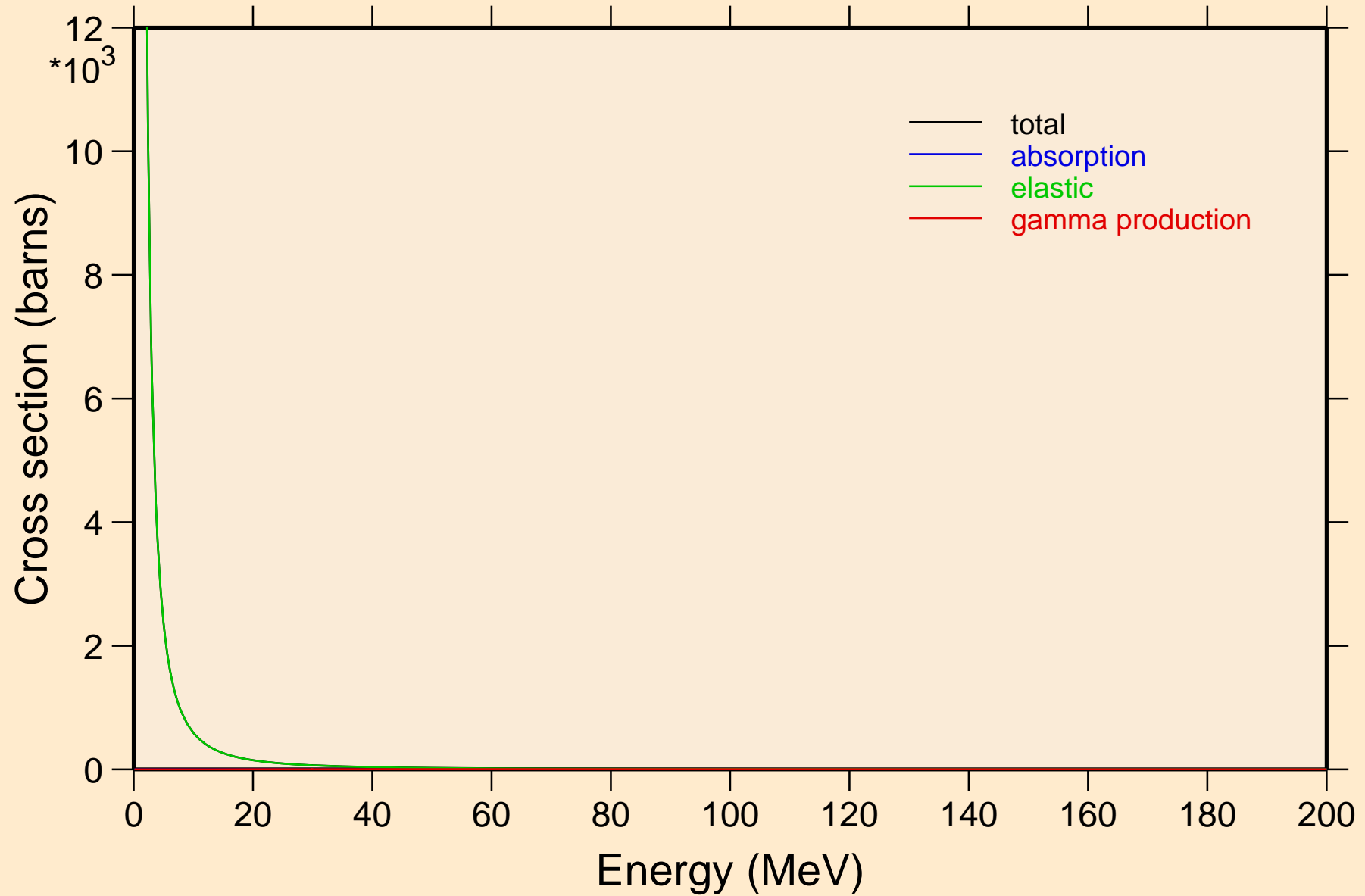

CD124 HELION ACER TENDL-2021 LIBRARY; T=0.K

Heating

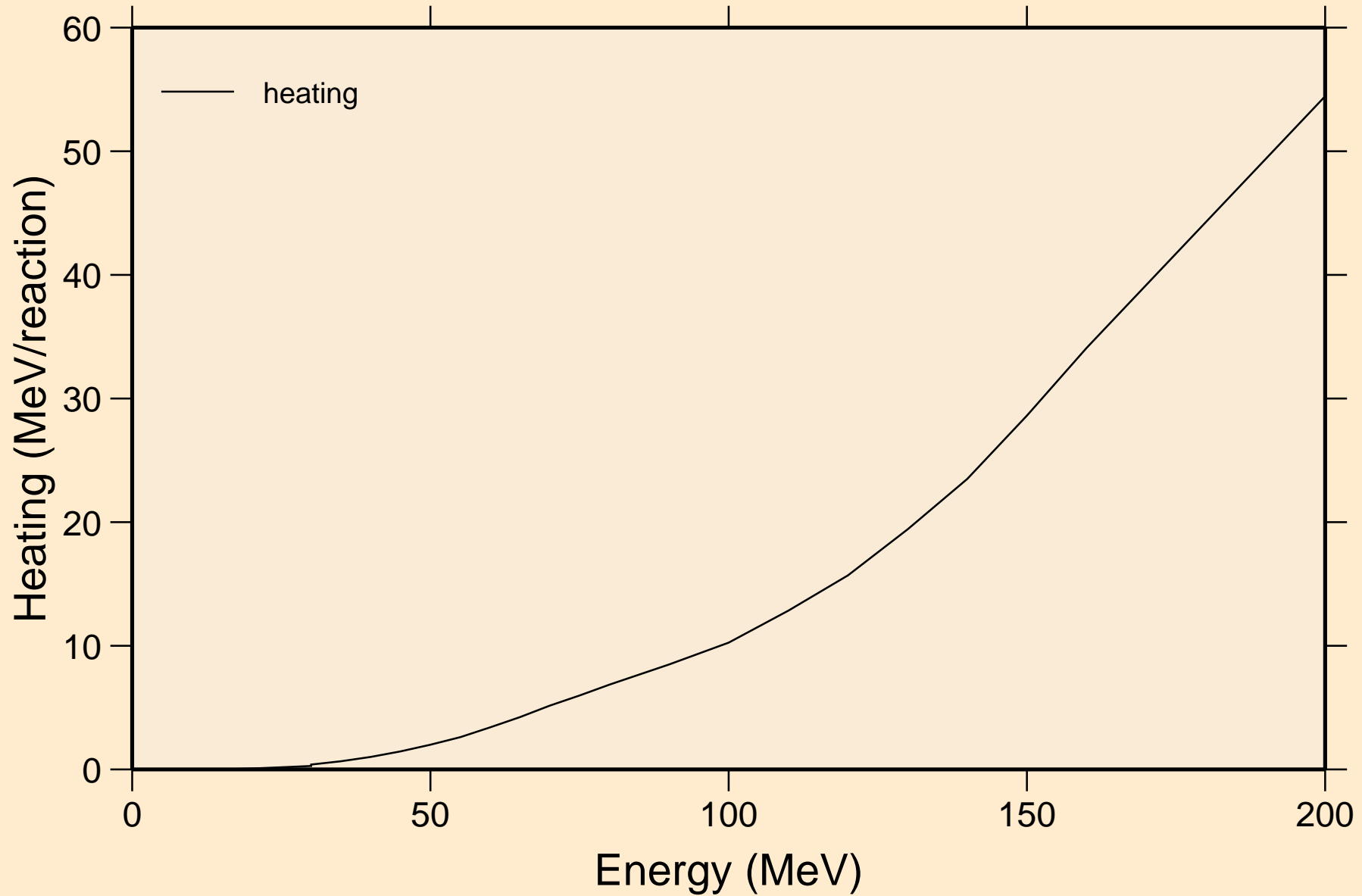

CD124 HELION ACER TENDL-2021 LIBRARY; T=0.K

Threshold reactions

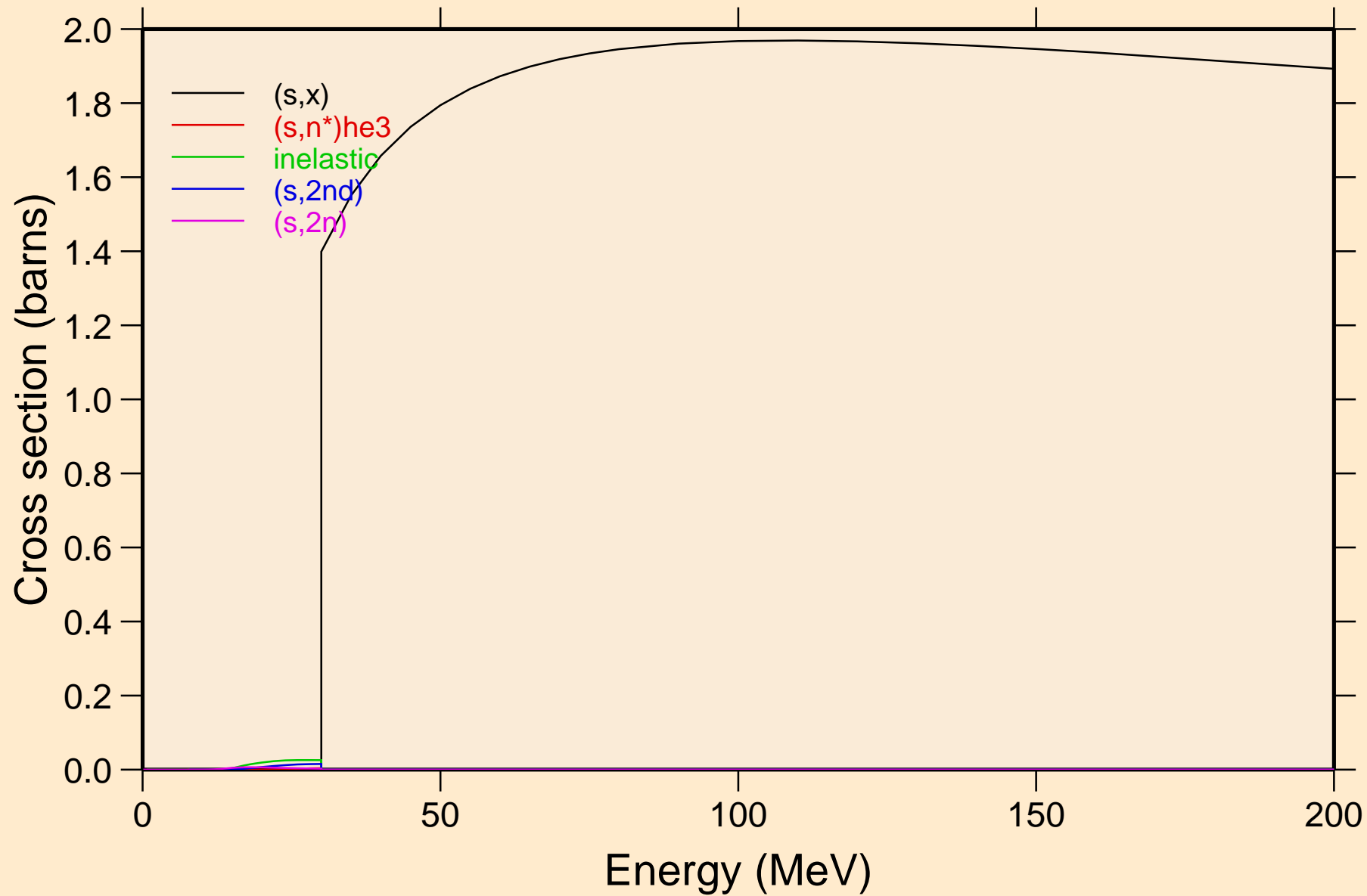

CD124 HELION ACER TENDL-2021 LIBRARY; T=0.K
Threshold reactions

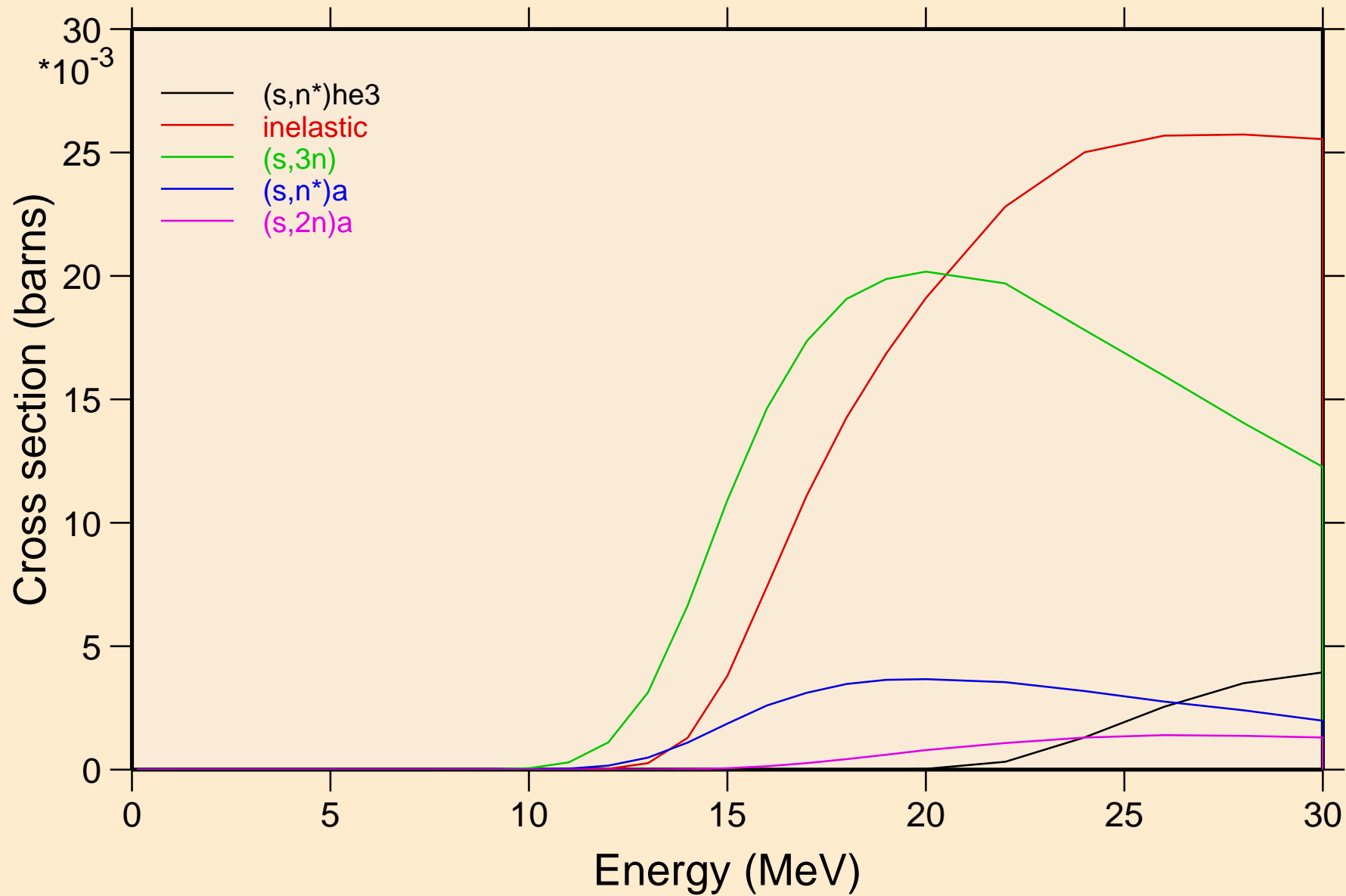

CD124 HELION ACER TENDL-2021 LIBRARY; T=0.K

Threshold reactions

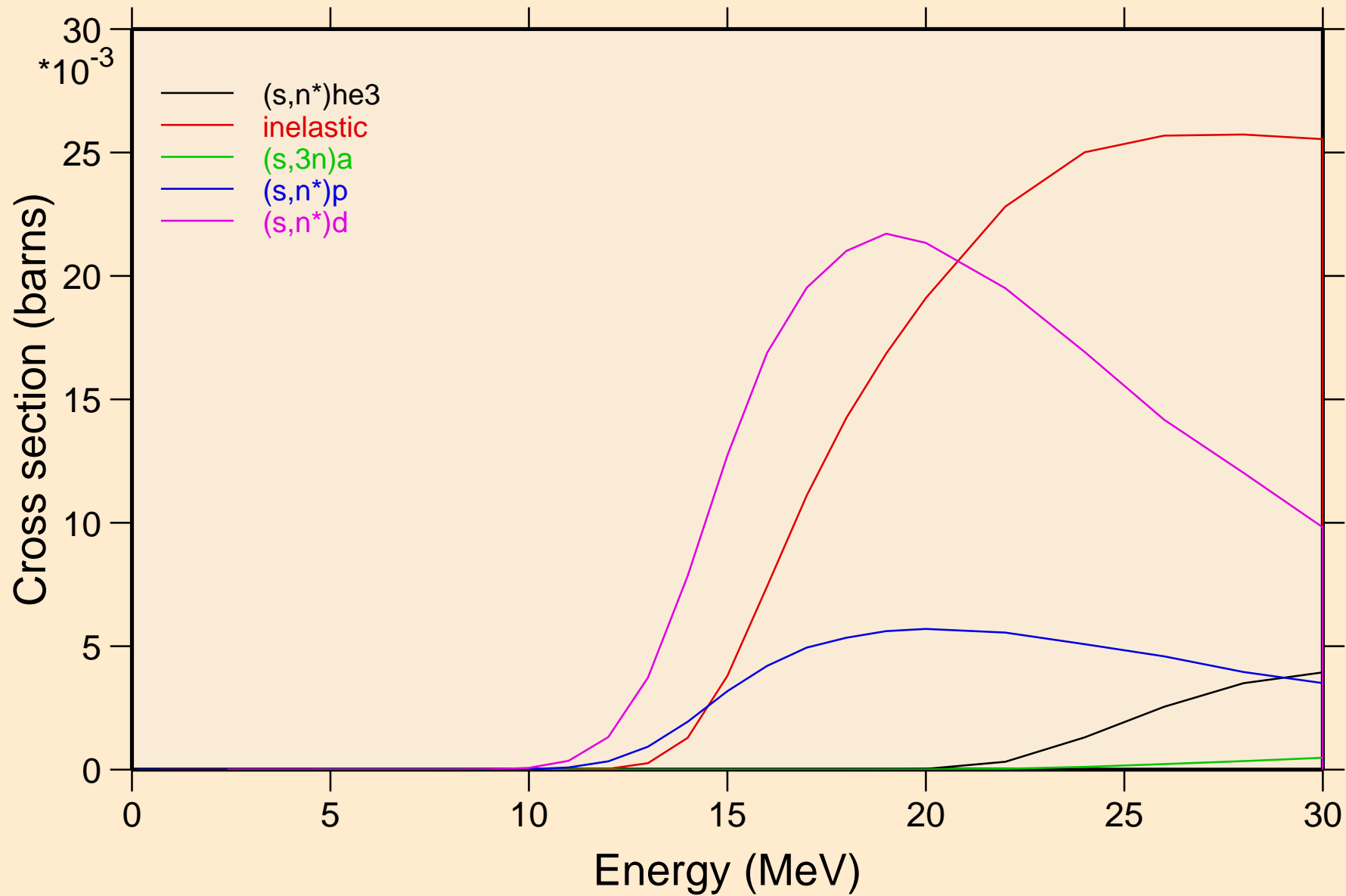

CD124 HELION ACER TENDL-2021 LIBRARY; T=0.K
Threshold reactions

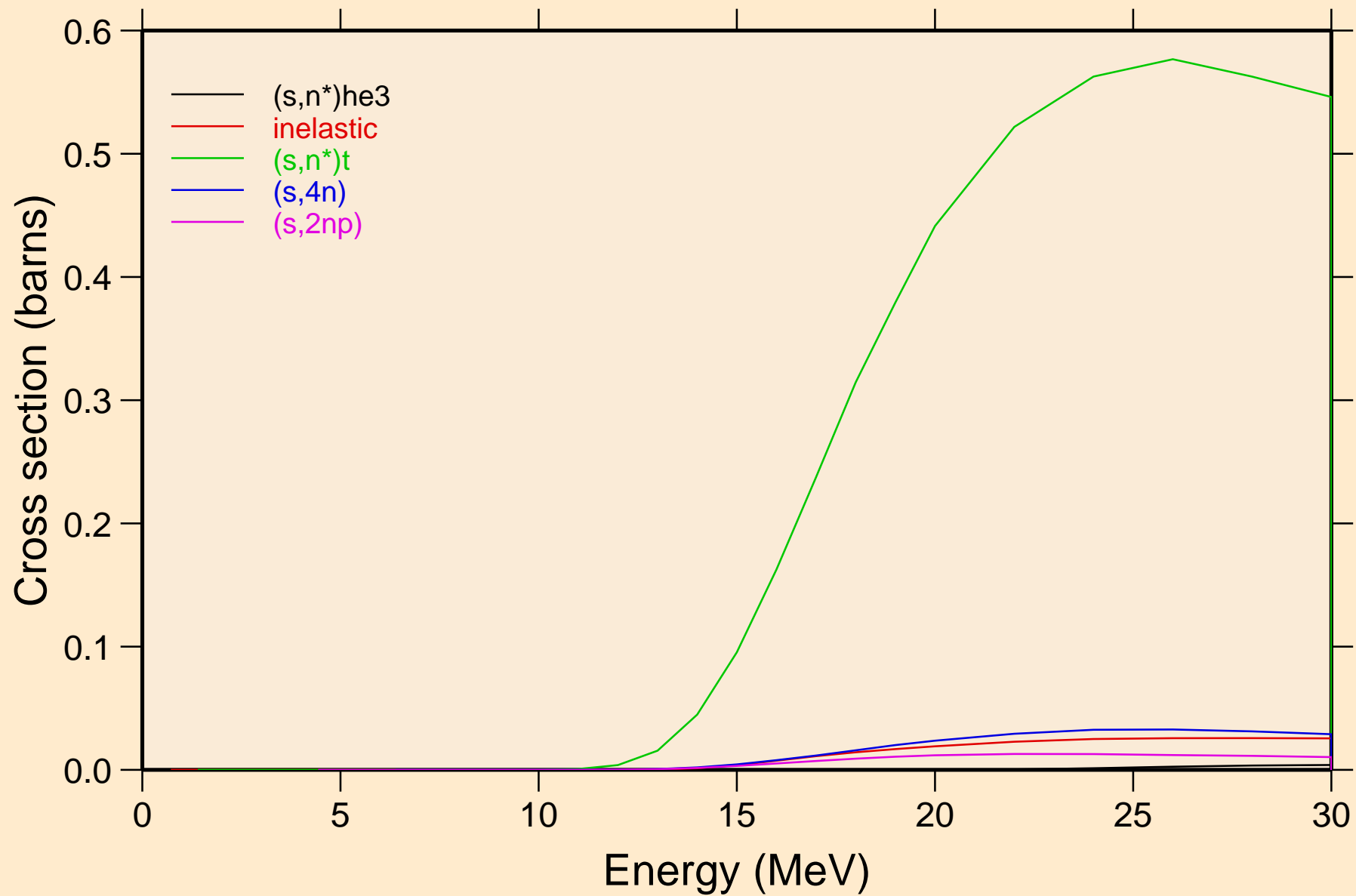

CD124 HELION ACER TENDL-2021 LIBRARY; T=0.K

Threshold reactions

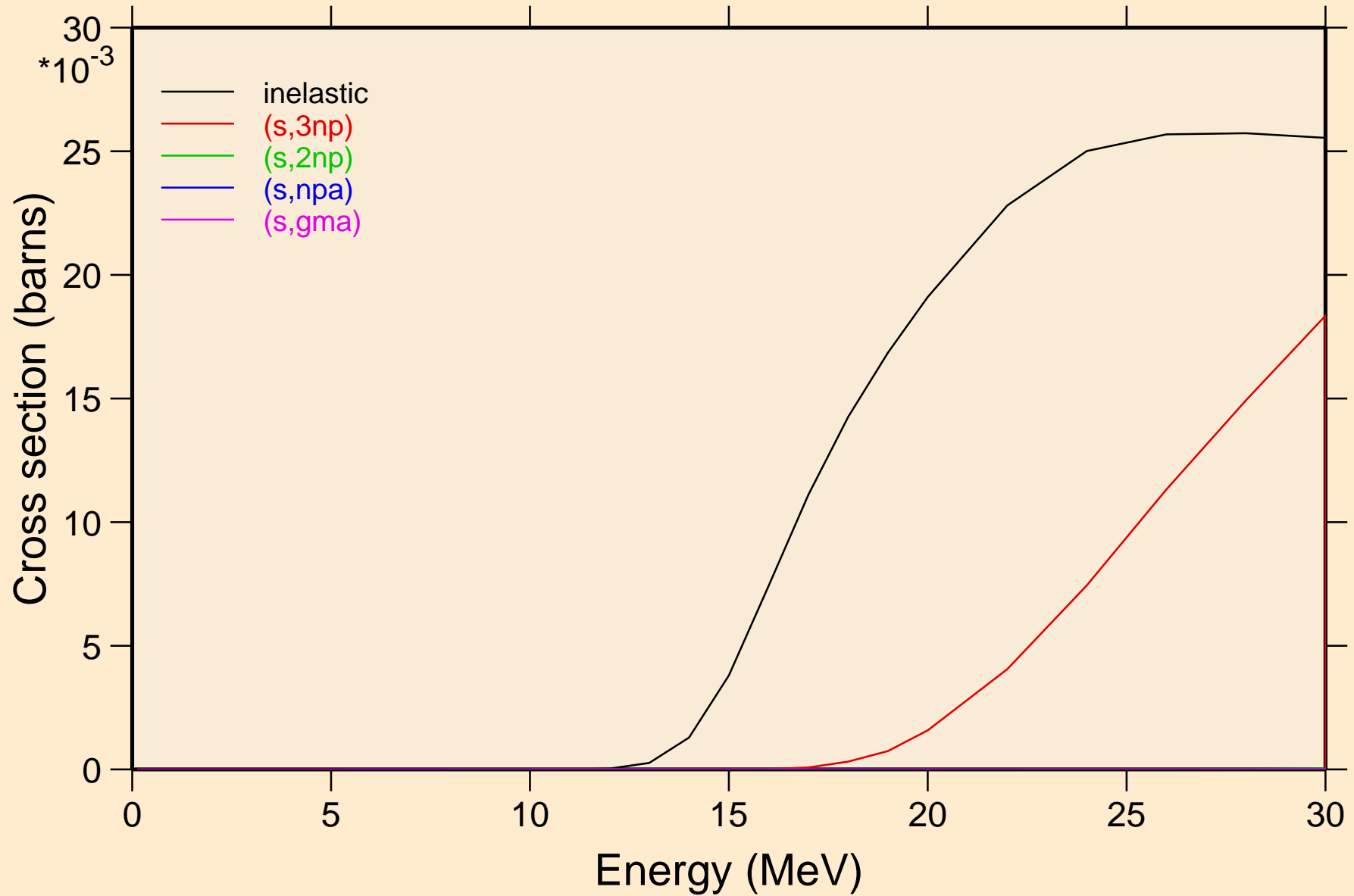

CD124 HELION ACER TENDL-2021 LIBRARY; T=0.K

Threshold reactions

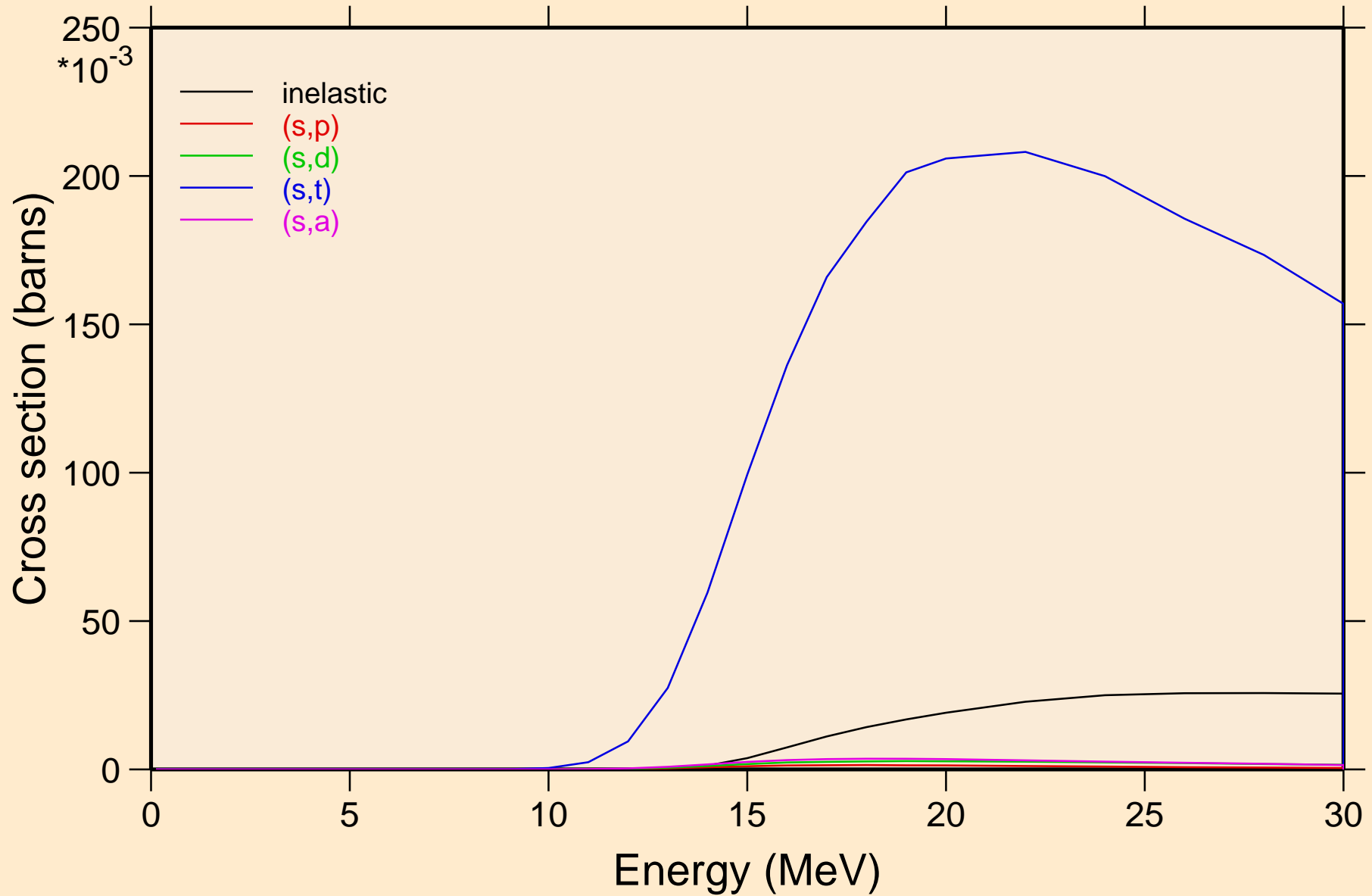

CD124 HELION ACER TENDL-2021 LIBRARY; T=0.K
Threshold reactions

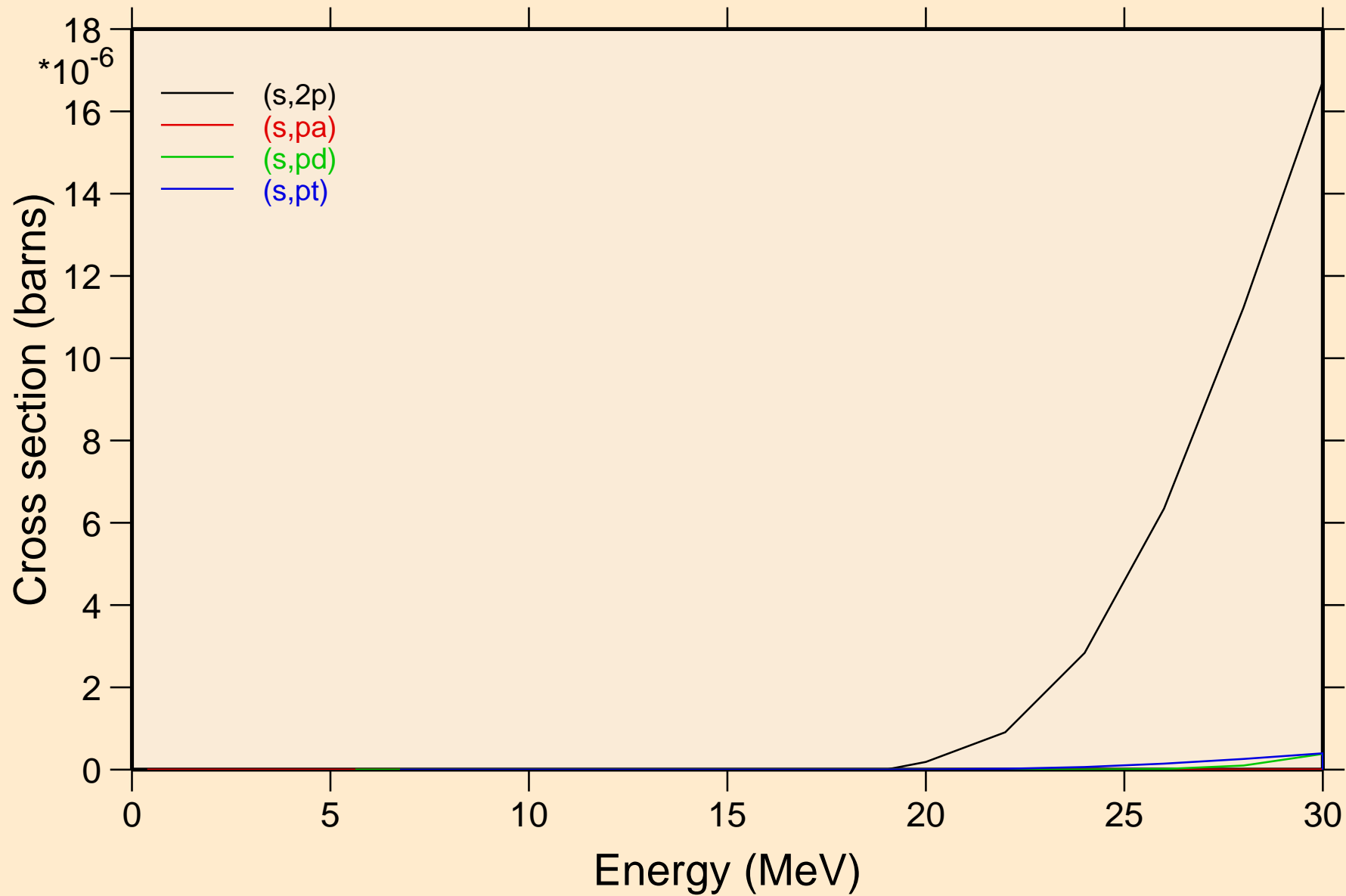

CD124 HELION ACER TENDL-2021 LIBRARY; T=0.K
angular distribution for elastic

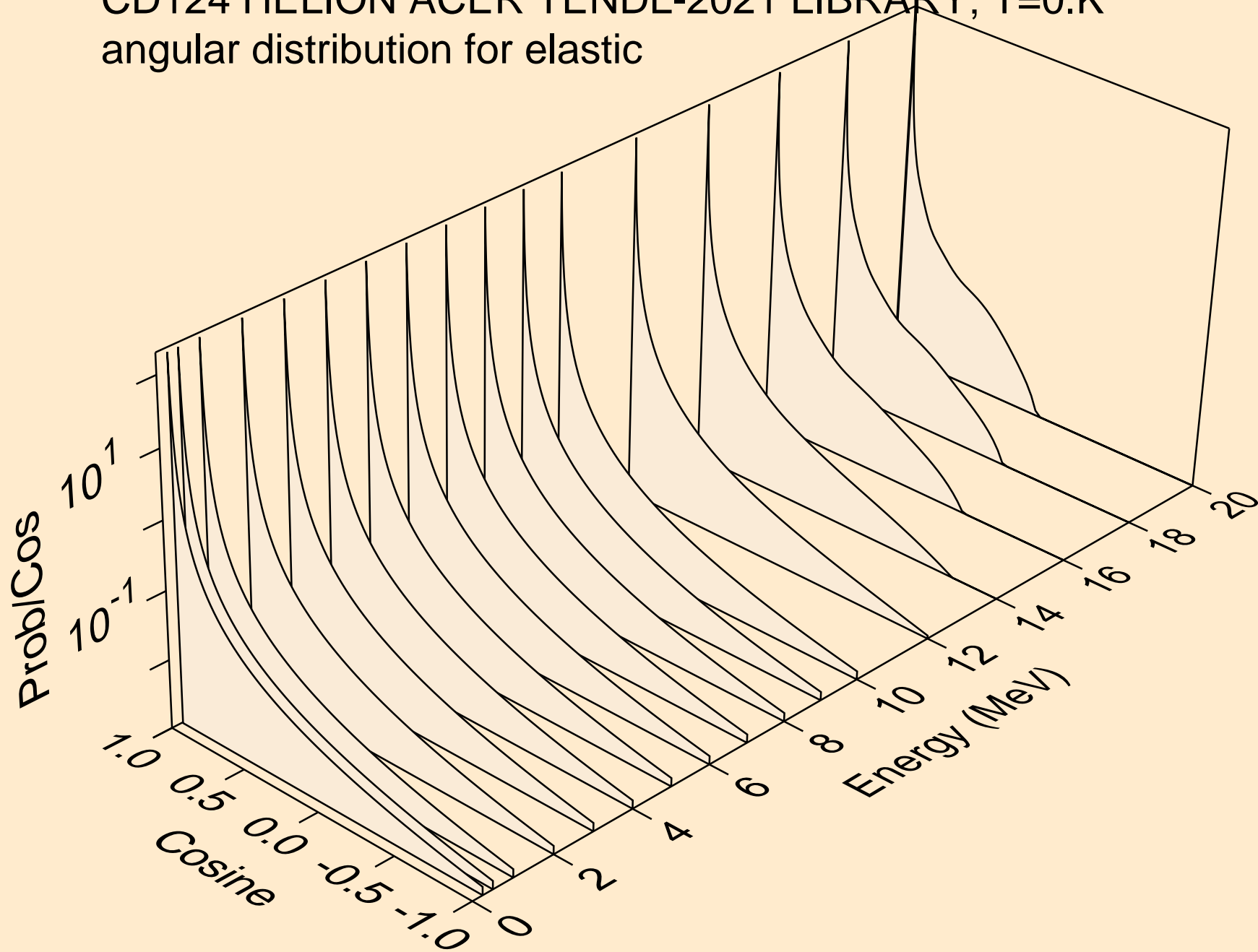

CD124 HELION ACER TENDL-2021 LIBRARY; T=0.K
angular distribution for elastic

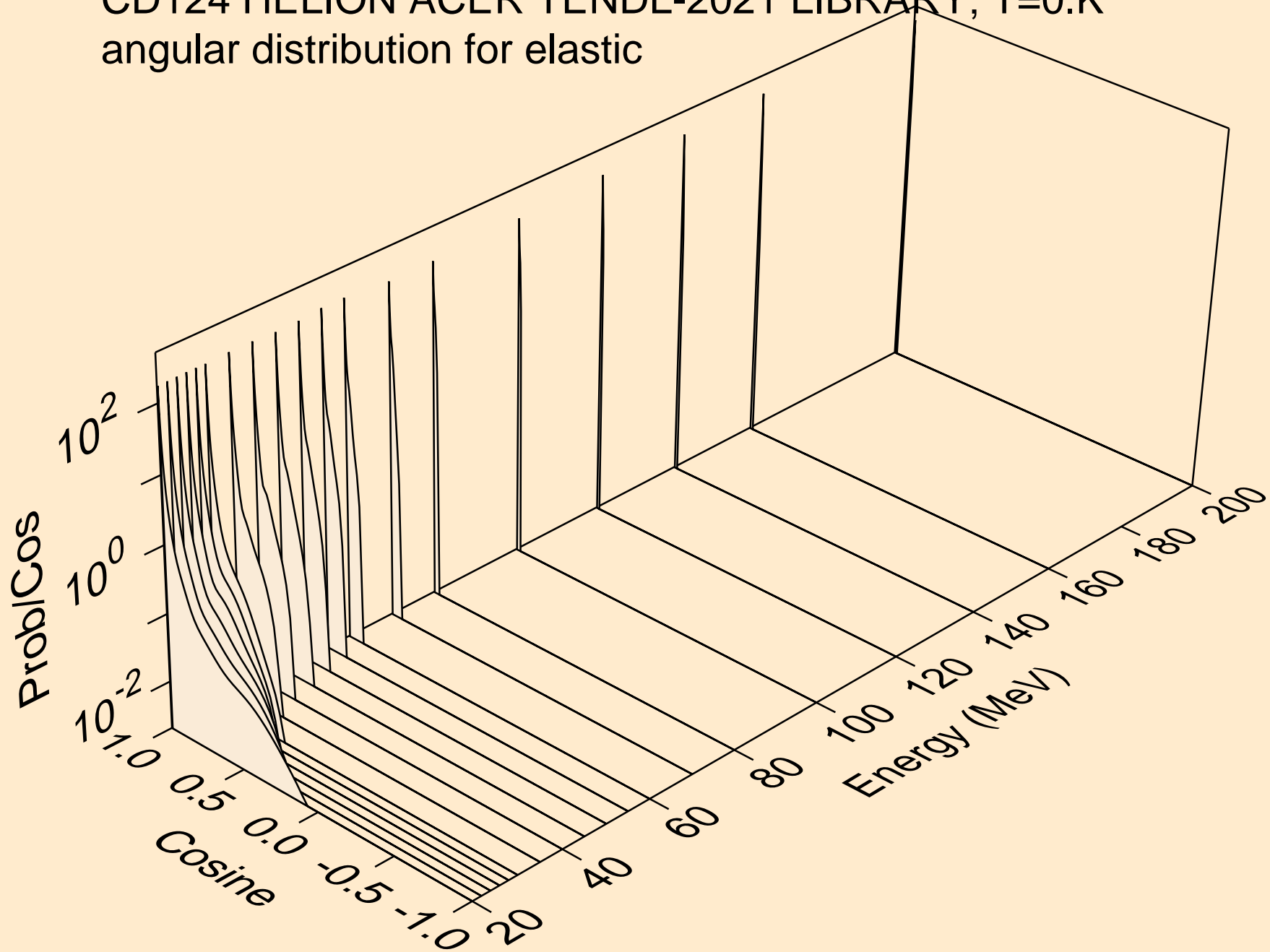

CD124 HELION ACER TENDL-2021 LIBRARY; T=0.K
He-3 emission for (s,x)

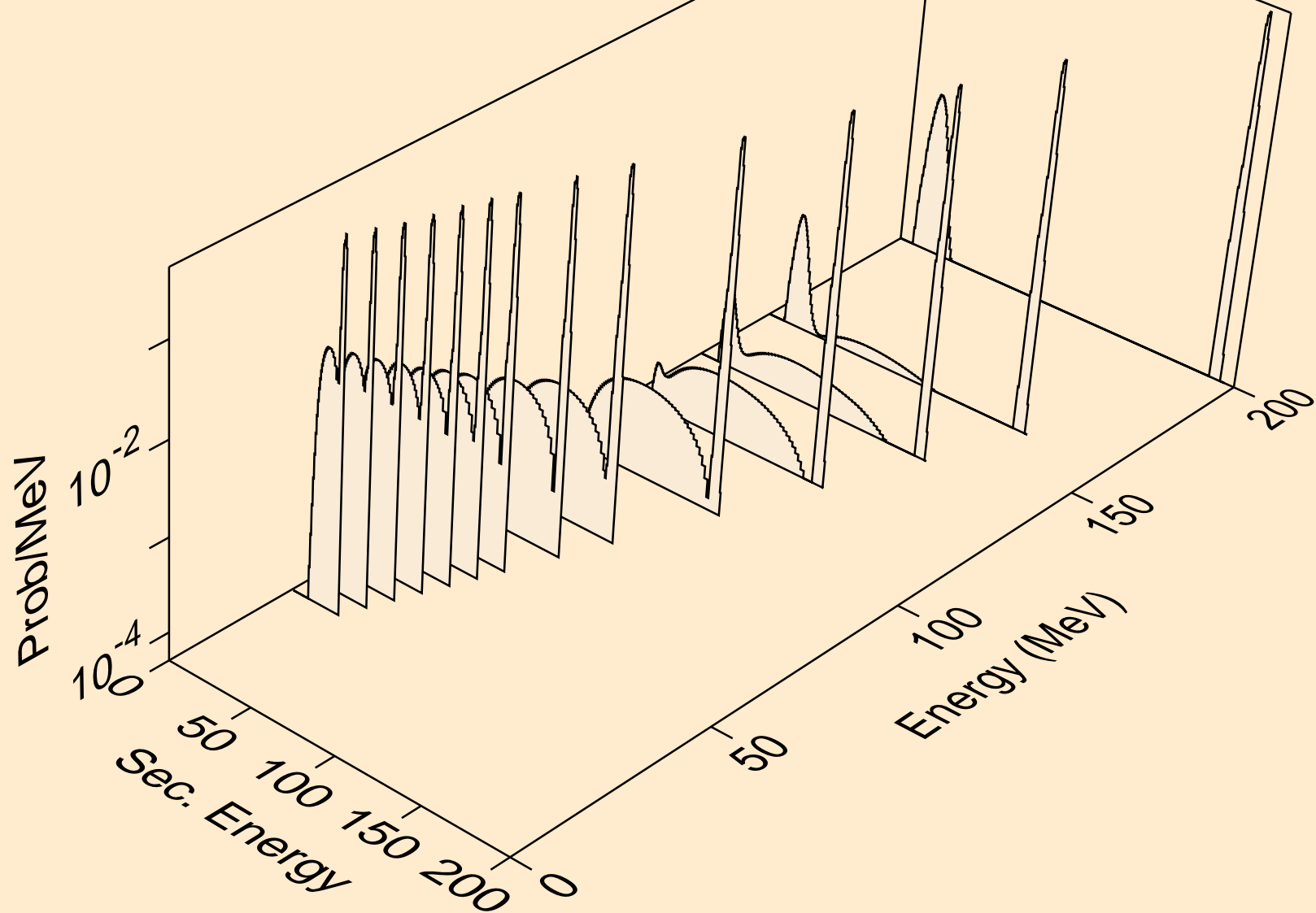

CD124 HELION ACER TENDL-2021 LIBRARY; T=0.K
He-3 emission for (s,n*)he3

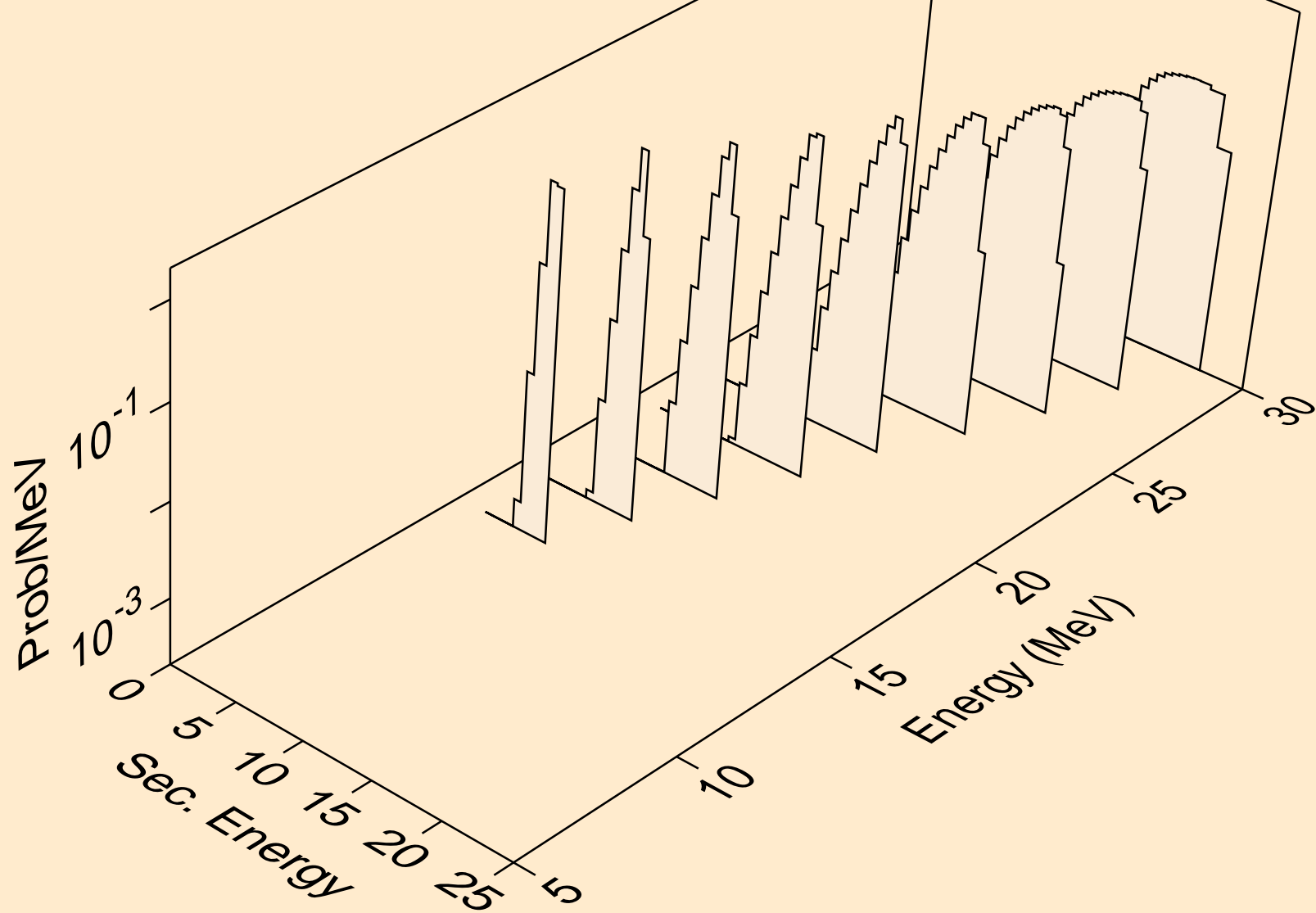

CD124 HELION ACER TENDL-2021 LIBRARY; T=0.K
He-3 emission for inelastic

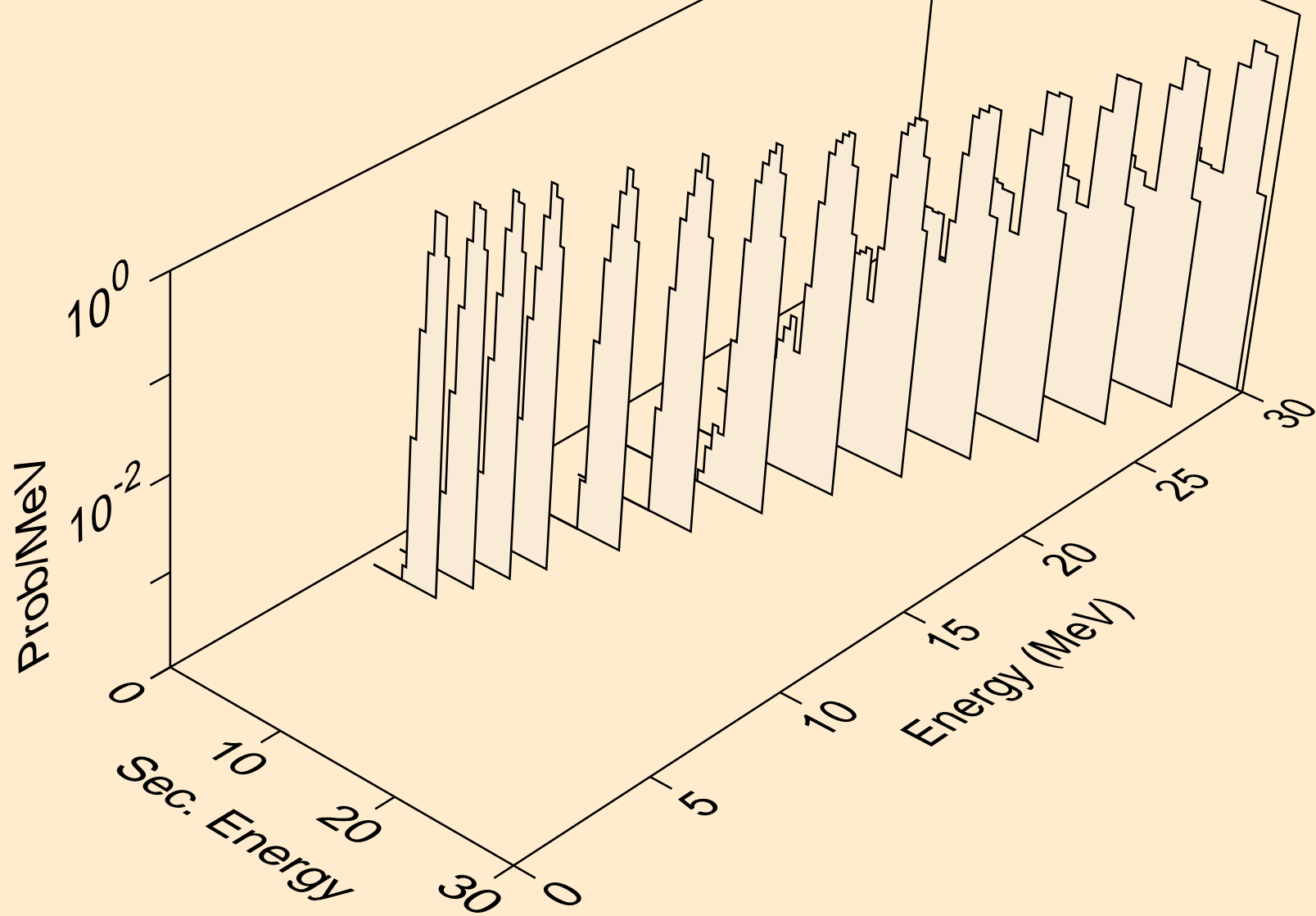

CD124 HELION ACER TENDL-2021 LIBRARY; T=0.K
Photon emission for (z,n)

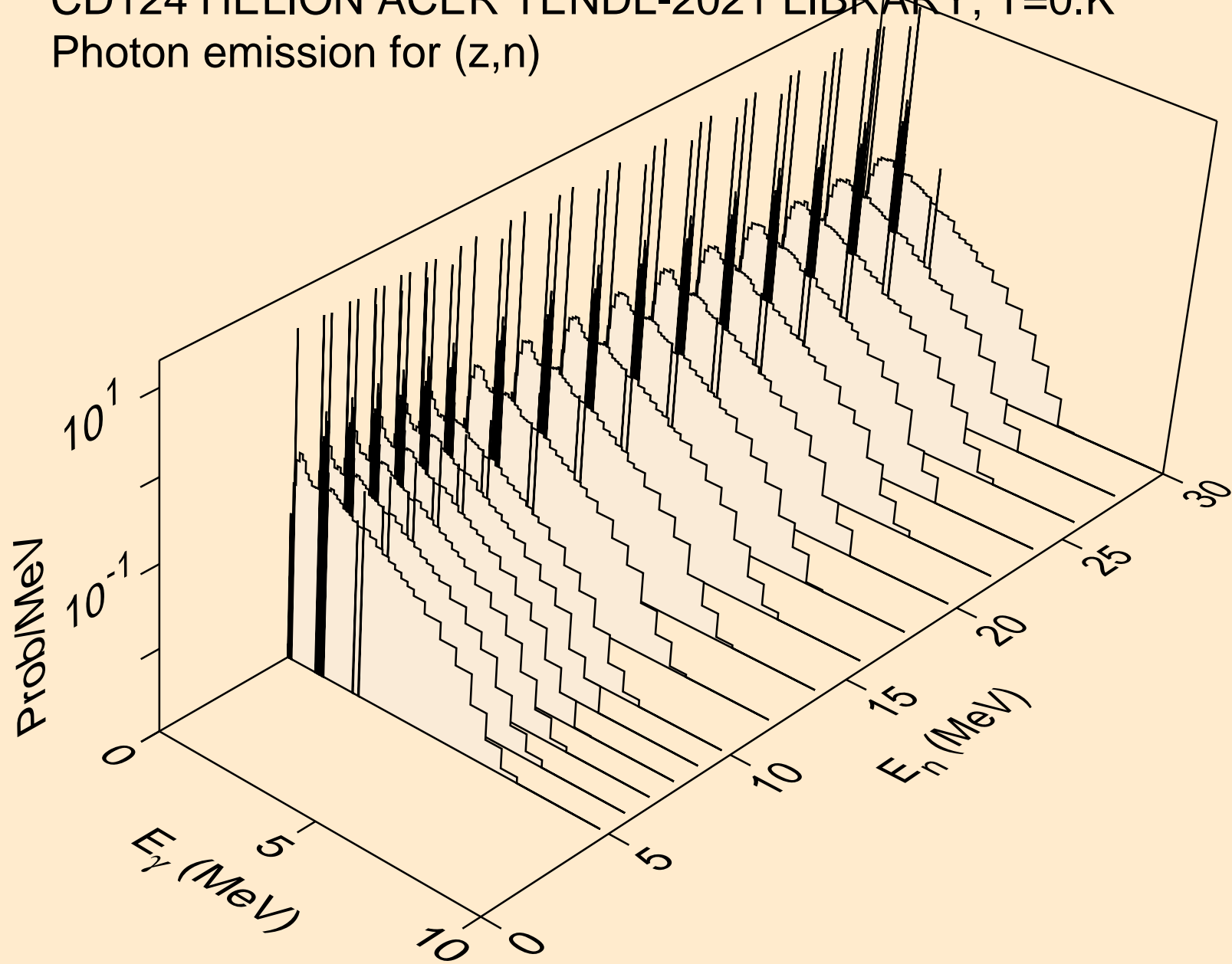

CD124 HELION ACER TENDL-2021 LIBRARY; T=0.K
Photon emission for (n,x)

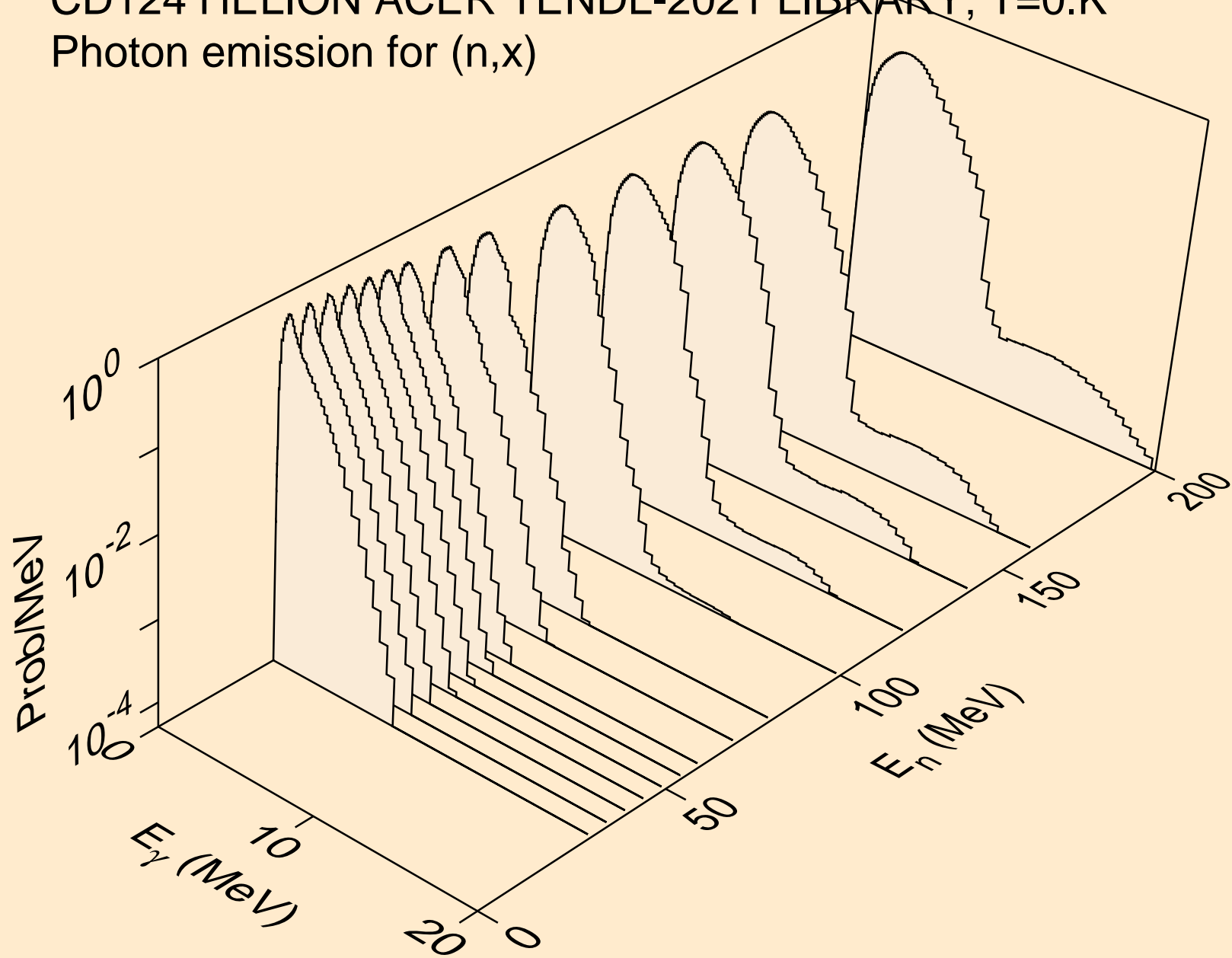

CD124 HELION ACER TENDL-2021 LIBRARY; T=0.K
Photon emission for (n,2nd)

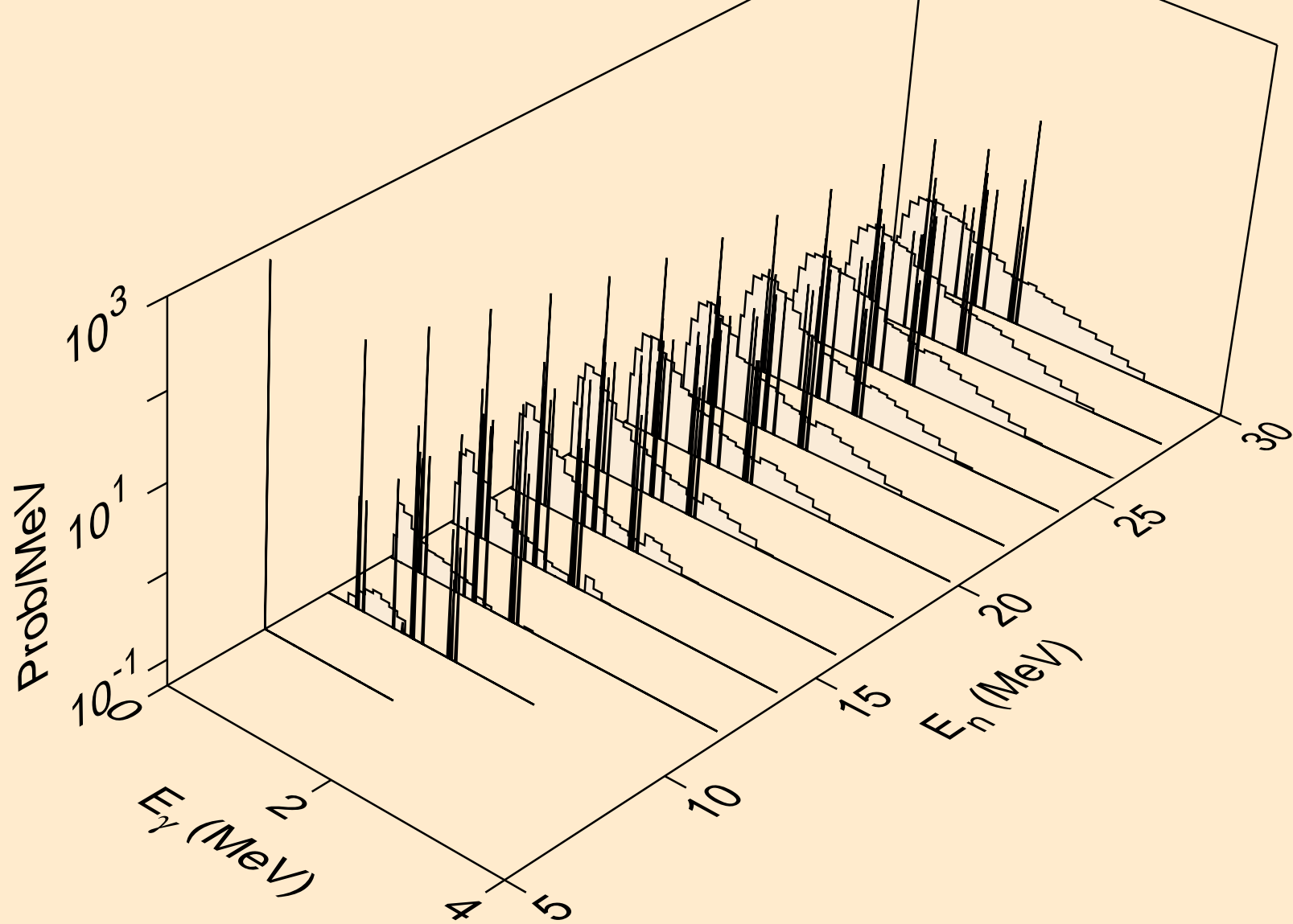

CD124 HELION ACER TENDL-2021 LIBRARY; T=0.K
Photon emission for (n,2n)

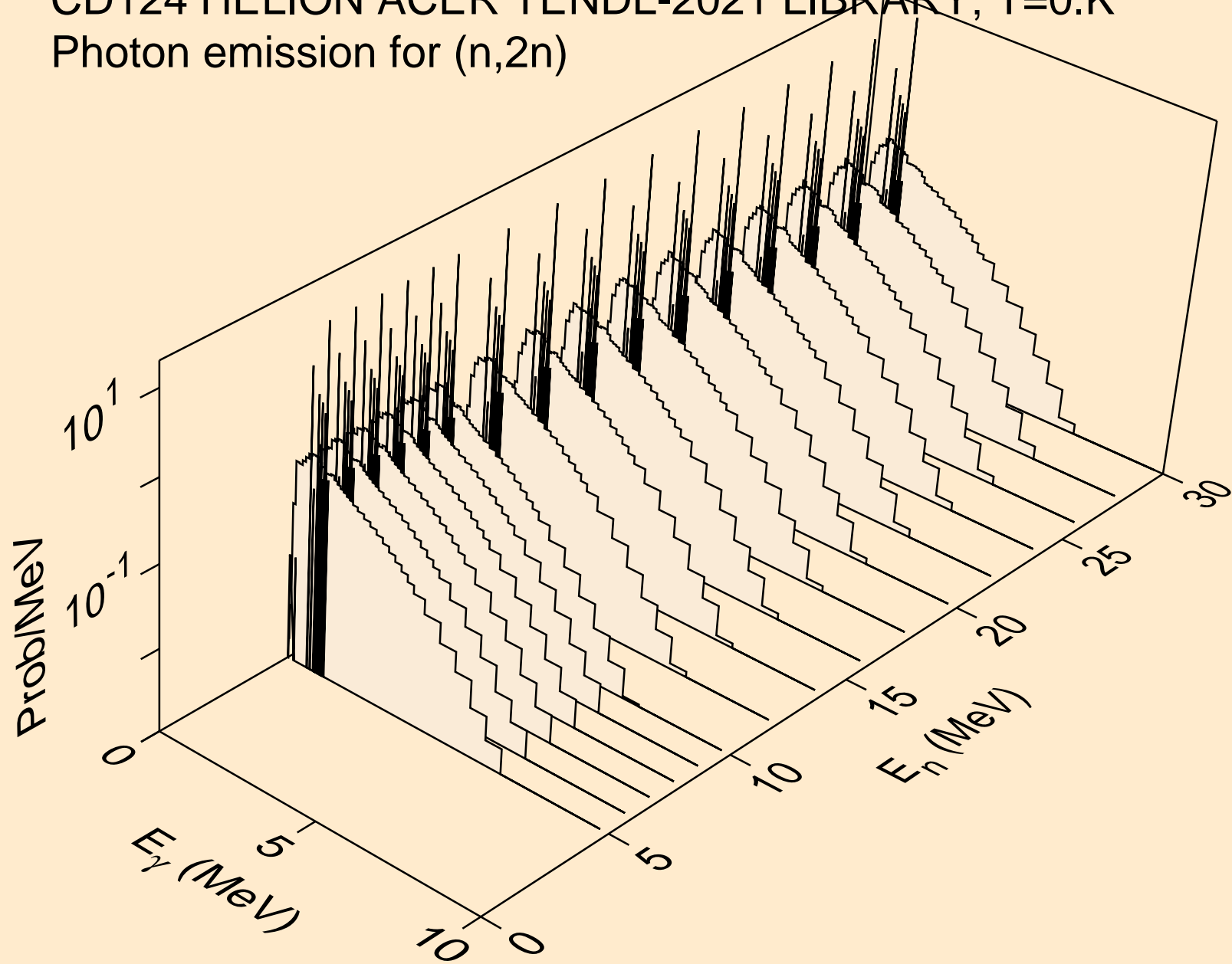

CD124 HELION ACER TENDL-2021 LIBRARY; T=0.K
Photon emission for (n,3n)

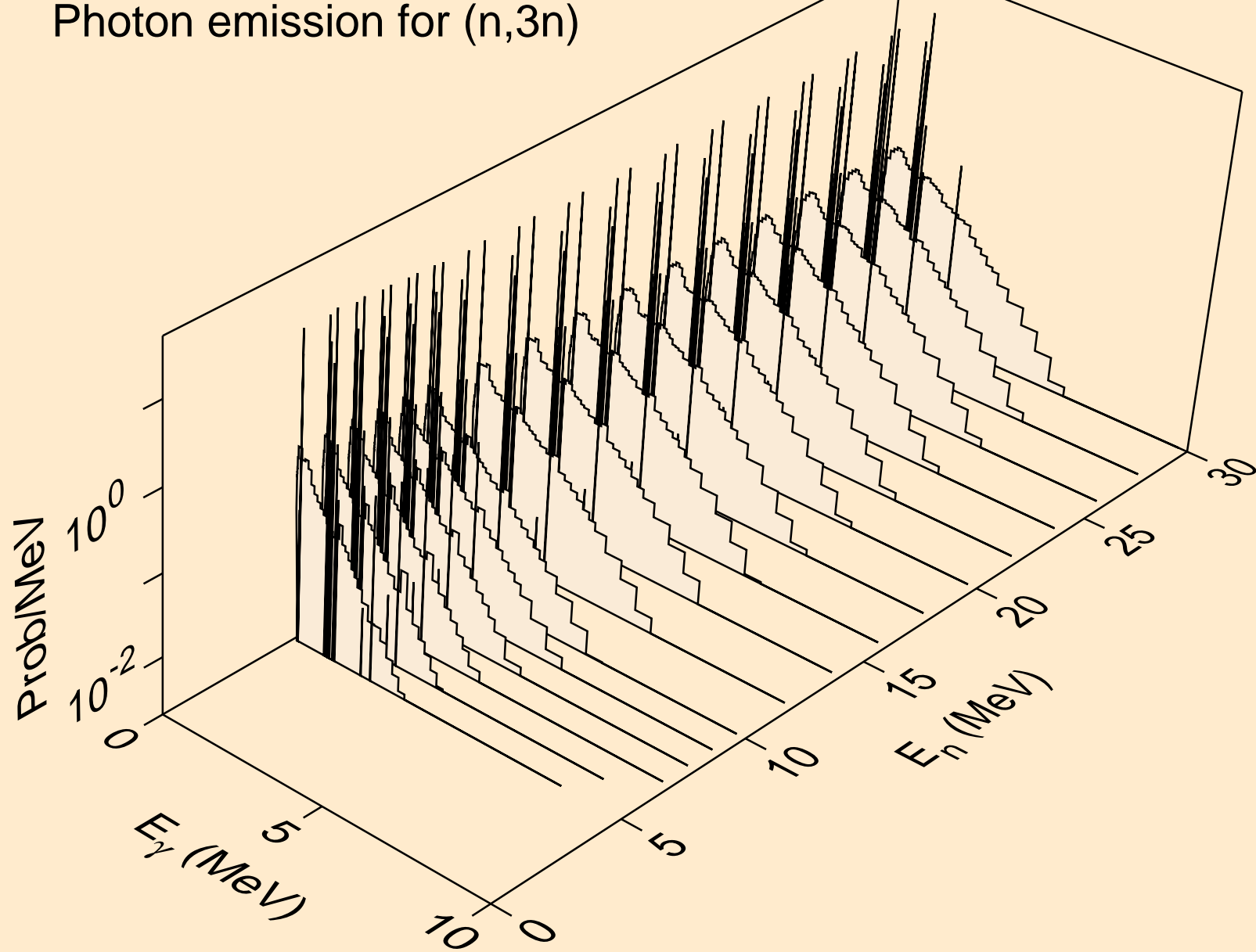

CD124 HELION ACER TENDL-2021 LIBRARY; T=0.K
Photon emission for (n,n*)a

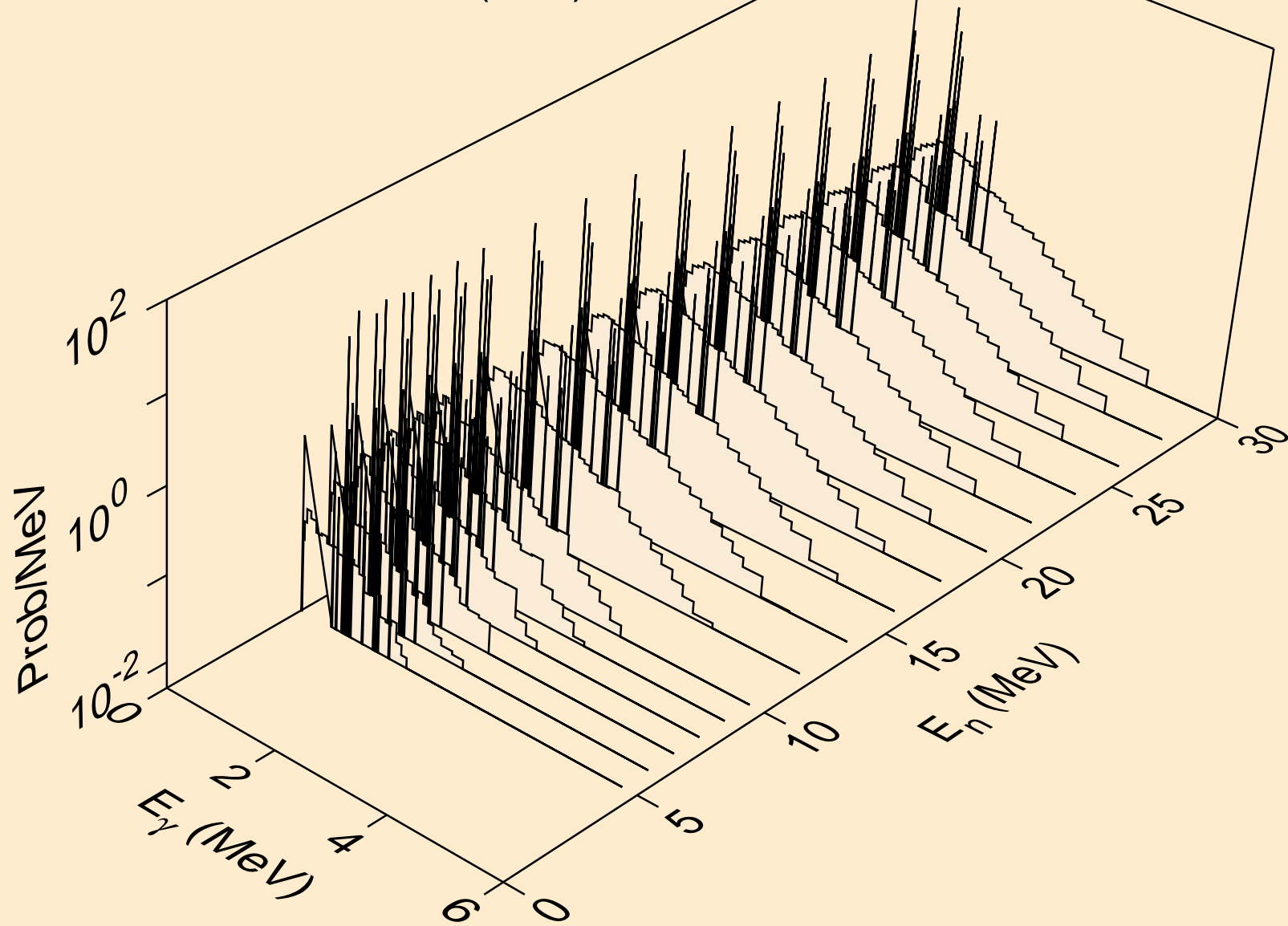

CD124 HELION ACER TENDL-2021 LIBRARY; T=0.K
Photon emission for (n,2n)a

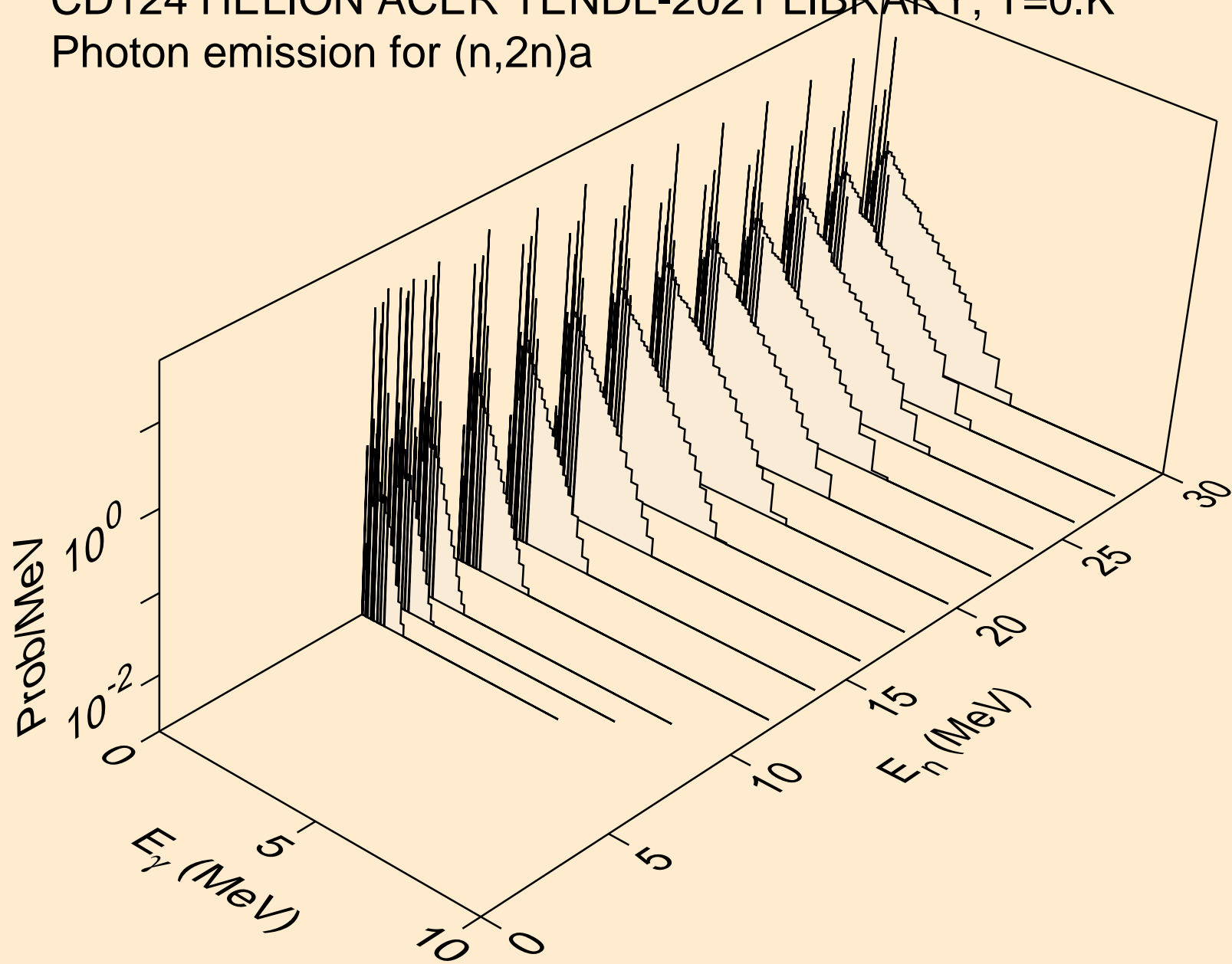

CD124 HELION ACER TENDL-2021 LIBRARY; T=0.K
Photon emission for (n,3n)a

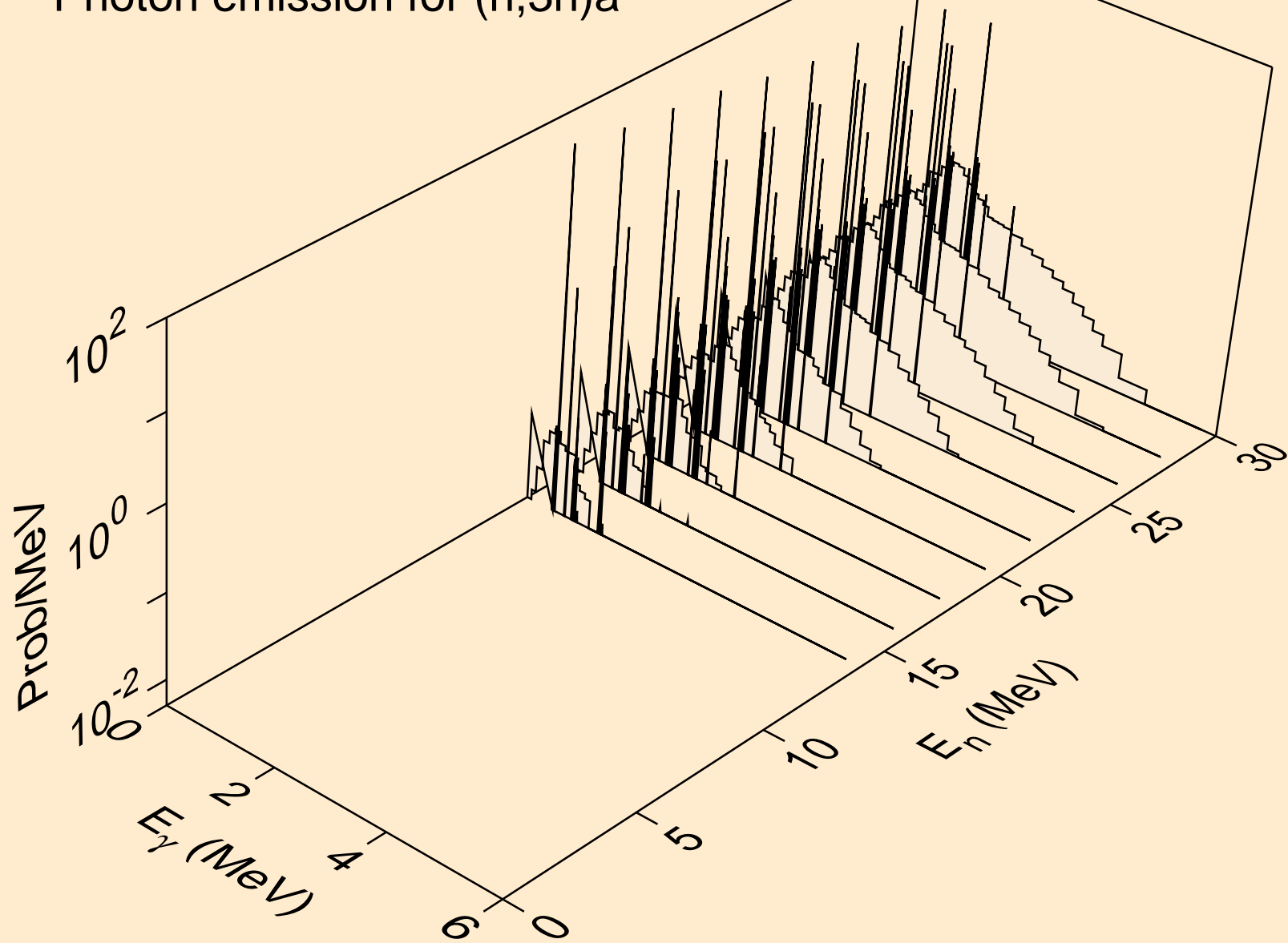

CD124 HELION ACER TENDL-2021 LIBRARY; T=0.K
Photon emission for (n,n*)p

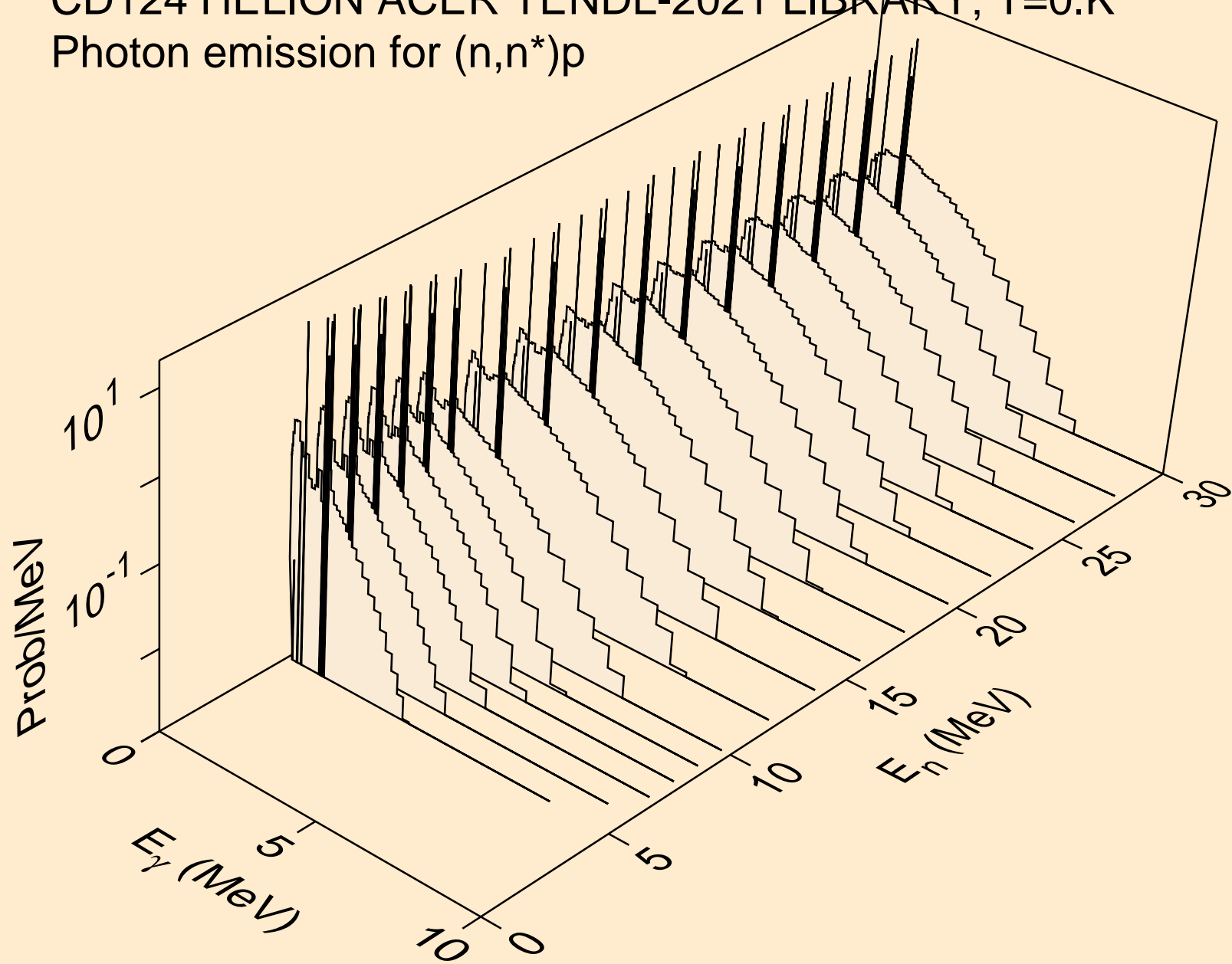

CD124 HELION ACER TENDL-2021 LIBRARY; T=0.K
Photon emission for (n,n*)d

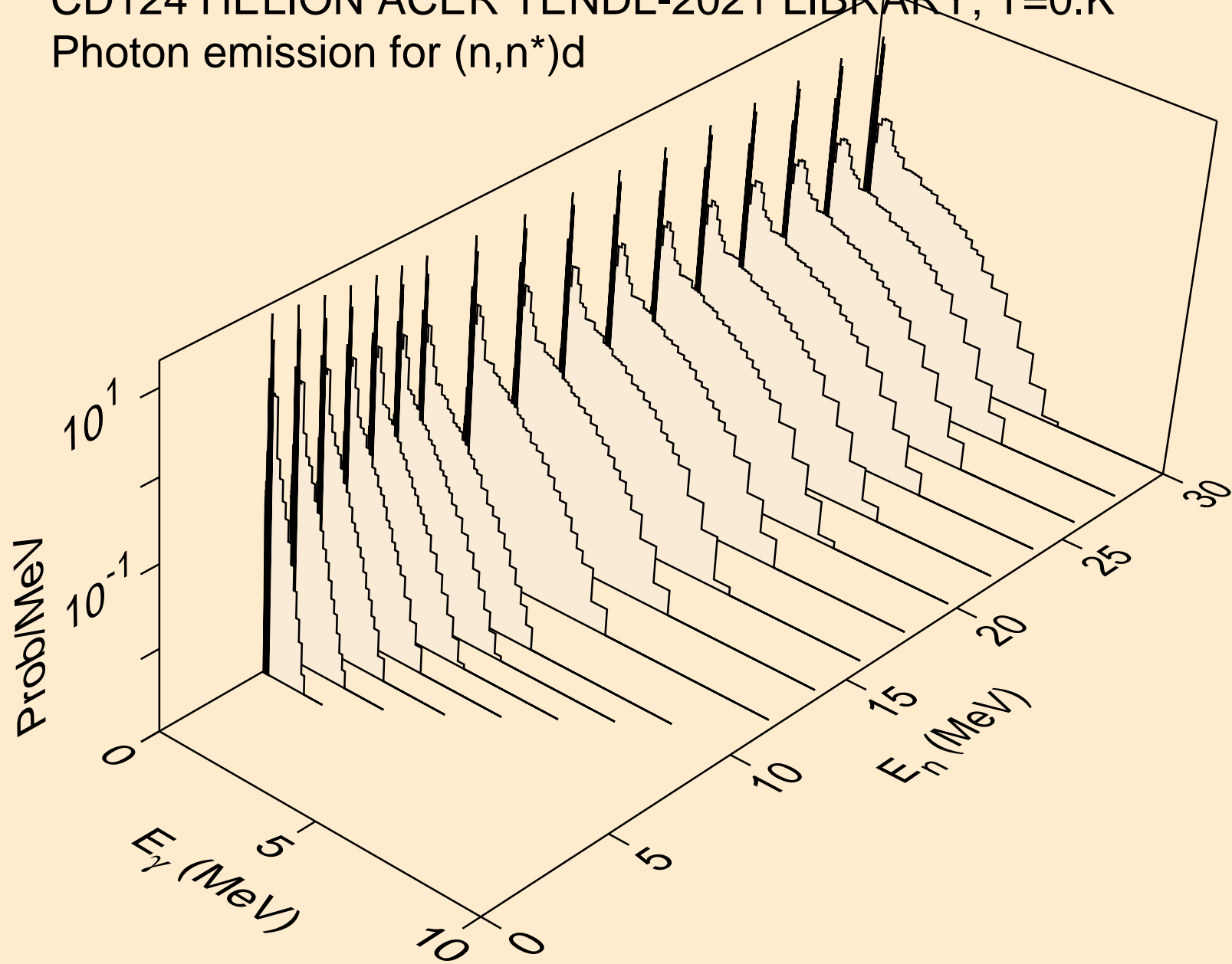

CD124 HELION ACER TENDL-2021 LIBRARY; T=0.K
Photon emission for (n,n*)t

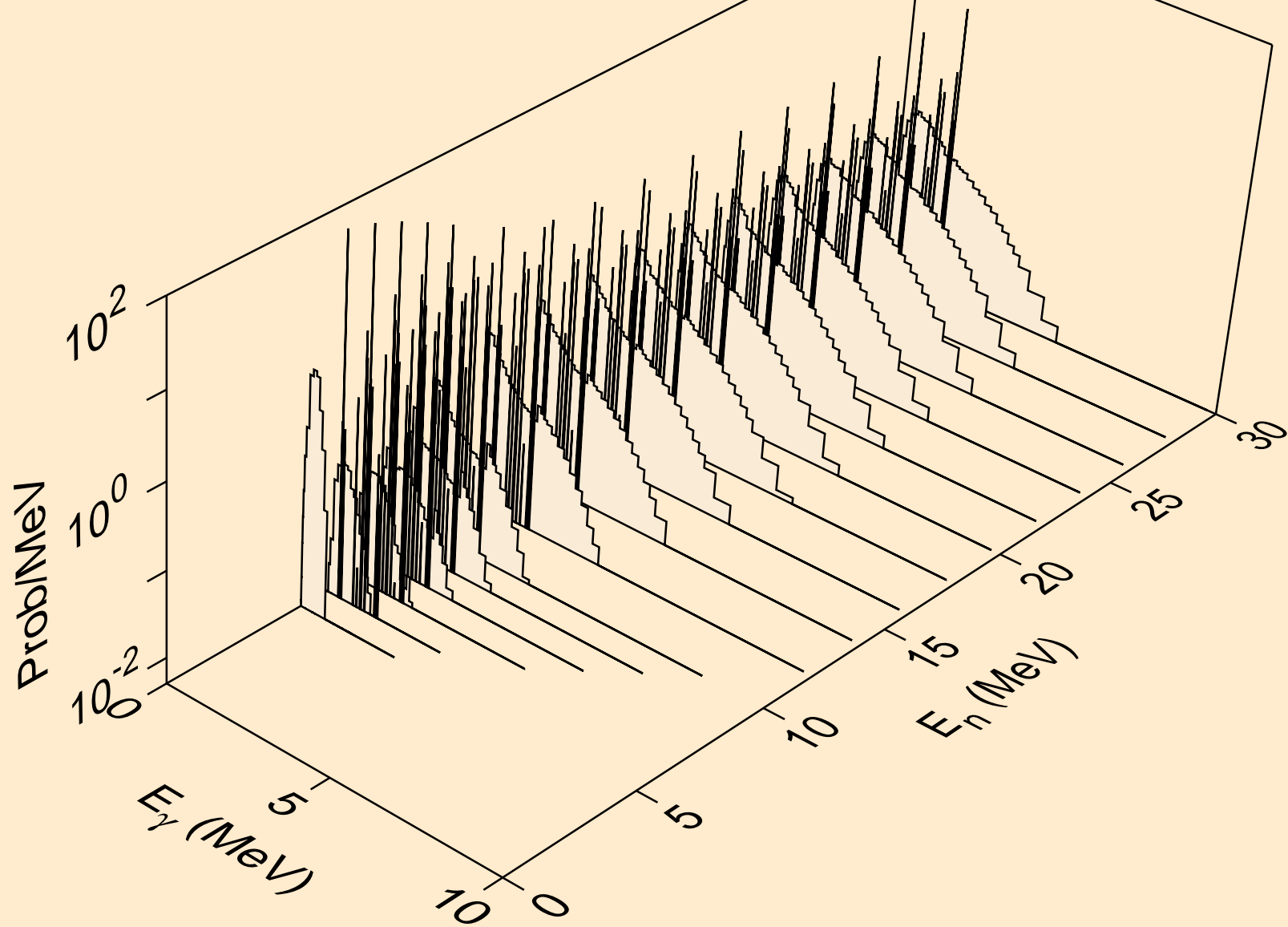

CD124 HELION ACER TENDL-2021 LIBRARY; T=0.K
Photon emission for (n,n*)he3

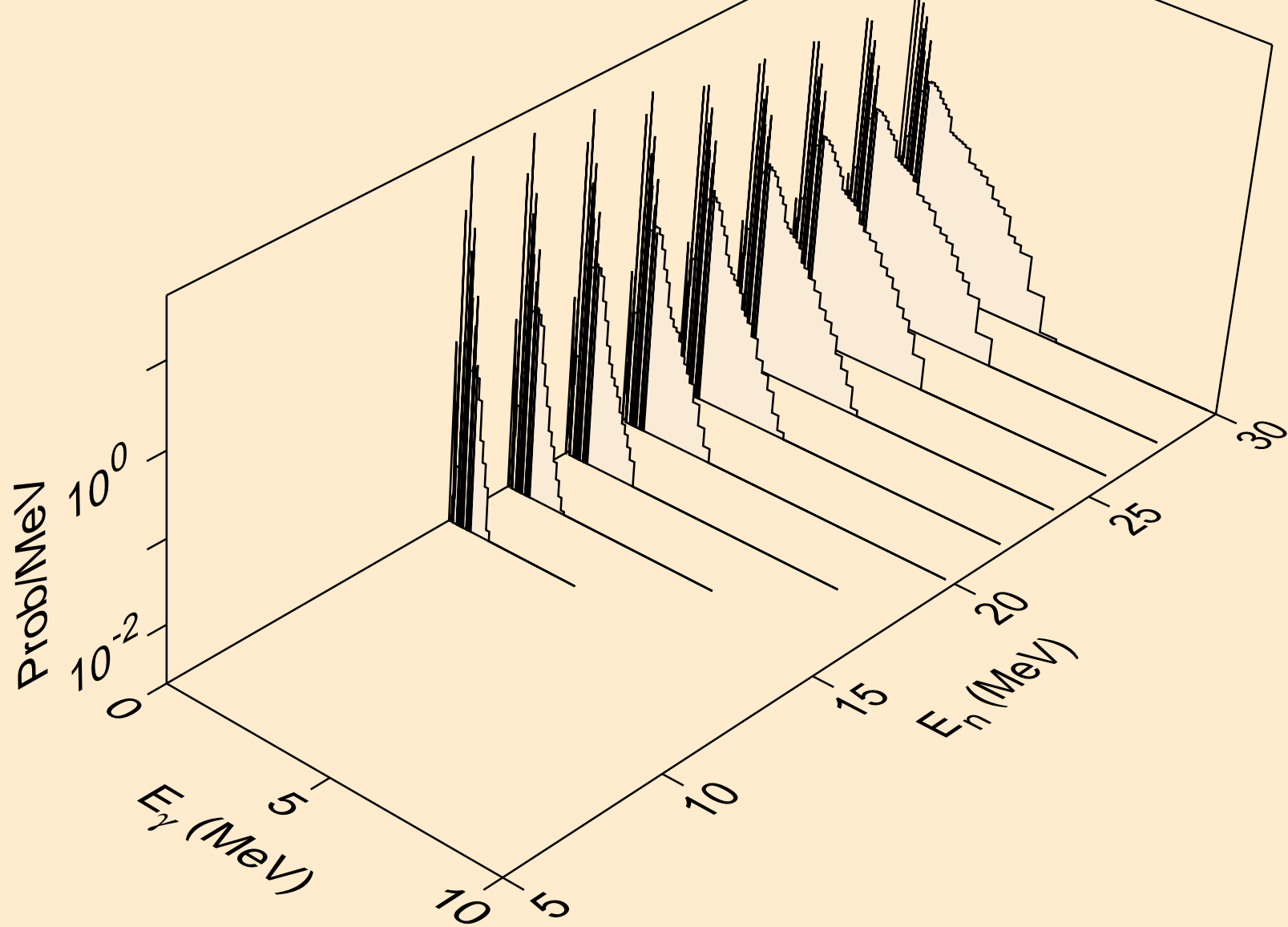

CD124 HELION ACER TENDL-2021 LIBRARY; T=0.K
Photon emission for (n,4n)

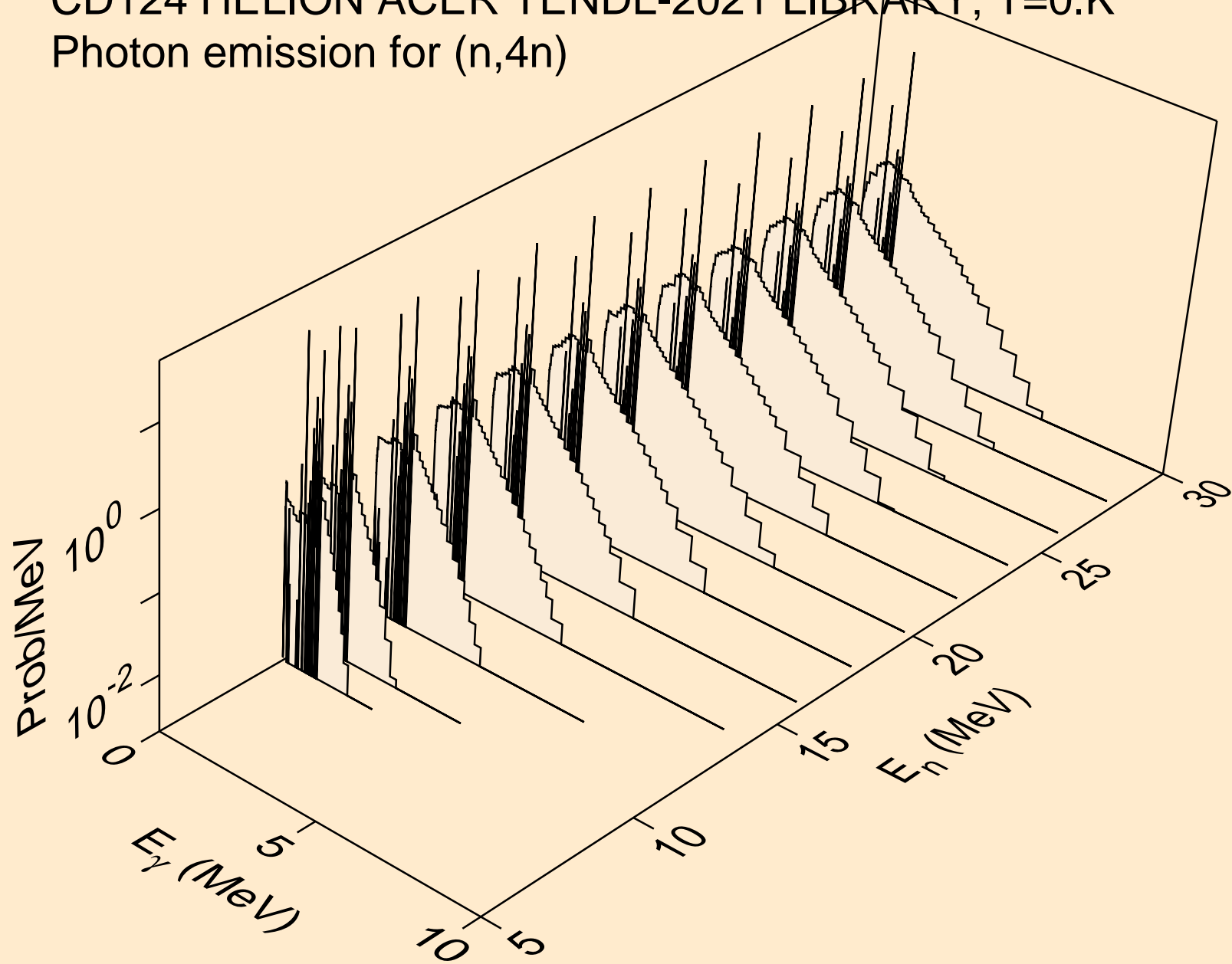

CD124 HELION ACER TENDL-2021 LIBRARY; T=0.K
Photon emission for (n,2np)

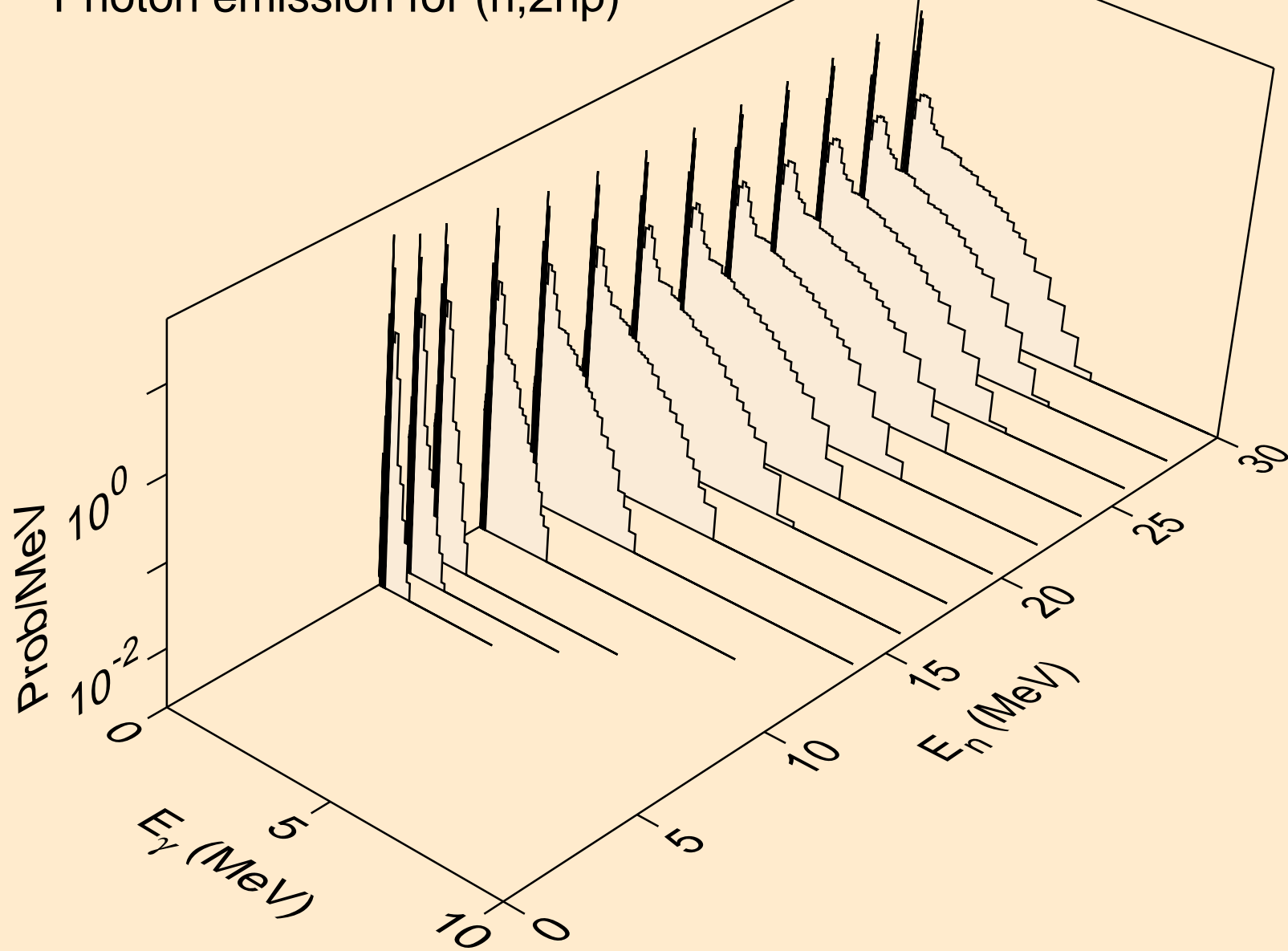

CD124 HELION ACER TENDL-2021 LIBRARY; T=0.K
Photon emission for (n,3np)

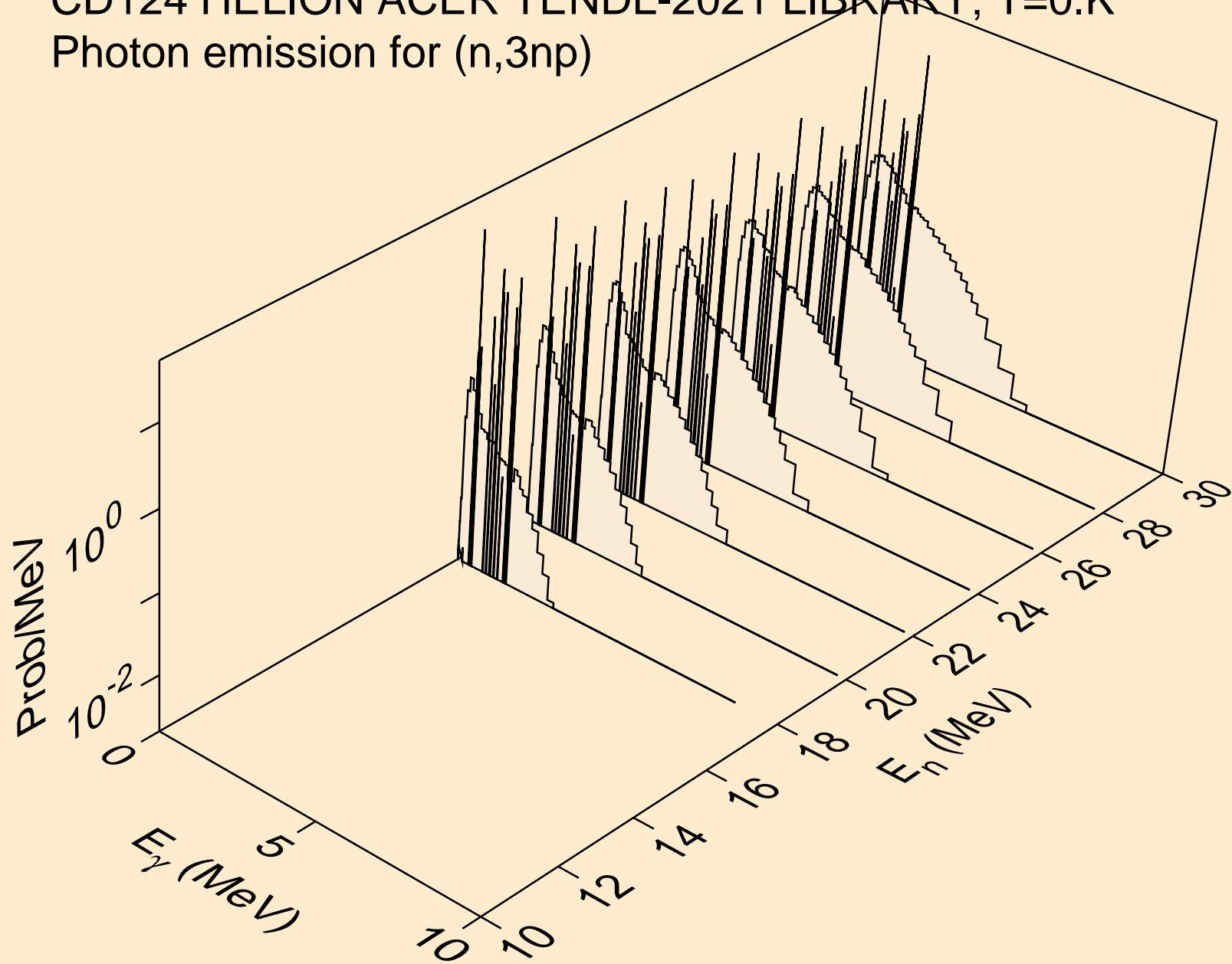

CD124 HELION ACER TENDL-2021 LIBRARY; T=0.K
Photon emission for (n,2np)

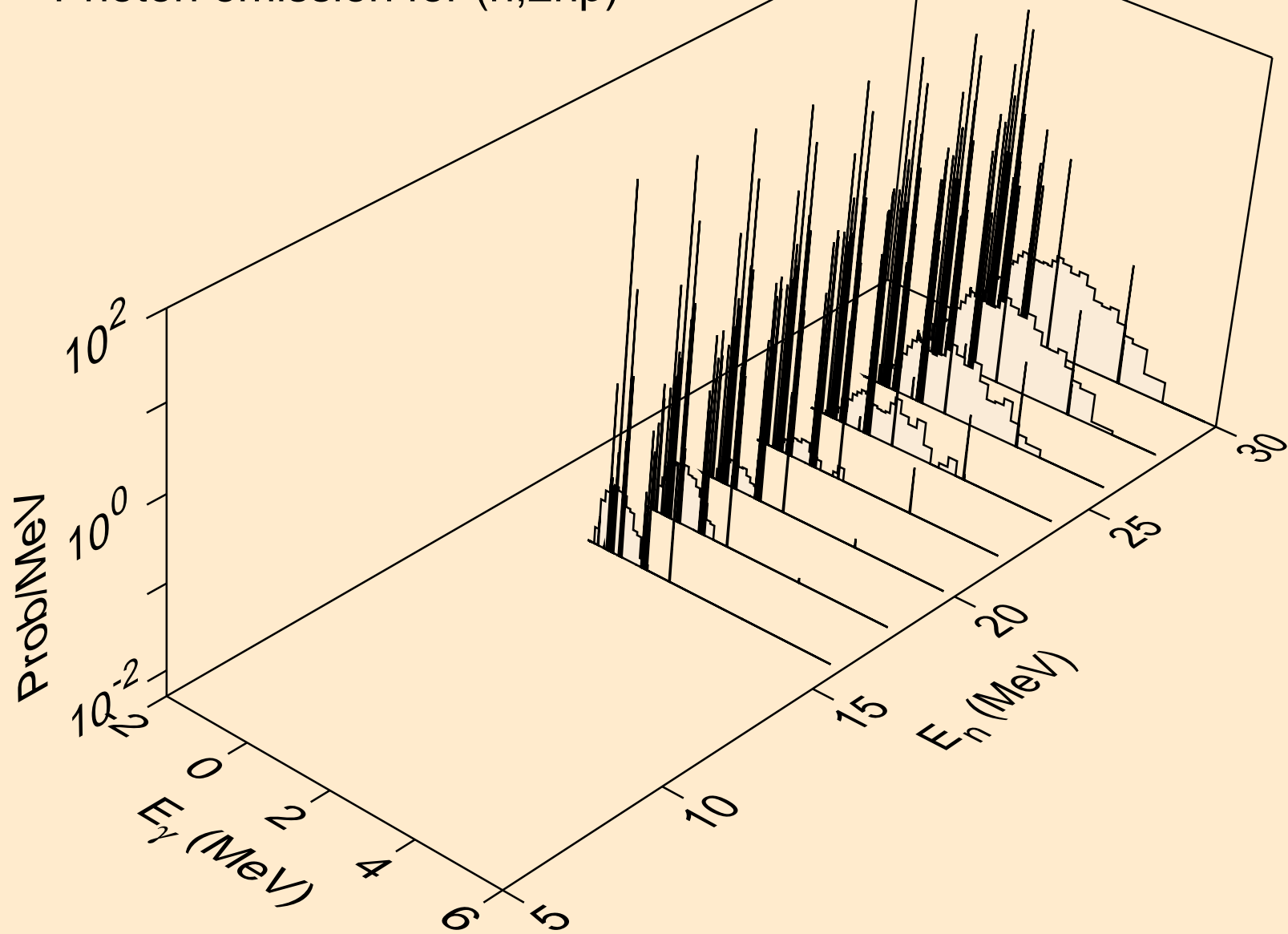

CD124 HELION ACER TENDL-2021 LIBRARY; T=0.K
Photon emission for (n,npa)

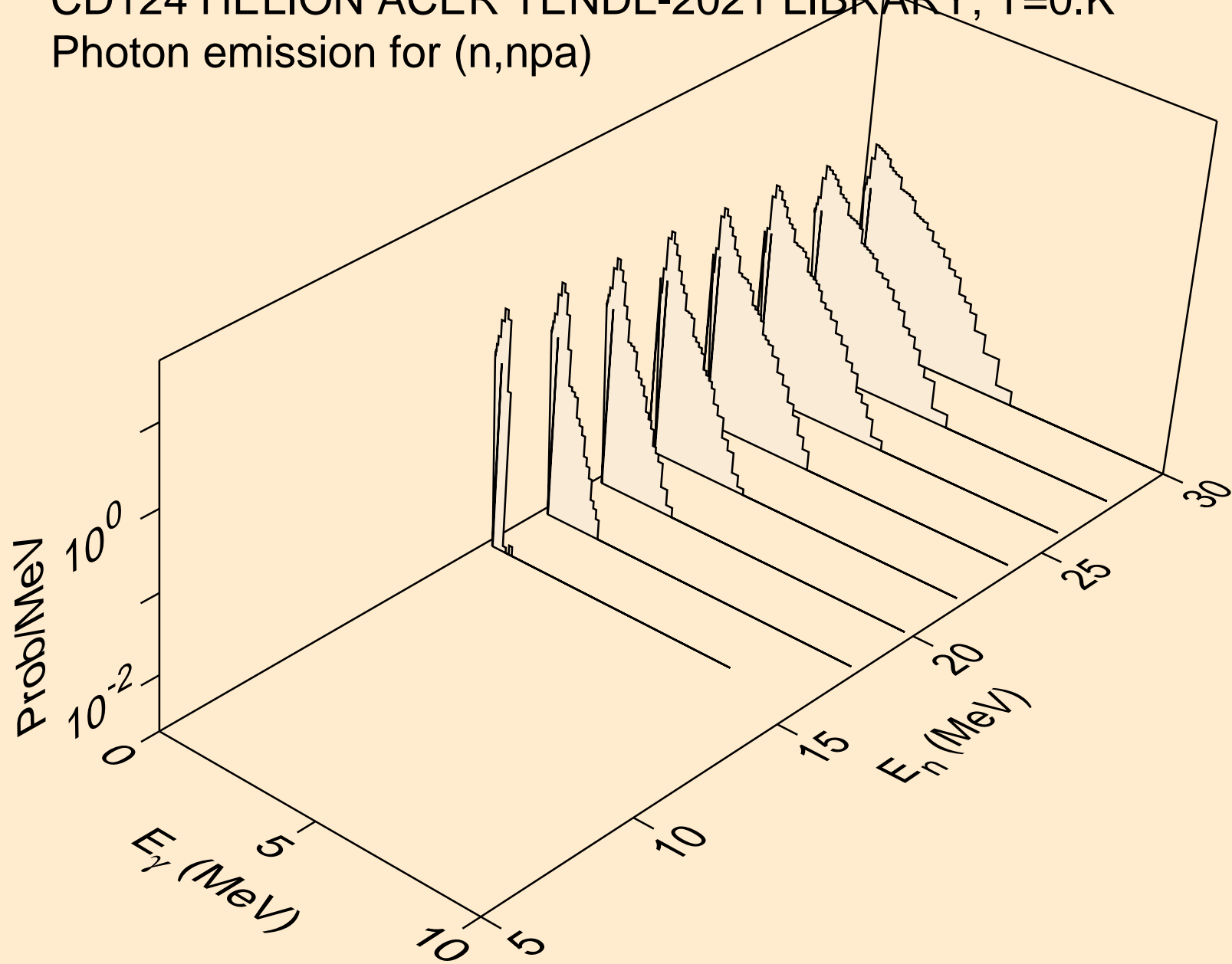

CD124 HELION ACER TENDL-2021 LIBRARY; T=0.K
Photon emission for (n,gma)

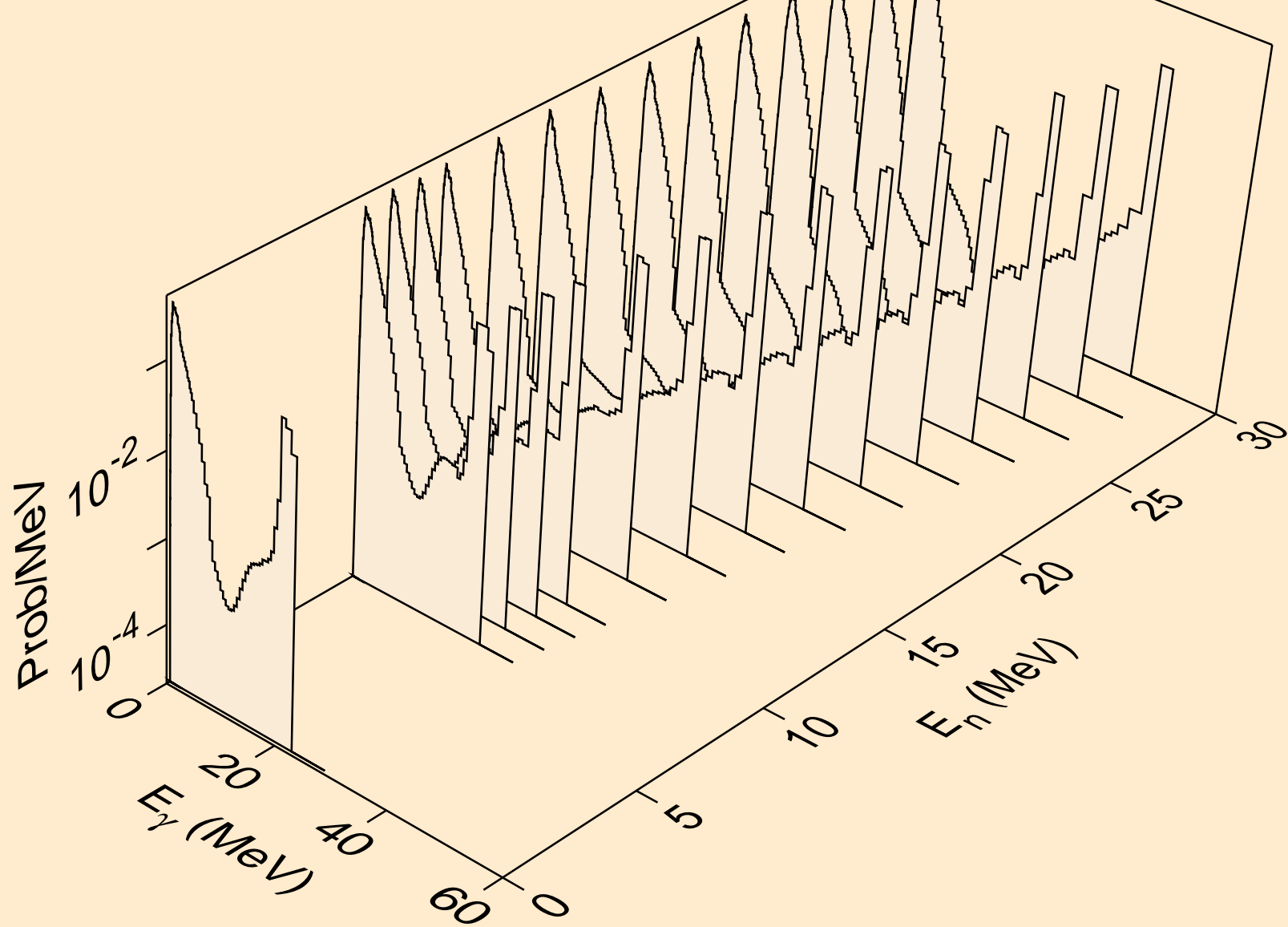

CD124 HELION ACER TENDL-2021 LIBRARY; T=0.K
Photon emission for (n,p)

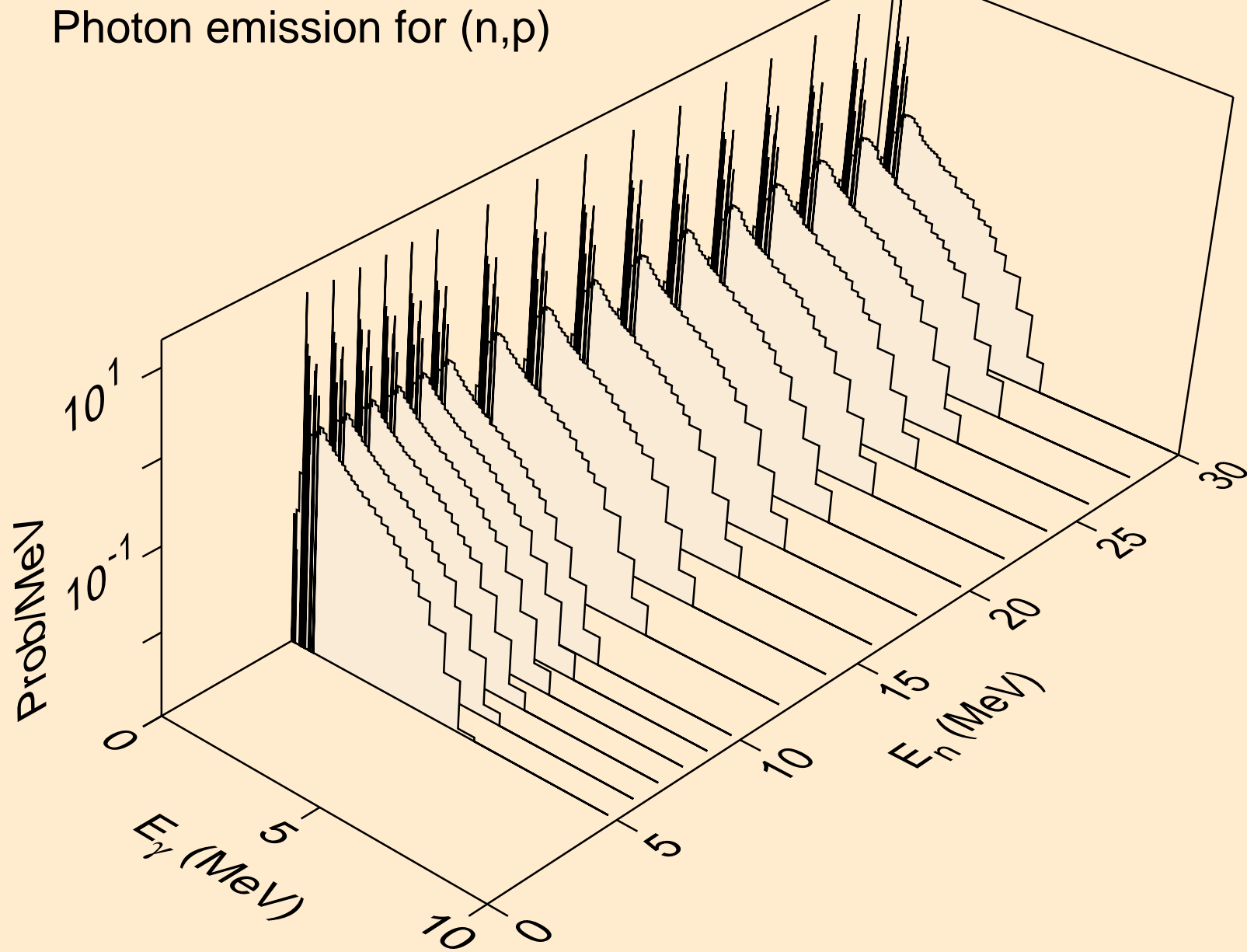

CD124 HELION ACER TENDL-2021 LIBRARY; T=0.K
Photon emission for (n,d)

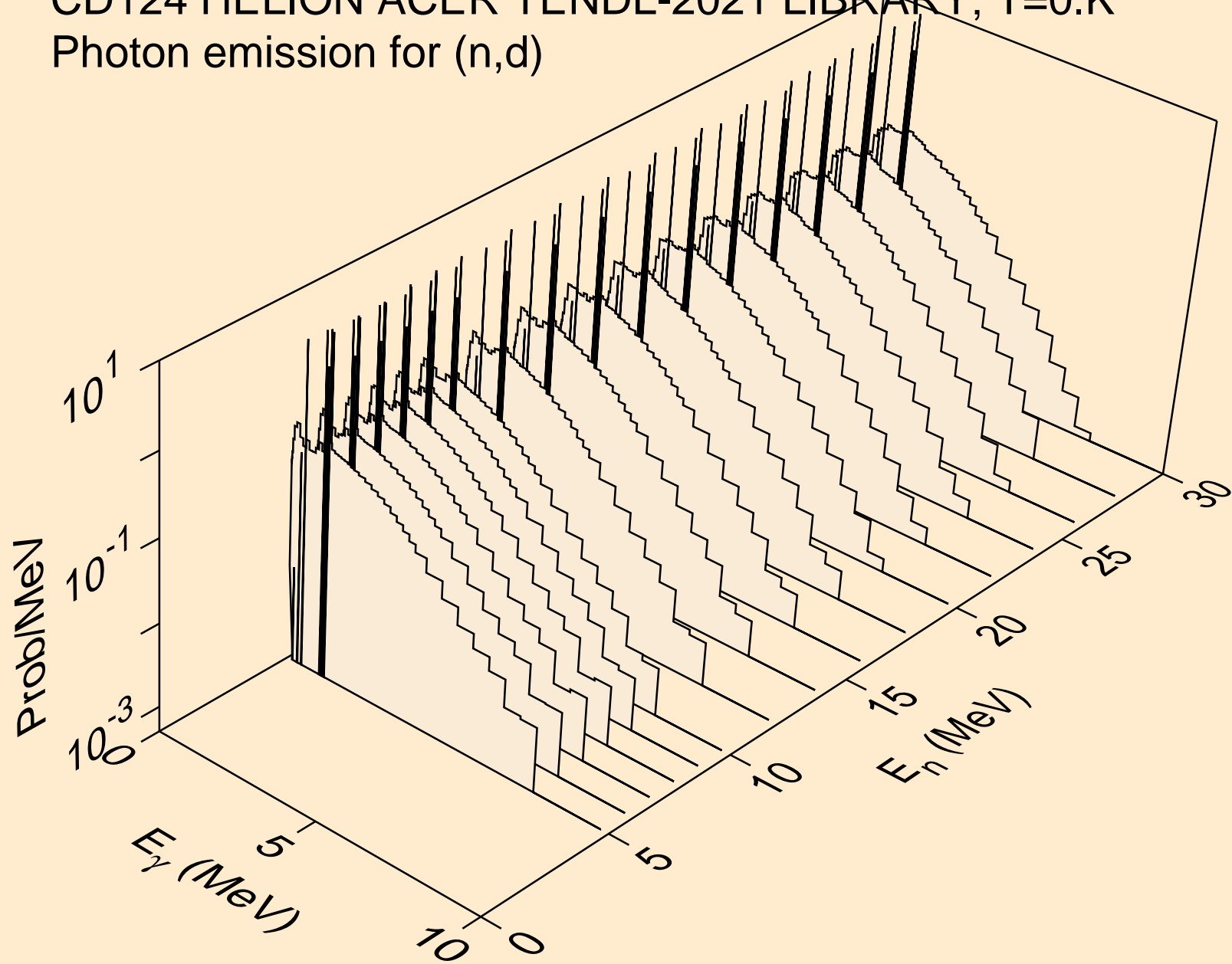

CD124 HELION ACER TENDL-2021 LIBRARY; T=0.K
Photon emission for (n,t)

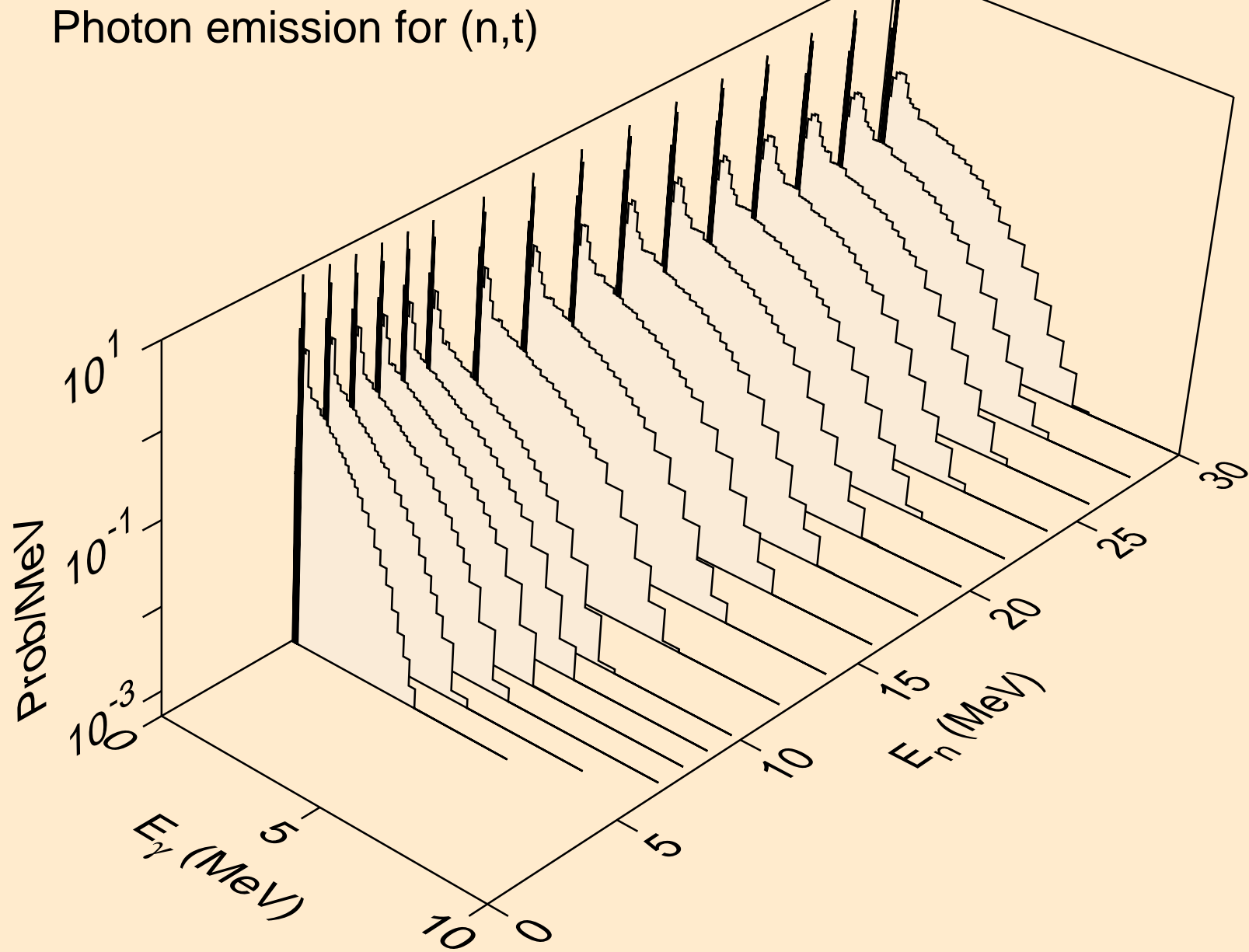

CD124 HELION ACER TENDL-2021 LIBRARY; T=0.K
Photon emission for inelastic

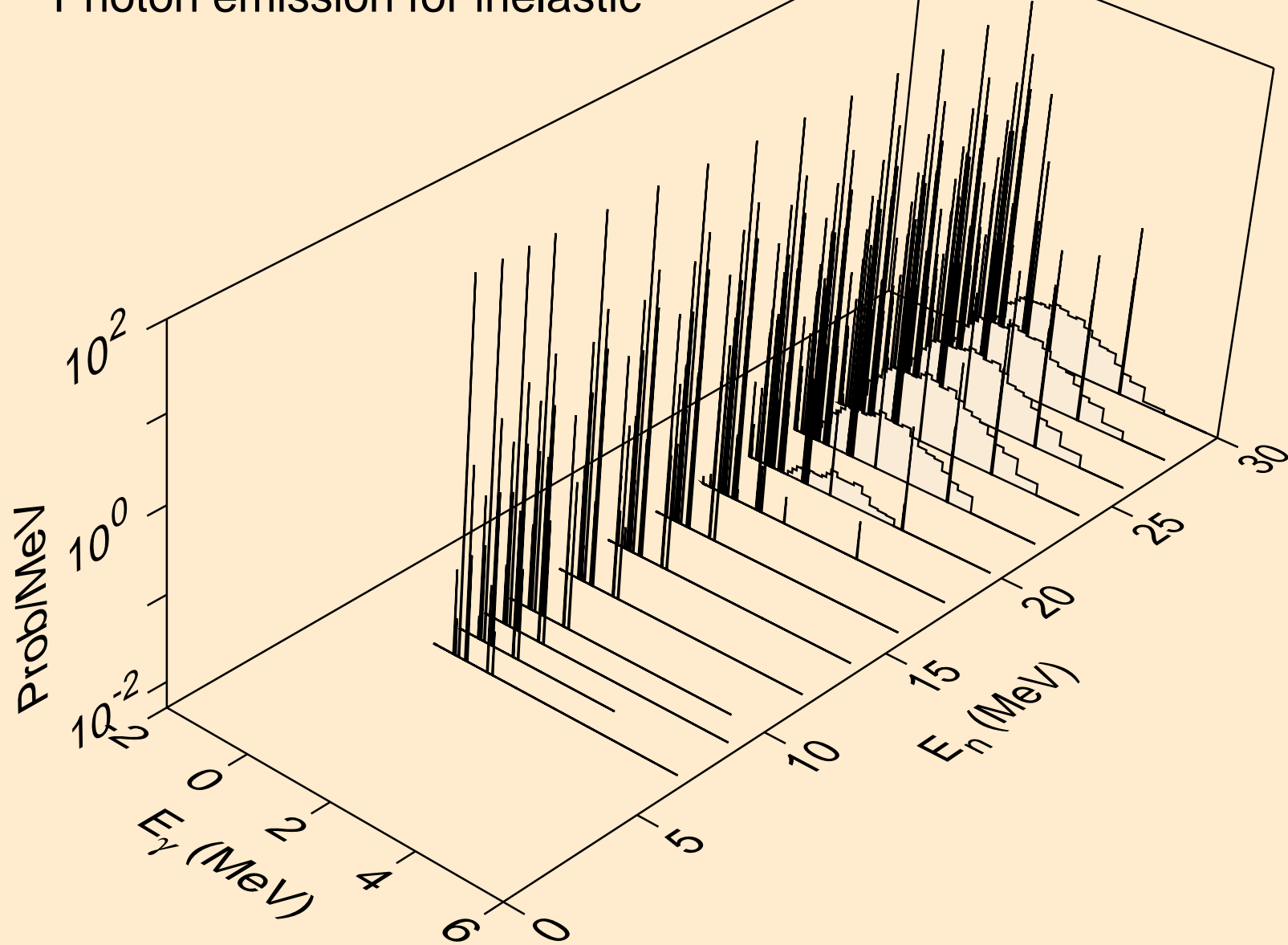

CD124 HELION ACER TENDL-2021 LIBRARY; T=0.K
Photon emission for (n,a)

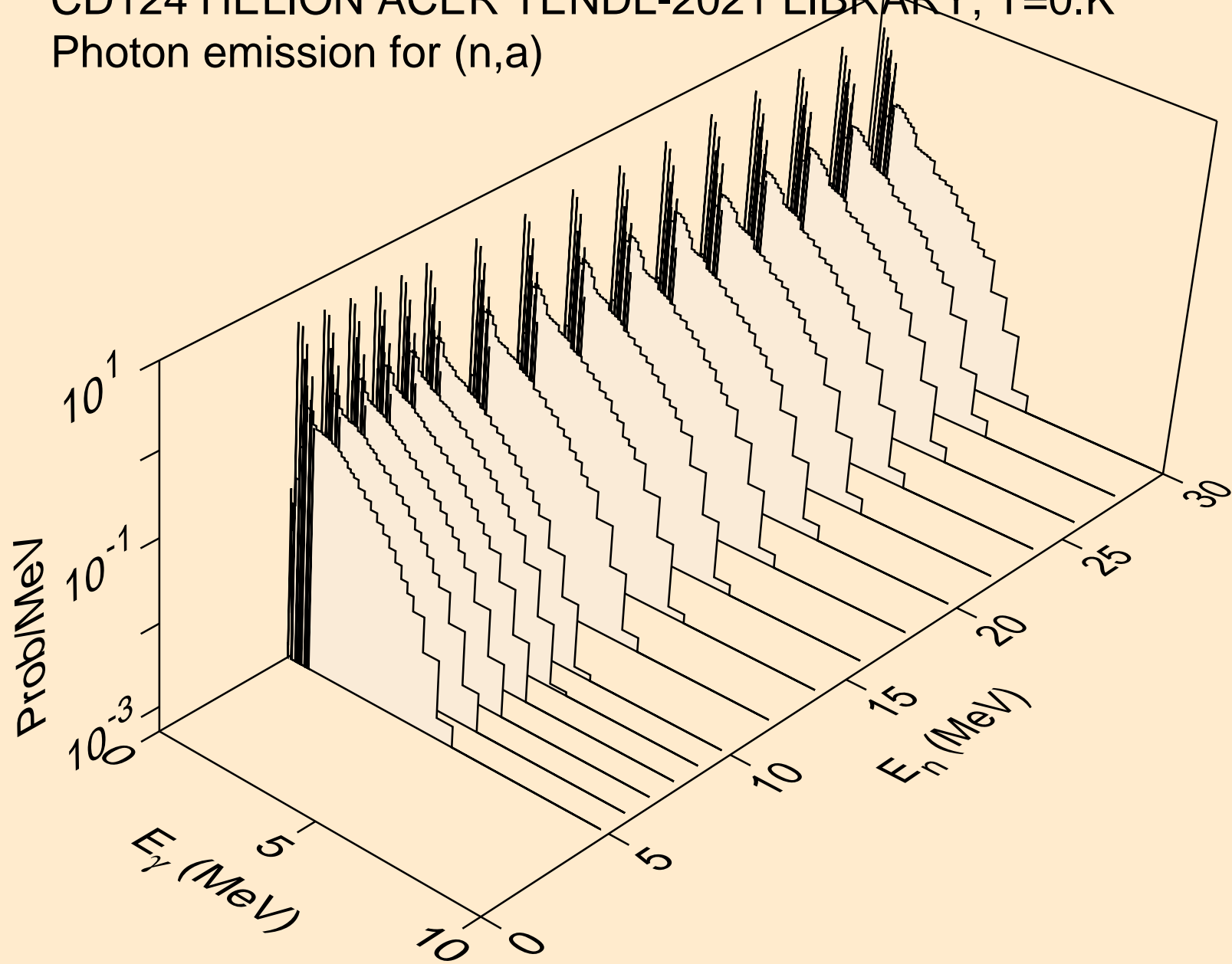

CD124 HELION ACER TENDL-2021 LIBRARY; T=0.K
Photon emission for (n,2p)

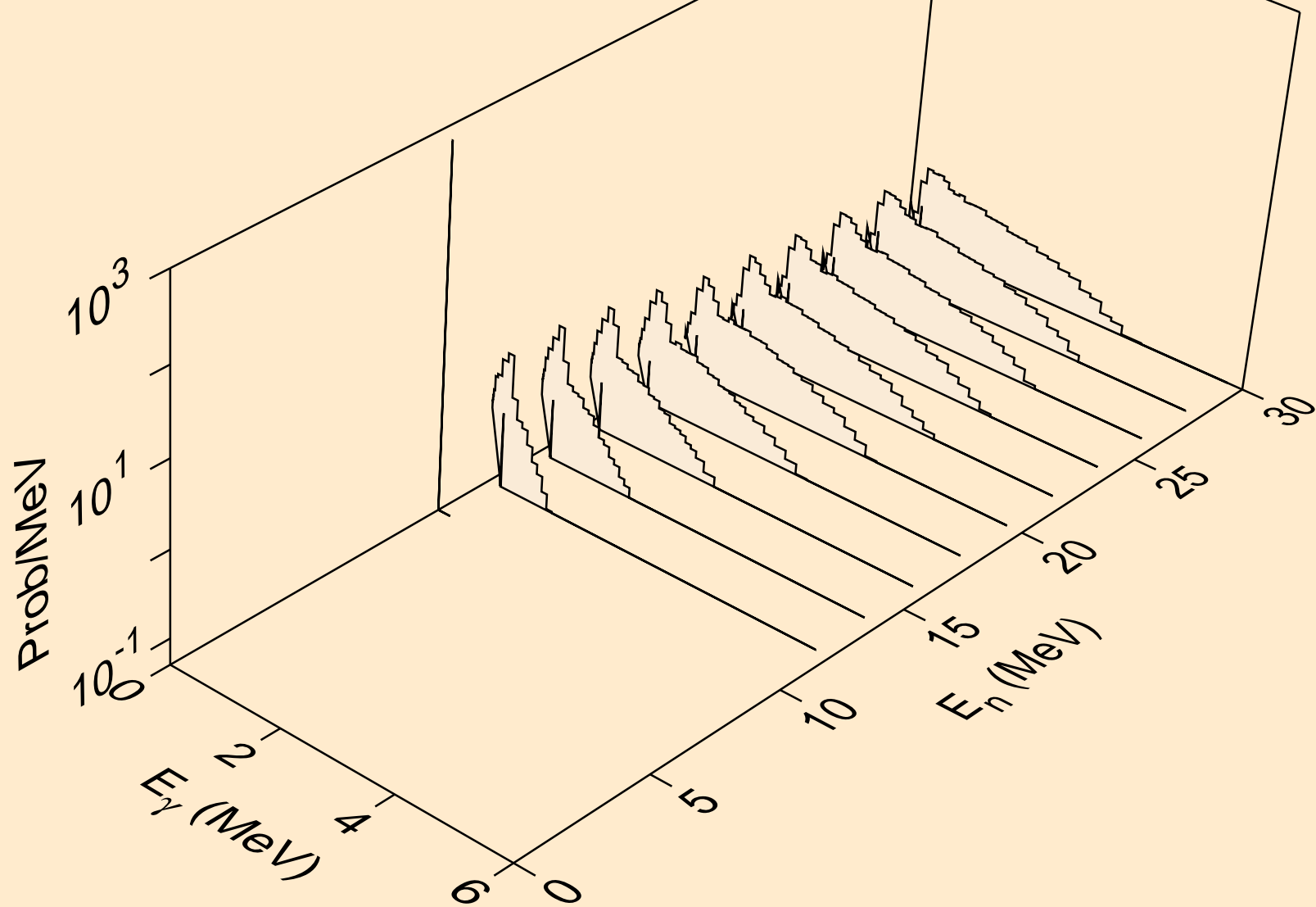

CD124 HELION ACER TENDL-2021 LIBRARY; T=0.K
Photon emission for (n,pa)

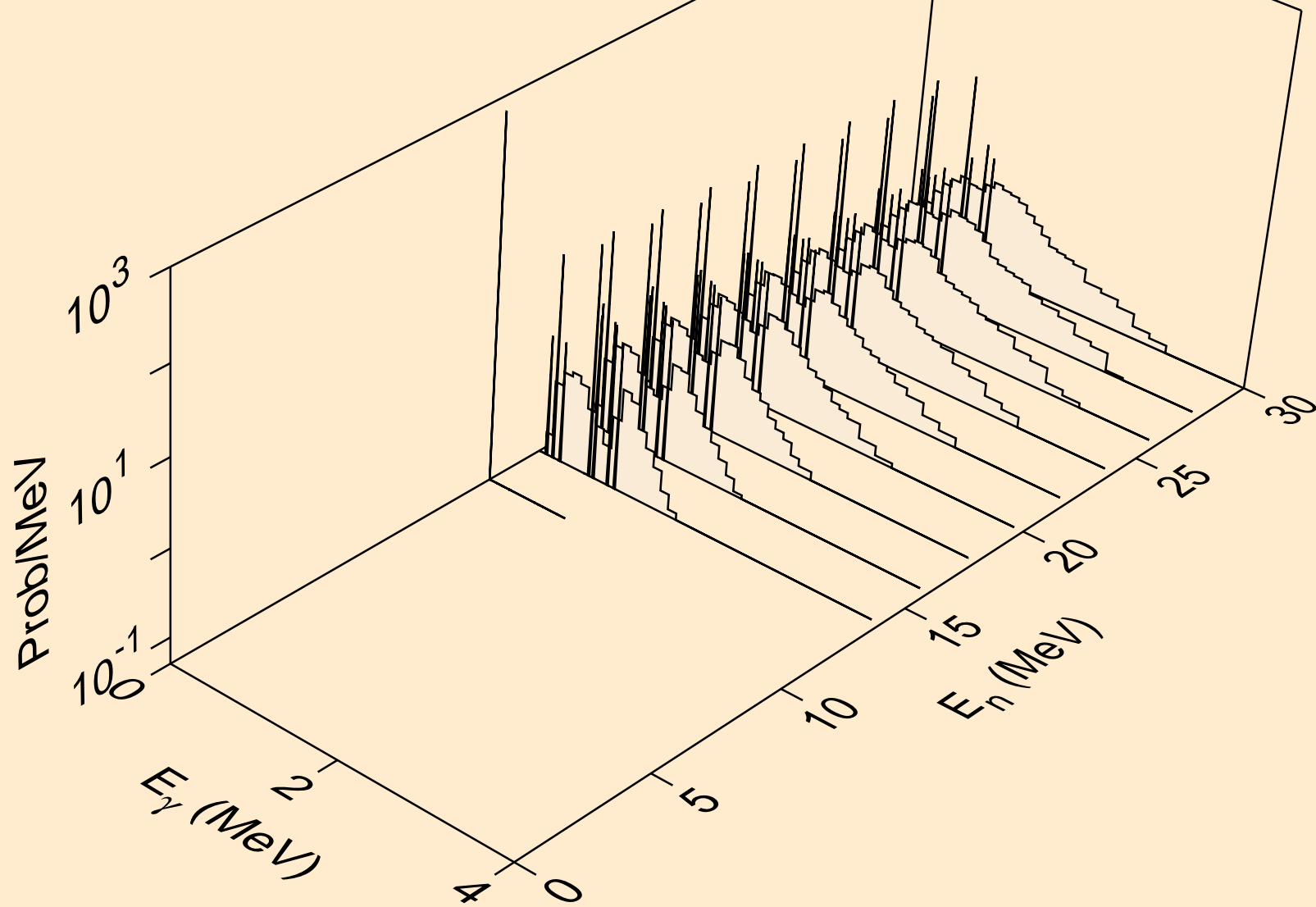

CD124 HELION ACER TENDL-2021 LIBRARY; T=0.K
Photon emission for (n,pd)

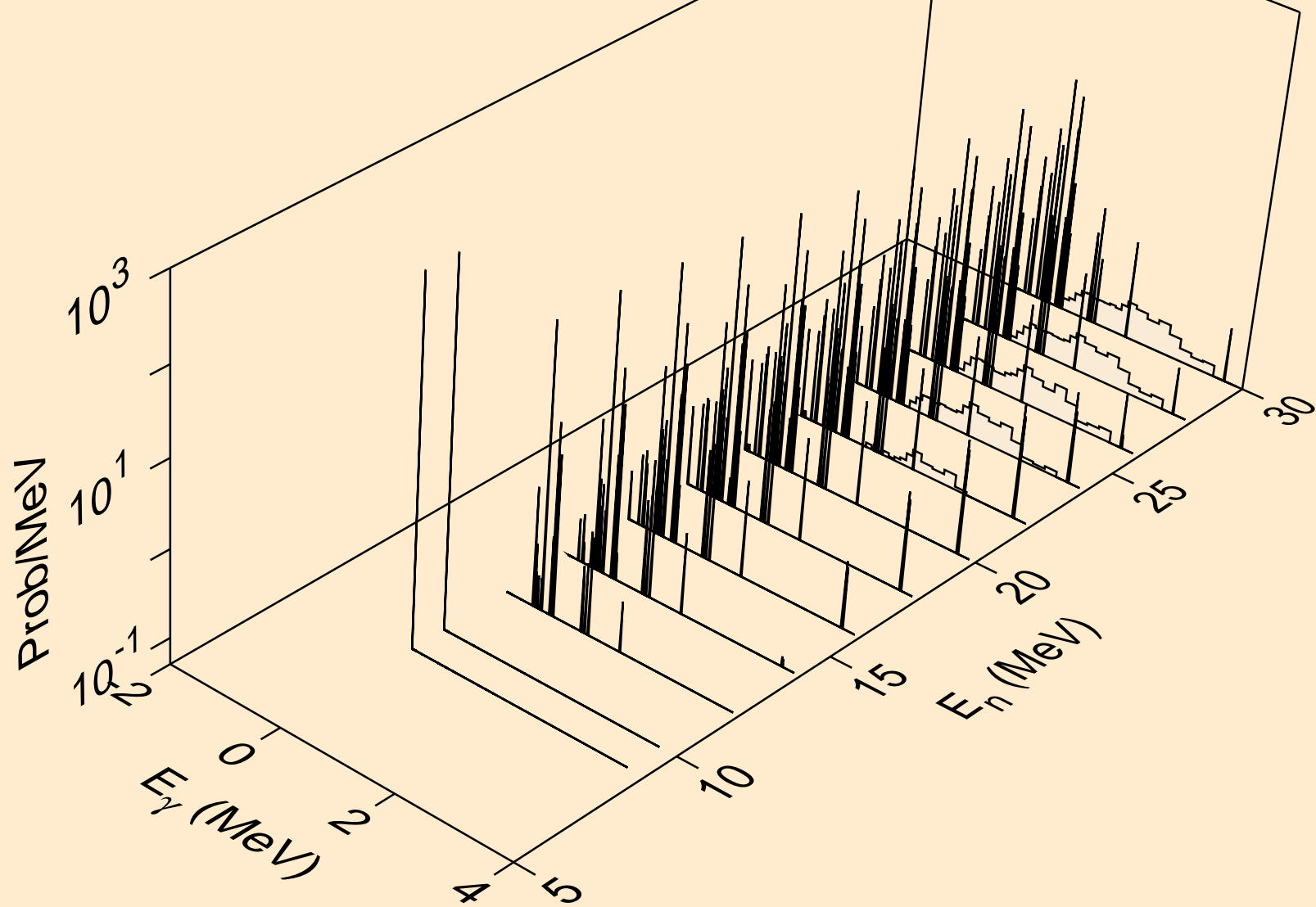

CD124 HELION ACER TENDL-2021 LIBRARY; T=0.K
Photon emission for (n,pt)

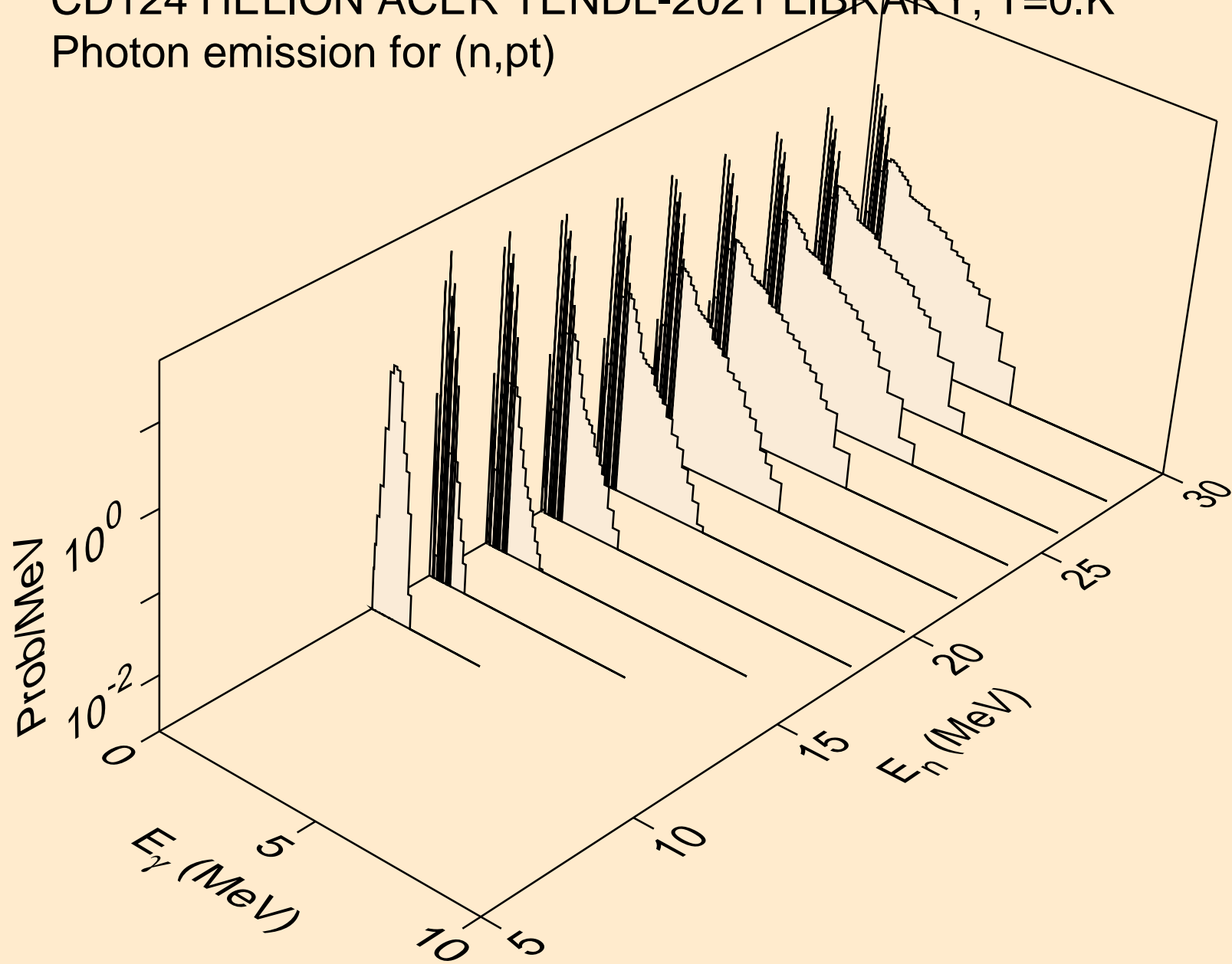

CD124 HELION ACER TENDL-2021 LIBRARY; T=0.K

Particle heating contributions

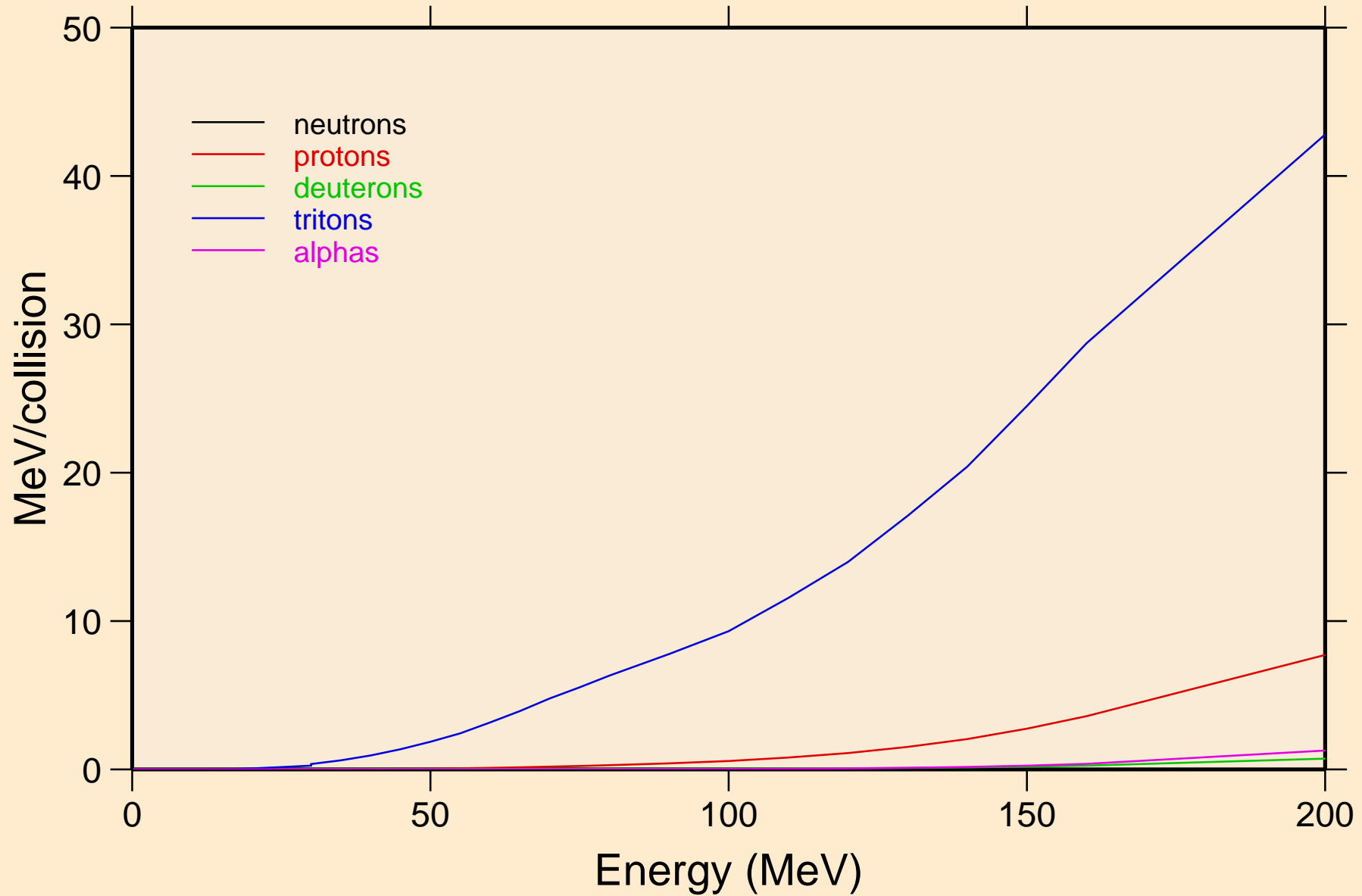

CD124 HELION ACER TENDL-2021 LIBRARY; T=0.K
Recoil Heating

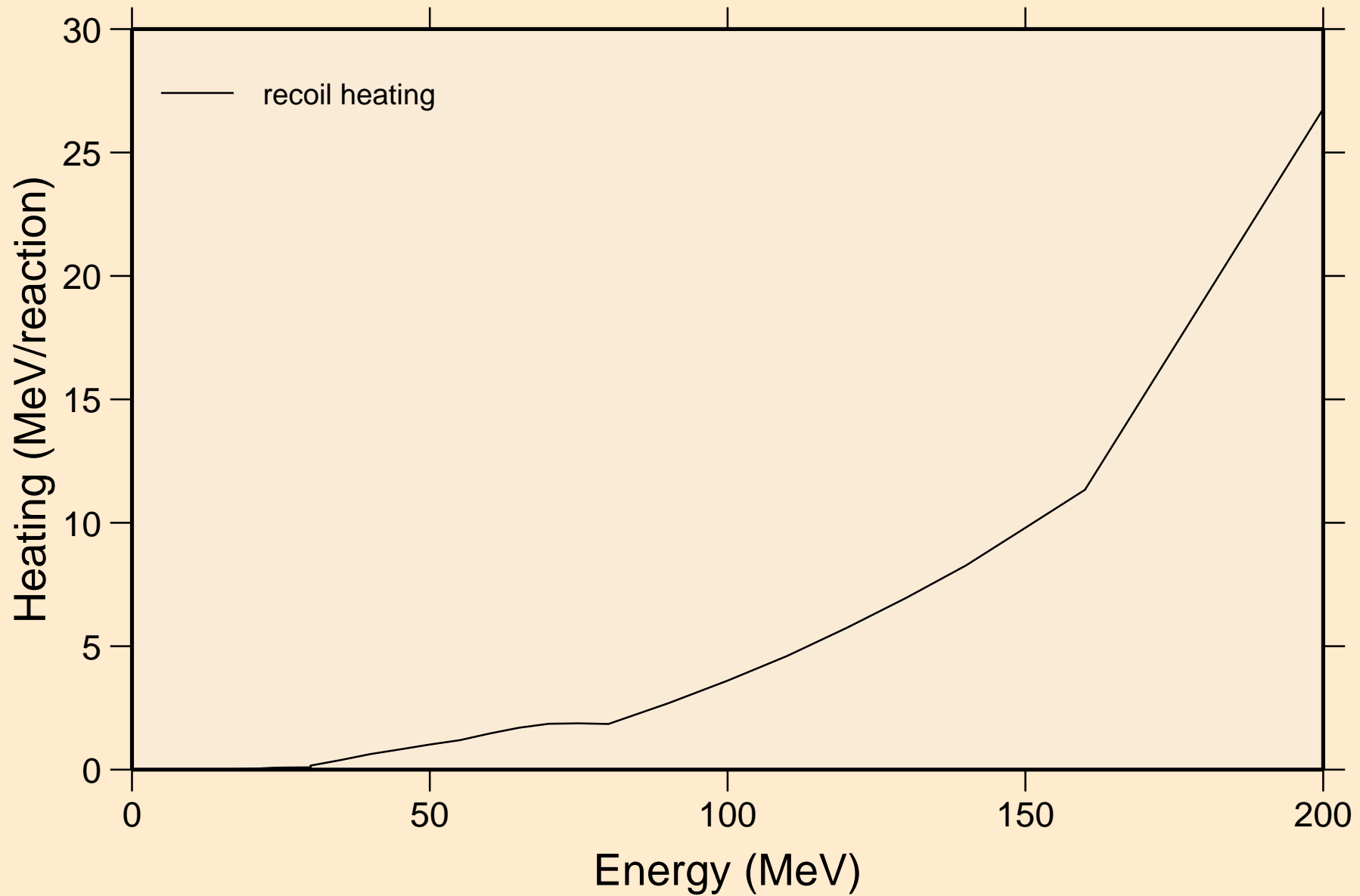

CD124 HELION ACER TENDL-2021 LIBRARY; T=0.K
Particle production cross sections

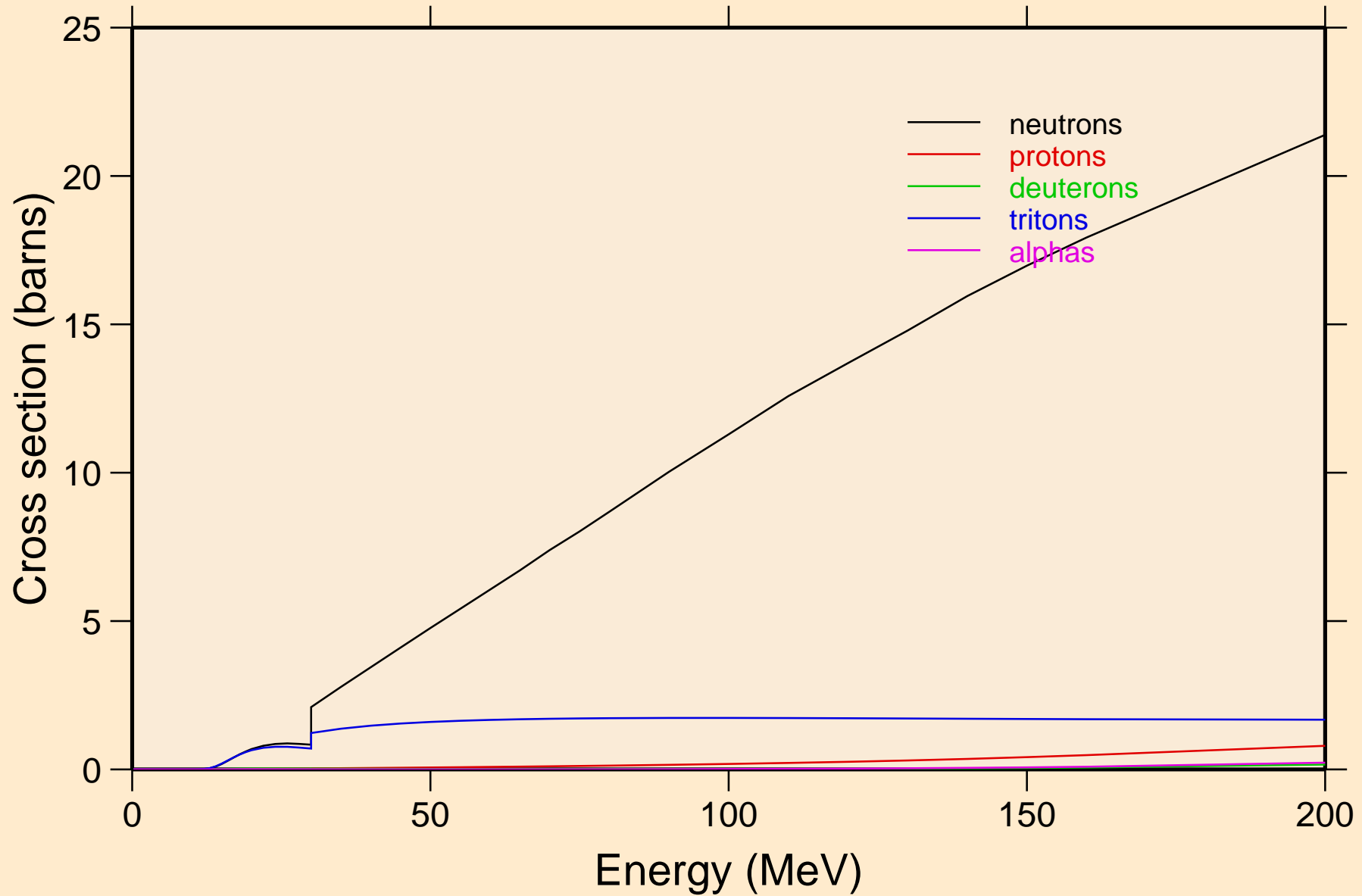

CD124 HELION ACER TENDL-2021 LIBRARY; T=0.K
neutrons from (s,n)

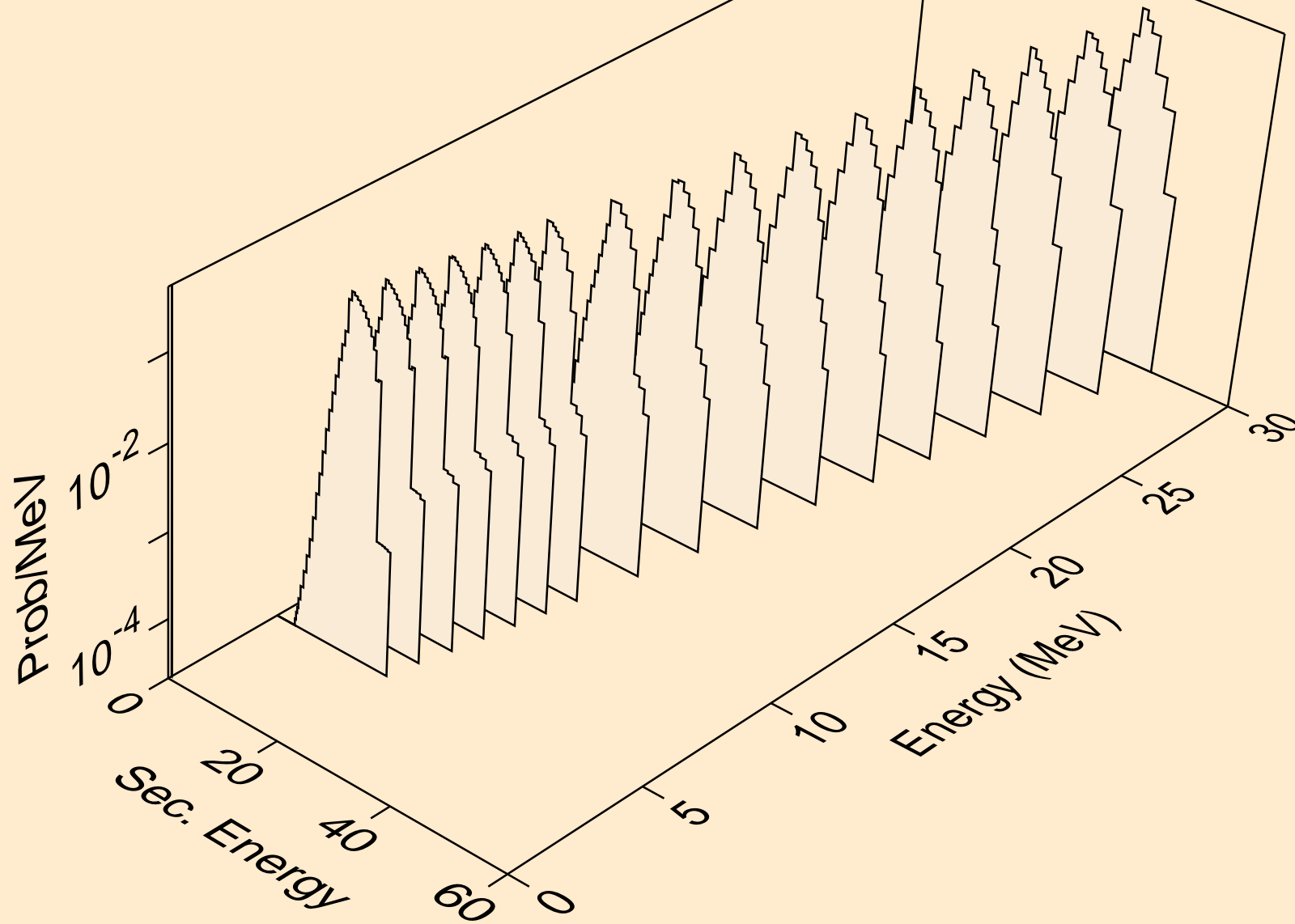

CD124 HELION ACER TENDL-2021 LIBRARY; T=0.K
neutrons from (s,x)

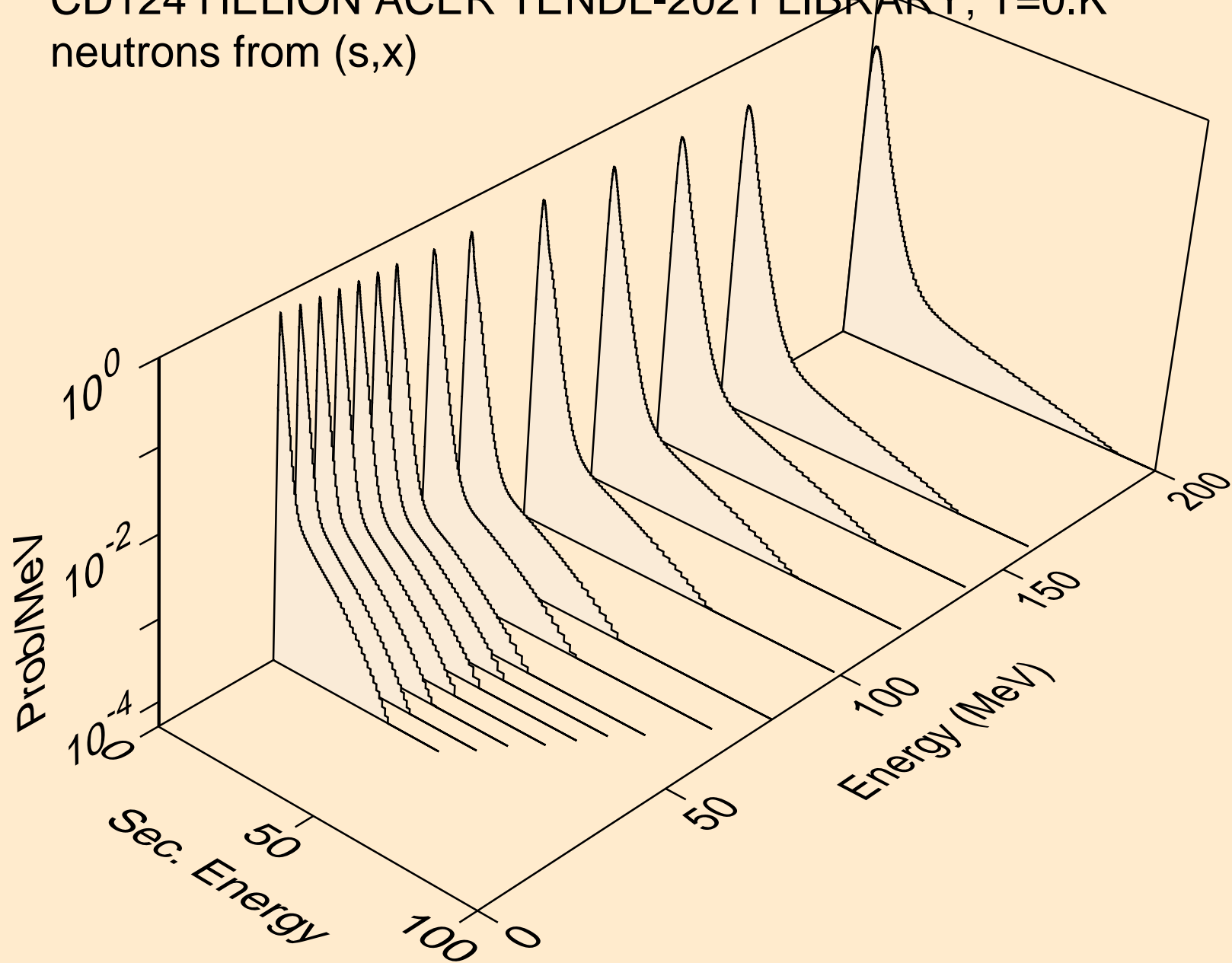

CD124 HELION ACER TENDL-2021 LIBRARY; T=0.K
neutrons from (s,2nd)

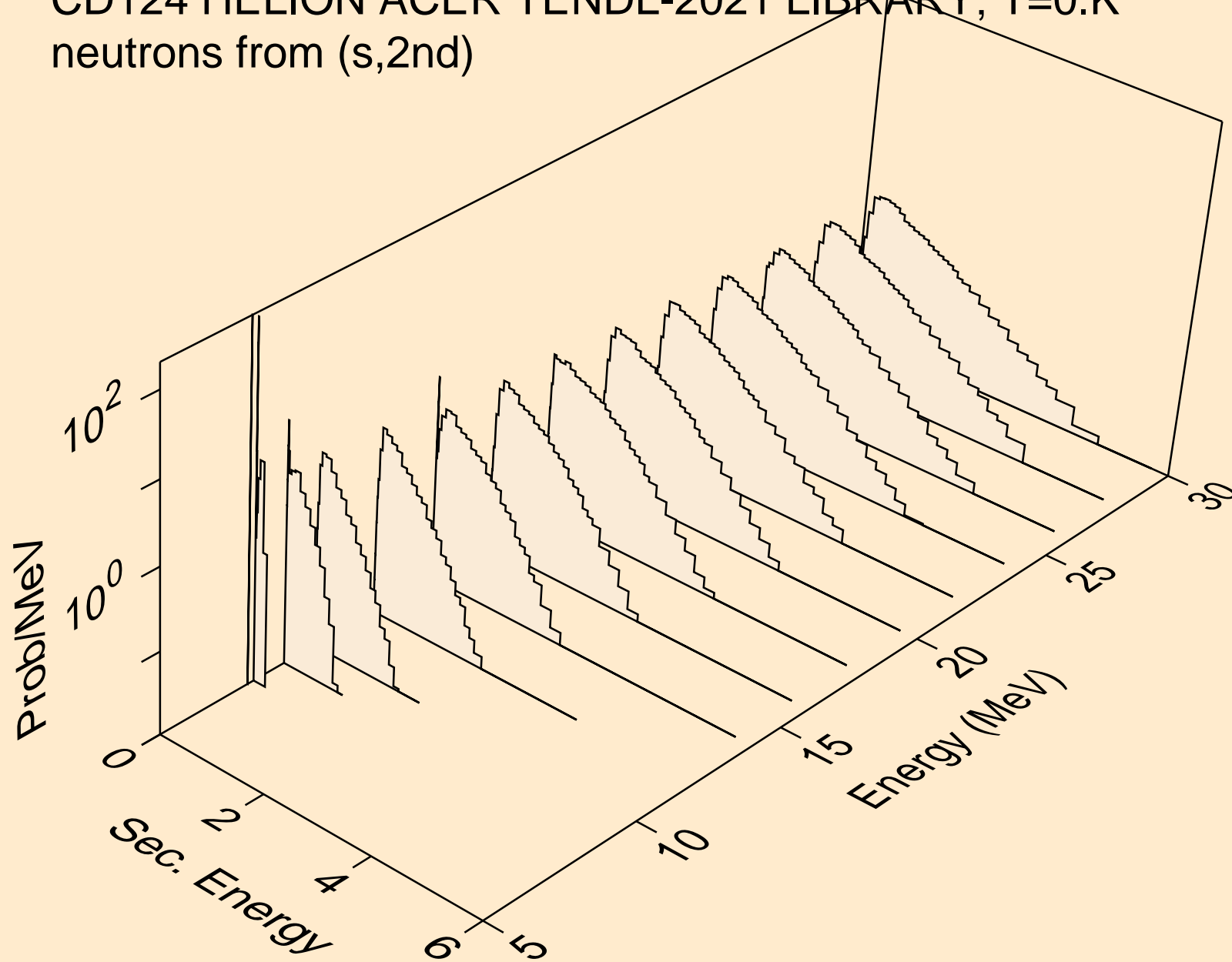

CD124 HELION ACER TENDL-2021 LIBRARY; T=0.K
neutrons from (s,2n)

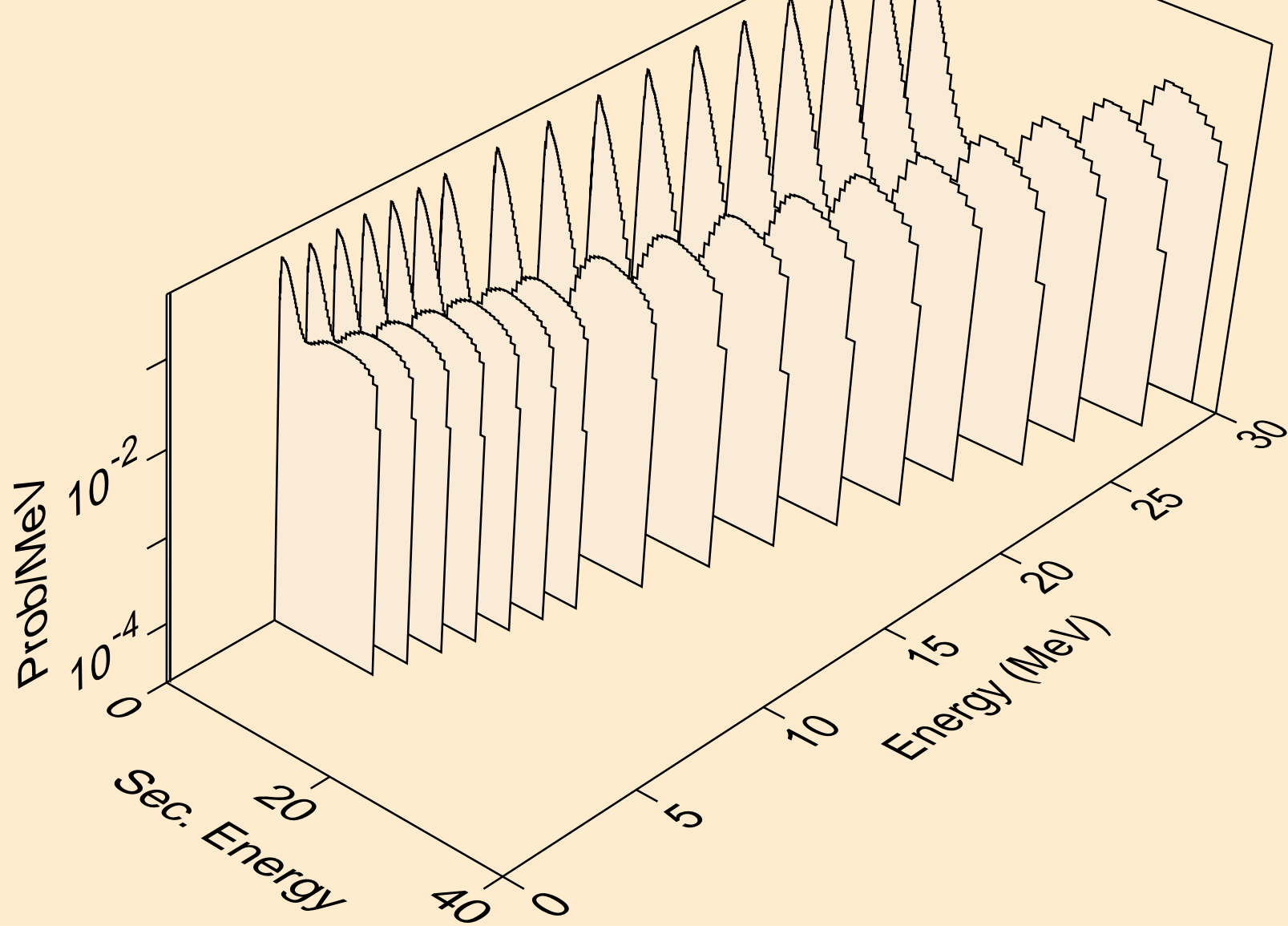

CD124 HELION ACER TENDL-2021 LIBRARY; T=0.K
neutrons from (s,3n)

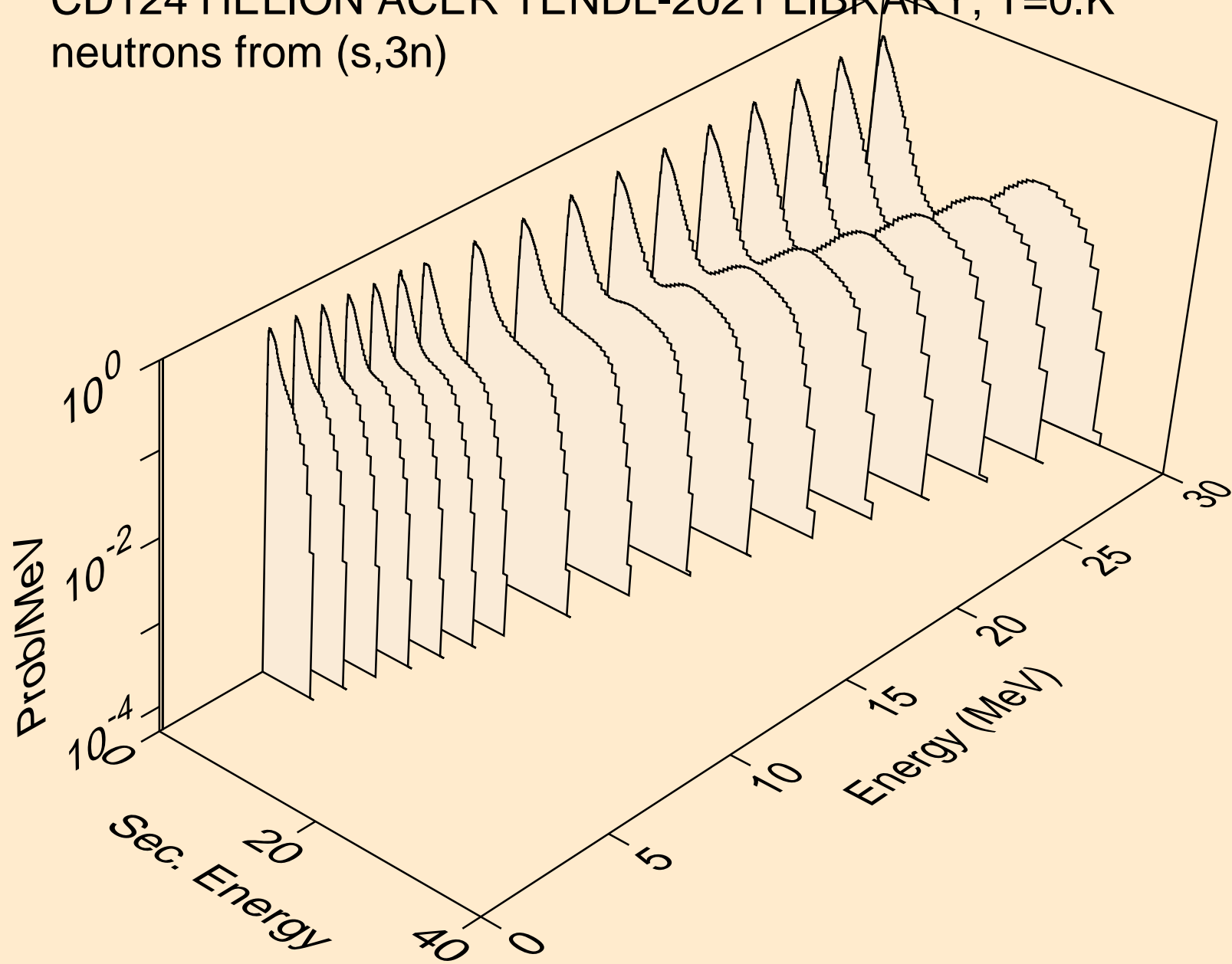

CD124 HELION ACER TENDL-2021 LIBRARY; T=0.K
neutrons from (s,n*)a

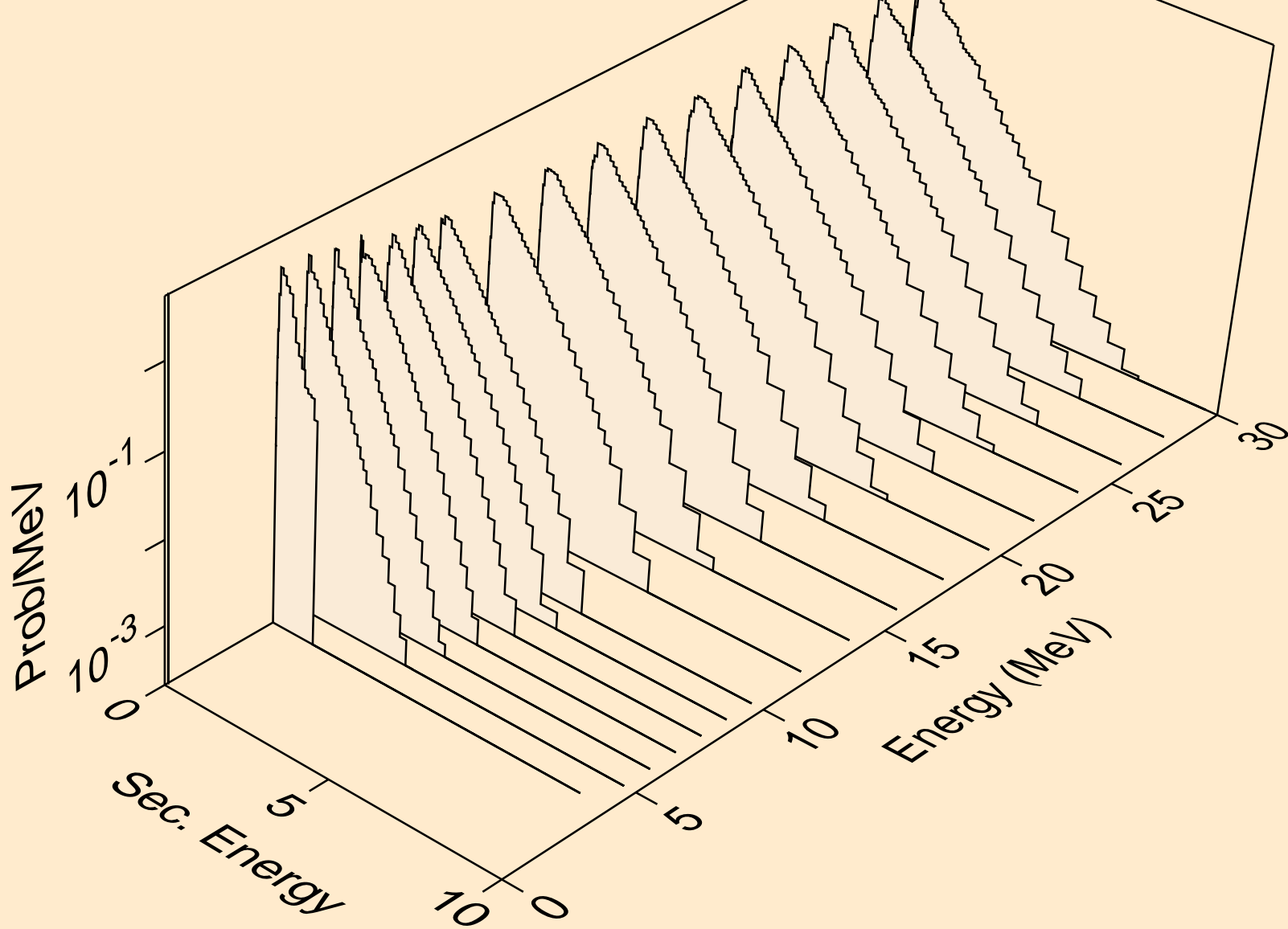

CD124 HELION ACER TENDL-2021 LIBRARY; T=0.K
neutrons from (s,2n)a

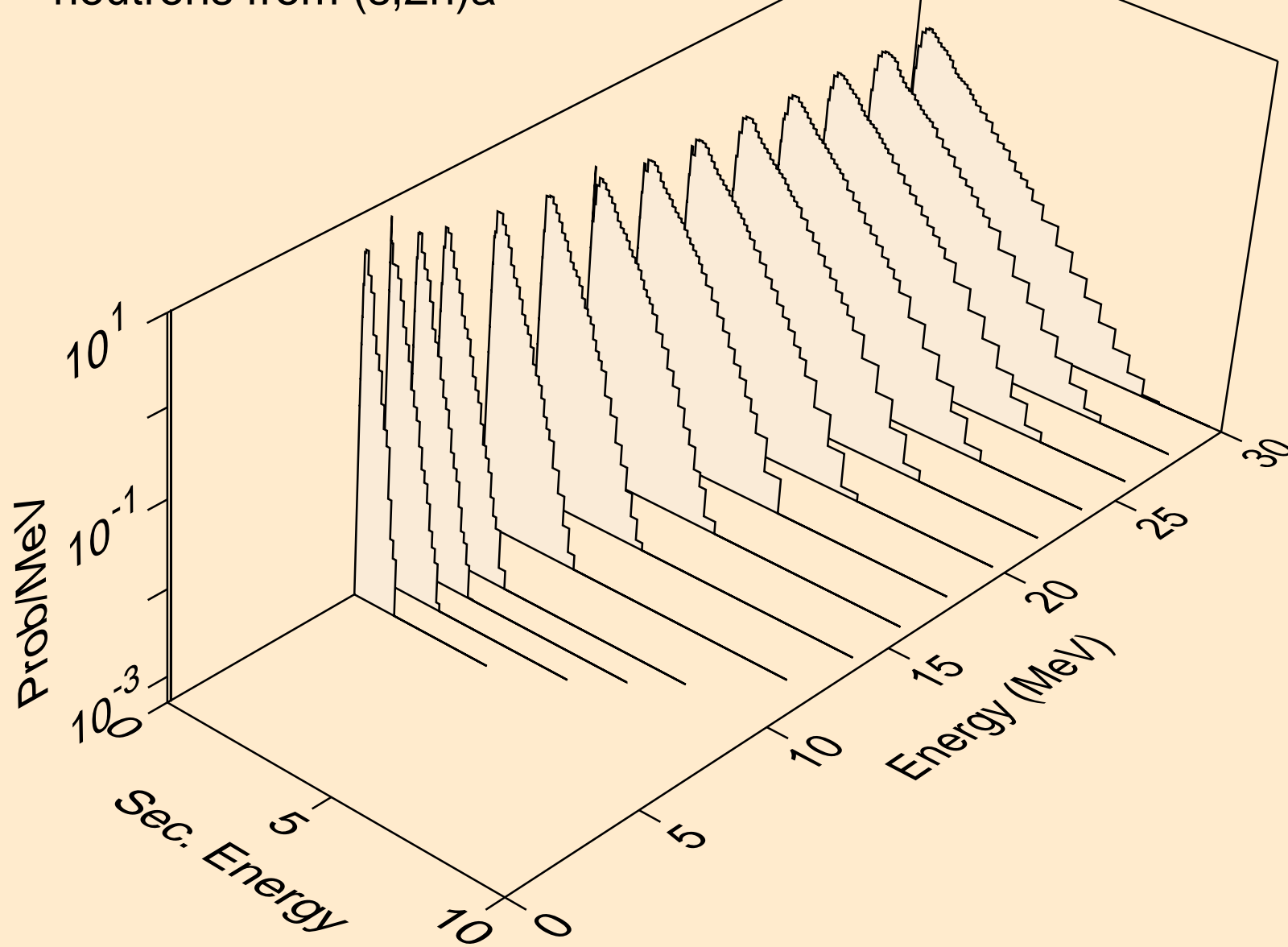

CD124 HELION ACER TENDL-2021 LIBRARY; T=0.K
neutrons from (s,3n)a

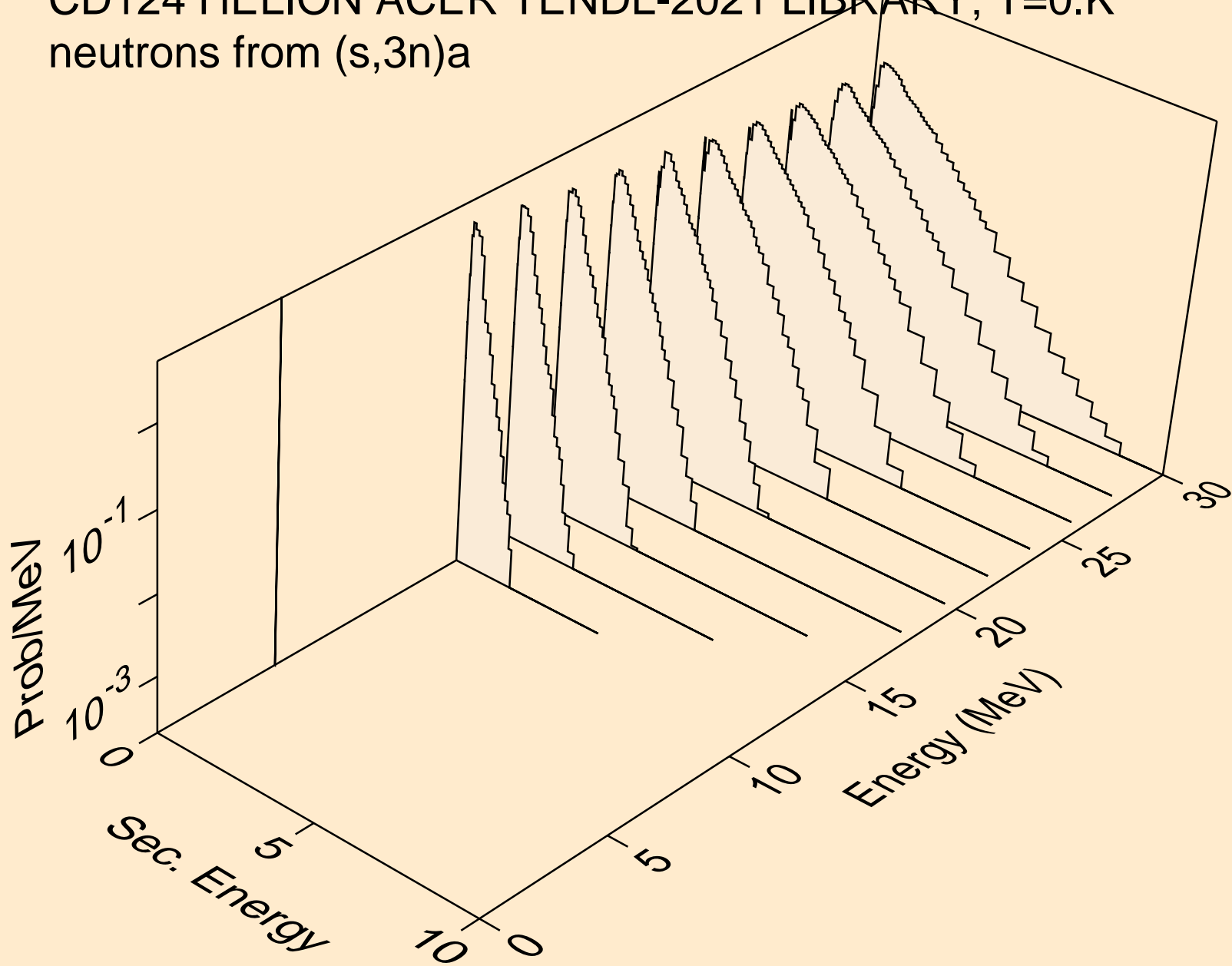

CD124 HELION ACER TENDL-2021 LIBRARY; T=0.K
neutrons from (s,n*)p

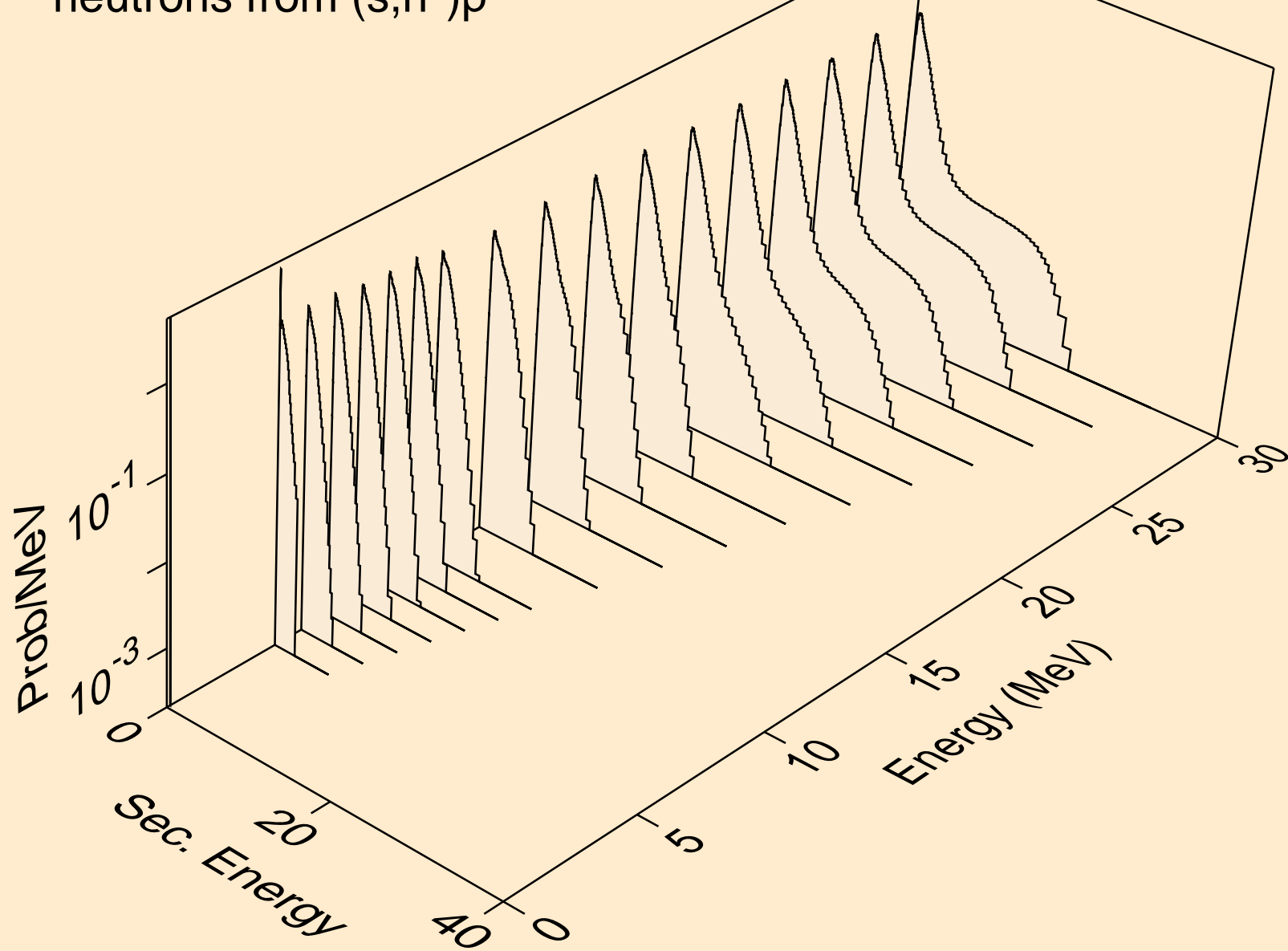

CD124 HELION ACER TENDL-2021 LIBRARY; T=0.K
neutrons from (s,n*)d

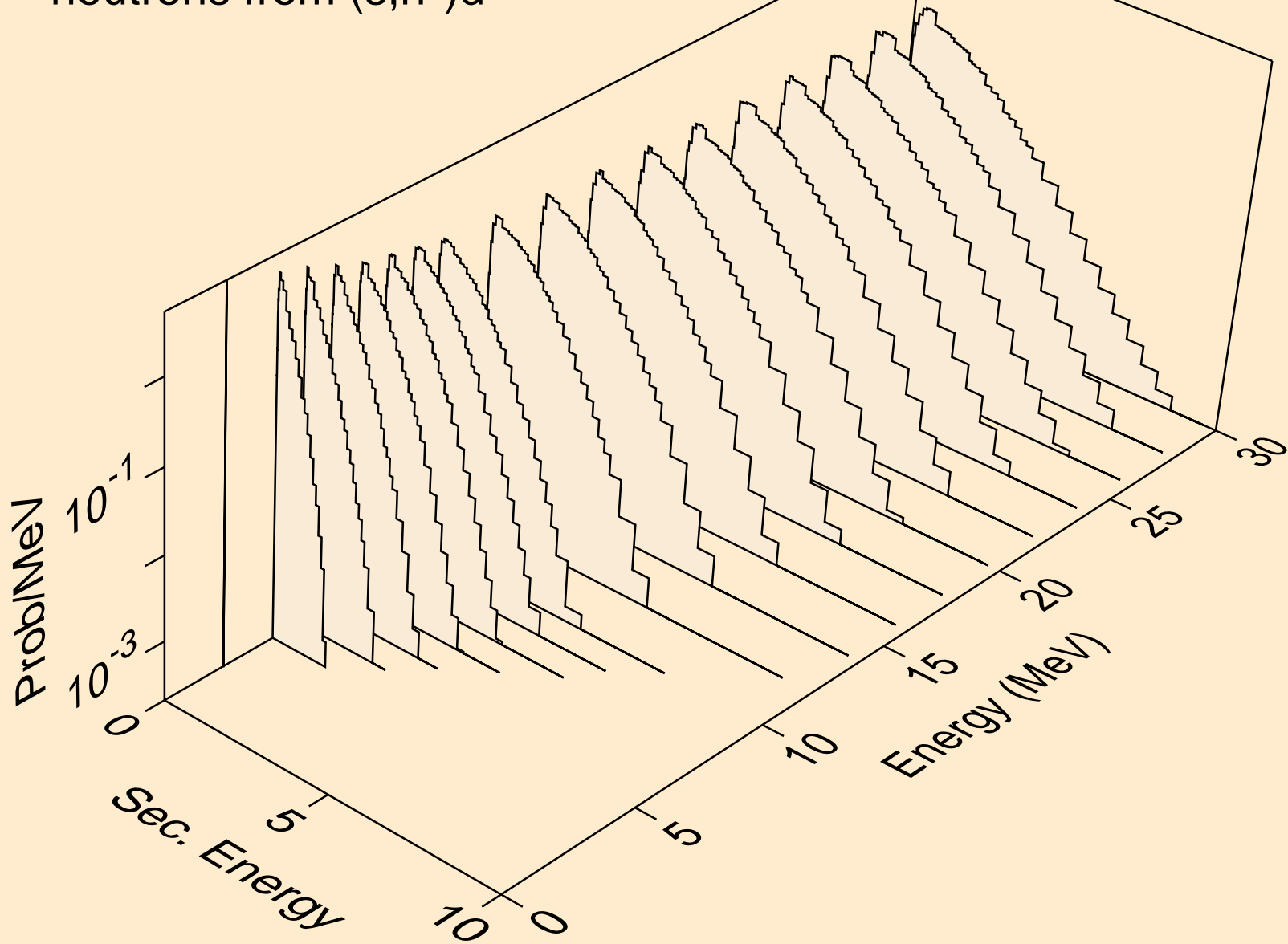

CD124 HELION ACER TENDL-2021 LIBRARY; T=0.K
neutrons from (s,n*)t

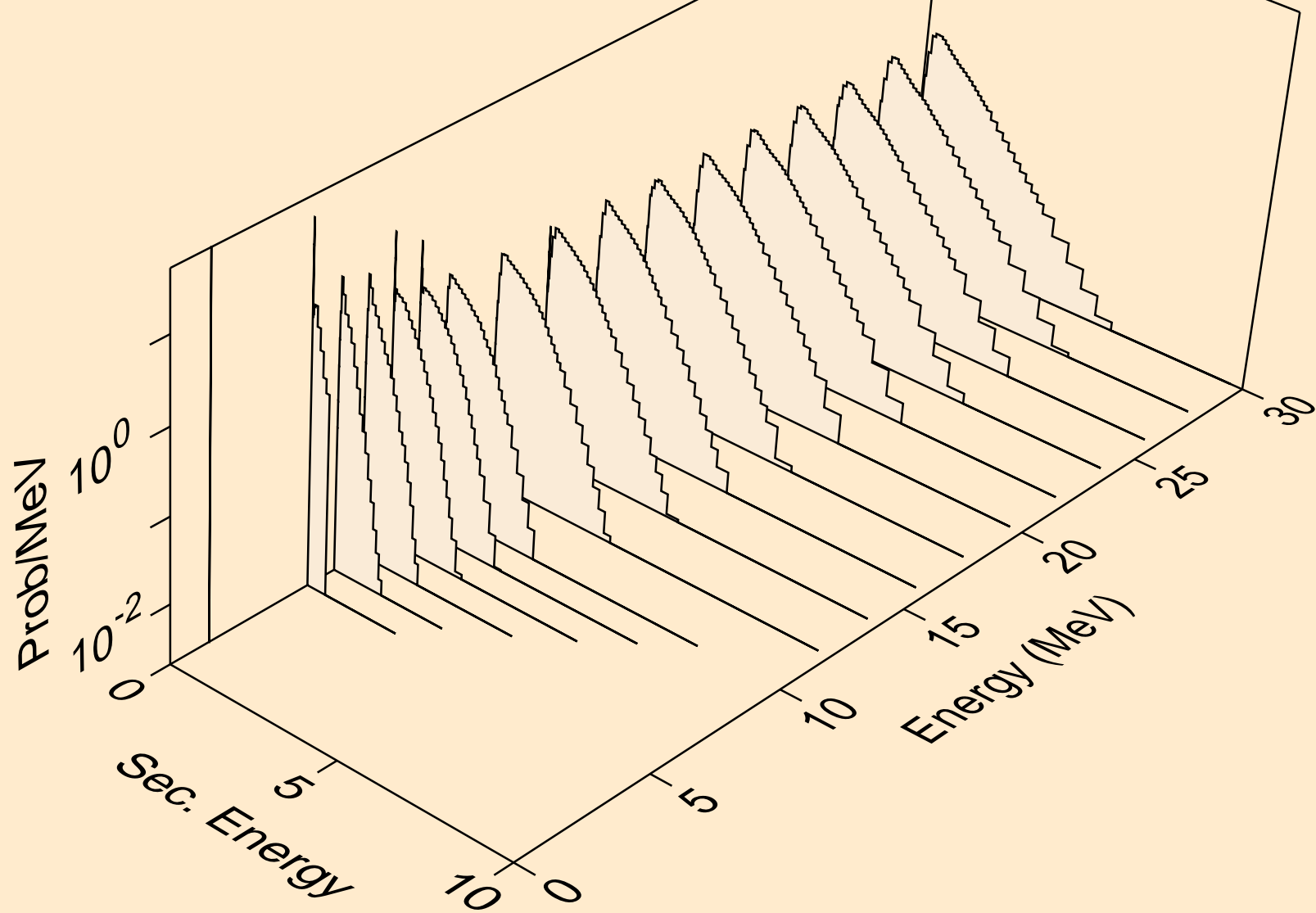

CD124 HELION ACER TENDL-2021 LIBRARY; T=0.K
neutrons from (s,n*)he3

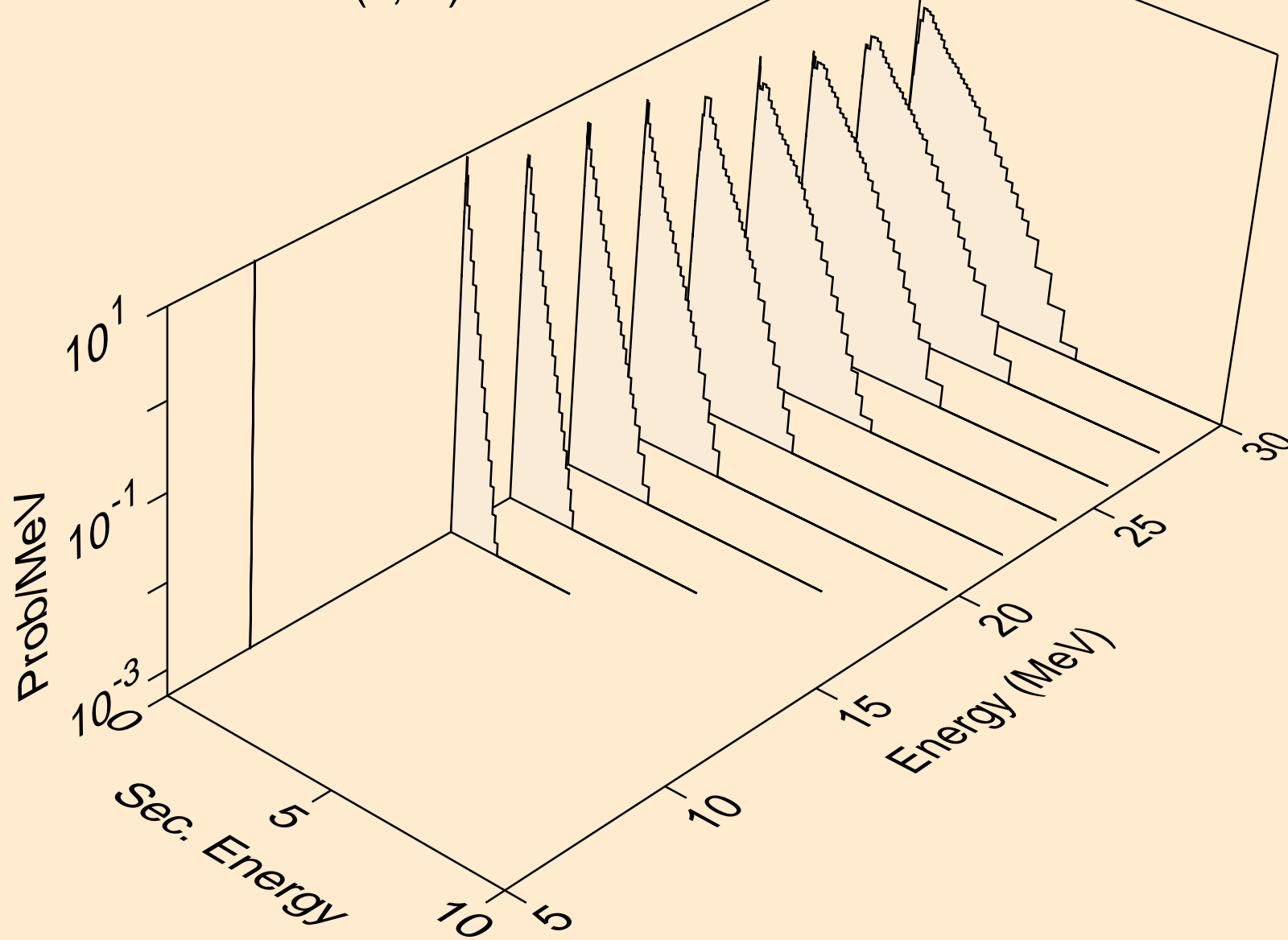

CD124 HELION ACER TENDL-2021 LIBRARY; T=0.K
neutrons from (s,4n)

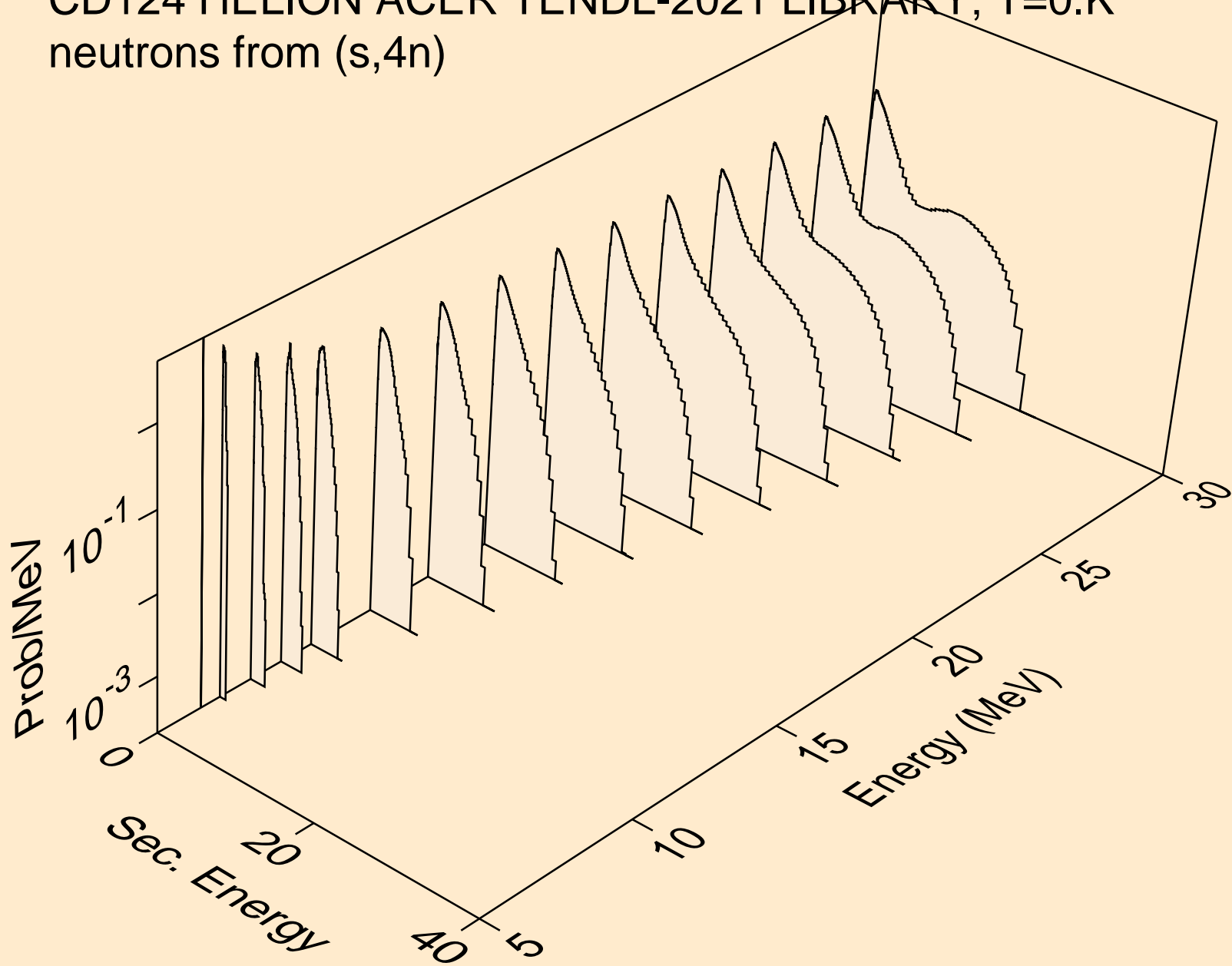

CD124 HELION ACER TENDL-2021 LIBRARY; T=0.K
neutrons from (s,2np)

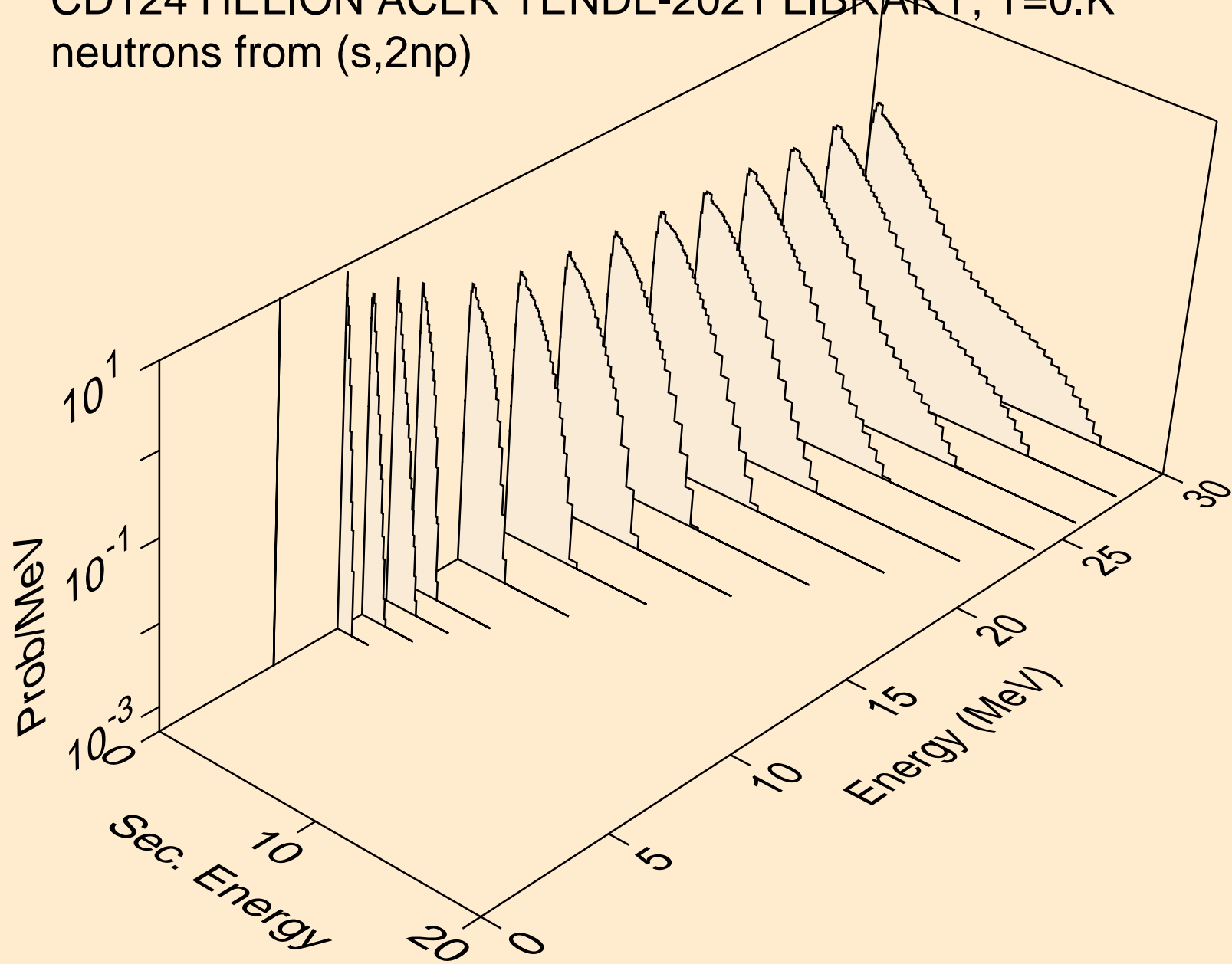

CD124 HELION ACER TENDL-2021 LIBRARY; T=0.K
neutrons from (s,3np)

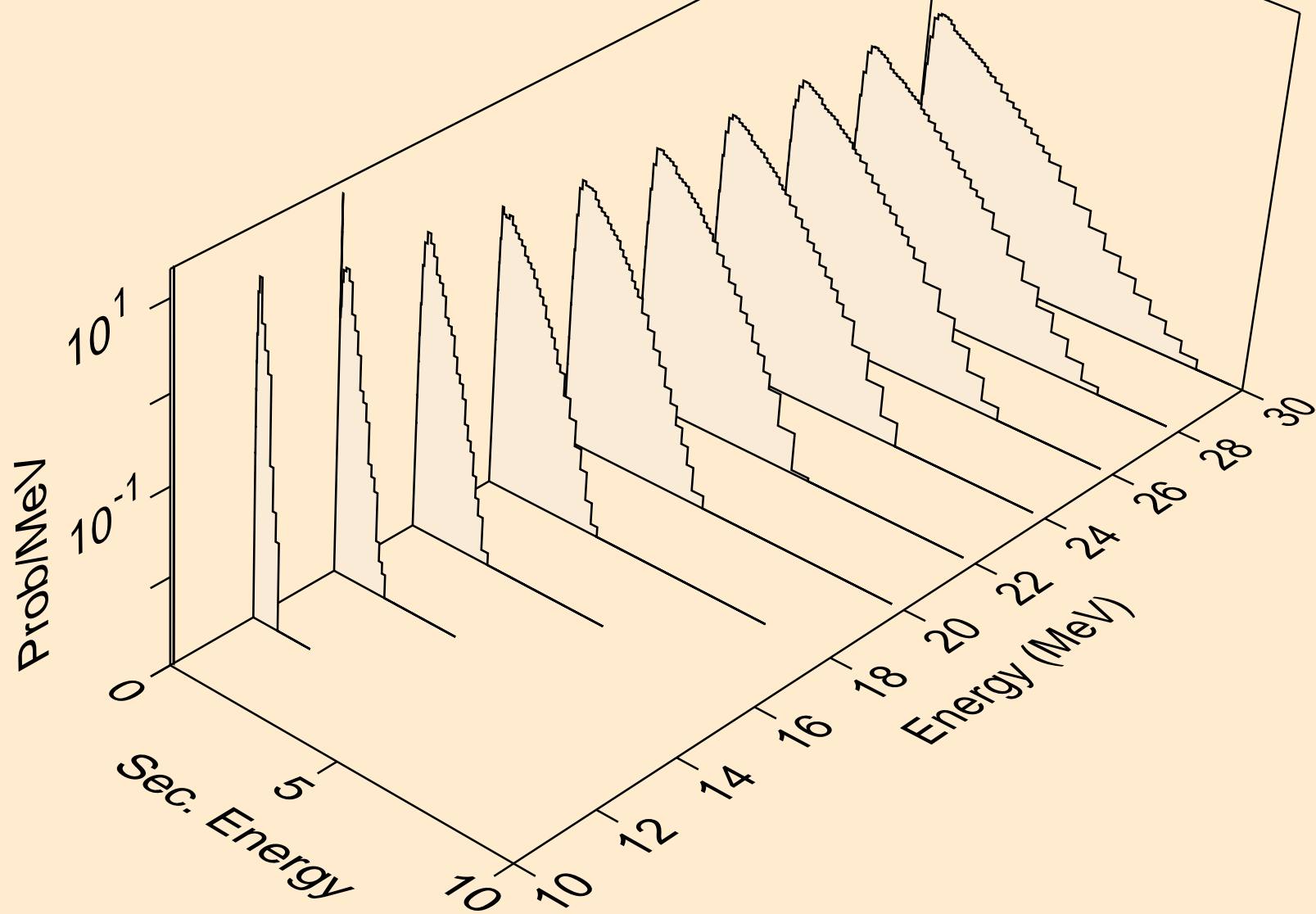

CD124 HELION ACER TENDL-2021 LIBRARY; T=0.K
neutrons from (s,2np)

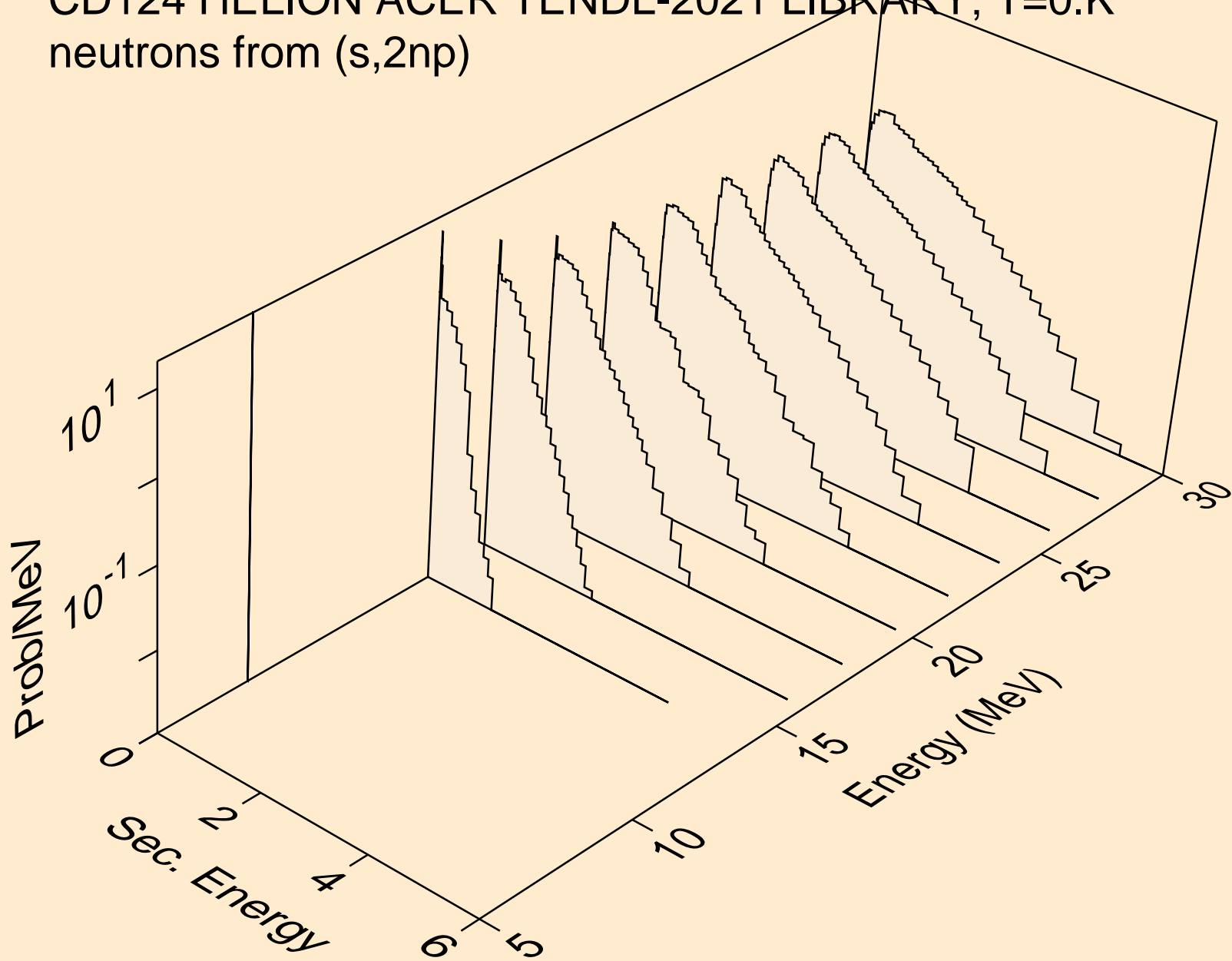

CD124 HELION ACER TENDL-2021 LIBRARY; T=0.K
neutrons from (s,npa)

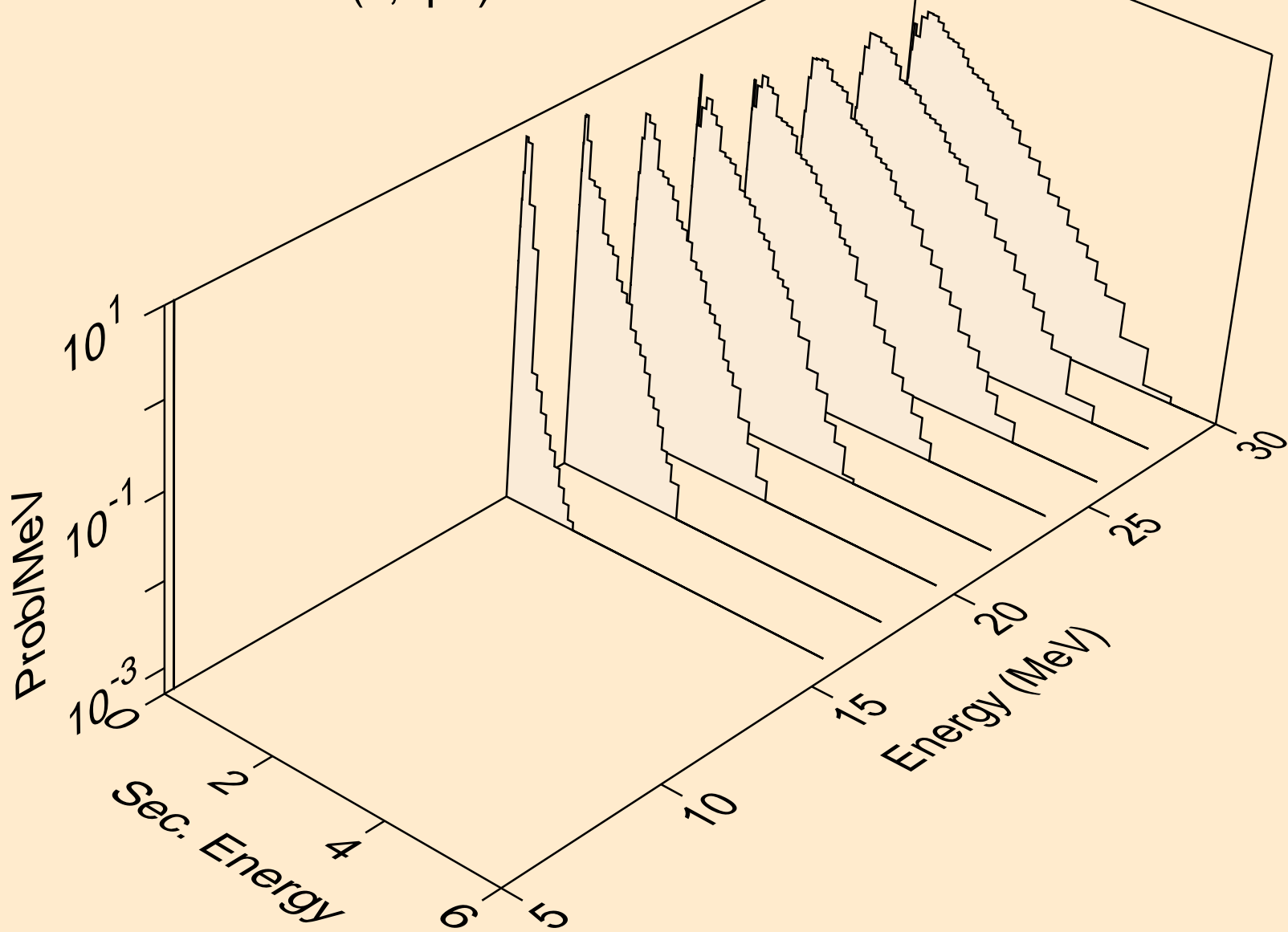

CD124 HELION ACER TENDL-2021 LIBRARY; T=0.K
protons from (s,x)

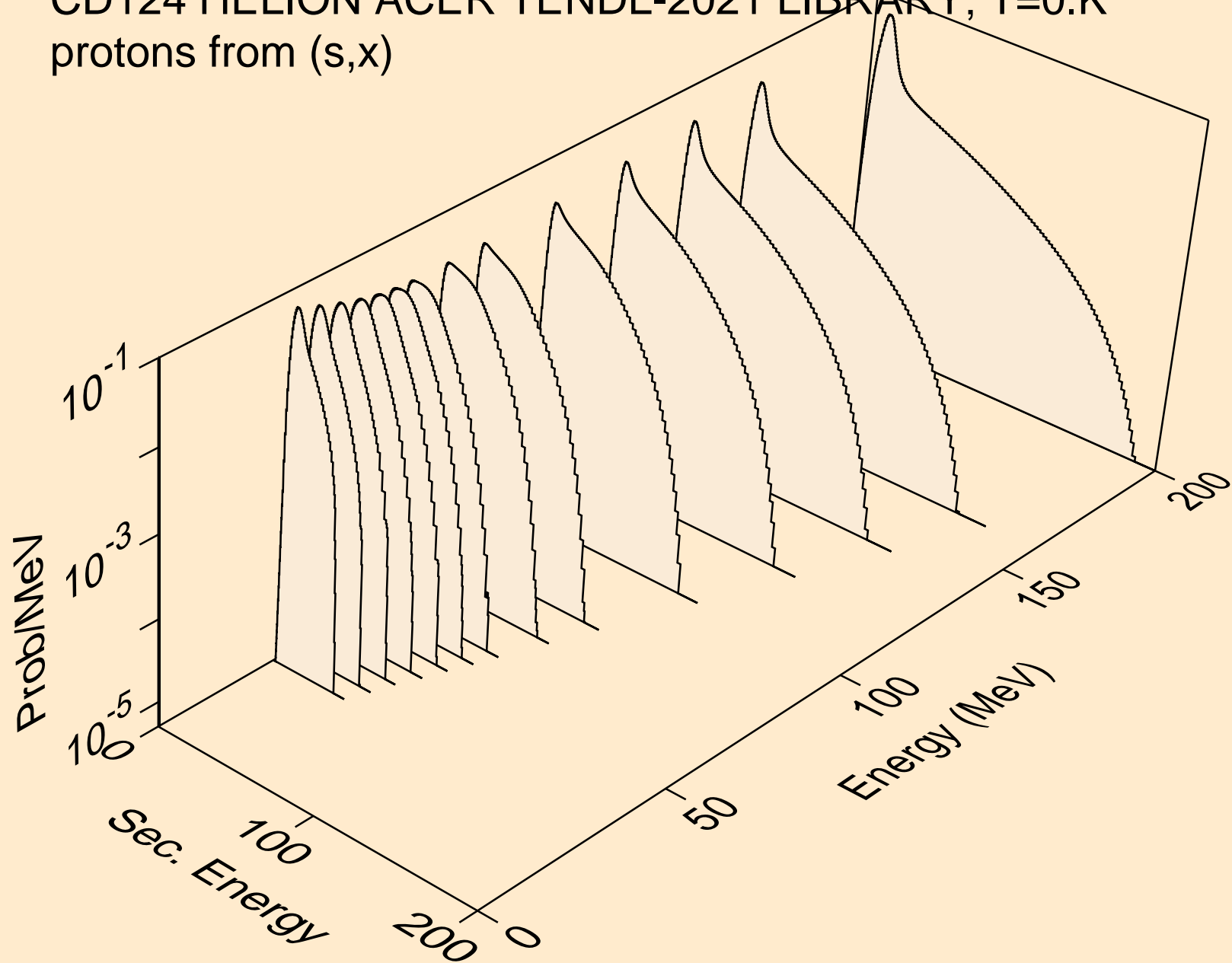

CD124 HELION ACER TENDL-2021 LIBRARY; T=0.K
protons from (s,n*)p

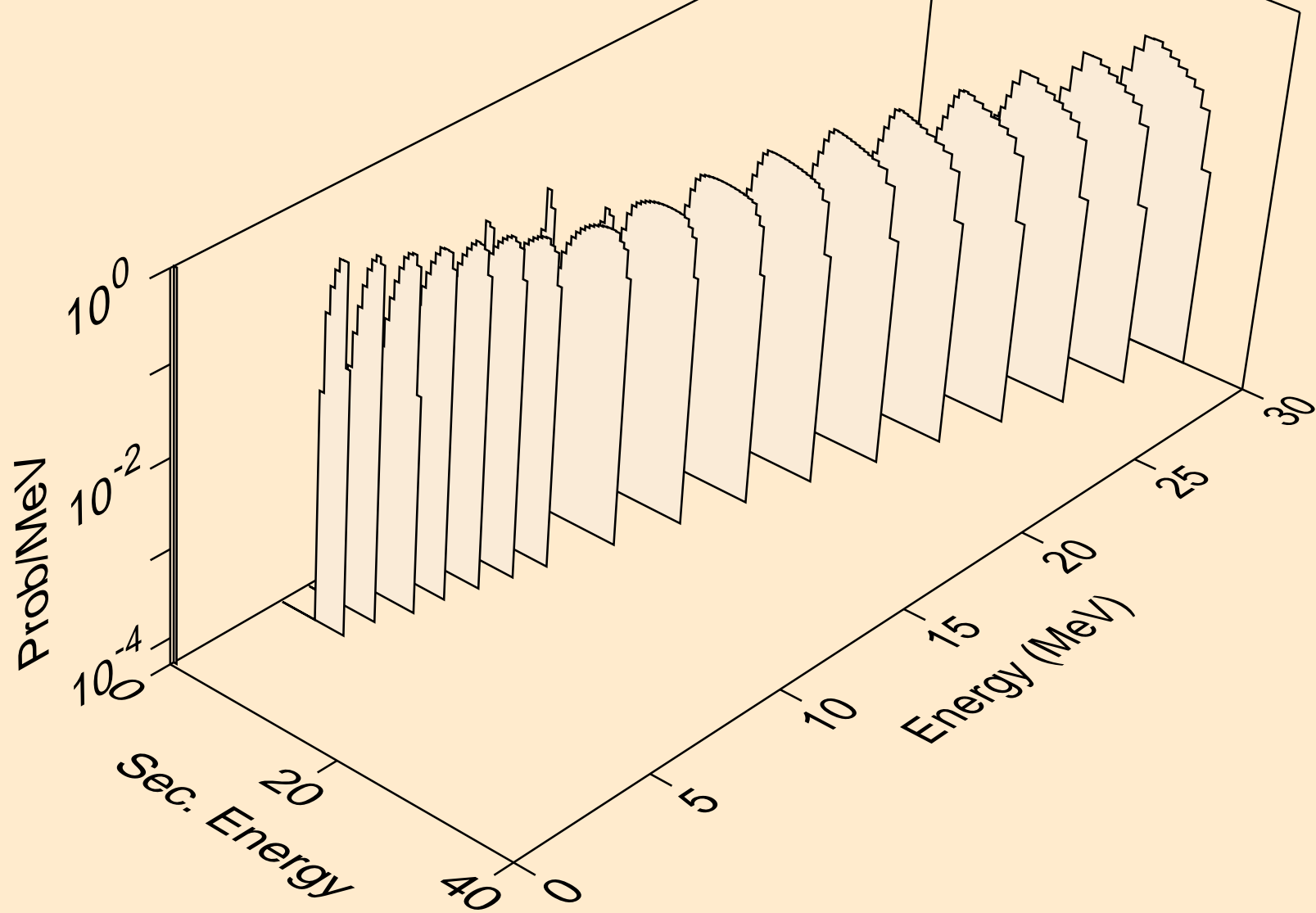

CD124 HELION ACER TENDL-2021 LIBRARY; T=0.K
protons from (s,2np)

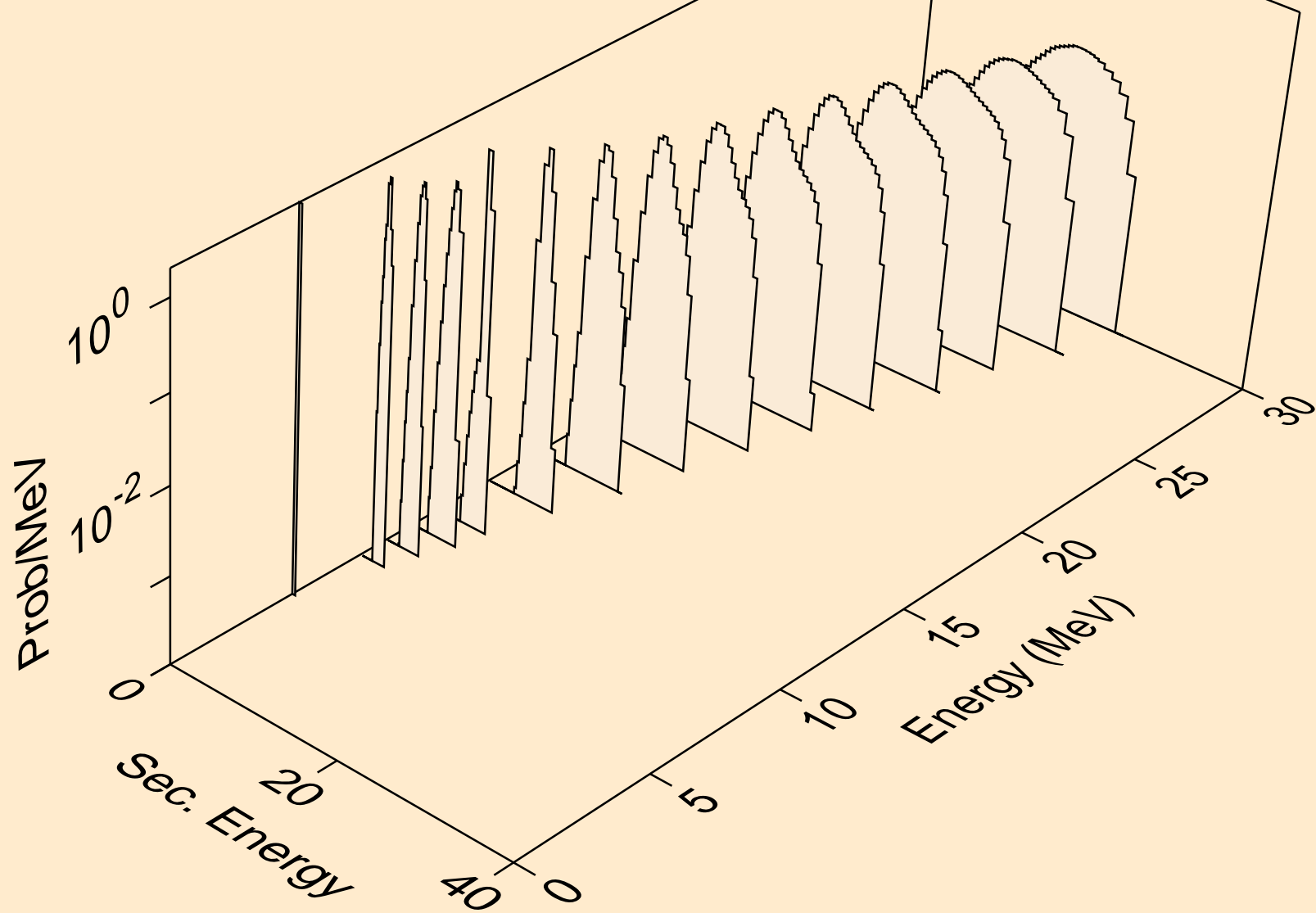

CD124 HELION ACER TENDL-2021 LIBRARY; T=0.K
protons from (s,3np)

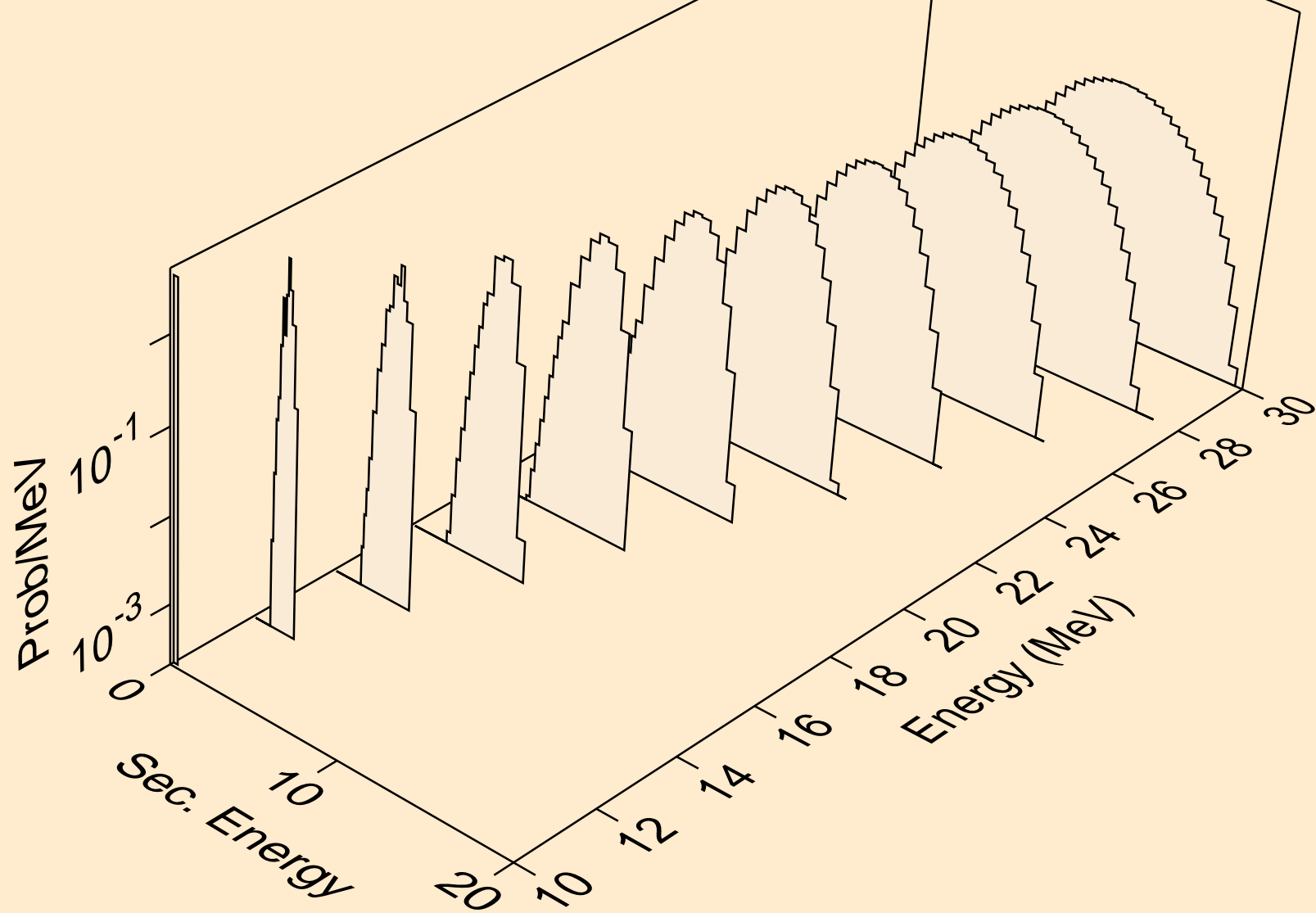

CD124 HELION ACER TENDL-2021 LIBRARY; T=0.K
protons from (s,2np)

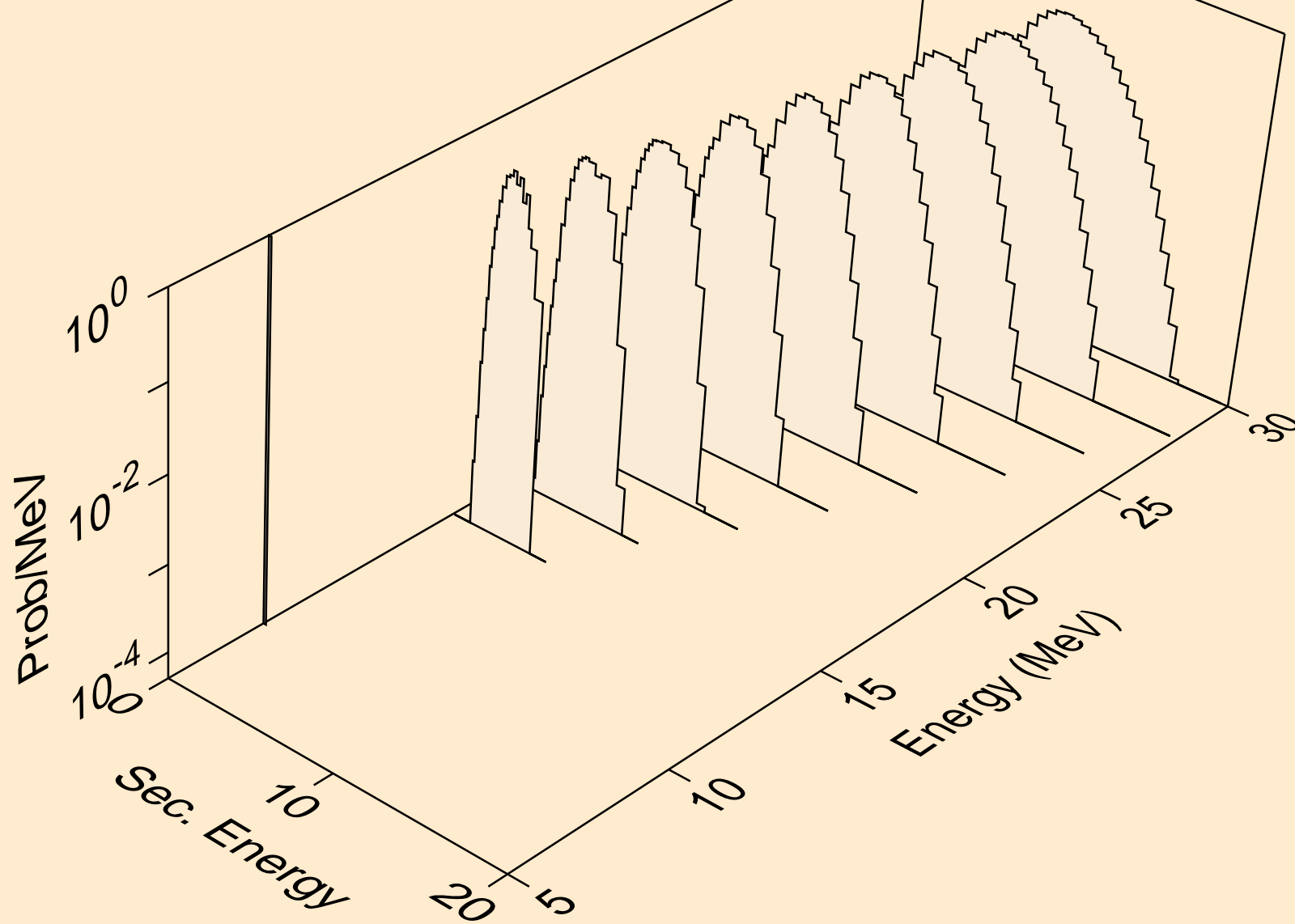

CD124 HELION ACER TENDL-2021 LIBRARY; T=0.K
protons from (s,npa)

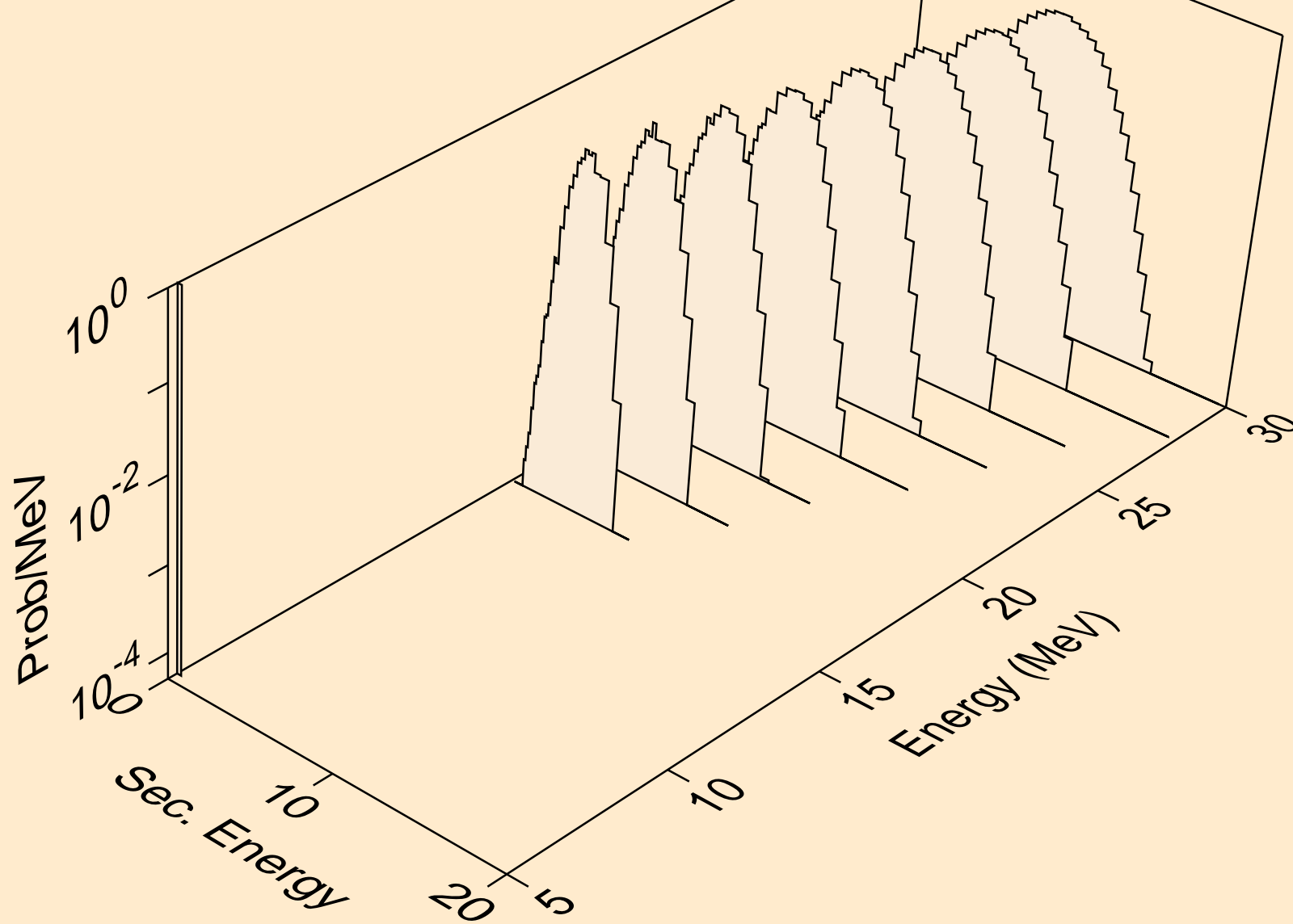

CD124 HELION ACER TENDL-2021 LIBRARY; T=0.K
protons from (s,p)

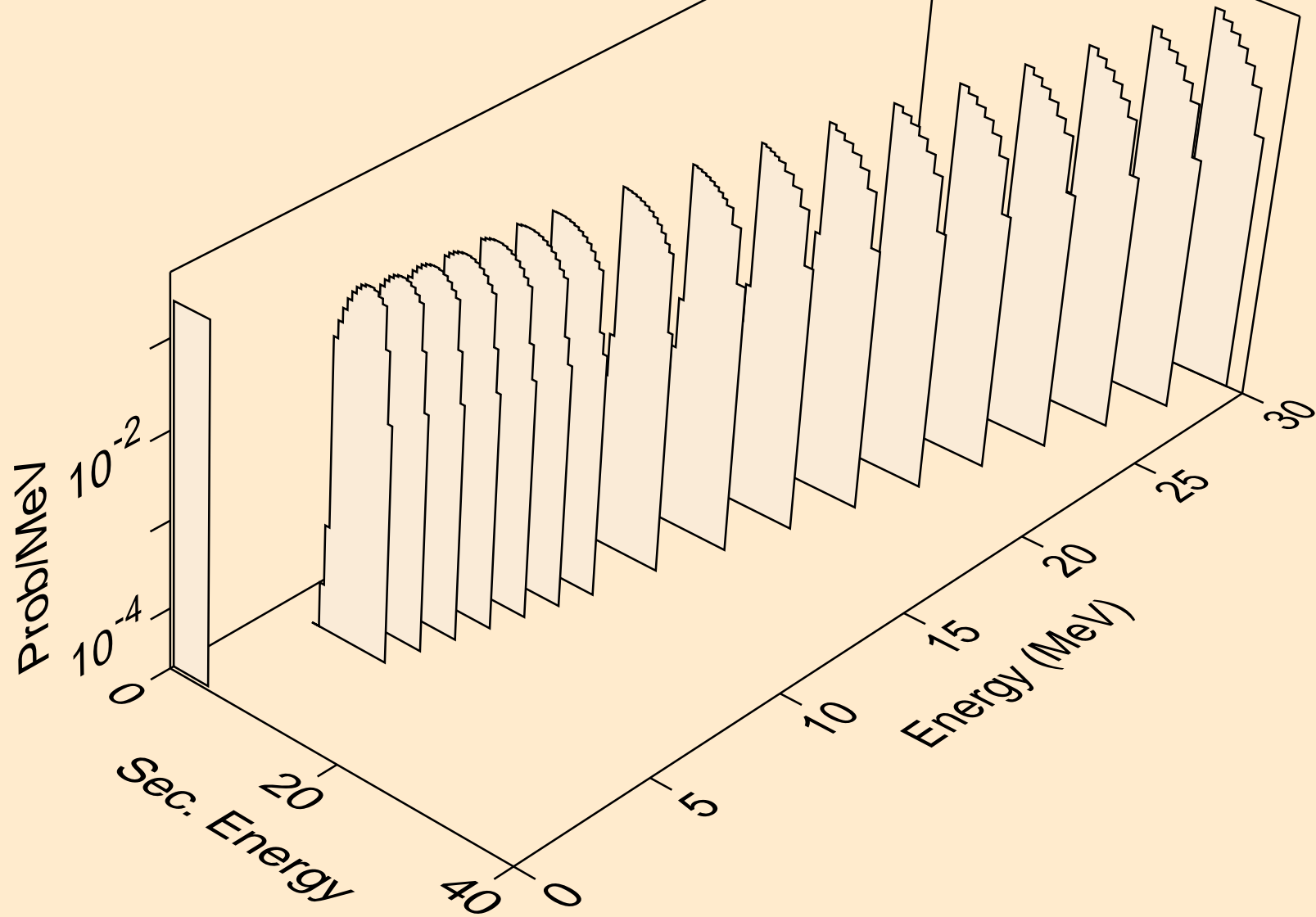

CD124 HELION ACER TENDL-2021 LIBRARY; T=0.K
protons from (s,2p)

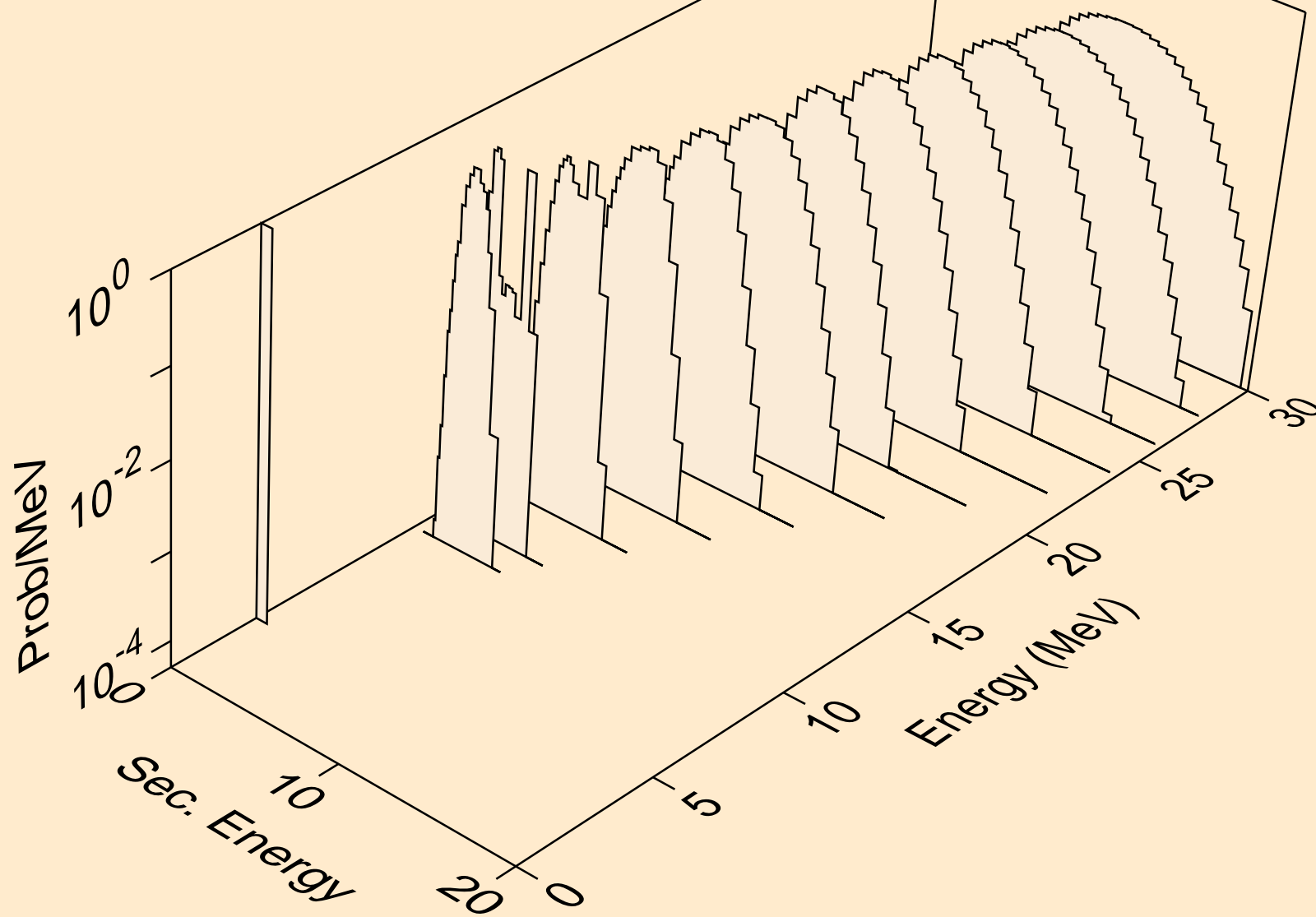

CD124 HELION ACER TENDL-2021 LIBRARY; T=0.K
protons from (s,pa)

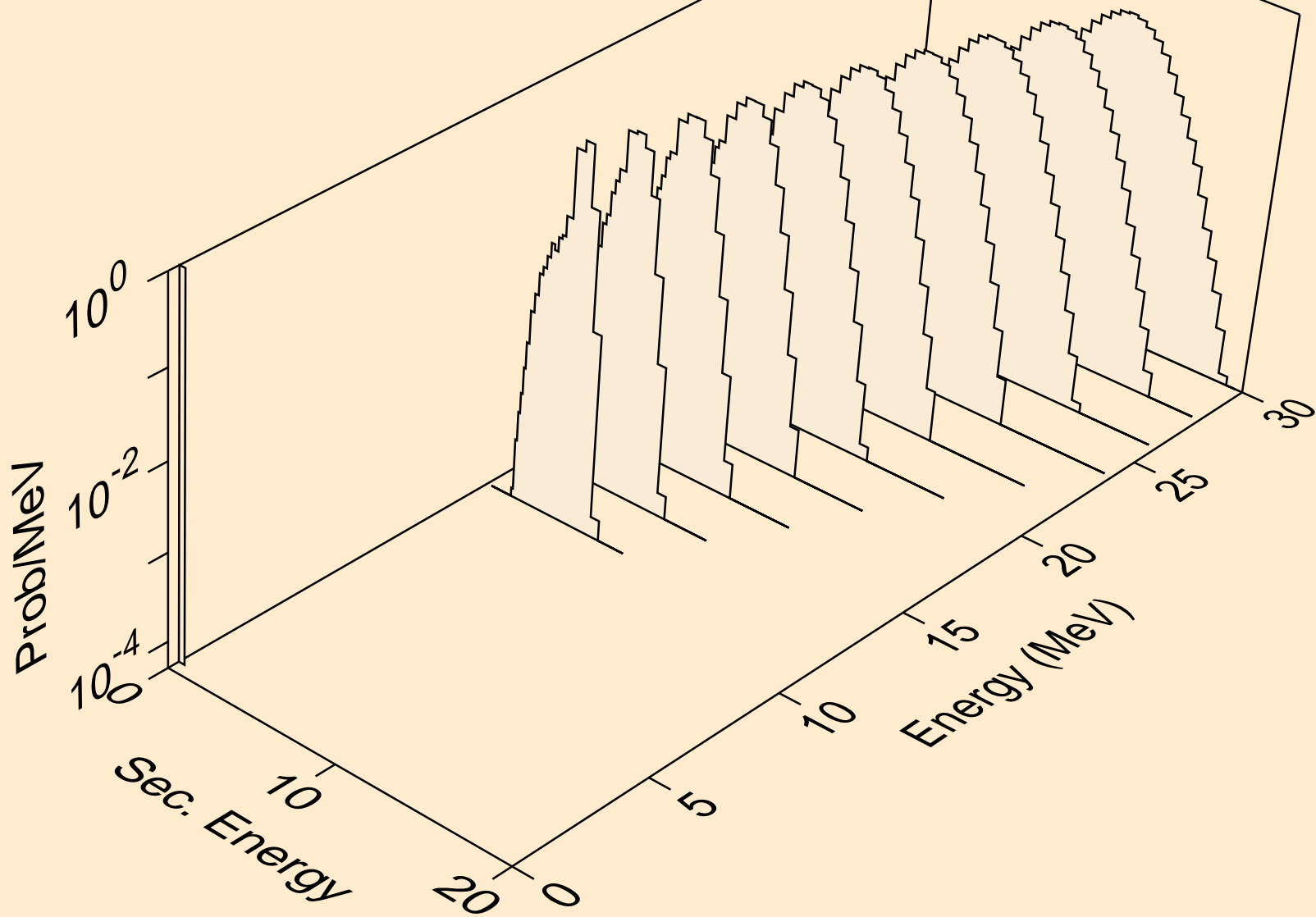

CD124 HELION ACER TENDL-2021 LIBRARY; T=0.K
protons from (s,pd)

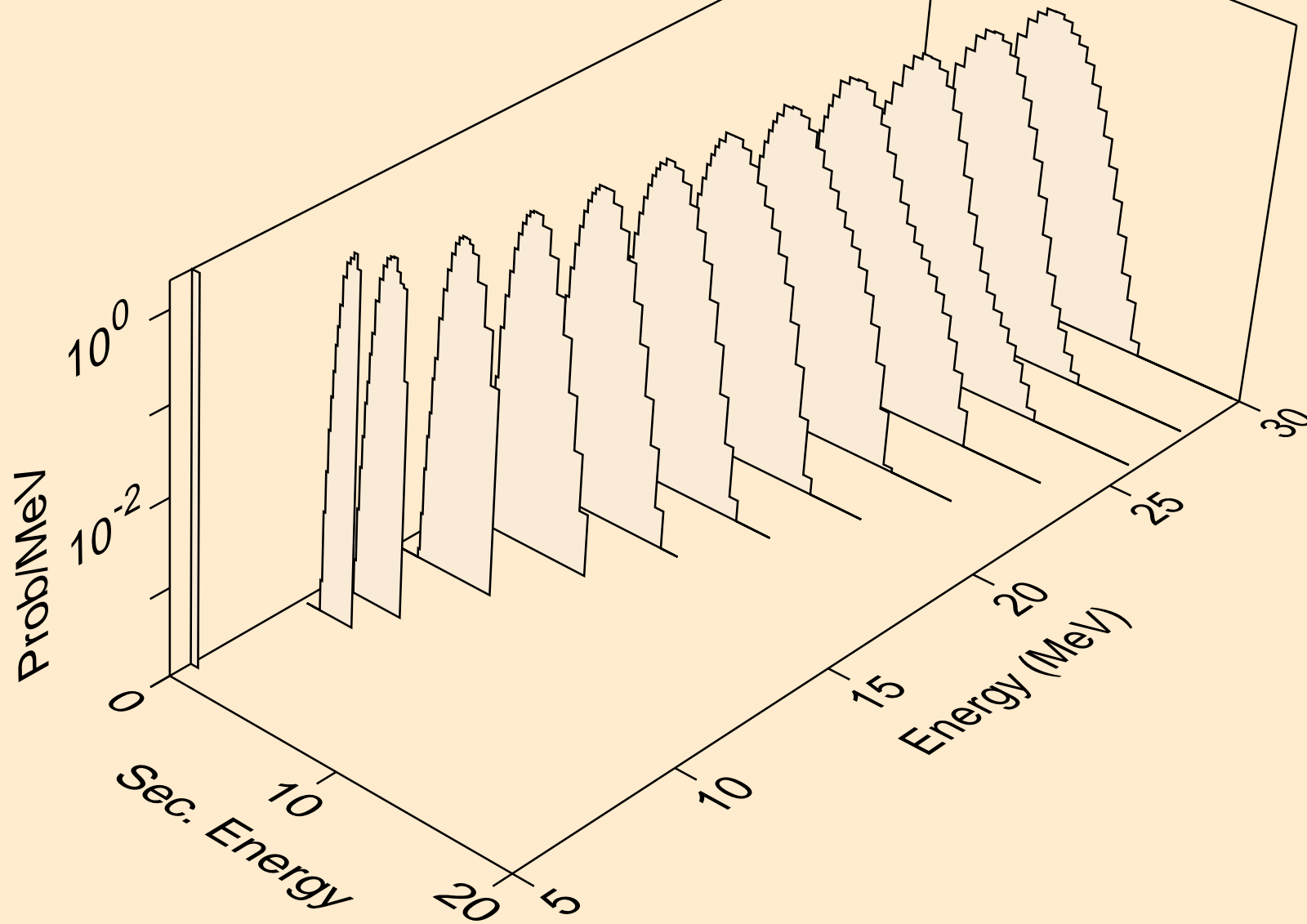

CD124 HELION ACER TENDL-2021 LIBRARY; T=0.K
protons from (s,pt)

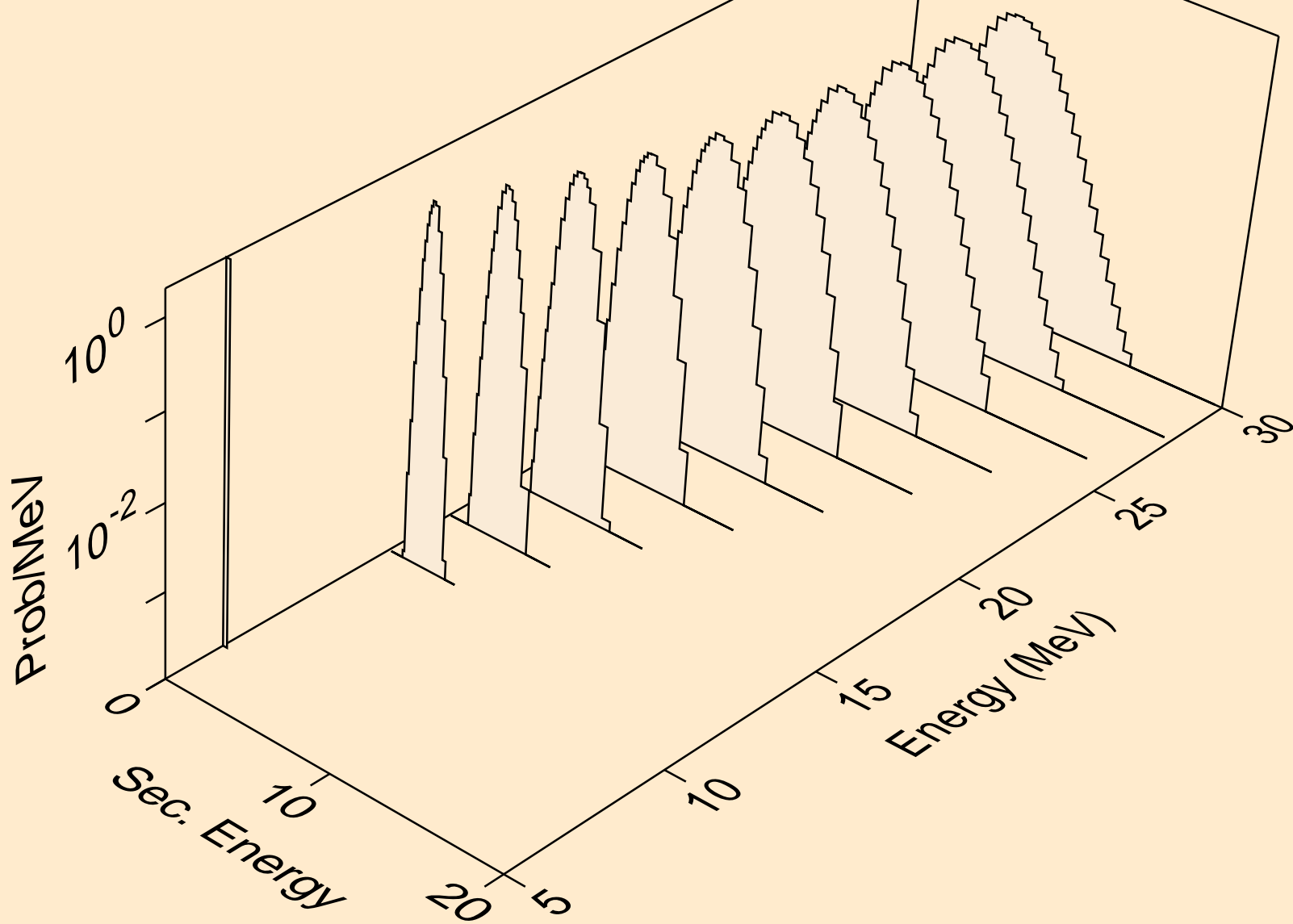

CD124 HELION ACER TENDL-2021 LIBRARY; T=0.K
deuterons from (s,x)

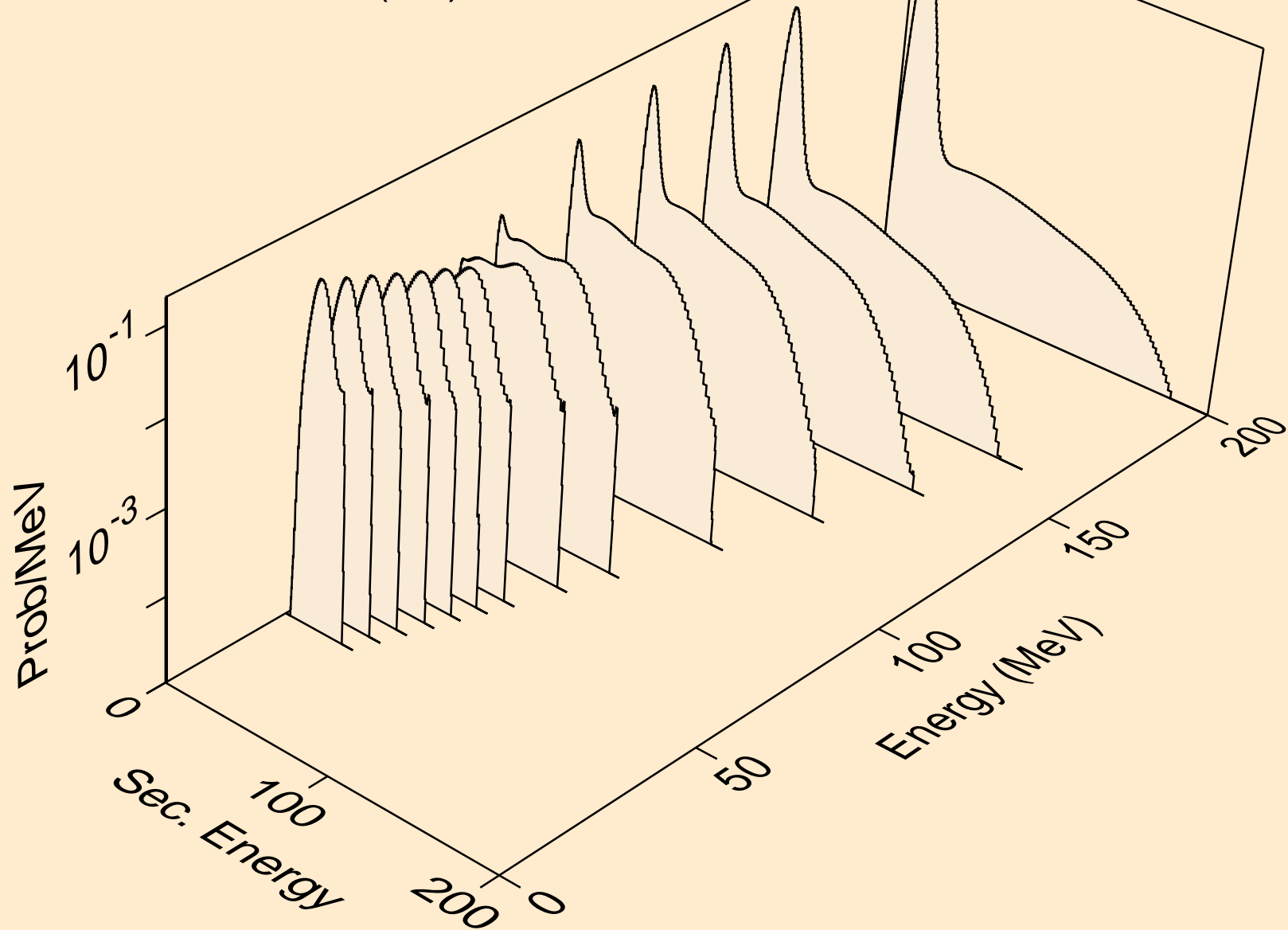

CD124 HELION ACER TENDL-2021 LIBRARY; T=0.K
deuterons from (s,2nd)

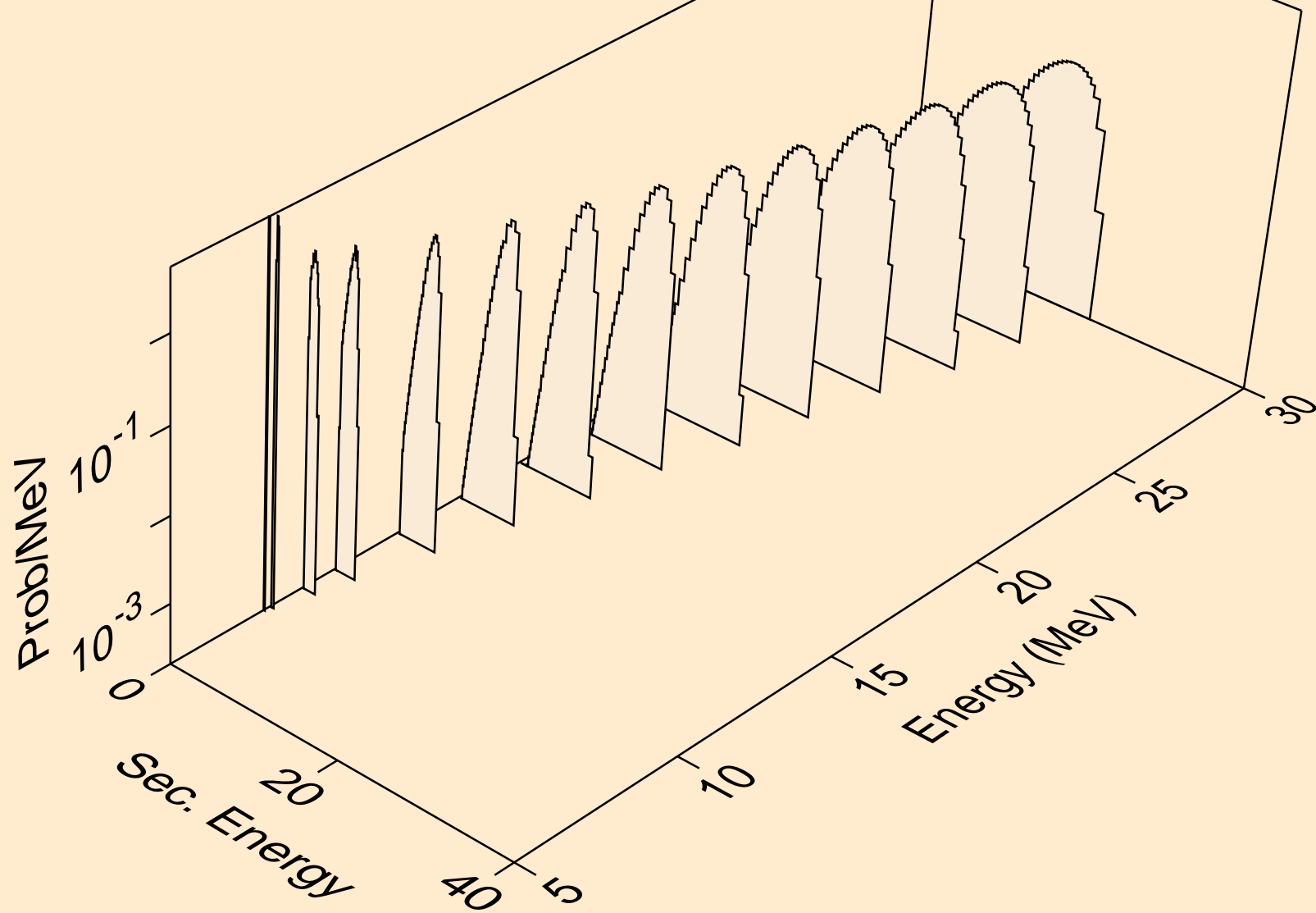

CD124 HELION ACER TENDL-2021 LIBRARY; T=0.K
deuterons from (s,n*)d

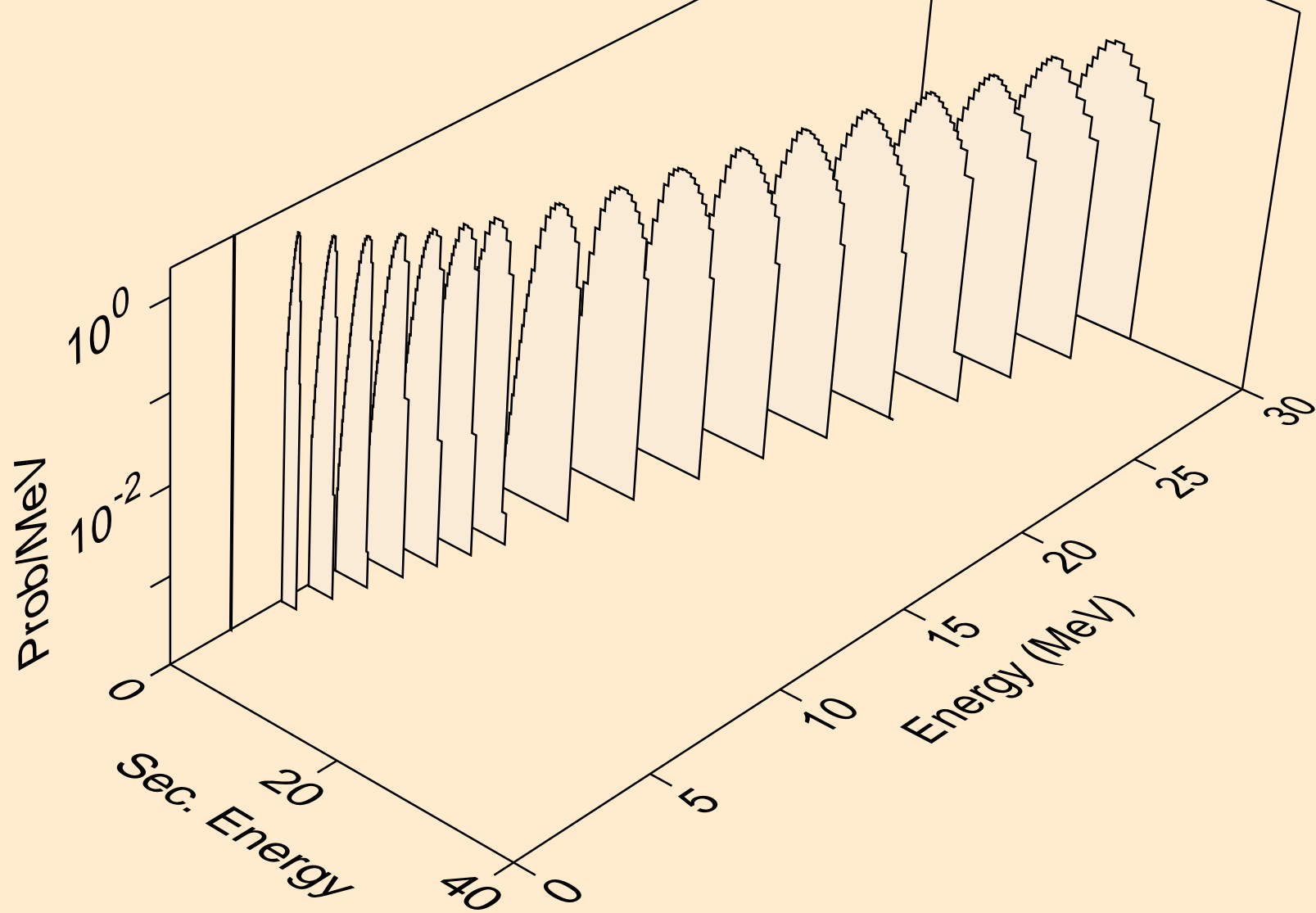

CD124 HELION ACER TENDL-2021 LIBRARY; T=0.K
deuterons from (s,d)

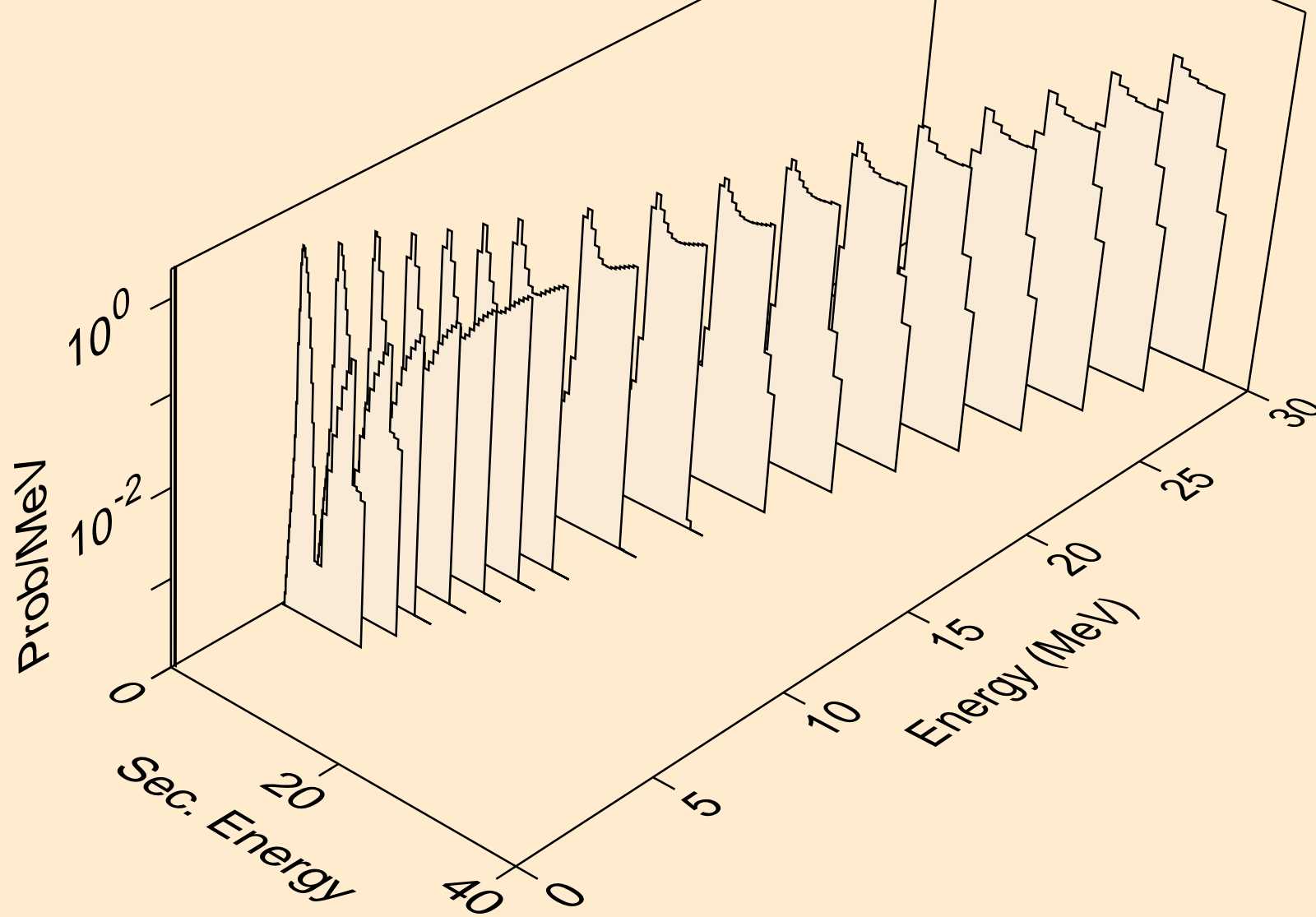

CD124 HELION ACER TENDL-2021 LIBRARY; T=0.K
deuterons from (s,pd)

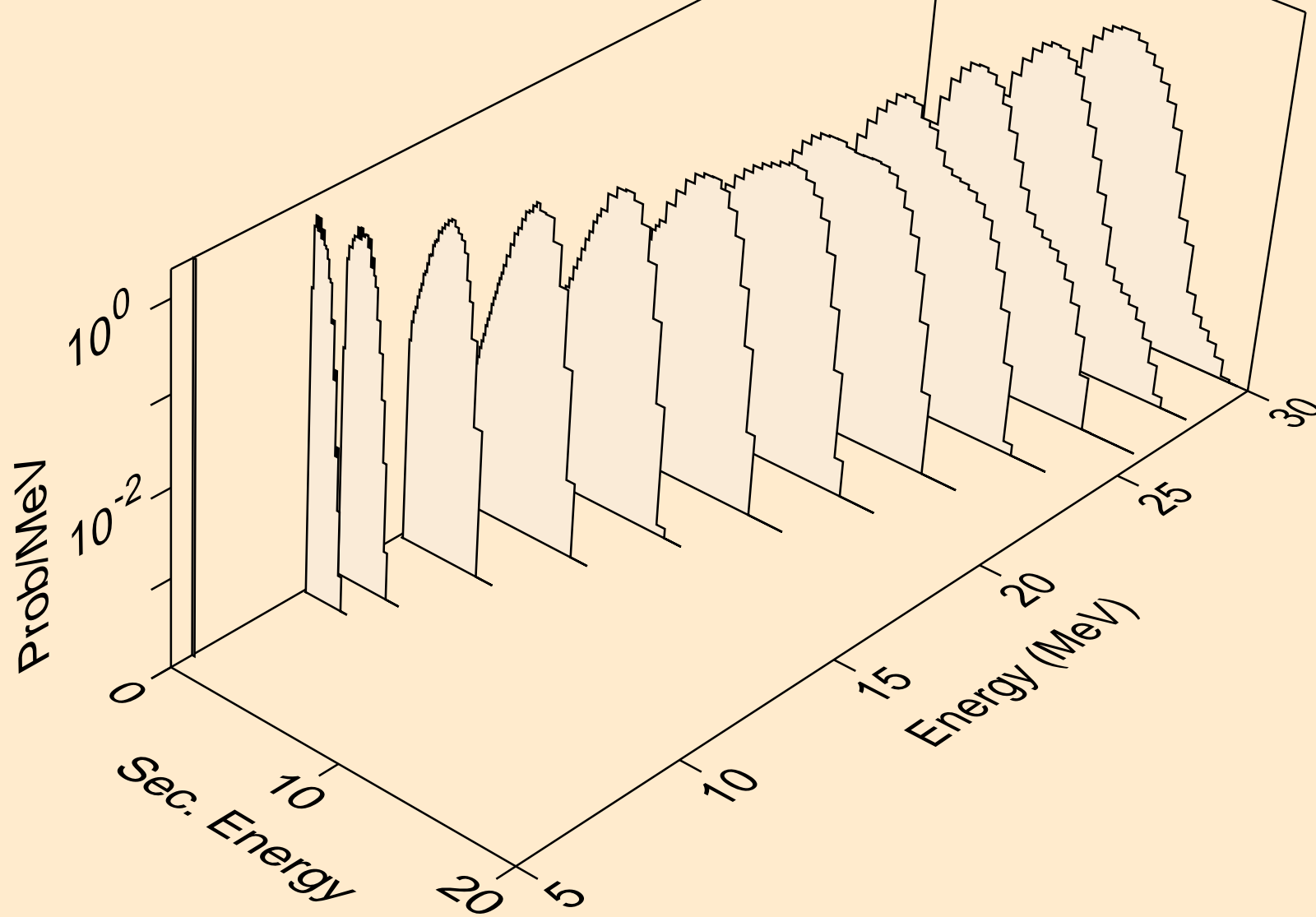

CD124 HELION ACER TENDL-2021 LIBRARY; T=0.K
tritons from (s,x)

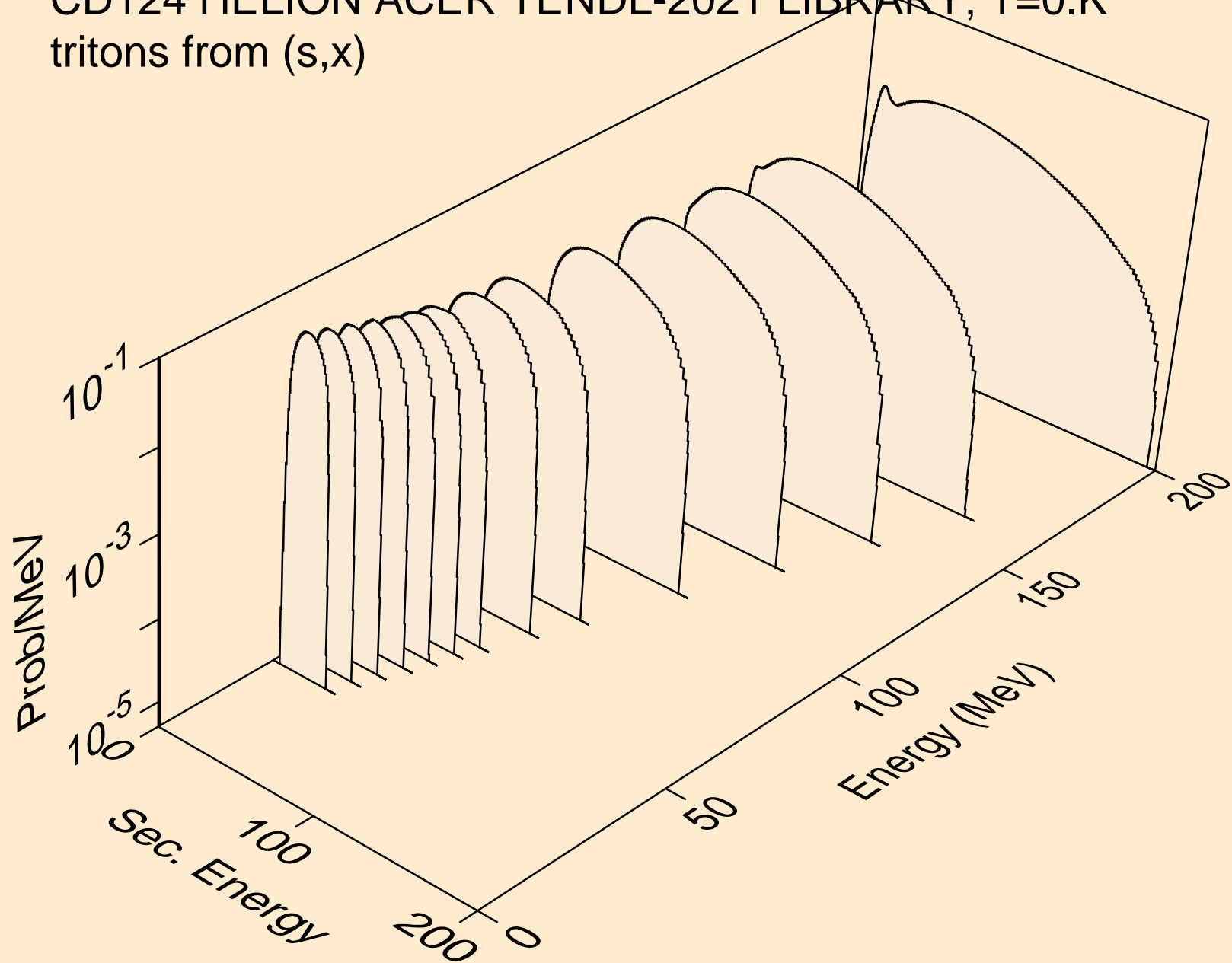

CD124 HELION ACER TENDL-2021 LIBRARY; T=0.K
tritons from (s,n*)t

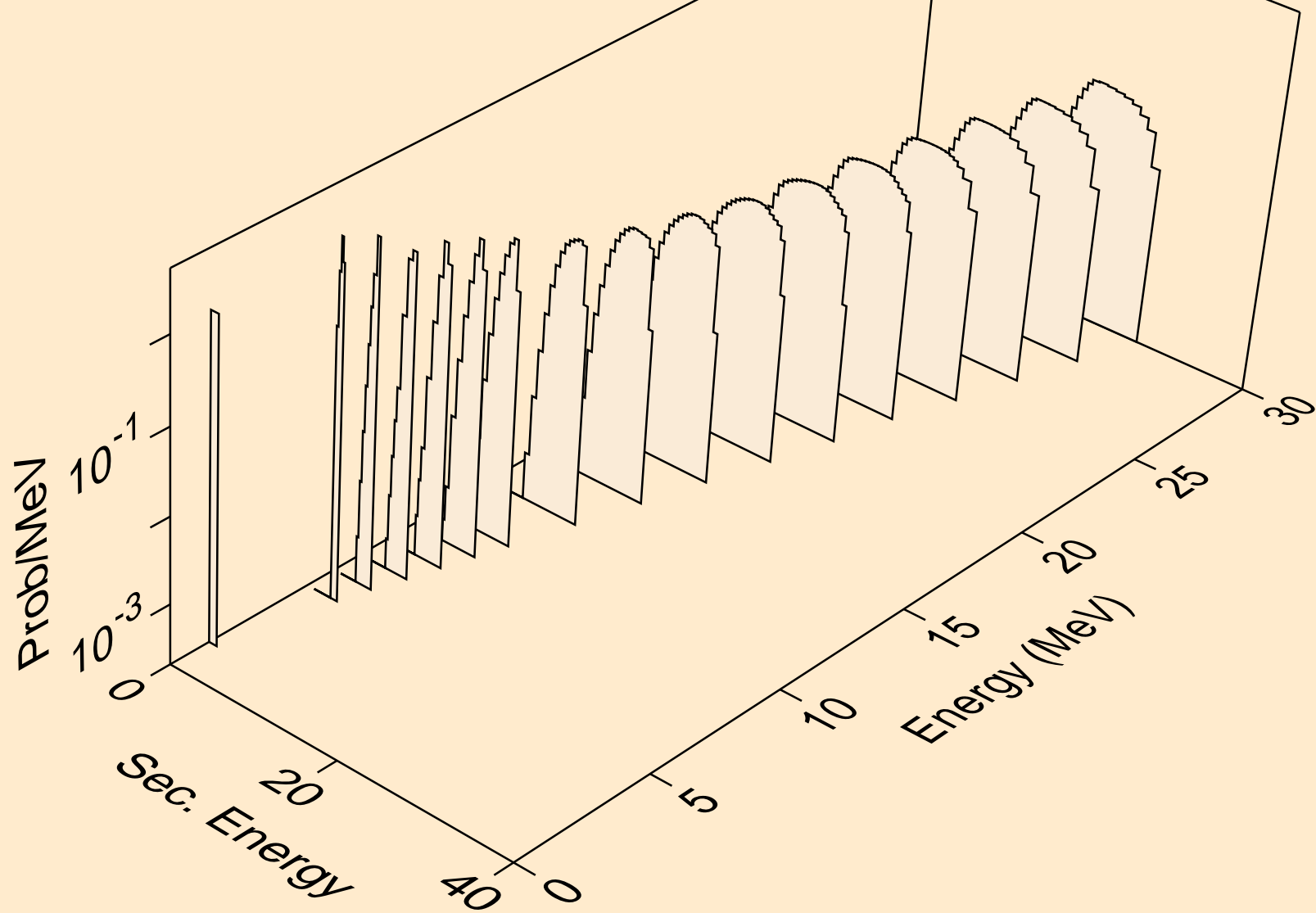

CD124 HELION ACER TENDL-2021 LIBRARY; T=0.K
tritons from (s,t)

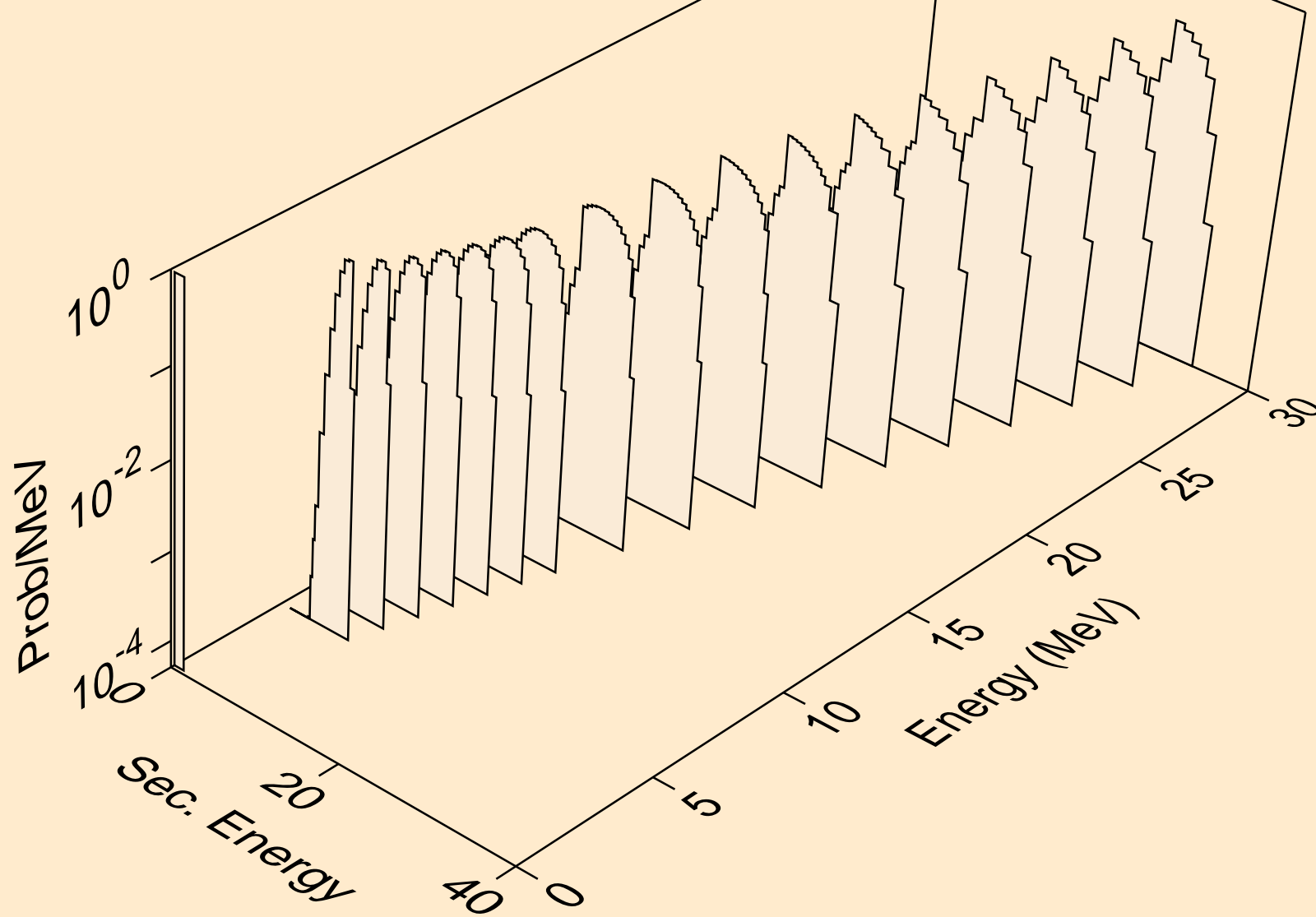

CD124 HELION ACER TENDL-2021 LIBRARY; T=0.K
tritons from (s,pt)

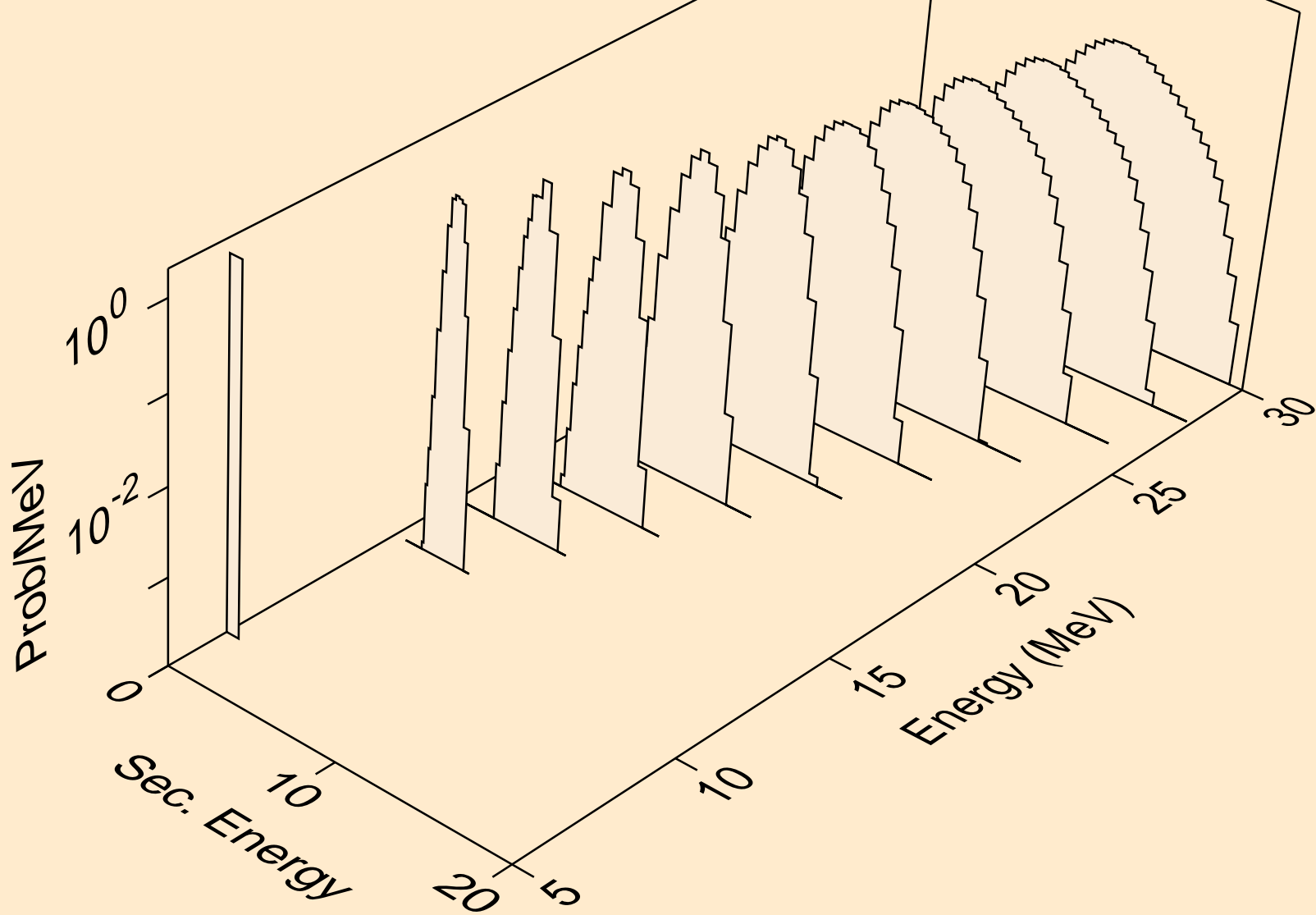

CD124 HELION ACER TENDL-2021 LIBRARY; T=0.K
alphas from (s,x)

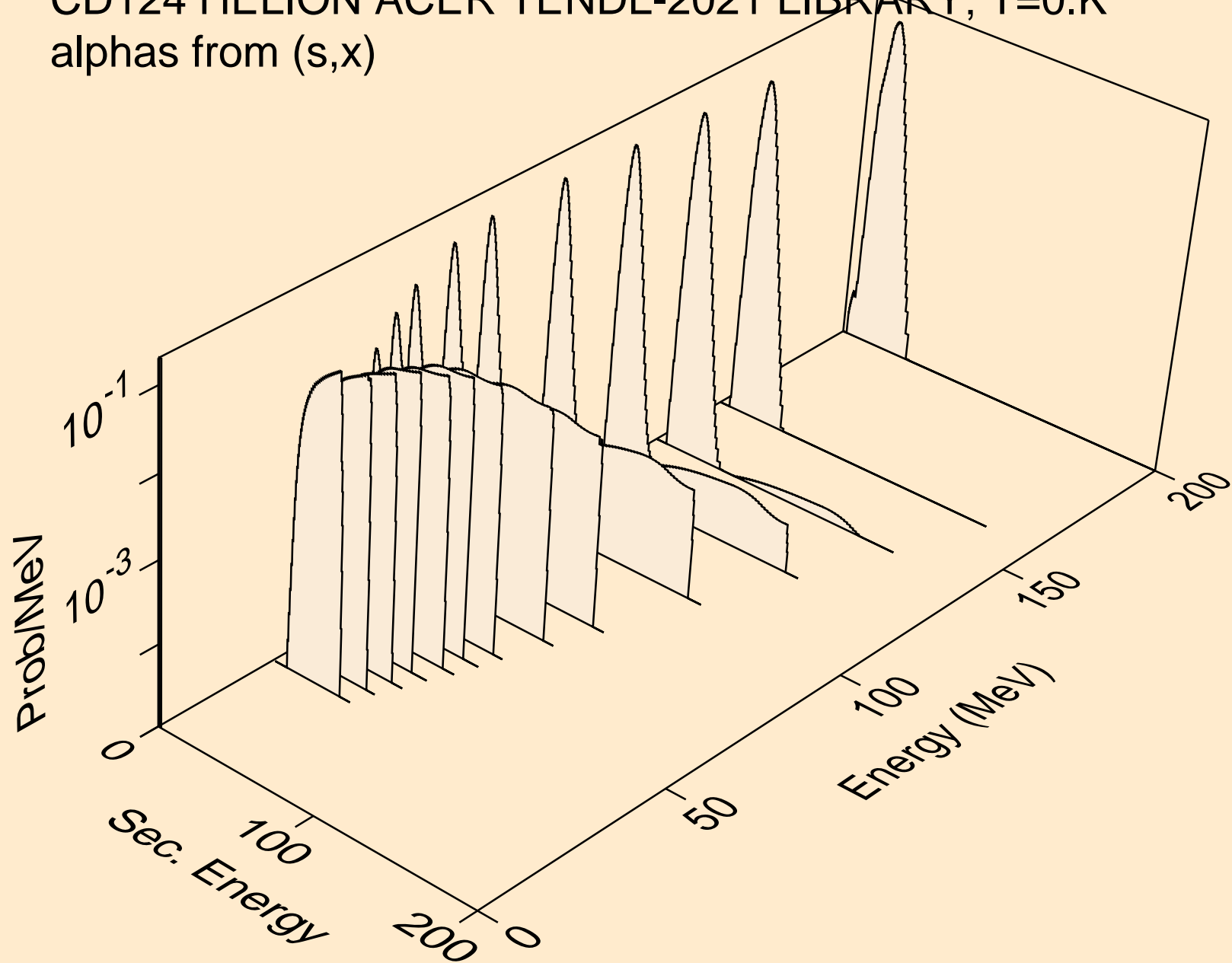

CD124 HELION ACER TENDL-2021 LIBRARY; T=0.K
alphas from (s,n*)a

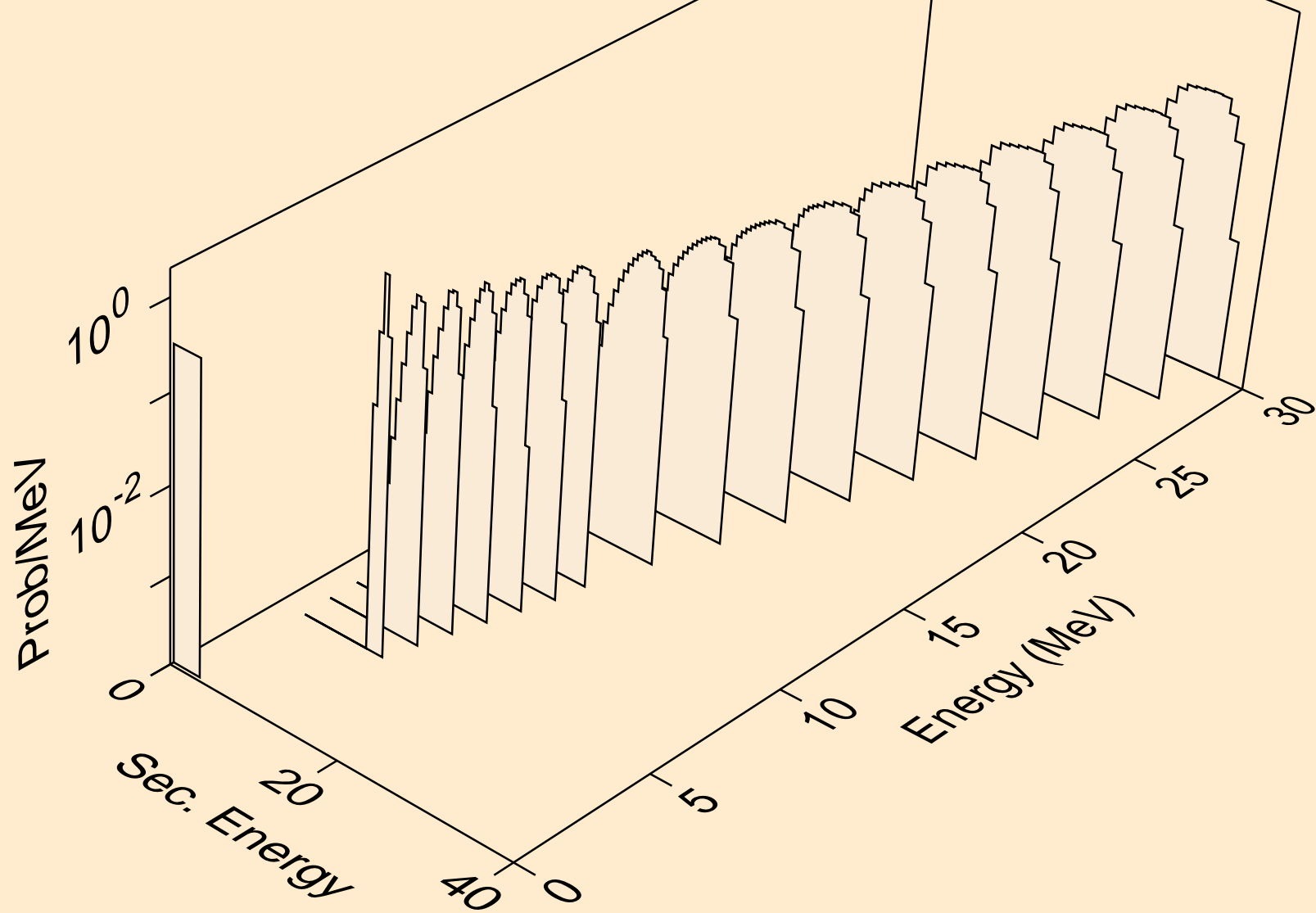

CD124 HELION ACER TENDL-2021 LIBRARY; T=0.K
alphas from (s,2n)a

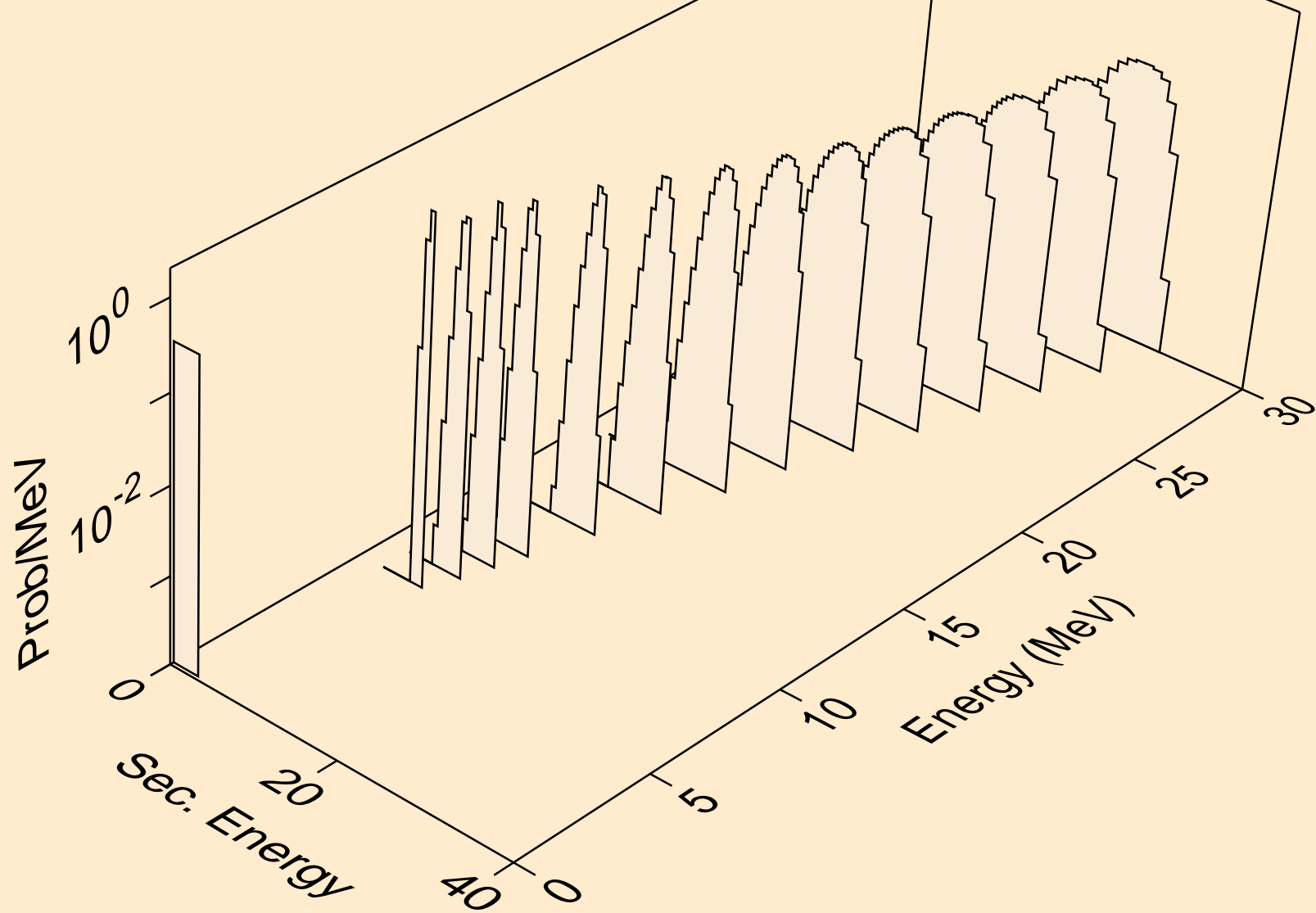

CD124 HELION ACER TENDL-2021 LIBRARY; T=0.K
alphas from (s,3n)a

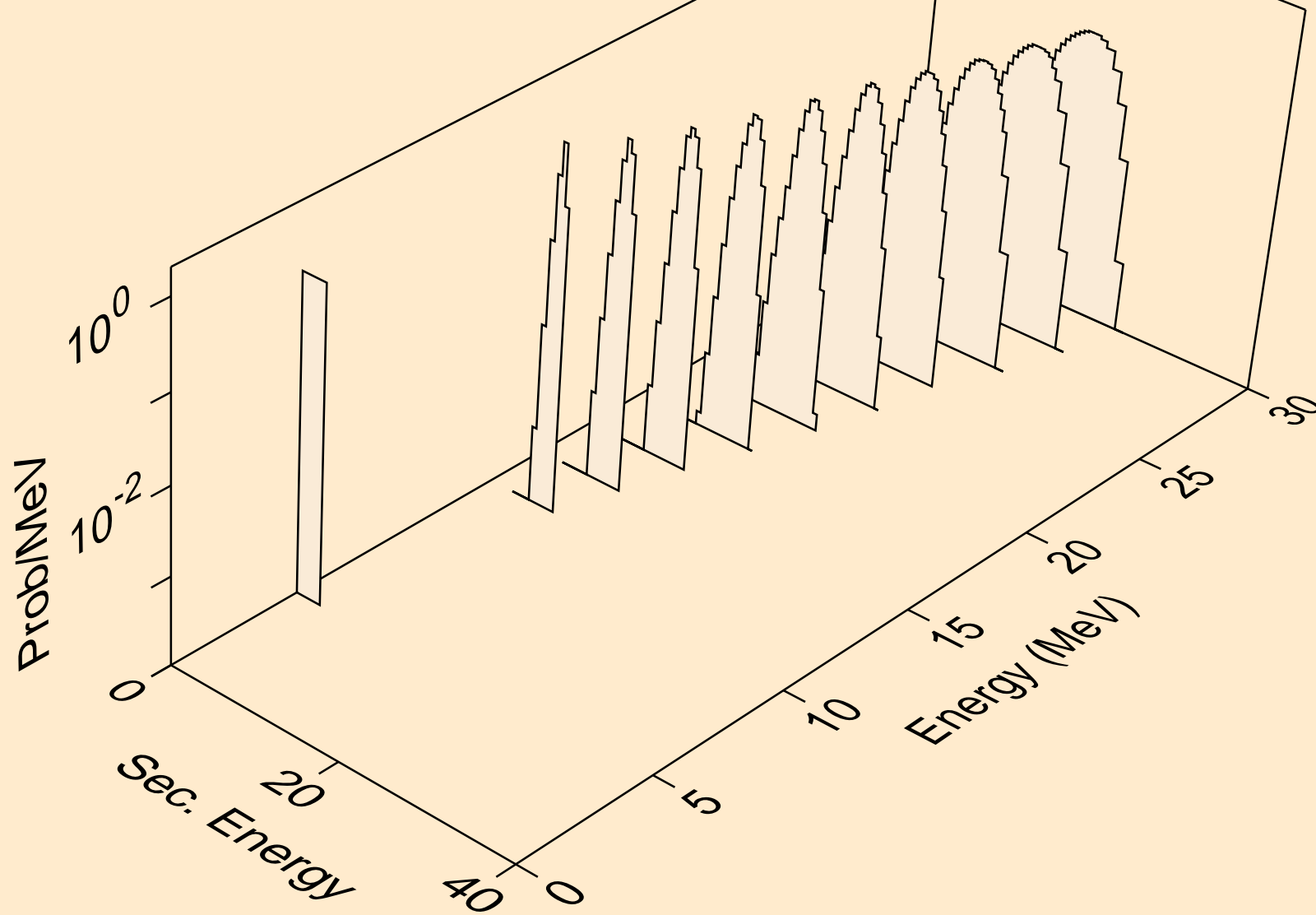

CD124 HELION ACER TENDL-2021 LIBRARY; T=0.K
alphas from (s,npa)

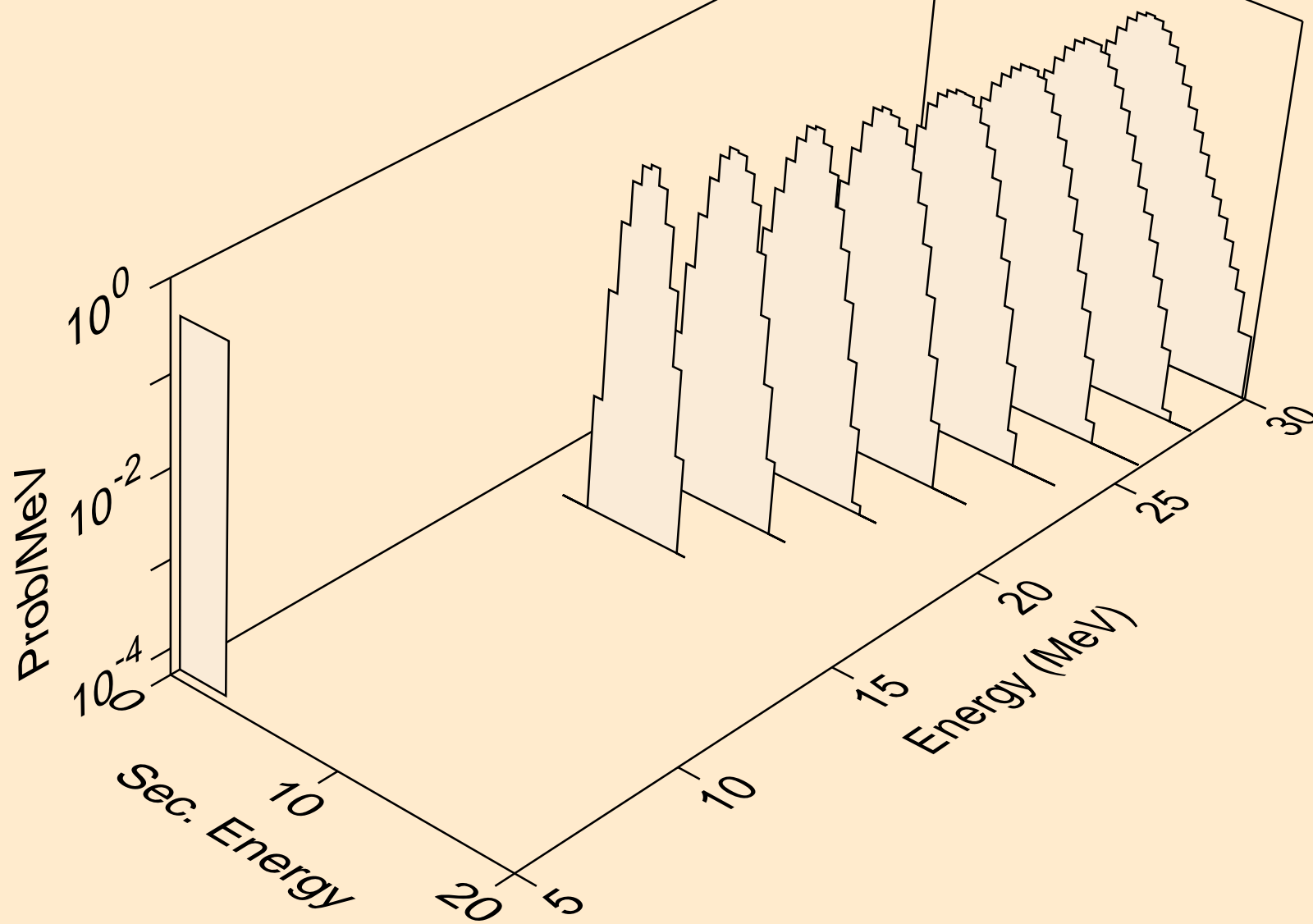

CD124 HELION ACER TENDL-2021 LIBRARY; T=0.K
alphas from (s,a)

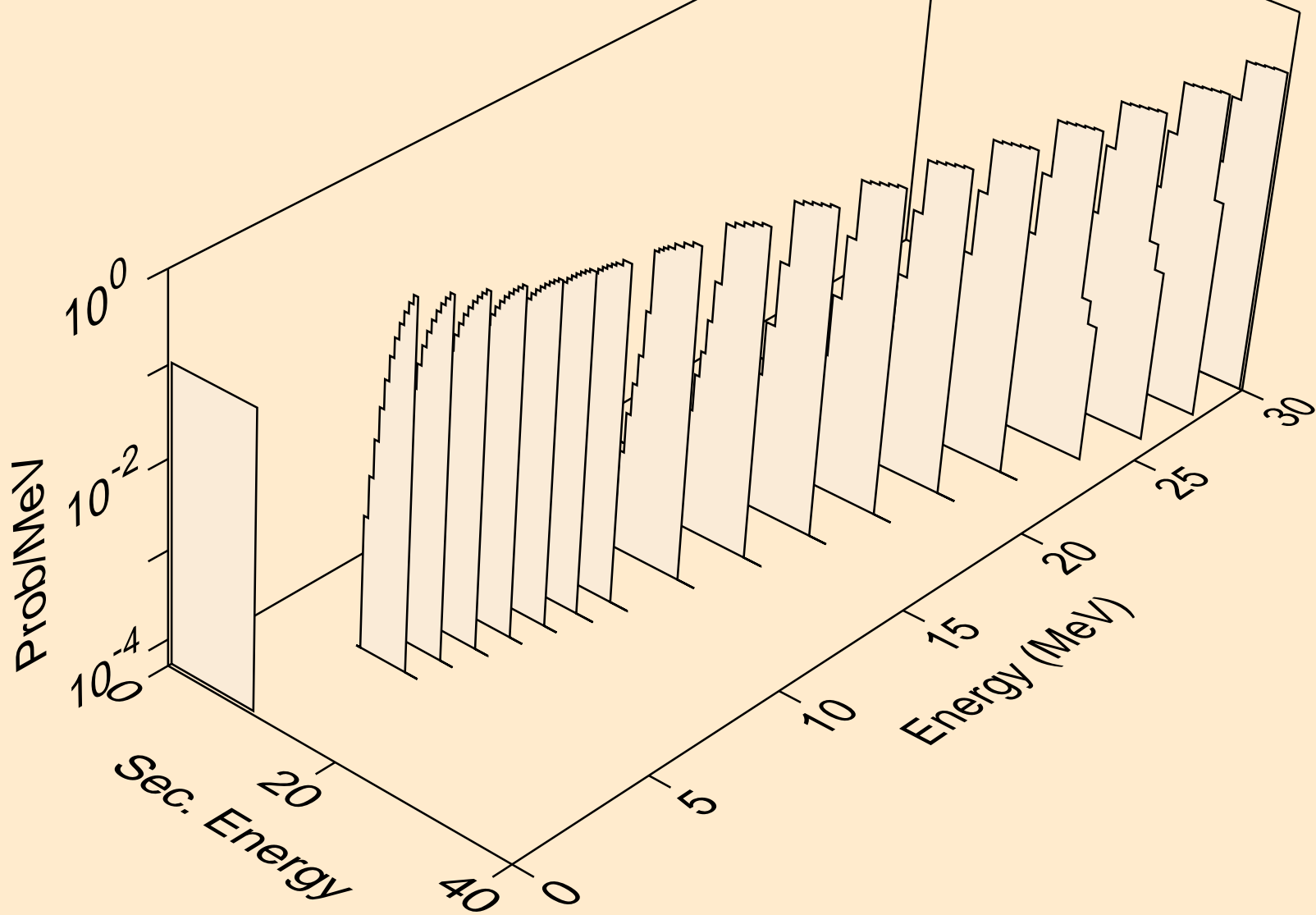

CD124 HELION ACER TENDL-2021 LIBRARY; T=0.K
alphas from (s,pa)

