

# CE124 HELION ACER TENDL-2021 LIBRARY; T=0.K

## Principal cross sections

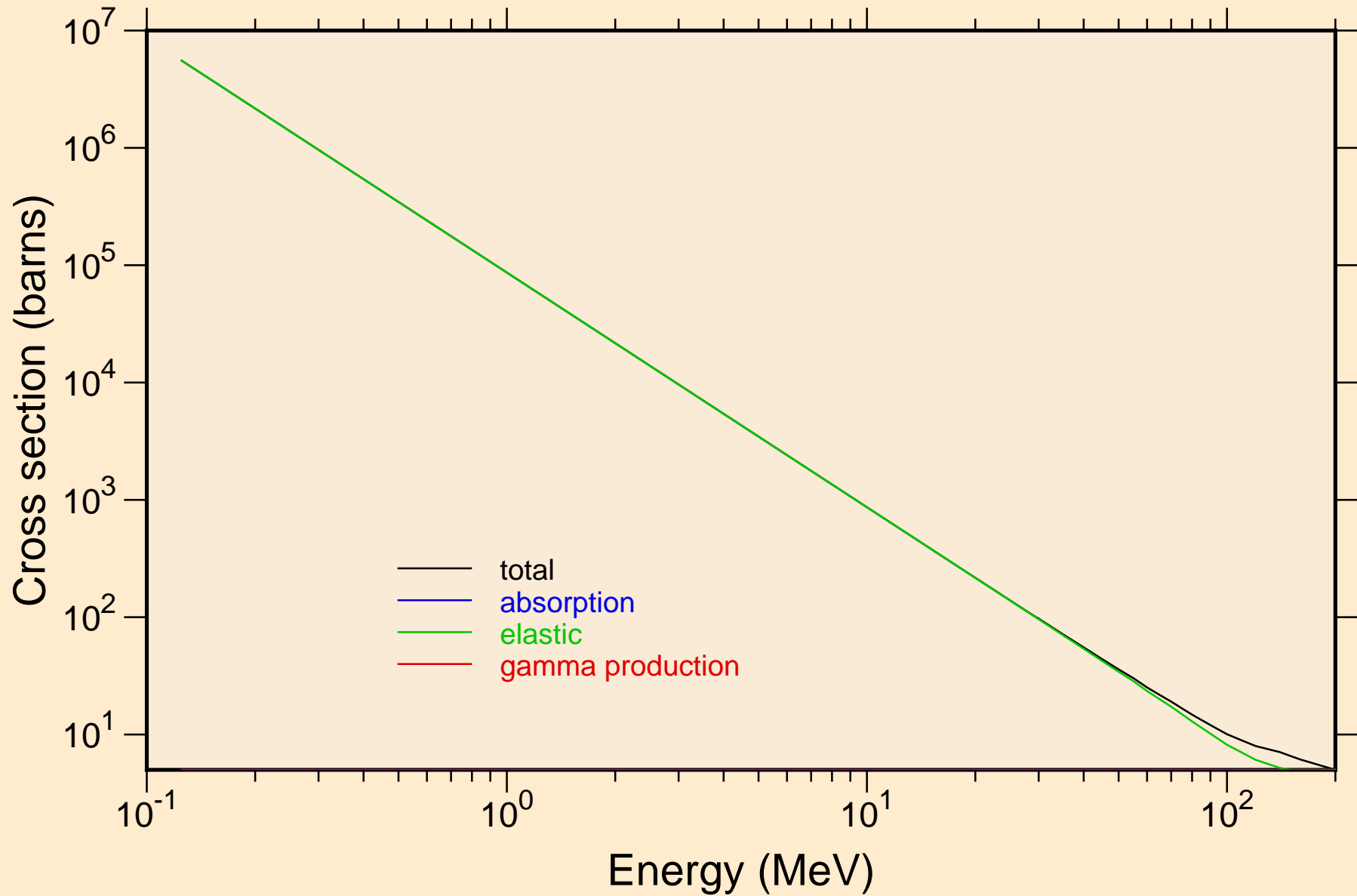

# CE124 HELION ACER TENDL-2021 LIBRARY; T=0.K

## Heating

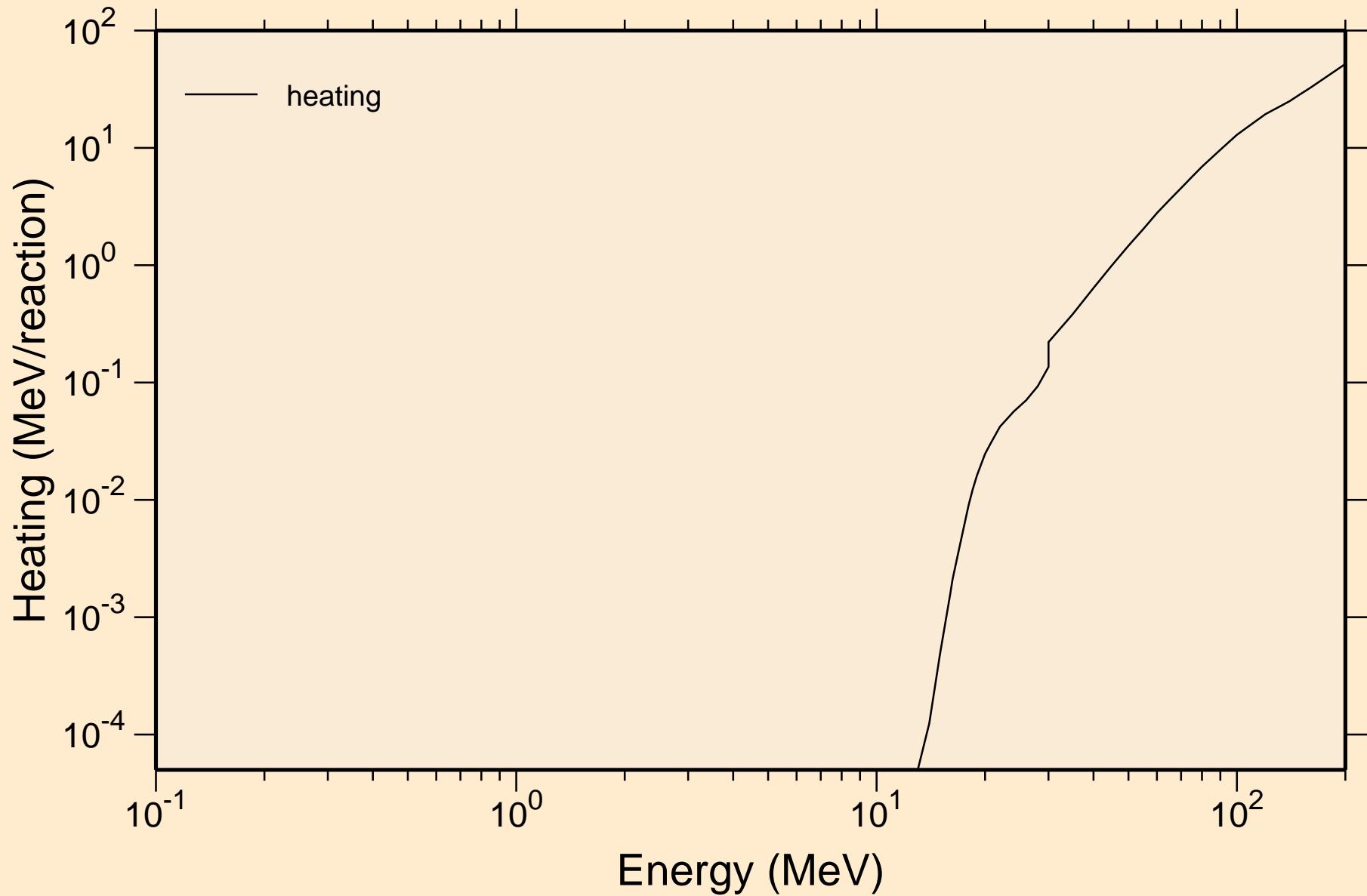

# CE124 HELION ACER TENDL-2021 LIBRARY; T=0.K

## Principal cross sections

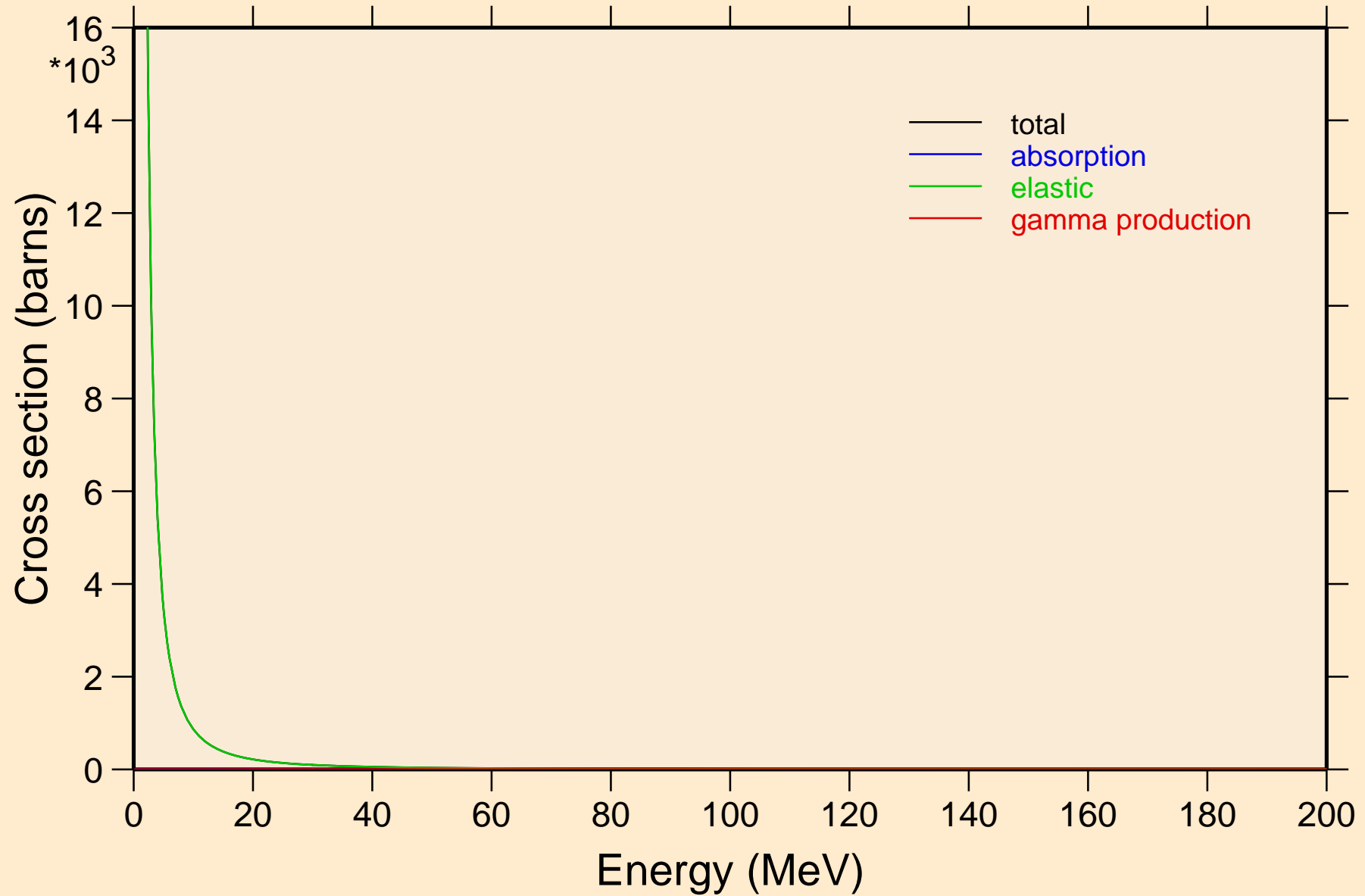

# CE124 HELION ACER TENDL-2021 LIBRARY; T=0.K

## Heating

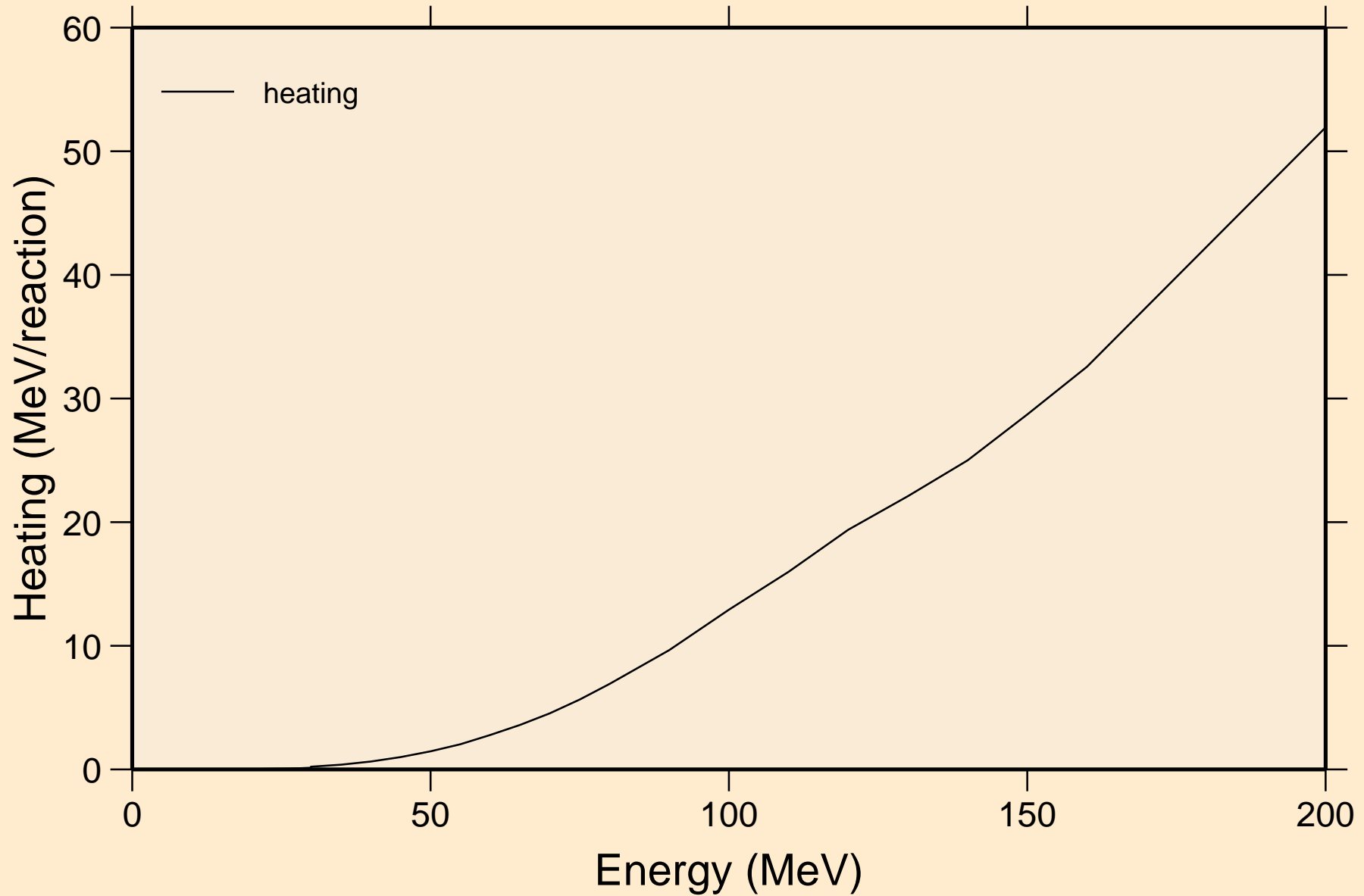

CE124 HELION ACER TENDL-2021 LIBRARY; T=0.K  
Threshold reactions

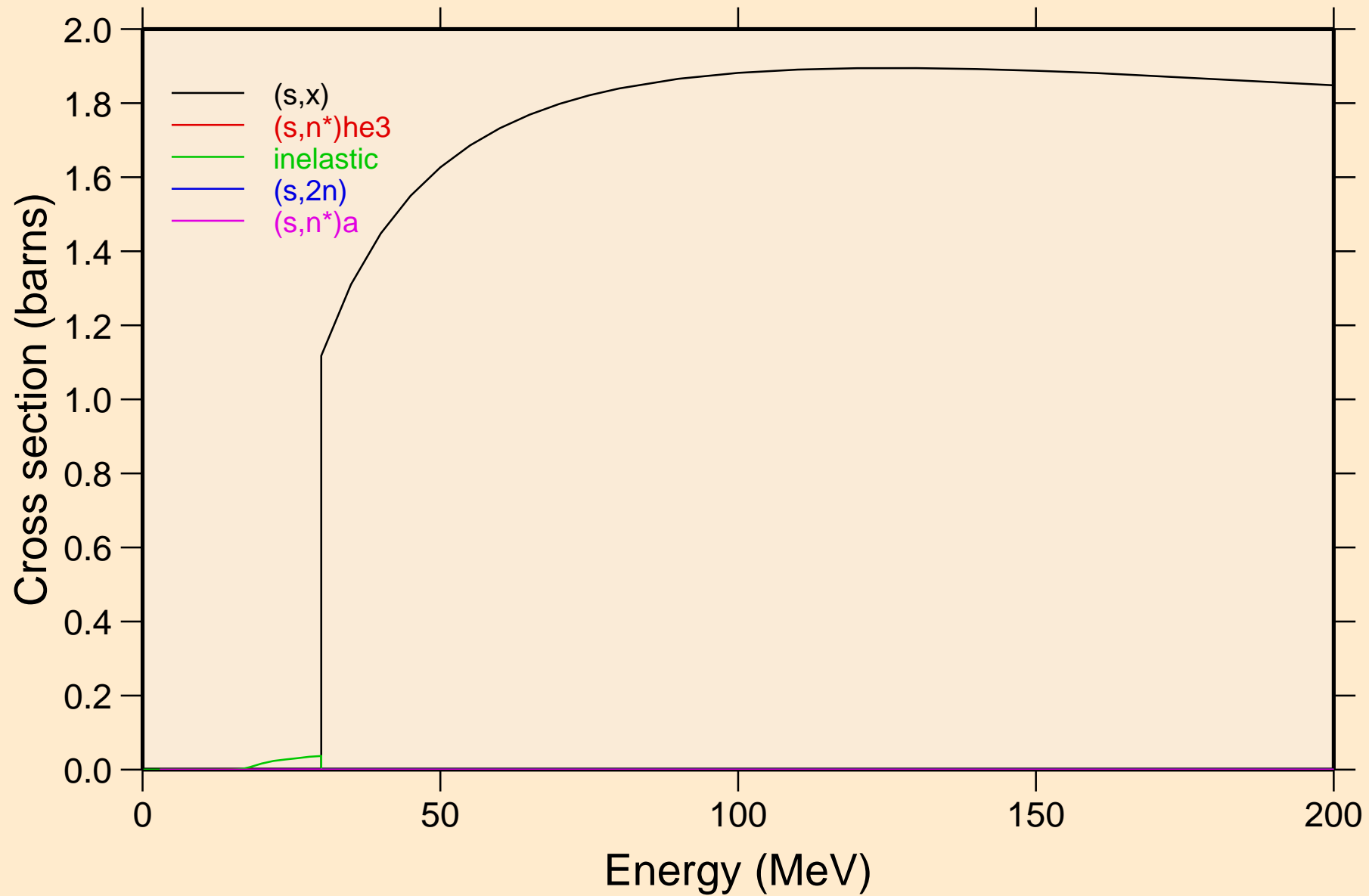

CE124 HELION ACER TENDL-2021 LIBRARY; T=0.K  
Threshold reactions

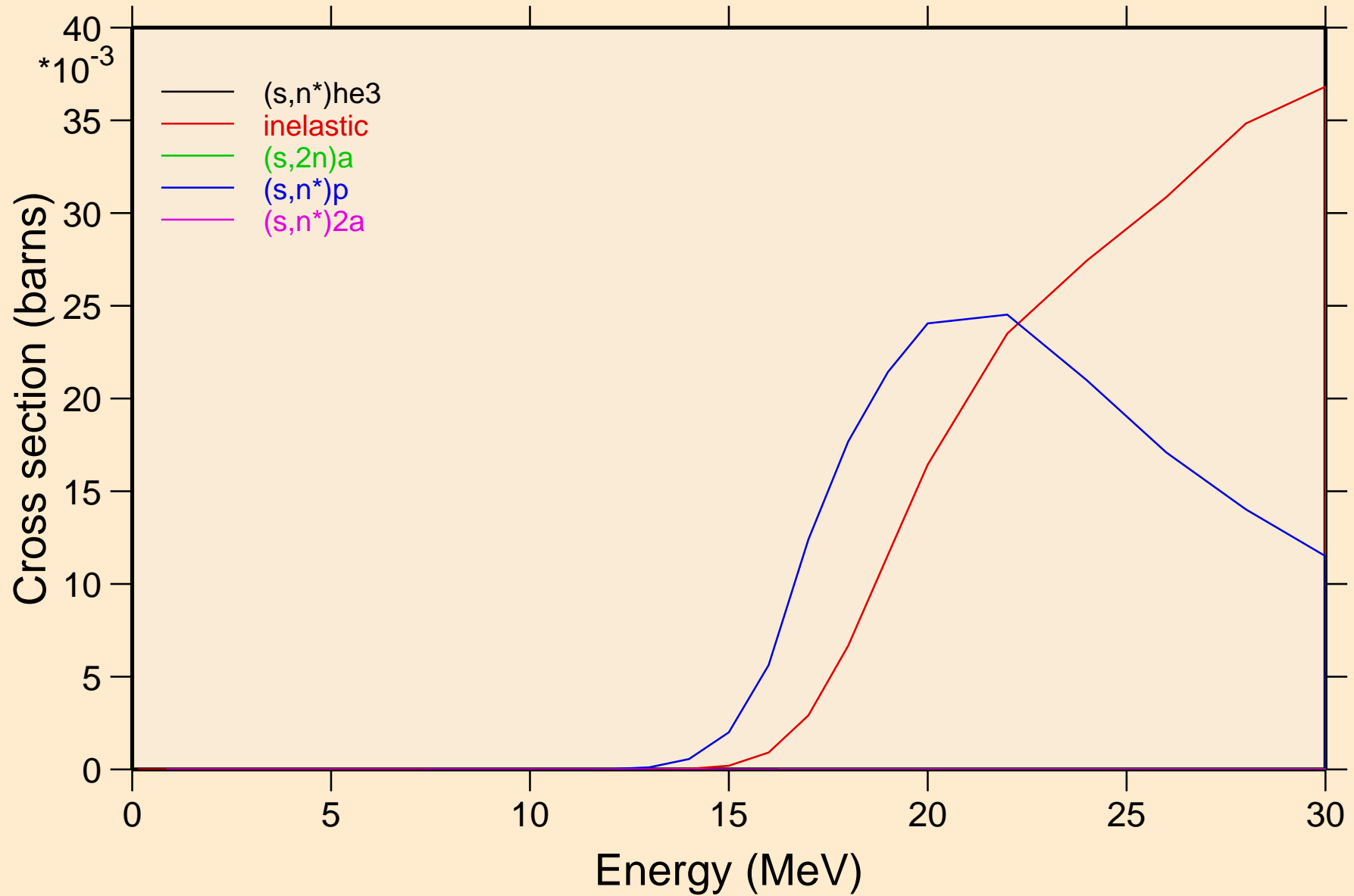

CE124 HELION ACER TENDL-2021 LIBRARY; T=0.K  
Threshold reactions

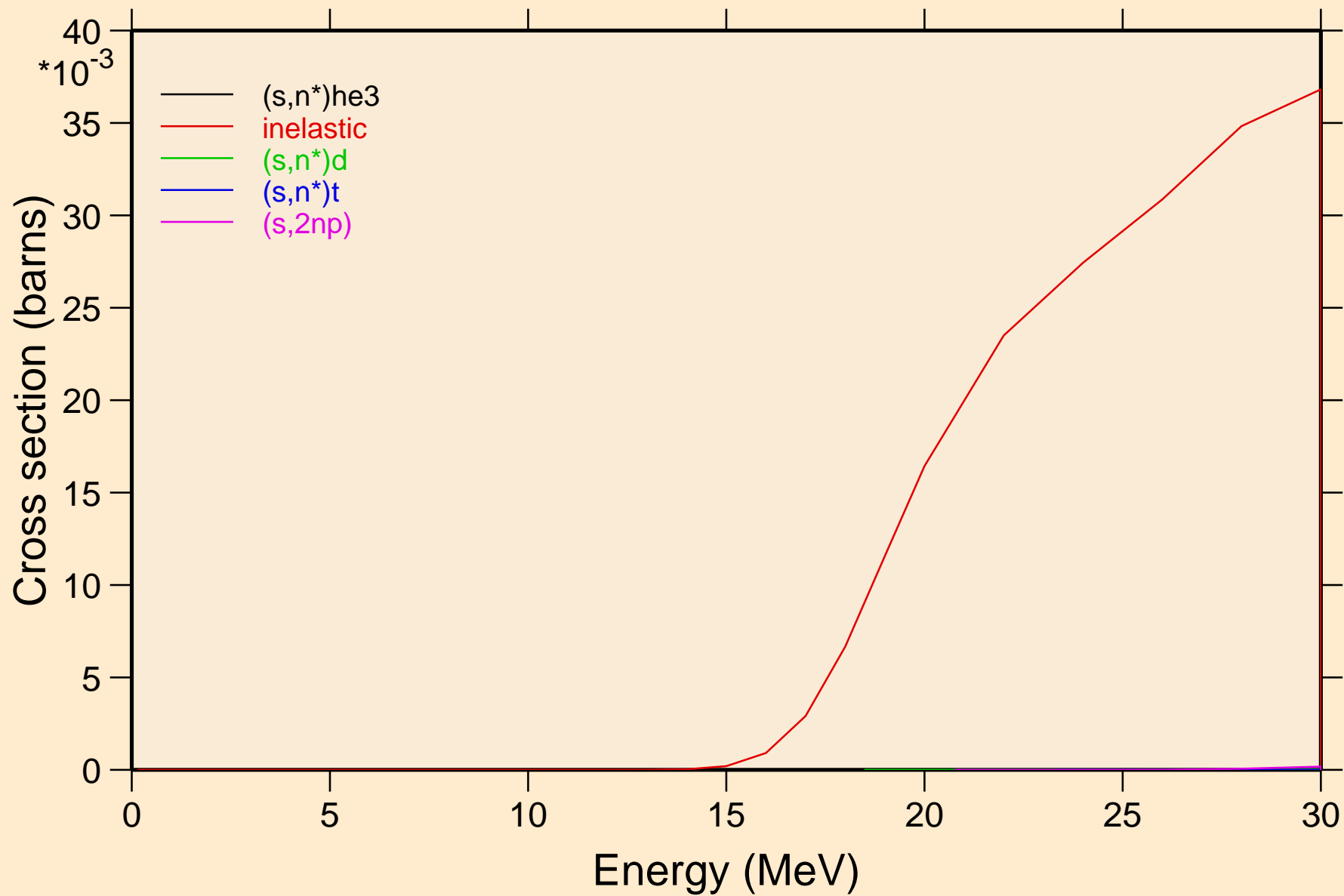

CE124 HELION ACER TENDL-2021 LIBRARY; T=0.K  
Threshold reactions

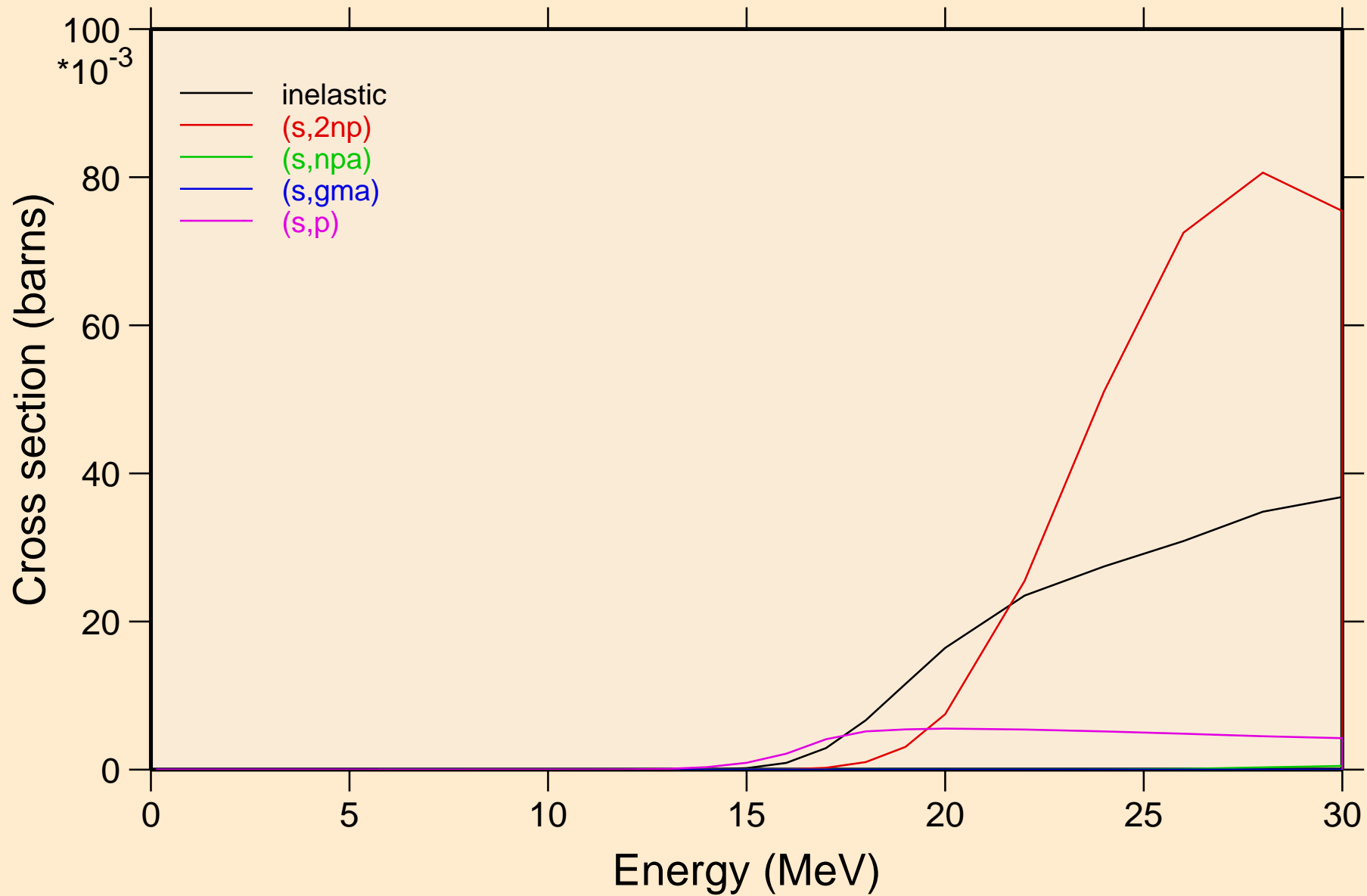



# CE124 HELION ACER TENDL-2021 LIBRARY; T=0.K

## Threshold reactions

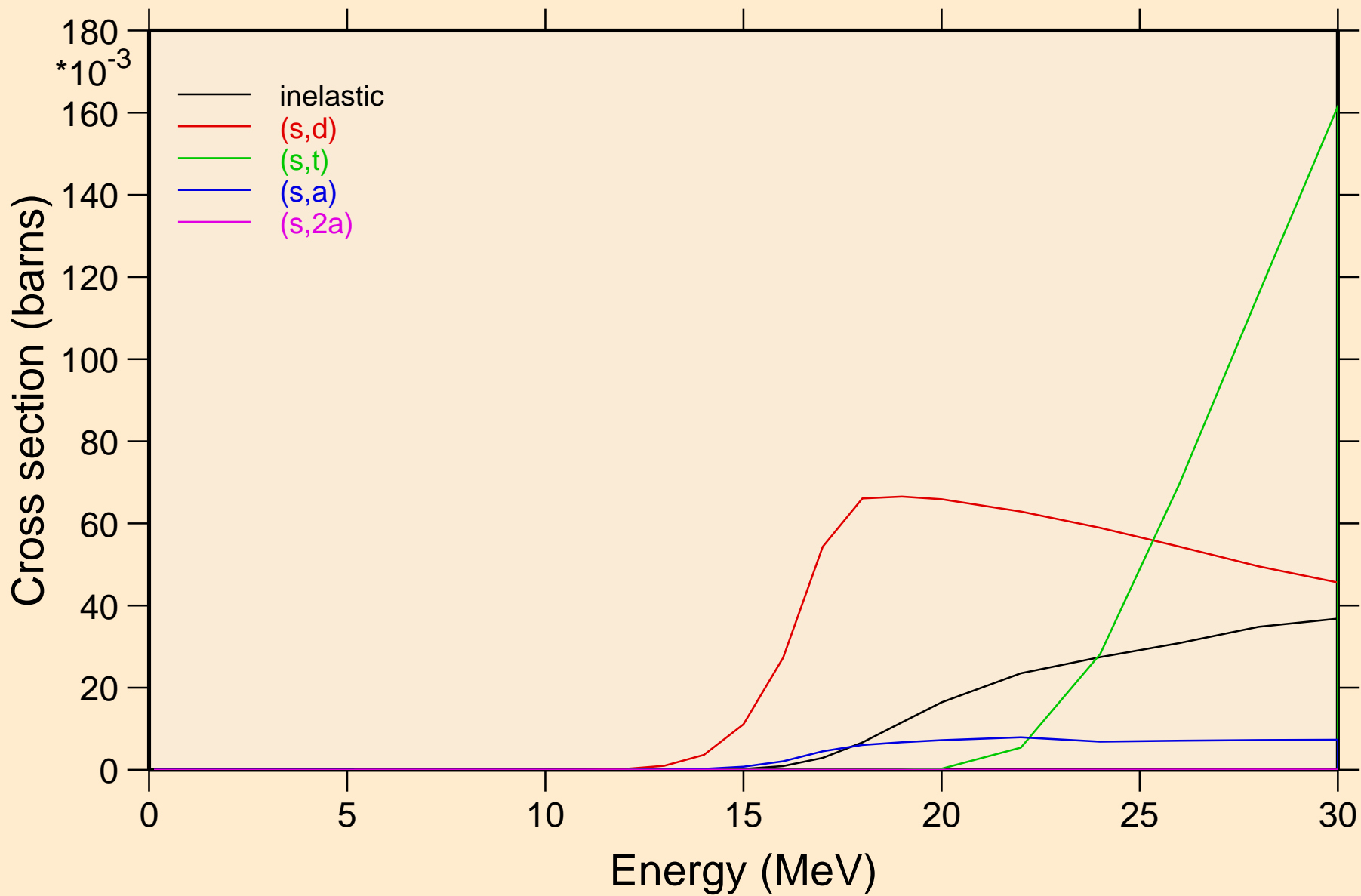

# CE124 HELION ACER TENDL-2021 LIBRARY; T=0.K

## Threshold reactions

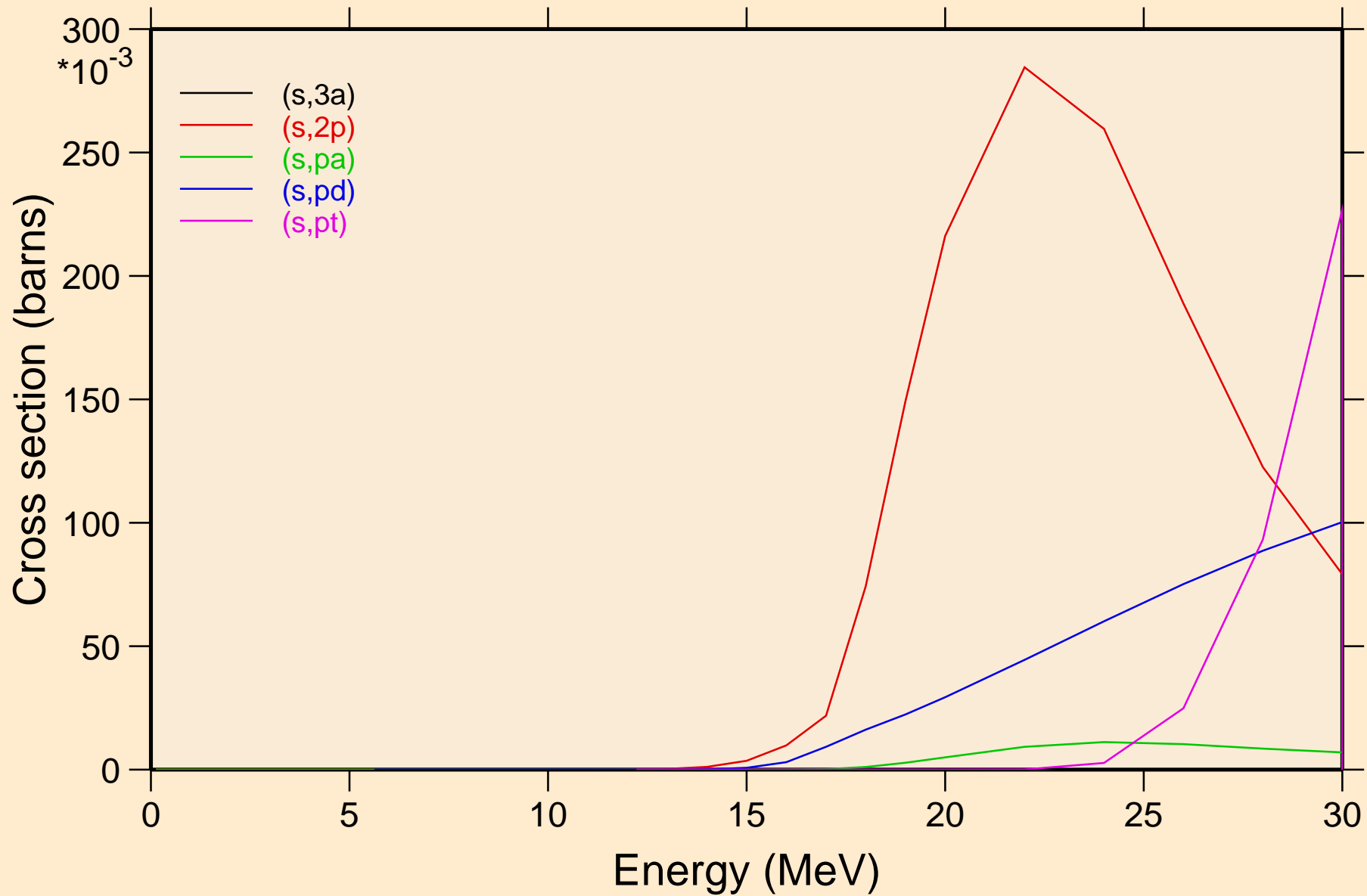

CE124 HELION ACER TENDL-2021 LIBRARY; T=0.K  
Threshold reactions

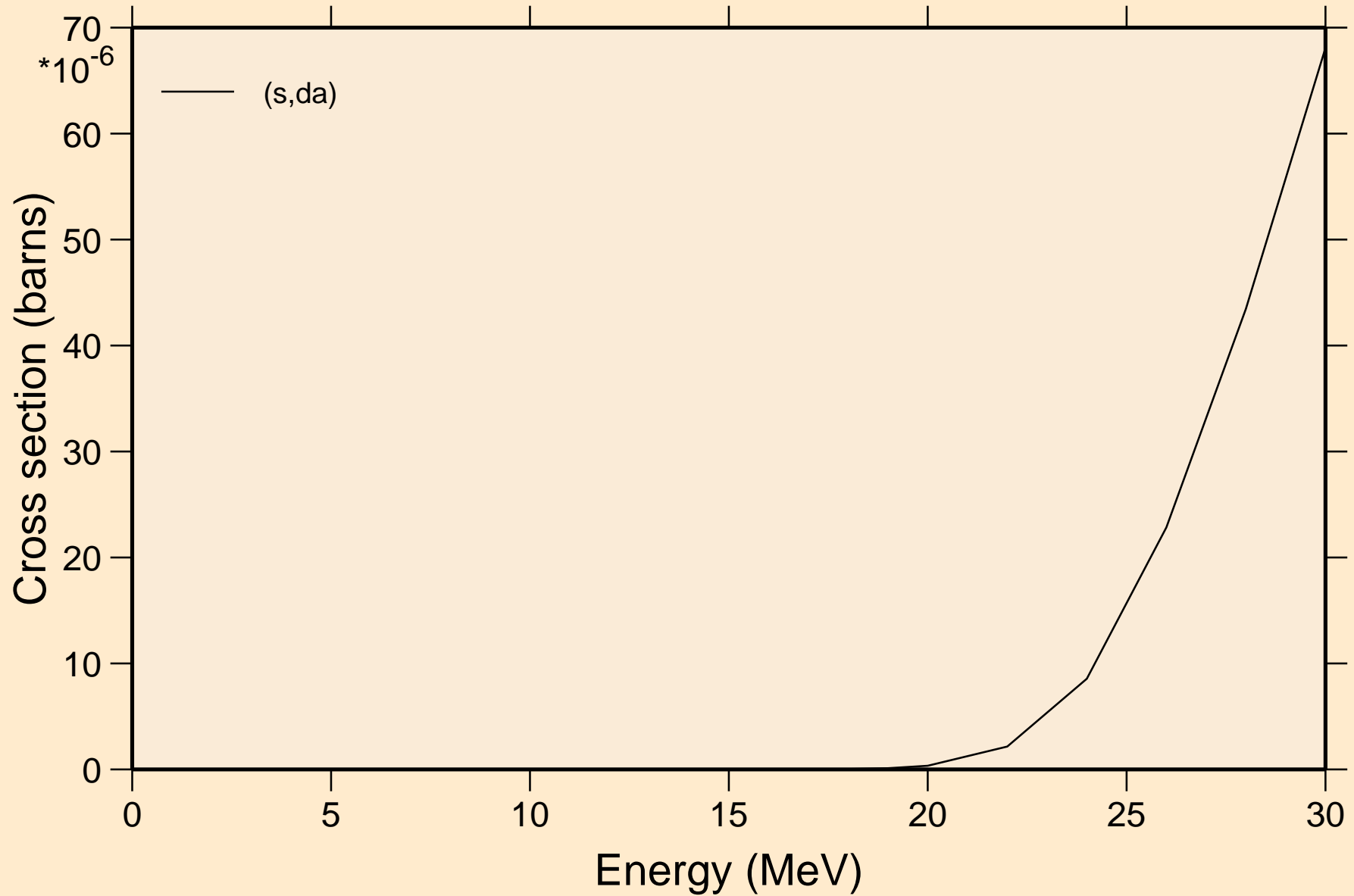

CE124 HELION ACER TENDL-2021 LIBRARY; T=0.K  
angular distribution for elastic

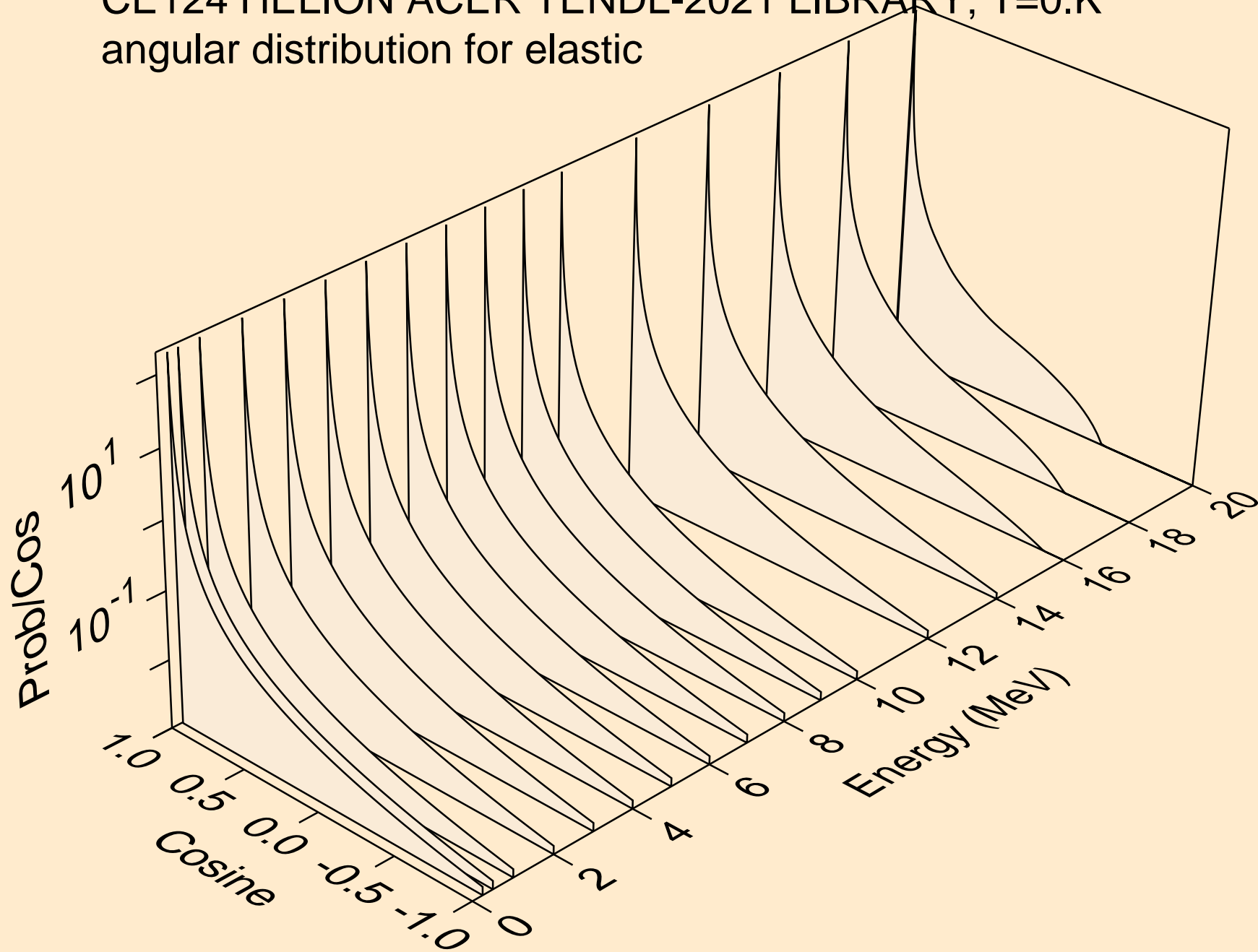

CE124 HELION ACER TENDL-2021 LIBRARY; T=0.K  
angular distribution for elastic

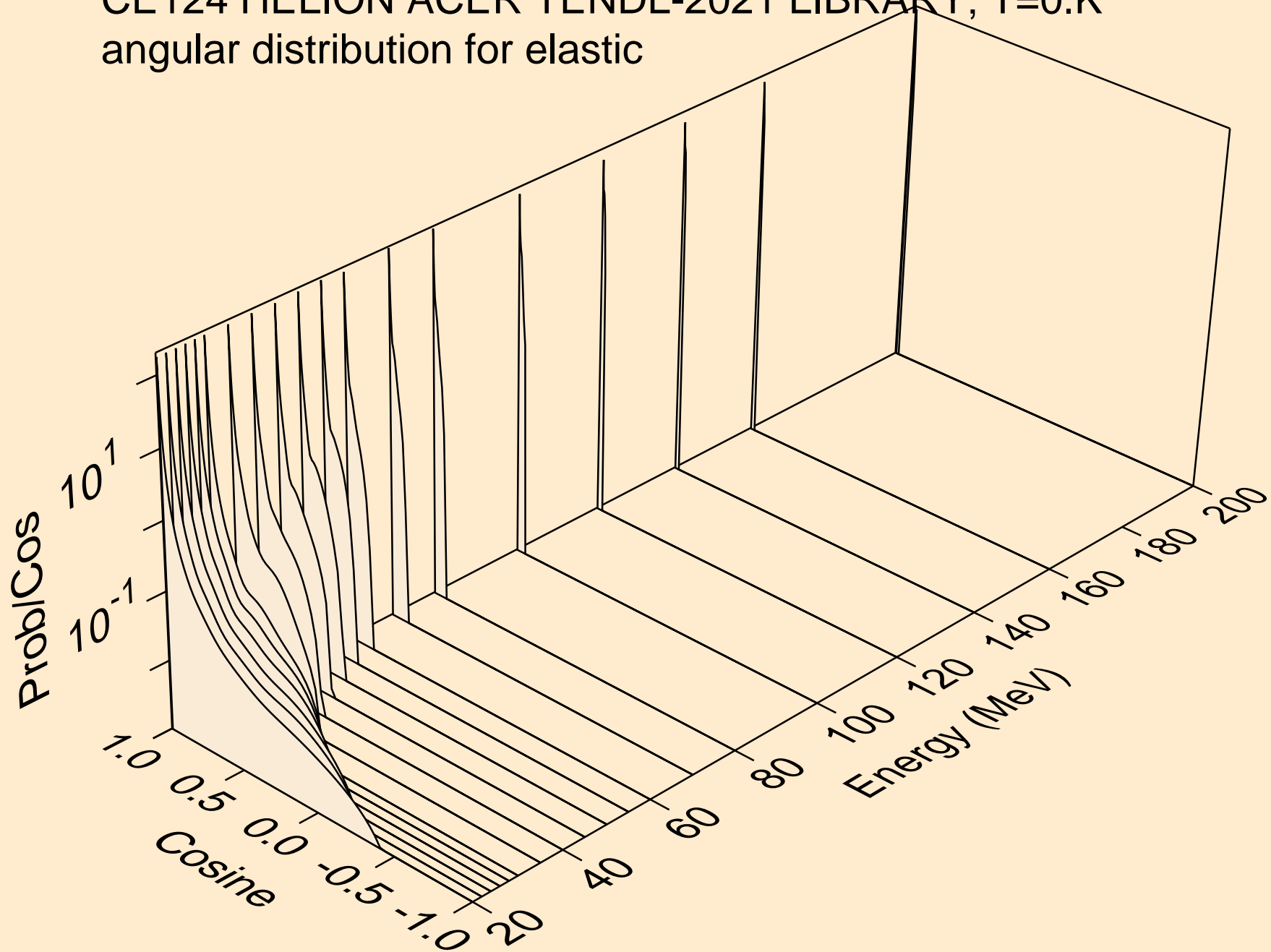

CE124 HELION ACER TENDL-2021 LIBRARY; T=0.K  
He-3 emission for (s,x)

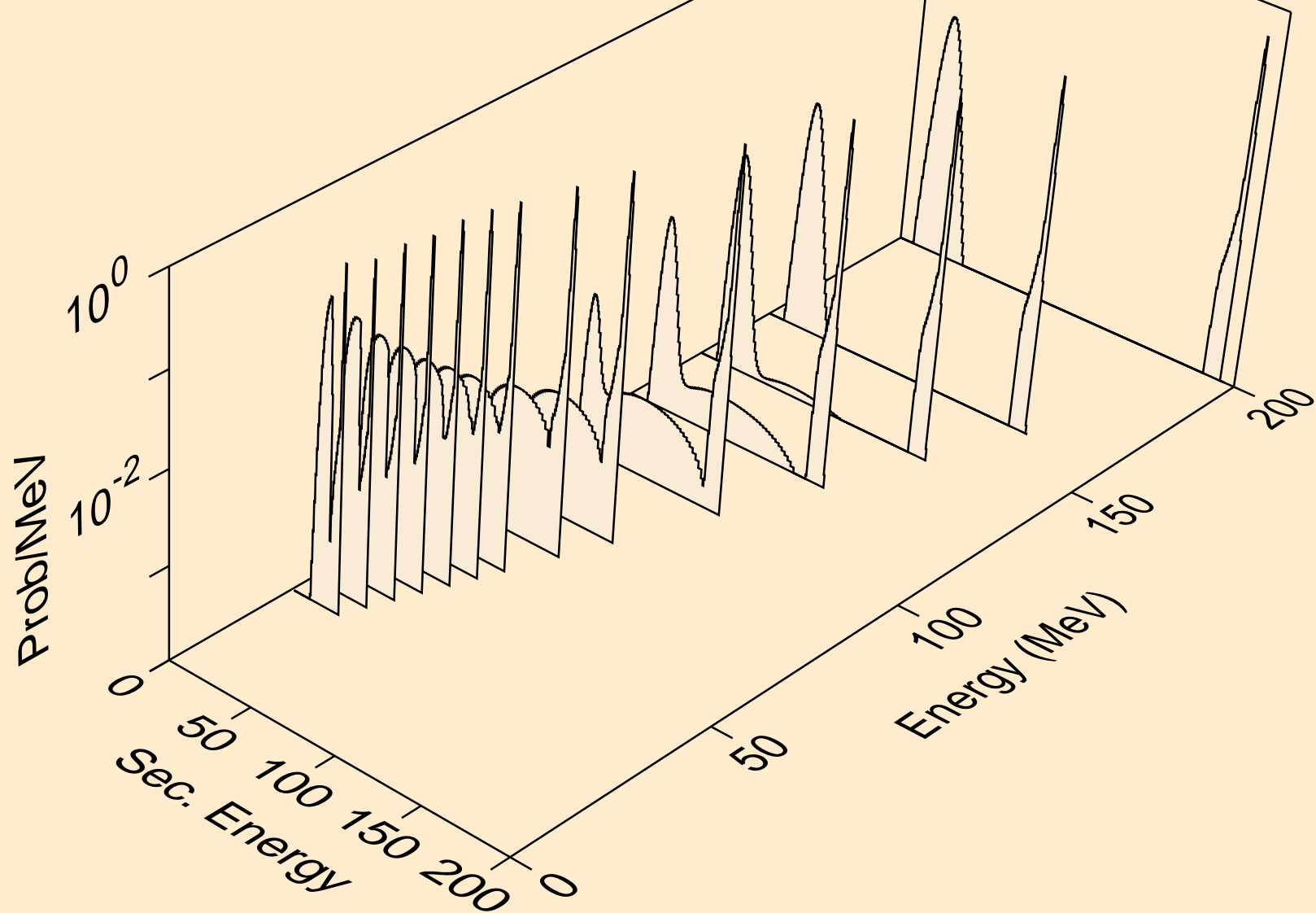

CE124 HELION ACER TENDL-2021 LIBRARY; T=0.K  
He-3 emission for (s,n\*)he3

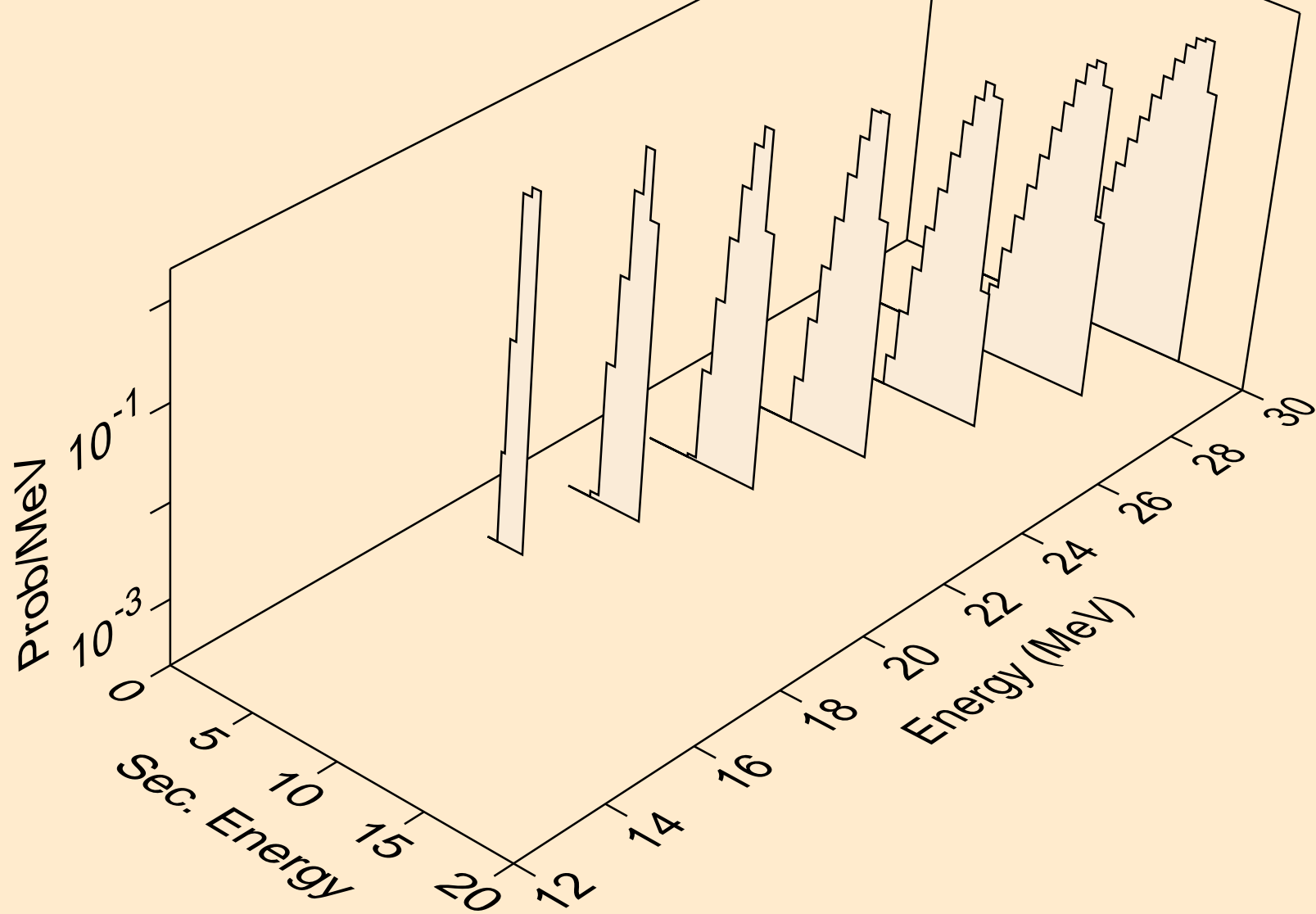

CE124 HELION ACER TENDL-2021 LIBRARY; T=0.K  
He-3 emission for inelastic

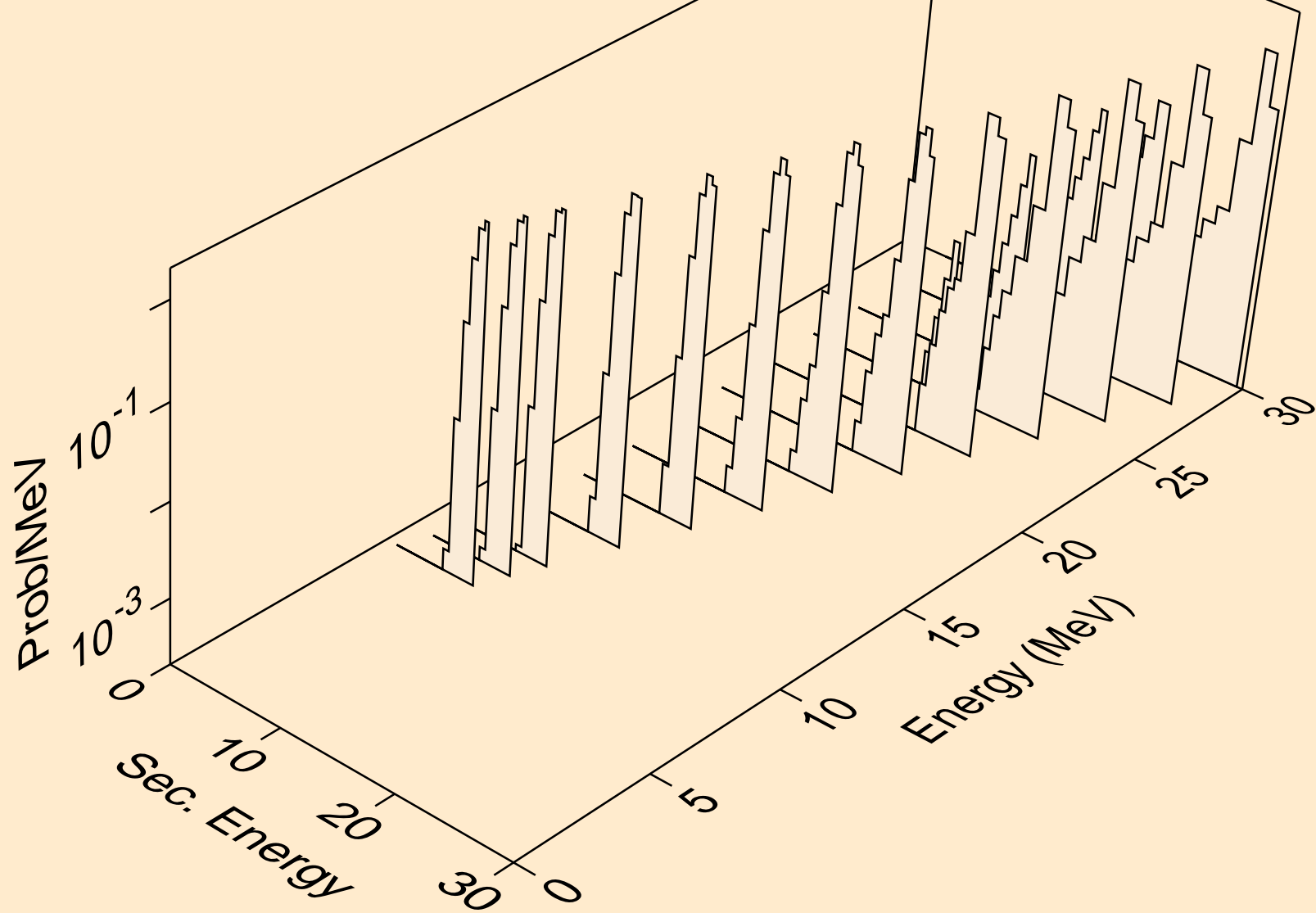



CE124 HELION ACER TENDL-2021 LIBRARY; T=0.K  
Photon emission for (z,n)

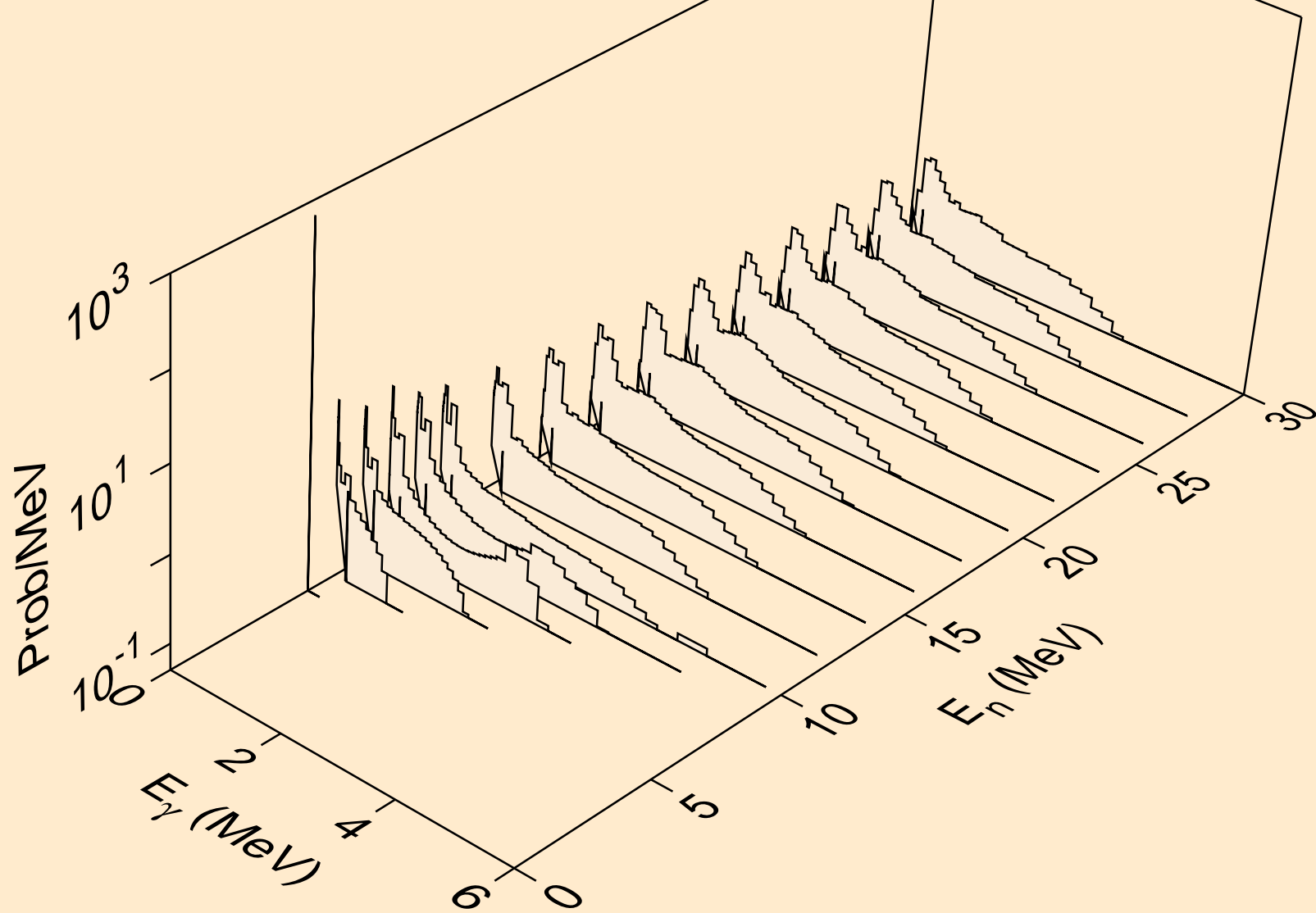

CE124 HELION ACER TENDL-2021 LIBRARY; T=0.K  
Photon emission for (n,x)

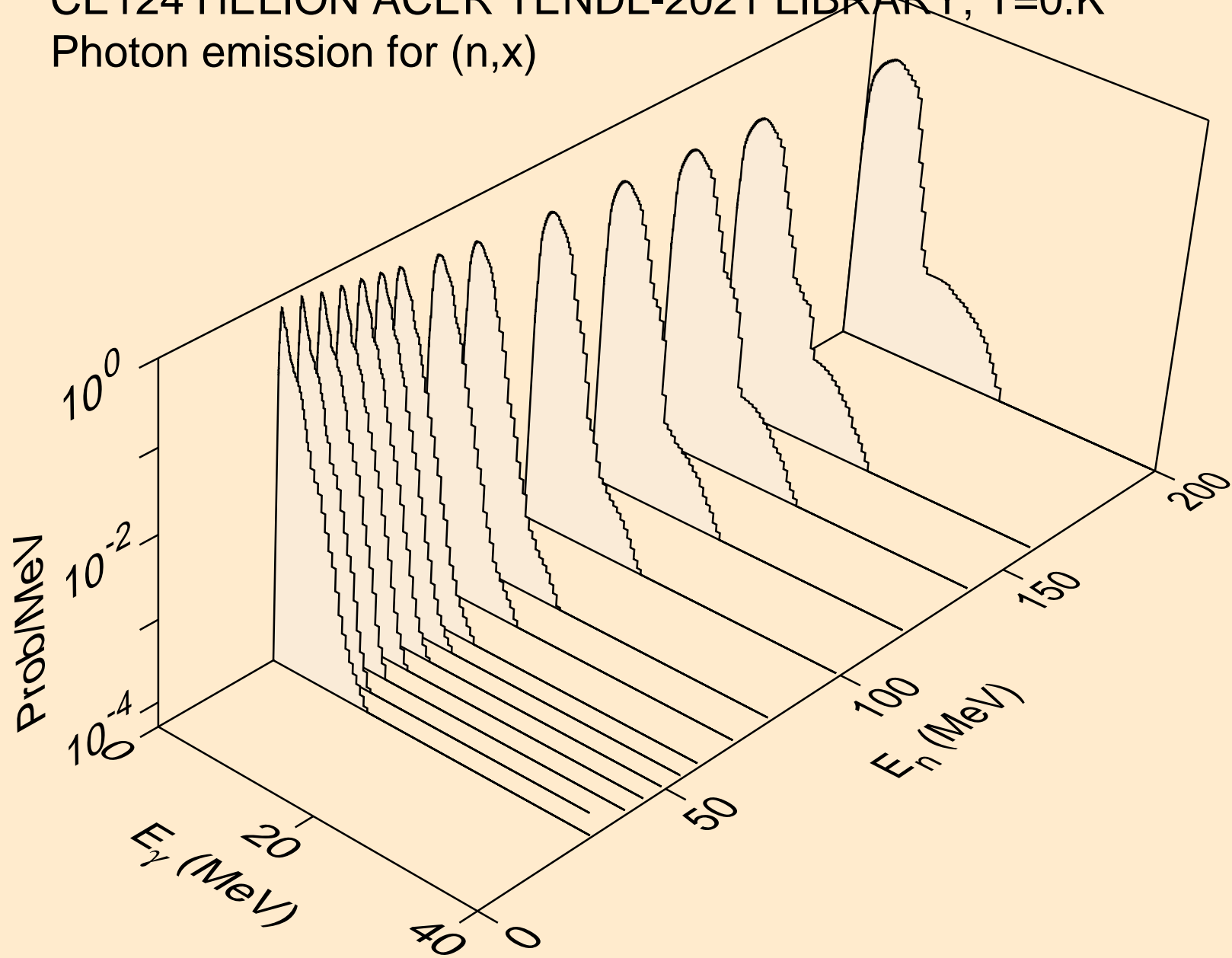

CE124 HELION ACER TENDL-2021 LIBRARY; T=0.K  
Photon emission for (n,2n)

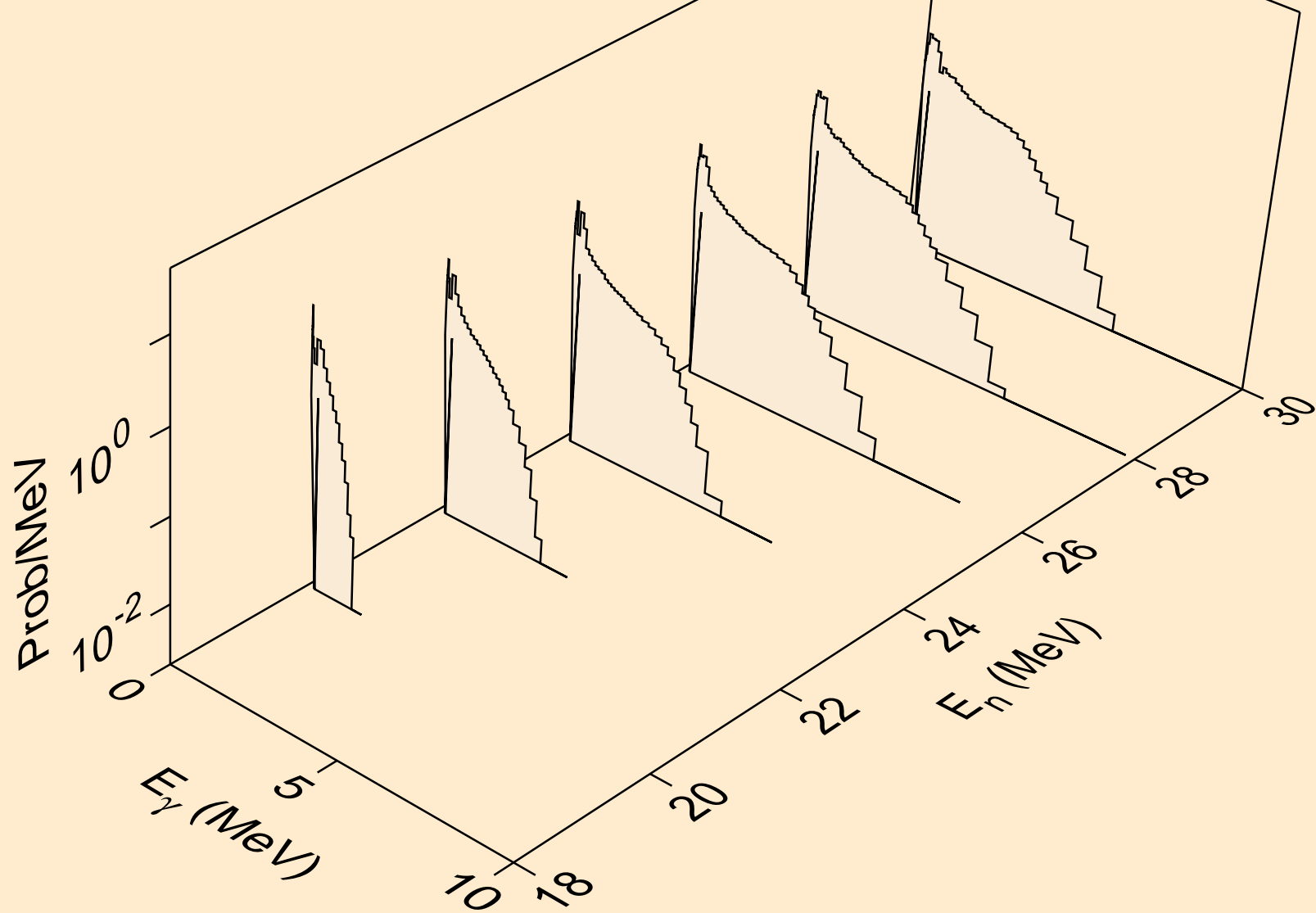

CE124 HELION ACER TENDL-2021 LIBRARY; T=0.K  
Photon emission for (n,n\*)a

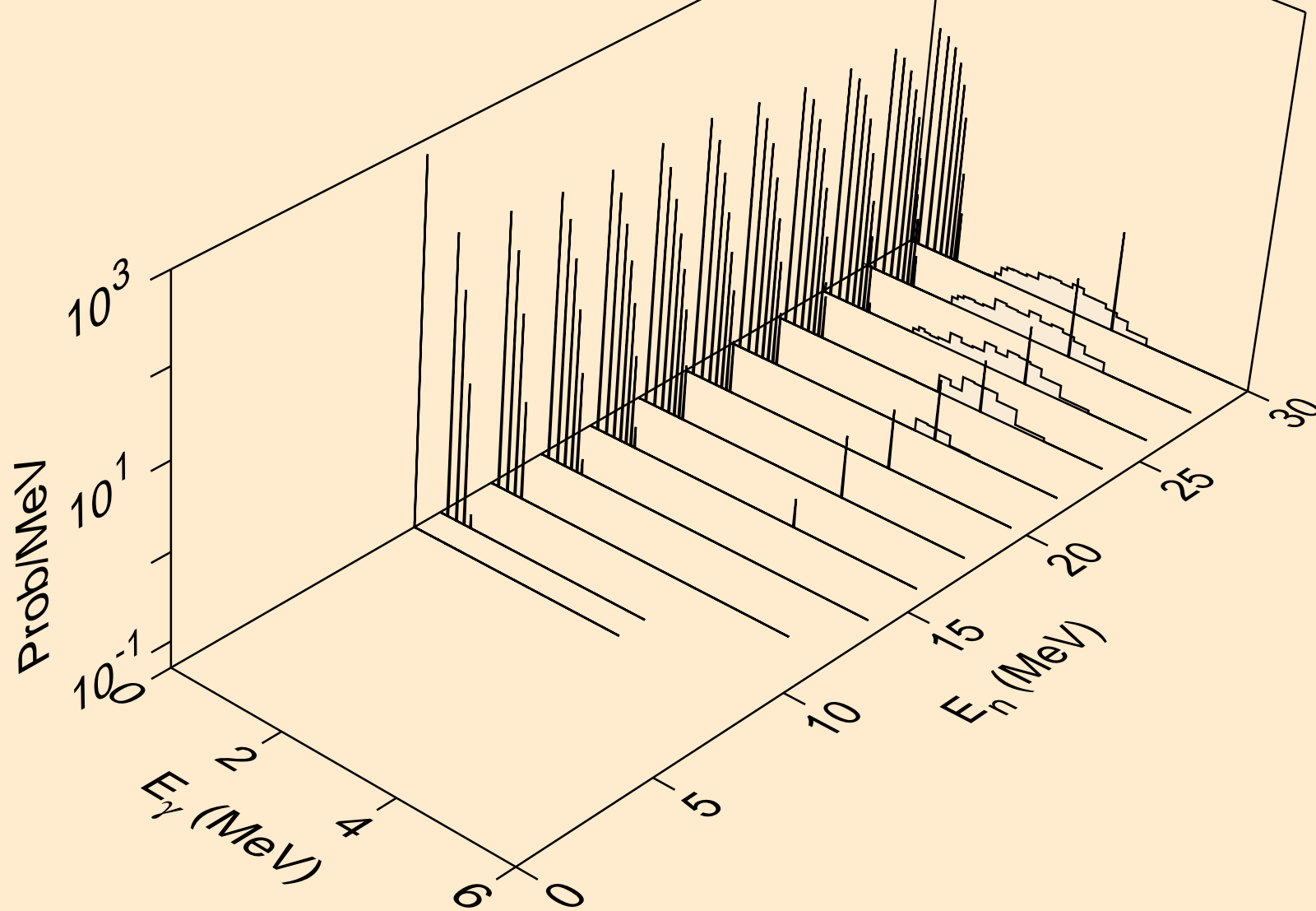

CE124 HELION ACER TENDL-2021 LIBRARY; T=0.K  
Photon emission for (n,2n)a

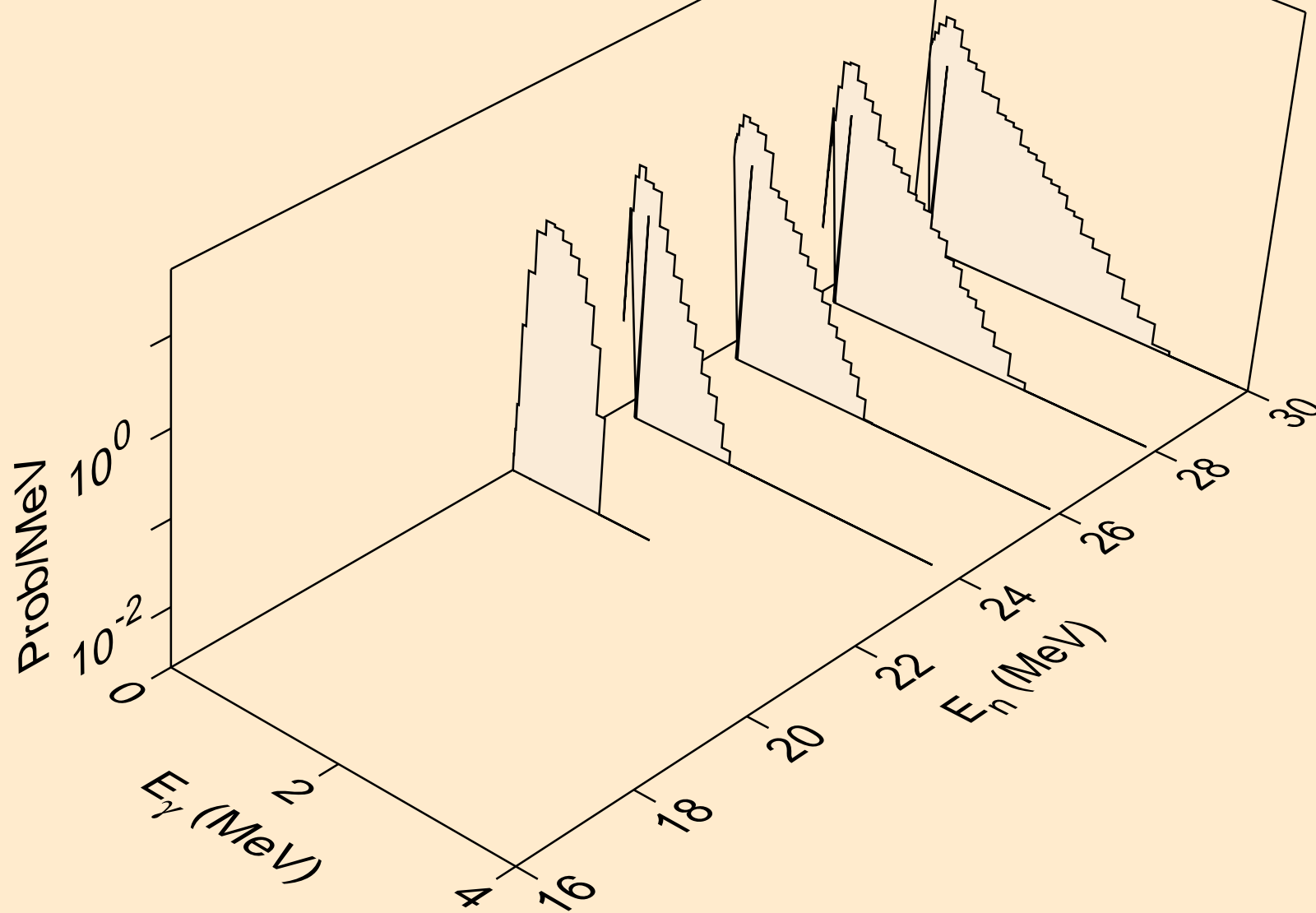

CE124 HELION ACER TENDL-2021 LIBRARY; T=0.K  
Photon emission for (n,n\*)p

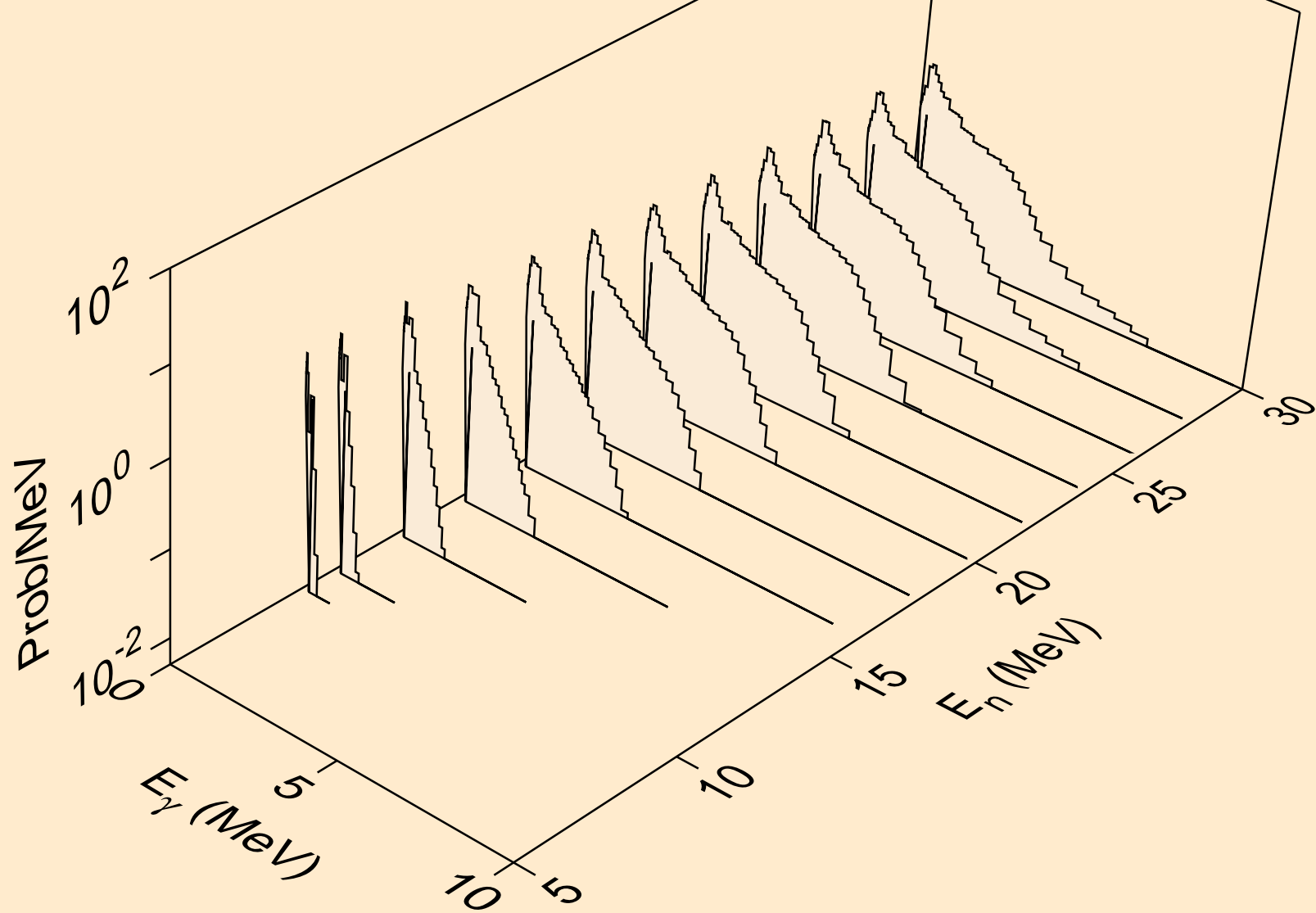

CE124 HELION ACER TENDL-2021 LIBRARY; T=0.K  
Photon emission for (n,n\*)2a

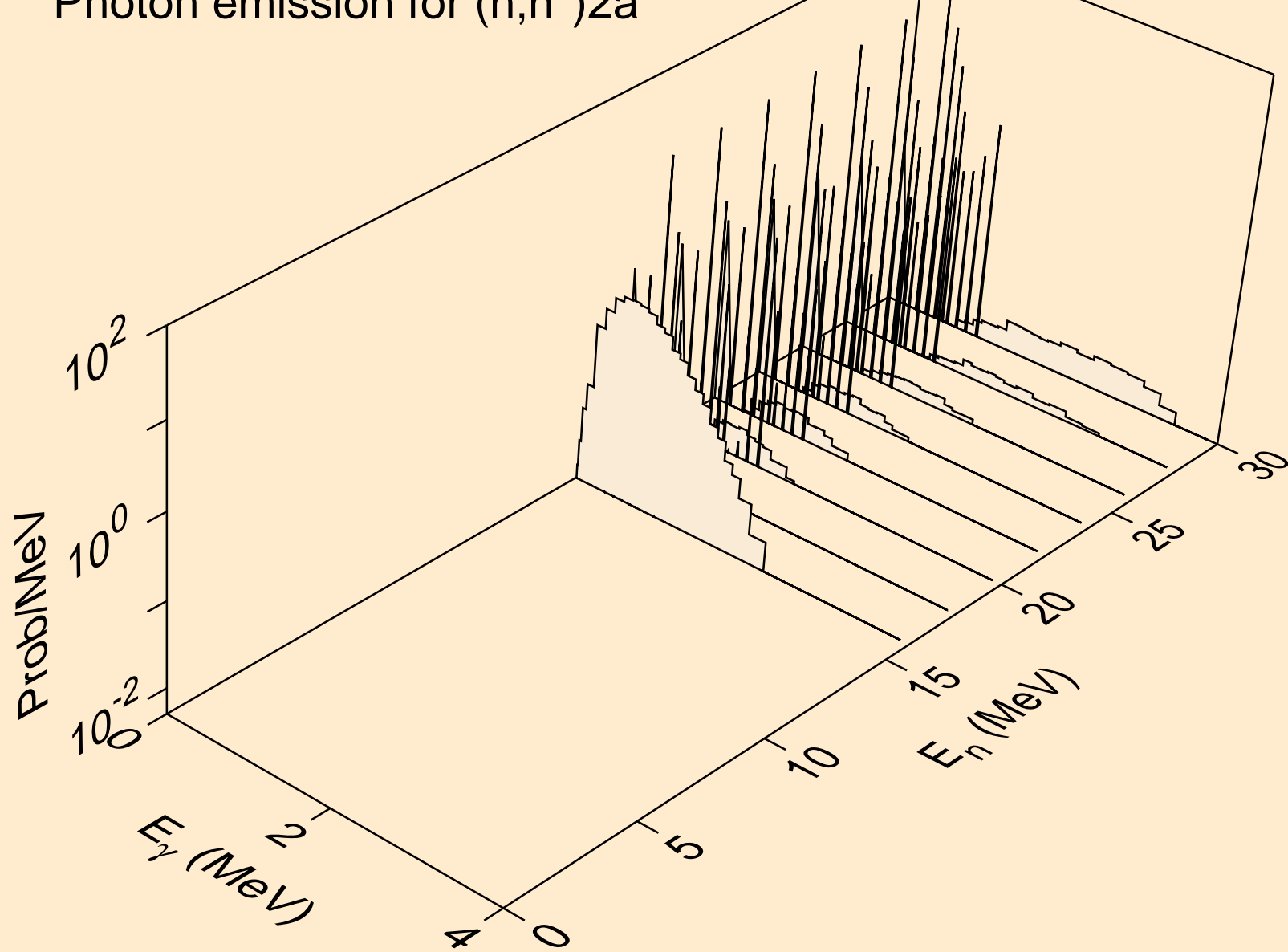

CE124 HELION ACER TENDL-2021 LIBRARY; T=0.K  
Photon emission for (n,n\*)d

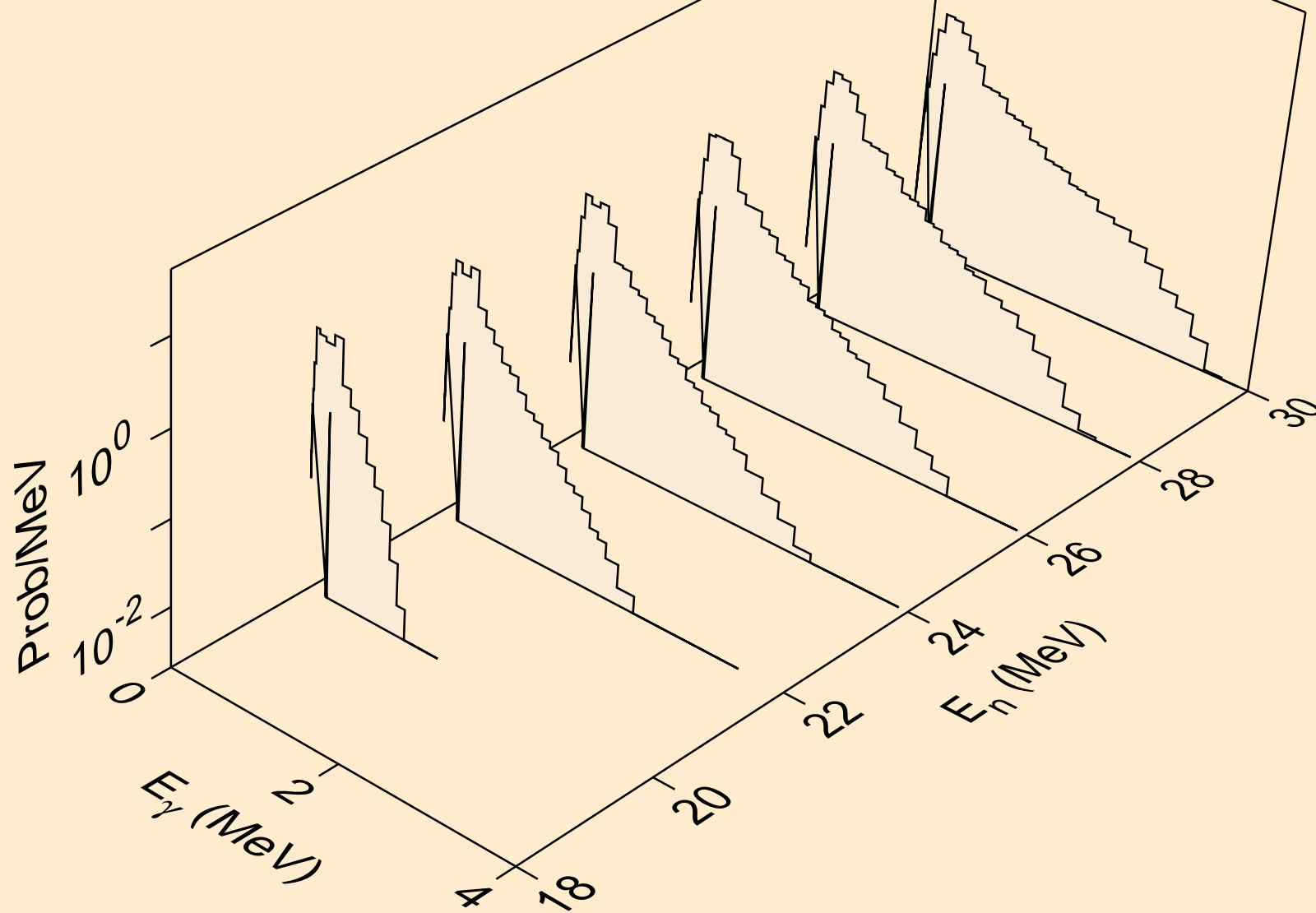



CE124 HELION ACER TENDL-2021 LIBRARY; T=0.K  
Photon emission for (n,n\*)t

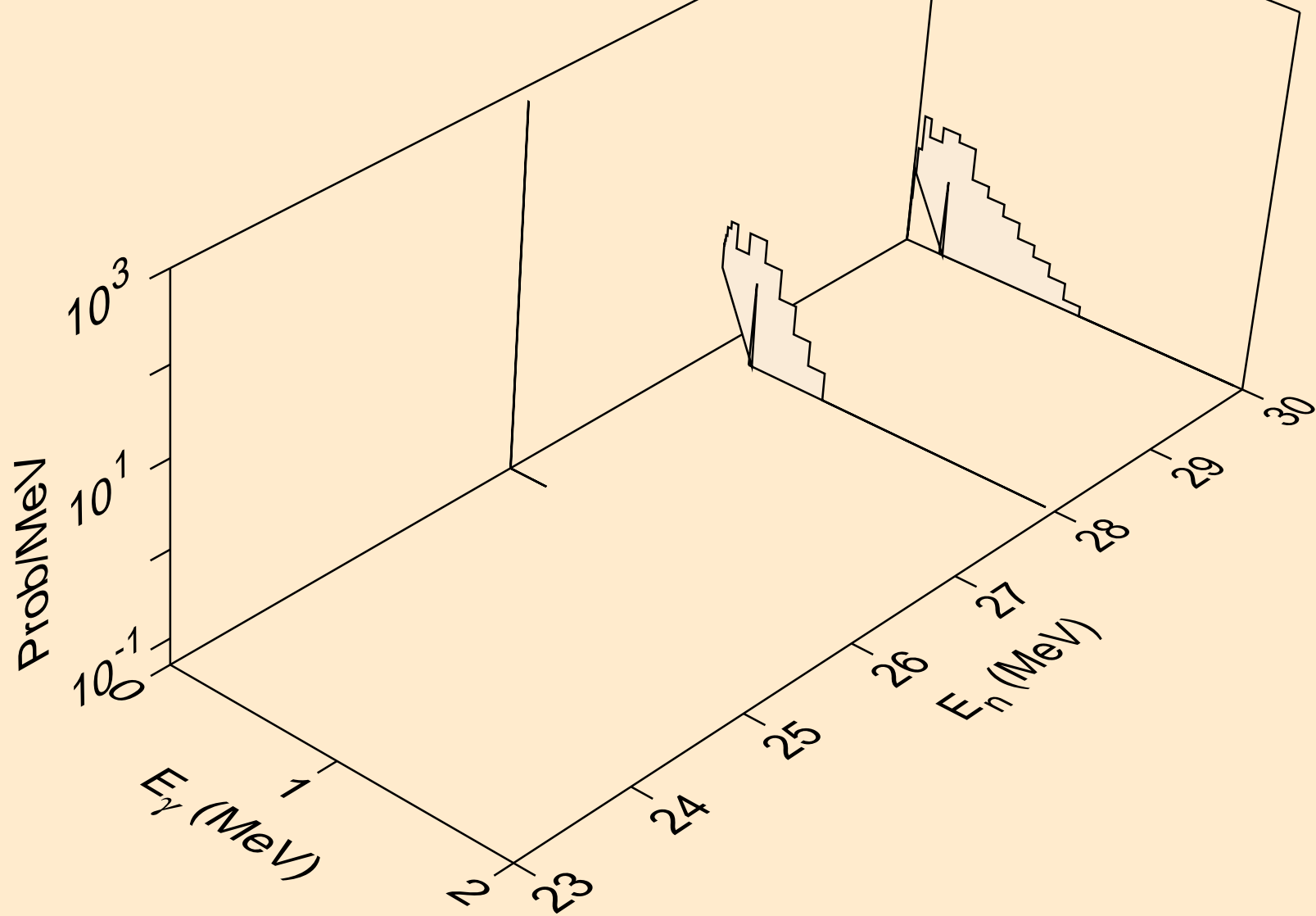

CE124 HELION ACER TENDL-2021 LIBRARY; T=0.K  
Photon emission for (n,n\*)he3

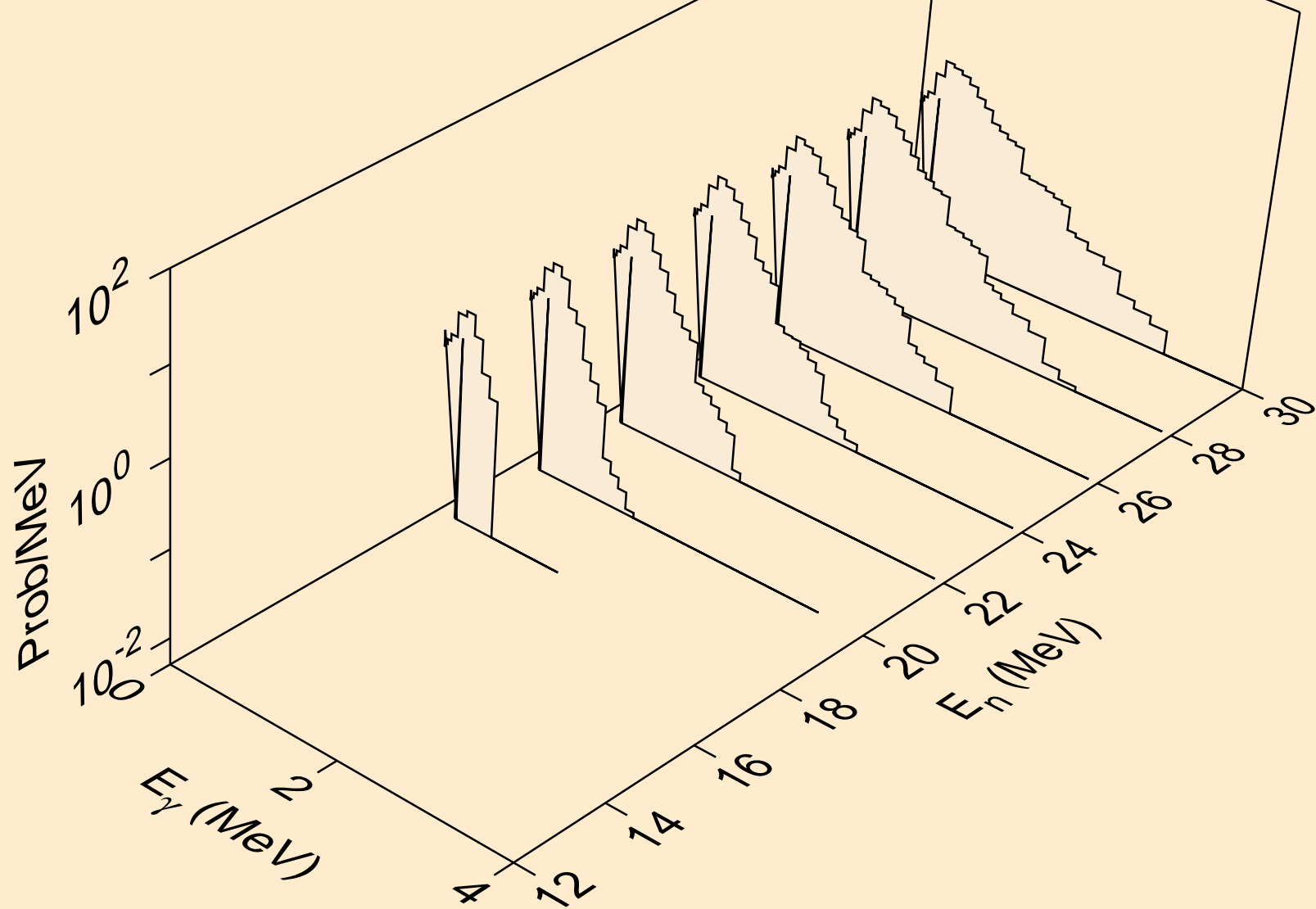

CE124 HELION ACER TENDL-2021 LIBRARY; T=0.K  
Photon emission for (n,2np)

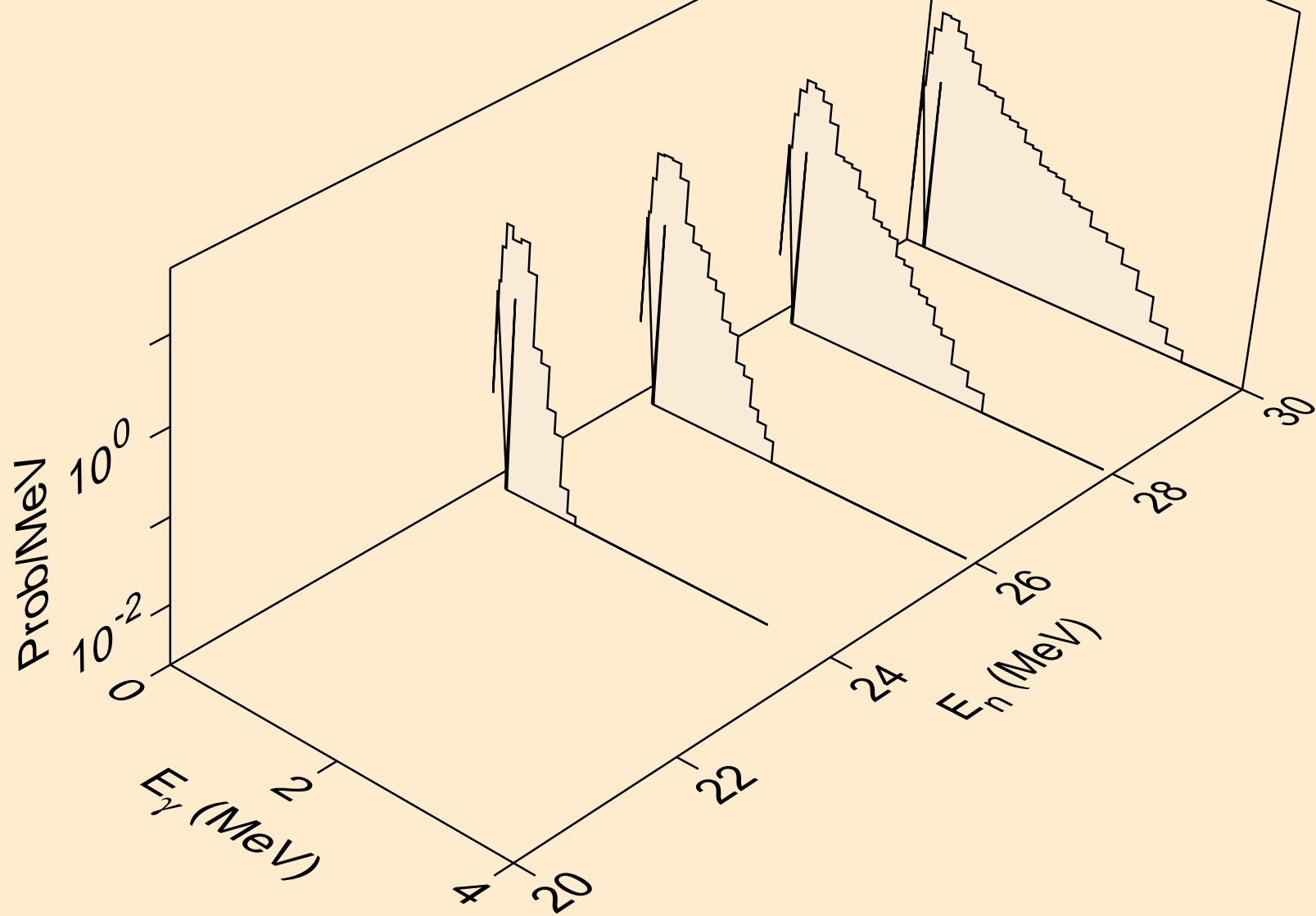

CE124 HELION ACER TENDL-2021 LIBRARY; T=0.K  
Photon emission for (n,2np)

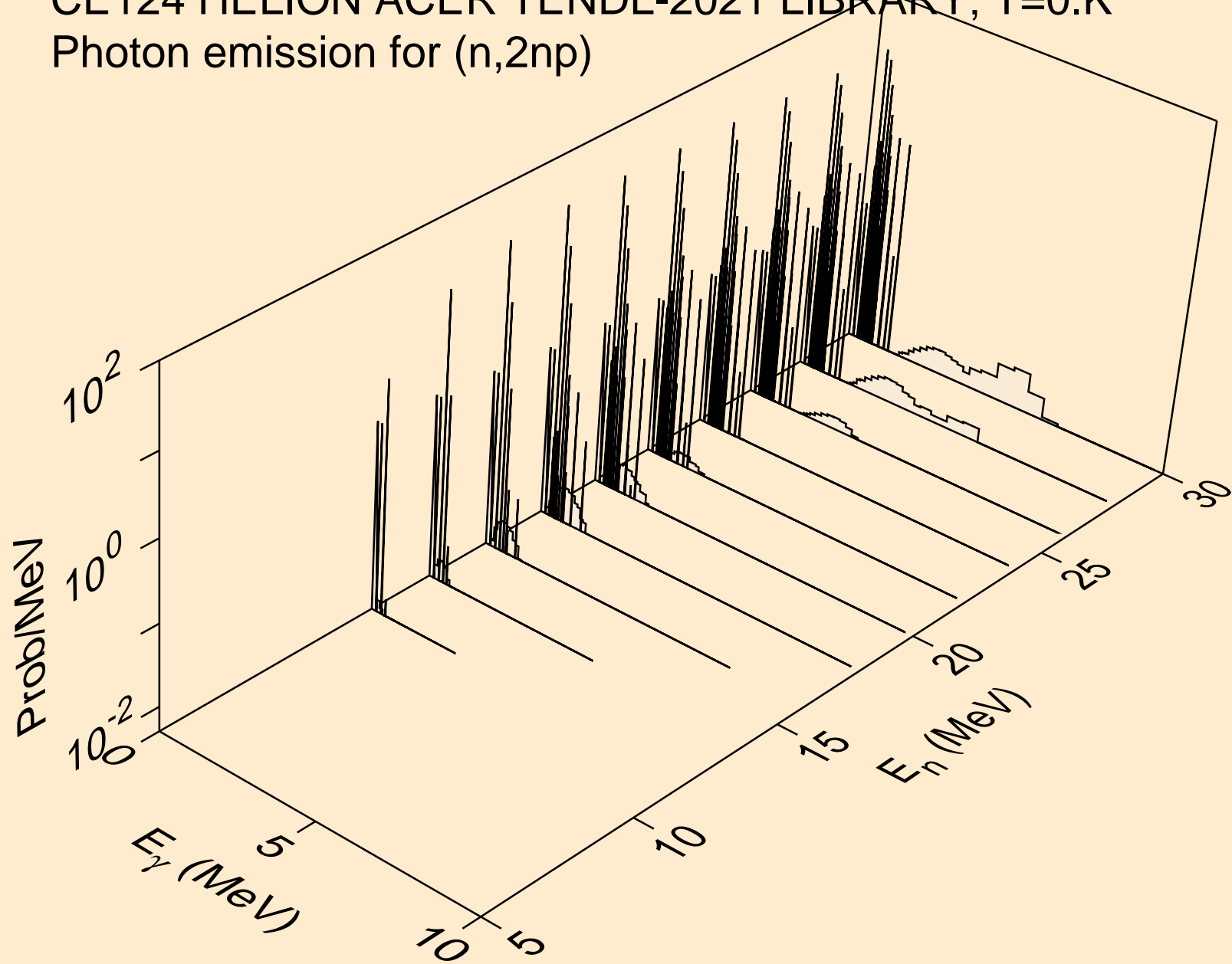

CE124 HELION ACER TENDL-2021 LIBRARY; T=0.K  
Photon emission for (n,npa)

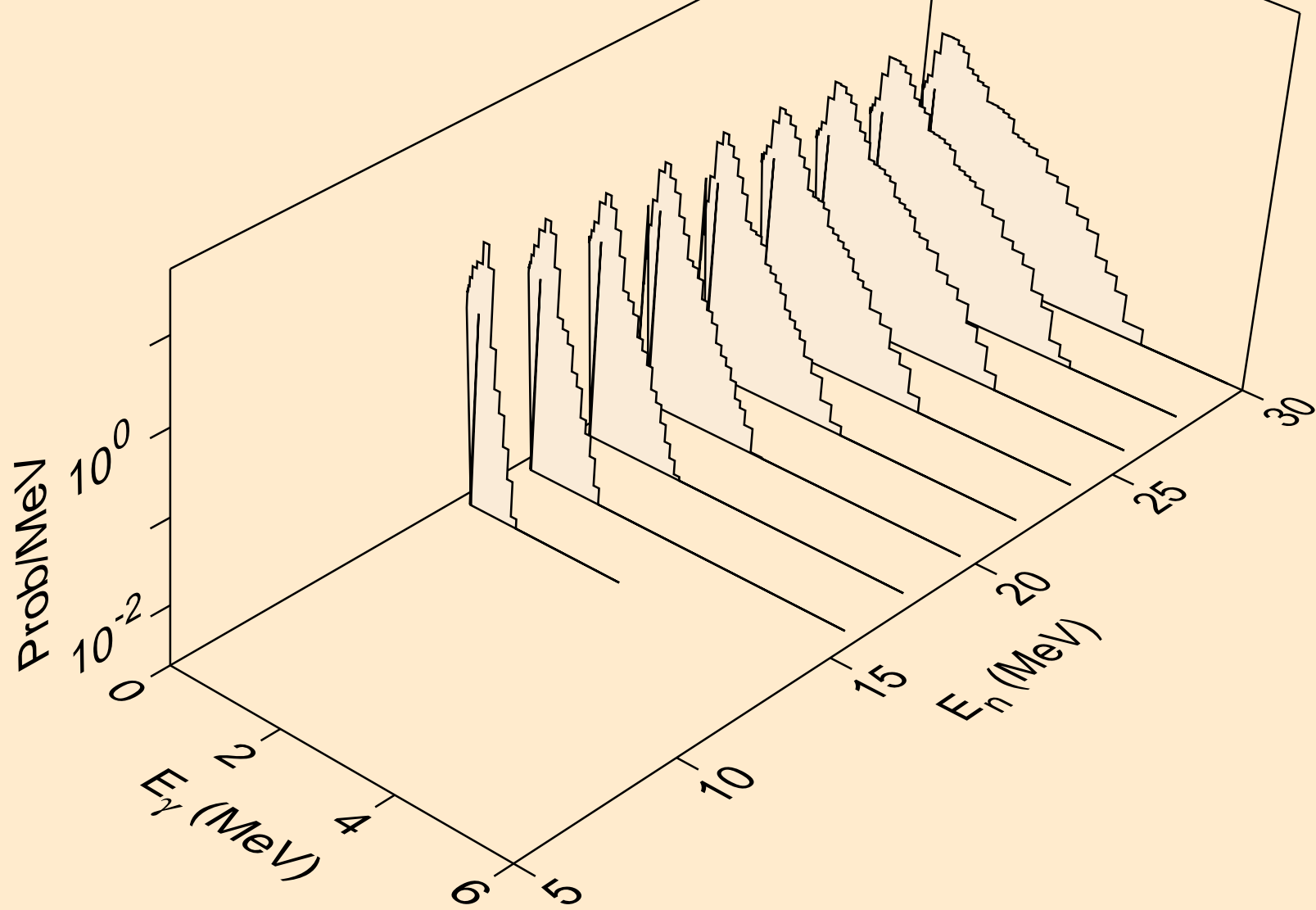

CE124 HELION ACER TENDL-2021 LIBRARY; T=0.K  
Photon emission for (n,gma)

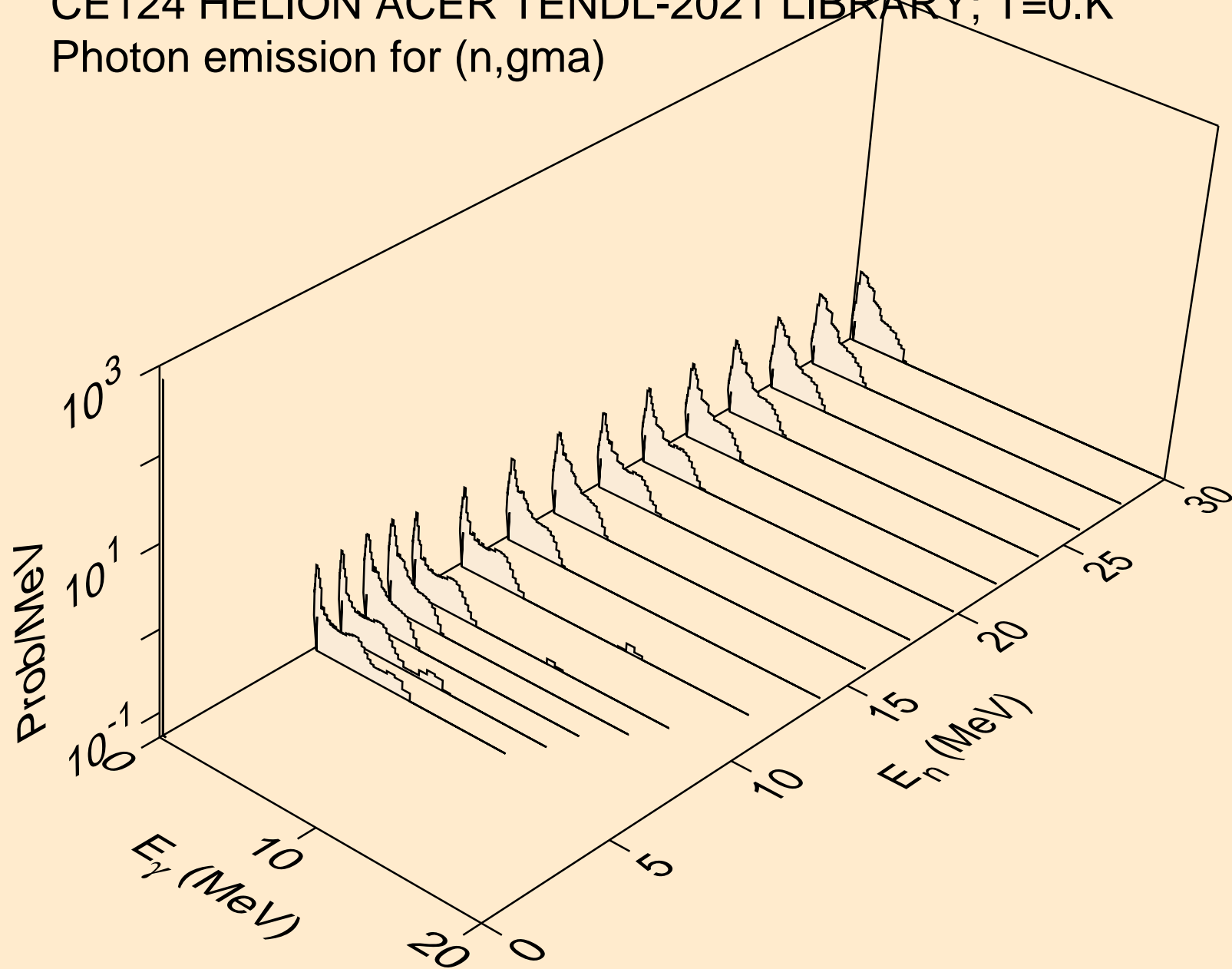

CE124 HELION ACER TENDL-2021 LIBRARY; T=0.K  
Photon emission for (n,p)

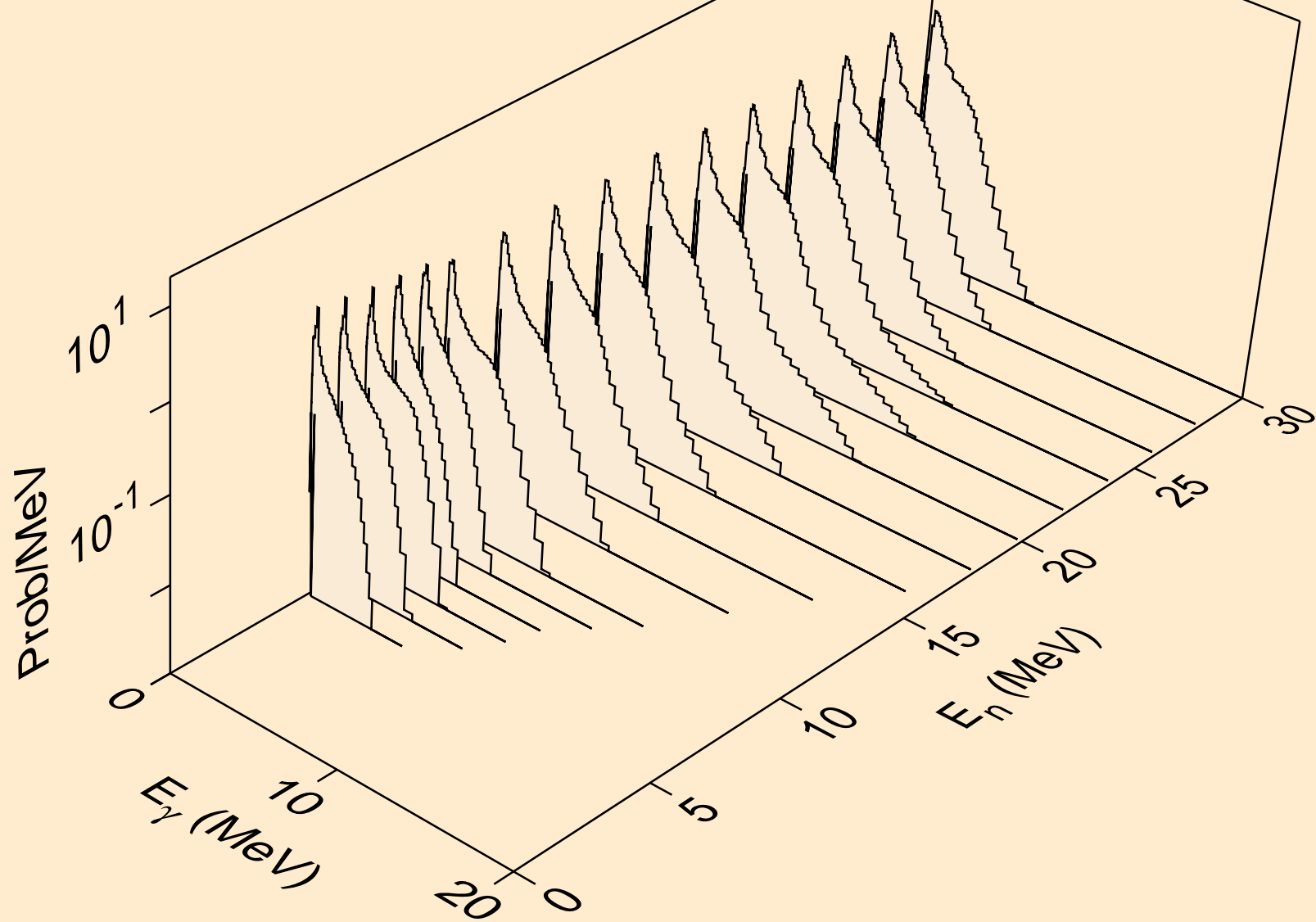

CE124 HELION ACER TENDL-2021 LIBRARY; T=0.K  
Photon emission for (n,d)

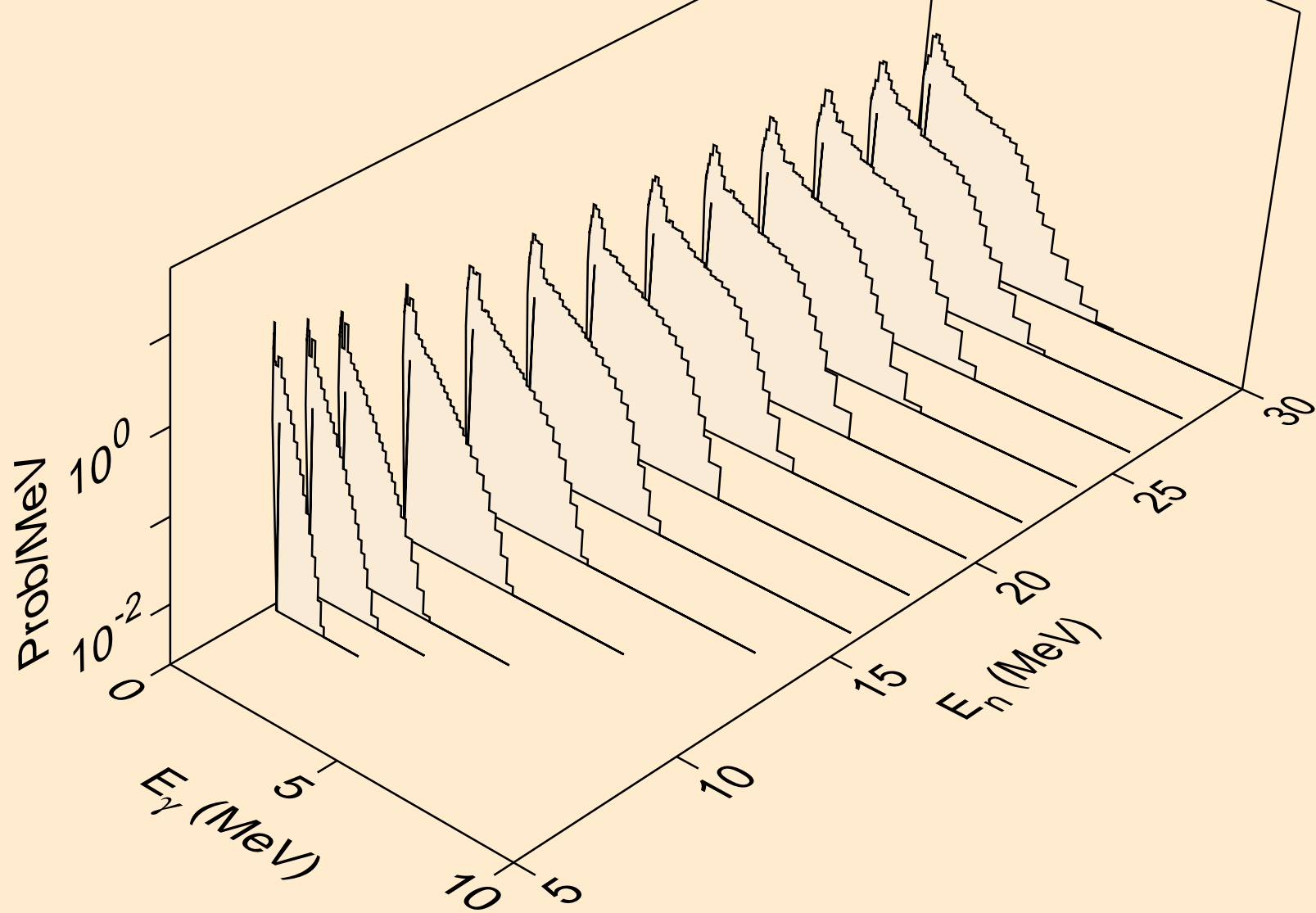



CE124 HELION ACER TENDL-2021 LIBRARY; T=0.K  
Photon emission for (n,t)

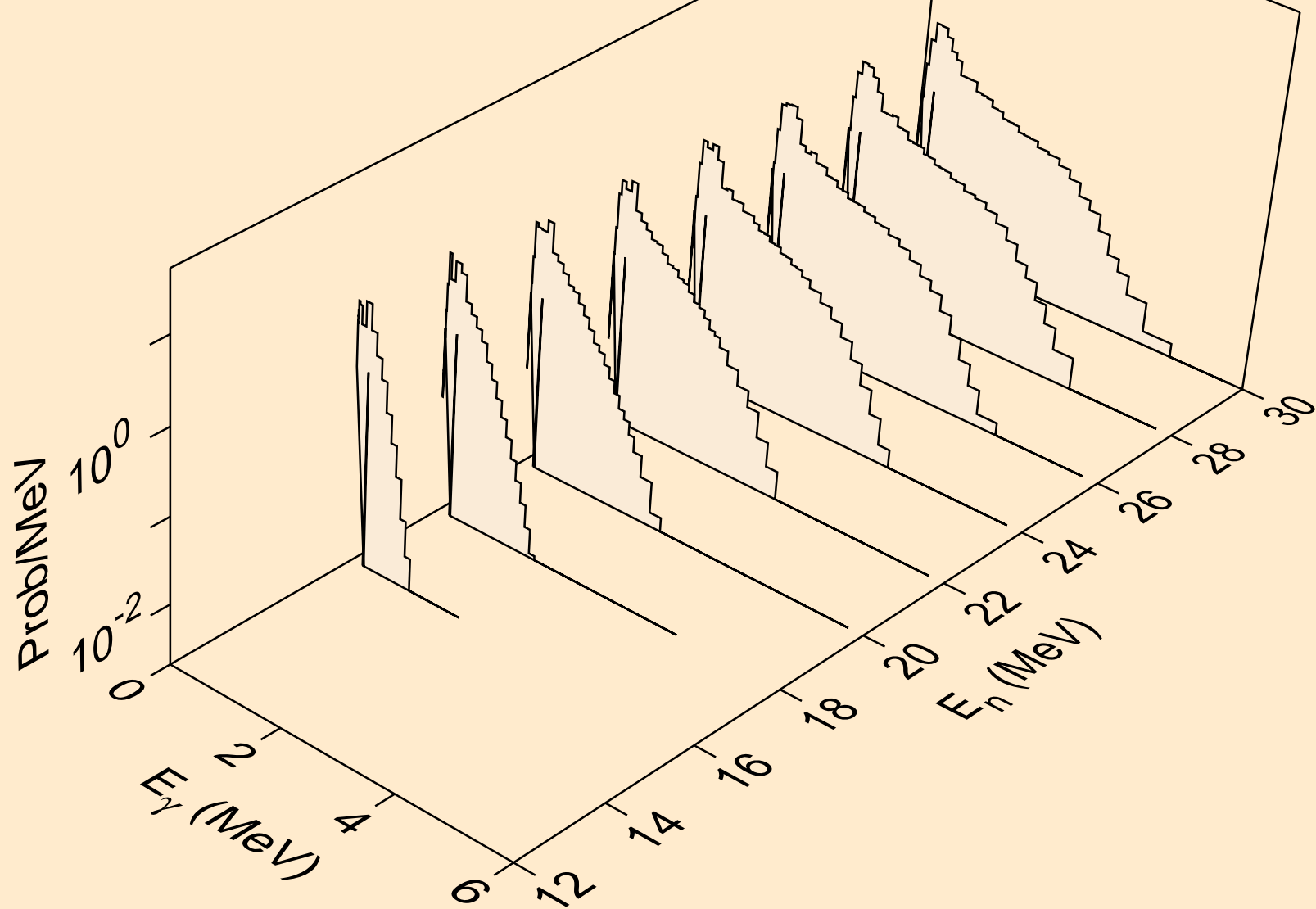

CE124 HELION ACER TENDL-2021 LIBRARY; T=0.K  
Photon emission for inelastic

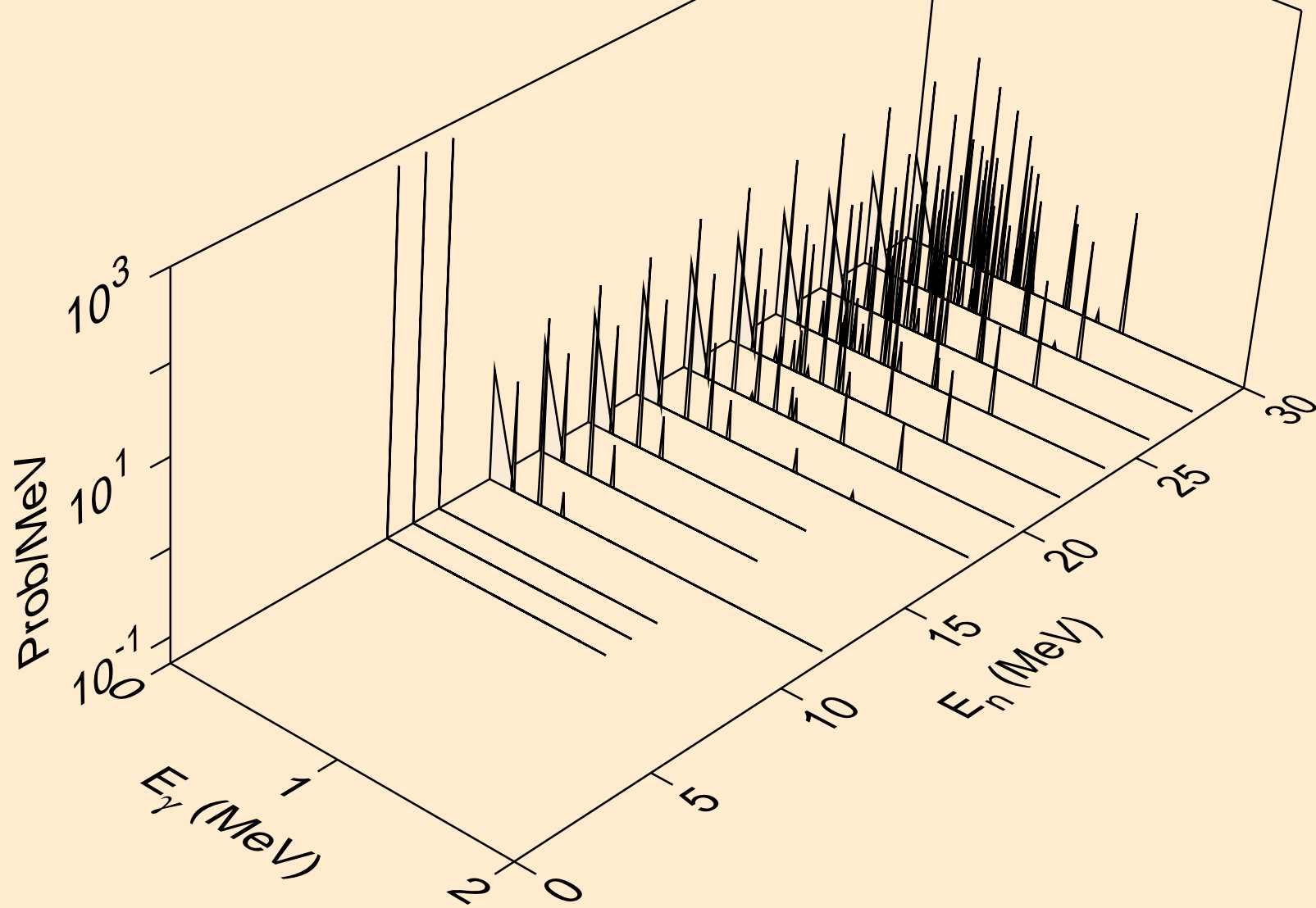

CE124 HELION ACER TENDL-2021 LIBRARY; T=0.K  
Photon emission for (n,a)

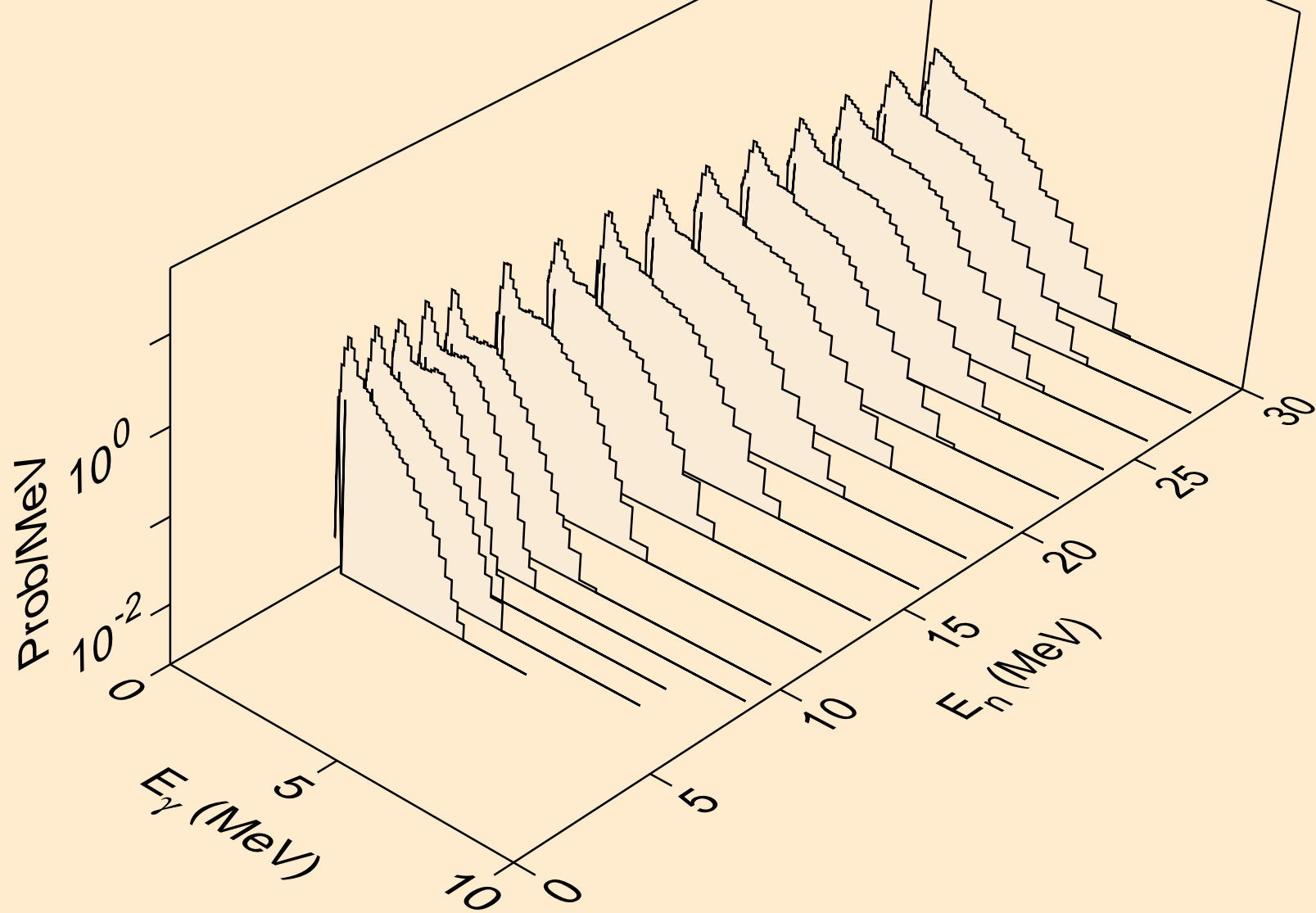

CE124 HELION ACER TENDL-2021 LIBRARY; T=0.K  
Photon emission for (n,2a)

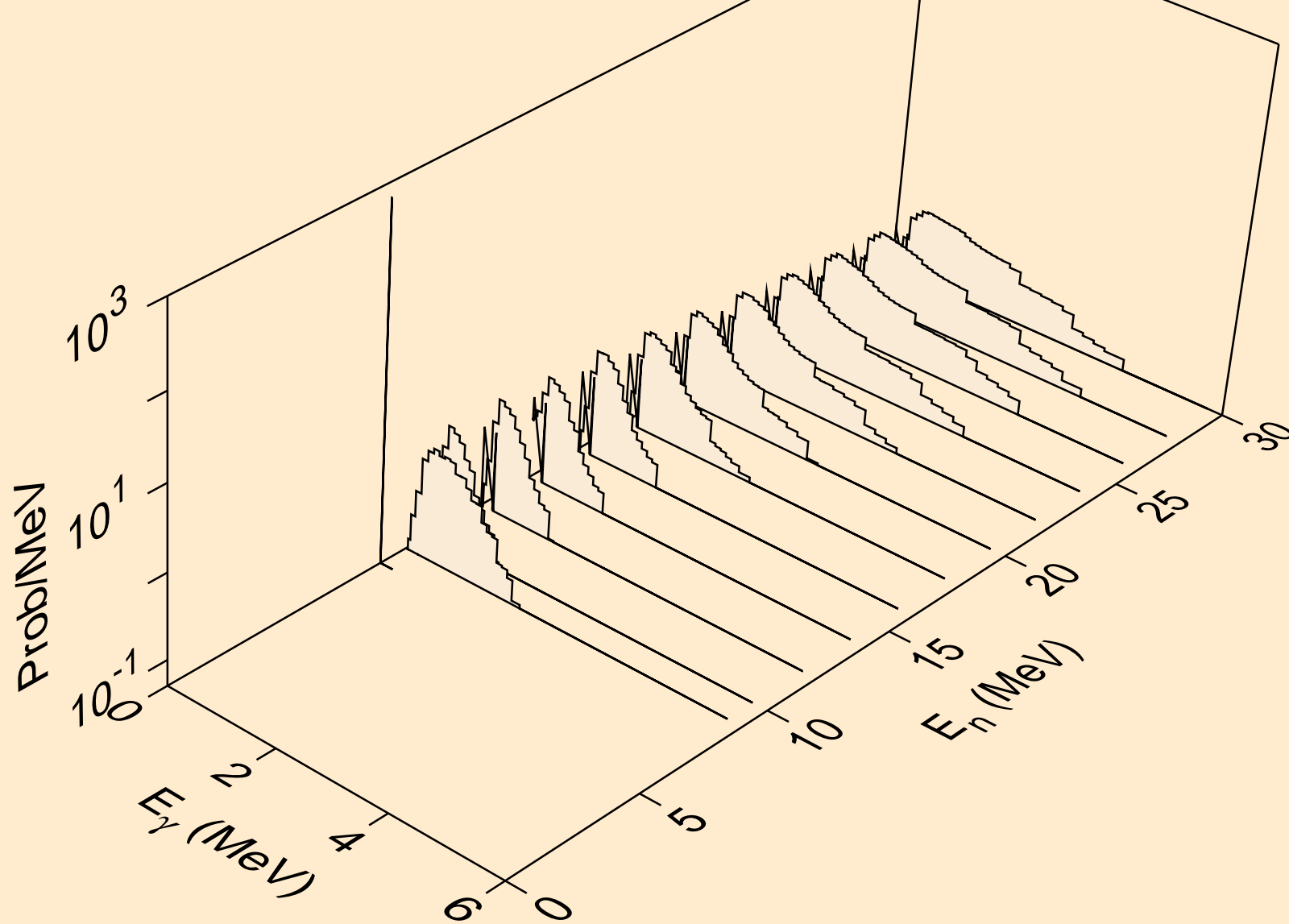

CE124 HELION ACER TENDL-2021 LIBRARY; T=0.K  
Photon emission for (n,3a)

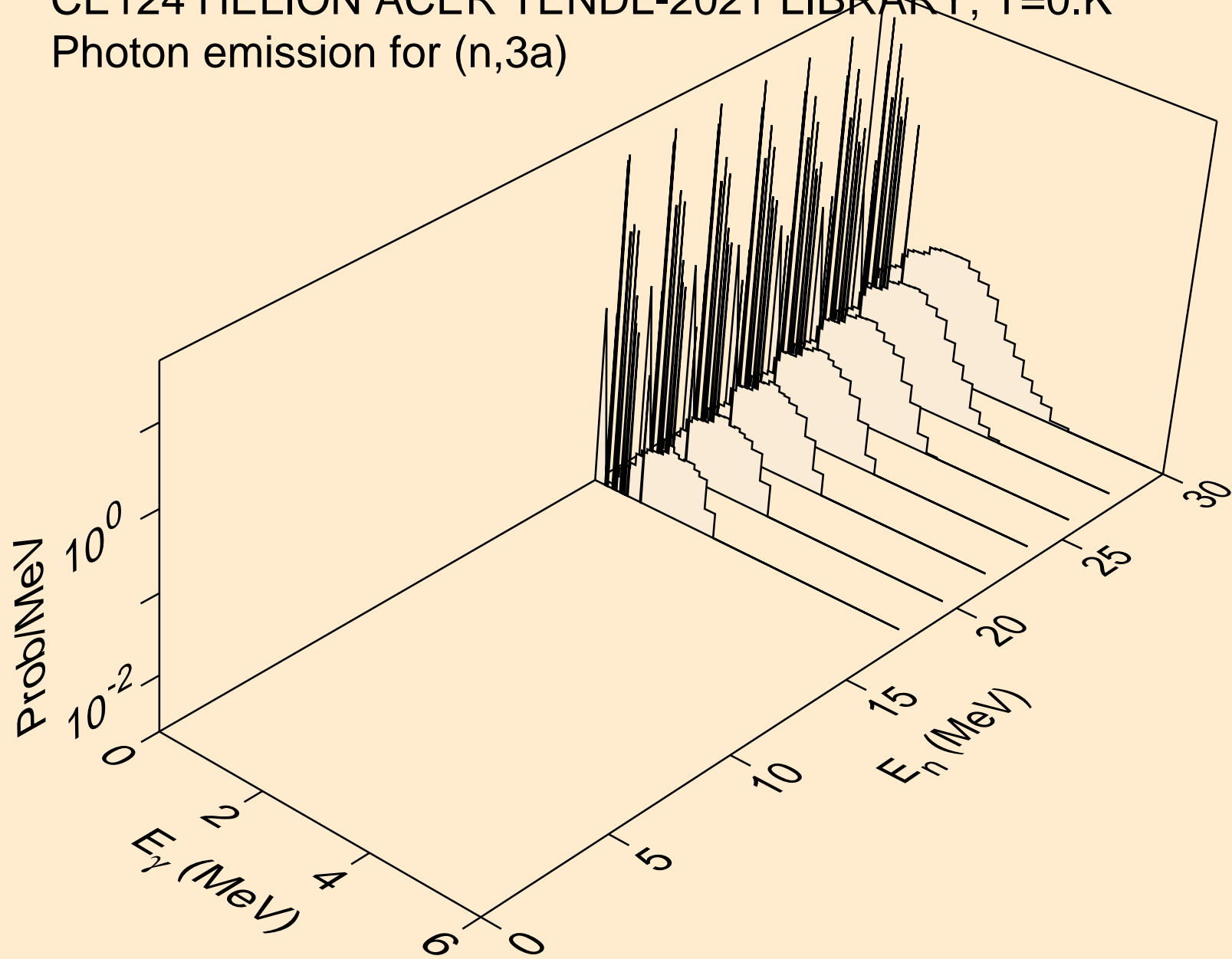

CE124 HELION ACER TENDL-2021 LIBRARY; T=0.K  
Photon emission for (n,2p)

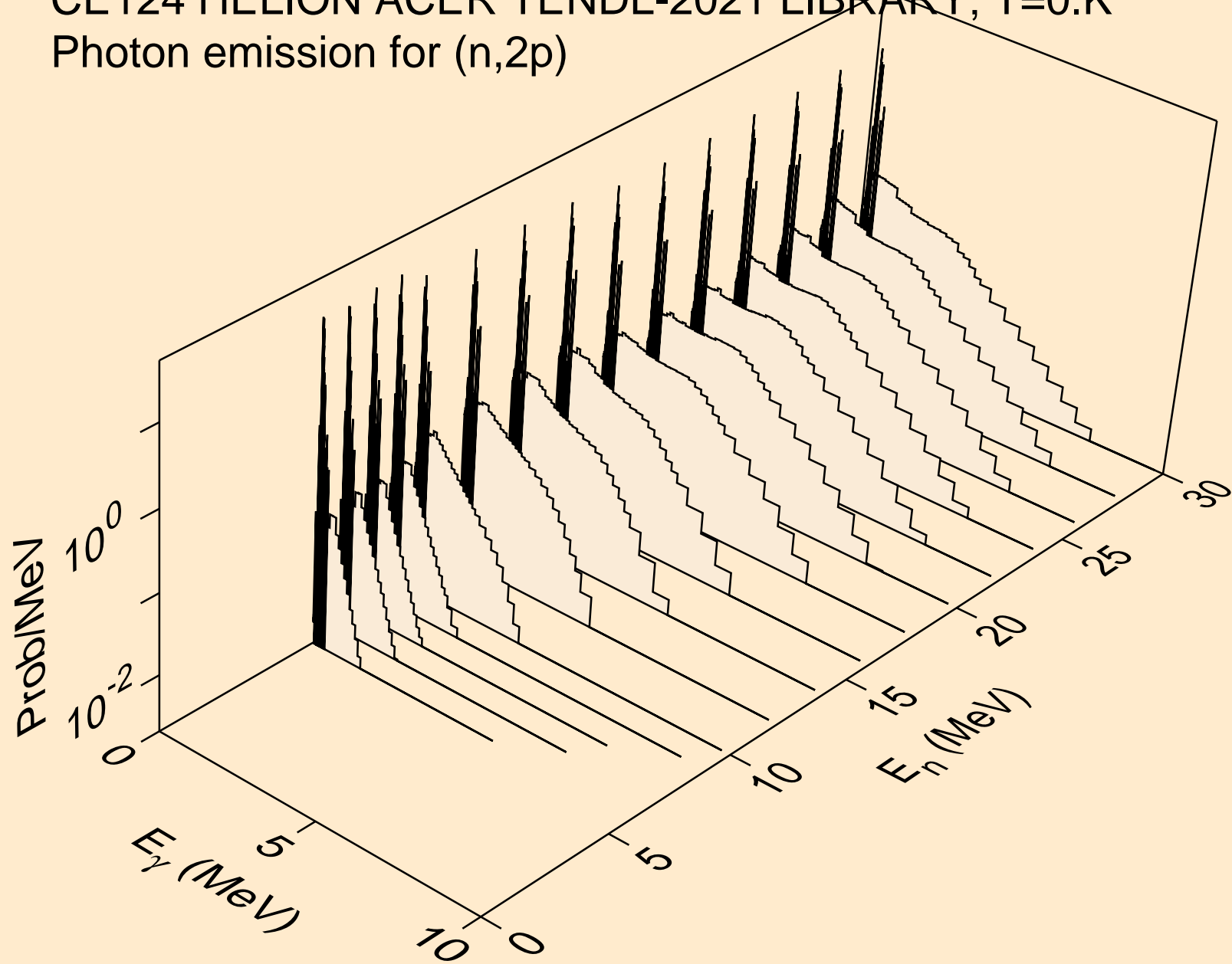

CE124 HELION ACER TENDL-2021 LIBRARY; T=0.K  
Photon emission for (n,pa)

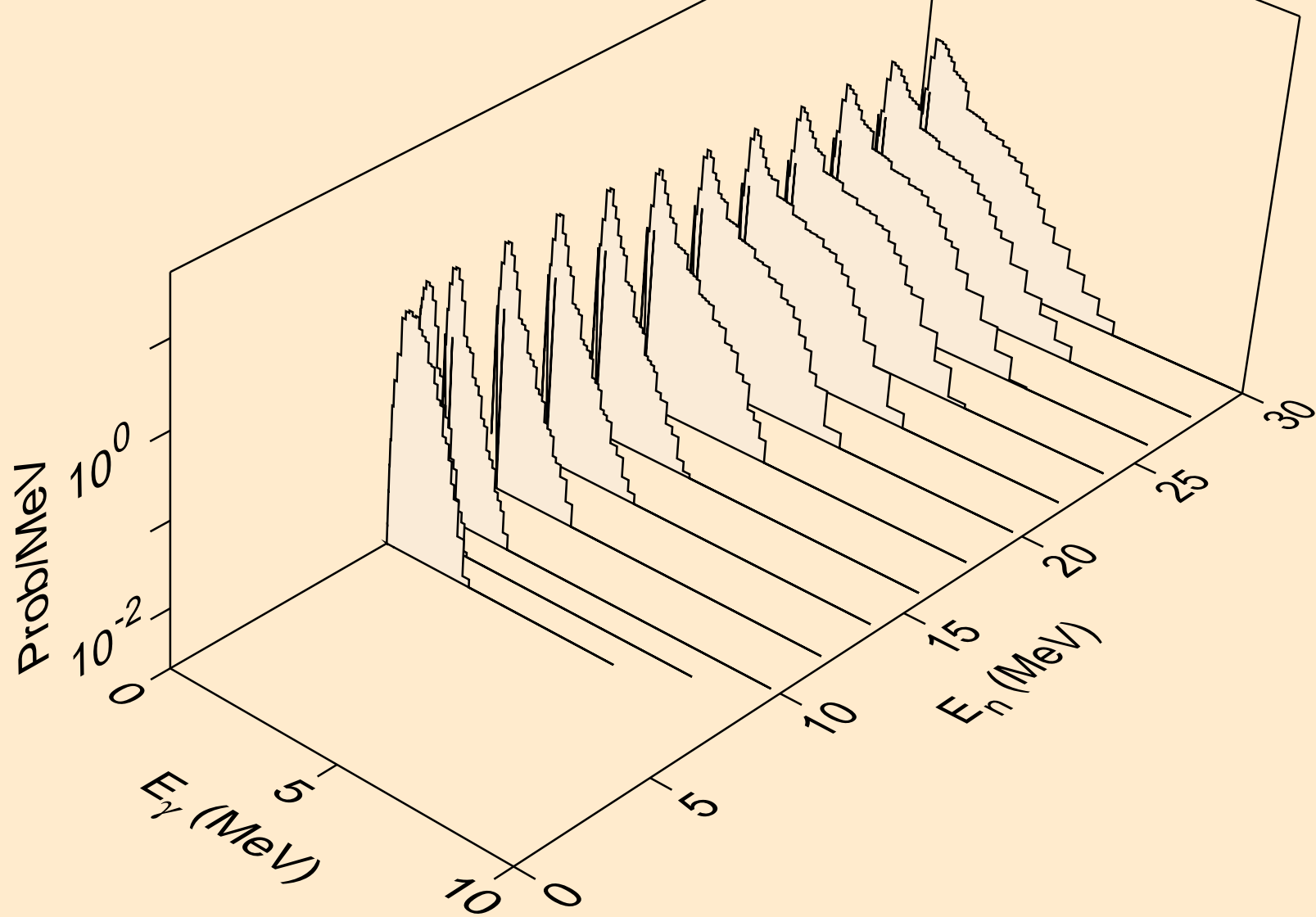

CE124 HELION ACER TENDL-2021 LIBRARY; T=0.K  
Photon emission for (n,pd)

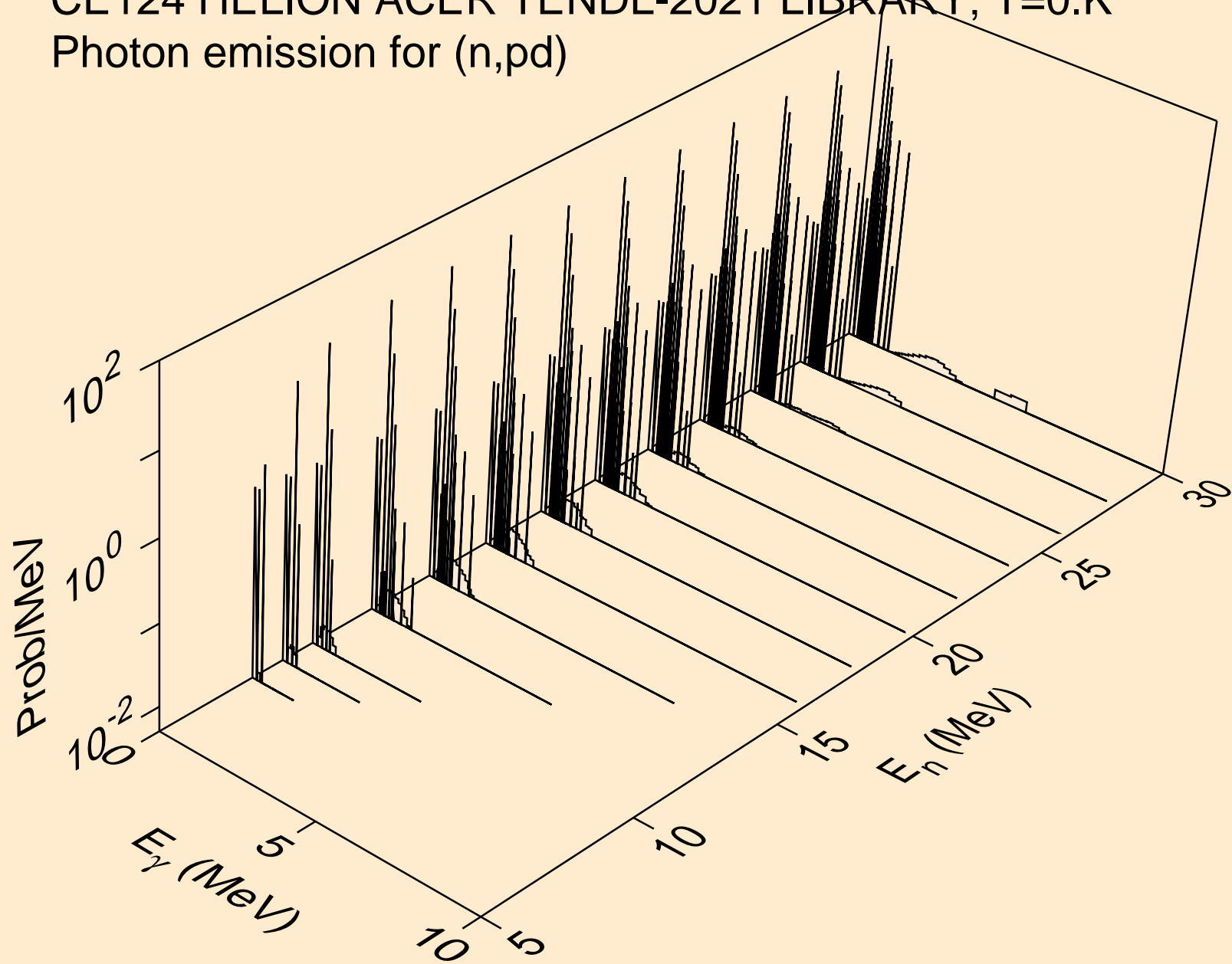



CE124 HELION ACER TENDL-2021 LIBRARY; T=0.K  
Photon emission for (n,pt)

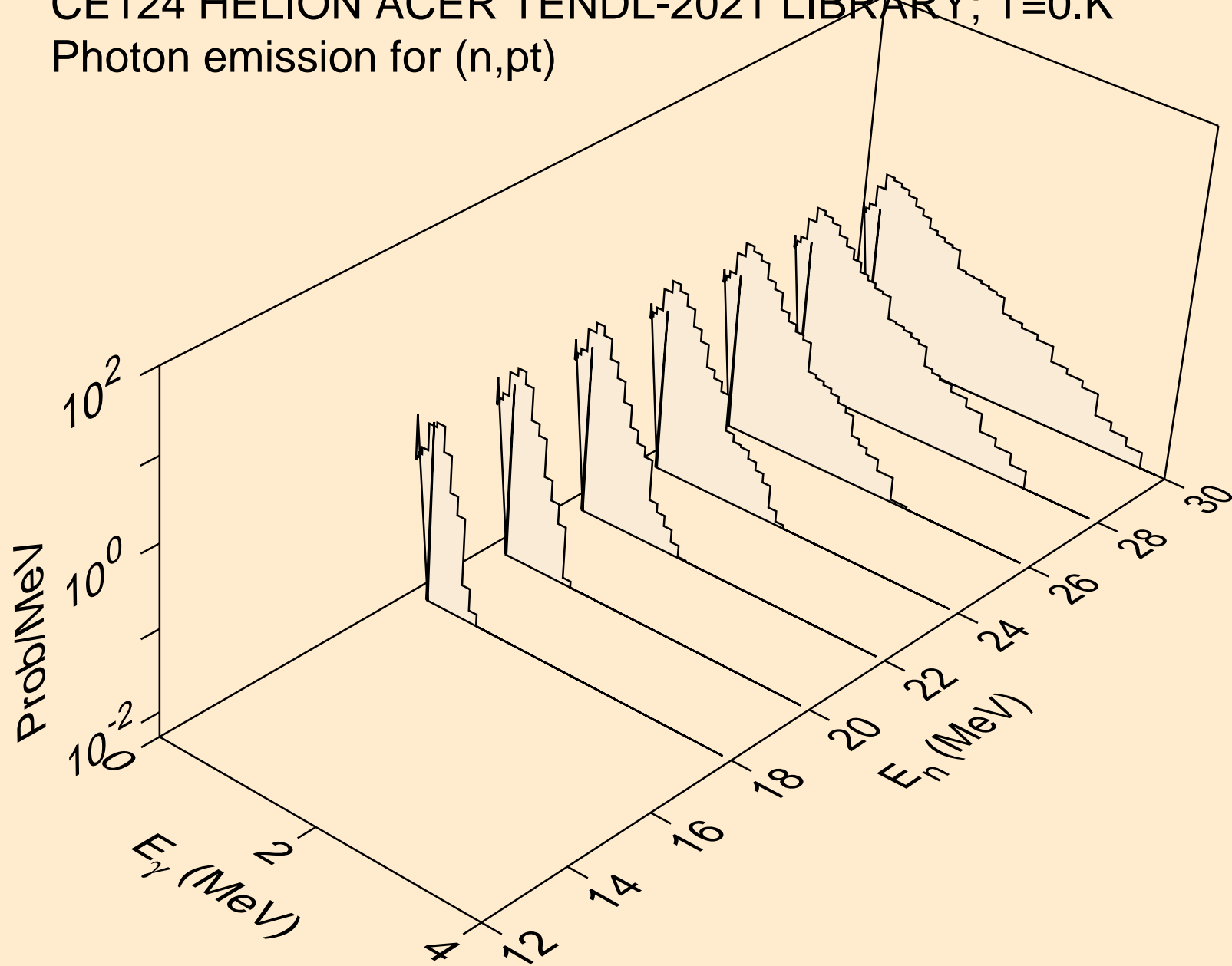

CE124 HELION ACER TENDL-2021 LIBRARY; T=0.K  
Photon emission for (n,da)

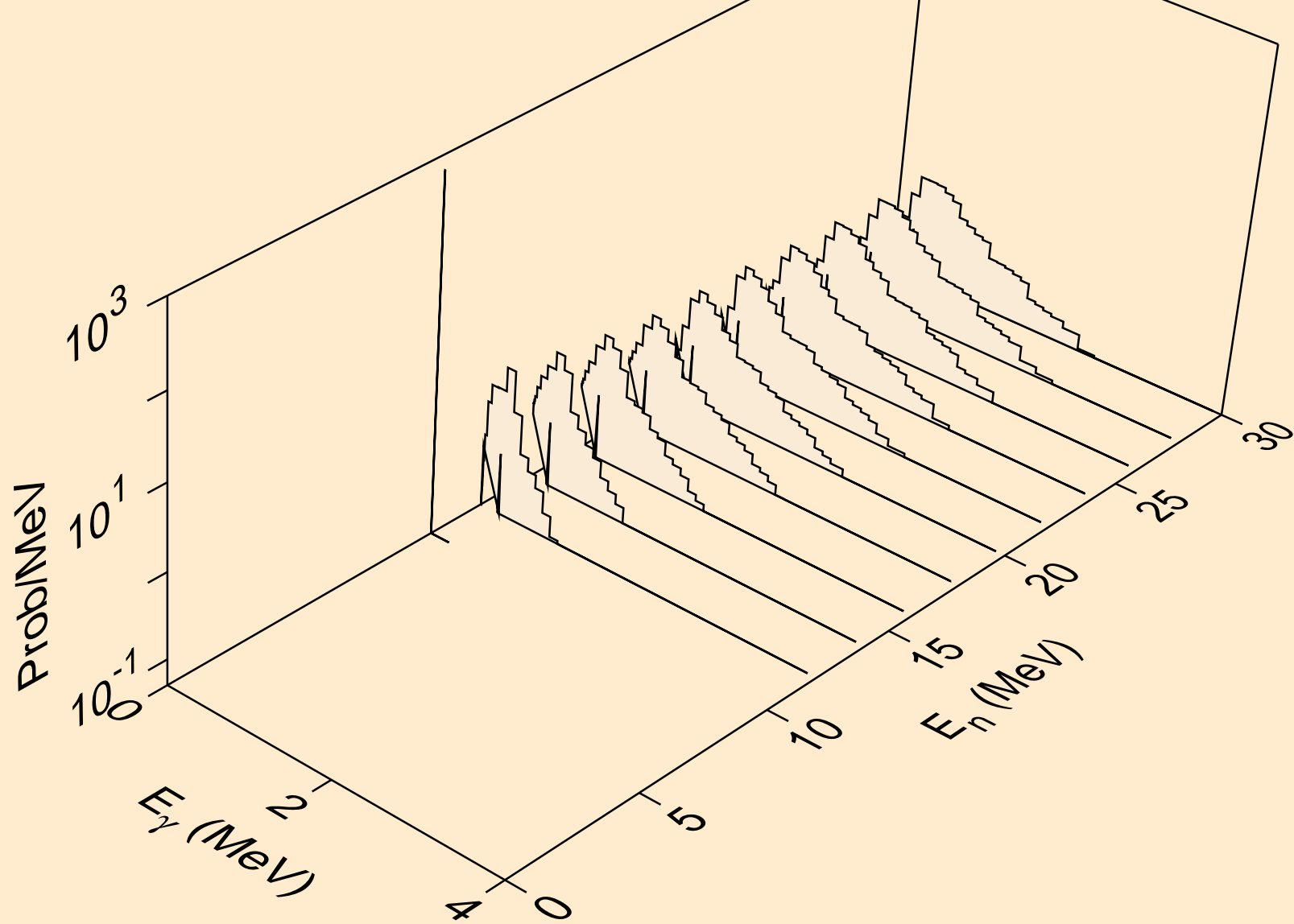

# CE124 HELION ACER TENDL-2021 LIBRARY; T=0.K

## Particle heating contributions

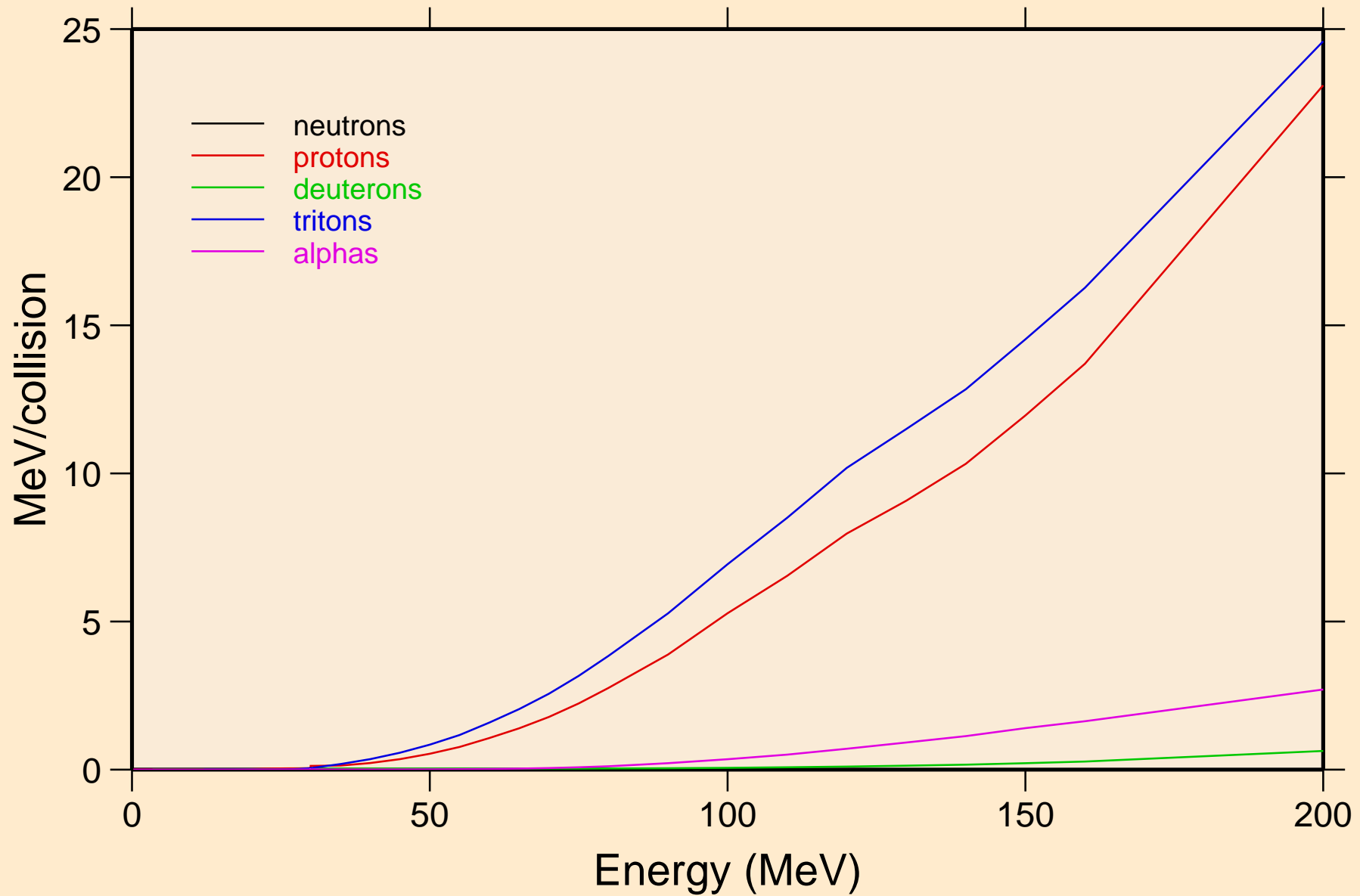

CE124 HELION ACER TENDL-2021 LIBRARY; T=0.K  
Recoil Heating

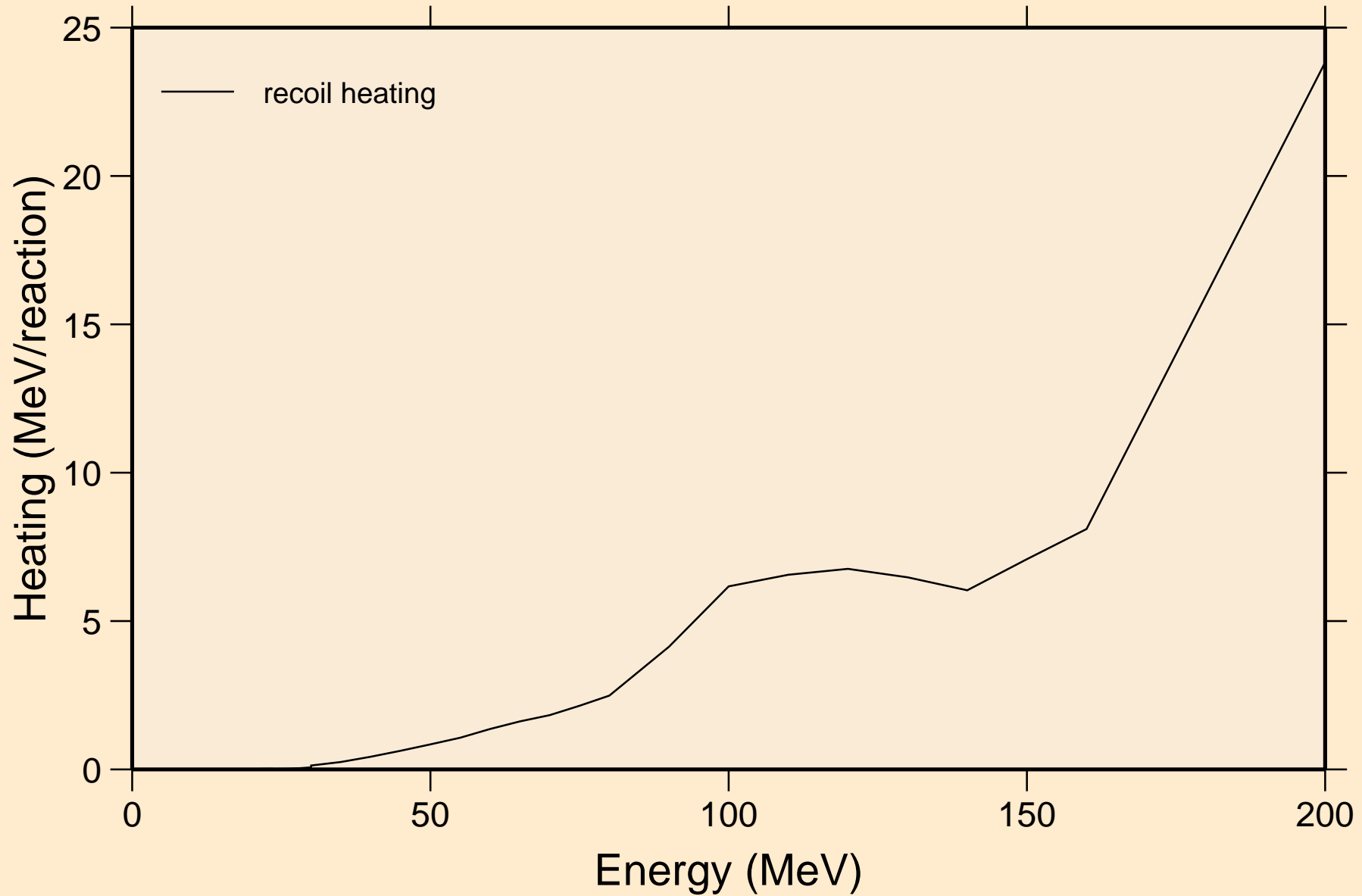

CE124 HELION ACER TENDL-2021 LIBRARY; T=0.K  
Particle production cross sections

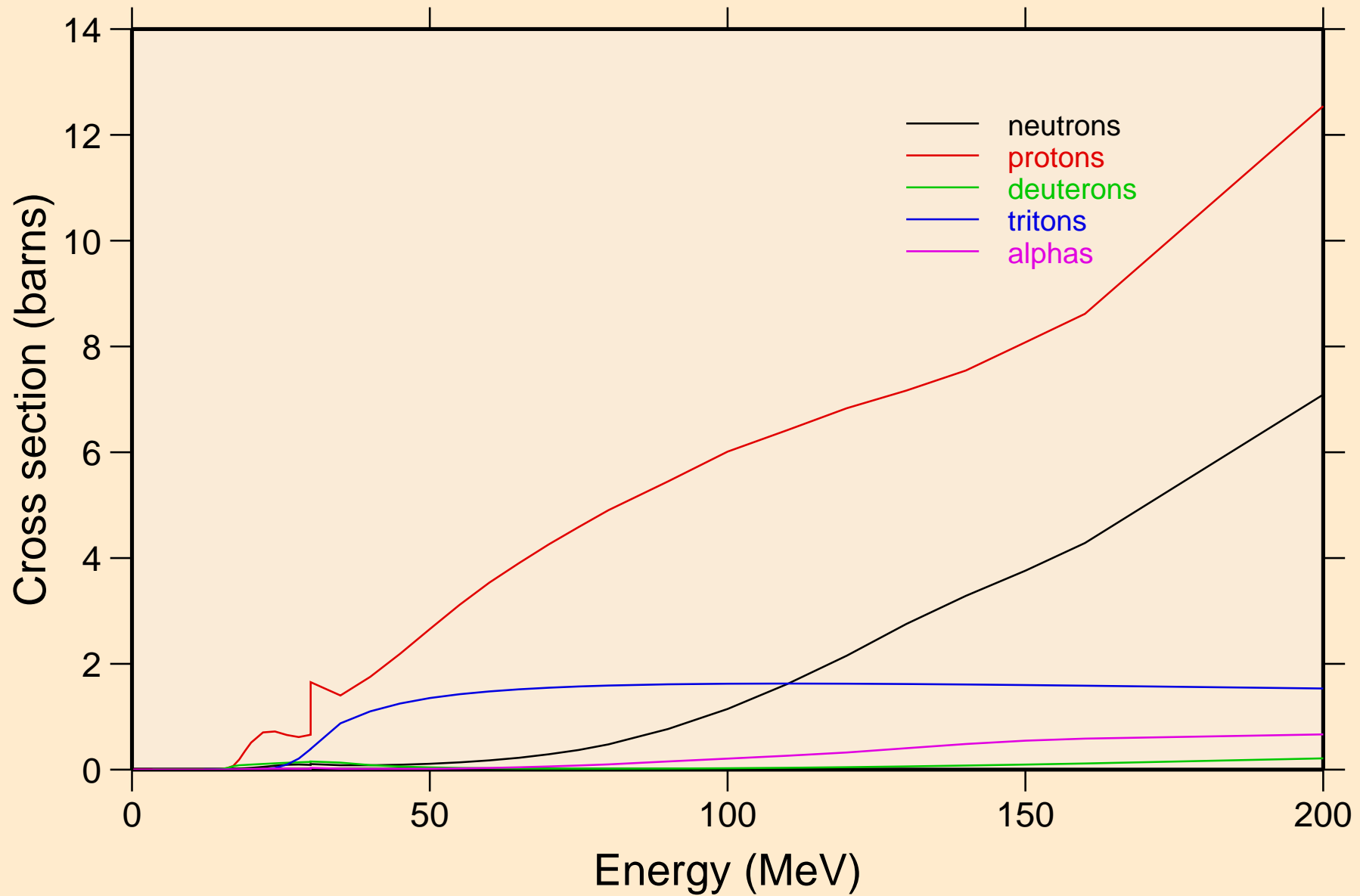

CE124 HELION ACER TENDL-2021 LIBRARY; T=0.K  
neutrons from (s,n)

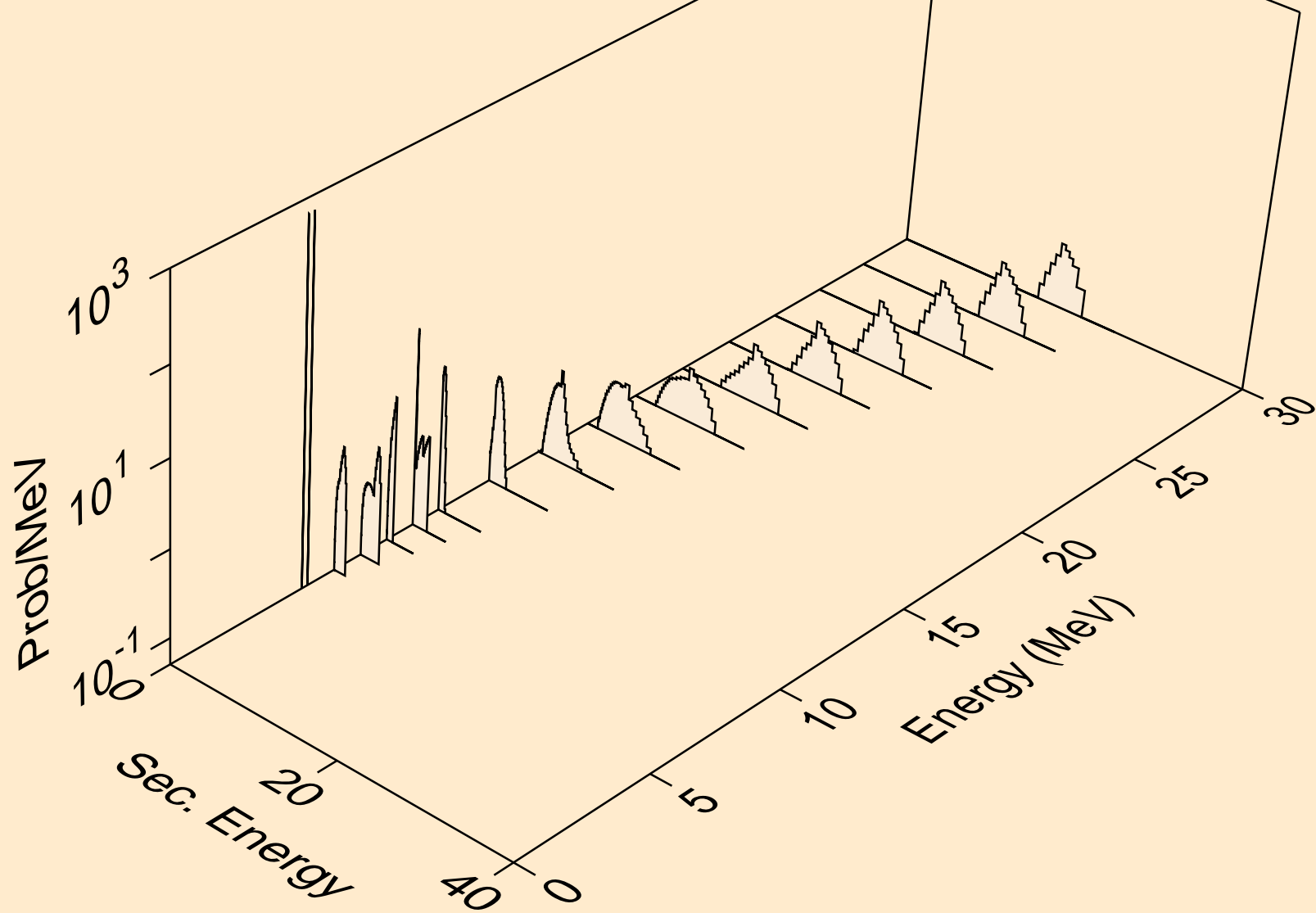

CE124 HELION ACER TENDL-2021 LIBRARY; T=0.K  
neutrons from (s,x)

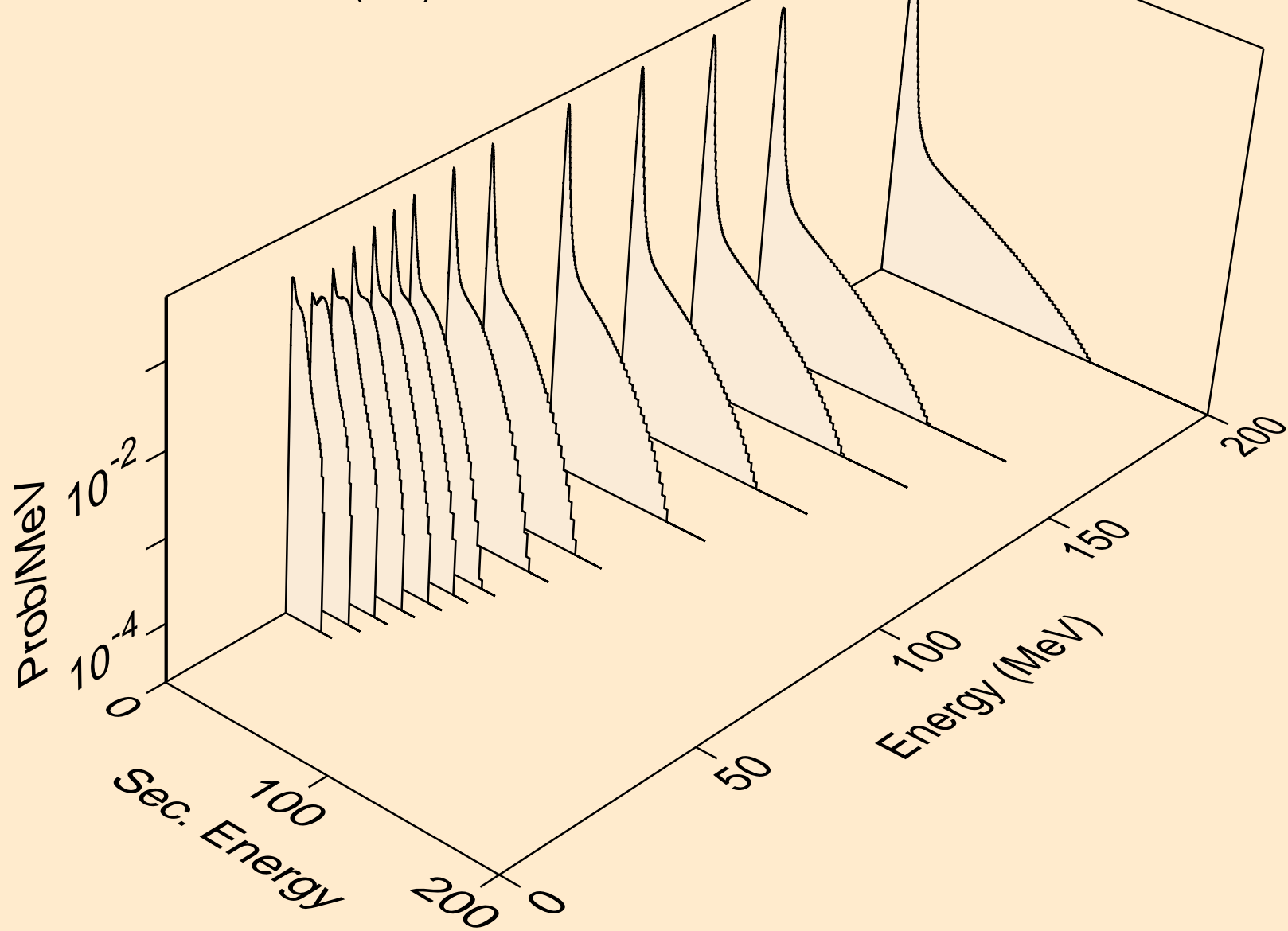

CE124 HELION ACER TENDL-2021 LIBRARY; T=0.K  
neutrons from (s,2n)

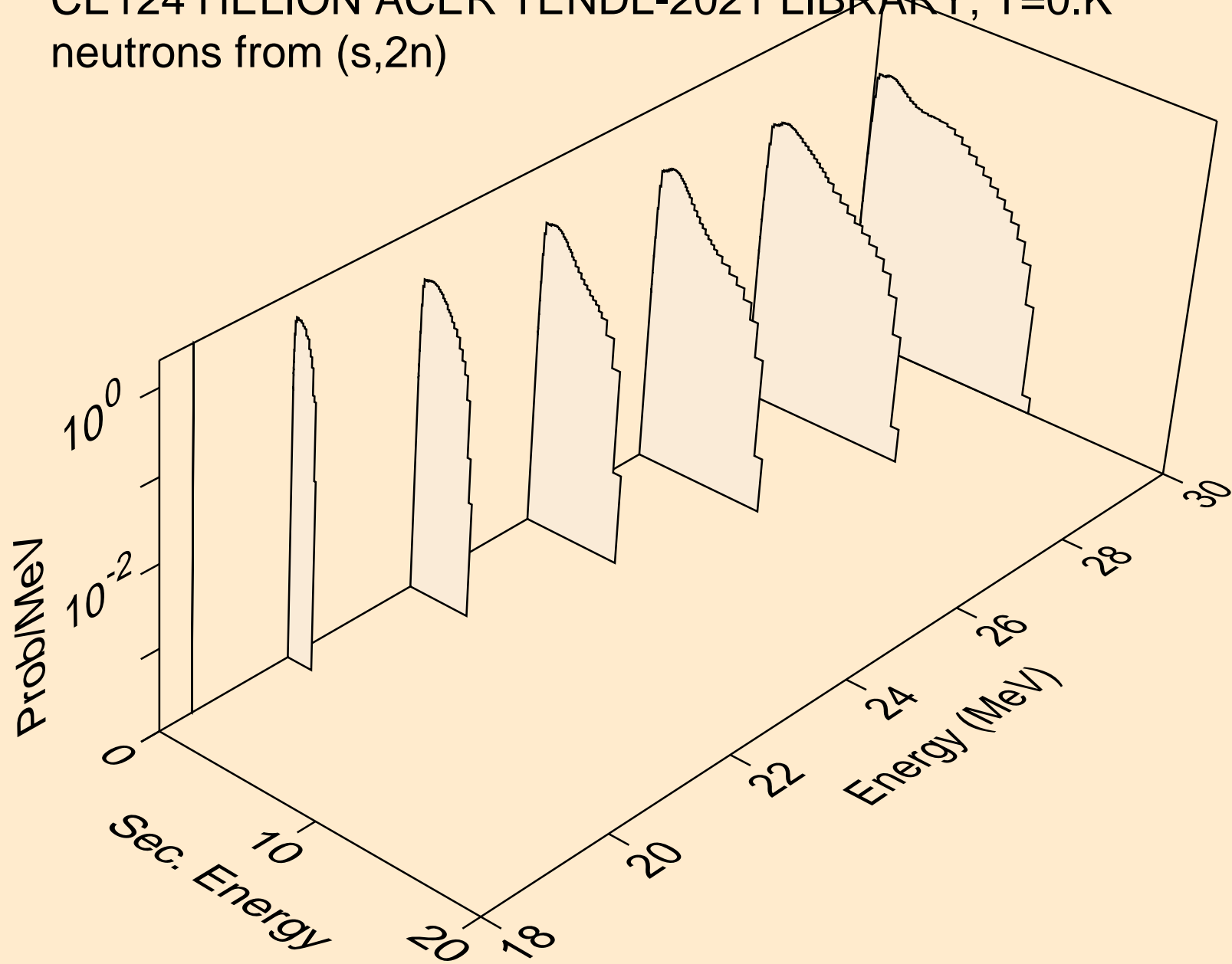



CE124 HELION ACER TENDL-2021 LIBRARY; T=0.K  
neutrons from (s,n\*)a

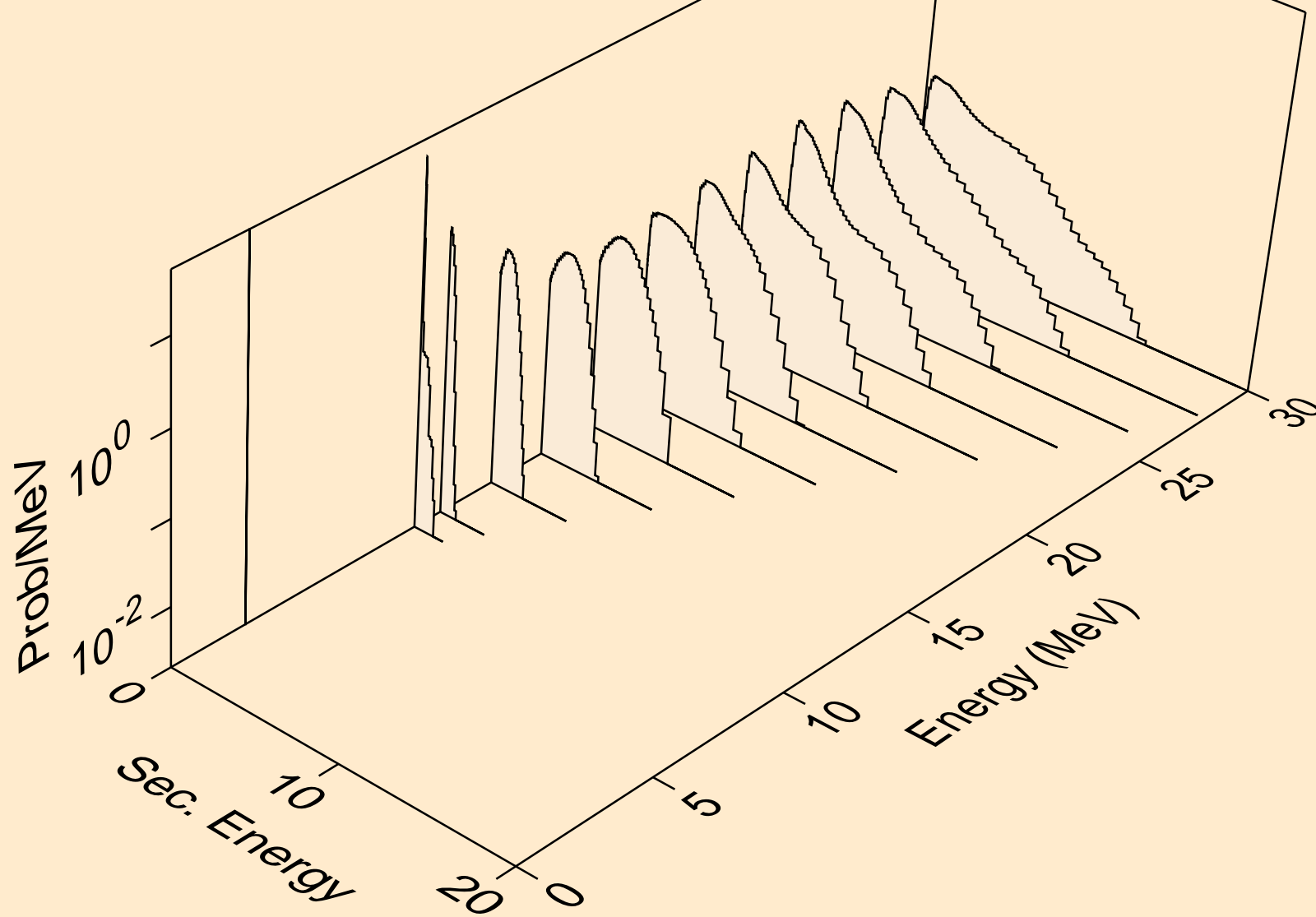

CE124 HELION ACER TENDL-2021 LIBRARY; T=0.K  
neutrons from (s,2n)a

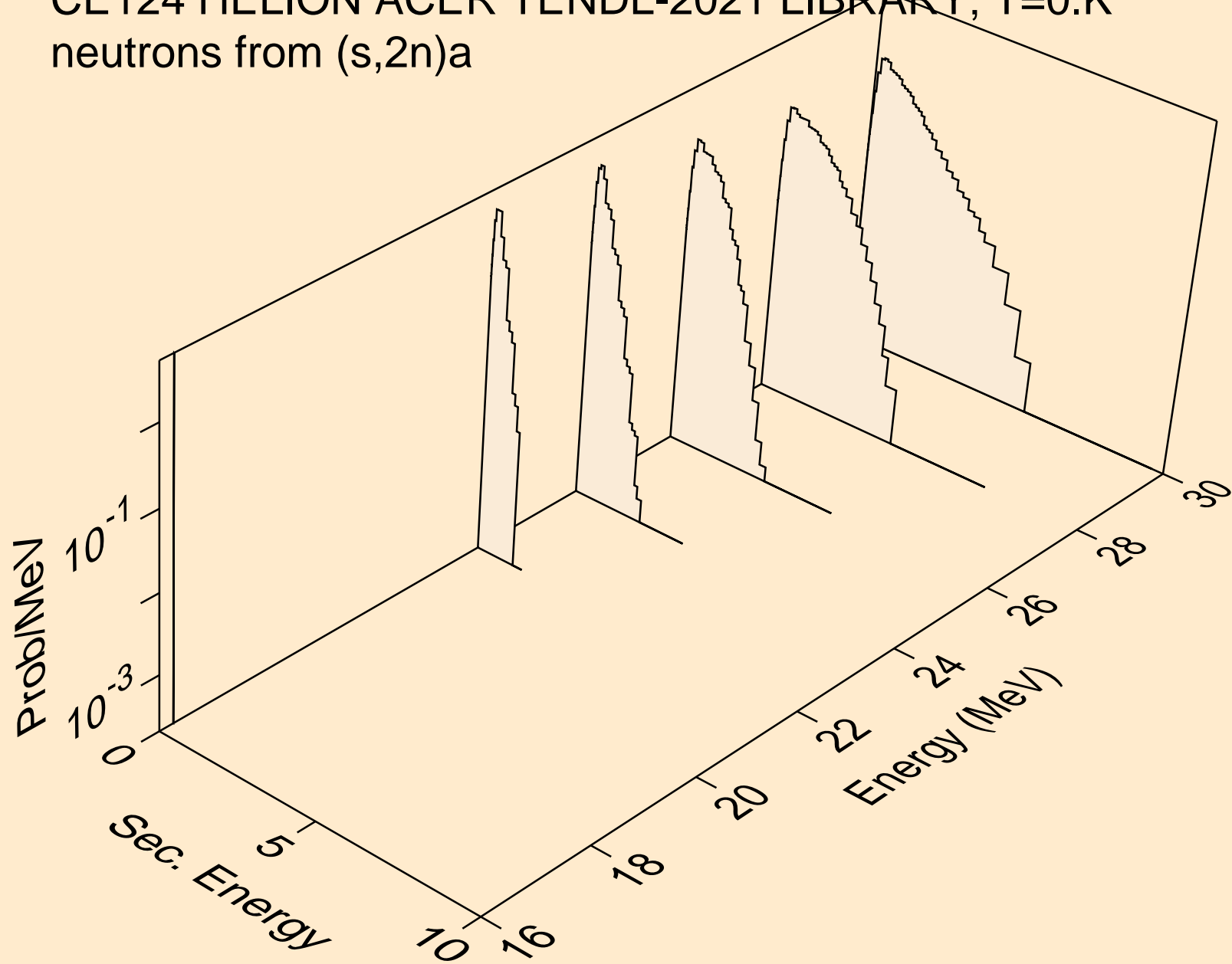

CE124 HELION ACER TENDL-2021 LIBRARY; T=0.K  
neutrons from (s,n\*)p

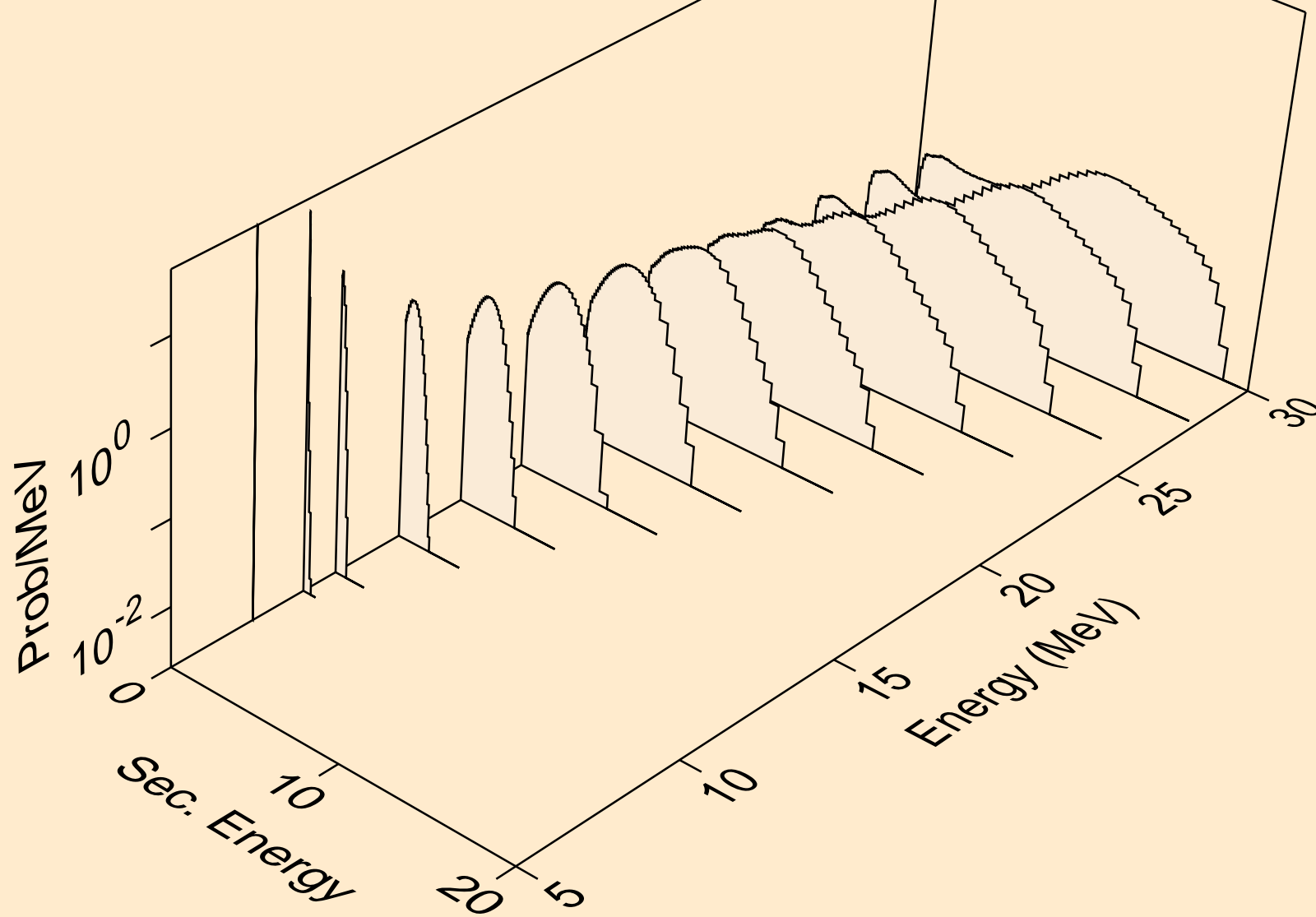

CE124 HELION ACER TENDL-2021 LIBRARY; T=0.K  
neutrons from (s,n\*)2a

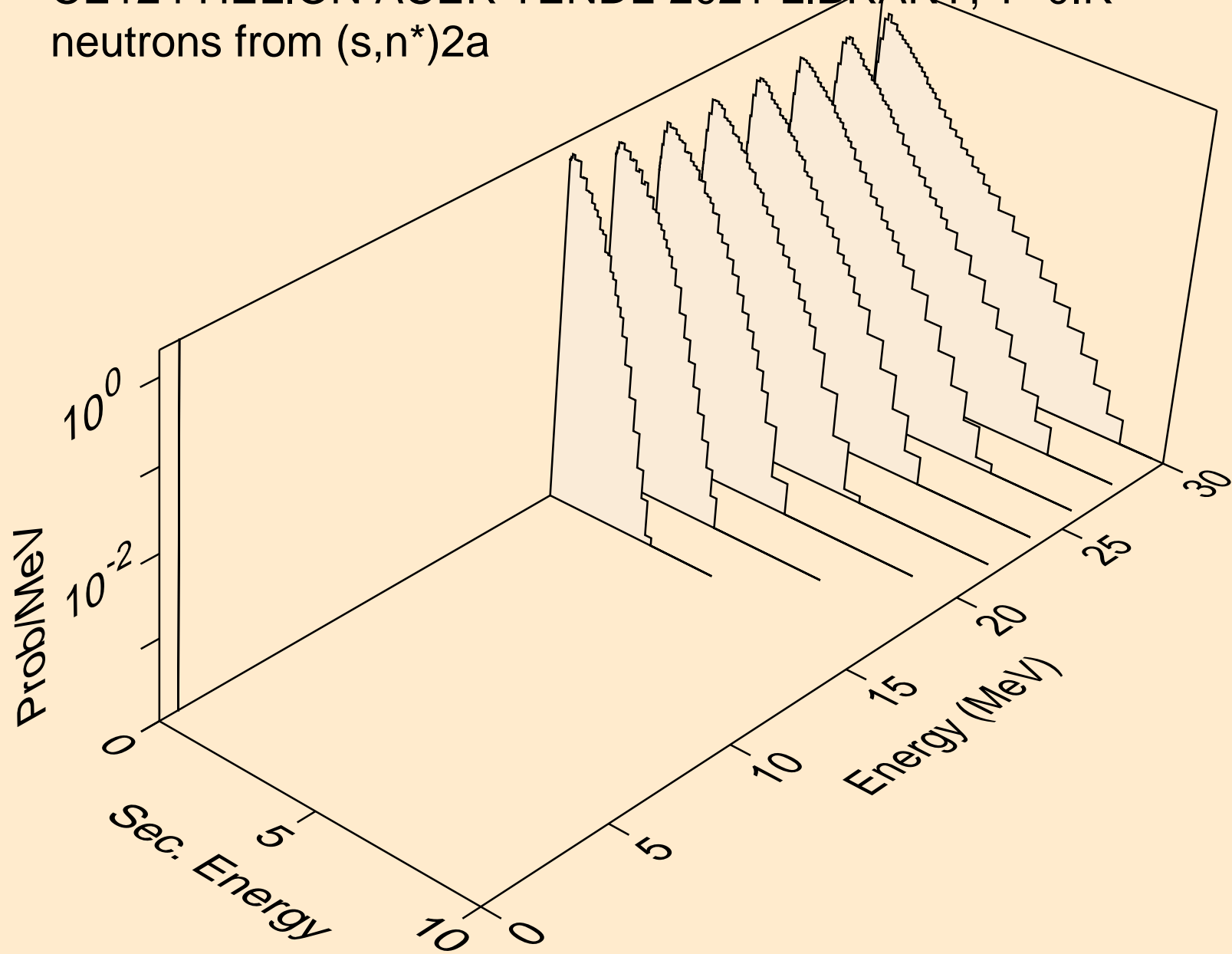

CE124 HELION ACER TENDL-2021 LIBRARY; T=0.K  
neutrons from (s,n\*)d

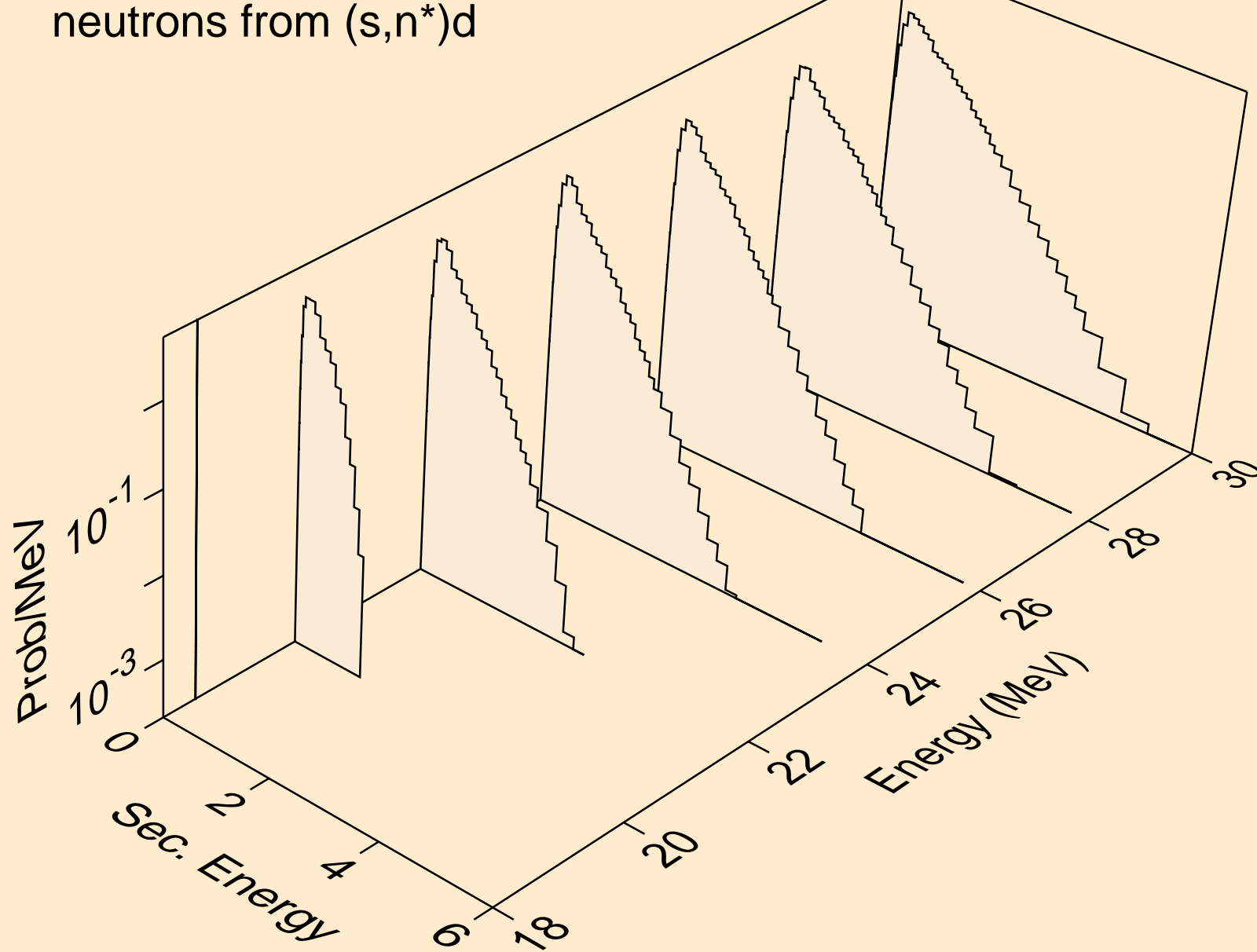

CE124 HELION ACER TENDL-2021 LIBRARY; T=0.K  
neutrons from (s,n\*)t

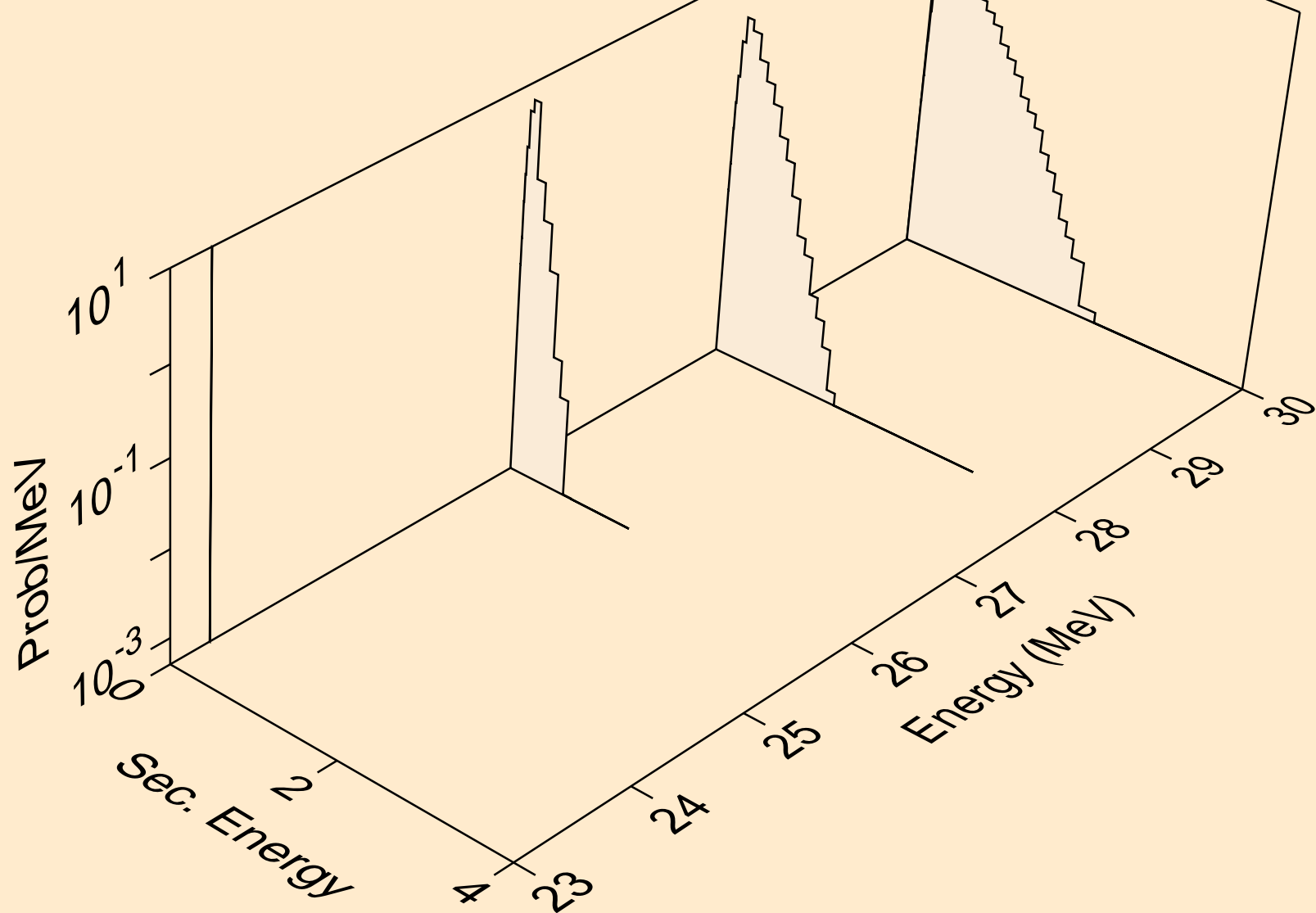

CE124 HELION ACER TENDL-2021 LIBRARY; T=0.K  
neutrons from (s,n\*)he3

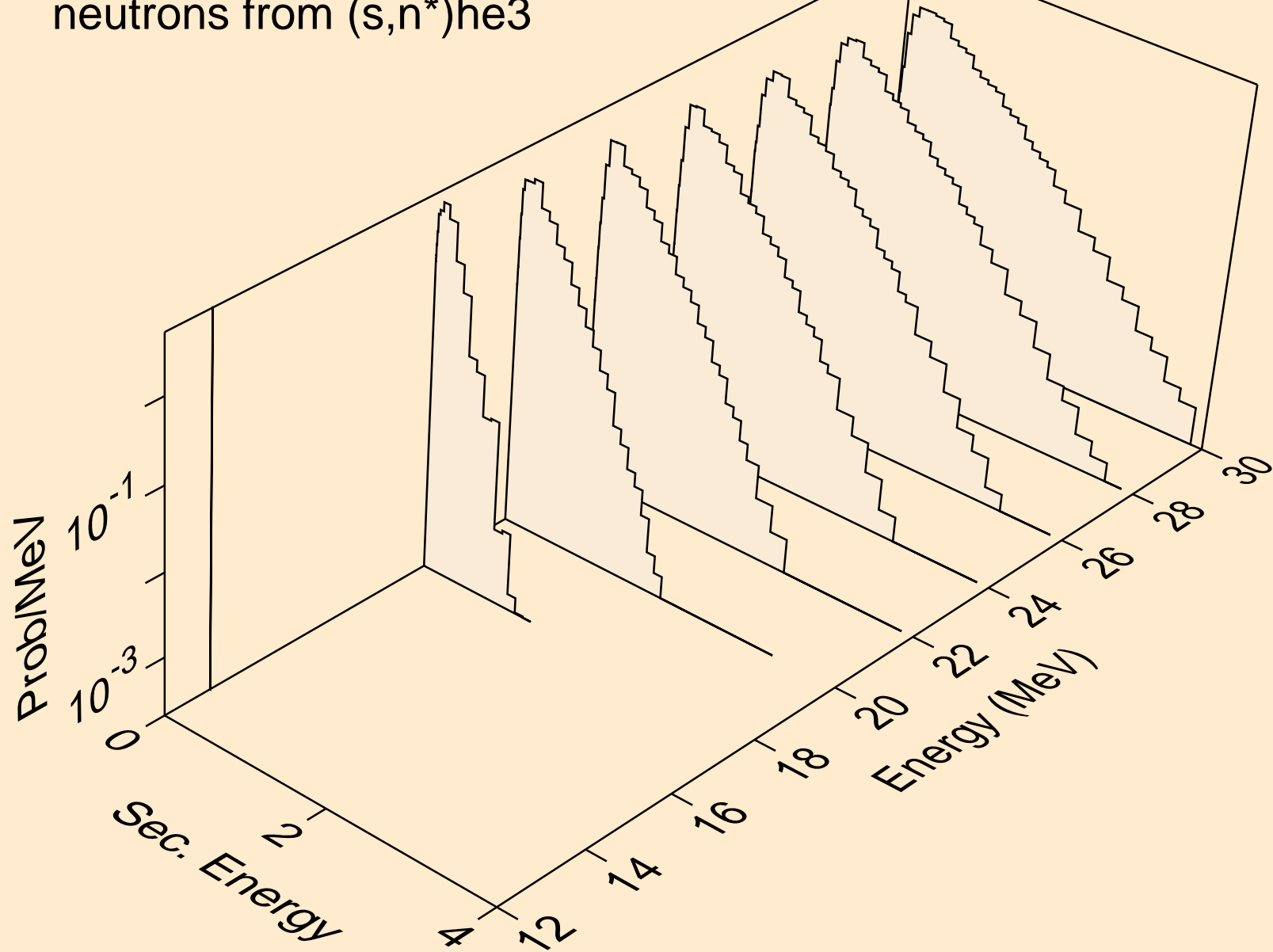

CE124 HELION ACER TENDL-2021 LIBRARY; T=0.K  
neutrons from (s,2np)

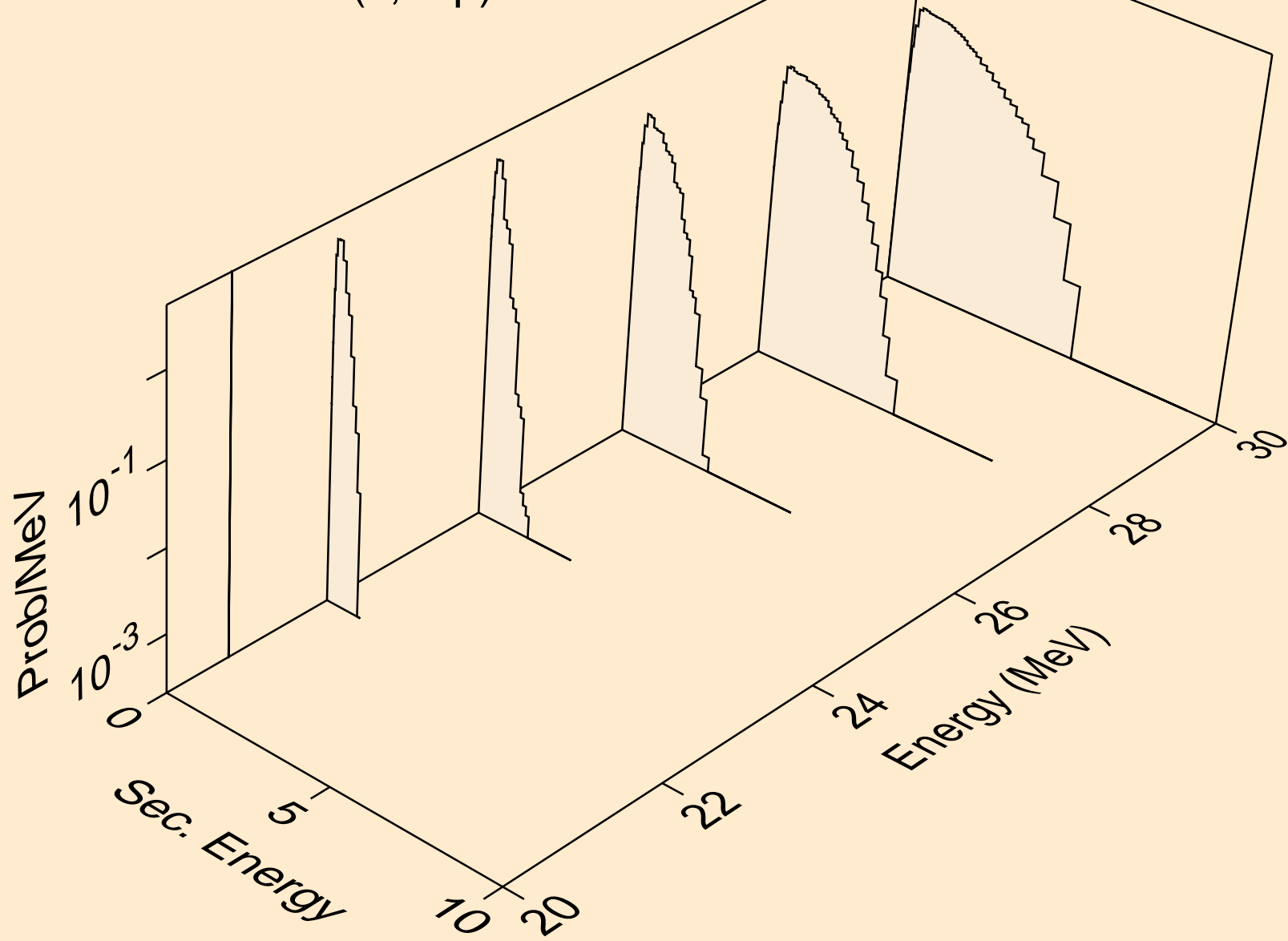



CE124 HELION ACER TENDL-2021 LIBRARY; T=0.K  
neutrons from (s,2np)

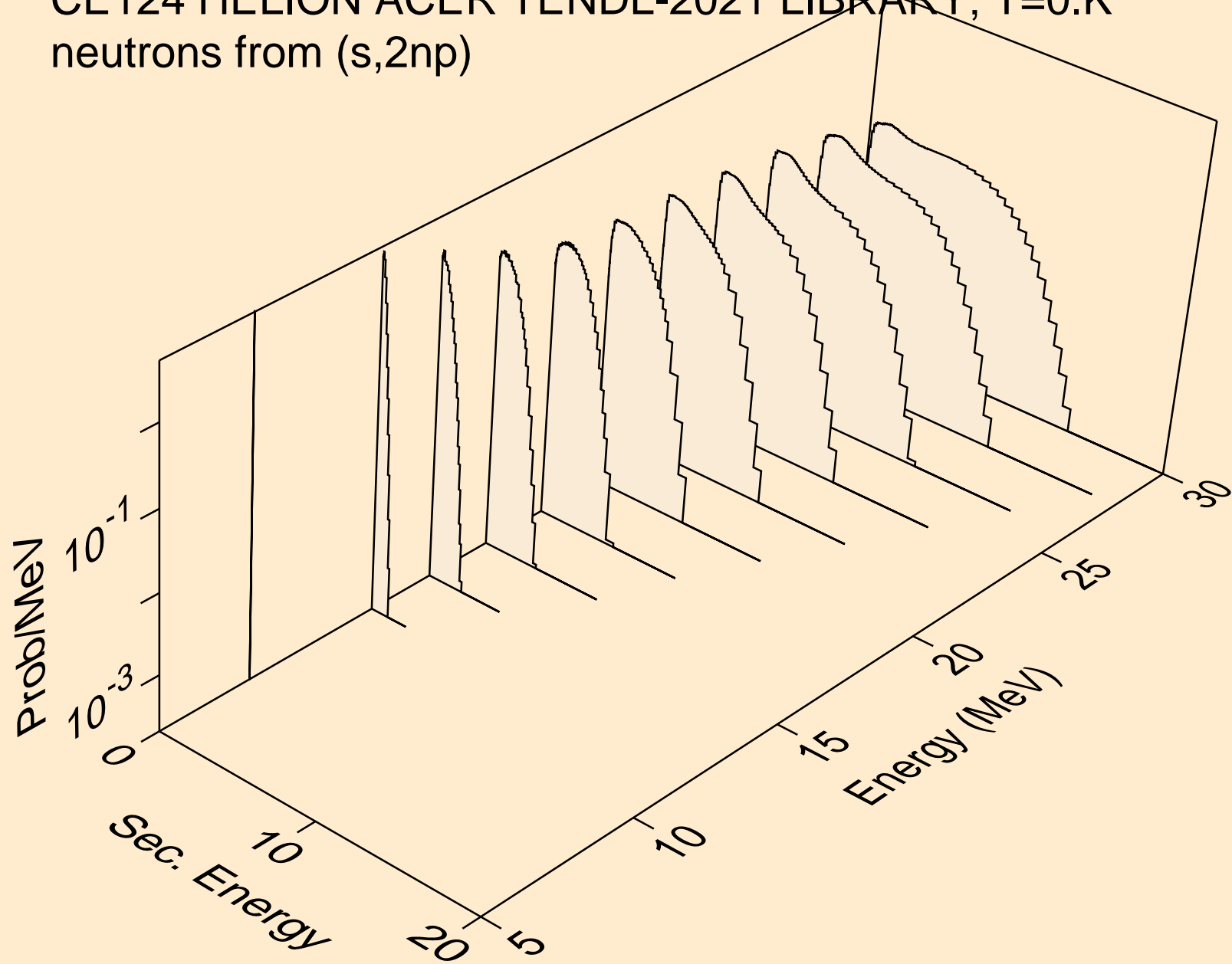

CE124 HELION ACER TENDL-2021 LIBRARY; T=0.K  
neutrons from (s,npa)

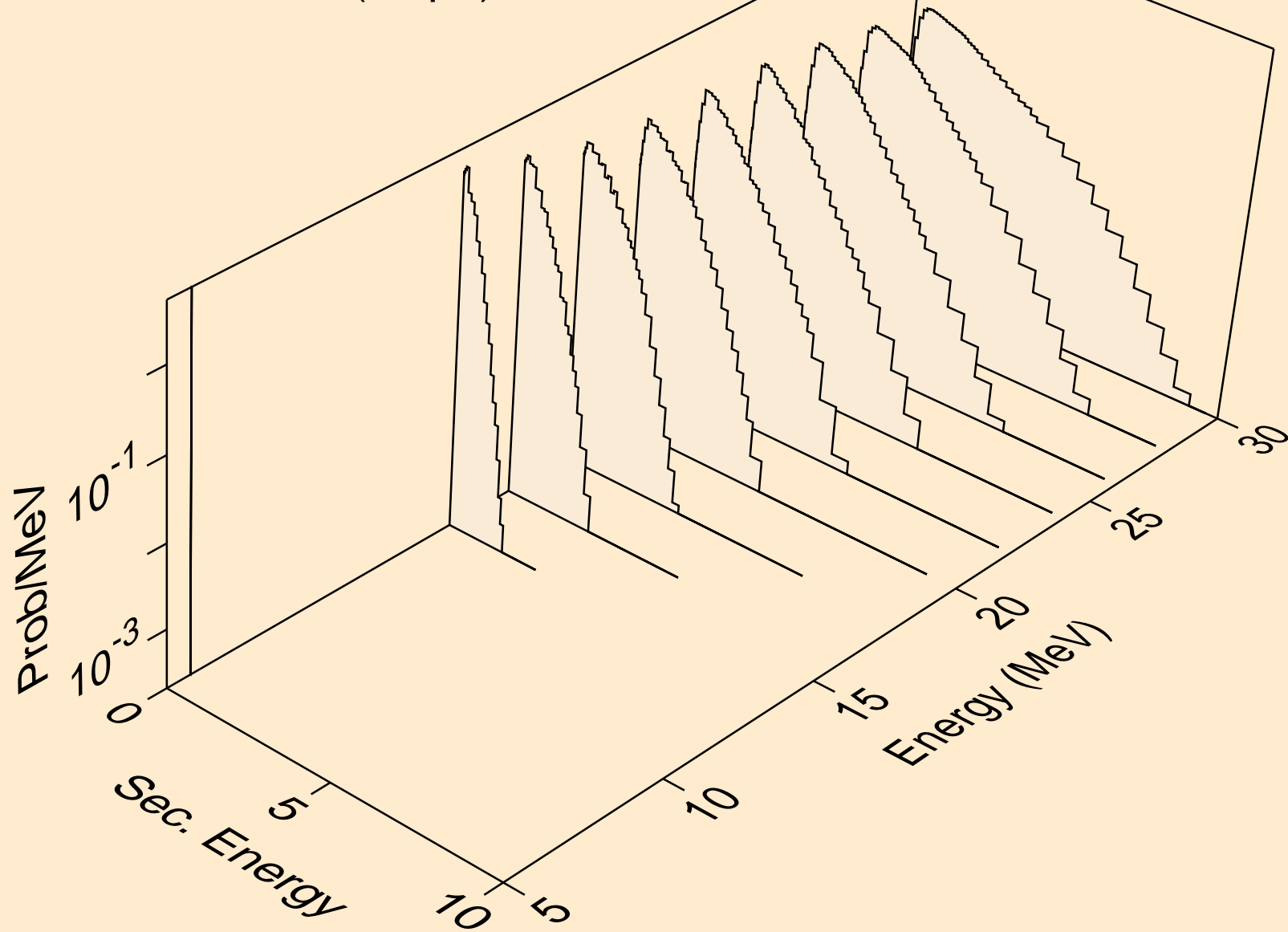

CE124 HELION ACER TENDL-2021 LIBRARY; T=0.K  
protons from (s,x)

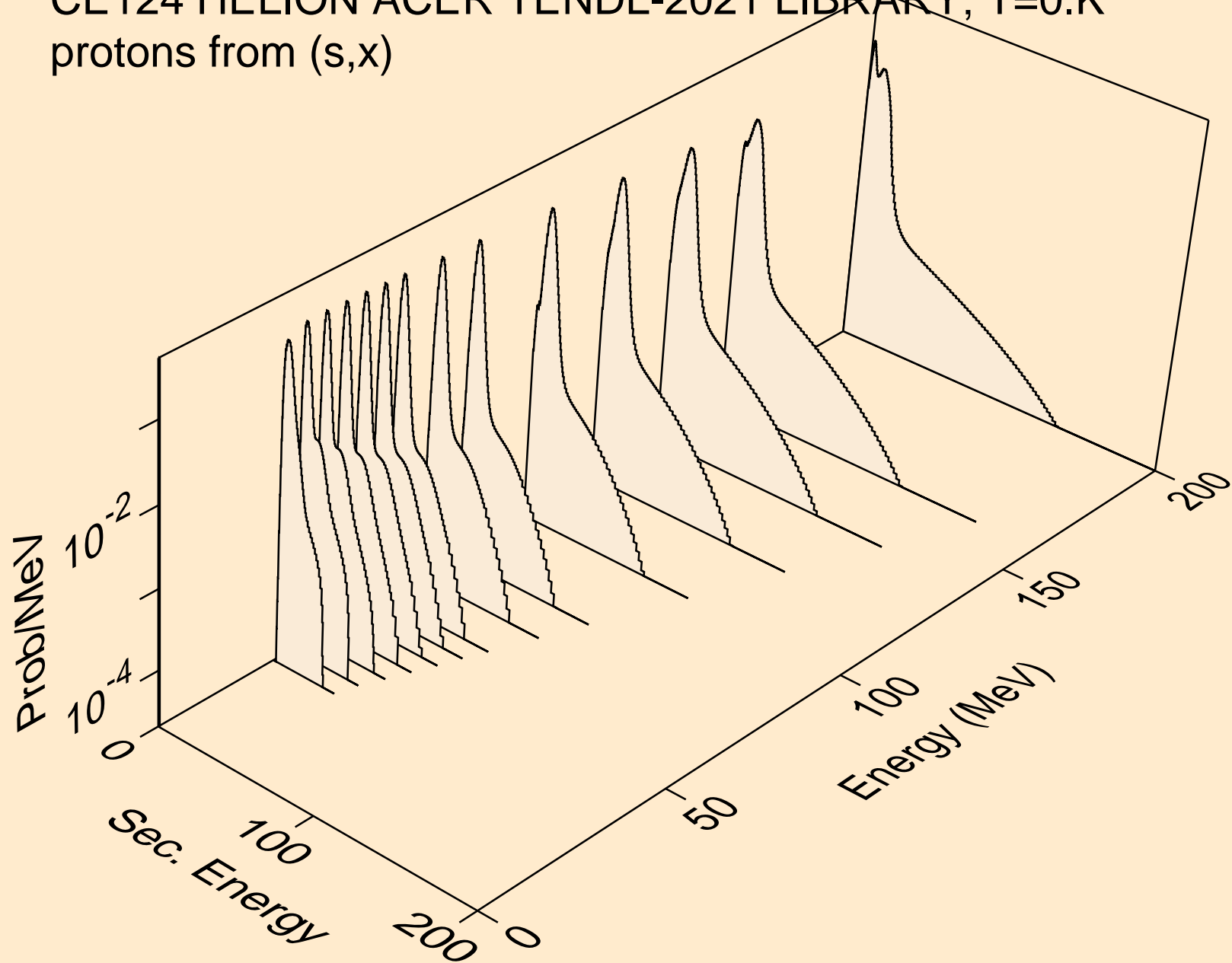

CE124 HELION ACER TENDL-2021 LIBRARY; T=0.K  
protons from (s,n\*)p

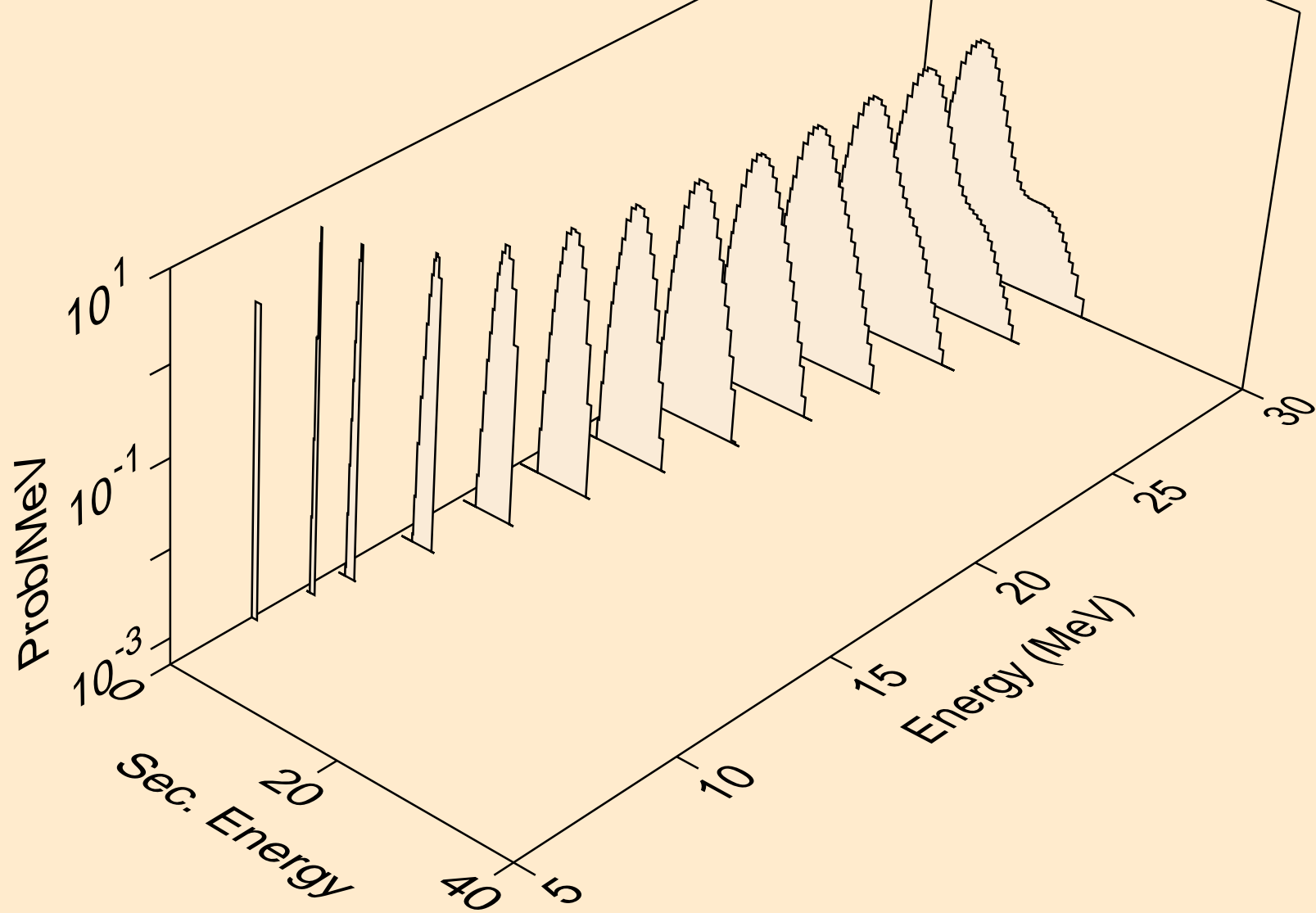

CE124 HELION ACER TENDL-2021 LIBRARY; T=0.K  
protons from (s,2np)

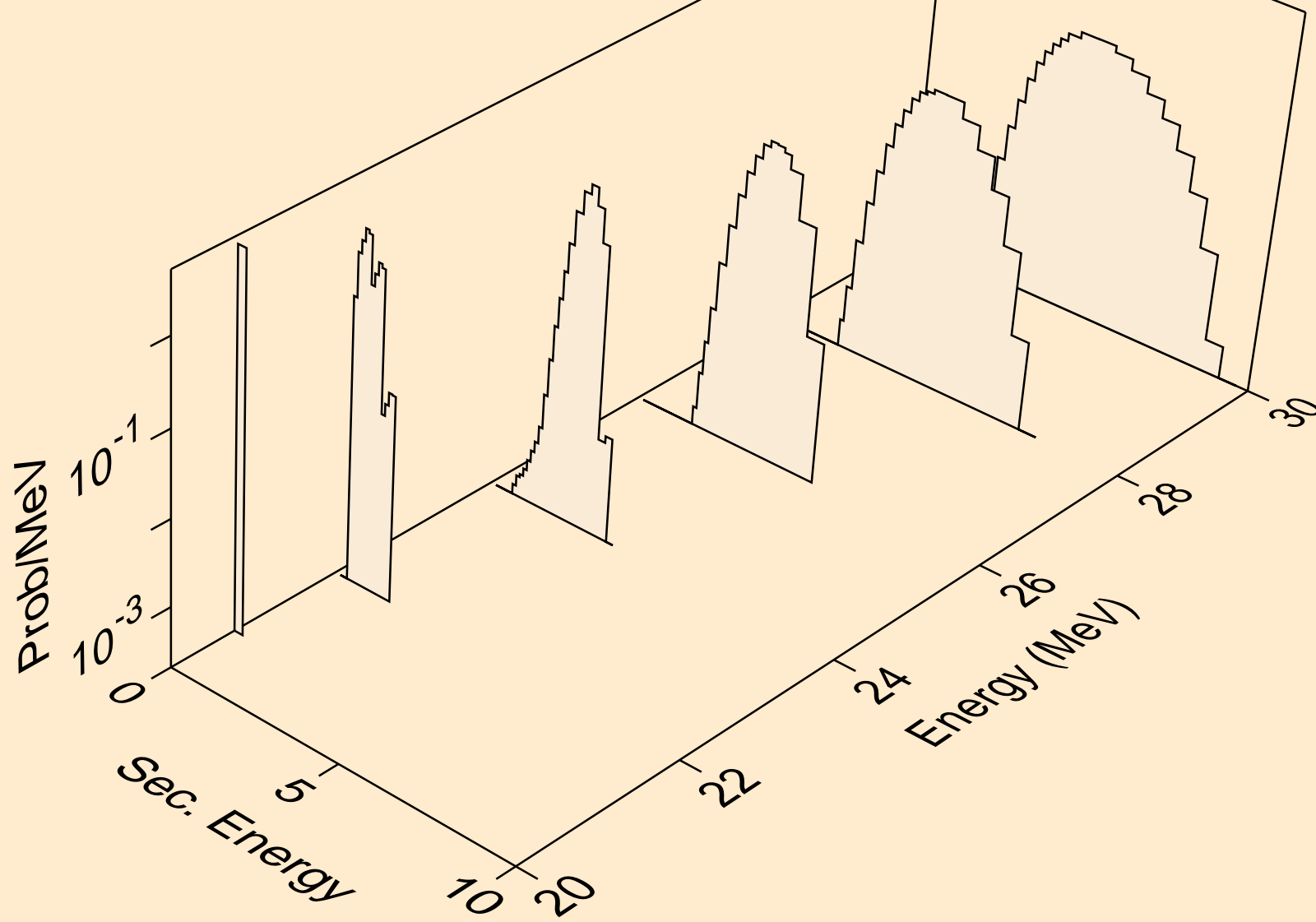

CE124 HELION ACER TENDL-2021 LIBRARY; T=0.K  
protons from (s,2np)

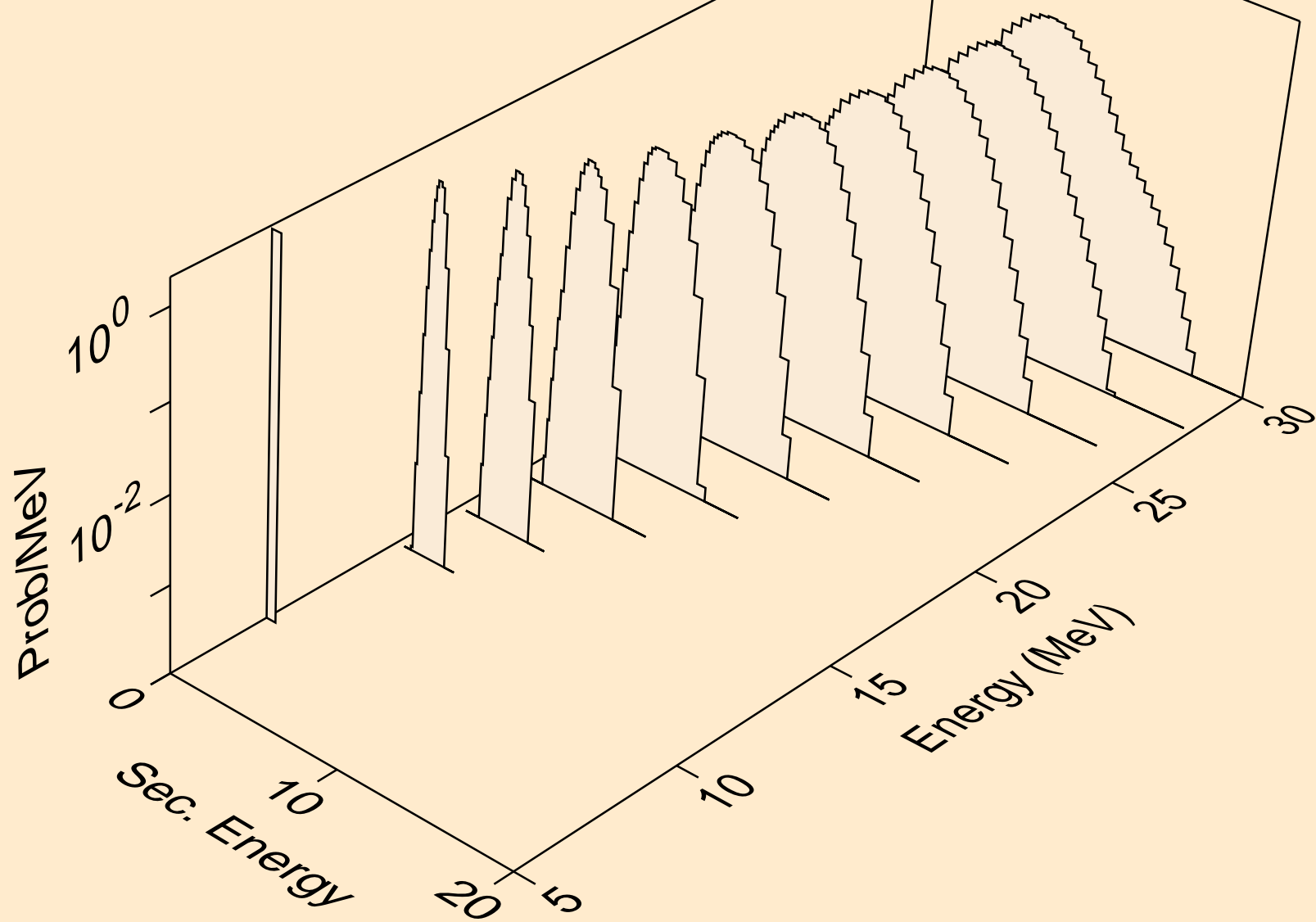

CE124 HELION ACER TENDL-2021 LIBRARY; T=0.K  
protons from (s,npa)

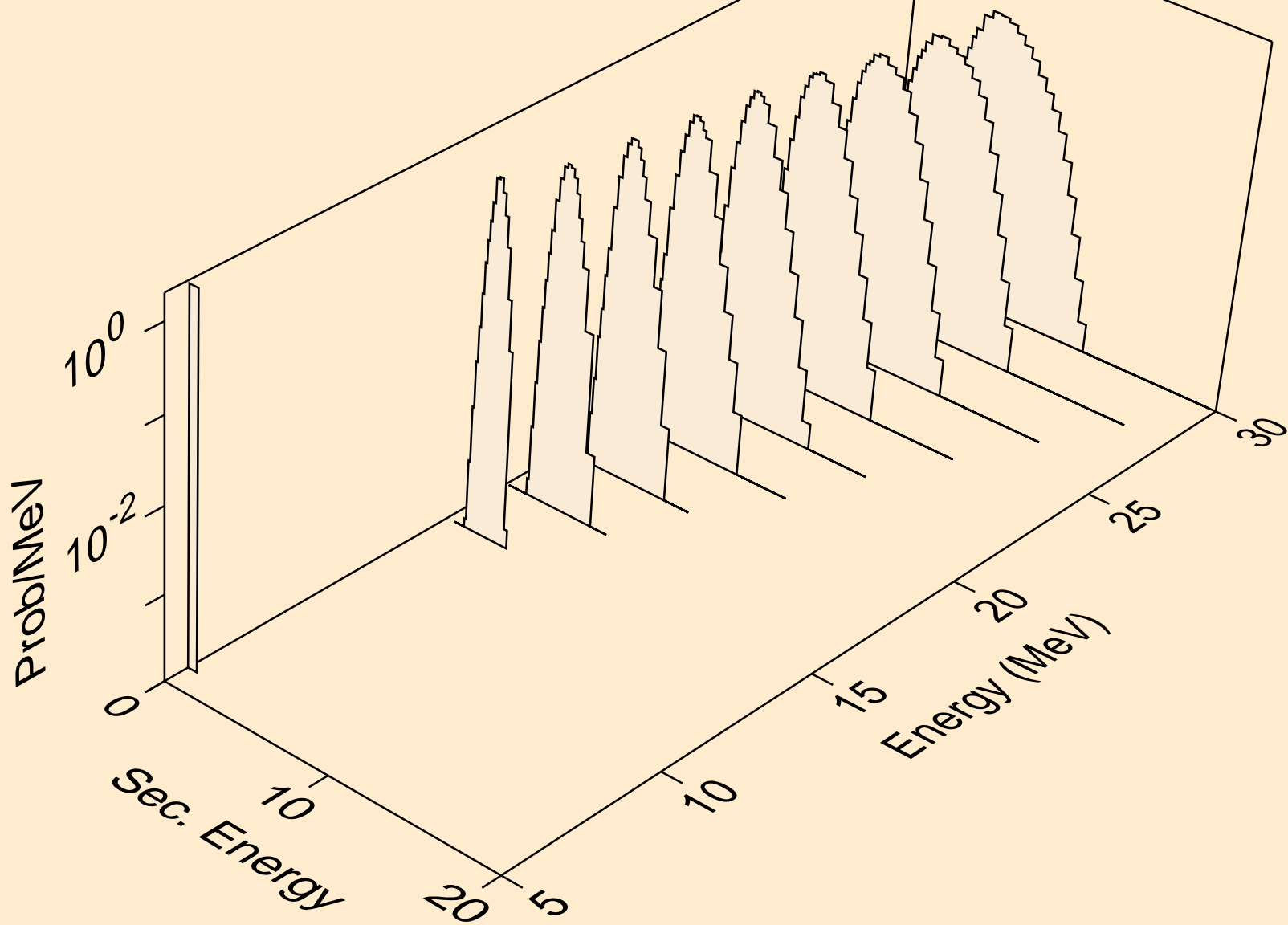

CE124 HELION ACER TENDL-2021 LIBRARY; T=0.K  
protons from (s,p)

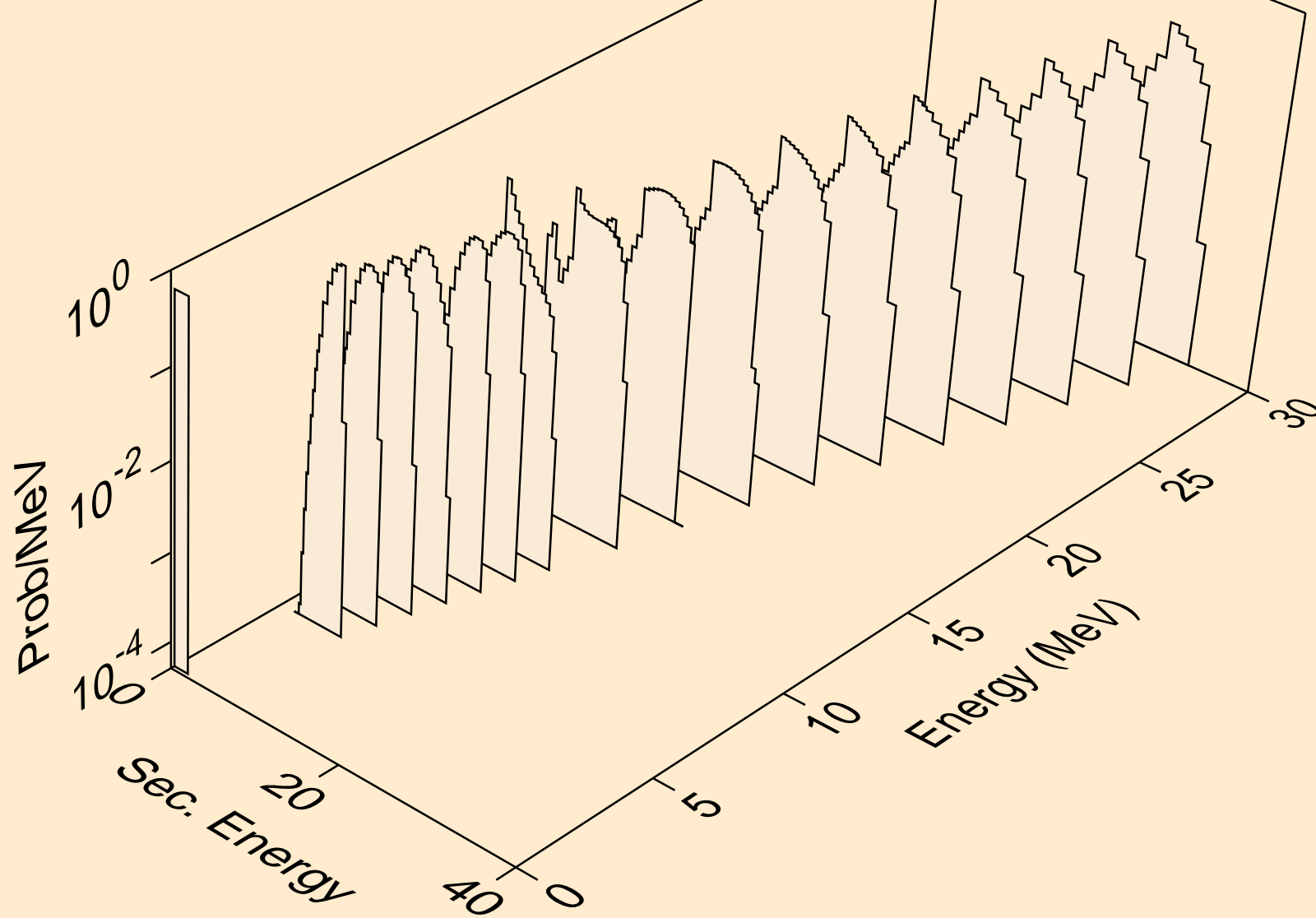



CE124 HELION ACER TENDL-2021 LIBRARY; T=0.K  
protons from (s,2p)

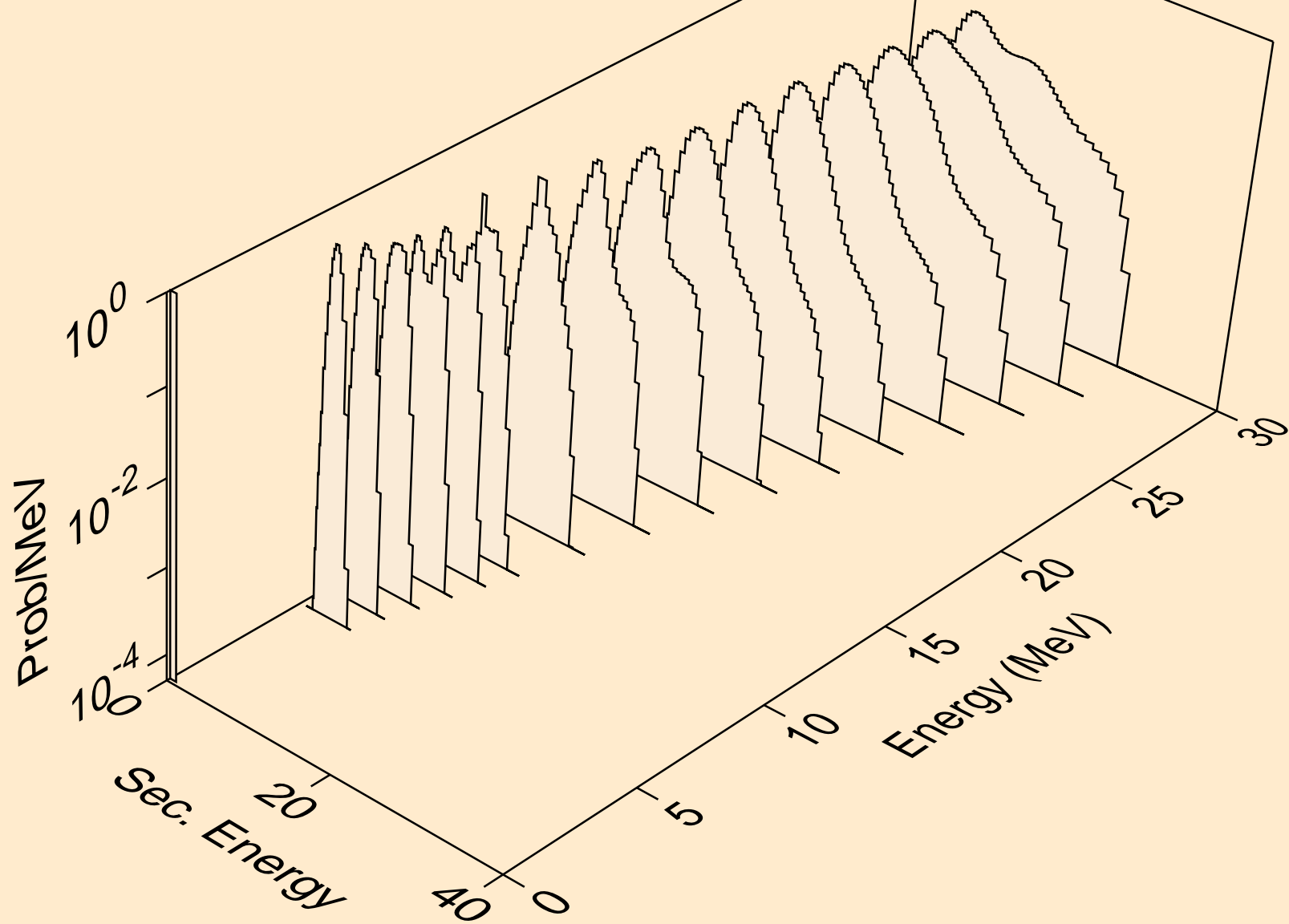

CE124 HELION ACER TENDL-2021 LIBRARY; T=0.K  
protons from (s,pa)

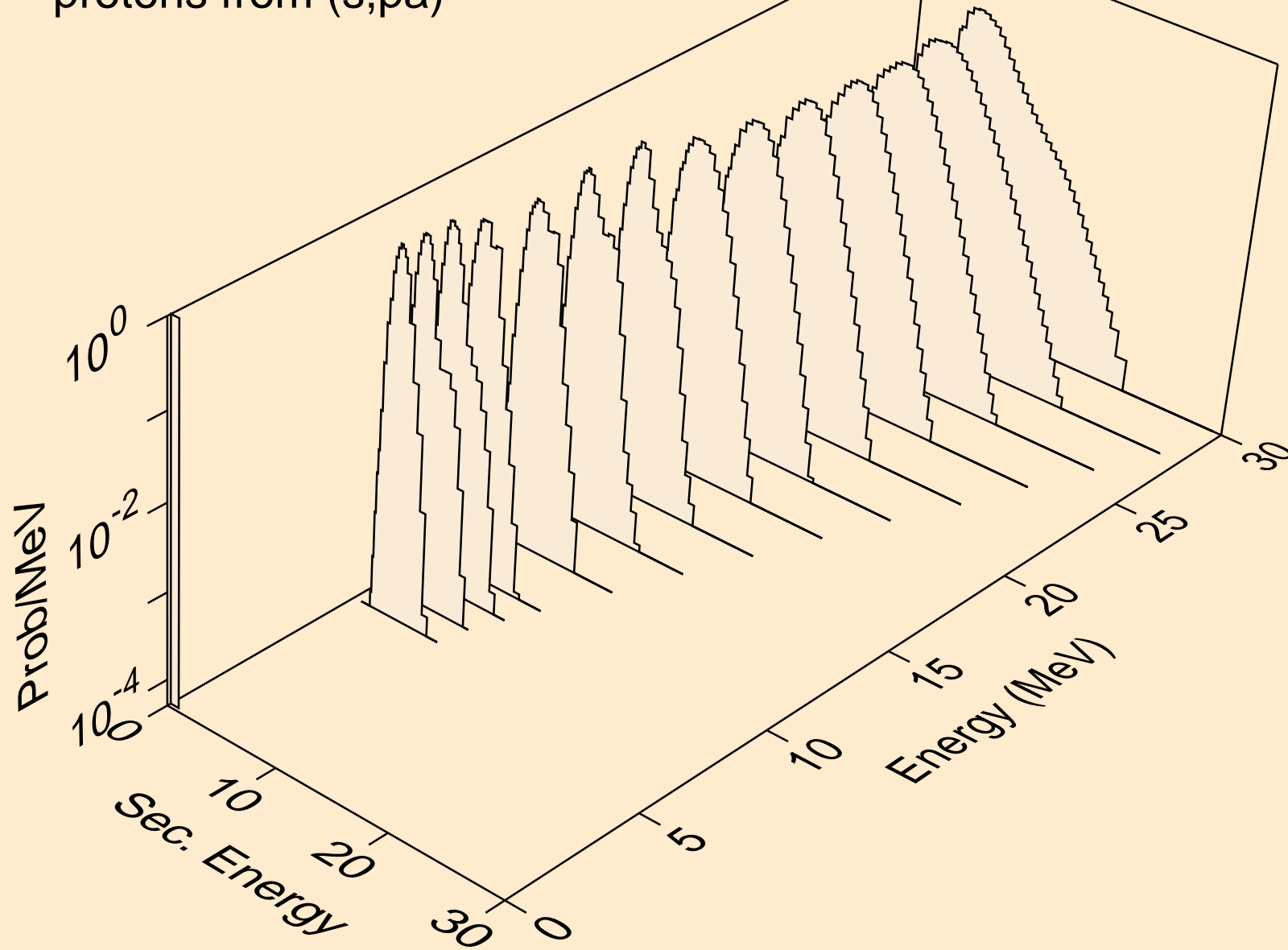

CE124 HELION ACER TENDL-2021 LIBRARY; T=0.K  
protons from (s,pd)

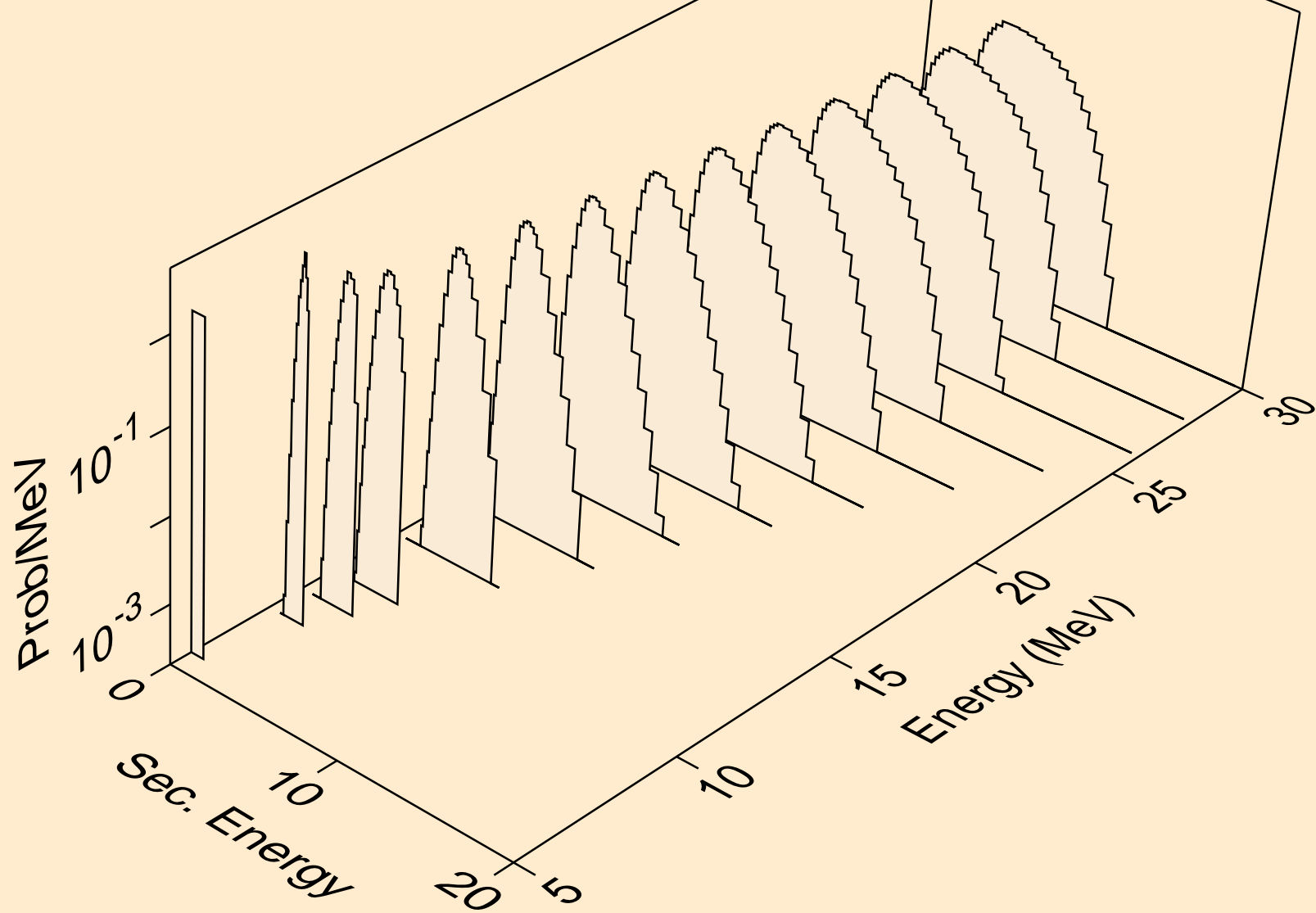

CE124 HELION ACER TENDL-2021 LIBRARY; T=0.K  
protons from (s,pt)

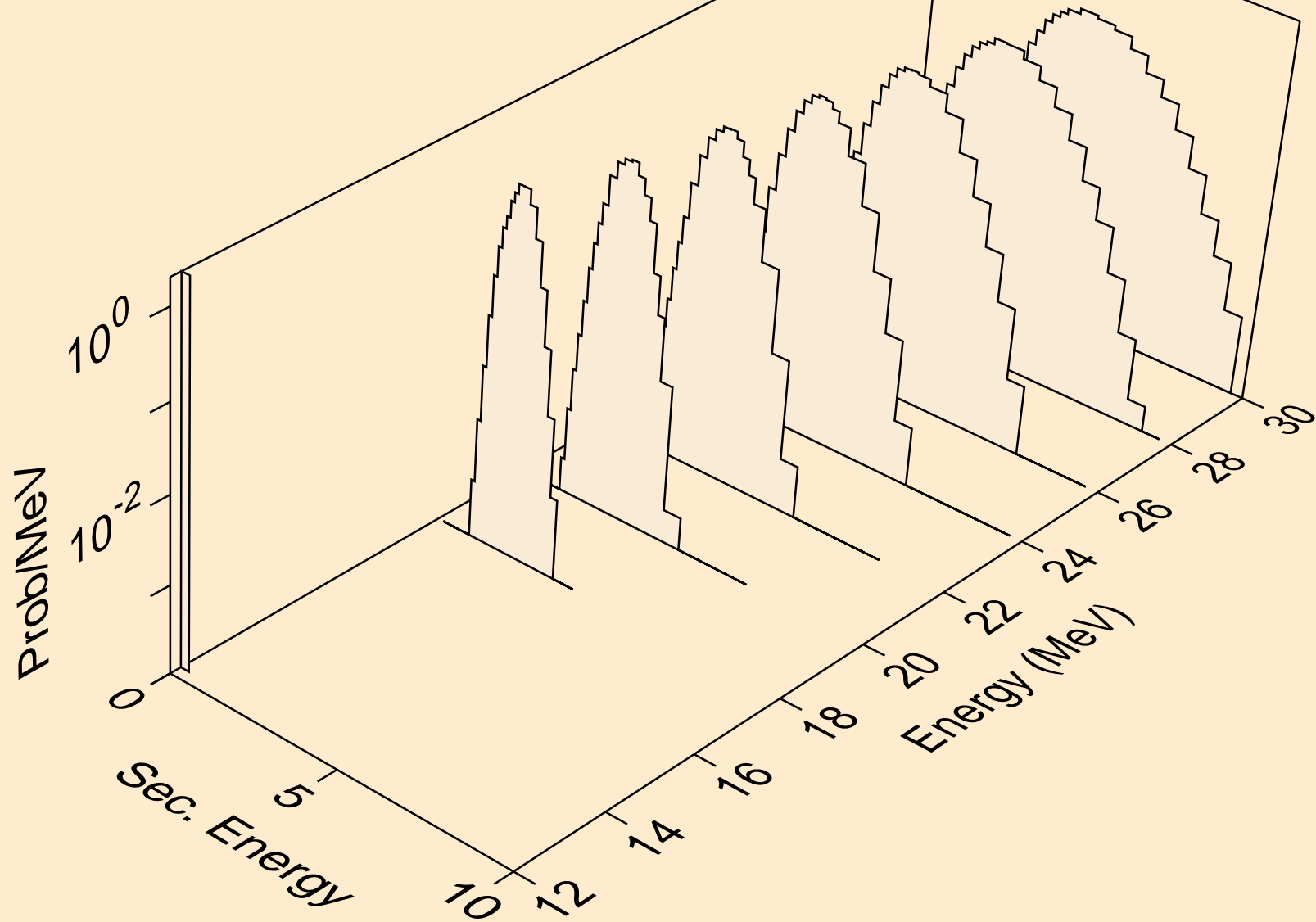

CE124 HELION ACER TENDL-2021 LIBRARY; T=0.K  
deuterons from (s,x)

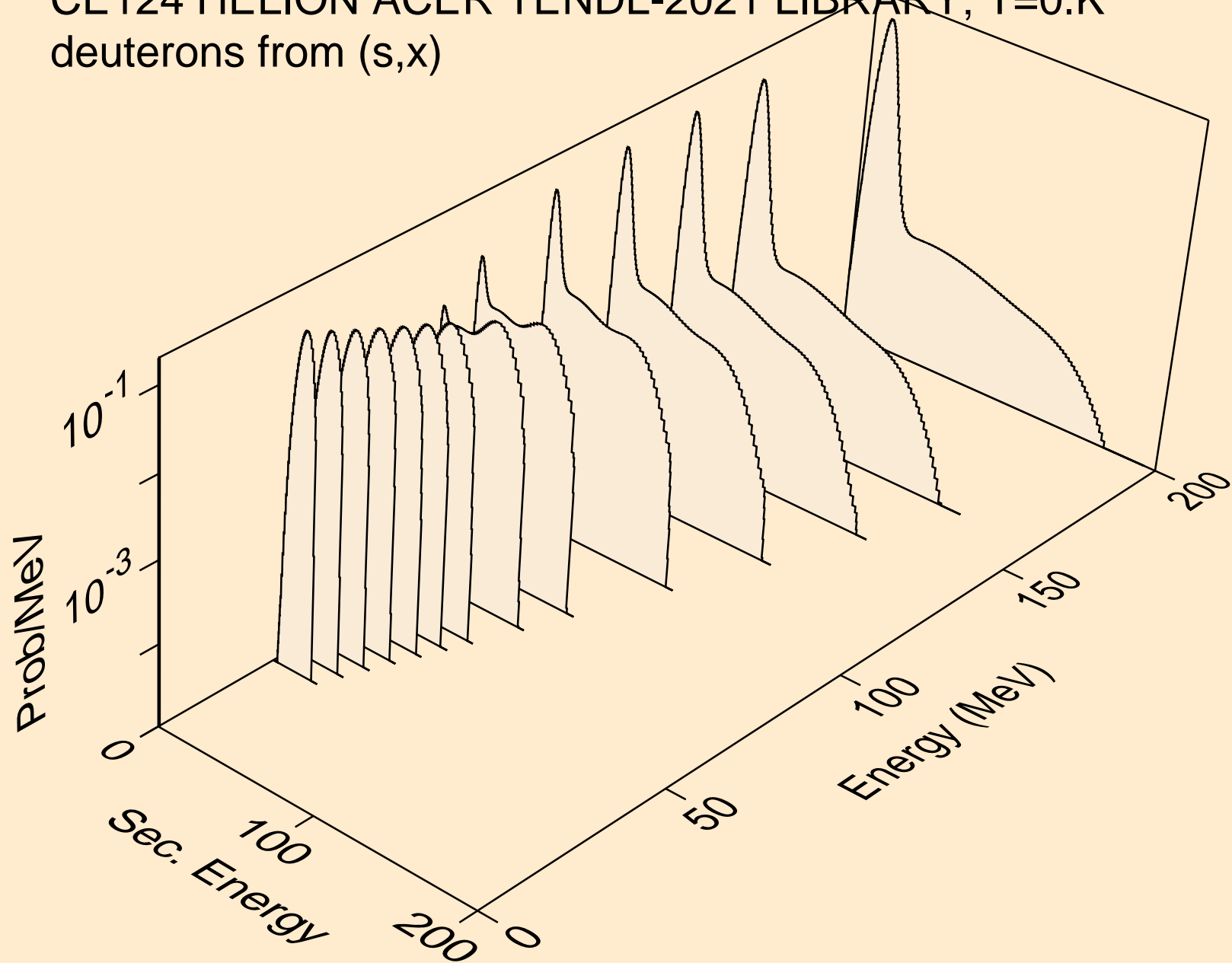

CE124 HELION ACER TENDL-2021 LIBRARY; T=0.K  
deuterons from (s,n\*)d

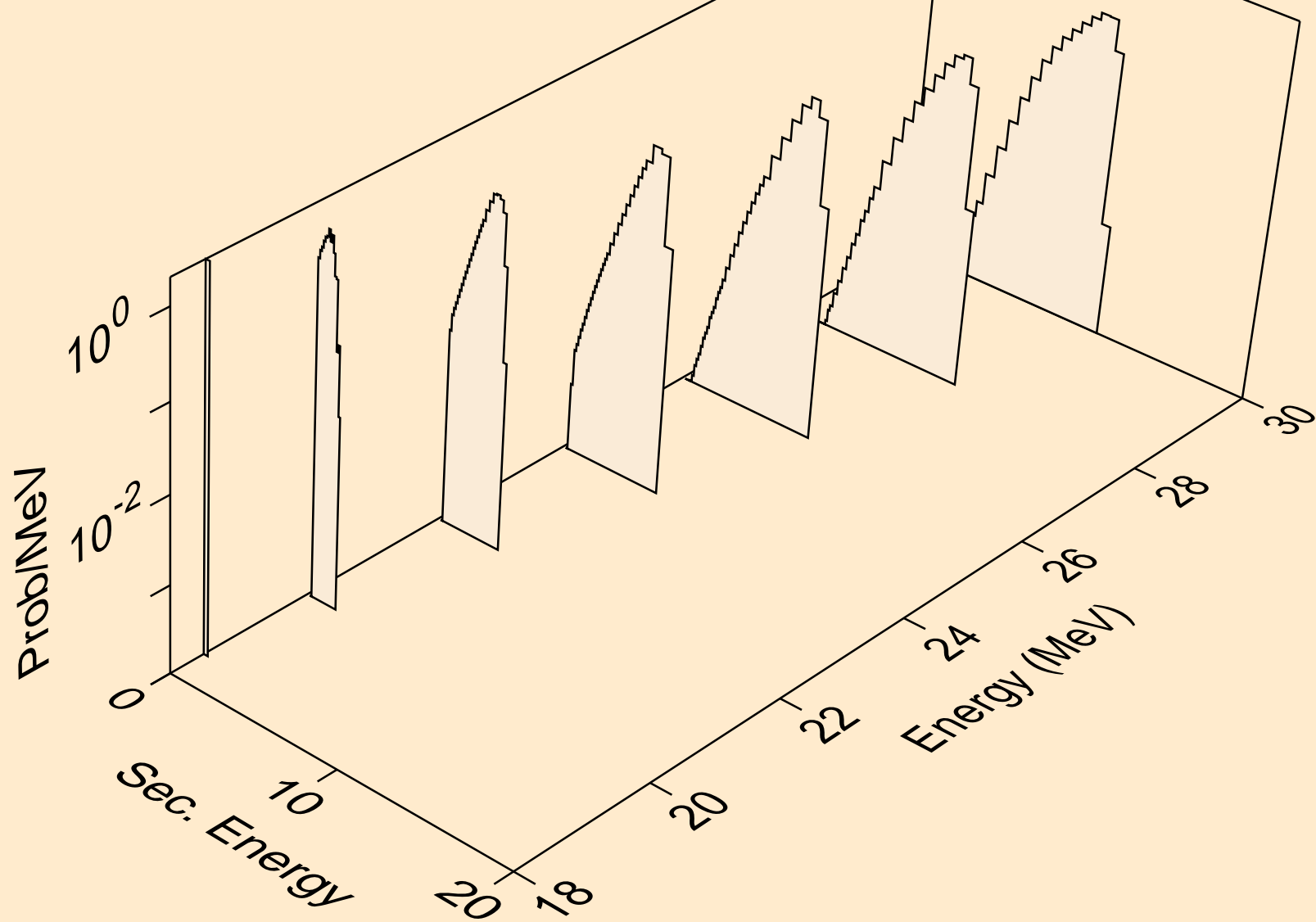

CE124 HELION ACER TENDL-2021 LIBRARY; T=0.K  
deuterons from (s,d)

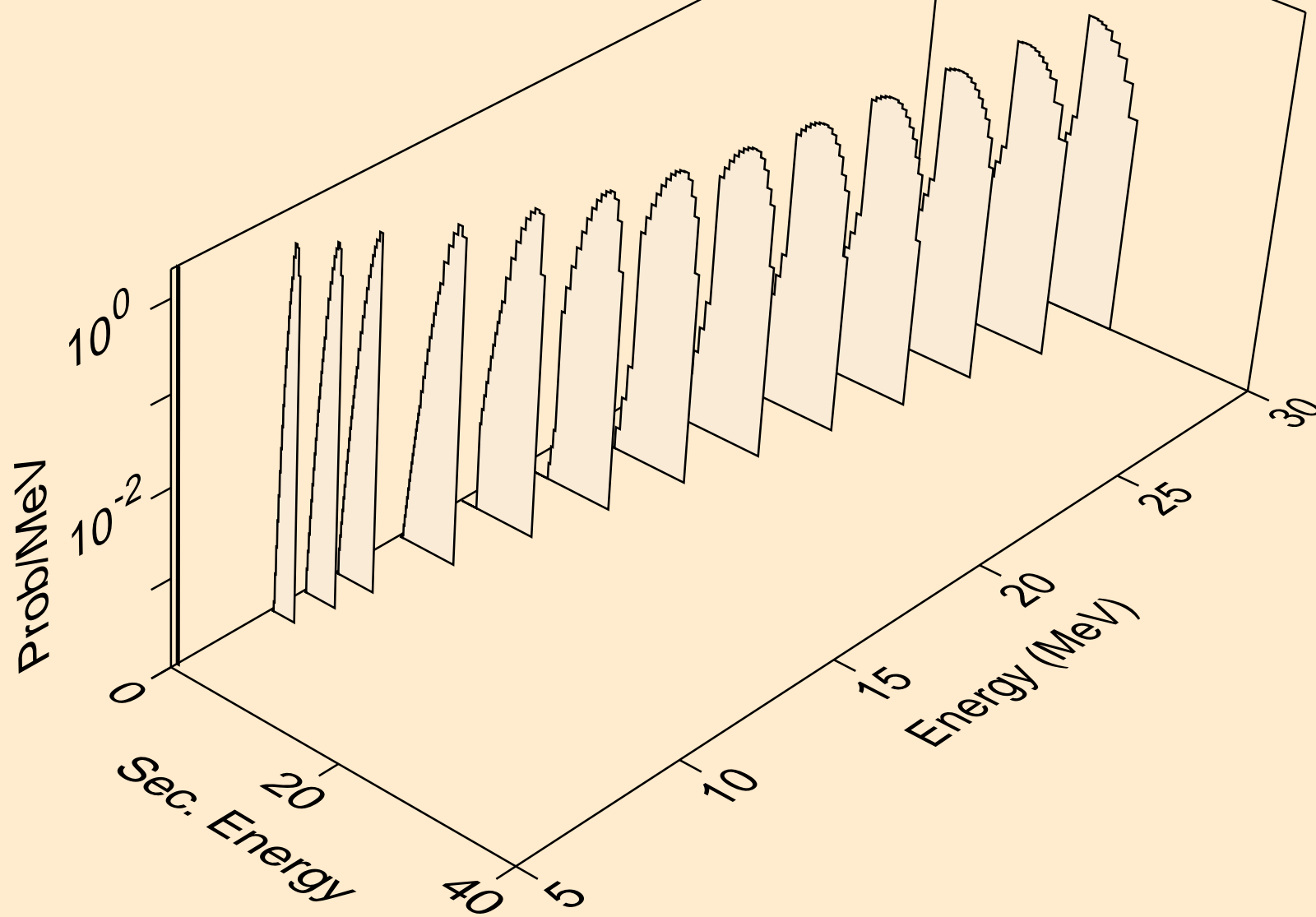

CE124 HELION ACER TENDL-2021 LIBRARY; T=0.K  
deuterons from (s,pd)

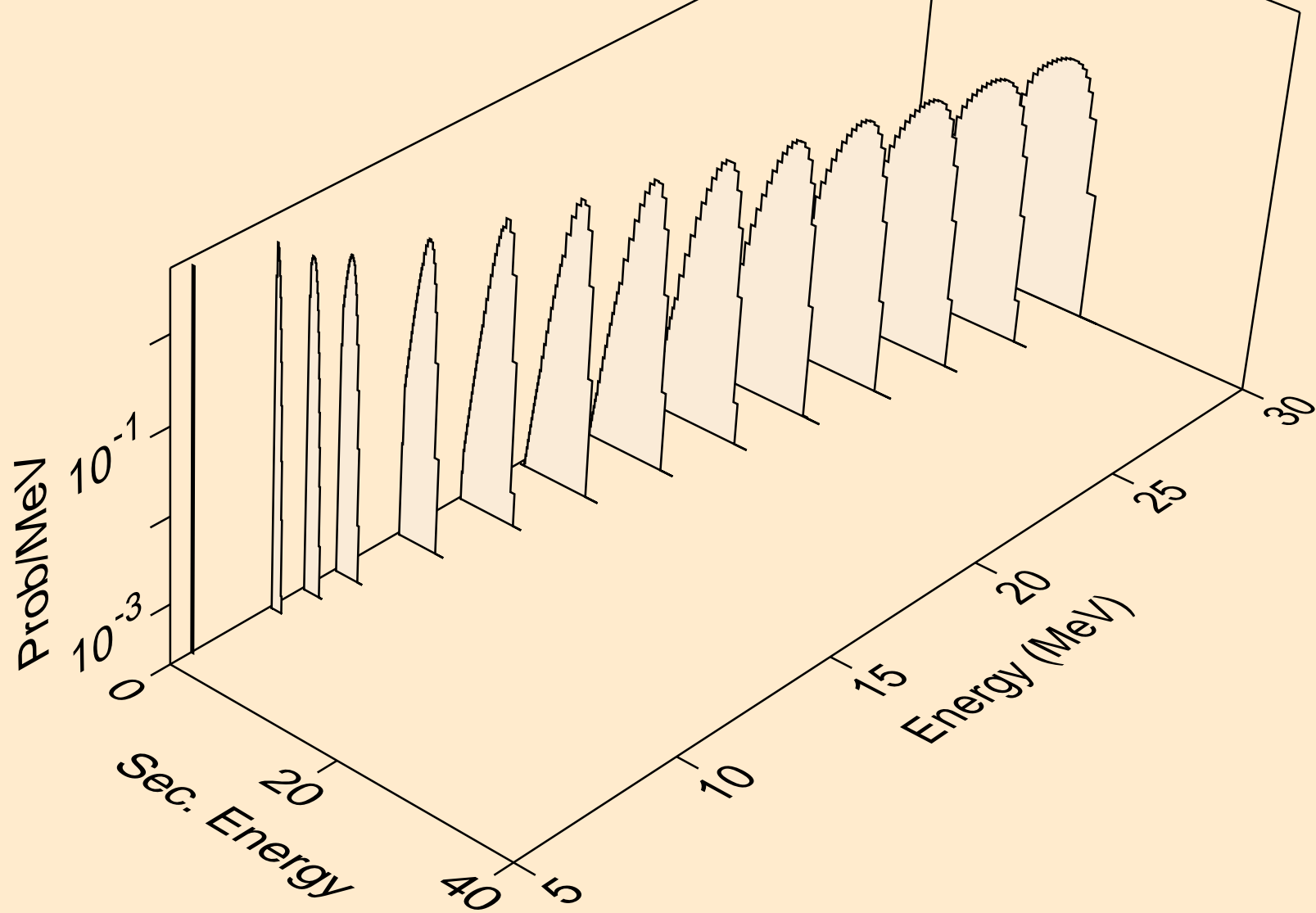



CE124 HELION ACER TENDL-2021 LIBRARY; T=0.K  
deuterons from (s,da)

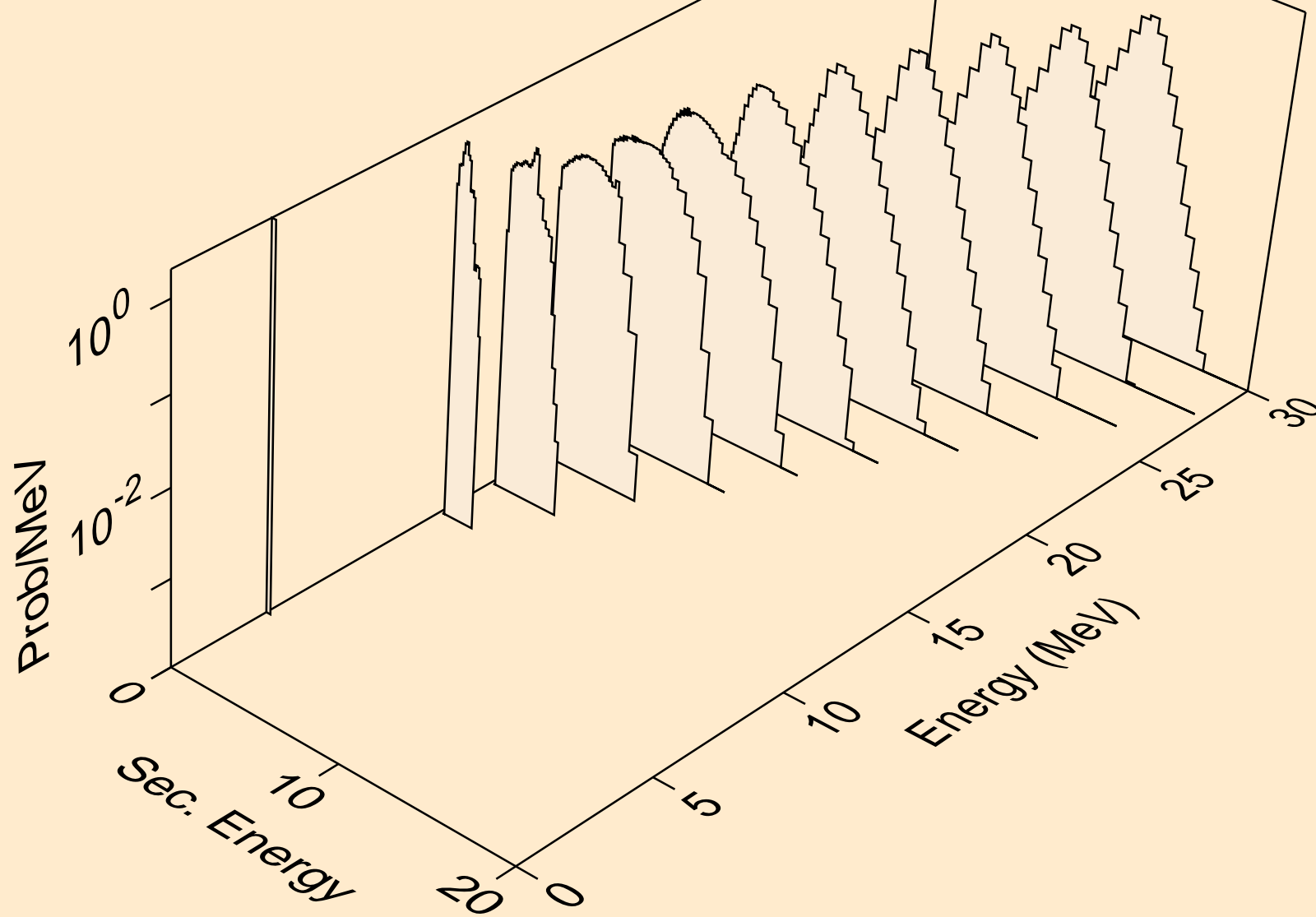

CE124 HELION ACER TENDL-2021 LIBRARY; T=0.K  
tritons from (s,x)

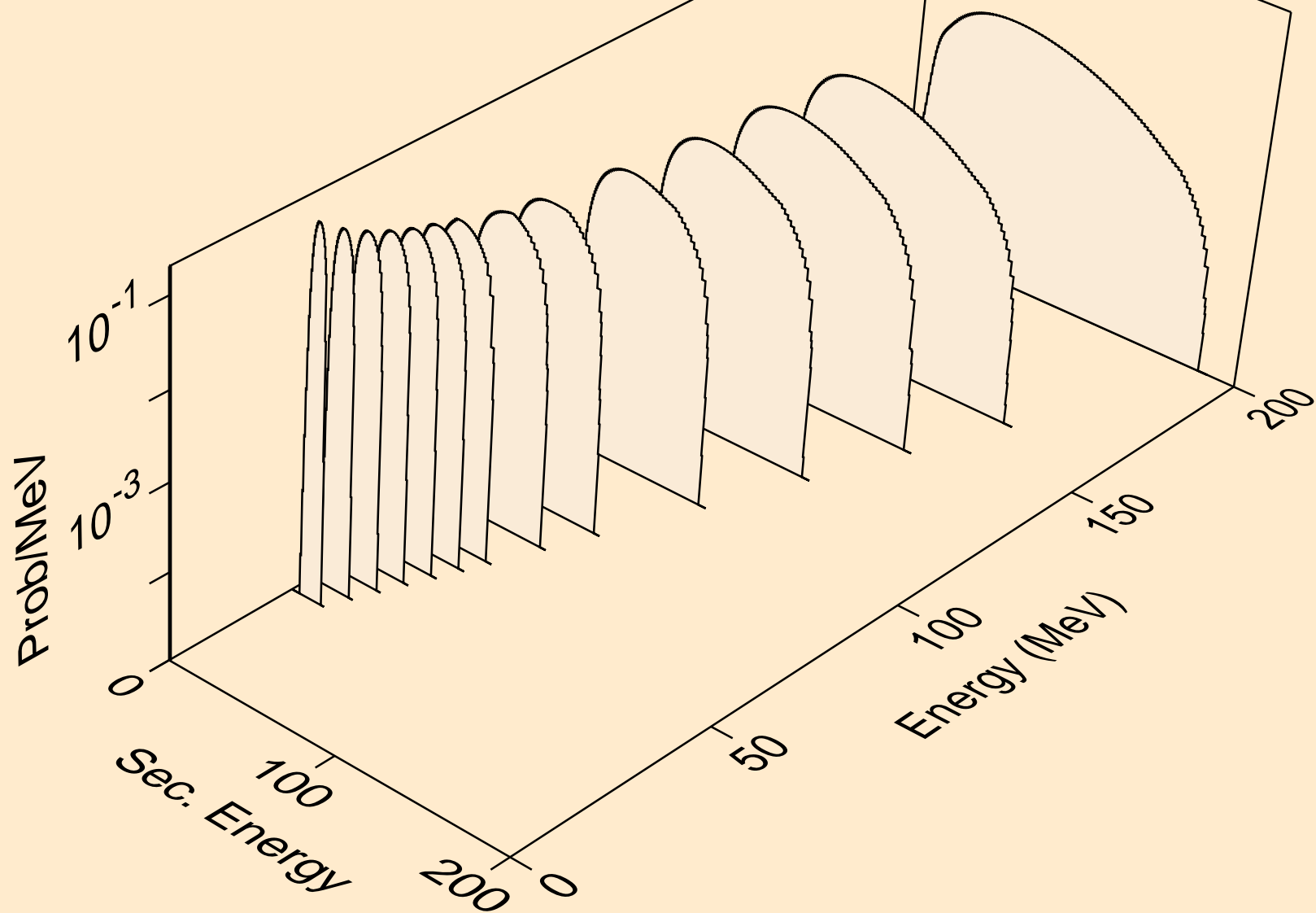

CE124 HELION ACER TENDL-2021 LIBRARY; T=0.K  
tritons from (s,n\*)t

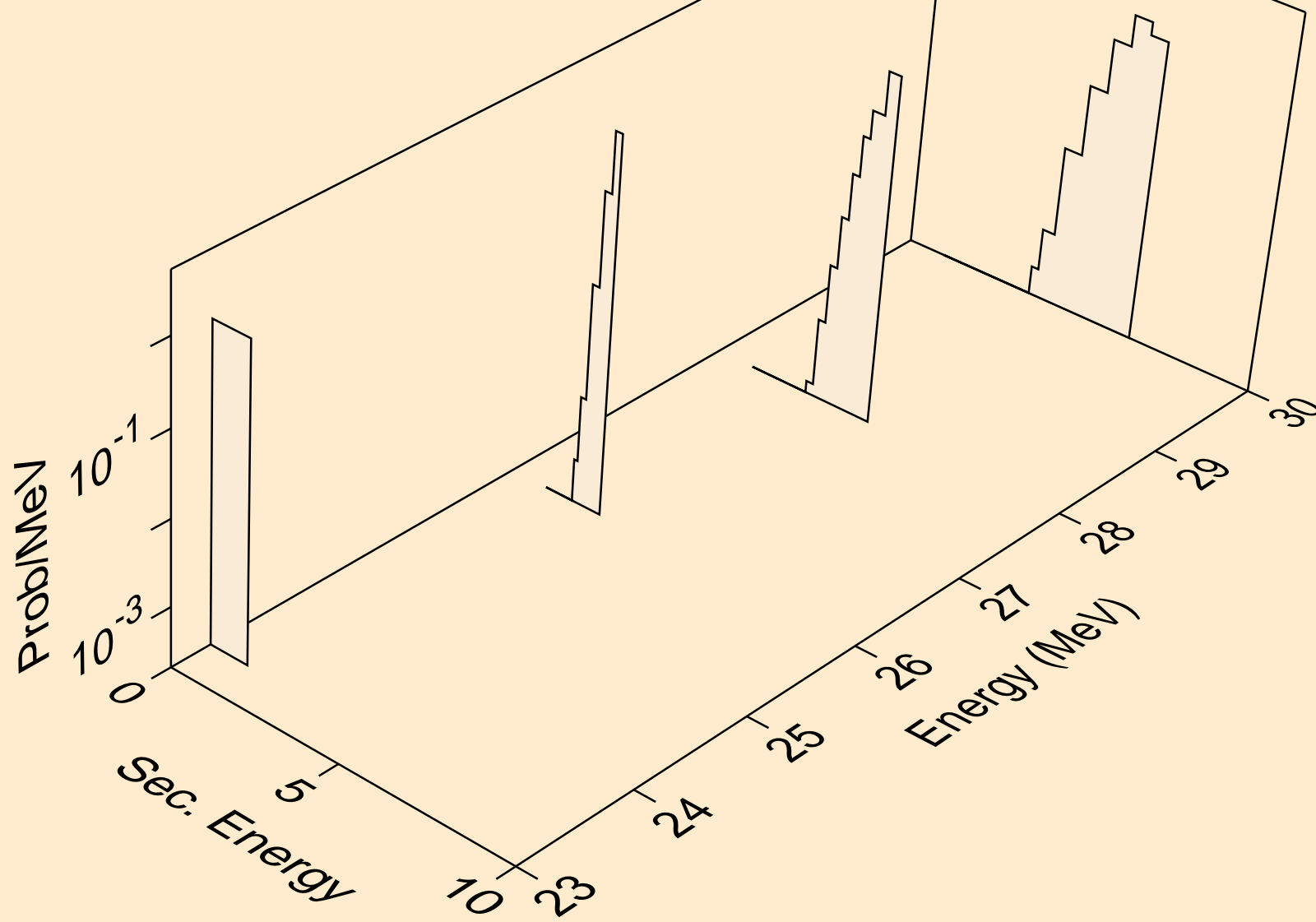

CE124 HELION ACER TENDL-2021 LIBRARY; T=0.K  
tritons from (s,t)

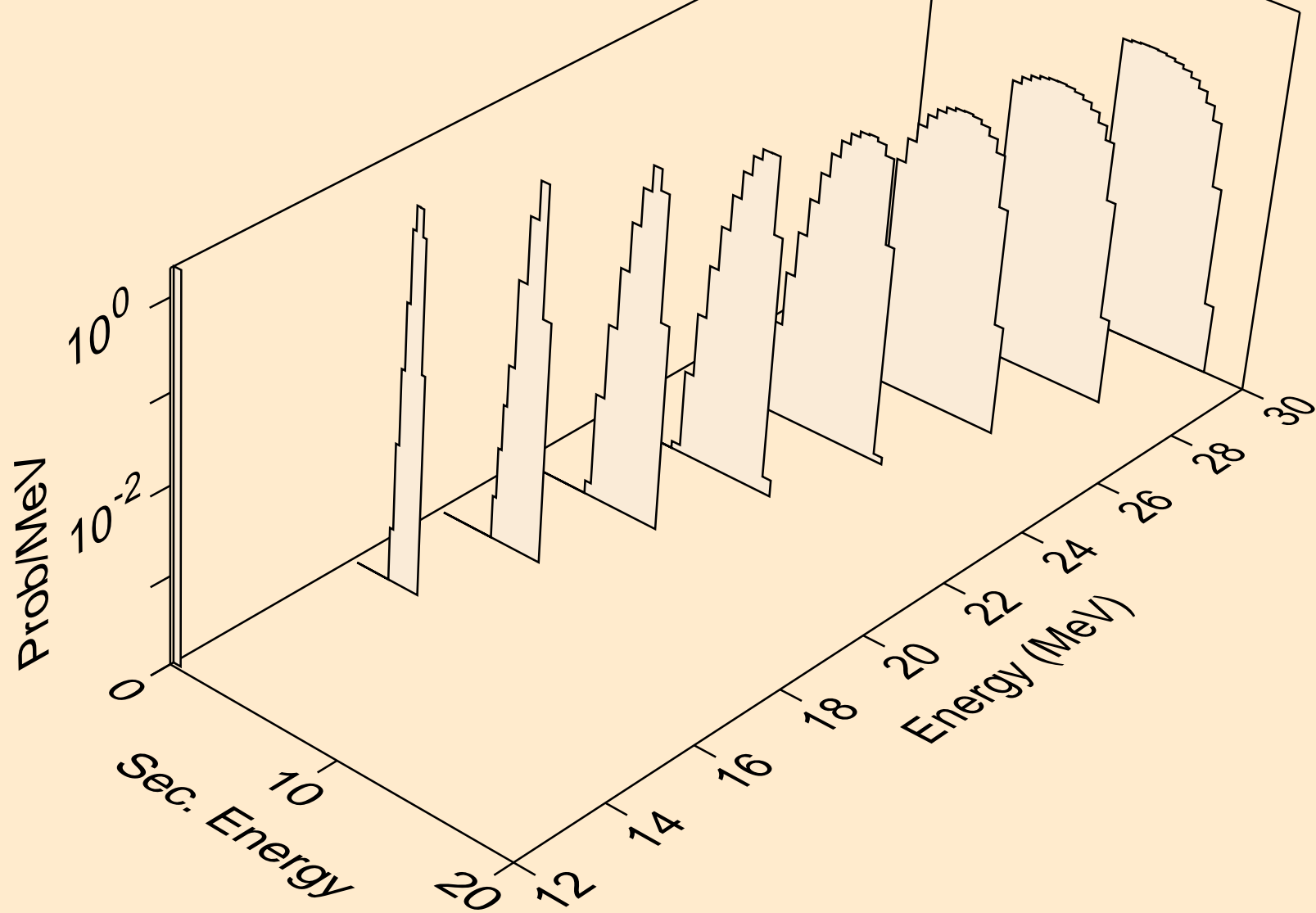

CE124 HELION ACER TENDL-2021 LIBRARY; T=0.K  
tritons from (s,pt)

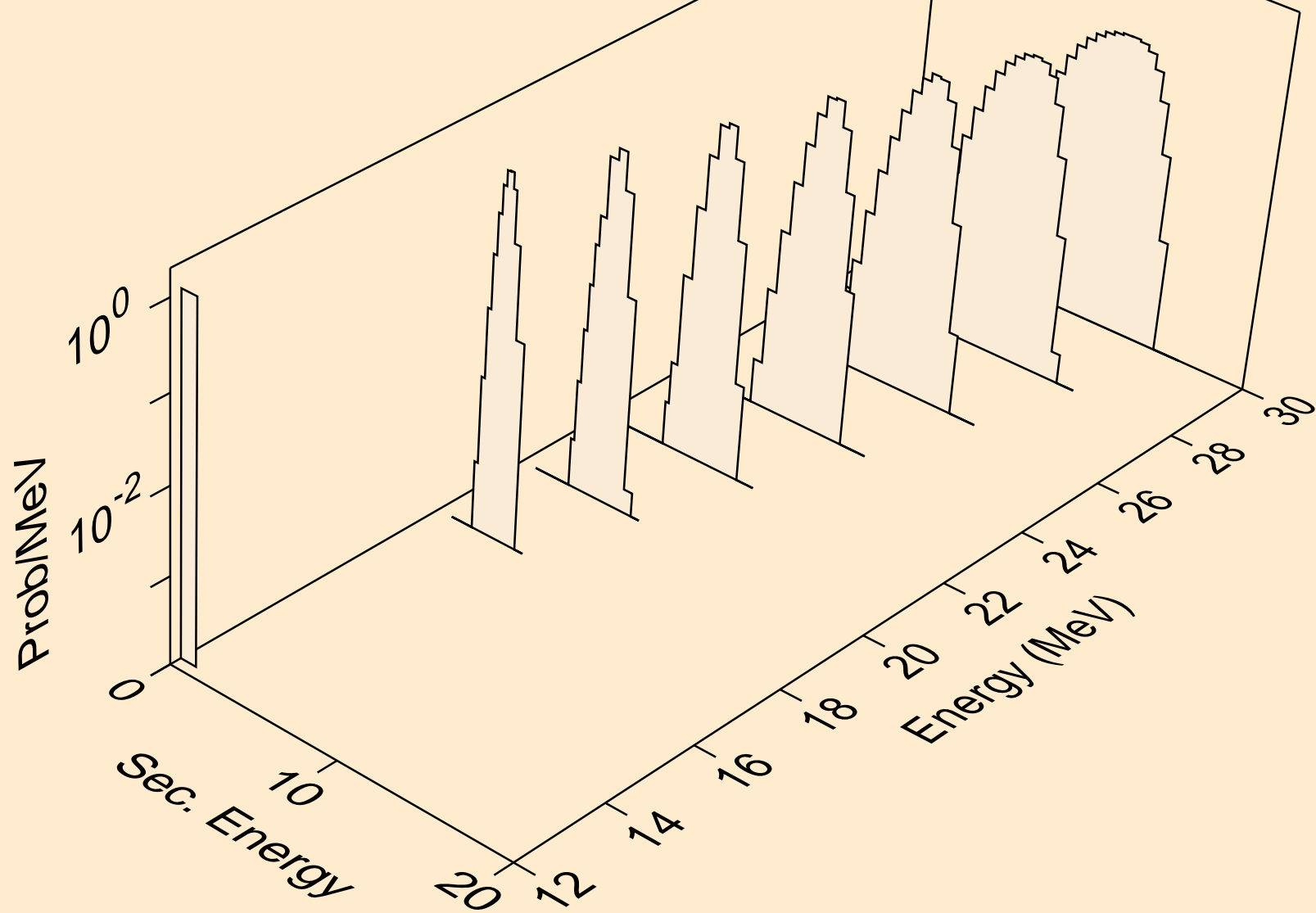

CE124 HELION ACER TENDL-2021 LIBRARY; T=0.K  
alphas from (s,x)

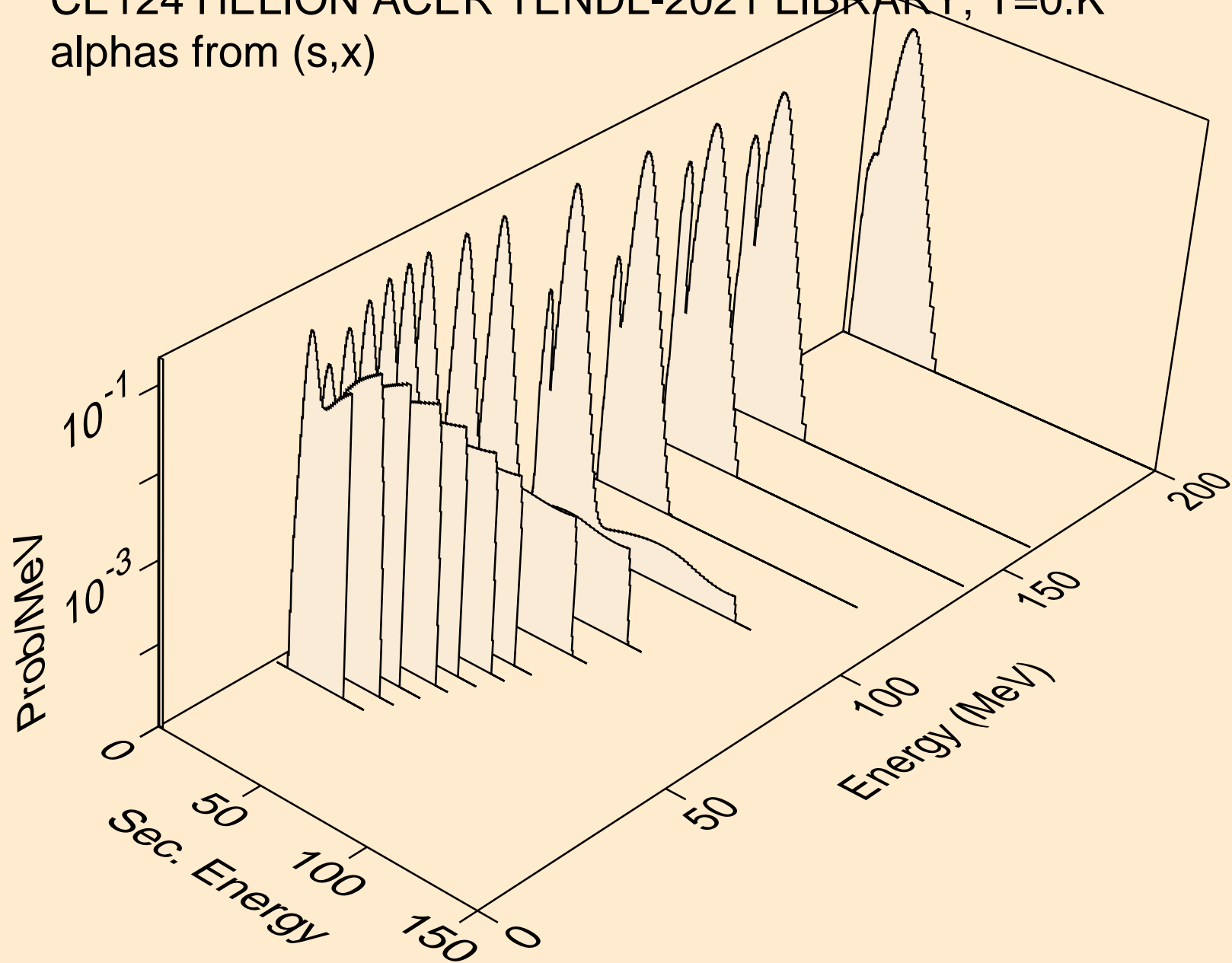

CE124 HELION ACER TENDL-2021 LIBRARY; T=0.K  
alphas from (s,n\*)a

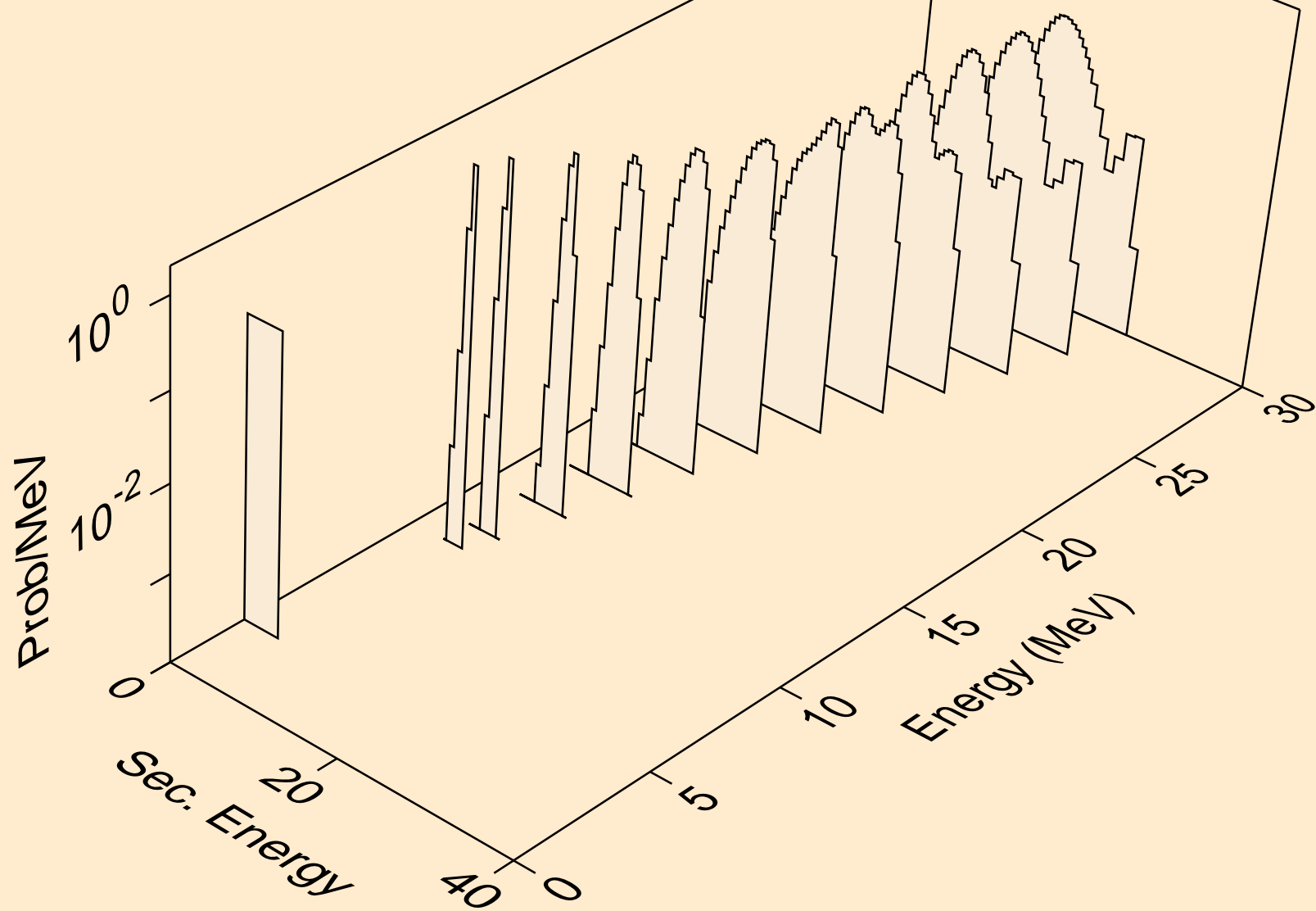

CE124 HELION ACER TENDL-2021 LIBRARY; T=0.K  
alphas from (s,2n)a

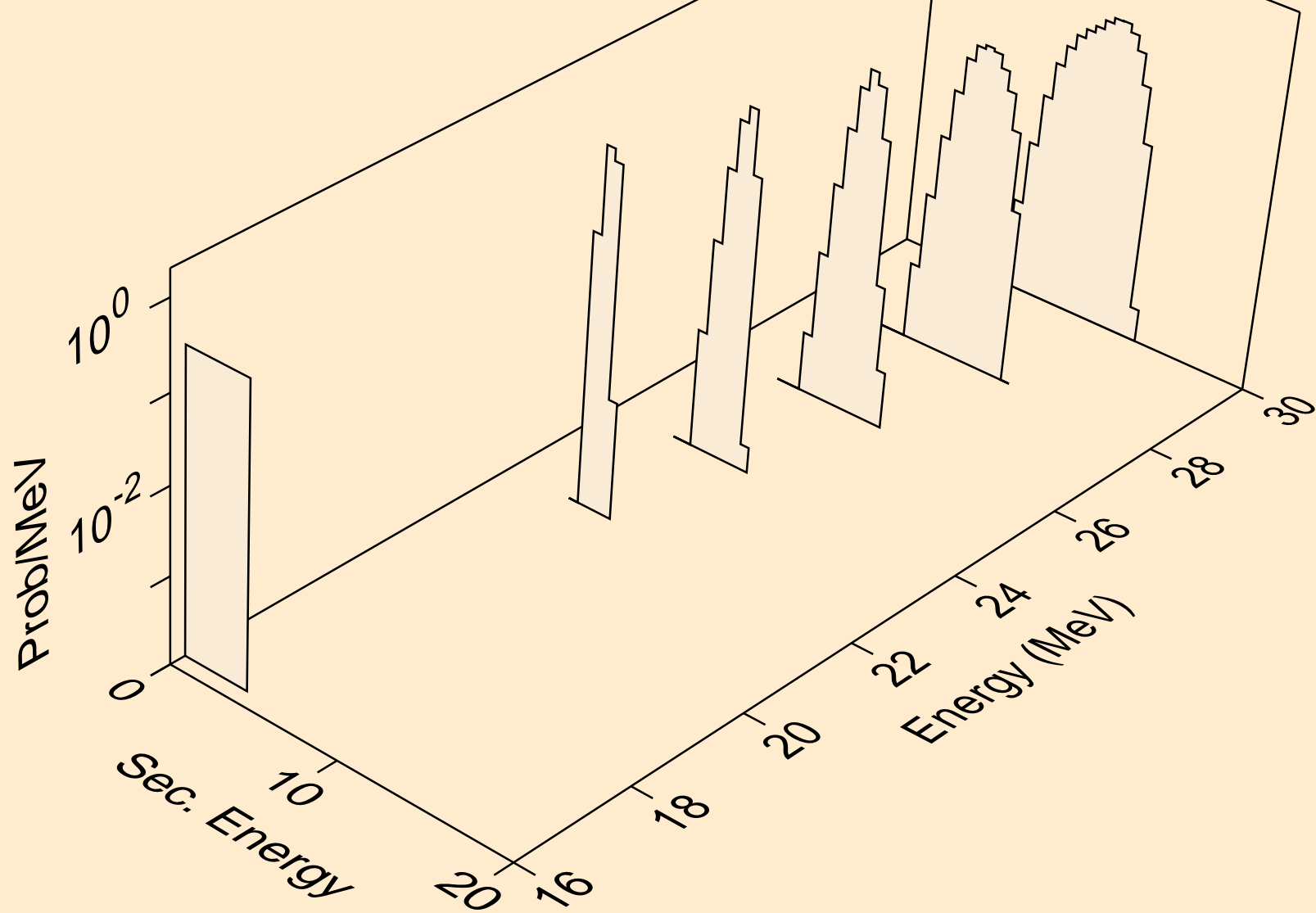



CE124 HELION ACER TENDL-2021 LIBRARY; T=0.K  
alphas from (s,n\*)2a

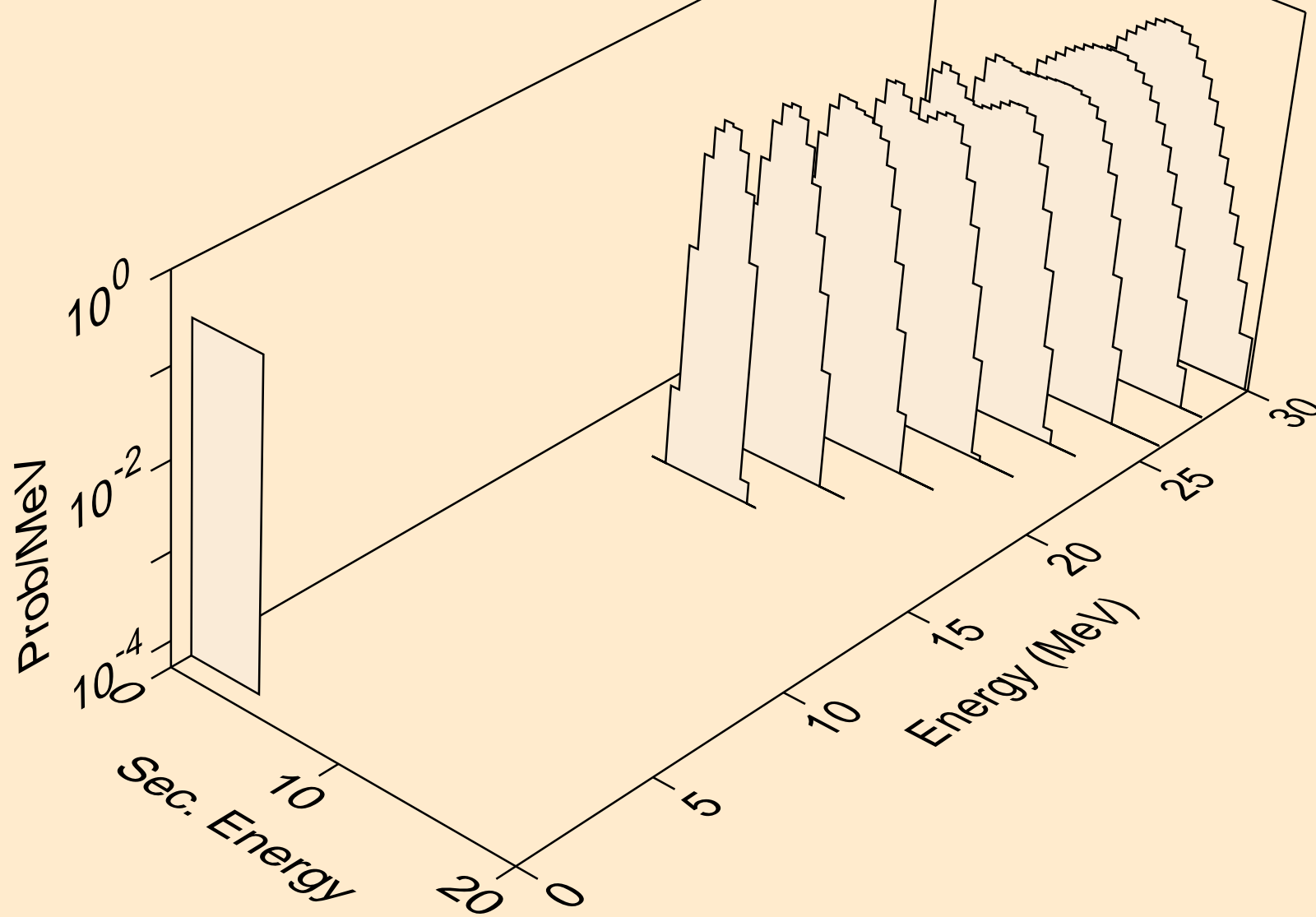

CE124 HELION ACER TENDL-2021 LIBRARY; T=0.K  
alphas from (s,npa)

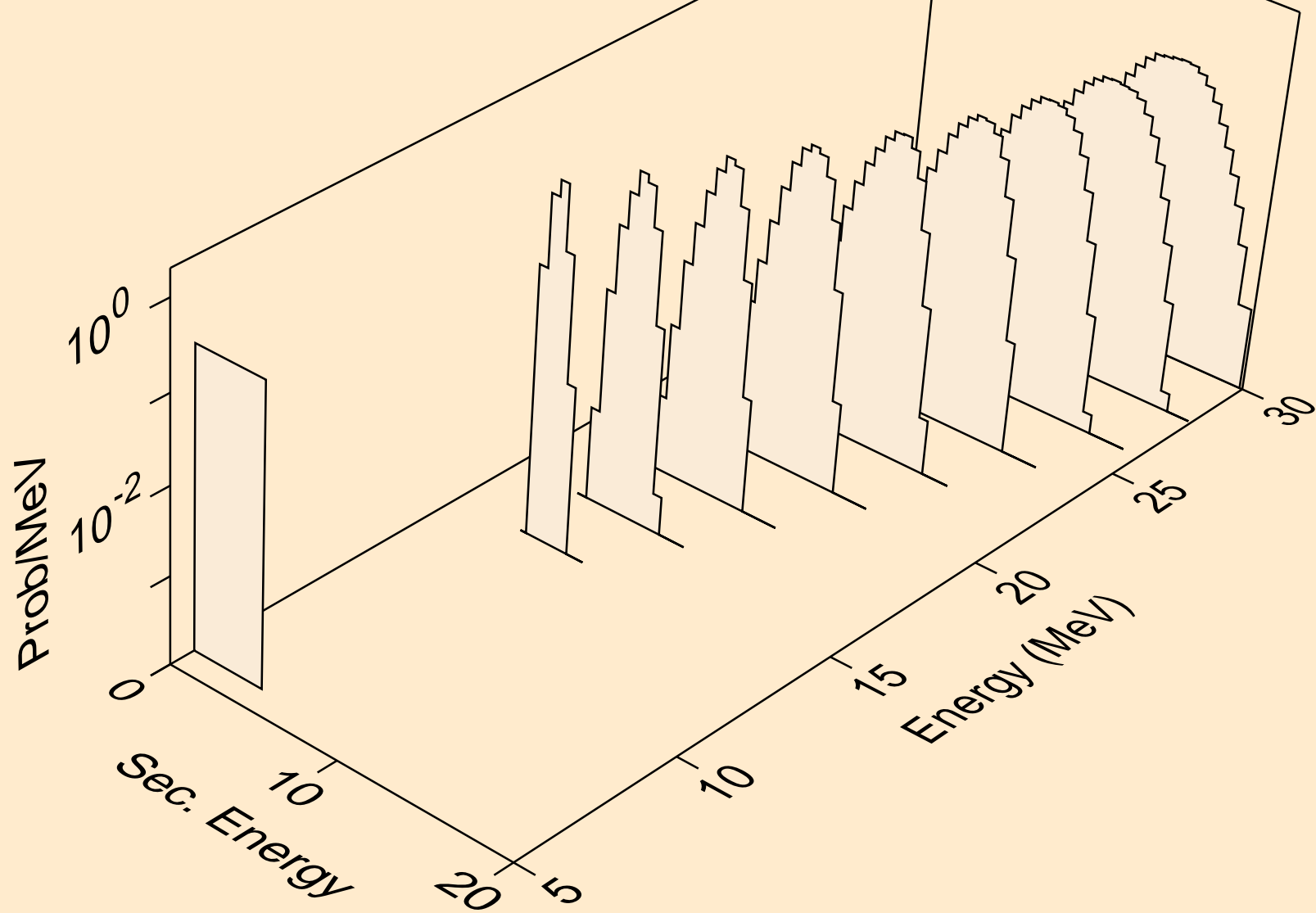

CE124 HELION ACER TENDL-2021 LIBRARY; T=0.K  
alphas from (s,a)

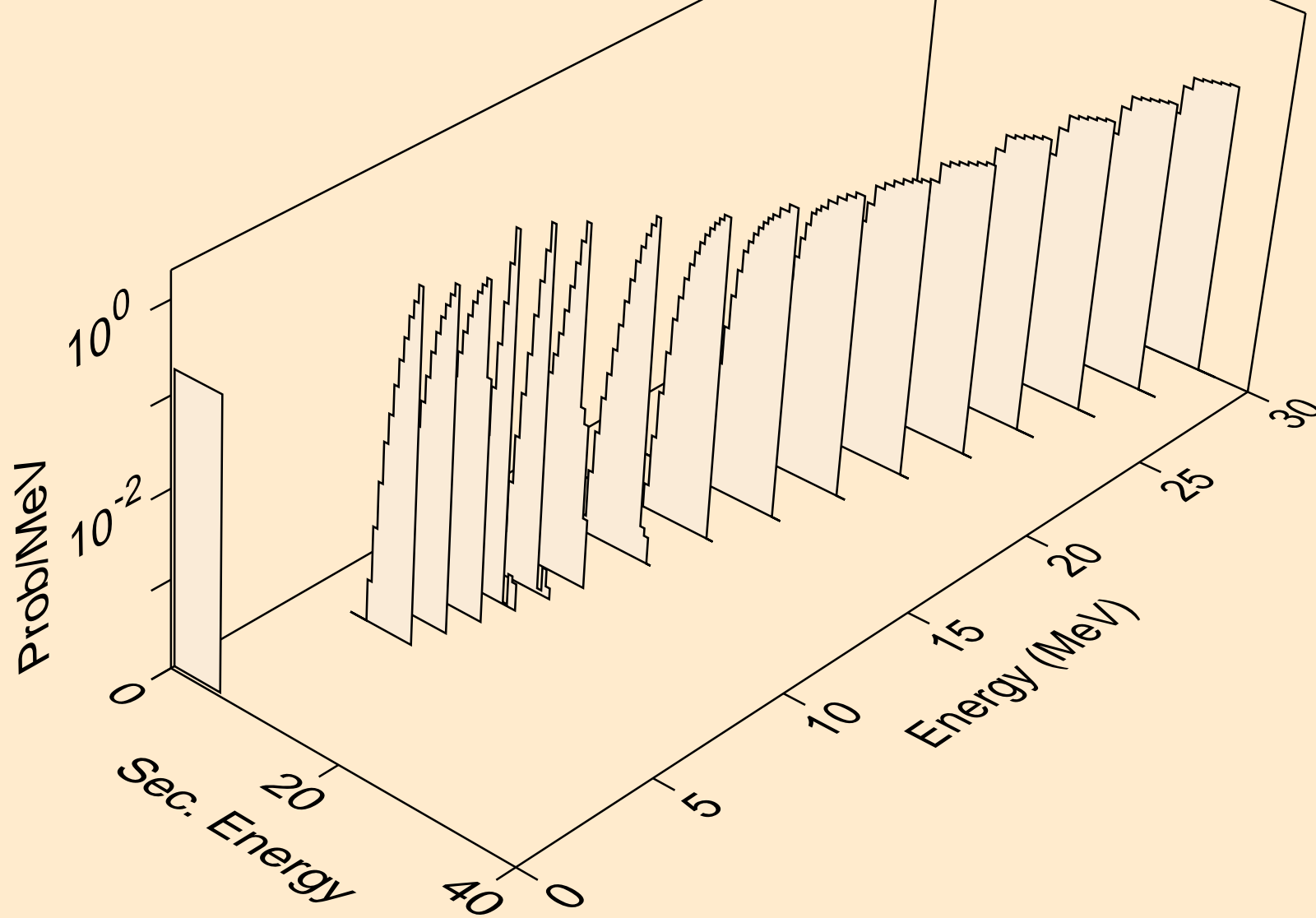

CE124 HELION ACER TENDL-2021 LIBRARY; T=0.K  
alphas from (s,2a)

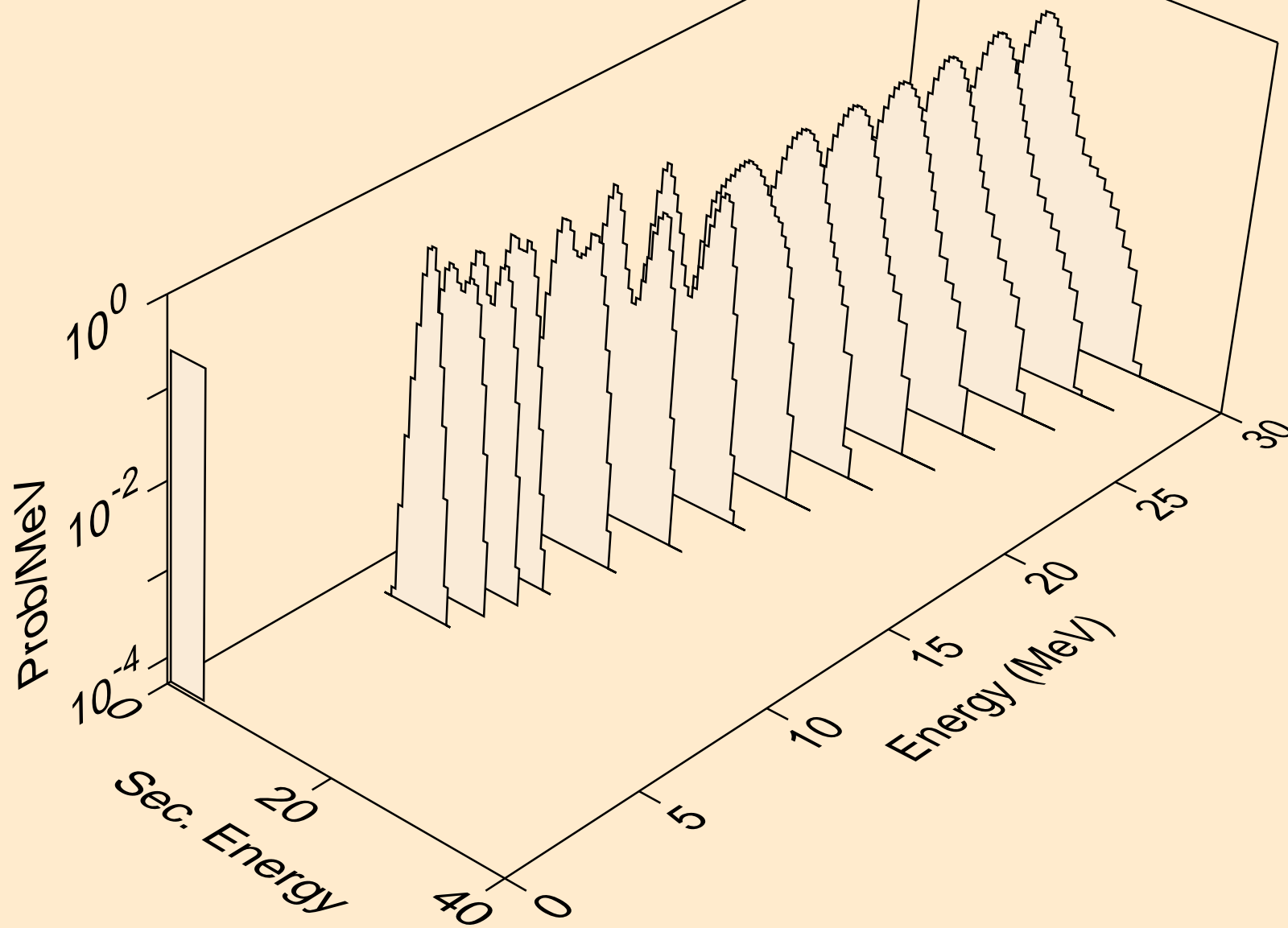

CE124 HELION ACER TENDL-2021 LIBRARY; T=0.K  
alphas from (s,3a)

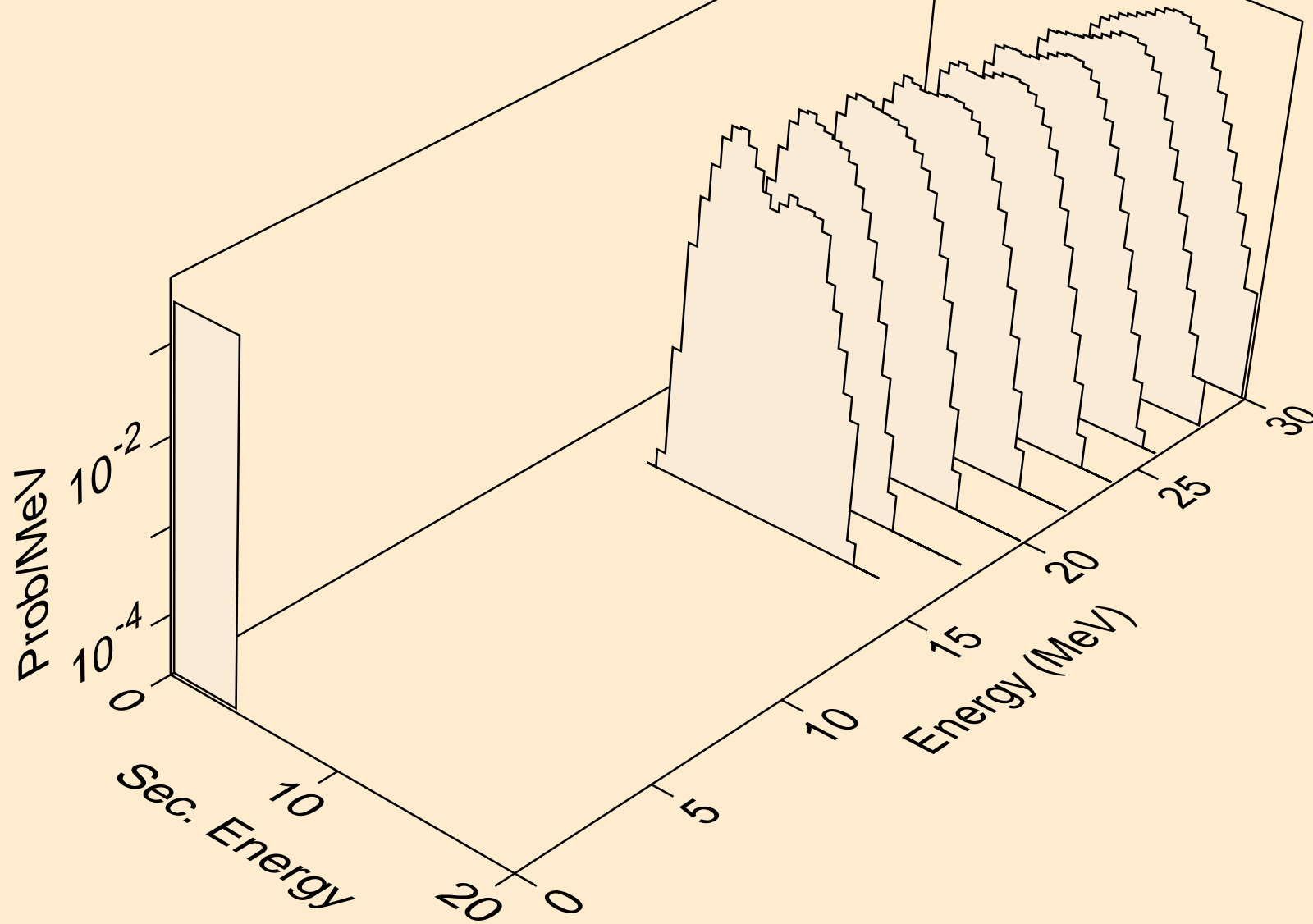

CE124 HELION ACER TENDL-2021 LIBRARY; T=0.K  
alphas from (s,pa)

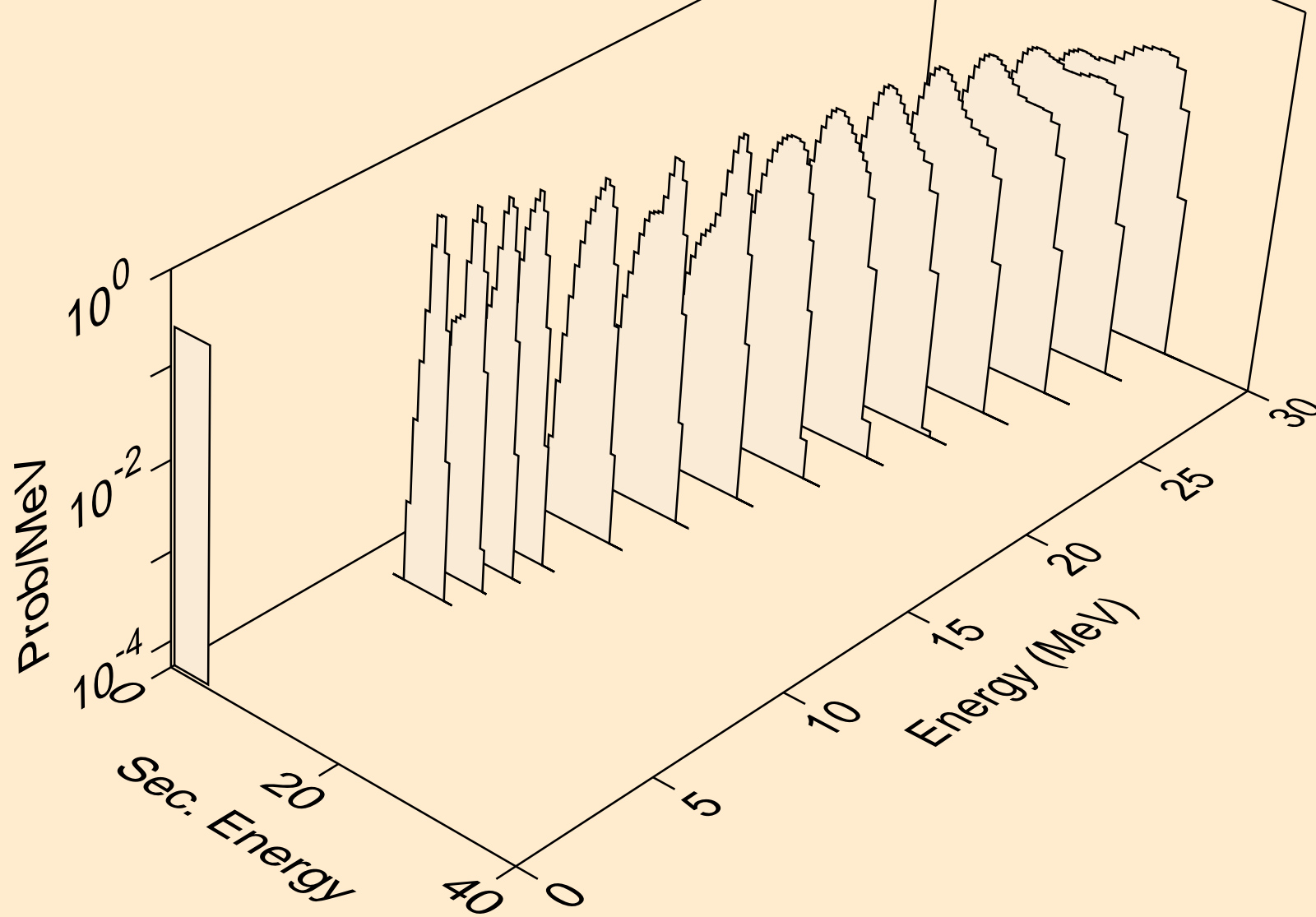

CE124 HELION ACER TENDL-2021 LIBRARY; T=0.K  
alphas from (s,da)

