

CM235 HELION ACER TENDL-2021 LIBRARY; T=0.K
Principal cross sections

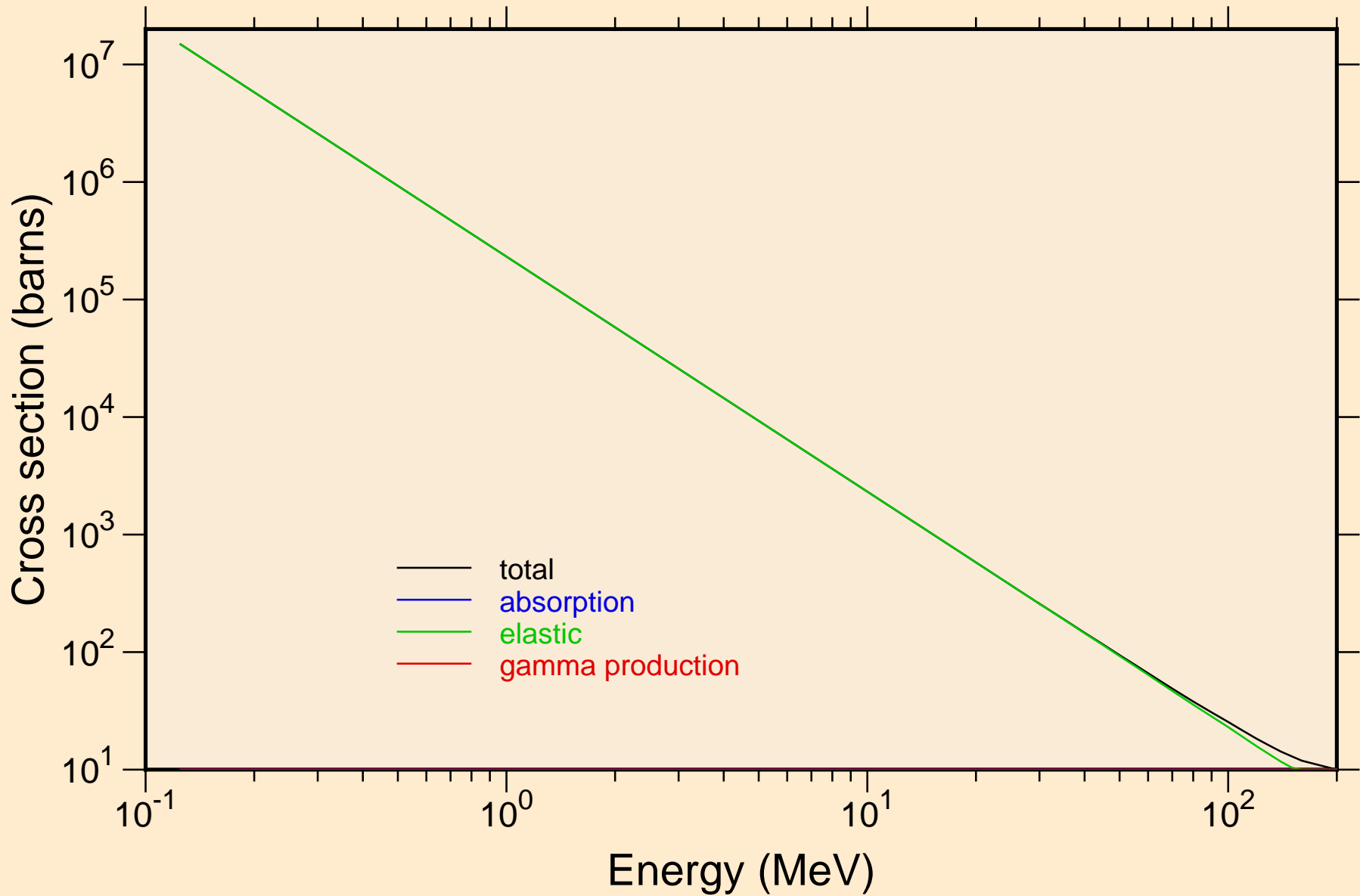

CM235 HELION ACER TENDL-2021 LIBRARY; T=0.K

Heating

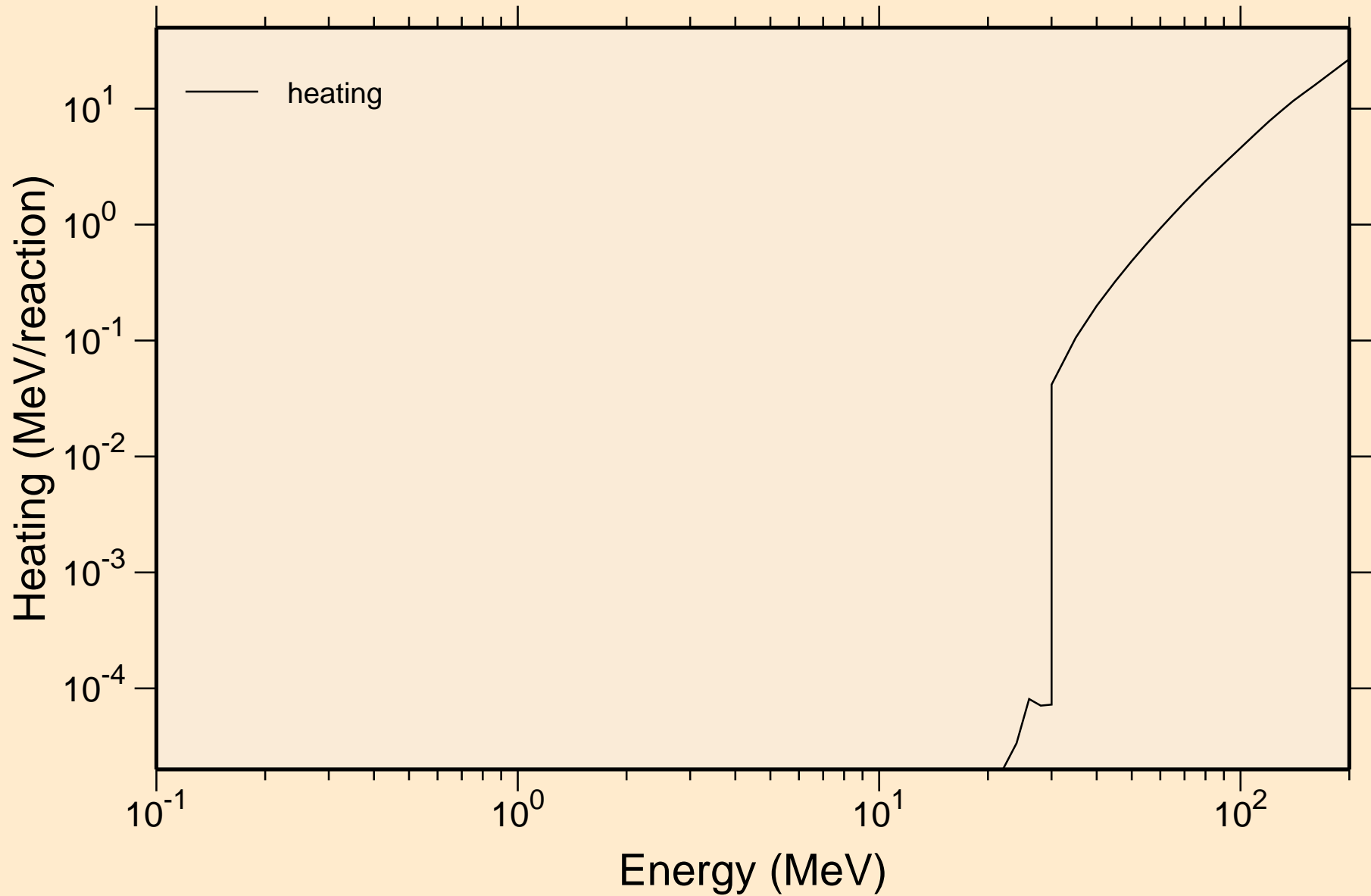

CM235 HELION ACER TENDL-2021 LIBRARY; T=0.K

Principal cross sections

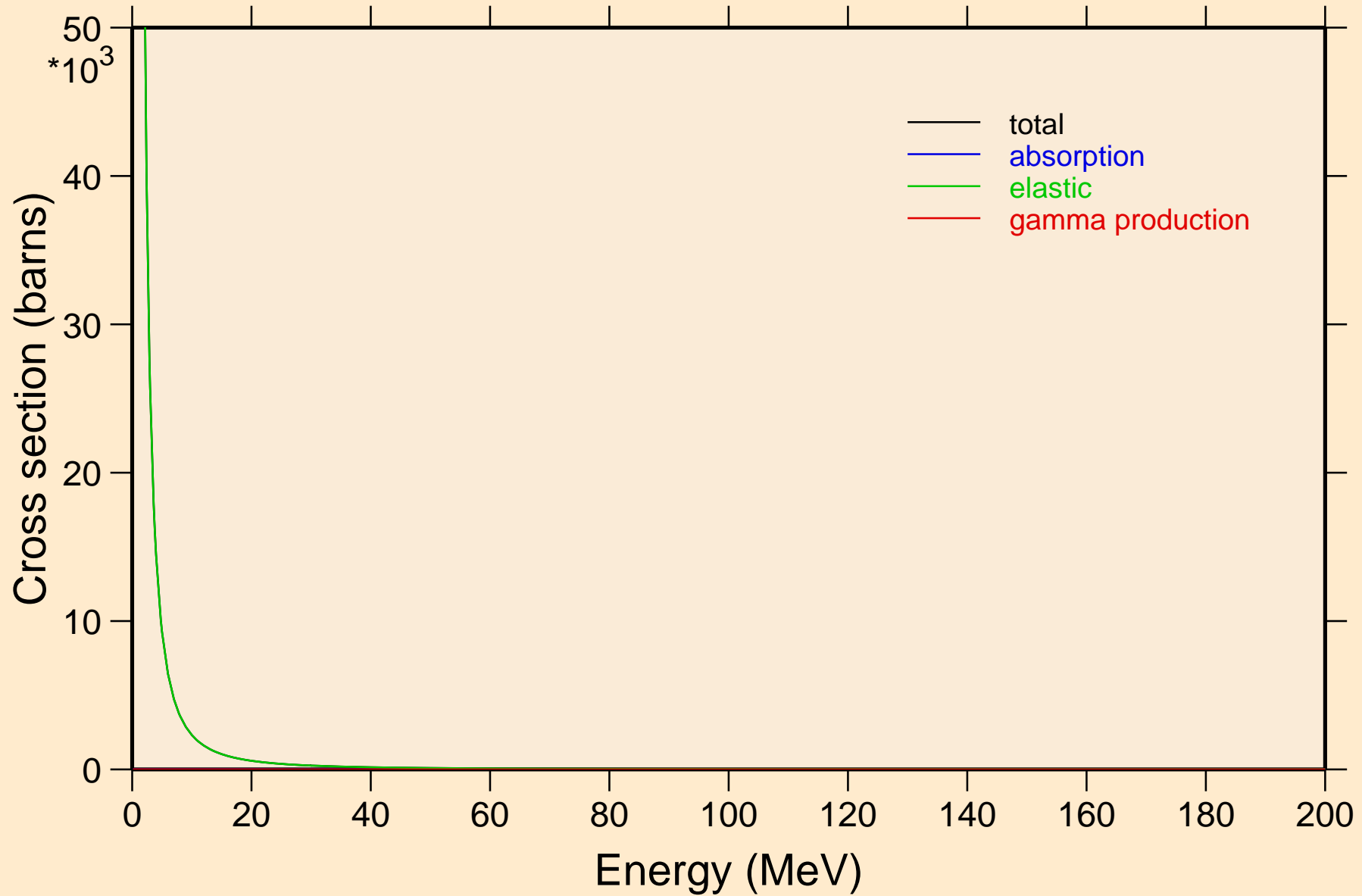

CM235 HELION ACER TENDL-2021 LIBRARY; T=0.K

Heating

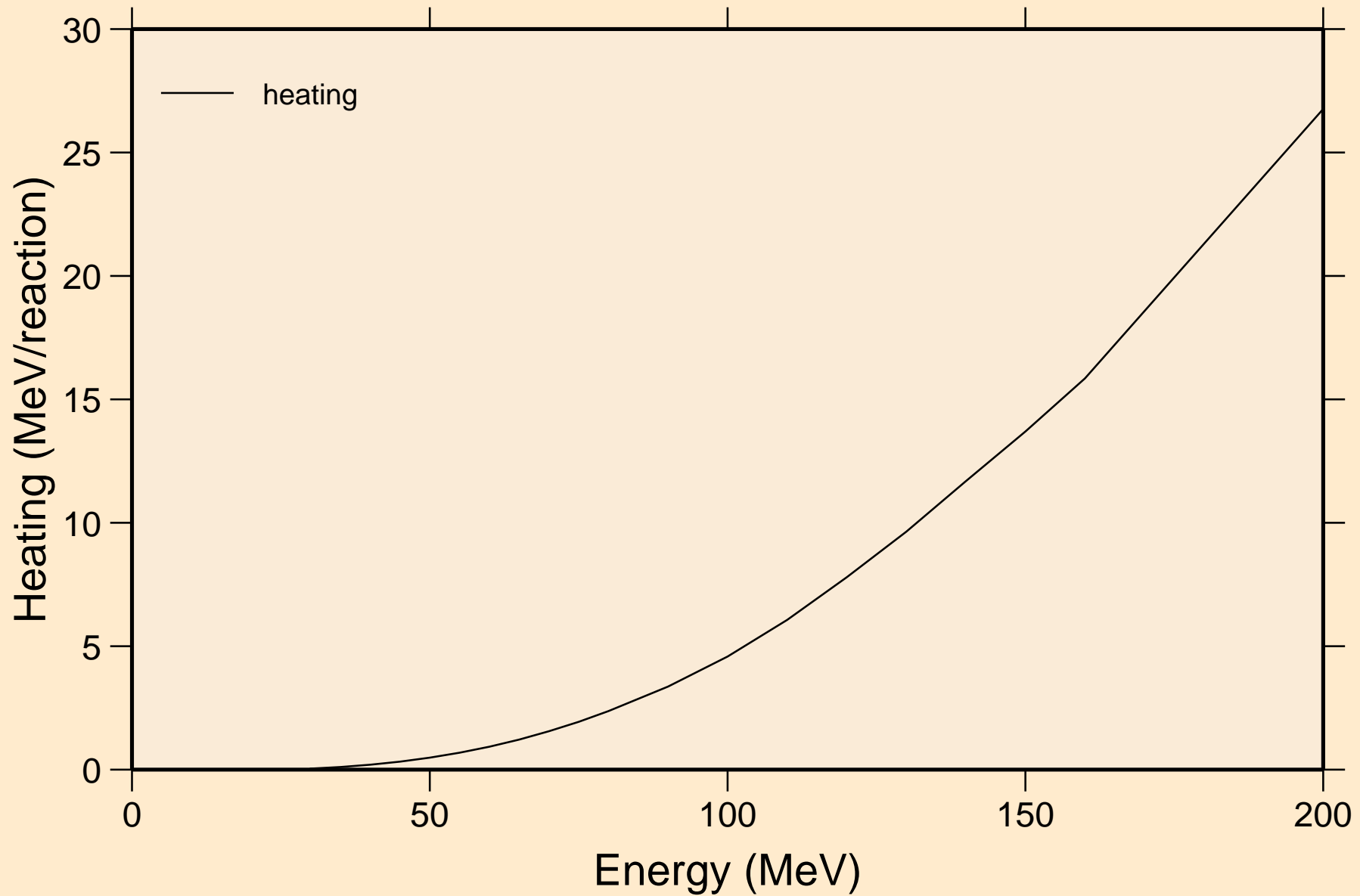

CM235 HELION ACER TENDL-2021 LIBRARY; T=0.K

Threshold reactions

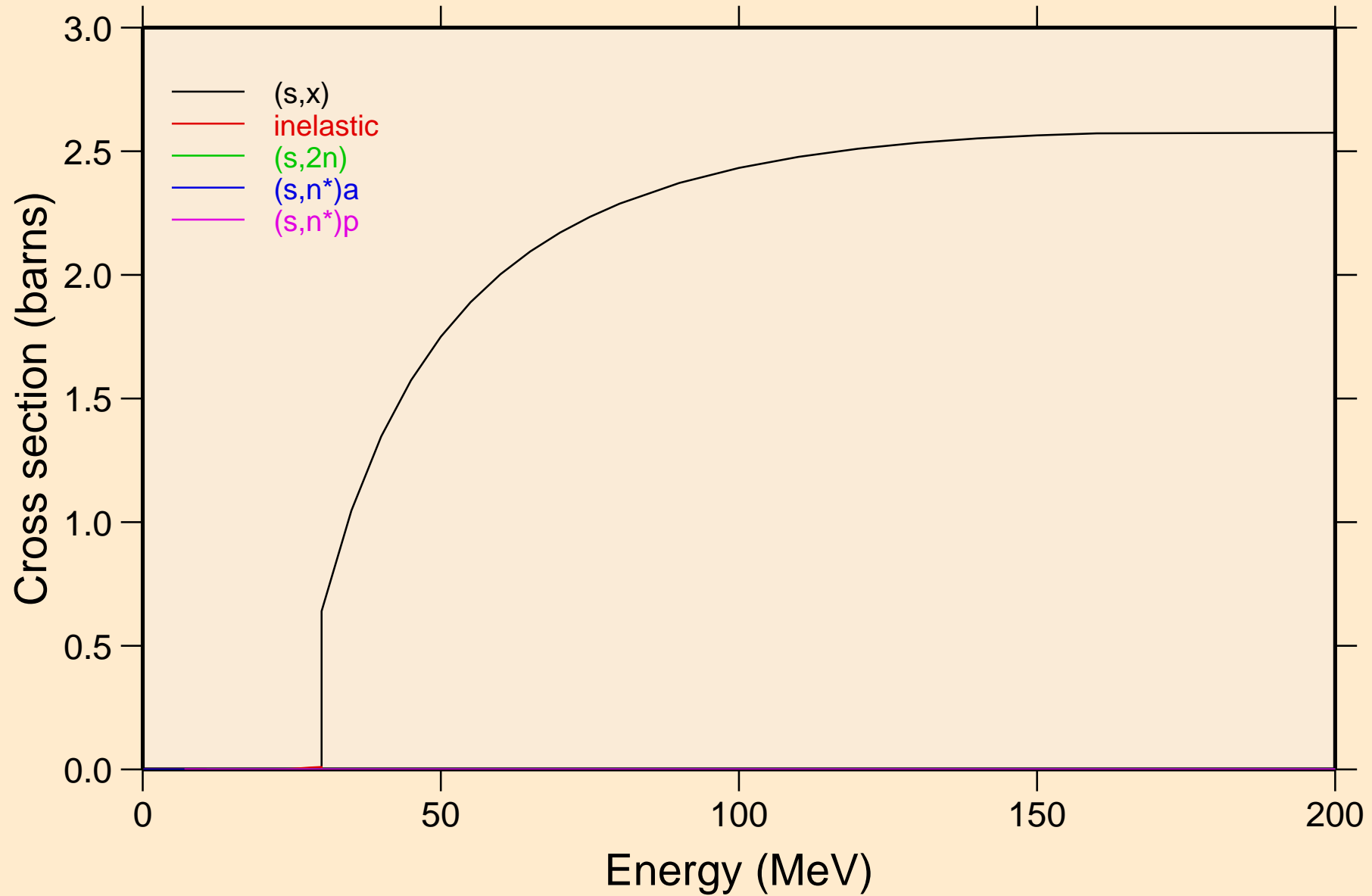

CM235 HELION ACER TENDL-2021 LIBRARY; T=0.K
Threshold reactions

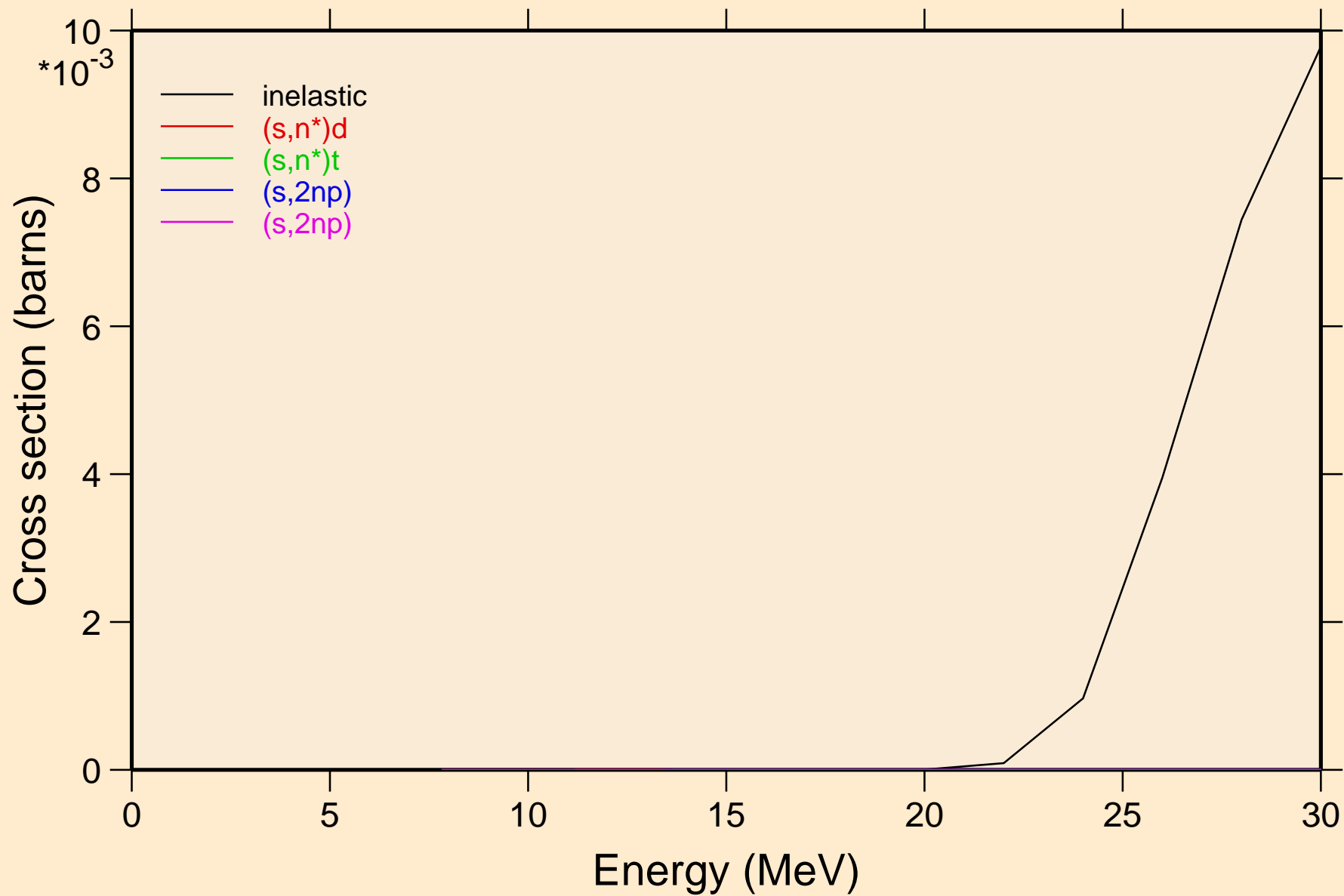

CM235 HELION ACER TENDL-2021 LIBRARY; T=0.K
Threshold reactions

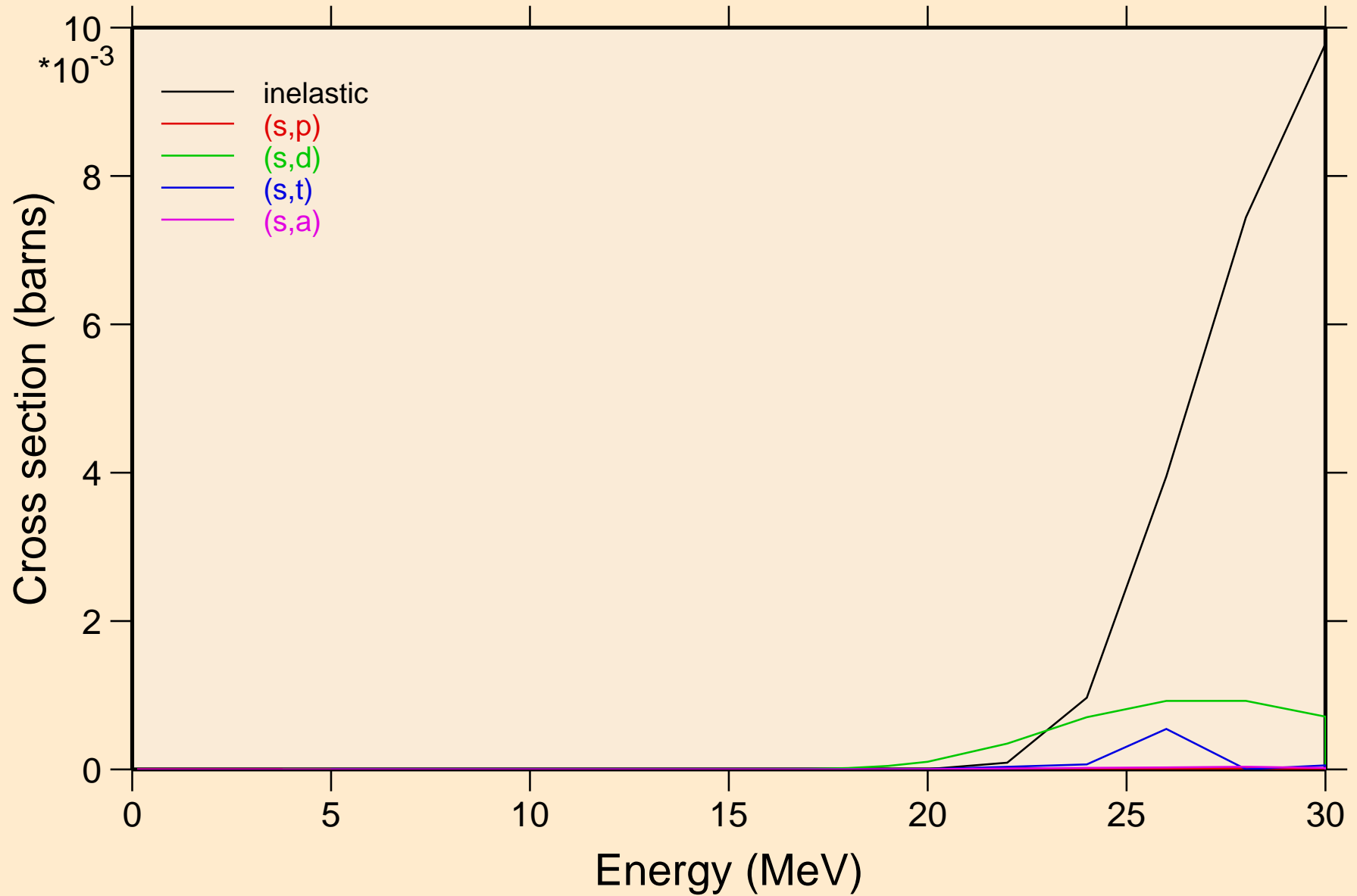

CM235 HELION ACER TENDL-2021 LIBRARY; T=0.K
Threshold reactions

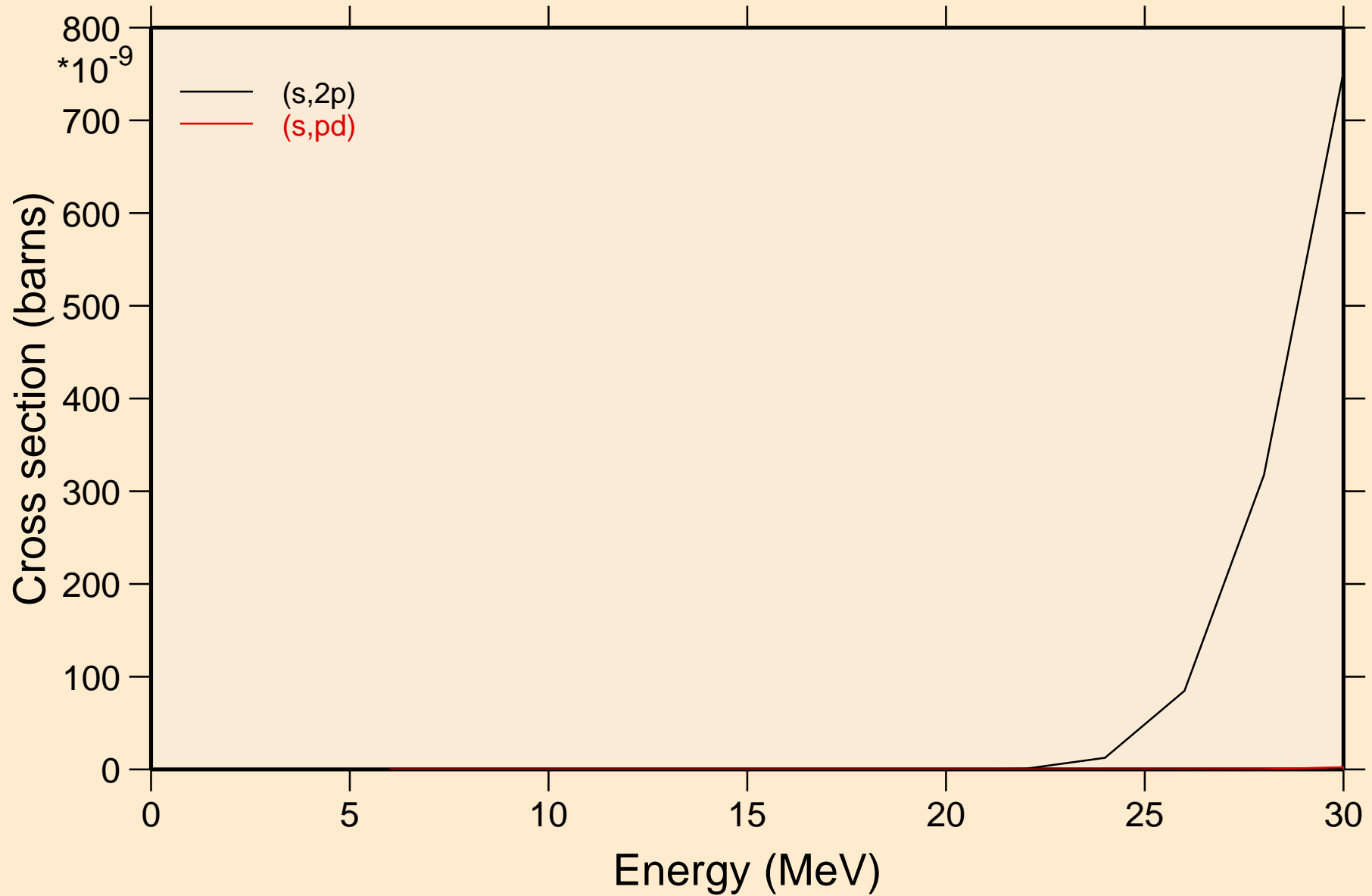

CM235 HELION ACER TENDL-2021 LIBRARY; T=0.K
angular distribution for elastic

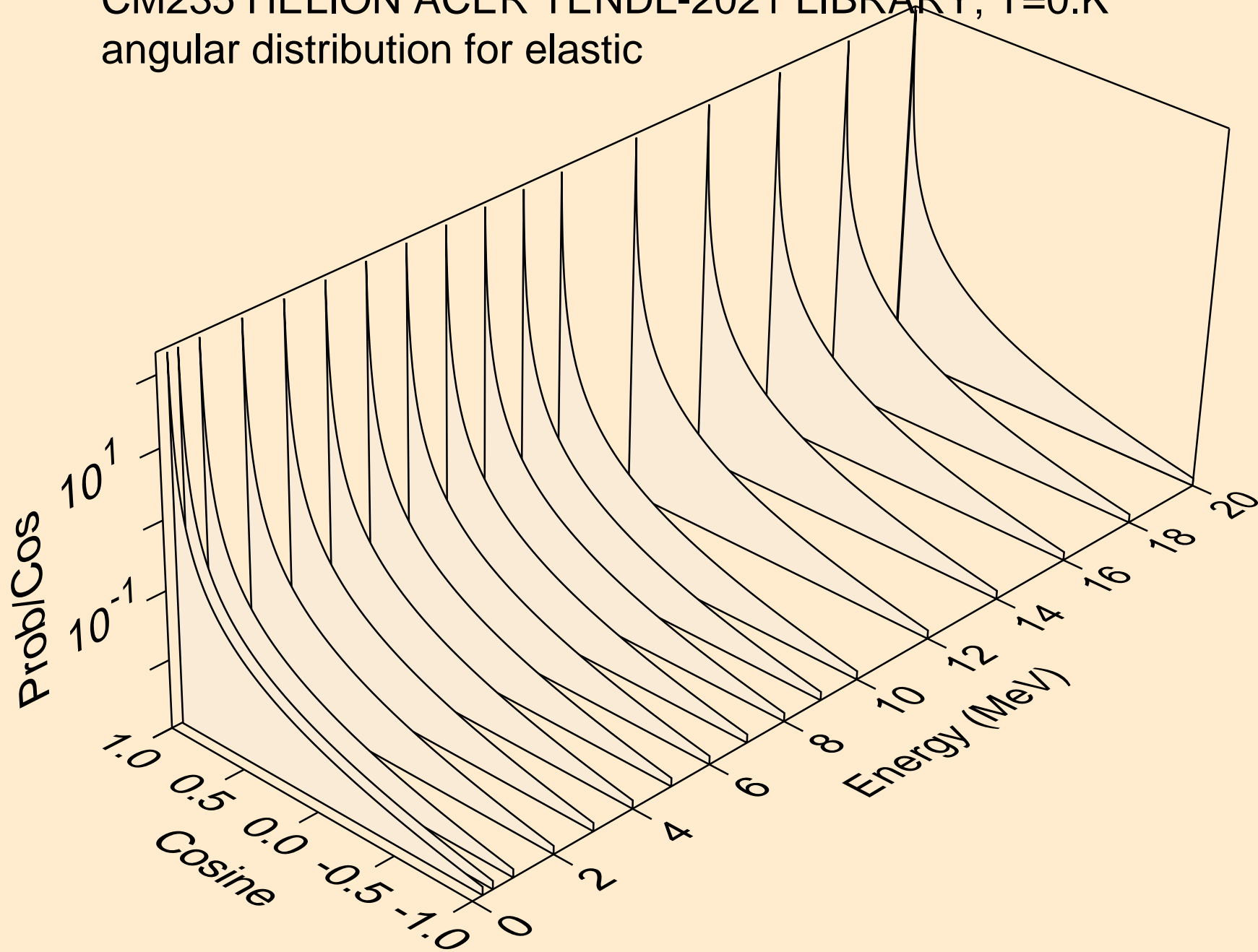

CM235 HELION ACER TENDL-2021 LIBRARY; T=0.K
angular distribution for elastic

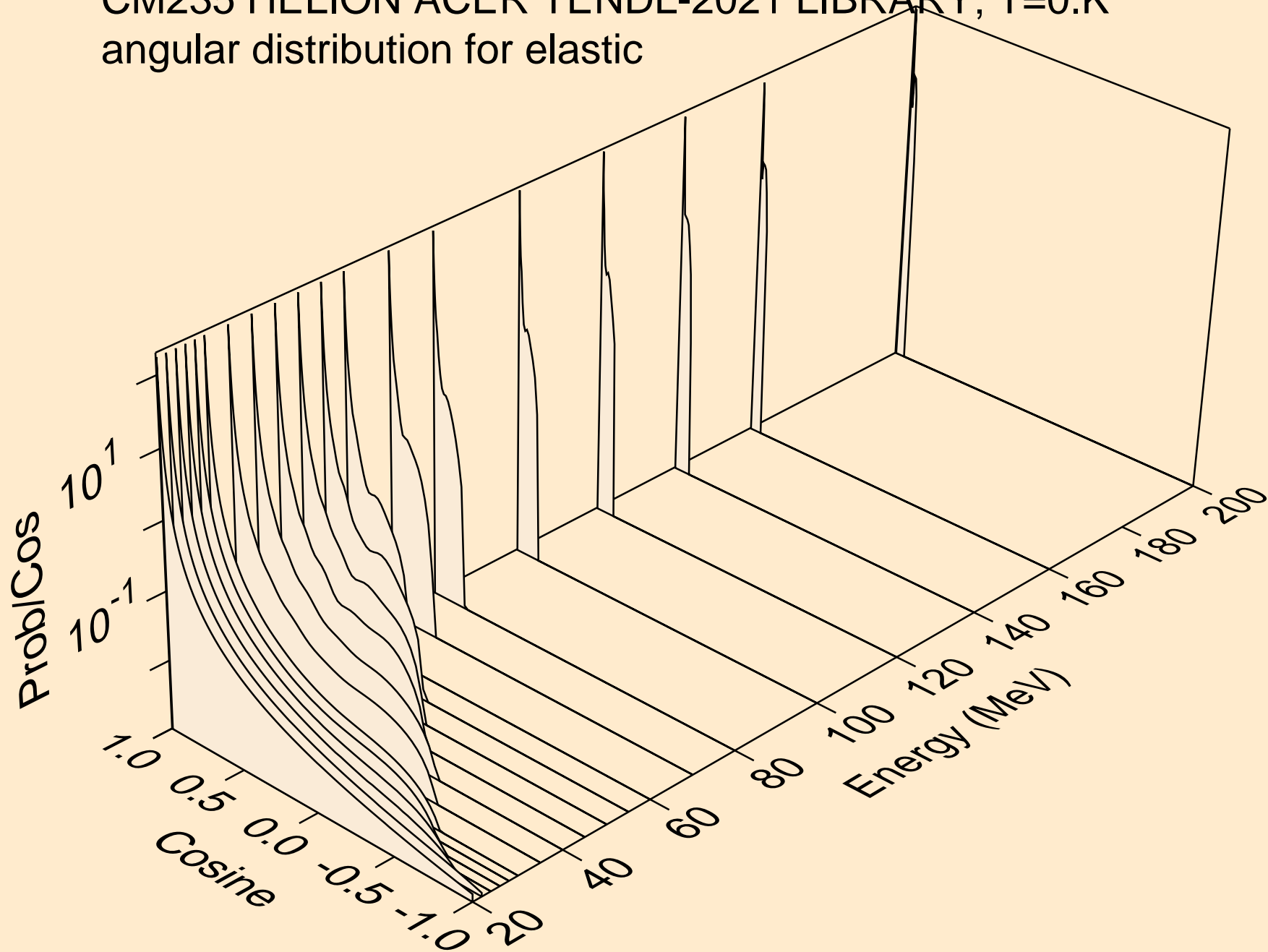

CM235 HELION ACER TENDL-2021 LIBRARY; T=0.K
He-3 emission for (s,x)

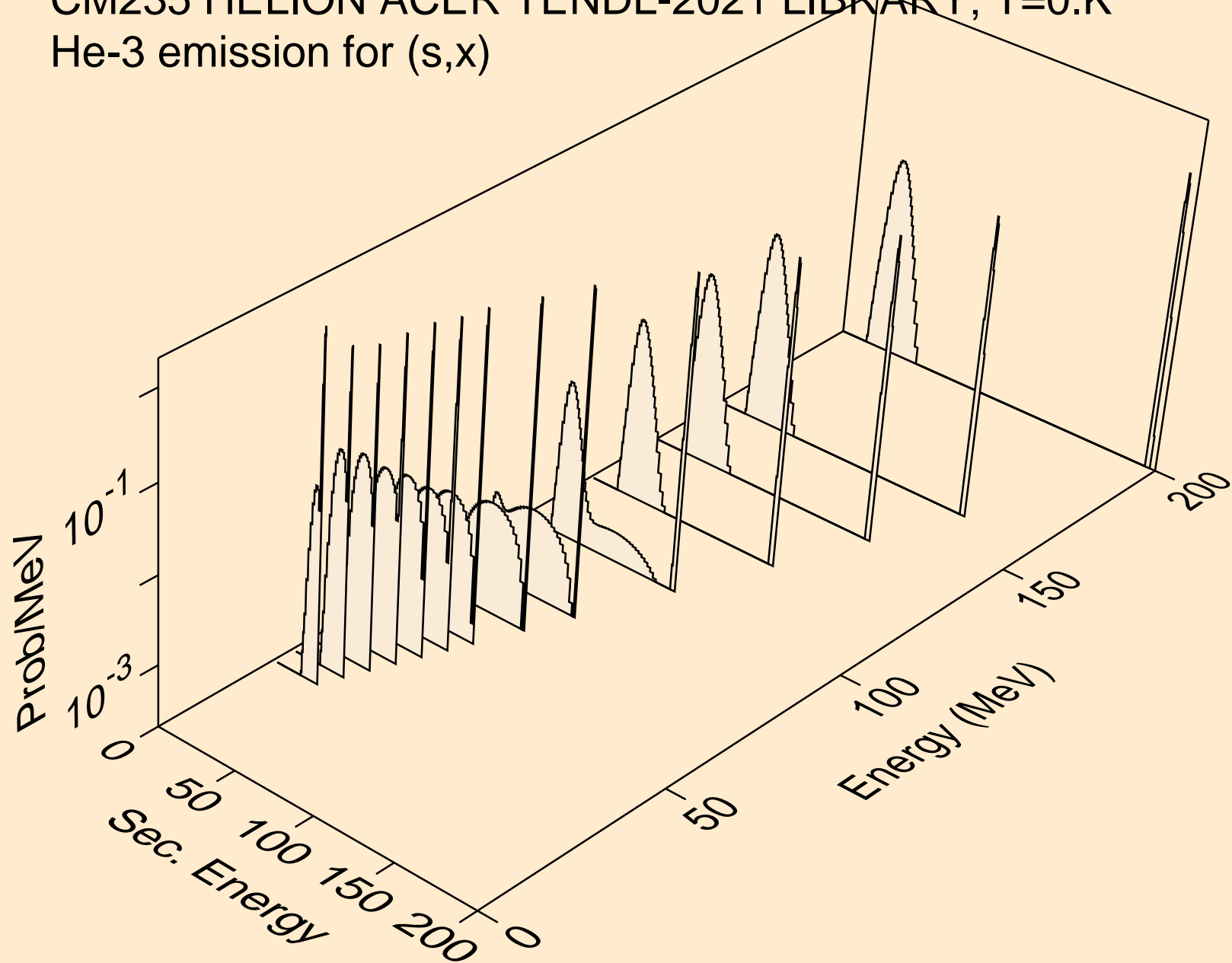

CM235 HELION ACER TENDL-2021 LIBRARY; T=0.K
He-3 emission for inelastic

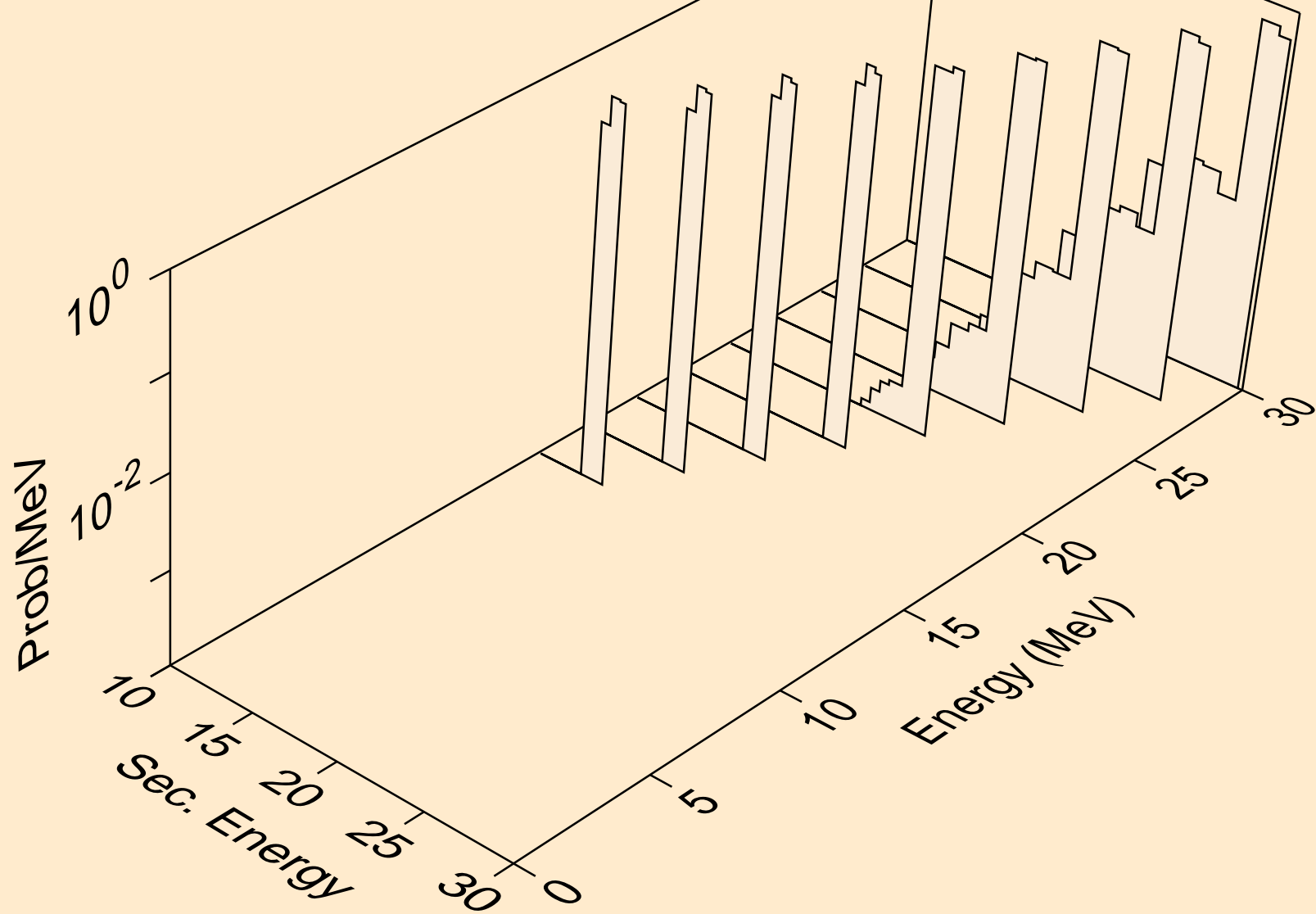

CM235 HELION ACER TENDL-2021 LIBRARY; T=0.K
Photon emission for (z,n)

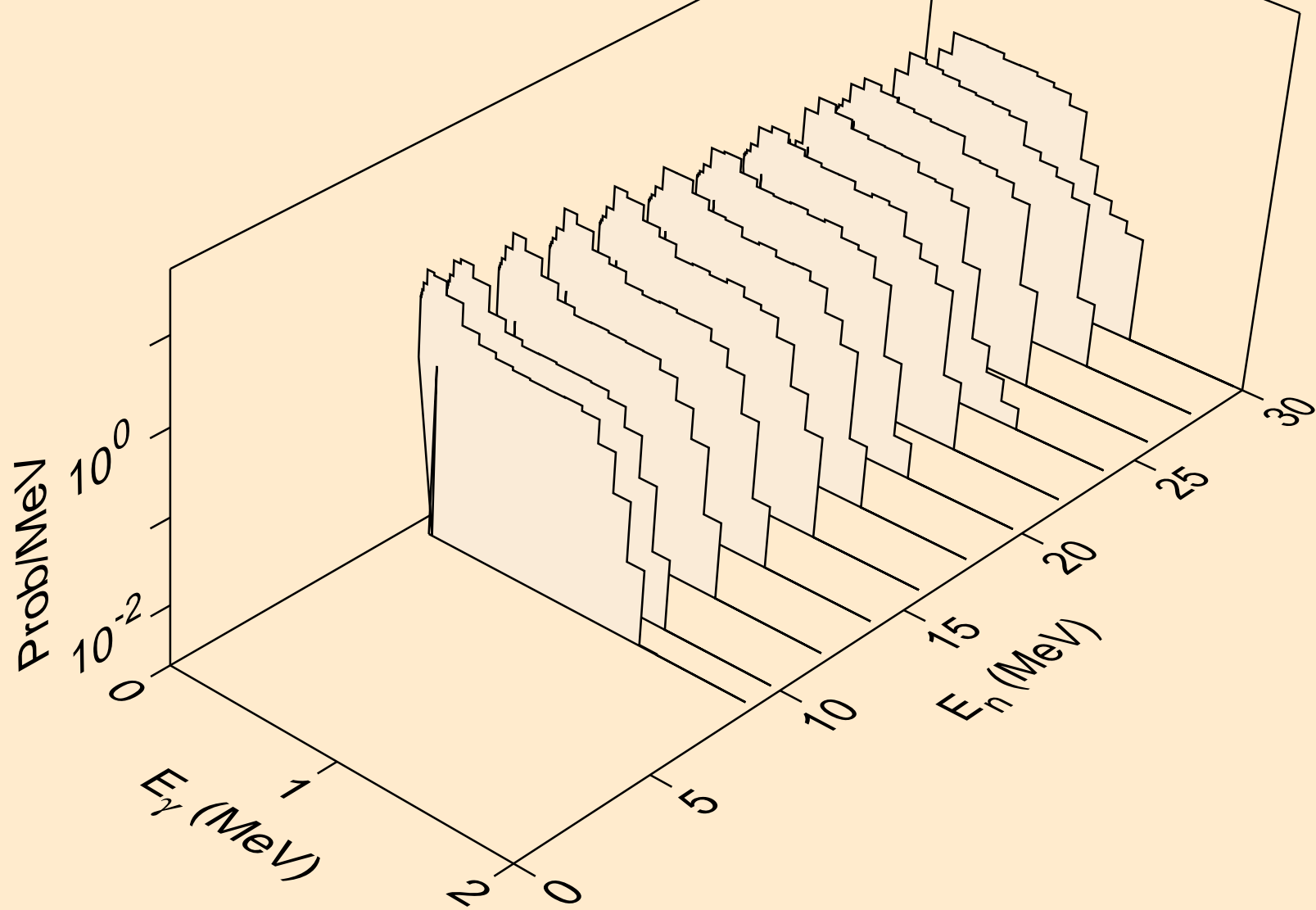

CM235 HELION ACER TENDL-2021 LIBRARY; T=0.K
Photon emission for (n,x)

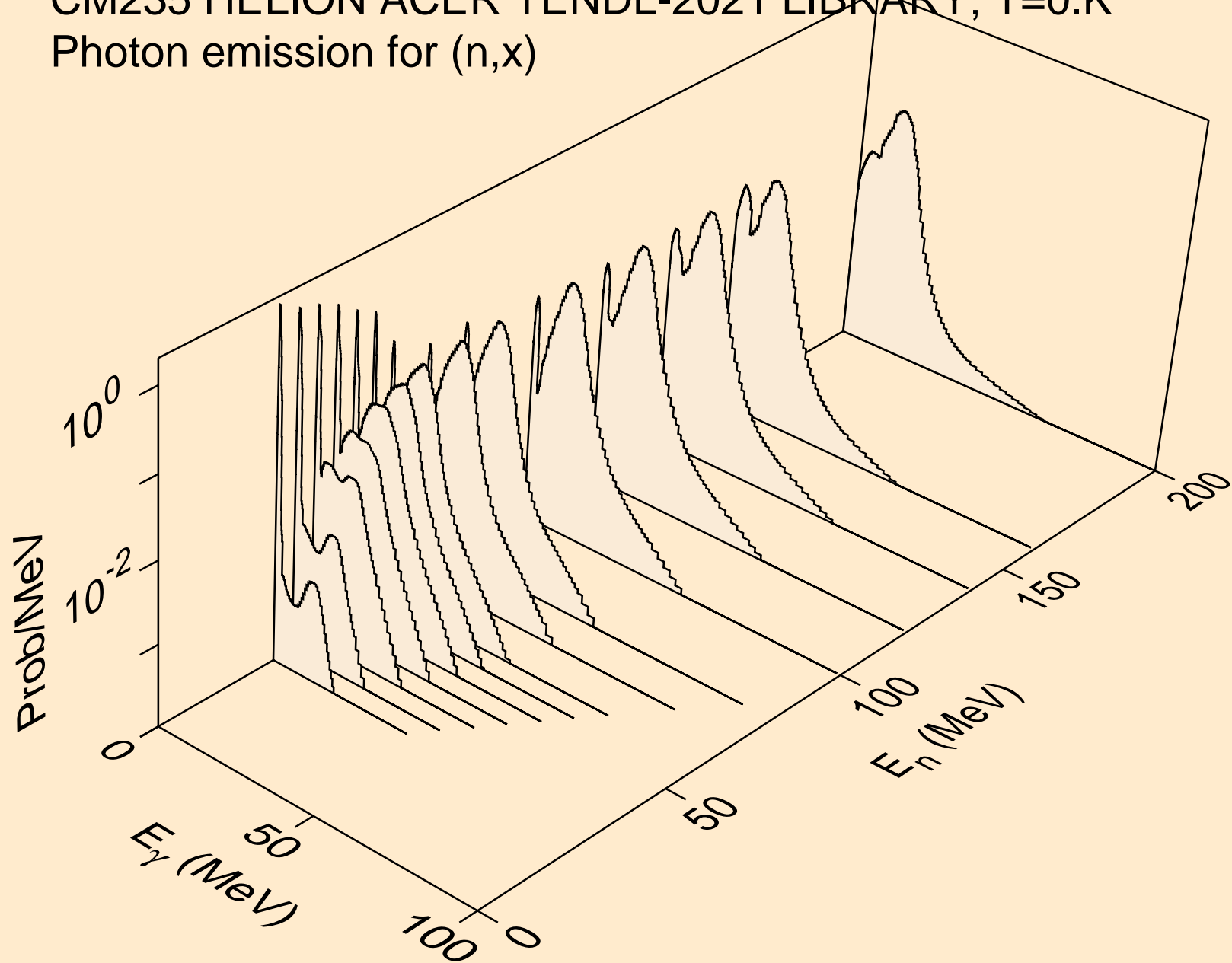

CM235 HELION ACER TENDL-2021 LIBRARY; T=0.K
Photon emission for (n,2n)

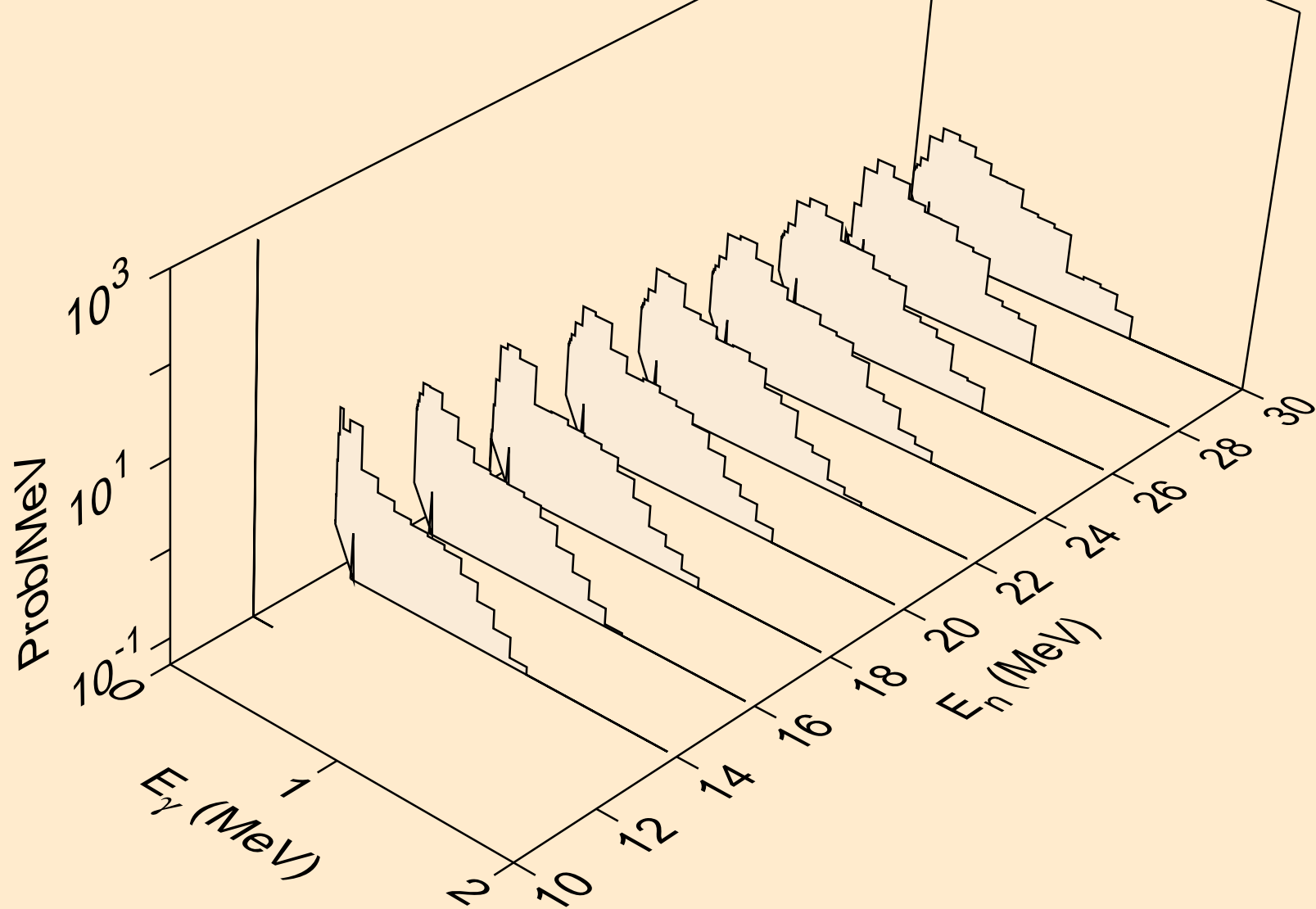

CM235 HELION ACER TENDL-2021 LIBRARY; T=0.K
Photon emission for (n,n*)a

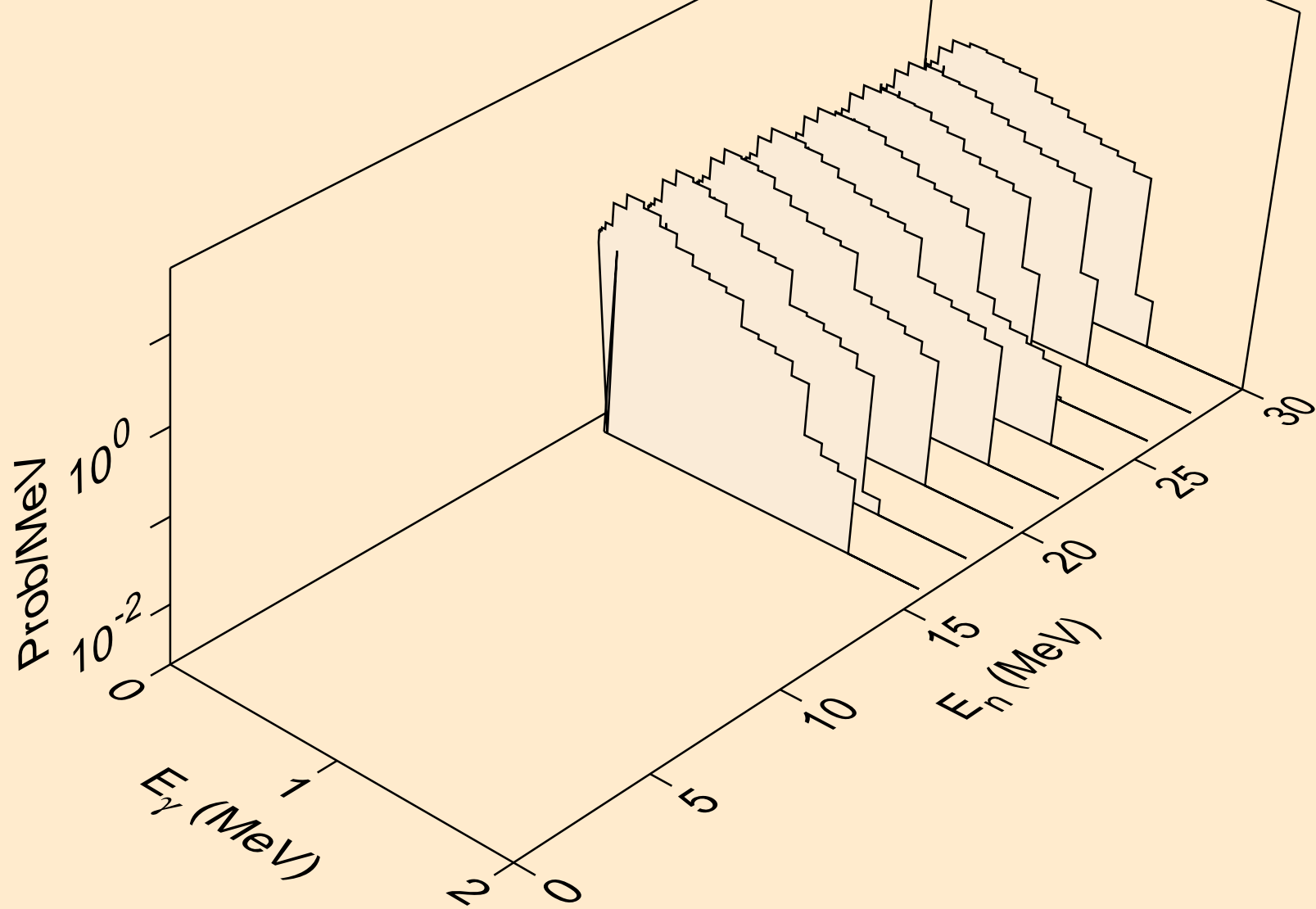

CM235 HELION ACER TENDL-2021 LIBRARY; T=0.K
Photon emission for (n,n*)p

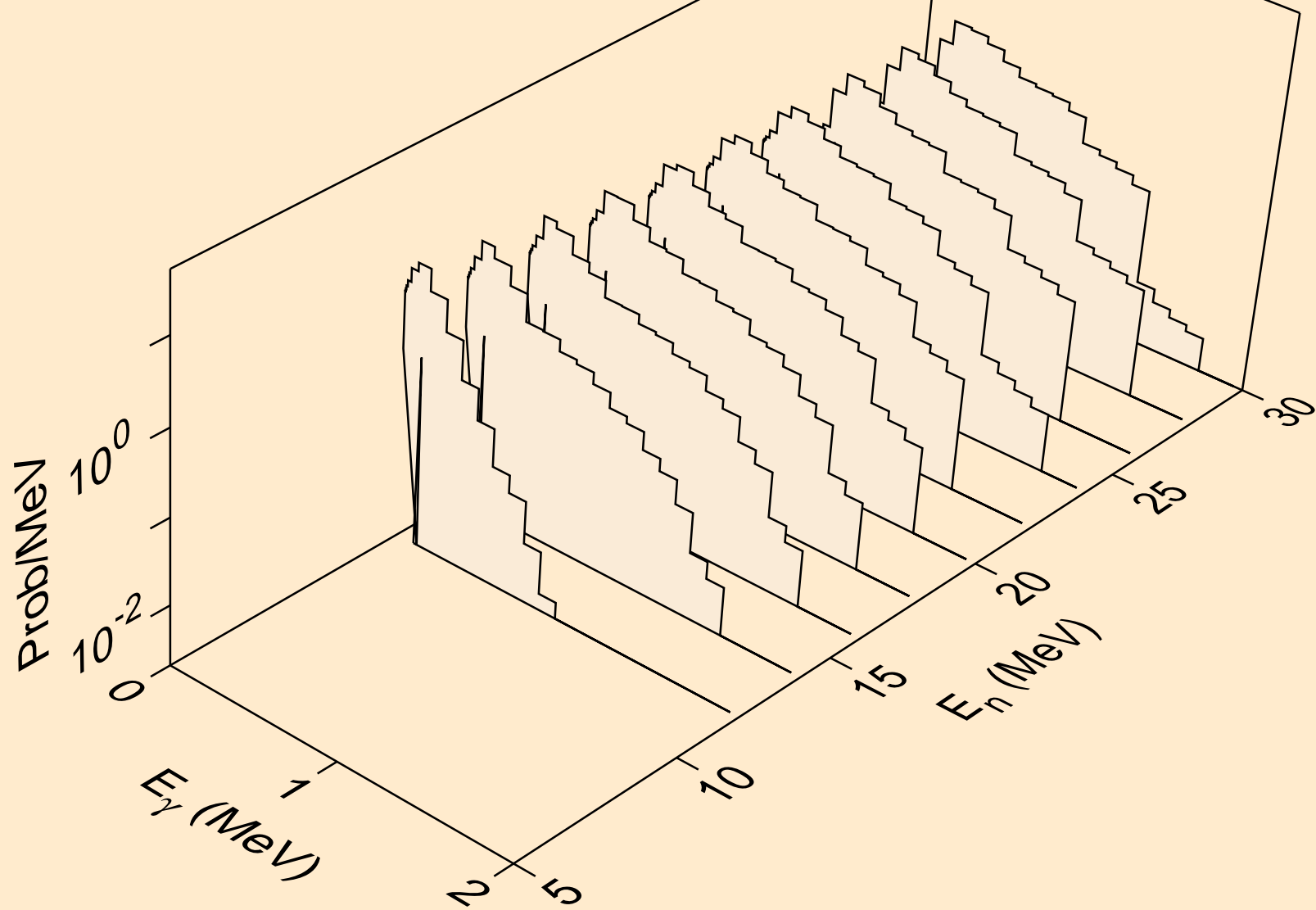

CM235 HELION ACER TENDL-2021 LIBRARY; T=0.K
Photon emission for (n,n*)d

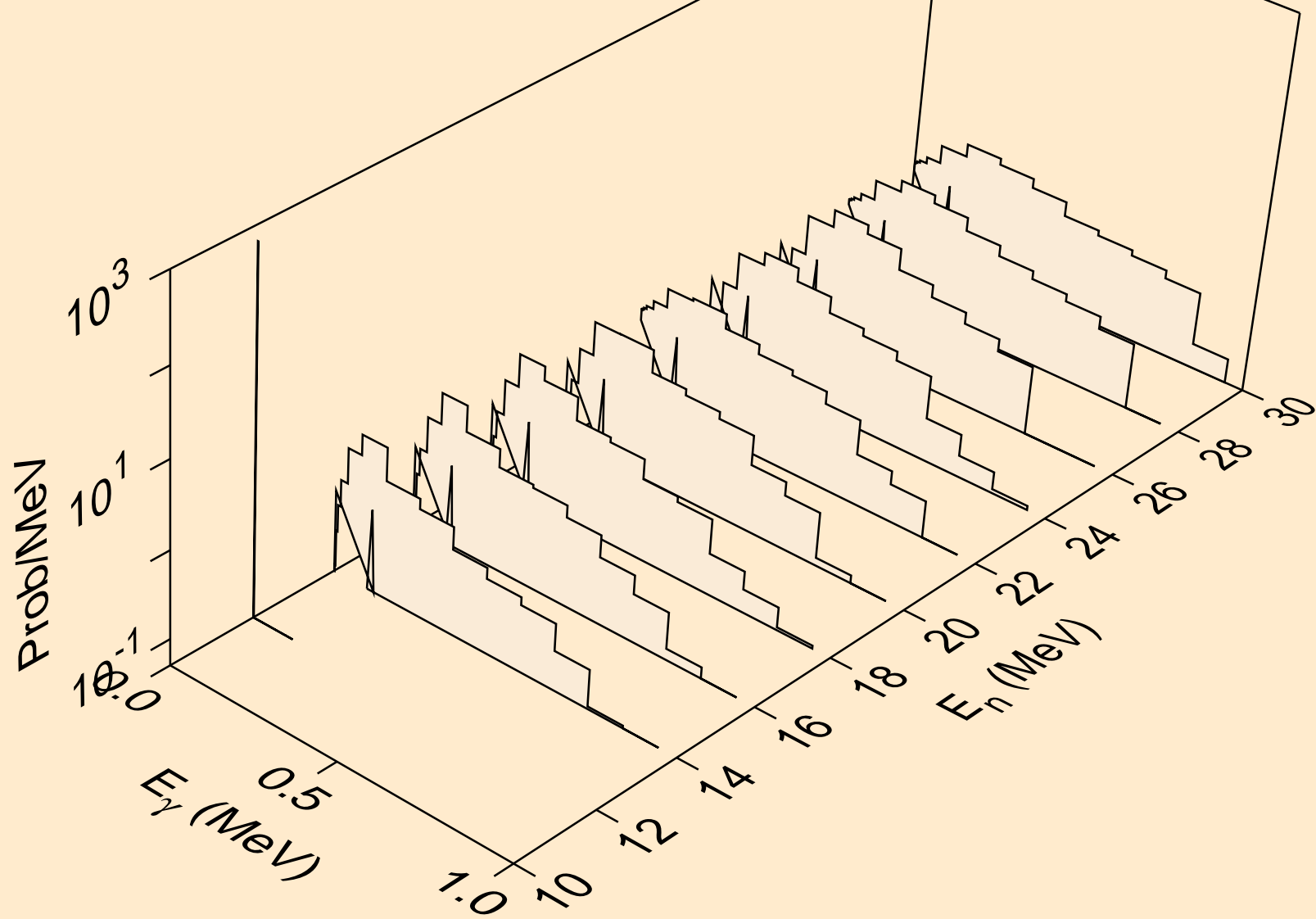

CM235 HELION ACER TENDL-2021 LIBRARY; T=0.K
Photon emission for (n,n*)t

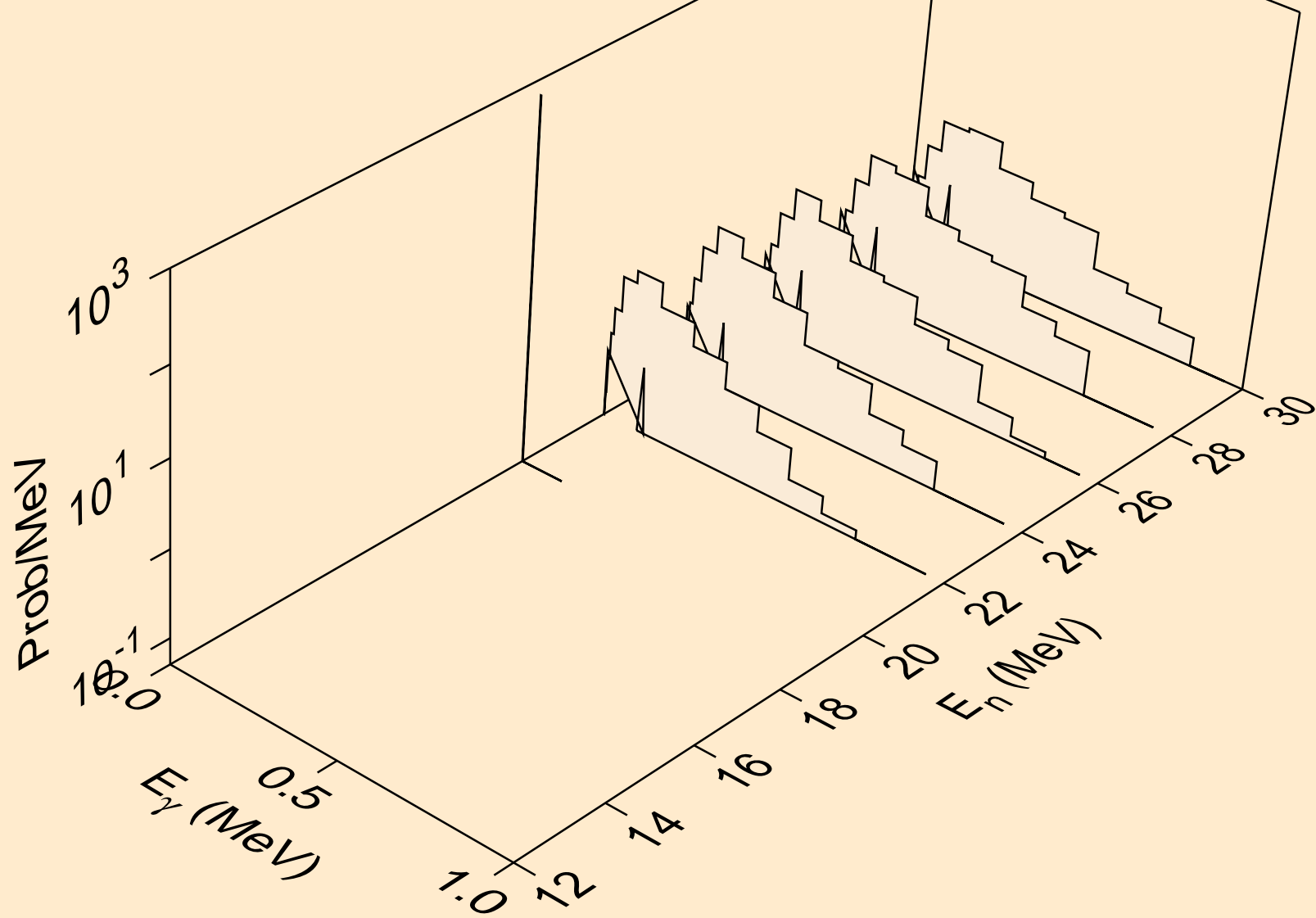

CM235 HELION ACER TENDL-2021 LIBRARY; T=0.K
Photon emission for (n,2np)

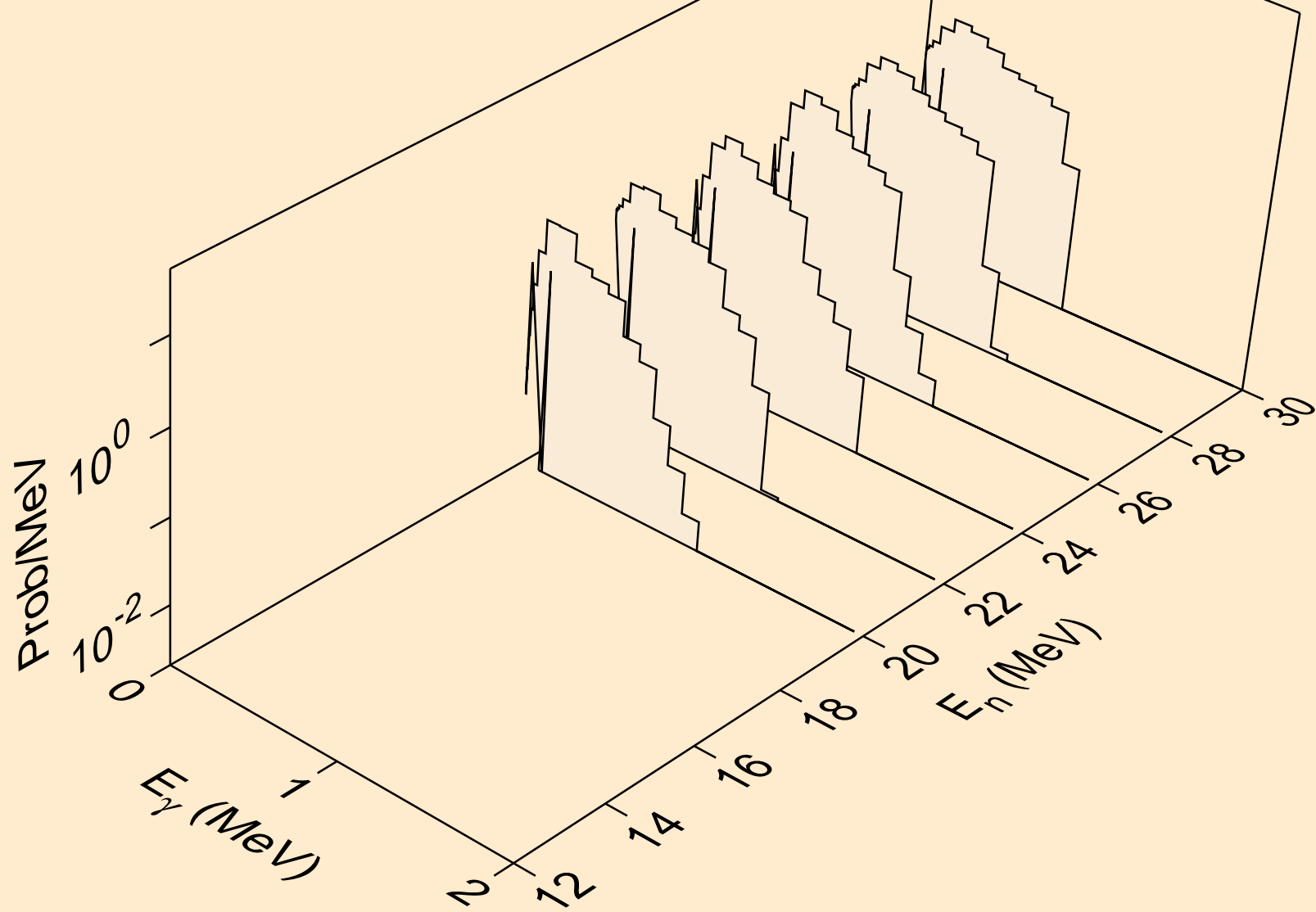

CM235 HELION ACER TENDL-2021 LIBRARY; T=0.K
Photon emission for (n,2np)

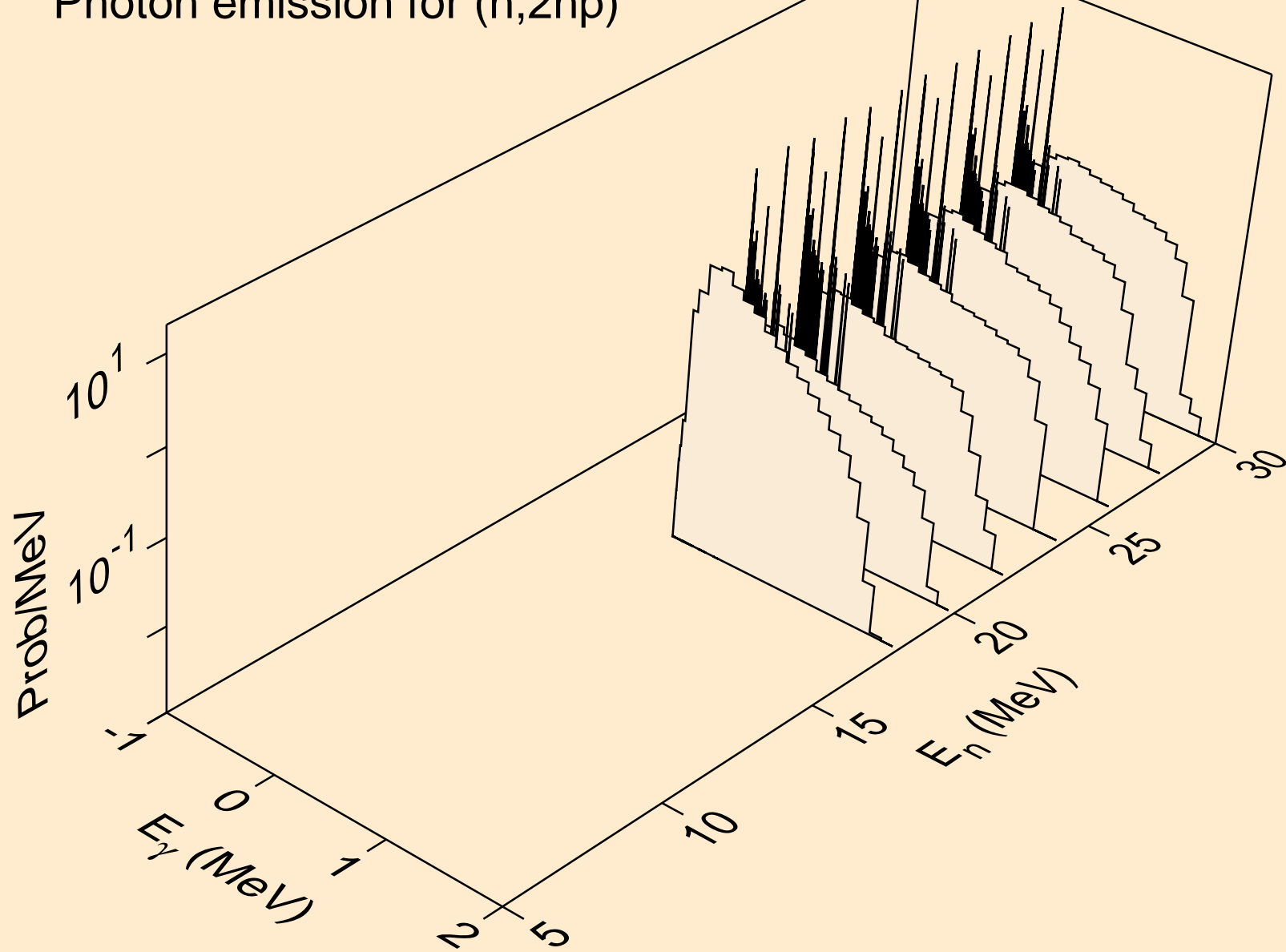

CM235 HELION ACER TENDL-2021 LIBRARY; T=0.K
Photon emission for (n,p)

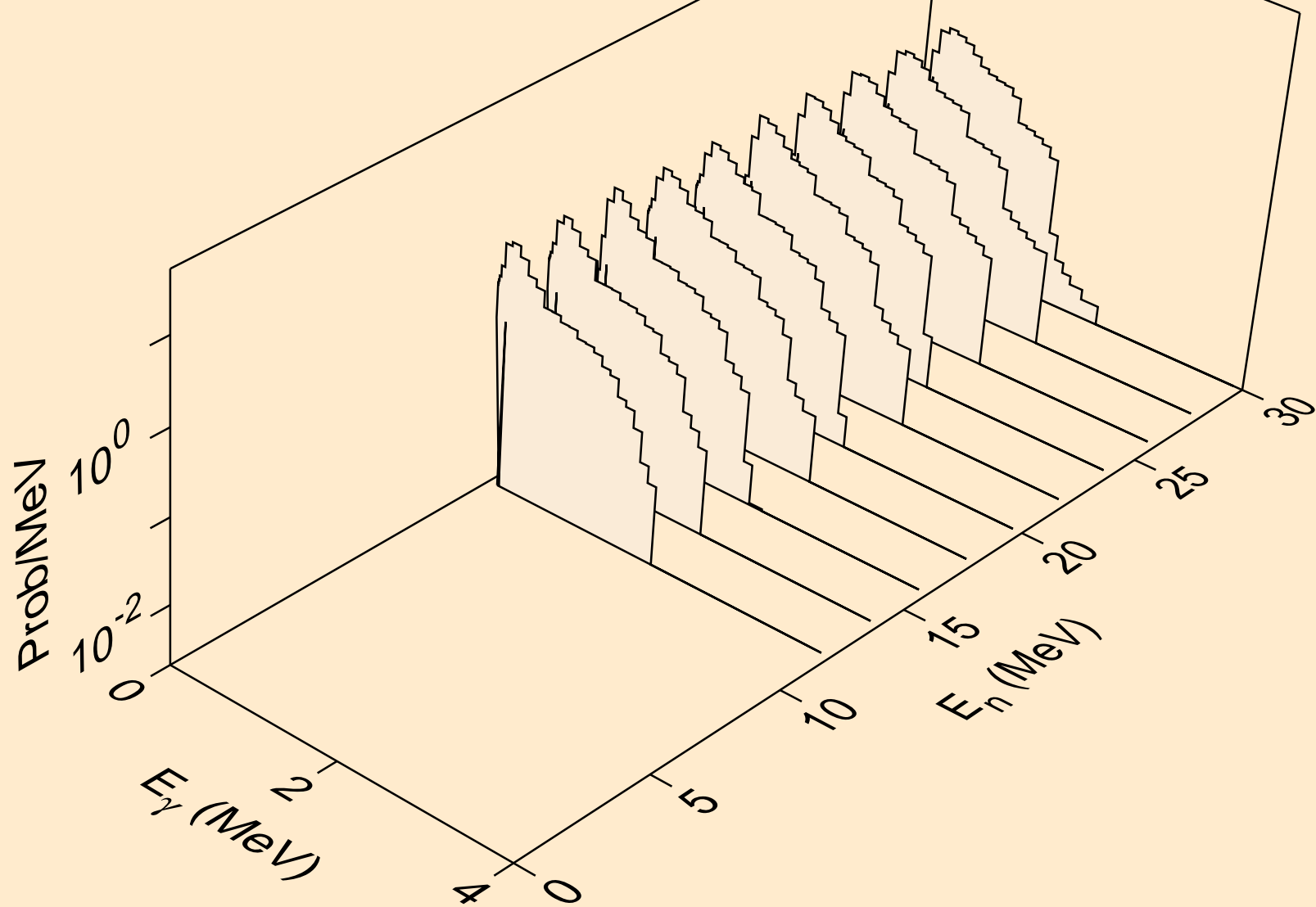

CM235 HELION ACER TENDL-2021 LIBRARY; T=0.K
Photon emission for (n,d)

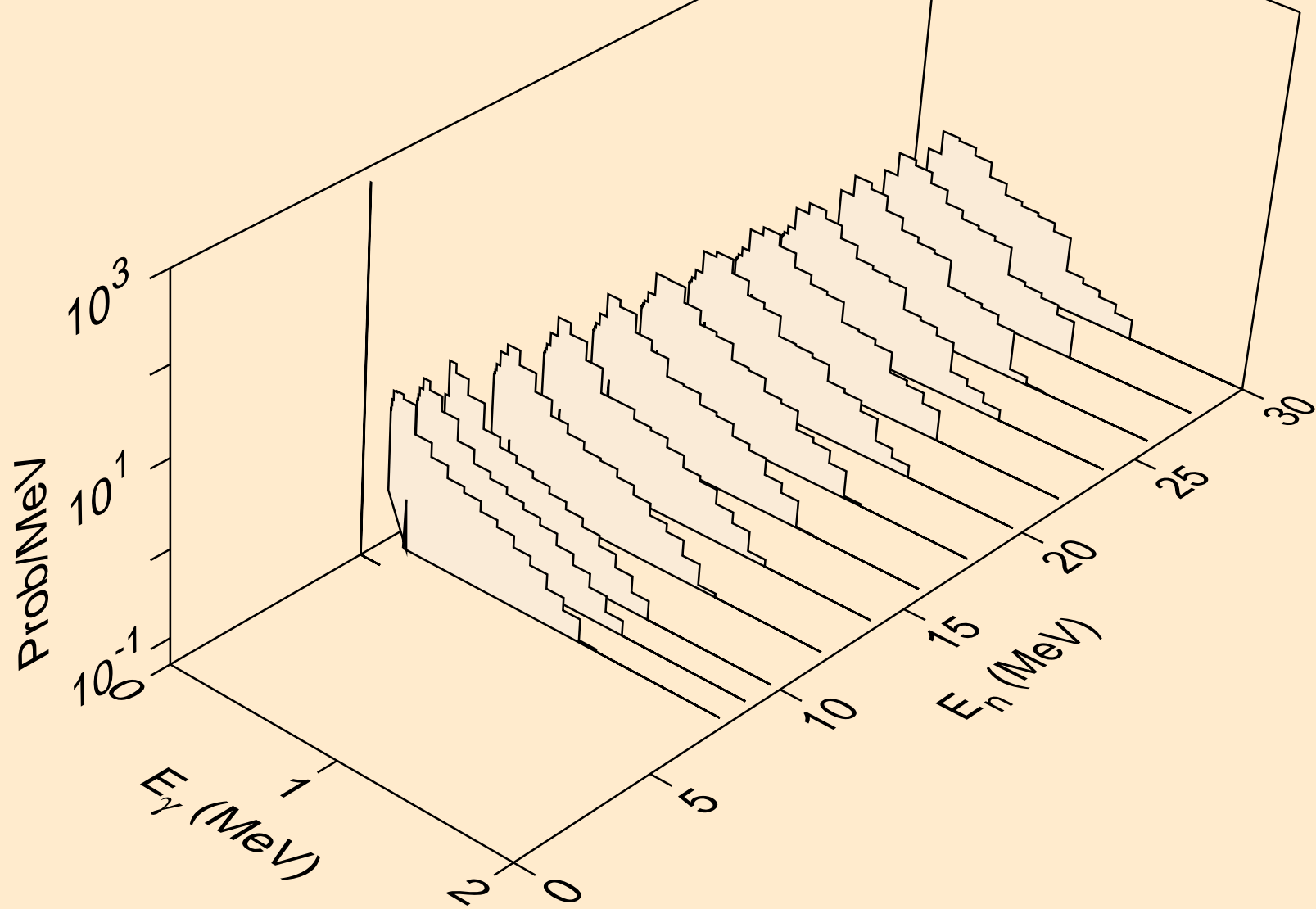

CM235 HELION ACER TENDL-2021 LIBRARY; T=0.K
Photon emission for (n,t)

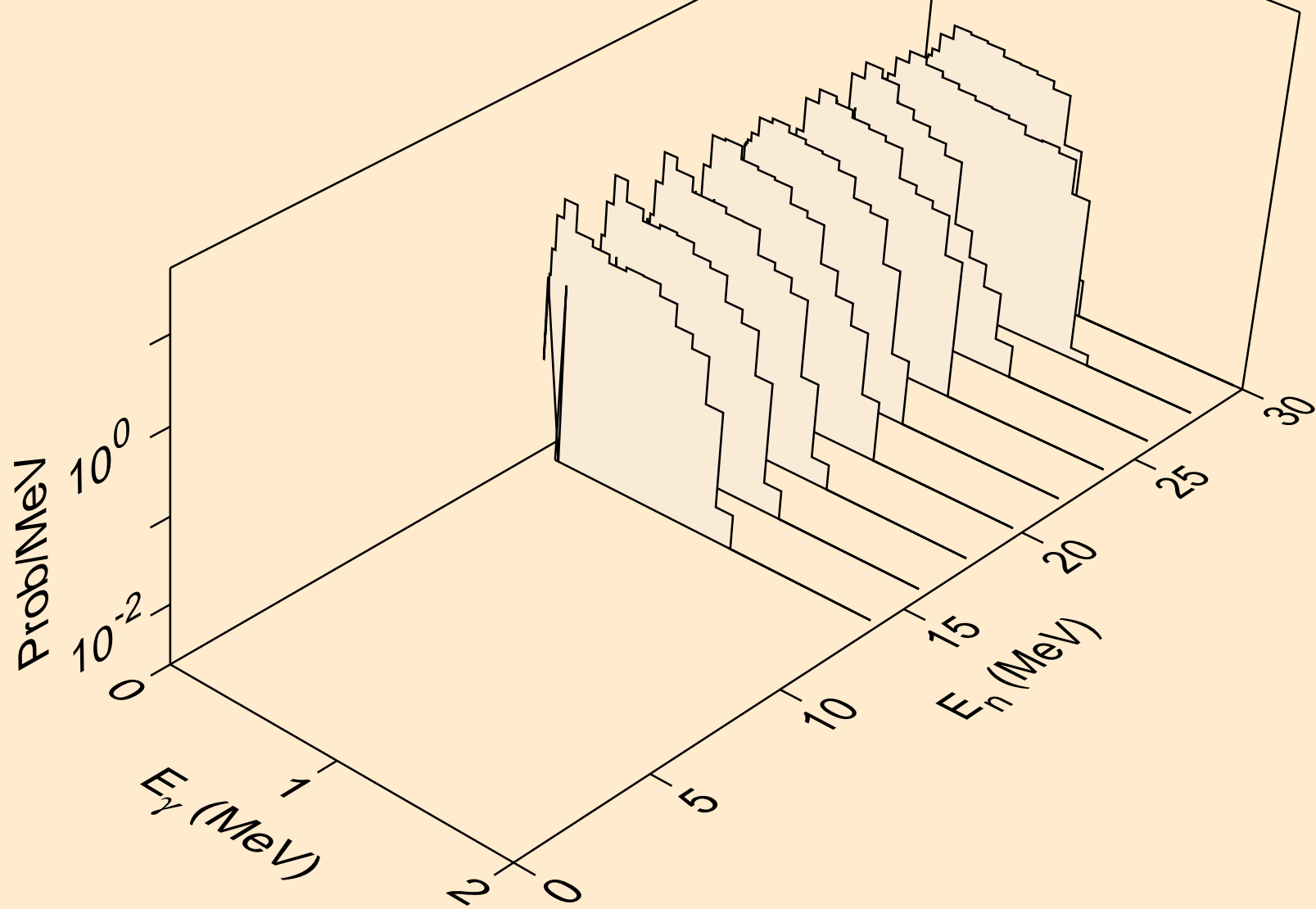

CM235 HELION ACER TENDL-2021 LIBRARY; T=0.K
Photon emission for inelastic

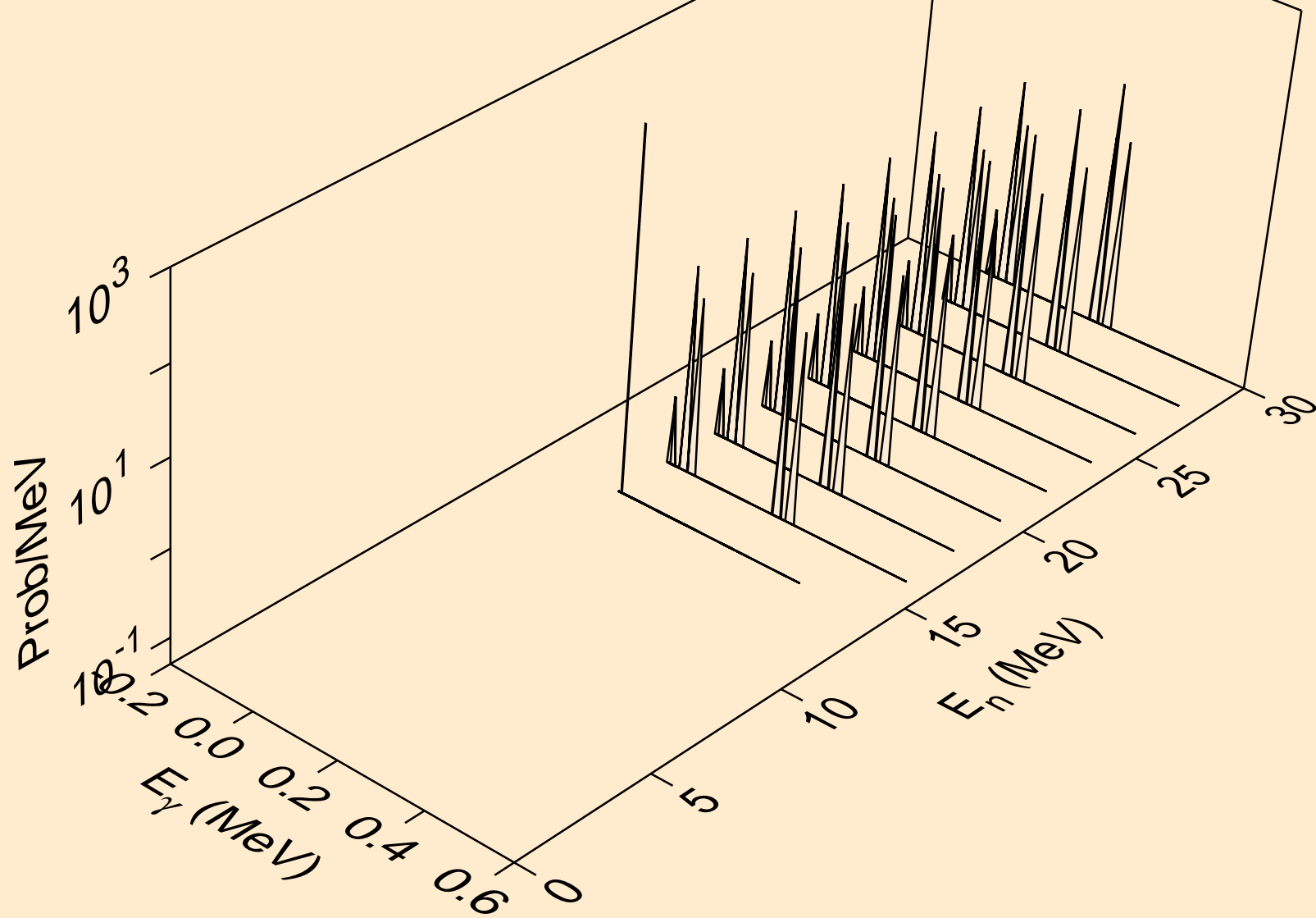

CM235 HELION ACER TENDL-2021 LIBRARY; T=0.K
Photon emission for (n,a)

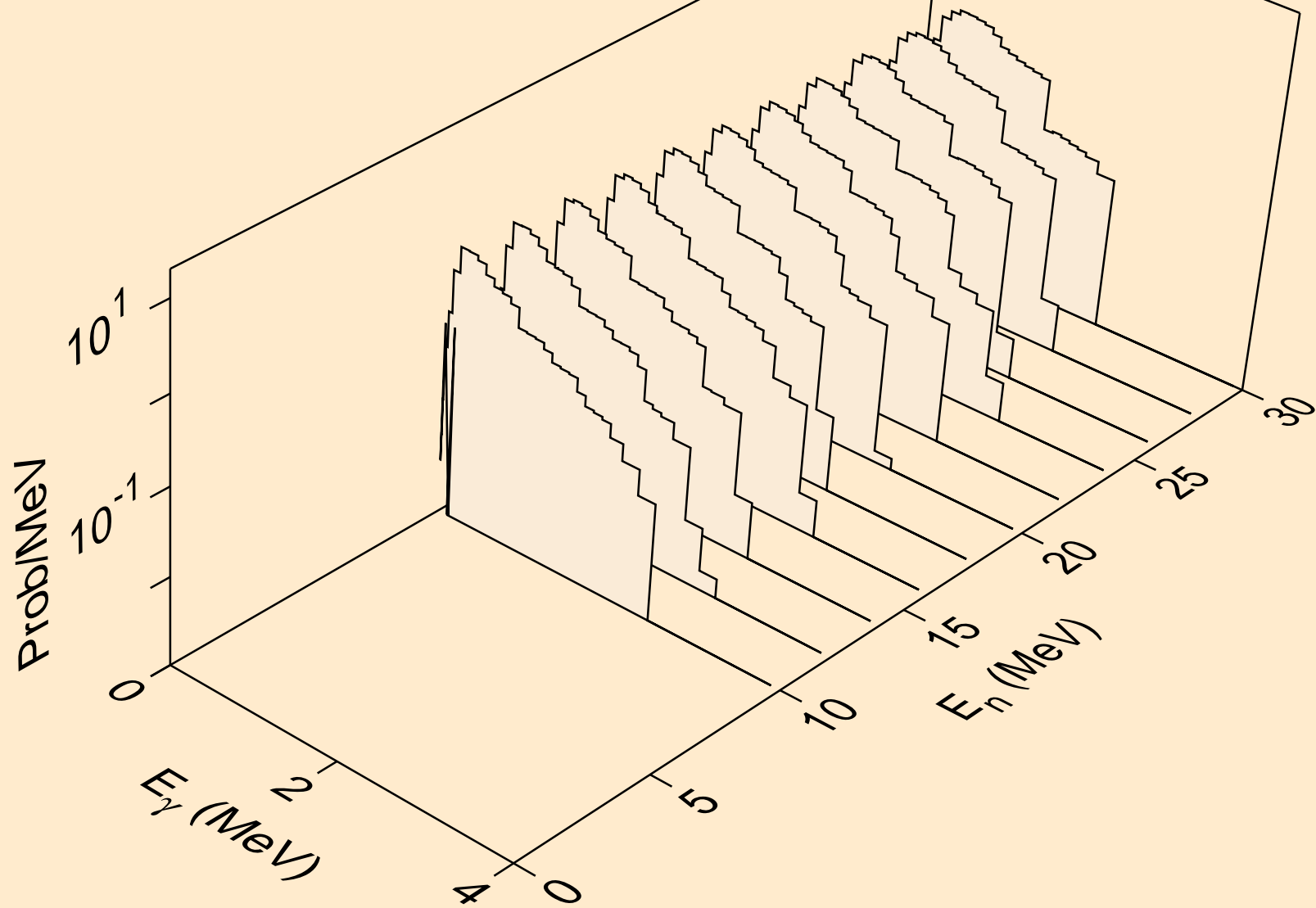

CM235 HELION ACER TENDL-2021 LIBRARY; T=0.K
Photon emission for (n,2p)

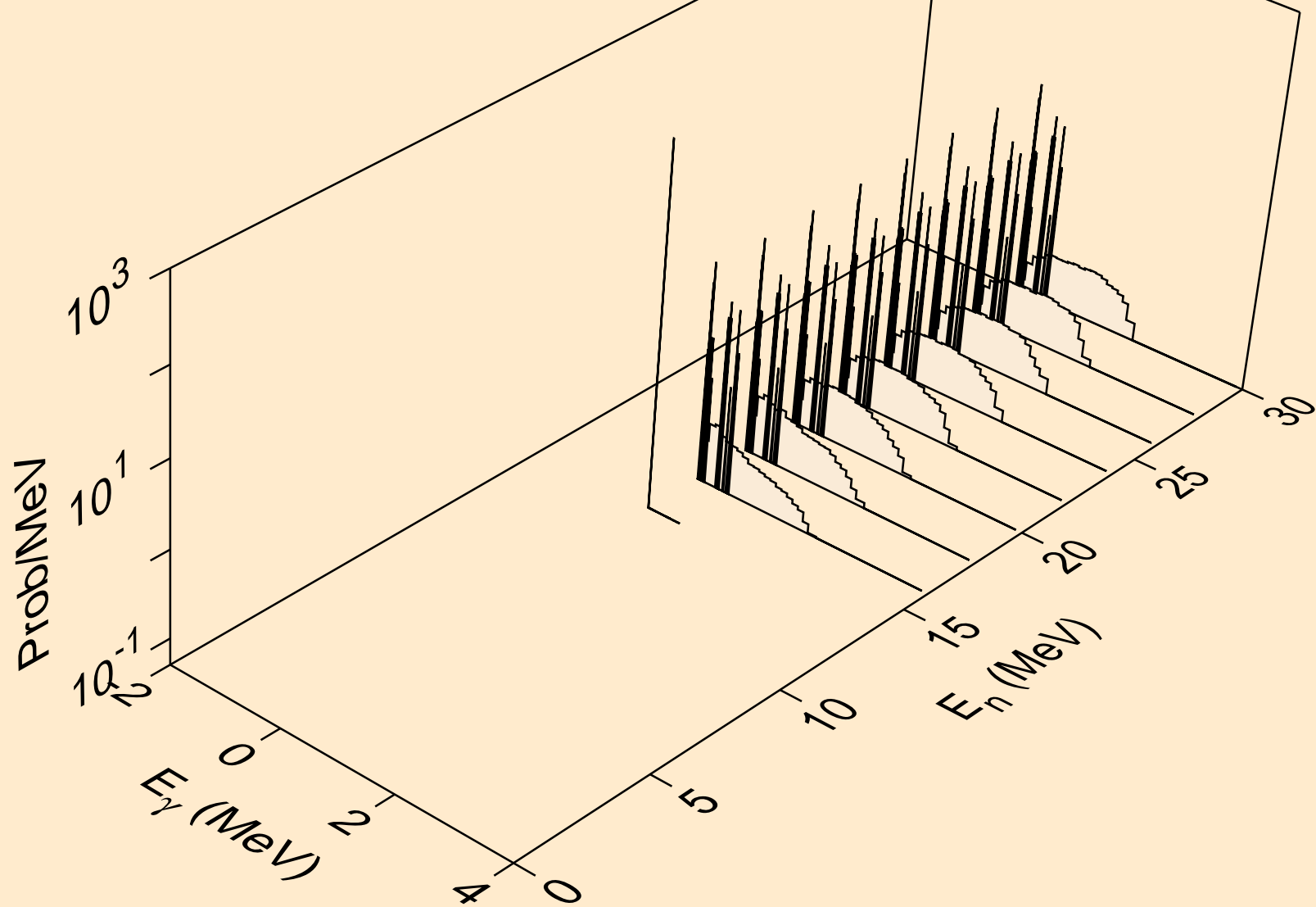

CM235 HELION ACER TENDL-2021 LIBRARY; T=0.K
Photon emission for (n,pd)

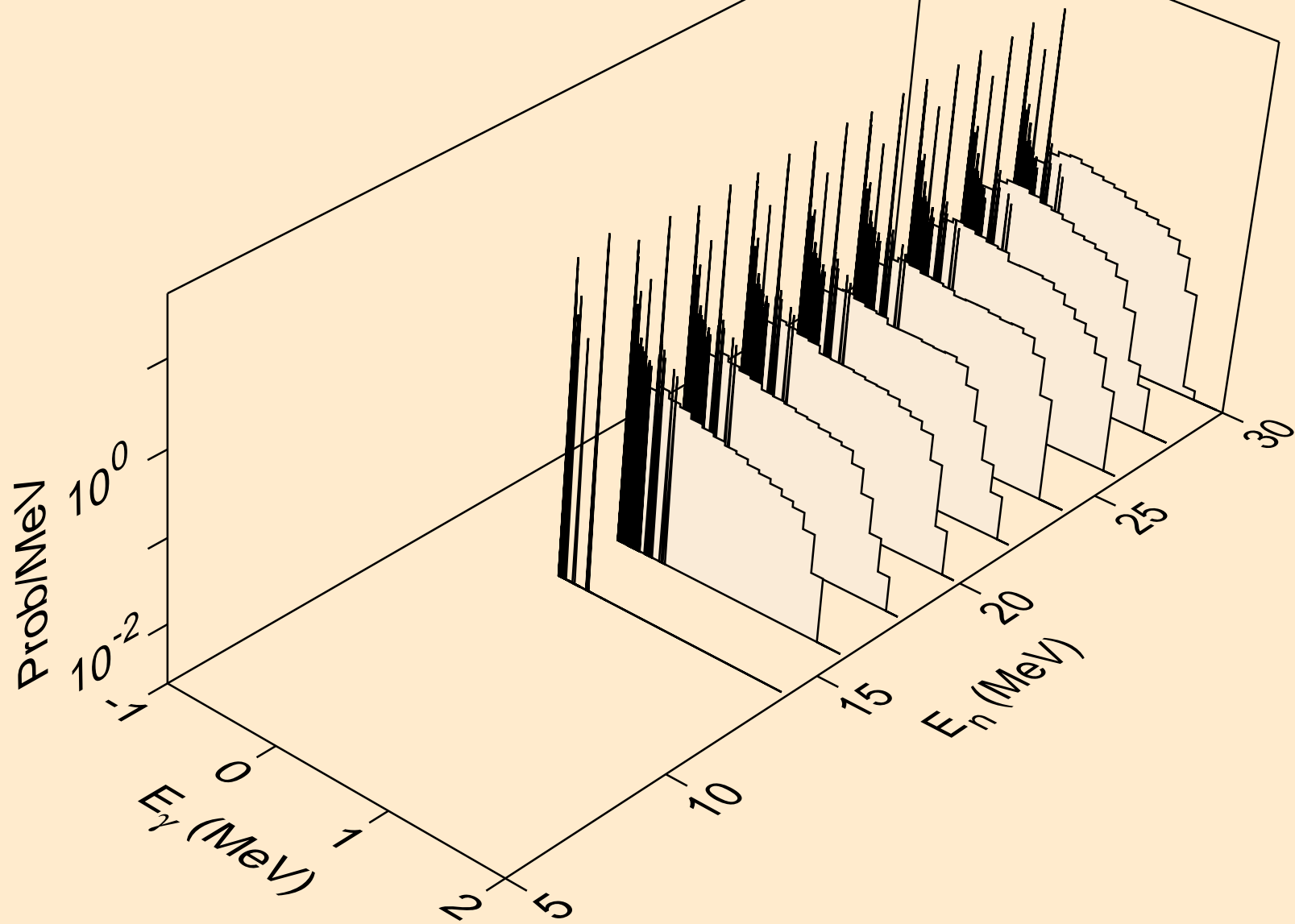

CM235 HELION ACER TENDL-2021 LIBRARY; T=0.K

Particle heating contributions

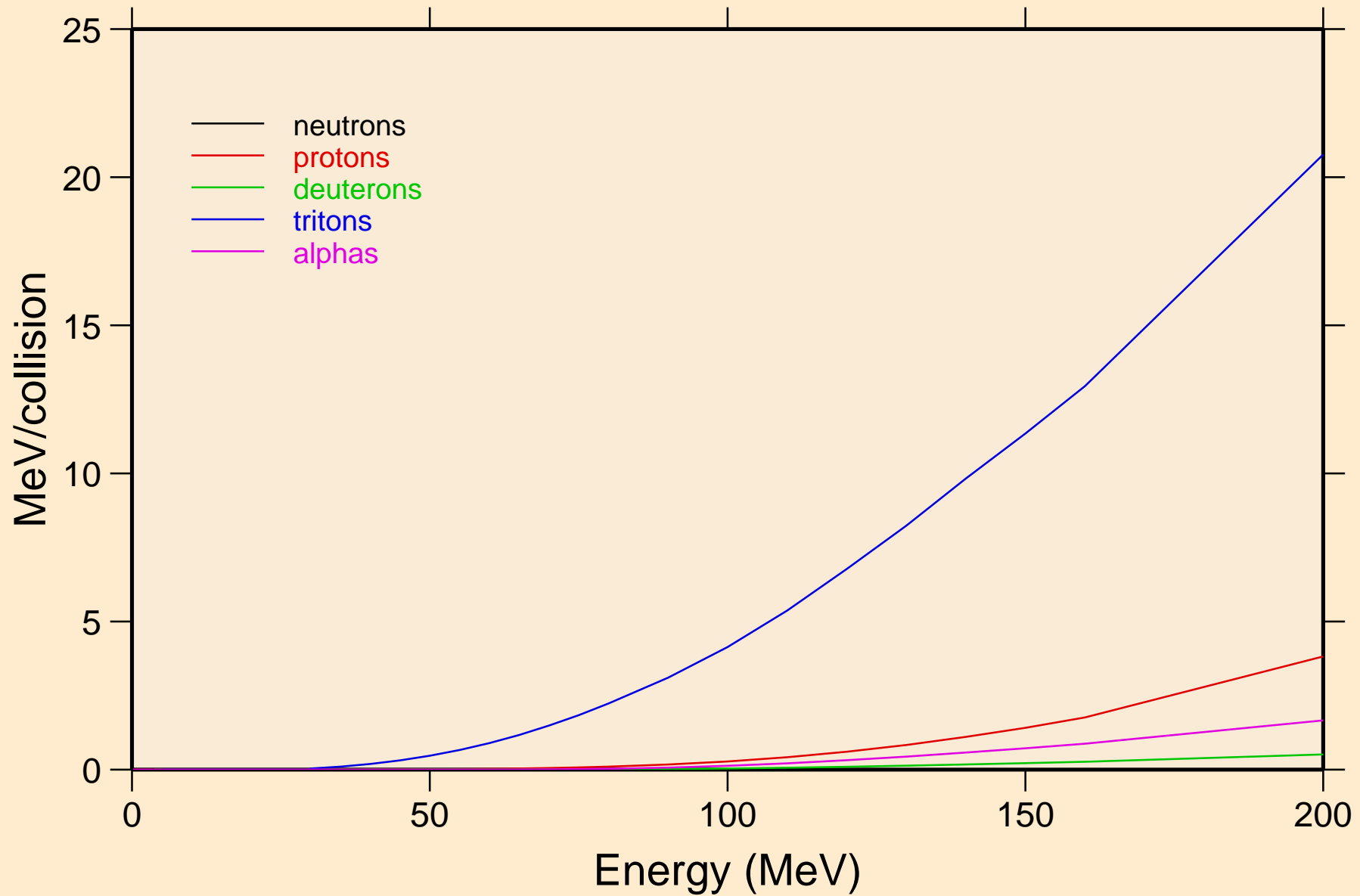

CM235 HELION ACER TENDL-2021 LIBRARY; T=0.K
Recoil Heating

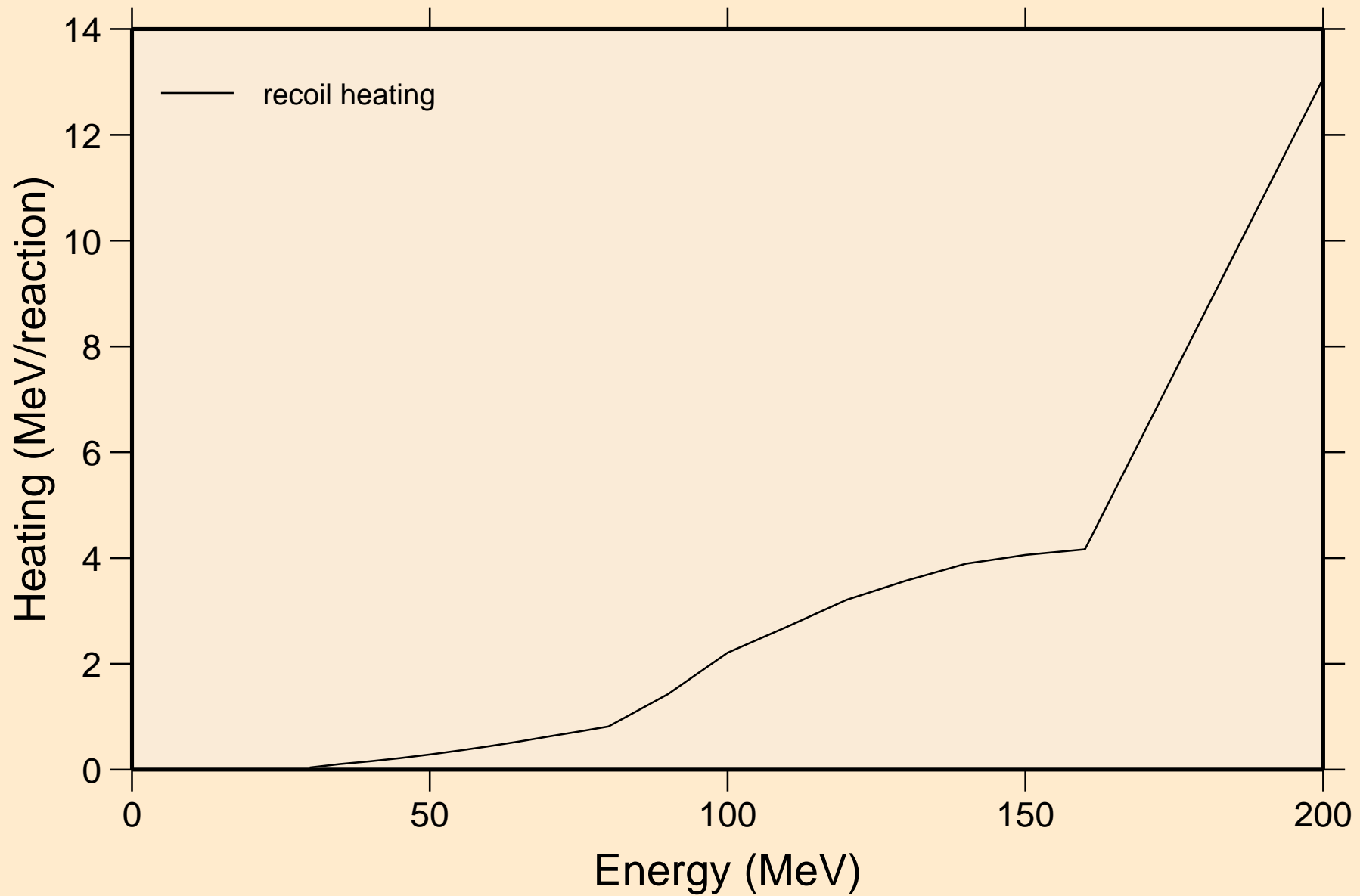

CM235 HELION ACER TENDL-2021 LIBRARY; T=0.K
Particle production cross sections

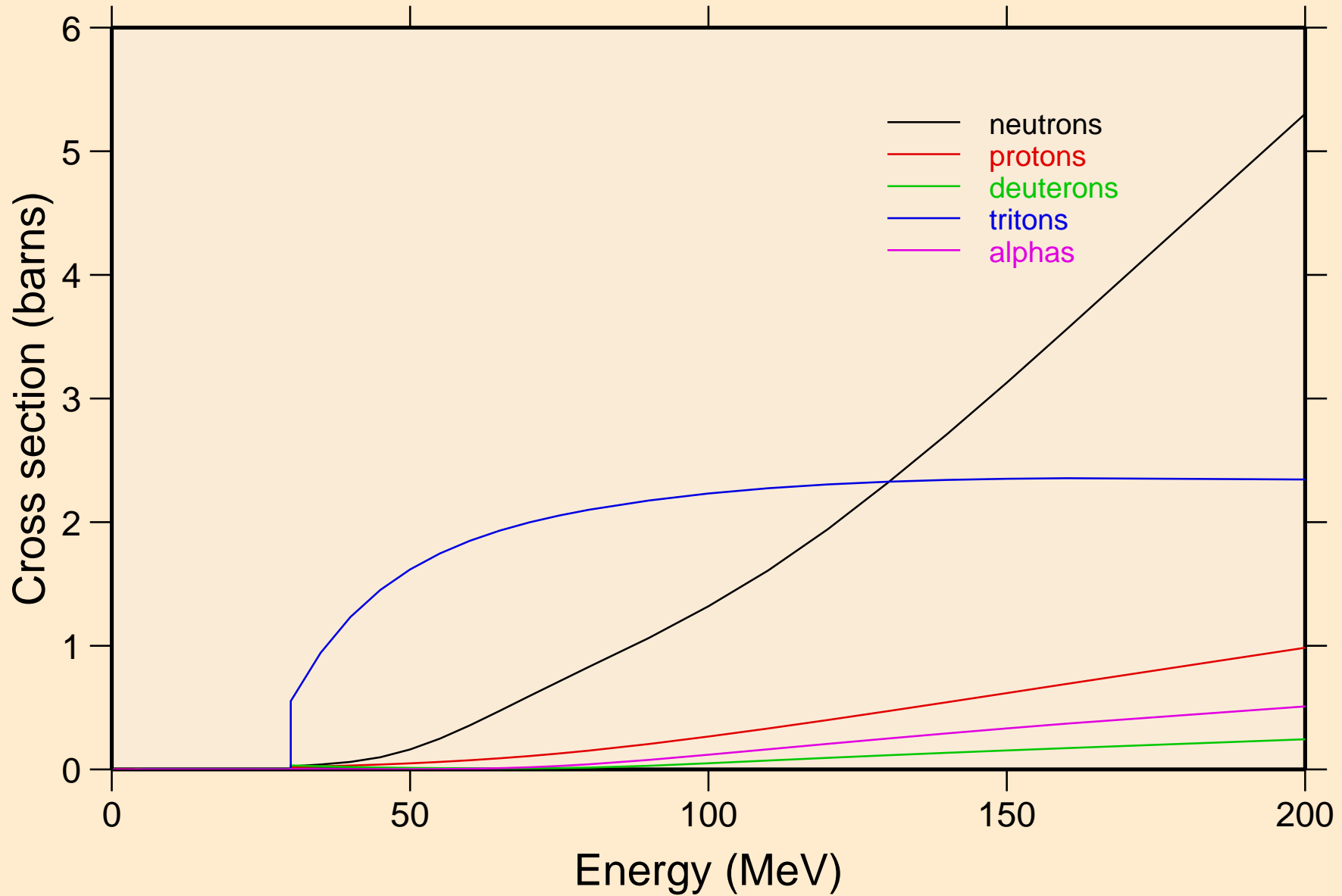

CM235 HELION ACER TENDL-2021 LIBRARY; T=0.K
neutrons from (s,n)

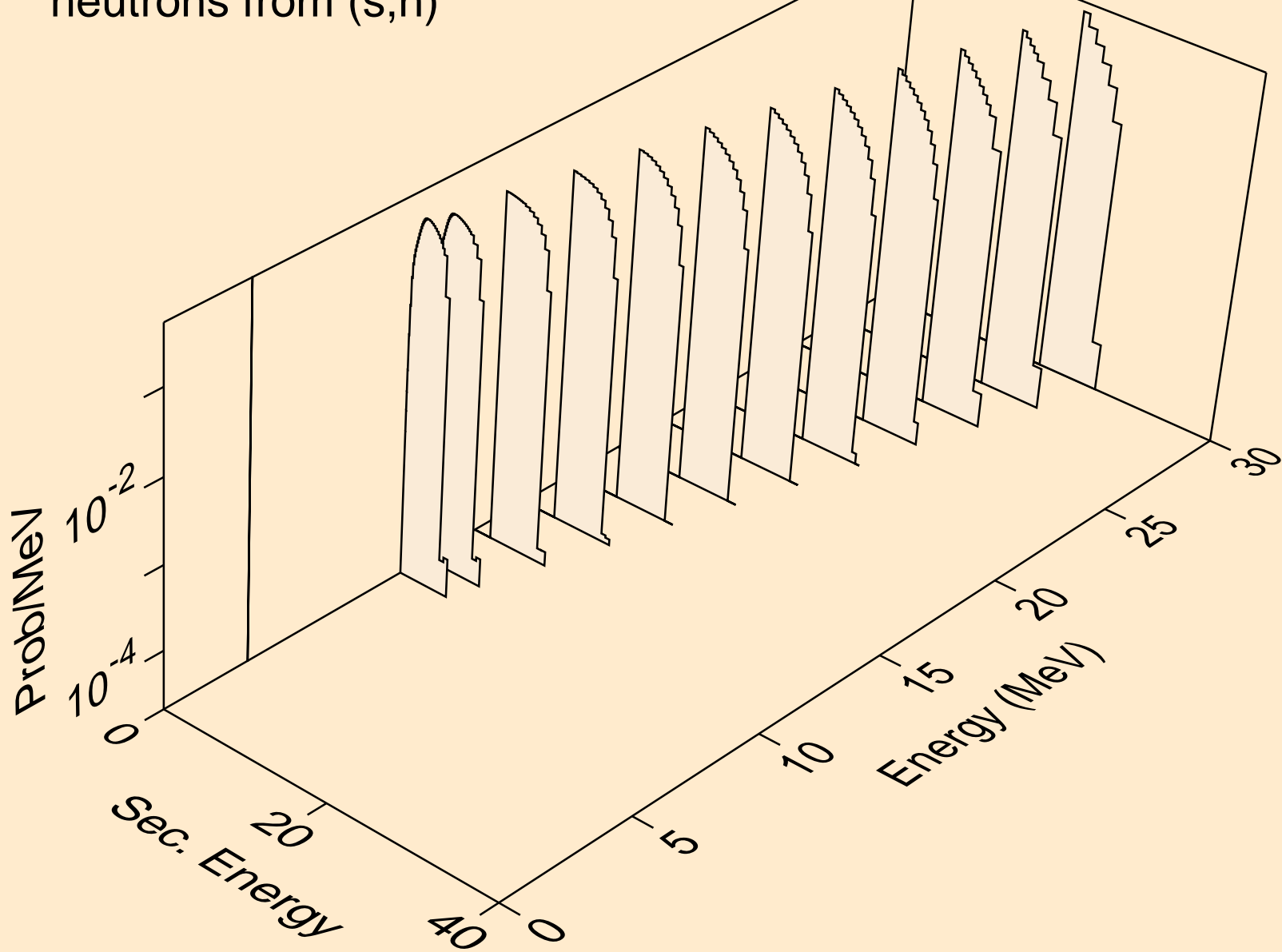

CM235 HELION ACER TENDL-2021 LIBRARY; T=0.K
neutrons from (s,x)

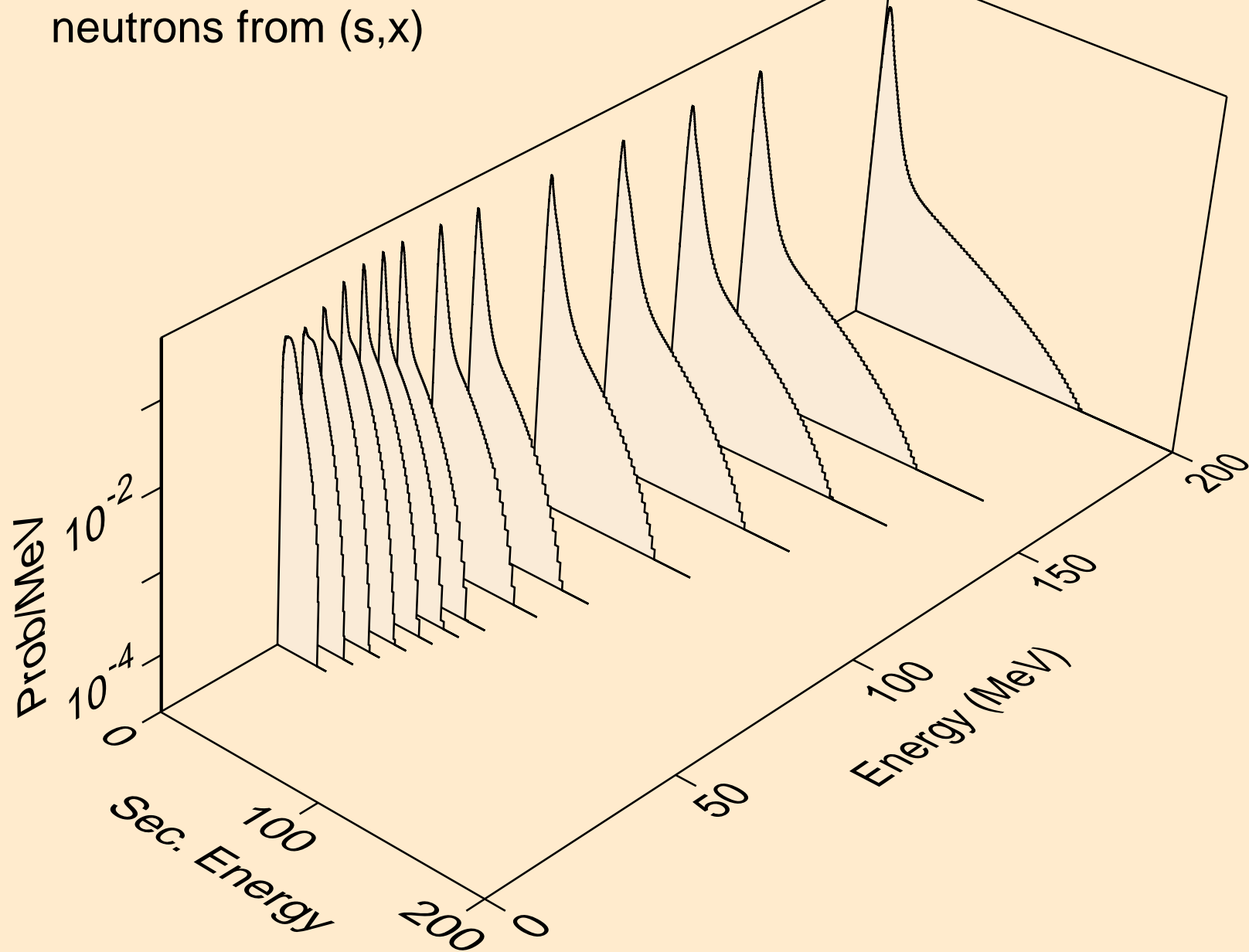

CM235 HELION ACER TENDL-2021 LIBRARY; T=0.K
neutrons from (s,2n)

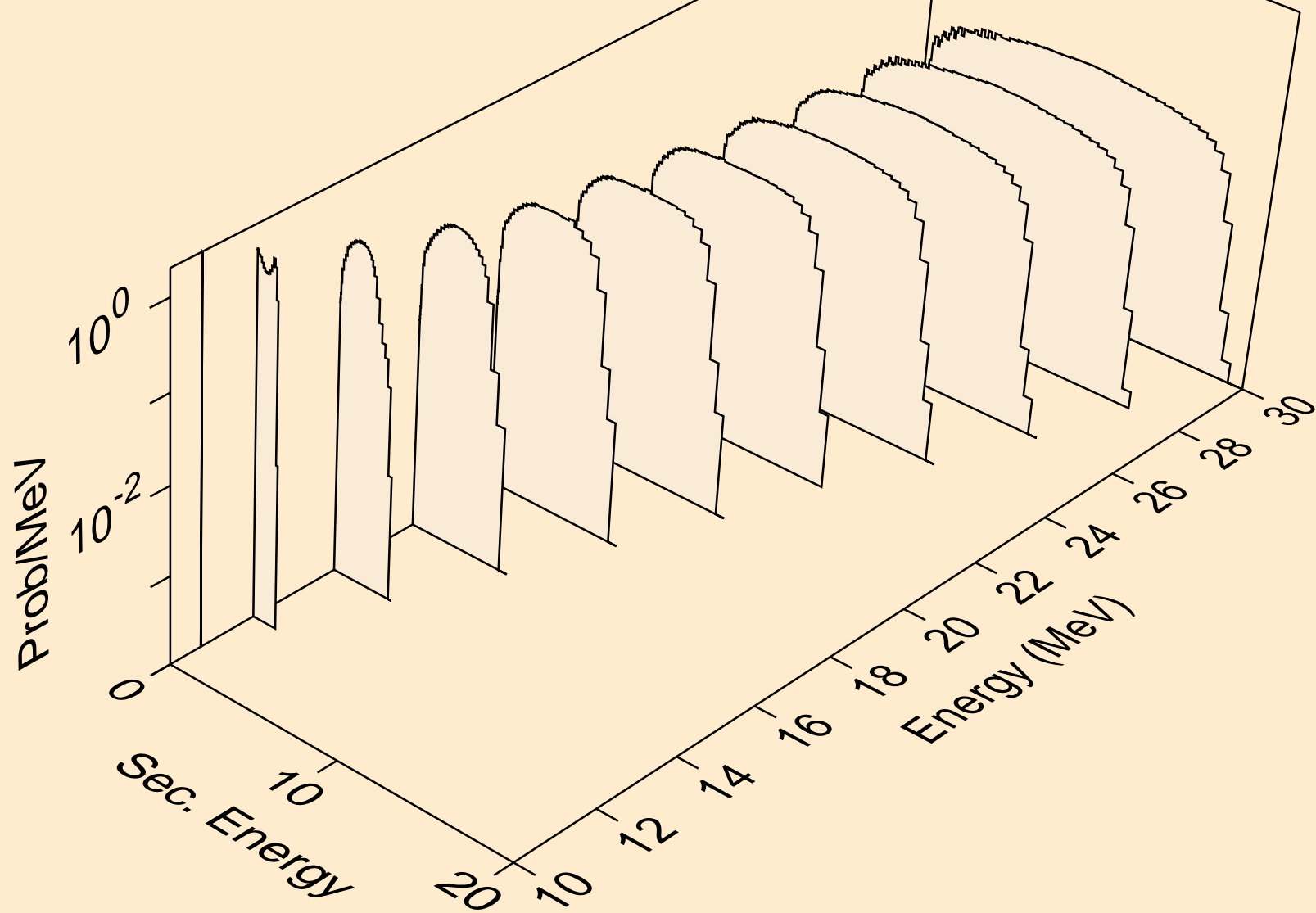

CM235 HELION ACER TENDL-2021 LIBRARY; T=0.K
neutrons from (s,n*)a

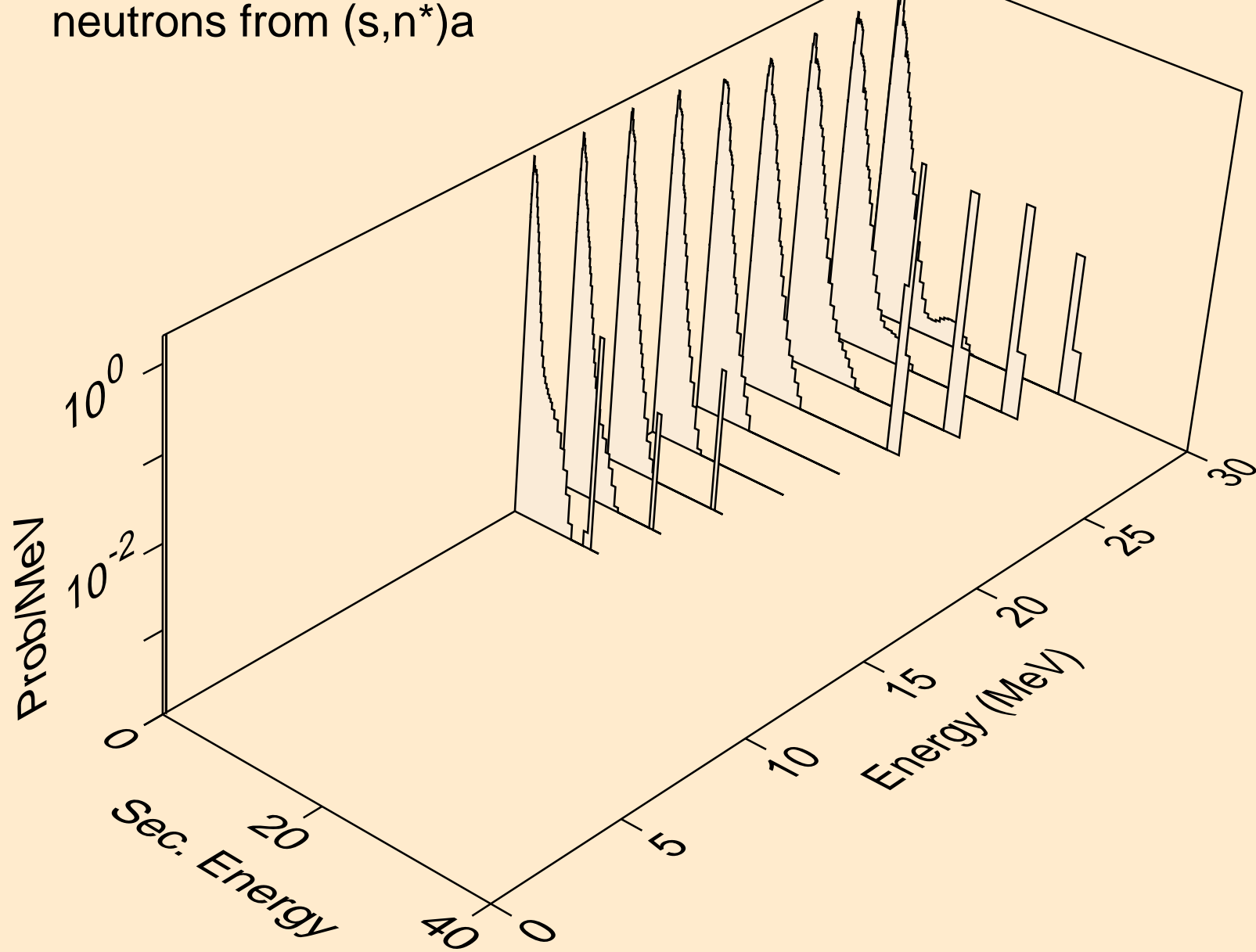

CM235 HELION ACER TENDL-2021 LIBRARY; T=0.K
neutrons from (s,n*)p

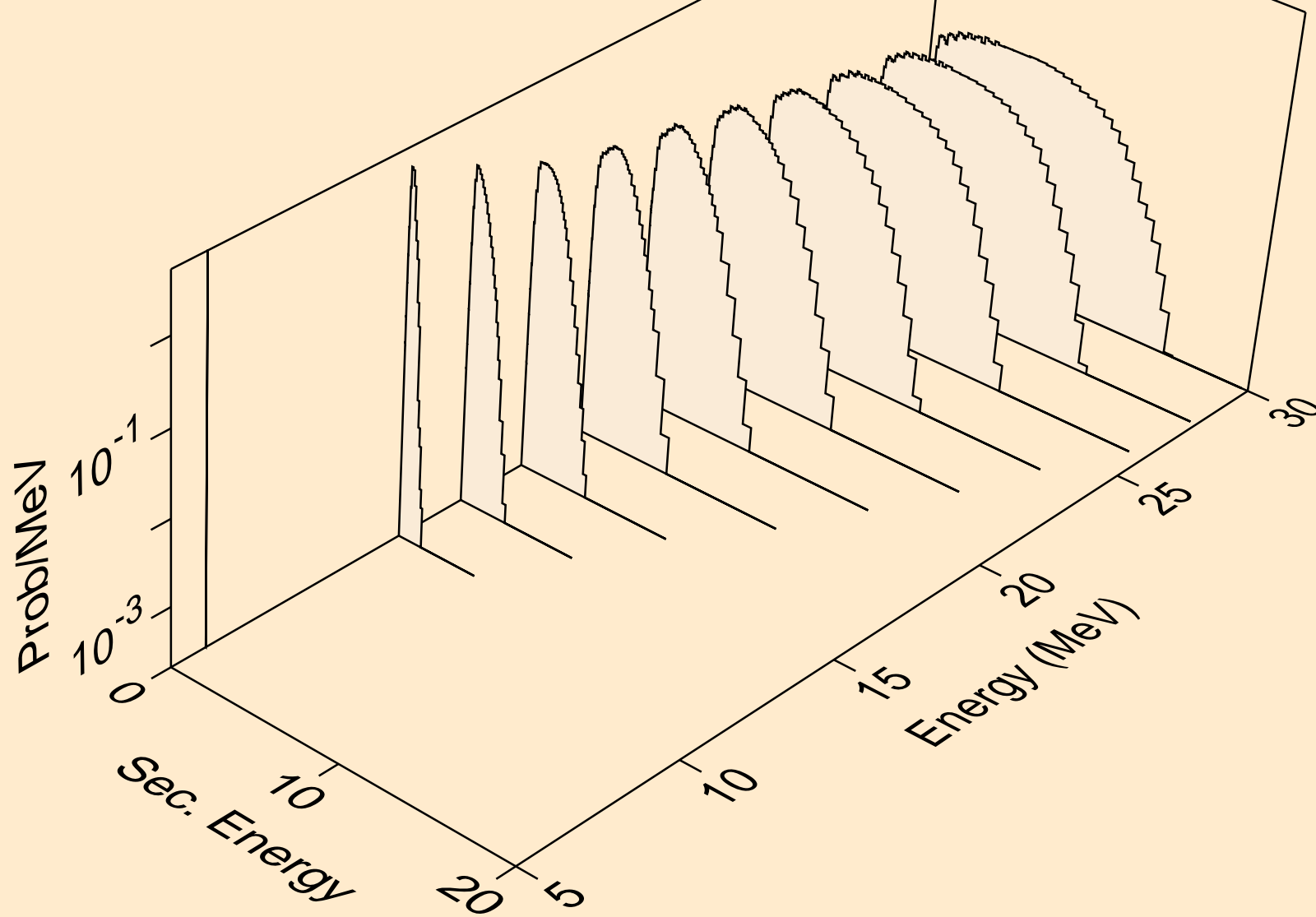

CM235 HELION ACER TENDL-2021 LIBRARY; T=0.K
neutrons from (s,n*)d

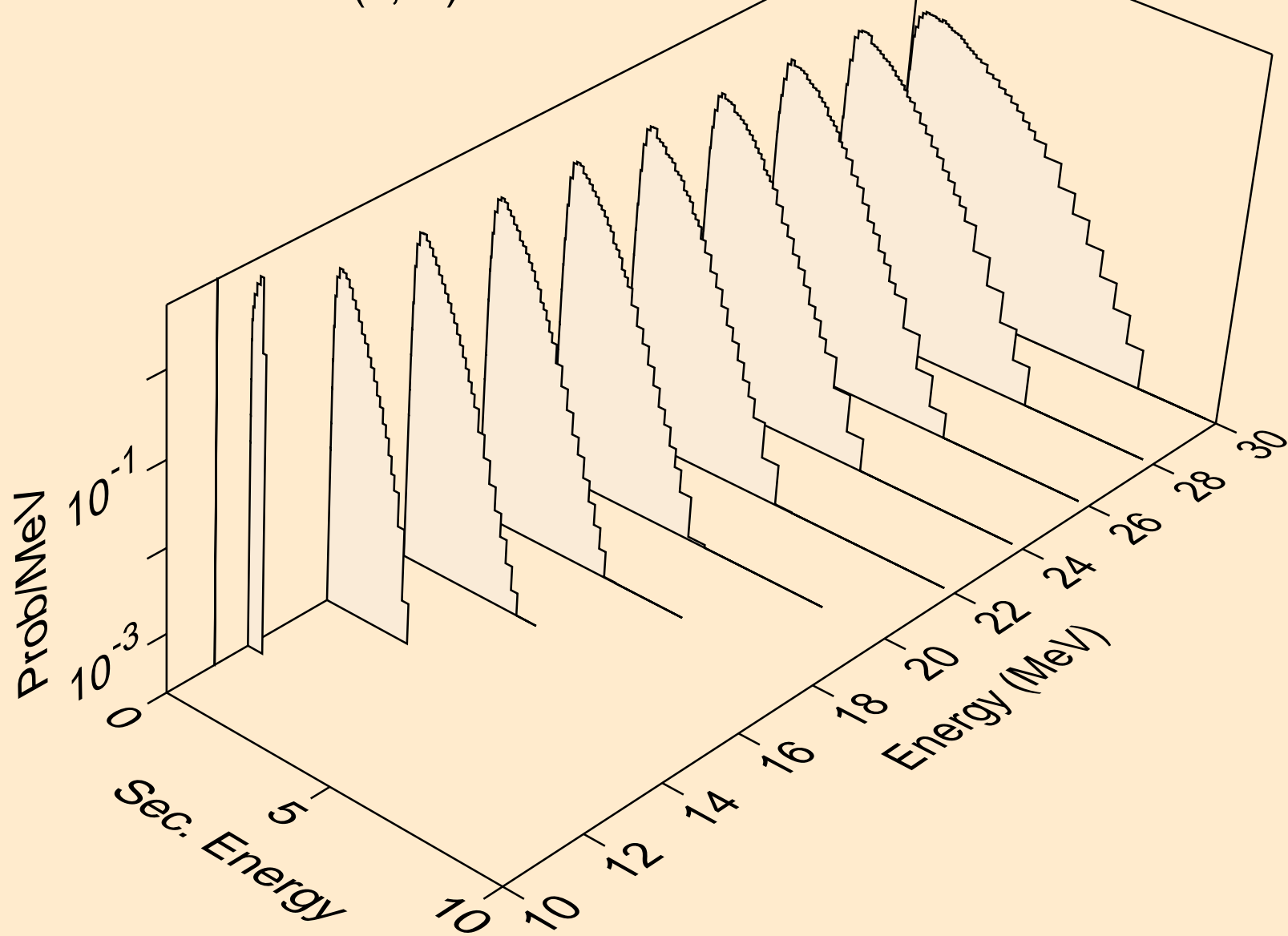

CM235 HELION ACER TENDL-2021 LIBRARY; T=0.K
neutrons from (s,n*)t

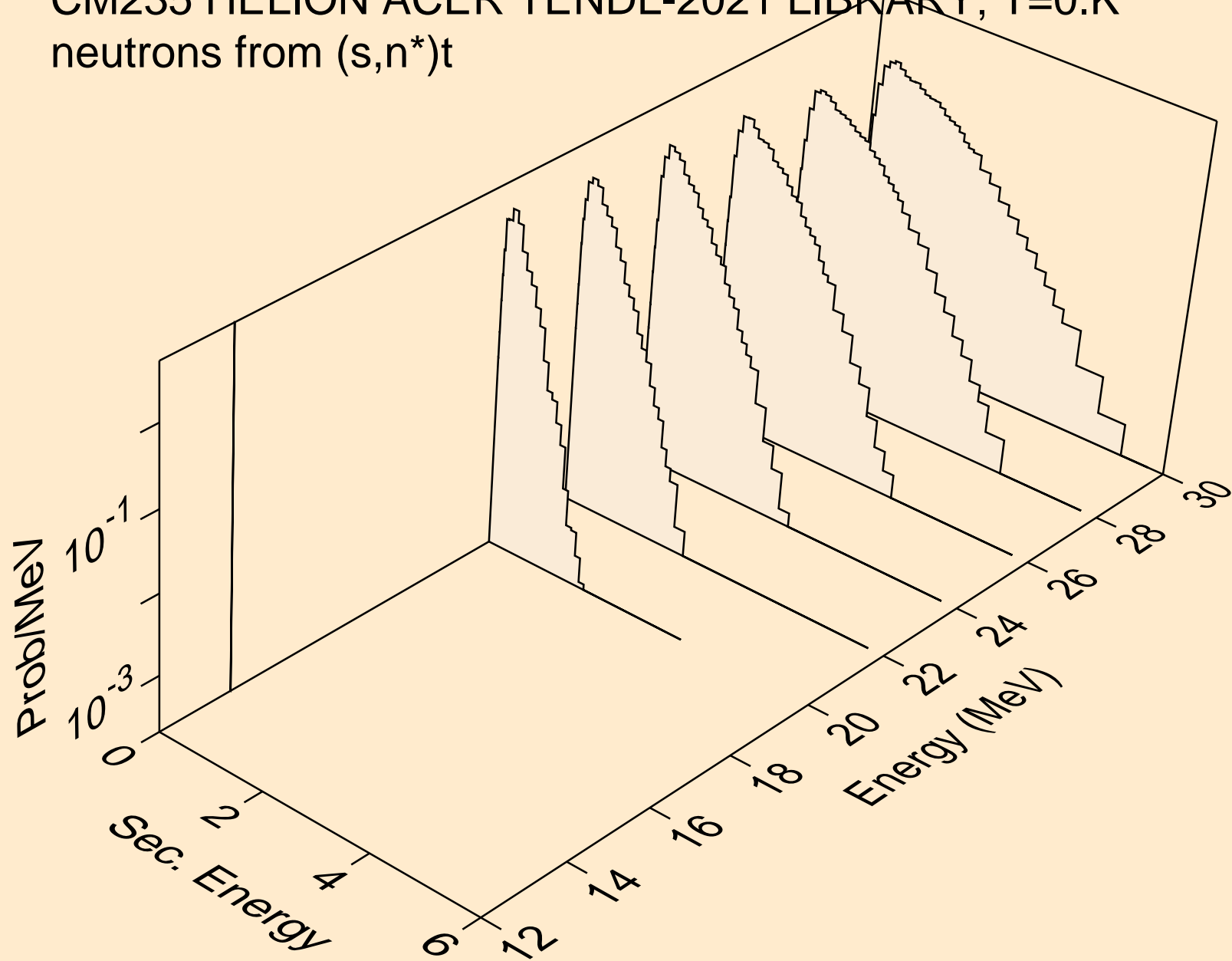

CM235 HELION ACER TENDL-2021 LIBRARY; T=0.K
neutrons from (s,2np)

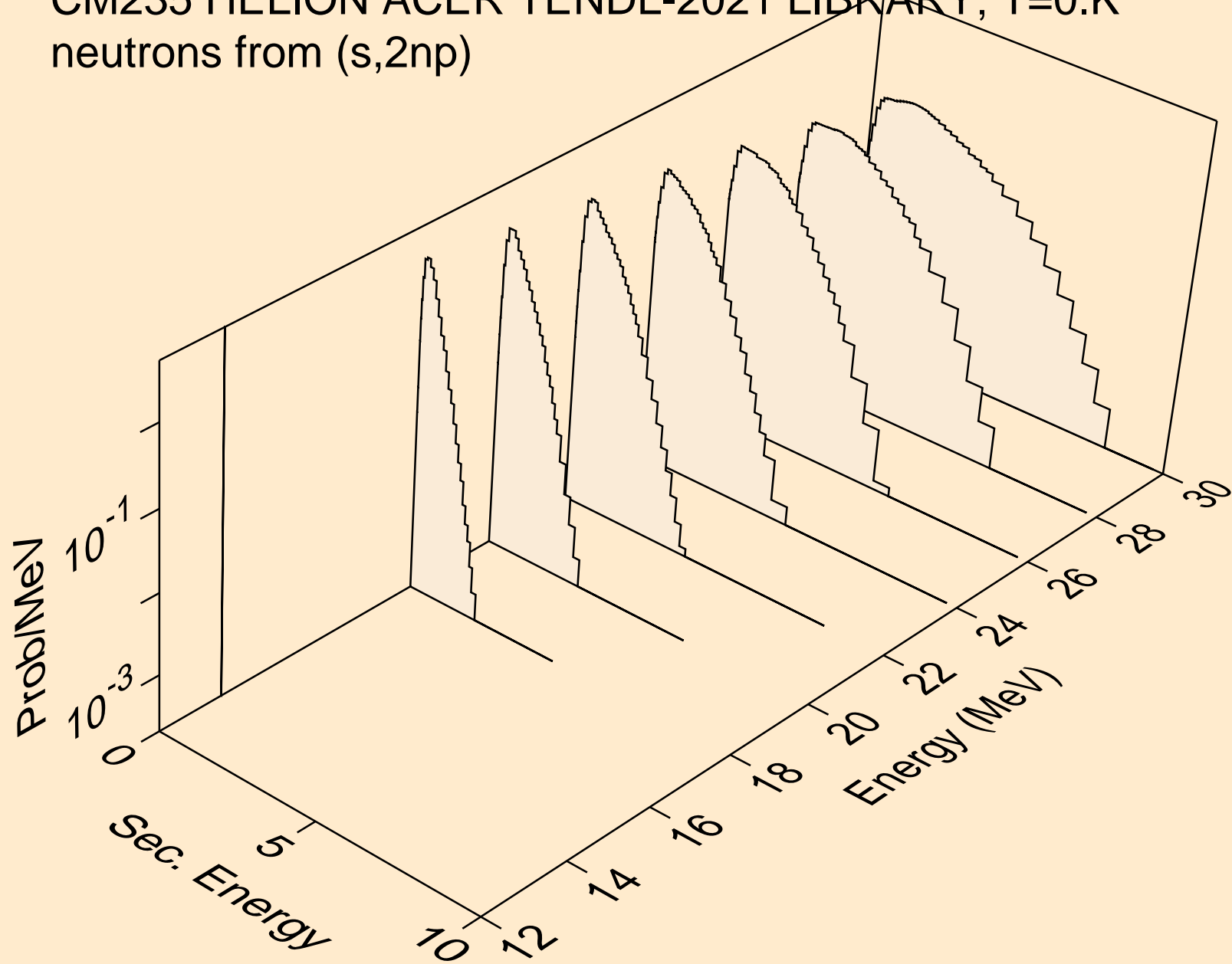

CM235 HELION ACER TENDL-2021 LIBRARY; T=0.K
neutrons from (s,2np)

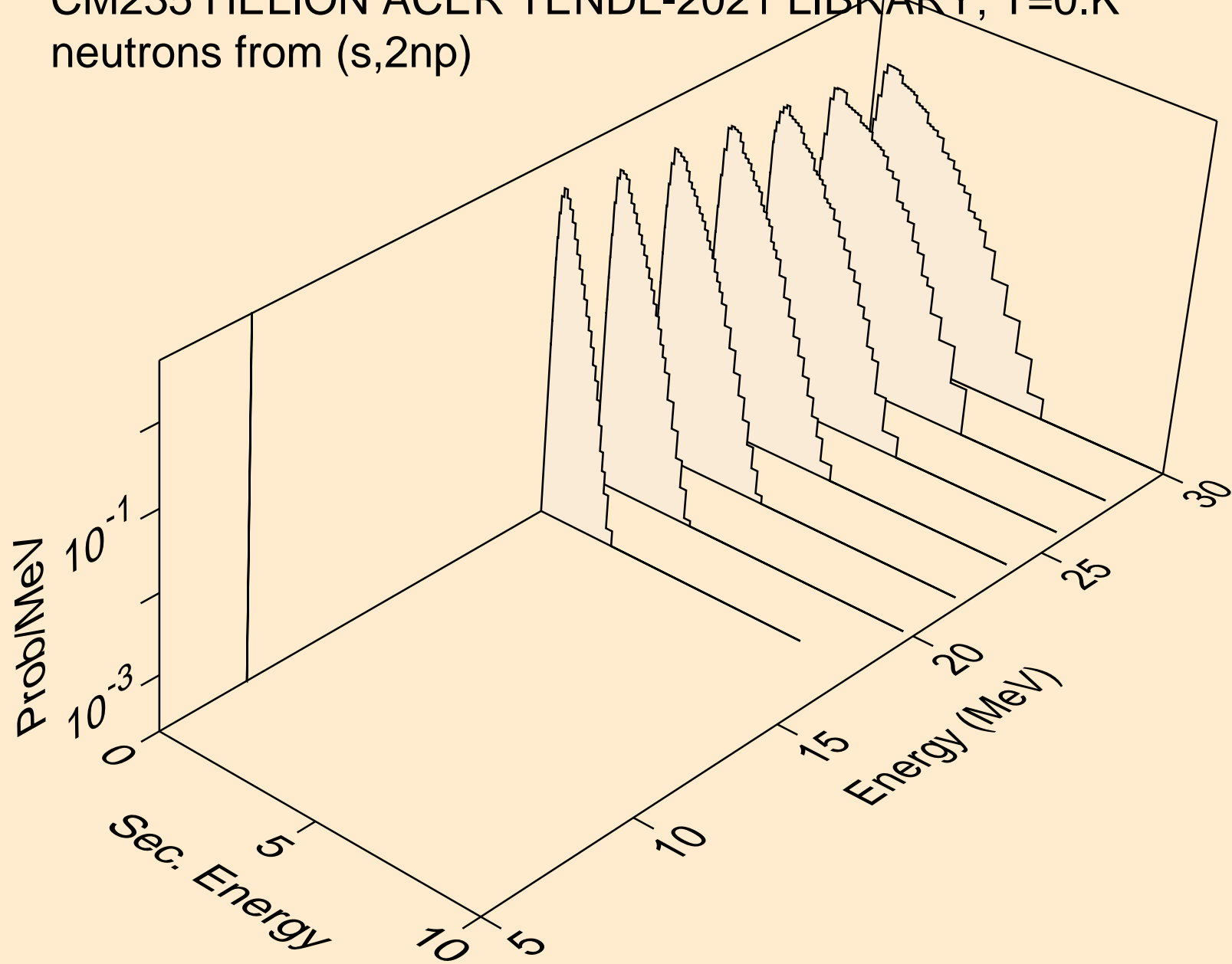

CM235 HELION ACER TENDL-2021 LIBRARY; T=0.K
protons from (s,x)

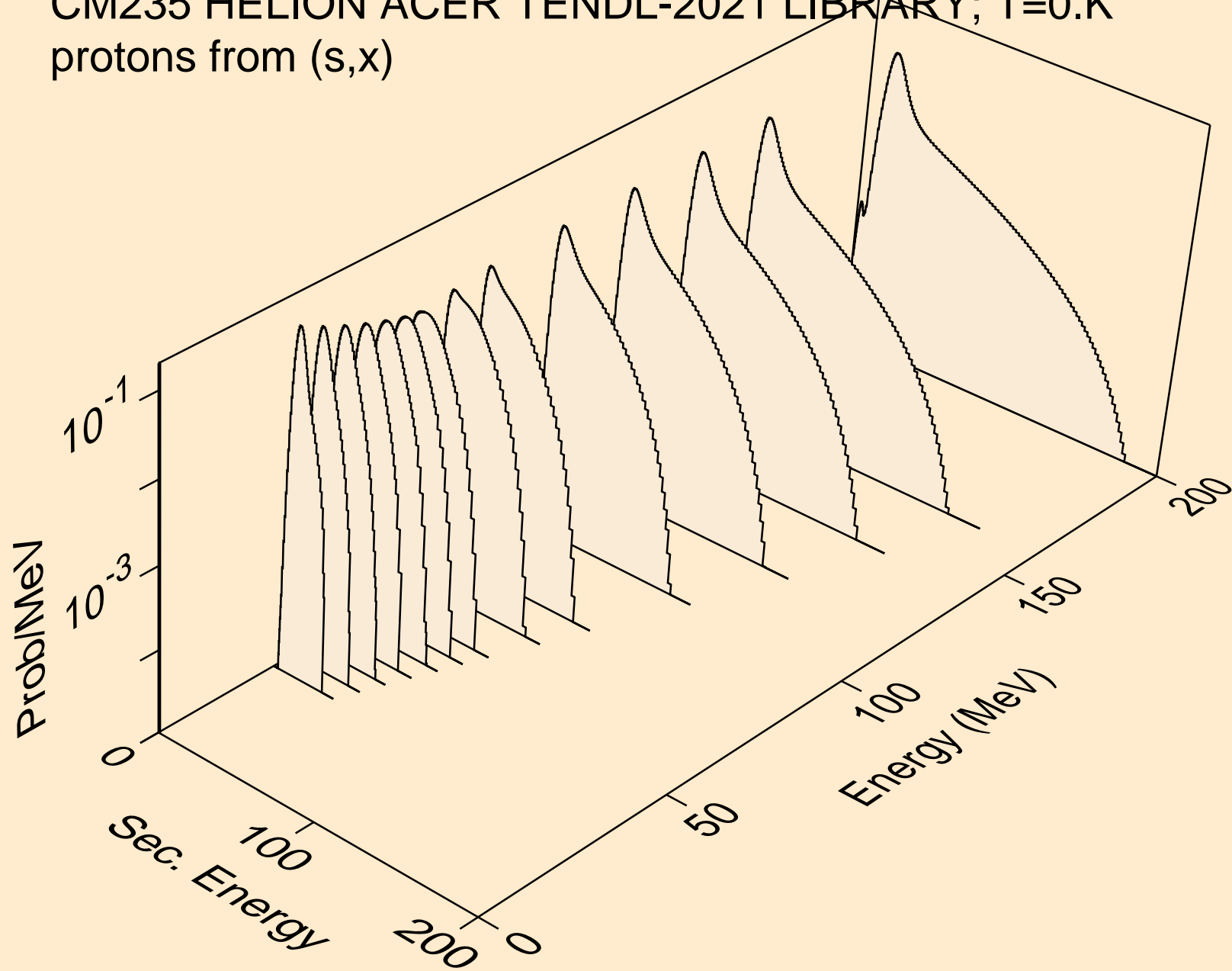

CM235 HELION ACER TENDL-2021 LIBRARY; T=0.K
protons from (s,n*)p

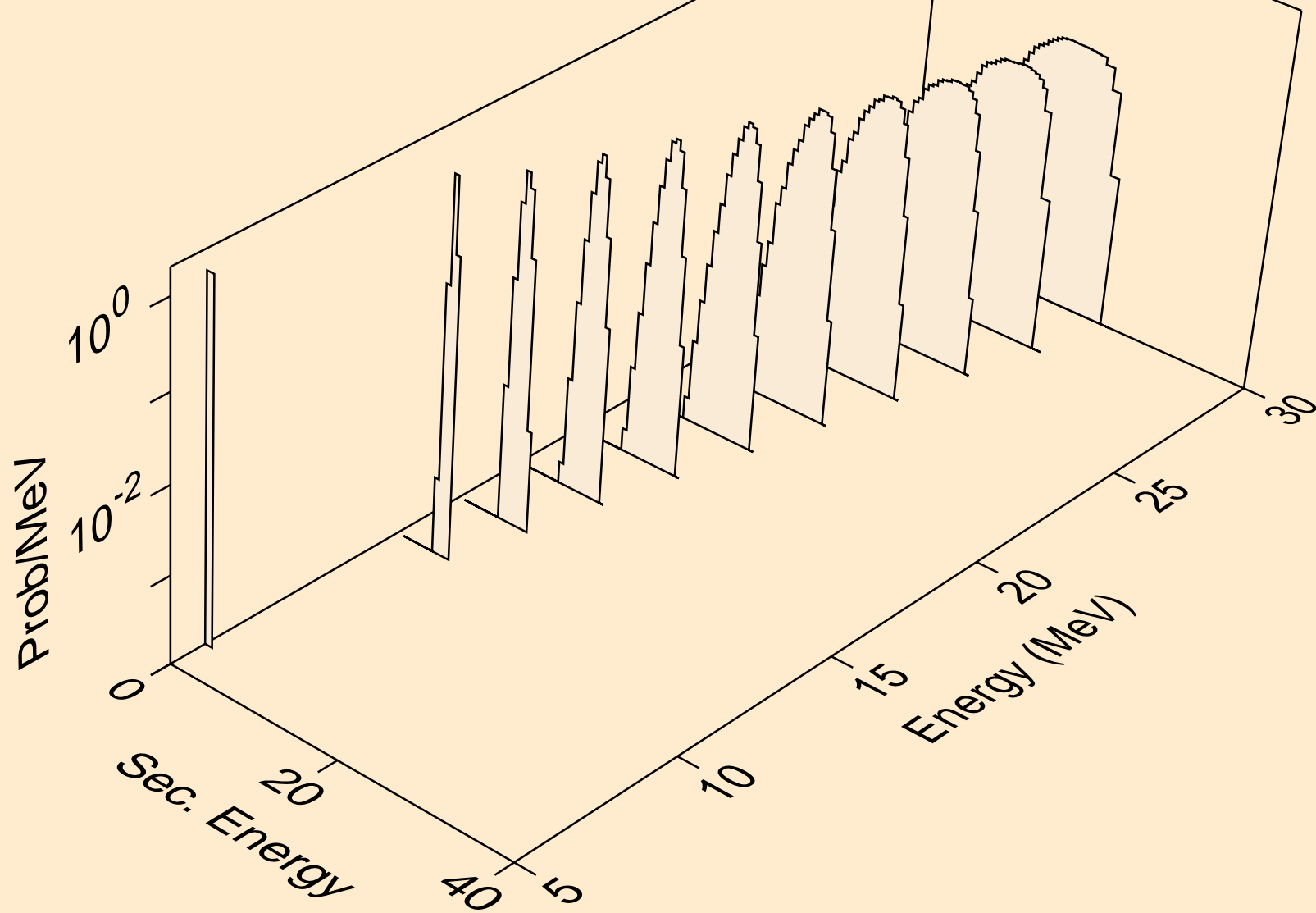

CM235 HELION ACER TENDL-2021 LIBRARY; T=0.K
protons from (s,2np)

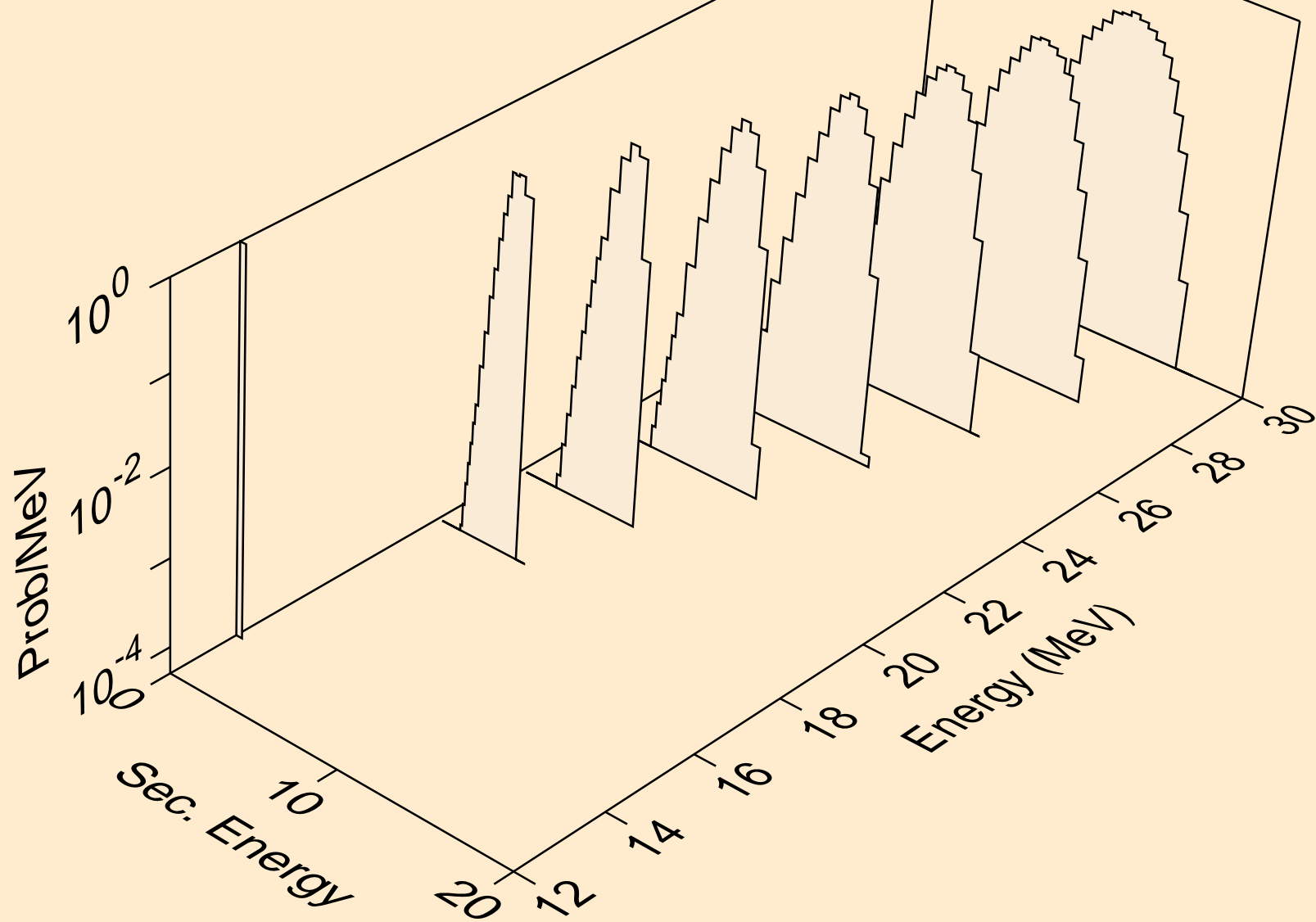

CM235 HELION ACER TENDL-2021 LIBRARY; T=0.K
protons from (s,2np)

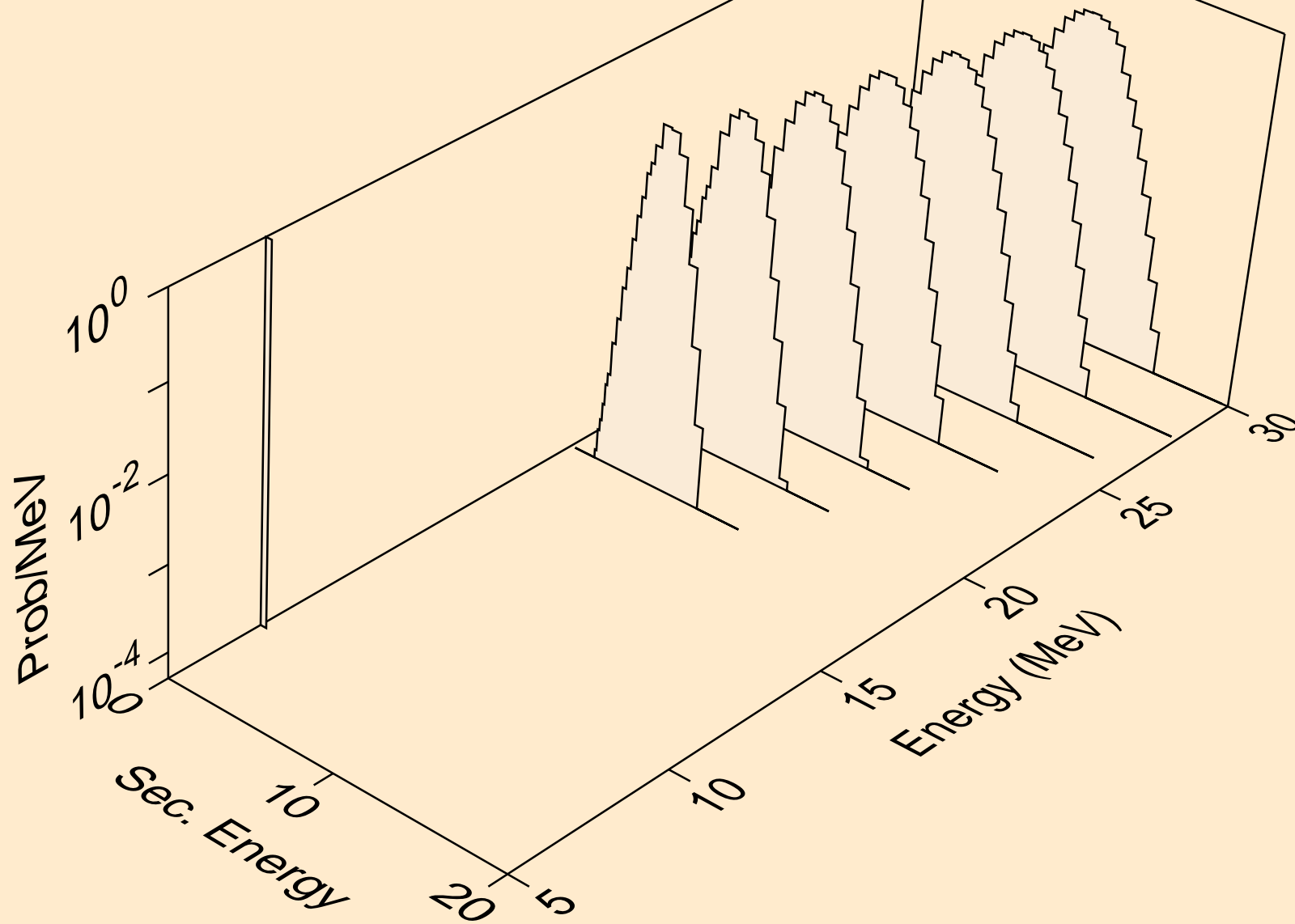

CM235 HELION ACER TENDL-2021 LIBRARY; T=0.K
protons from (s,p)

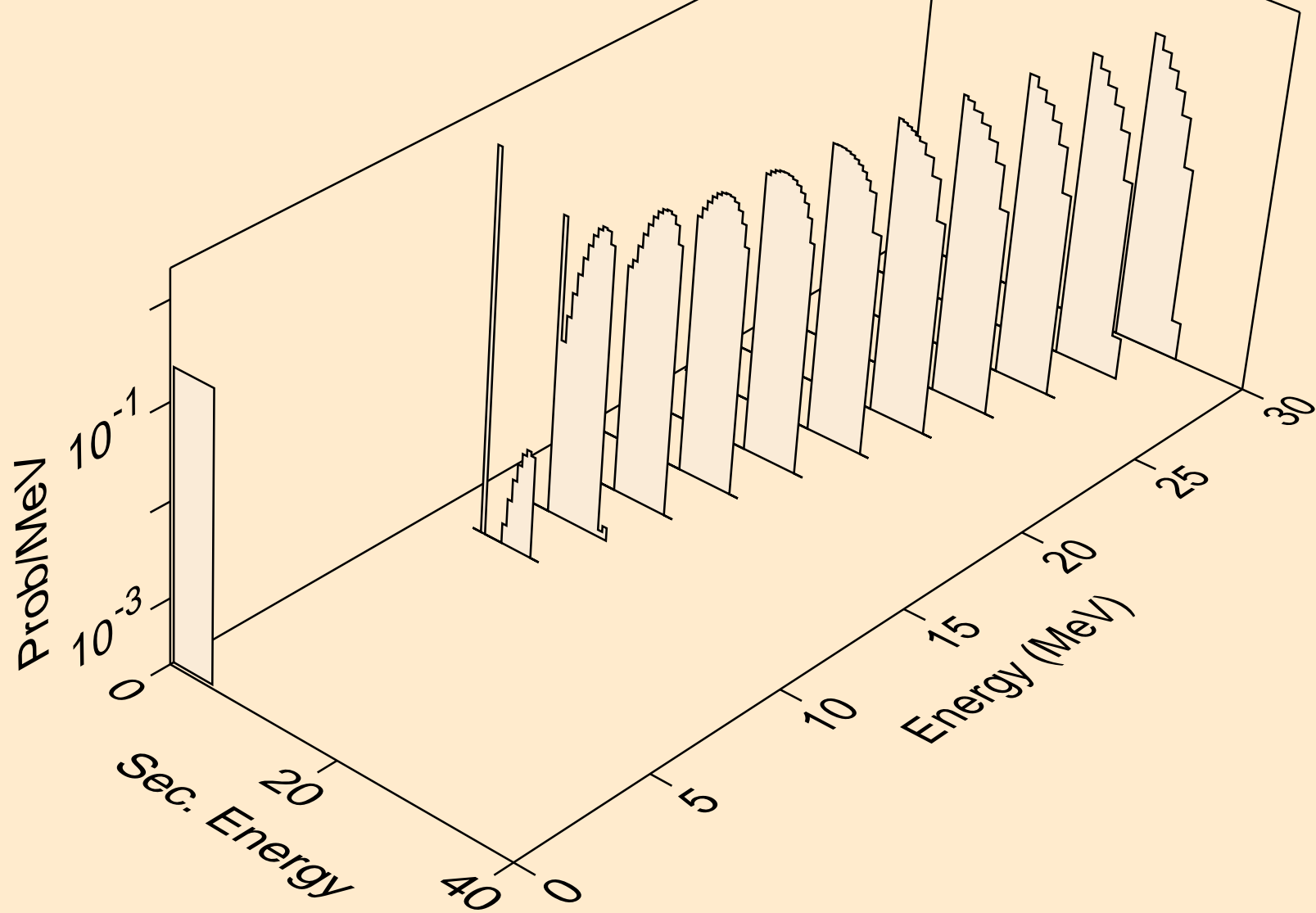

CM235 HELION ACER TENDL-2021 LIBRARY; T=0.K
protons from (s,2p)

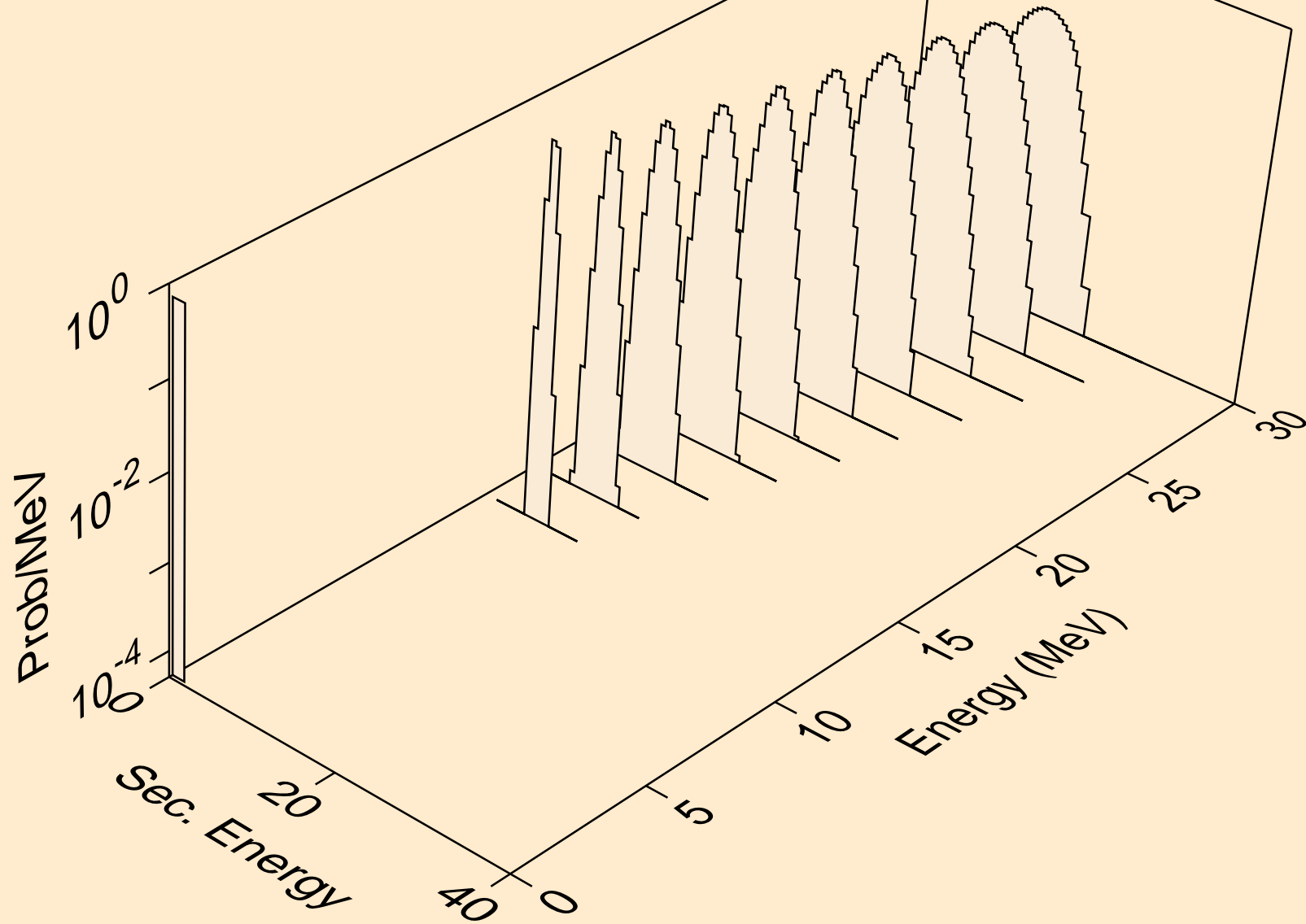

CM235 HELION ACER TENDL-2021 LIBRARY; T=0.K
protons from (s,pd)

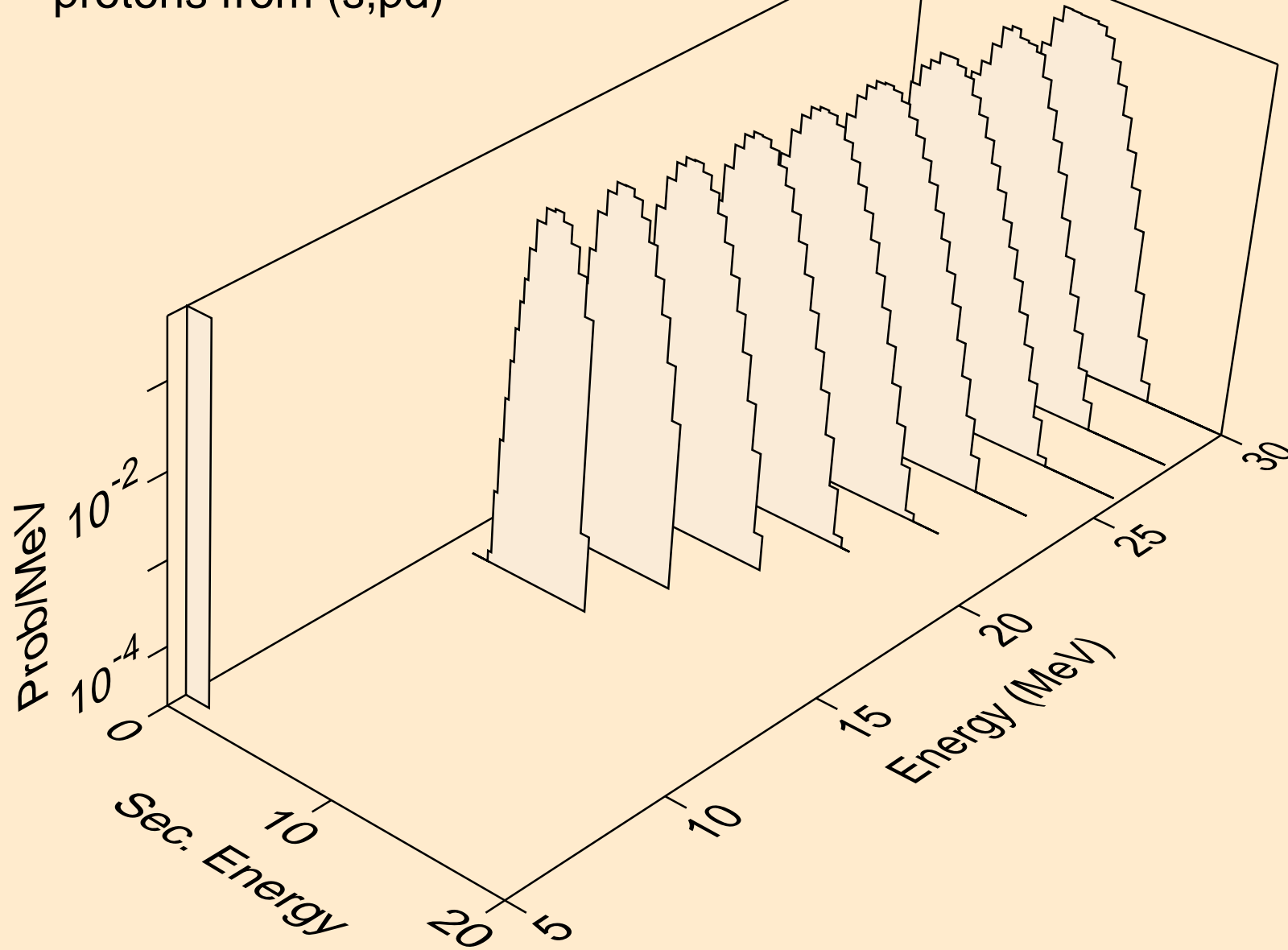

CM235 HELION ACER TENDL-2021 LIBRARY; T=0.K
deuterons from (s,x)

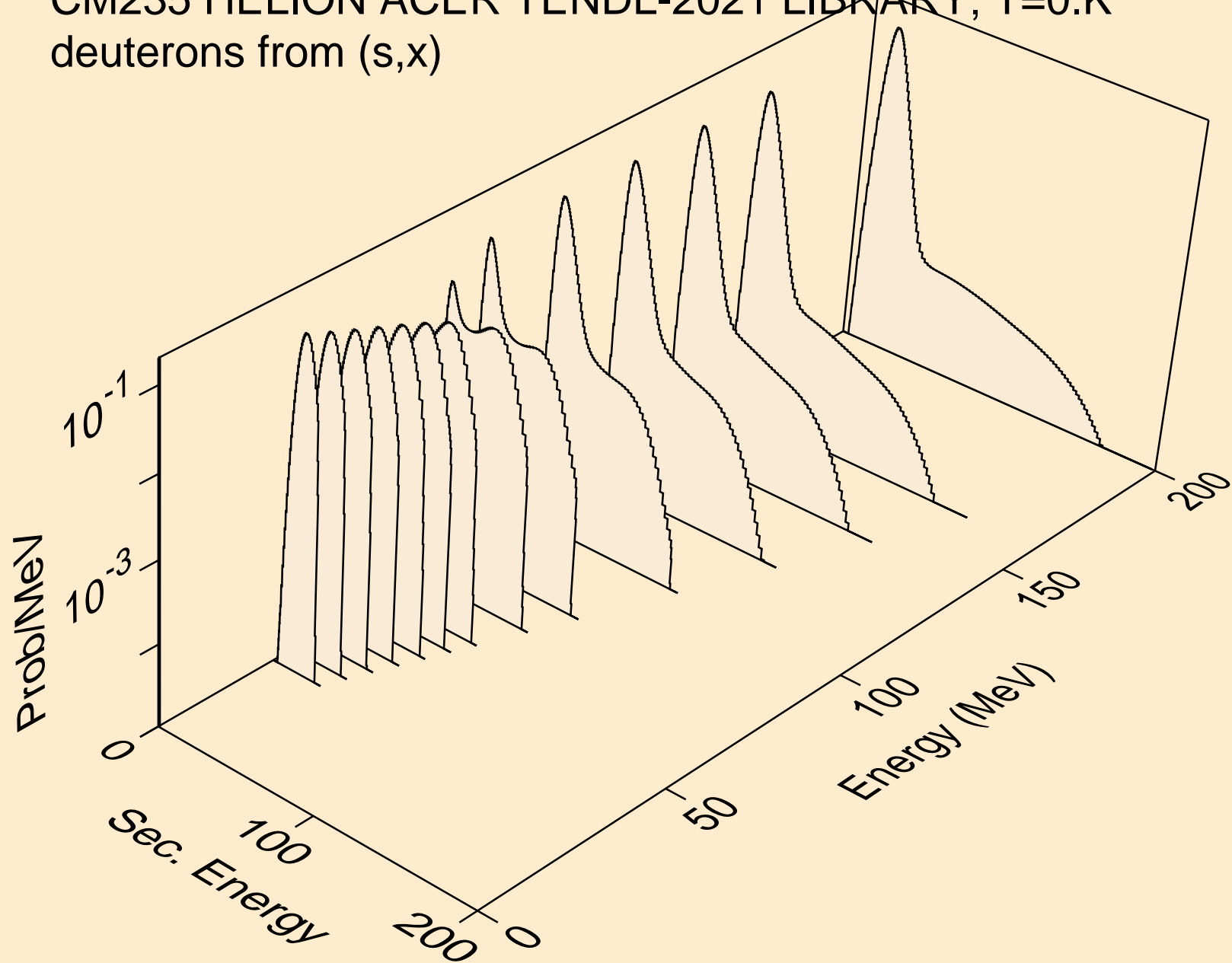

CM235 HELION ACER TENDL-2021 LIBRARY; T=0.K
deuterons from (s,n*)d

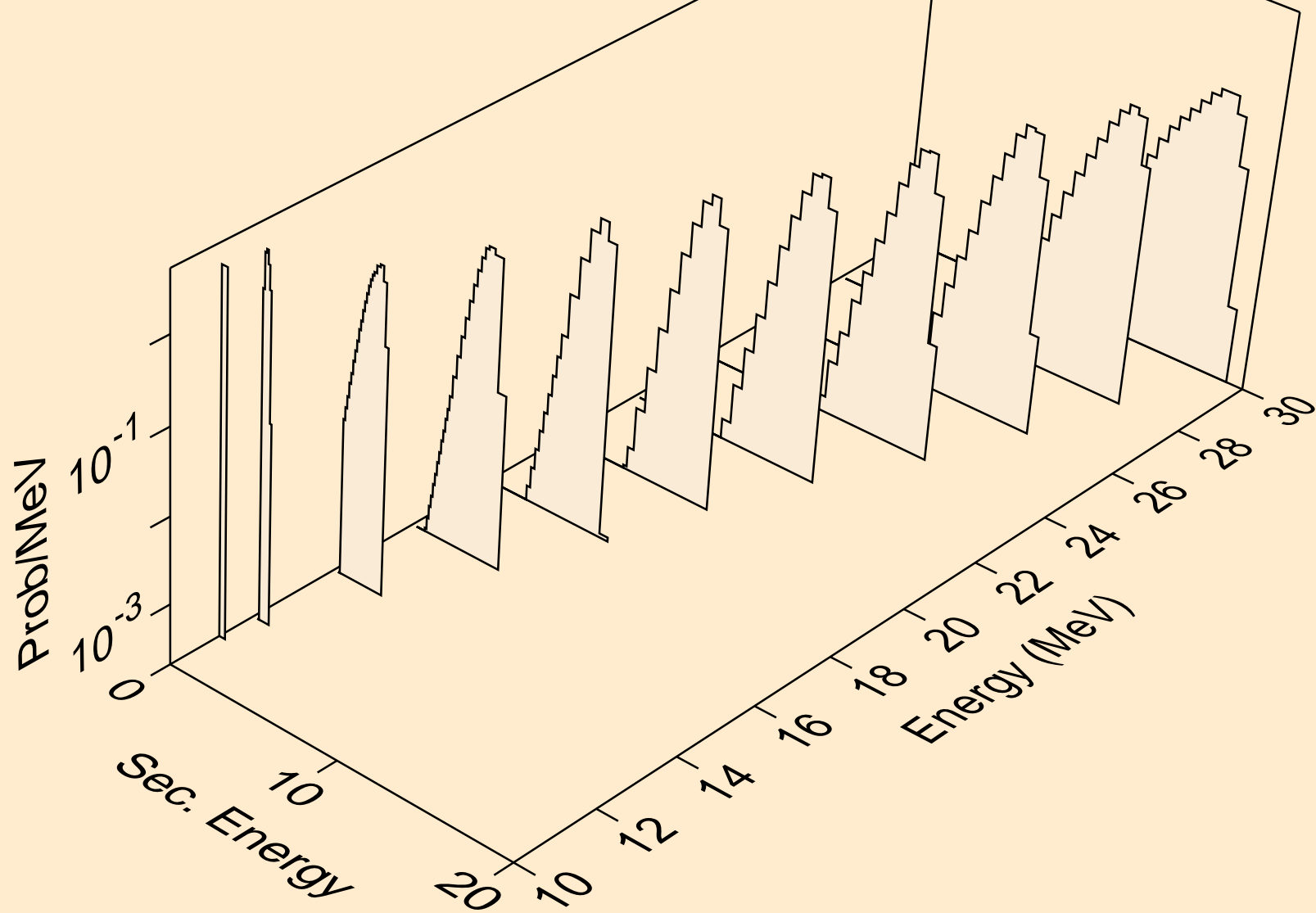

CM235 HELION ACER TENDL-2021 LIBRARY; T=0.K
deuterons from (s,d)

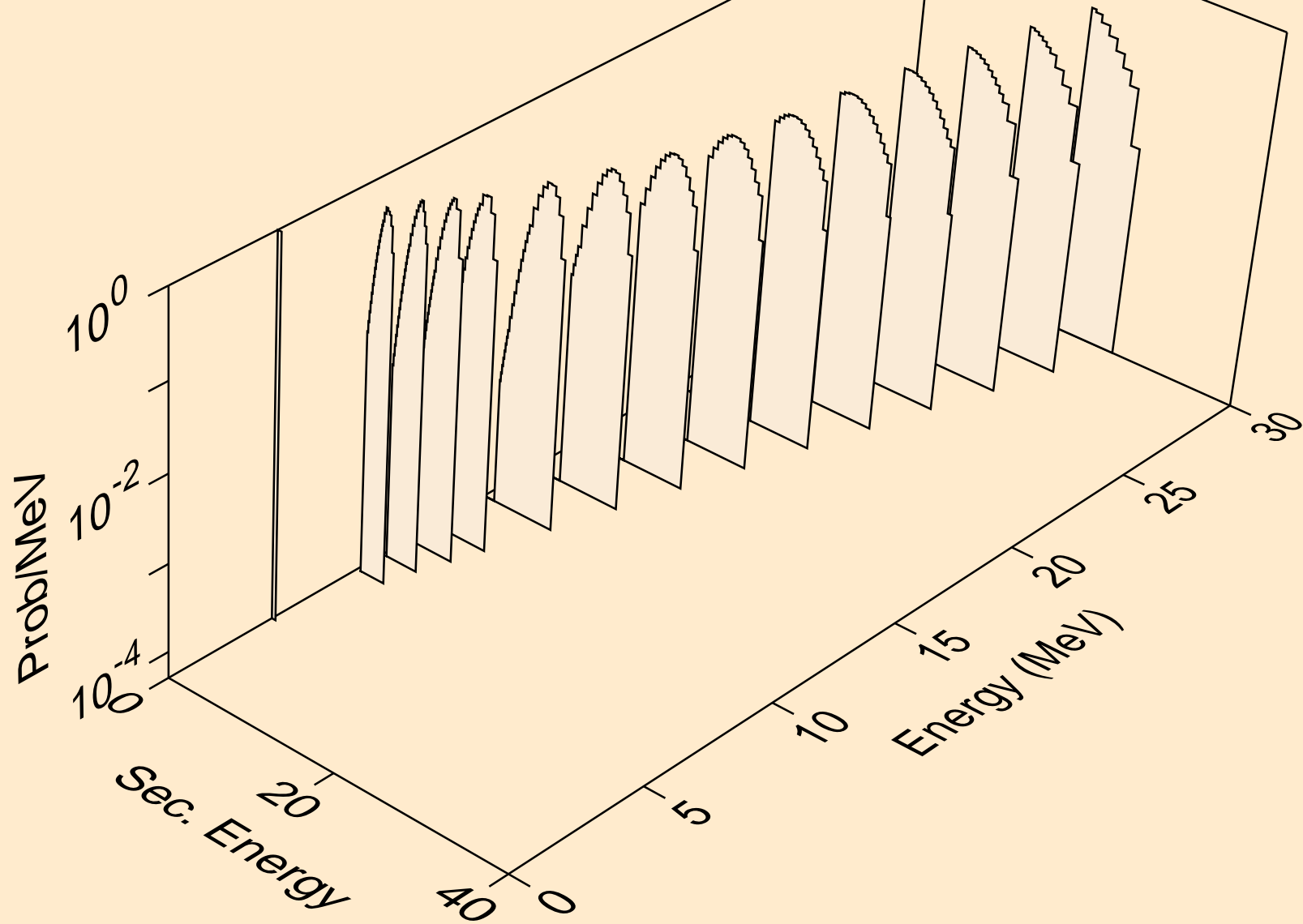

CM235 HELION ACER TENDL-2021 LIBRARY; T=0.K
deuterons from (s,pd)

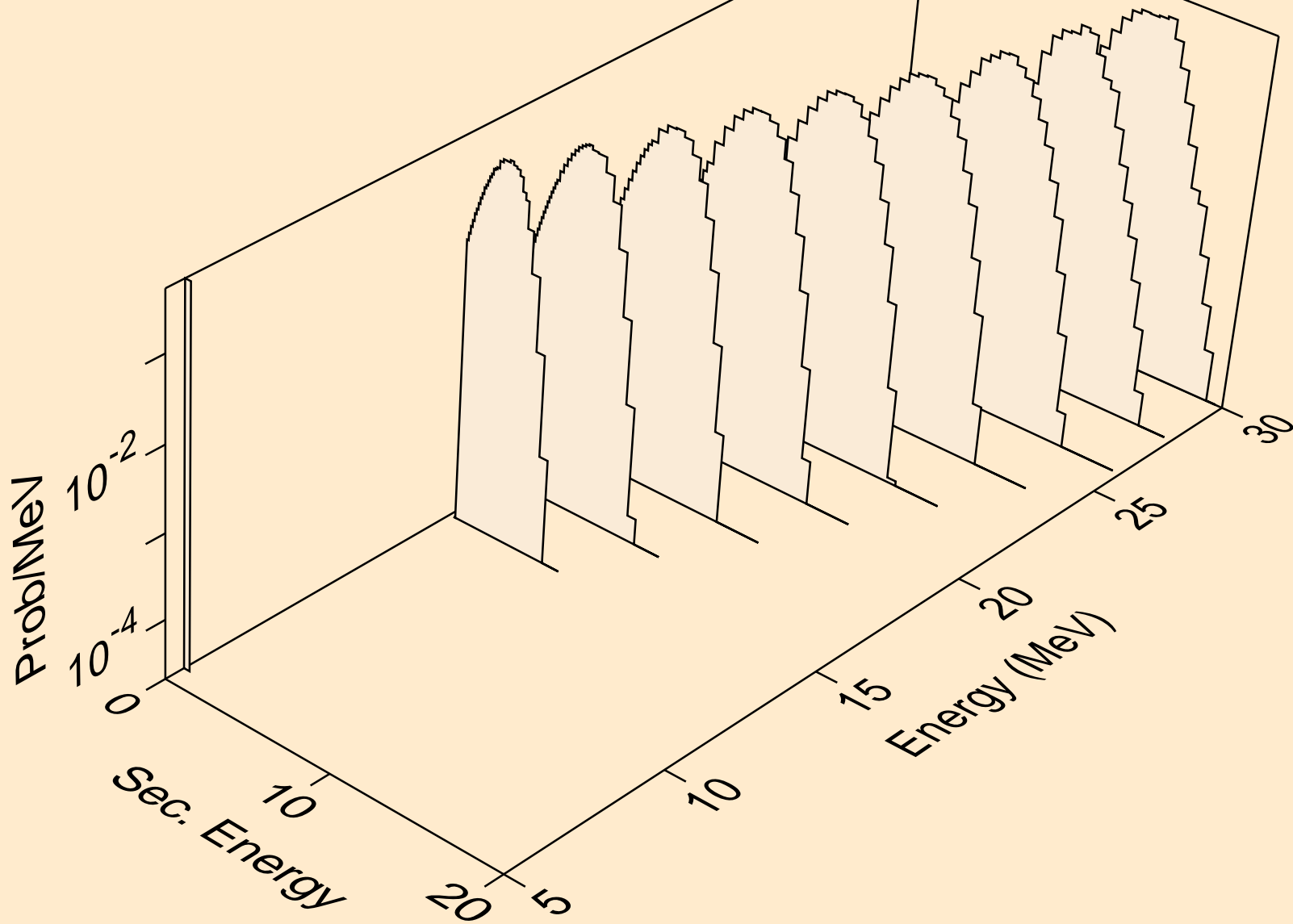

CM235 HELION ACER TENDL-2021 LIBRARY; T=0.K
tritons from (s,x)

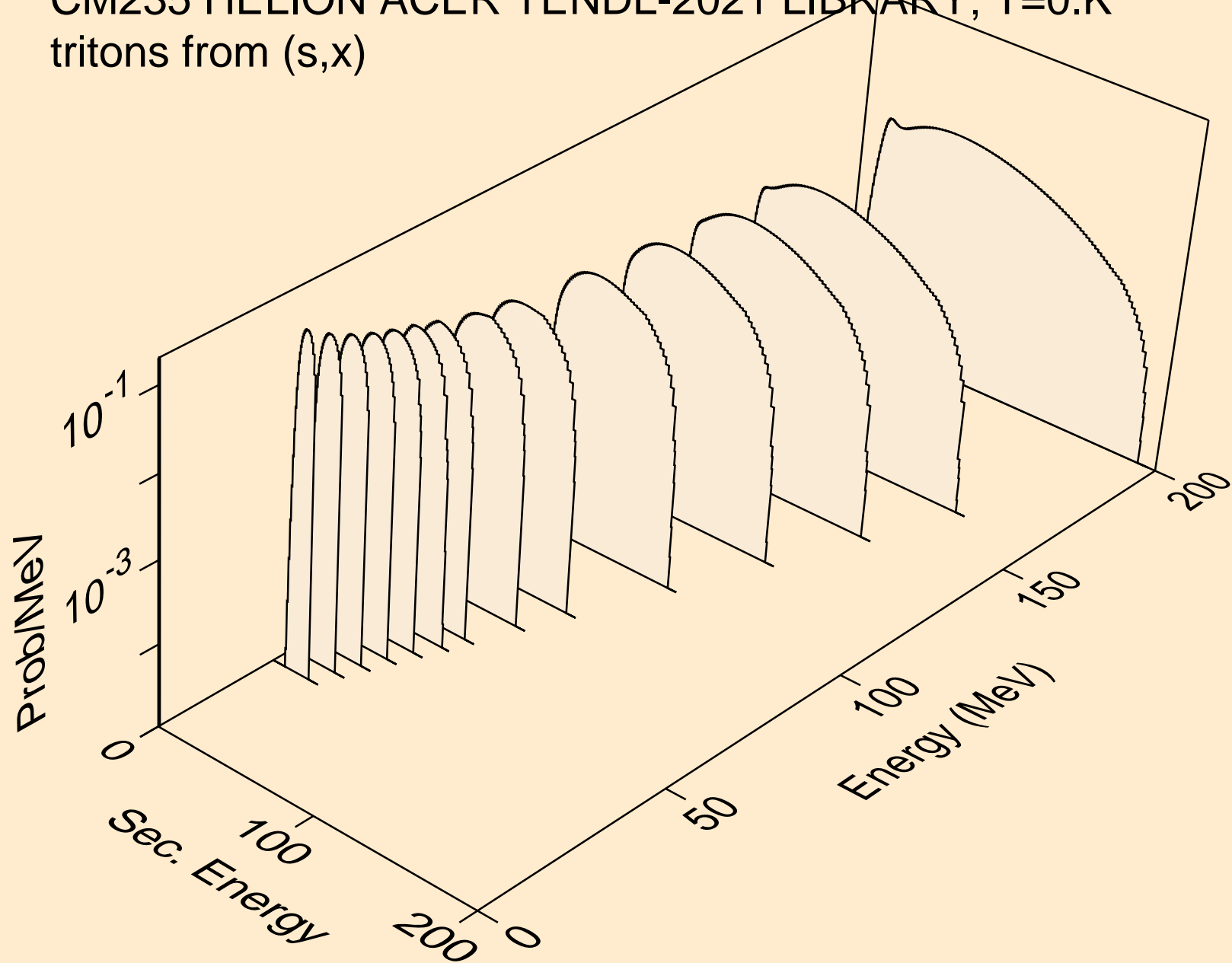

CM235 HELION ACER TENDL-2021 LIBRARY; T=0.K
tritons from (s,n*)t

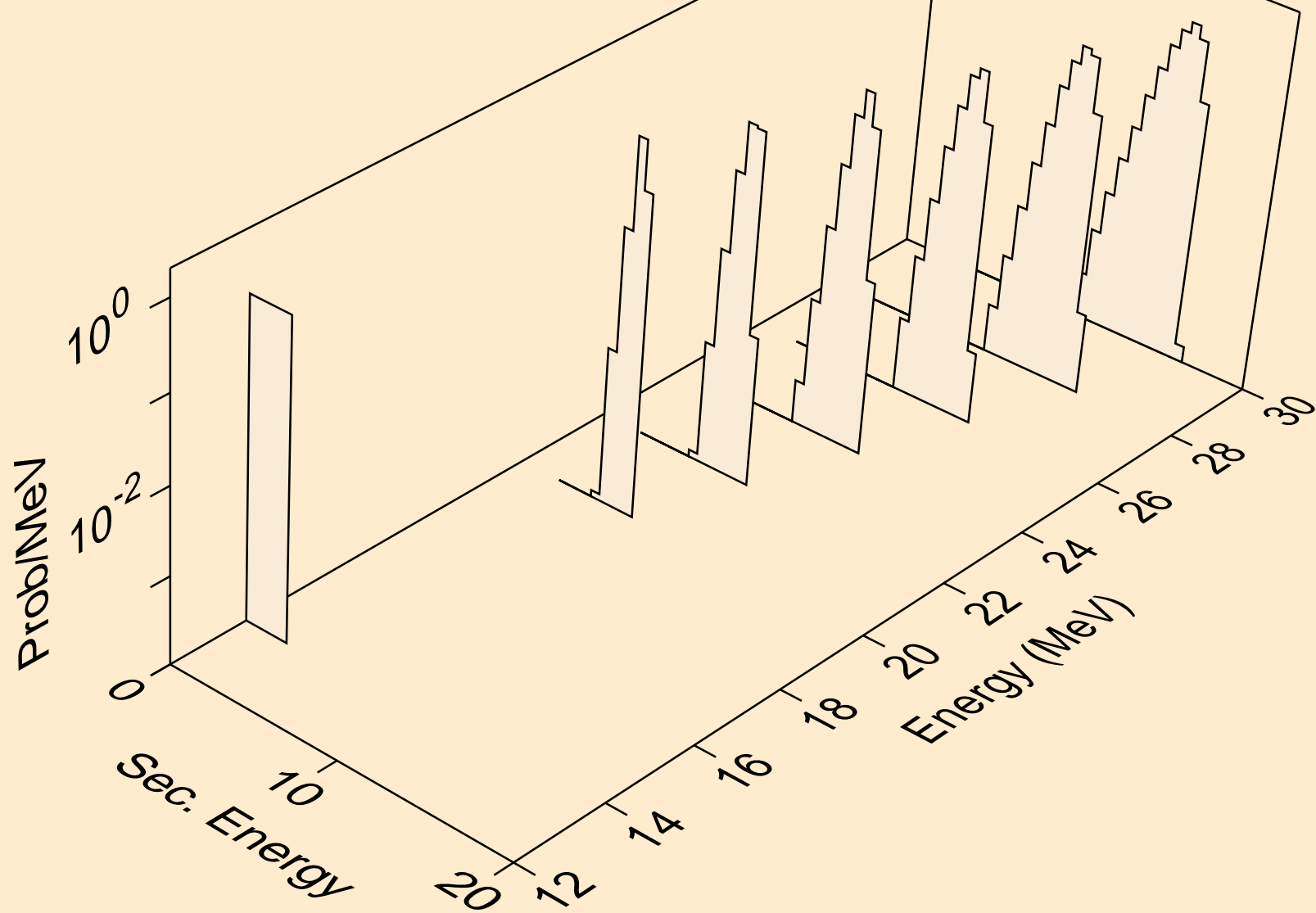

CM235 HELION ACER TENDL-2021 LIBRARY; T=0.K
tritons from (s,t)

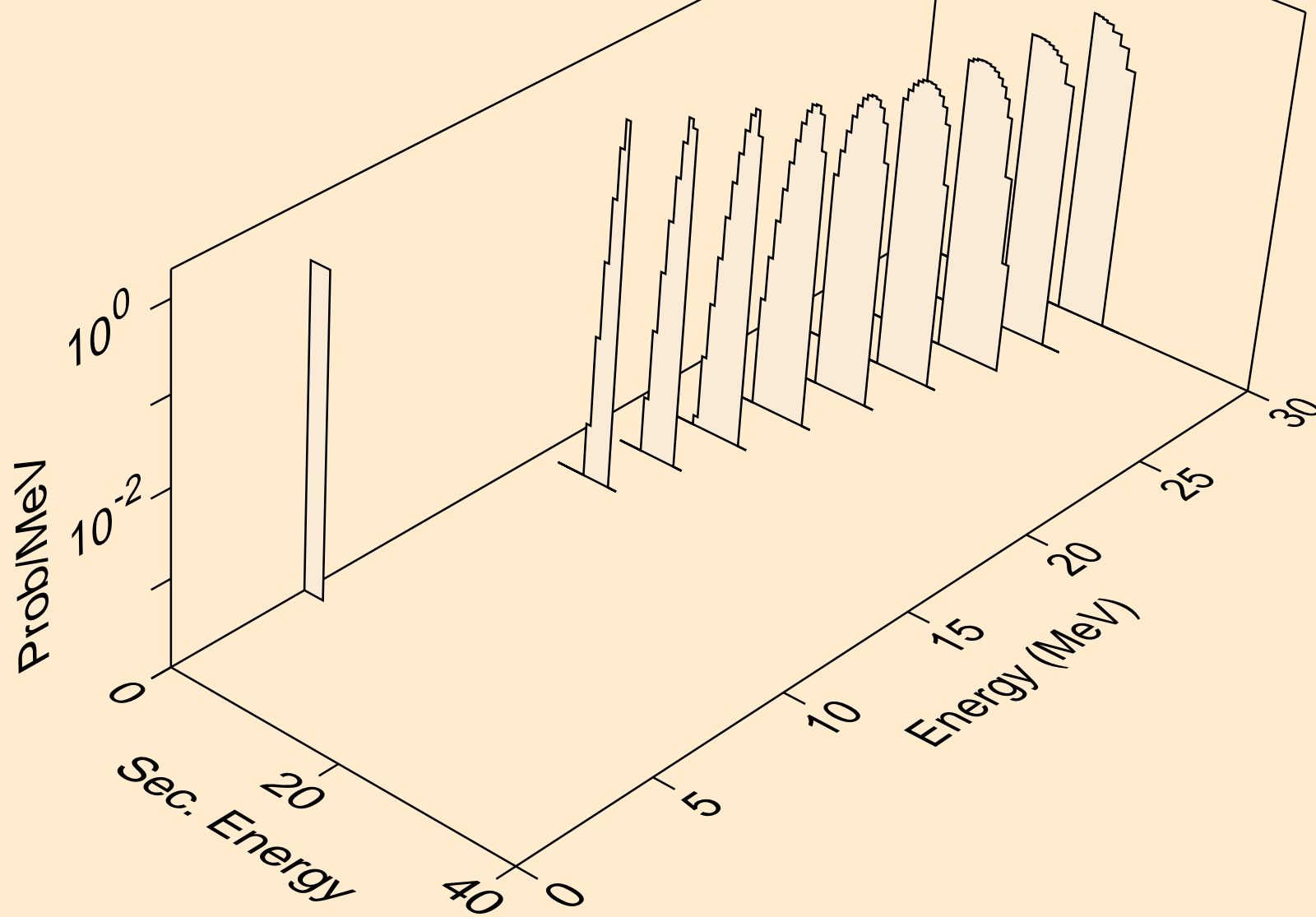

CM235 HELION ACER TENDL-2021 LIBRARY; T=0.K
alphas from (s,x)

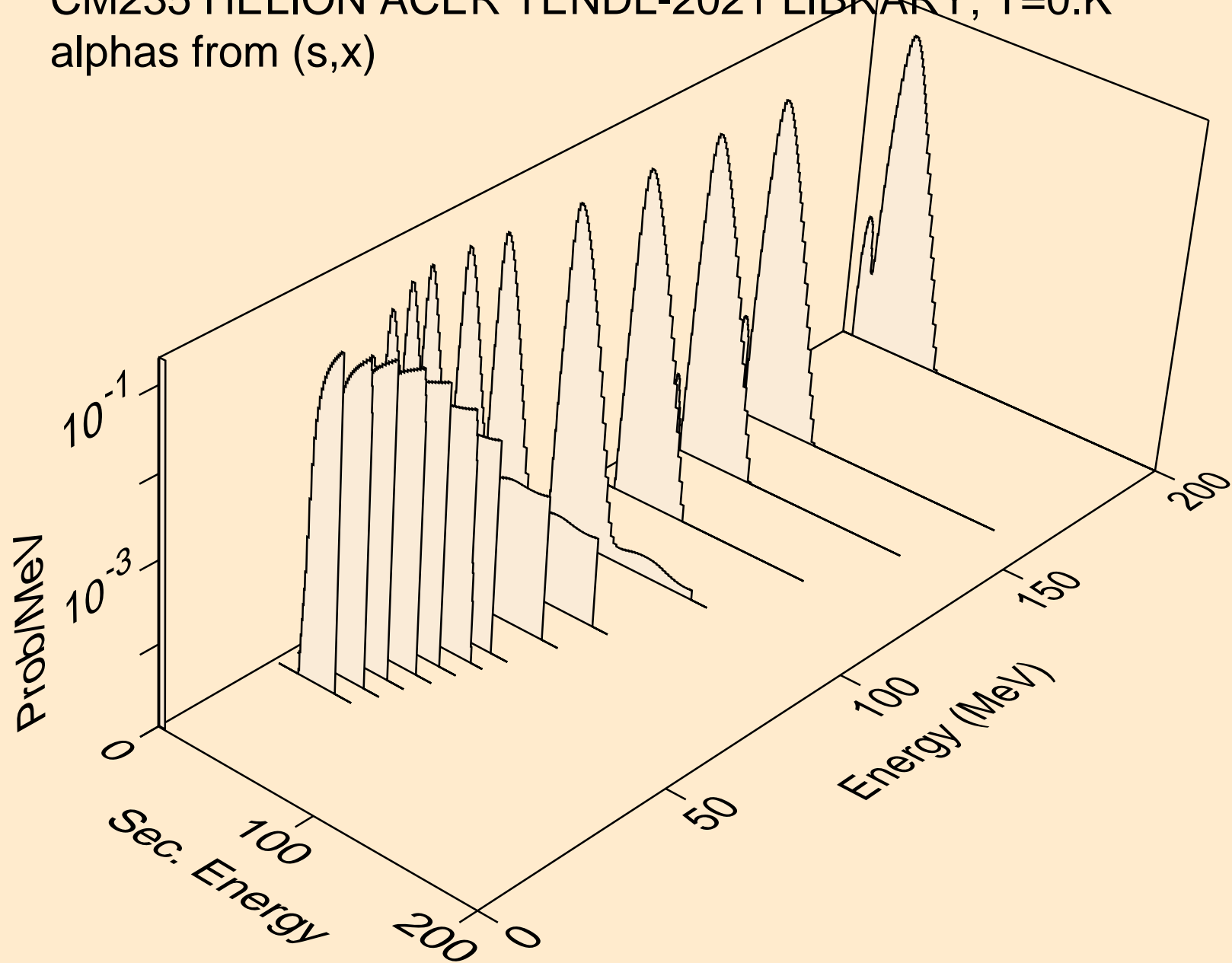

CM235 HELION ACER TENDL-2021 LIBRARY; T=0.K
alphas from (s,n*)a

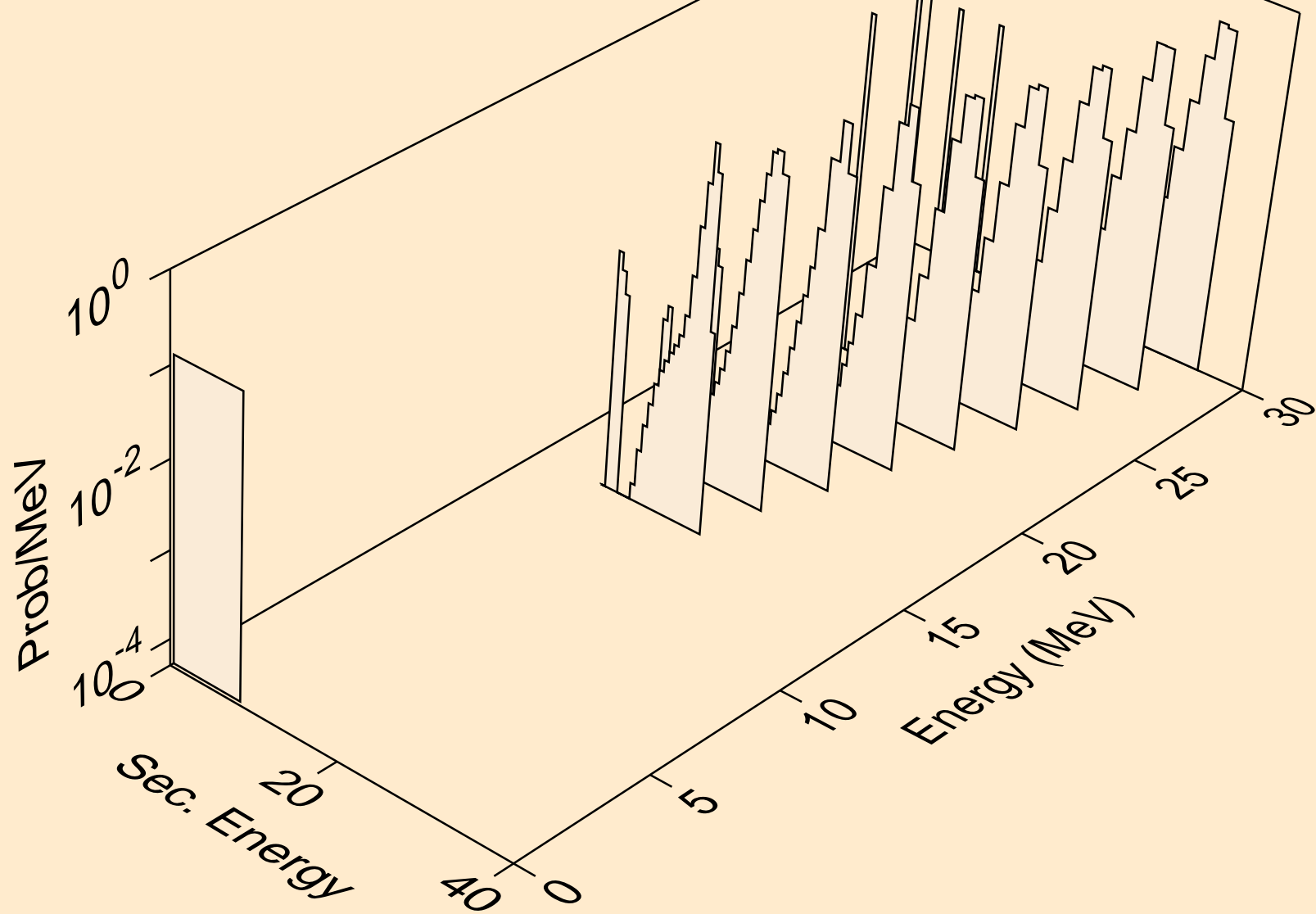

CM235 HELION ACER TENDL-2021 LIBRARY; T=0.K
alphas from (s,a)

