

CM237 HELION ACER TENDL-2021 LIBRARY; T=0.K

Principal cross sections

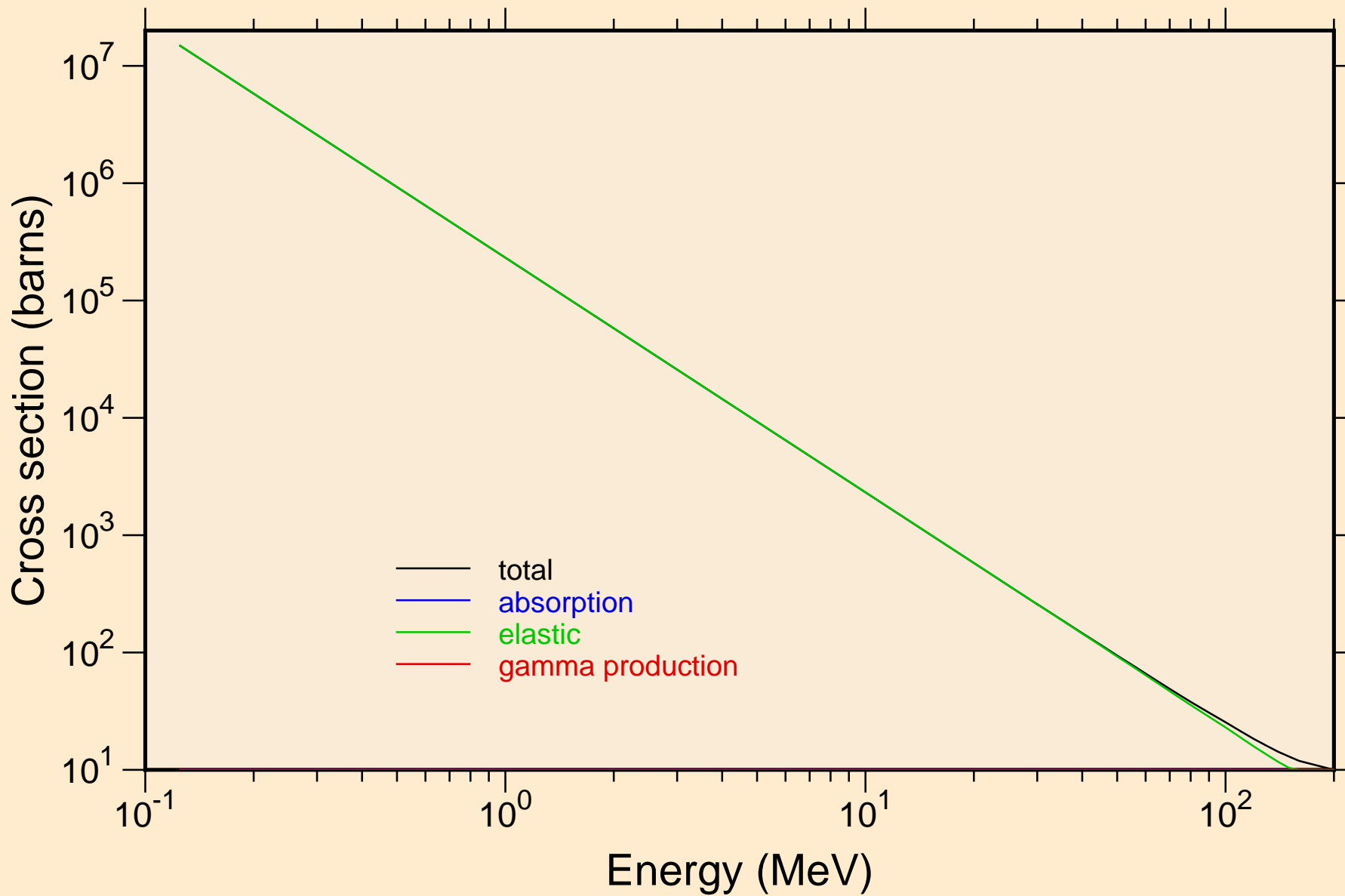

CM237 HELION ACER TENDL-2021 LIBRARY; T=0.K

Heating

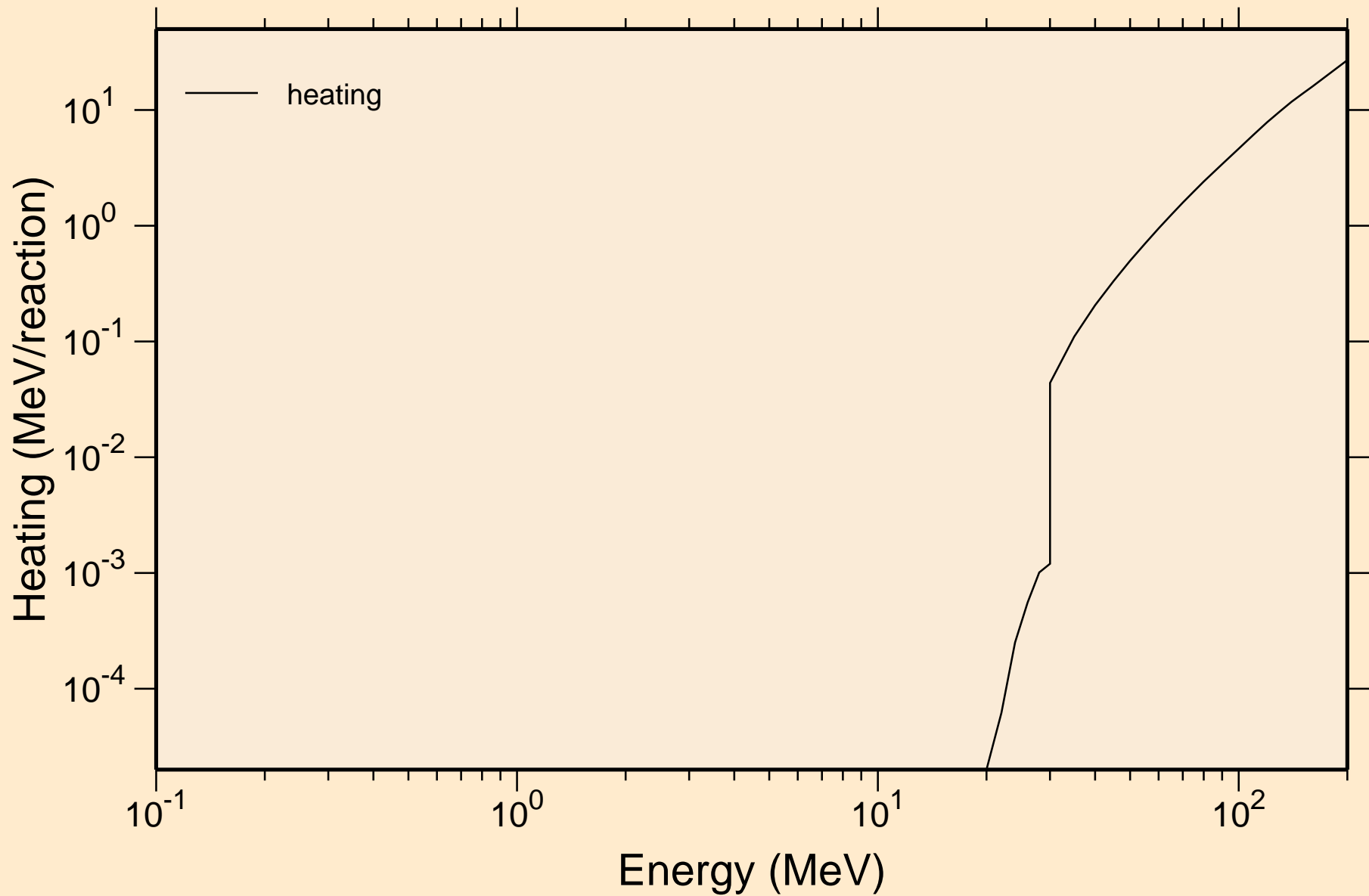

CM237 HELION ACER TENDL-2021 LIBRARY; T=0.K

Principal cross sections

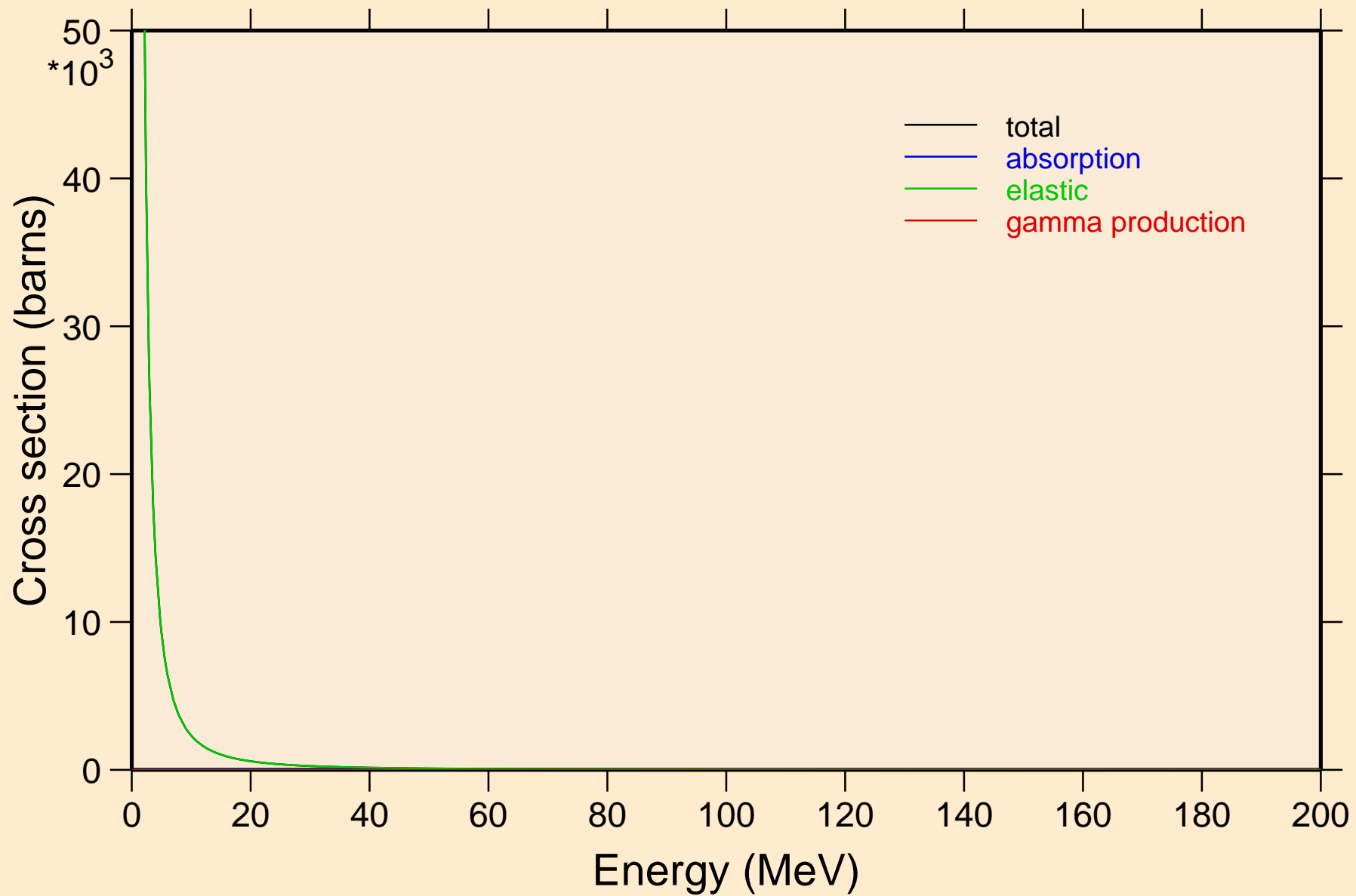

CM237 HELION ACER TENDL-2021 LIBRARY; T=0.K

Heating

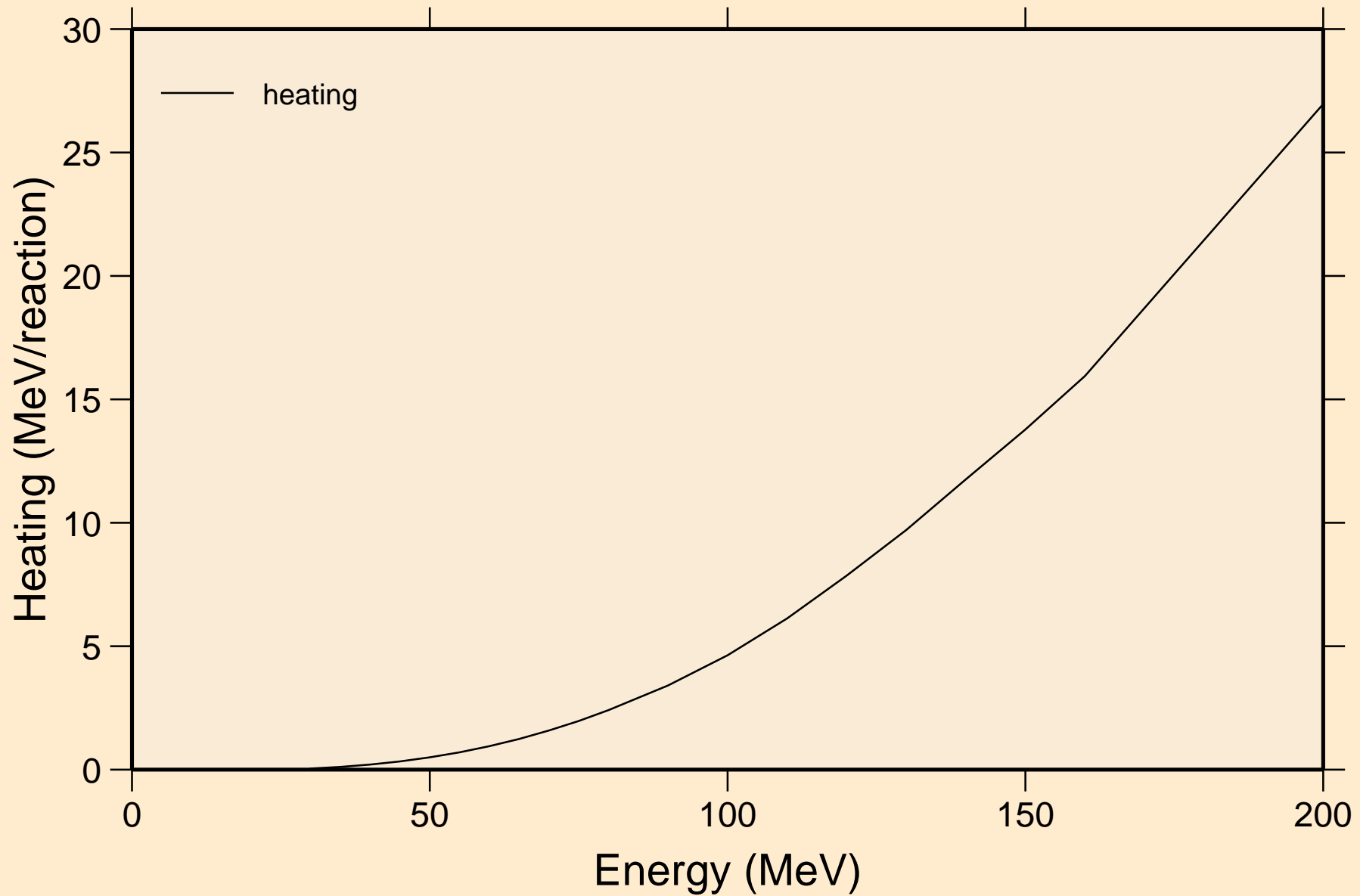

CM237 HELION ACER TENDL-2021 LIBRARY; T=0.K
Threshold reactions

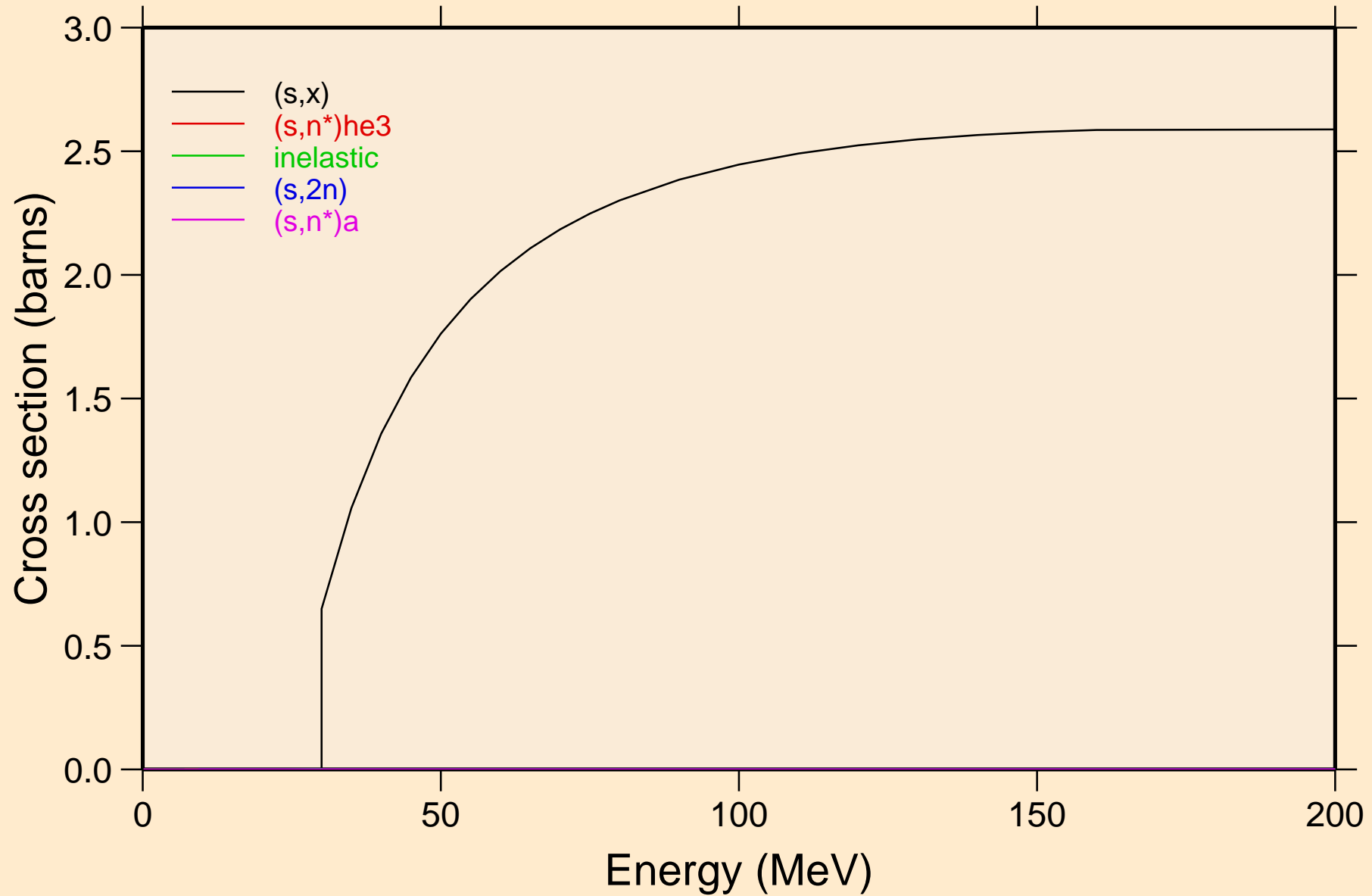

CM237 HELION ACER TENDL-2021 LIBRARY; T=0.K
Threshold reactions

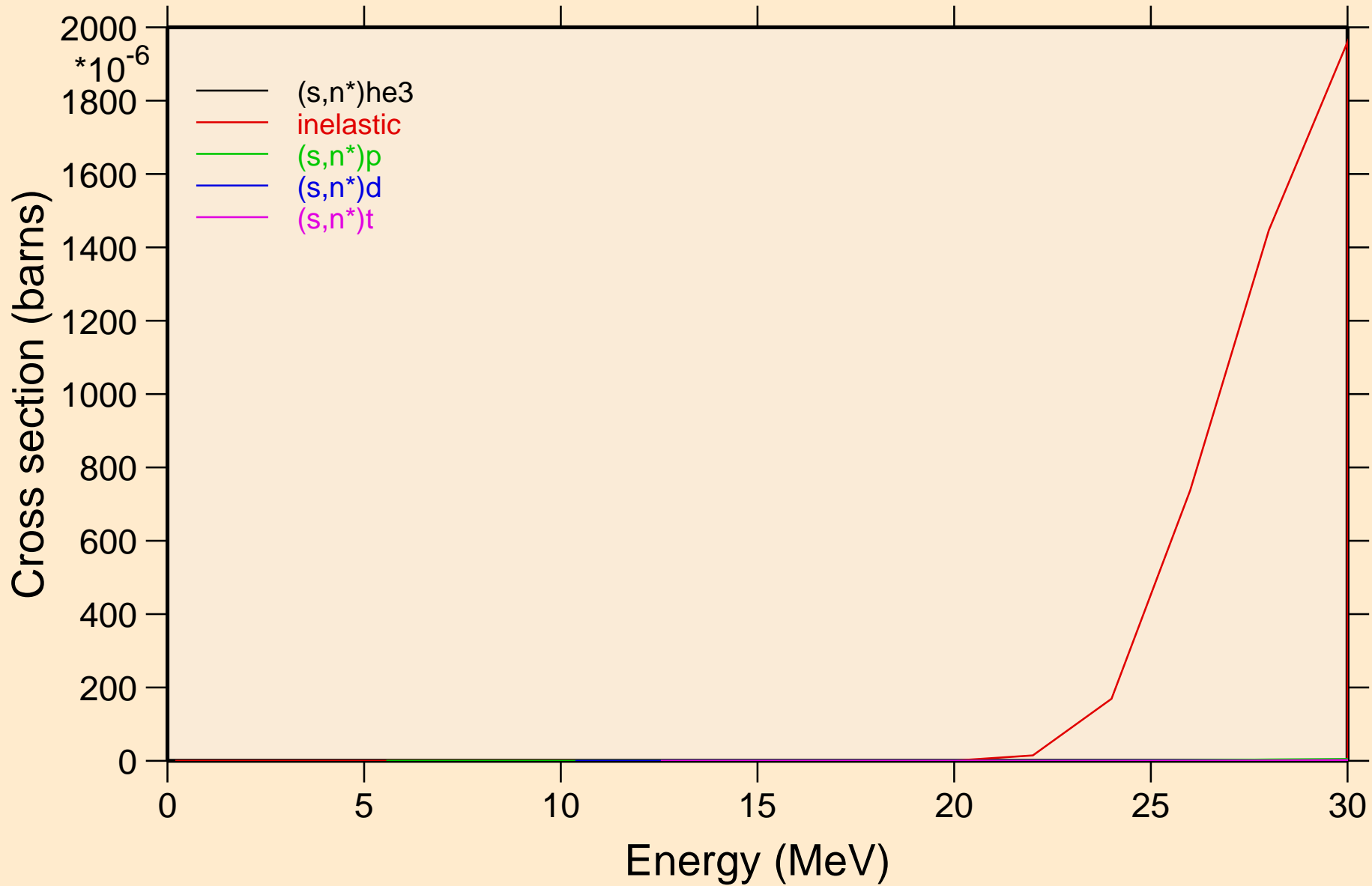

CM237 HELION ACER TENDL-2021 LIBRARY; T=0.K
Threshold reactions

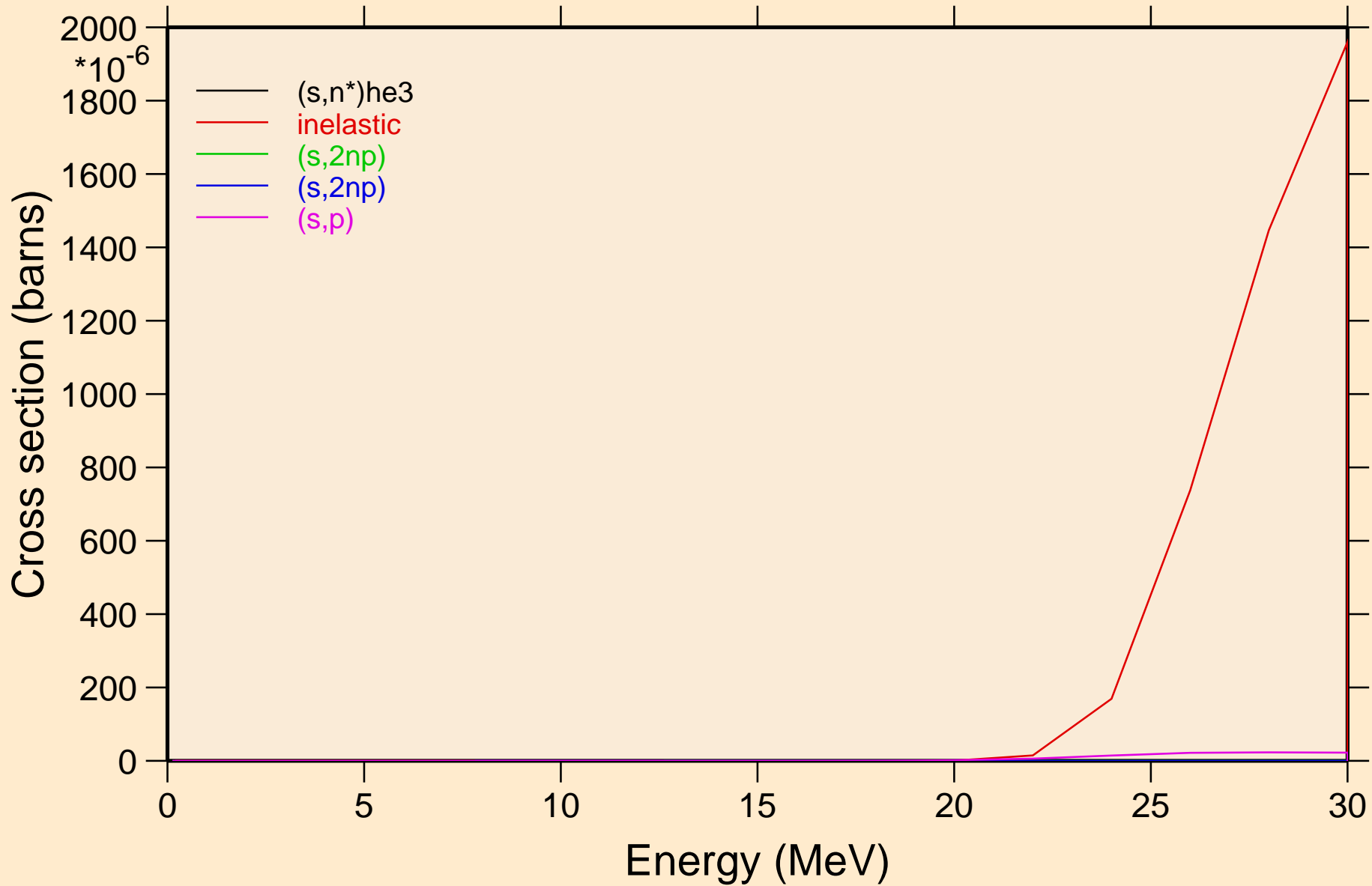

CM237 HELION ACER TENDL-2021 LIBRARY; T=0.K
Threshold reactions

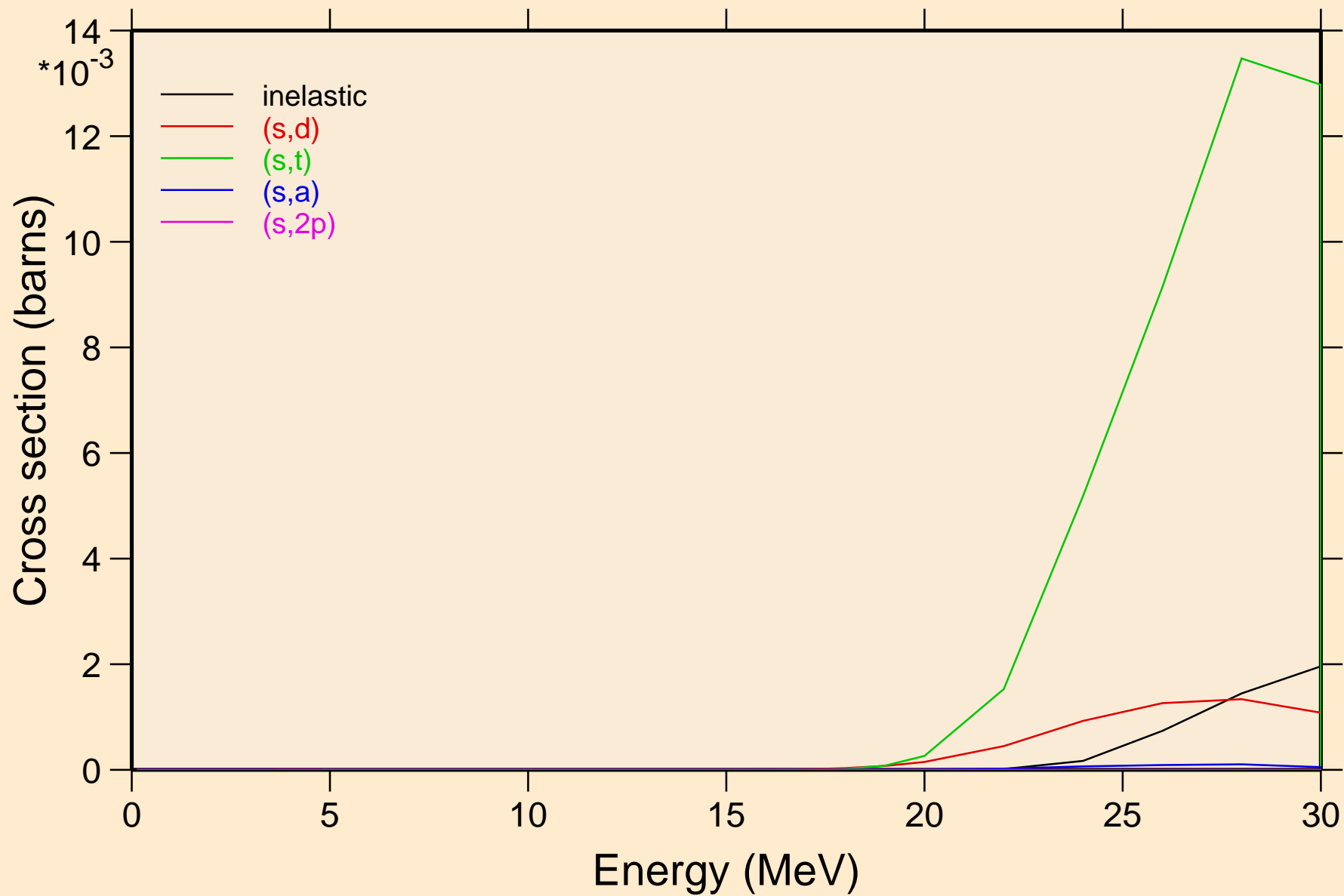

CM237 HELION ACER TENDL-2021 LIBRARY; T=0.K
Threshold reactions

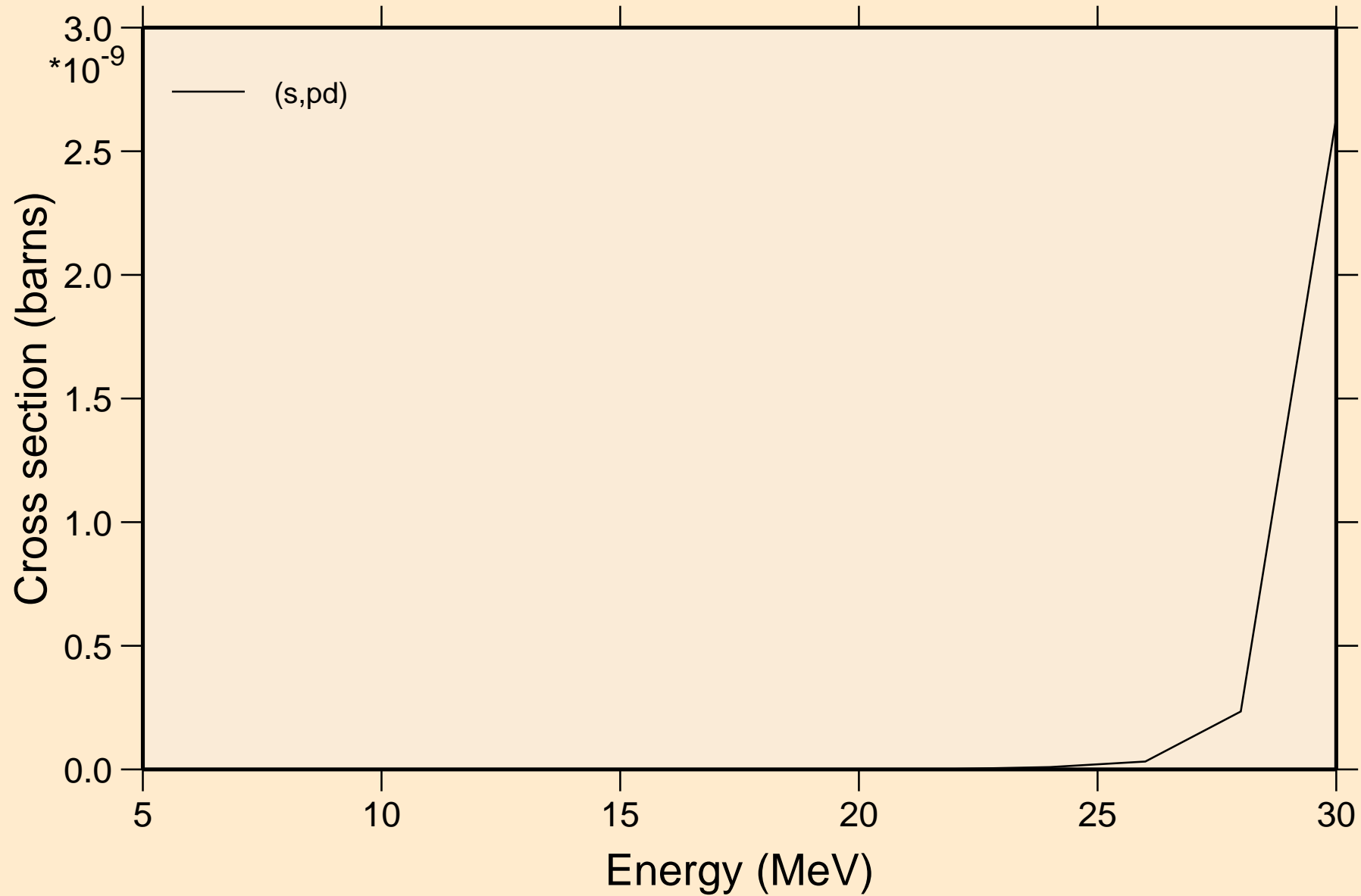

CM237 HELION ACER TENDL-2021 LIBRARY; T=0.K
angular distribution for elastic

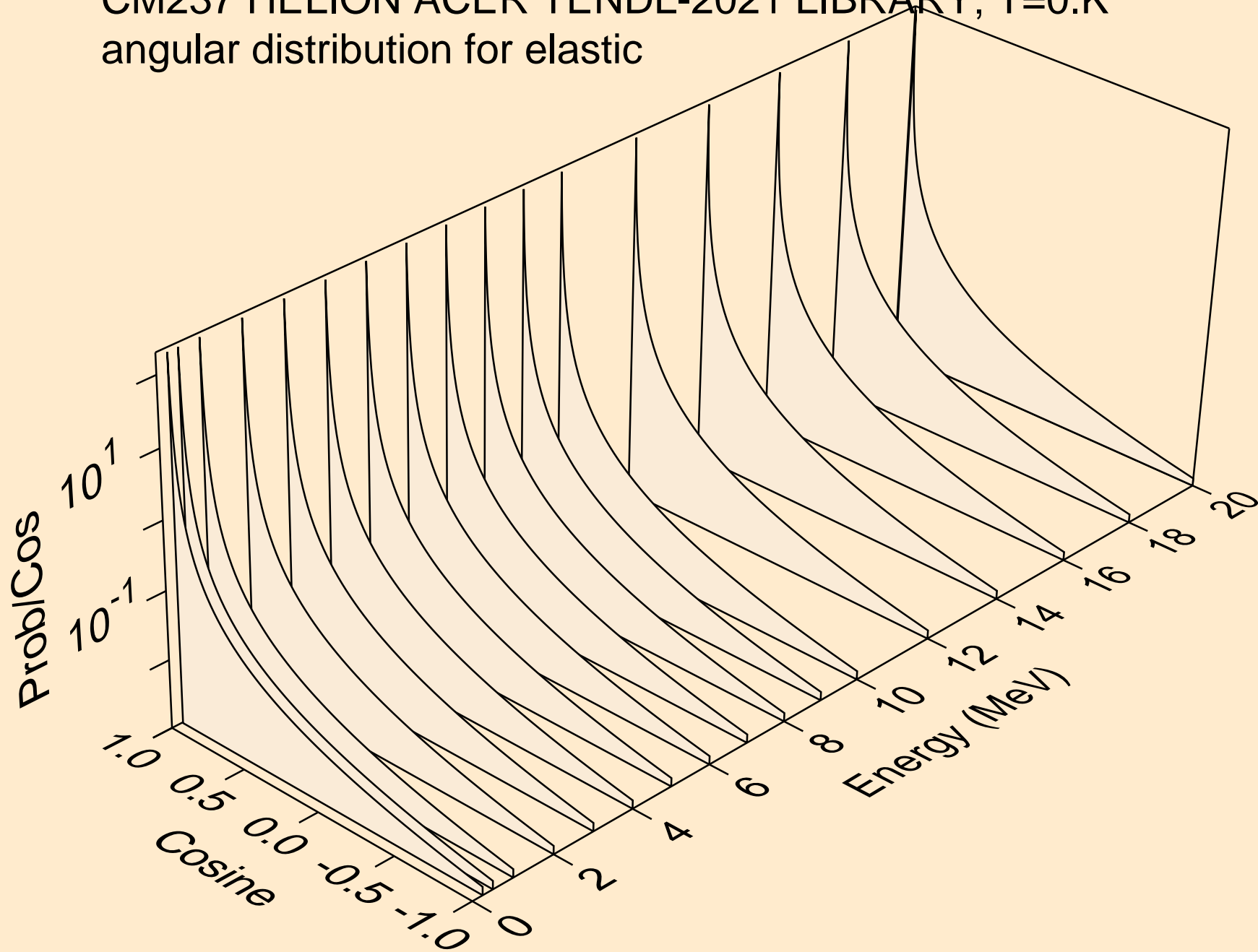

CM237 HELION ACER TENDL-2021 LIBRARY; T=0.K
angular distribution for elastic

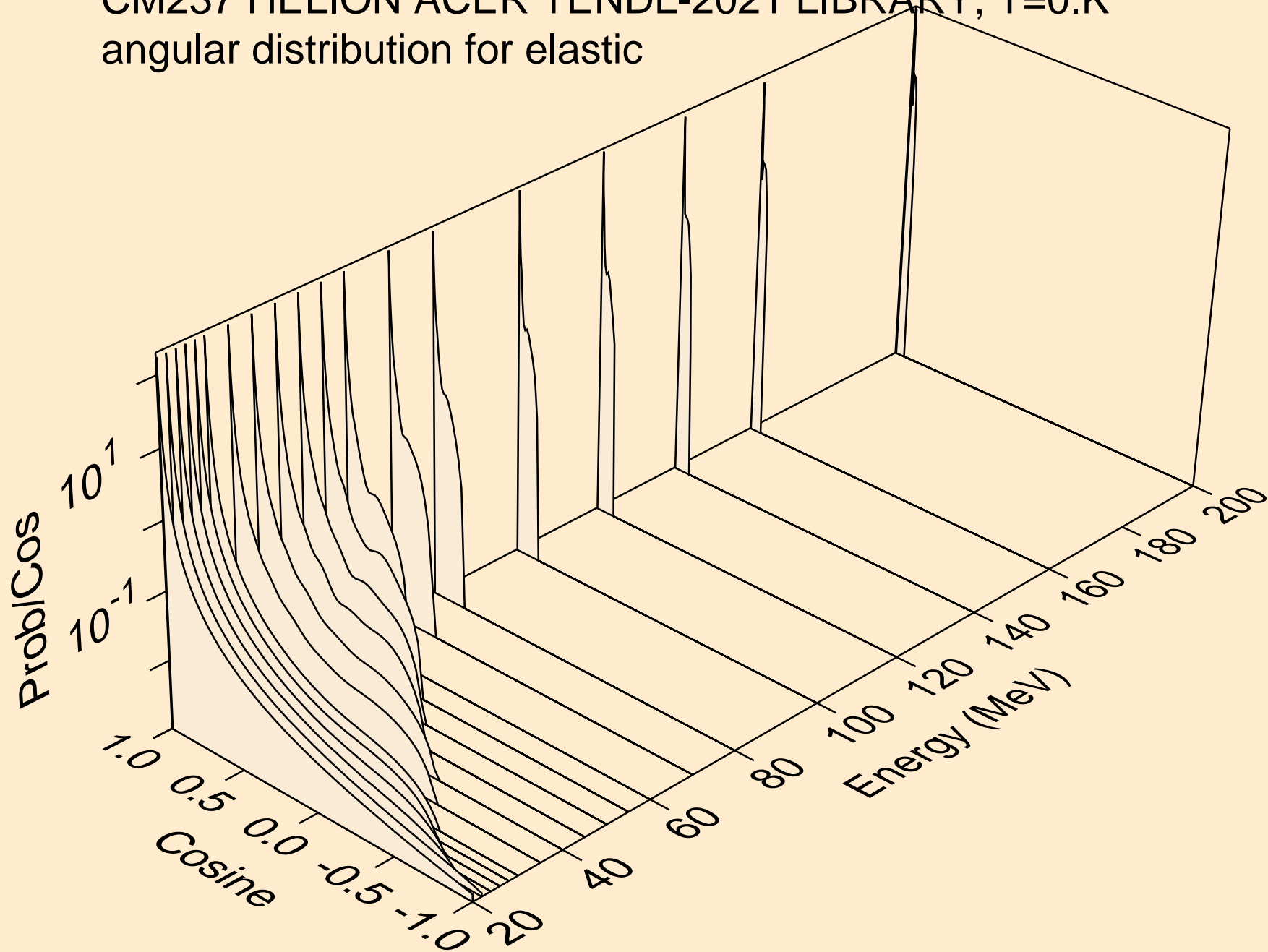

CM237 HELION ACER TENDL-2021 LIBRARY; T=0.K
He-3 emission for (s,x)

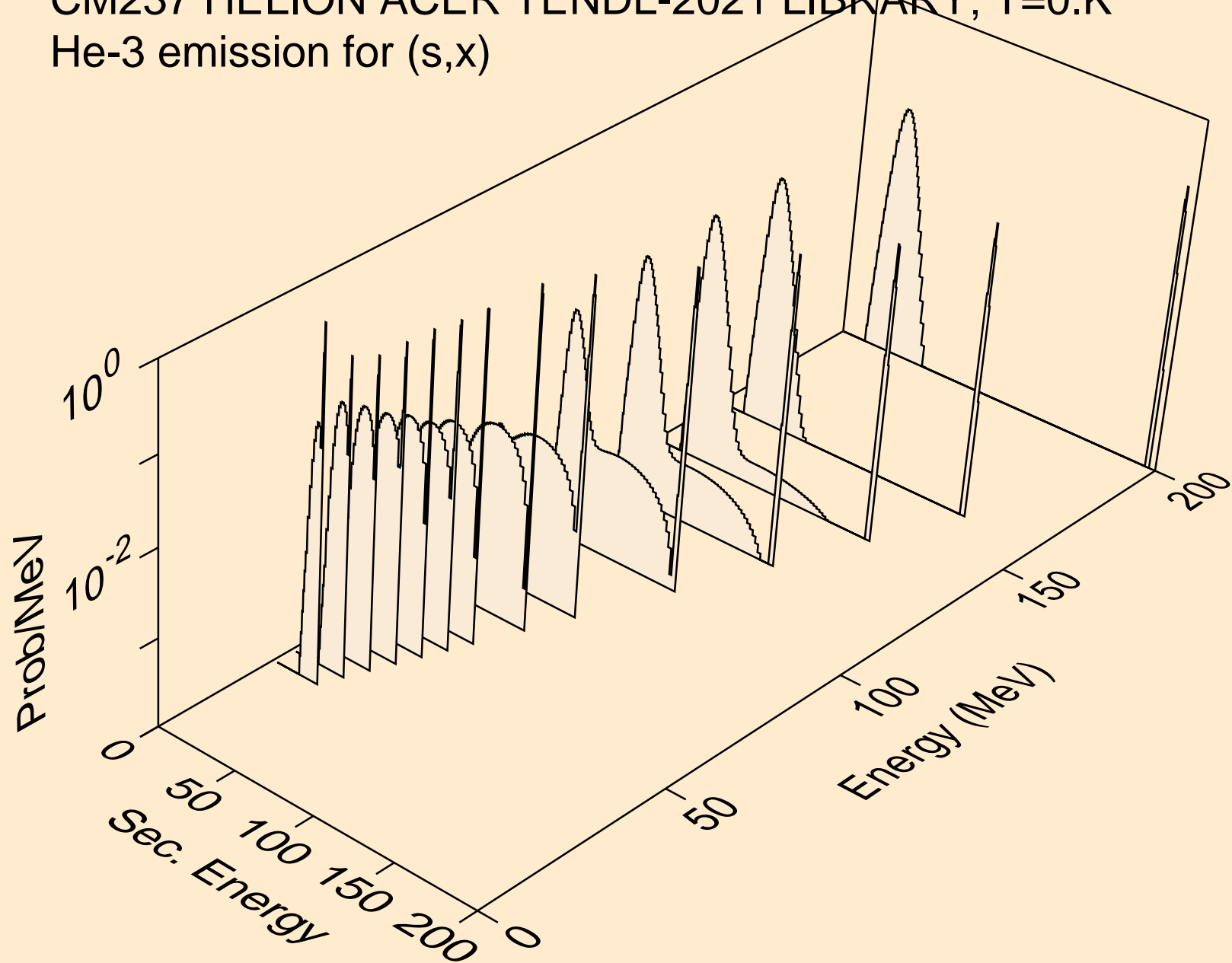

CM237 HELION ACER TENDL-2021 LIBRARY; T=0.K
He-3 emission for (s,n*)he3

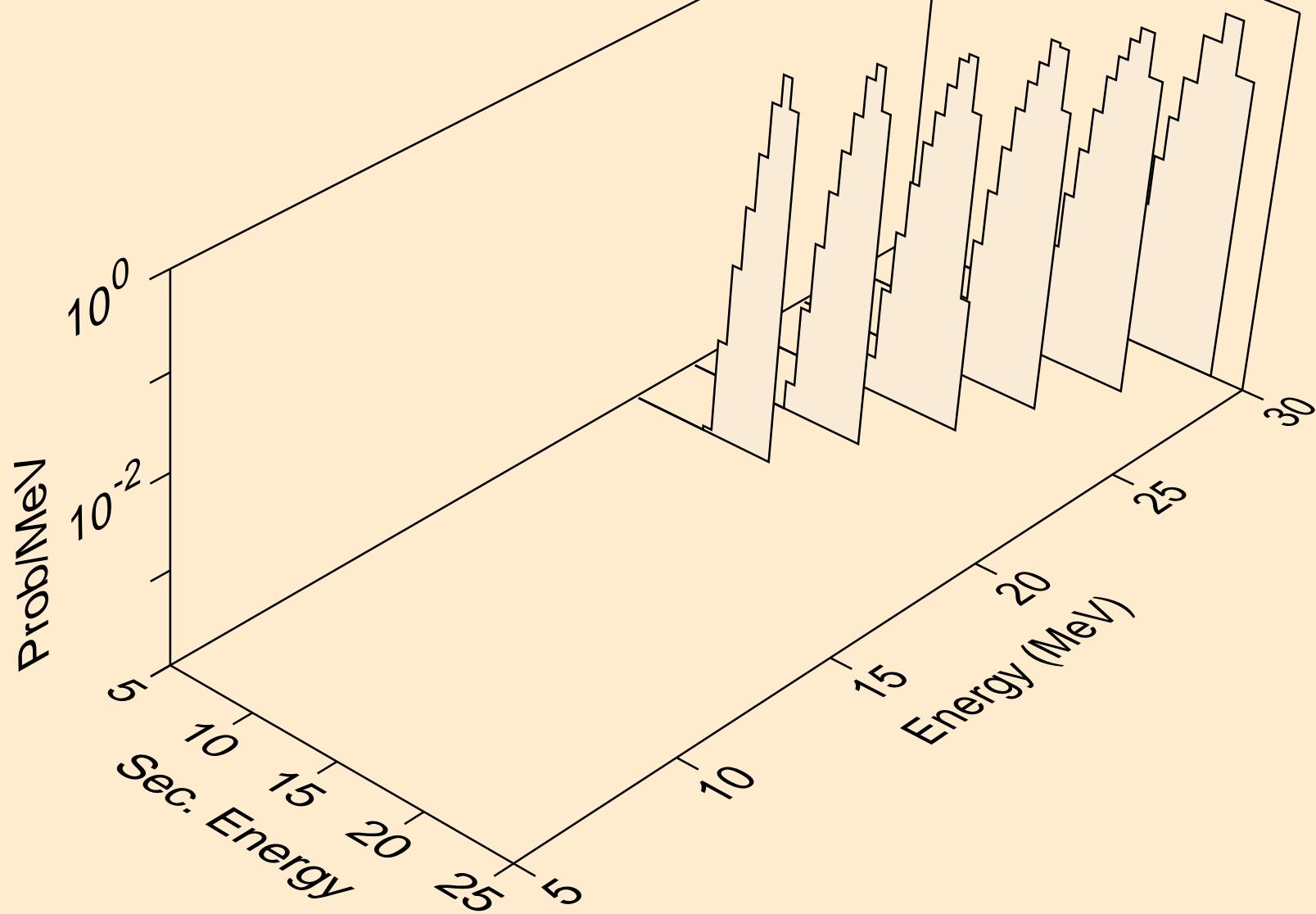

CM237 HELION ACER TENDL-2021 LIBRARY; T=0.K
He-3 emission for inelastic

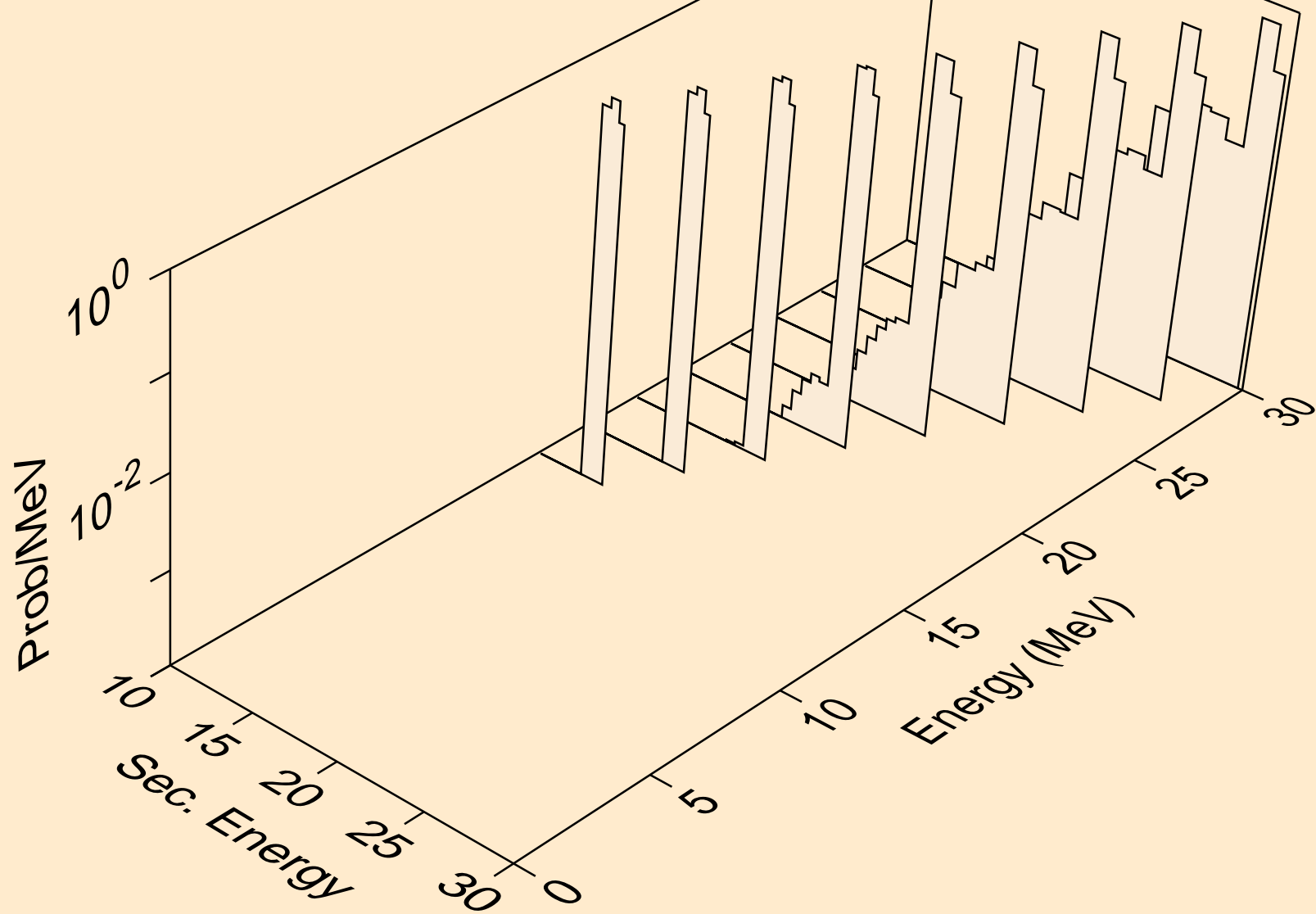

CM237 HELION ACER TENDL-2021 LIBRARY; T=0.K
Photon emission for (z,n)

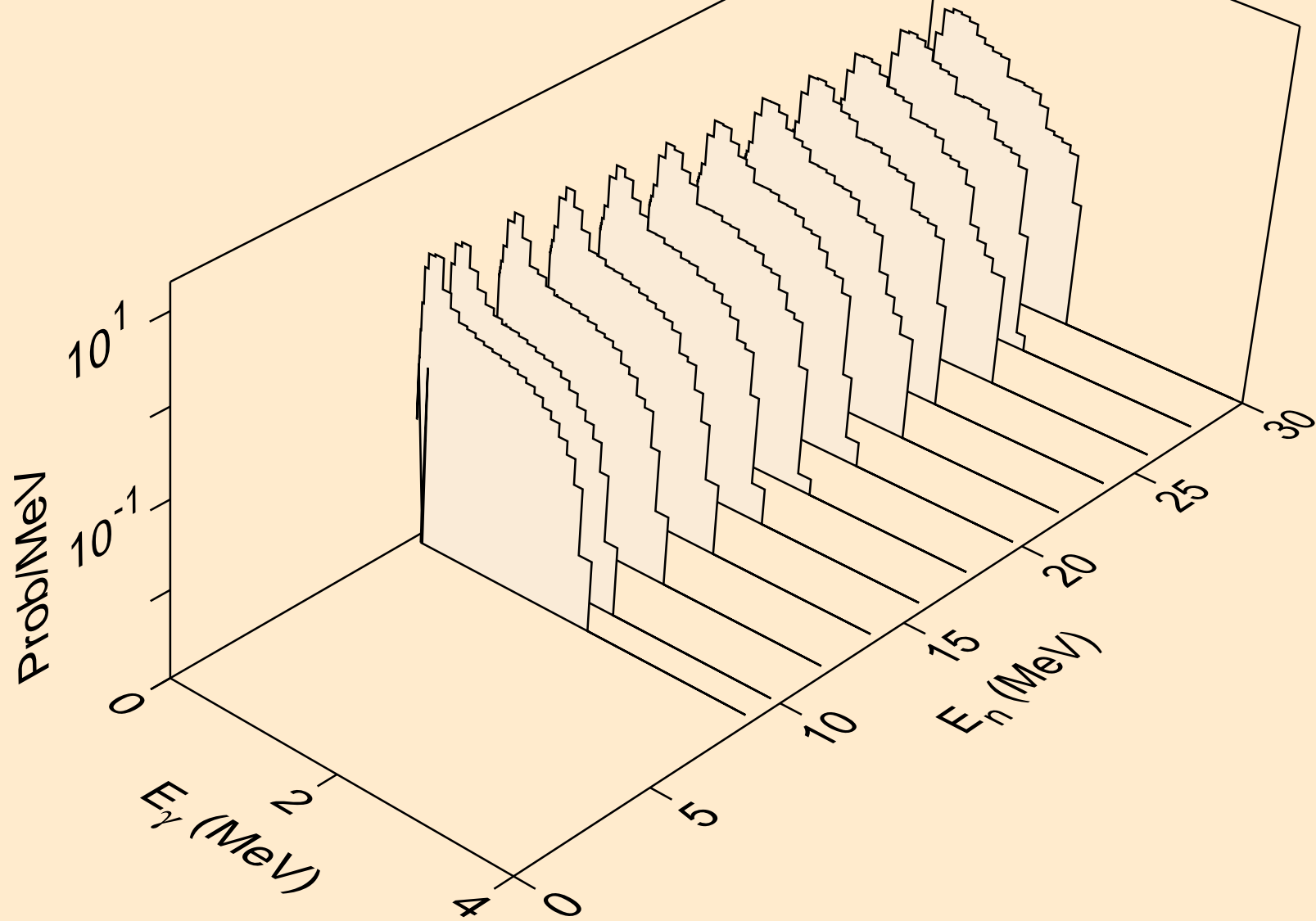

CM237 HELION ACER TENDL-2021 LIBRARY; T=0.K
Photon emission for (n,x)

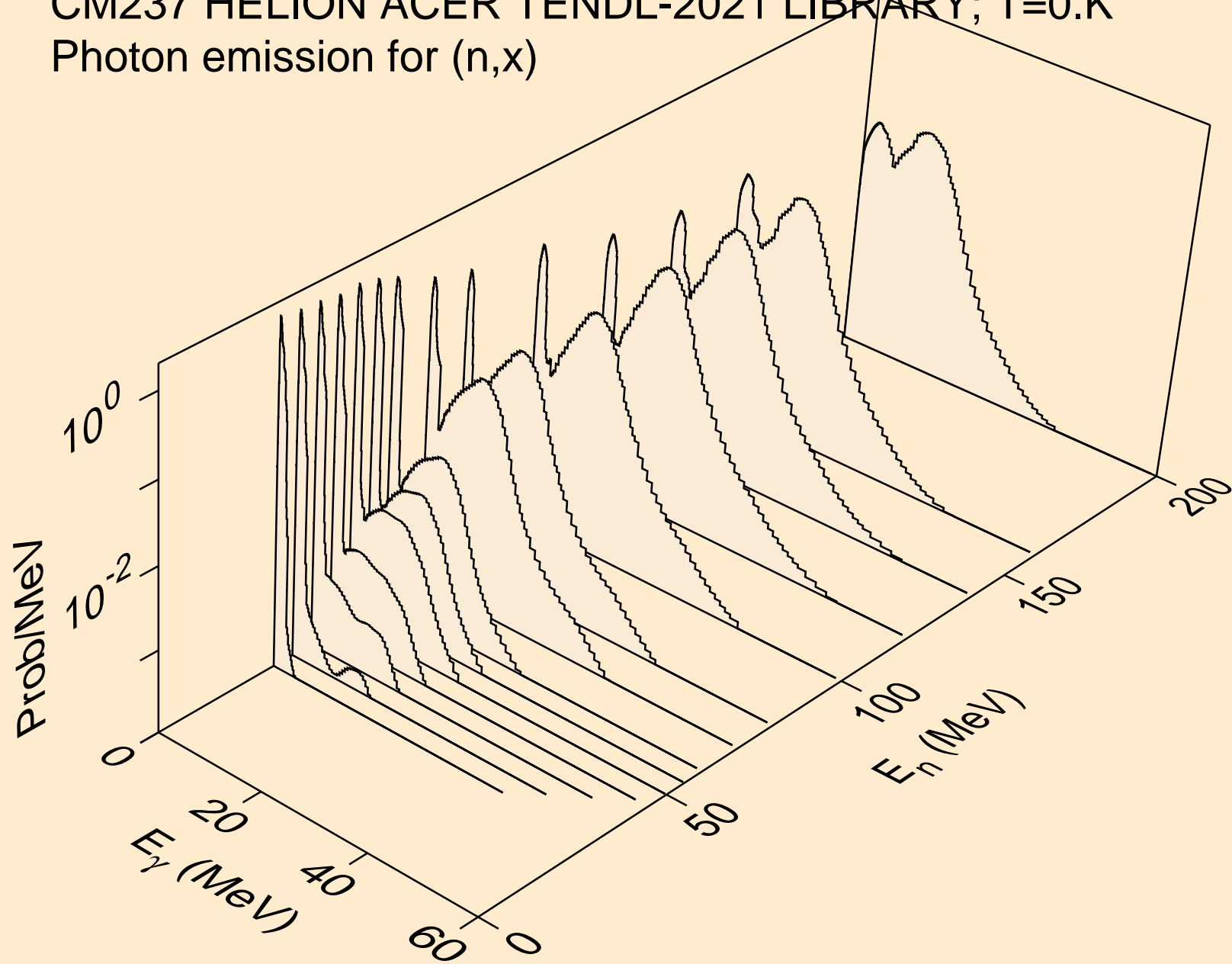

CM237 HELION ACER TENDL-2021 LIBRARY; T=0.K
Photon emission for (n,2n)

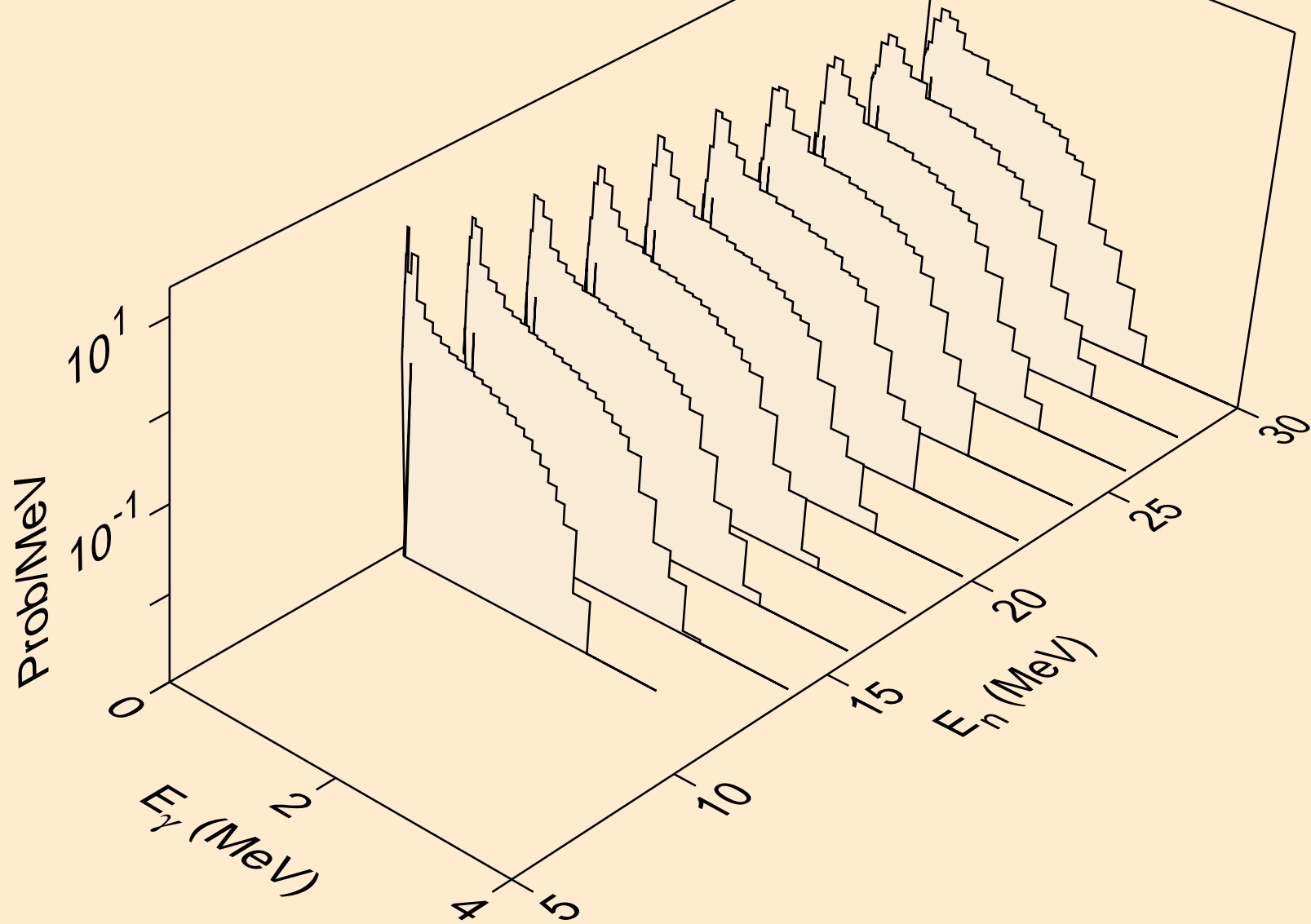

CM237 HELION ACER TENDL-2021 LIBRARY; T=0.K
Photon emission for (n,n*)a

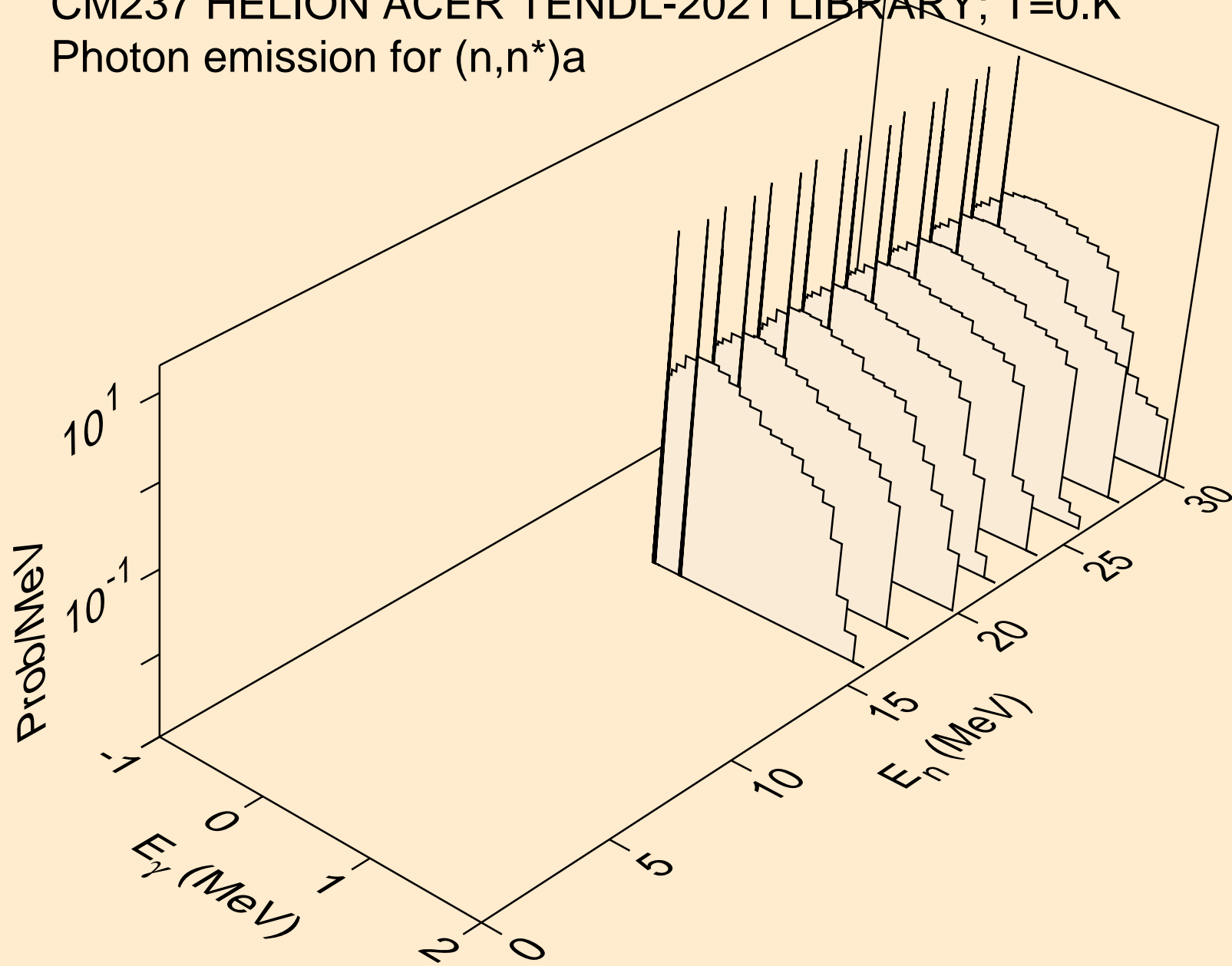

CM237 HELION ACER TENDL-2021 LIBRARY; T=0.K
Photon emission for (n,n*)p

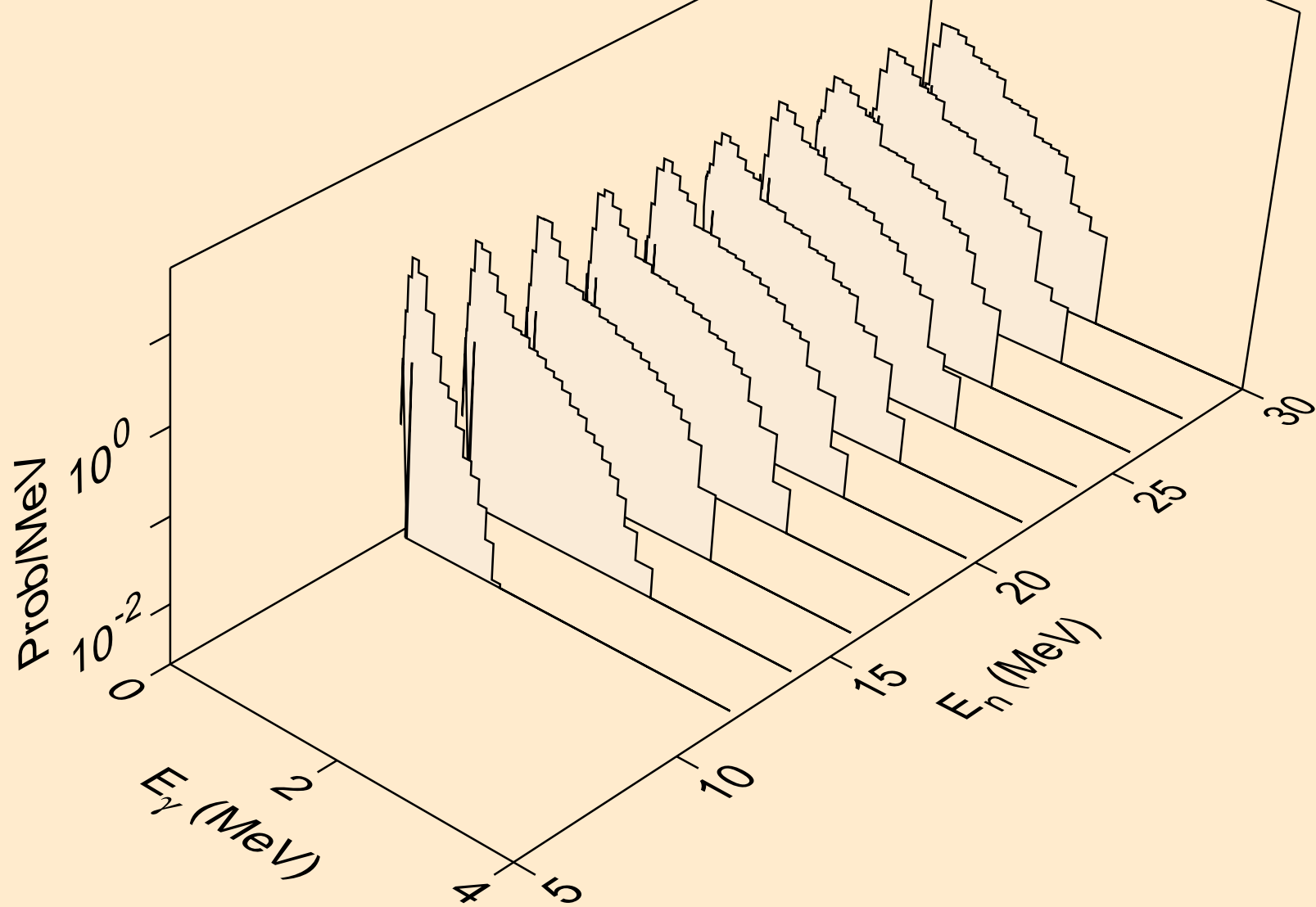

CM237 HELION ACER TENDL-2021 LIBRARY; T=0.K
Photon emission for (n,n*)d

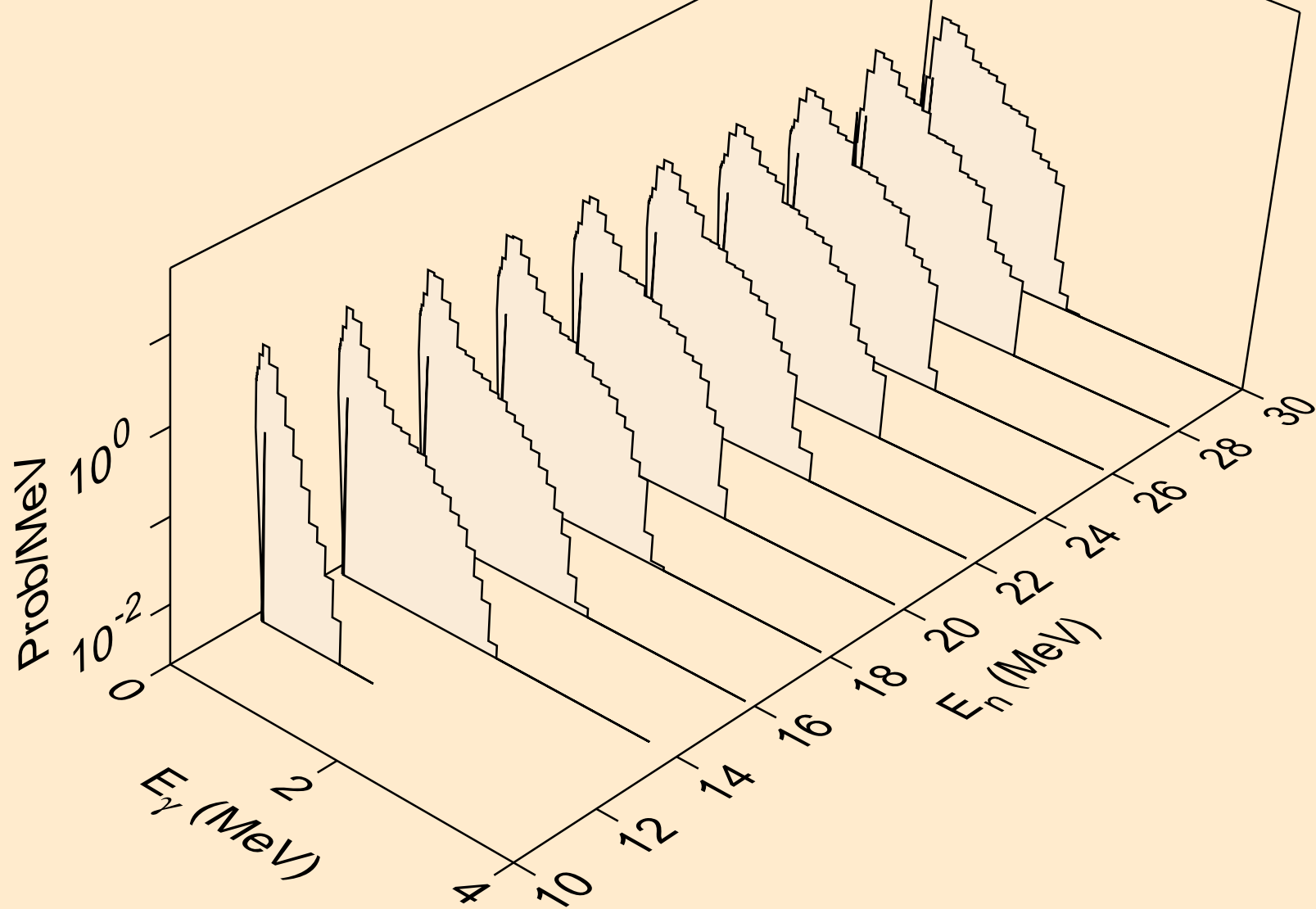

CM237 HELION ACER TENDL-2021 LIBRARY; T=0.K
Photon emission for (n,n*)t

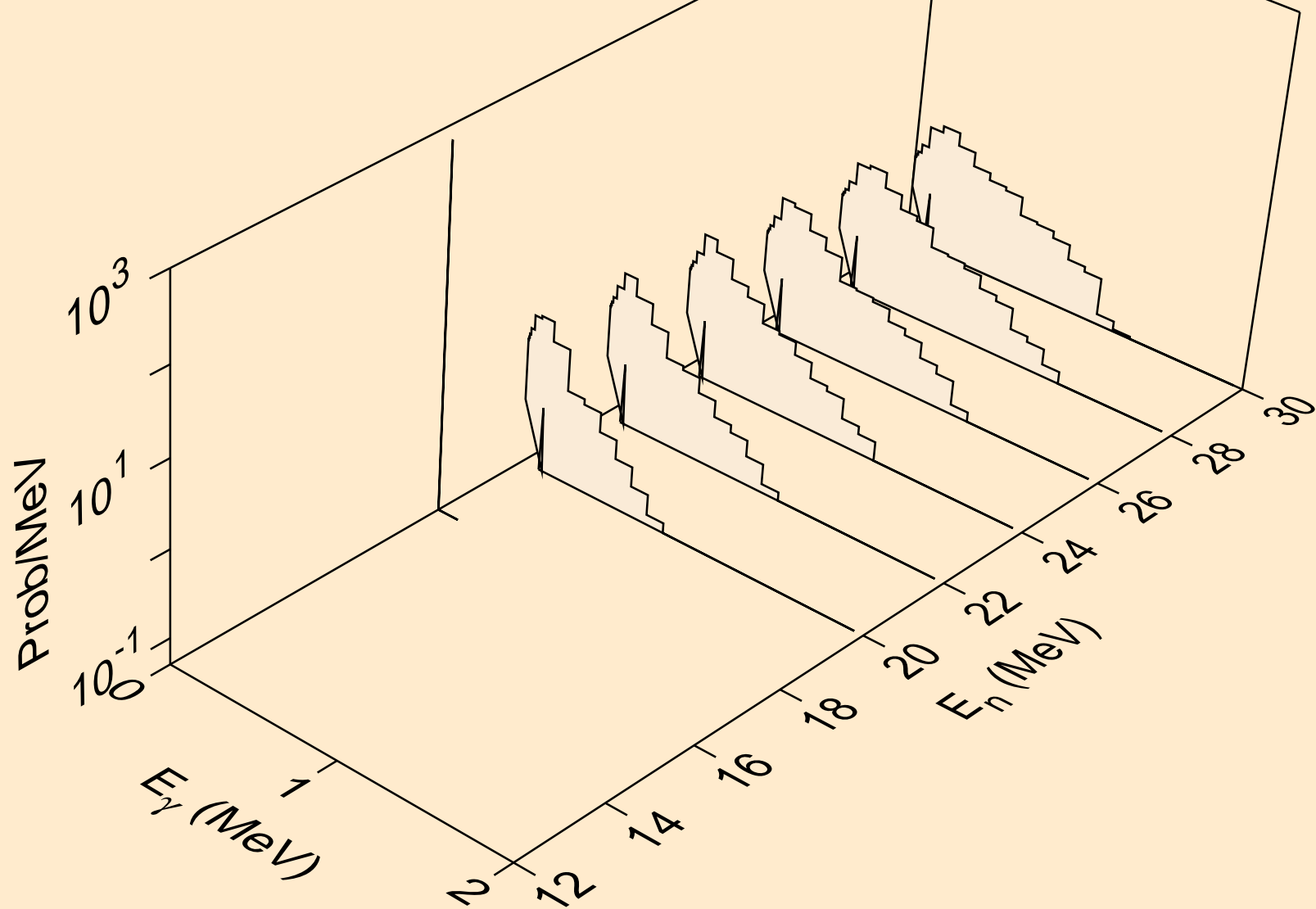

CM237 HELION ACER TENDL-2021 LIBRARY; T=0.K
Photon emission for (n,n*)he3

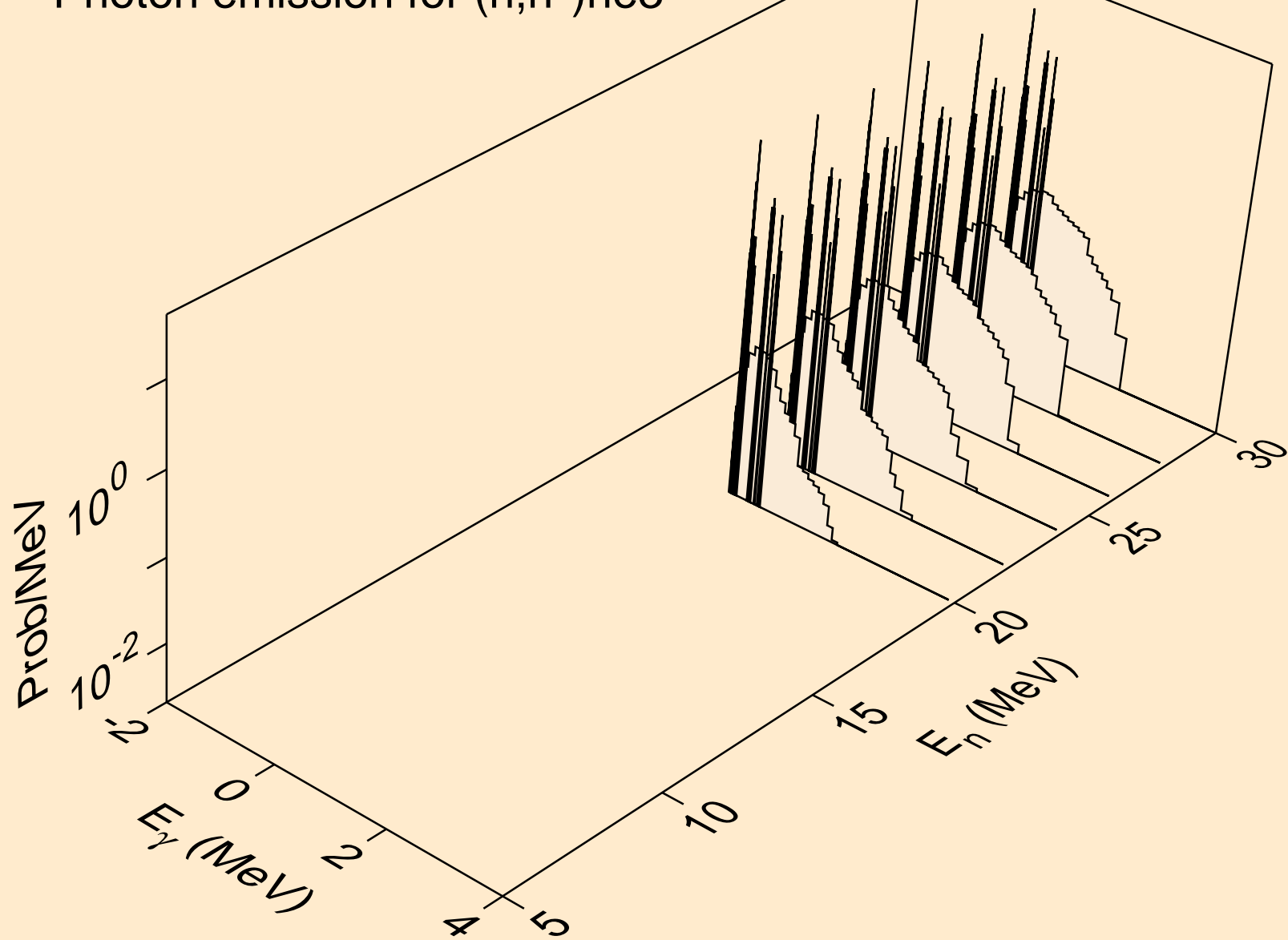

CM237 HELION ACER TENDL-2021 LIBRARY; T=0.K
Photon emission for (n,2np)

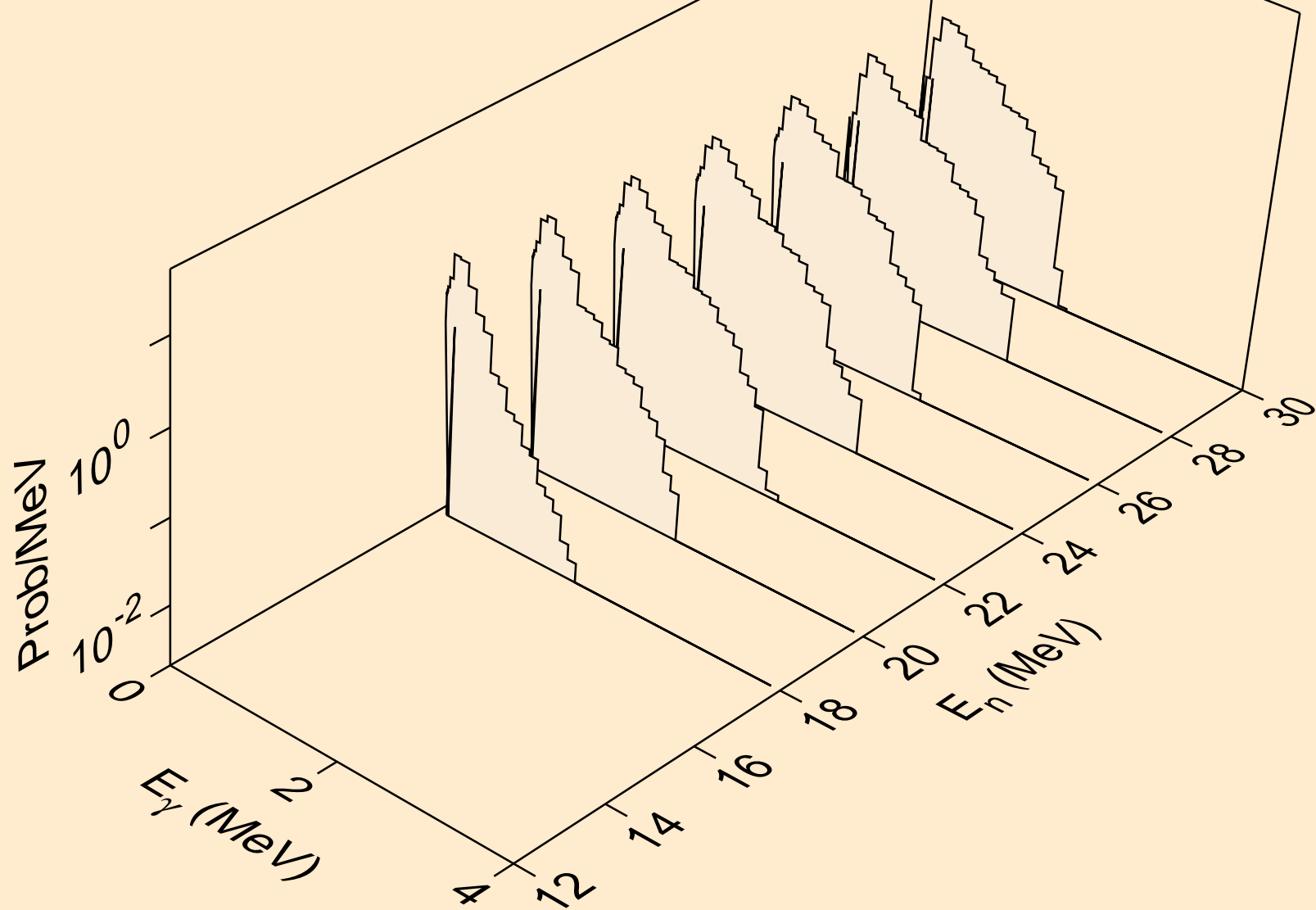

CM237 HELION ACER TENDL-2021 LIBRARY; T=0.K
Photon emission for (n,2np)

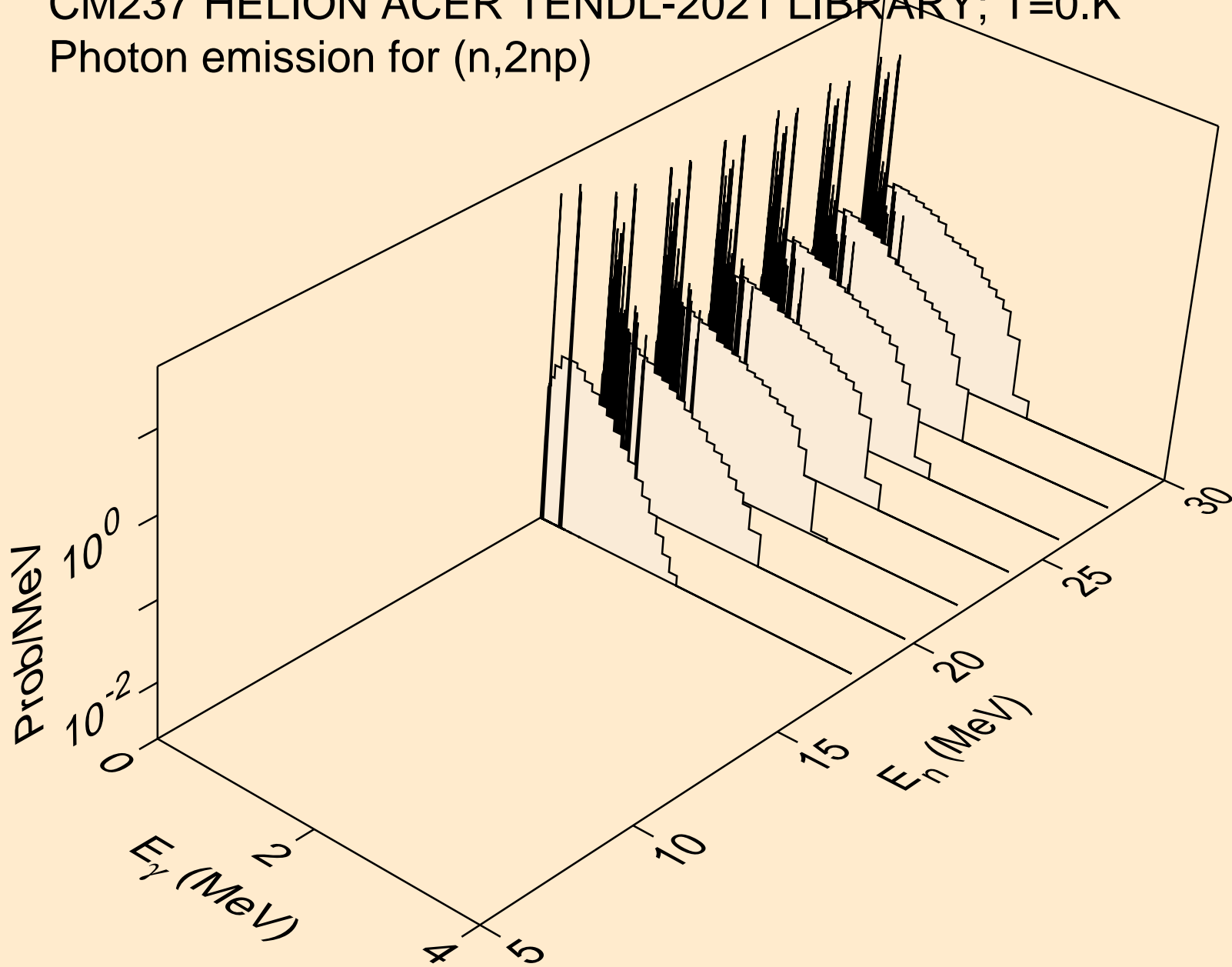

CM237 HELION ACER TENDL-2021 LIBRARY; T=0.K
Photon emission for (n,p)

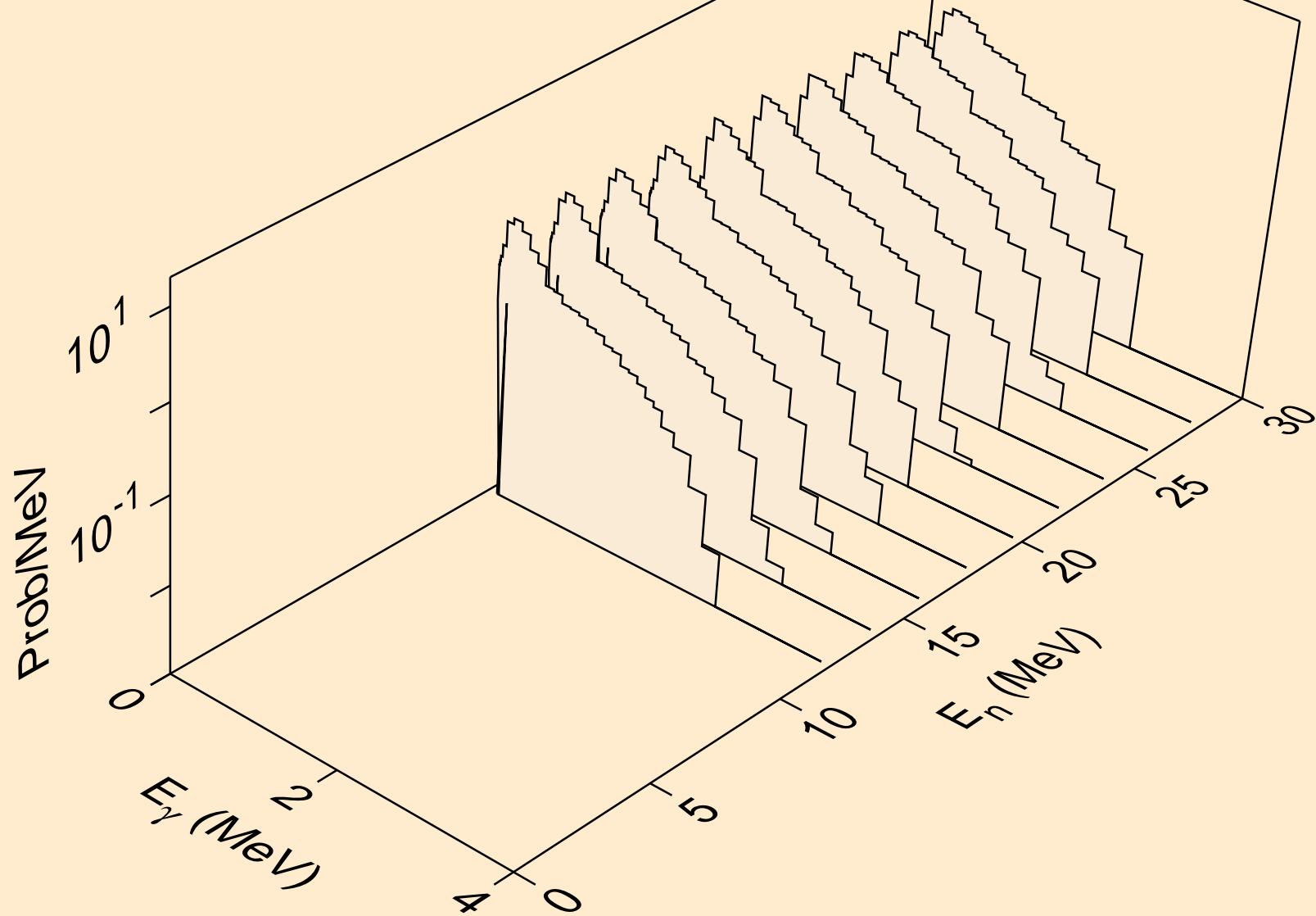

CM237 HELION ACER TENDL-2021 LIBRARY; T=0.K
Photon emission for (n,d)

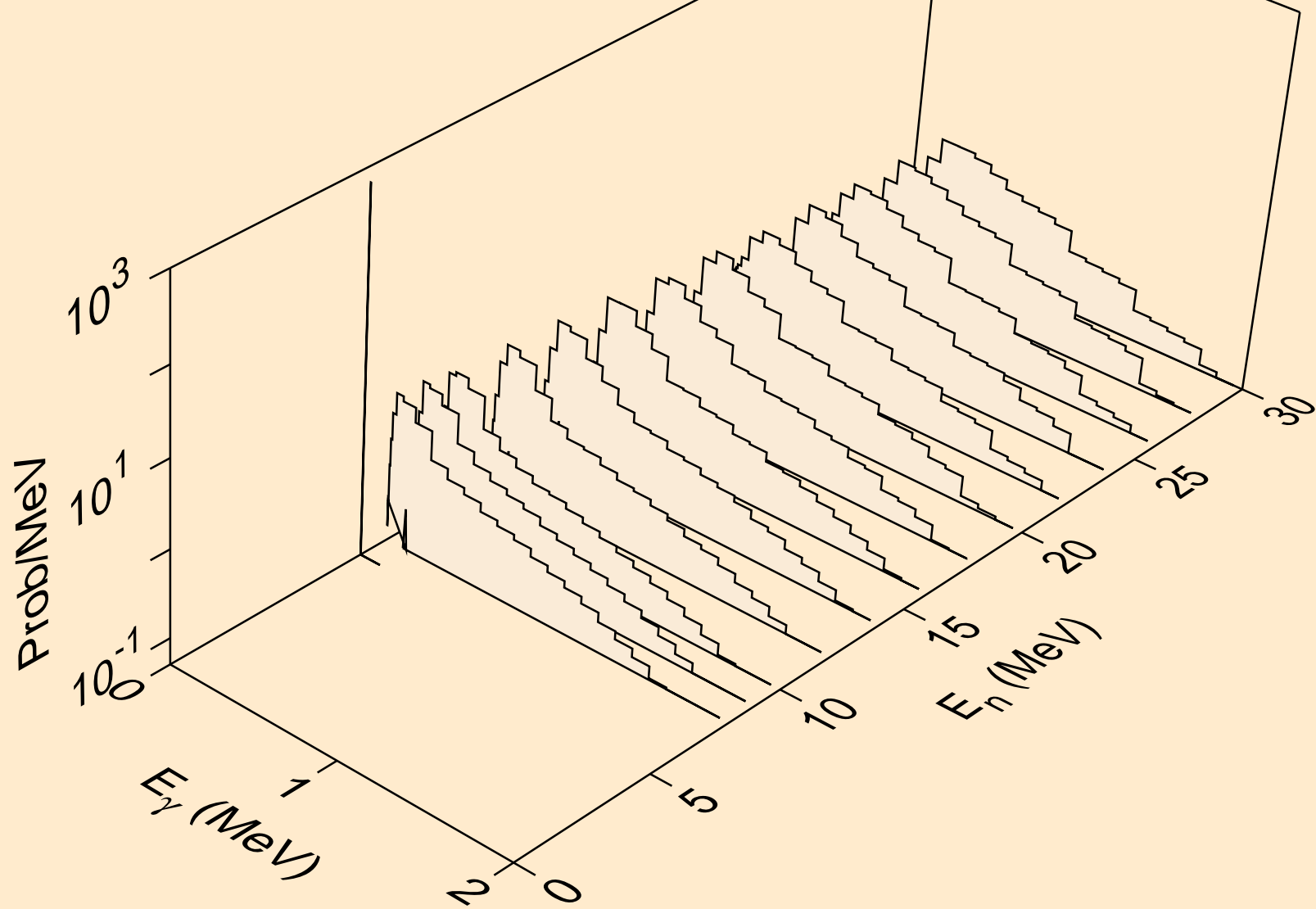

CM237 HELION ACER TENDL-2021 LIBRARY; T=0.K
Photon emission for (n,t)

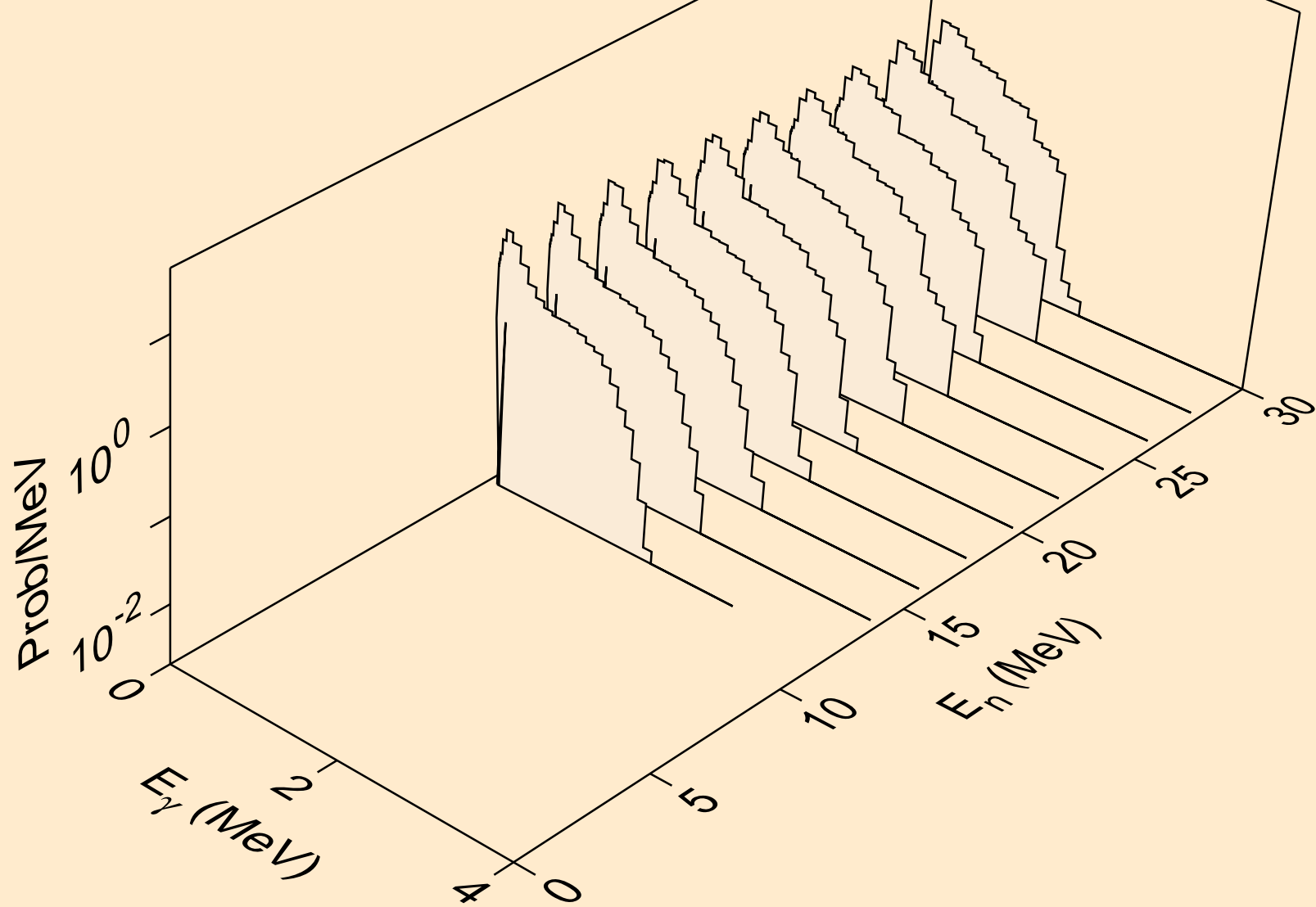

CM237 HELION ACER TENDL-2021 LIBRARY; T=0.K
Photon emission for inelastic

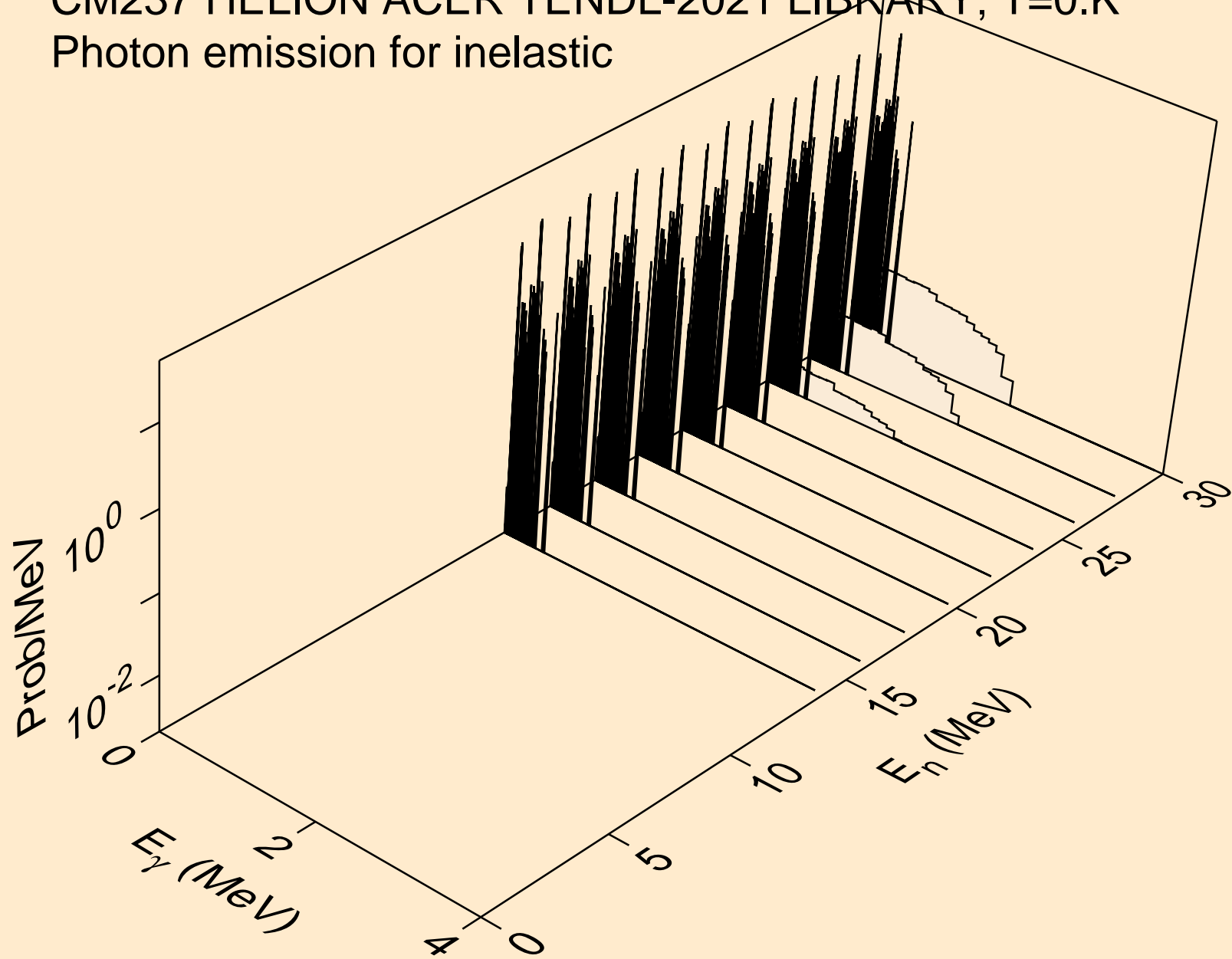

CM237 HELION ACER TENDL-2021 LIBRARY; T=0.K
Photon emission for (n,a)

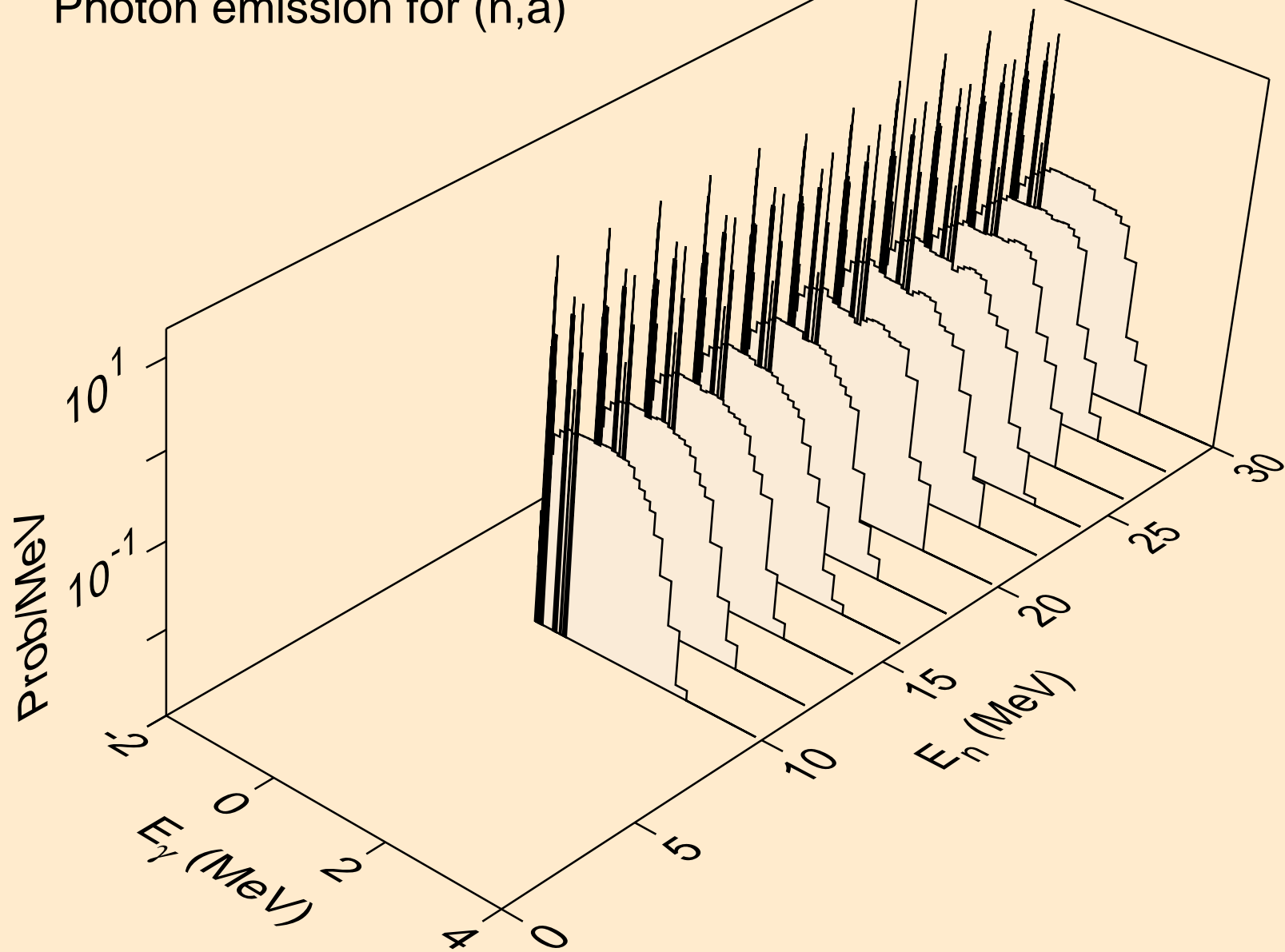

CM237 HELION ACER TENDL-2021 LIBRARY; T=0.K
Photon emission for (n,2p)

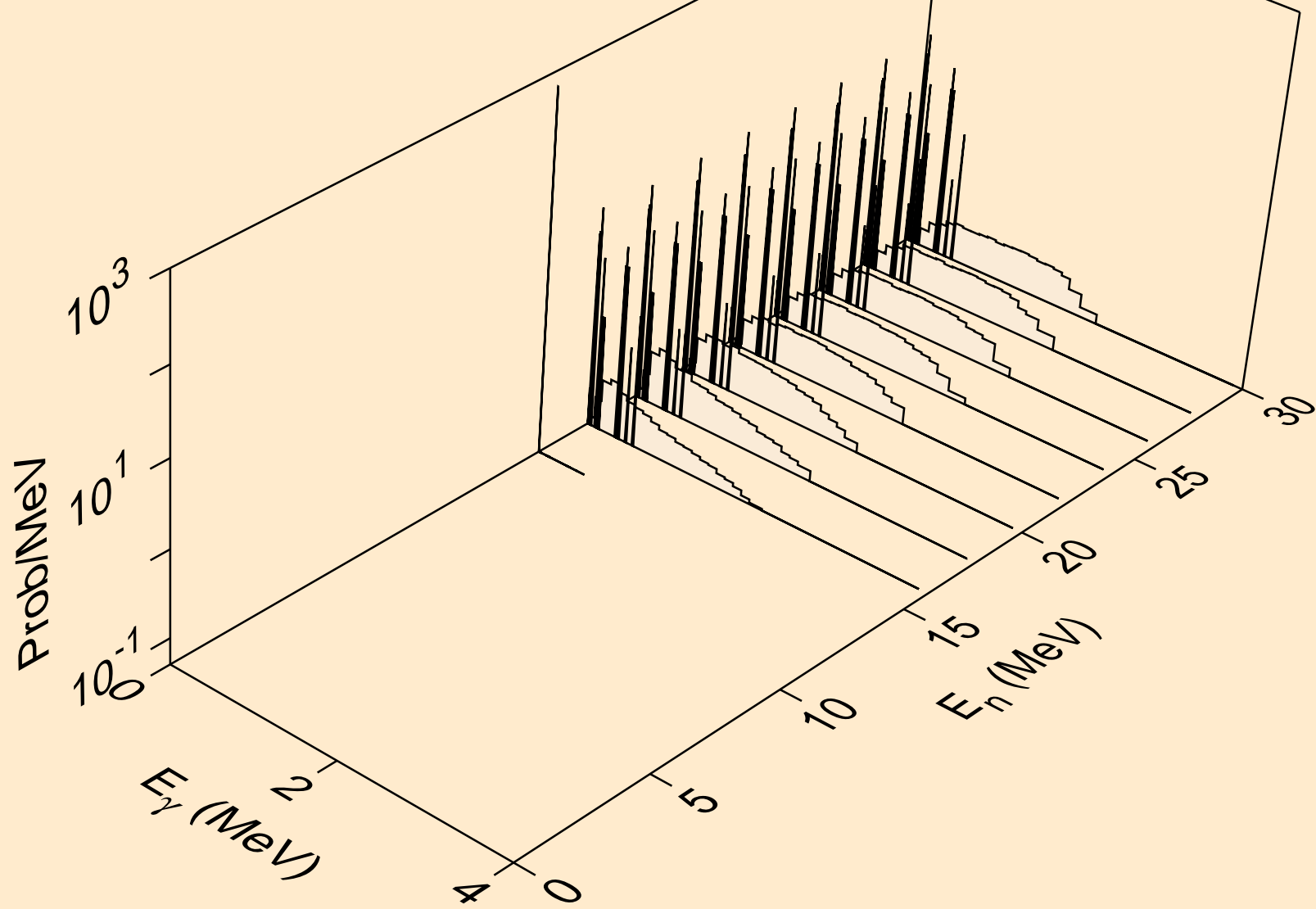

CM237 HELION ACER TENDL-2021 LIBRARY; T=0.K
Photon emission for (n,pd)

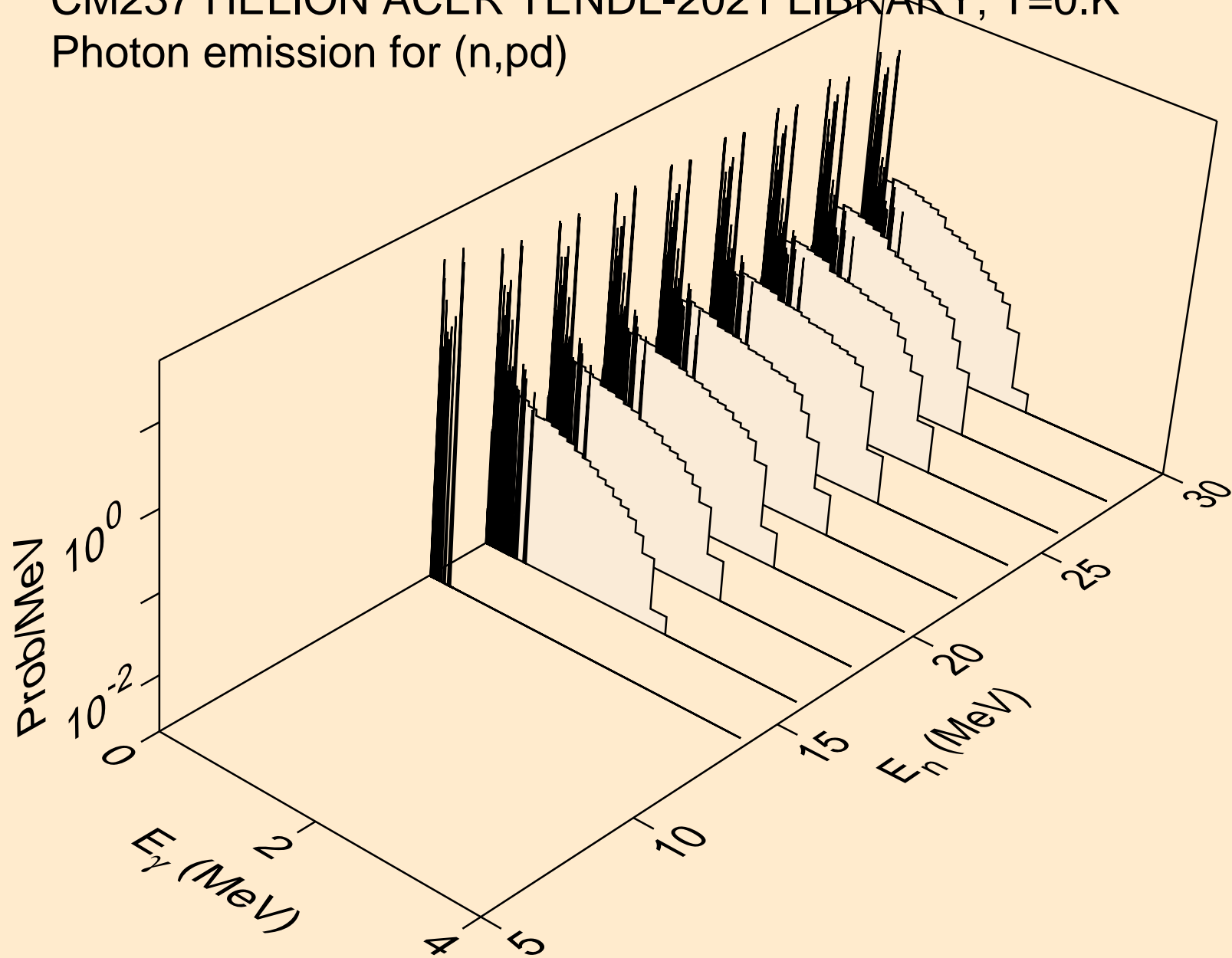

CM237 HELION ACER TENDL-2021 LIBRARY; T=0.K
Particle heating contributions

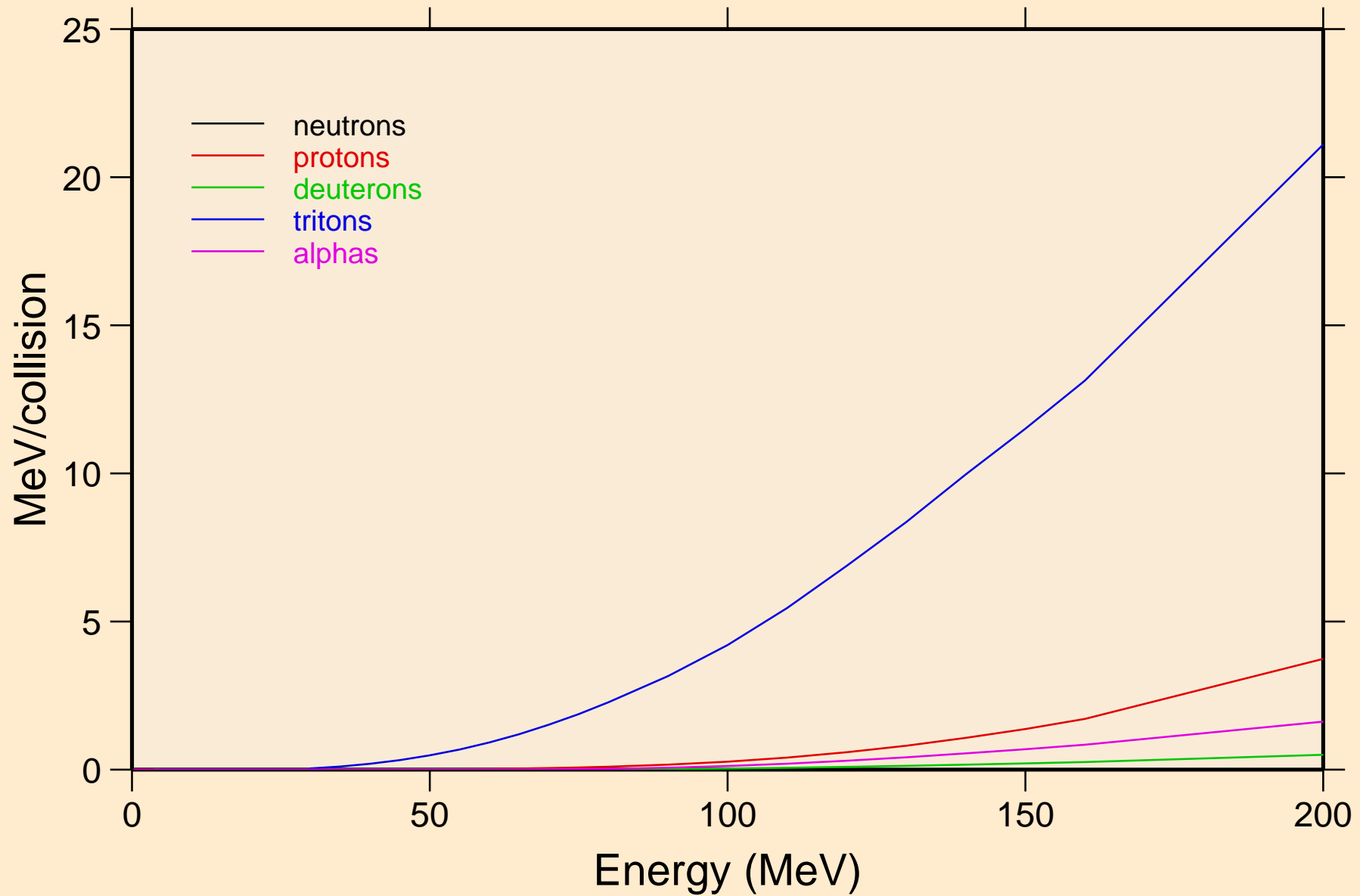

CM237 HELION ACER TENDL-2021 LIBRARY; T=0.K

Recoil Heating

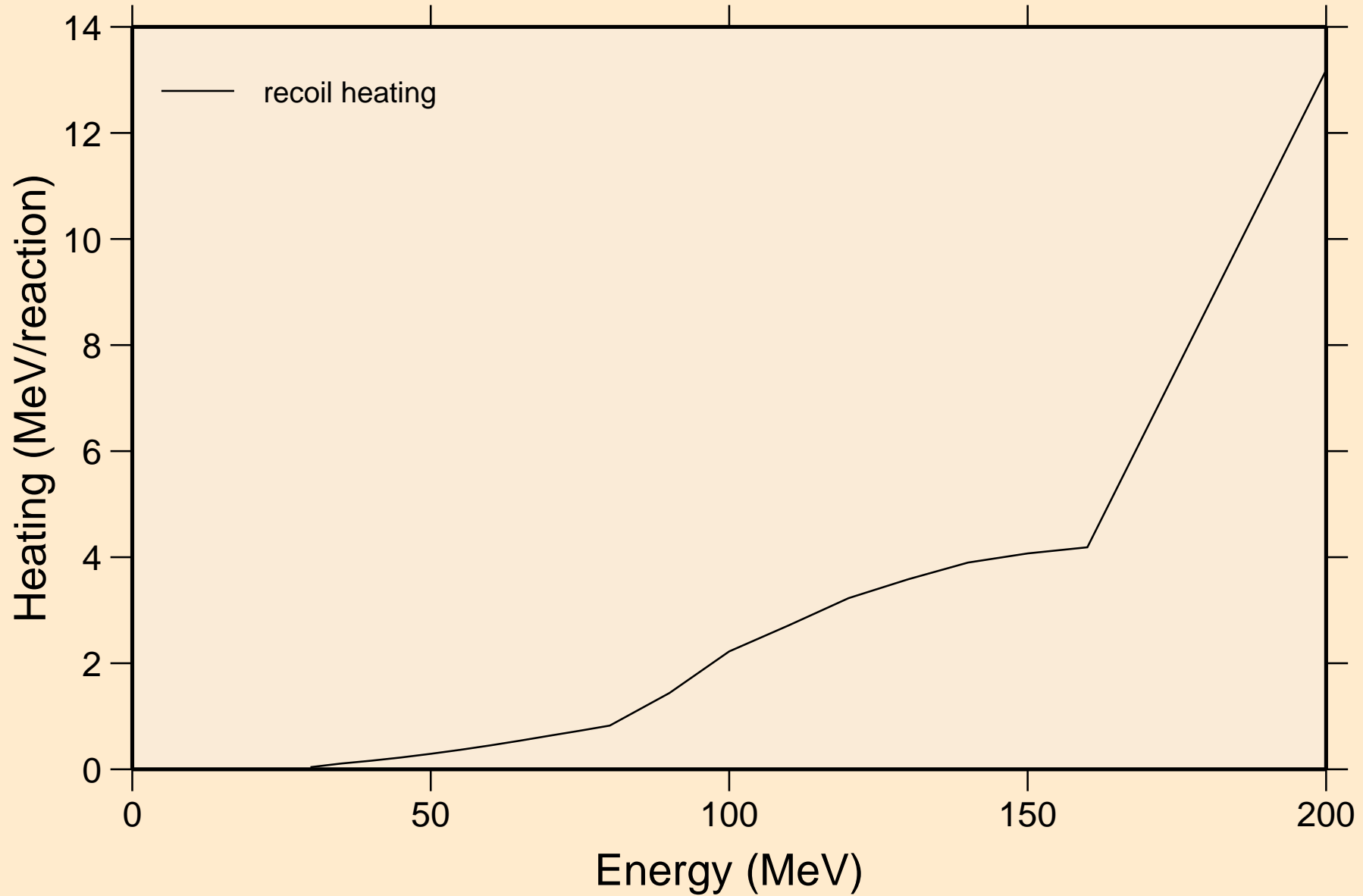

CM237 HELION ACER TENDL-2021 LIBRARY; T=0.K
Particle production cross sections

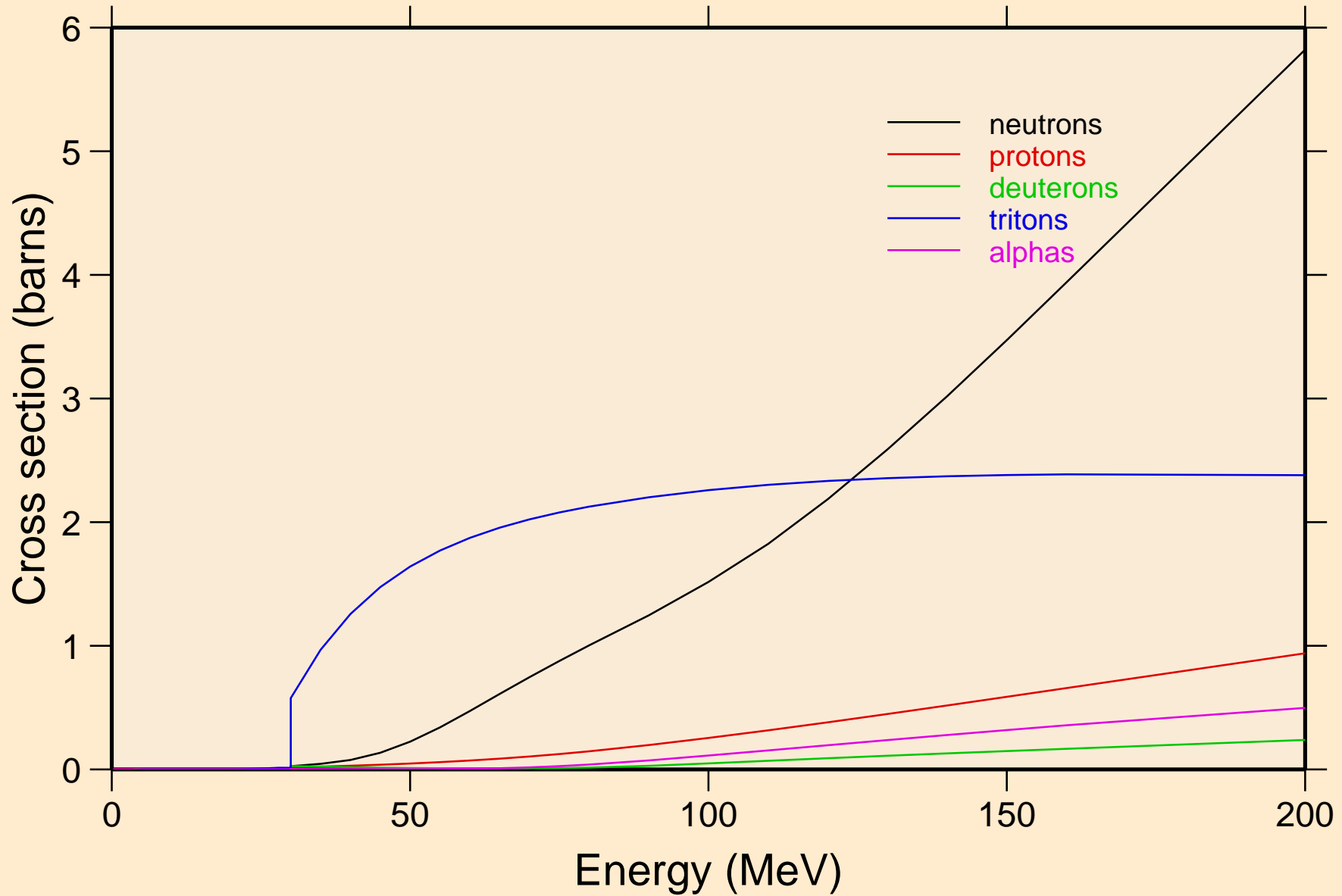

CM237 HELION ACER TENDL-2021 LIBRARY; T=0.K
neutrons from (s,n)

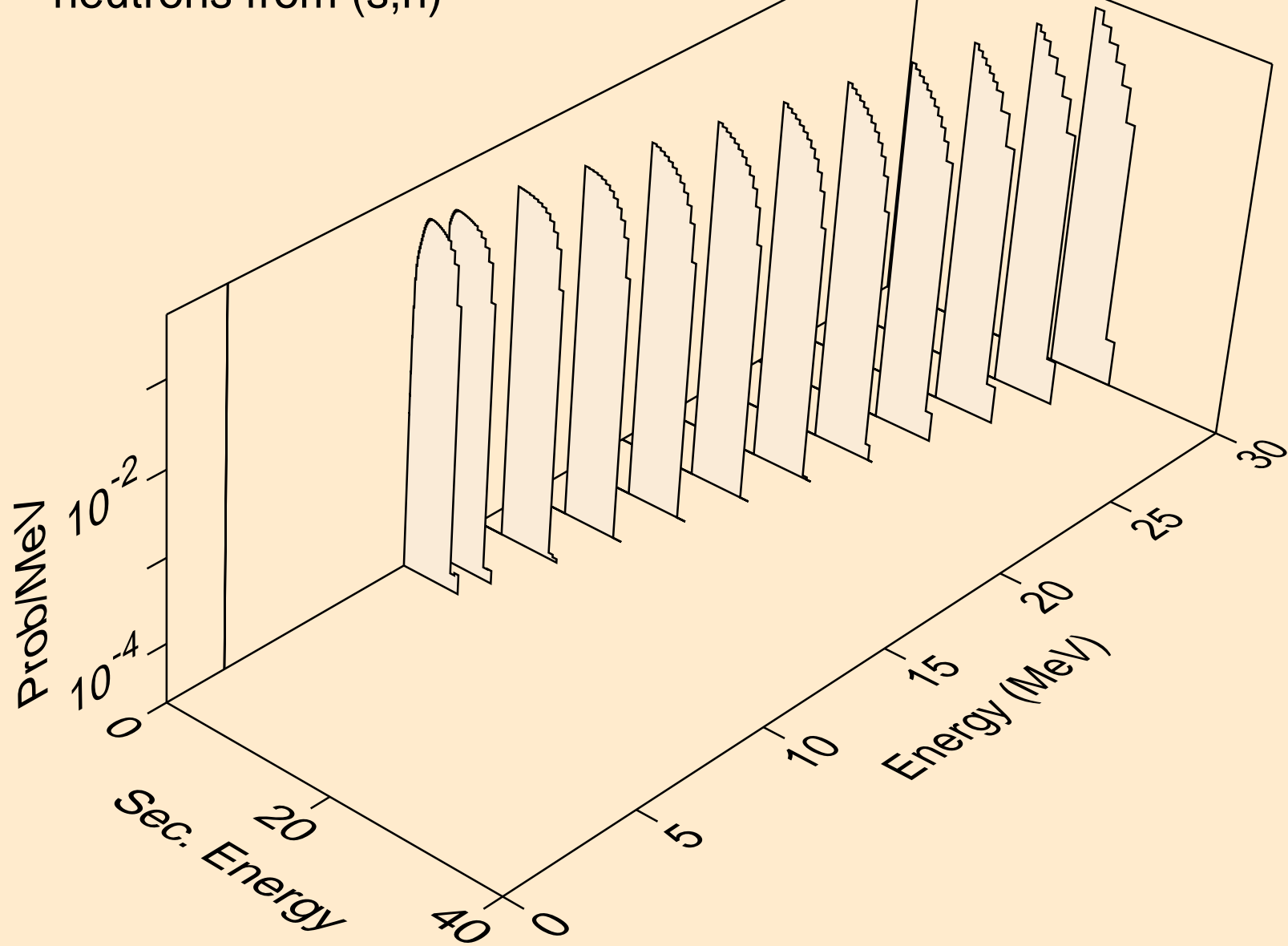

CM237 HELION ACER TENDL-2021 LIBRARY; T=0.K
neutrons from (s,x)

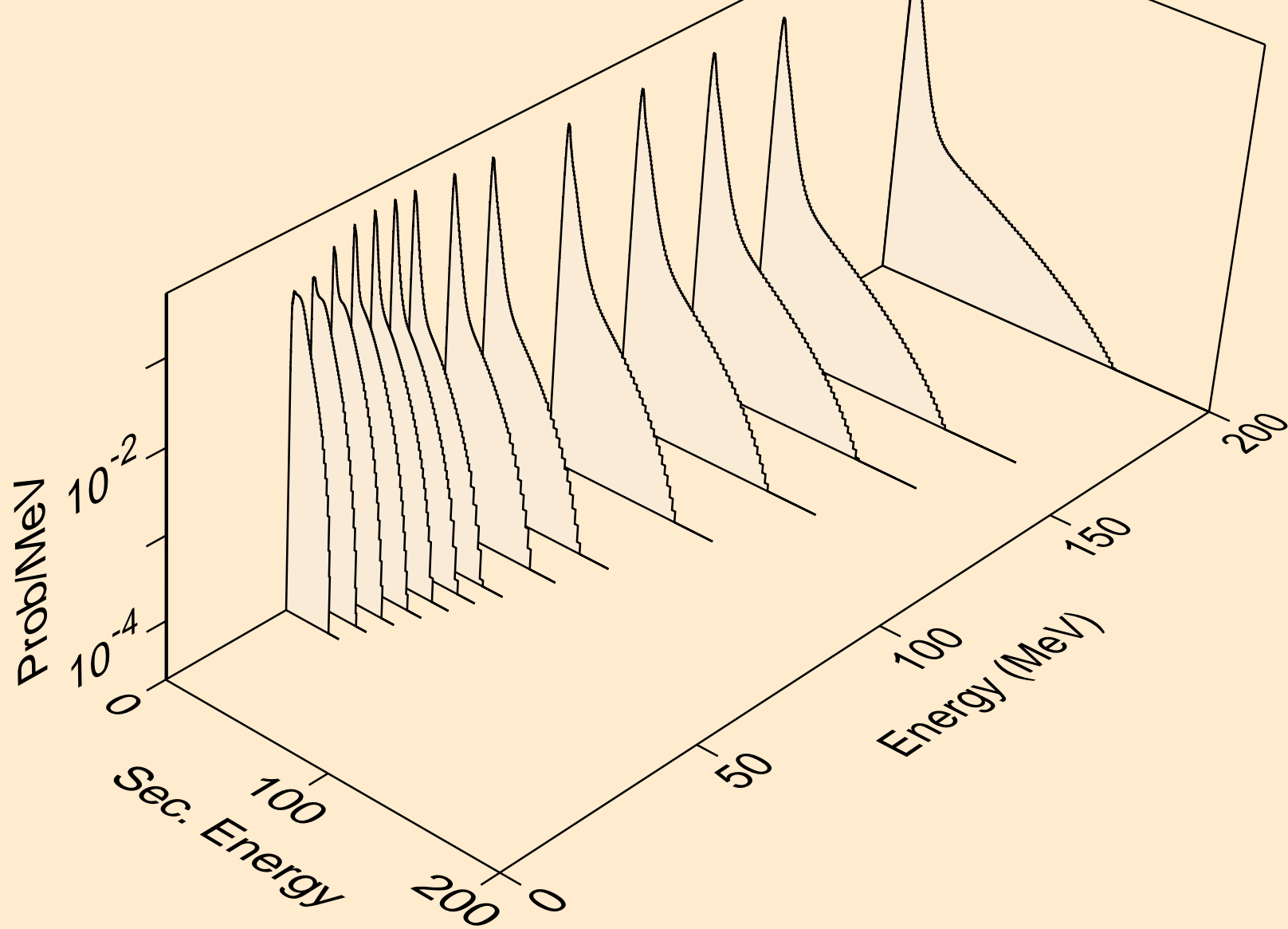

CM237 HELION ACER TENDL-2021 LIBRARY; T=0.K
neutrons from (s,2n)

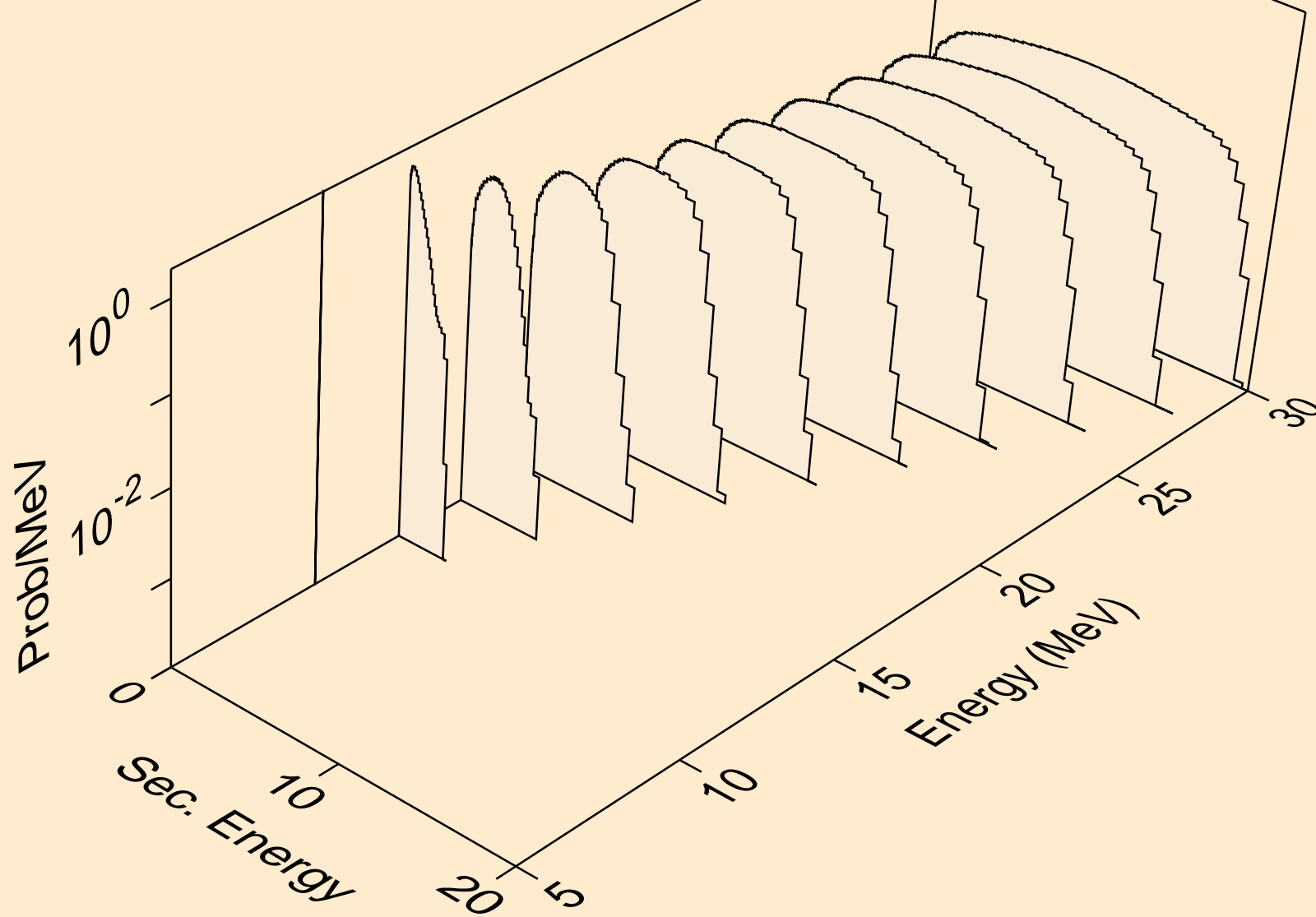

CM237 HELION ACER TENDL-2021 LIBRARY; T=0.K
neutrons from (s,n*)a

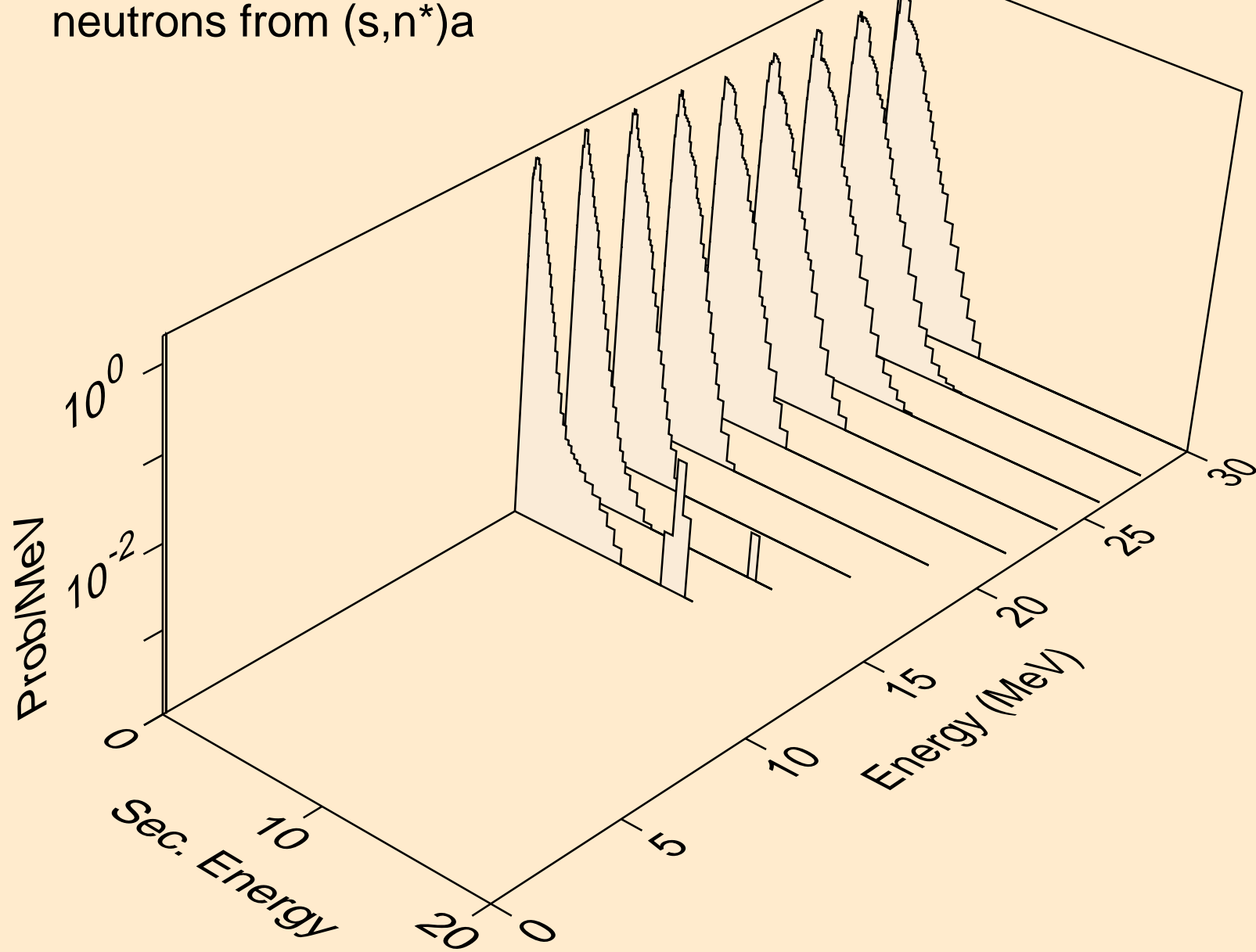

CM237 HELION ACER TENDL-2021 LIBRARY; T=0.K
neutrons from (s,n*)p

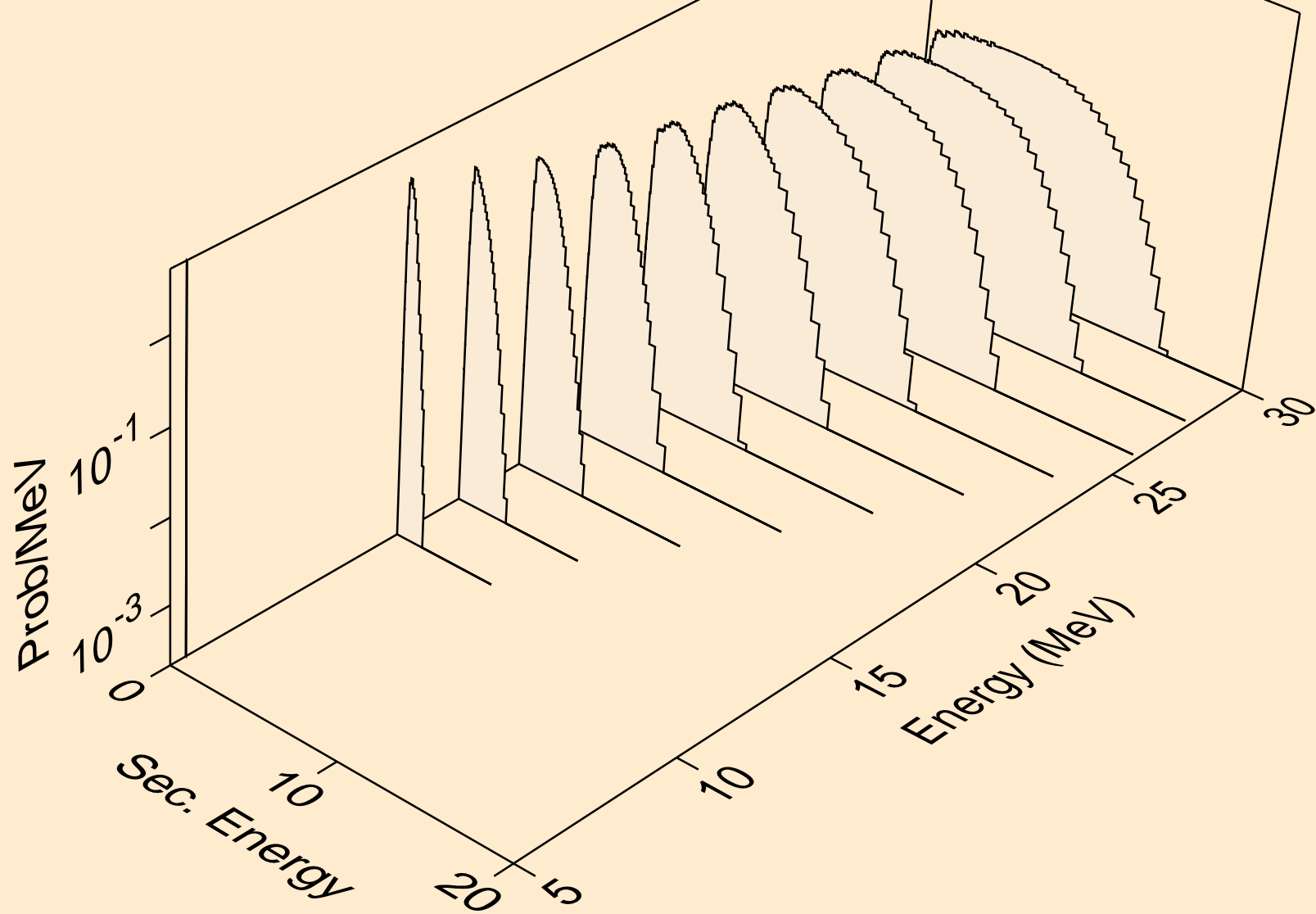

CM237 HELION ACER TENDL-2021 LIBRARY; T=0.K
neutrons from (s,n*)d

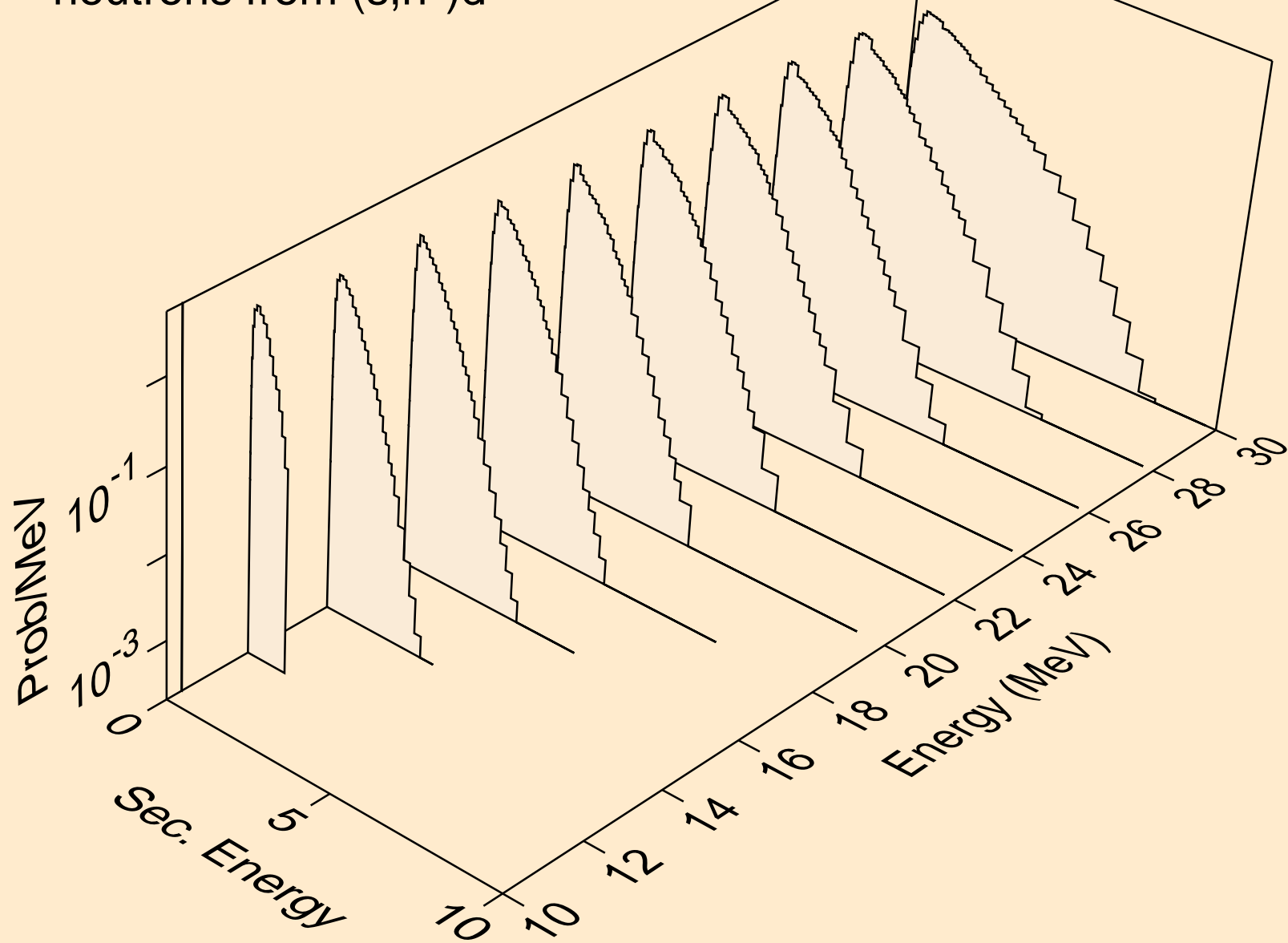

CM237 HELION ACER TENDL-2021 LIBRARY; T=0.K
neutrons from (s,n*)t

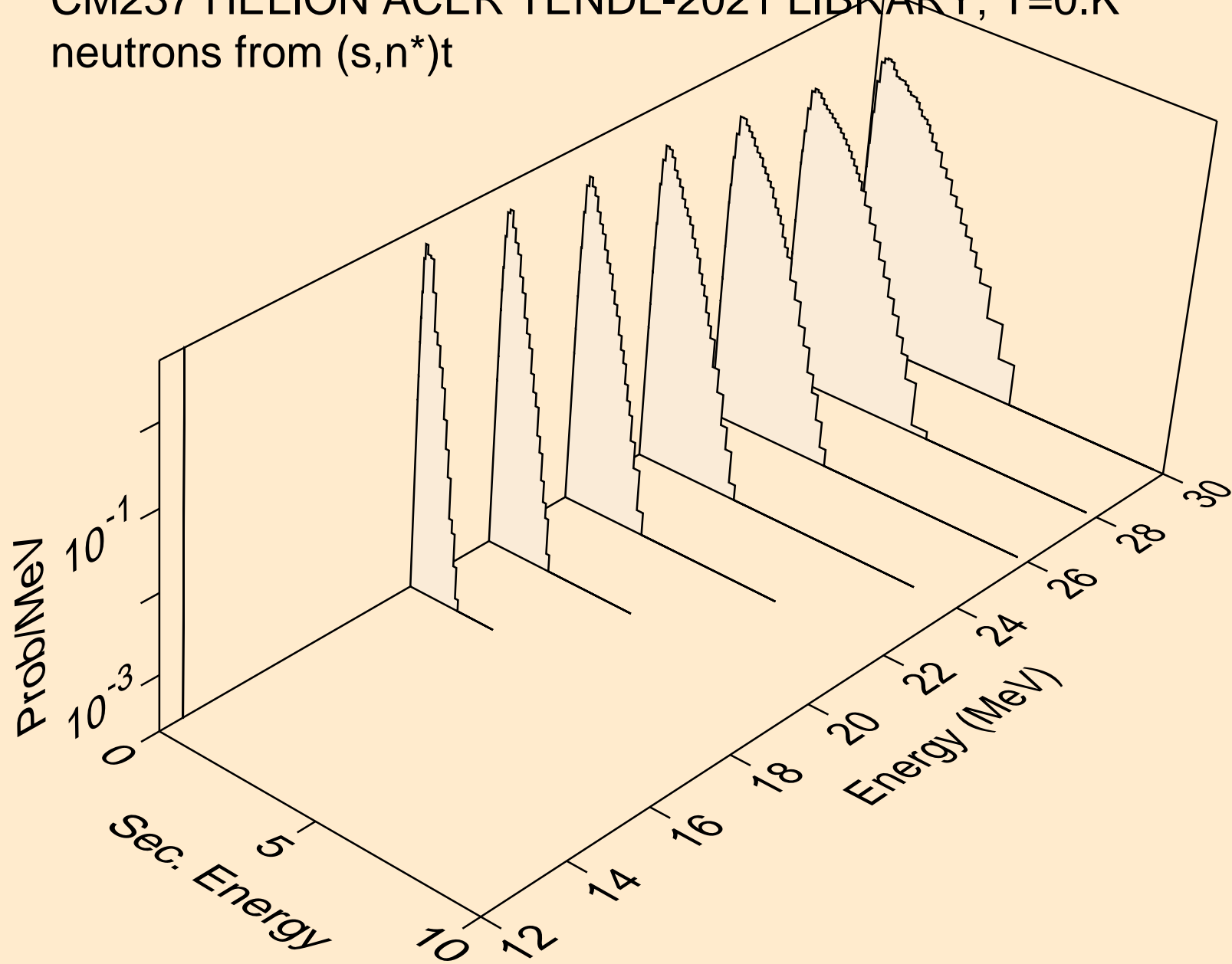

CM237 HELION ACER TENDL-2021 LIBRARY; T=0.K
neutrons from (s,n*)he3

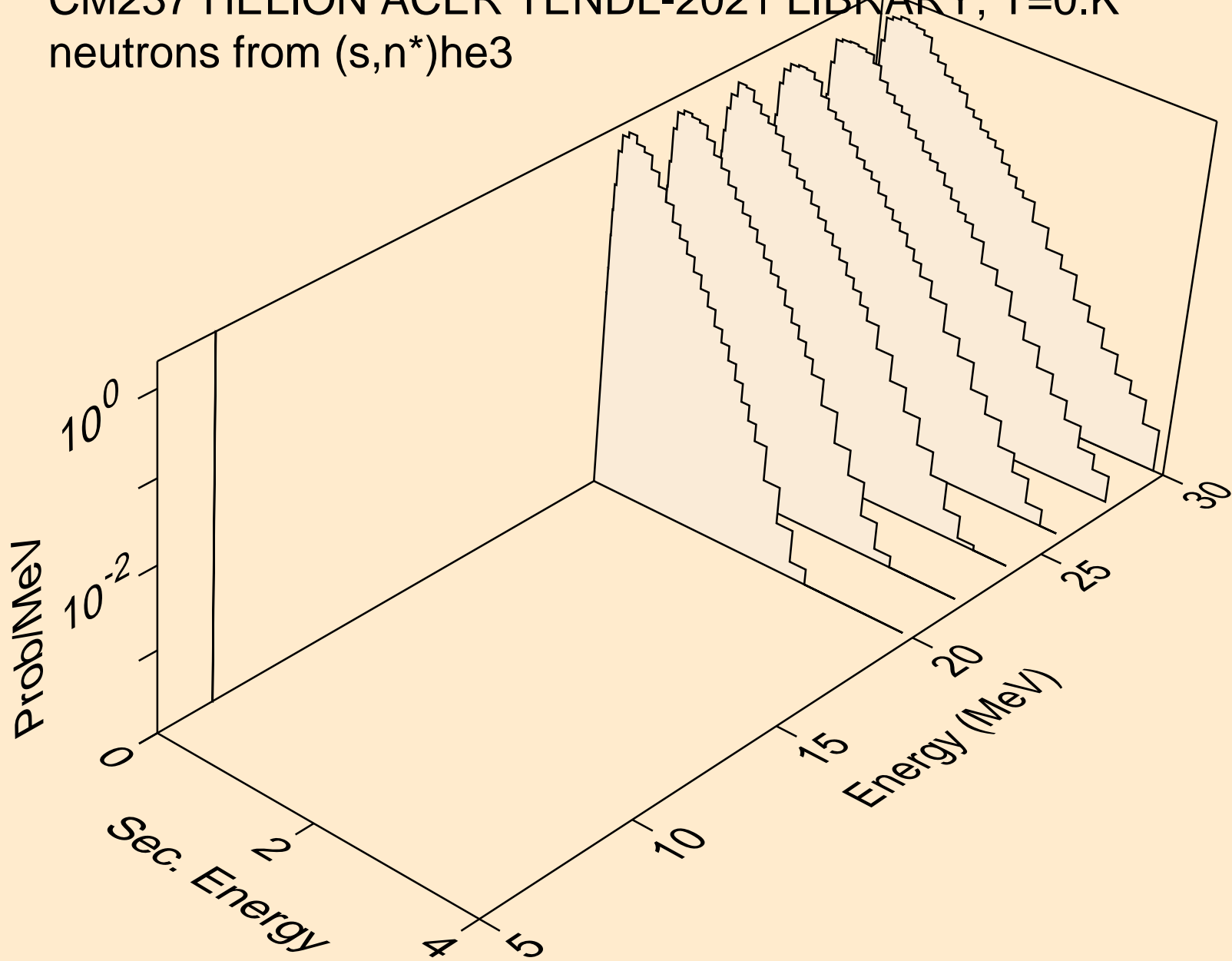

CM237 HELION ACER TENDL-2021 LIBRARY; T=0.K
neutrons from (s,2np)

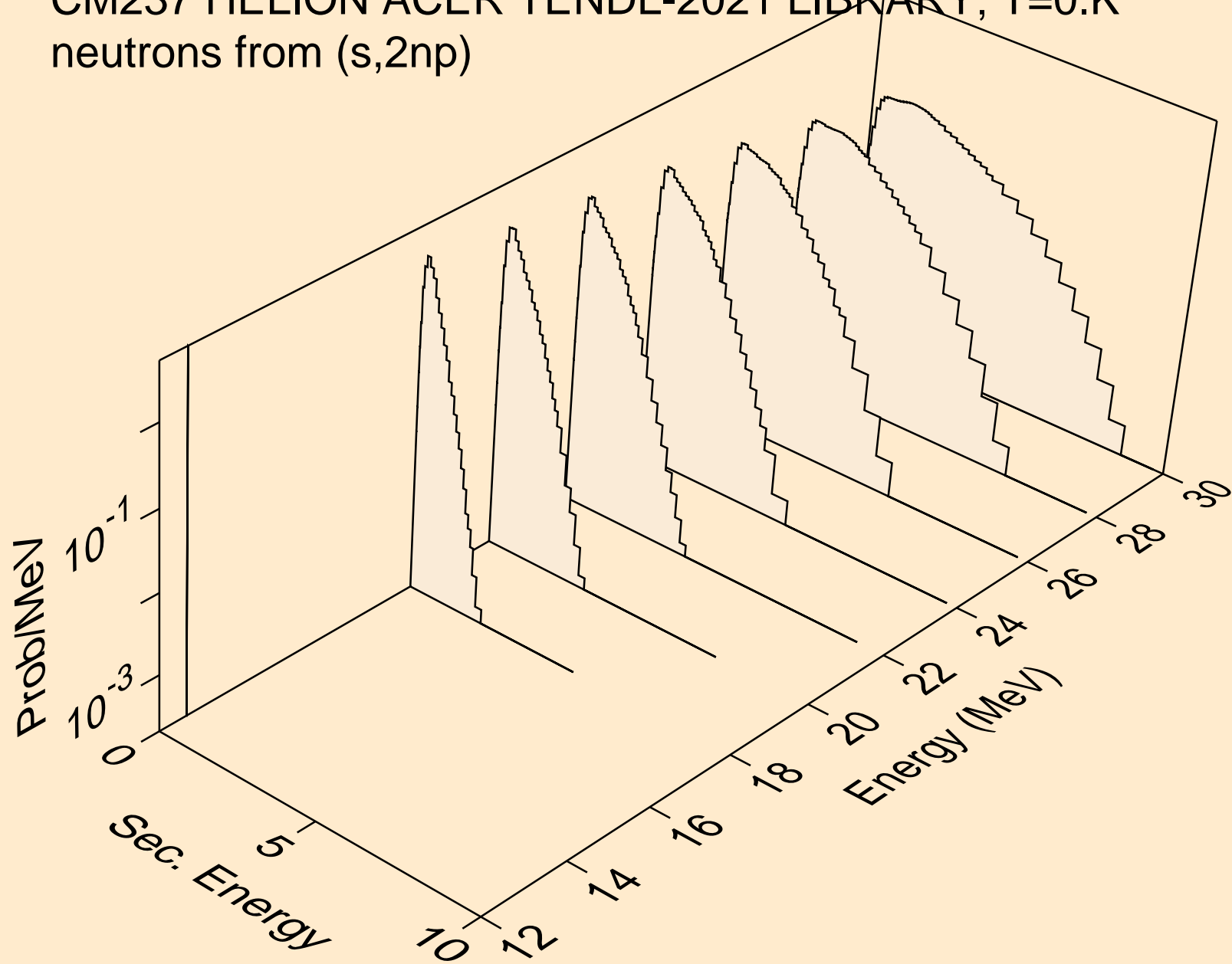

CM237 HELION ACER TENDL-2021 LIBRARY; T=0.K
neutrons from (s,2np)

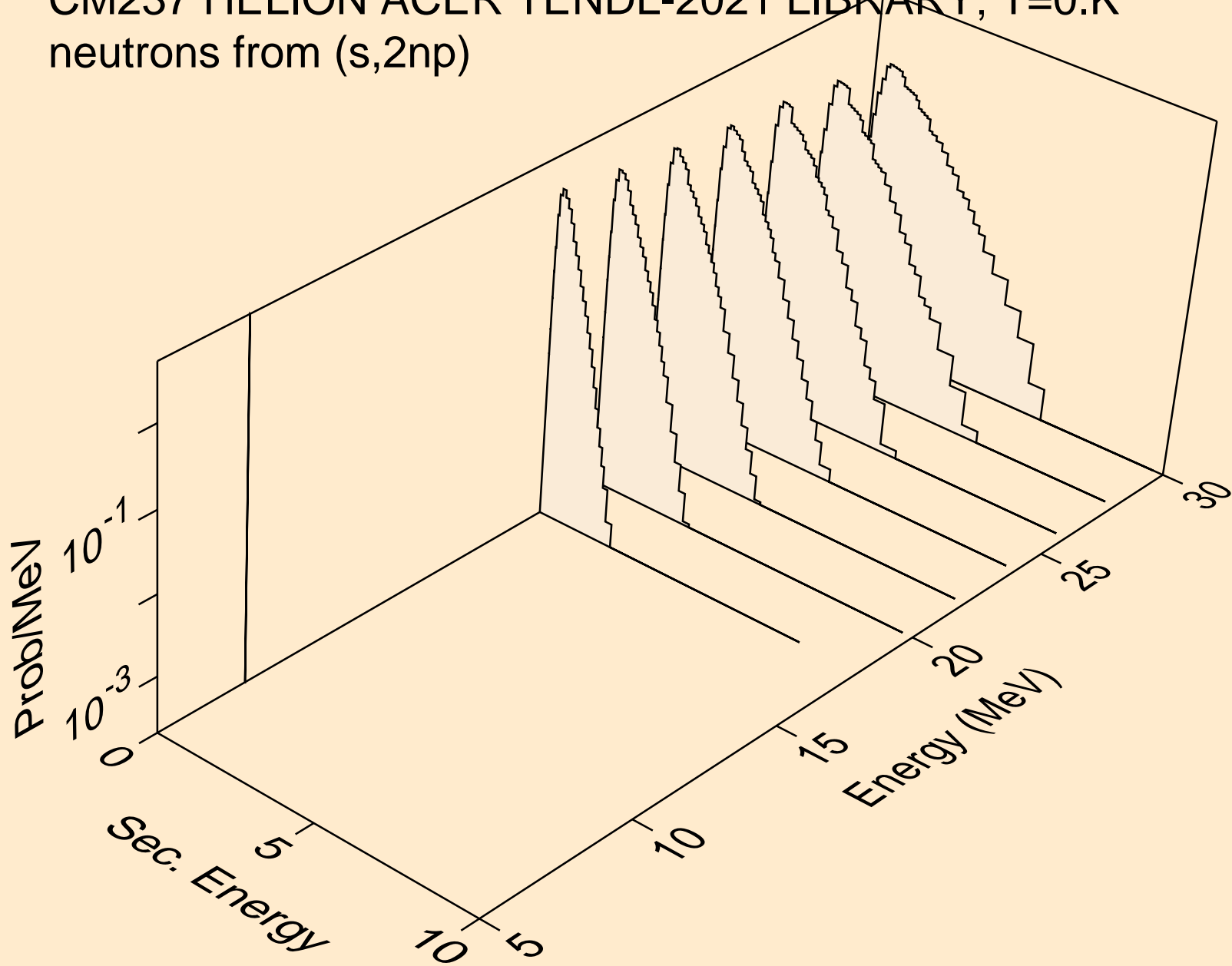

CM237 HELION ACER TENDL-2021 LIBRARY; T=0.K
protons from (s,x)

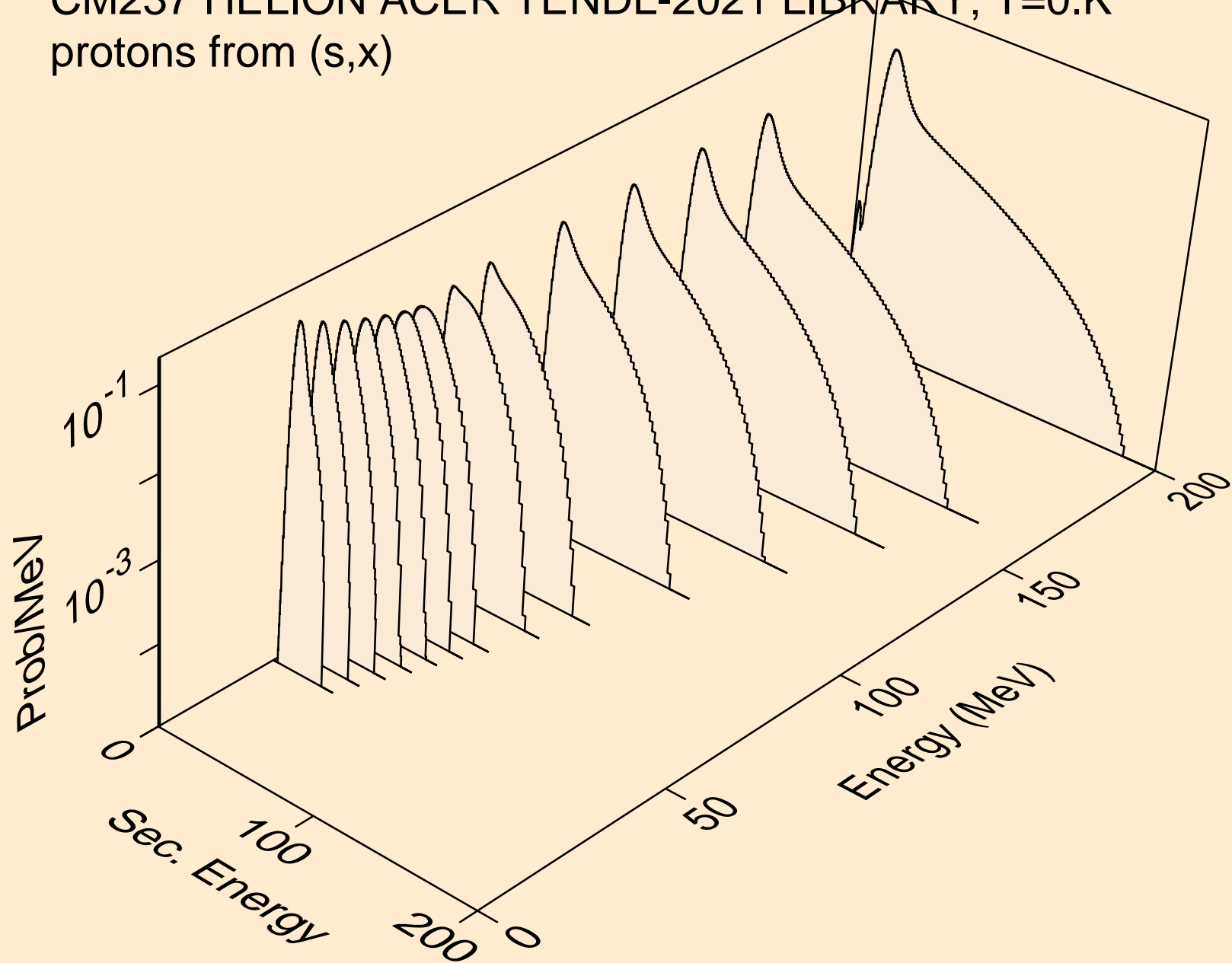

CM237 HELION ACER TENDL-2021 LIBRARY; T=0.K
protons from (s,n*)p

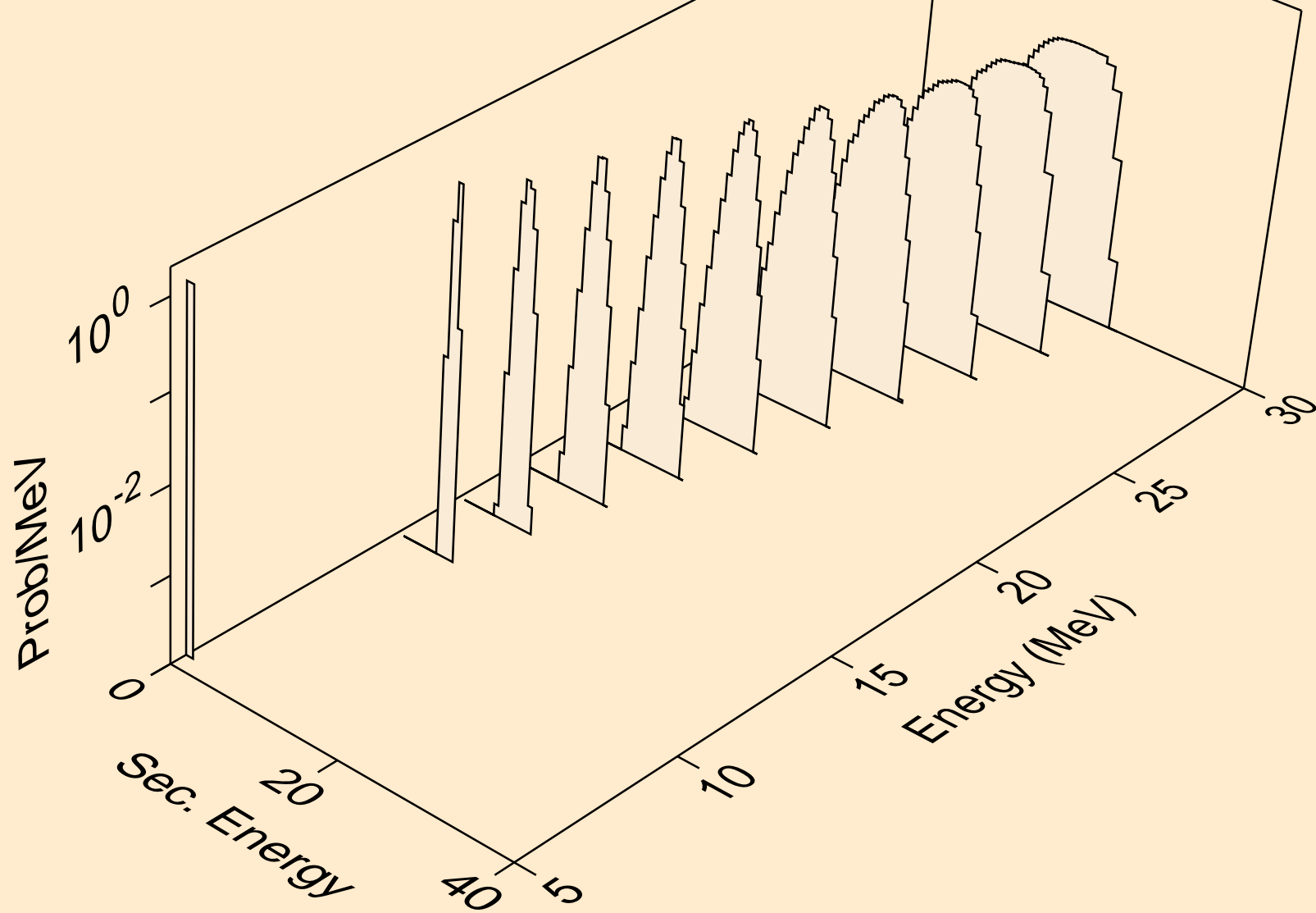

CM237 HELION ACER TENDL-2021 LIBRARY; T=0.K
protons from (s,2np)

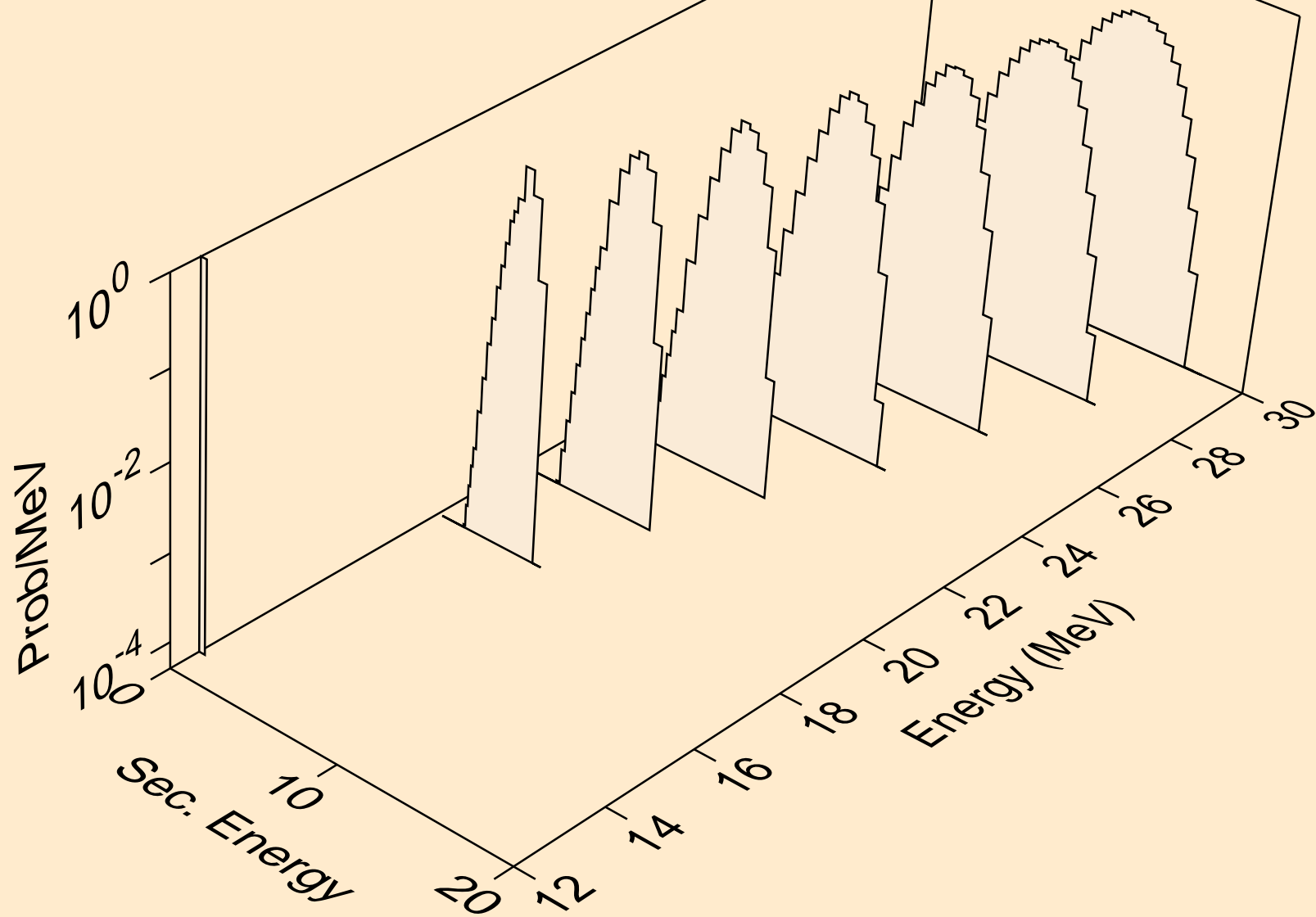

CM237 HELION ACER TENDL-2021 LIBRARY; T=0.K
protons from (s,2np)

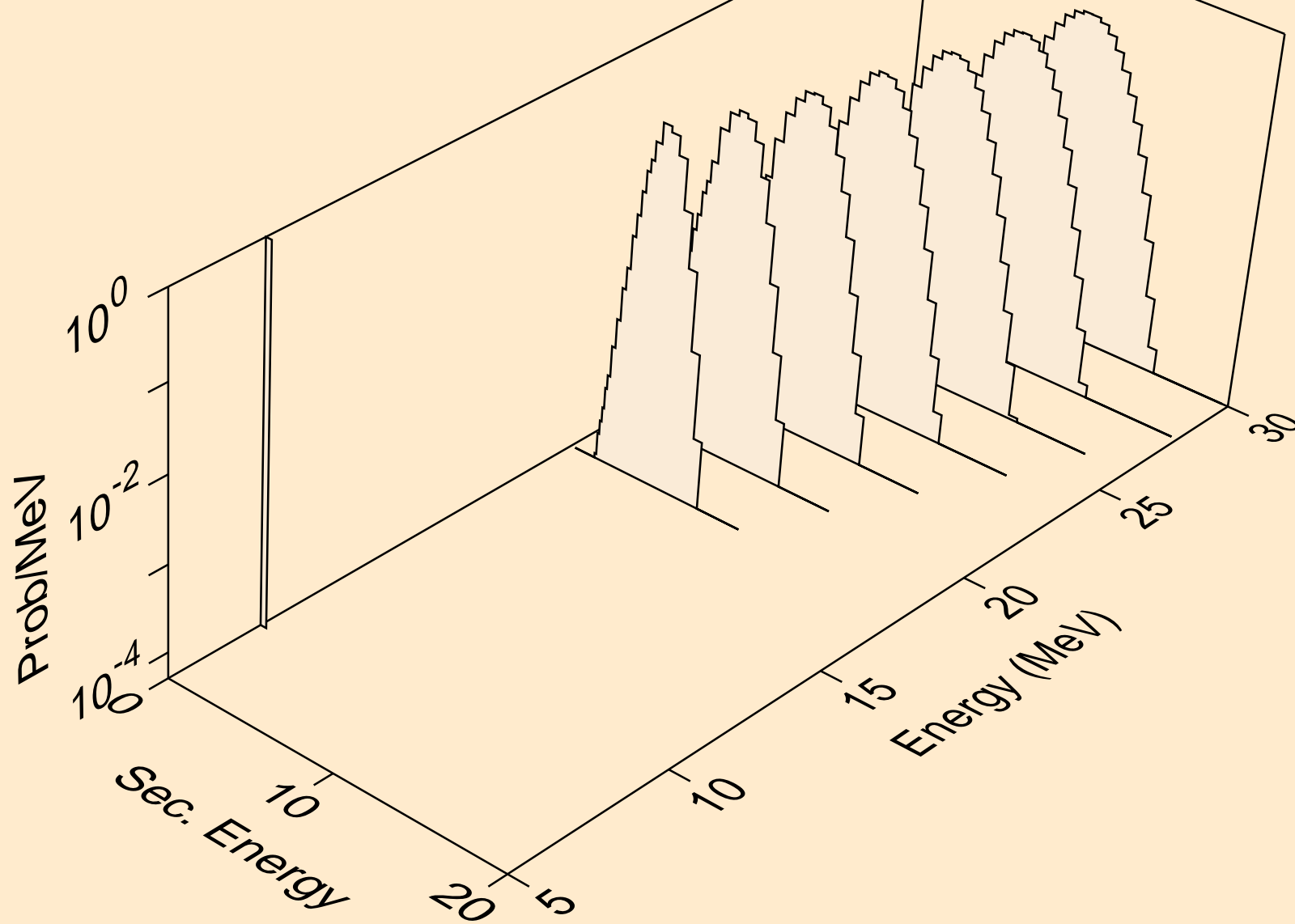

CM237 HELION ACER TENDL-2021 LIBRARY; T=0.K
protons from (s,p)

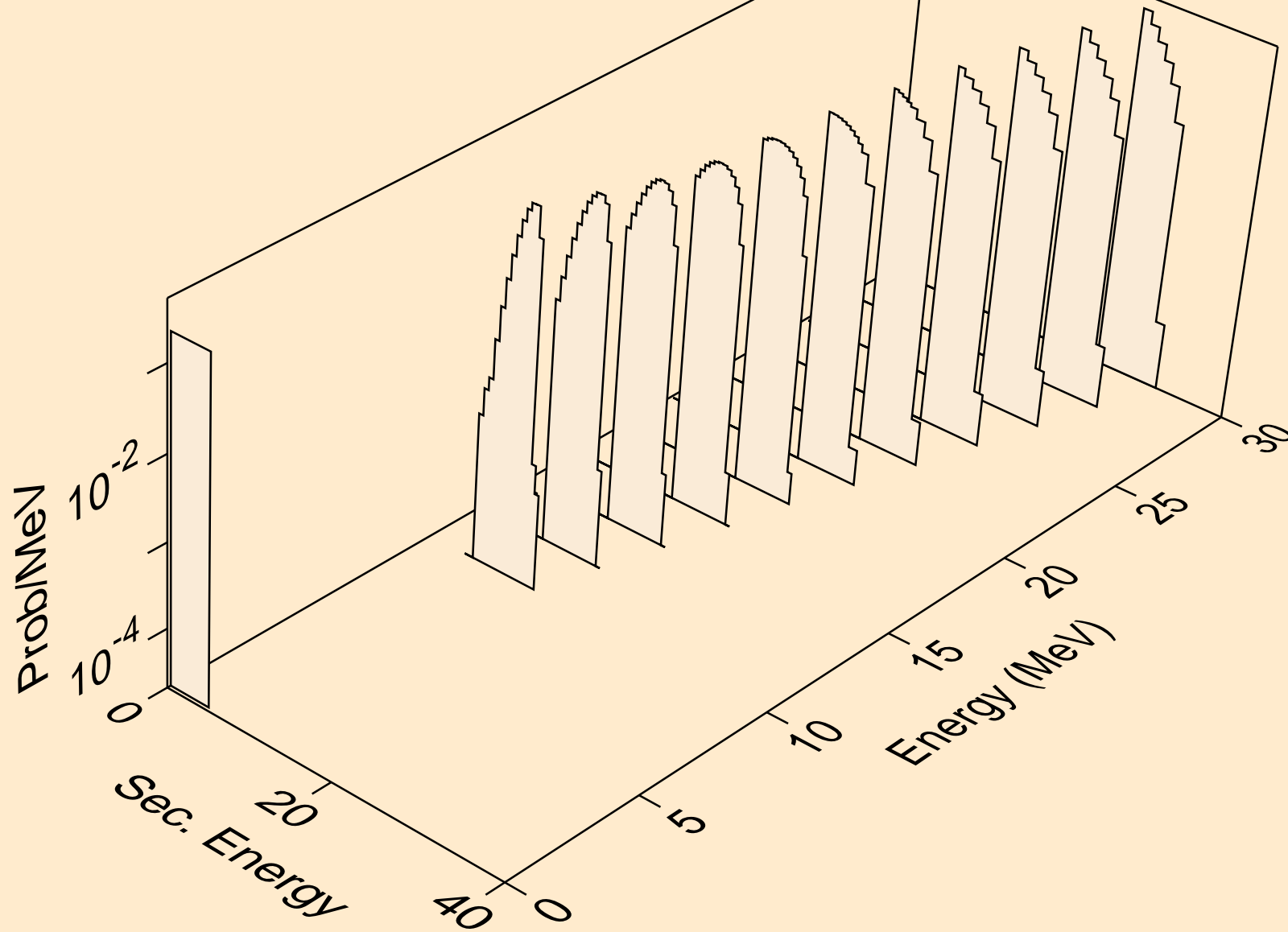

CM237 HELION ACER TENDL-2021 LIBRARY; T=0.K
protons from (s,2p)

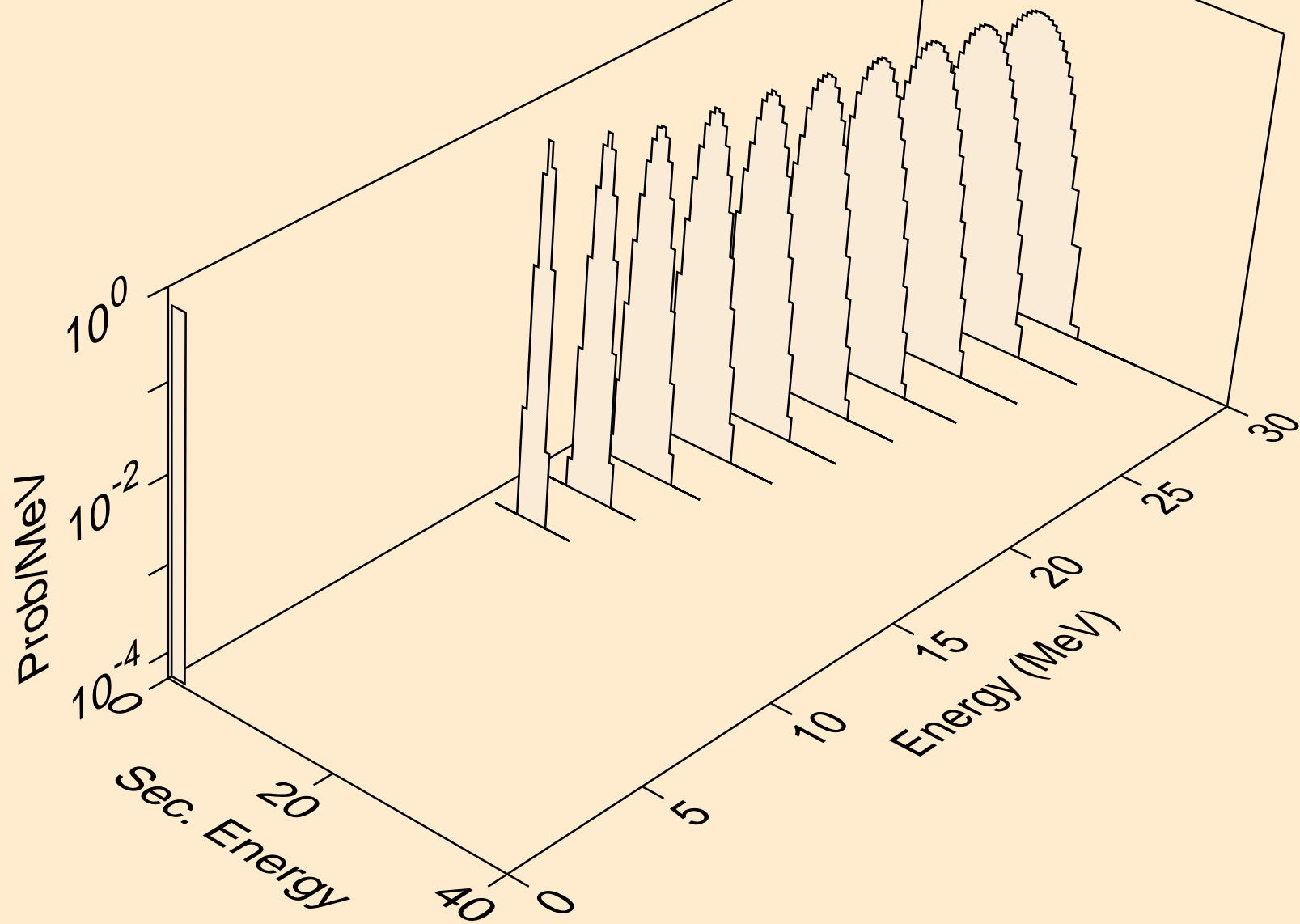

CM237 HELION ACER TENDL-2021 LIBRARY; T=0.K
protons from (s,pd)

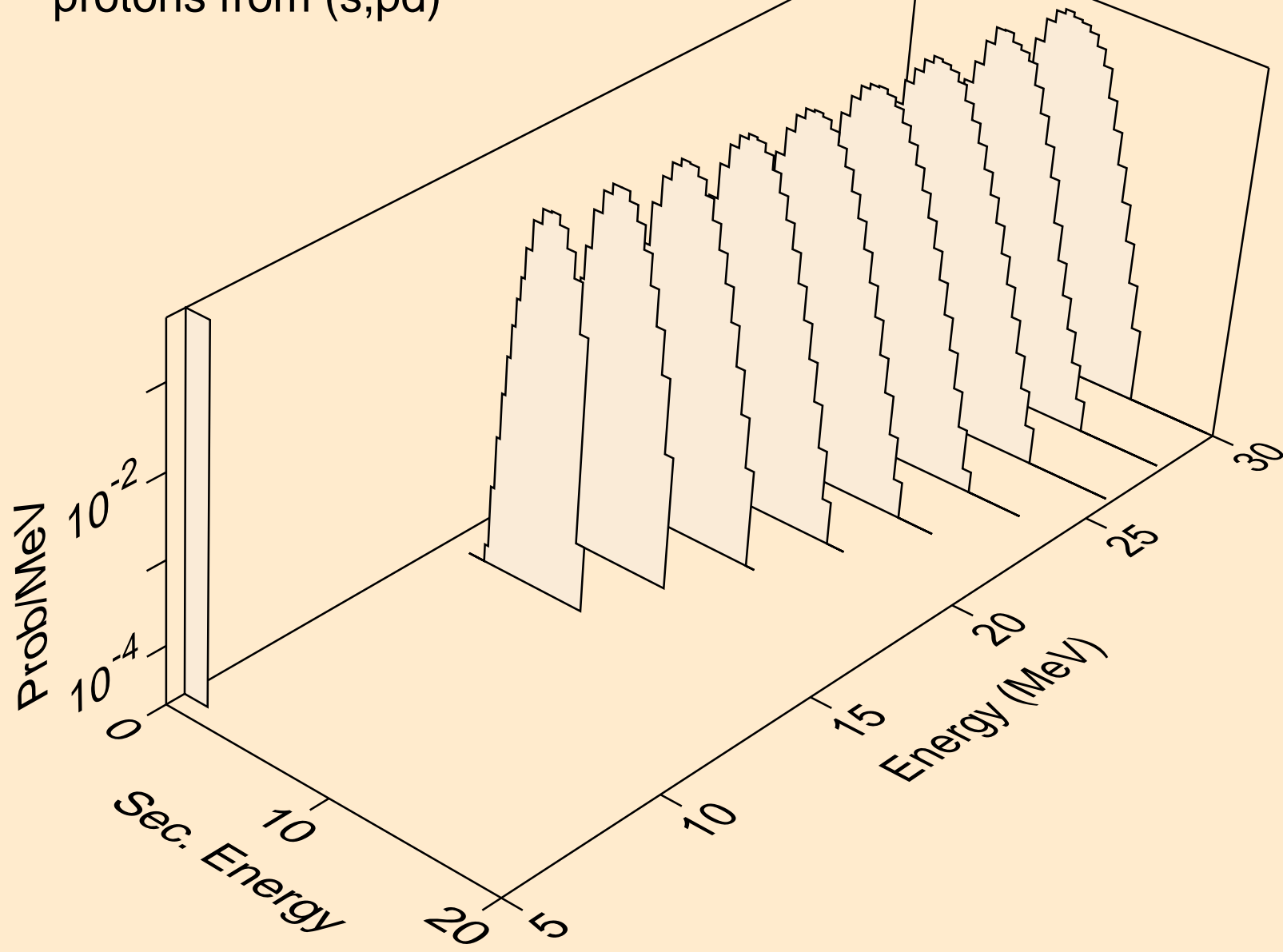

CM237 HELION ACER TENDL-2021 LIBRARY; T=0.K
deuterons from (s,x)

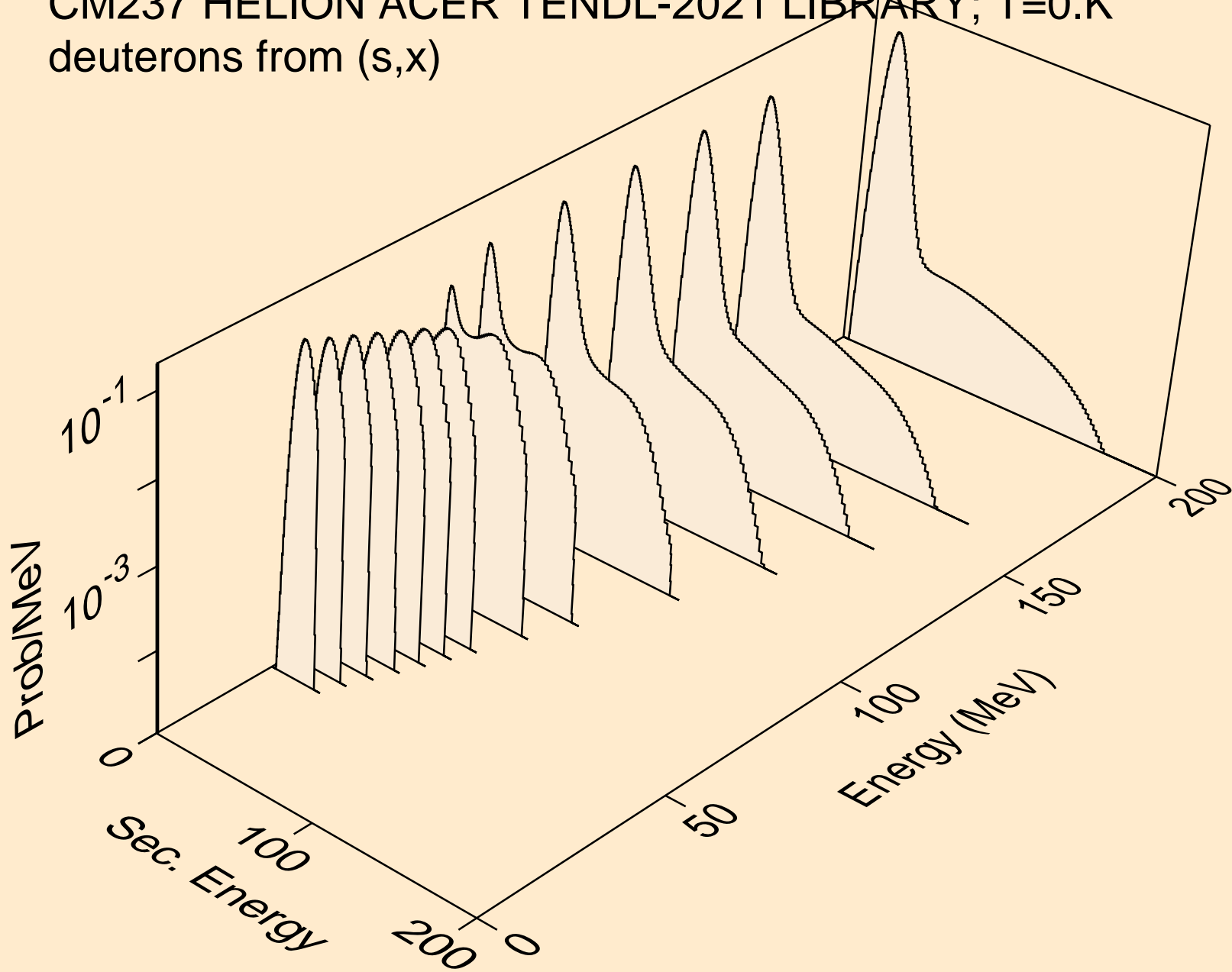

CM237 HELION ACER TENDL-2021 LIBRARY; T=0.K
deuterons from (s,n*)d

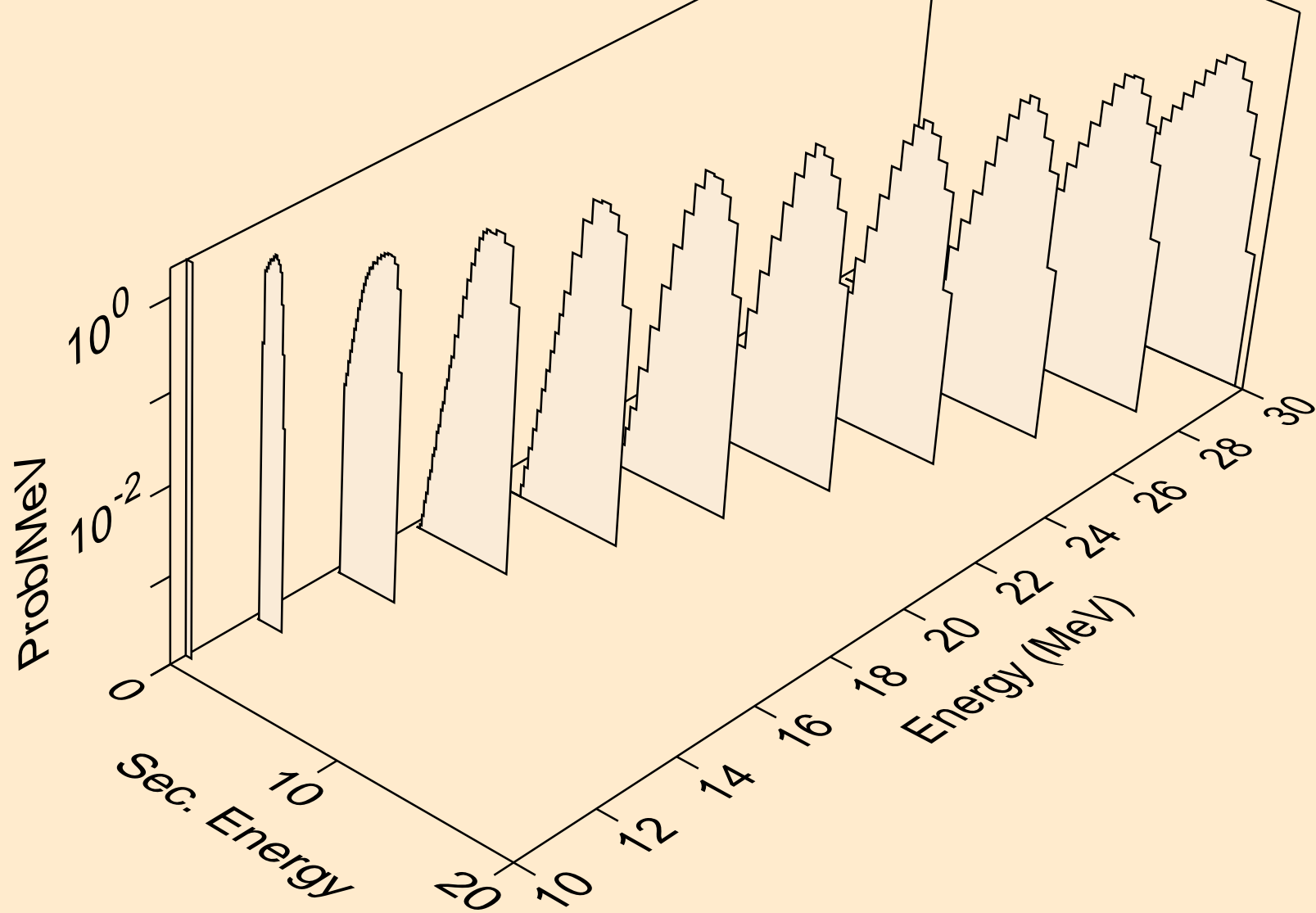

CM237 HELION ACER TENDL-2021 LIBRARY; T=0.K
deuterons from (s,d)

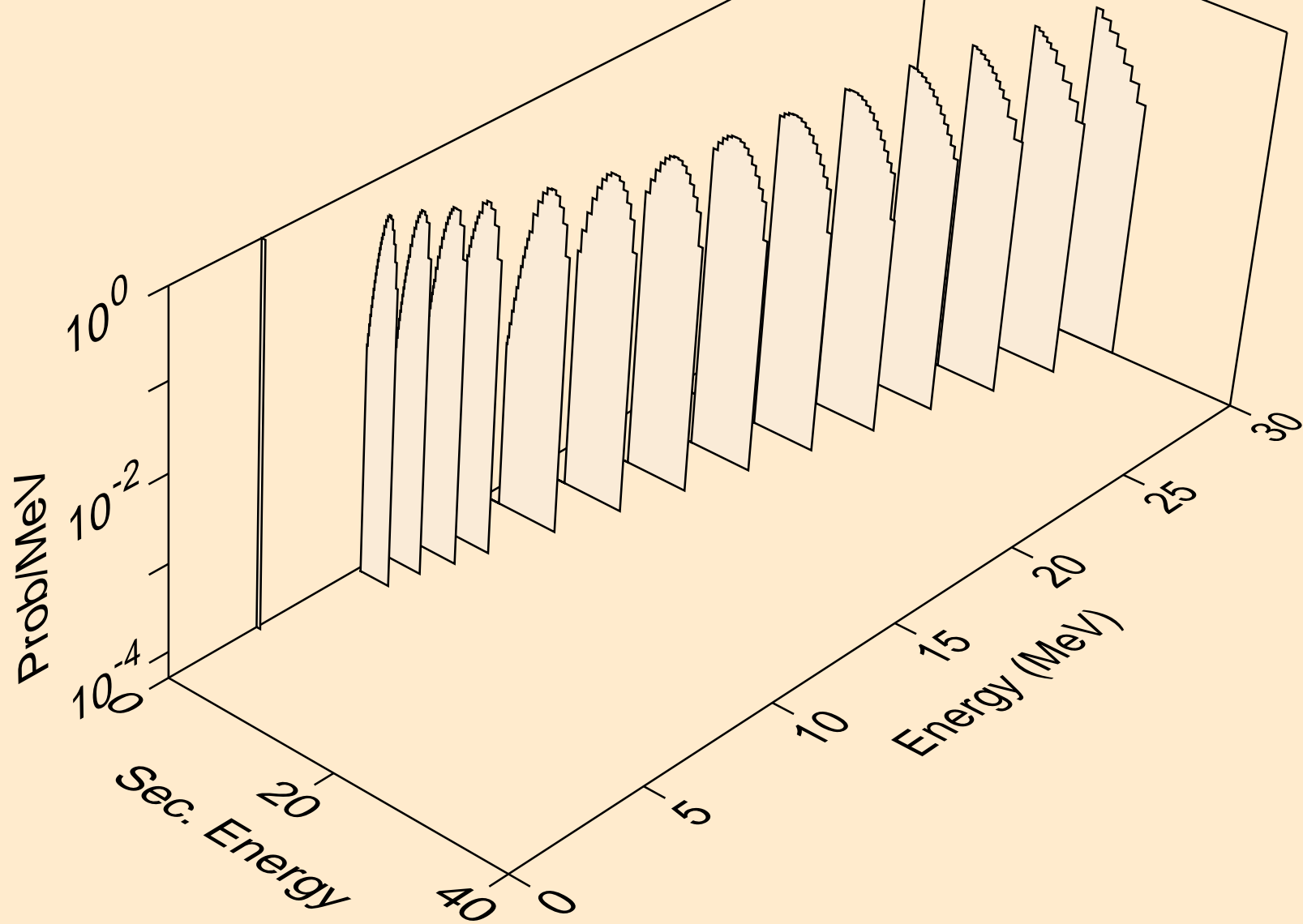

CM237 HELION ACER TENDL-2021 LIBRARY; T=0.K
deuterons from (s,pd)

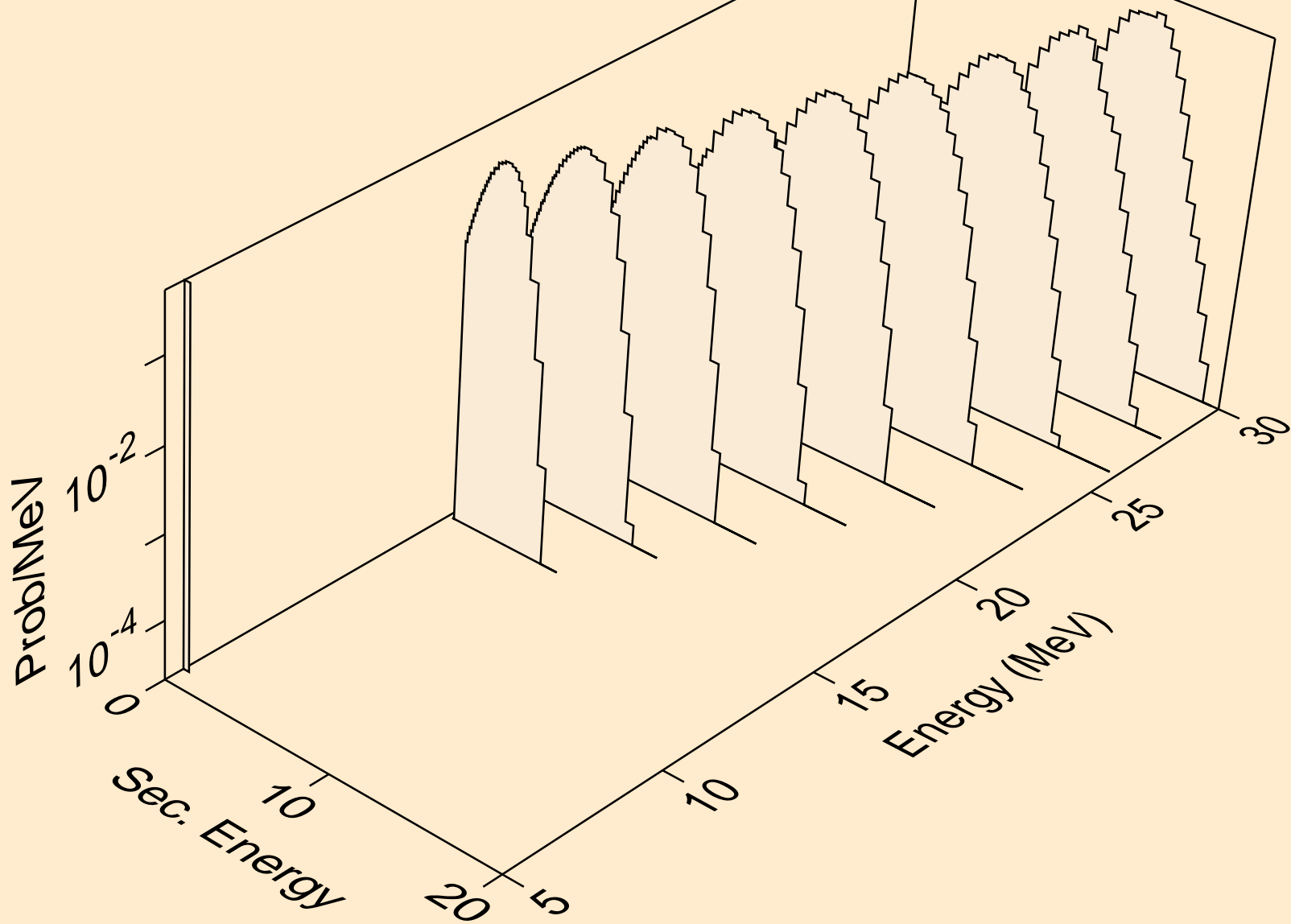

CM237 HELION ACER TENDL-2021 LIBRARY; T=0.K
tritons from (s,x)

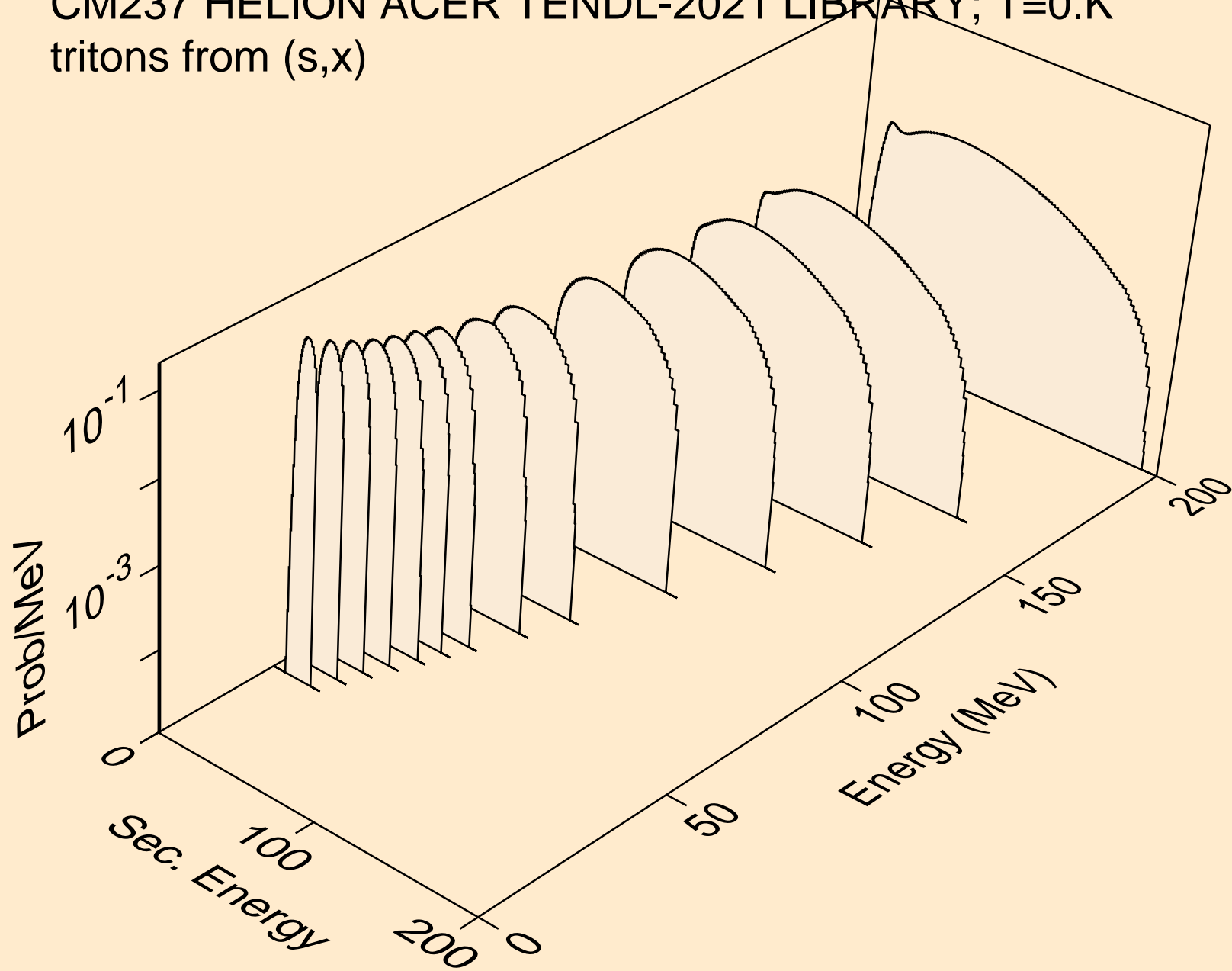

CM237 HELION ACER TENDL-2021 LIBRARY; T=0.K
tritons from (s,n*)t

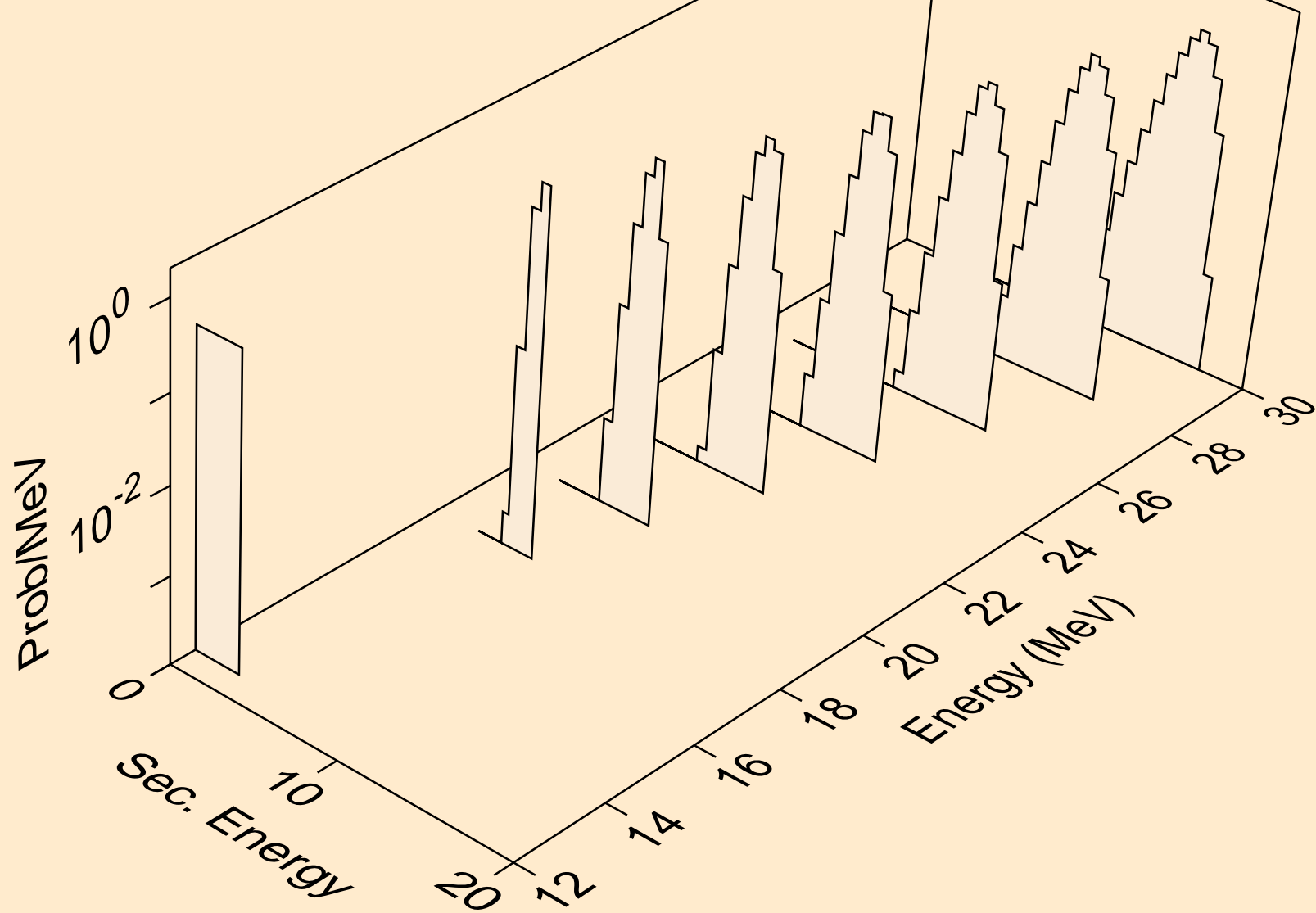

CM237 HELION ACER TENDL-2021 LIBRARY; T=0.K
tritons from (s,t)

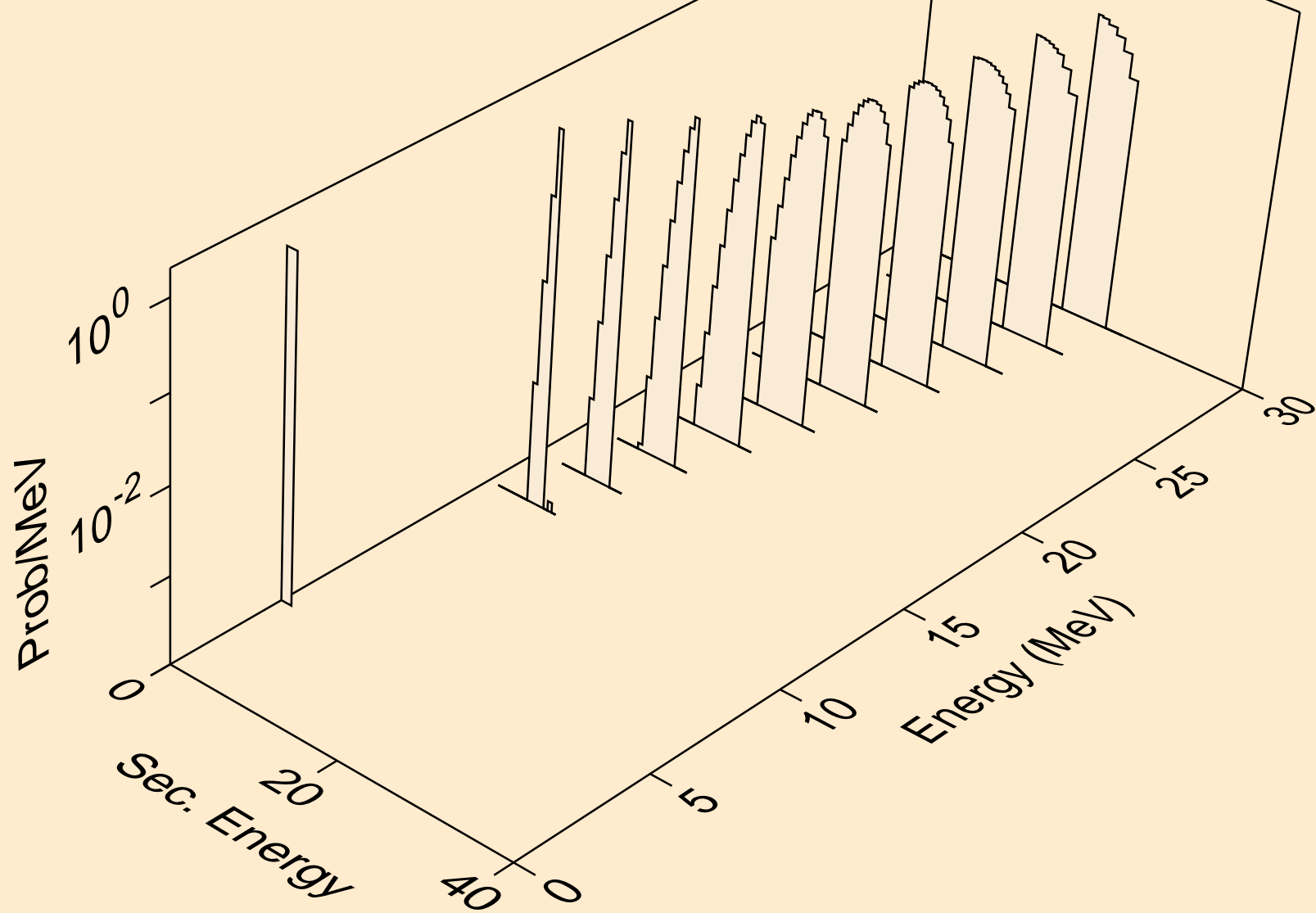

CM237 HELION ACER TENDL-2021 LIBRARY; T=0.K
alphas from (s,x)

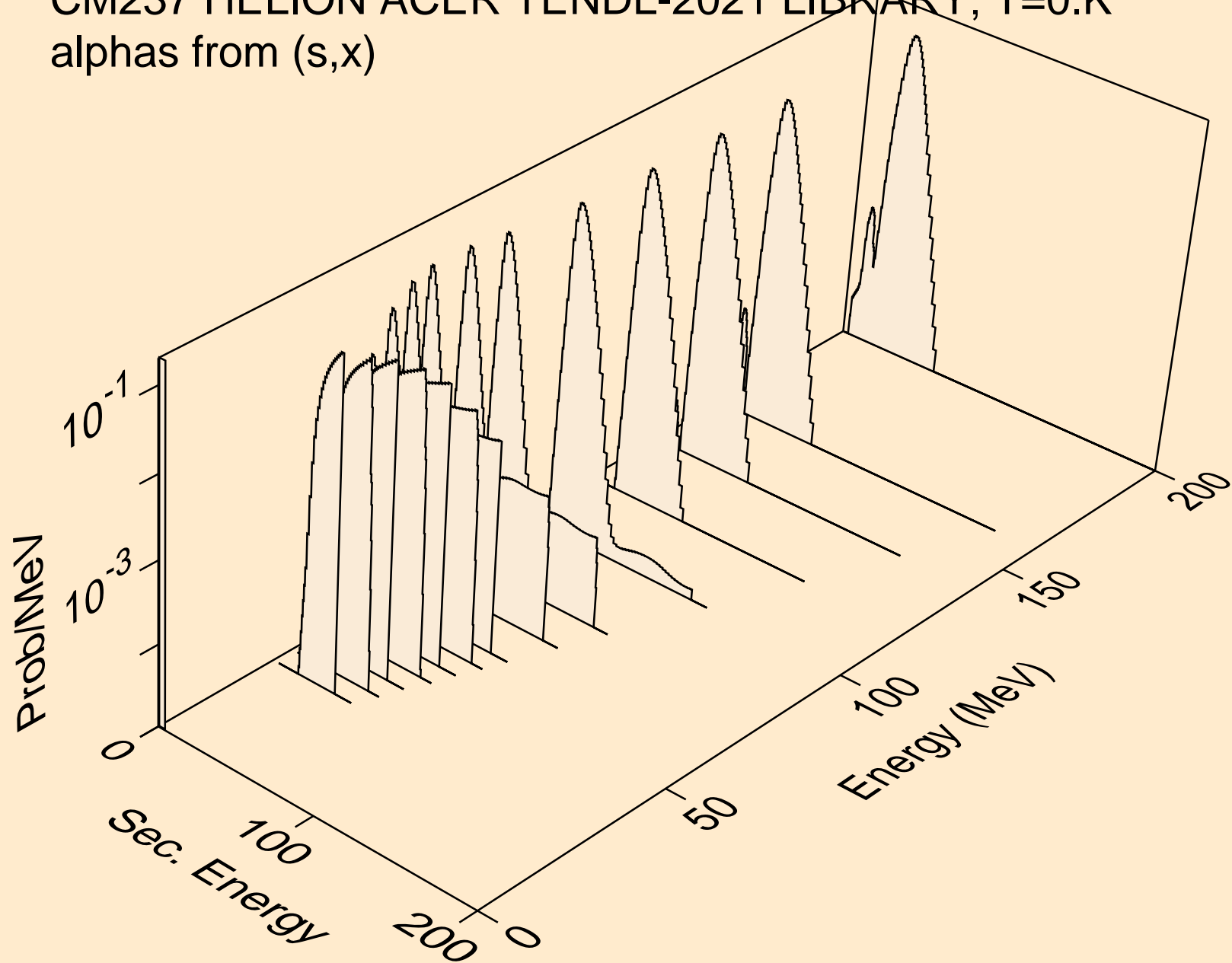

CM237 HELION ACER TENDL-2021 LIBRARY; T=0.K
alphas from (s,n*)a

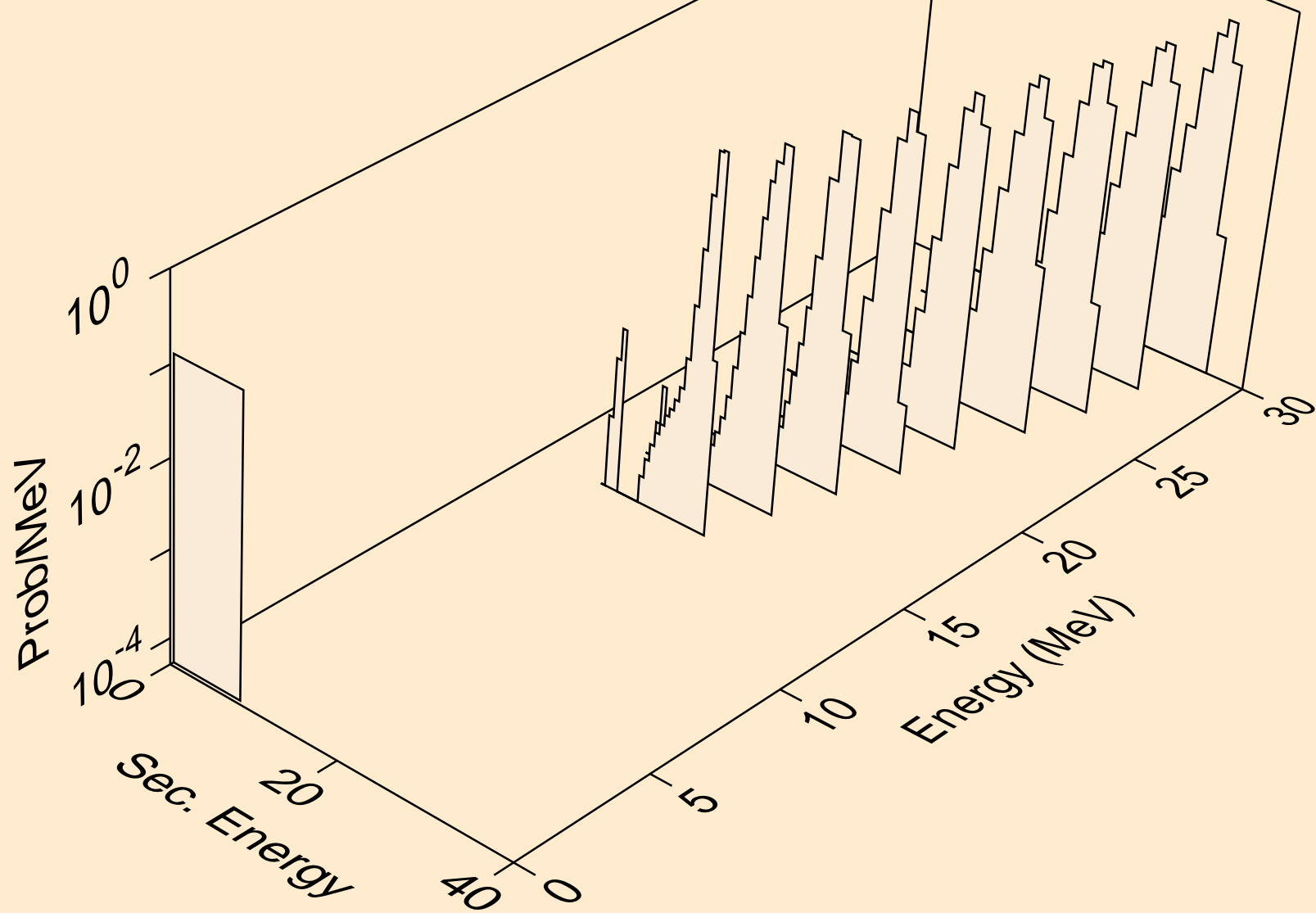

CM237 HELION ACER TENDL-2021 LIBRARY; T=0.K
alphas from (s,a)

