

DB269 HELION ACER TENDL-2021 LIBRARY; T=0.K  
Principal cross sections

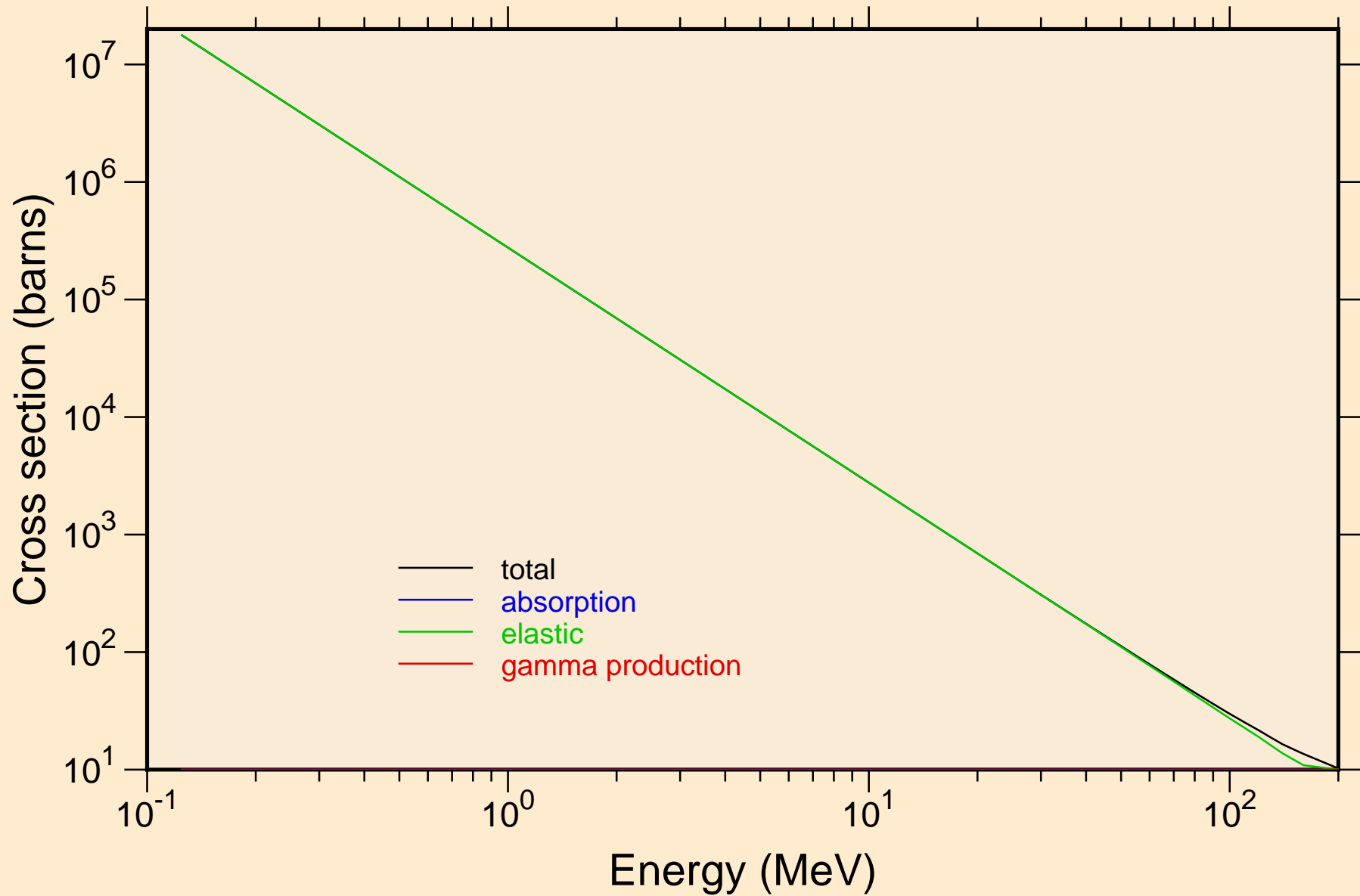

DB269 HELION ACER TENDL-2021 LIBRARY; T=0.K

Heating

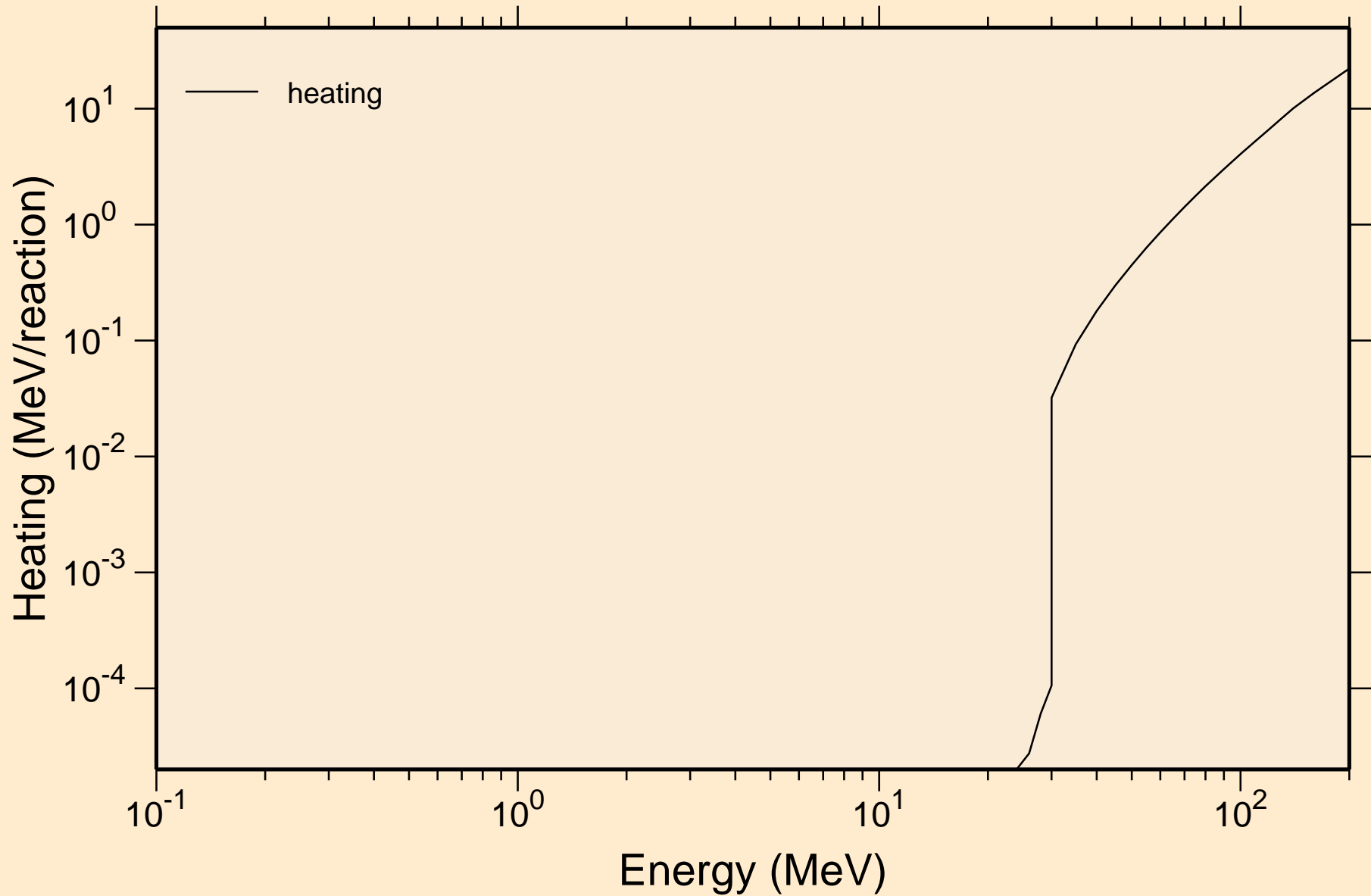

DB269 HELION ACER TENDL-2021 LIBRARY; T=0.K

Principal cross sections

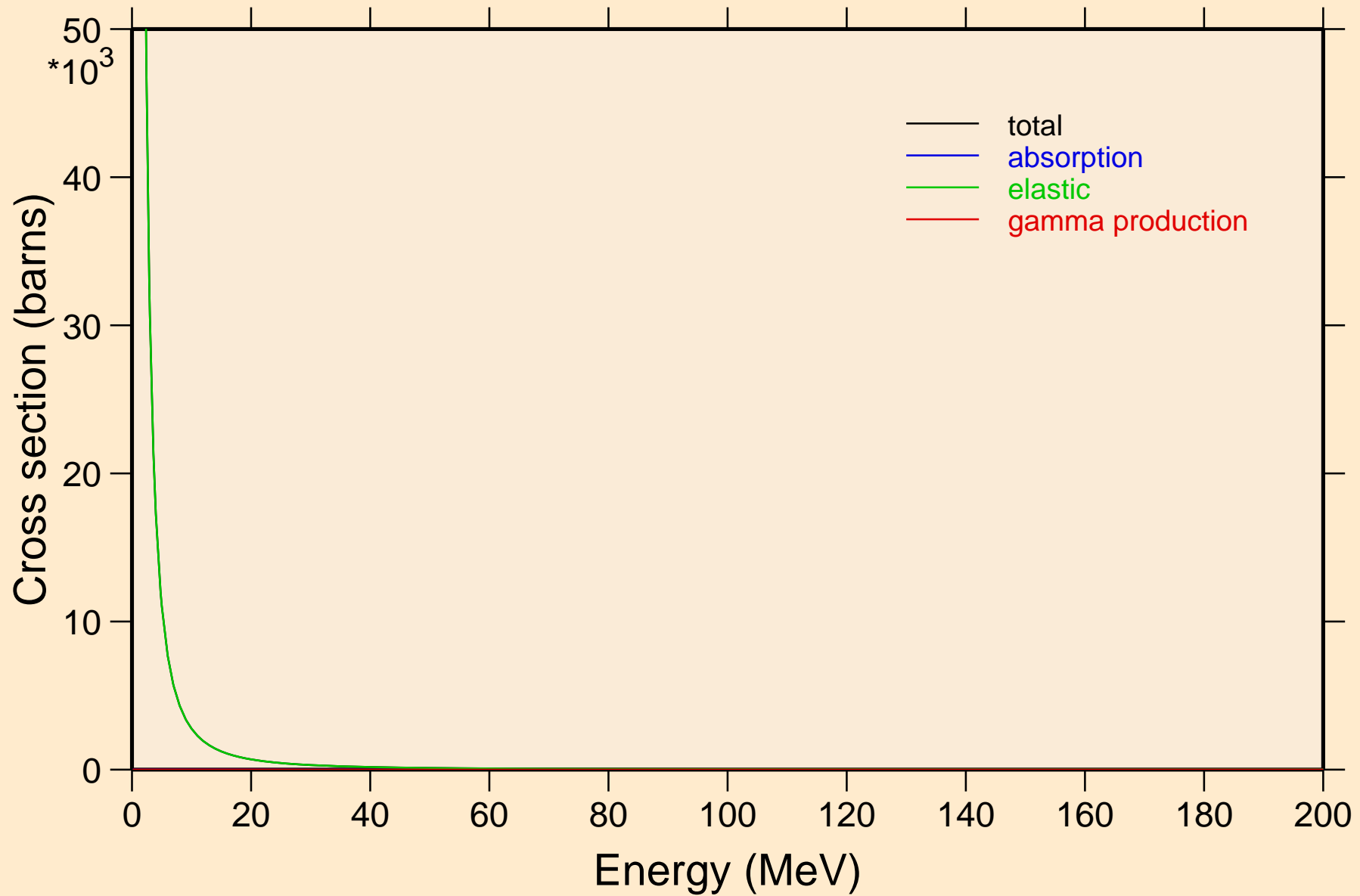

DB269 HELION ACER TENDL-2021 LIBRARY; T=0.K

Heating

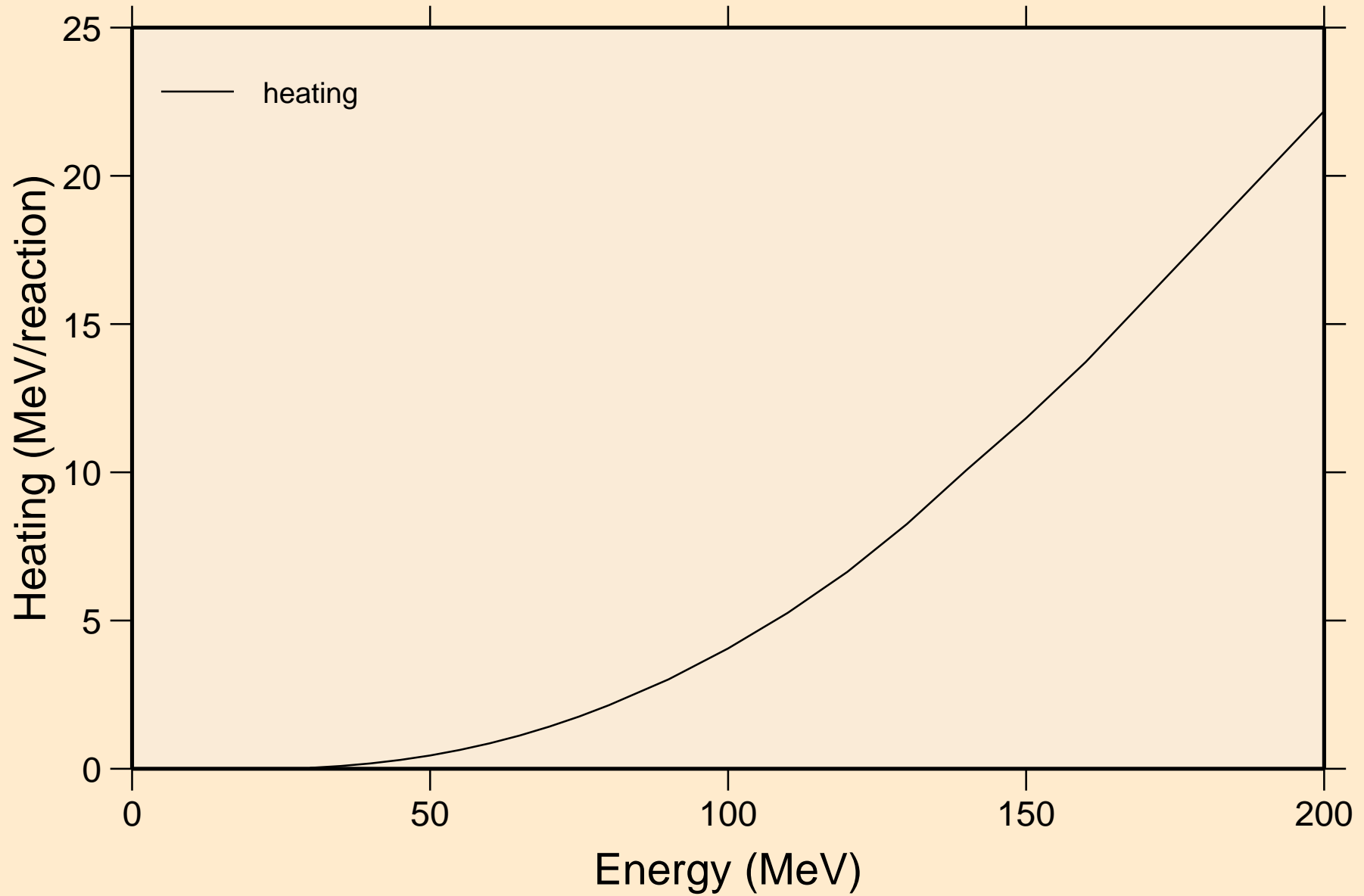

DB269 HELION ACER TENDL-2021 LIBRARY; T=0.K  
Threshold reactions

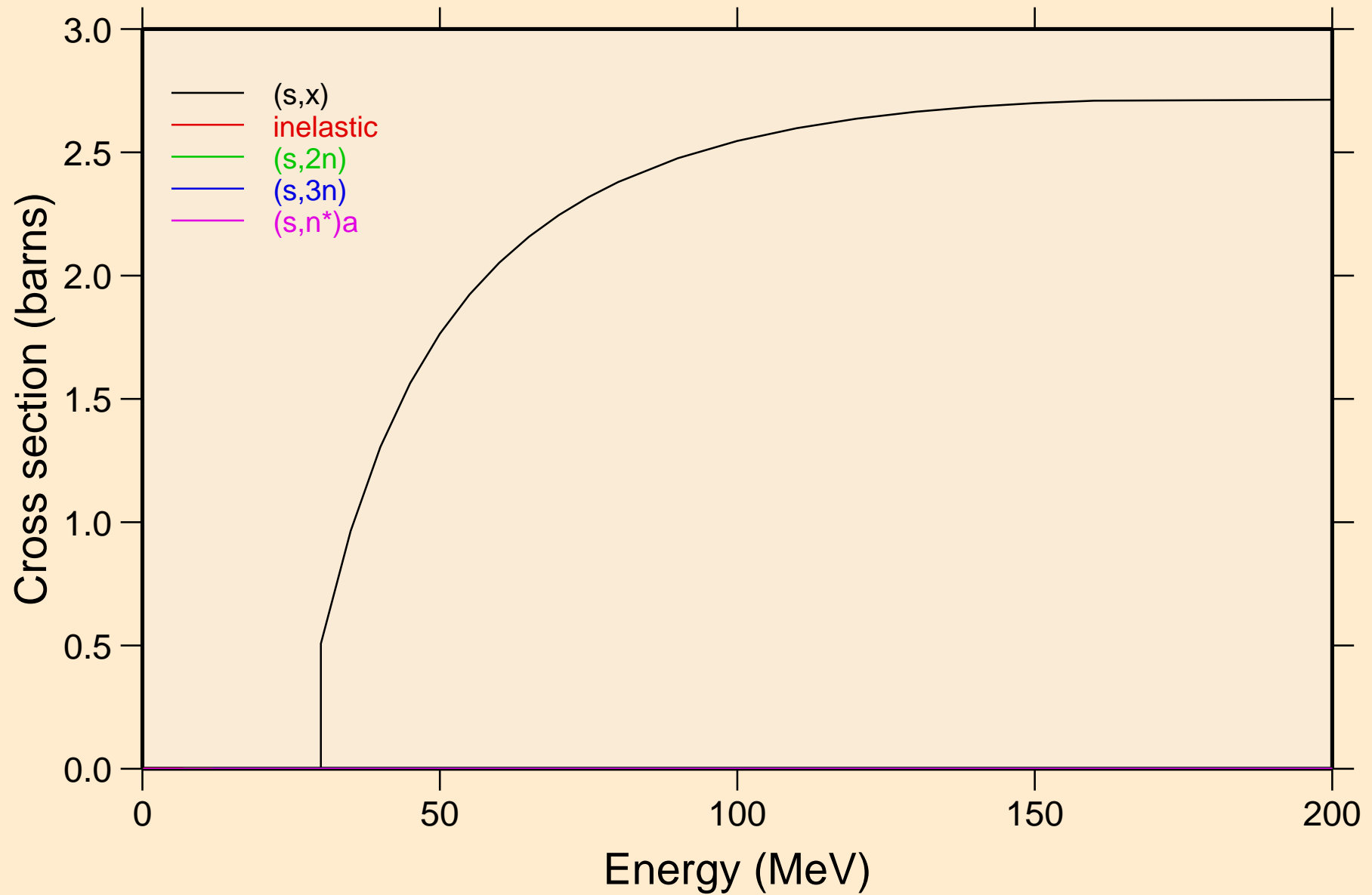

DB269 HELION ACER TENDL-2021 LIBRARY; T=0.K  
Threshold reactions

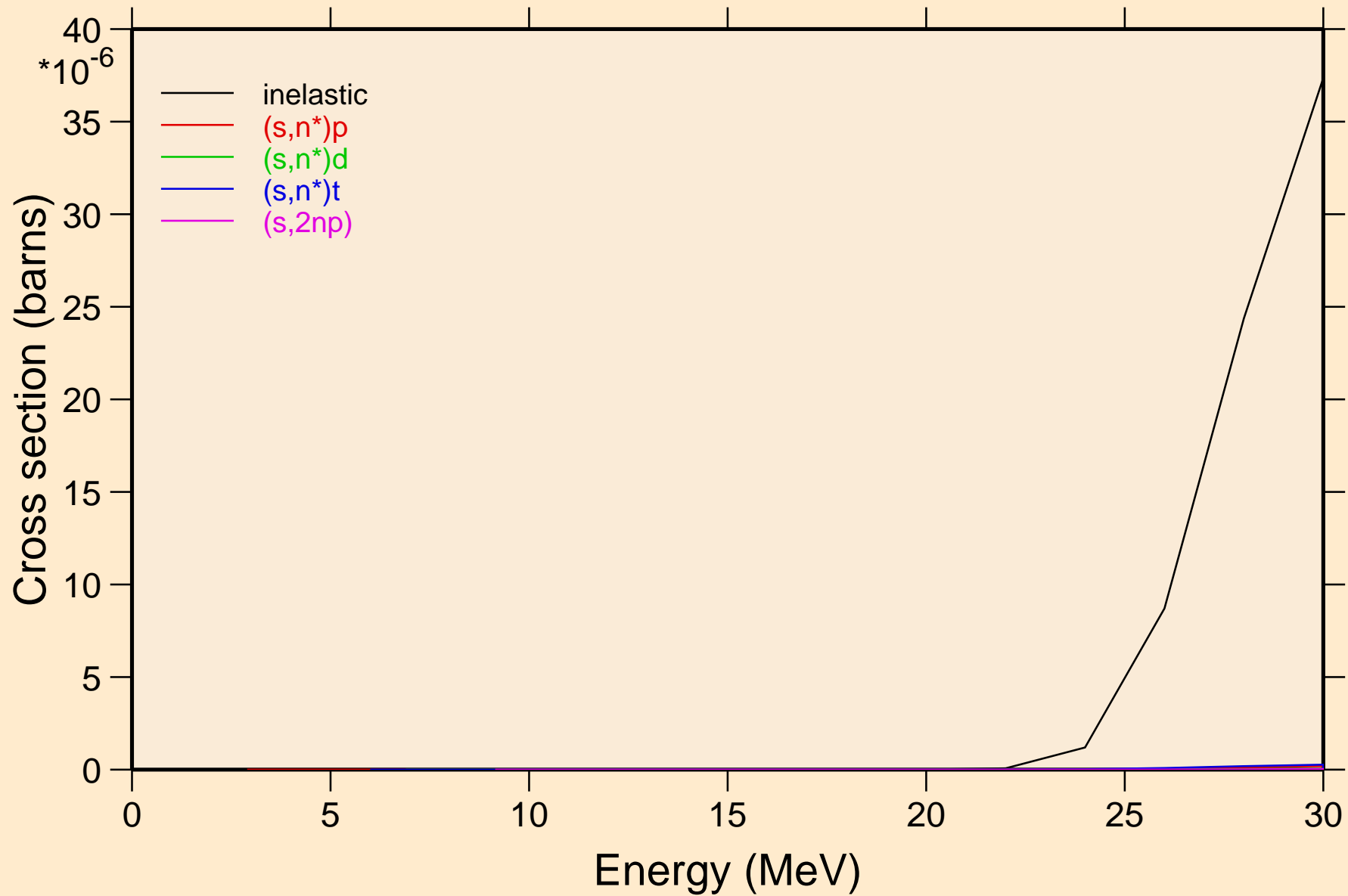

DB269 HELION ACER TENDL-2021 LIBRARY; T=0.K  
Threshold reactions

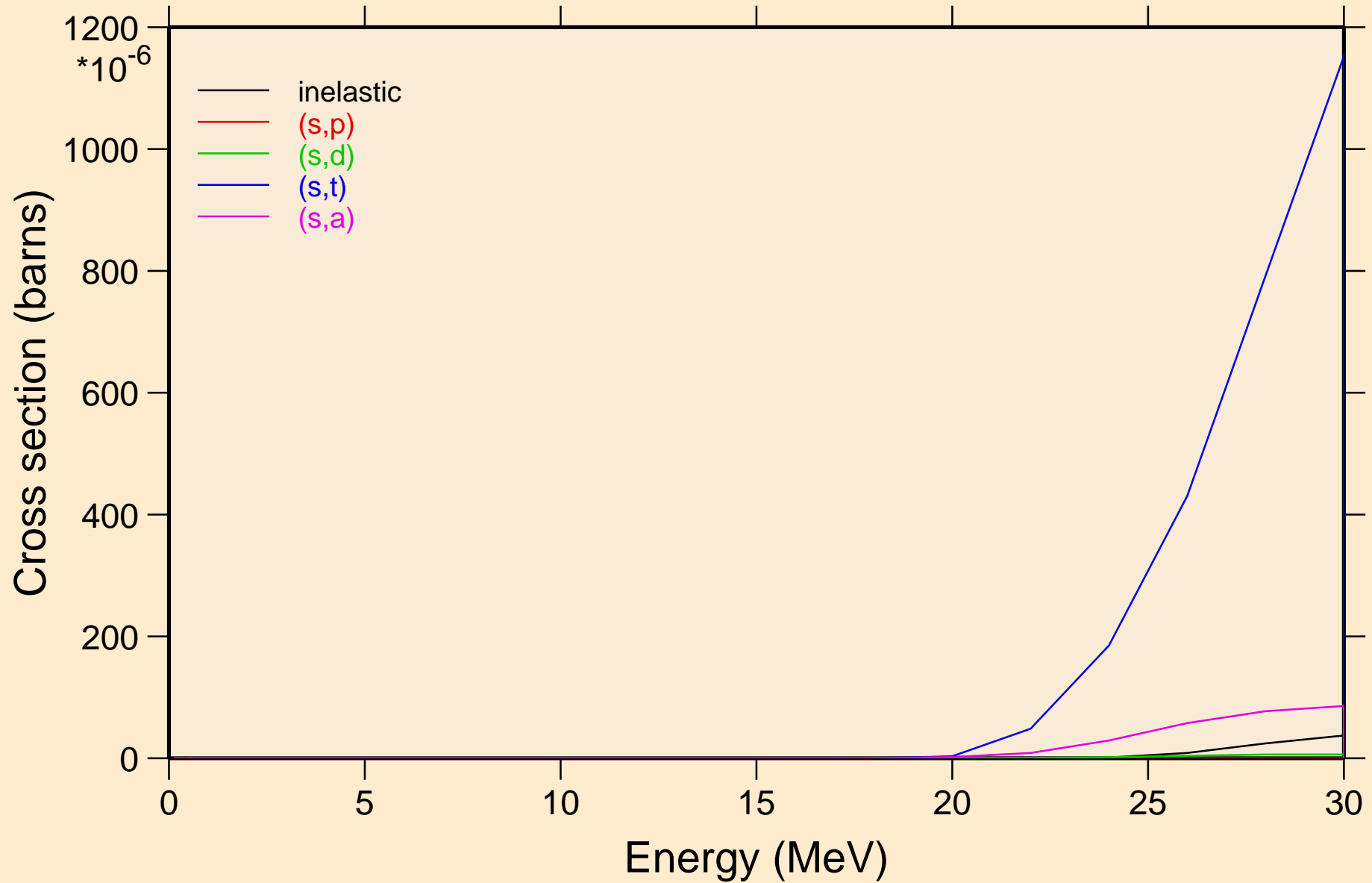

DB269 HELION ACER TENDL-2021 LIBRARY; T=0.K  
angular distribution for elastic

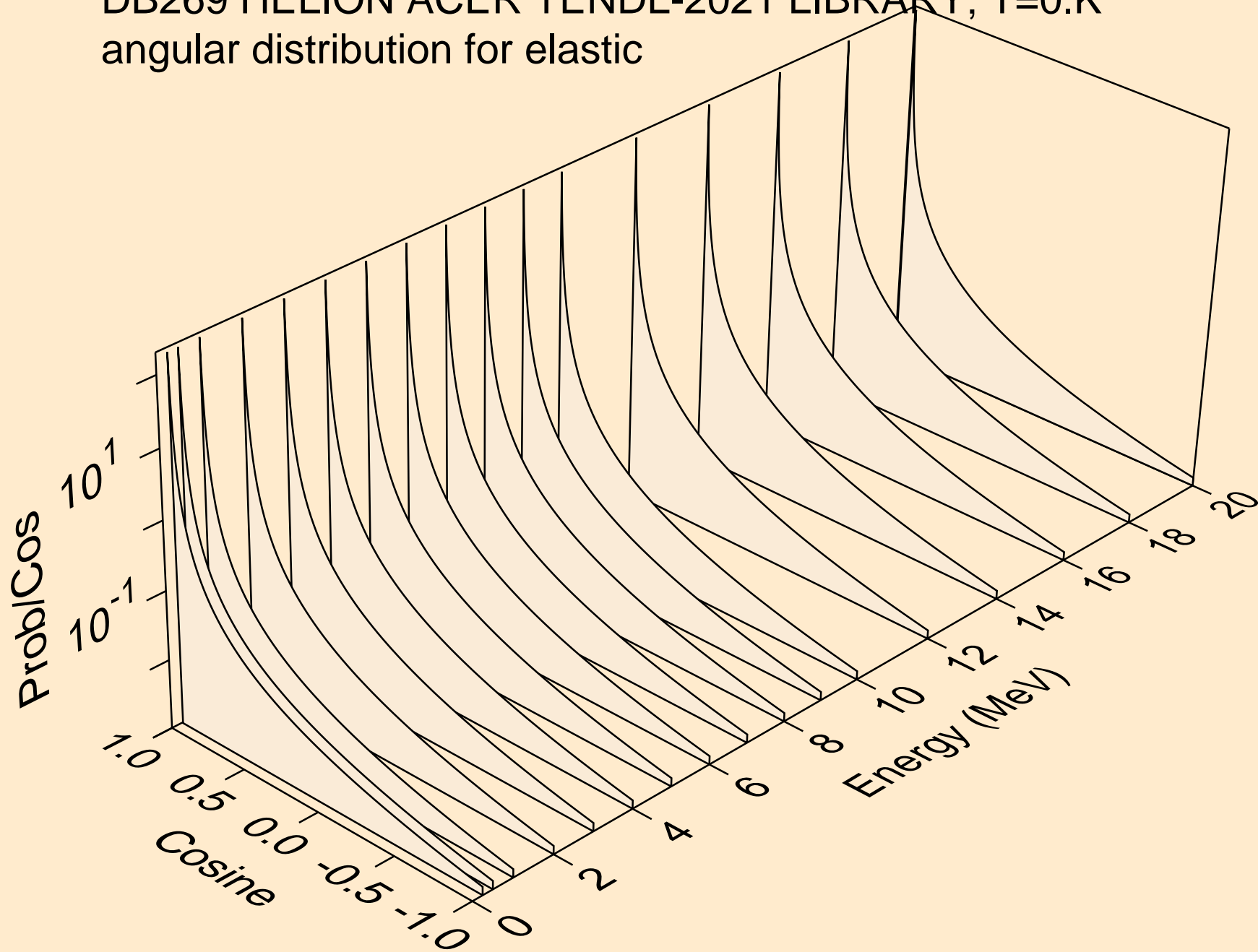



DB269 HELION ACER TENDL-2021 LIBRARY; T=0.K  
angular distribution for elastic

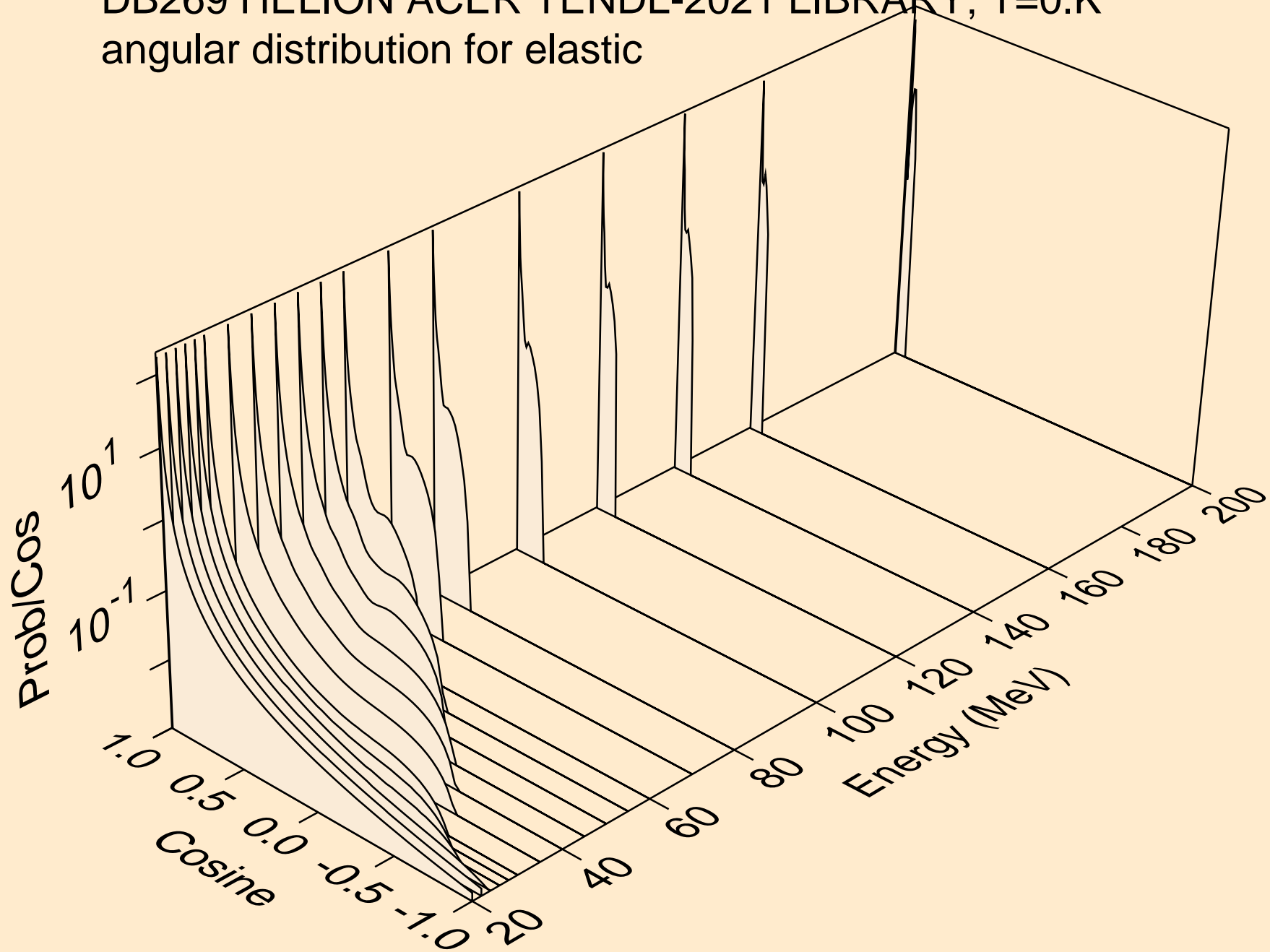

DB269 HELION ACER TENDL-2021 LIBRARY; T=0.K  
He-3 emission for (s,x)

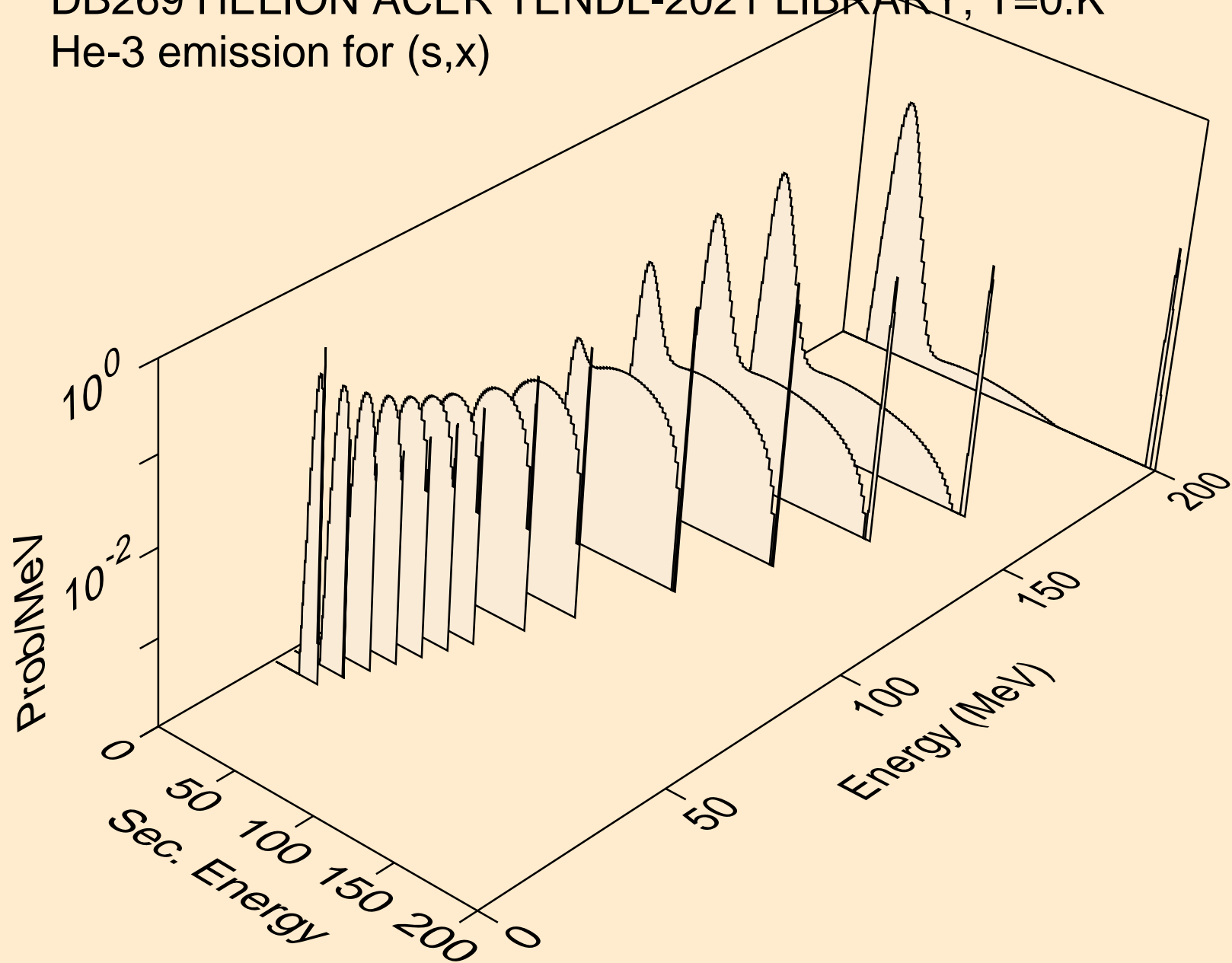

DB269 HELION ACER TENDL-2021 LIBRARY; T=0.K  
He-3 emission for inelastic

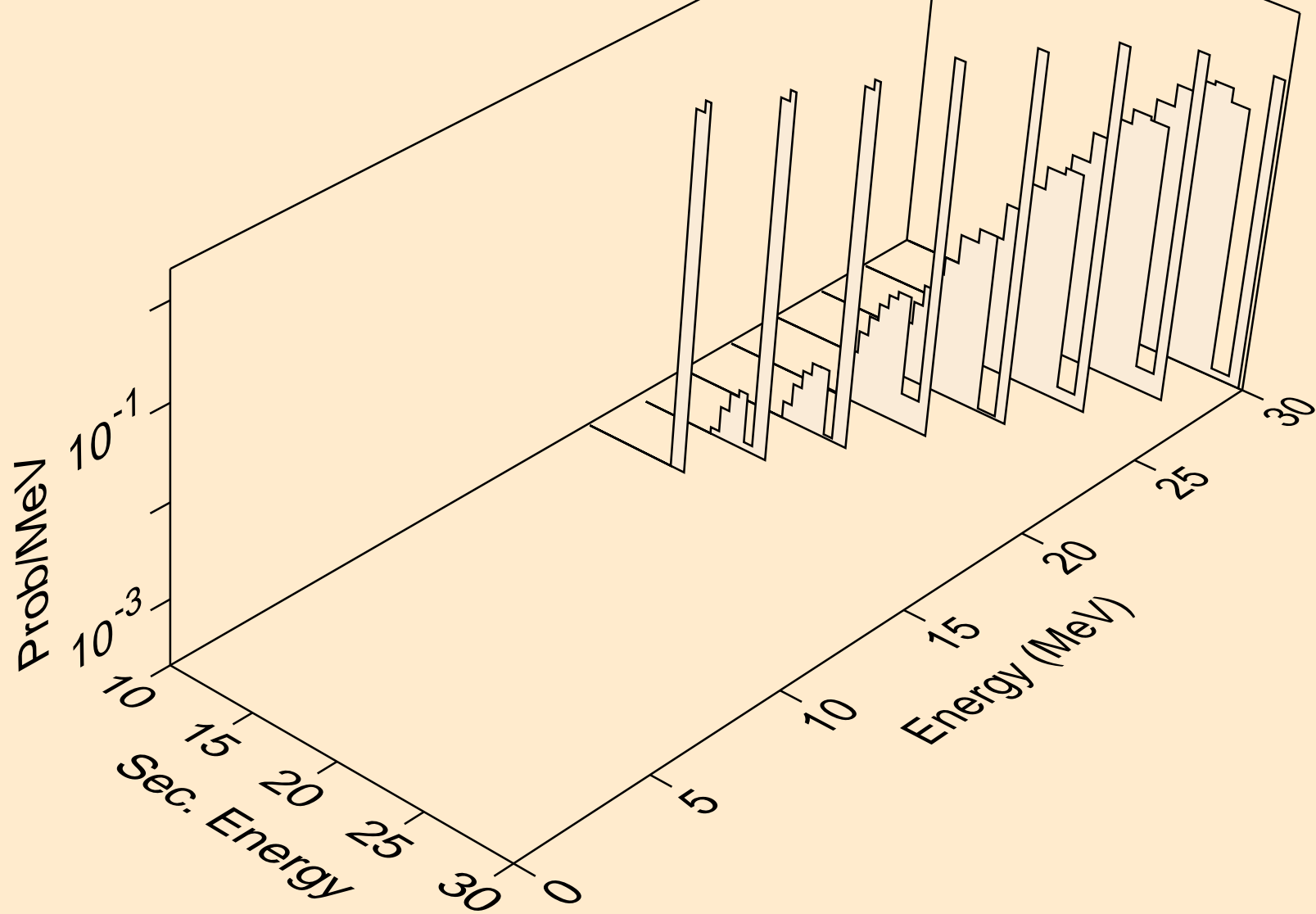

DB269 HELION ACER TENDL-2021 LIBRARY; T=0.K  
Photon emission for (z,n)

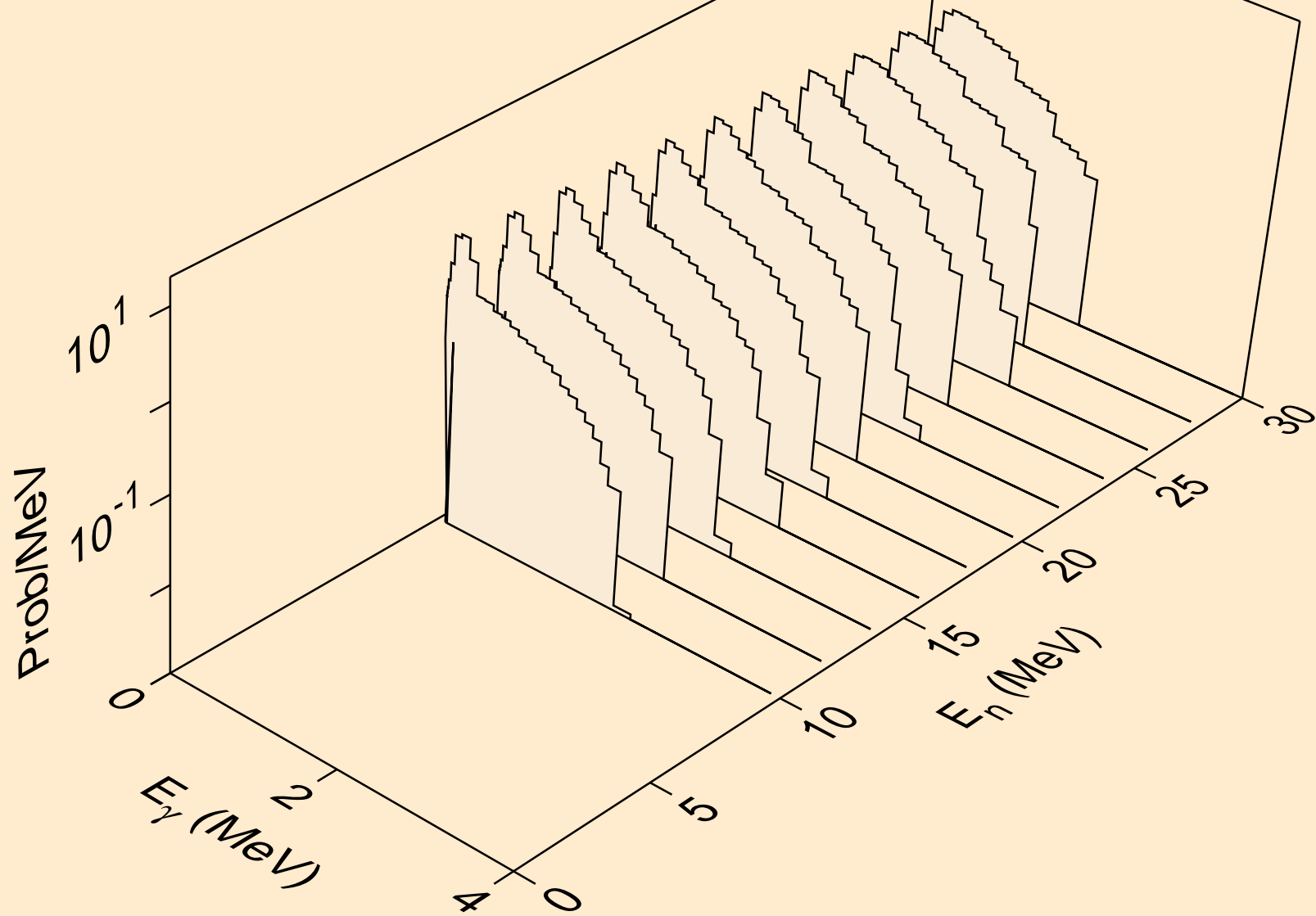

DB269 HELION ACER TENDL-2021 LIBRARY; T=0.K  
Photon emission for (n,x)

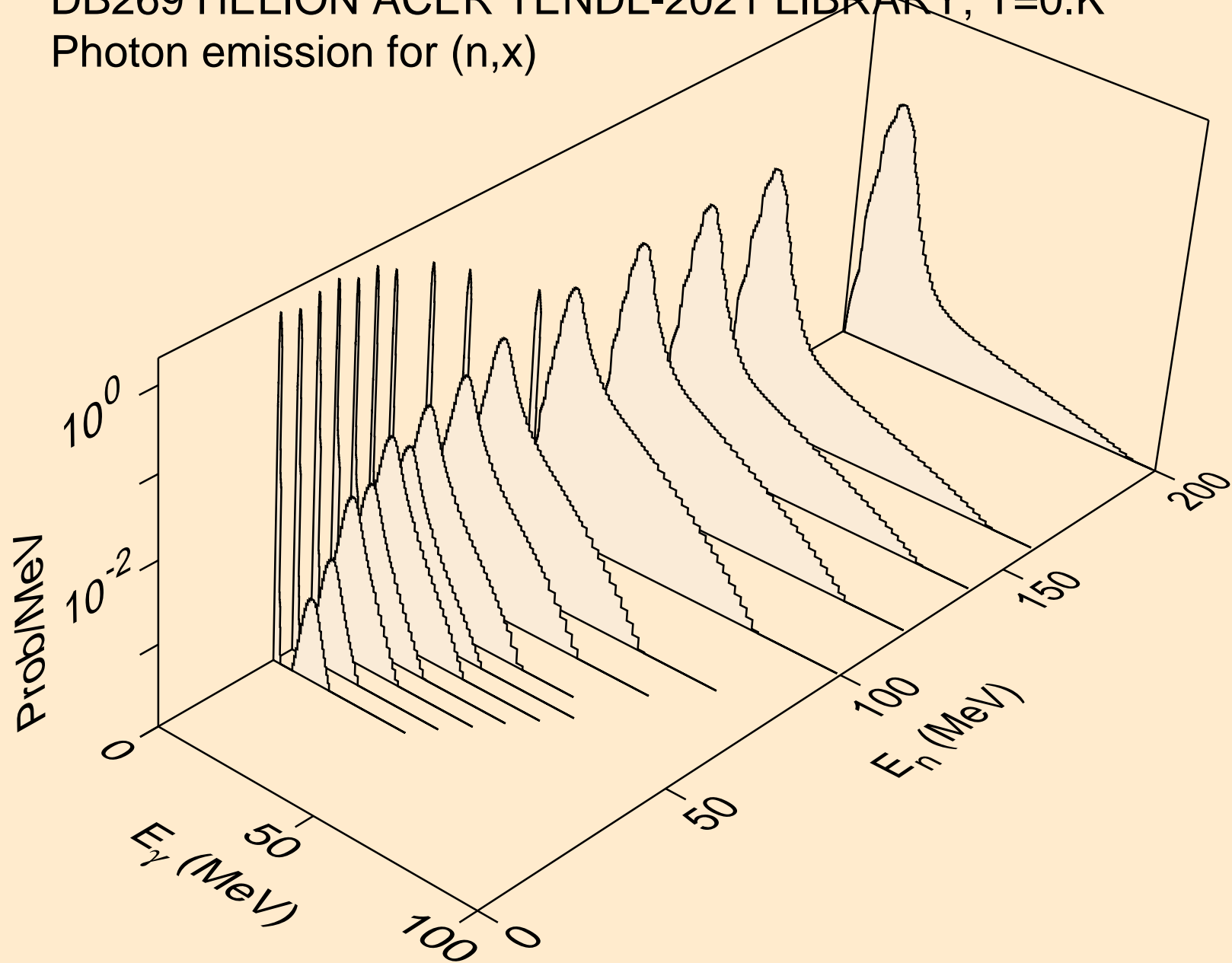

DB269 HELION ACER TENDL-2021 LIBRARY; T=0.K  
Photon emission for (n,2n)

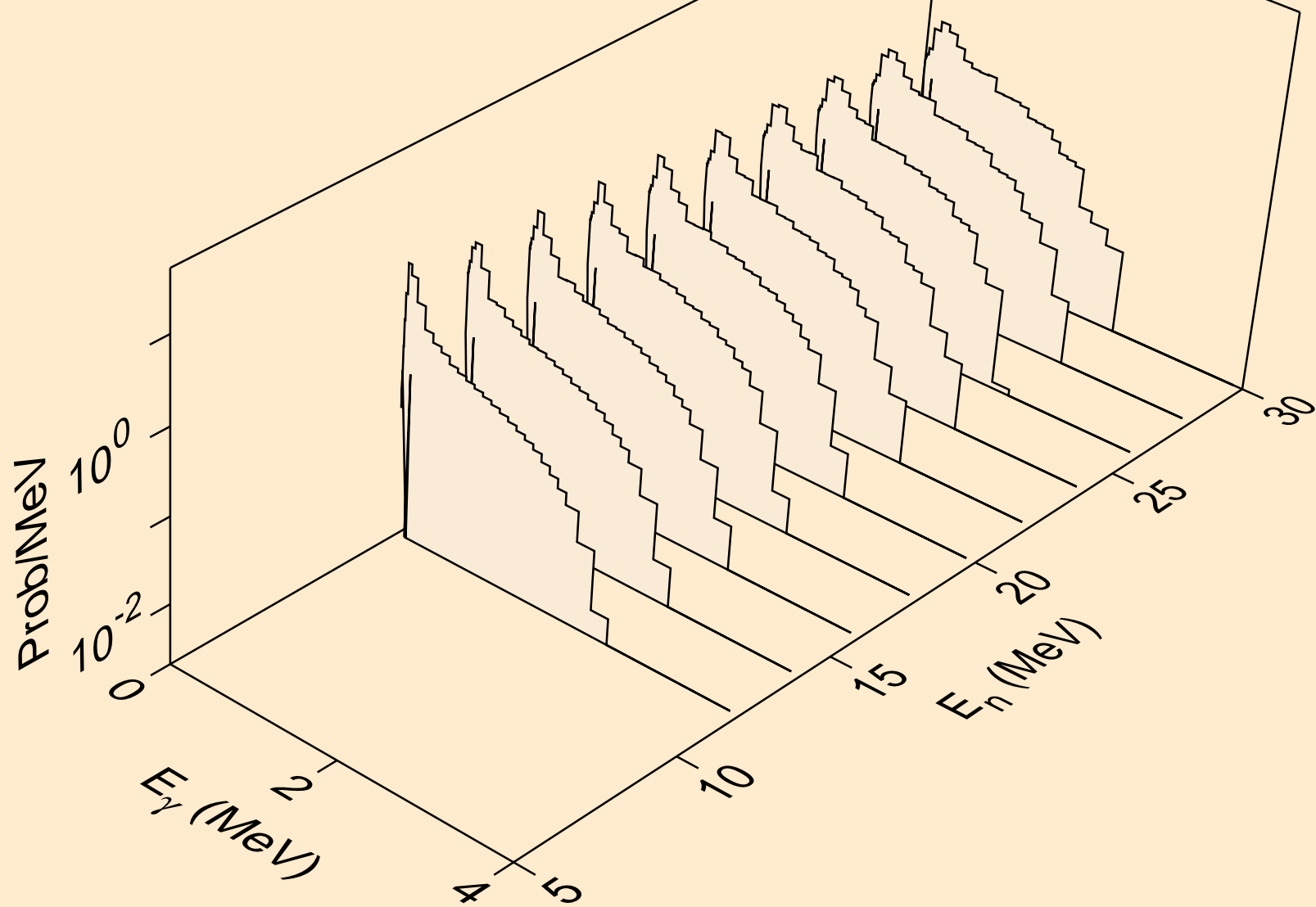

DB269 HELION ACER TENDL-2021 LIBRARY; T=0.K  
Photon emission for (n,3n)

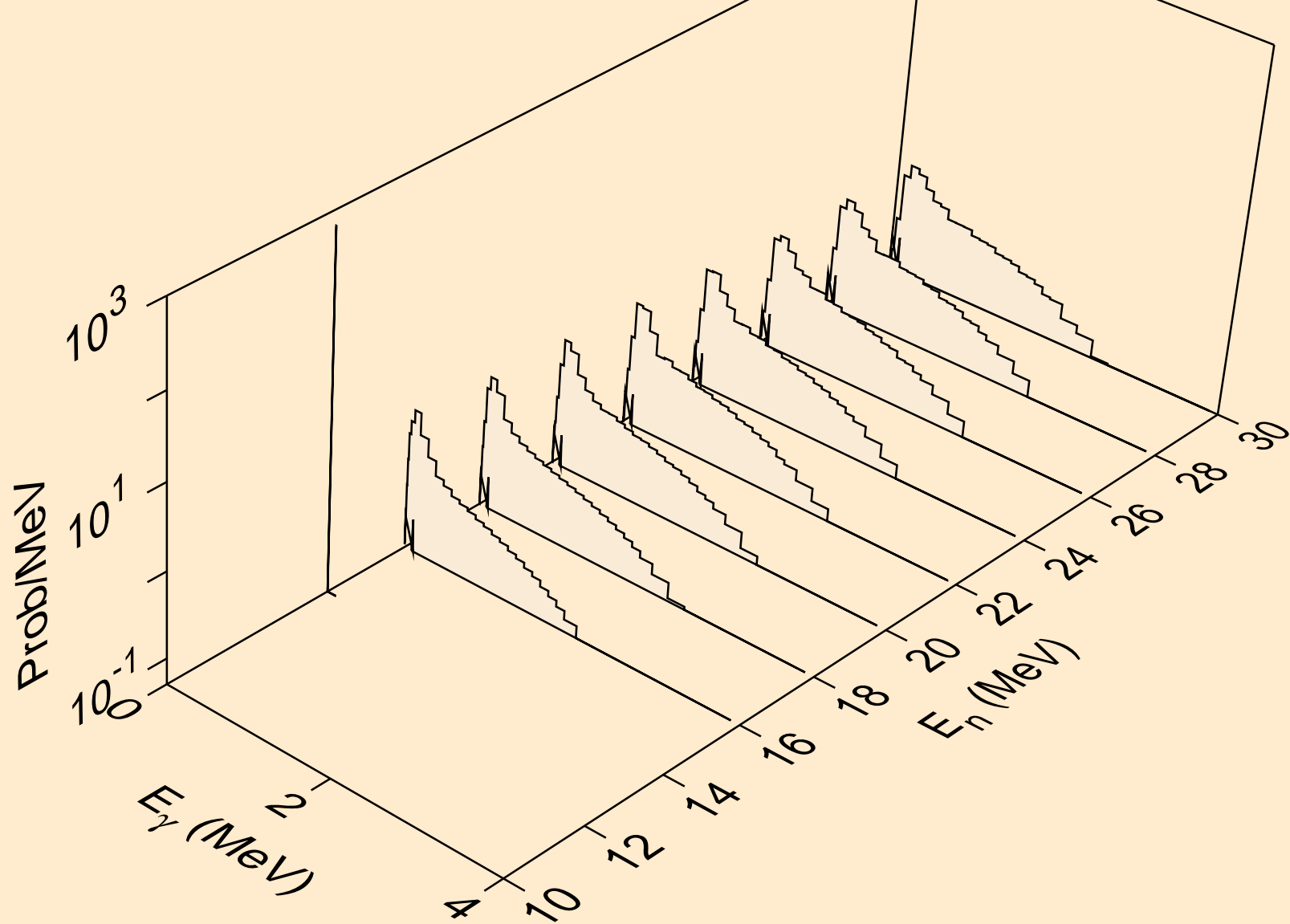

DB269 HELION ACER TENDL-2021 LIBRARY; T=0.K  
Photon emission for (n,n\*)a

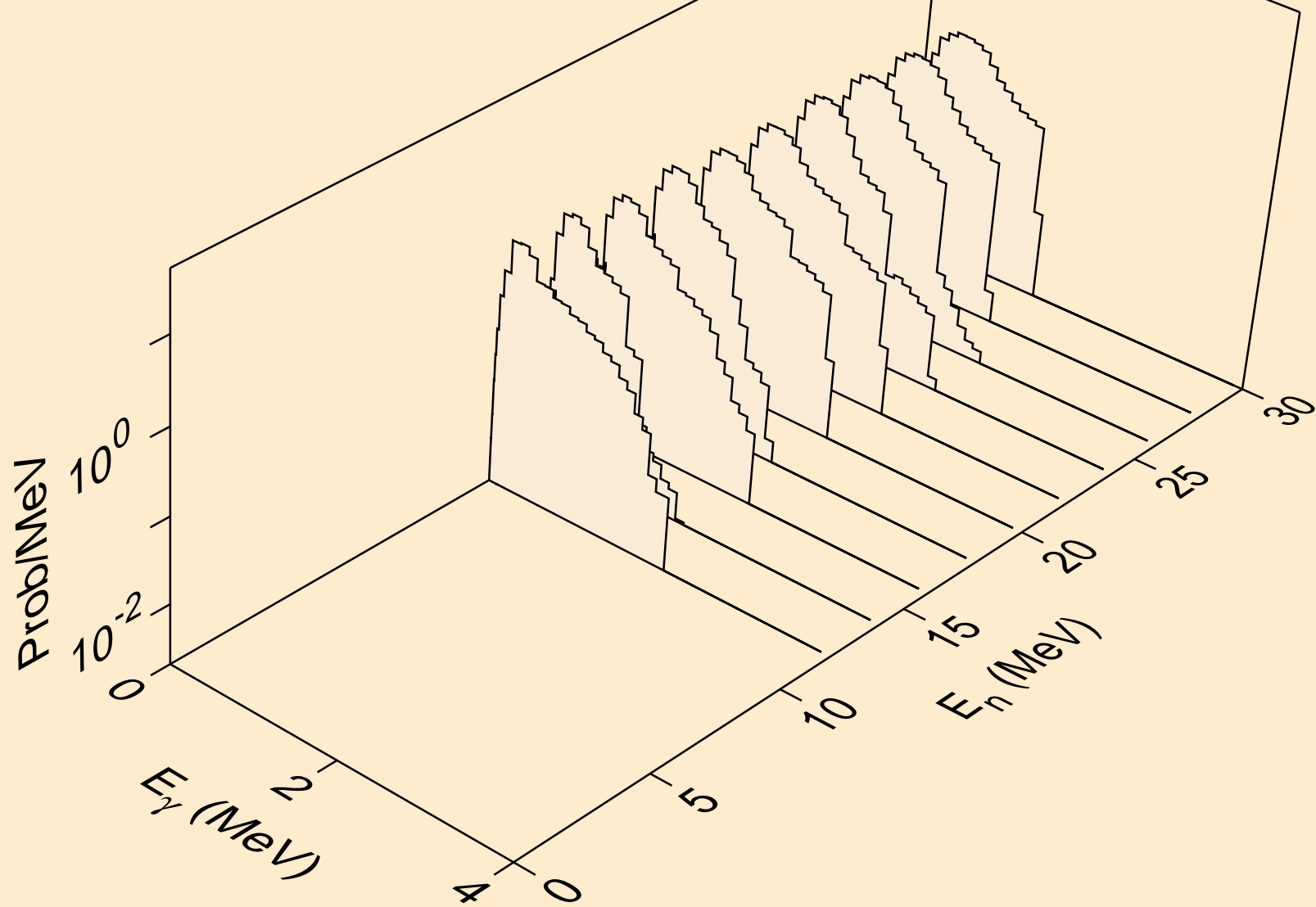



DB269 HELION ACER TENDL-2021 LIBRARY; T=0.K  
Photon emission for (n,n\*)p

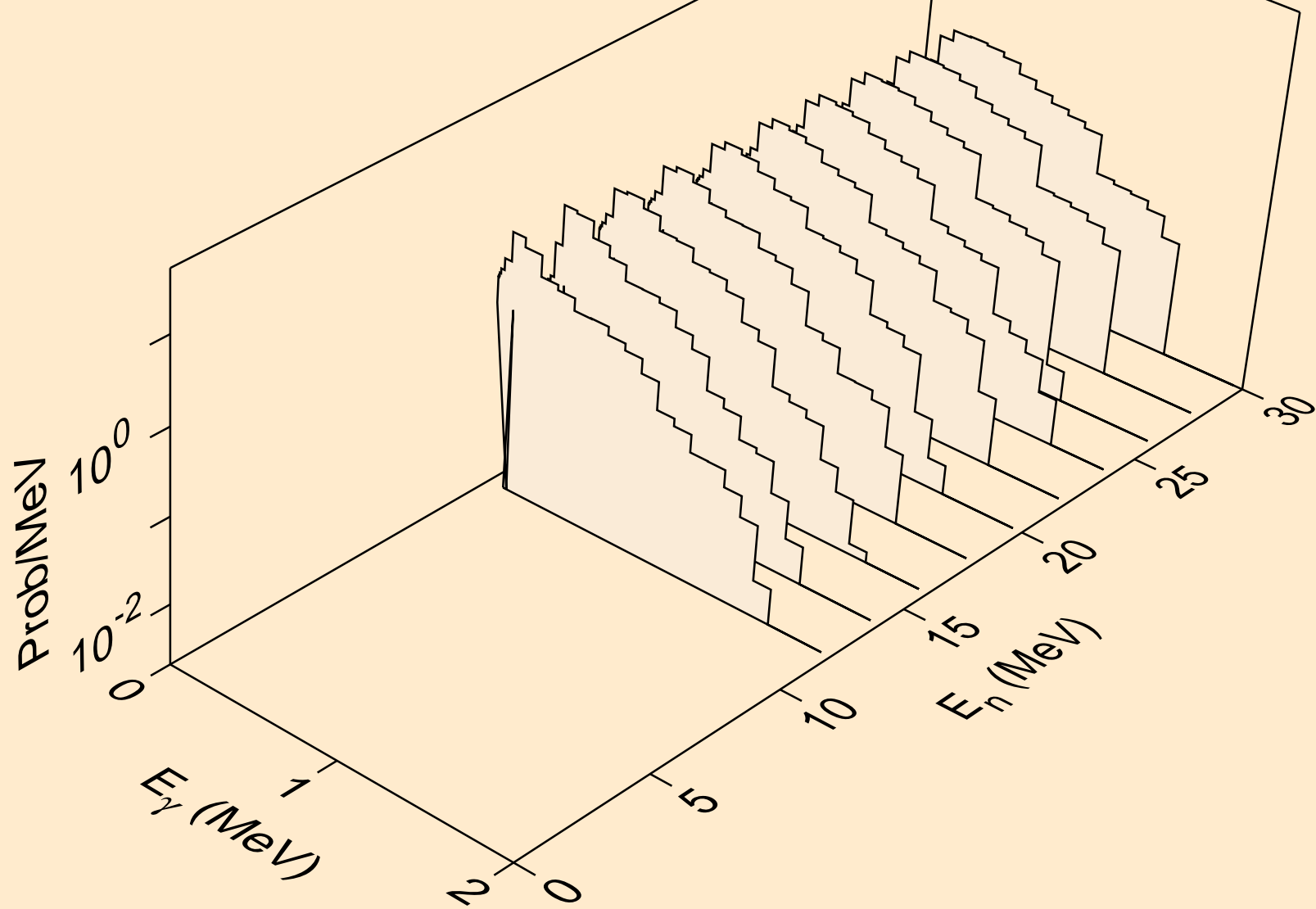

DB269 HELION ACER TENDL-2021 LIBRARY; T=0.K  
Photon emission for (n,n\*)d

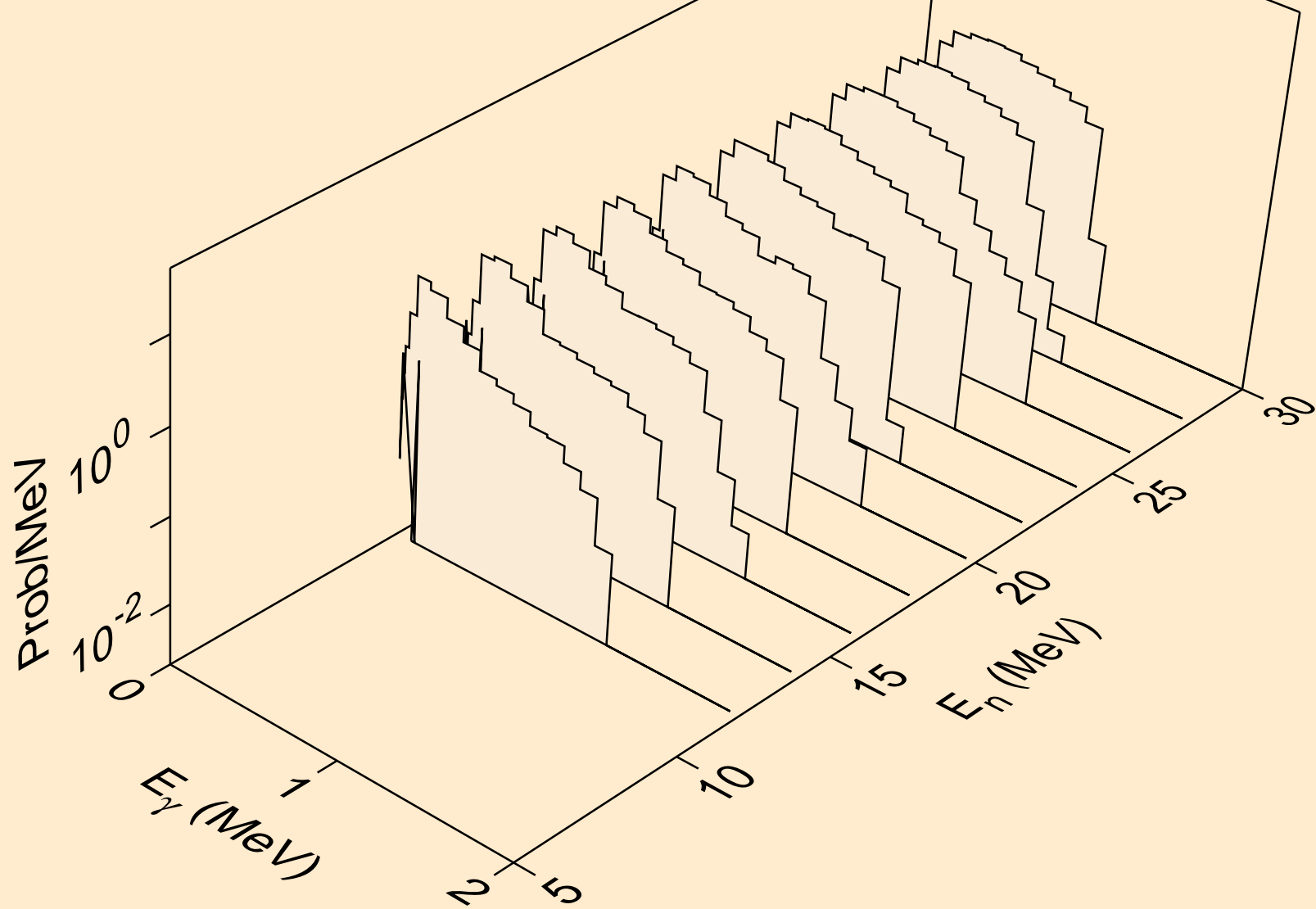

DB269 HELION ACER TENDL-2021 LIBRARY; T=0.K  
Photon emission for (n,n\*)t

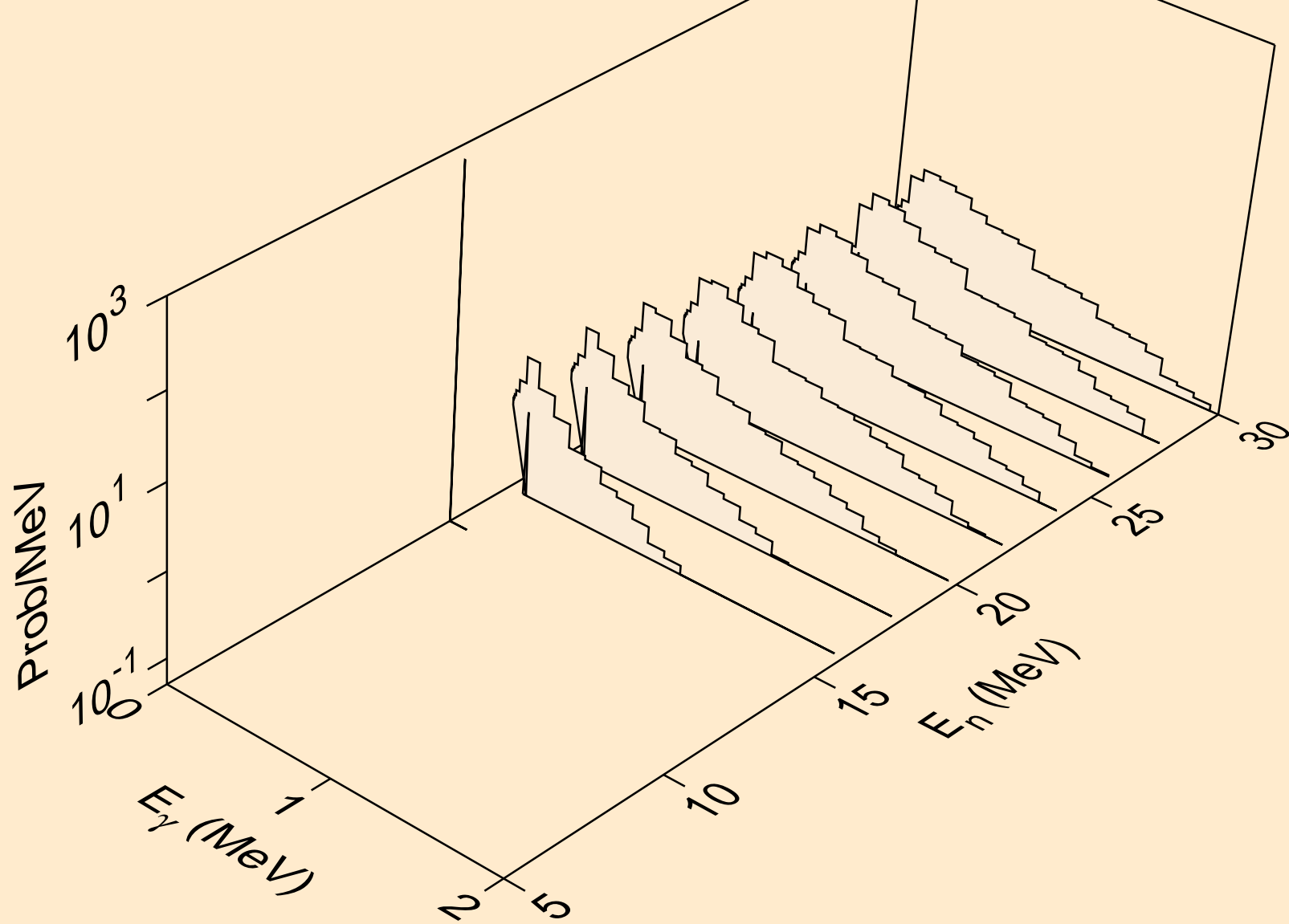

DB269 HELION ACER TENDL-2021 LIBRARY; T=0.K  
Photon emission for (n,2np)

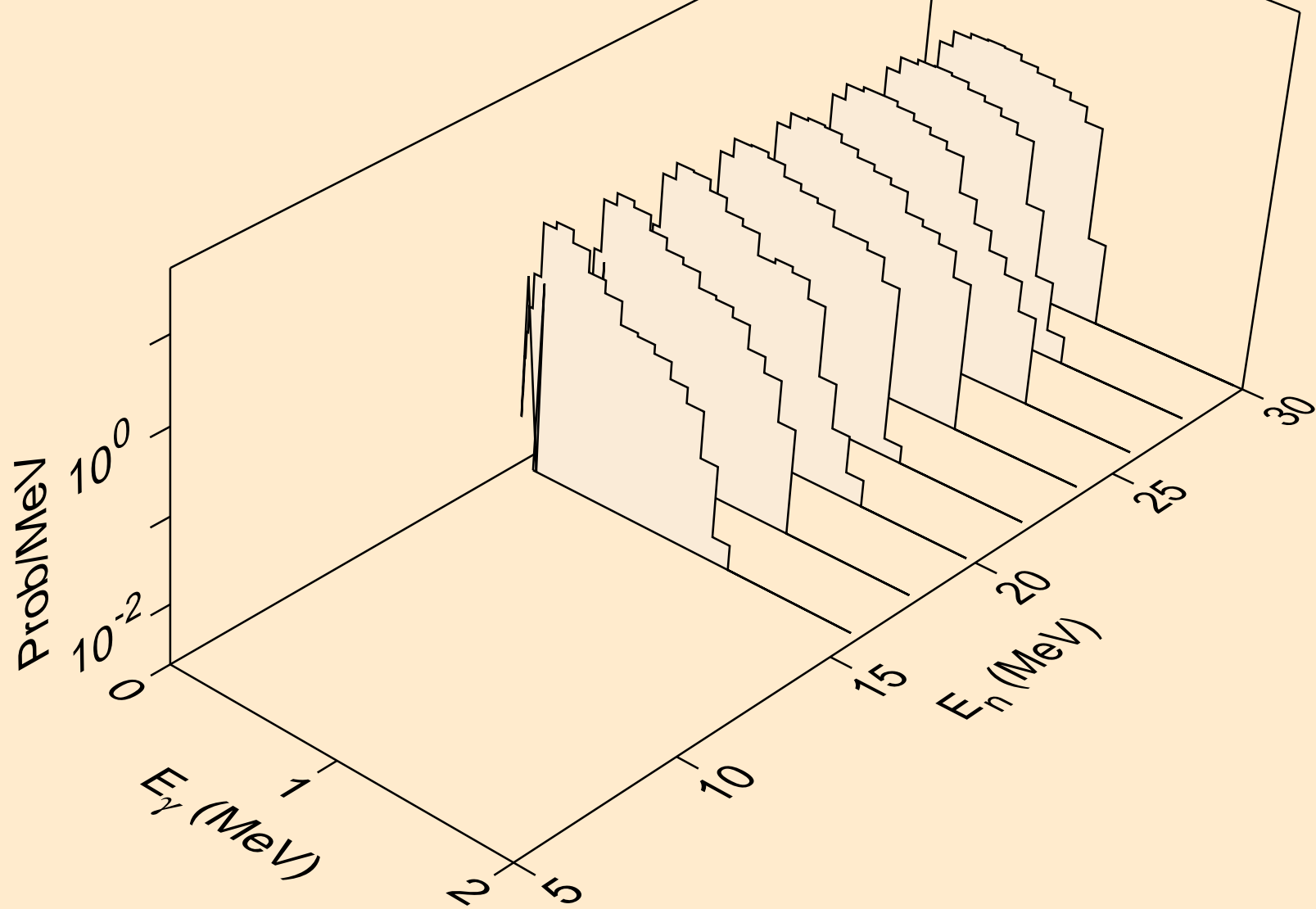

DB269 HELION ACER TENDL-2021 LIBRARY; T=0.K  
Photon emission for (n,p)

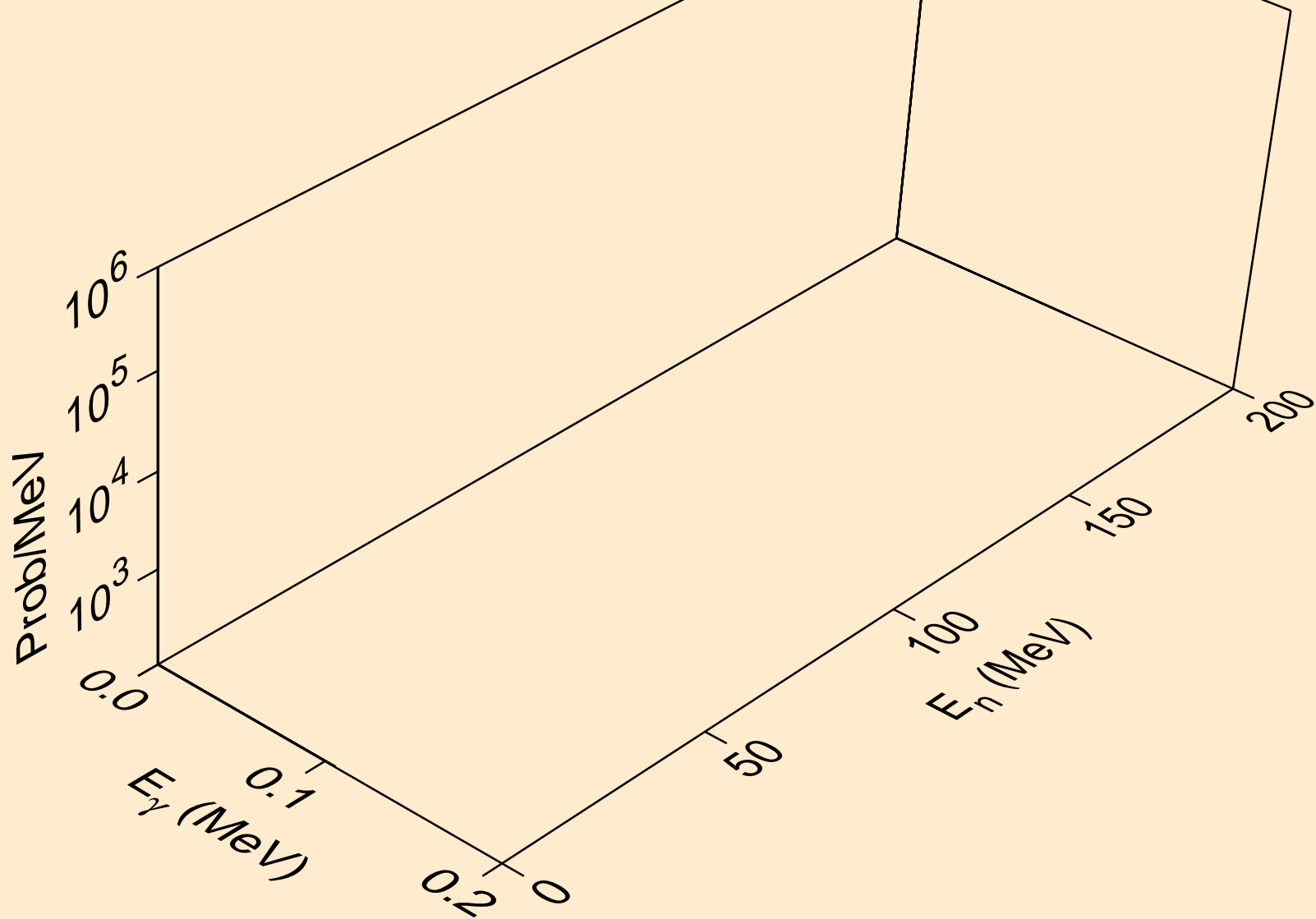

DB269 HELION ACER TENDL-2021 LIBRARY; T=0.K  
Photon emission for (n,d)

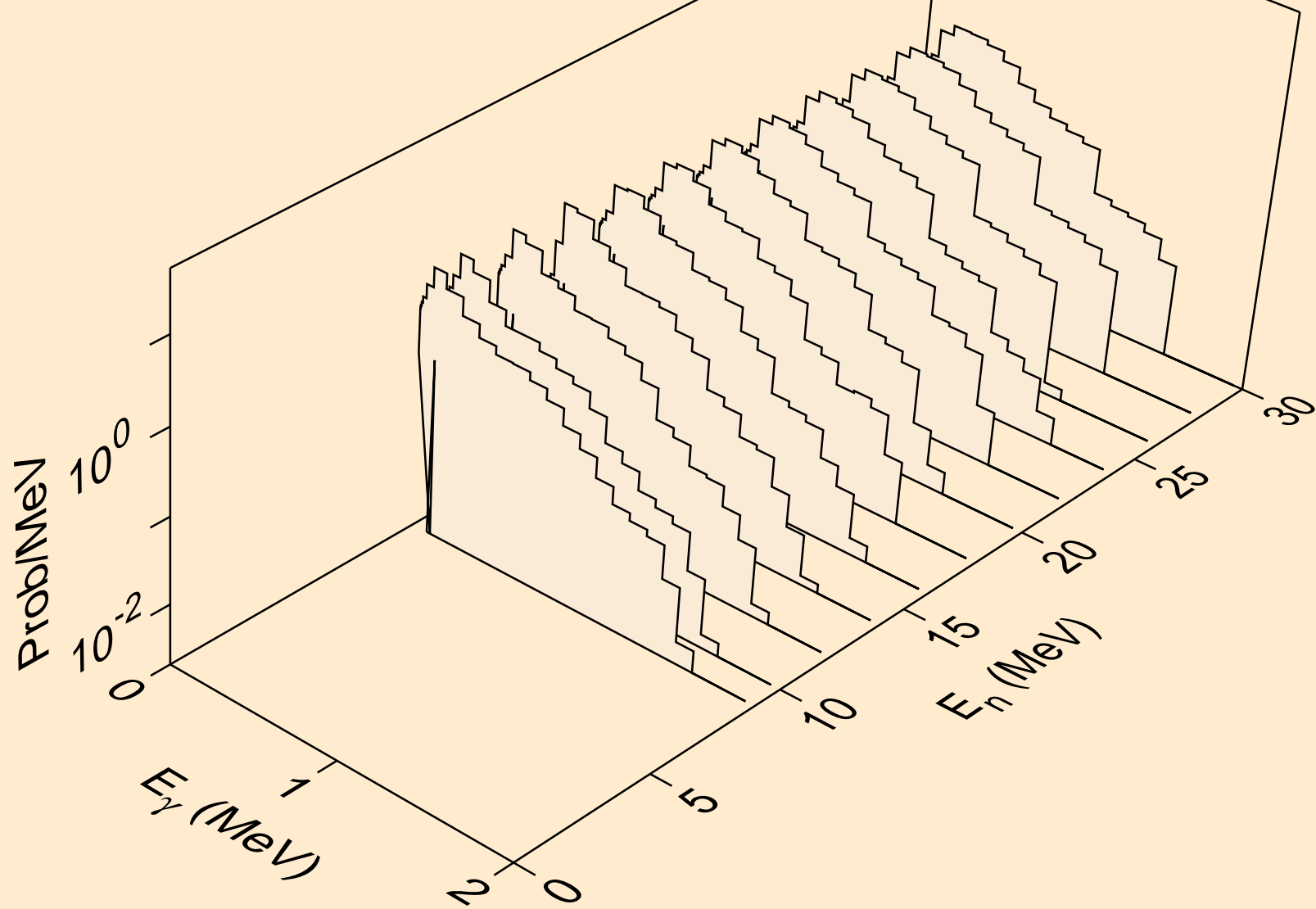

DB269 HELION ACER TENDL-2021 LIBRARY; T=0.K  
Photon emission for (n,t)

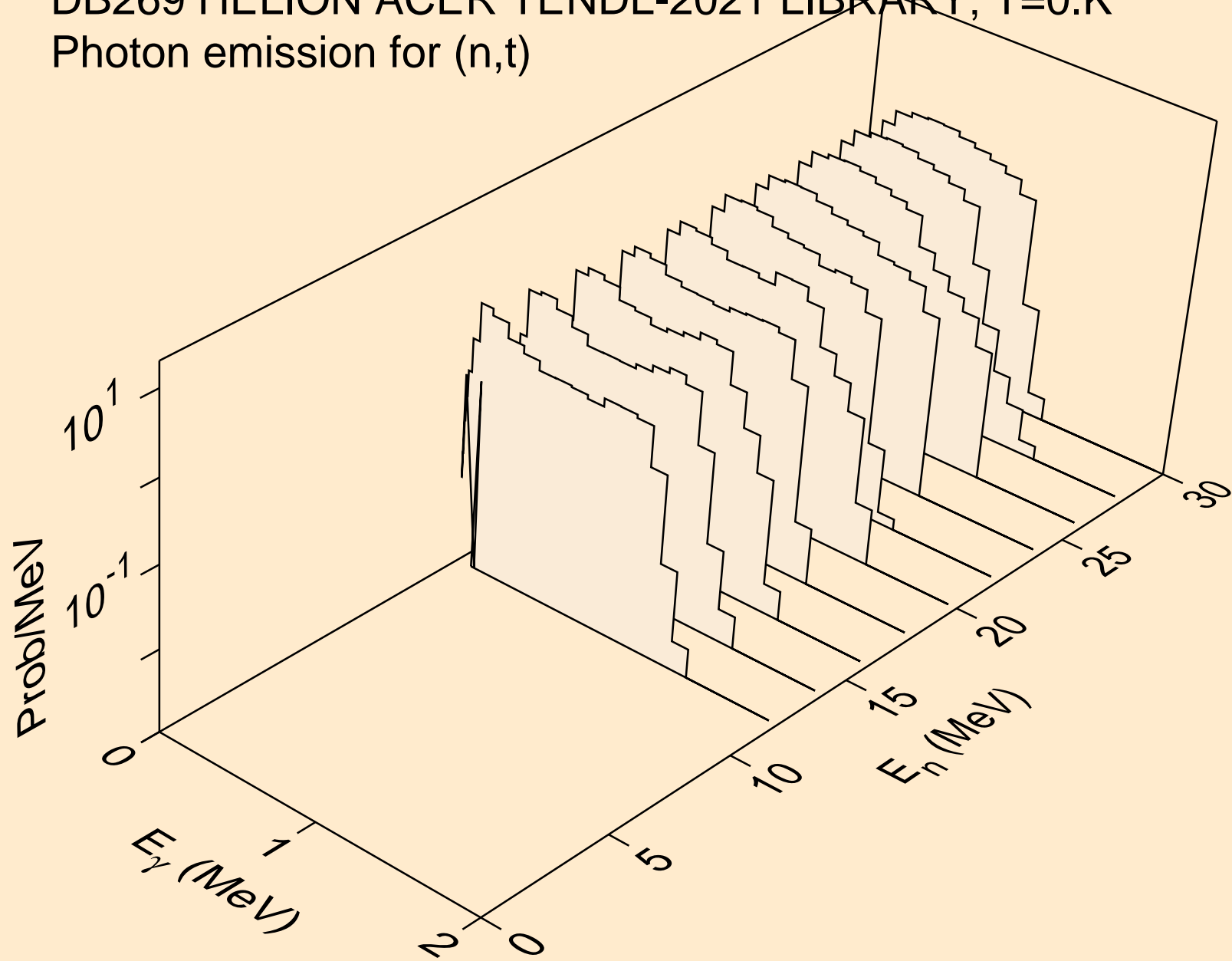

DB269 HELION ACER TENDL-2021 LIBRARY; T=0.K  
Photon emission for inelastic

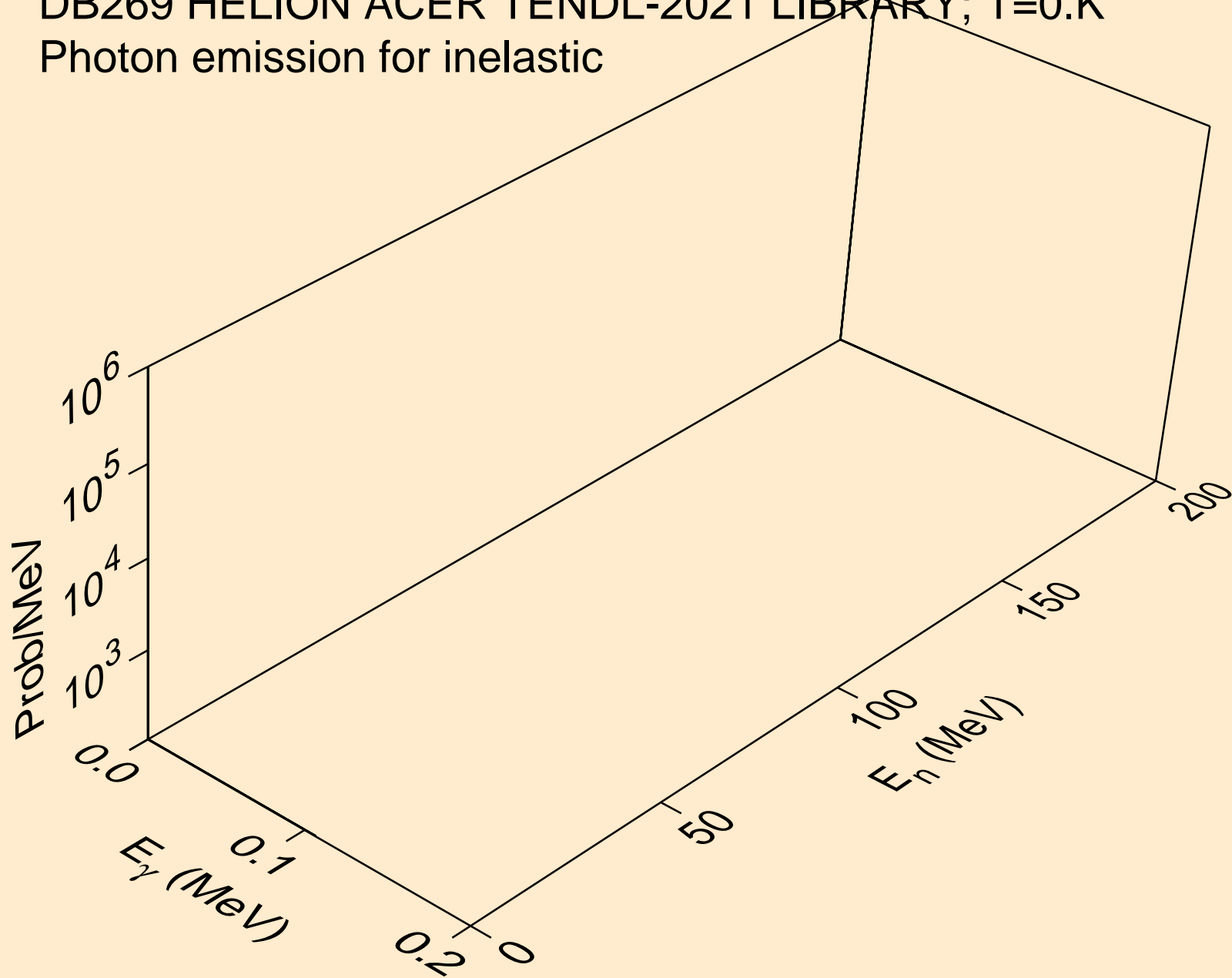



DB269 HELION ACER TENDL-2021 LIBRARY; T=0.K  
Photon emission for (n,a)

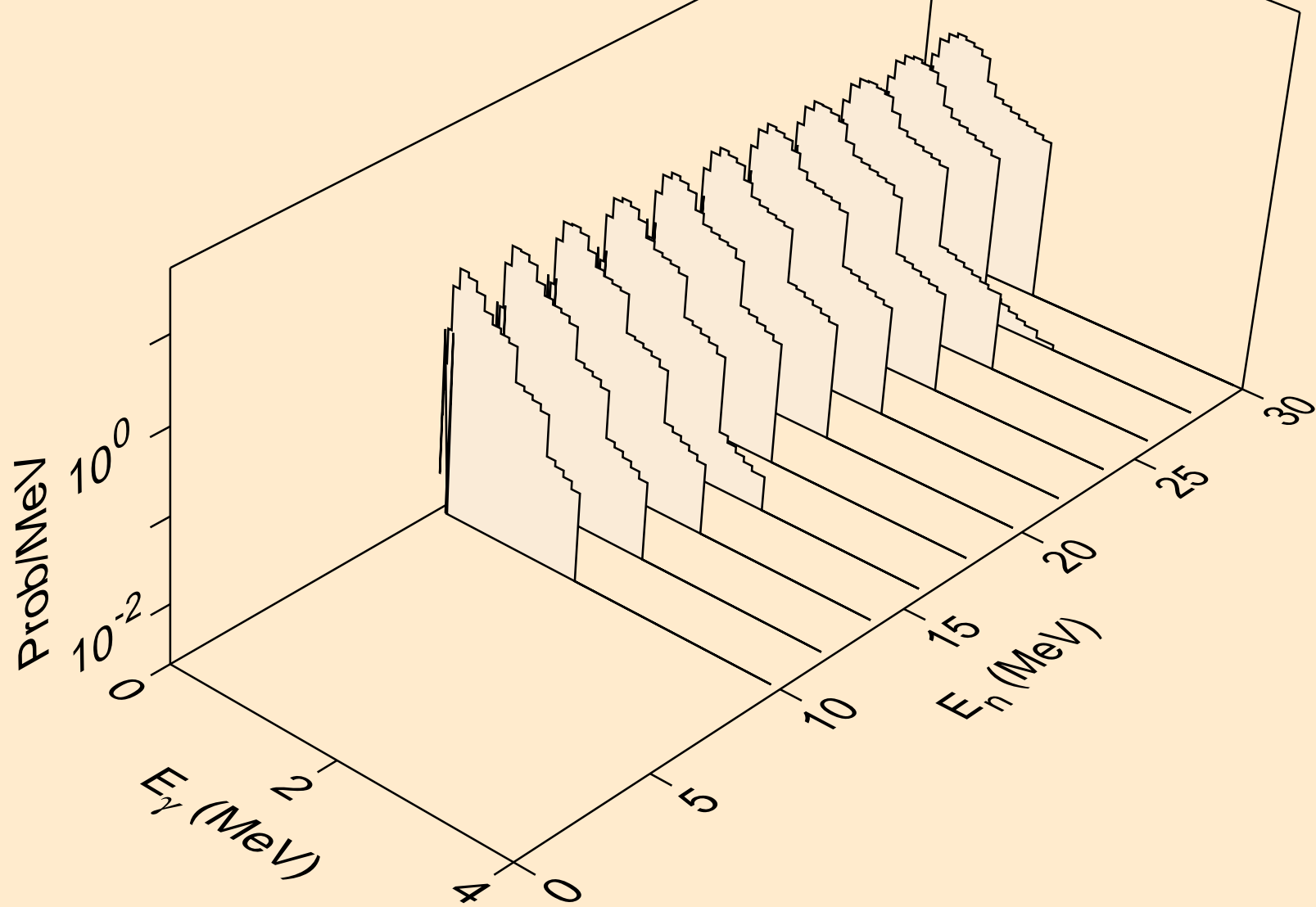

DB269 HELION ACER TENDL-2021 LIBRARY; T=0.K  
Particle heating contributions

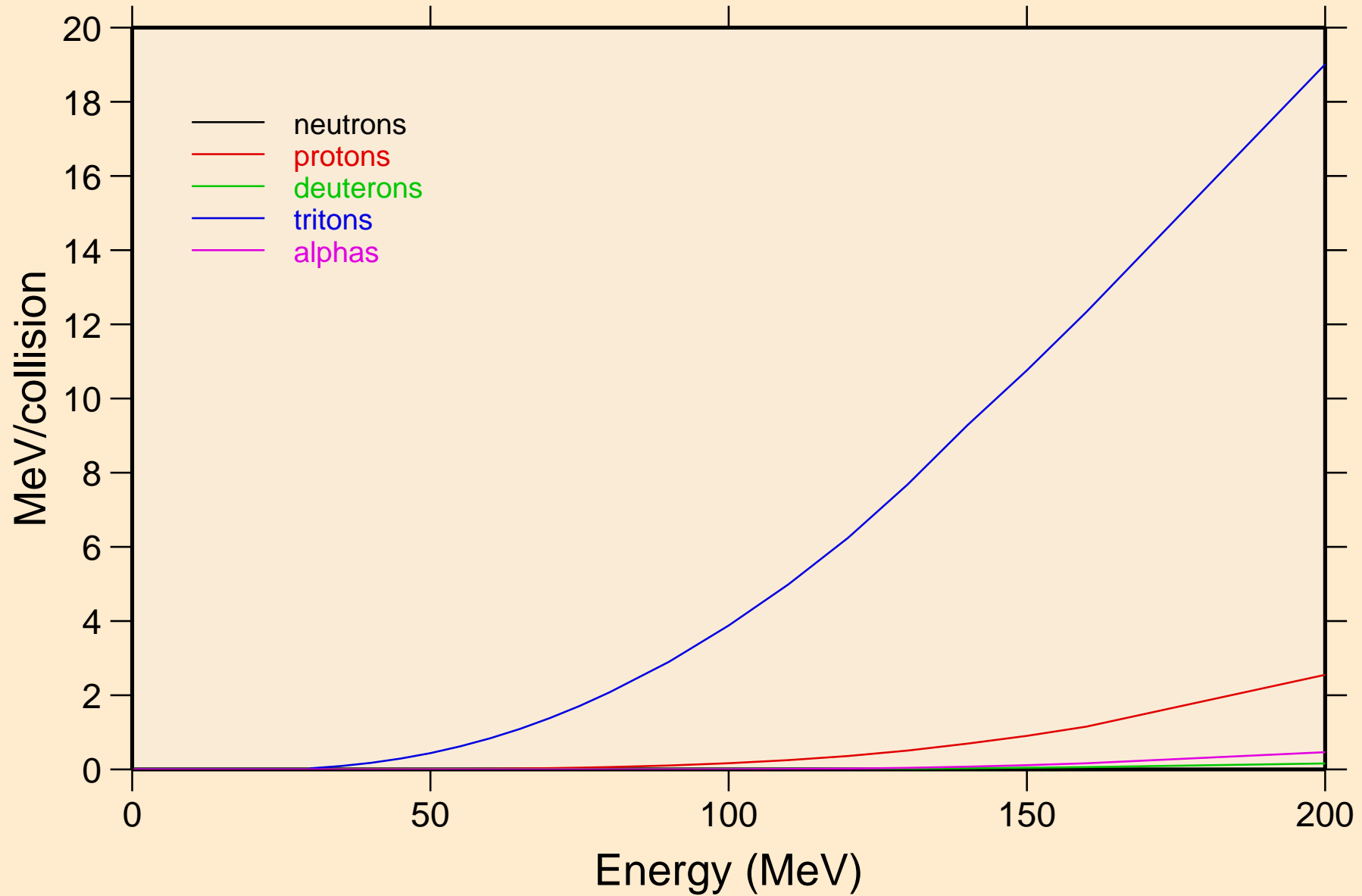

DB269 HELION ACER TENDL-2021 LIBRARY; T=0.K  
Recoil Heating

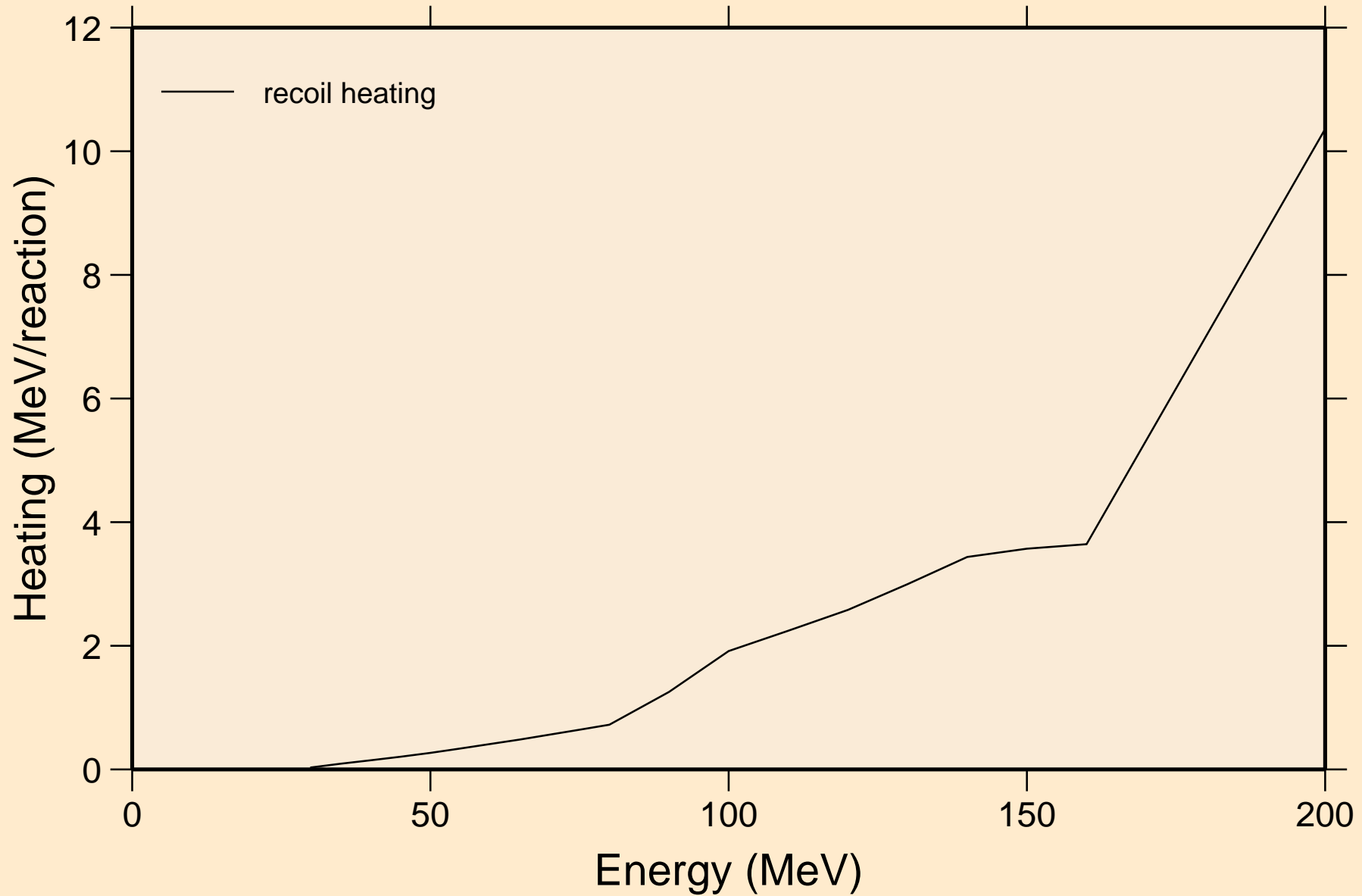

DB269 HELION ACER TENDL-2021 LIBRARY; T=0.K  
Particle production cross sections

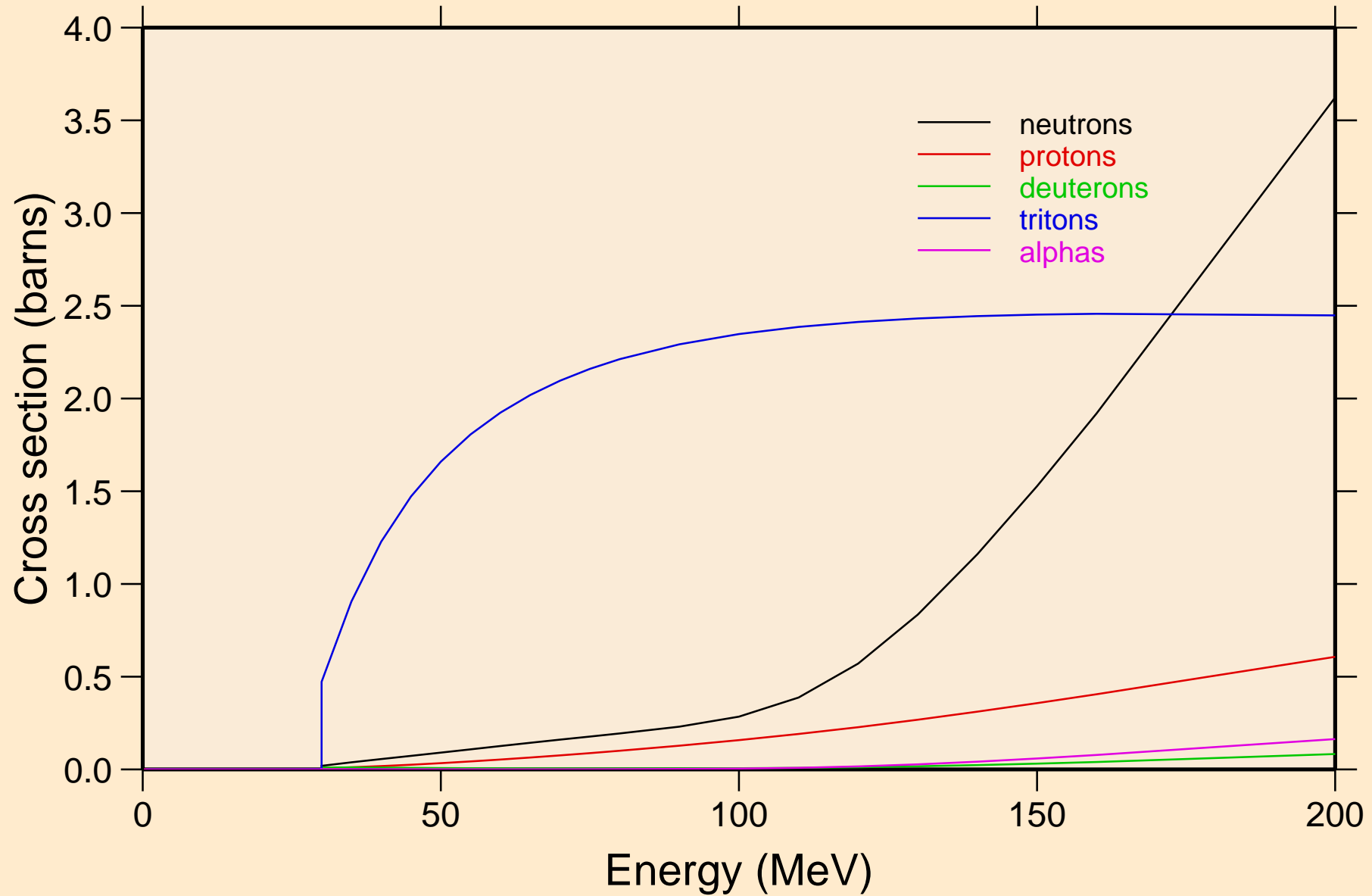

DB269 HELION ACER TENDL-2021 LIBRARY; T=0.K  
neutrons from (s,n)

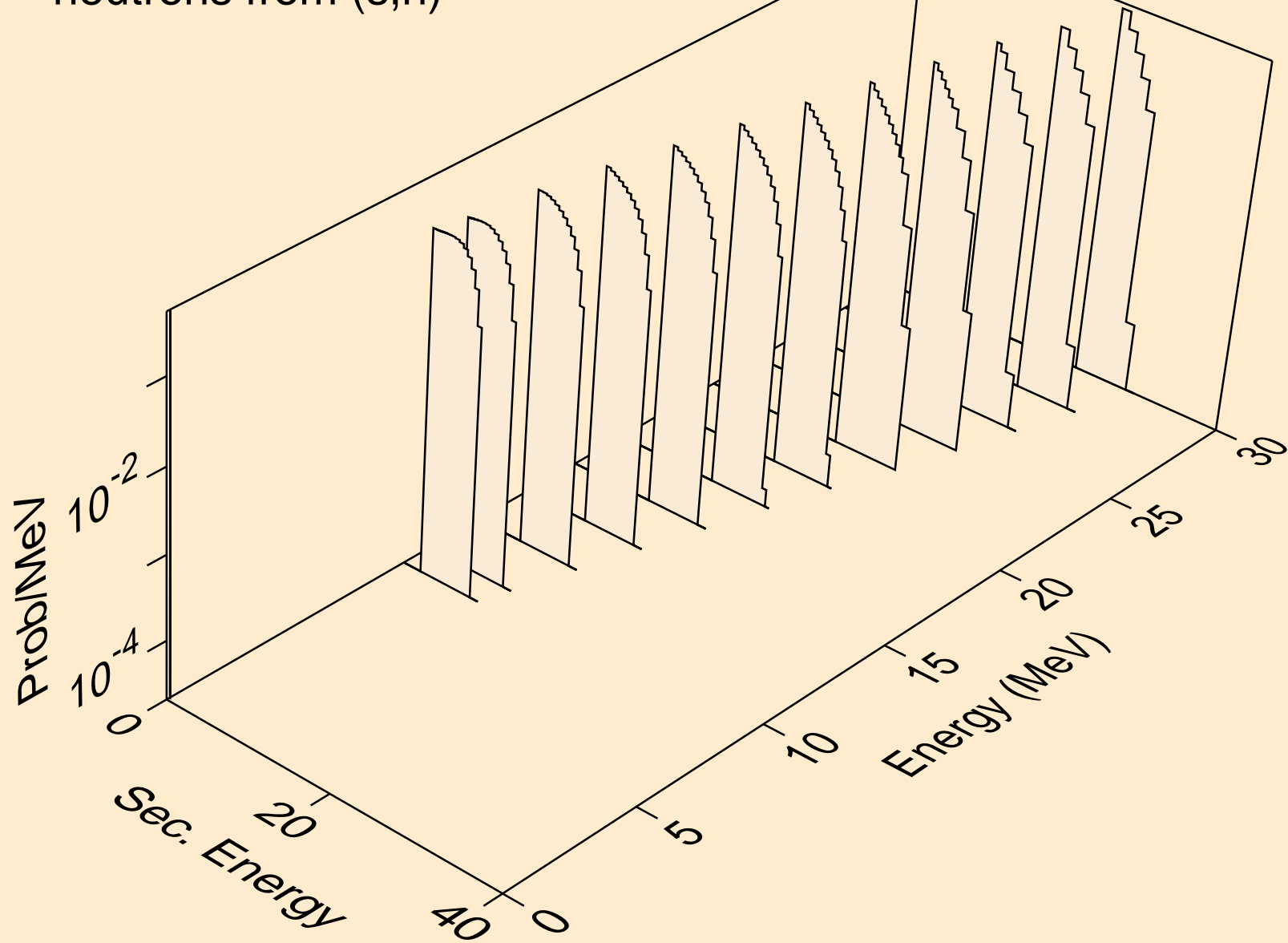

DB269 HELION ACER TENDL-2021 LIBRARY; T=0.K  
neutrons from (s,x)

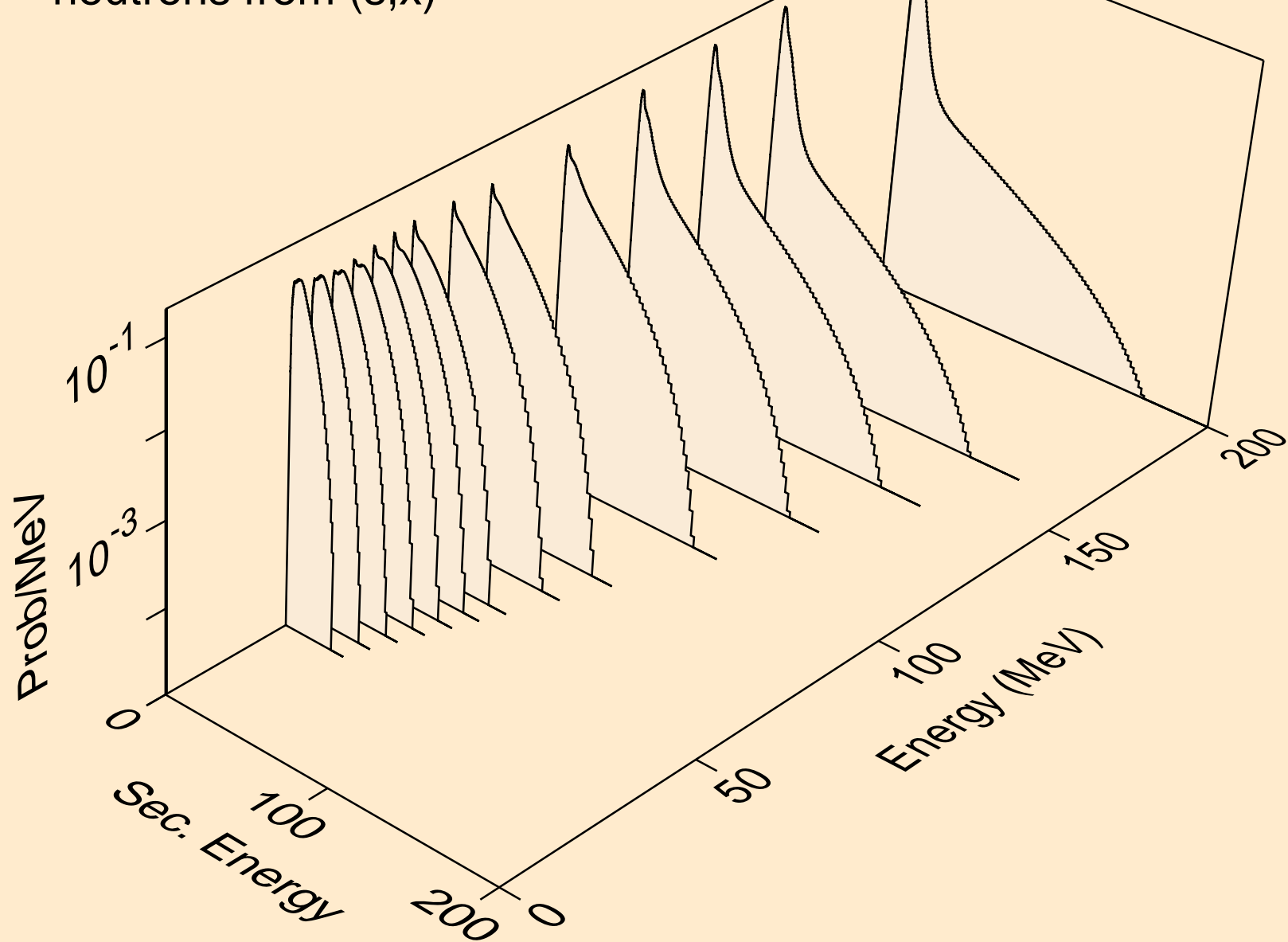

DB269 HELION ACER TENDL-2021 LIBRARY; T=0.K  
neutrons from (s,2n)

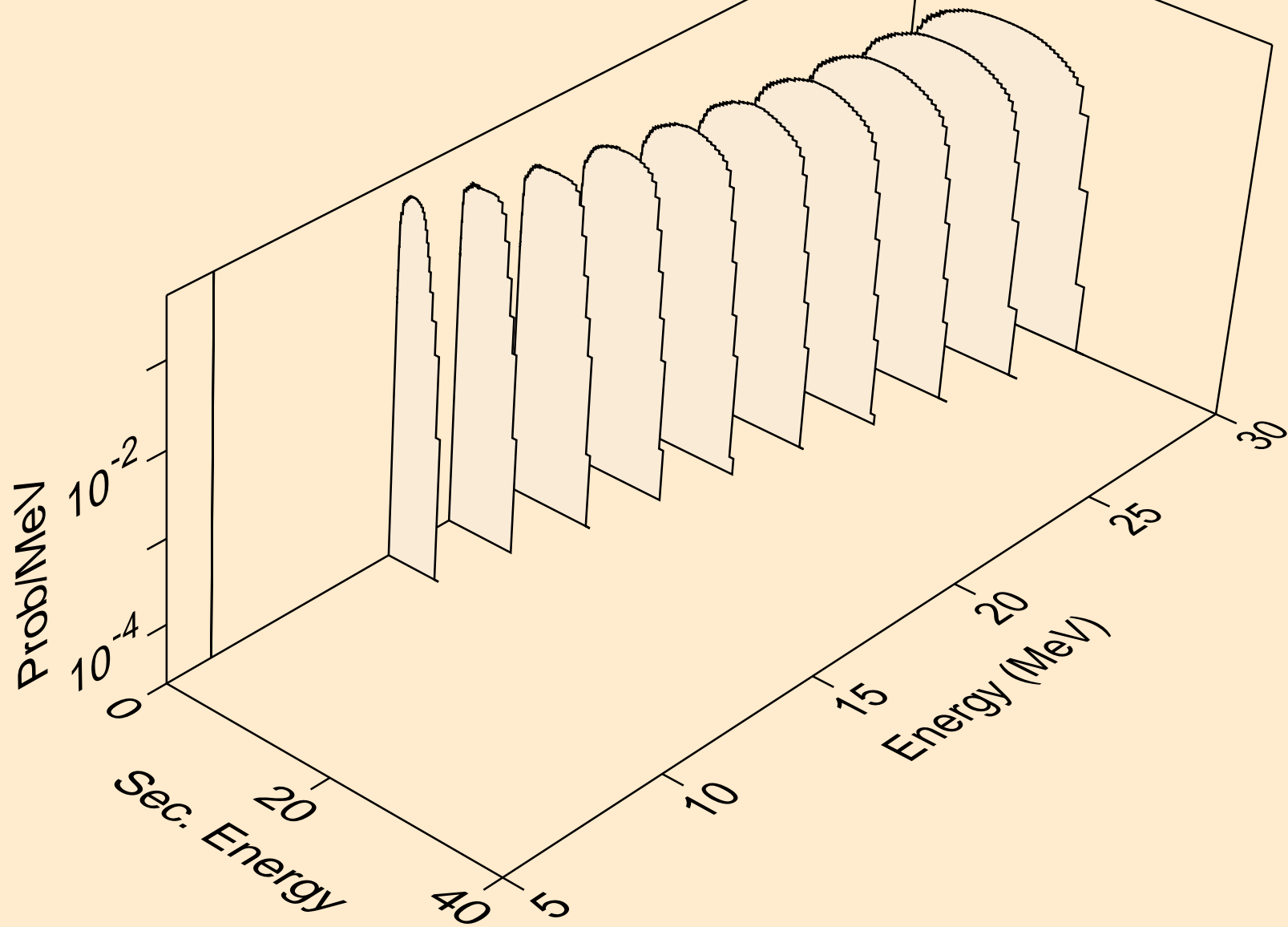

DB269 HELION ACER TENDL-2021 LIBRARY; T=0.K  
neutrons from (s,3n)

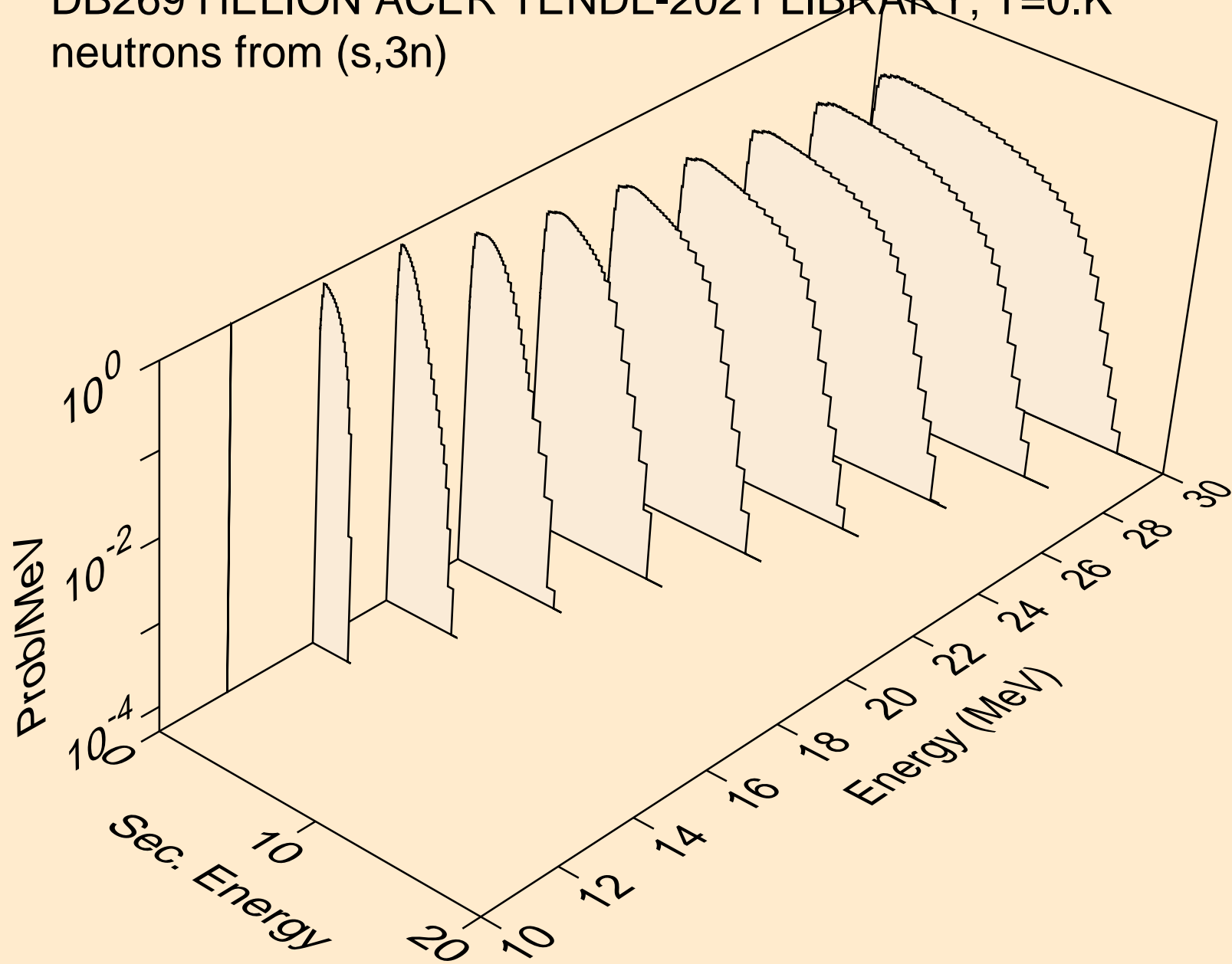



DB269 HELION ACER TENDL-2021 LIBRARY; T=0.K  
neutrons from (s,n\*)a

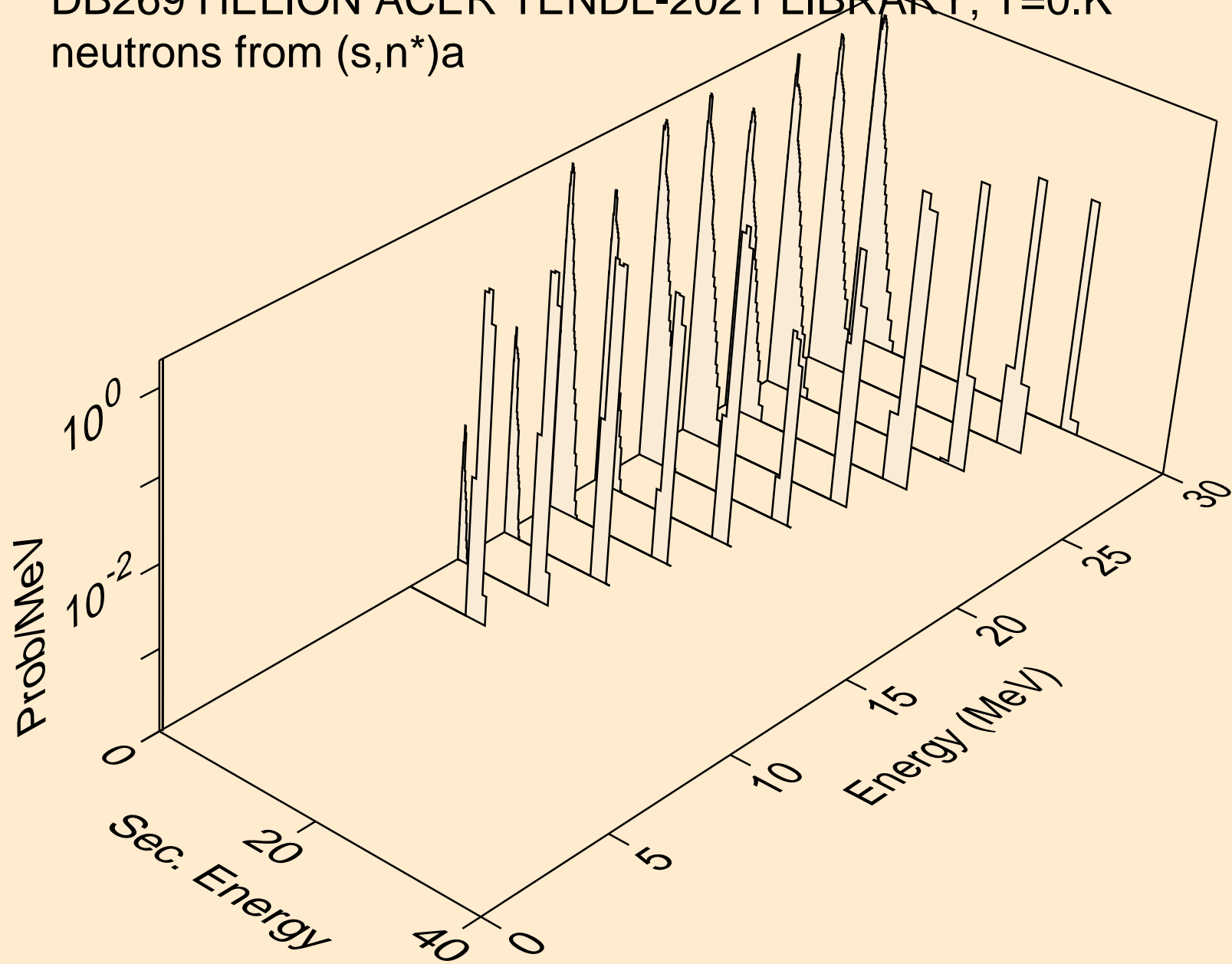

DB269 HELION ACER TENDL-2021 LIBRARY; T=0.K  
neutrons from (s,n\*)p

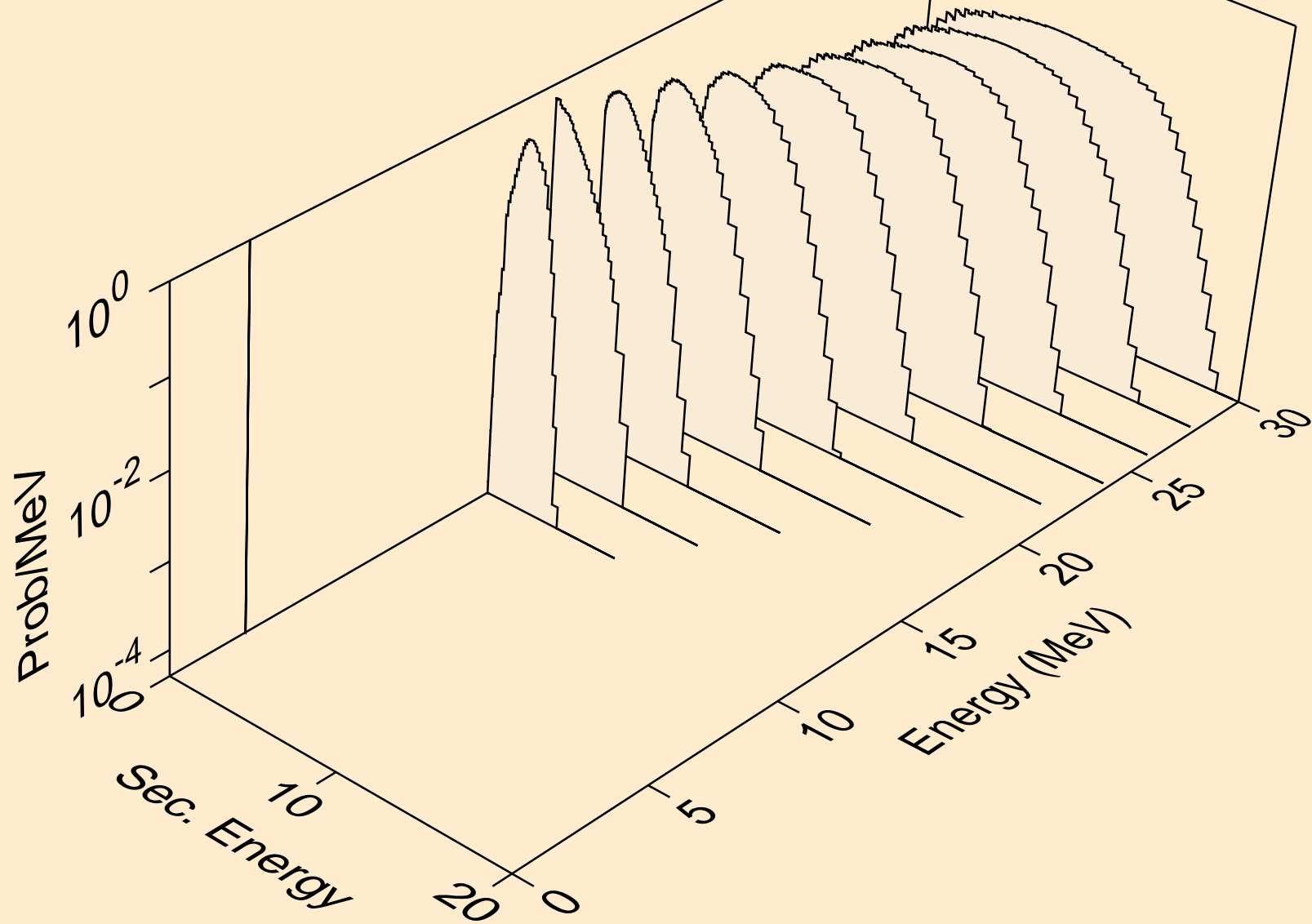

DB269 HELION ACER TENDL-2021 LIBRARY; T=0.K  
neutrons from (s,n\*)d

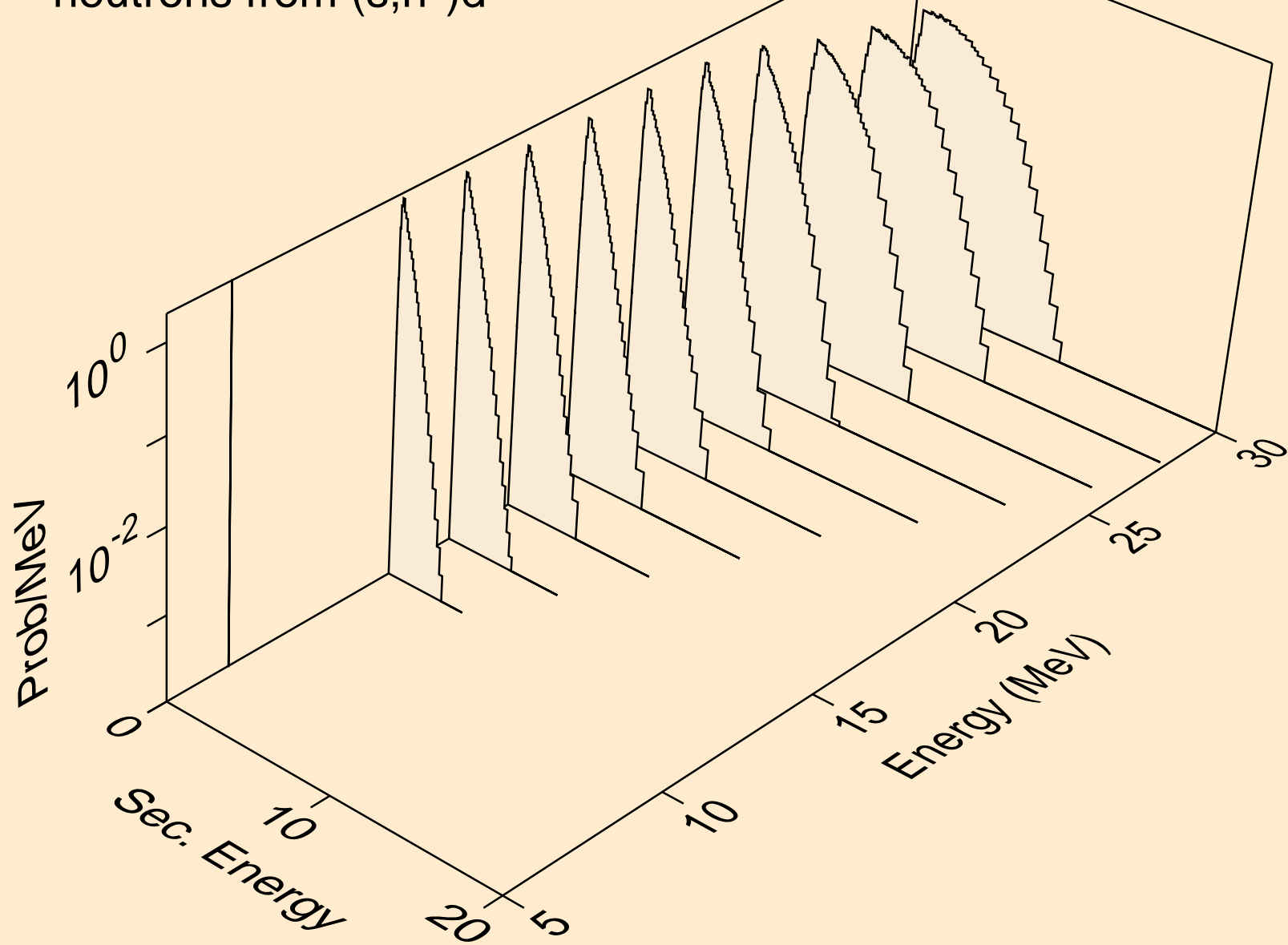

DB269 HELION ACER TENDL-2021 LIBRARY; T=0.K  
neutrons from (s,n\*)t

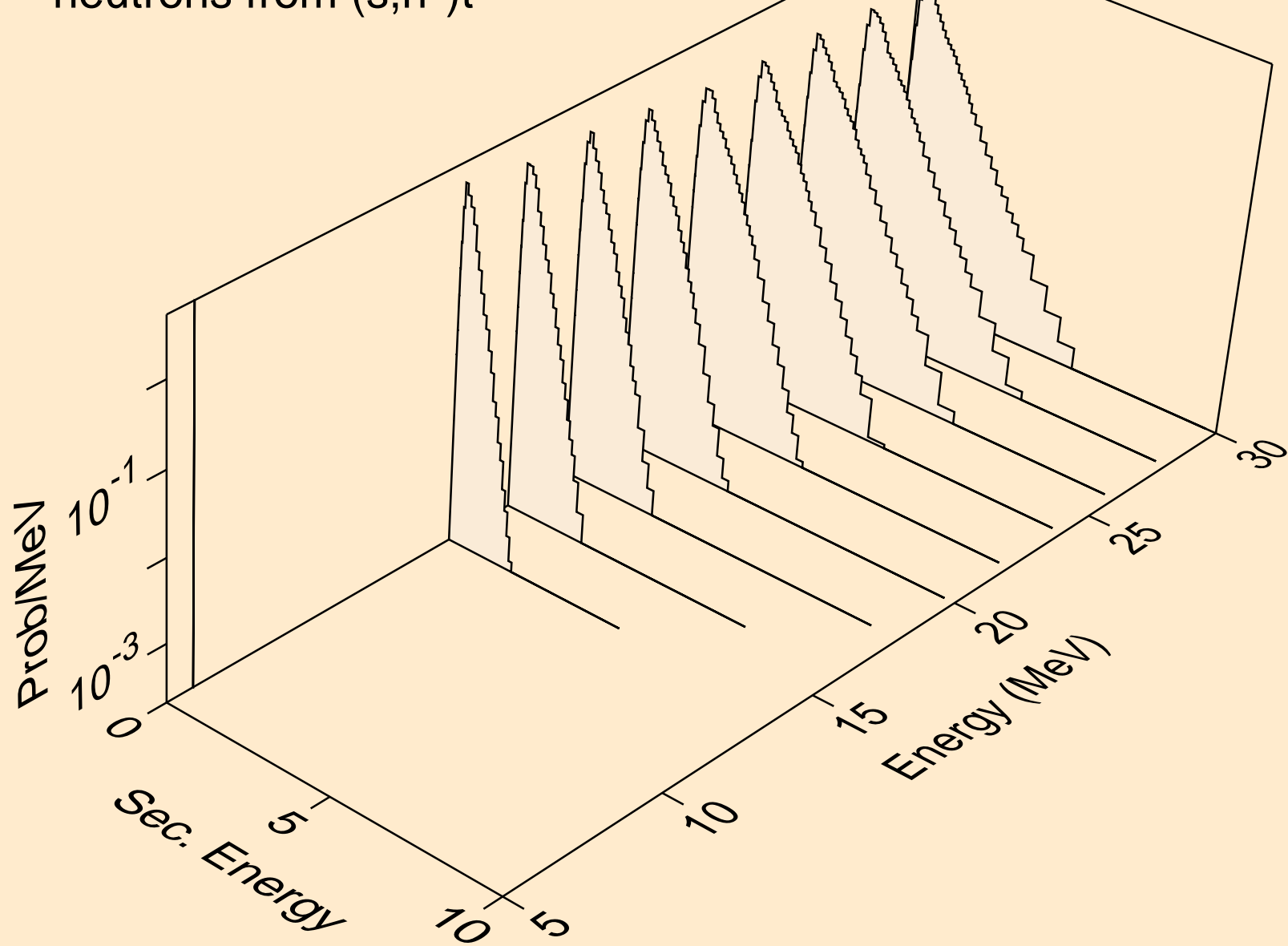

DB269 HELION ACER TENDL-2021 LIBRARY; T=0.K  
neutrons from (s,2np)

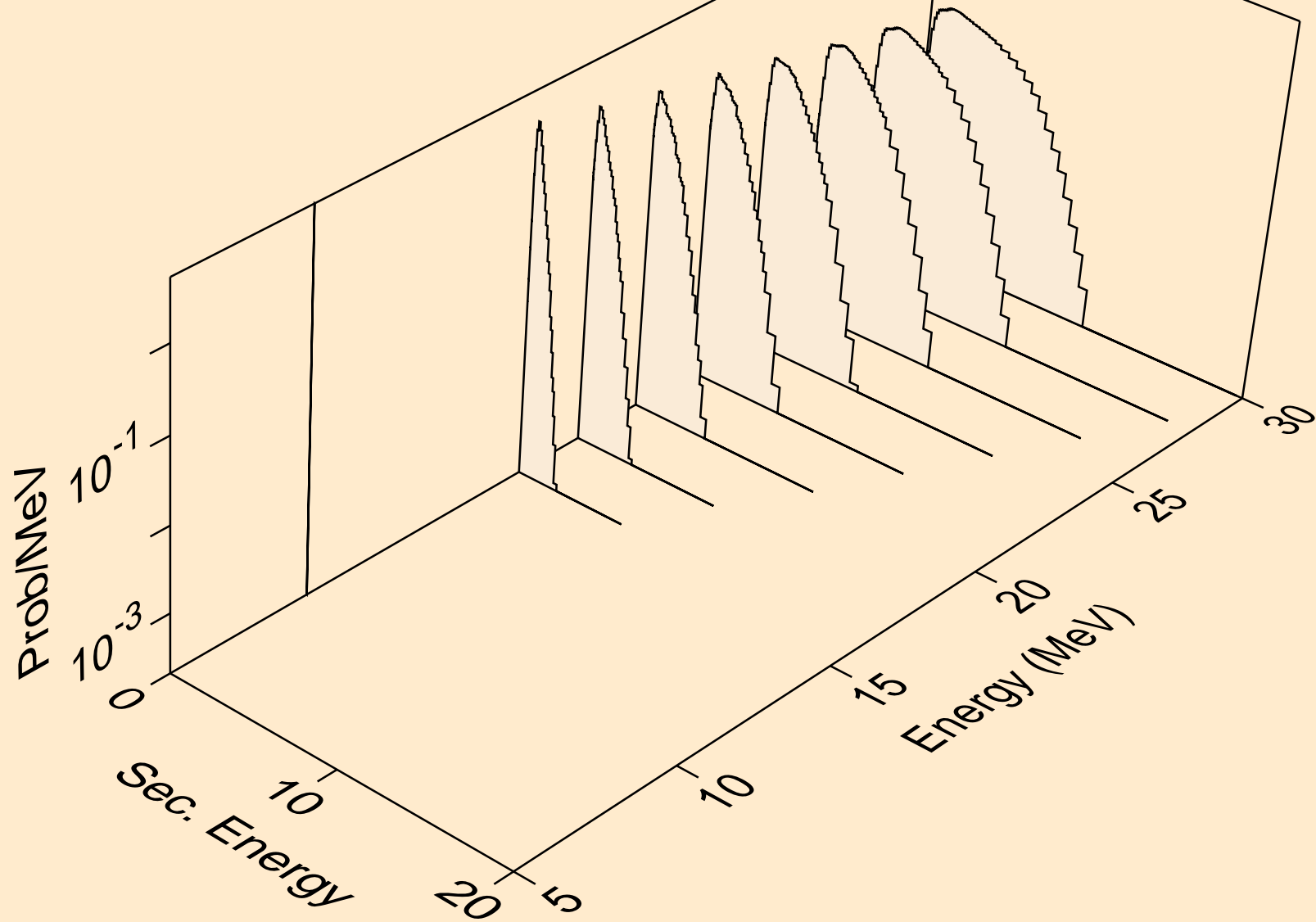

DB269 HELION ACER TENDL-2021 LIBRARY; T=0.K  
protons from (s,x)

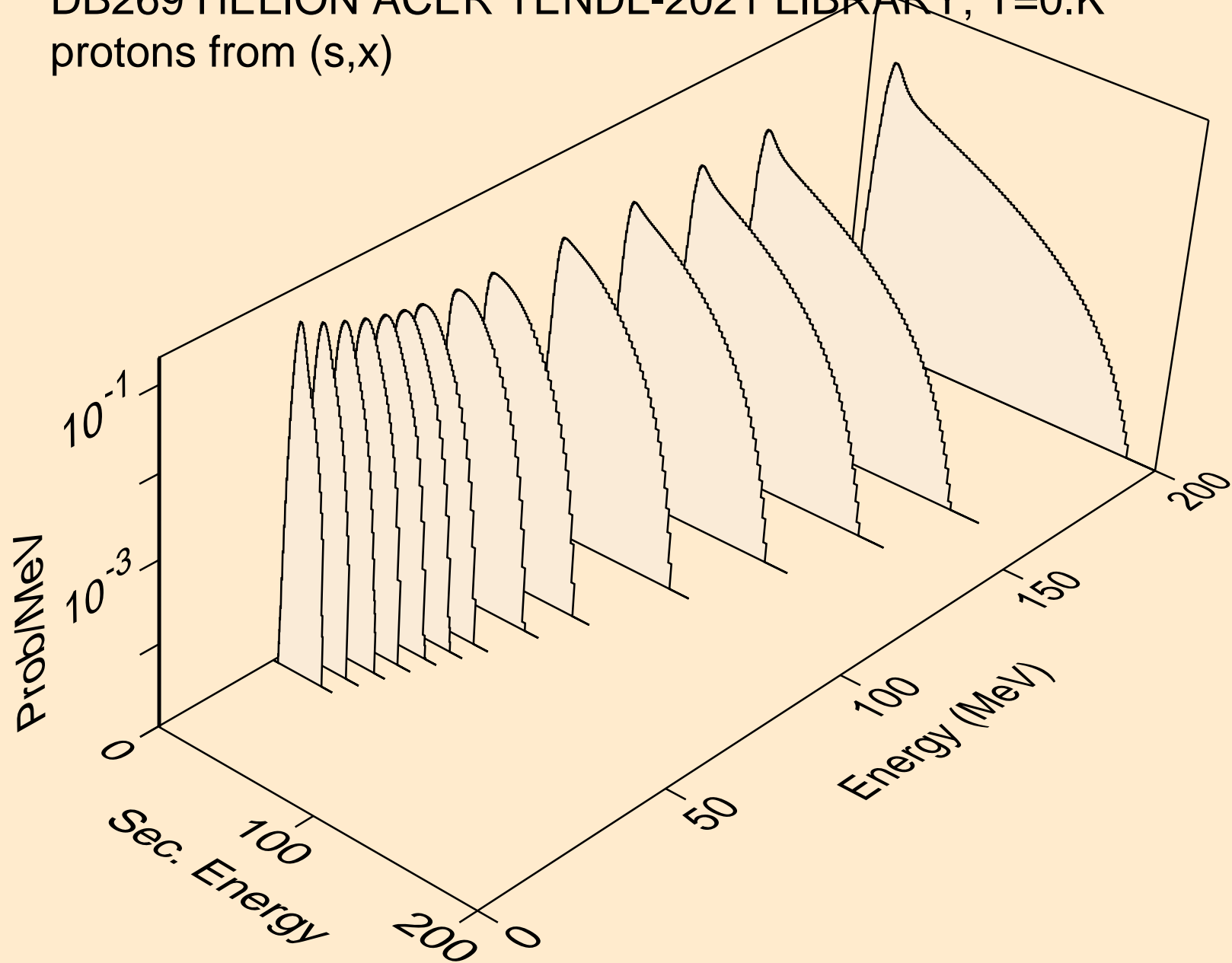

DB269 HELION ACER TENDL-2021 LIBRARY; T=0.K  
protons from (s,n\*)p

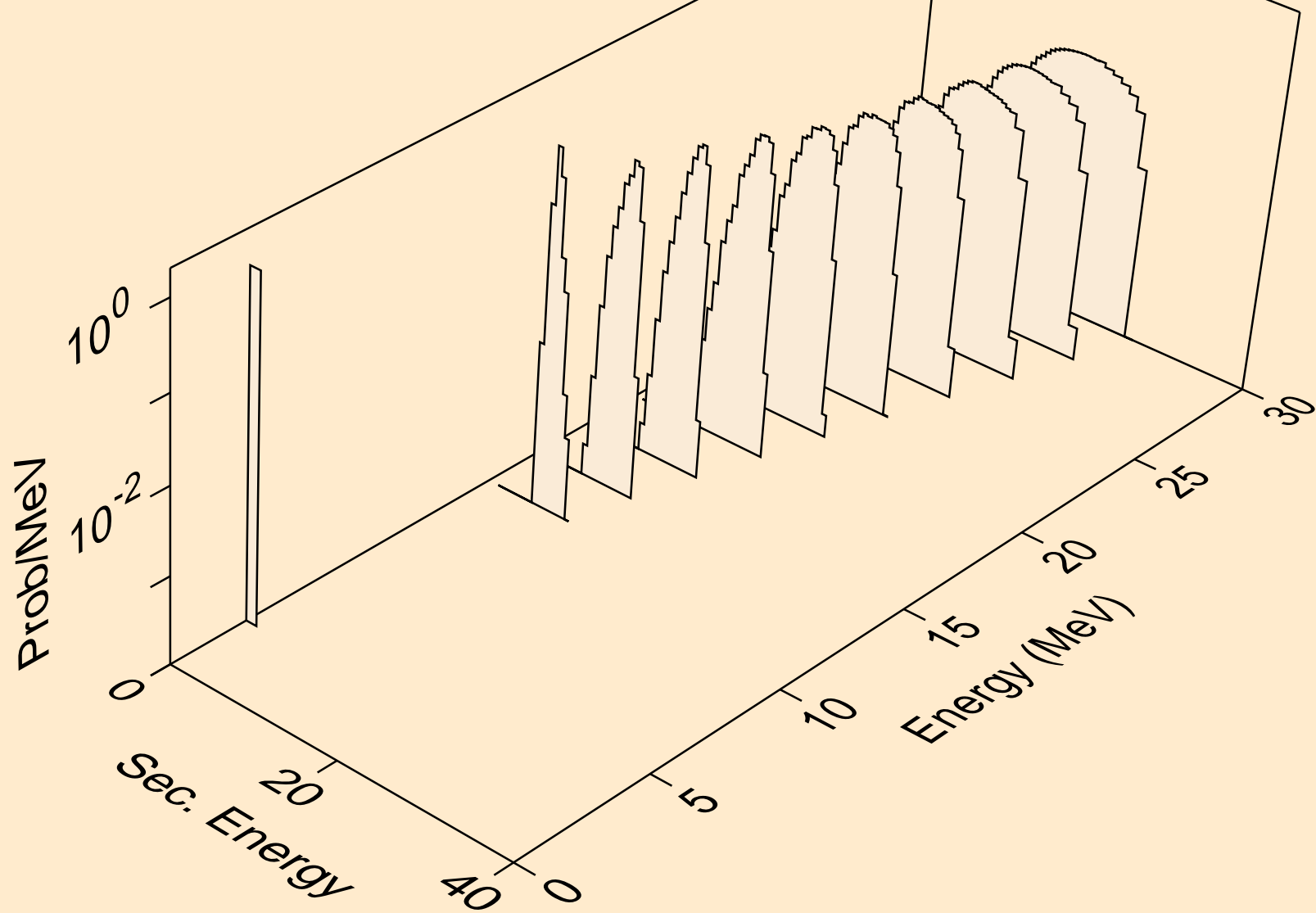

DB269 HELION ACER TENDL-2021 LIBRARY; T=0.K  
protons from (s,2np)

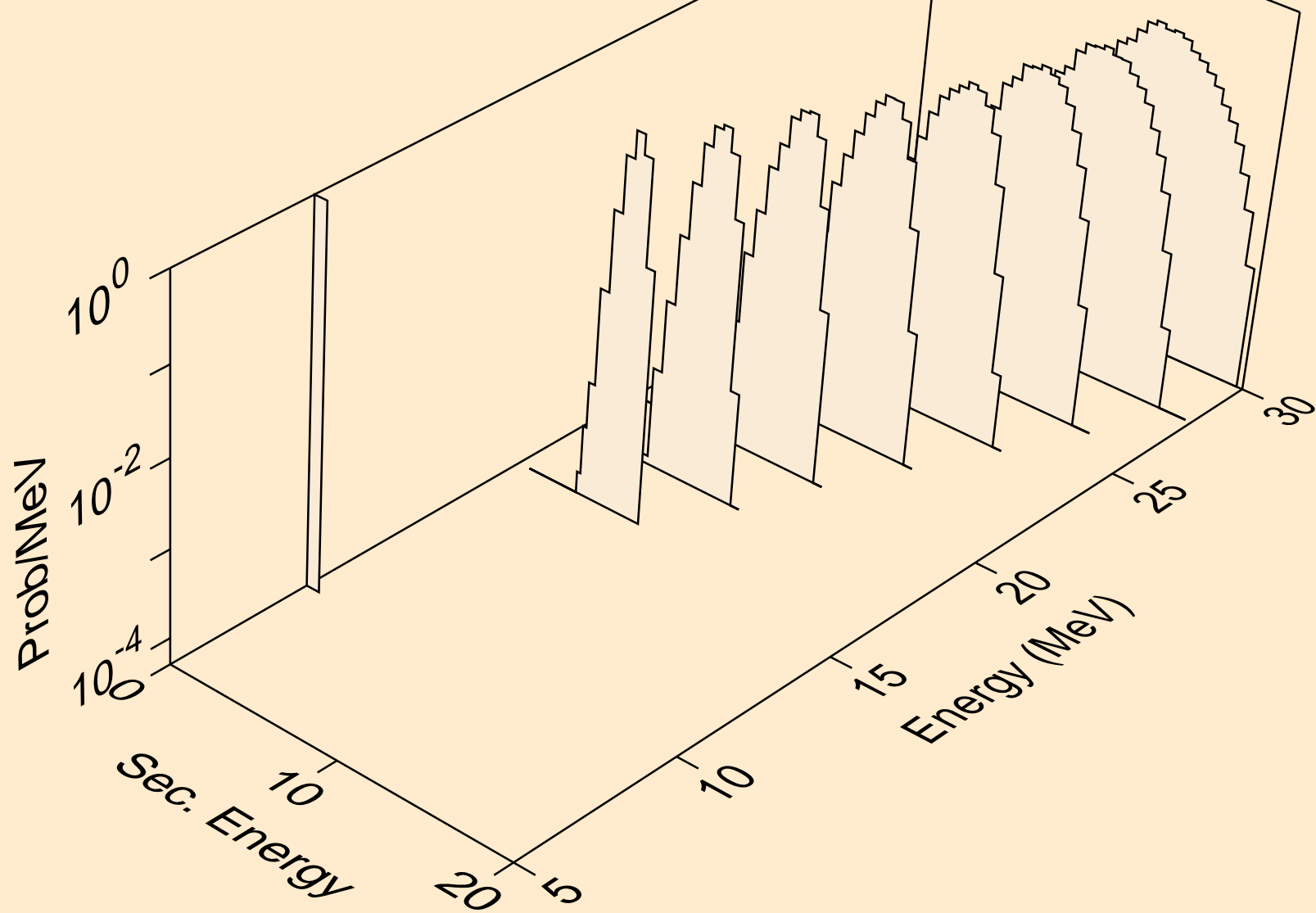



DB269 HELION ACER TENDL-2021 LIBRARY; T=0.K  
protons from (s,p)

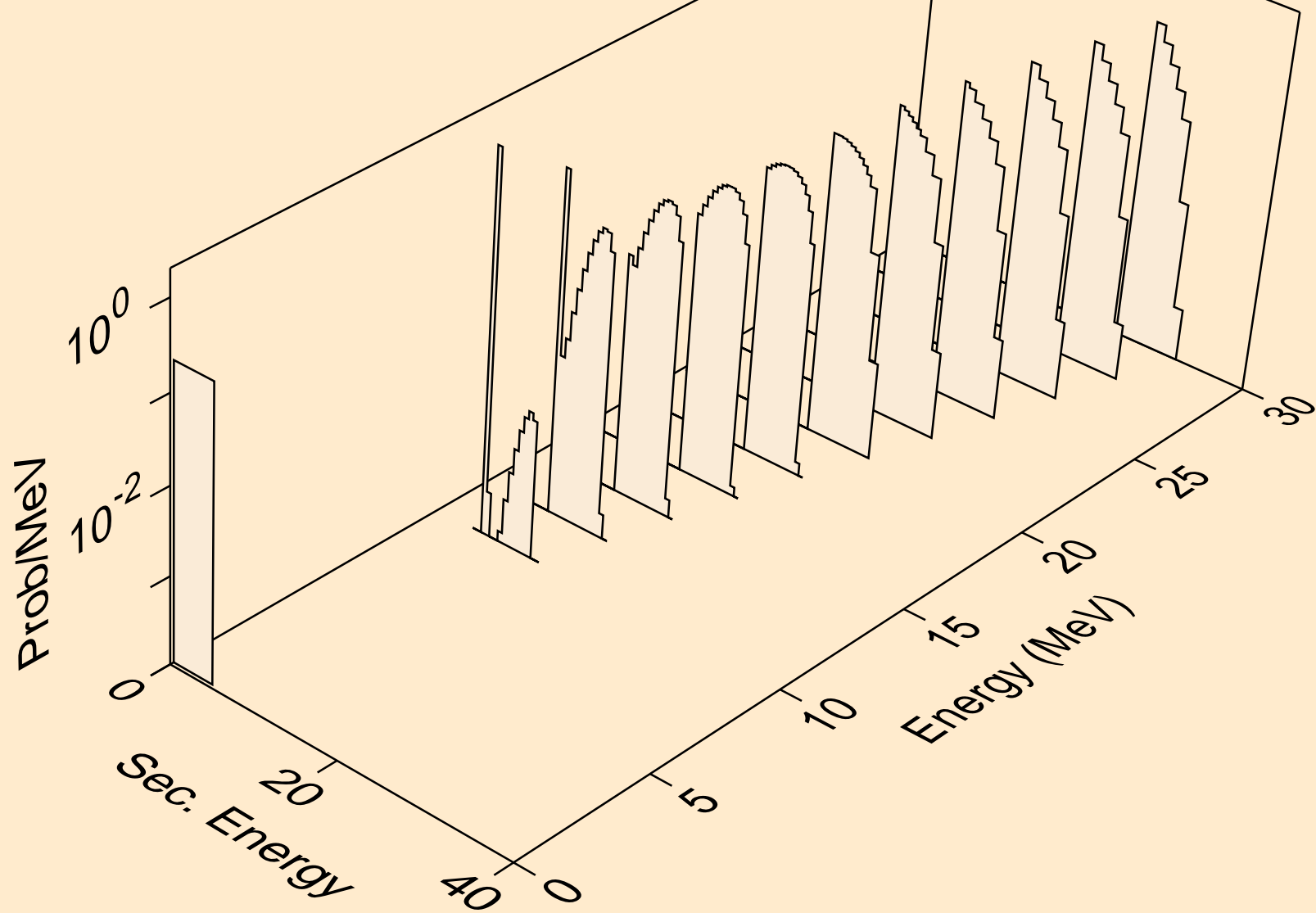

DB269 HELION ACER TENDL-2021 LIBRARY; T=0.K  
deuterons from (s,x)

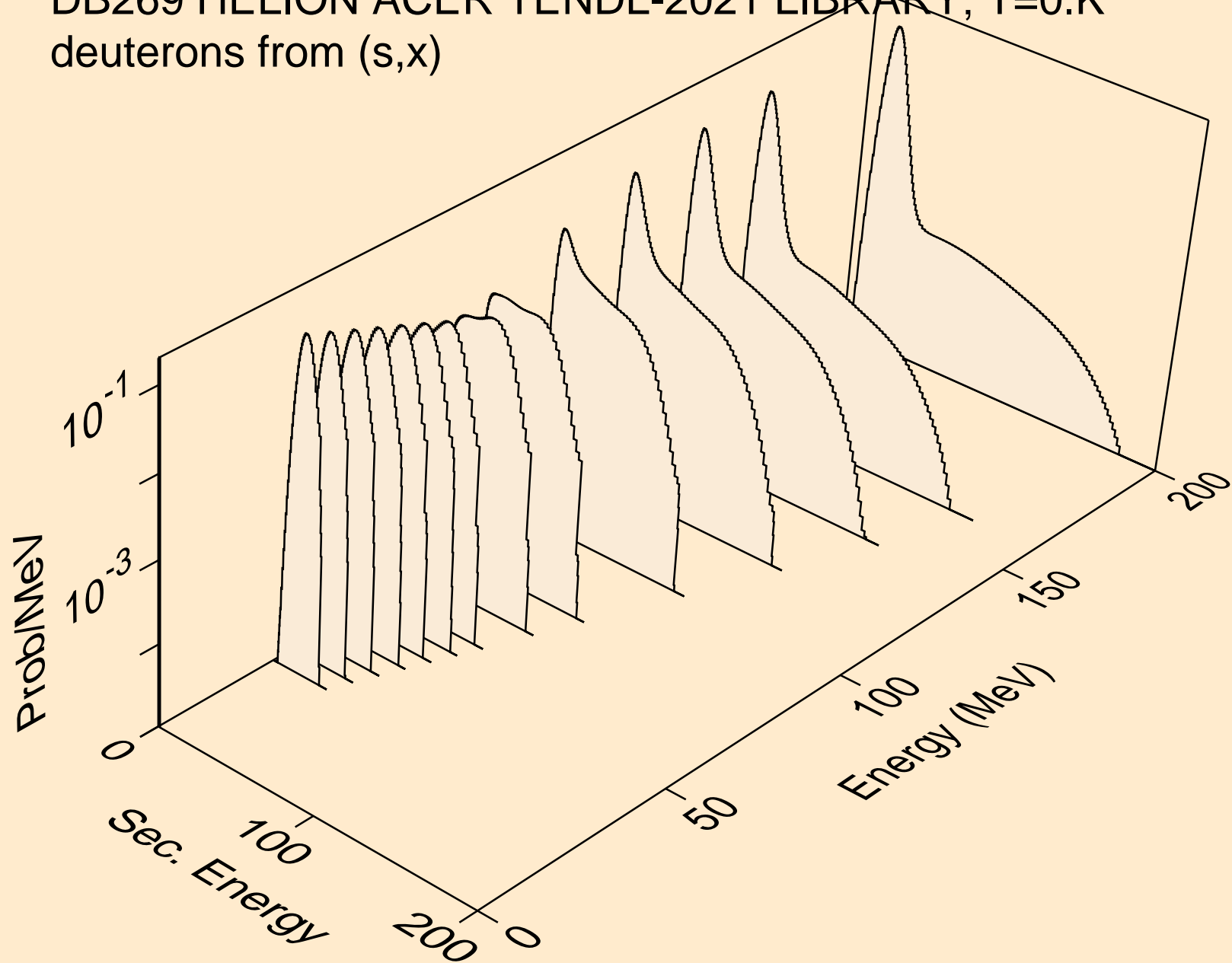

DB269 HELION ACER TENDL-2021 LIBRARY; T=0.K  
deuterons from (s,n\*)d

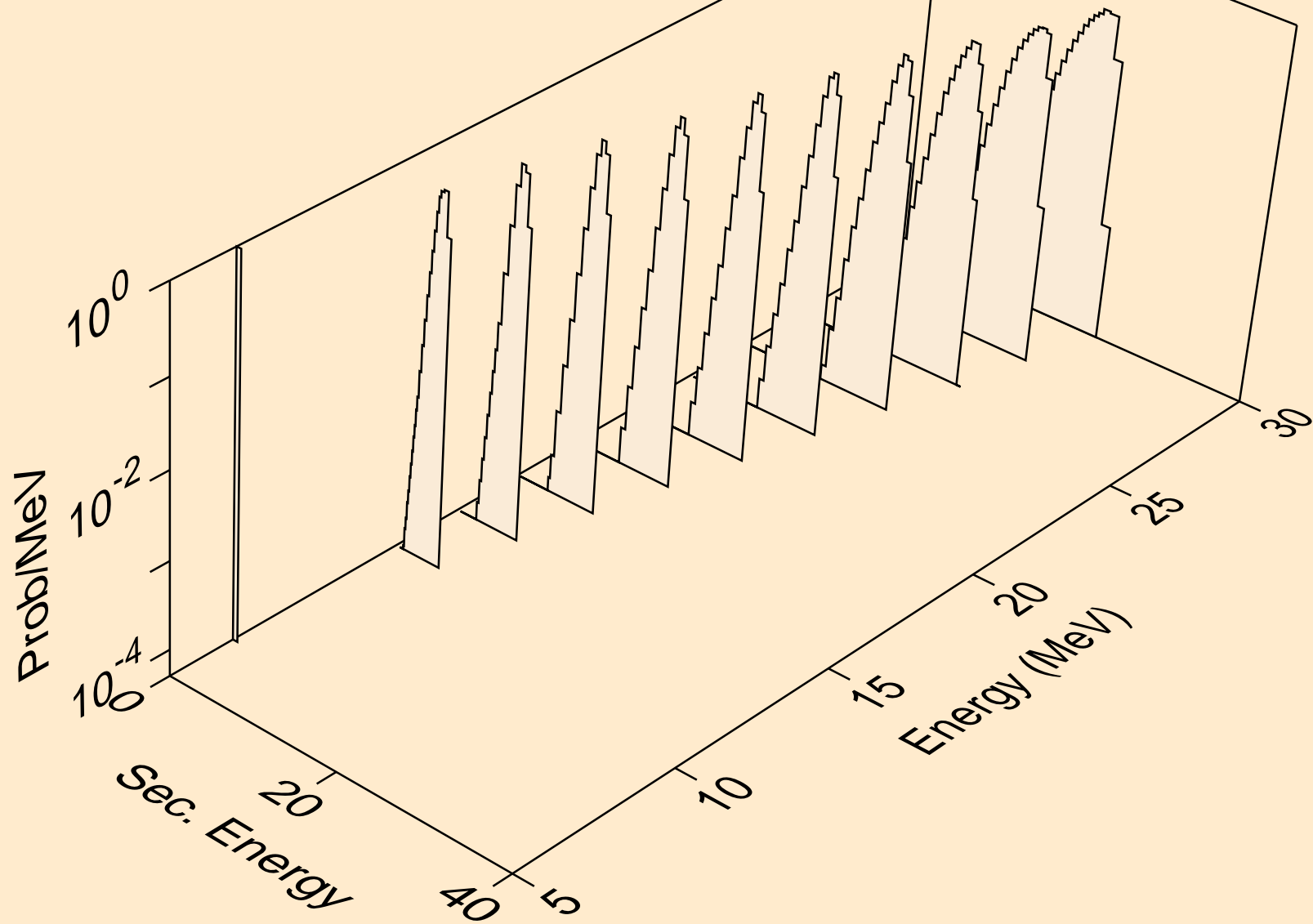

DB269 HELION ACER TENDL-2021 LIBRARY; T=0.K  
deuterons from (s,d)

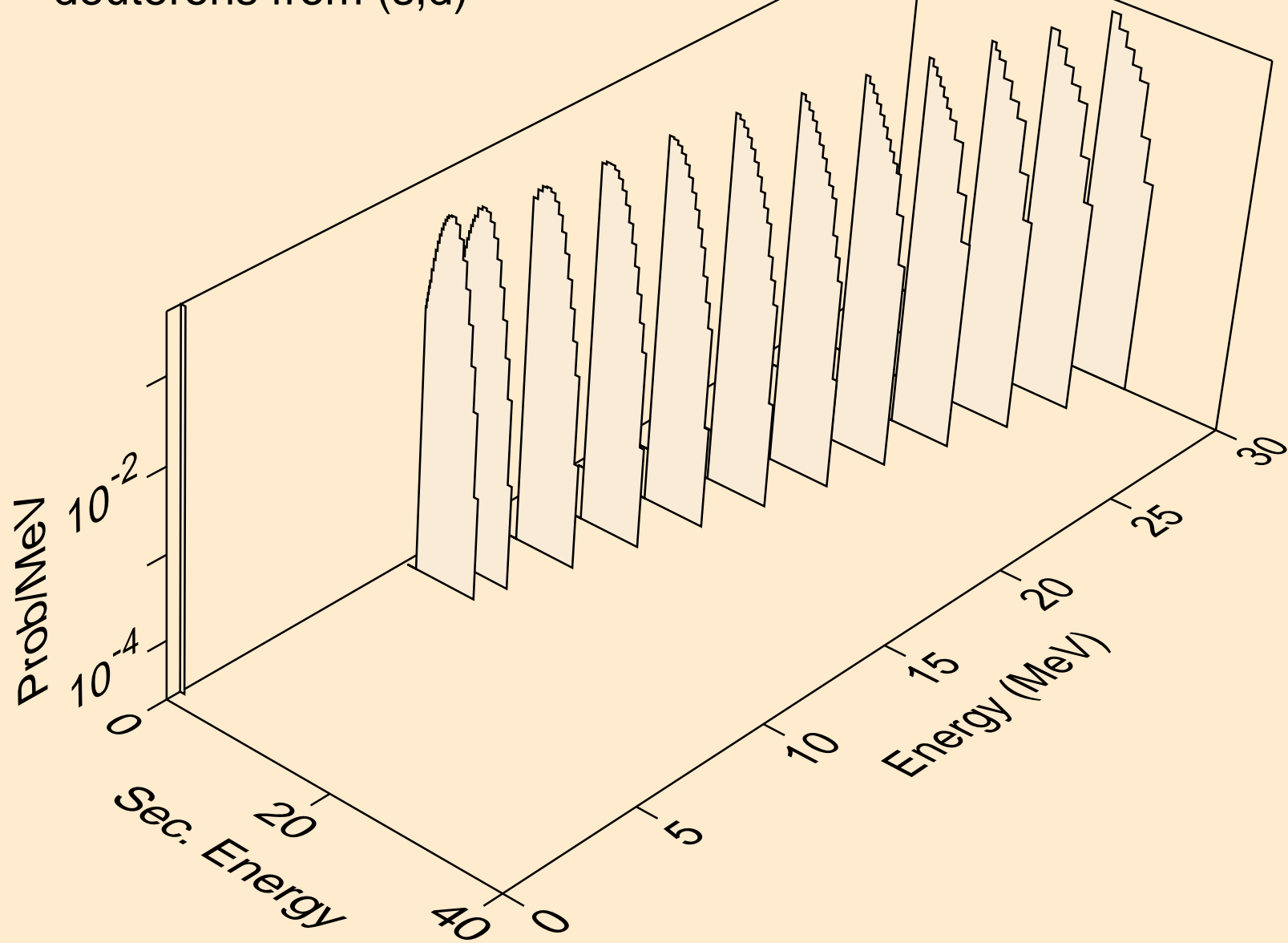

DB269 HELION ACER TENDL-2021 LIBRARY; T=0.K  
tritons from (s,x)

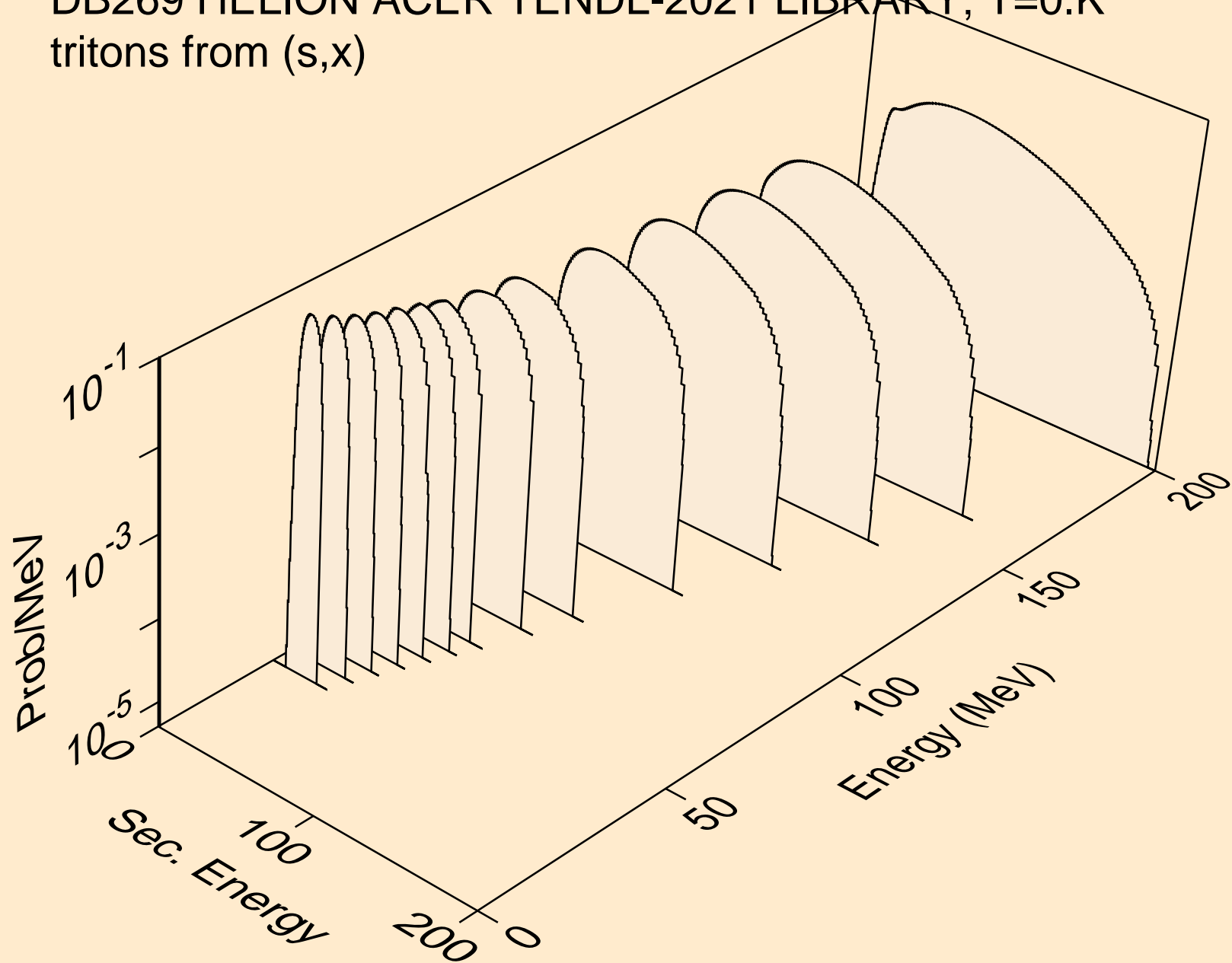

DB269 HELION ACER TENDL-2021 LIBRARY; T=0.K  
tritons from (s,n\*)t

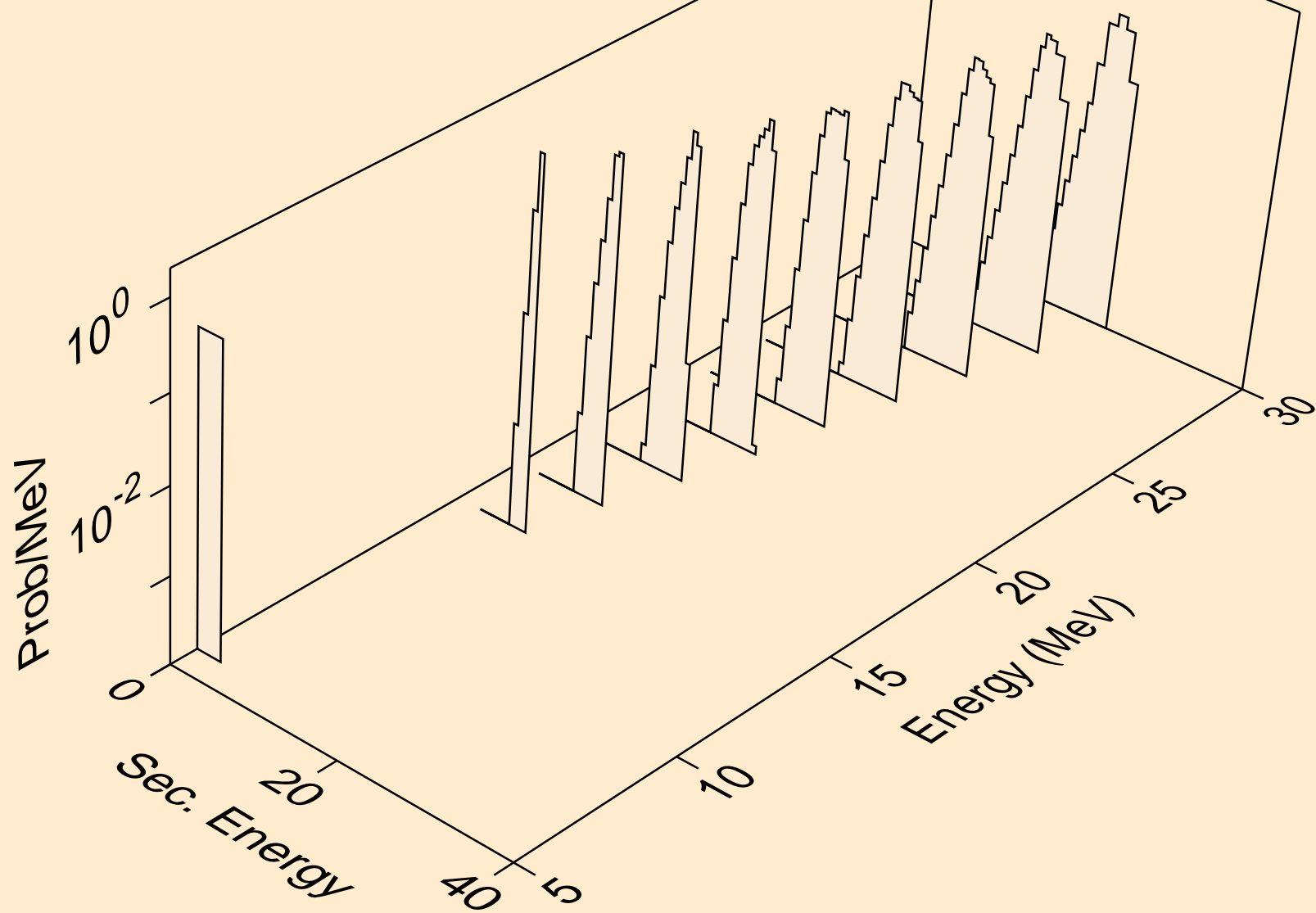

DB269 HELION ACER TENDL-2021 LIBRARY; T=0.K  
tritons from (s,t)

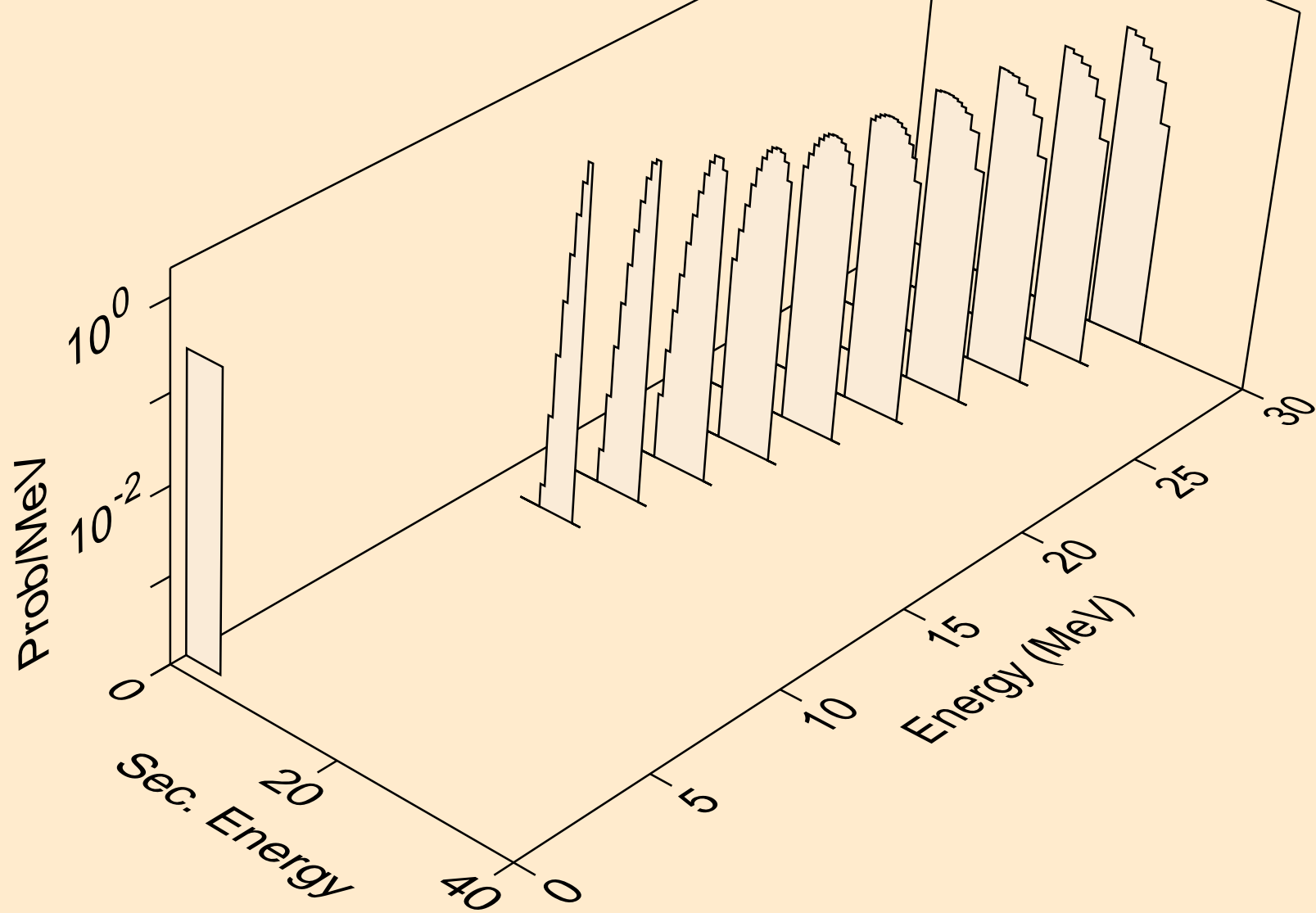

DB269 HELION ACER TENDL-2021 LIBRARY; T=0.K  
alphas from (s,x)

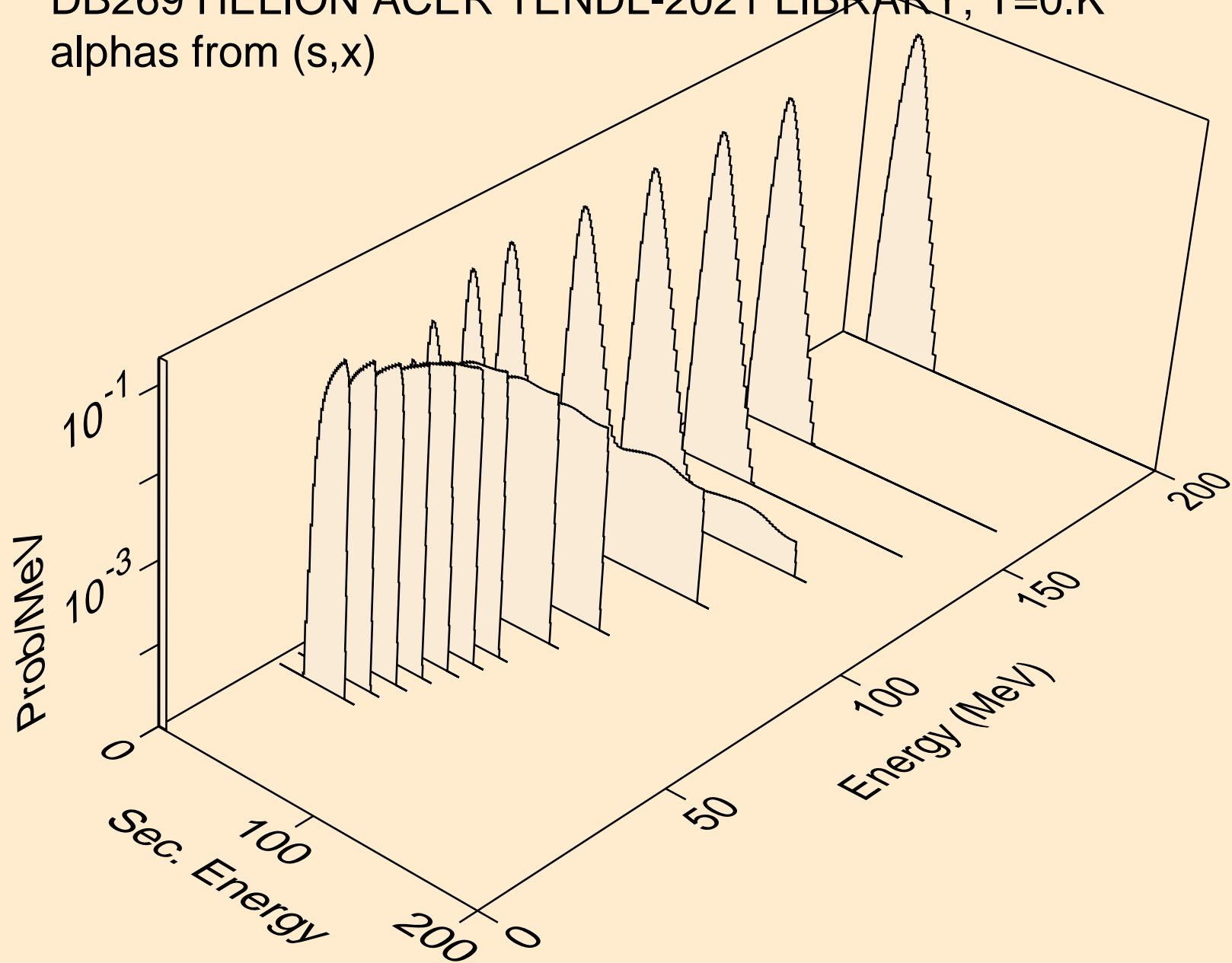



DB269 HELION ACER TENDL-2021 LIBRARY; T=0.K  
alphas from (s,n\*)a

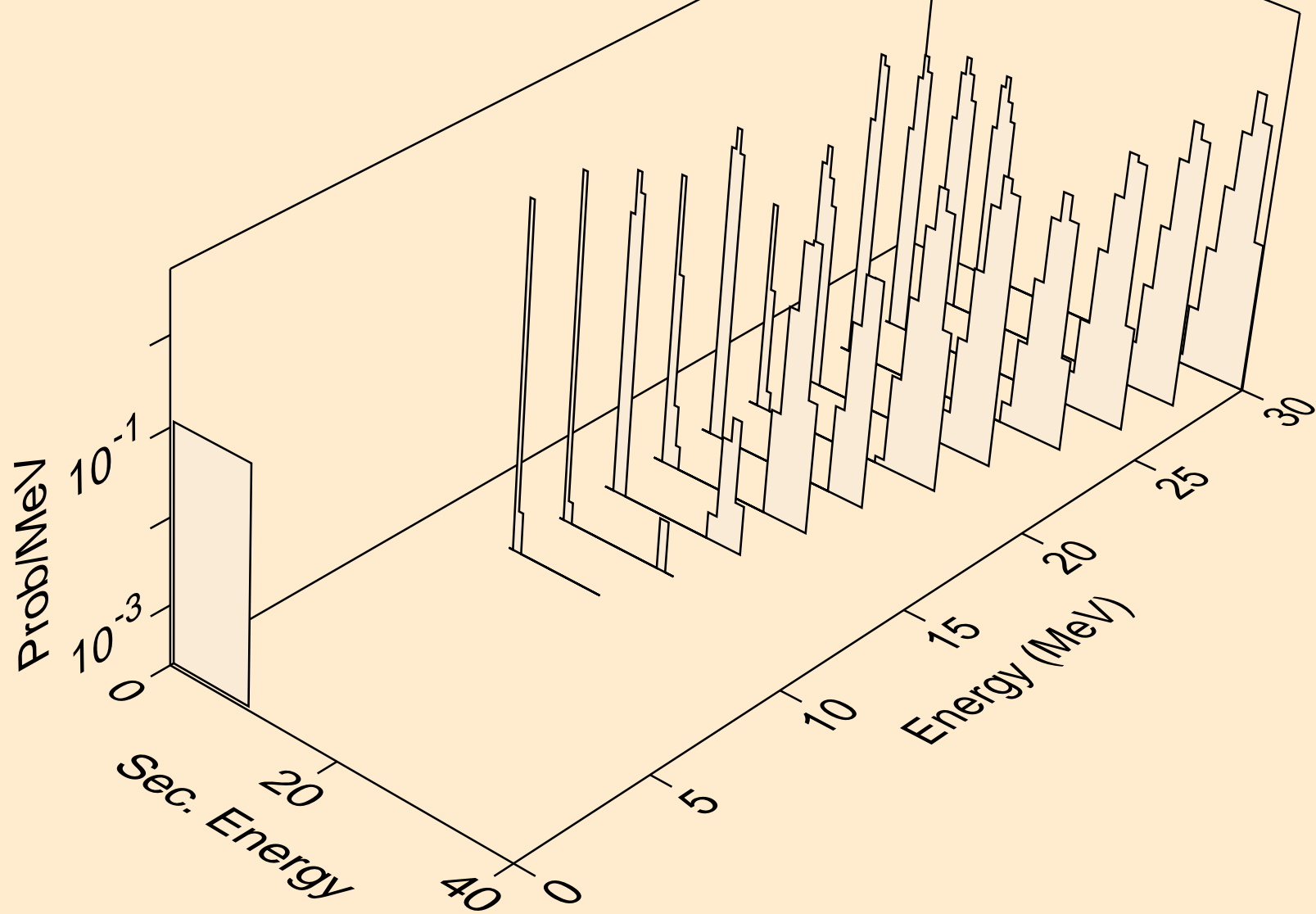

DB269 HELION ACER TENDL-2021 LIBRARY; T=0.K  
alphas from (s,a)

