

DY169 HELION ACER TENDL-2021 LIBRARY; T=0.K  
Principal cross sections

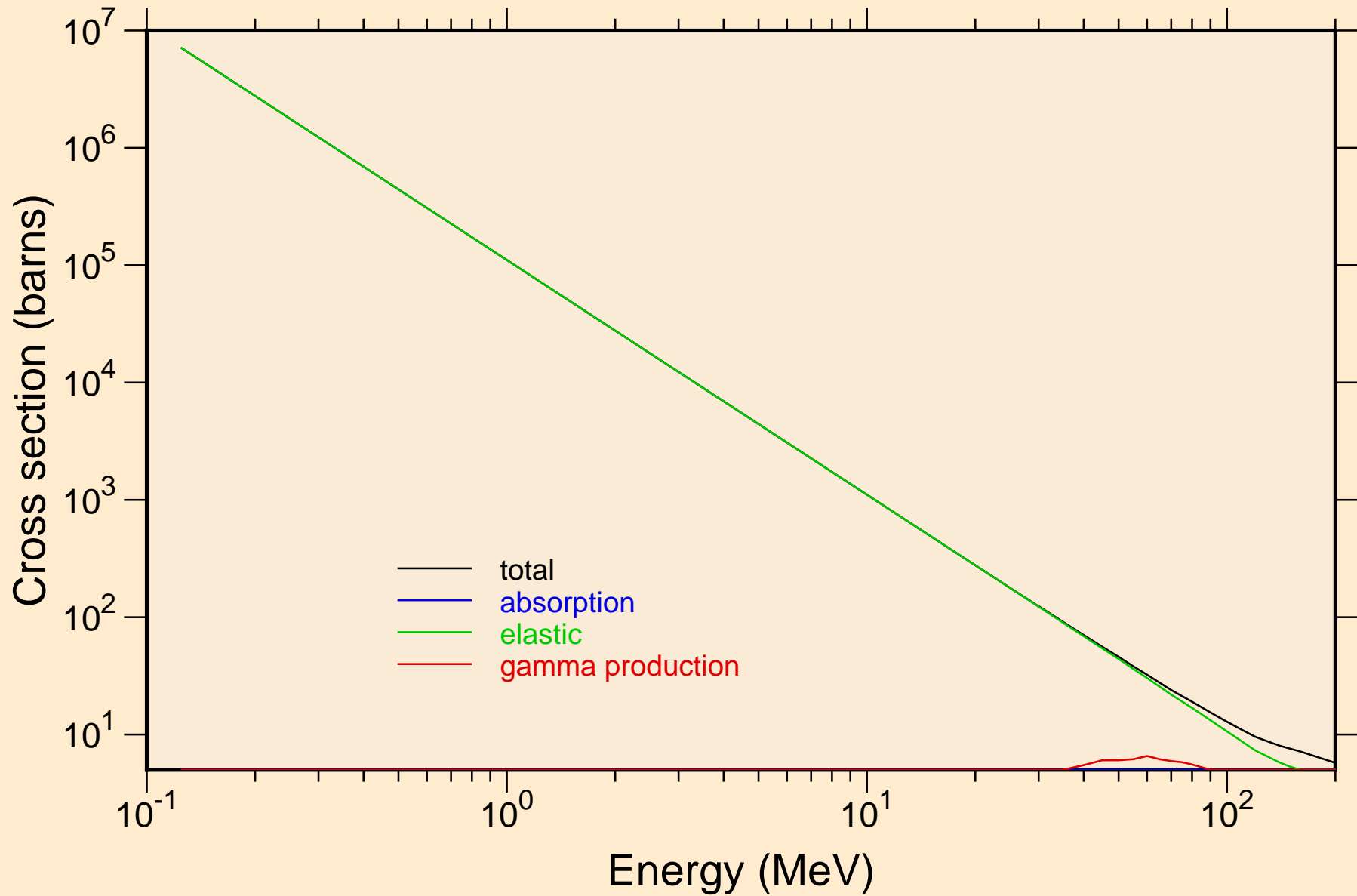

DY169 HELION ACER TENDL-2021 LIBRARY; T=0.K

Heating

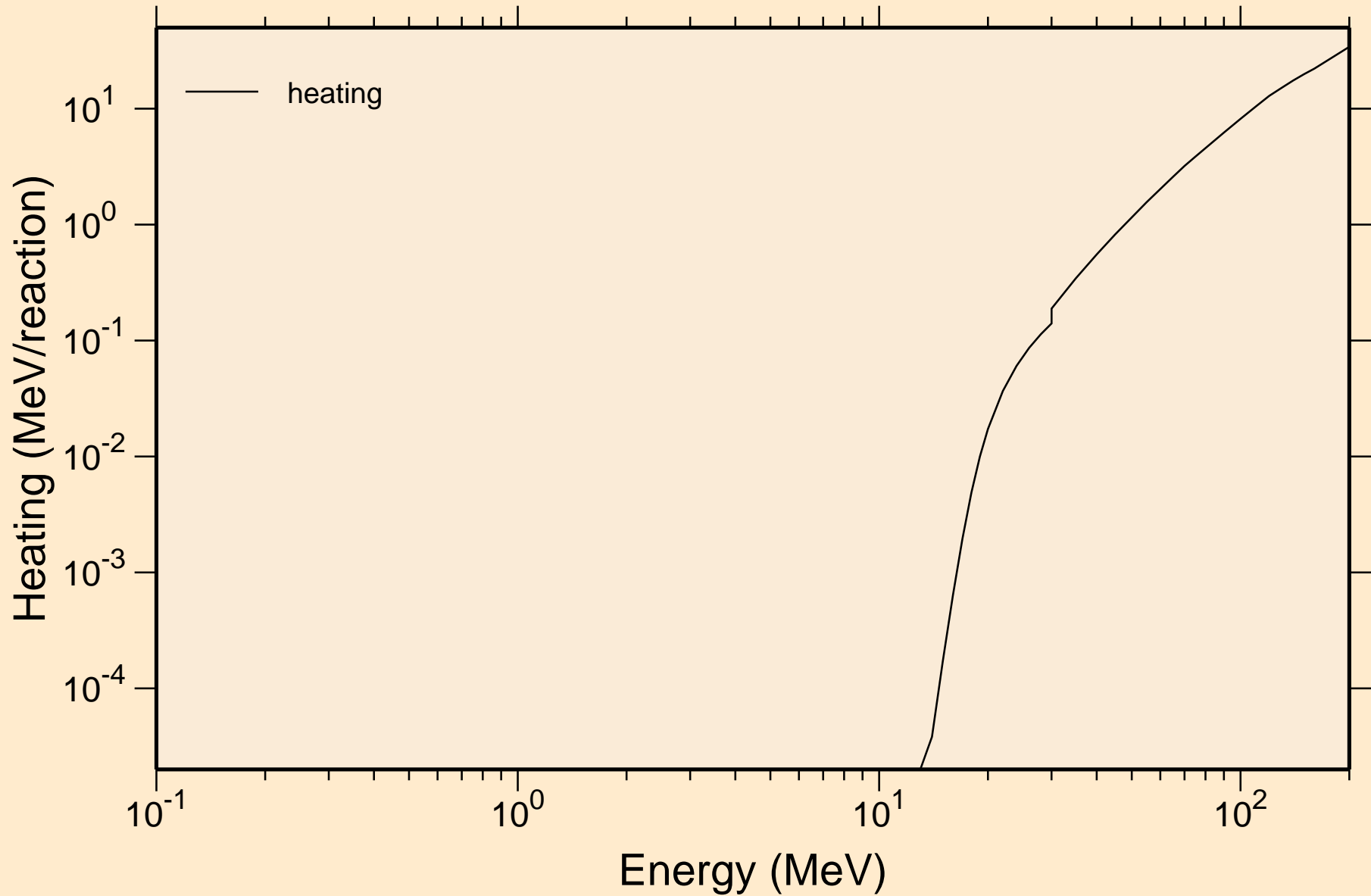

# DY169 HELION ACER TENDL-2021 LIBRARY; T=0.K

## Principal cross sections

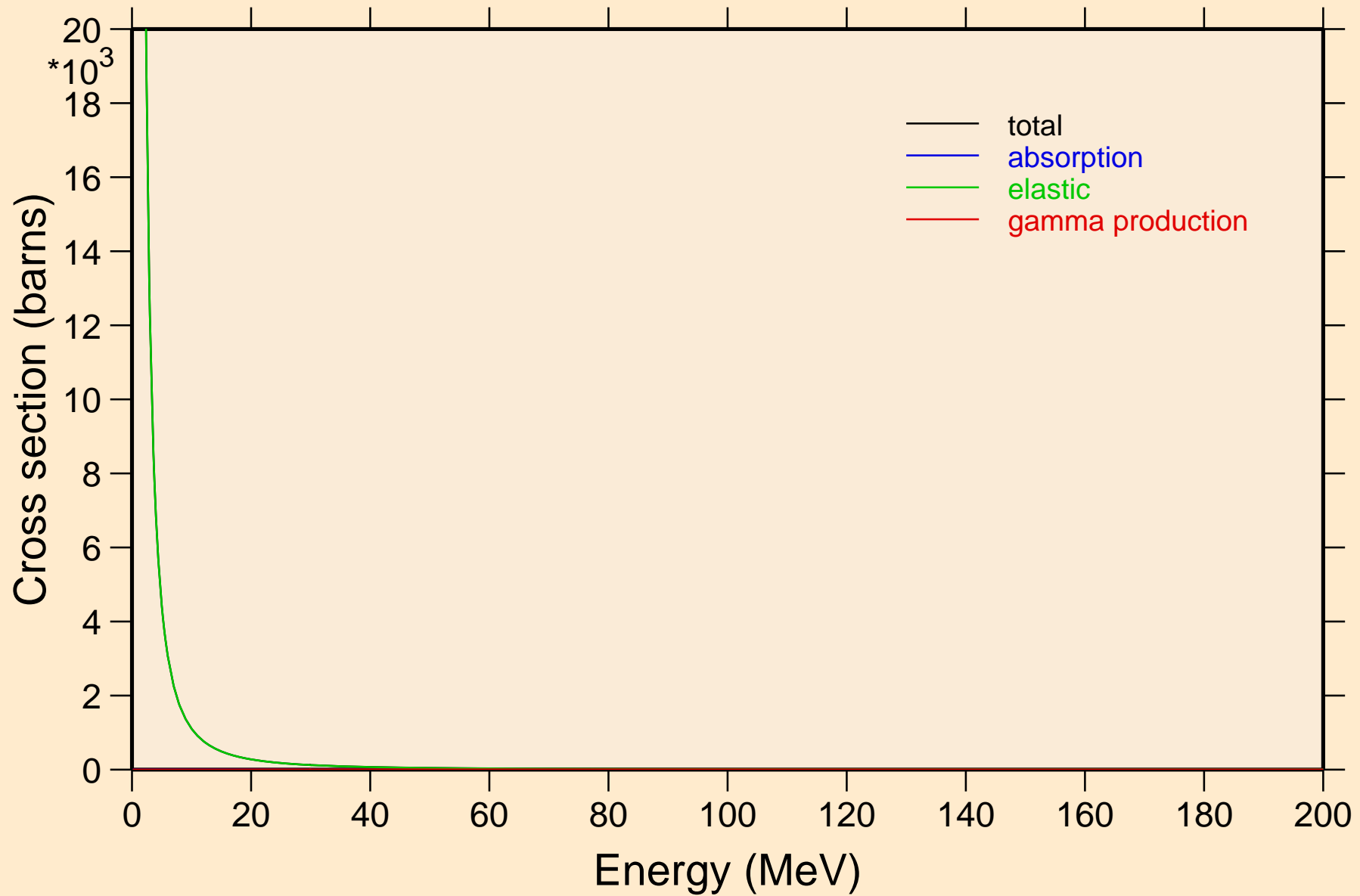

DY169 HELION ACER TENDL-2021 LIBRARY; T=0.K

Heating

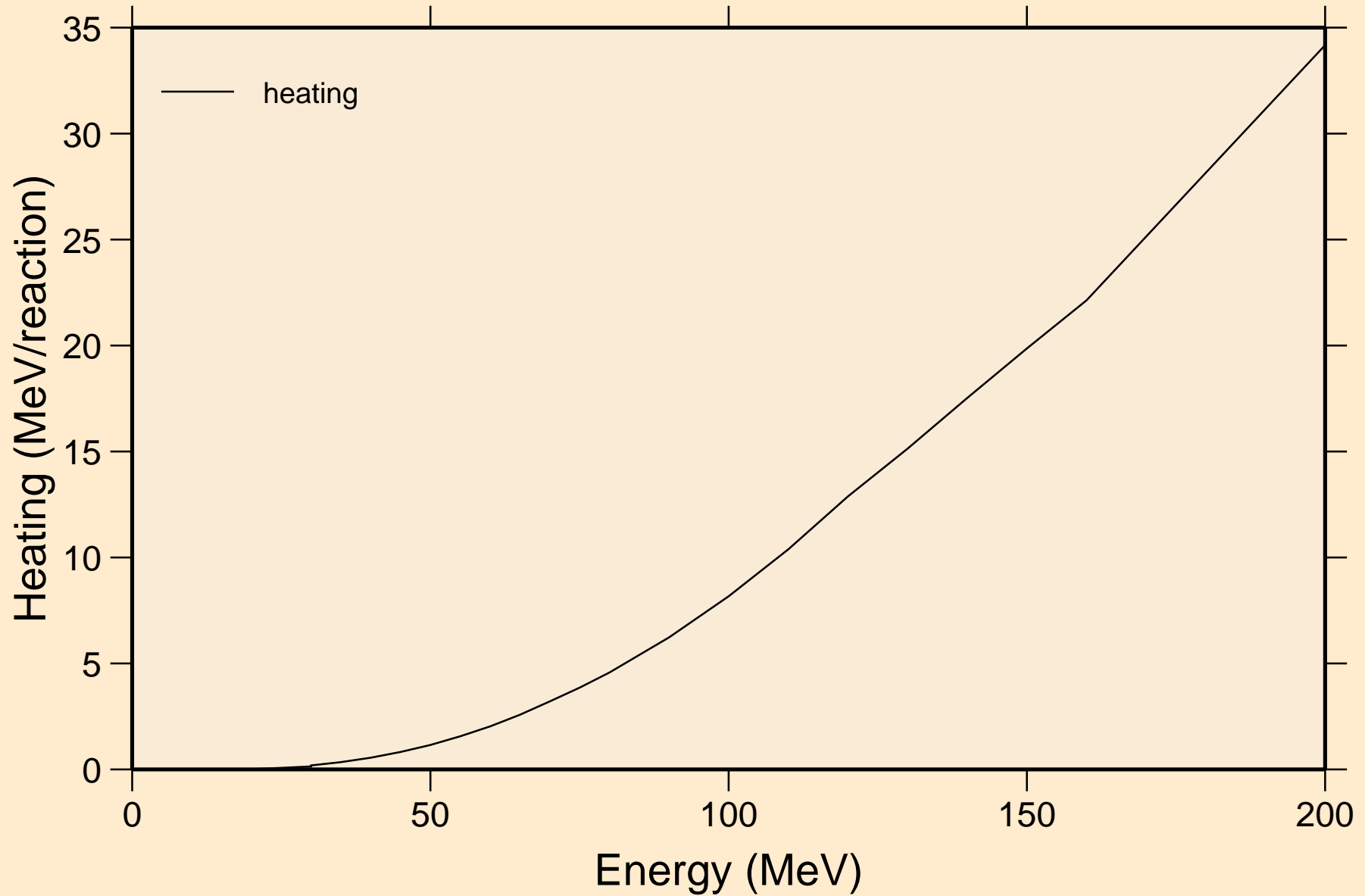

DY169 HELION ACER TENDL-2021 LIBRARY; T=0.K  
Threshold reactions

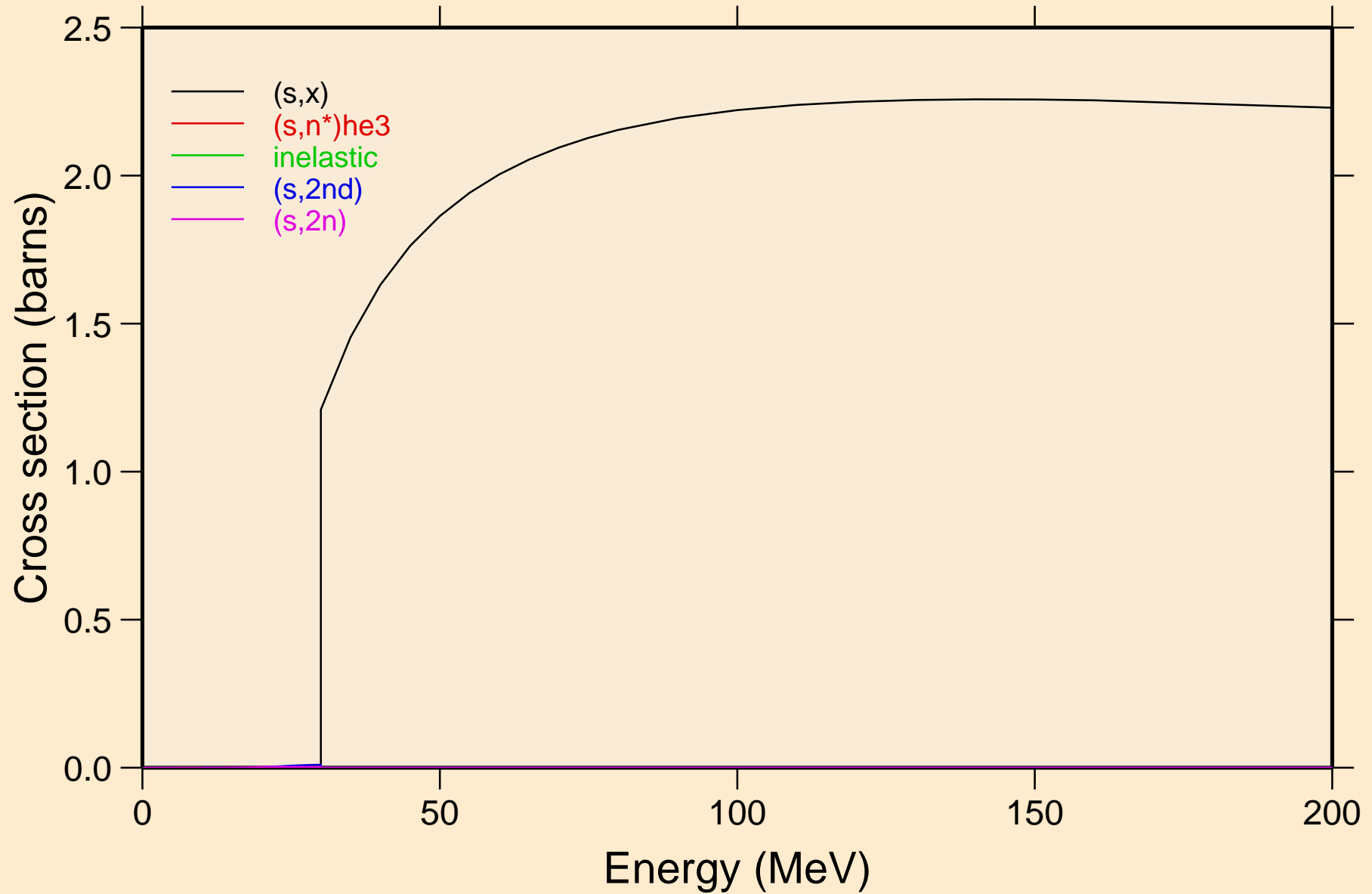

DY169 HELION ACER TENDL-2021 LIBRARY; T=0.K  
Threshold reactions

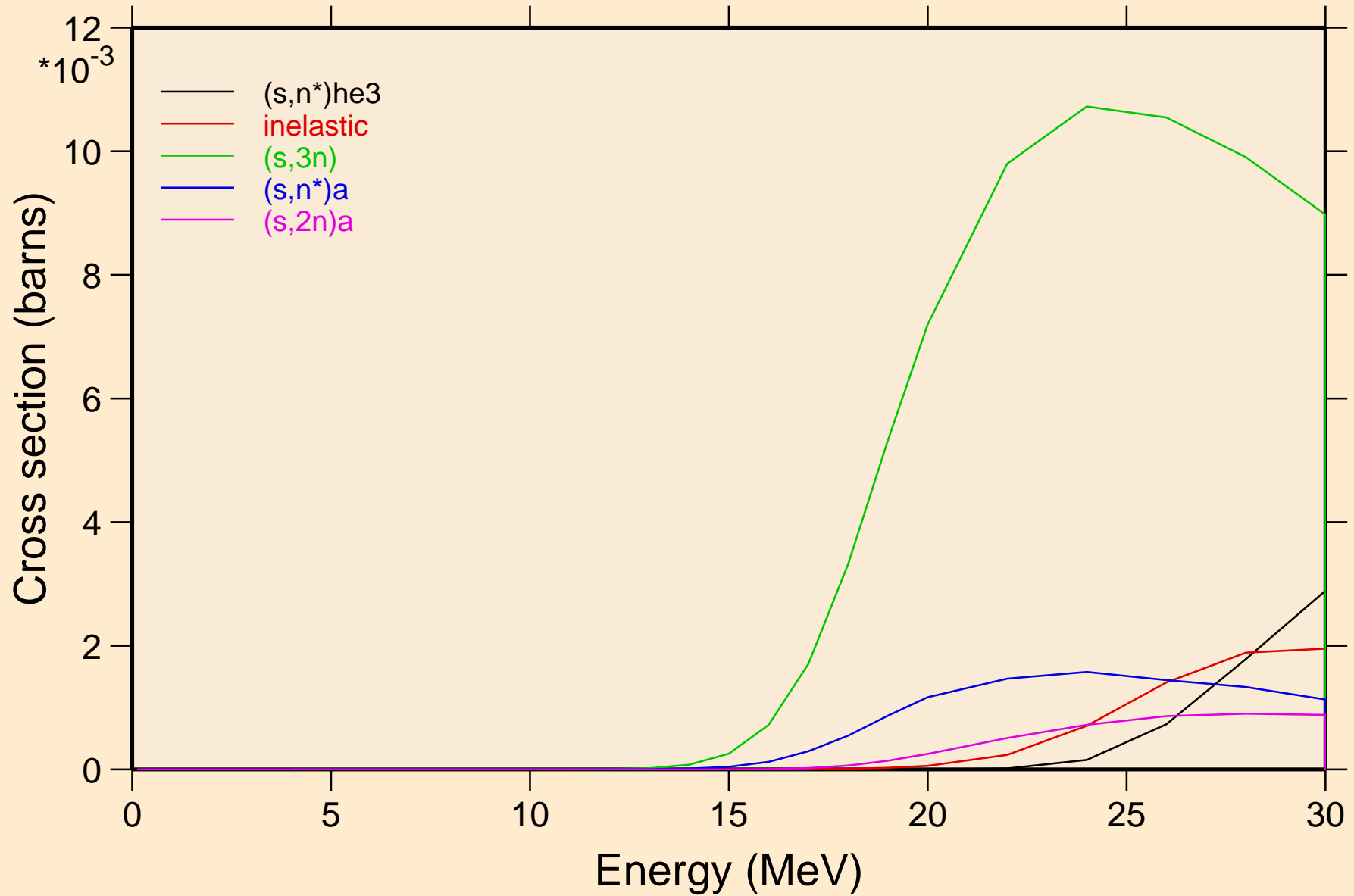

DY169 HELION ACER TENDL-2021 LIBRARY; T=0.K  
Threshold reactions

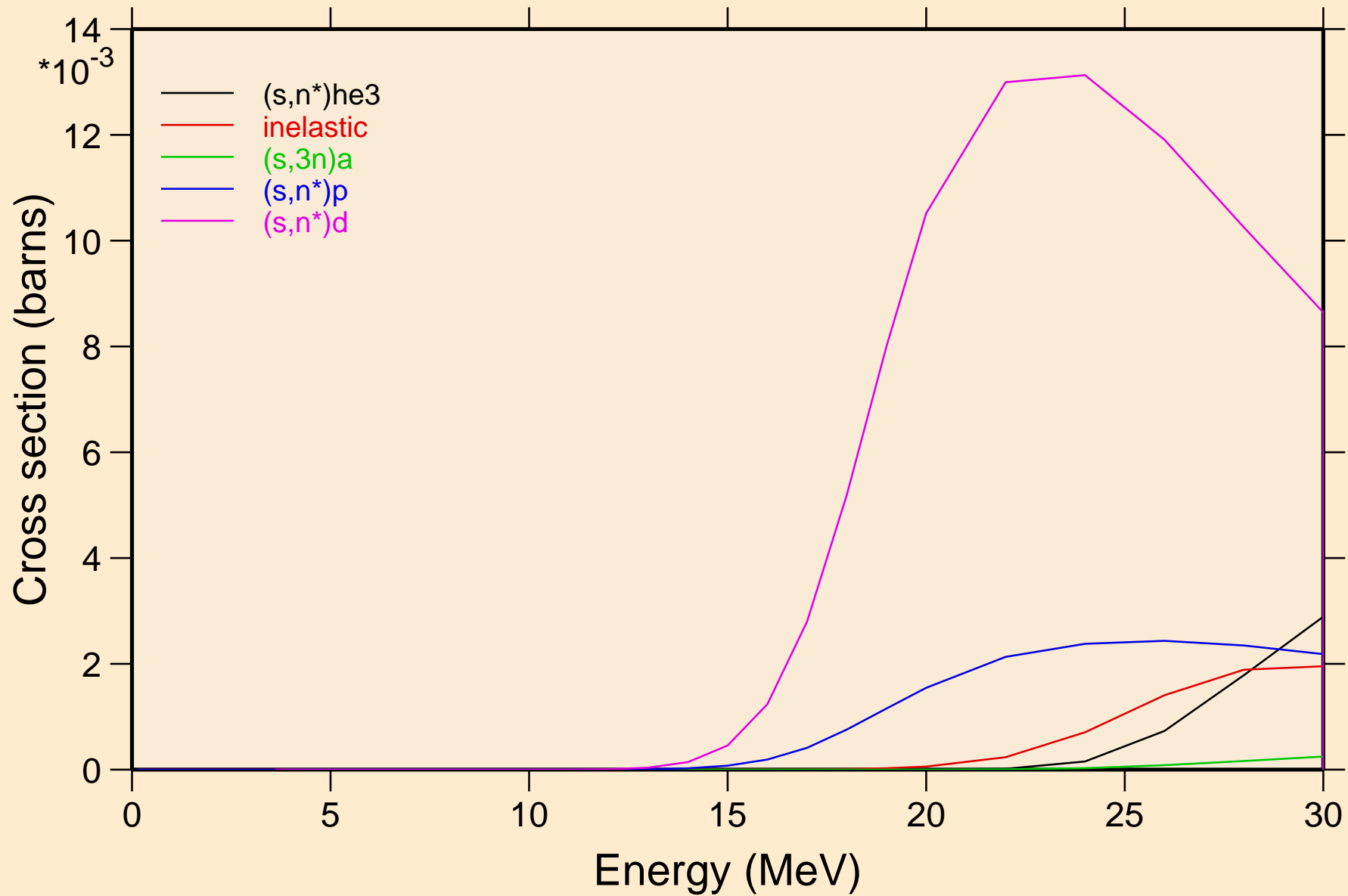

DY169 HELION ACER TENDL-2021 LIBRARY; T=0.K  
Threshold reactions

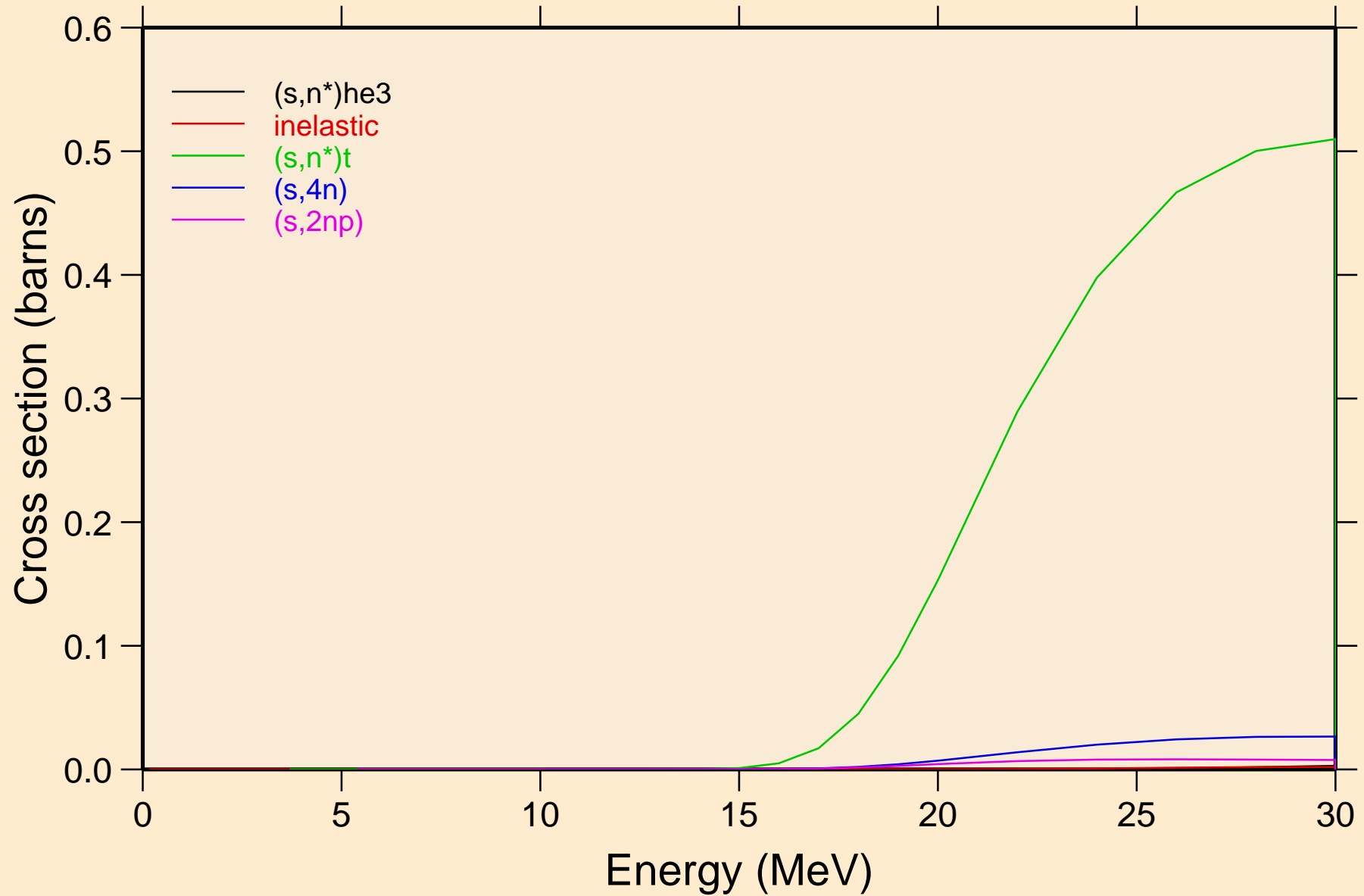



DY169 HELION ACER TENDL-2021 LIBRARY; T=0.K  
Threshold reactions

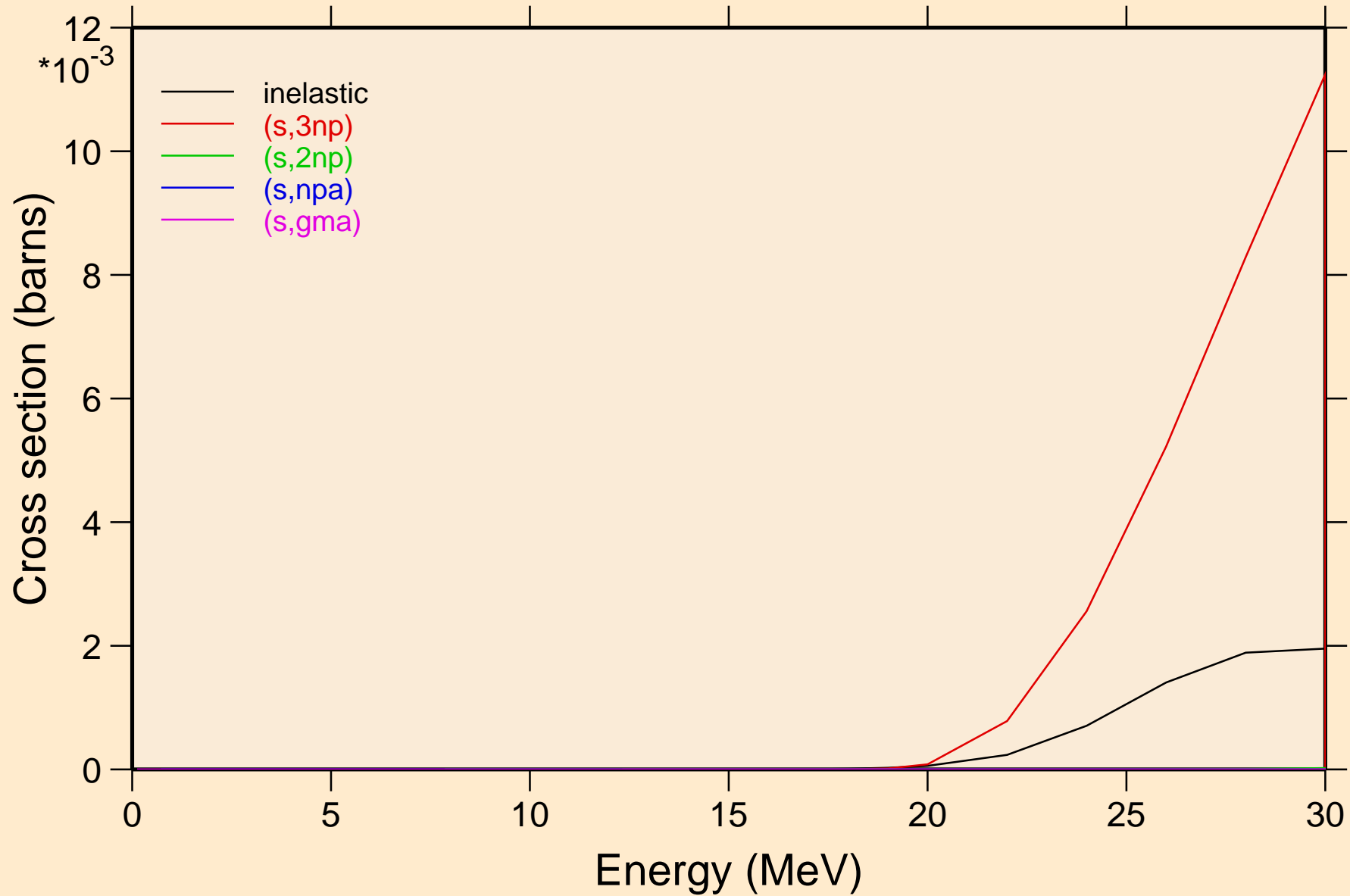

DY169 HELION ACER TENDL-2021 LIBRARY; T=0.K  
Threshold reactions

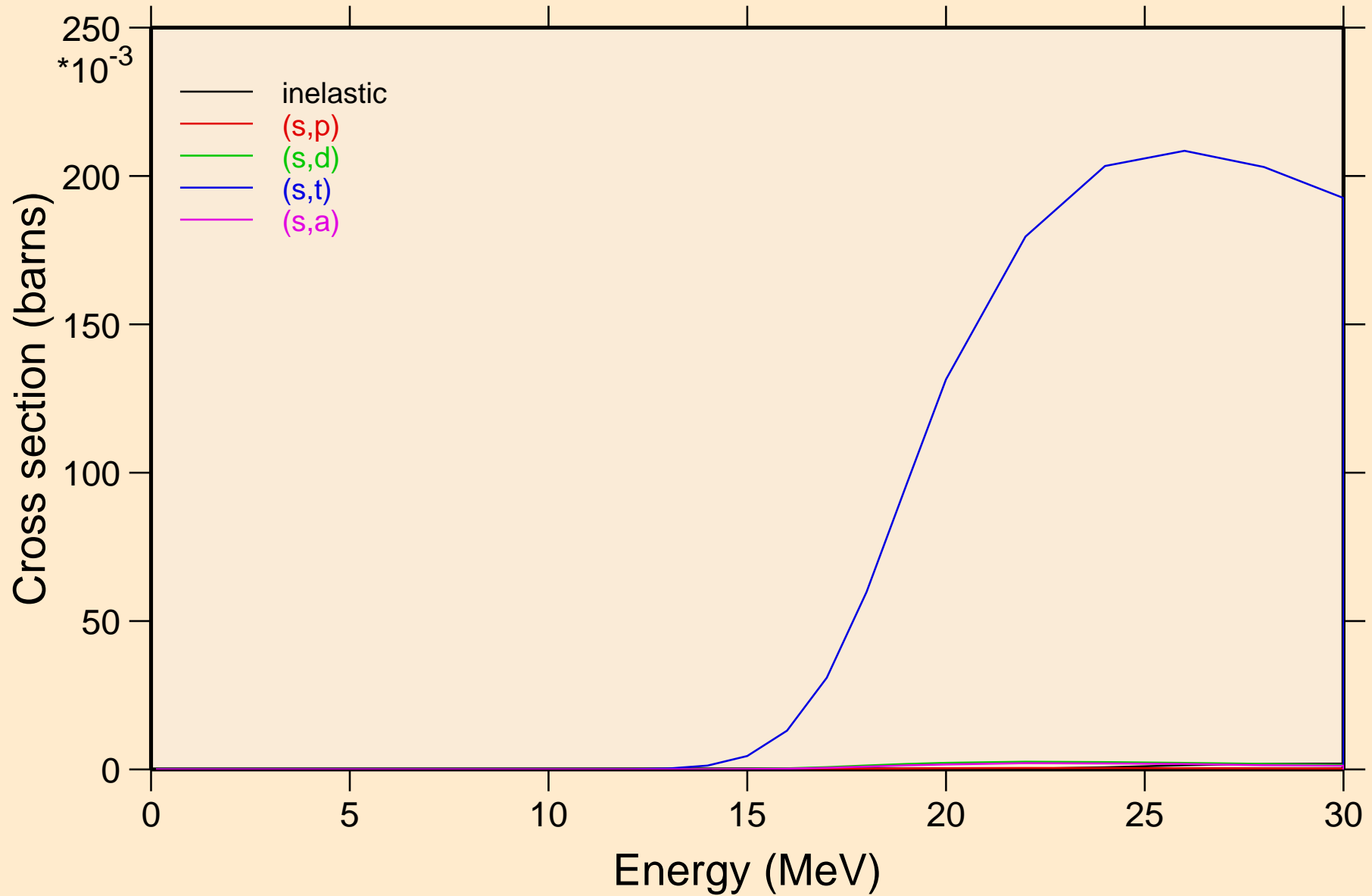

DY169 HELION ACER TENDL-2021 LIBRARY; T=0.K  
Threshold reactions

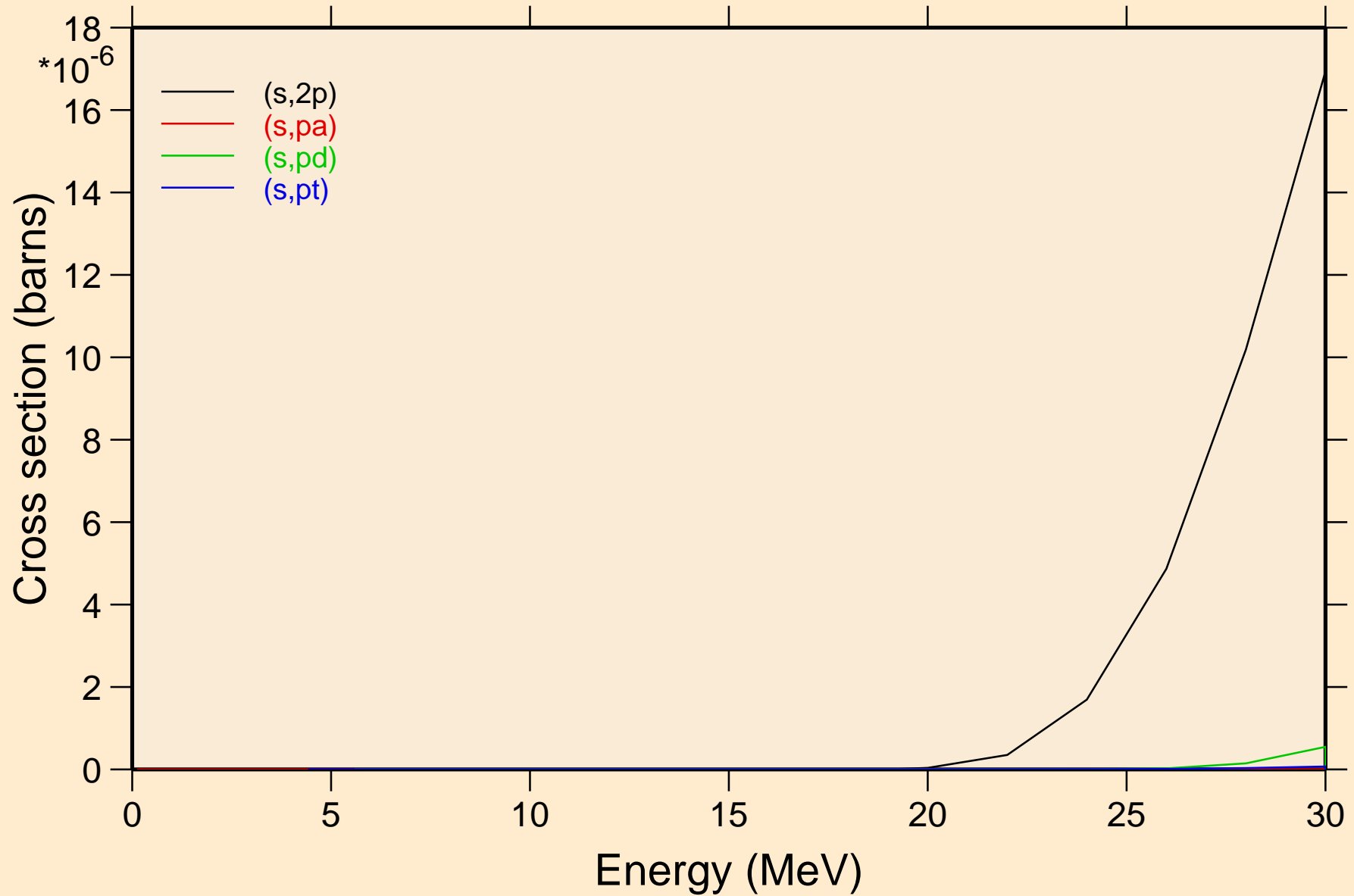

DY169 HELION ACER TENDL-2021 LIBRARY; T=0.K  
angular distribution for elastic

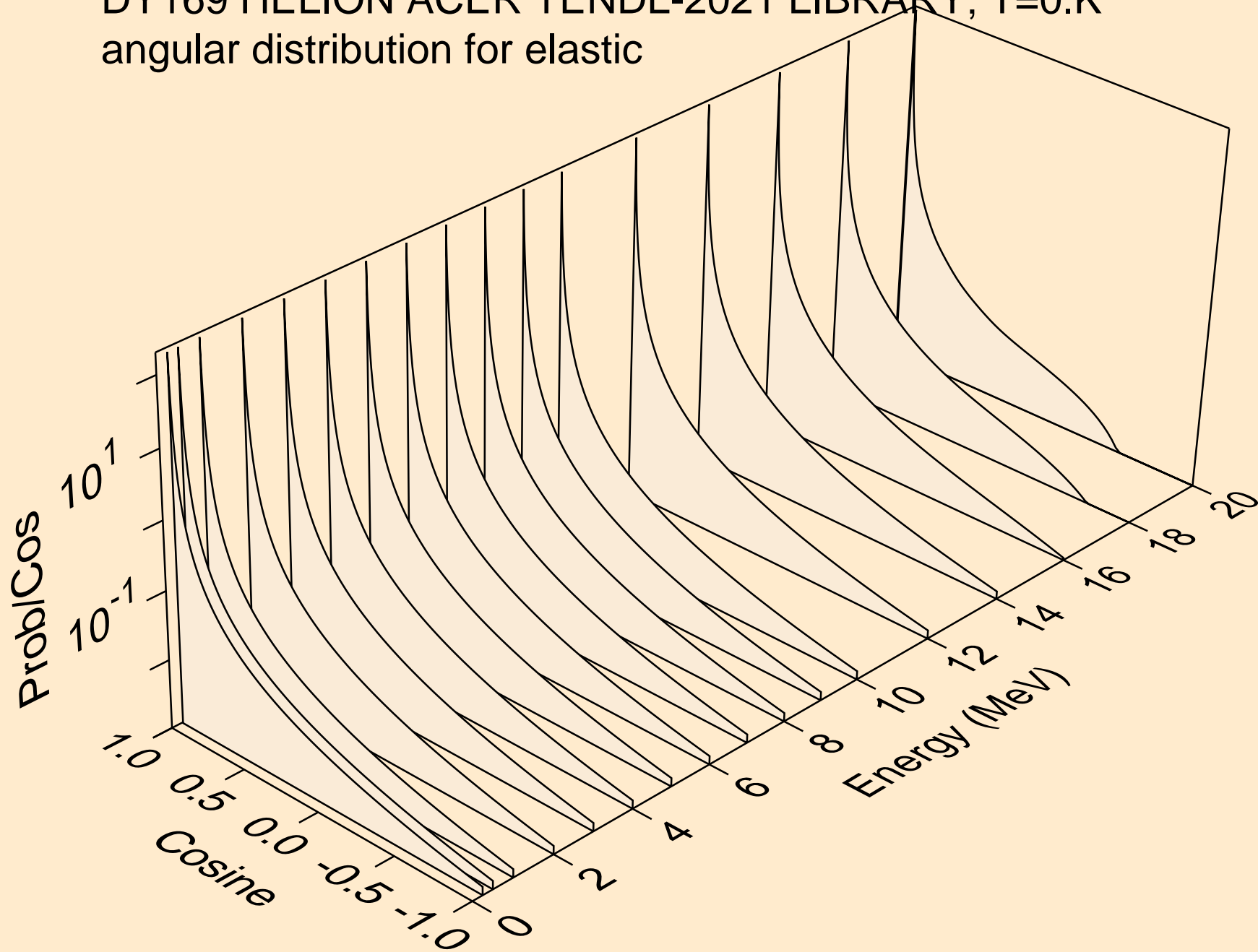

DY169 HELION ACER TENDL-2021 LIBRARY; T=0.K  
angular distribution for elastic

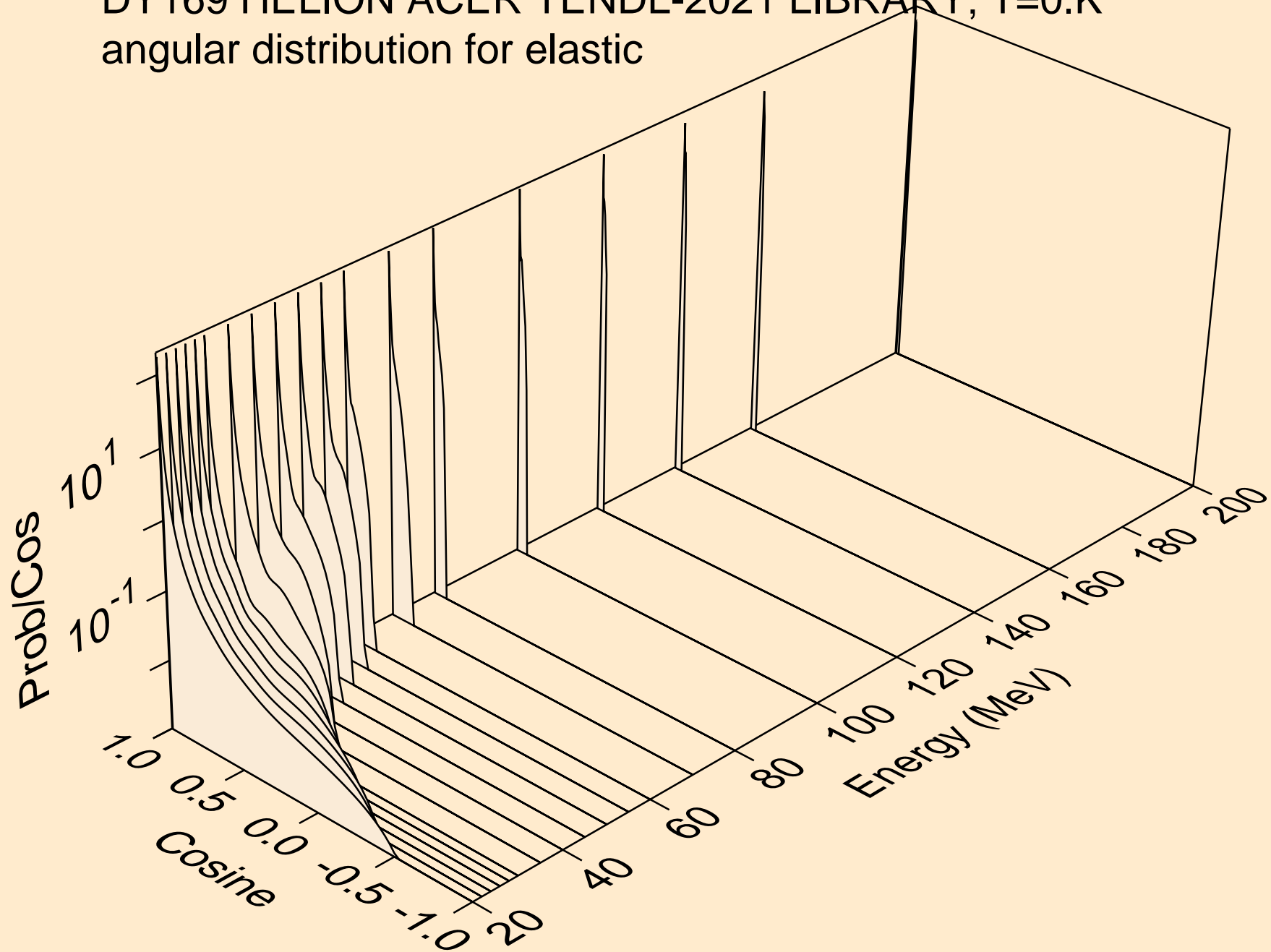

DY169 HELION ACER TENDL-2021 LIBRARY; T=0.K  
He-3 emission for (s,x)

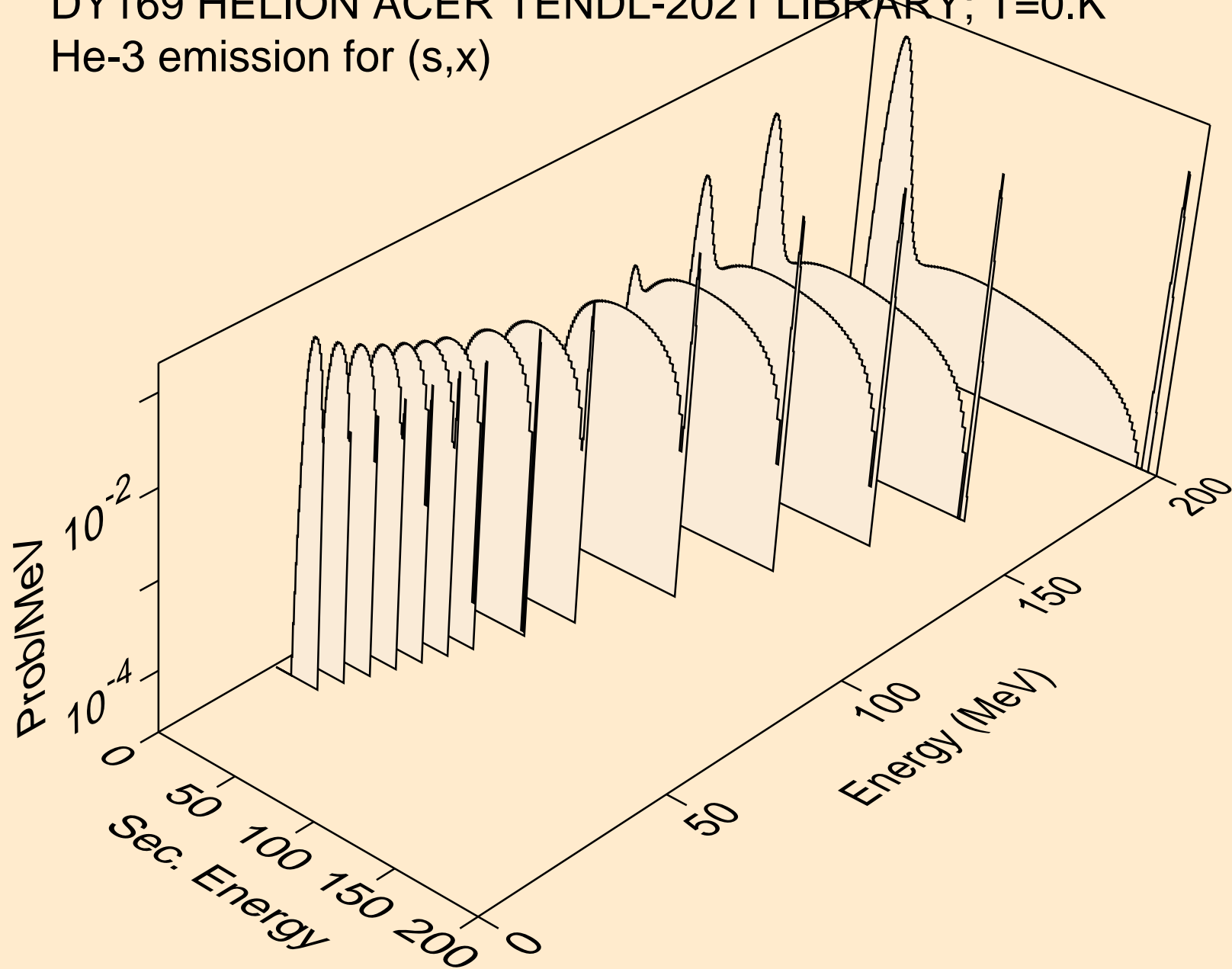

DY169 HELION ACER TENDL-2021 LIBRARY; T=0.K  
He-3 emission for (s,n\*)he3

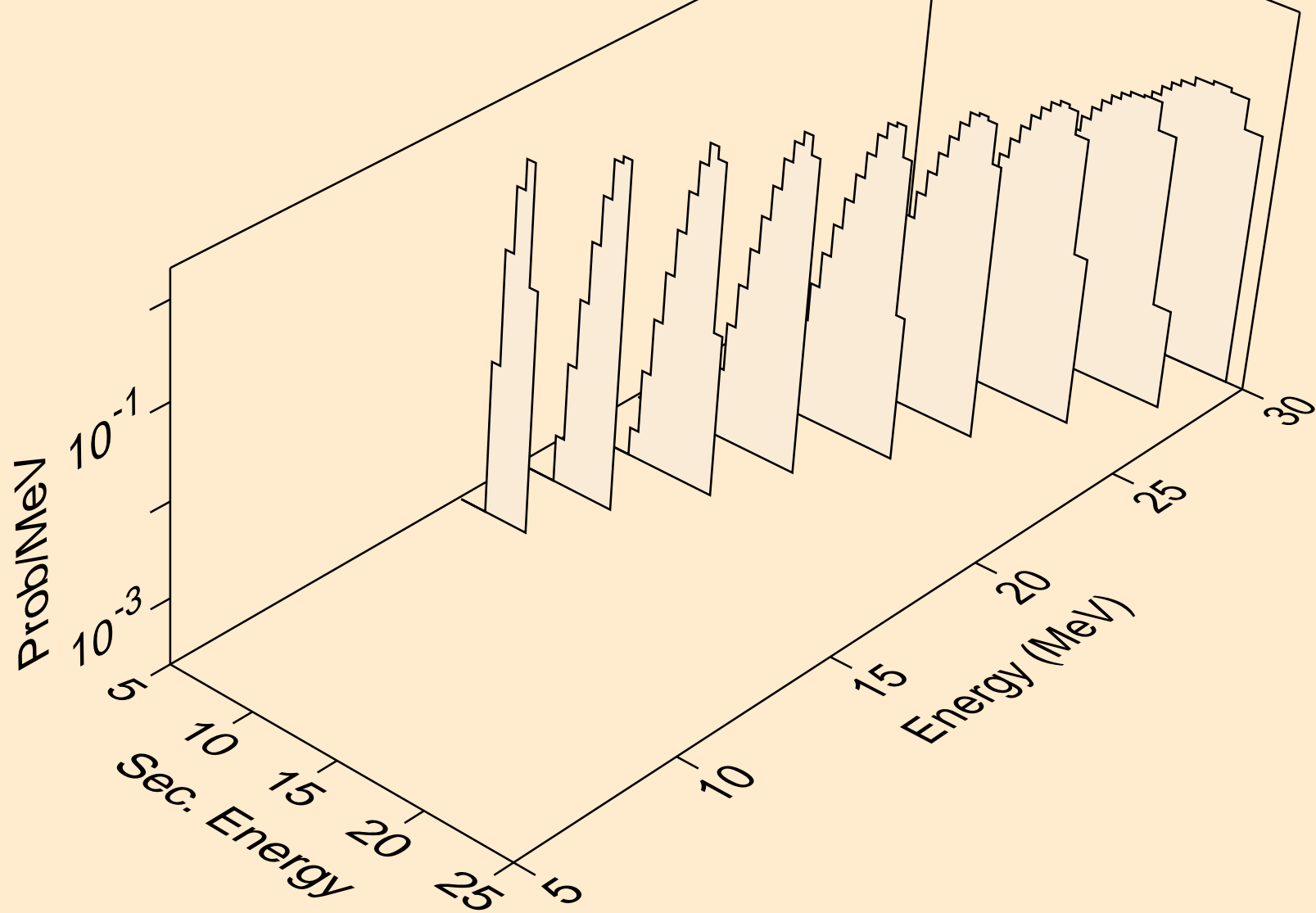

DY169 HELION ACER TENDL-2021 LIBRARY; T=0.K  
He-3 emission for inelastic

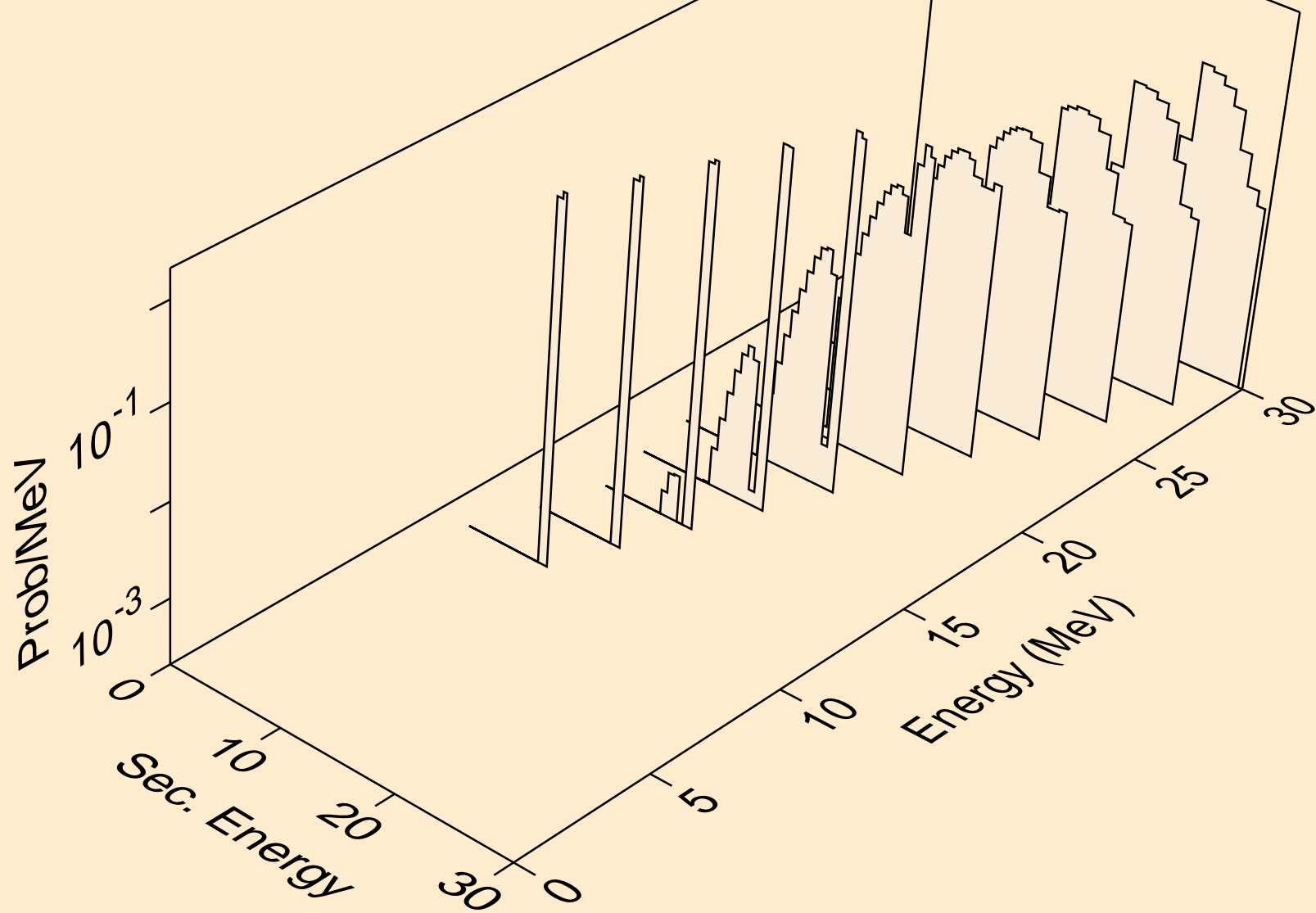



DY169 HELION ACER TENDL-2021 LIBRARY; T=0.K  
Photon emission for (z,n)

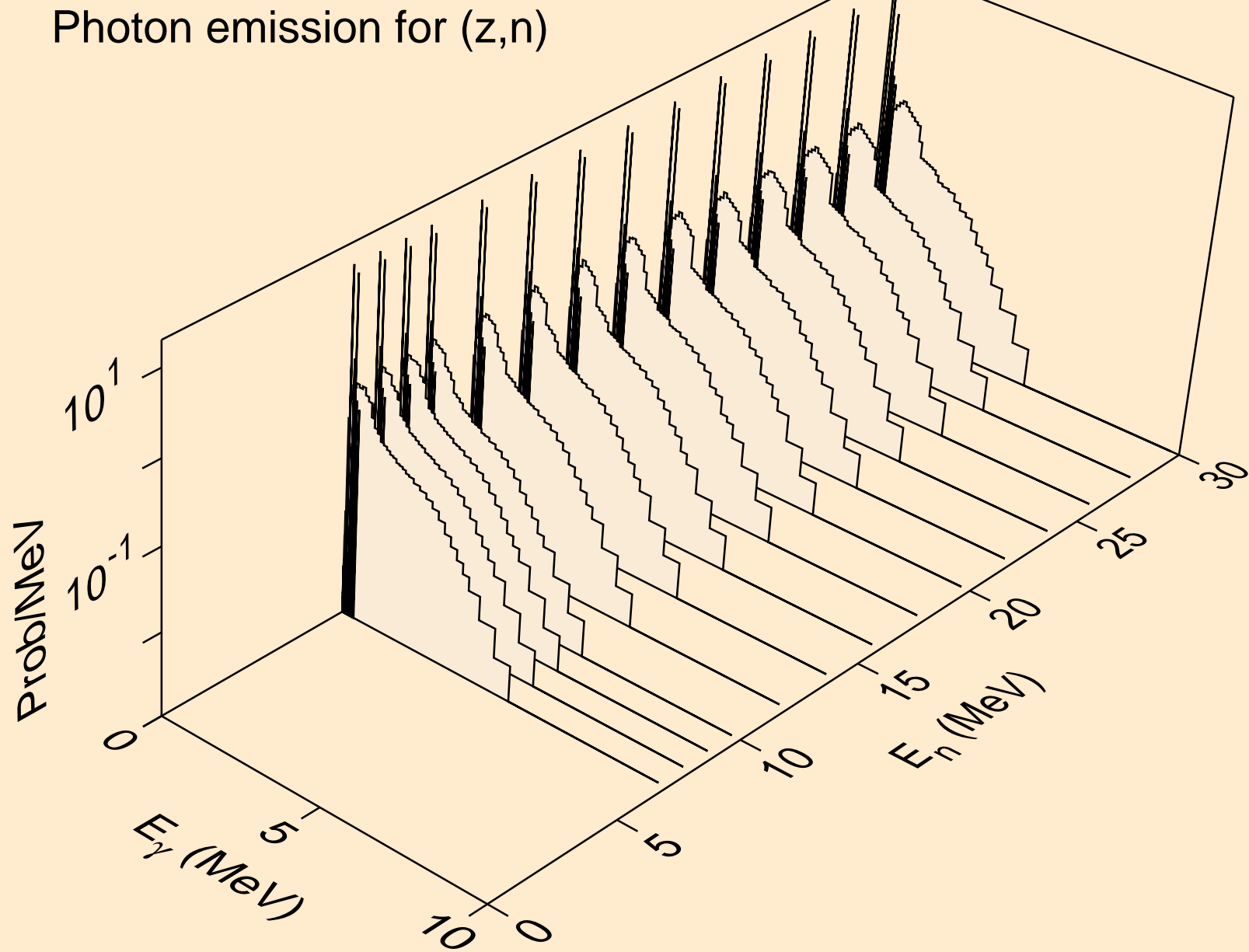

DY169 HELION ACER TENDL-2021 LIBRARY; T=0.K  
Photon emission for (n,x)

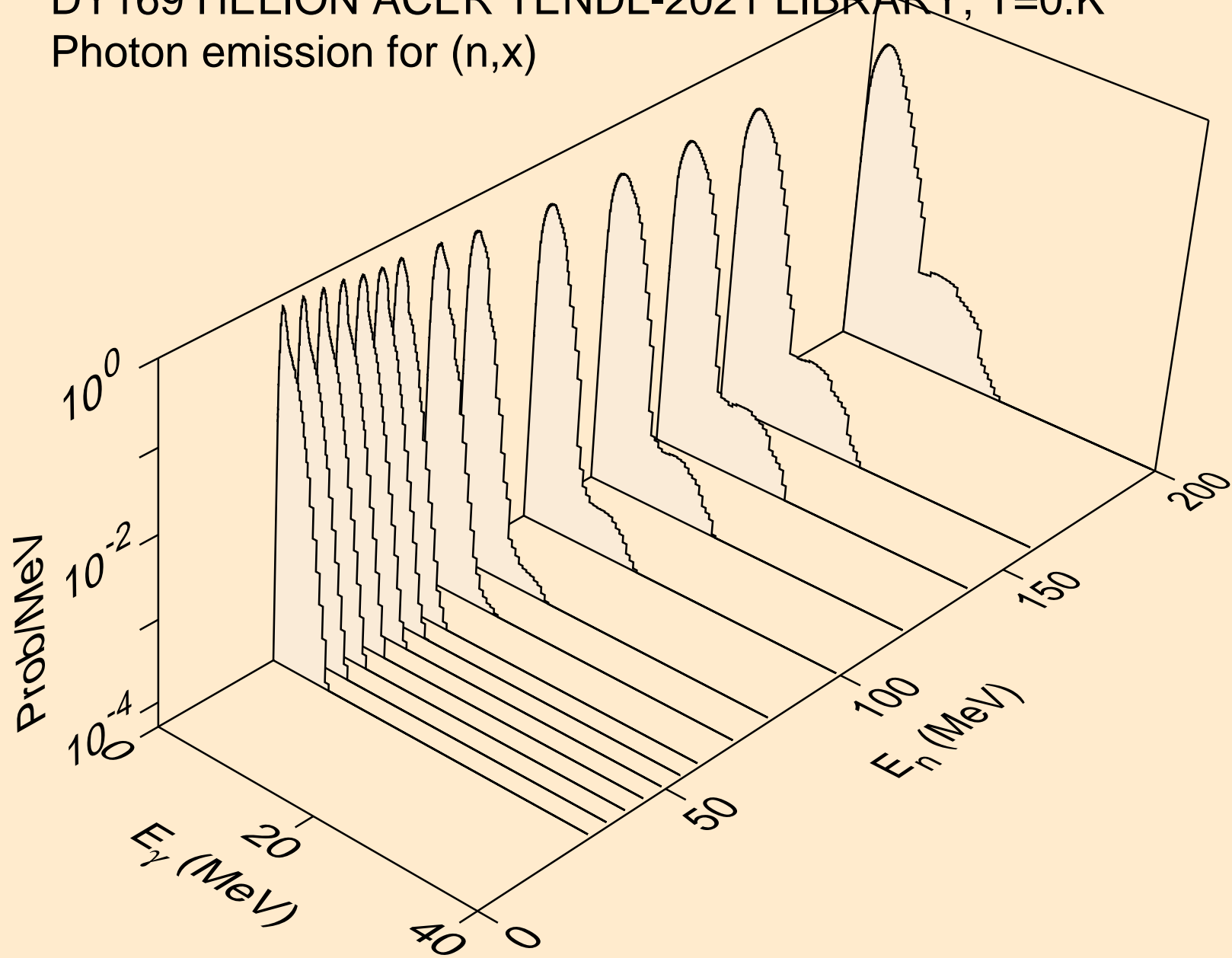

DY169 HELION ACER TENDL-2021 LIBRARY; T=0.K  
Photon emission for (n,2nd)

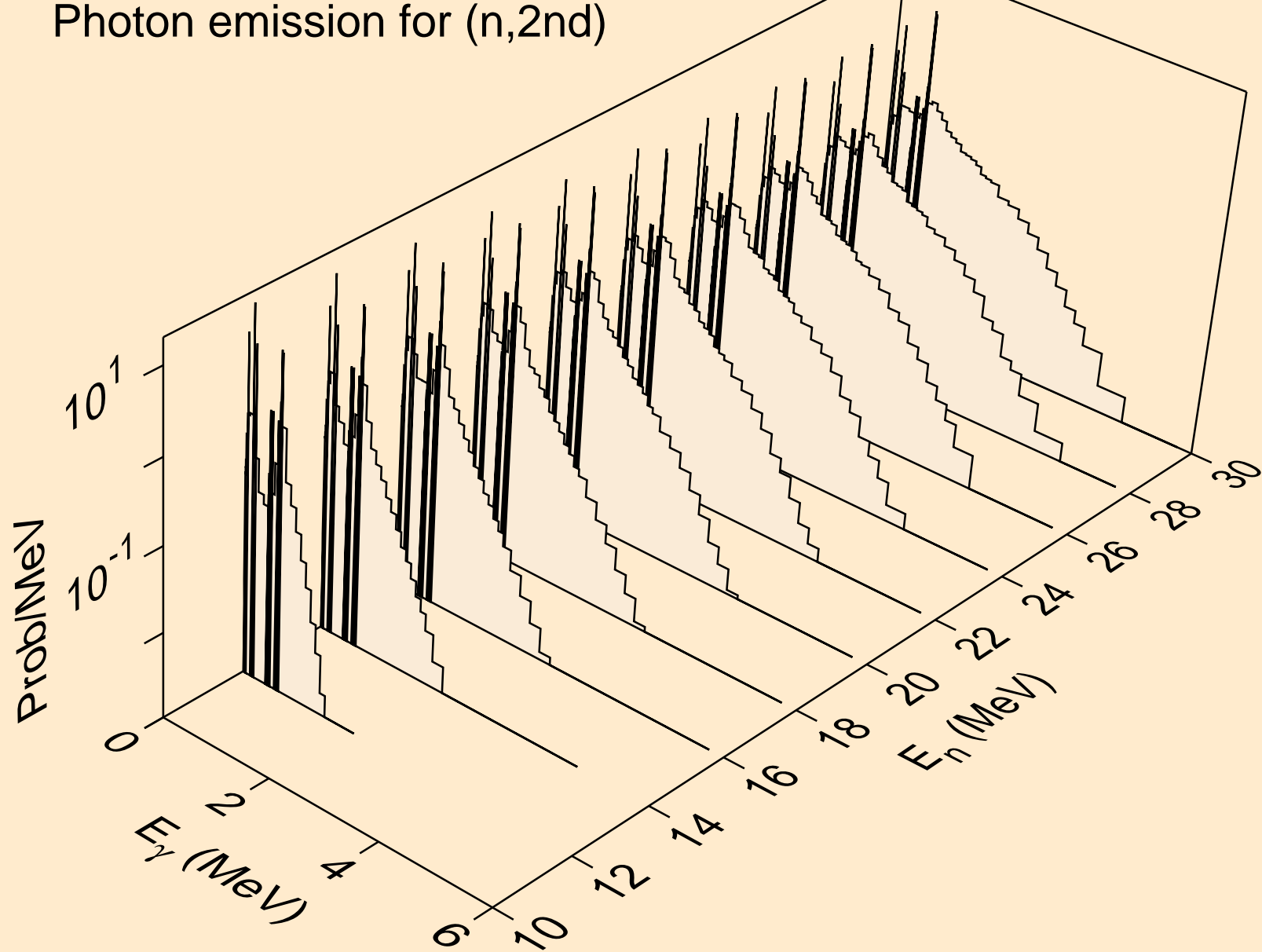

DY169 HELION ACER TENDL-2021 LIBRARY; T=0.K  
Photon emission for (n,2n)

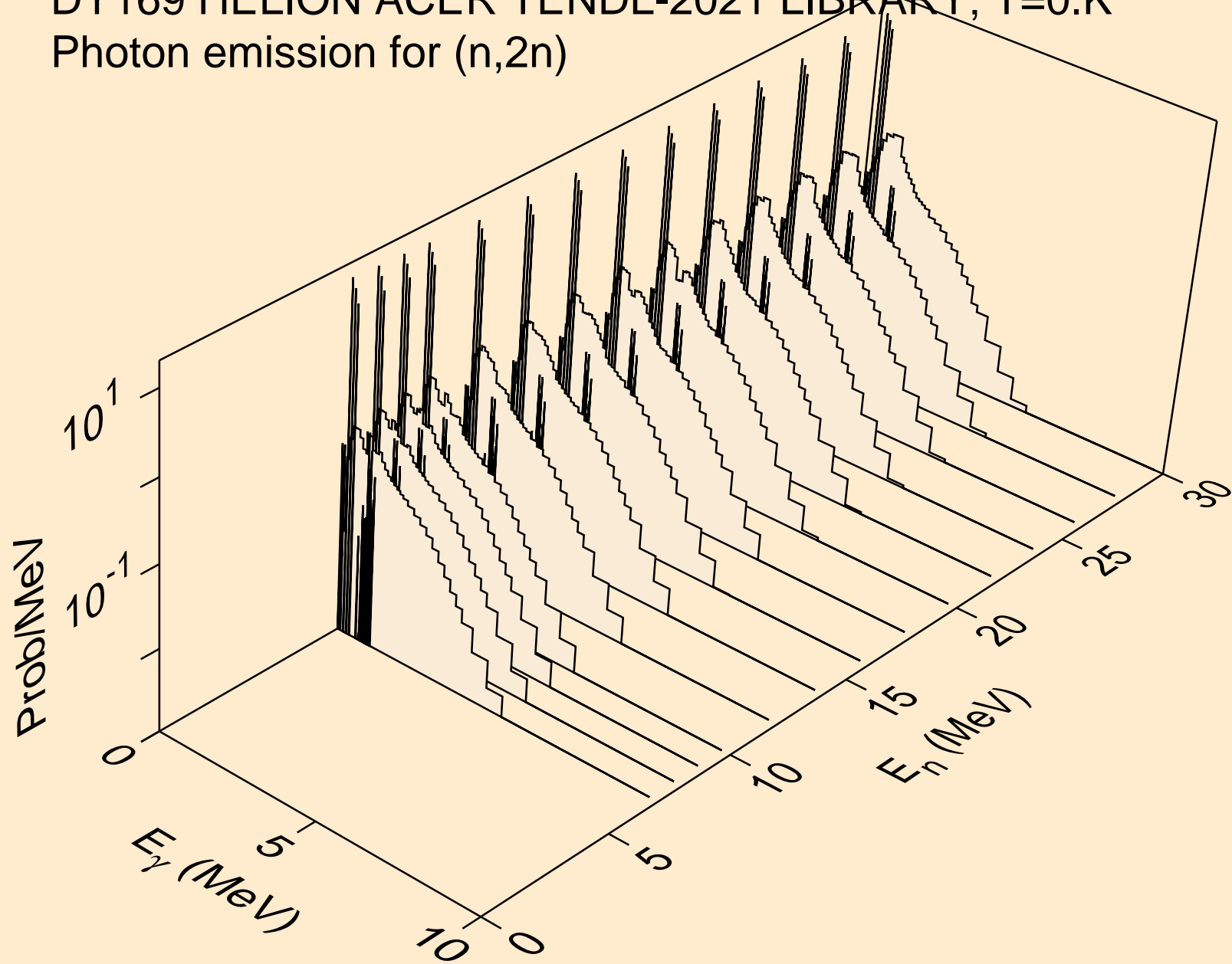

DY169 HELION ACER TENDL-2021 LIBRARY; T=0.K  
Photon emission for (n,3n)

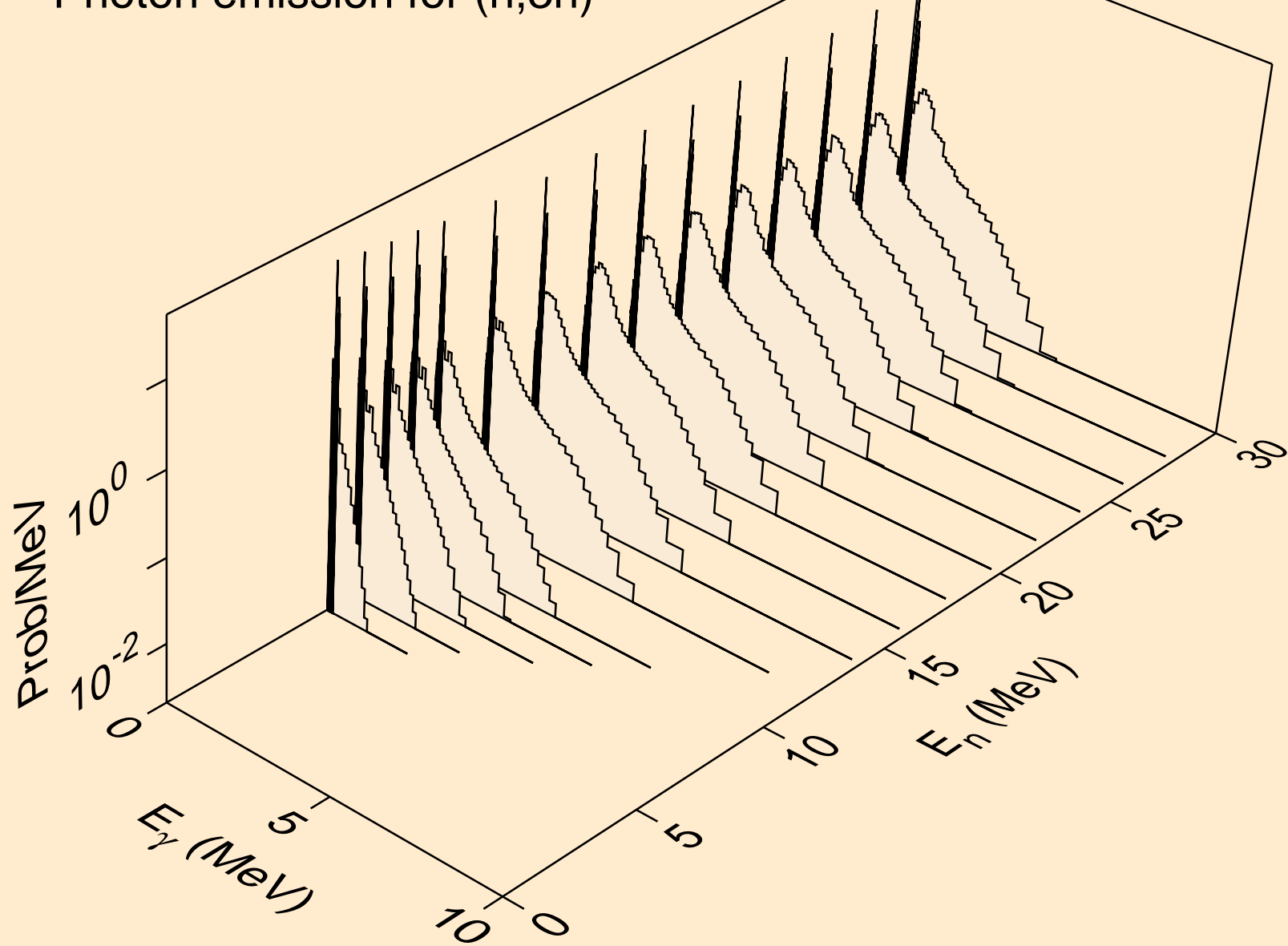

DY169 HELION ACER TENDL-2021 LIBRARY; T=0.K  
Photon emission for (n,n\*)a

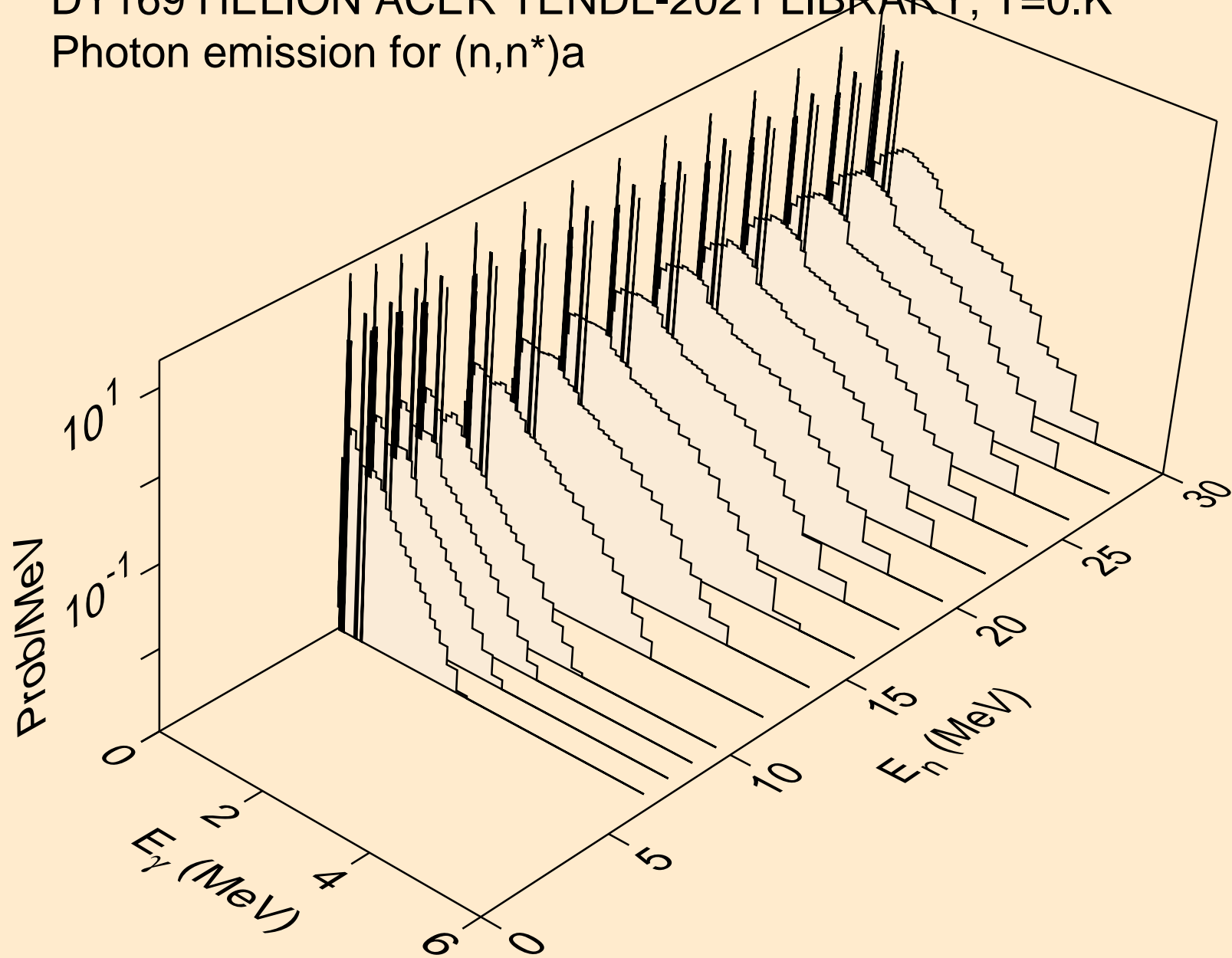

DY169 HELION ACER TENDL-2021 LIBRARY; T=0.K  
Photon emission for (n,2n)a

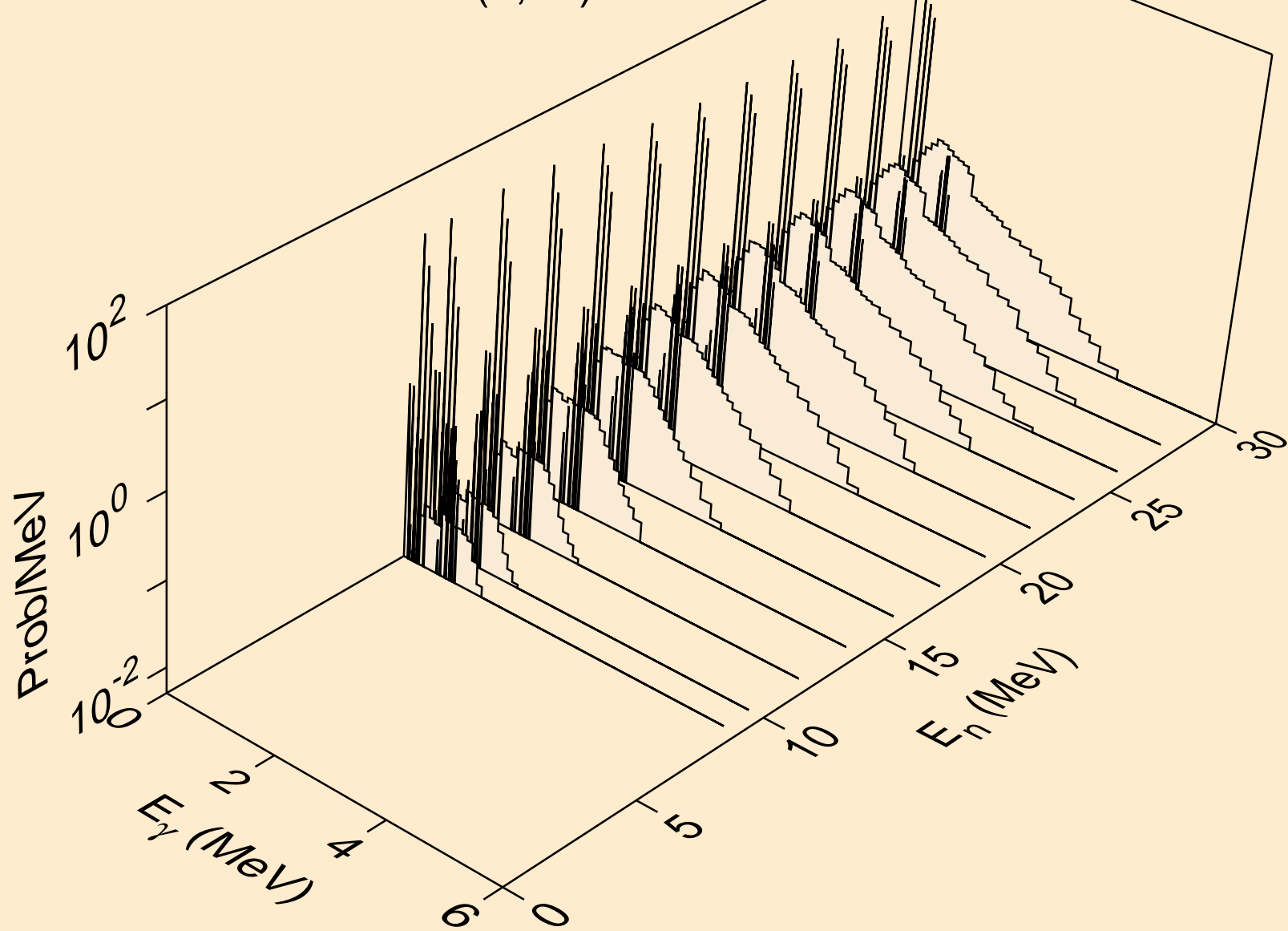

DY169 HELION ACER TENDL-2021 LIBRARY; T=0.K  
Photon emission for (n,3n)a

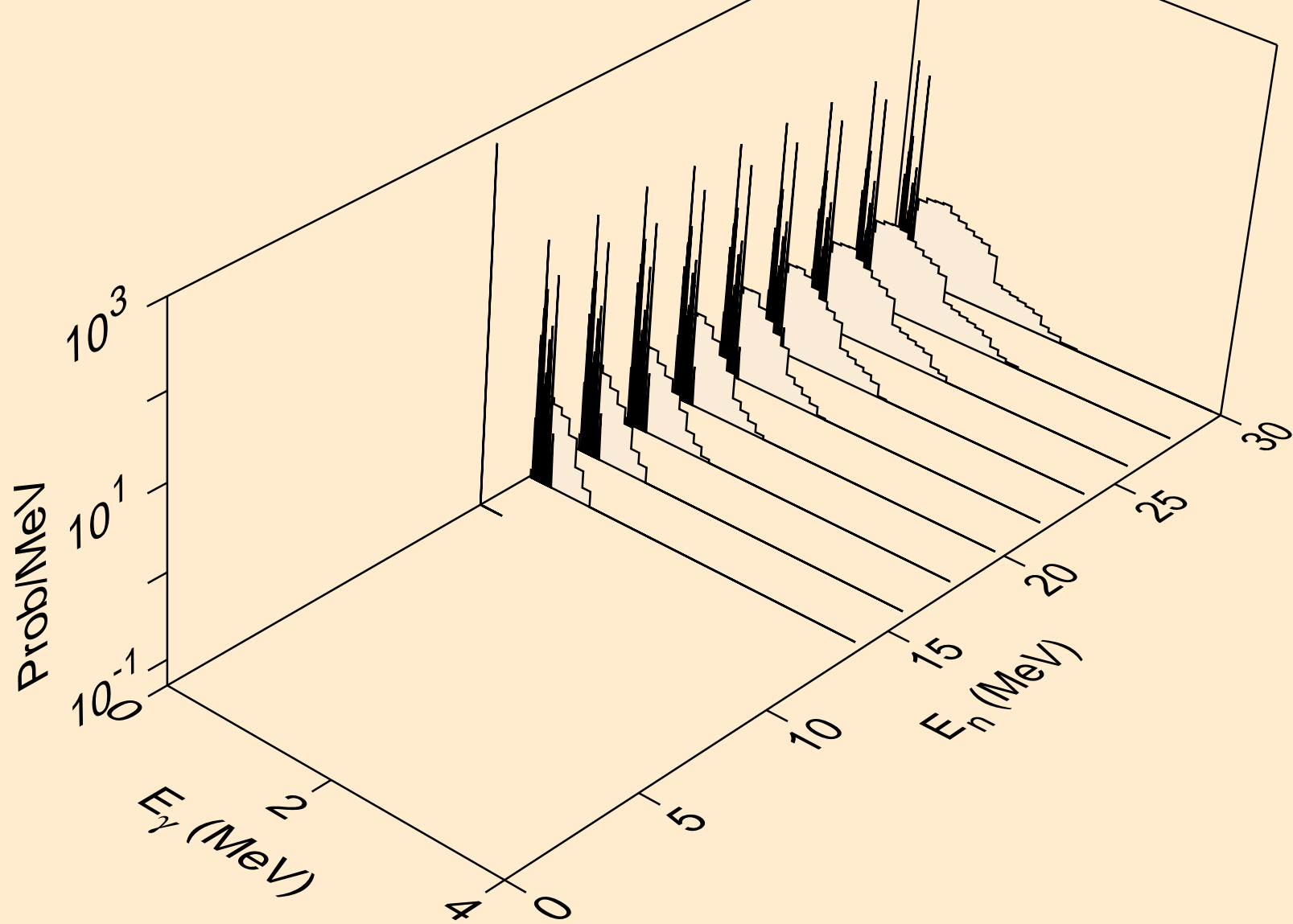



DY169 HELION ACER TENDL-2021 LIBRARY; T=0.K  
Photon emission for (n,n\*)p

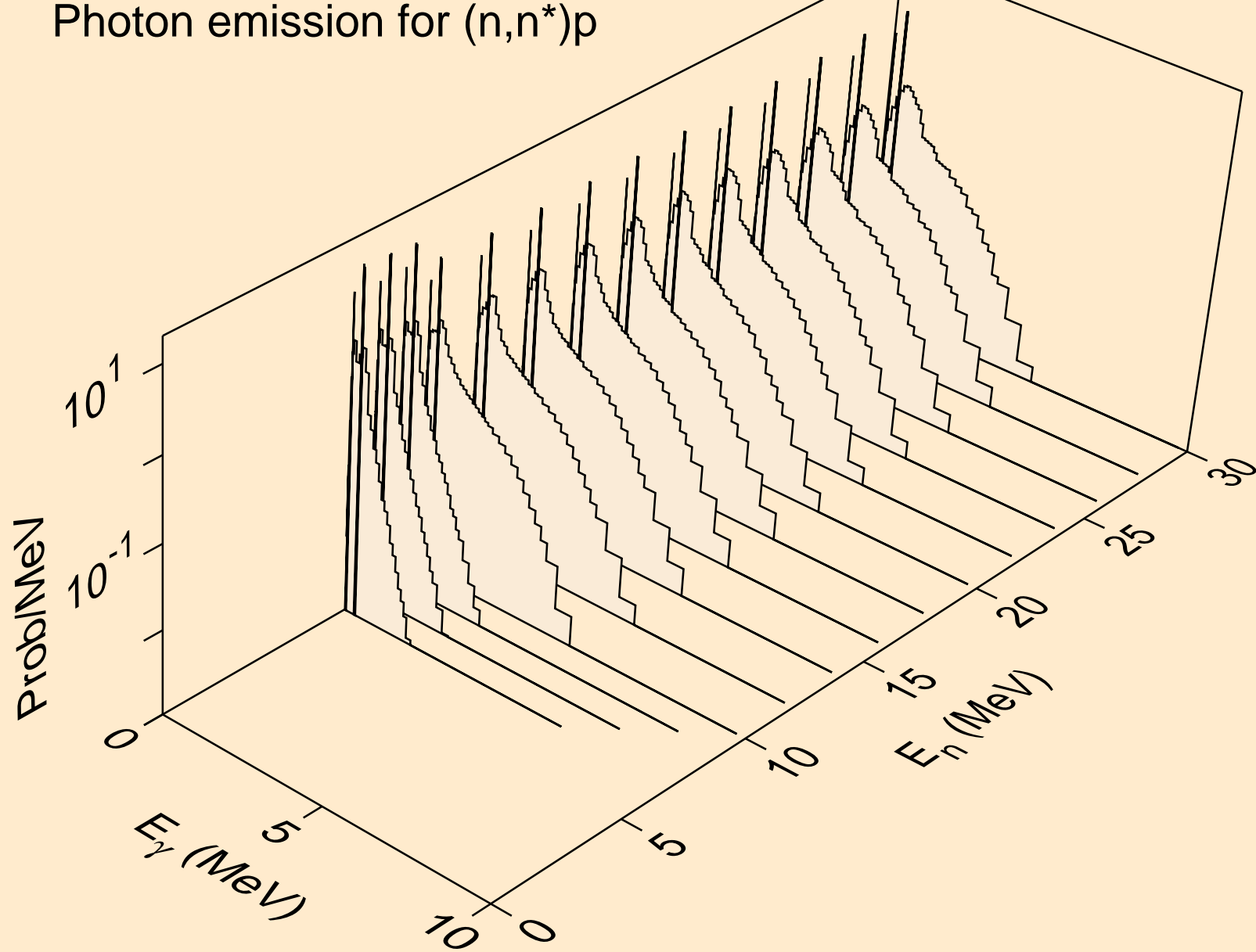

DY169 HELION ACER TENDL-2021 LIBRARY; T=0.K  
Photon emission for (n,n\*)d

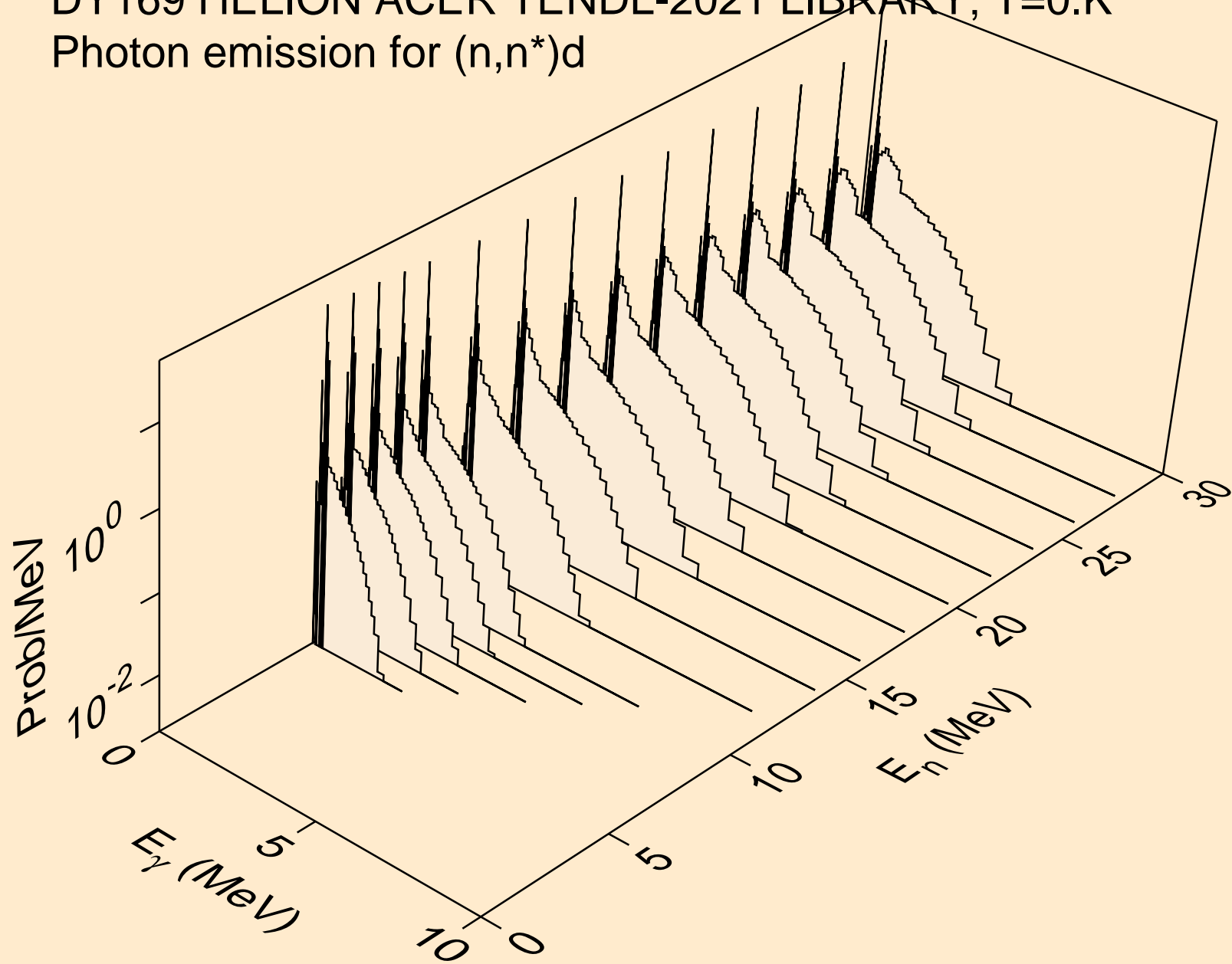

DY169 HELION ACER TENDL-2021 LIBRARY; T=0.K  
Photon emission for (n,n\*)t

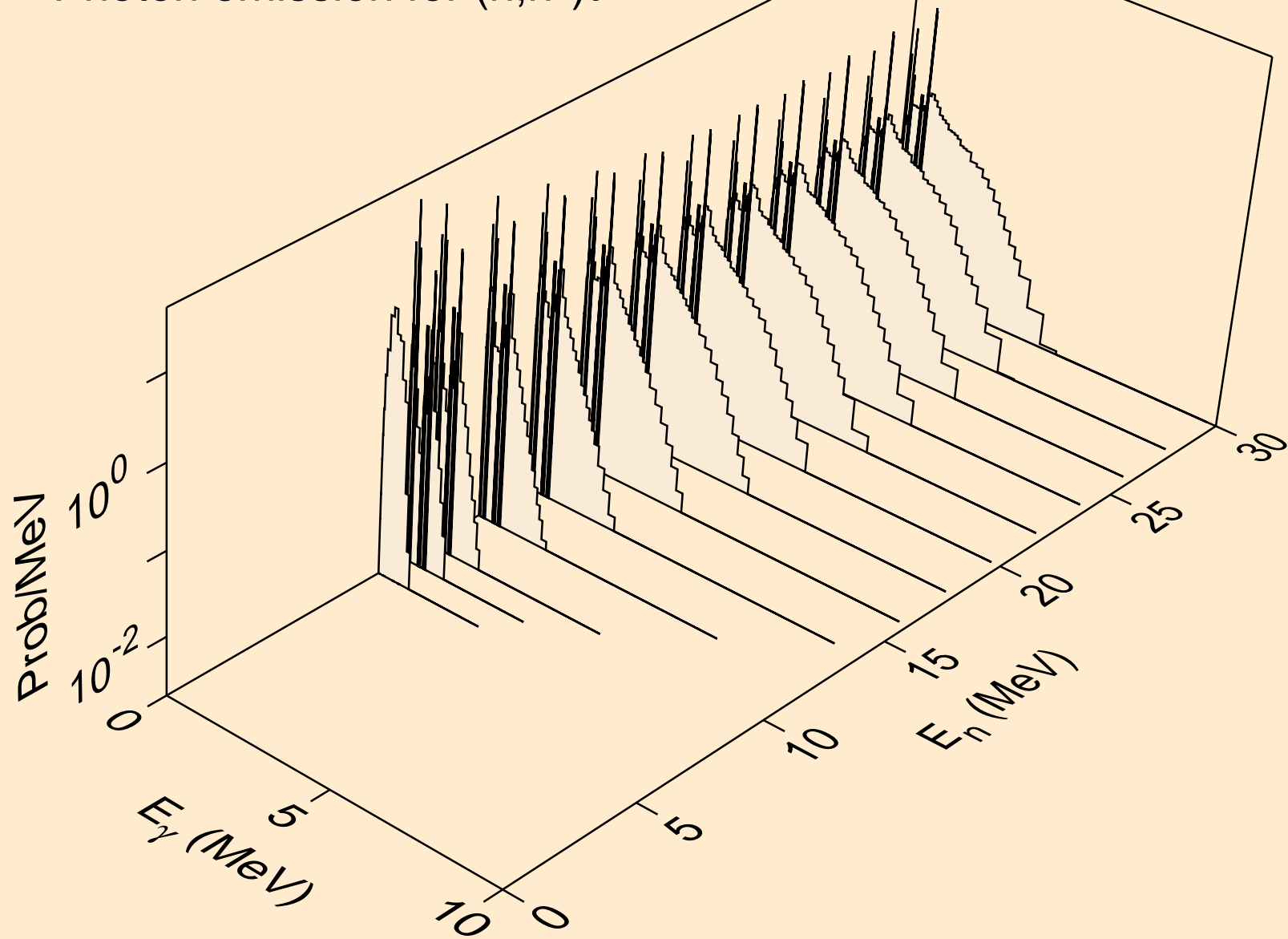

DY169 HELION ACER TENDL-2021 LIBRARY; T=0.K  
Photon emission for (n,n\*)he3

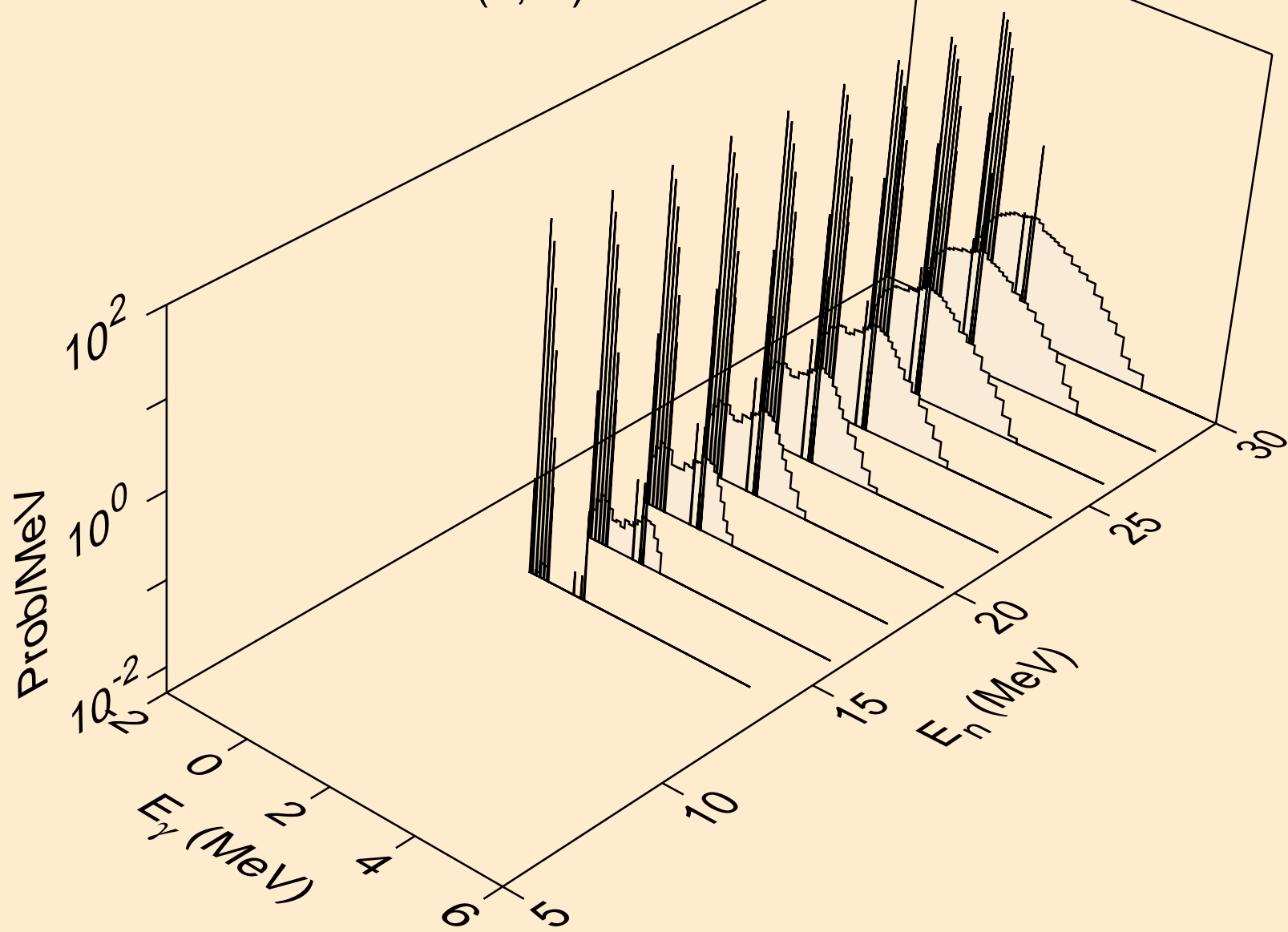

DY169 HELION ACER TENDL-2021 LIBRARY; T=0.K  
Photon emission for (n,4n)

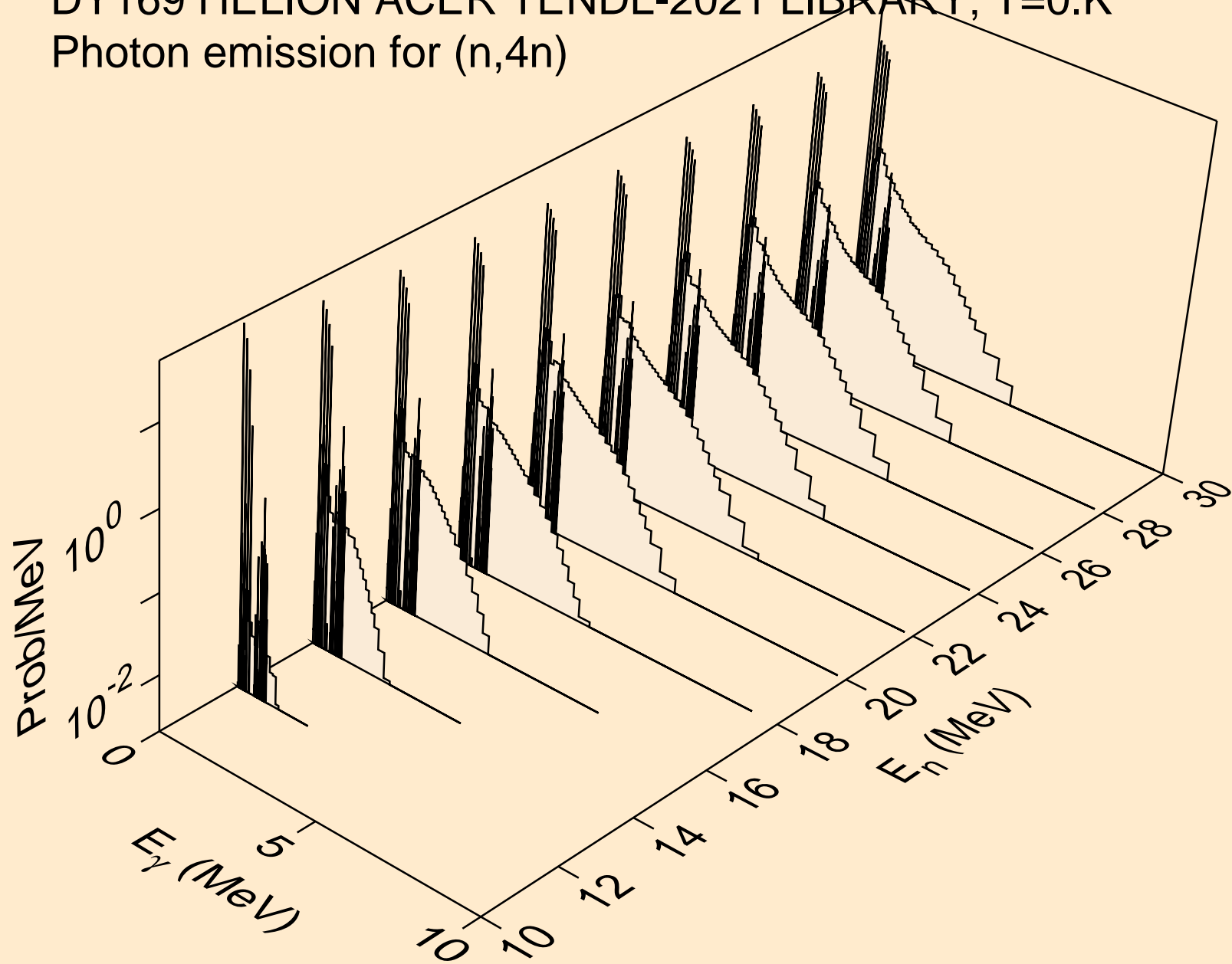

DY169 HELION ACER TENDL-2021 LIBRARY; T=0.K  
Photon emission for (n,2np)

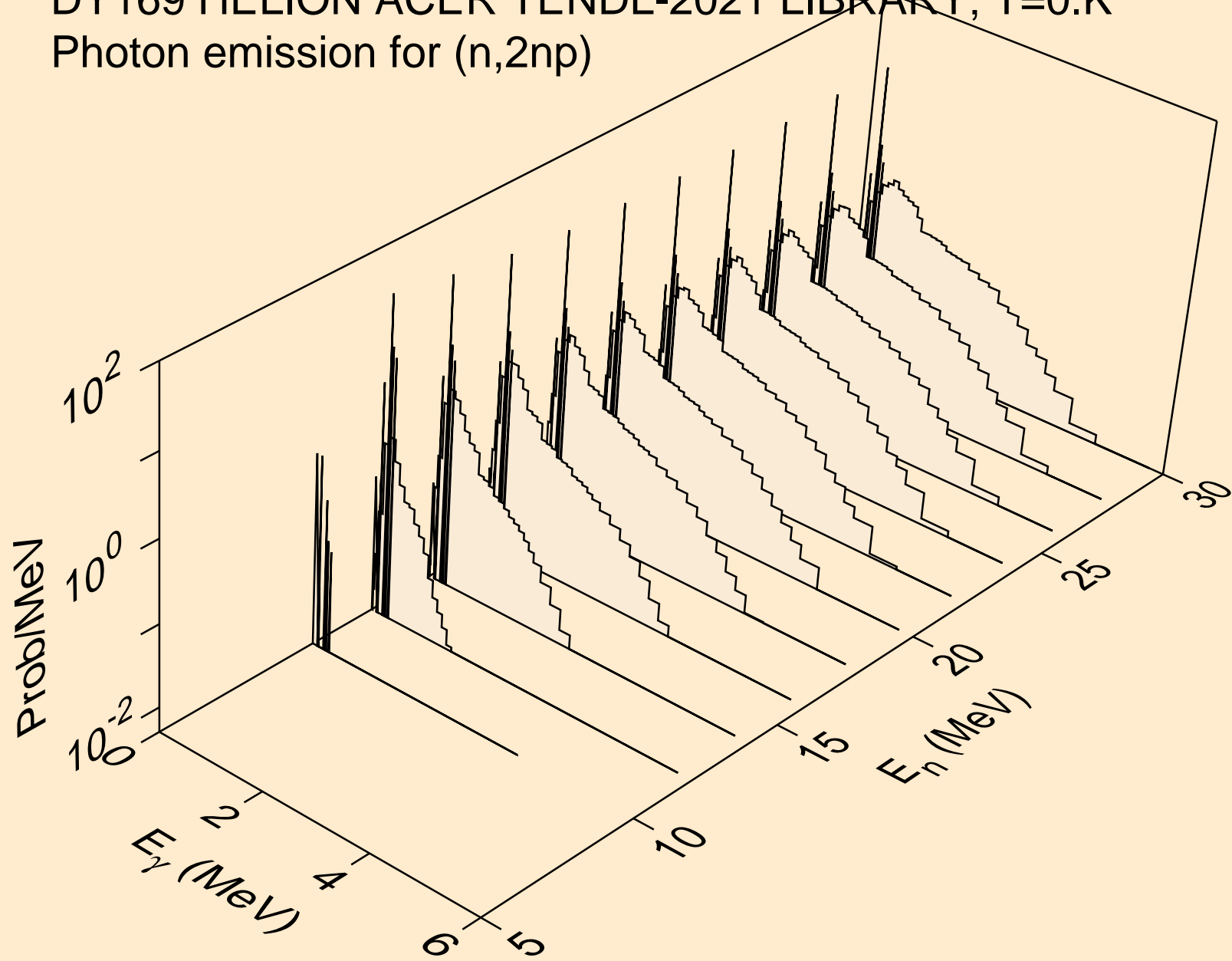

DY169 HELION ACER TENDL-2021 LIBRARY; T=0.K  
Photon emission for (n,3np)

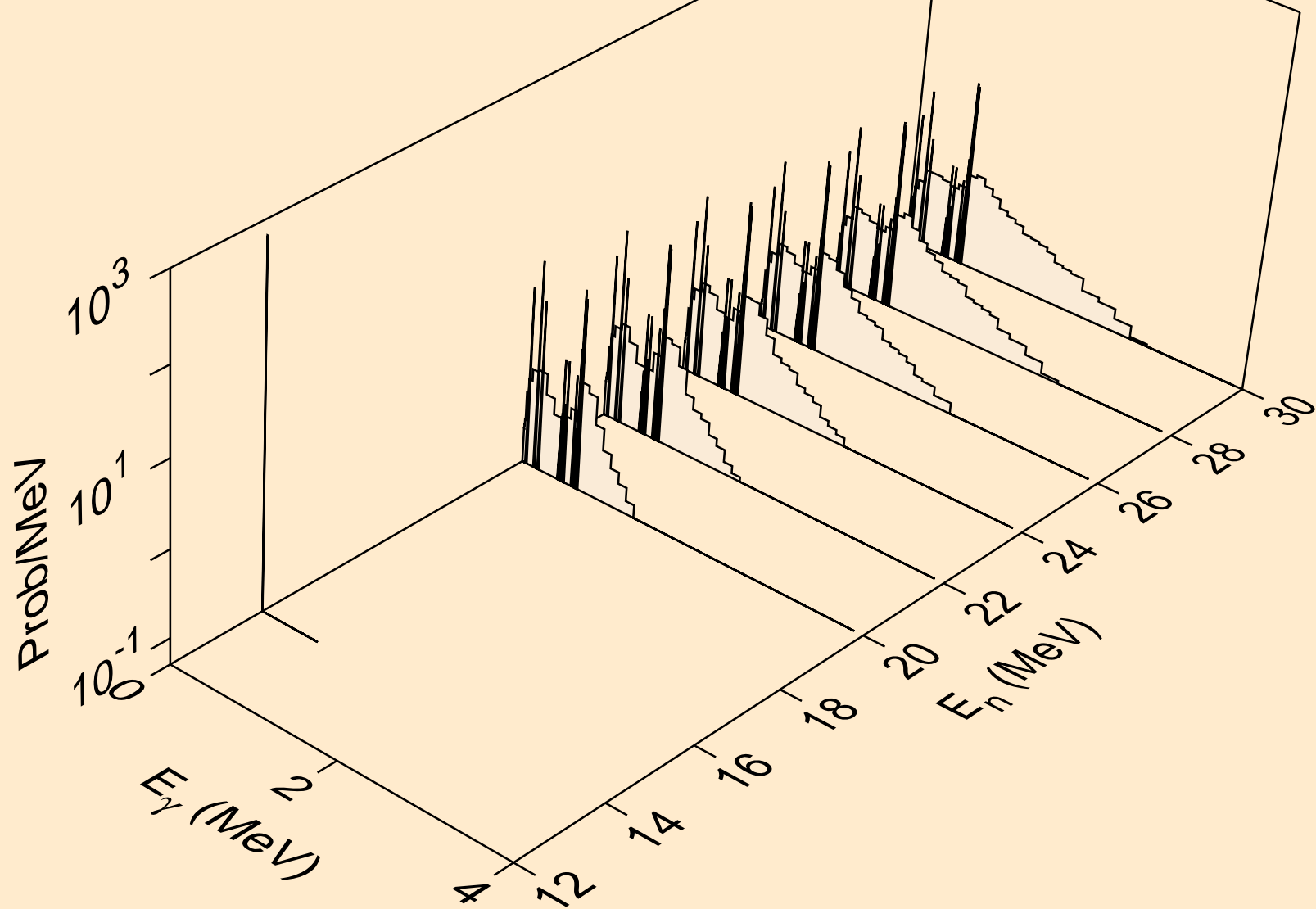

DY169 HELION ACER TENDL-2021 LIBRARY; T=0.K  
Photon emission for (n,2np)

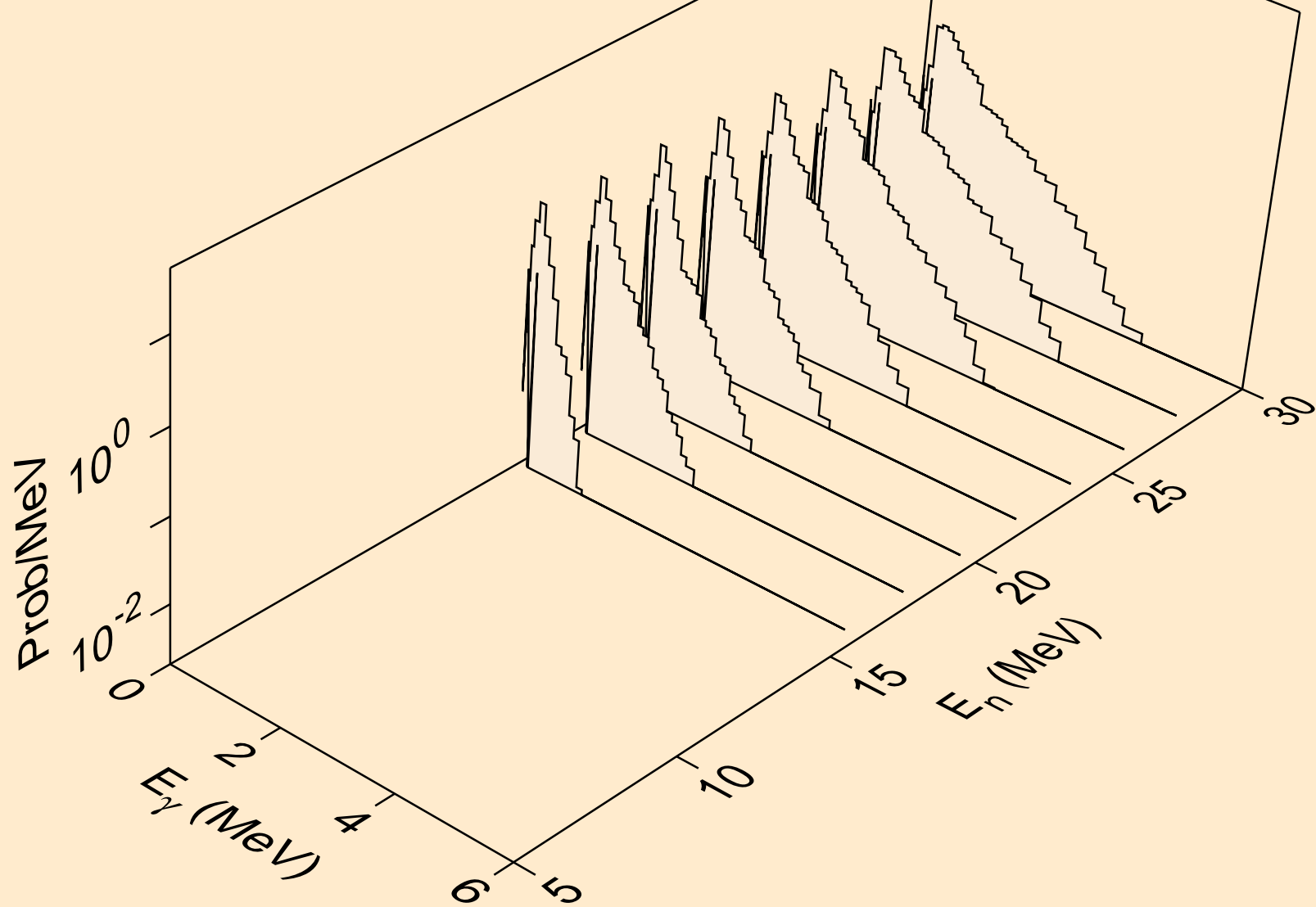



DY169 HELION ACER TENDL-2021 LIBRARY; T=0.K  
Photon emission for (n,npa)

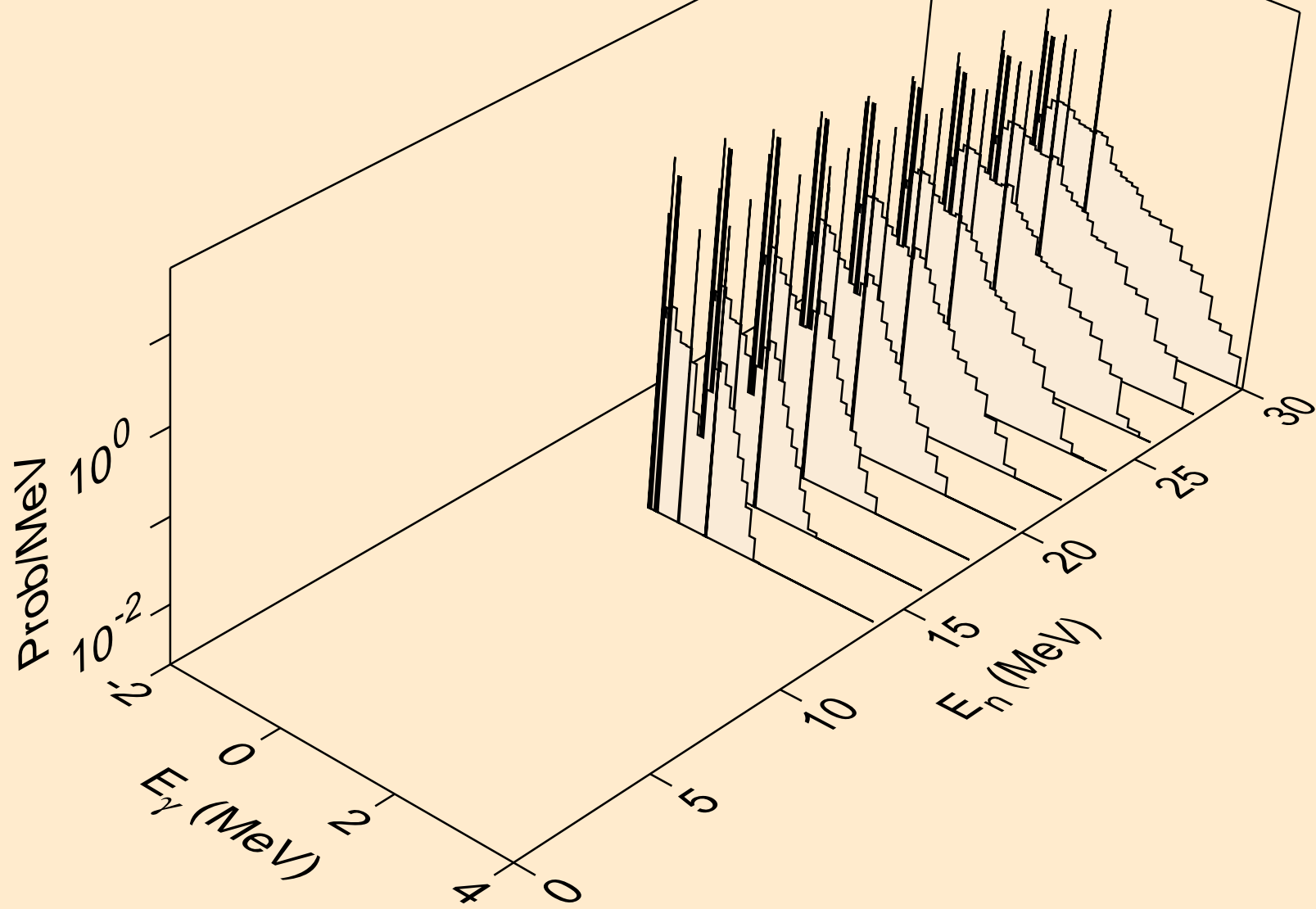

DY169 HELION ACER TENDL-2021 LIBRARY; T=0.K  
Photon emission for (n,gma)

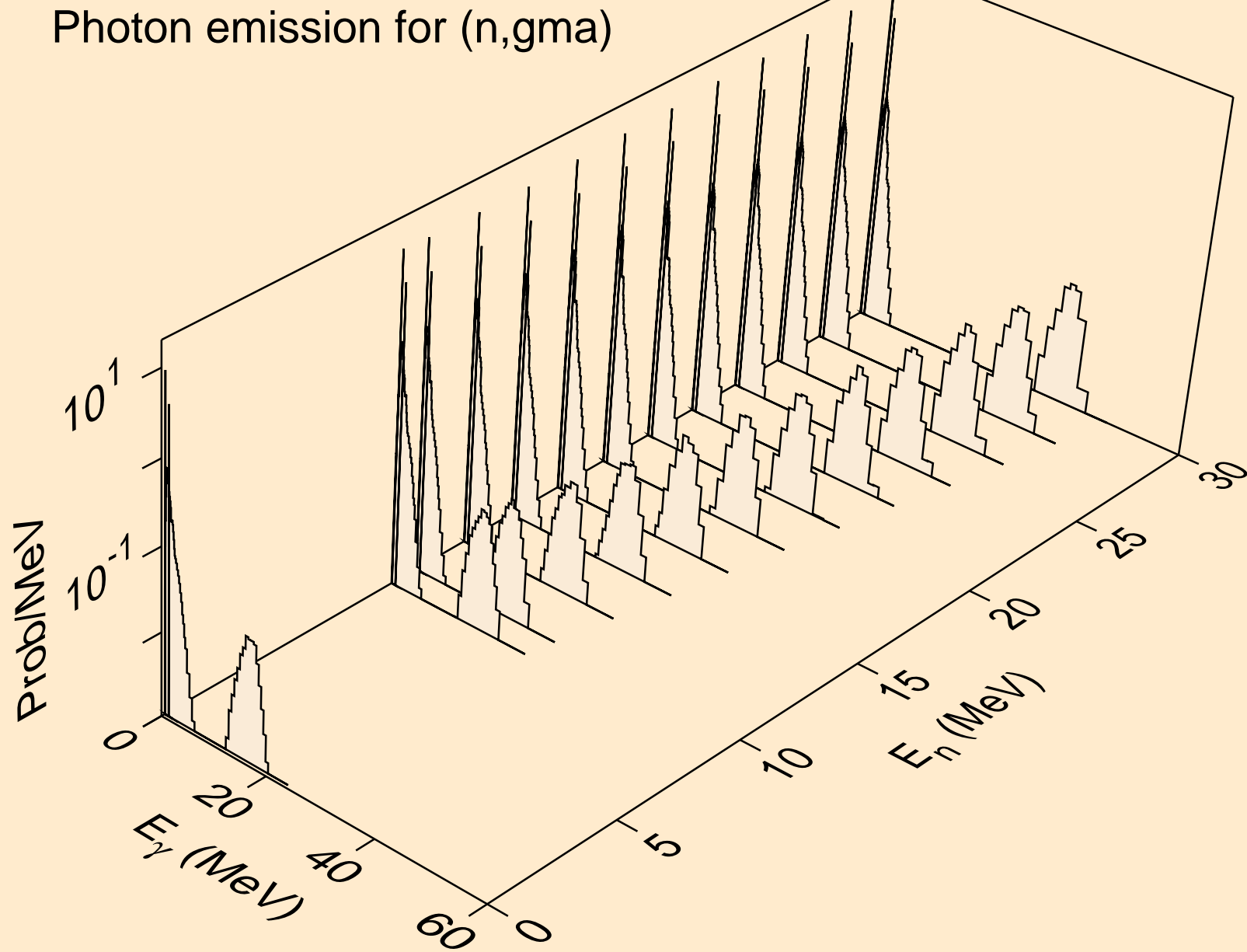

DY169 HELION ACER TENDL-2021 LIBRARY; T=0.K  
Photon emission for (n,p)

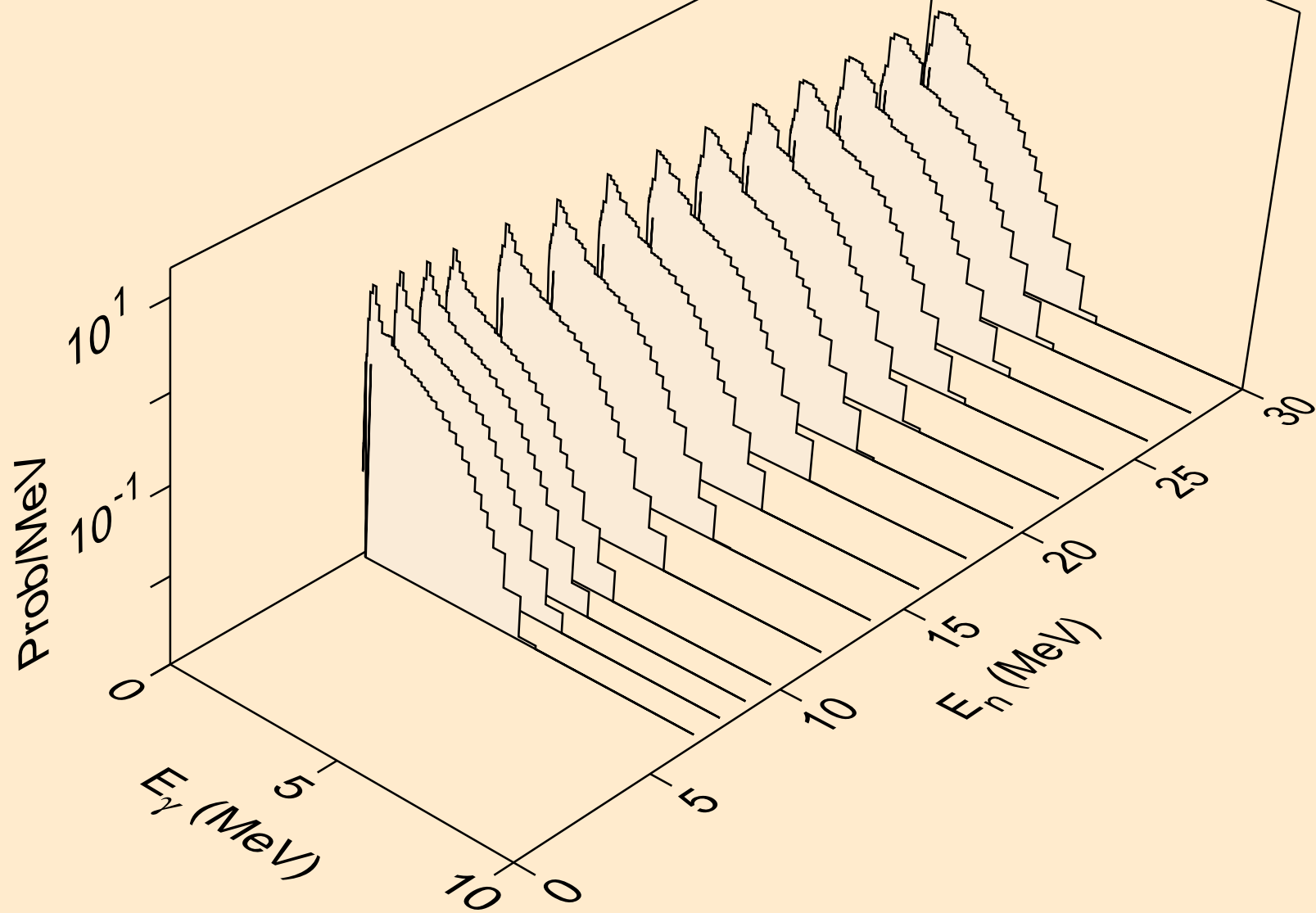

DY169 HELION ACER TENDL-2021 LIBRARY; T=0.K  
Photon emission for (n,d)

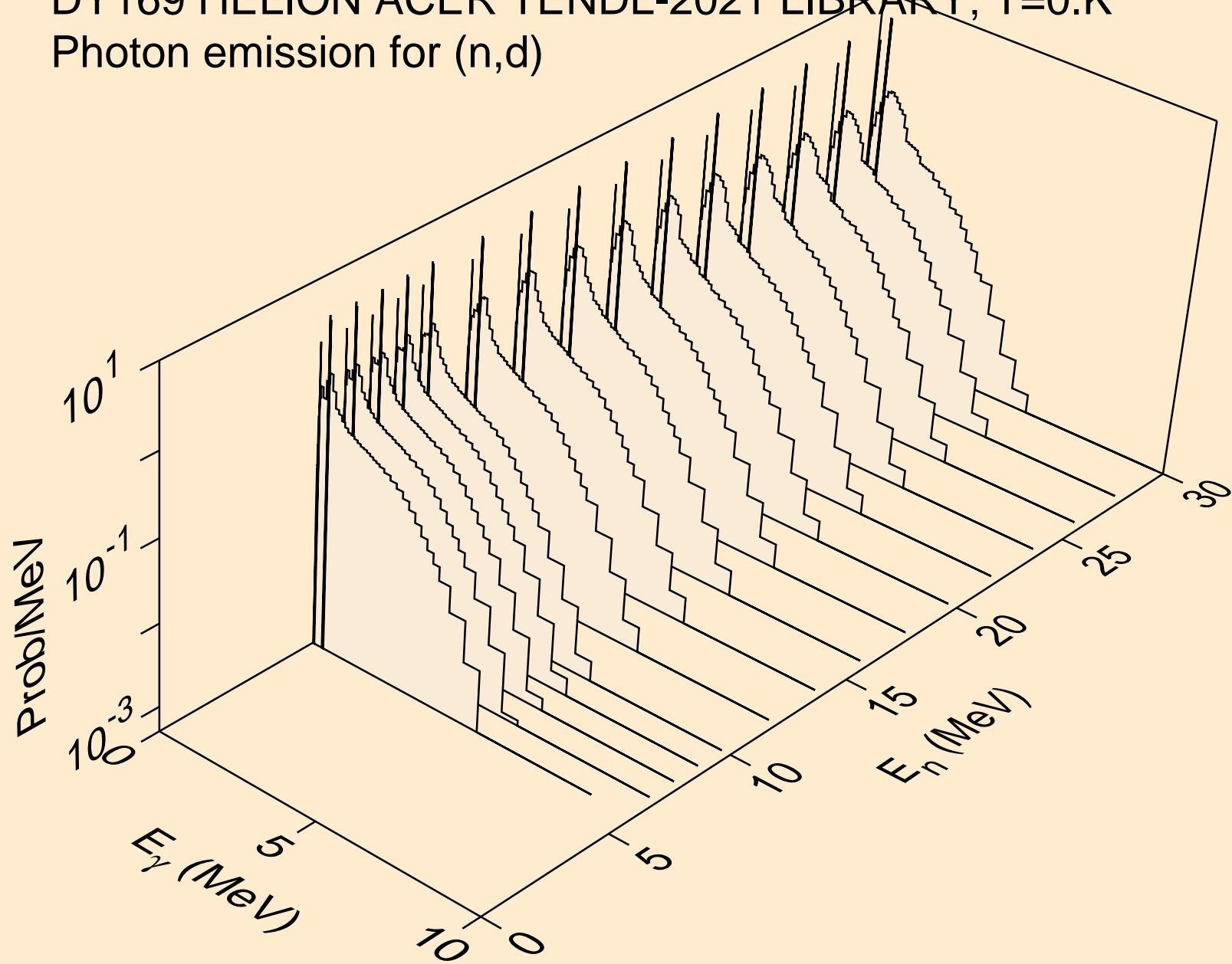

DY169 HELION ACER TENDL-2021 LIBRARY; T=0.K  
Photon emission for (n,t)

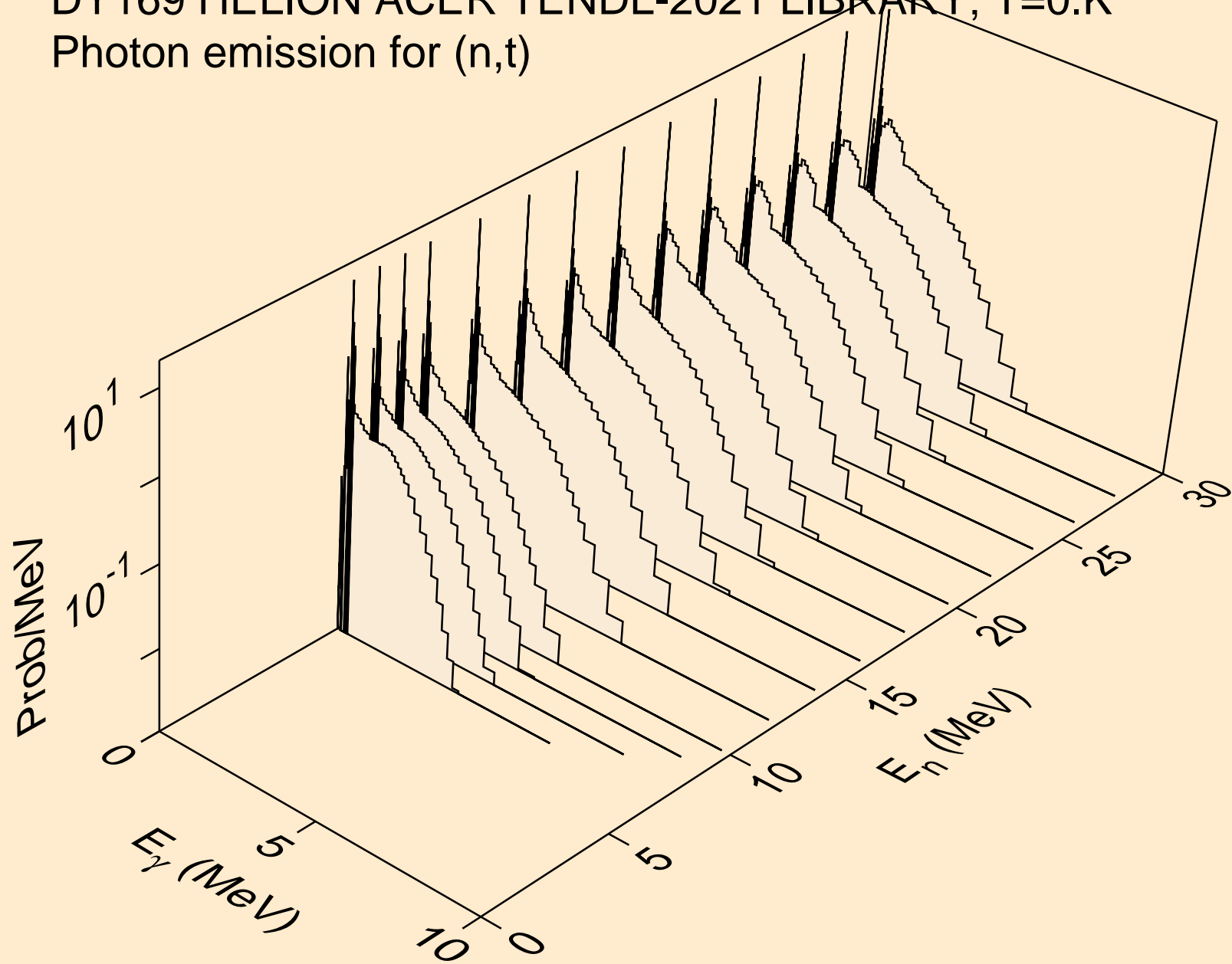

DY169 HELION ACER TENDL-2021 LIBRARY; T=0.K  
Photon emission for inelastic

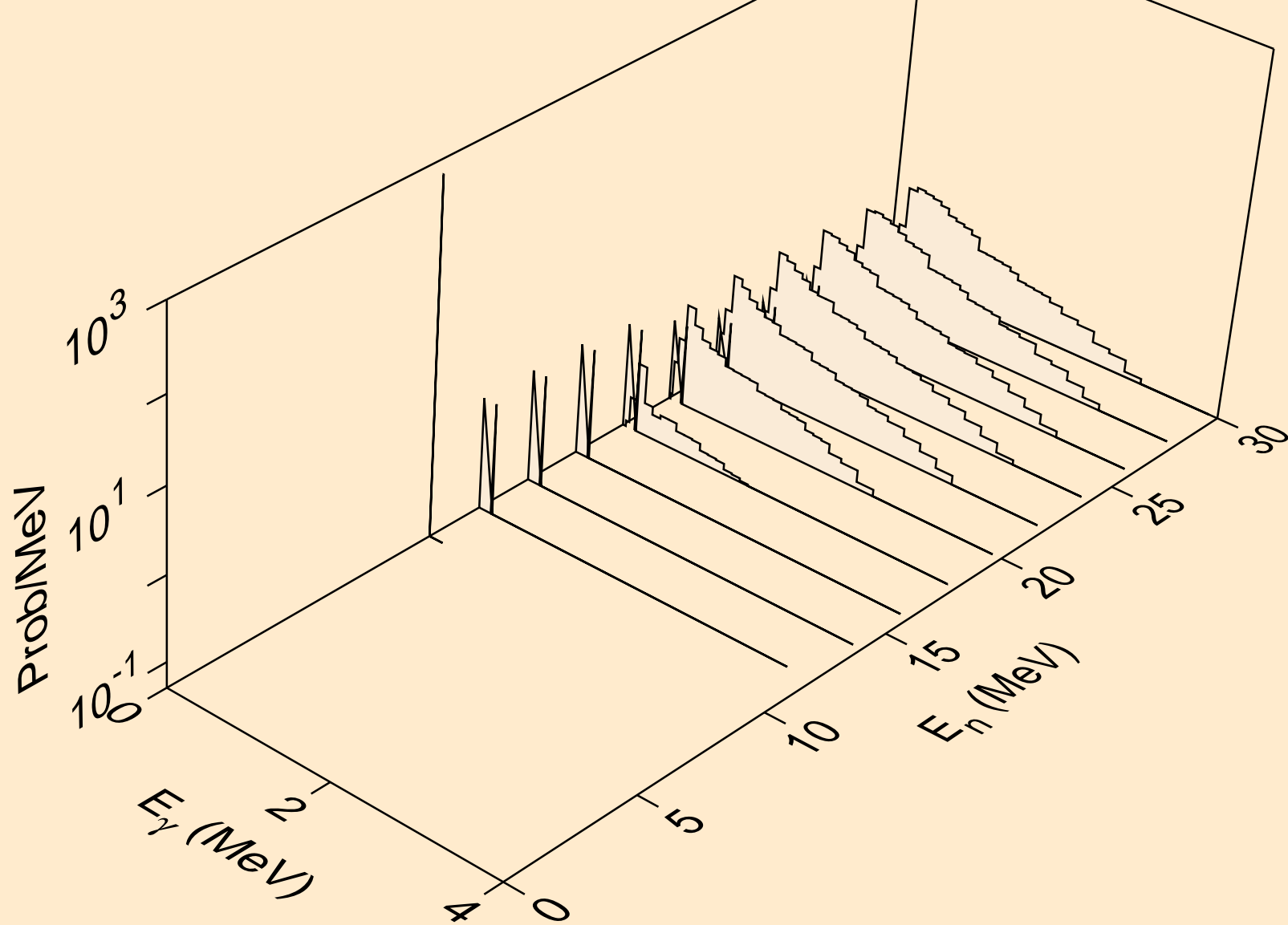

DY169 HELION ACER TENDL-2021 LIBRARY; T=0.K  
Photon emission for (n,a)

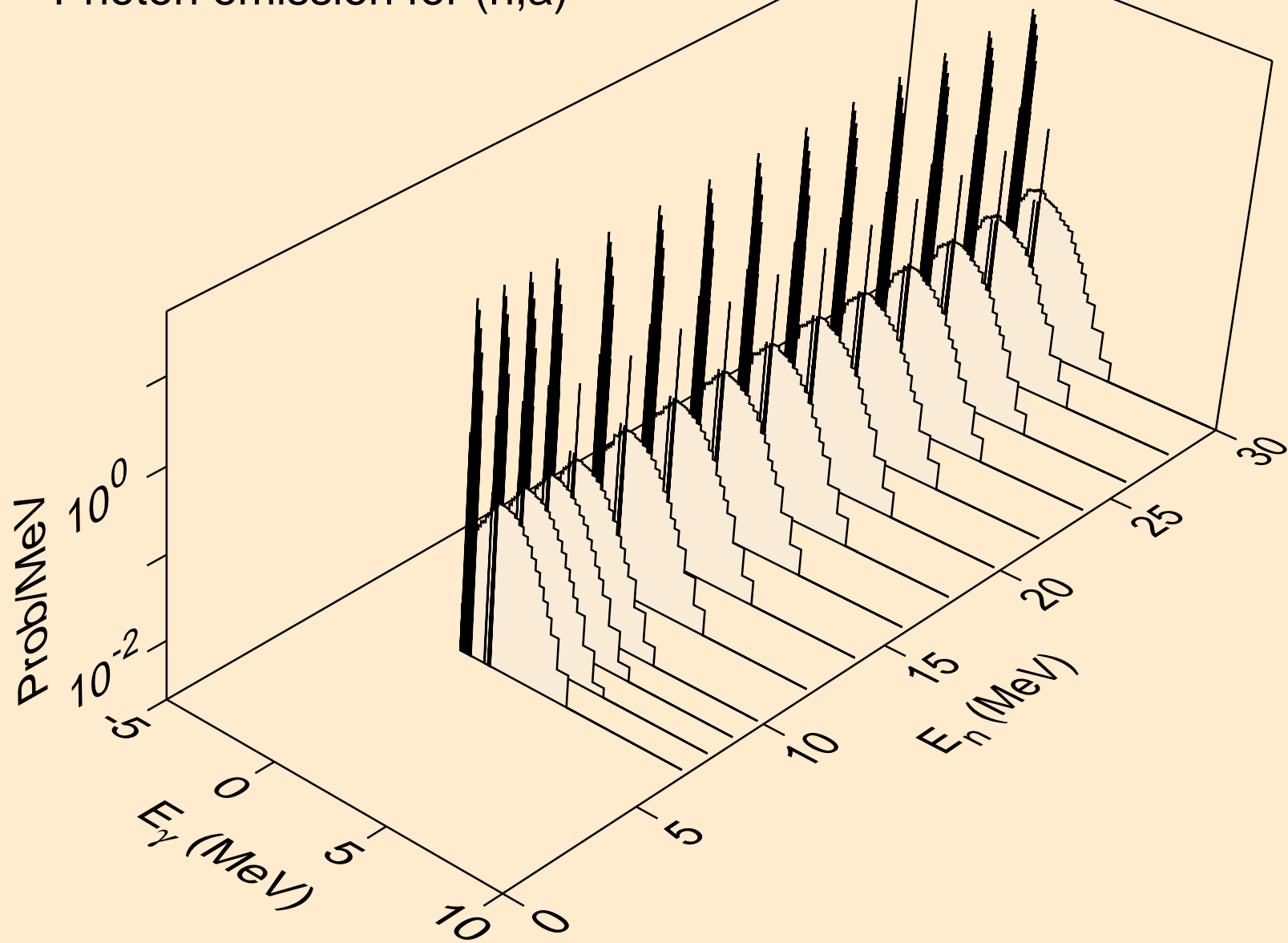

DY169 HELION ACER TENDL-2021 LIBRARY; T=0.K  
Photon emission for (n,2p)

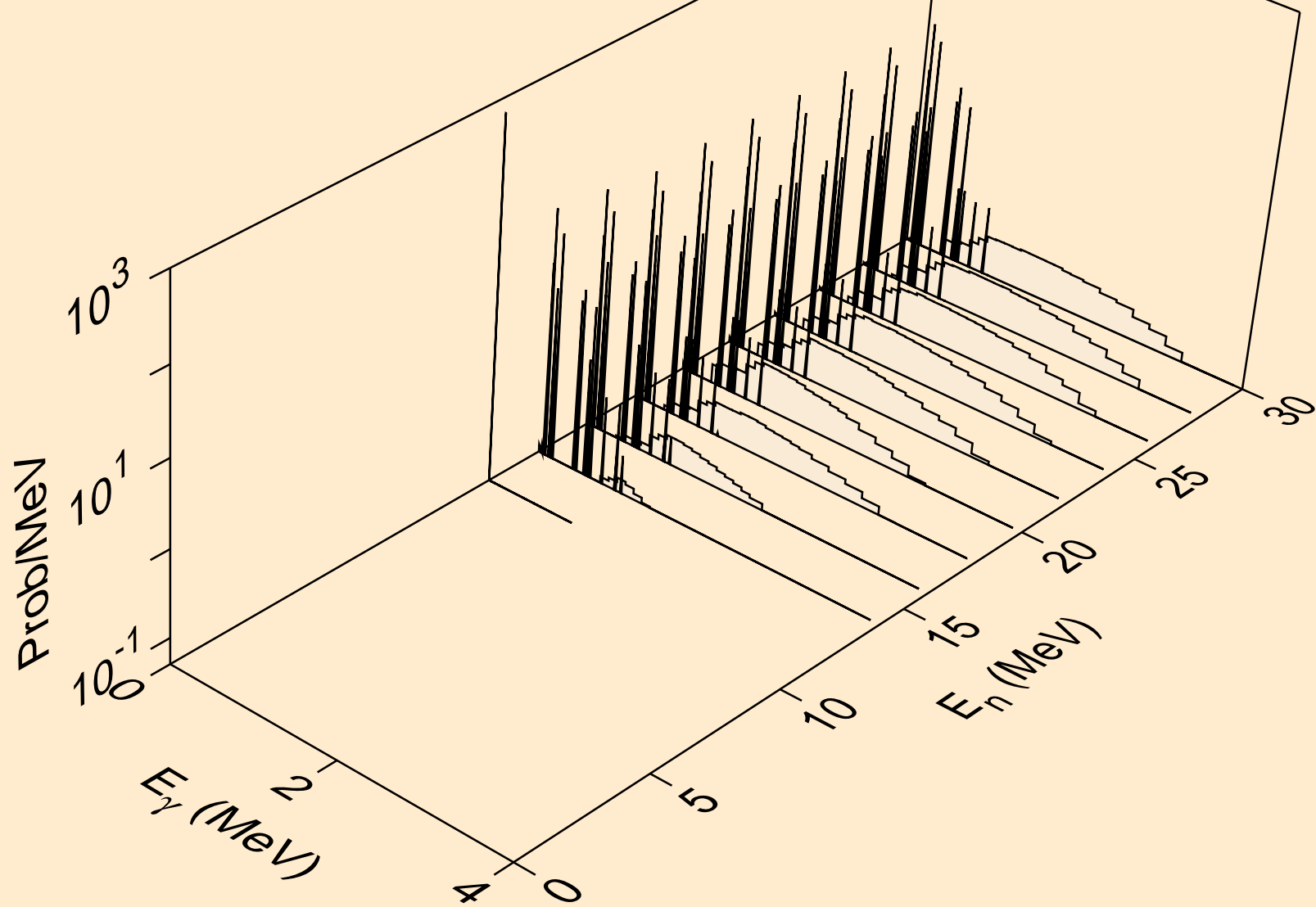



DY169 HELION ACER TENDL-2021 LIBRARY; T=0.K  
Photon emission for (n,pa)

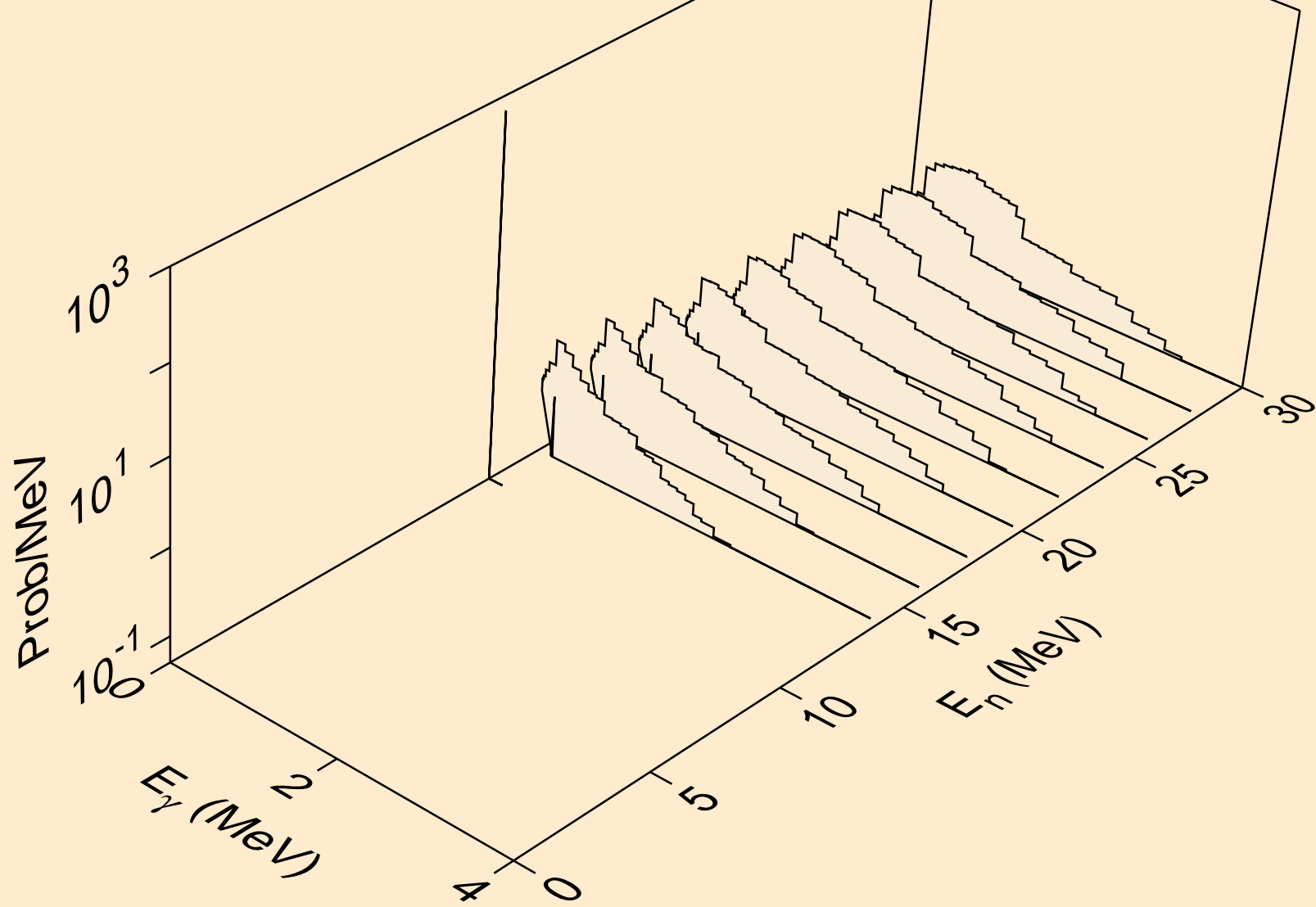

DY169 HELION ACER TENDL-2021 LIBRARY; T=0.K  
Photon emission for (n,pd)

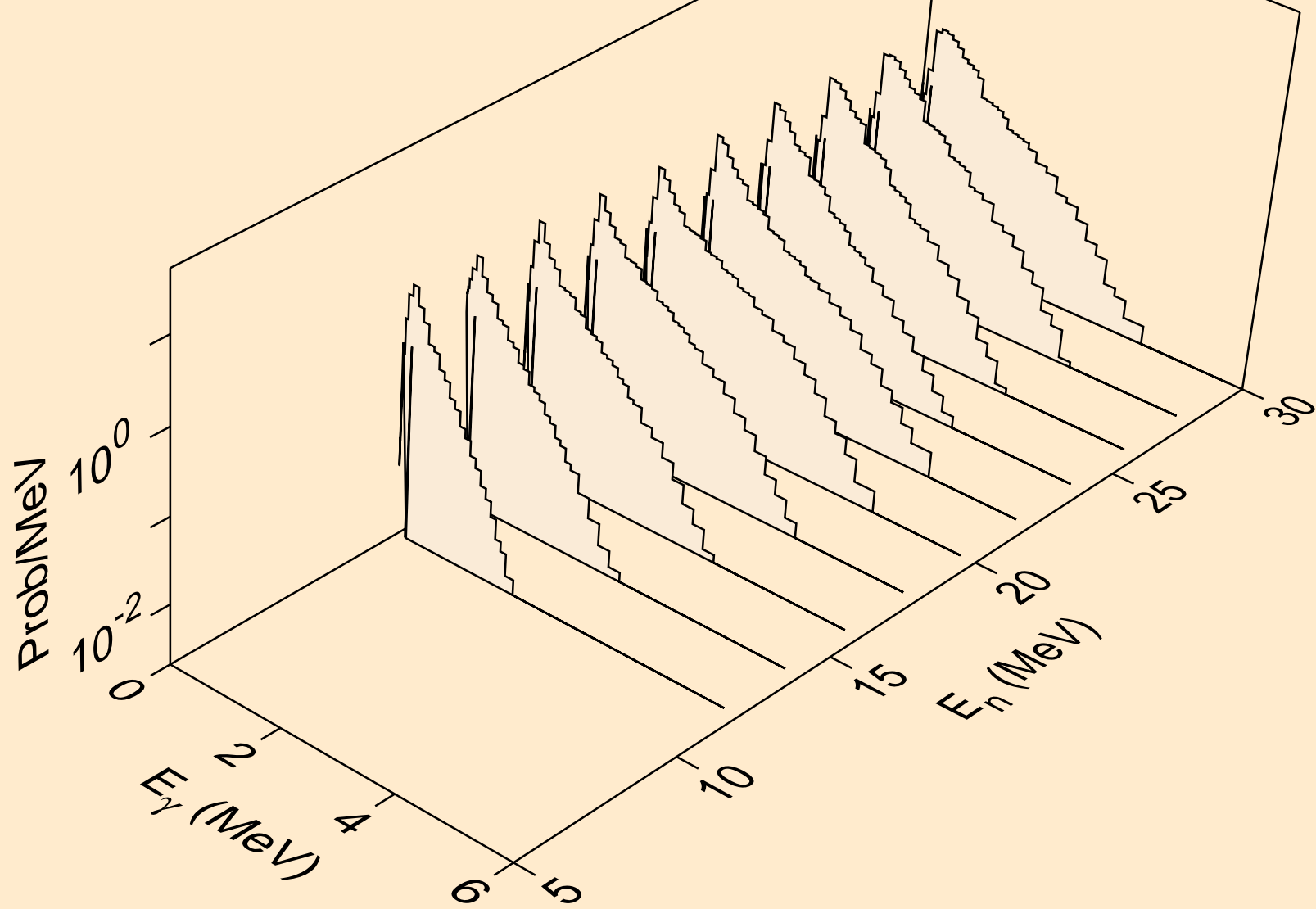

DY169 HELION ACER TENDL-2021 LIBRARY; T=0.K  
Photon emission for (n,pt)

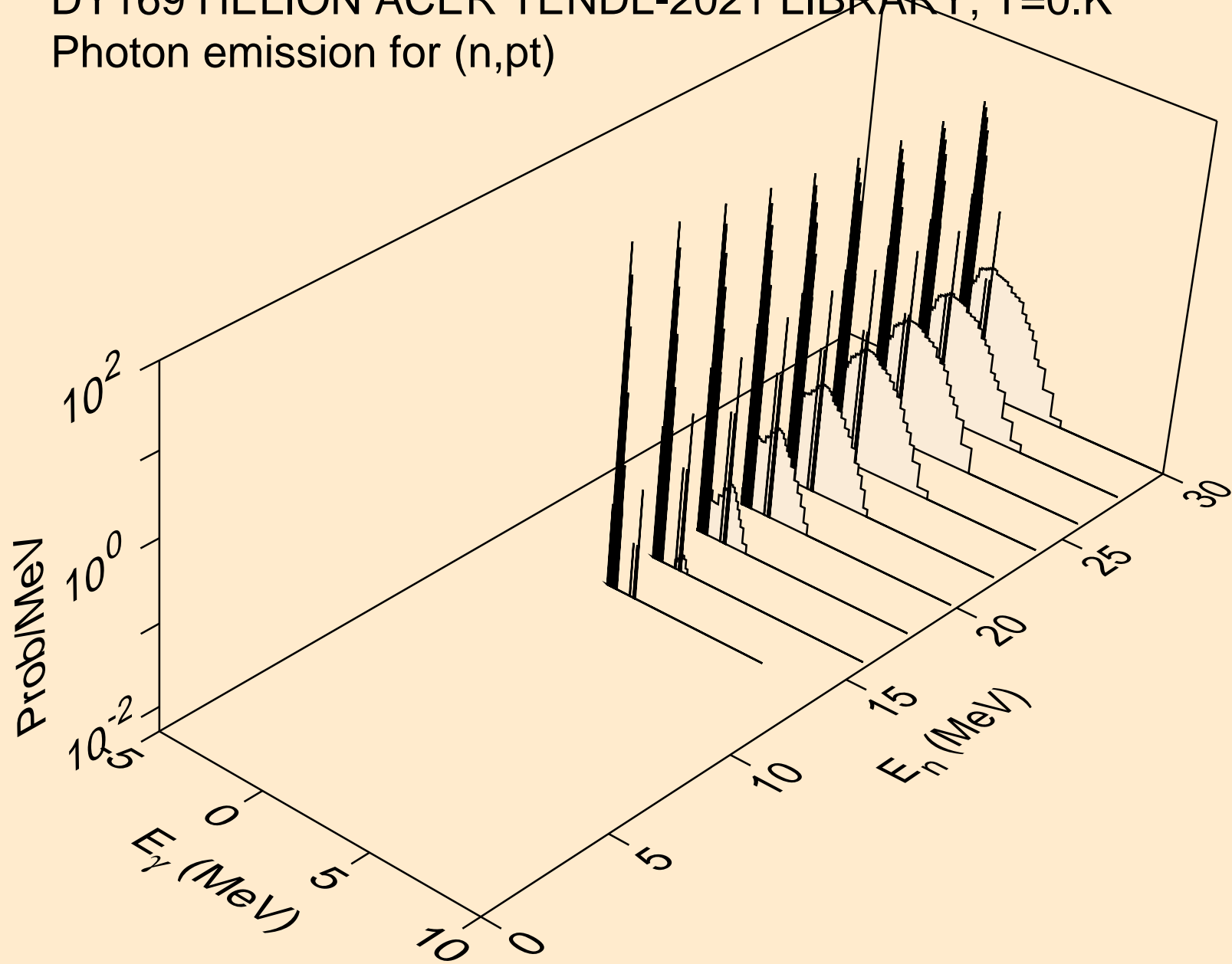

DY169 HELION ACER TENDL-2021 LIBRARY; T=0.K  
Particle heating contributions

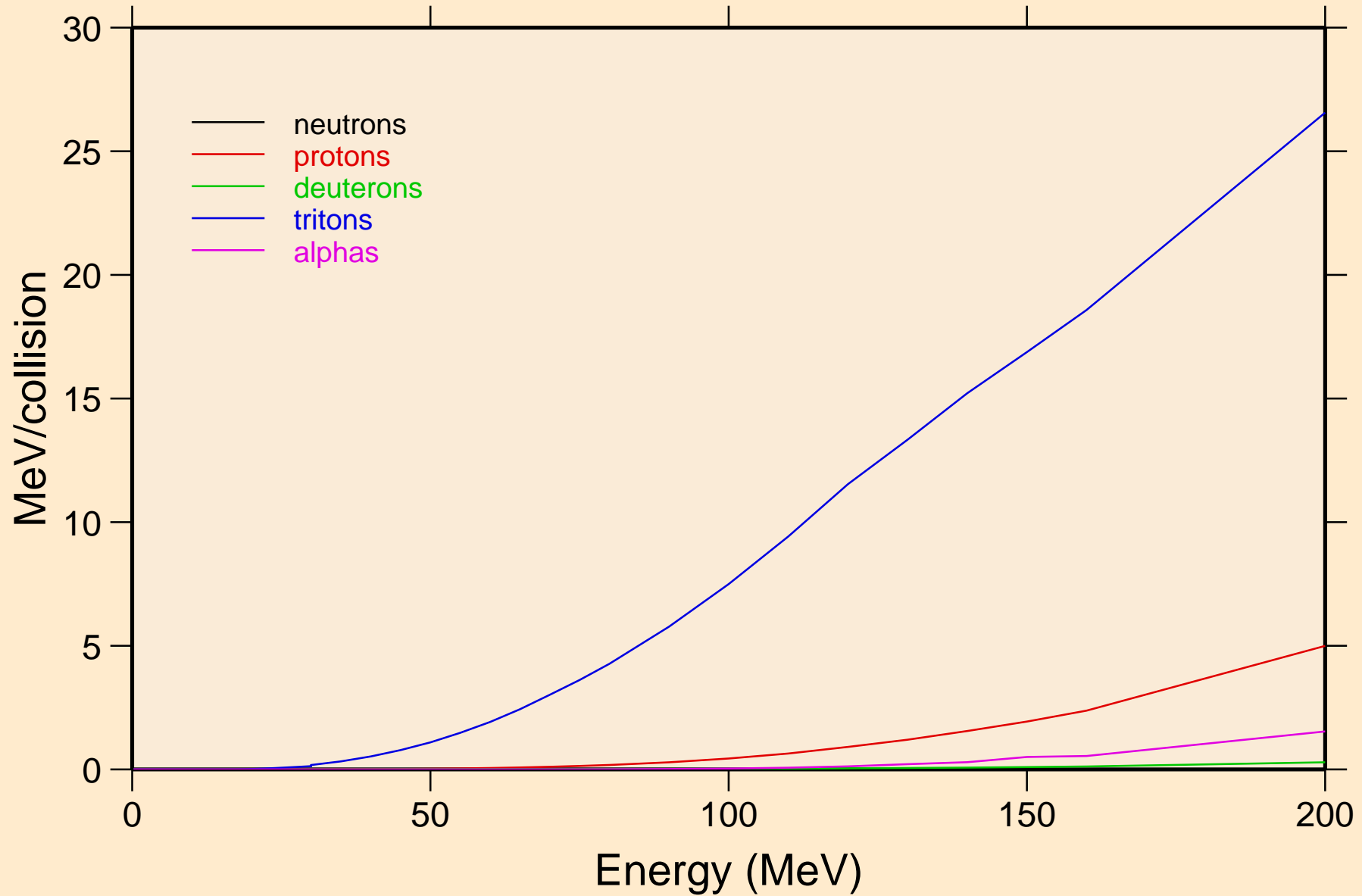

DY169 HELION ACER TENDL-2021 LIBRARY; T=0.K  
Recoil Heating

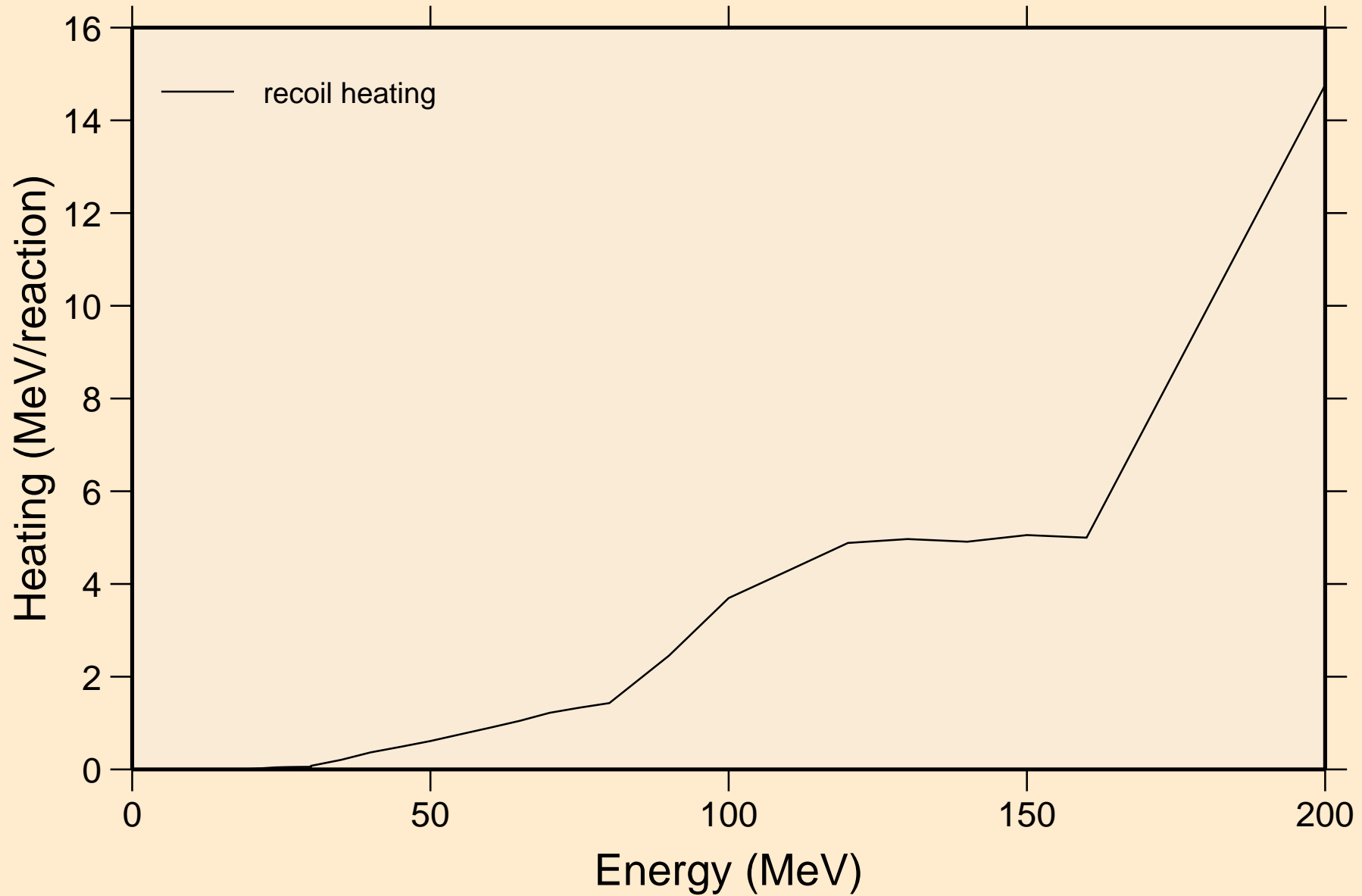

DY169 HELION ACER TENDL-2021 LIBRARY; T=0.K  
Particle production cross sections

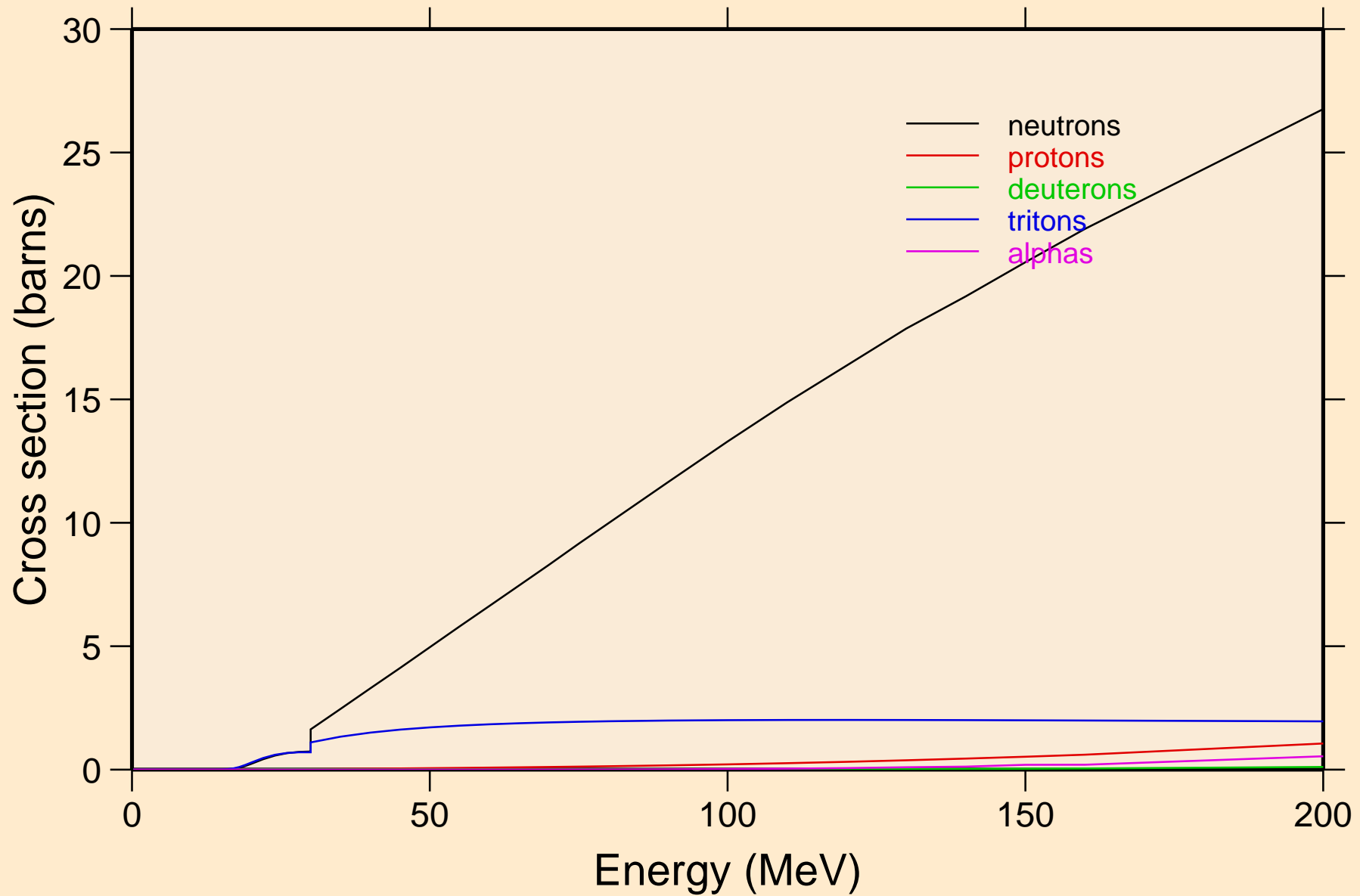

DY169 HELION ACER TENDL-2021 LIBRARY; T=0.K  
neutrons from (s,n)

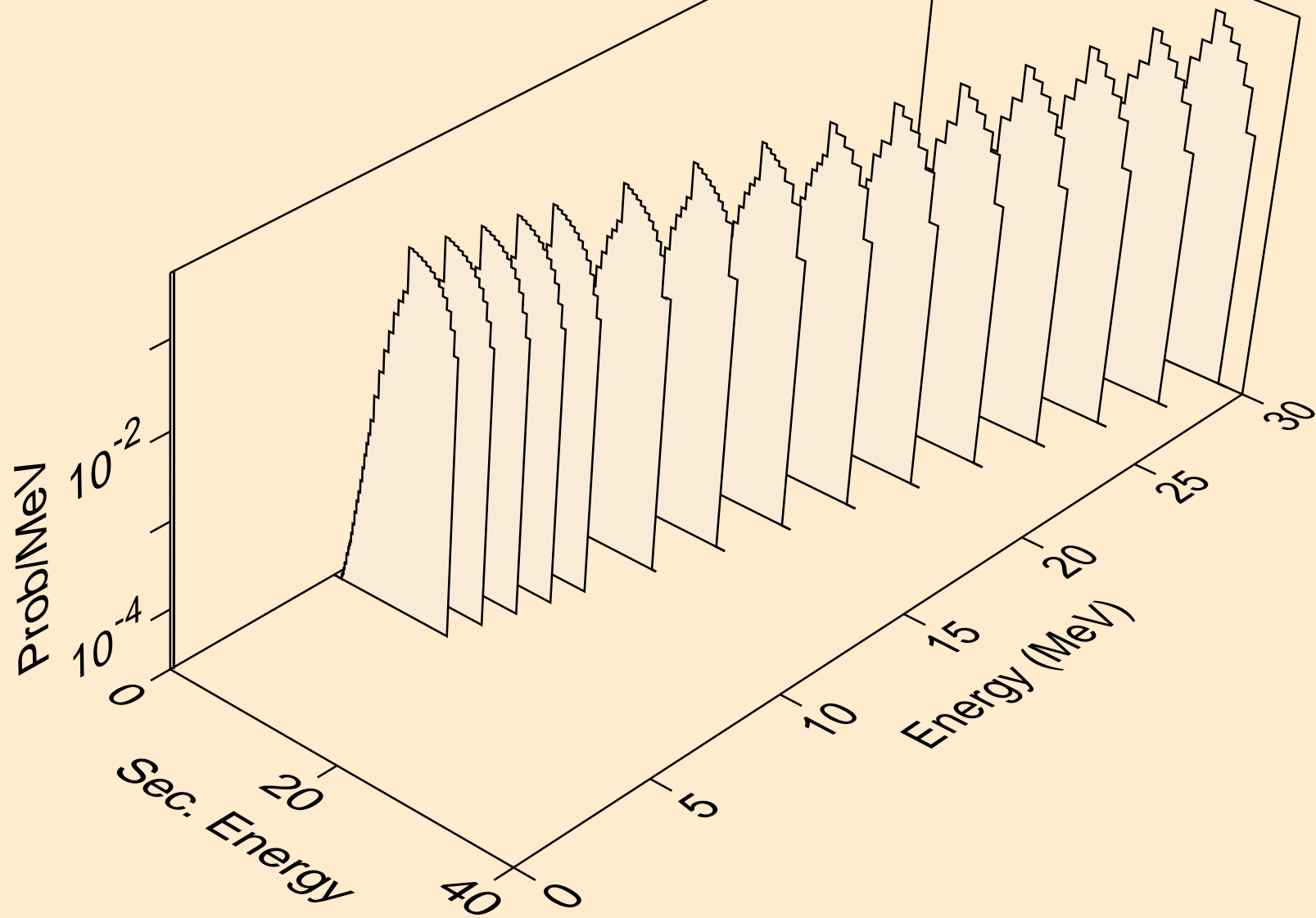

DY169 HELION ACER TENDL-2021 LIBRARY; T=0.K  
neutrons from (s,x)

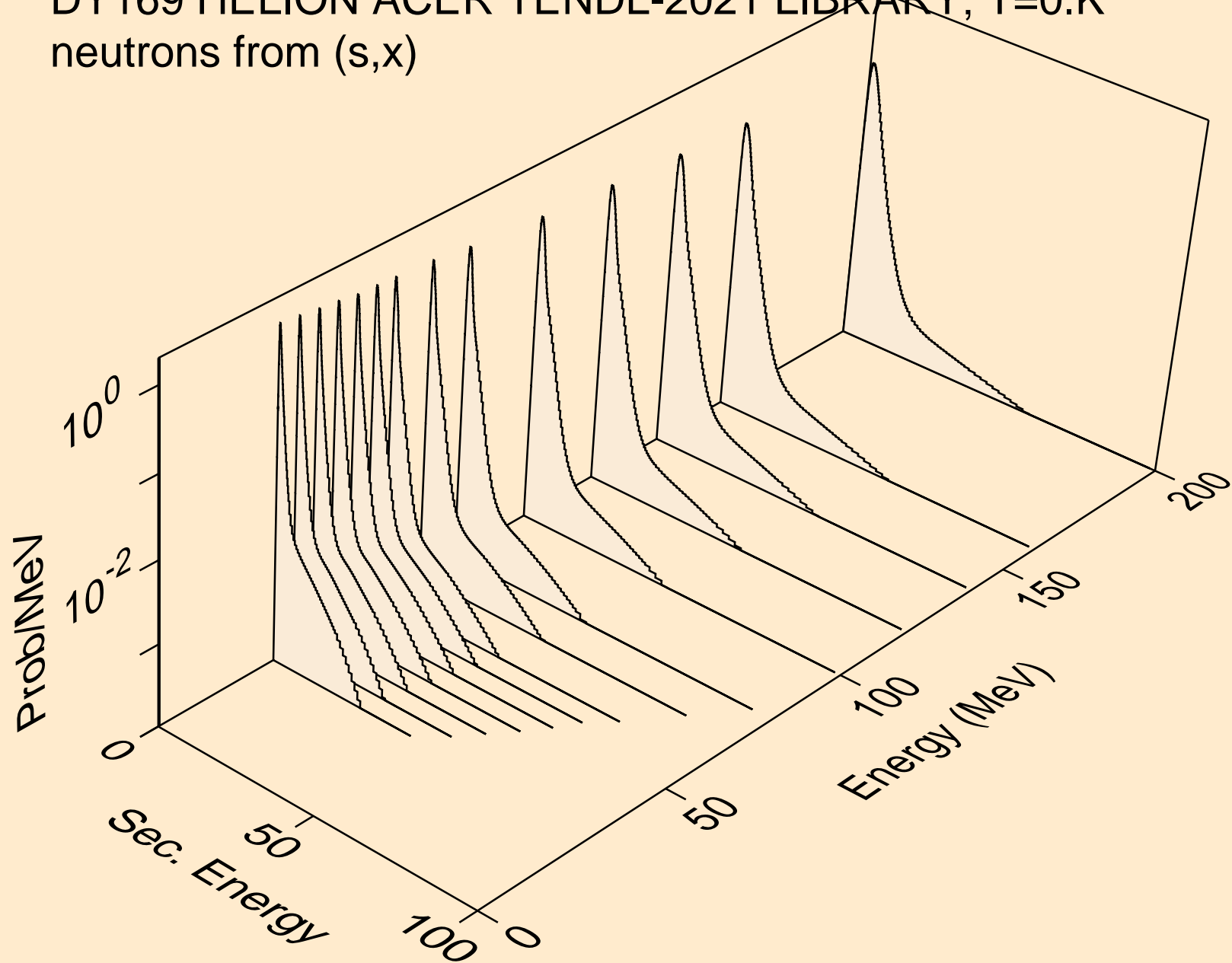



DY169 HELION ACER TENDL-2021 LIBRARY; T=0.K  
neutrons from (s,2nd)

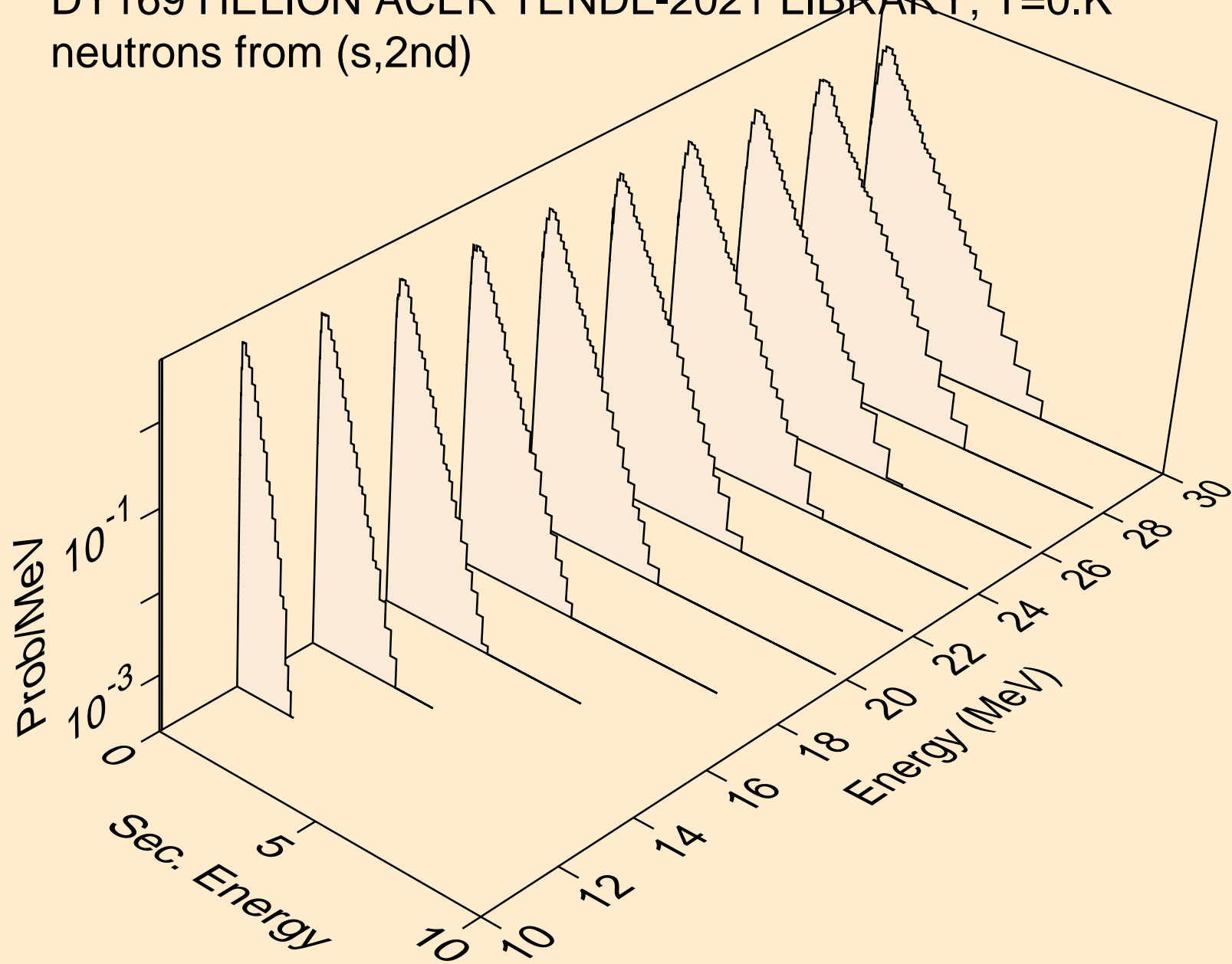

DY169 HELION ACER TENDL-2021 LIBRARY; T=0.K  
neutrons from (s,2n)

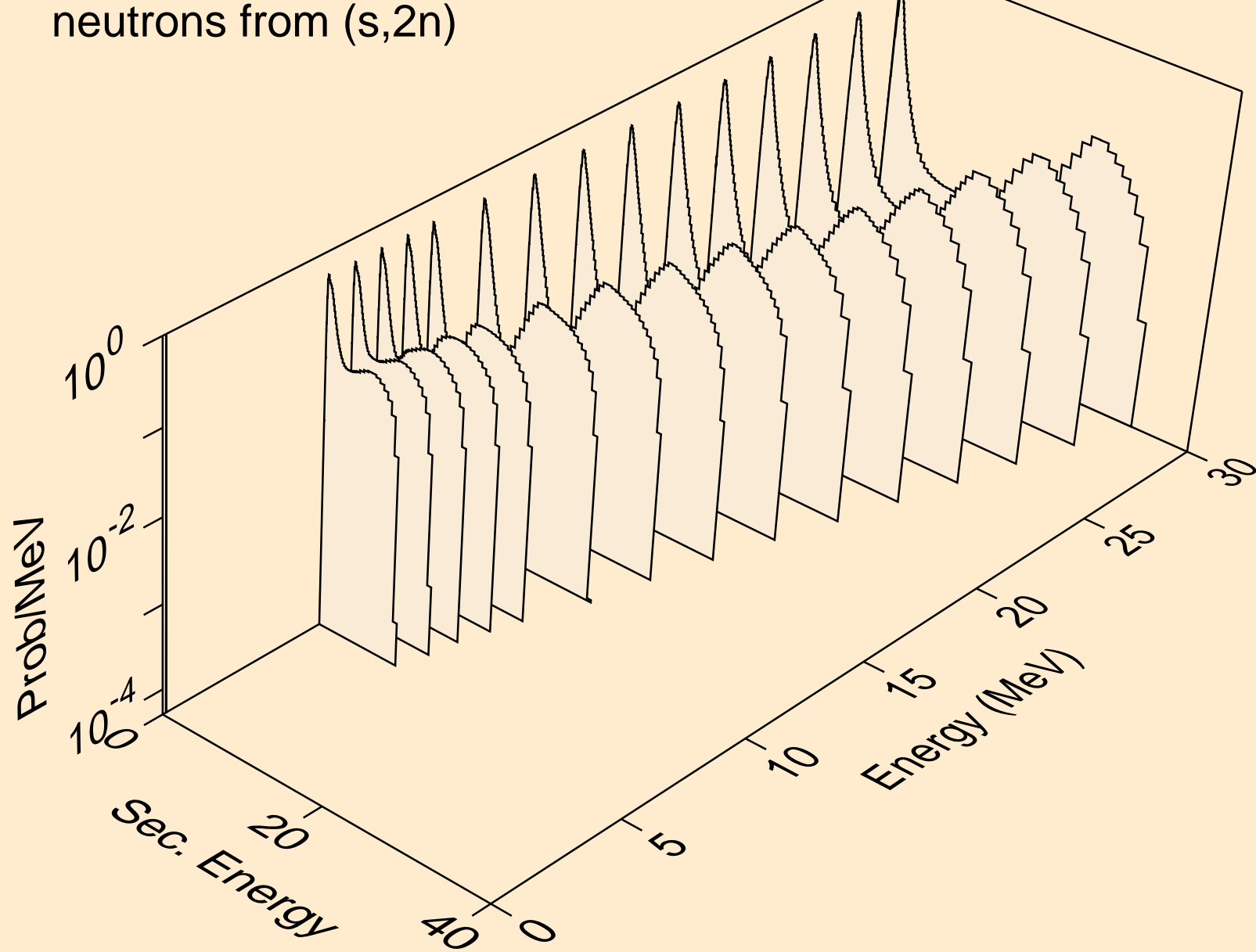

DY169 HELION ACER TENDL-2021 LIBRARY; T=0.K  
neutrons from (s,3n)

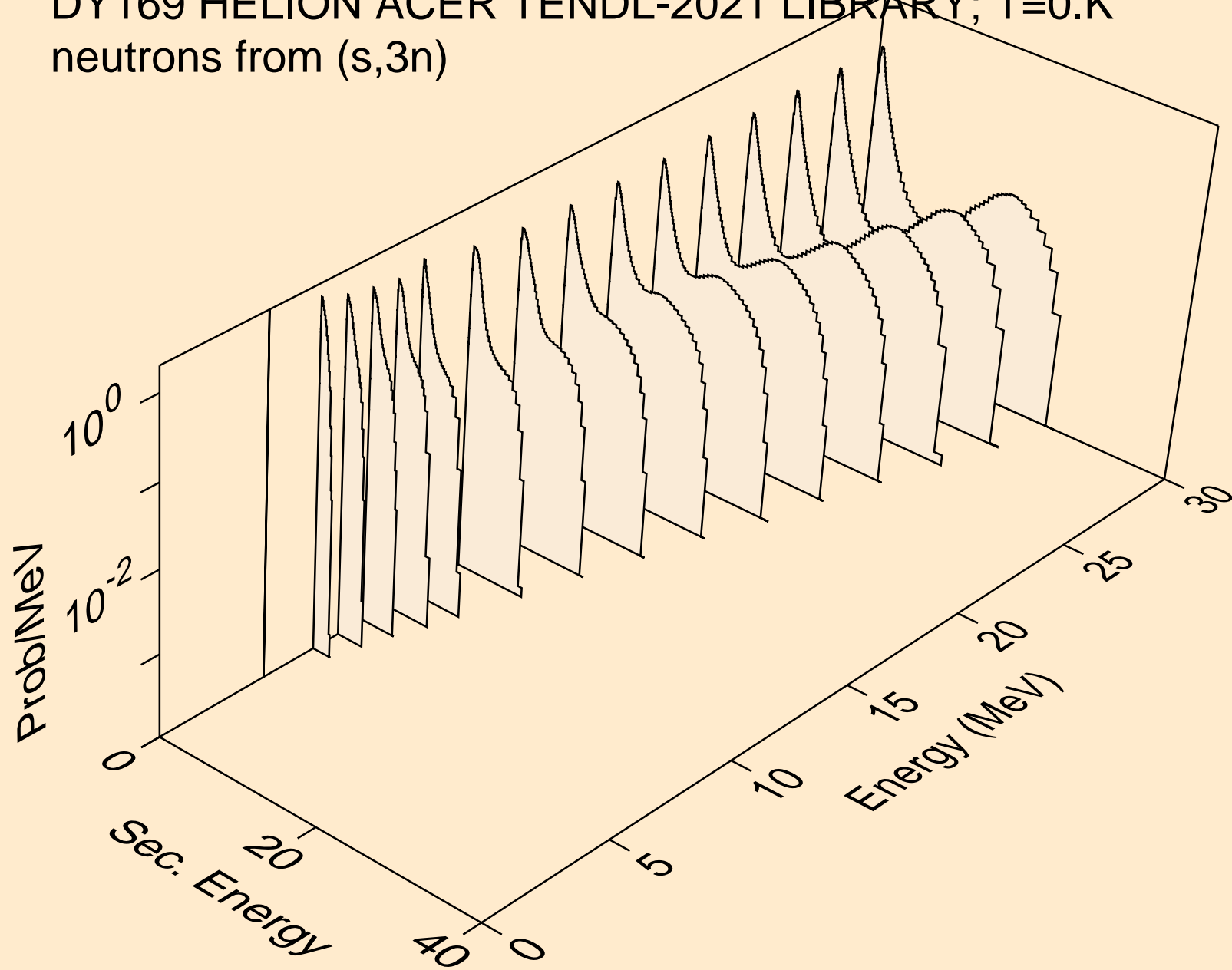

DY169 HELION ACER TENDL-2021 LIBRARY; T=0.K  
neutrons from (s,n\*)a

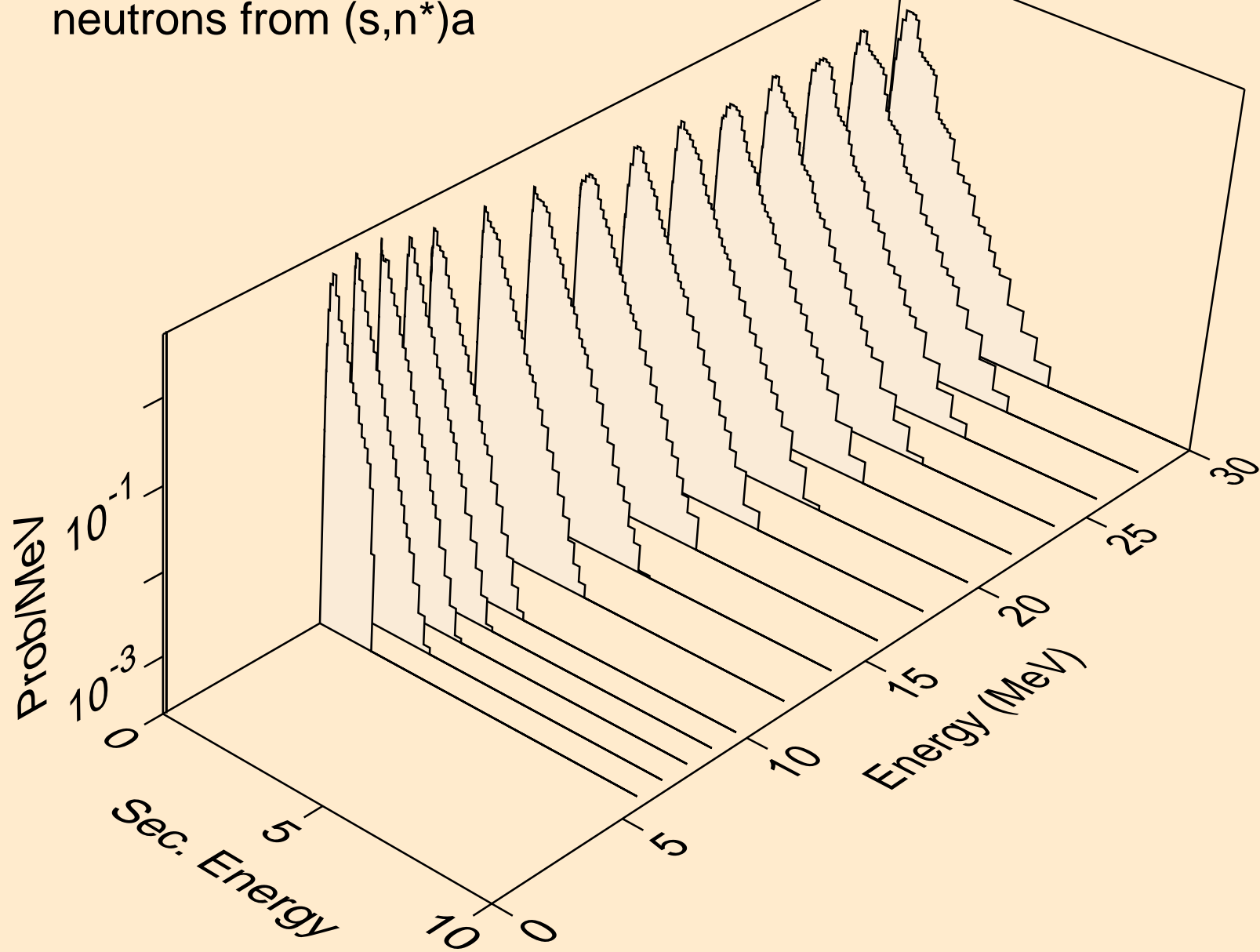

DY169 HELION ACER TENDL-2021 LIBRARY; T=0.K  
neutrons from (s,2n)a

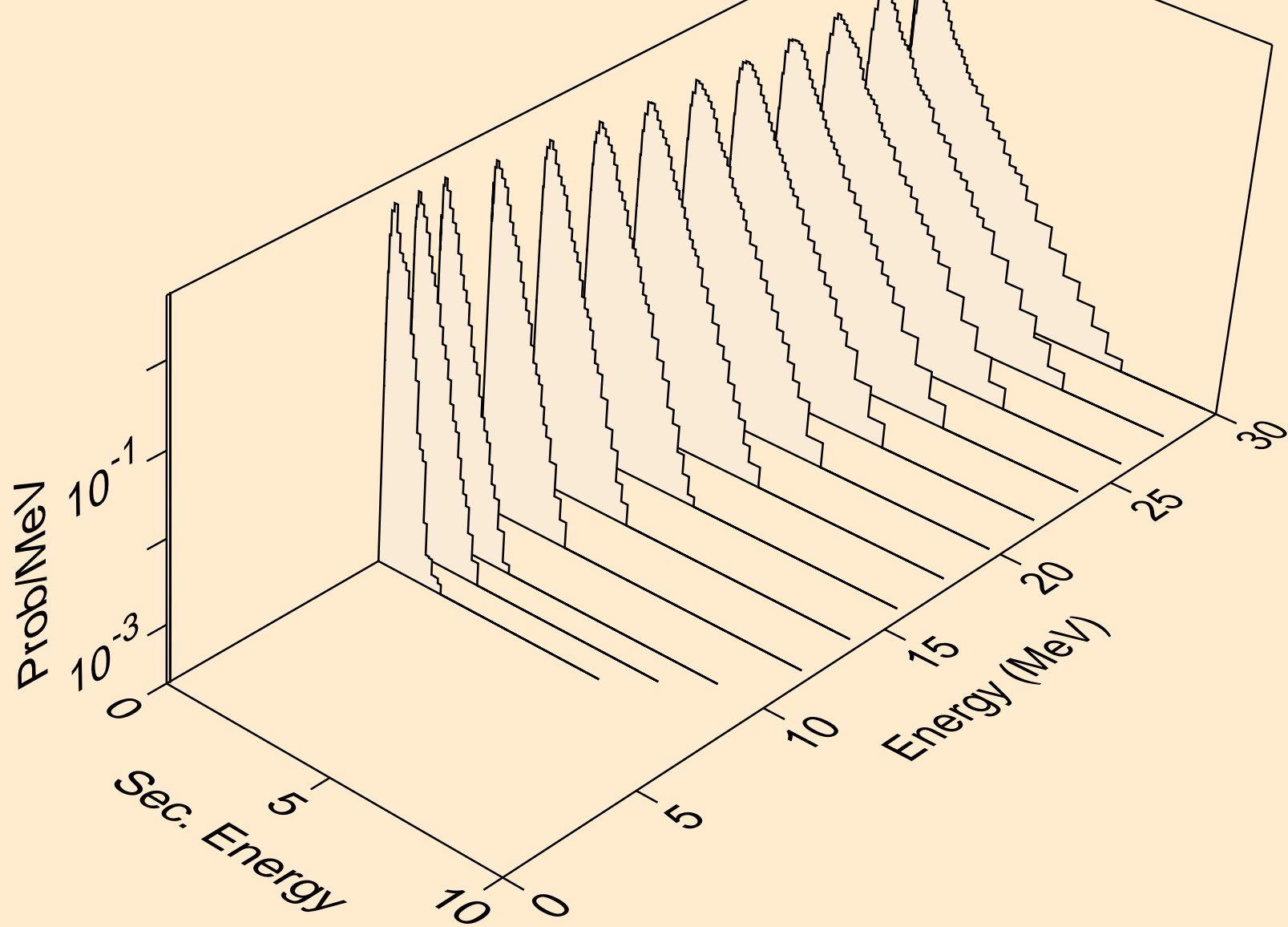

DY169 HELION ACER TENDL-2021 LIBRARY; T=0.K  
neutrons from (s,3n)a

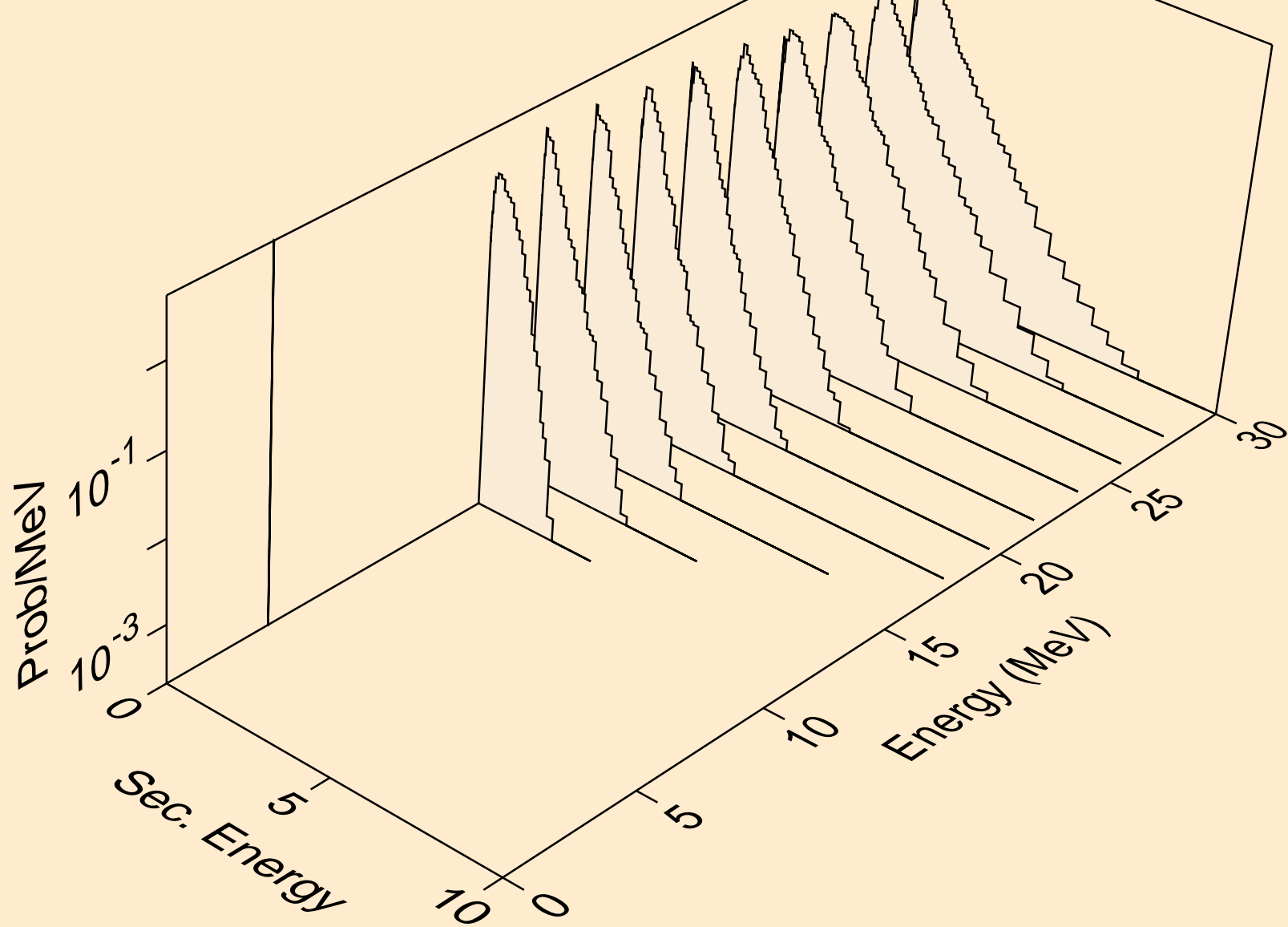

DY169 HELION ACER TENDL-2021 LIBRARY; T=0.K  
neutrons from (s,n\*)p

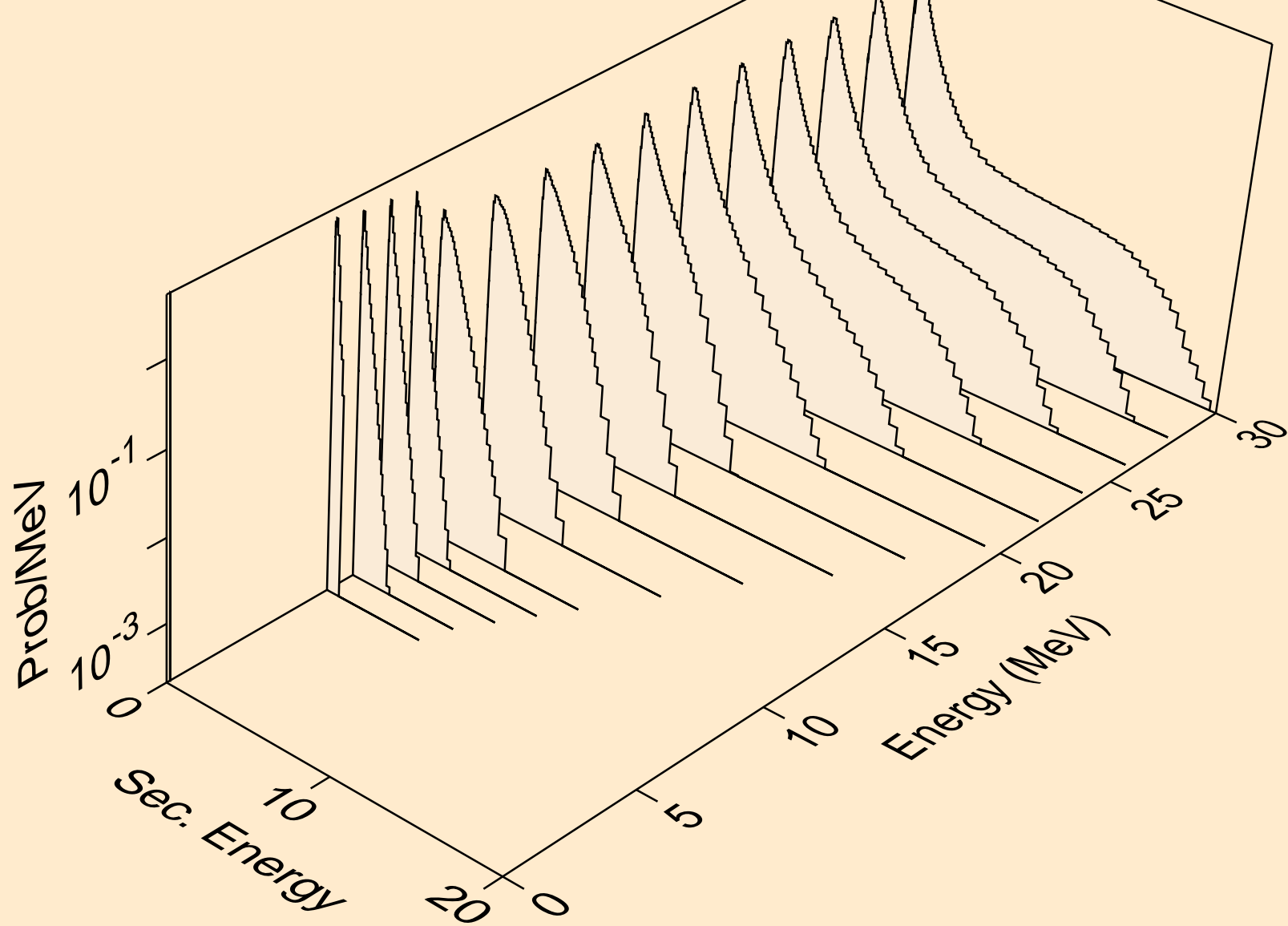

DY169 HELION ACER TENDL-2021 LIBRARY; T=0.K  
neutrons from (s,n\*)d

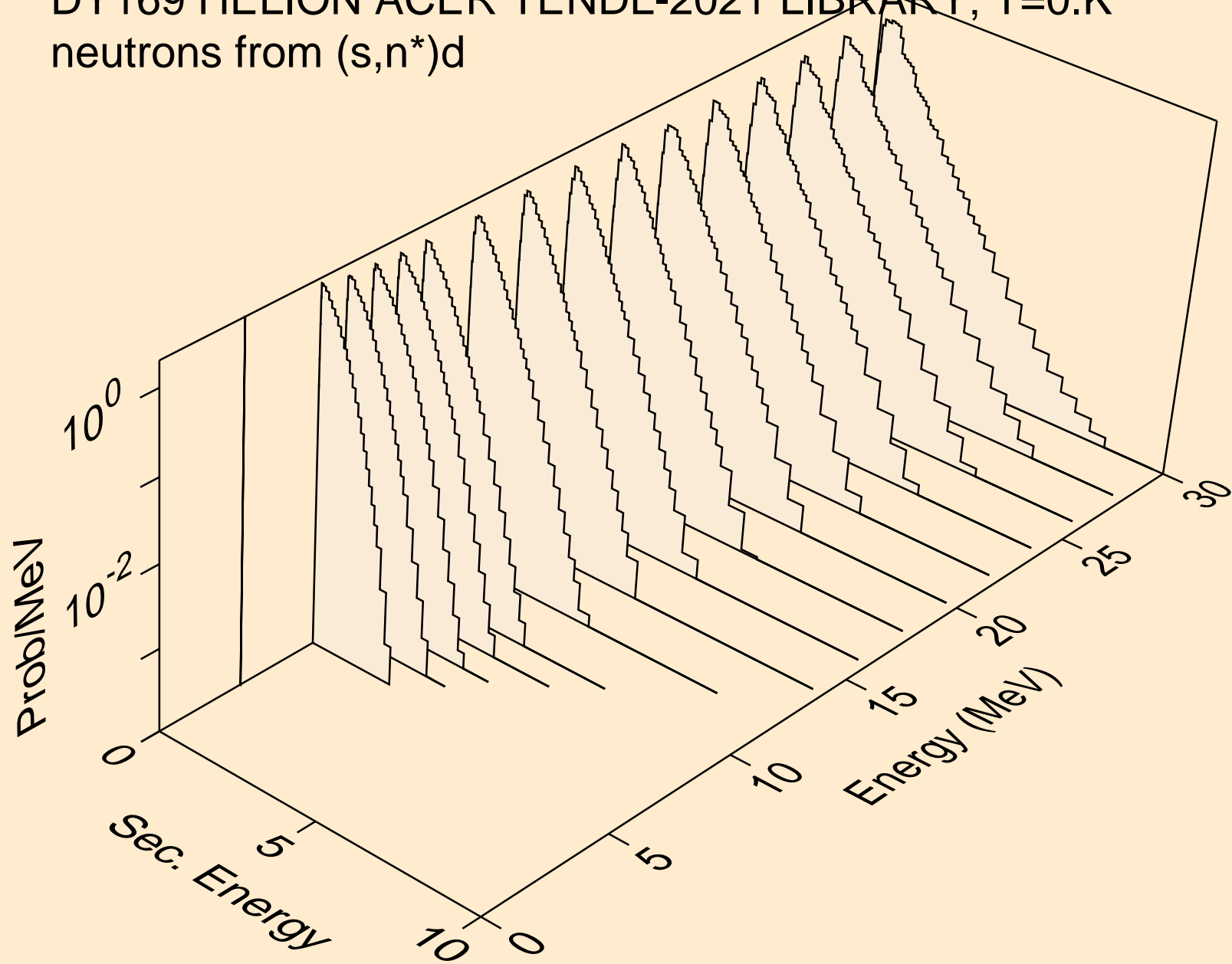



DY169 HELION ACER TENDL-2021 LIBRARY; T=0.K  
neutrons from (s,n\*)t

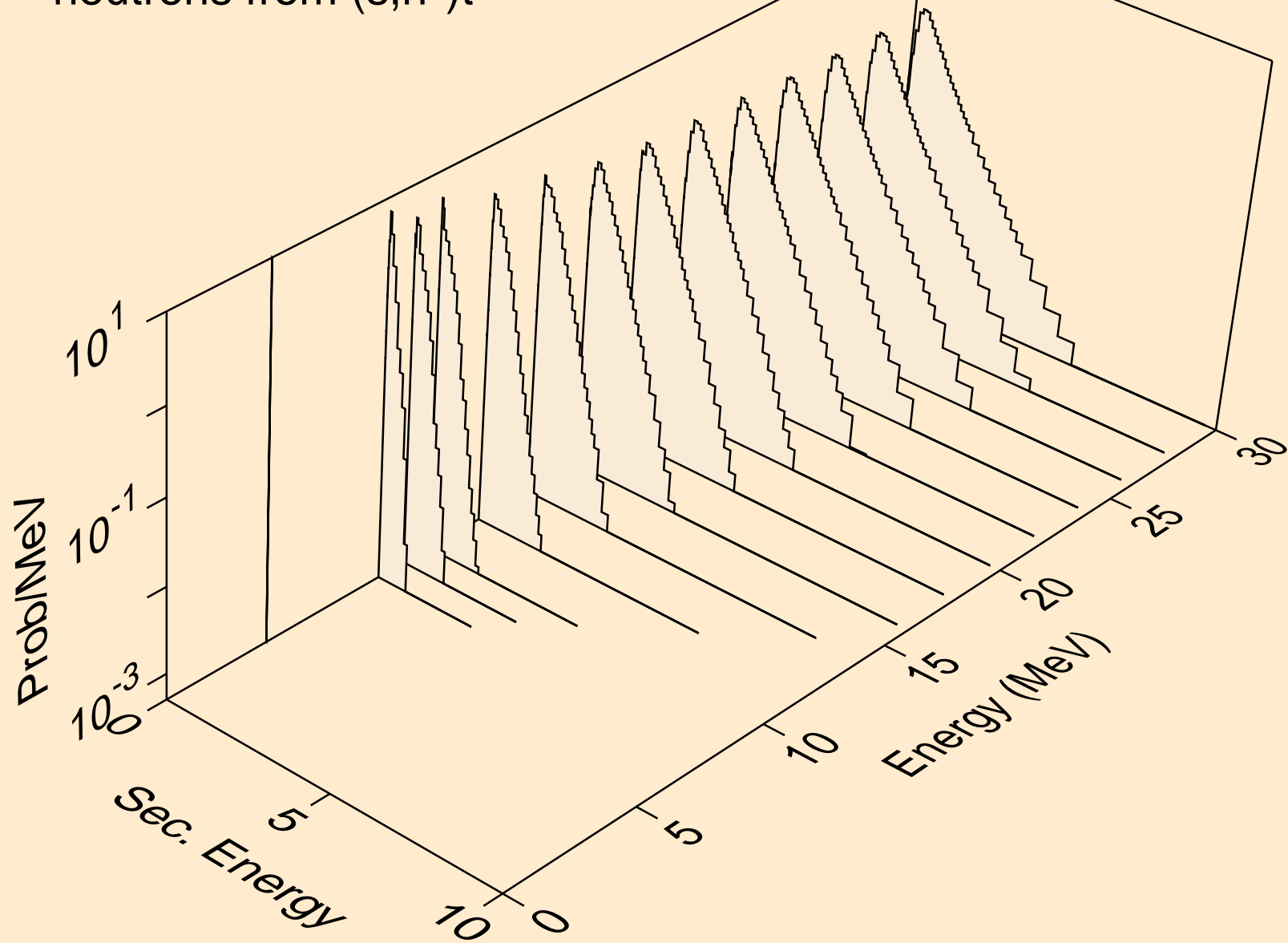

DY169 HELION ACER TENDL-2021 LIBRARY; T=0.K  
neutrons from (s,n\*)he3

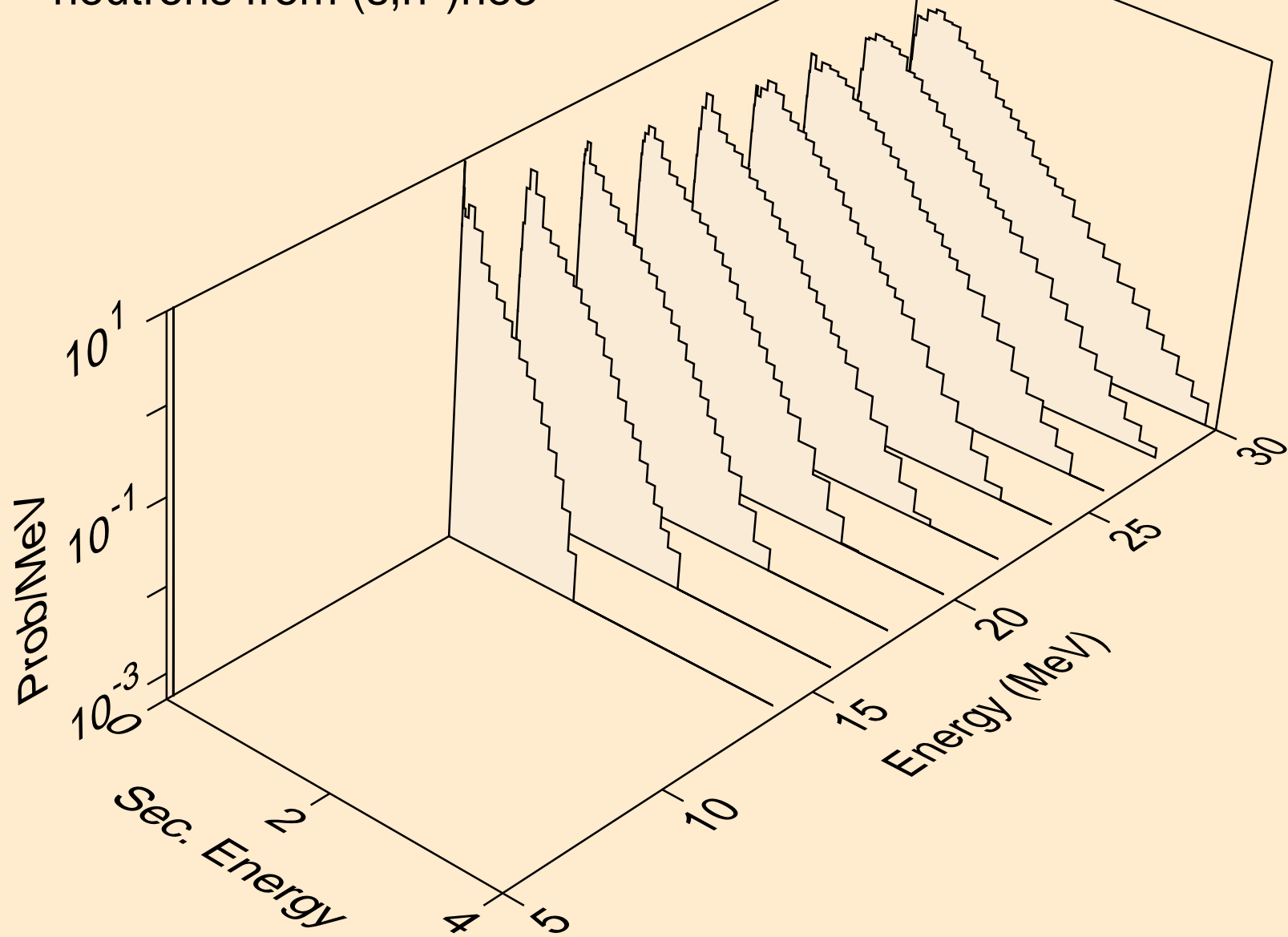

DY169 HELION ACER TENDL-2021 LIBRARY; T=0.K  
neutrons from (s,4n)

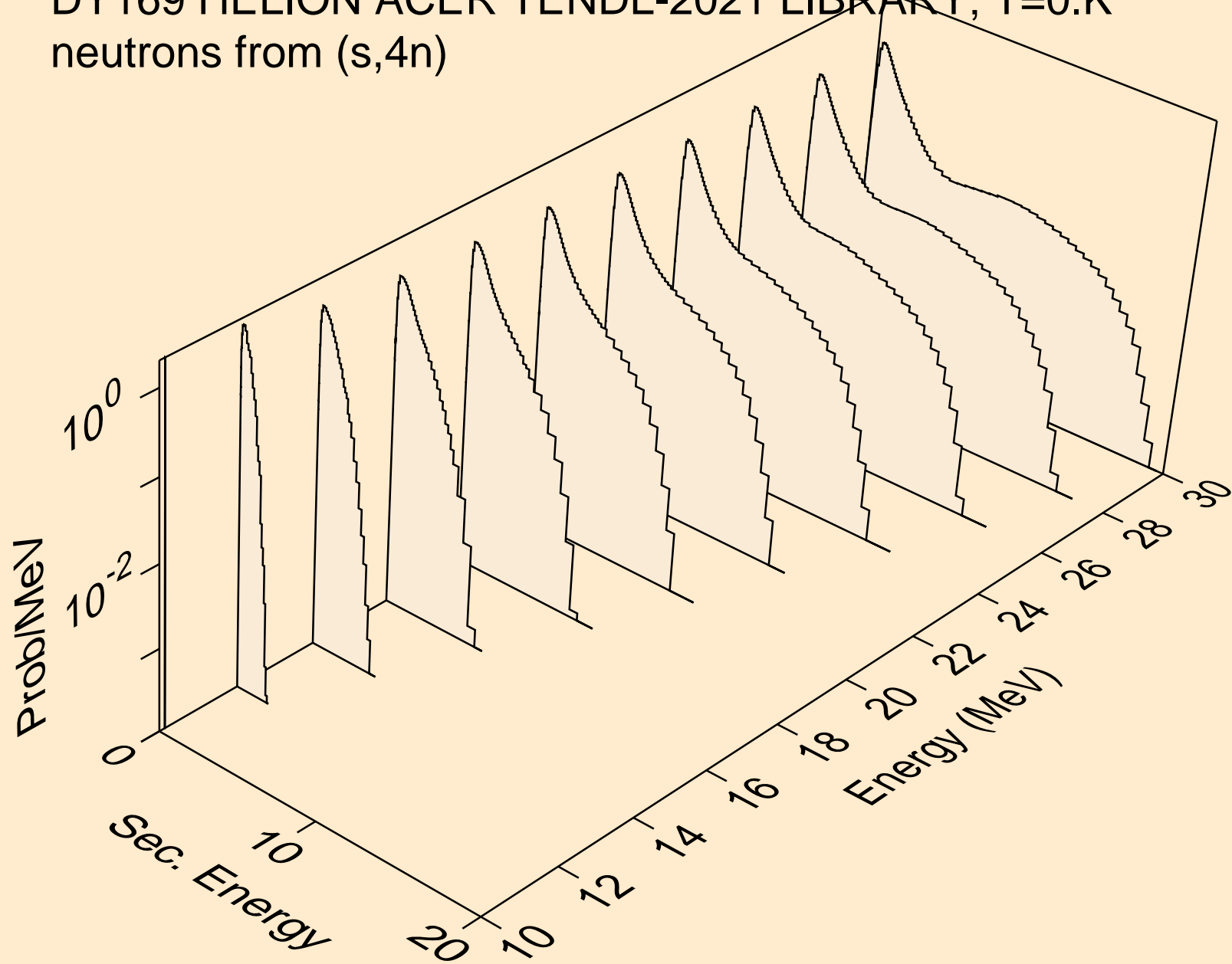

DY169 HELION ACER TENDL-2021 LIBRARY; T=0.K  
neutrons from (s,2np)

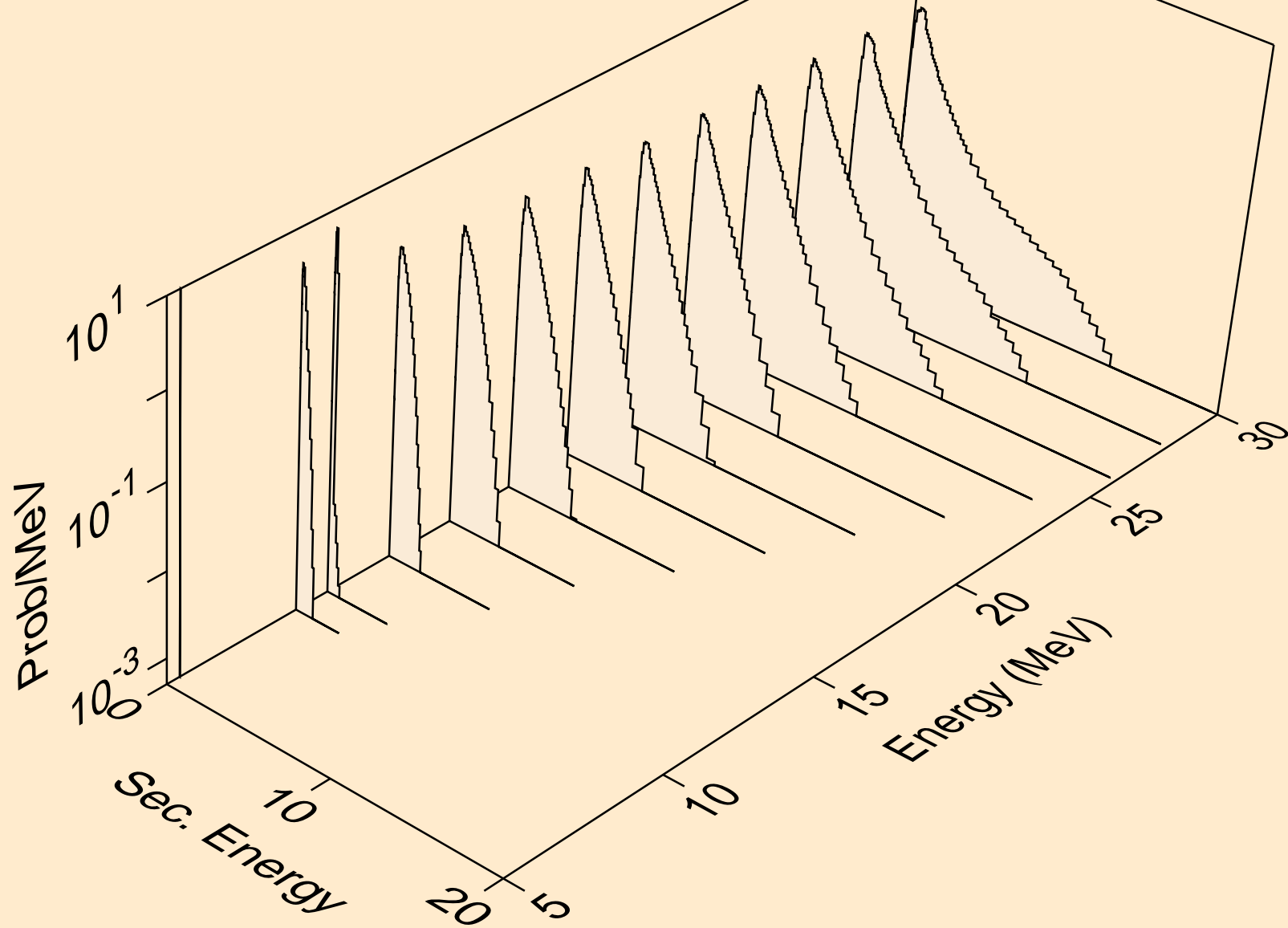

DY169 HELION ACER TENDL-2021 LIBRARY; T=0.K  
neutrons from (s,3np)

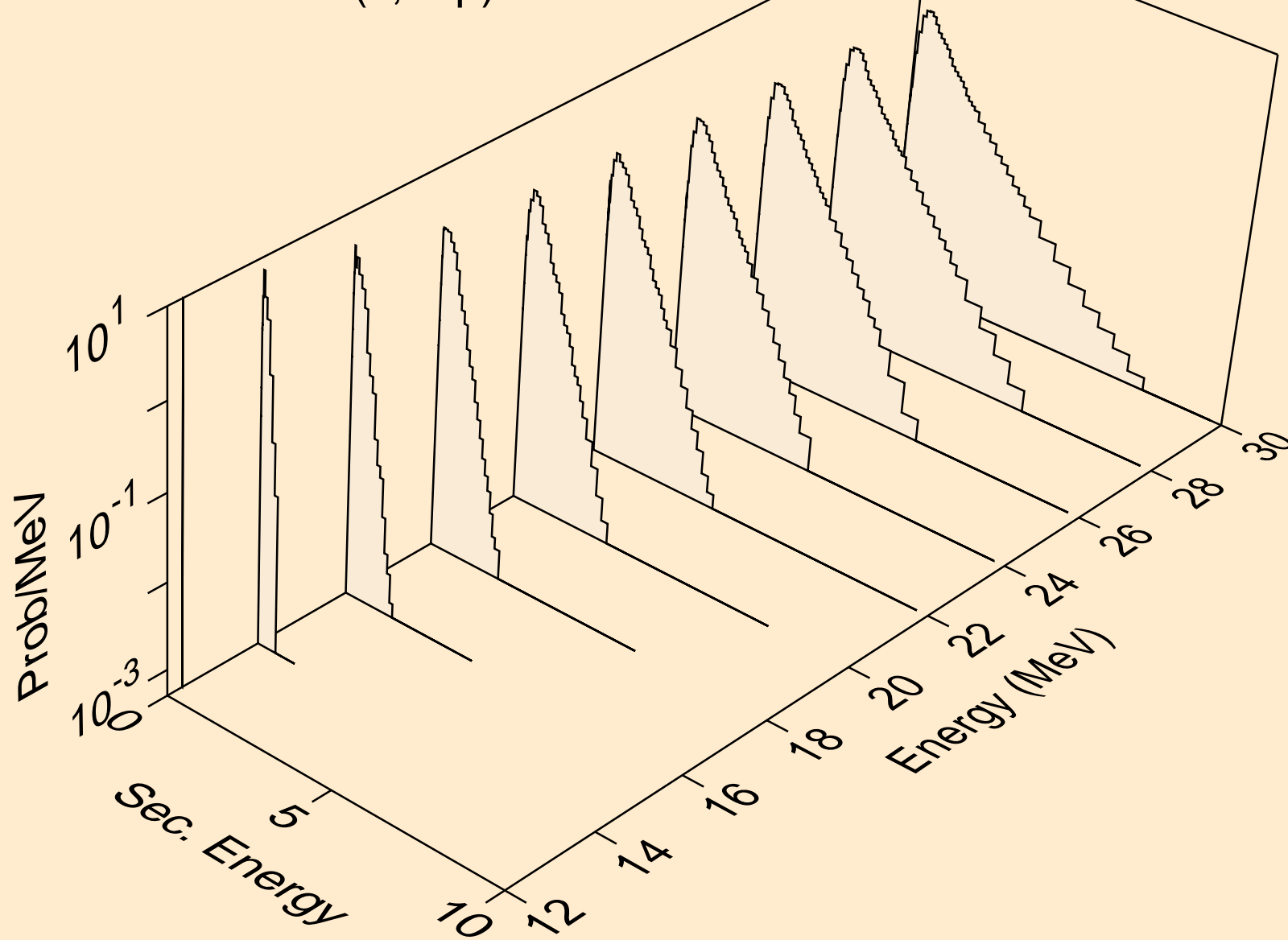

DY169 HELION ACER TENDL-2021 LIBRARY; T=0.K  
neutrons from (s,2np)

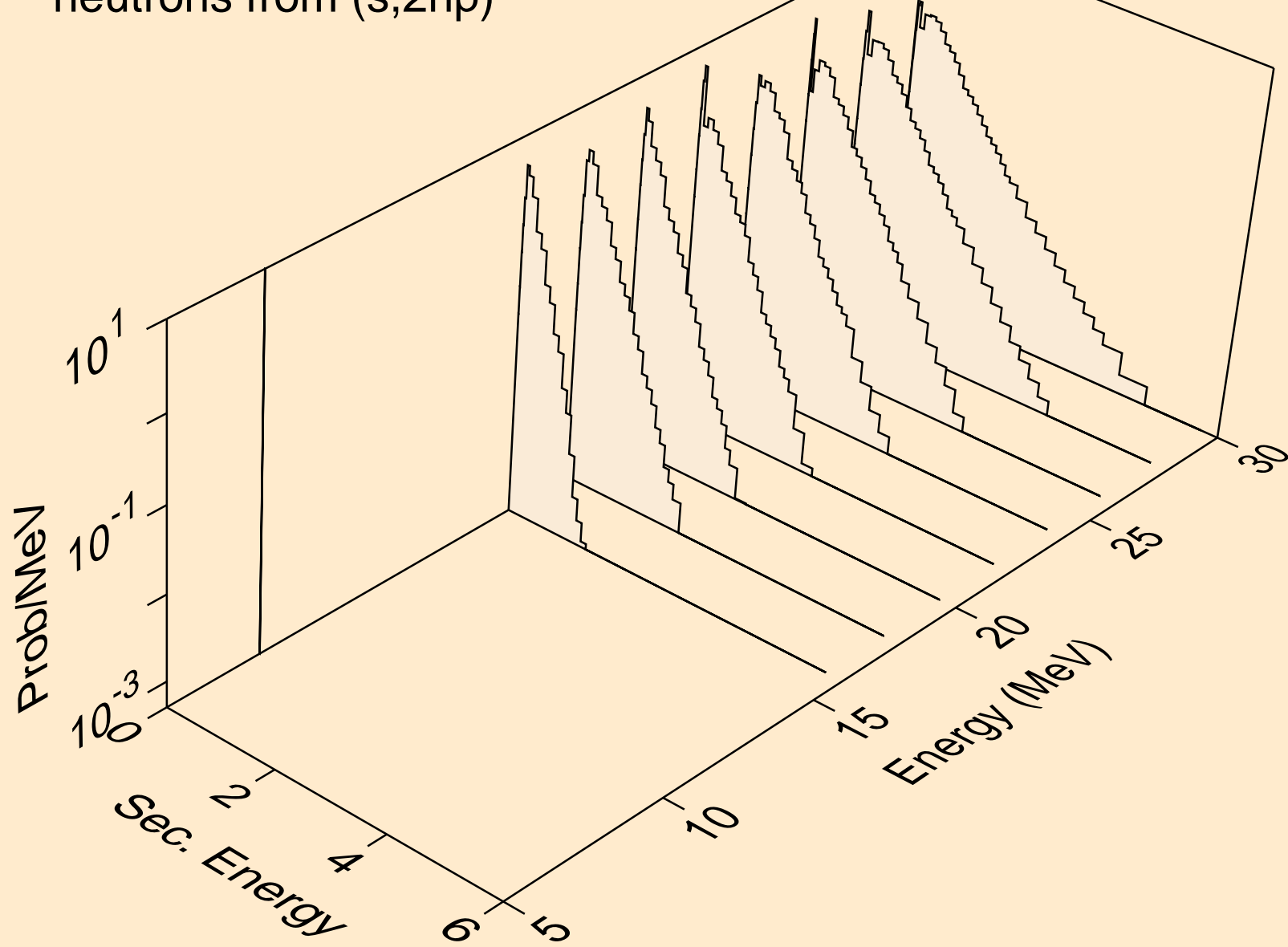

DY169 HELION ACER TENDL-2021 LIBRARY; T=0.K  
neutrons from (s,npa)

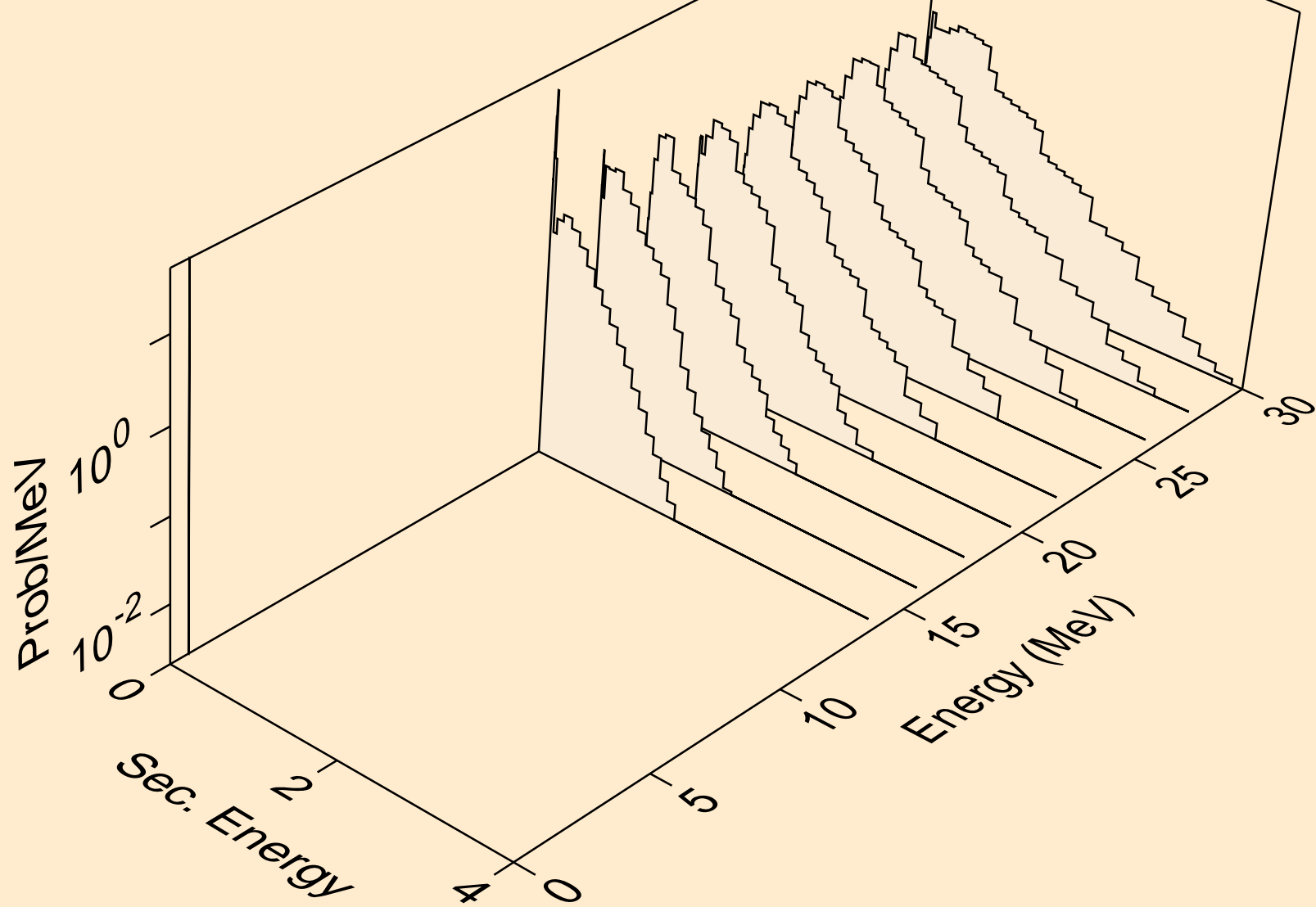

DY169 HELION ACER TENDL-2021 LIBRARY; T=0.K  
protons from (s,x)

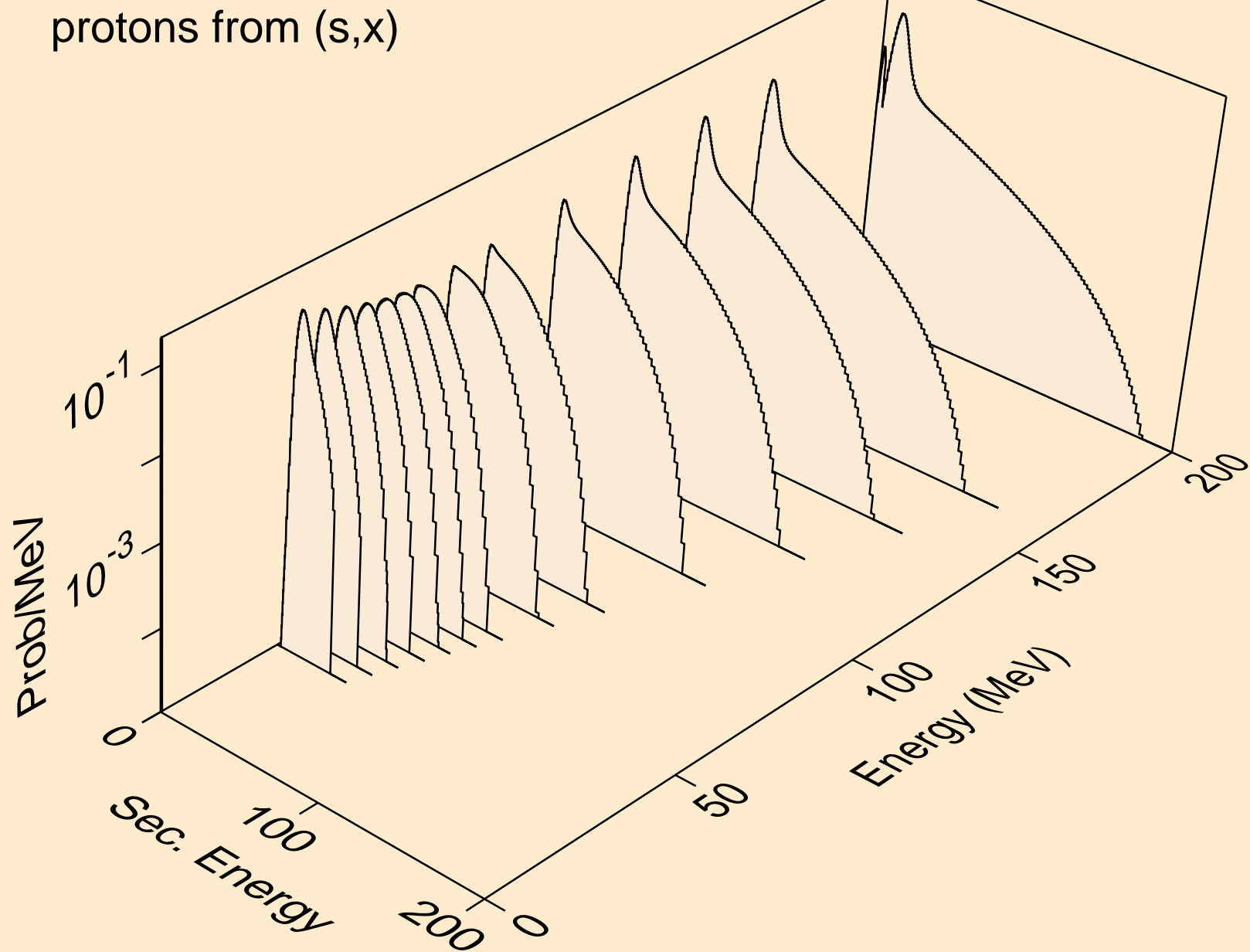



DY169 HELION ACER TENDL-2021 LIBRARY; T=0.K  
protons from (s,n\*)p

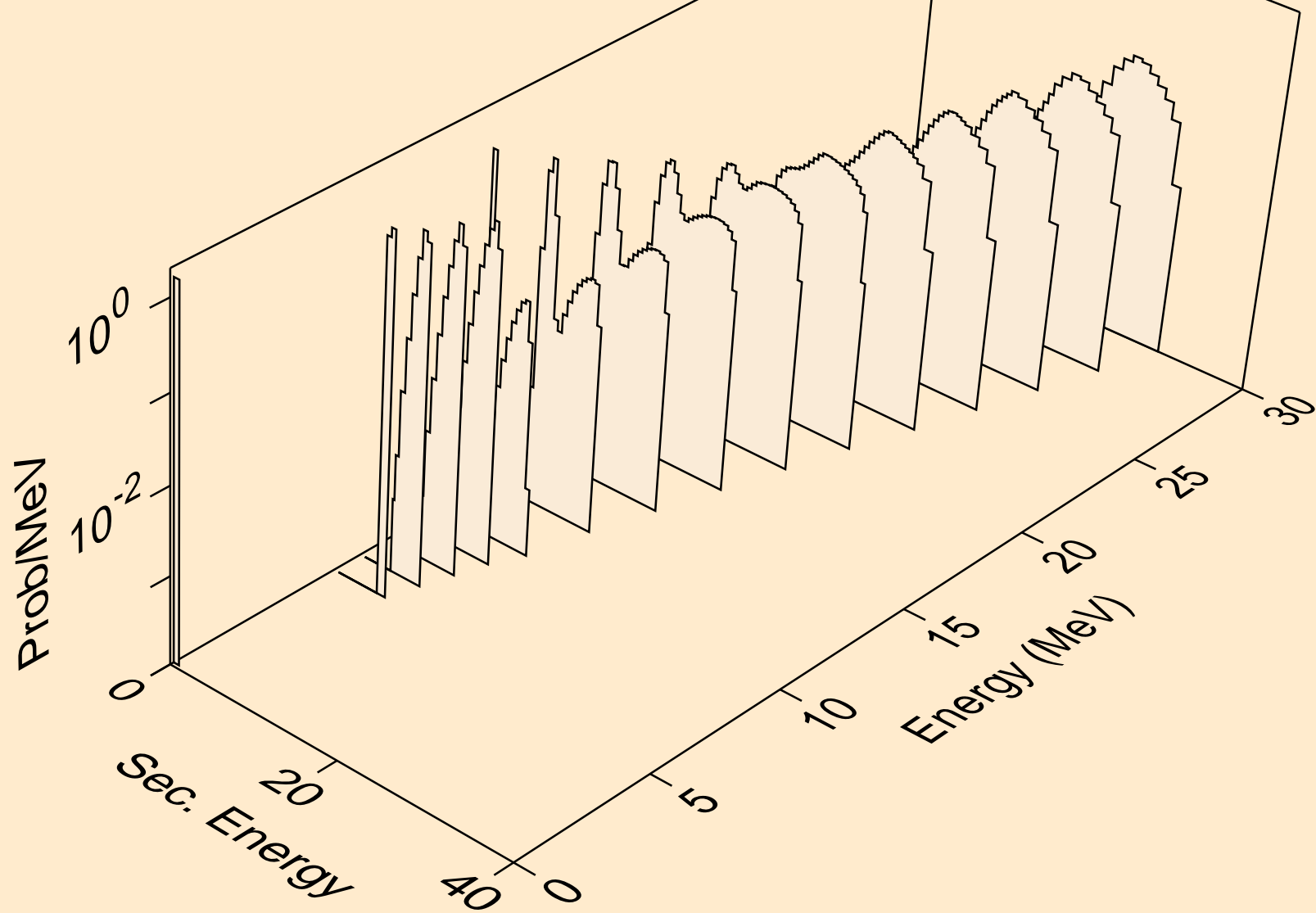

DY169 HELION ACER TENDL-2021 LIBRARY; T=0.K  
protons from (s,2np)

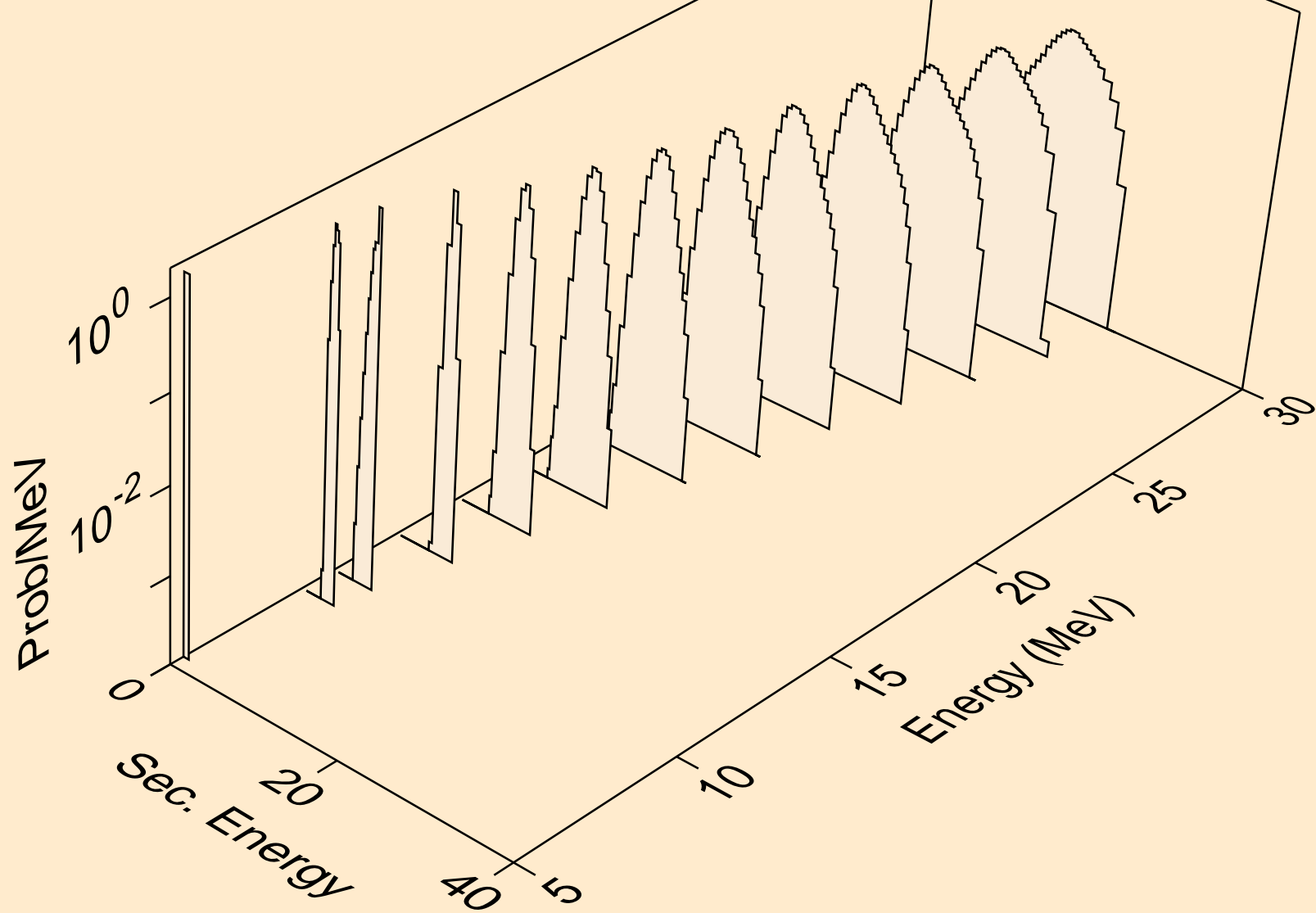

DY169 HELION ACER TENDL-2021 LIBRARY; T=0.K  
protons from (s,3np)

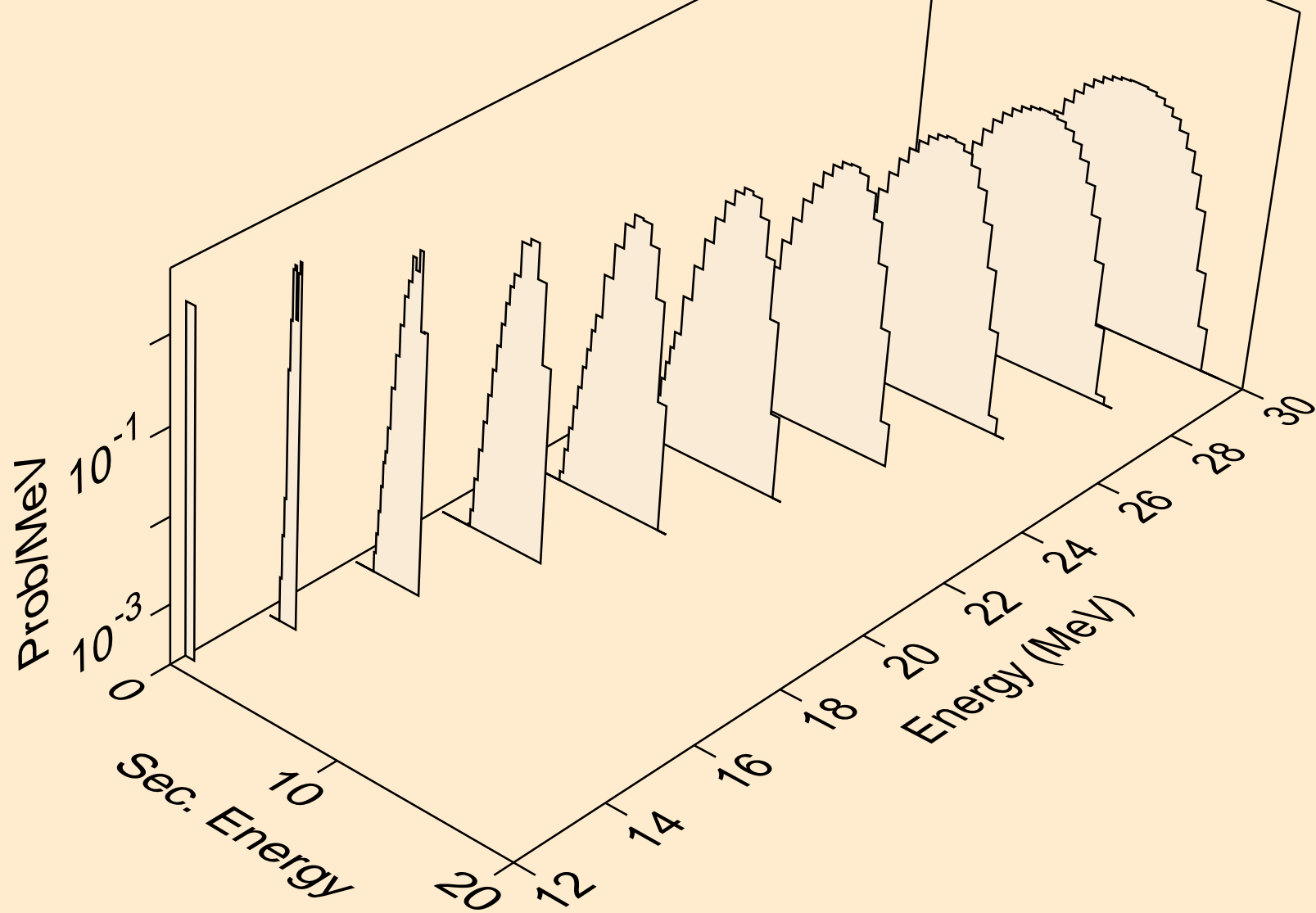

DY169 HELION ACER TENDL-2021 LIBRARY; T=0.K  
protons from (s,2np)

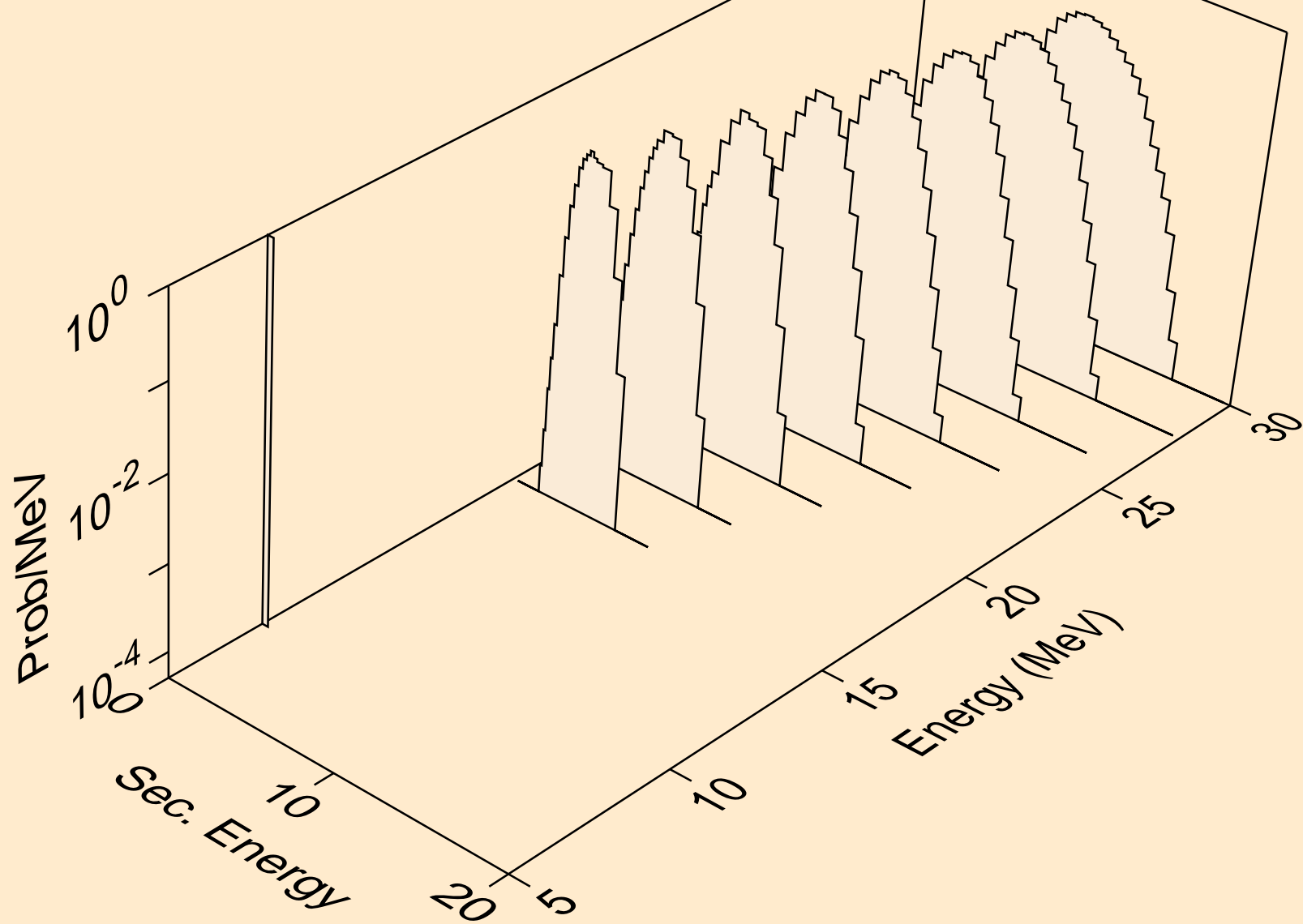

DY169 HELION ACER TENDL-2021 LIBRARY; T=0.K  
protons from (s,npa)

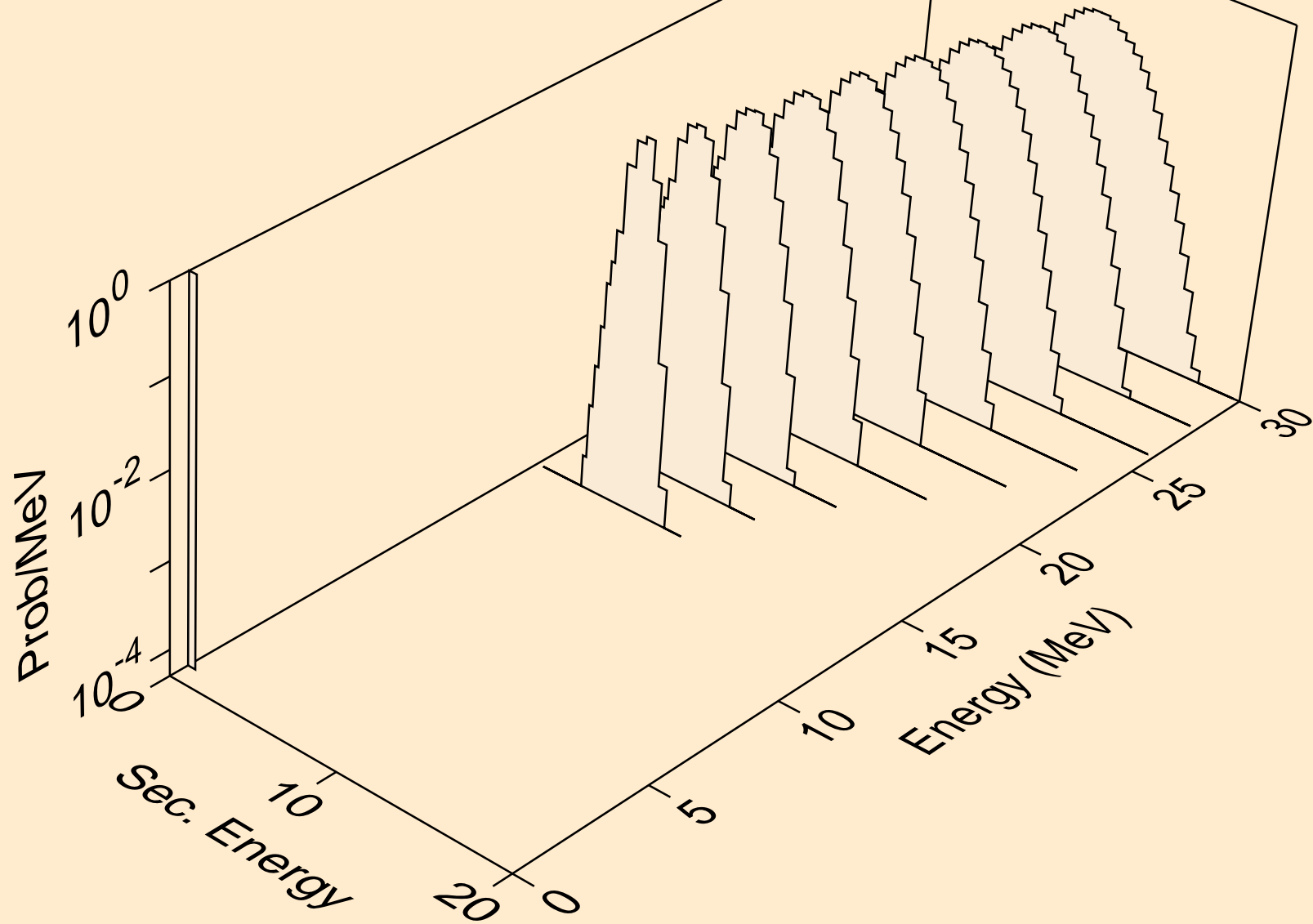

DY169 HELION ACER TENDL-2021 LIBRARY; T=0.K  
protons from (s,p)

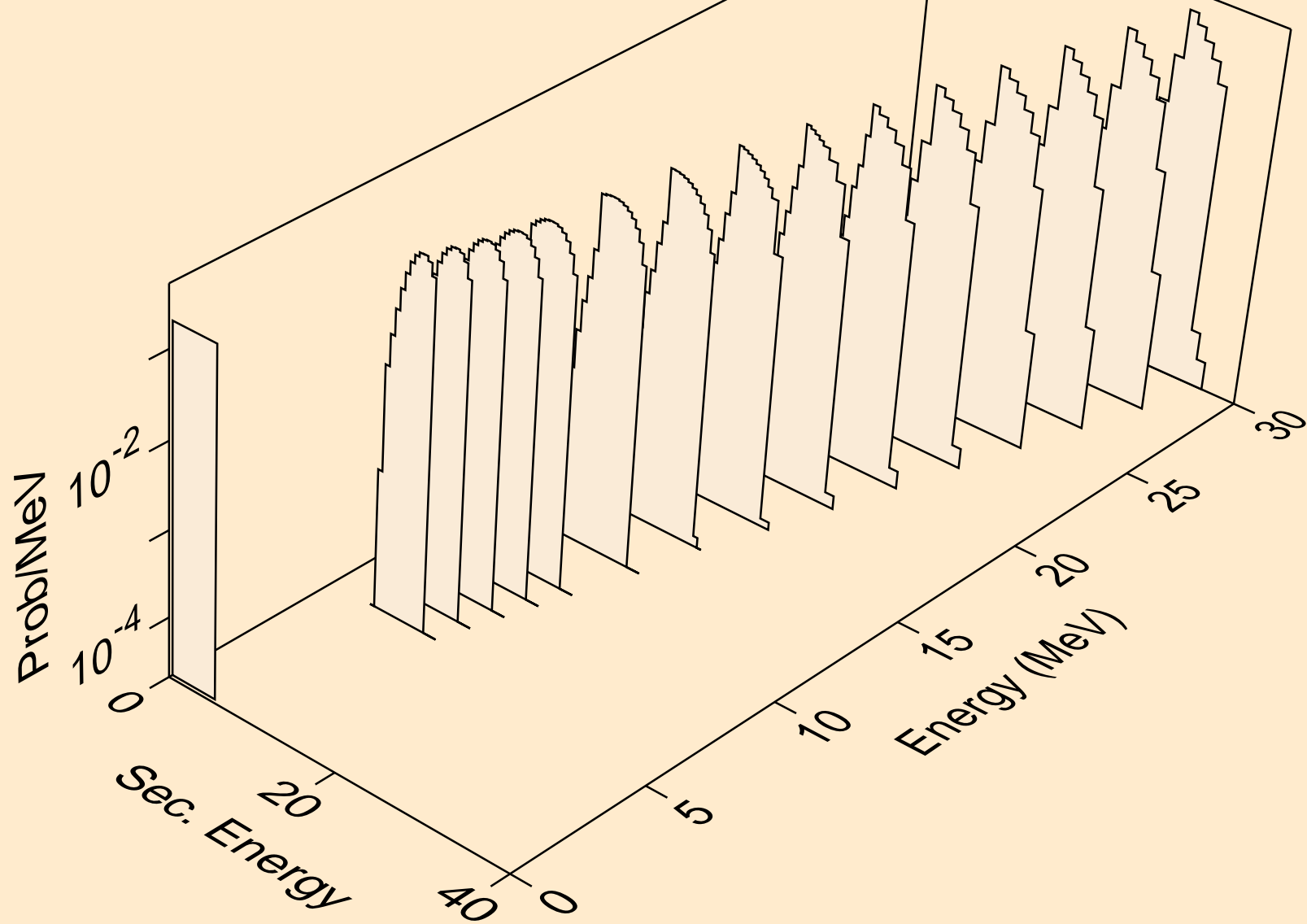

DY169 HELION ACER TENDL-2021 LIBRARY; T=0.K  
protons from (s,2p)

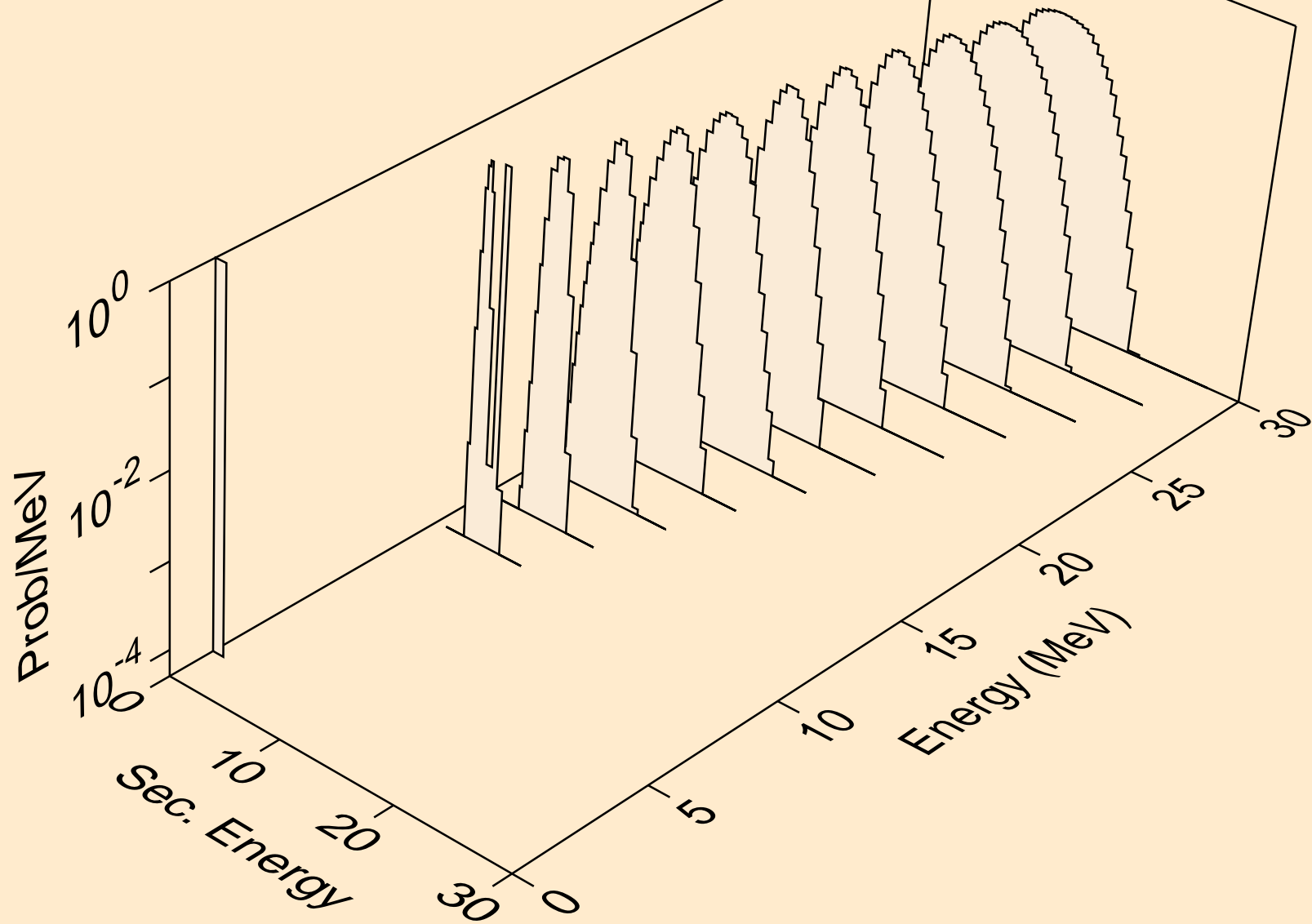

DY169 HELION ACER TENDL-2021 LIBRARY; T=0.K  
protons from (s,pa)

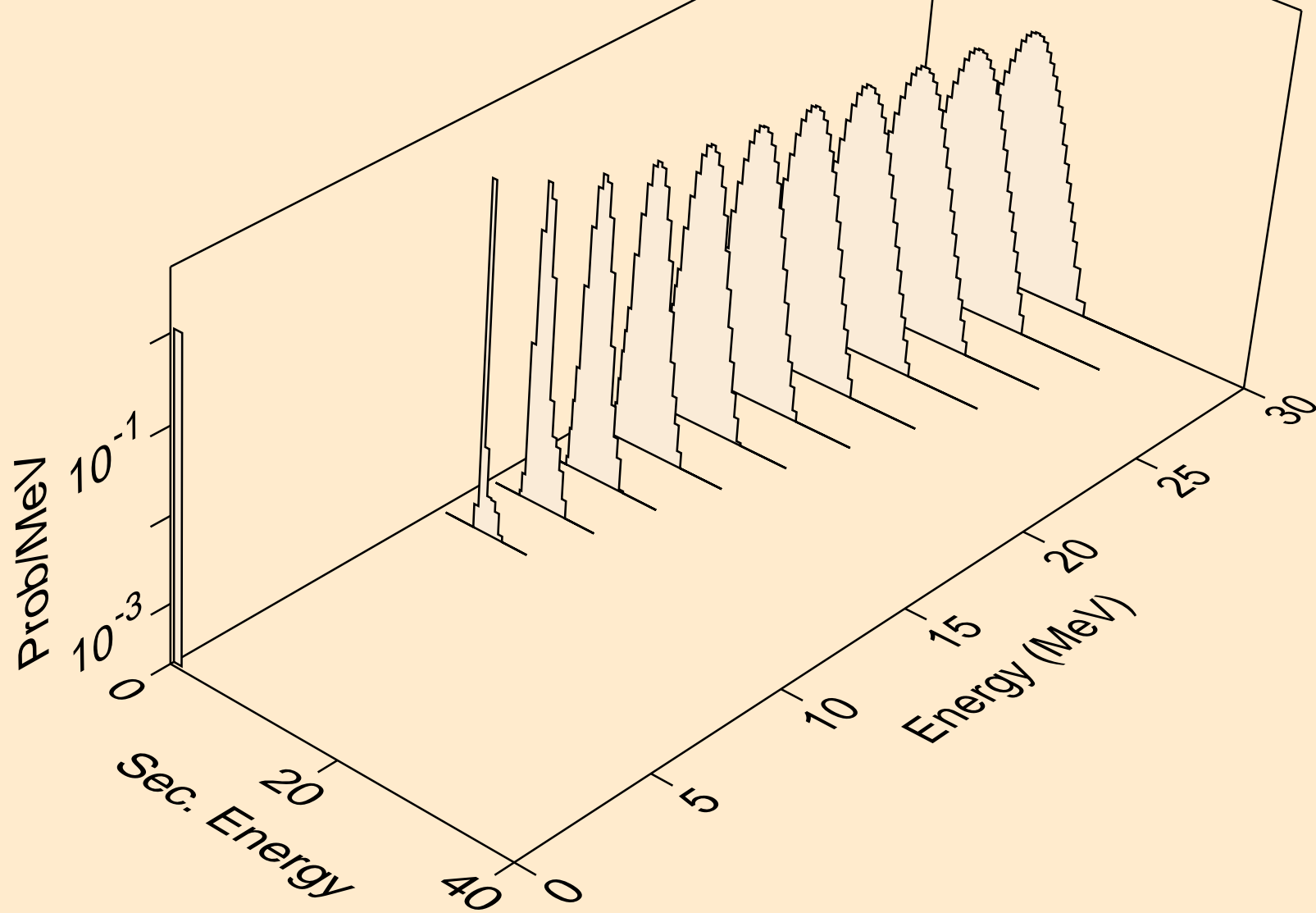



DY169 HELION ACER TENDL-2021 LIBRARY; T=0.K  
protons from (s,pd)

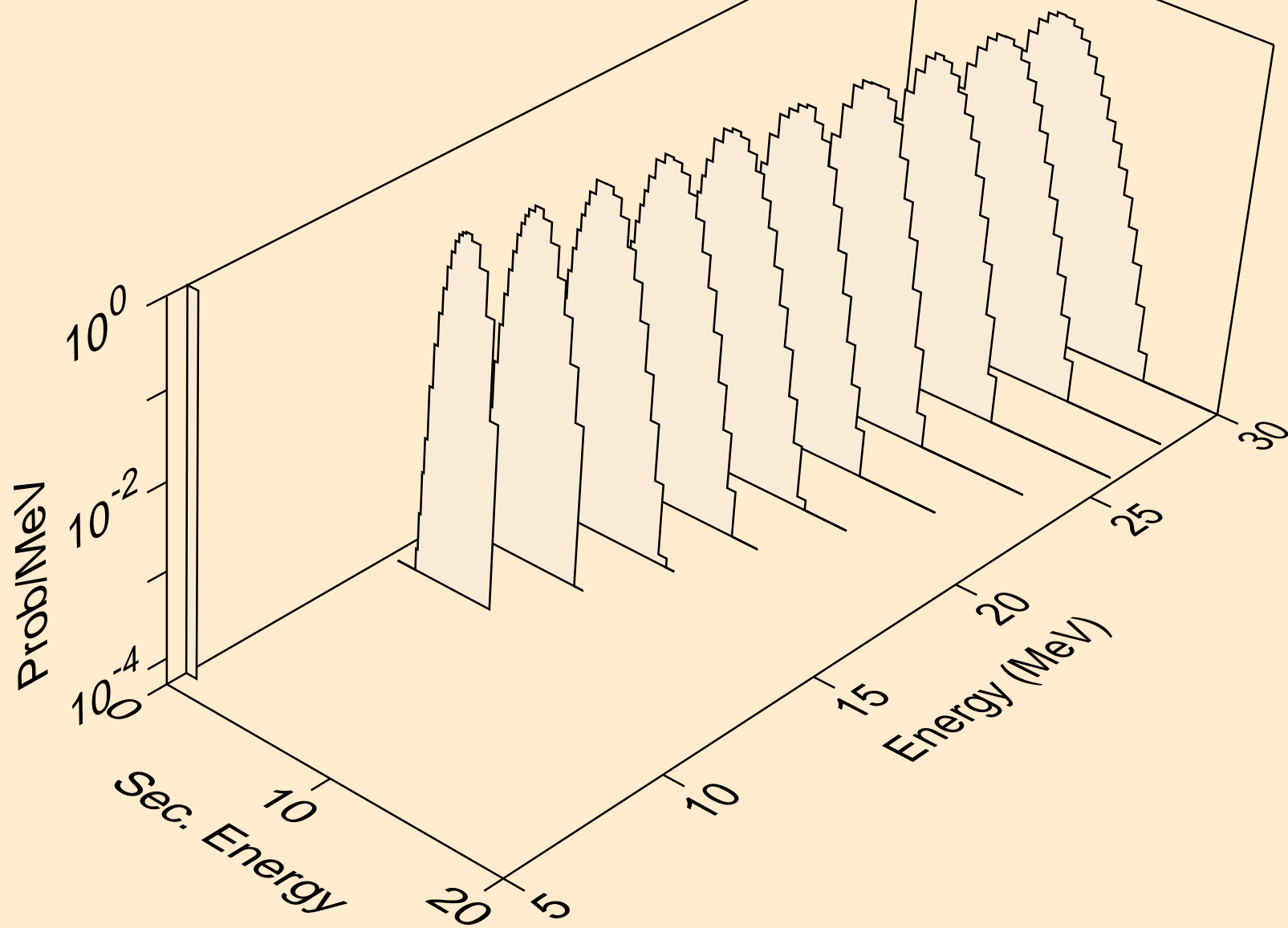

DY169 HELION ACER TENDL-2021 LIBRARY; T=0.K  
protons from (s,pt)

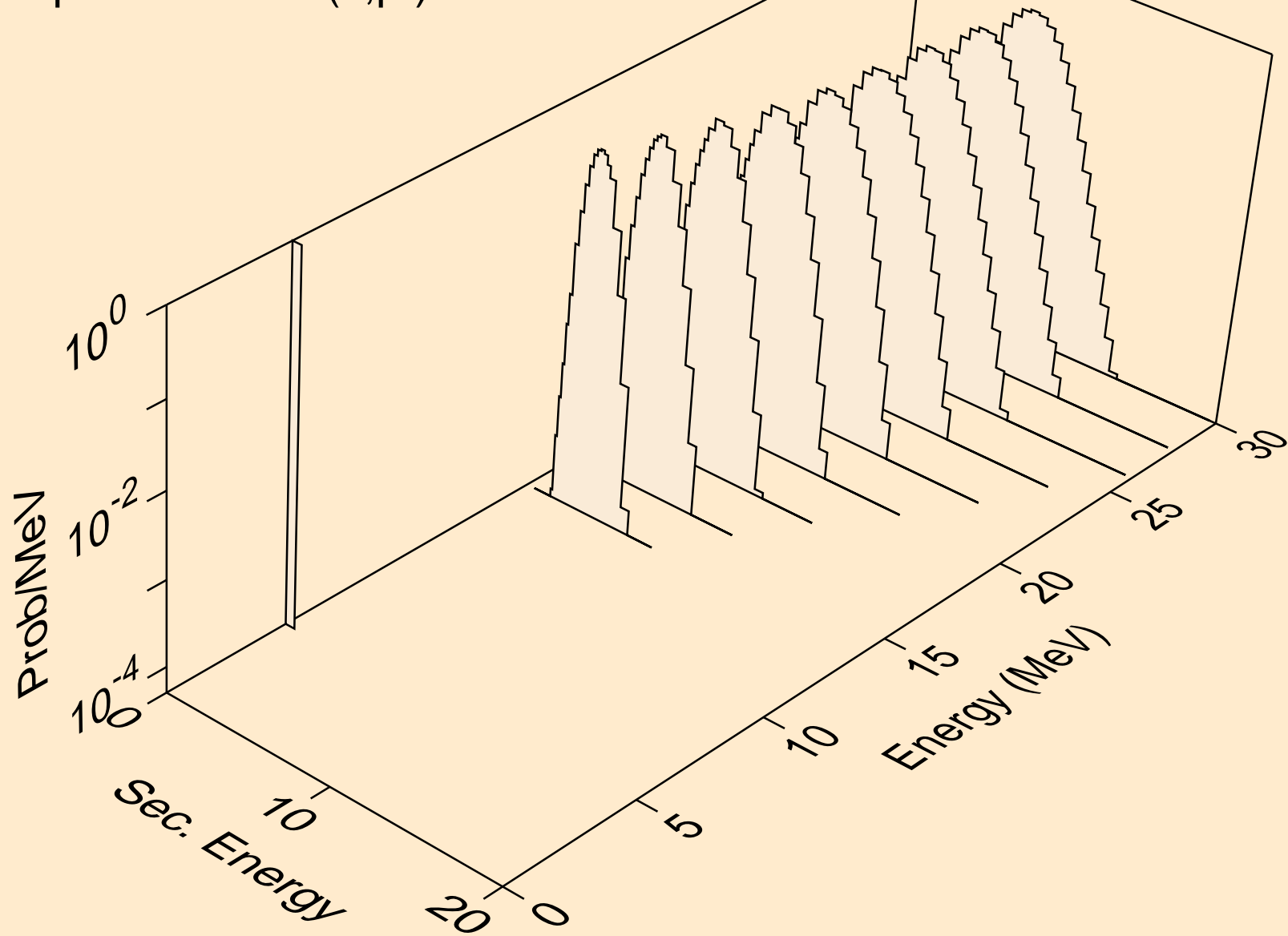

DY169 HELION ACER TENDL-2021 LIBRARY; T=0.K  
deuterons from (s,x)

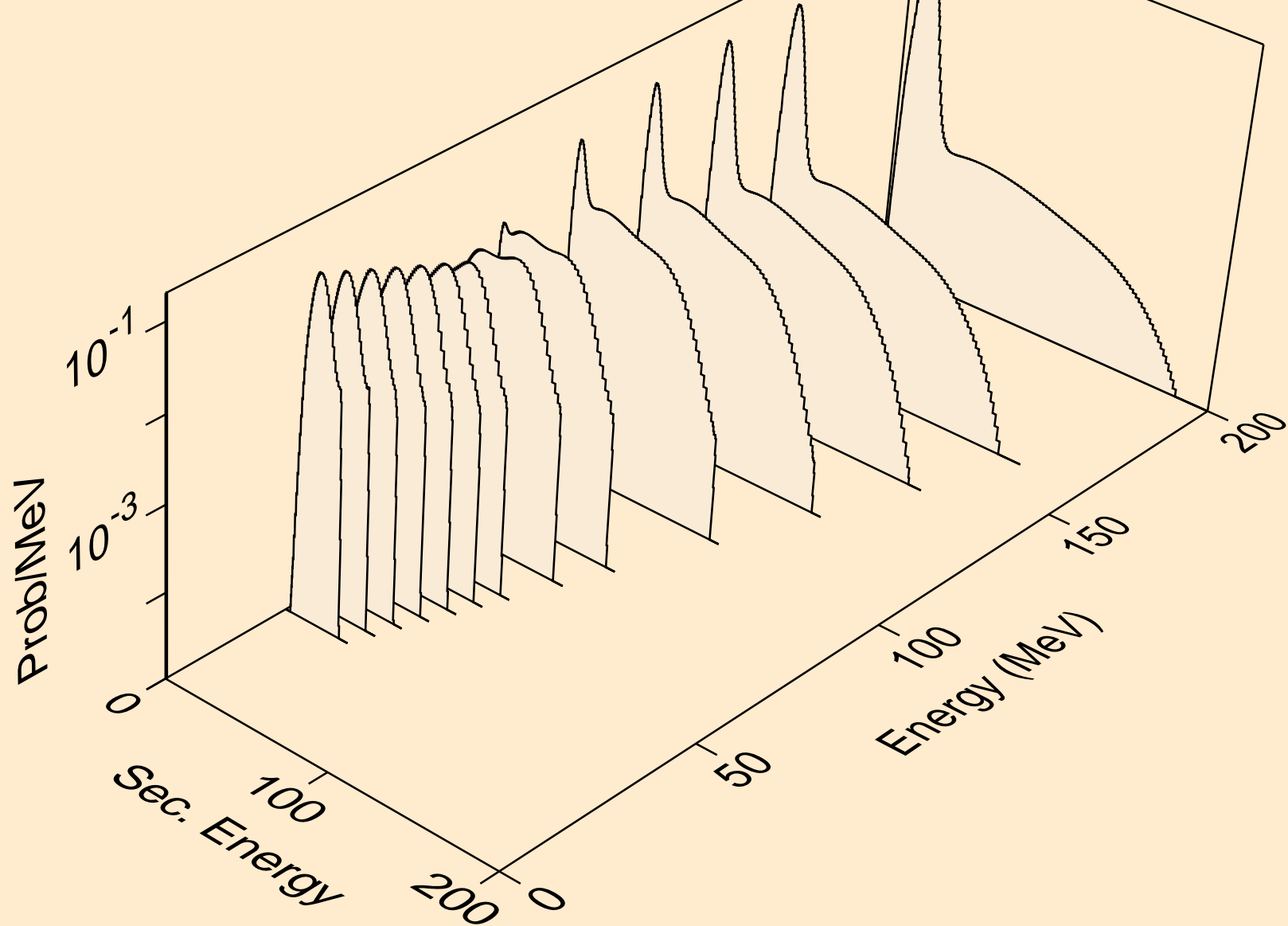

DY169 HELION ACER TENDL-2021 LIBRARY; T=0.K  
deuterons from (s,2nd)

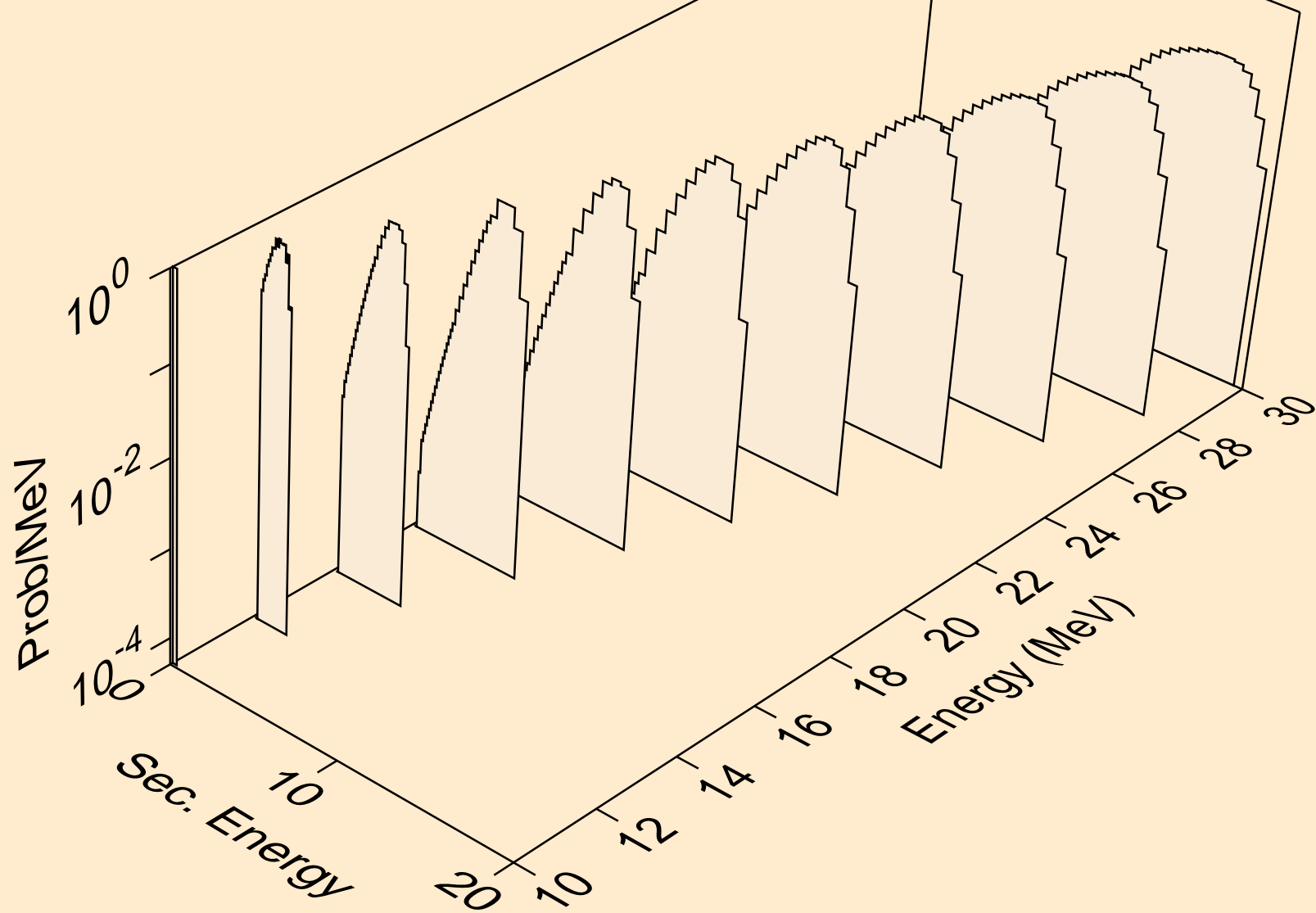

DY169 HELION ACER TENDL-2021 LIBRARY; T=0.K  
deuterons from (s,n\*)d

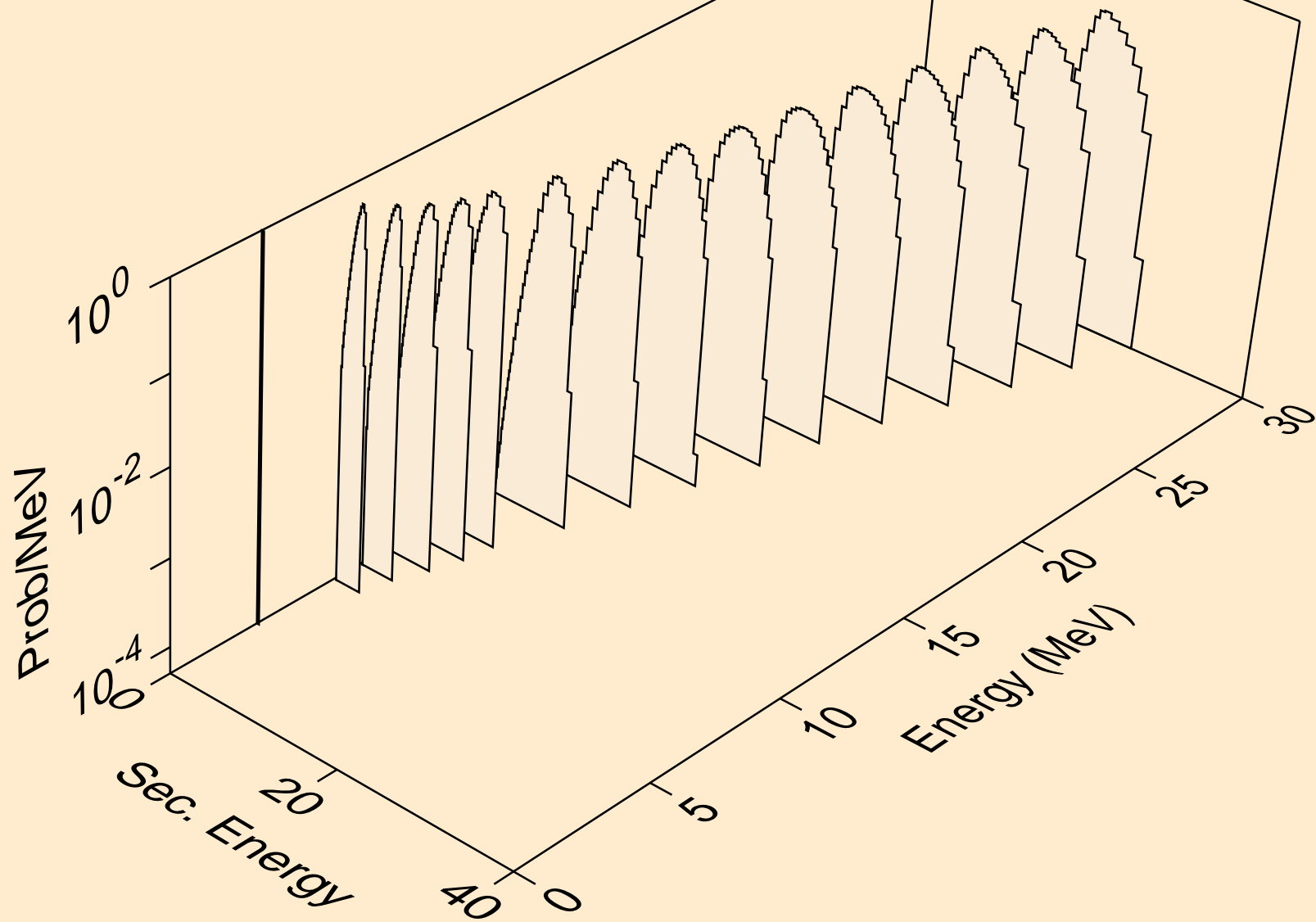

DY169 HELION ACER TENDL-2021 LIBRARY; T=0.K  
deuterons from (s,d)

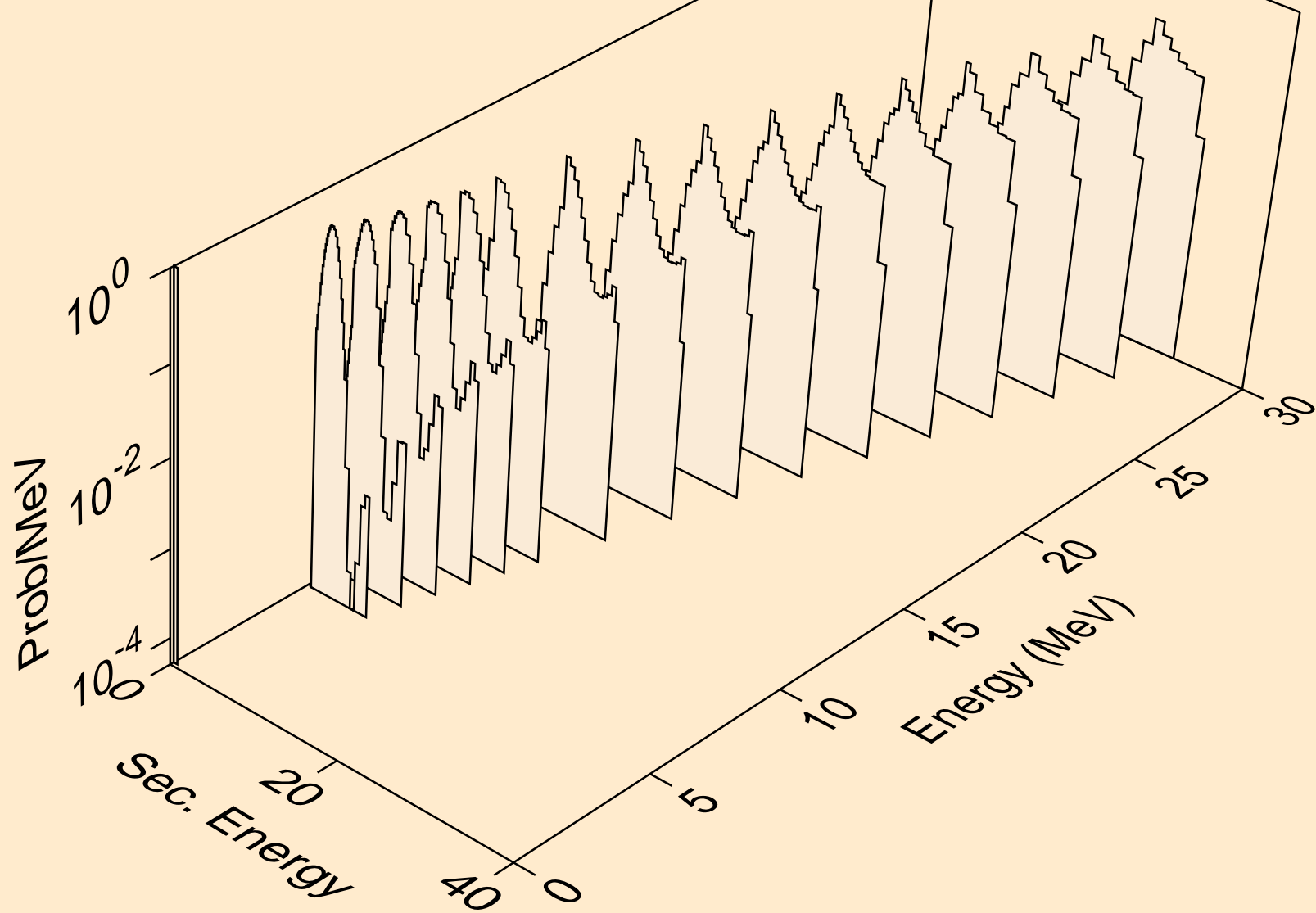

DY169 HELION ACER TENDL-2021 LIBRARY; T=0.K  
deuterons from (s,pd)

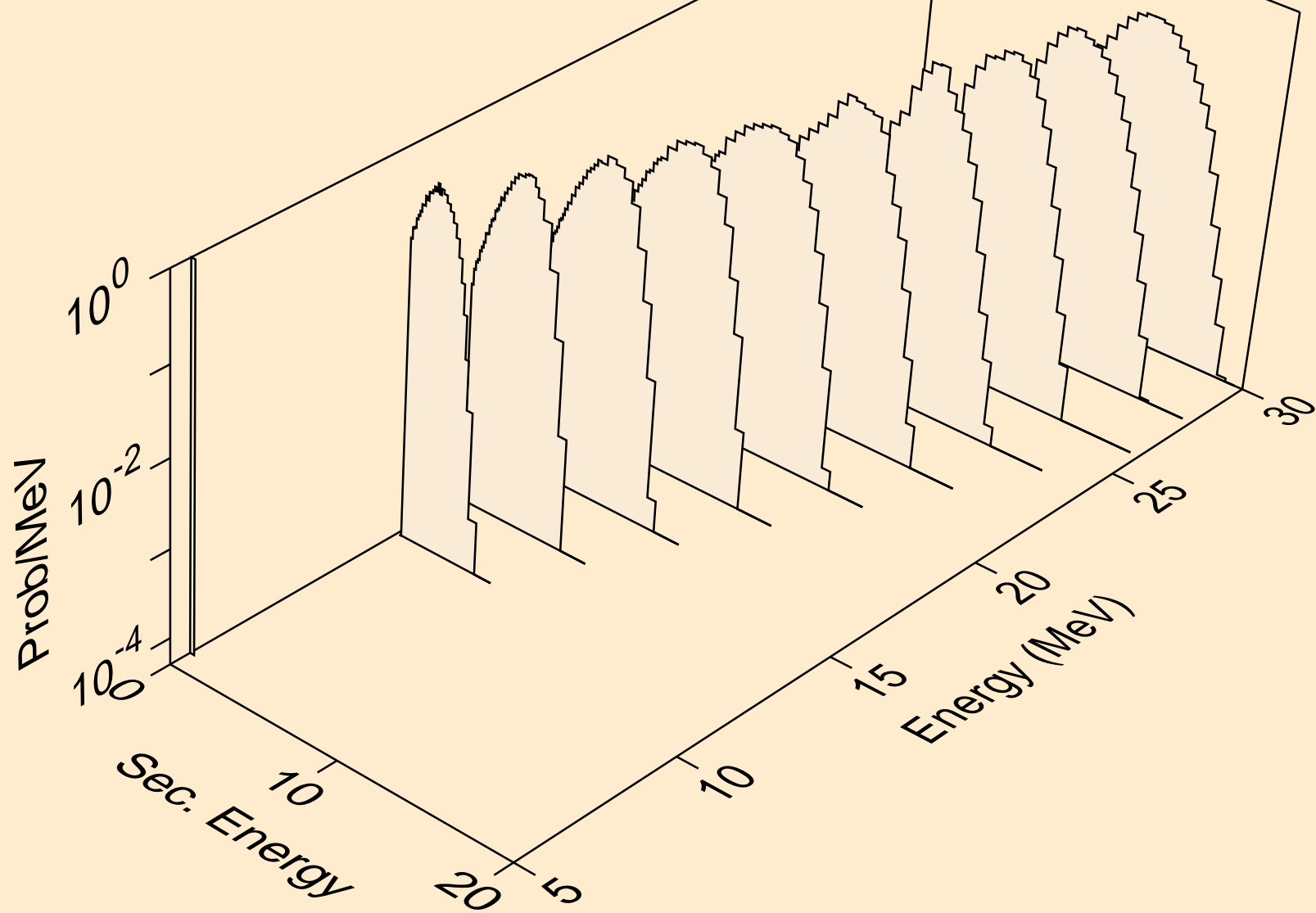

DY169 HELION ACER TENDL-2021 LIBRARY; T=0.K  
tritons from (s,x)

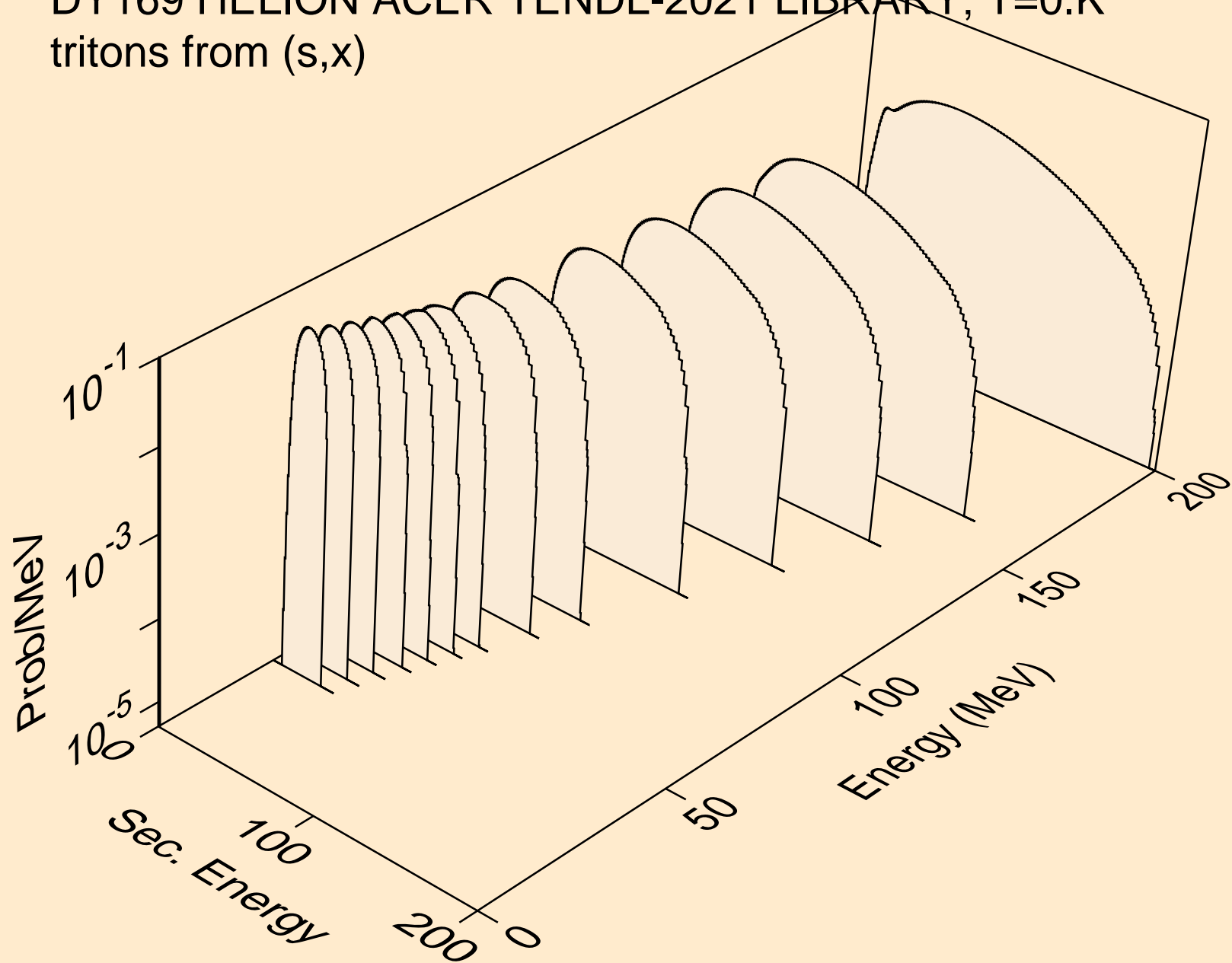



DY169 HELION ACER TENDL-2021 LIBRARY; T=0.K  
tritons from (s,n\*)t

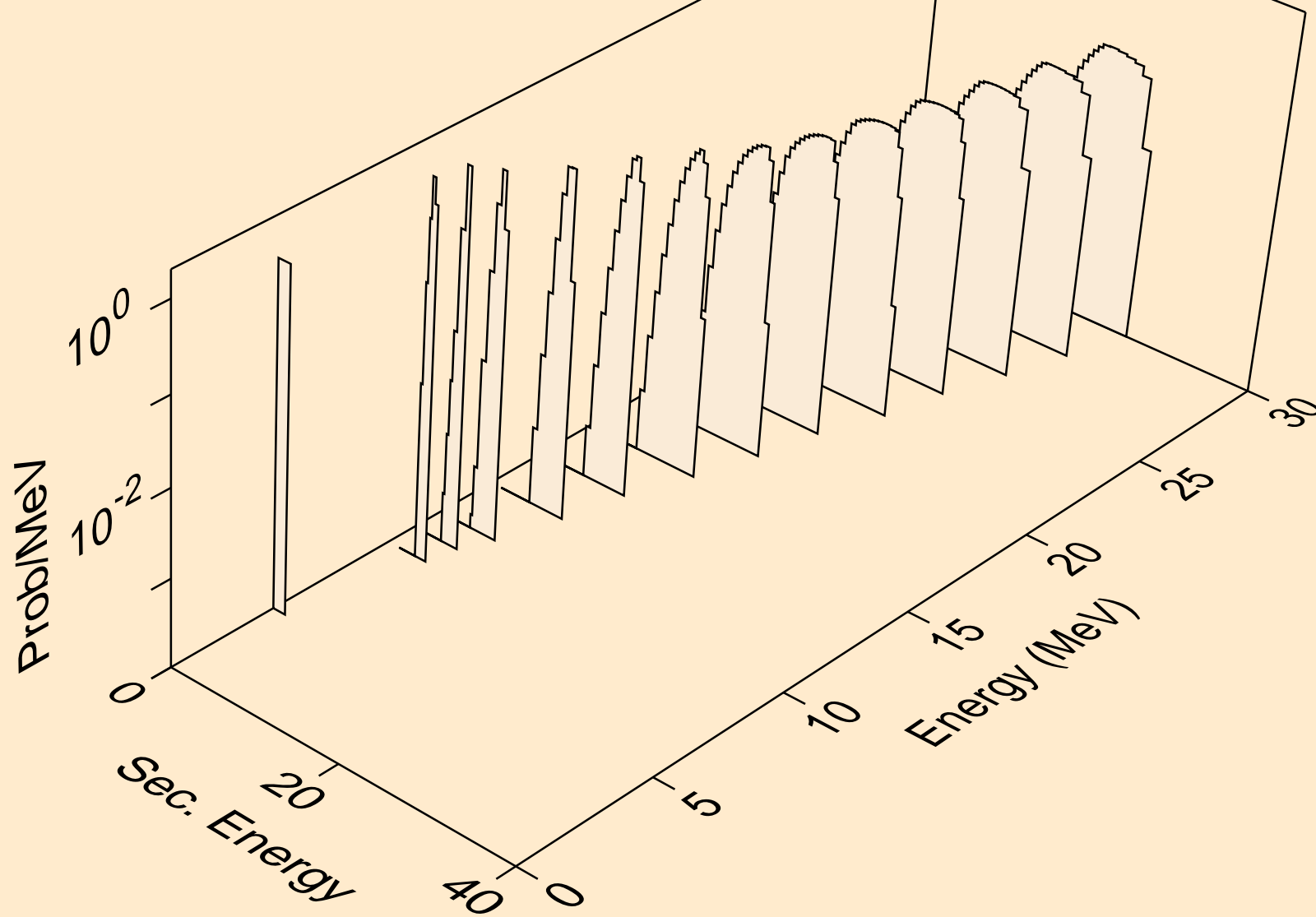

DY169 HELION ACER TENDL-2021 LIBRARY; T=0.K  
tritons from (s,t)

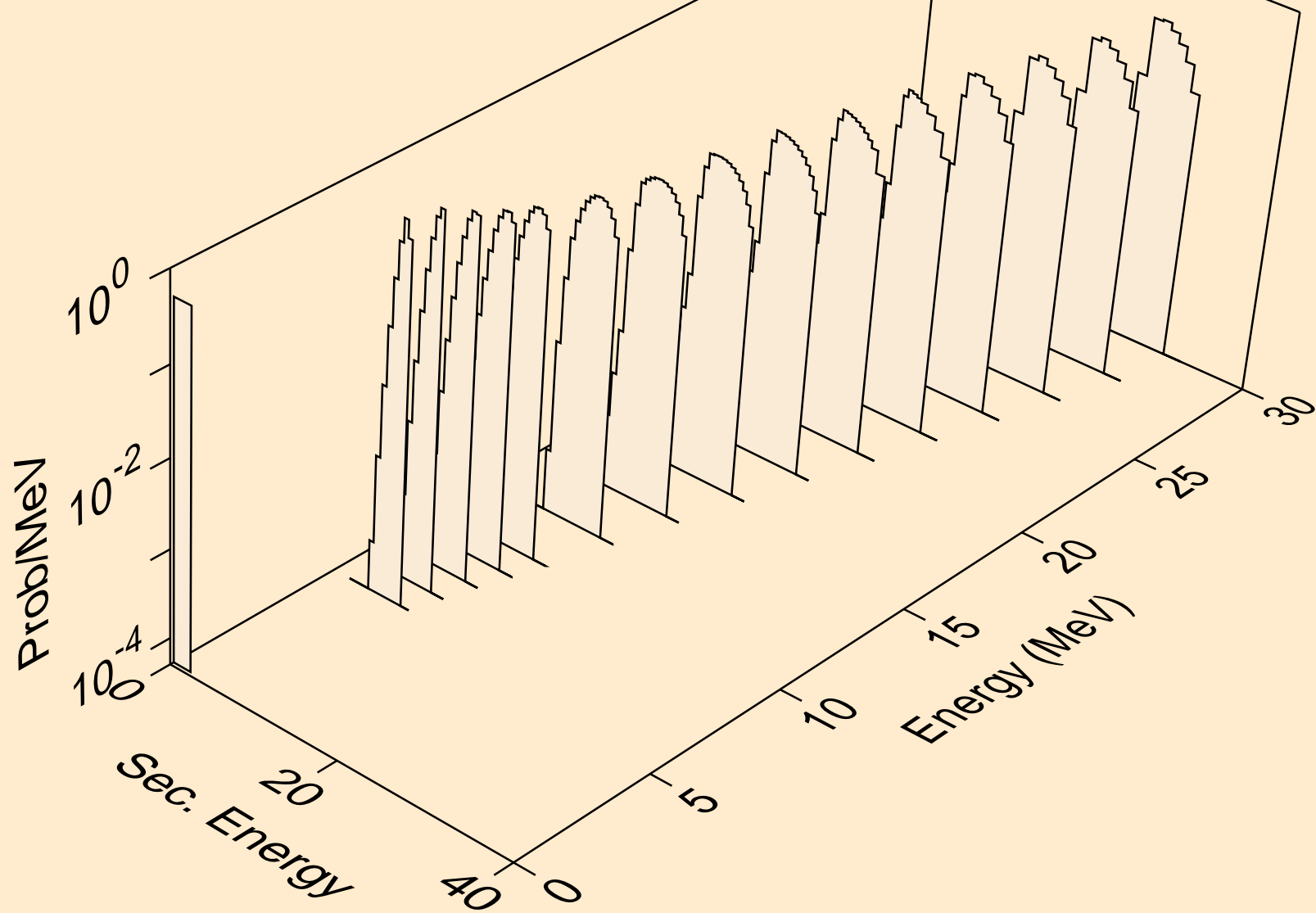

DY169 HELION ACER TENDL-2021 LIBRARY; T=0.K  
tritons from (s,pt)

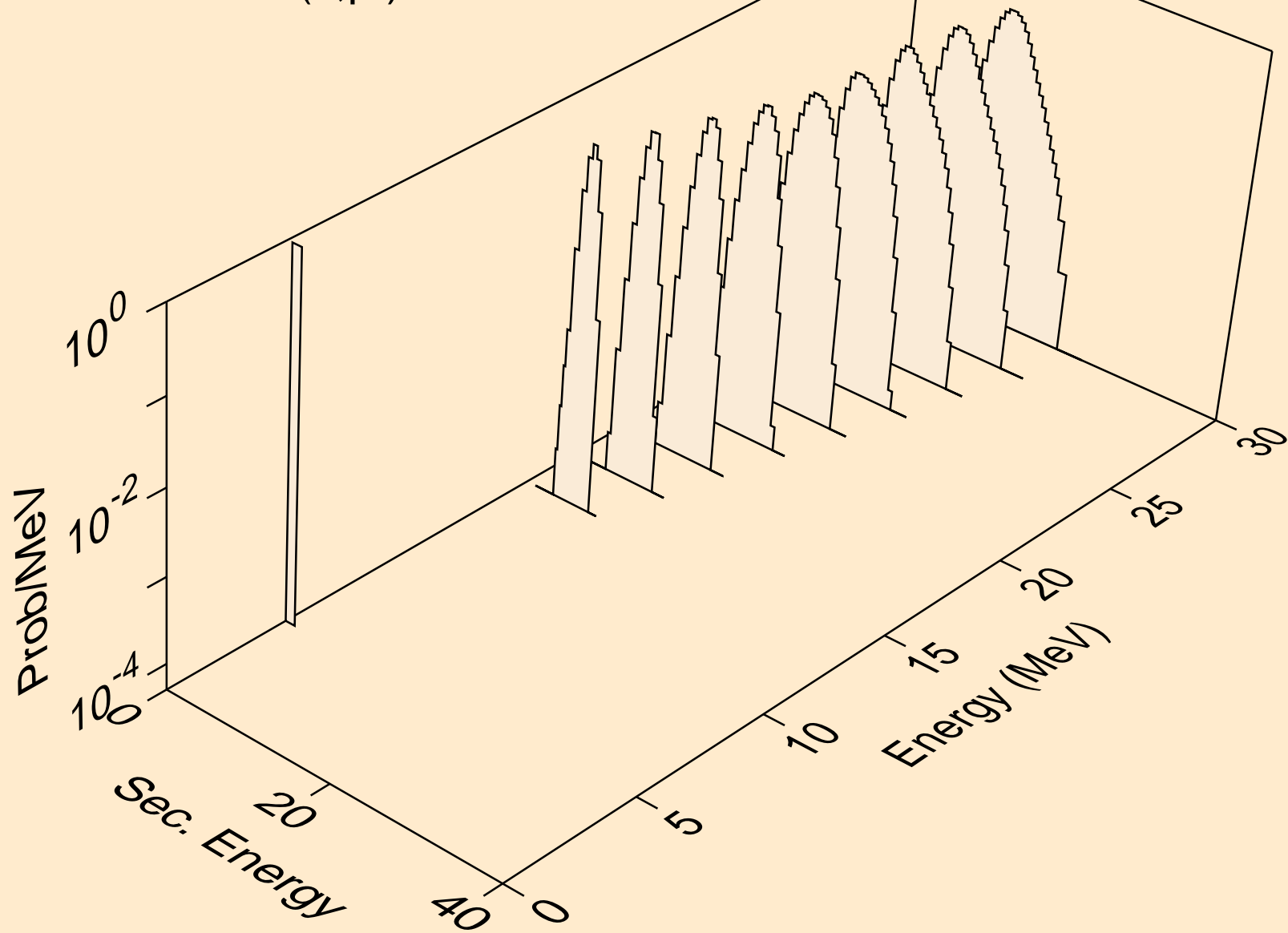

DY169 HELION ACER TENDL-2021 LIBRARY; T=0.K  
alphas from (s,x)

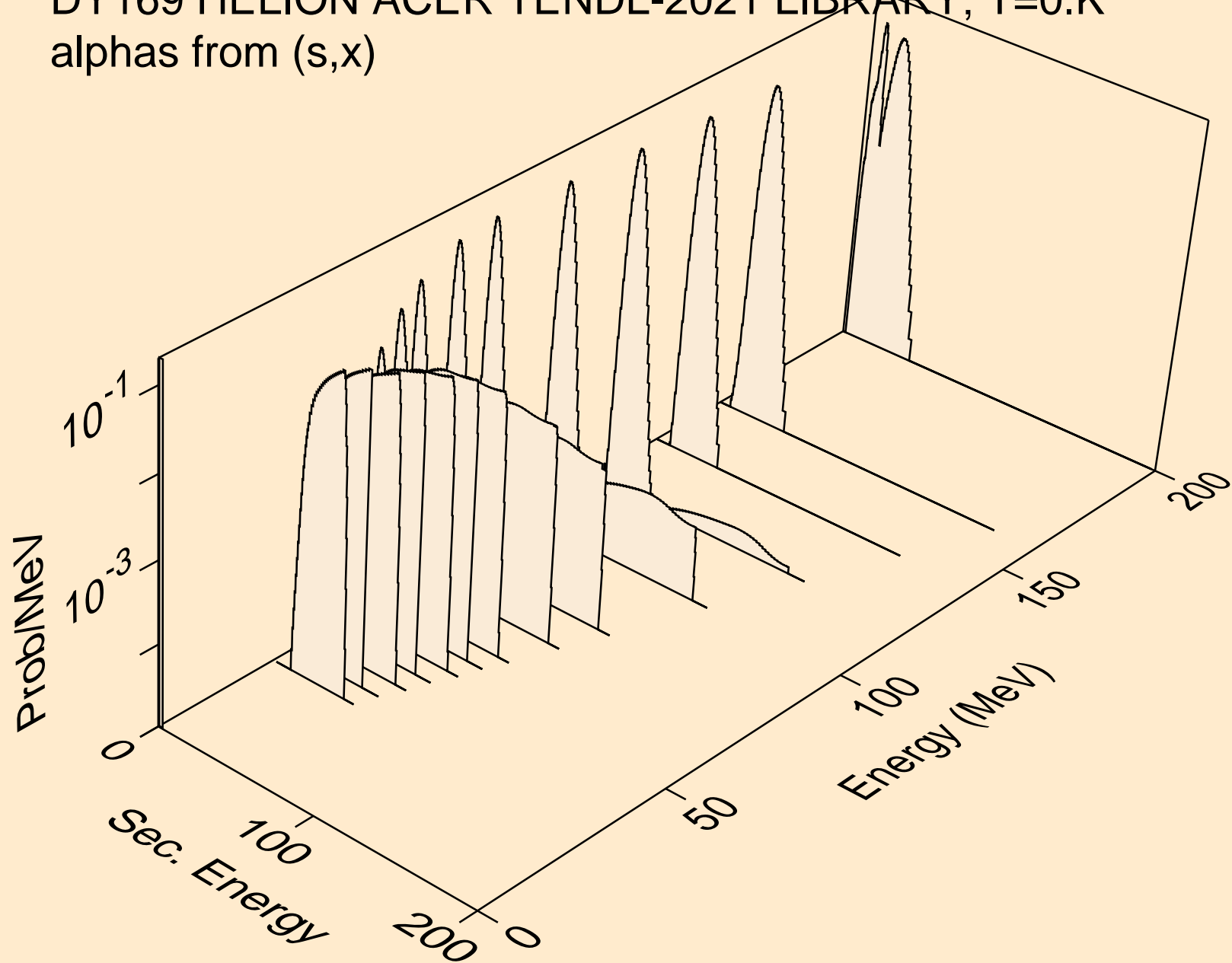

DY169 HELION ACER TENDL-2021 LIBRARY; T=0.K  
alphas from (s,n\*)a

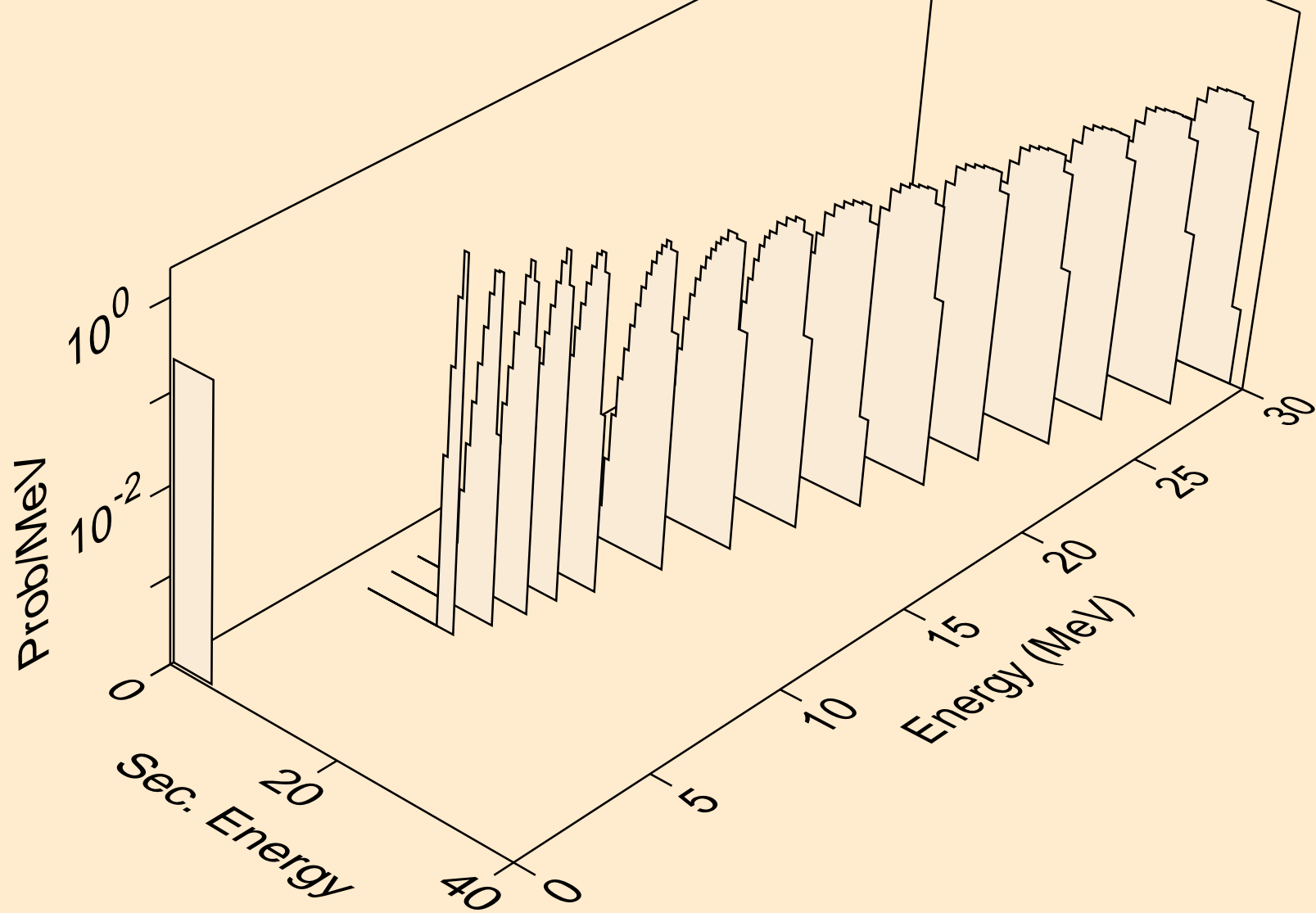

DY169 HELION ACER TENDL-2021 LIBRARY; T=0.K  
alphas from (s,2n)a

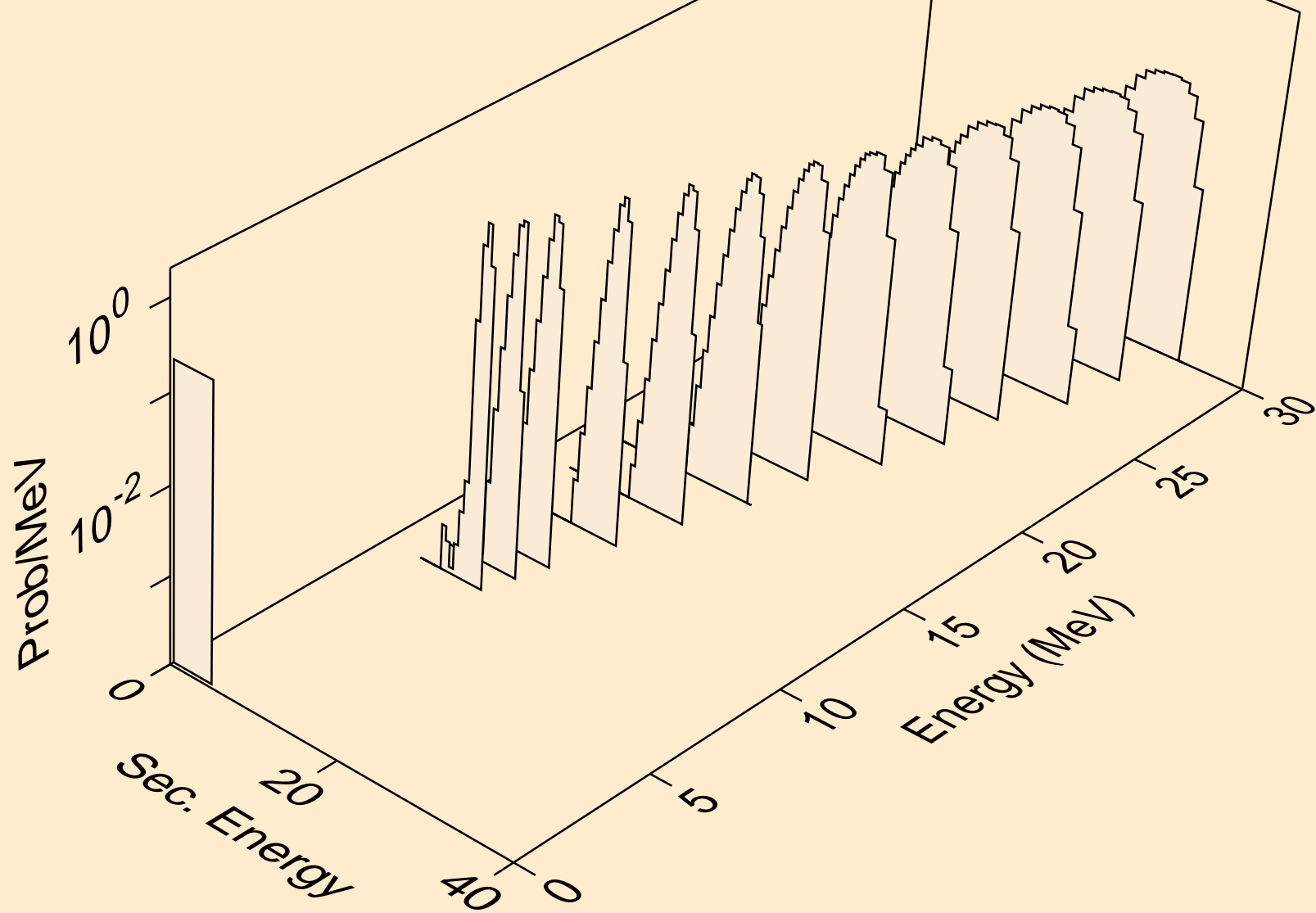

DY169 HELION ACER TENDL-2021 LIBRARY; T=0.K  
alphas from (s,3n)a

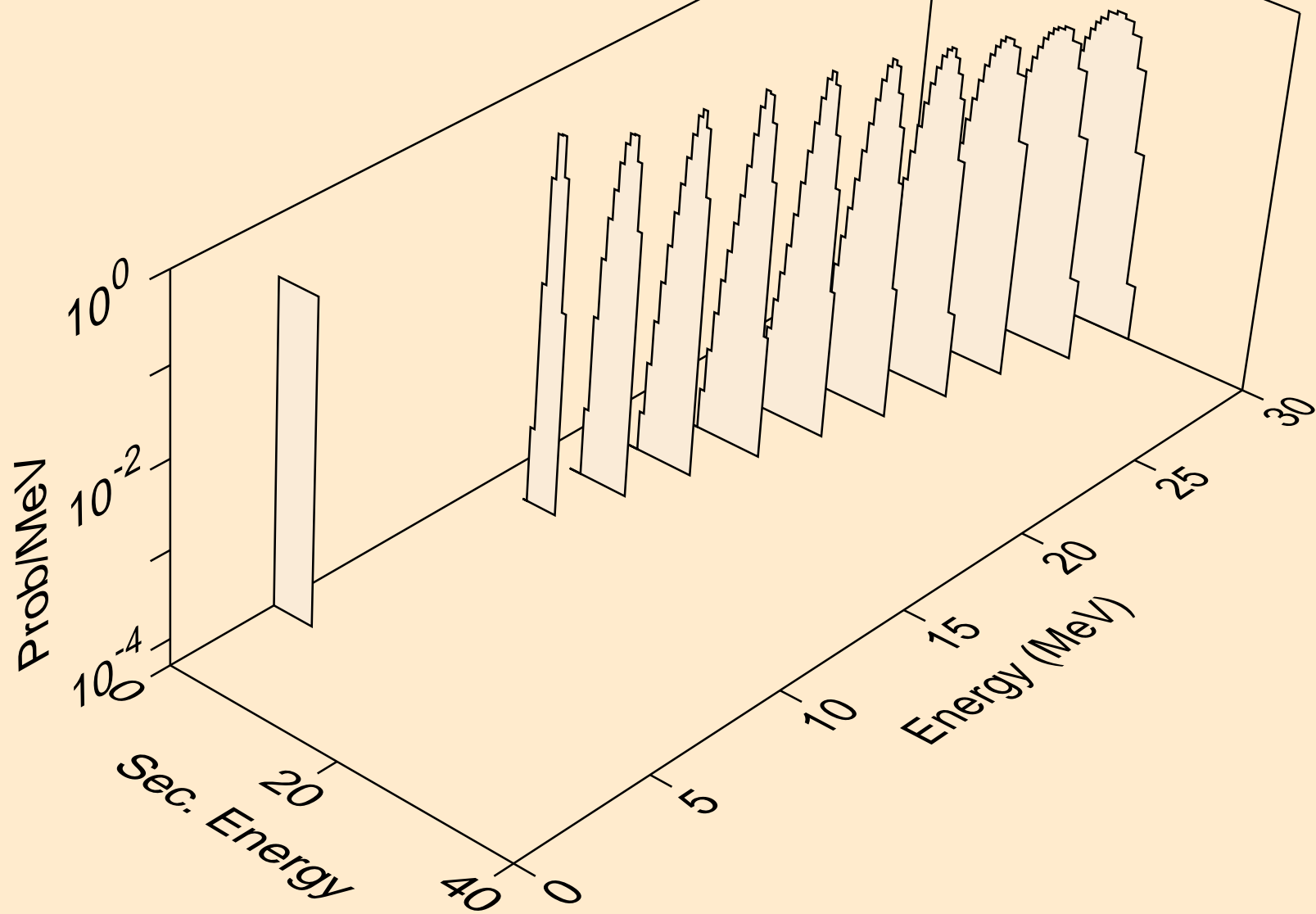

DY169 HELION ACER TENDL-2021 LIBRARY; T=0.K  
alphas from (s,npa)

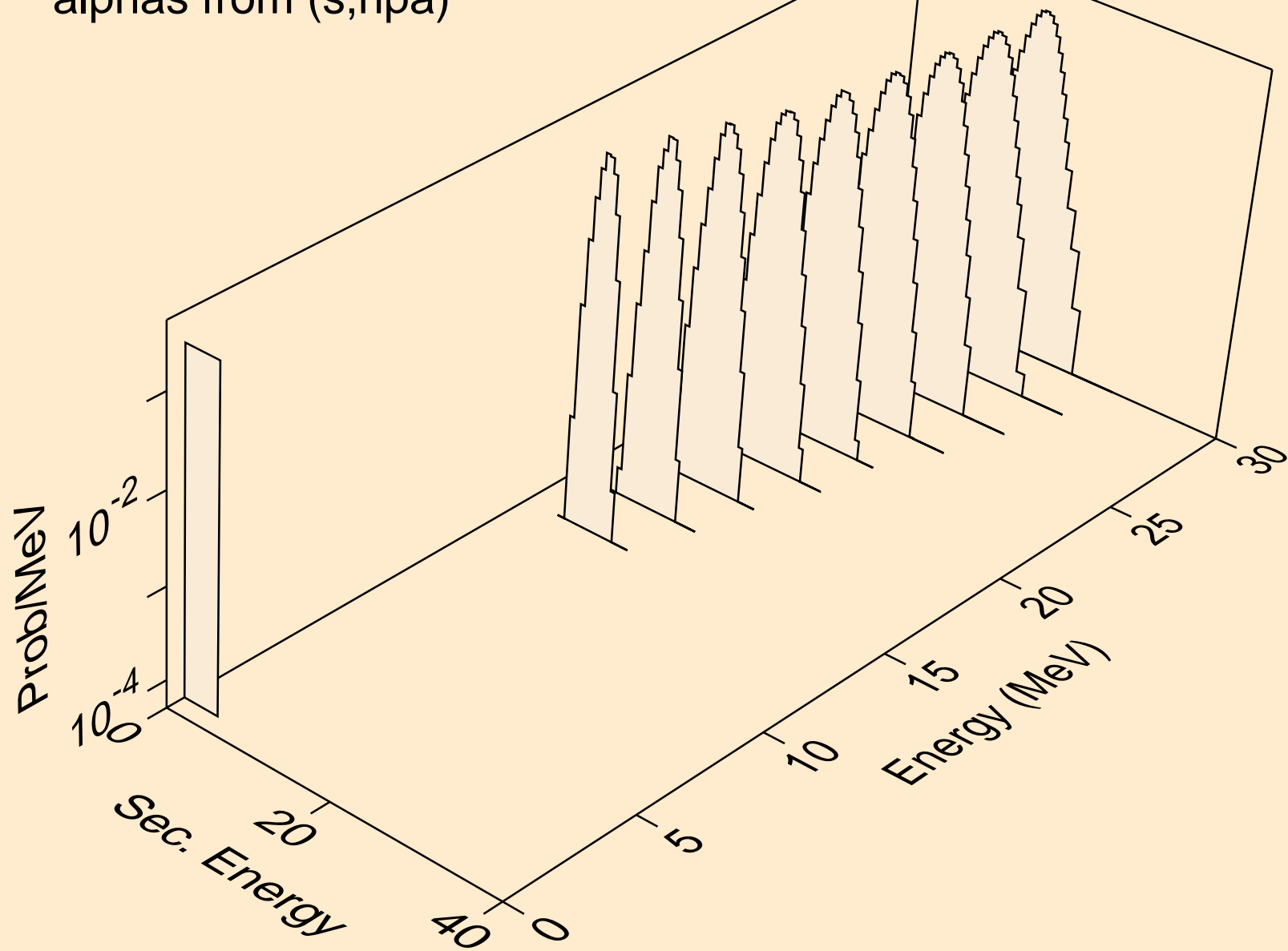



DY169 HELION ACER TENDL-2021 LIBRARY; T=0.K  
alphas from (s,a)

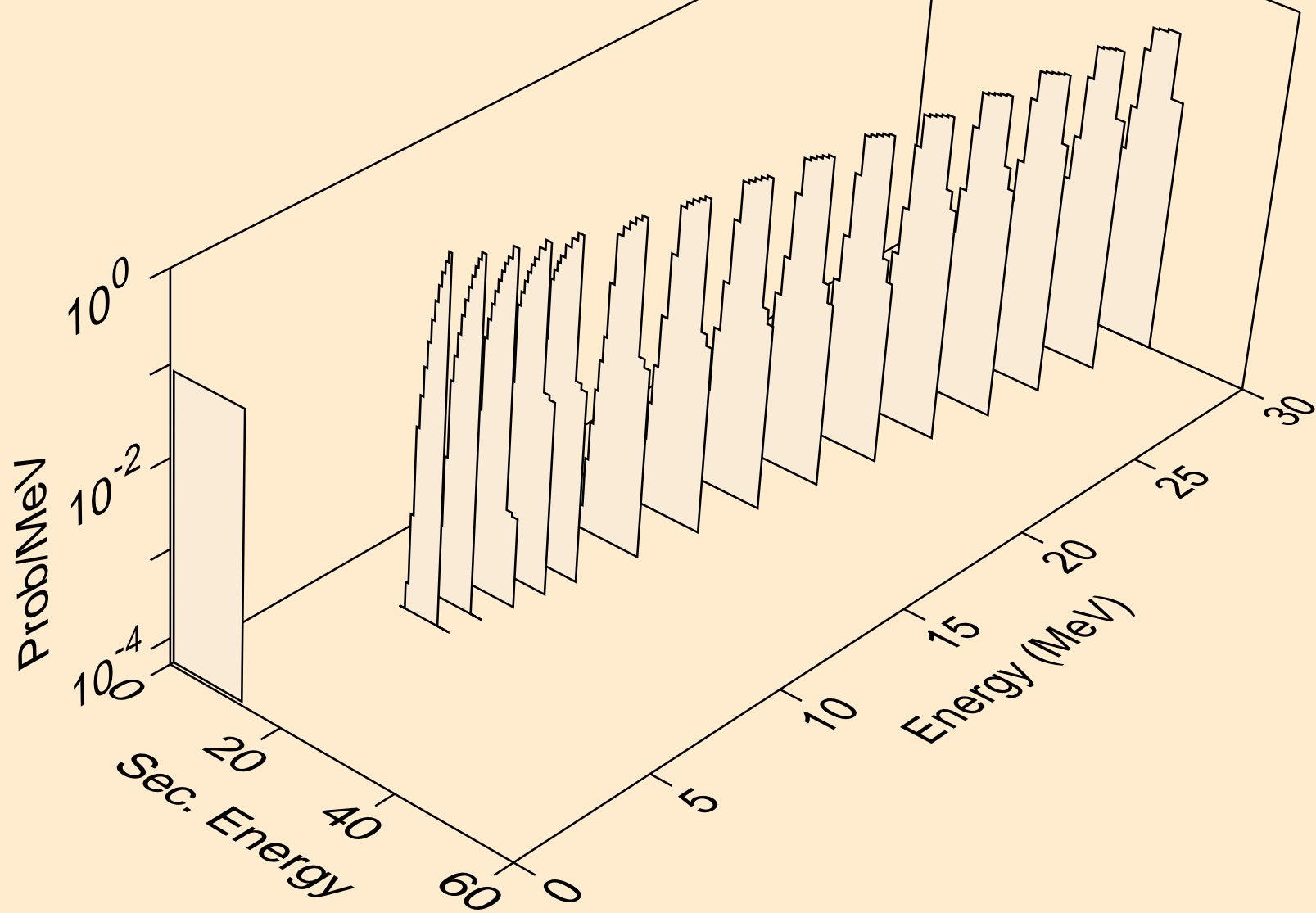

DY169 HELION ACER TENDL-2021 LIBRARY; T=0.K  
alphas from (s,pa)

