

ES243 HELION ACER TENDL-2021 LIBRARY; T=0.K
Principal cross sections

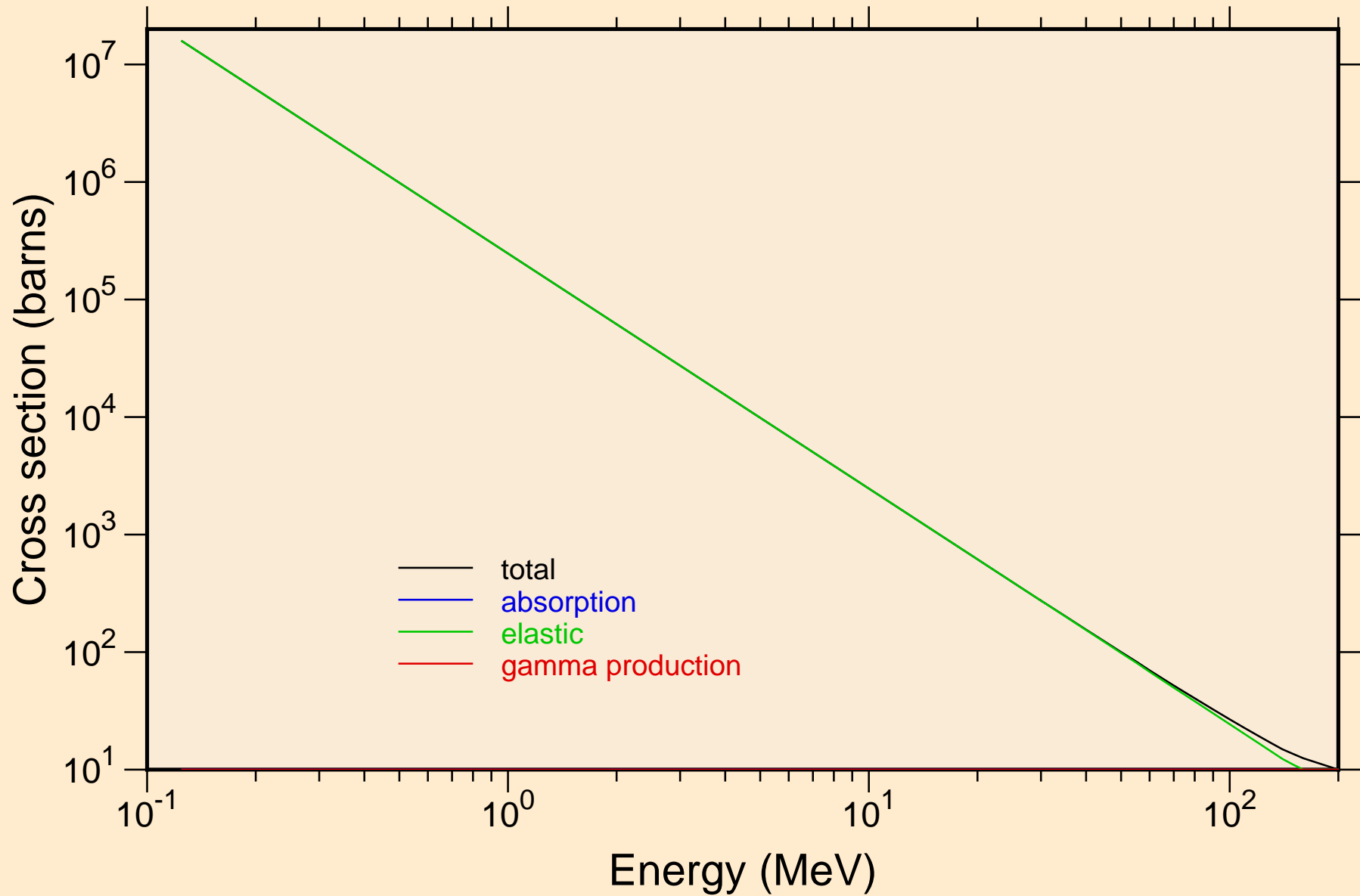

ES243 HELION ACER TENDL-2021 LIBRARY; T=0.K

Heating

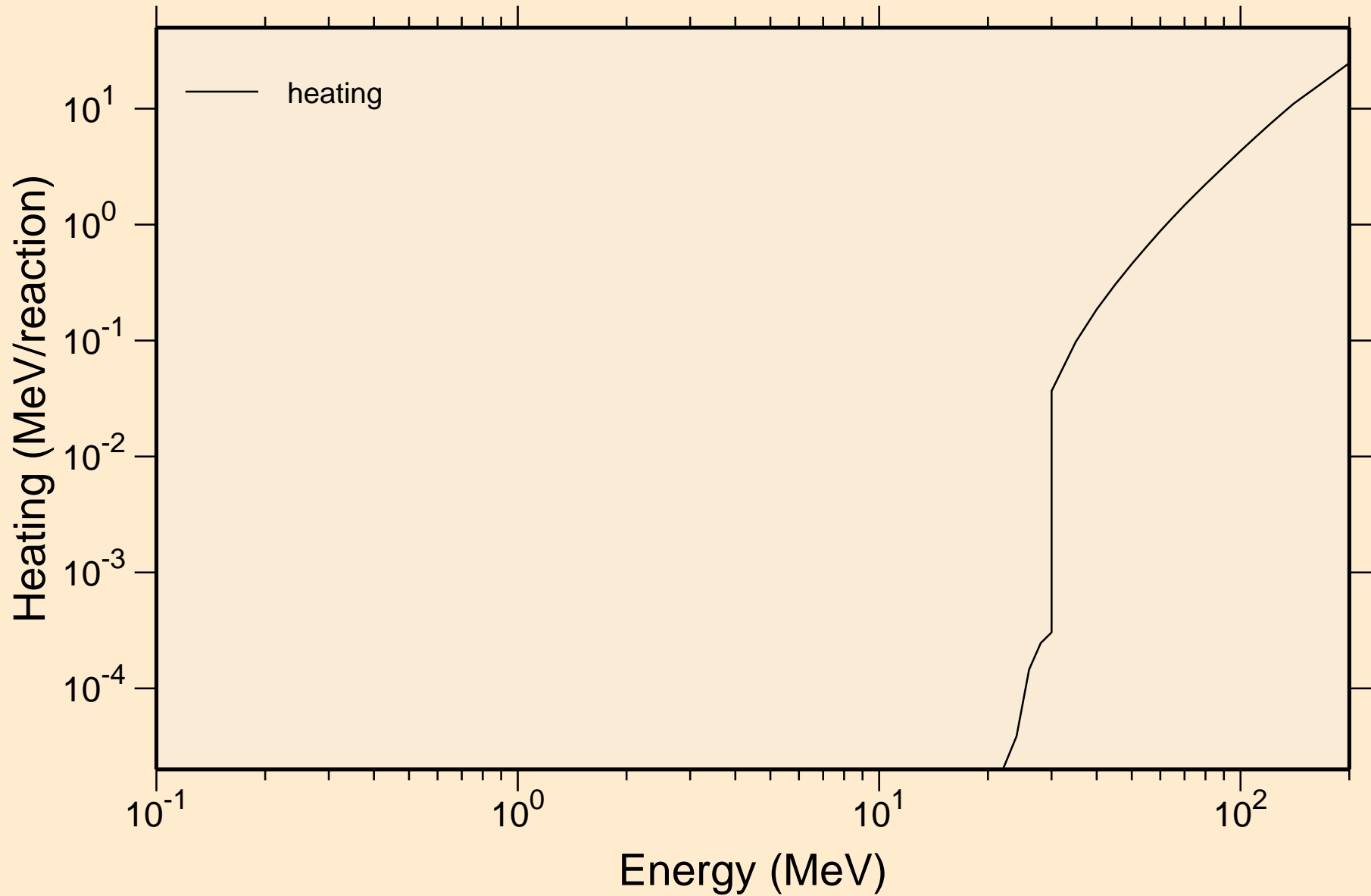

ES243 HELION ACER TENDL-2021 LIBRARY; T=0.K

Principal cross sections

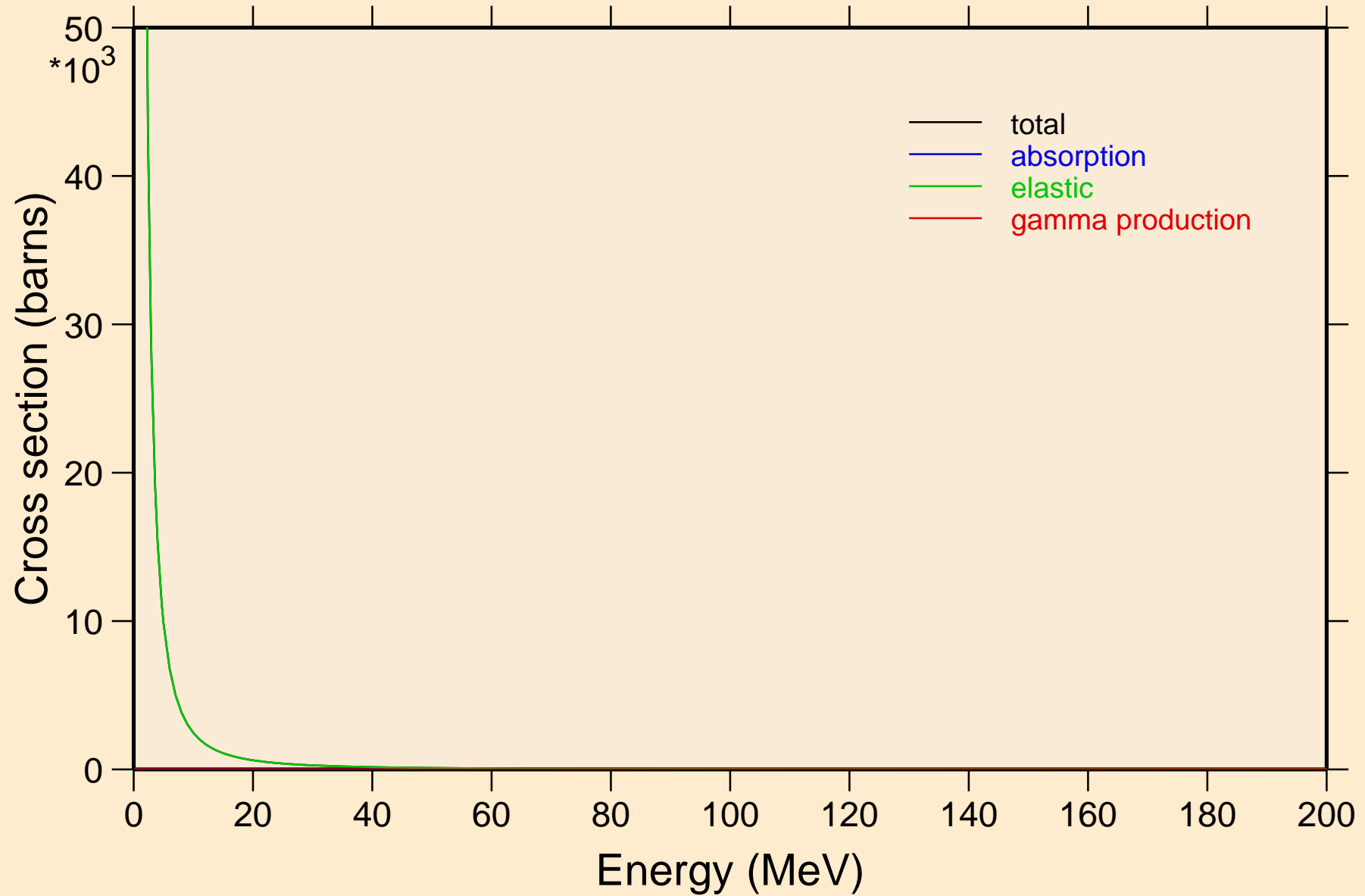

ES243 HELION ACER TENDL-2021 LIBRARY; T=0.K

Heating

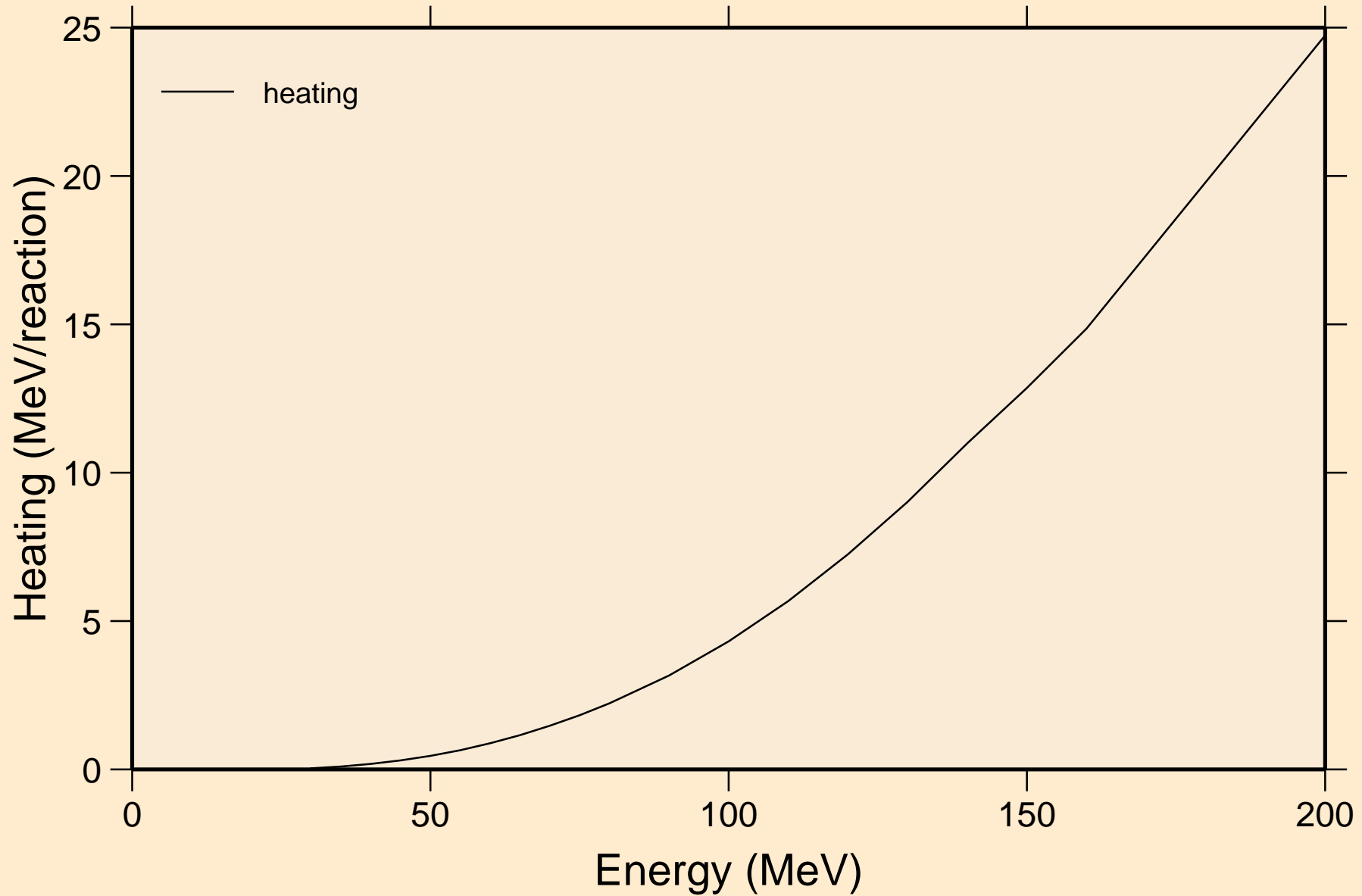

ES243 HELION ACER TENDL-2021 LIBRARY; T=0.K
Threshold reactions

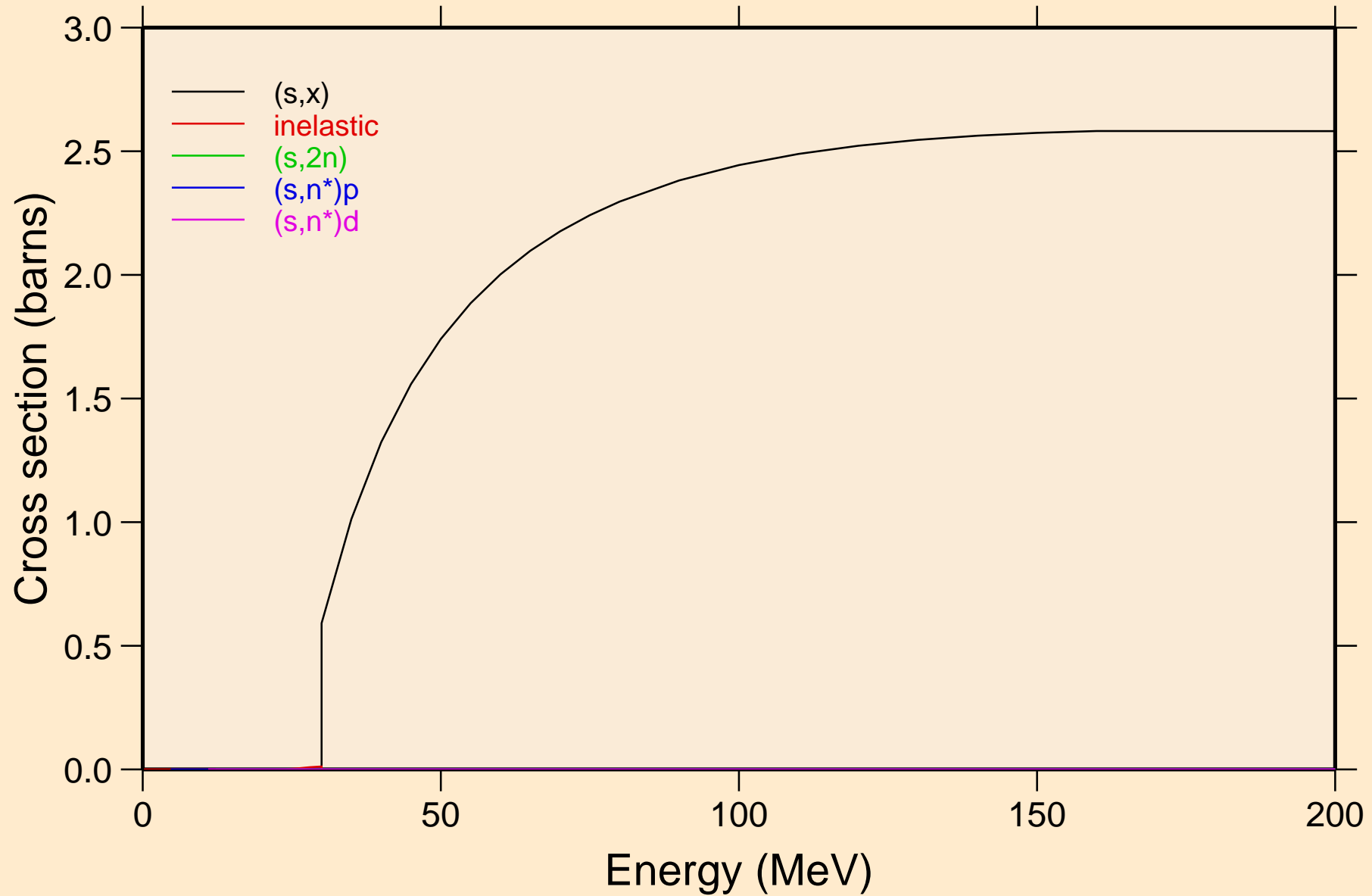

ES243 HELION ACER TENDL-2021 LIBRARY; T=0.K
Threshold reactions

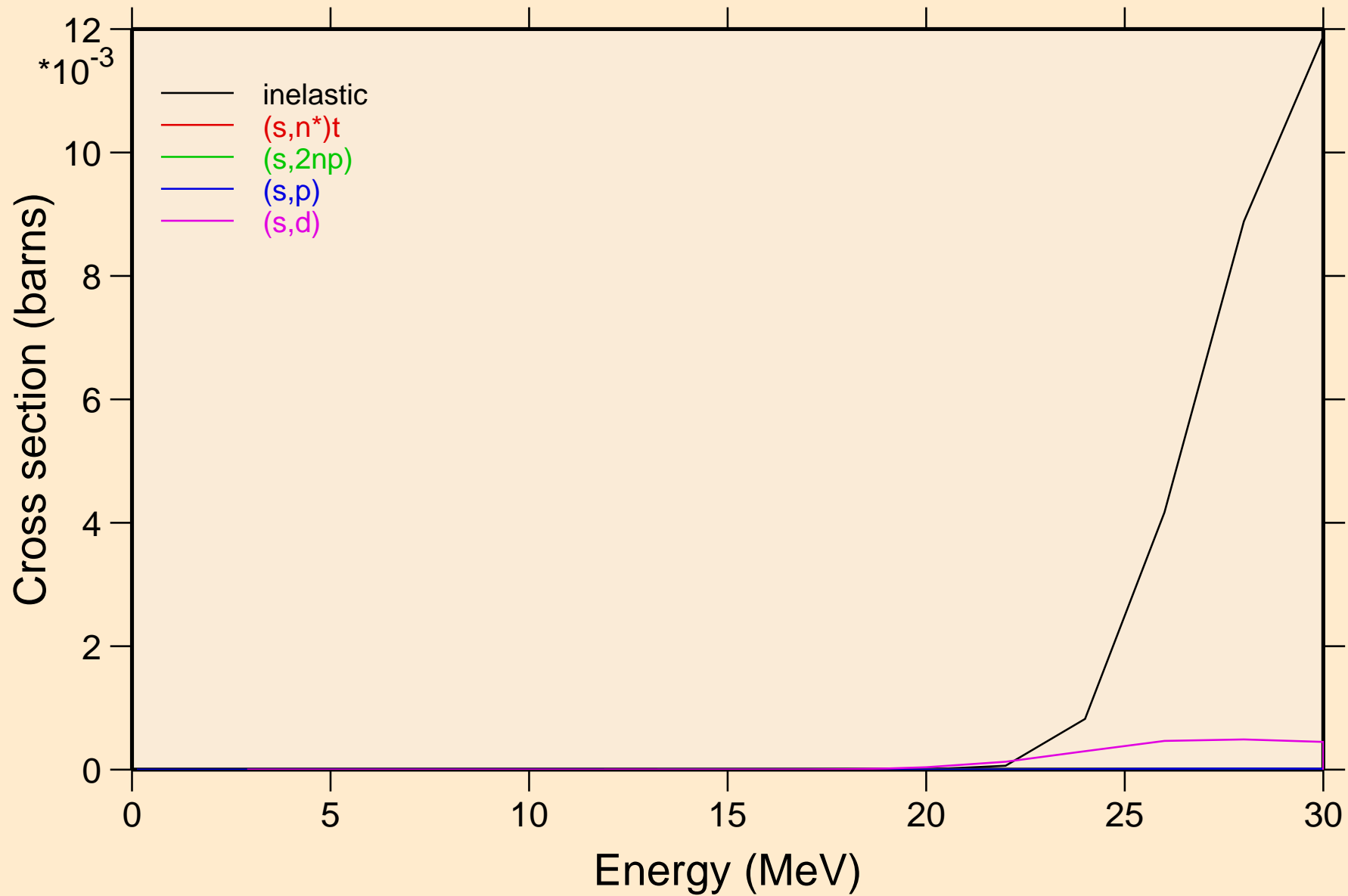

ES243 HELION ACER TENDL-2021 LIBRARY; T=0.K
Threshold reactions

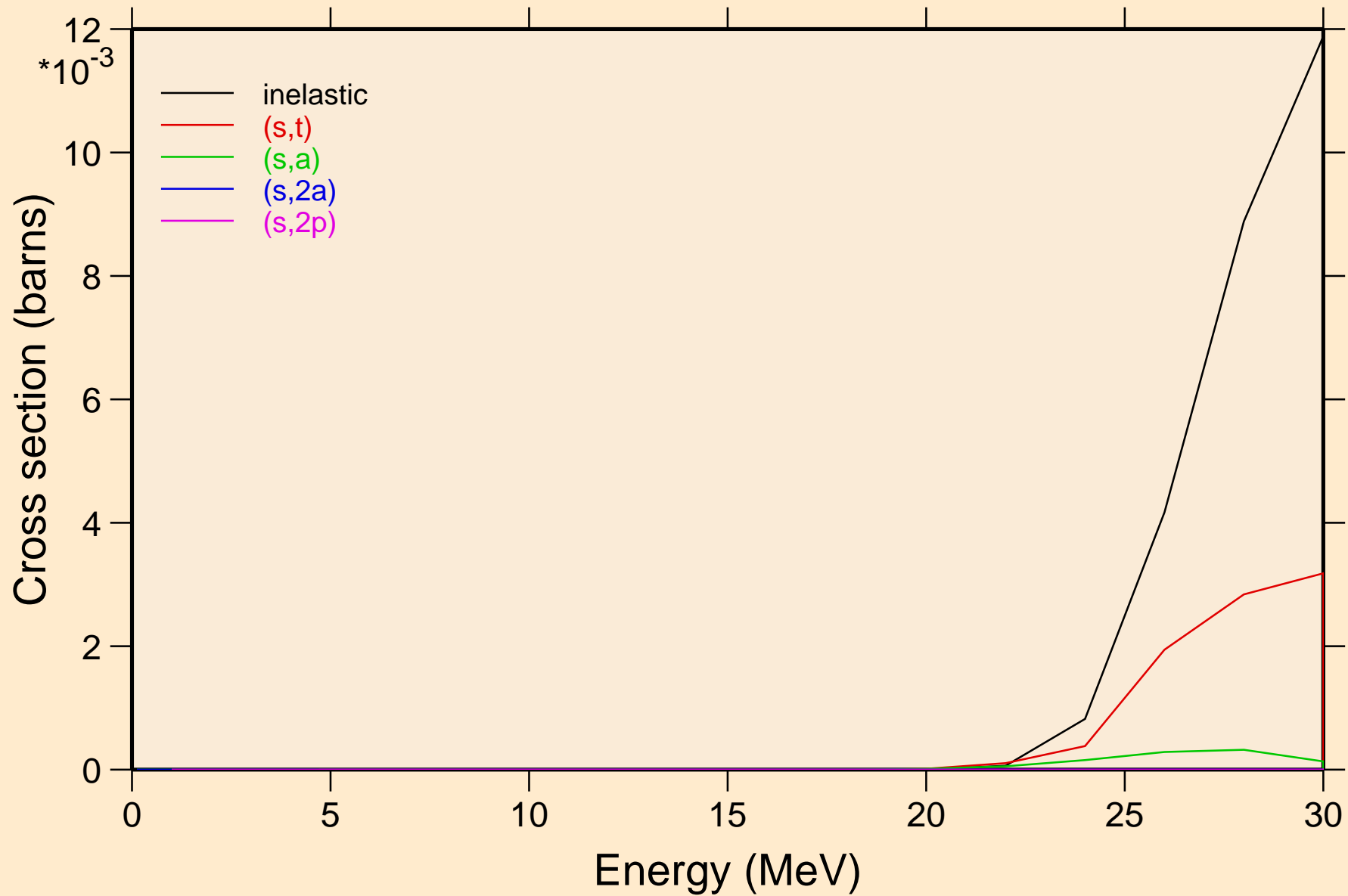

ES243 HELION ACER TENDL-2021 LIBRARY; T=0.K
Threshold reactions

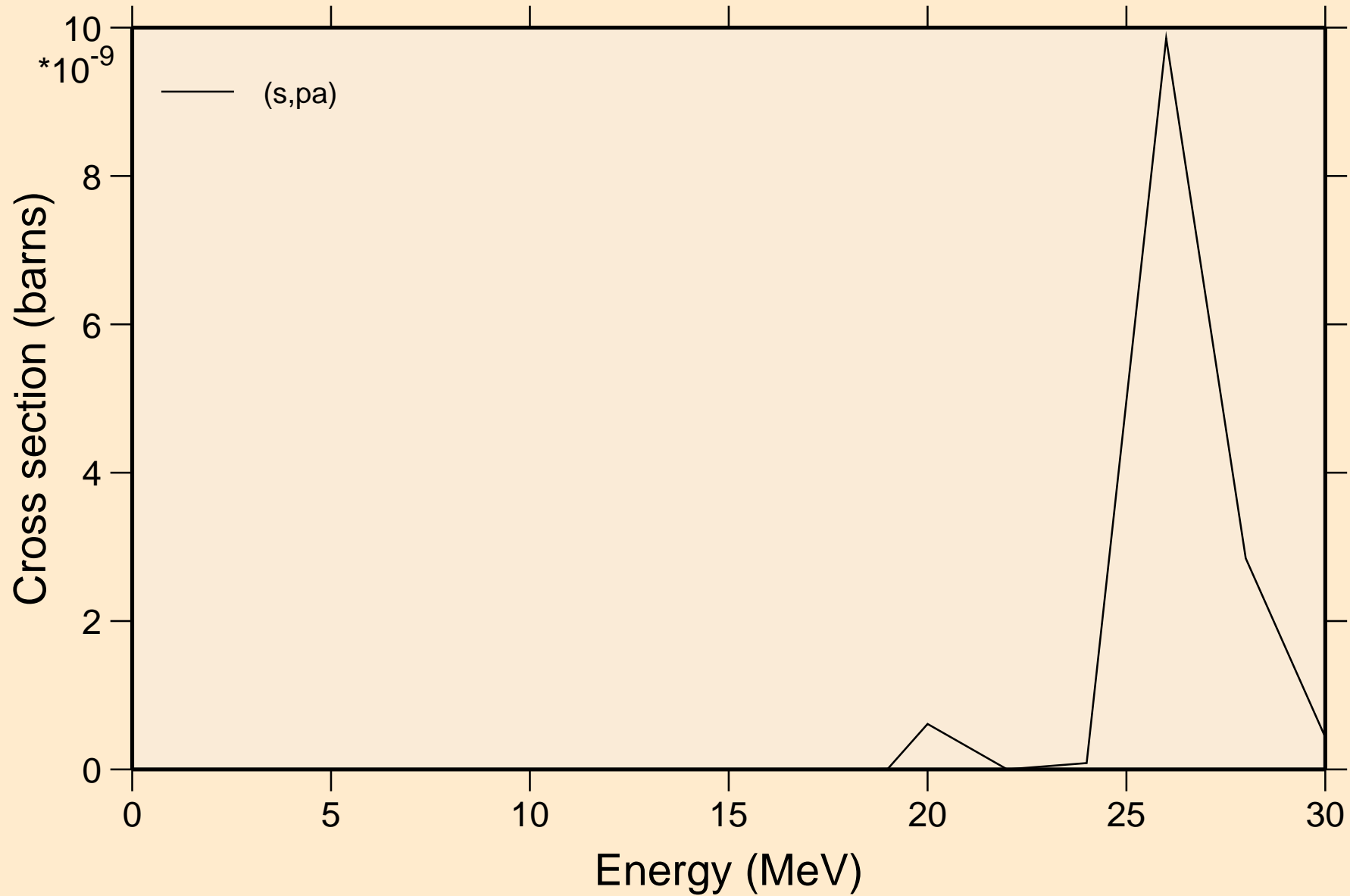

ES243 HELION ACER TENDL-2021 LIBRARY; T=0.K
angular distribution for elastic

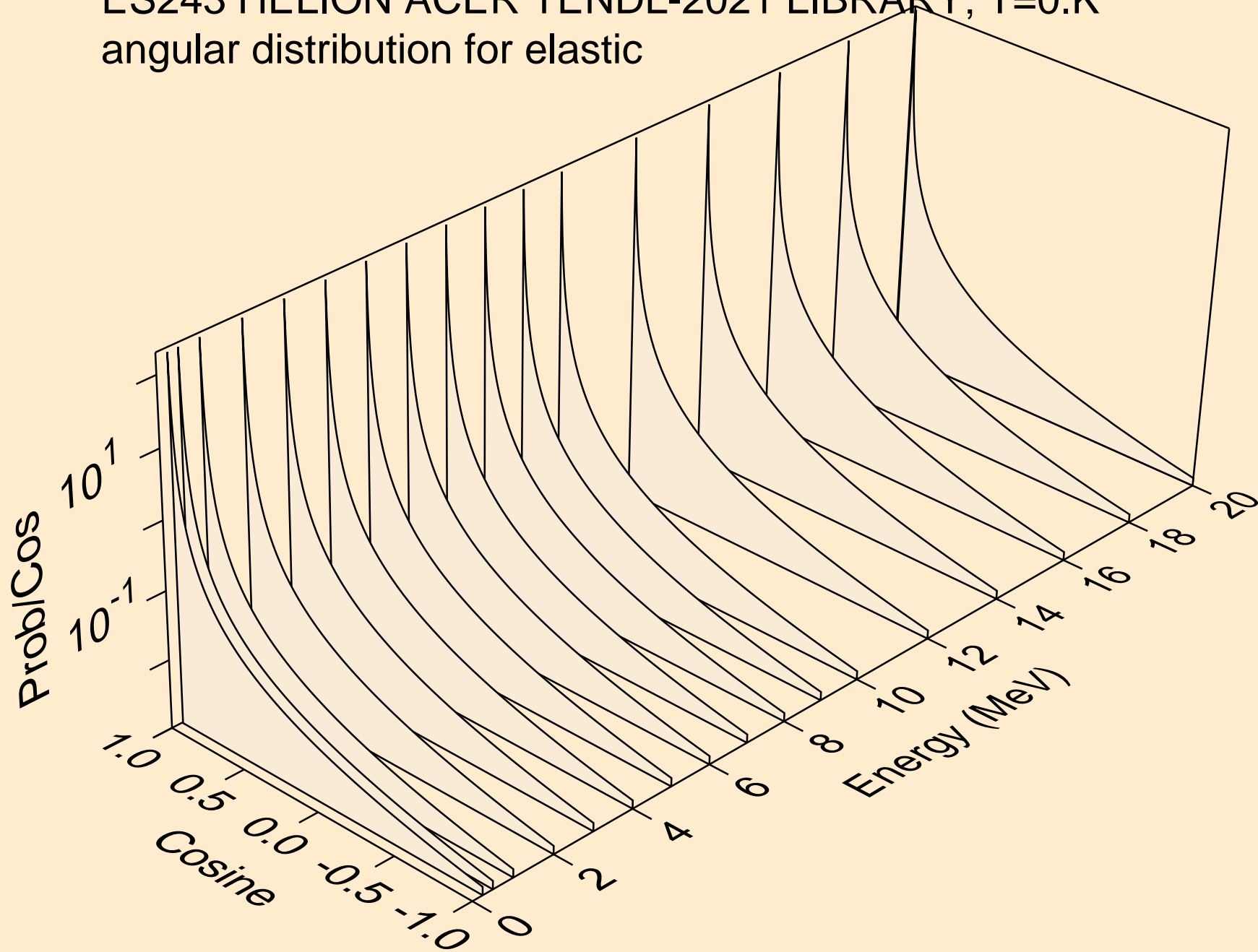

ES243 HELION ACER TENDL-2021 LIBRARY; T=0.K
angular distribution for elastic

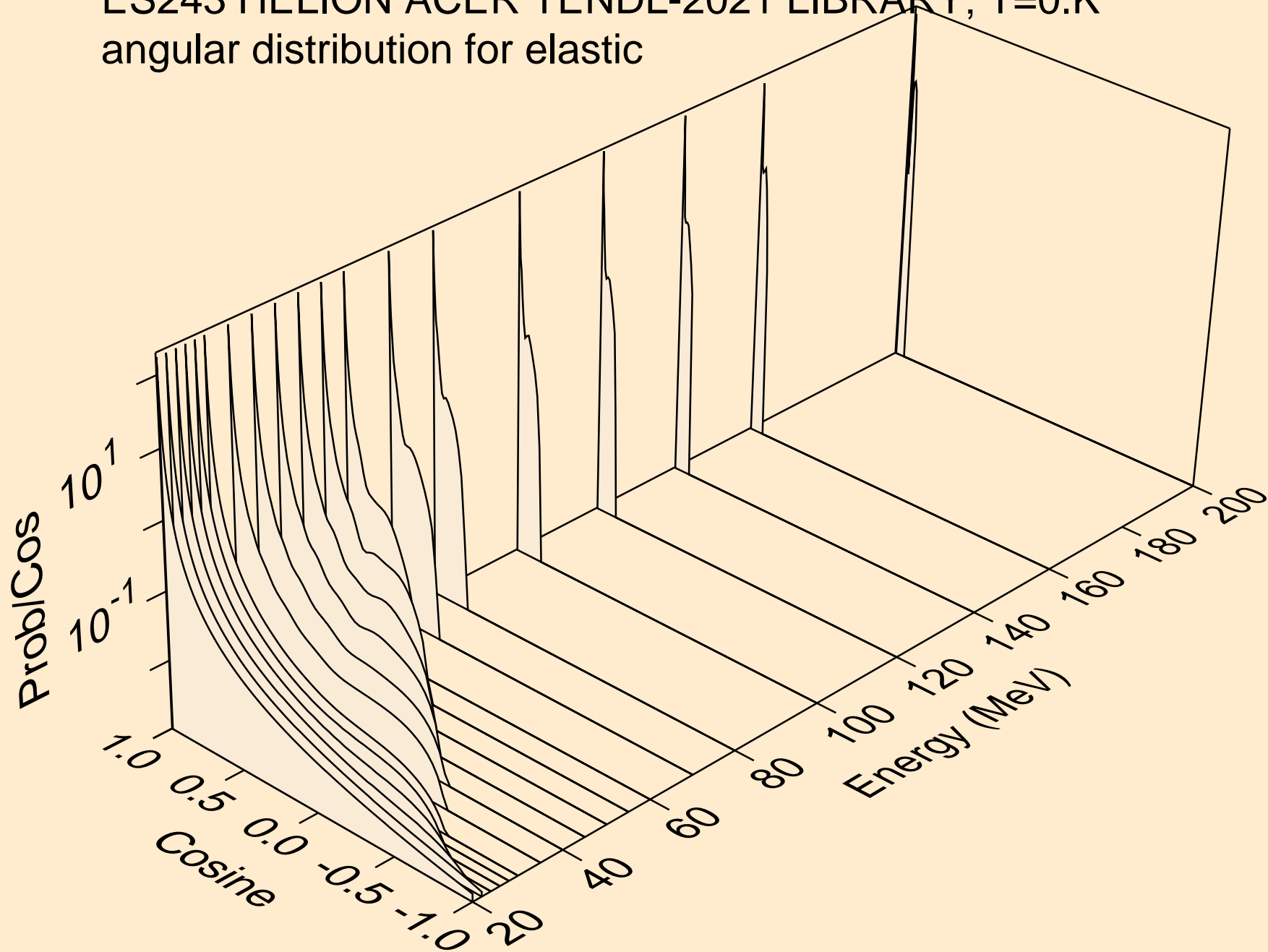

ES243 HELION ACER TENDL-2021 LIBRARY; T=0.K
He-3 emission for (s,x)

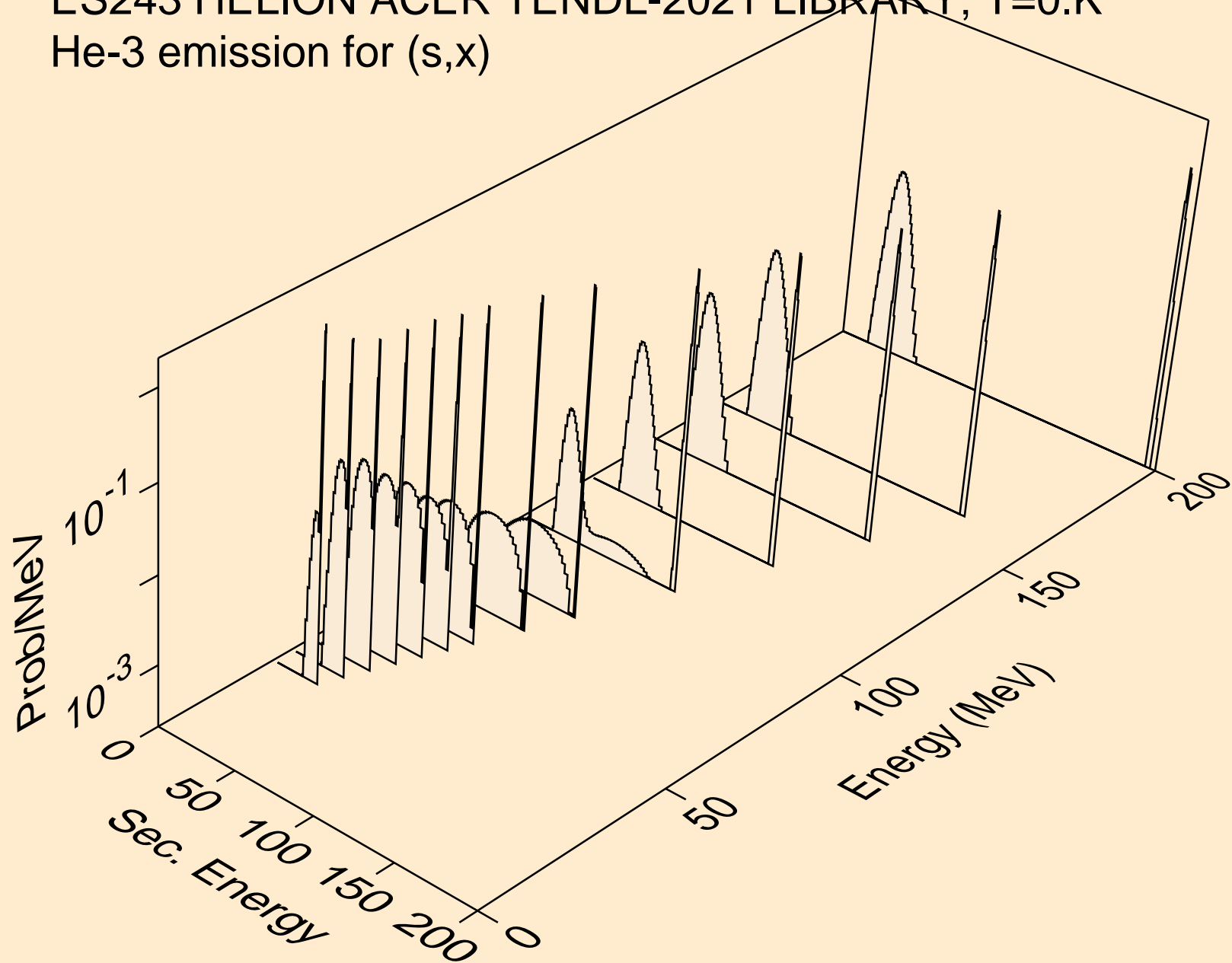

ES243 HELION ACER TENDL-2021 LIBRARY; T=0.K
He-3 emission for inelastic

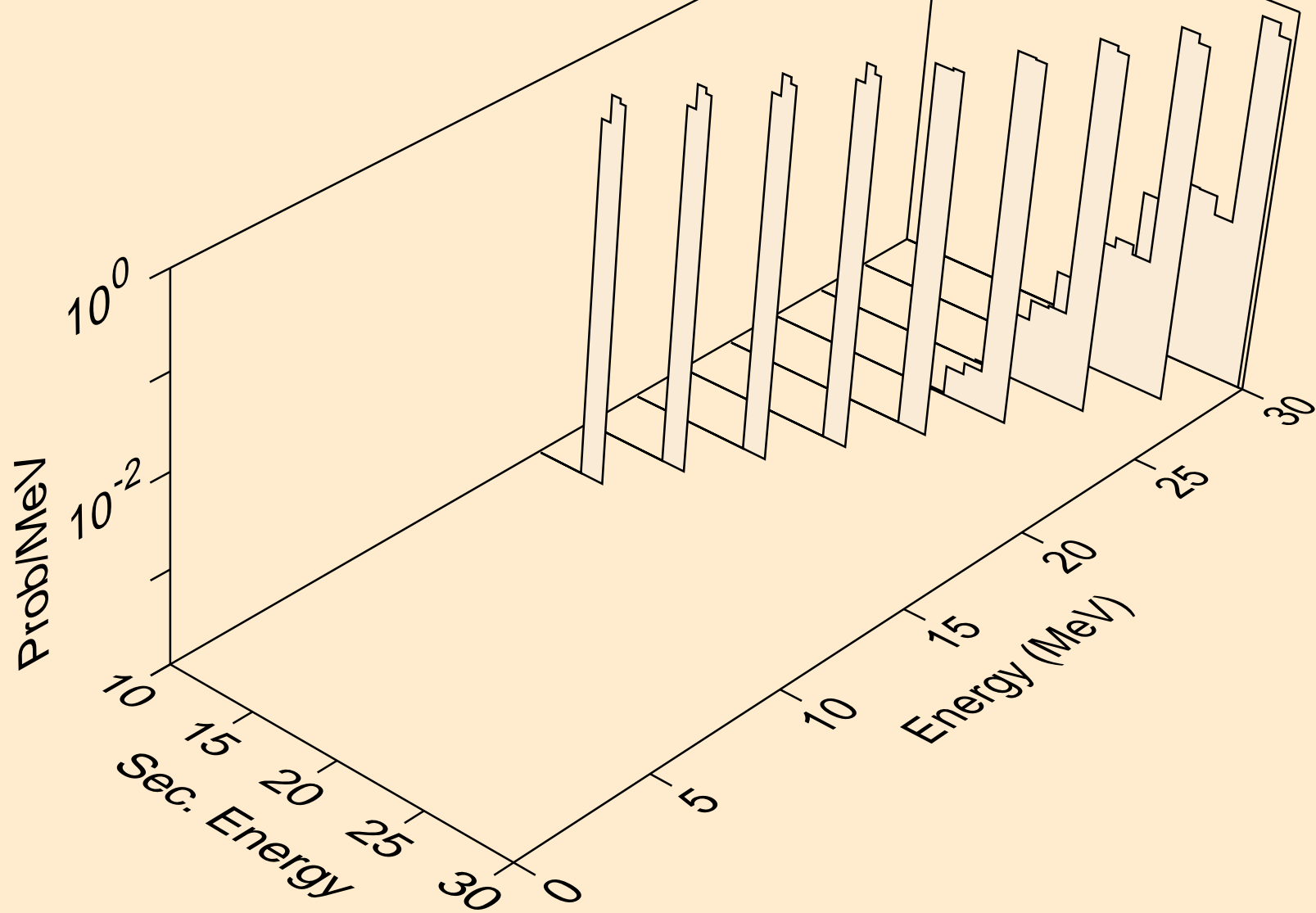

ES243 HELION ACER TENDL-2021 LIBRARY; T=0.K
Photon emission for (z,n)

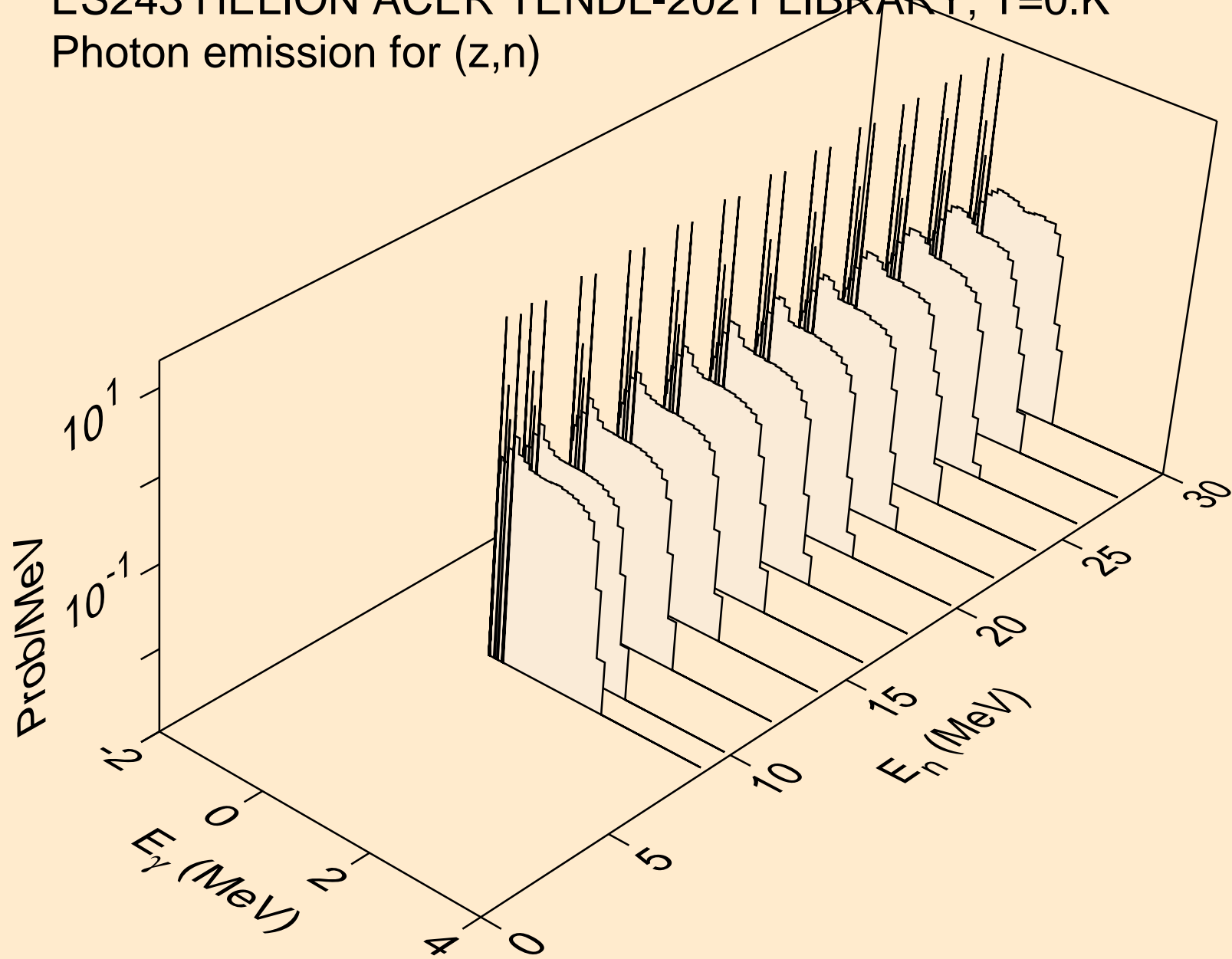

ES243 HELION ACER TENDL-2021 LIBRARY; T=0.K
Photon emission for (n,x)

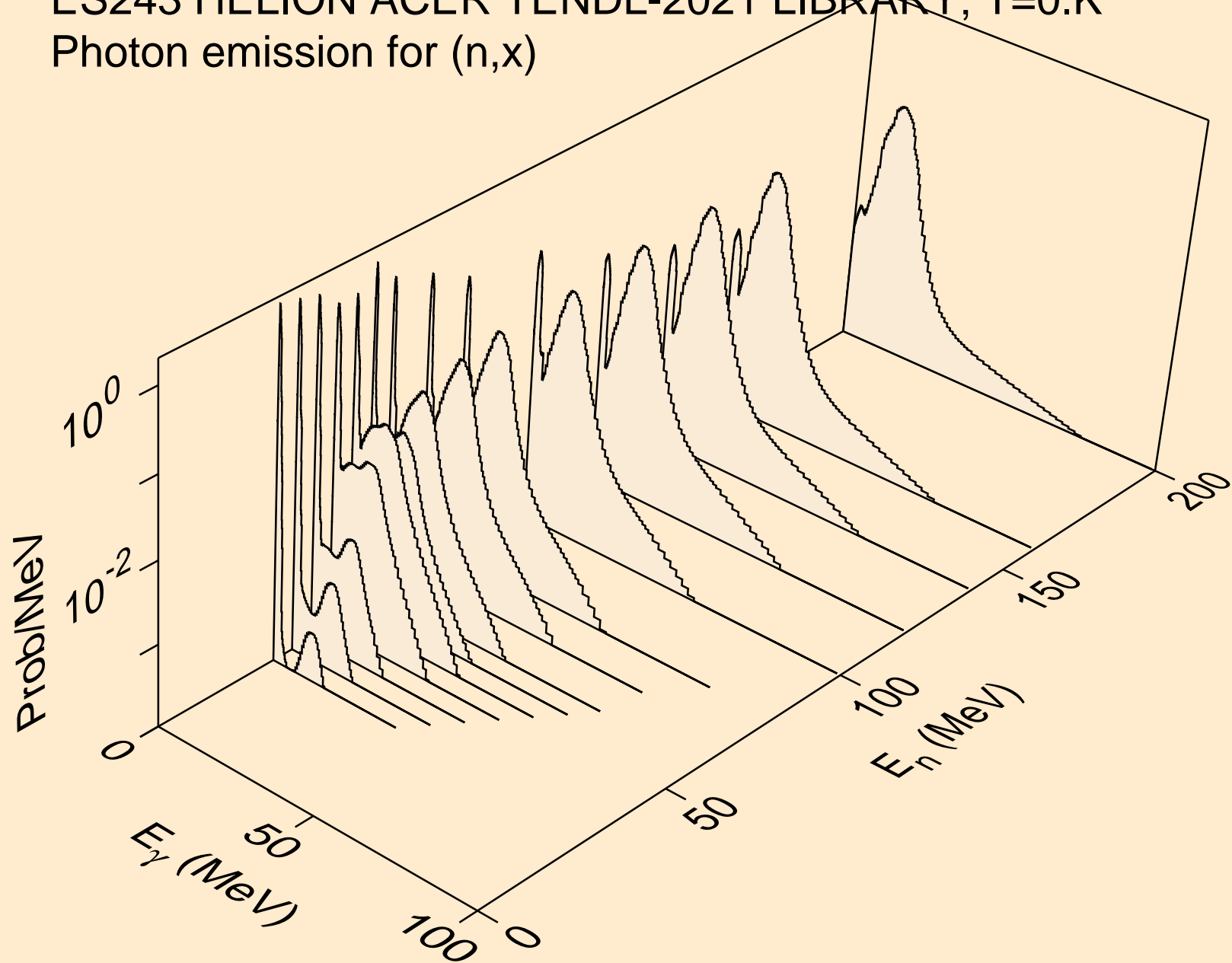

ES243 HELION ACER TENDL-2021 LIBRARY; T=0.K
Photon emission for (n,2n)

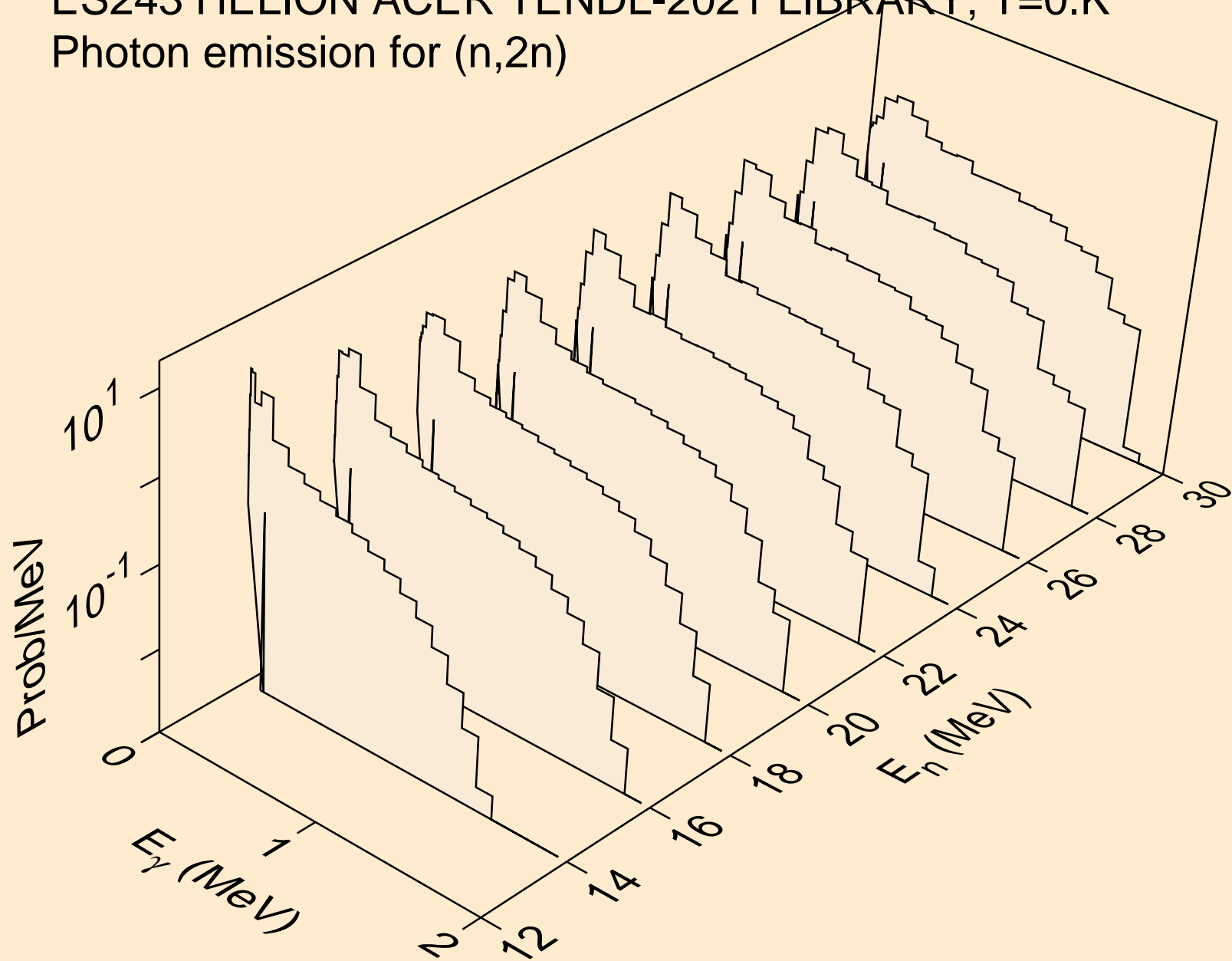

ES243 HELION ACER TENDL-2021 LIBRARY; T=0.K
Photon emission for (n,n*)p

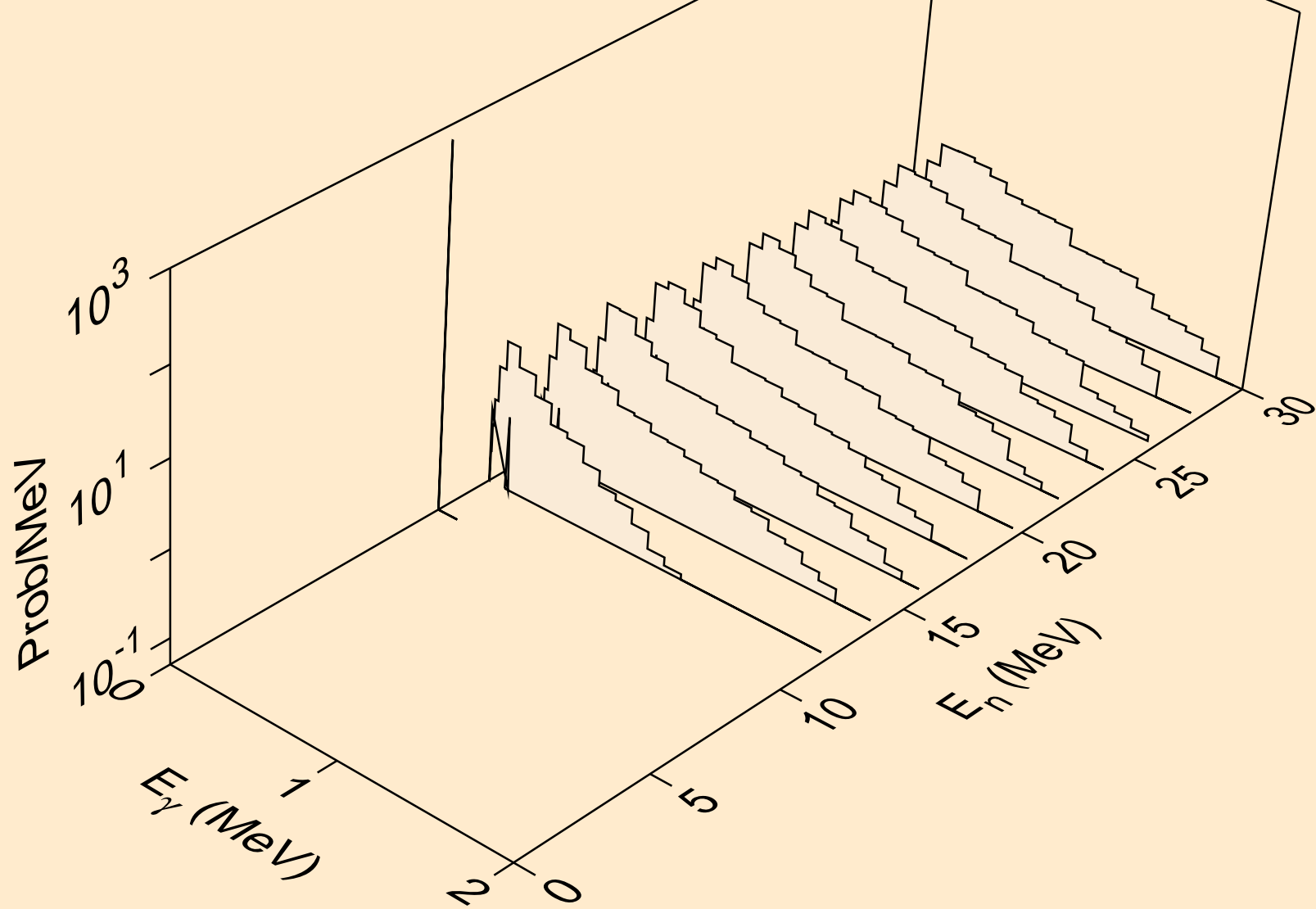

ES243 HELION ACER TENDL-2021 LIBRARY; T=0.K
Photon emission for (n,n*)d

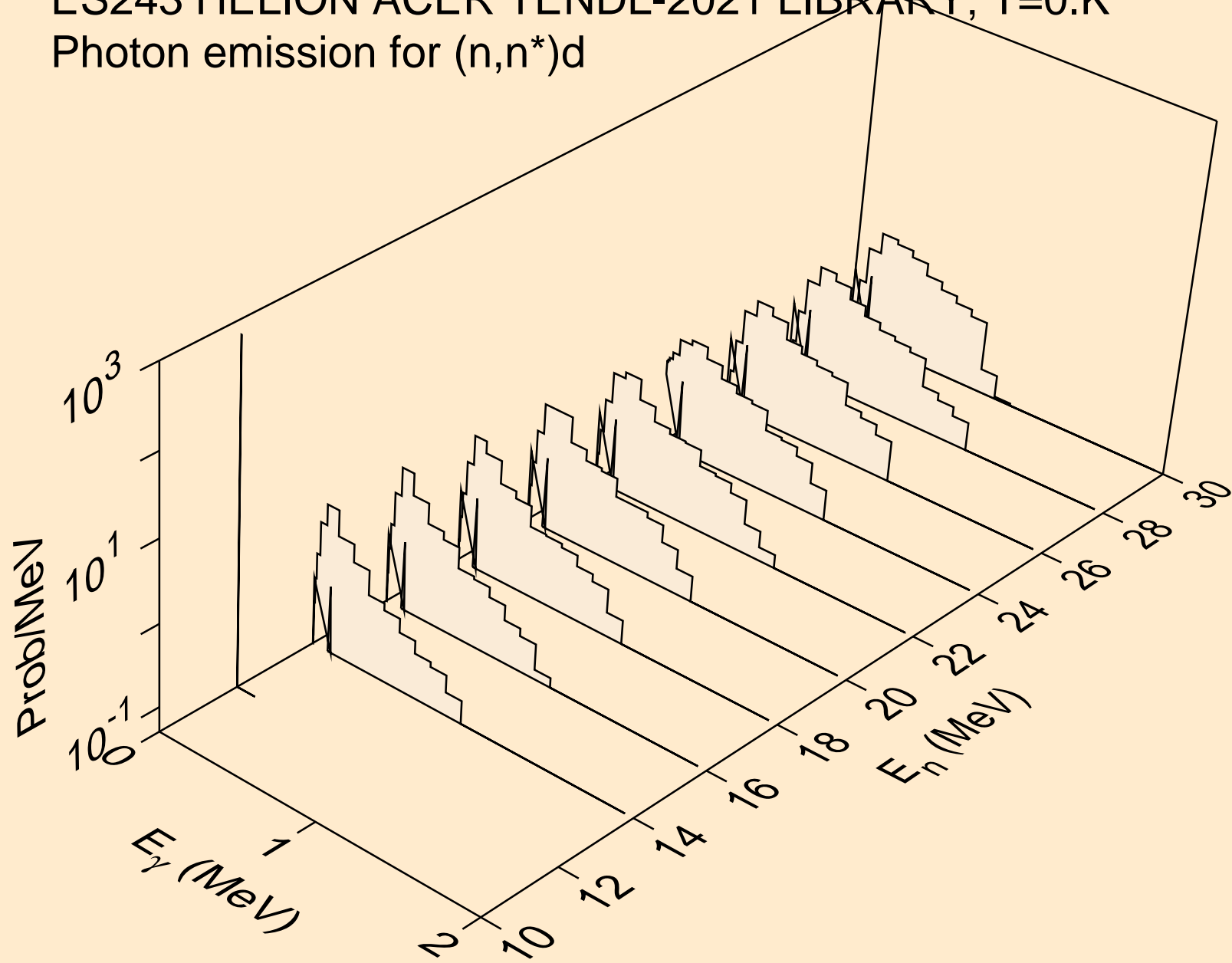

ES243 HELION ACER TENDL-2021 LIBRARY; T=0.K
Photon emission for (n,n*)t

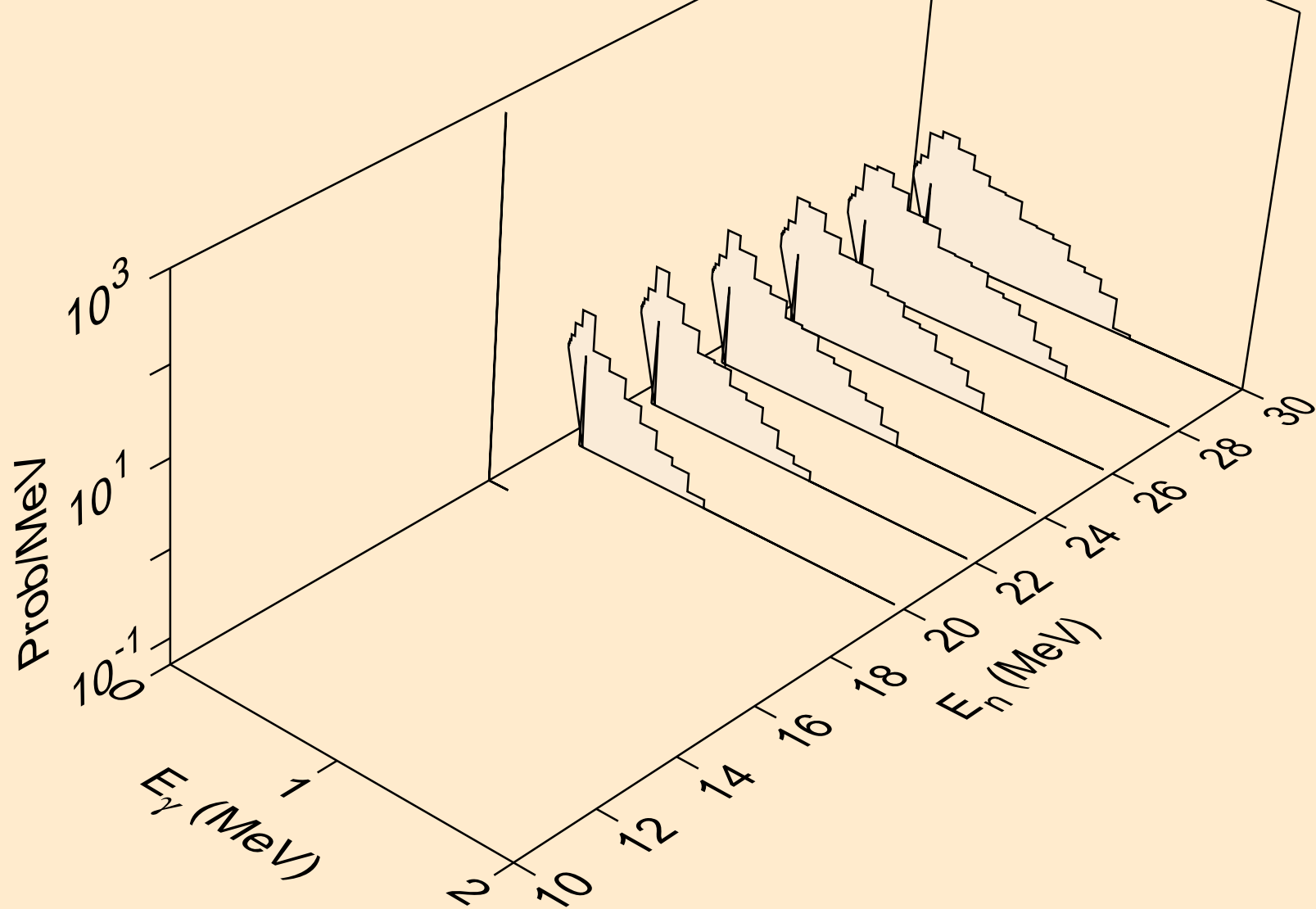

ES243 HELION ACER TENDL-2021 LIBRARY; T=0.K
Photon emission for (n,2np)

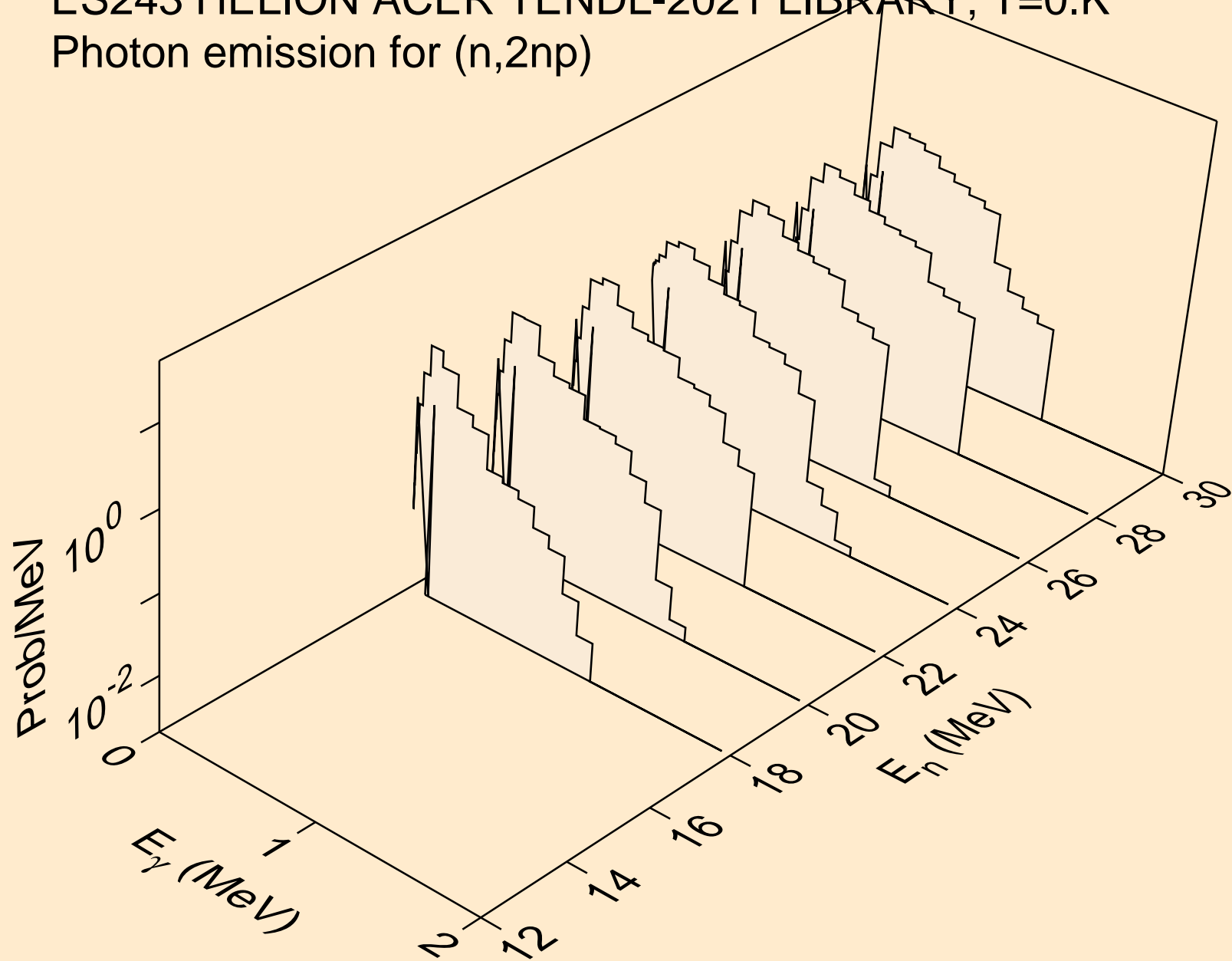

ES243 HELION ACER TENDL-2021 LIBRARY; T=0.K
Photon emission for (n,p)

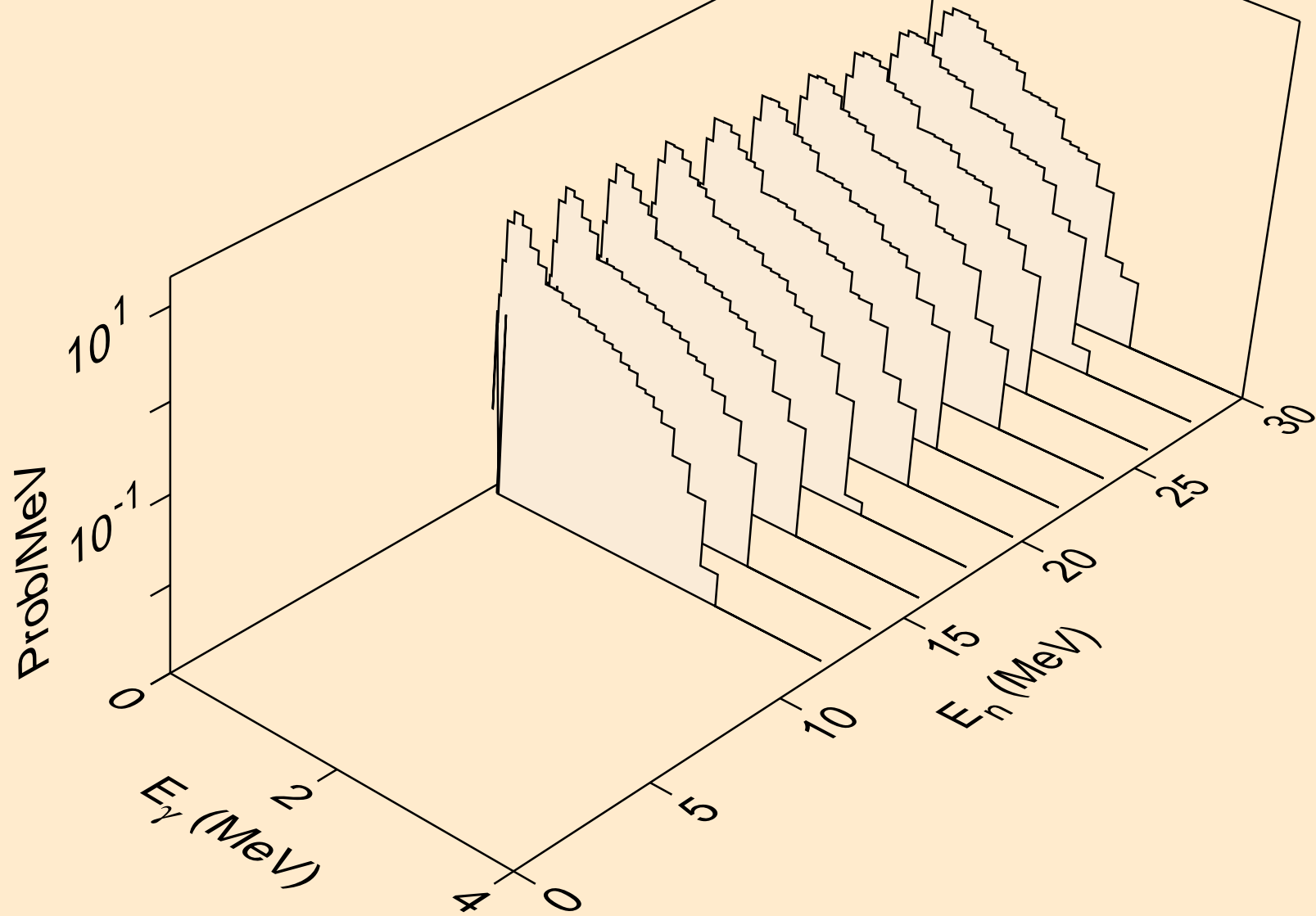

ES243 HELION ACER TENDL-2021 LIBRARY; T=0.K
Photon emission for (n,d)

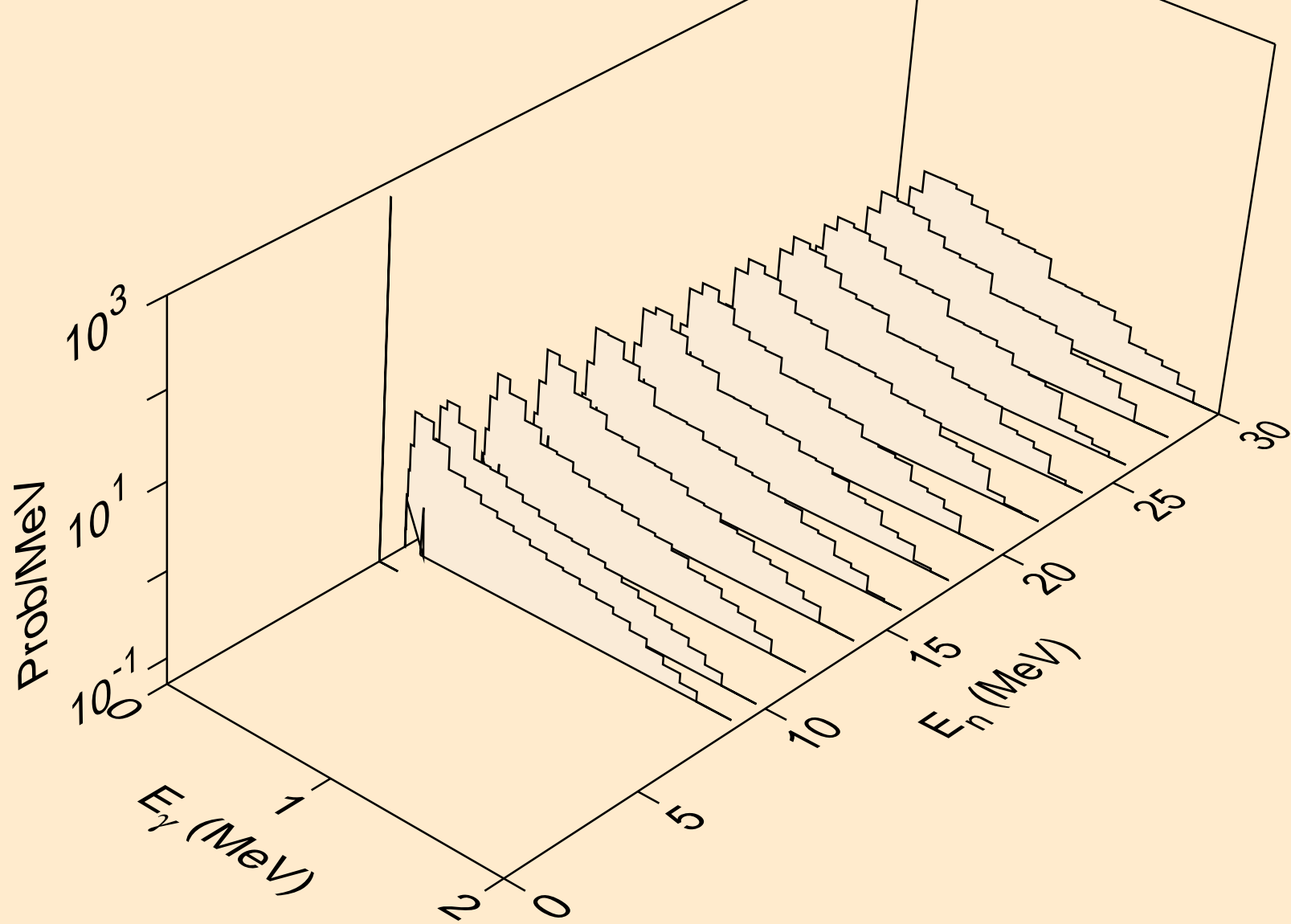

ES243 HELION ACER TENDL-2021 LIBRARY; T=0.K
Photon emission for (n,t)

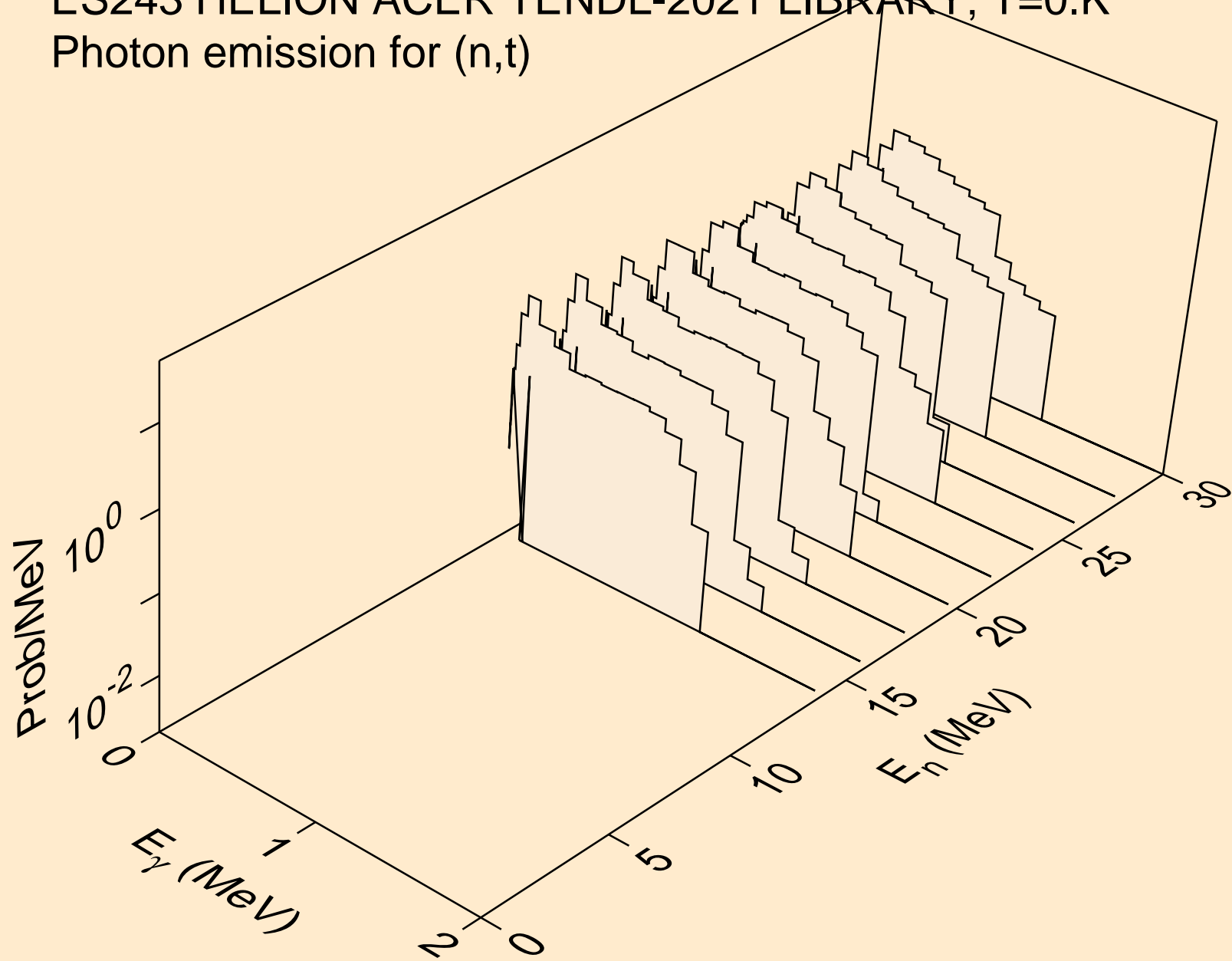

ES243 HELION ACER TENDL-2021 LIBRARY; T=0.K
Photon emission for inelastic

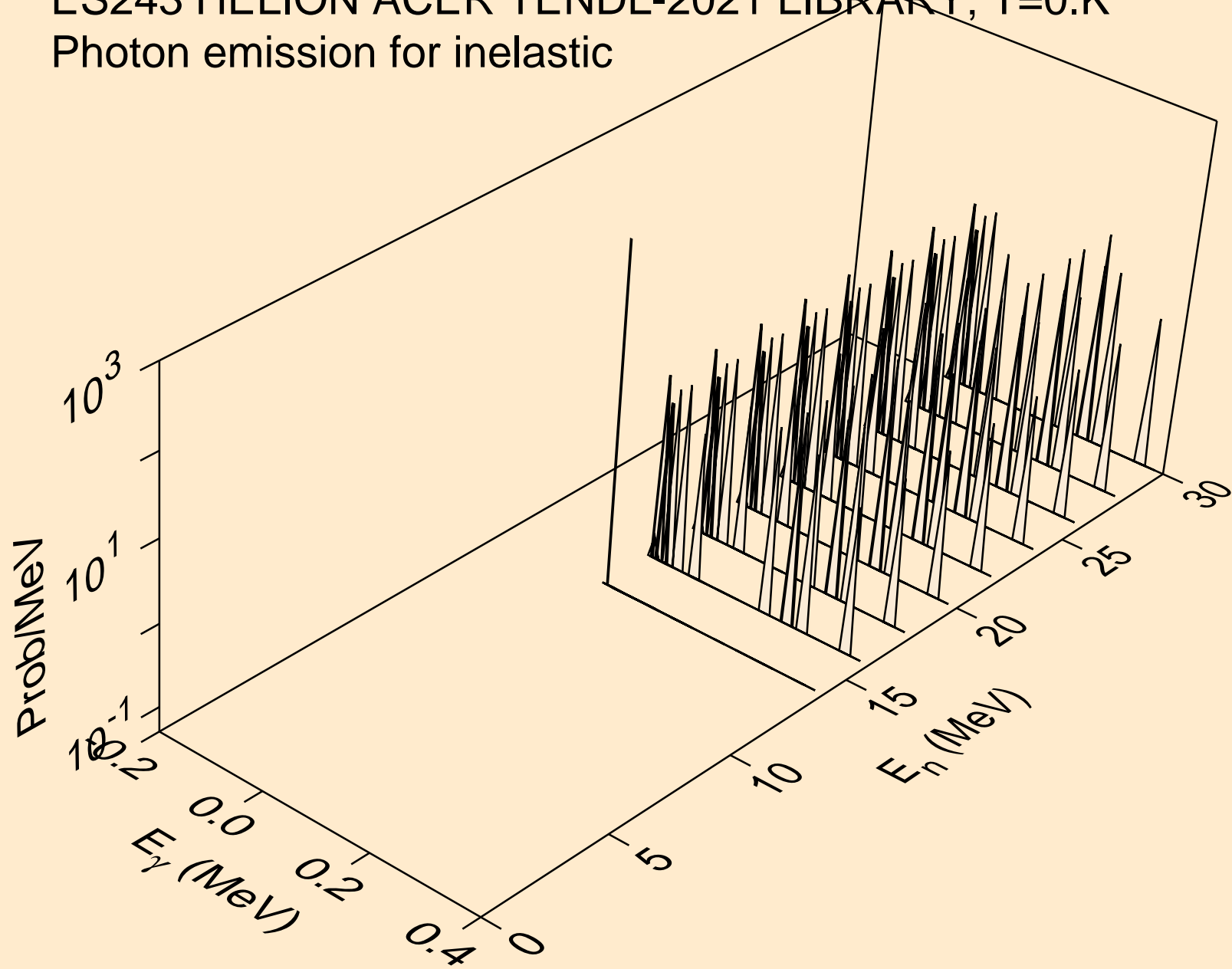

ES243 HELION ACER TENDL-2021 LIBRARY; T=0.K
Photon emission for (n,a)

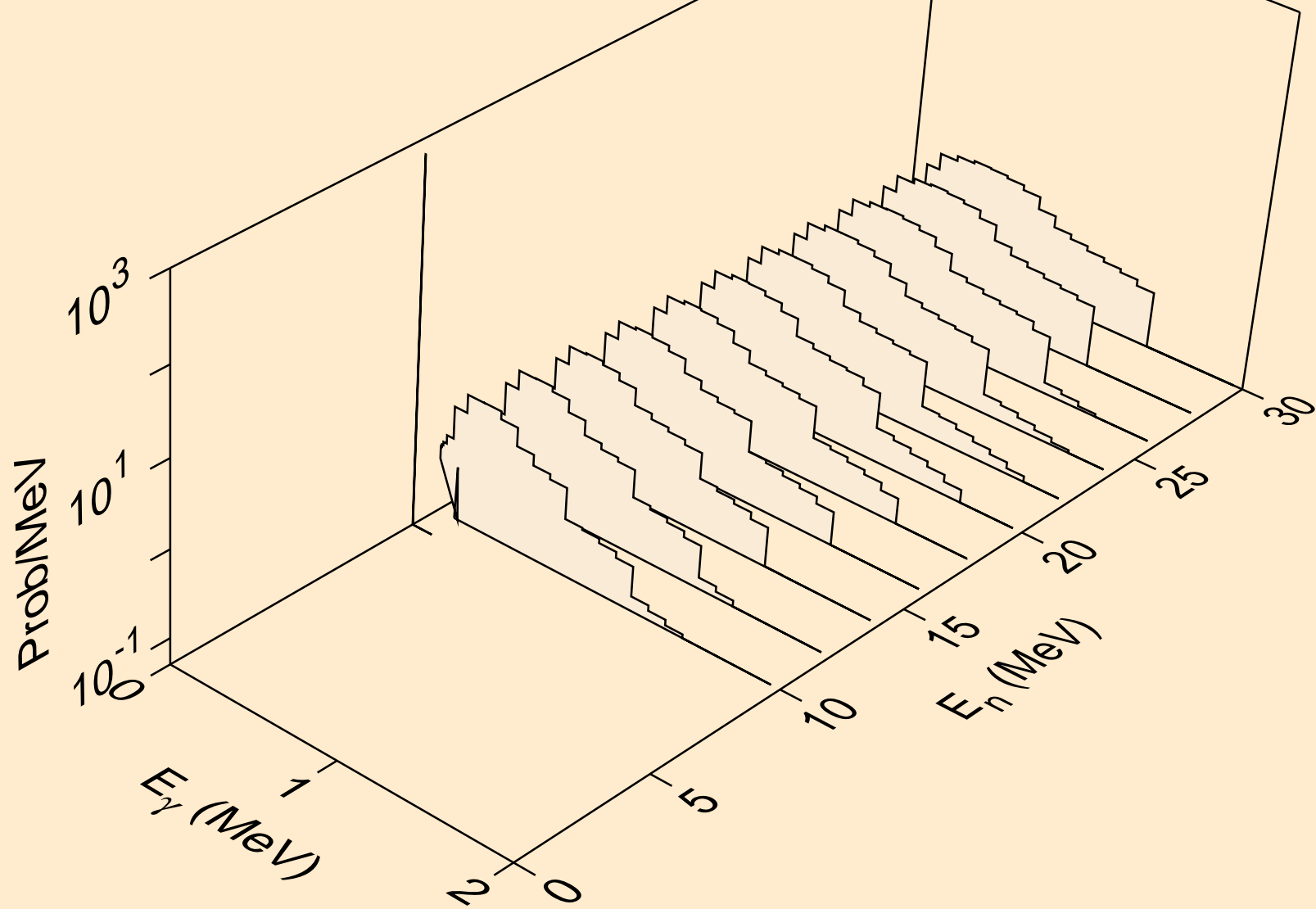

ES243 HELION ACER TENDL-2021 LIBRARY; T=0.K
Photon emission for (n,2a)

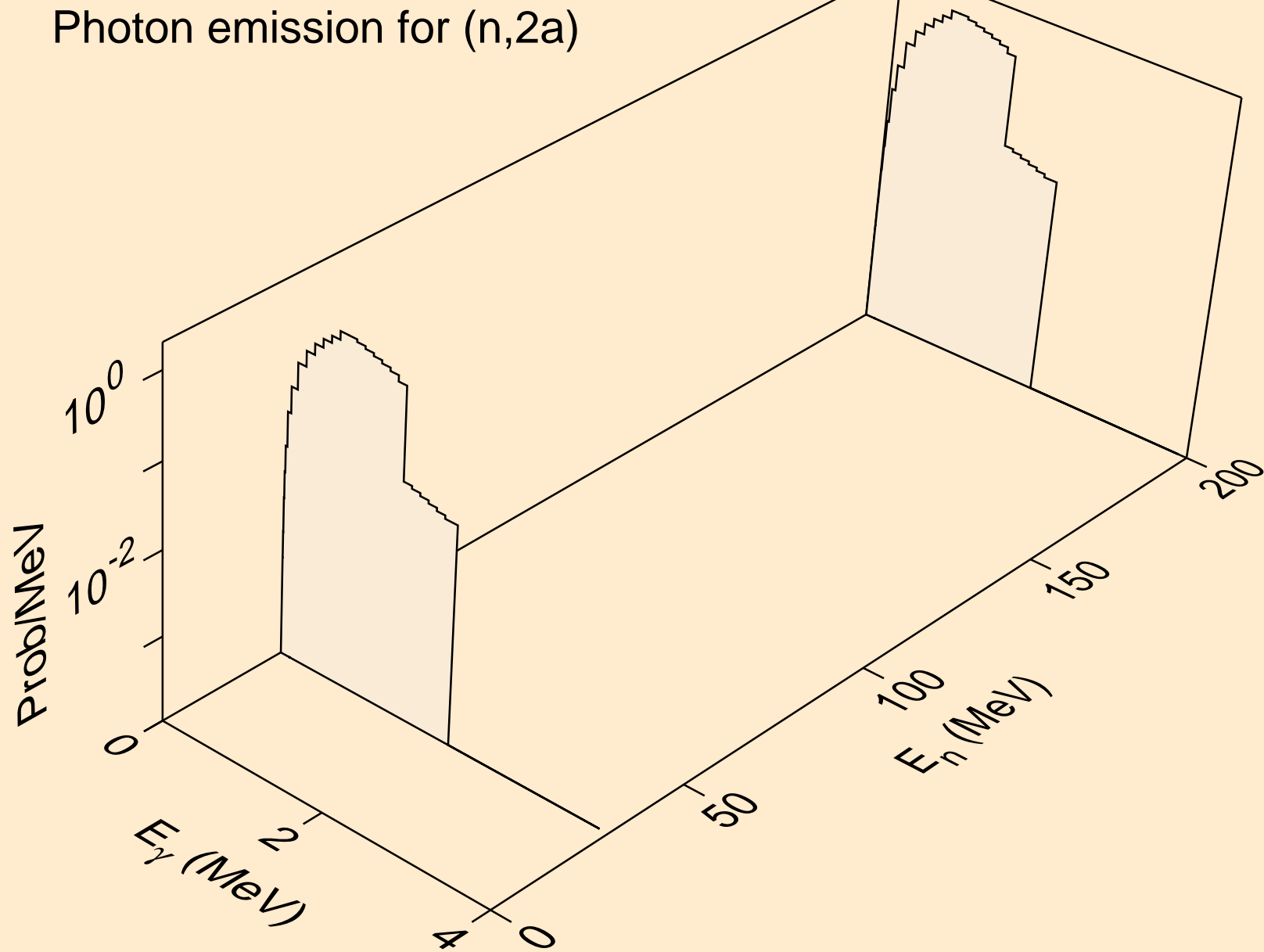

ES243 HELION ACER TENDL-2021 LIBRARY; T=0.K
Photon emission for (n,2p)

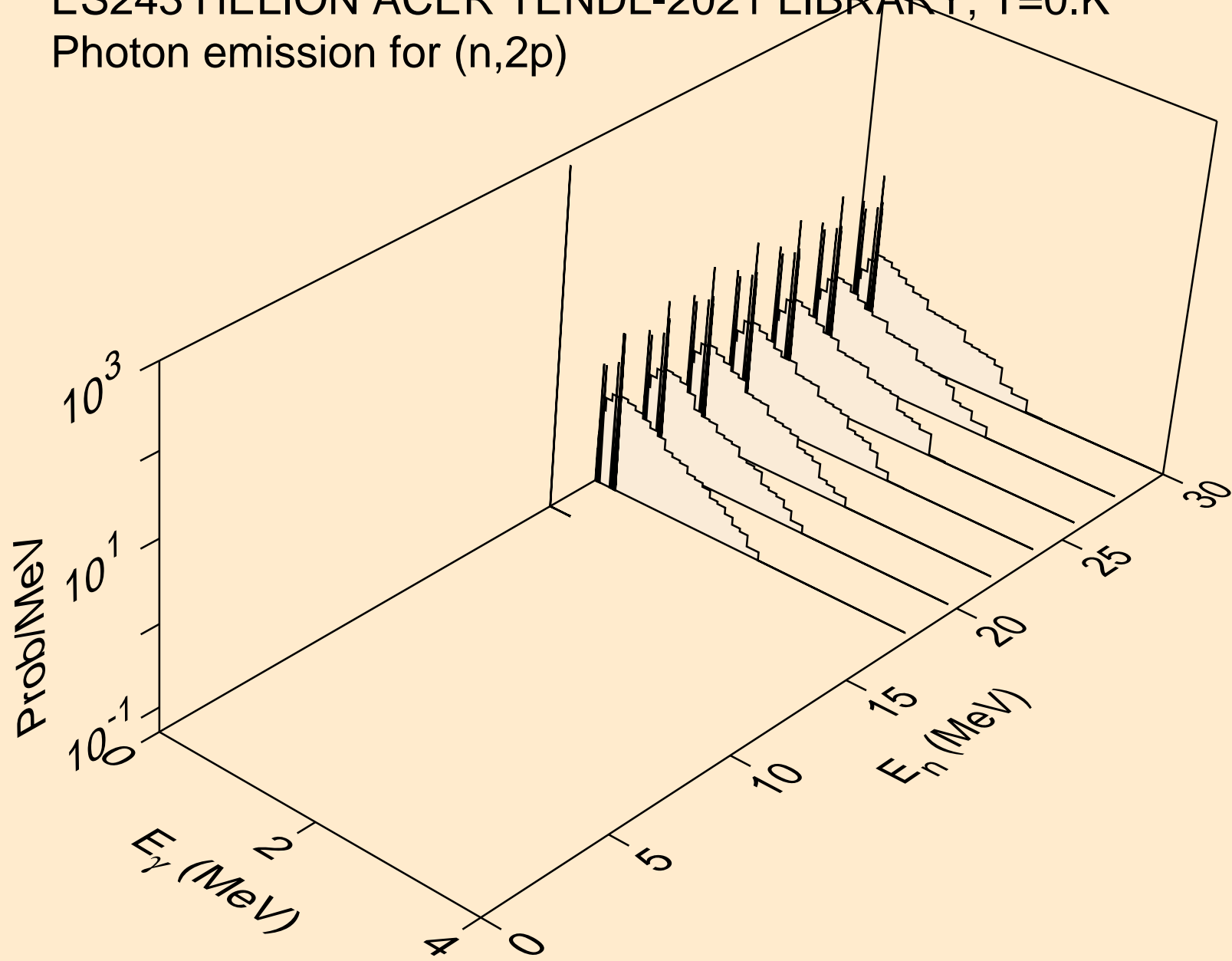

ES243 HELION ACER TENDL-2021 LIBRARY; T=0.K
Photon emission for (n,pa)

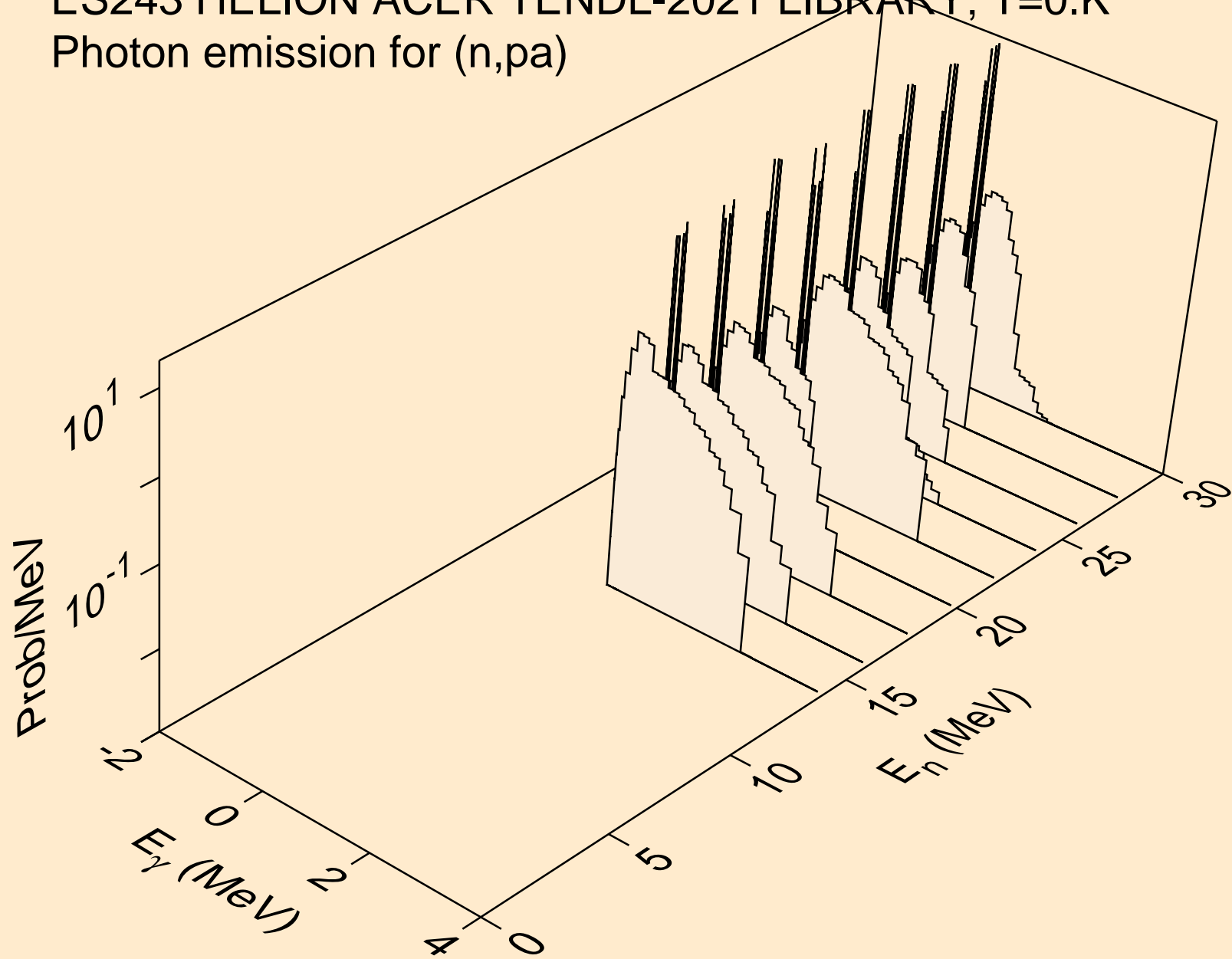

ES243 HELION ACER TENDL-2021 LIBRARY; T=0.K
Particle heating contributions

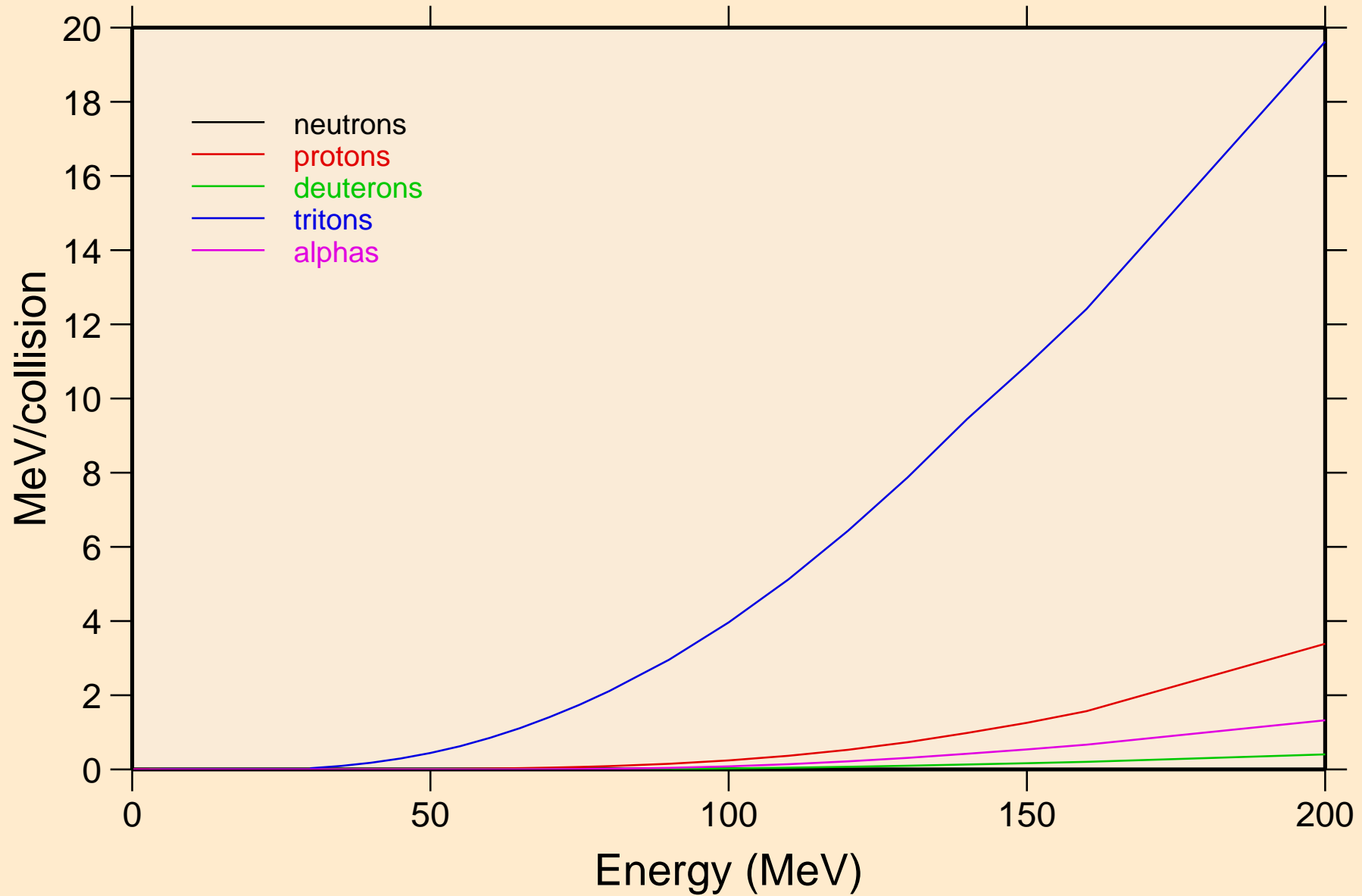

ES243 HELION ACER TENDL-2021 LIBRARY; T=0.K
Recoil Heating

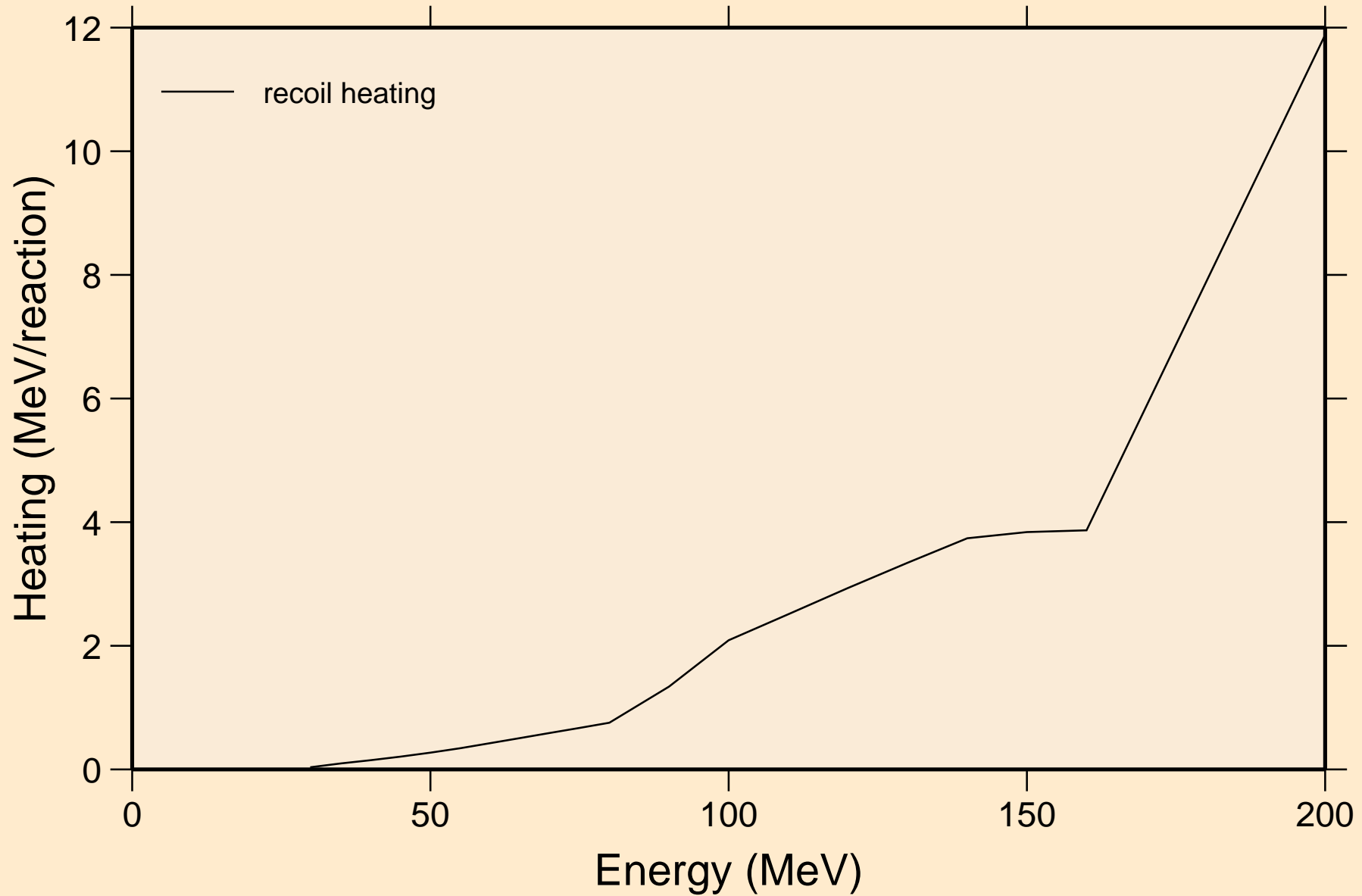

ES243 HELION ACER TENDL-2021 LIBRARY; T=0.K
Particle production cross sections

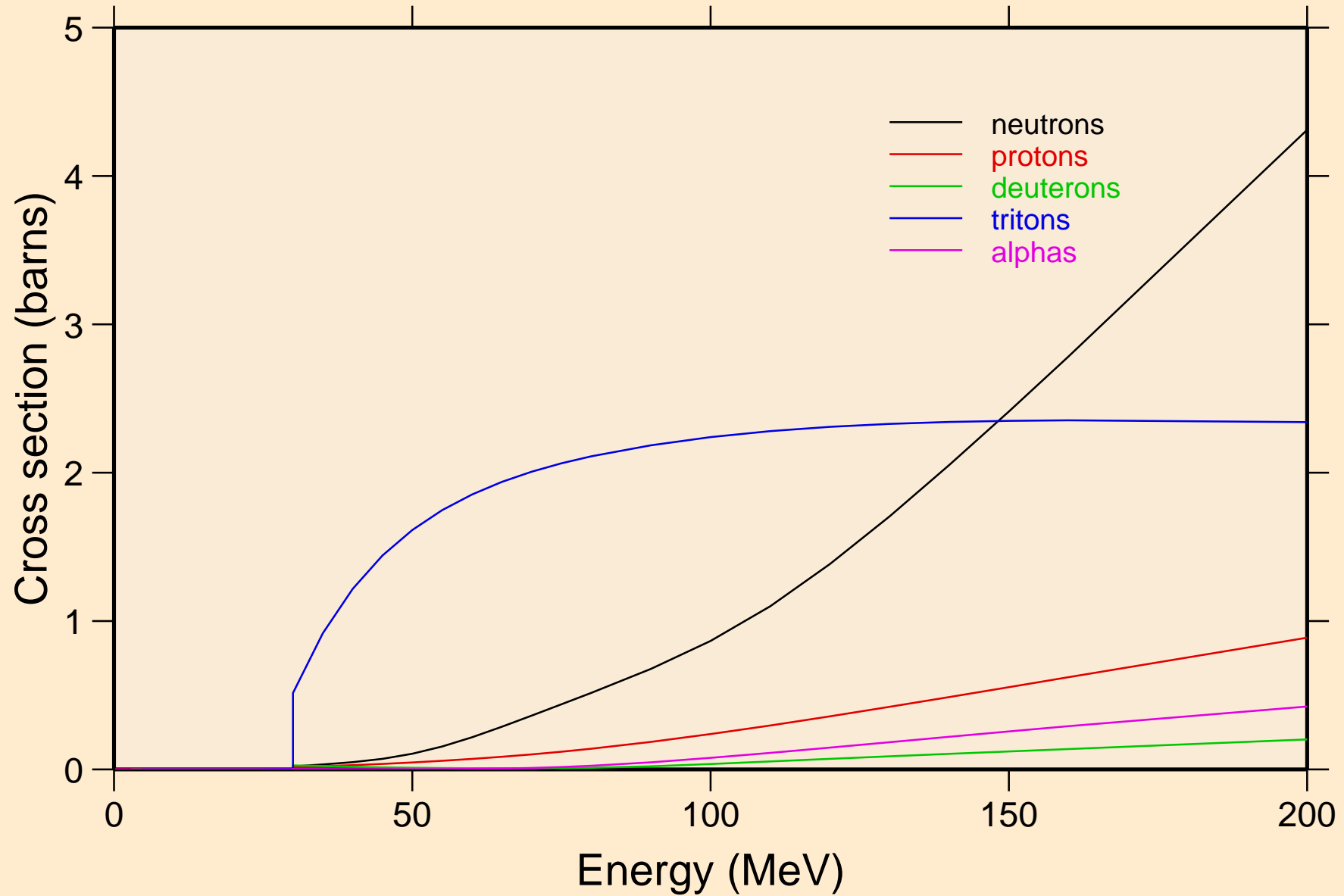

ES243 HELION ACER TENDL-2021 LIBRARY; T=0.K
neutrons from (s,n)

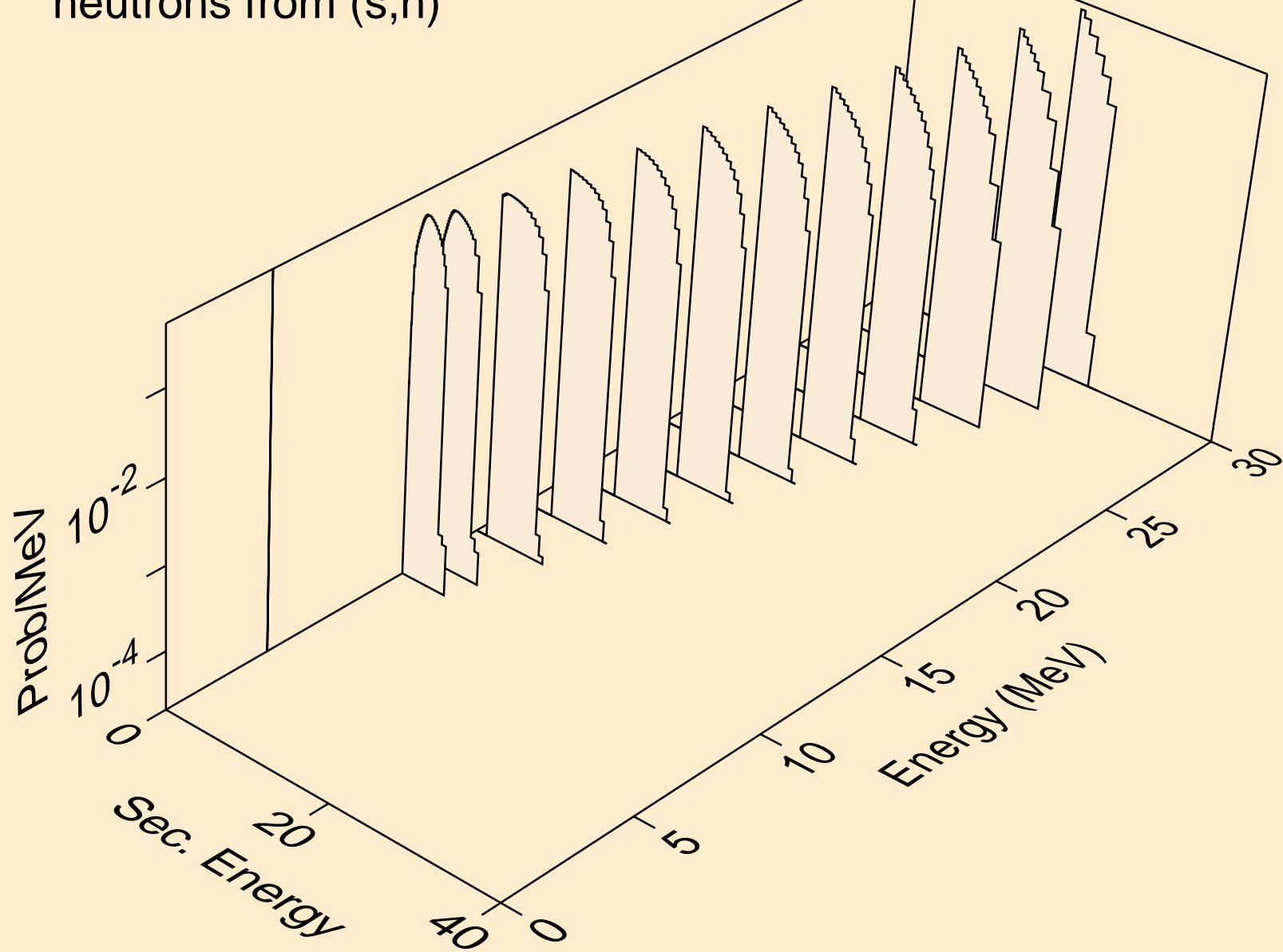

ES243 HELION ACER TENDL-2021 LIBRARY; T=0.K
neutrons from (s,x)

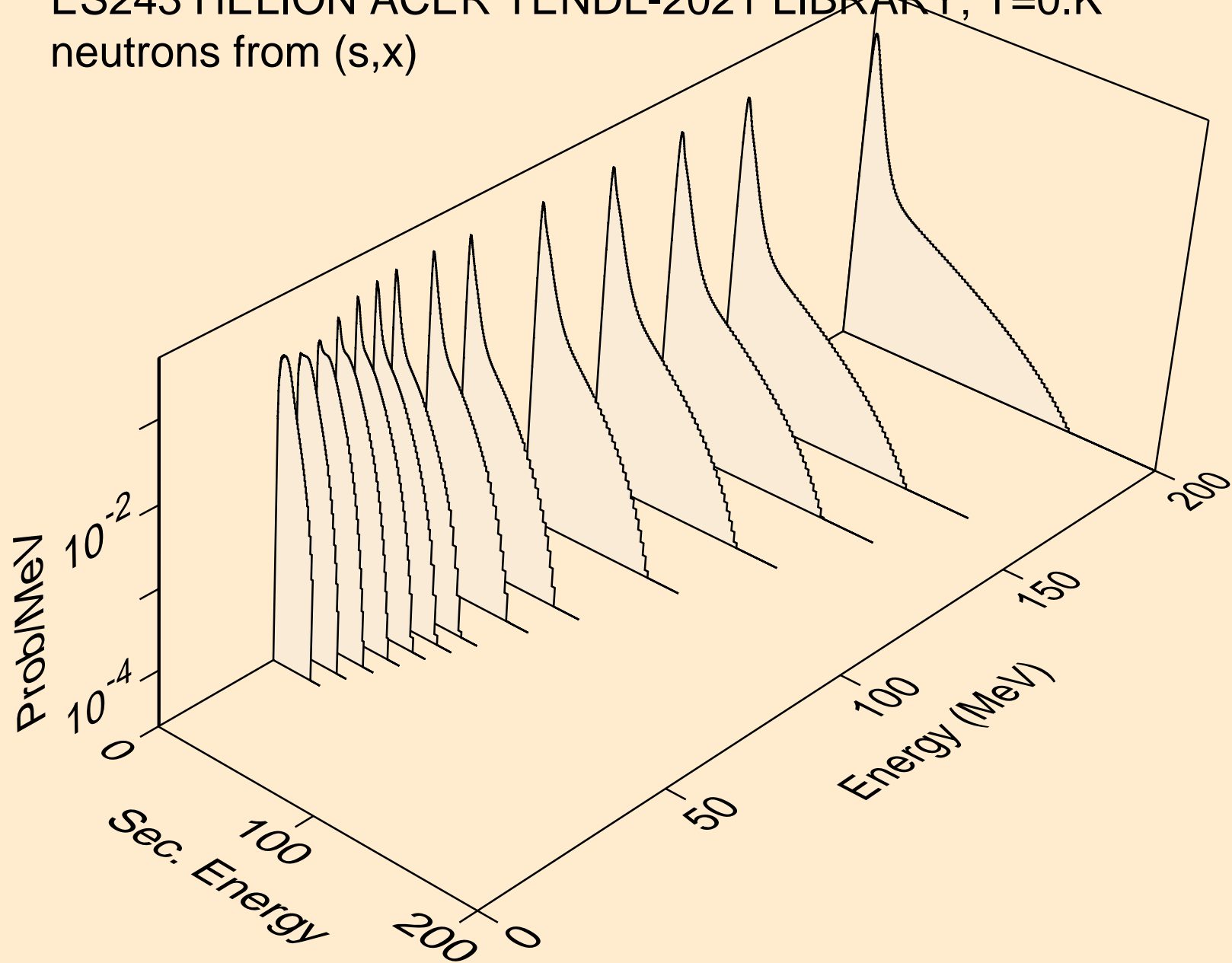

ES243 HELION ACER TENDL-2021 LIBRARY; T=0.K
neutrons from (s,2n)

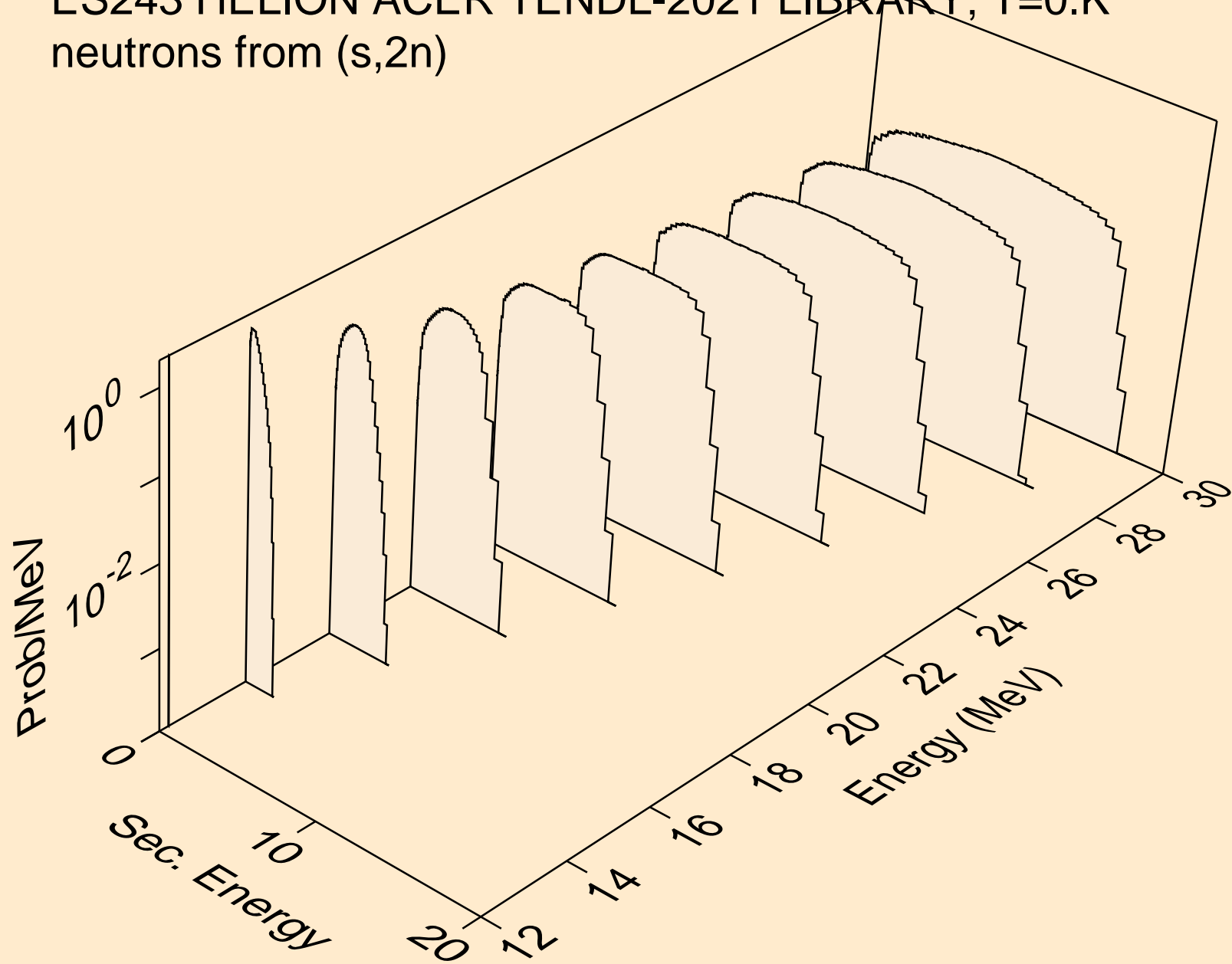

ES243 HELION ACER TENDL-2021 LIBRARY; T=0.K
neutrons from (s,n*)p

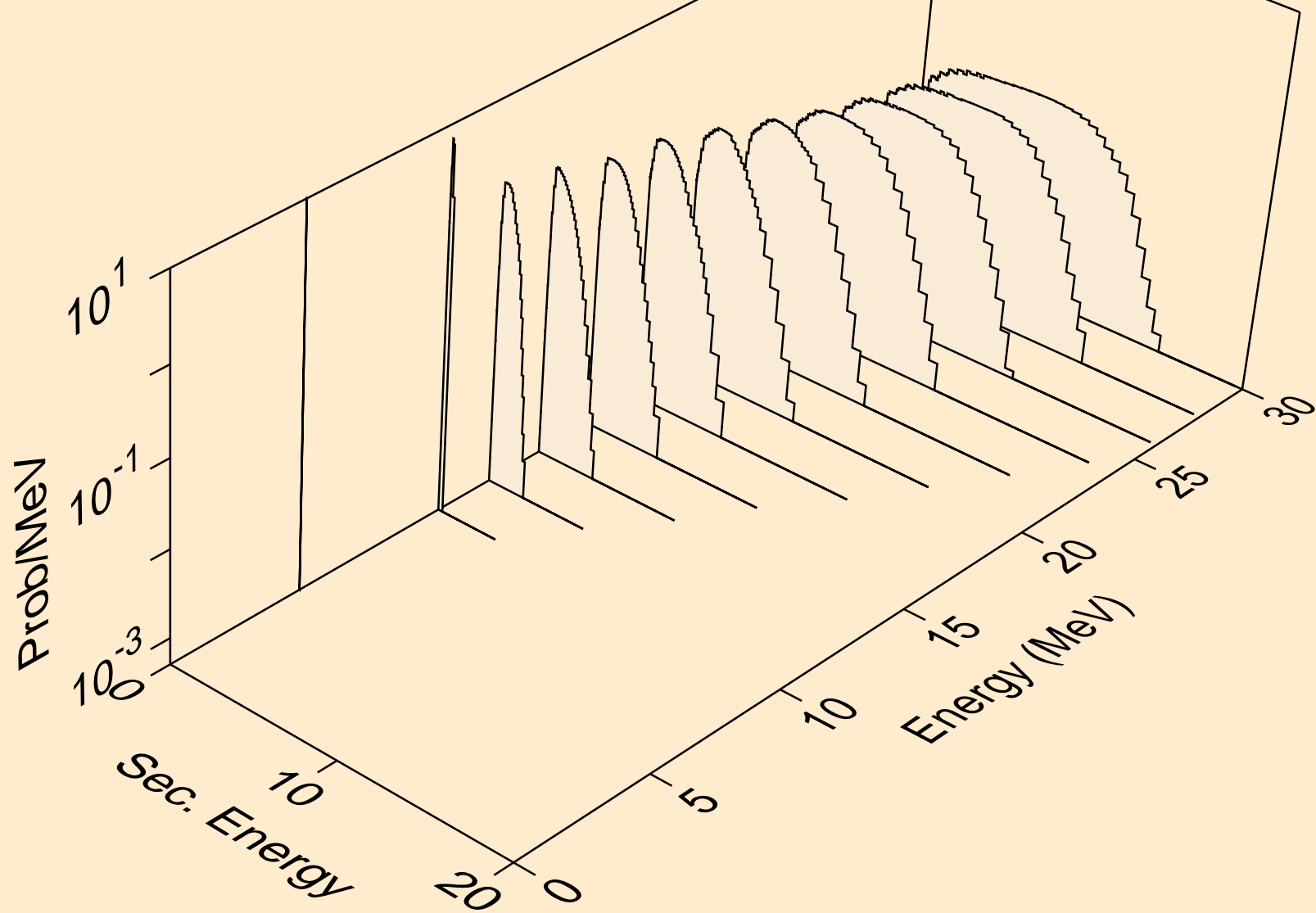

ES243 HELION ACER TENDL-2021 LIBRARY; T=0.K
neutrons from (s,n*)d

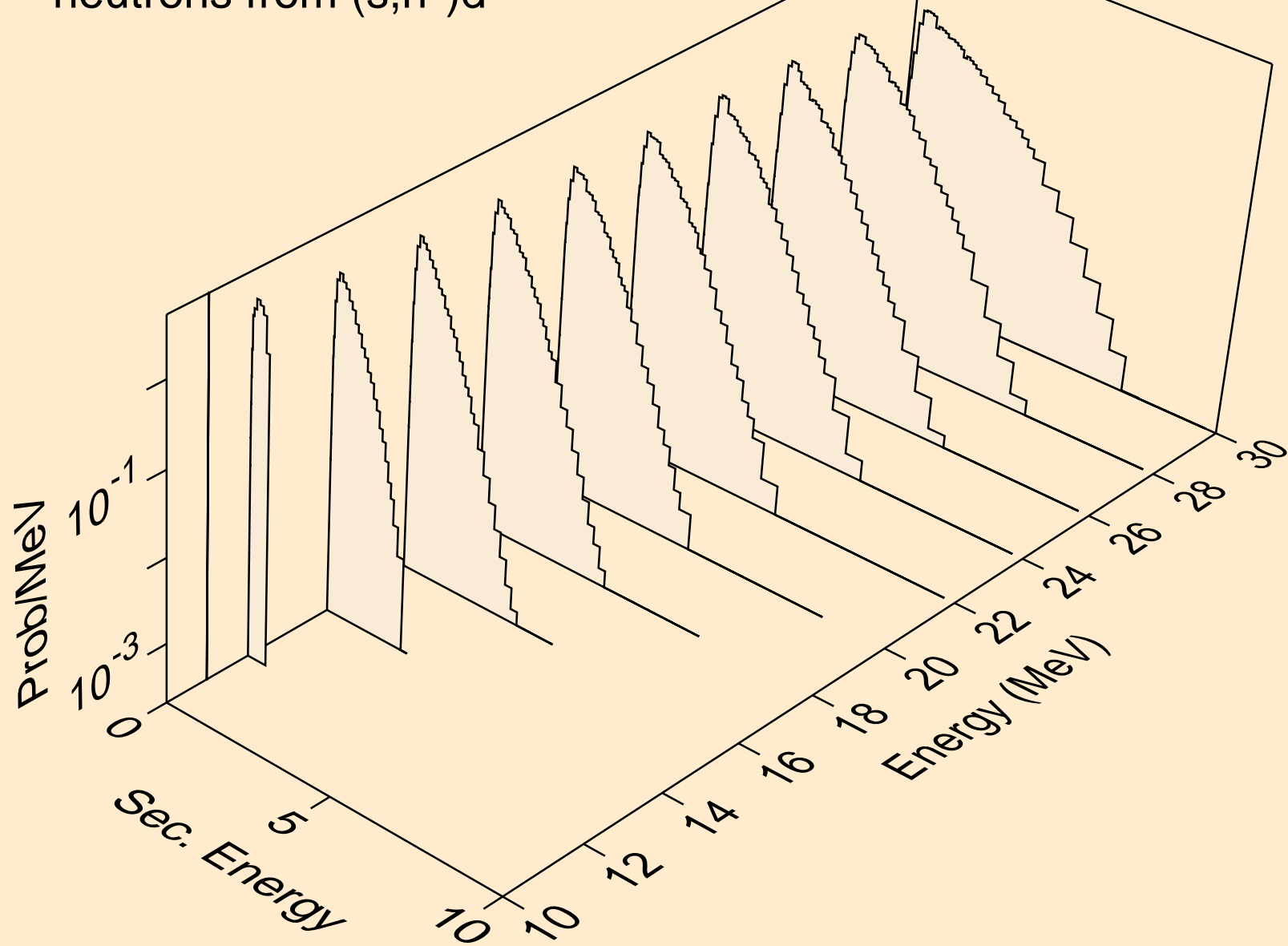

ES243 HELION ACER TENDL-2021 LIBRARY; T=0.K
neutrons from (s,n*)t

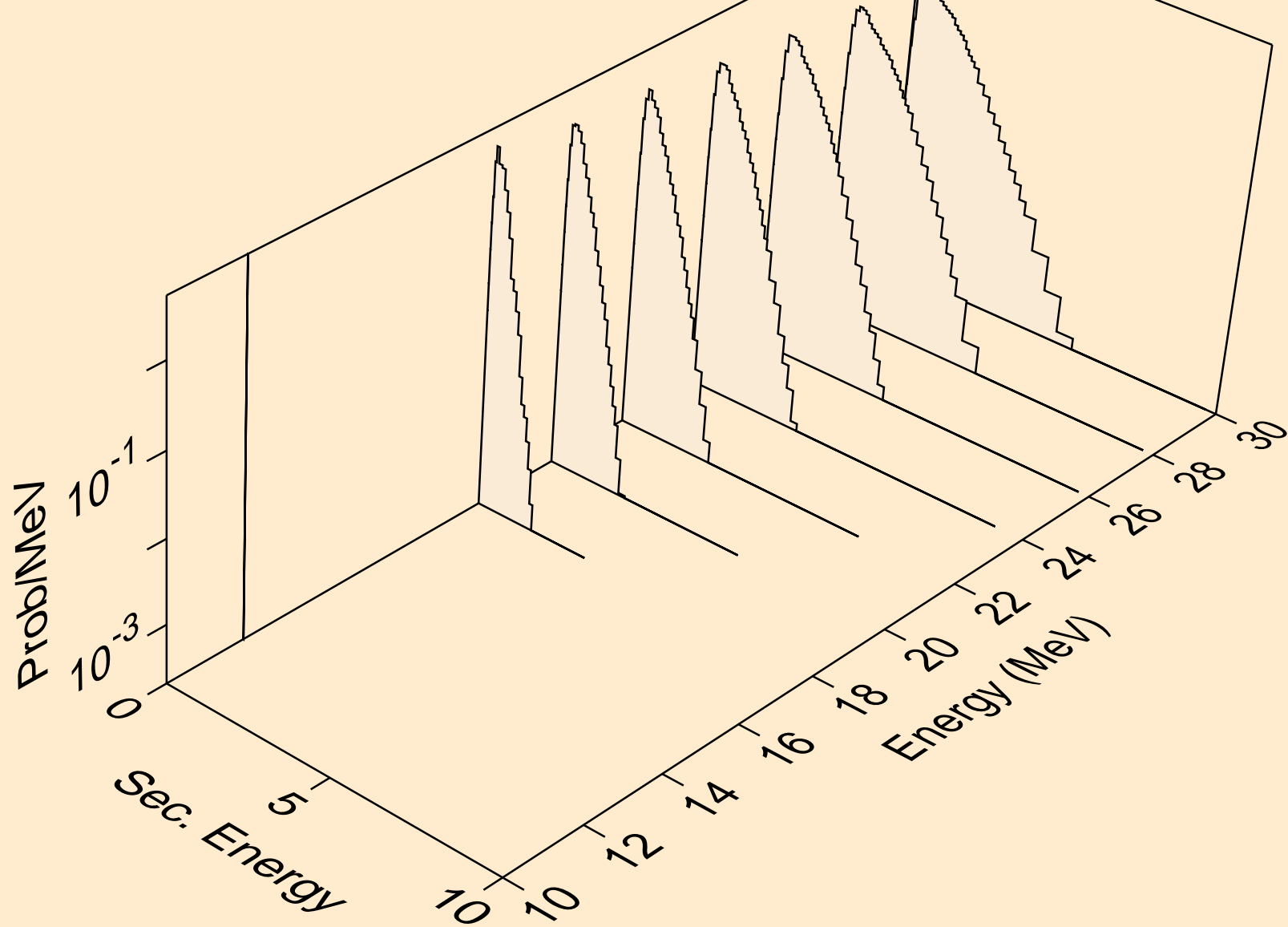

ES243 HELION ACER TENDL-2021 LIBRARY; T=0.K
neutrons from (s,2np)

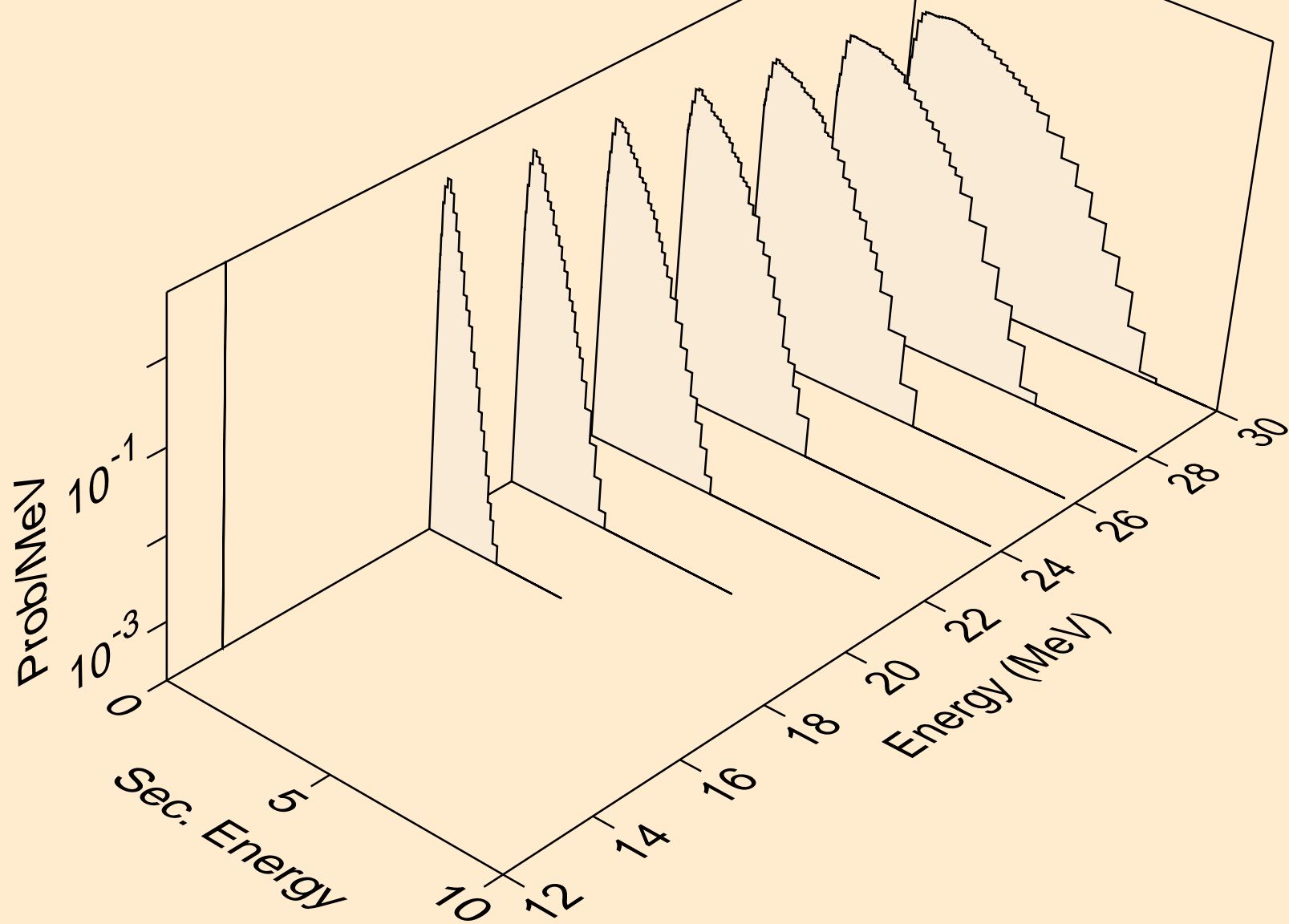

ES243 HELION ACER TENDL-2021 LIBRARY; T=0.K
protons from (s,x)

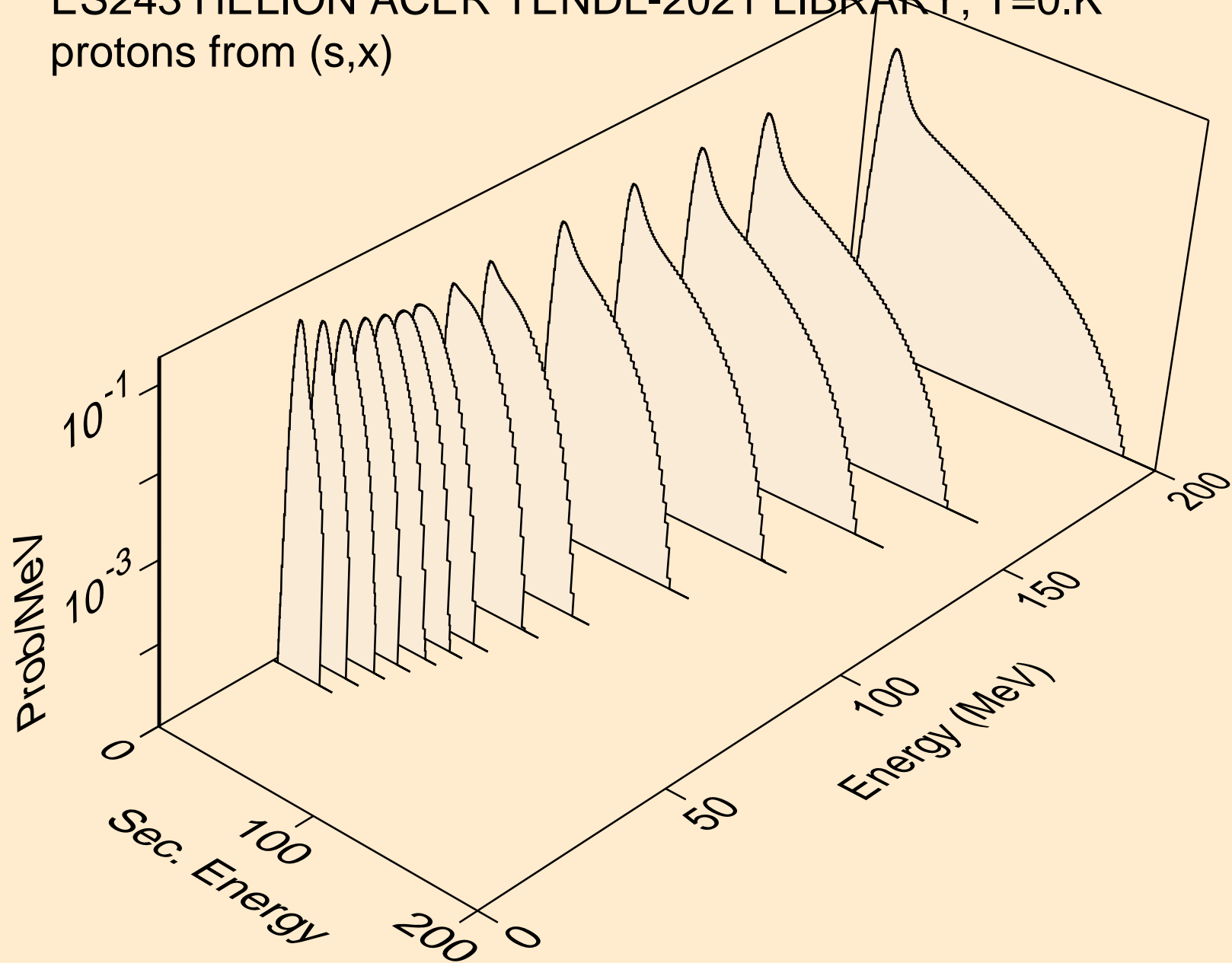

ES243 HELION ACER TENDL-2021 LIBRARY; T=0.K
protons from (s,n*)p

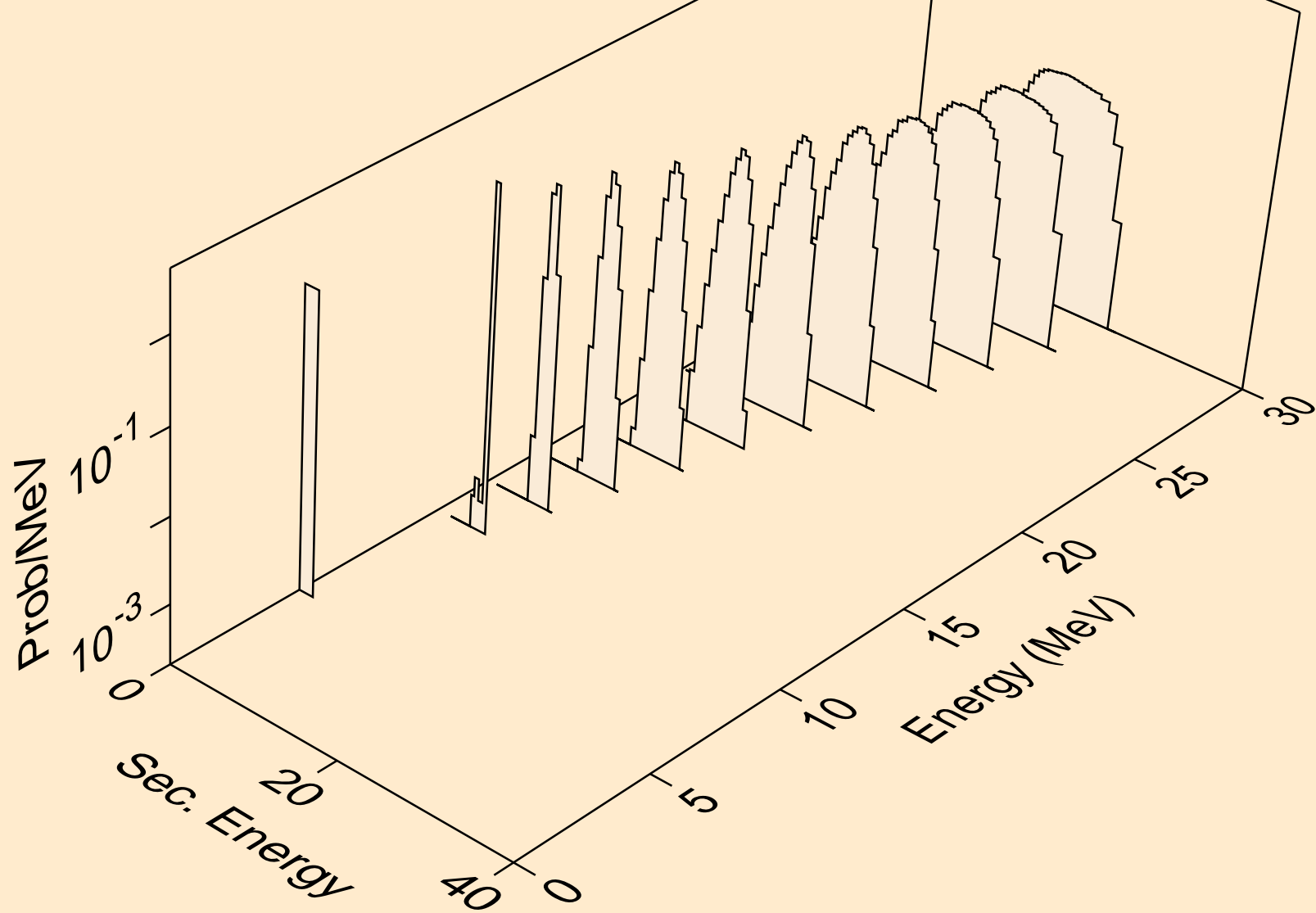

ES243 HELION ACER TENDL-2021 LIBRARY; T=0.K
protons from (s,2np)

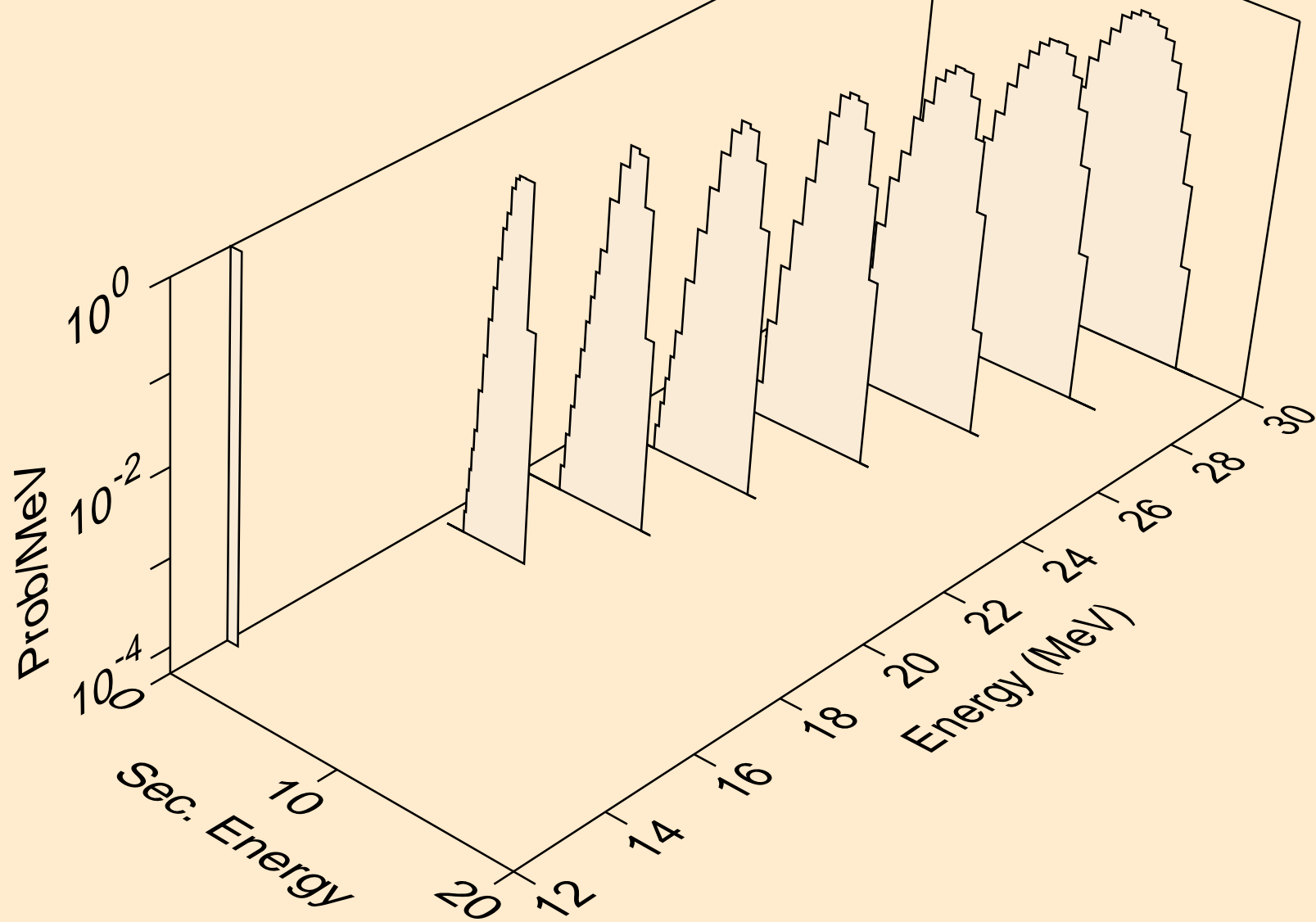

ES243 HELION ACER TENDL-2021 LIBRARY; T=0.K
protons from (s,p)

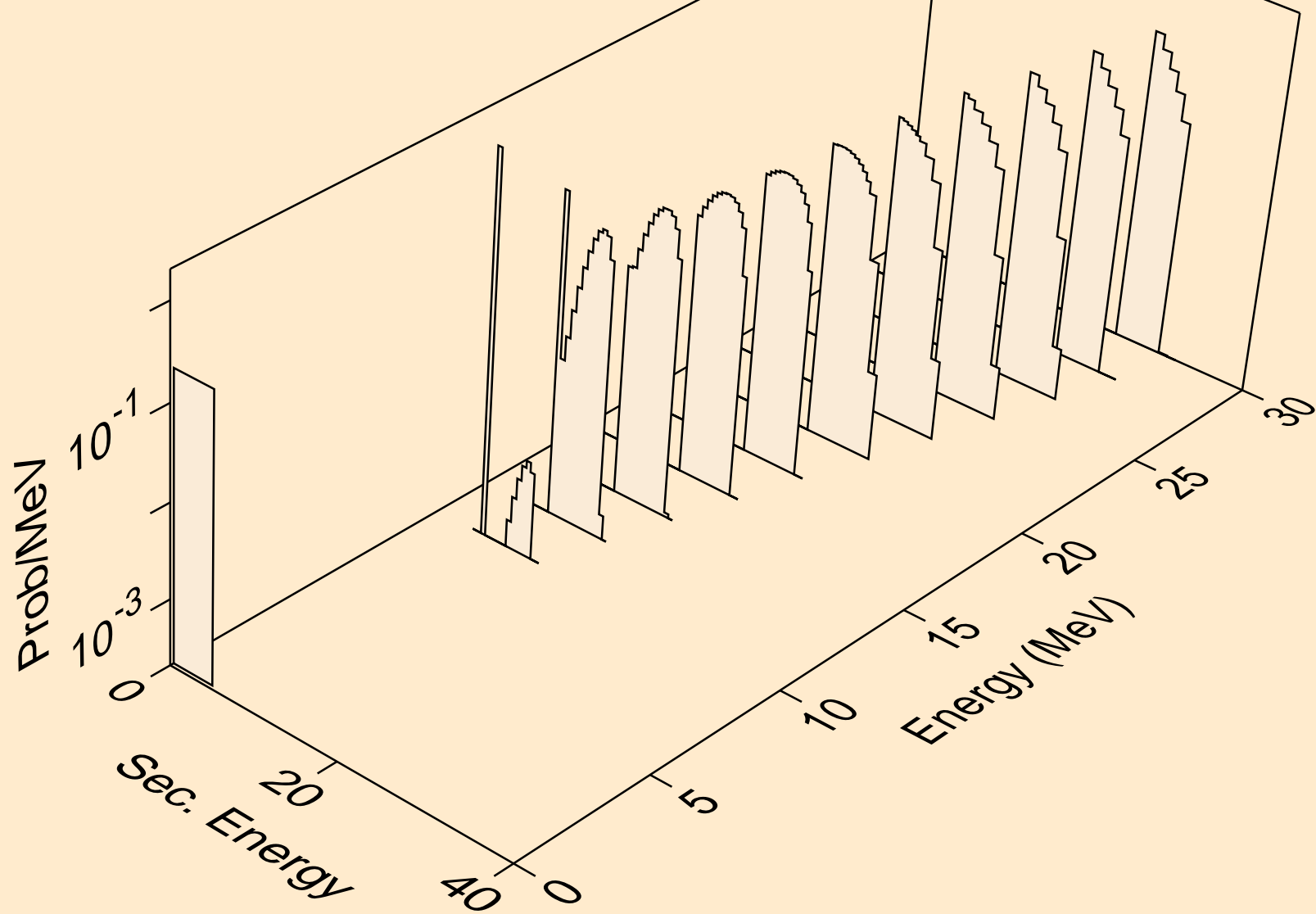

ES243 HELION ACER TENDL-2021 LIBRARY; T=0.K
protons from (s,2p)

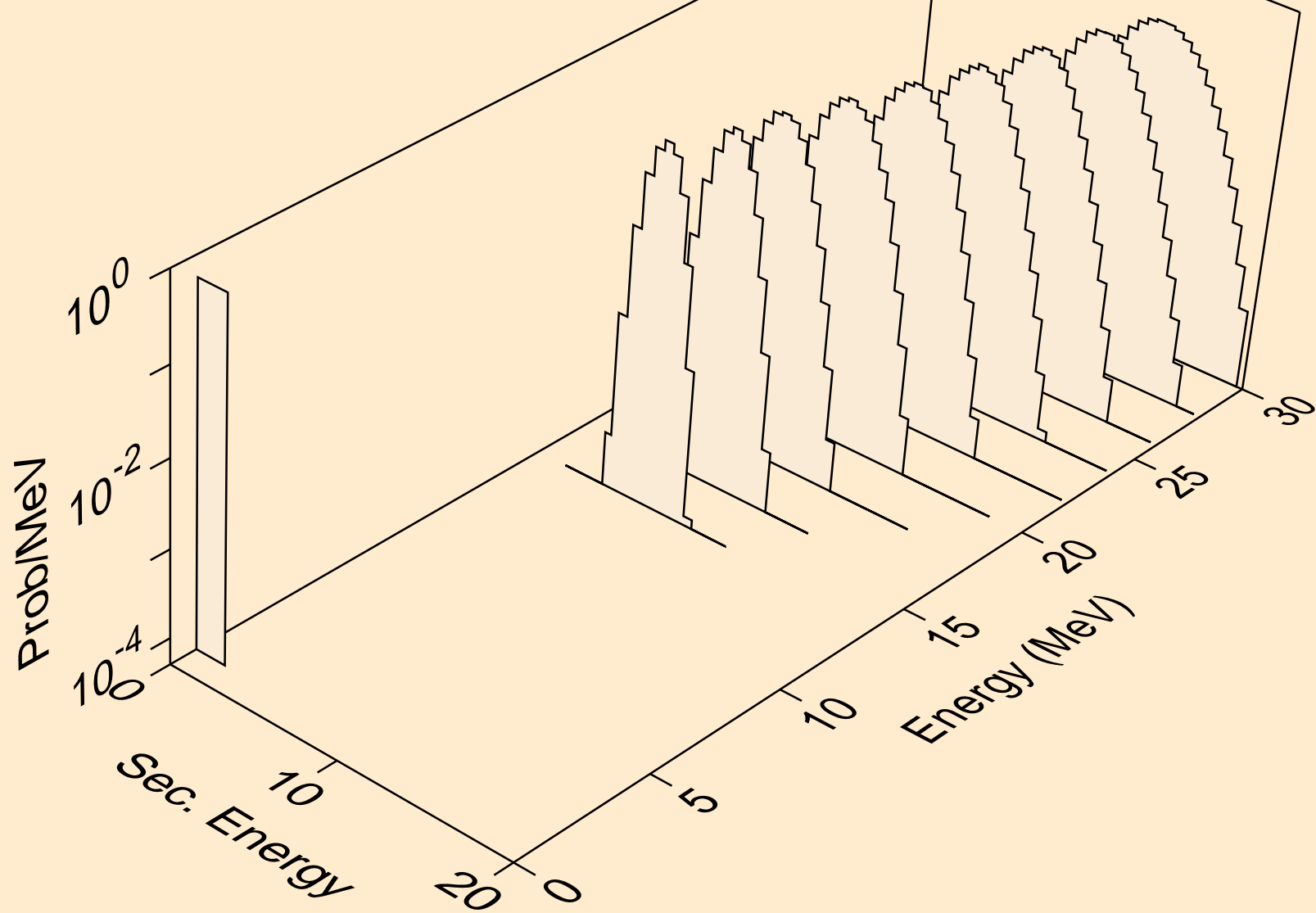

ES243 HELION ACER TENDL-2021 LIBRARY; T=0.K
protons from (s,pa)

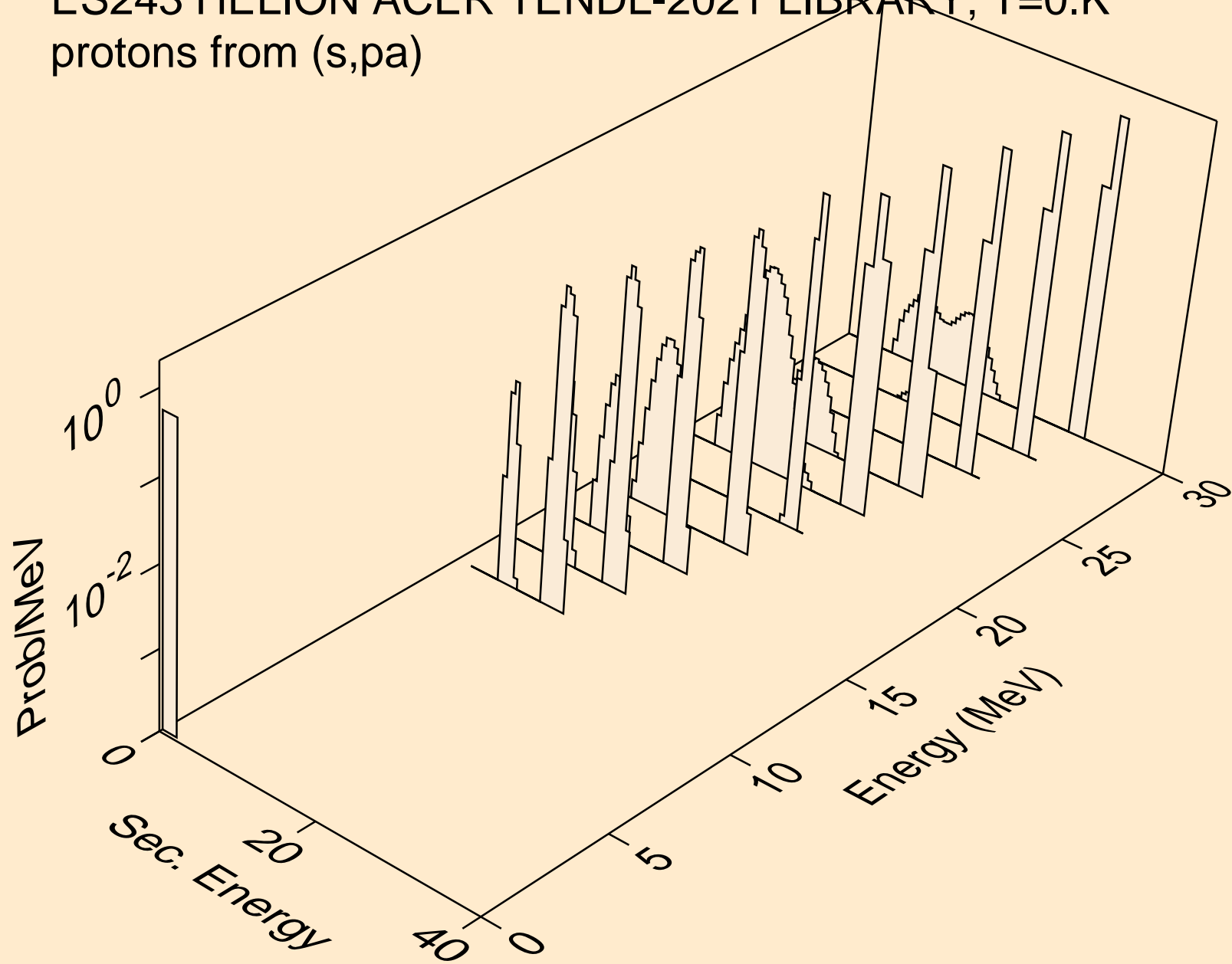

ES243 HELION ACER TENDL-2021 LIBRARY; T=0.K
deuterons from (s,x)

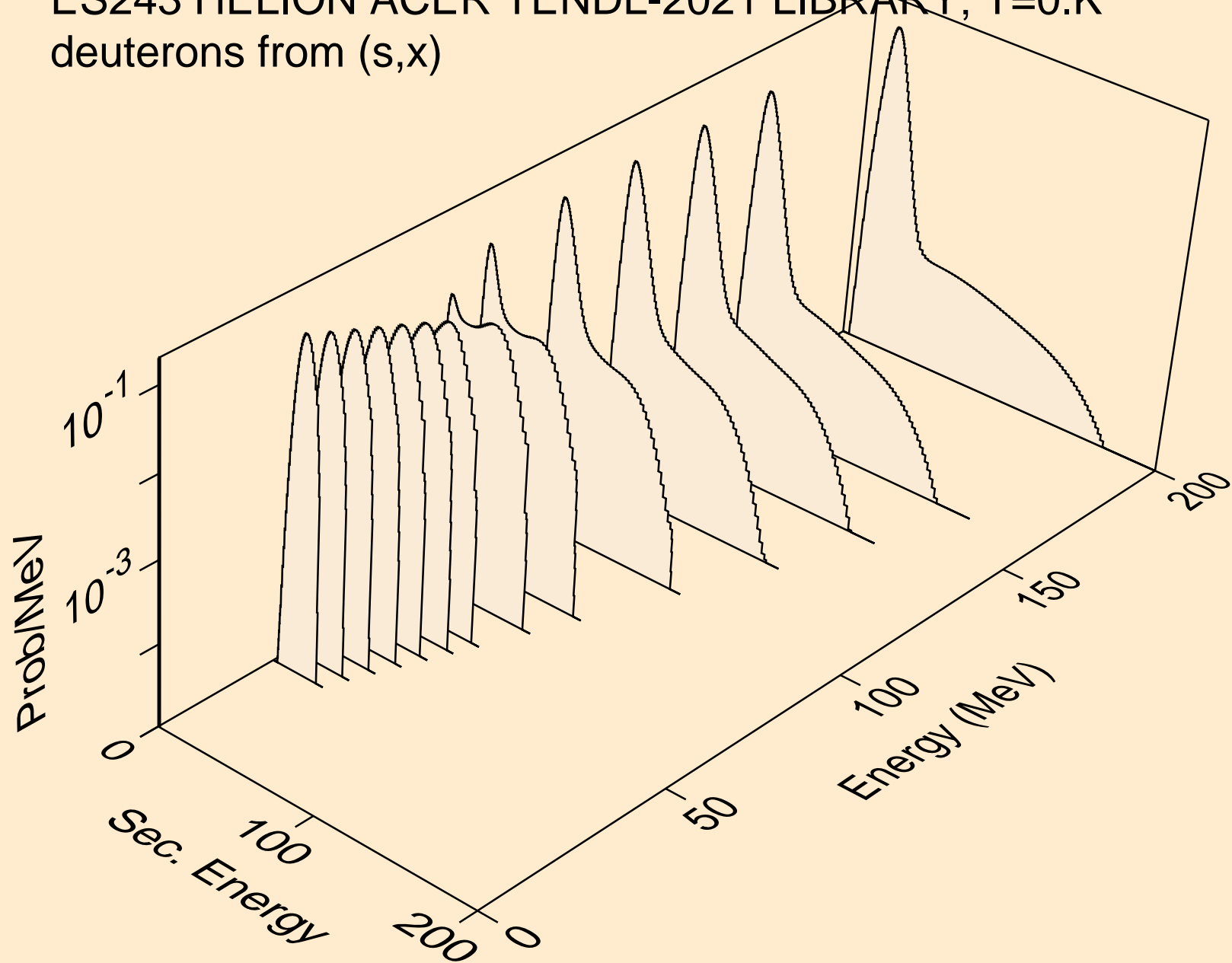

ES243 HELION ACER TENDL-2021 LIBRARY; T=0.K
deuterons from (s,n*)d

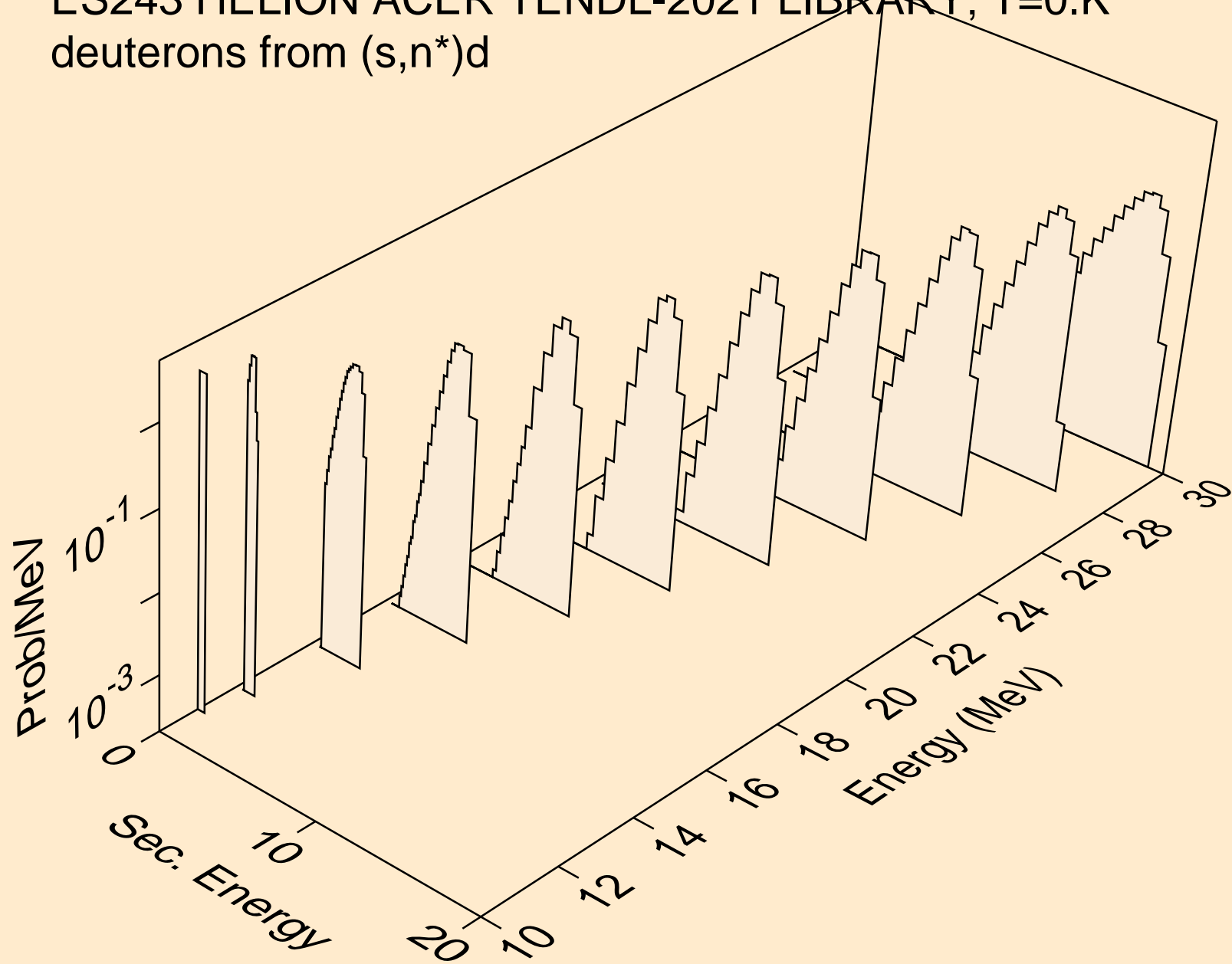

ES243 HELION ACER TENDL-2021 LIBRARY; T=0.K
deuterons from (s,d)

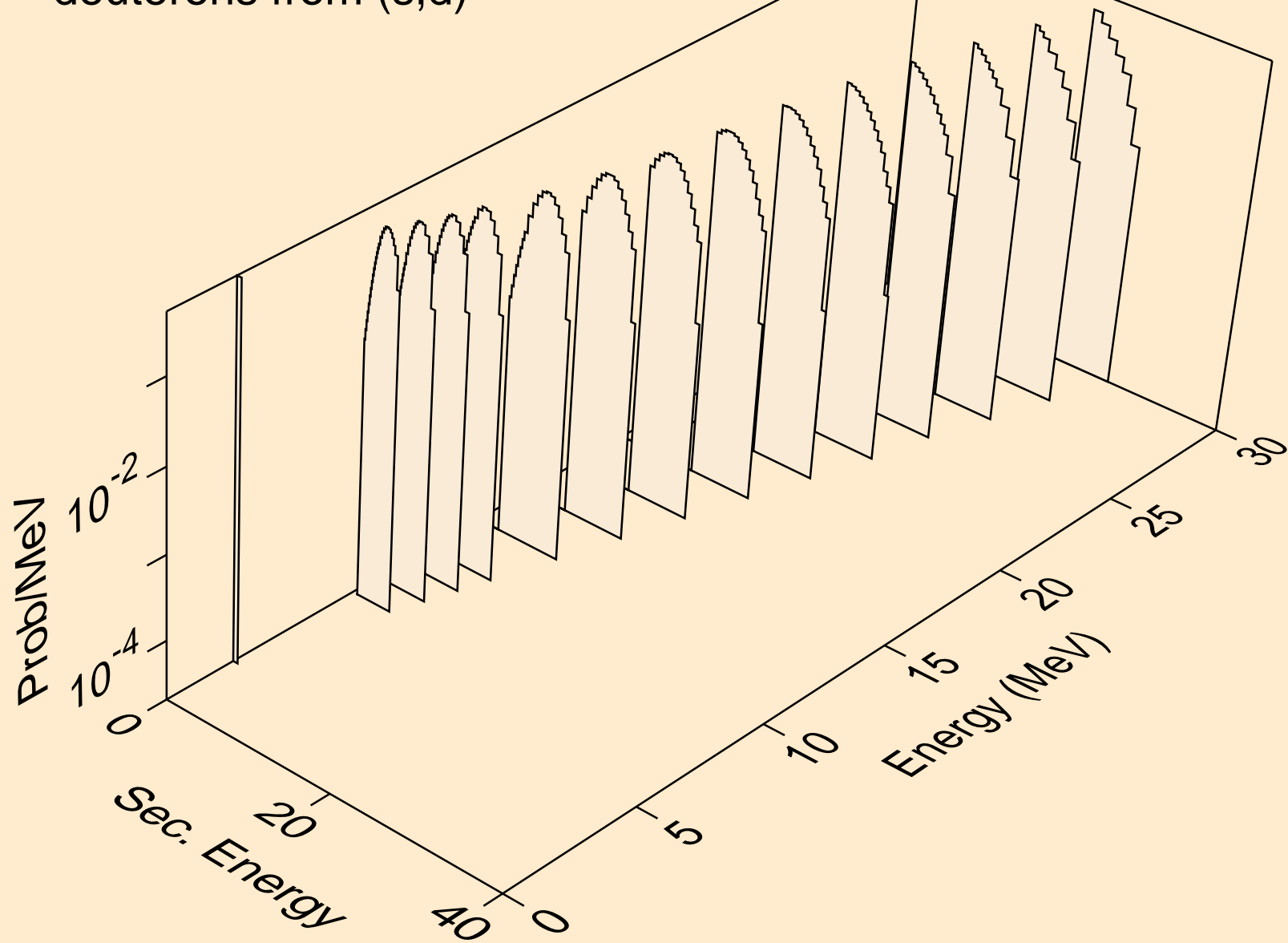

ES243 HELION ACER TENDL-2021 LIBRARY; T=0.K
tritons from (s,x)

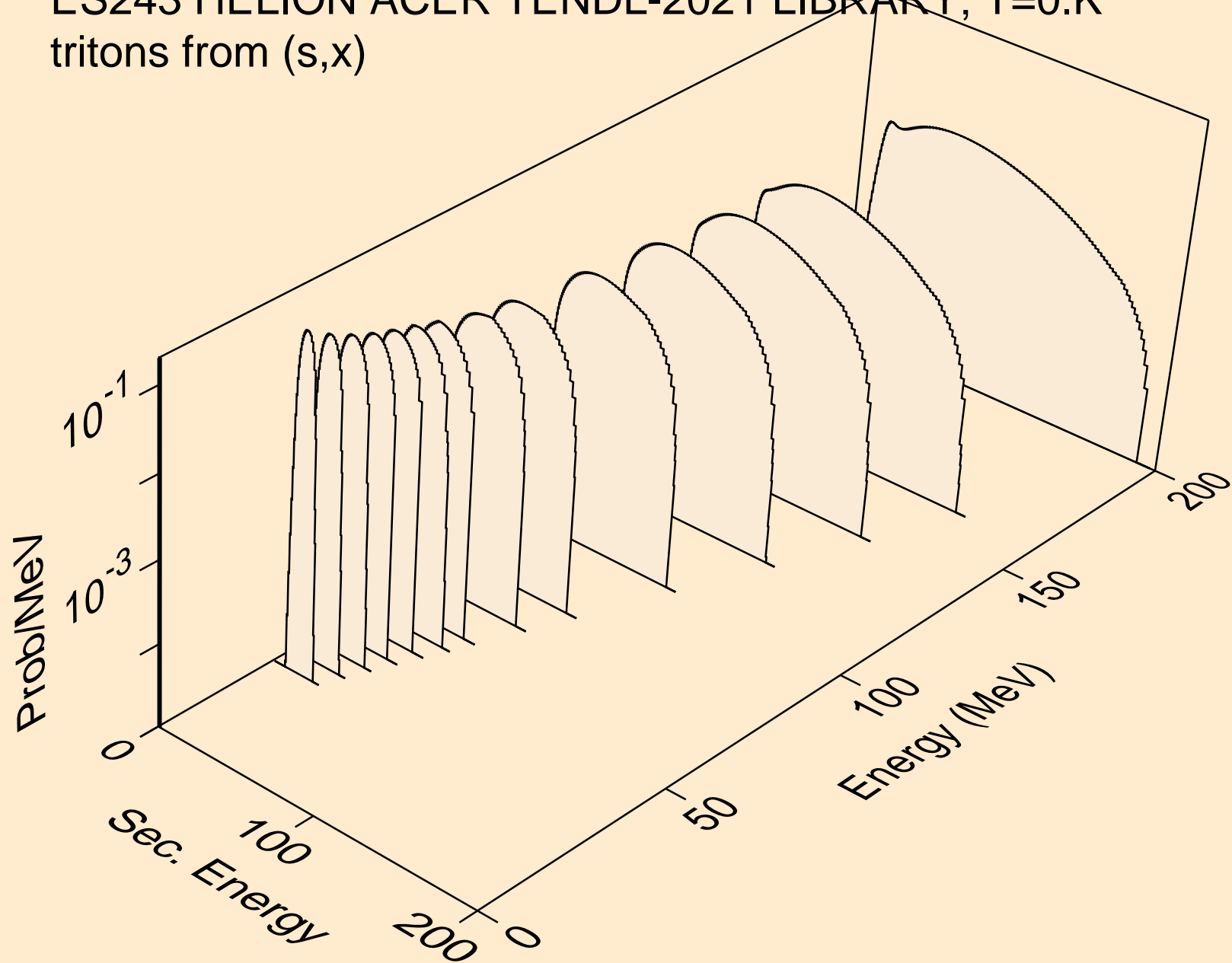

ES243 HELION ACER TENDL-2021 LIBRARY; T=0.K
tritons from (s,n*)t

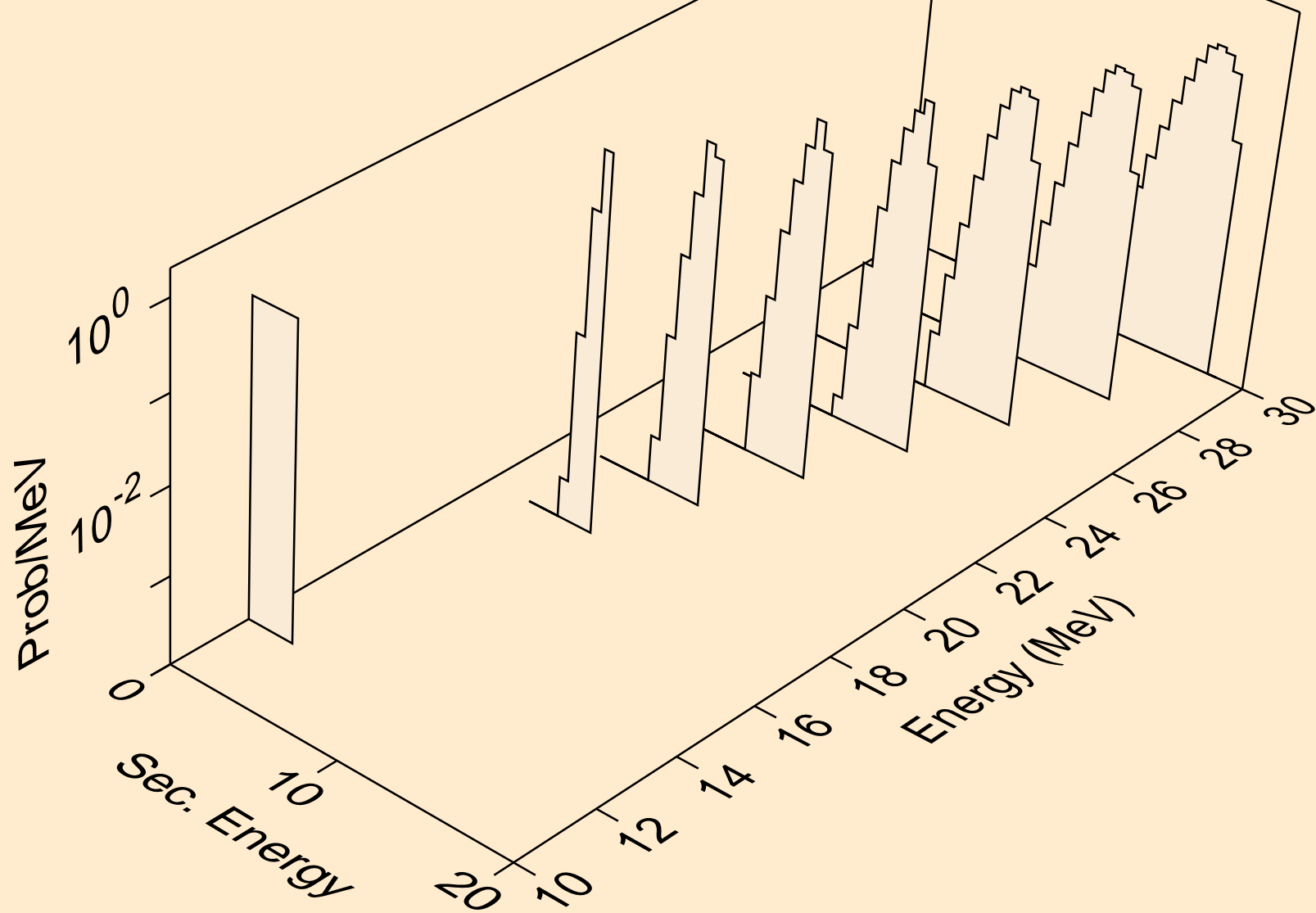

ES243 HELION ACER TENDL-2021 LIBRARY; T=0.K
tritons from (s,t)

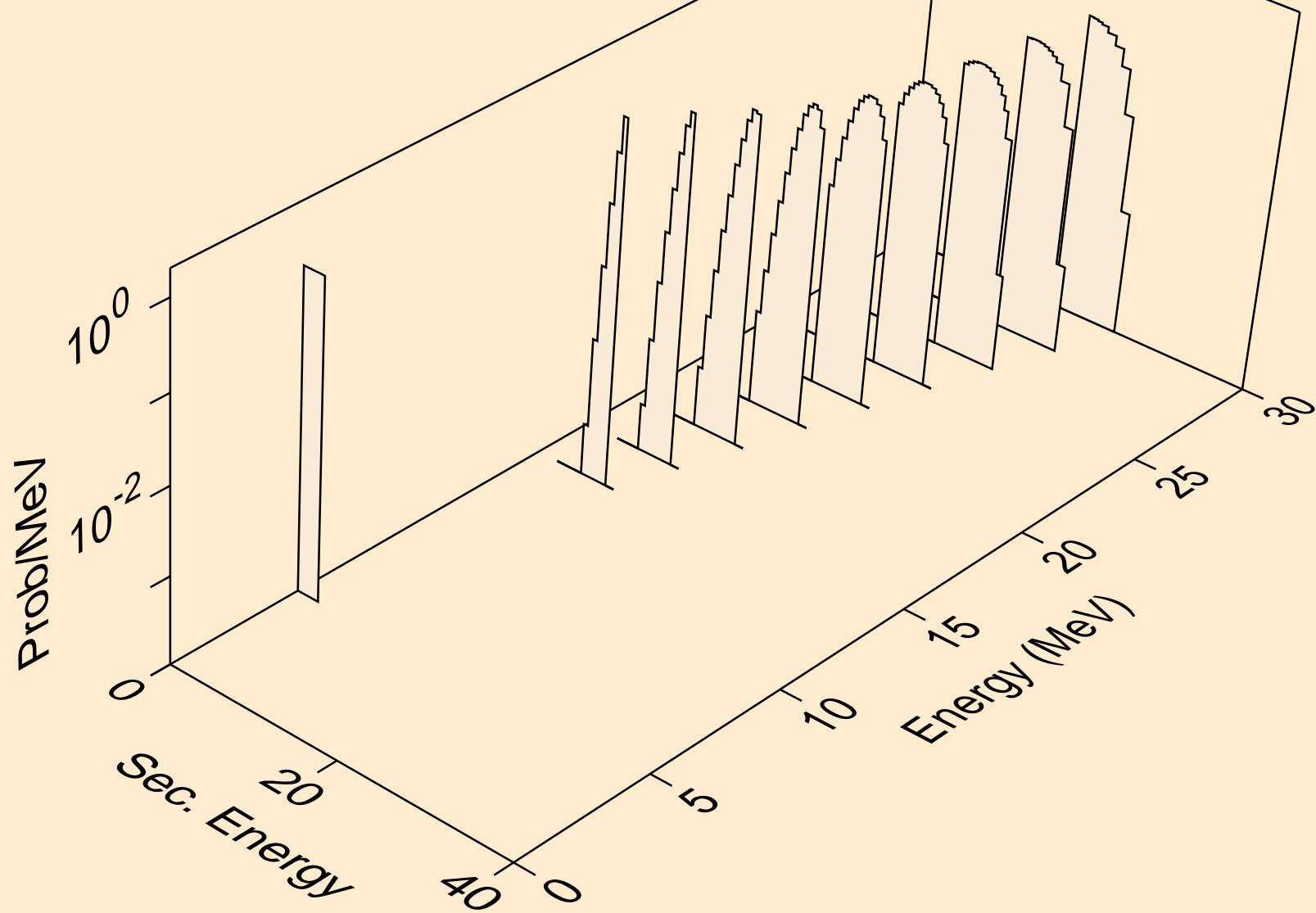

ES243 HELION ACER TENDL-2021 LIBRARY; T=0.K
alphas from (s,x)

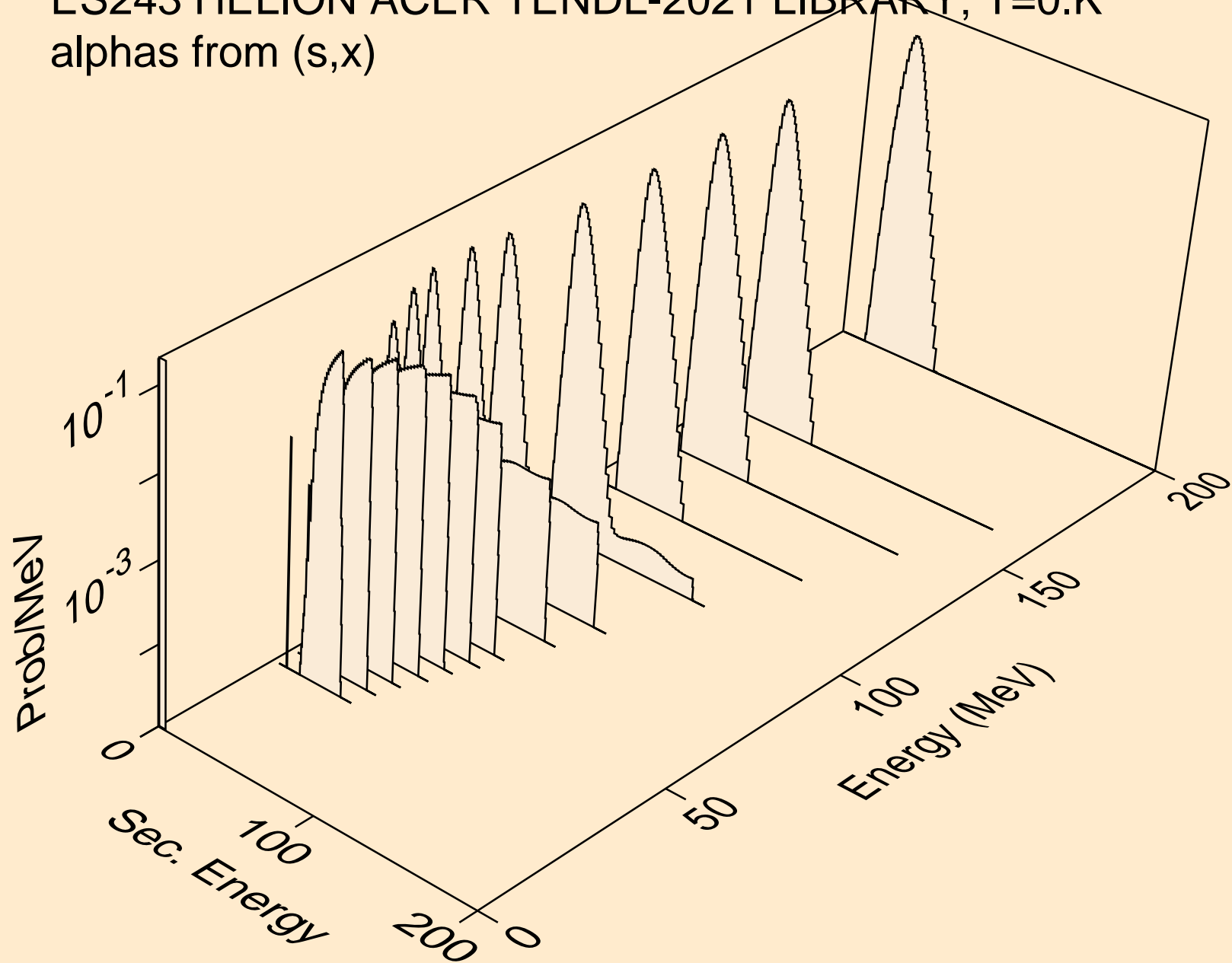

ES243 HELION ACER TENDL-2021 LIBRARY; T=0.K
alphas from (s,a)

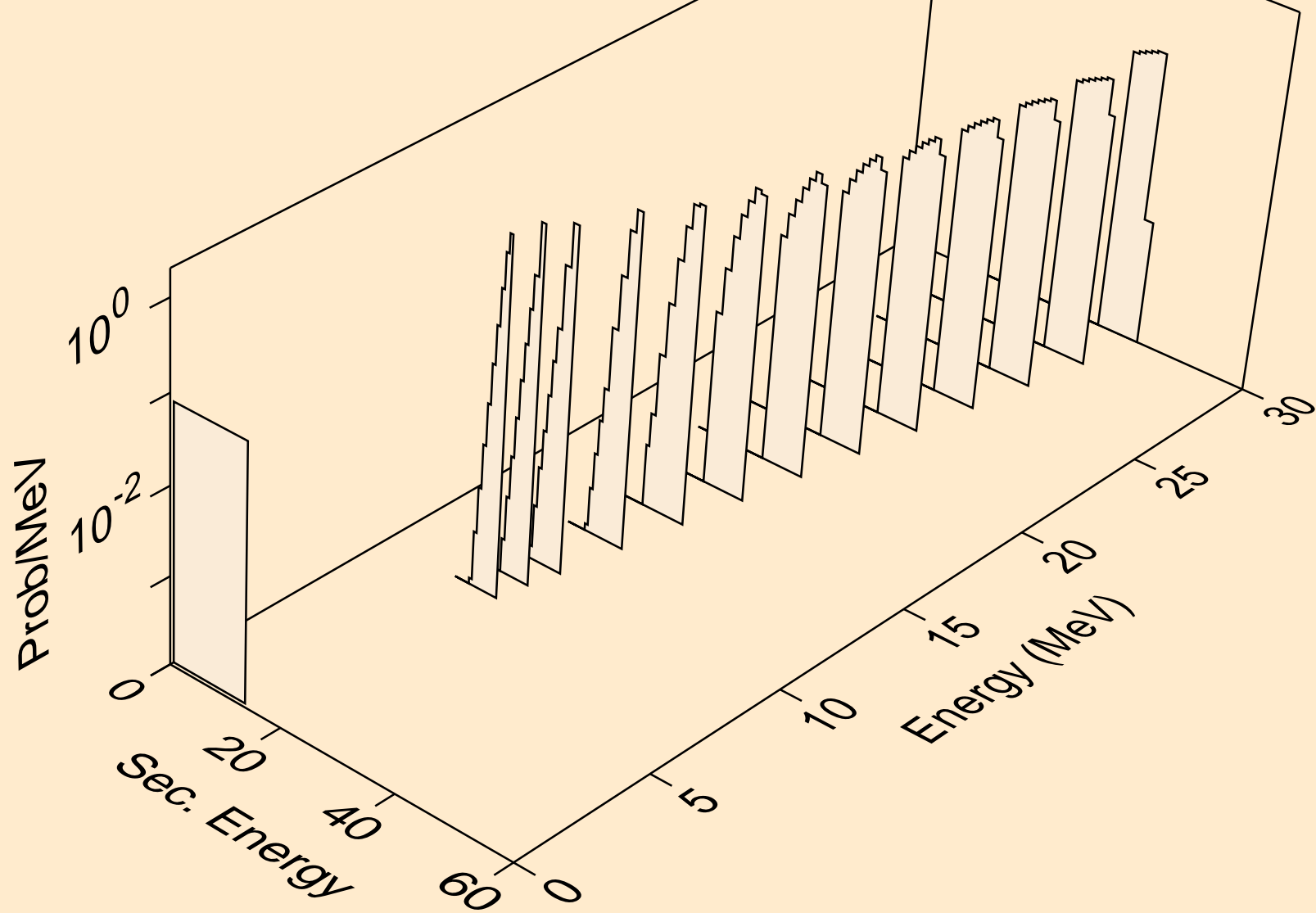

ES243 HELION ACER TENDL-2021 LIBRARY; T=0.K
alphas from (s,2a)

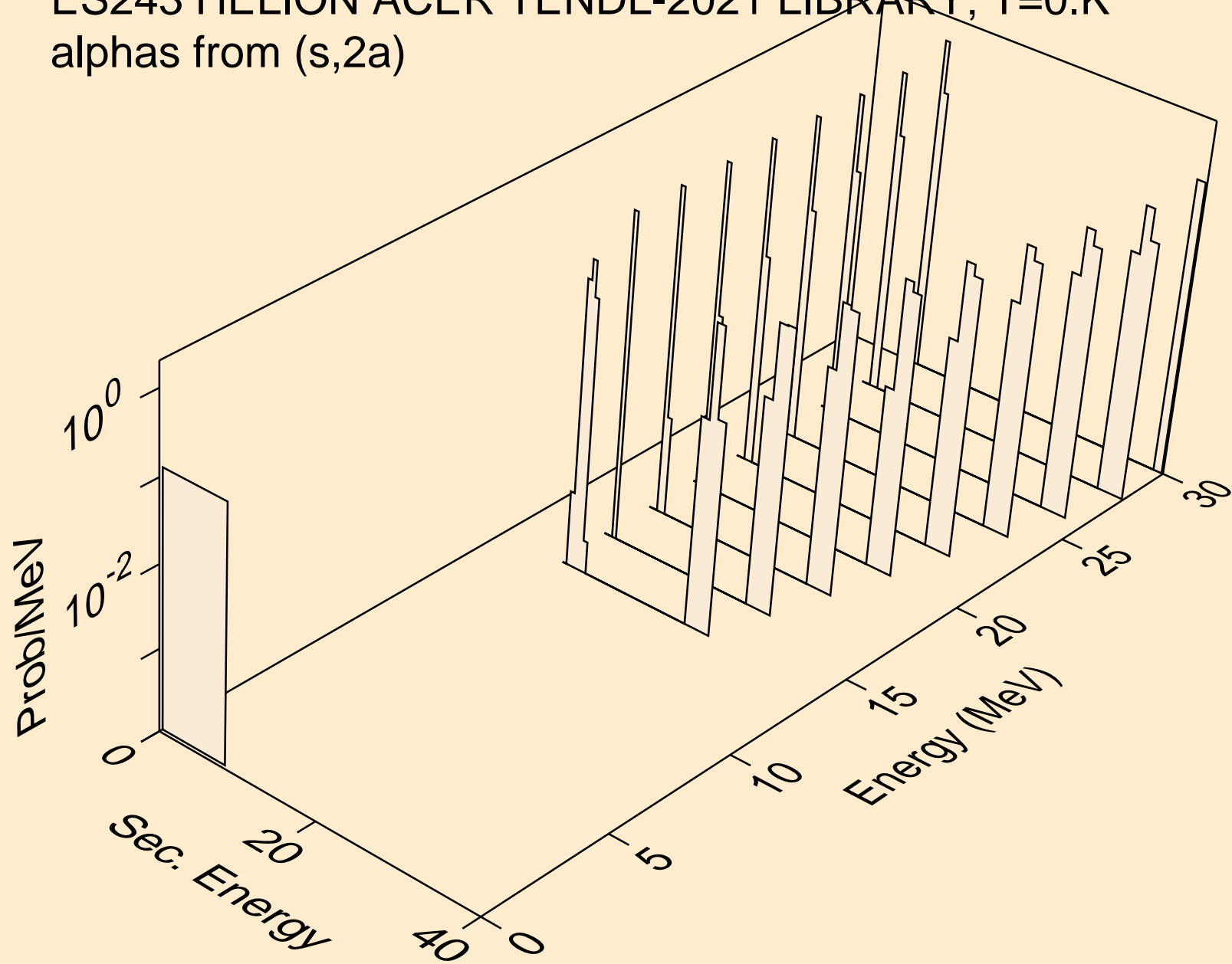

ES243 HELION ACER TENDL-2021 LIBRARY; T=0.K
alphas from (s,pa)

