

ES244 HELION ACER TENDL-2021 LIBRARY; T=0.K  
Principal cross sections

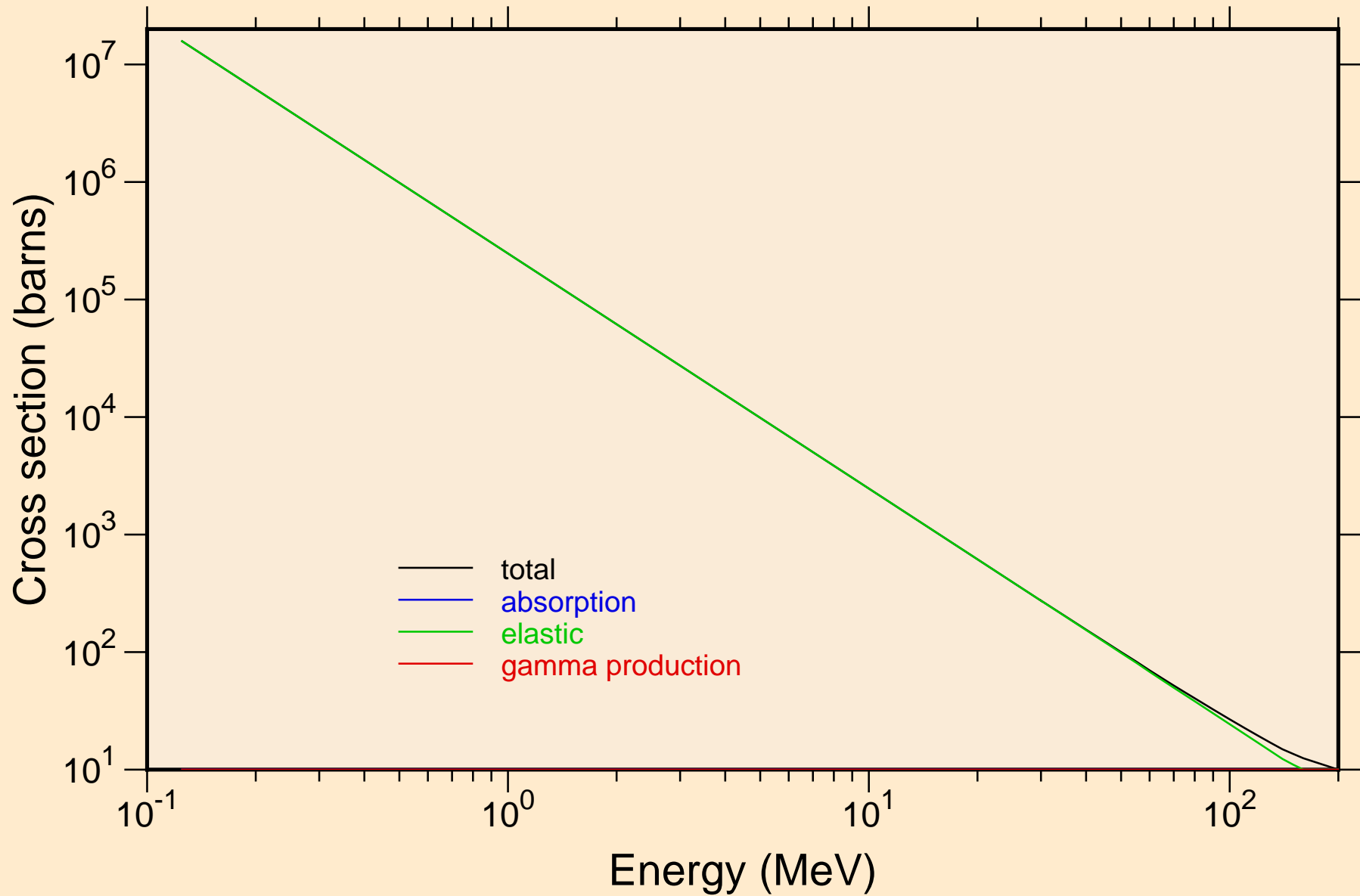

ES244 HELION ACER TENDL-2021 LIBRARY; T=0.K

Heating

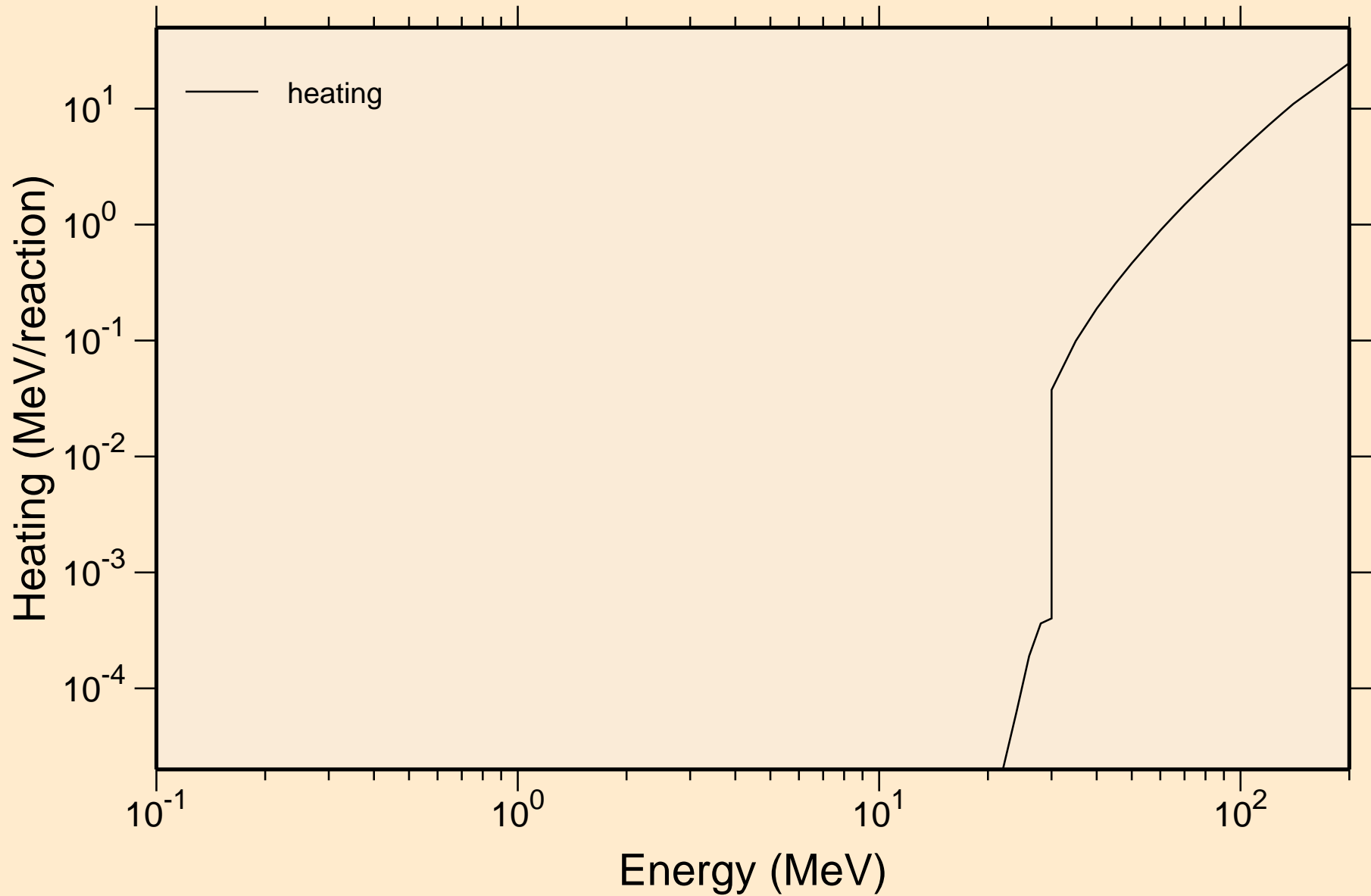

# ES244 HELION ACER TENDL-2021 LIBRARY; T=0.K

## Principal cross sections

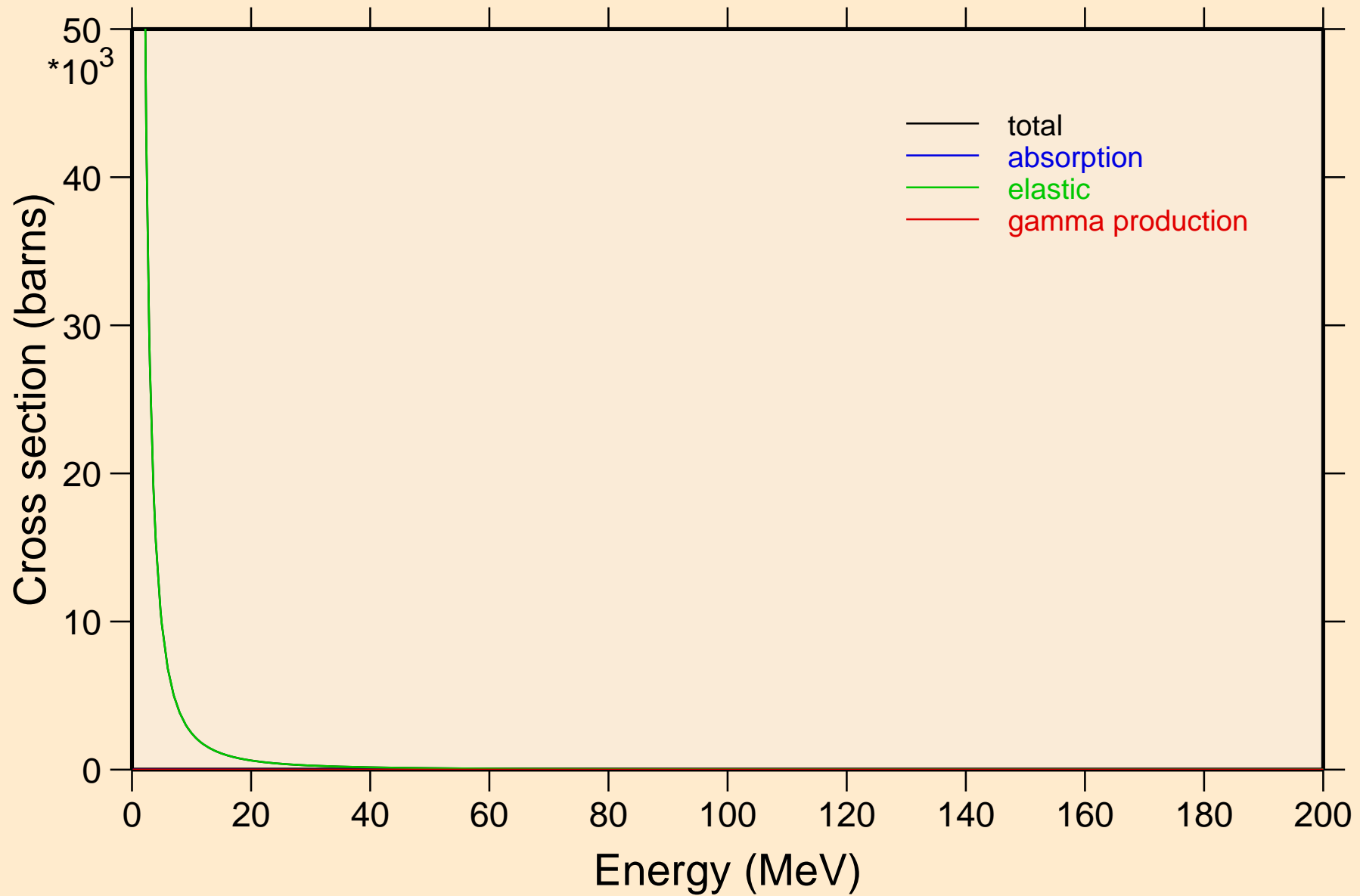

ES244 HELION ACER TENDL-2021 LIBRARY; T=0.K

Heating

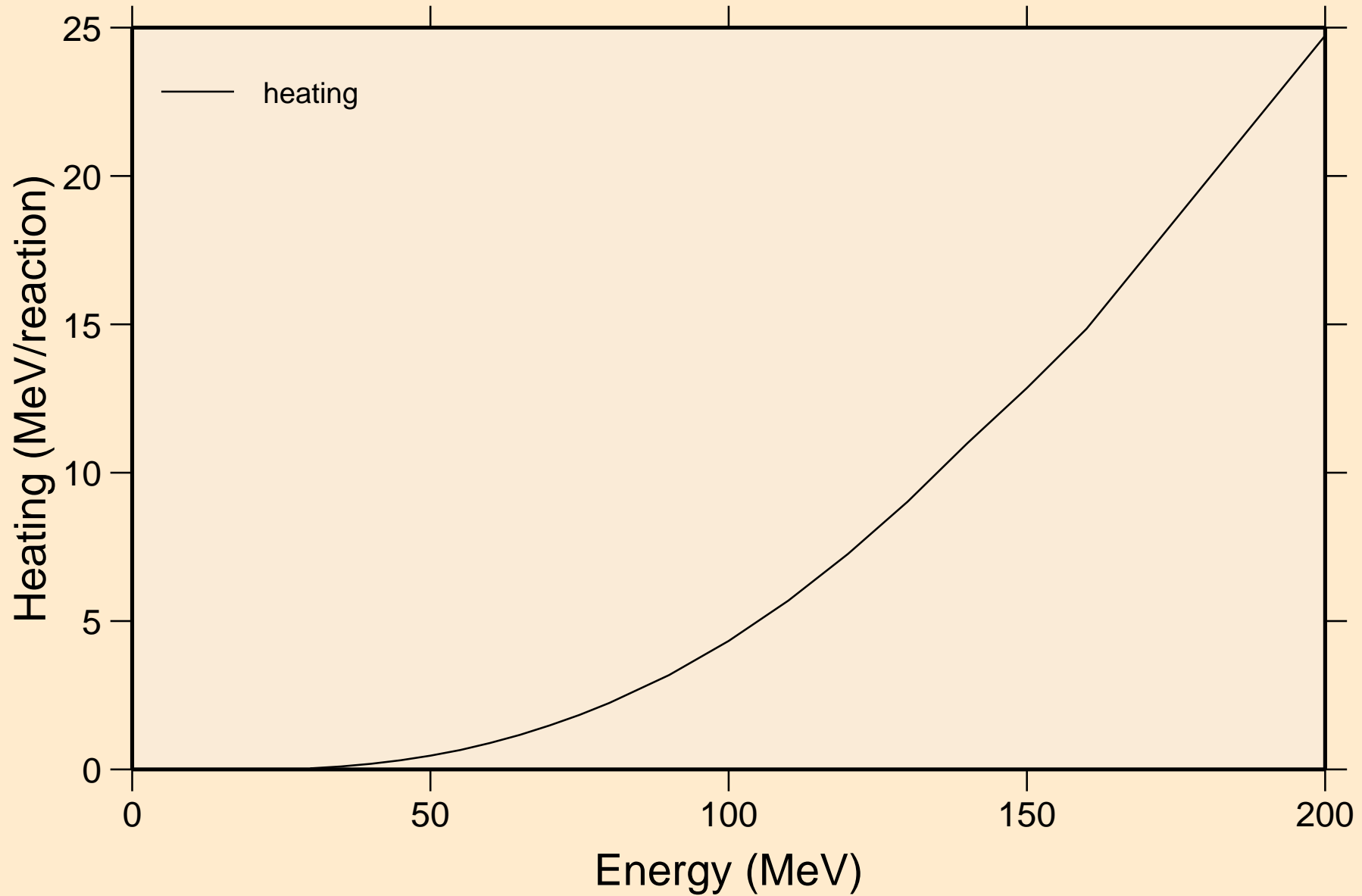

ES244 HELION ACER TENDL-2021 LIBRARY; T=0.K  
Threshold reactions

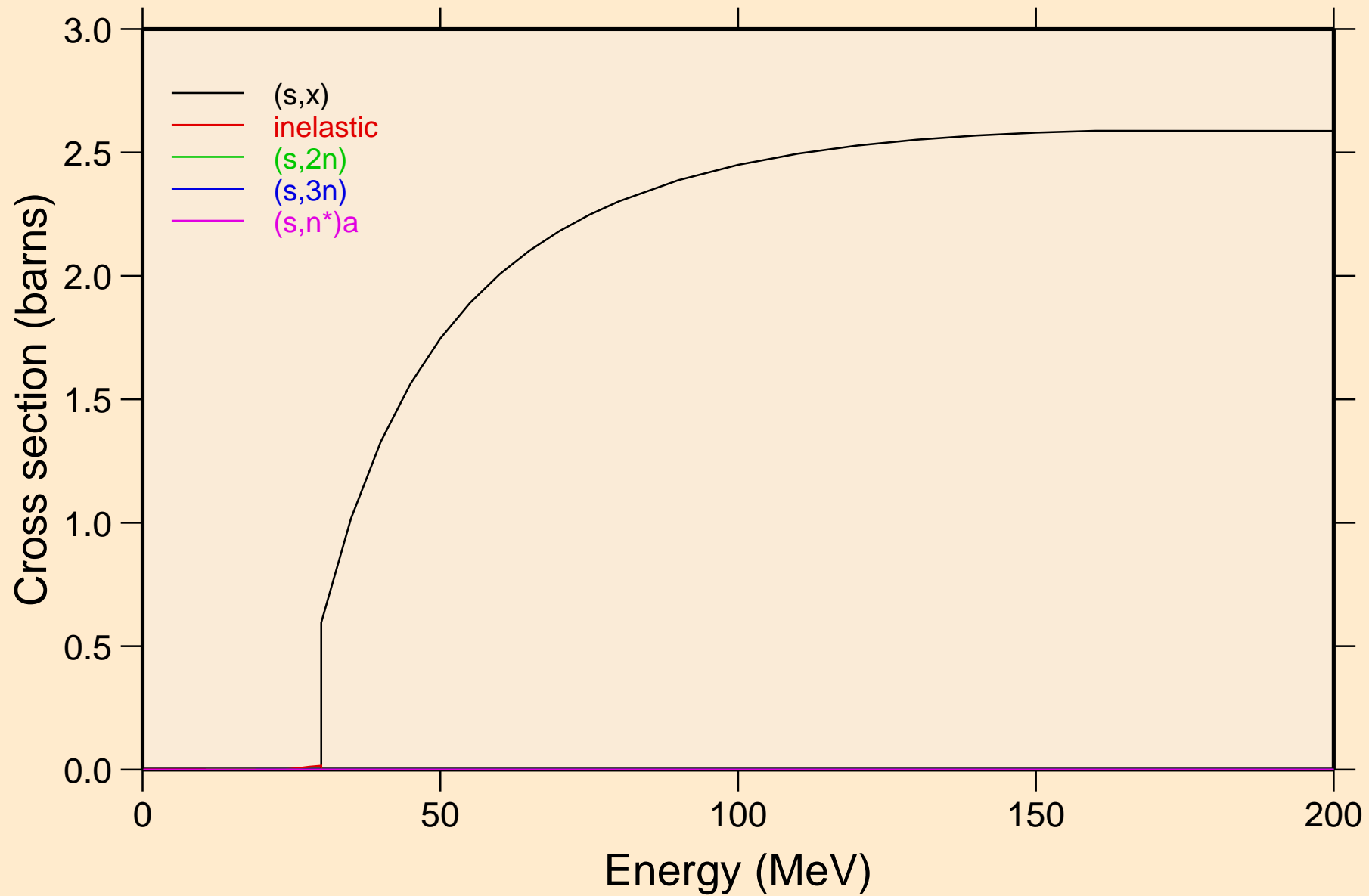

ES244 HELION ACER TENDL-2021 LIBRARY; T=0.K  
Threshold reactions

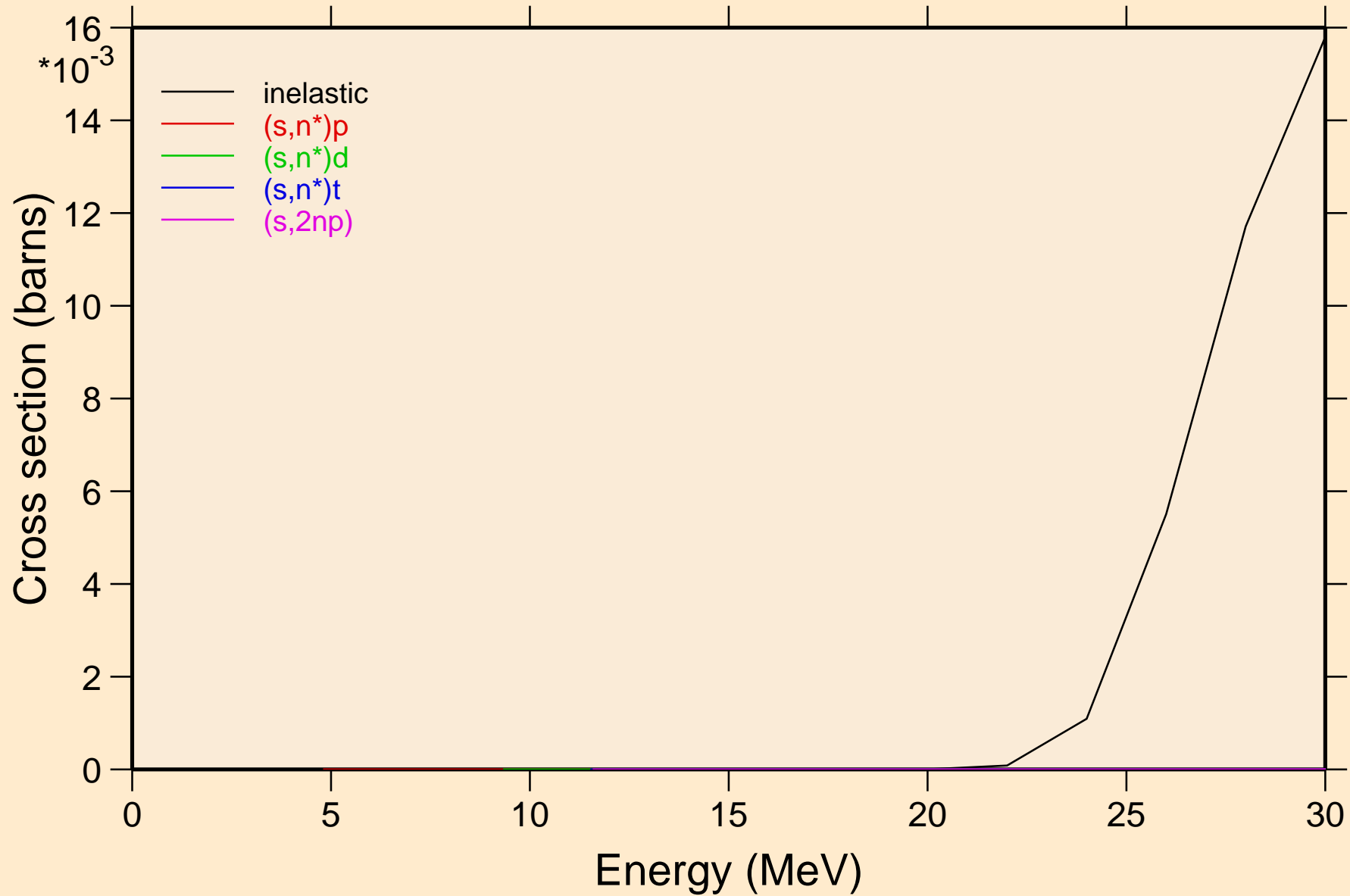

ES244 HELION ACER TENDL-2021 LIBRARY; T=0.K  
Threshold reactions

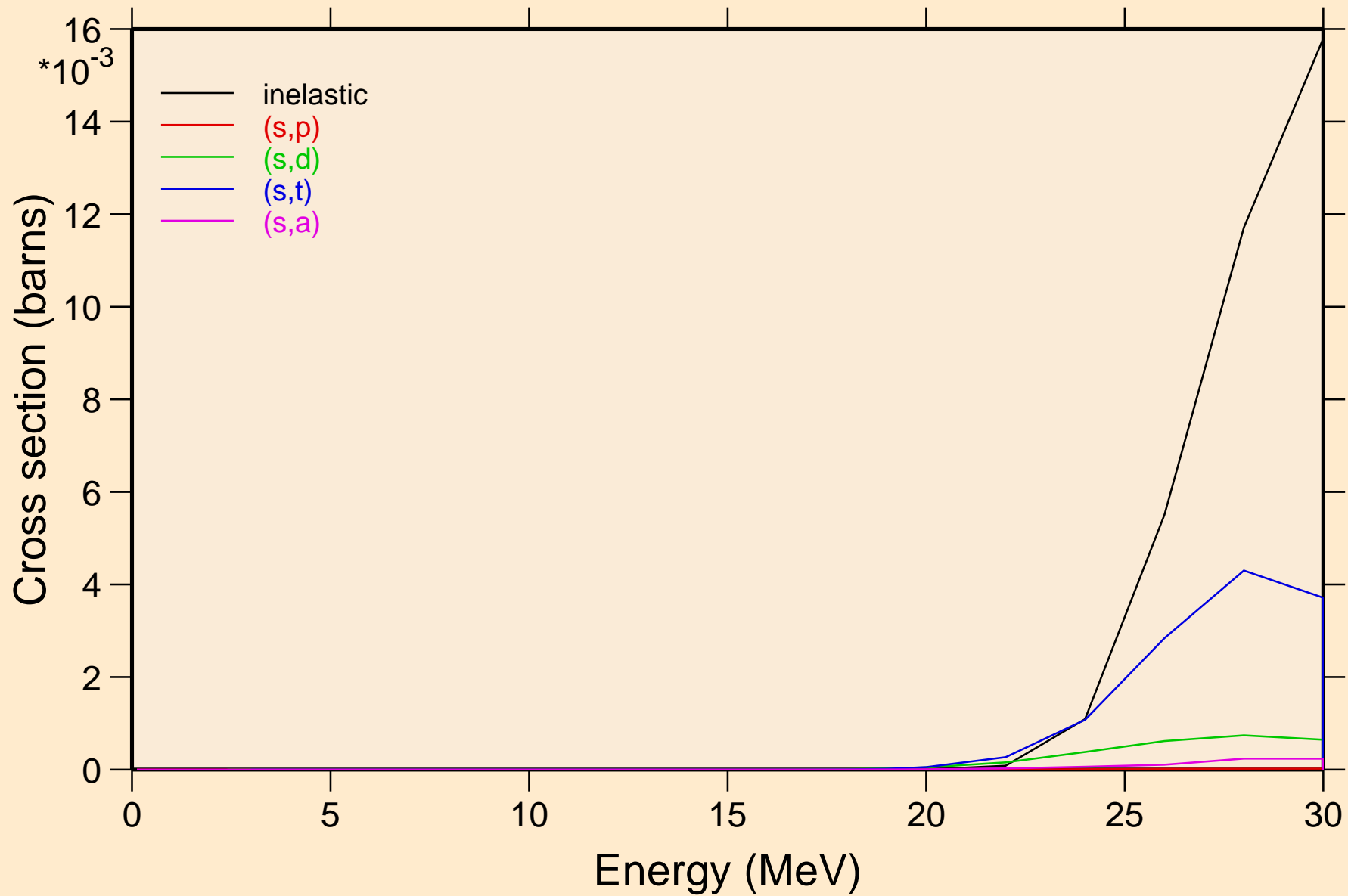

ES244 HELION ACER TENDL-2021 LIBRARY; T=0.K  
Threshold reactions

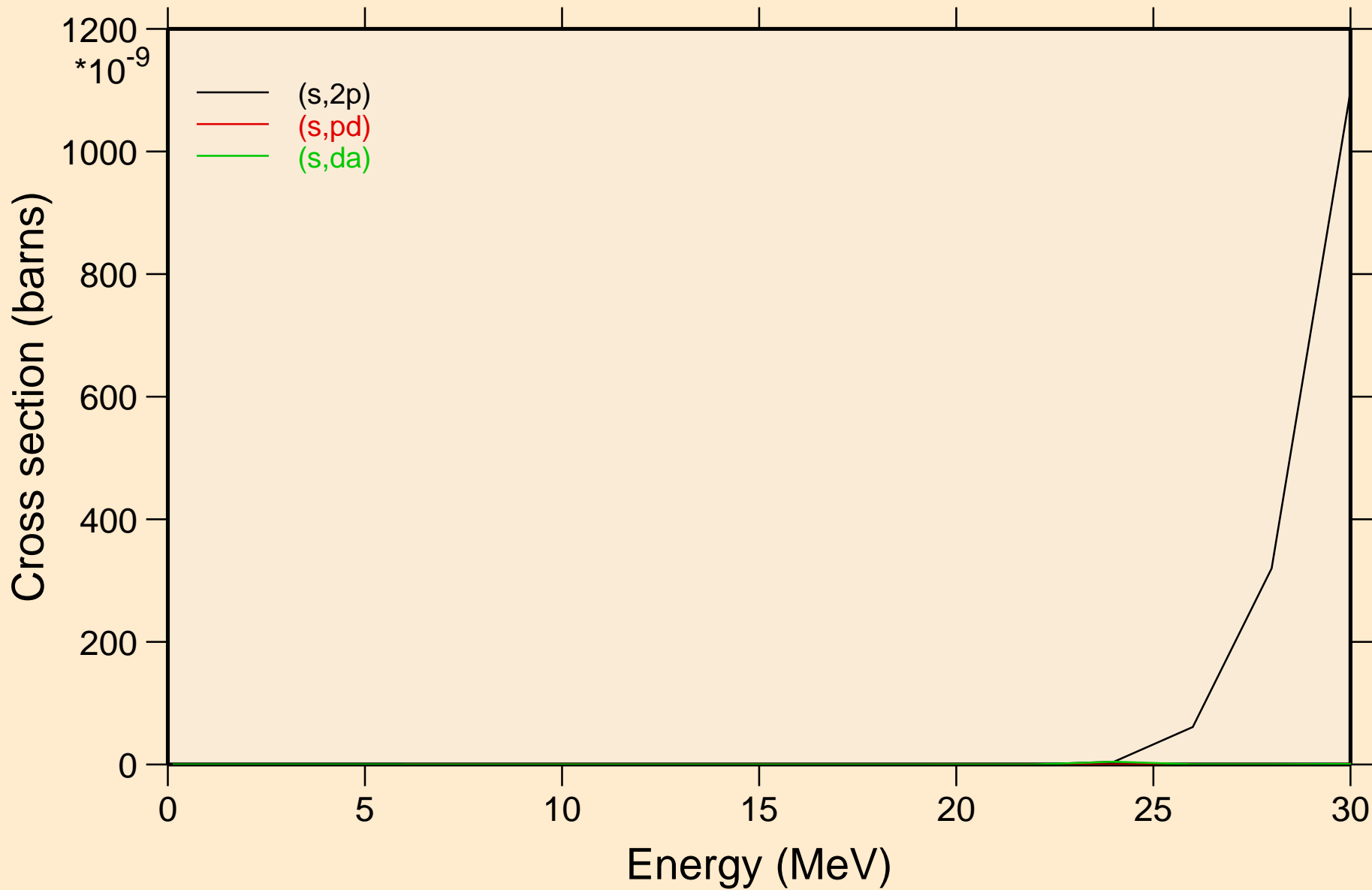



ES244 HELION ACER TENDL-2021 LIBRARY; T=0.K  
angular distribution for elastic

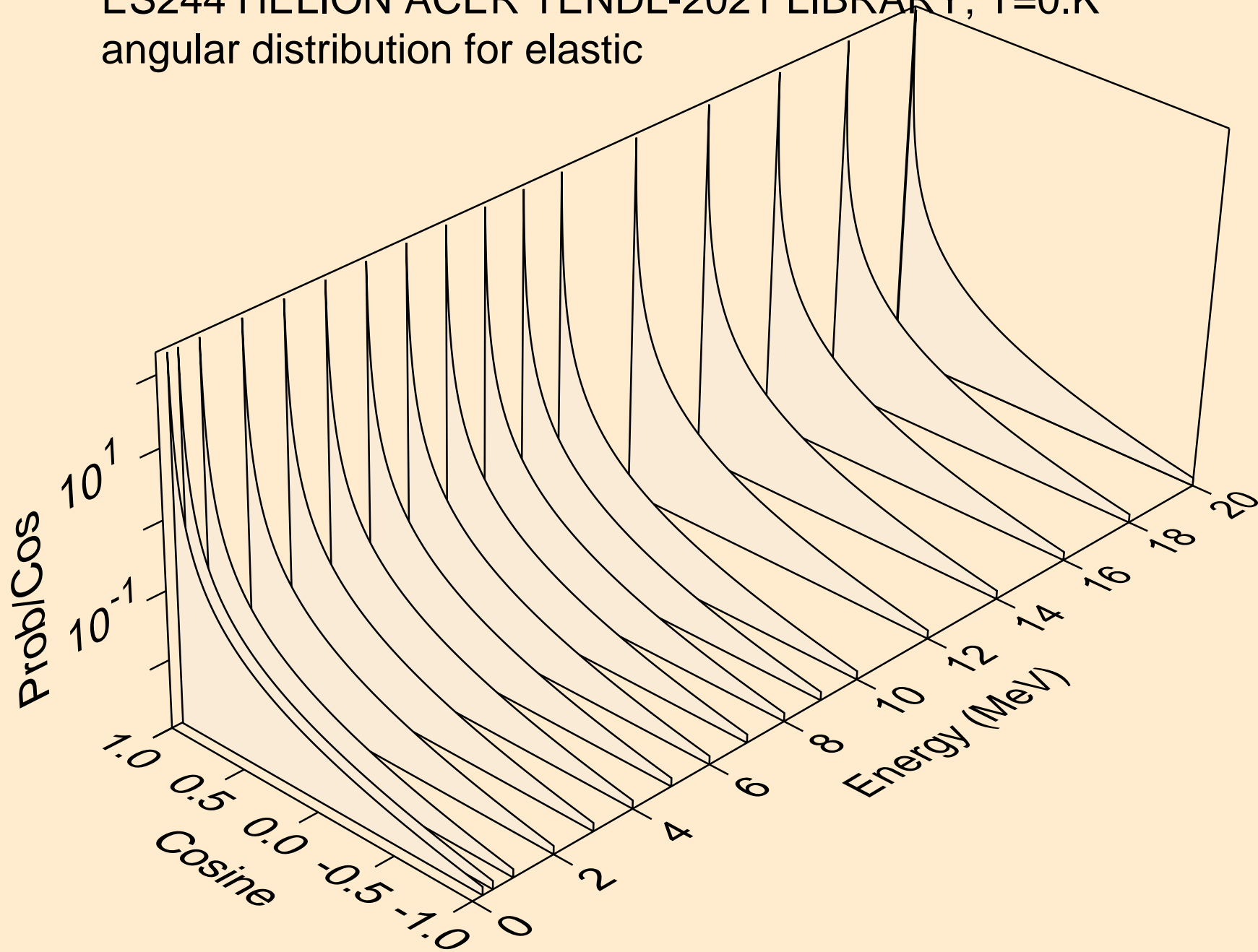

ES244 HELION ACER TENDL-2021 LIBRARY; T=0.K  
angular distribution for elastic

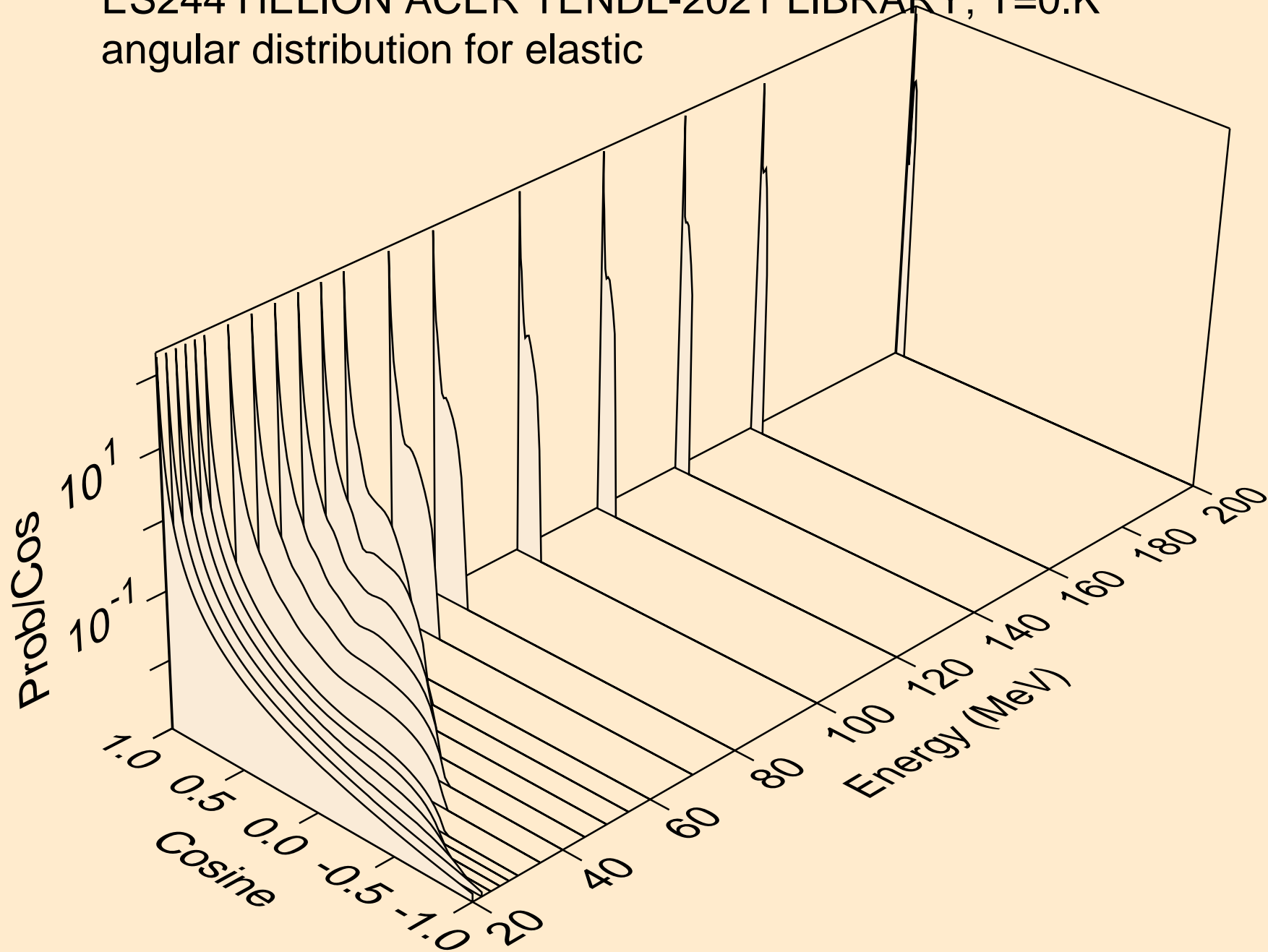

ES244 HELION ACER TENDL-2021 LIBRARY; T=0.K  
He-3 emission for (s,x)

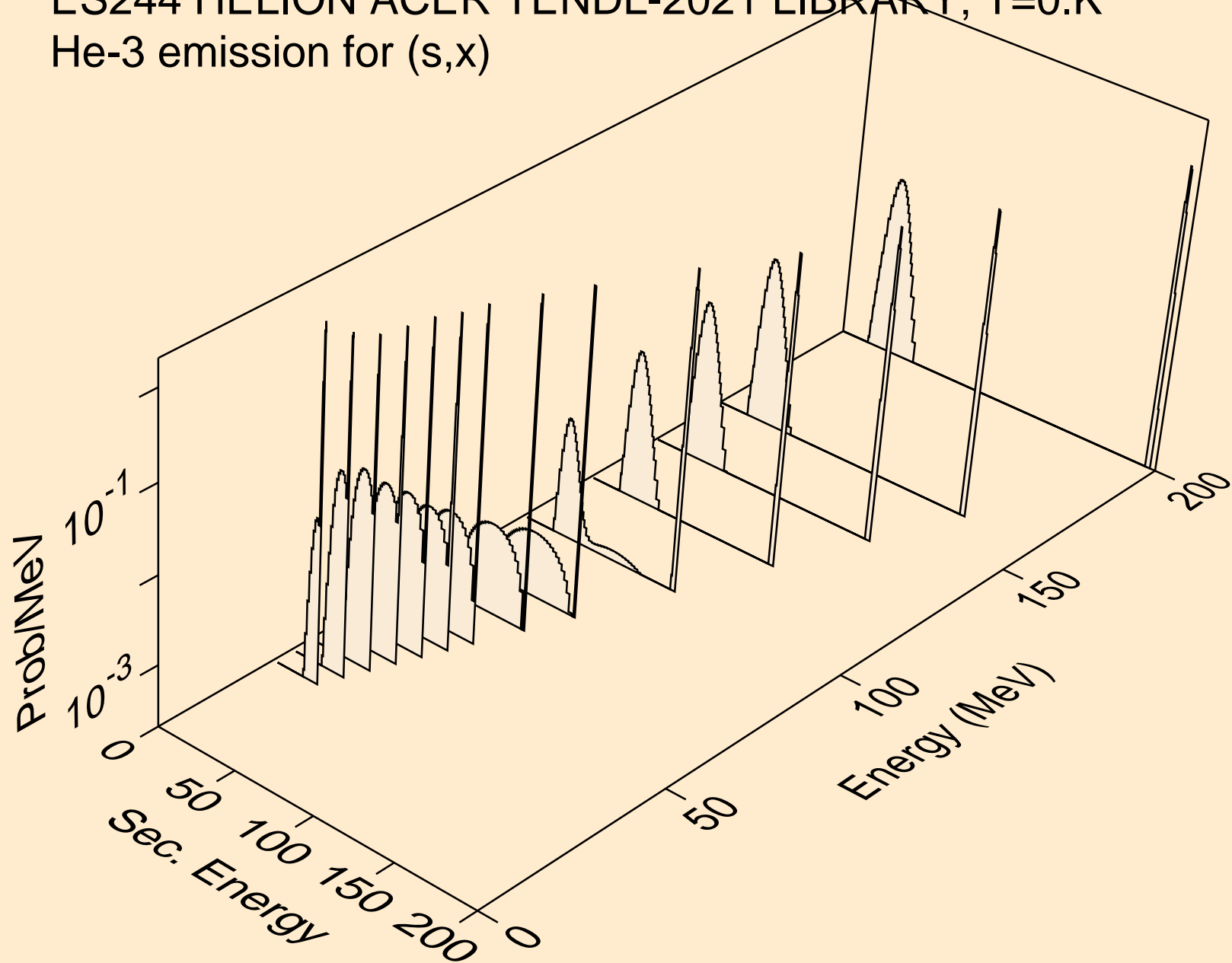

ES244 HELION ACER TENDL-2021 LIBRARY; T=0.K  
He-3 emission for inelastic

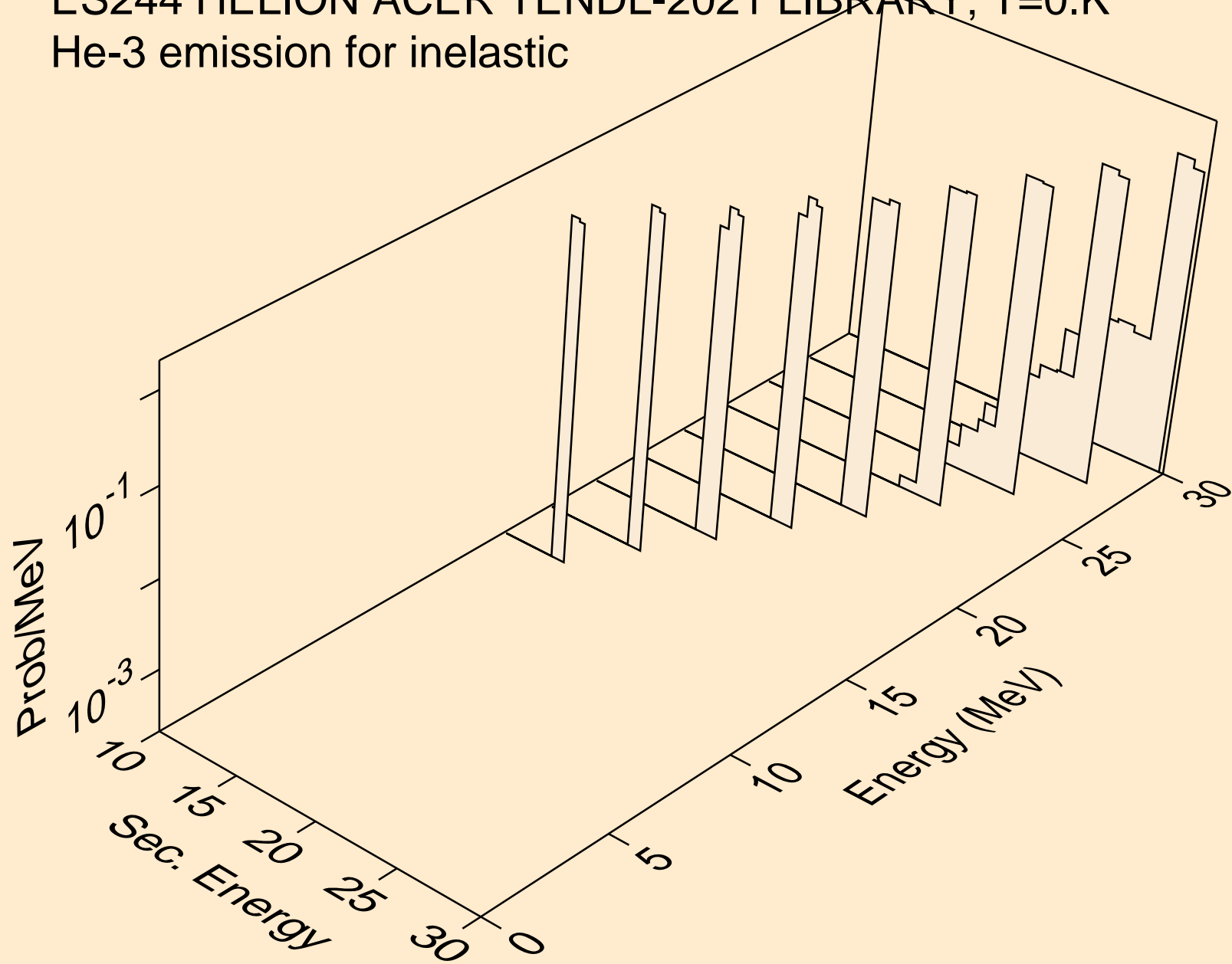

ES244 HELION ACER TENDL-2021 LIBRARY; T=0.K  
Photon emission for (z,n)

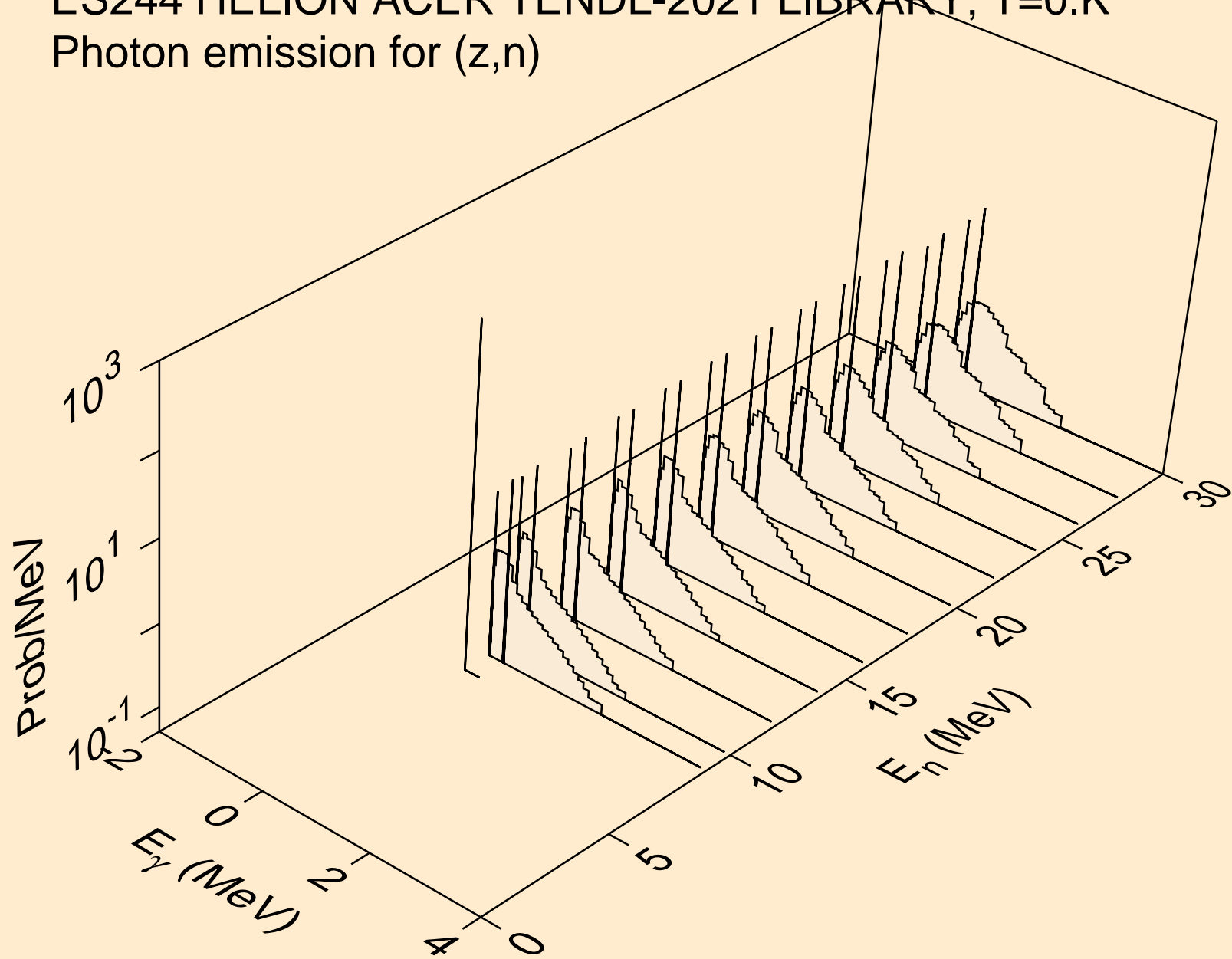

ES244 HELION ACER TENDL-2021 LIBRARY; T=0.K  
Photon emission for (n,x)

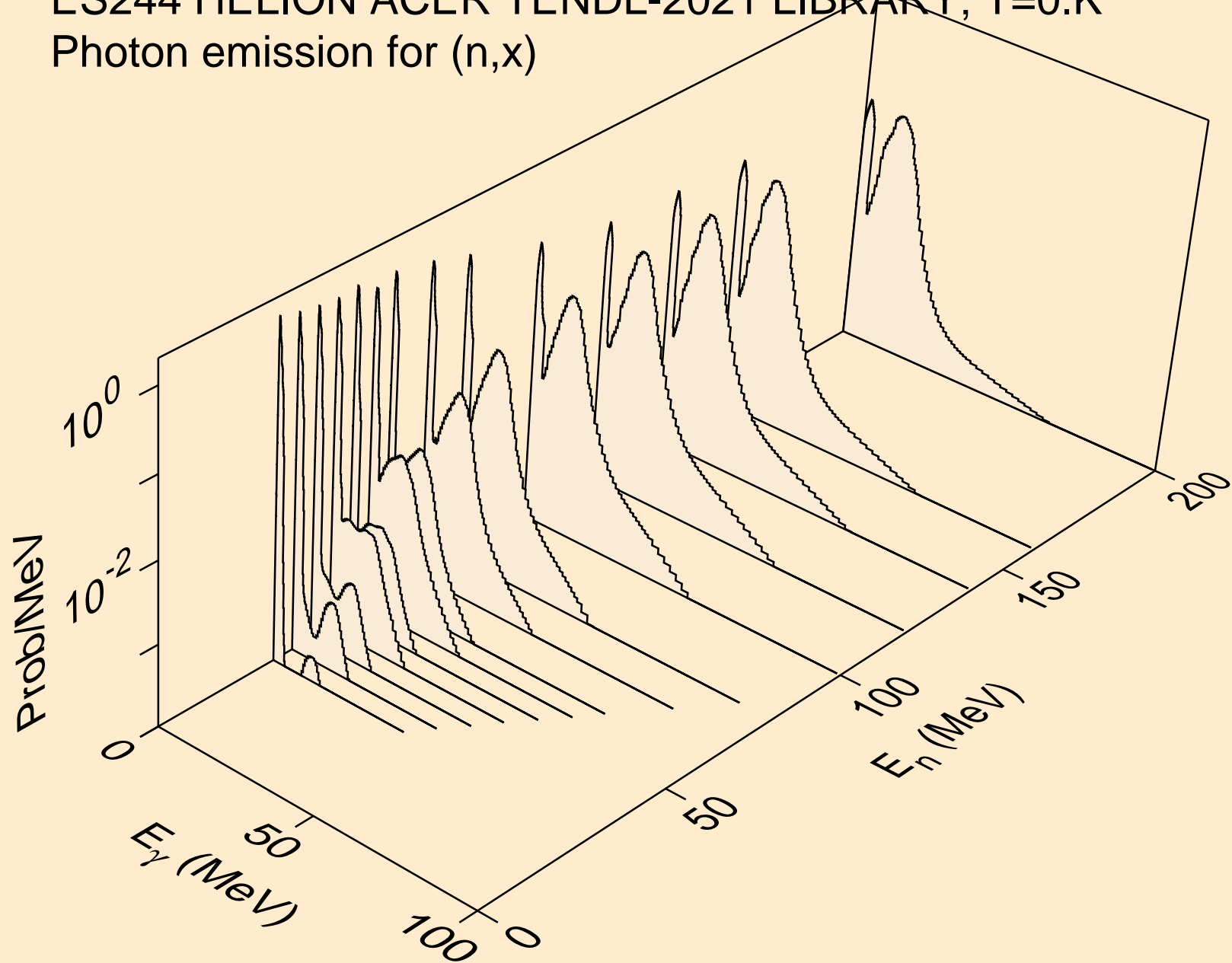

ES244 HELION ACER TENDL-2021 LIBRARY; T=0.K  
Photon emission for (n,2n)

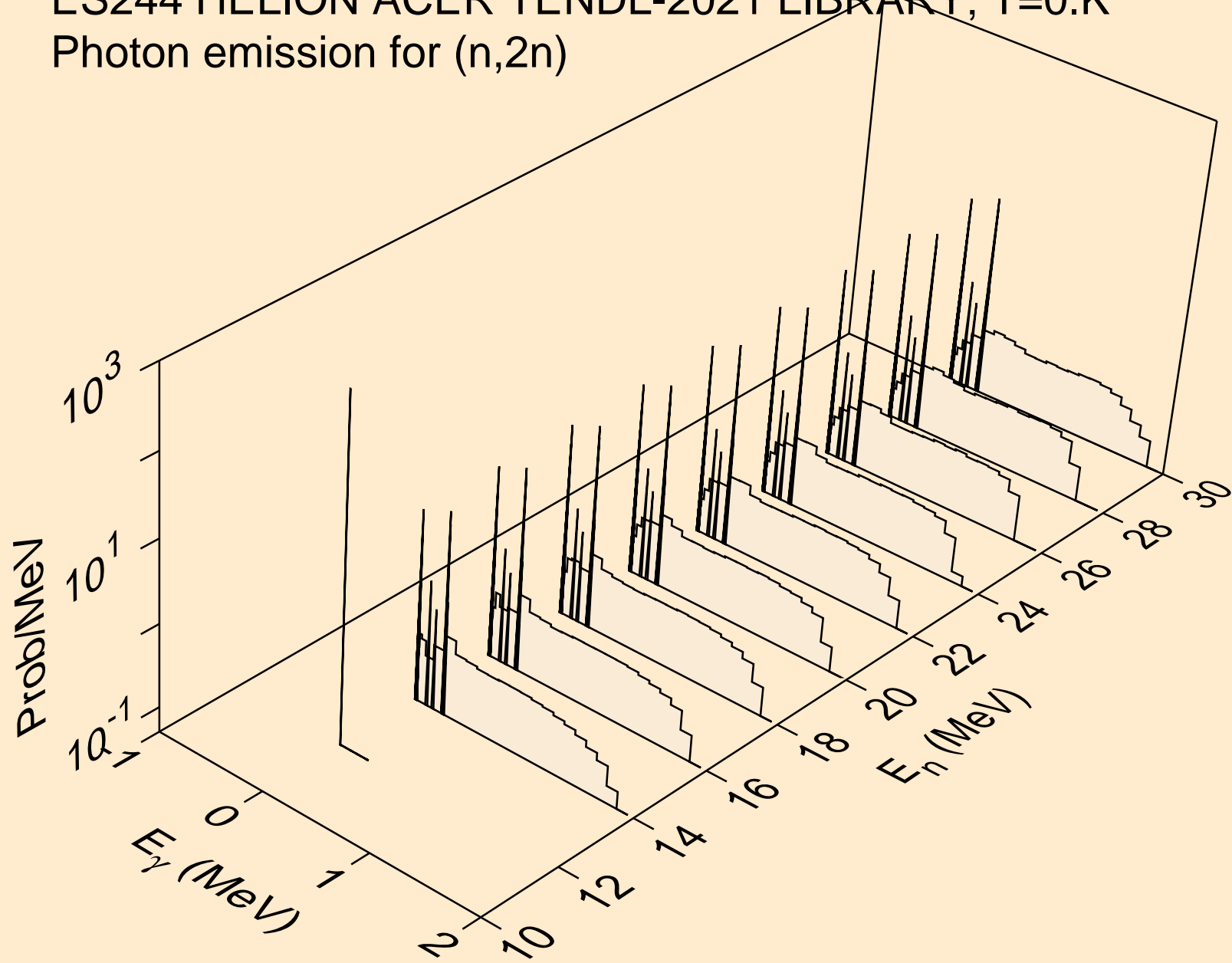

ES244 HELION ACER TENDL-2021 LIBRARY; T=0.K  
Photon emission for (n,3n)

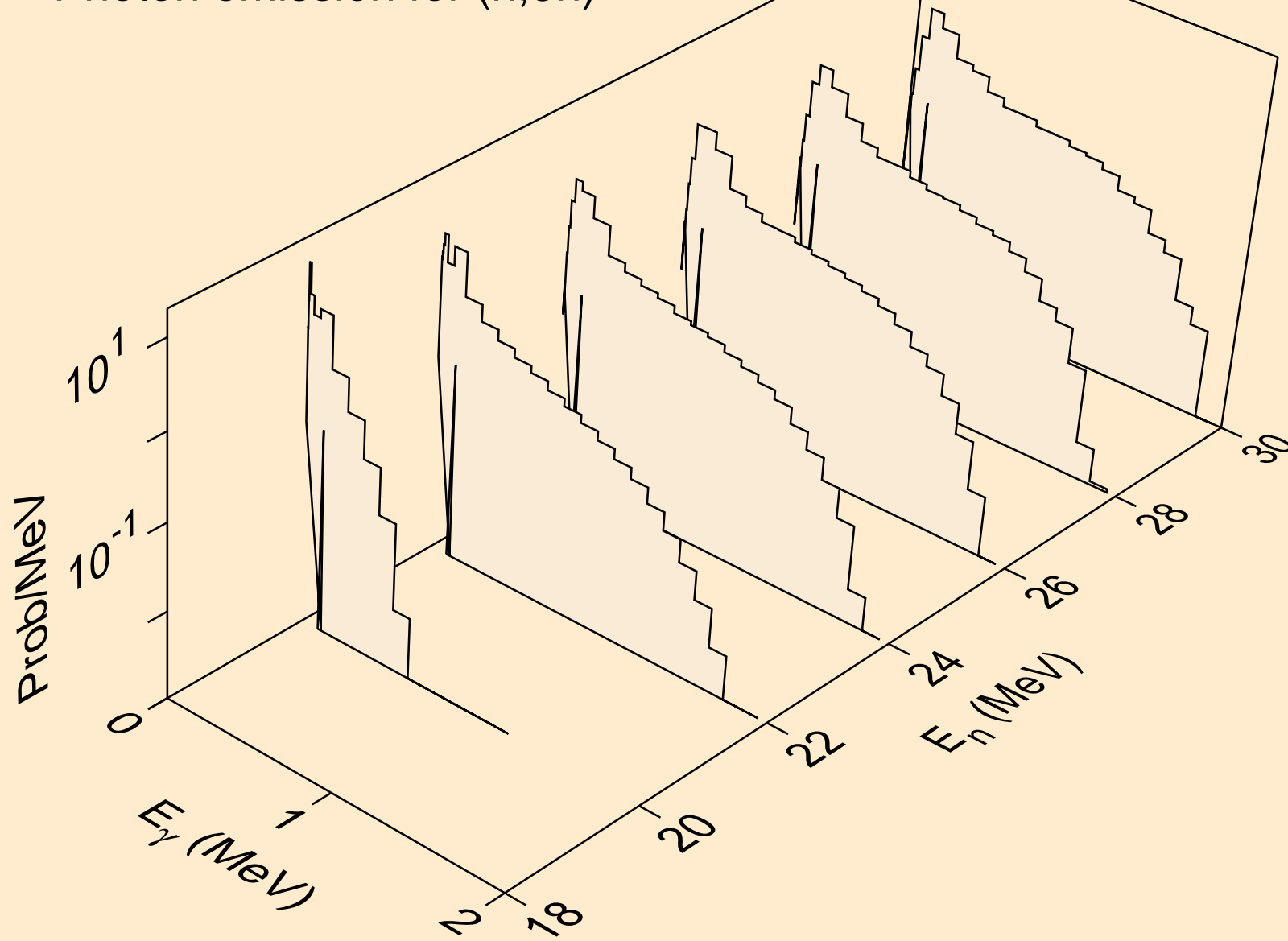



ES244 HELION ACER TENDL-2021 LIBRARY; T=0.K  
Photon emission for (n,n\*)a

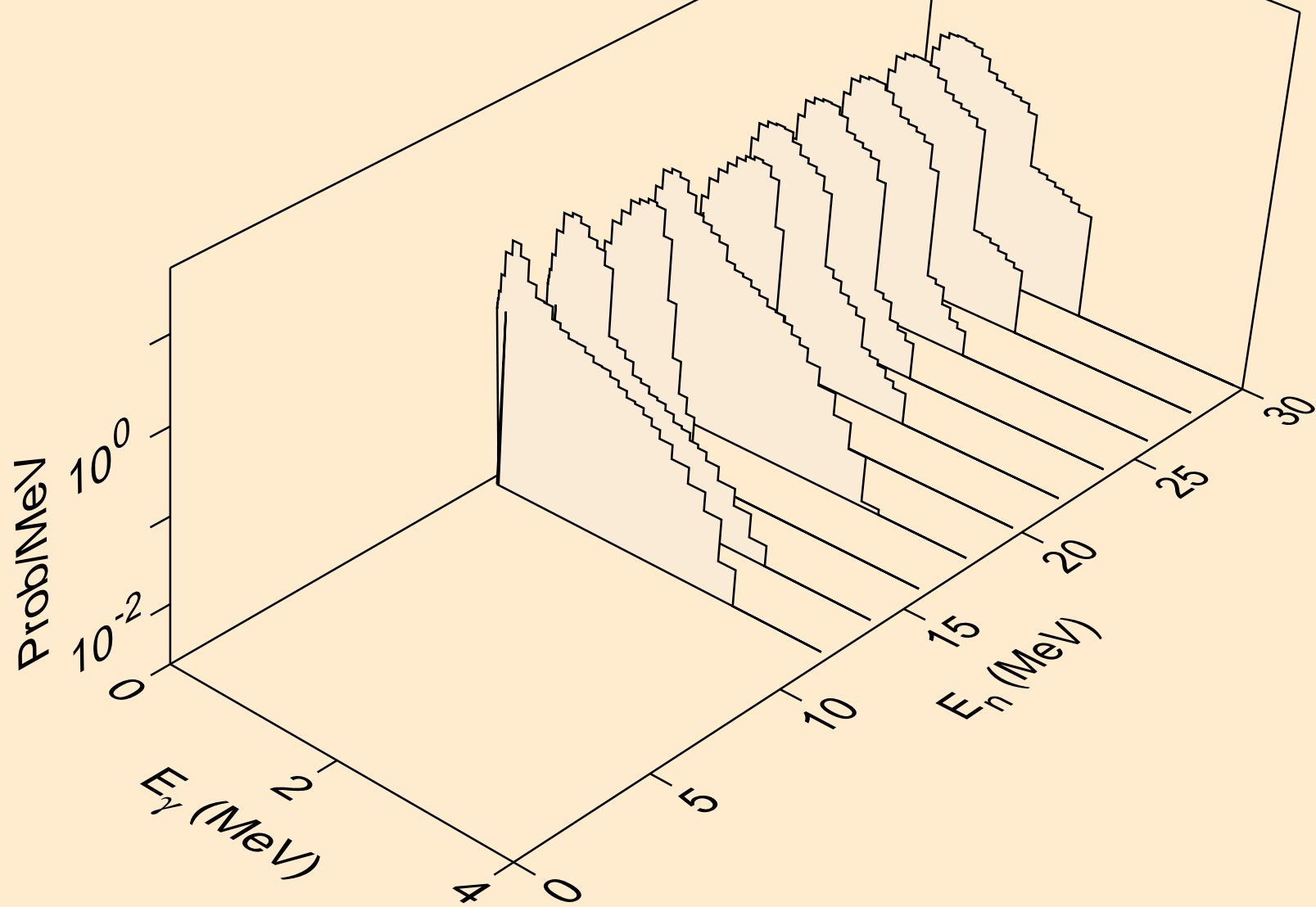

ES244 HELION ACER TENDL-2021 LIBRARY; T=0.K  
Photon emission for (n,n\*)p

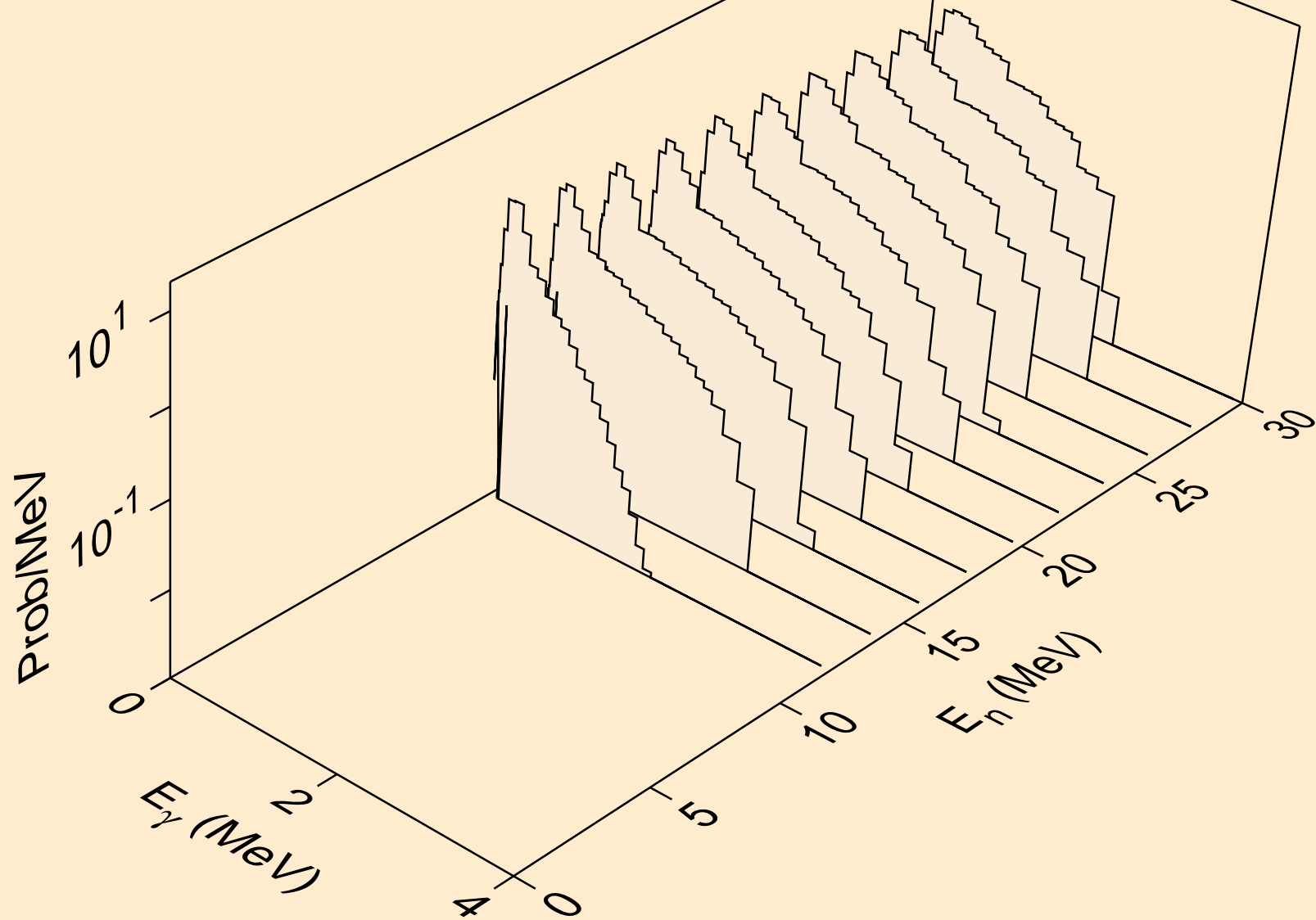

ES244 HELION ACER TENDL-2021 LIBRARY; T=0.K  
Photon emission for (n,n\*)d

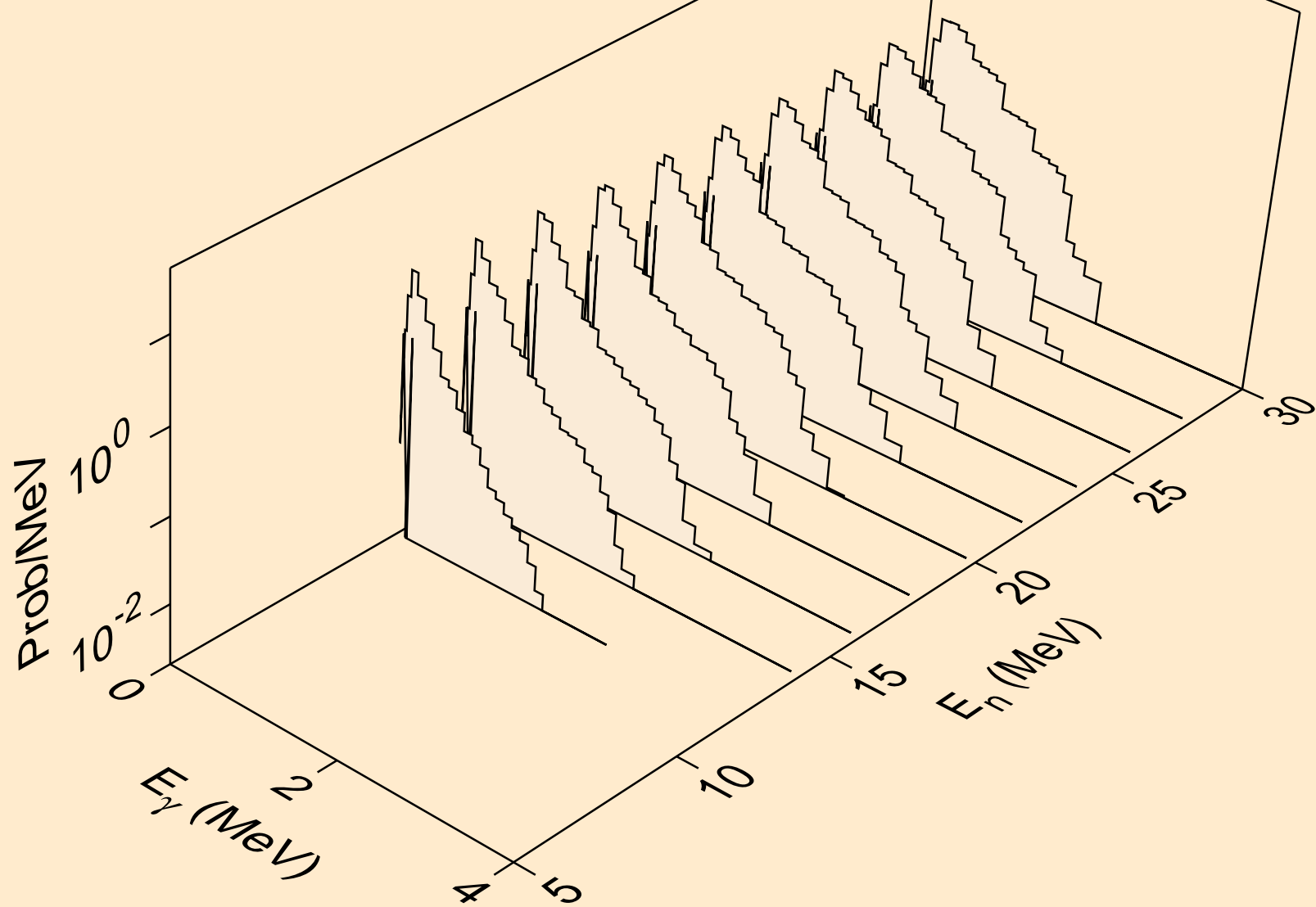

ES244 HELION ACER TENDL-2021 LIBRARY; T=0.K  
Photon emission for (n,n\*)t

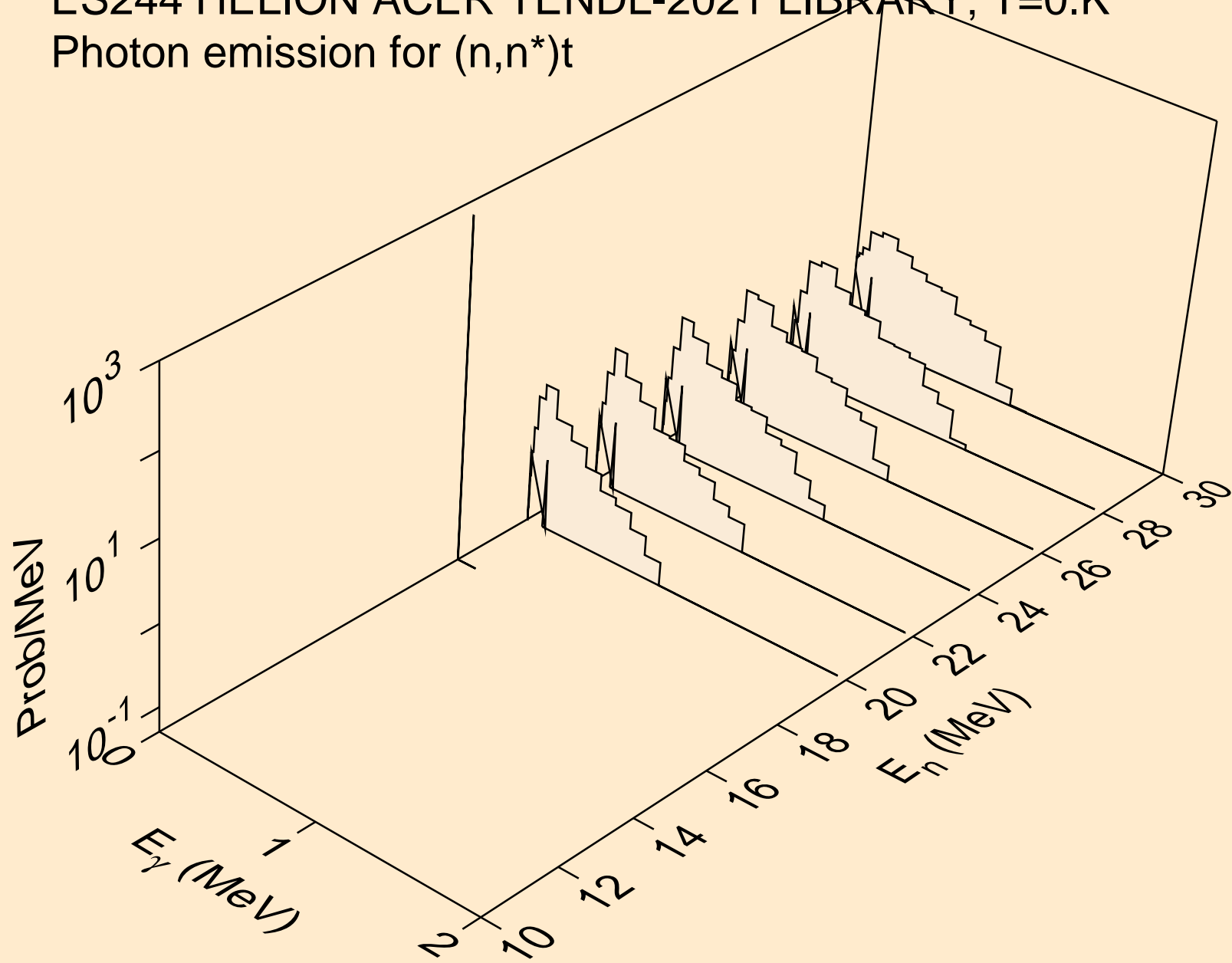

ES244 HELION ACER TENDL-2021 LIBRARY; T=0.K  
Photon emission for (n,2np)

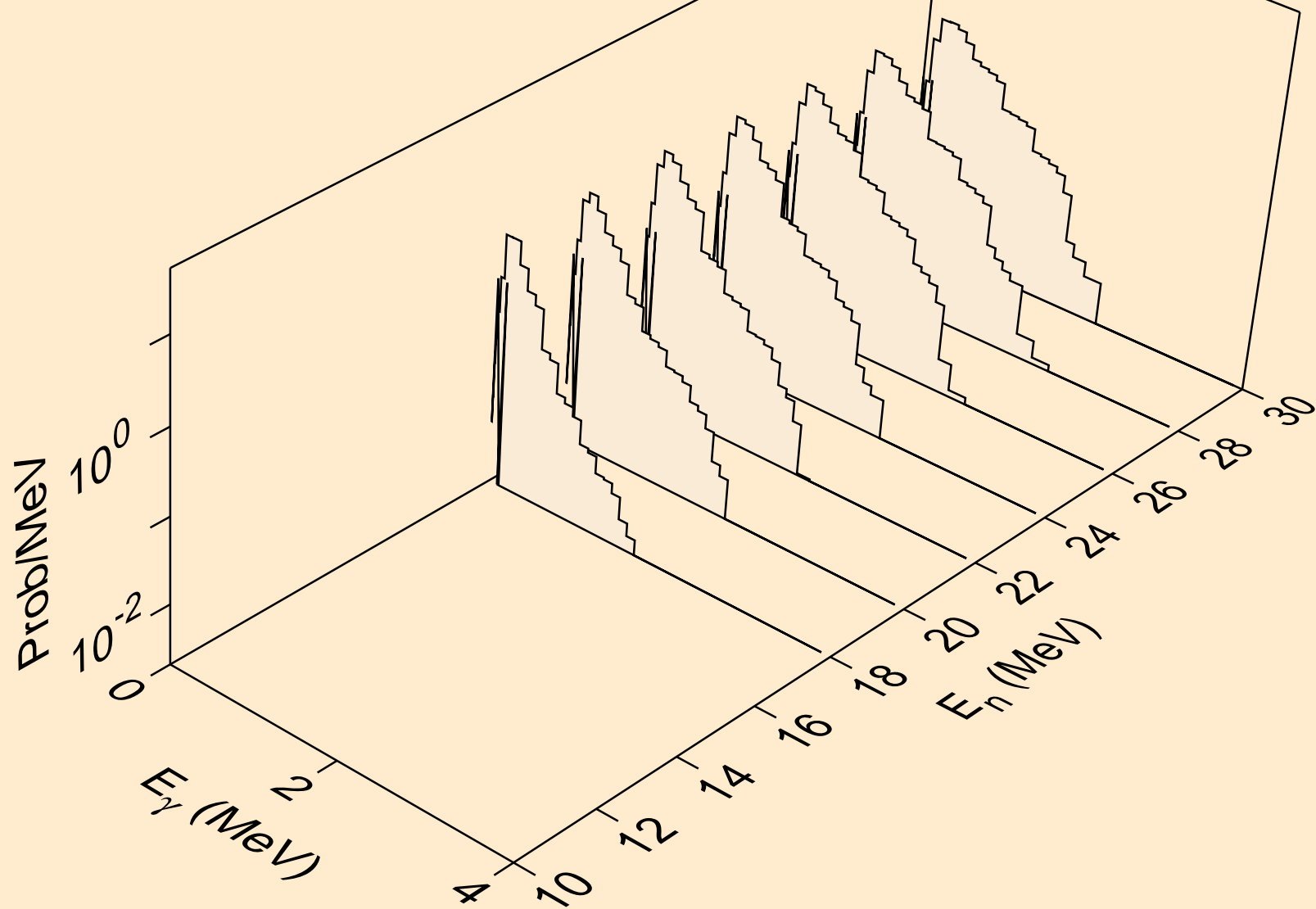

ES244 HELION ACER TENDL-2021 LIBRARY; T=0.K  
Photon emission for (n,p)

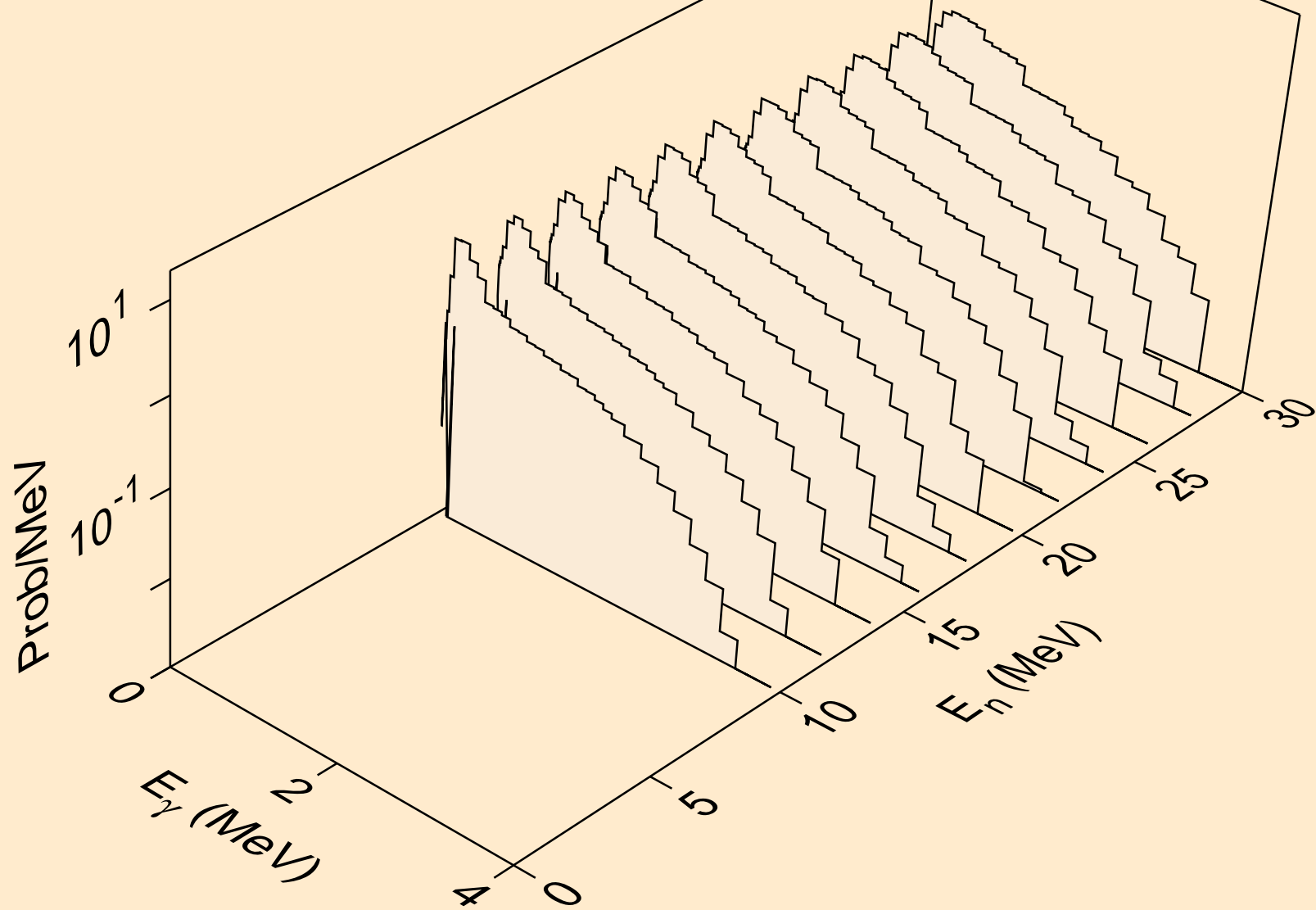

ES244 HELION ACER TENDL-2021 LIBRARY; T=0.K  
Photon emission for (n,d)

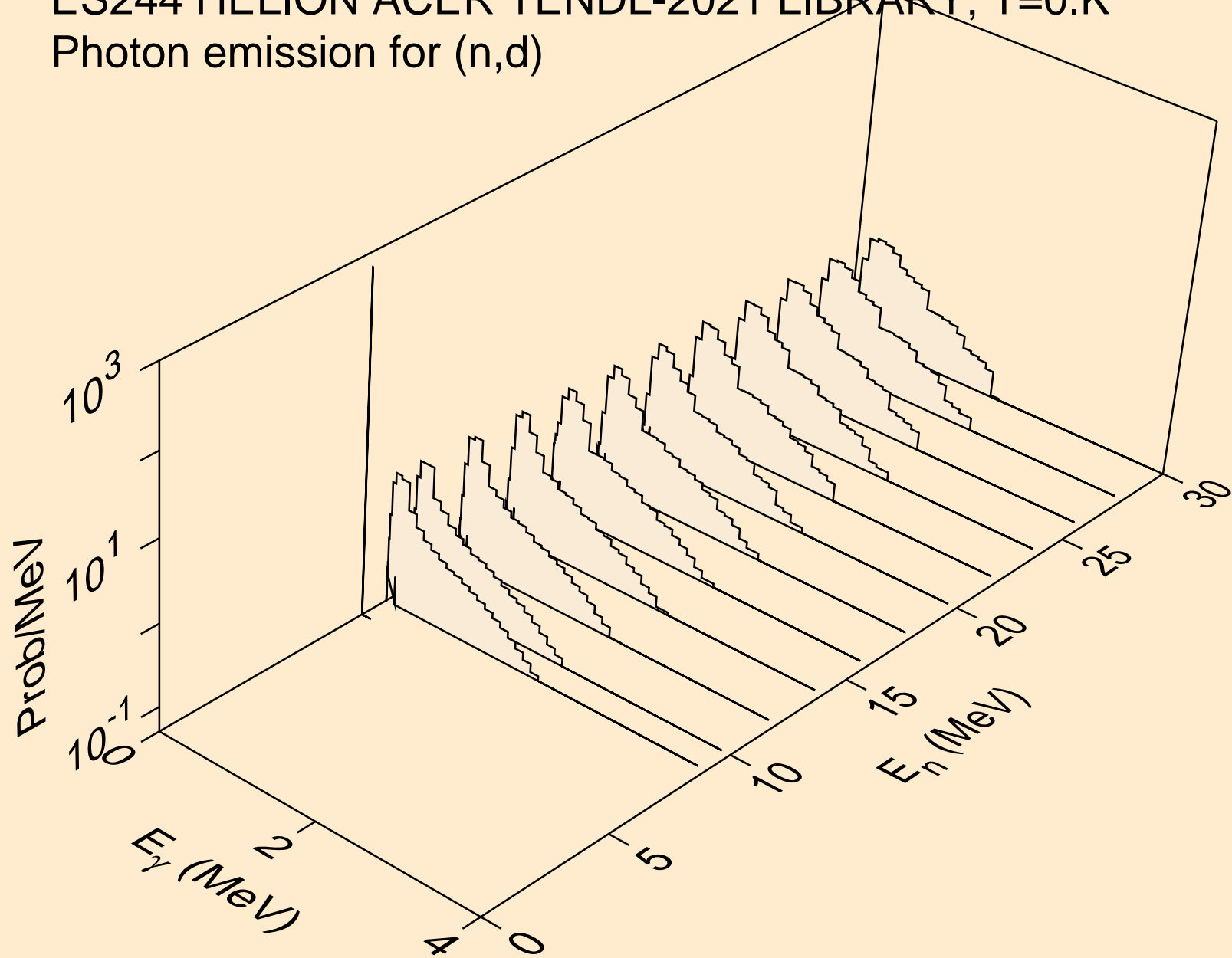

ES244 HELION ACER TENDL-2021 LIBRARY; T=0.K  
Photon emission for (n,t)

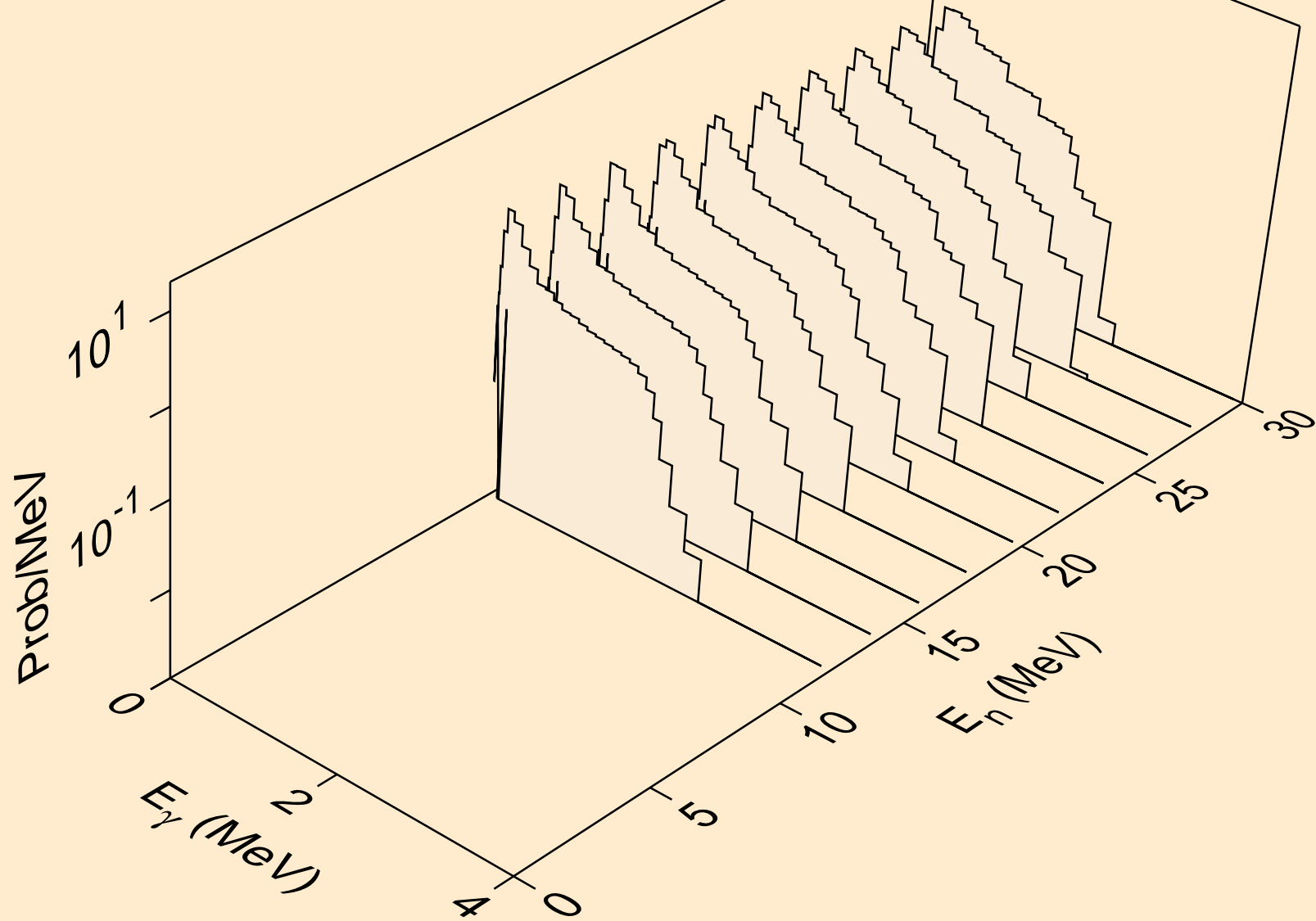



ES244 HELION ACER TENDL-2021 LIBRARY; T=0.K  
Photon emission for inelastic

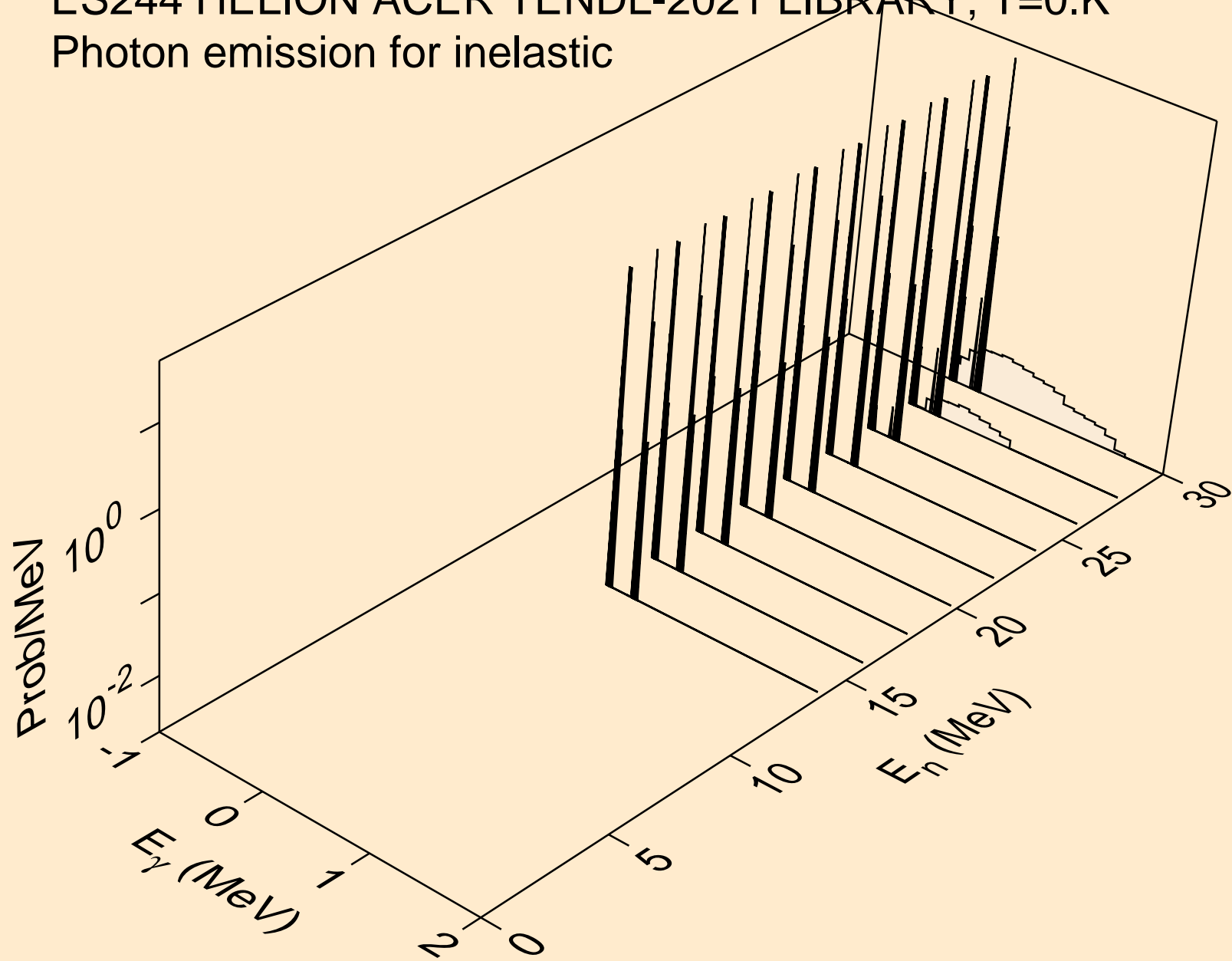

ES244 HELION ACER TENDL-2021 LIBRARY; T=0.K  
Photon emission for (n,a)

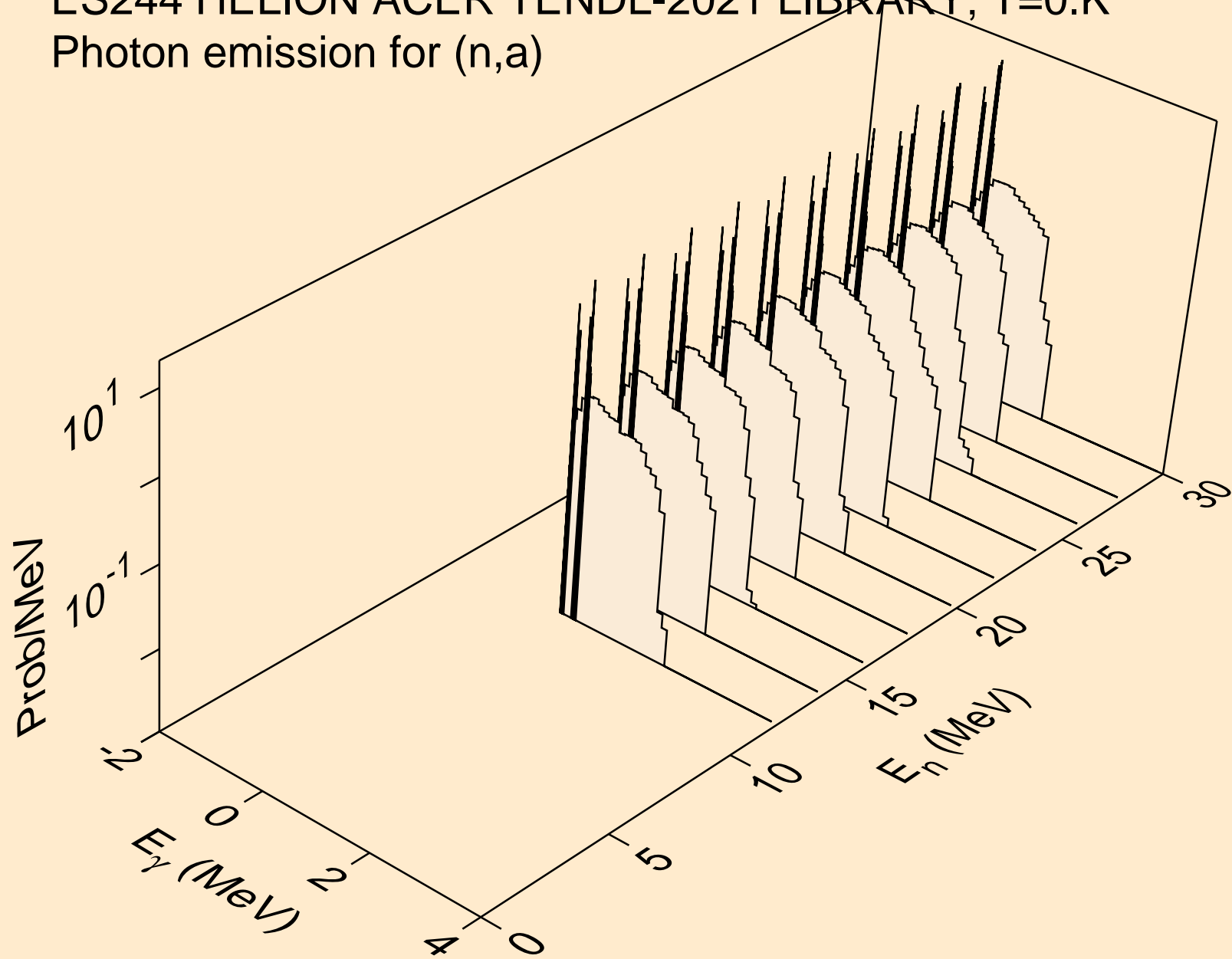

ES244 HELION ACER TENDL-2021 LIBRARY; T=0.K  
Photon emission for (n,2p)

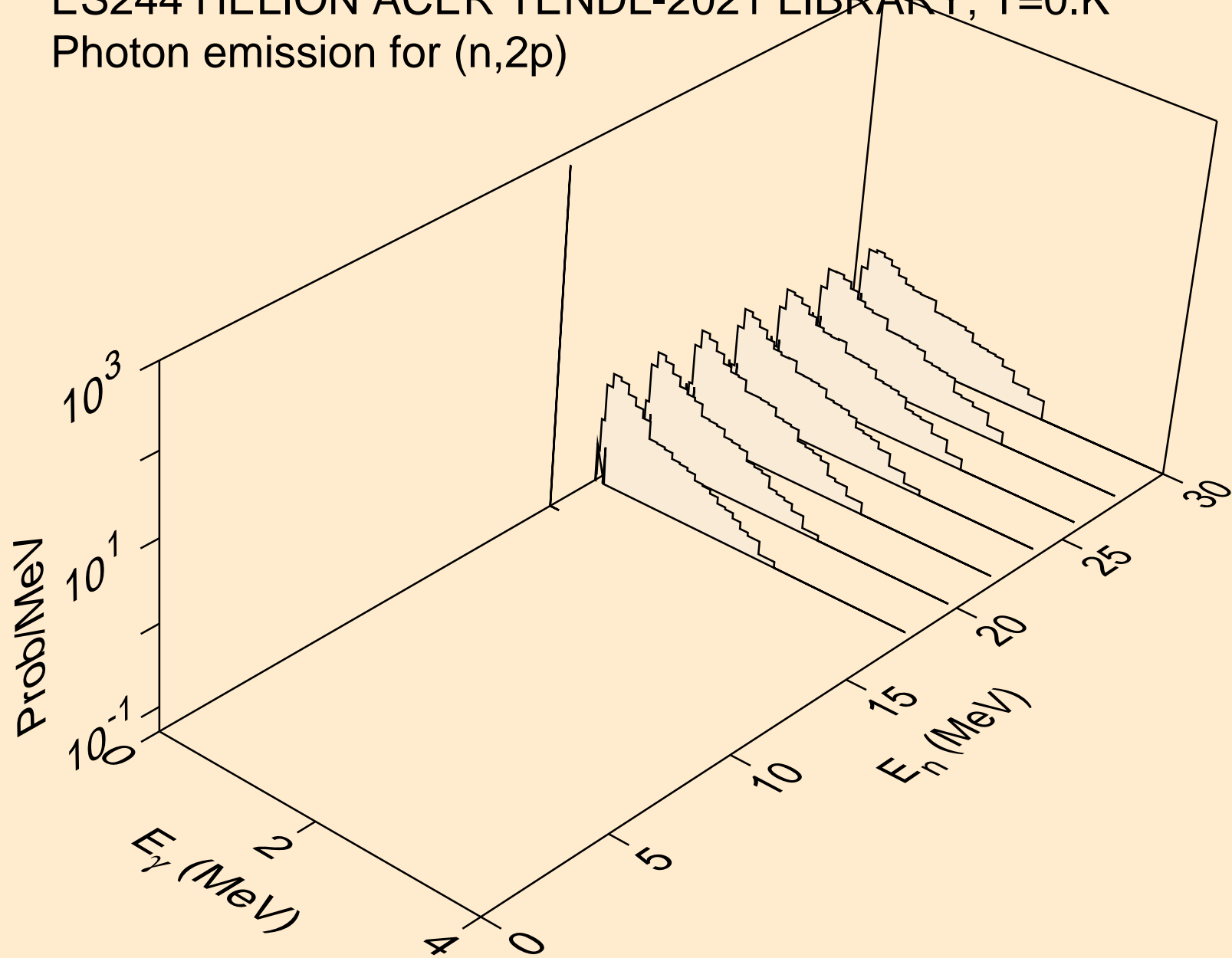

ES244 HELION ACER TENDL-2021 LIBRARY; T=0.K  
Photon emission for (n,pd)

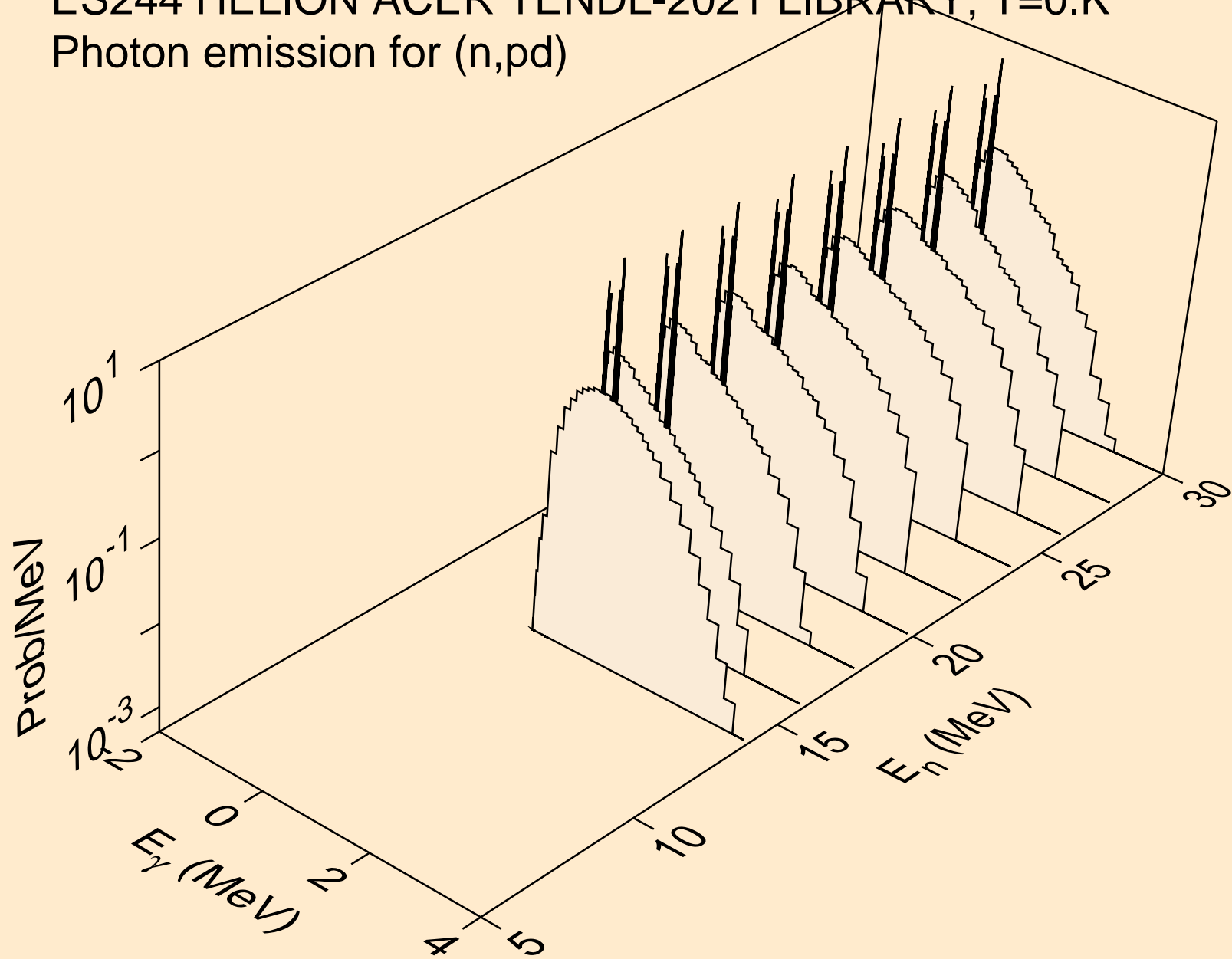

ES244 HELION ACER TENDL-2021 LIBRARY; T=0.K  
Photon emission for (n,da)

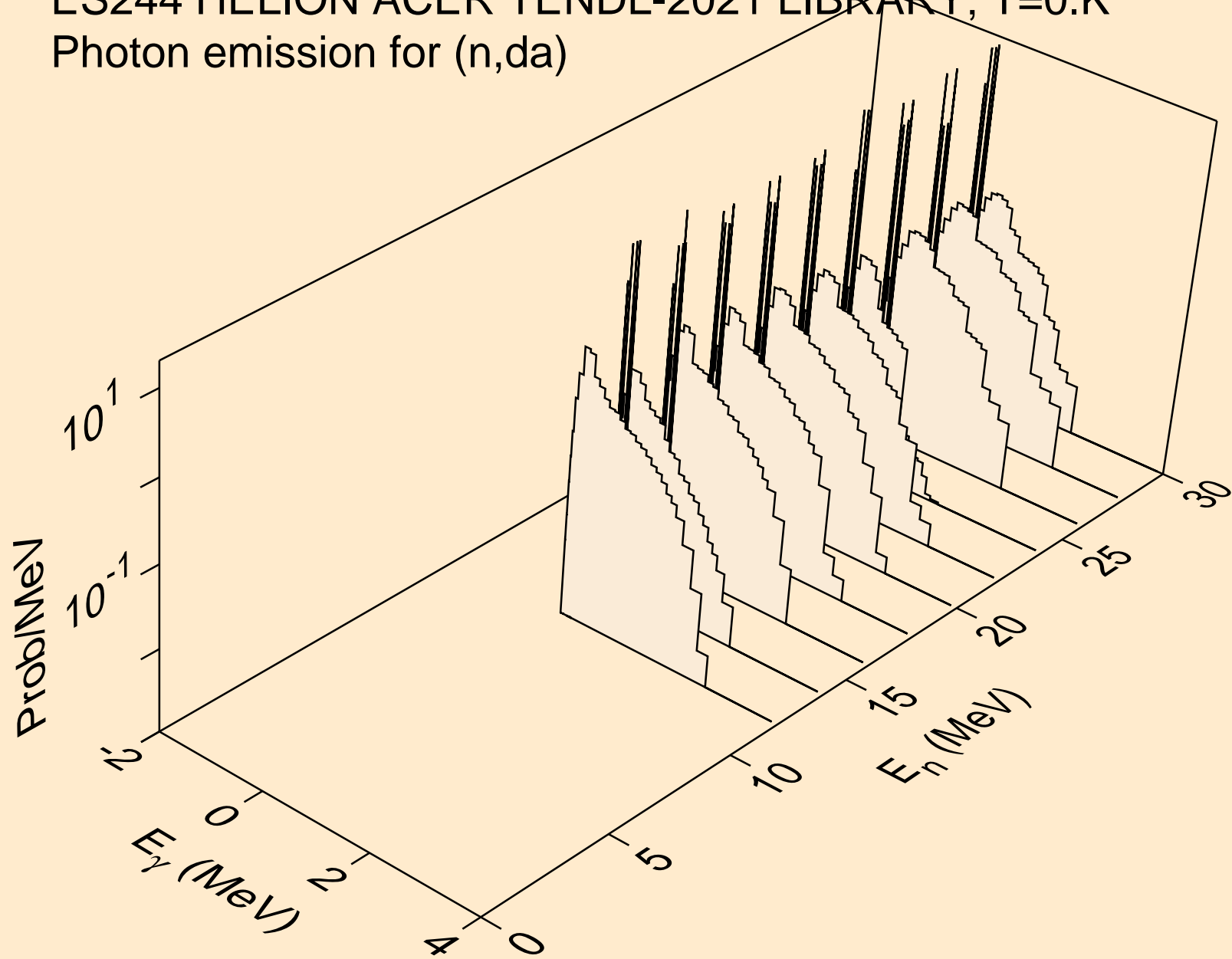

ES244 HELION ACER TENDL-2021 LIBRARY; T=0.K  
Particle heating contributions

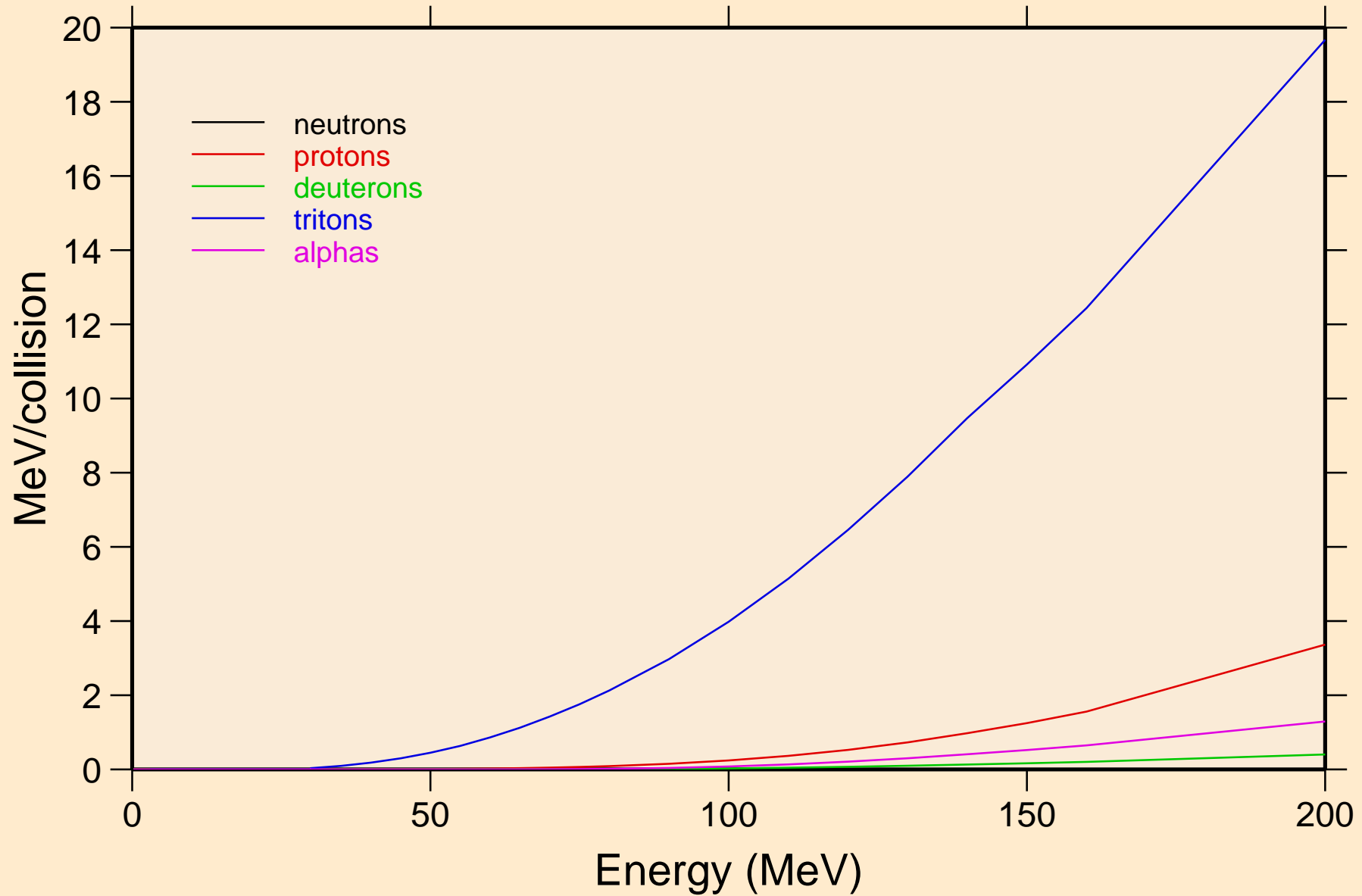

ES244 HELION ACER TENDL-2021 LIBRARY; T=0.K  
Recoil Heating

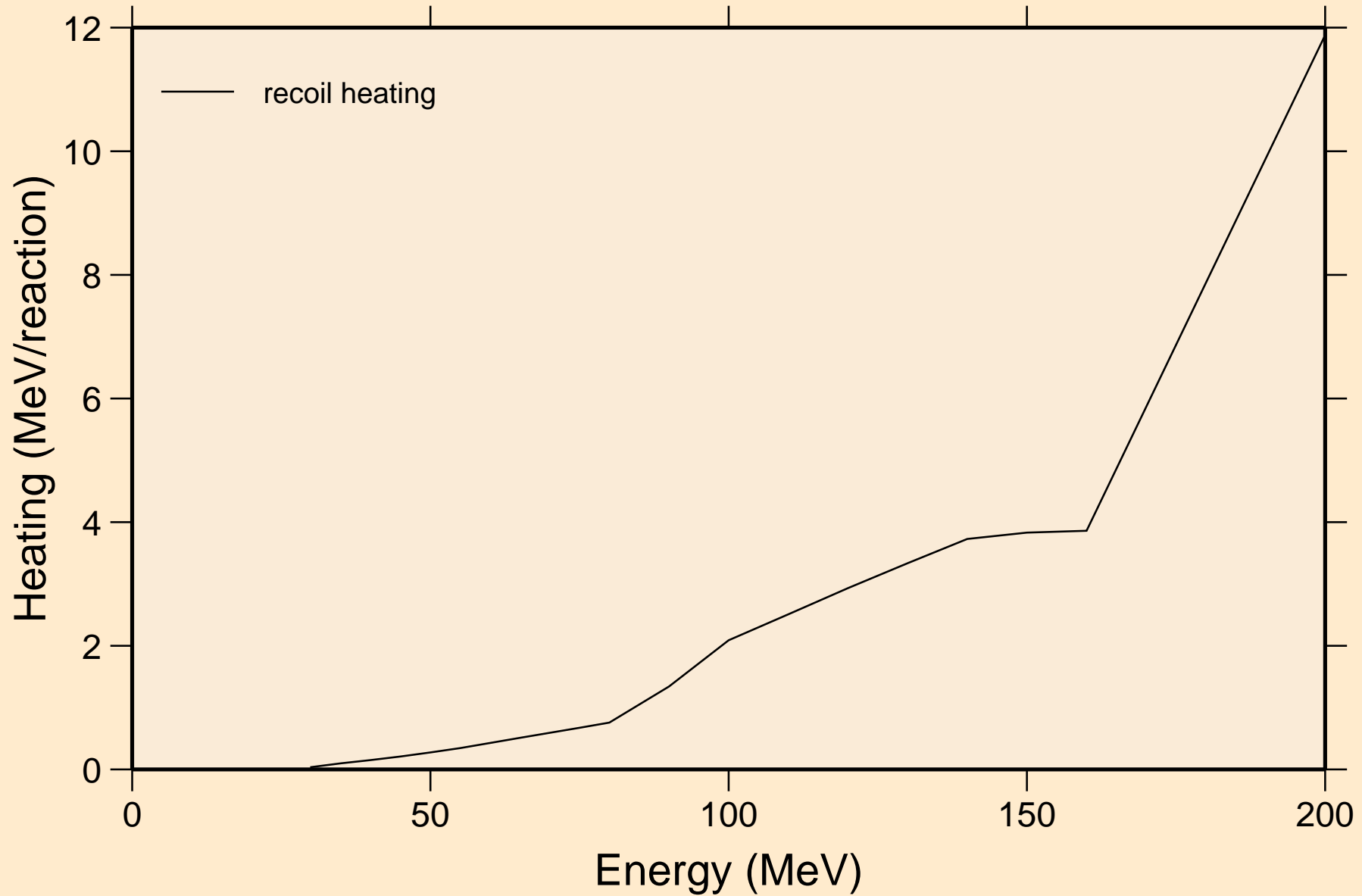

ES244 HELION ACER TENDL-2021 LIBRARY; T=0.K  
Particle production cross sections

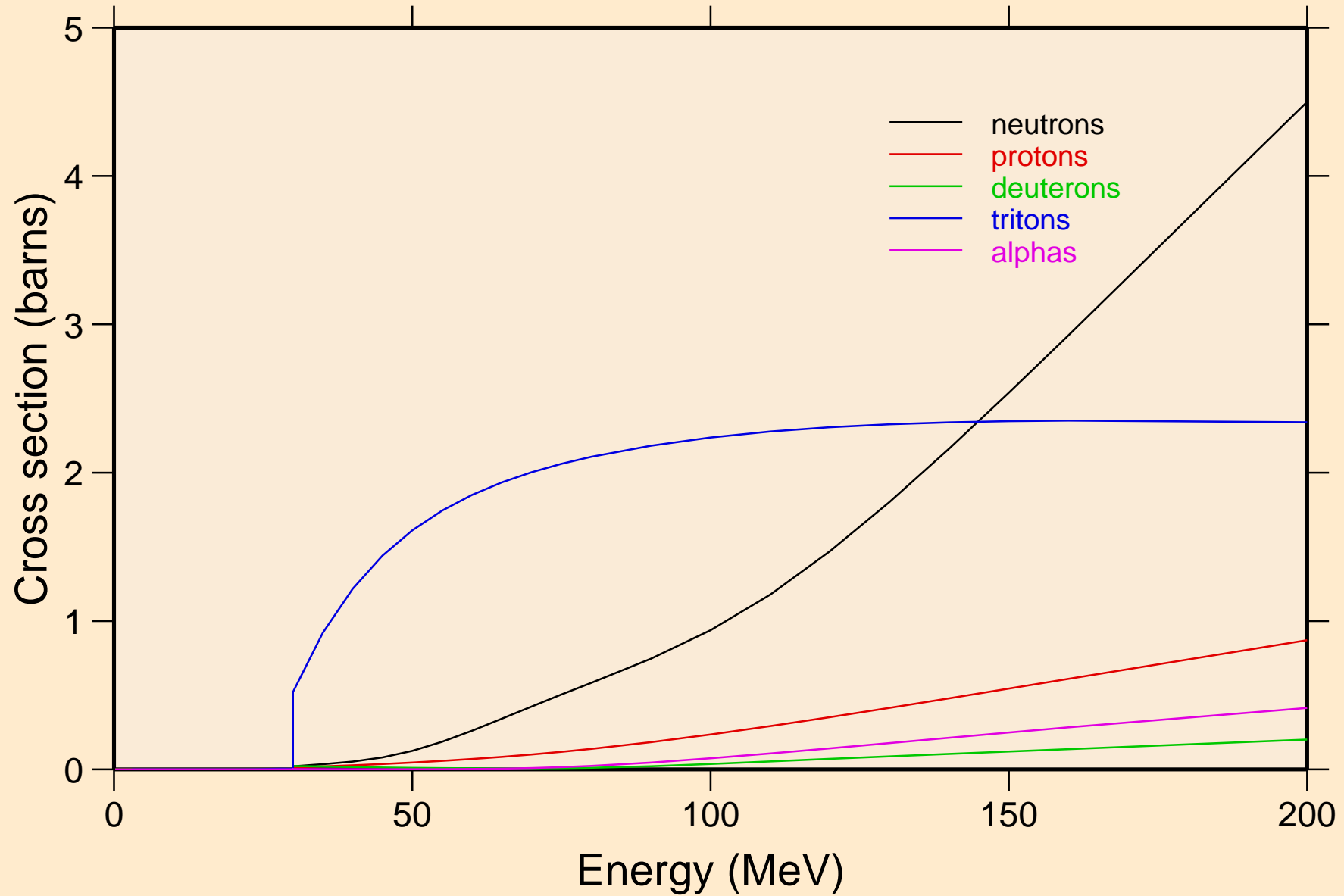



ES244 HELION ACER TENDL-2021 LIBRARY; T=0.K  
neutrons from (s,n)

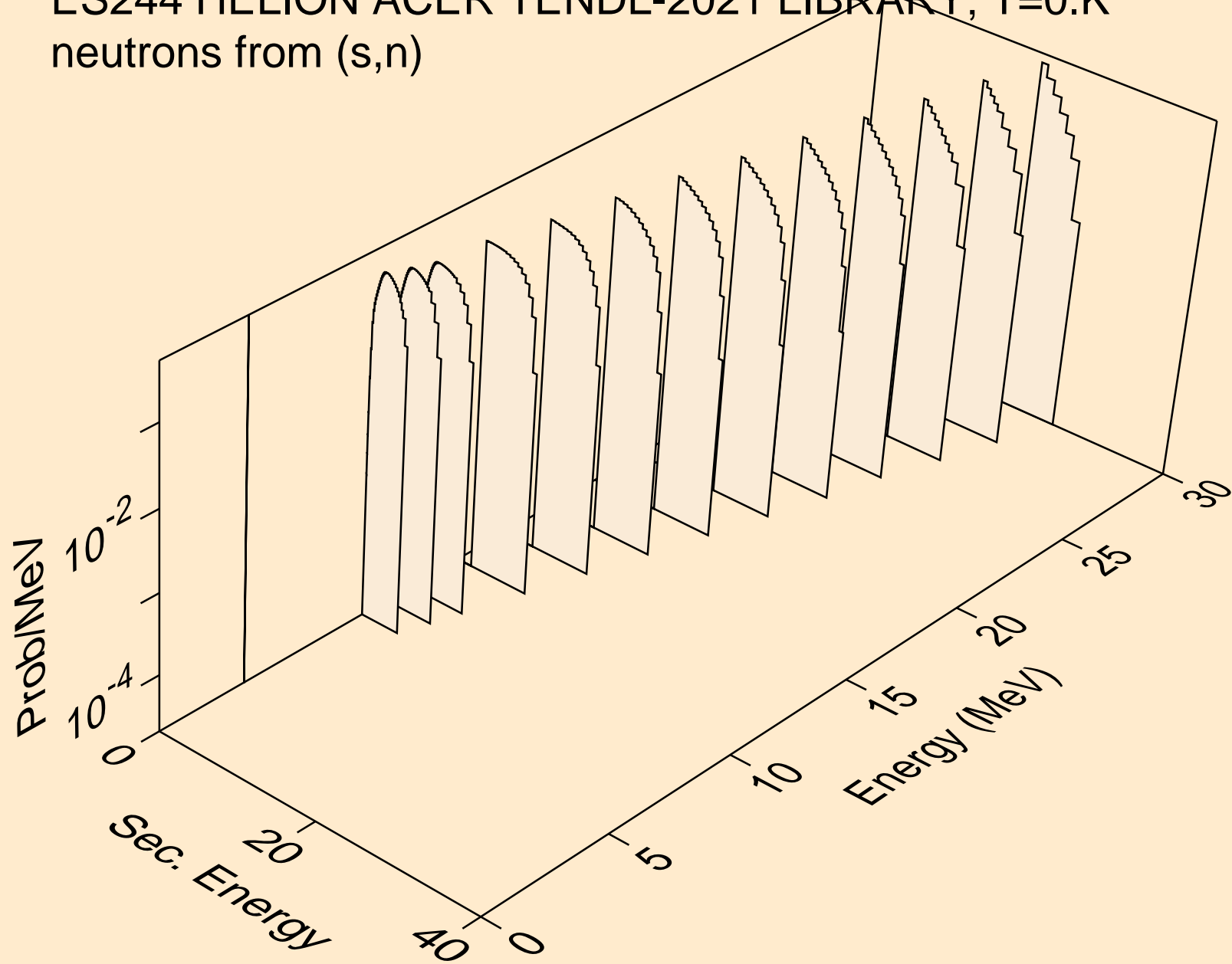

ES244 HELION ACER TENDL-2021 LIBRARY; T=0.K  
neutrons from (s,x)

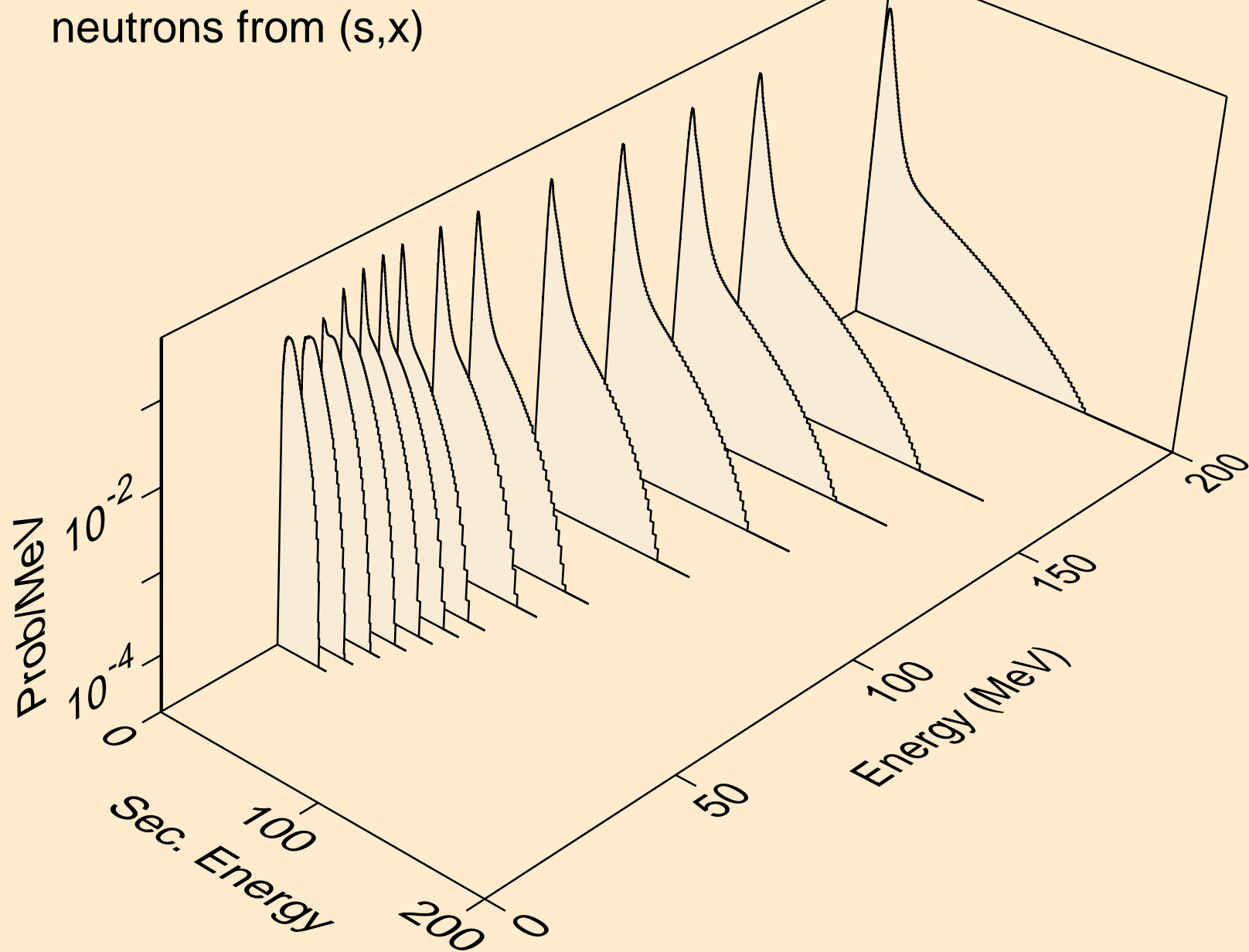

ES244 HELION ACER TENDL-2021 LIBRARY; T=0.K  
neutrons from (s,2n)

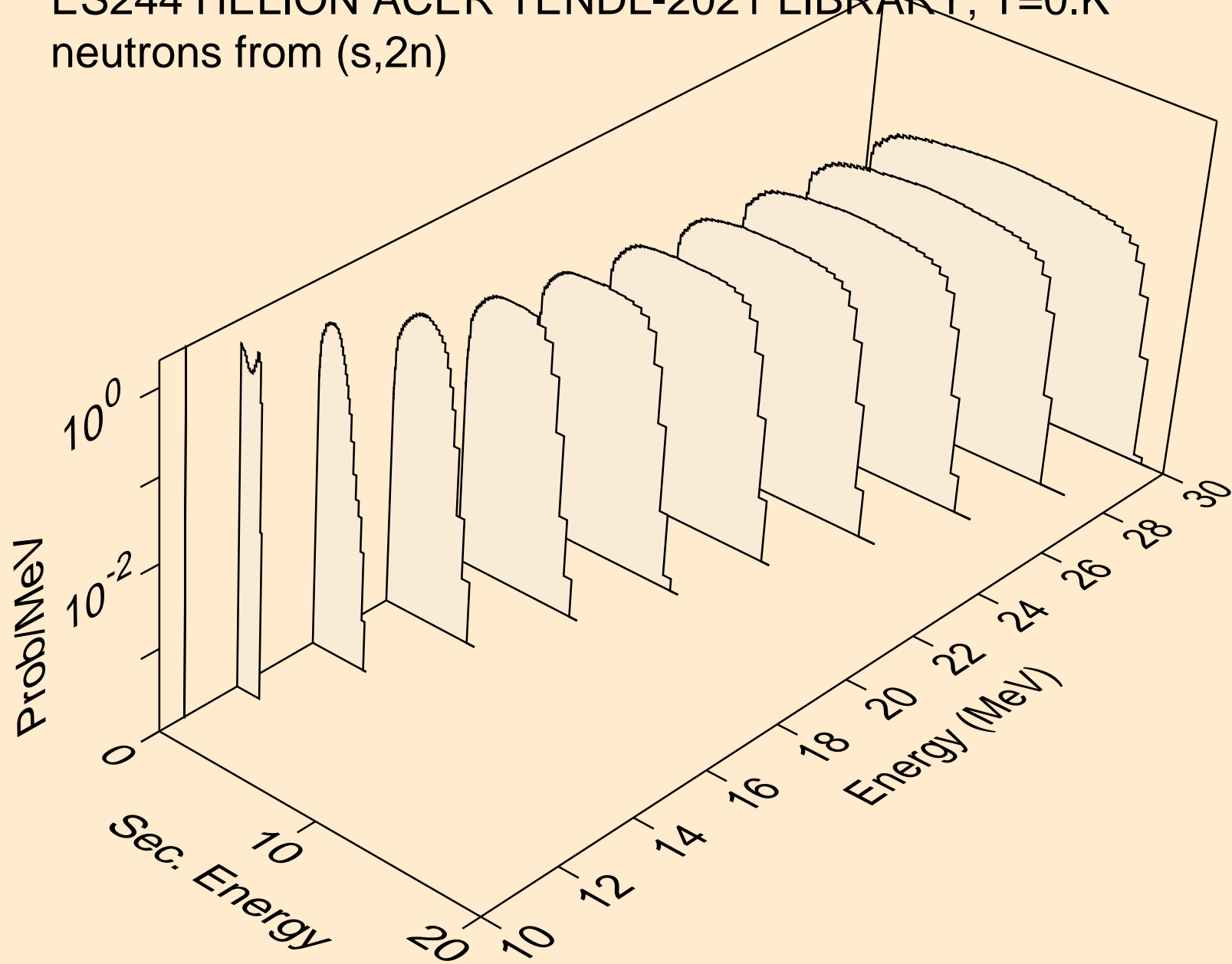

ES244 HELION ACER TENDL-2021 LIBRARY; T=0.K  
neutrons from (s,3n)

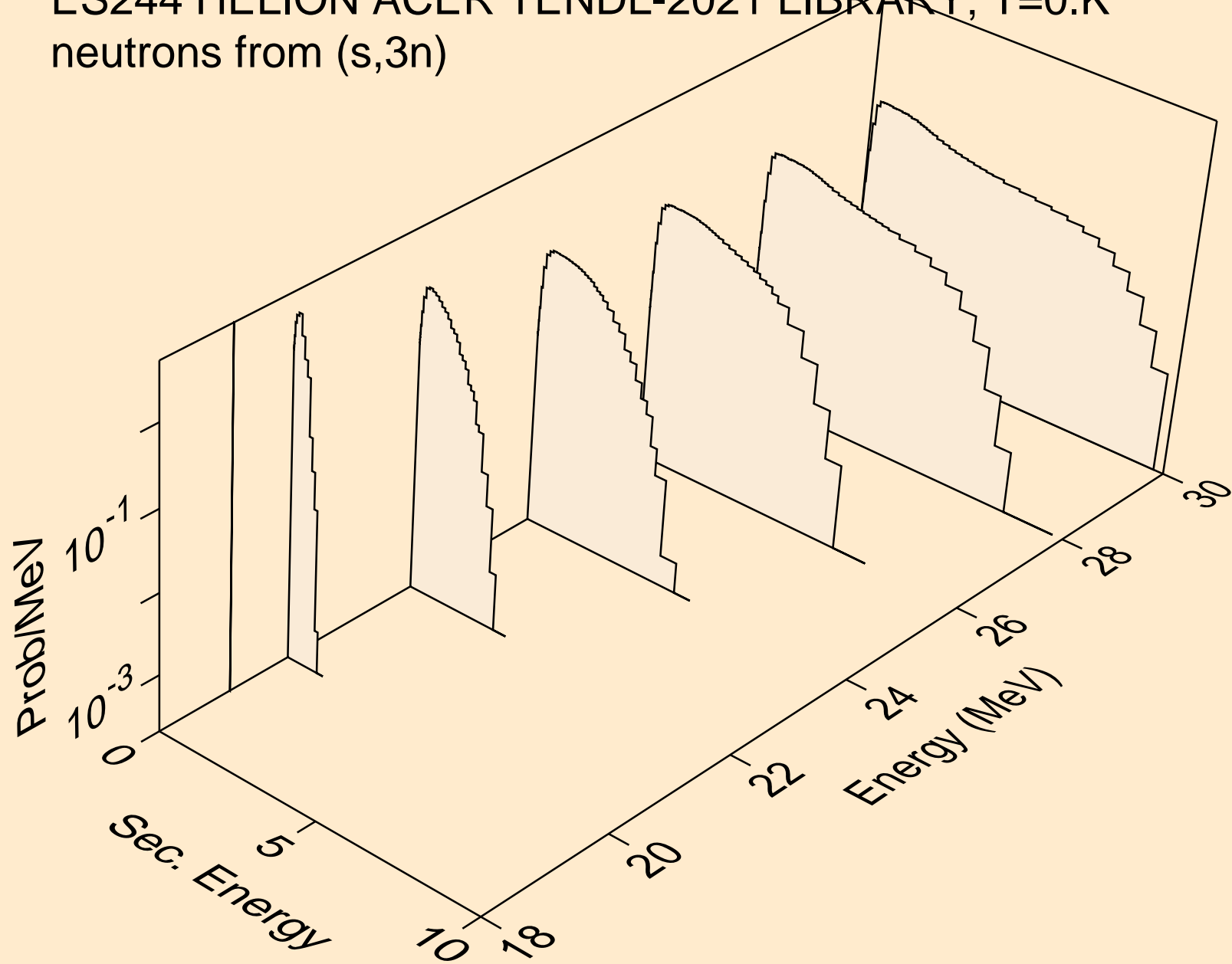

ES244 HELION ACER TENDL-2021 LIBRARY; T=0.K  
neutrons from (s,n\*)a

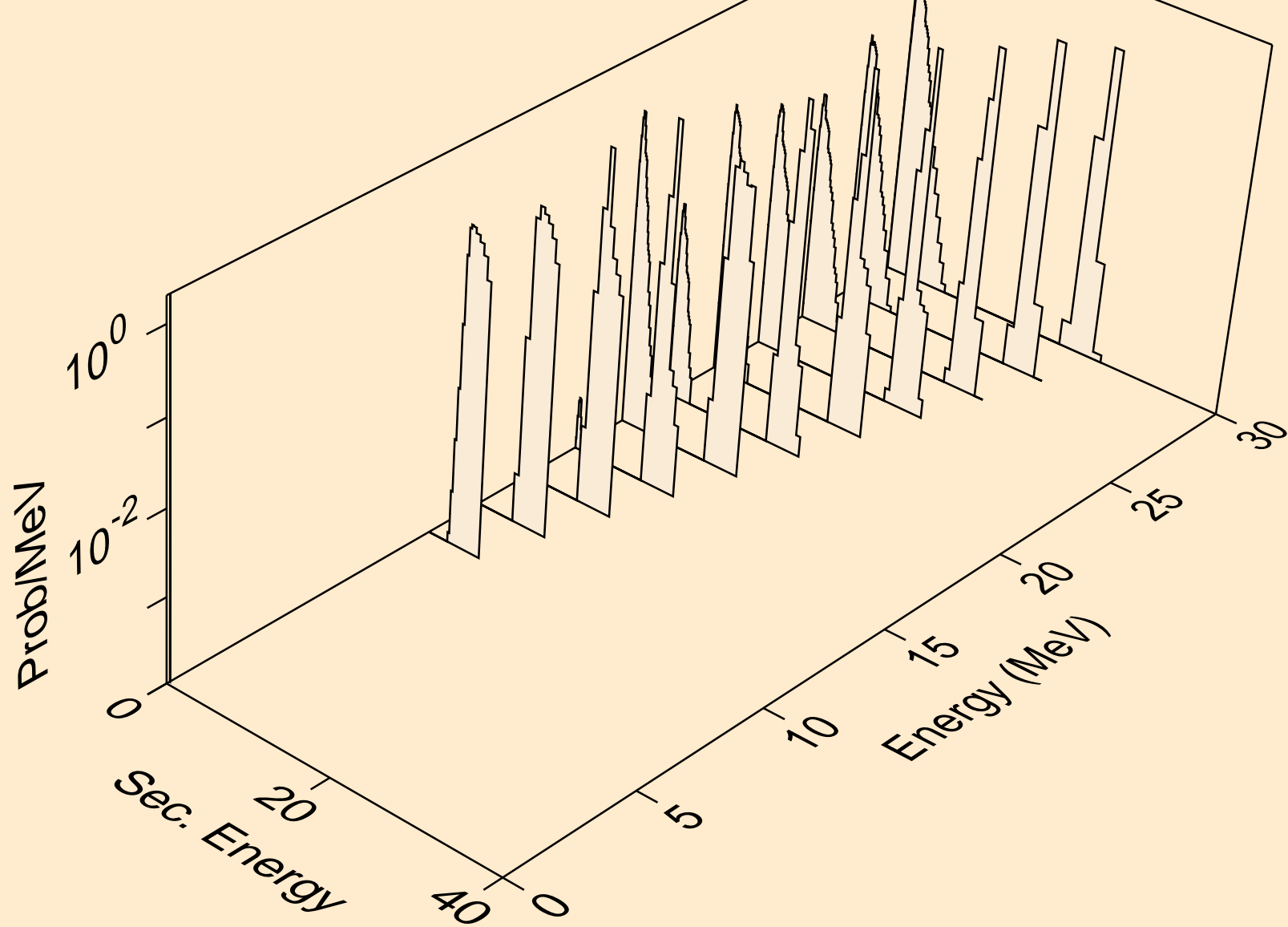

ES244 HELION ACER TENDL-2021 LIBRARY; T=0.K  
neutrons from (s,n\*)p

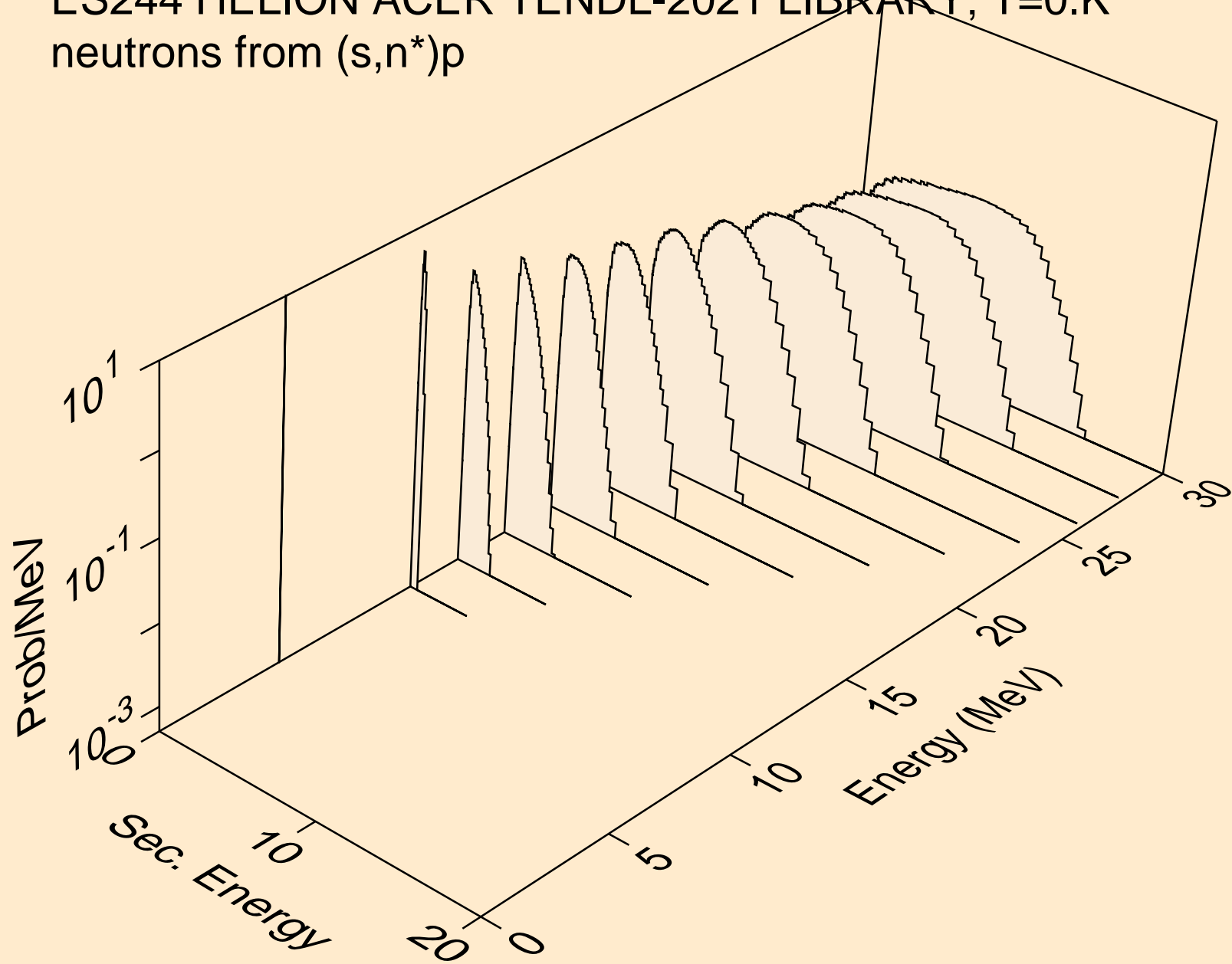

ES244 HELION ACER TENDL-2021 LIBRARY; T=0.K  
neutrons from (s,n\*)d

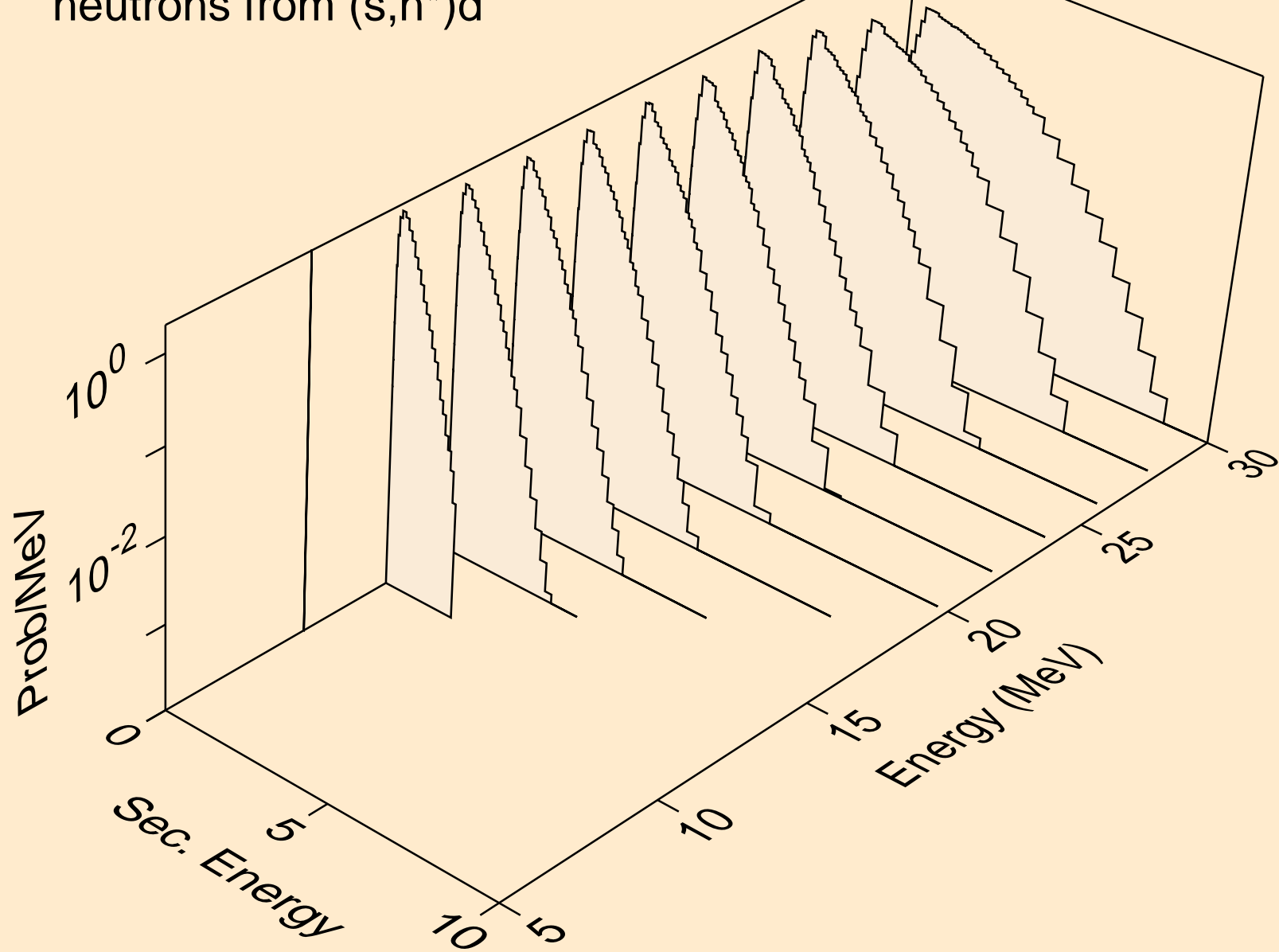

ES244 HELION ACER TENDL-2021 LIBRARY; T=0.K  
neutrons from (s,n\*)t

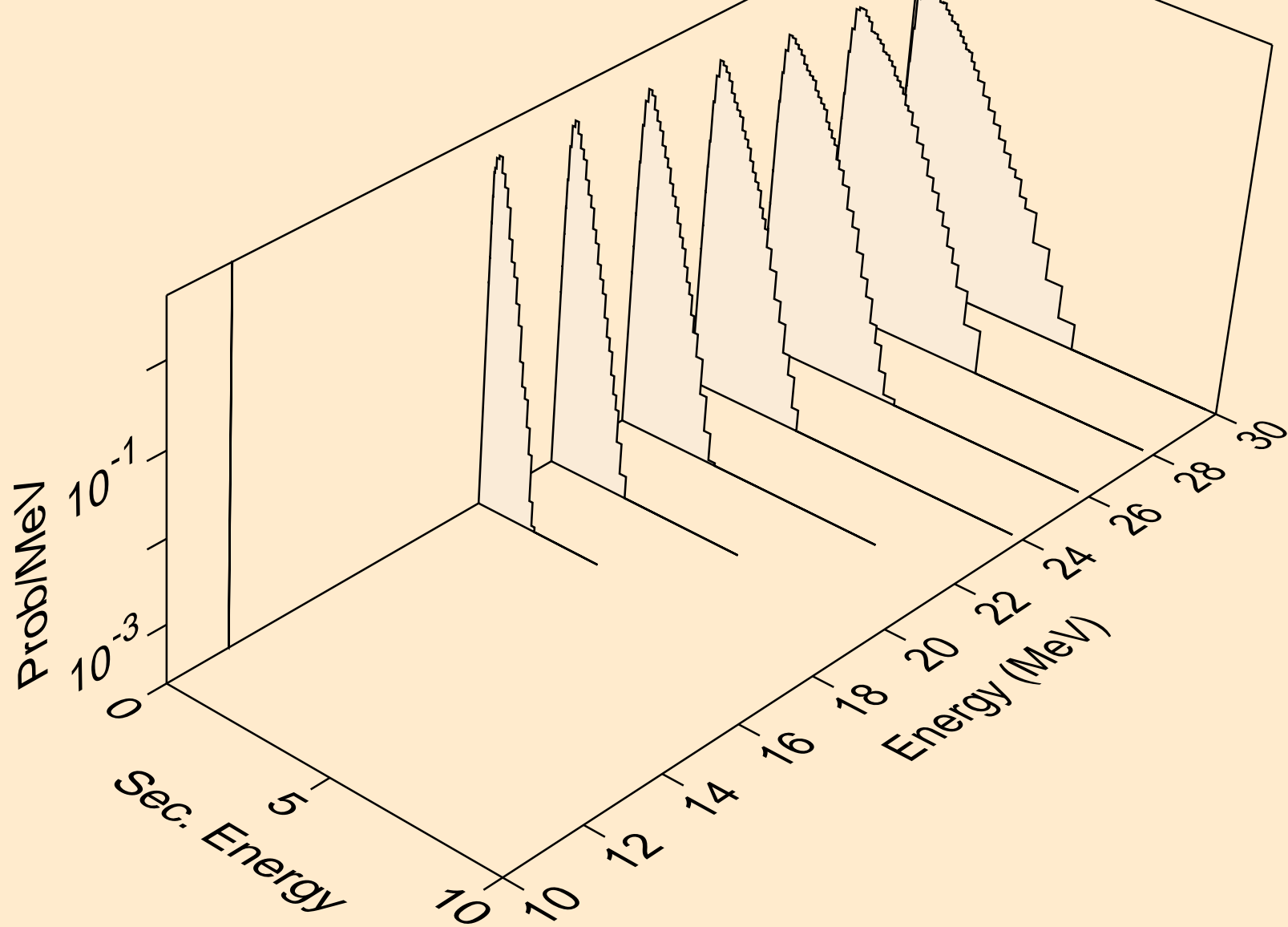



ES244 HELION ACER TENDL-2021 LIBRARY; T=0.K  
neutrons from (s,2np)

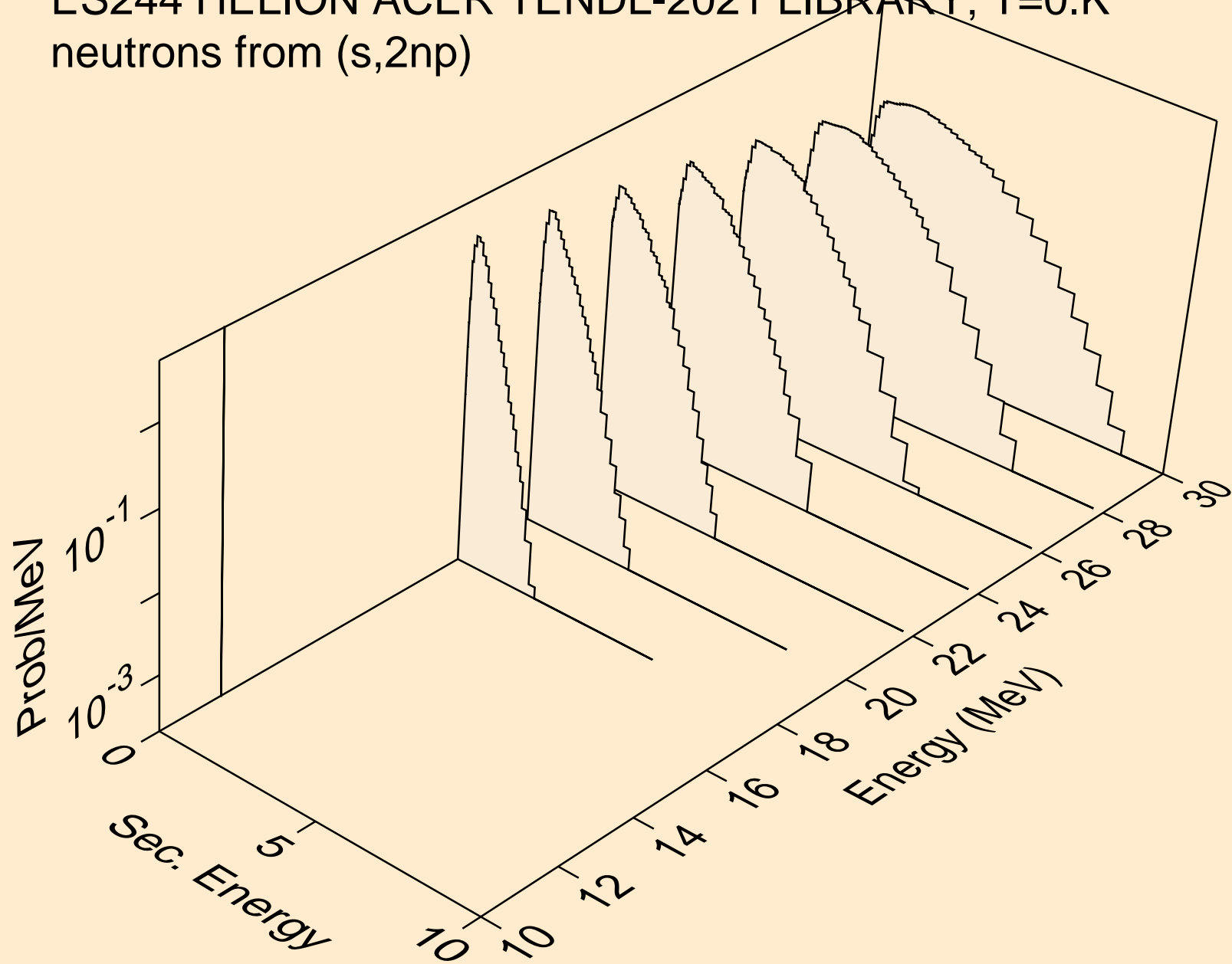

ES244 HELION ACER TENDL-2021 LIBRARY; T=0.K  
protons from (s,x)

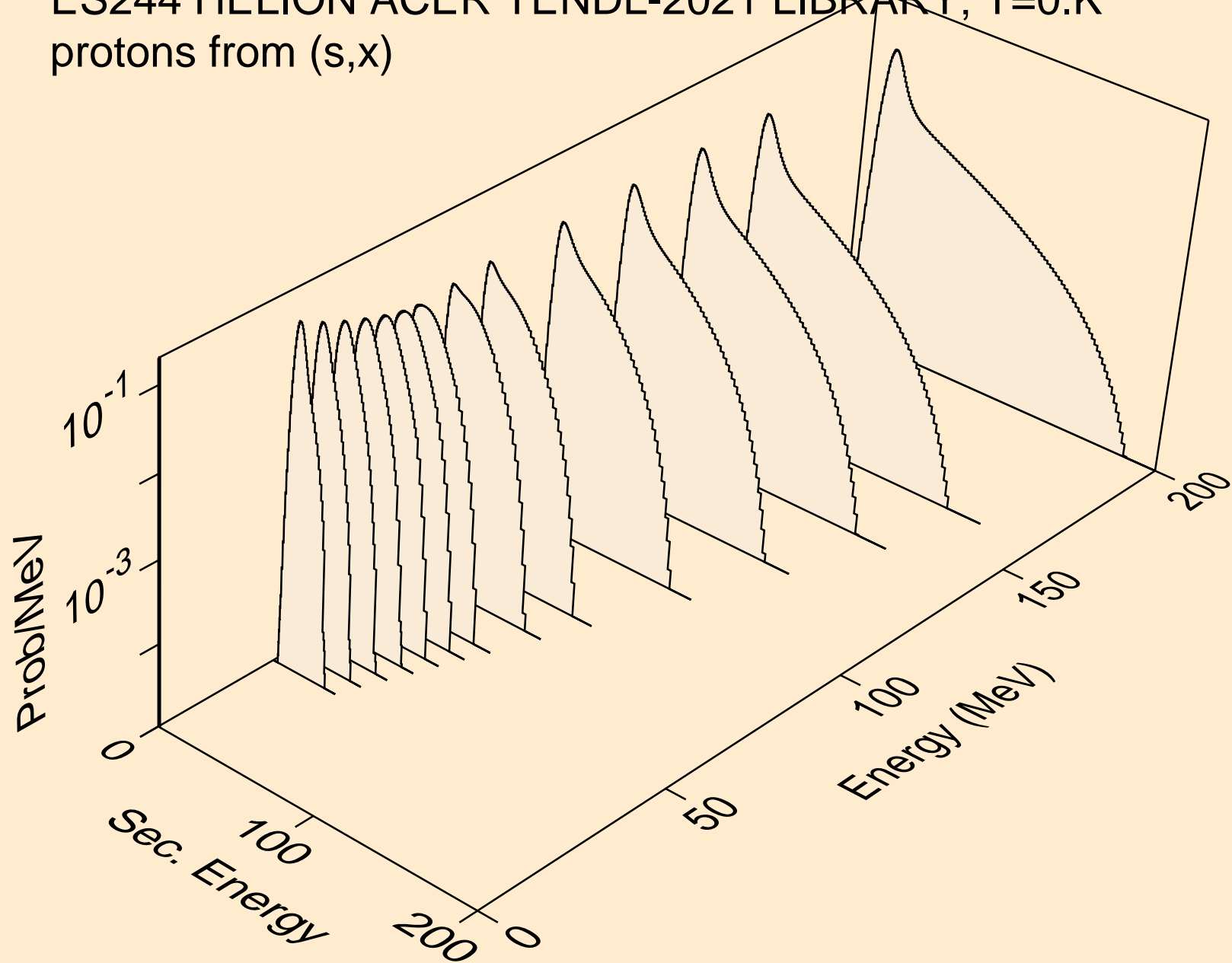

ES244 HELION ACER TENDL-2021 LIBRARY; T=0.K  
protons from (s,n\*)p

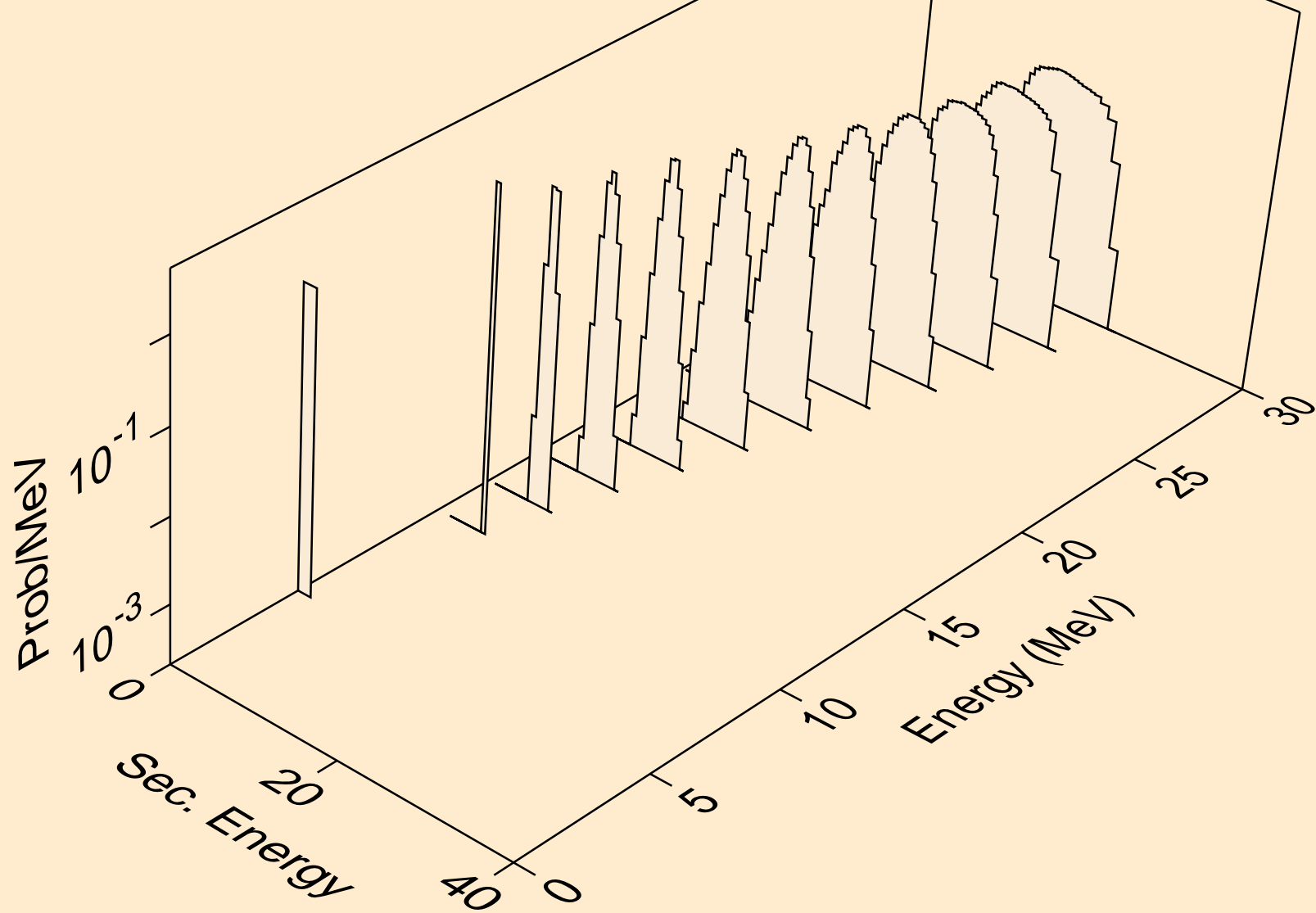

ES244 HELION ACER TENDL-2021 LIBRARY; T=0.K  
protons from (s,2np)

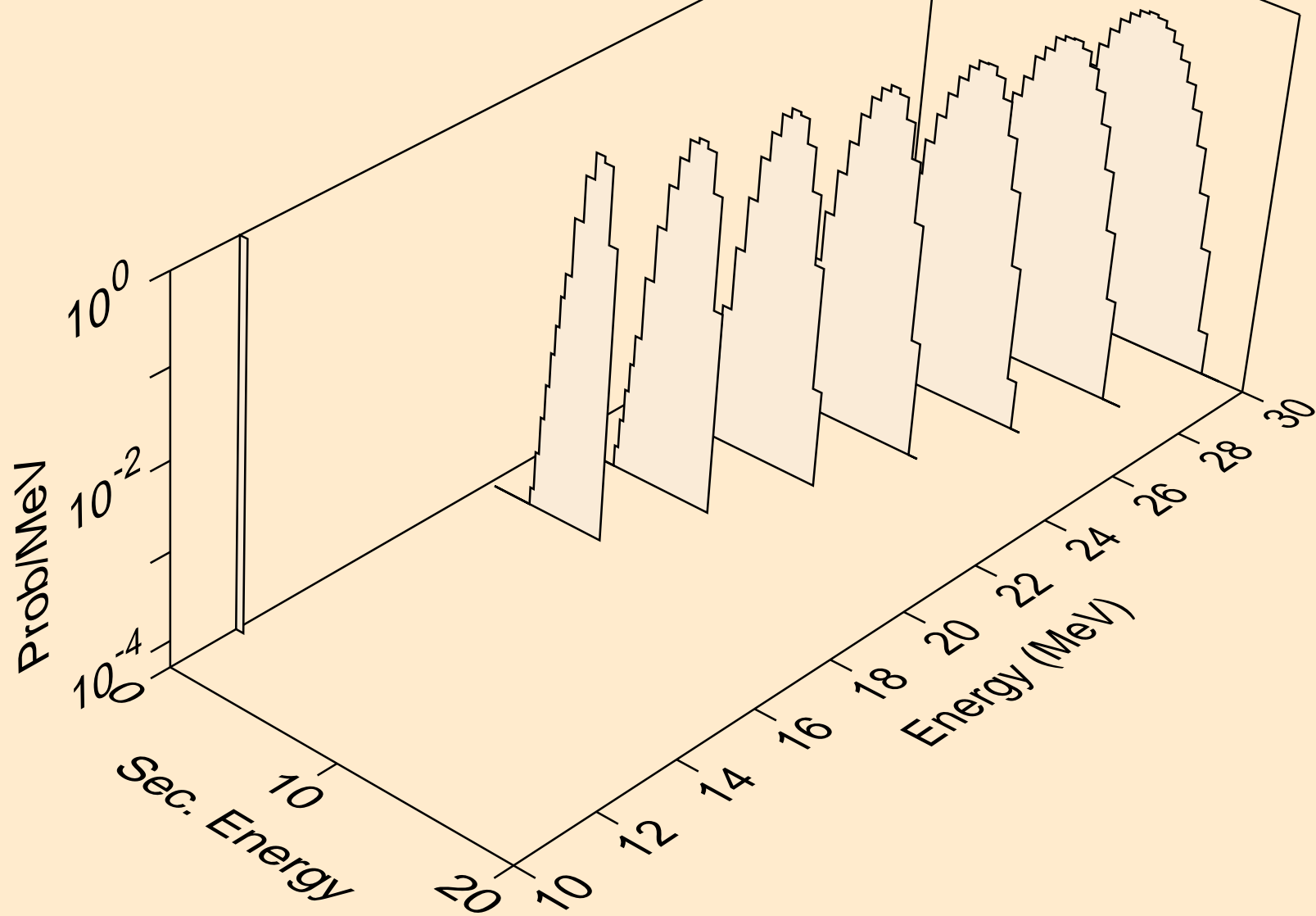

ES244 HELION ACER TENDL-2021 LIBRARY; T=0.K  
protons from (s,p)

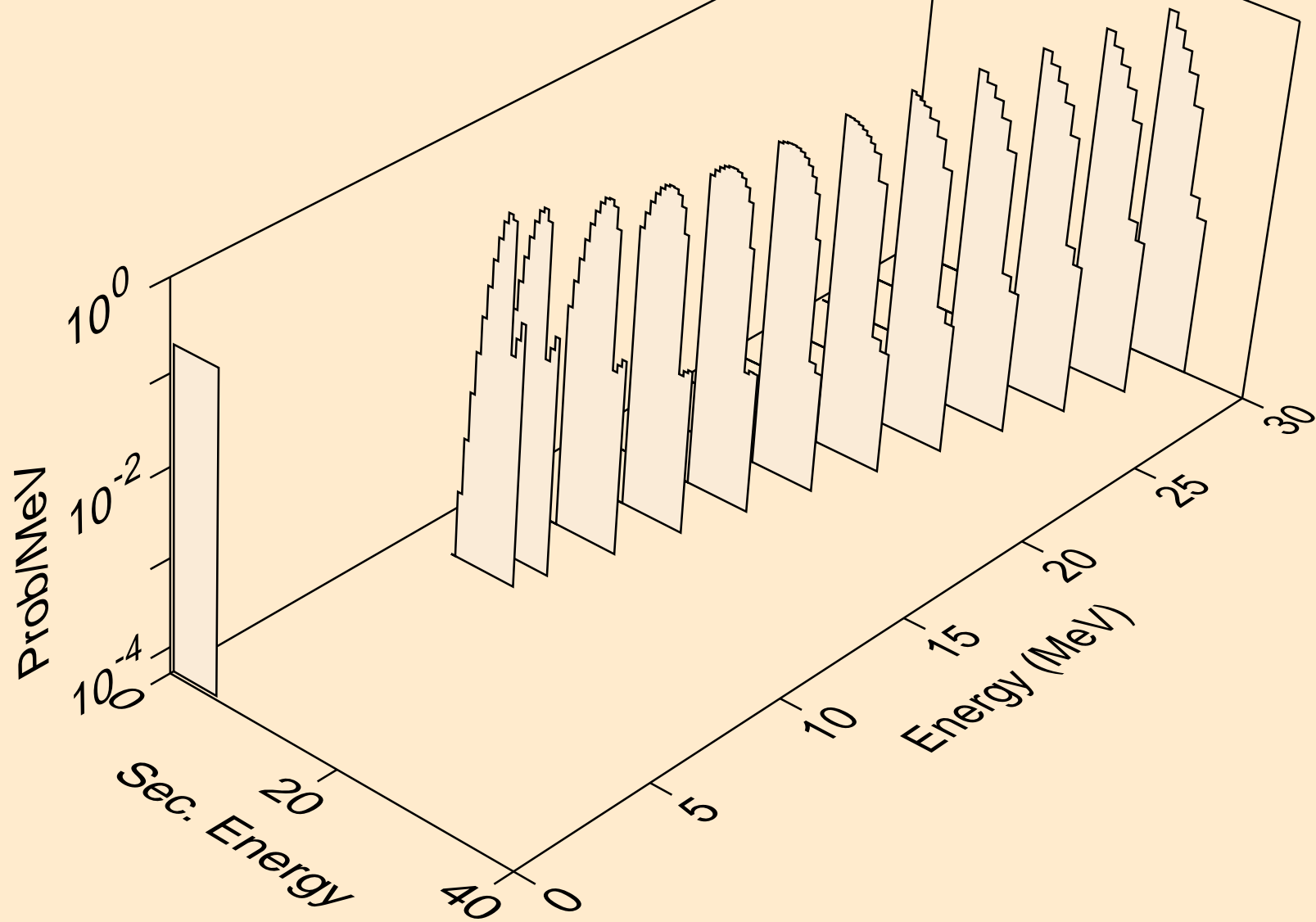

ES244 HELION ACER TENDL-2021 LIBRARY; T=0.K  
protons from (s,2p)

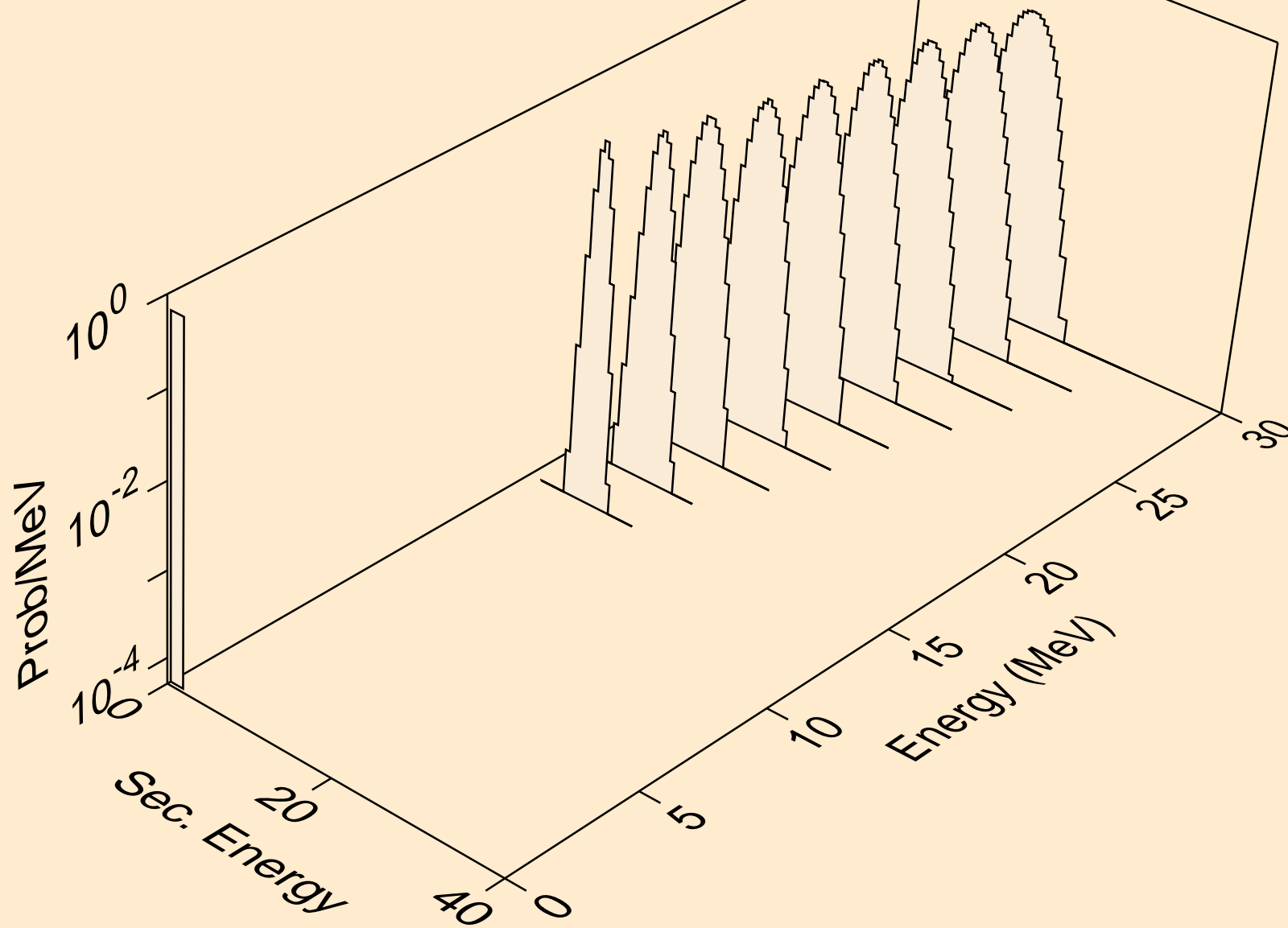

ES244 HELION ACER TENDL-2021 LIBRARY; T=0.K  
protons from (s,pd)

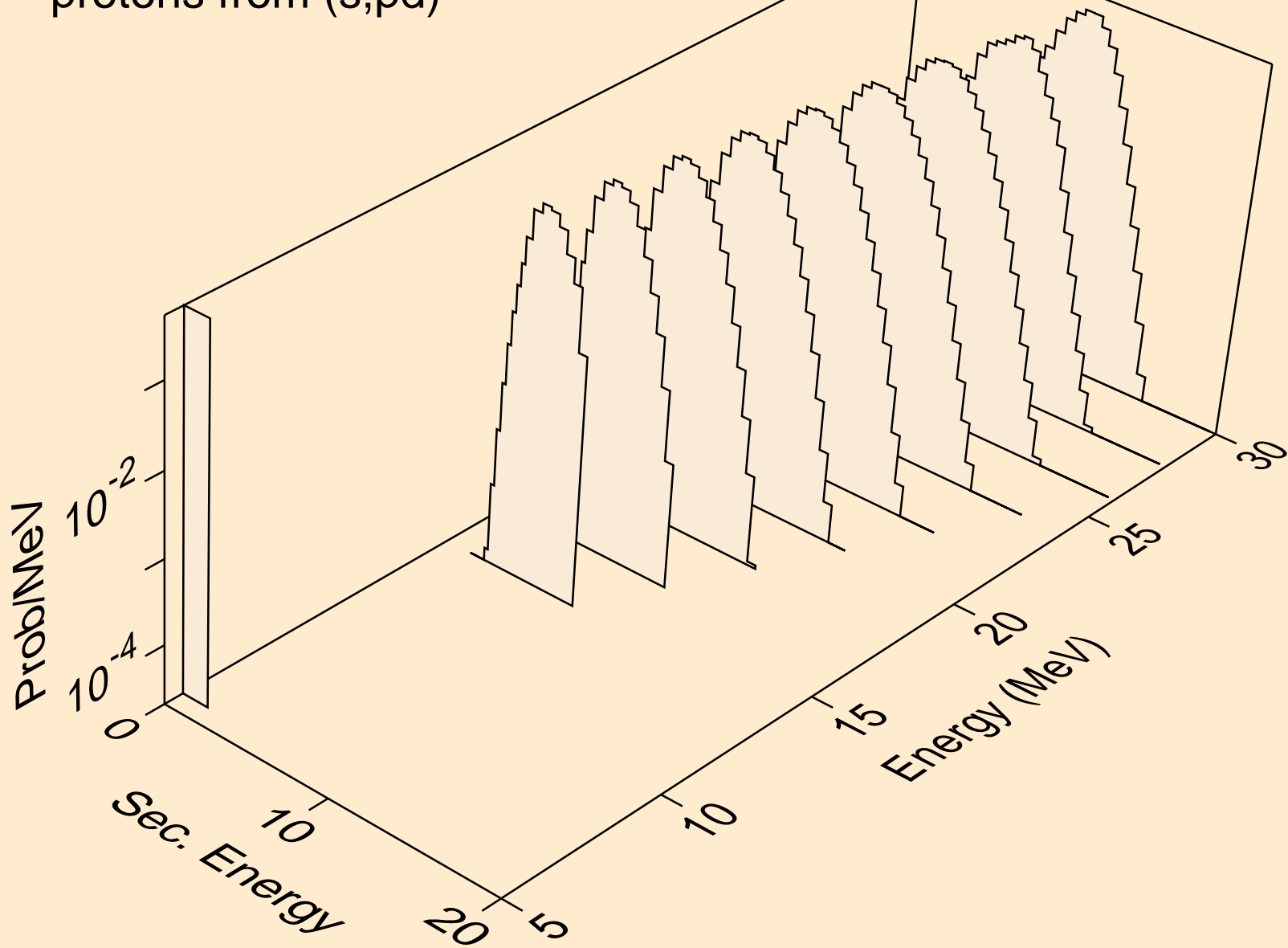

ES244 HELION ACER TENDL-2021 LIBRARY; T=0.K  
deuterons from (s,x)

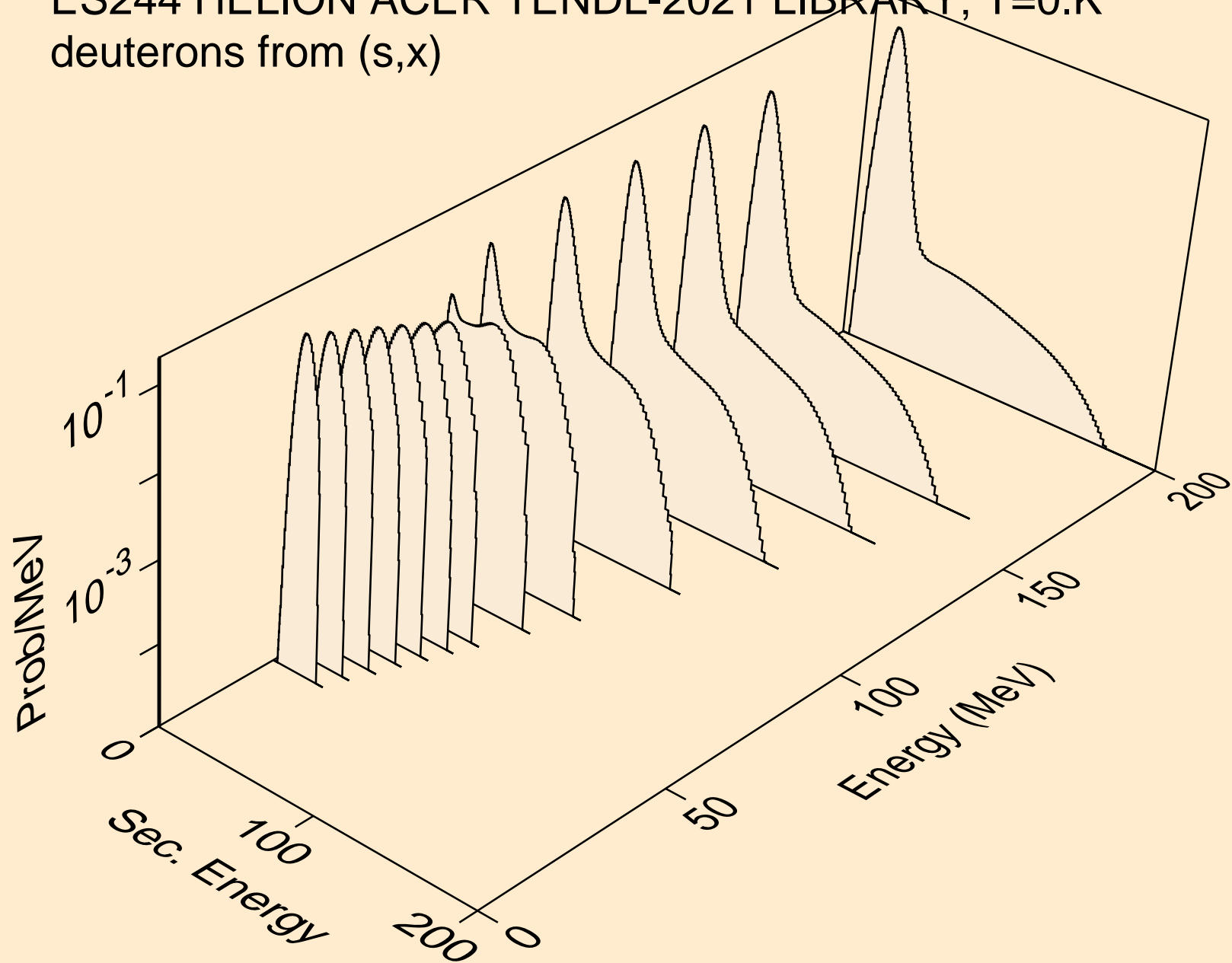



ES244 HELION ACER TENDL-2021 LIBRARY; T=0.K  
deuterons from (s,n\*)d

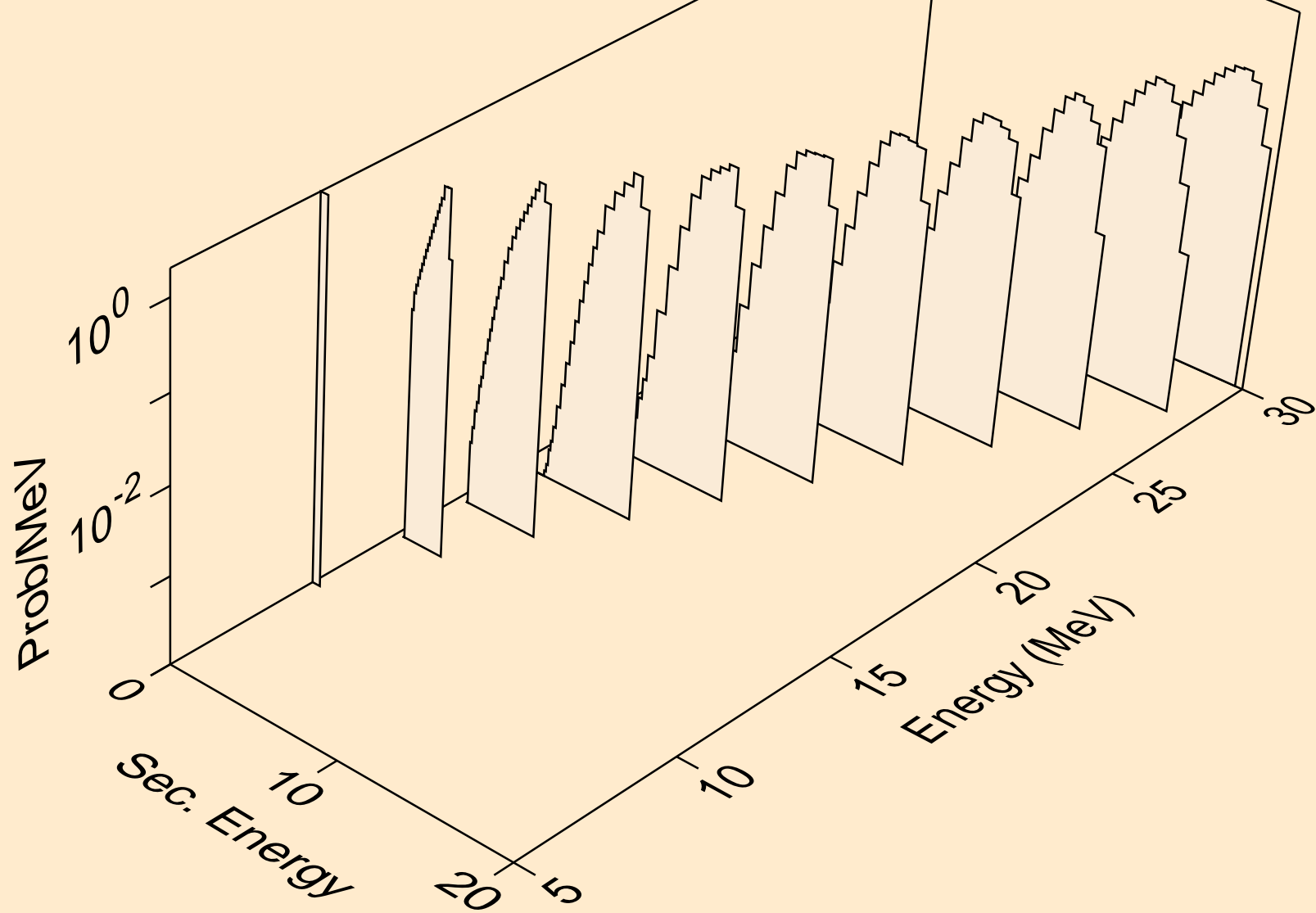

ES244 HELION ACER TENDL-2021 LIBRARY; T=0.K  
deuterons from (s,d)

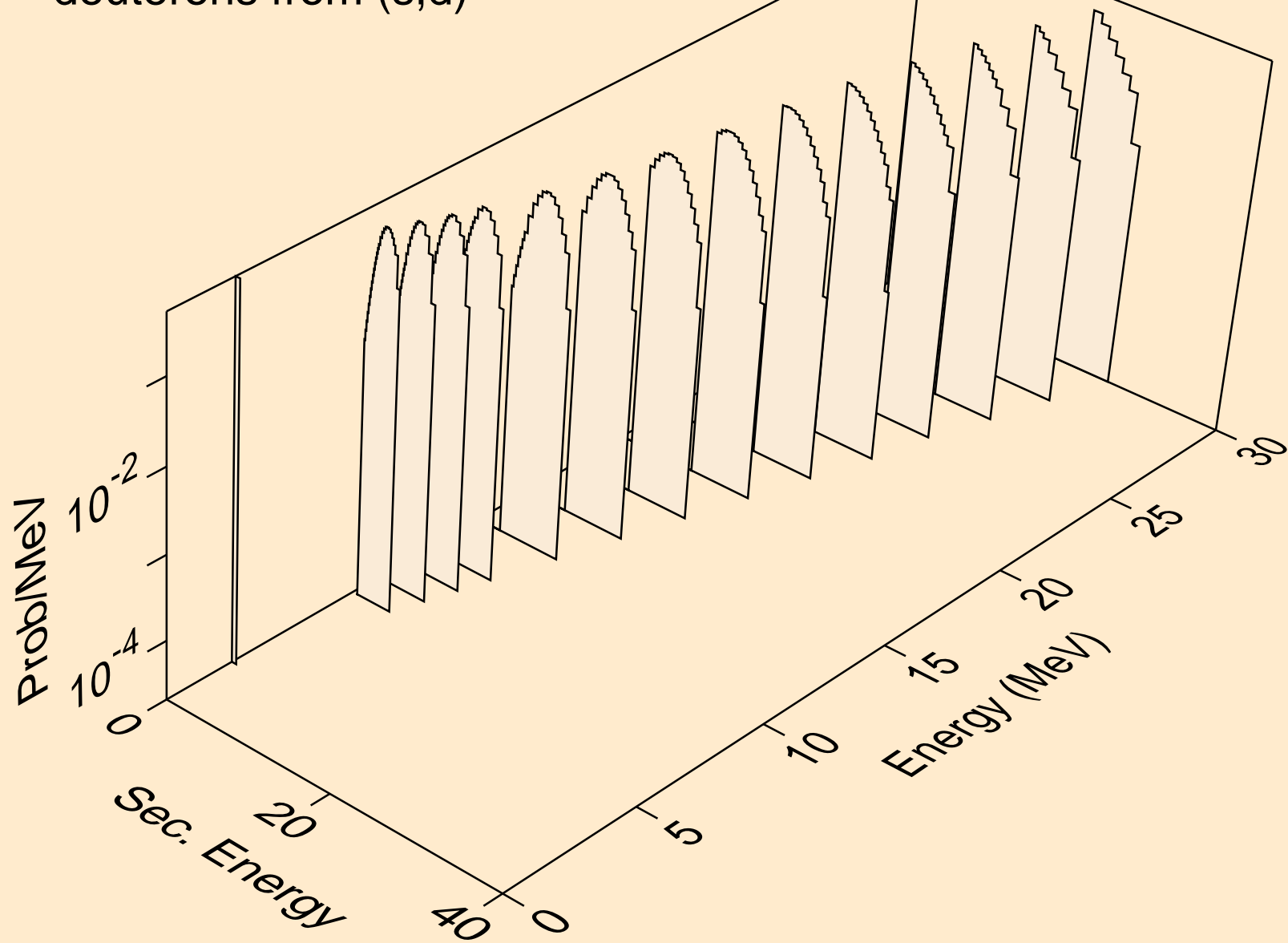

ES244 HELION ACER TENDL-2021 LIBRARY; T=0.K  
deuterons from (s,pd)

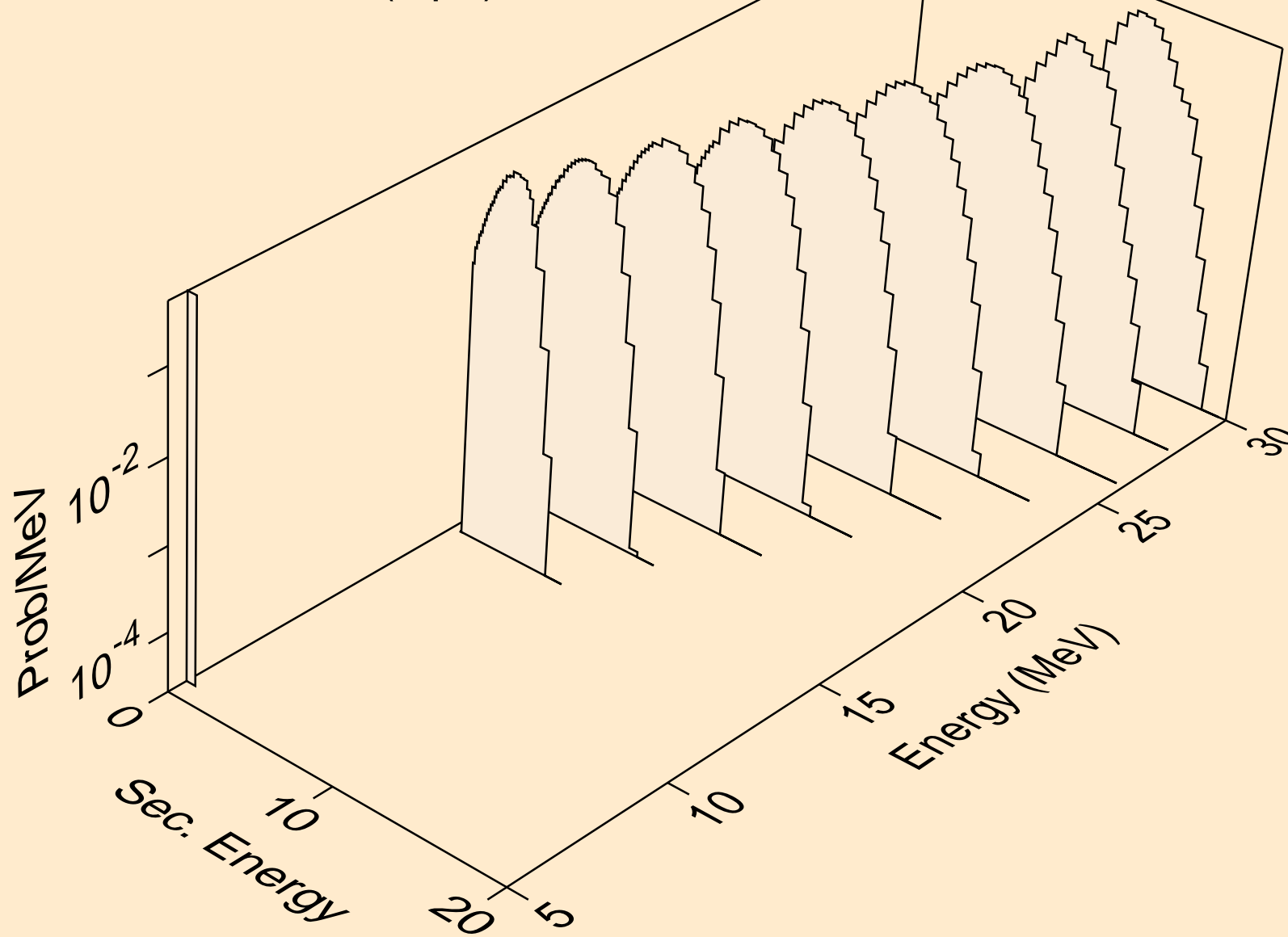

ES244 HELION ACER TENDL-2021 LIBRARY; T=0.K  
deuterons from (s,da)

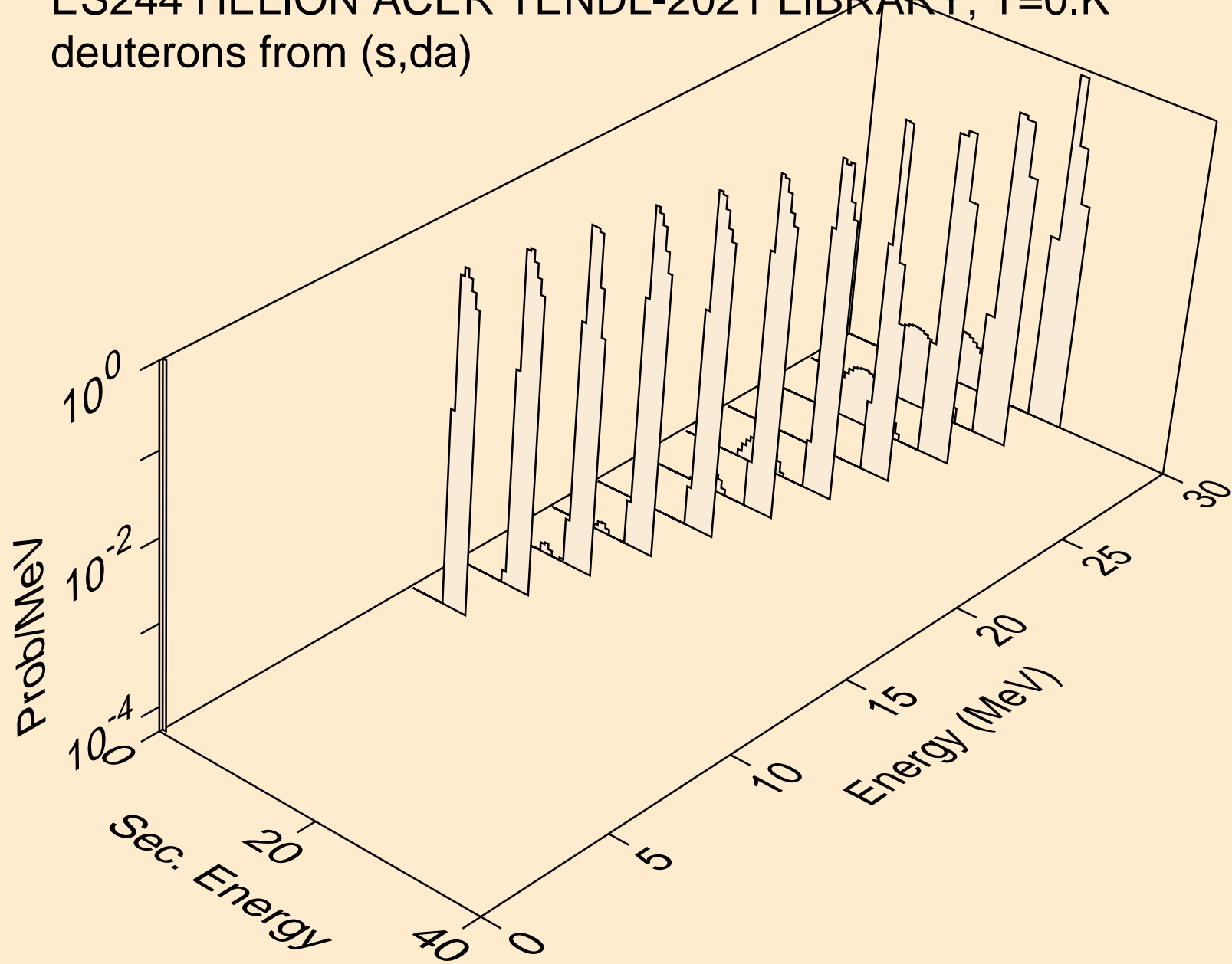

ES244 HELION ACER TENDL-2021 LIBRARY; T=0.K  
tritons from (s,x)

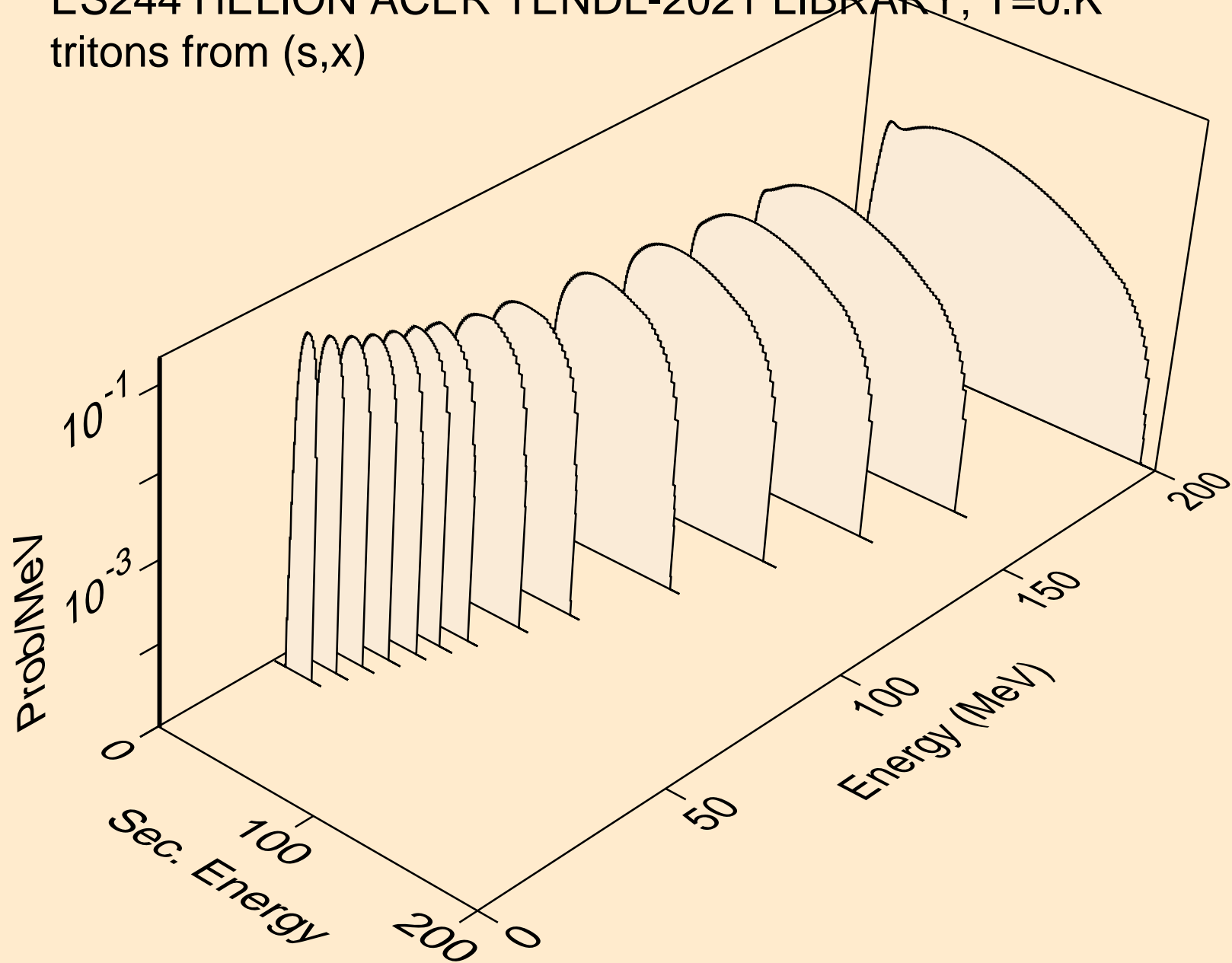

ES244 HELION ACER TENDL-2021 LIBRARY; T=0.K  
tritons from (s,n\*)t

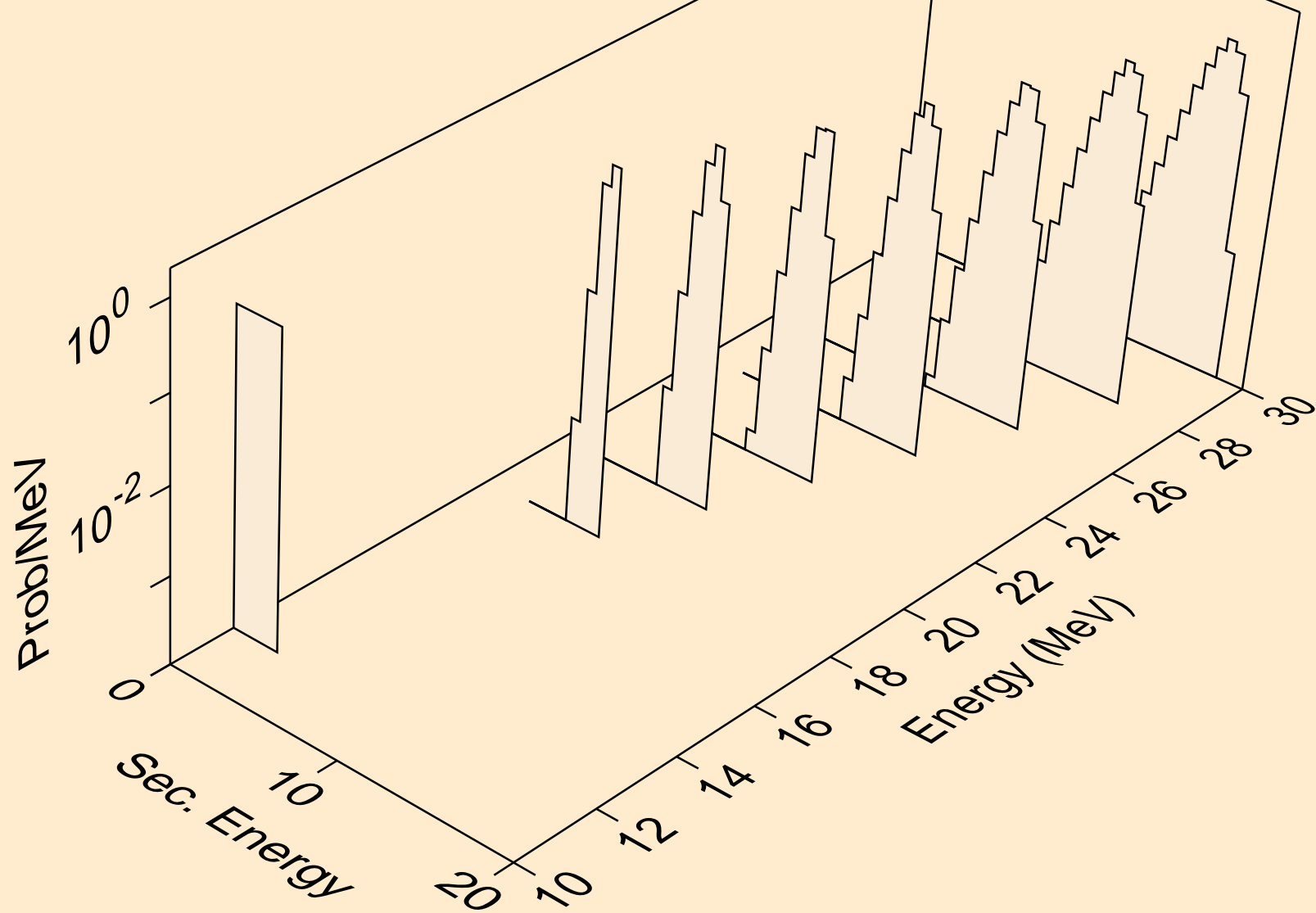

ES244 HELION ACER TENDL-2021 LIBRARY; T=0.K  
tritons from (s,t)

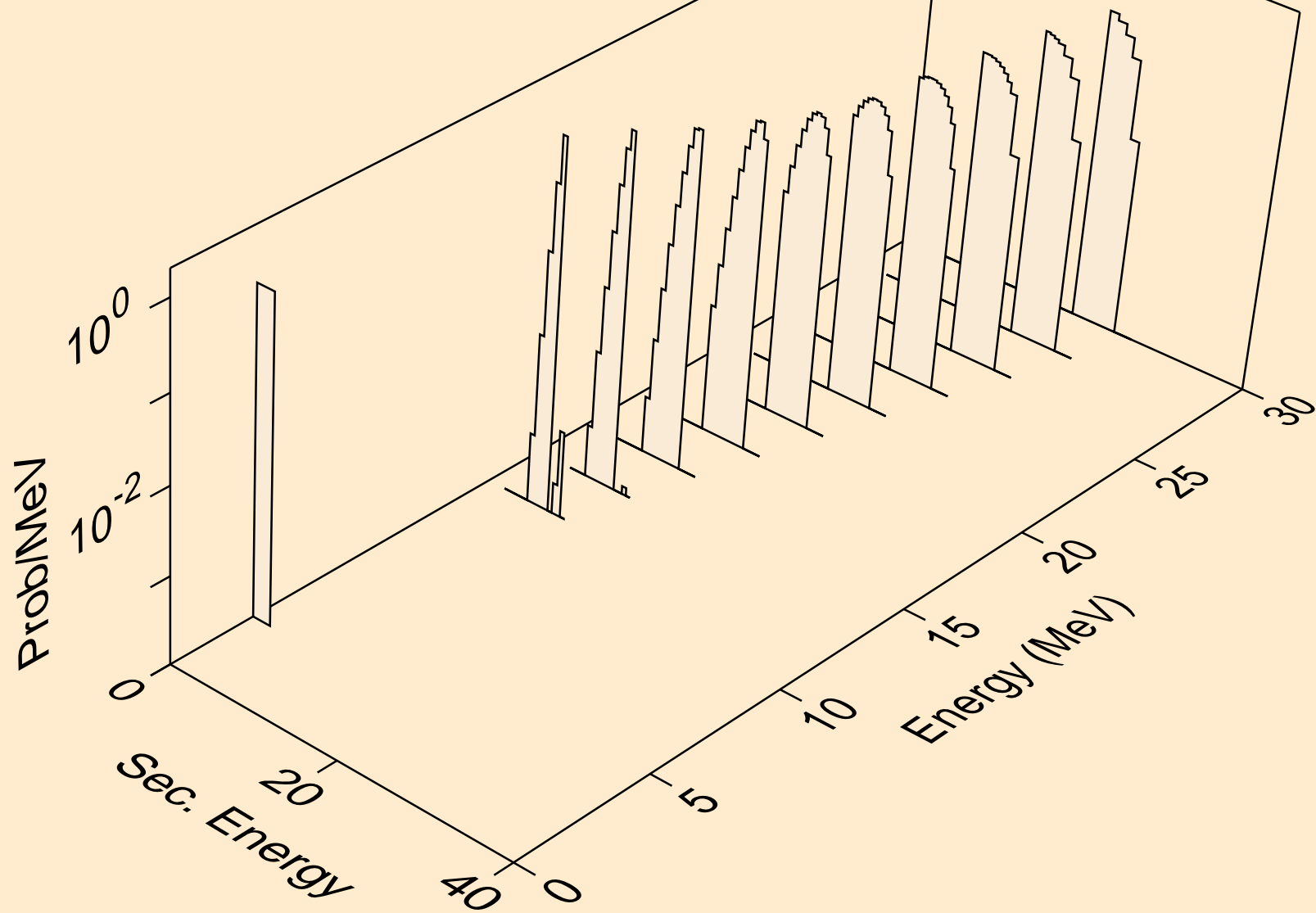

ES244 HELION ACER TENDL-2021 LIBRARY; T=0.K  
alphas from (s,x)

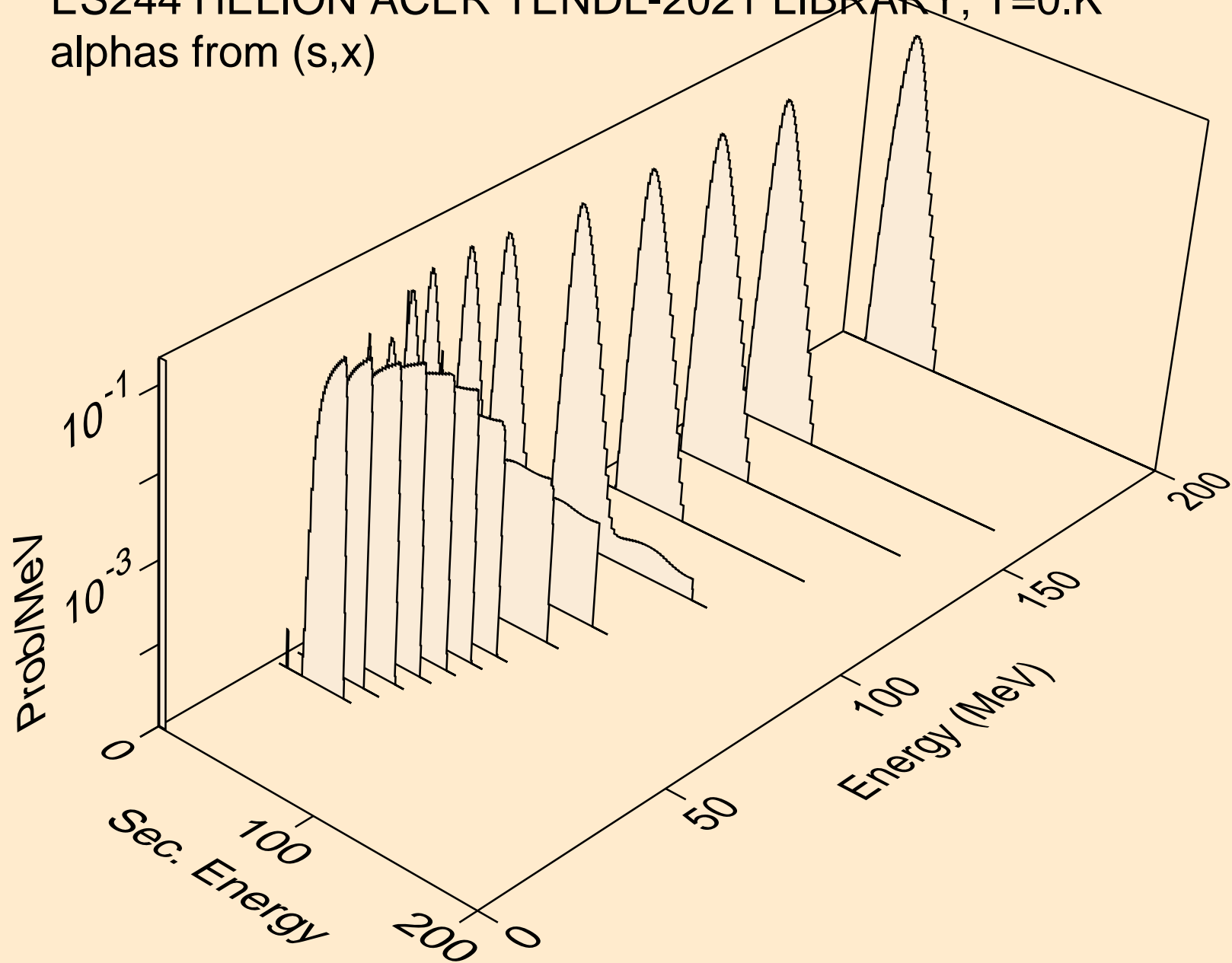



ES244 HELION ACER TENDL-2021 LIBRARY; T=0.K  
alphas from (s,n\*)a

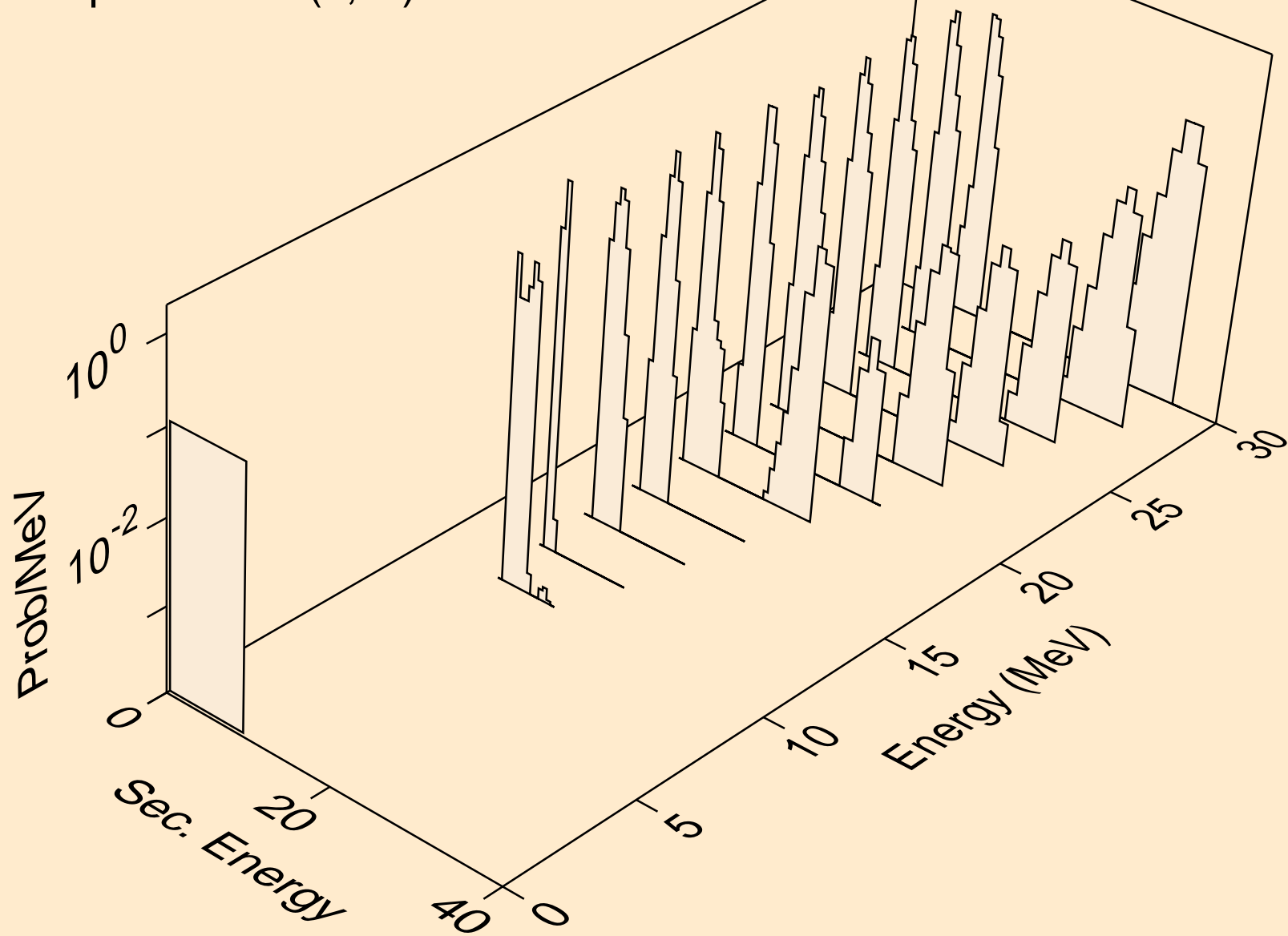

ES244 HELION ACER TENDL-2021 LIBRARY; T=0.K  
alphas from (s,a)

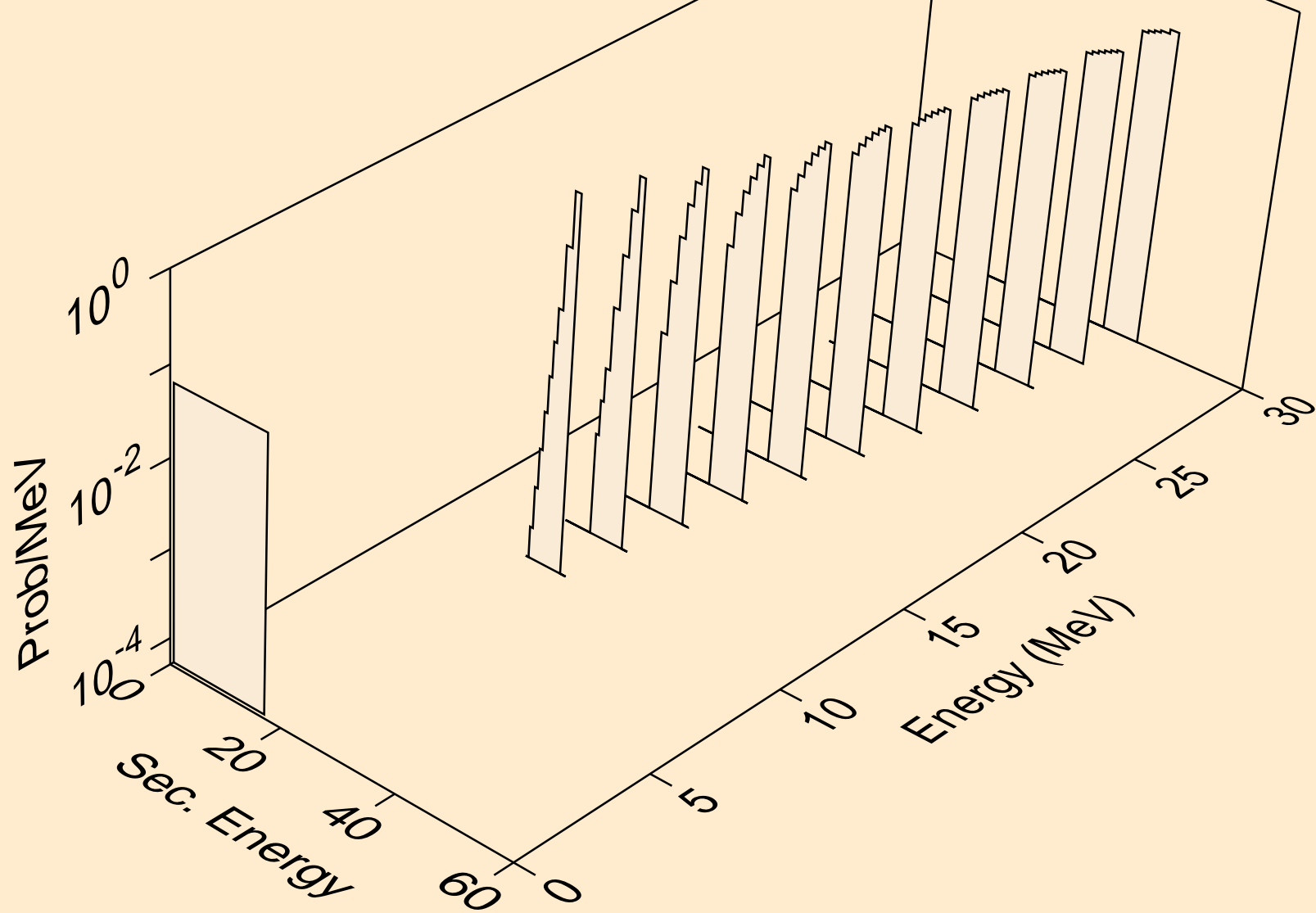

ES244 HELION ACER TENDL-2021 LIBRARY; T=0.K  
alphas from (s,da)

