

ES251 HELION ACER TENDL-2021 LIBRARY; T=0.K  
Principal cross sections

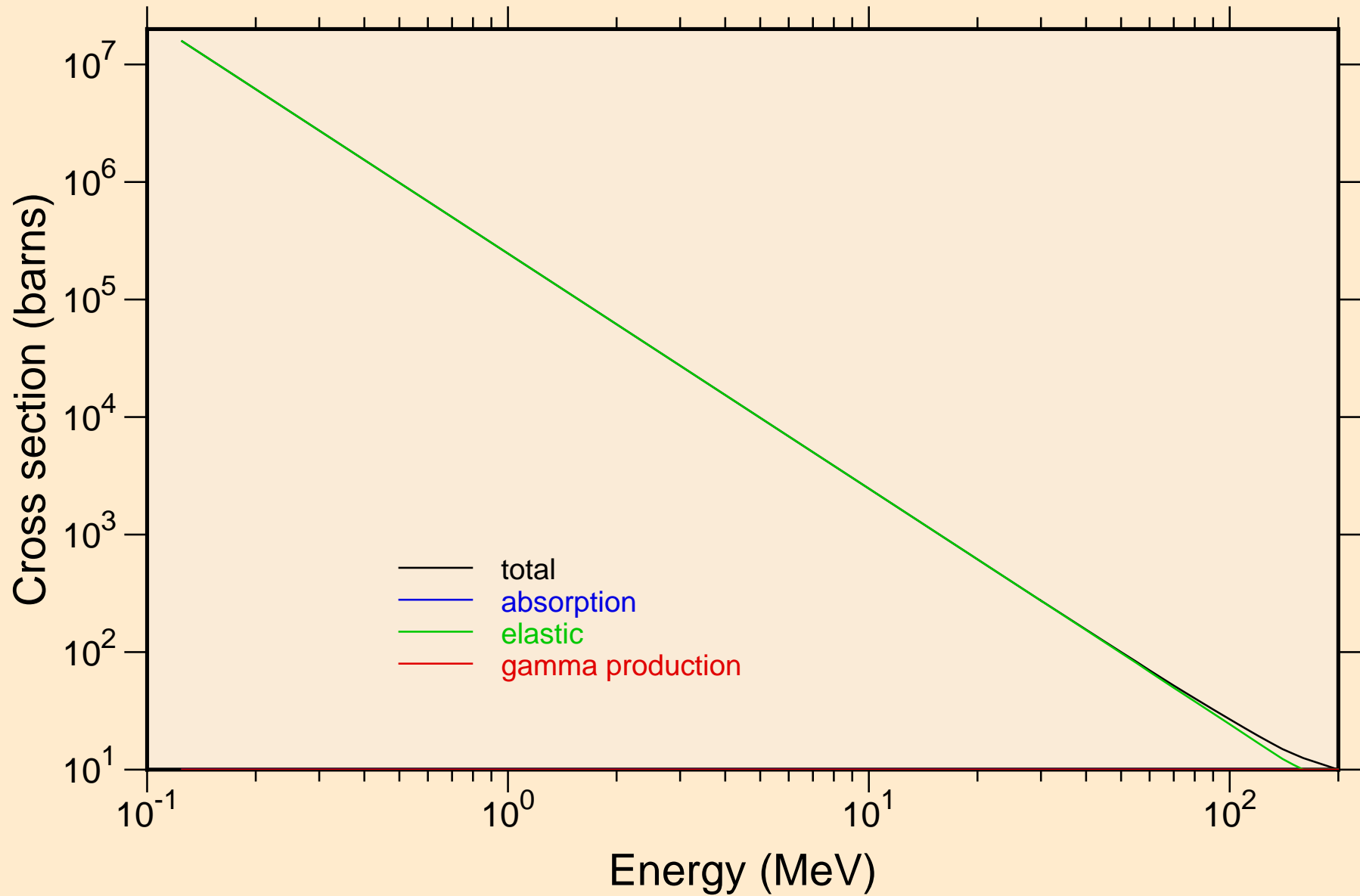

ES251 HELION ACER TENDL-2021 LIBRARY; T=0.K

Heating

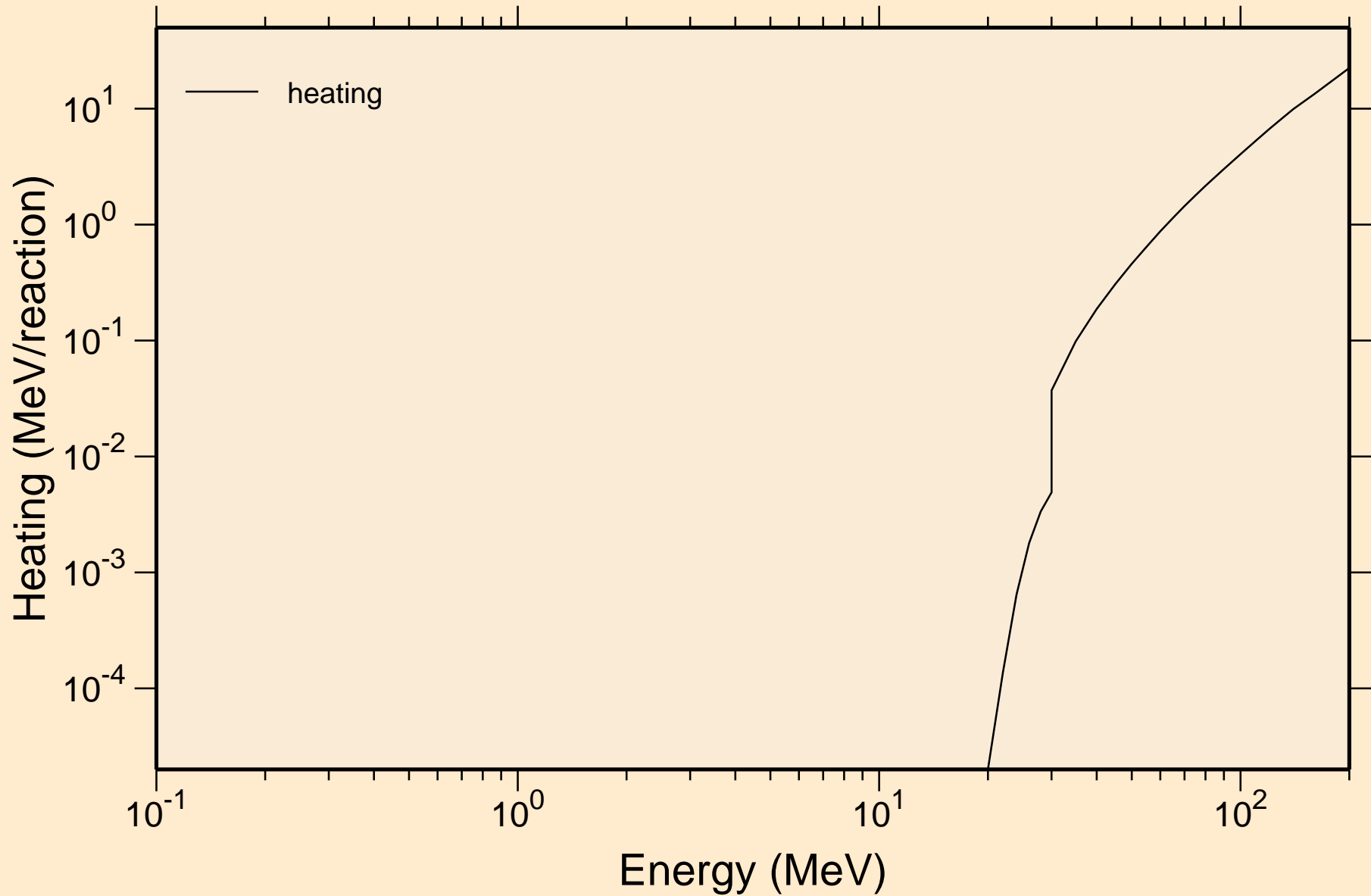

# ES251 HELION ACER TENDL-2021 LIBRARY; T=0.K

## Principal cross sections

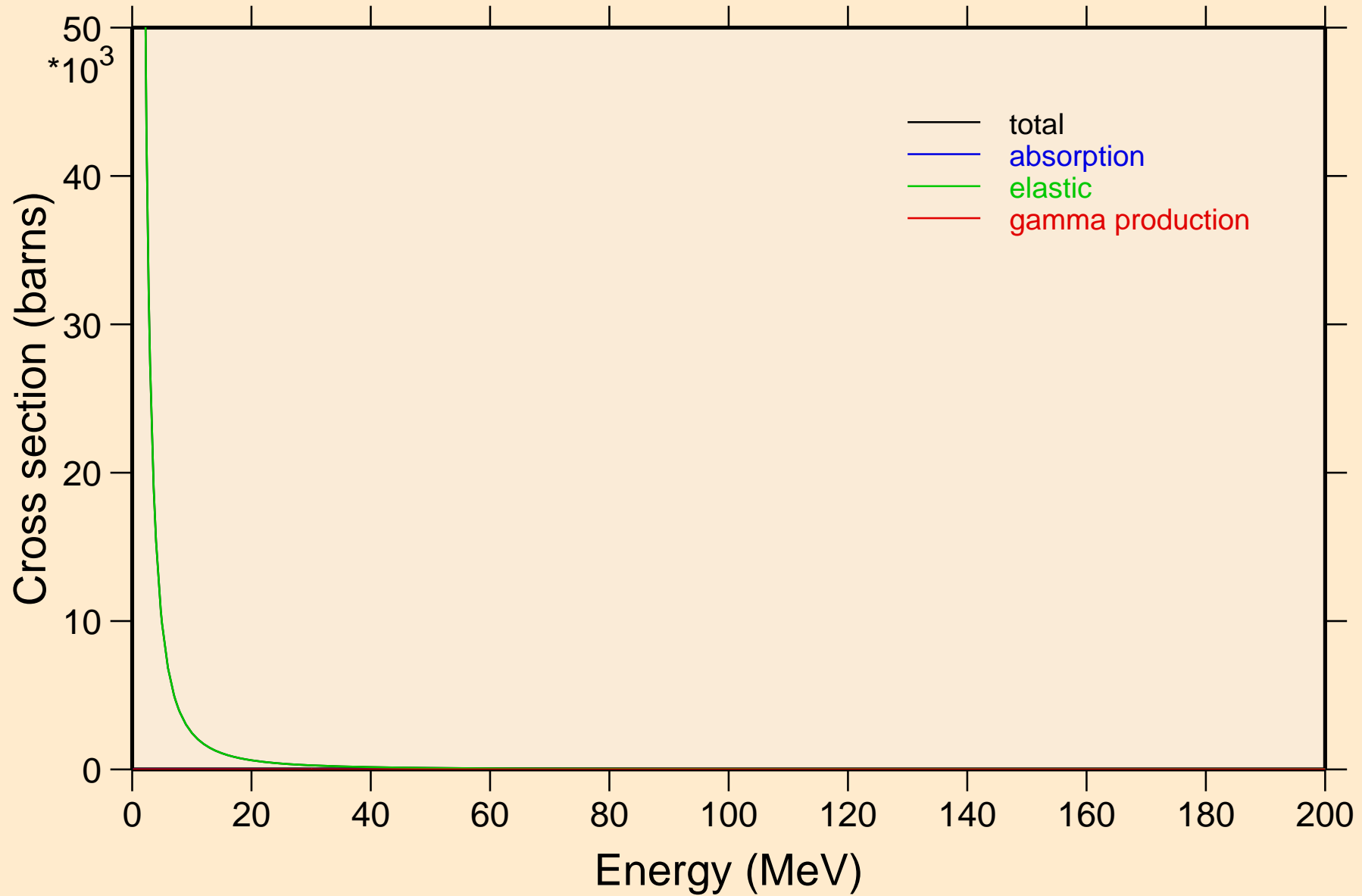

ES251 HELION ACER TENDL-2021 LIBRARY; T=0.K

Heating

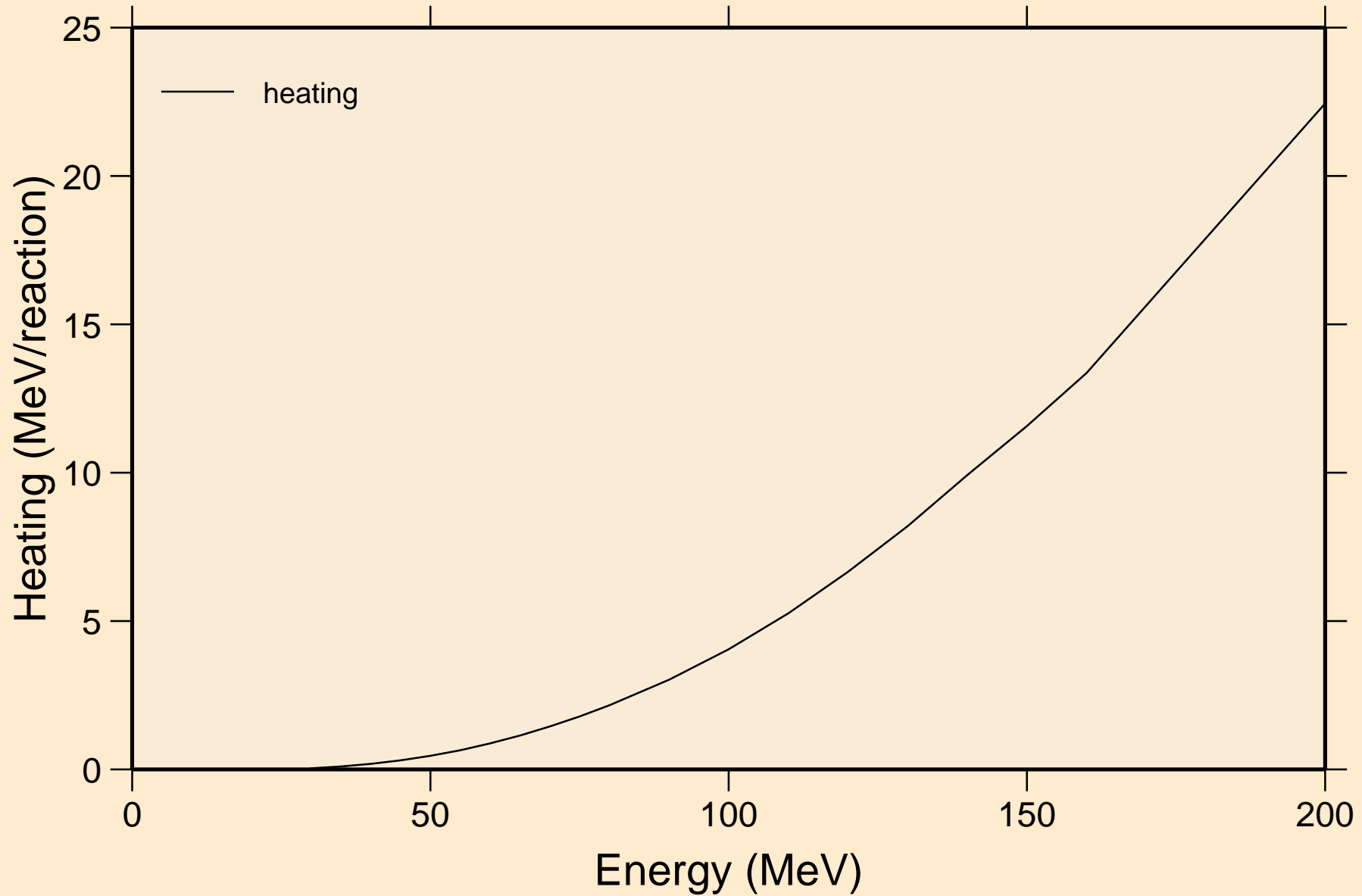

ES251 HELION ACER TENDL-2021 LIBRARY; T=0.K  
Threshold reactions

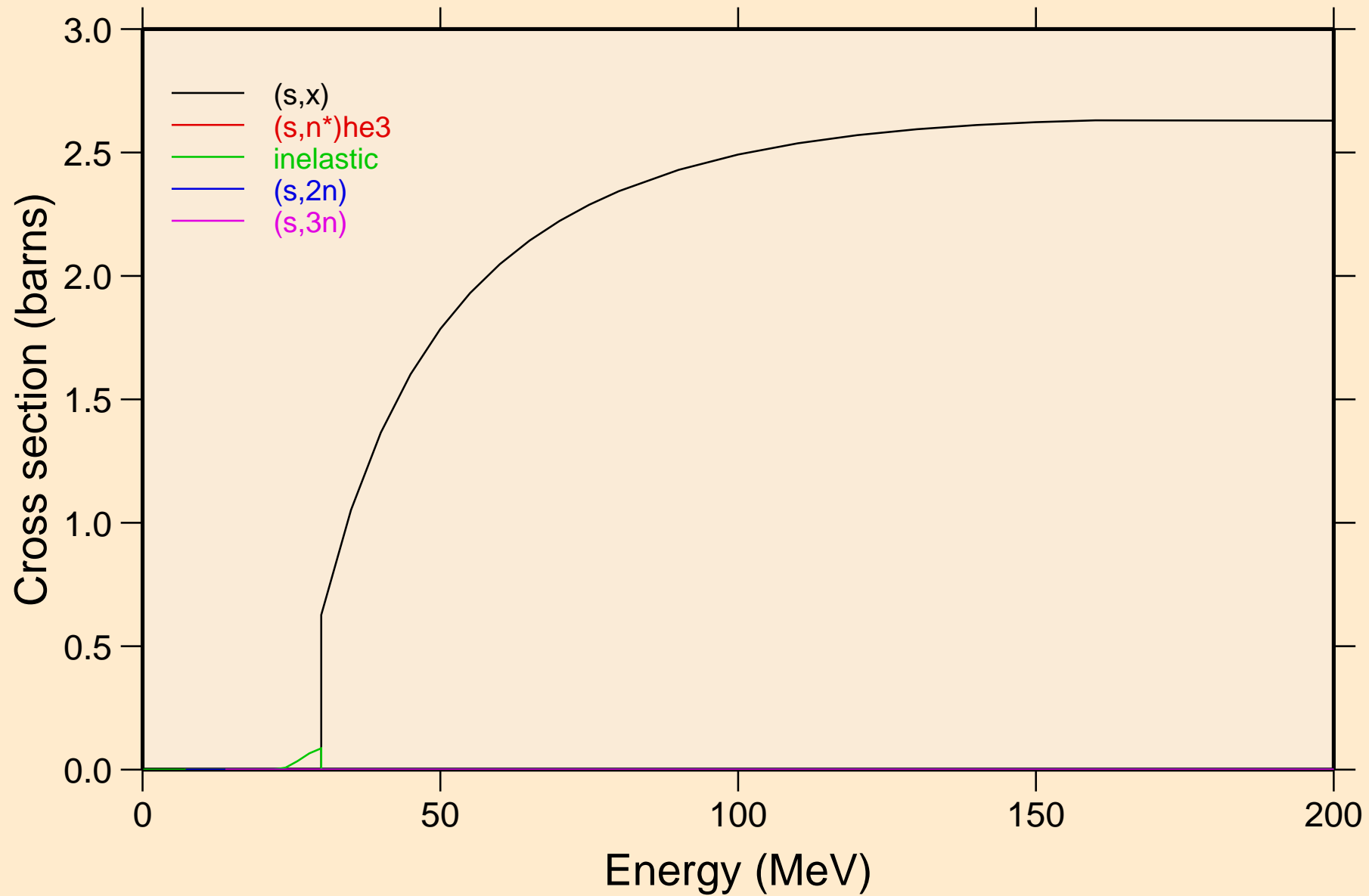

ES251 HELION ACER TENDL-2021 LIBRARY; T=0.K  
Threshold reactions

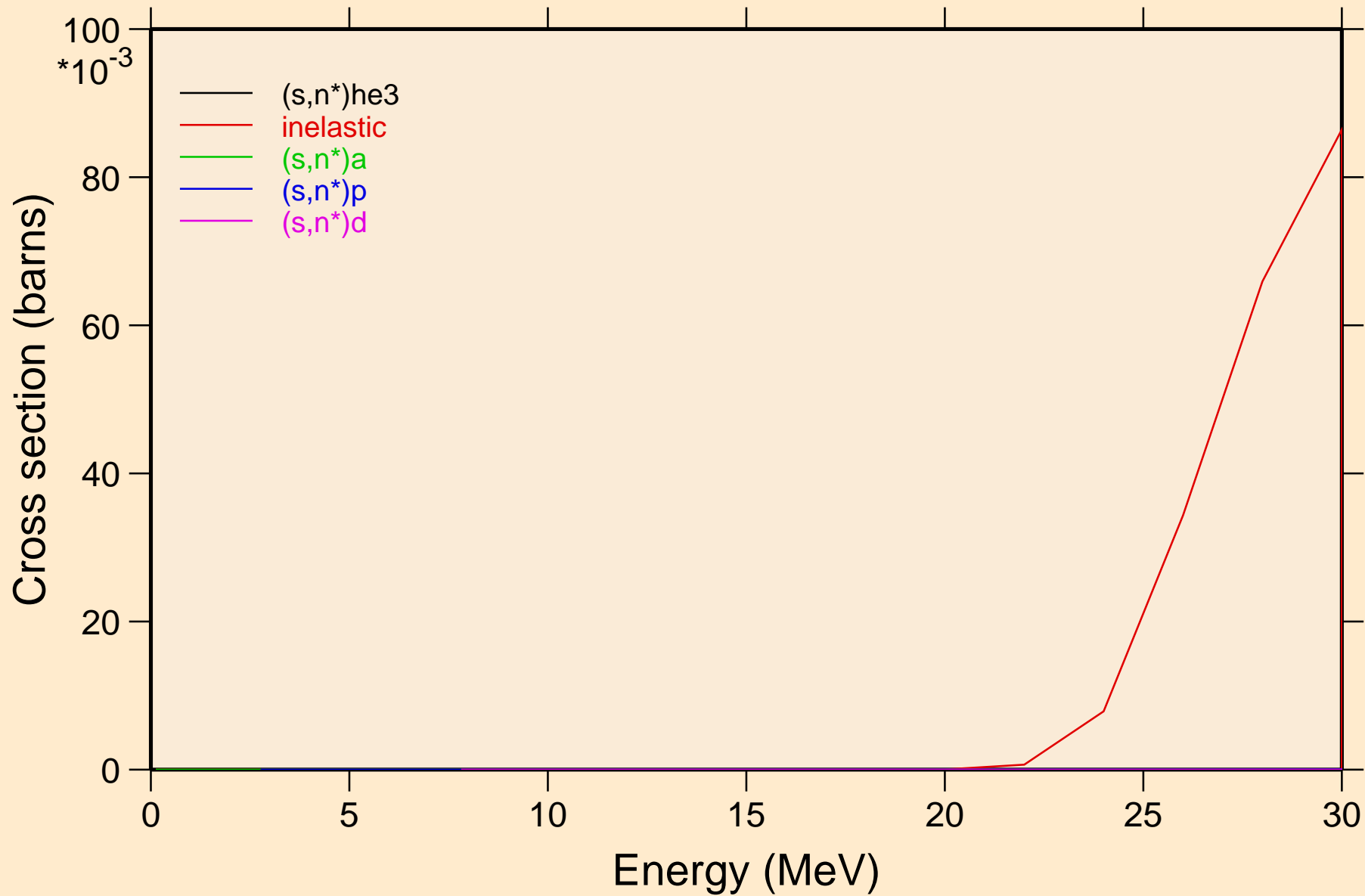

ES251 HELION ACER TENDL-2021 LIBRARY; T=0.K  
Threshold reactions

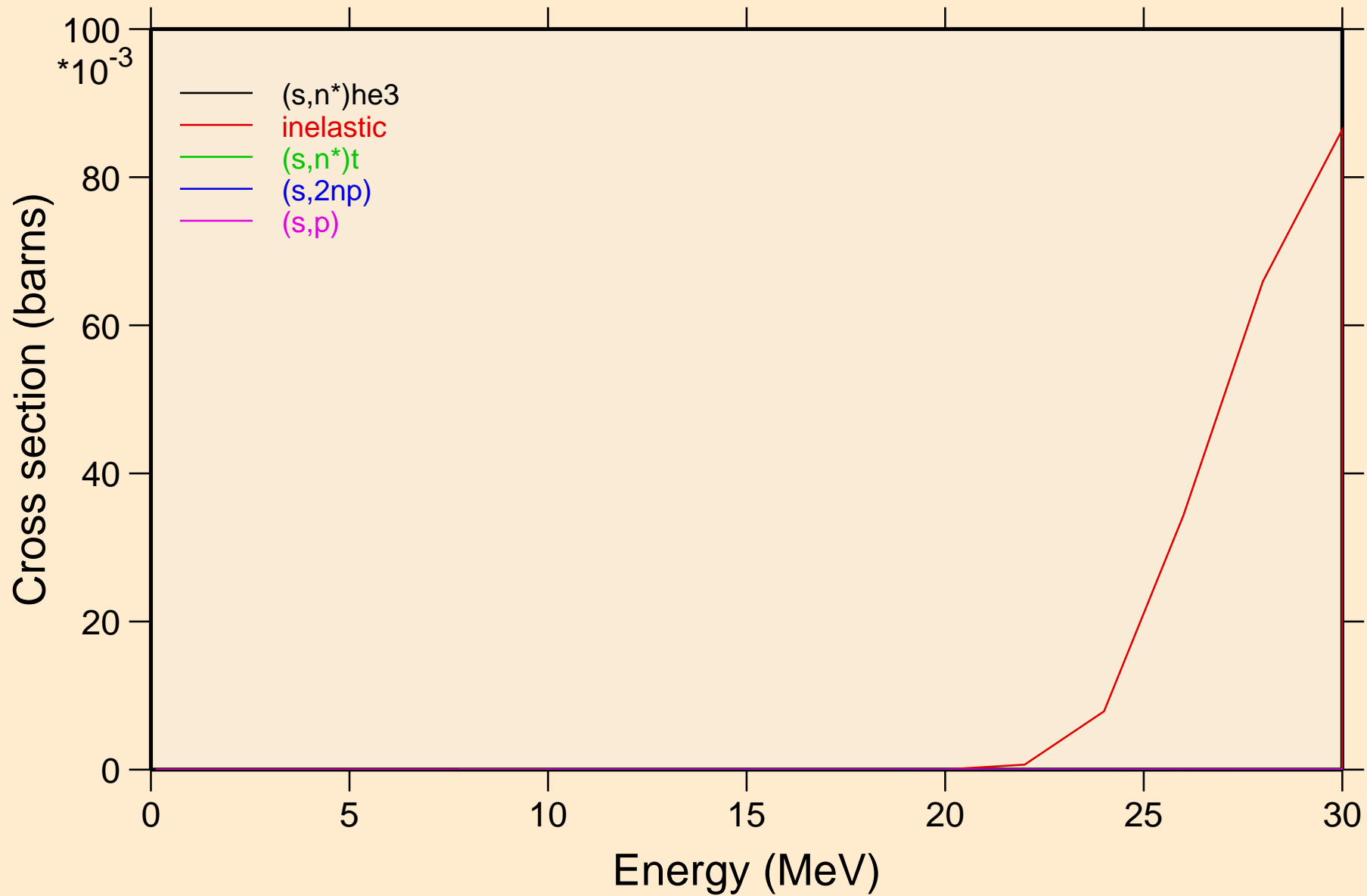

ES251 HELION ACER TENDL-2021 LIBRARY; T=0.K  
Threshold reactions

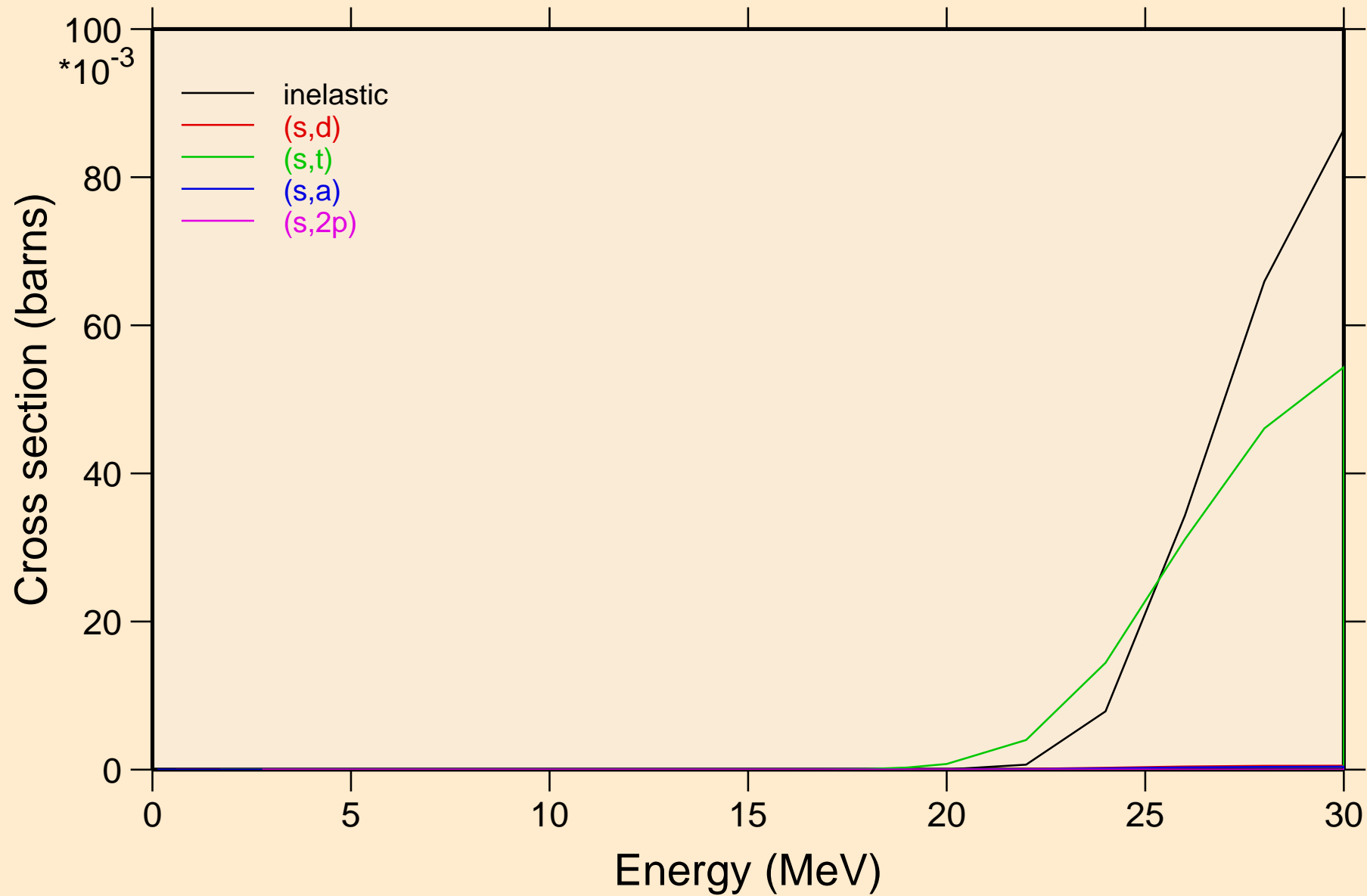



ES251 HELION ACER TENDL-2021 LIBRARY; T=0.K  
angular distribution for elastic

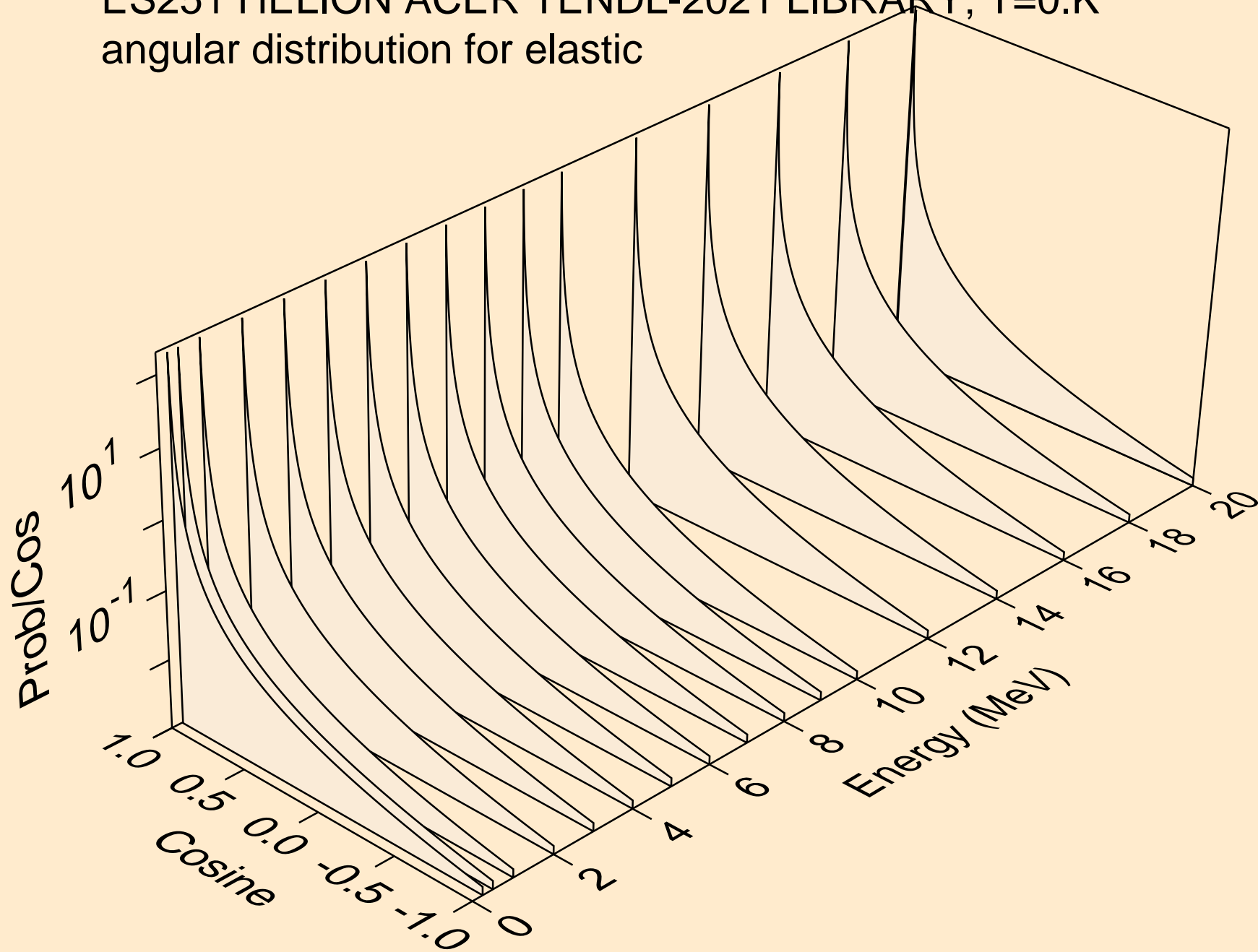

ES251 HELION ACER TENDL-2021 LIBRARY; T=0.K  
angular distribution for elastic

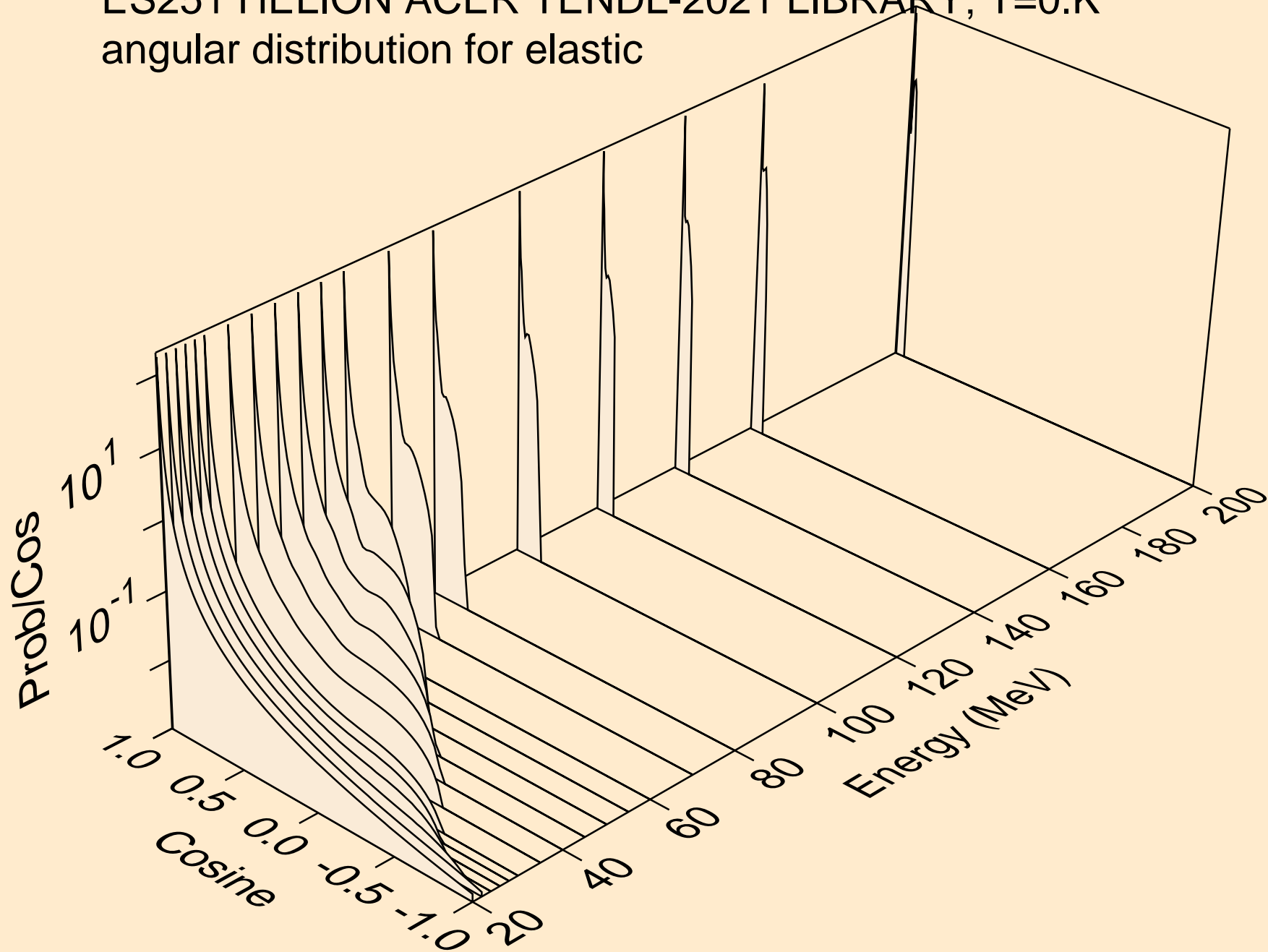

ES251 HELION ACER TENDL-2021 LIBRARY; T=0.K  
He-3 emission for (s,x)

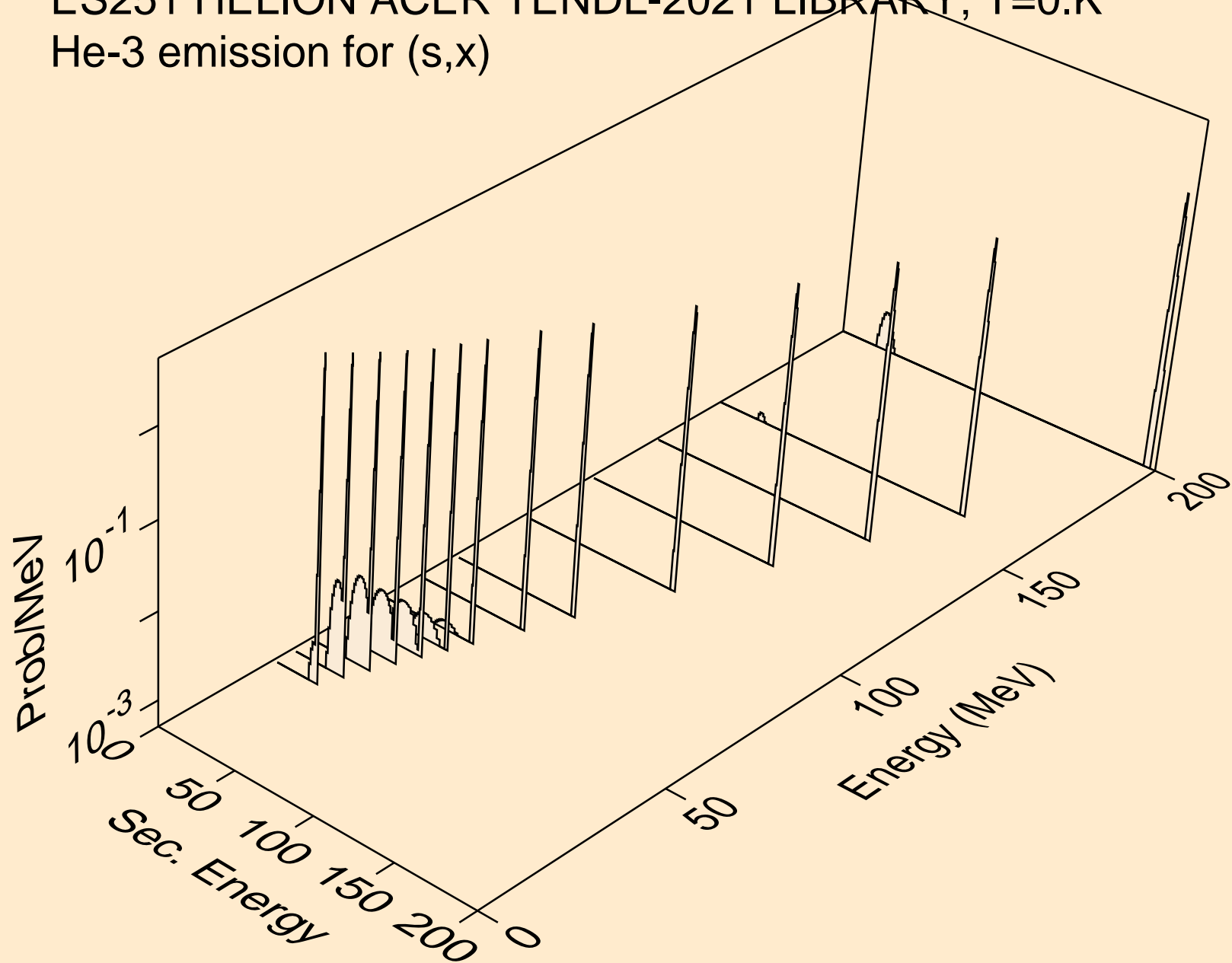

ES251 HELION ACER TENDL-2021 LIBRARY; T=0.K  
He-3 emission for (s,n\*)he3

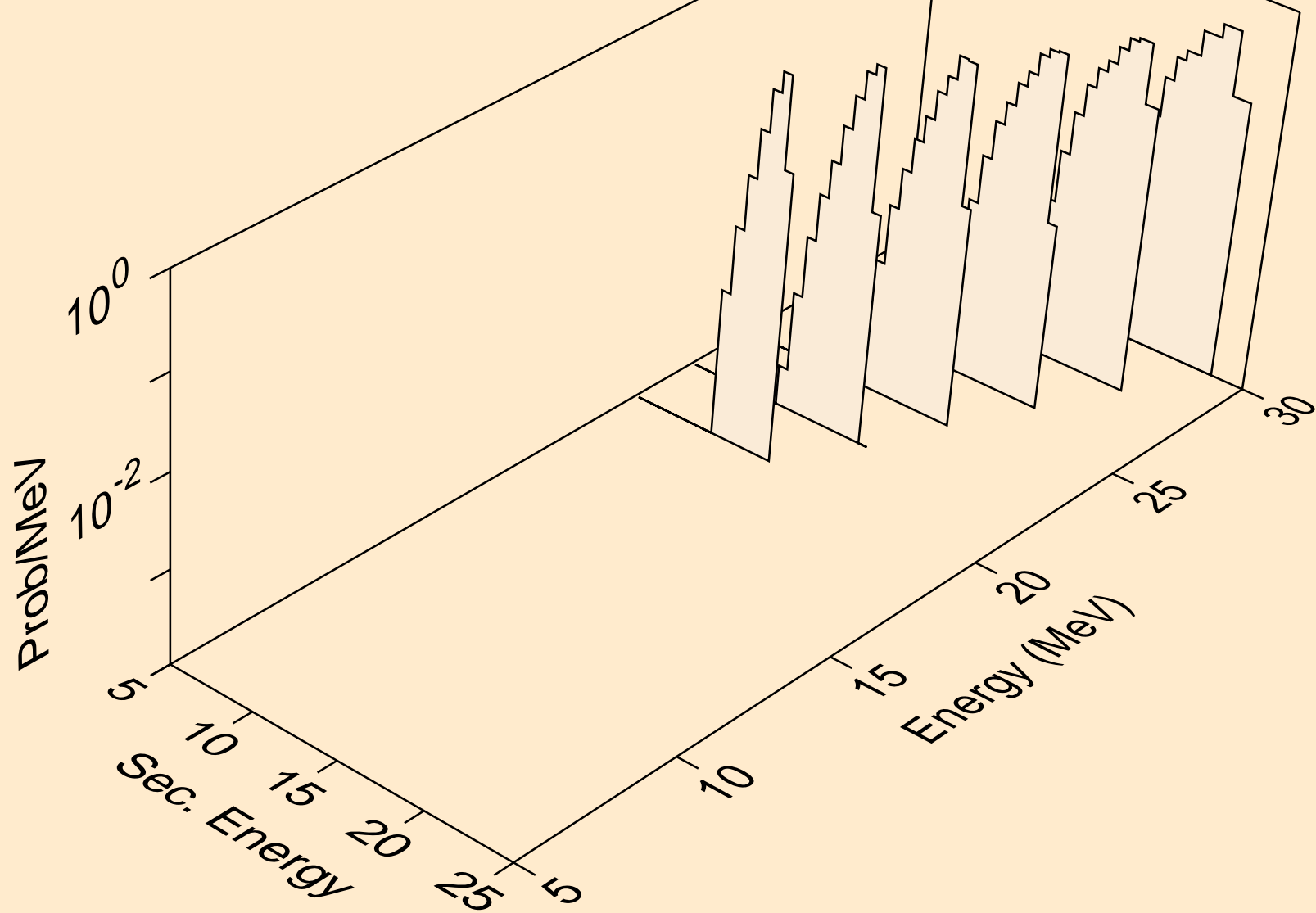

ES251 HELION ACER TENDL-2021 LIBRARY; T=0.K  
He-3 emission for inelastic

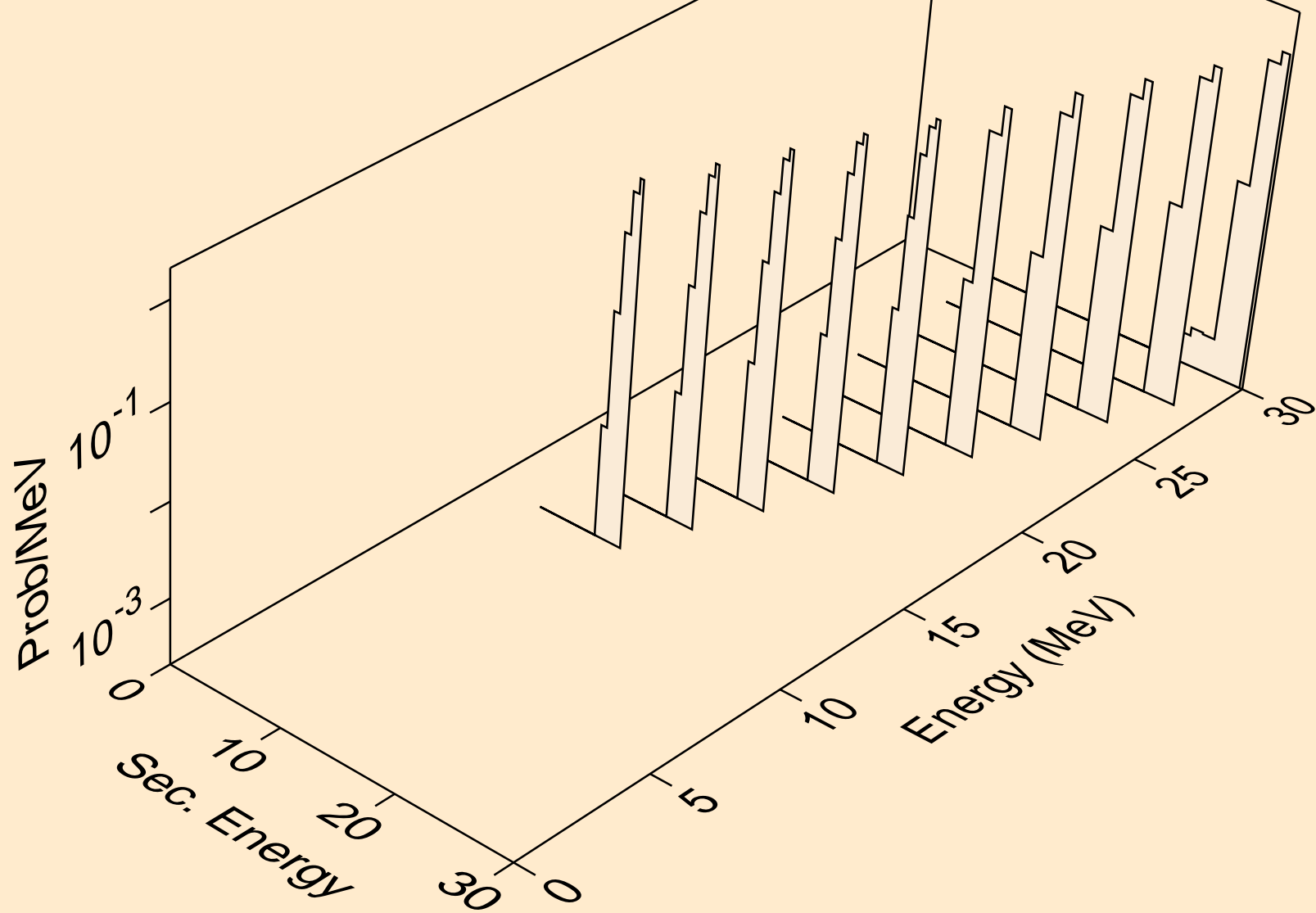

ES251 HELION ACER TENDL-2021 LIBRARY; T=0.K  
Photon emission for (z,n)

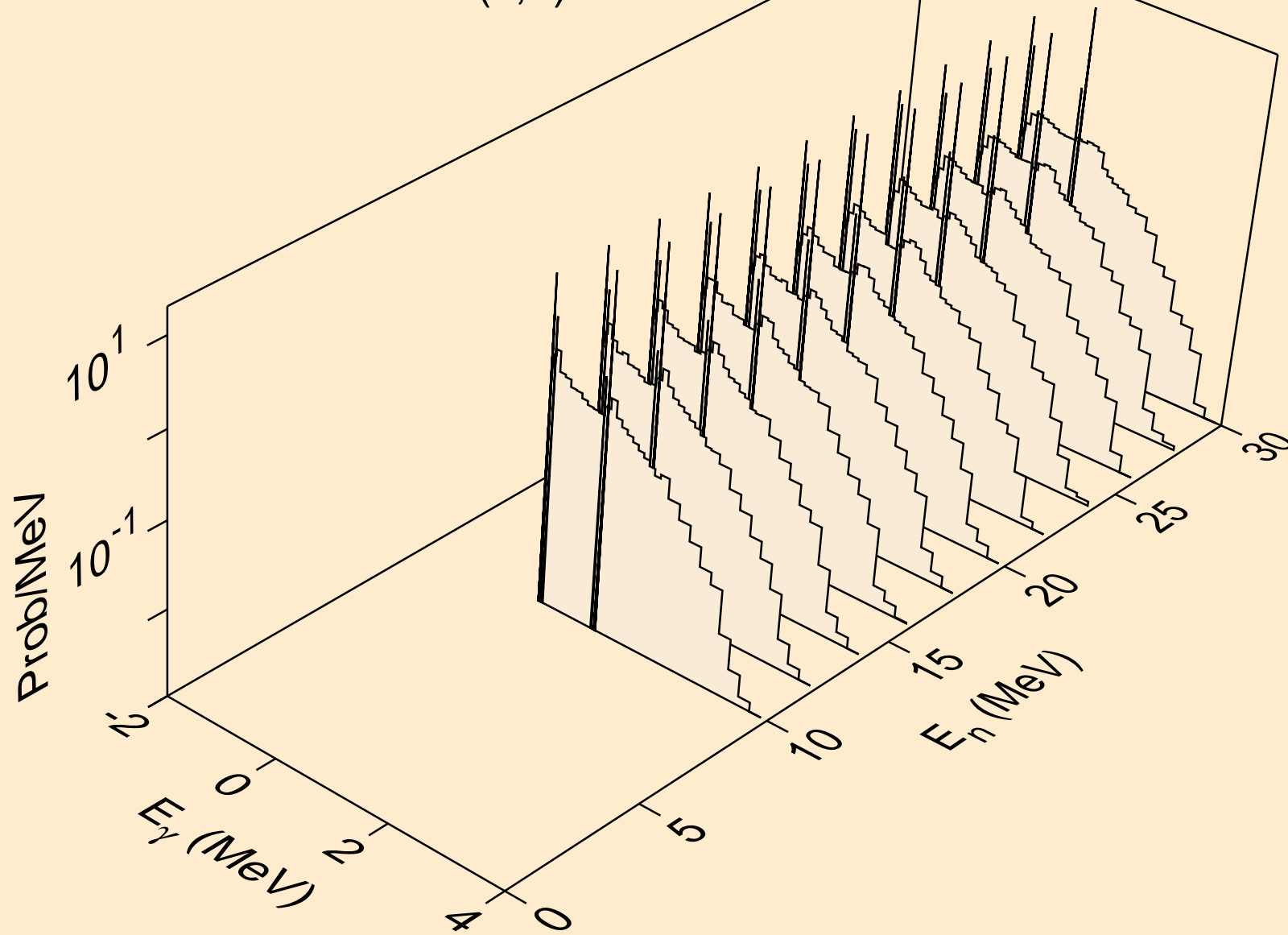

ES251 HELION ACER TENDL-2021 LIBRARY; T=0.K  
Photon emission for (n,x)

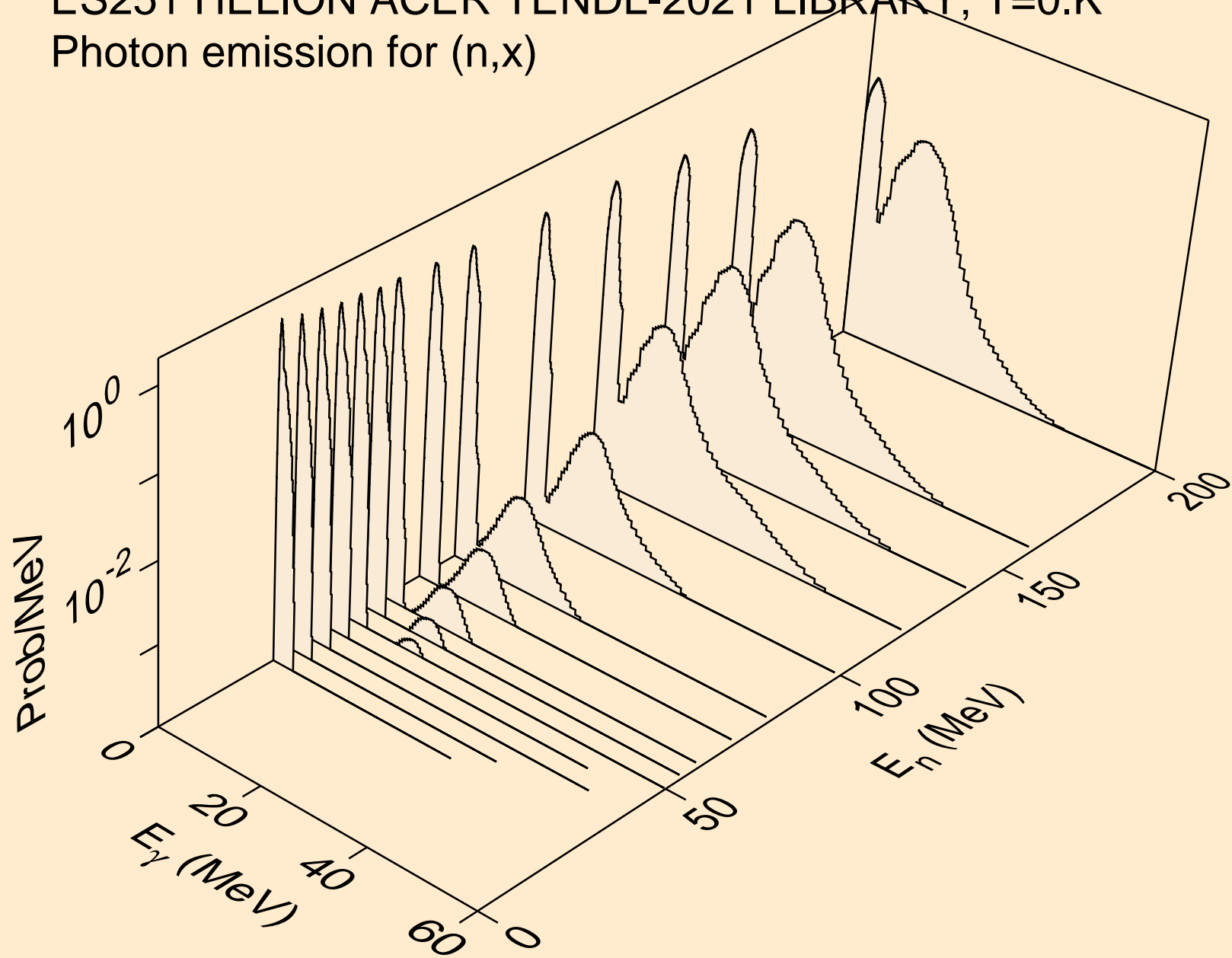

ES251 HELION ACER TENDL-2021 LIBRARY; T=0.K  
Photon emission for (n,2n)

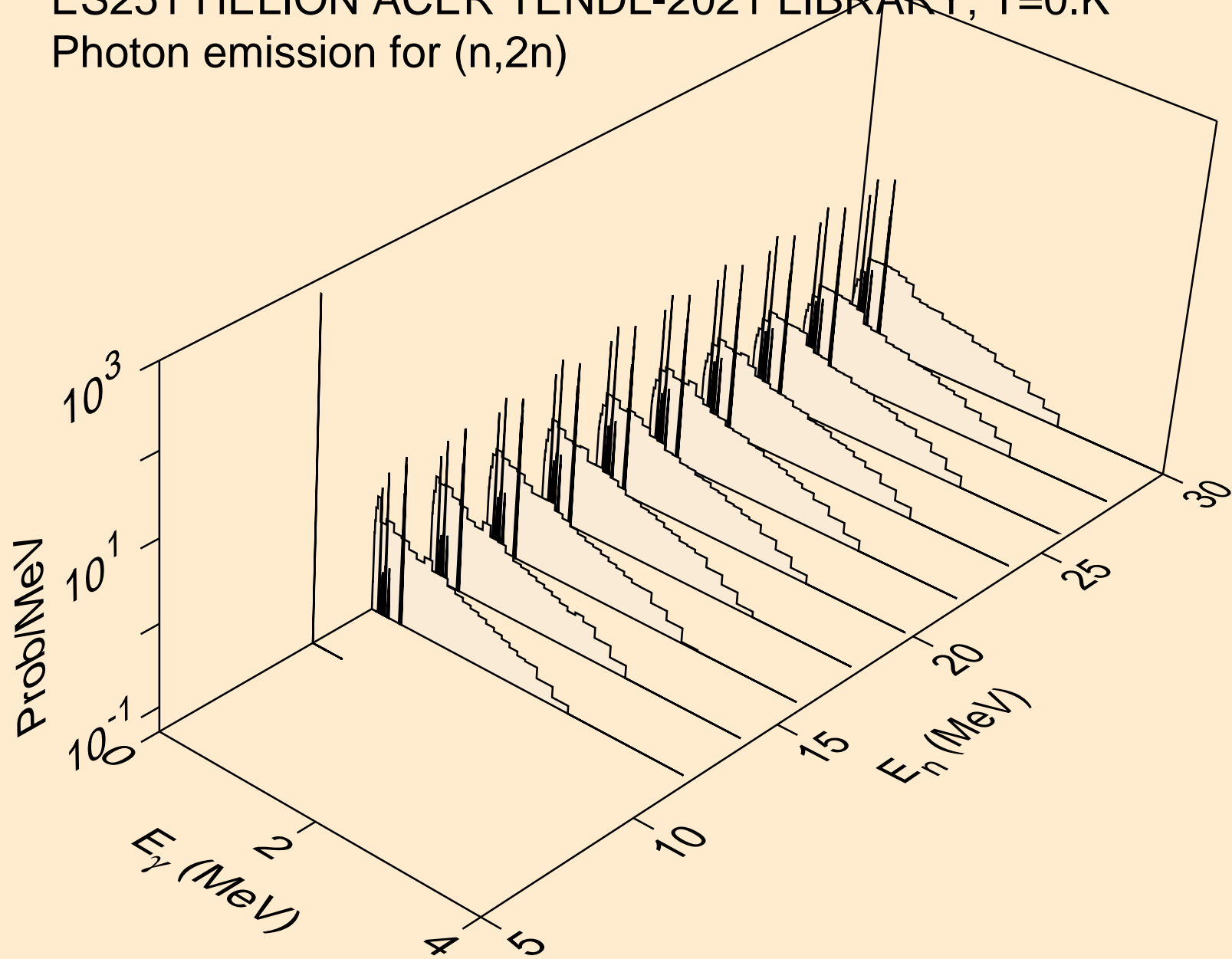



ES251 HELION ACER TENDL-2021 LIBRARY; T=0.K  
Photon emission for (n,3n)

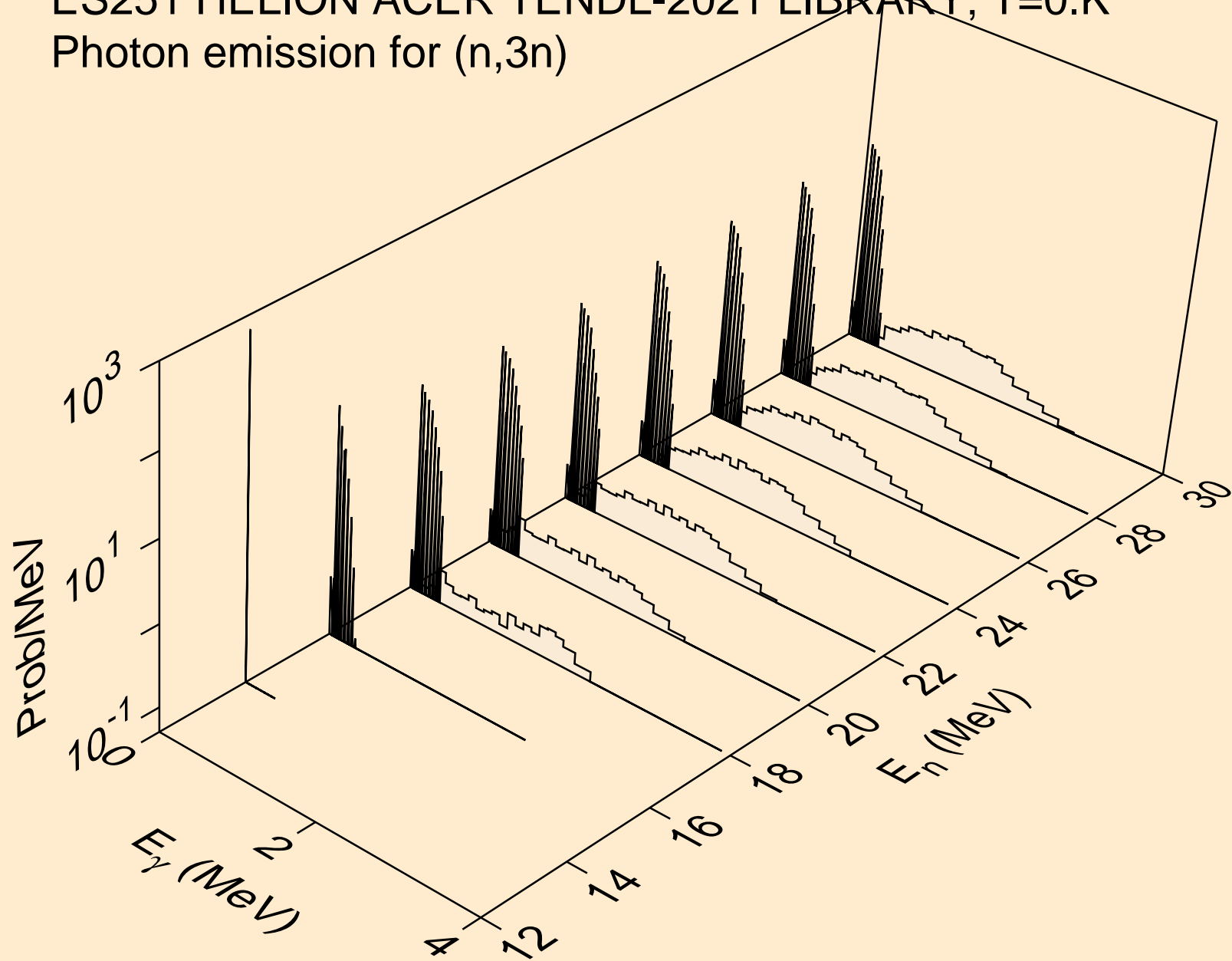

ES251 HELION ACER TENDL-2021 LIBRARY; T=0.K  
Photon emission for (n,n\*)a

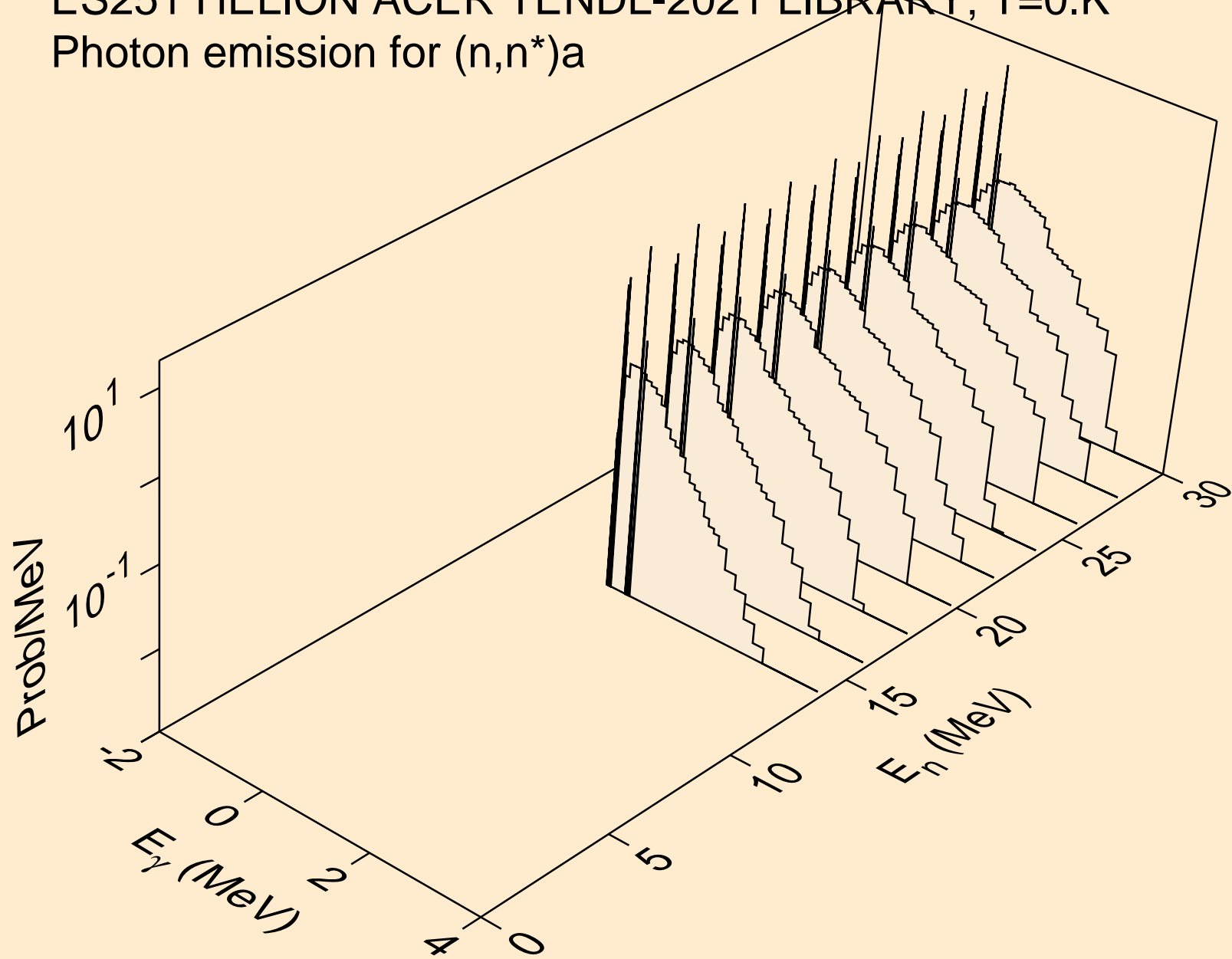

ES251 HELION ACER TENDL-2021 LIBRARY; T=0.K  
Photon emission for (n,n\*)p

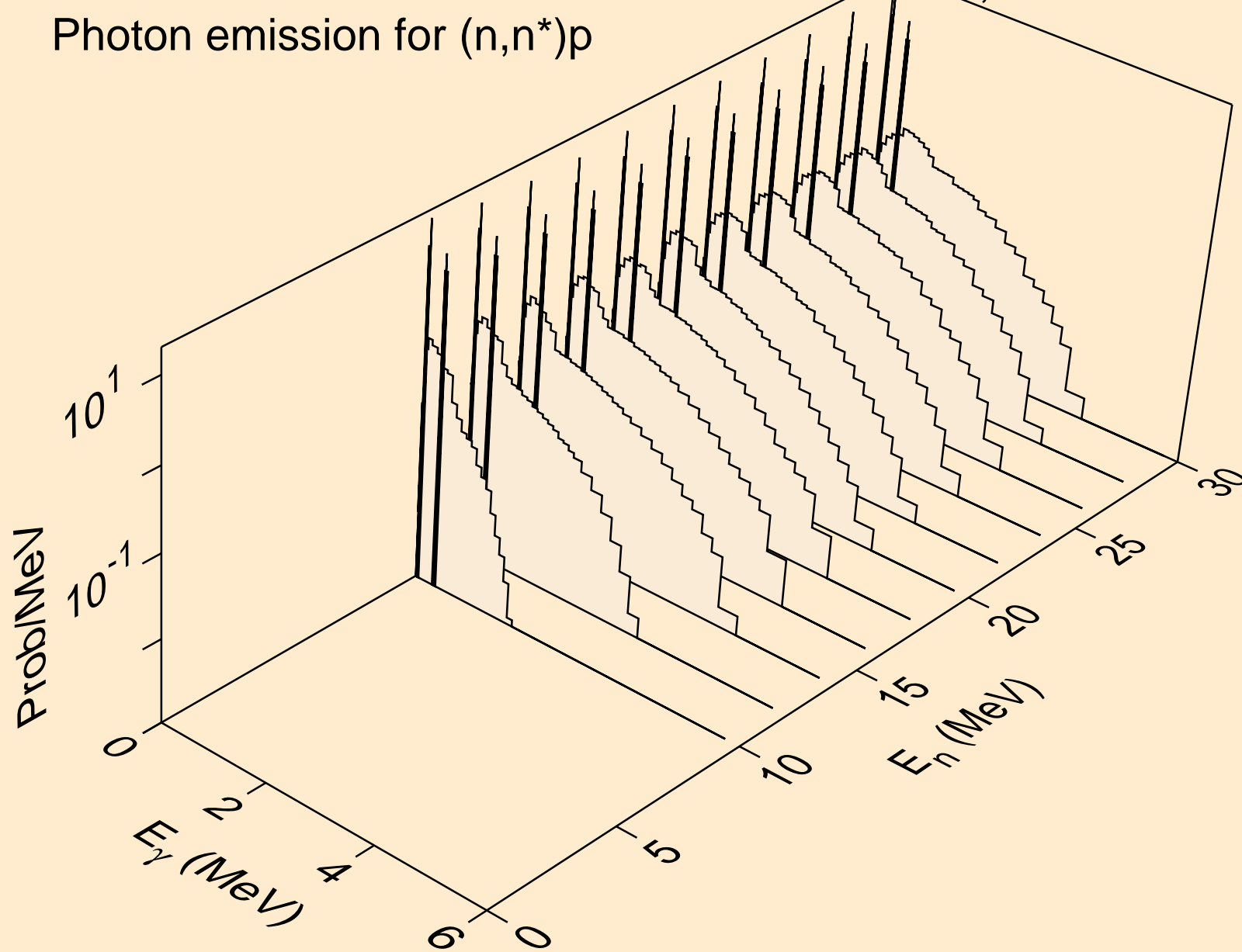

ES251 HELION ACER TENDL-2021 LIBRARY; T=0.K  
Photon emission for (n,n\*)d

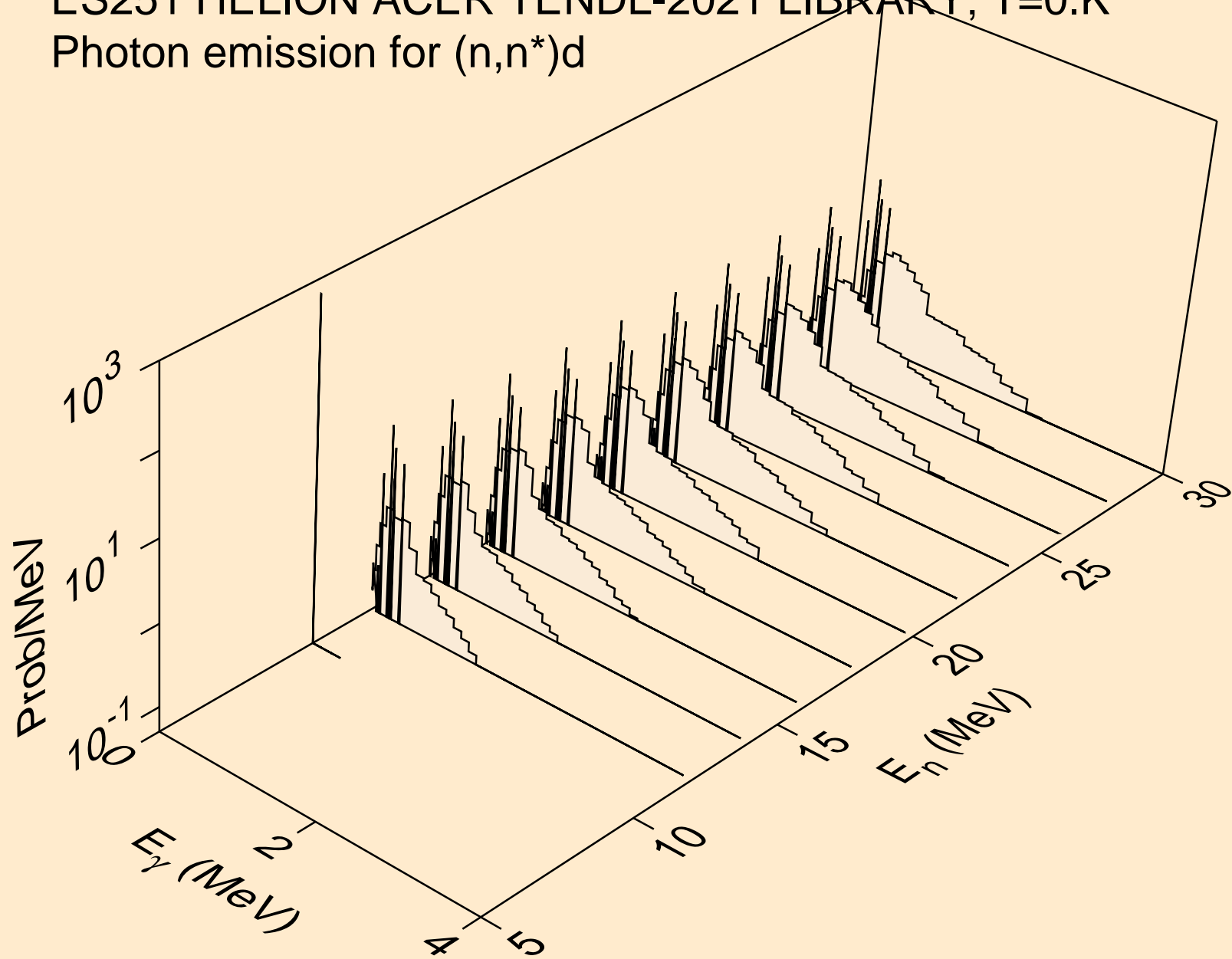

ES251 HELION ACER TENDL-2021 LIBRARY; T=0.K  
Photon emission for (n,n\*)t

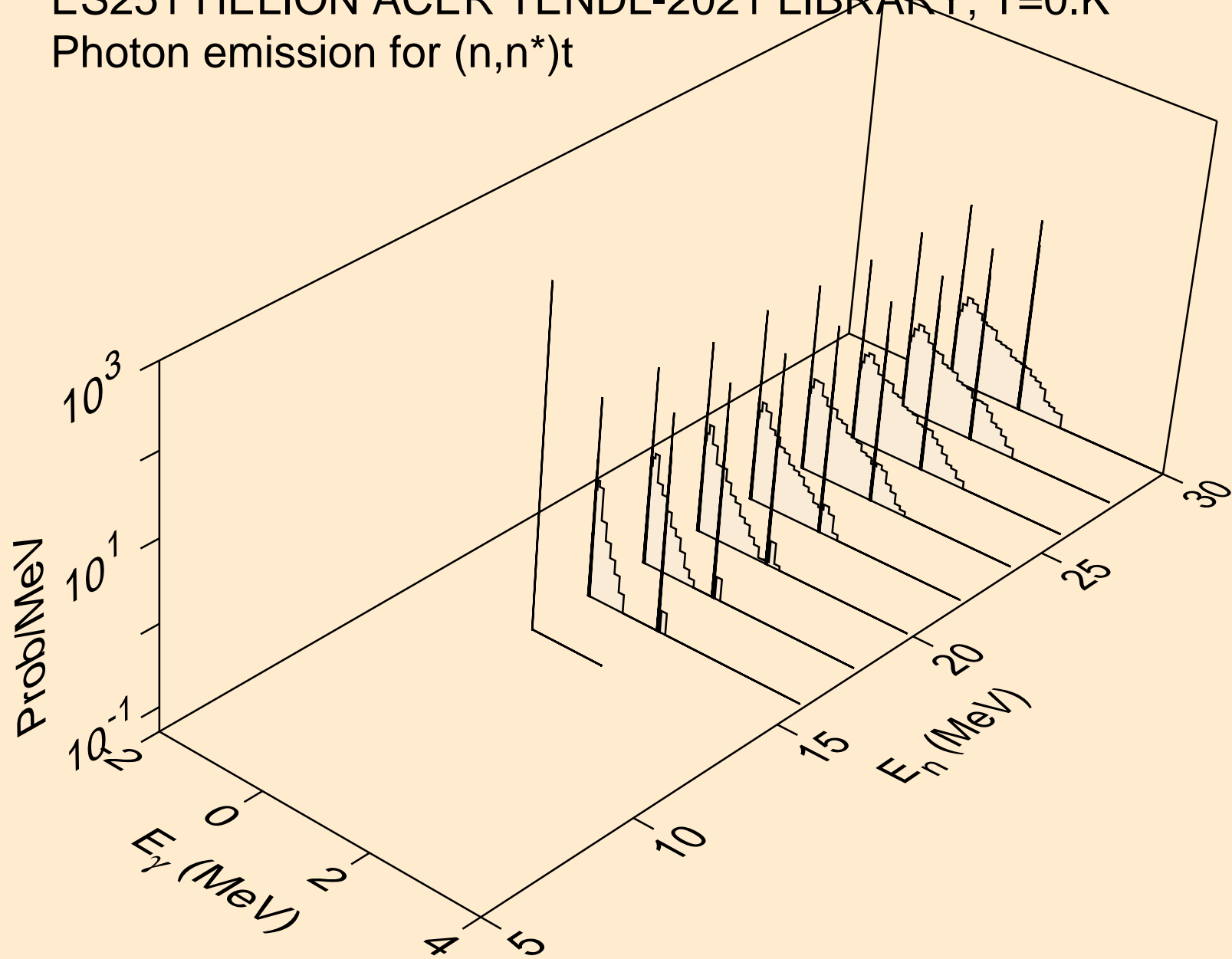

ES251 HELION ACER TENDL-2021 LIBRARY; T=0.K  
Photon emission for (n,n\*)he3

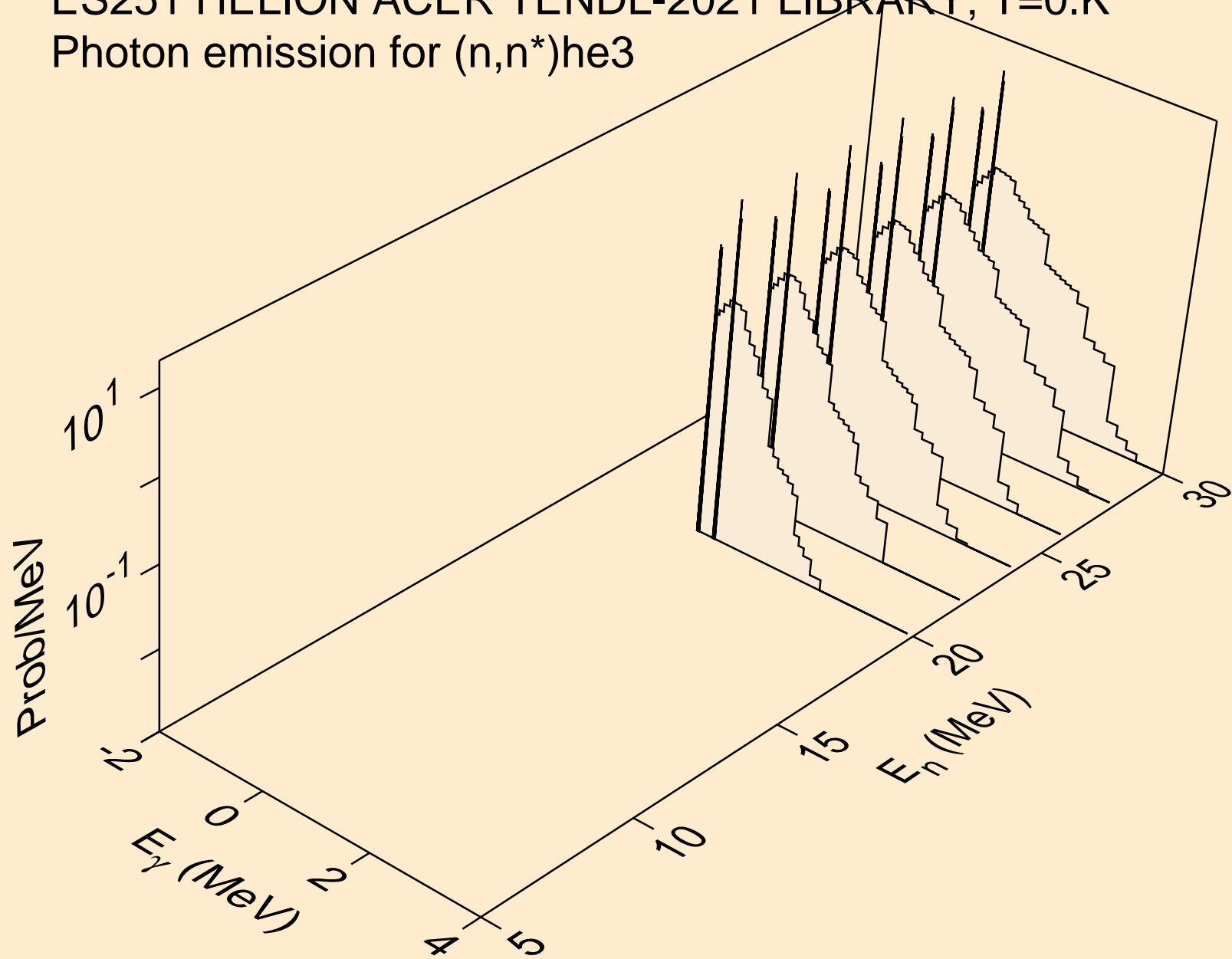

ES251 HELION ACER TENDL-2021 LIBRARY; T=0.K  
Photon emission for (n,2np)

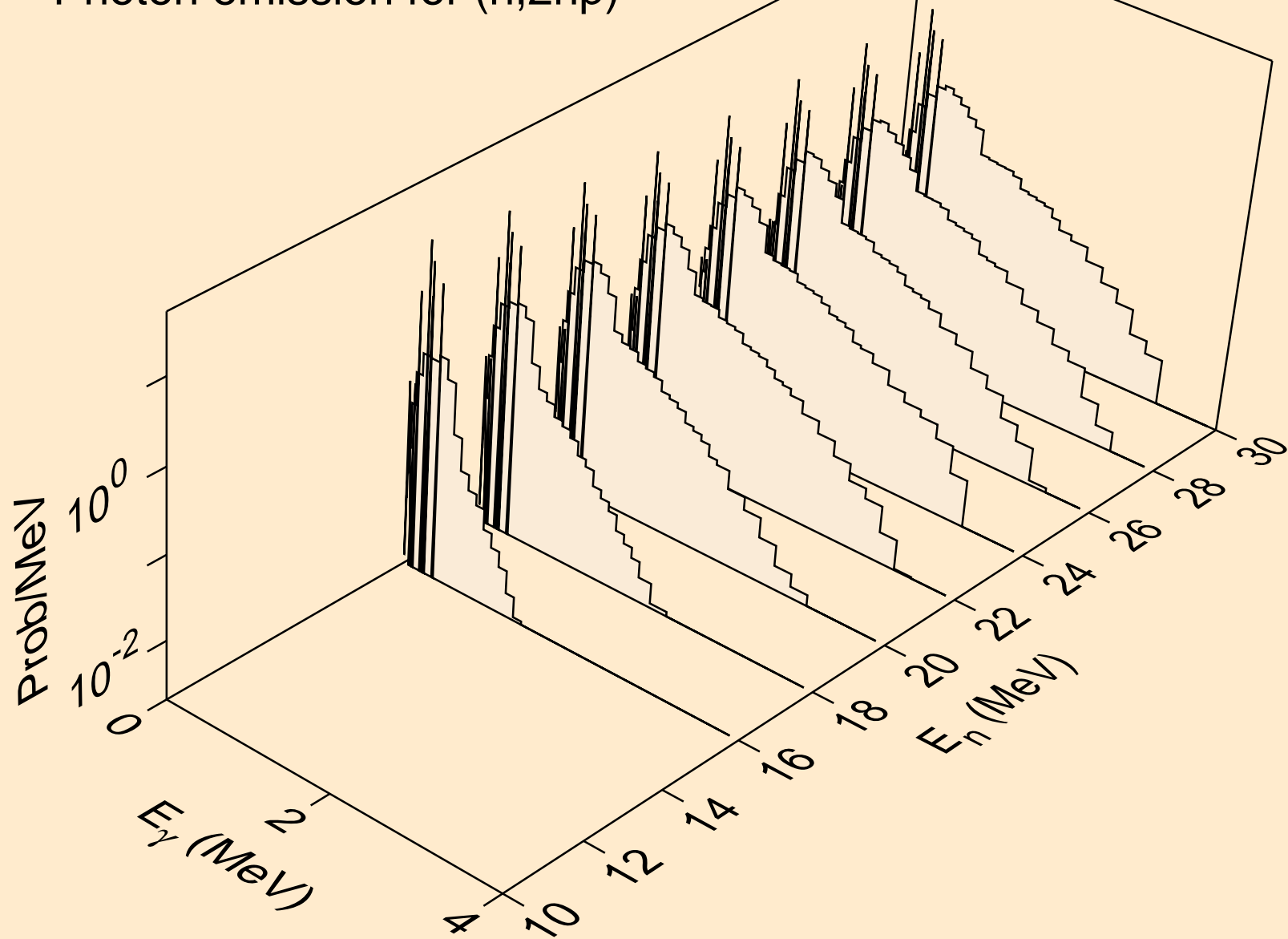

ES251 HELION ACER TENDL-2021 LIBRARY; T=0.K  
Photon emission for (n,p)

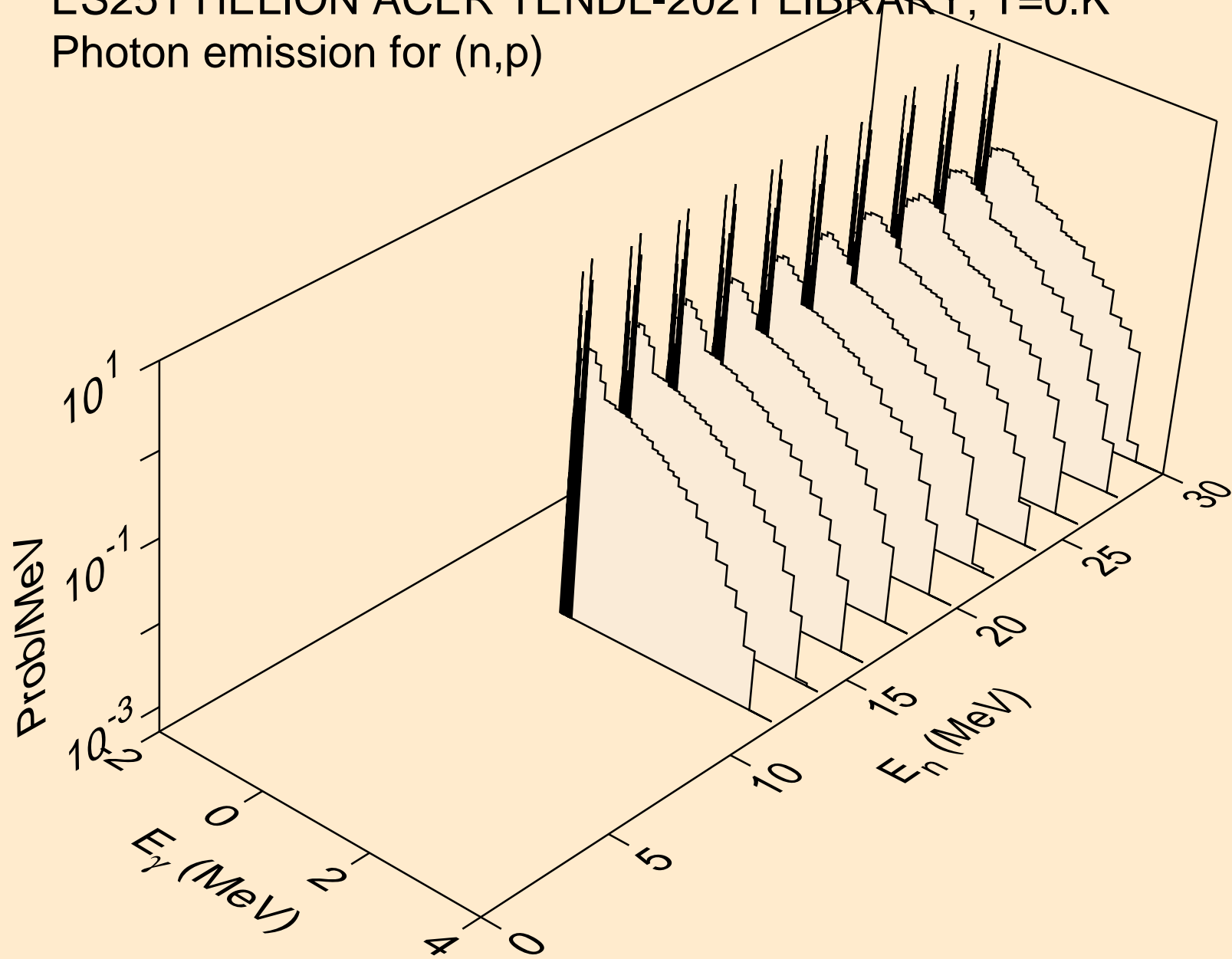



ES251 HELION ACER TENDL-2021 LIBRARY; T=0.K  
Photon emission for (n,d)

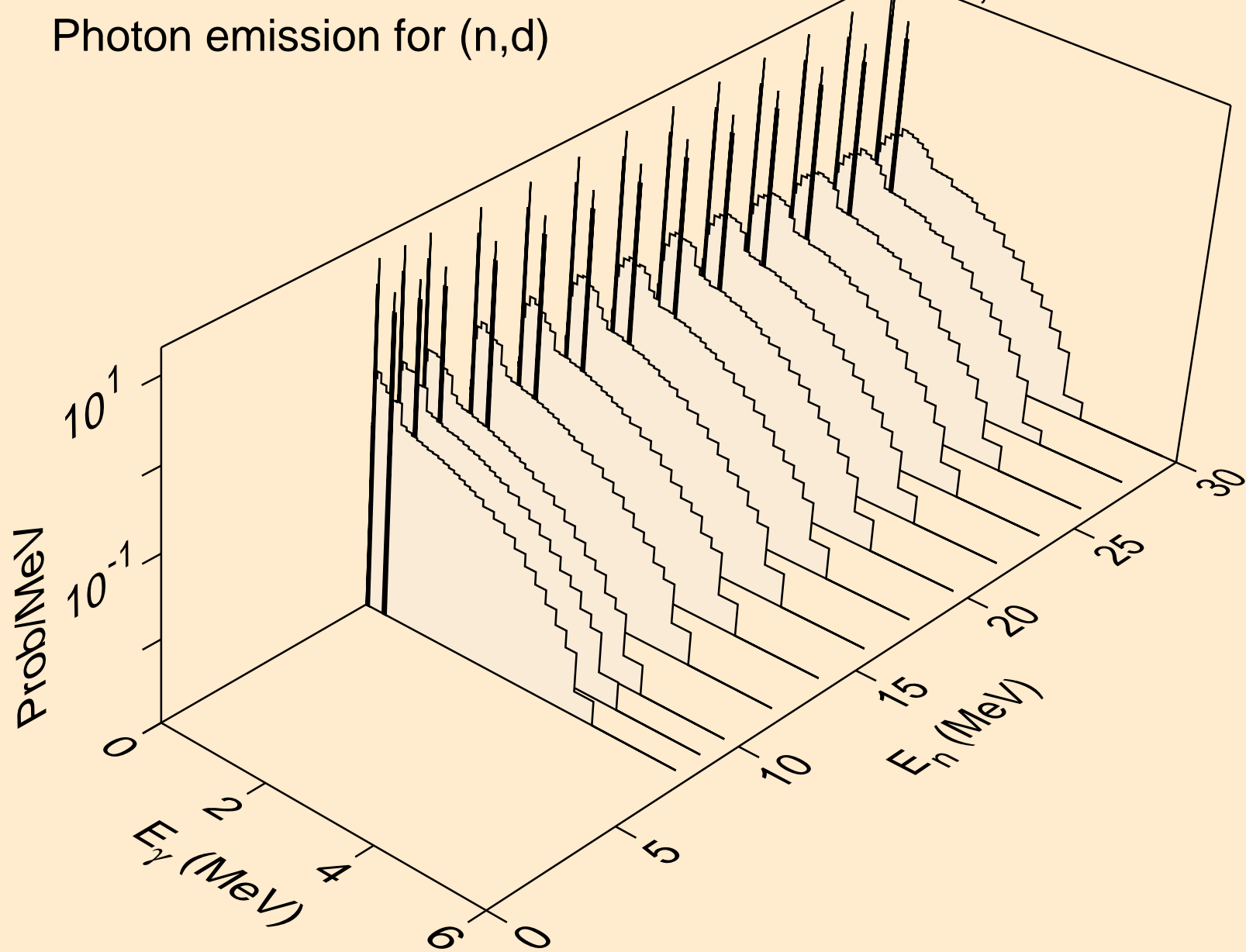

ES251 HELION ACER TENDL-2021 LIBRARY; T=0.K  
Photon emission for (n,t)

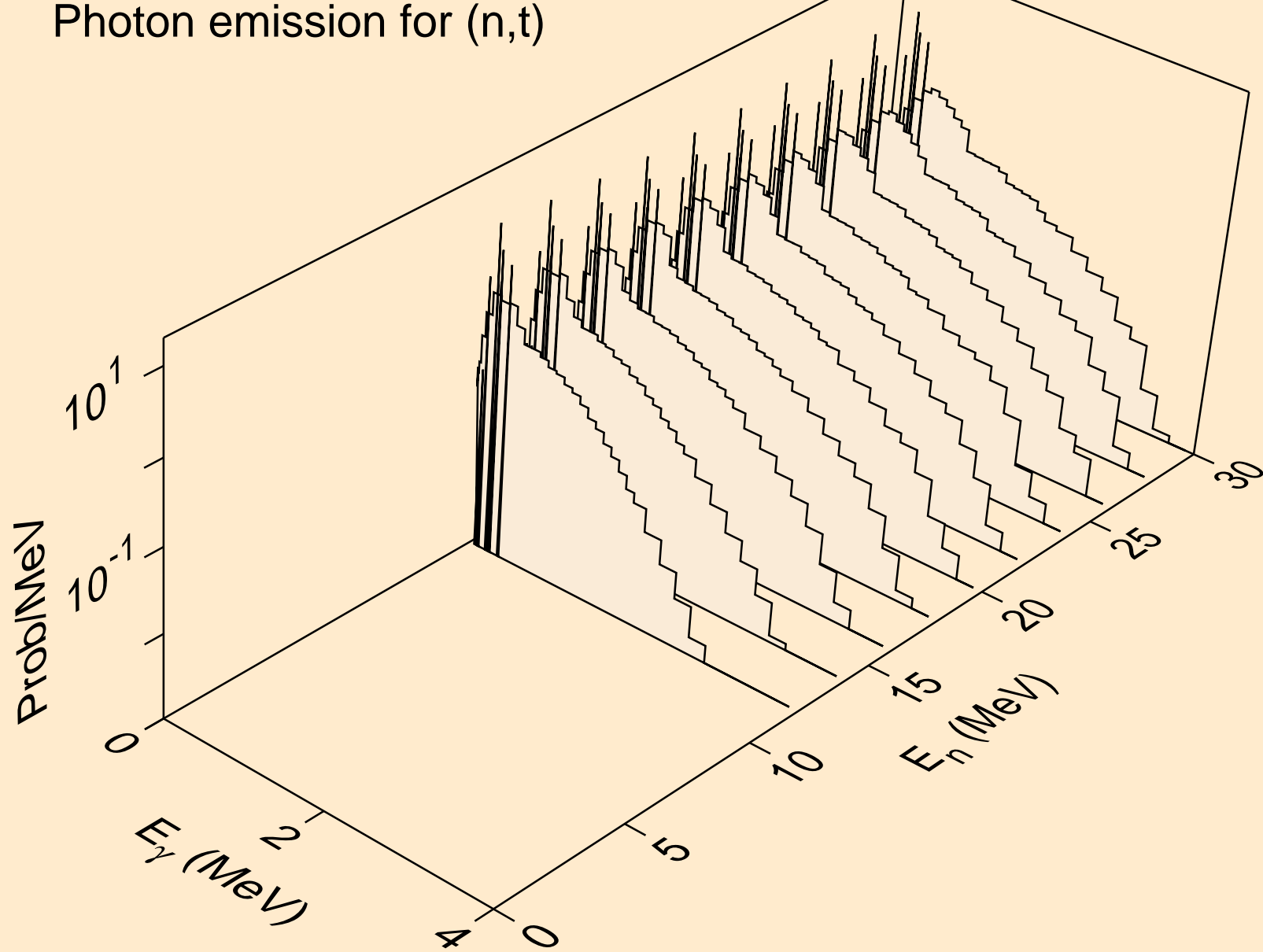

ES251 HELION ACER TENDL-2021 LIBRARY; T=0.K  
Photon emission for inelastic

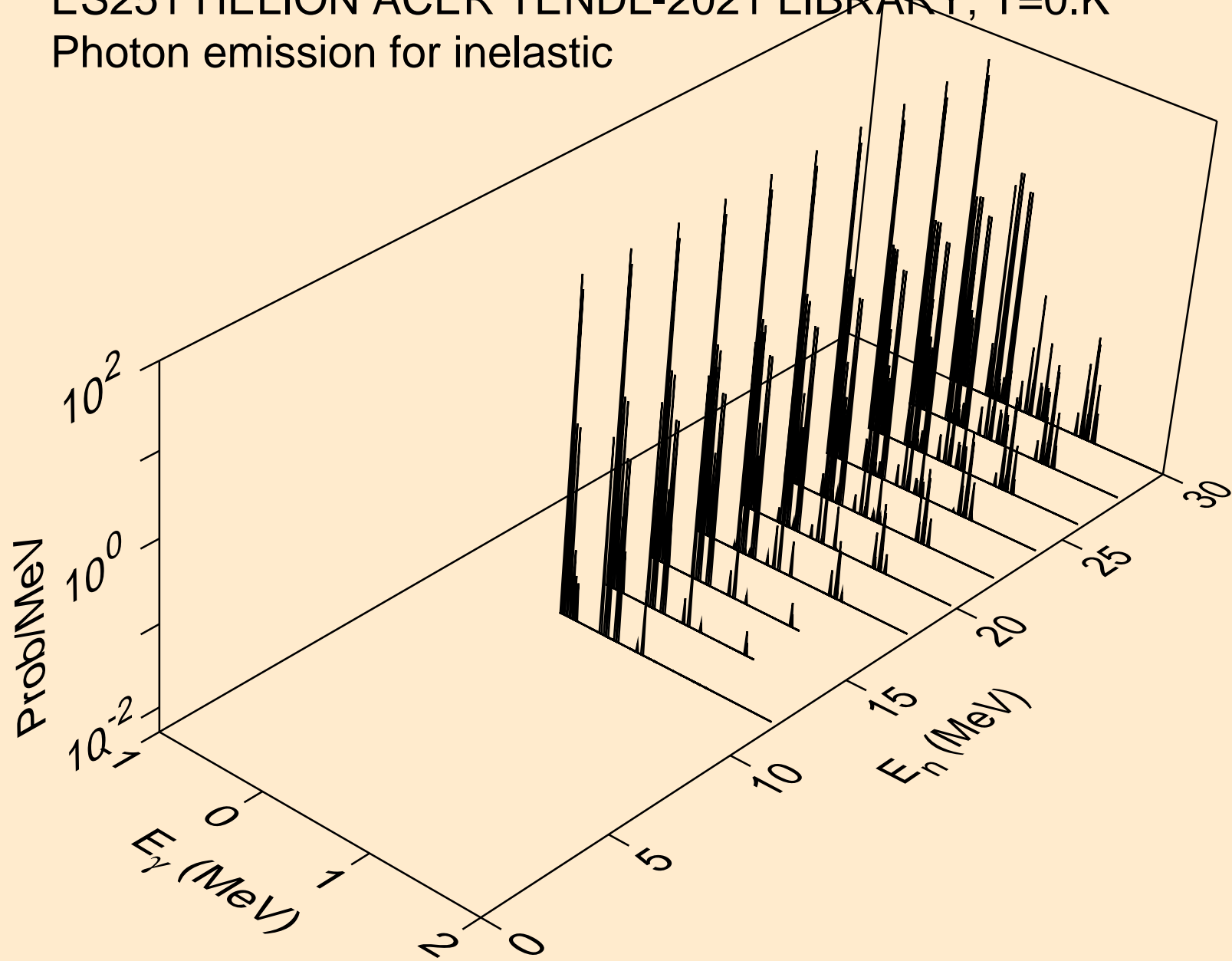

ES251 HELION ACER TENDL-2021 LIBRARY; T=0.K  
Photon emission for (n,a)

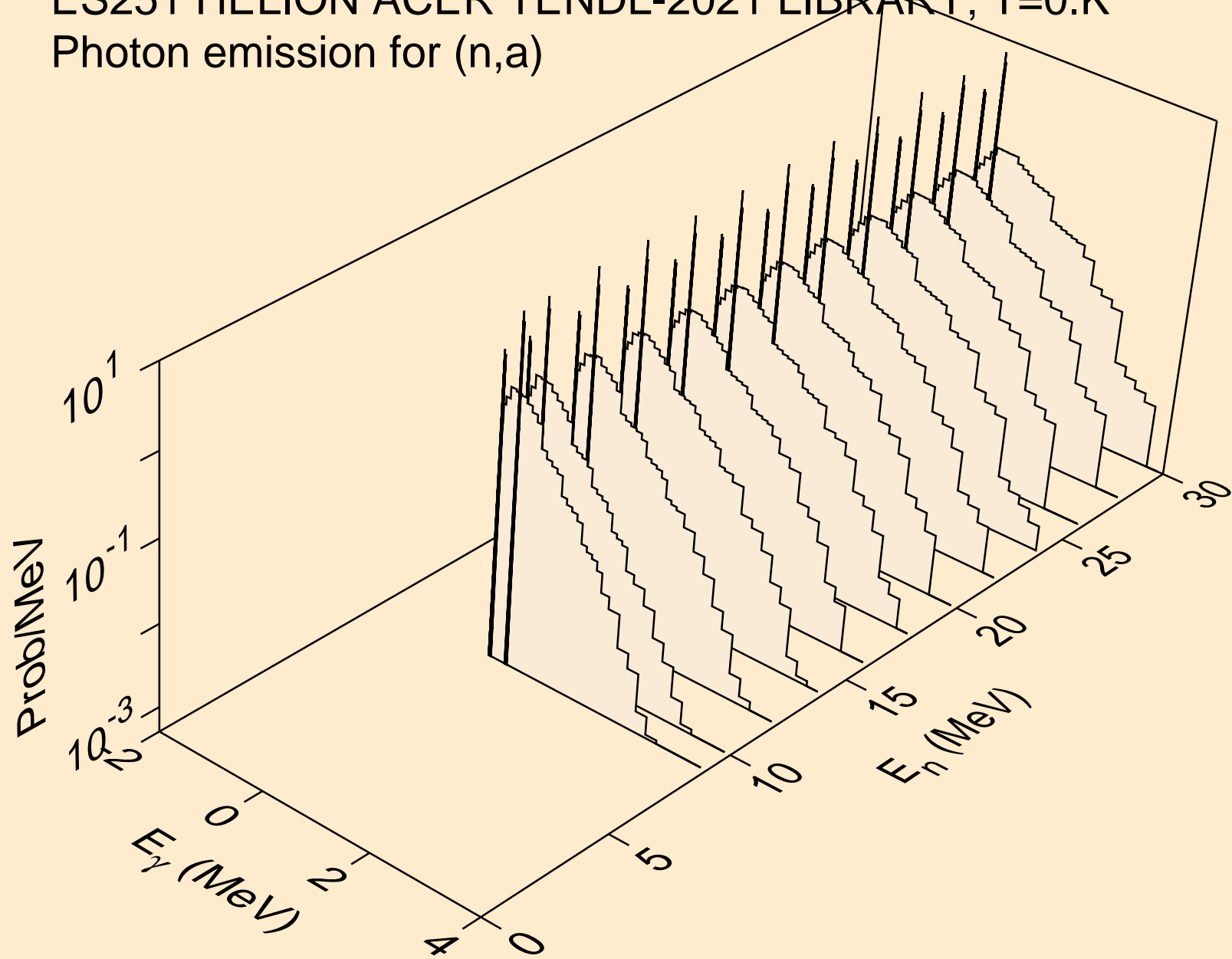

ES251 HELION ACER TENDL-2021 LIBRARY; T=0.K  
Photon emission for (n,2p)

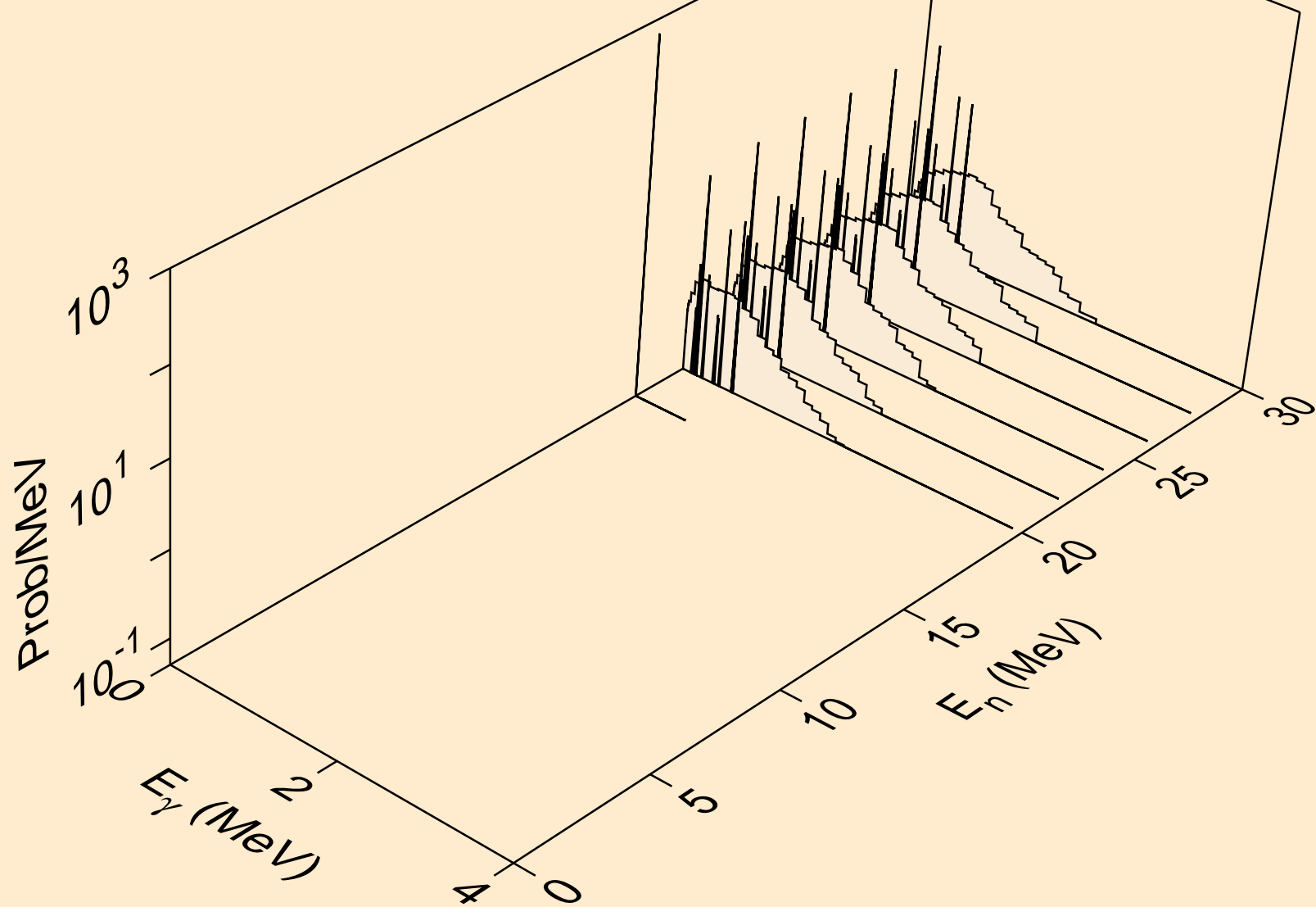

ES251 HELION ACER TENDL-2021 LIBRARY; T=0.K  
Particle heating contributions

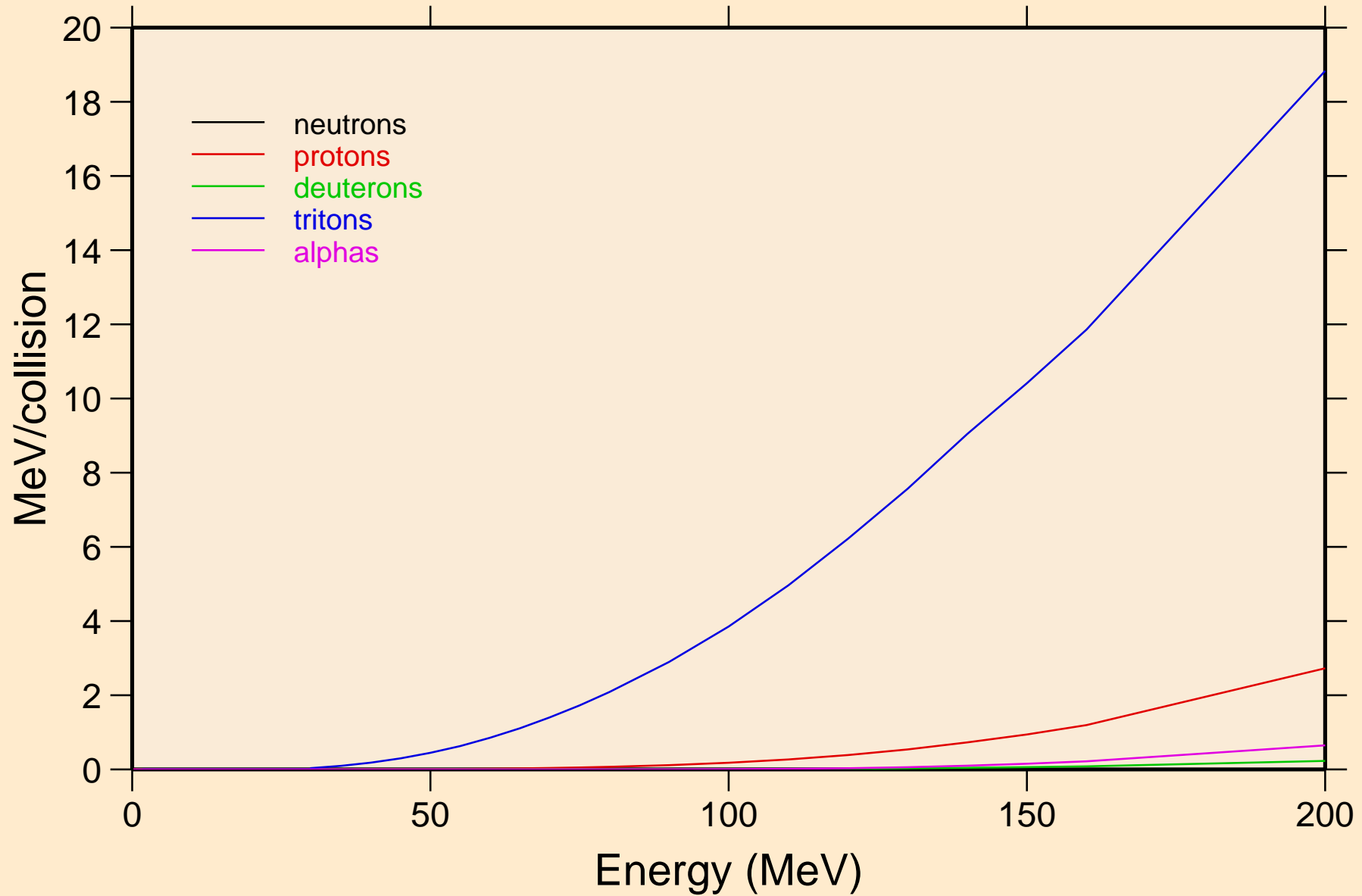

ES251 HELION ACER TENDL-2021 LIBRARY; T=0.K  
Recoil Heating

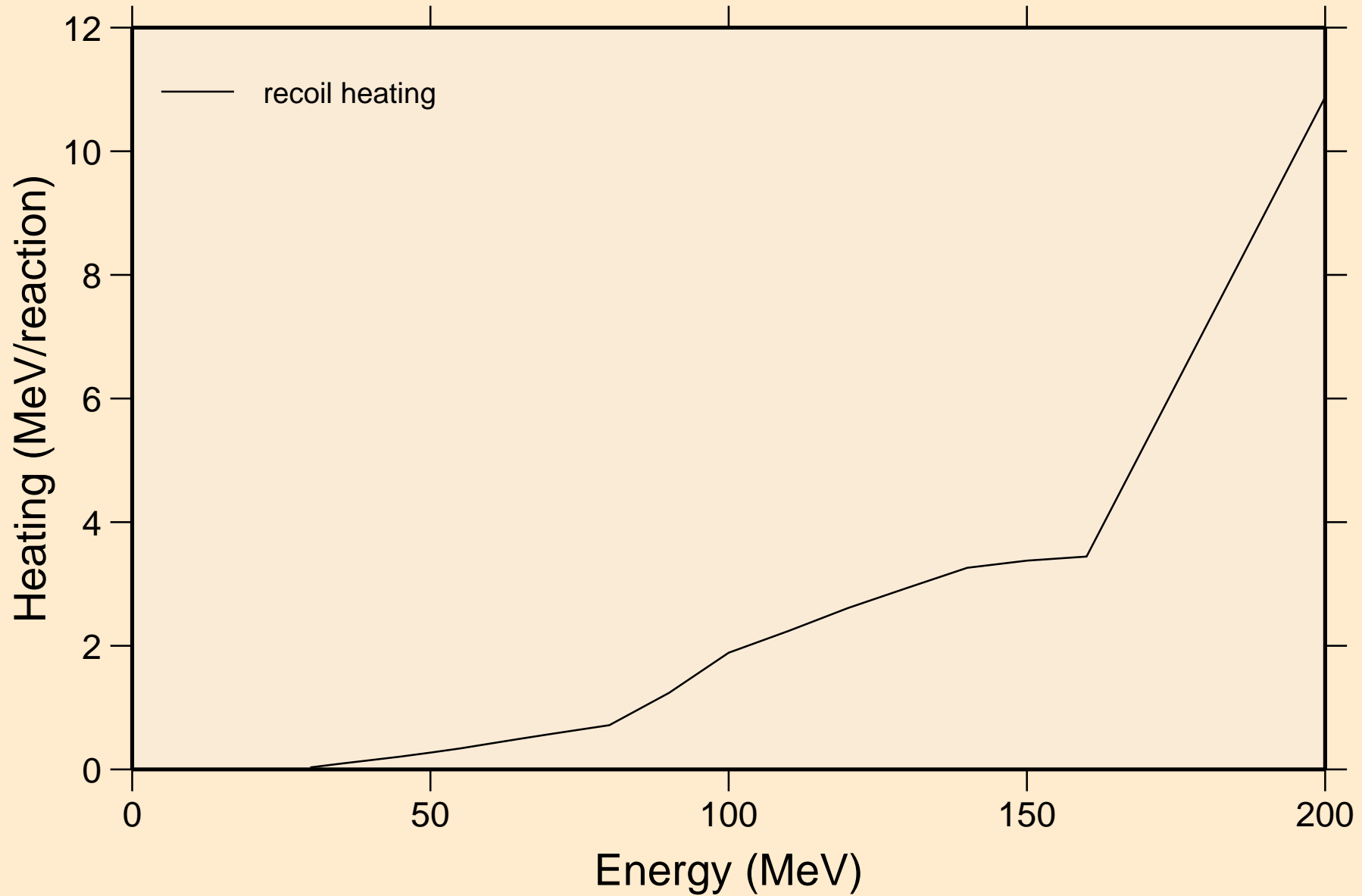

# ES251 HELION ACER TENDL-2021 LIBRARY; T=0.K

## Particle production cross sections

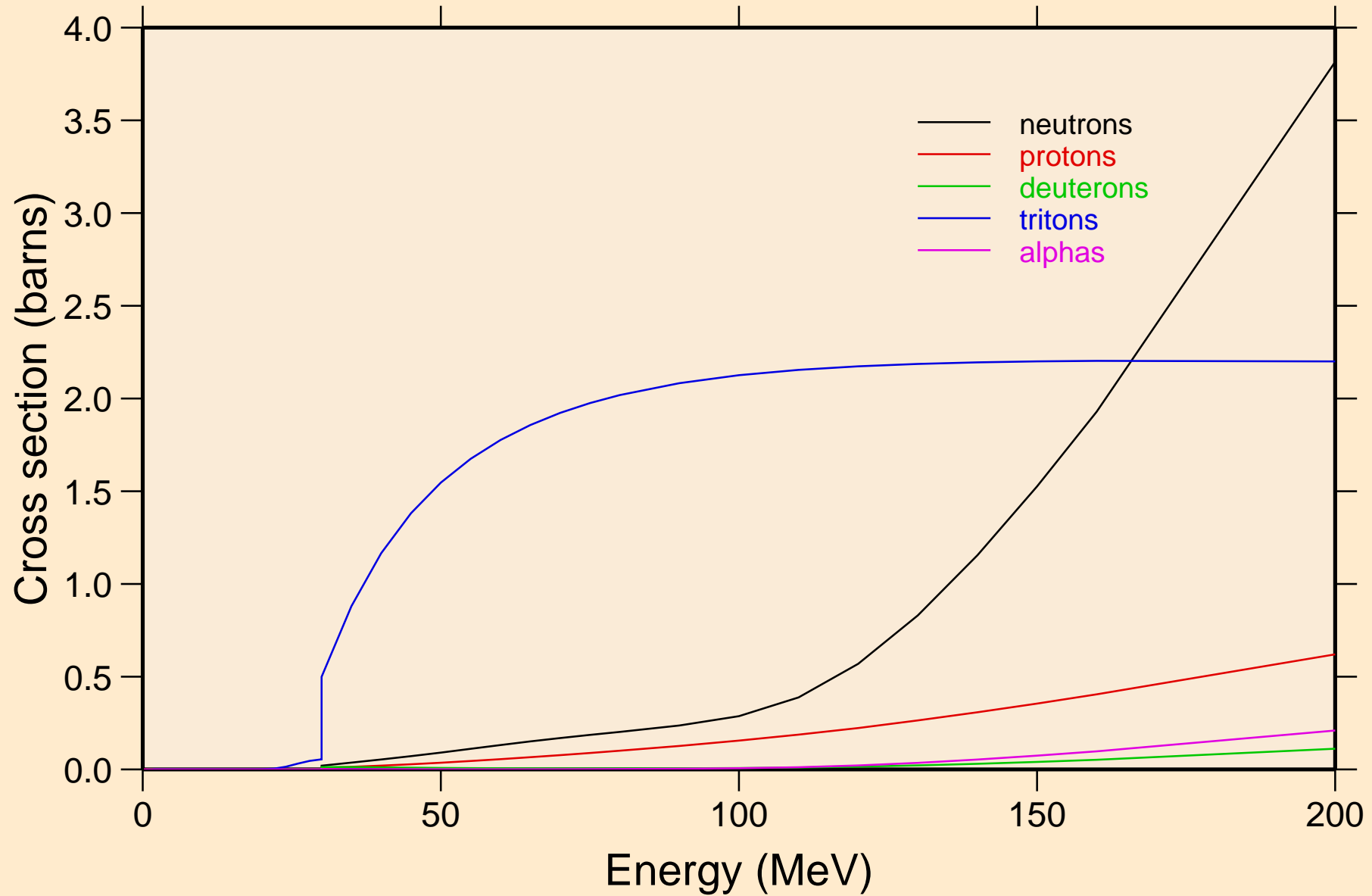



ES251 HELION ACER TENDL-2021 LIBRARY; T=0.K  
neutrons from (s,n)

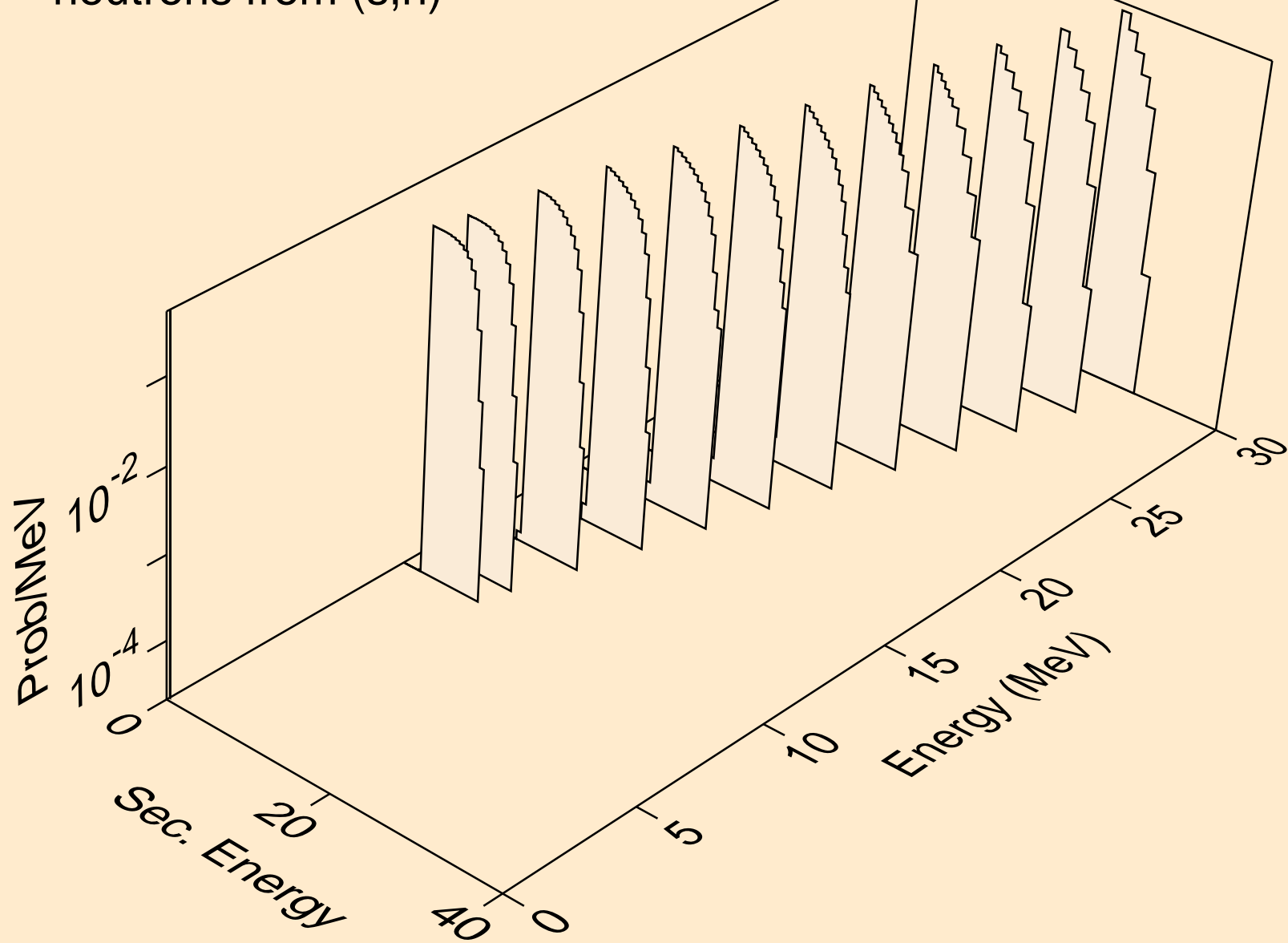

ES251 HELION ACER TENDL-2021 LIBRARY; T=0.K  
neutrons from (s,x)

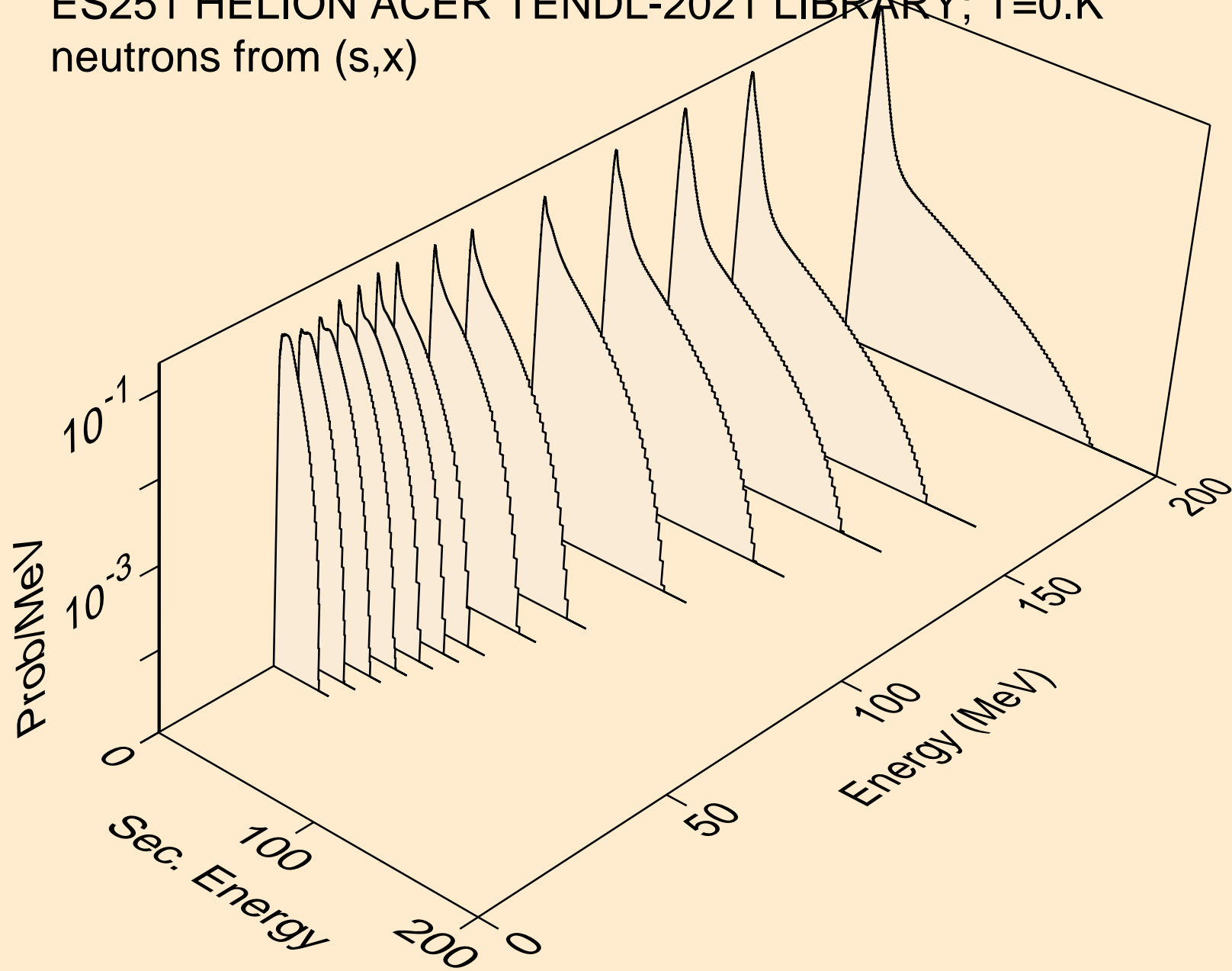

ES251 HELION ACER TENDL-2021 LIBRARY; T=0.K  
neutrons from (s,2n)

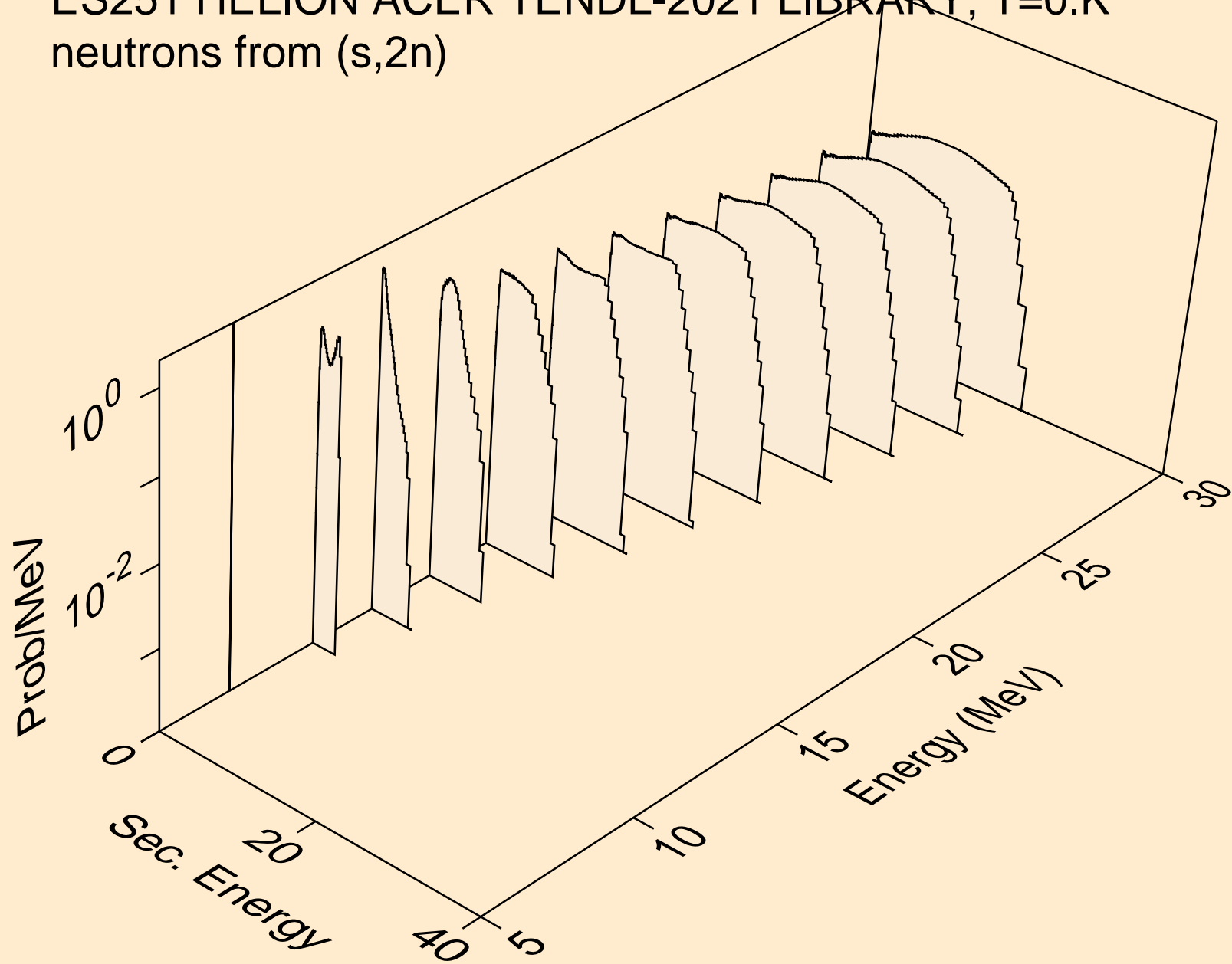

ES251 HELION ACER TENDL-2021 LIBRARY; T=0.K  
neutrons from (s,3n)

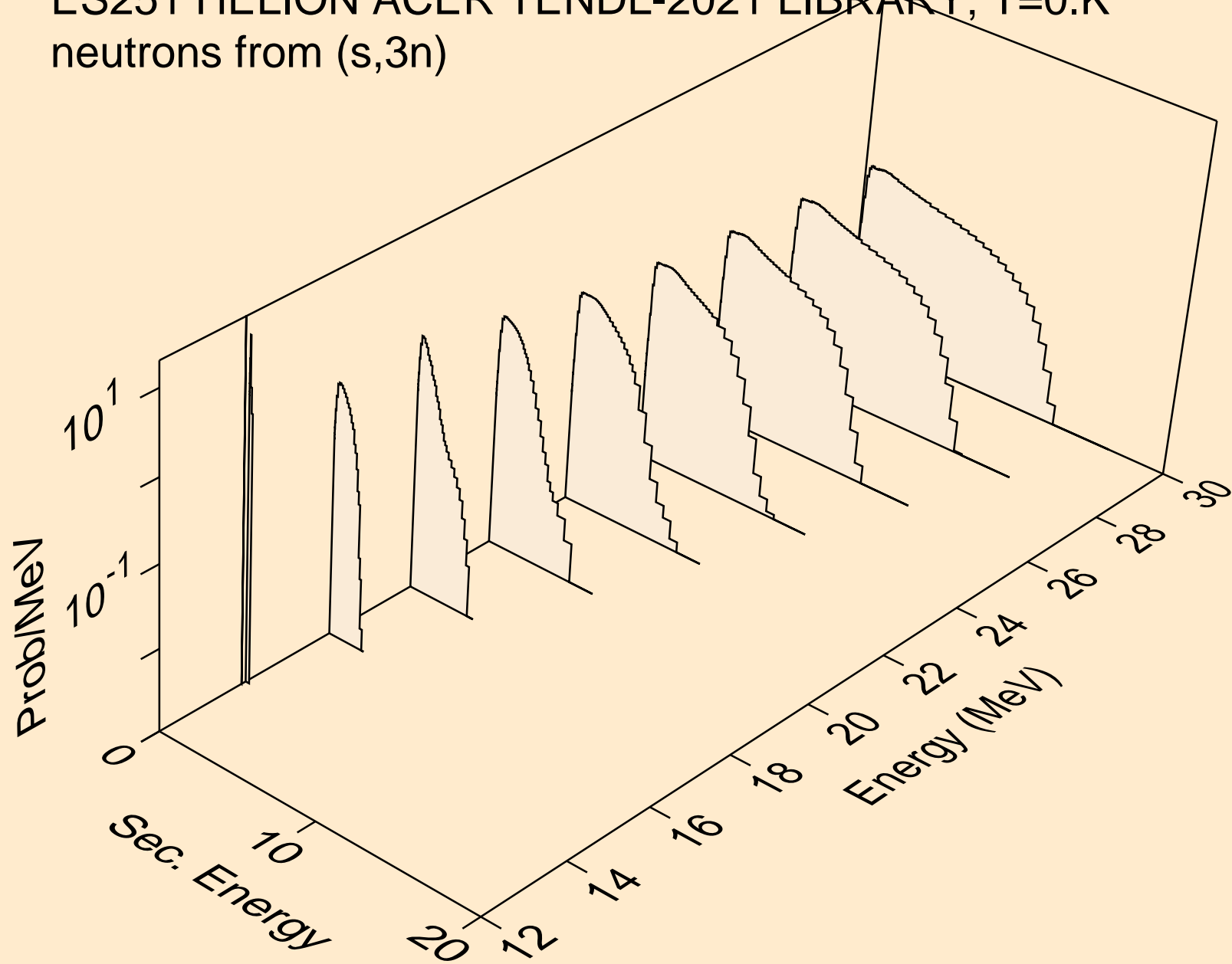

ES251 HELION ACER TENDL-2021 LIBRARY; T=0.K  
neutrons from (s,n\*)a

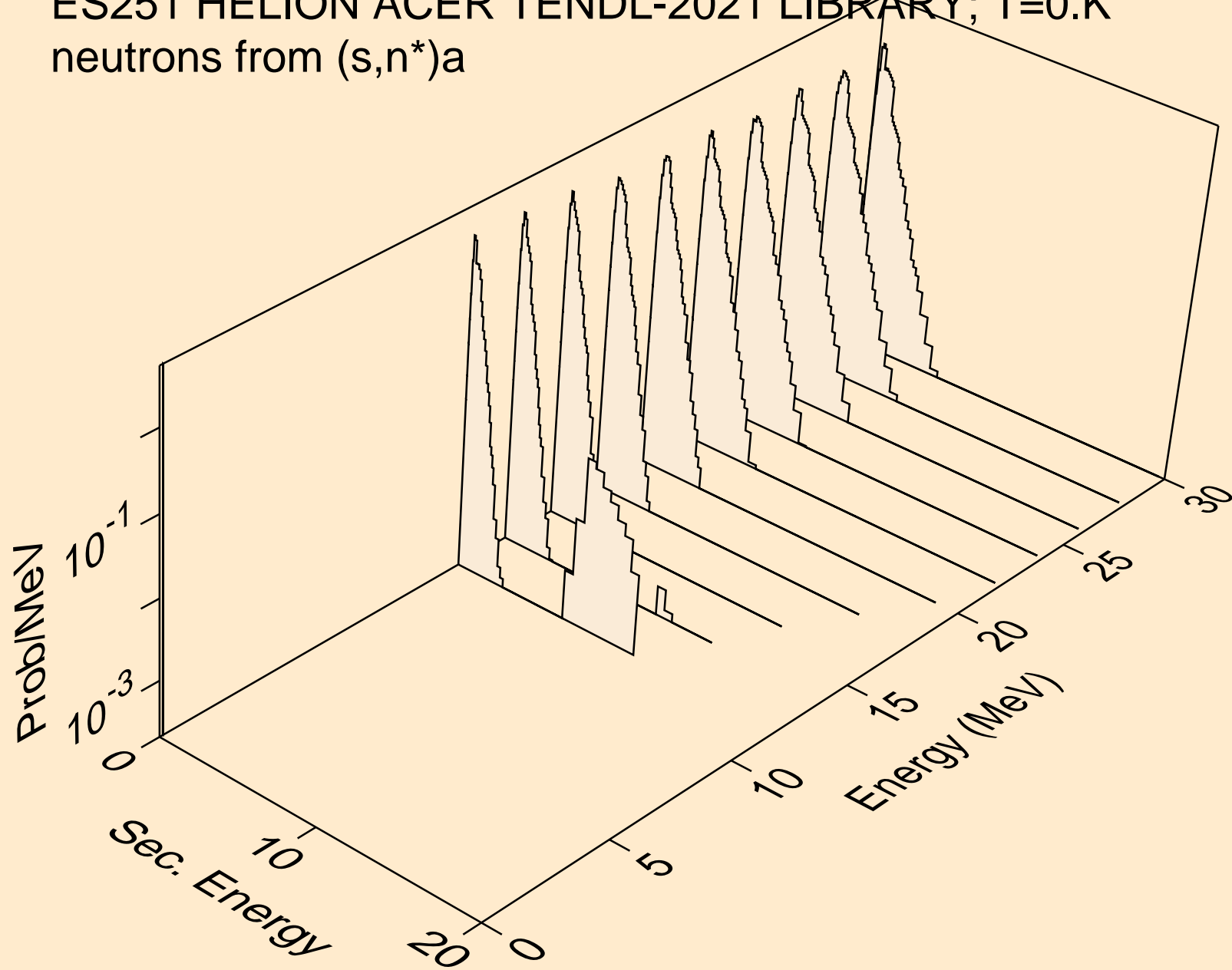

ES251 HELION ACER TENDL-2021 LIBRARY; T=0.K  
neutrons from (s,n\*)p

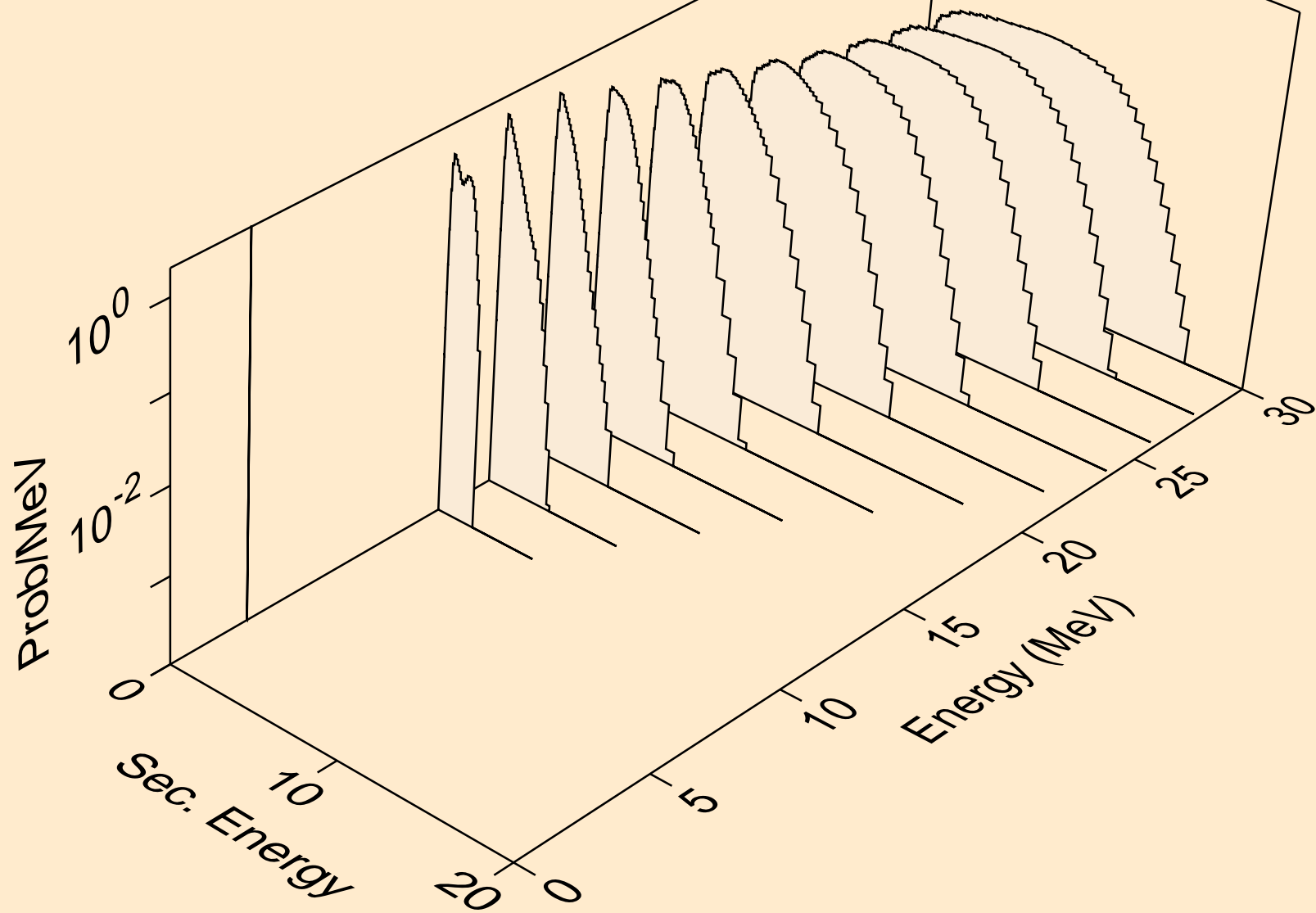

ES251 HELION ACER TENDL-2021 LIBRARY; T=0.K  
neutrons from (s,n\*)d

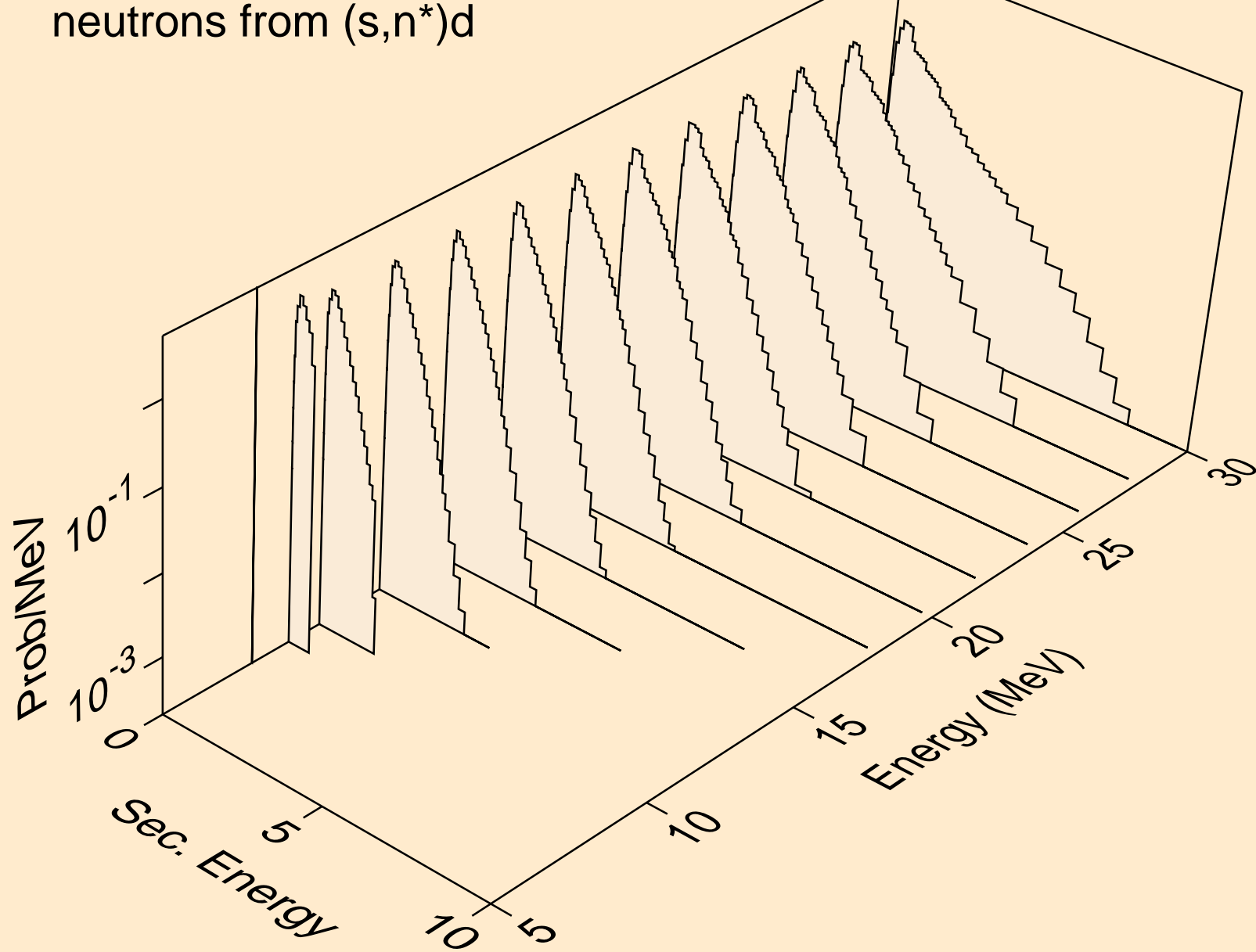

ES251 HELION ACER TENDL-2021 LIBRARY; T=0.K  
neutrons from (s,n\*)t

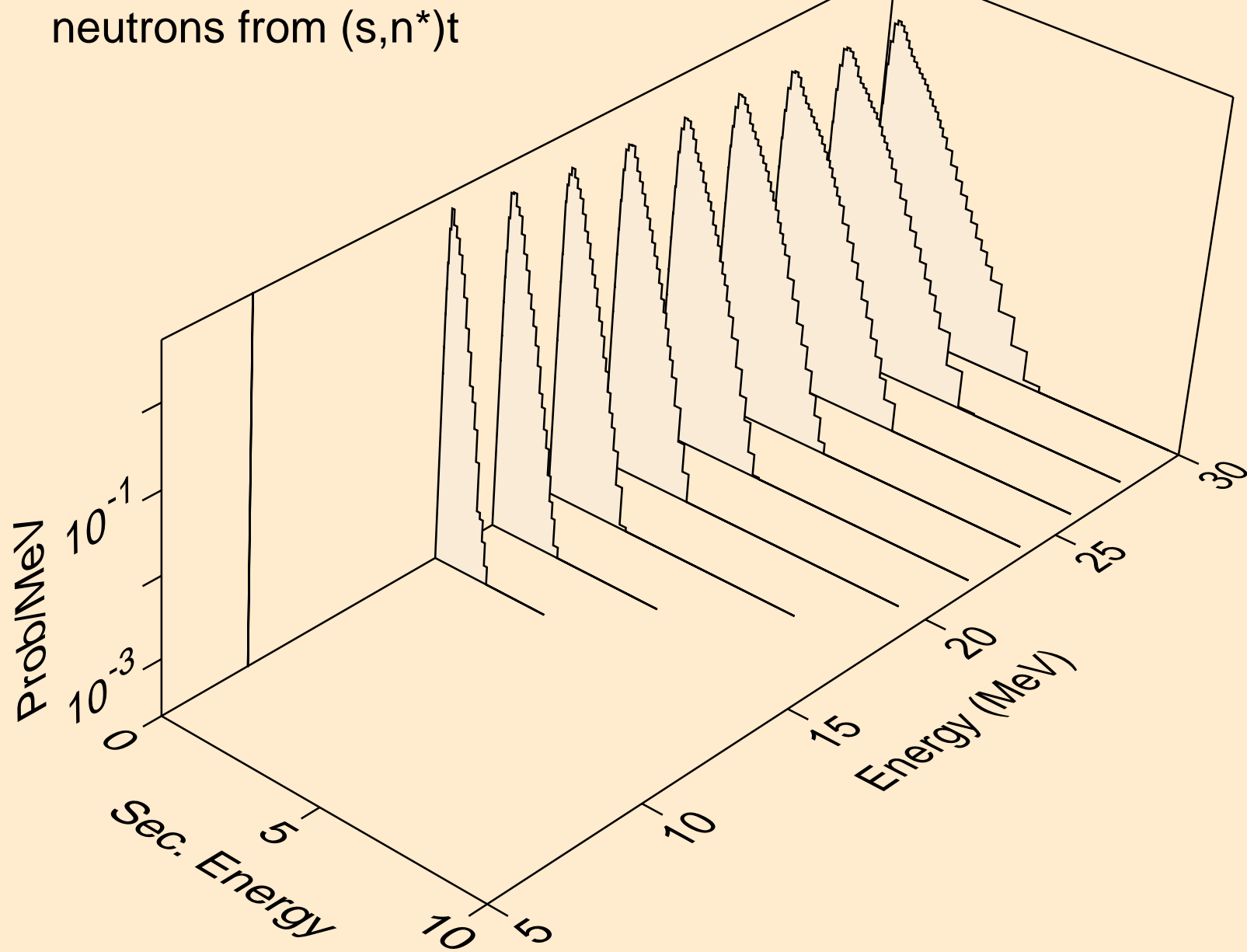



ES251 HELION ACER TENDL-2021 LIBRARY; T=0.K  
neutrons from (s,n\*)he3

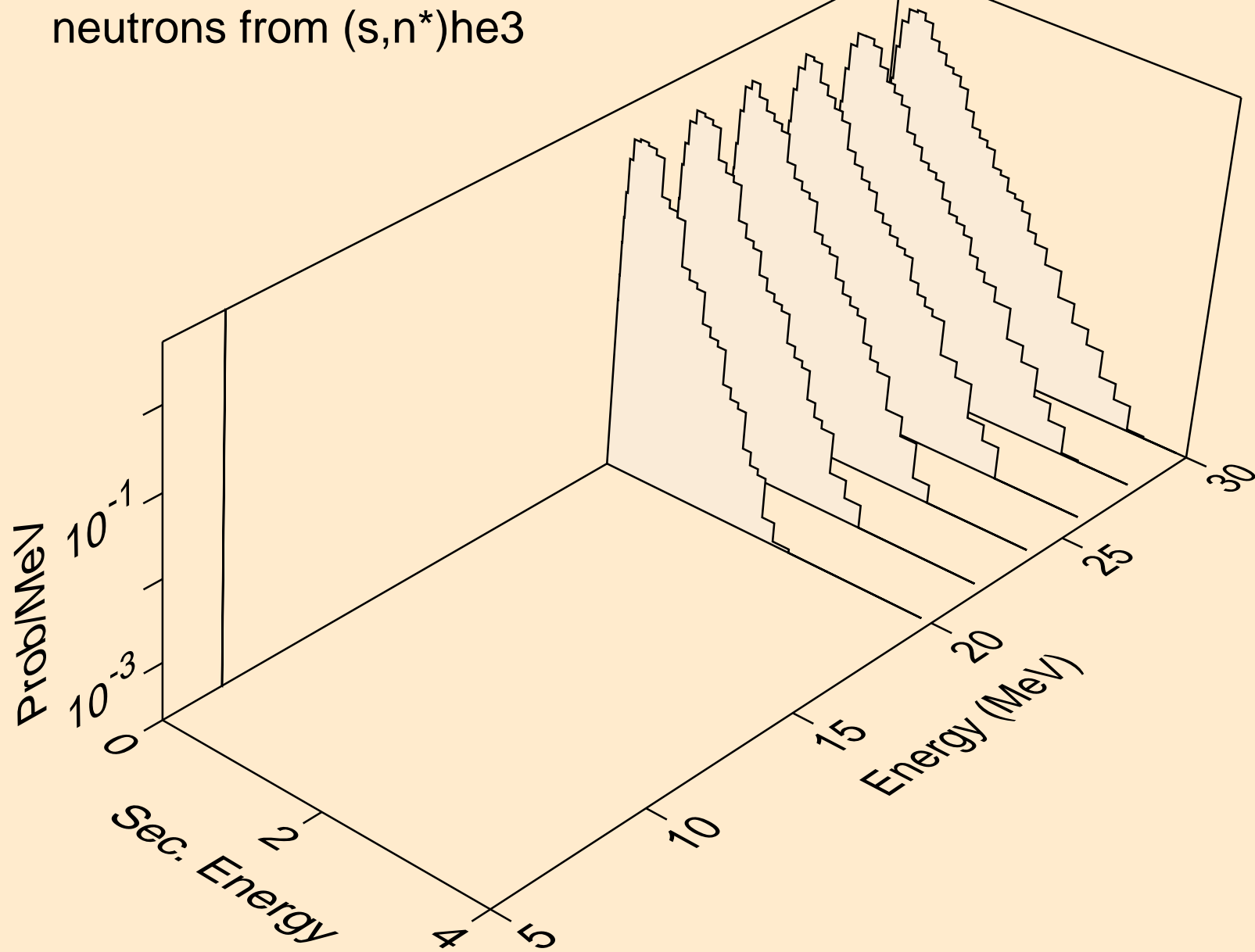

ES251 HELION ACER TENDL-2021 LIBRARY; T=0.K  
neutrons from (s,2np)

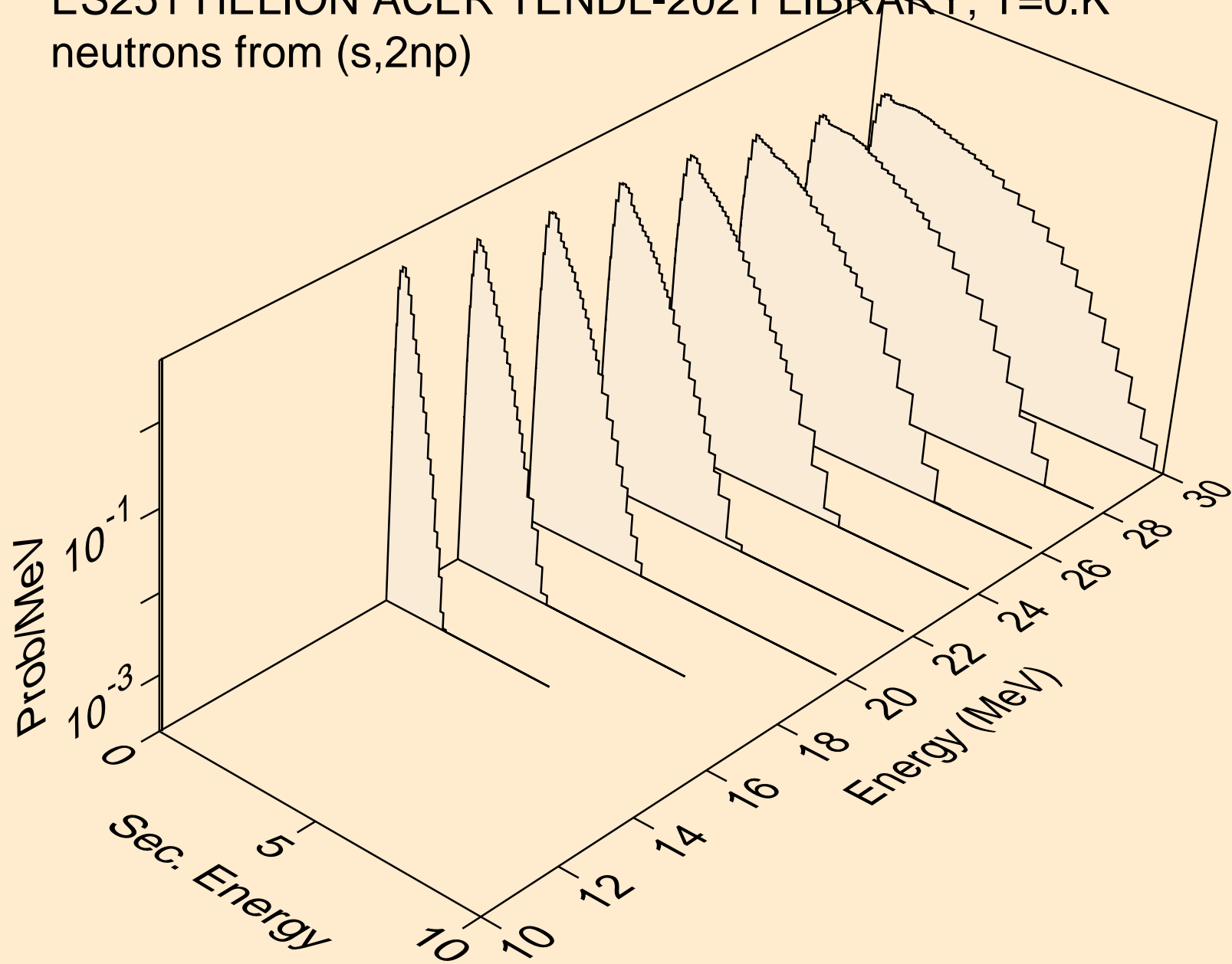

ES251 HELION ACER TENDL-2021 LIBRARY; T=0.K  
protons from (s,x)

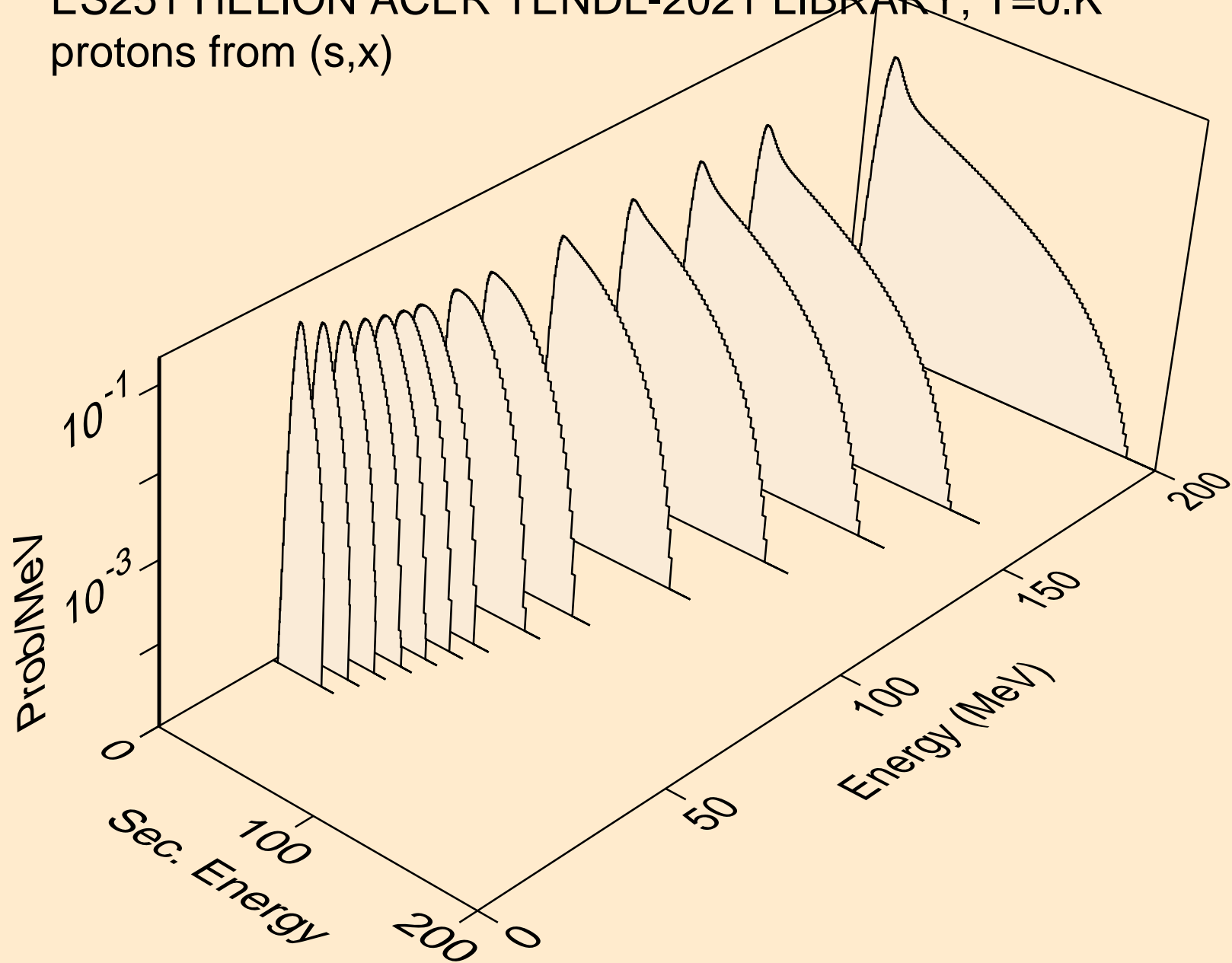

ES251 HELION ACER TENDL-2021 LIBRARY; T=0.K  
protons from (s,n\*)p

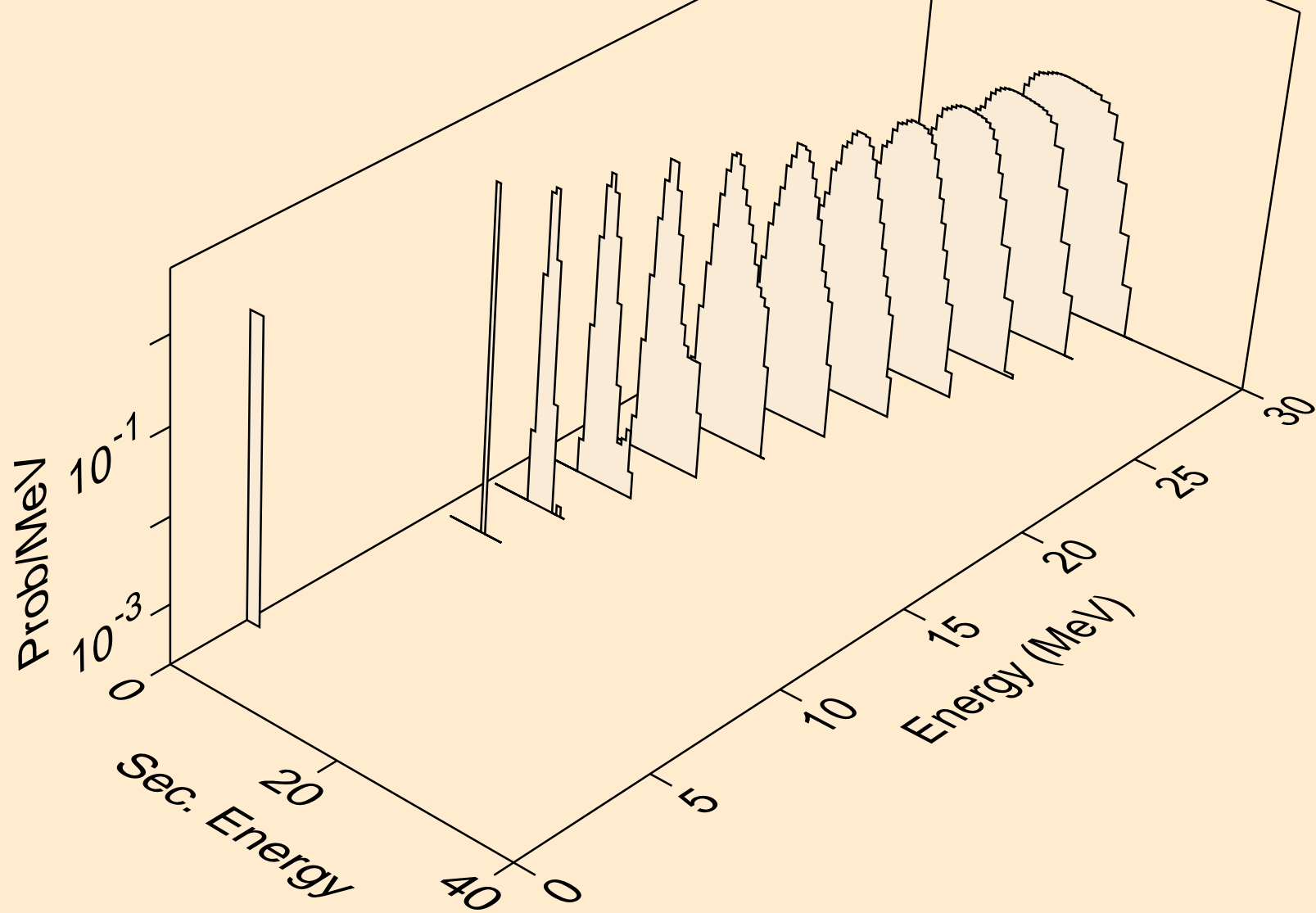

ES251 HELION ACER TENDL-2021 LIBRARY; T=0.K  
protons from (s,2np)

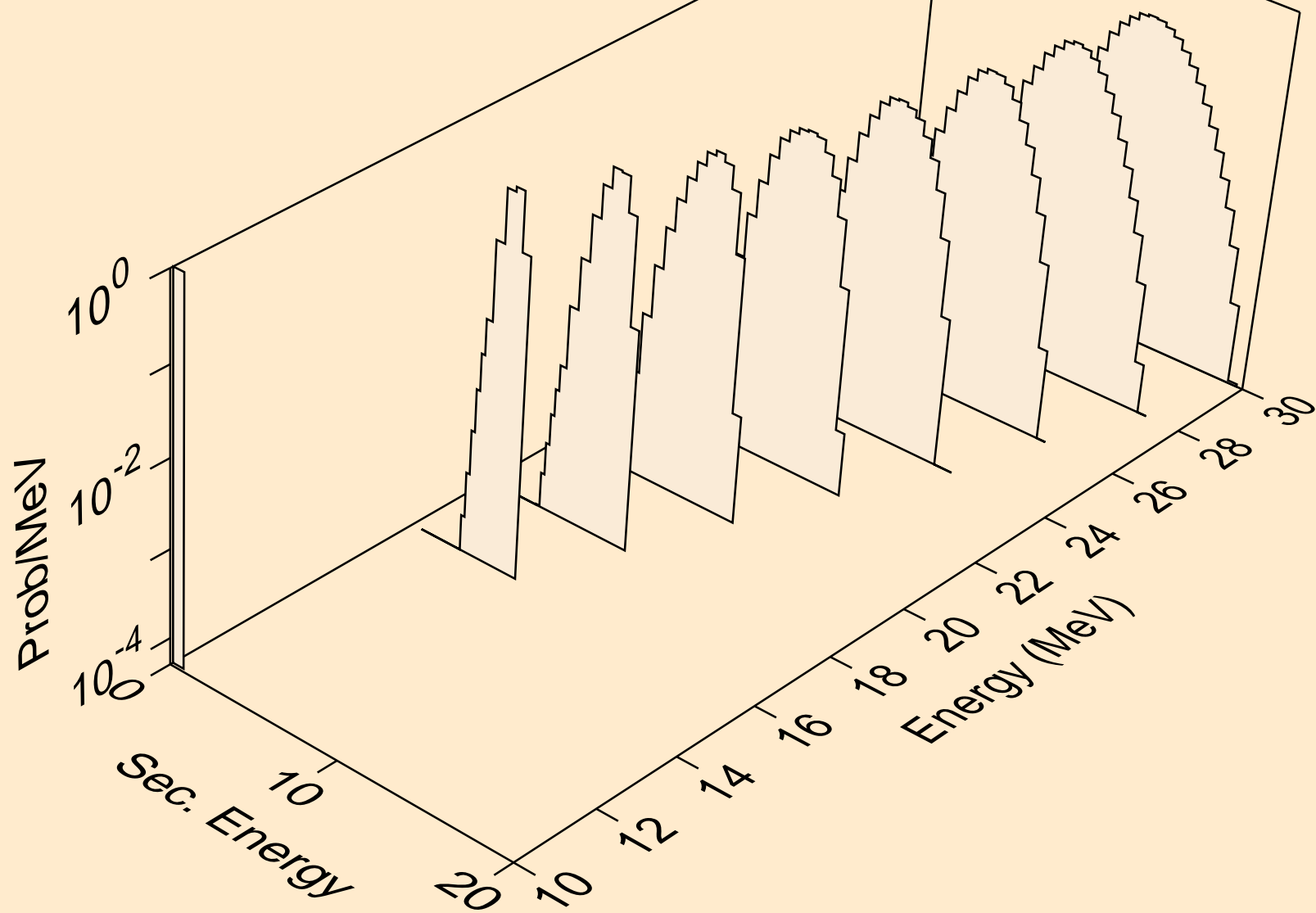

ES251 HELION ACER TENDL-2021 LIBRARY; T=0.K  
protons from (s,p)

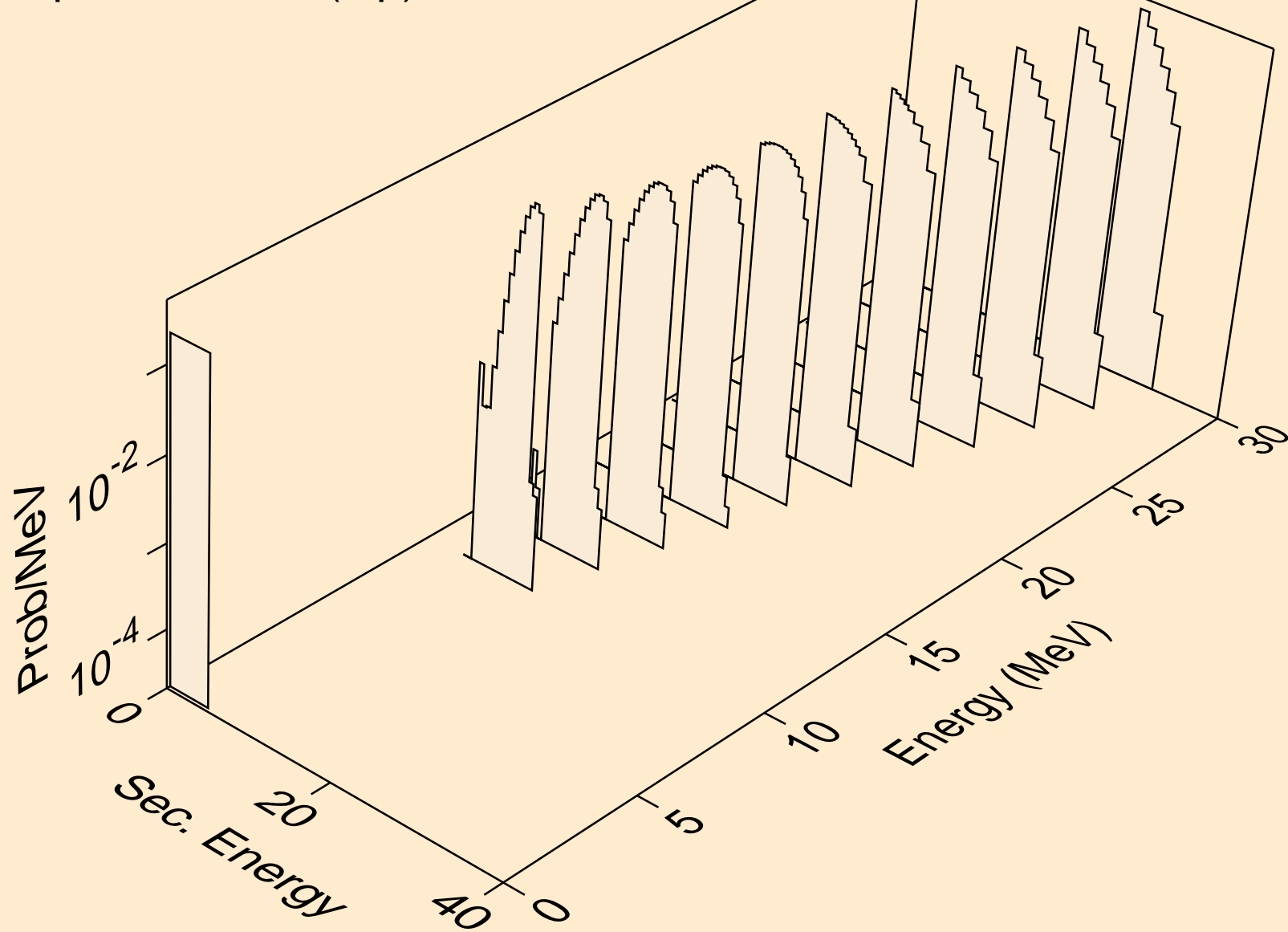

ES251 HELION ACER TENDL-2021 LIBRARY; T=0.K  
protons from (s,2p)

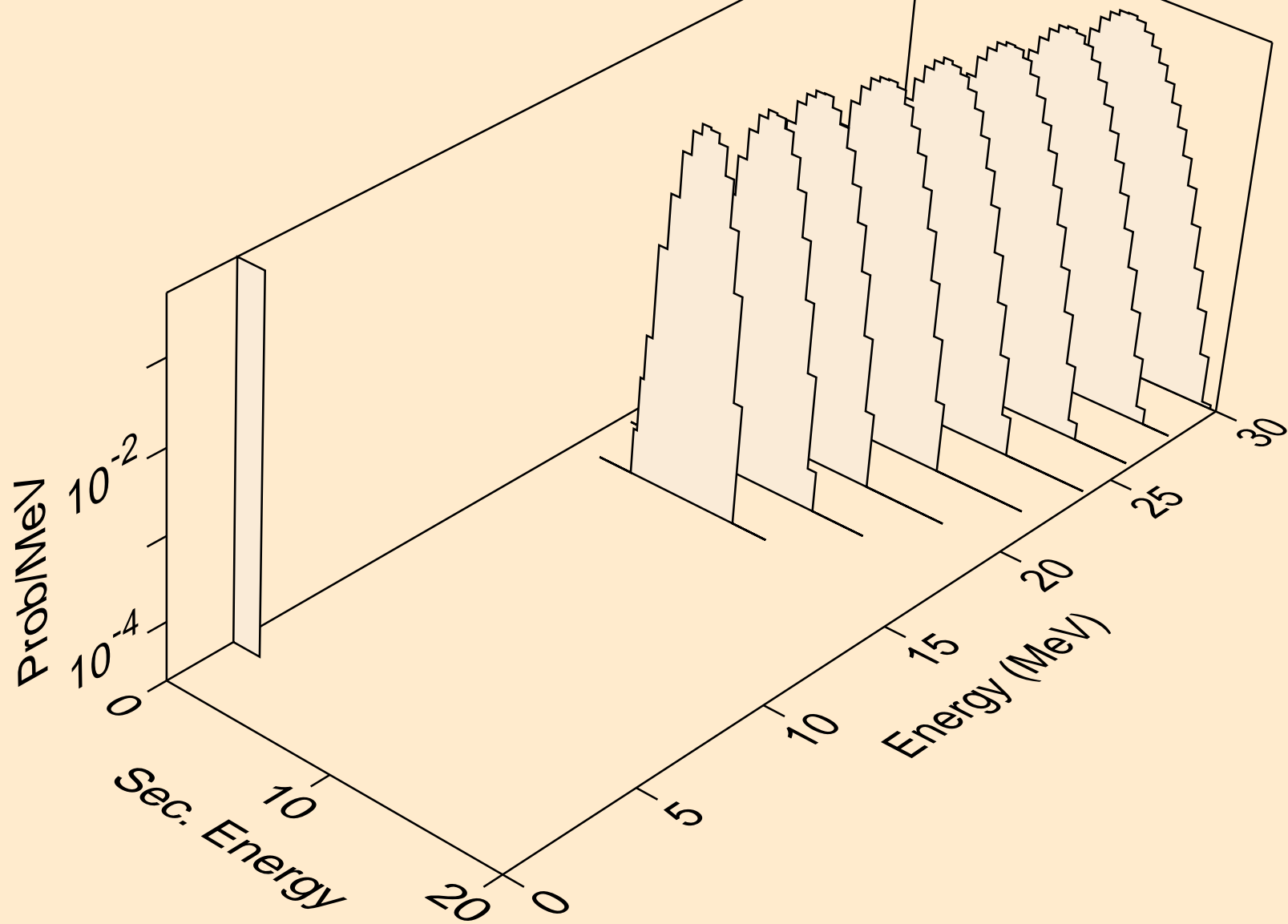

ES251 HELION ACER TENDL-2021 LIBRARY; T=0.K  
deuterons from (s,x)

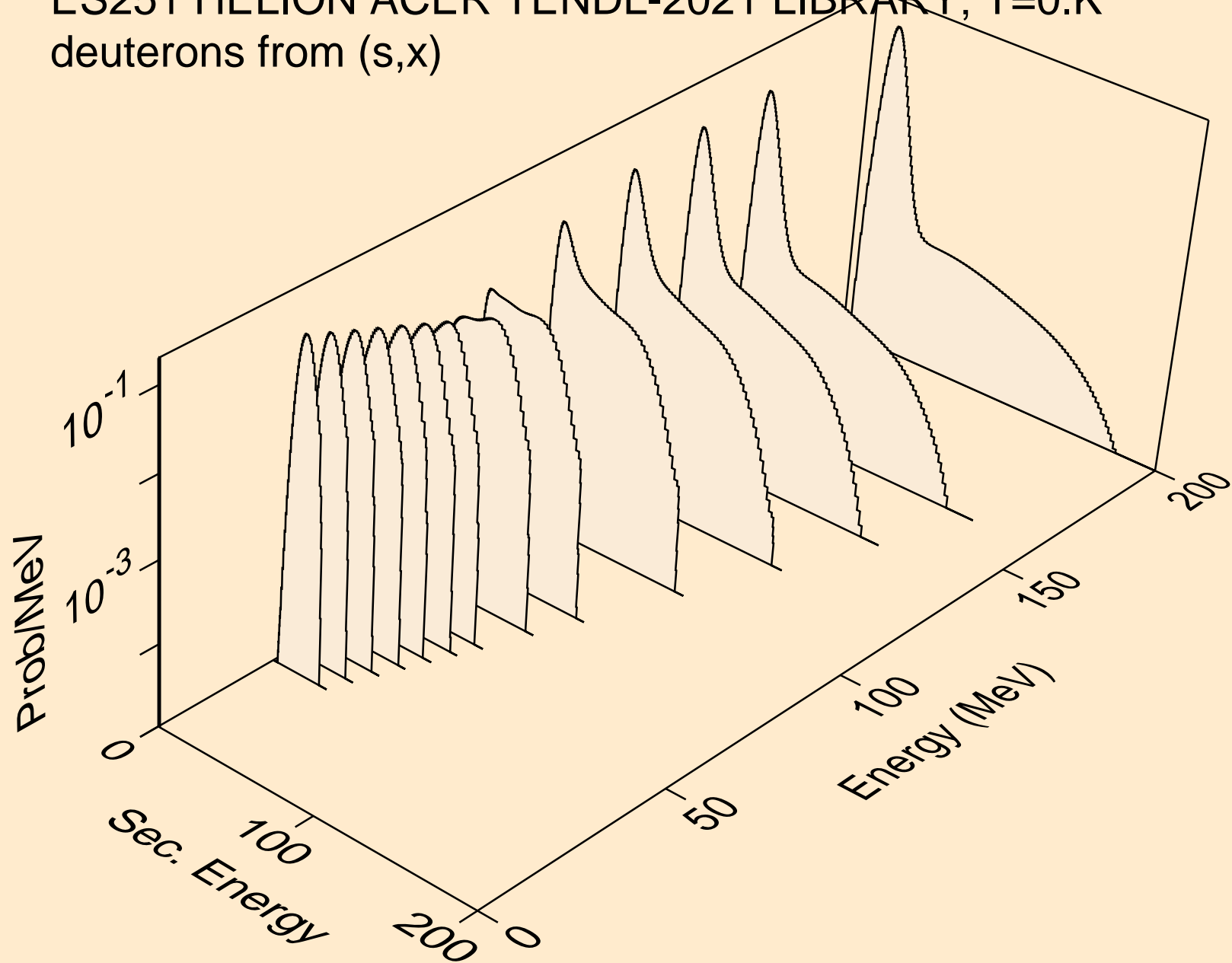



ES251 HELION ACER TENDL-2021 LIBRARY; T=0.K  
deuterons from (s,n\*)d

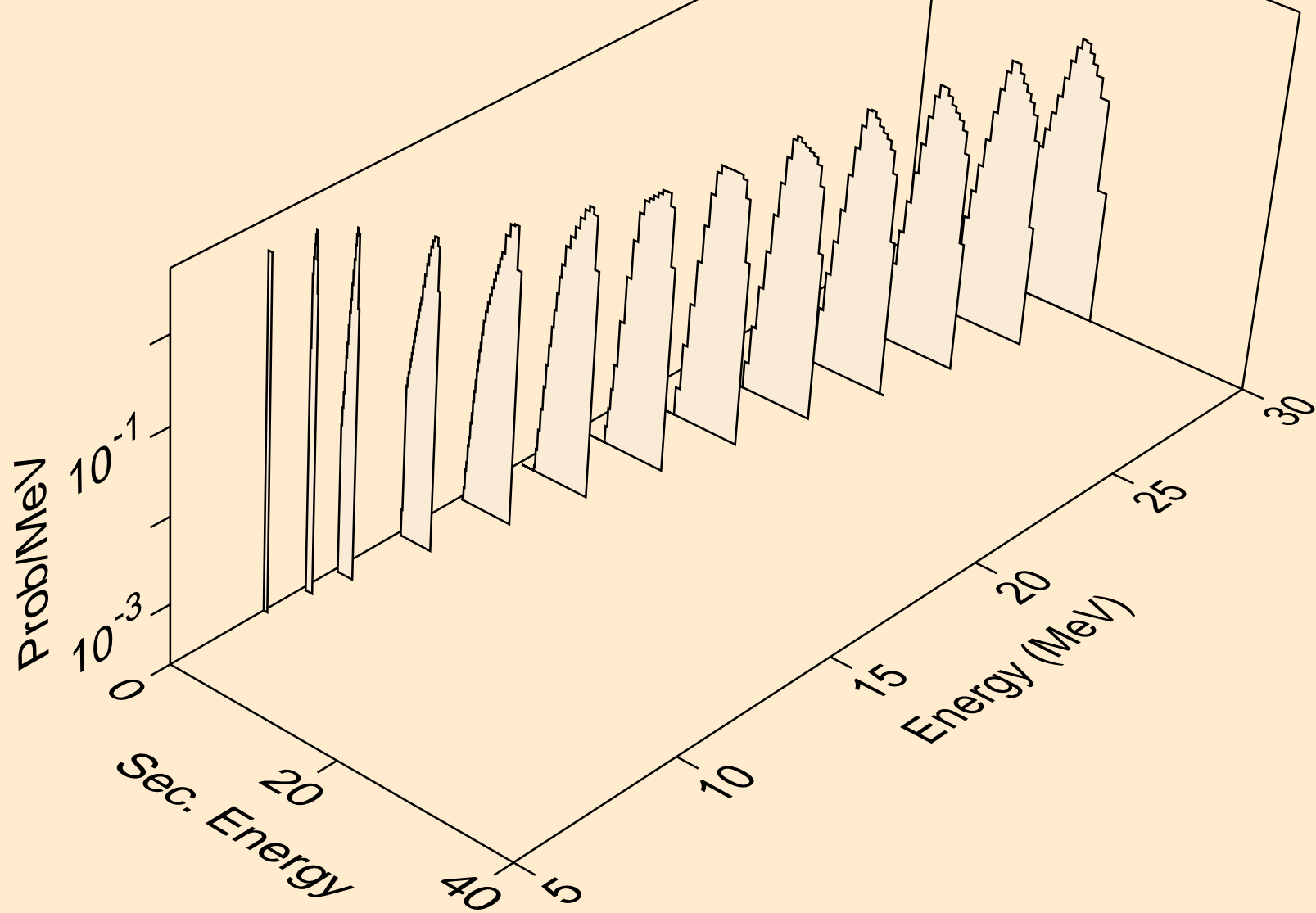

ES251 HELION ACER TENDL-2021 LIBRARY; T=0.K  
deuterons from (s,d)

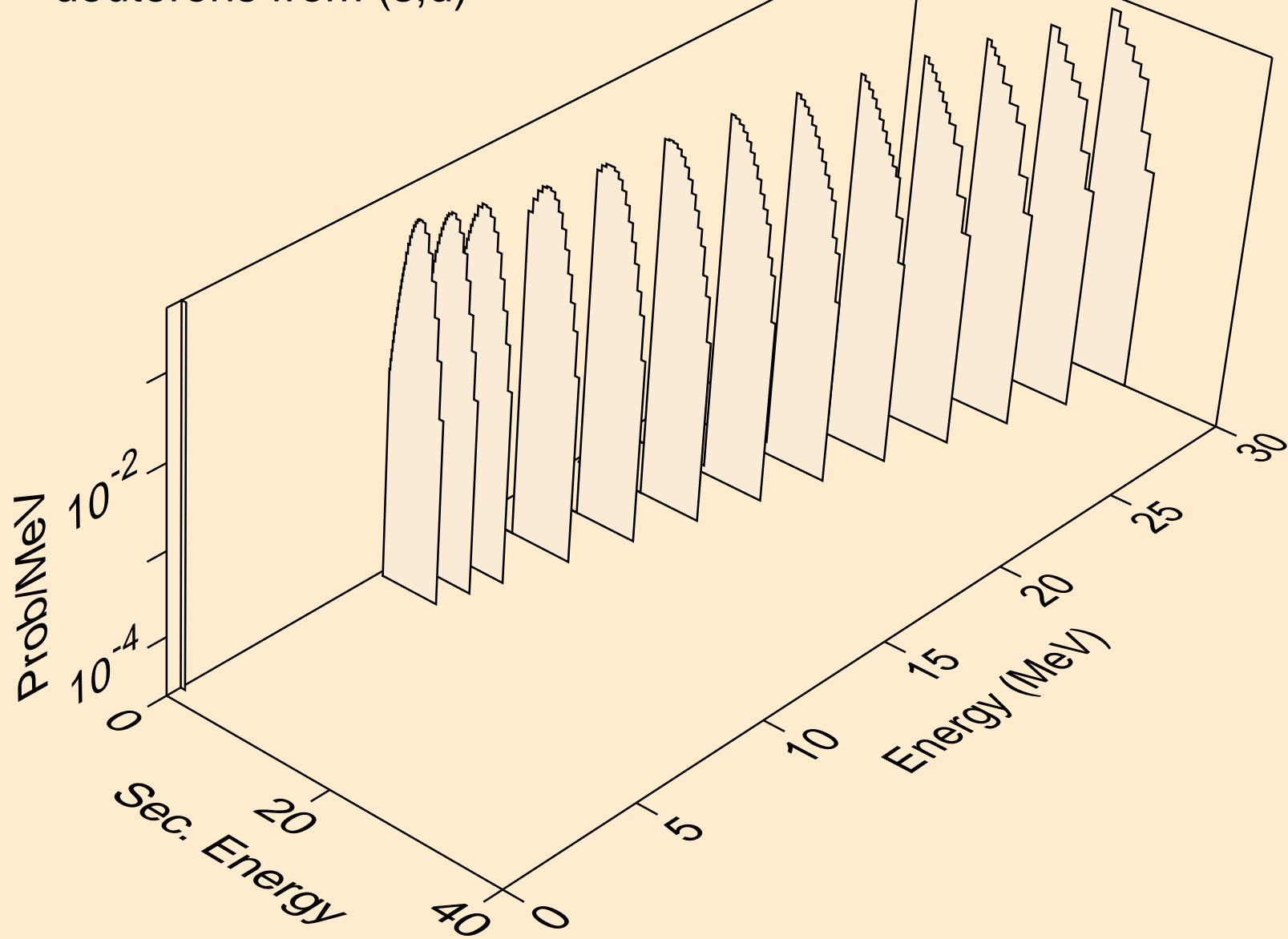

ES251 HELION ACER TENDL-2021 LIBRARY; T=0.K  
tritons from (s,x)

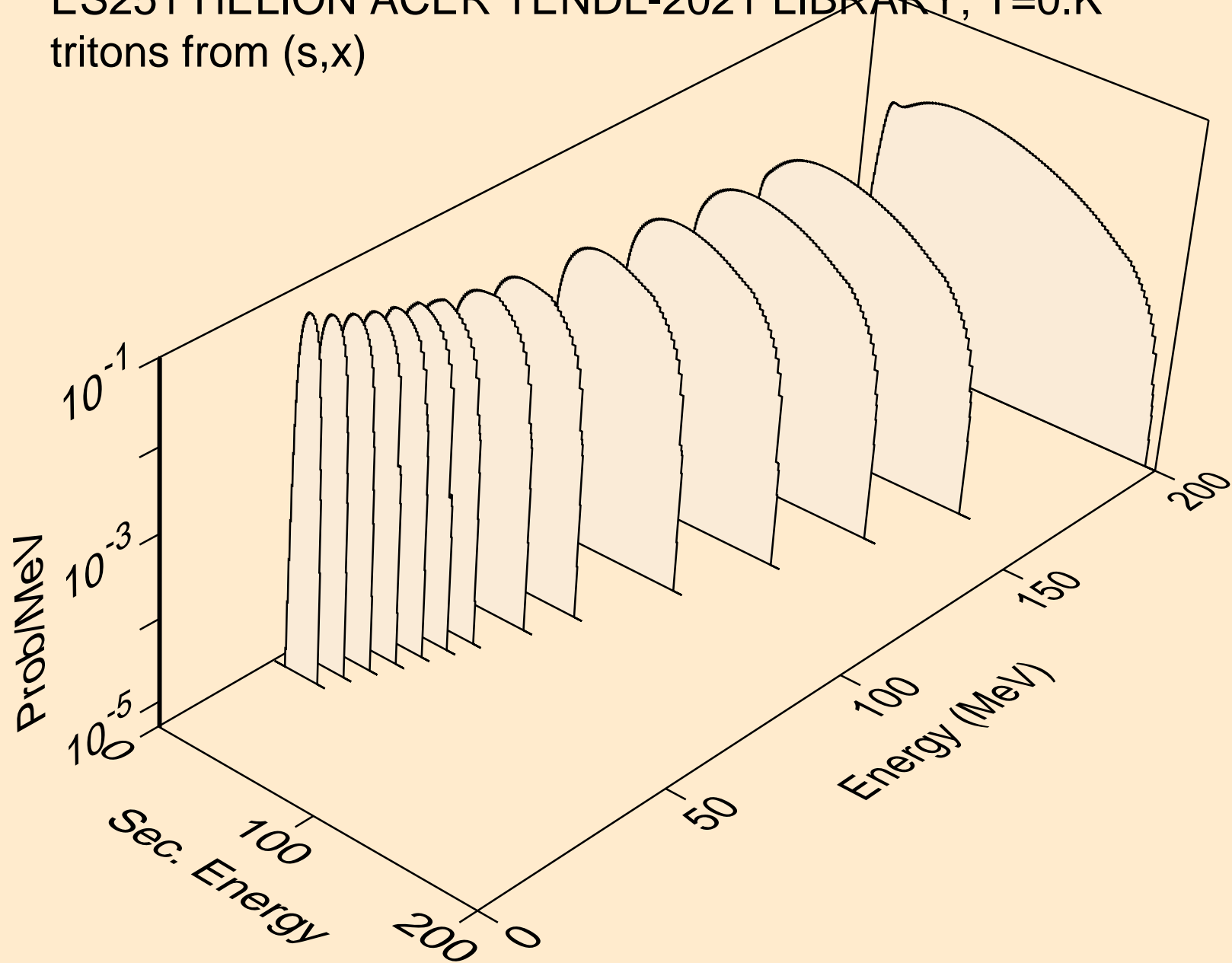

ES251 HELION ACER TENDL-2021 LIBRARY; T=0.K  
tritons from (s,n\*)t

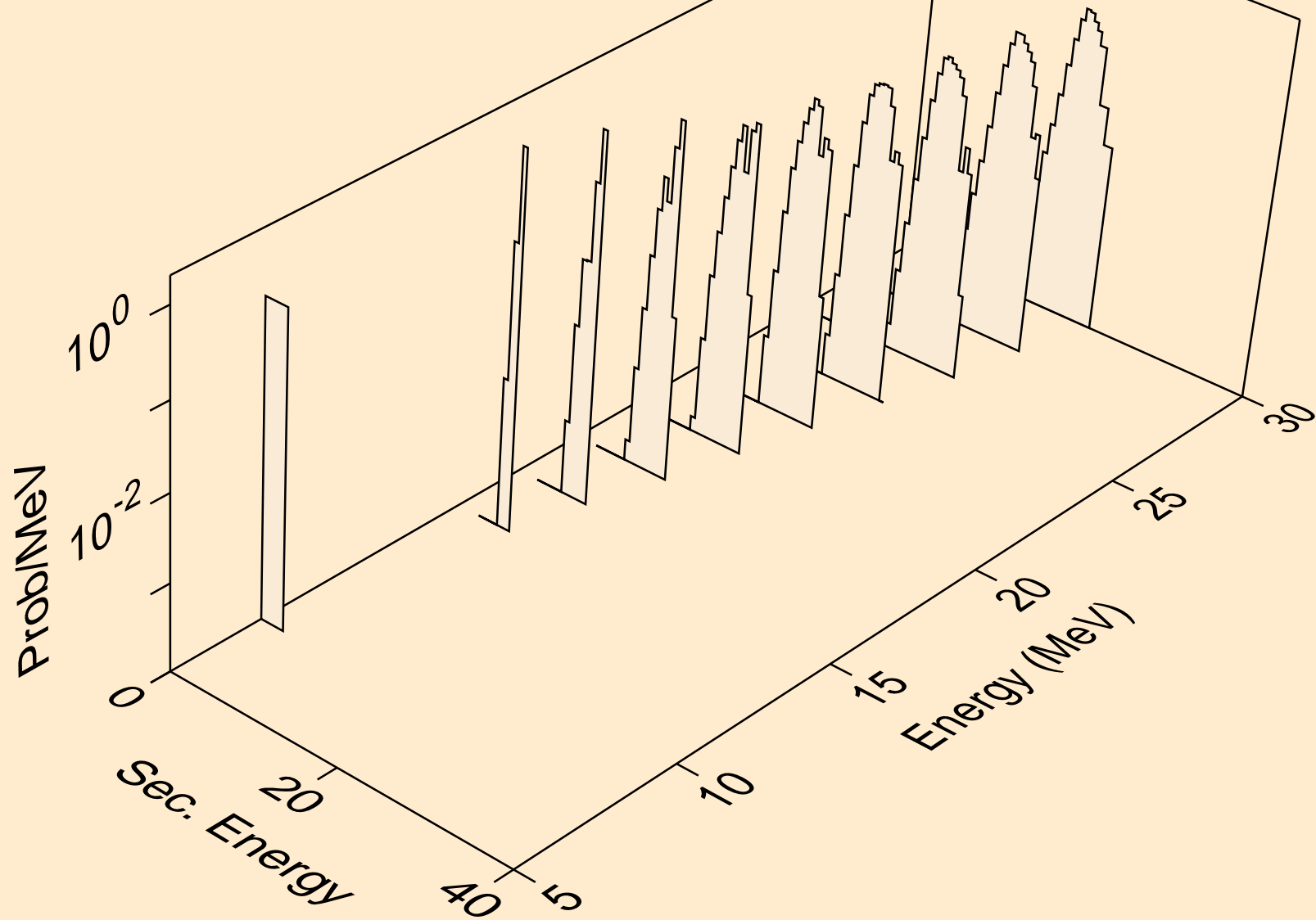

ES251 HELION ACER TENDL-2021 LIBRARY; T=0.K  
tritons from (s,t)

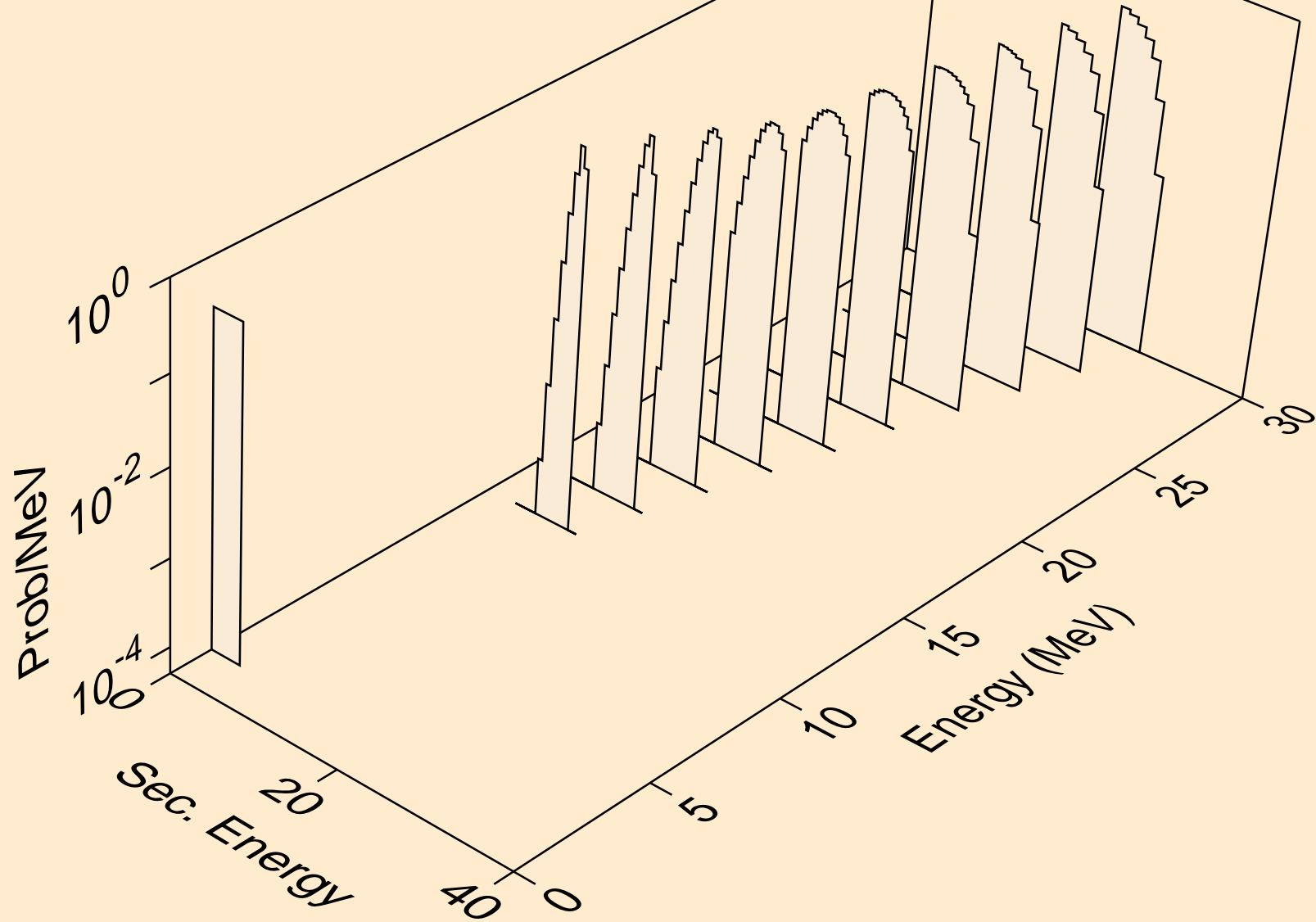

ES251 HELION ACER TENDL-2021 LIBRARY; T=0.K  
alphas from (s,x)

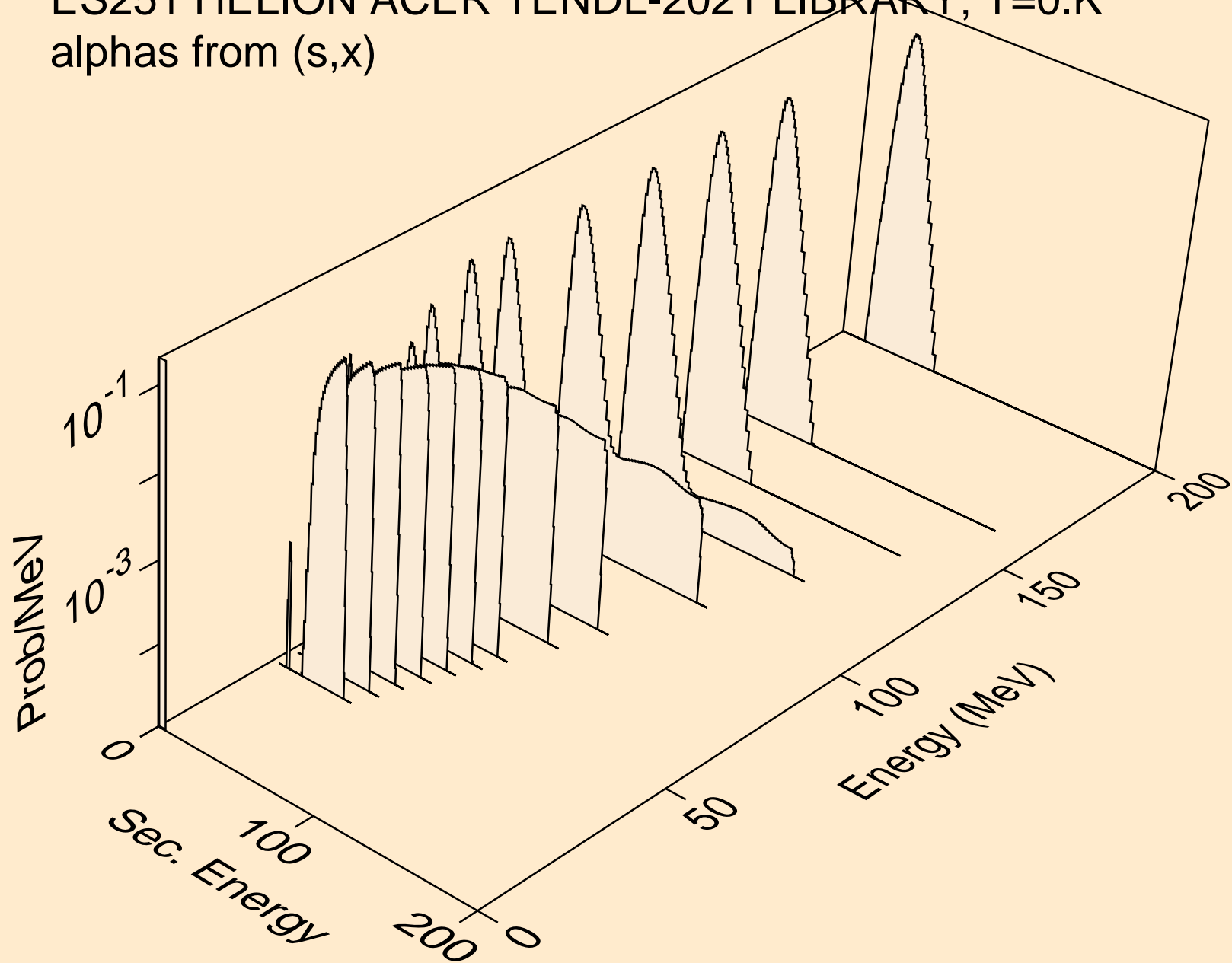

ES251 HELION ACER TENDL-2021 LIBRARY; T=0.K  
alphas from (s,n\*)a

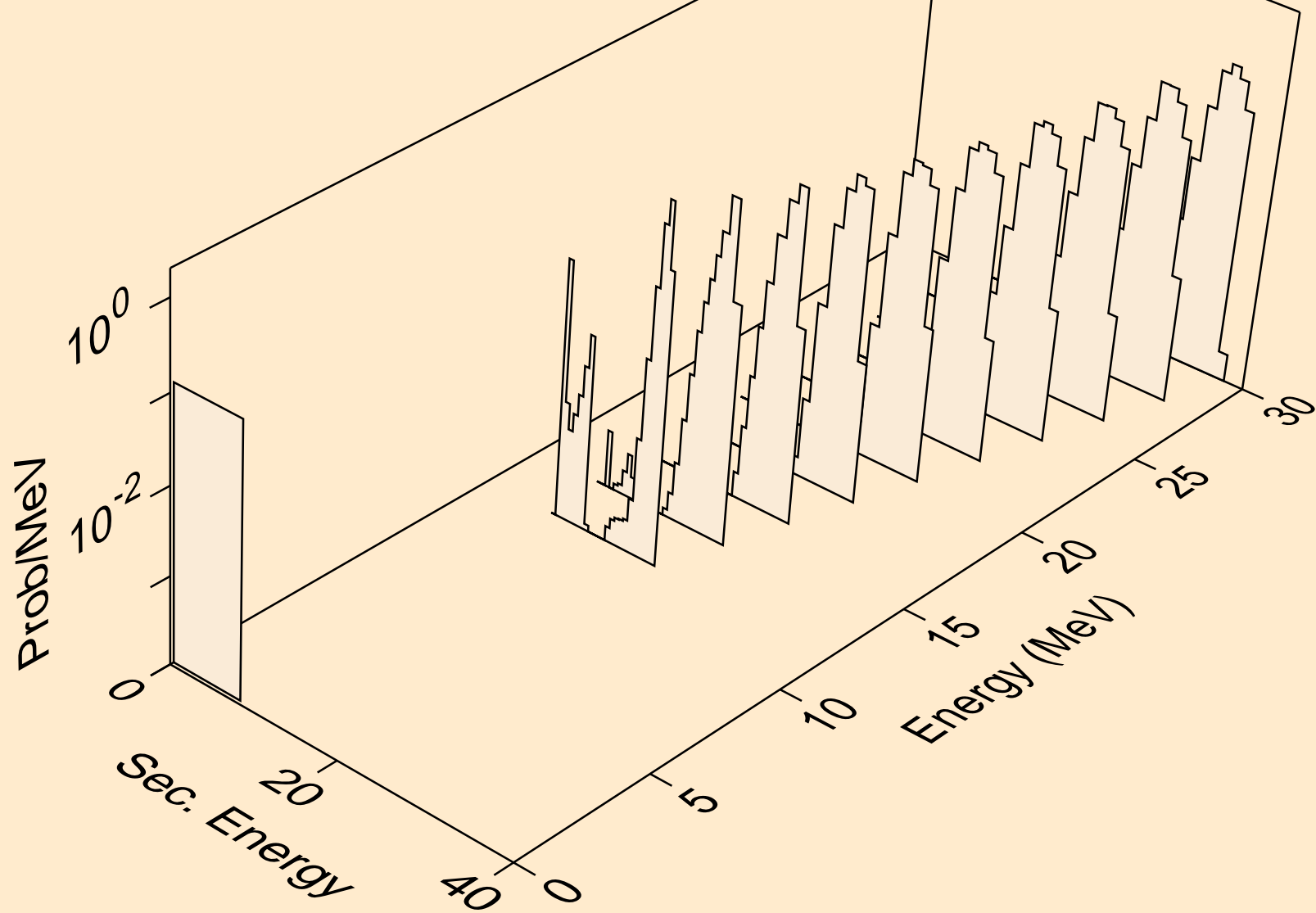

ES251 HELION ACER TENDL-2021 LIBRARY; T=0.K  
alphas from (s,a)

