

FM254 HELION ACER TENDL-2021 LIBRARY; T=0.K
Principal cross sections

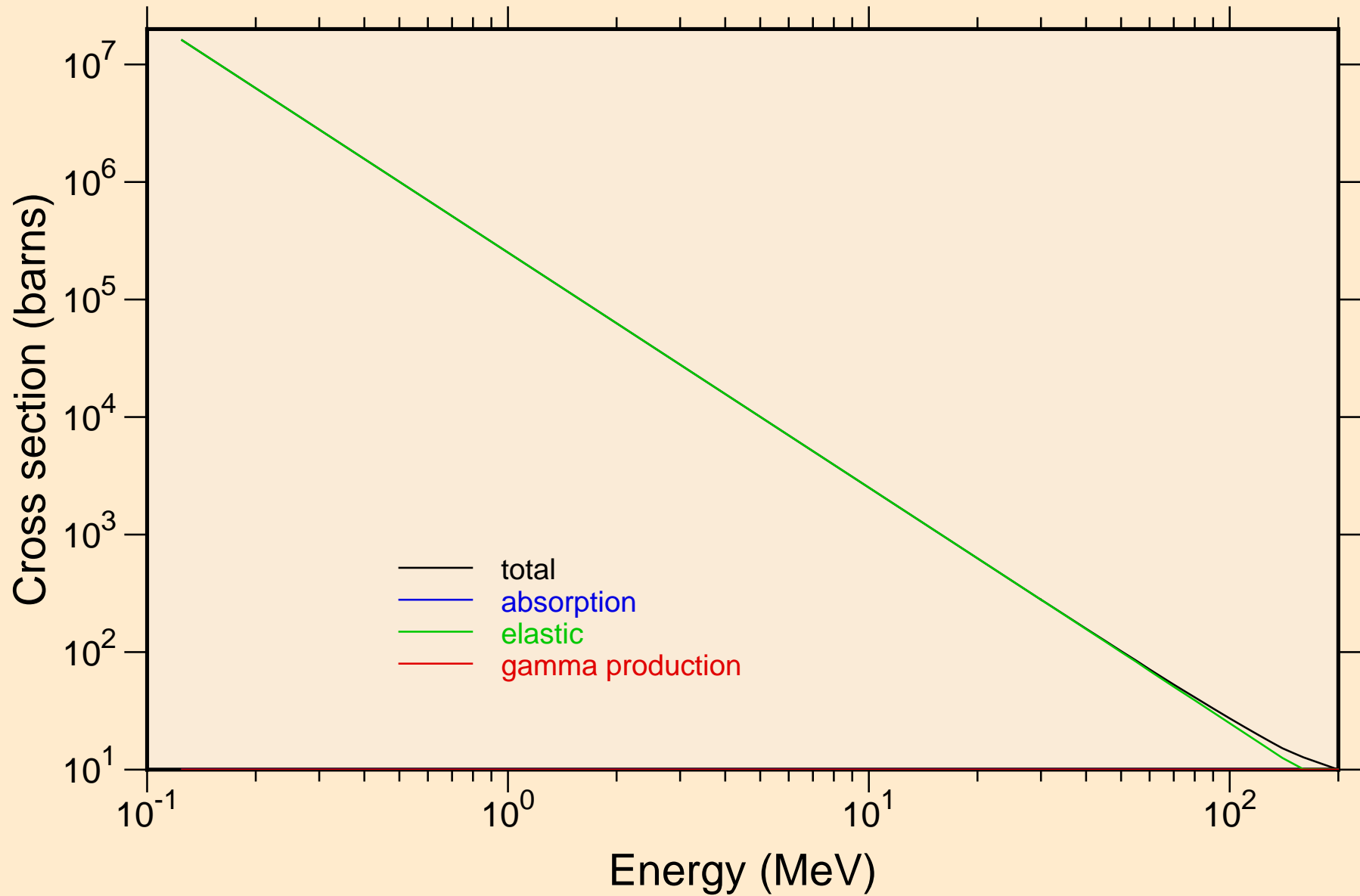

FM254 HELION ACER TENDL-2021 LIBRARY; T=0.K

Heating

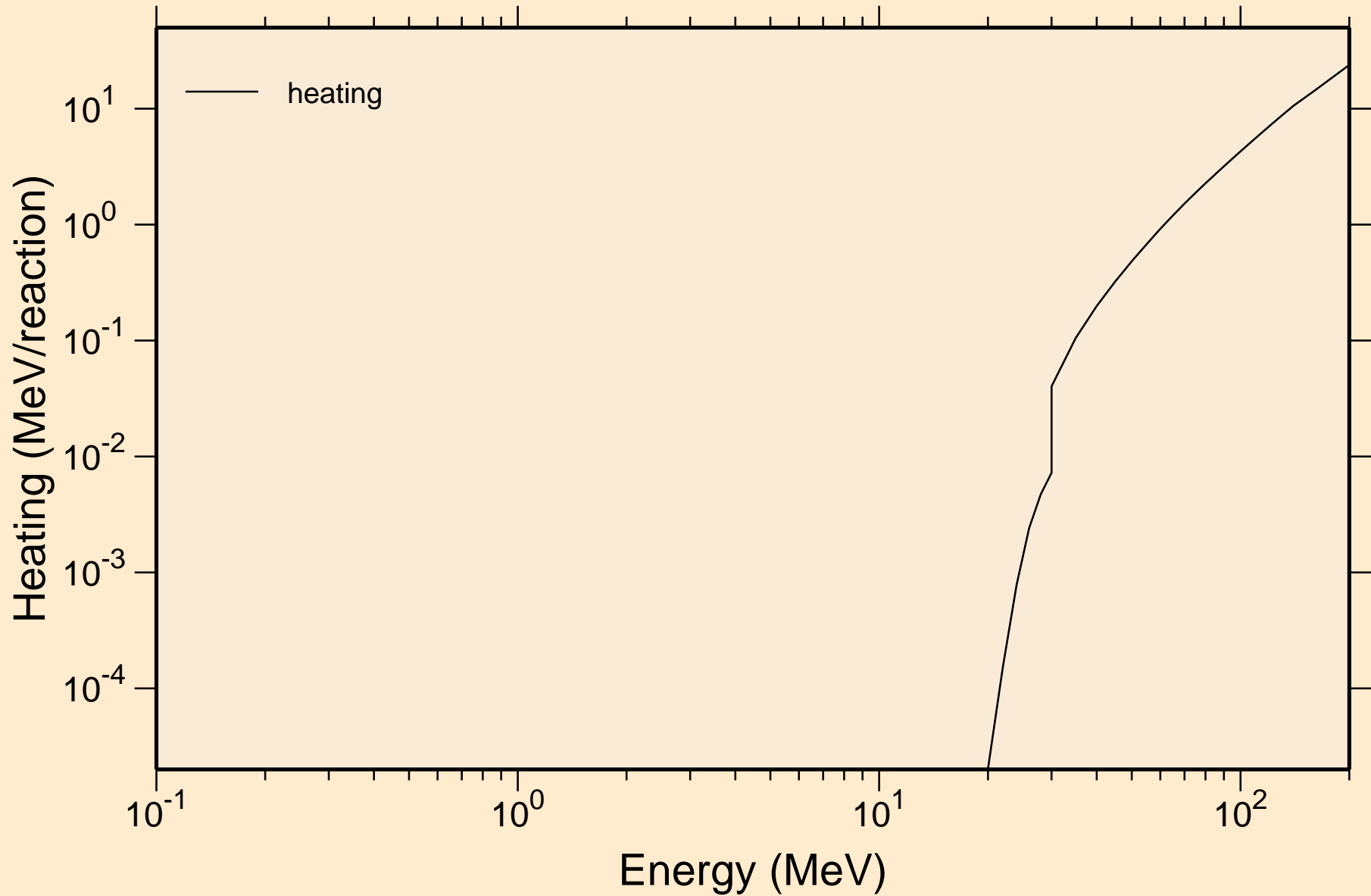

FM254 HELION ACER TENDL-2021 LIBRARY; T=0.K

Principal cross sections

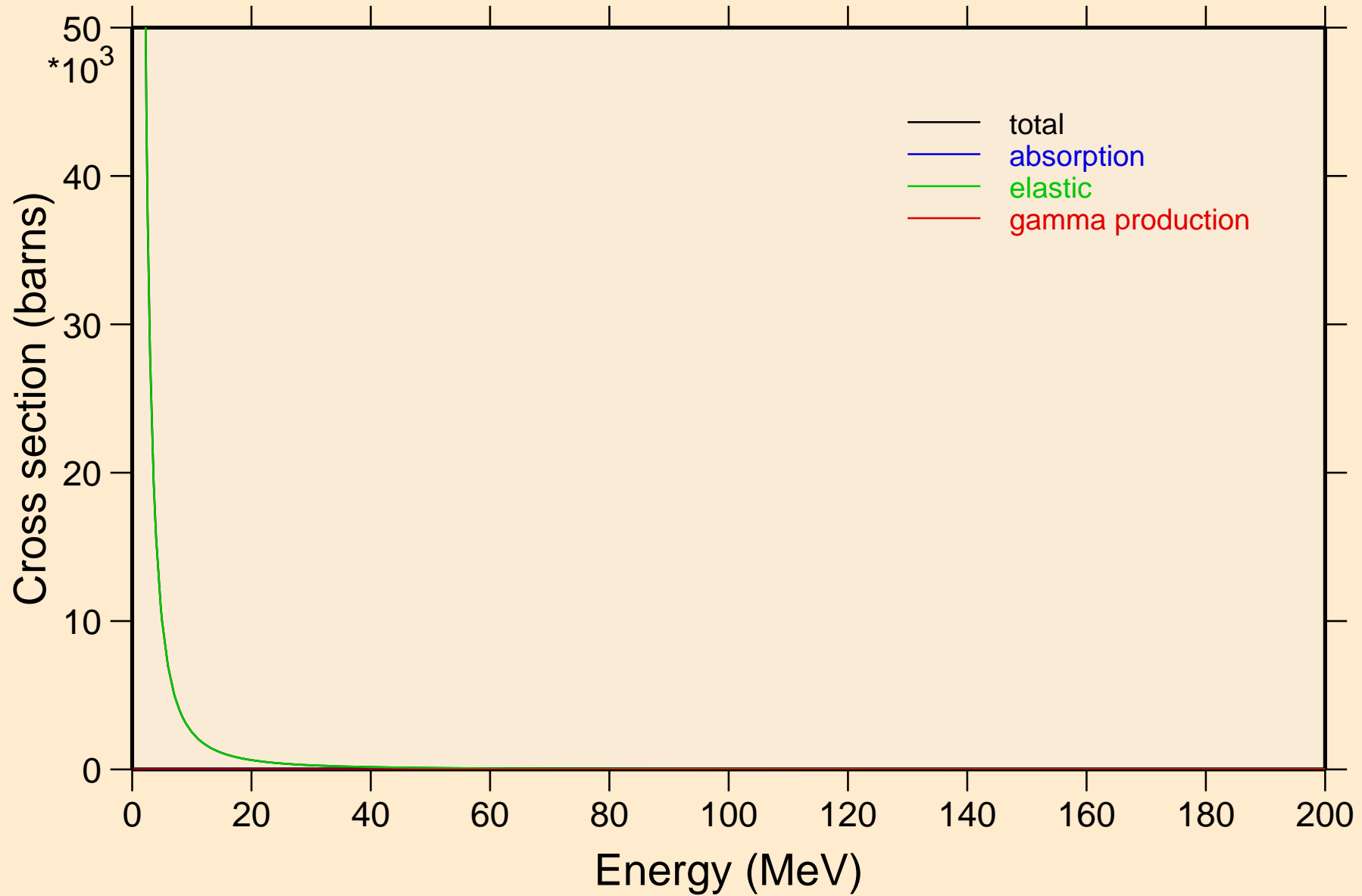

FM254 HELION ACER TENDL-2021 LIBRARY; T=0.K

Heating

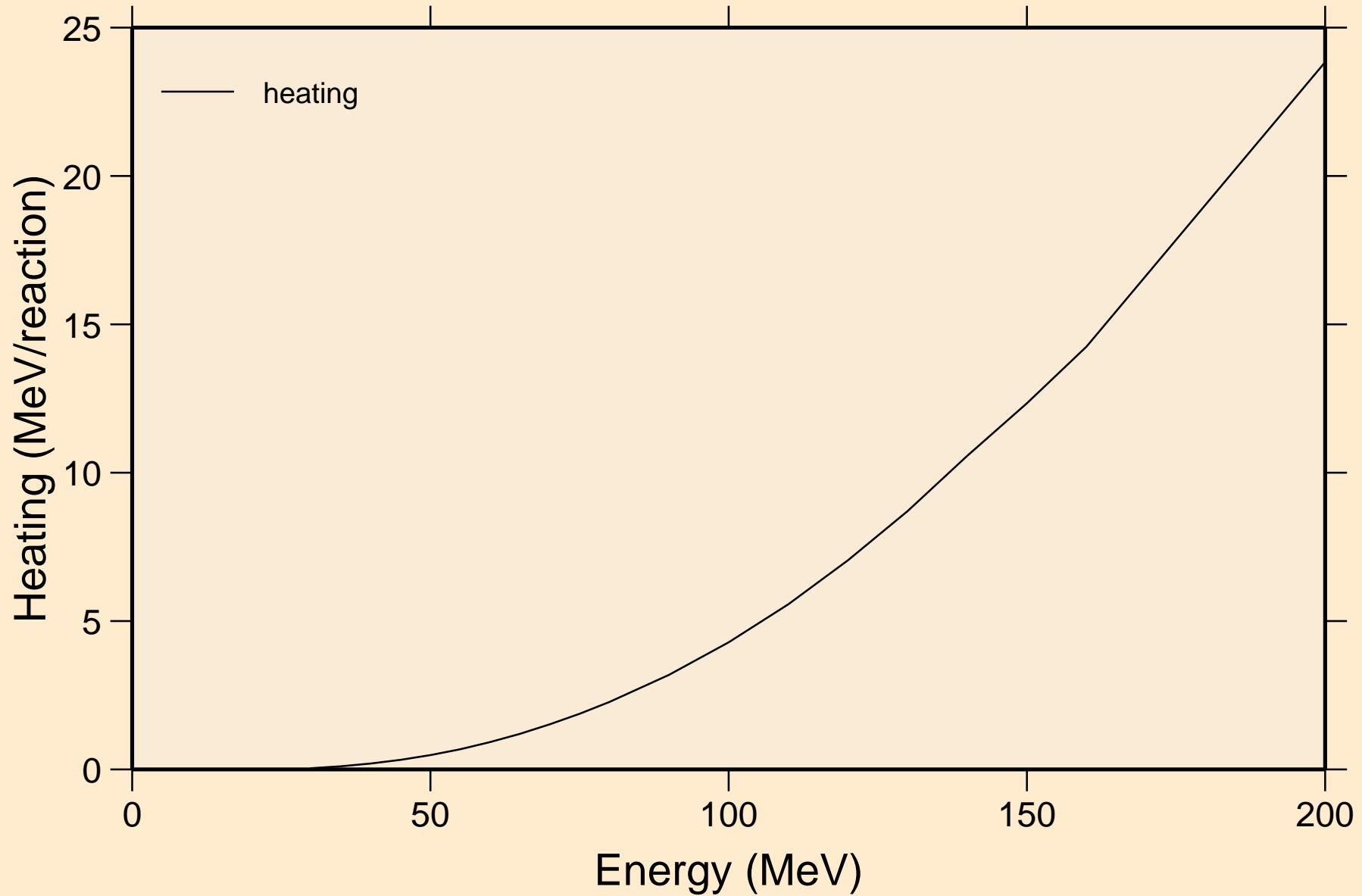

FM254 HELION ACER TENDL-2021 LIBRARY; T=0.K
Threshold reactions

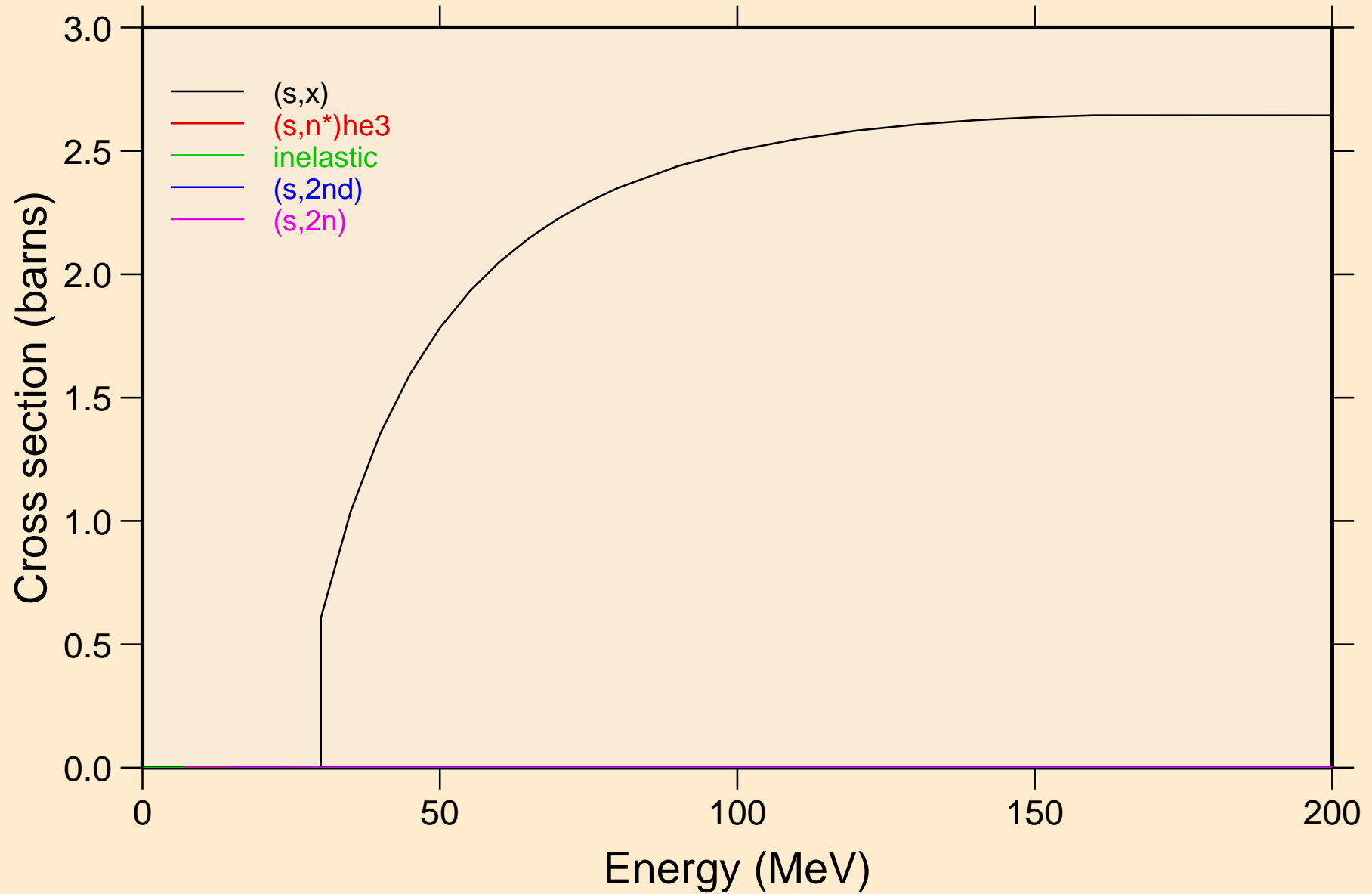

FM254 HELION ACER TENDL-2021 LIBRARY; T=0.K
Threshold reactions

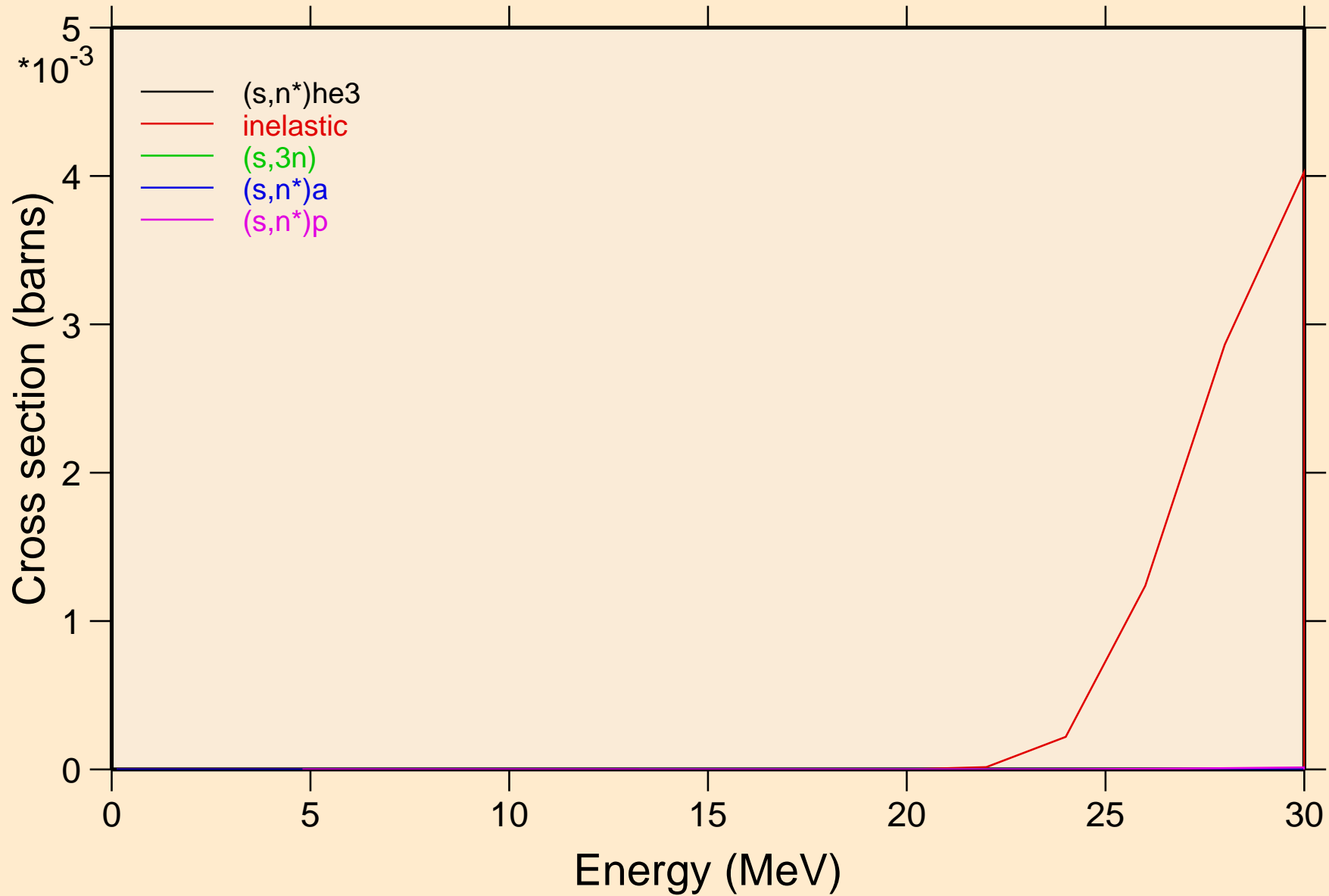

FM254 HELION ACER TENDL-2021 LIBRARY; T=0.K
Threshold reactions

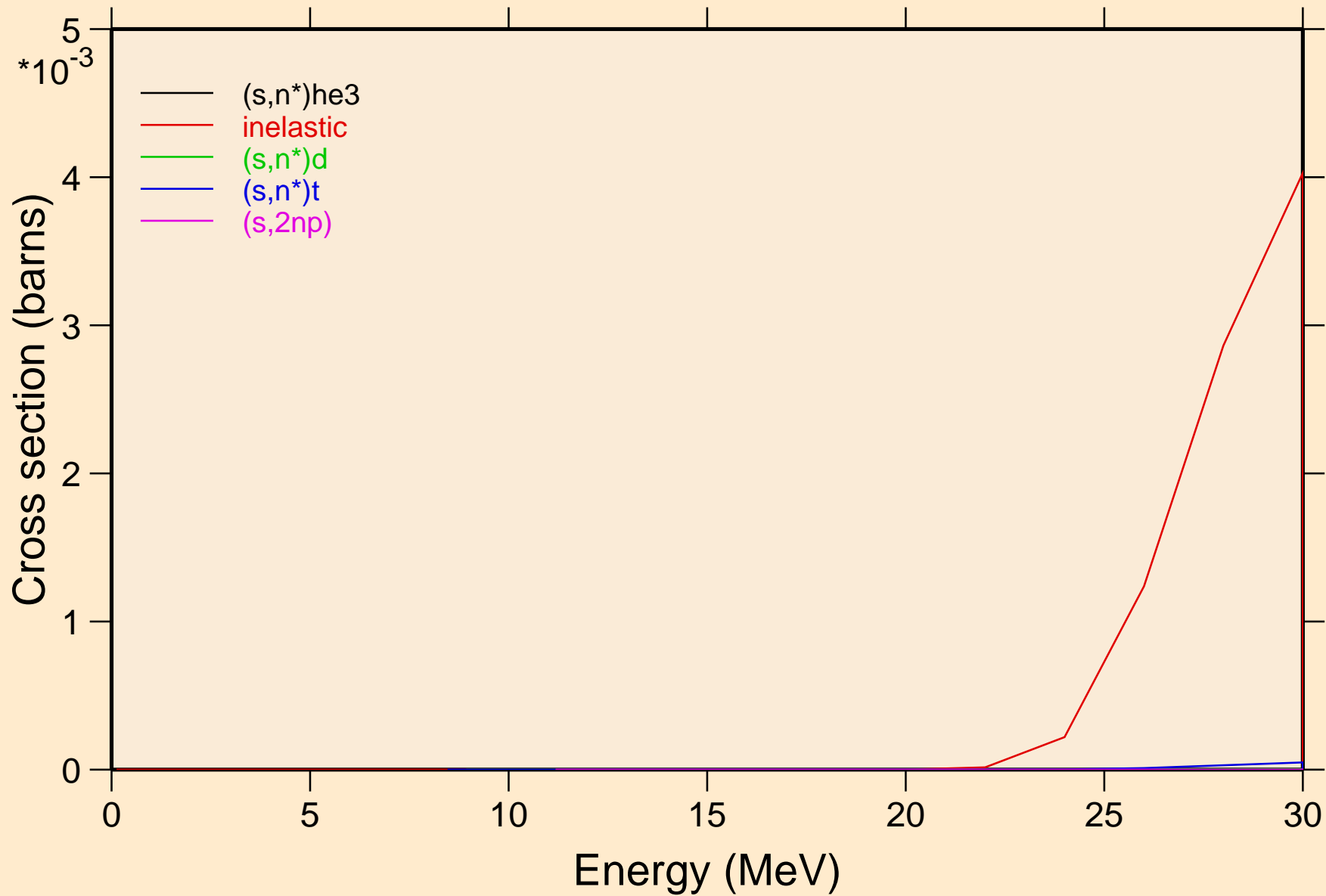

FM254 HELION ACER TENDL-2021 LIBRARY; T=0.K

Threshold reactions

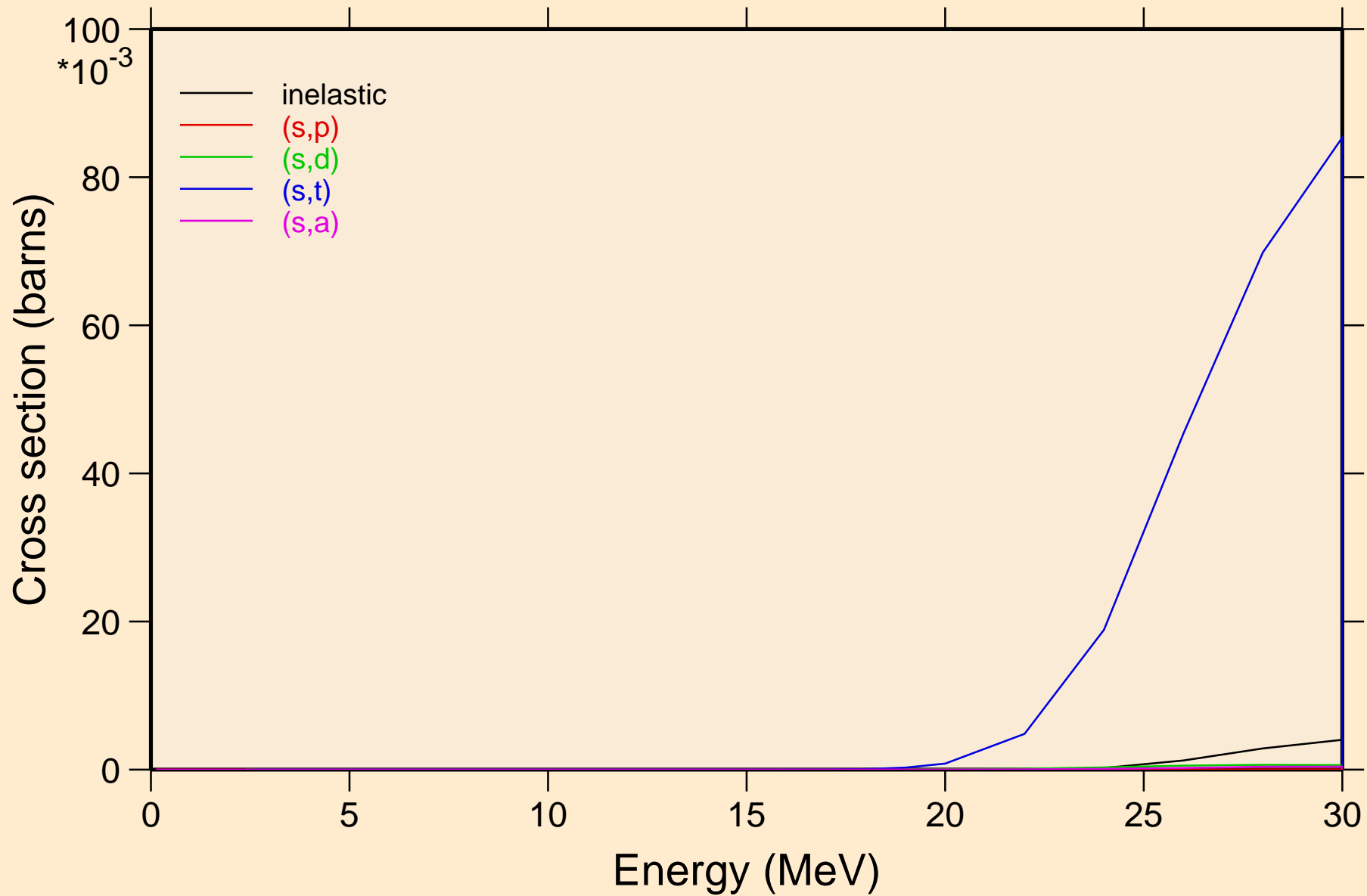

FM254 HELION ACER TENDL-2021 LIBRARY; T=0.K
Threshold reactions

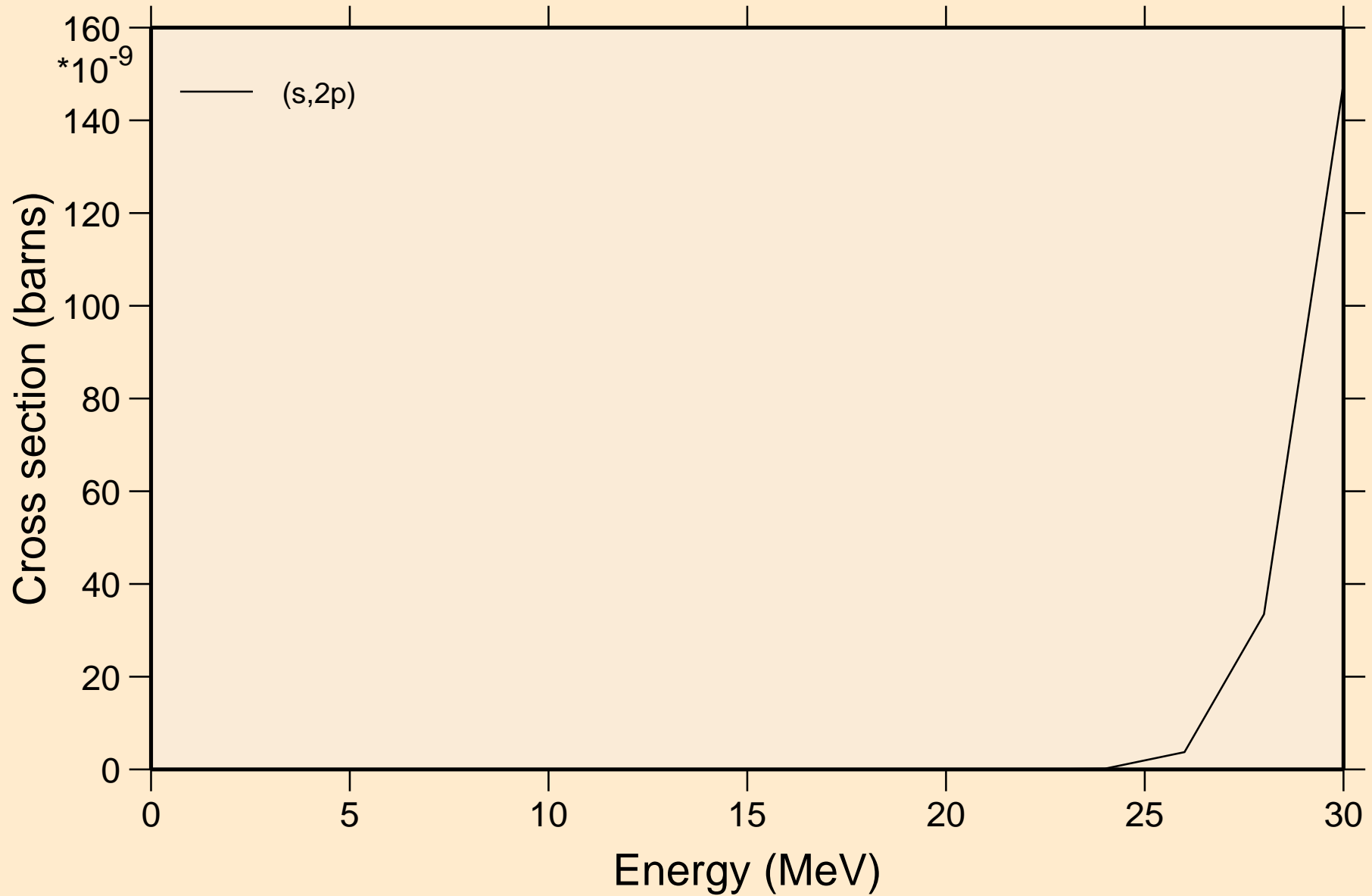

FM254 HELION ACER TENDL-2021 LIBRARY; T=0.K
angular distribution for elastic

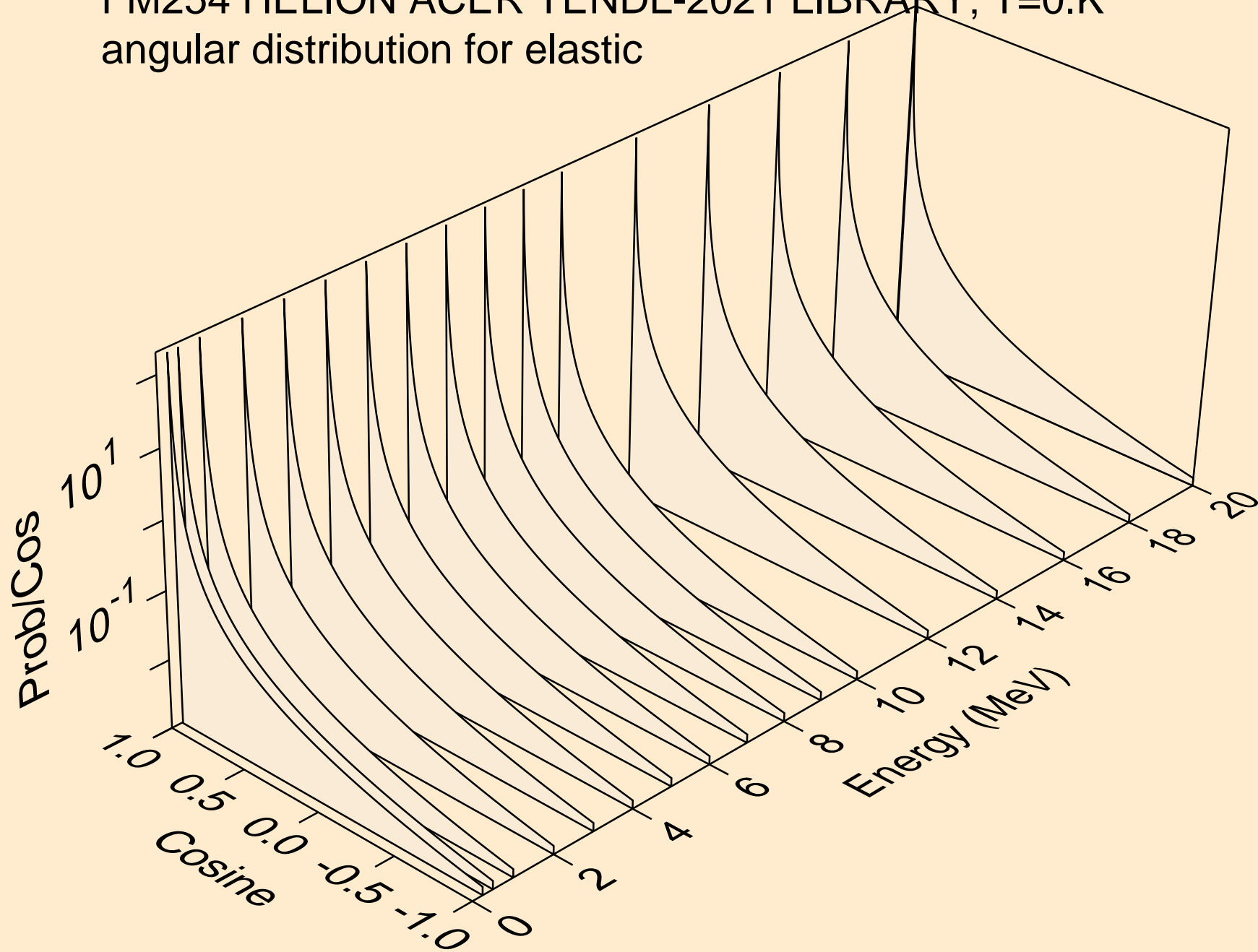

FM254 HELION ACER TENDL-2021 LIBRARY; T=0.K
angular distribution for elastic

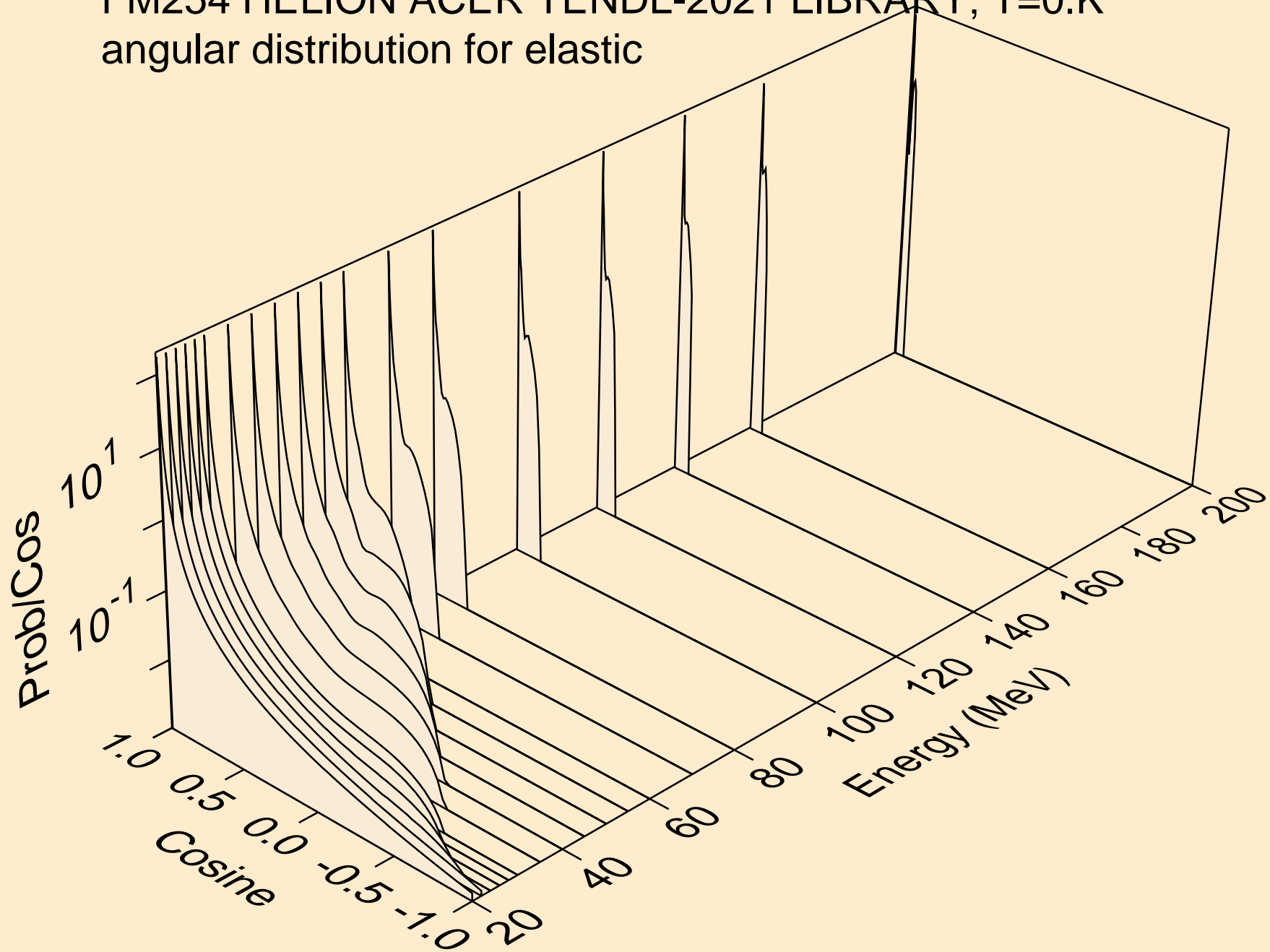

FM254 HELION ACER TENDL-2021 LIBRARY; T=0.K
He-3 emission for (s,x)

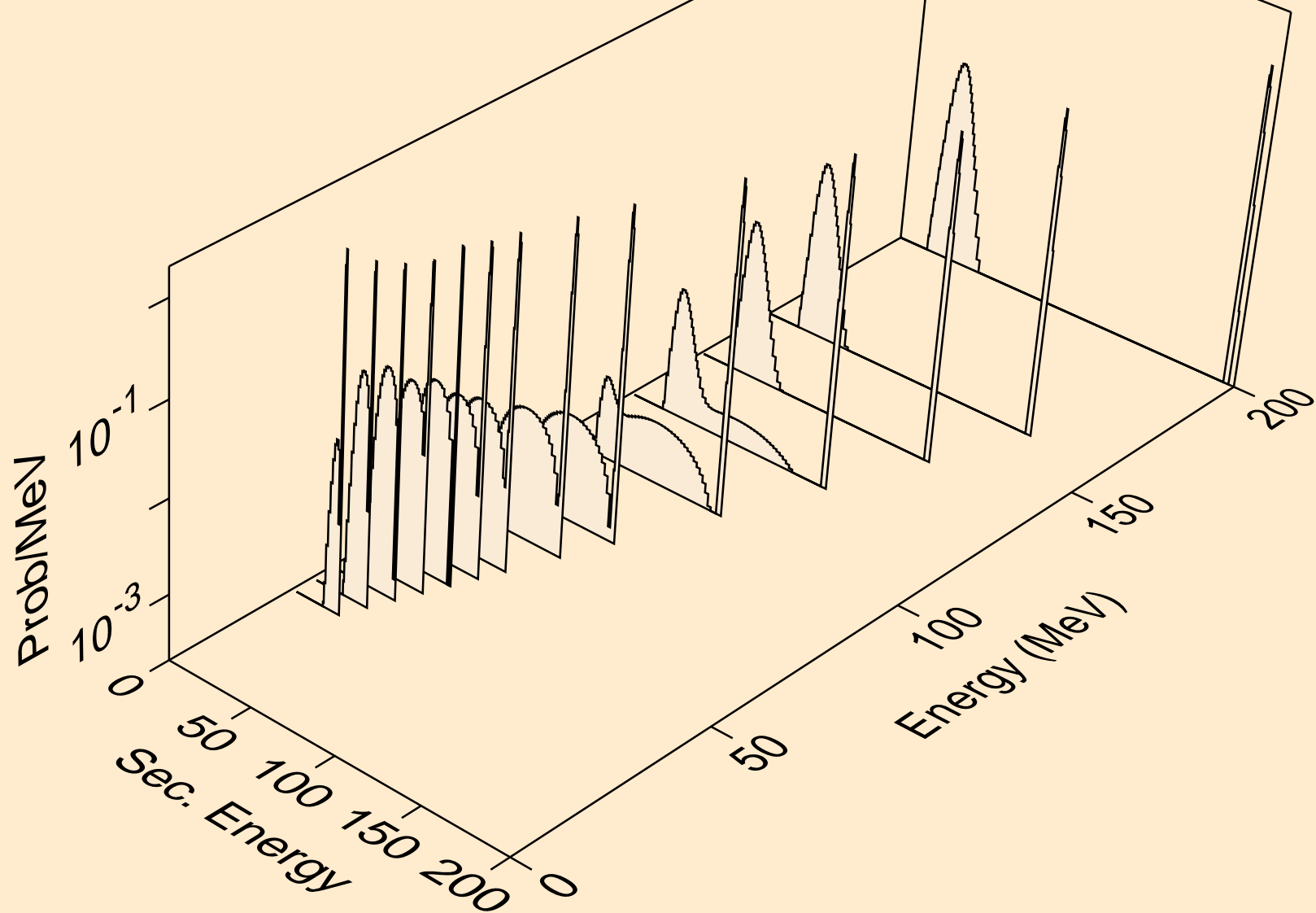

FM254 HELION ACER TENDL-2021 LIBRARY; T=0.K
He-3 emission for (s,n*)he3

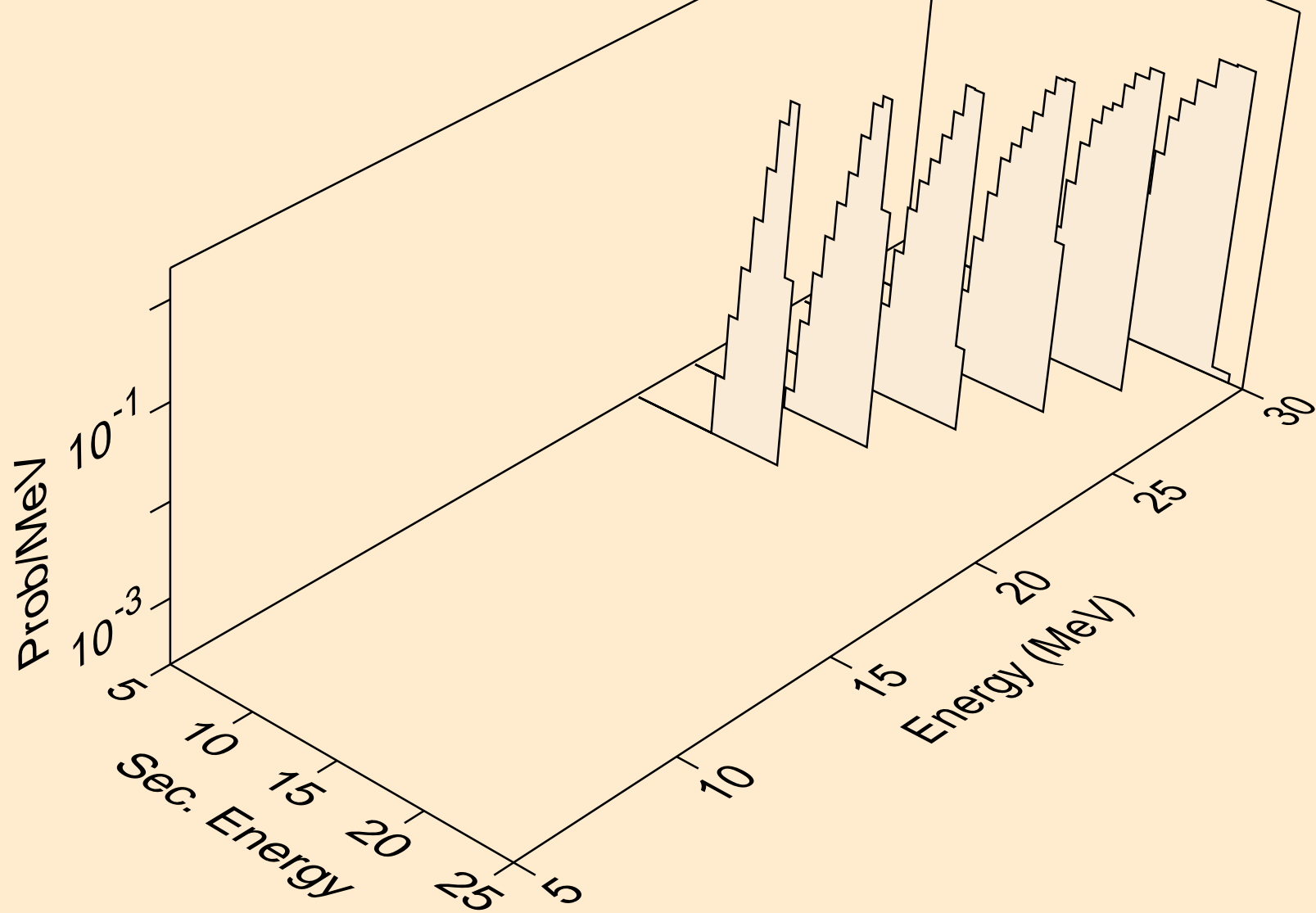

FM254 HELION ACER TENDL-2021 LIBRARY; T=0.K
He-3 emission for inelastic

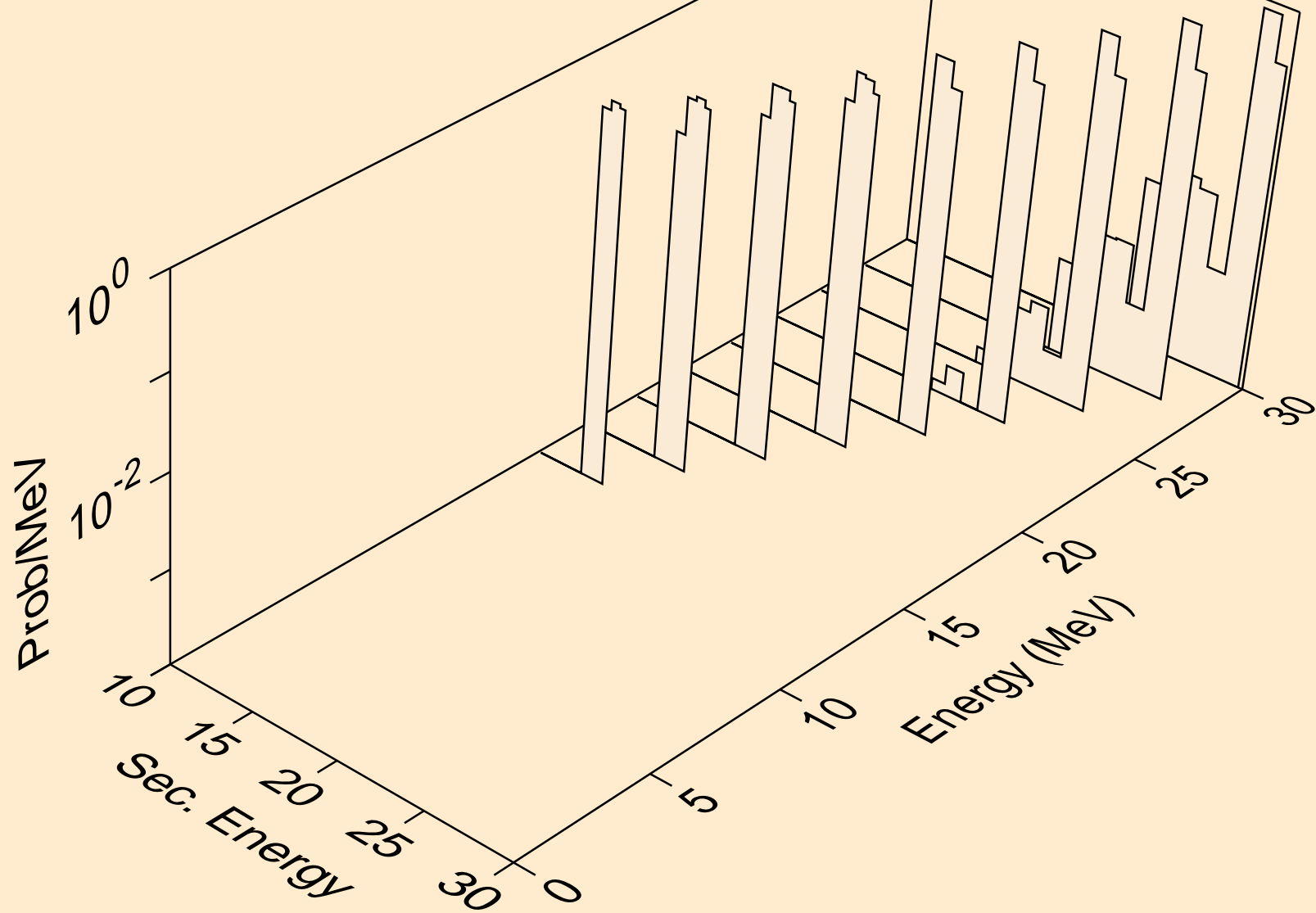

FM254 HELION ACER TENDL-2021 LIBRARY; T=0.K
Photon emission for (z,n)

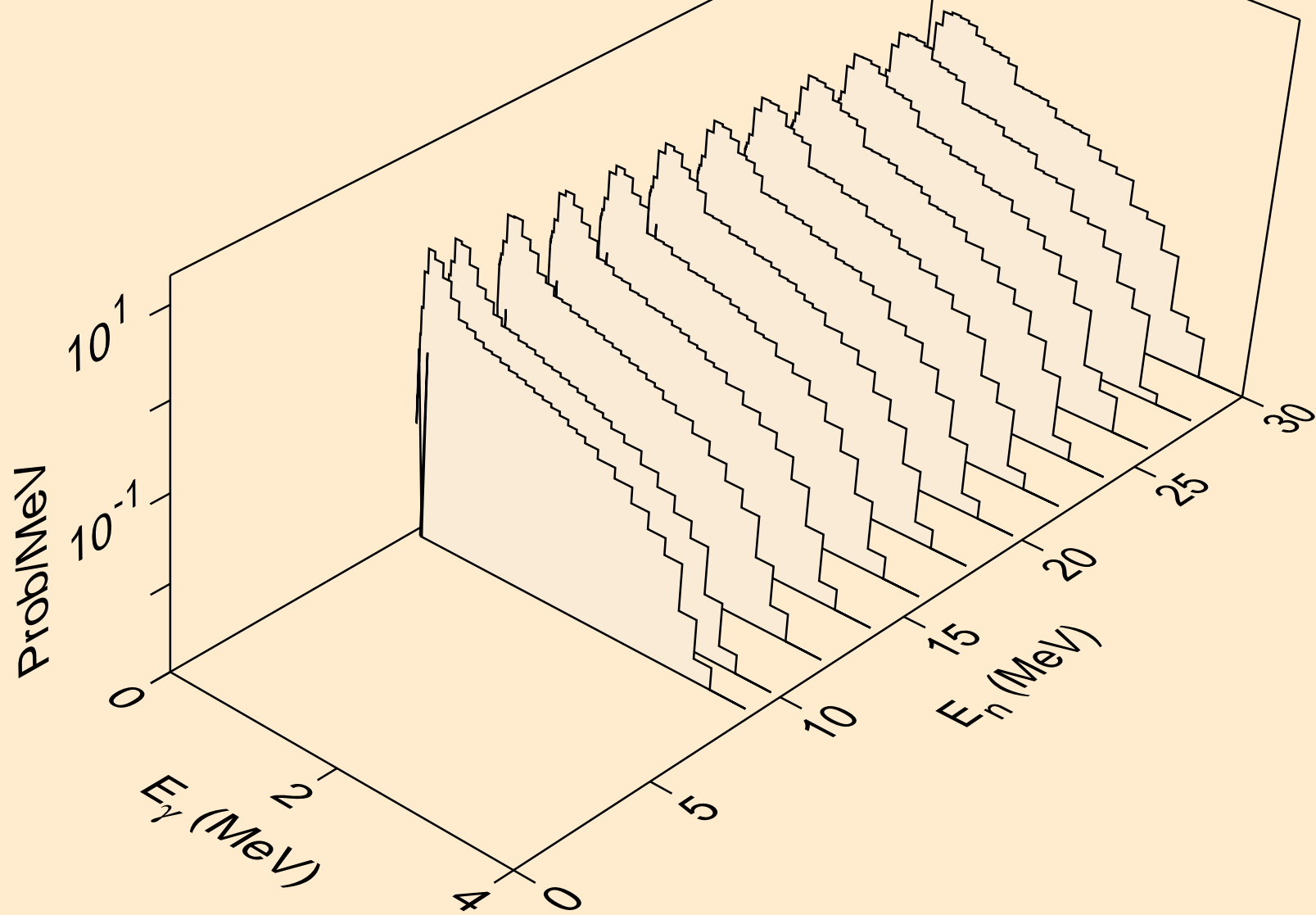

FM254 HELION ACER TENDL-2021 LIBRARY; T=0.K
Photon emission for (n,x)

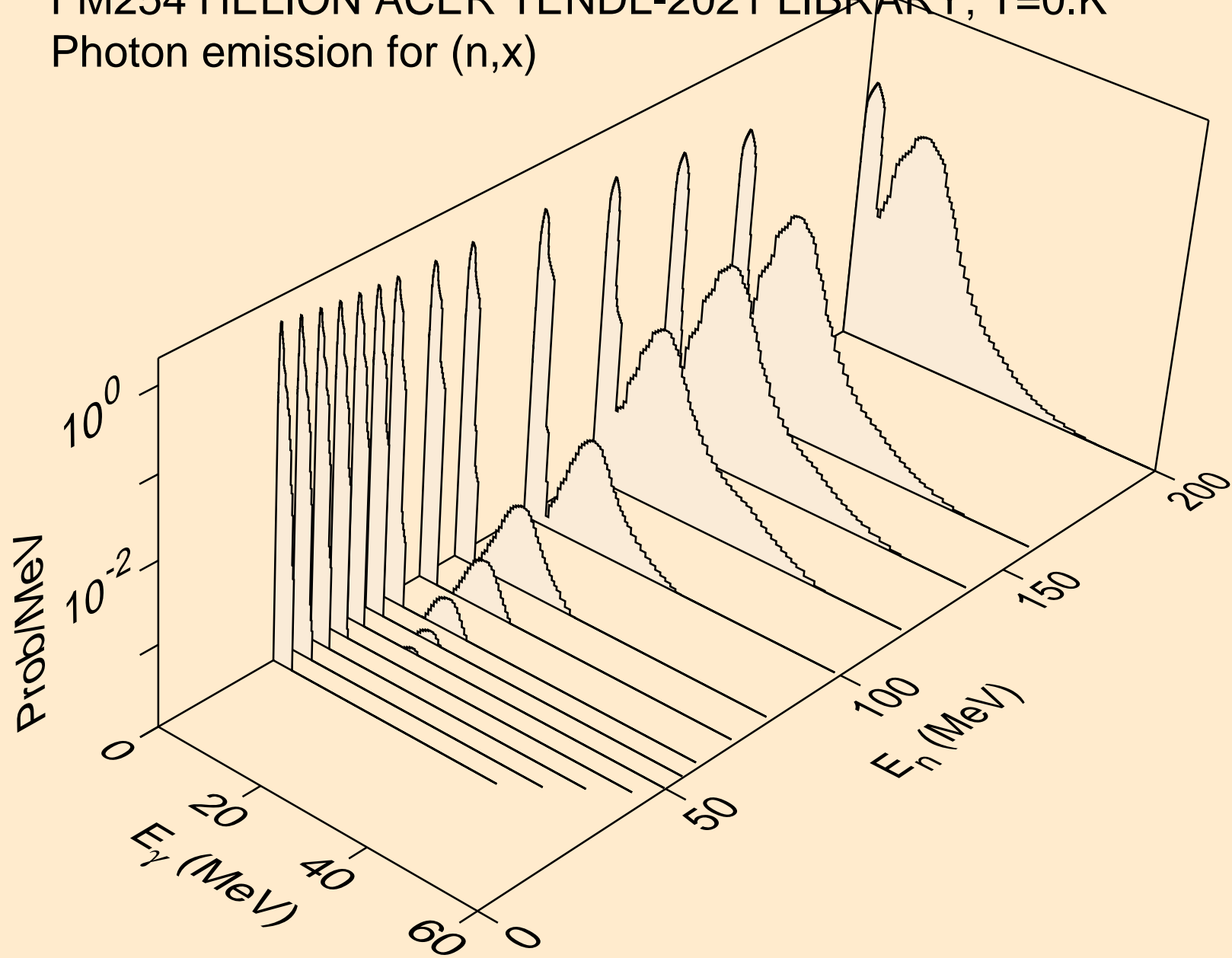

FM254 HELION ACER TENDL-2021 LIBRARY; T=0.K
Photon emission for (n,2nd)

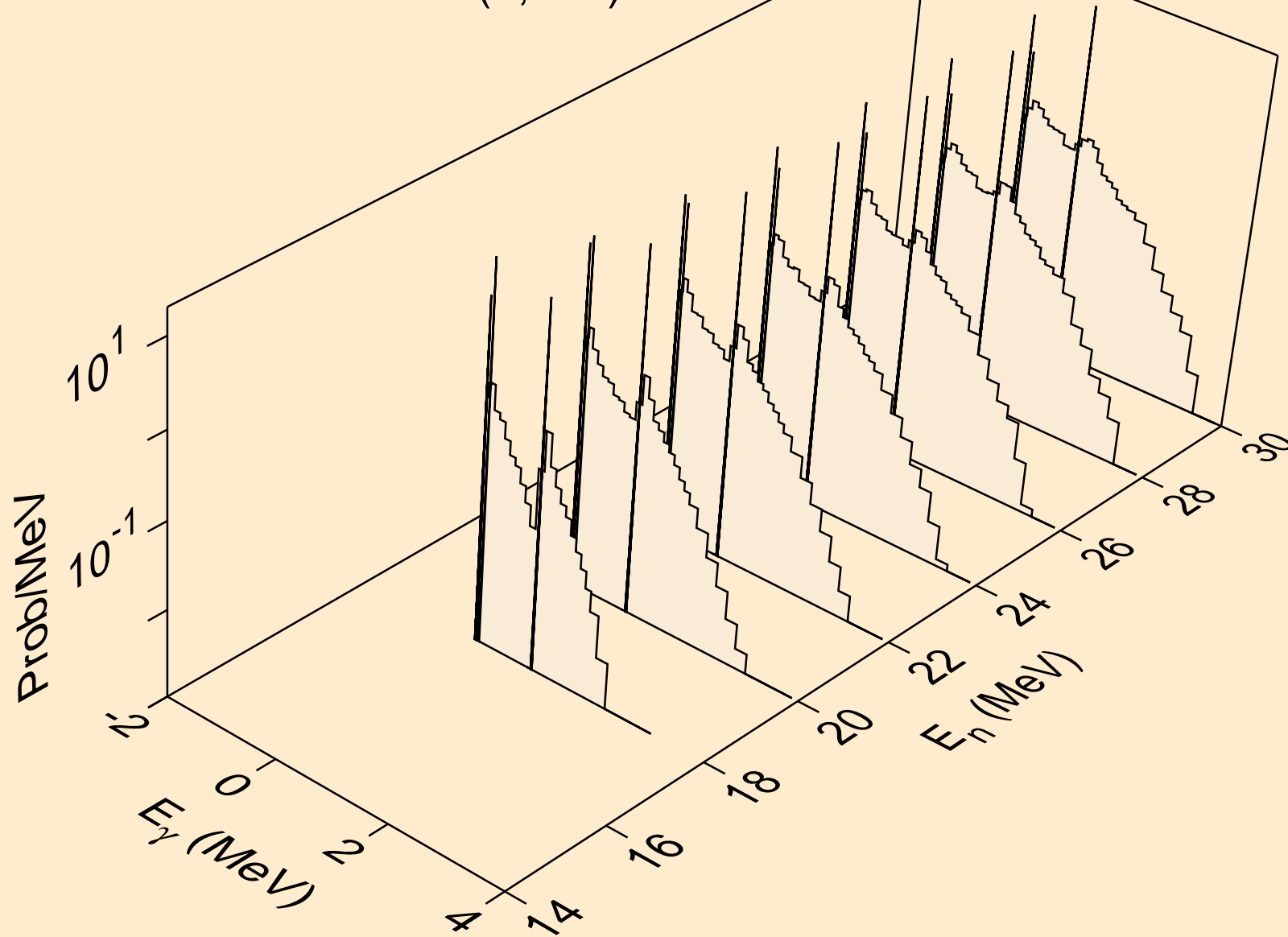

FM254 HELION ACER TENDL-2021 LIBRARY; T=0.K
Photon emission for (n,2n)

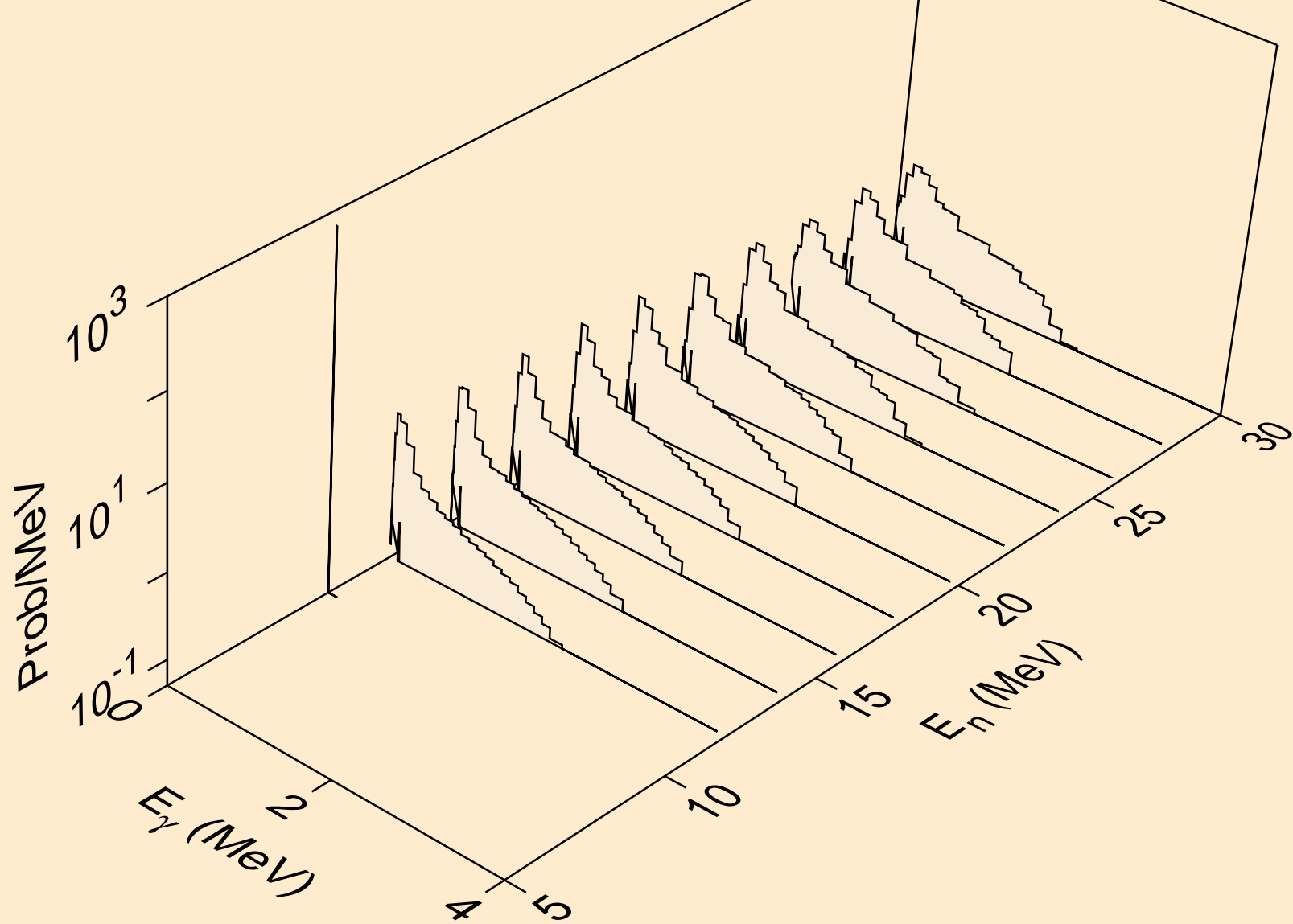

FM254 HELION ACER TENDL-2021 LIBRARY; T=0.K
Photon emission for (n,3n)

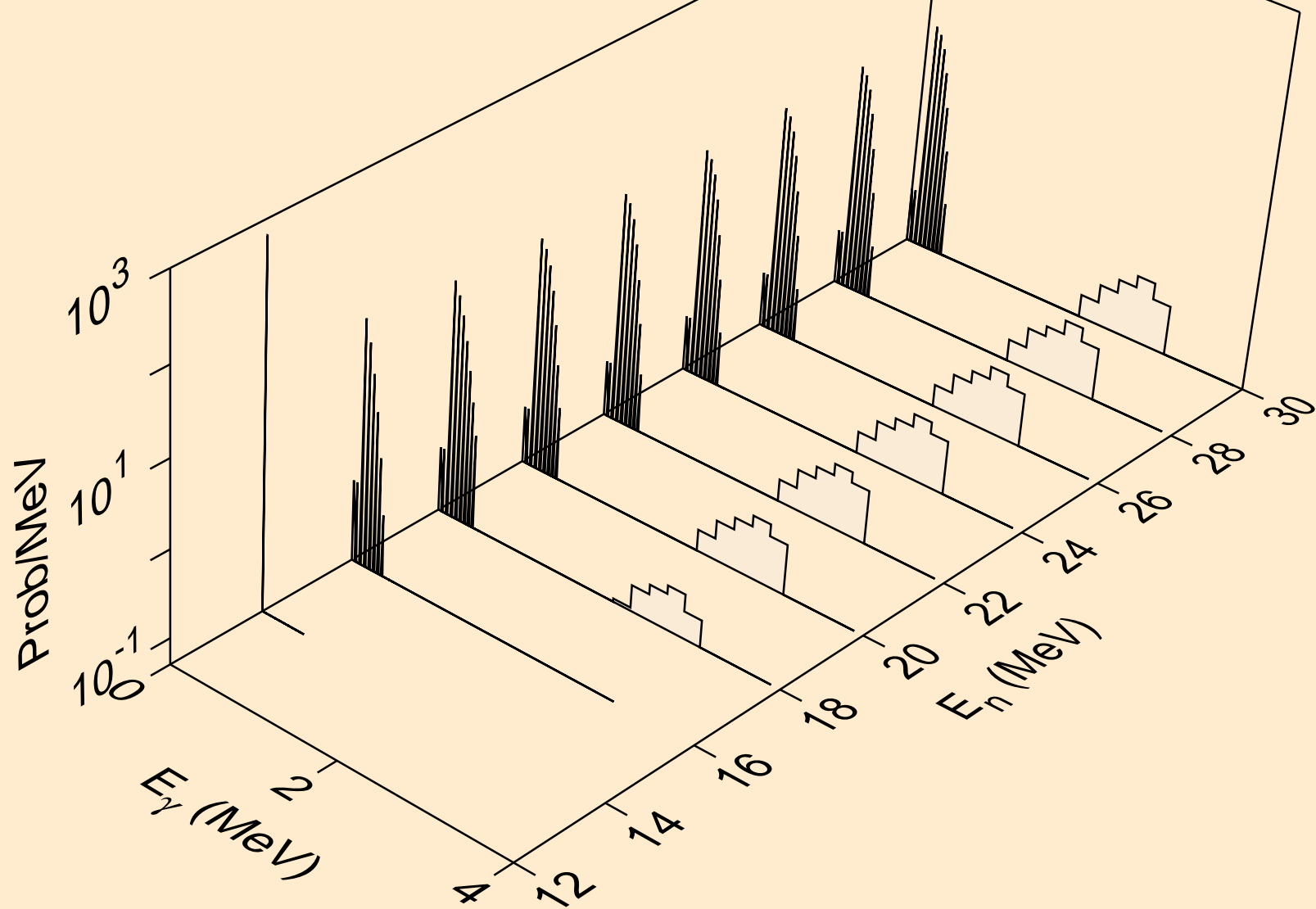

FM254 HELION ACER TENDL-2021 LIBRARY; T=0.K
Photon emission for (n,n*)a

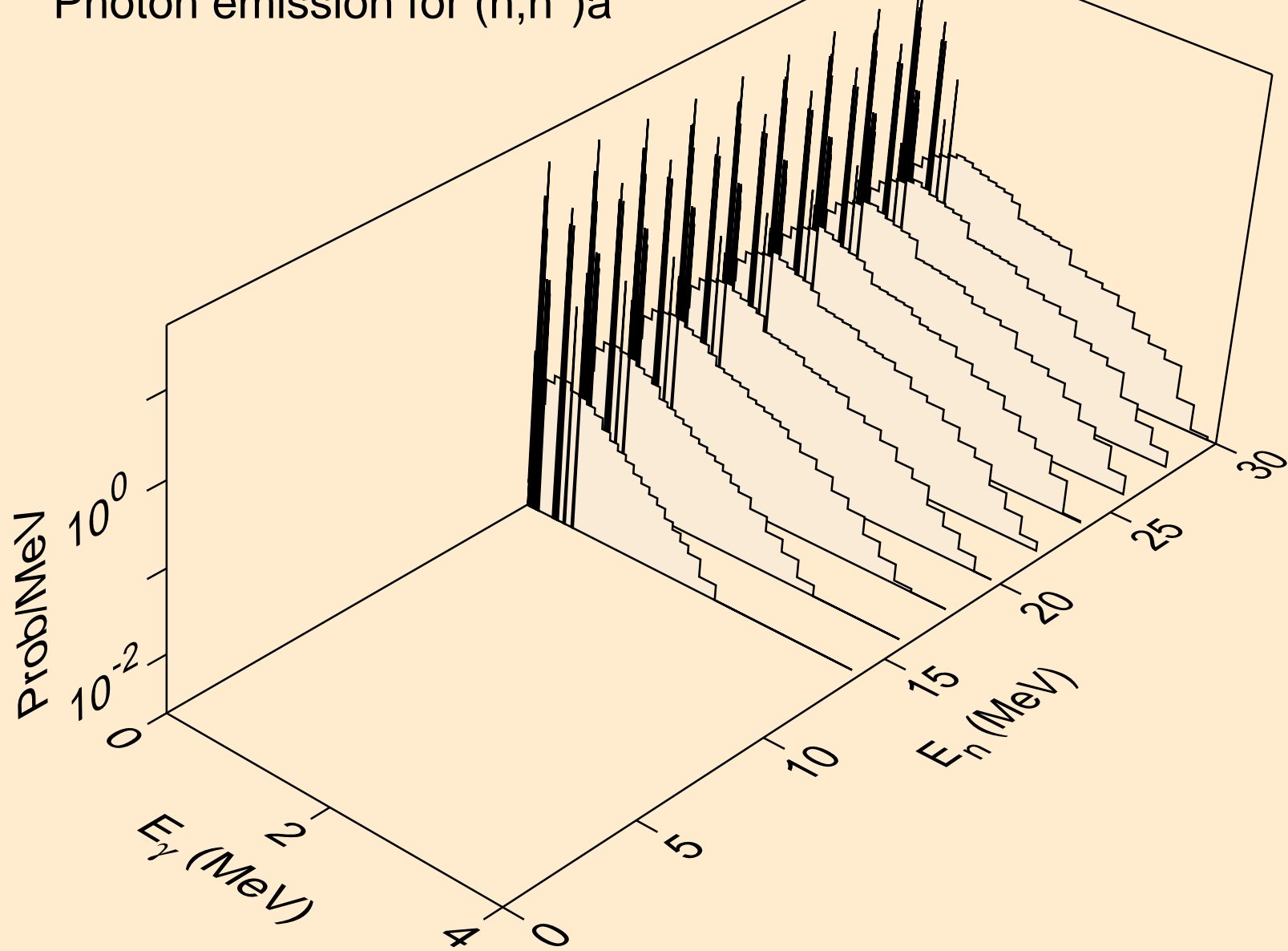

FM254 HELION ACER TENDL-2021 LIBRARY; T=0.K
Photon emission for (n,n*)p

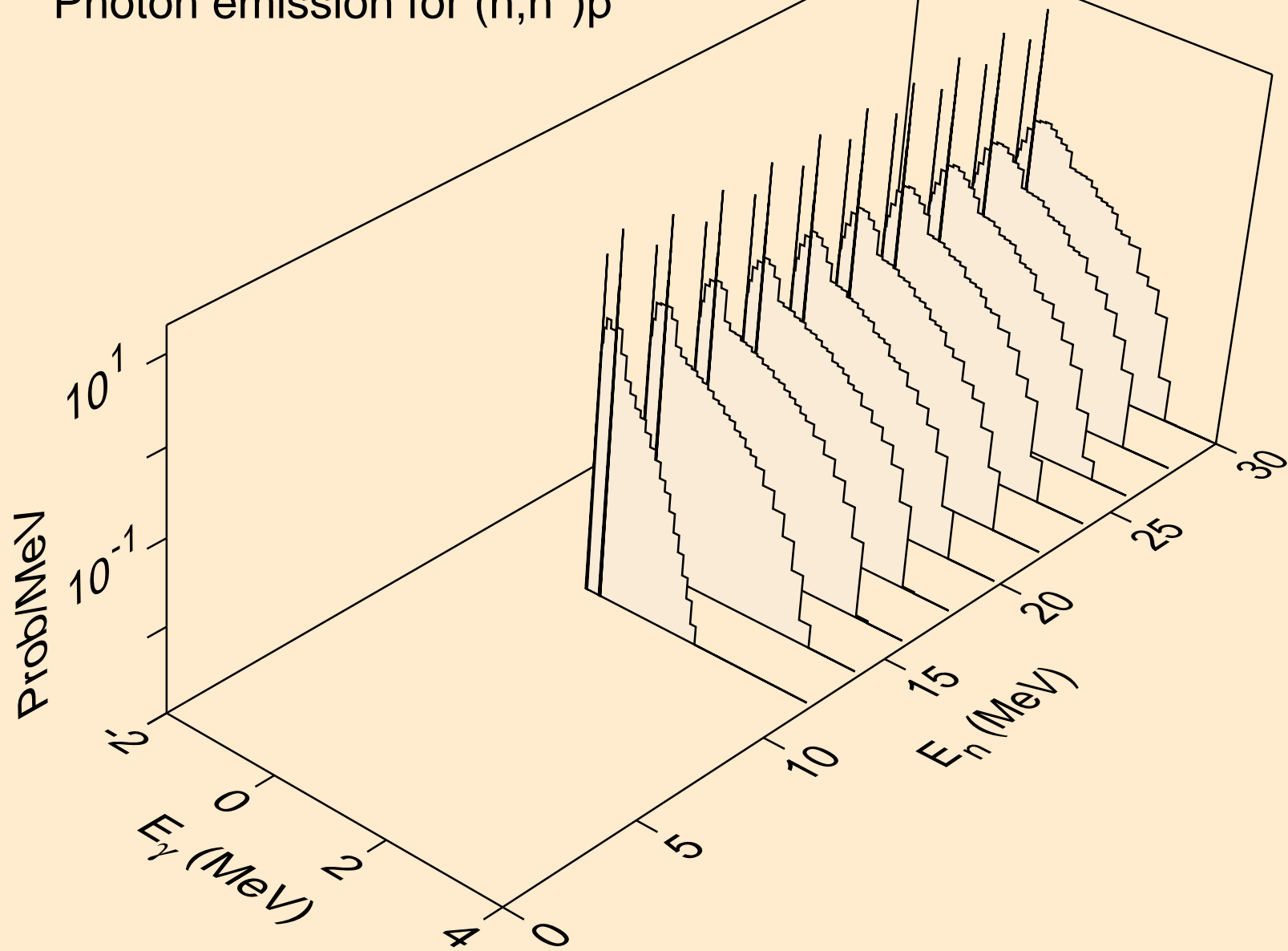

FM254 HELION ACER TENDL-2021 LIBRARY; T=0.K
Photon emission for (n,n*)d

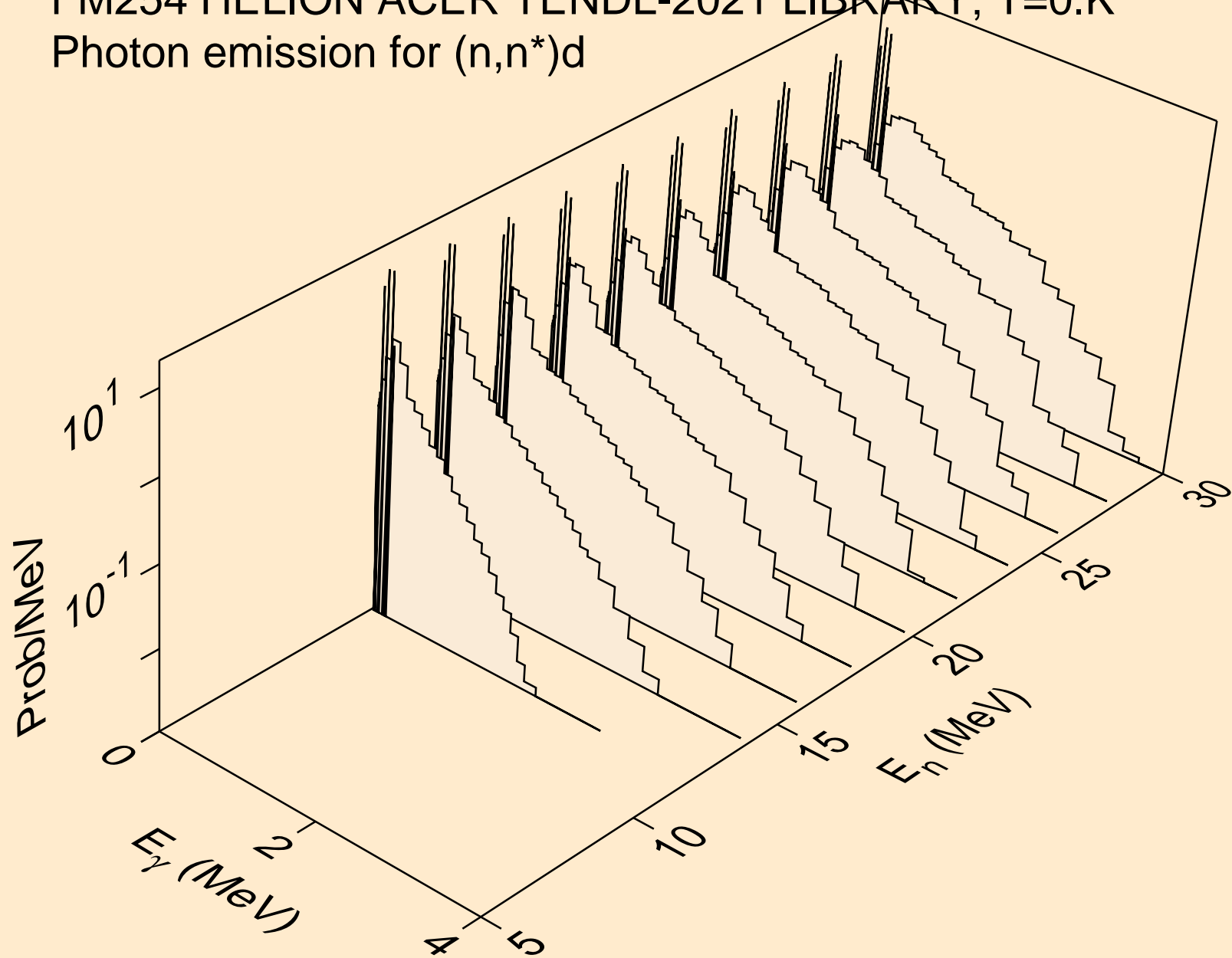

FM254 HELION ACER TENDL-2021 LIBRARY; T=0.K
Photon emission for (n,n*)t

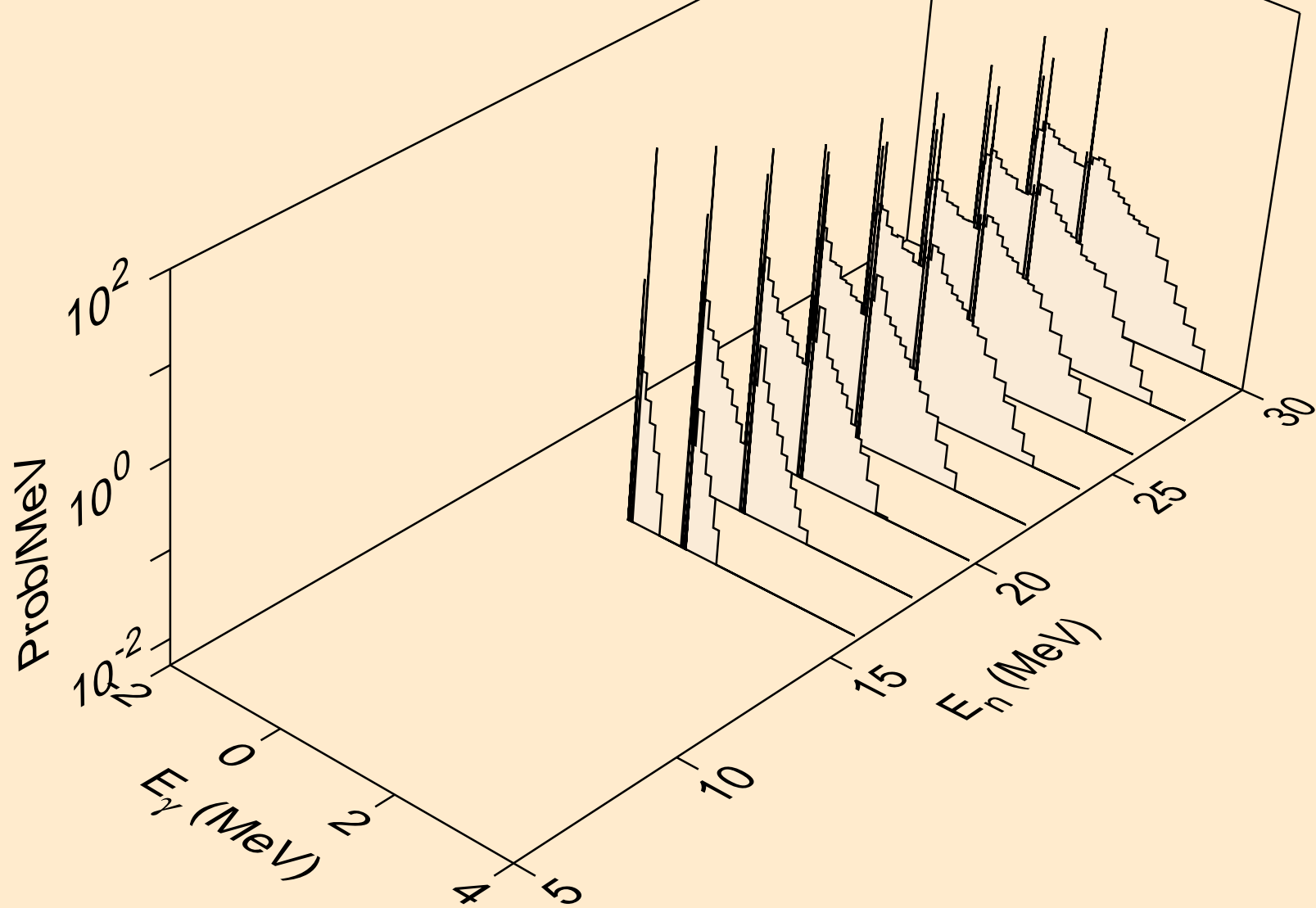

FM254 HELION ACER TENDL-2021 LIBRARY; T=0.K
Photon emission for (n,n*)he3

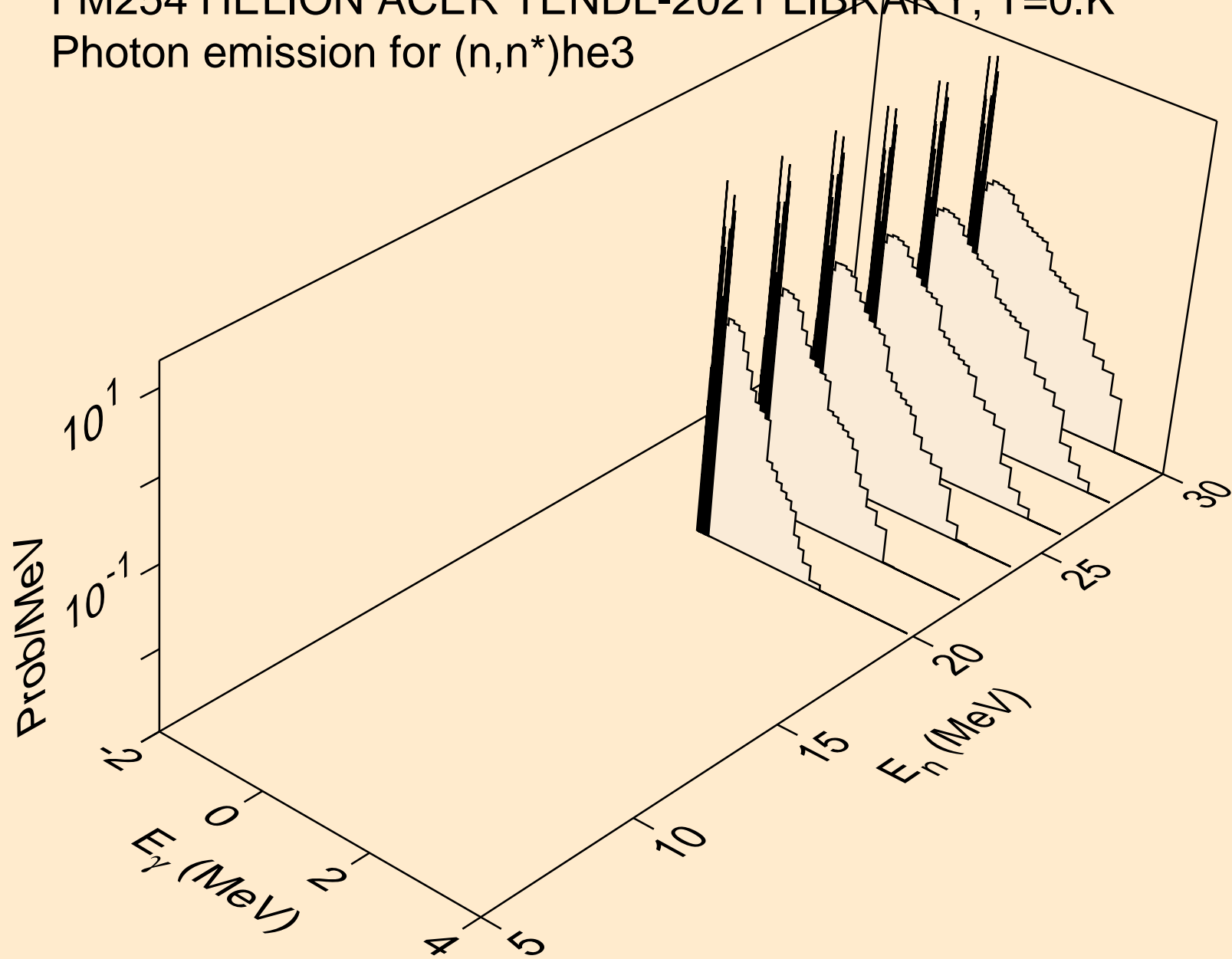

FM254 HELION ACER TENDL-2021 LIBRARY; T=0.K
Photon emission for (n,2np)

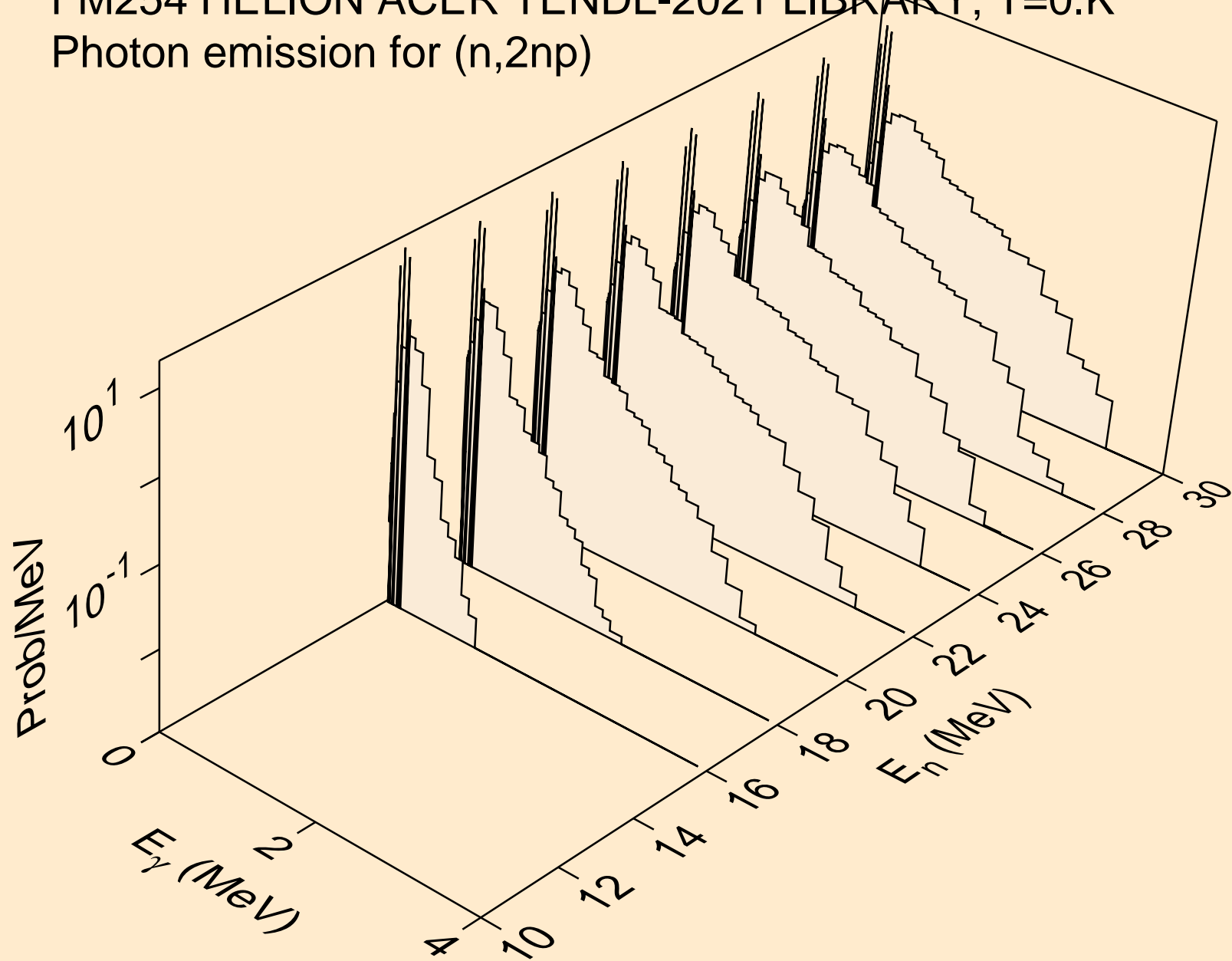

FM254 HELION ACER TENDL-2021 LIBRARY; T=0.K
Photon emission for (n,p)

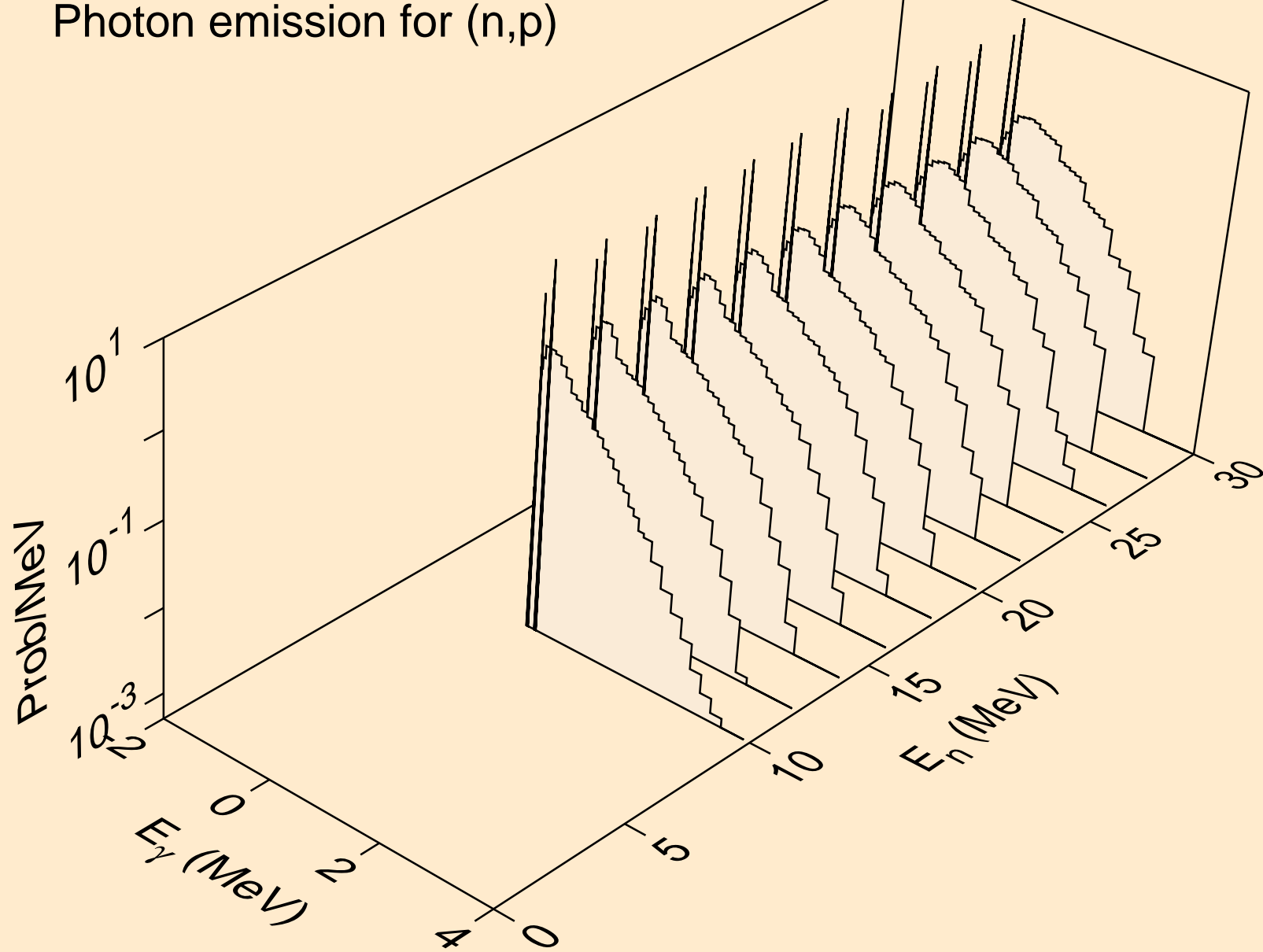

FM254 HELION ACER TENDL-2021 LIBRARY; T=0.K
Photon emission for (n,d)

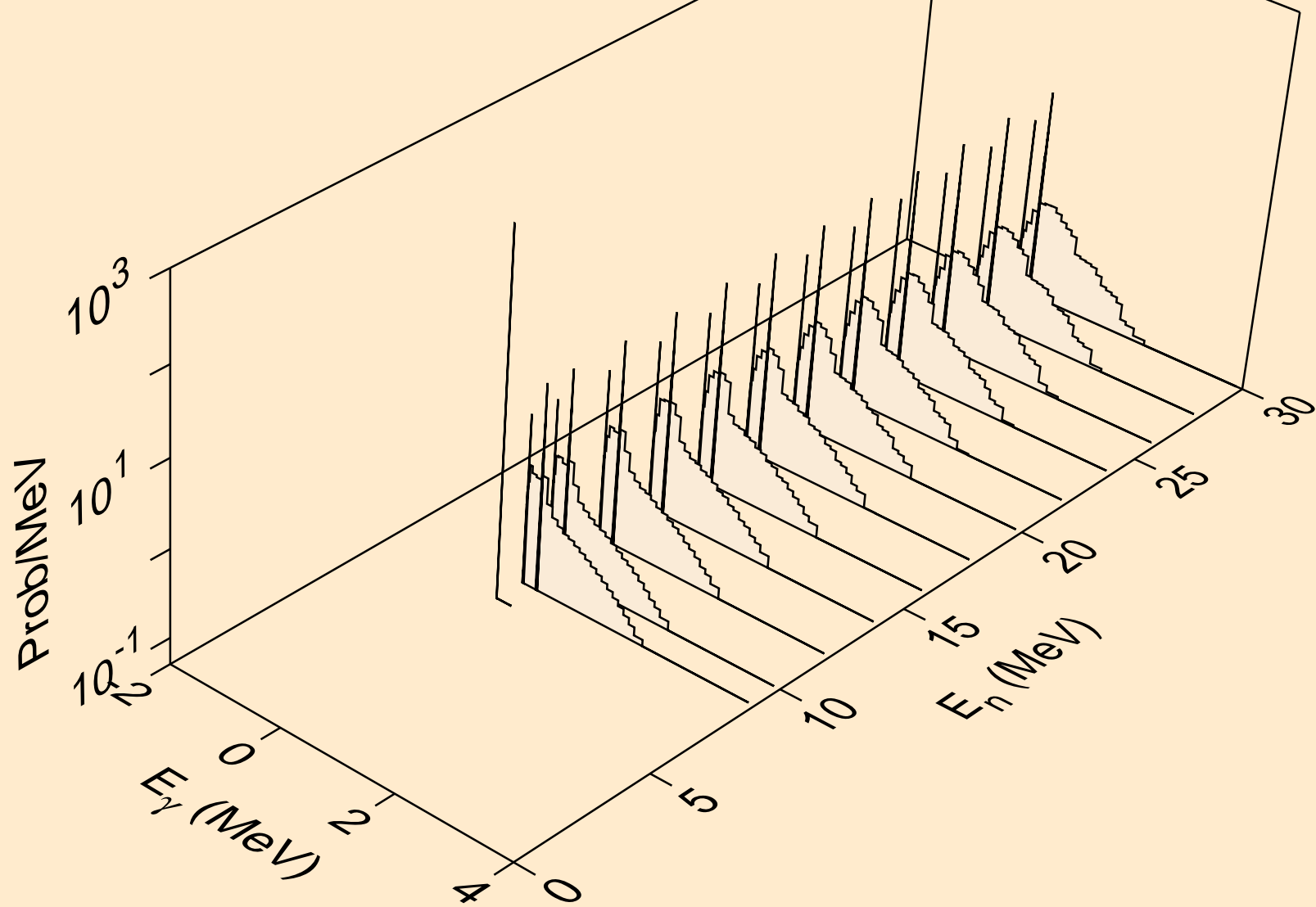

FM254 HELION ACER TENDL-2021 LIBRARY; T=0.K
Photon emission for (n,t)

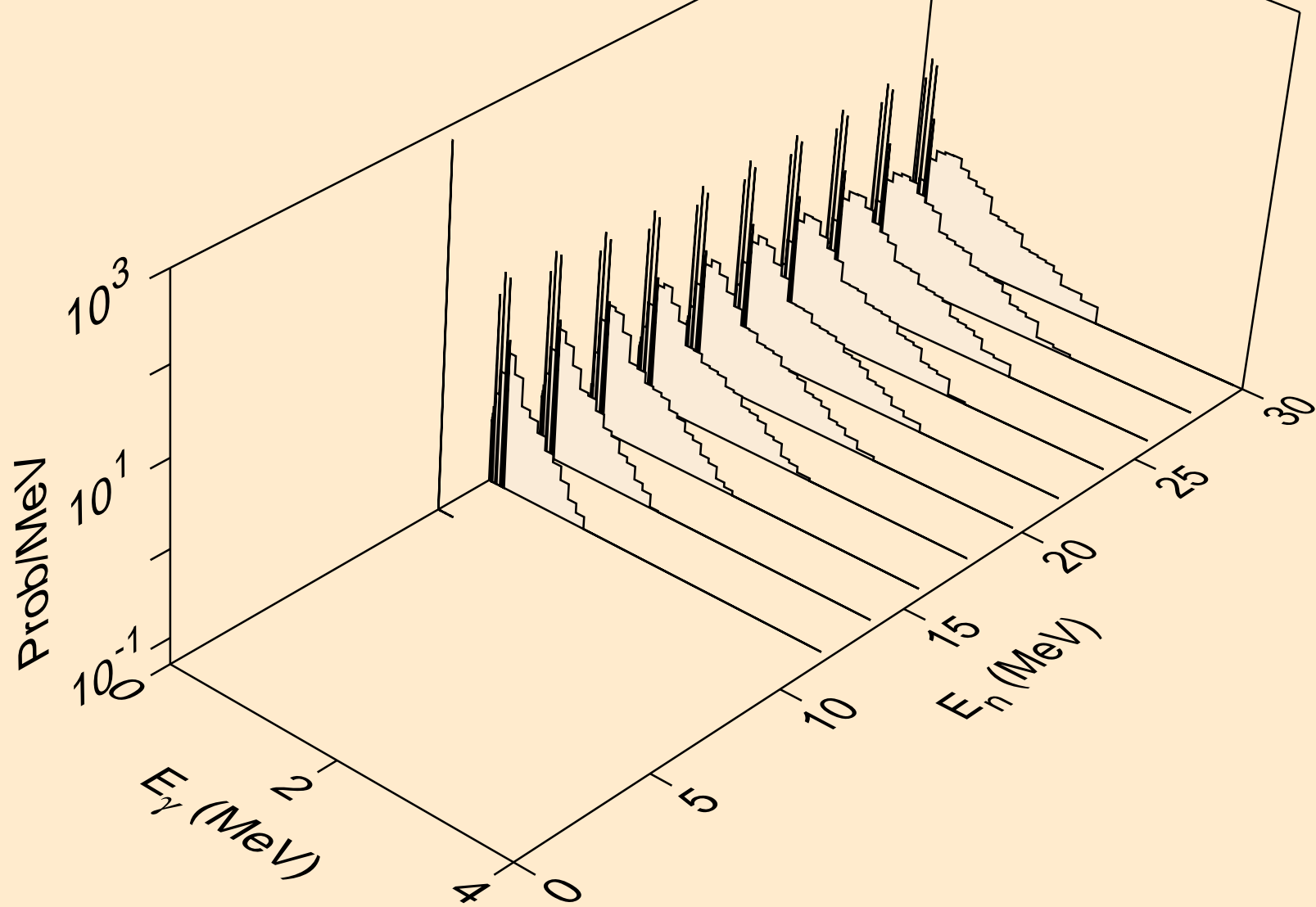

FM254 HELION ACER TENDL-2021 LIBRARY; T=0.K
Photon emission for inelastic

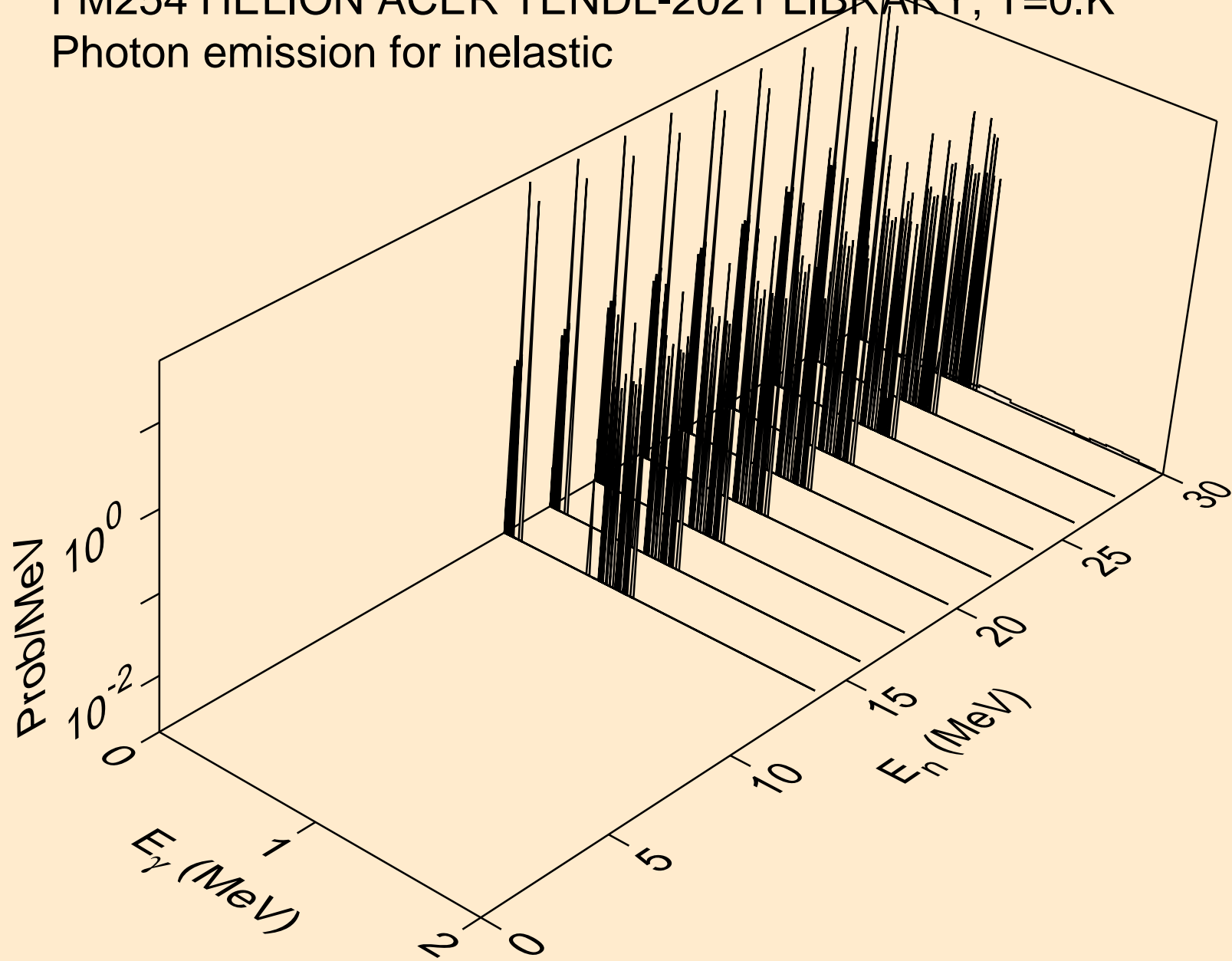

FM254 HELION ACER TENDL-2021 LIBRARY; T=0.K
Photon emission for (n,a)

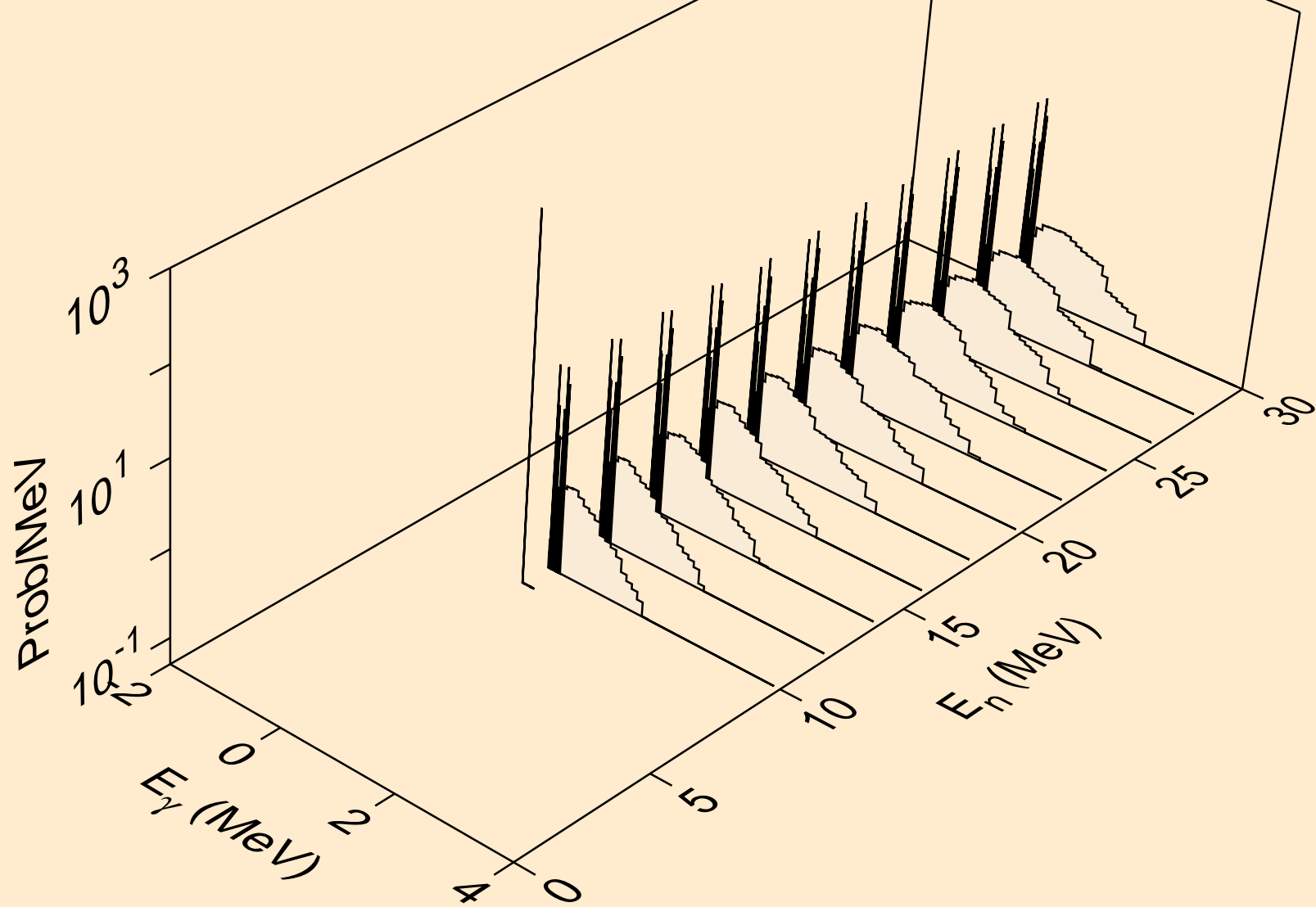

FM254 HELION ACER TENDL-2021 LIBRARY; T=0.K
Photon emission for (n,2p)

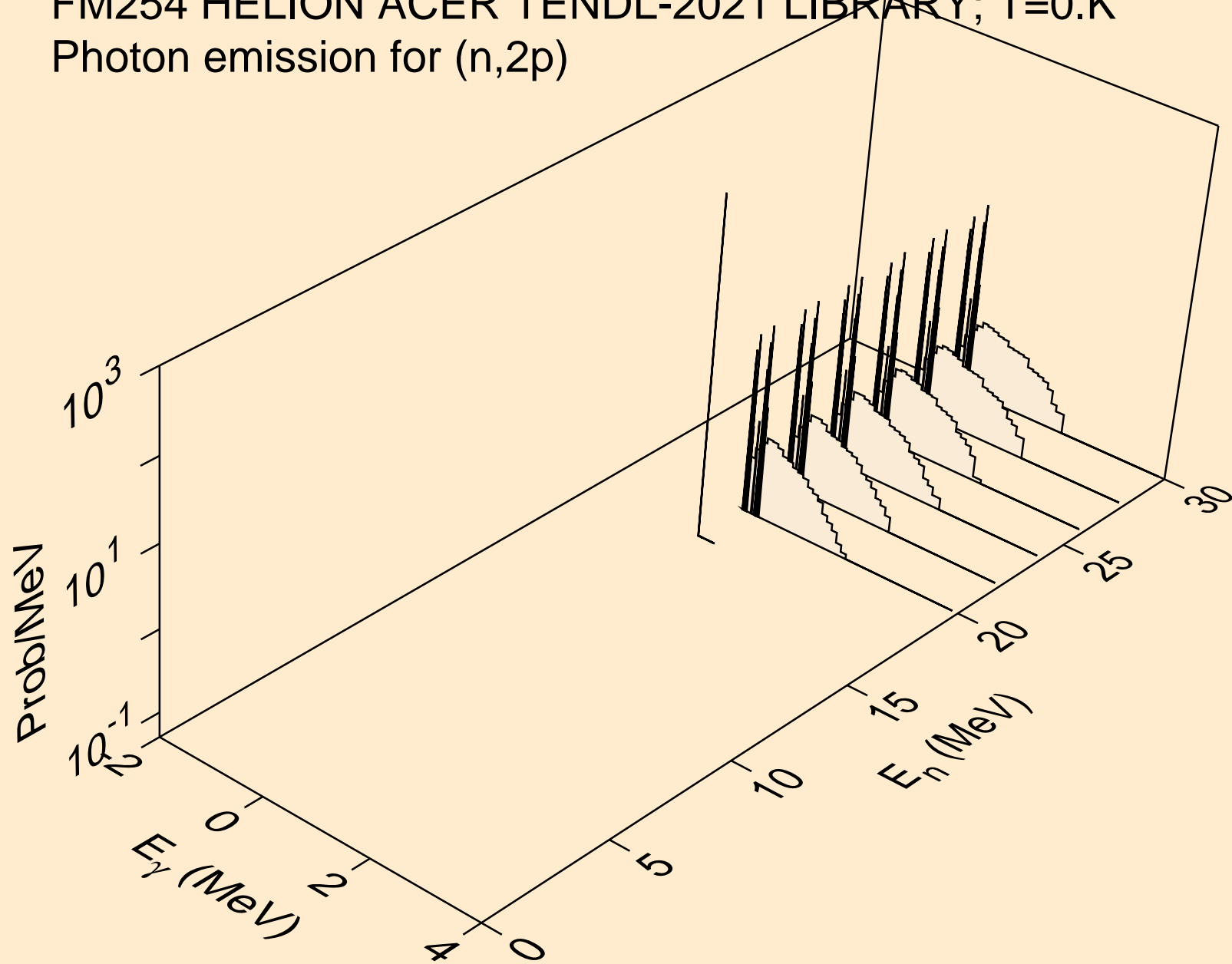

FM254 HELION ACER TENDL-2021 LIBRARY; T=0.K
Particle heating contributions

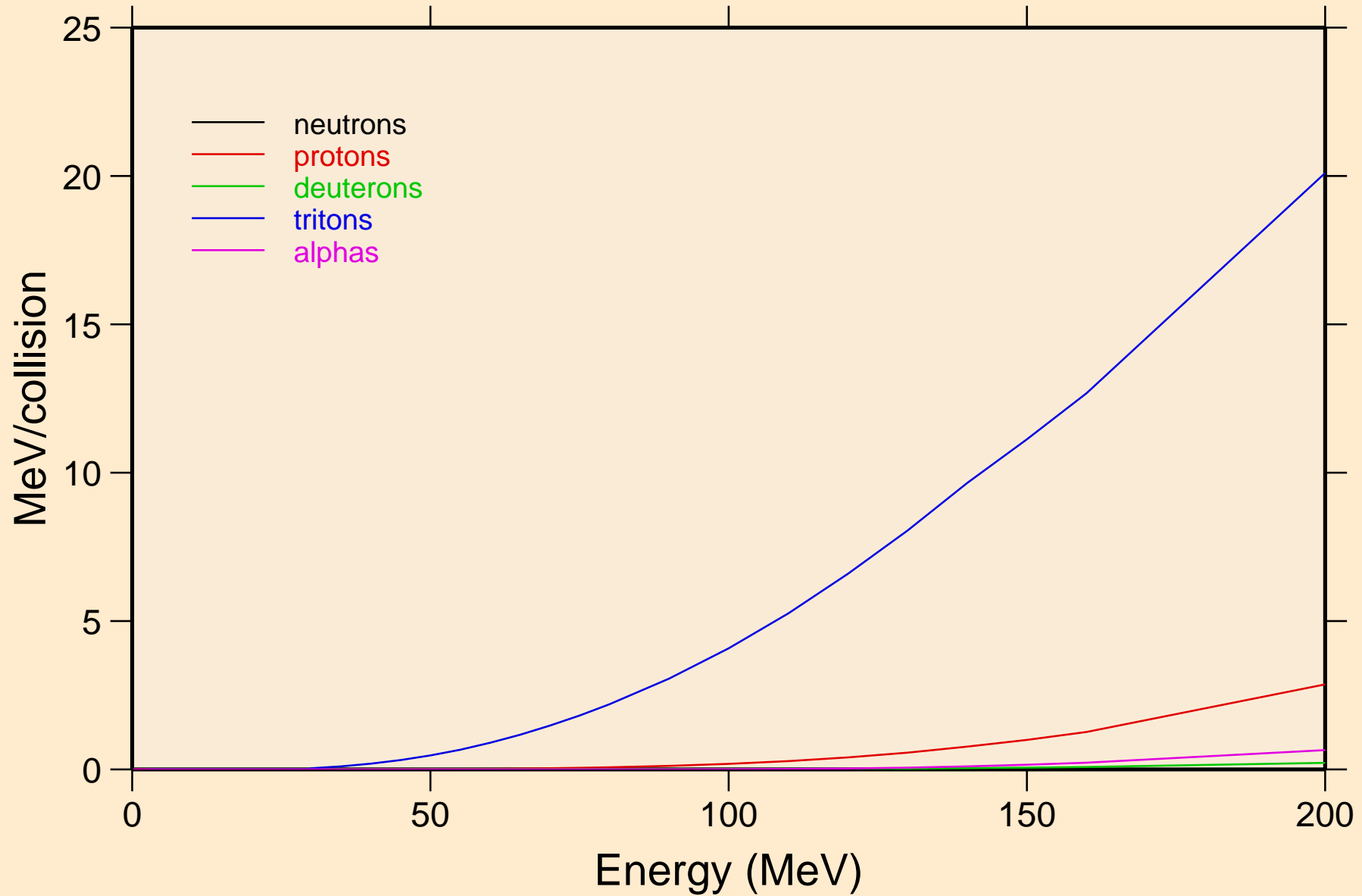

FM254 HELION ACER TENDL-2021 LIBRARY; T=0.K
Recoil Heating

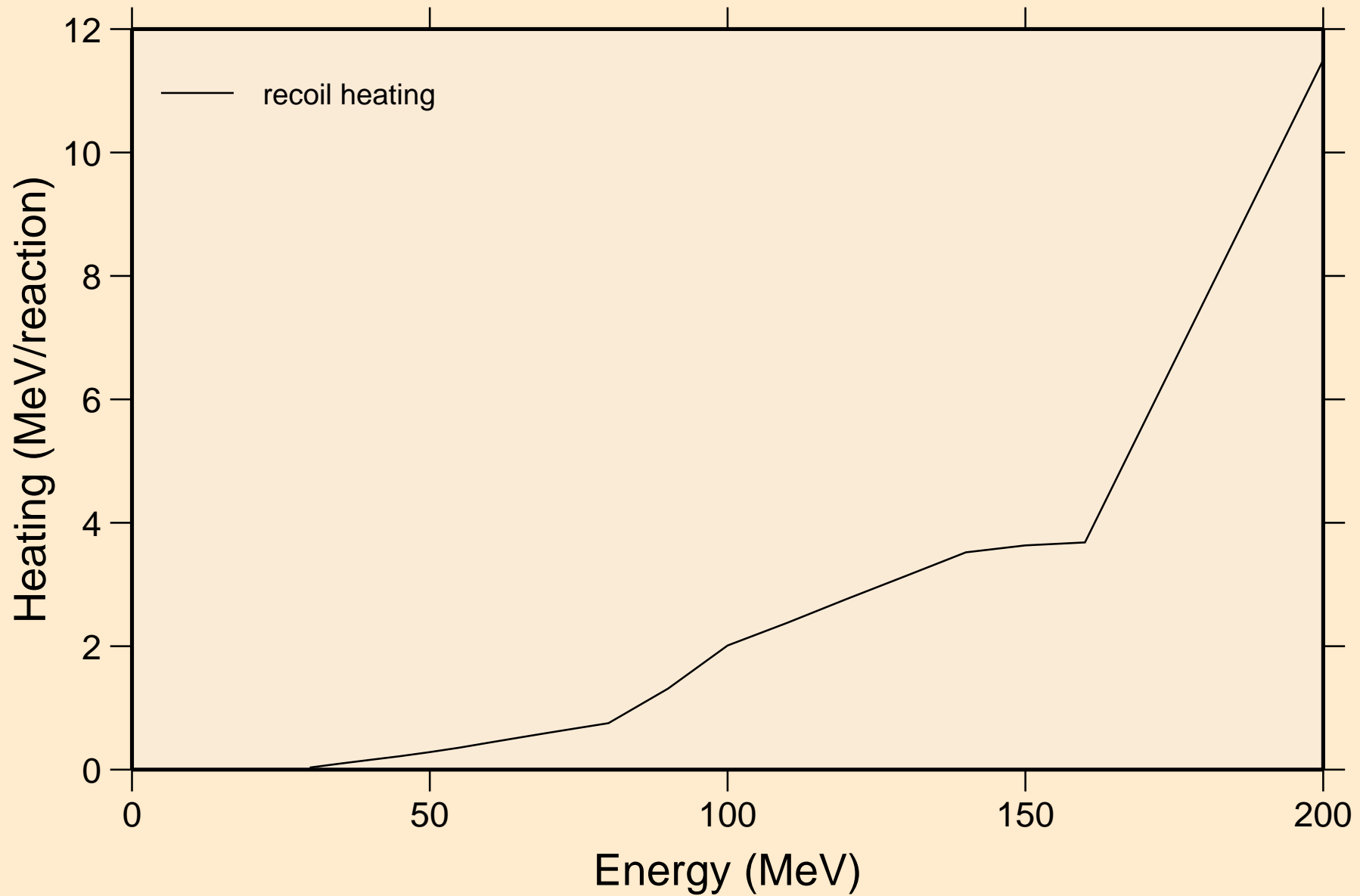

FM254 HELION ACER TENDL-2021 LIBRARY; T=0.K
Particle production cross sections

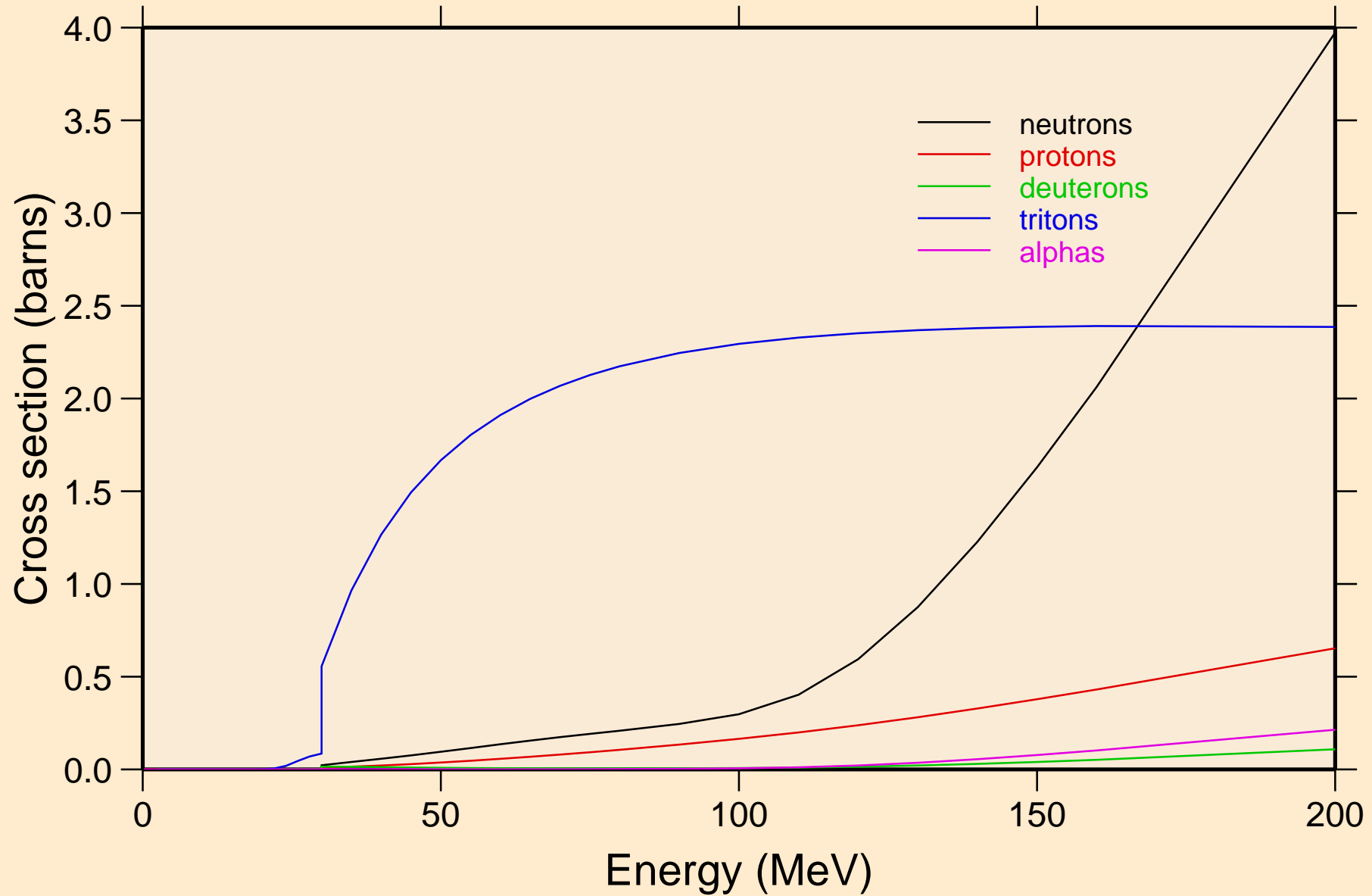

FM254 HELION ACER TENDL-2021 LIBRARY; T=0.K
neutrons from (s,n)

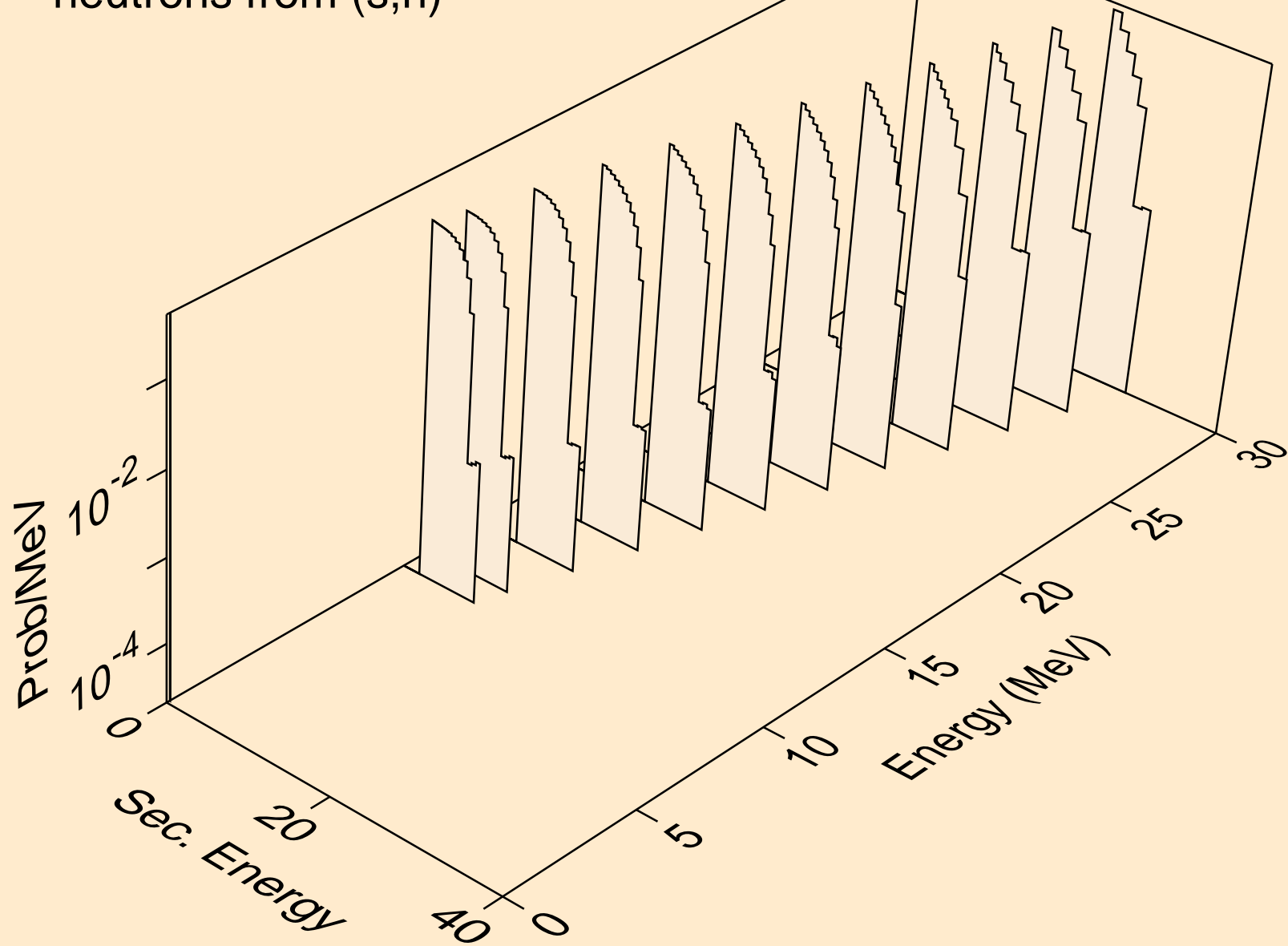

FM254 HELION ACER TENDL-2021 LIBRARY; T=0.K
neutrons from (s,x)

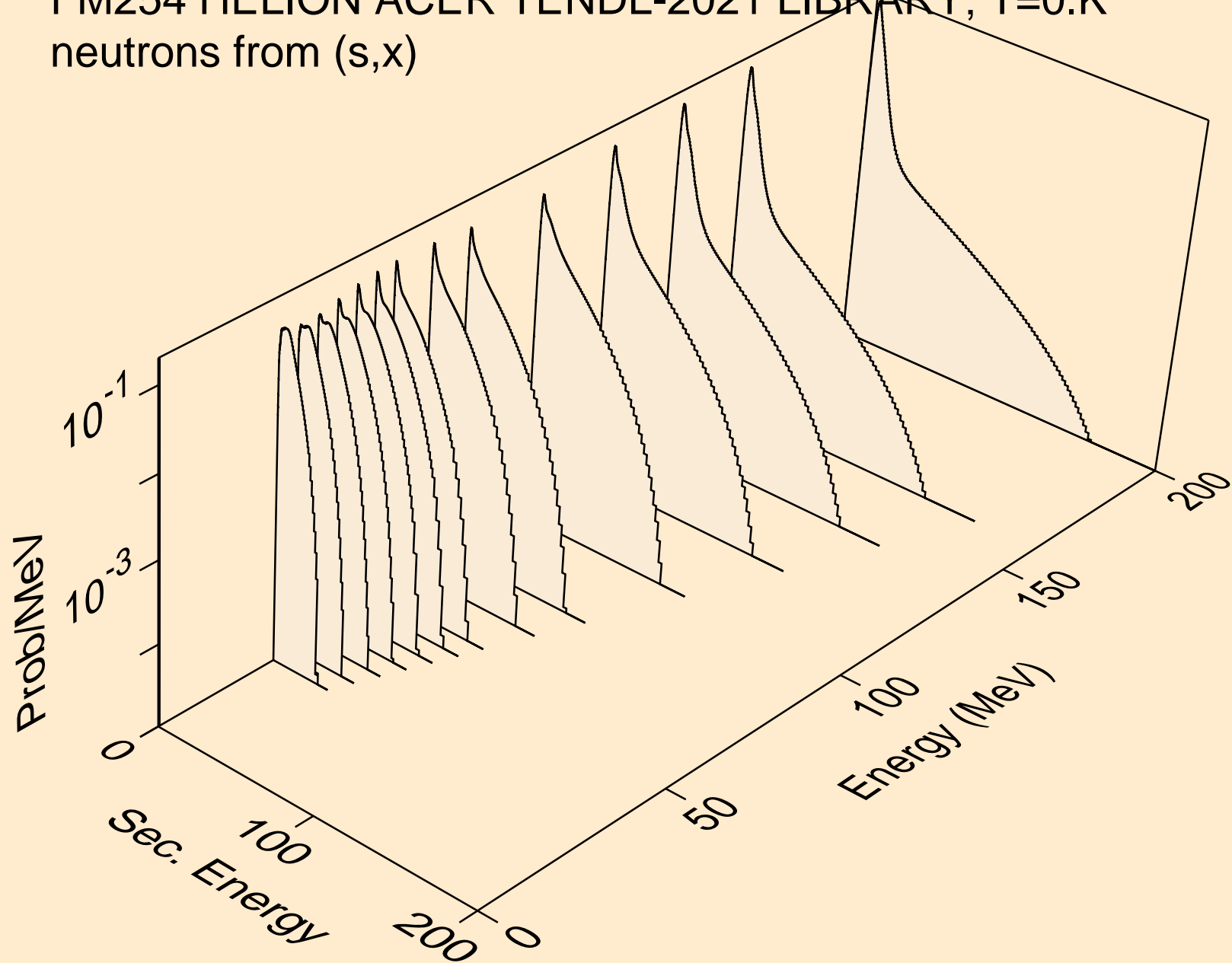

FM254 HELION ACER TENDL-2021 LIBRARY; T=0.K
neutrons from (s,2nd)

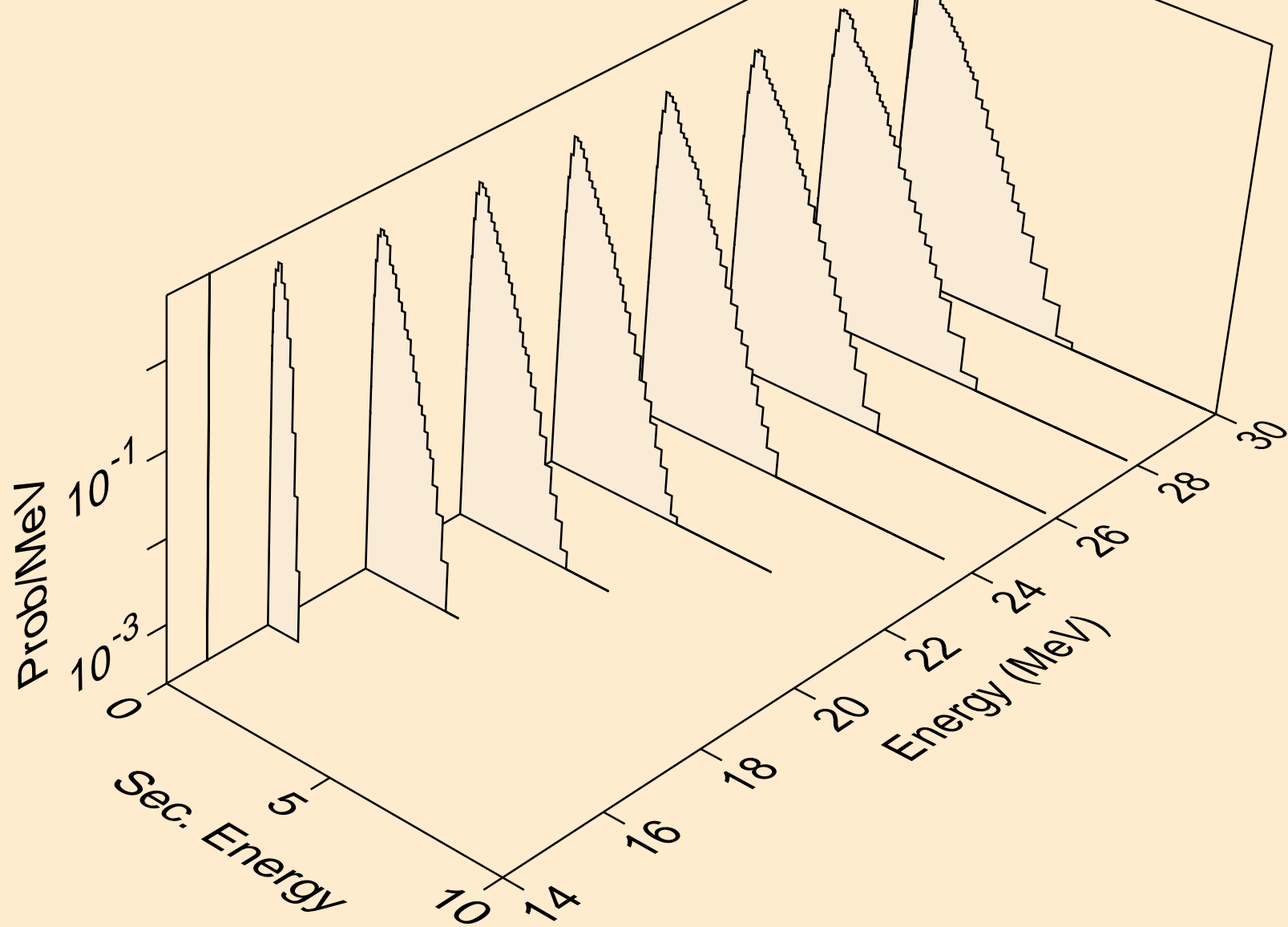

FM254 HELION ACER TENDL-2021 LIBRARY; T=0.K
neutrons from (s,2n)

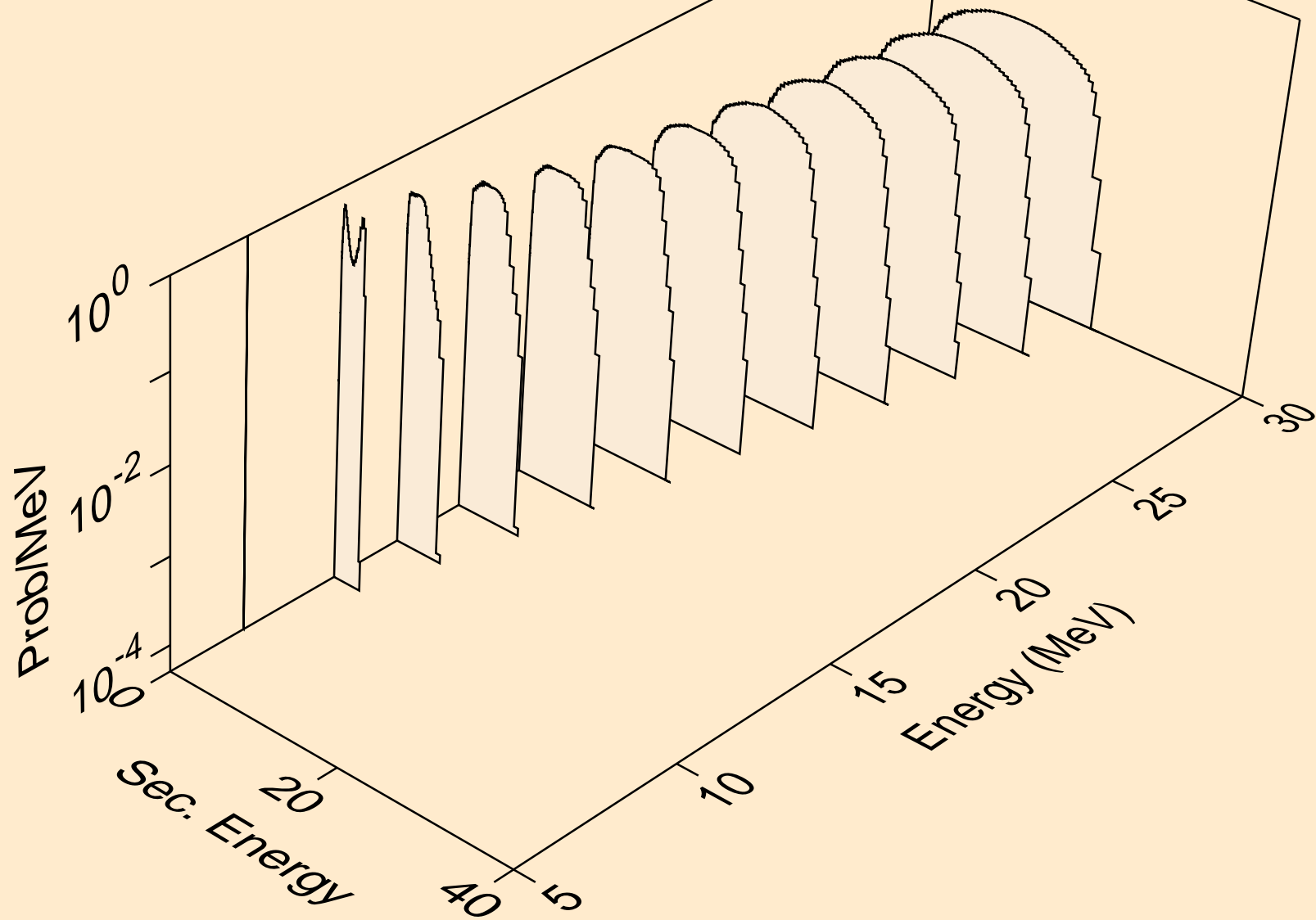

FM254 HELION ACER TENDL-2021 LIBRARY; T=0.K
neutrons from (s,3n)

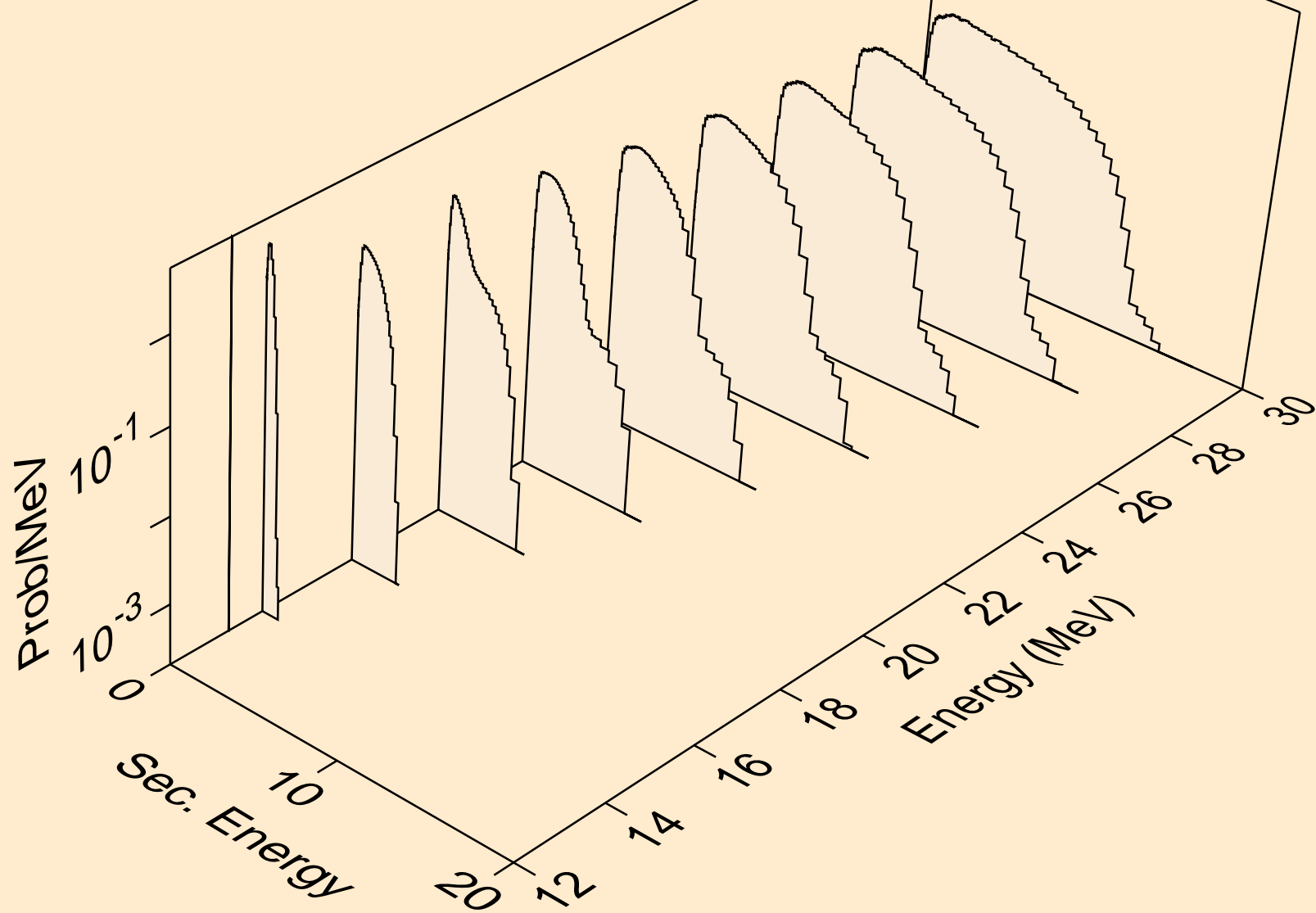

FM254 HELION ACER TENDL-2021 LIBRARY; T=0.K
neutrons from (s,n*)a

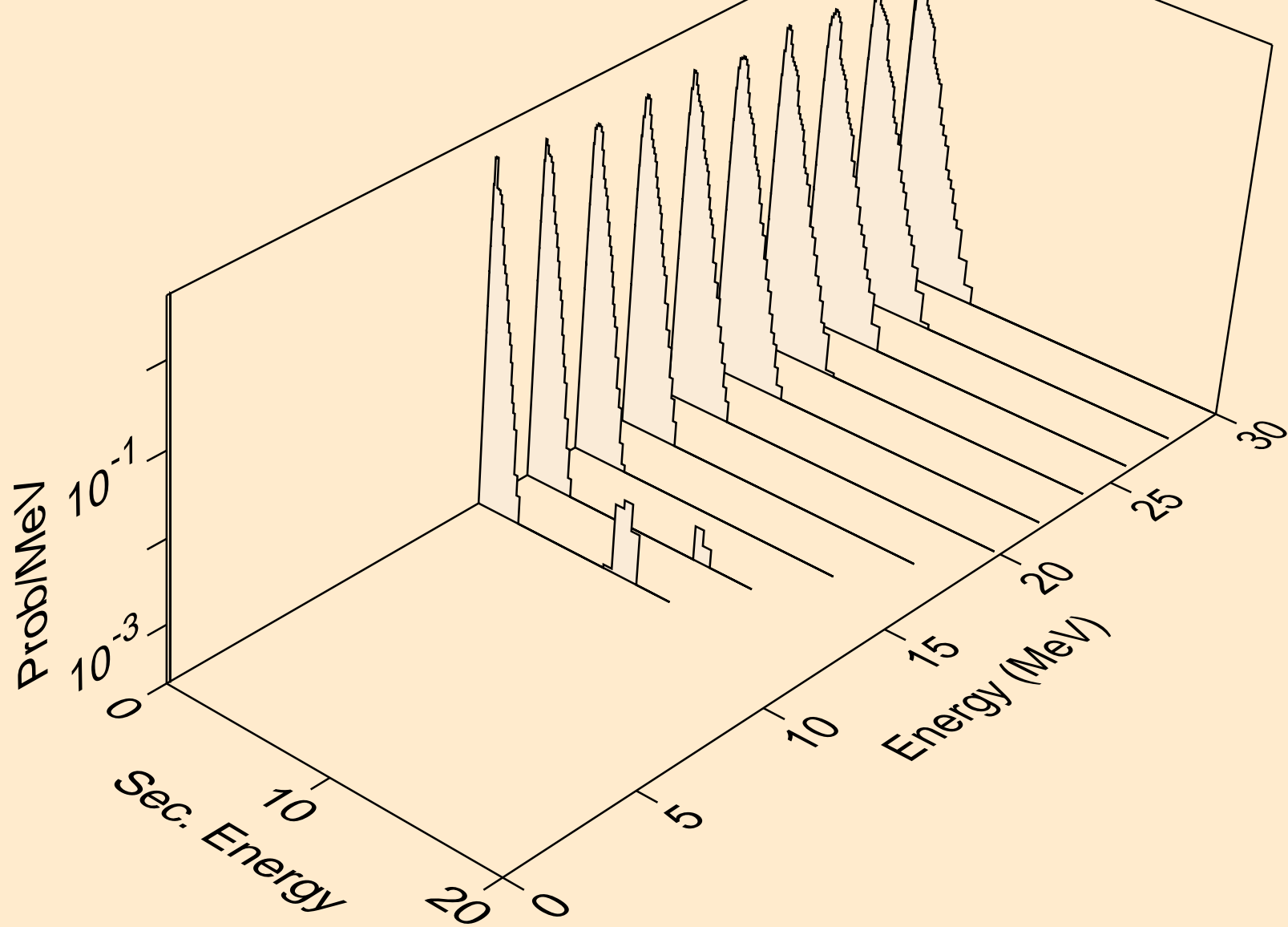

FM254 HELION ACER TENDL-2021 LIBRARY; T=0.K
neutrons from (s,n*)p

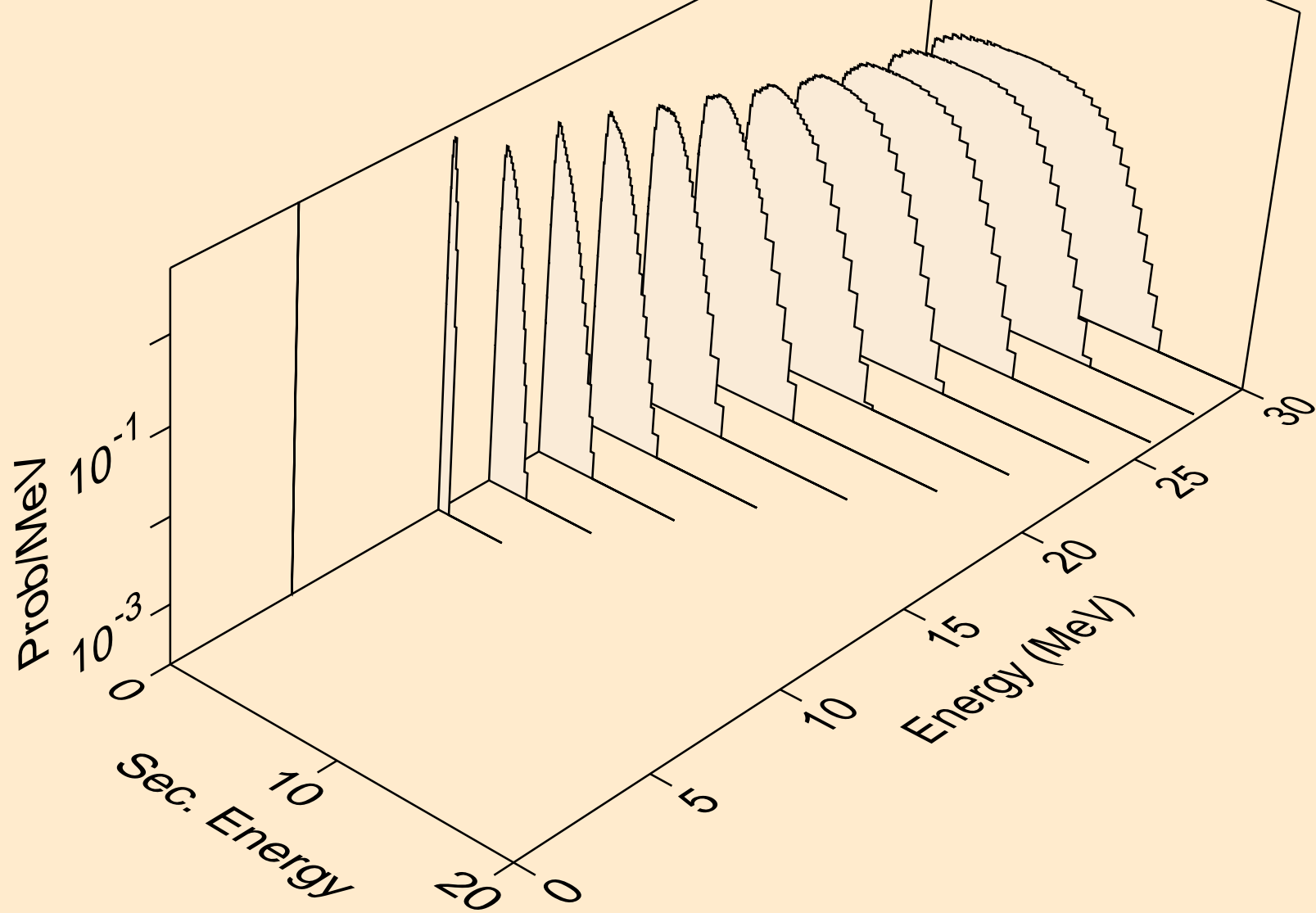

FM254 HELION ACER TENDL-2021 LIBRARY; T=0.K
neutrons from (s,n*)d

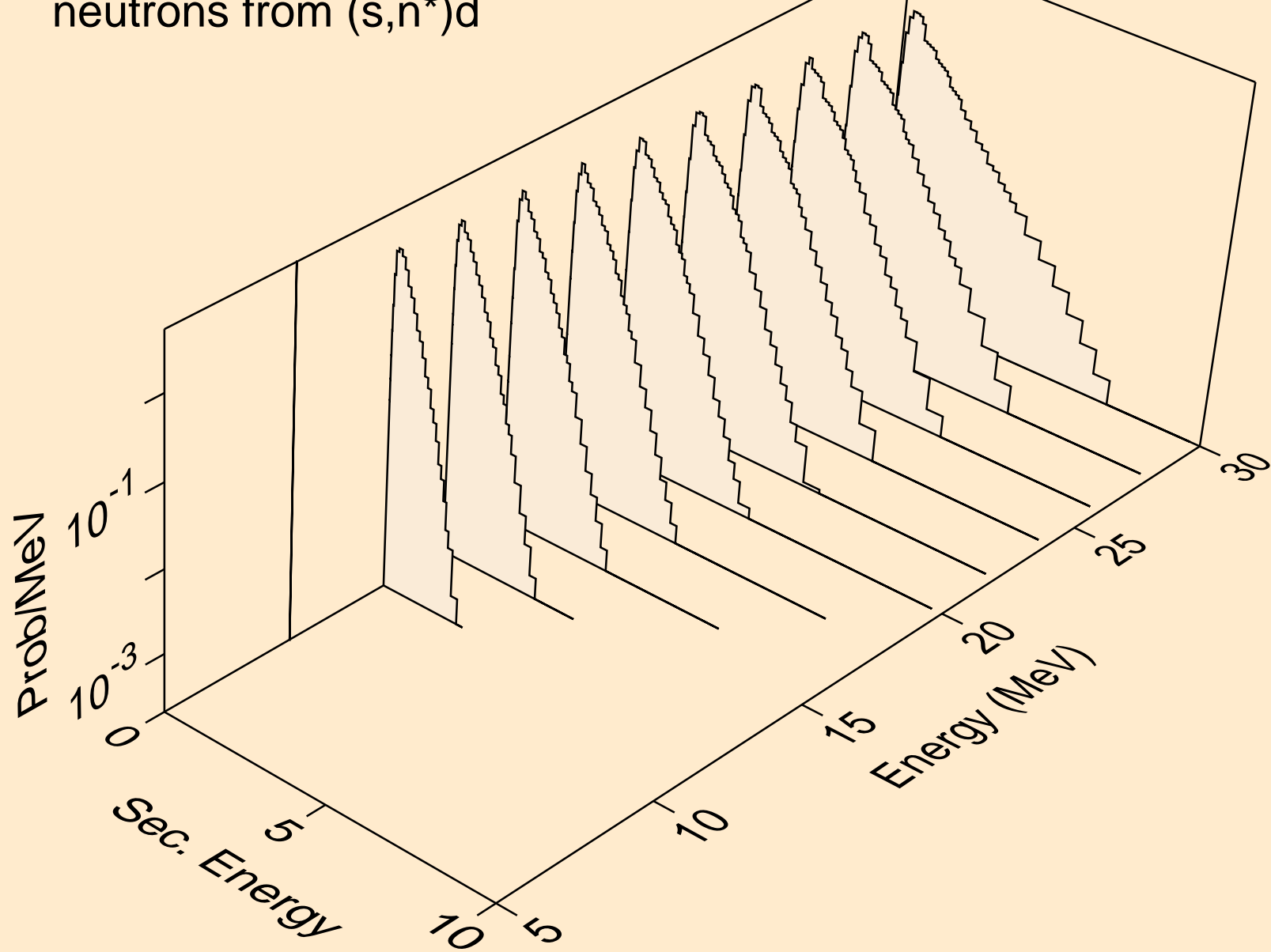

FM254 HELION ACER TENDL-2021 LIBRARY; T=0.K
neutrons from (s,n*)t

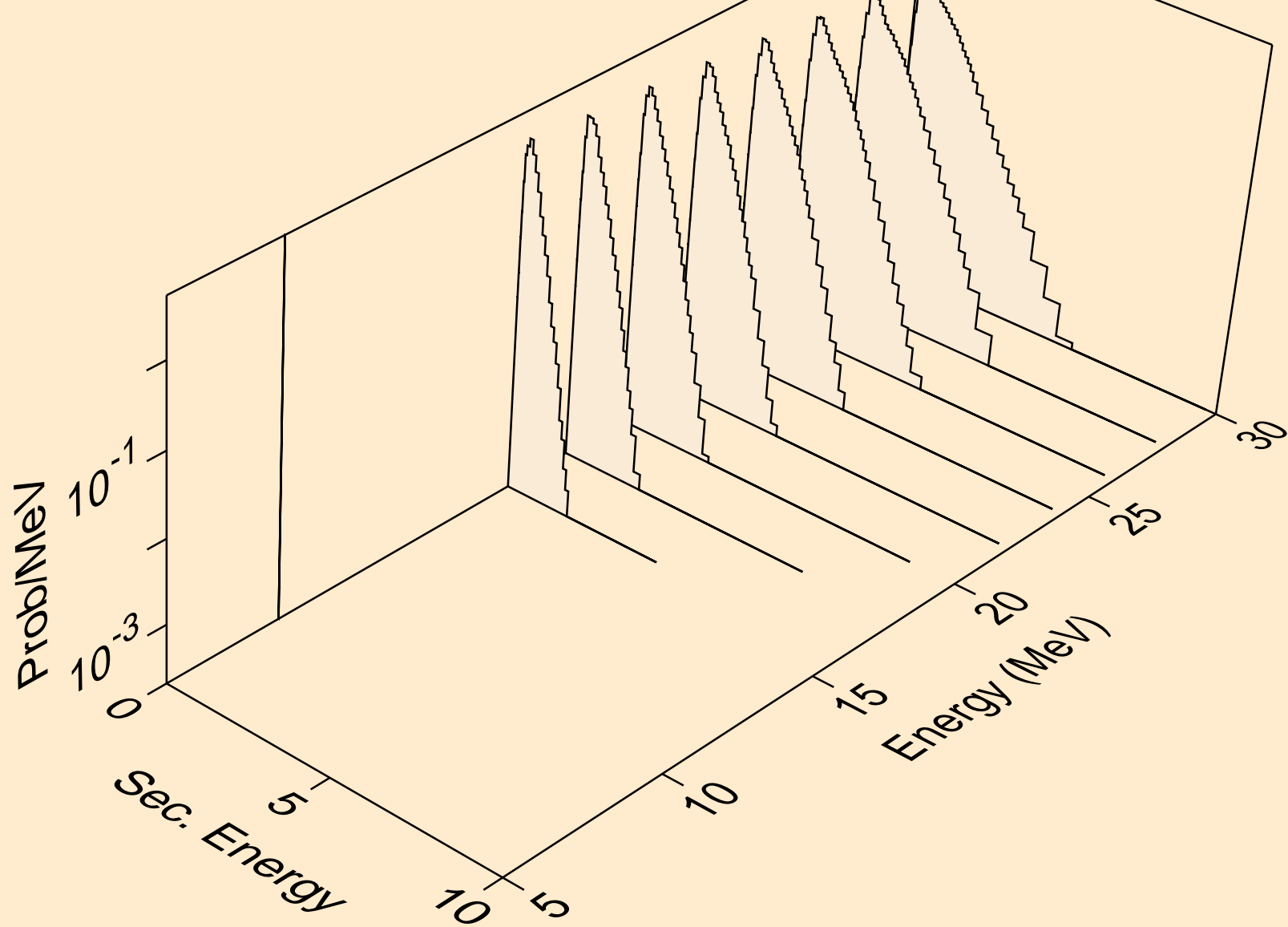

FM254 HELION ACER TENDL-2021 LIBRARY; T=0.K
neutrons from (s,n*)he3

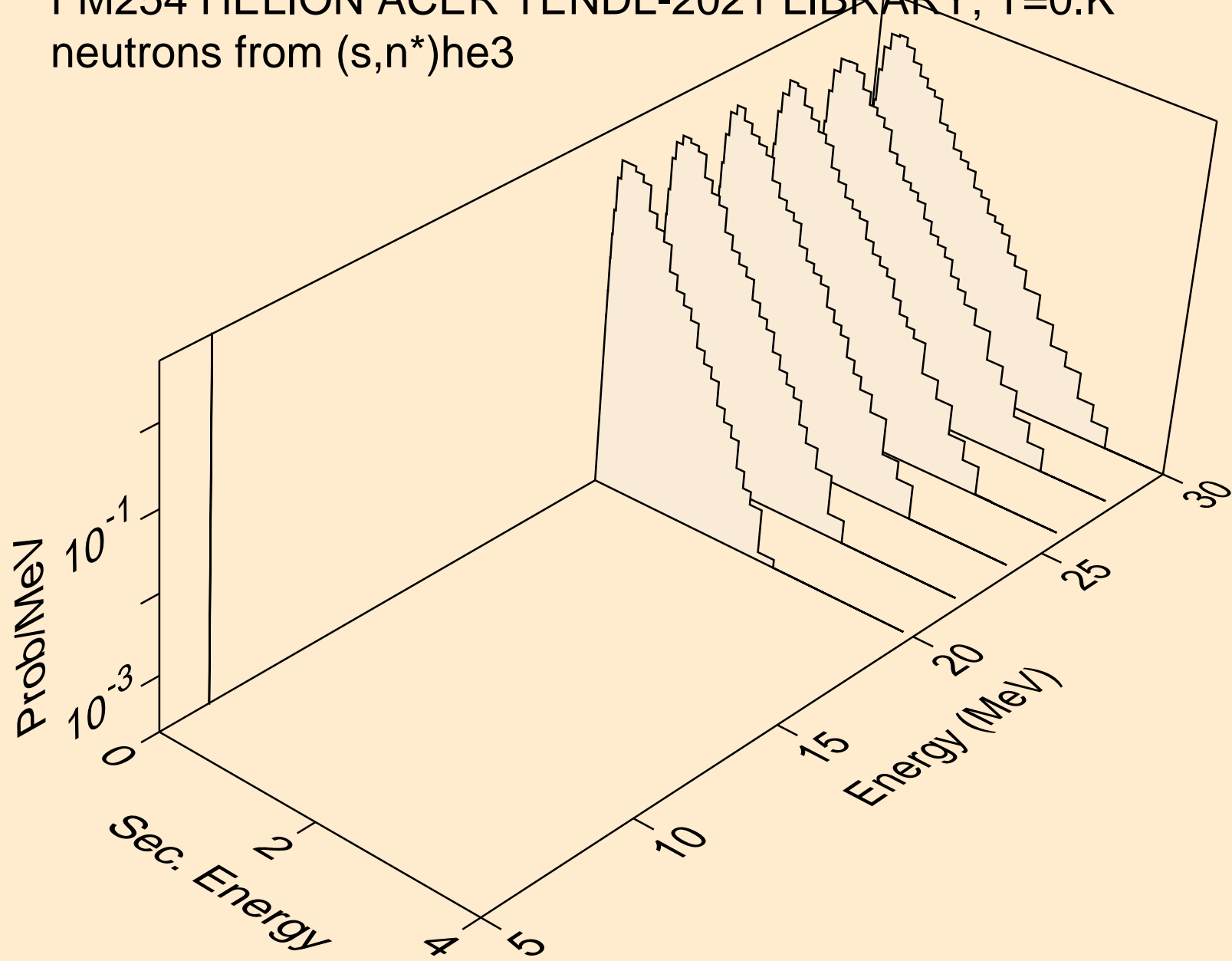

FM254 HELION ACER TENDL-2021 LIBRARY; T=0.K
neutrons from (s,2np)

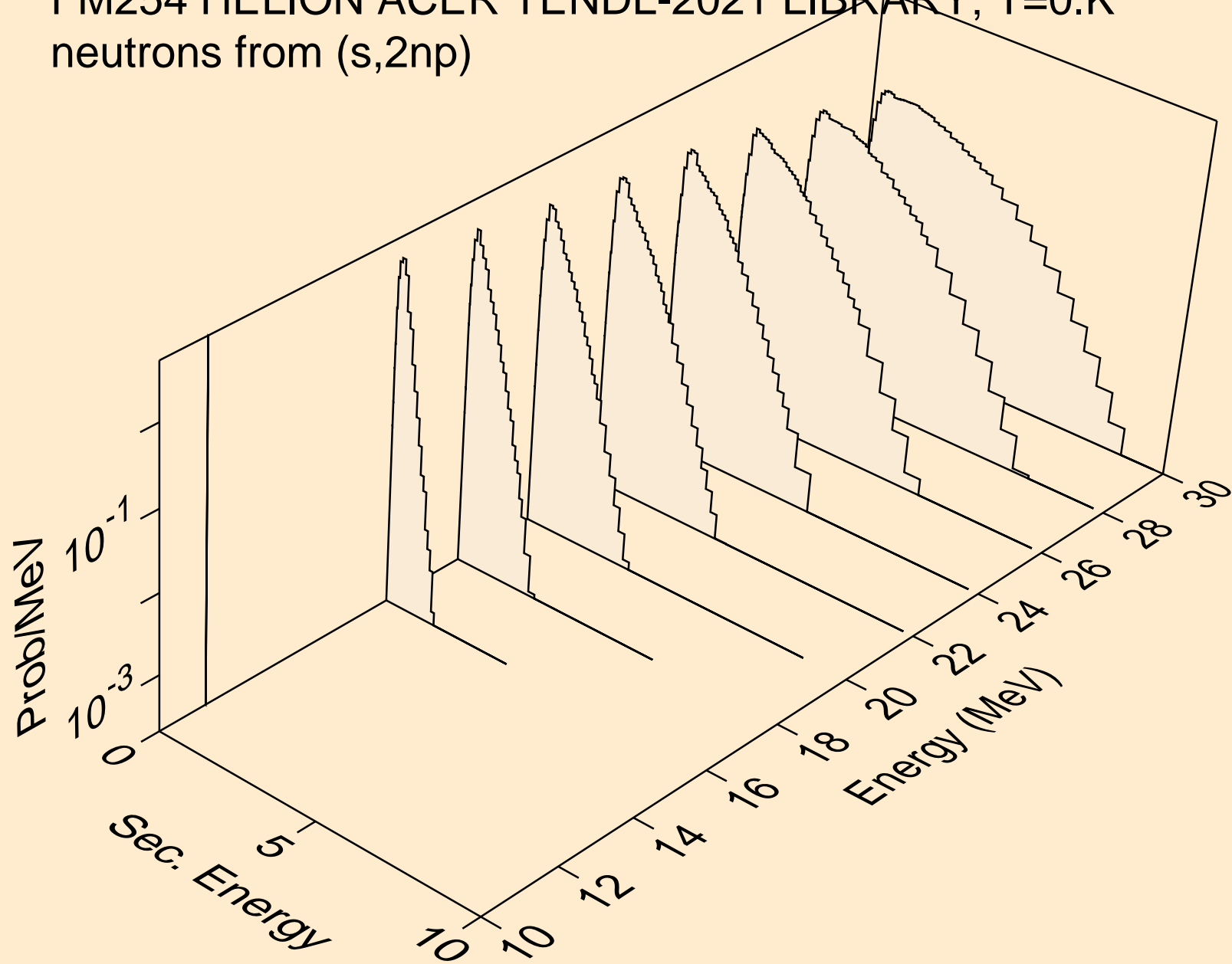

FM254 HELION ACER TENDL-2021 LIBRARY; T=0.K
protons from (s,x)

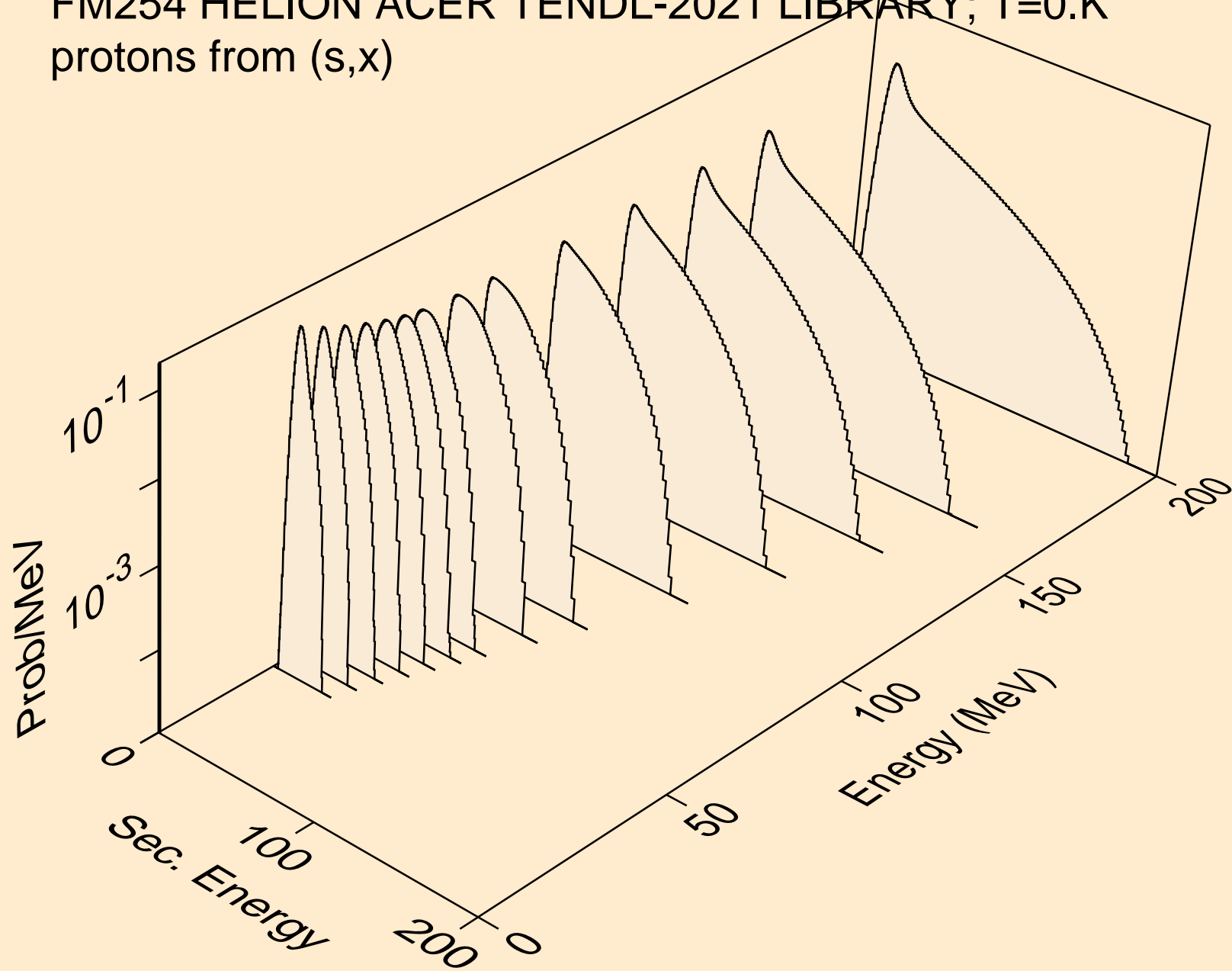

FM254 HELION ACER TENDL-2021 LIBRARY; T=0.K
protons from (s,n*)p

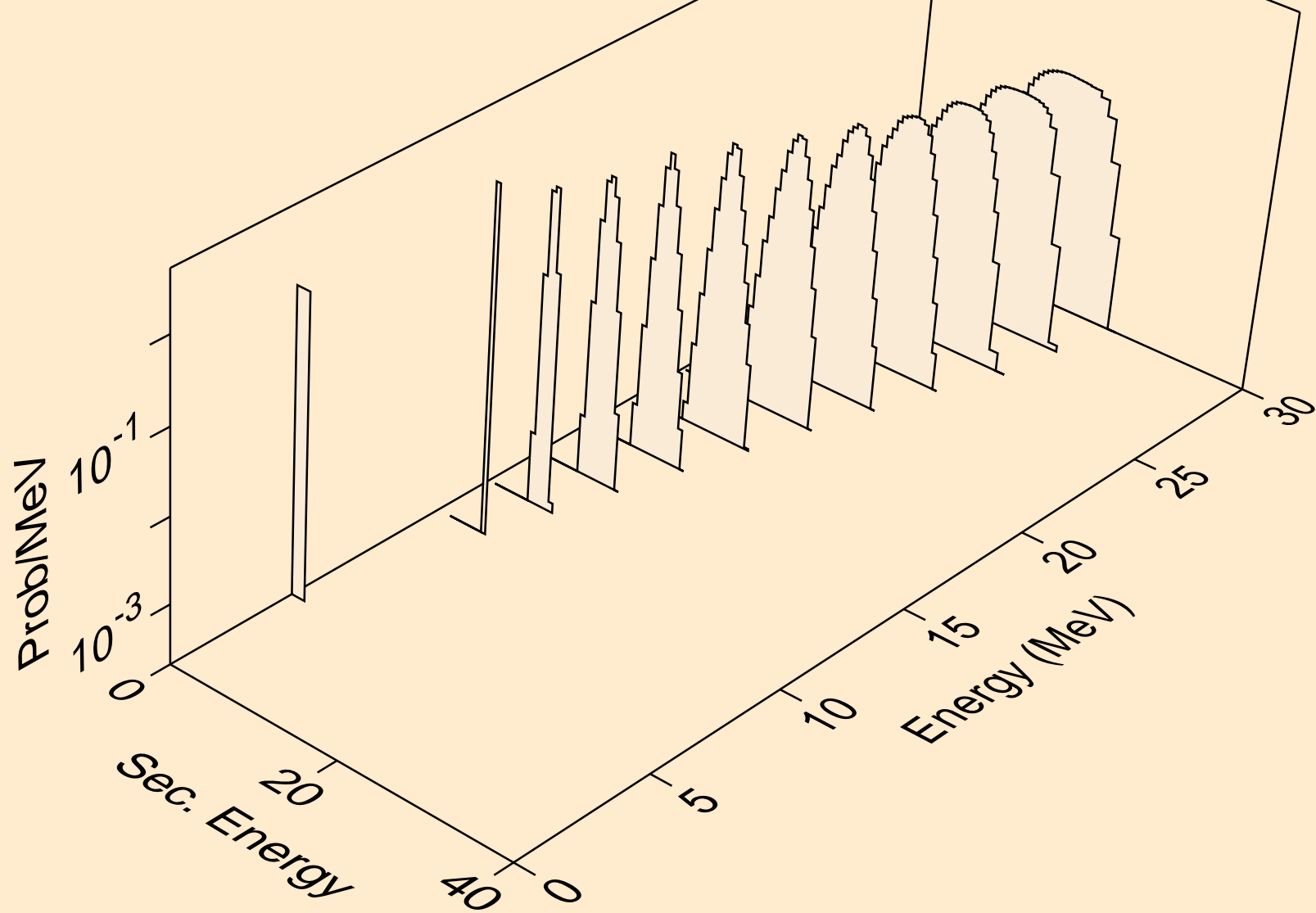

FM254 HELION ACER TENDL-2021 LIBRARY; T=0.K
protons from (s,2np)

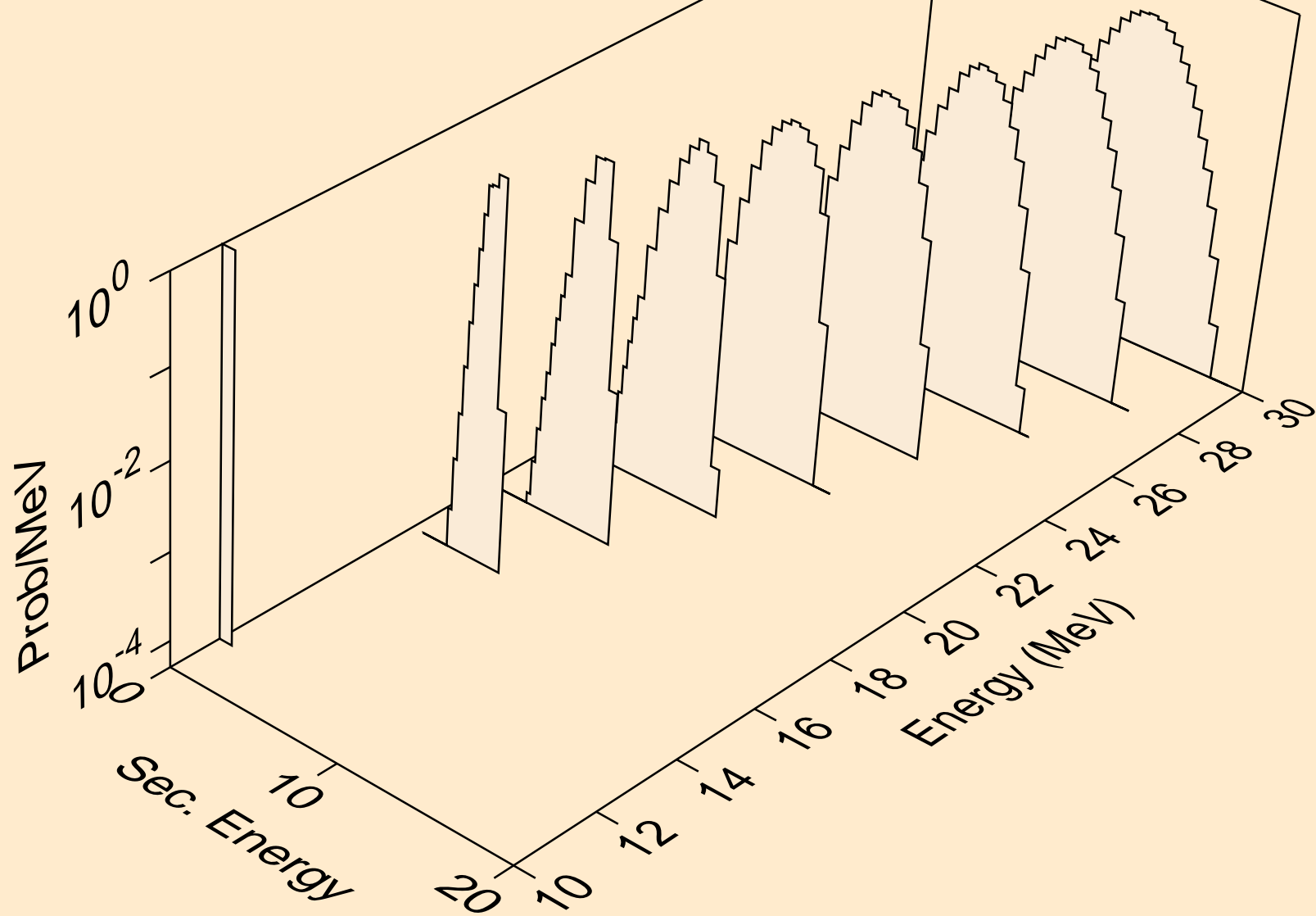

FM254 HELION ACER TENDL-2021 LIBRARY; T=0.K
protons from (s,p)

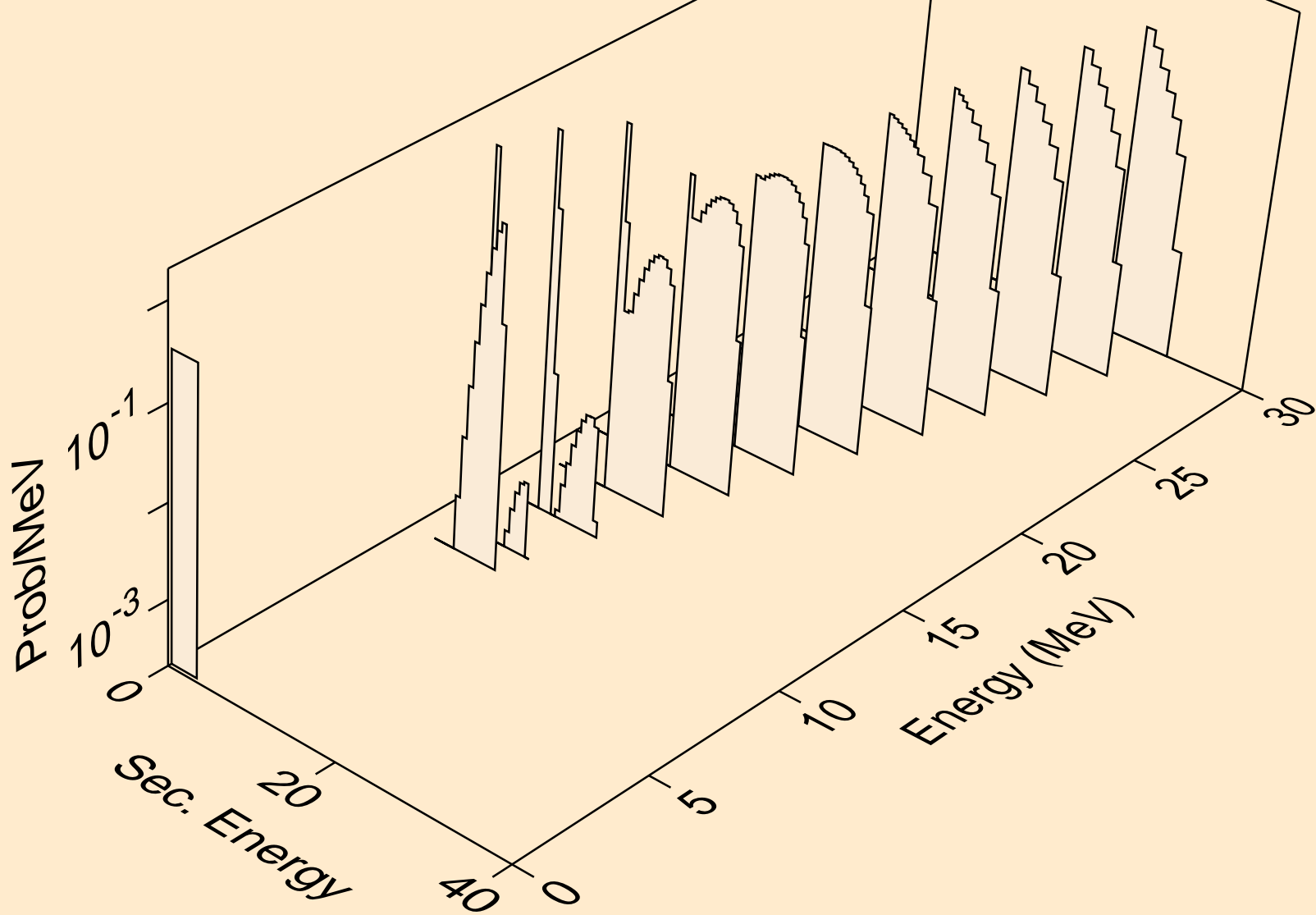

FM254 HELION ACER TENDL-2021 LIBRARY; T=0.K
protons from (s,2p)

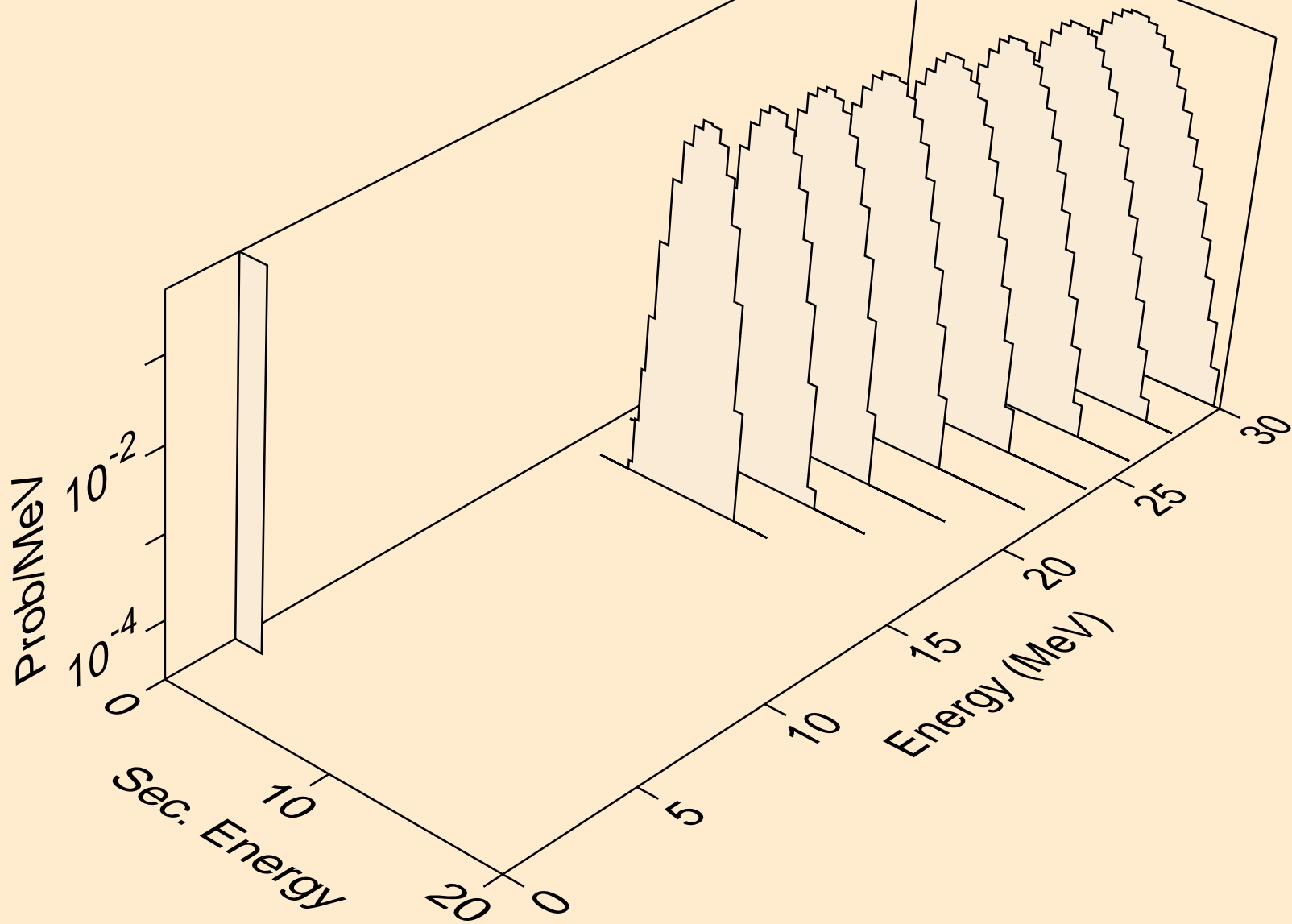

FM254 HELION ACER TENDL-2021 LIBRARY; T=0.K
deuterons from (s,x)

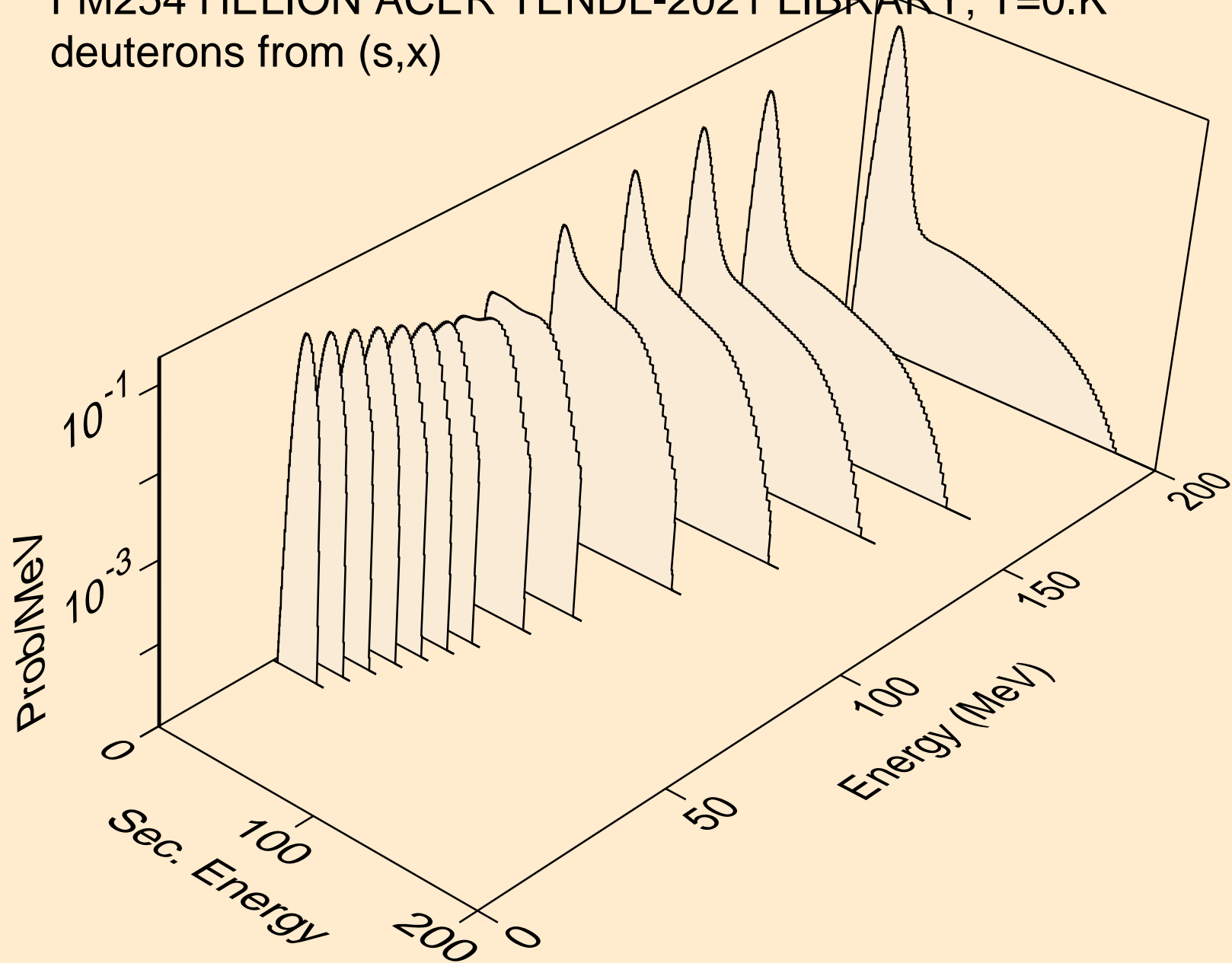

FM254 HELION ACER TENDL-2021 LIBRARY; T=0.K
deuterons from (s,2nd)

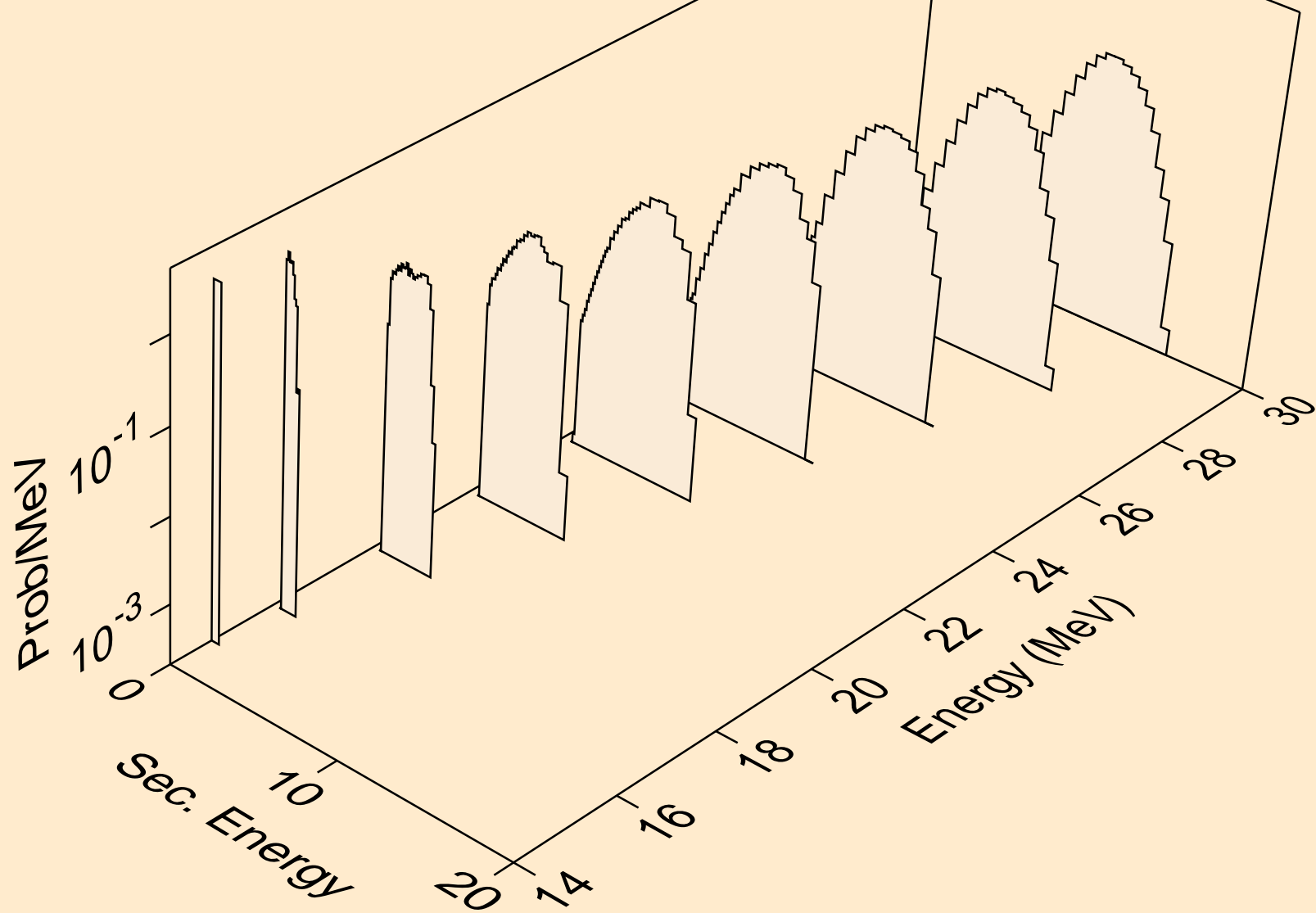

FM254 HELION ACER TENDL-2021 LIBRARY; T=0.K
deuterons from (s,n*)d

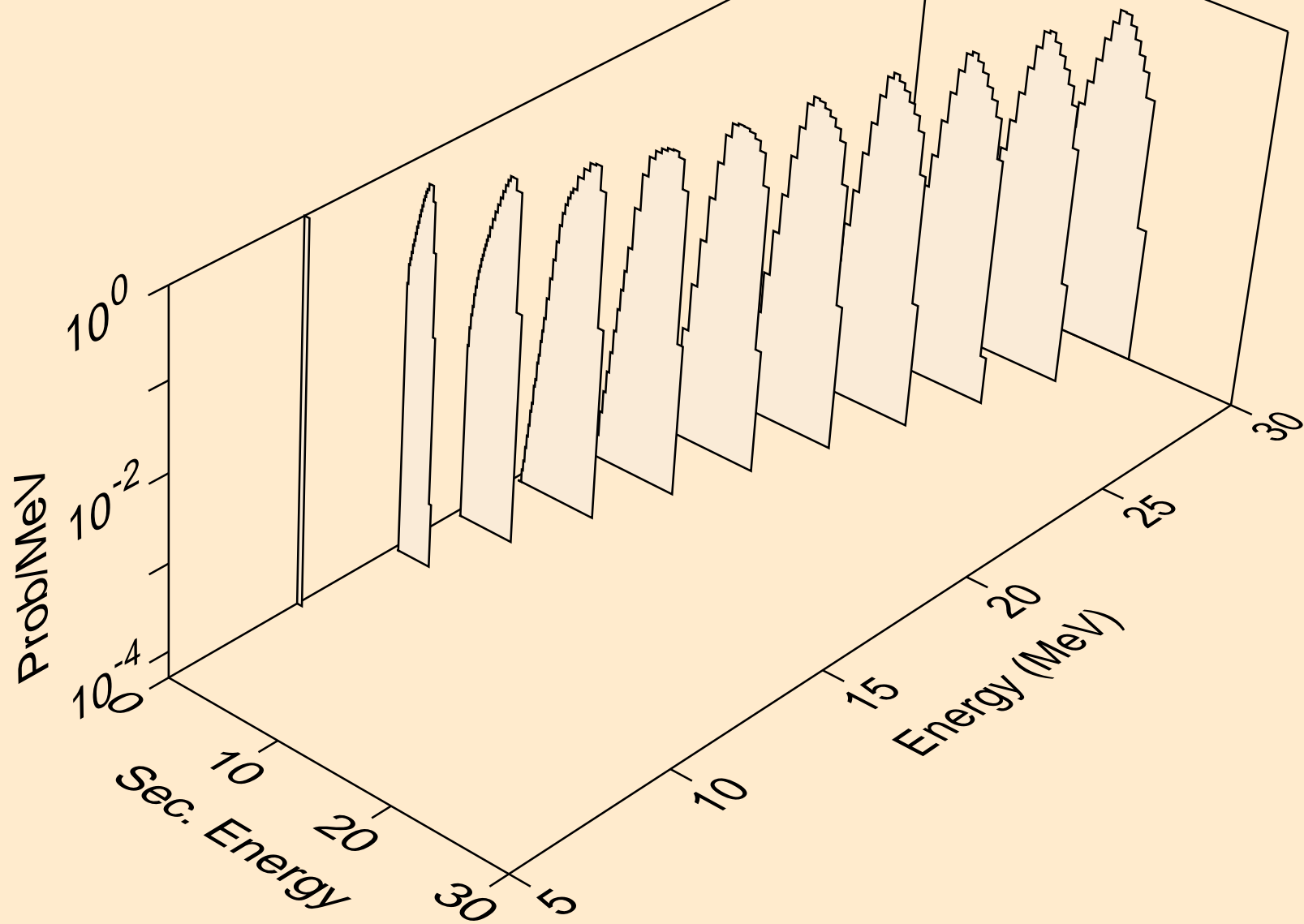

FM254 HELION ACER TENDL-2021 LIBRARY; T=0.K
deuterons from (s,d)

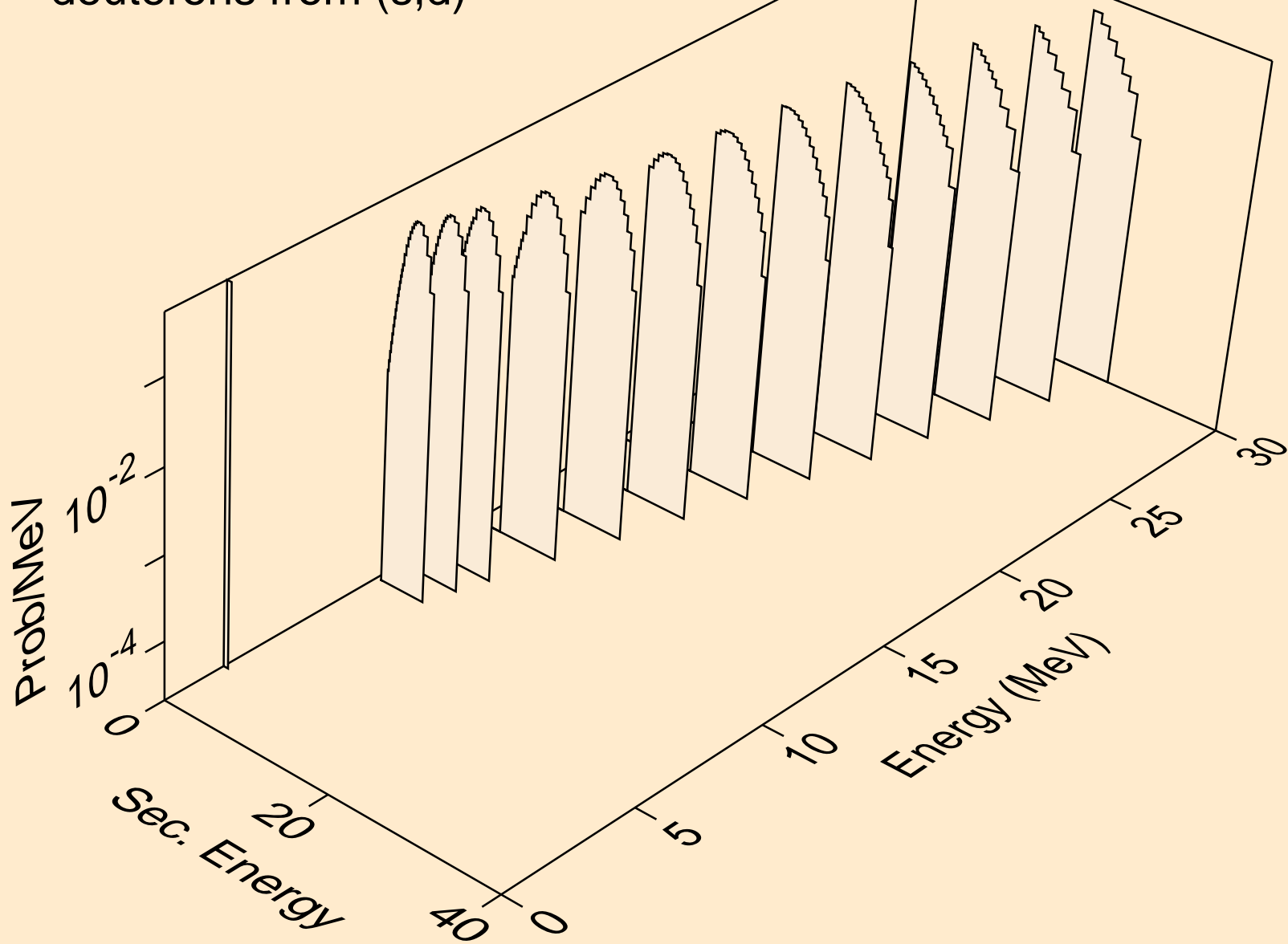

FM254 HELION ACER TENDL-2021 LIBRARY; T=0.K
tritons from (s,x)

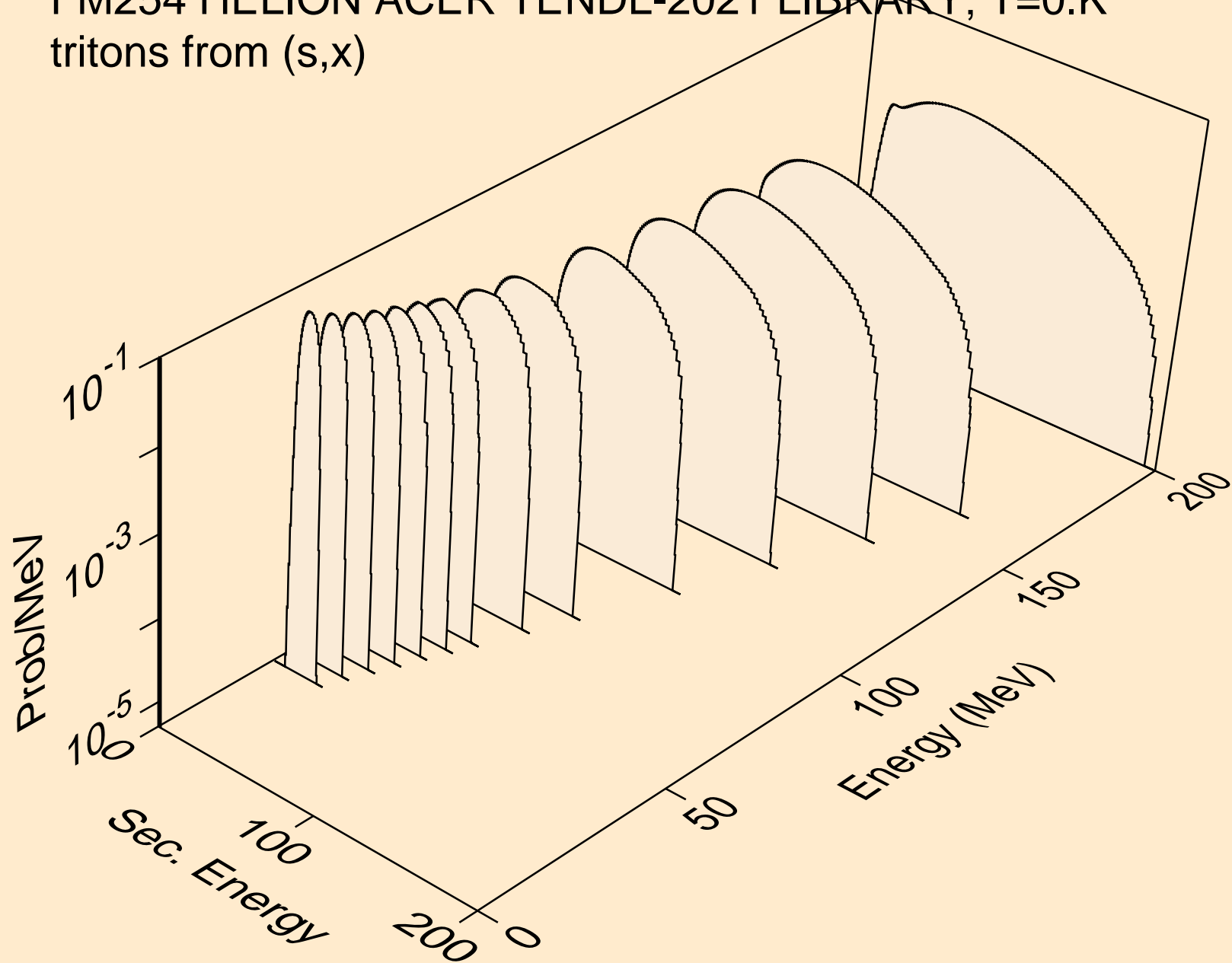

FM254 HELION ACER TENDL-2021 LIBRARY; T=0.K
tritons from (s,n*)t

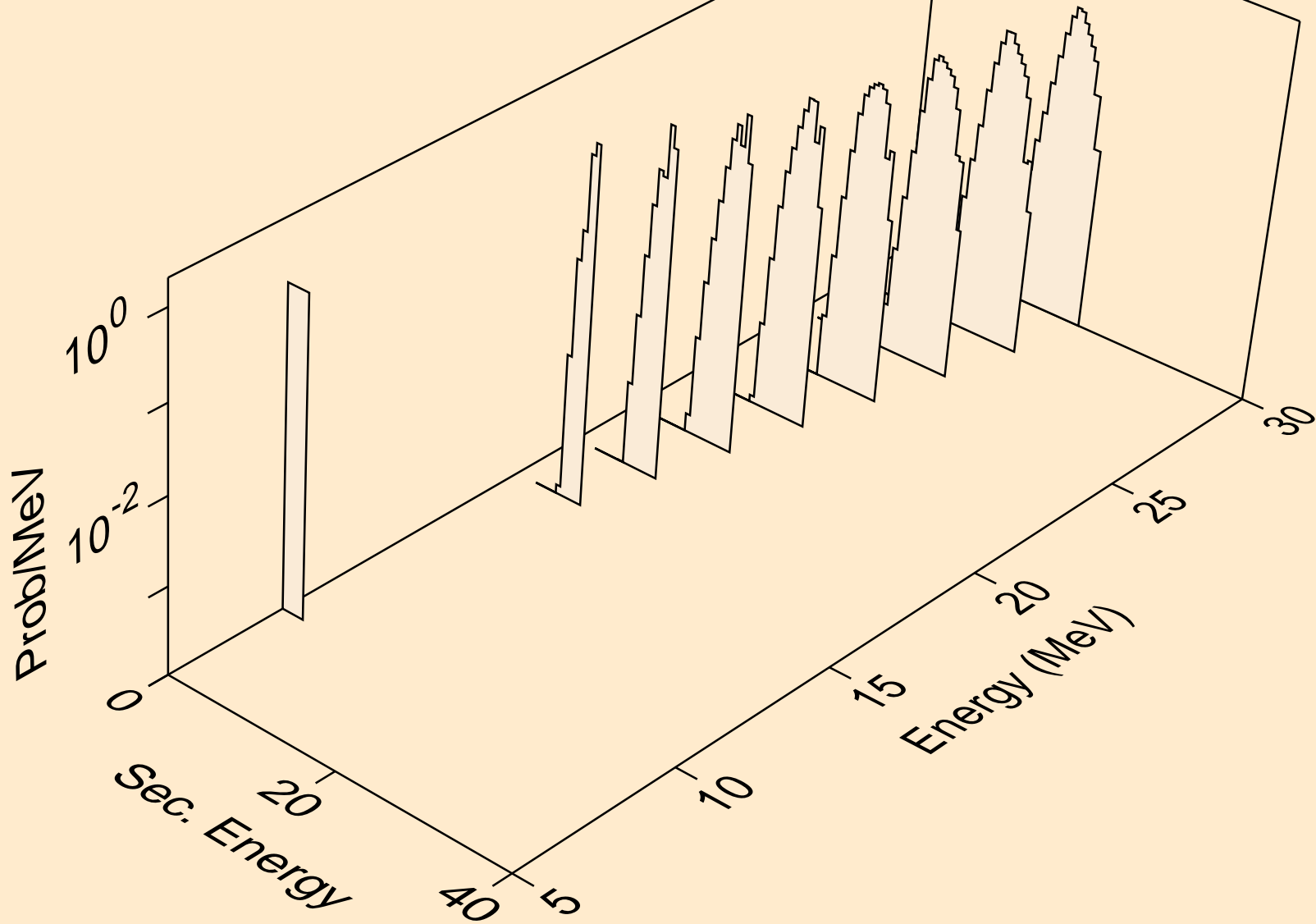

FM254 HELION ACER TENDL-2021 LIBRARY; T=0.K
tritons from (s,t)

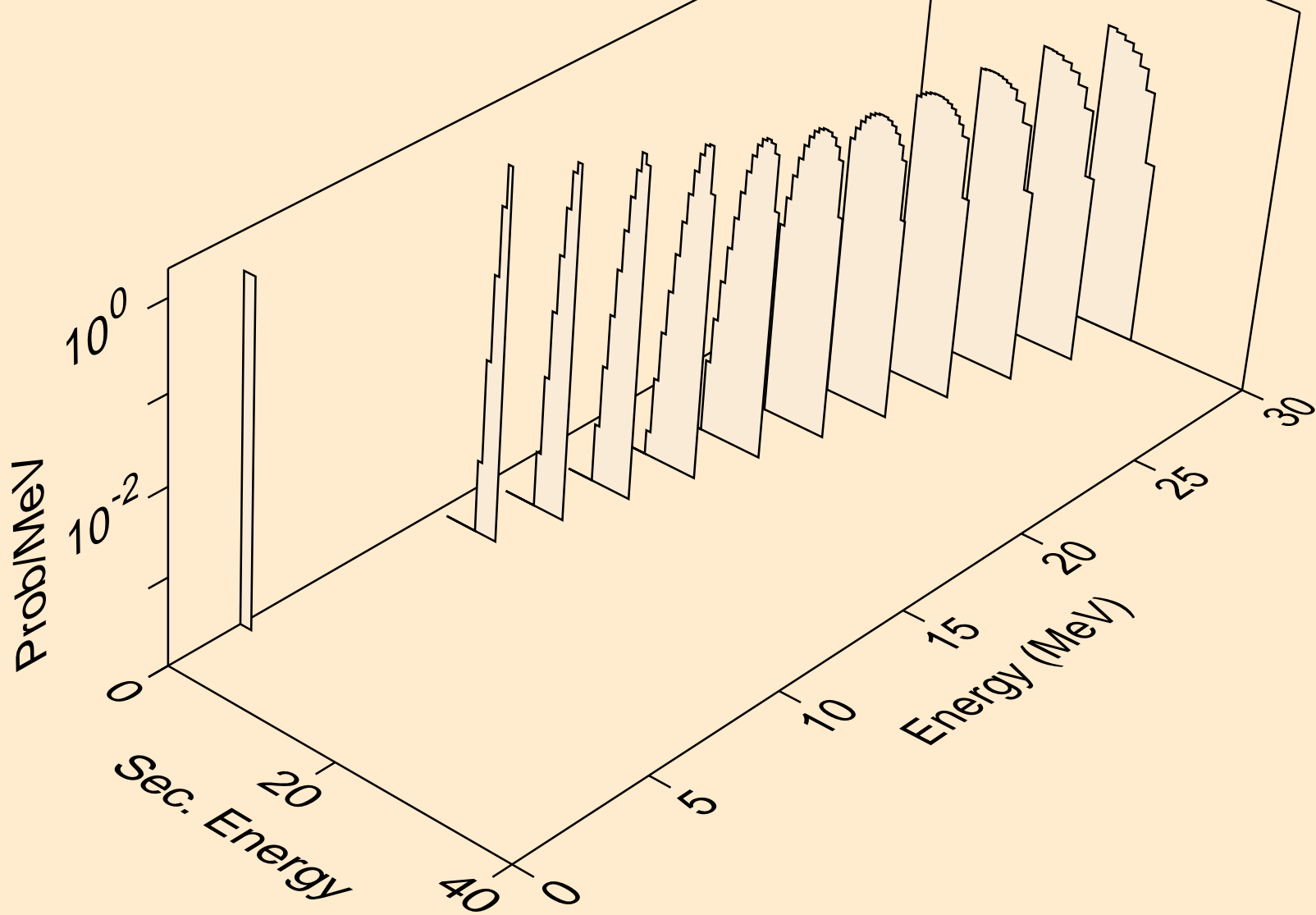

FM254 HELION ACER TENDL-2021 LIBRARY; T=0.K
alphas from (s,x)

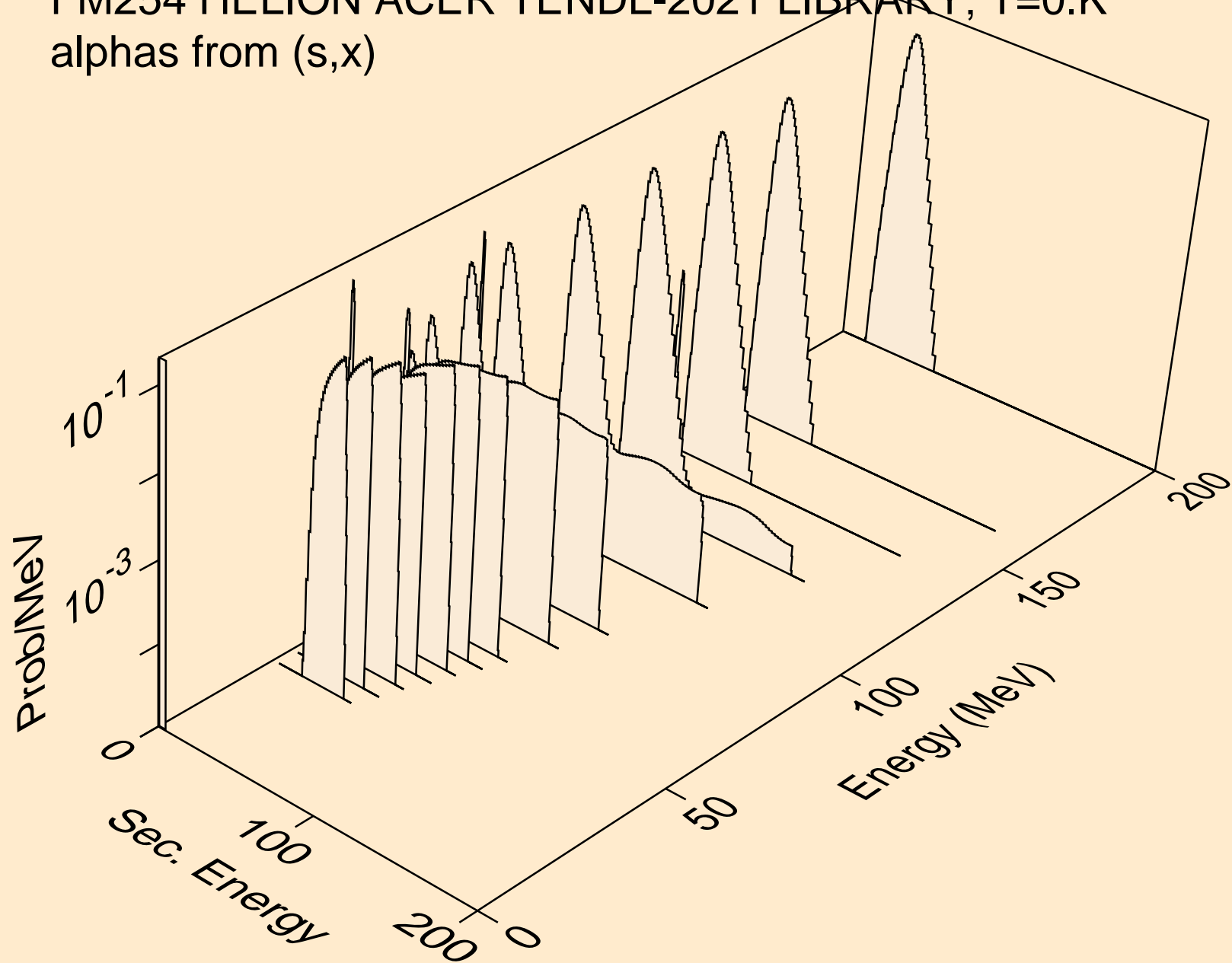

FM254 HELION ACER TENDL-2021 LIBRARY; T=0.K
alphas from (s,n*)a

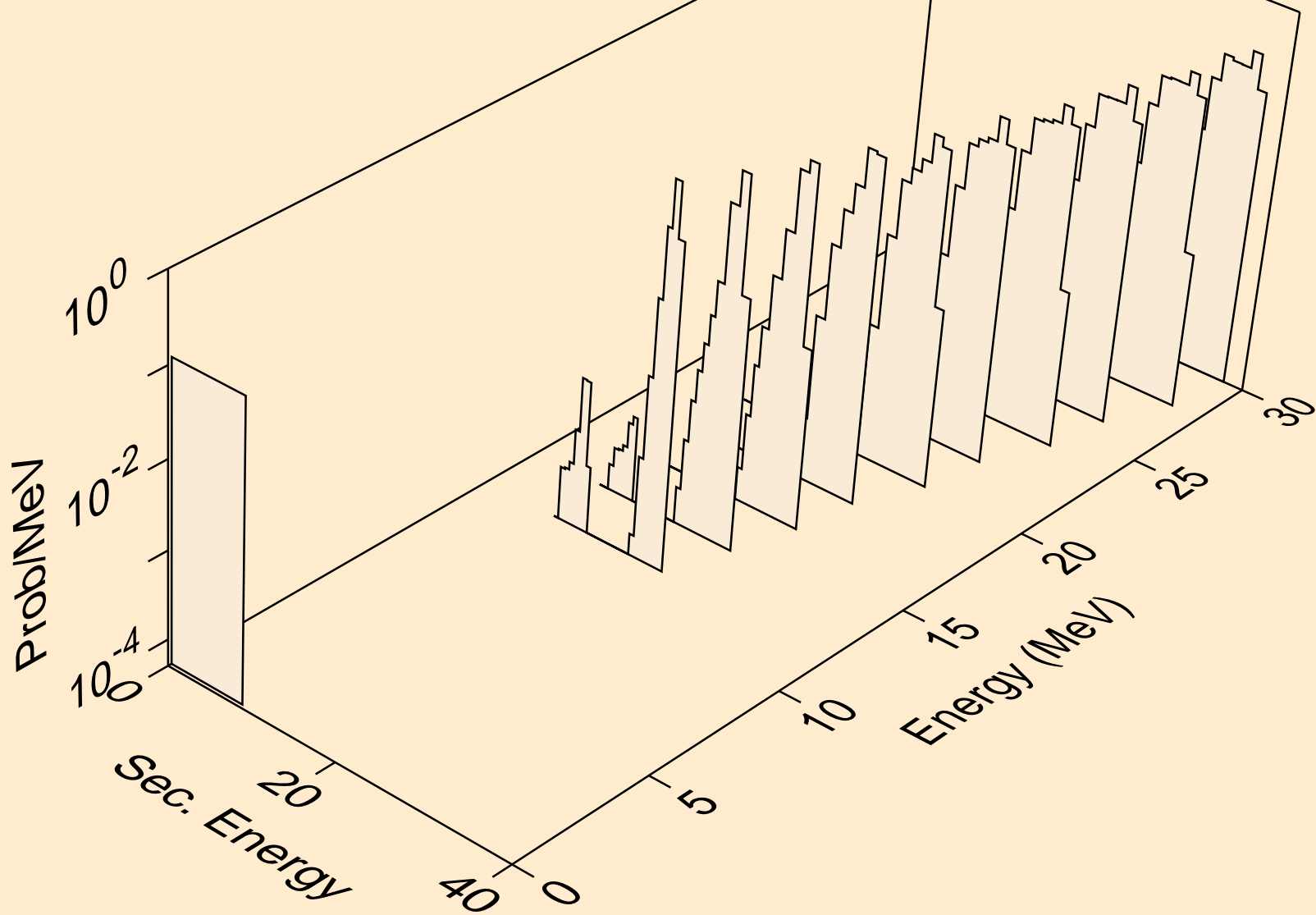

FM254 HELION ACER TENDL-2021 LIBRARY; T=0.K
alphas from (s,a)

