

FR204 HELION ACER TENDL-2021 LIBRARY; T=0.K
Principal cross sections

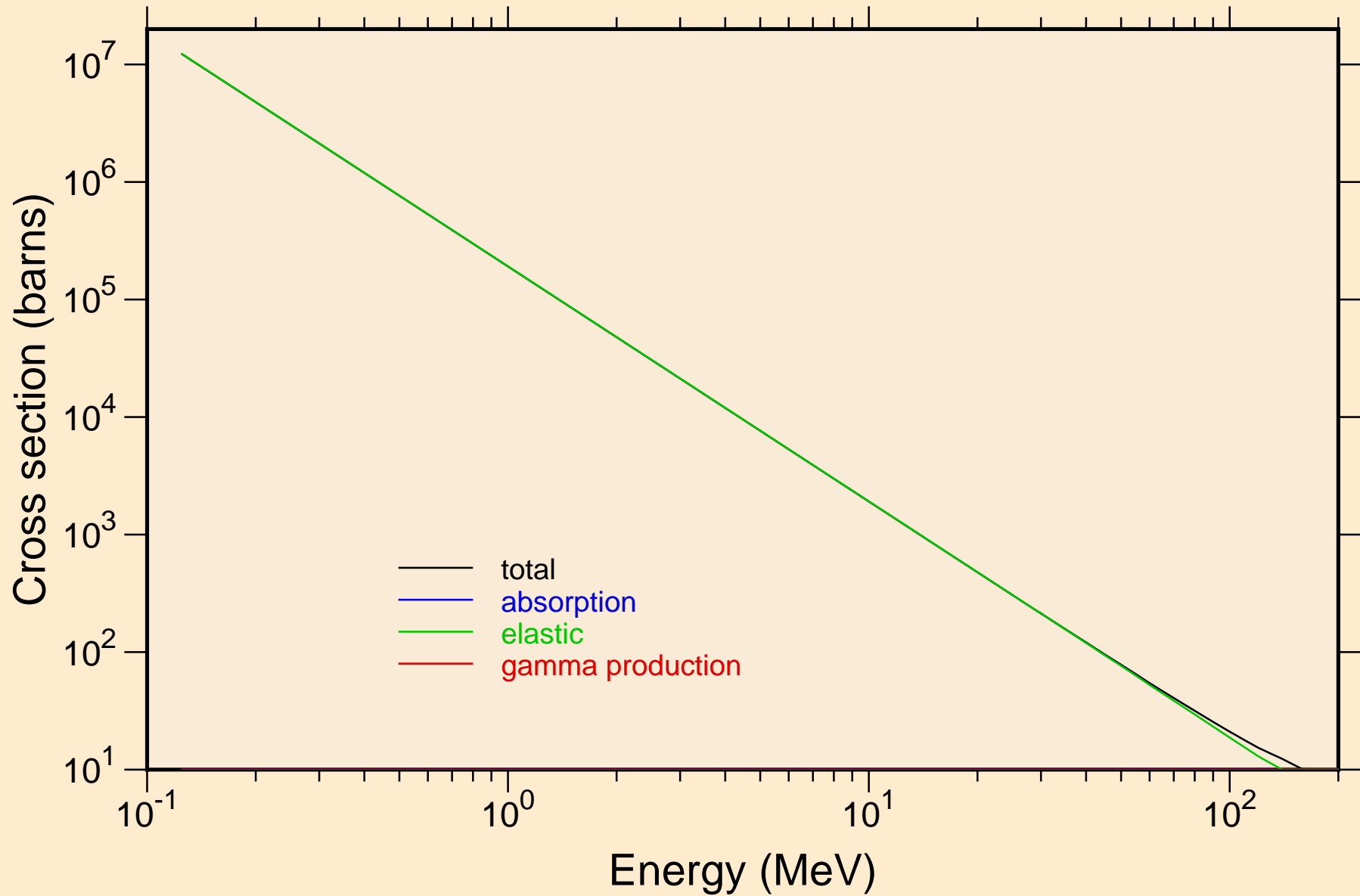

FR204 HELION ACER TENDL-2021 LIBRARY; T=0.K
Heating

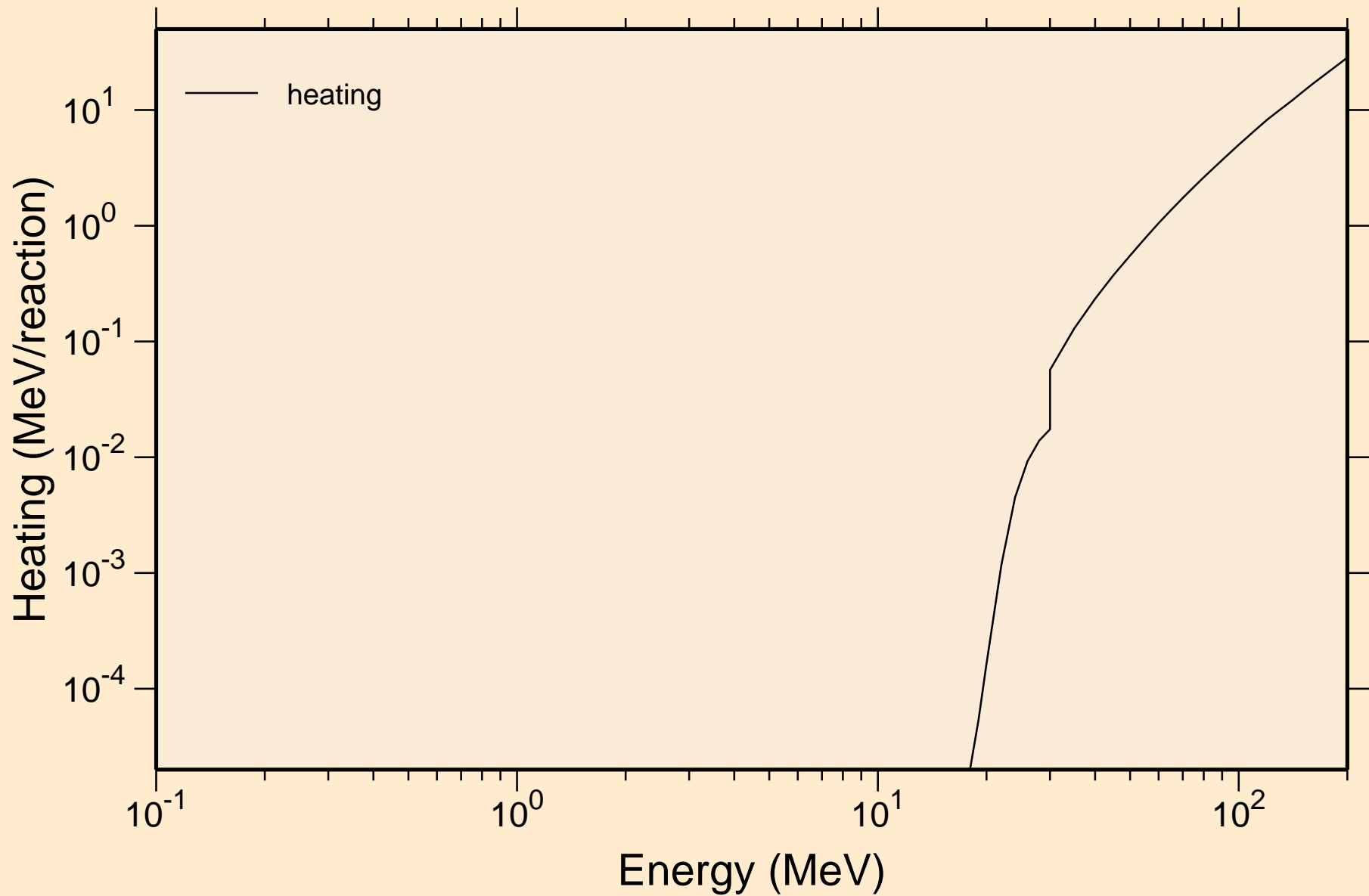

FR204 HELION ACER TENDL-2021 LIBRARY; T=0.K

Principal cross sections

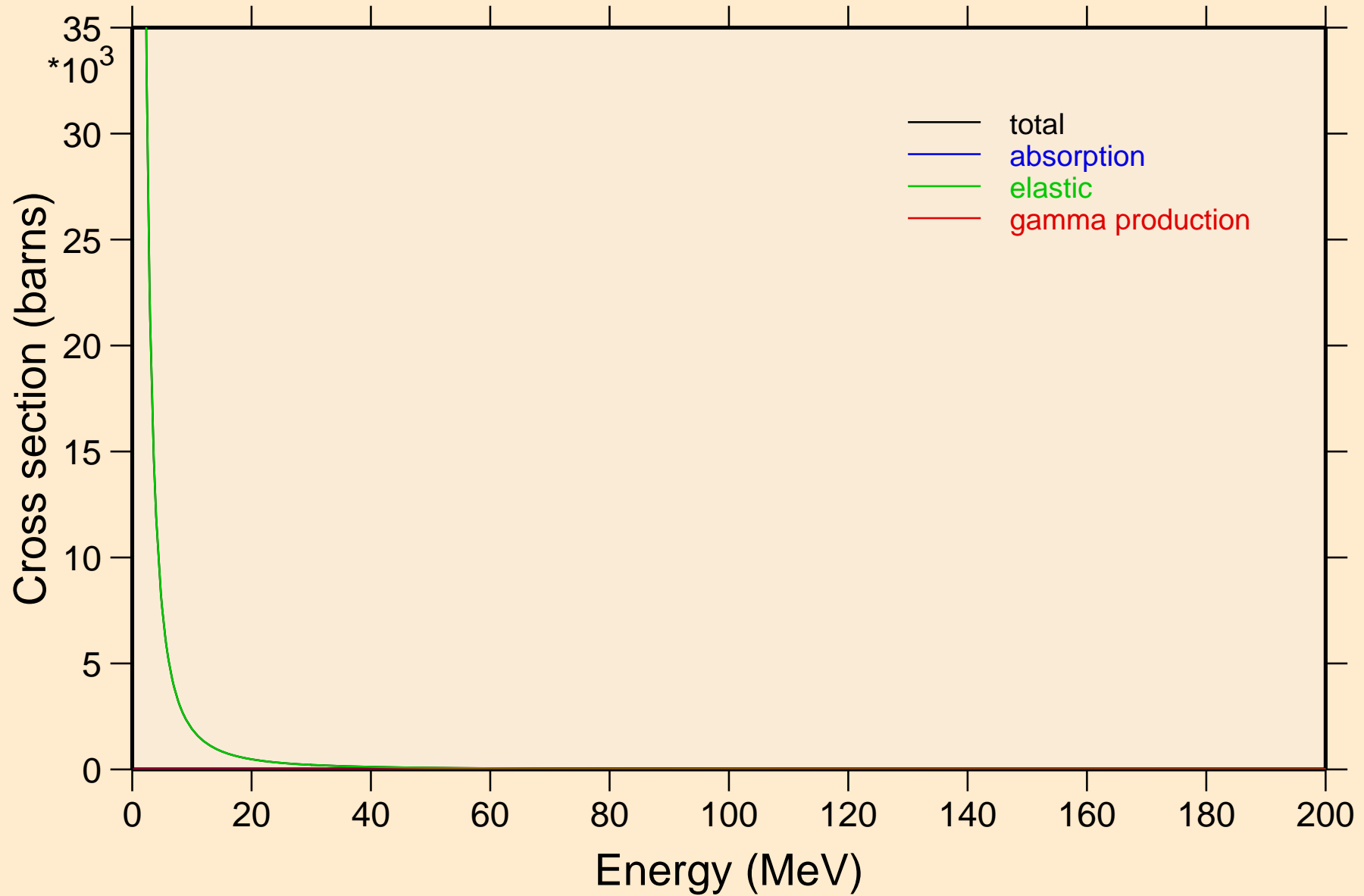

FR204 HELION ACER TENDL-2021 LIBRARY; T=0.K

Heating

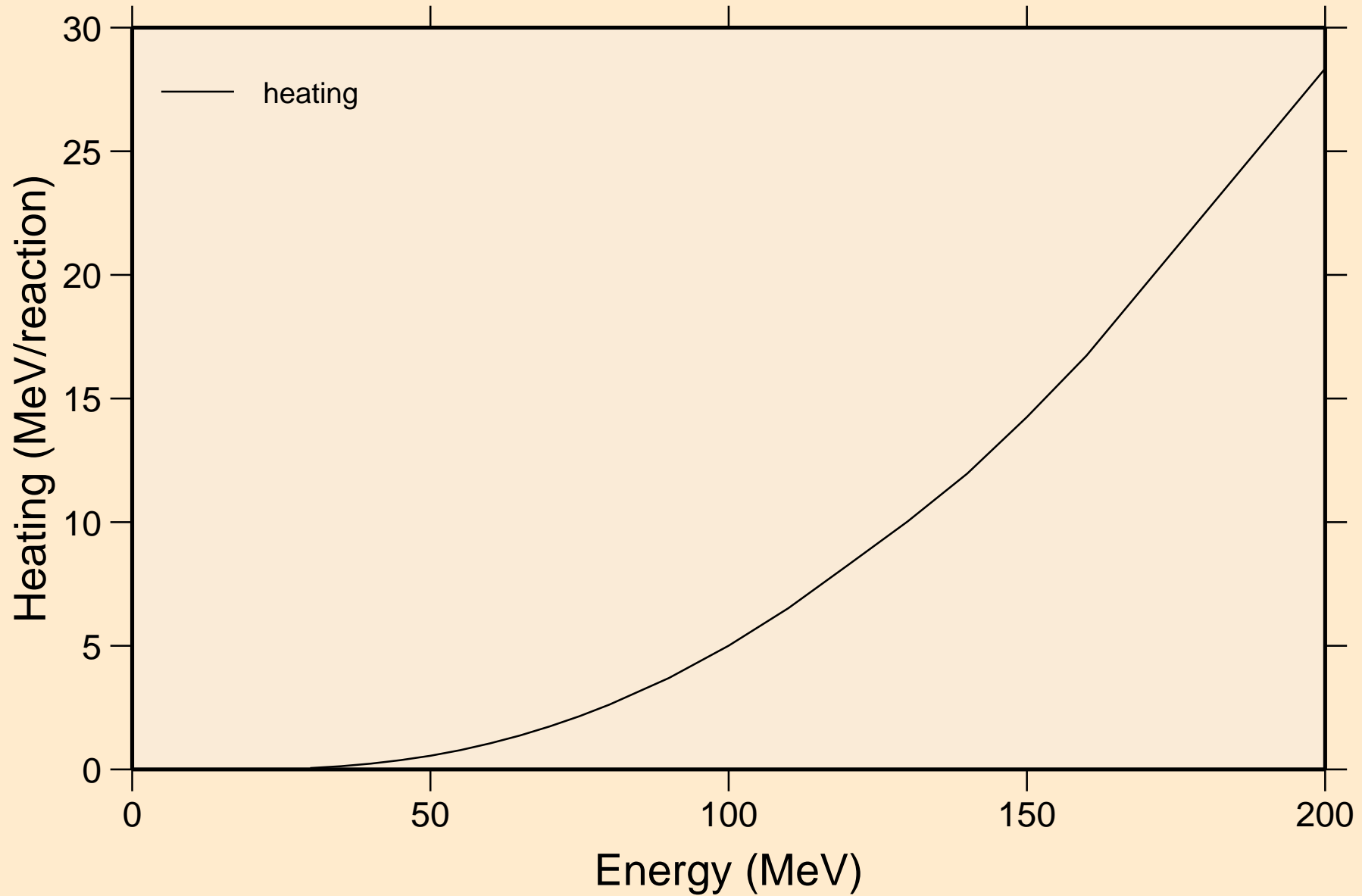

FR204 HELION ACER TENDL-2021 LIBRARY; T=0.K
Threshold reactions

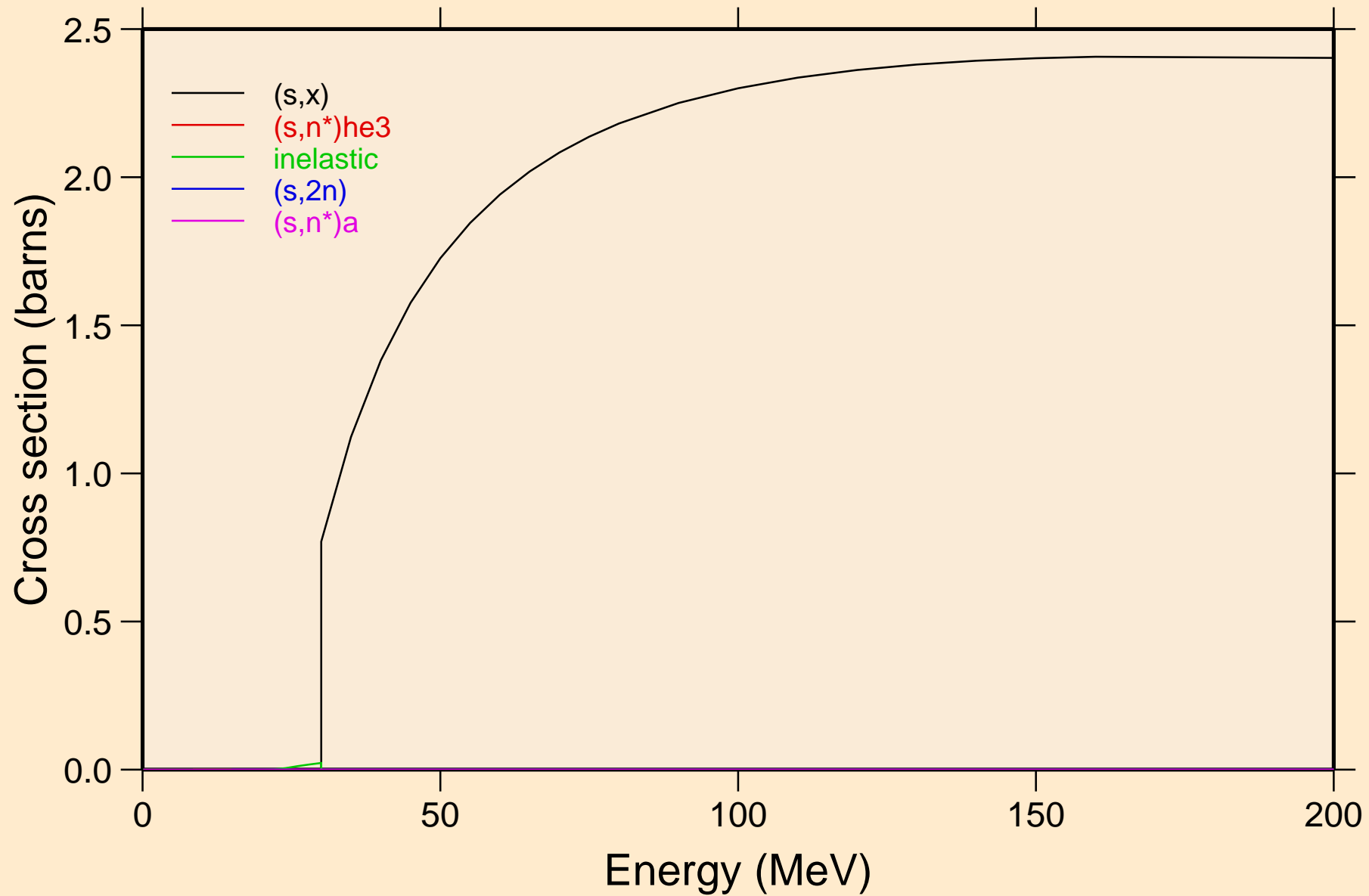

FR204 HELION ACER TENDL-2021 LIBRARY; T=0.K
Threshold reactions

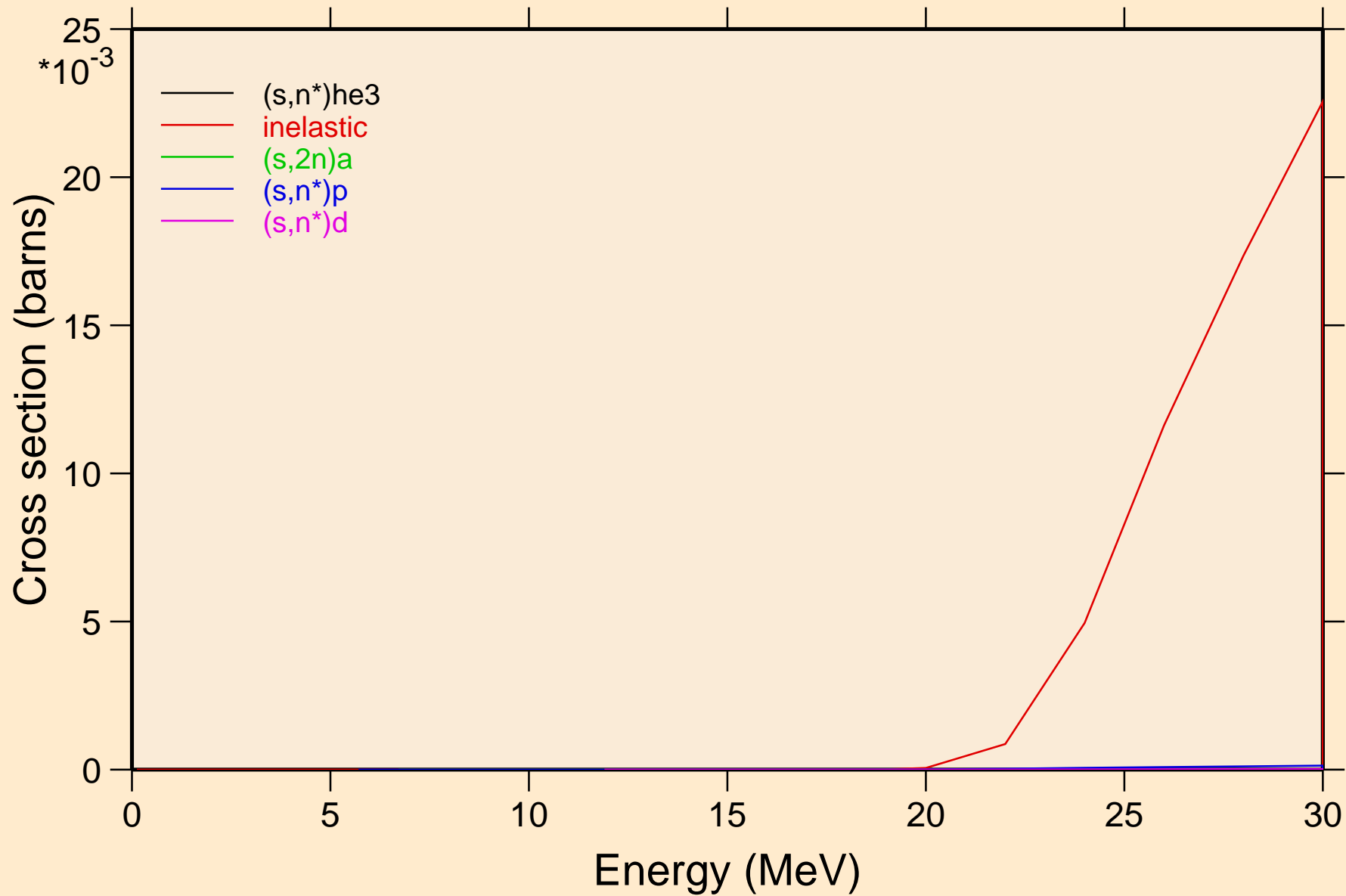

FR204 HELION ACER TENDL-2021 LIBRARY; T=0.K
Threshold reactions

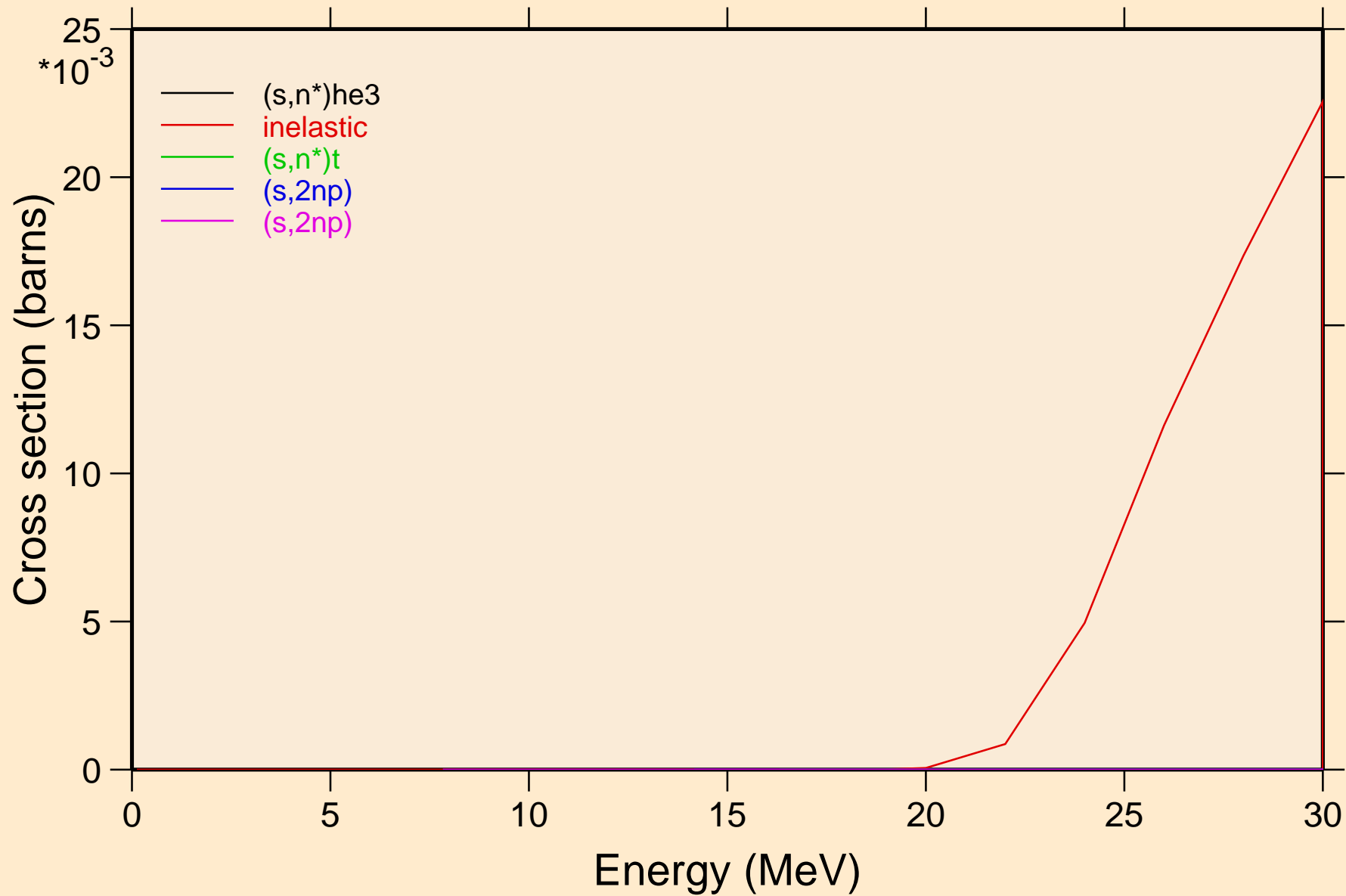

FR204 HELION ACER TENDL-2021 LIBRARY; T=0.K
Threshold reactions

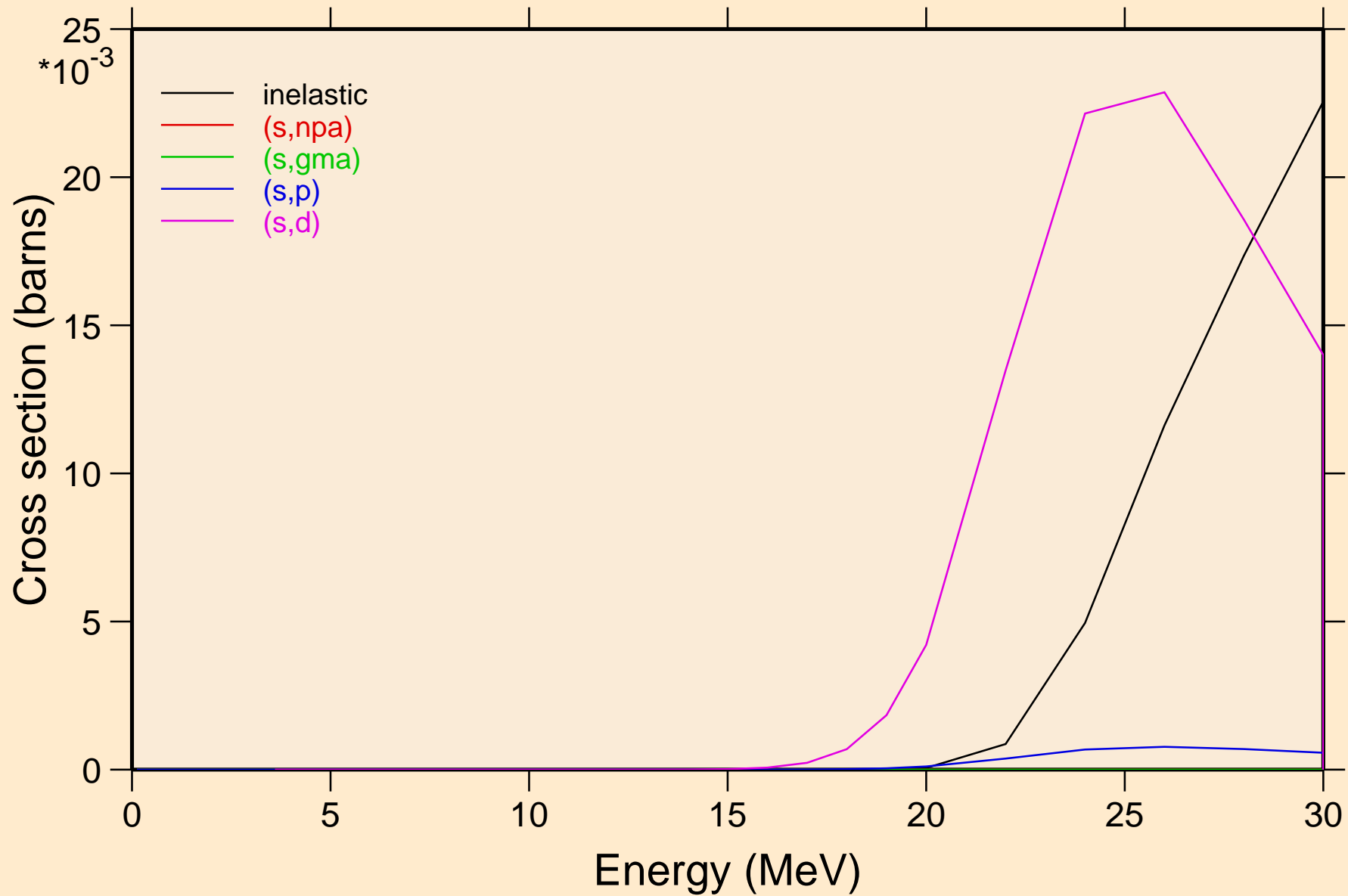

FR204 HELION ACER TENDL-2021 LIBRARY; T=0.K
Threshold reactions

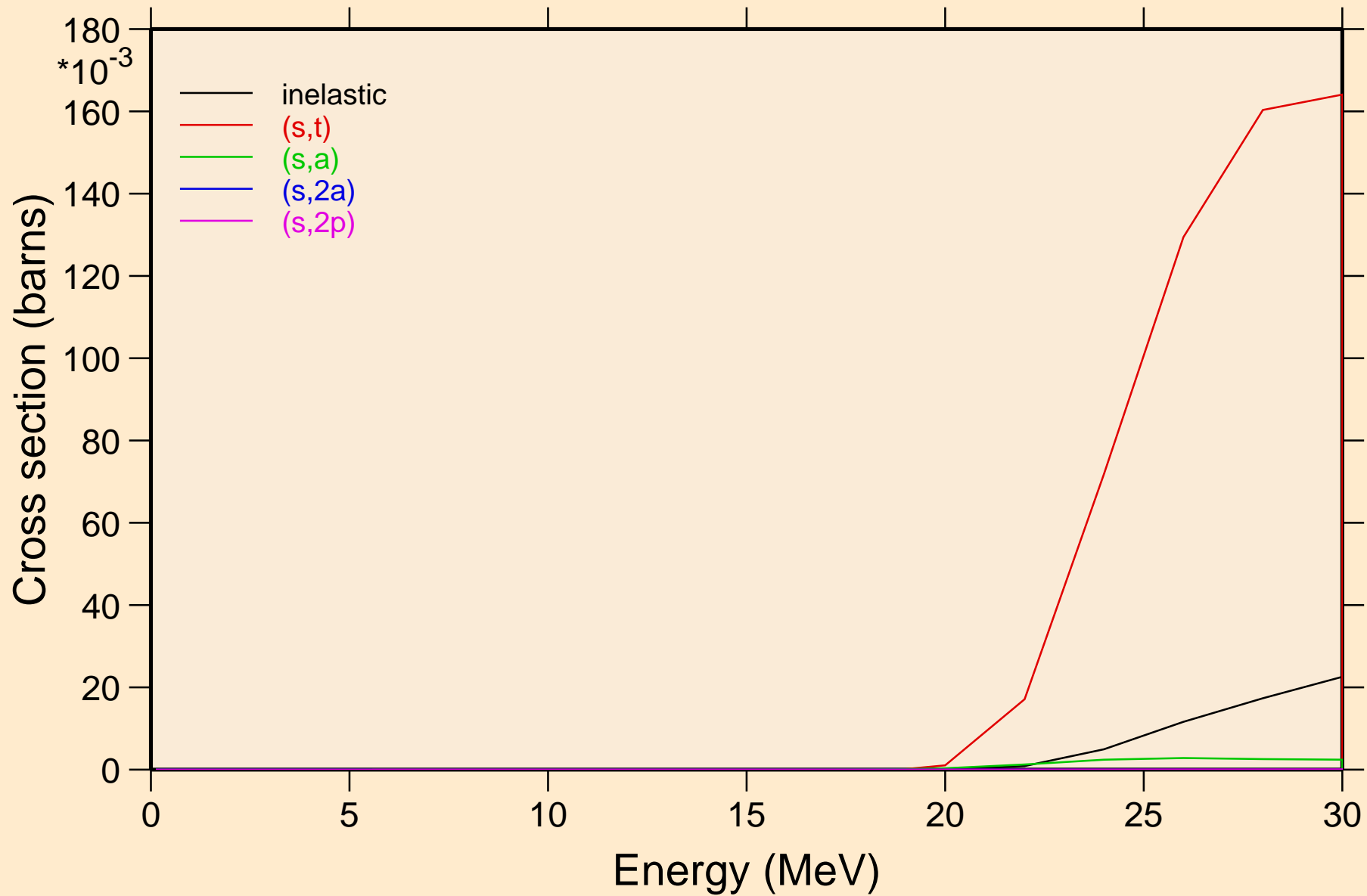

FR204 HELION ACER TENDL-2021 LIBRARY; T=0.K
Threshold reactions

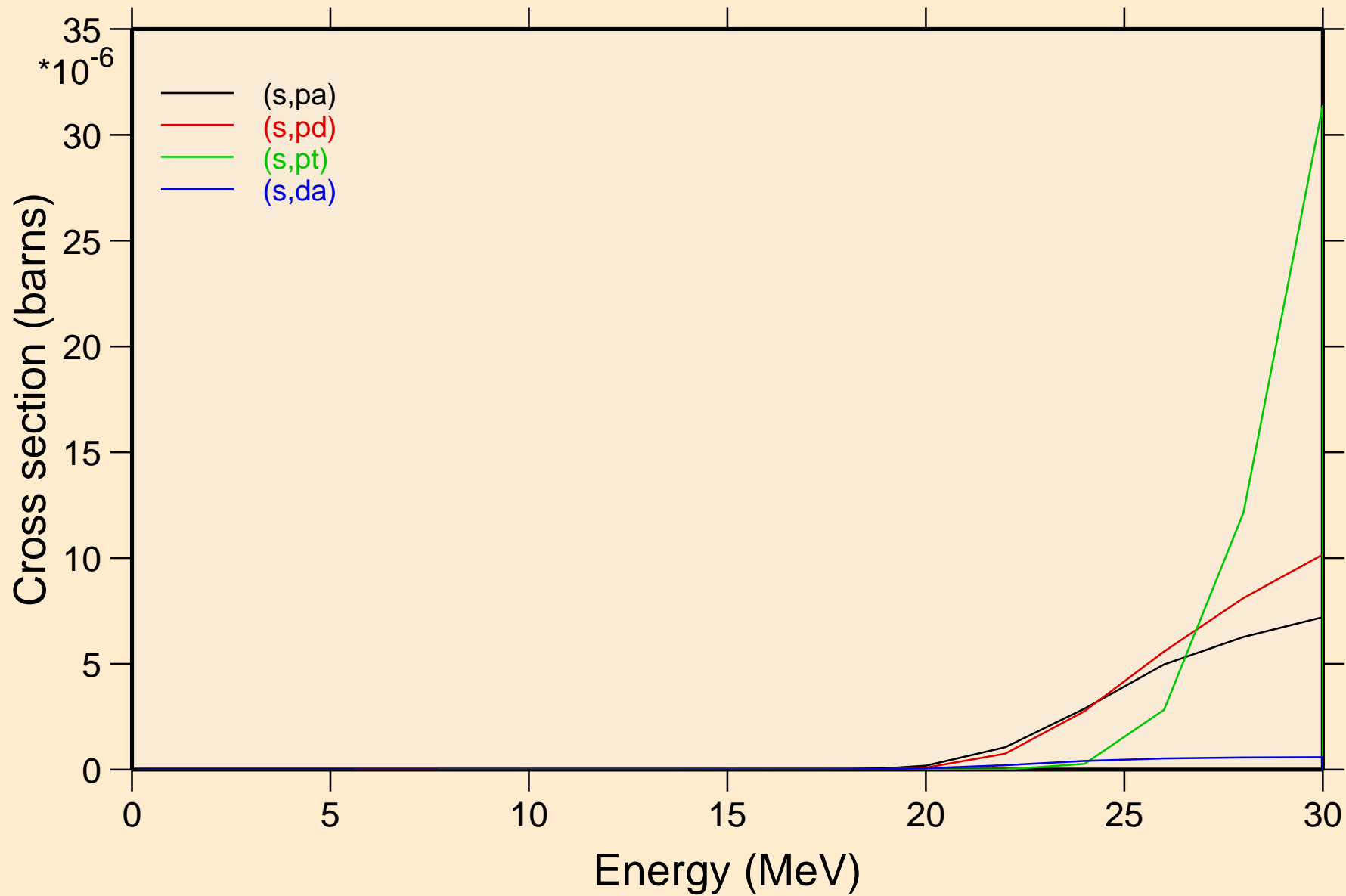

FR204 HELION ACER TENDL-2021 LIBRARY; T=0.K
angular distribution for elastic

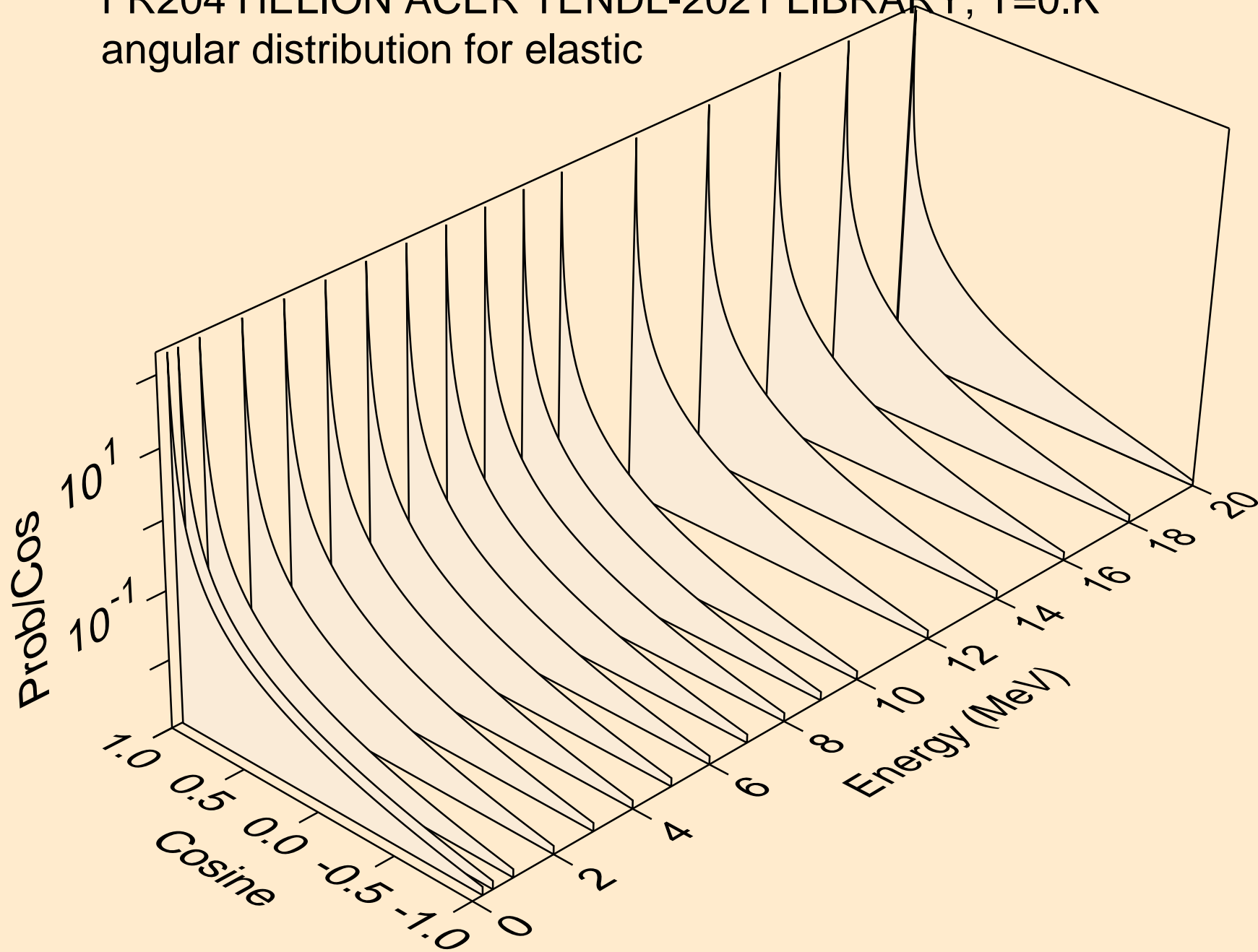

FR204 HELION ACER TENDL-2021 LIBRARY; T=0.K
angular distribution for elastic

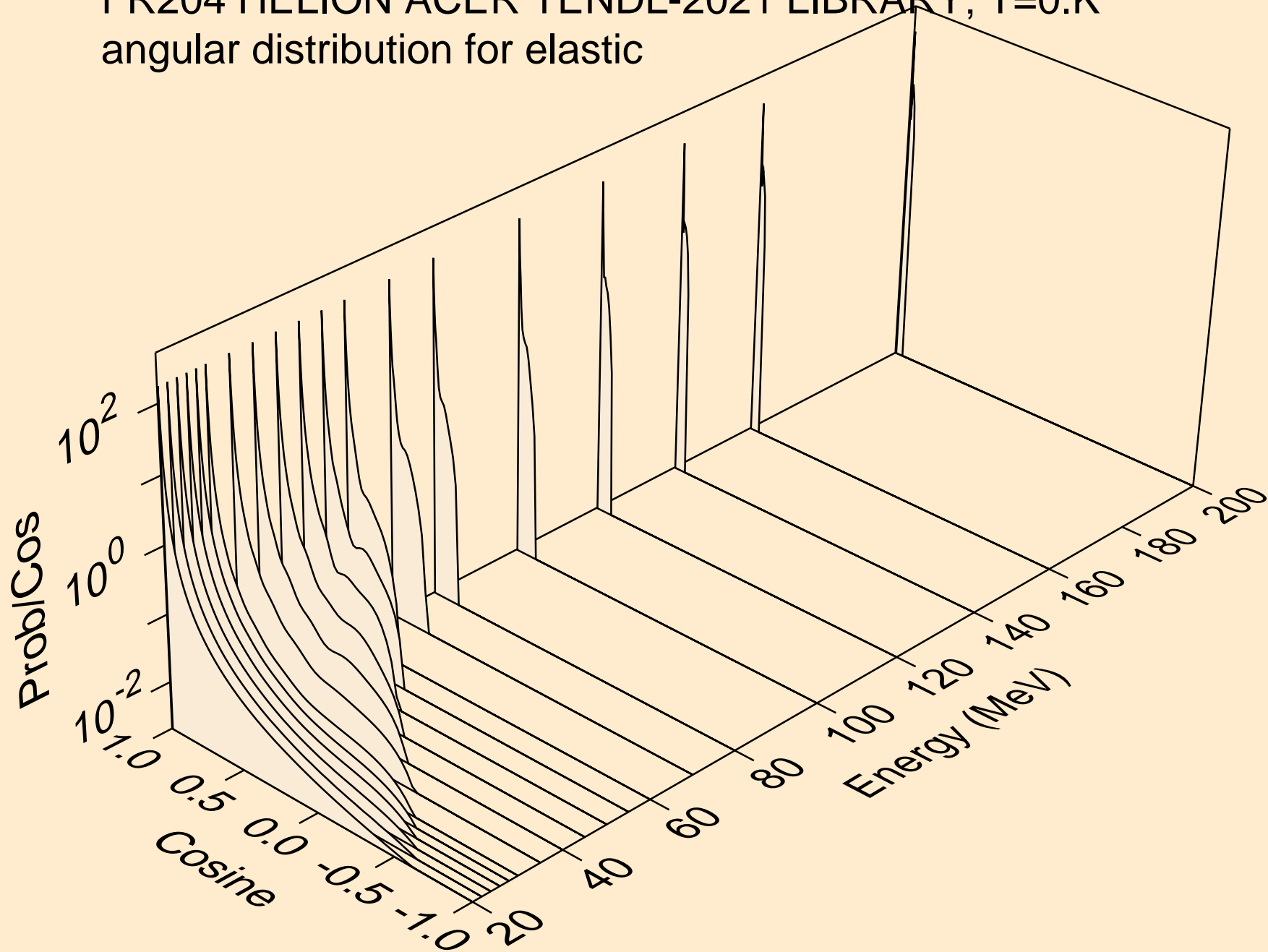

FR204 HELION ACER TENDL-2021 LIBRARY; T=0.K
He-3 emission for (s,x)

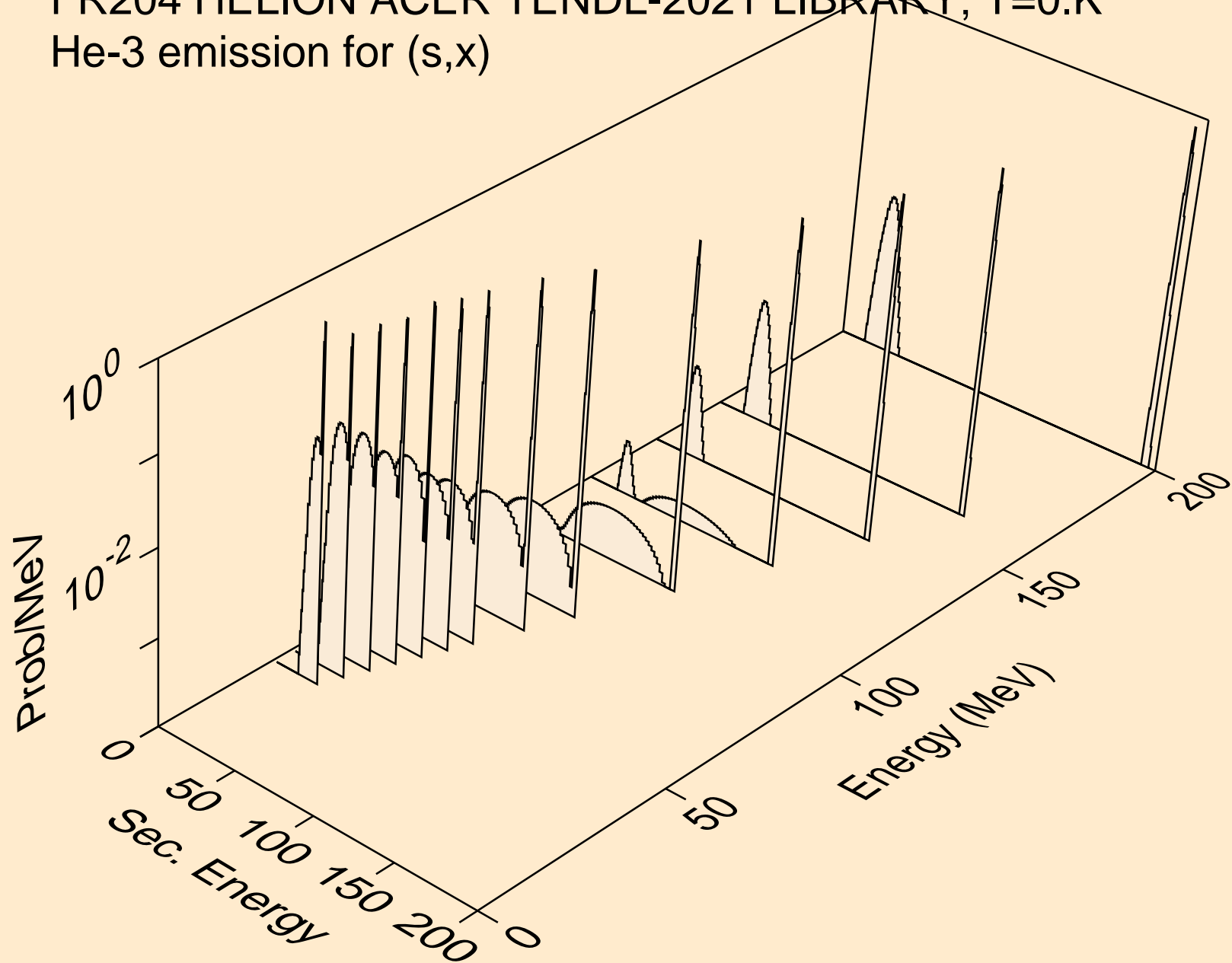

FR204 HELION ACER TENDL-2021 LIBRARY; T=0.K
He-3 emission for (s,n*)he3

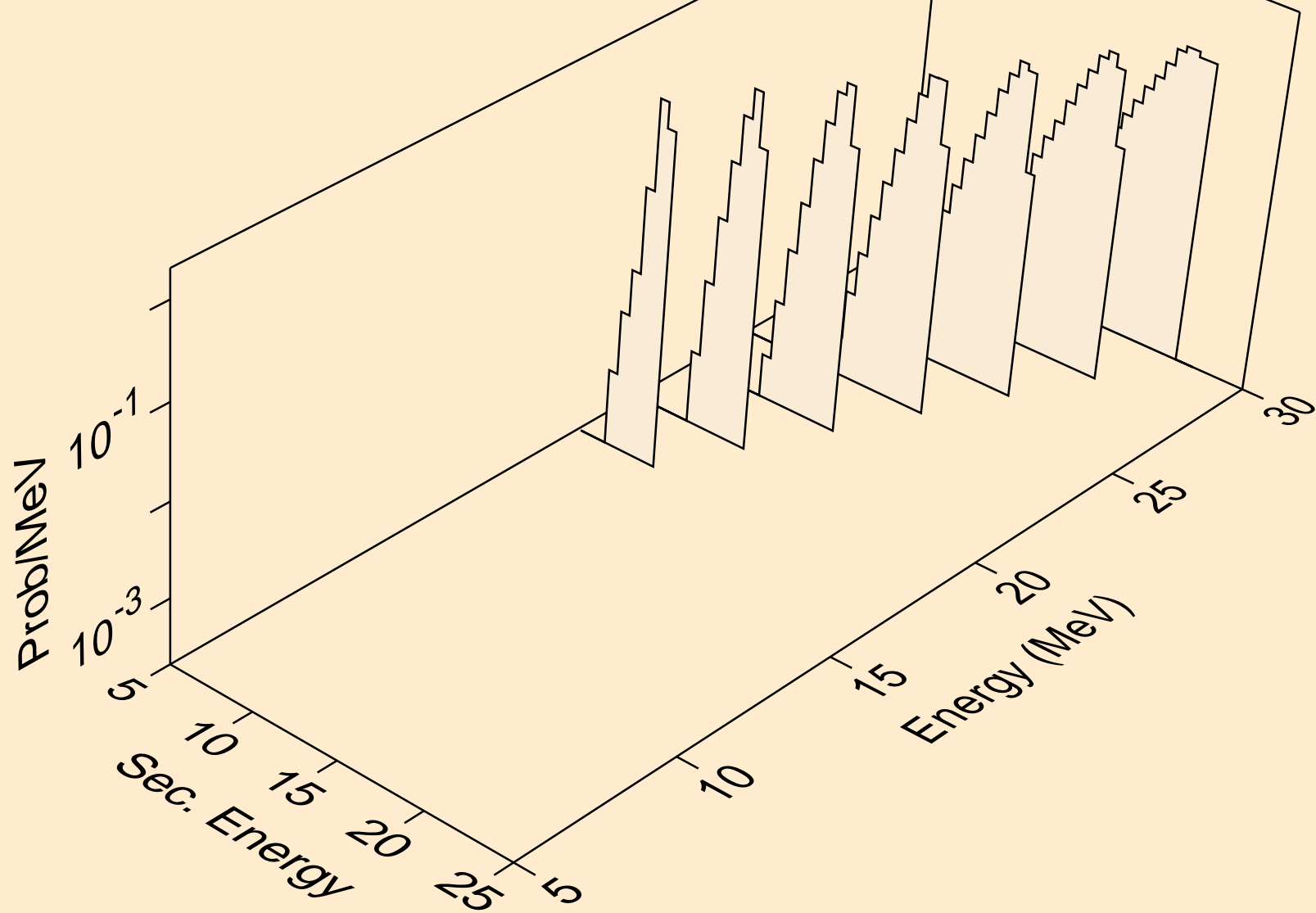

FR204 HELION ACER TENDL-2021 LIBRARY; T=0.K
He-3 emission for inelastic

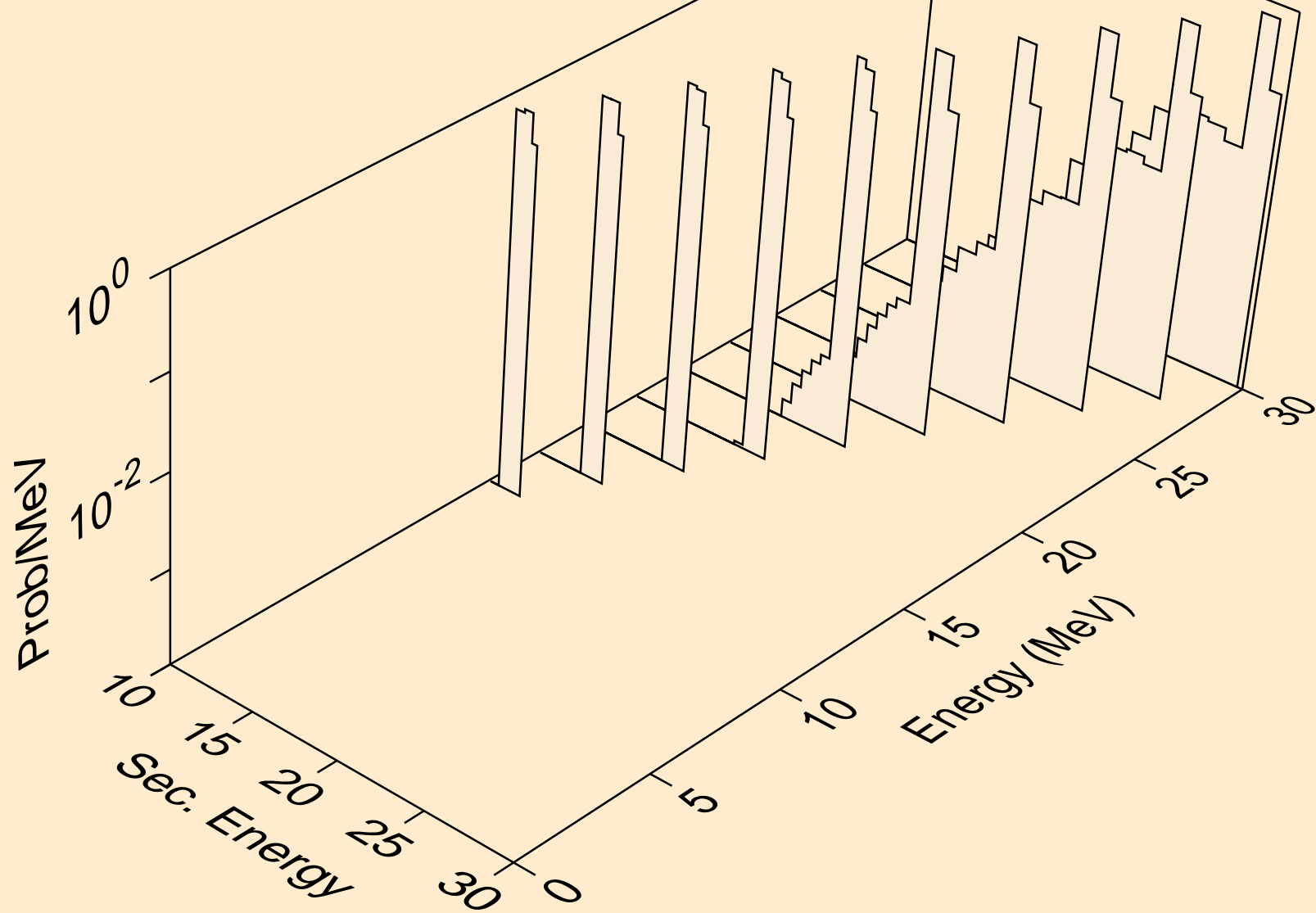

FR204 HELION ACER TENDL-2021 LIBRARY; T=0.K
Photon emission for (z,n)

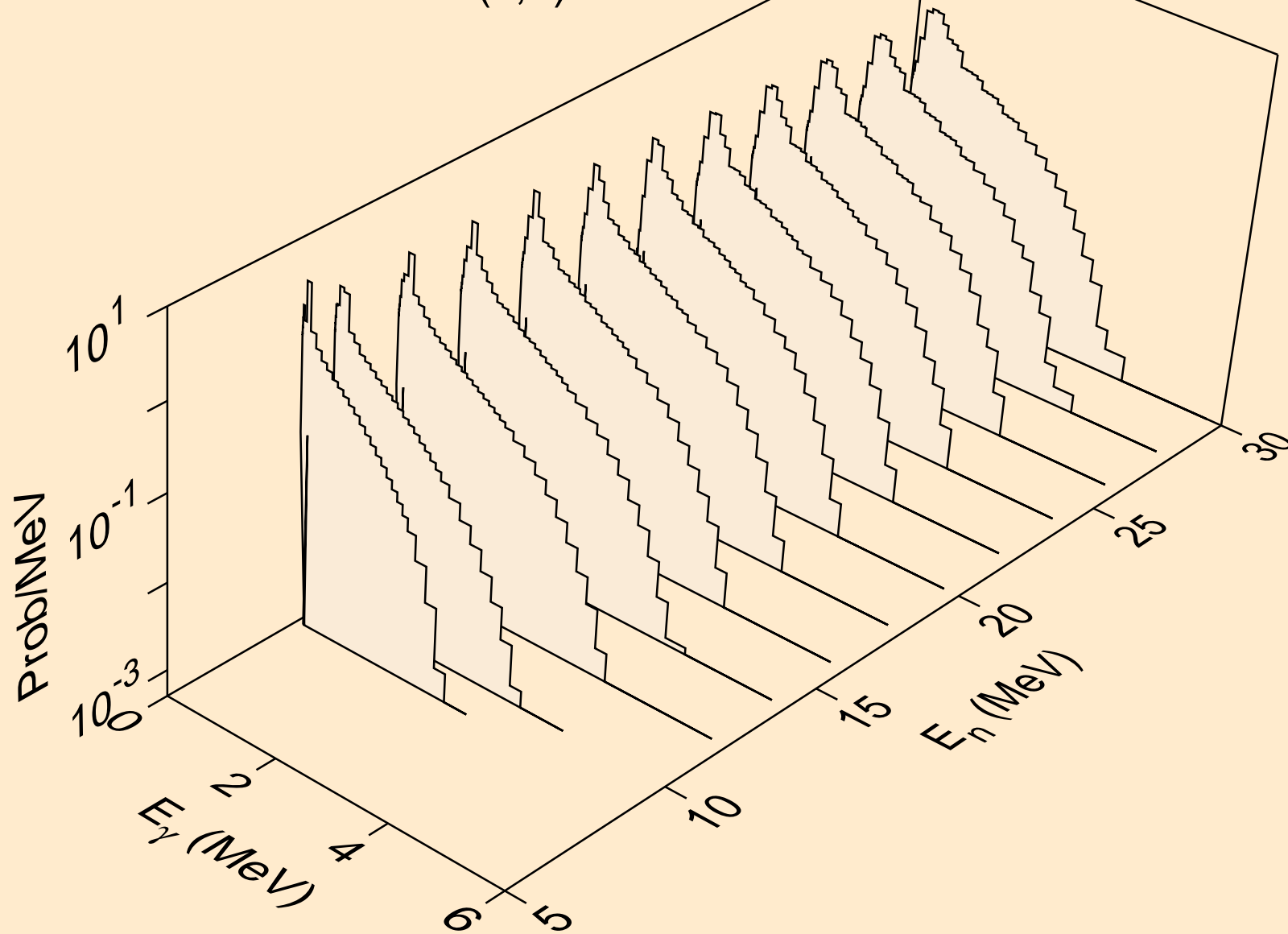

FR204 HELION ACER TENDL-2021 LIBRARY; T=0.K
Photon emission for (n,x)

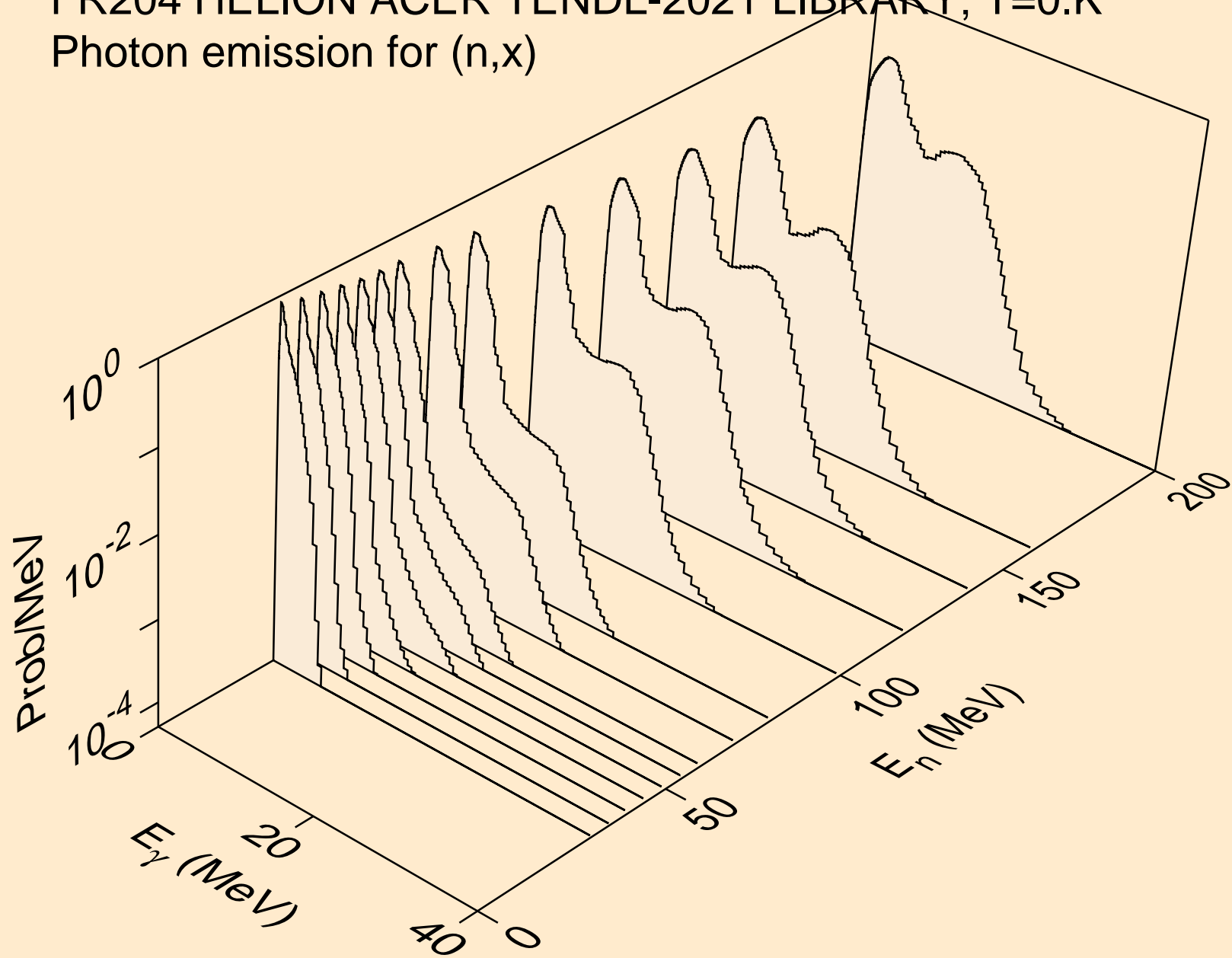

FR204 HELION ACER TENDL-2021 LIBRARY; T=0.K
Photon emission for (n,2n)

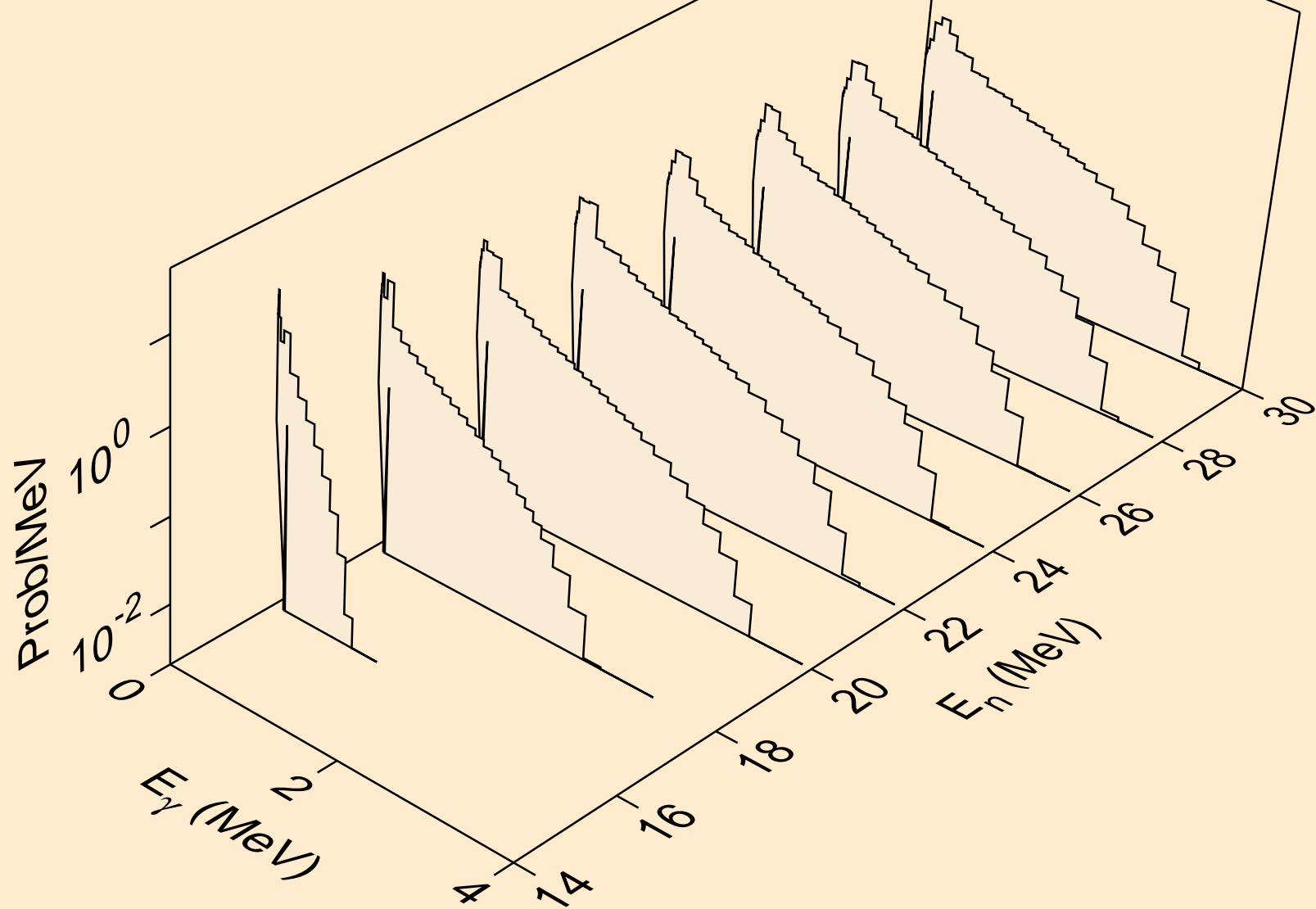

FR204 HELION ACER TENDL-2021 LIBRARY; T=0.K
Photon emission for (n,n*)a

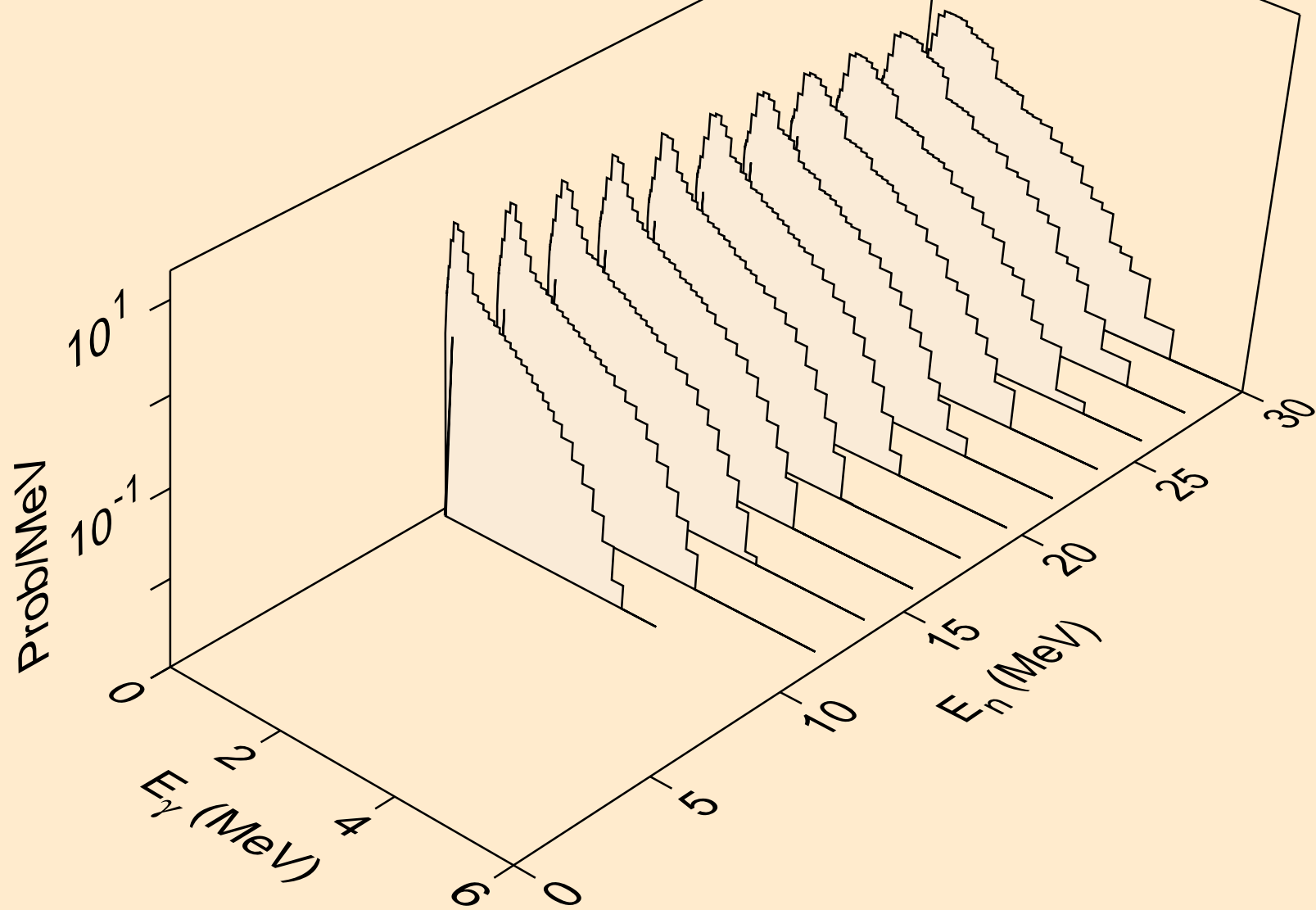

FR204 HELION ACER TENDL-2021 LIBRARY; T=0.K
Photon emission for (n,2n)a

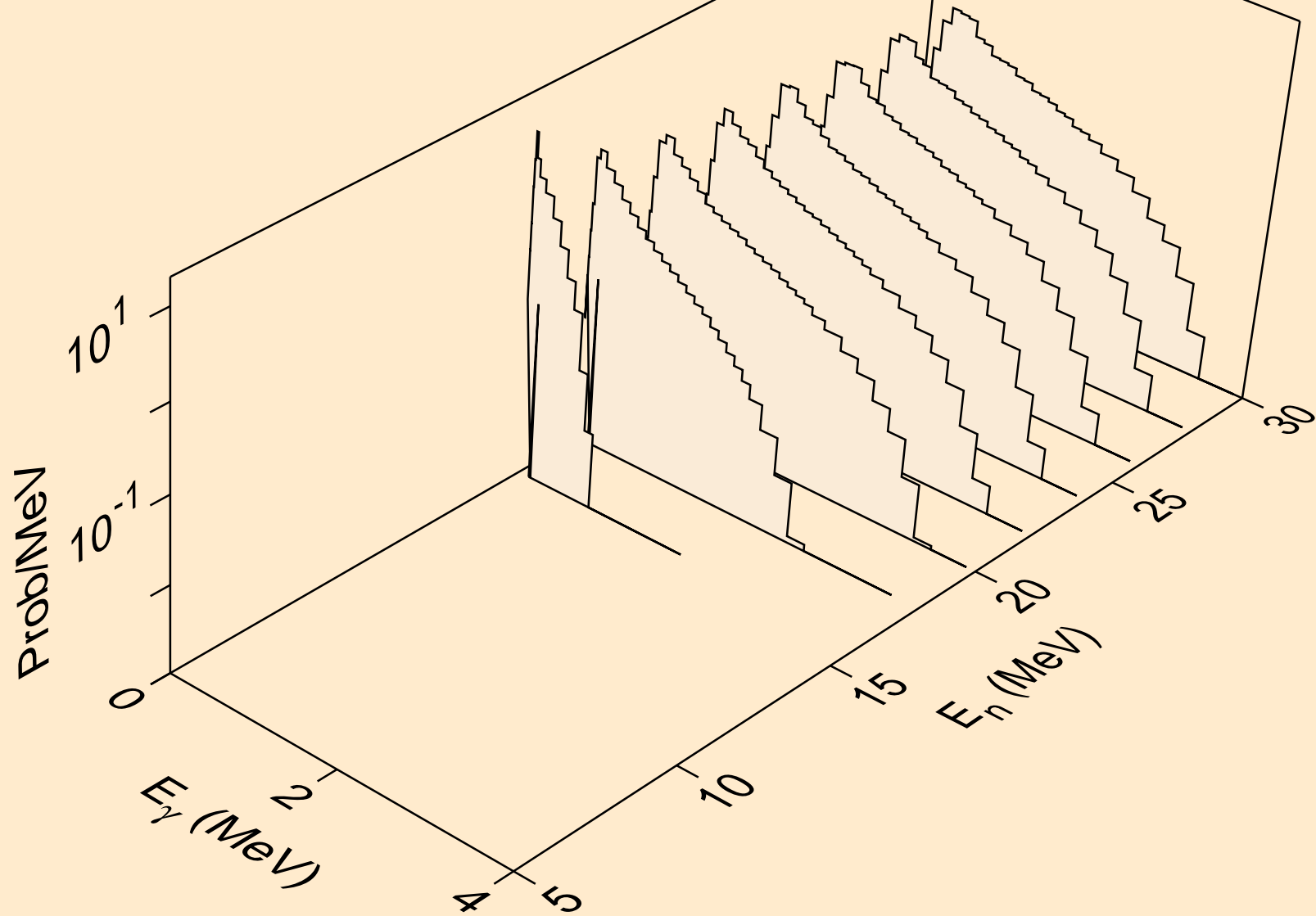

FR204 HELION ACER TENDL-2021 LIBRARY; T=0.K
Photon emission for (n,n*)p

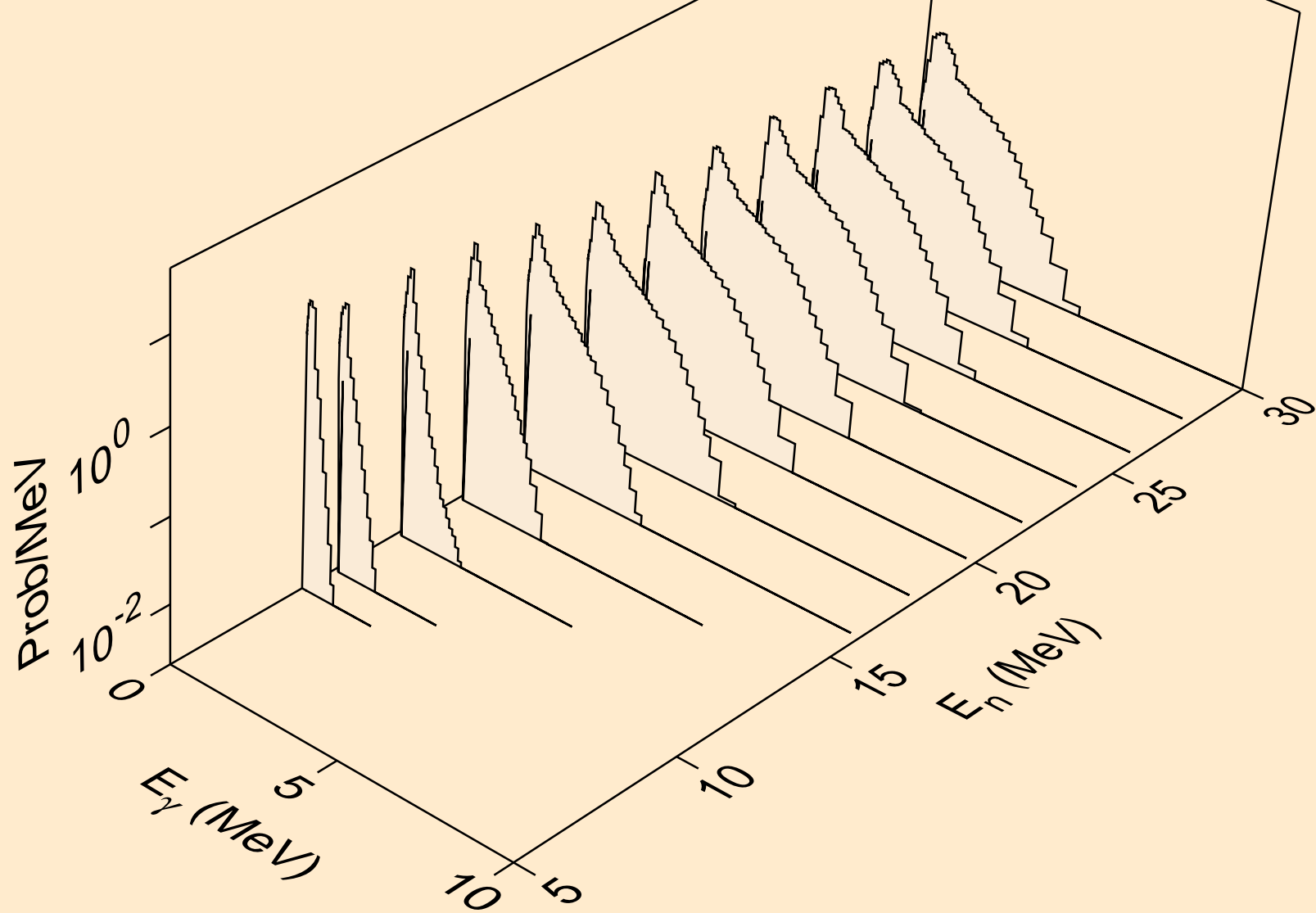

FR204 HELION ACER TENDL-2021 LIBRARY; T=0.K
Photon emission for (n,n*)d

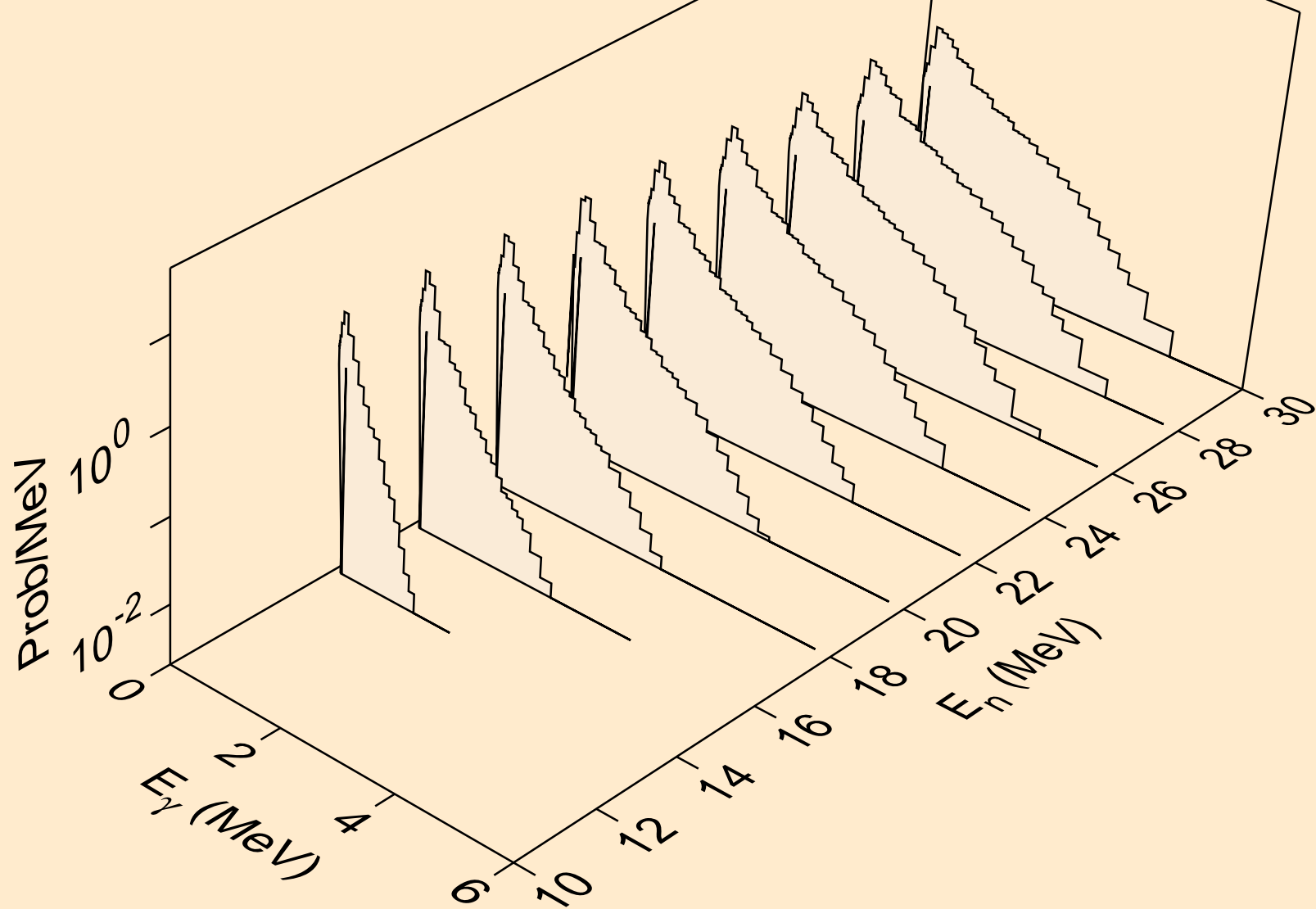

FR204 HELION ACER TENDL-2021 LIBRARY; T=0.K
Photon emission for (n,n*)t

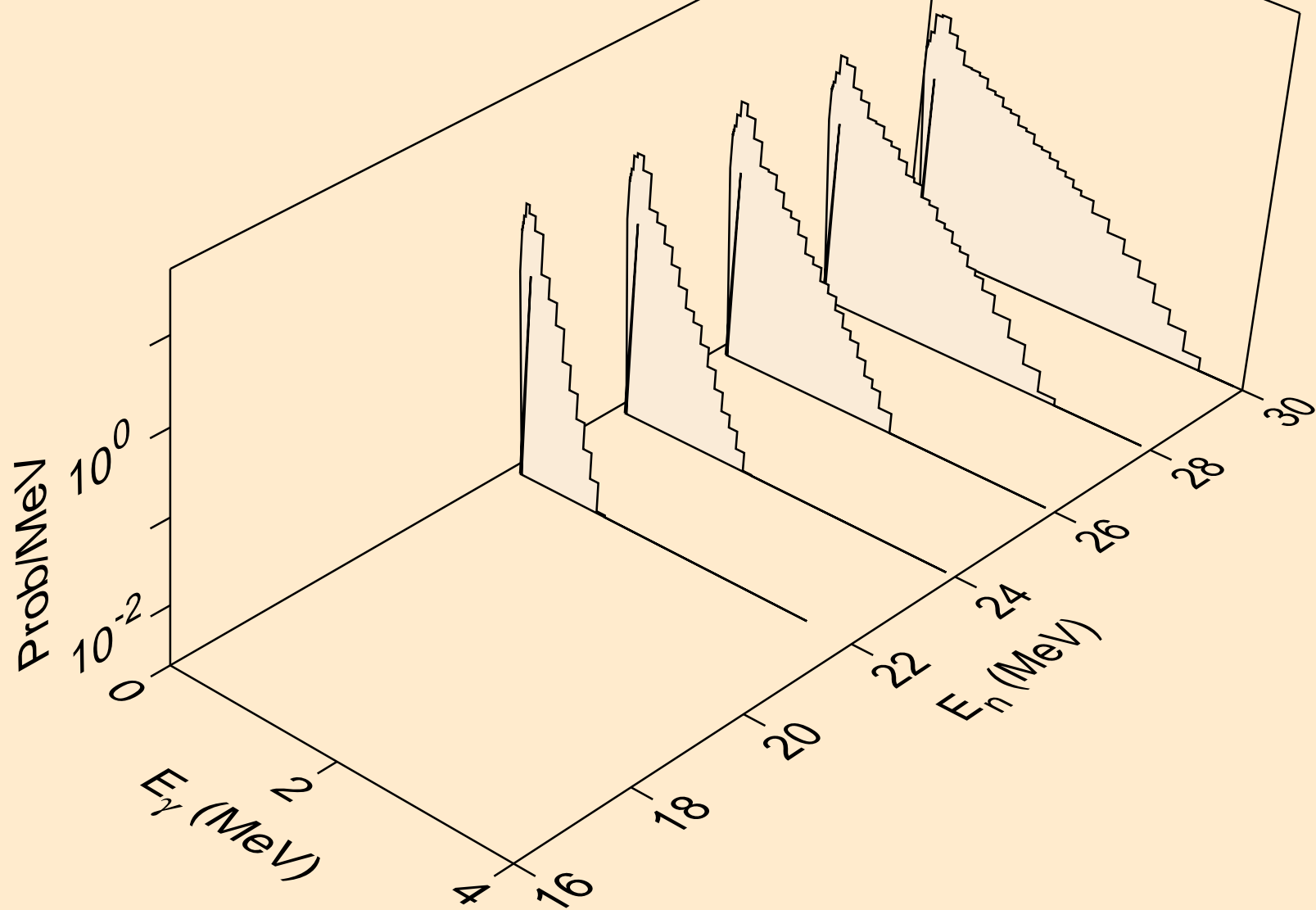

FR204 HELION ACER TENDL-2021 LIBRARY; T=0.K
Photon emission for (n,n*)he3

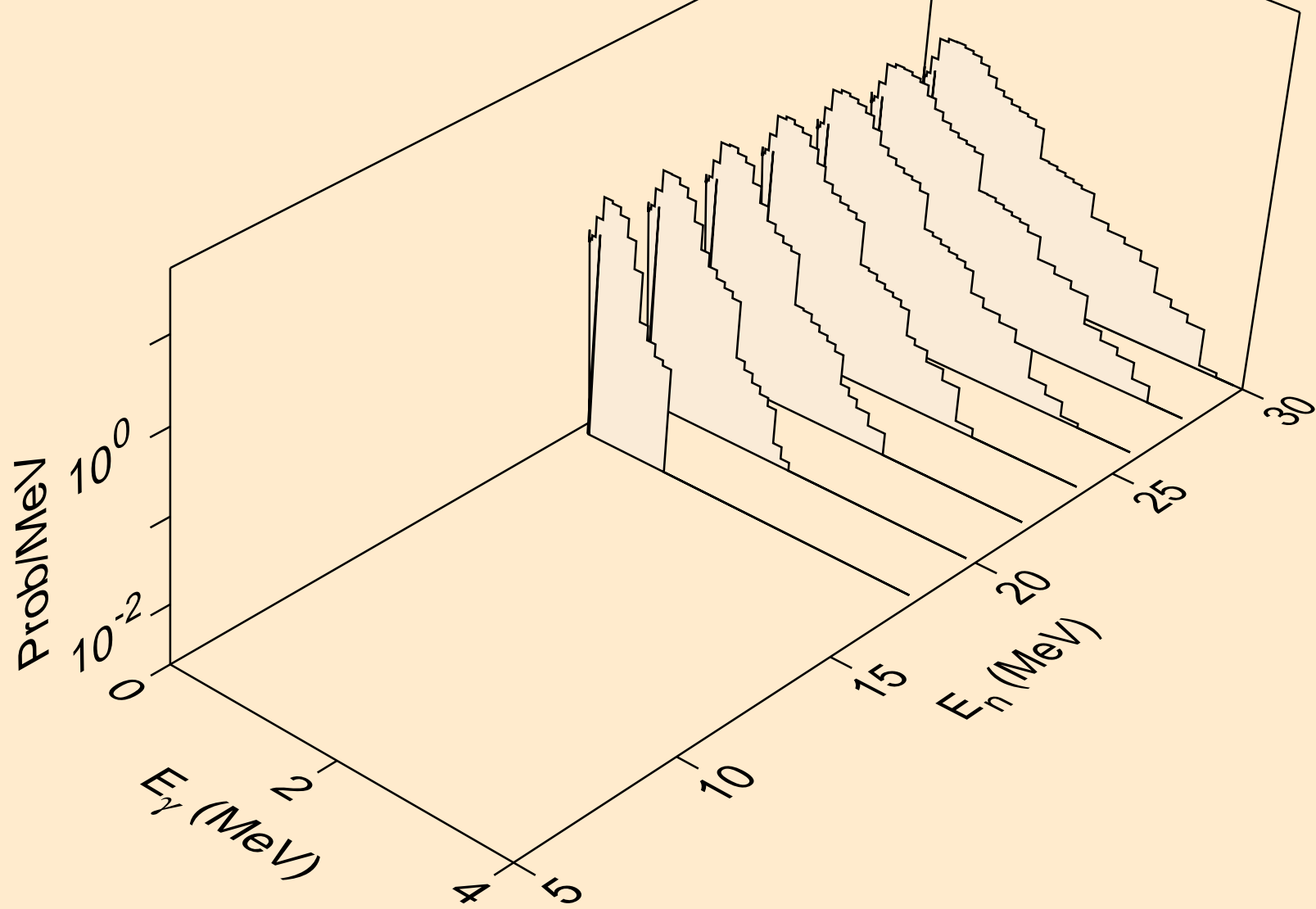

FR204 HELION ACER TENDL-2021 LIBRARY; T=0.K
Photon emission for (n,2np)

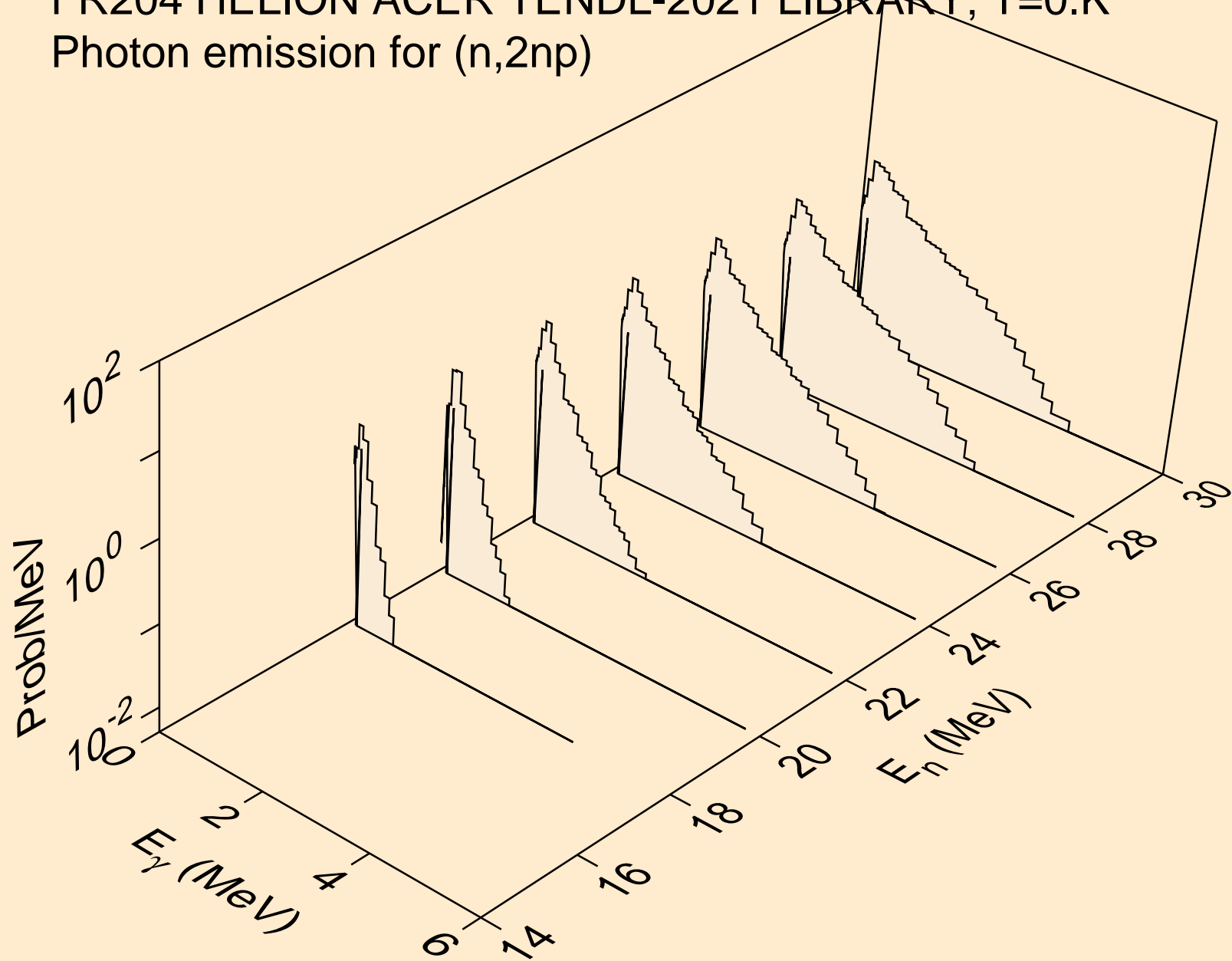

FR204 HELION ACER TENDL-2021 LIBRARY; T=0.K
Photon emission for (n,2np)

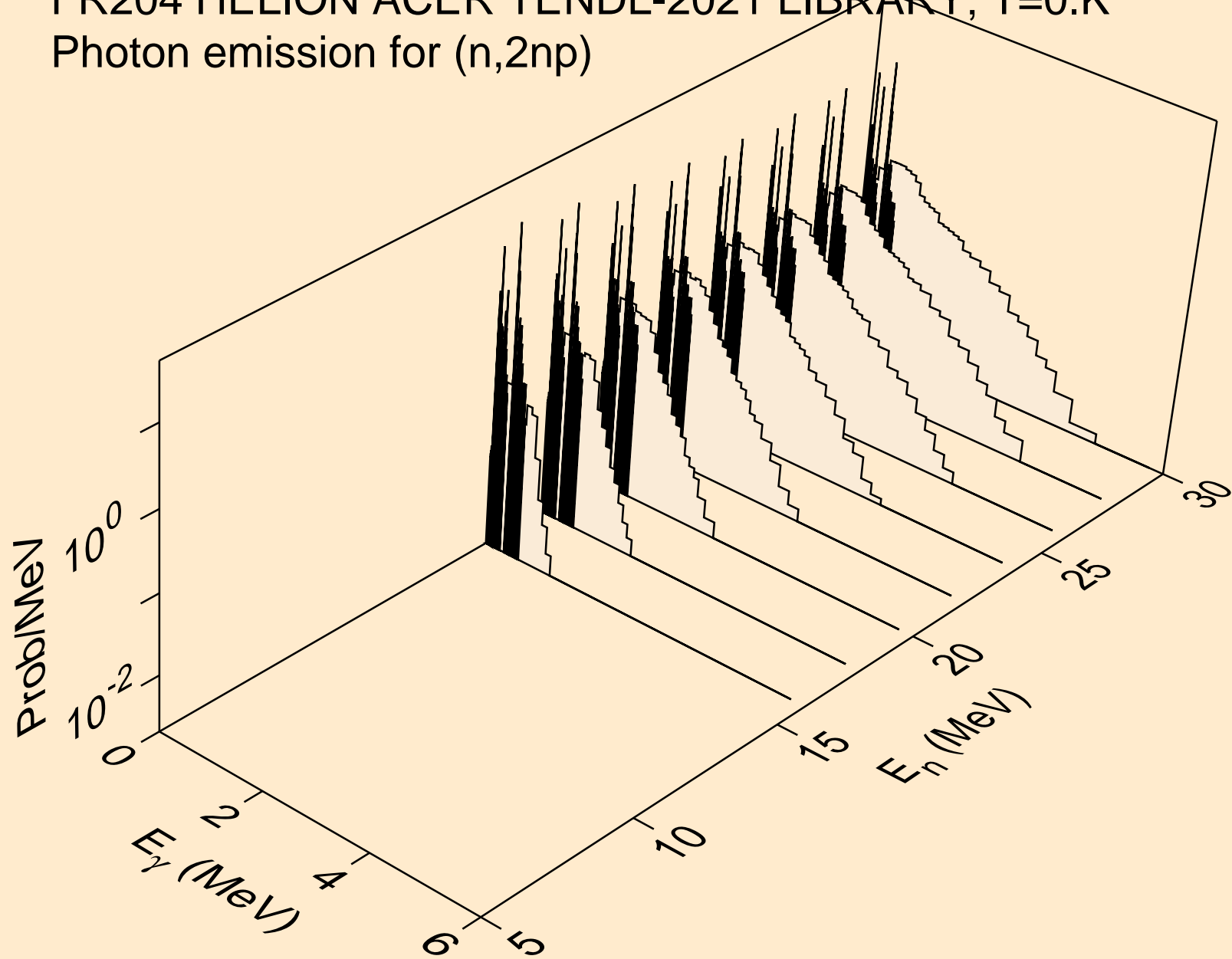

FR204 HELION ACER TENDL-2021 LIBRARY; T=0.K
Photon emission for (n,npa)

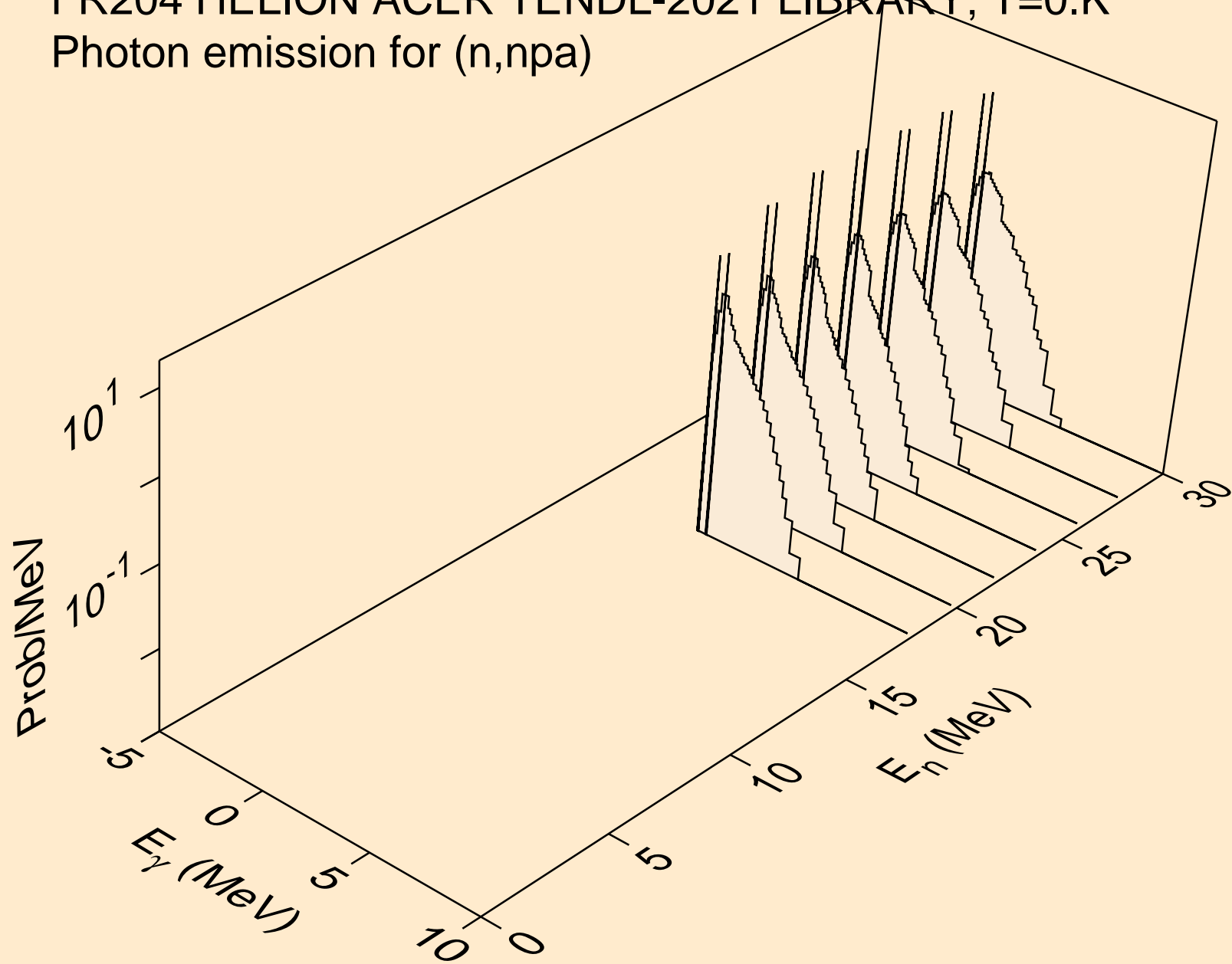

FR204 HELION ACER TENDL-2021 LIBRARY; T=0.K
Photon emission for (n,gma)

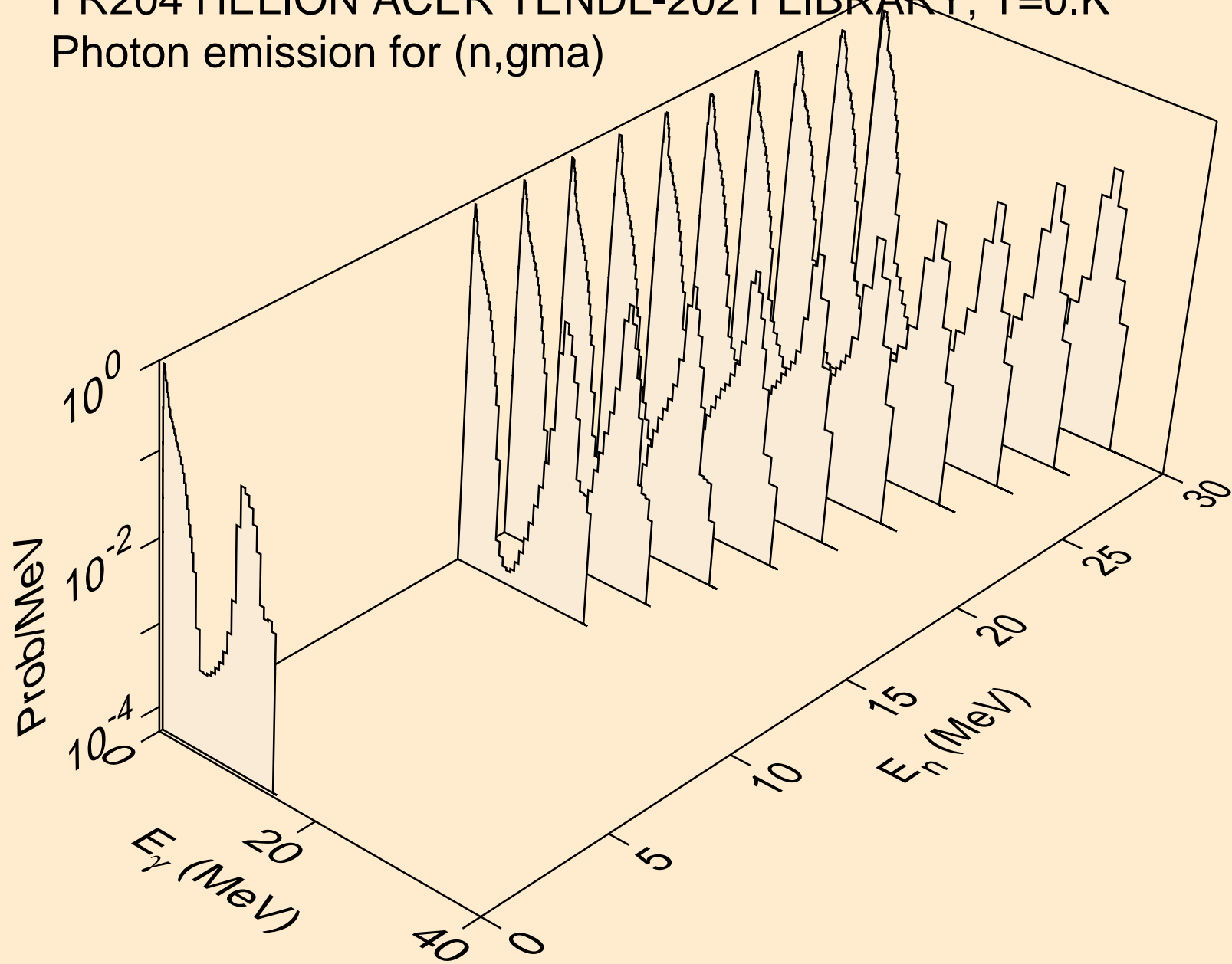

FR204 HELION ACER TENDL-2021 LIBRARY; T=0.K
Photon emission for (n,p)

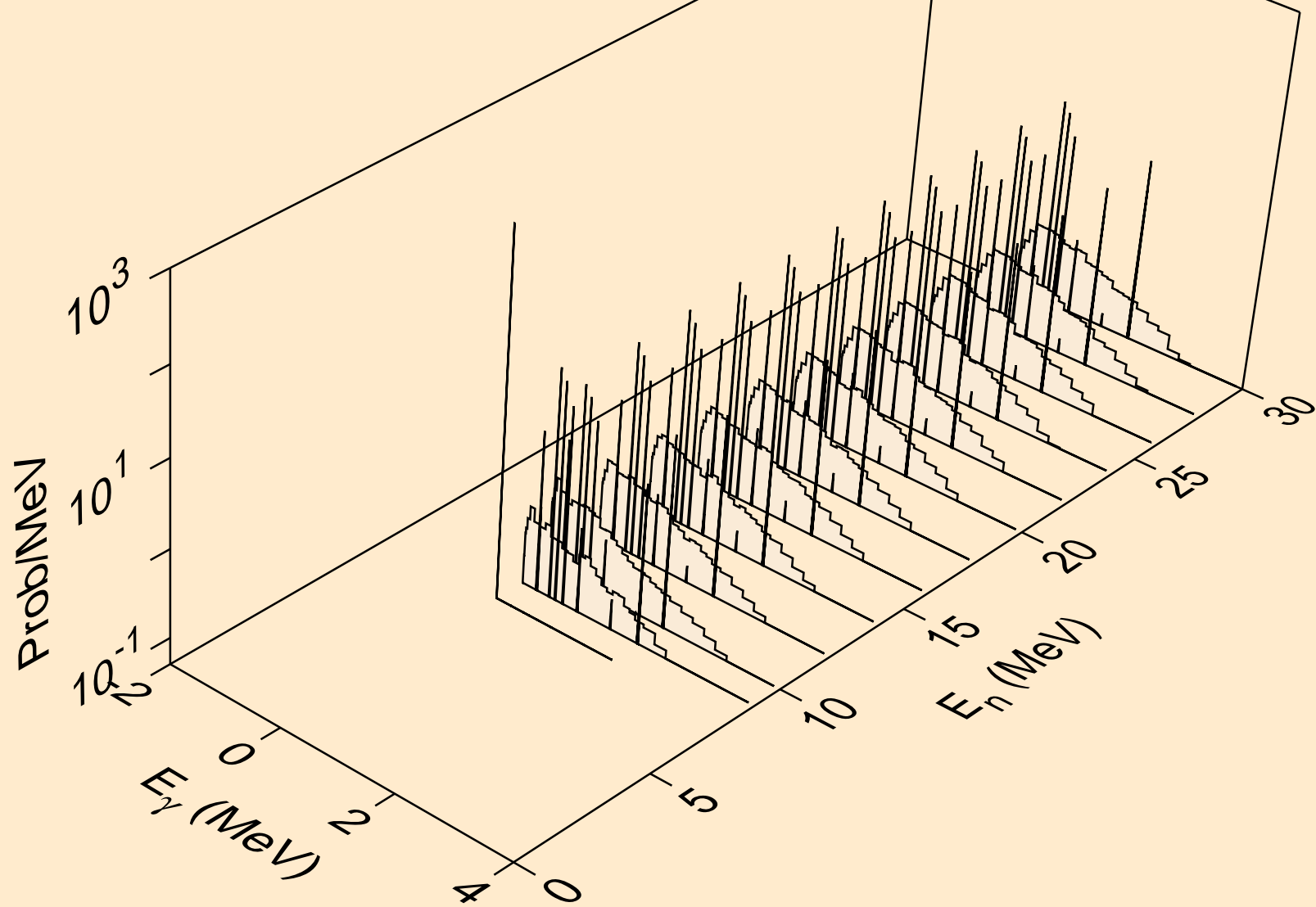

FR204 HELION ACER TENDL-2021 LIBRARY; T=0.K
Photon emission for (n,d)

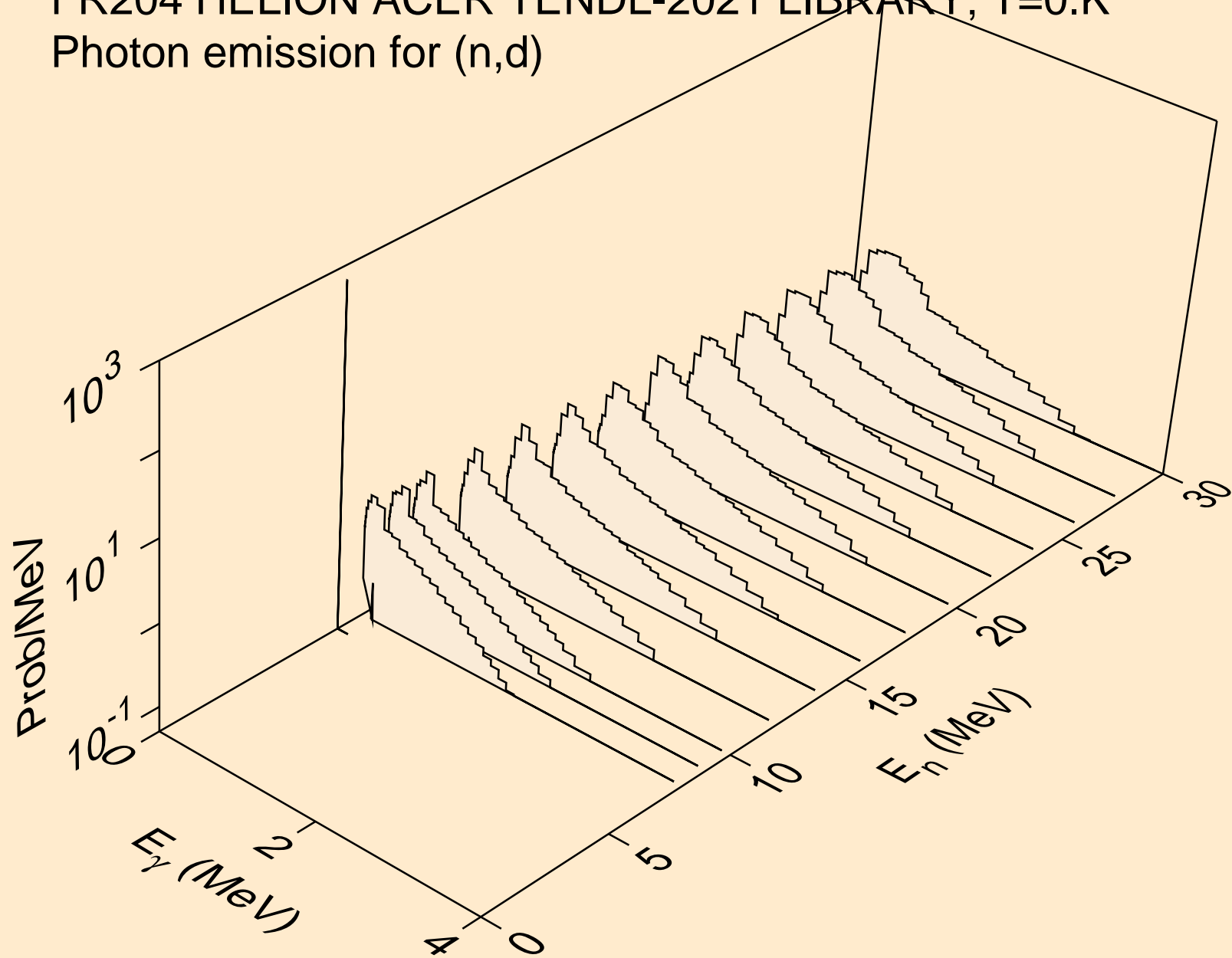

FR204 HELION ACER TENDL-2021 LIBRARY; T=0.K
Photon emission for (n,t)

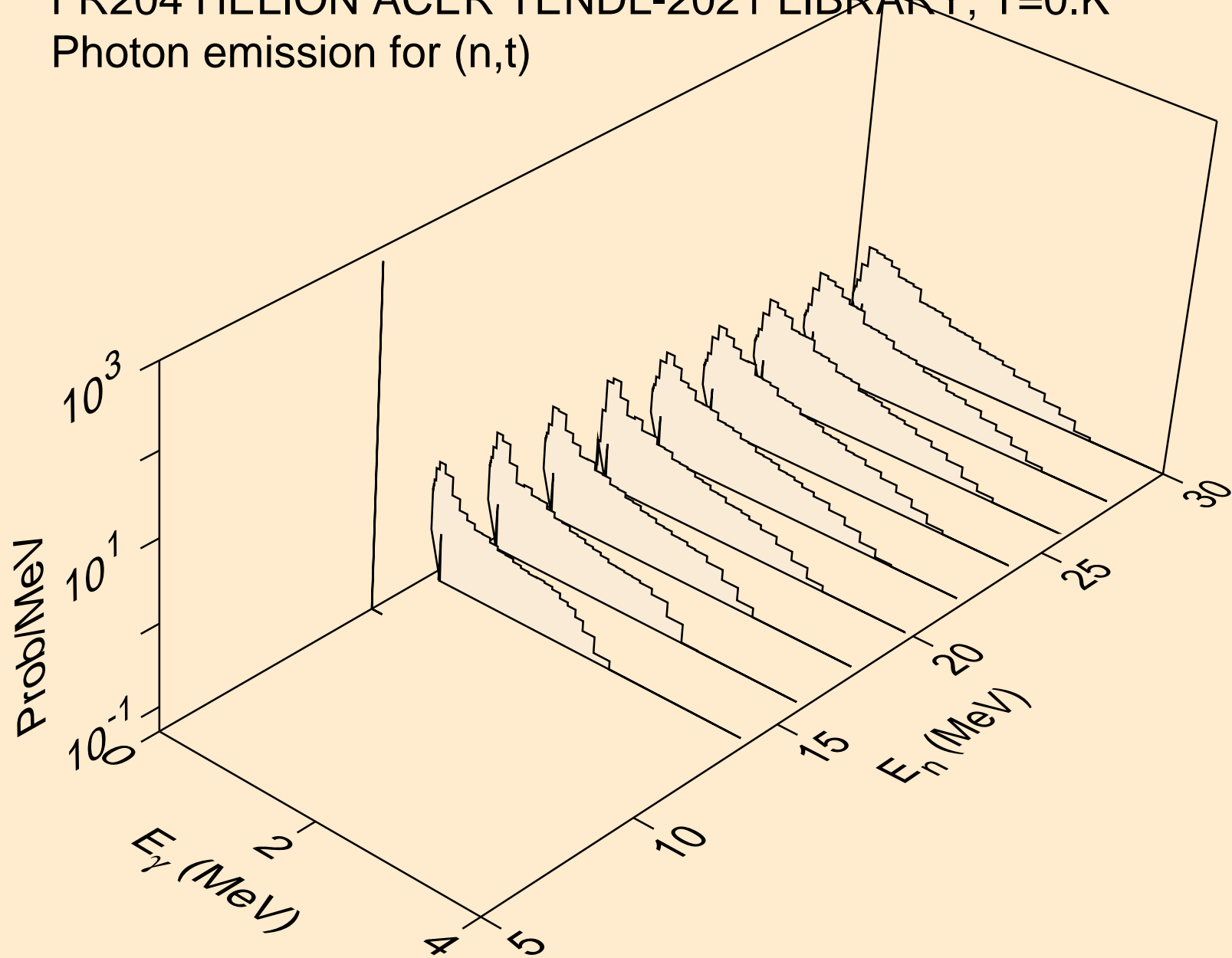

FR204 HELION ACER TENDL-2021 LIBRARY; T=0.K
Photon emission for inelastic

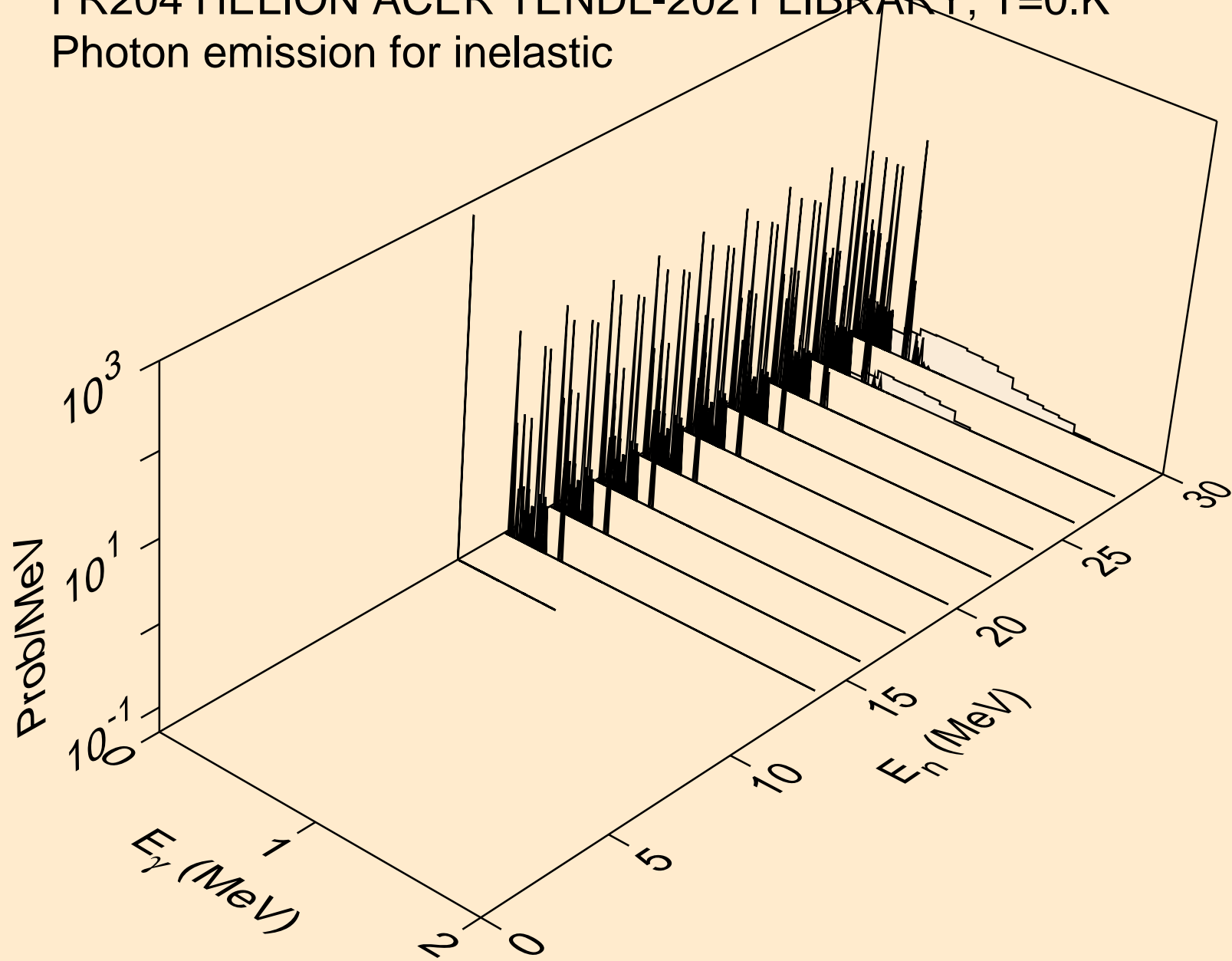

FR204 HELION ACER TENDL-2021 LIBRARY; T=0.K
Photon emission for (n,a)

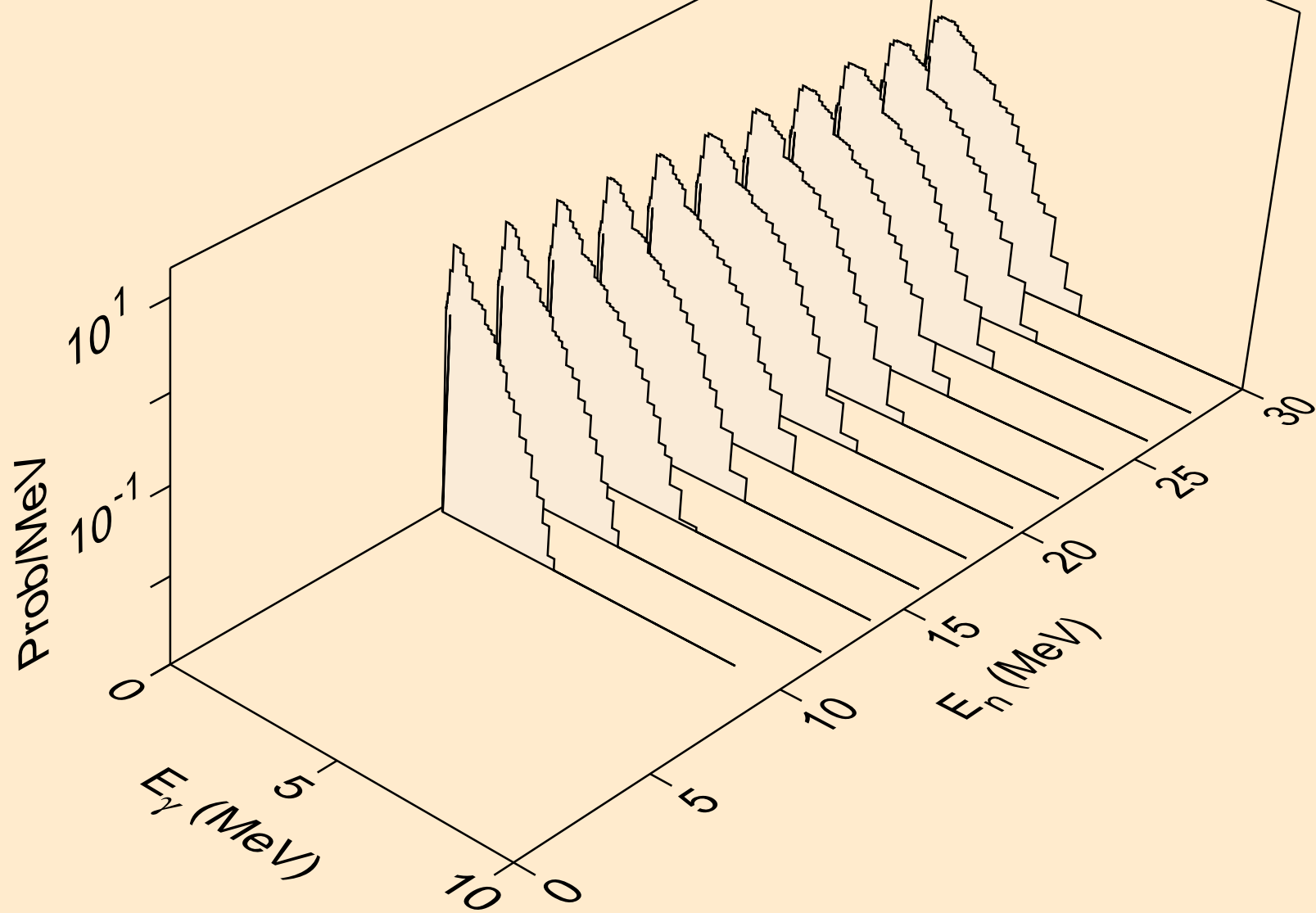

FR204 HELION ACER TENDL-2021 LIBRARY; T=0.K
Photon emission for (n,2a)

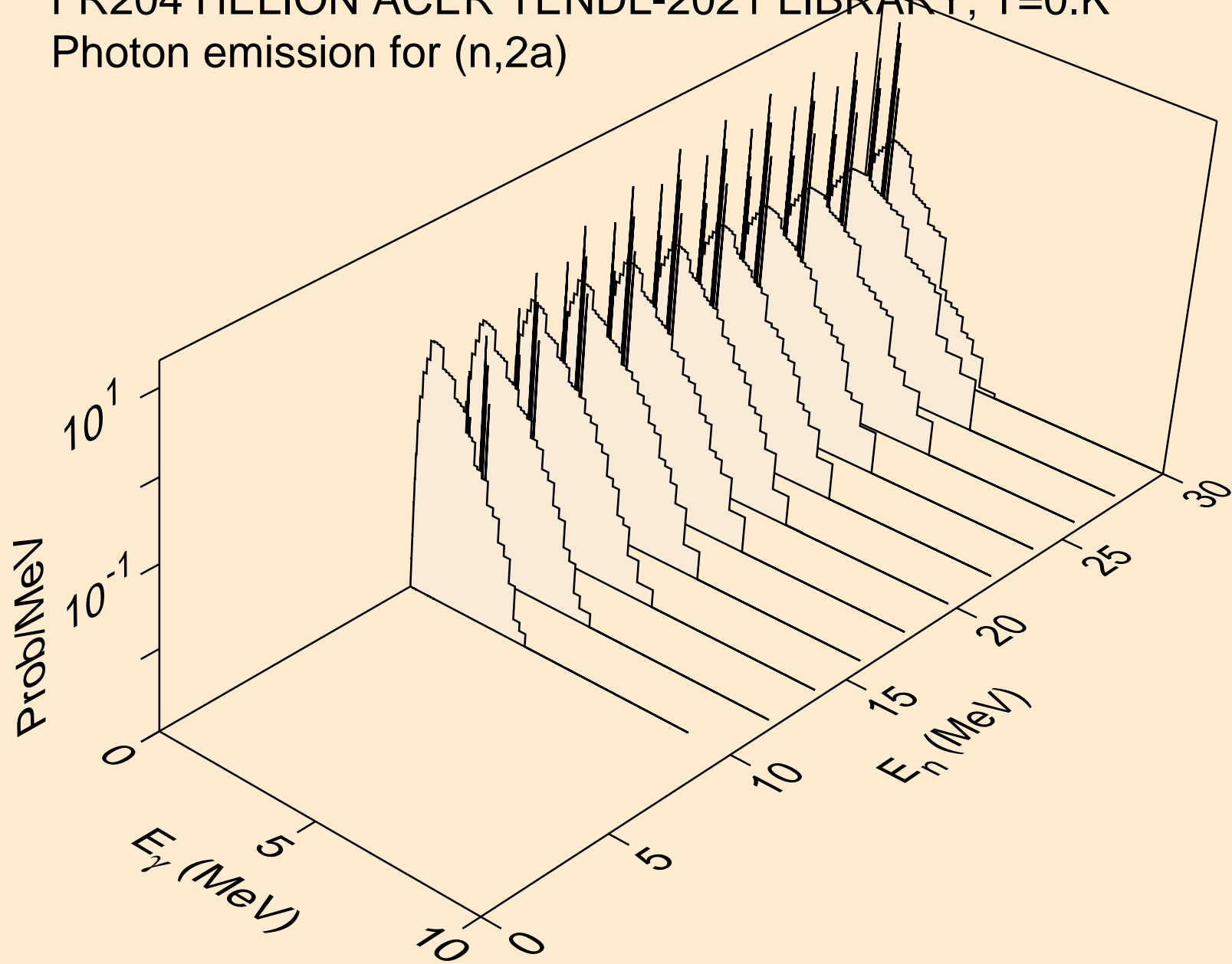

FR204 HELION ACER TENDL-2021 LIBRARY; T=0.K
Photon emission for (n,2p)

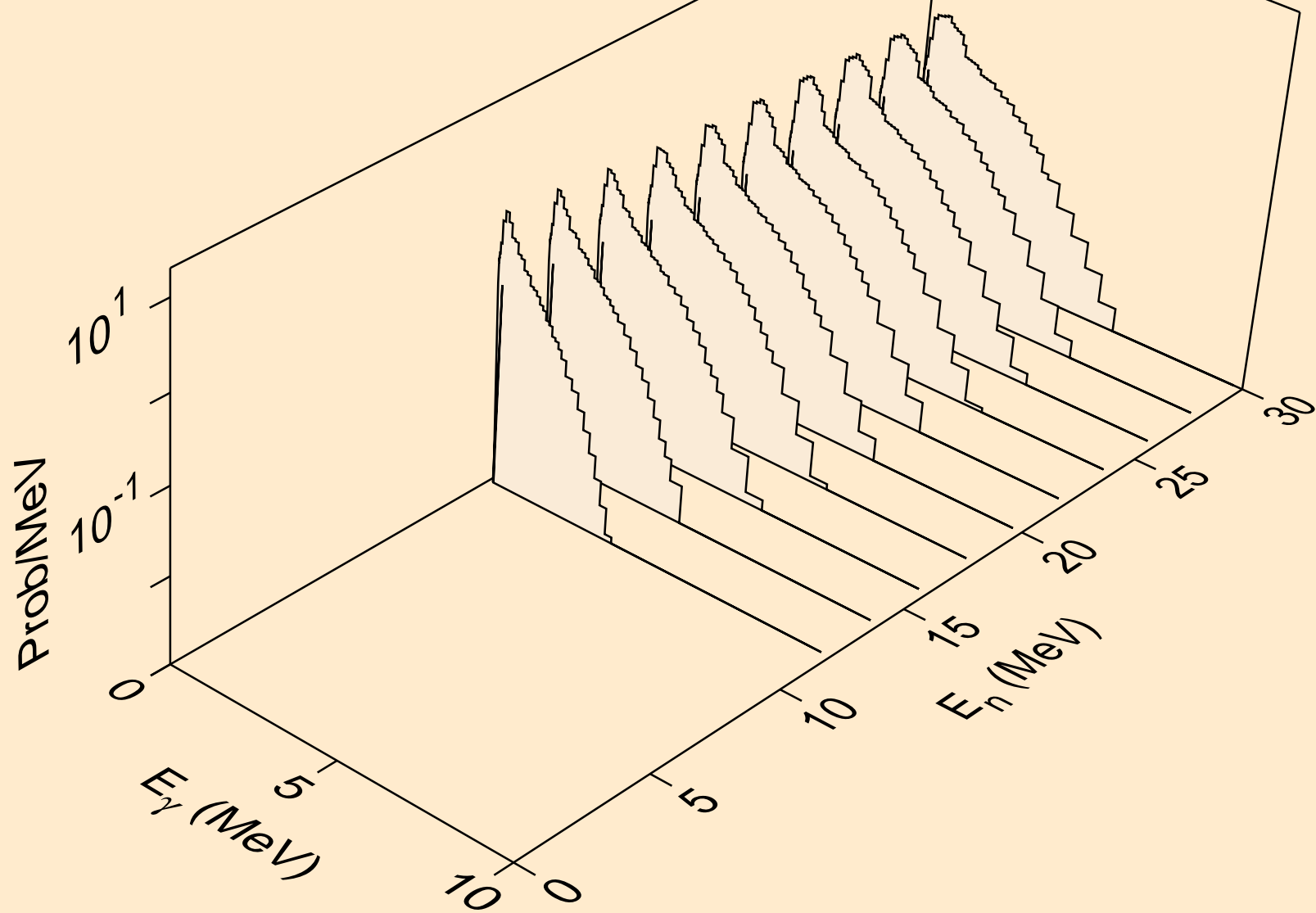

FR204 HELION ACER TENDL-2021 LIBRARY; T=0.K
Photon emission for (n,pa)

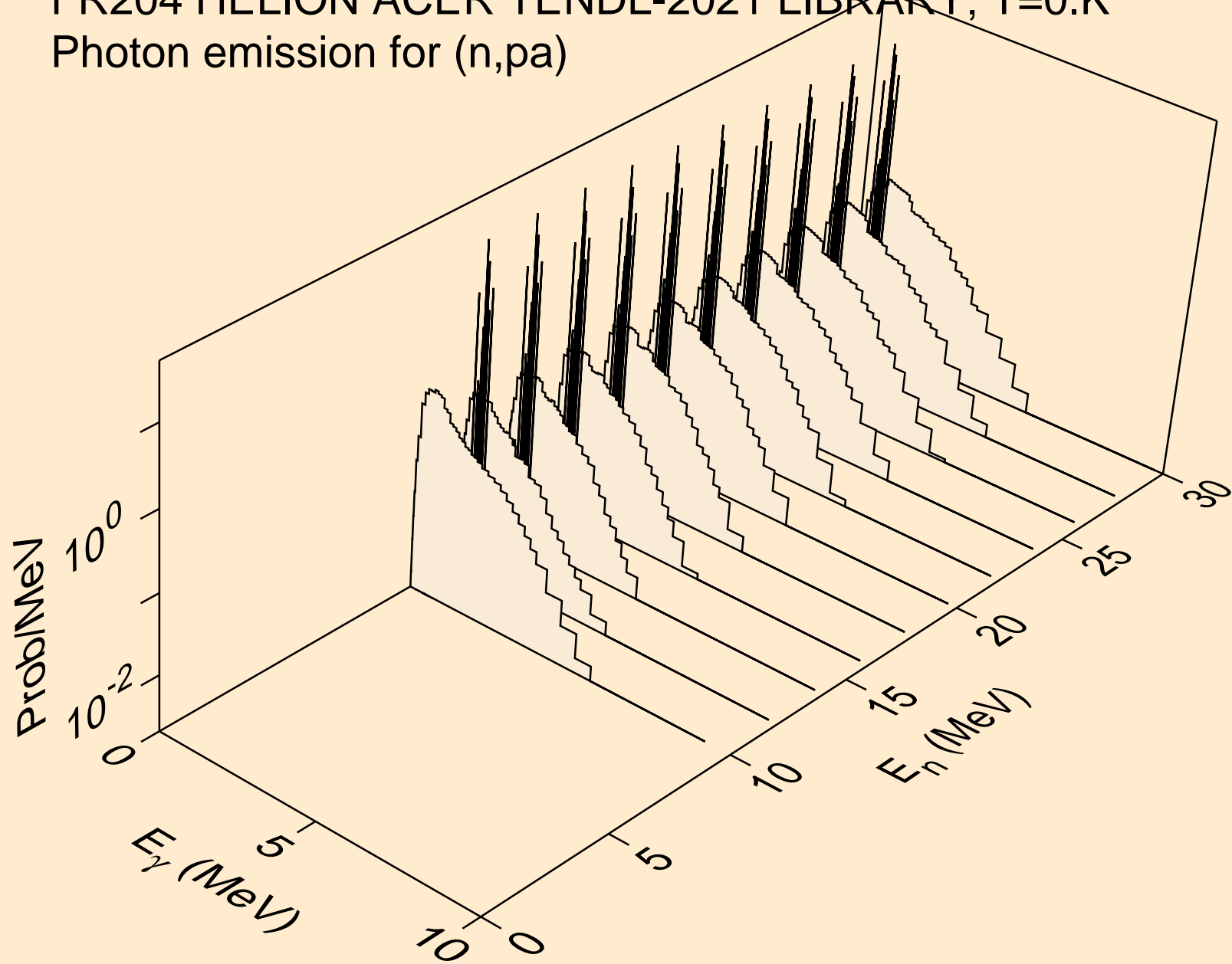

FR204 HELION ACER TENDL-2021 LIBRARY; T=0.K
Photon emission for (n,pd)

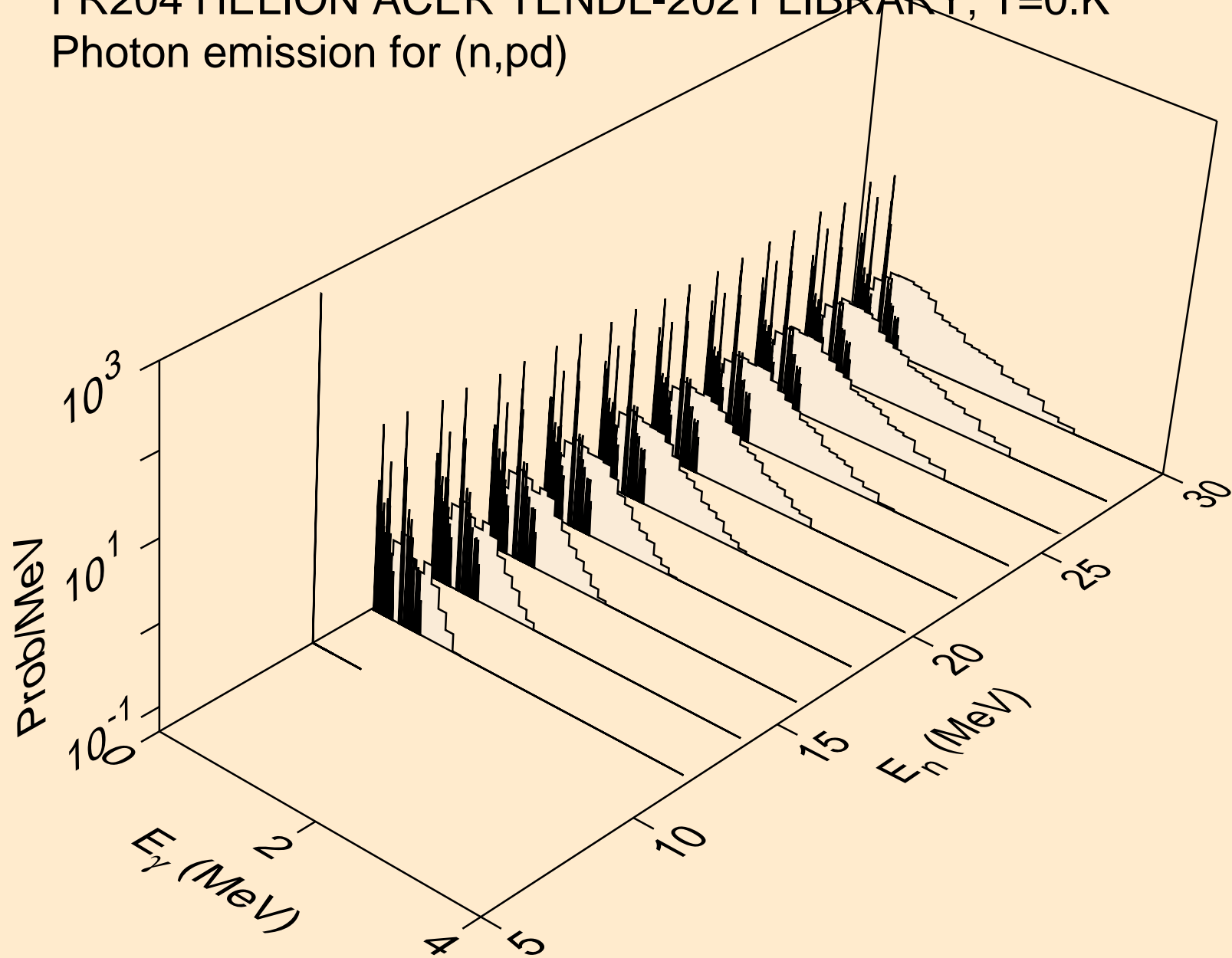

FR204 HELION ACER TENDL-2021 LIBRARY; T=0.K
Photon emission for (n,pt)

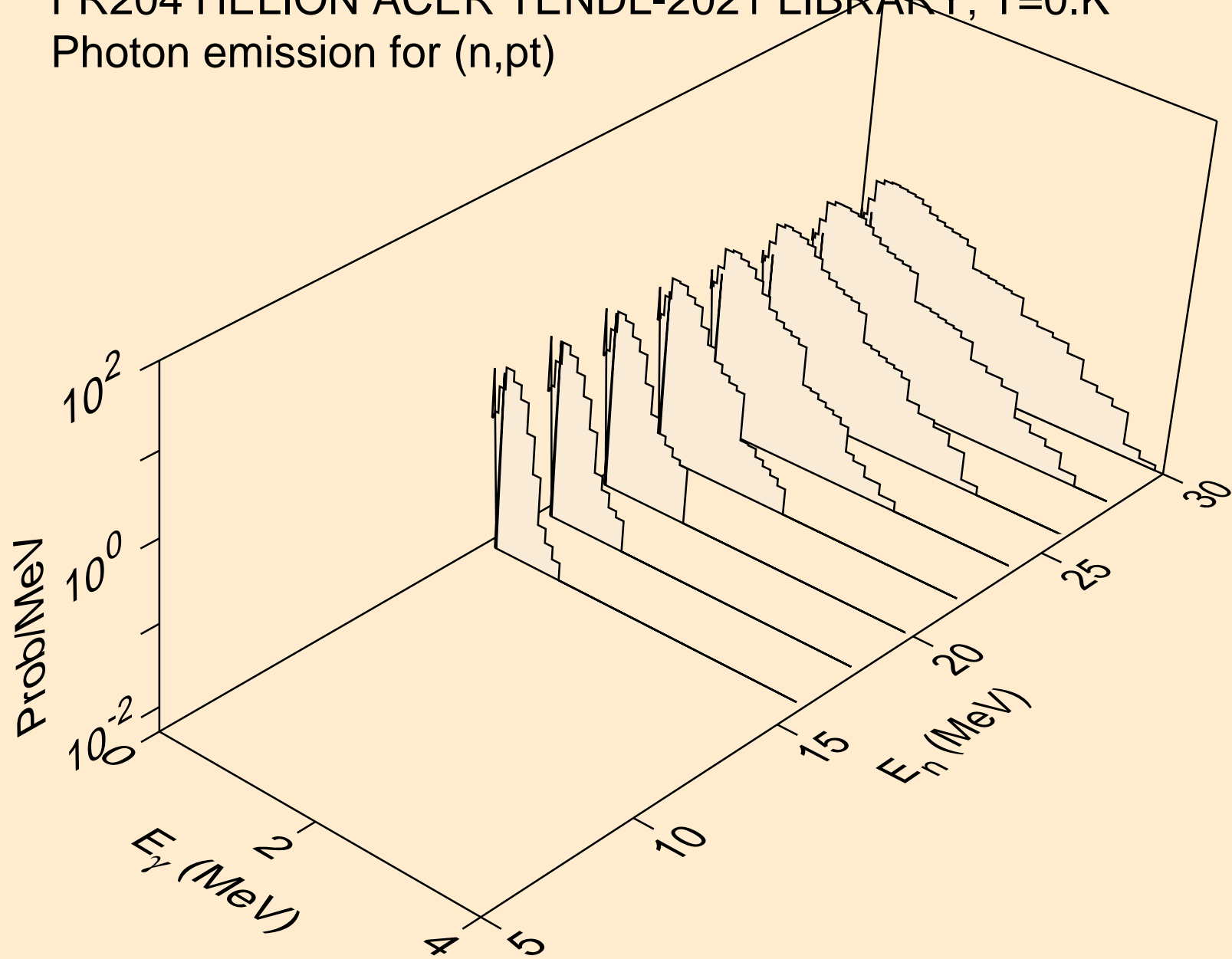

FR204 HELION ACER TENDL-2021 LIBRARY; T=0.K
Photon emission for (n,da)

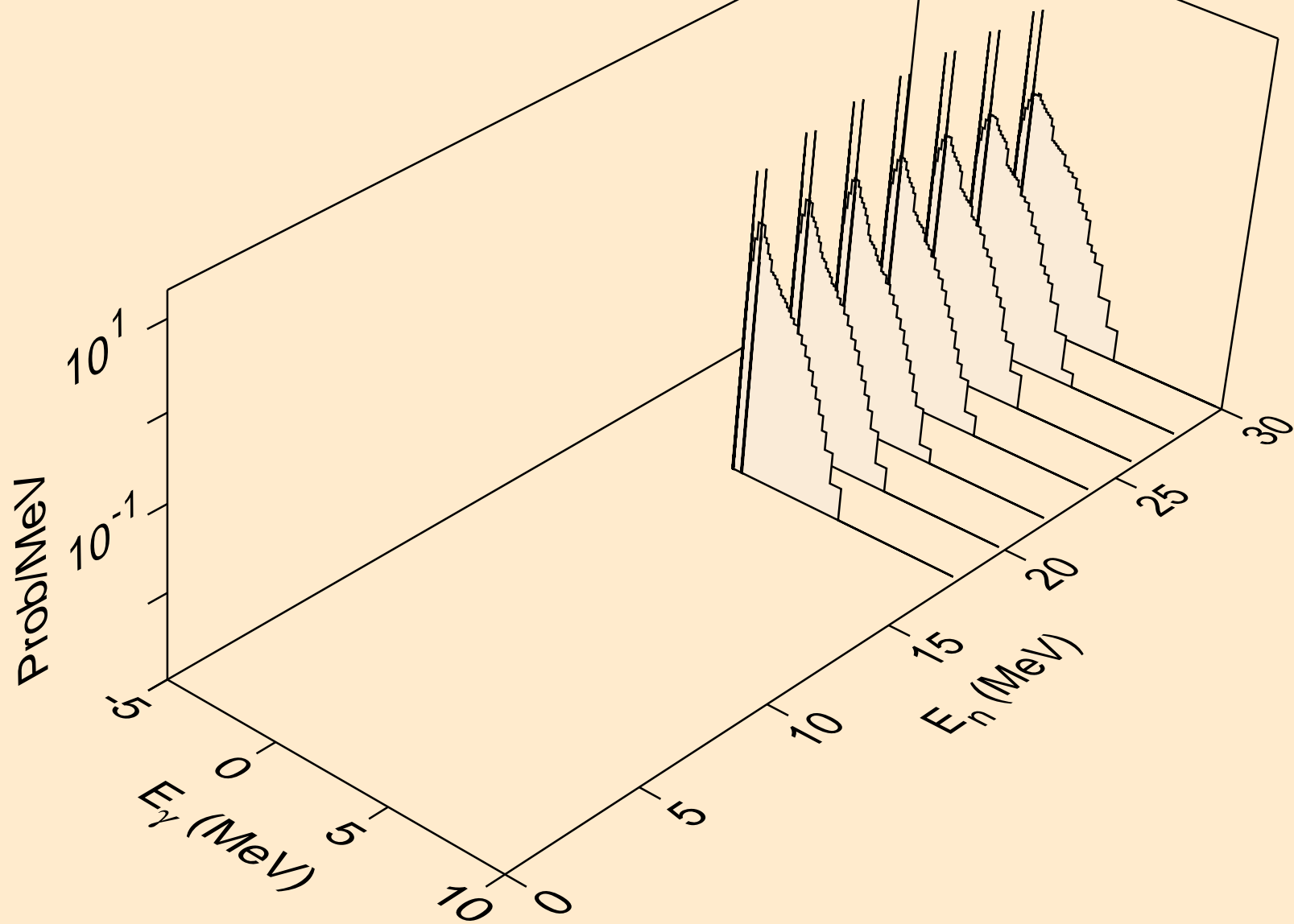

FR204 HELION ACER TENDL-2021 LIBRARY; T=0.K
Particle heating contributions

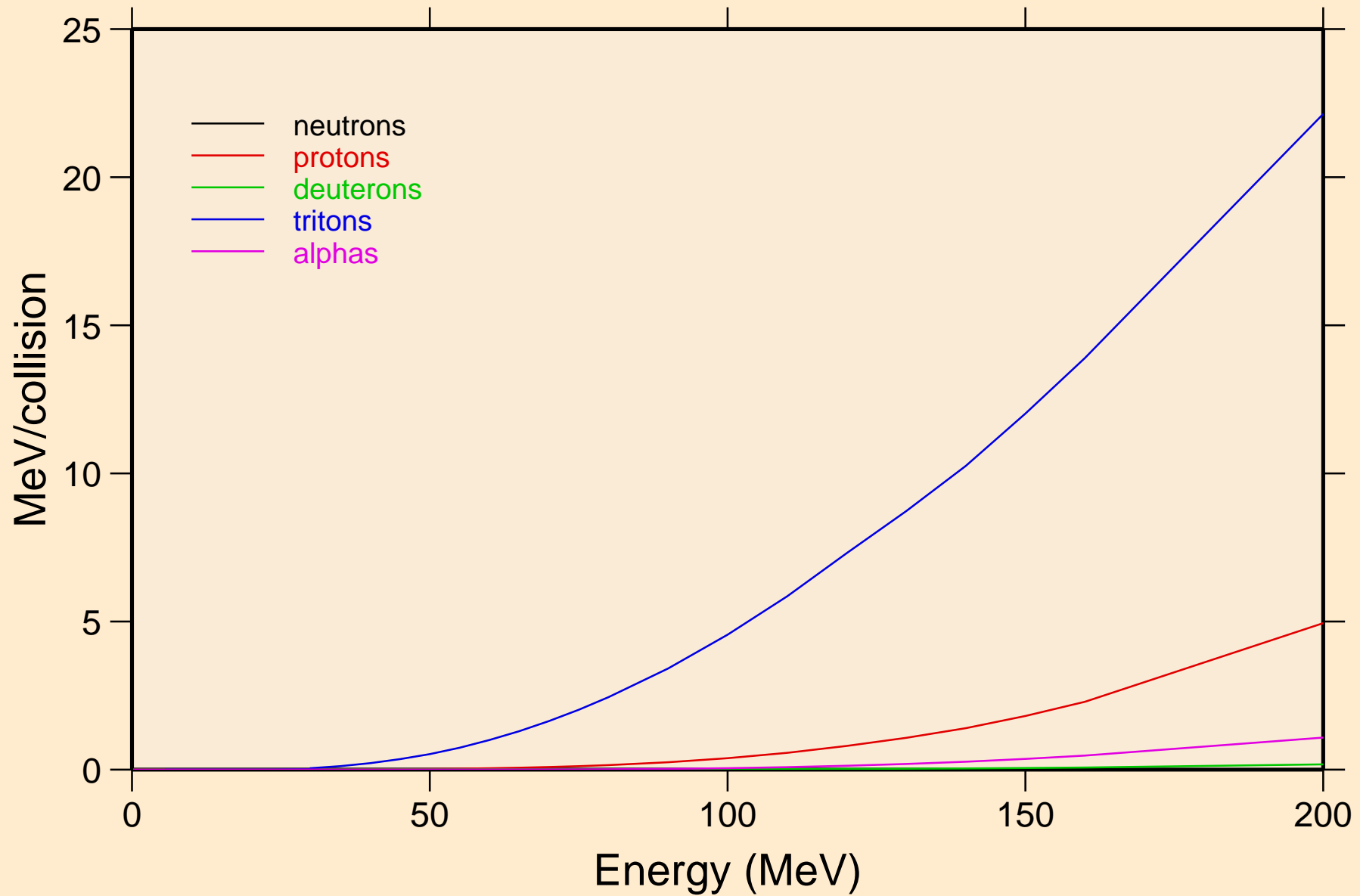

FR204 HELION ACER TENDL-2021 LIBRARY; T=0.K
Recoil Heating

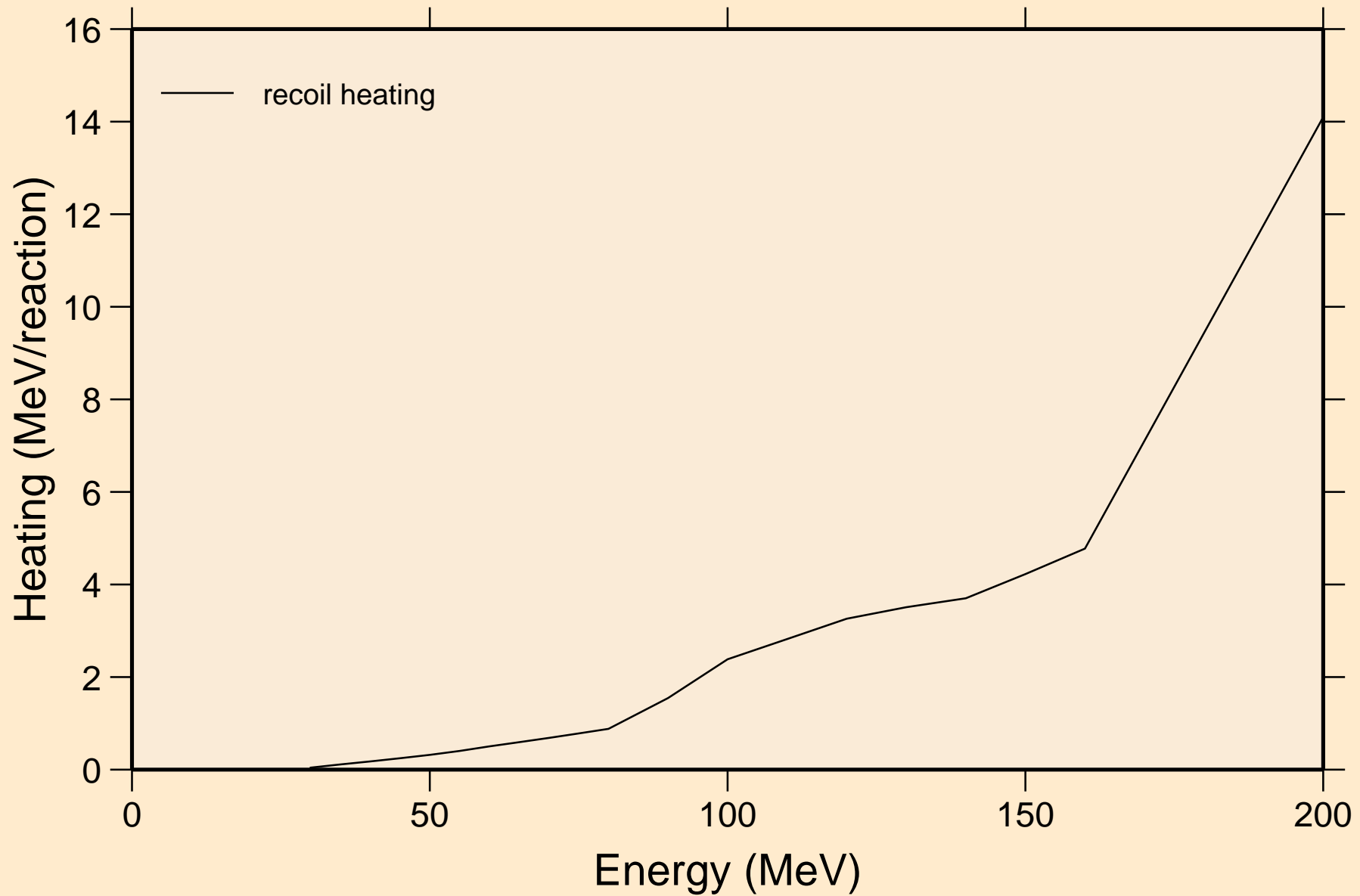

FR204 HELION ACER TENDL-2021 LIBRARY; T=0.K
Particle production cross sections

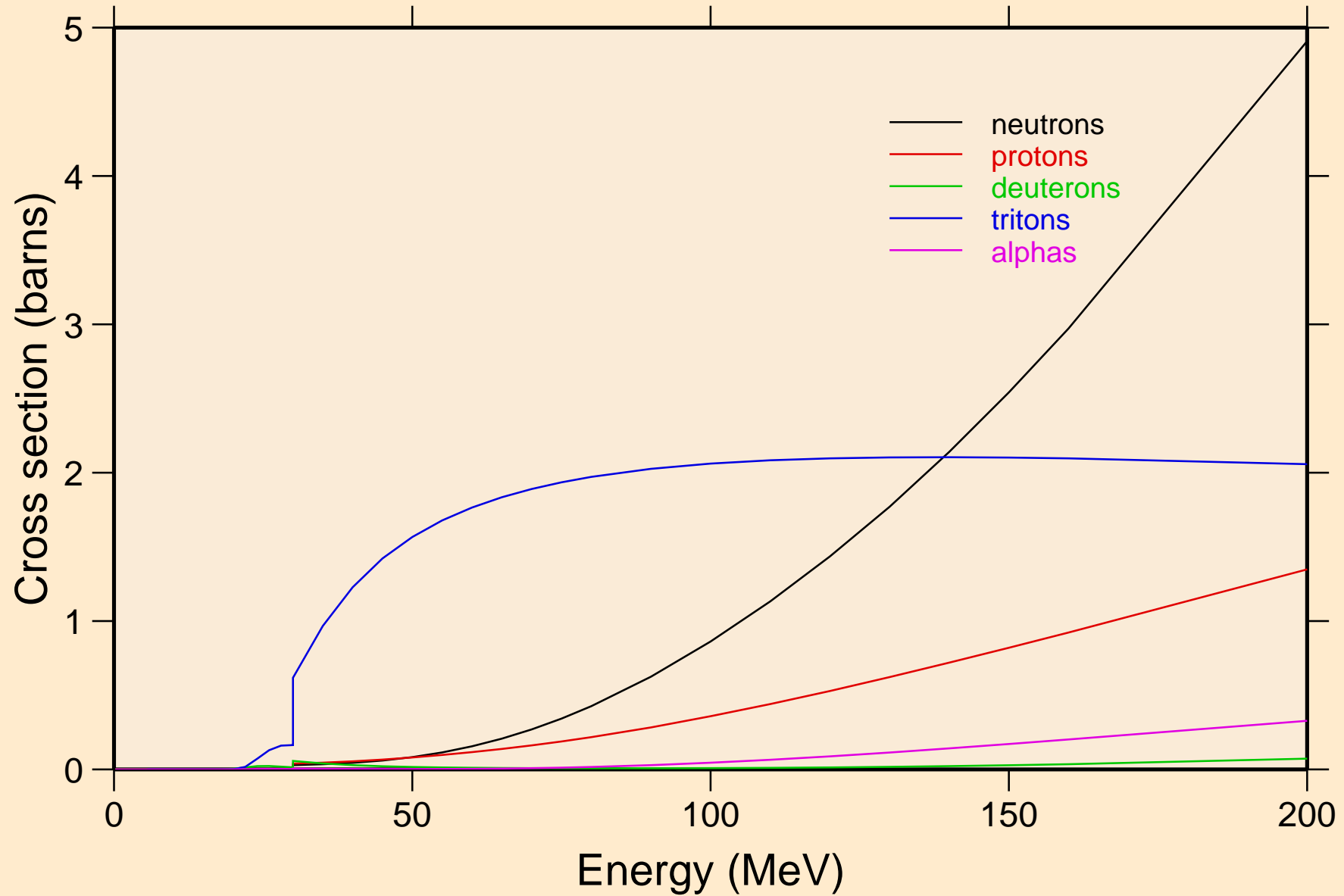

FR204 HELION ACER TENDL-2021 LIBRARY; T=0.K
neutrons from (s,n)

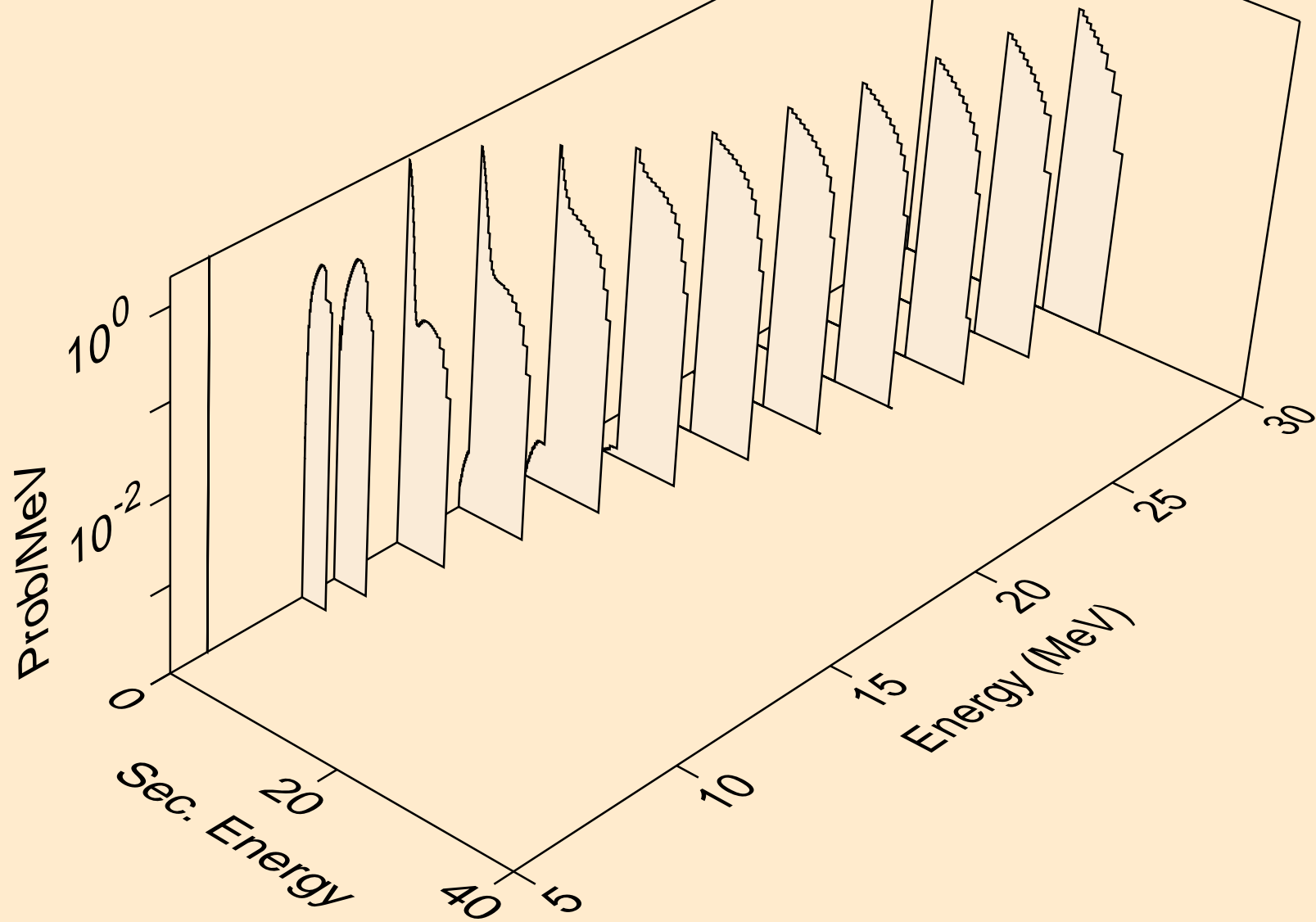

FR204 HELION ACER TENDL-2021 LIBRARY; T=0.K
neutrons from (s,x)

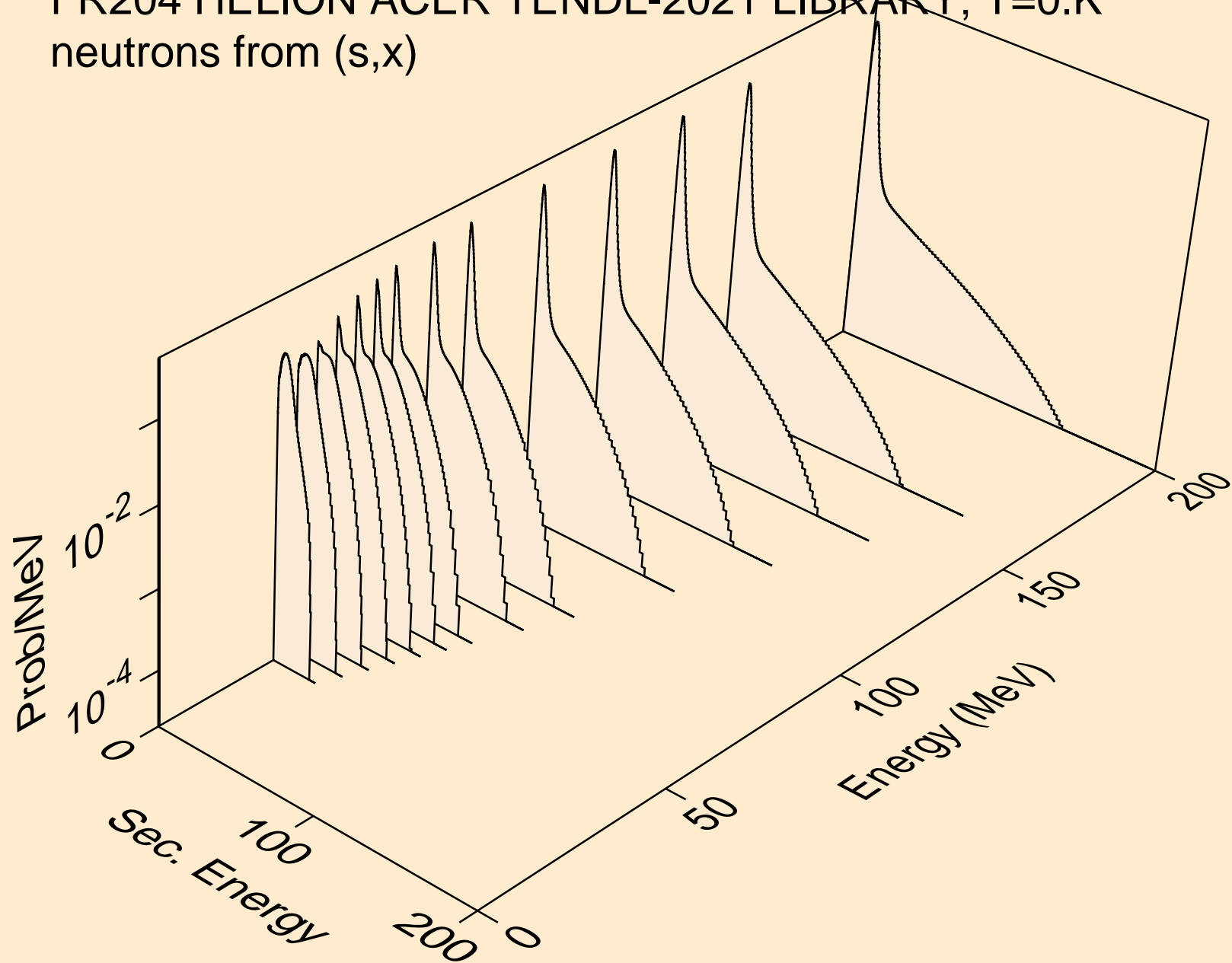

FR204 HELION ACER TENDL-2021 LIBRARY; T=0.K
neutrons from (s,2n)

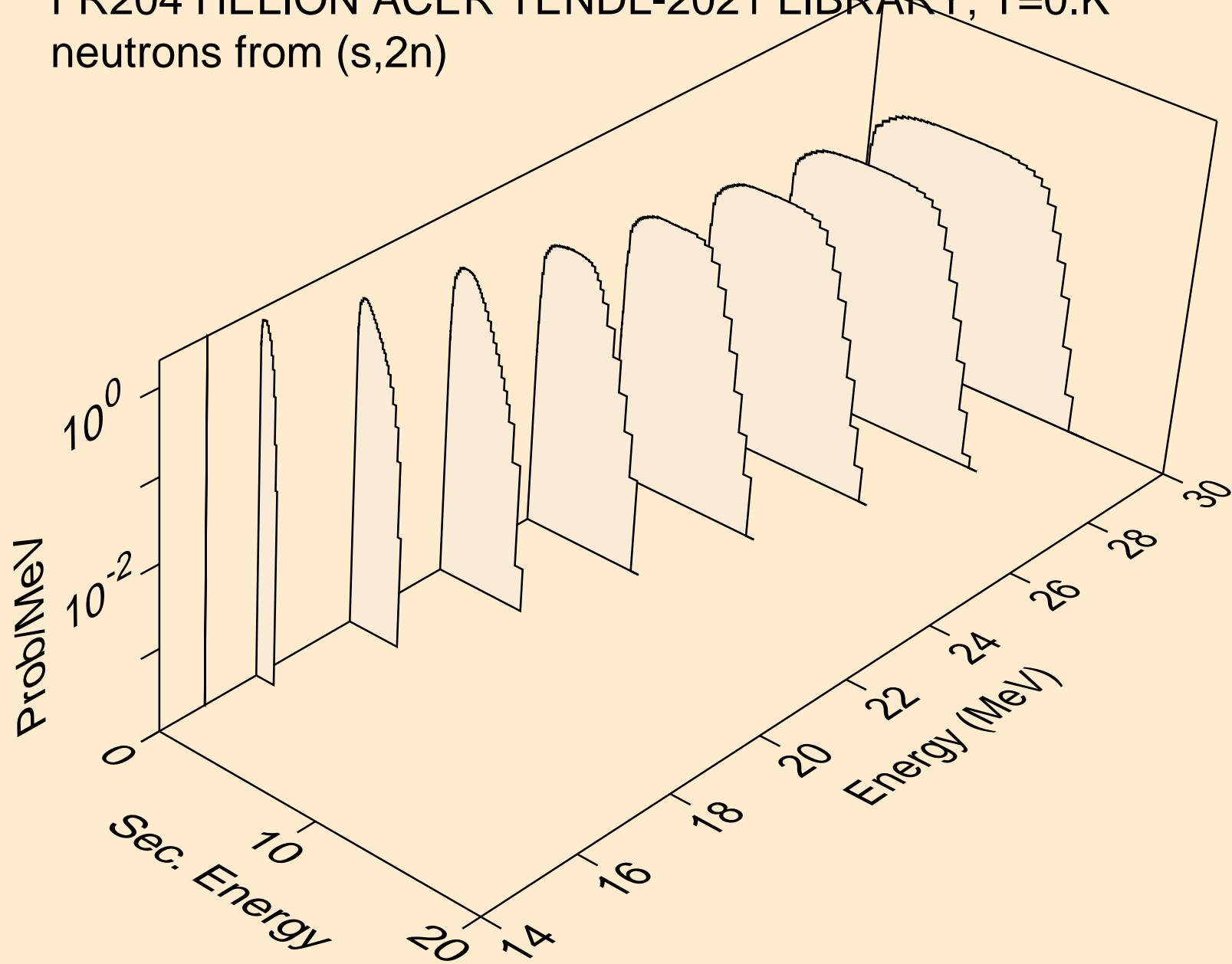

FR204 HELION ACER TENDL-2021 LIBRARY; T=0.K
neutrons from (s,n*)a

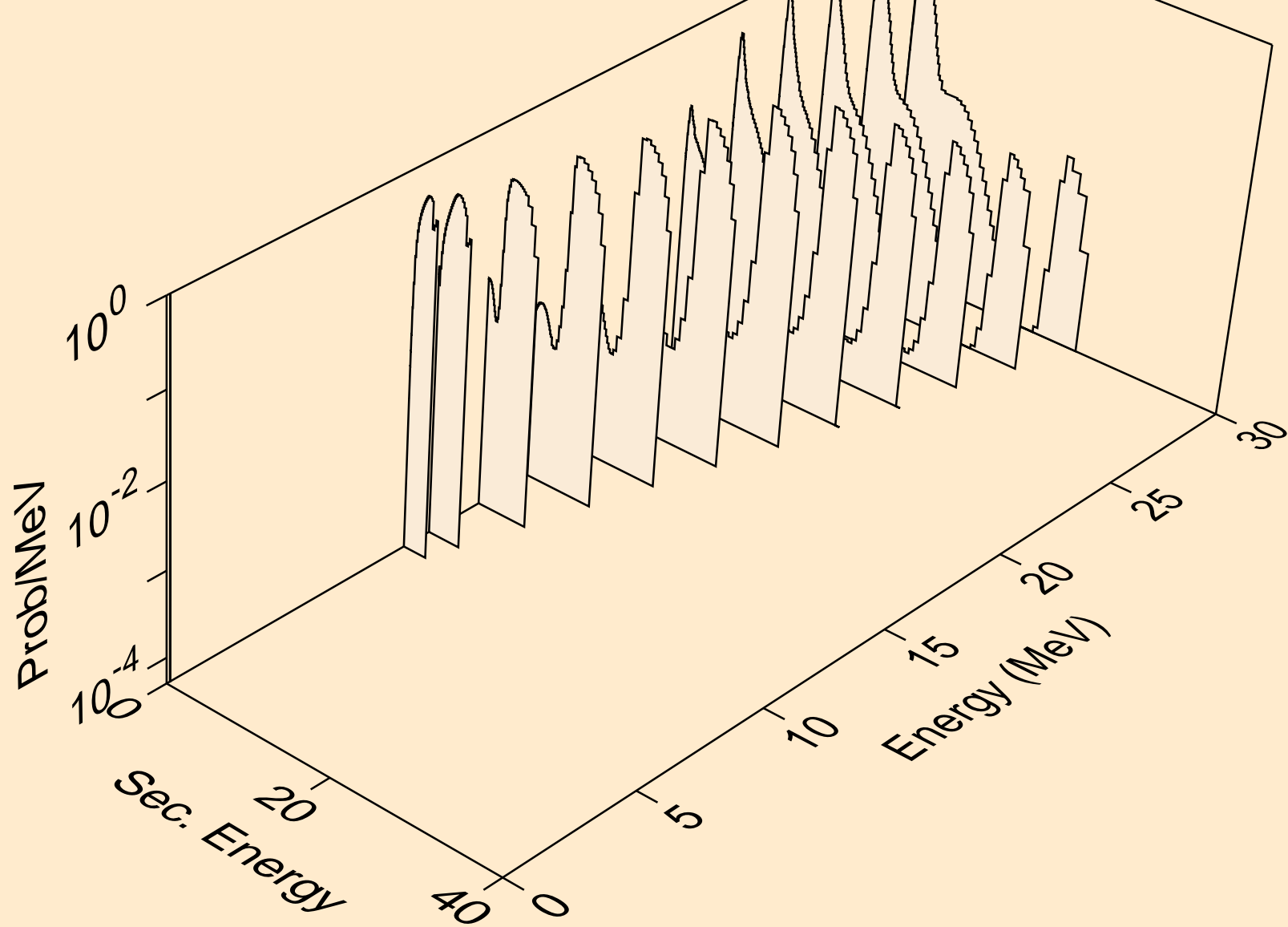

FR204 HELION ACER TENDL-2021 LIBRARY; T=0.K
neutrons from (s,2n)a

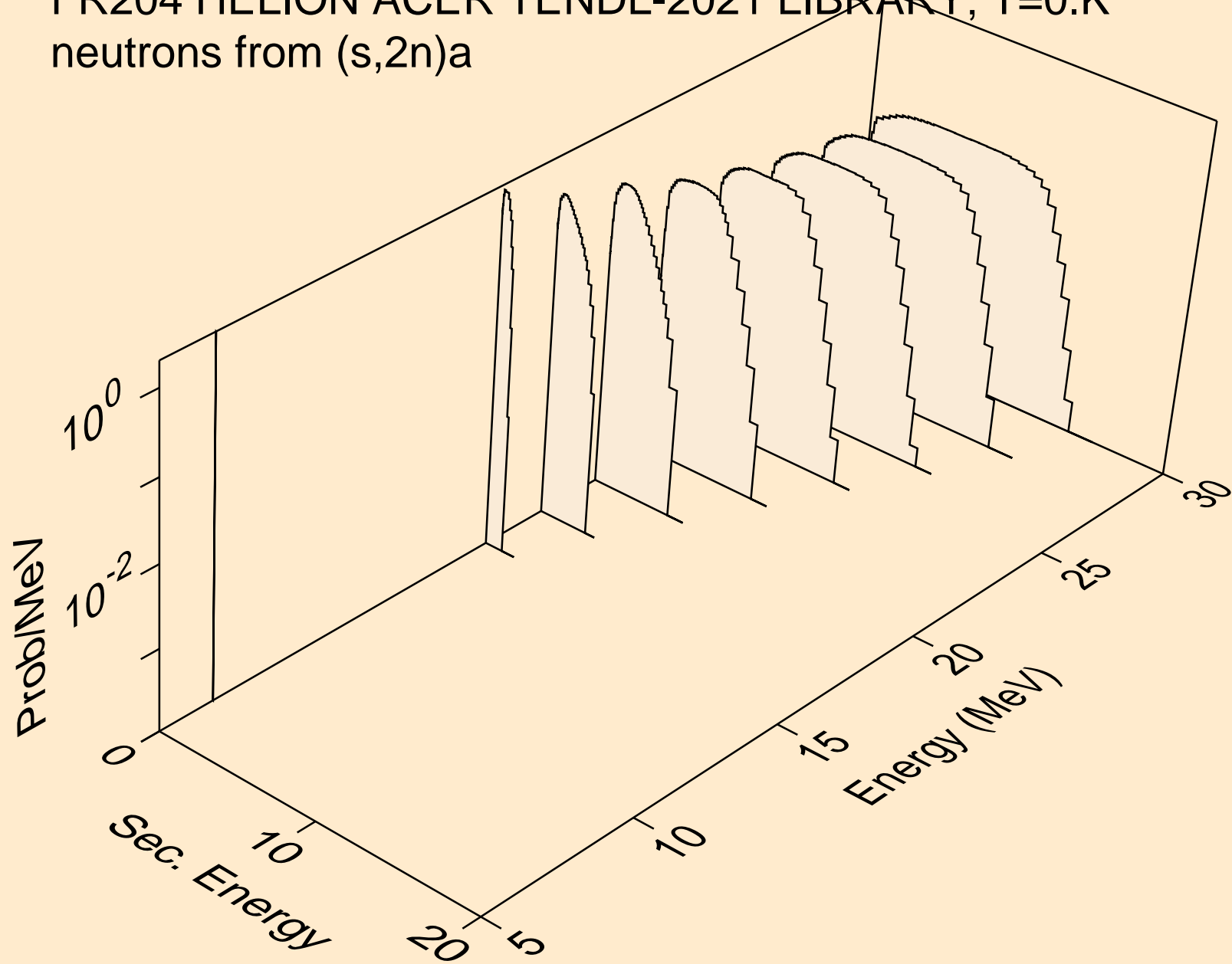

FR204 HELION ACER TENDL-2021 LIBRARY; T=0.K
neutrons from (s,n*)p

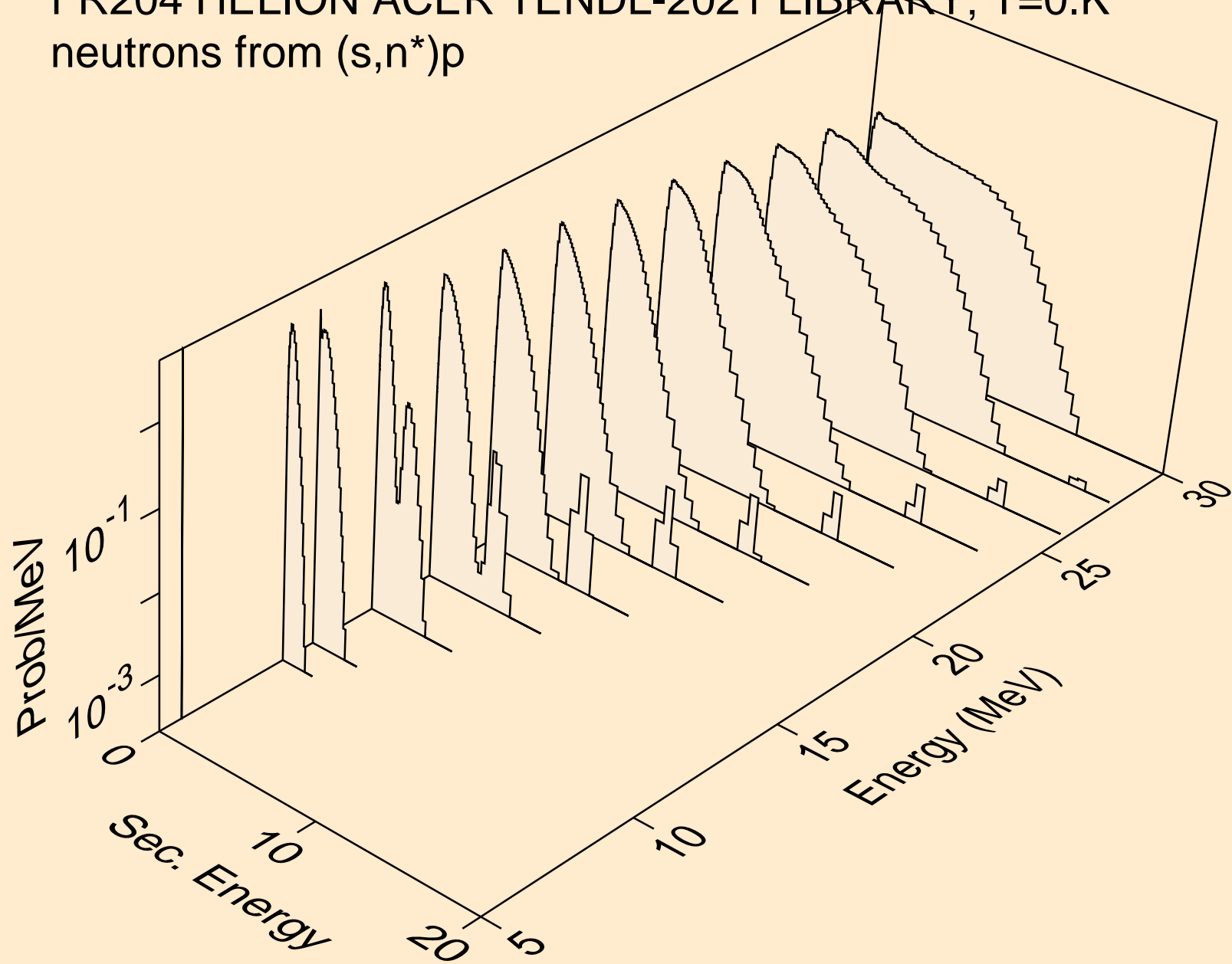

FR204 HELION ACER TENDL-2021 LIBRARY; T=0.K
neutrons from (s,n*)d

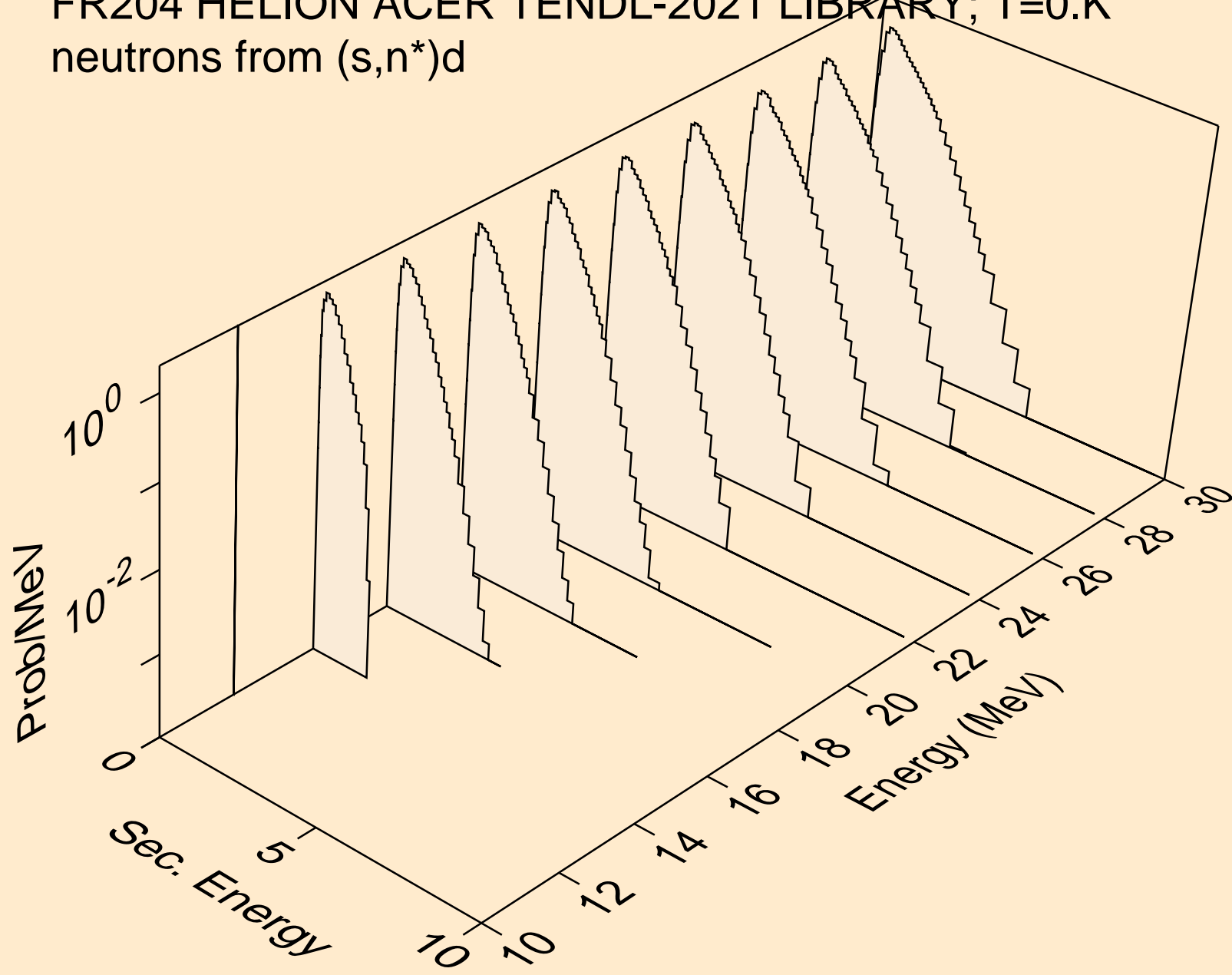

FR204 HELION ACER TENDL-2021 LIBRARY; T=0.K
neutrons from (s,n*)t

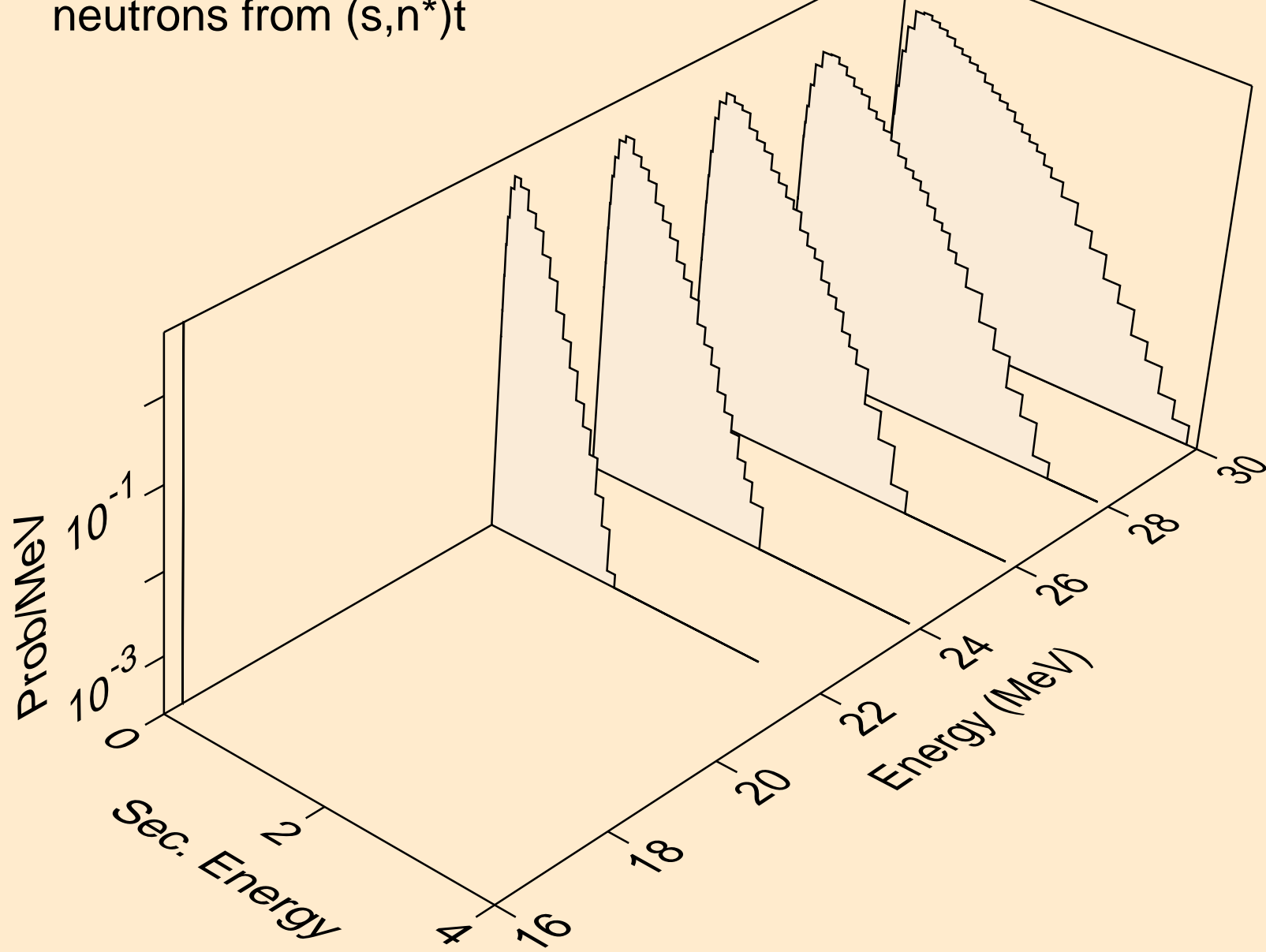

FR204 HELION ACER TENDL-2021 LIBRARY; T=0.K
neutrons from (s,n*)he3

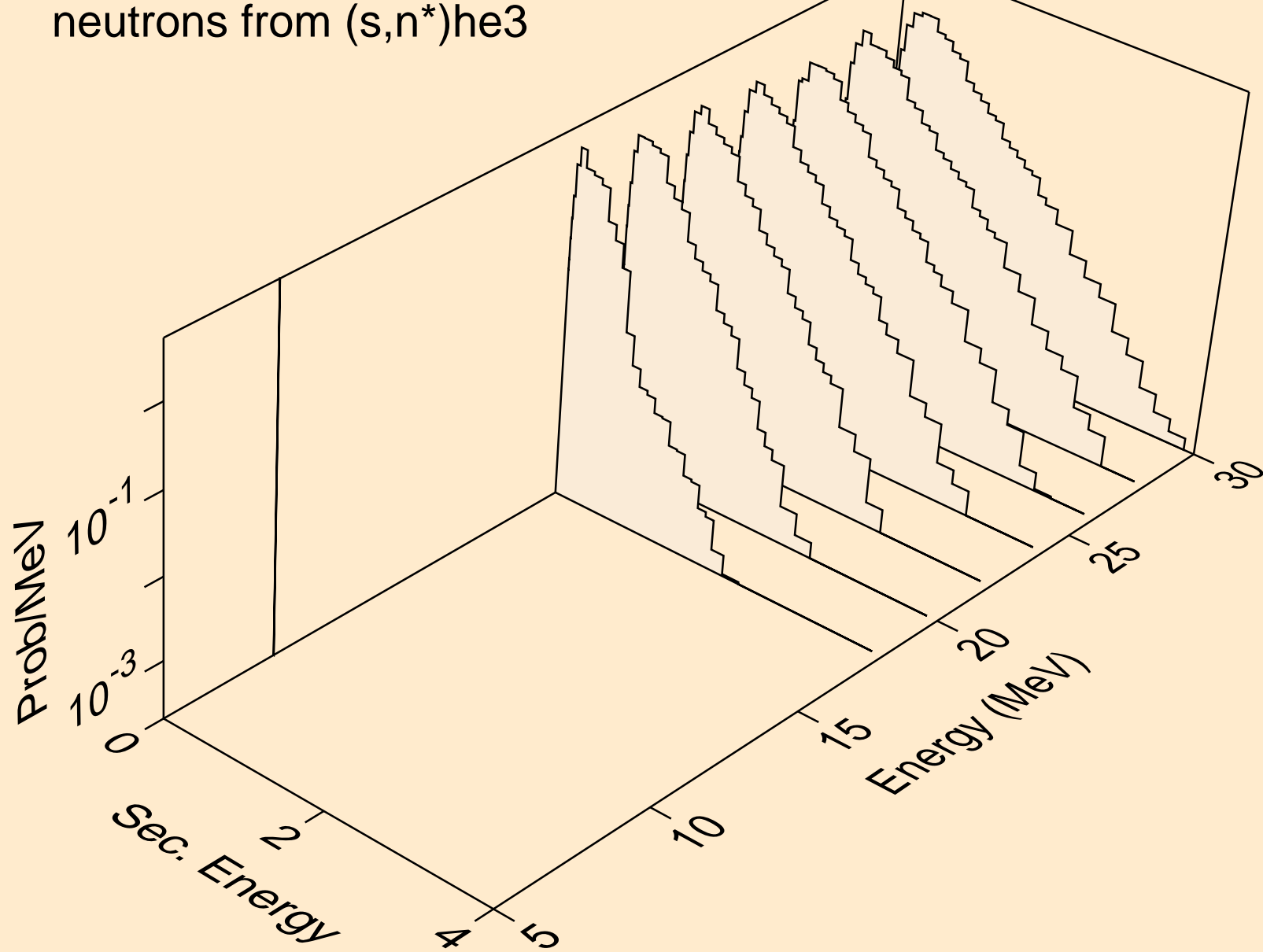

FR204 HELION ACER TENDL-2021 LIBRARY; T=0.K
neutrons from (s,2np)

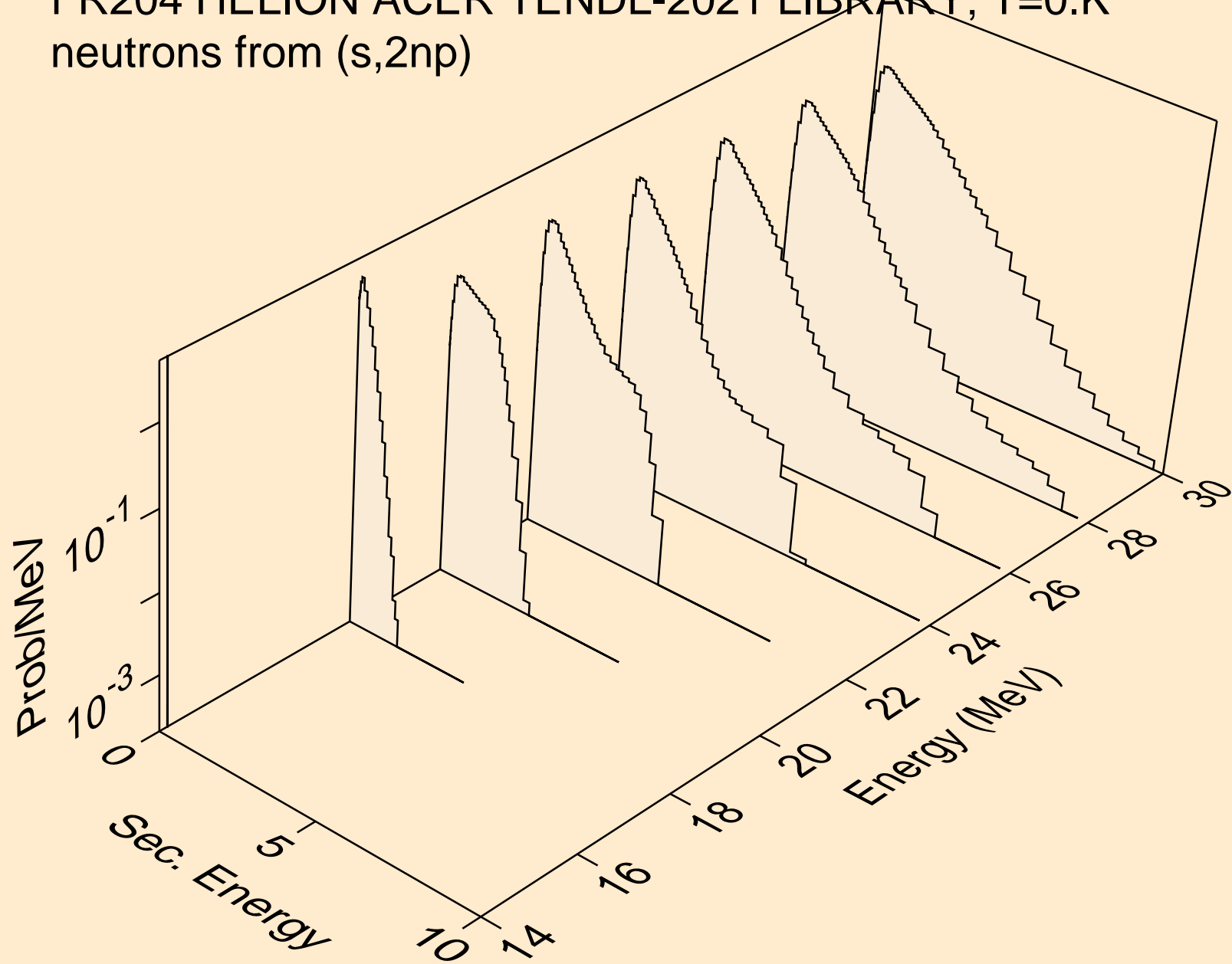

FR204 HELION ACER TENDL-2021 LIBRARY; T=0.K
neutrons from (s,2np)

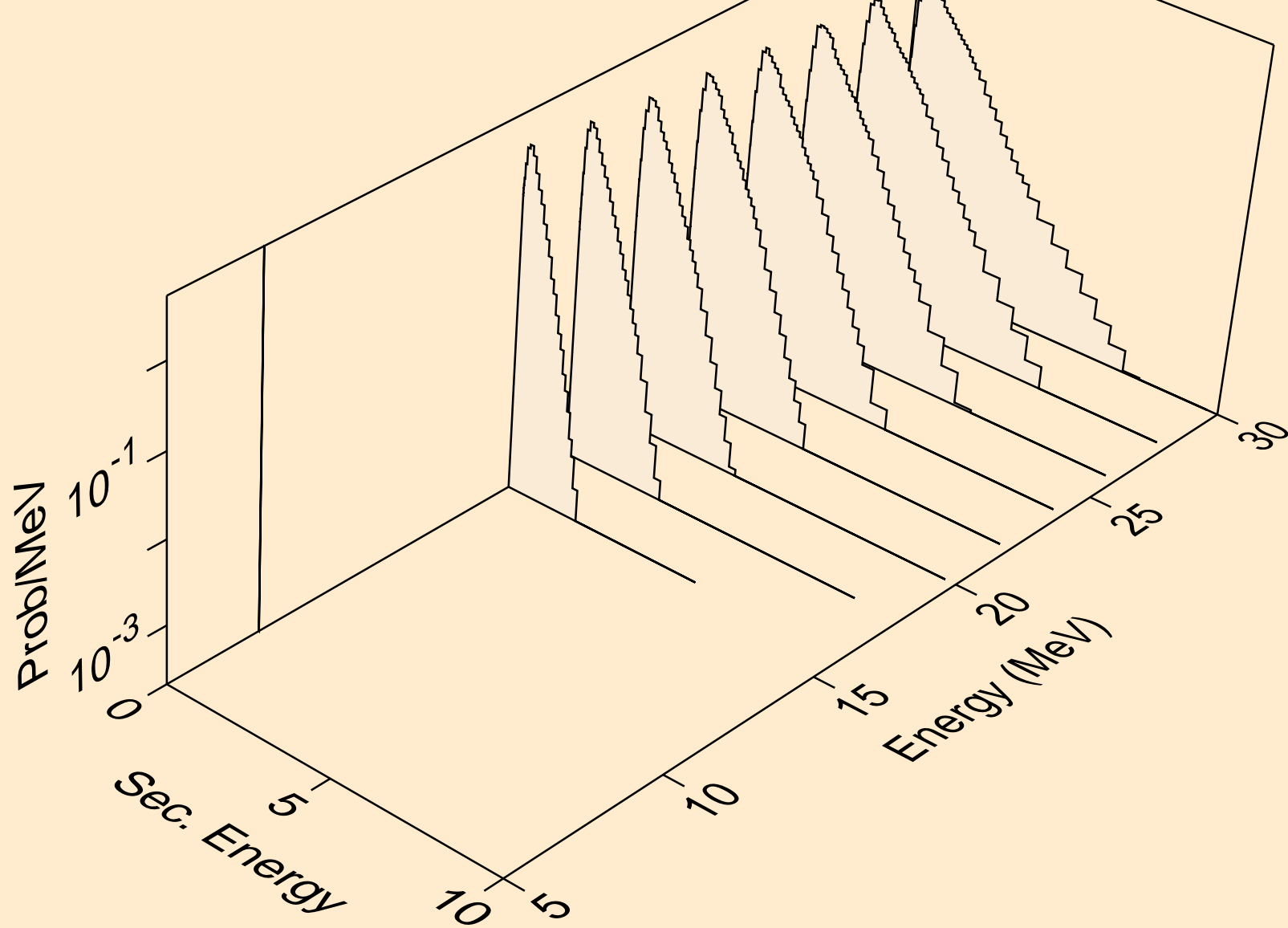

FR204 HELION ACER TENDL-2021 LIBRARY; T=0.K
neutrons from (s,npa)

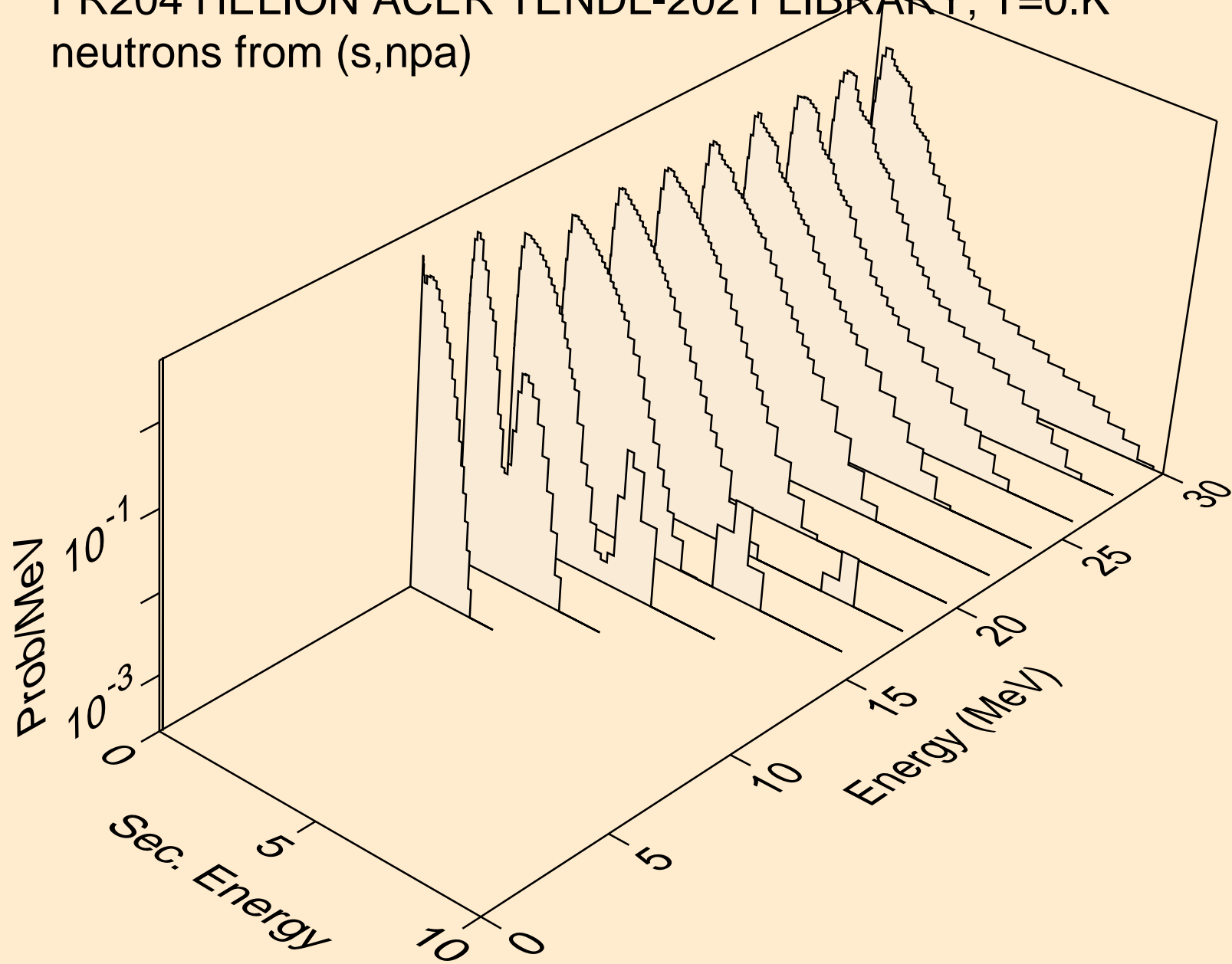

FR204 HELION ACER TENDL-2021 LIBRARY; T=0.K
protons from (s,x)

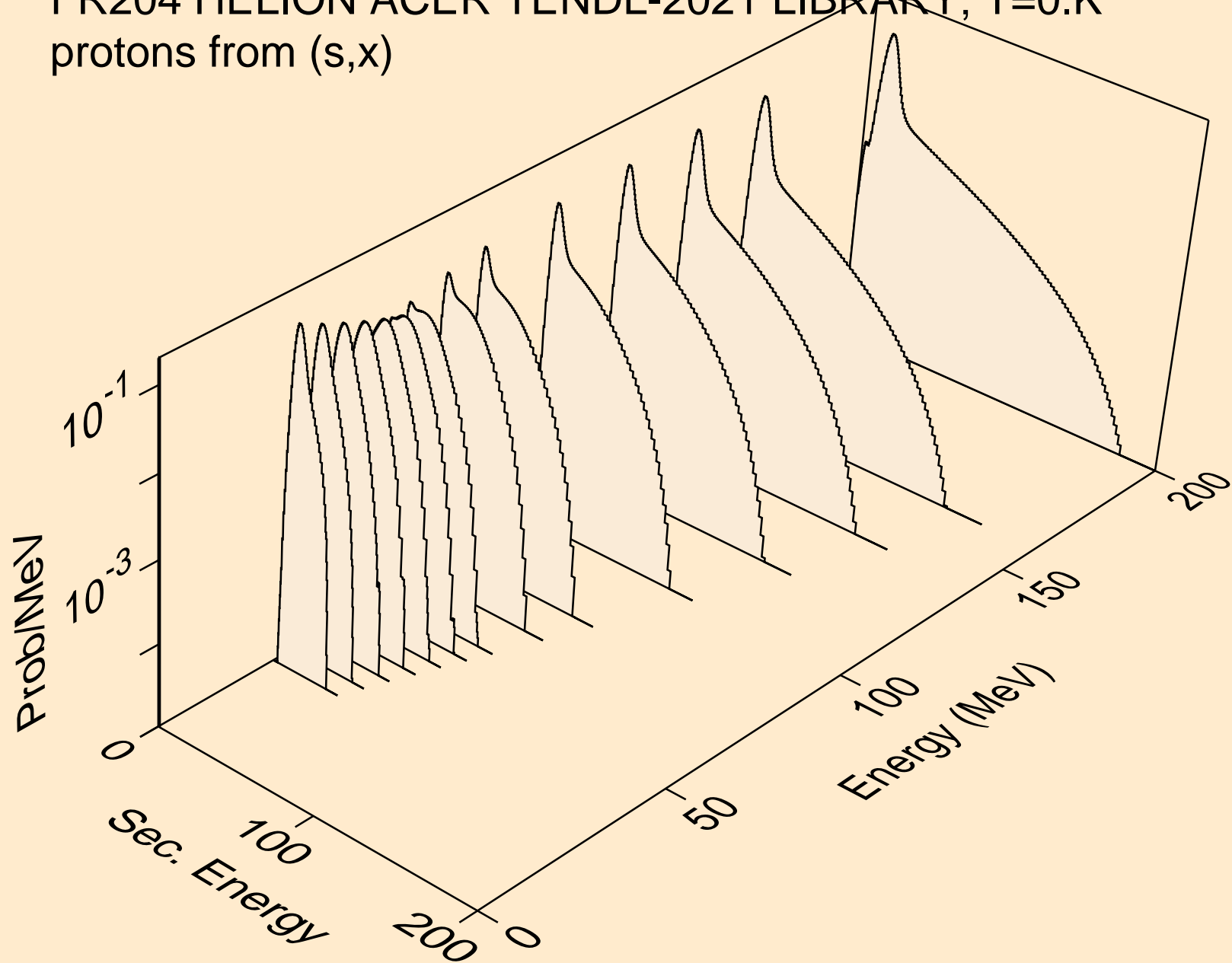

FR204 HELION ACER TENDL-2021 LIBRARY; T=0.K
protons from (s,n*)p

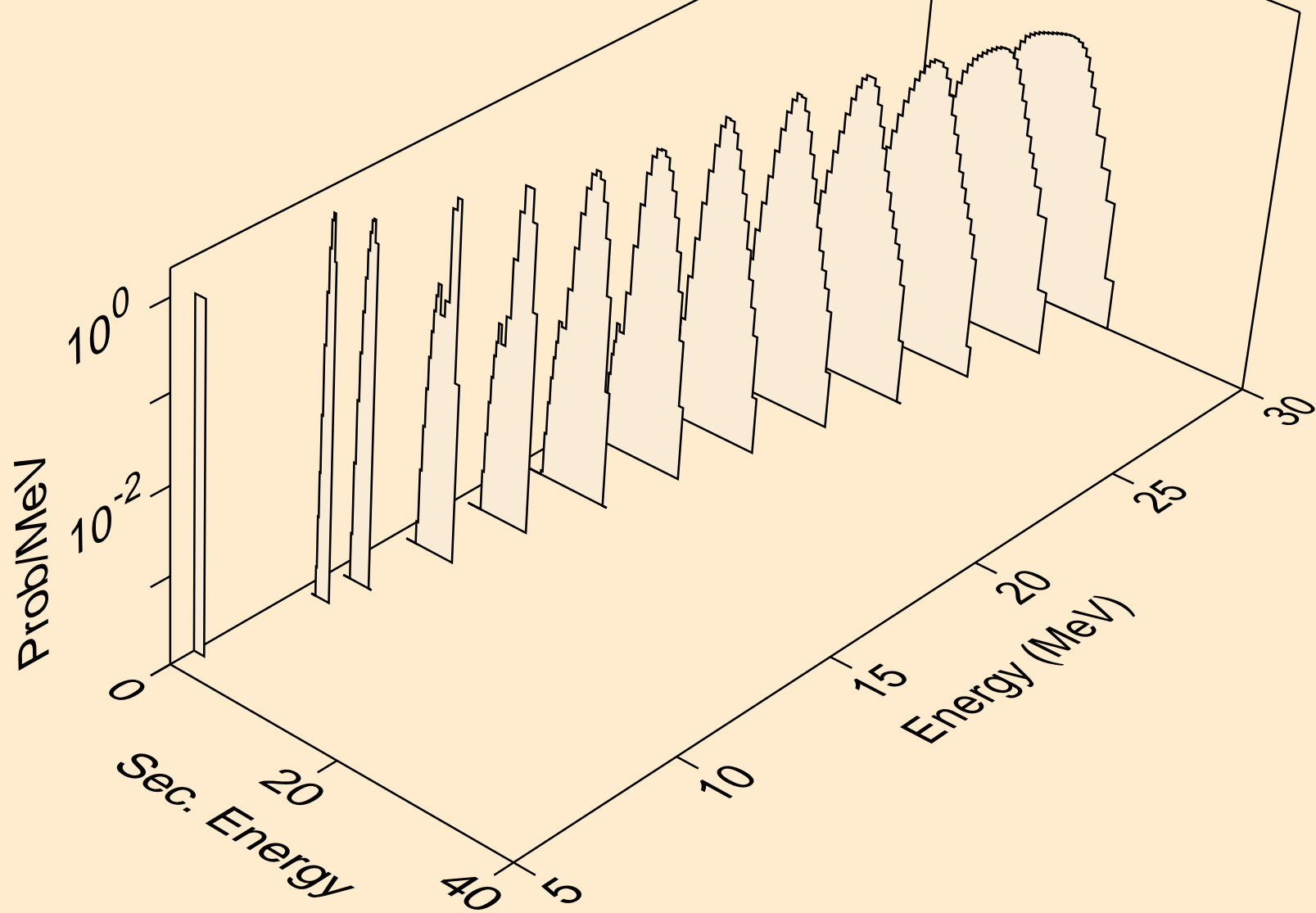

FR204 HELION ACER TENDL-2021 LIBRARY; T=0.K
protons from (s,2np)

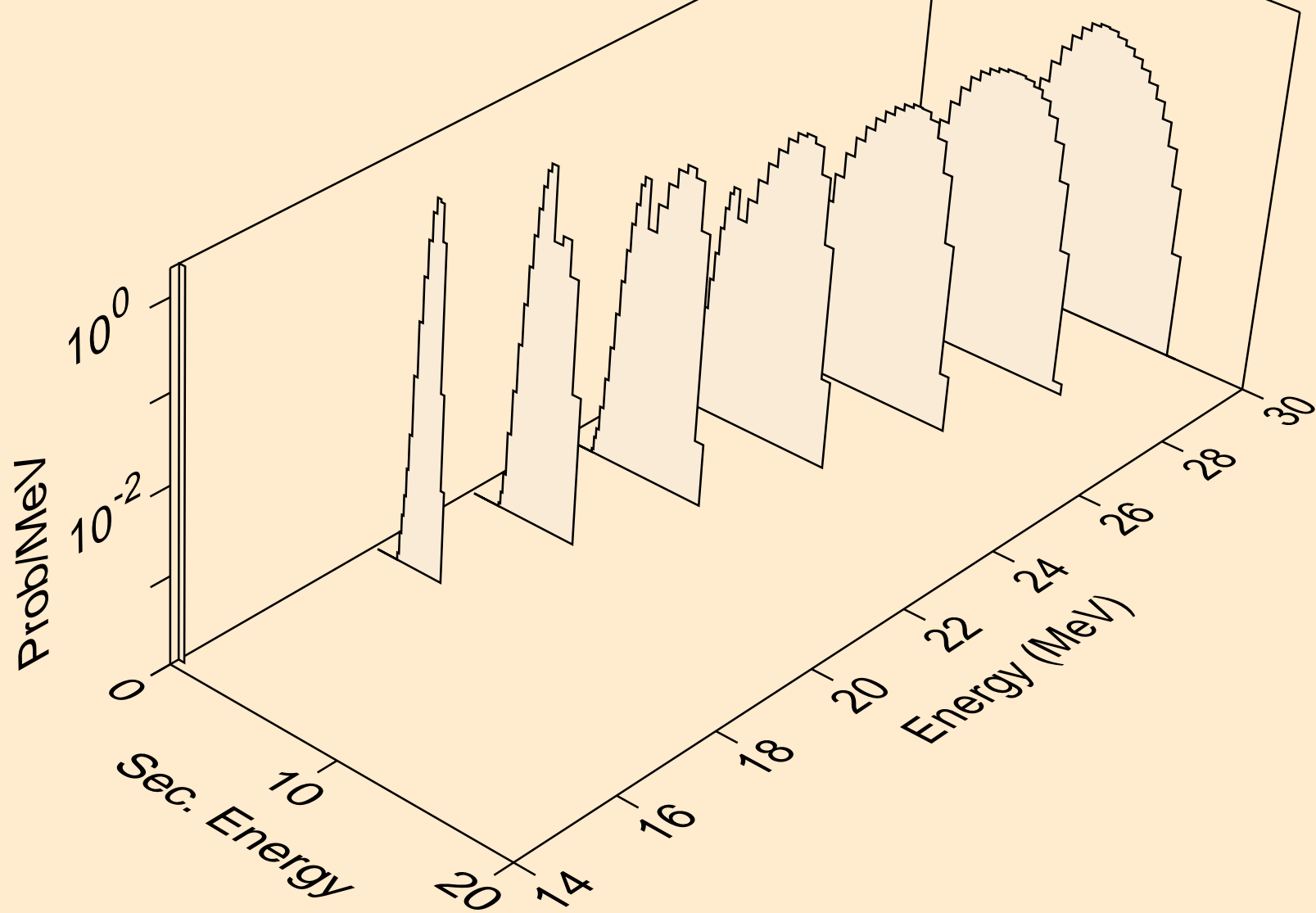

FR204 HELION ACER TENDL-2021 LIBRARY; T=0.K
protons from (s,2np)

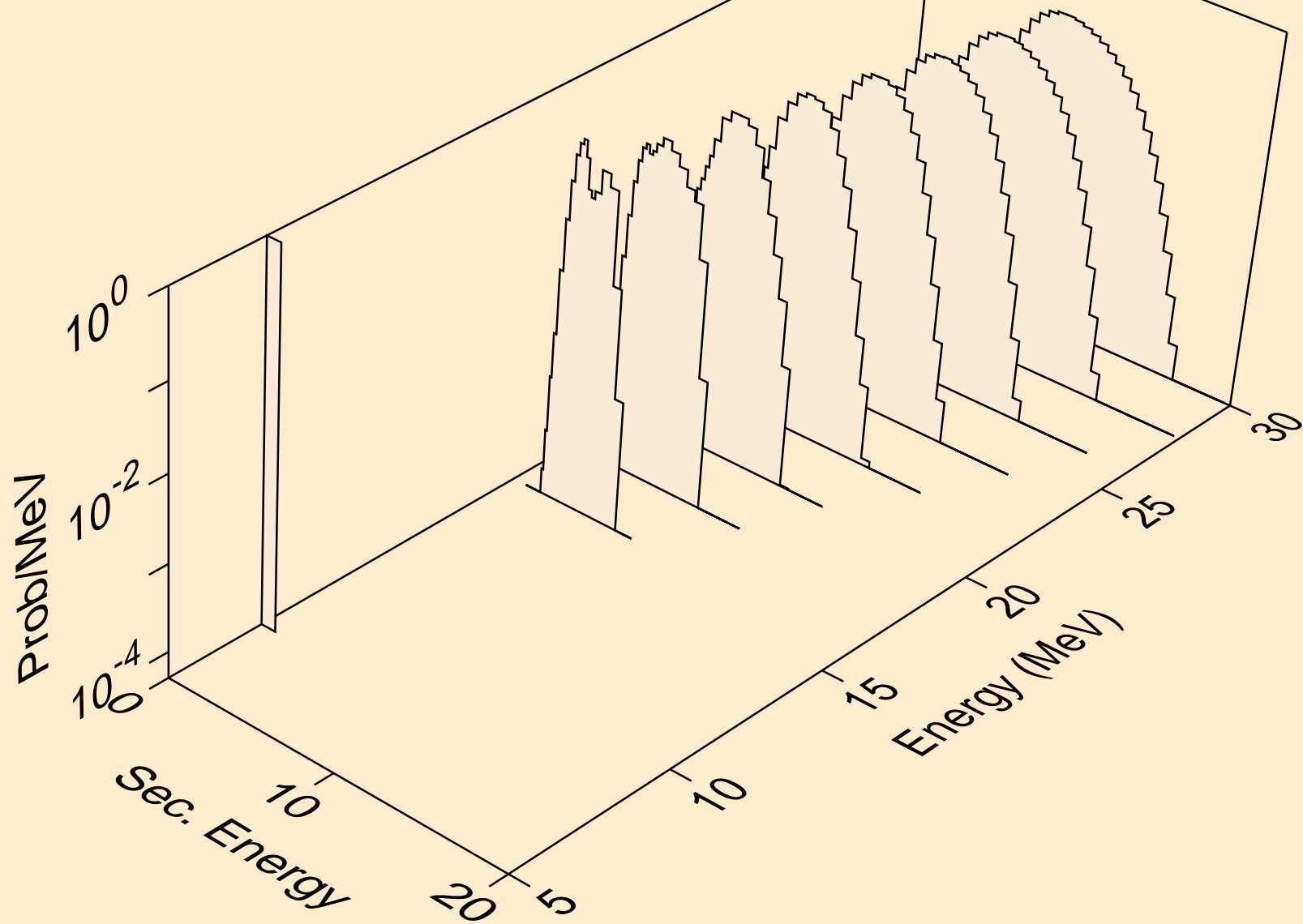

FR204 HELION ACER TENDL-2021 LIBRARY; T=0.K
protons from (s,npa)

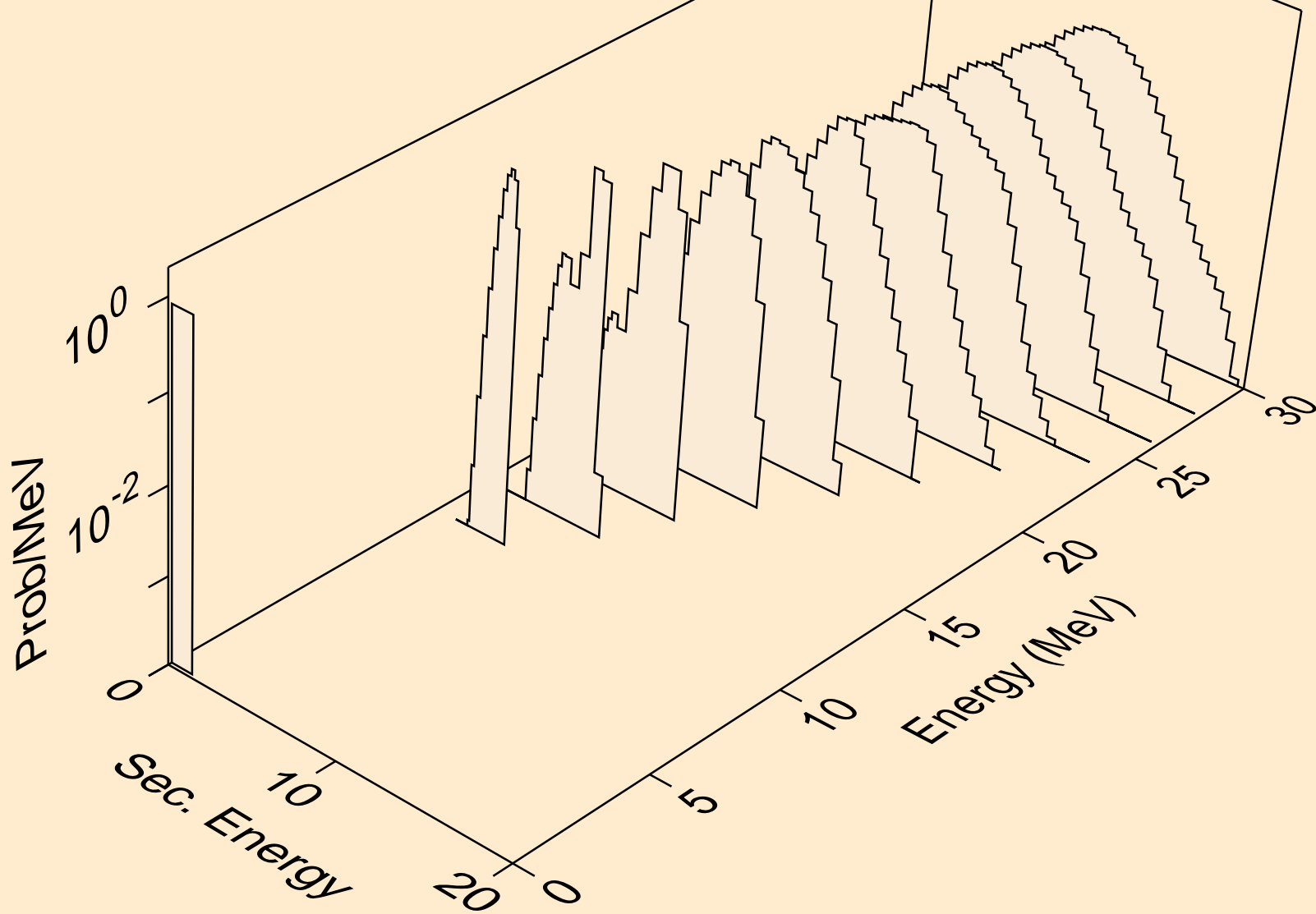

FR204 HELION ACER TENDL-2021 LIBRARY; T=0.K
protons from (s,p)

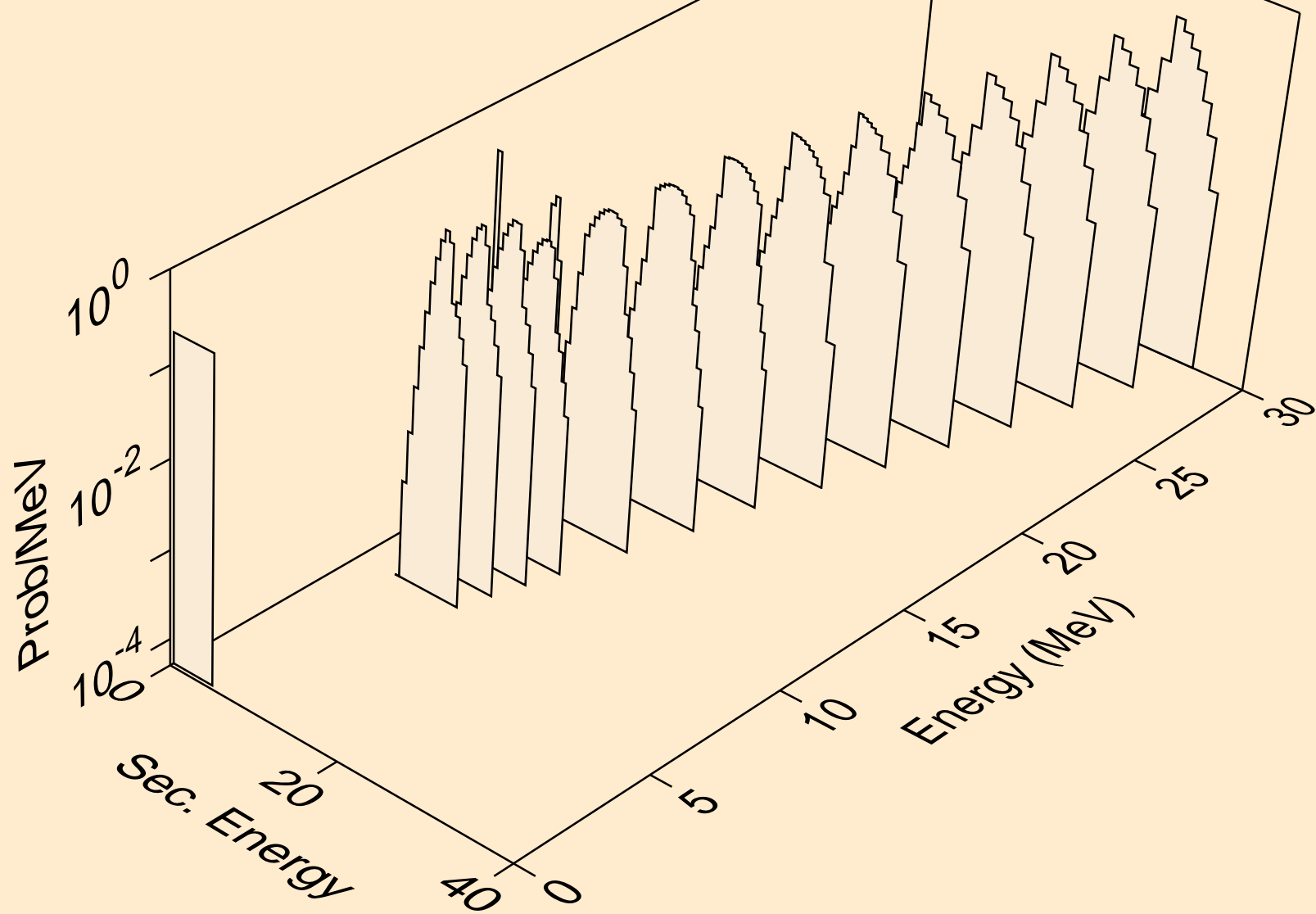

FR204 HELION ACER TENDL-2021 LIBRARY; T=0.K
protons from (s,2p)

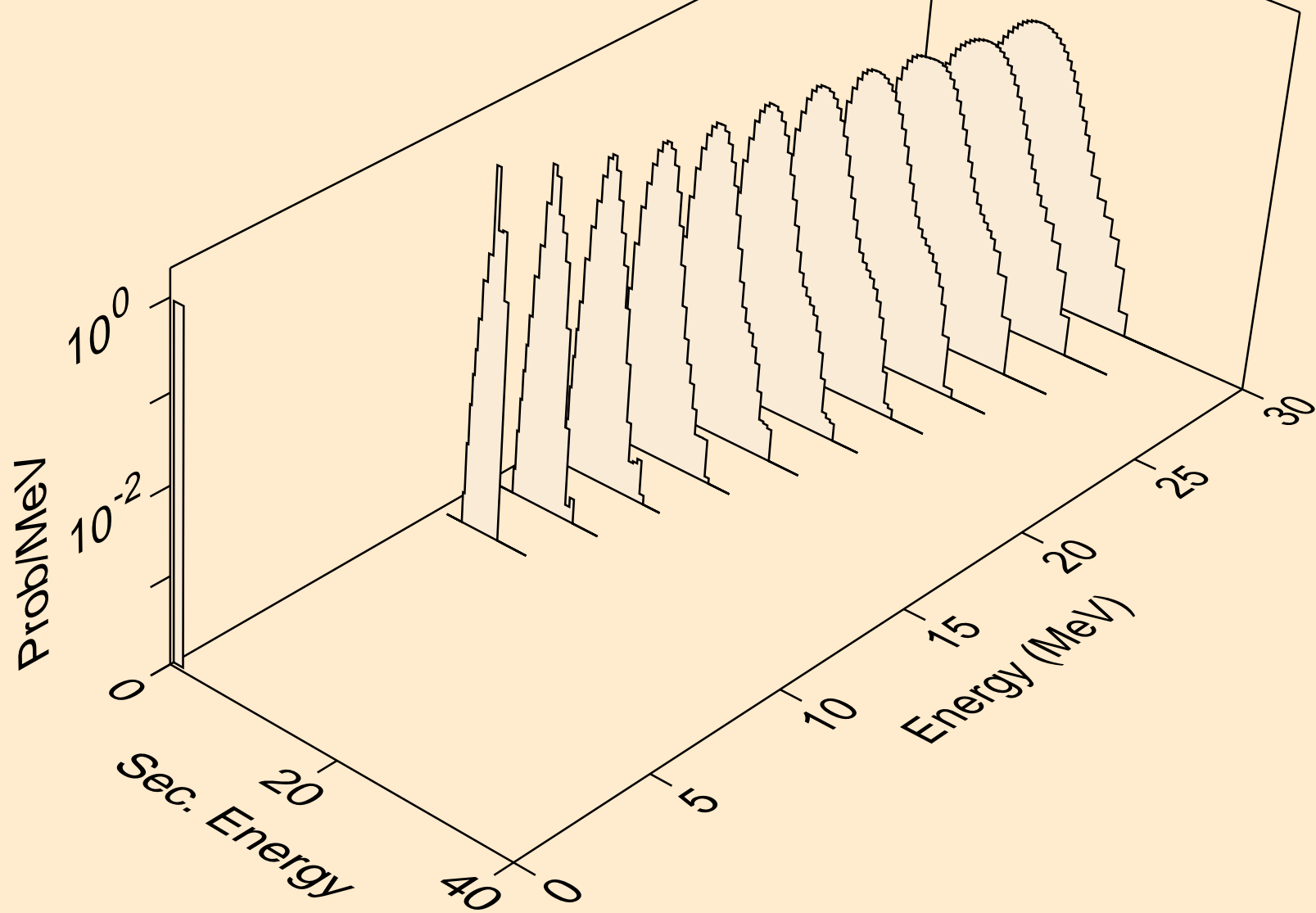

FR204 HELION ACER TENDL-2021 LIBRARY; T=0.K
protons from (s,pa)

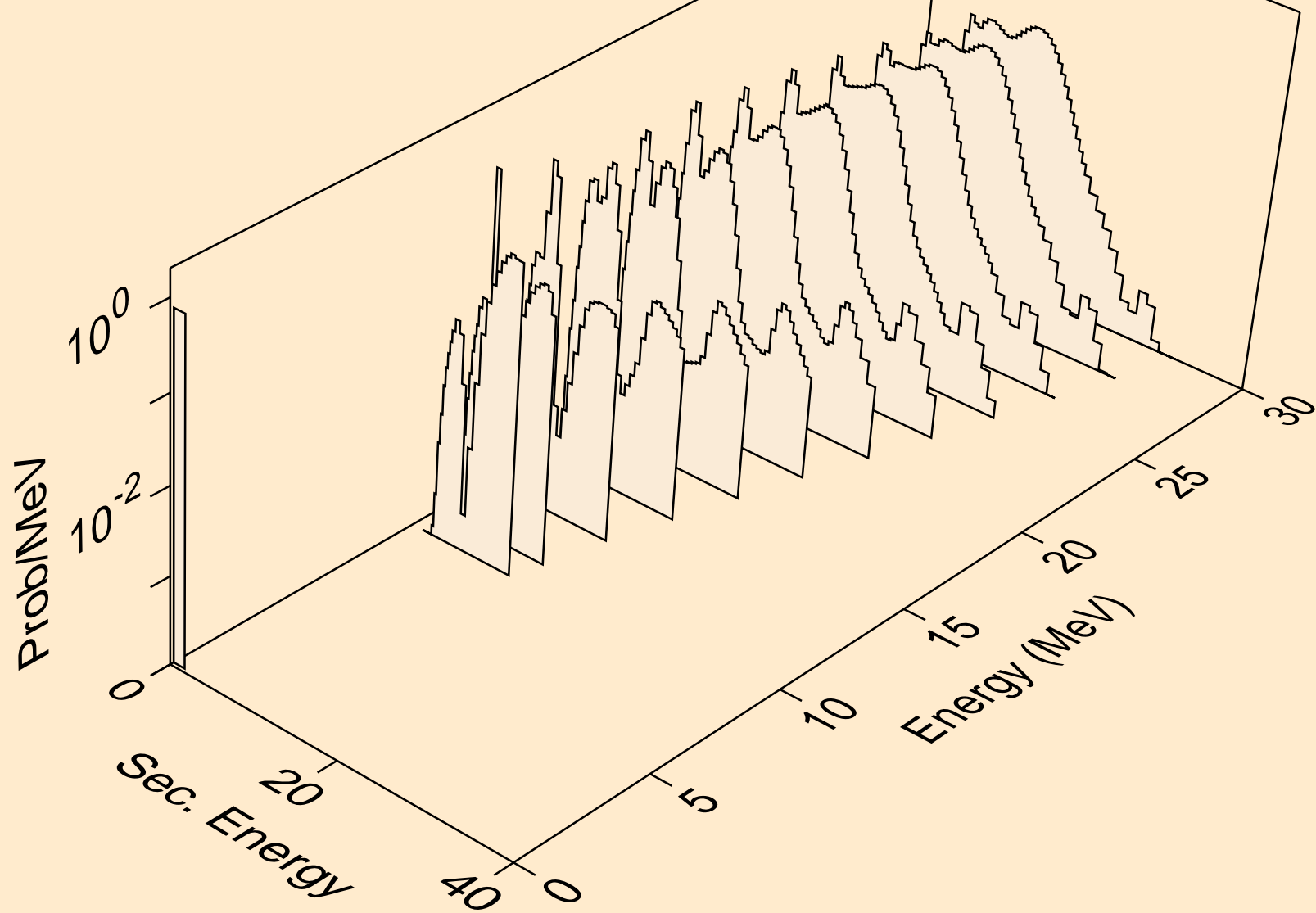

FR204 HELION ACER TENDL-2021 LIBRARY; T=0.K
protons from (s,pd)

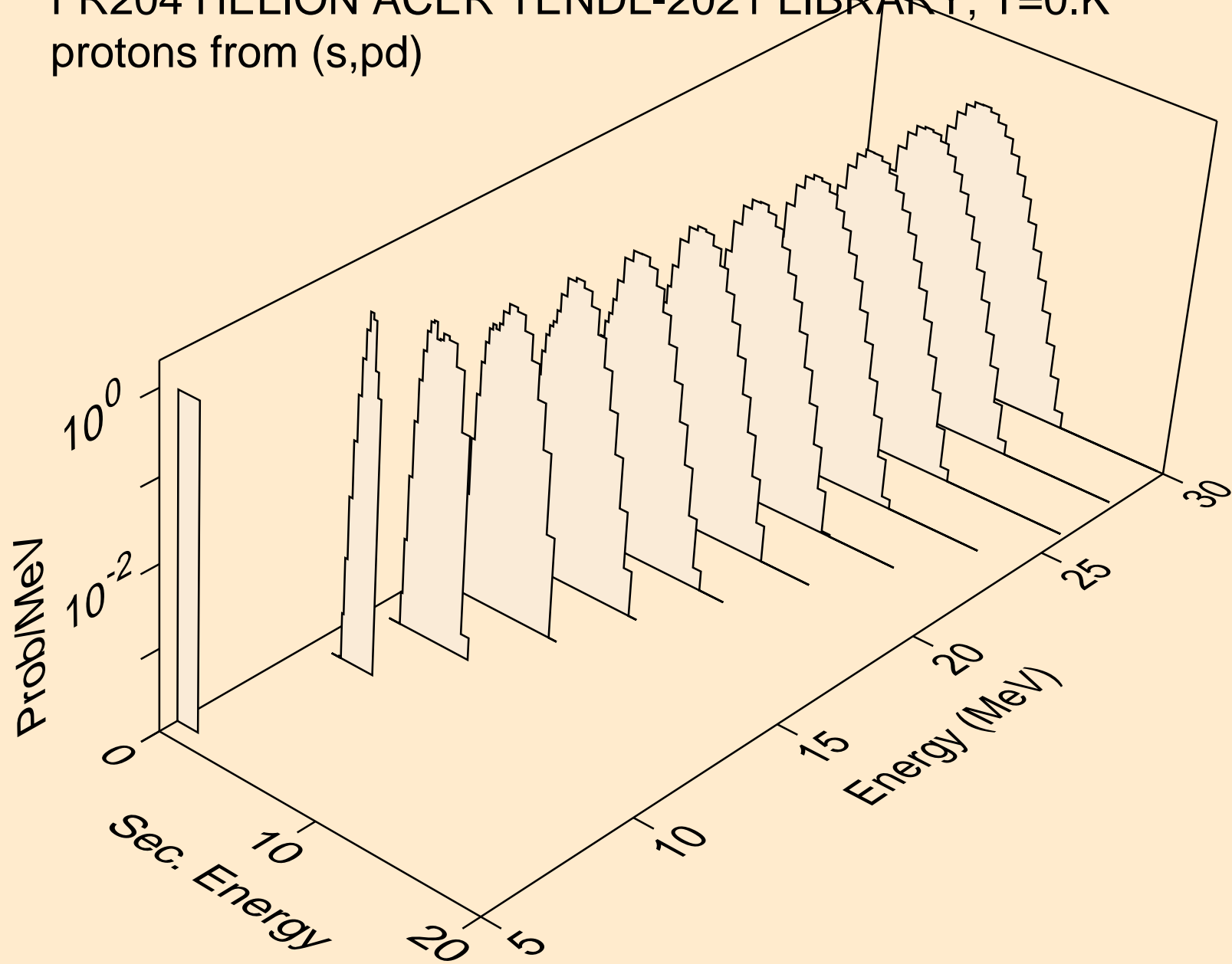

FR204 HELION ACER TENDL-2021 LIBRARY; T=0.K
protons from (s,pt)

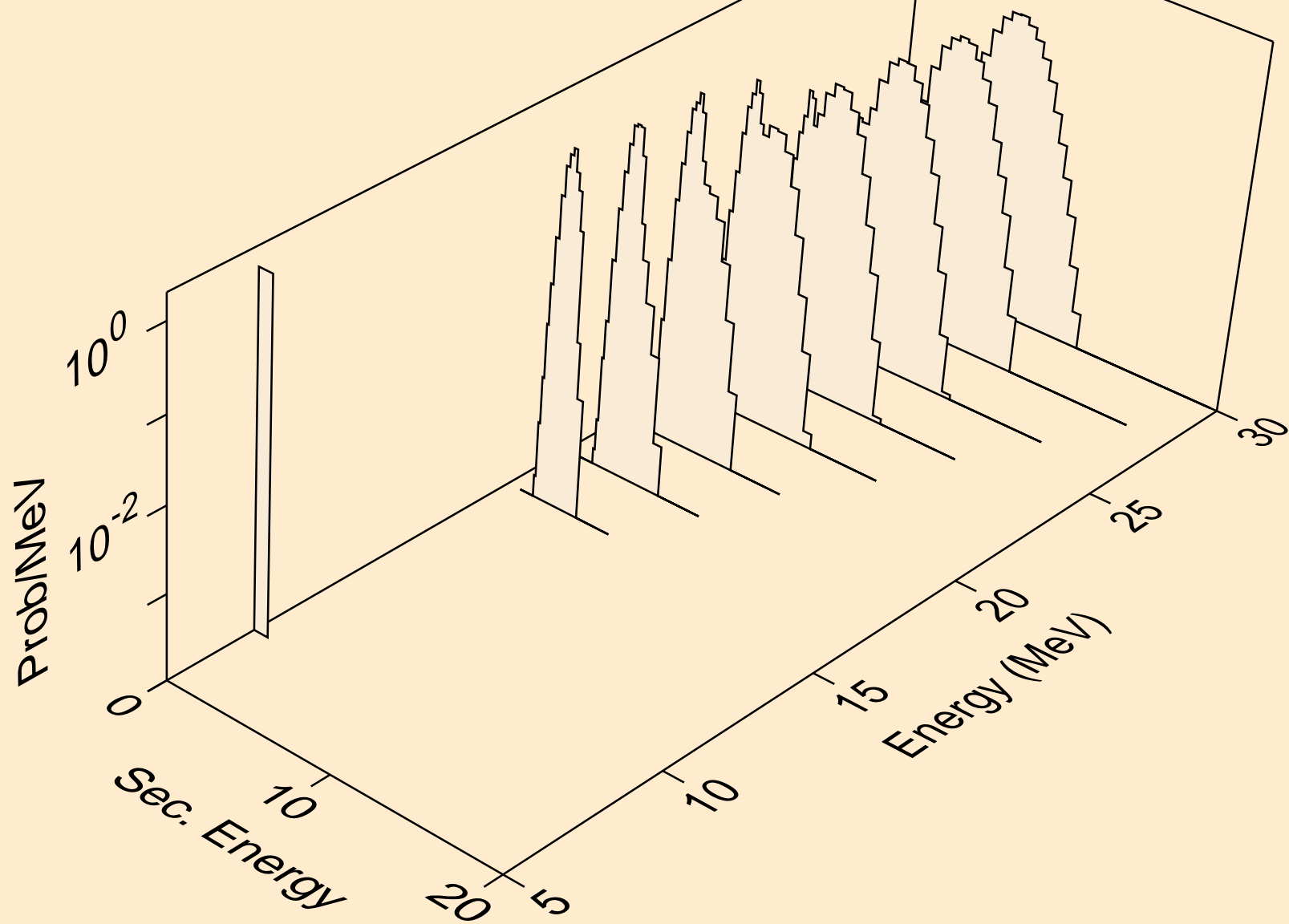

FR204 HELION ACER TENDL-2021 LIBRARY; T=0.K
deuterons from (s,x)

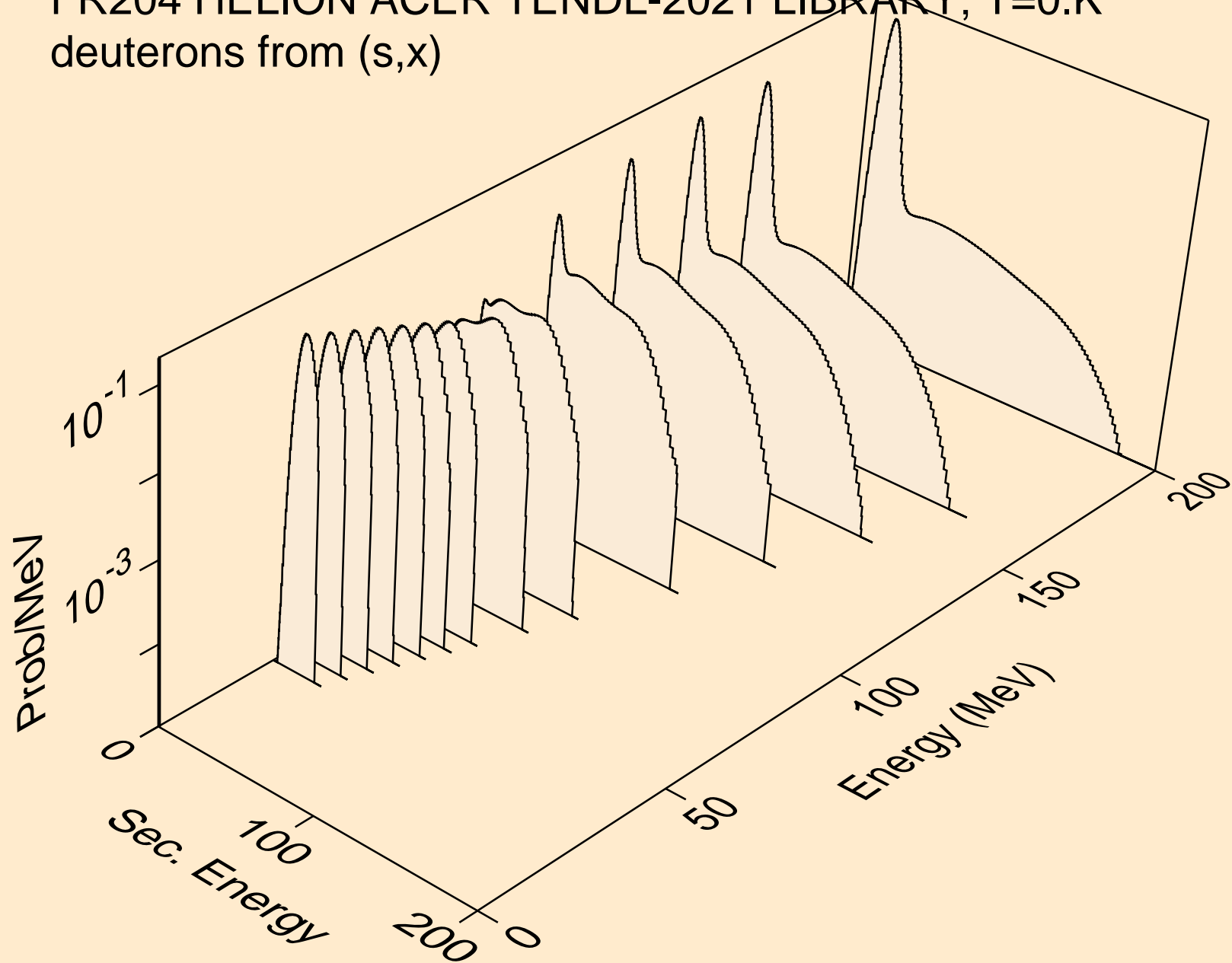

FR204 HELION ACER TENDL-2021 LIBRARY; T=0.K
deuterons from (s,n*)d

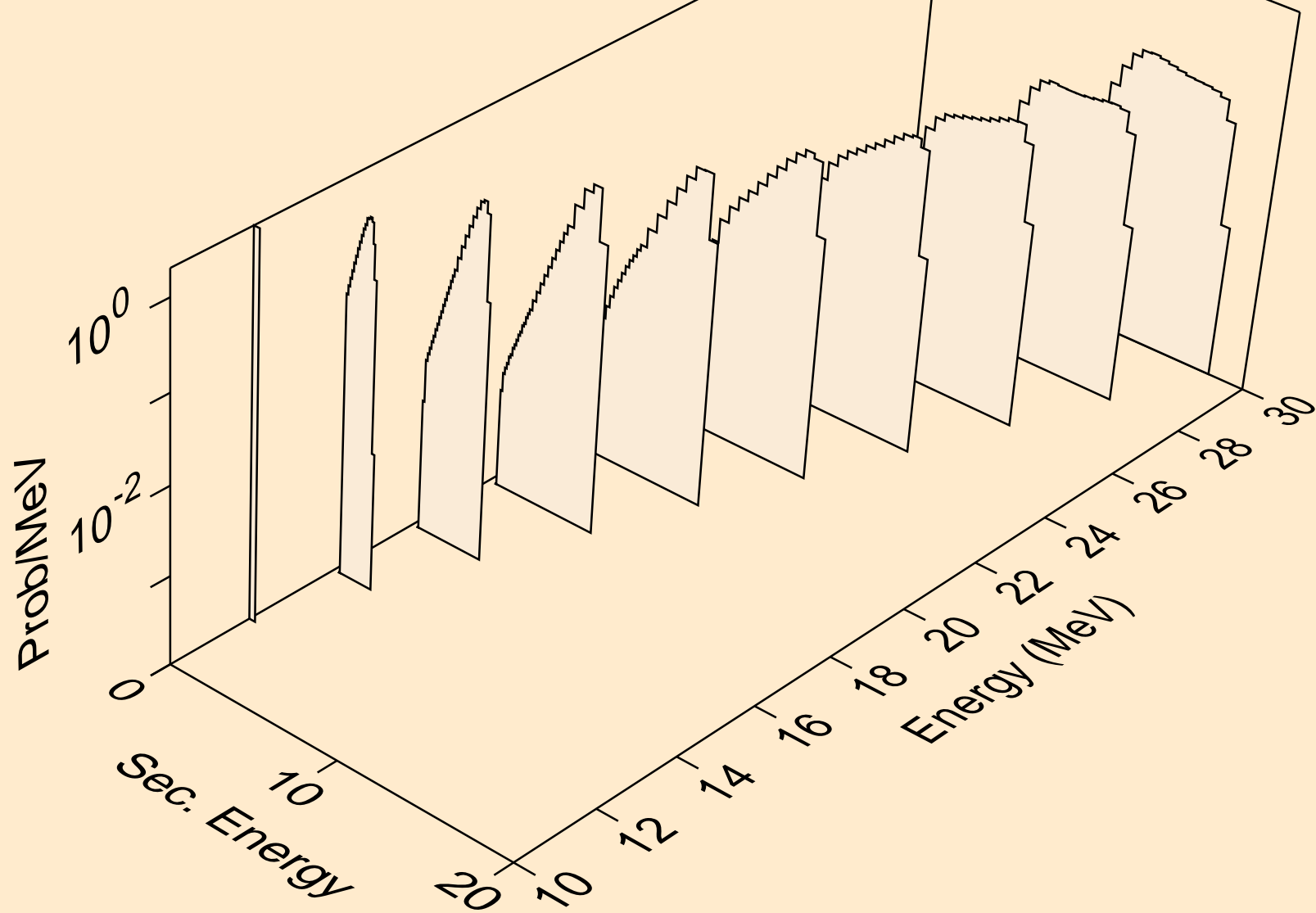

FR204 HELION ACER TENDL-2021 LIBRARY; T=0.K
deuterons from (s,d)

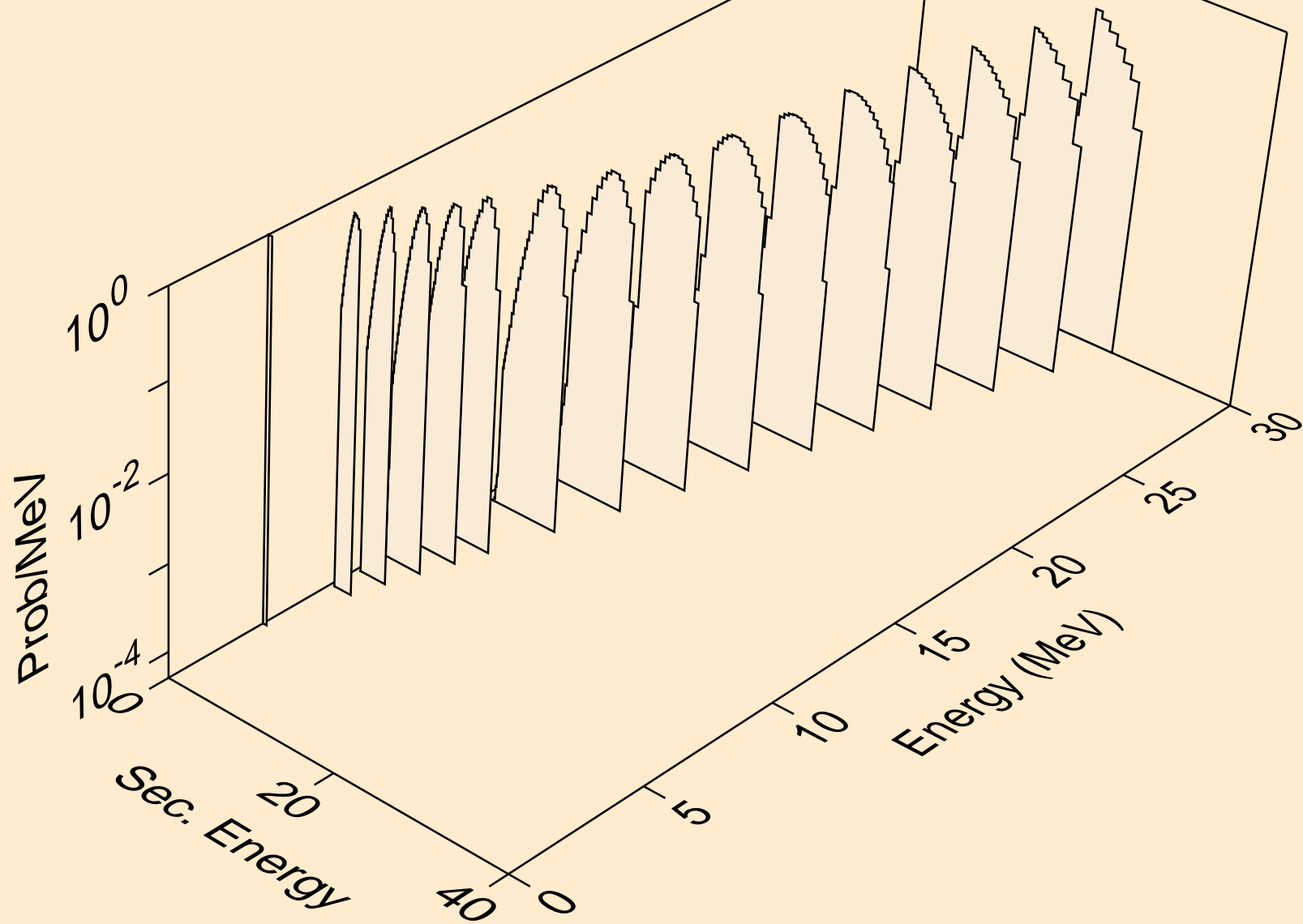

FR204 HELION ACER TENDL-2021 LIBRARY; T=0.K
deuterons from (s,pd)

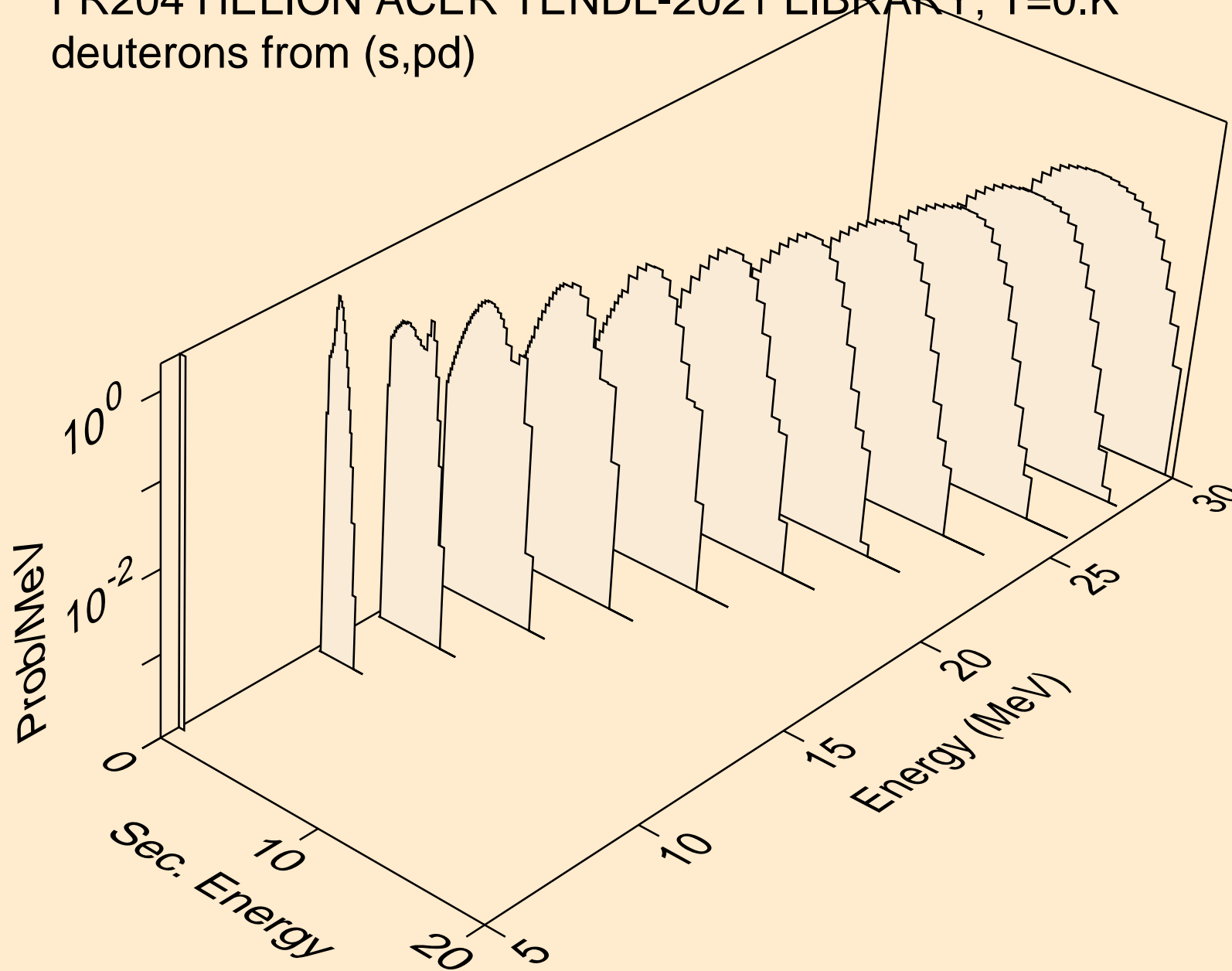

FR204 HELION ACER TENDL-2021 LIBRARY; T=0.K
deuterons from (s,da)

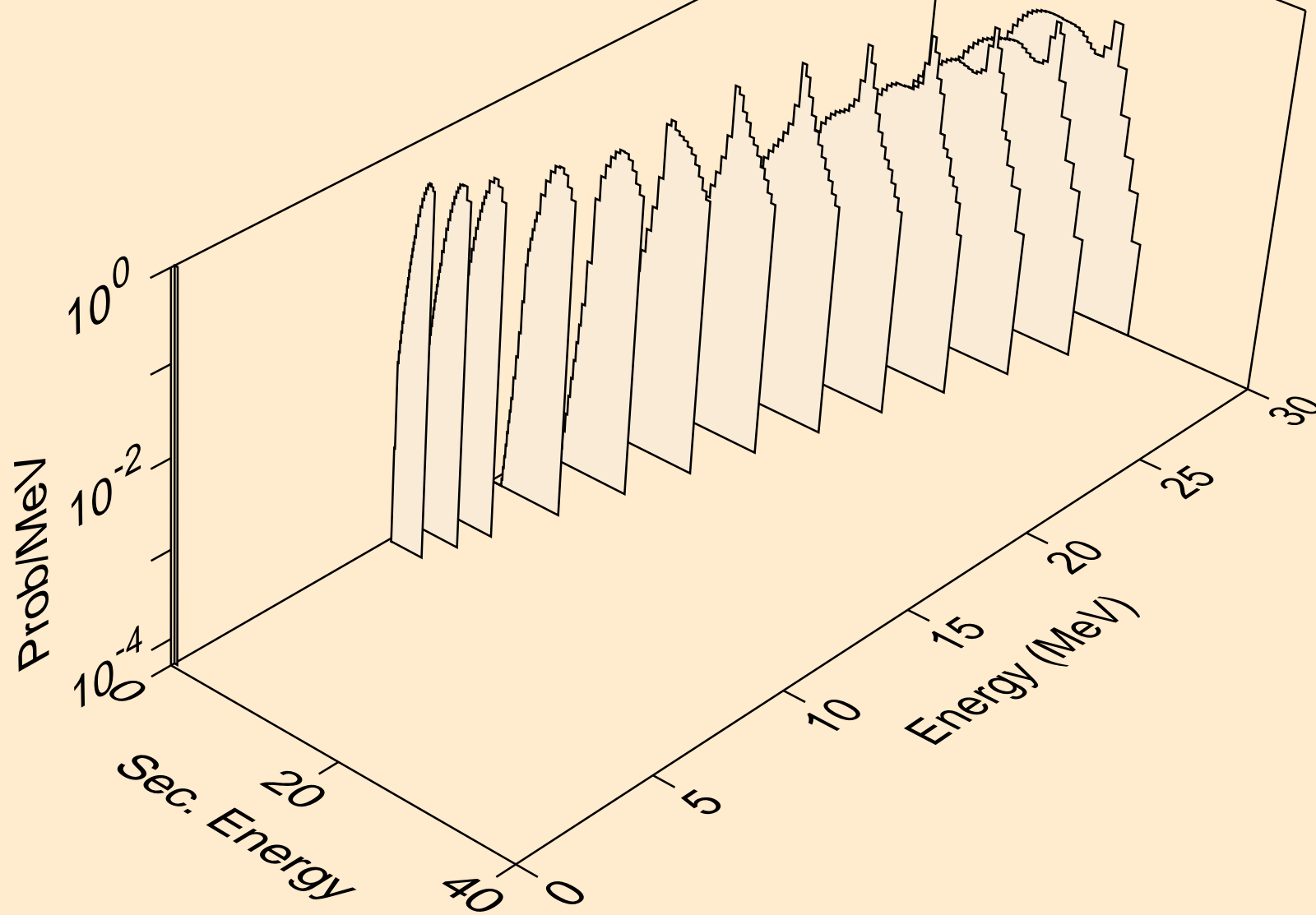

FR204 HELION ACER TENDL-2021 LIBRARY; T=0.K
tritons from (s,x)

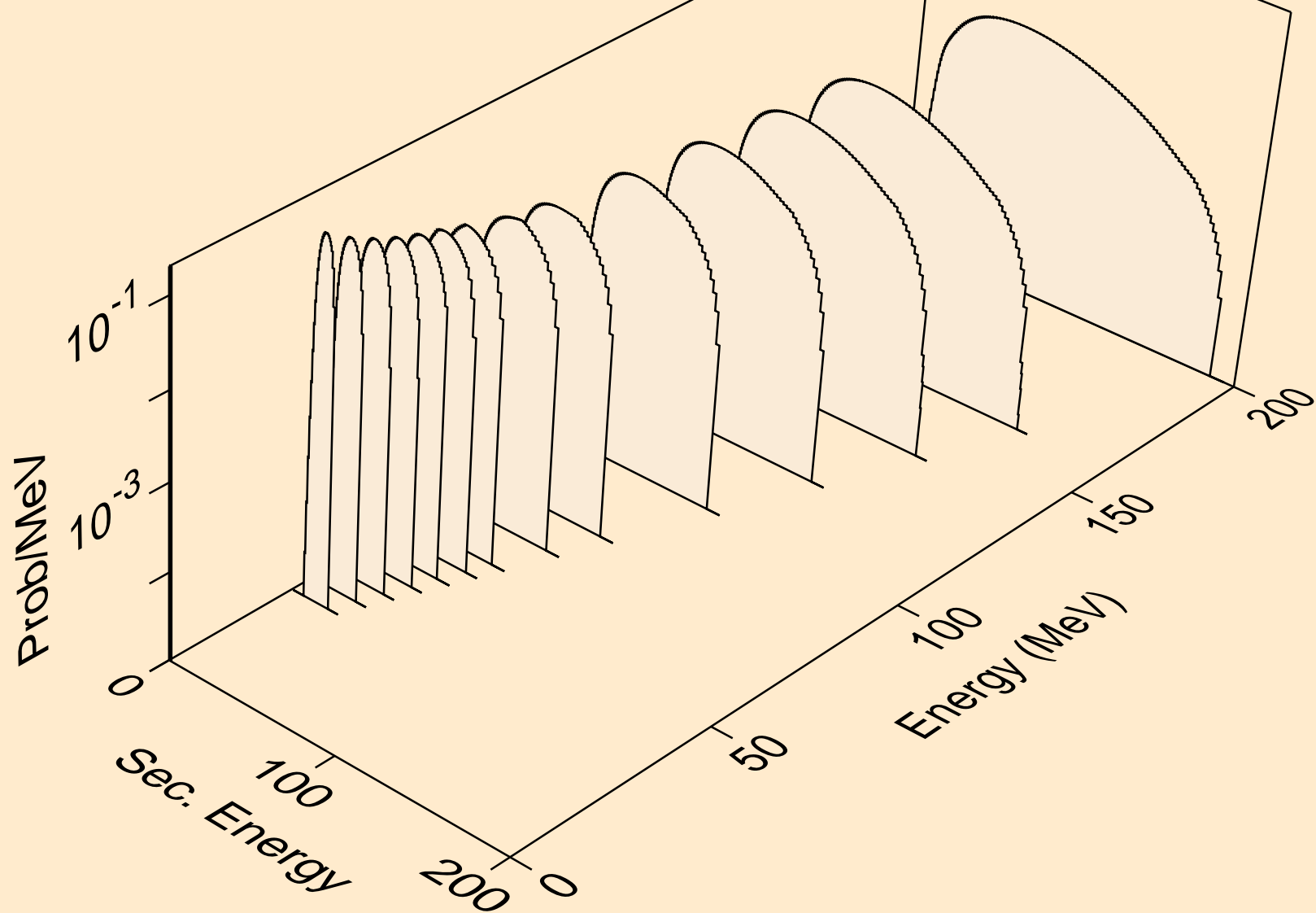

FR204 HELION ACER TENDL-2021 LIBRARY; T=0.K
tritons from (s,n*)t

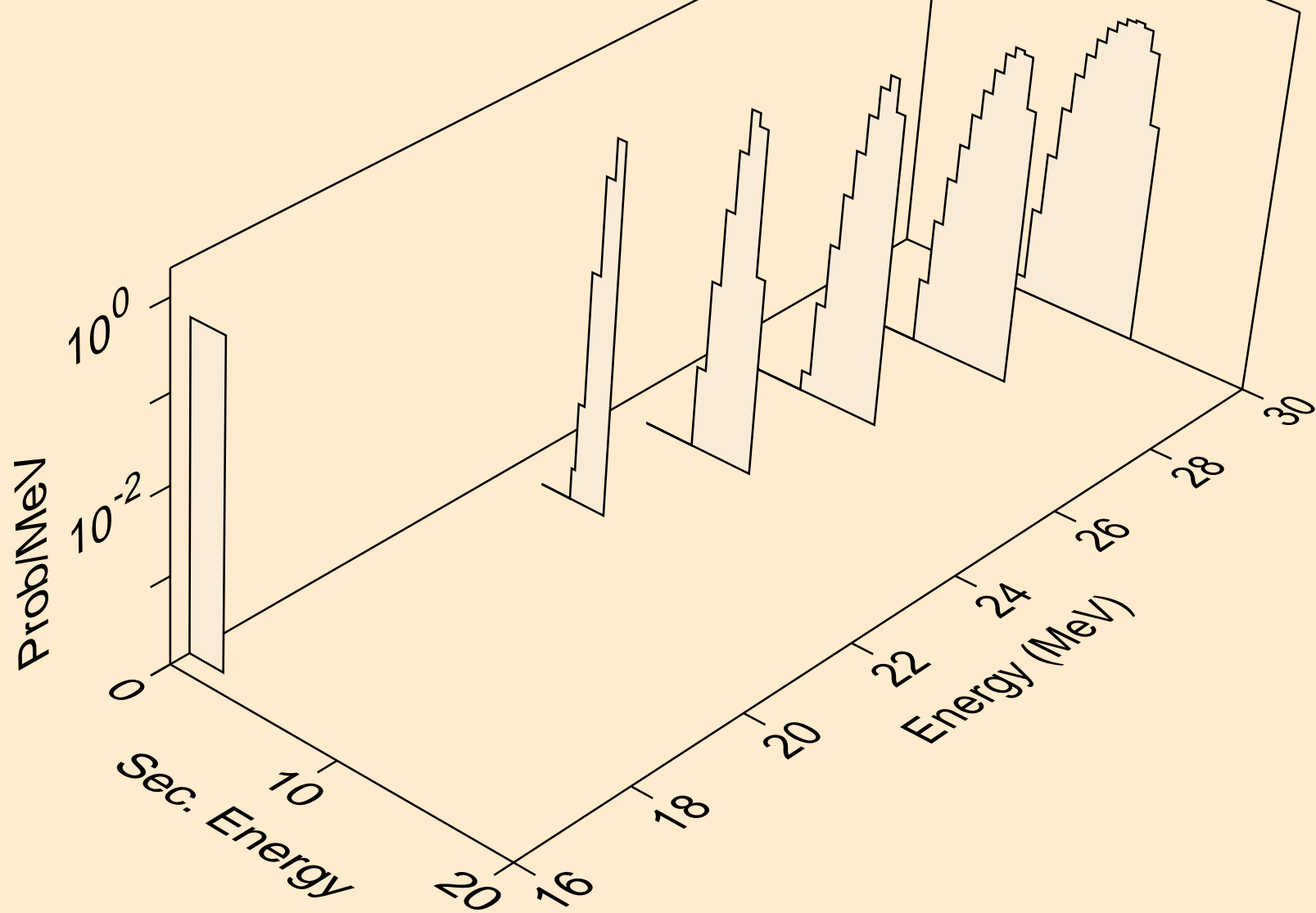

FR204 HELION ACER TENDL-2021 LIBRARY; T=0.K
tritons from (s,t)

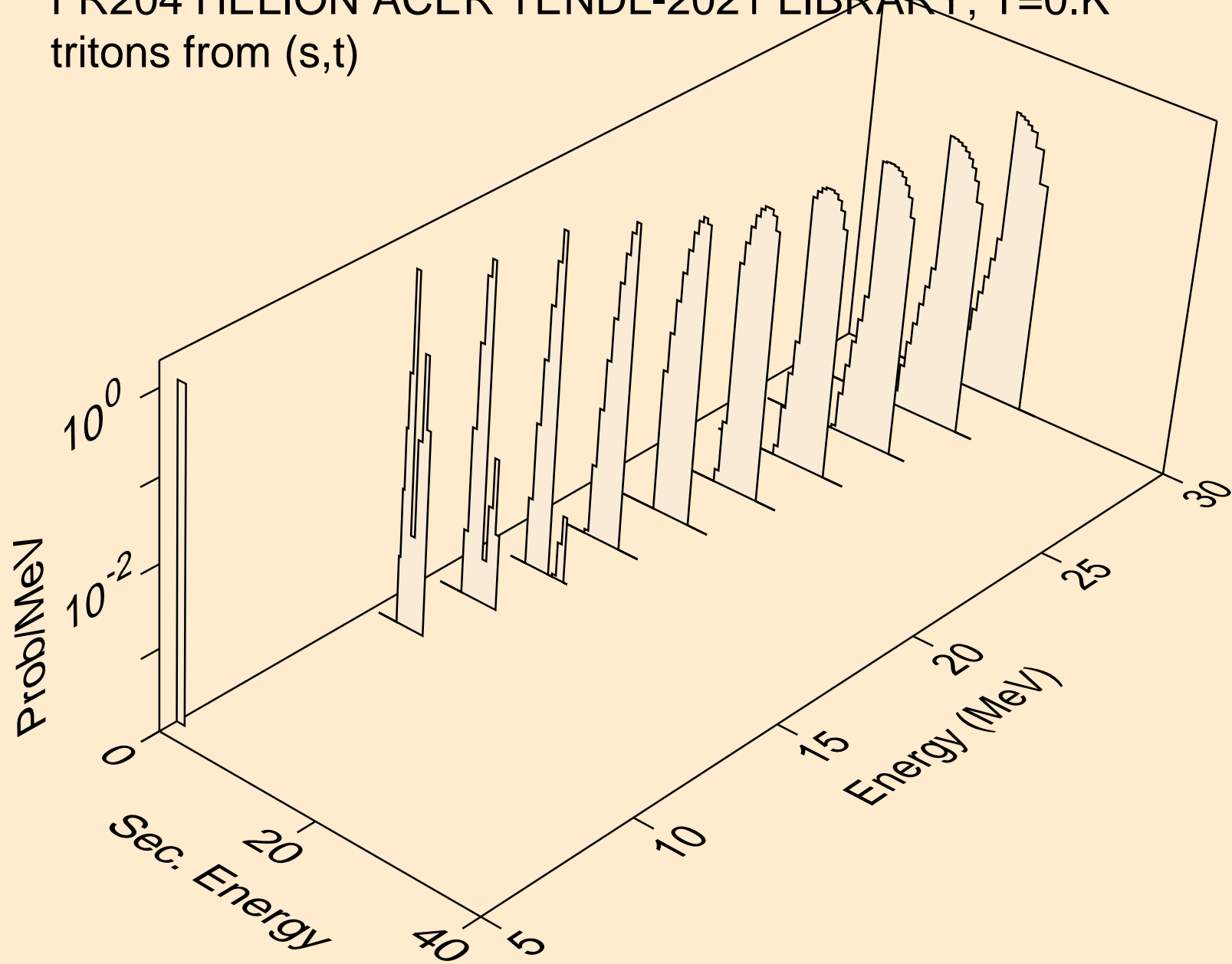

FR204 HELION ACER TENDL-2021 LIBRARY; T=0.K
tritons from (s,pt)

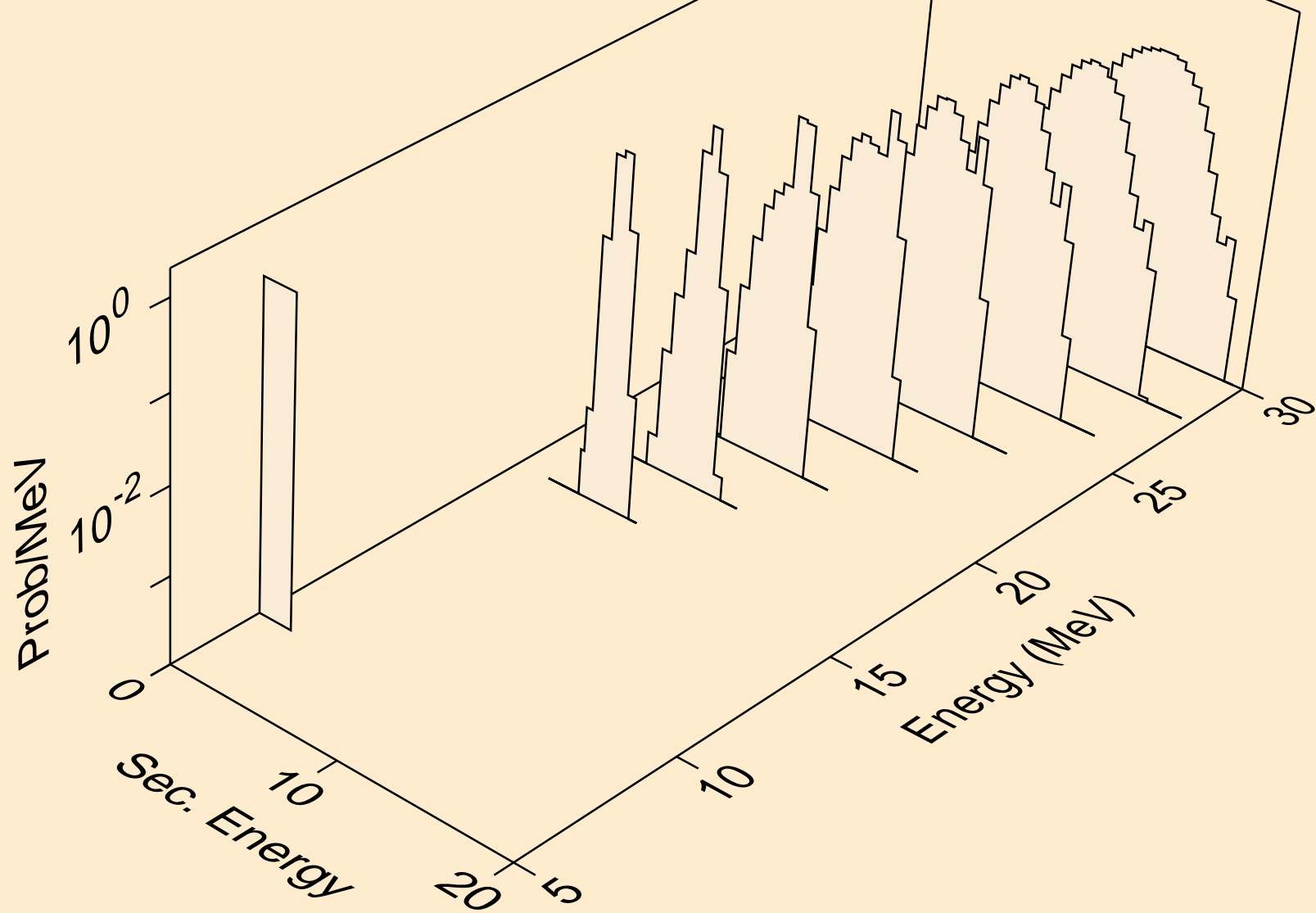

FR204 HELION ACER TENDL-2021 LIBRARY; T=0.K
alphas from (s,x)

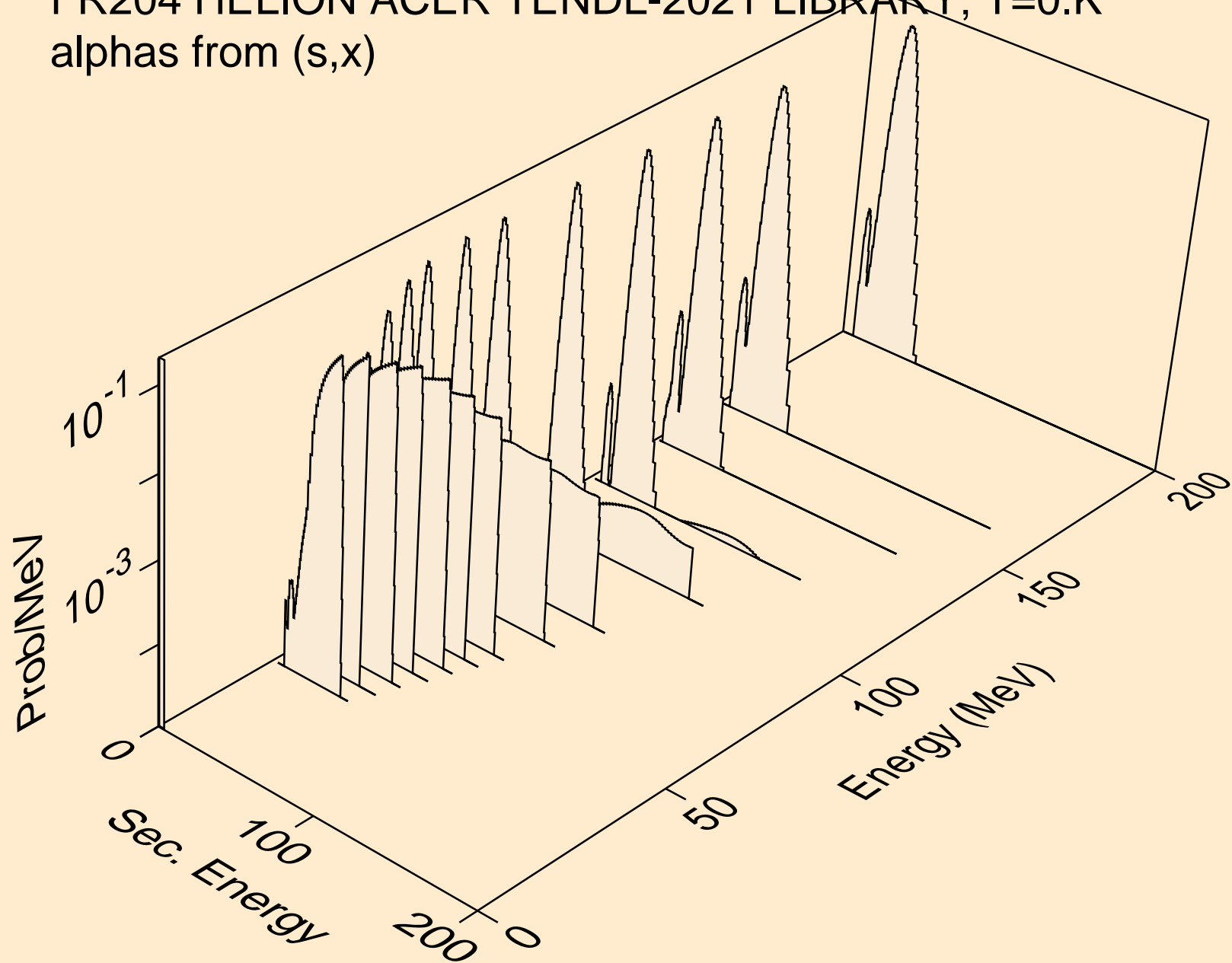

FR204 HELION ACER TENDL-2021 LIBRARY; T=0.K
alphas from (s,n*)a

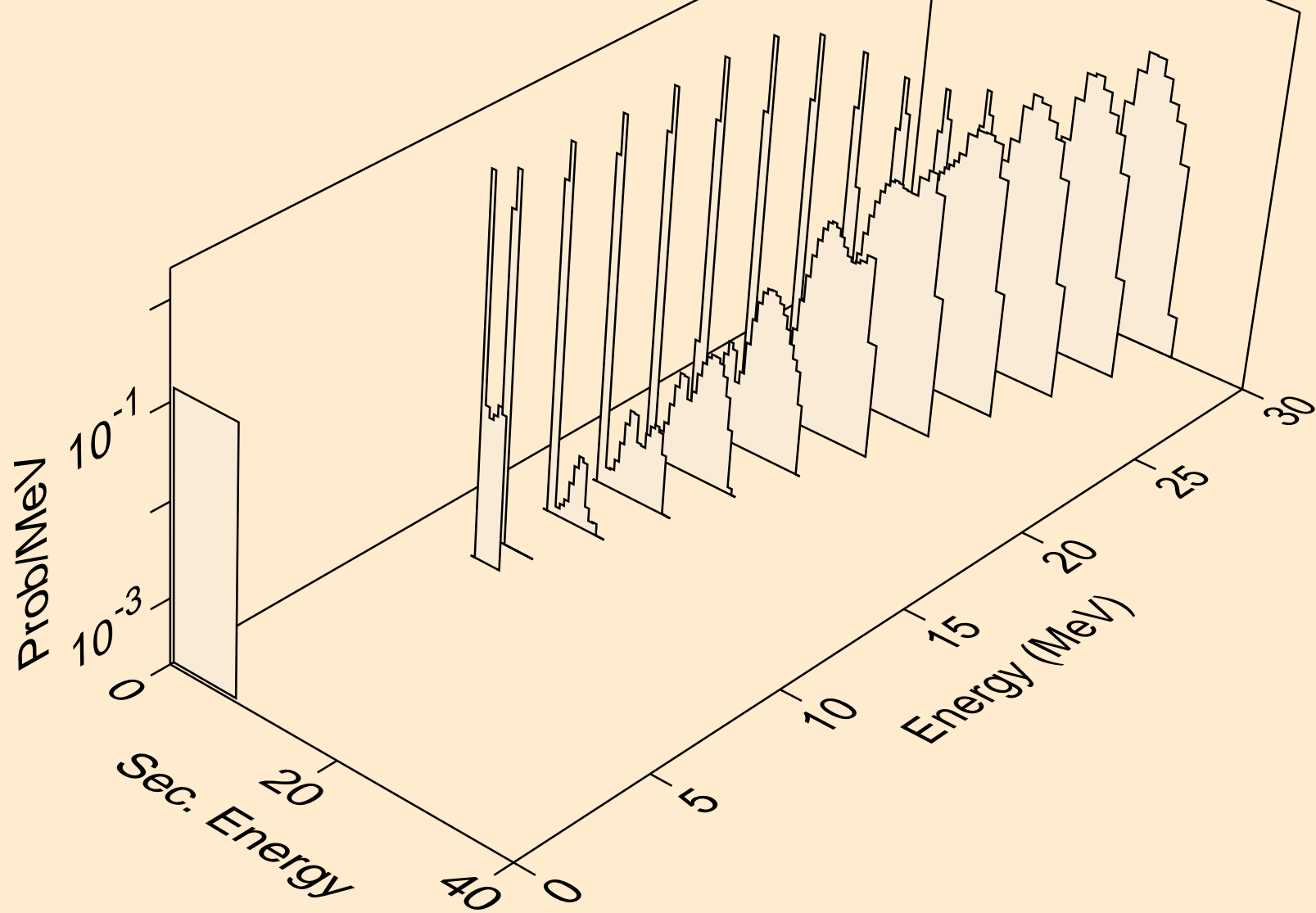

FR204 HELION ACER TENDL-2021 LIBRARY; T=0.K
alphas from (s,2n)a

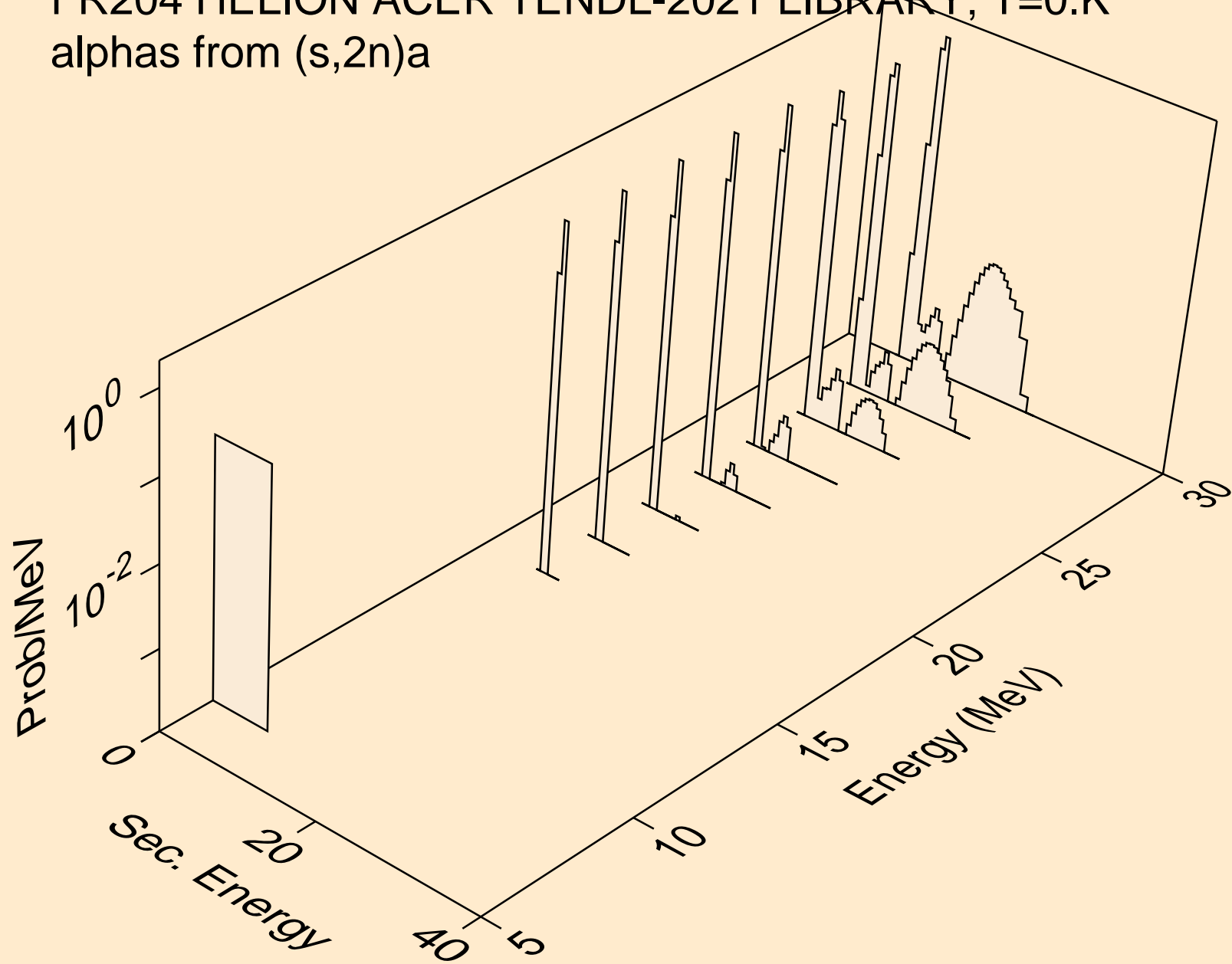

FR204 HELION ACER TENDL-2021 LIBRARY; T=0.K
alphas from (s,npa)

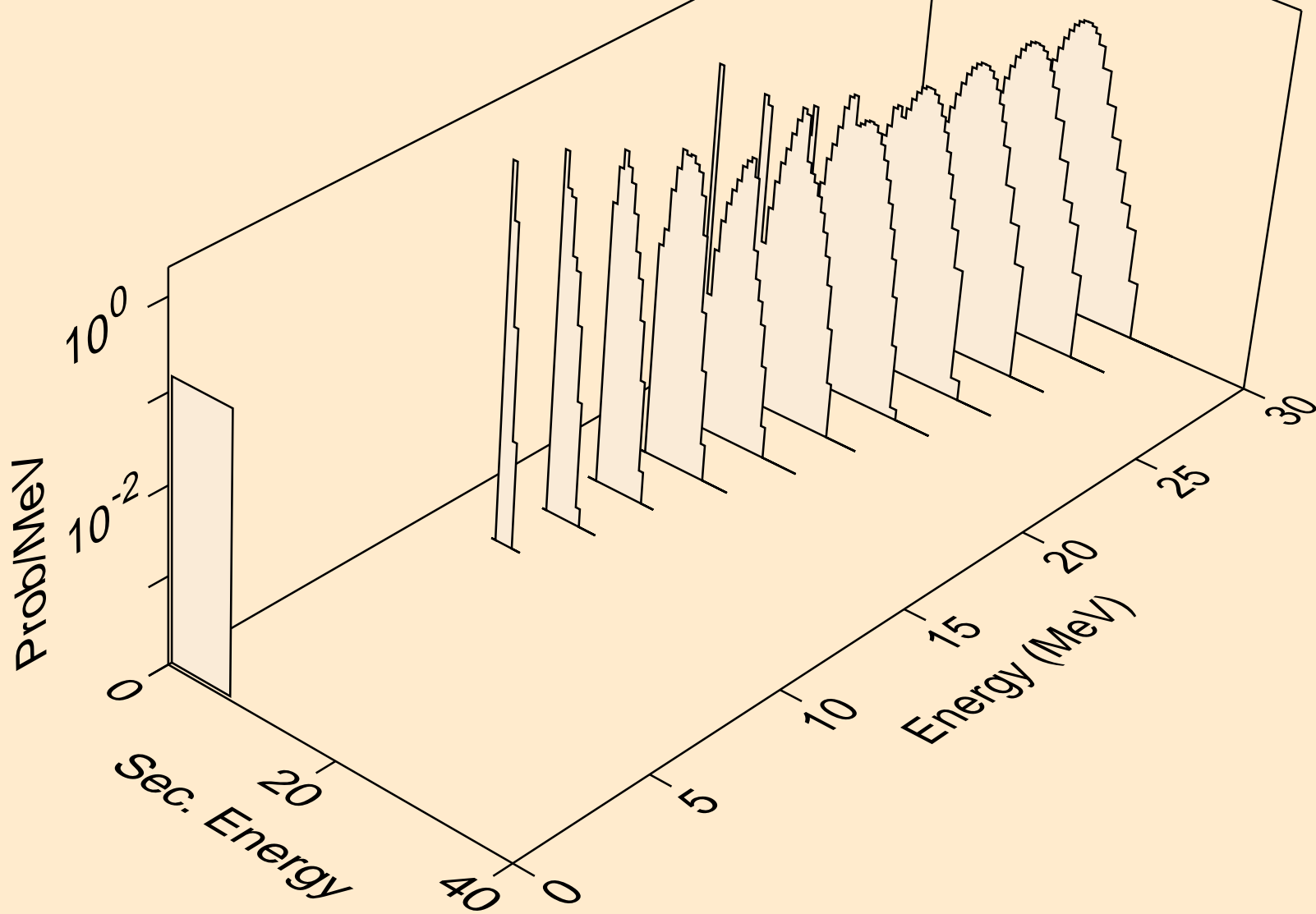

FR204 HELION ACER TENDL-2021 LIBRARY; T=0.K
alphas from (s,a)

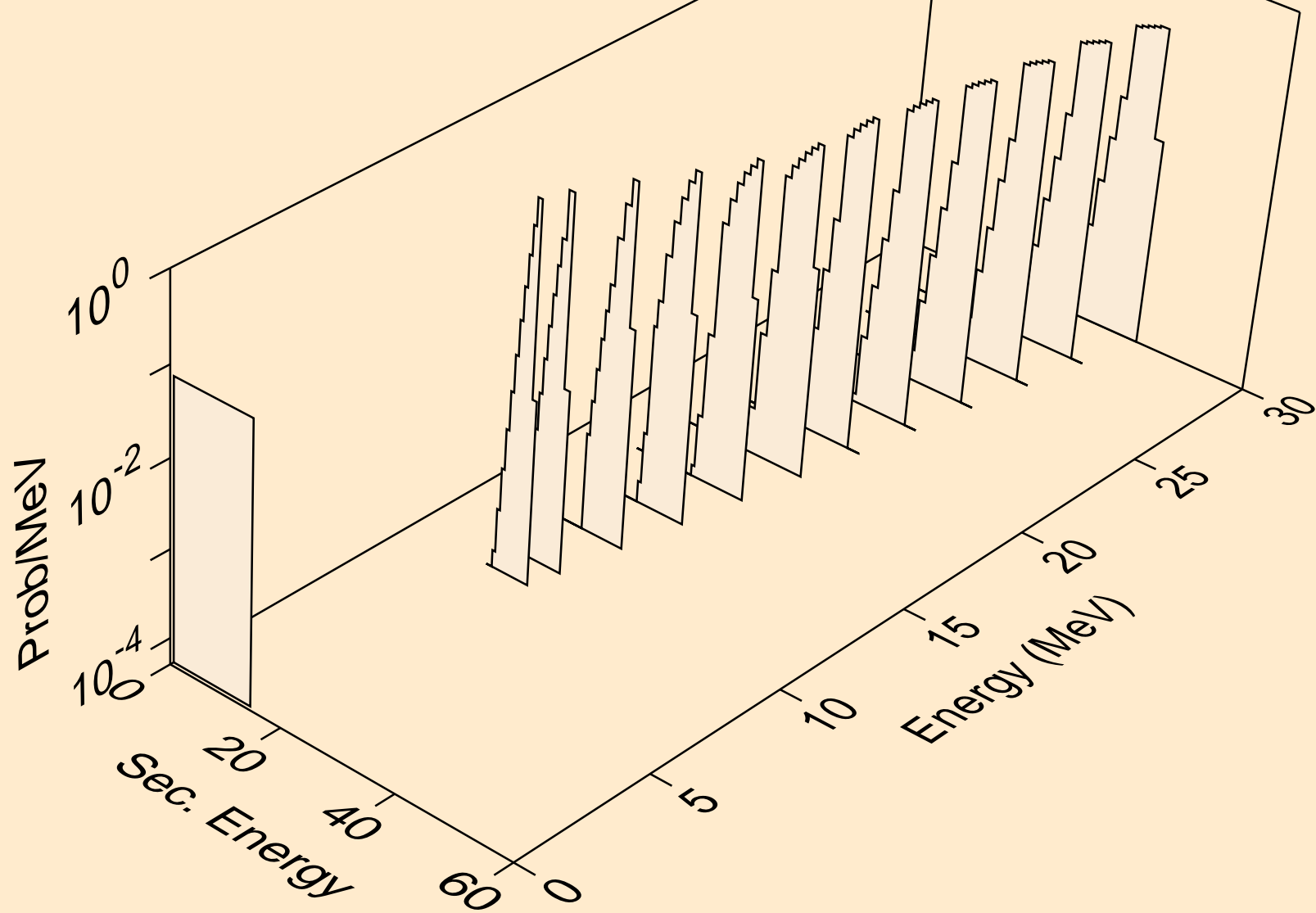

FR204 HELION ACER TENDL-2021 LIBRARY; T=0.K
alphas from (s,2a)

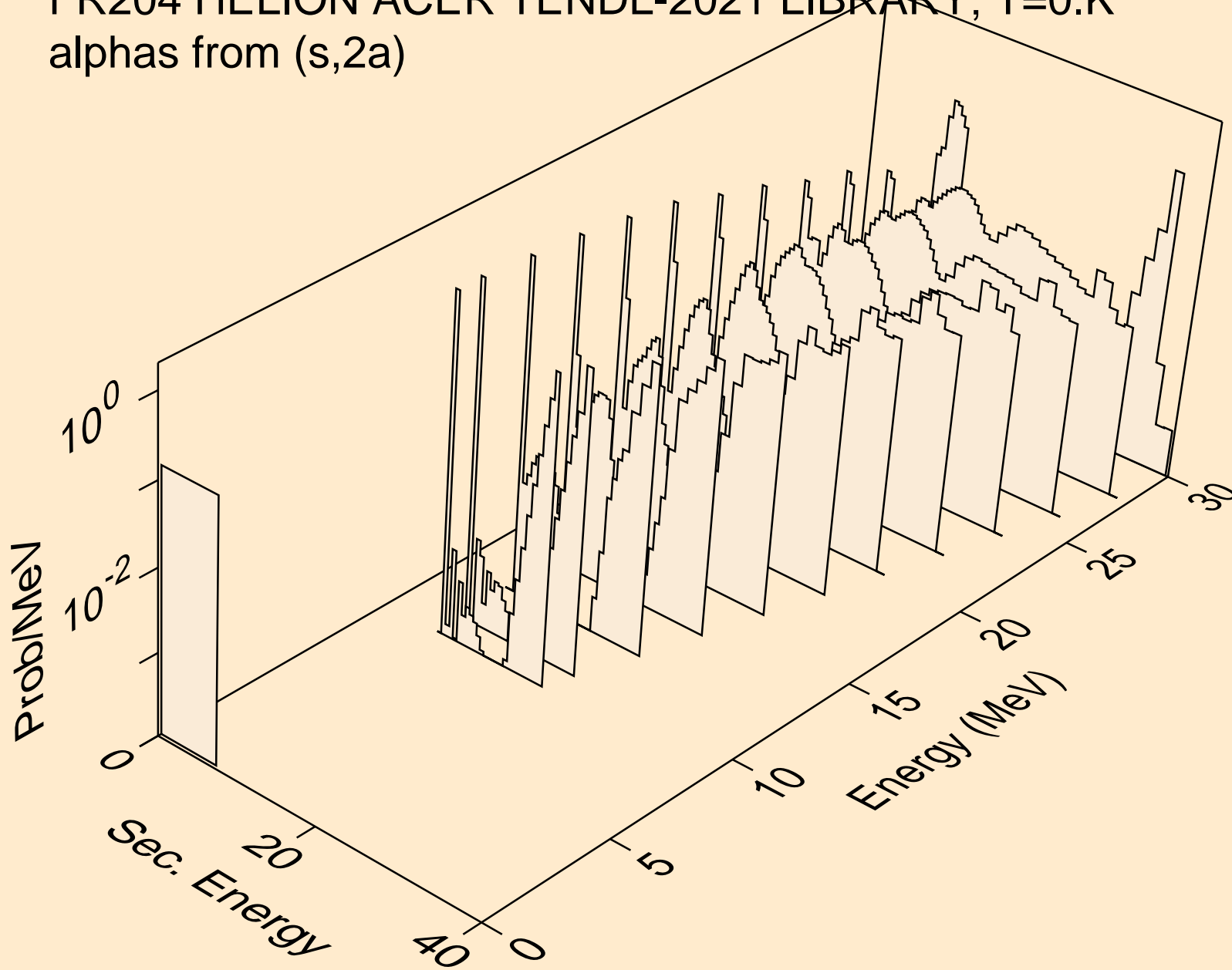

FR204 HELION ACER TENDL-2021 LIBRARY; T=0.K
alphas from (s,pa)

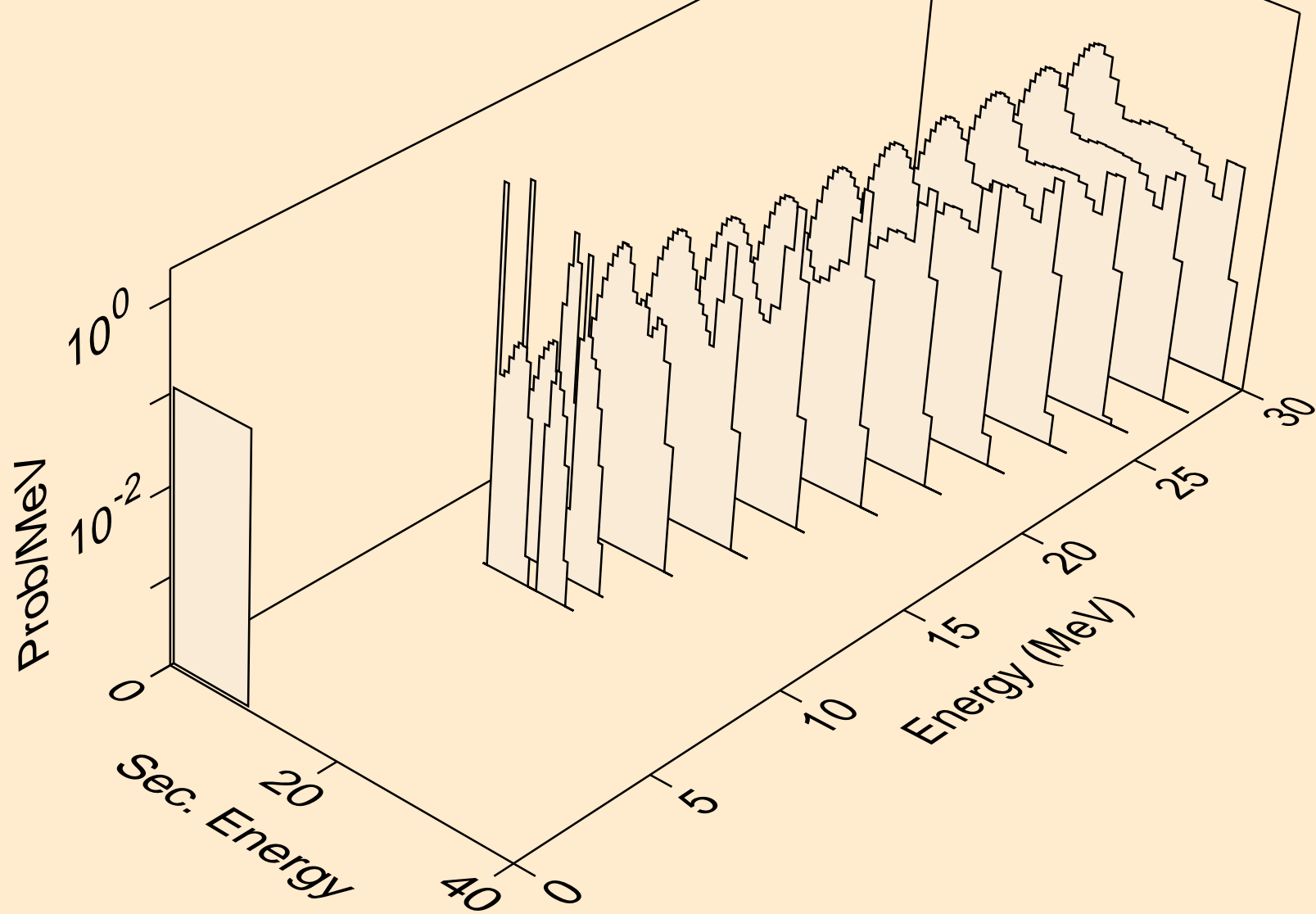

FR204 HELION ACER TENDL-2021 LIBRARY; T=0.K
alphas from (s,da)

