

GA064 HELION ACER TENDL-2021 LIBRARY; T=0.K

Principal cross sections

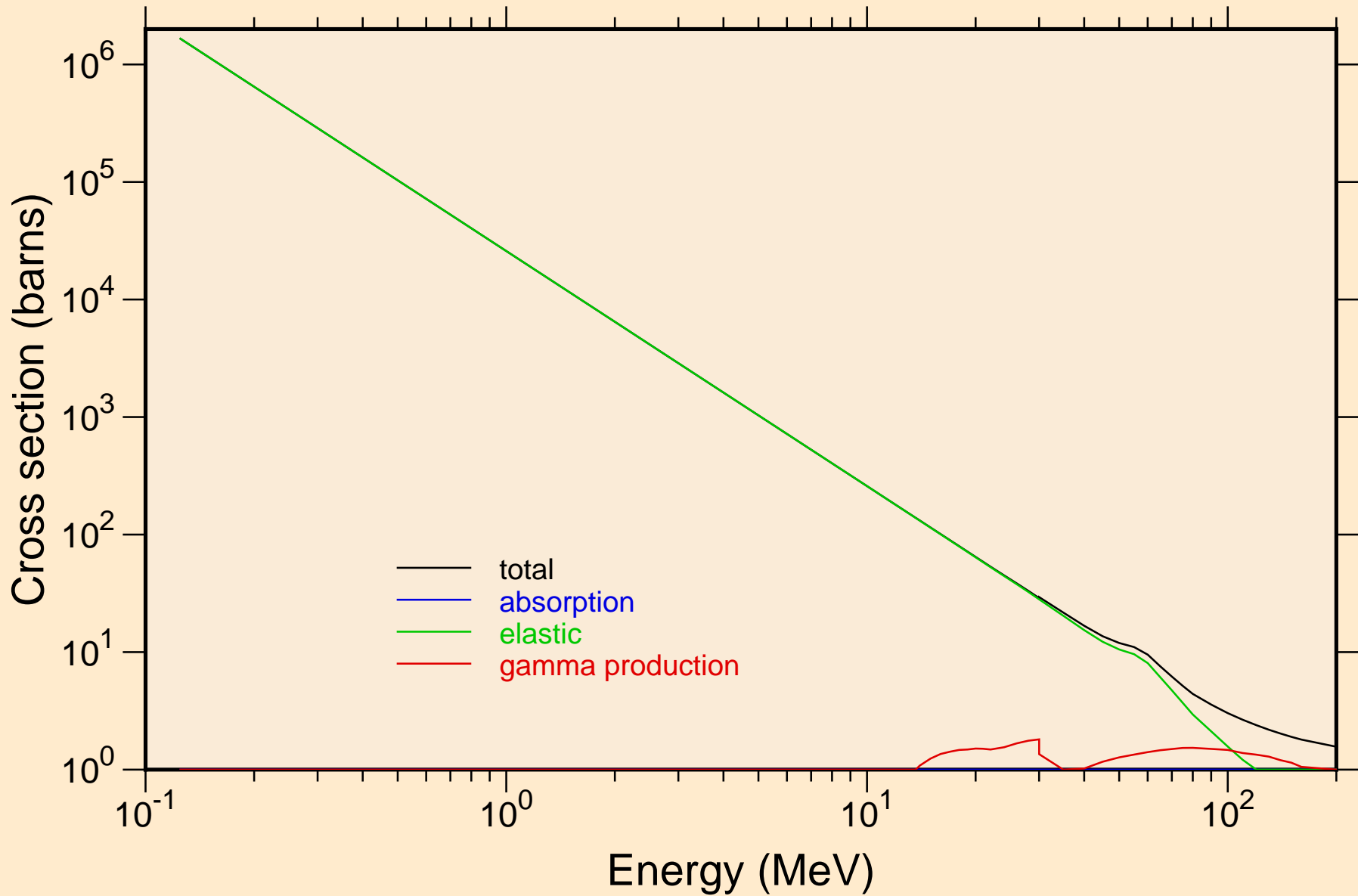

GA064 HELION ACER TENDL-2021 LIBRARY; T=0.K

Heating

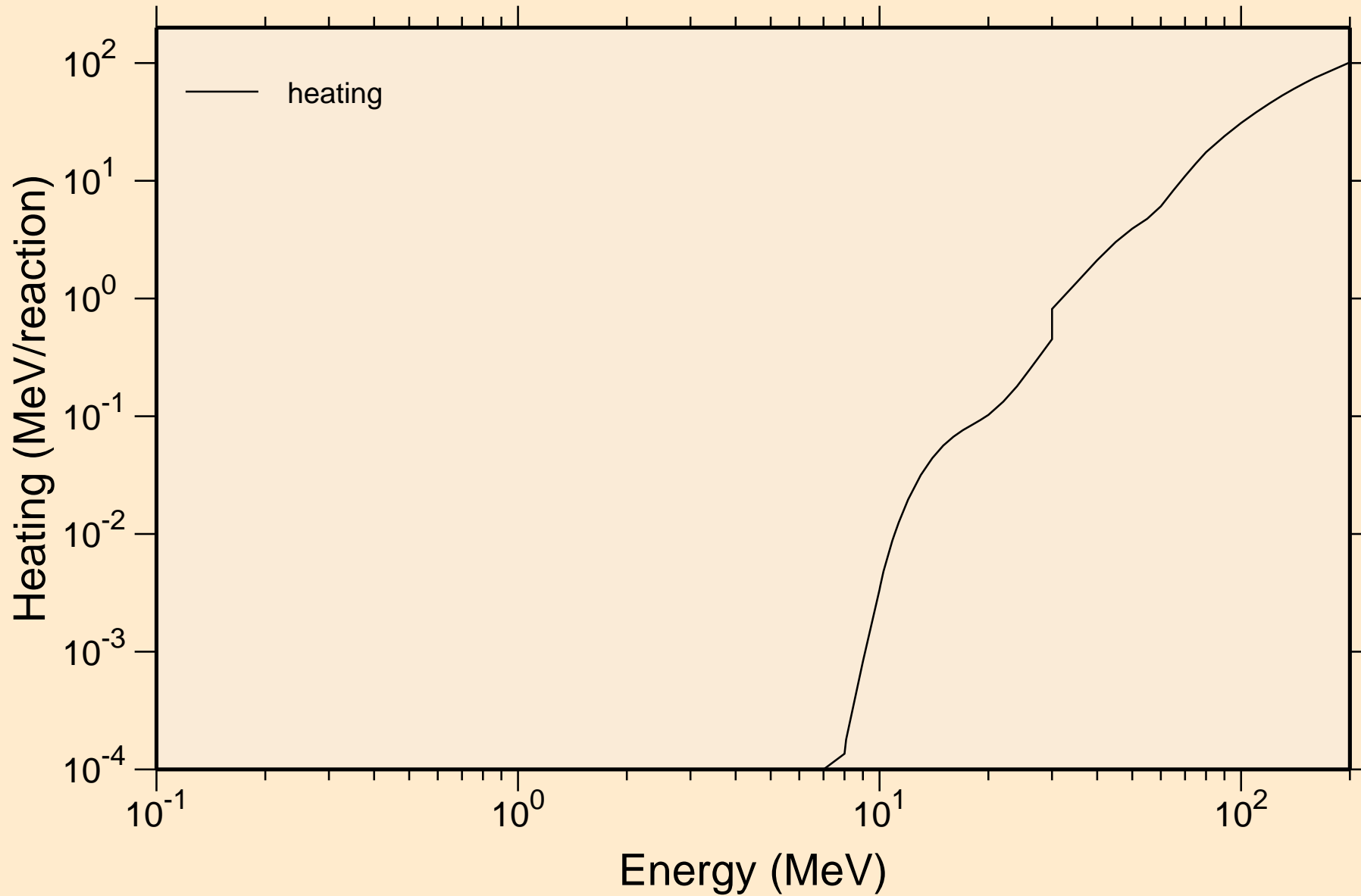

GA064 HELION ACER TENDL-2021 LIBRARY; T=0.K

Principal cross sections

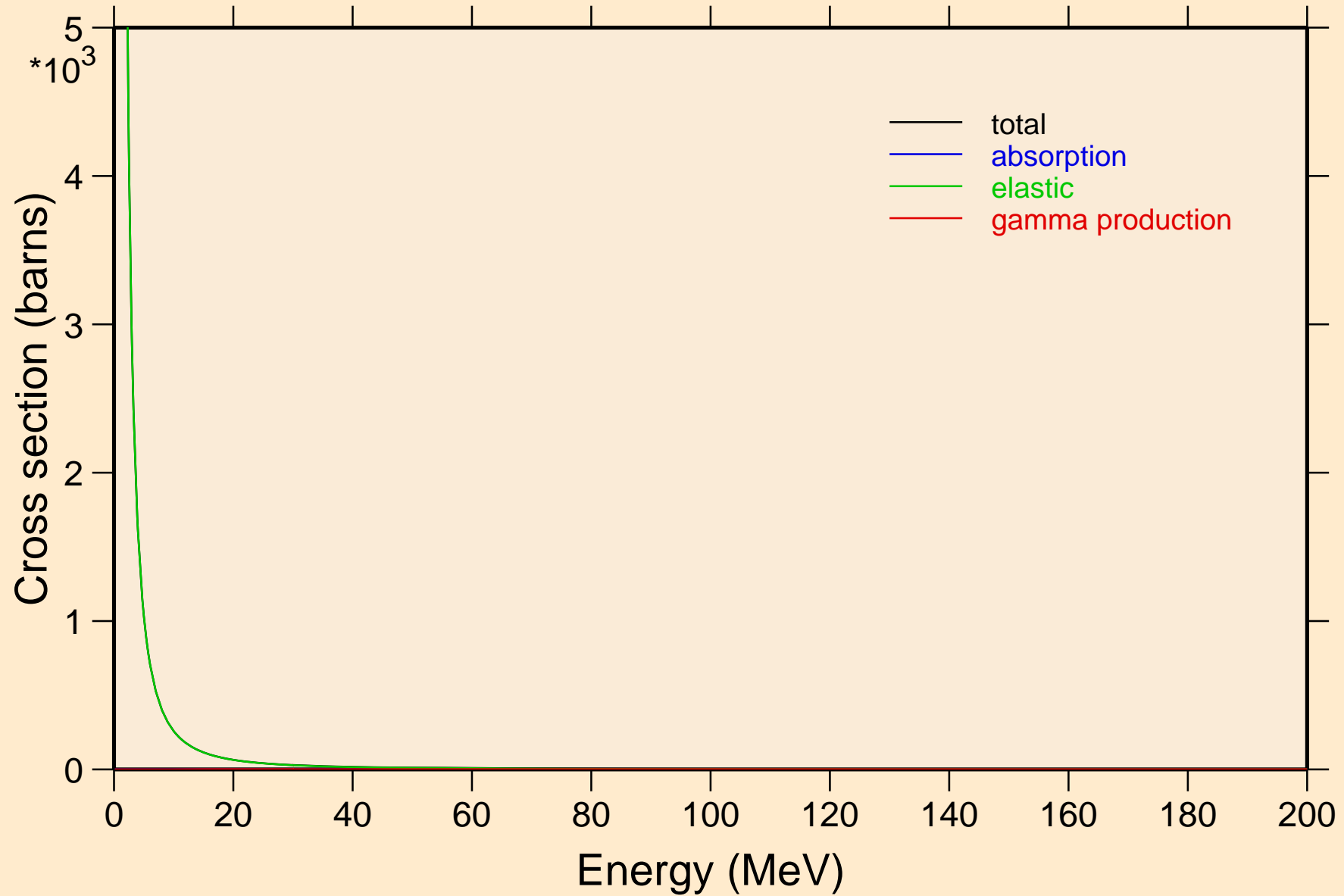

GA064 HELION ACER TENDL-2021 LIBRARY; T=0.K

Heating

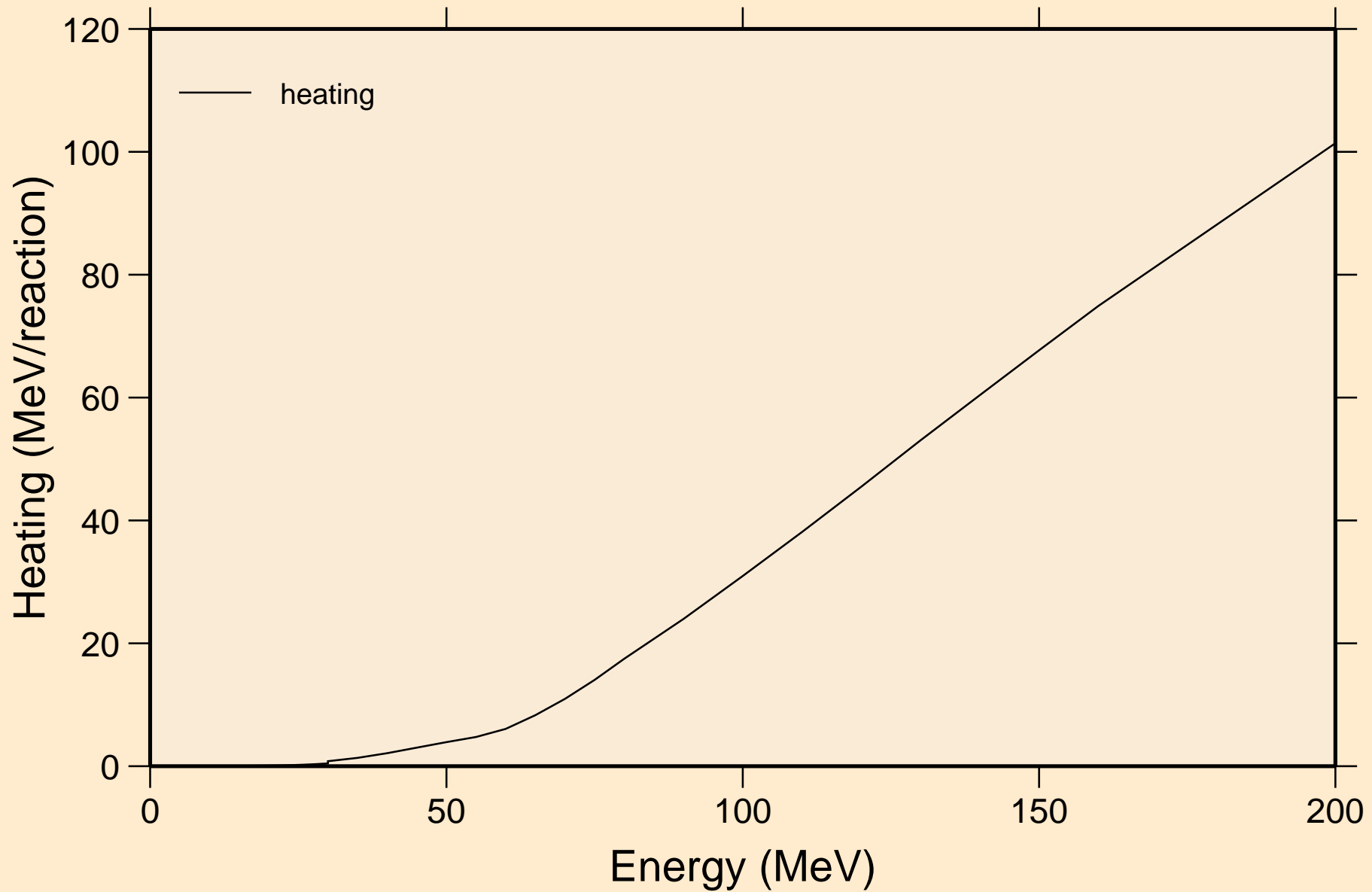

GA064 HELION ACER TENDL-2021 LIBRARY; T=0.K
Threshold reactions

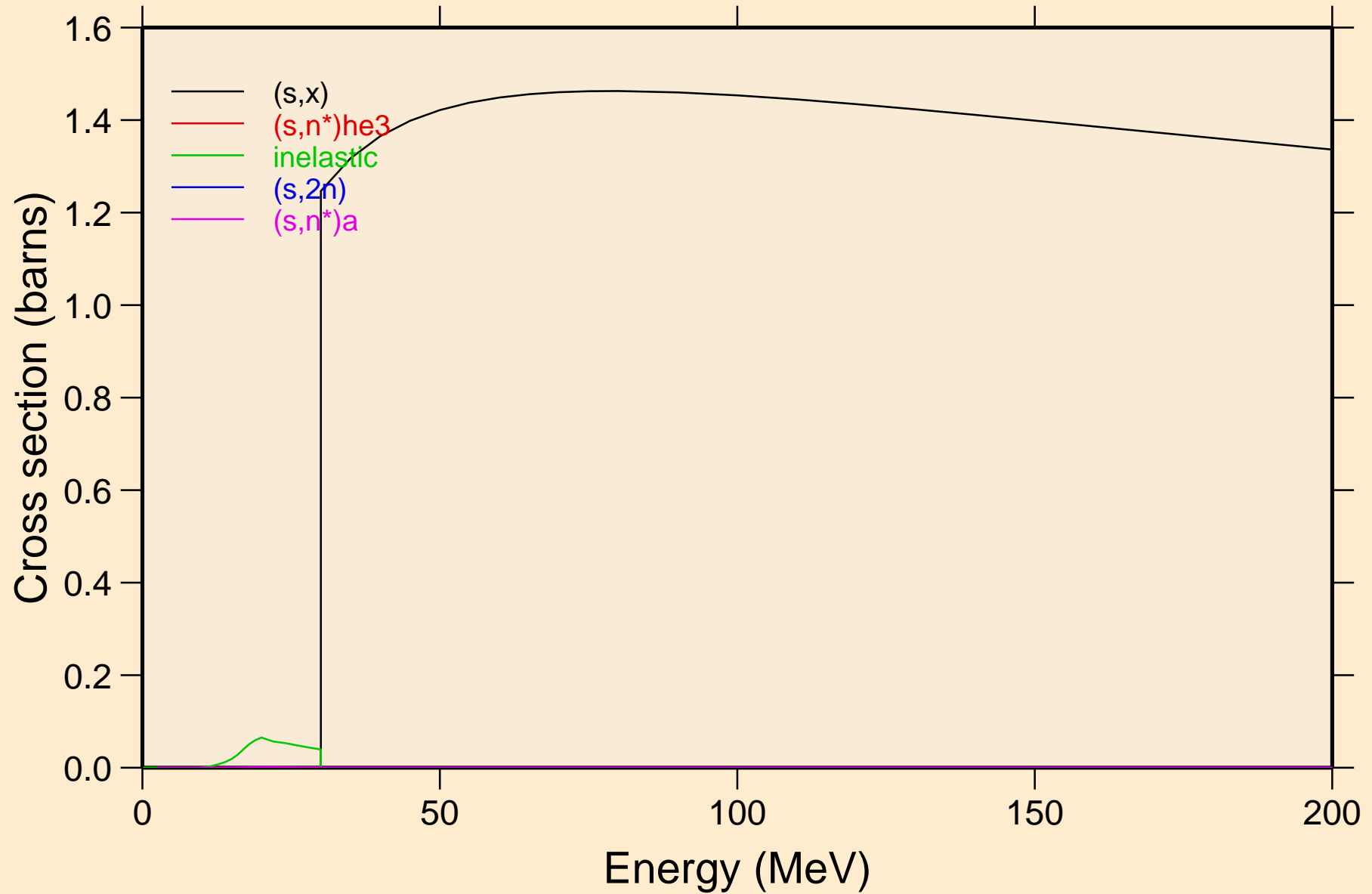

GA064 HELION ACER TENDL-2021 LIBRARY; T=0.K
Threshold reactions

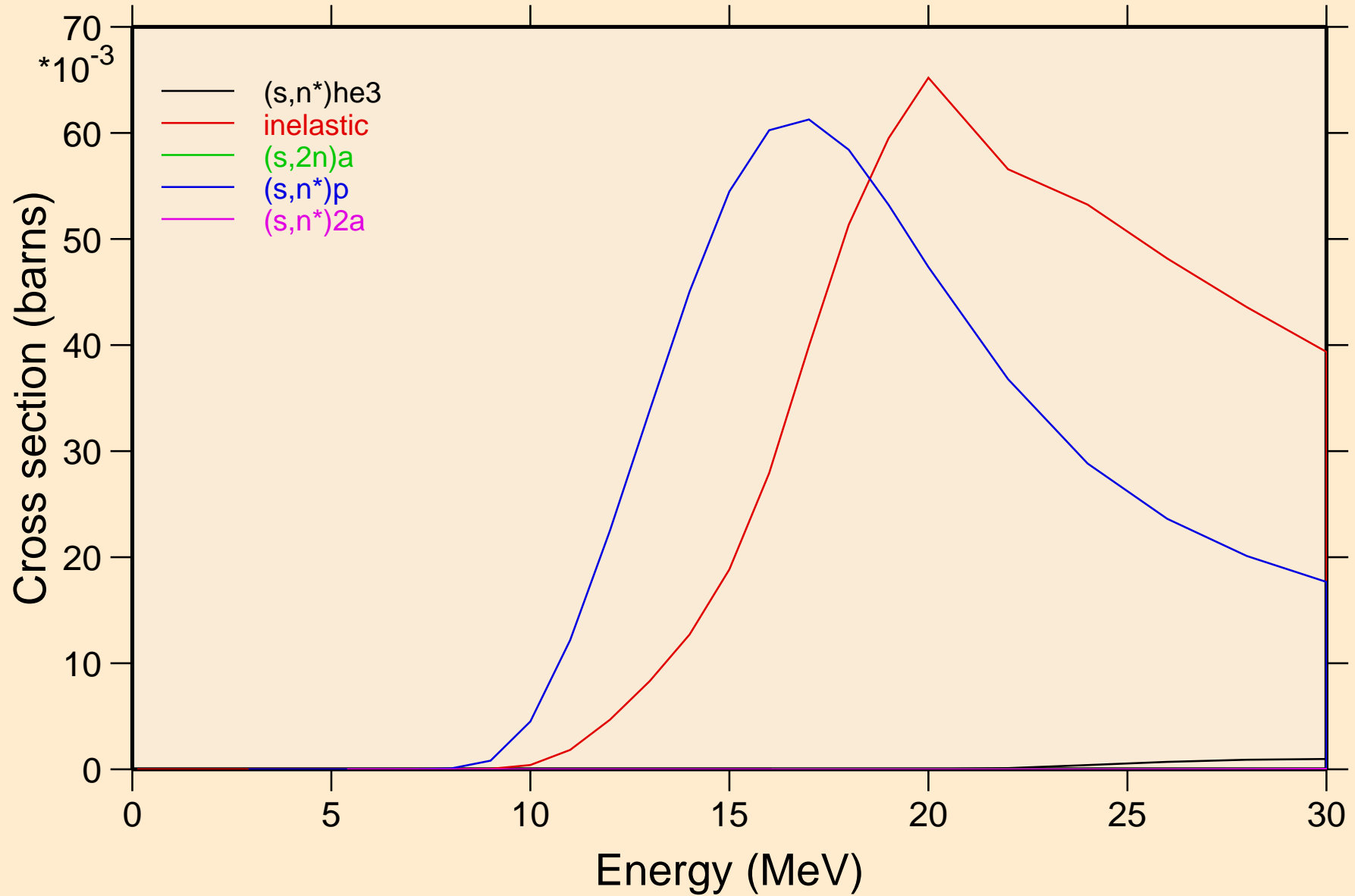

GA064 HELION ACER TENDL-2021 LIBRARY; T=0.K
Threshold reactions

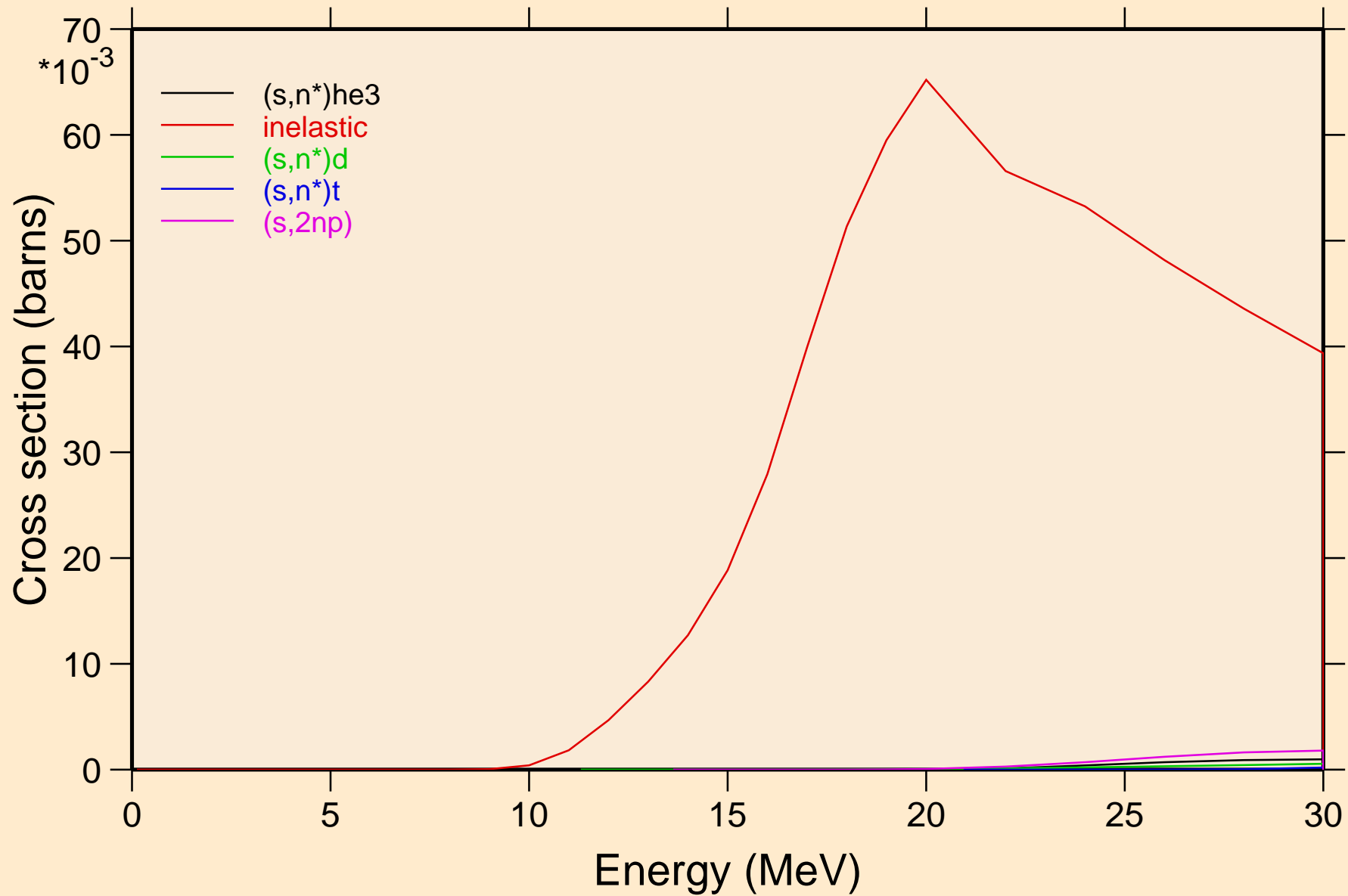

GA064 HELION ACER TENDL-2021 LIBRARY; T=0.K
Threshold reactions

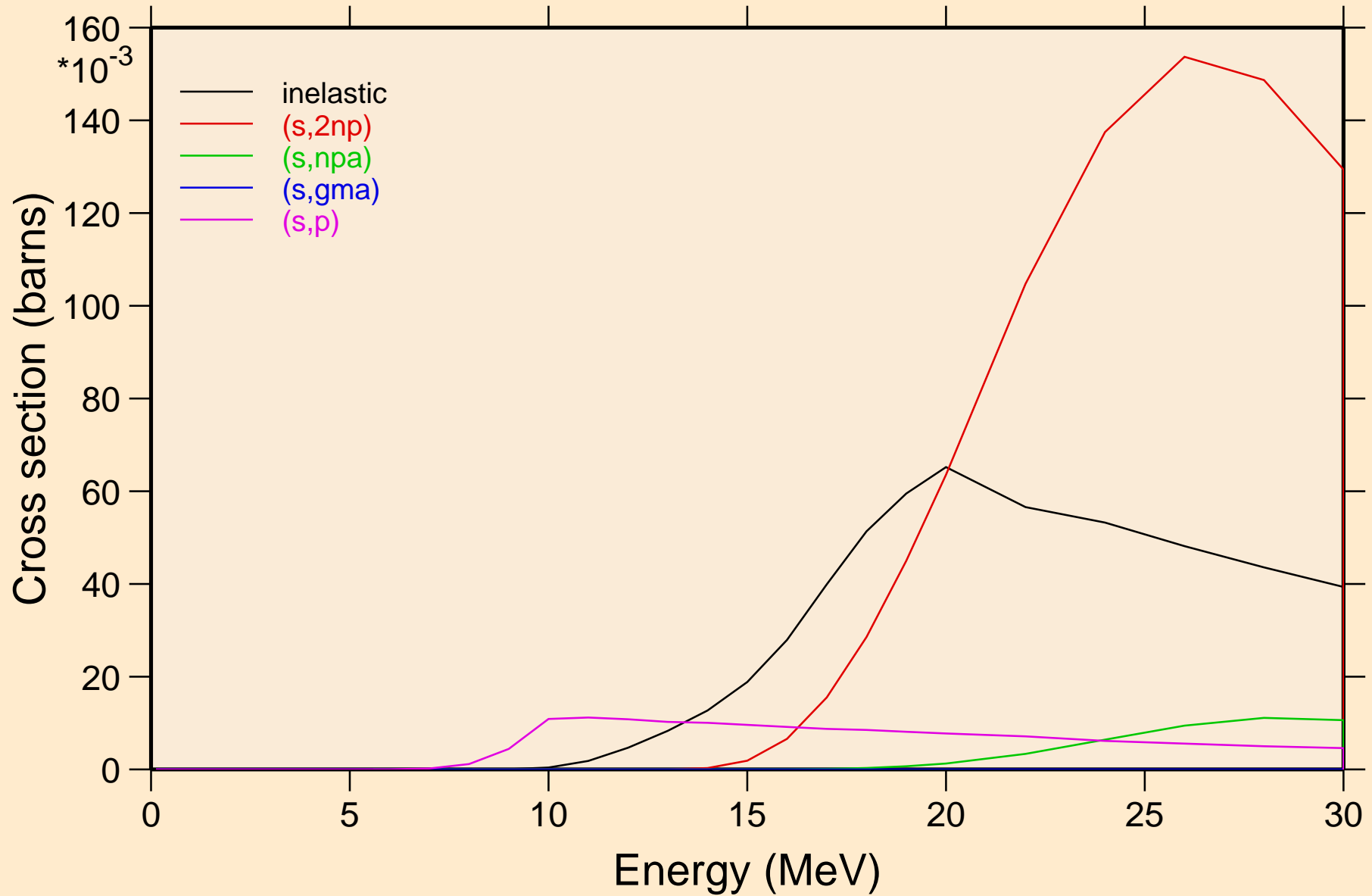

GA064 HELION ACER TENDL-2021 LIBRARY; T=0.K
Threshold reactions

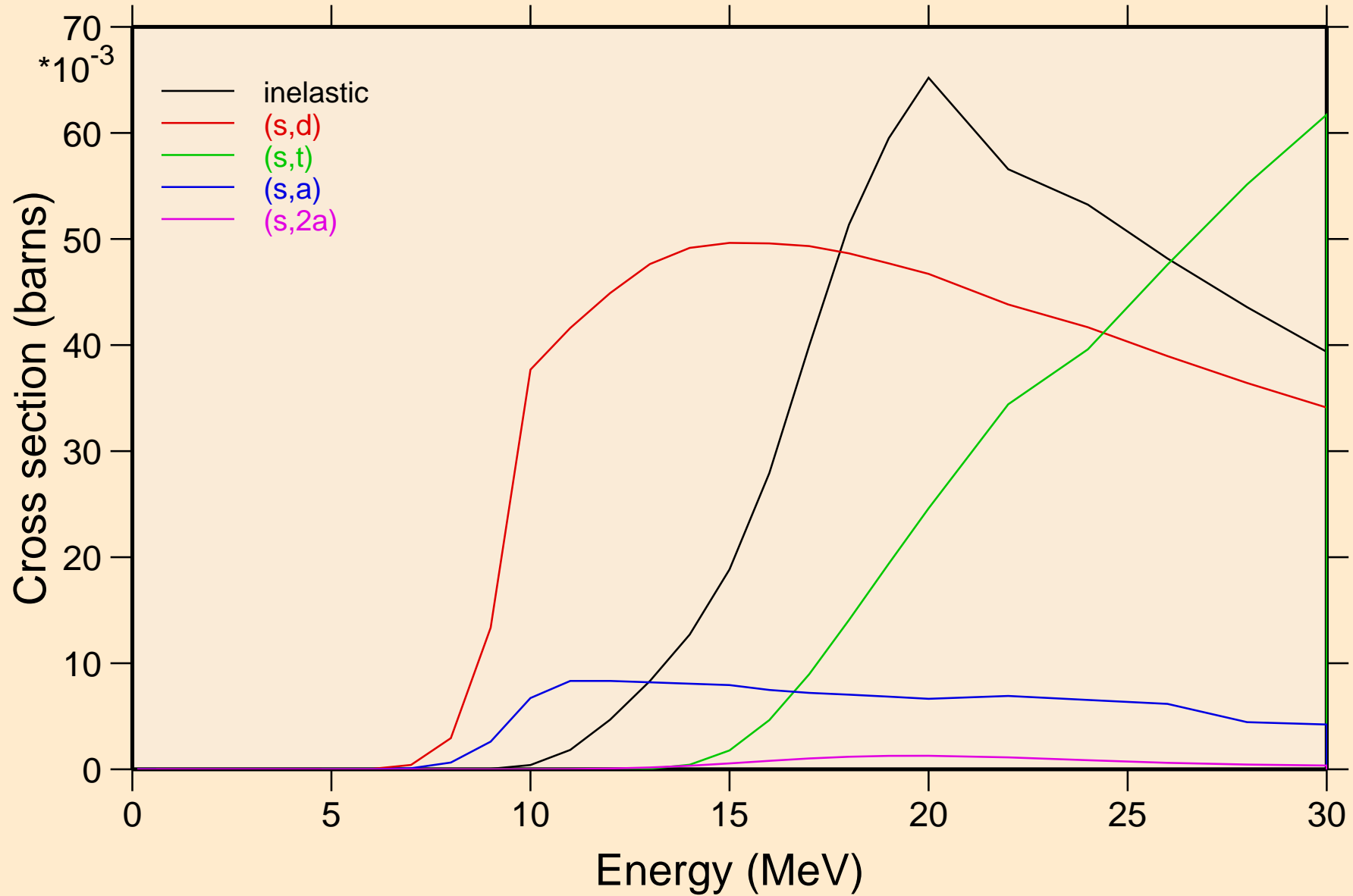

GA064 HELION ACER TENDL-2021 LIBRARY; T=0.K
Threshold reactions

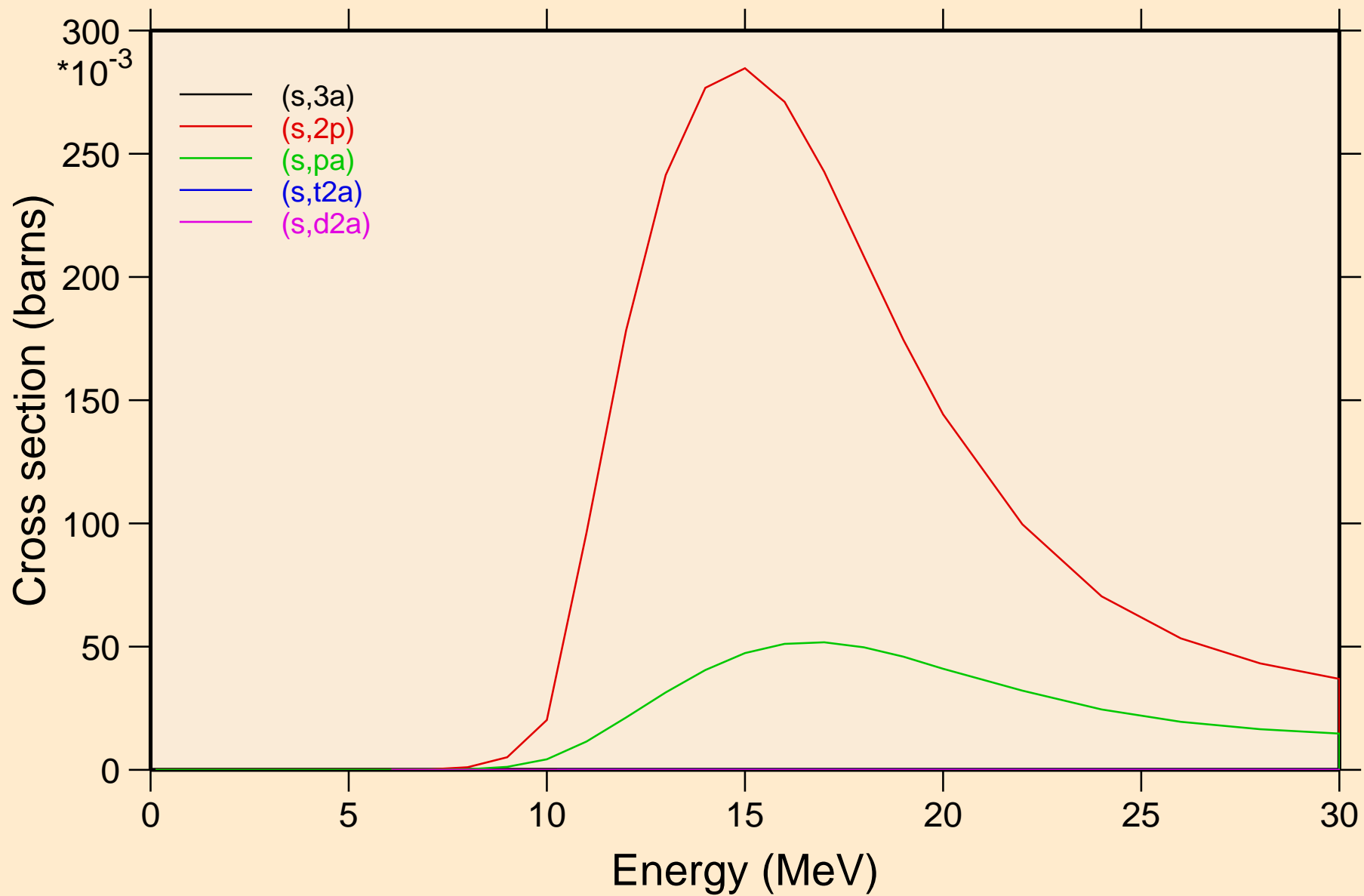

GA064 HELION ACER TENDL-2021 LIBRARY; T=0.K
Threshold reactions

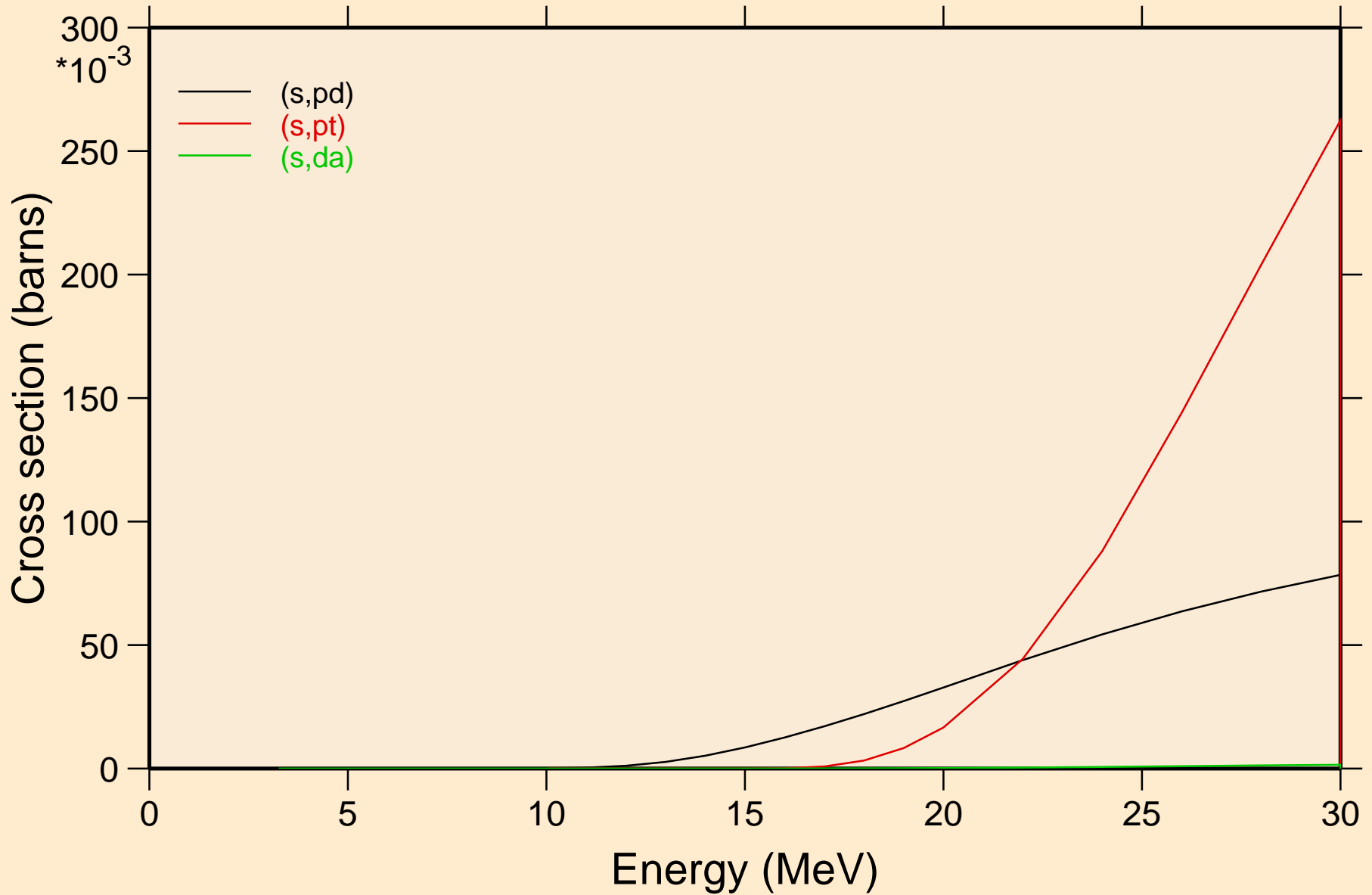

GA064 HELION ACER TENDL-2021 LIBRARY; T=0.K
angular distribution for elastic

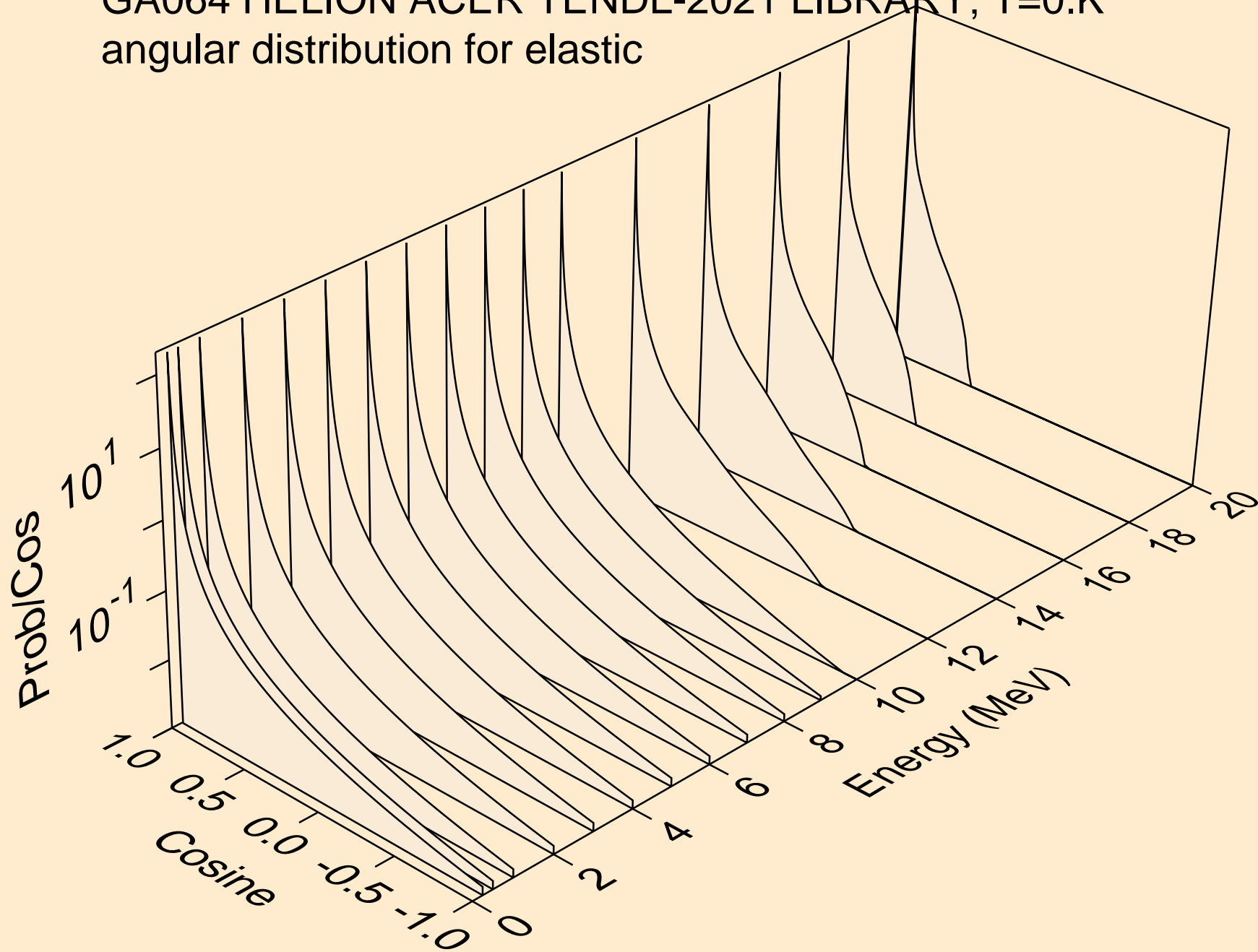

GA064 HELION ACER TENDL-2021 LIBRARY; T=0.K
angular distribution for elastic

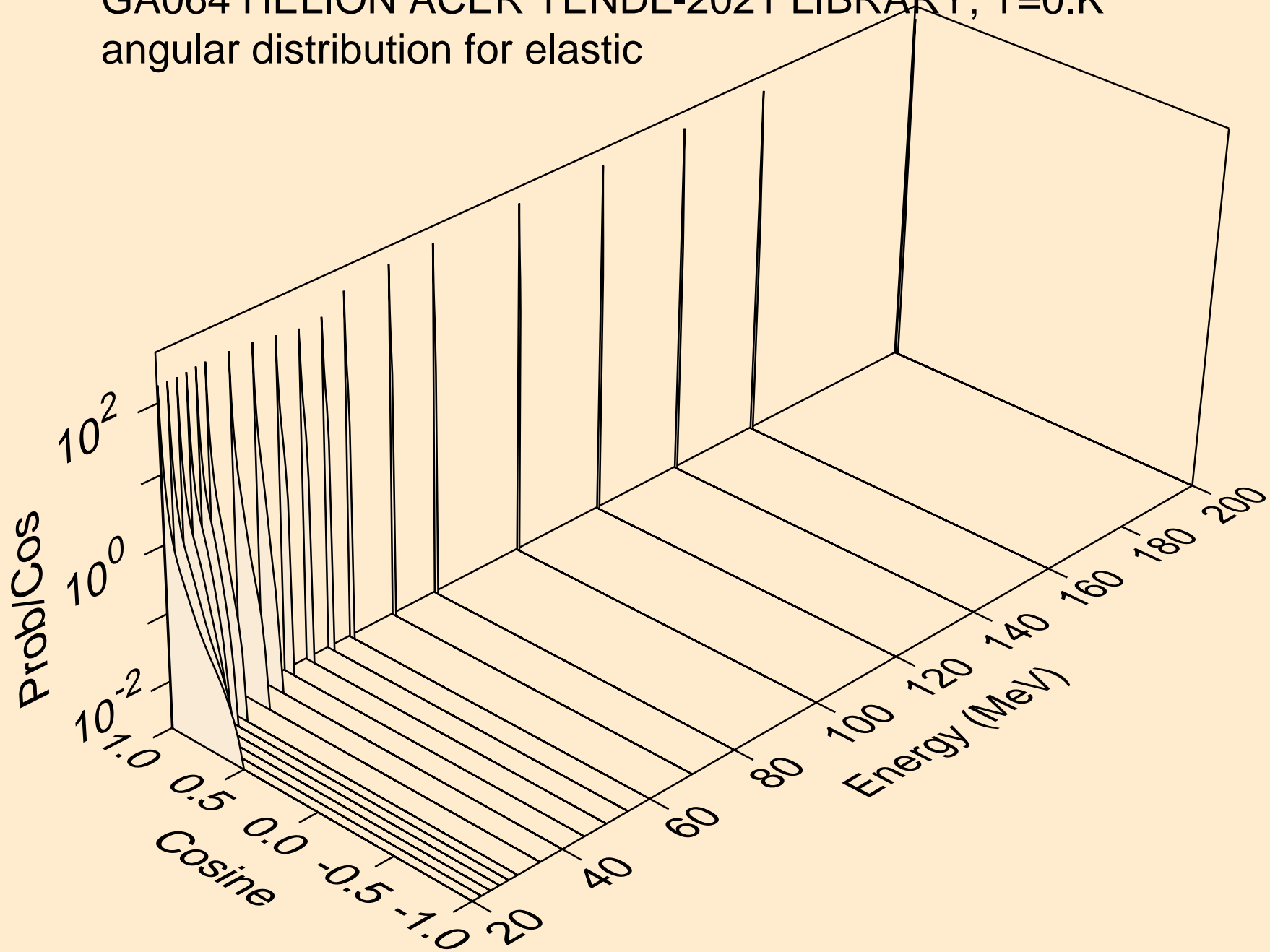

GA064 HELION ACER TENDL-2021 LIBRARY; T=0.K
He-3 emission for (s,x)

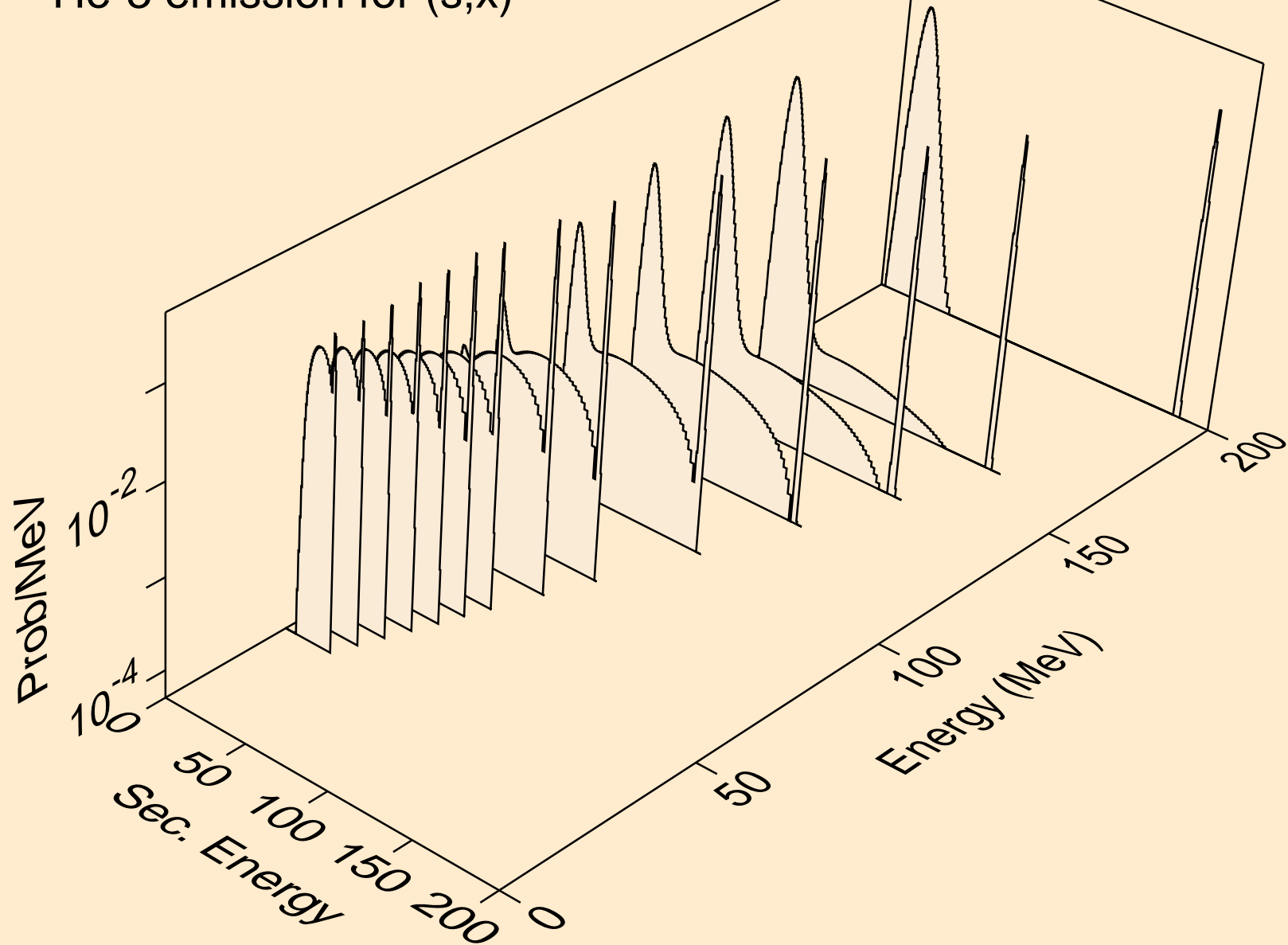

GA064 HELION ACER TENDL-2021 LIBRARY; T=0.K
He-3 emission for (s,n*)he3

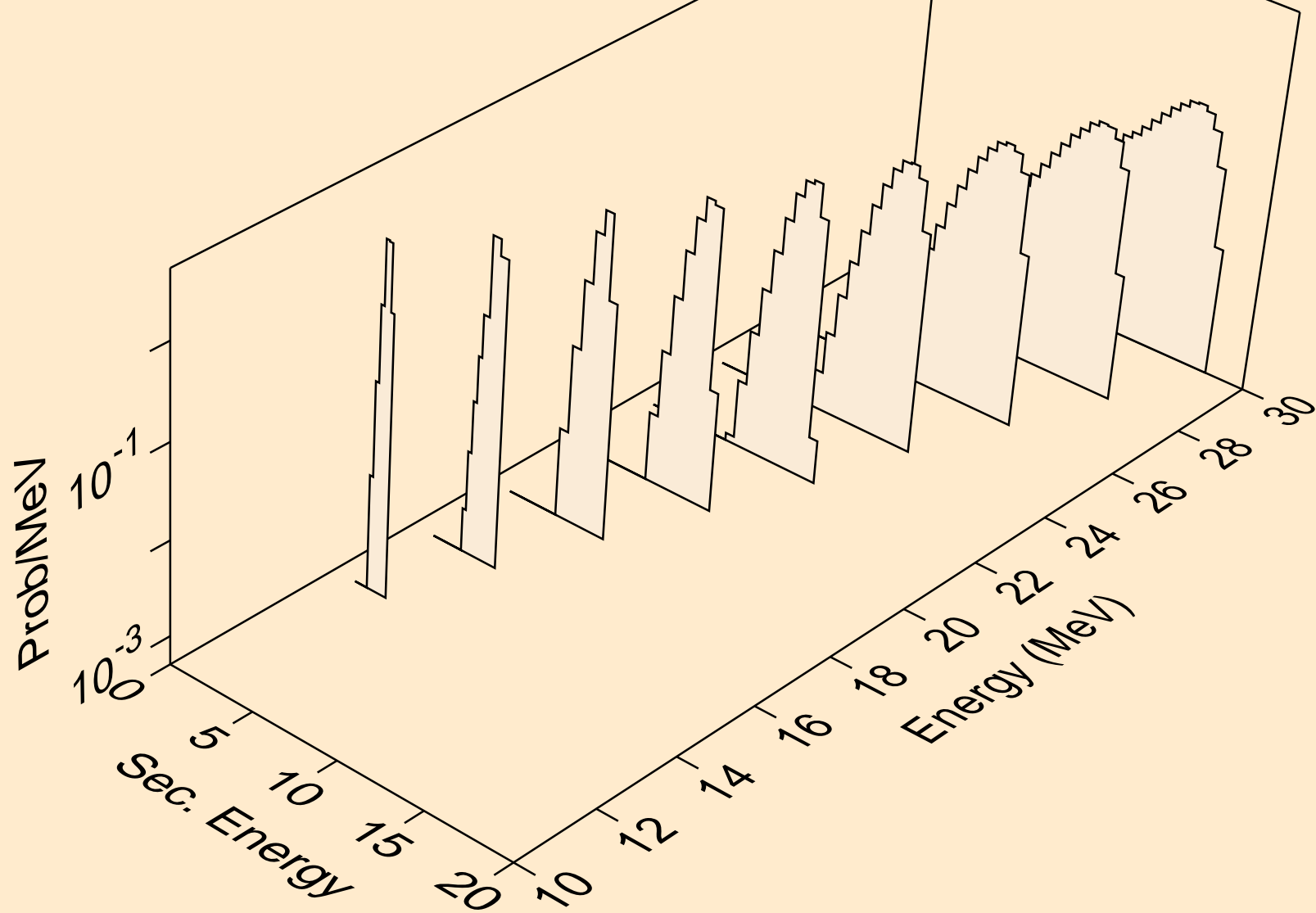

GA064 HELION ACER TENDL-2021 LIBRARY; T=0.K
He-3 emission for inelastic

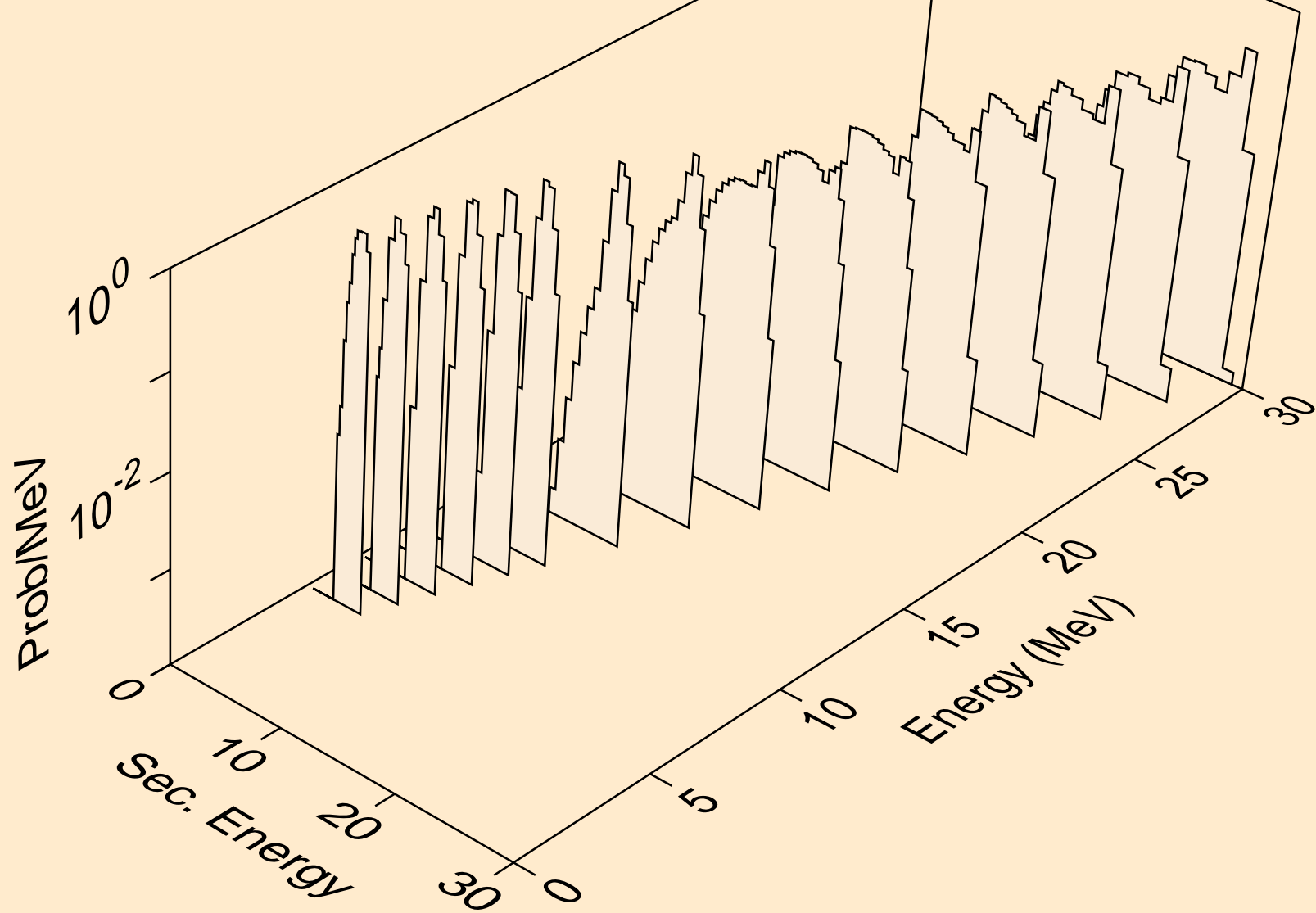

GA064 HELION ACER TENDL-2021 LIBRARY; T=0.K
Photon emission for (z,n)

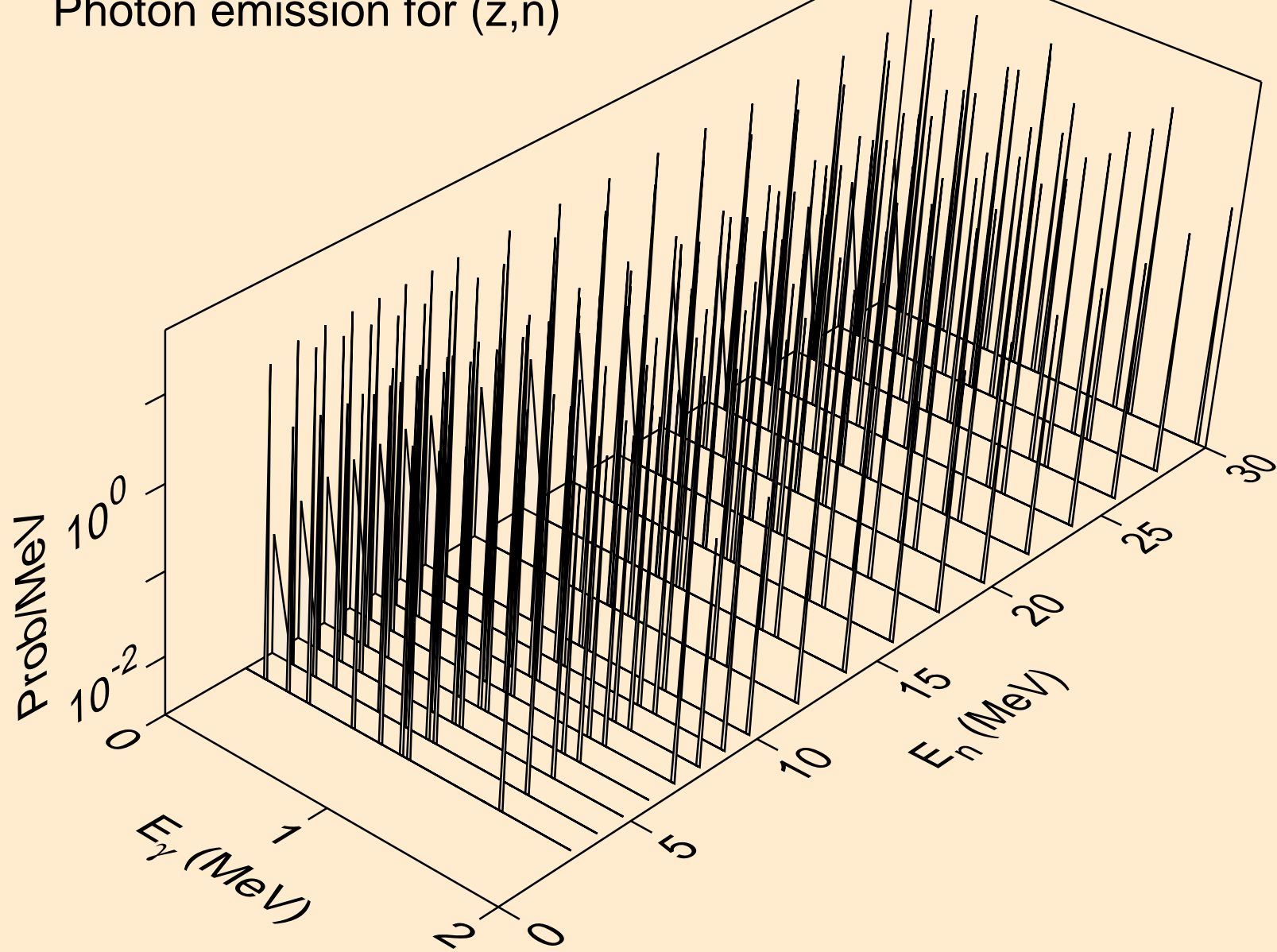

GA064 HELION ACER TENDL-2021 LIBRARY; T=0.K
Photon emission for (n,x)

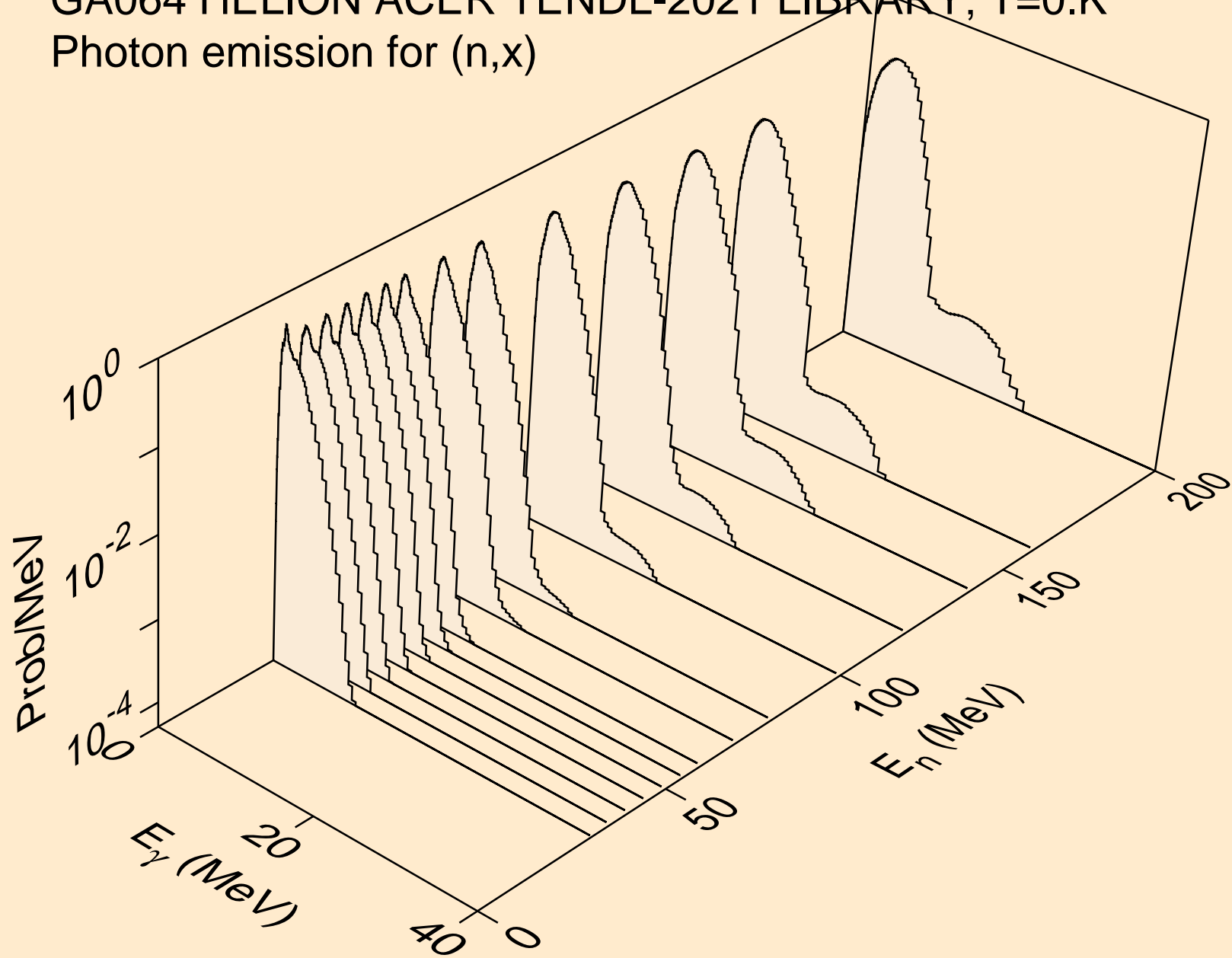

GA064 HELION ACER TENDL-2021 LIBRARY; T=0.K
Photon emission for (n,2n)

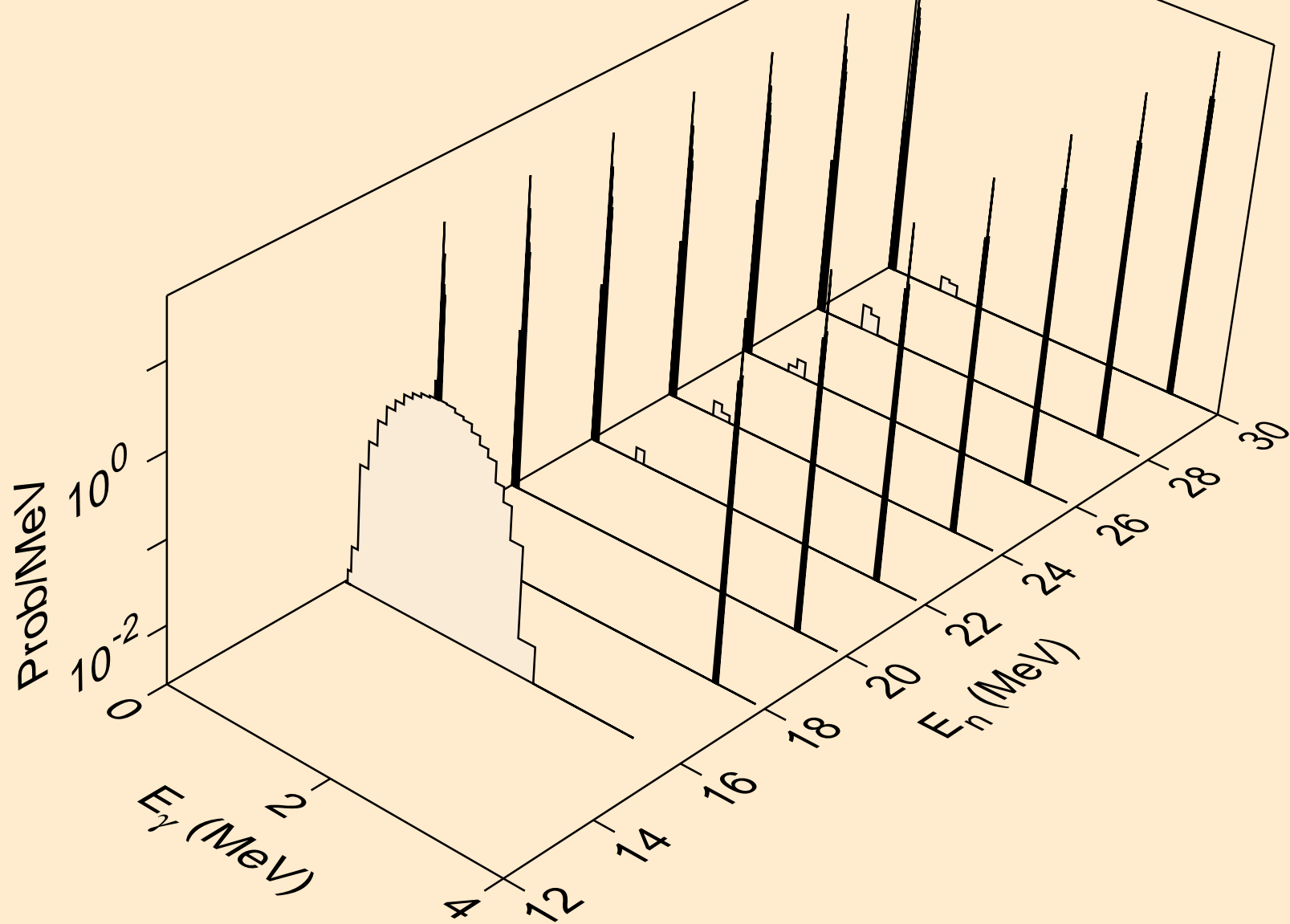

GA064 HELION ACER TENDL-2021 LIBRARY; T=0.K
Photon emission for (n,n*)a

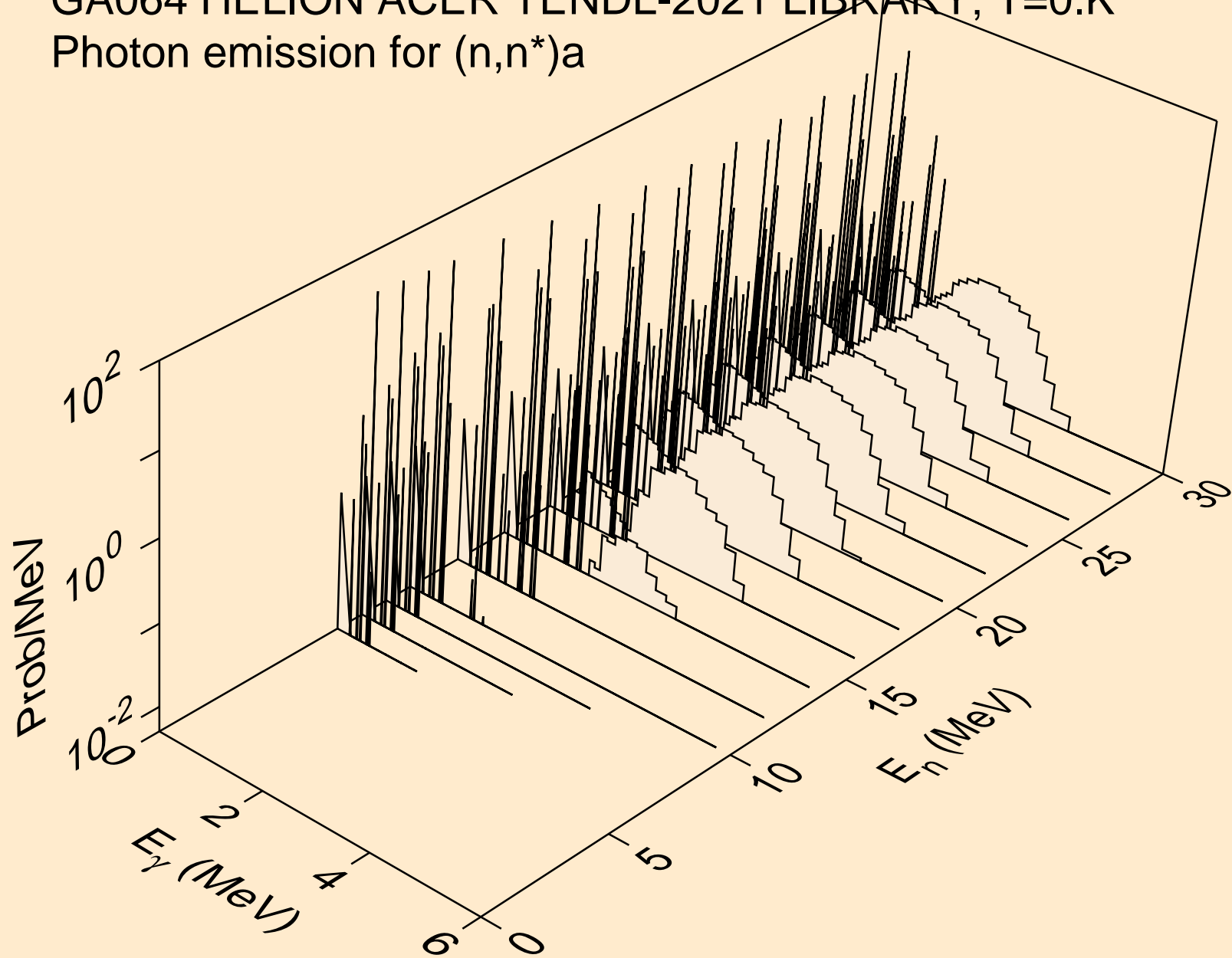

GA064 HELION ACER TENDL-2021 LIBRARY; T=0.K
Photon emission for (n,2n)a

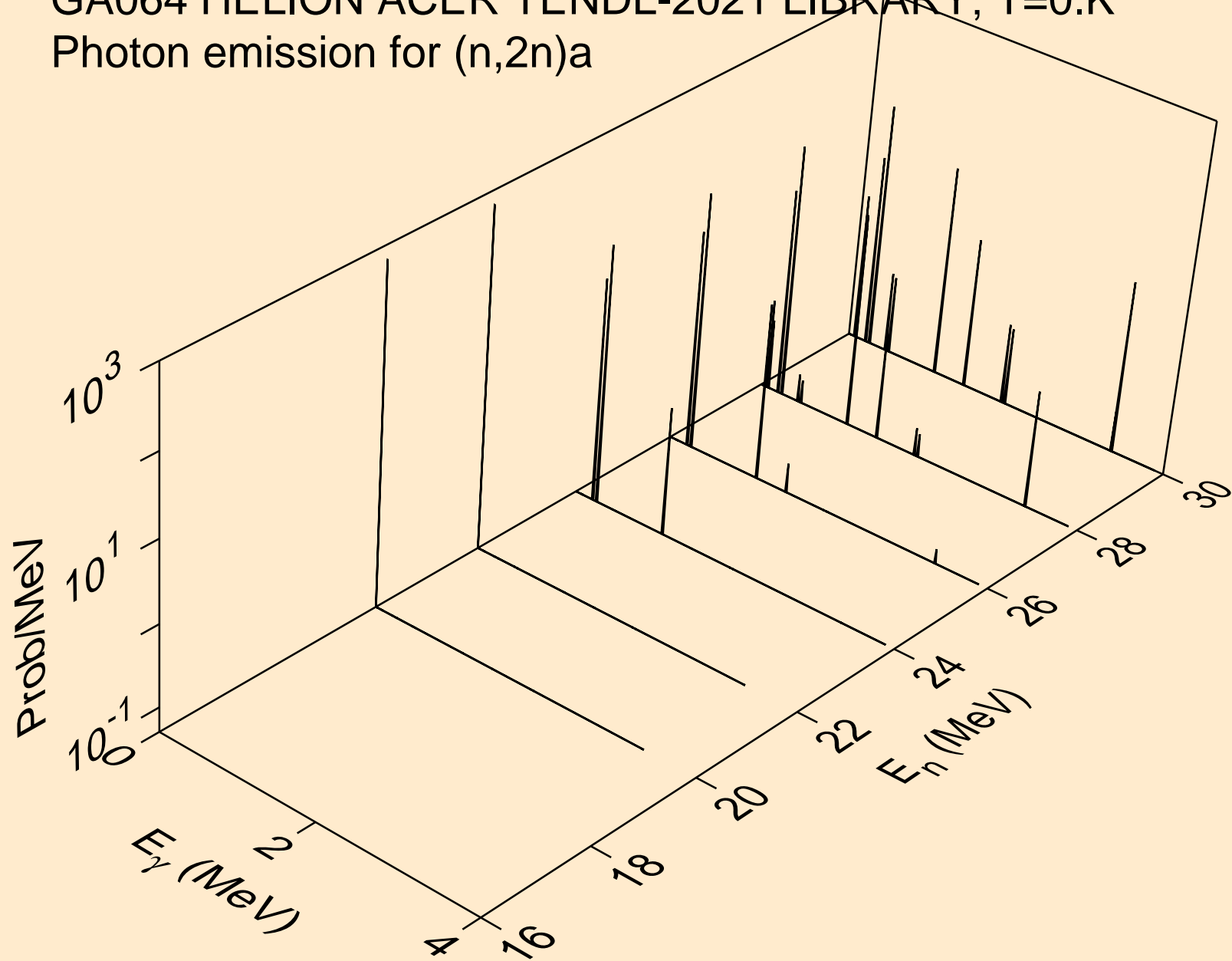

GA064 HELION ACER TENDL-2021 LIBRARY; T=0.K
Photon emission for (n,n*)p

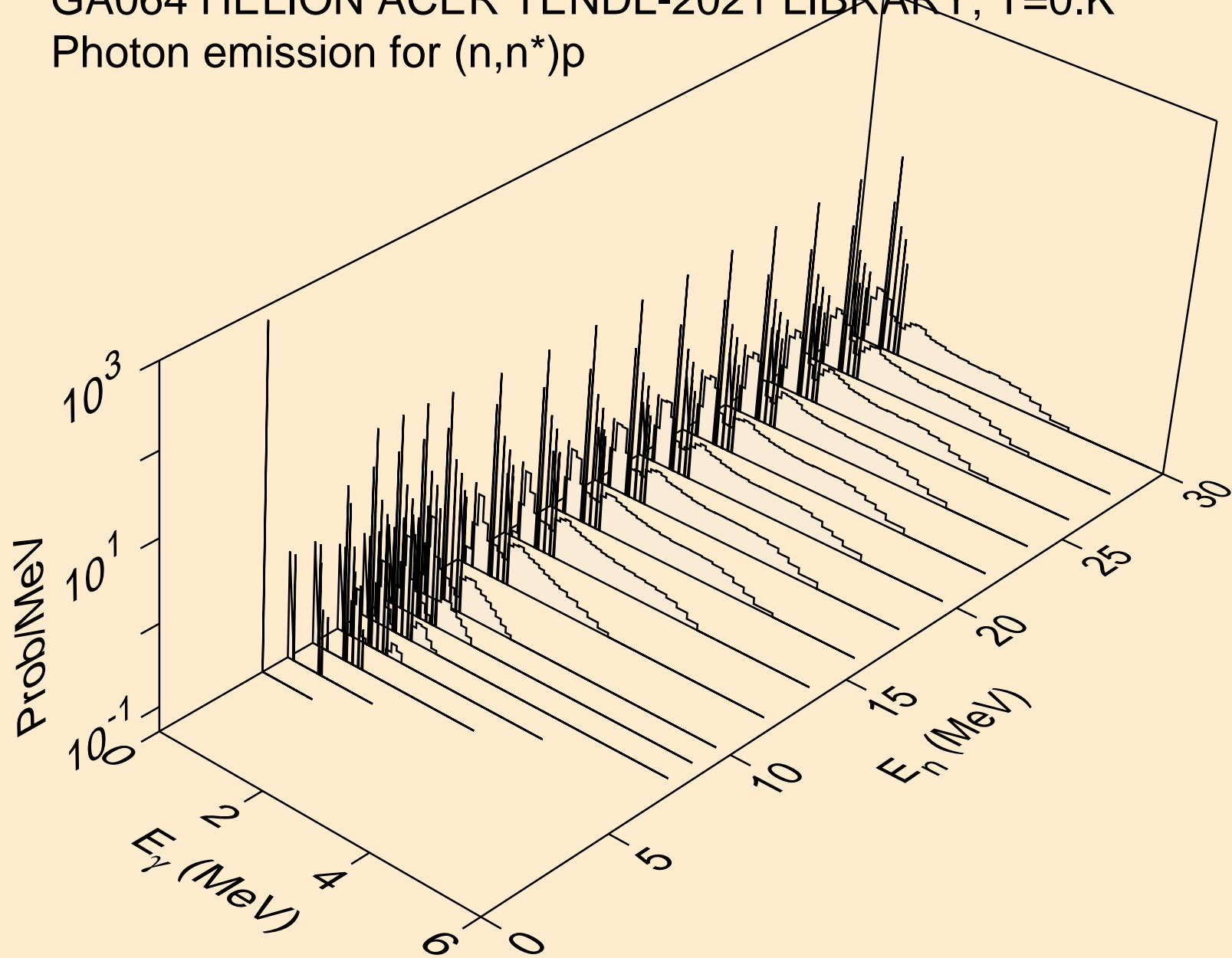

GA064 HELION ACER TENDL-2021 LIBRARY; T=0.K
Photon emission for (n,n*)2a

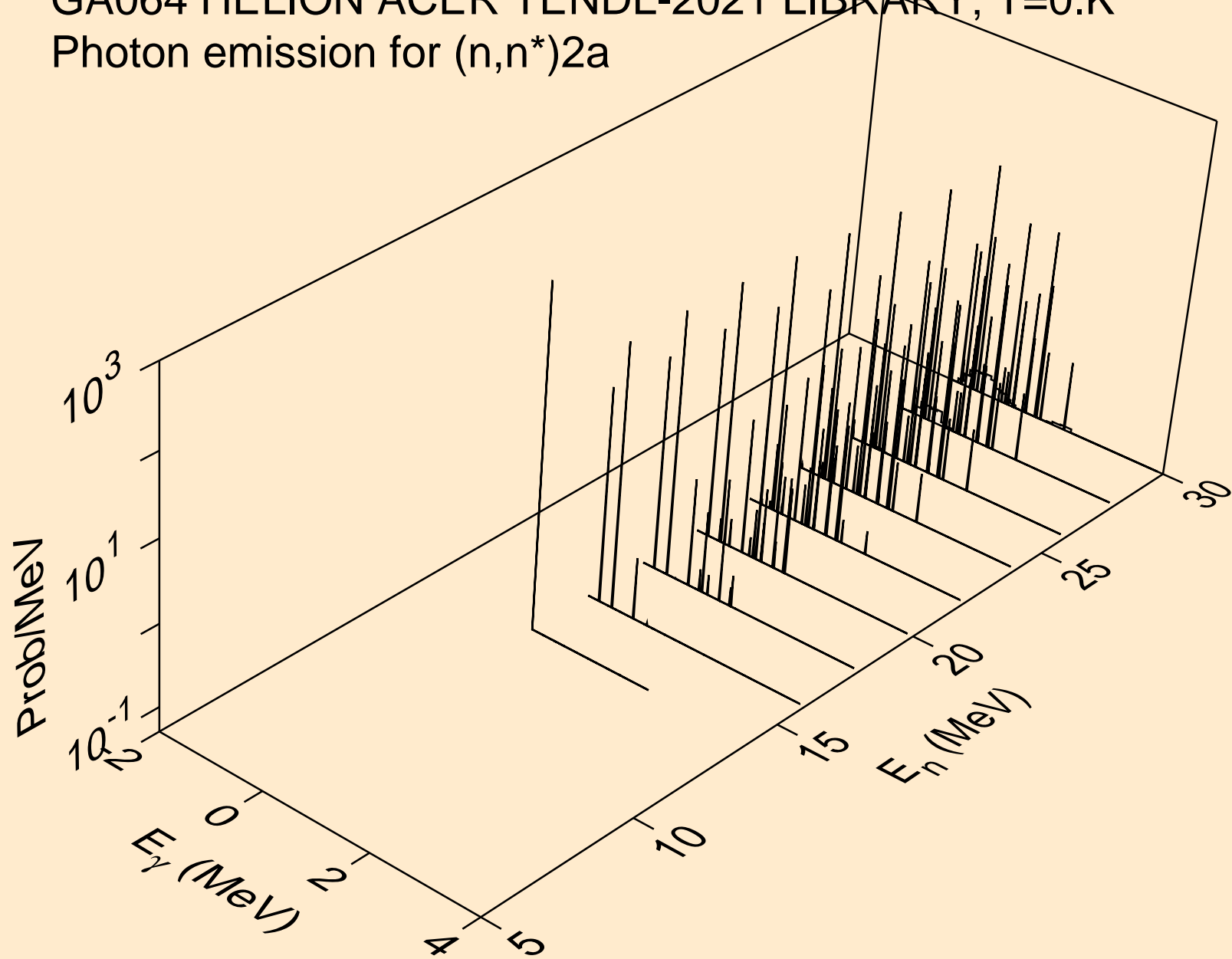

GA064 HELION ACER TENDL-2021 LIBRARY; T=0.K
Photon emission for (n,n*)d

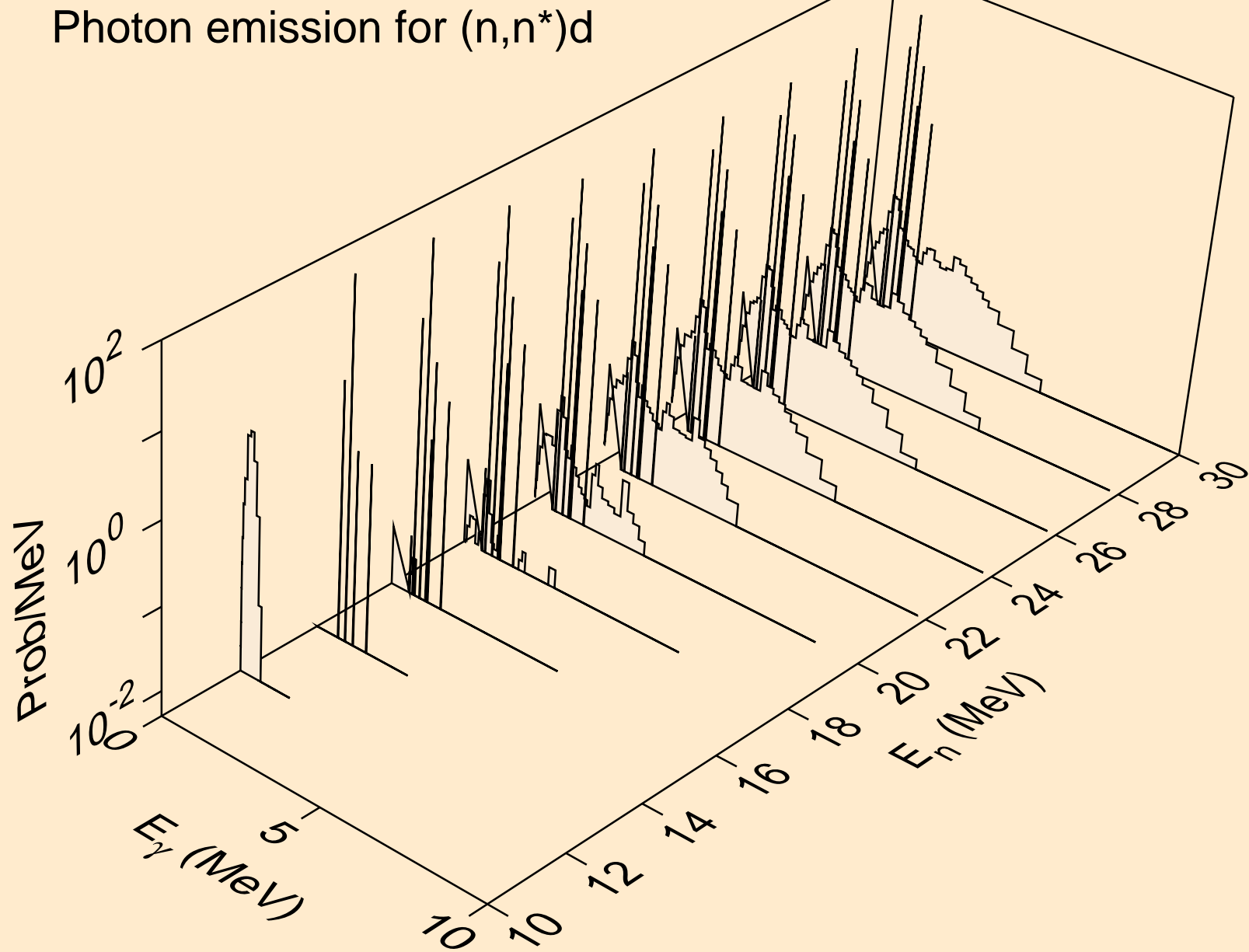

GA064 HELION ACER TENDL-2021 LIBRARY; T=0.K
Photon emission for (n,n*)t

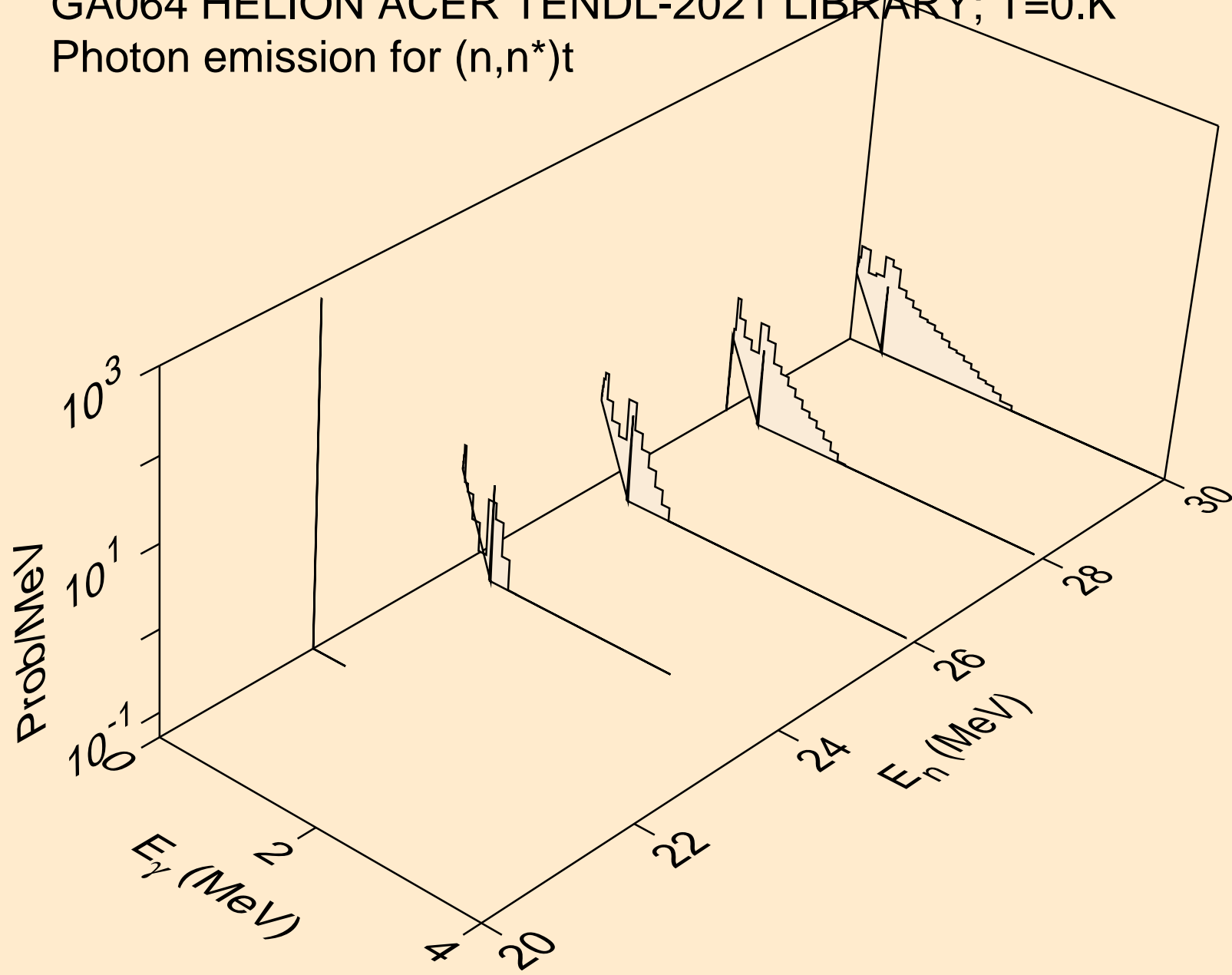

GA064 HELION ACER TENDL-2021 LIBRARY; T=0.K
Photon emission for (n,n*)he3

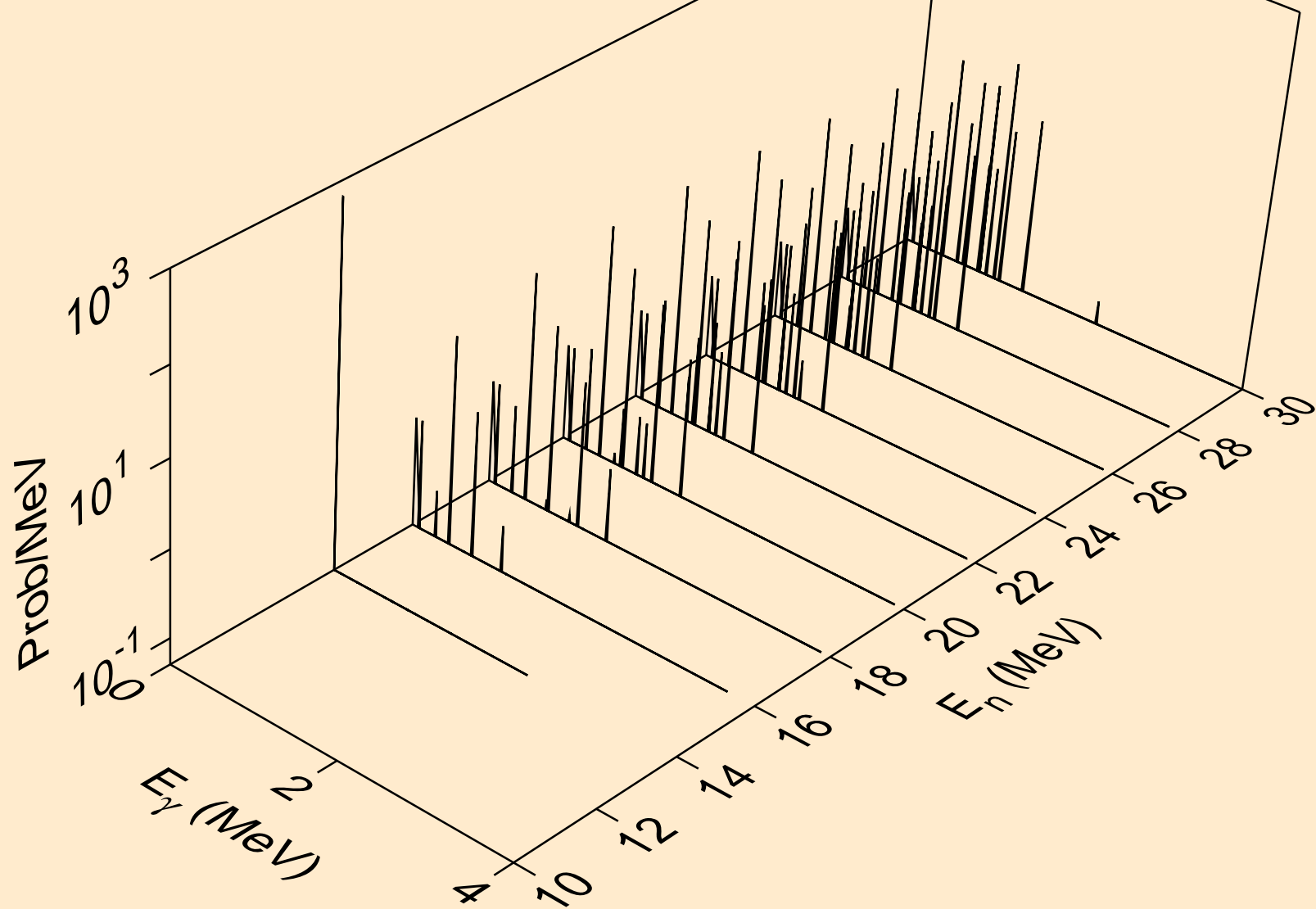

GA064 HELION ACER TENDL-2021 LIBRARY; T=0.K
Photon emission for (n,2np)

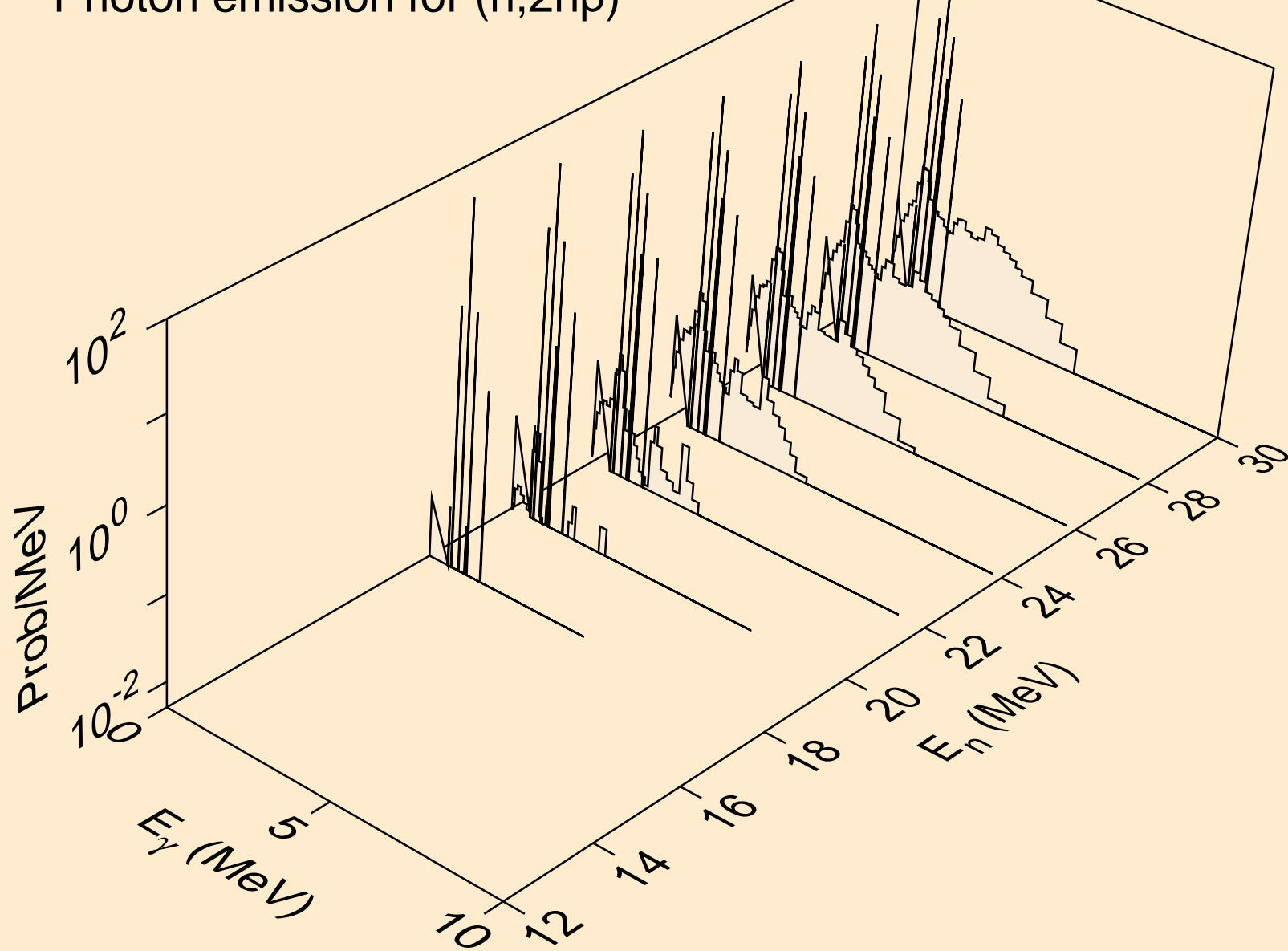

GA064 HELION ACER TENDL-2021 LIBRARY; T=0.K
Photon emission for (n,2np)

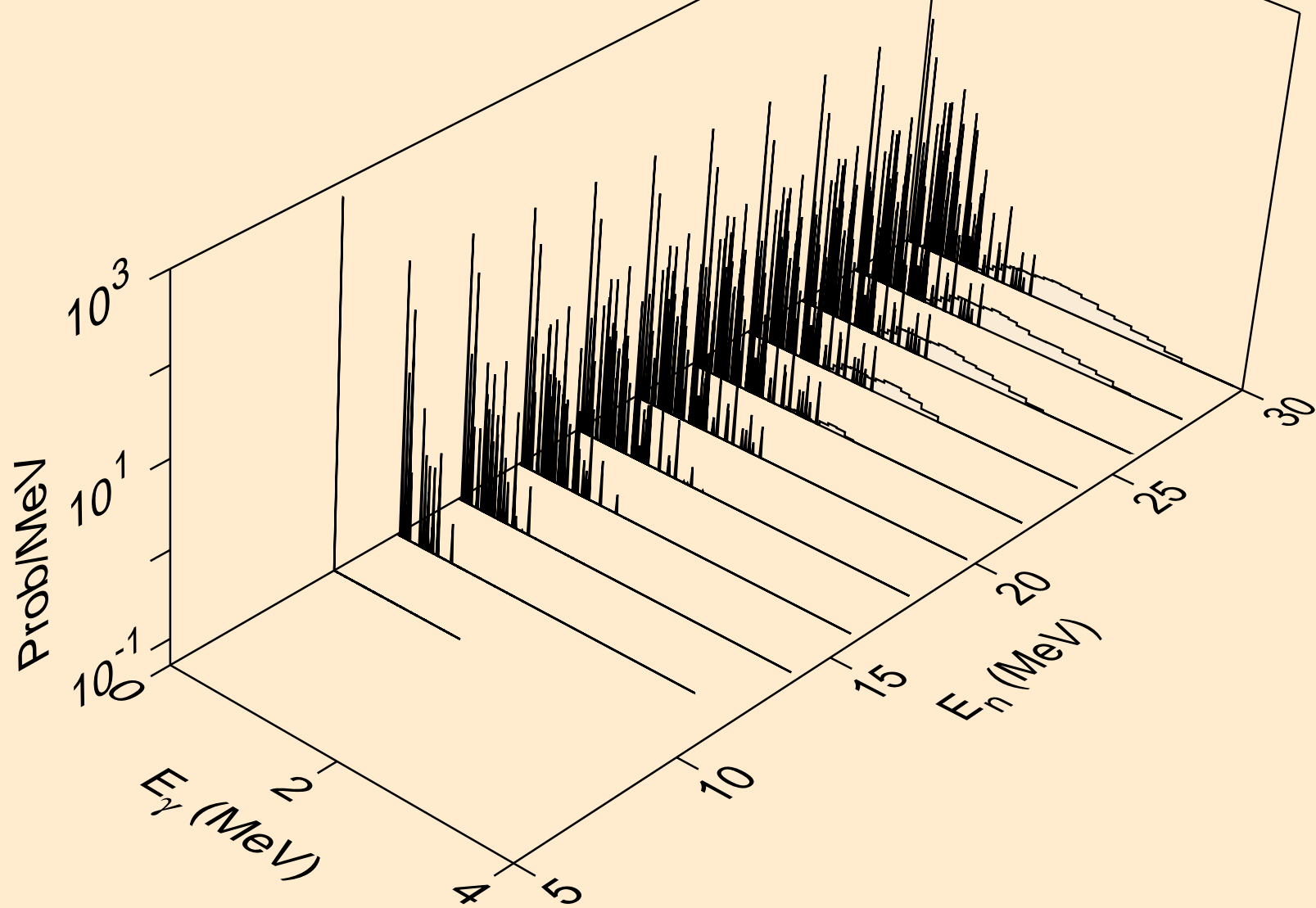

GA064 HELION ACER TENDL-2021 LIBRARY; T=0.K
Photon emission for (n,npa)

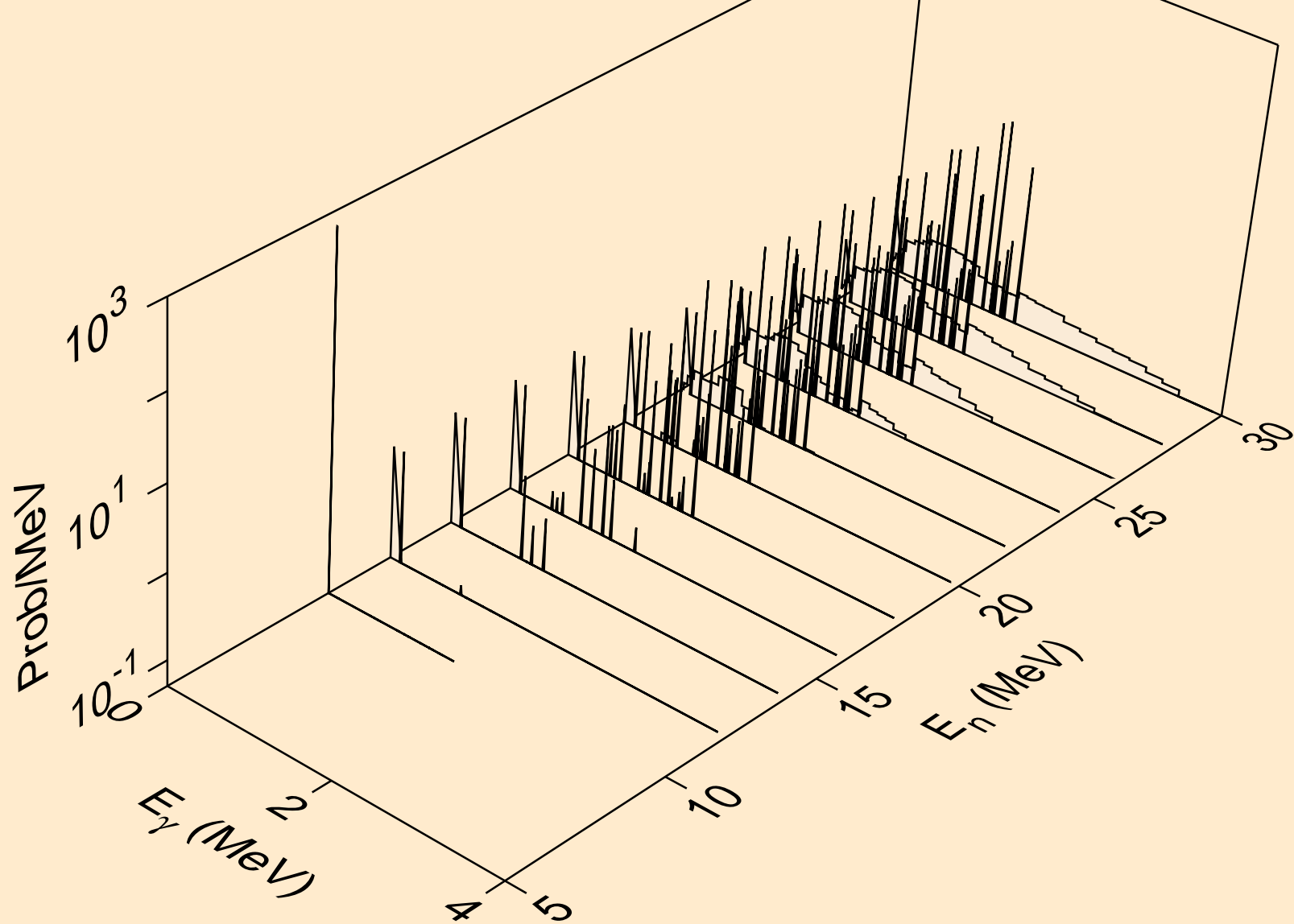

GA064 HELION ACER TENDL-2021 LIBRARY; T=0.K
Photon emission for (n,gma)

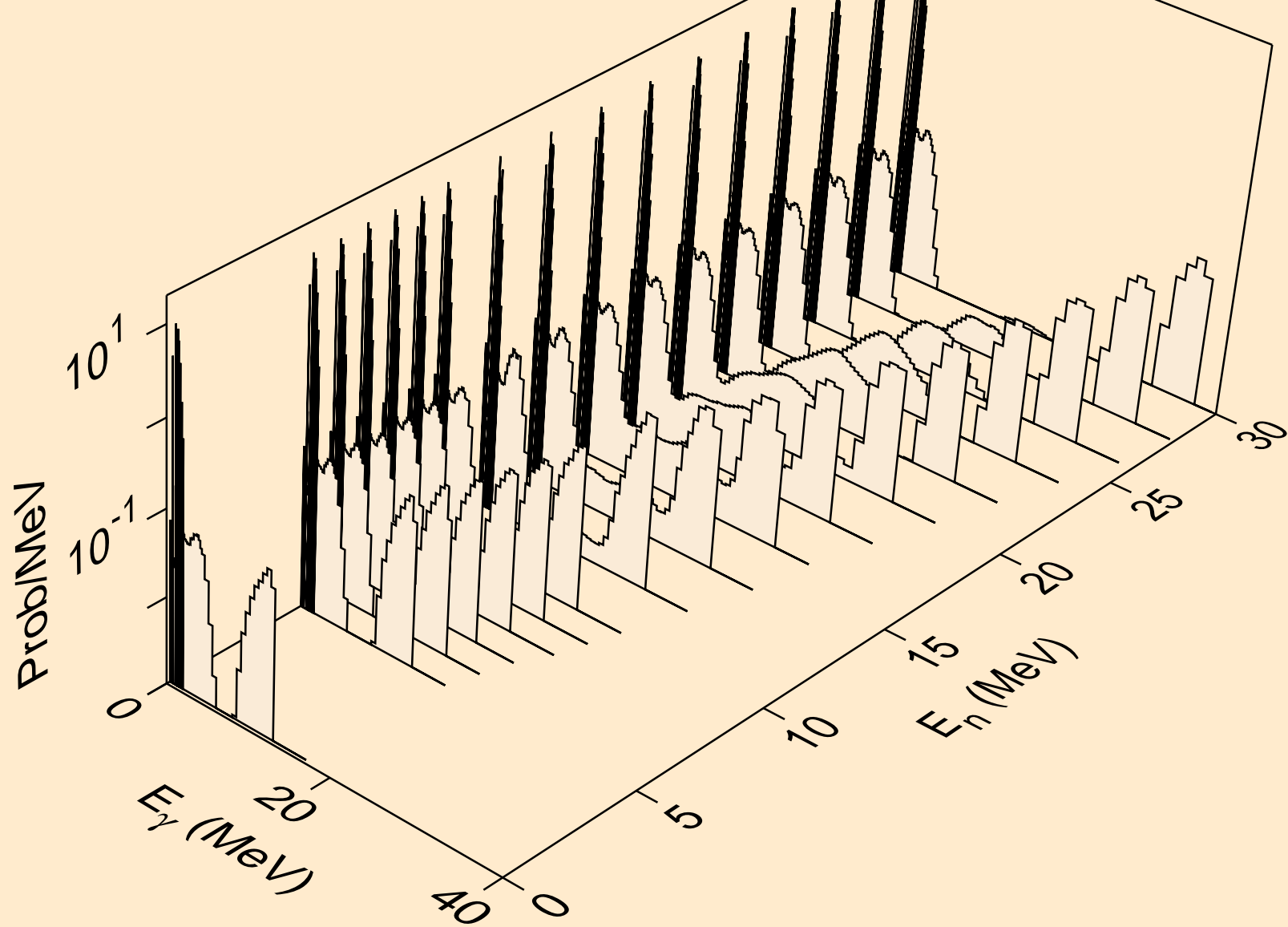

GA064 HELION ACER TENDL-2021 LIBRARY; T=0.K
Photon emission for (n,p)

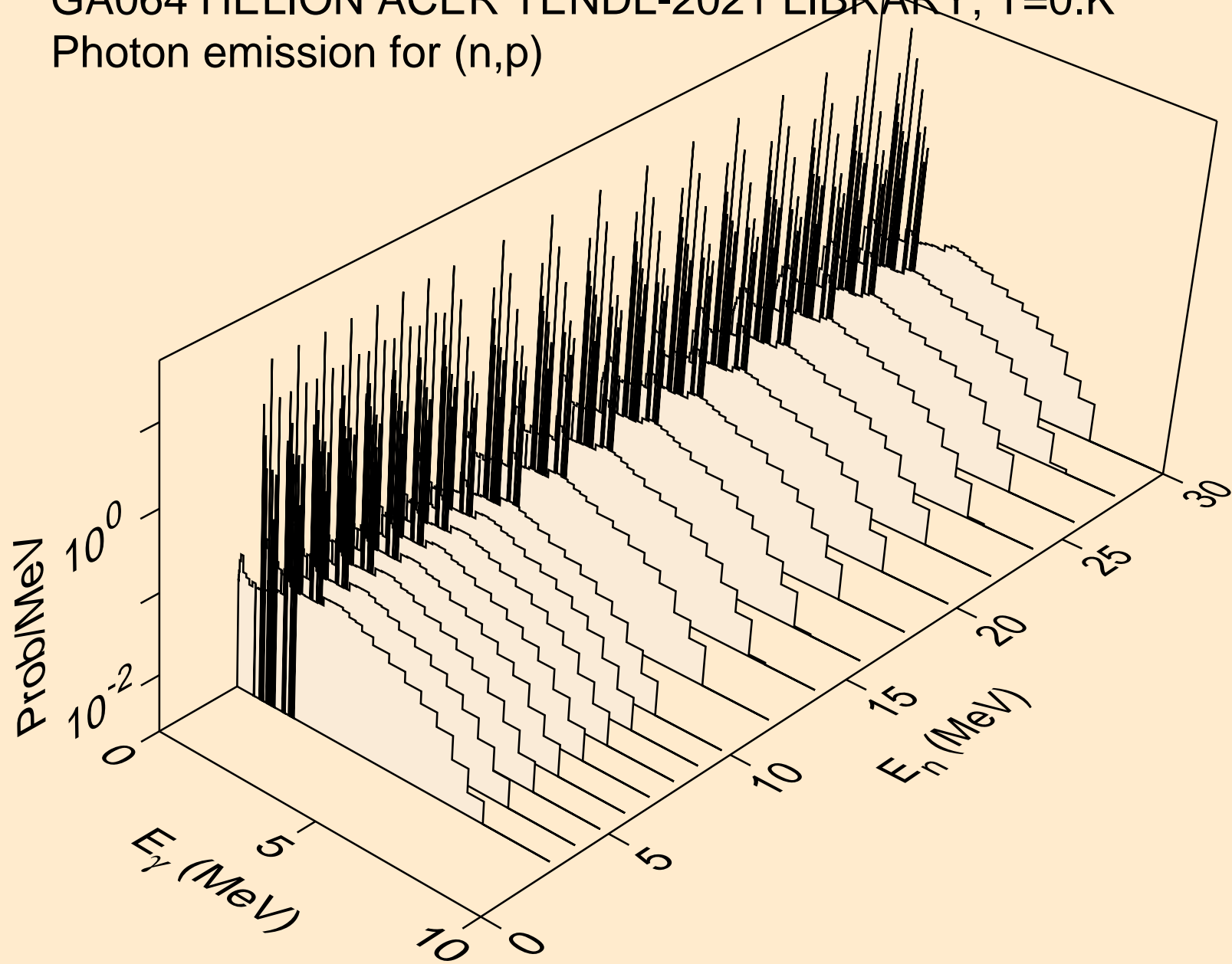

GA064 HELION ACER TENDL-2021 LIBRARY; T=0.K
Photon emission for (n,d)

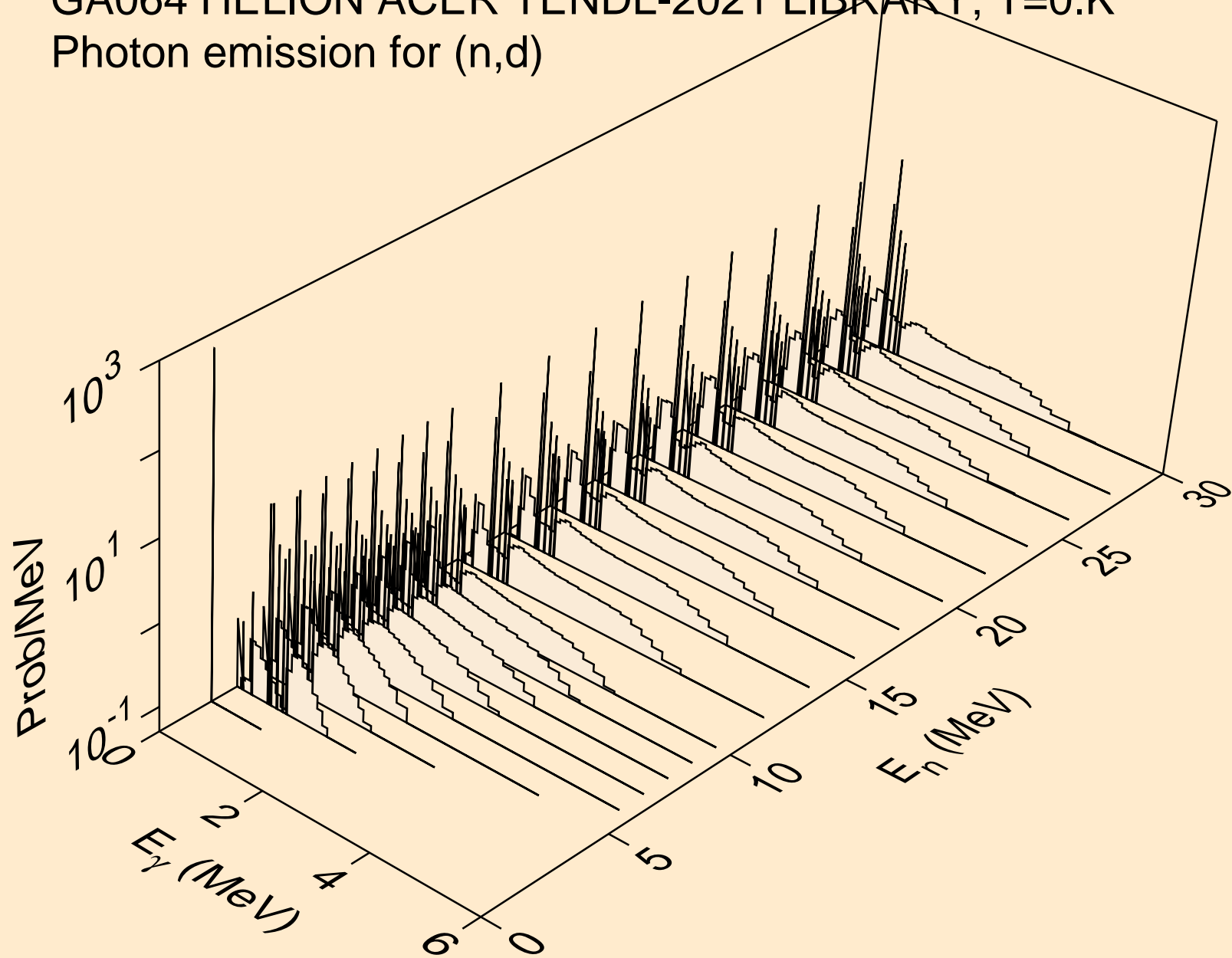

GA064 HELION ACER TENDL-2021 LIBRARY; T=0.K
Photon emission for (n,t)

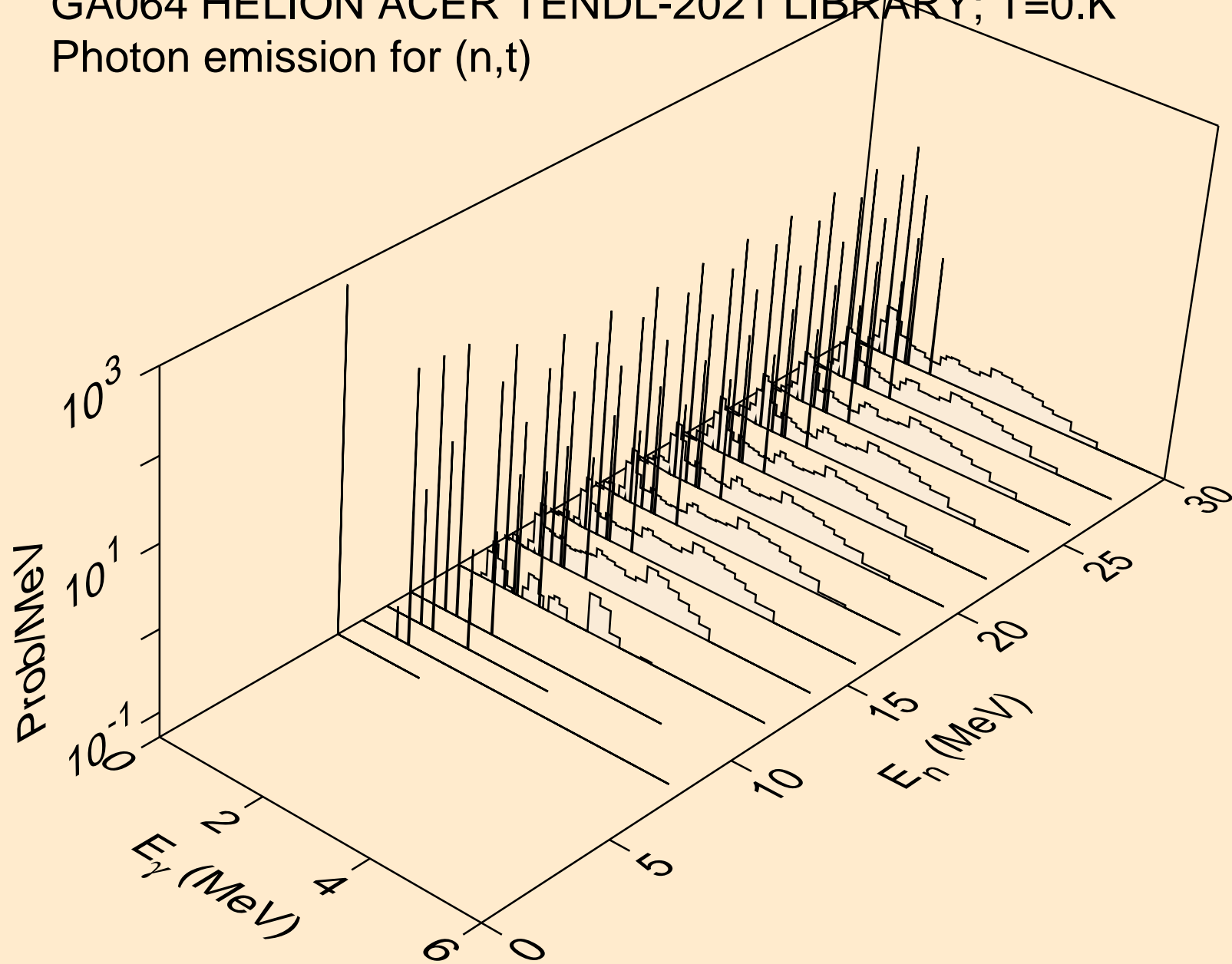

GA064 HELION ACER TENDL-2021 LIBRARY; T=0.K
Photon emission for inelastic

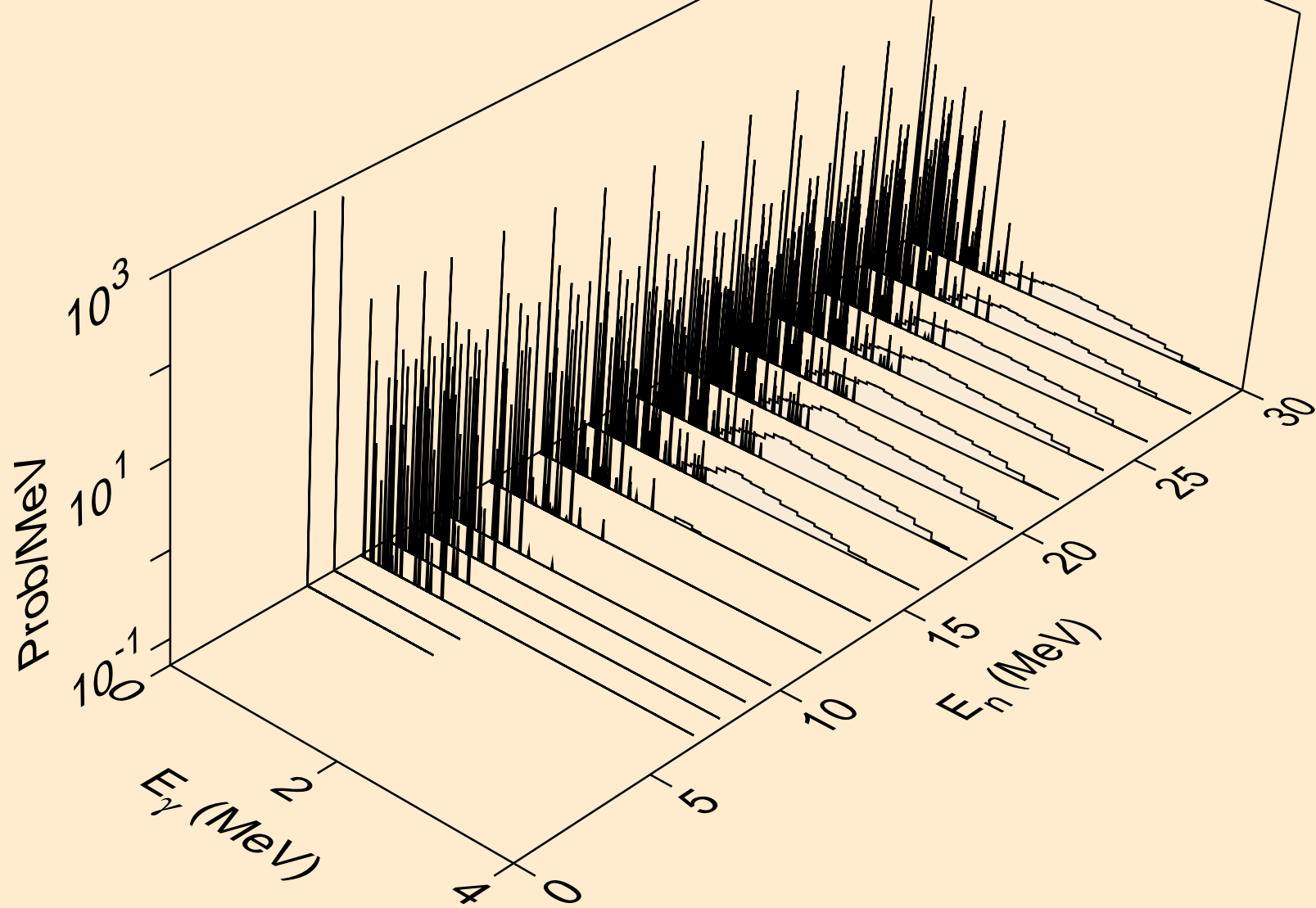

GA064 HELION ACER TENDL-2021 LIBRARY; T=0.K
Photon emission for (n,a)

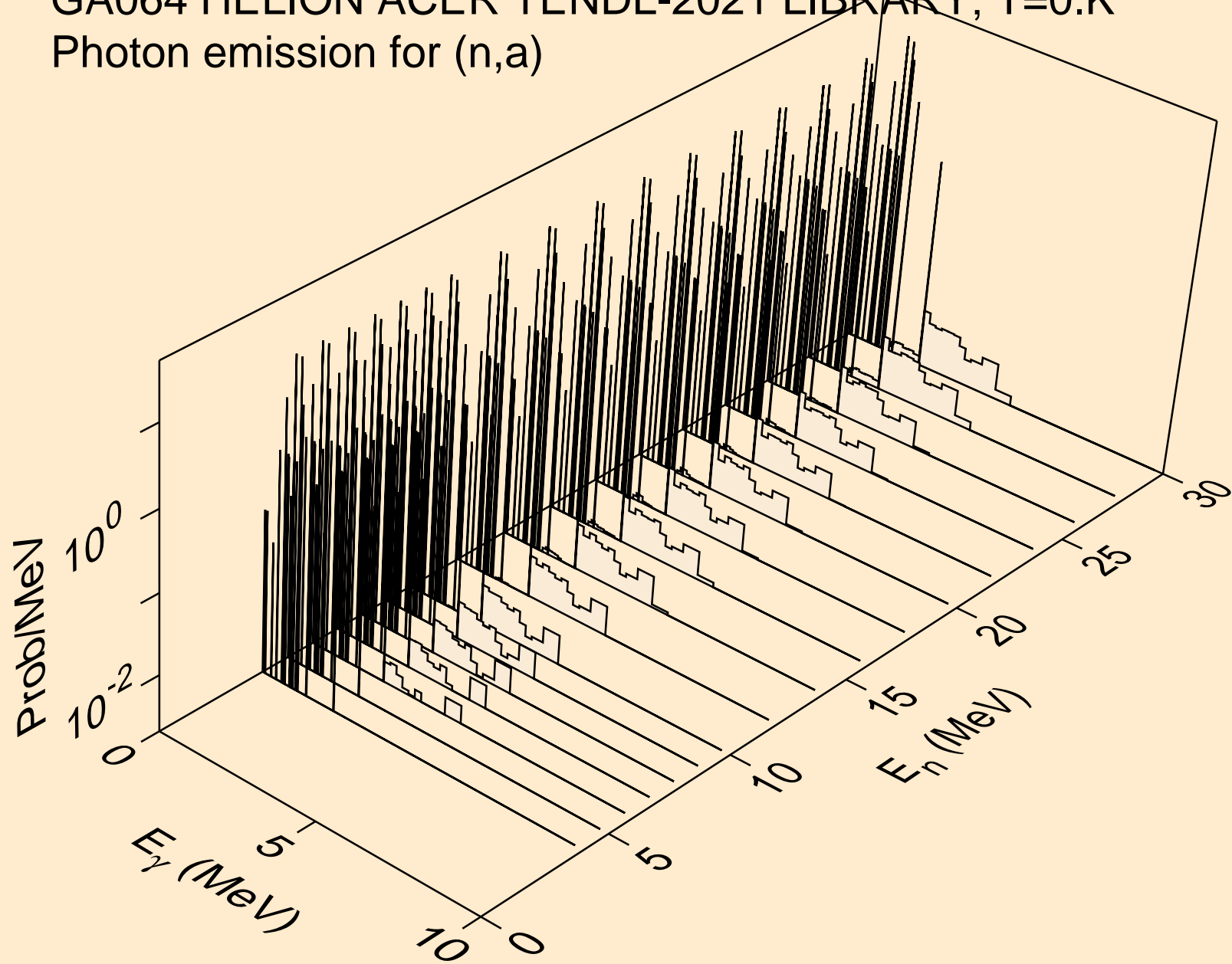

GA064 HELION ACER TENDL-2021 LIBRARY; T=0.K
Photon emission for (n,2a)

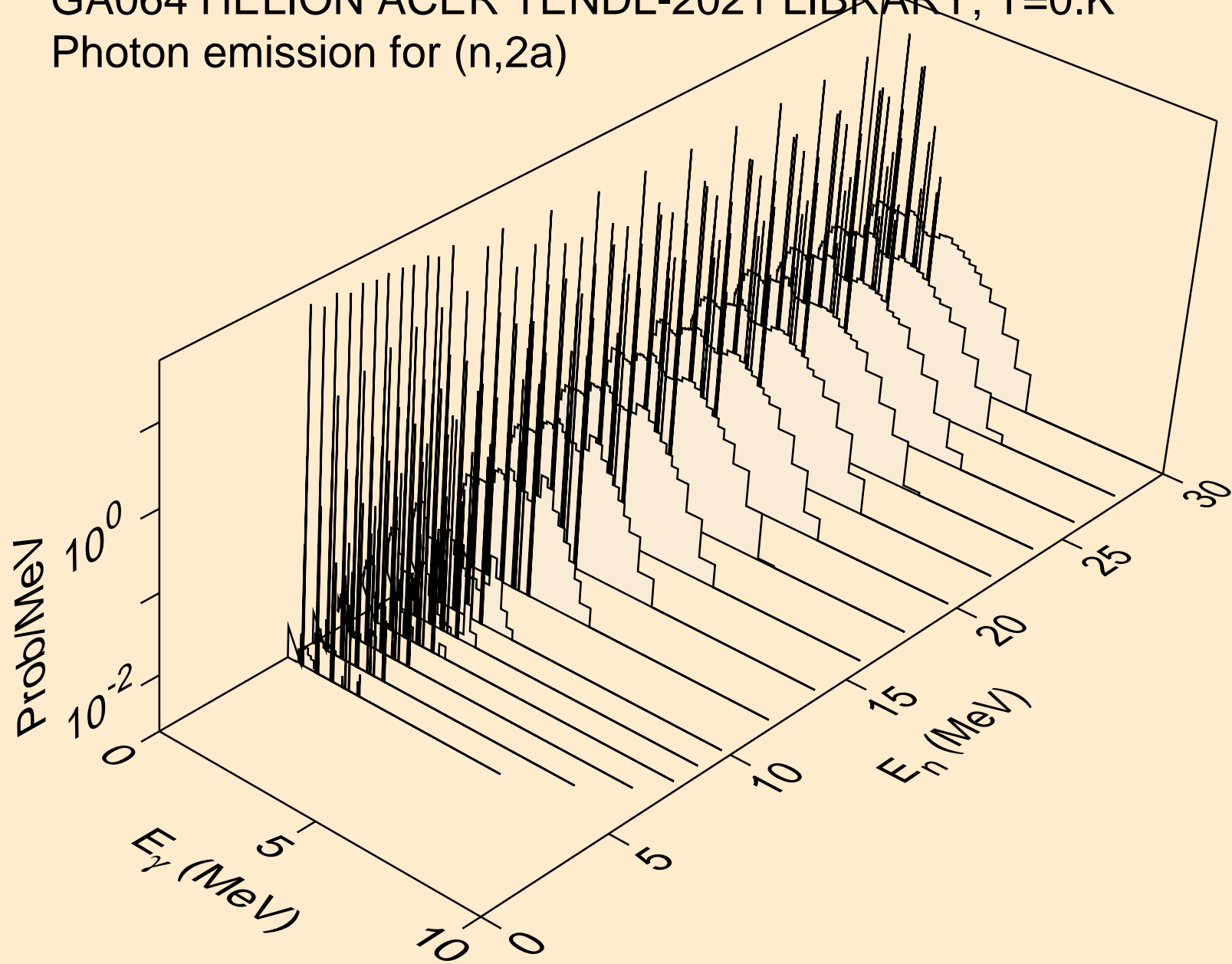

GA064 HELION ACER TENDL-2021 LIBRARY; T=0.K
Photon emission for (n,3a)

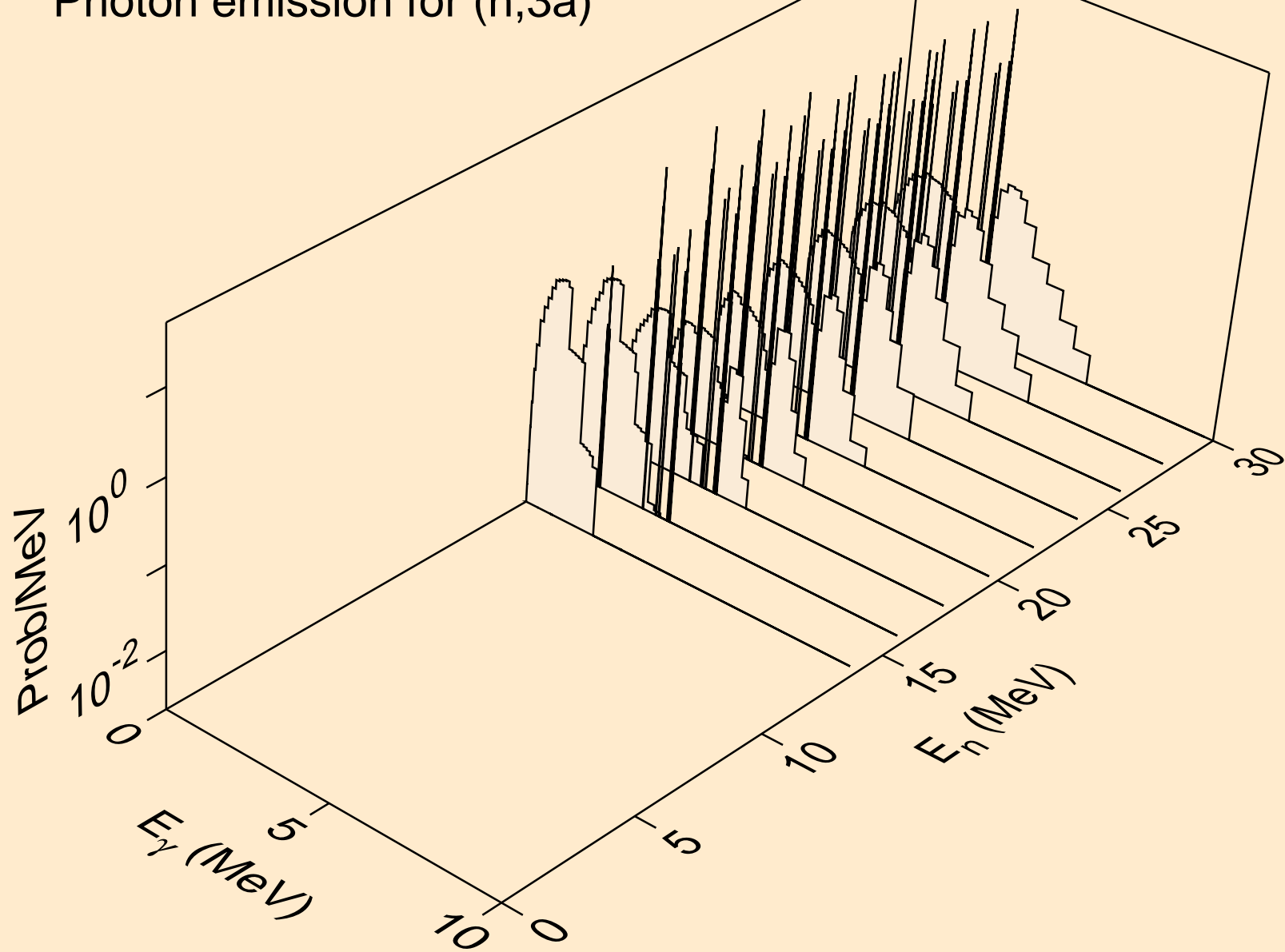

GA064 HELION ACER TENDL-2021 LIBRARY; T=0.K
Photon emission for (n,2p)

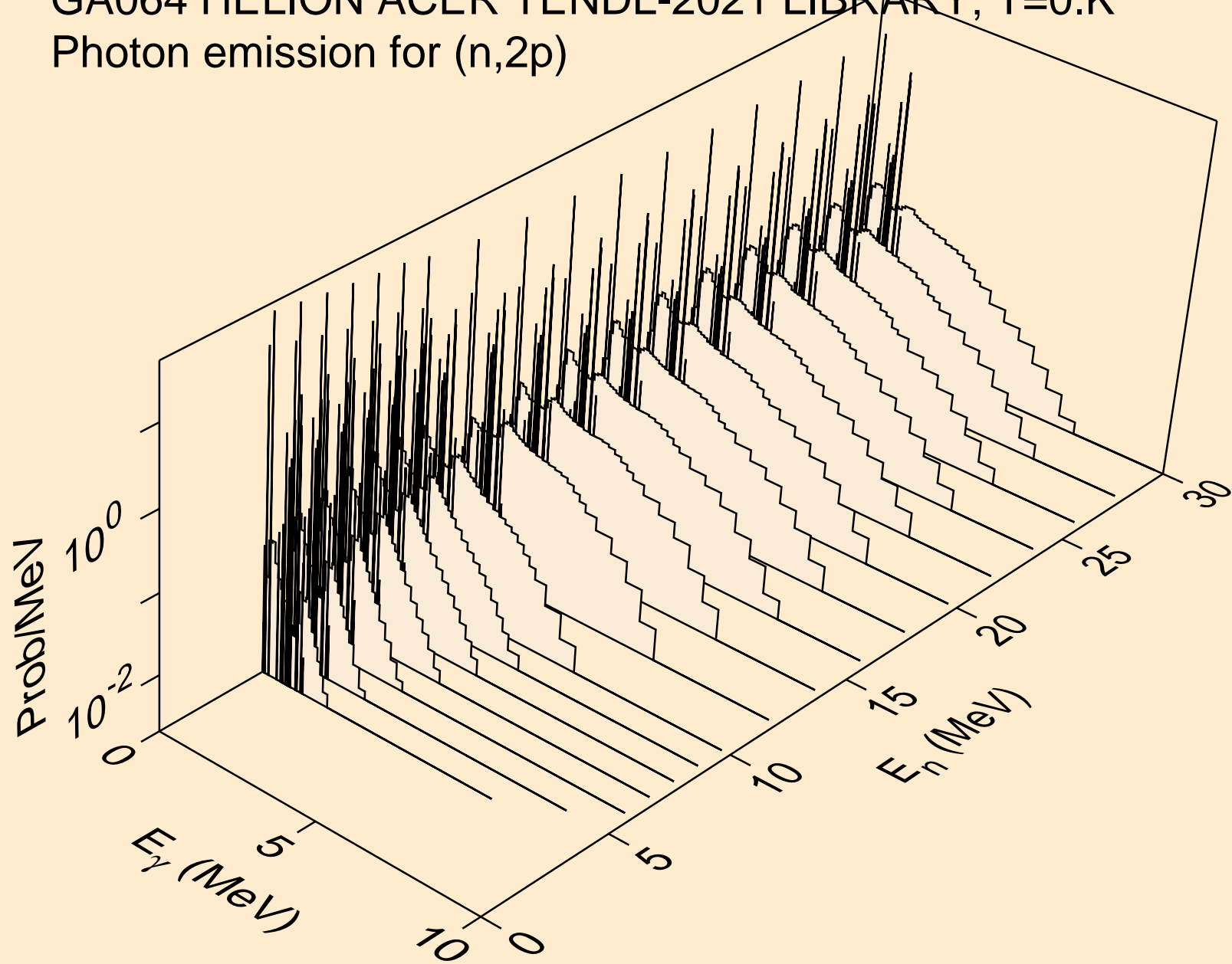

GA064 HELION ACER TENDL-2021 LIBRARY; T=0.K
Photon emission for (n,p α)

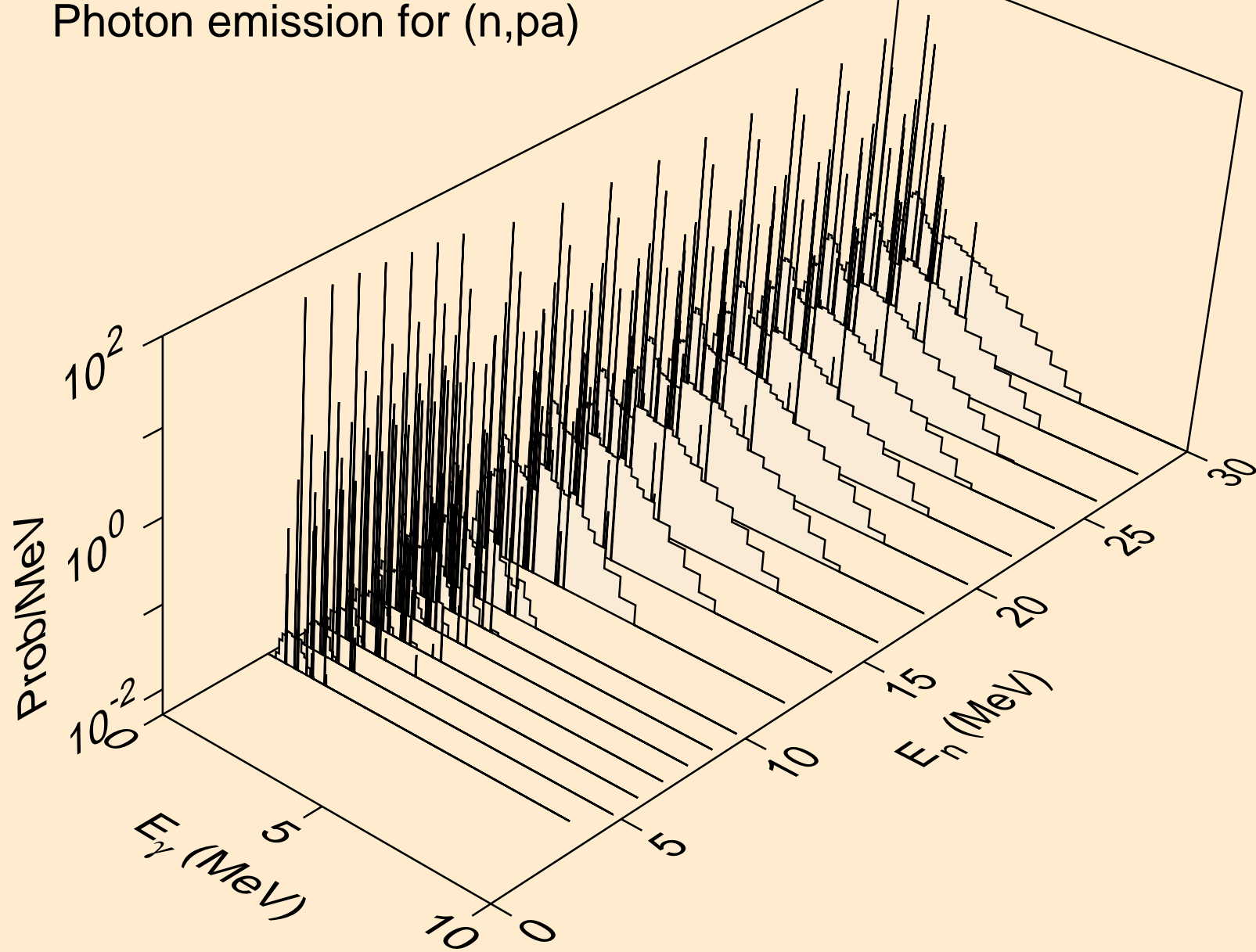

GA064 HELION ACER TENDL-2021 LIBRARY; T=0.K
Photon emission for (n,t2a)

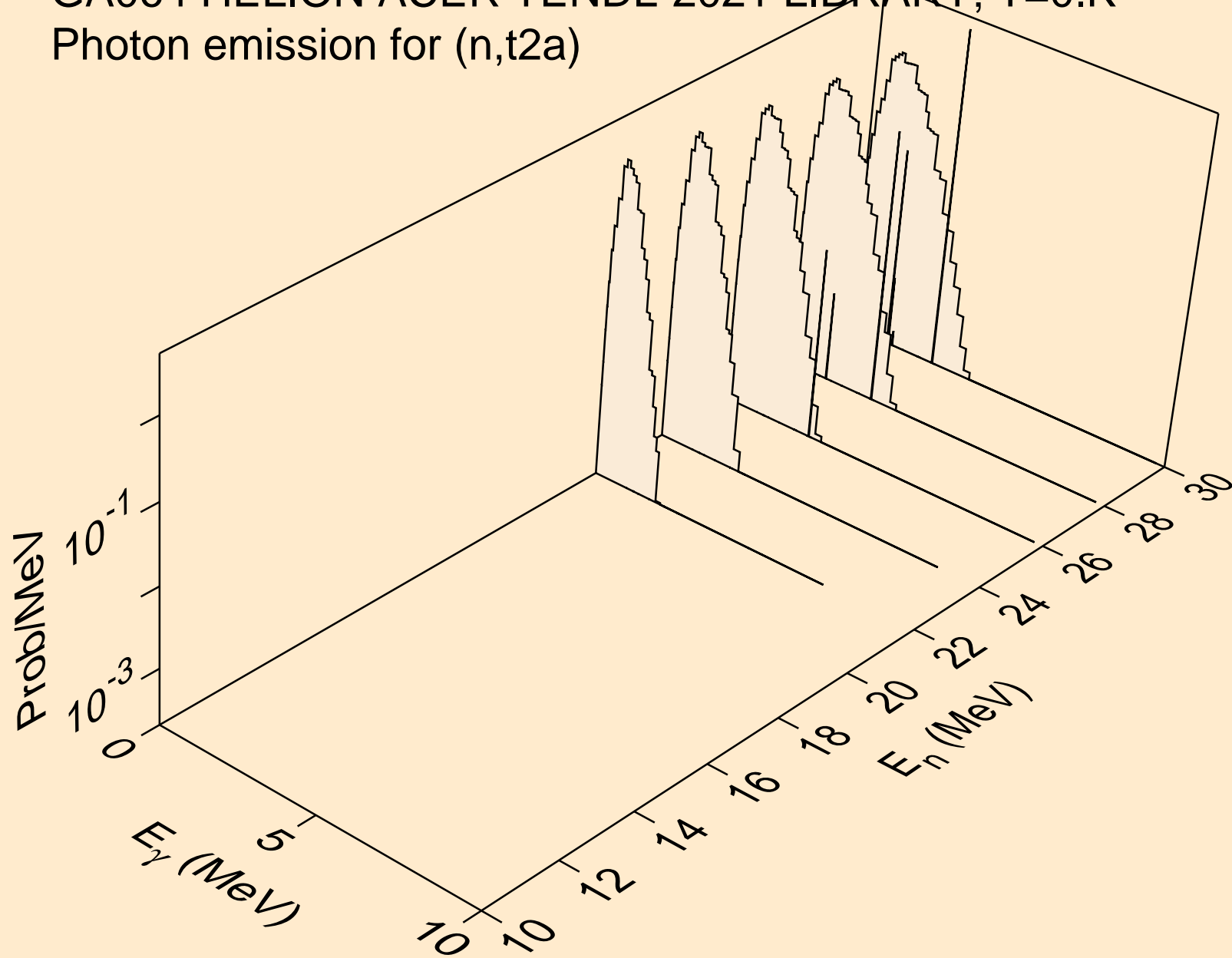

GA064 HELION ACER TENDL-2021 LIBRARY; T=0.K
Photon emission for (n,d2a)

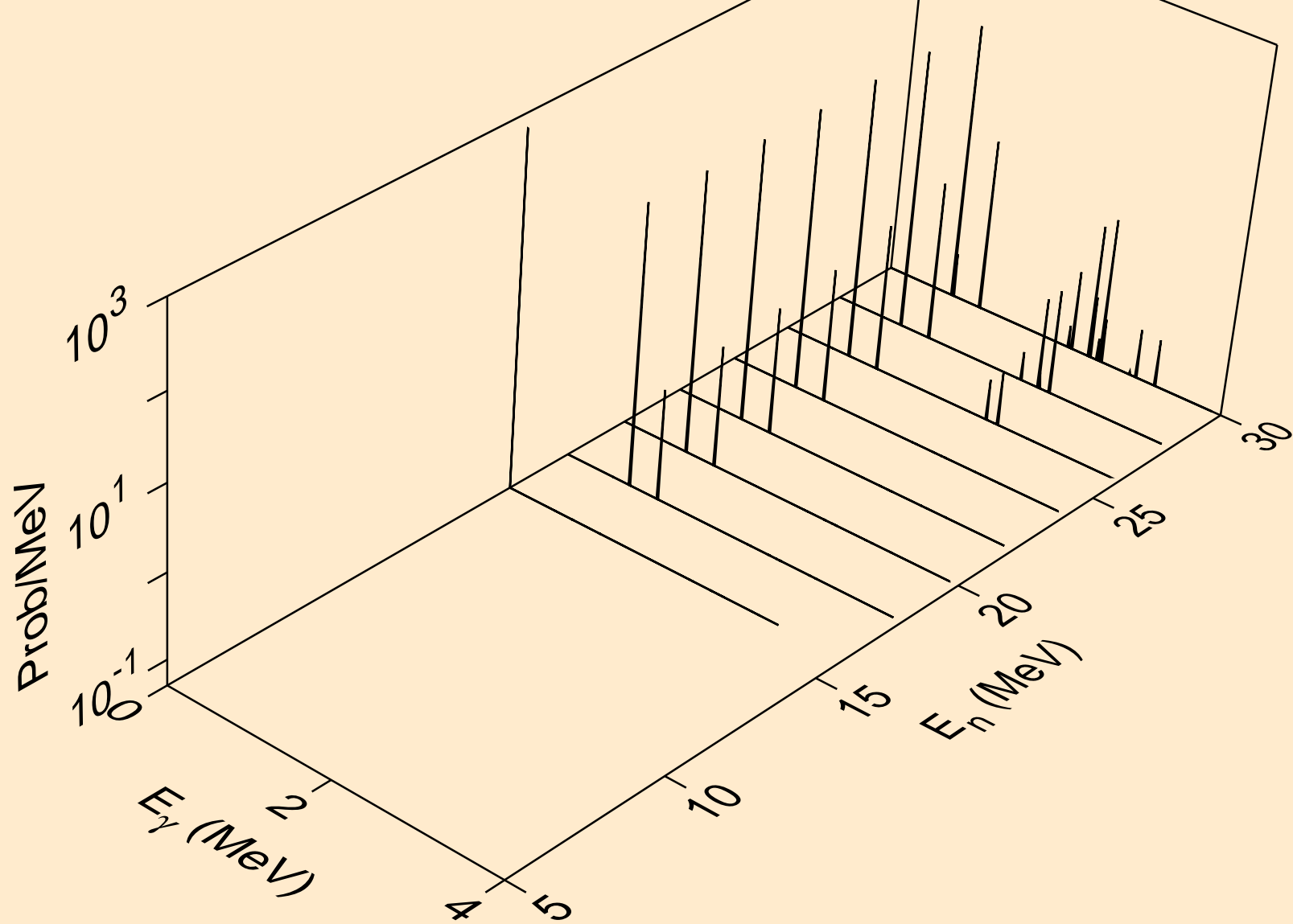

GA064 HELION ACER TENDL-2021 LIBRARY; T=0.K
Photon emission for (n,pd)

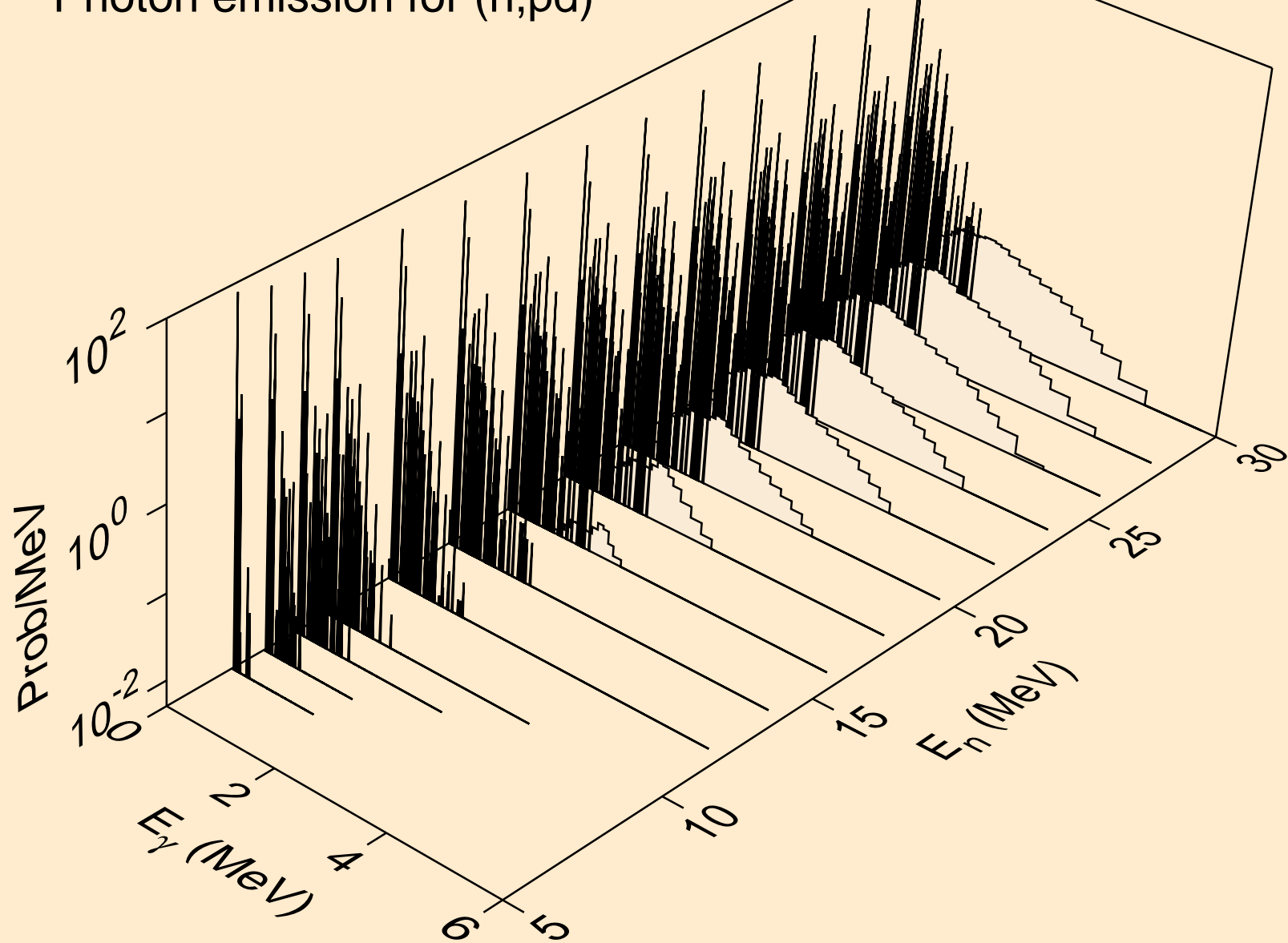

GA064 HELION ACER TENDL-2021 LIBRARY; T=0.K
Photon emission for (n,pt)

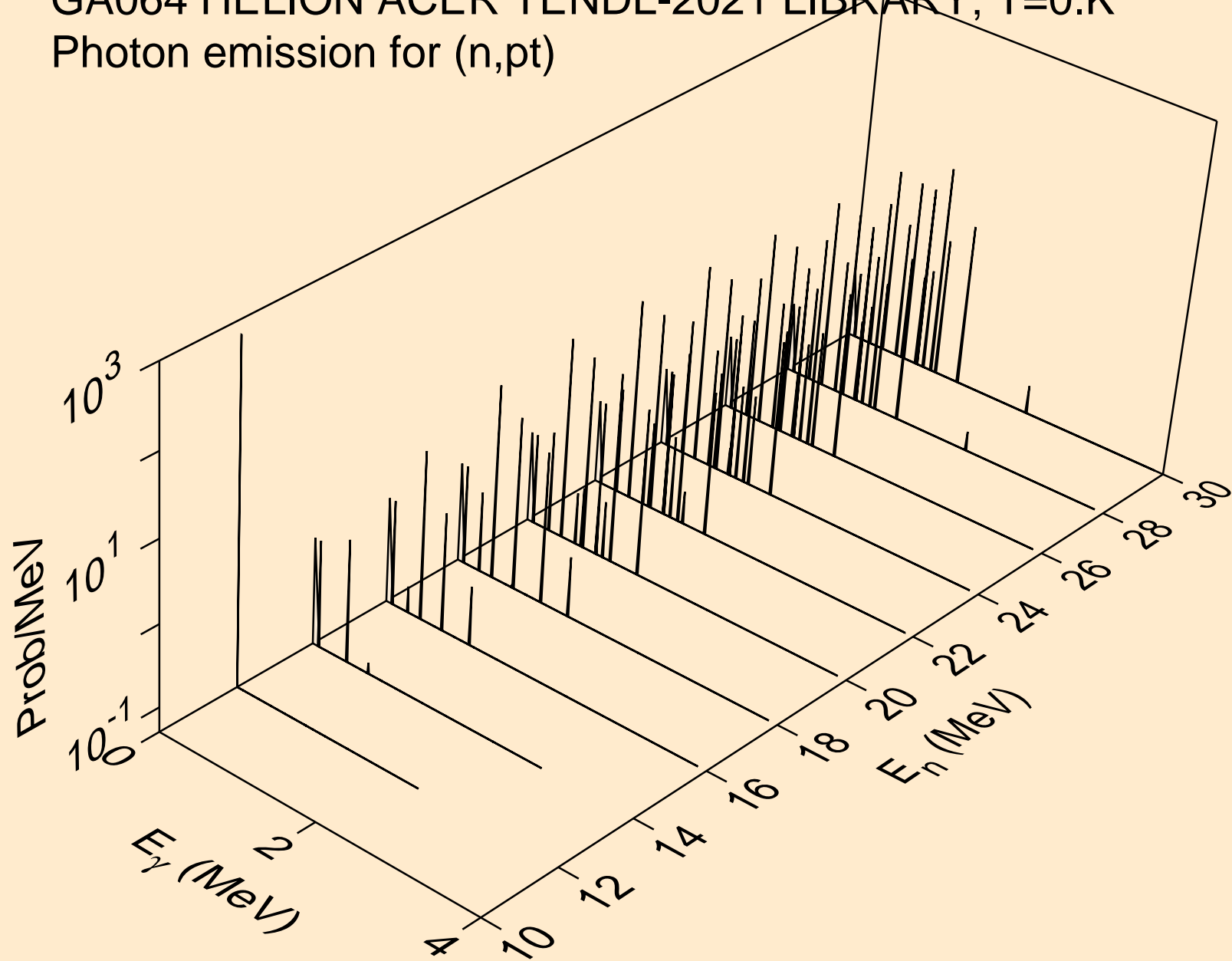

GA064 HELION ACER TENDL-2021 LIBRARY; T=0.K
Photon emission for (n,da)

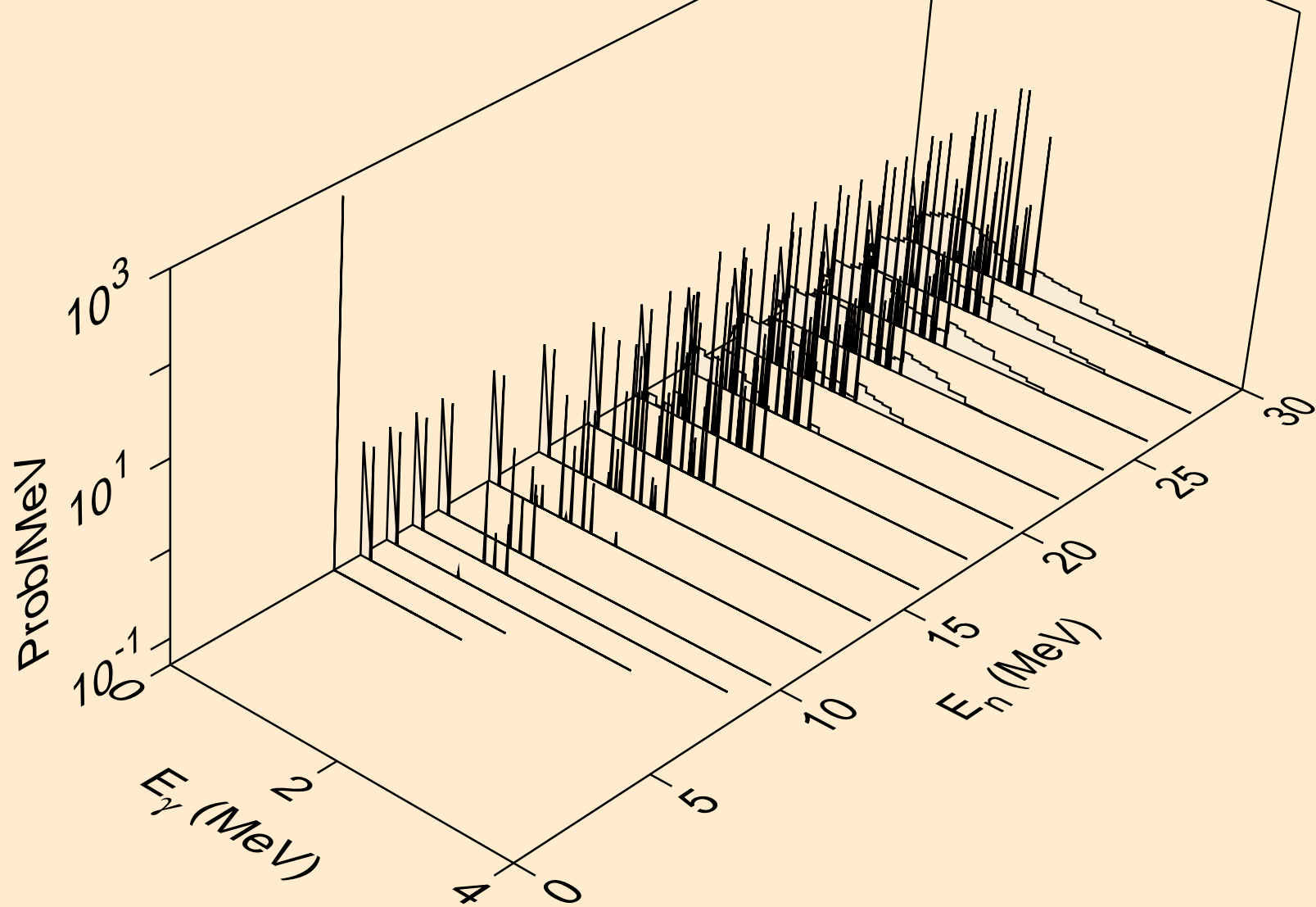

GA064 HELION ACER TENDL-2021 LIBRARY; T=0.K

Particle heating contributions

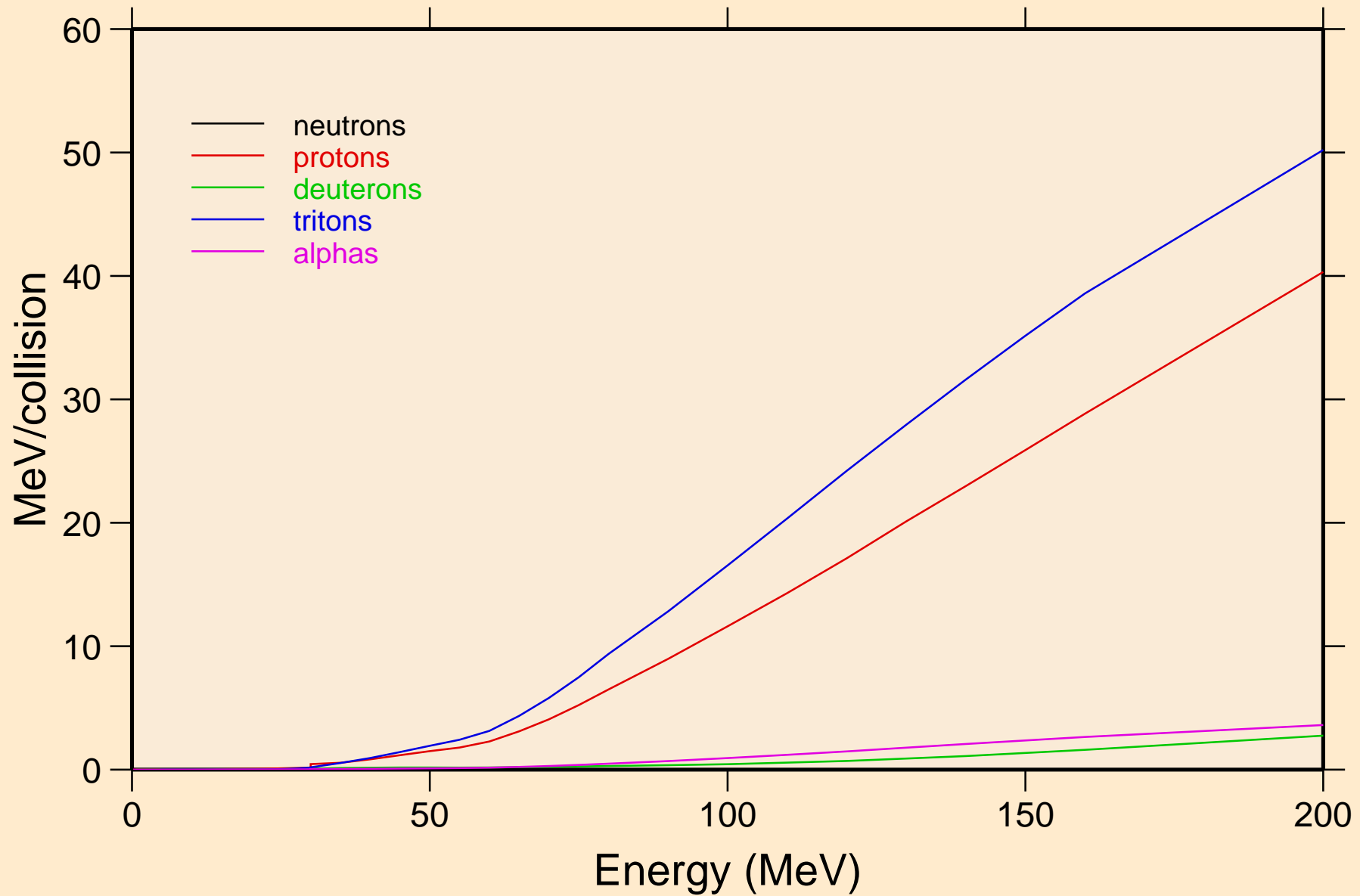

GA064 HELION ACER TENDL-2021 LIBRARY; T=0.K
Recoil Heating

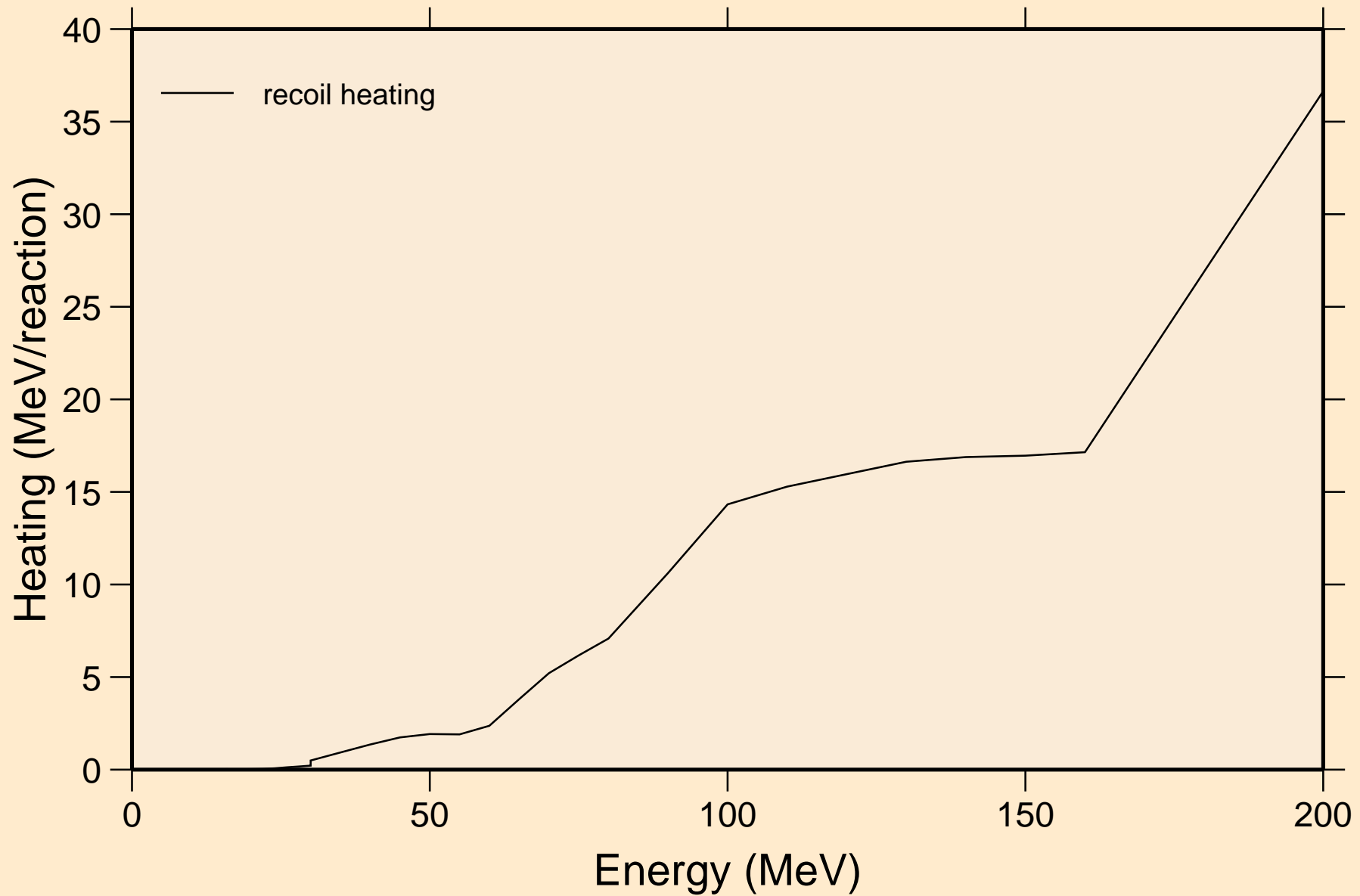

GA064 HELION ACER TENDL-2021 LIBRARY; T=0.K
Particle production cross sections

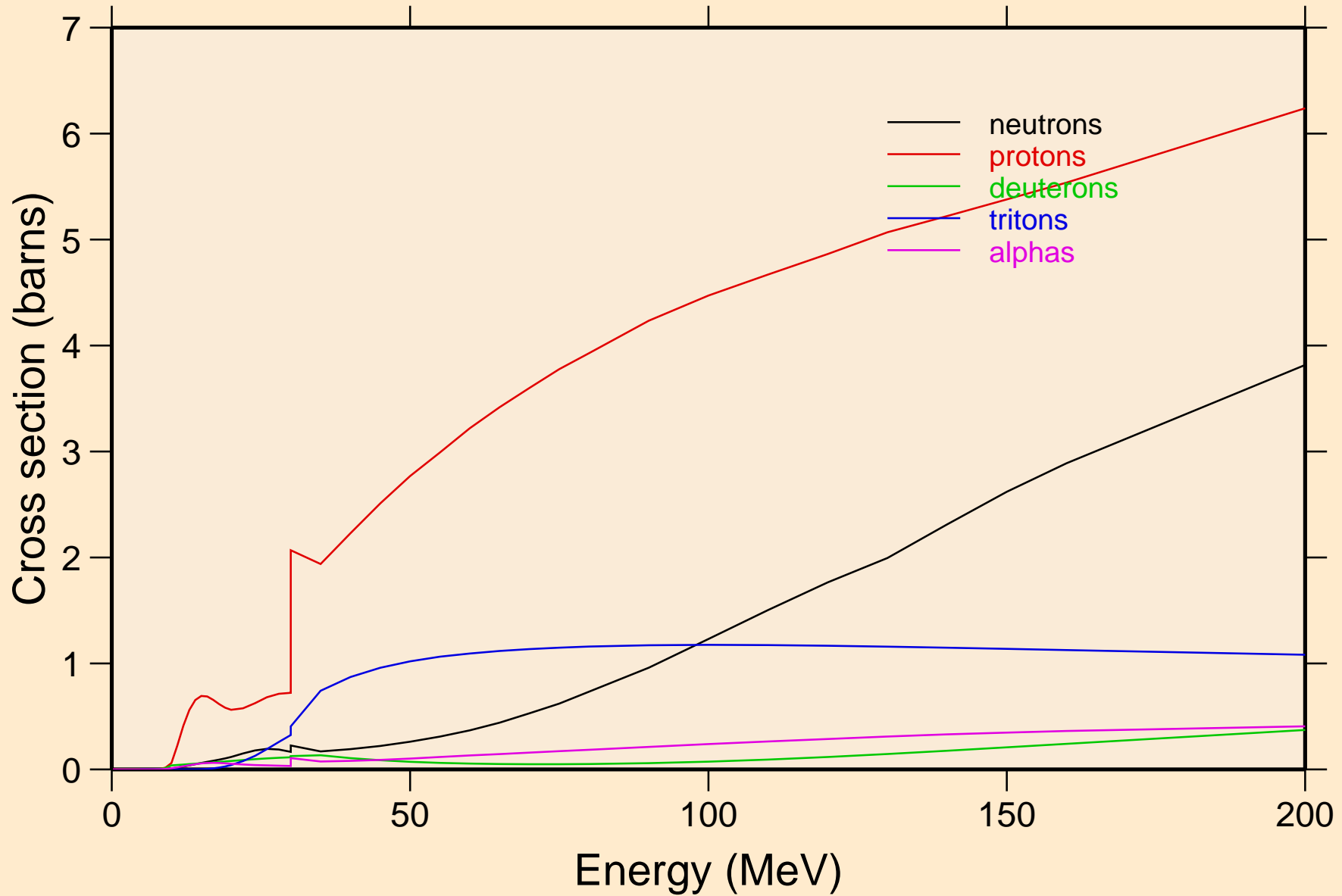

GA064 HELION ACER TENDL-2021 LIBRARY; T=0.K
neutrons from (s,n)

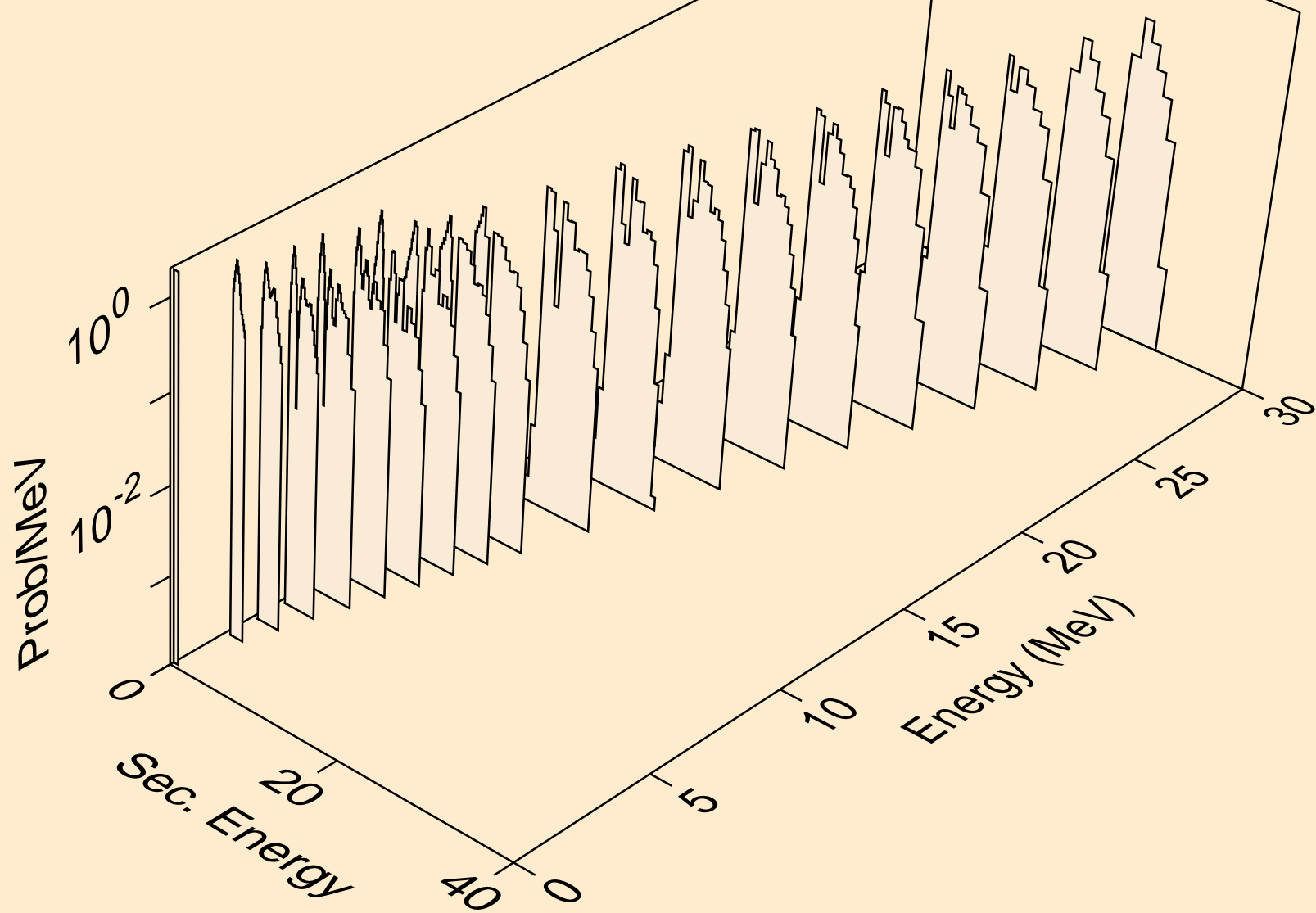

GA064 HELION ACER TENDL-2021 LIBRARY; T=0.K
neutrons from (s,x)

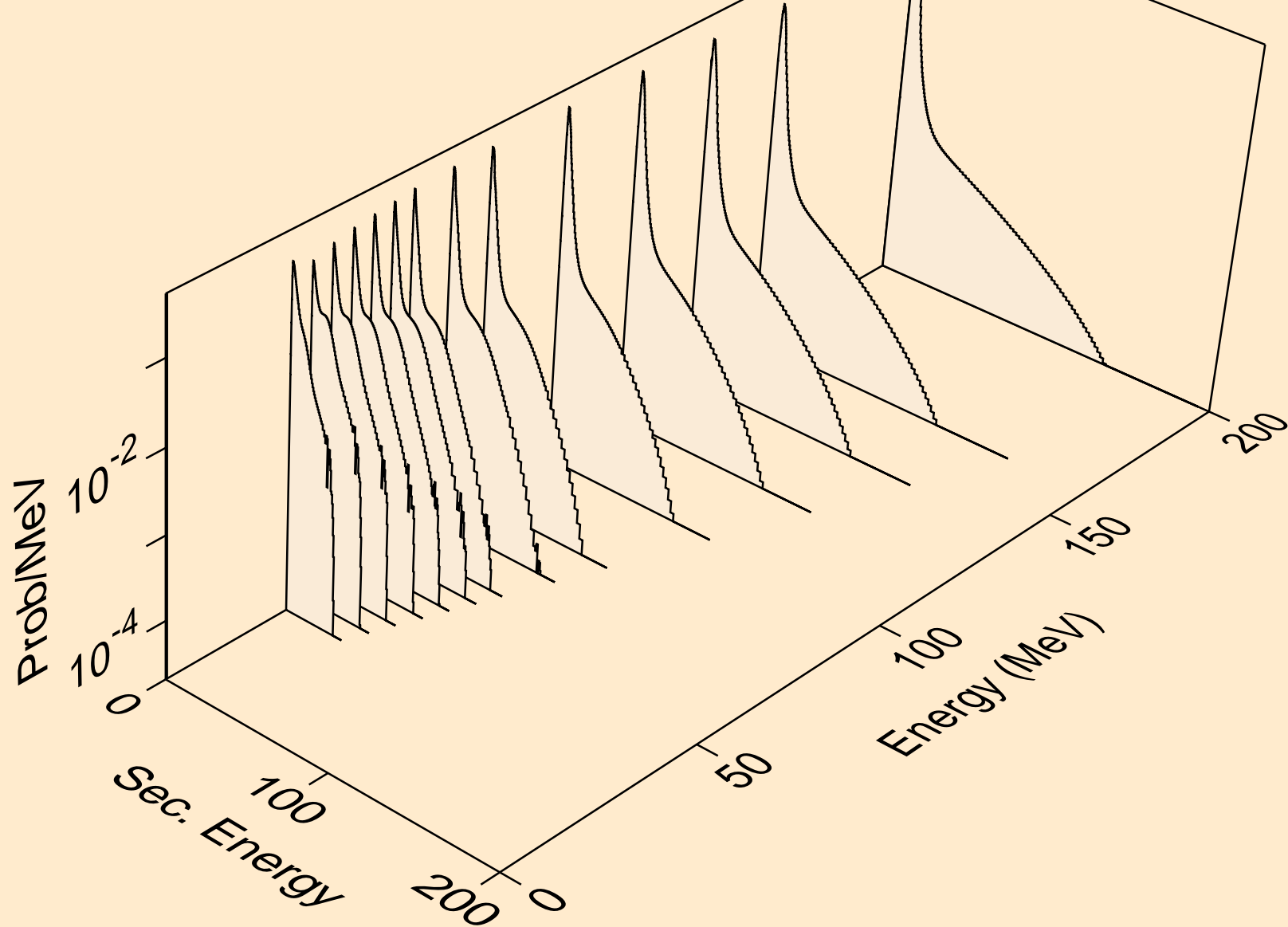

GA064 HELION ACER TENDL-2021 LIBRARY; T=0.K
neutrons from (s,2n)

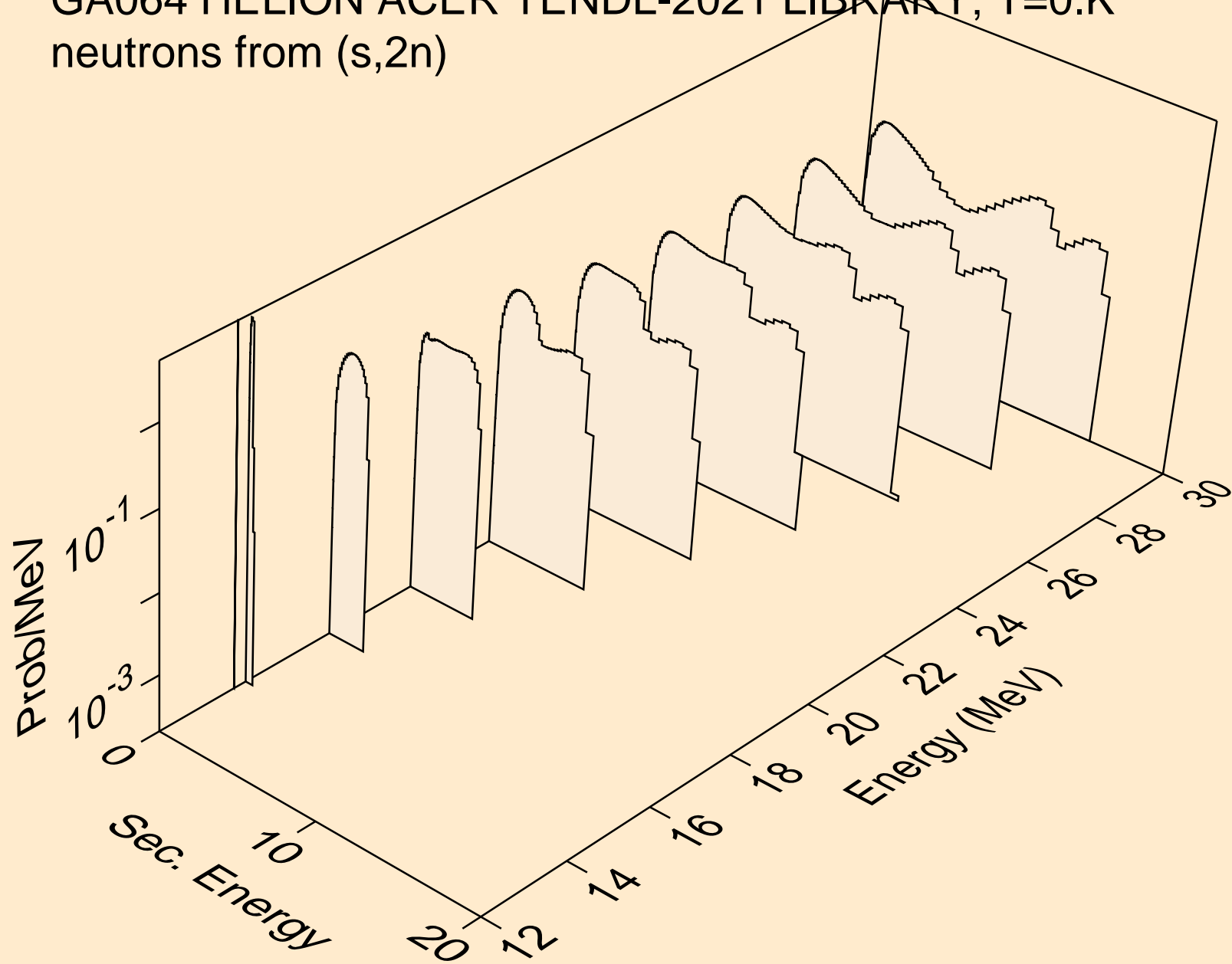

GA064 HELION ACER TENDL-2021 LIBRARY; T=0.K
neutrons from (s,n*)a

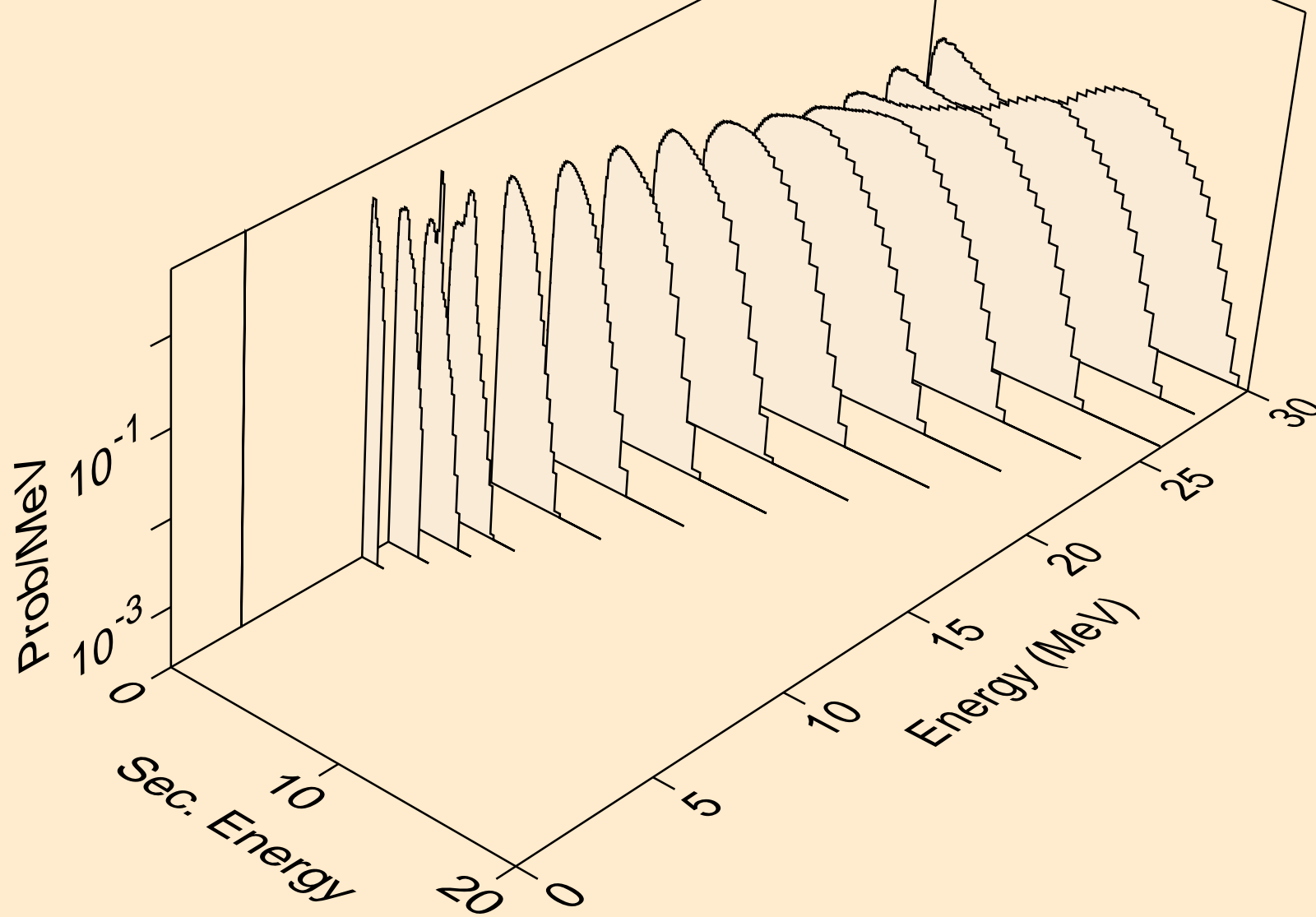

GA064 HELION ACER TENDL-2021 LIBRARY; T=0.K
neutrons from (s,2n)a

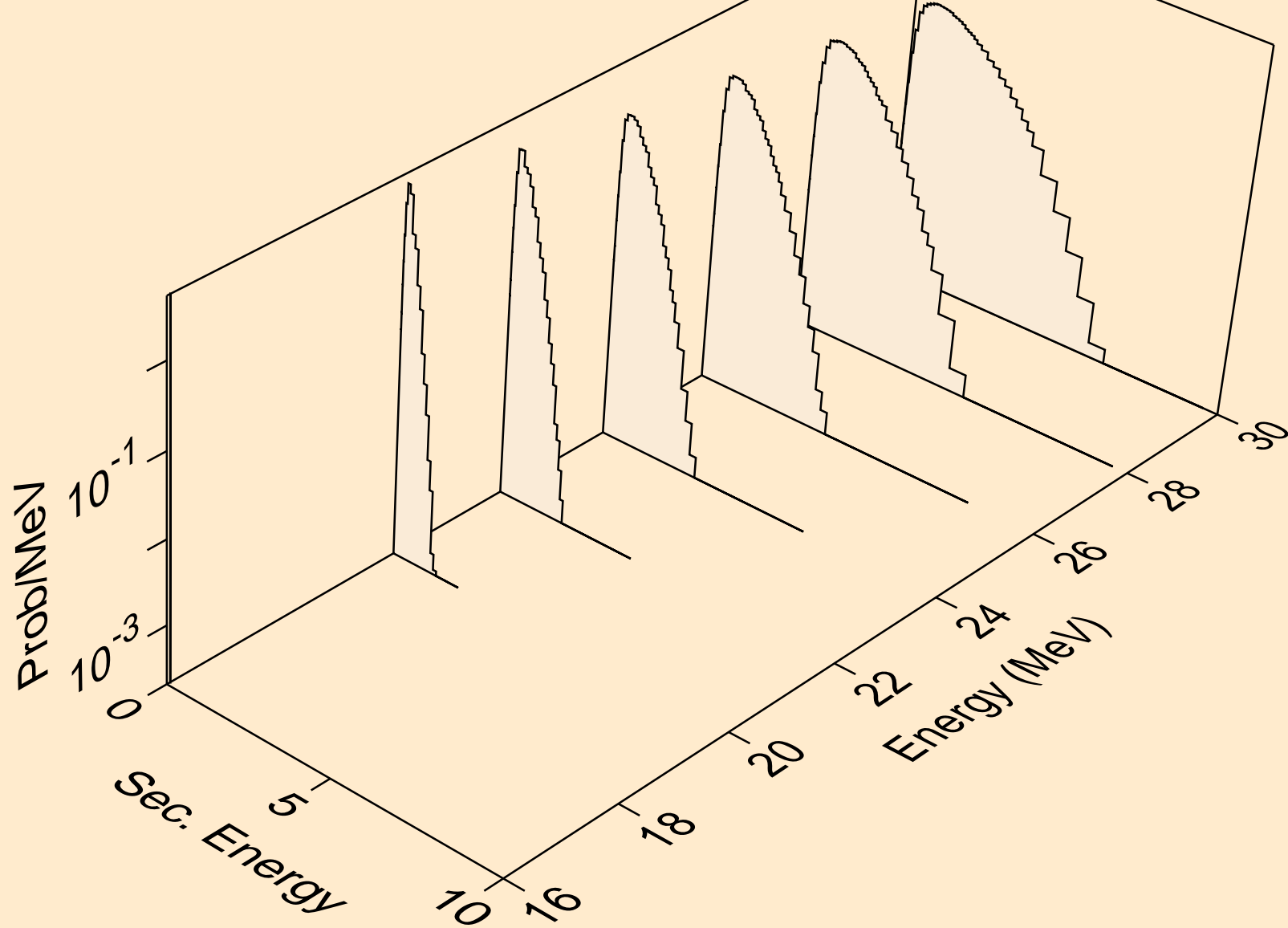

GA064 HELION ACER TENDL-2021 LIBRARY; T=0.K
neutrons from (s,n*)p

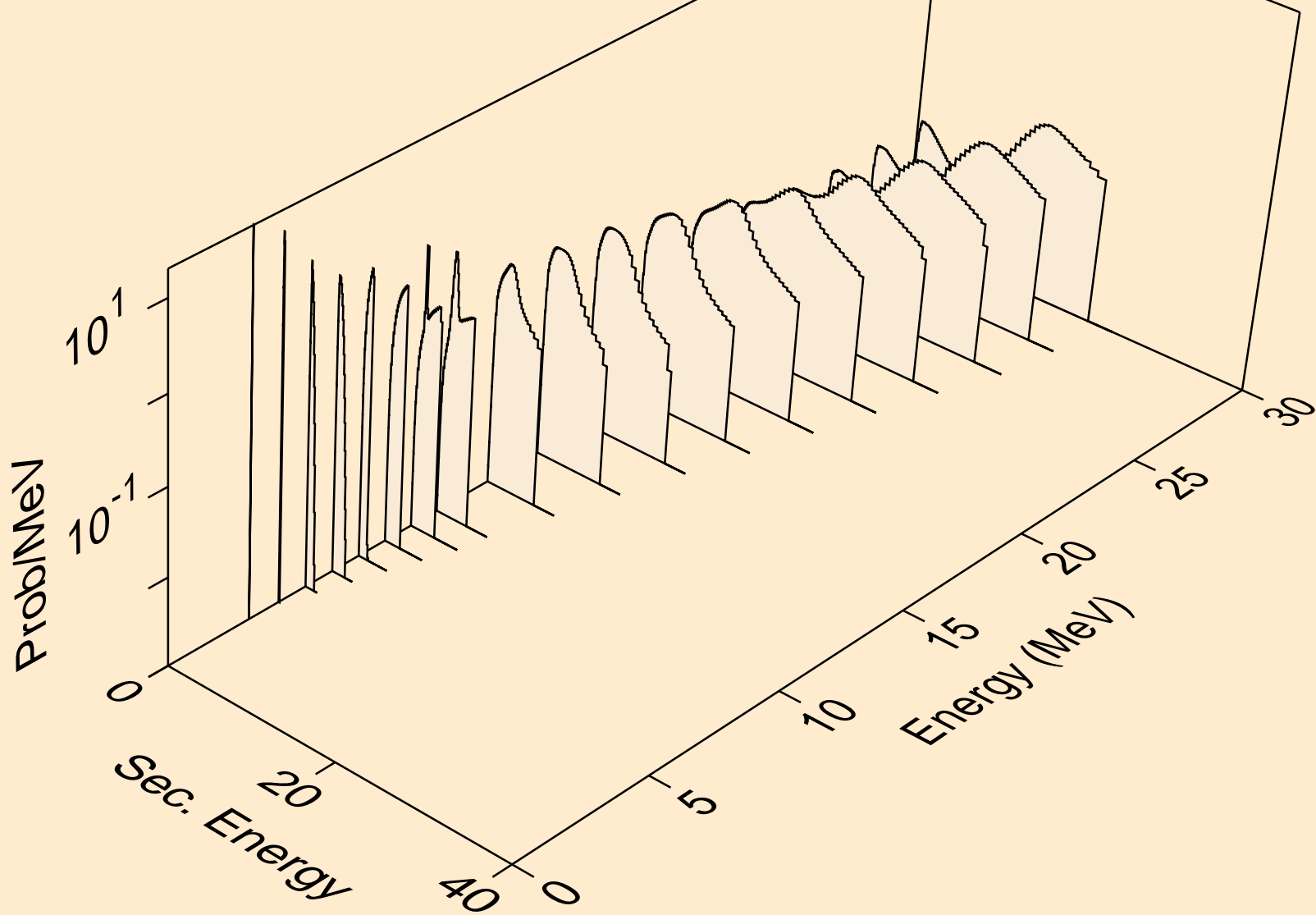

GA064 HELION ACER TENDL-2021 LIBRARY; T=0.K
neutrons from (s,n*)2a

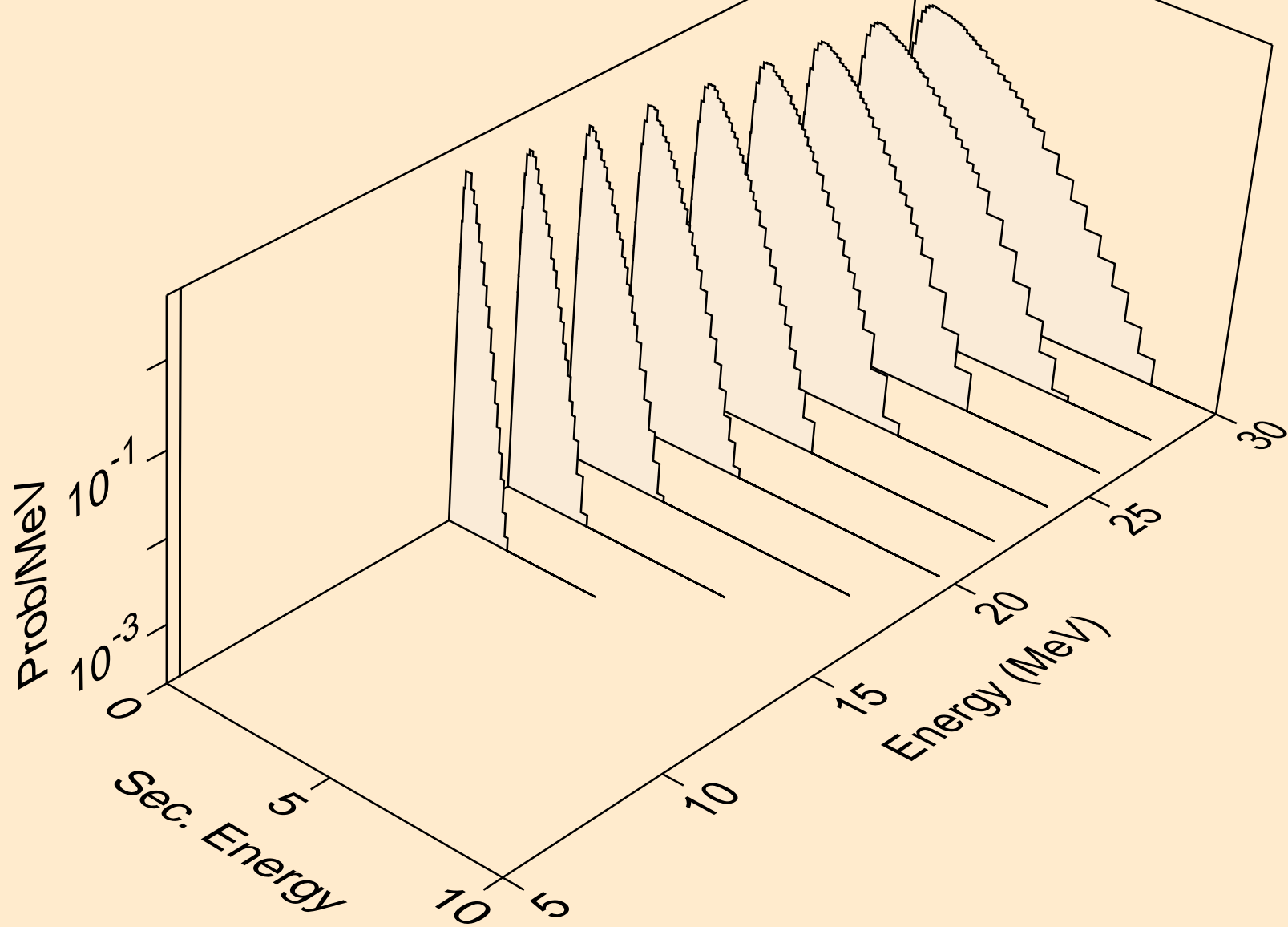

GA064 HELION ACER TENDL-2021 LIBRARY; T=0.K
neutrons from (s,n*)d

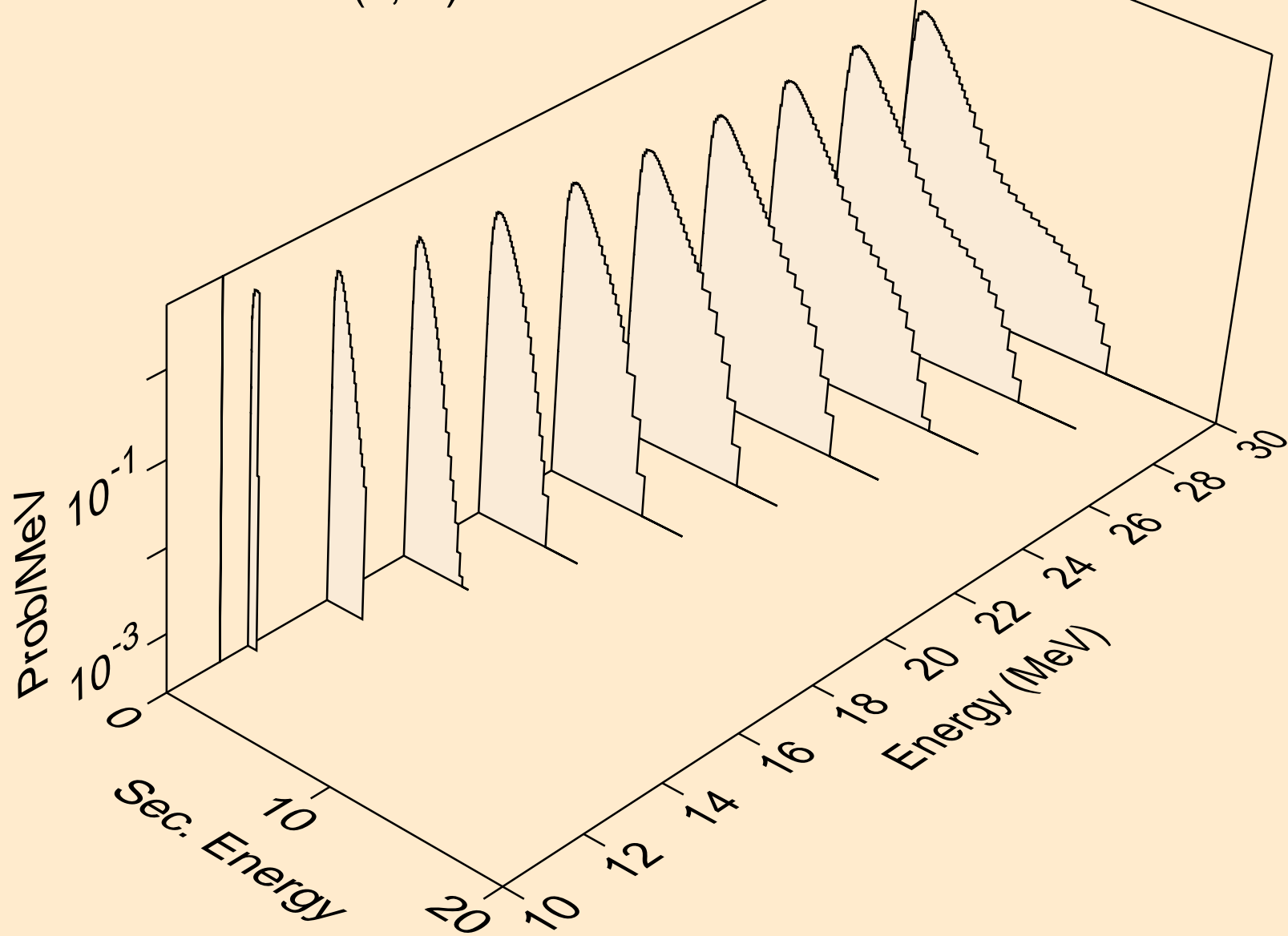

GA064 HELION ACER TENDL-2021 LIBRARY; T=0.K
neutrons from (s,n*)t

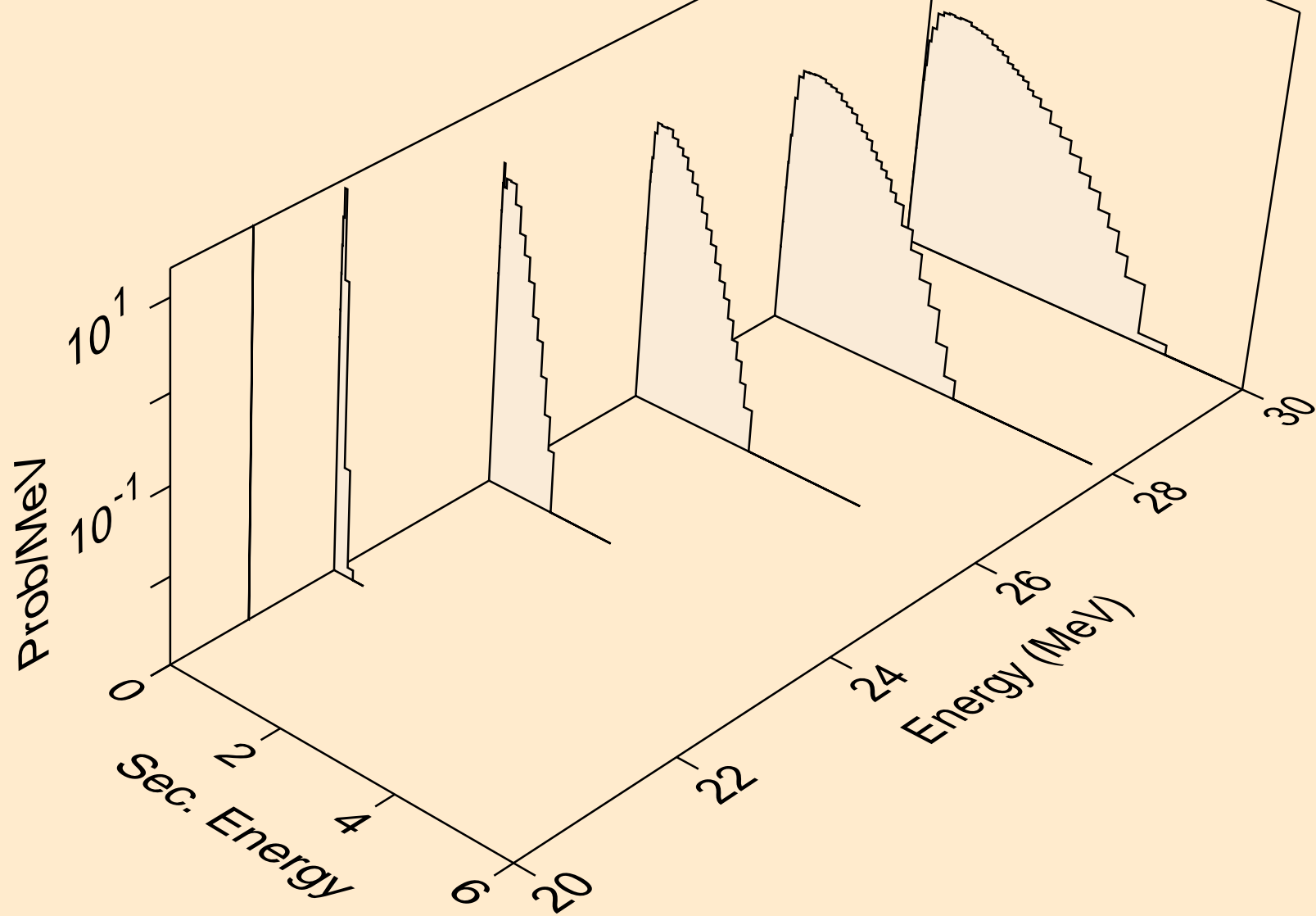

GA064 HELION ACER TENDL-2021 LIBRARY; T=0.K
neutrons from (s,n*)he3

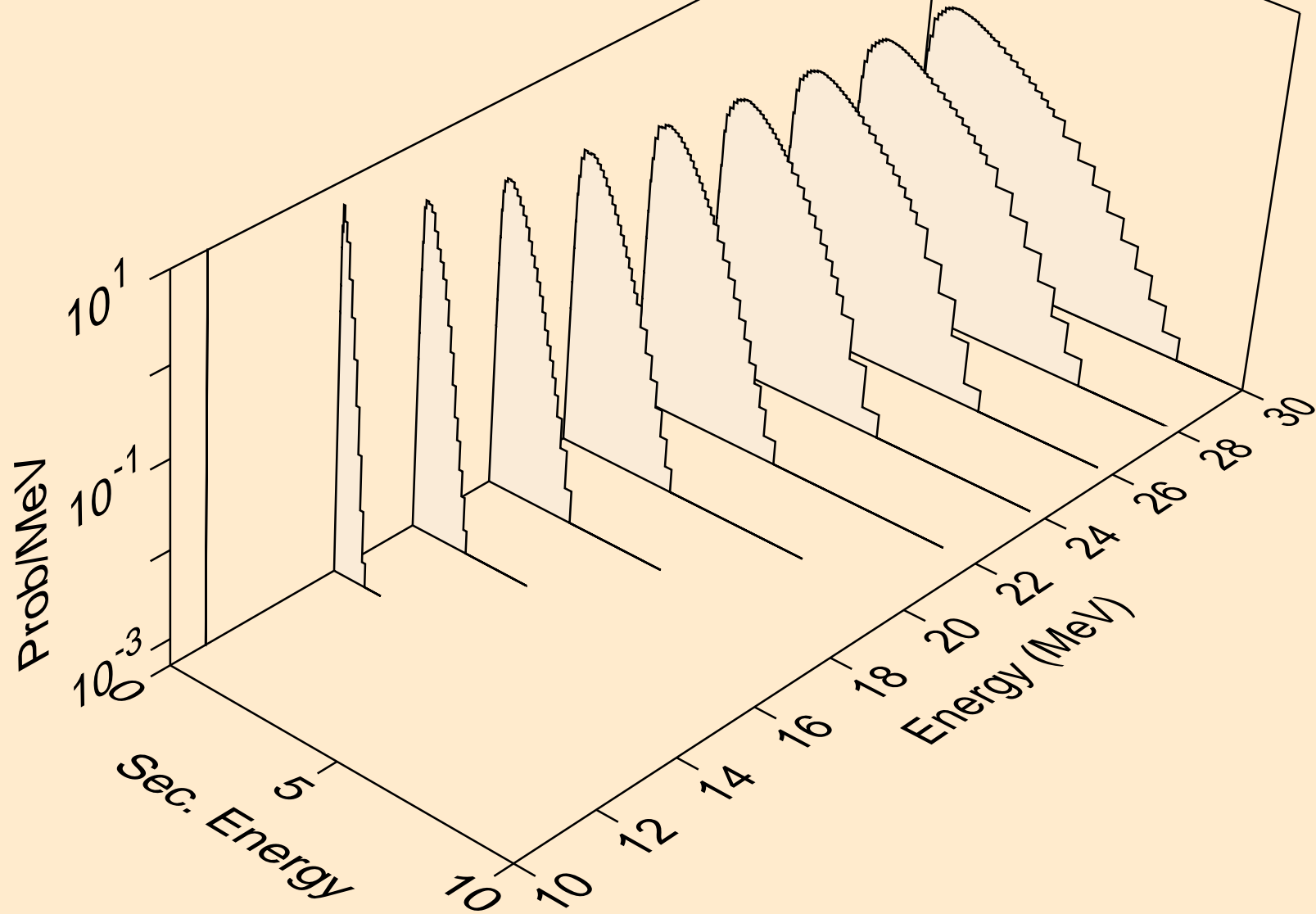

GA064 HELION ACER TENDL-2021 LIBRARY; T=0.K
neutrons from (s,2np)

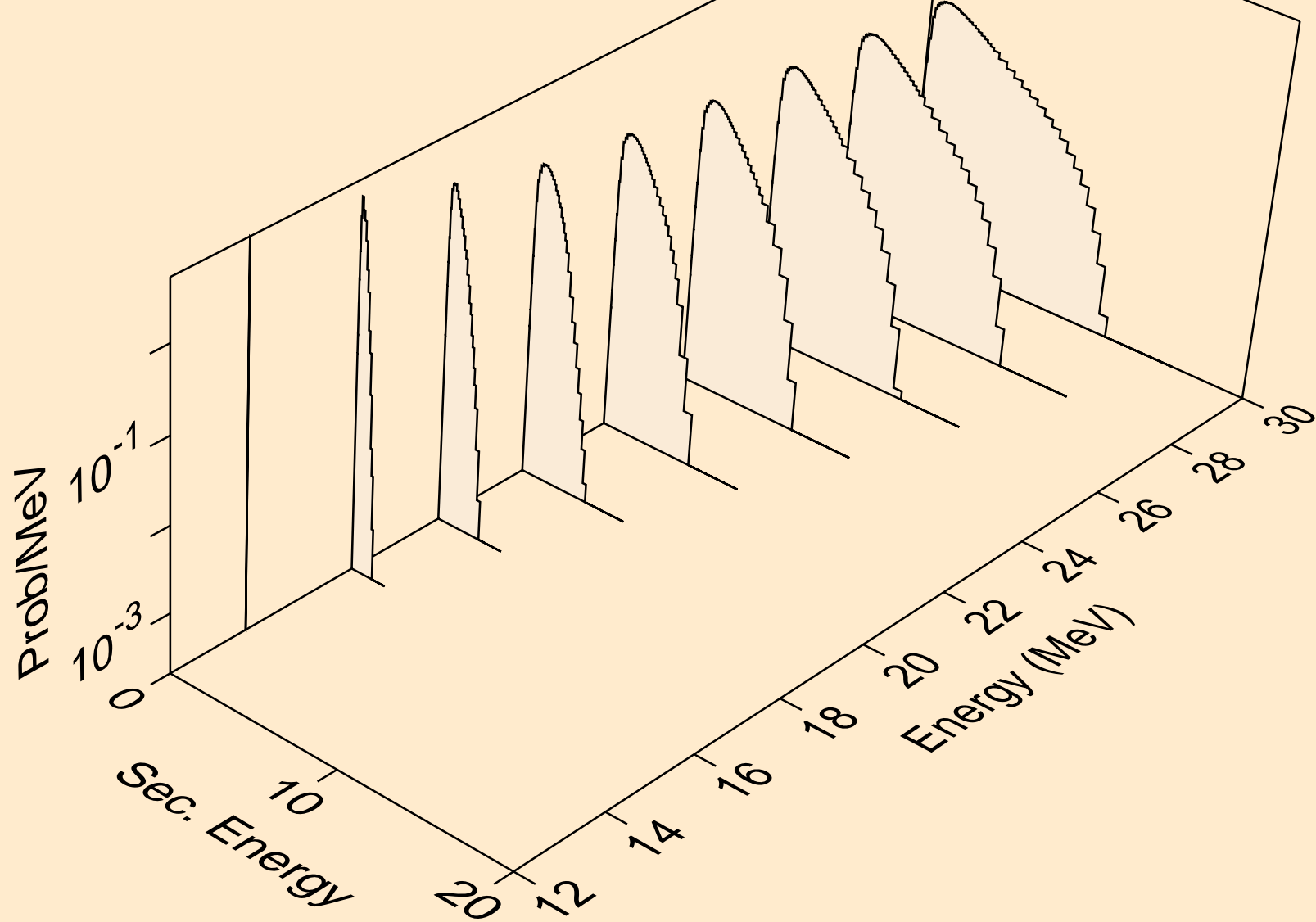

GA064 HELION ACER TENDL-2021 LIBRARY; T=0.K
neutrons from (s,2np)

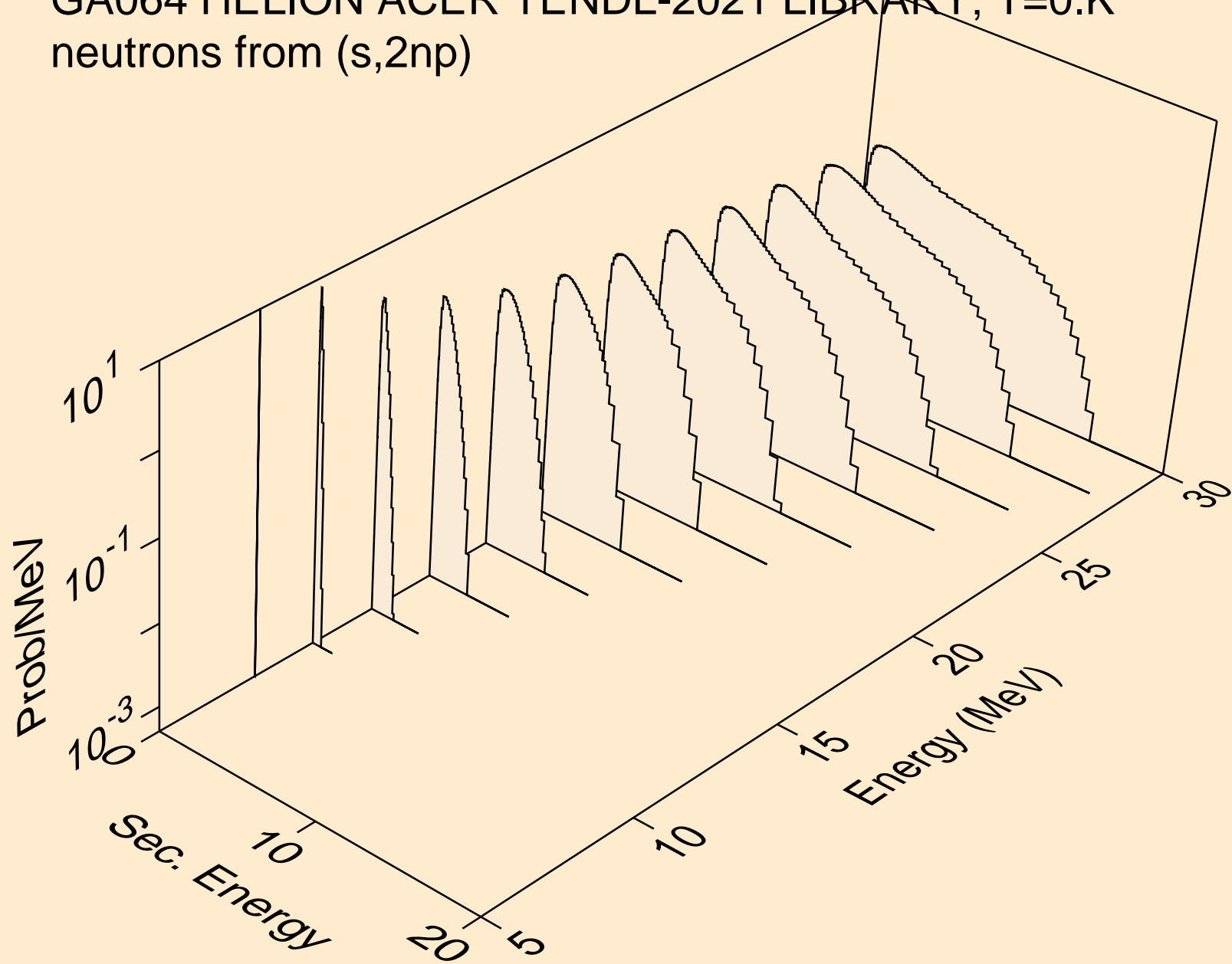

GA064 HELION ACER TENDL-2021 LIBRARY; T=0.K
neutrons from (s,npa)

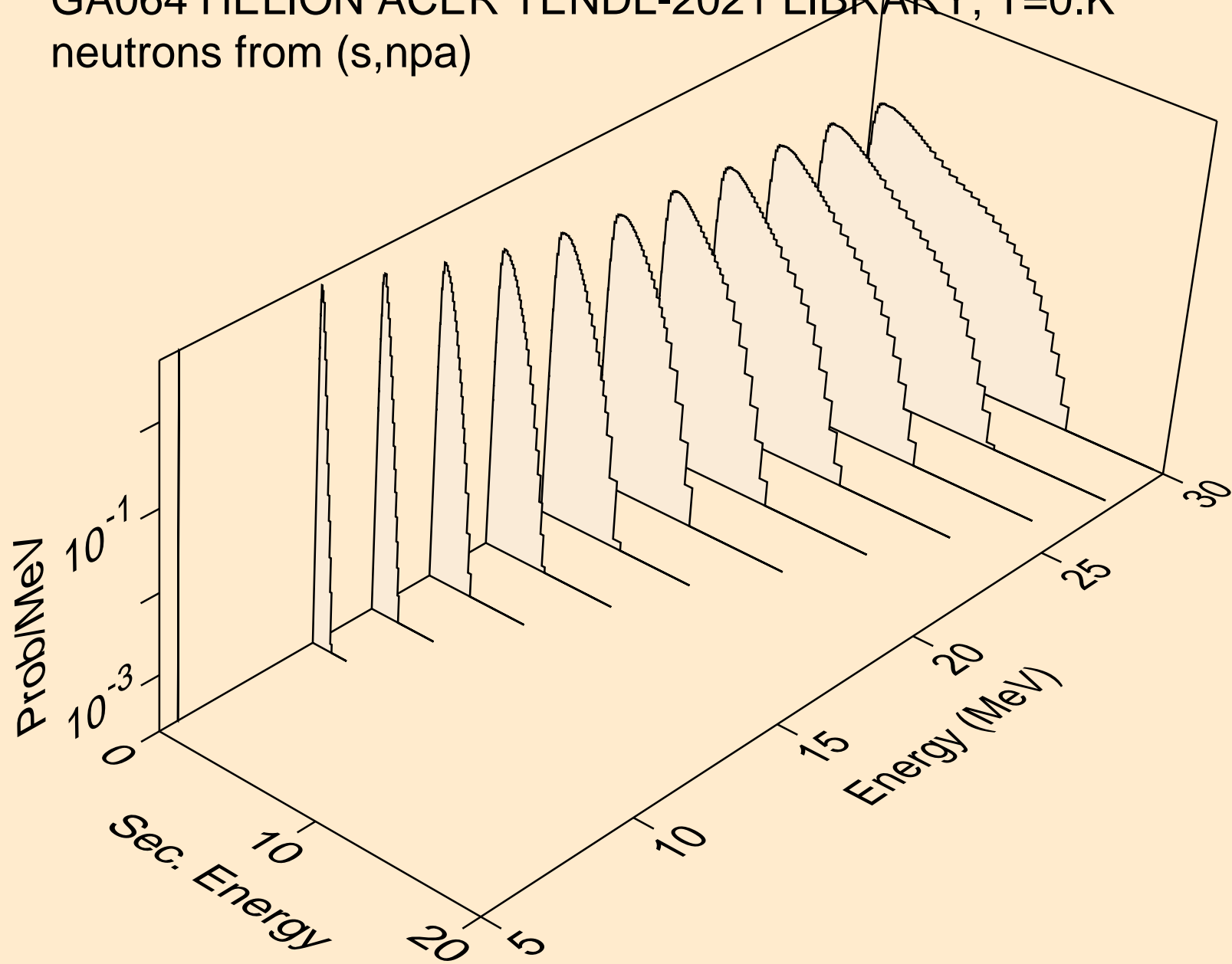

GA064 HELION ACER TENDL-2021 LIBRARY; T=0.K
protons from (s,x)

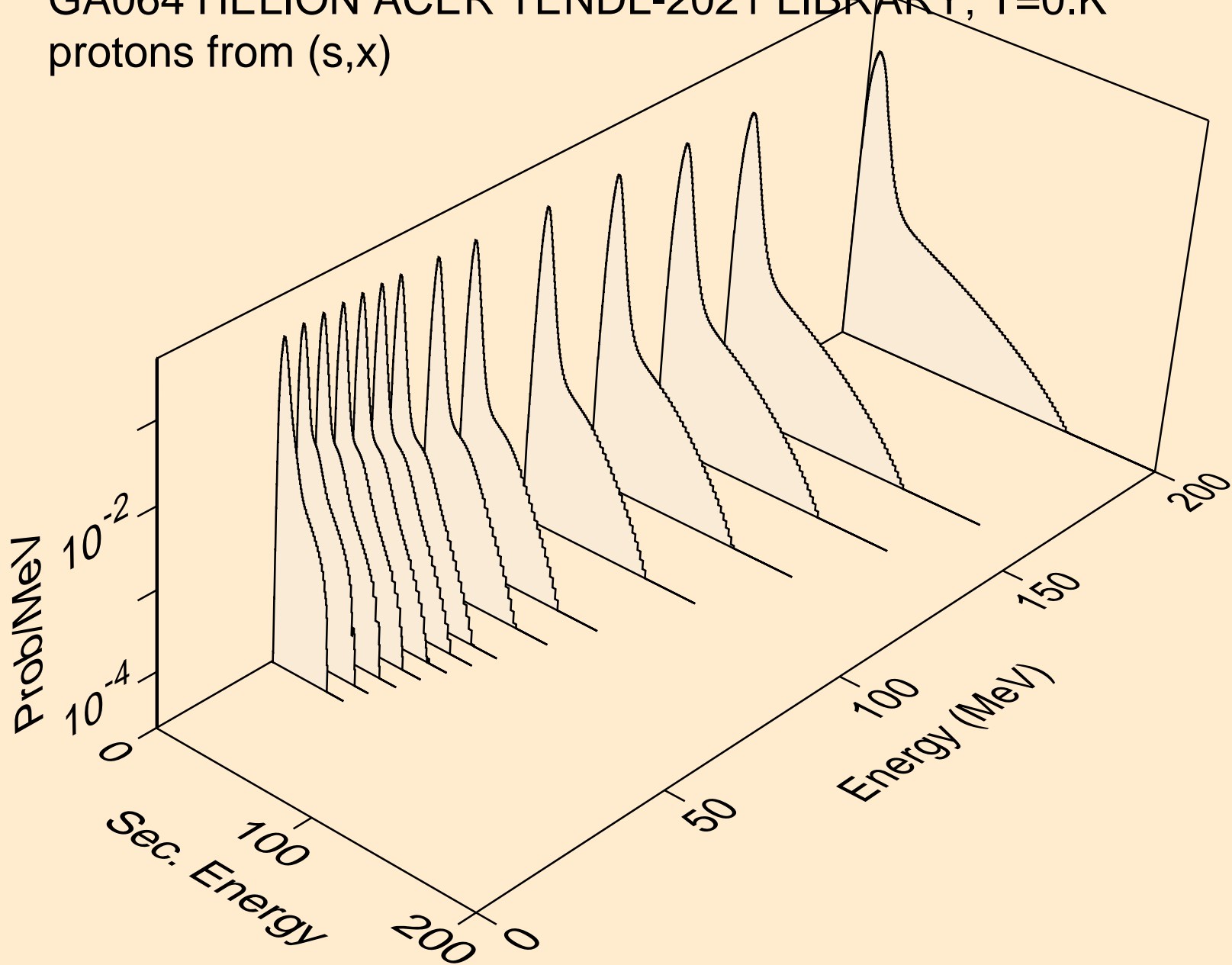

GA064 HELION ACER TENDL-2021 LIBRARY; T=0.K
protons from (s,n*)p

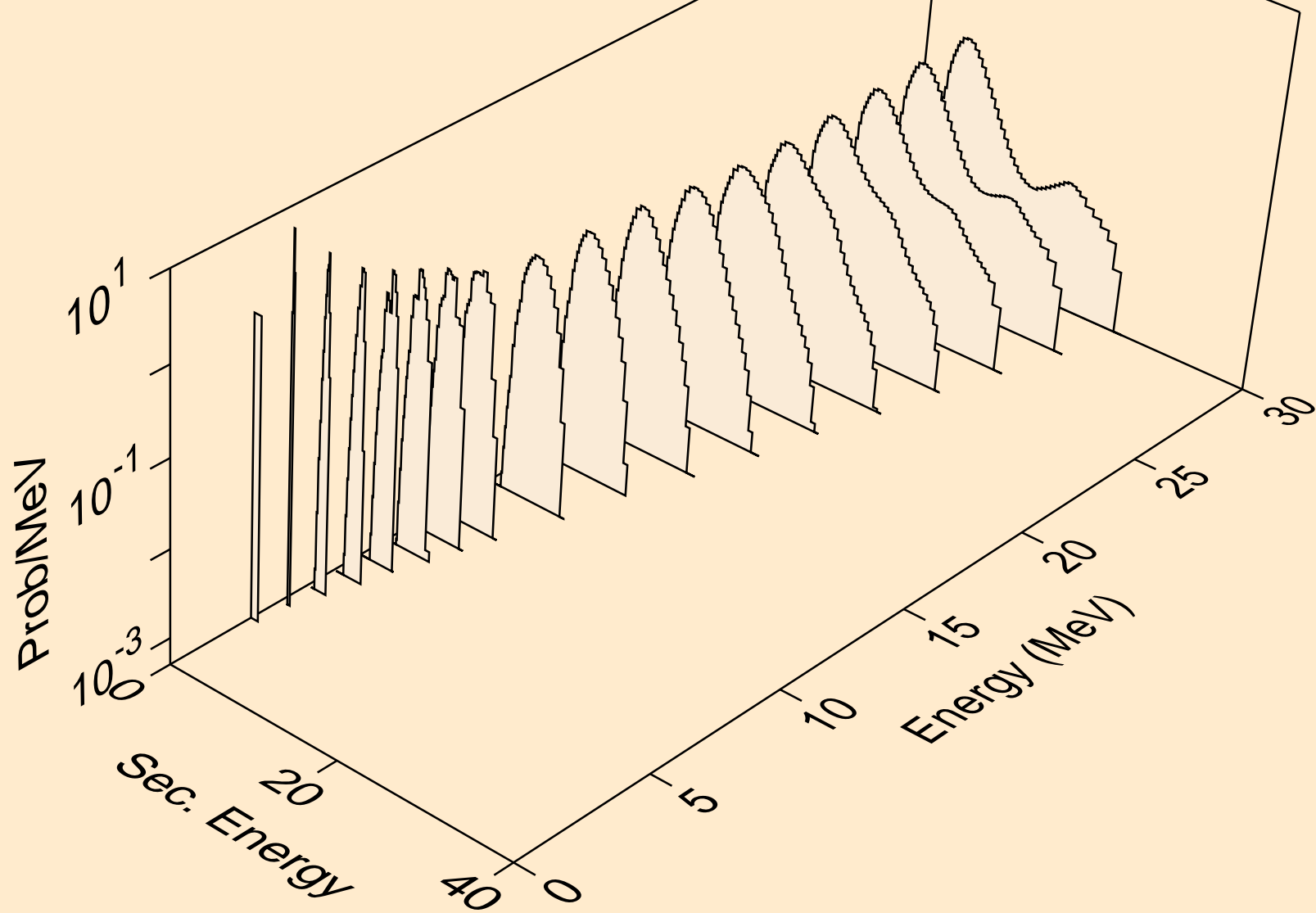

GA064 HELION ACER TENDL-2021 LIBRARY; T=0.K
protons from (s,2np)

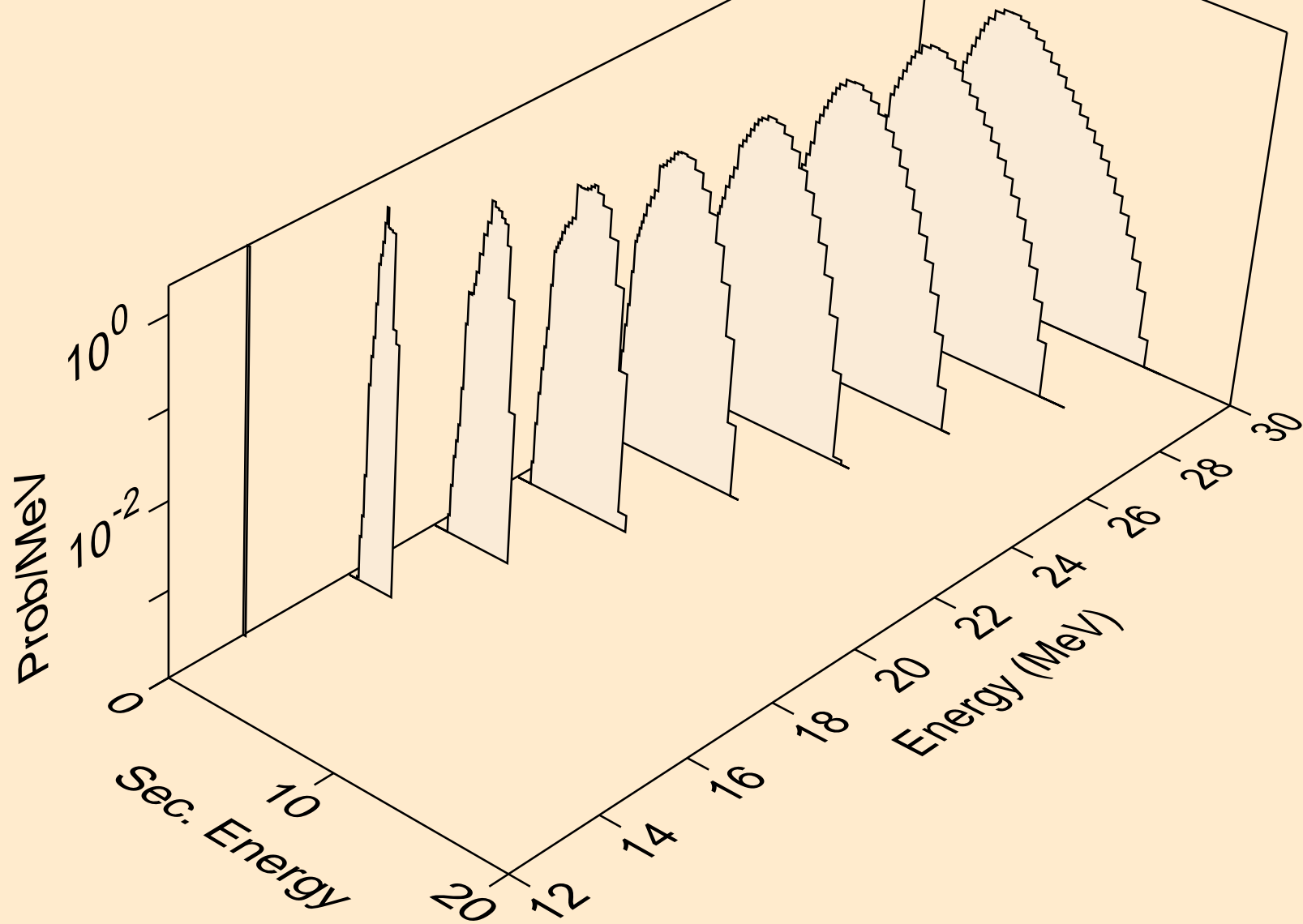

GA064 HELION ACER TENDL-2021 LIBRARY; T=0.K
protons from (s,2np)

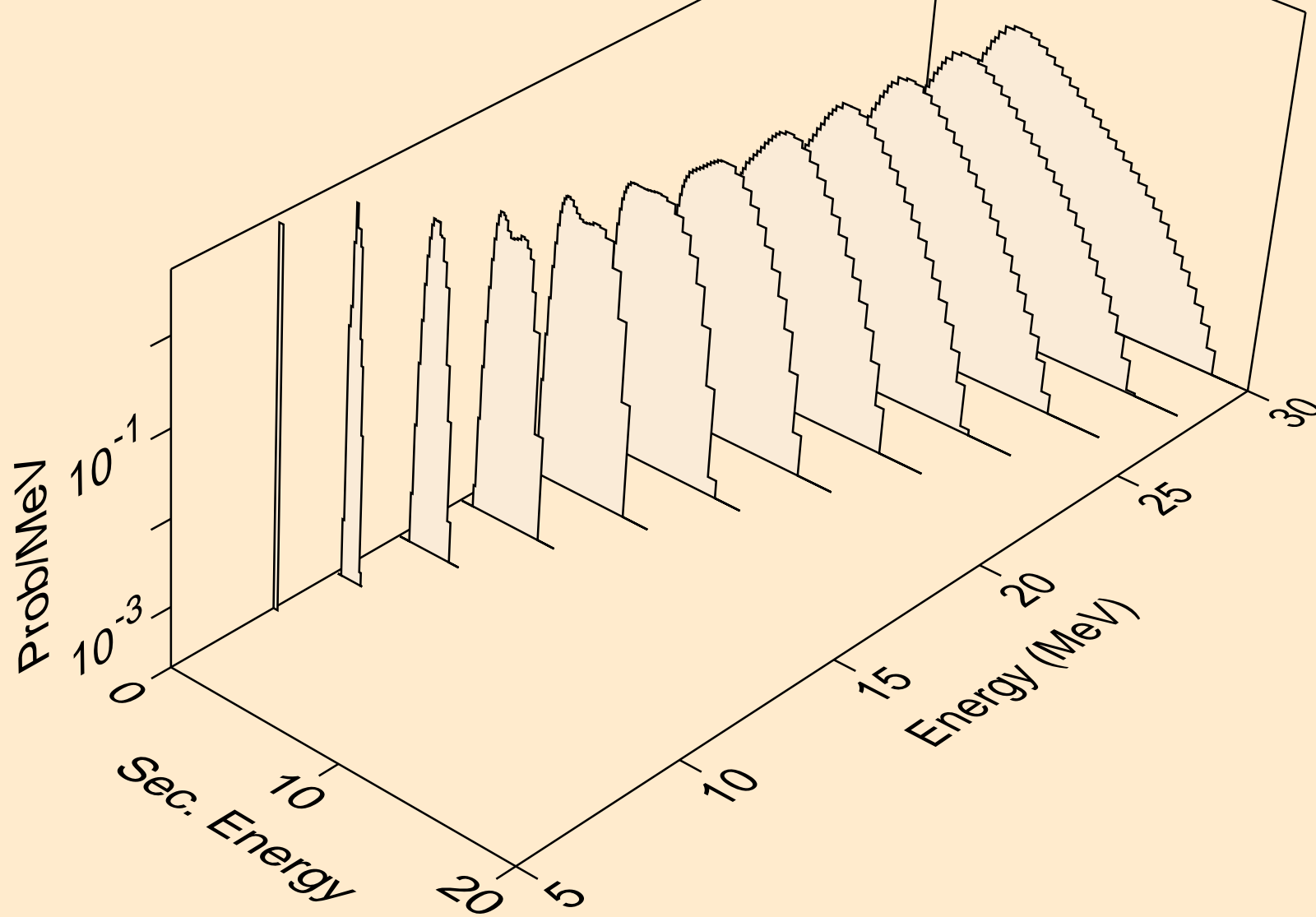

GA064 HELION ACER TENDL-2021 LIBRARY; T=0.K
protons from (s,npa)

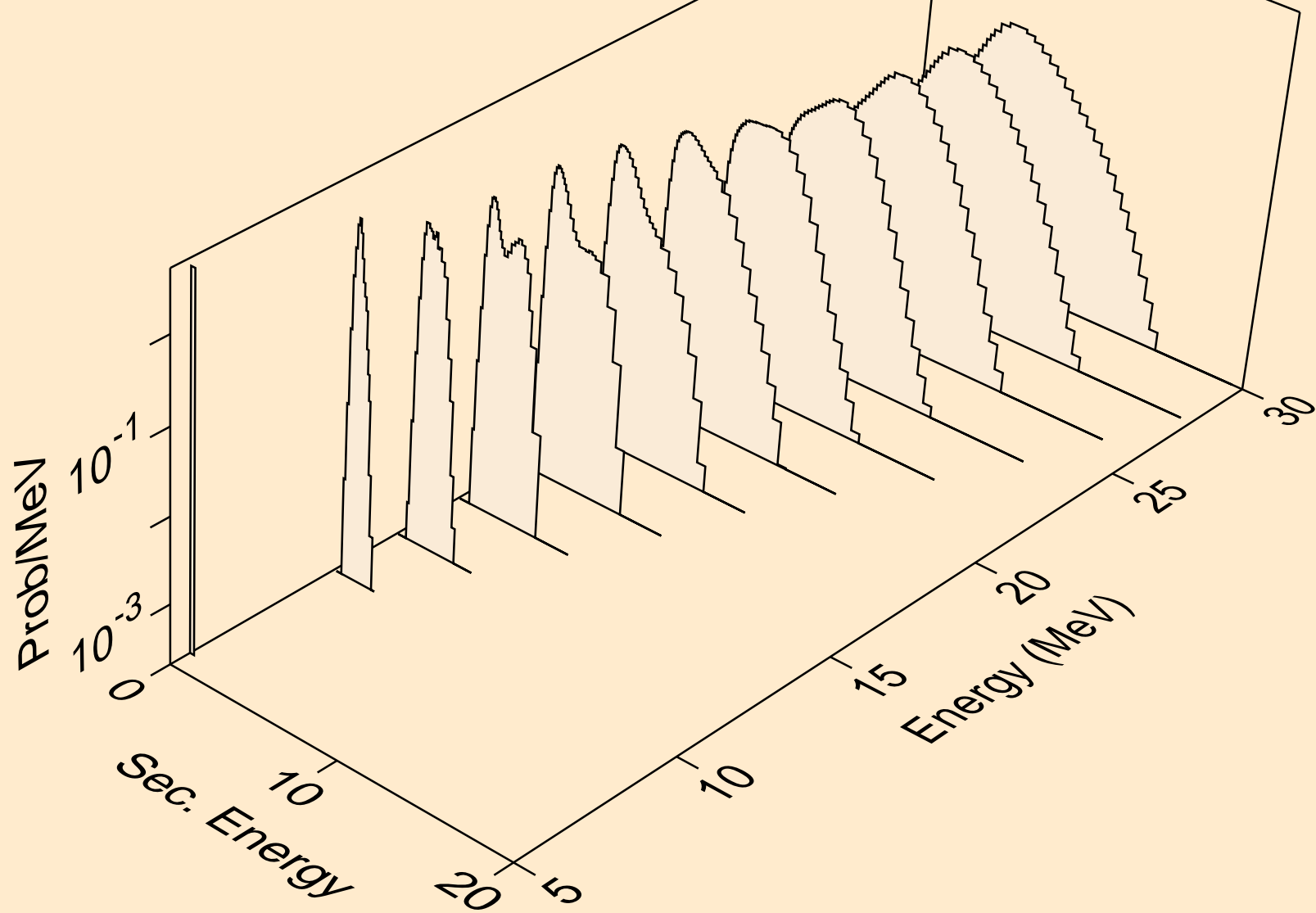

GA064 HELION ACER TENDL-2021 LIBRARY; T=0.K
protons from (s,p)

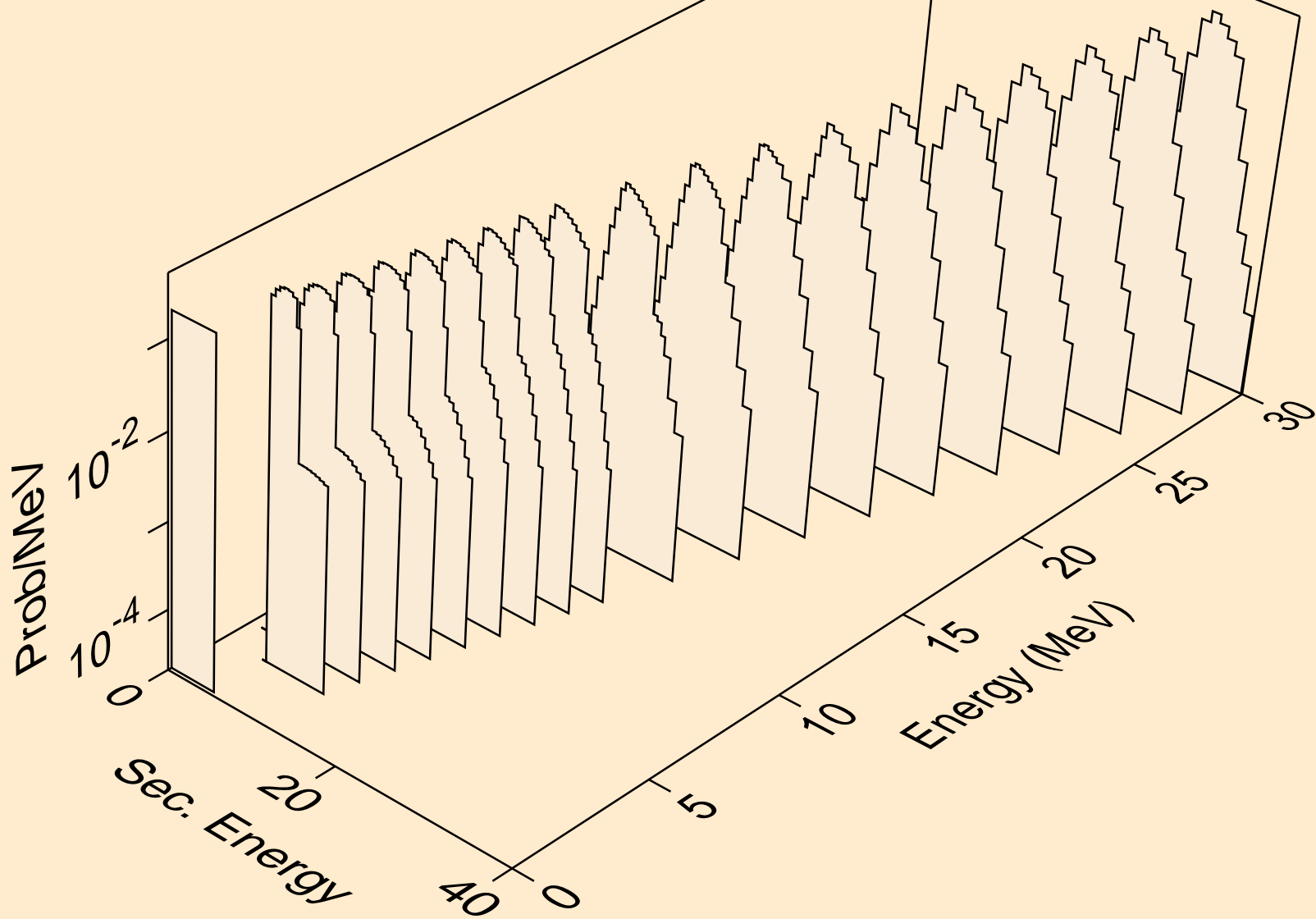

GA064 HELION ACER TENDL-2021 LIBRARY; T=0.K
protons from (s,2p)

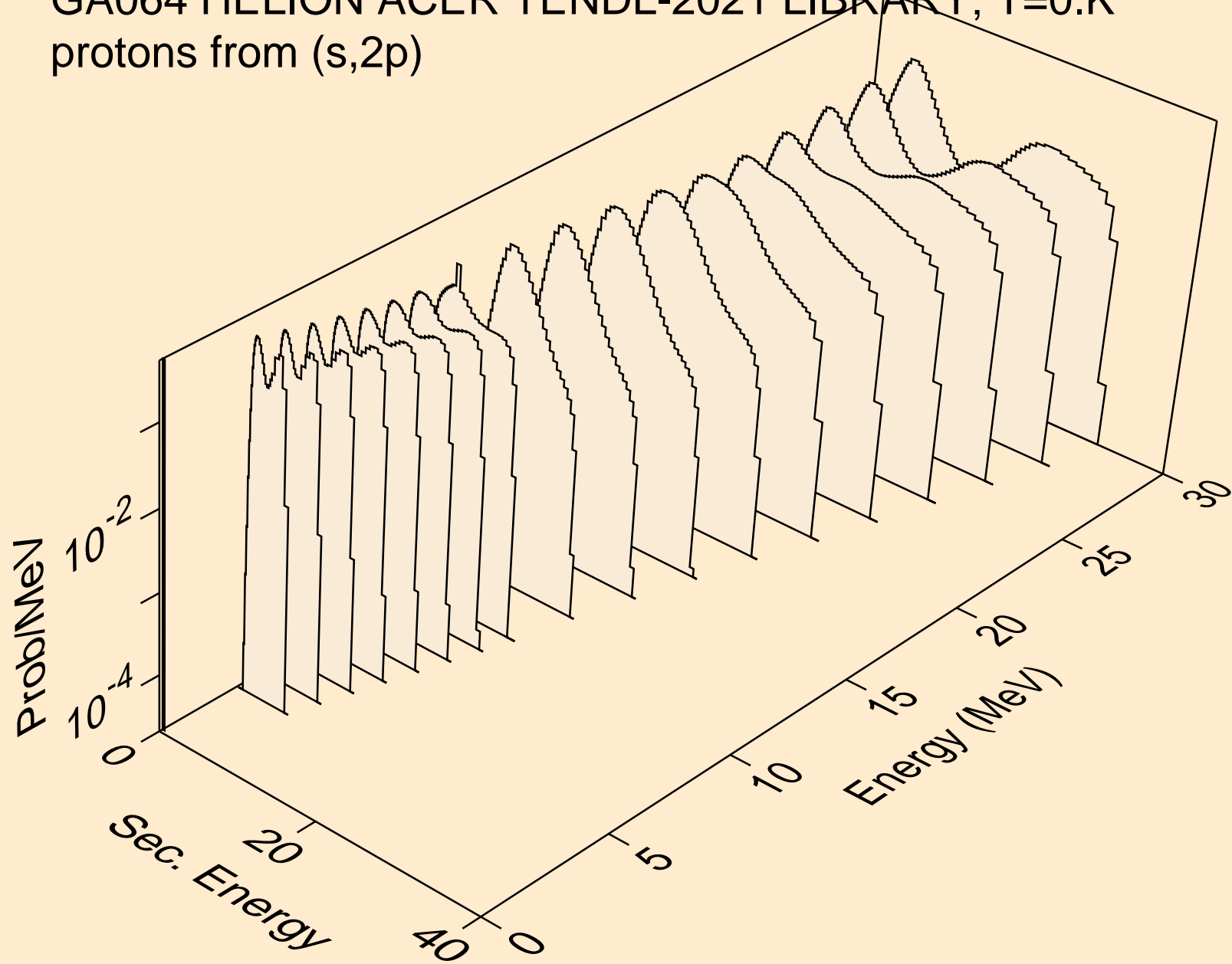

GA064 HELION ACER TENDL-2021 LIBRARY; T=0.K
protons from (s,pa)

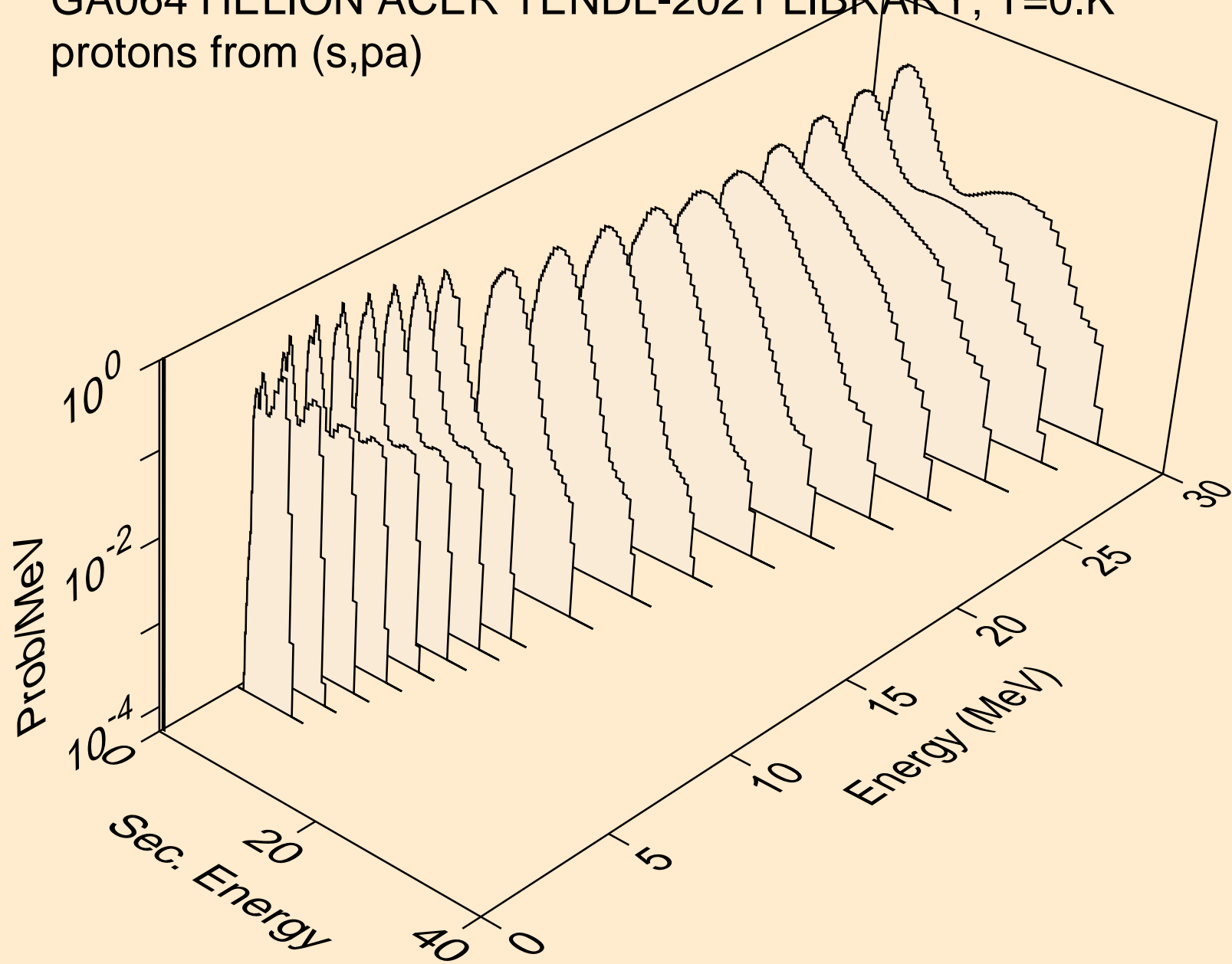

GA064 HELION ACER TENDL-2021 LIBRARY; T=0.K
protons from (s,pd)

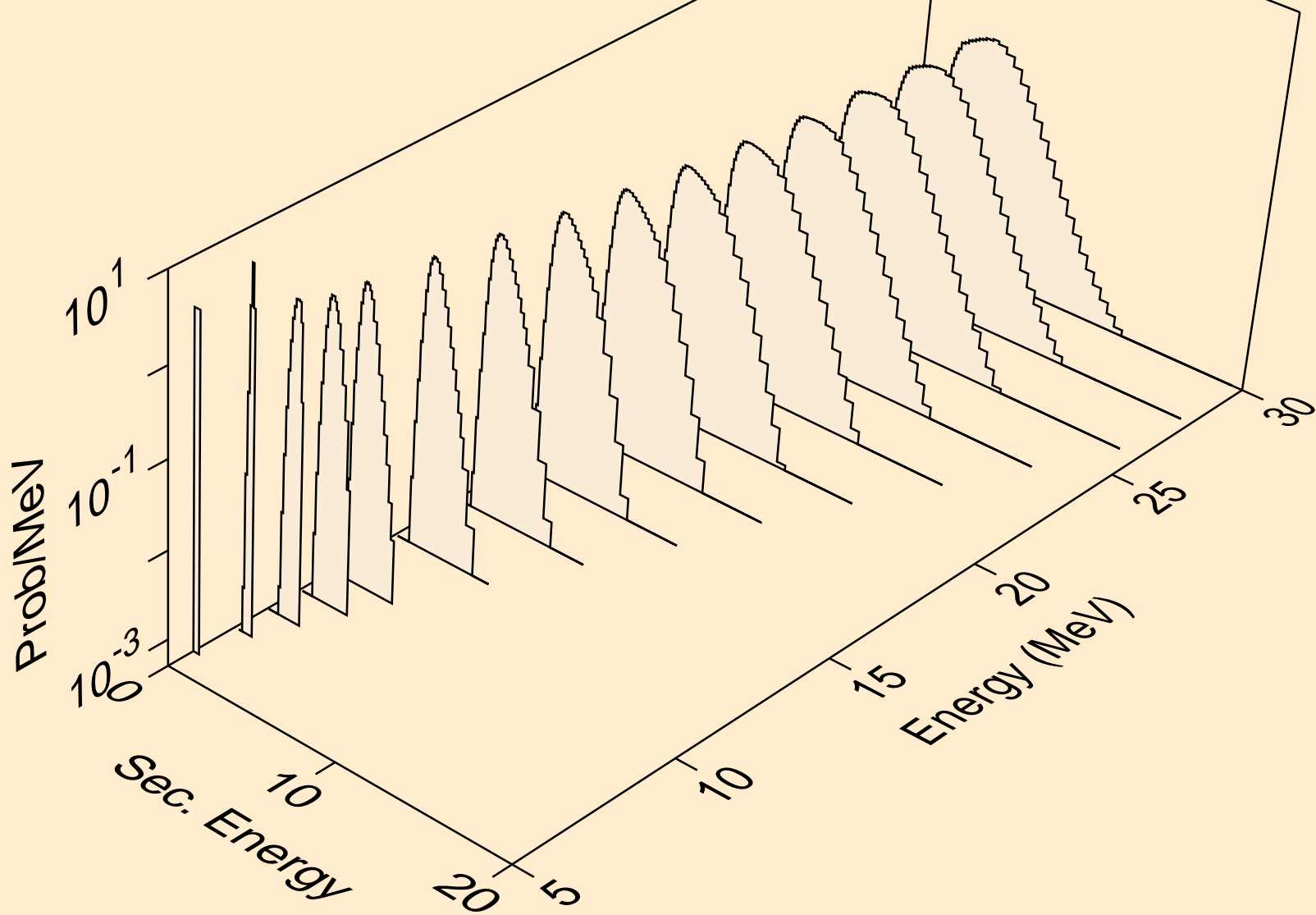

GA064 HELION ACER TENDL-2021 LIBRARY; T=0.K
protons from (s,pt)

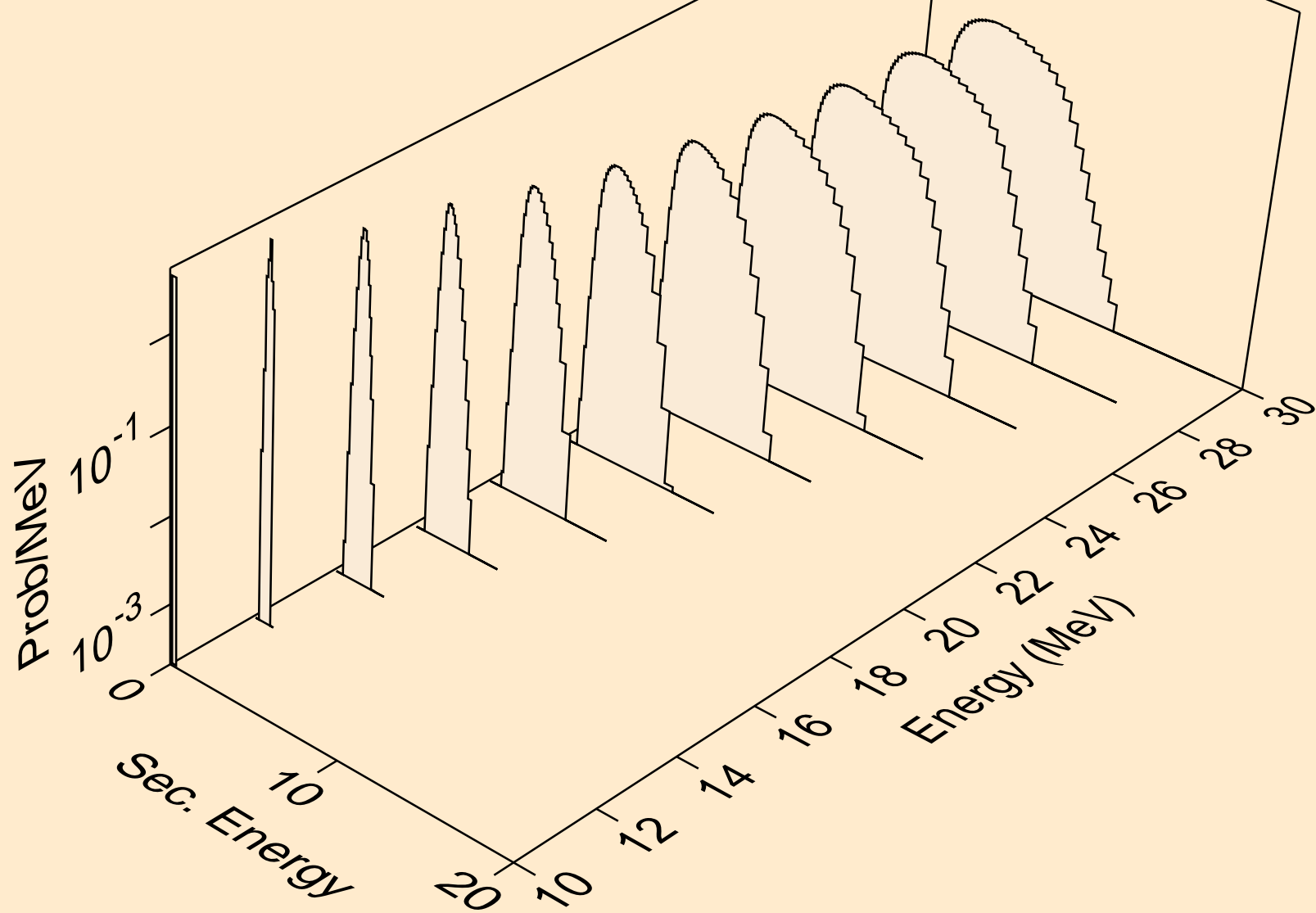

GA064 HELION ACER TENDL-2021 LIBRARY; T=0.K
deuterons from (s,x)

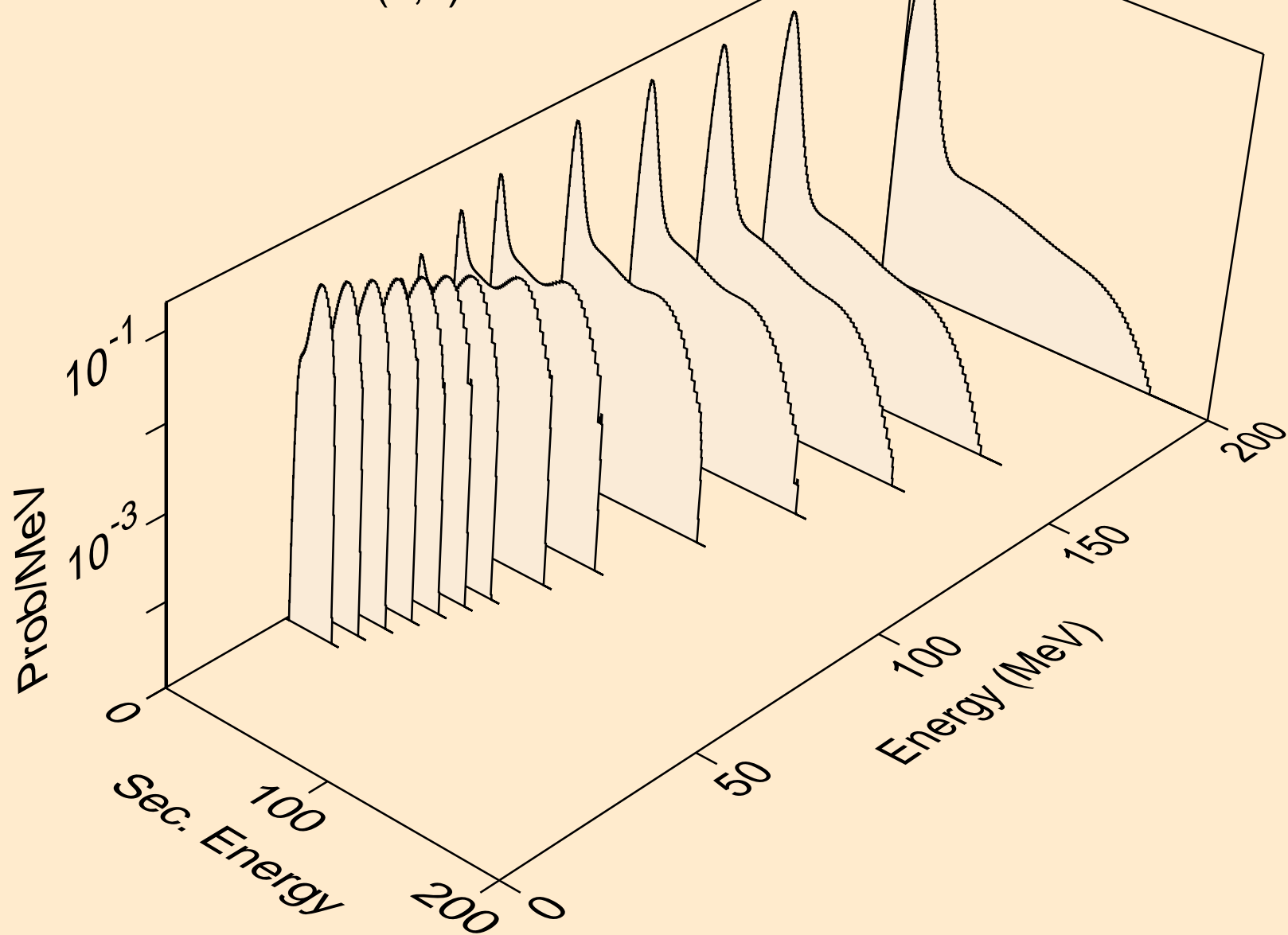

GA064 HELION ACER TENDL-2021 LIBRARY; T=0.K
deuterons from (s,n*)d

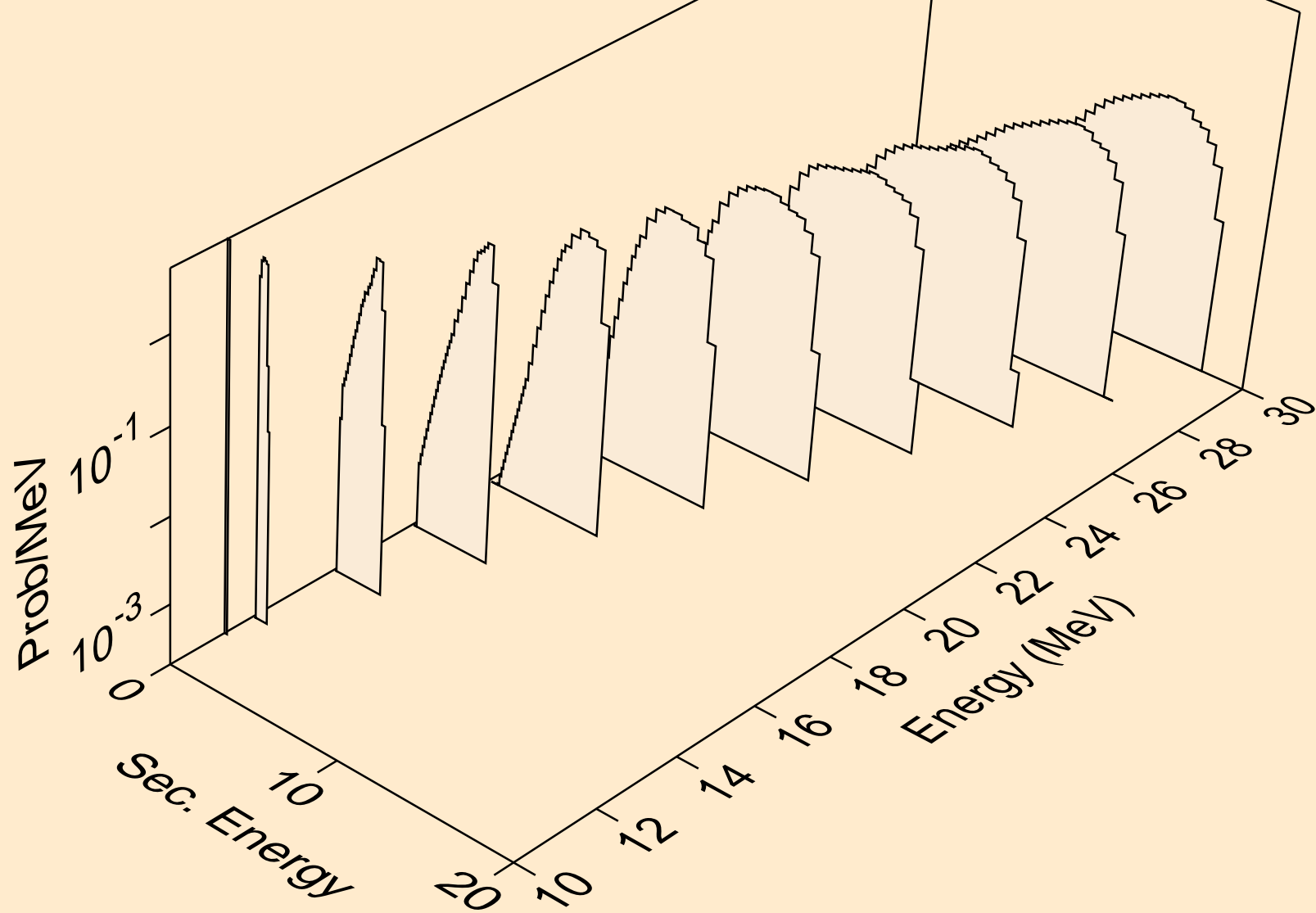

GA064 HELION ACER TENDL-2021 LIBRARY; T=0.K
deuterons from (s,d)

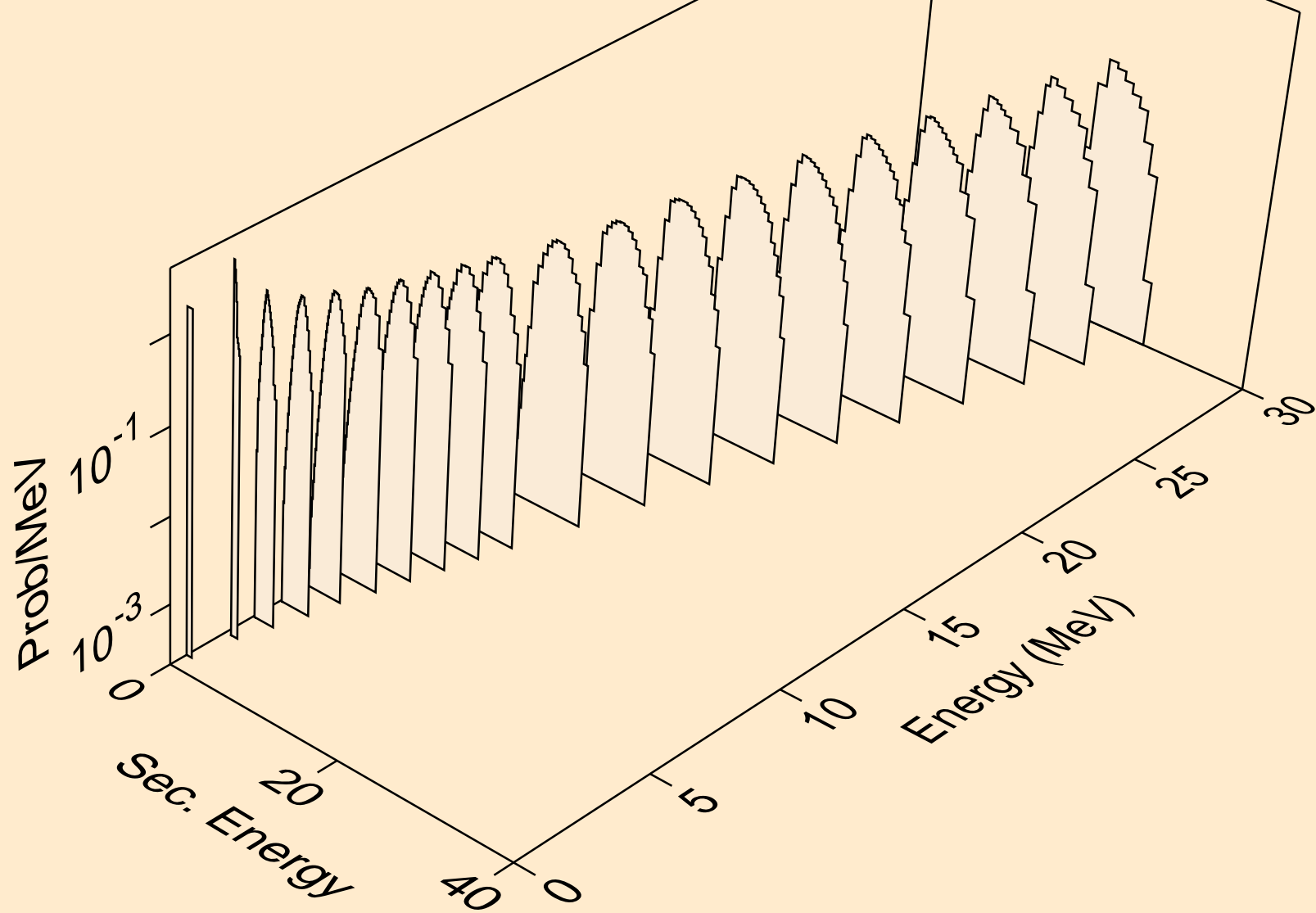

GA064 HELION ACER TENDL-2021 LIBRARY; T=0.K
deuterons from (s,d2a)

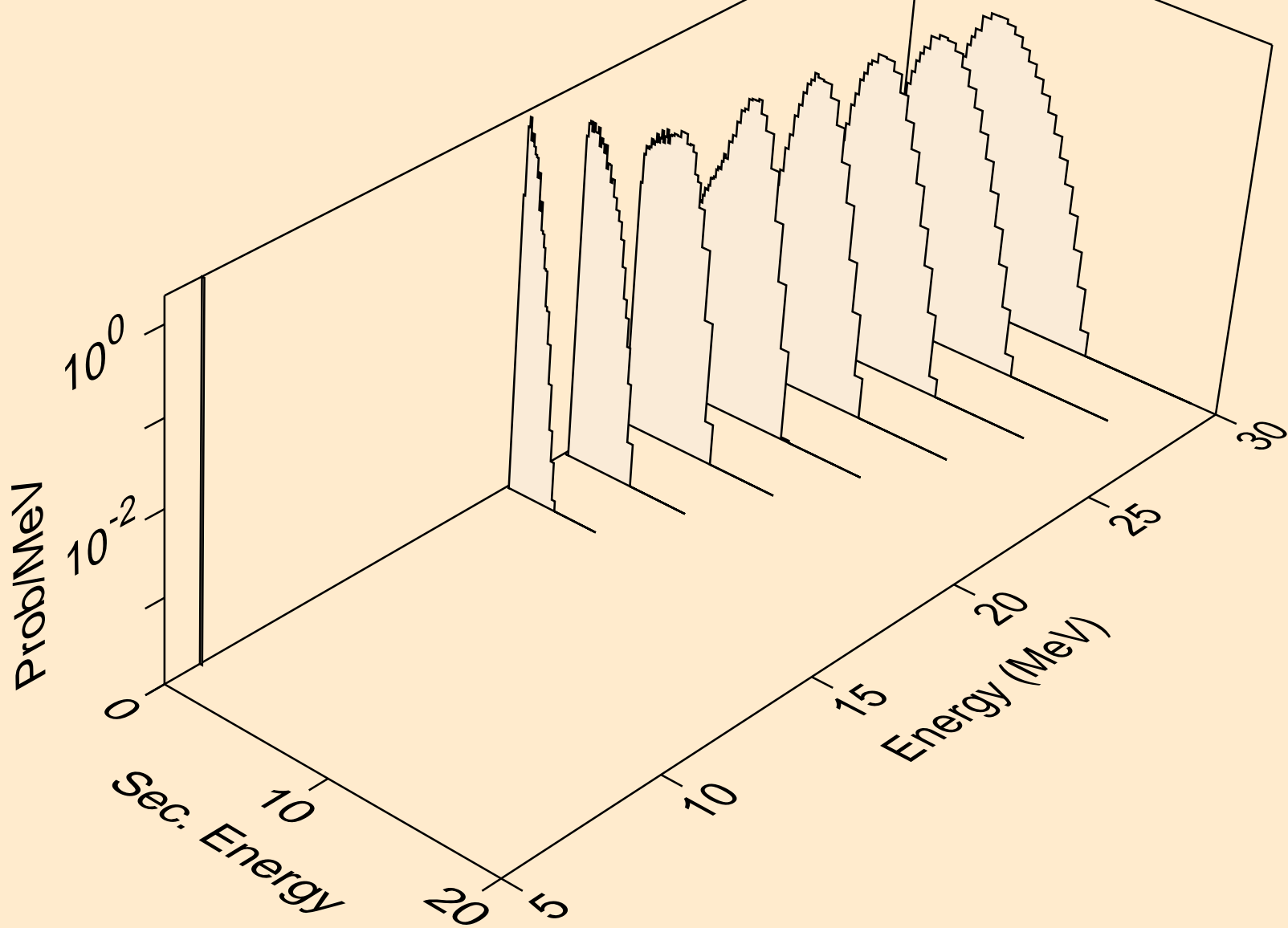

GA064 HELION ACER TENDL-2021 LIBRARY; T=0.K
deuterons from (s,pd)

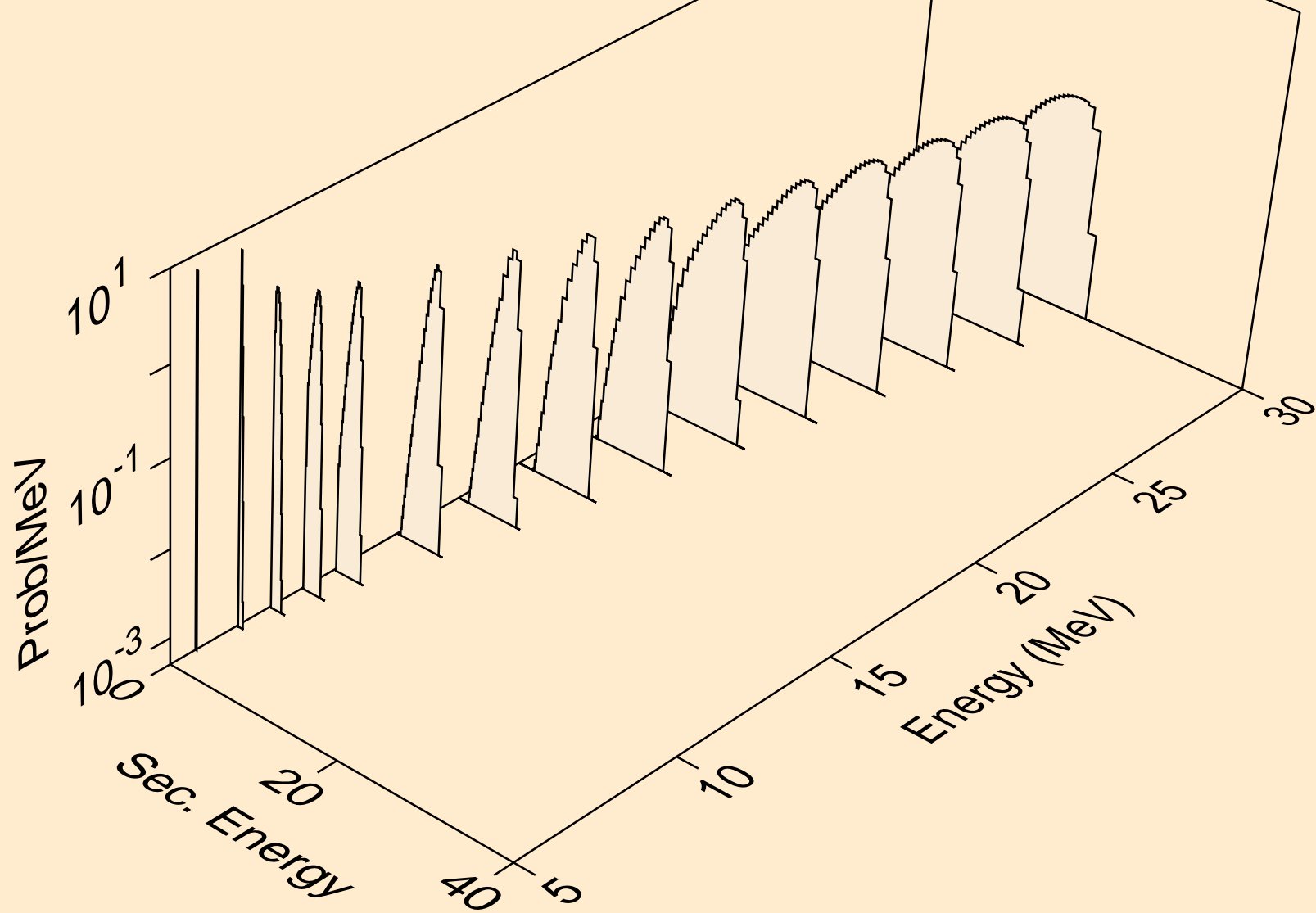

GA064 HELION ACER TENDL-2021 LIBRARY; T=0.K
deuterons from (s,da)

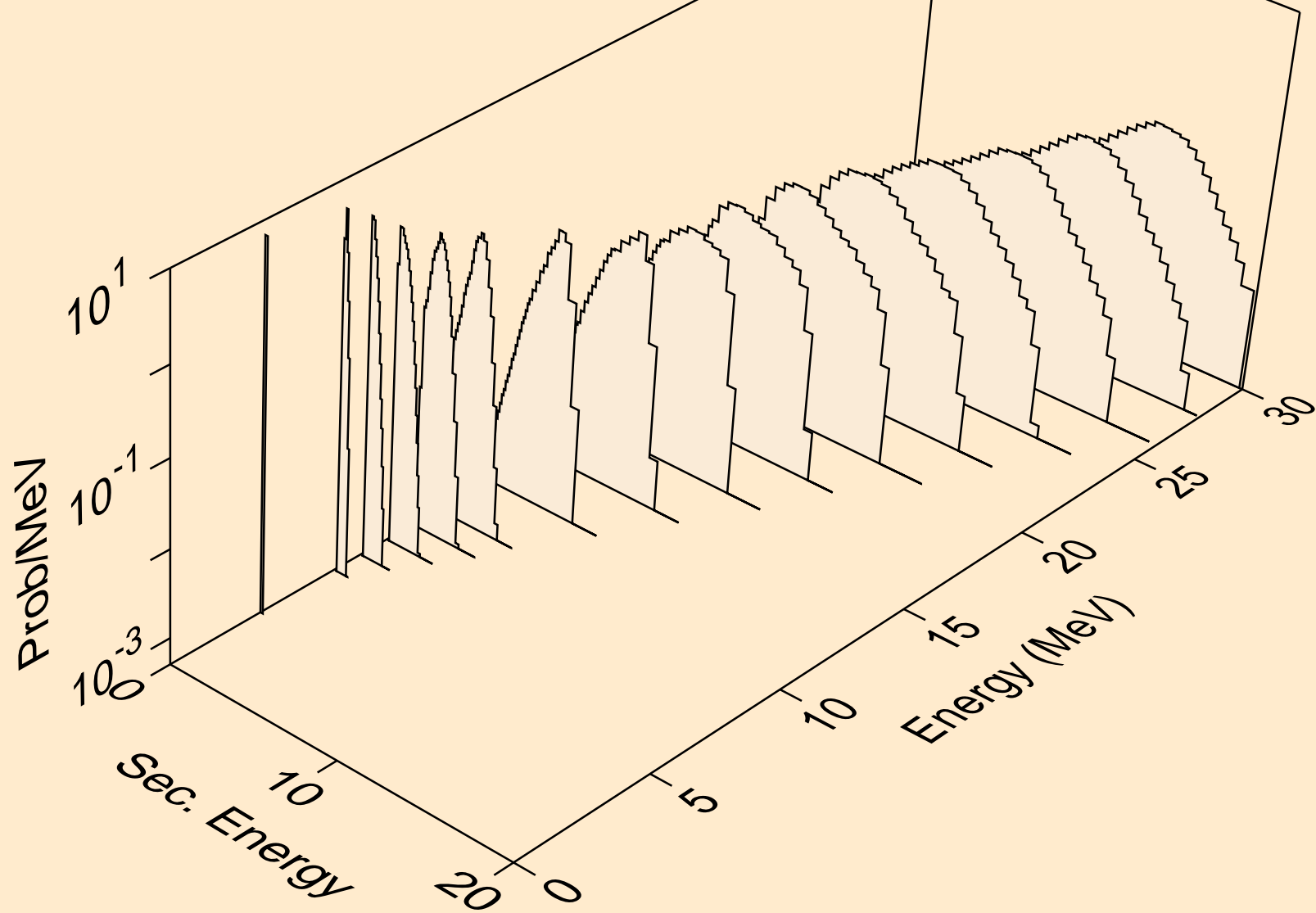

GA064 HELION ACER TENDL-2021 LIBRARY; T=0.K
tritons from (s,x)

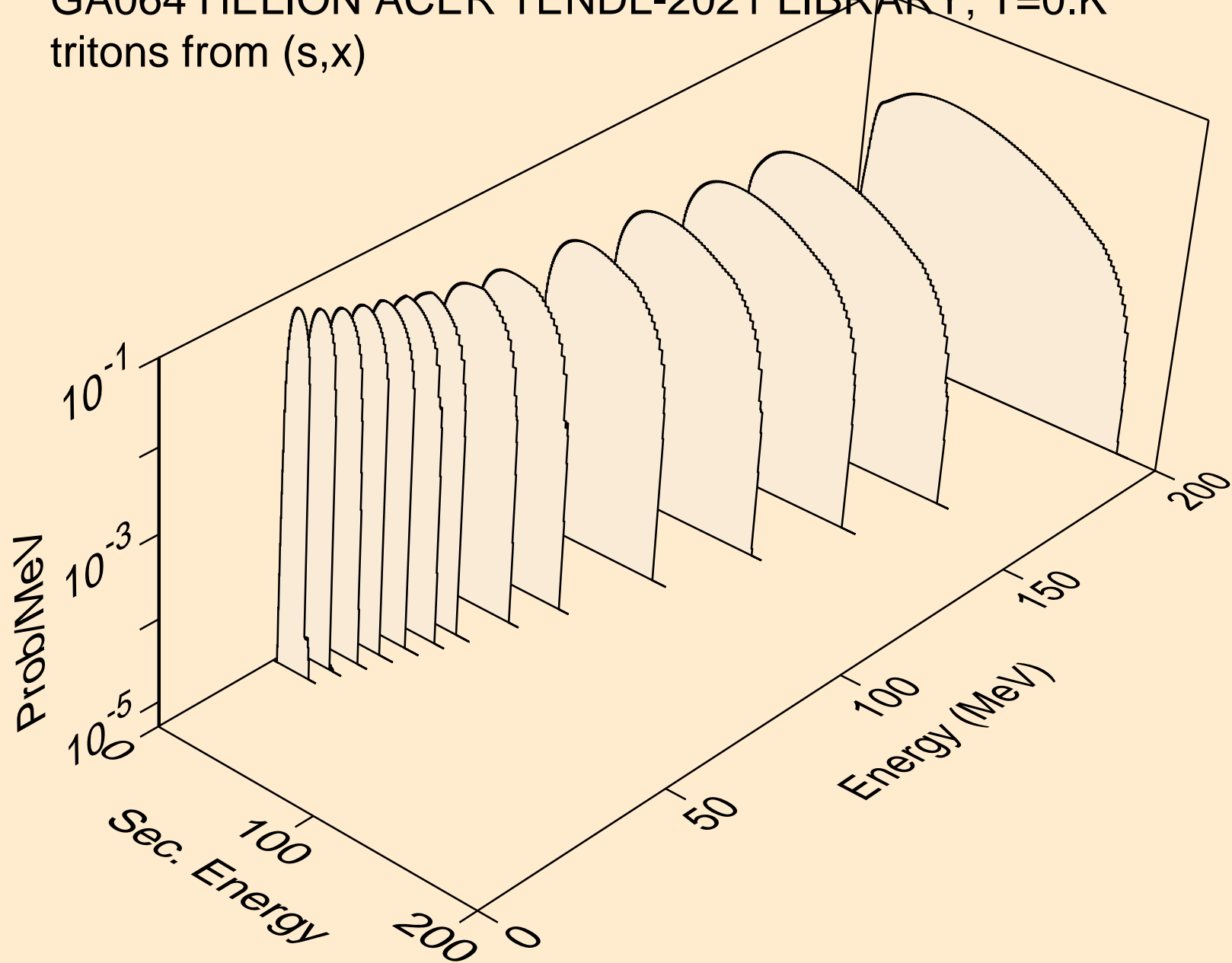

GA064 HELION ACER TENDL-2021 LIBRARY; T=0.K
tritons from (s,n*)t

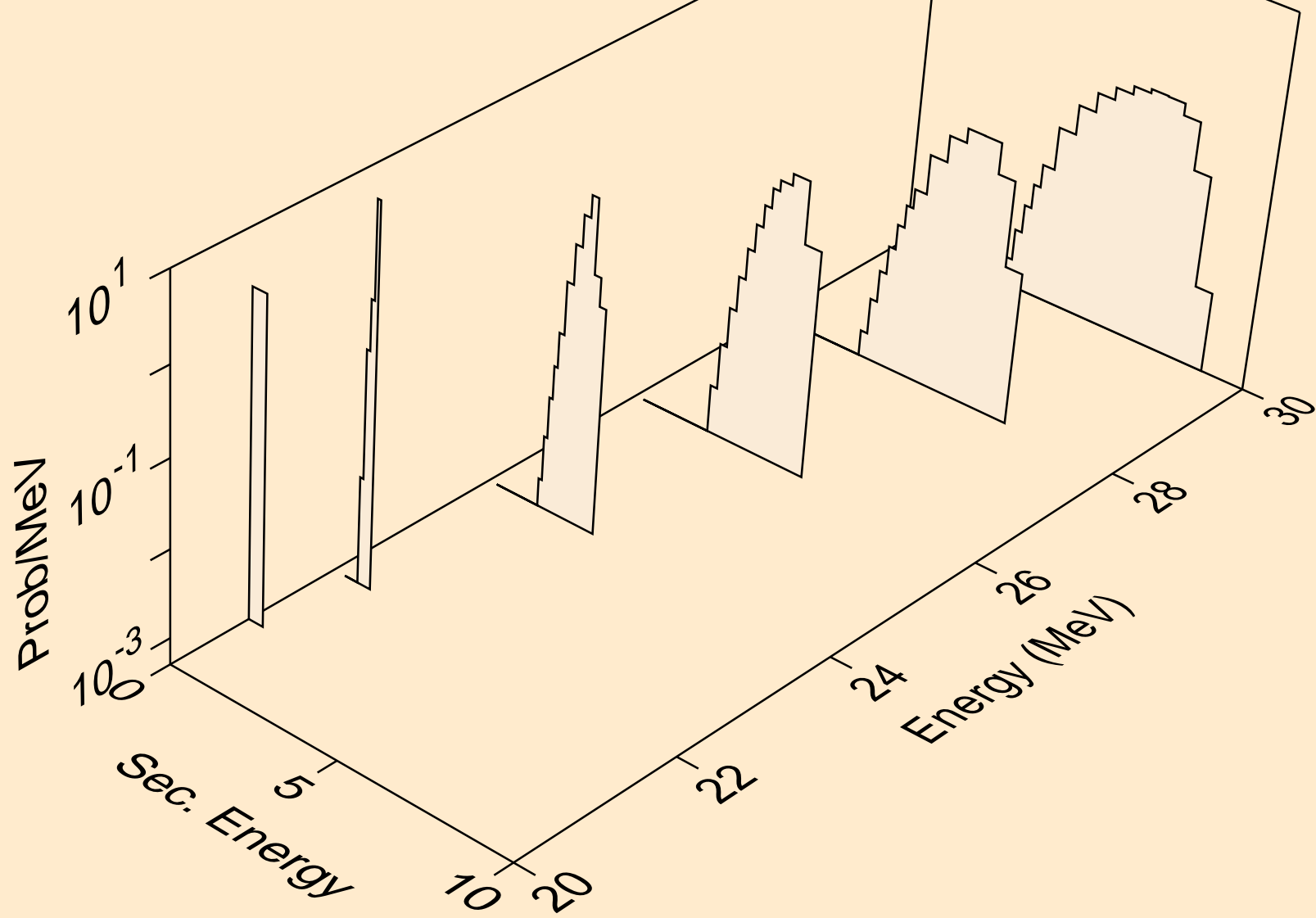

GA064 HELION ACER TENDL-2021 LIBRARY; T=0.K
tritons from (s,t)

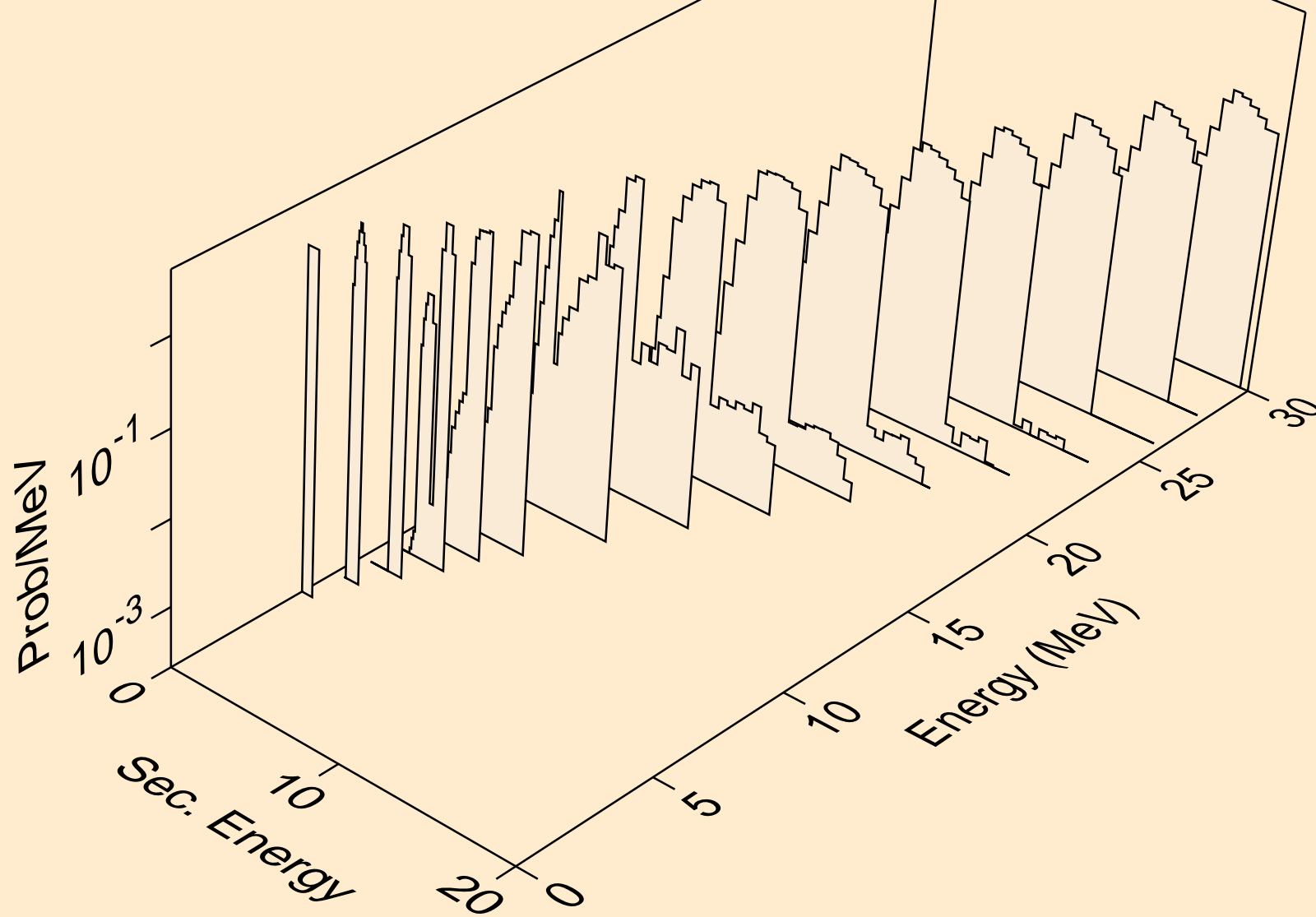

GA064 HELION ACER TENDL-2021 LIBRARY; T=0.K
tritons from (s,t2a)

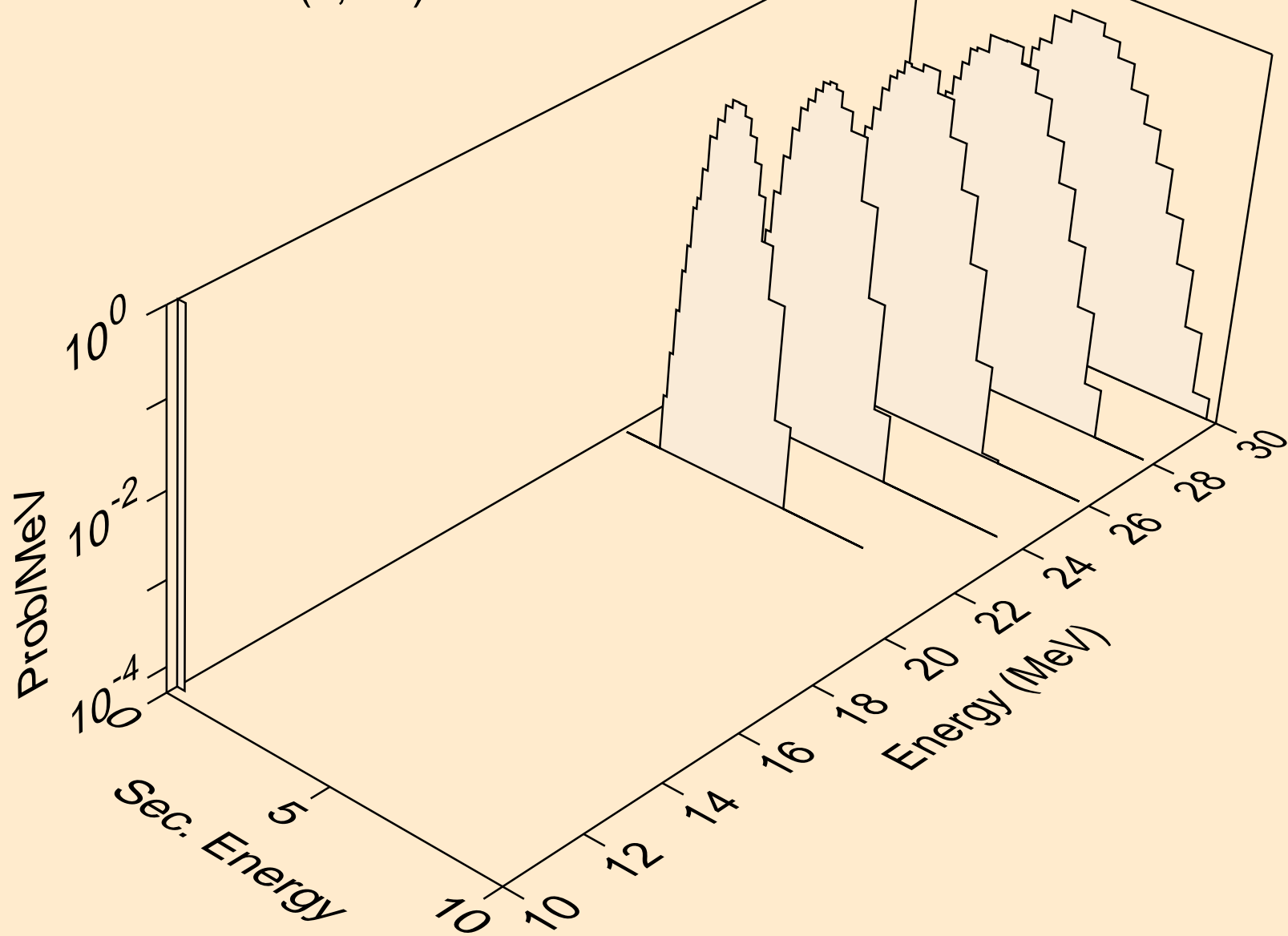

GA064 HELION ACER TENDL-2021 LIBRARY; T=0.K
tritons from (s,pt)

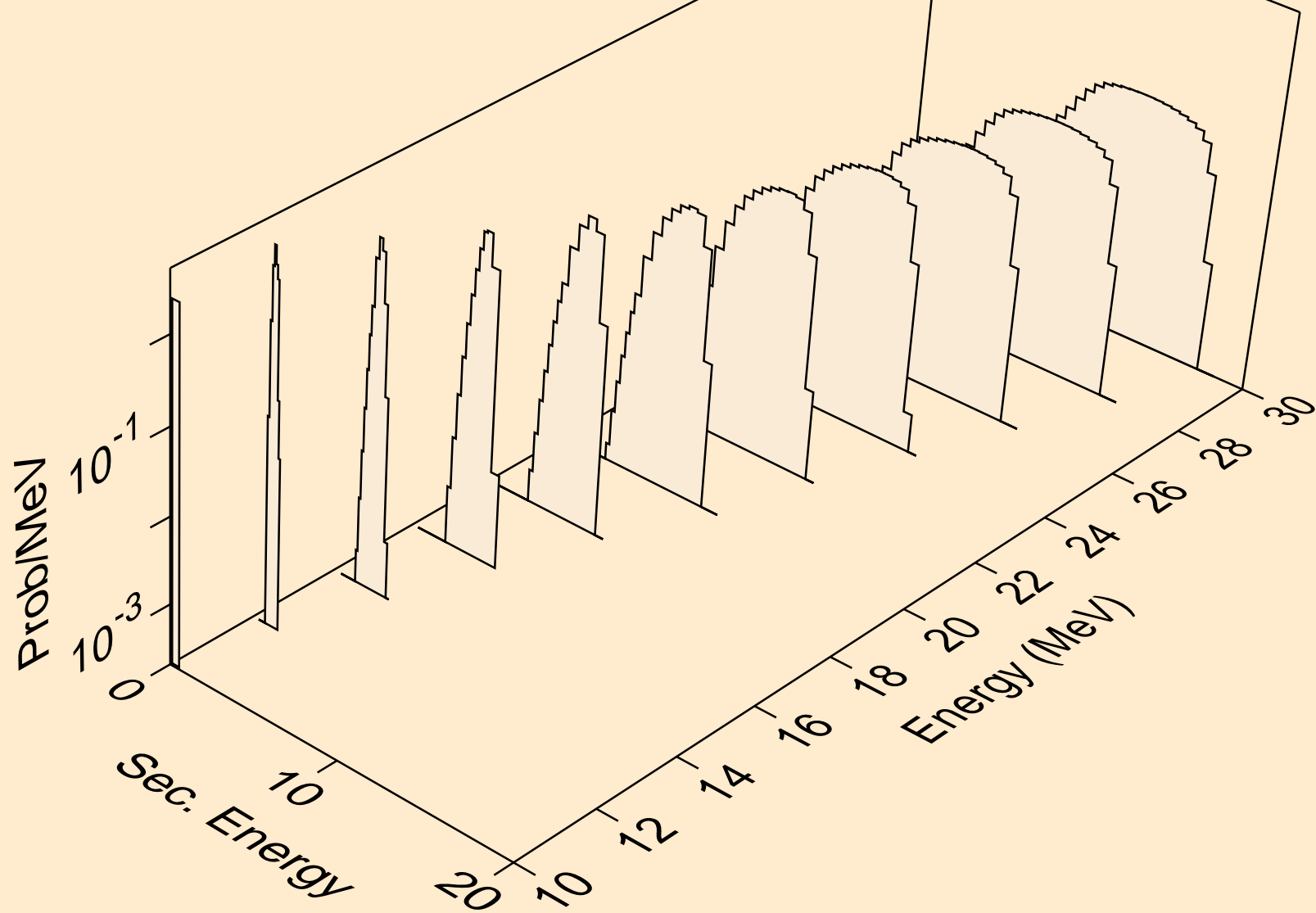

GA064 HELION ACER TENDL-2021 LIBRARY; T=0.K
alphas from (s,x)

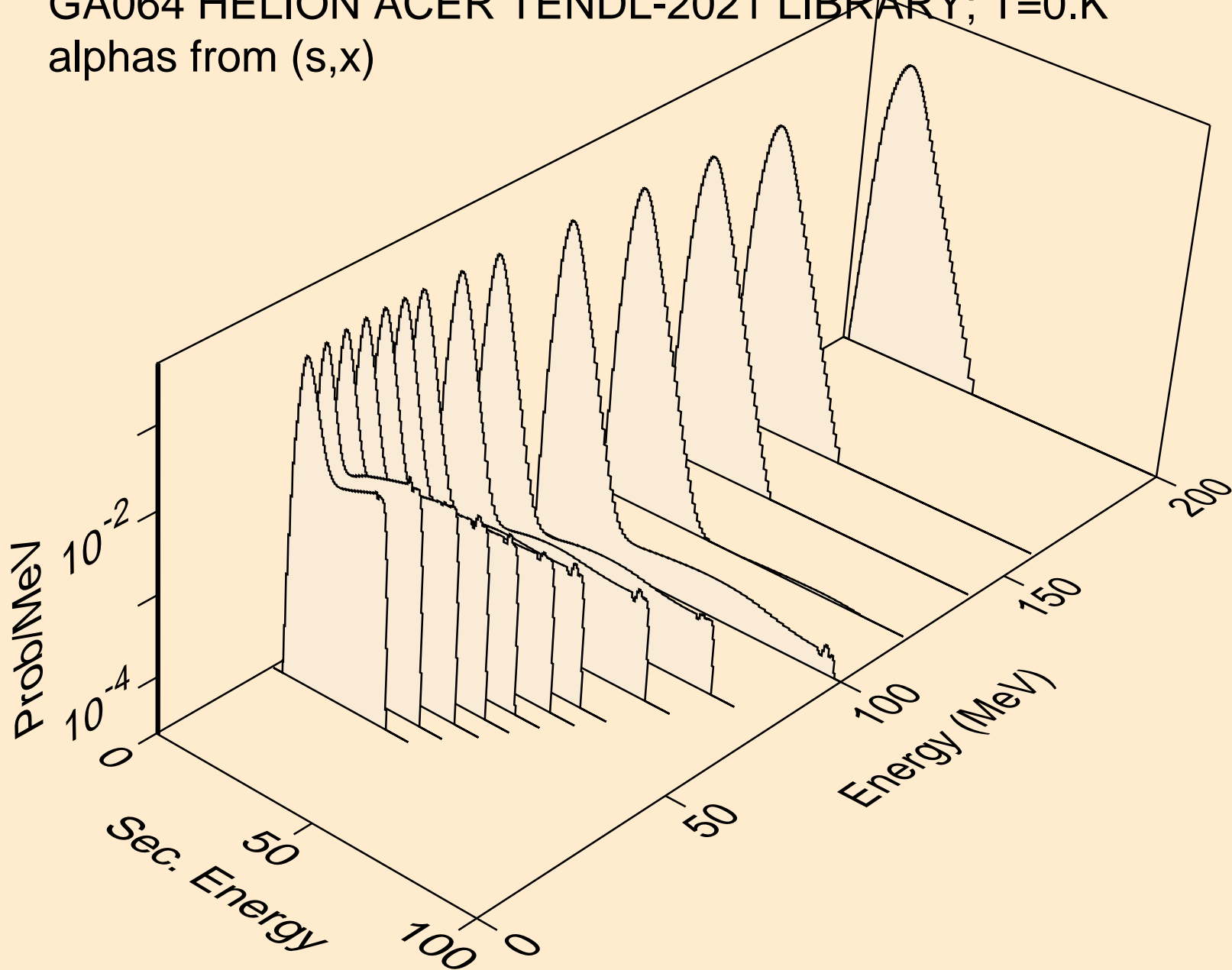

GA064 HELION ACER TENDL-2021 LIBRARY; T=0.K
alphas from (s,n*)a

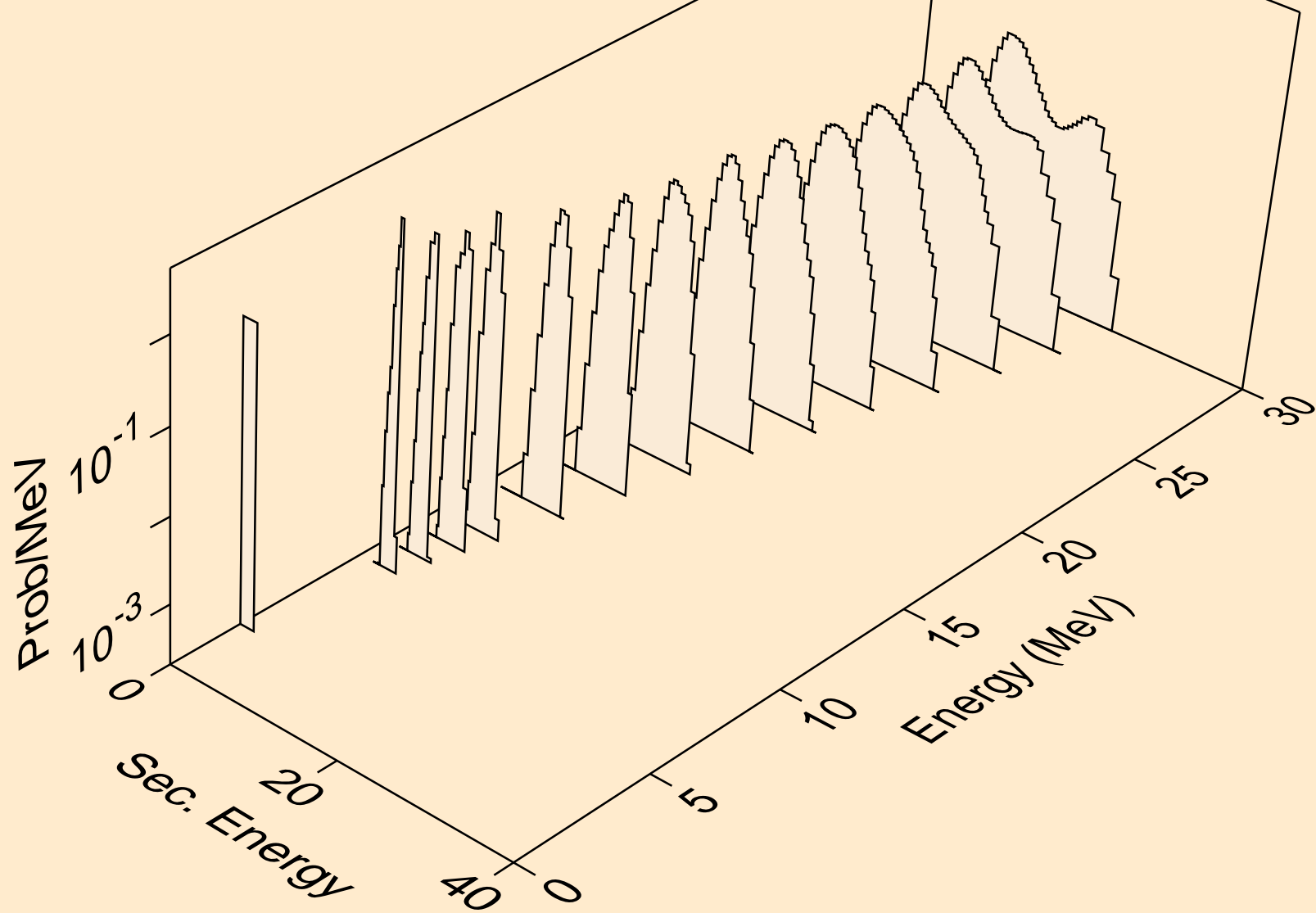

GA064 HELION ACER TENDL-2021 LIBRARY; T=0.K
alphas from (s,2n)a

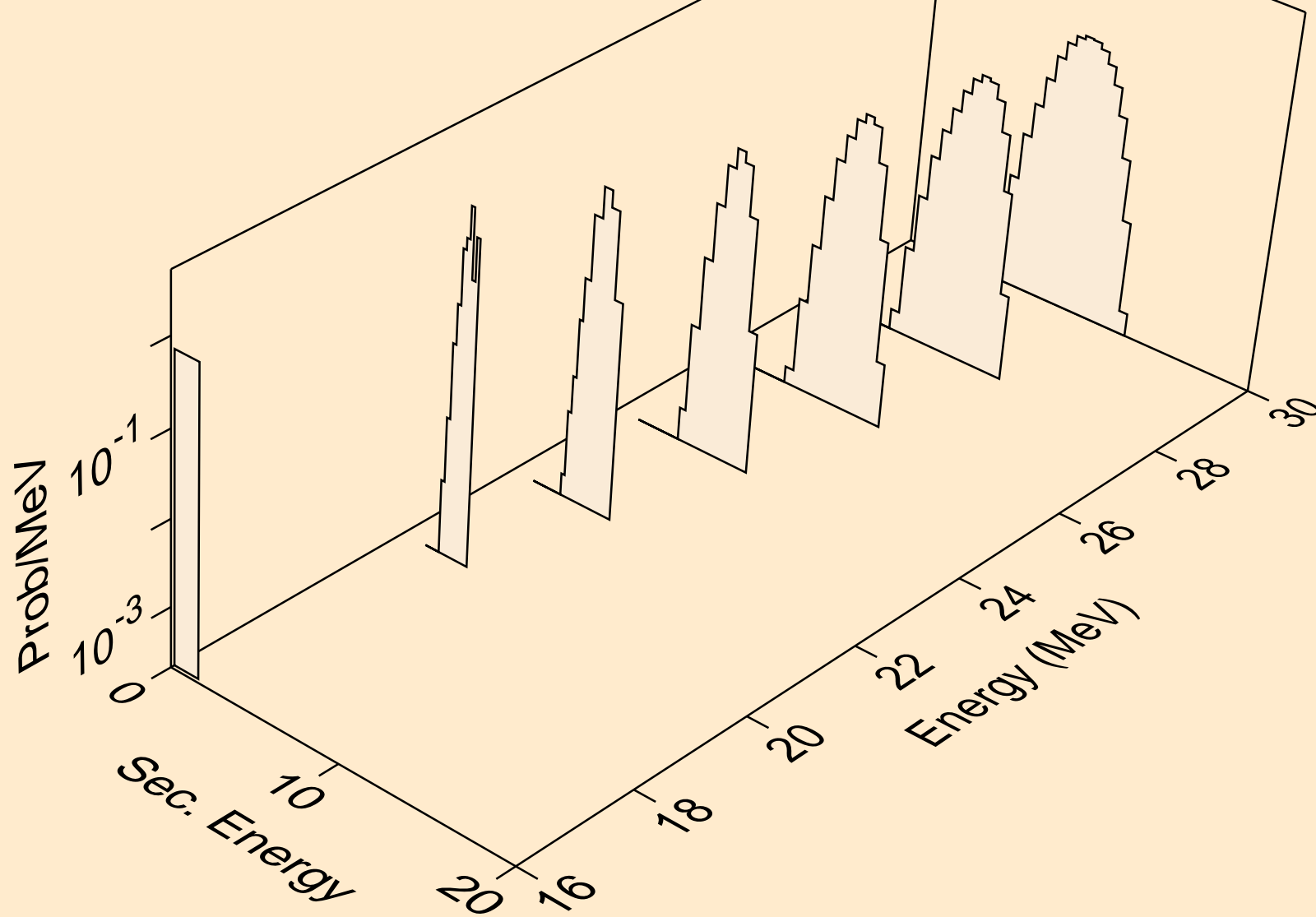

GA064 HELION ACER TENDL-2021 LIBRARY; T=0.K
alphas from (s,n*)2a

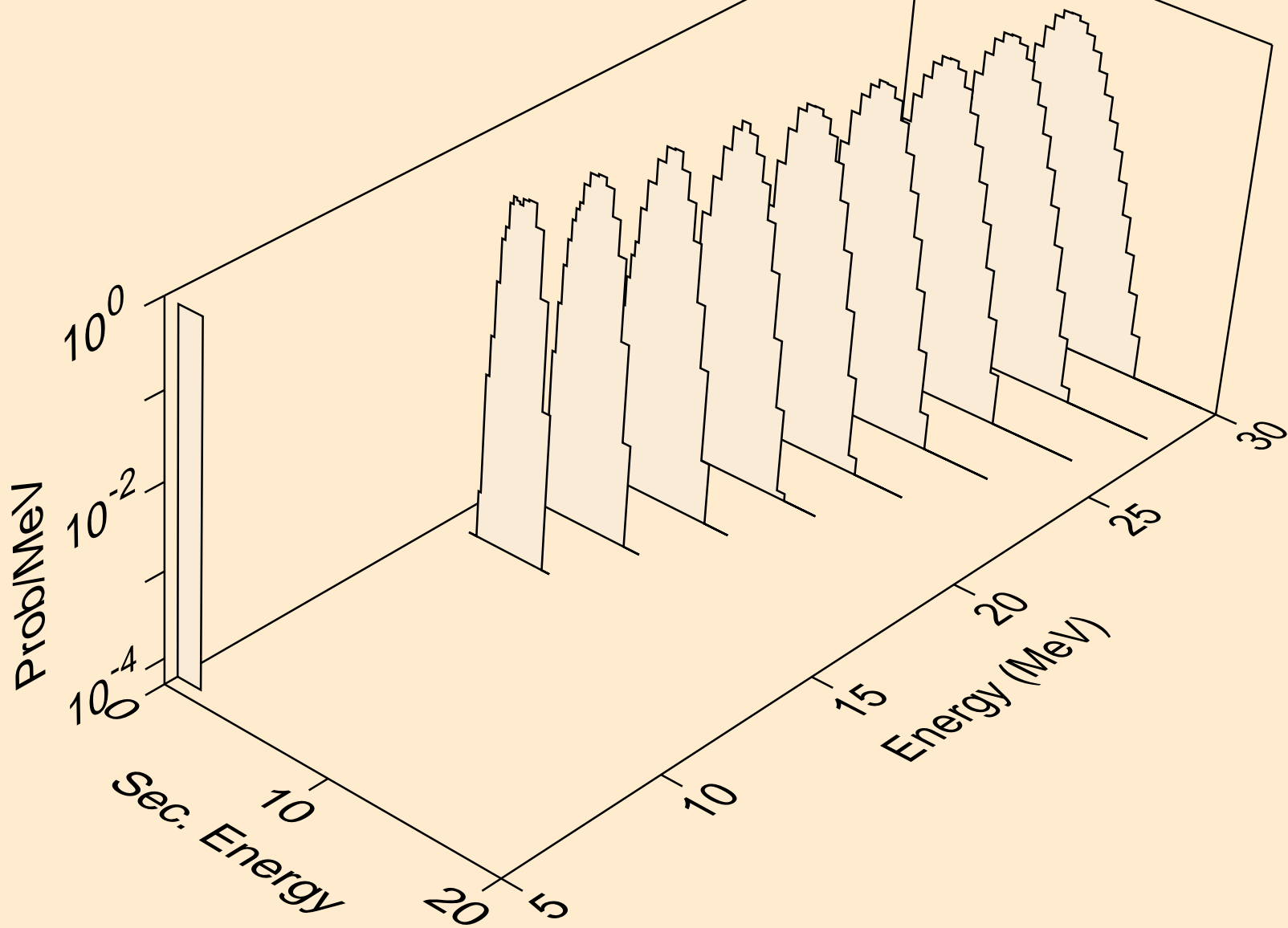

GA064 HELION ACER TENDL-2021 LIBRARY; T=0.K
alphas from (s,npa)

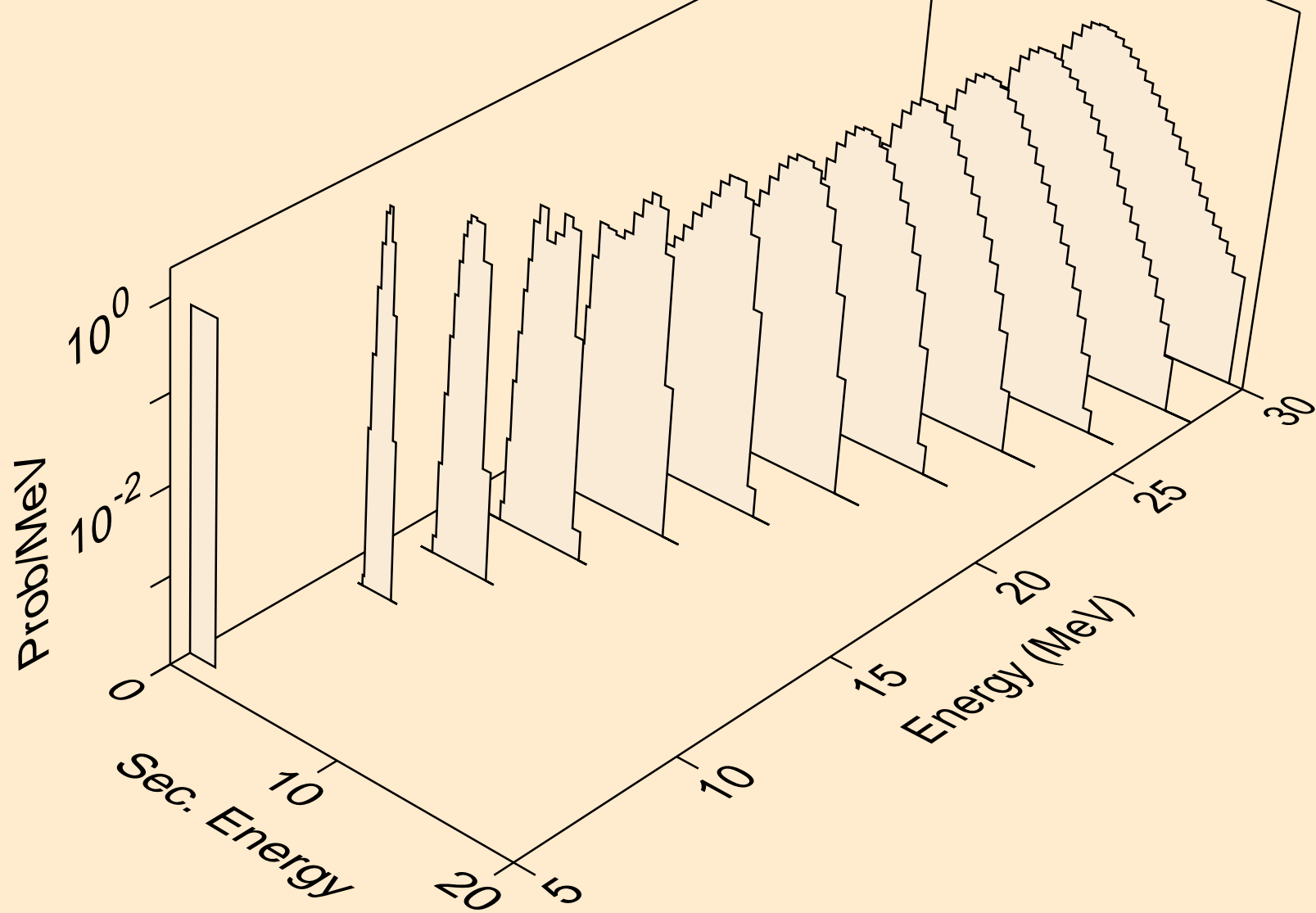

GA064 HELION ACER TENDL-2021 LIBRARY; T=0.K
alphas from (s,a)

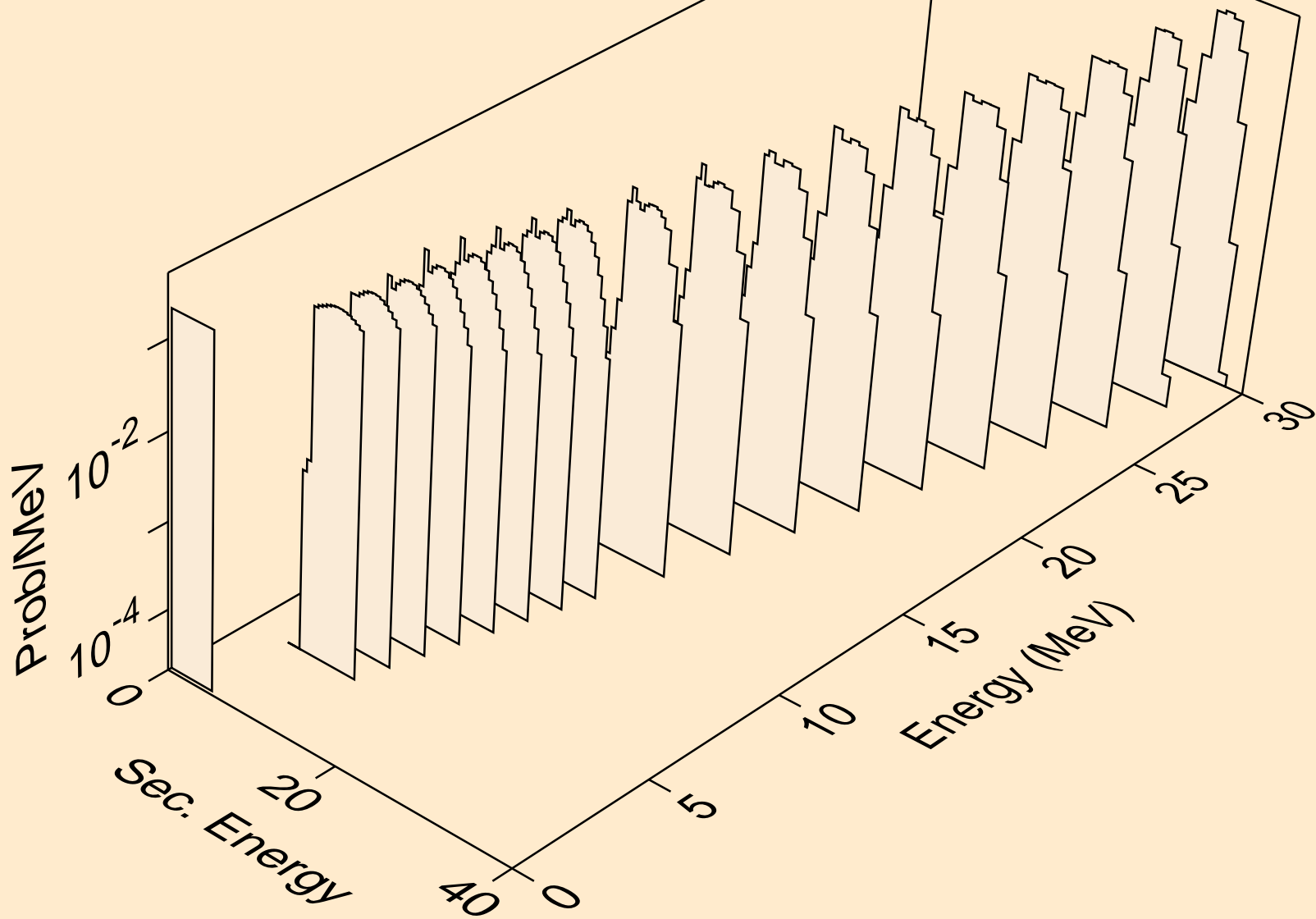

GA064 HELION ACER TENDL-2021 LIBRARY; T=0.K
alphas from (s,2a)

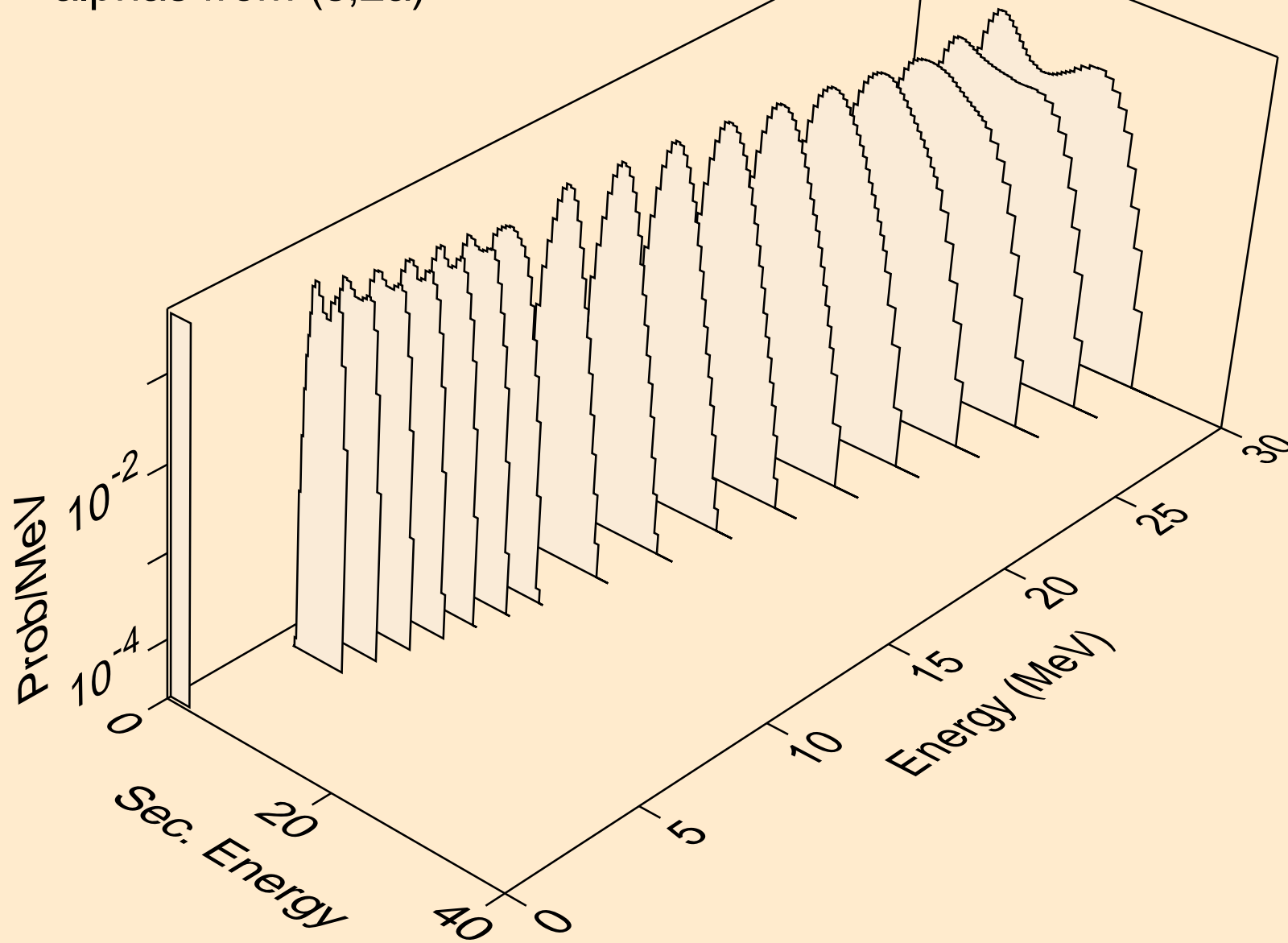

GA064 HELION ACER TENDL-2021 LIBRARY; T=0.K
alphas from (s,3a)

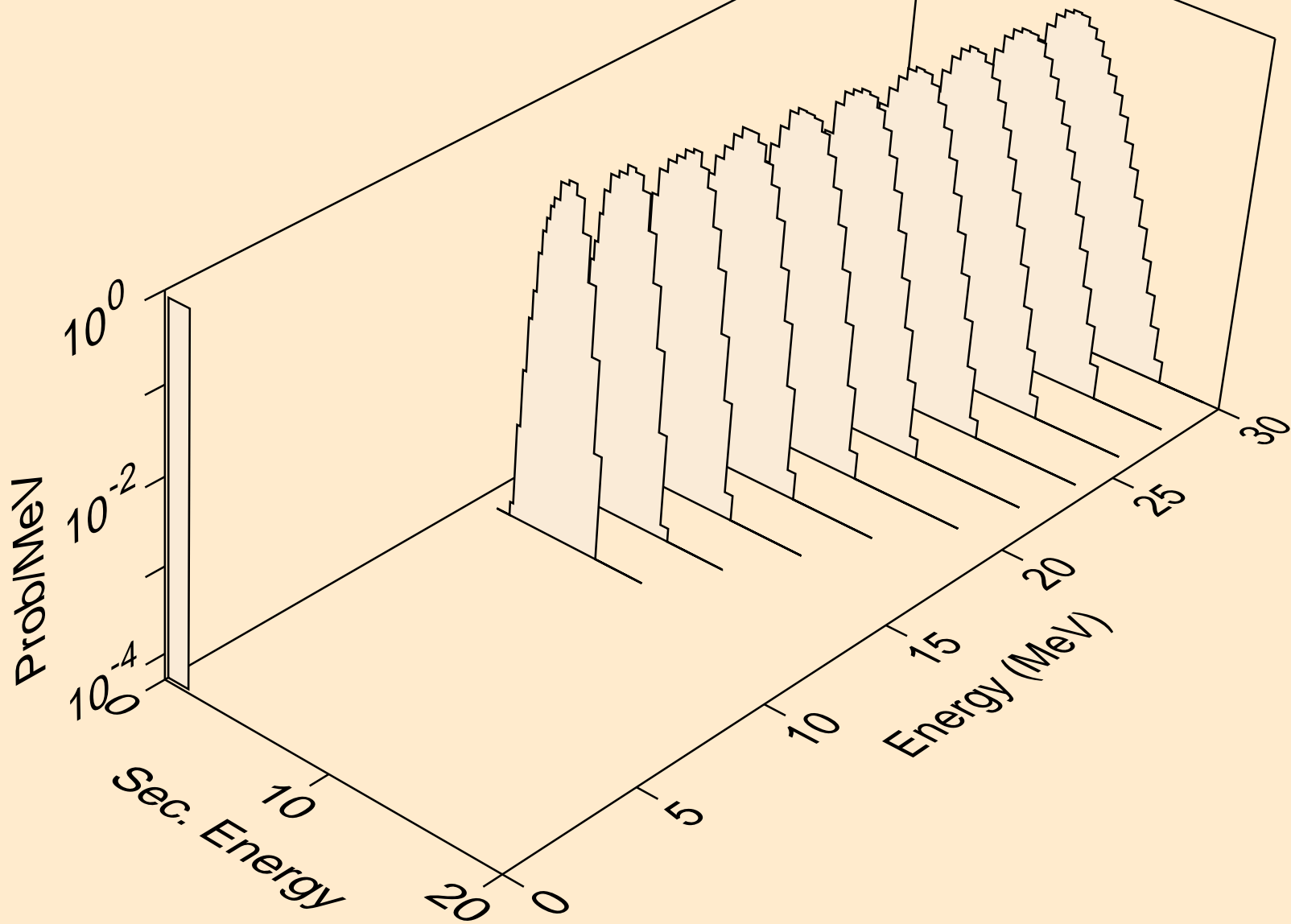

GA064 HELION ACER TENDL-2021 LIBRARY; T=0.K
alphas from (s,pa)

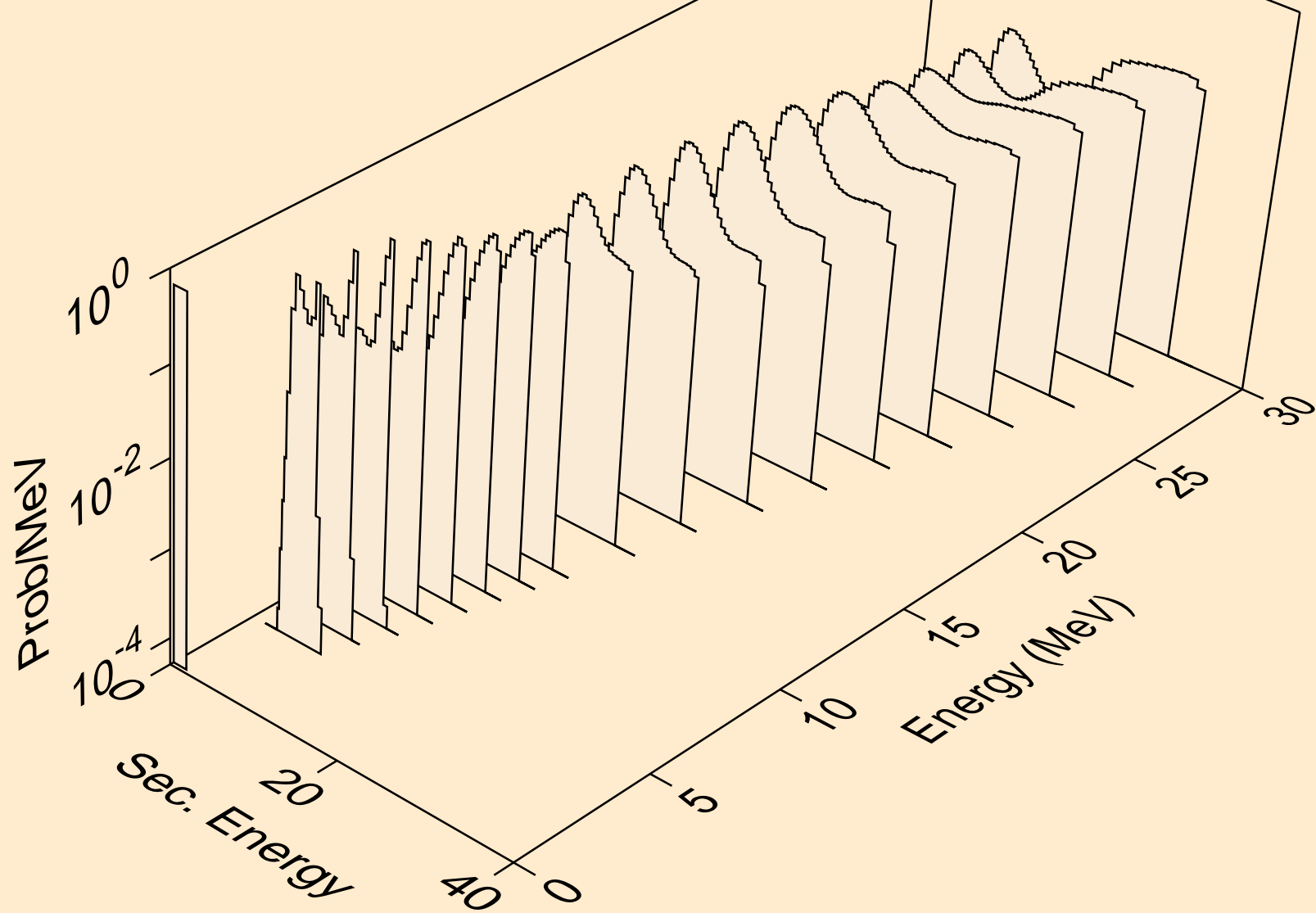

GA064 HELION ACER TENDL-2021 LIBRARY; T=0.K
alphas from (s,t2a)

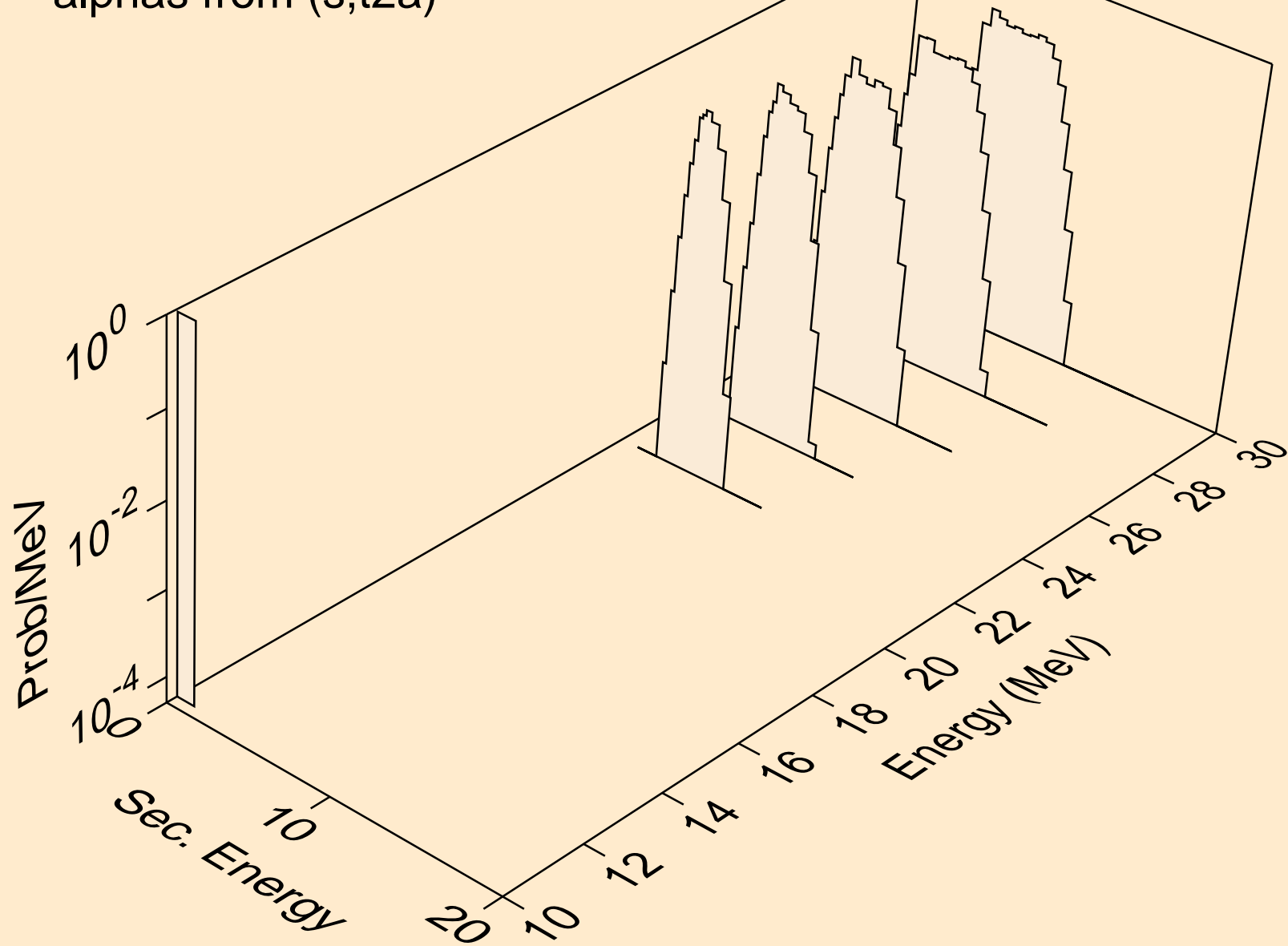

GA064 HELION ACER TENDL-2021 LIBRARY; T=0.K
alphas from (s,d2a)

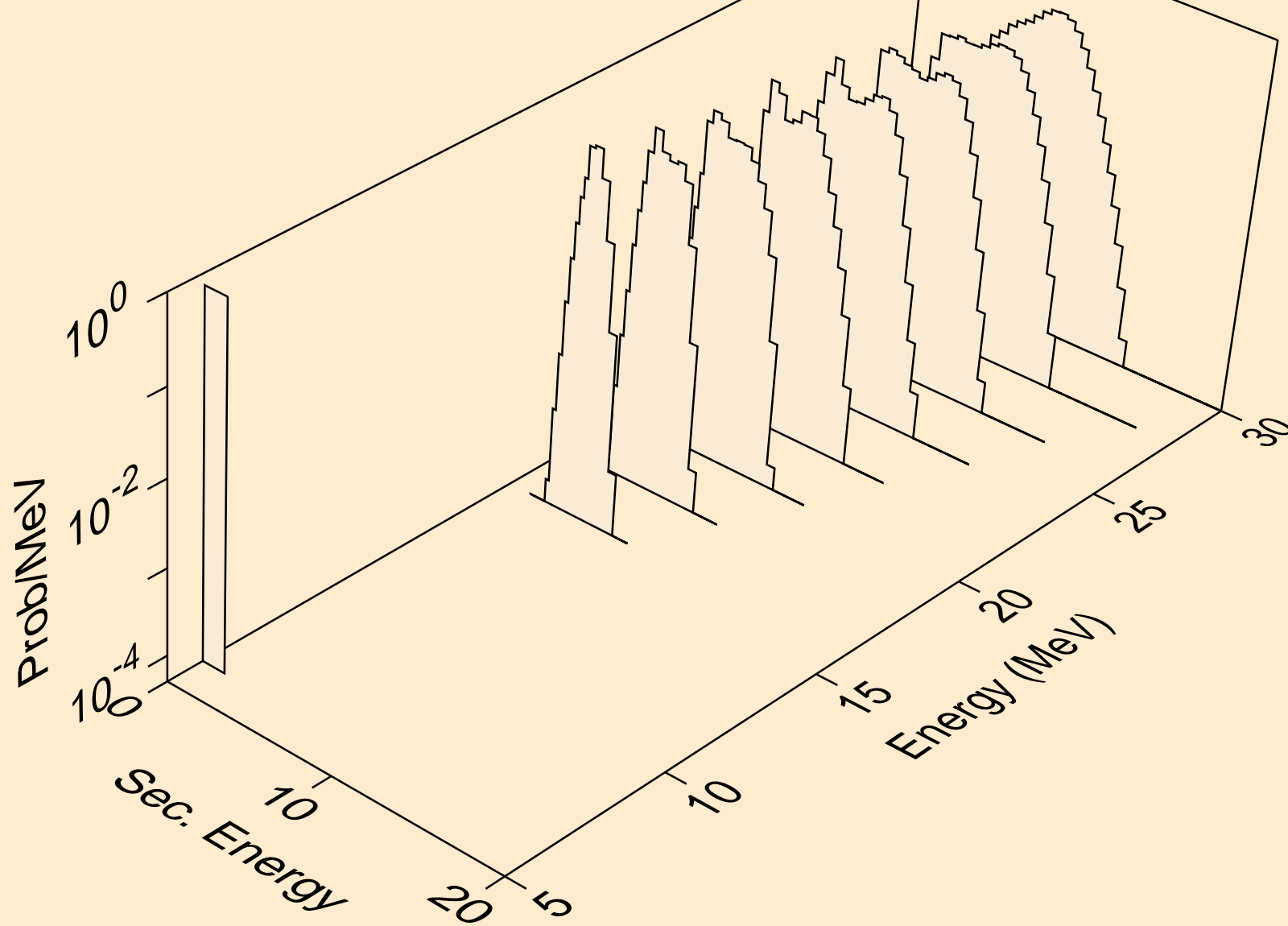

GA064 HELION ACER TENDL-2021 LIBRARY; T=0.K
alphas from (s,da)

