

# GA080 HELION ACER TENDL-2021 LIBRARY; T=0.K

## Principal cross sections

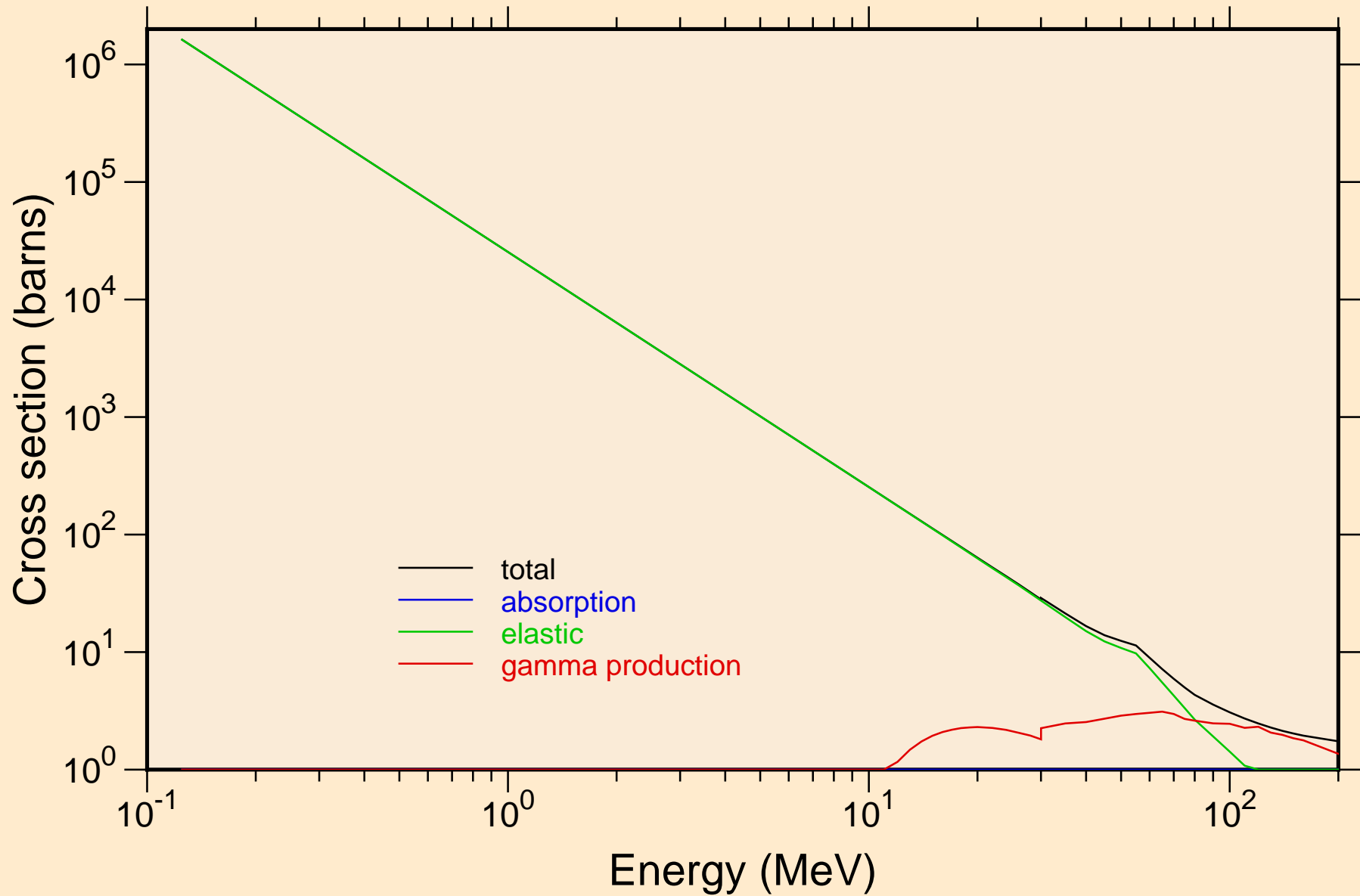

# GA080 HELION ACER TENDL-2021 LIBRARY; T=0.K

## Heating

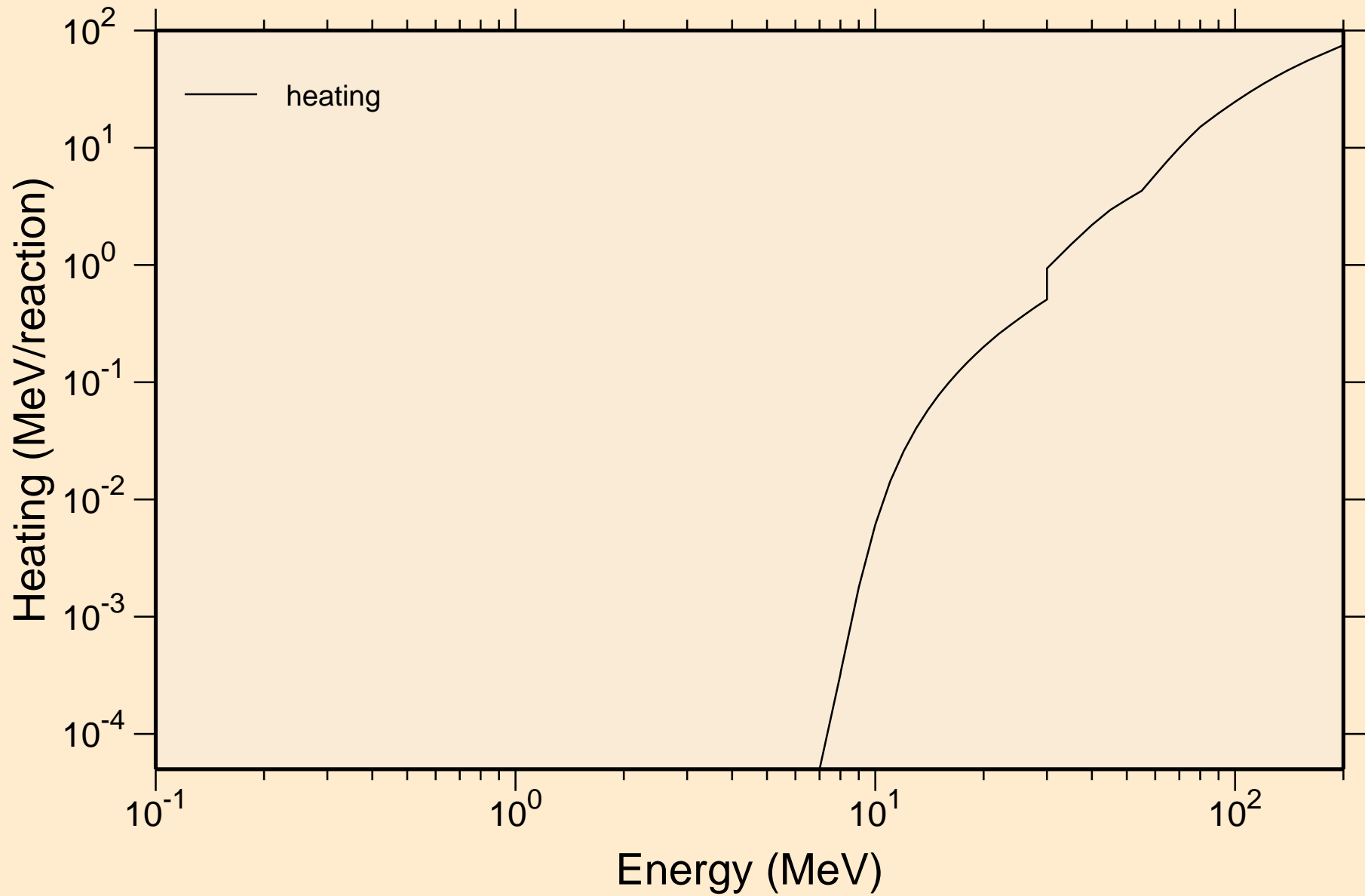

# GA080 HELION ACER TENDL-2021 LIBRARY; T=0.K

## Principal cross sections

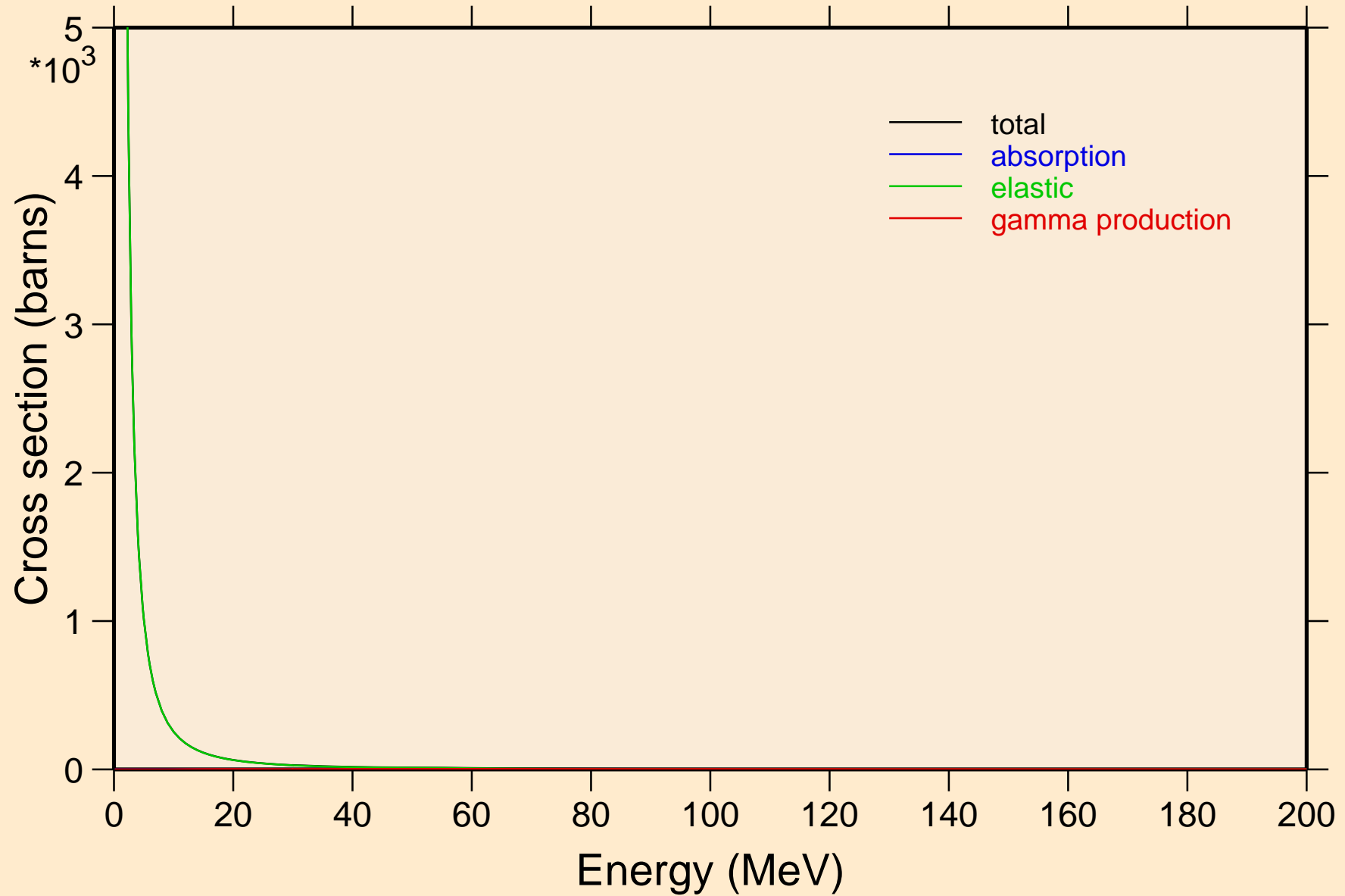

GA080 HELION ACER TENDL-2021 LIBRARY; T=0.K

Heating

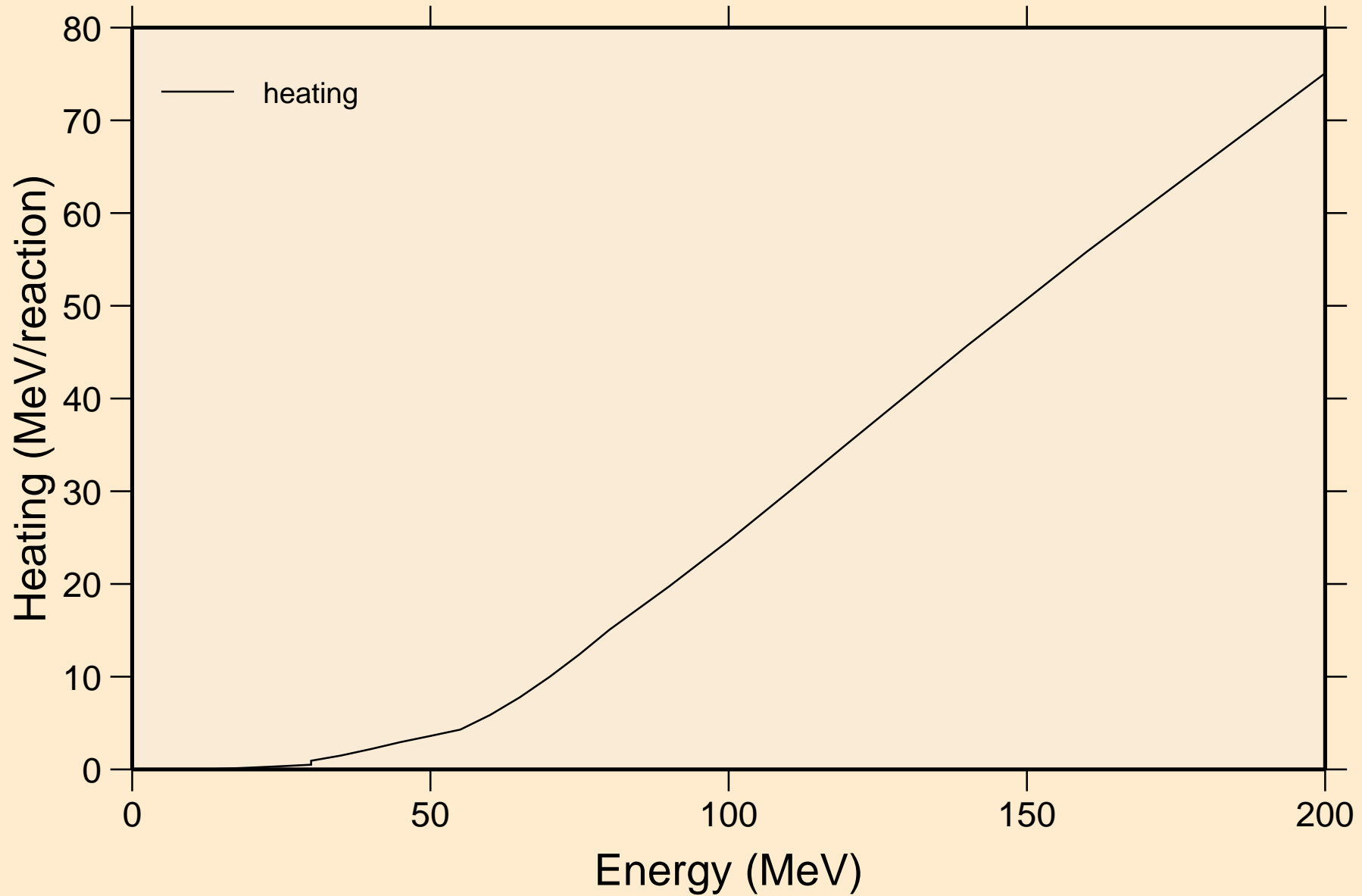

GA080 HELION ACER TENDL-2021 LIBRARY; T=0.K  
Threshold reactions

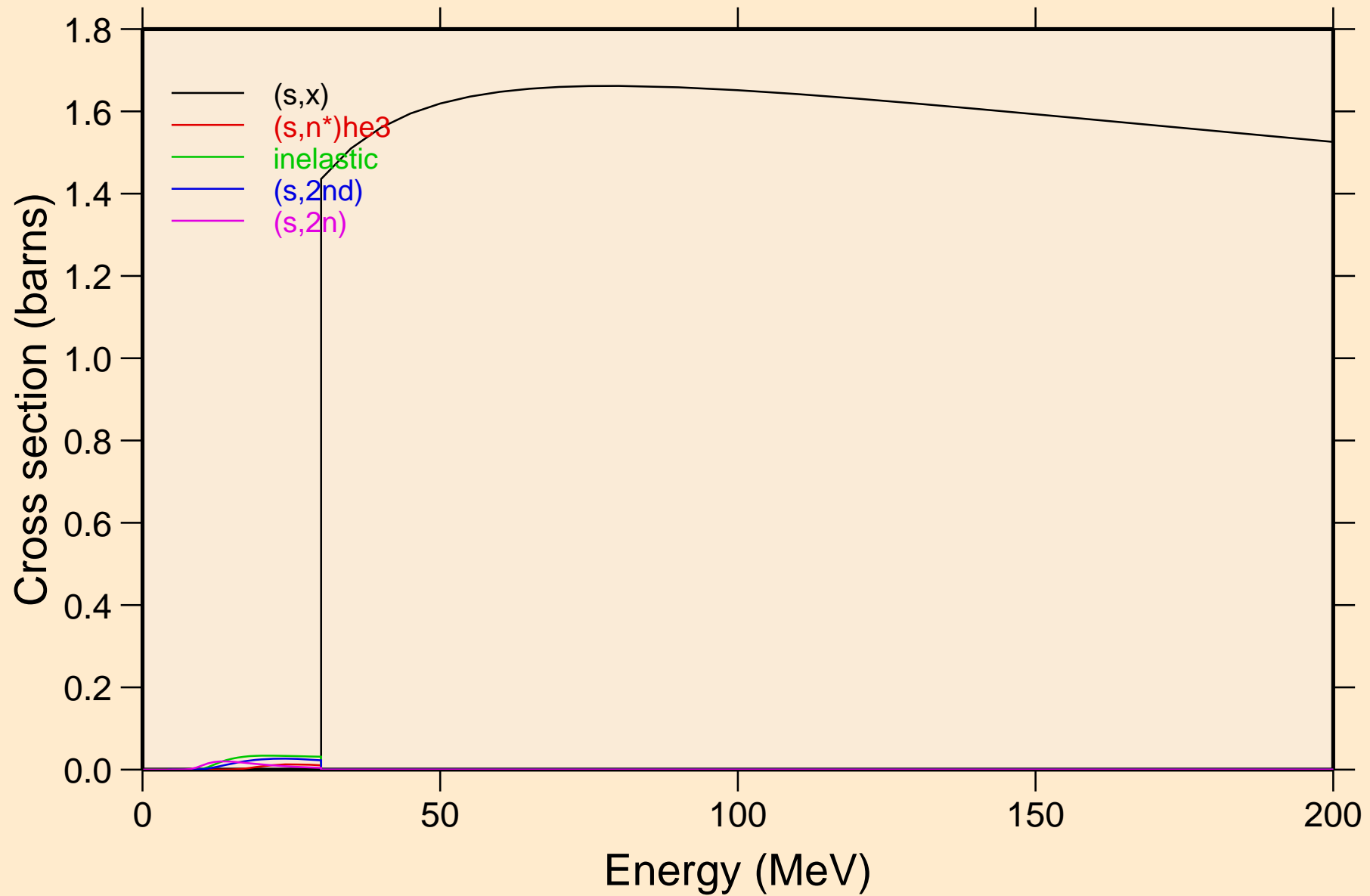

GA080 HELION ACER TENDL-2021 LIBRARY; T=0.K  
Threshold reactions

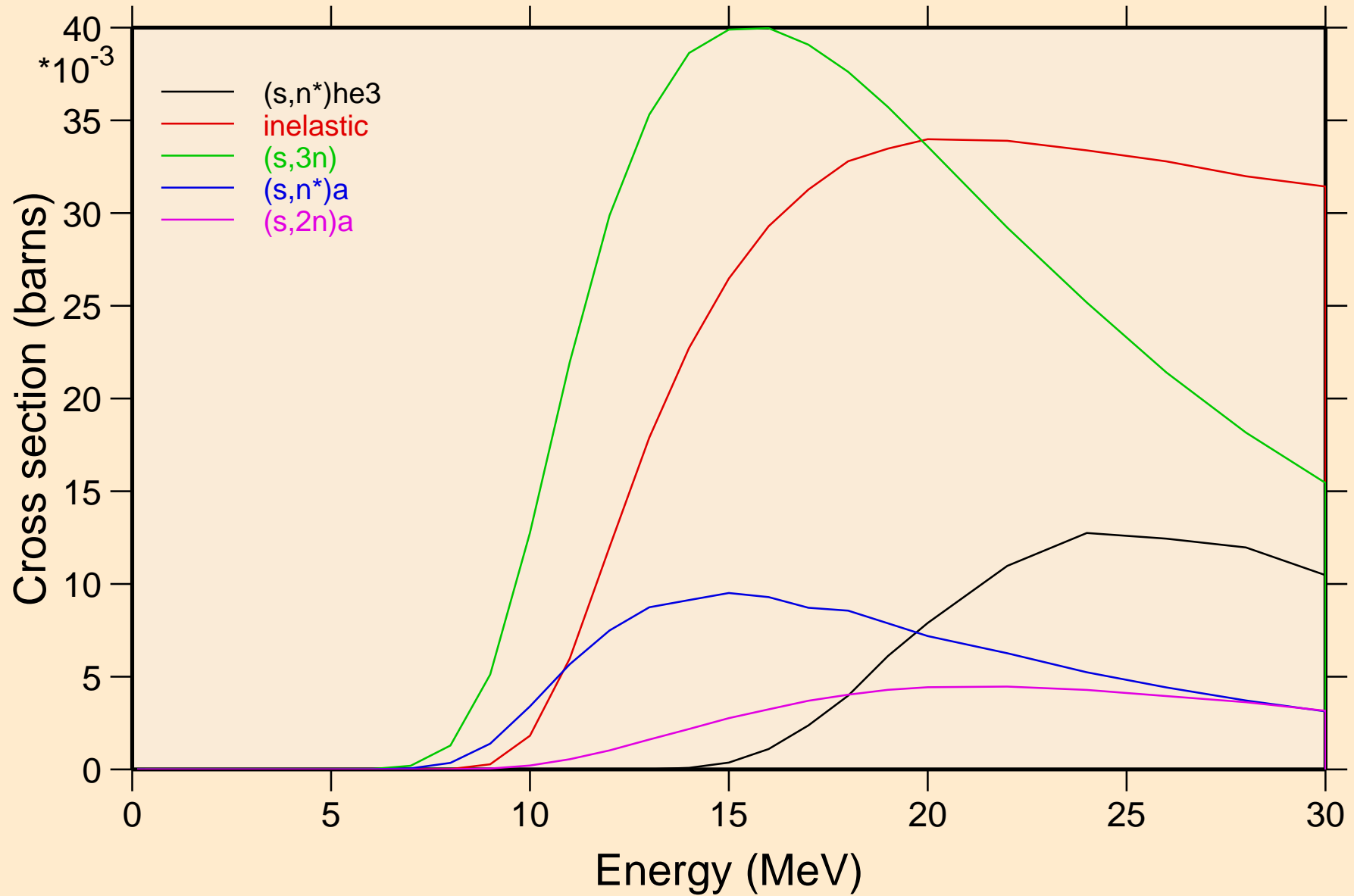

GA080 HELION ACER TENDL-2021 LIBRARY; T=0.K  
Threshold reactions

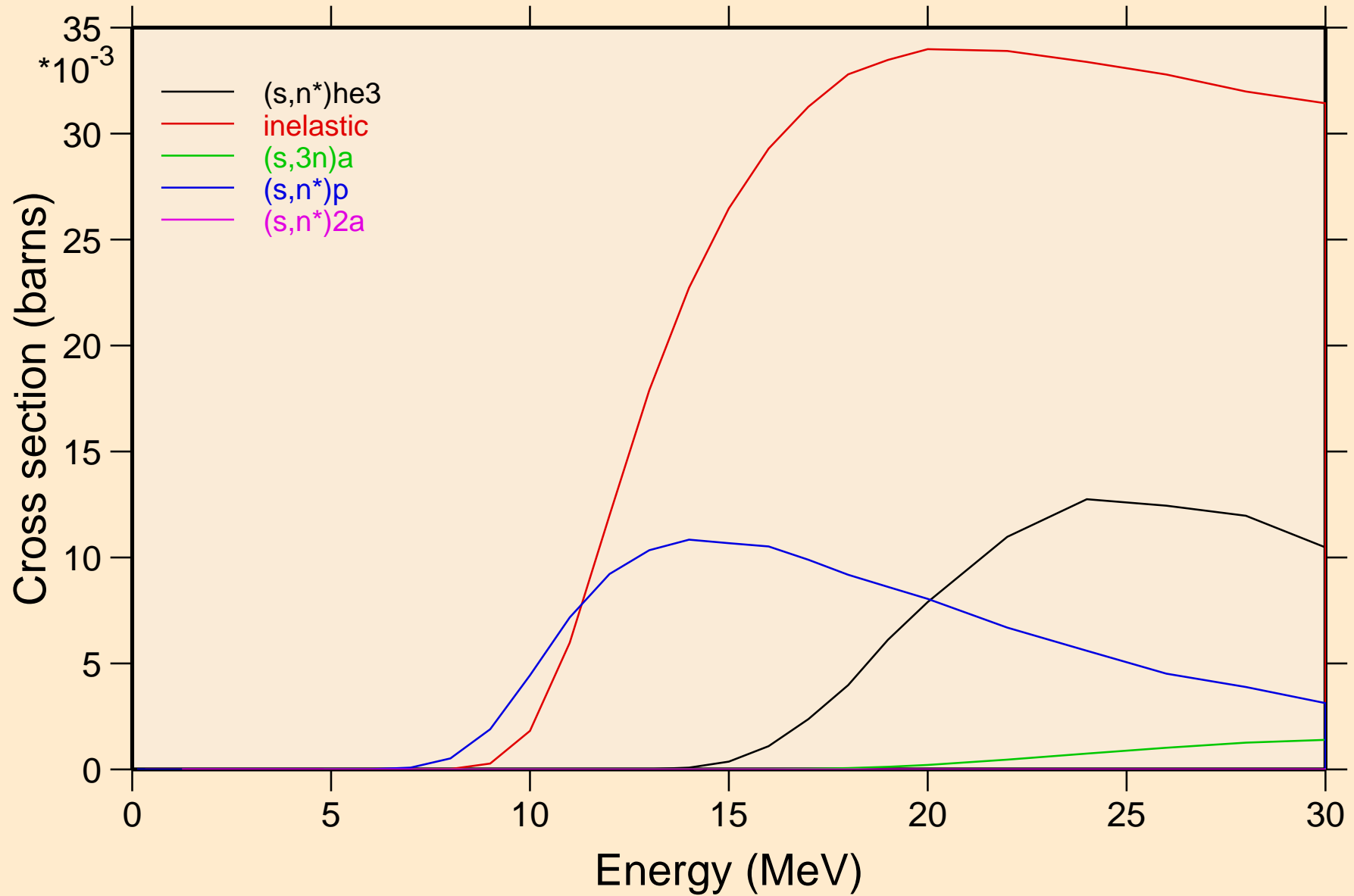

GA080 HELION ACER TENDL-2021 LIBRARY; T=0.K  
Threshold reactions

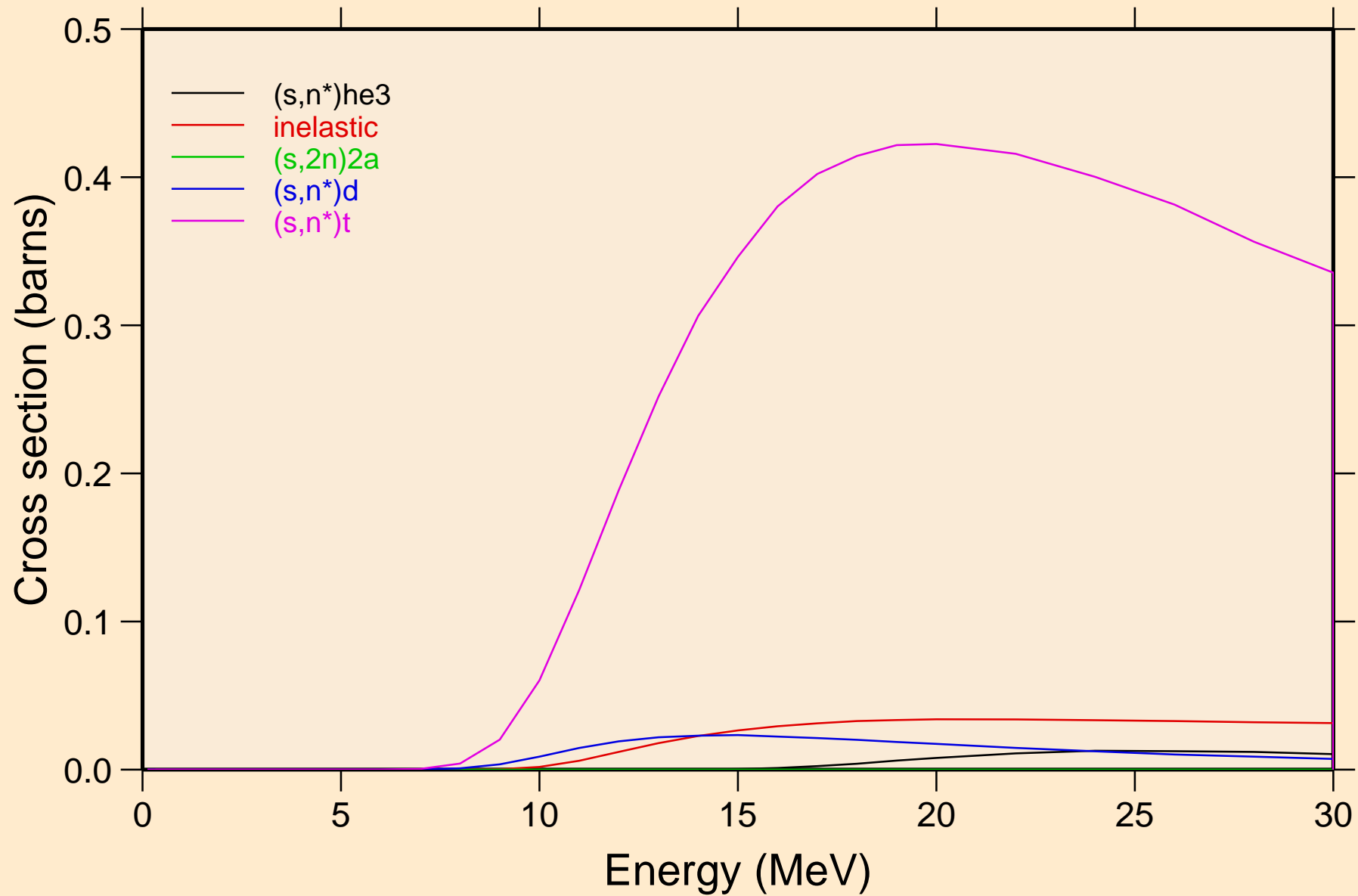



GA080 HELION ACER TENDL-2021 LIBRARY; T=0.K  
Threshold reactions

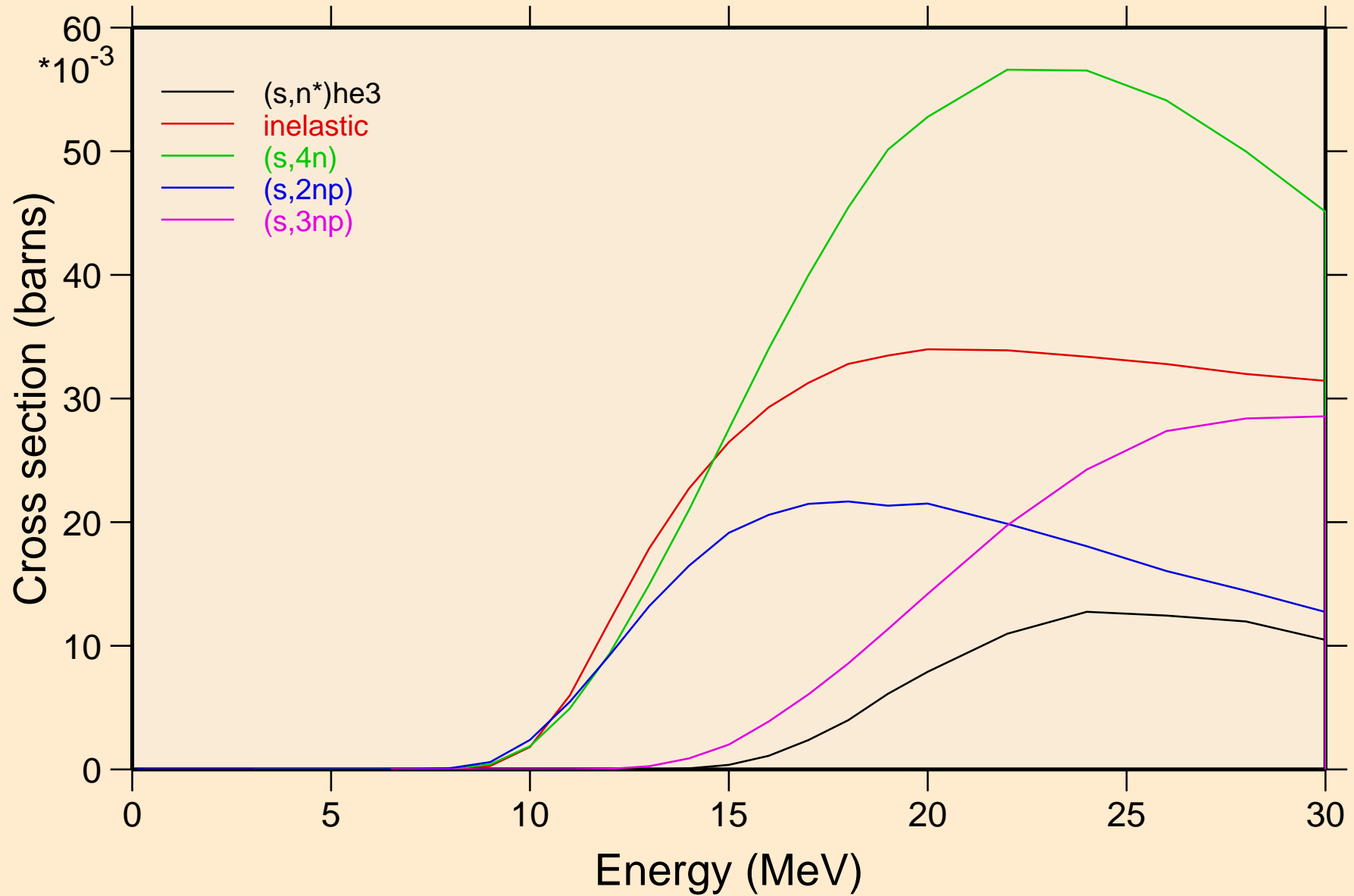

# GA080 HELION ACER TENDL-2021 LIBRARY; T=0.K

## Threshold reactions

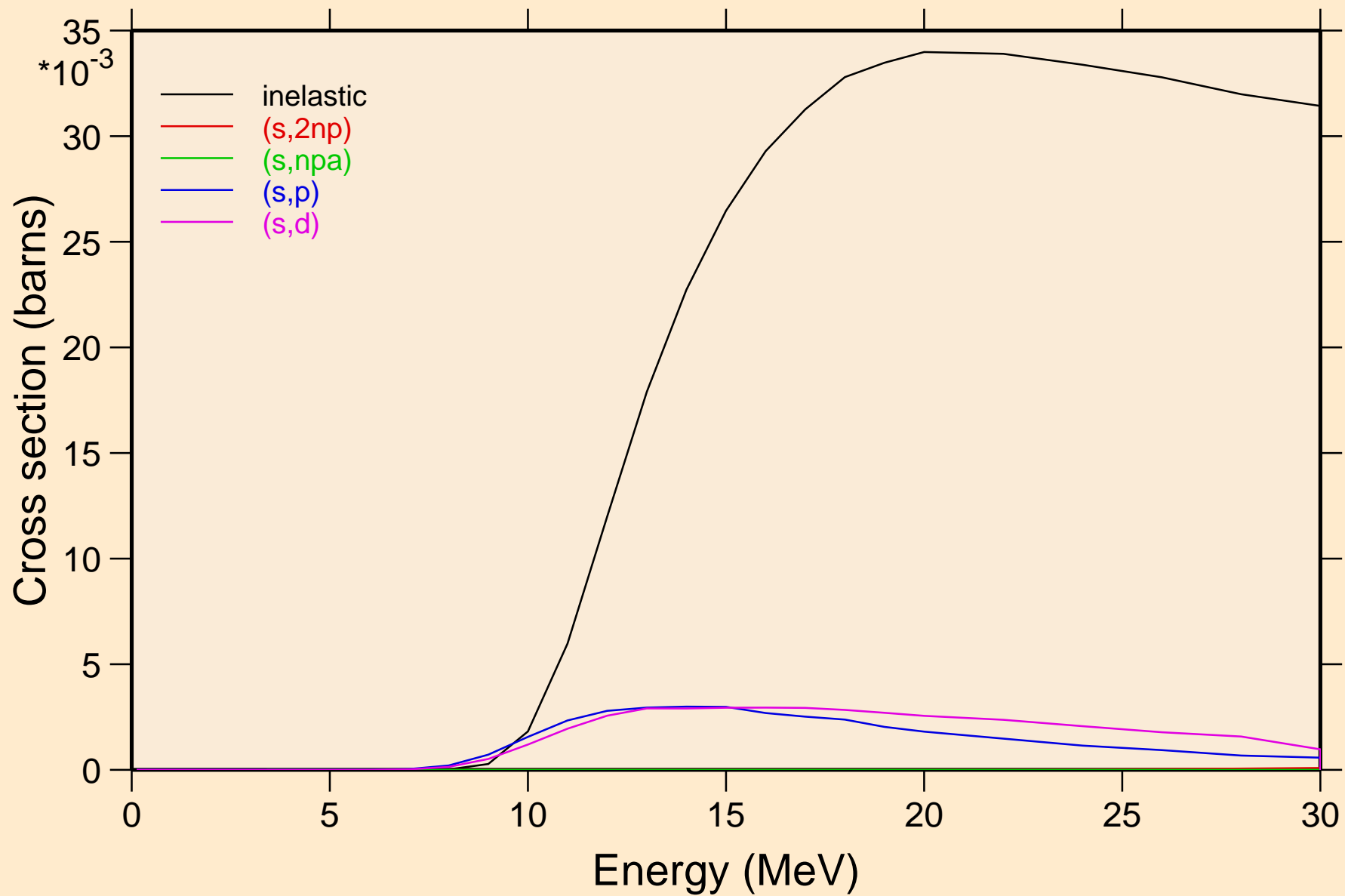

# GA080 HELION ACER TENDL-2021 LIBRARY; T=0.K

## Threshold reactions

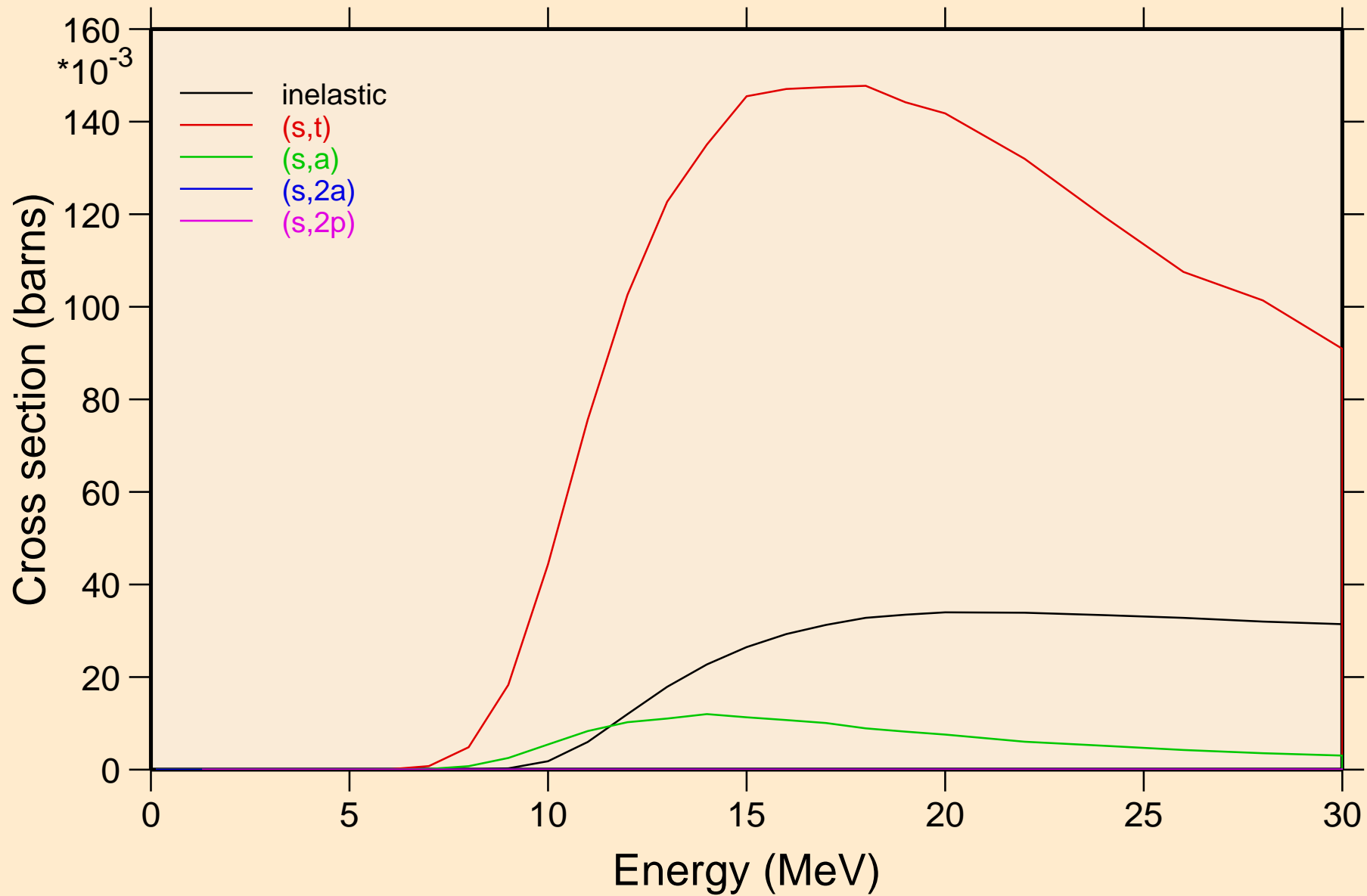

GA080 HELION ACER TENDL-2021 LIBRARY; T=0.K  
Threshold reactions

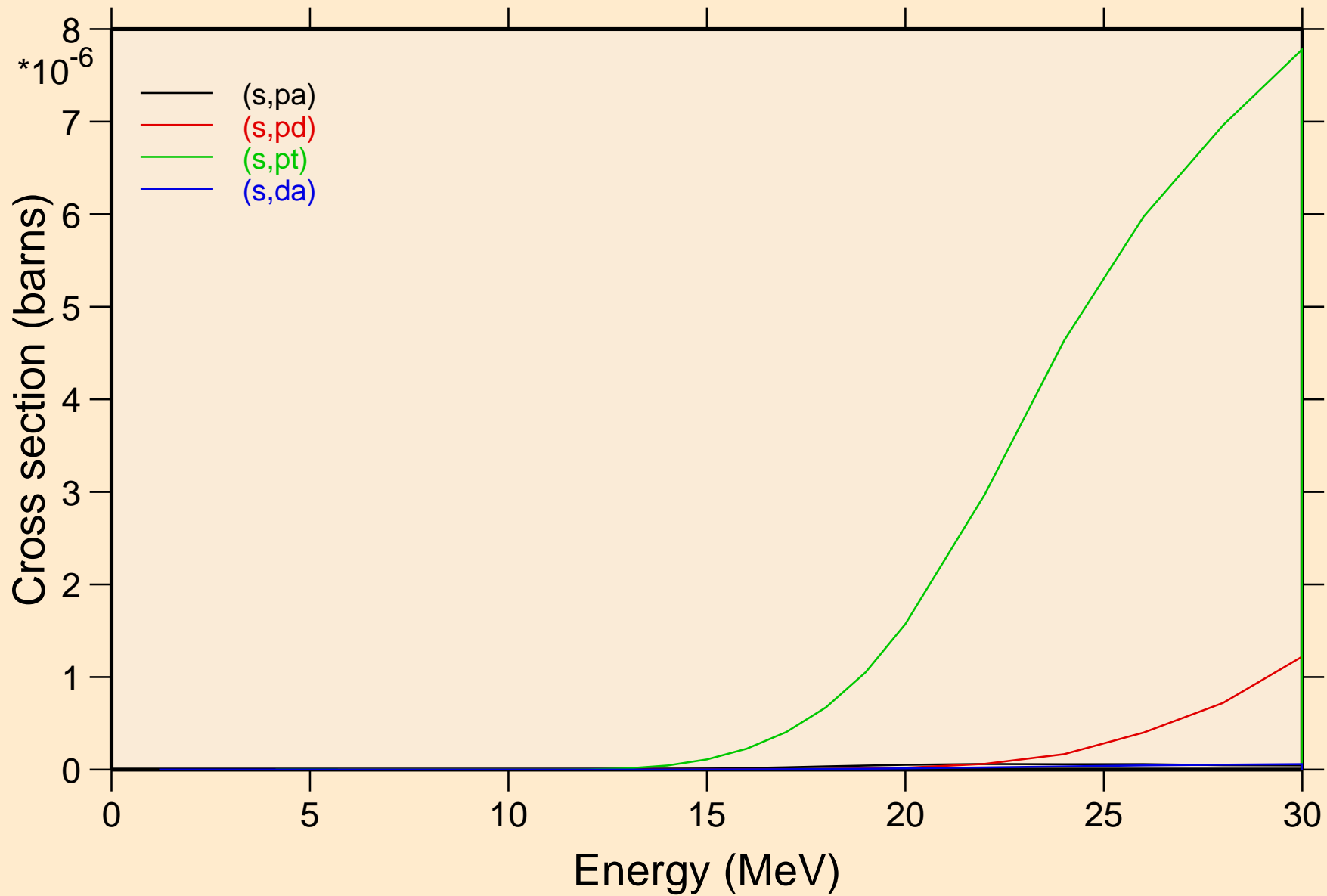

GA080 HELION ACER TENDL-2021 LIBRARY; T=0.K  
angular distribution for elastic

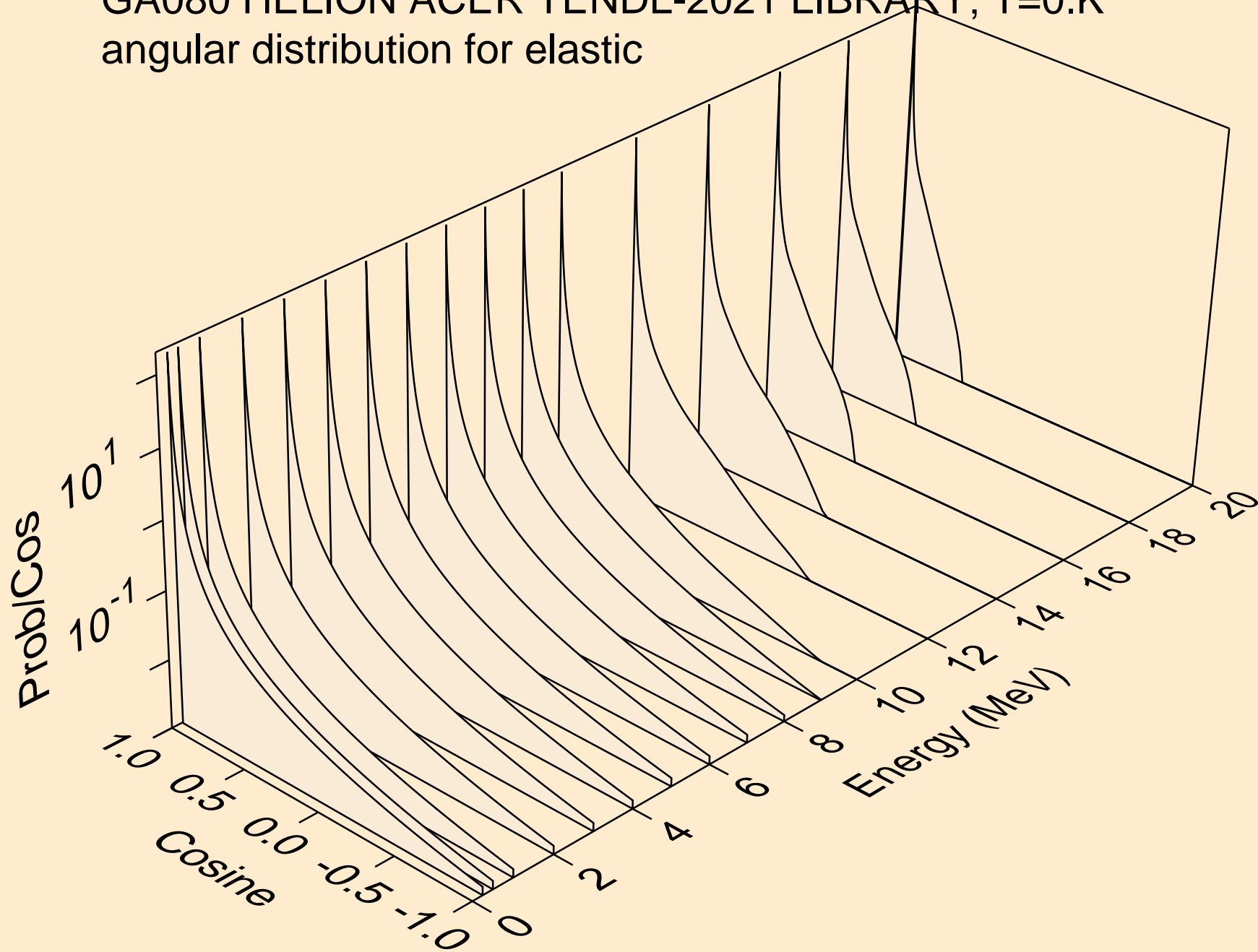

GA080 HELION ACER TENDL-2021 LIBRARY; T=0.K  
angular distribution for elastic

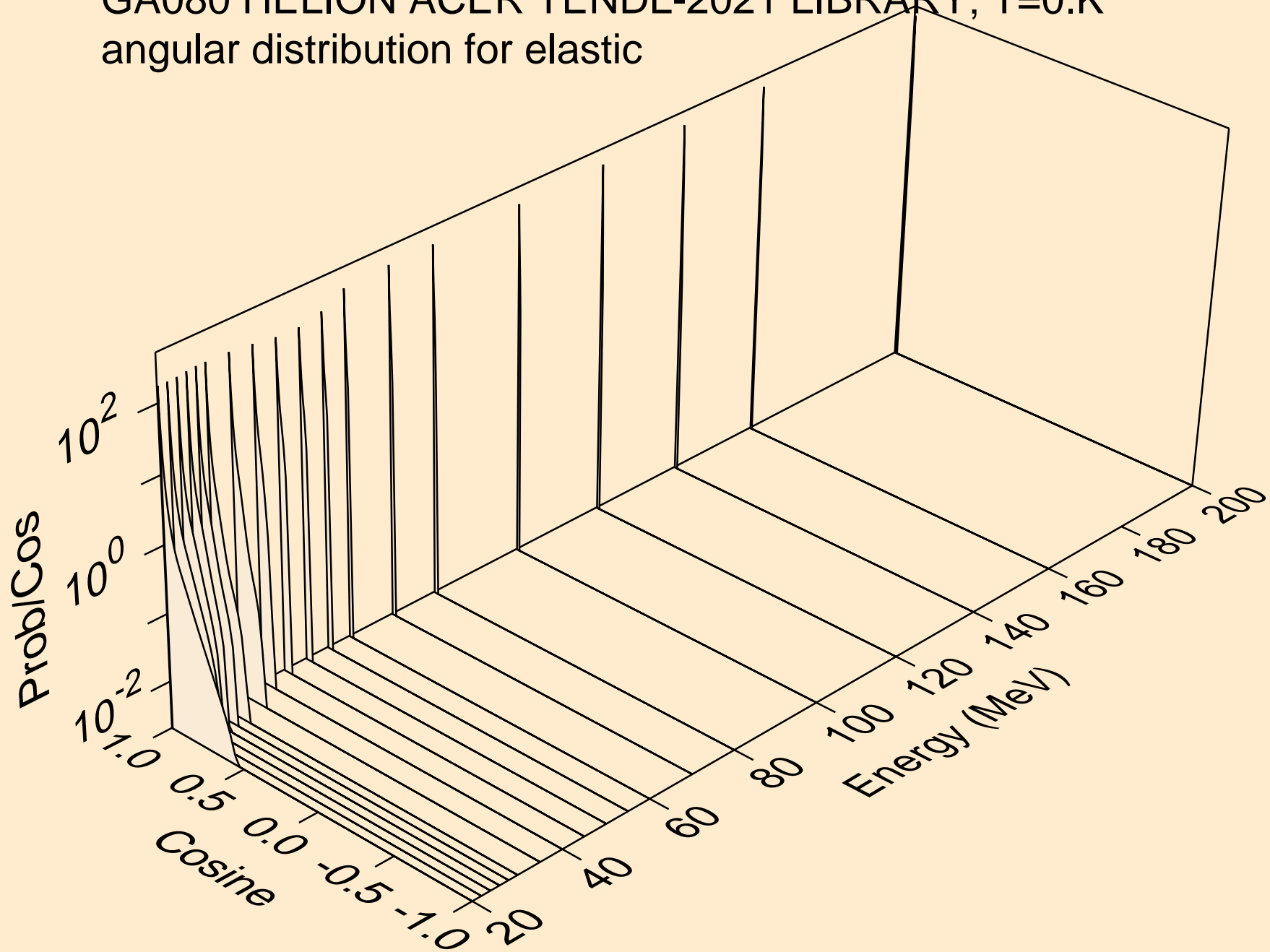

GA080 HELION ACER TENDL-2021 LIBRARY; T=0.K  
He-3 emission for (s,x)

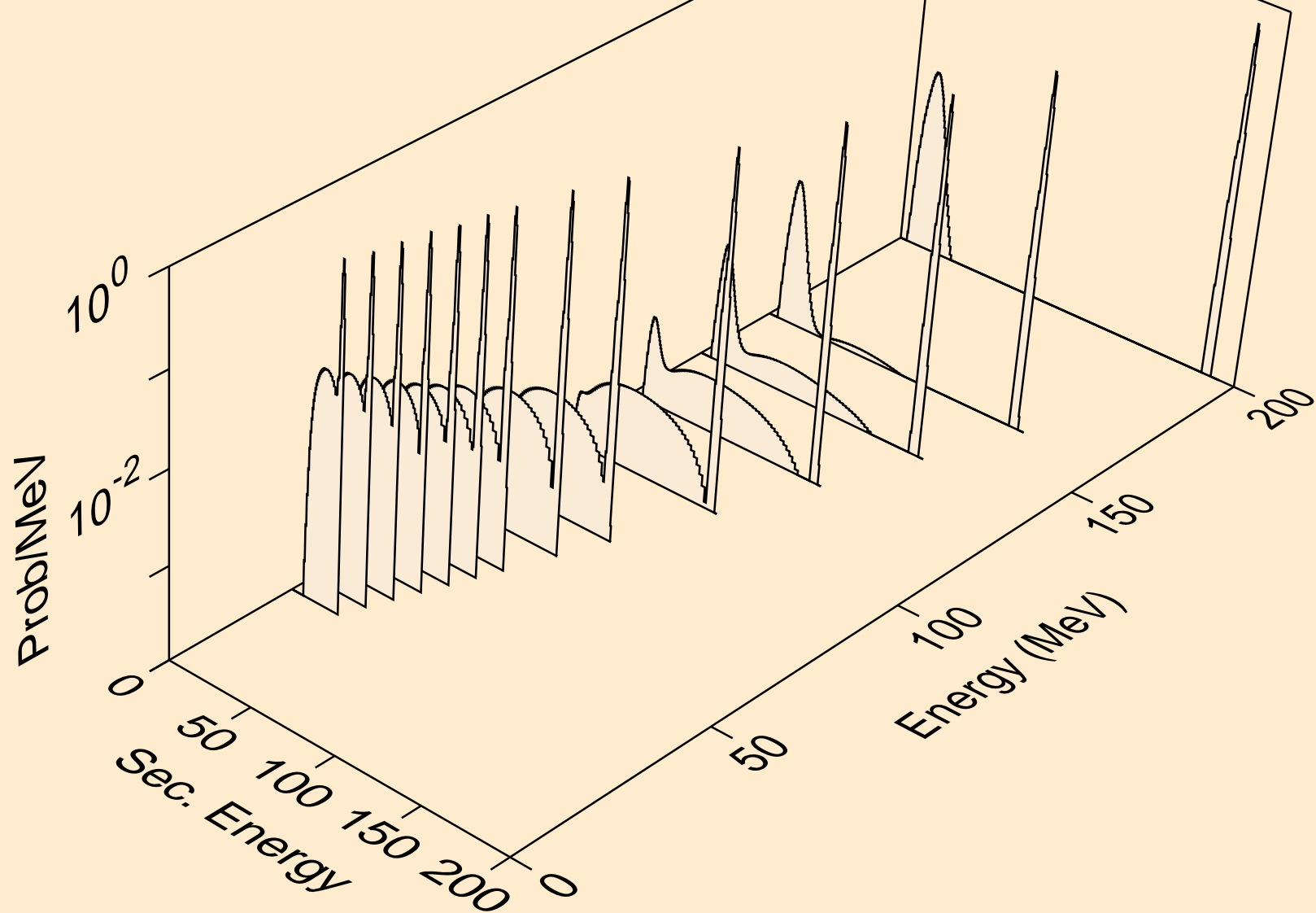

GA080 HELION ACER TENDL-2021 LIBRARY; T=0.K  
He-3 emission for (s,n\*)he3

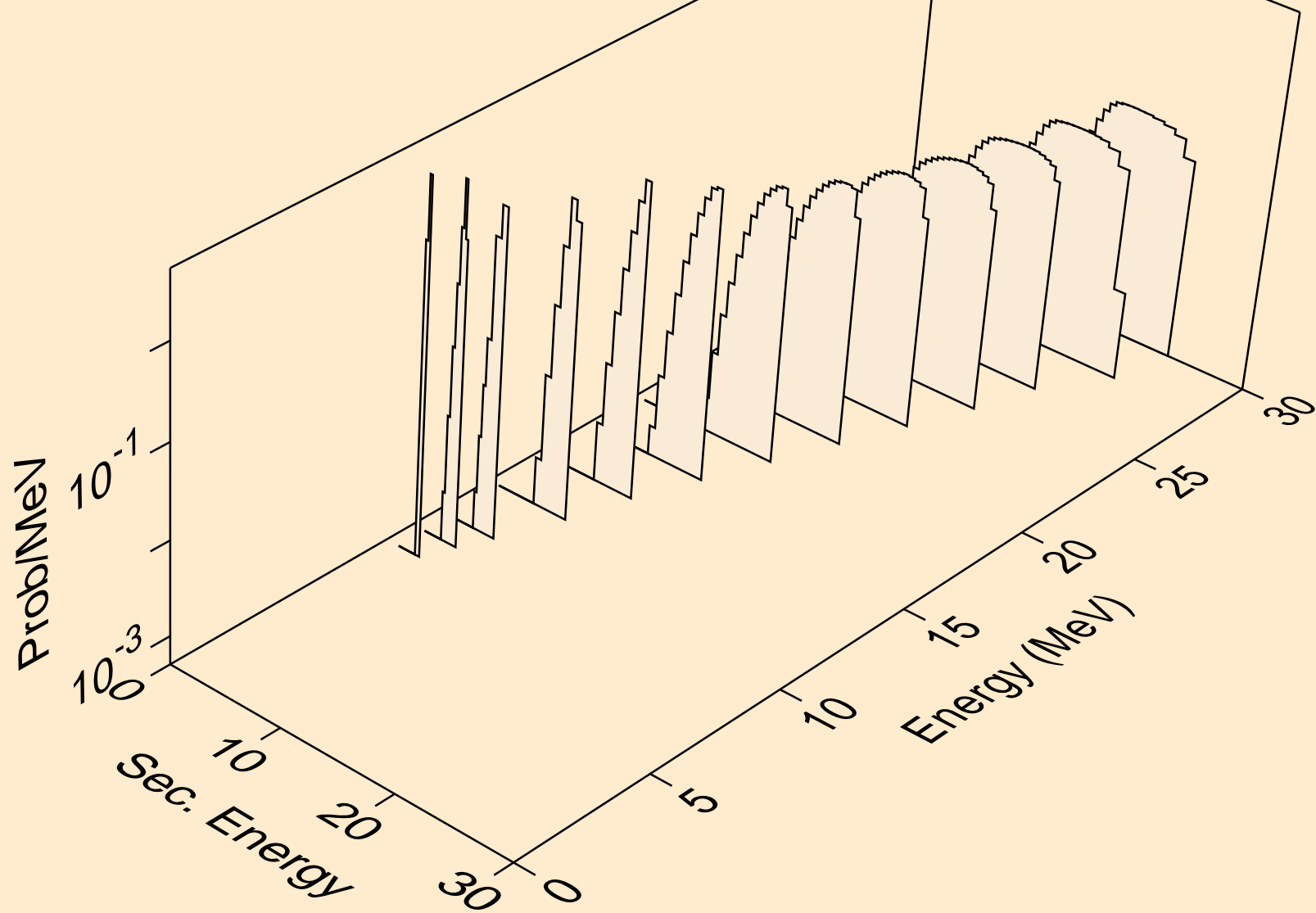



GA080 HELION ACER TENDL-2021 LIBRARY; T=0.K  
He-3 emission for inelastic

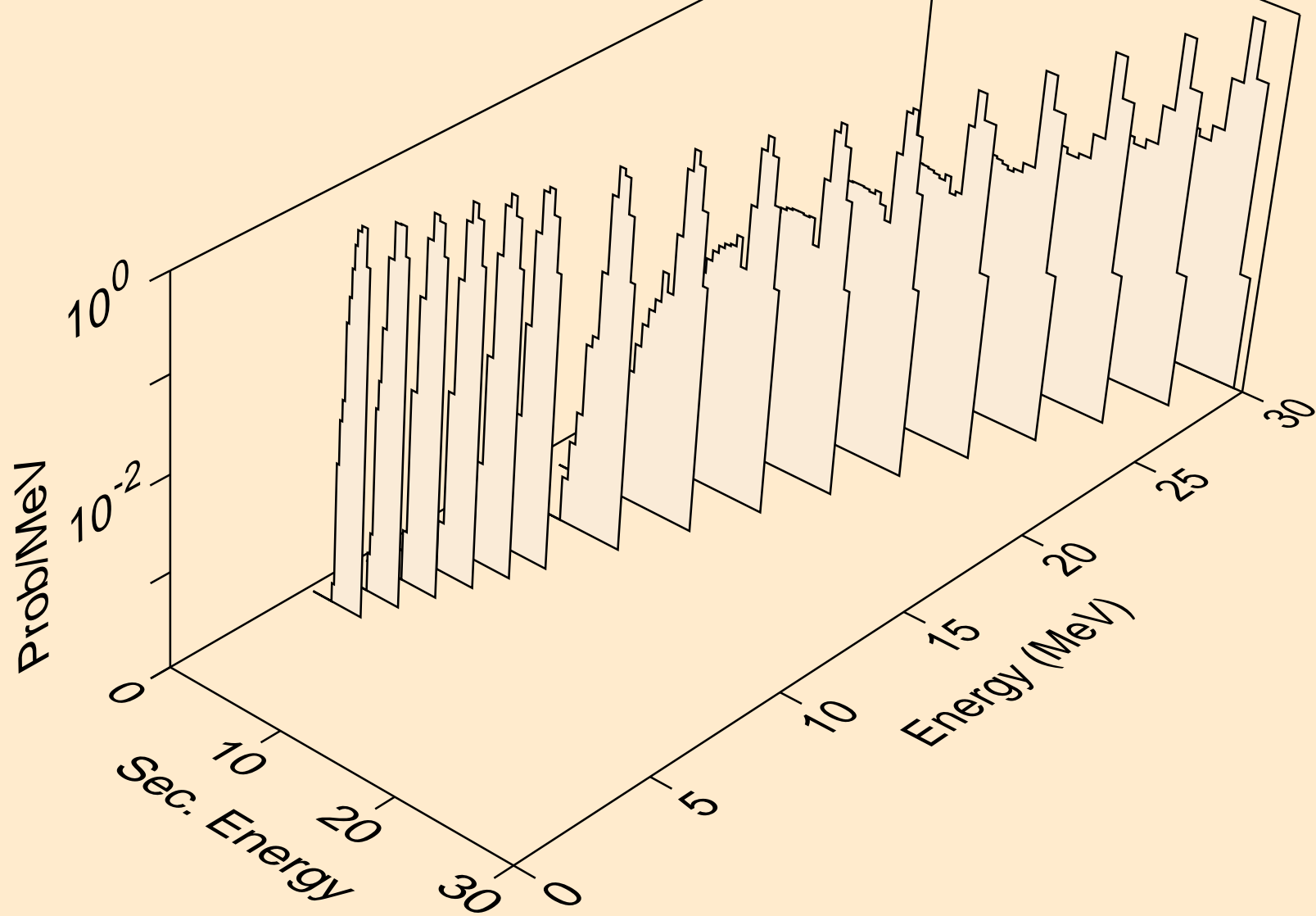

GA080 HELION ACER TENDL-2021 LIBRARY; T=0.K  
Photon emission for (z,n)

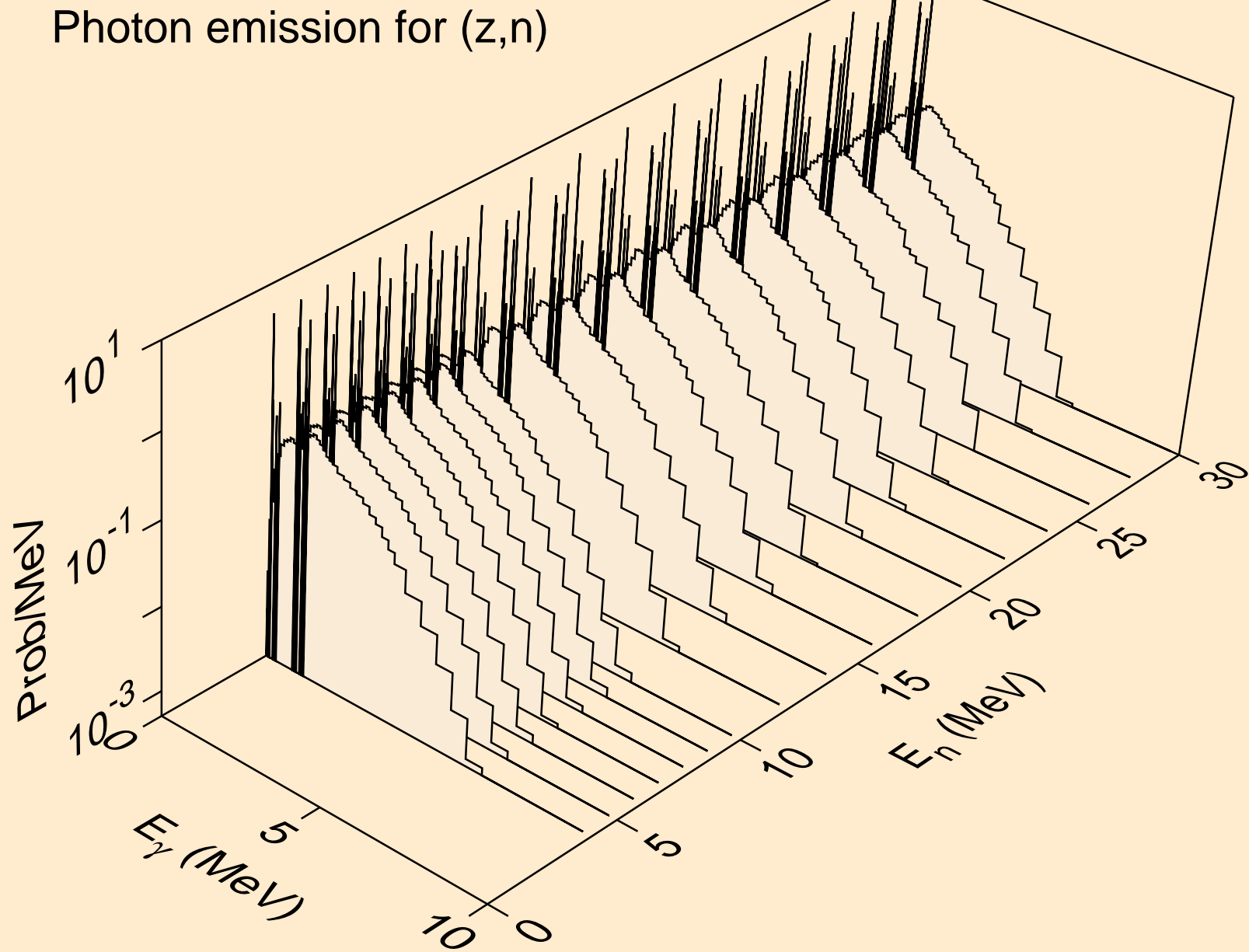

GA080 HELION ACER TENDL-2021 LIBRARY; T=0.K  
Photon emission for (n,x)

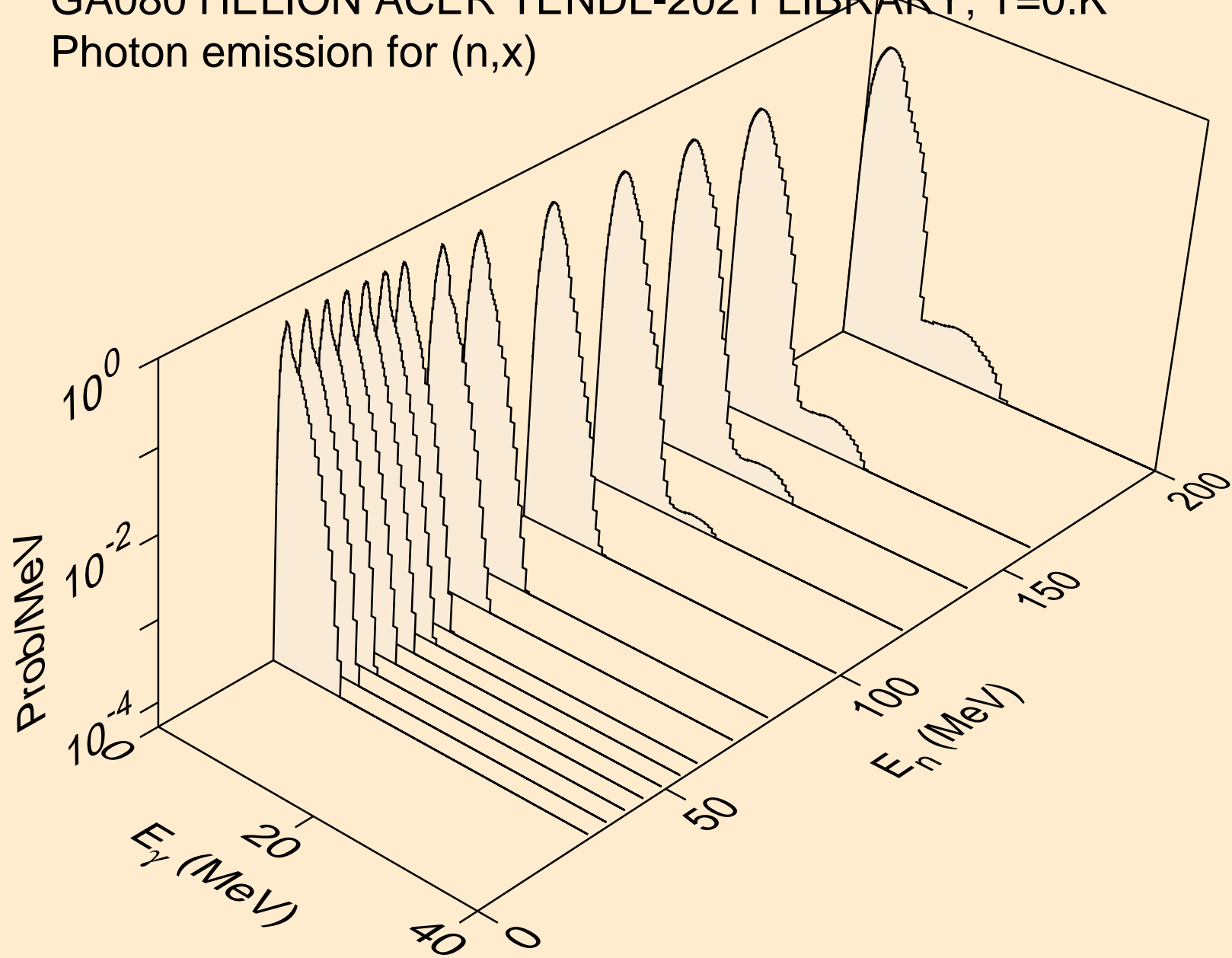

GA080 HELION ACER TENDL-2021 LIBRARY; T=0.K  
Photon emission for (n,2nd)

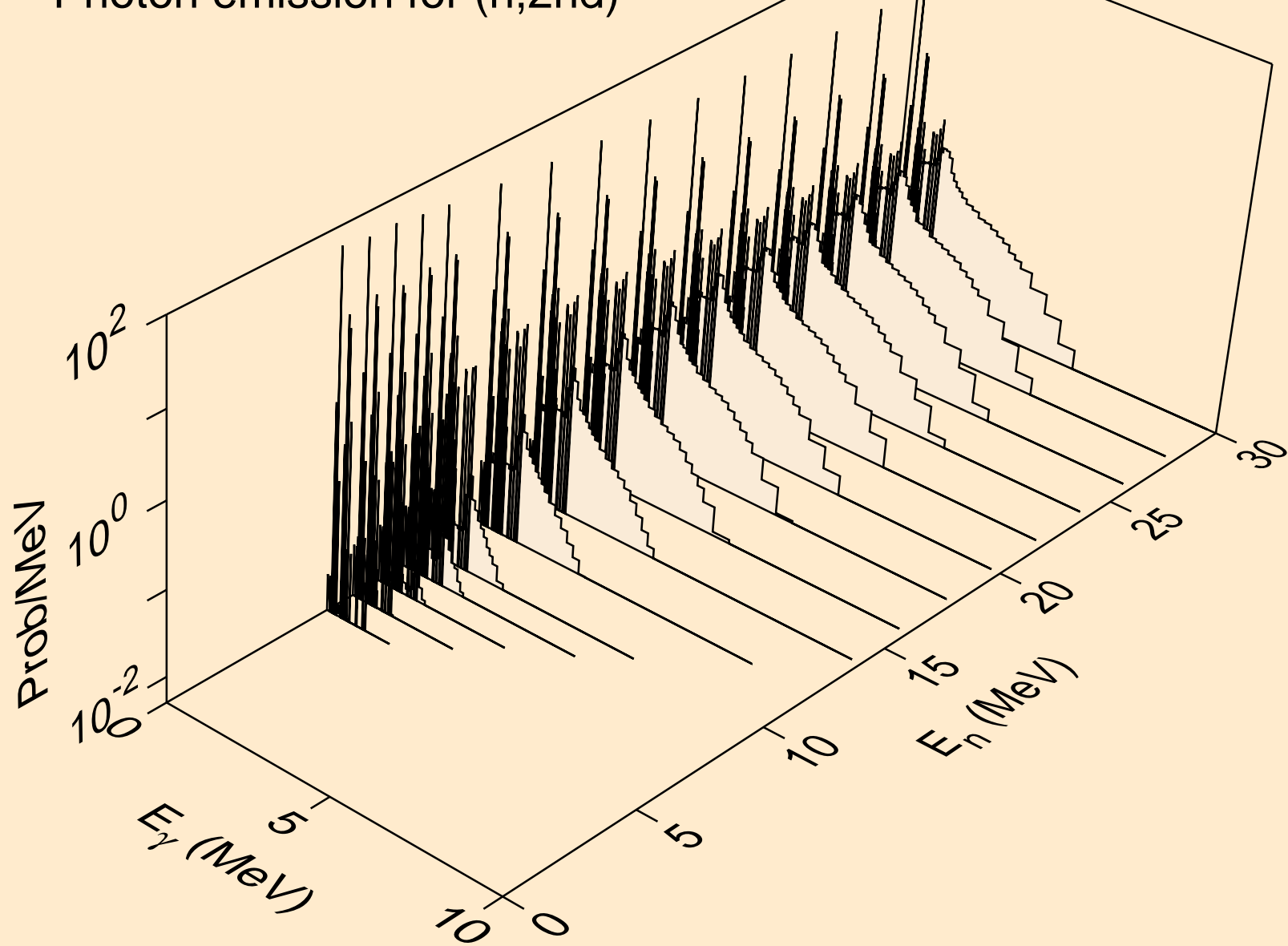

GA080 HELION ACER TENDL-2021 LIBRARY; T=0.K  
Photon emission for (n,2n)

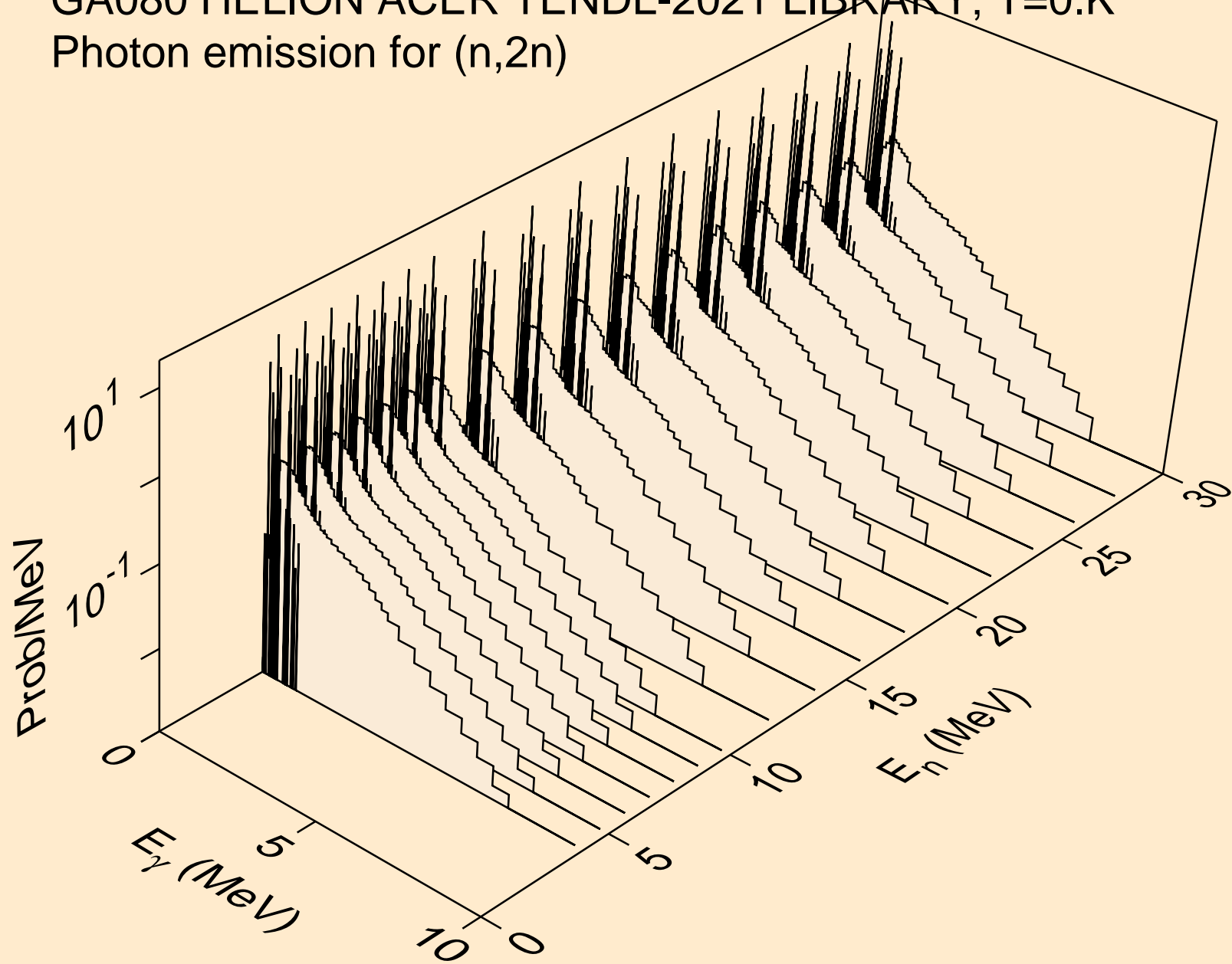

GA080 HELION ACER TENDL-2021 LIBRARY; T=0.K  
Photon emission for (n,3n)

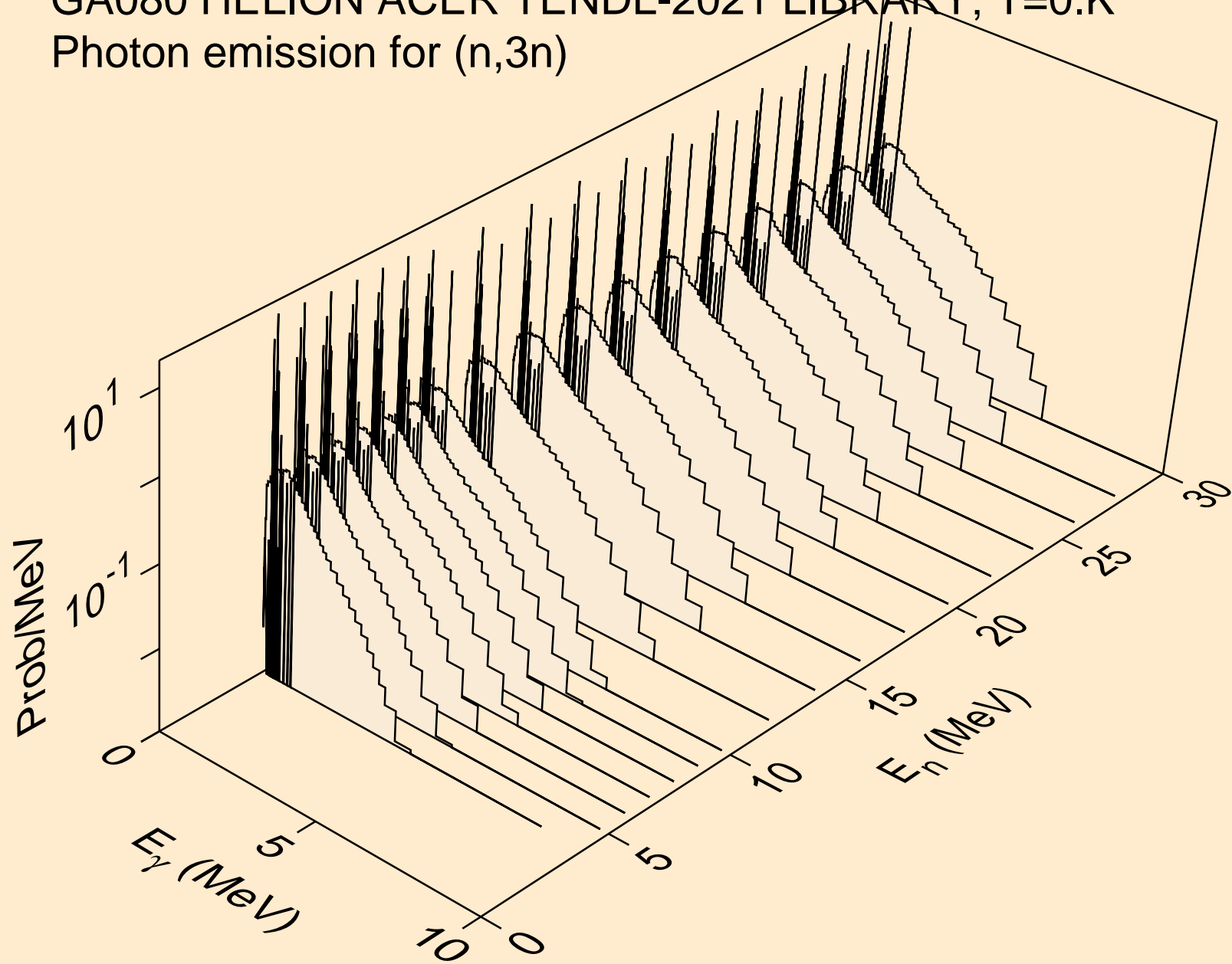

GA080 HELION ACER TENDL-2021 LIBRARY; T=0.K  
Photon emission for (n,n\*)a

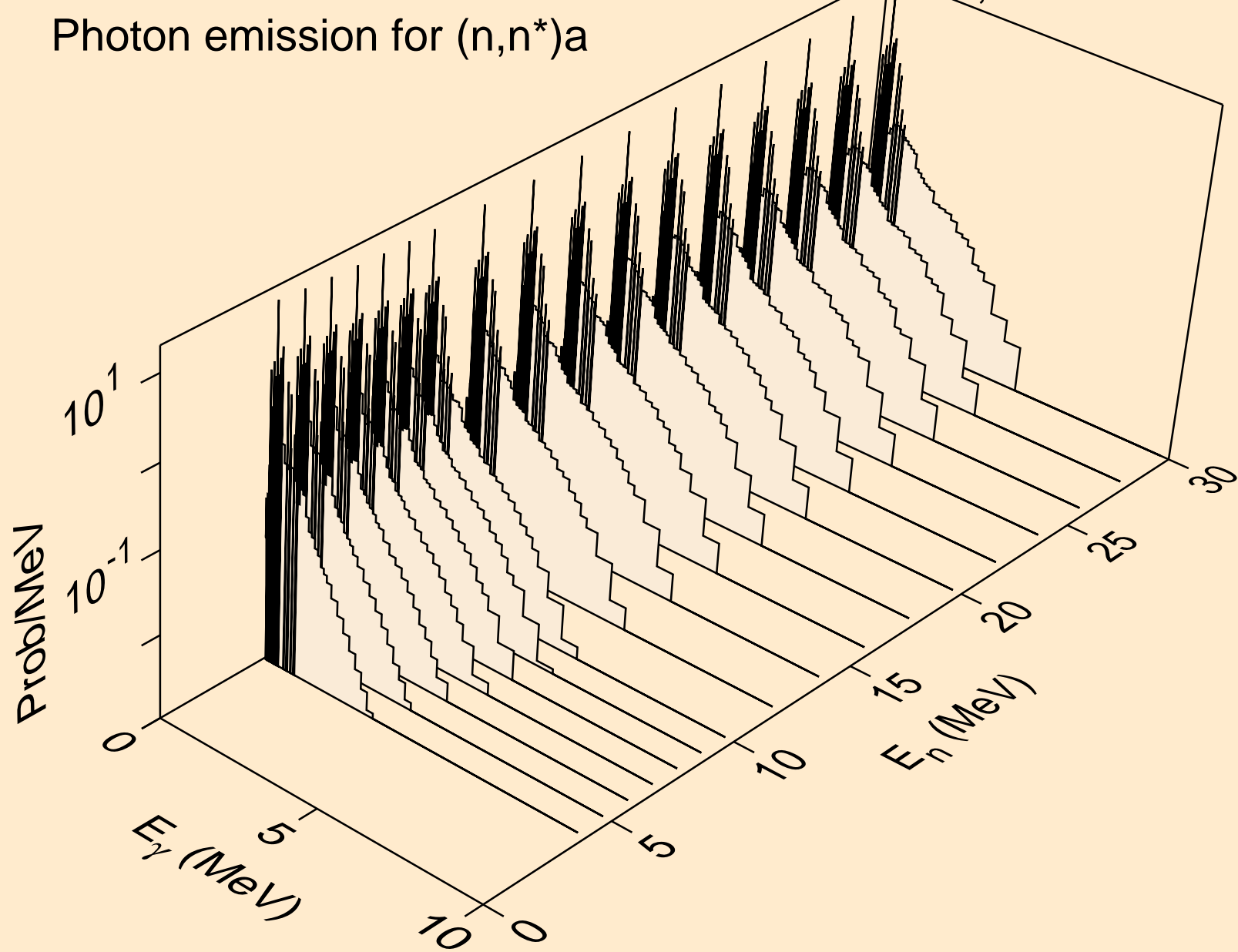

GA080 HELION ACER TENDL-2021 LIBRARY; T=0.K  
Photon emission for (n,2n)a

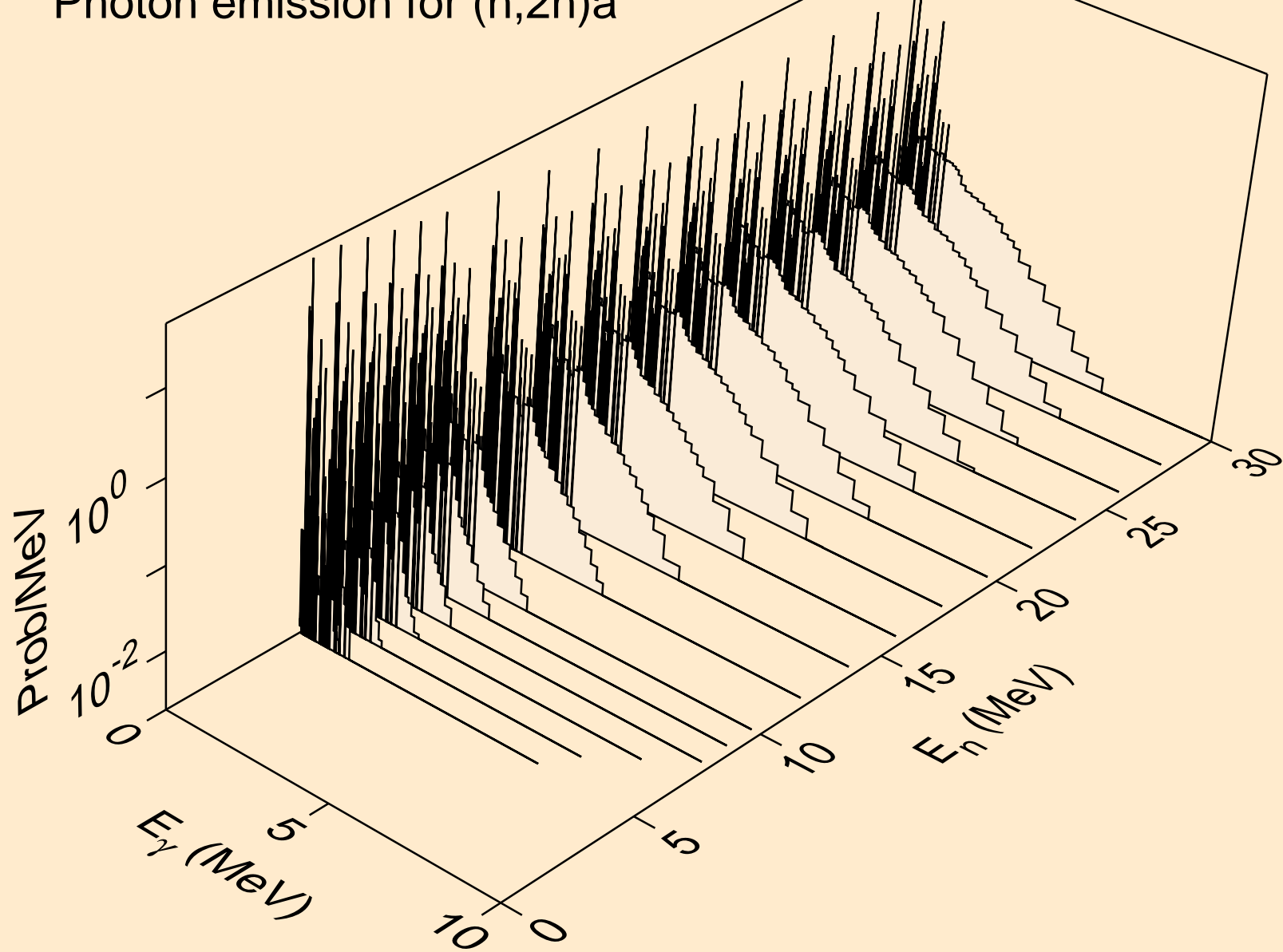



GA080 HELION ACER TENDL-2021 LIBRARY; T=0.K  
Photon emission for (n,3n)a

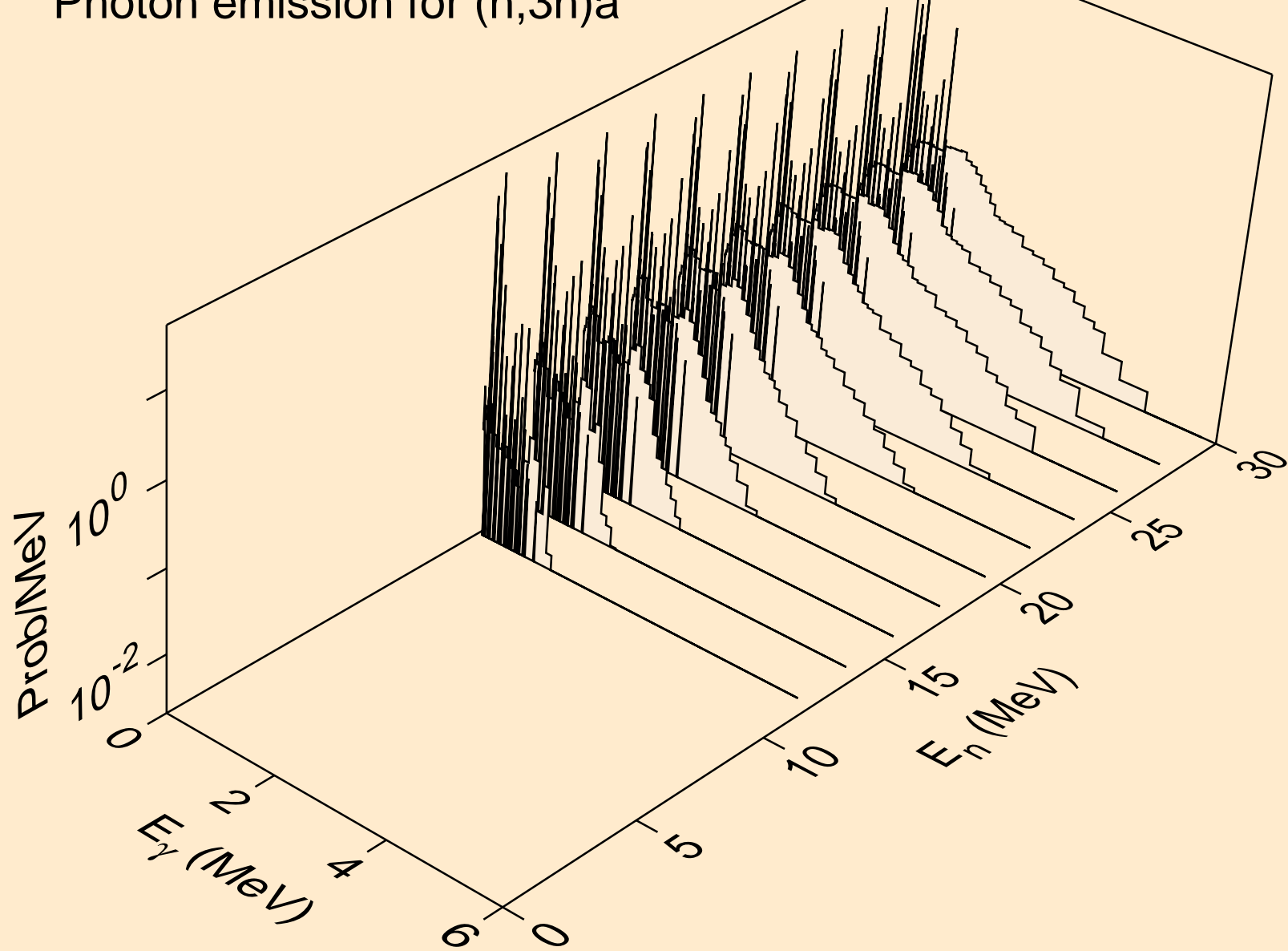

GA080 HELION ACER TENDL-2021 LIBRARY; T=0.K  
Photon emission for (n,n\*)p

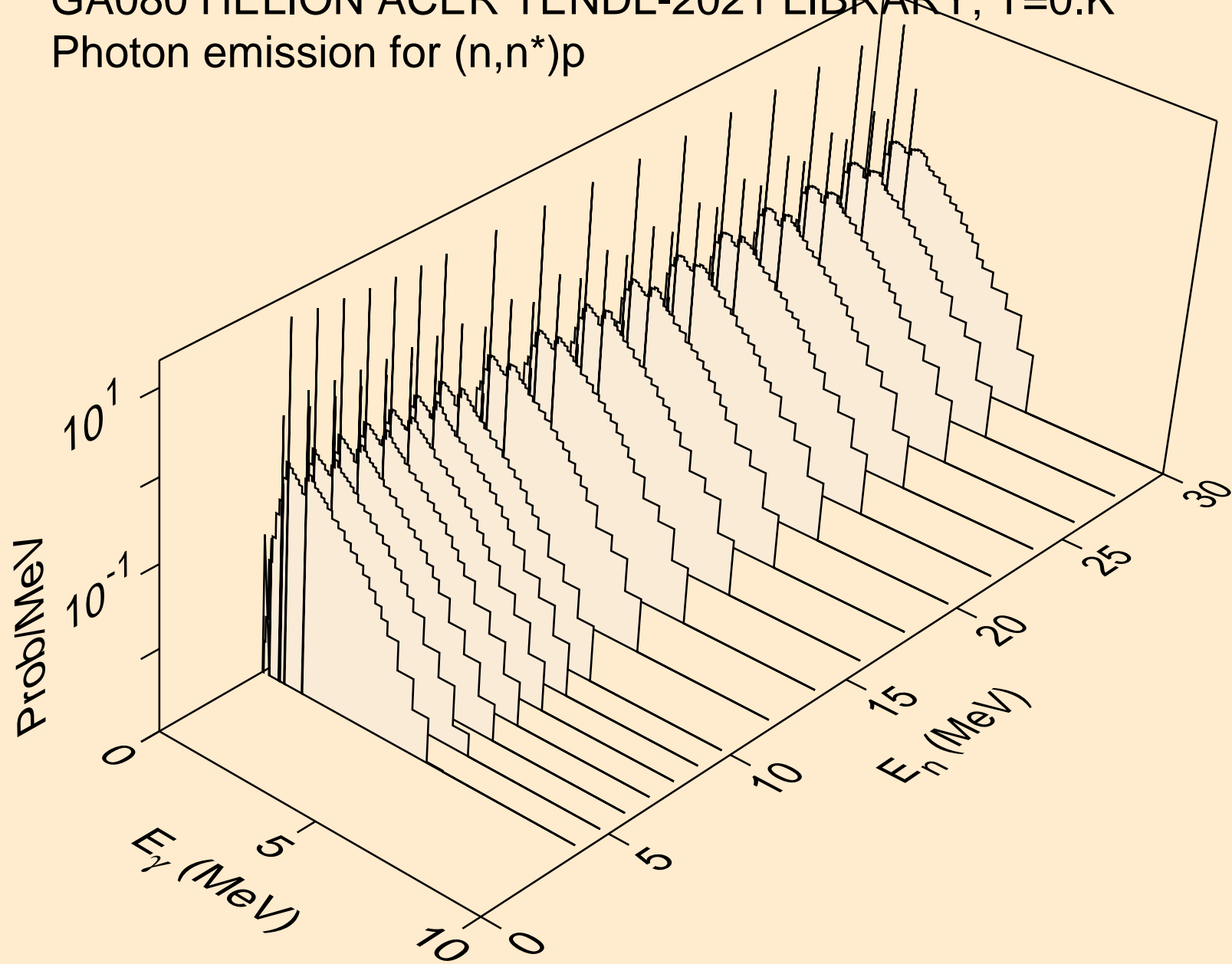

GA080 HELION ACER TENDL-2021 LIBRARY; T=0.K  
Photon emission for (n,n\*)2a

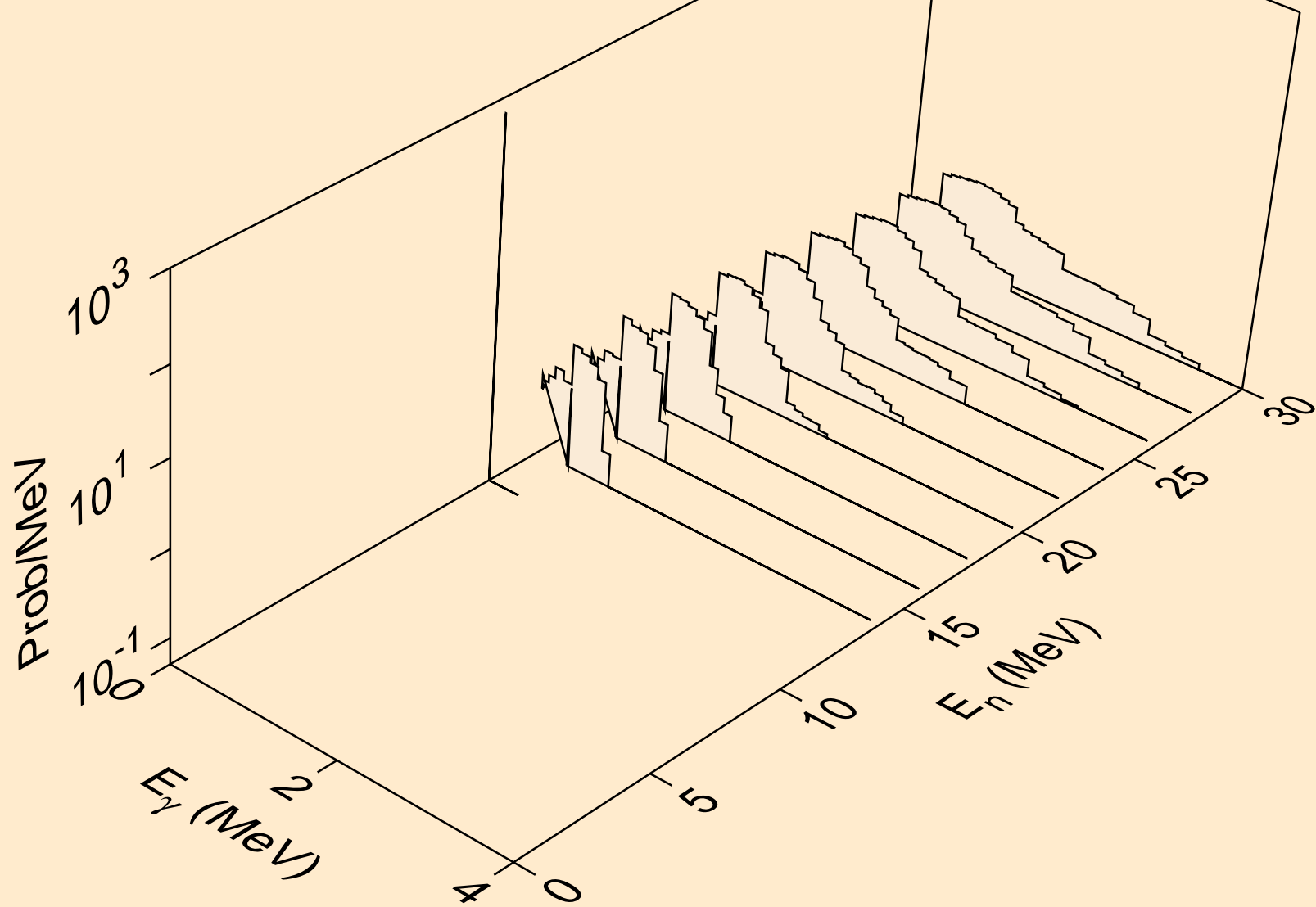

GA080 HELION ACER TENDL-2021 LIBRARY; T=0.K  
Photon emission for (n,2n)2a

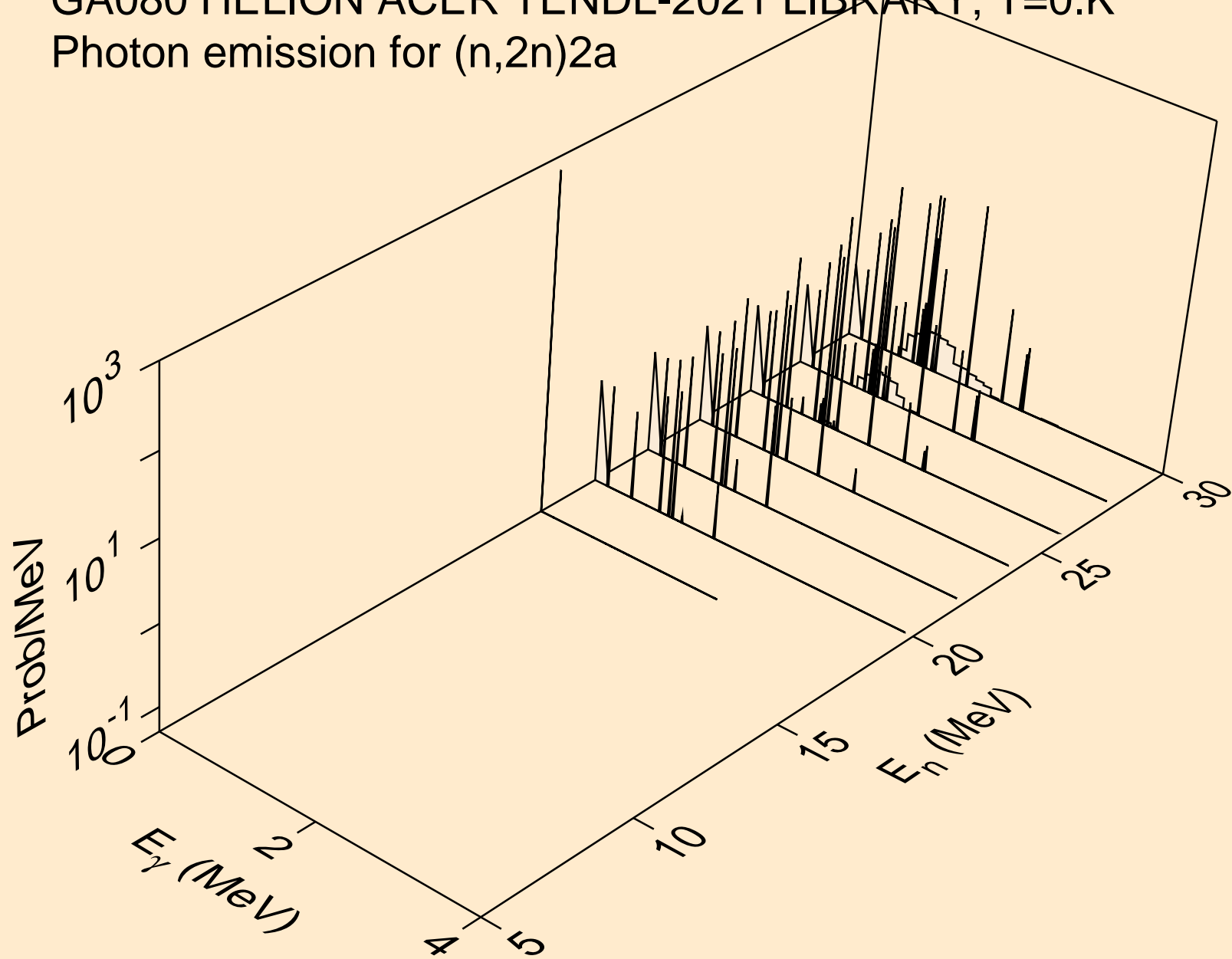

GA080 HELION ACER TENDL-2021 LIBRARY; T=0.K  
Photon emission for (n,n\*)d

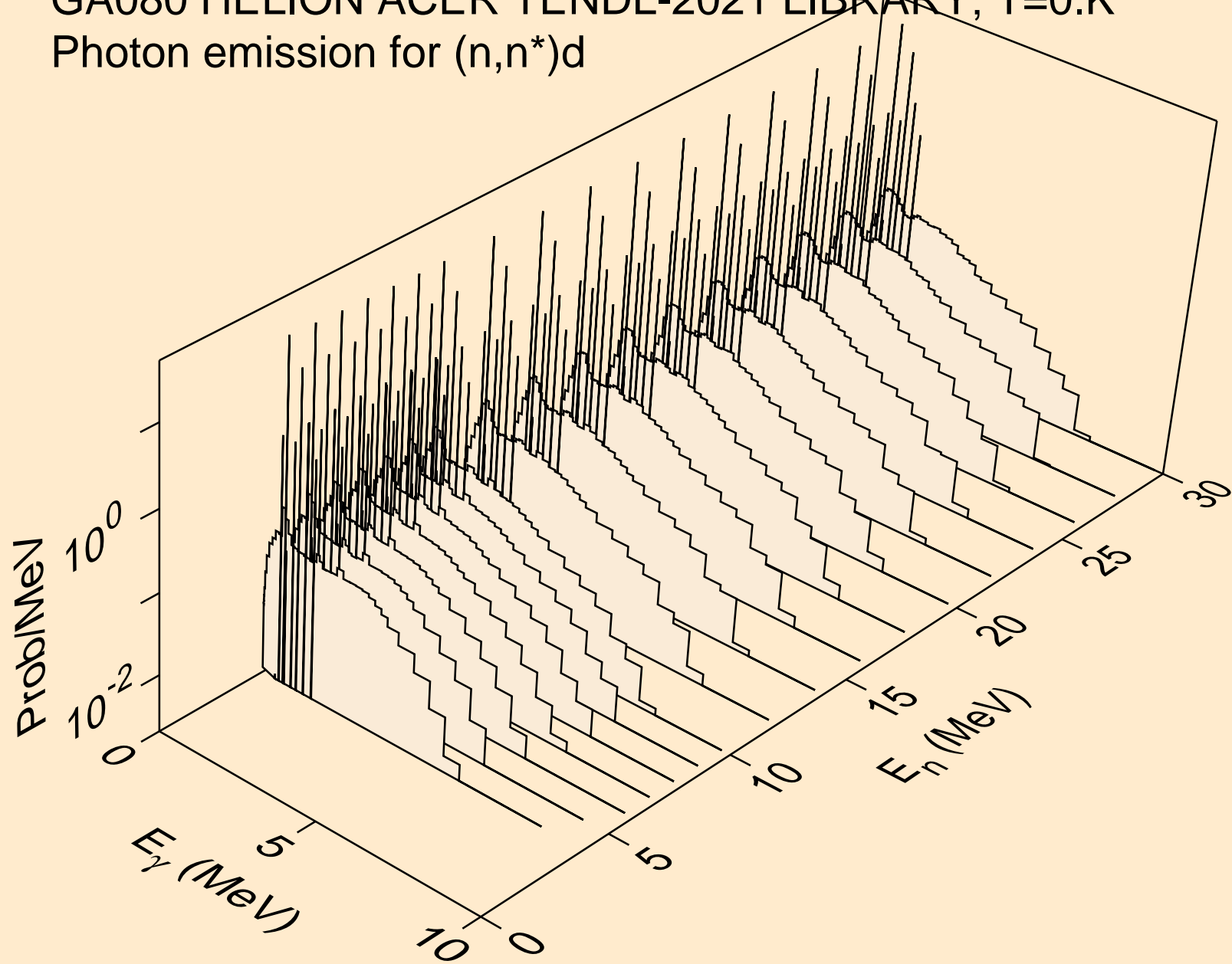

GA080 HELION ACER TENDL-2021 LIBRARY; T=0.K  
Photon emission for (n,n\*)t

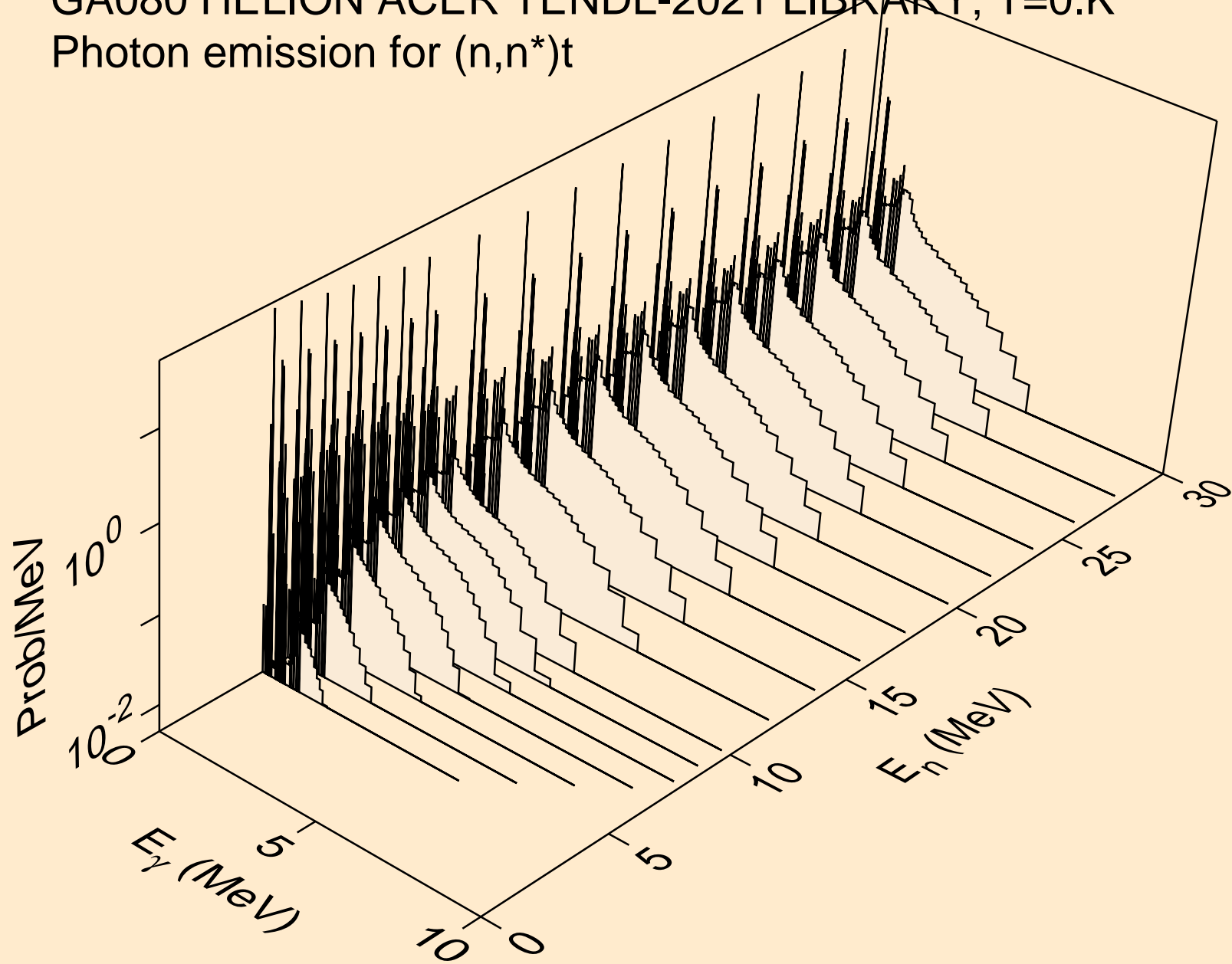

GA080 HELION ACER TENDL-2021 LIBRARY; T=0.K  
Photon emission for (n,n\*)he3

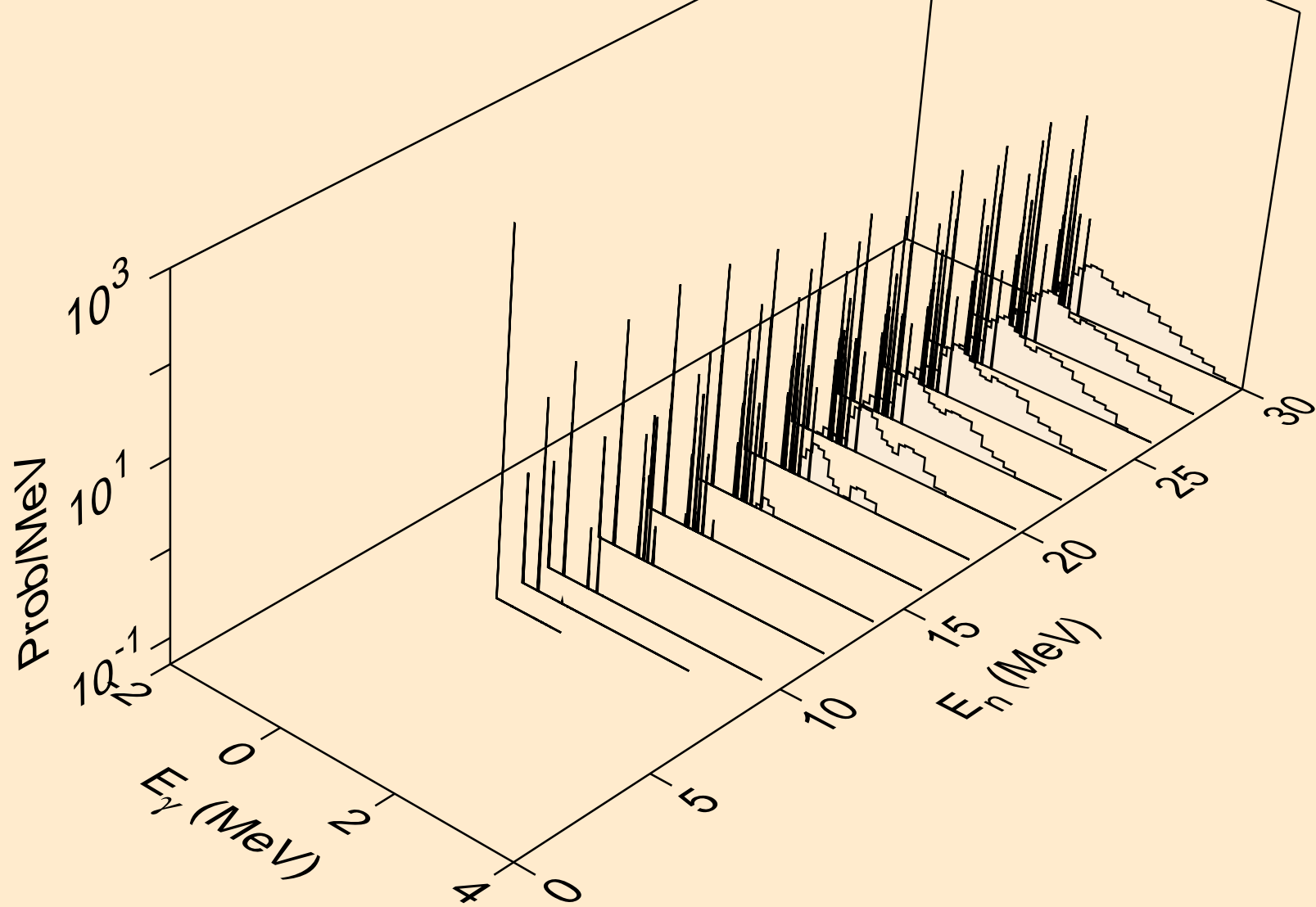

GA080 HELION ACER TENDL-2021 LIBRARY; T=0.K  
Photon emission for (n,4n)

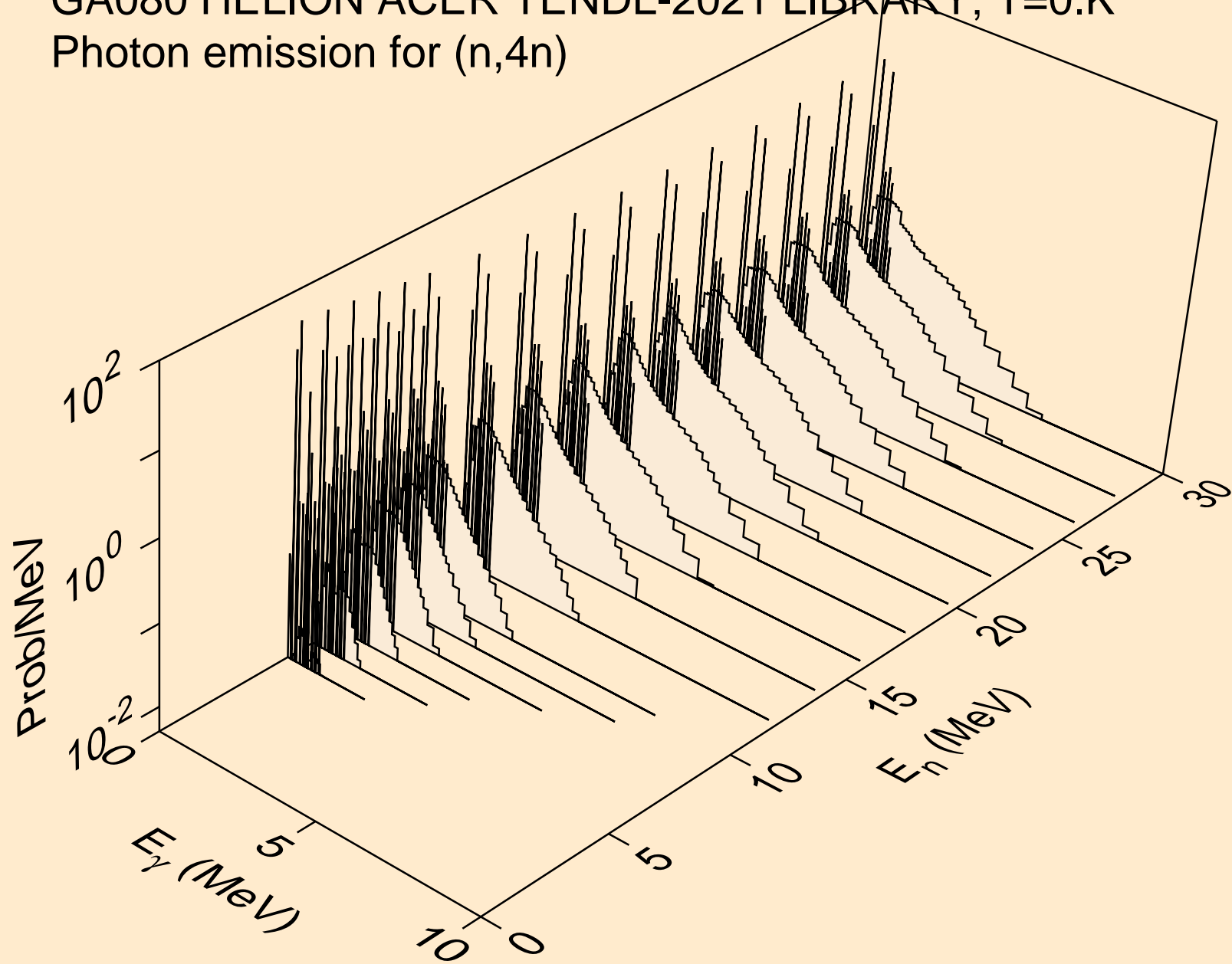



GA080 HELION ACER TENDL-2021 LIBRARY; T=0.K  
Photon emission for (n,2np)

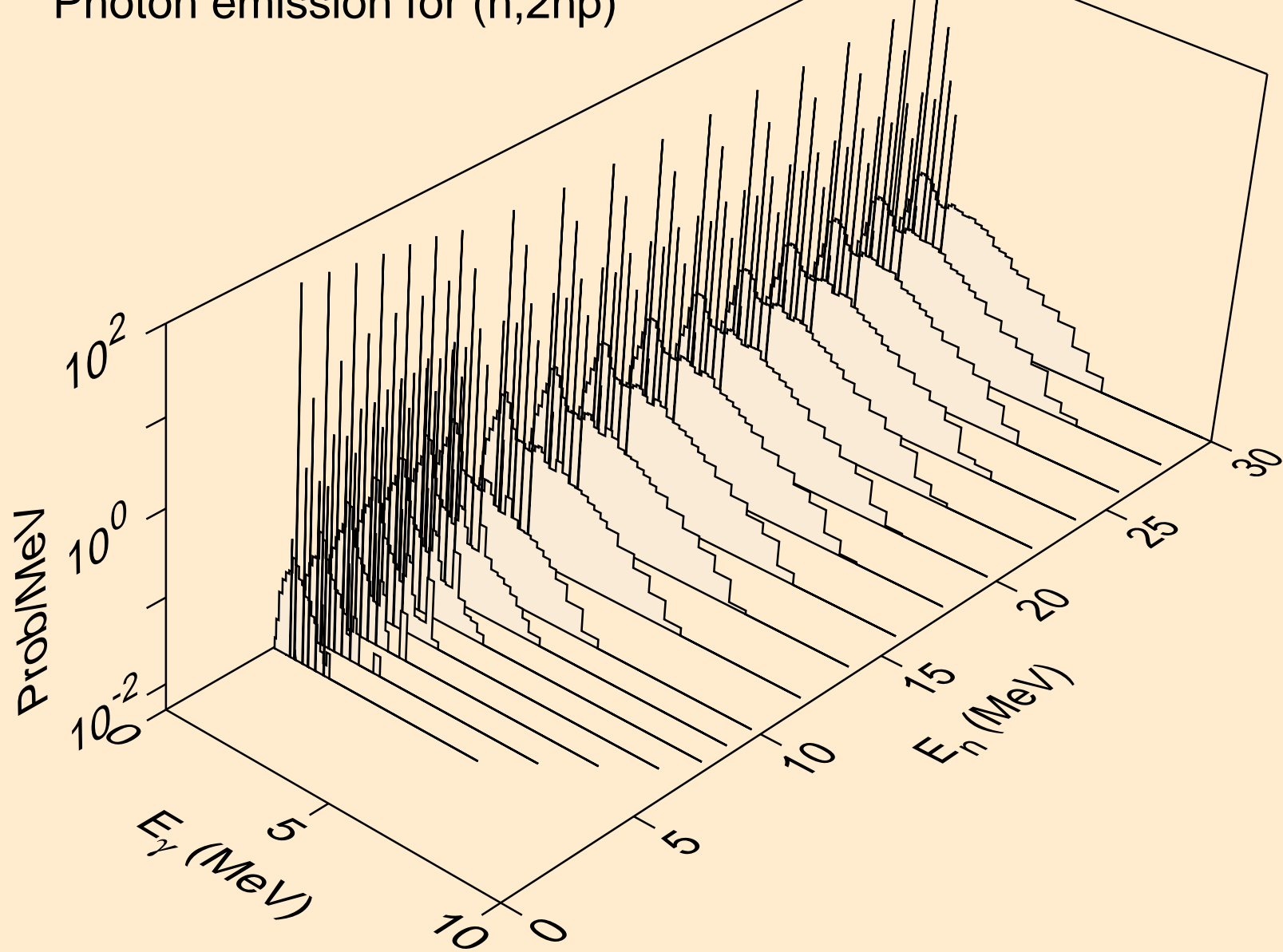

GA080 HELION ACER TENDL-2021 LIBRARY; T=0.K  
Photon emission for (n,3np)

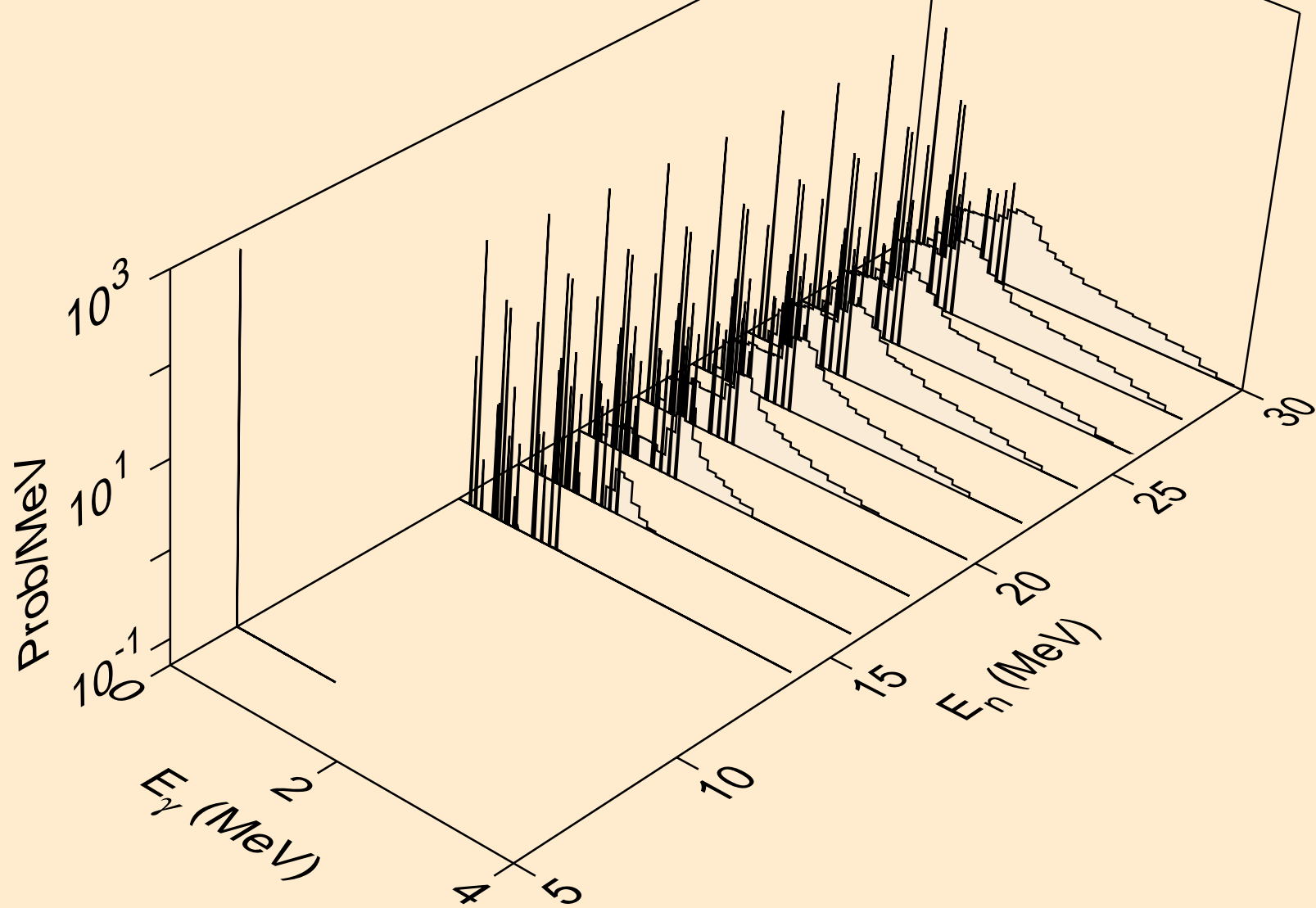

GA080 HELION ACER TENDL-2021 LIBRARY; T=0.K  
Photon emission for (n,2np)

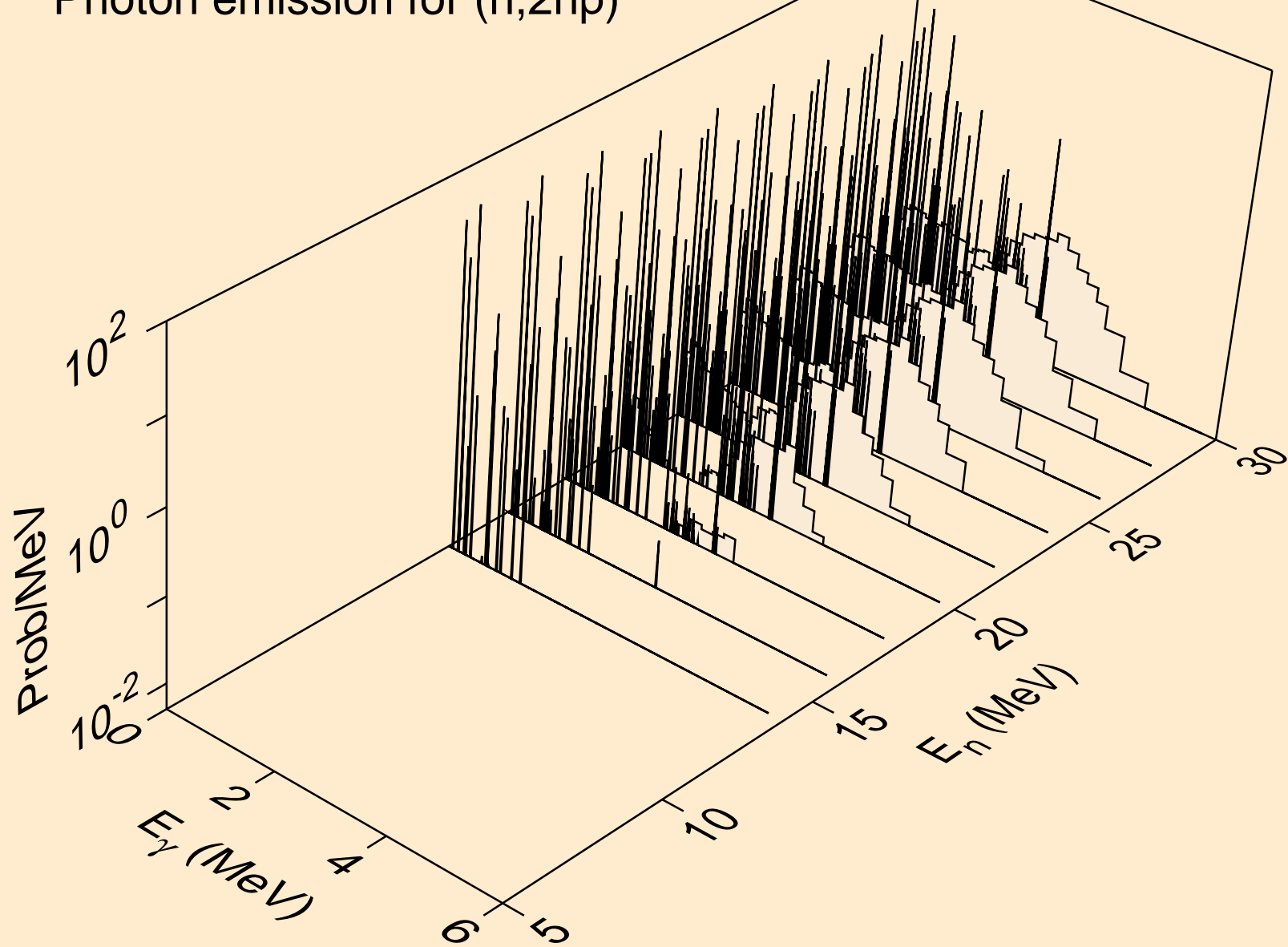

GA080 HELION ACER TENDL-2021 LIBRARY; T=0.K  
Photon emission for (n,npa)

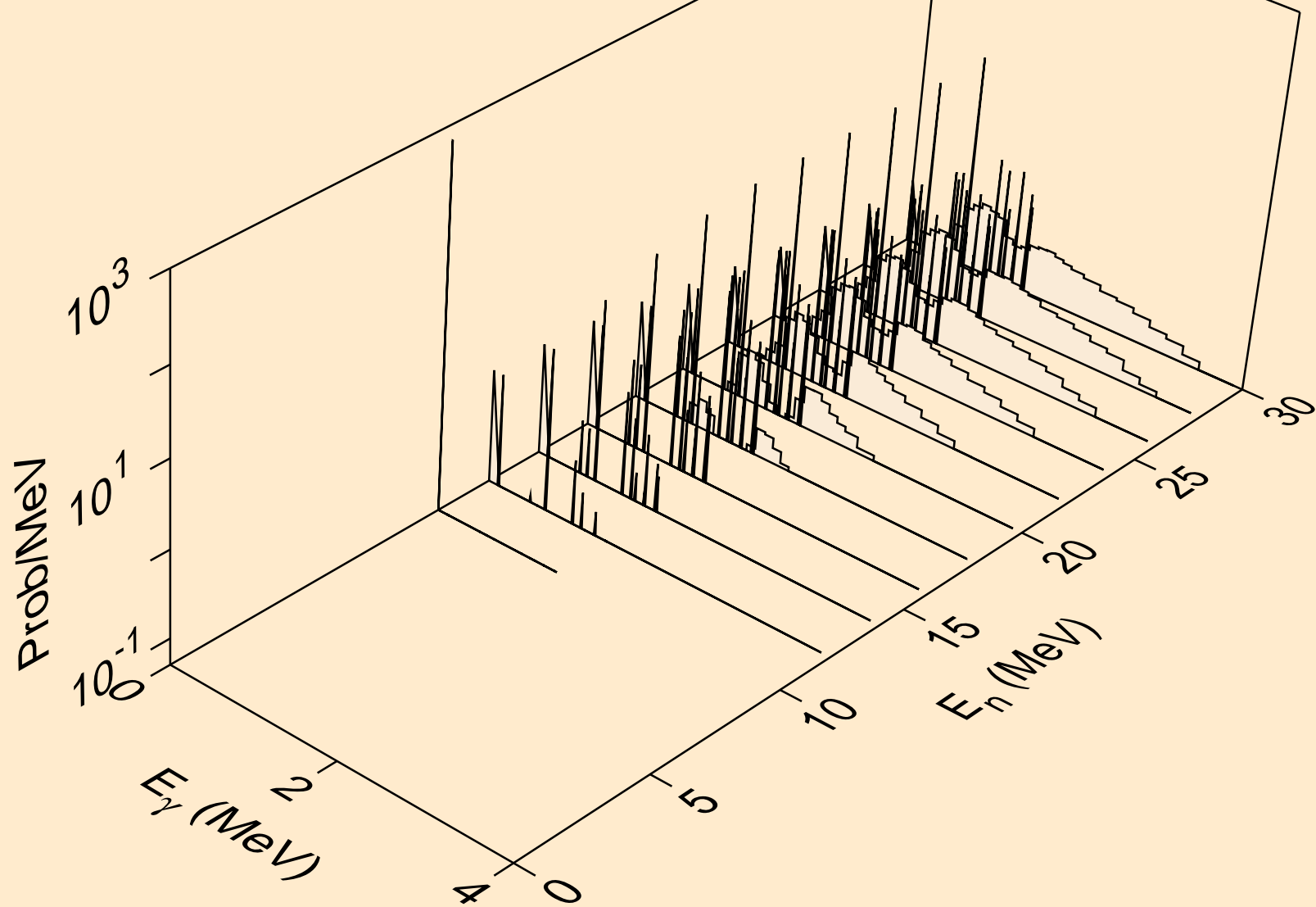

GA080 HELION ACER TENDL-2021 LIBRARY; T=0.K  
Photon emission for (n,p)

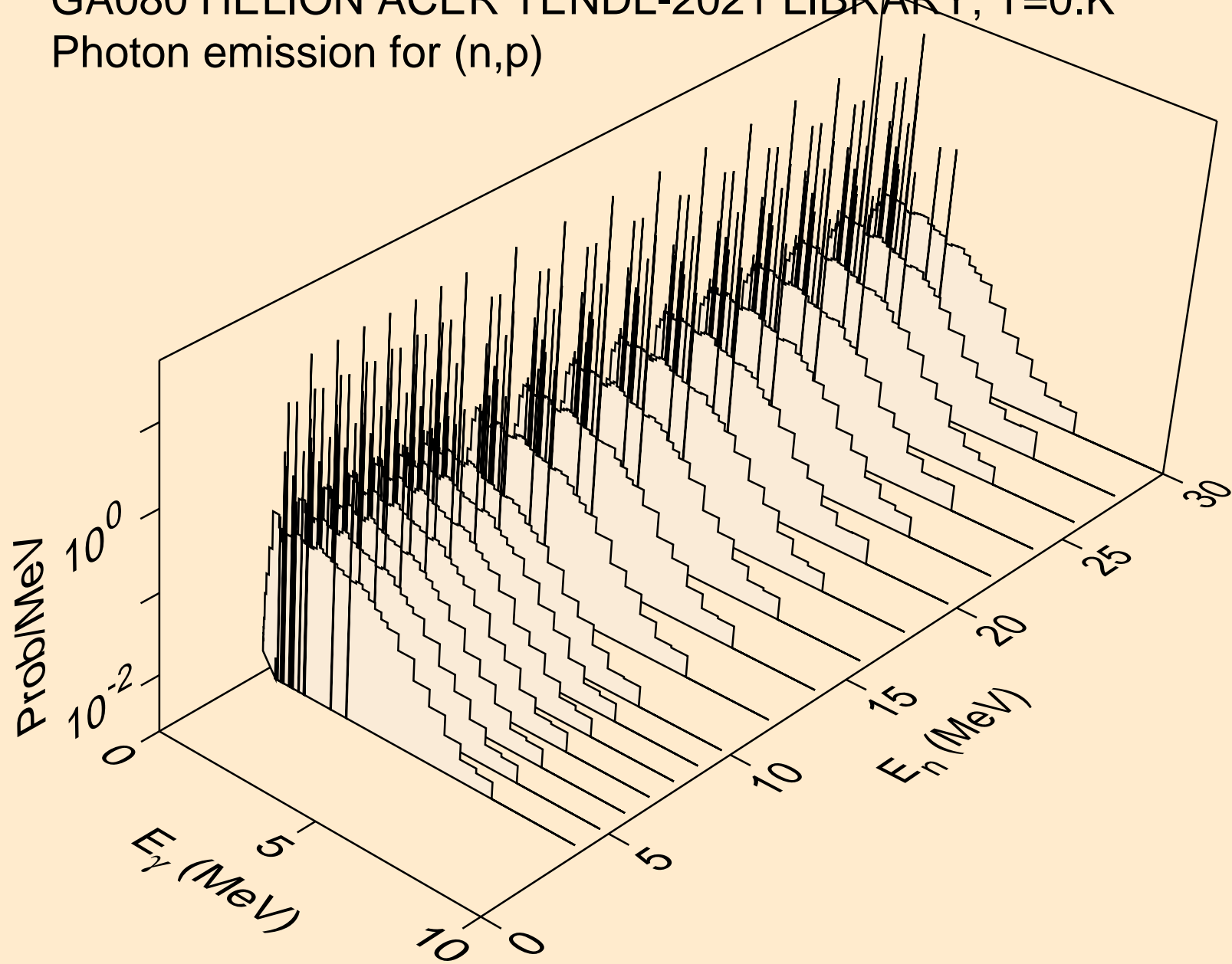

GA080 HELION ACER TENDL-2021 LIBRARY; T=0.K  
Photon emission for (n,d)

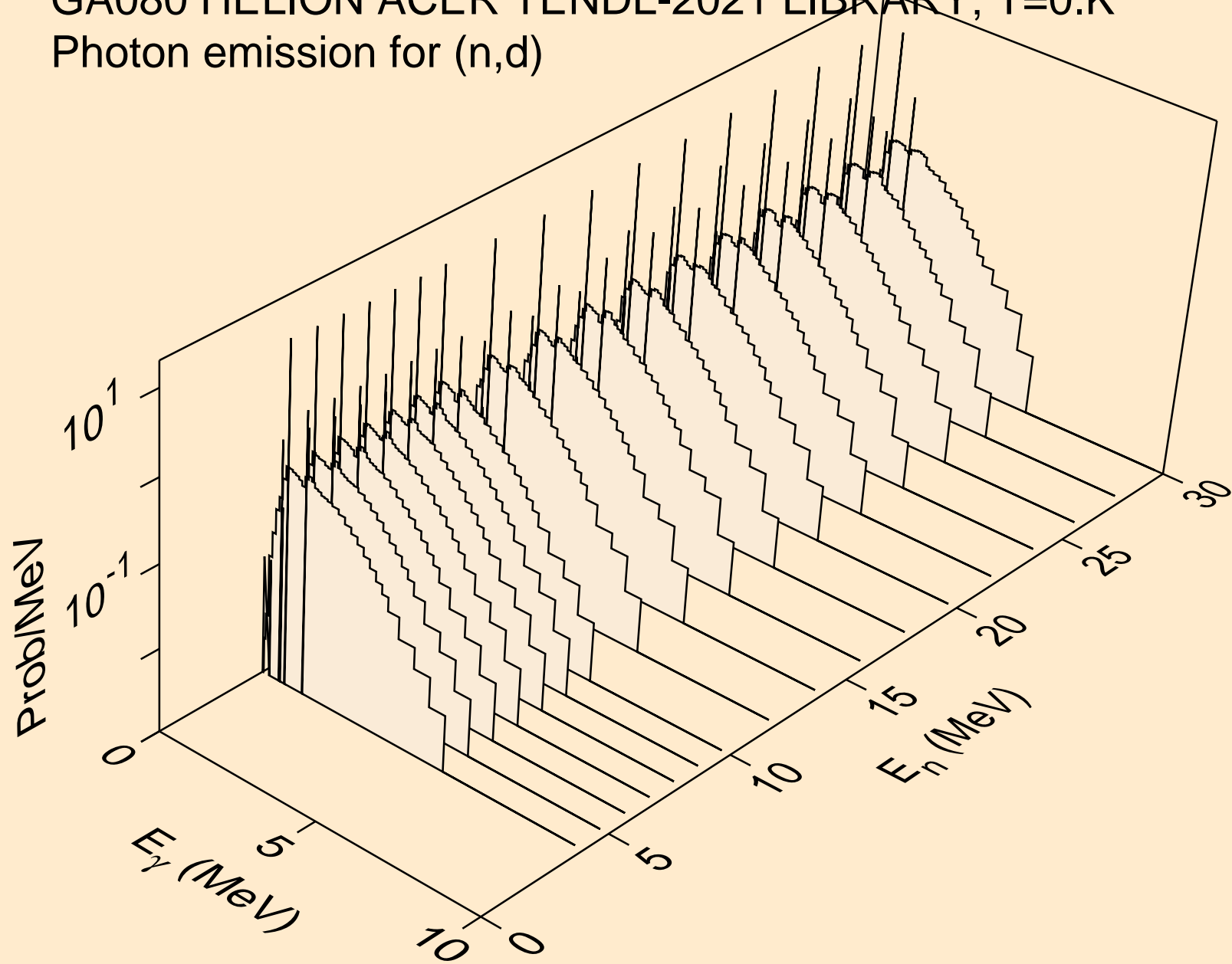

GA080 HELION ACER TENDL-2021 LIBRARY; T=0.K  
Photon emission for (n,t)

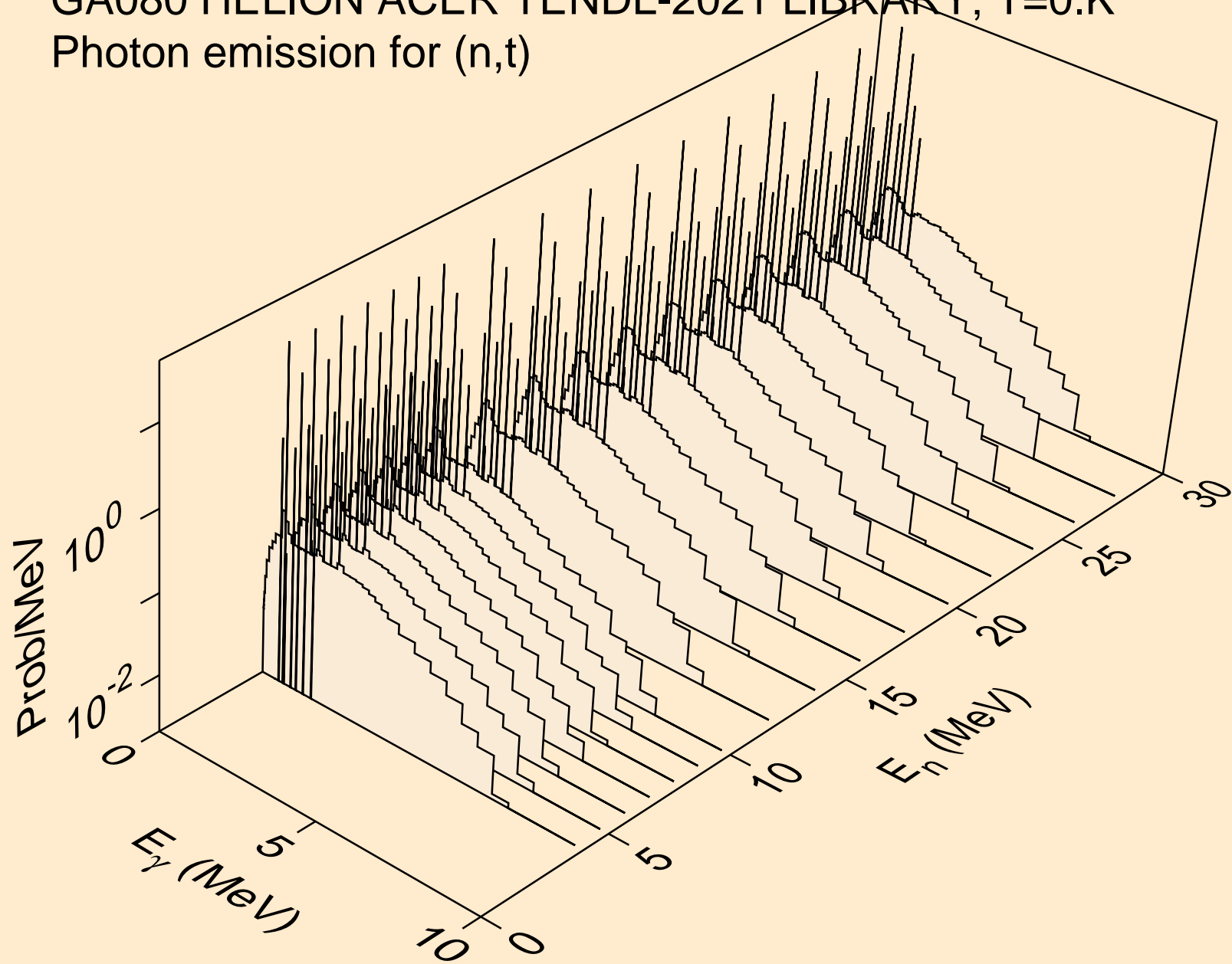

GA080 HELION ACER TENDL-2021 LIBRARY; T=0.K  
Photon emission for inelastic

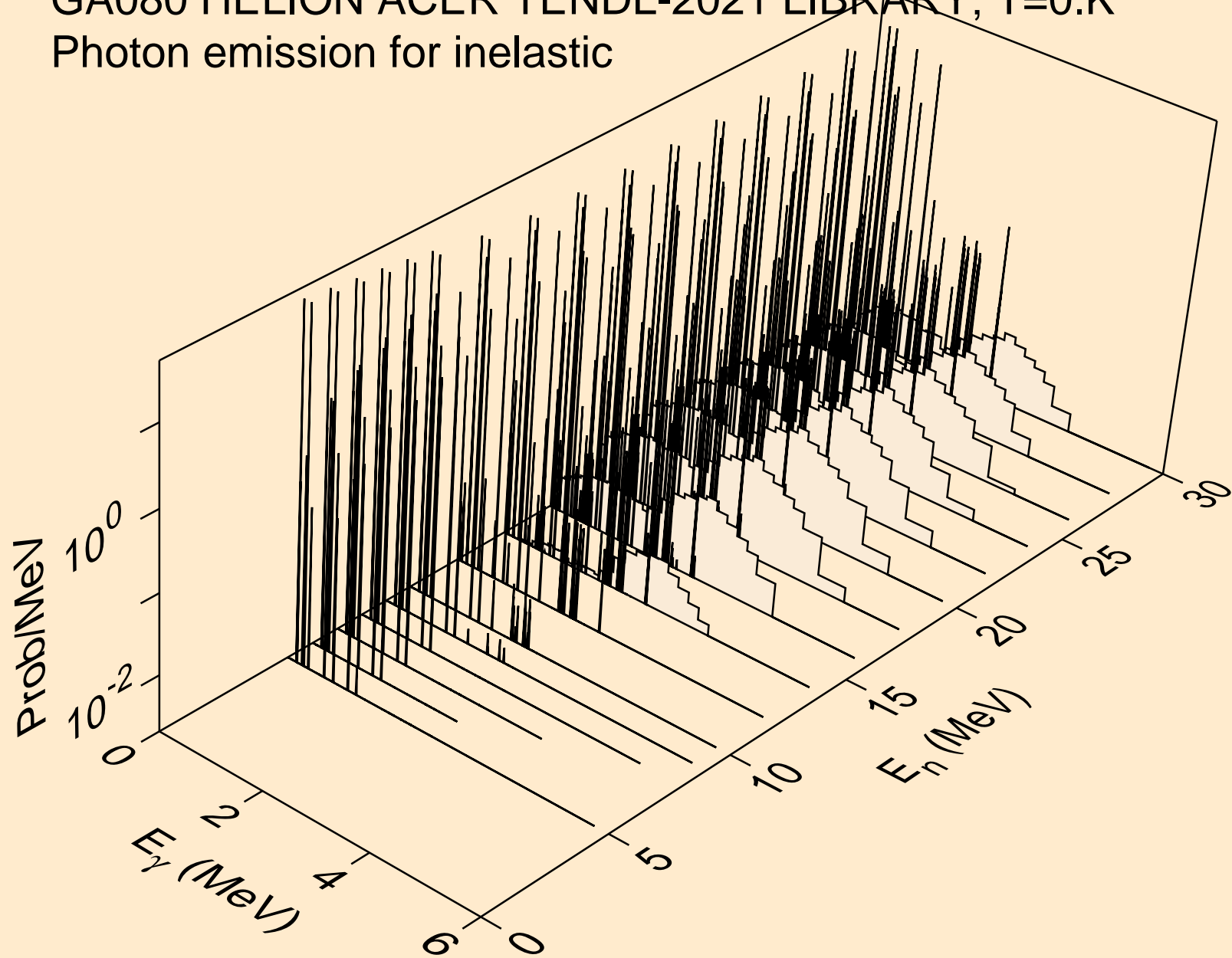



GA080 HELION ACER TENDL-2021 LIBRARY; T=0.K  
Photon emission for (n,a)

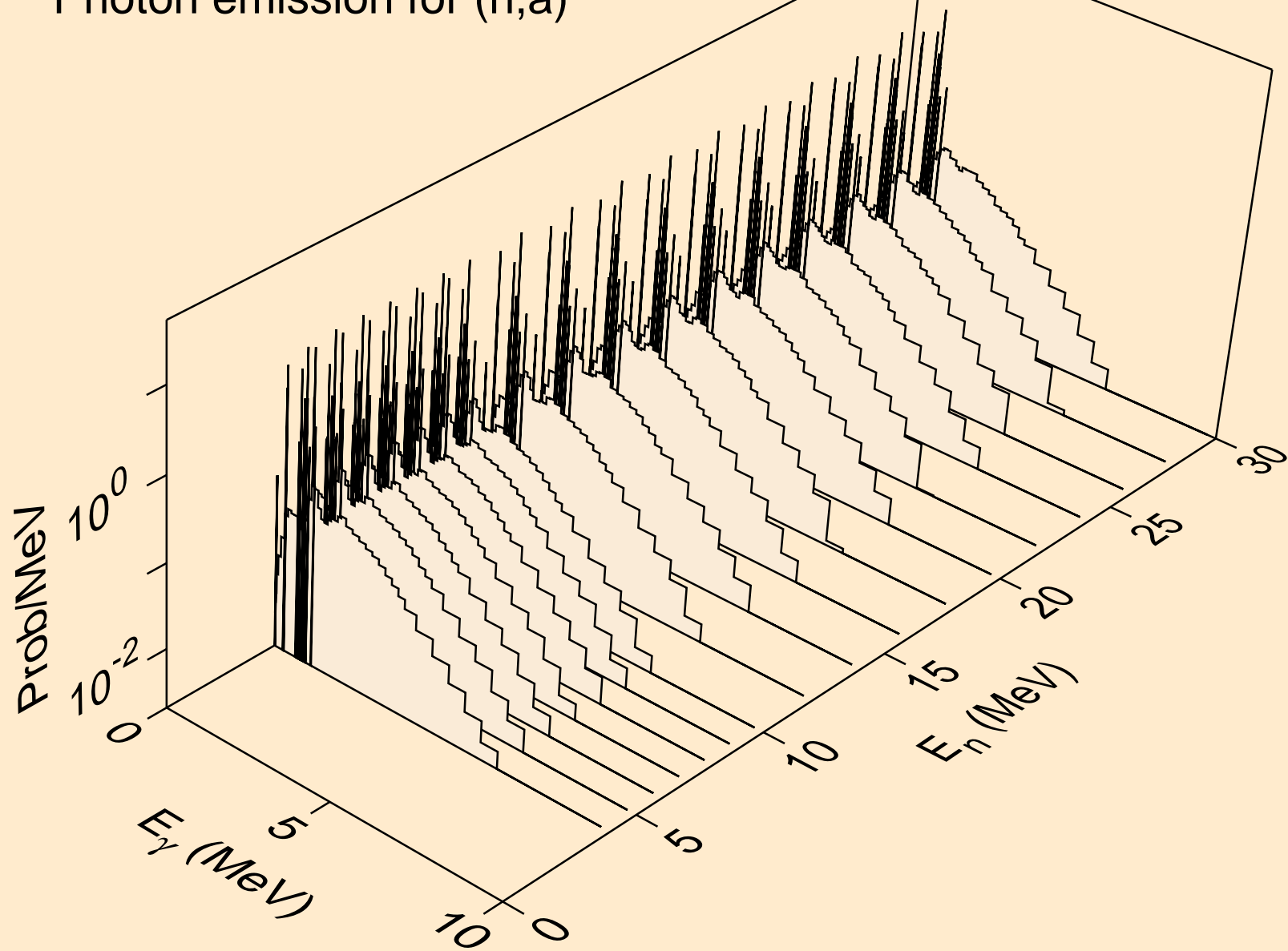

GA080 HELION ACER TENDL-2021 LIBRARY; T=0.K  
Photon emission for (n,2a)

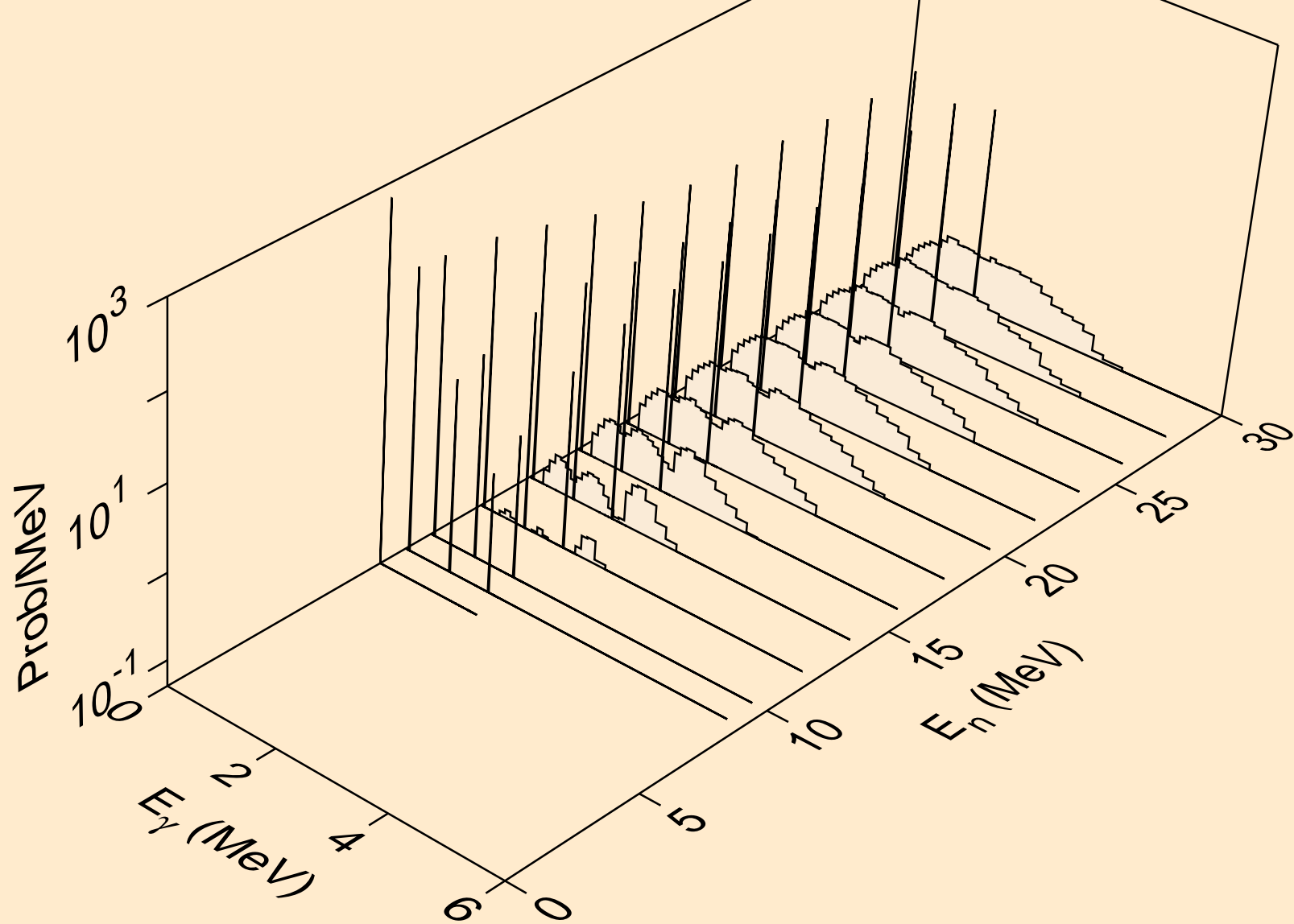

GA080 HELION ACER TENDL-2021 LIBRARY; T=0.K  
Photon emission for (n,2p)

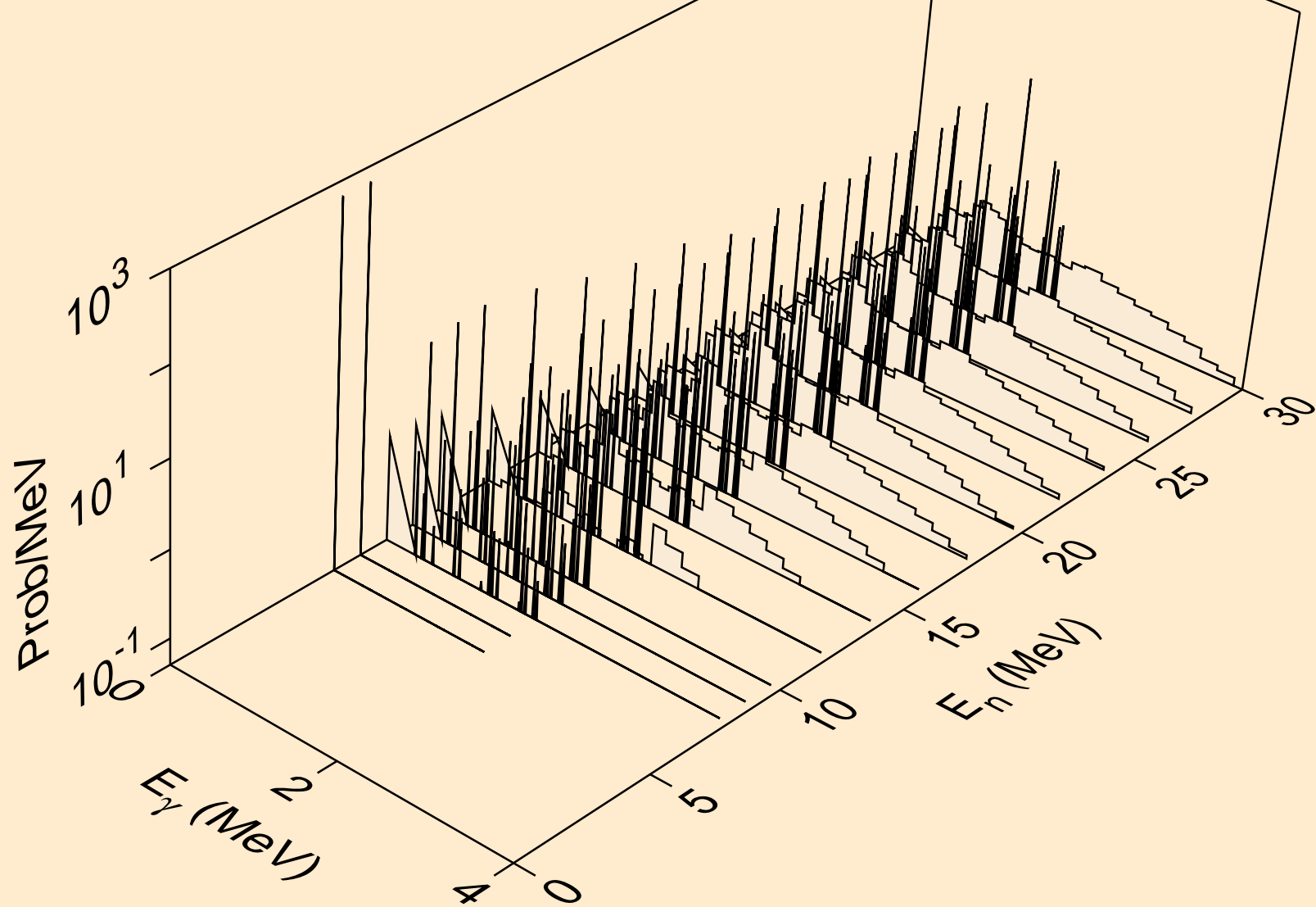

GA080 HELION ACER TENDL-2021 LIBRARY; T=0.K  
Photon emission for (n,p $\alpha$ )

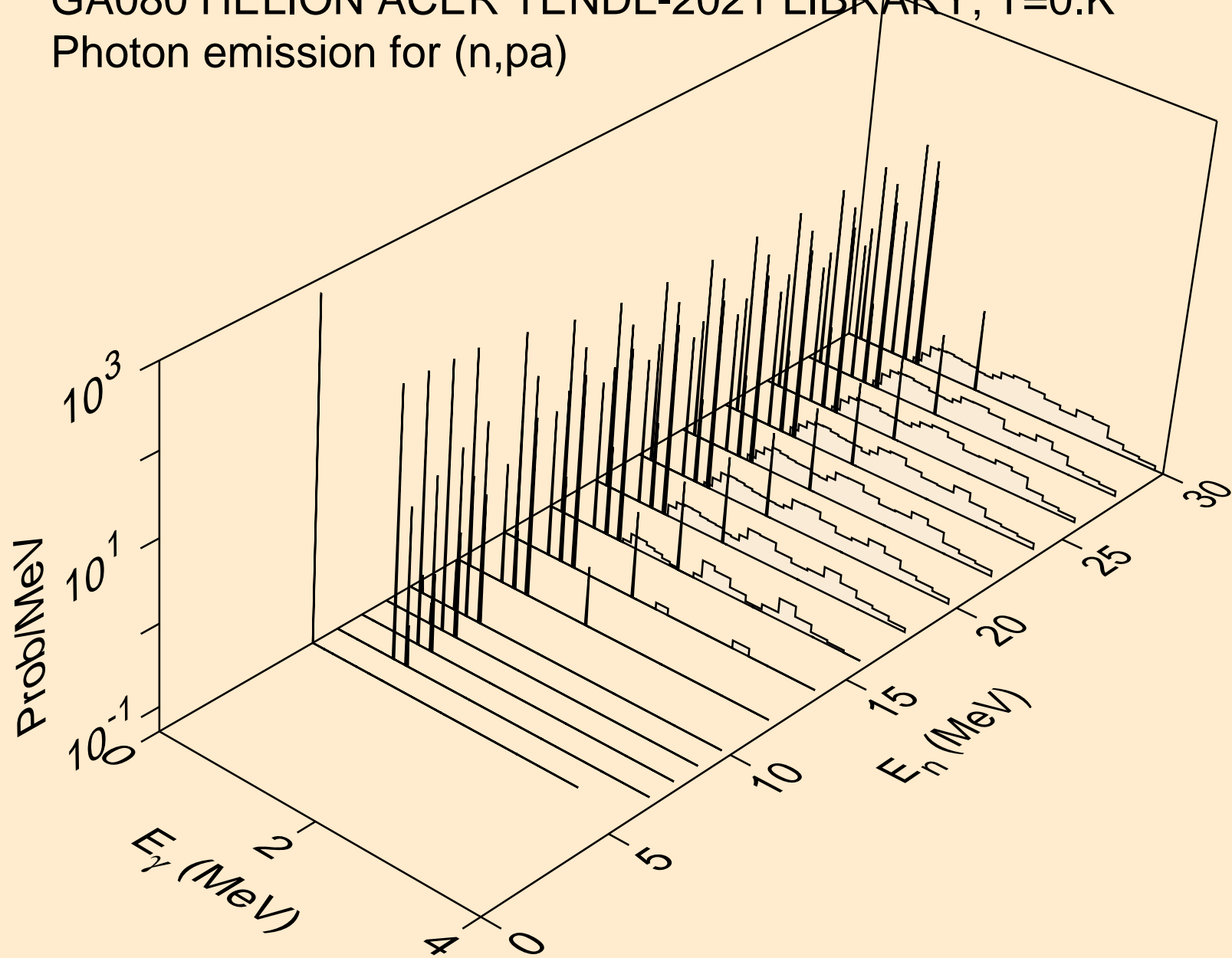

GA080 HELION ACER TENDL-2021 LIBRARY; T=0.K  
Photon emission for (n,pd)

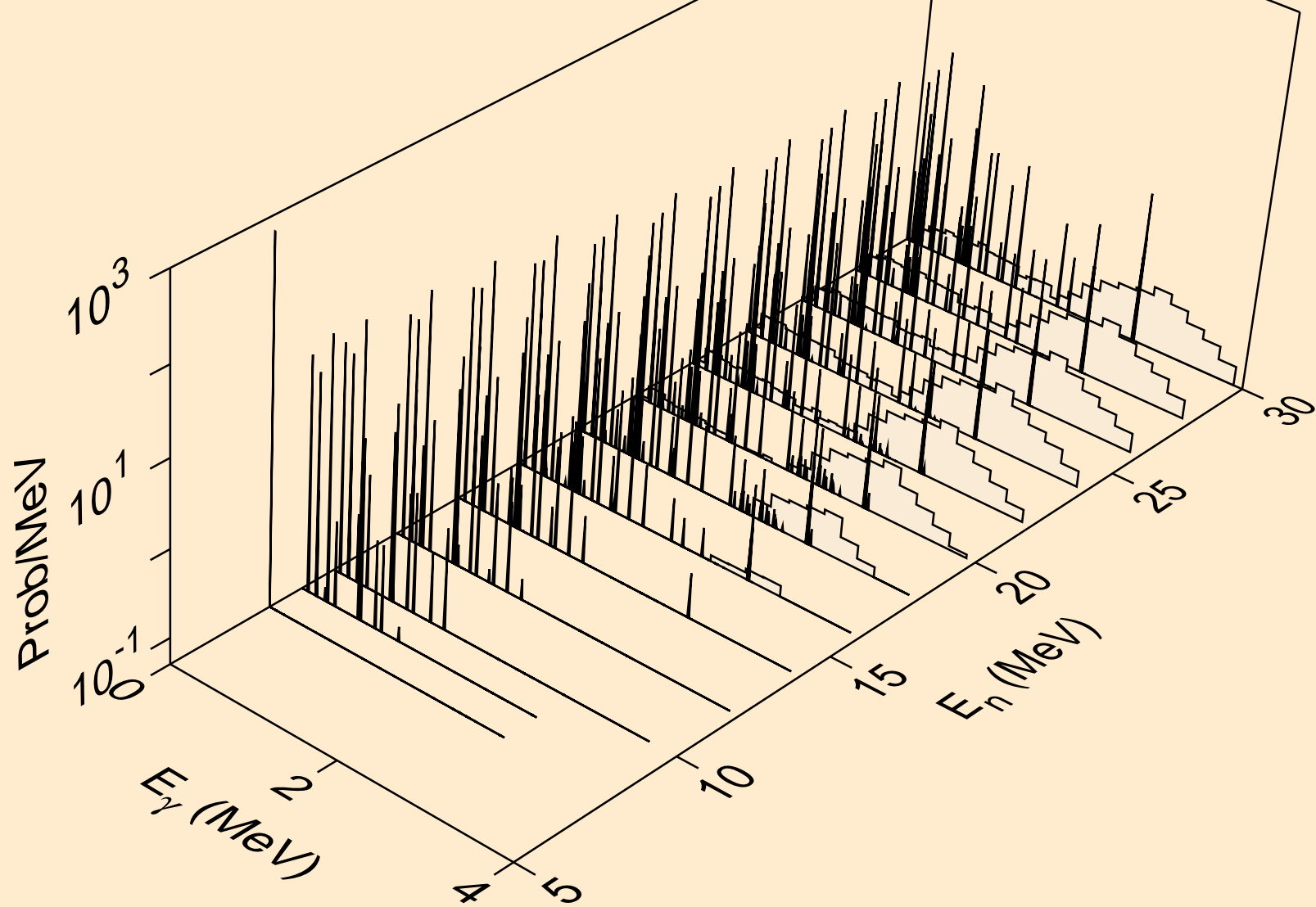

GA080 HELION ACER TENDL-2021 LIBRARY; T=0.K  
Photon emission for (n,pt)

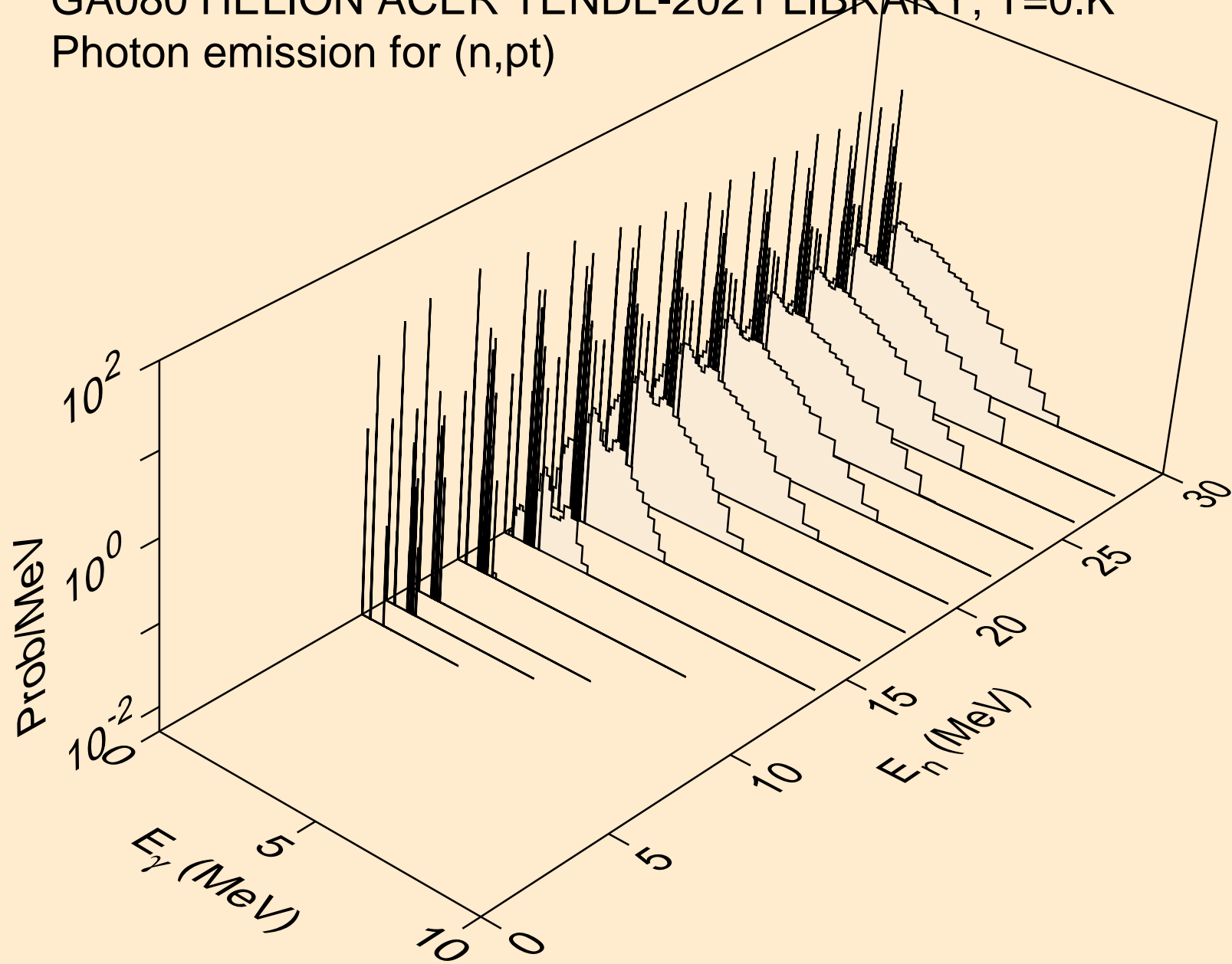

GA080 HELION ACER TENDL-2021 LIBRARY; T=0.K  
Photon emission for (n,da)

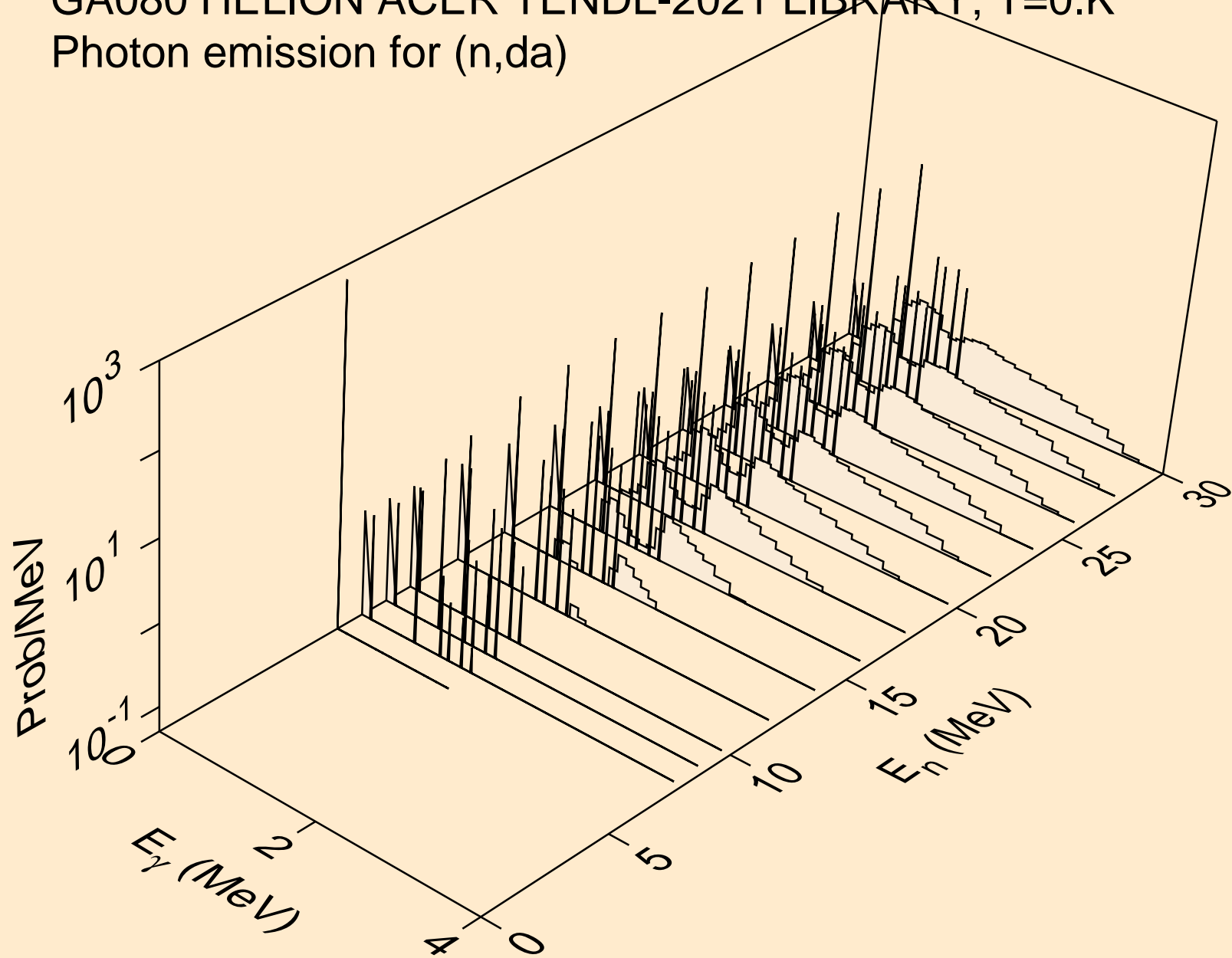

GA080 HELION ACER TENDL-2021 LIBRARY; T=0.K  
Particle heating contributions

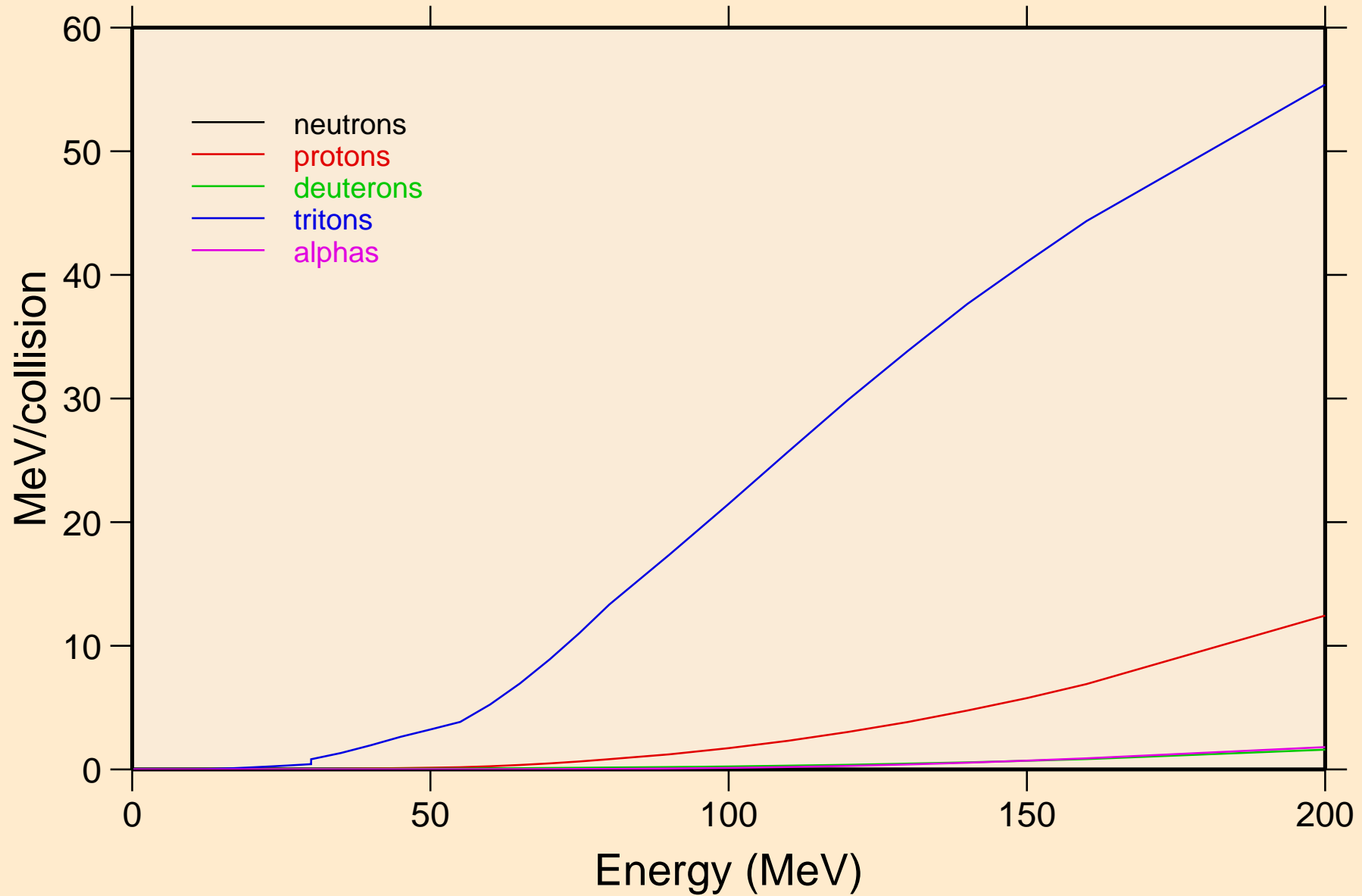



GA080 HELION ACER TENDL-2021 LIBRARY; T=0.K

Recoil Heating

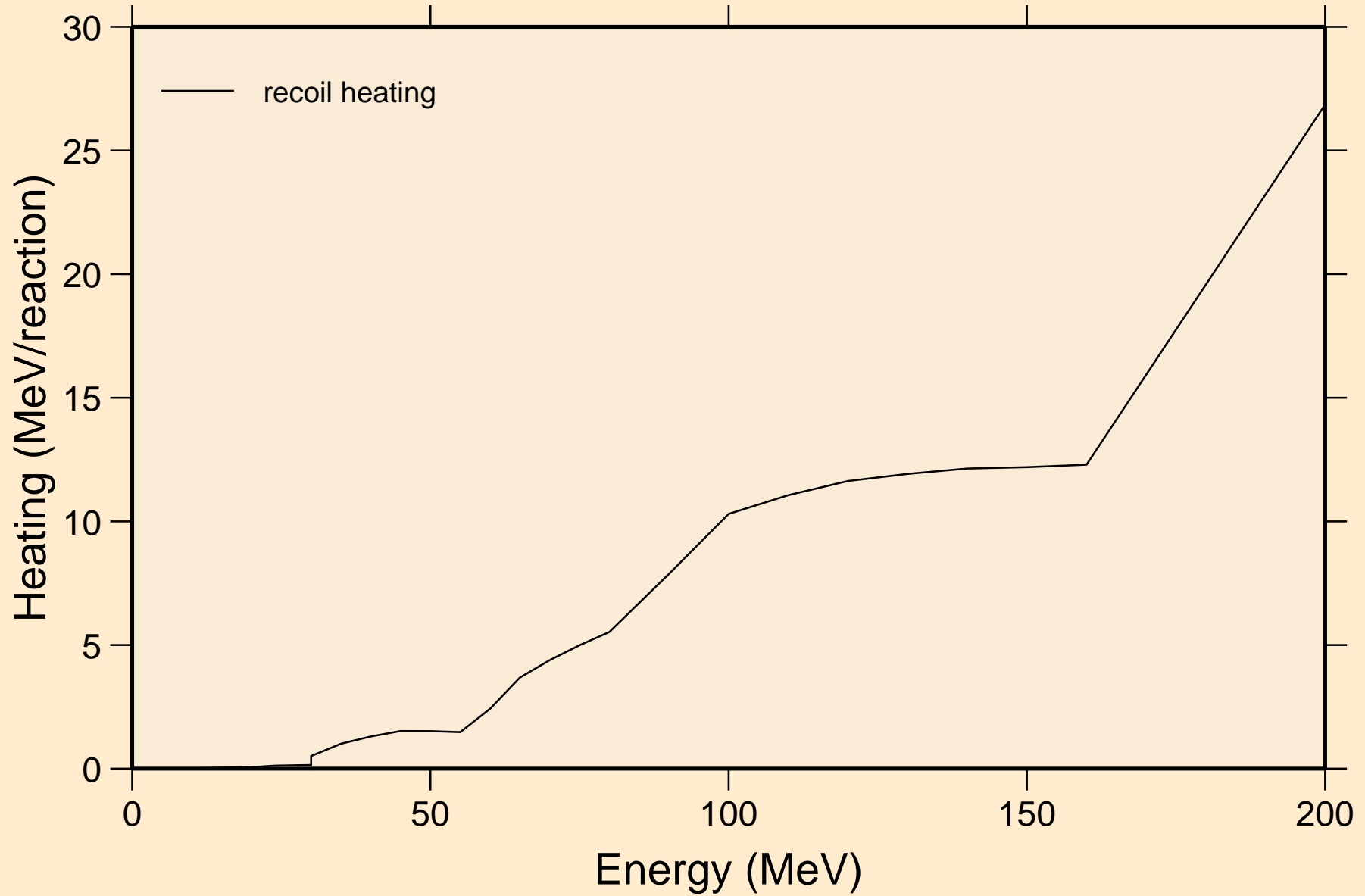

GA080 HELION ACER TENDL-2021 LIBRARY; T=0.K  
Particle production cross sections

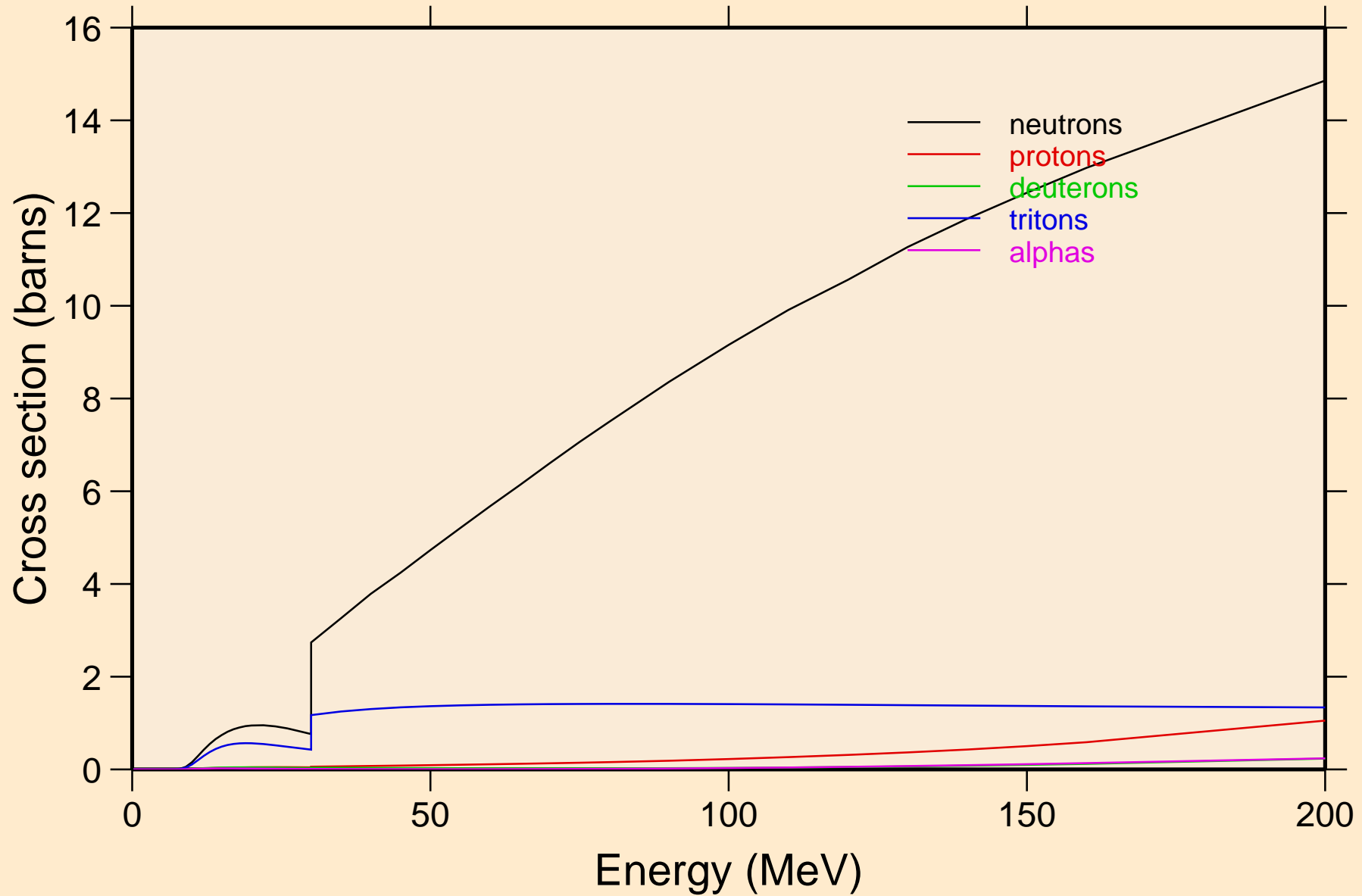

GA080 HELION ACER TENDL-2021 LIBRARY; T=0.K  
neutrons from (s,n)

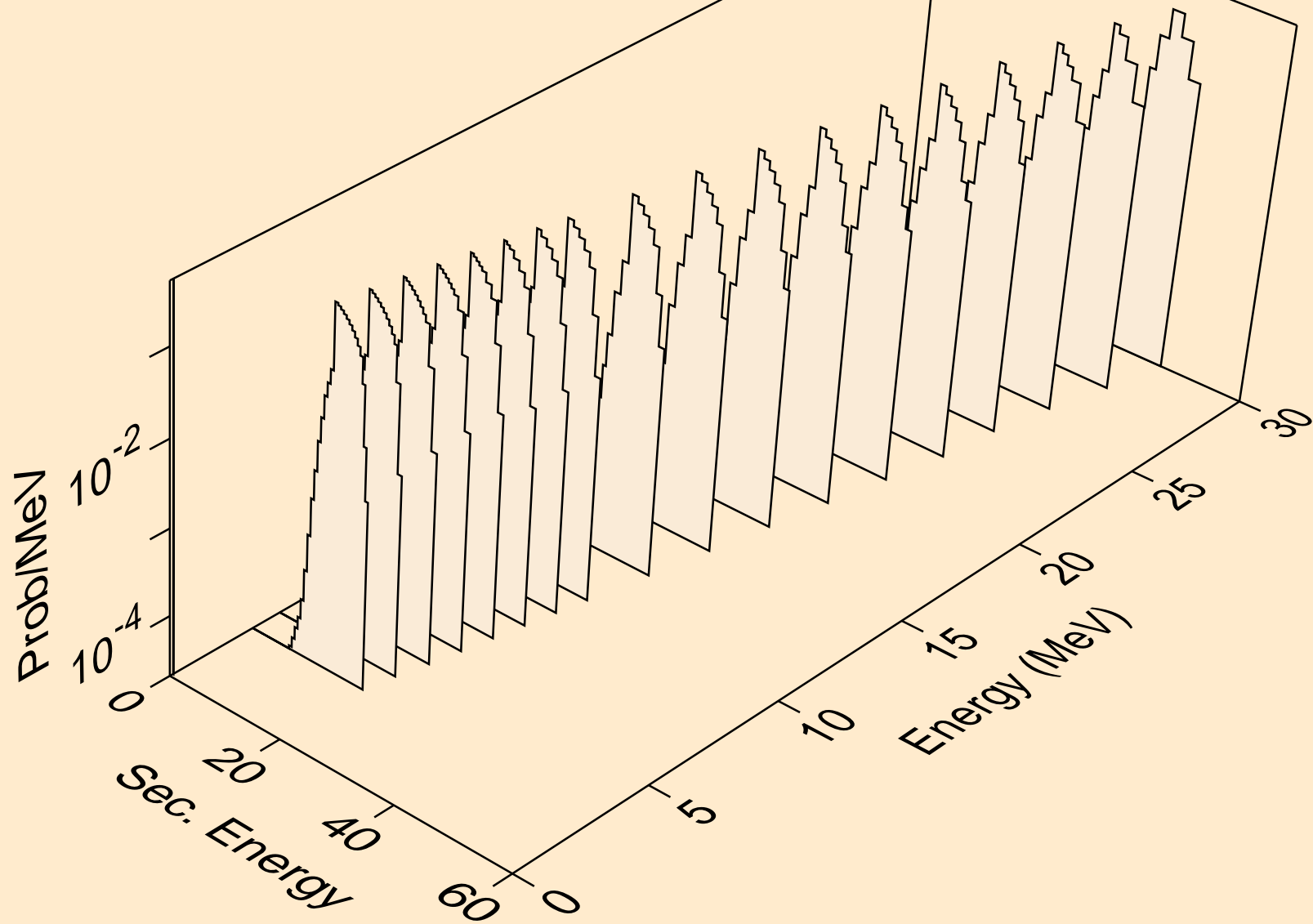

GA080 HELION ACER TENDL-2021 LIBRARY; T=0.K  
neutrons from (s,x)

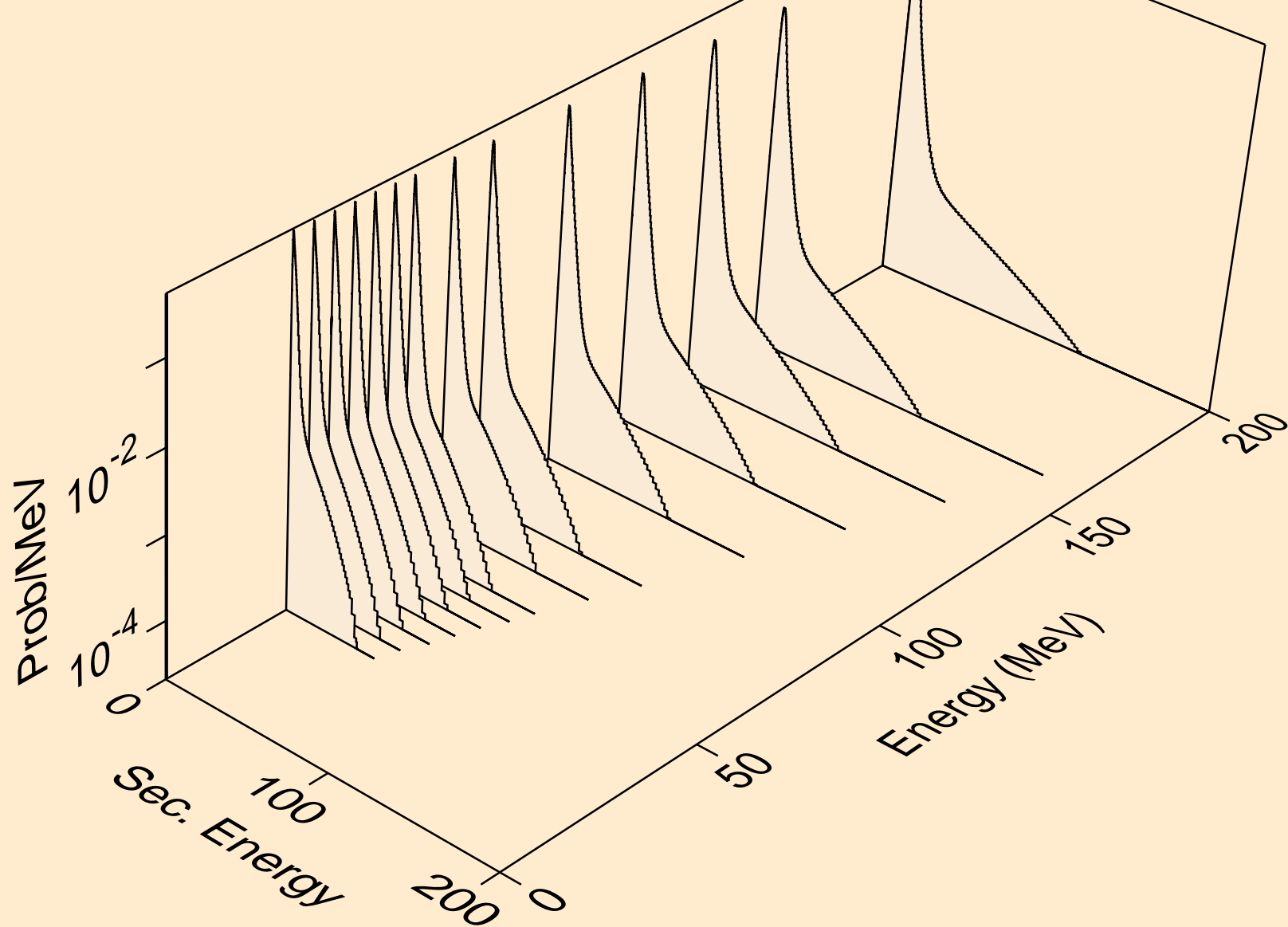

GA080 HELION ACER TENDL-2021 LIBRARY; T=0.K  
neutrons from (s,2nd)

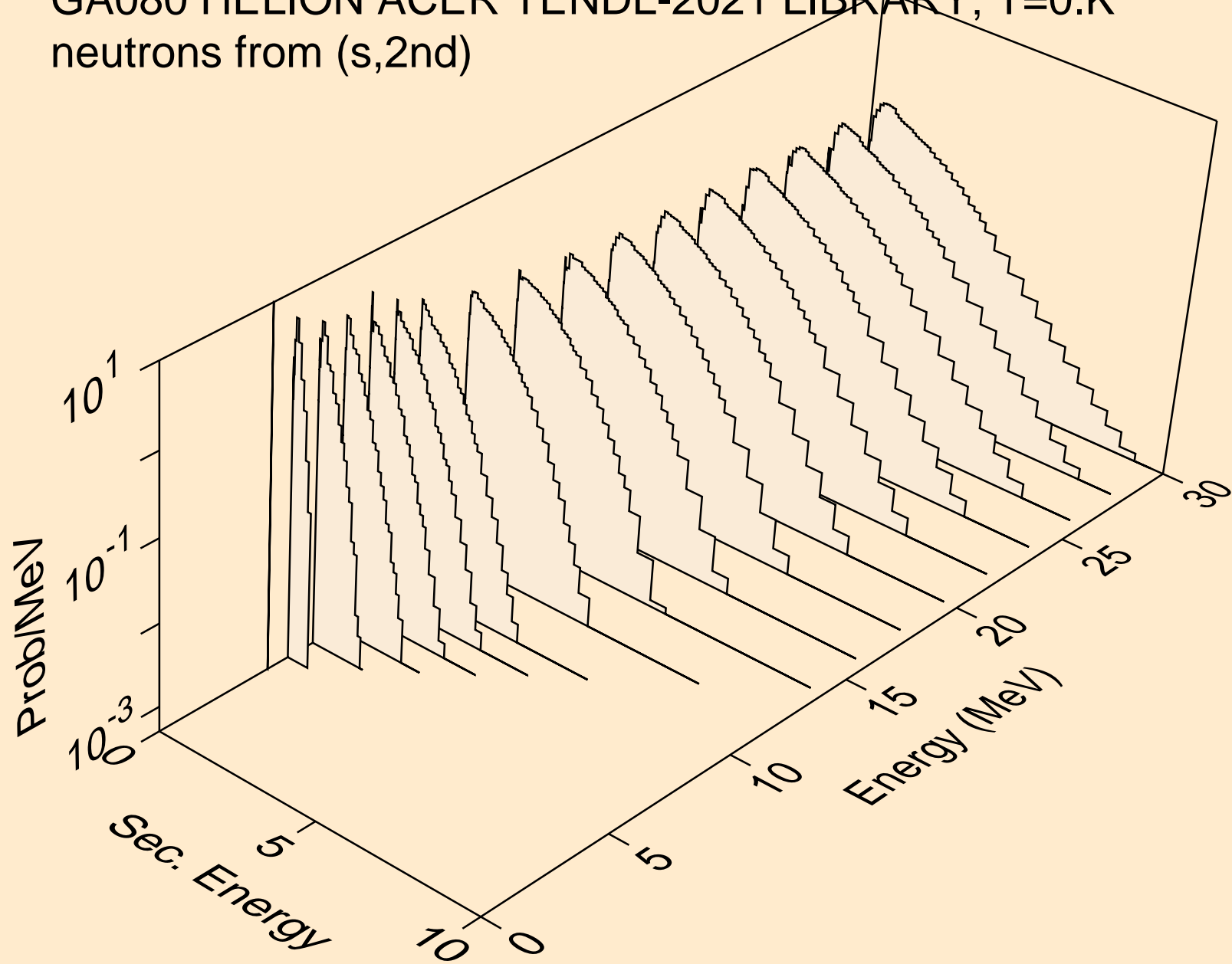

GA080 HELION ACER TENDL-2021 LIBRARY; T=0.K  
neutrons from (s,2n)

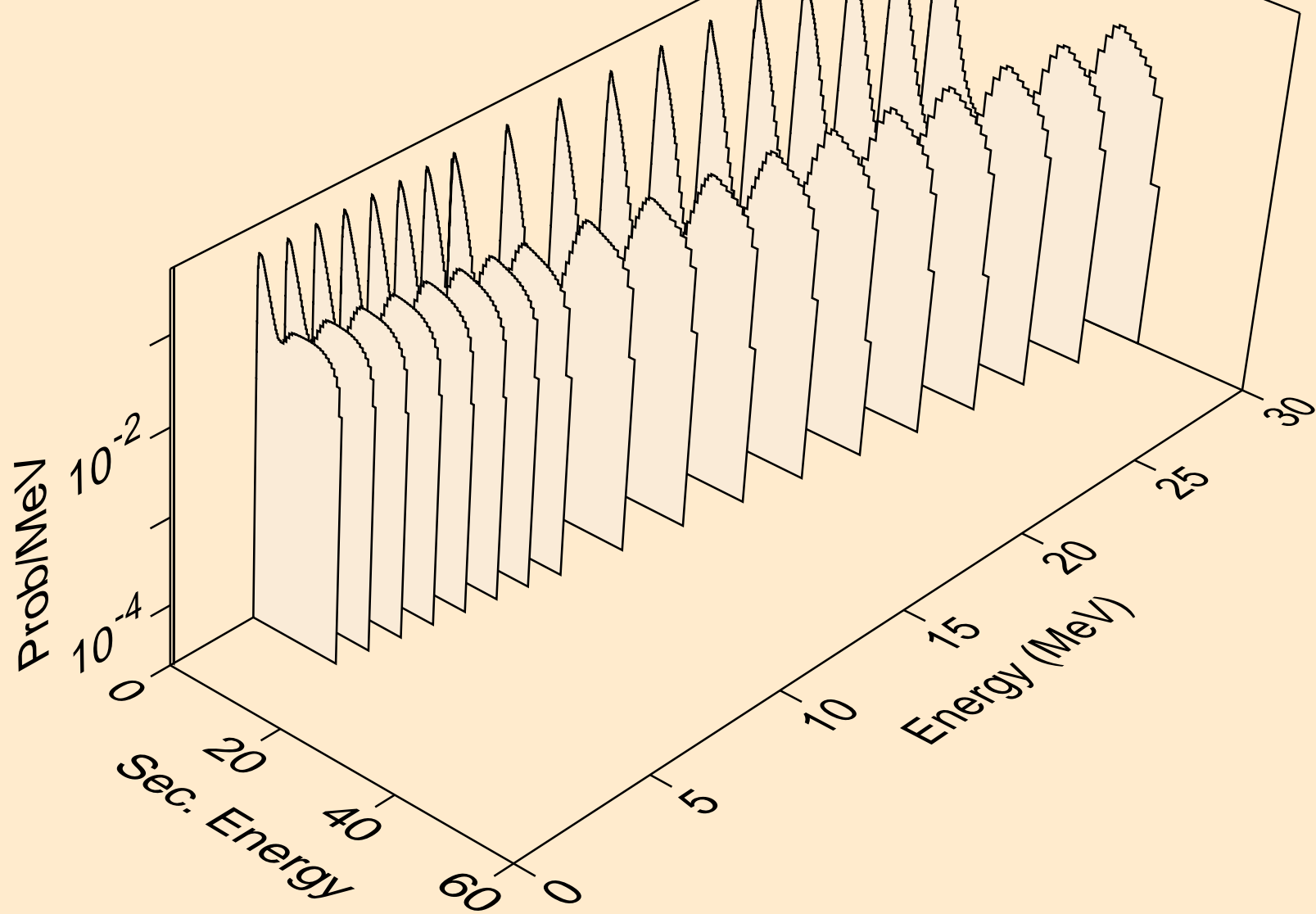

GA080 HELION ACER TENDL-2021 LIBRARY; T=0.K  
neutrons from (s,3n)

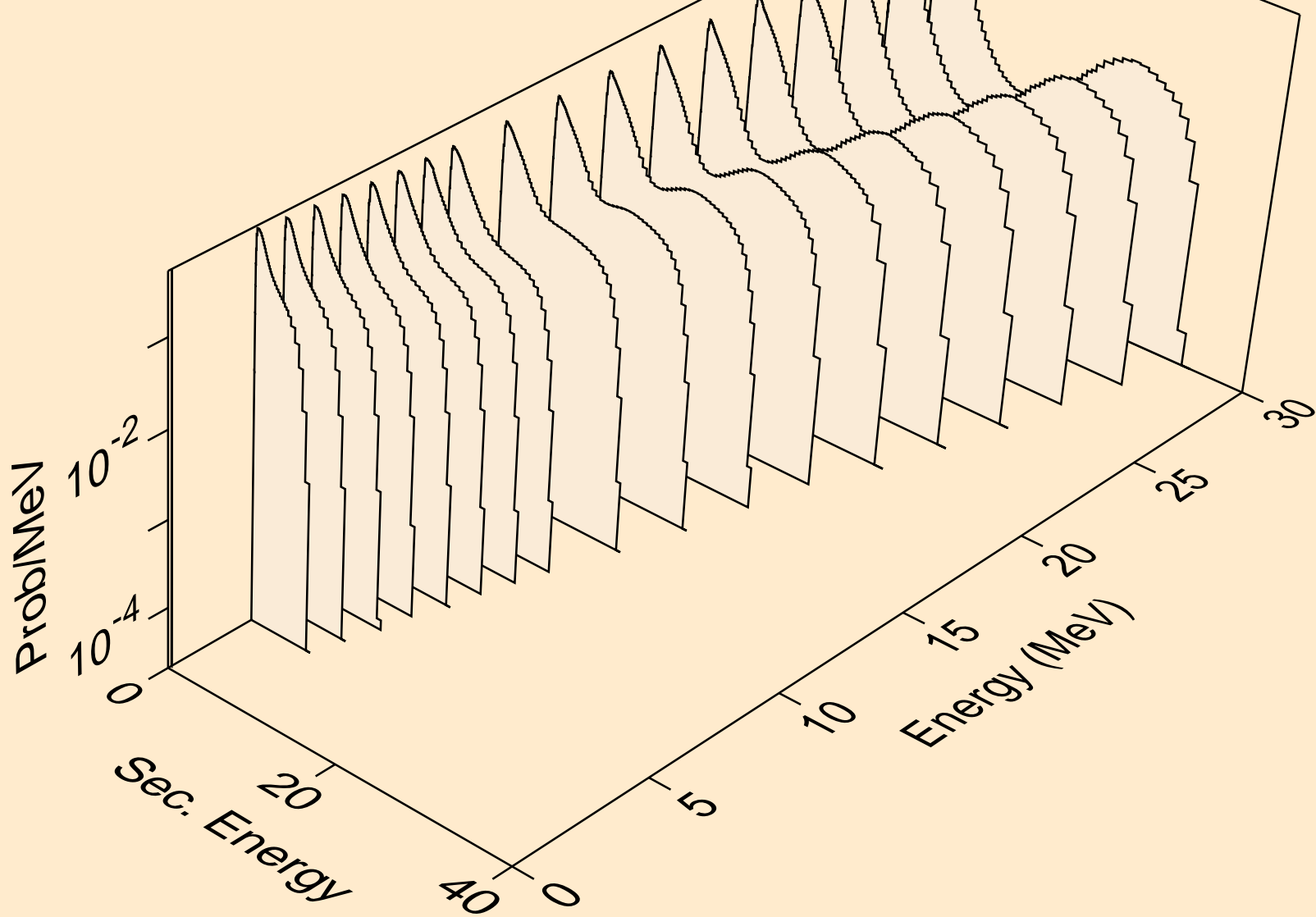

GA080 HELION ACER TENDL-2021 LIBRARY; T=0.K  
neutrons from (s,n\*)a

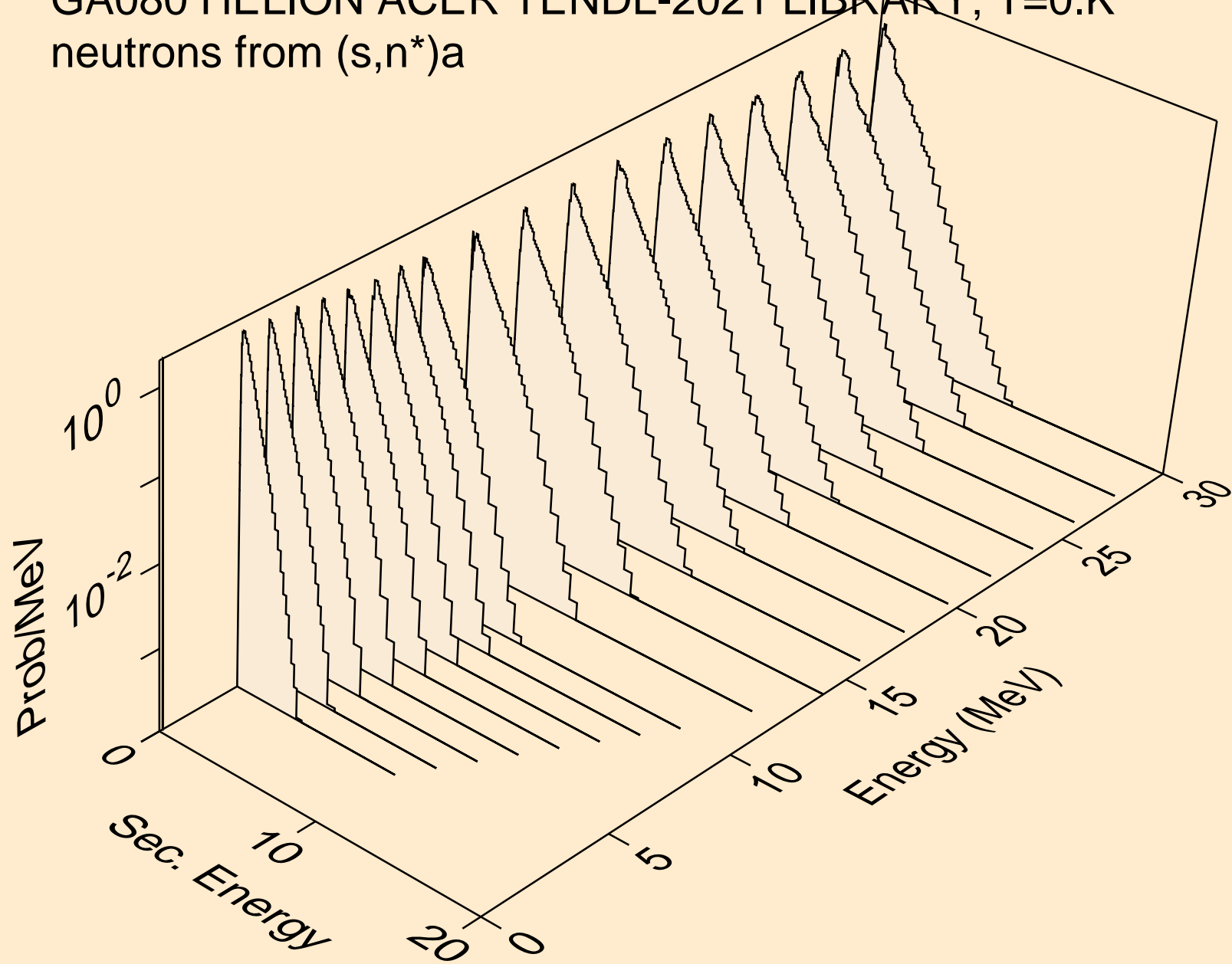



GA080 HELION ACER TENDL-2021 LIBRARY; T=0.K  
neutrons from (s,2n)a

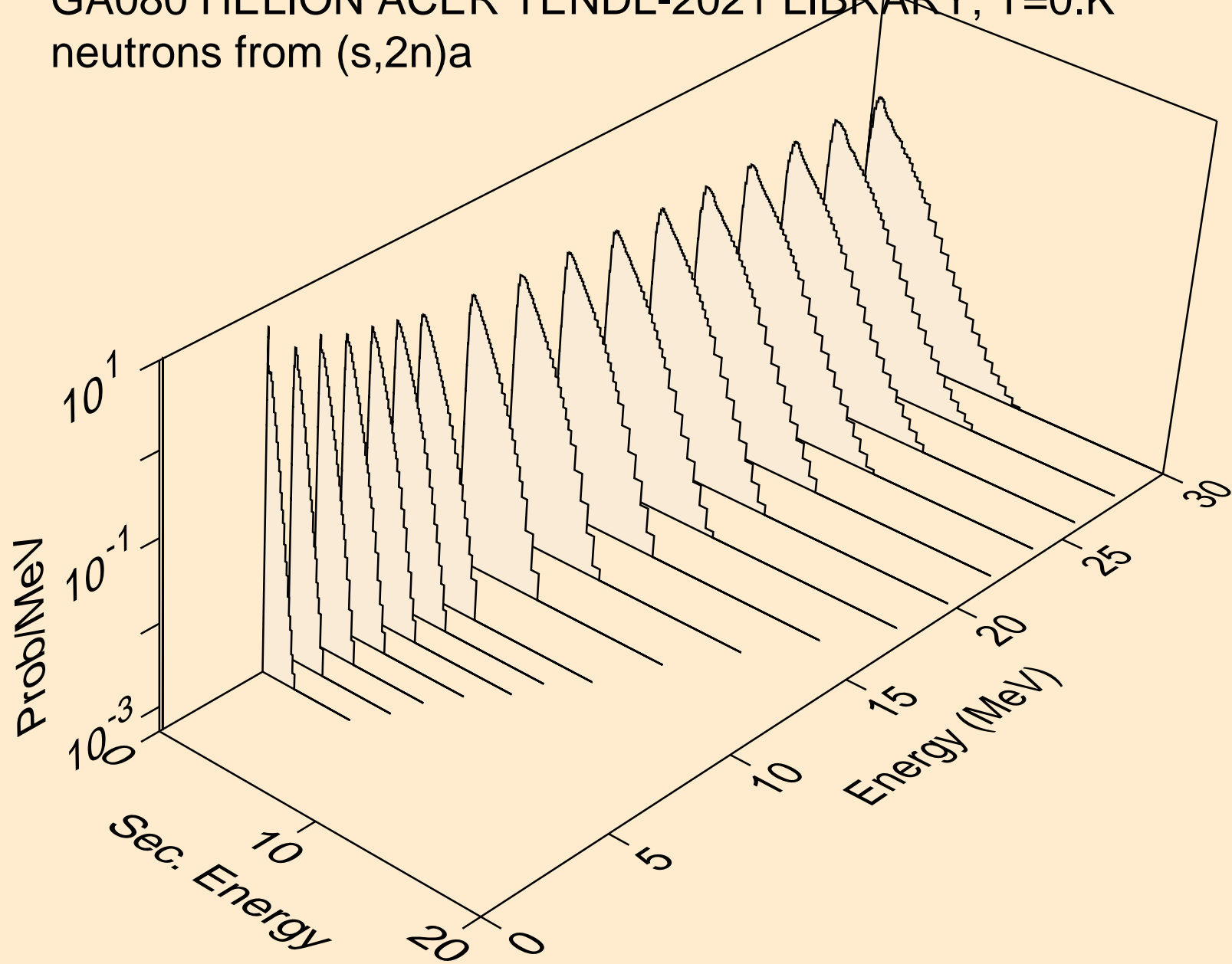

GA080 HELION ACER TENDL-2021 LIBRARY; T=0.K  
neutrons from (s,3n)a

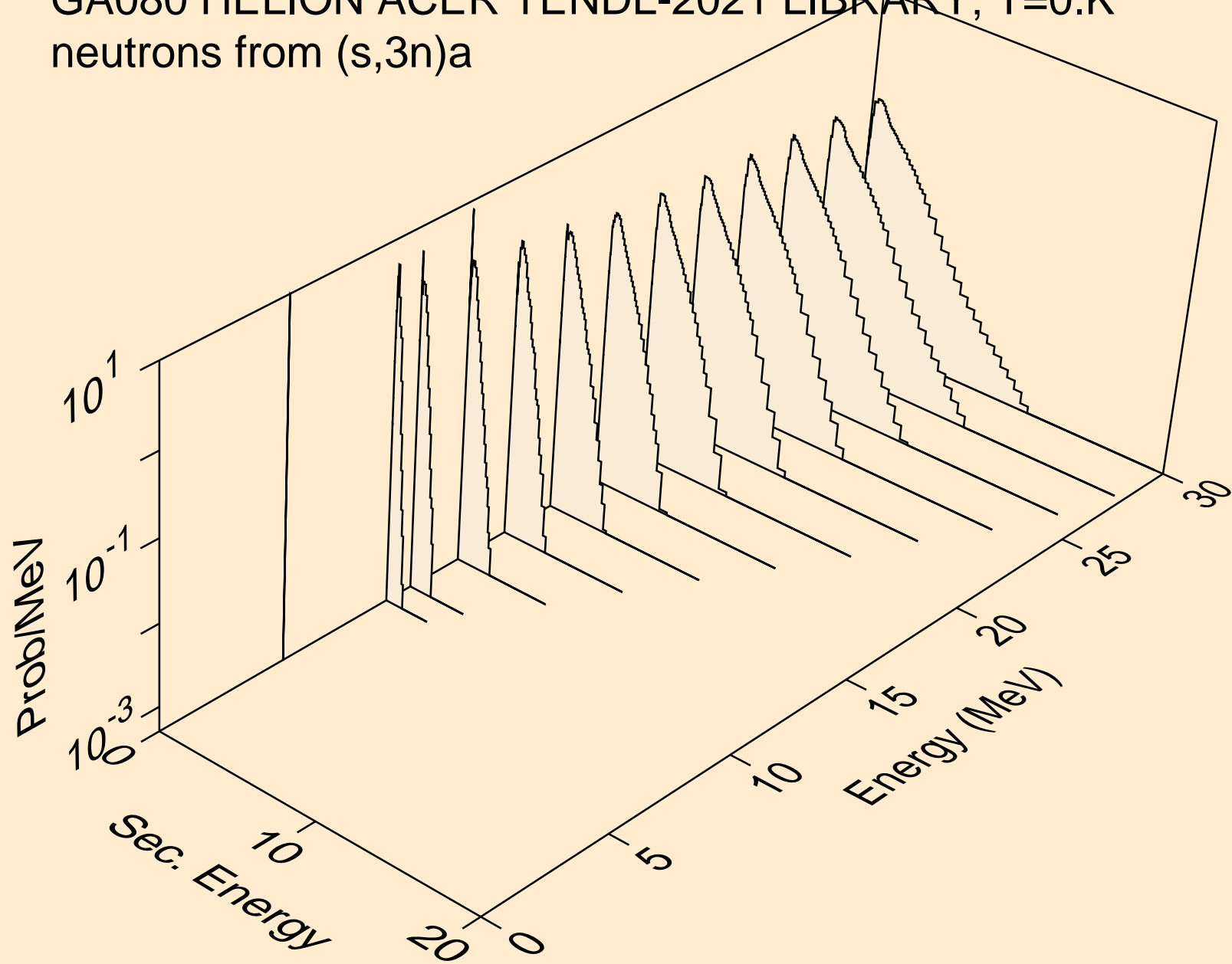

GA080 HELION ACER TENDL-2021 LIBRARY; T=0.K  
neutrons from (s,n\*)p

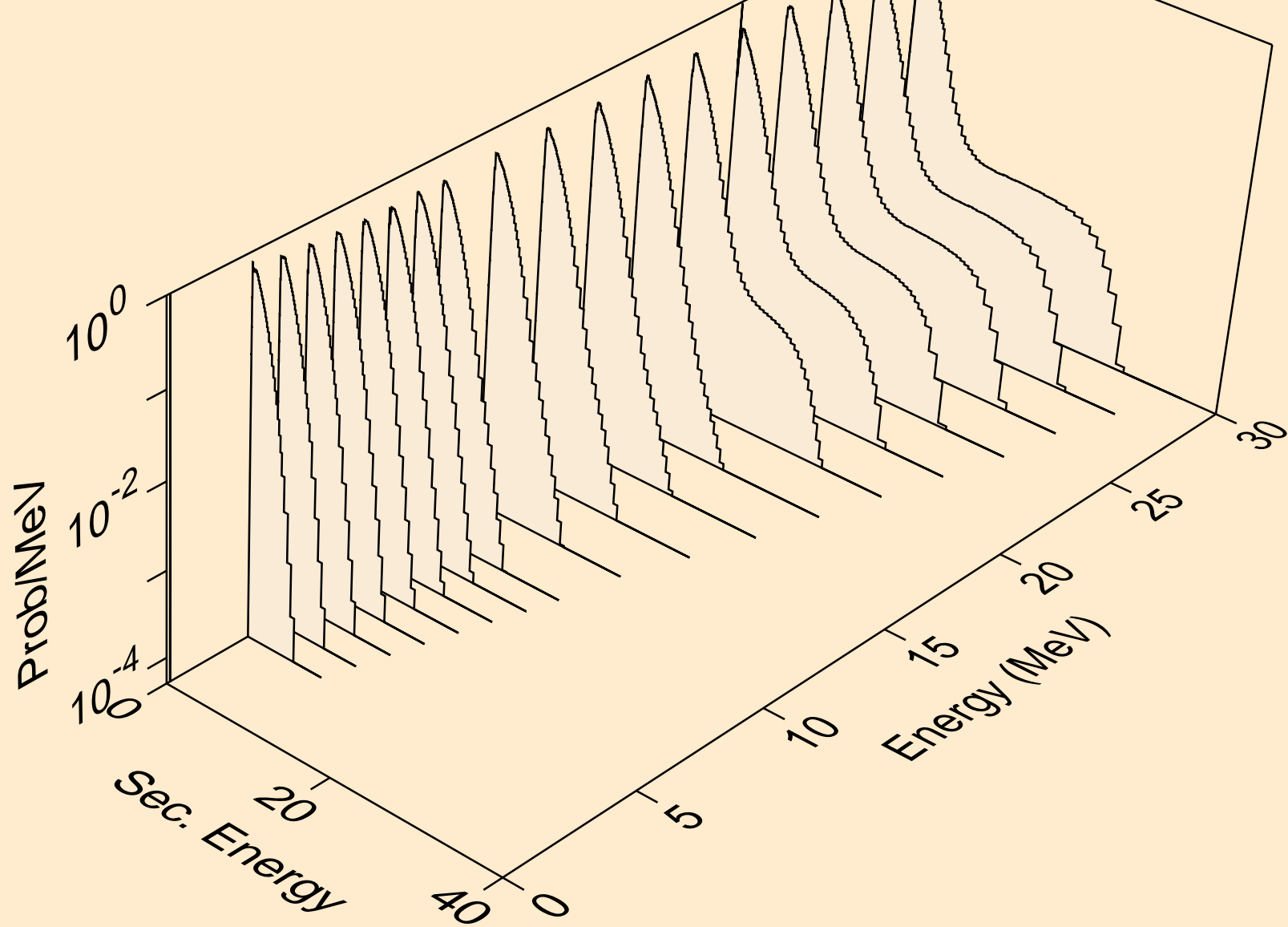

GA080 HELION ACER TENDL-2021 LIBRARY; T=0.K  
neutrons from (s,n\*)2a

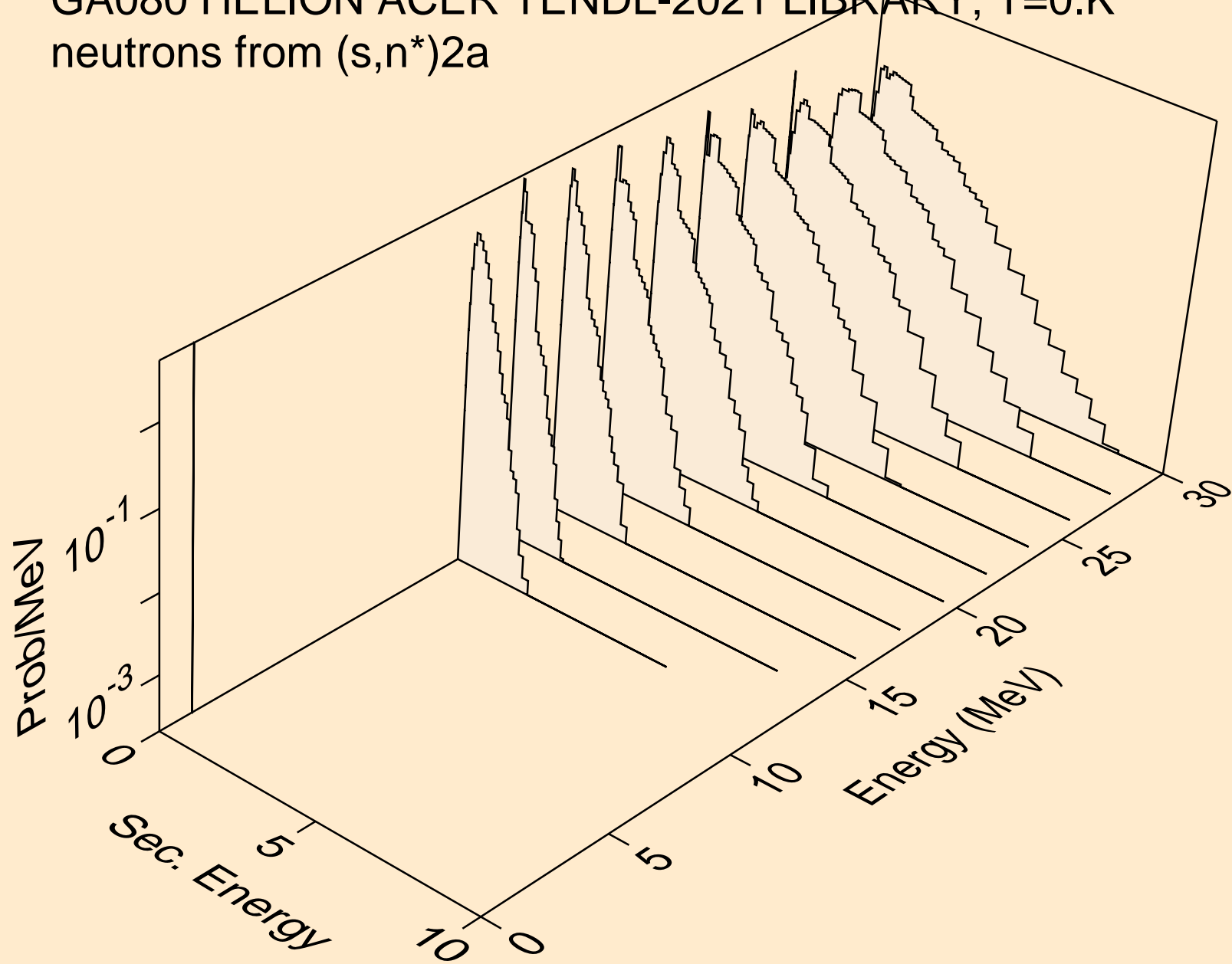

GA080 HELION ACER TENDL-2021 LIBRARY; T=0.K  
neutrons from (s,2n)2a

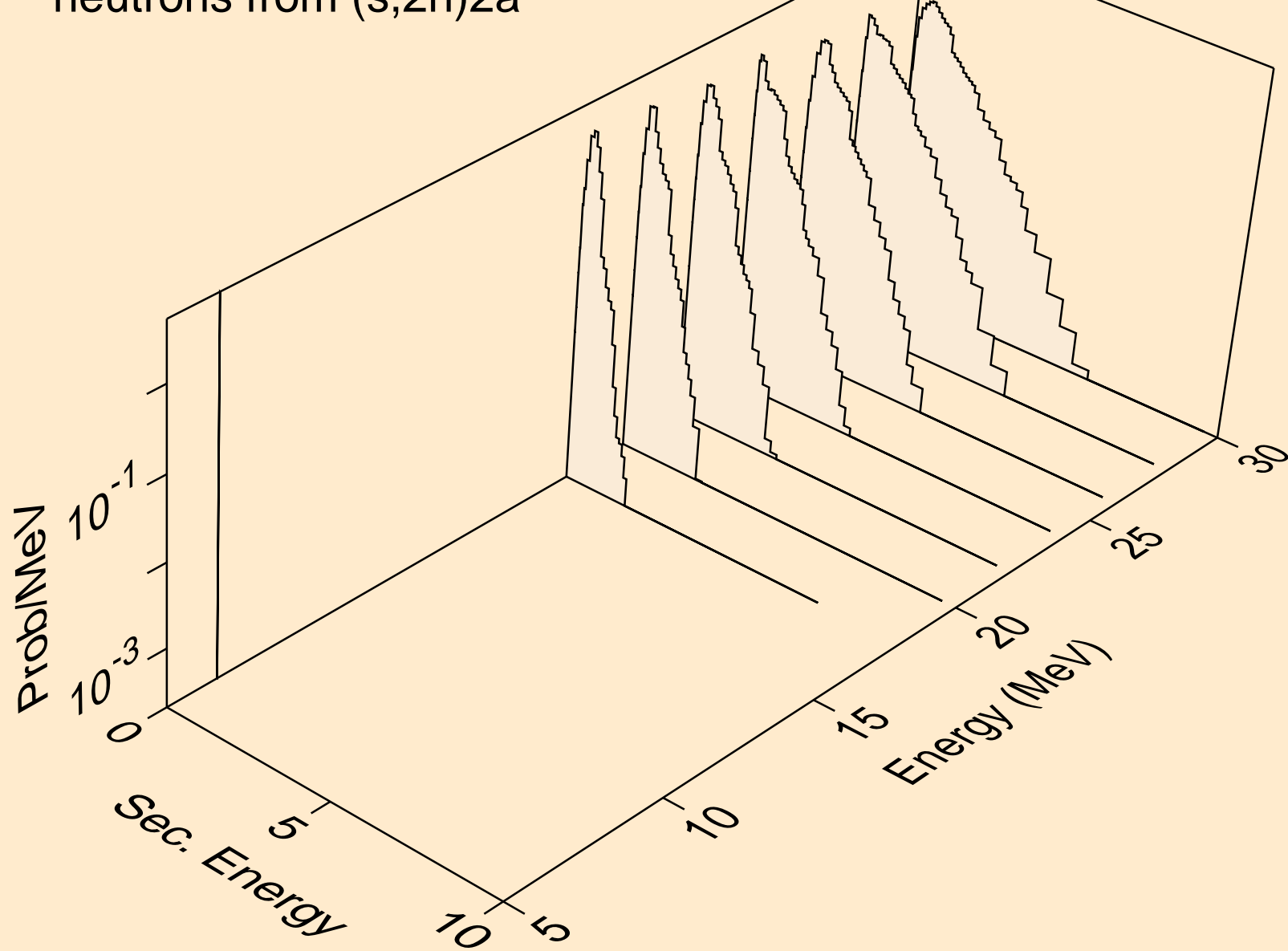

GA080 HELION ACER TENDL-2021 LIBRARY; T=0.K  
neutrons from (s,n\*)d

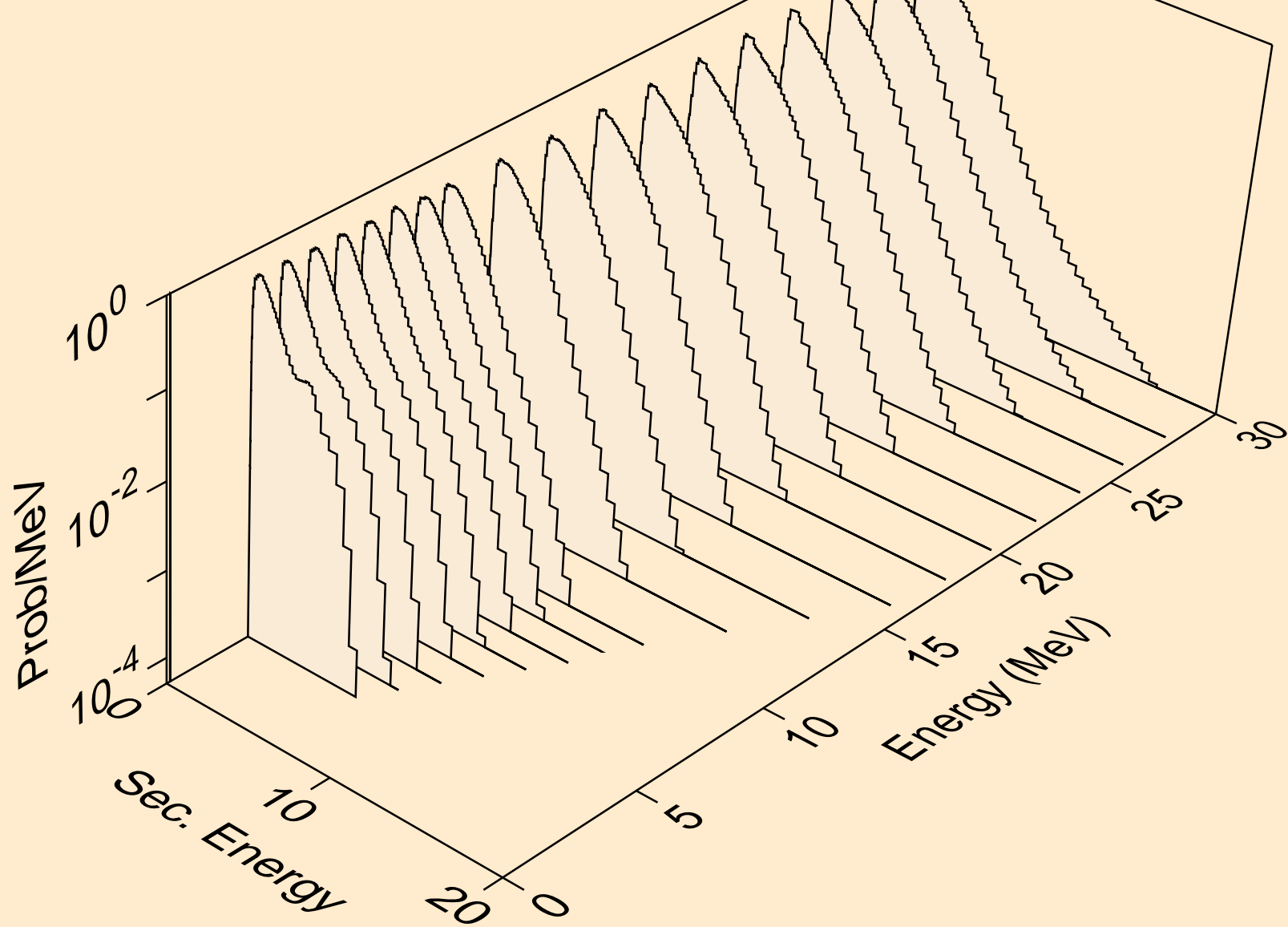

GA080 HELION ACER TENDL-2021 LIBRARY; T=0.K  
neutrons from (s,n\*)t

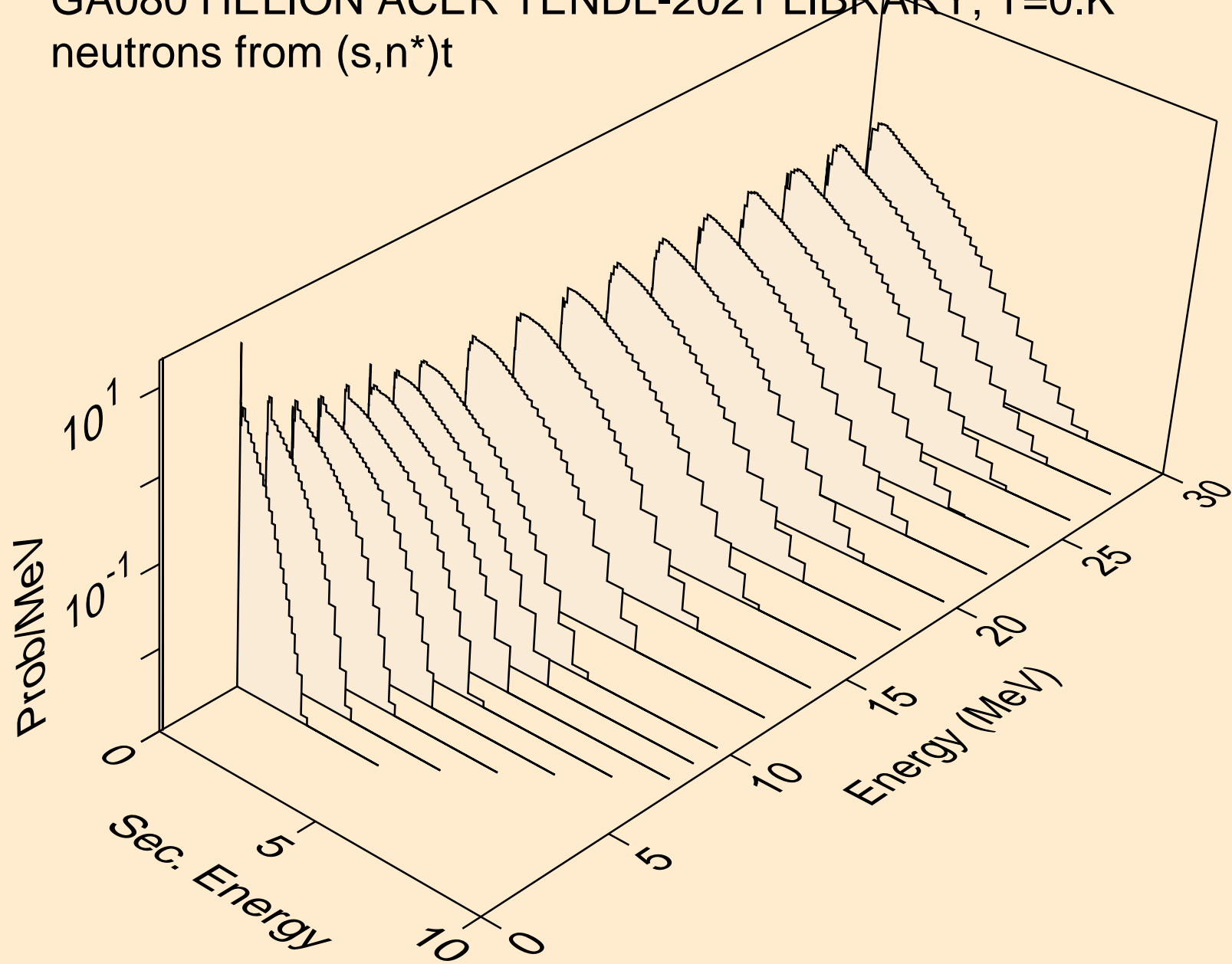

GA080 HELION ACER TENDL-2021 LIBRARY; T=0.K  
neutrons from (s,n\*)he3

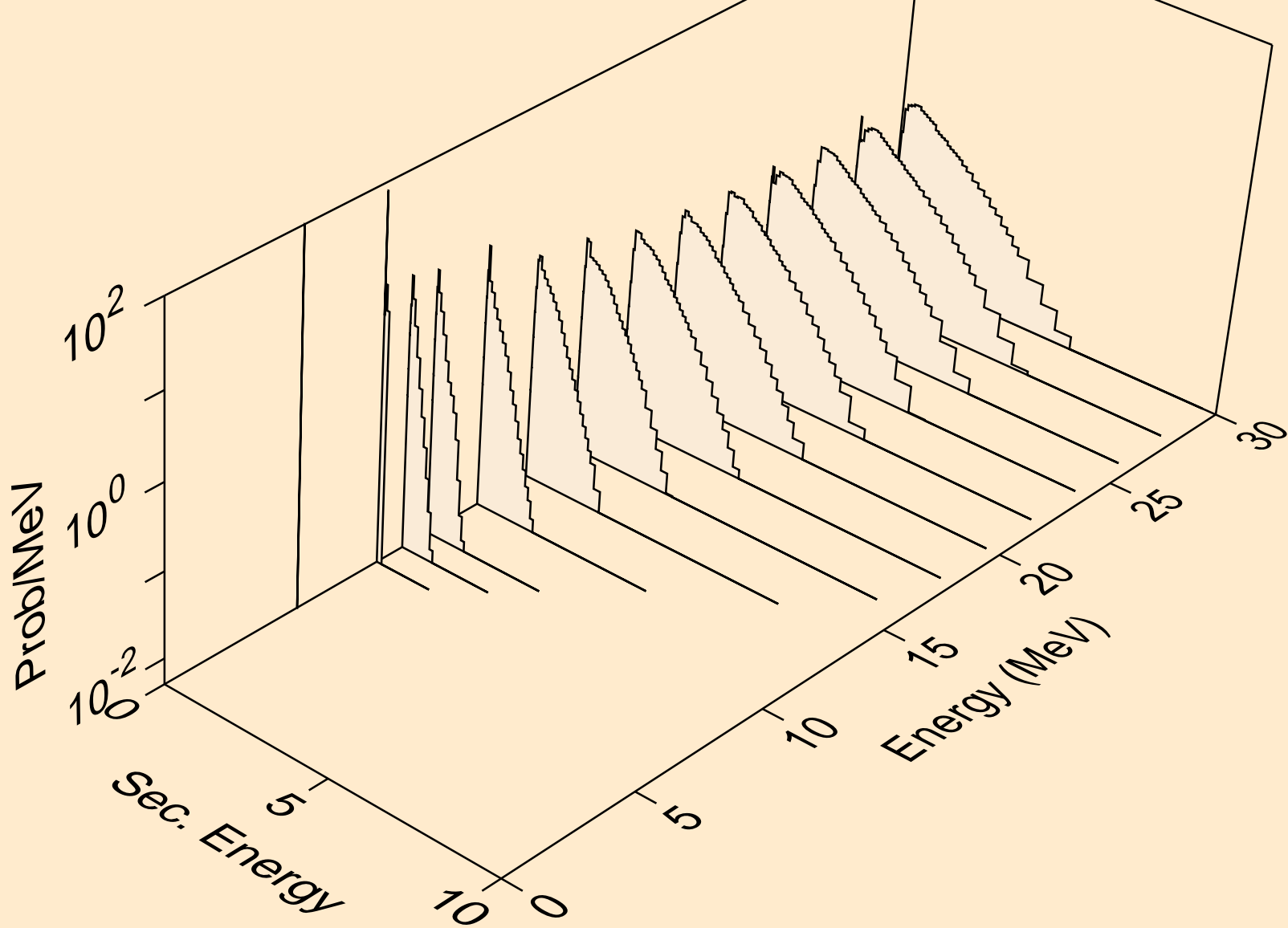



GA080 HELION ACER TENDL-2021 LIBRARY; T=0.K  
neutrons from (s,4n)

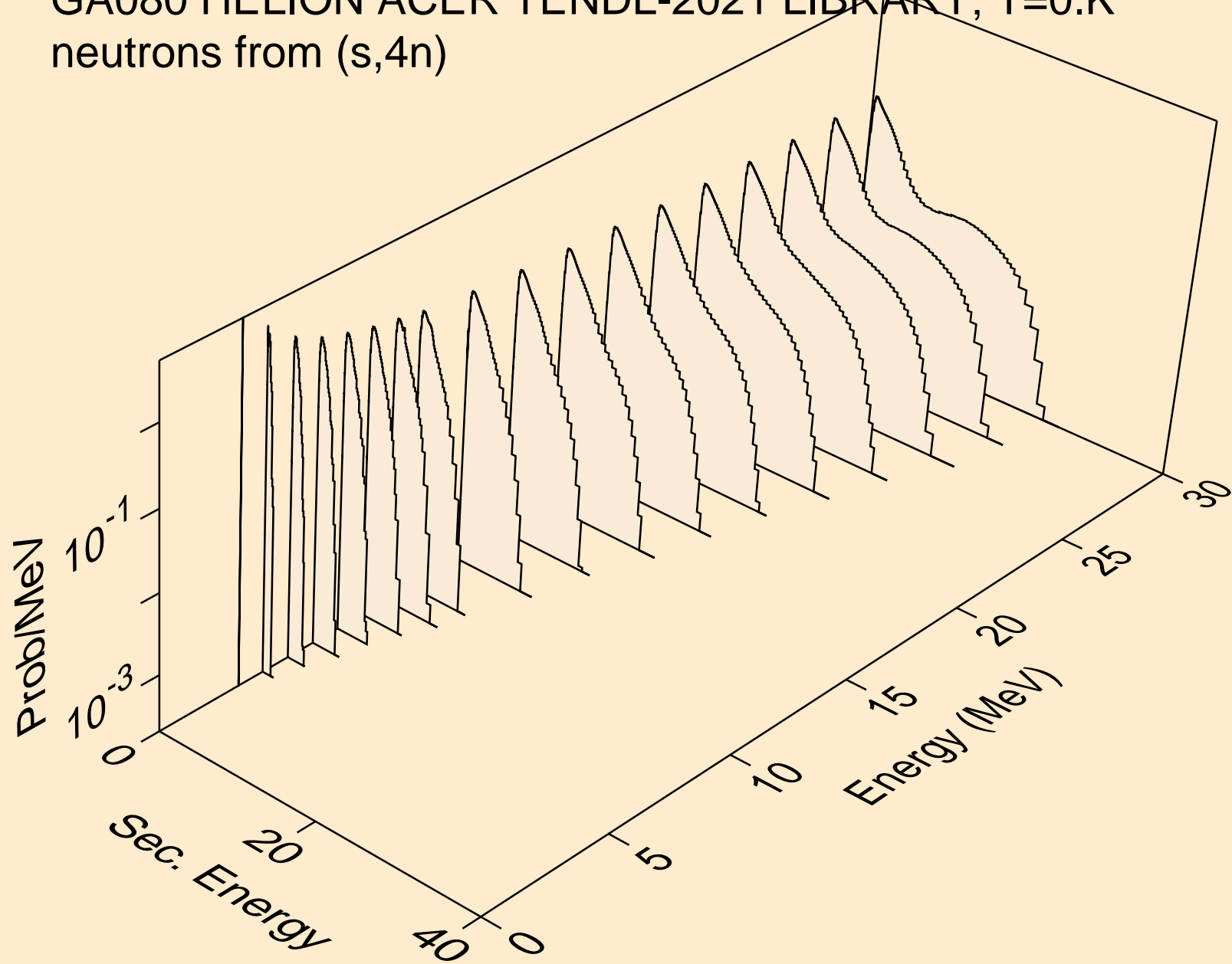

GA080 HELION ACER TENDL-2021 LIBRARY; T=0.K  
neutrons from (s,2np)

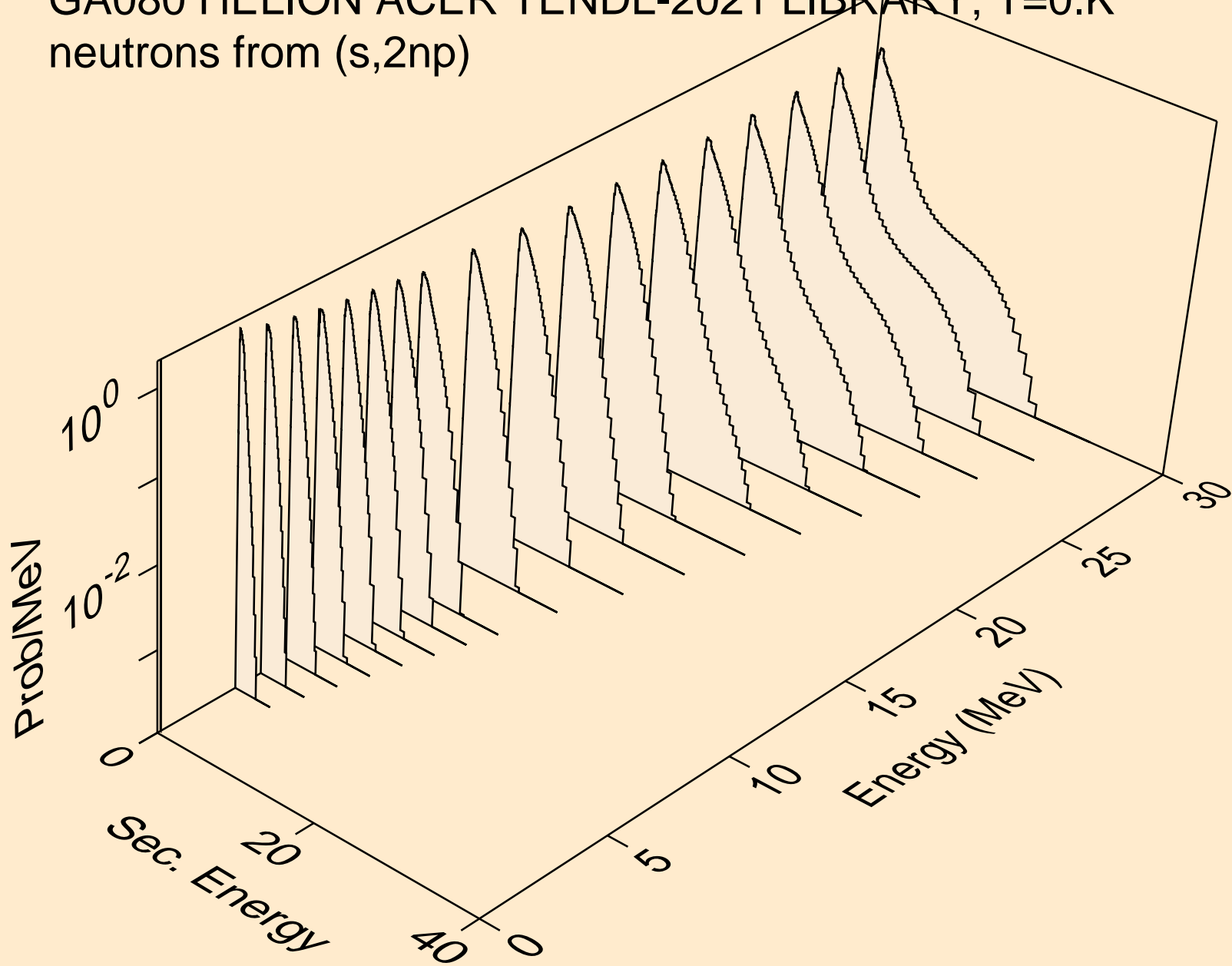

GA080 HELION ACER TENDL-2021 LIBRARY; T=0.K  
neutrons from (s,3np)

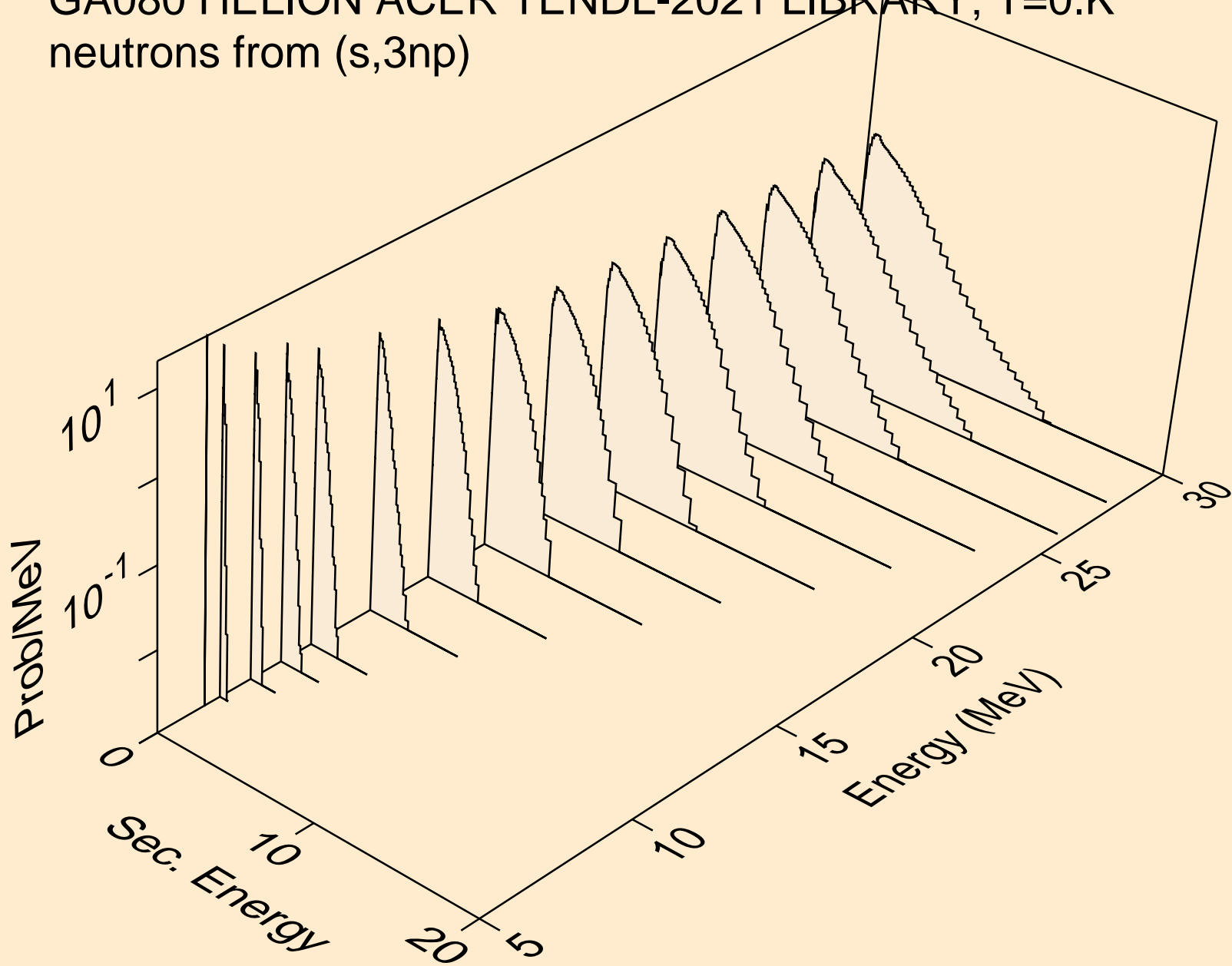

GA080 HELION ACER TENDL-2021 LIBRARY; T=0.K  
neutrons from (s,2np)

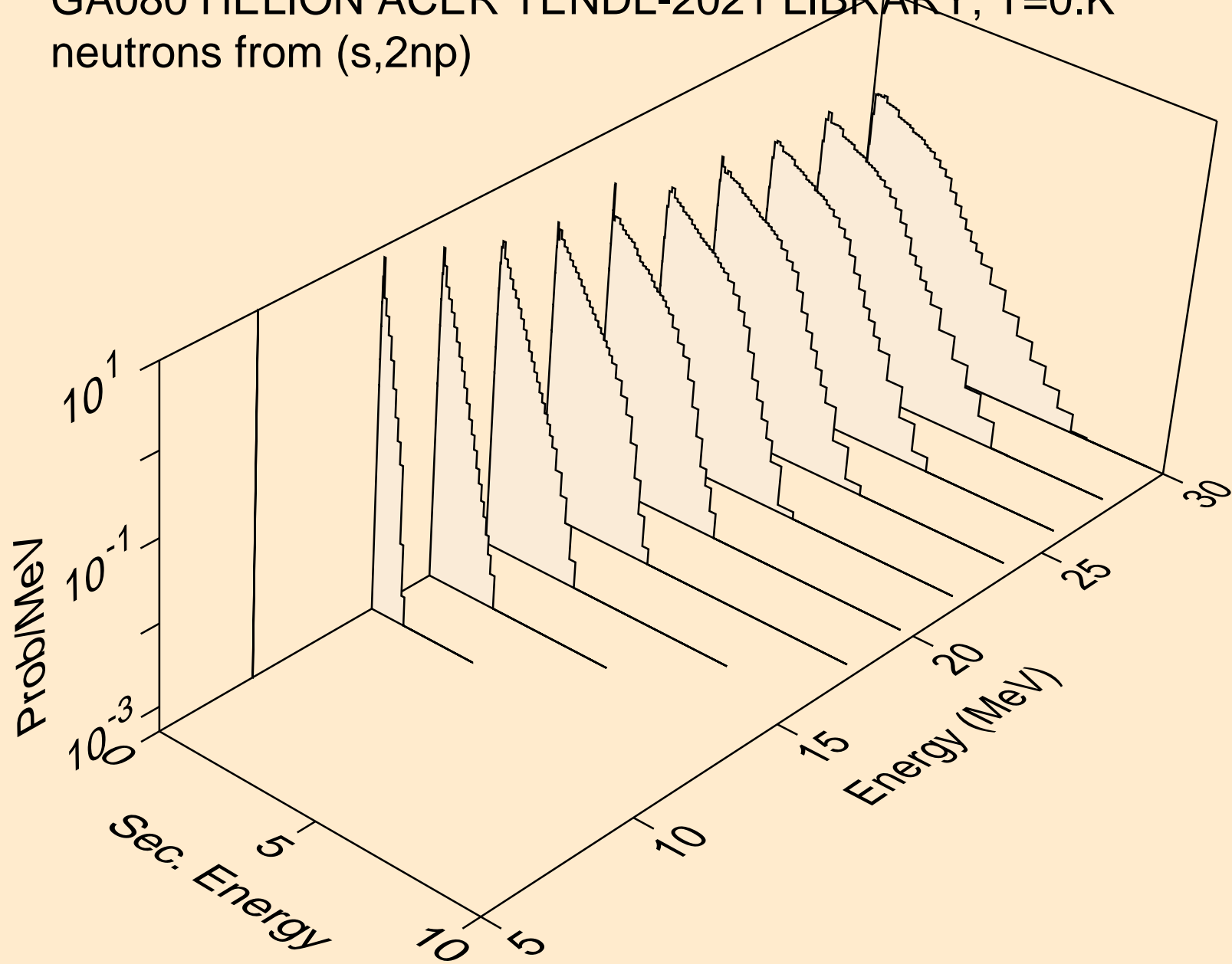

GA080 HELION ACER TENDL-2021 LIBRARY; T=0.K  
neutrons from (s,npa)

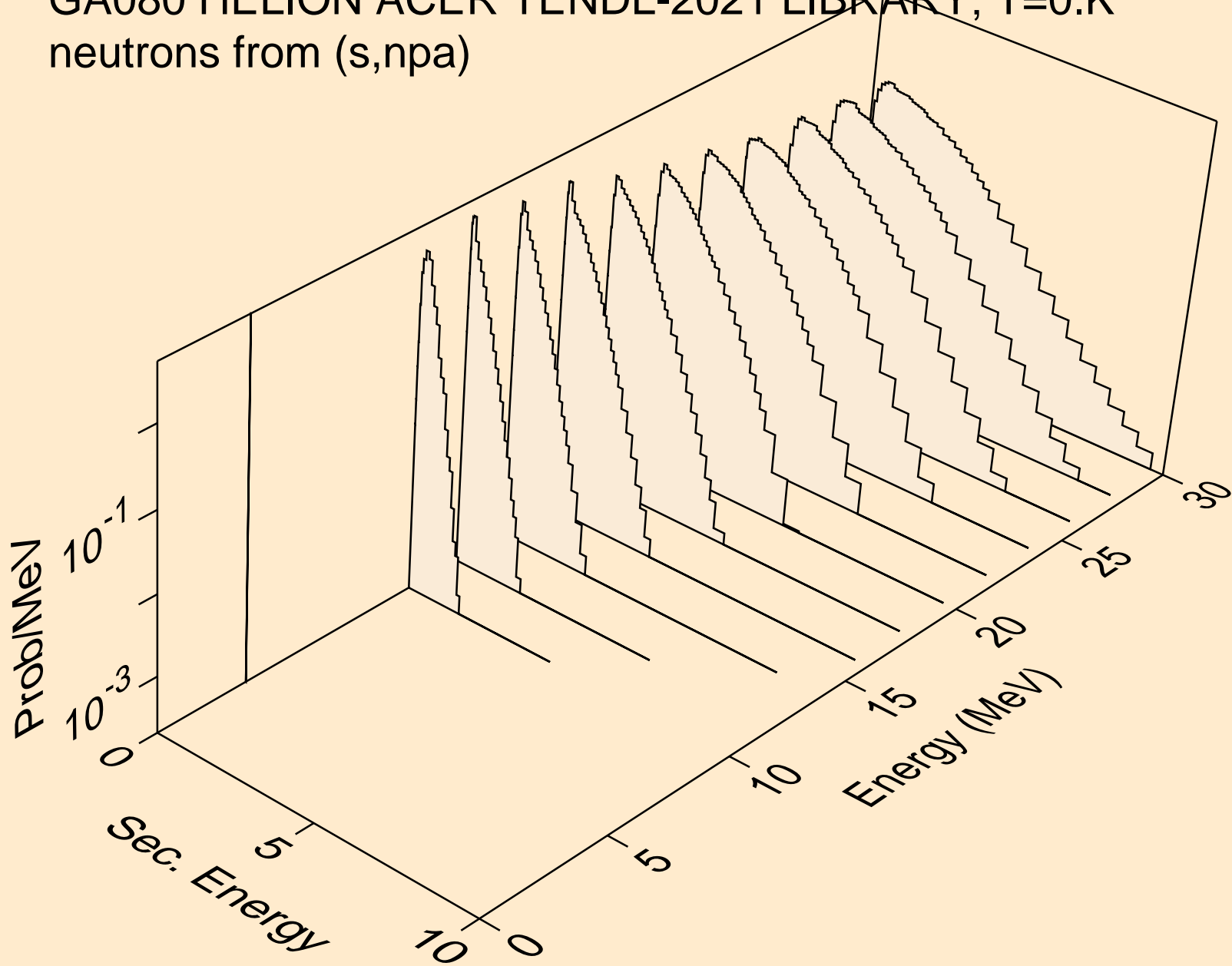

GA080 HELION ACER TENDL-2021 LIBRARY; T=0.K  
protons from (s,x)

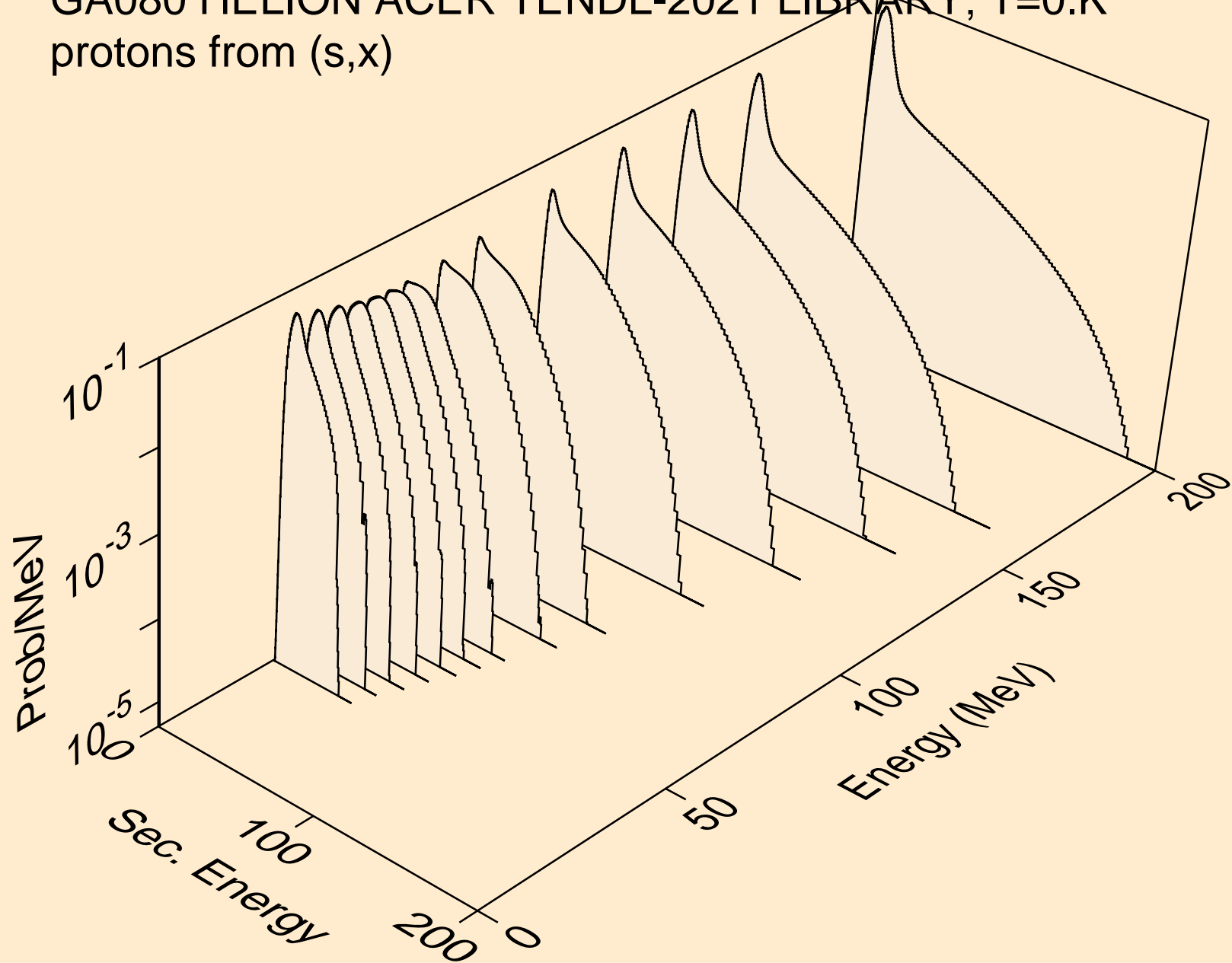

GA080 HELION ACER TENDL-2021 LIBRARY; T=0.K  
protons from (s,n\*)p

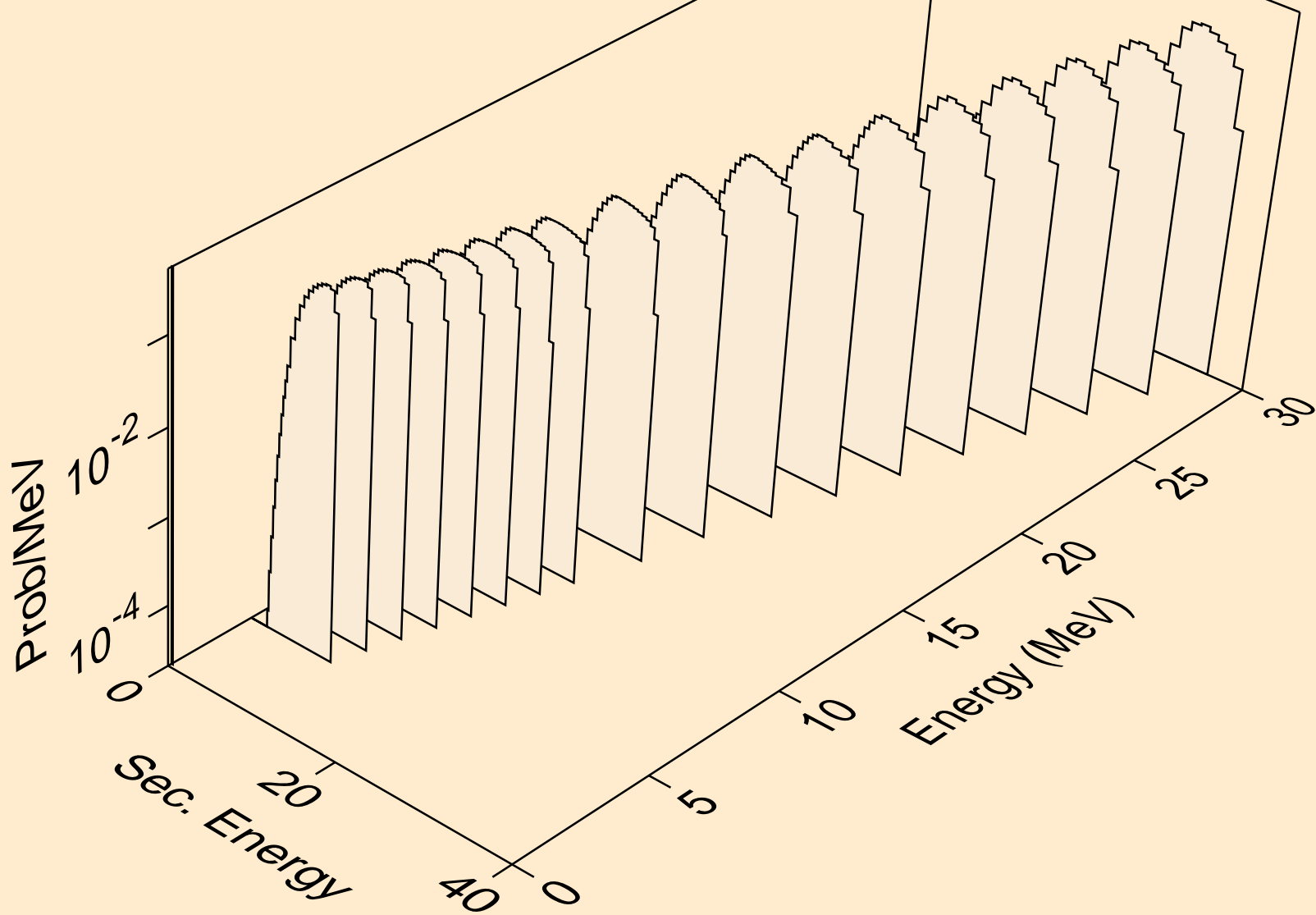

GA080 HELION ACER TENDL-2021 LIBRARY; T=0.K  
protons from (s,2np)

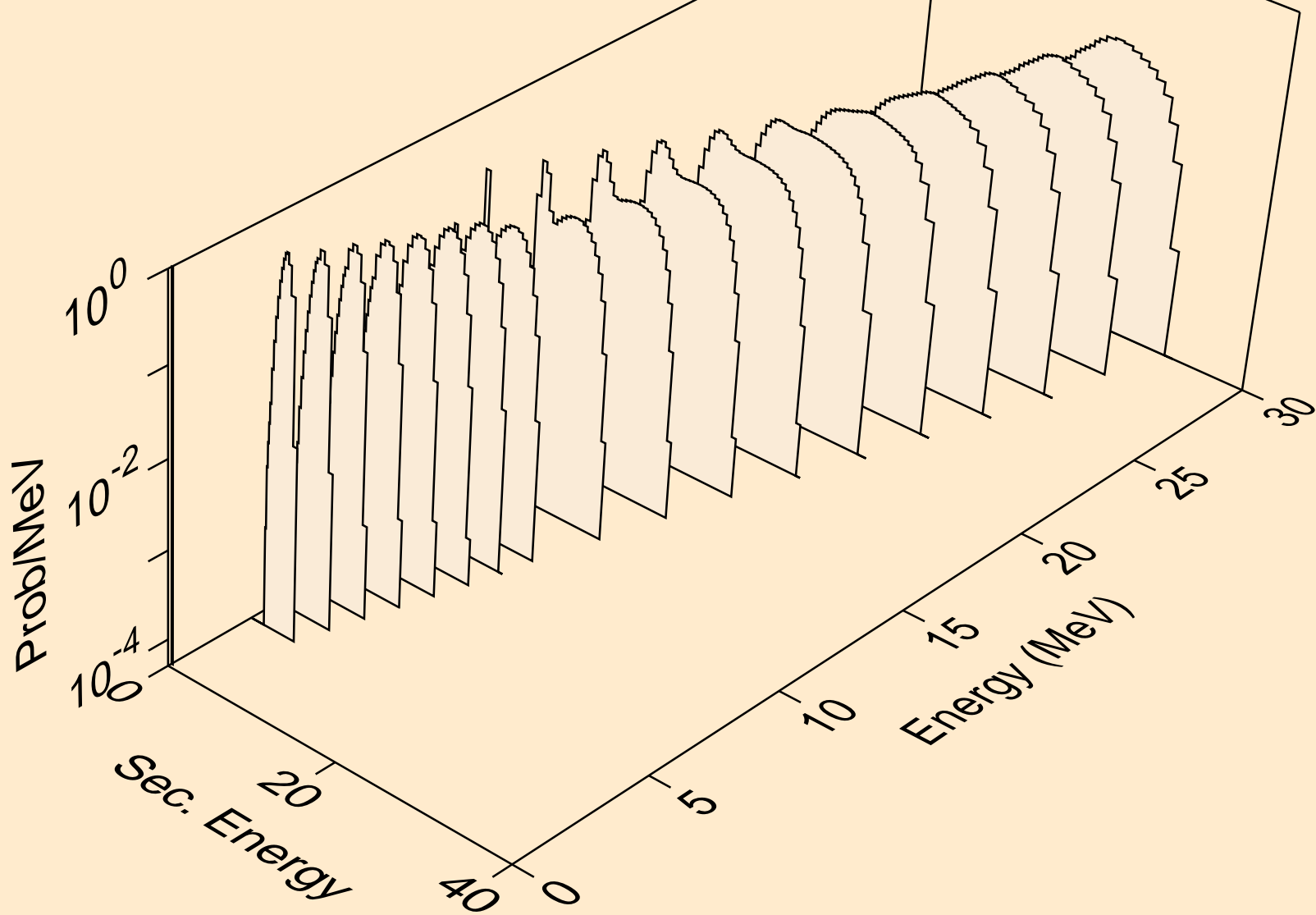



GA080 HELION ACER TENDL-2021 LIBRARY; T=0.K  
protons from (s,3np)

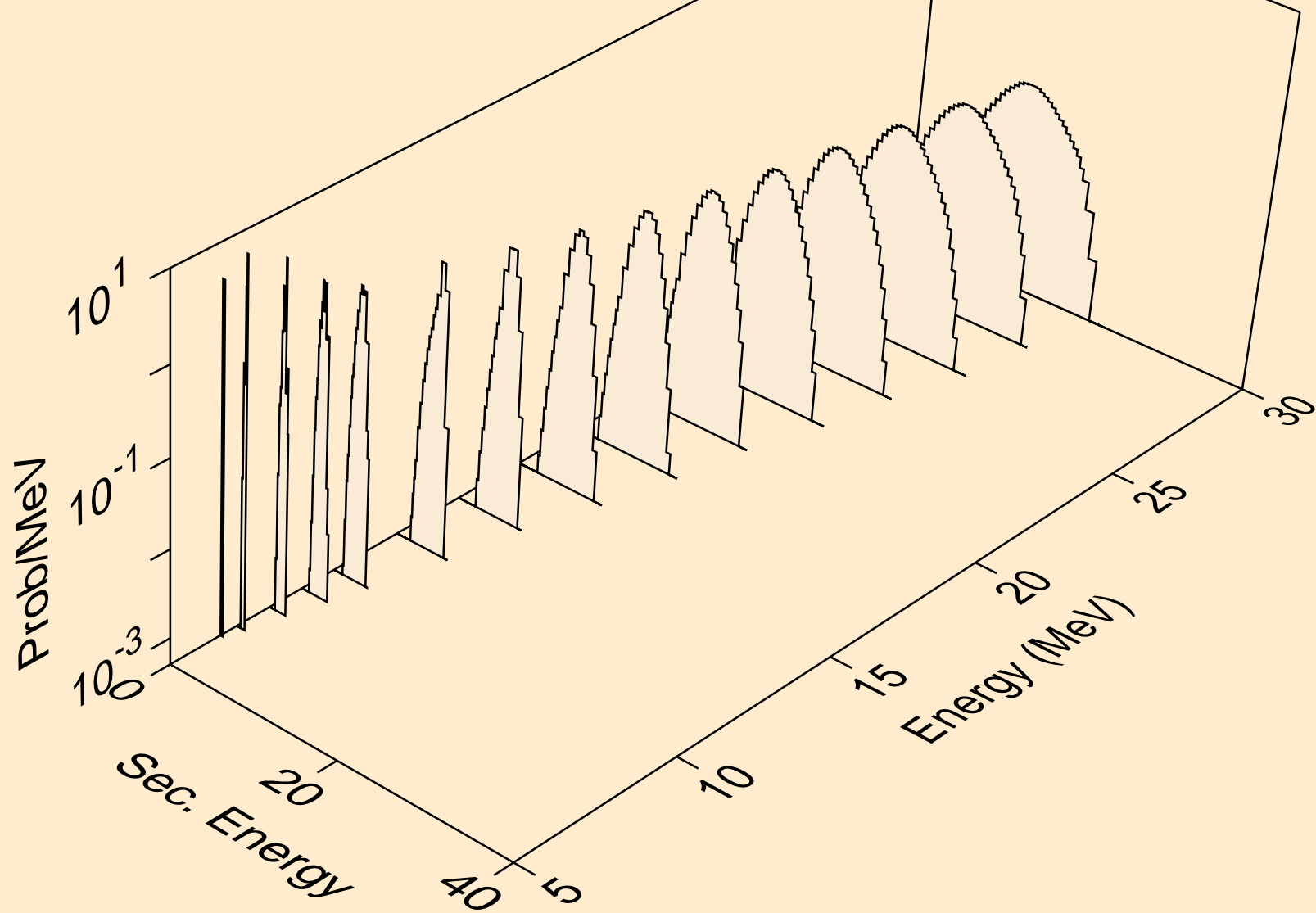

GA080 HELION ACER TENDL-2021 LIBRARY; T=0.K  
protons from (s,2np)

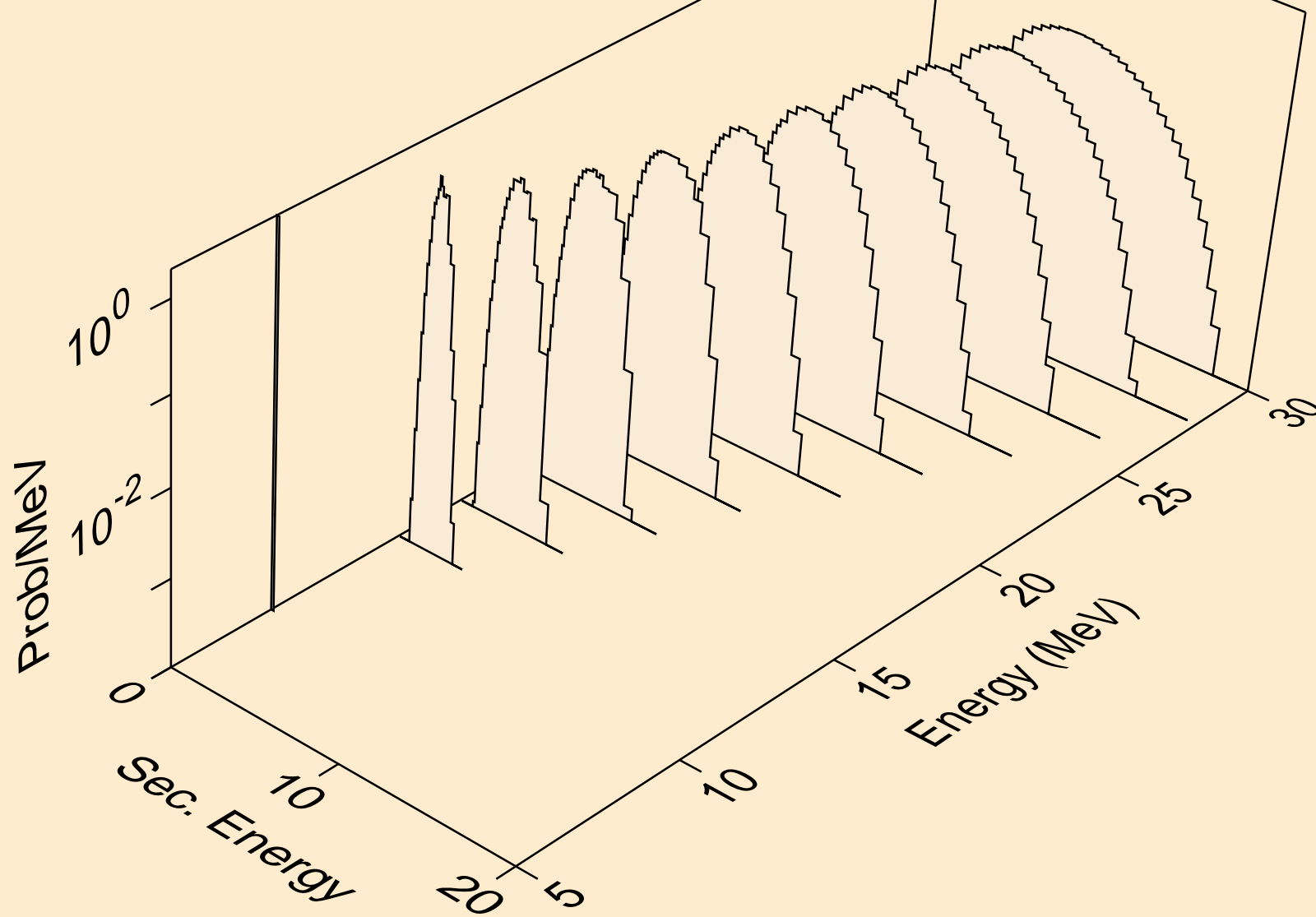

GA080 HELION ACER TENDL-2021 LIBRARY; T=0.K  
protons from (s,npa)

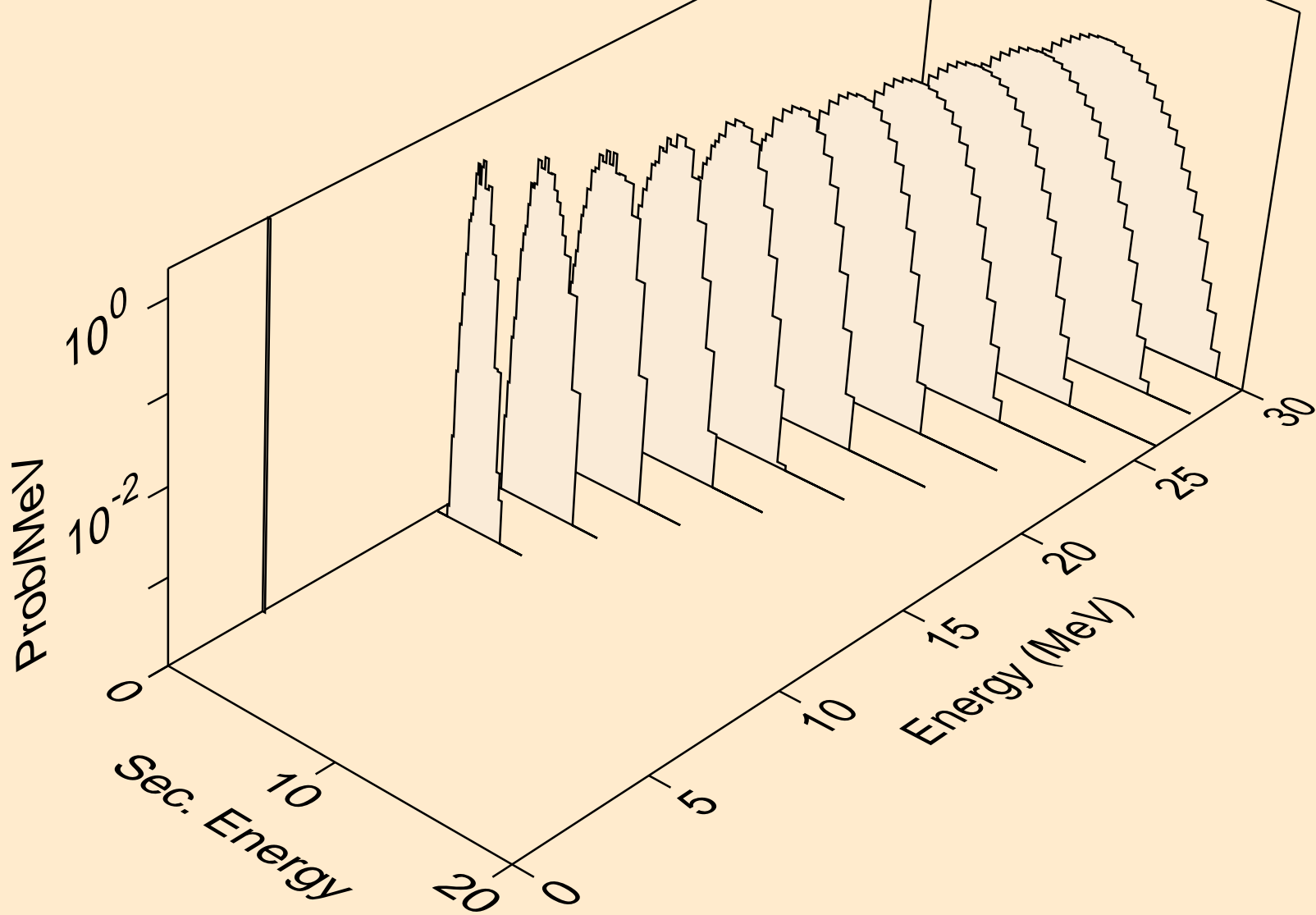

GA080 HELION ACER TENDL-2021 LIBRARY; T=0.K  
protons from (s,p)

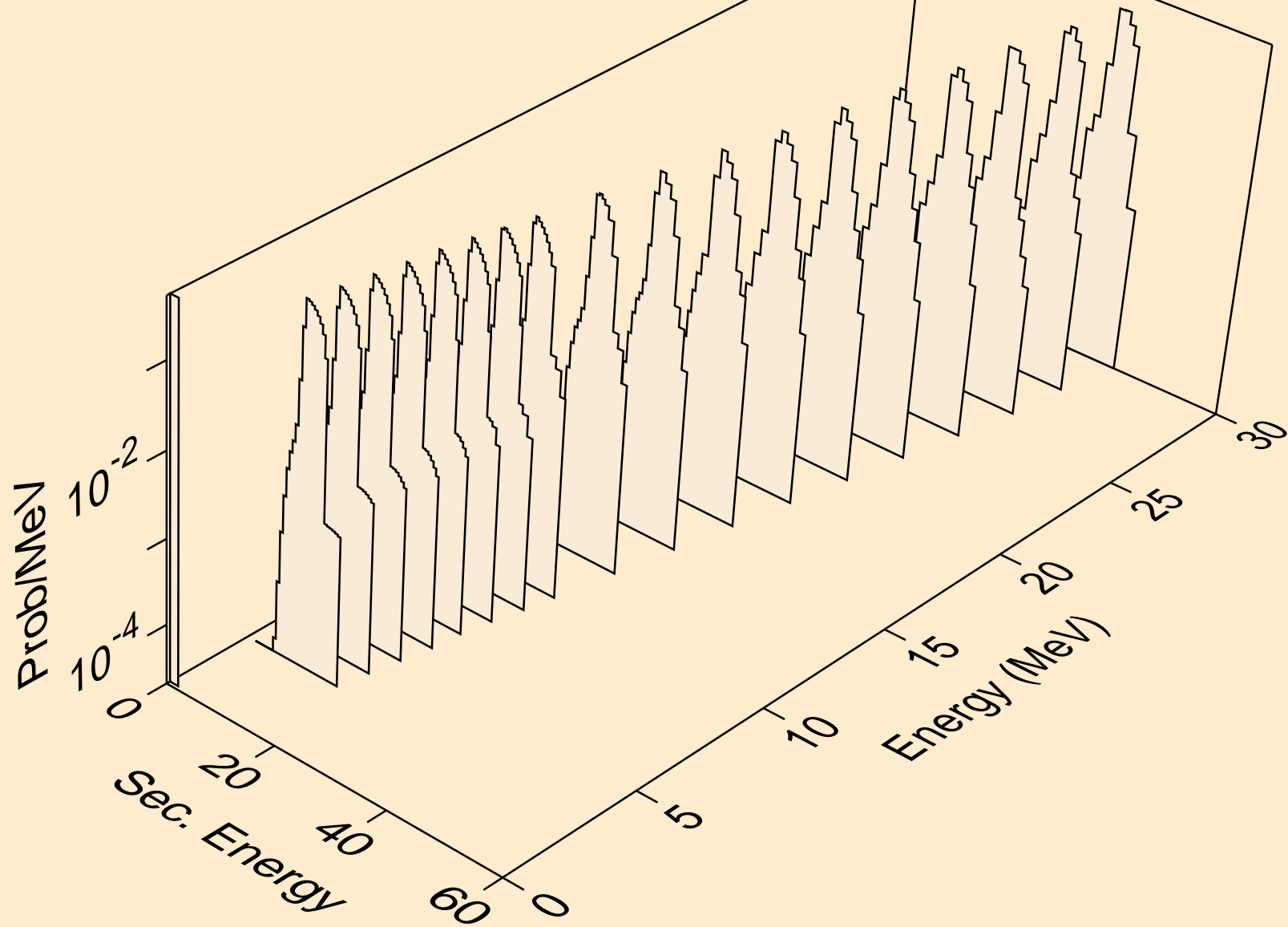

GA080 HELION ACER TENDL-2021 LIBRARY; T=0.K  
protons from (s,2p)

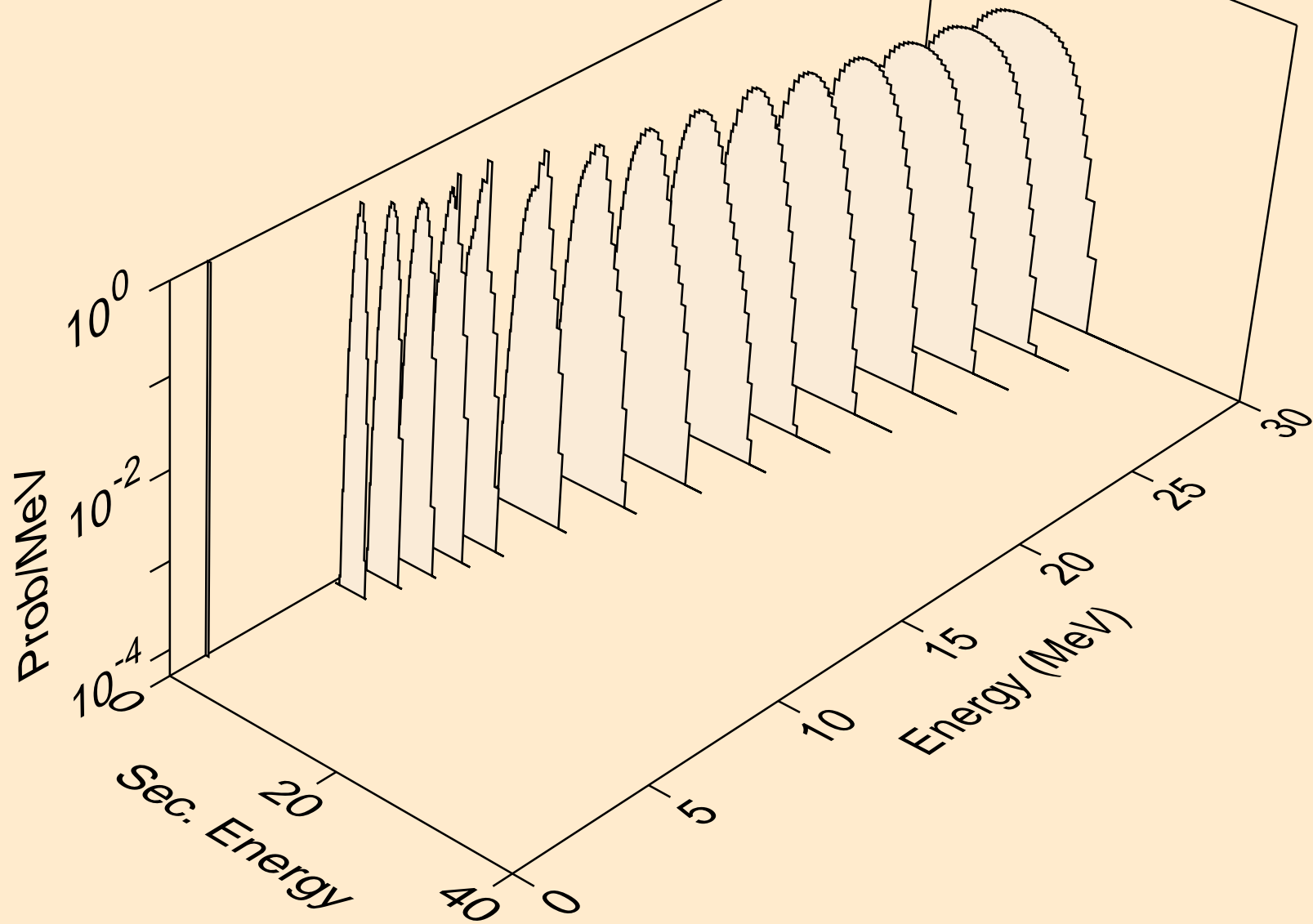

GA080 HELION ACER TENDL-2021 LIBRARY; T=0.K  
protons from (s,pa)

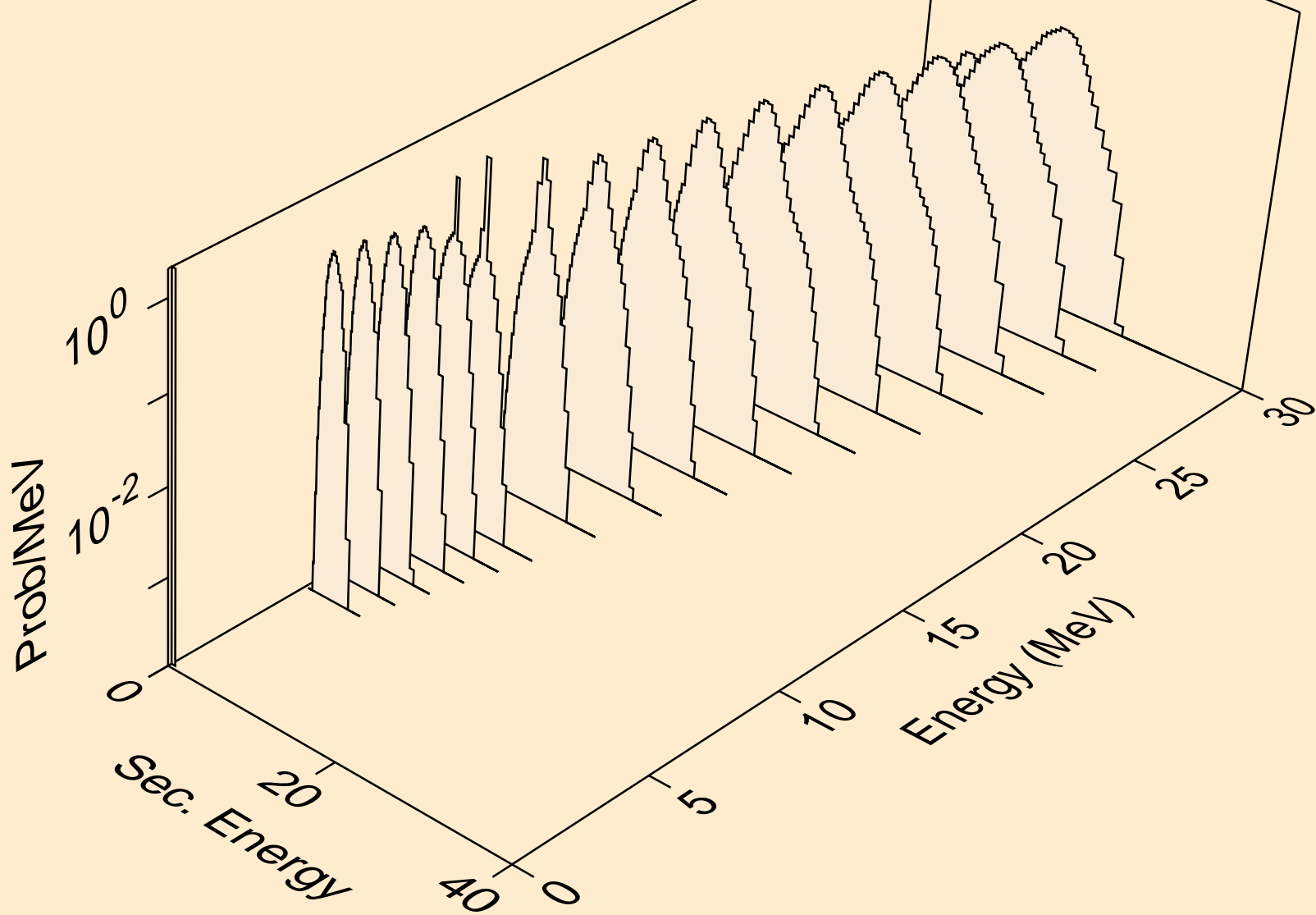

GA080 HELION ACER TENDL-2021 LIBRARY; T=0.K  
protons from (s,pd)

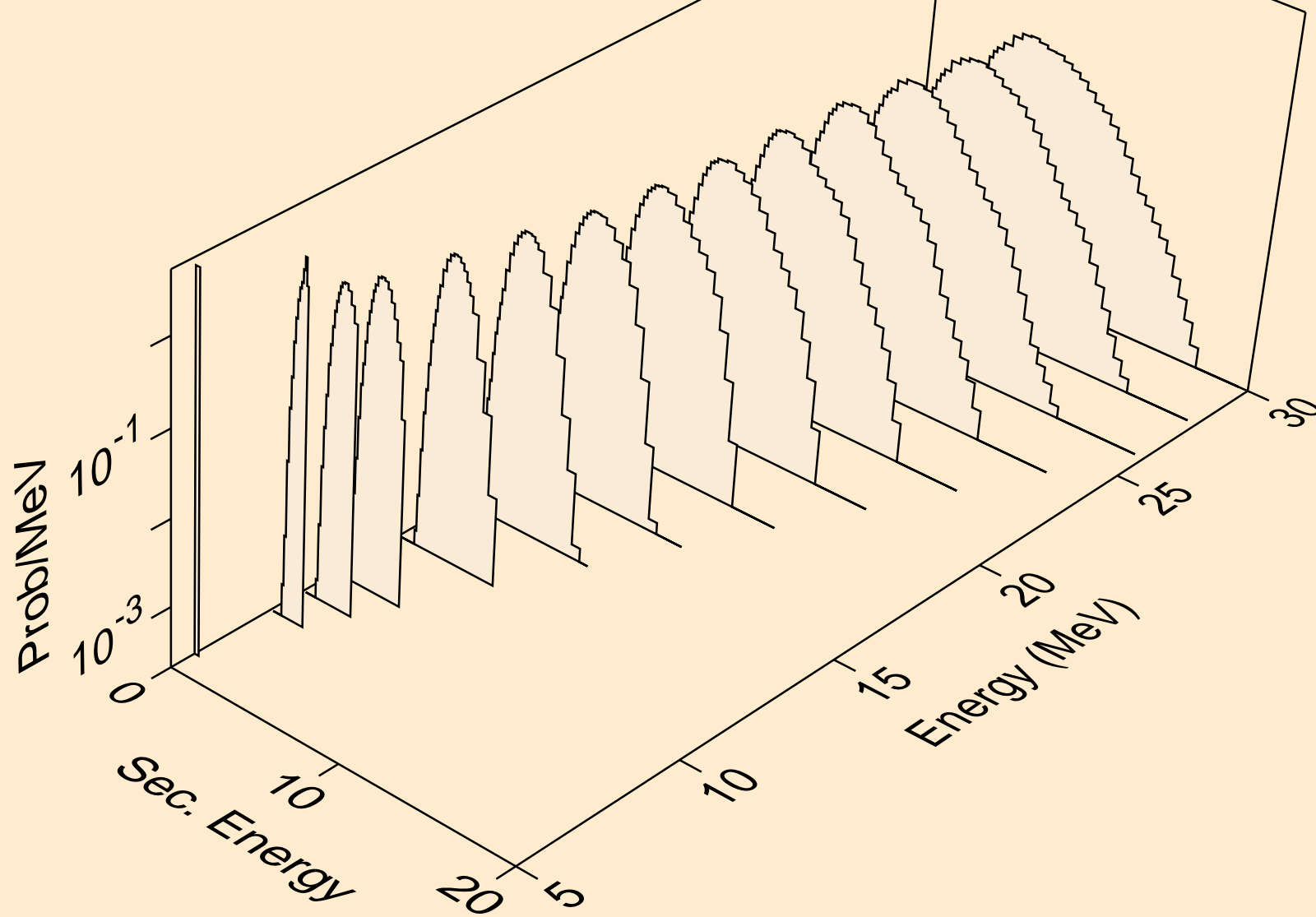

GA080 HELION ACER TENDL-2021 LIBRARY; T=0.K  
protons from (s,pt)

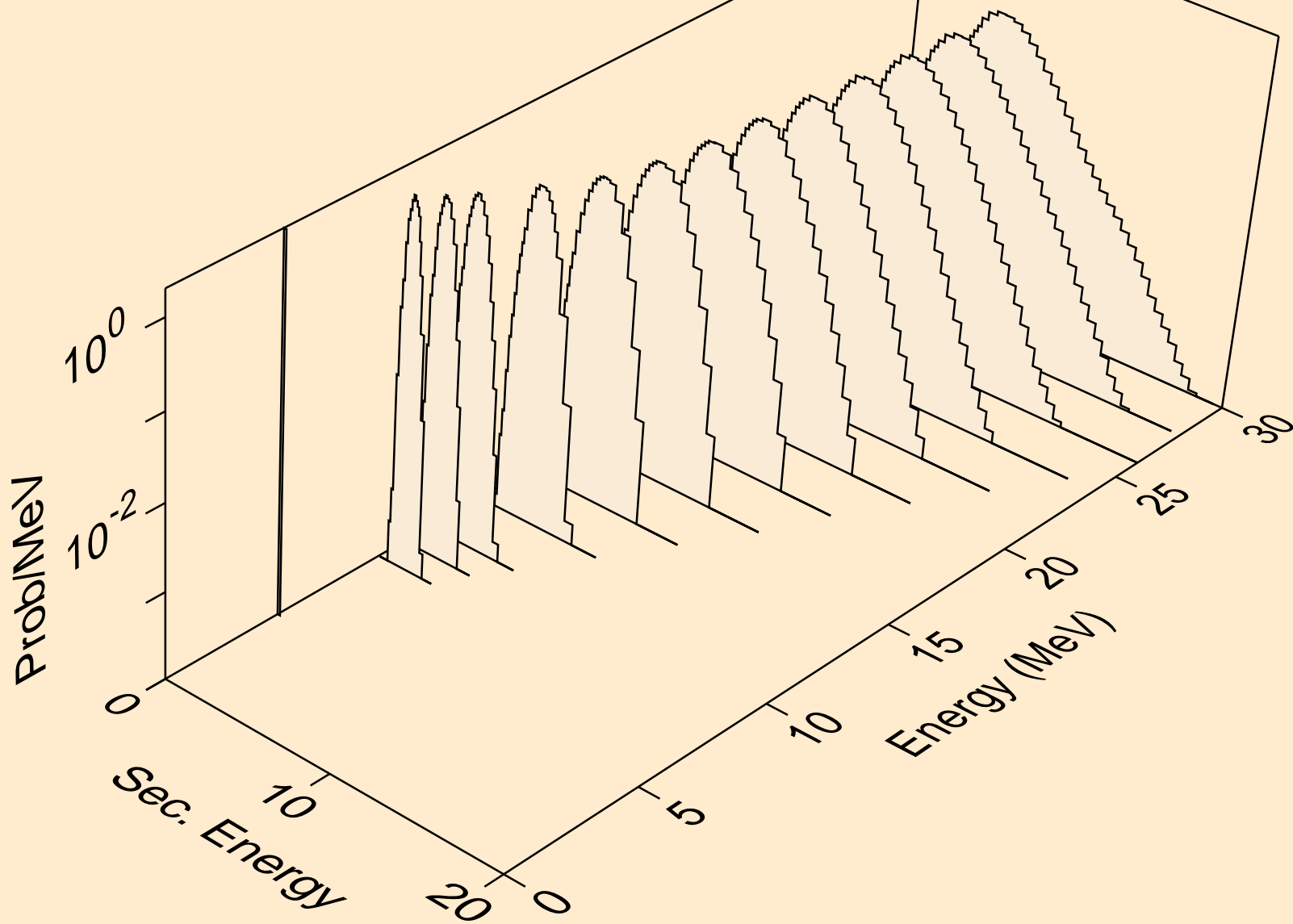



GA080 HELION ACER TENDL-2021 LIBRARY; T=0.K  
deuterons from (s,x)

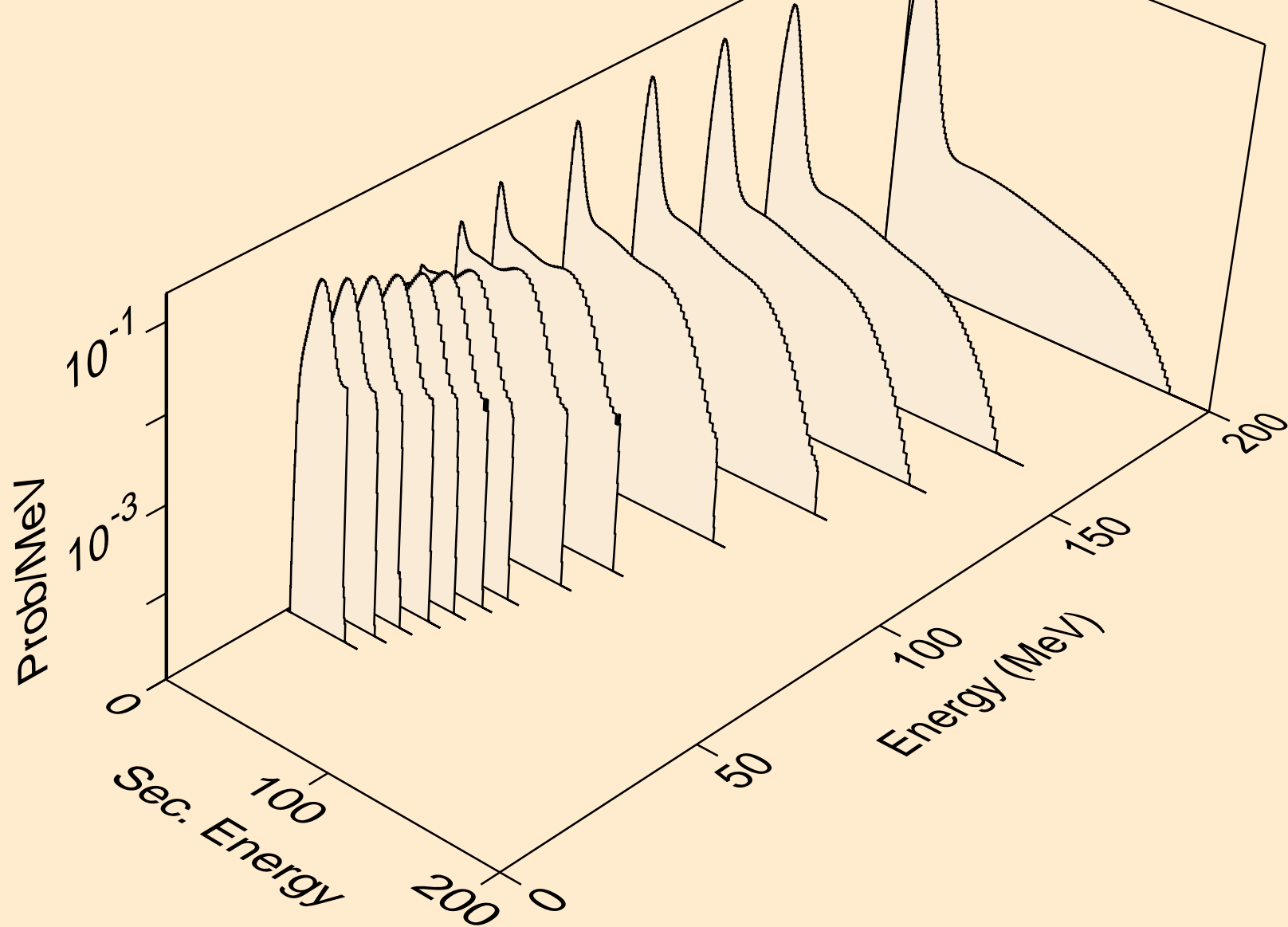

GA080 HELION ACER TENDL-2021 LIBRARY; T=0.K  
deuterons from (s,2nd)

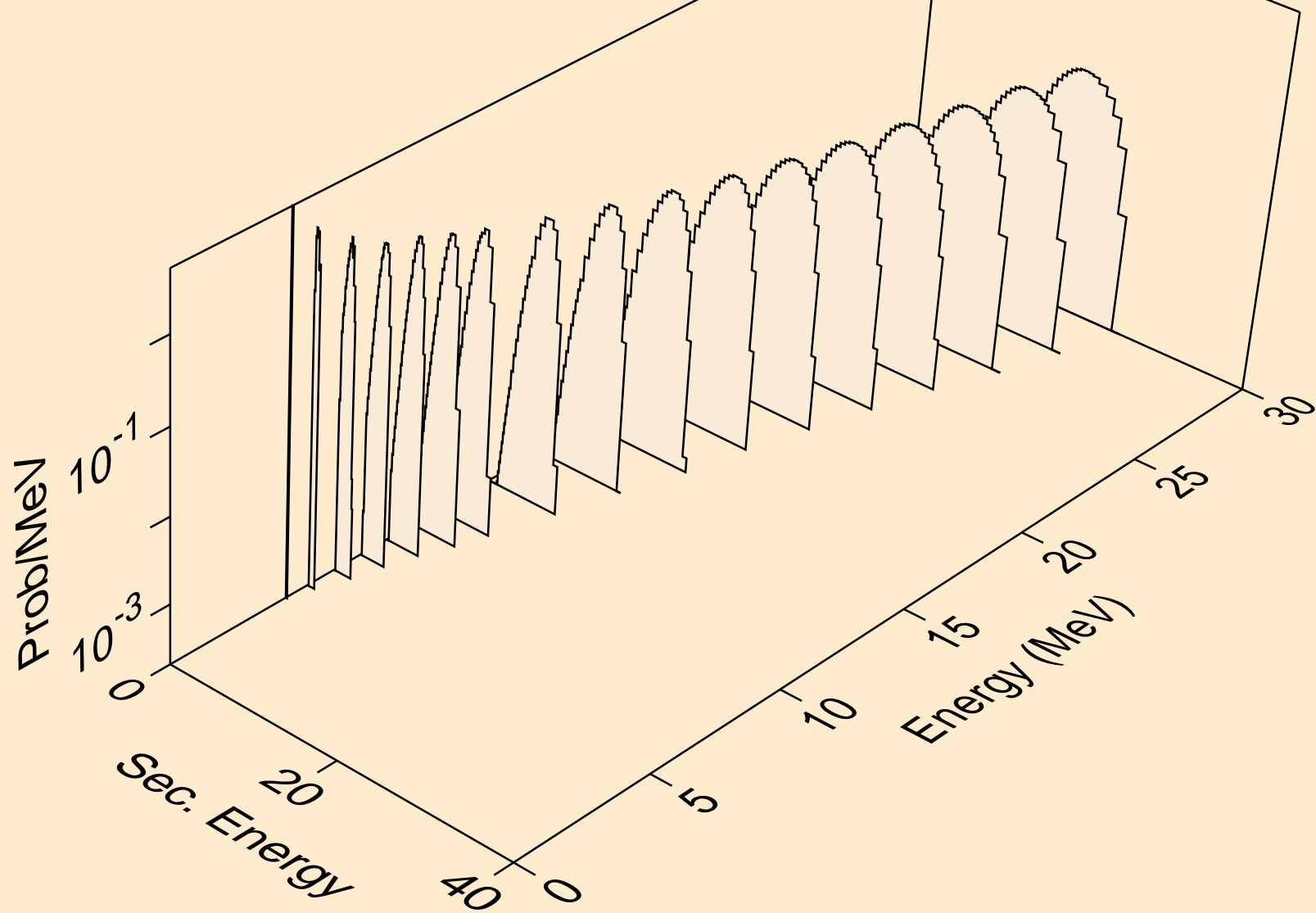

GA080 HELION ACER TENDL-2021 LIBRARY; T=0.K  
deuterons from (s,n\*)d

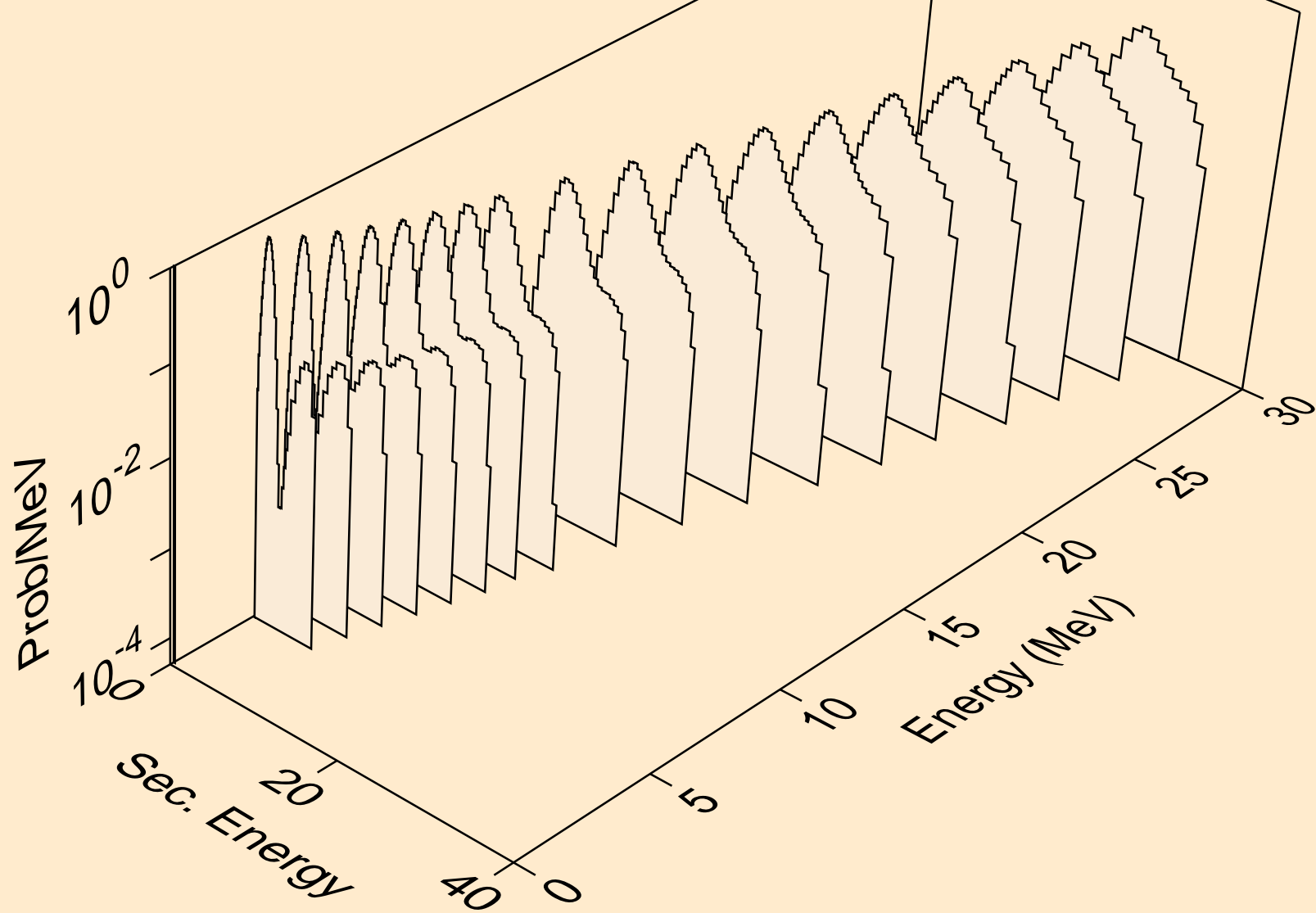

GA080 HELION ACER TENDL-2021 LIBRARY; T=0.K  
deuterons from (s,d)

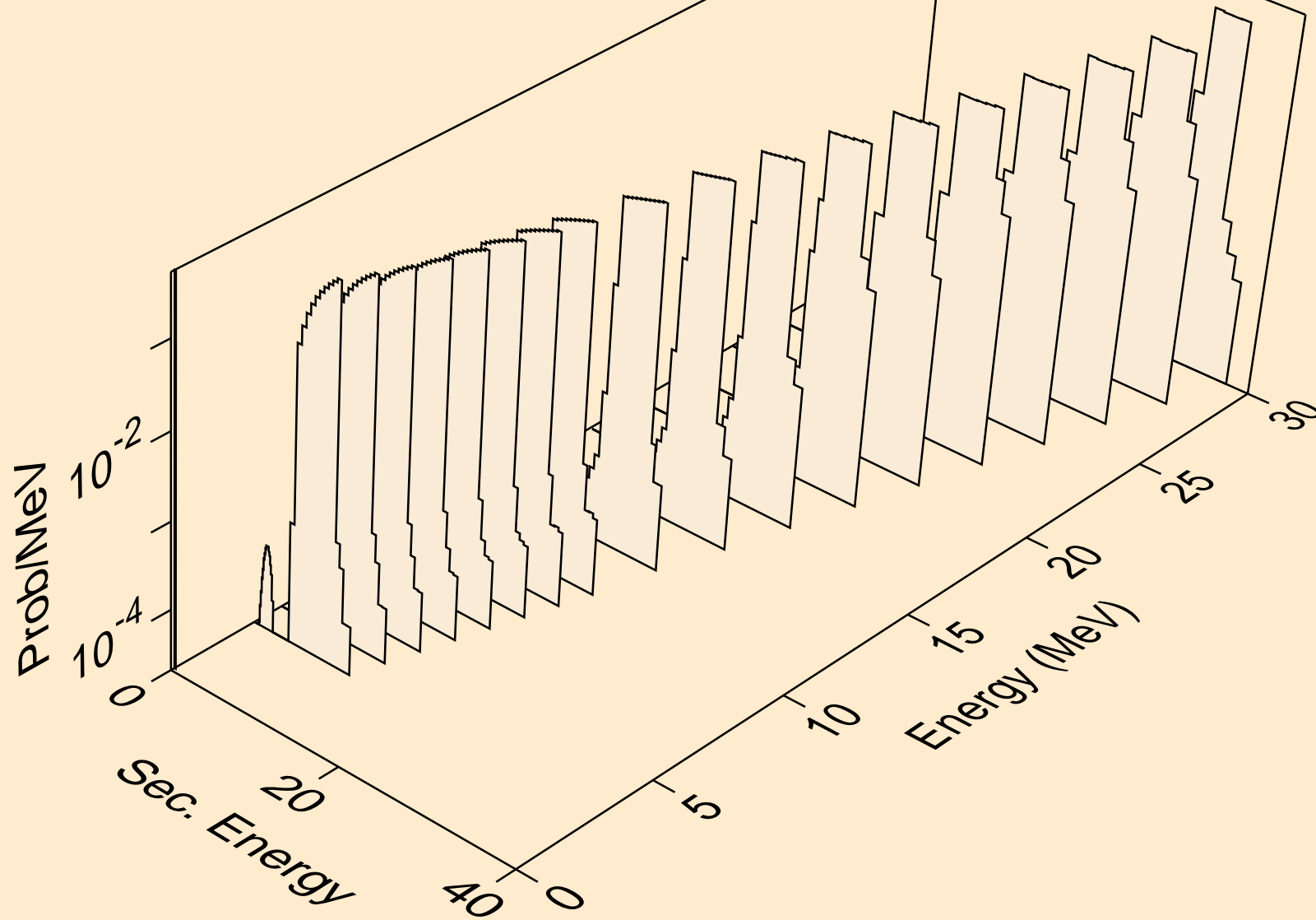

GA080 HELION ACER TENDL-2021 LIBRARY; T=0.K  
deuterons from (s,pd)

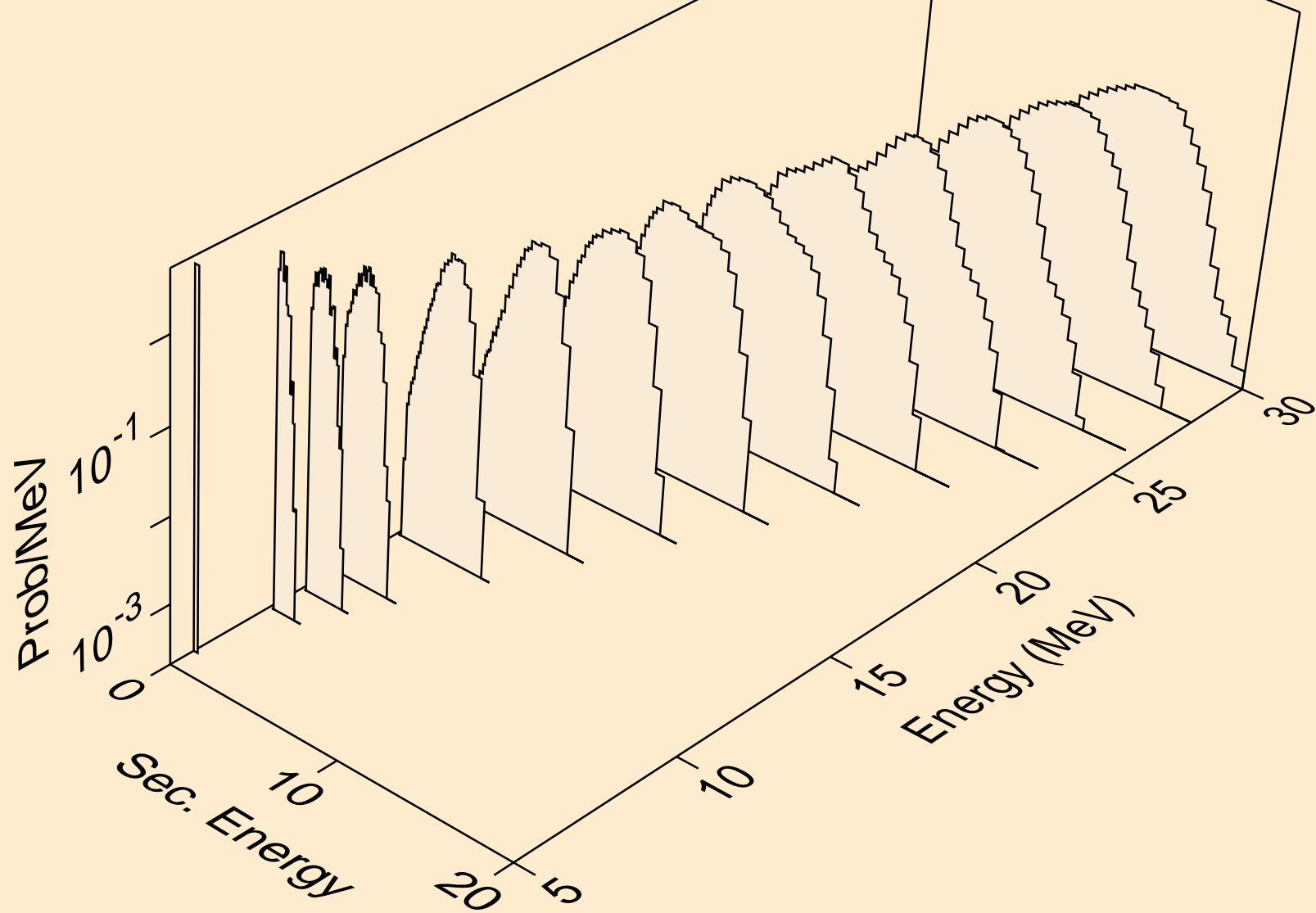

GA080 HELION ACER TENDL-2021 LIBRARY; T=0.K  
deuterons from (s,da)

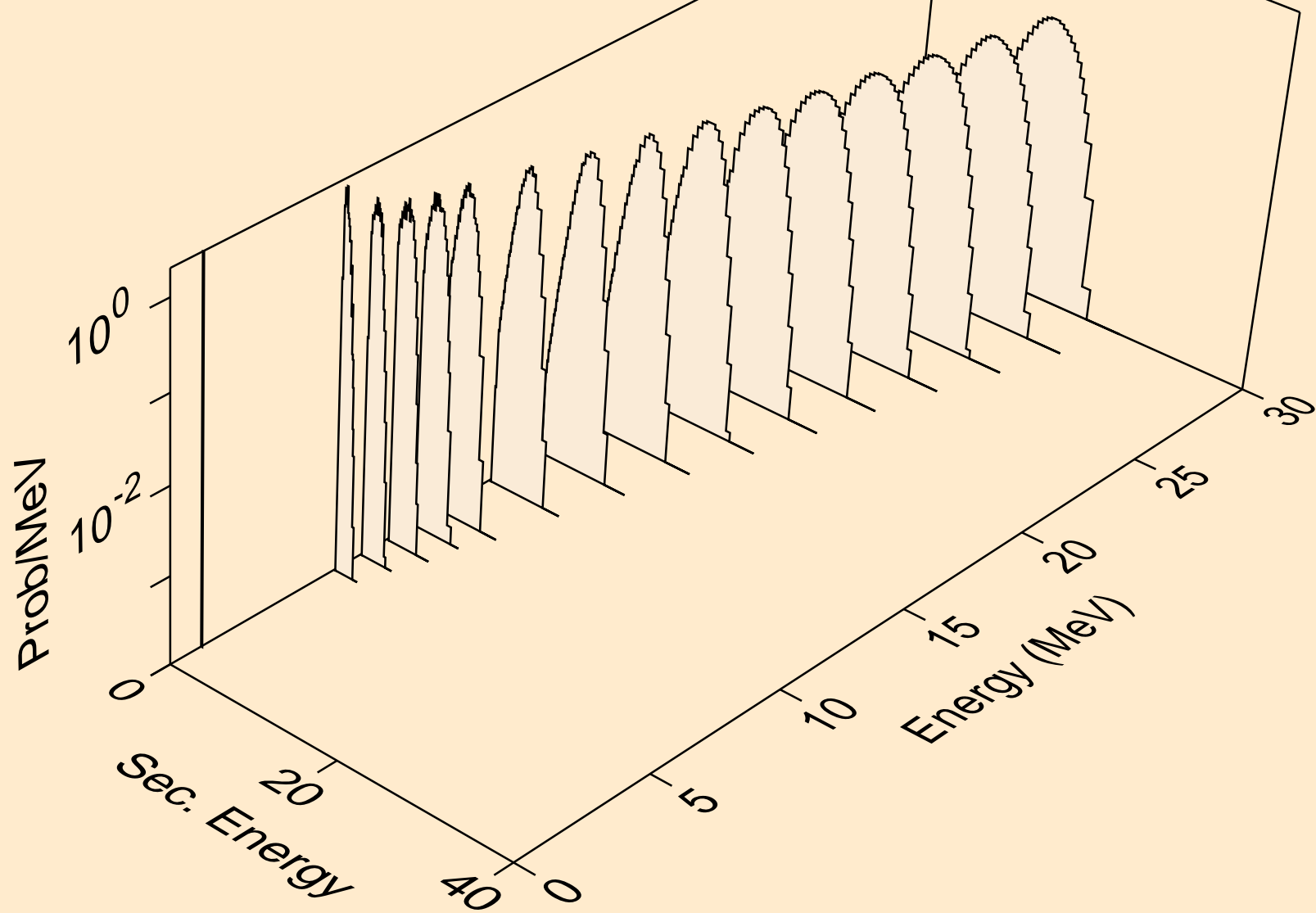

GA080 HELION ACER TENDL-2021 LIBRARY; T=0.K  
tritons from (s,x)

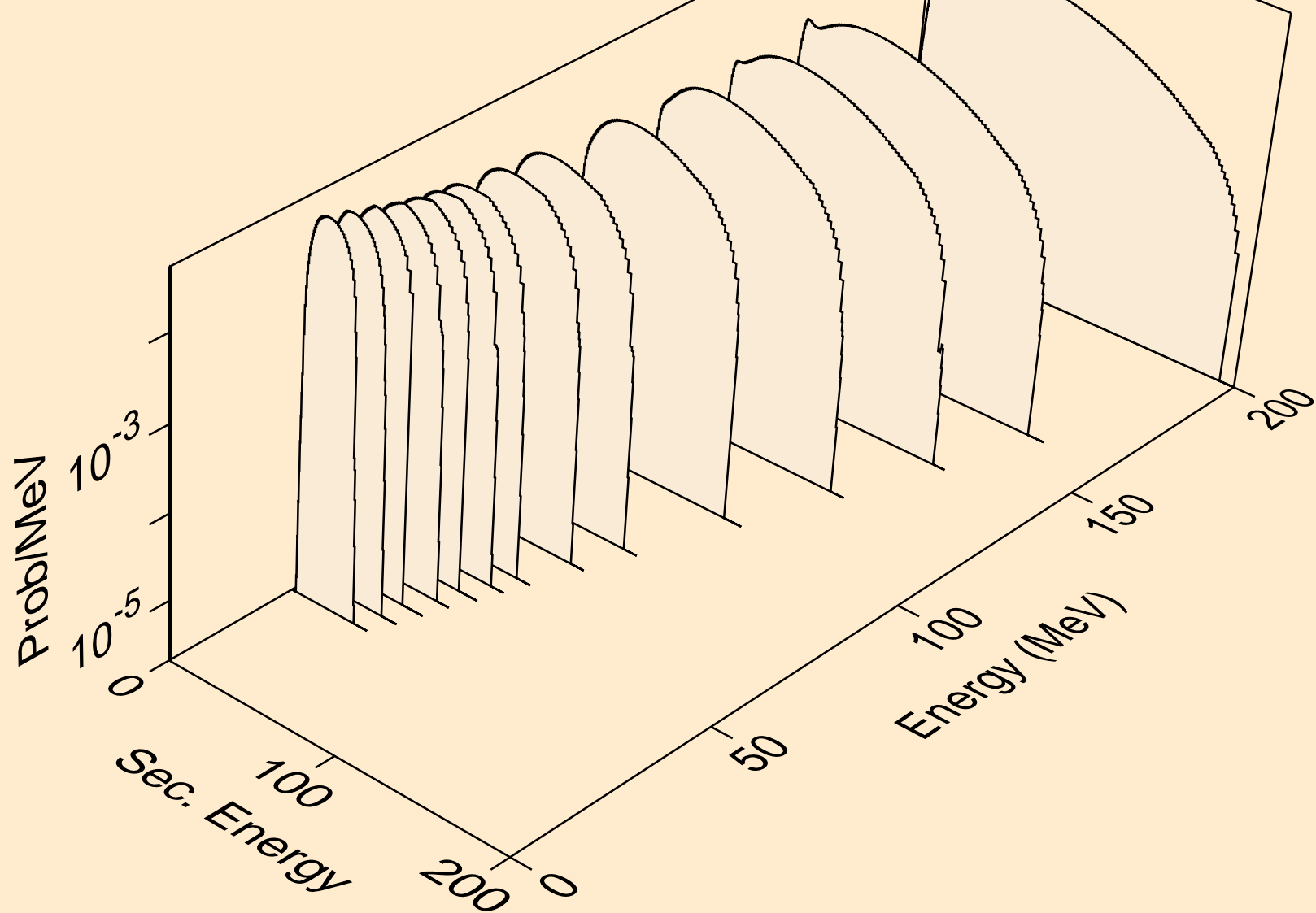

GA080 HELION ACER TENDL-2021 LIBRARY; T=0.K  
tritons from (s,n\*)t

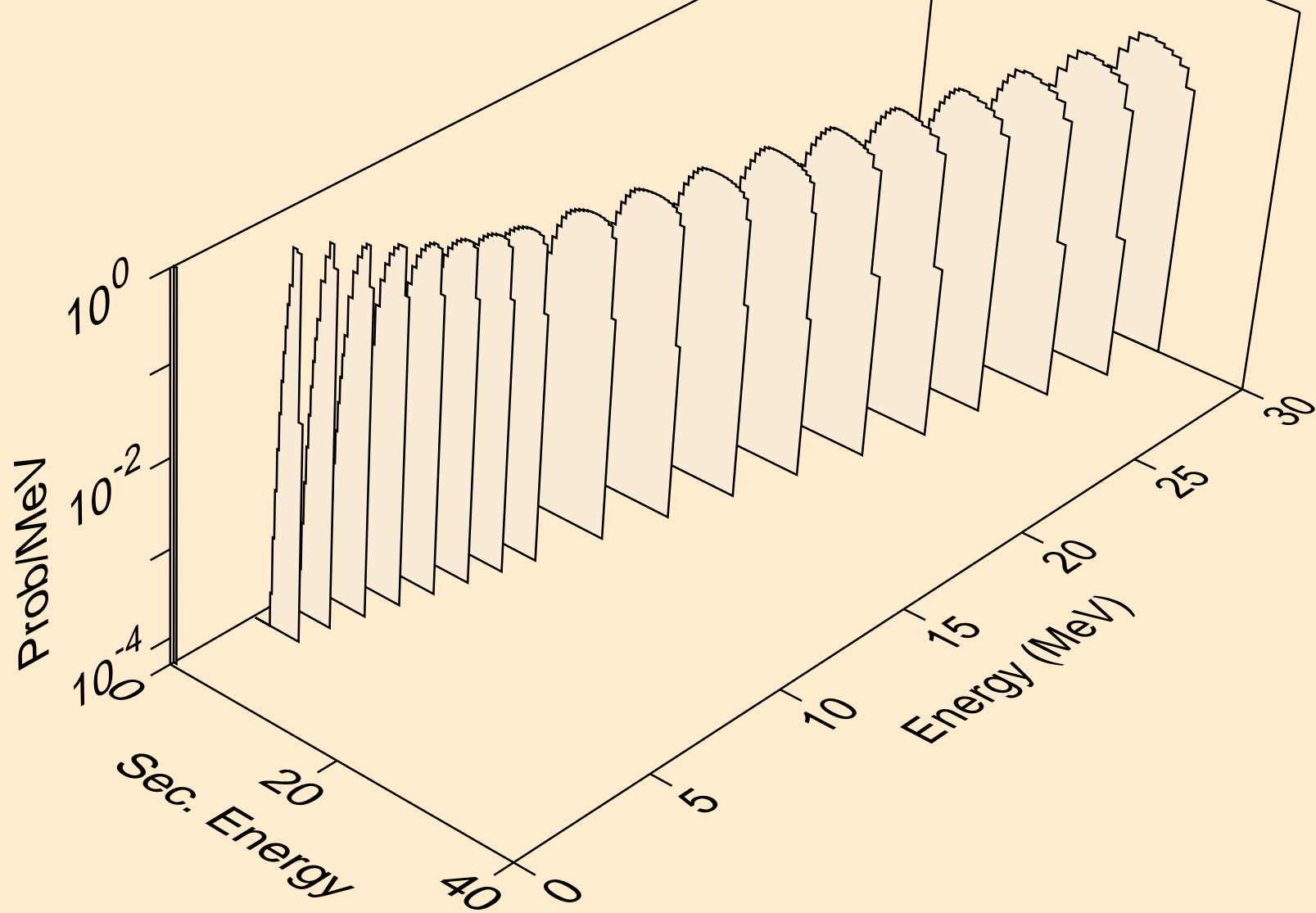



GA080 HELION ACER TENDL-2021 LIBRARY; T=0.K  
tritons from (s,t)

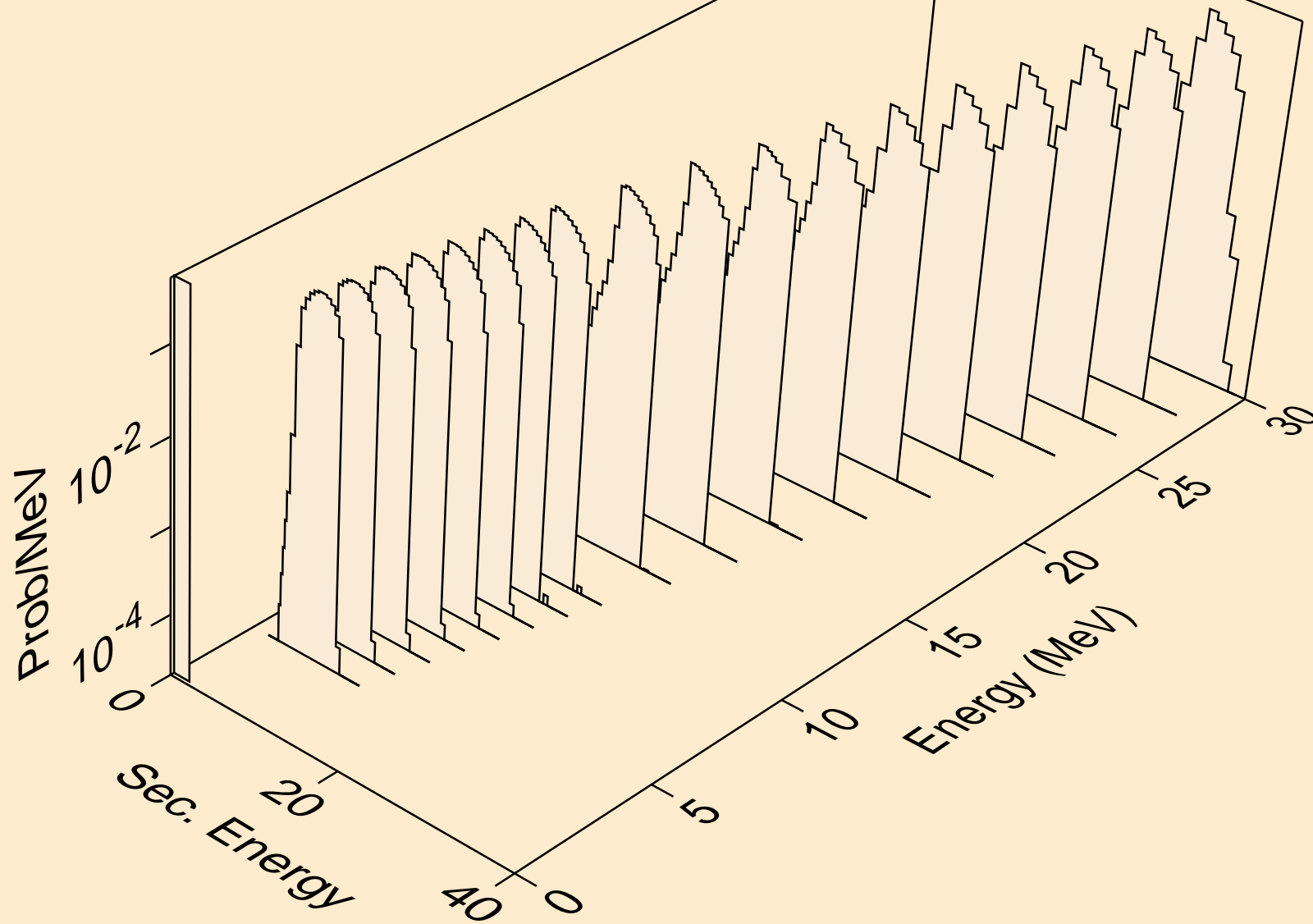

GA080 HELION ACER TENDL-2021 LIBRARY; T=0.K  
tritons from (s,pt)

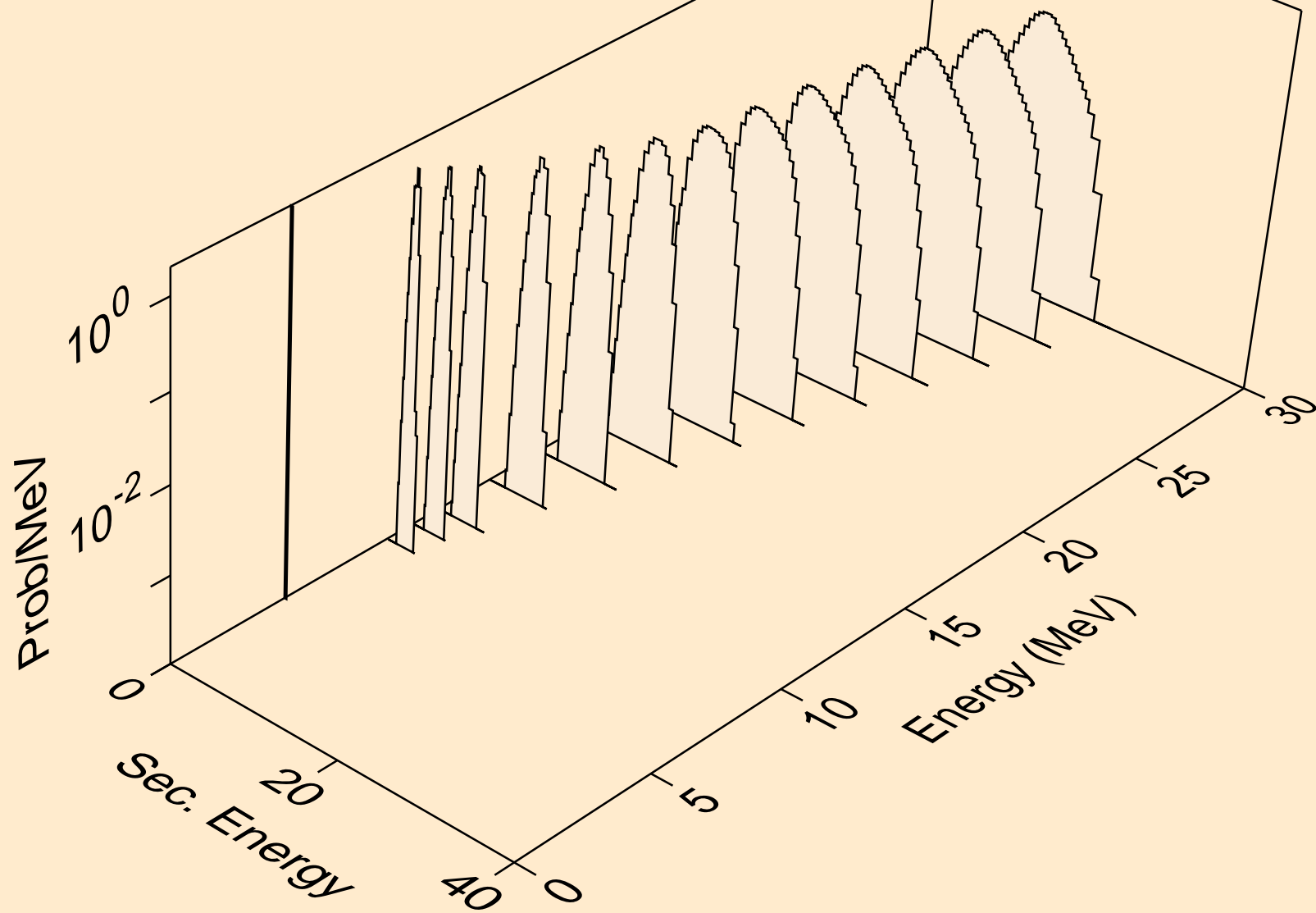

GA080 HELION ACER TENDL-2021 LIBRARY; T=0.K  
alphas from (s,x)

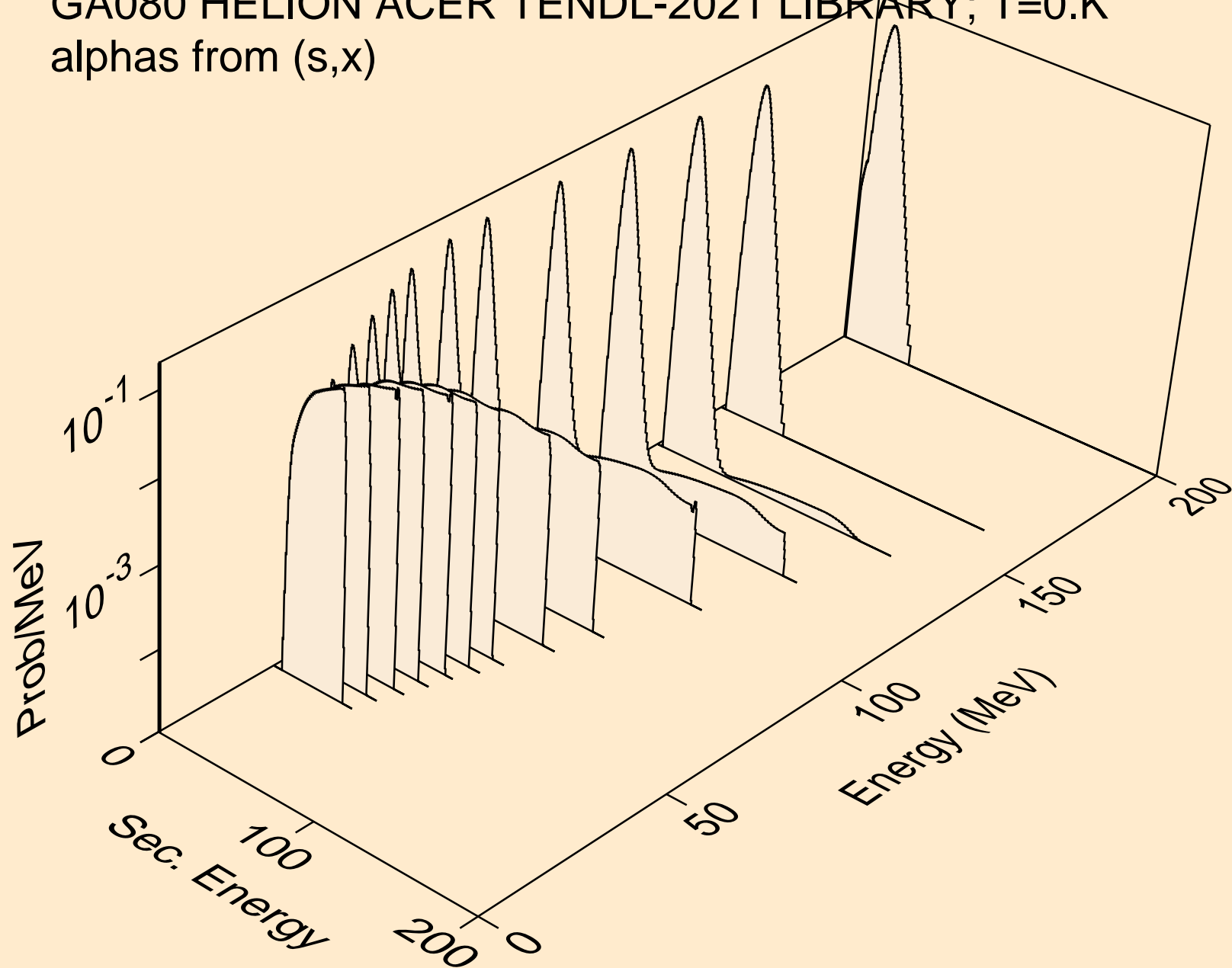

GA080 HELION ACER TENDL-2021 LIBRARY; T=0.K  
alphas from (s,n\*)a

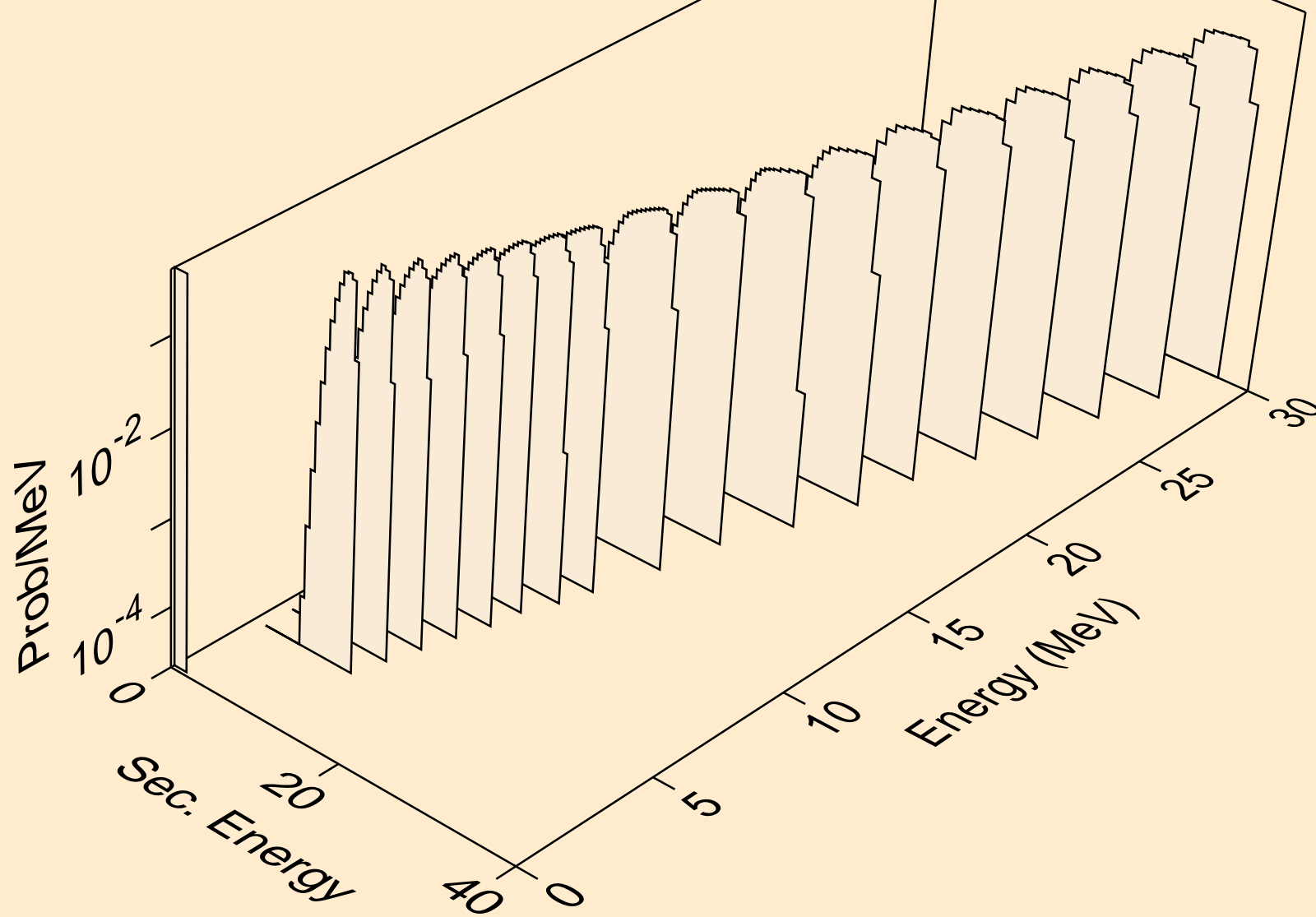

GA080 HELION ACER TENDL-2021 LIBRARY; T=0.K  
alphas from (s,2n)a

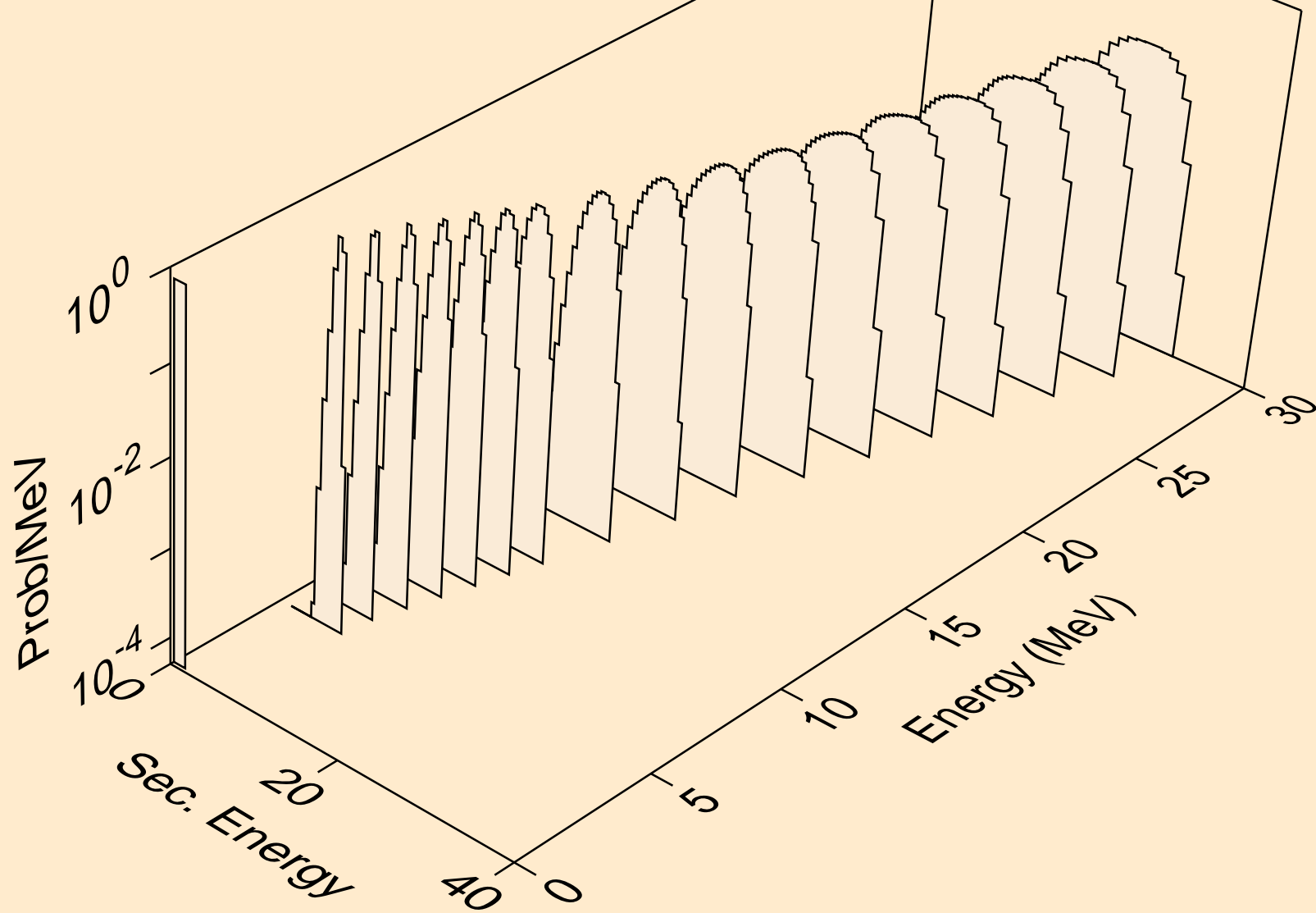

GA080 HELION ACER TENDL-2021 LIBRARY; T=0.K  
alphas from (s,3n)a

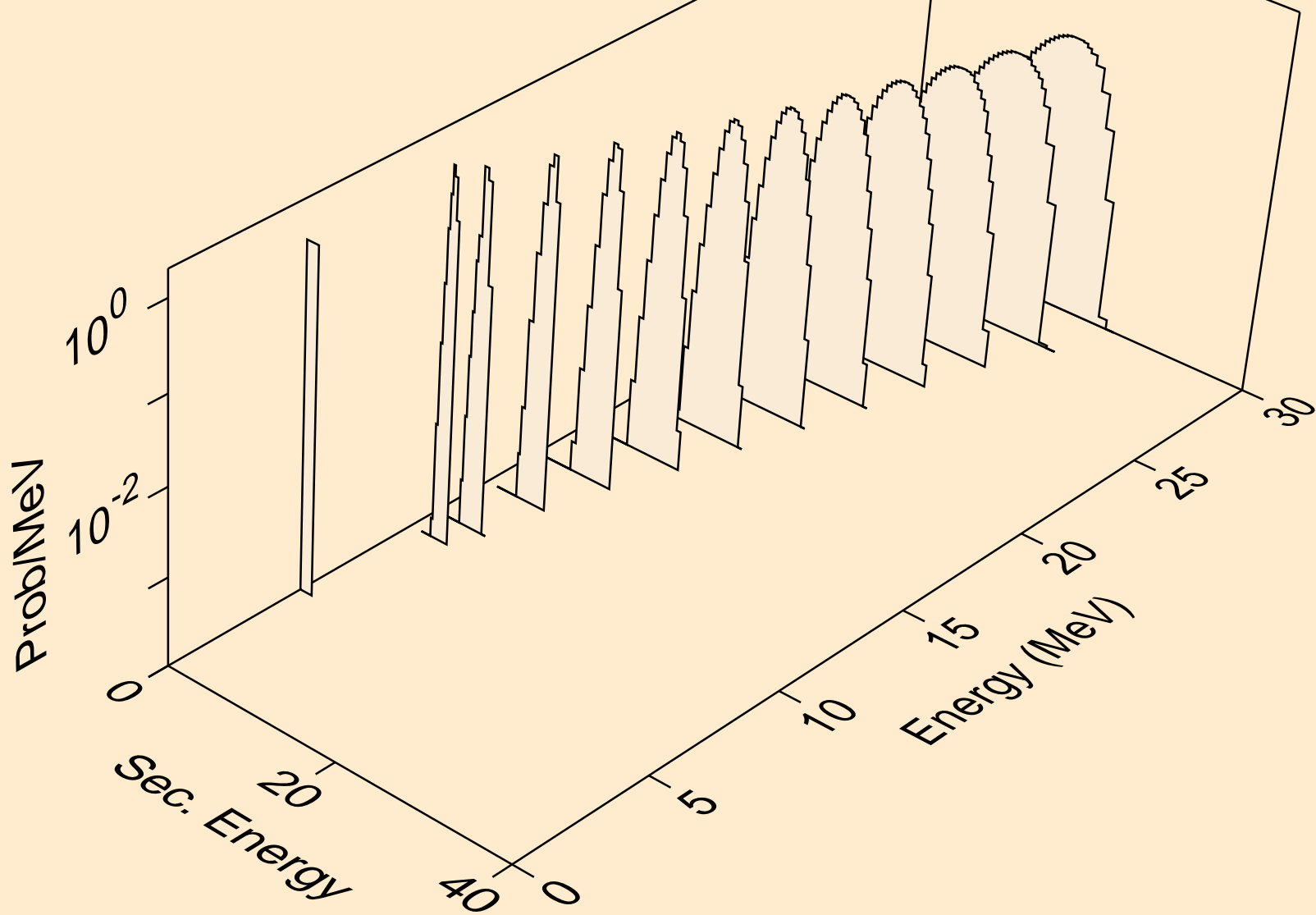

GA080 HELION ACER TENDL-2021 LIBRARY; T=0.K  
alphas from (s,n\*)2a

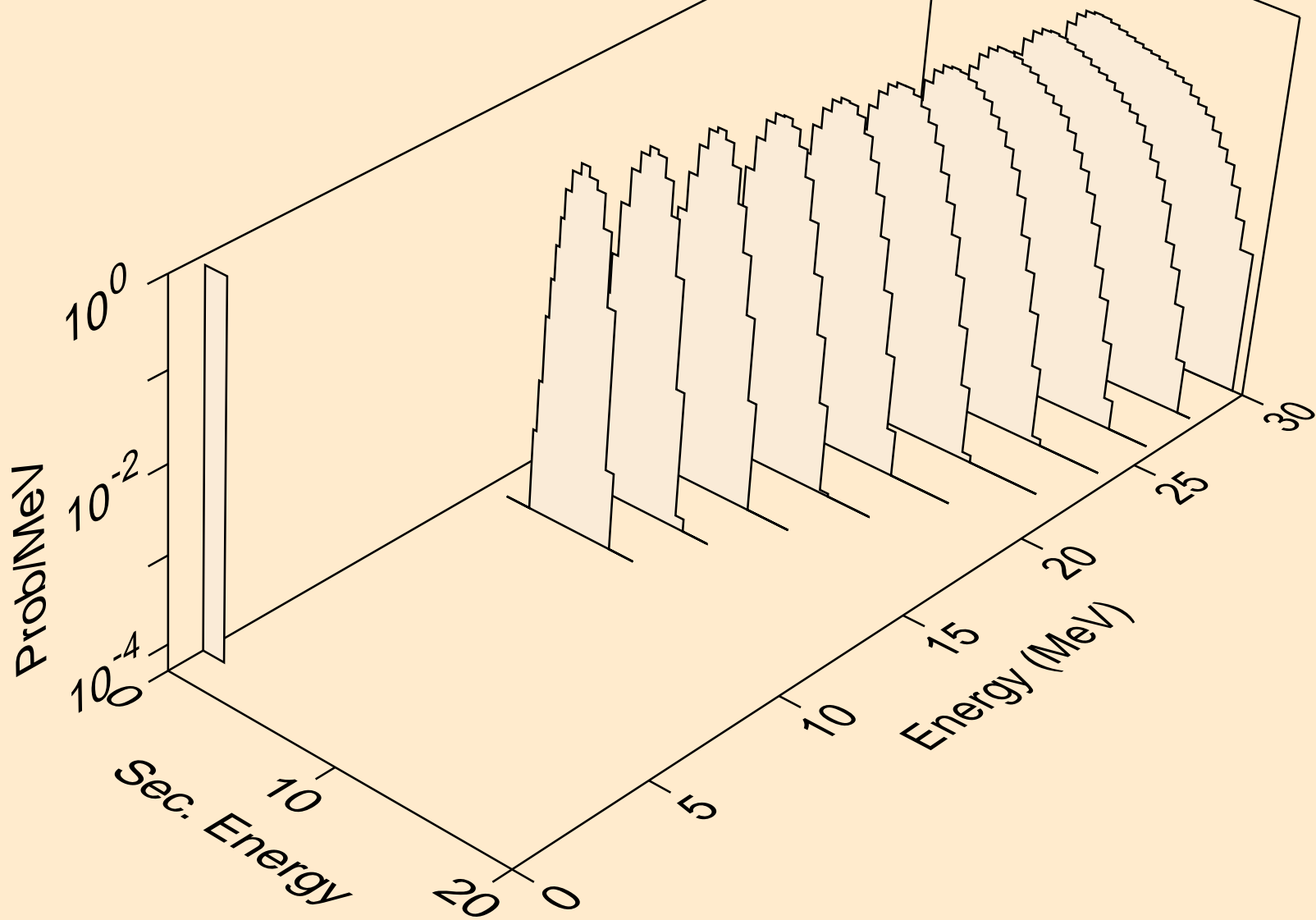

GA080 HELION ACER TENDL-2021 LIBRARY; T=0.K  
alphas from (s,2n)2a

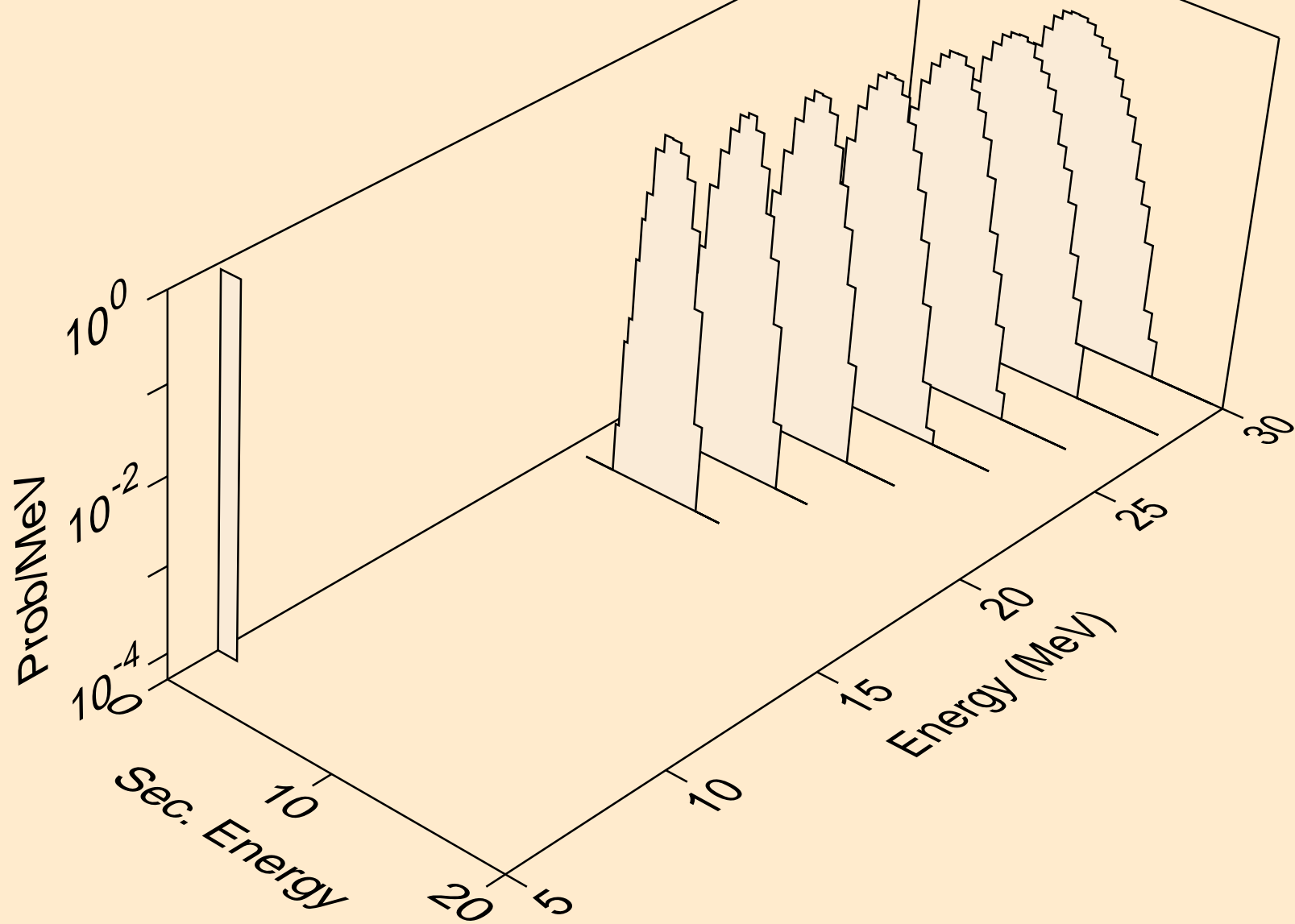



GA080 HELION ACER TENDL-2021 LIBRARY; T=0.K  
alphas from (s,npa)

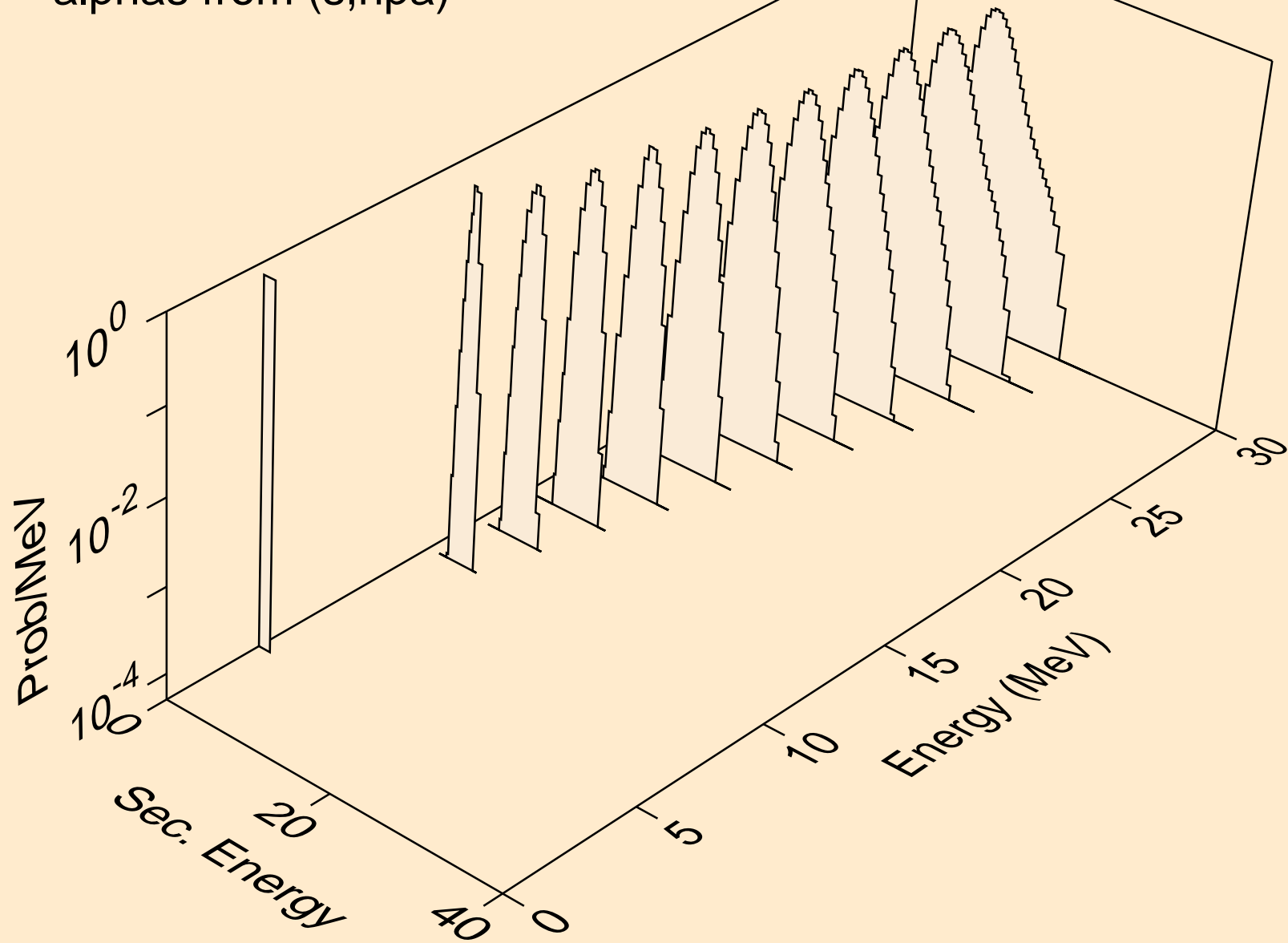

GA080 HELION ACER TENDL-2021 LIBRARY; T=0.K  
alphas from (s,a)

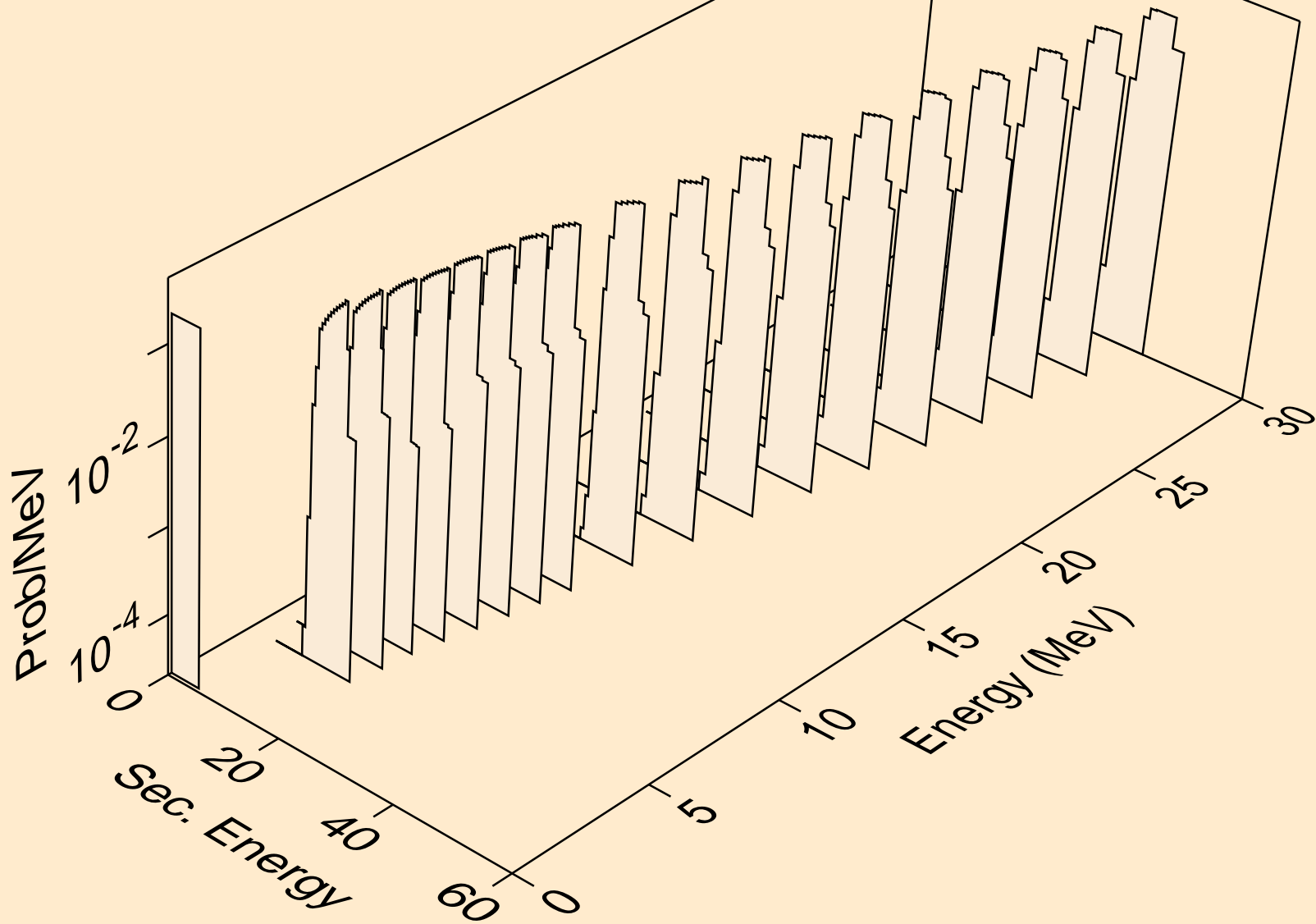

GA080 HELION ACER TENDL-2021 LIBRARY; T=0.K  
alphas from (s,2a)

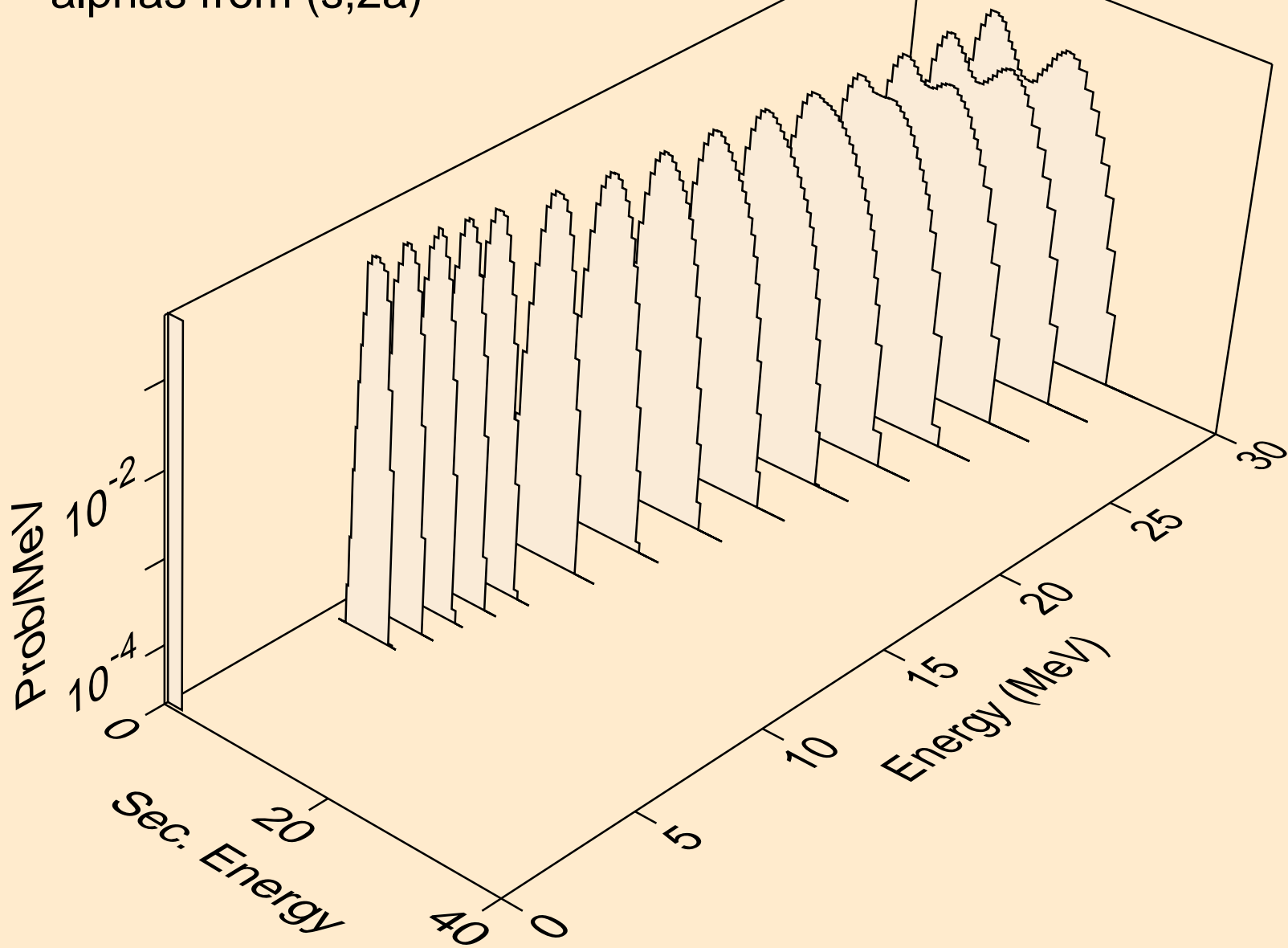

GA080 HELION ACER TENDL-2021 LIBRARY; T=0.K  
alphas from (s,pa)

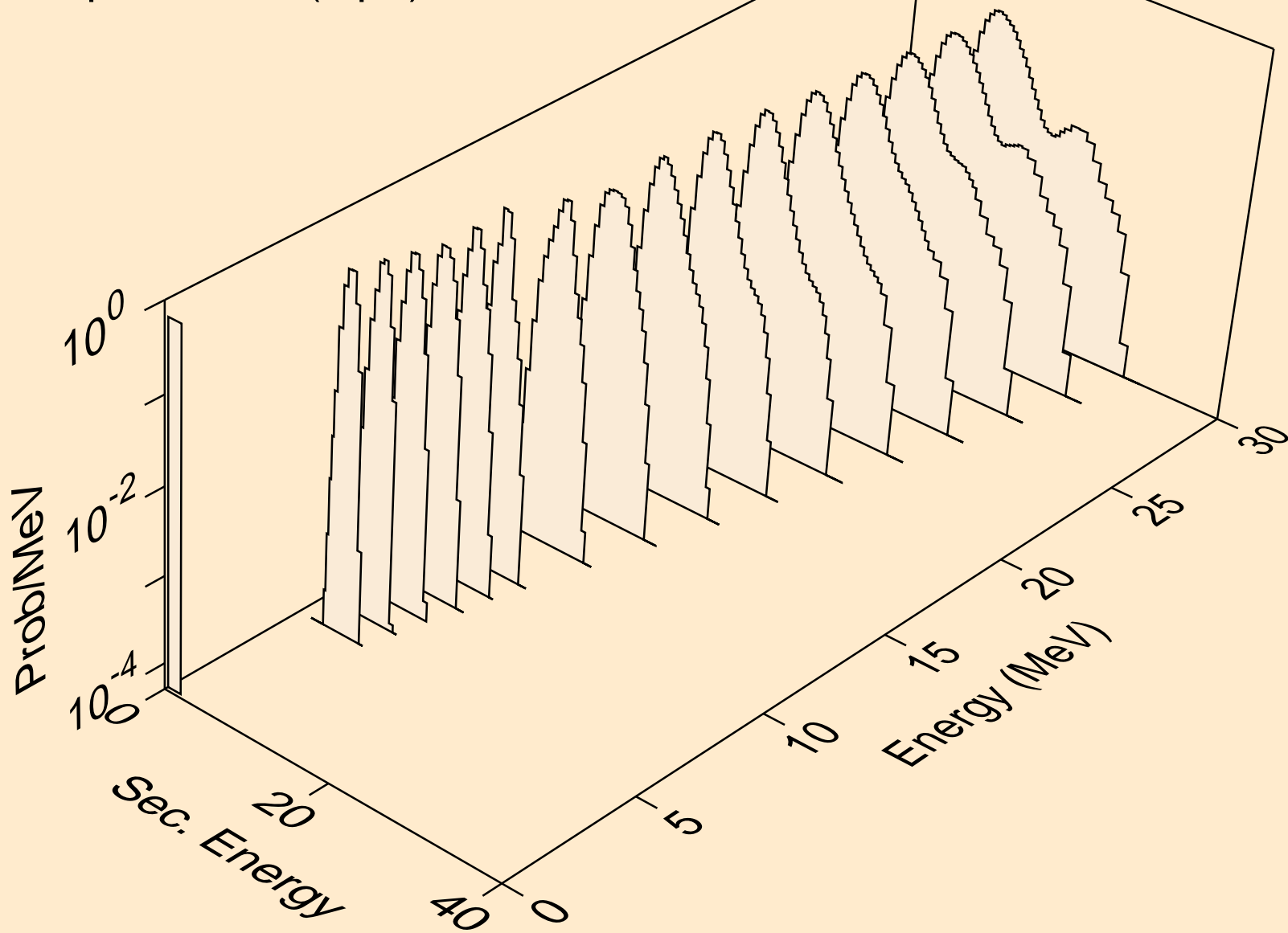

GA080 HELION ACER TENDL-2021 LIBRARY; T=0.K  
alphas from (s,da)

