

# HG181 HELION ACER TENDL-2021 LIBRARY; T=0.K

## Principal cross sections

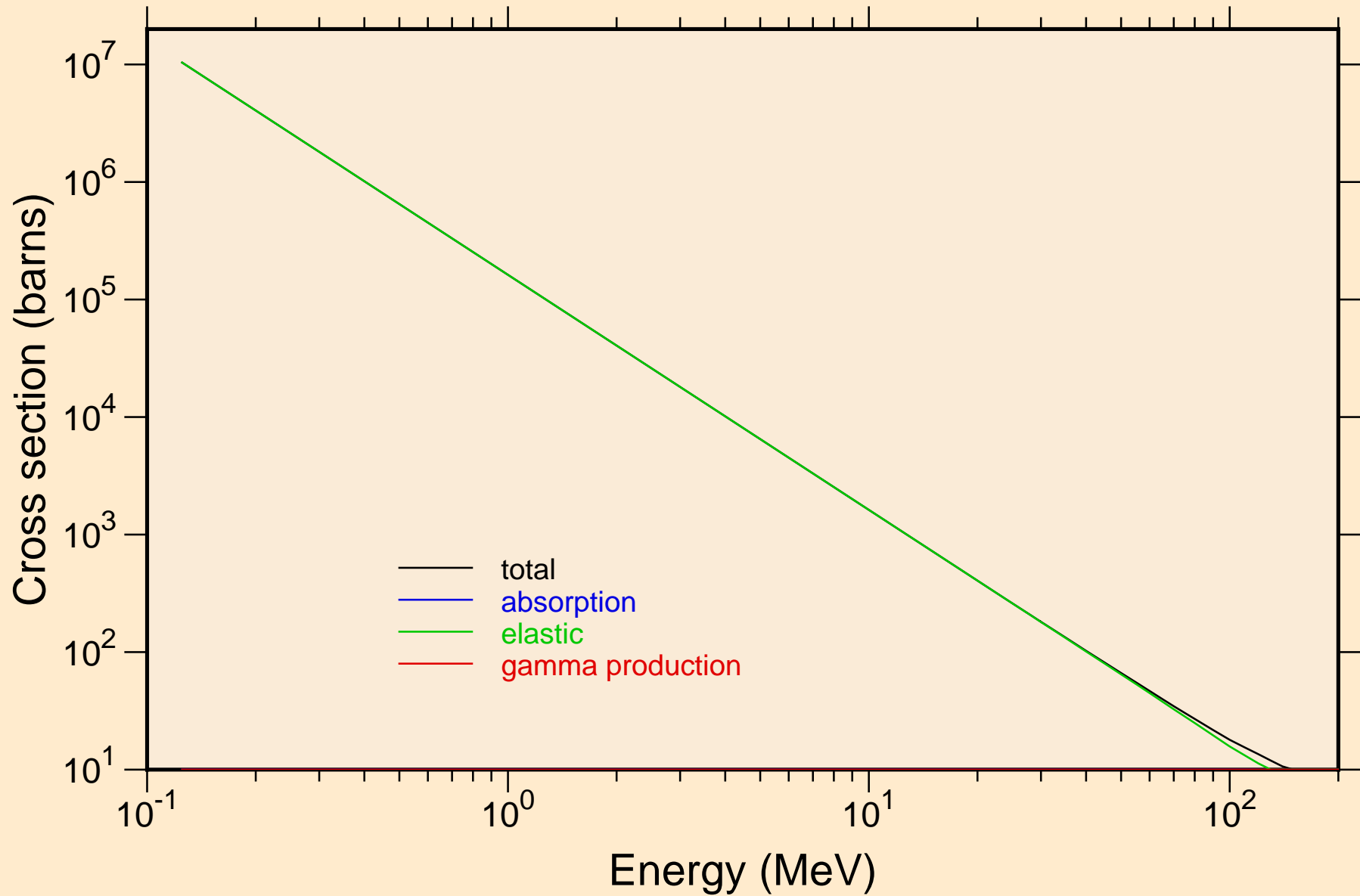

HG181 HELION ACER TENDL-2021 LIBRARY; T=0.K  
Heating

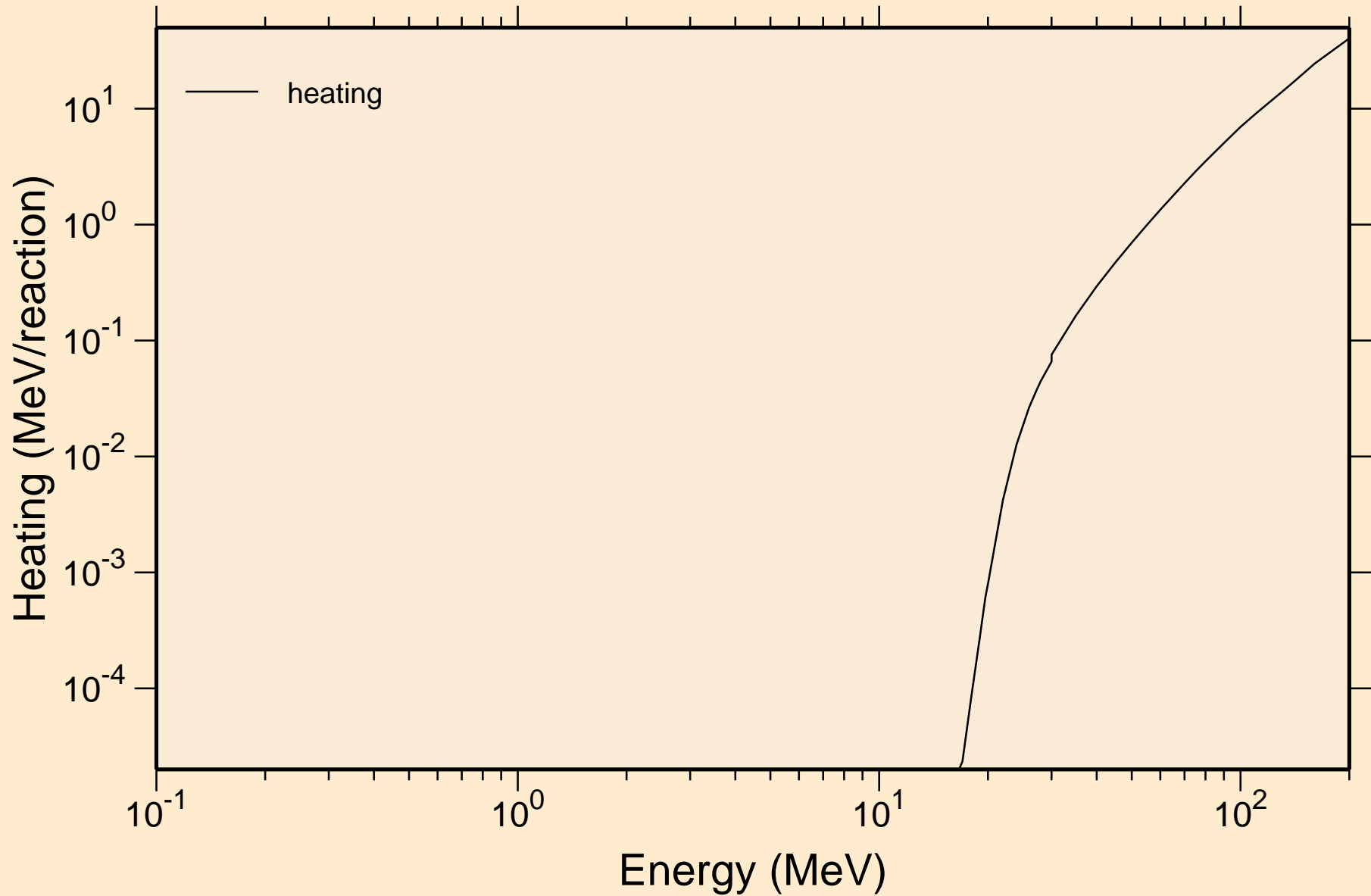

# HG181 HELION ACER TENDL-2021 LIBRARY; T=0.K

## Principal cross sections

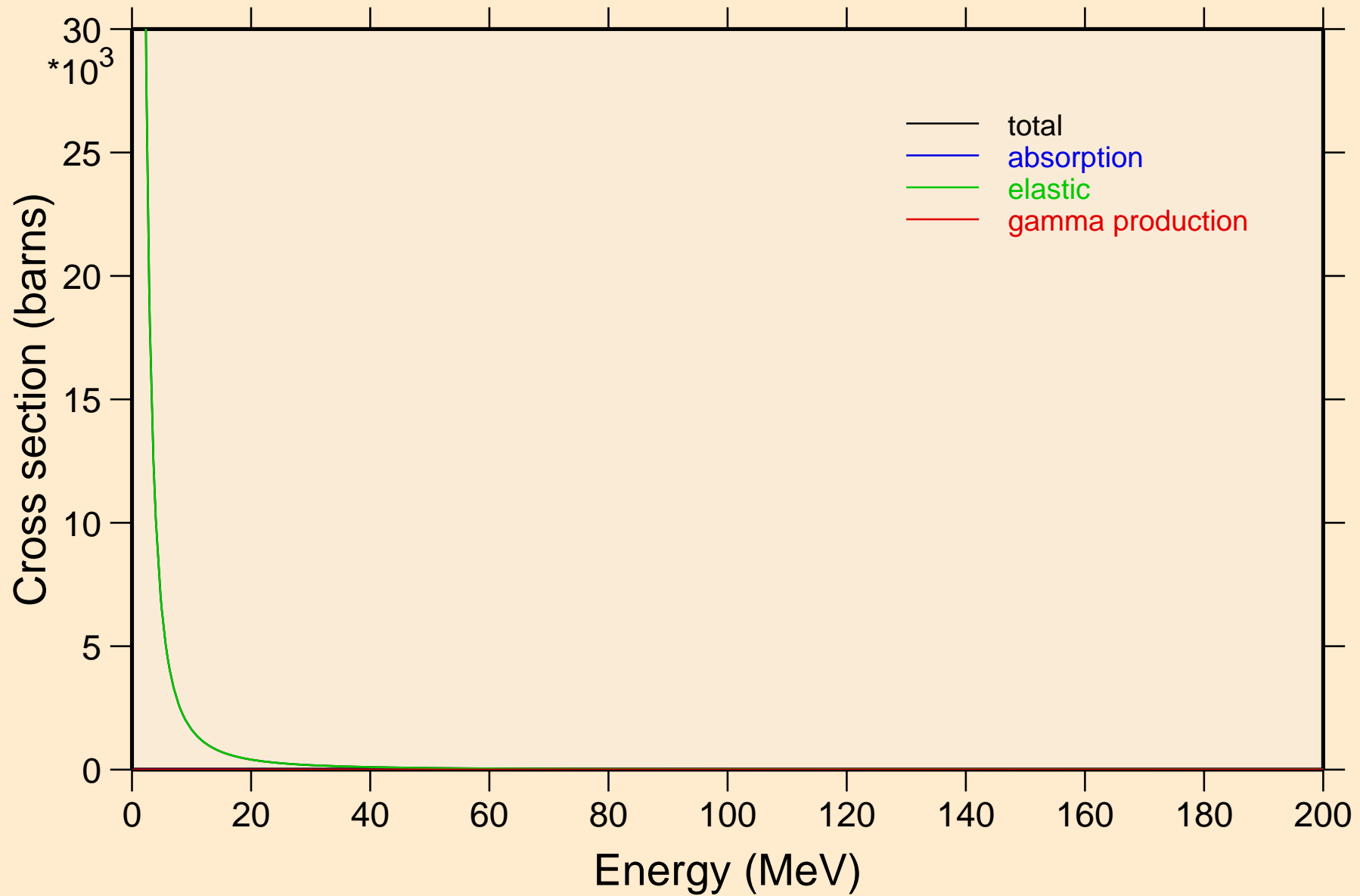

# HG181 HELION ACER TENDL-2021 LIBRARY; T=0.K

## Heating

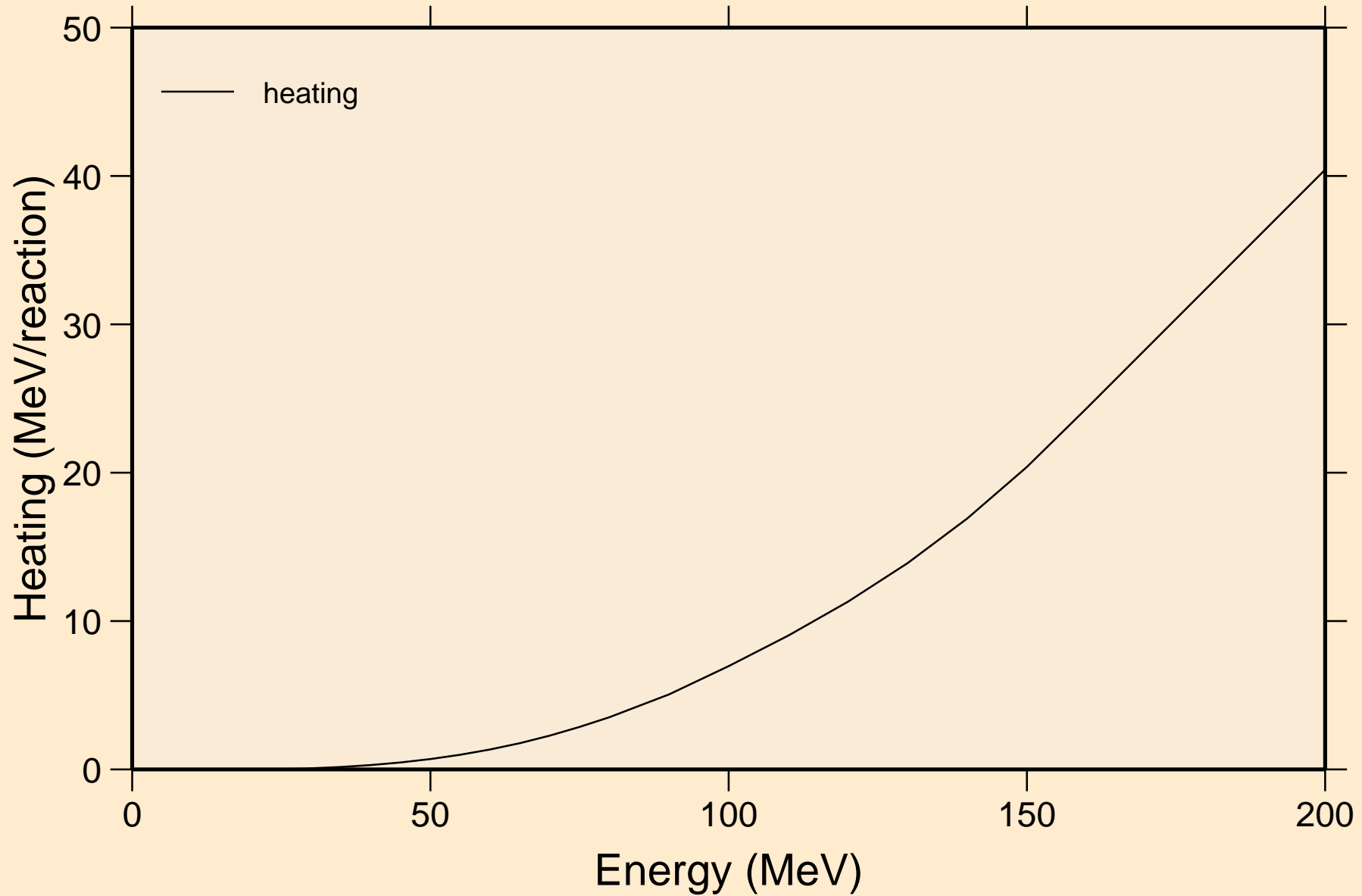

# HG181 HELION ACER TENDL-2021 LIBRARY; T=0.K

## Threshold reactions

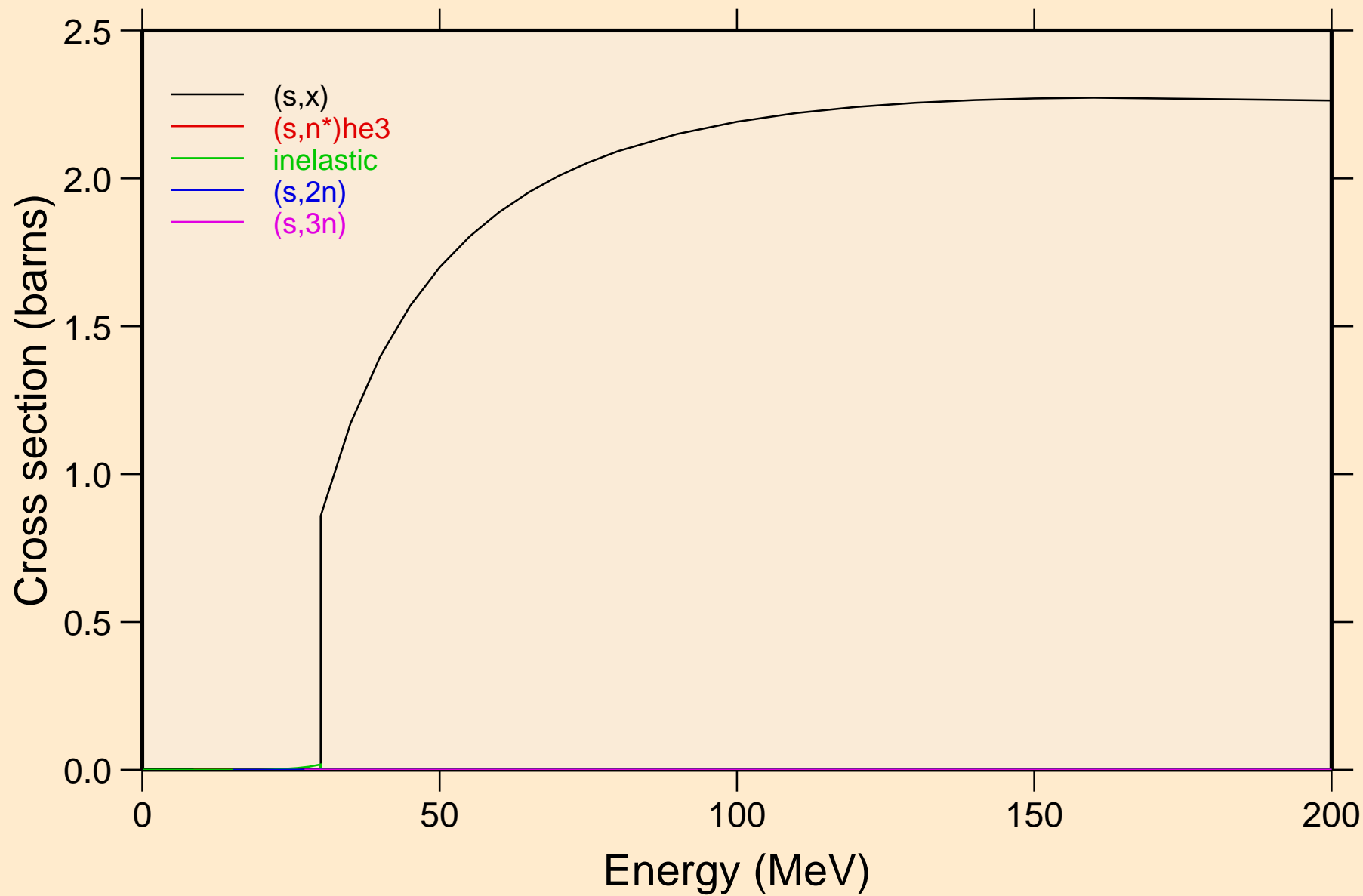

# HG181 HELION ACER TENDL-2021 LIBRARY; T=0.K

## Threshold reactions

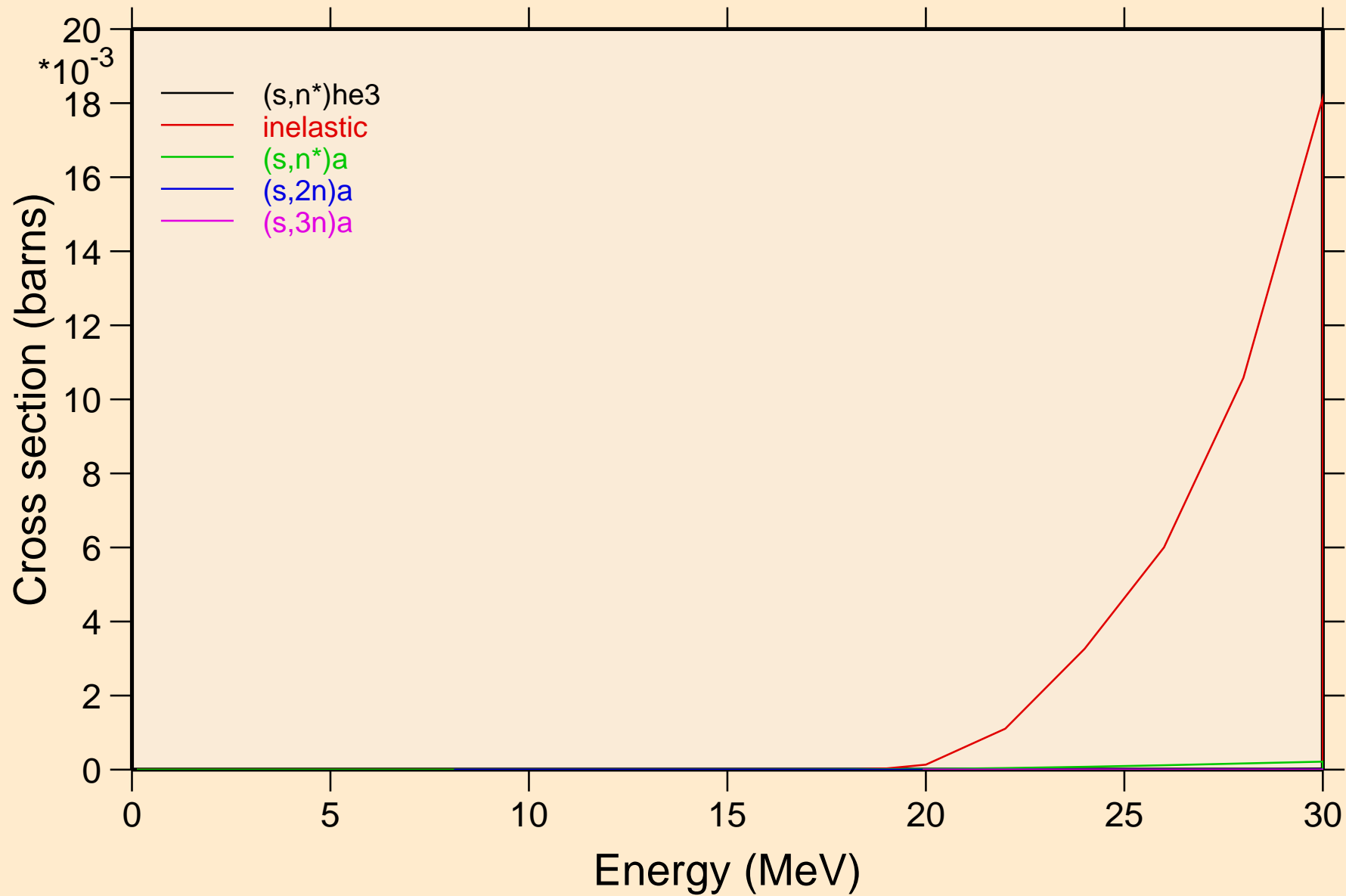

# HG181 HELION ACER TENDL-2021 LIBRARY; T=0.K

## Threshold reactions

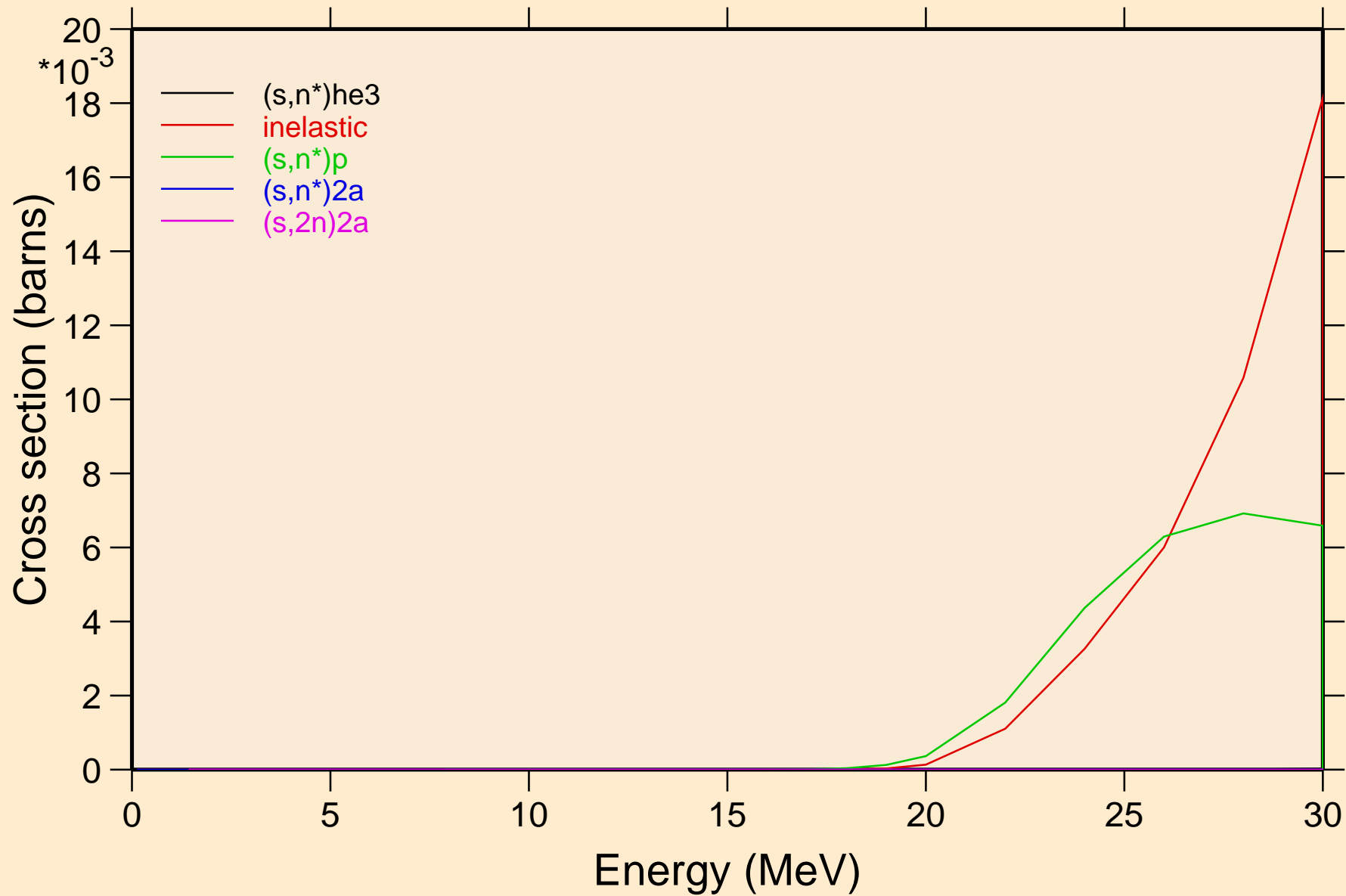

HG181 HELION ACER TENDL-2021 LIBRARY; T=0.K  
Threshold reactions

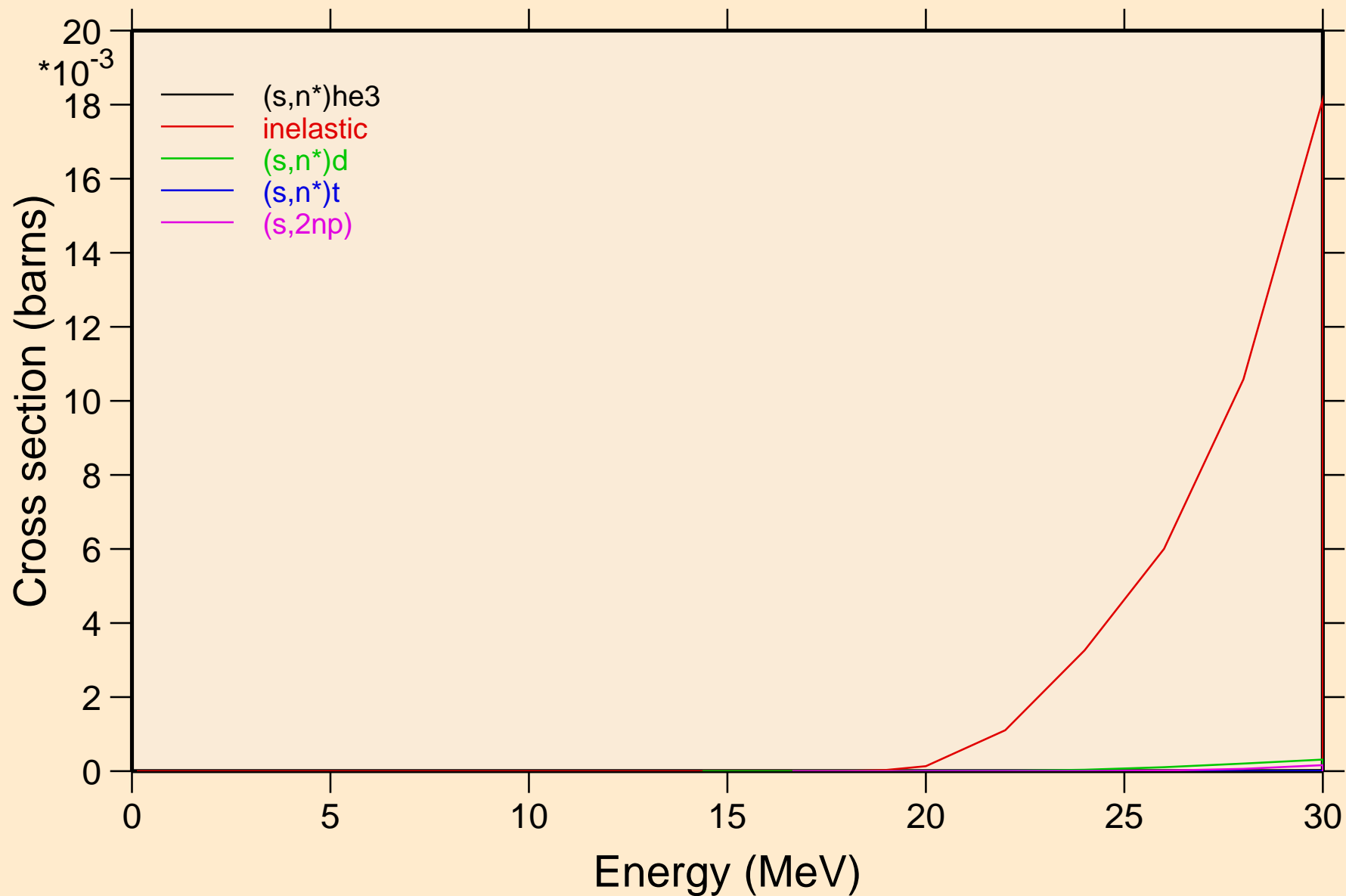



# HG181 HELION ACER TENDL-2021 LIBRARY; T=0.K

## Threshold reactions

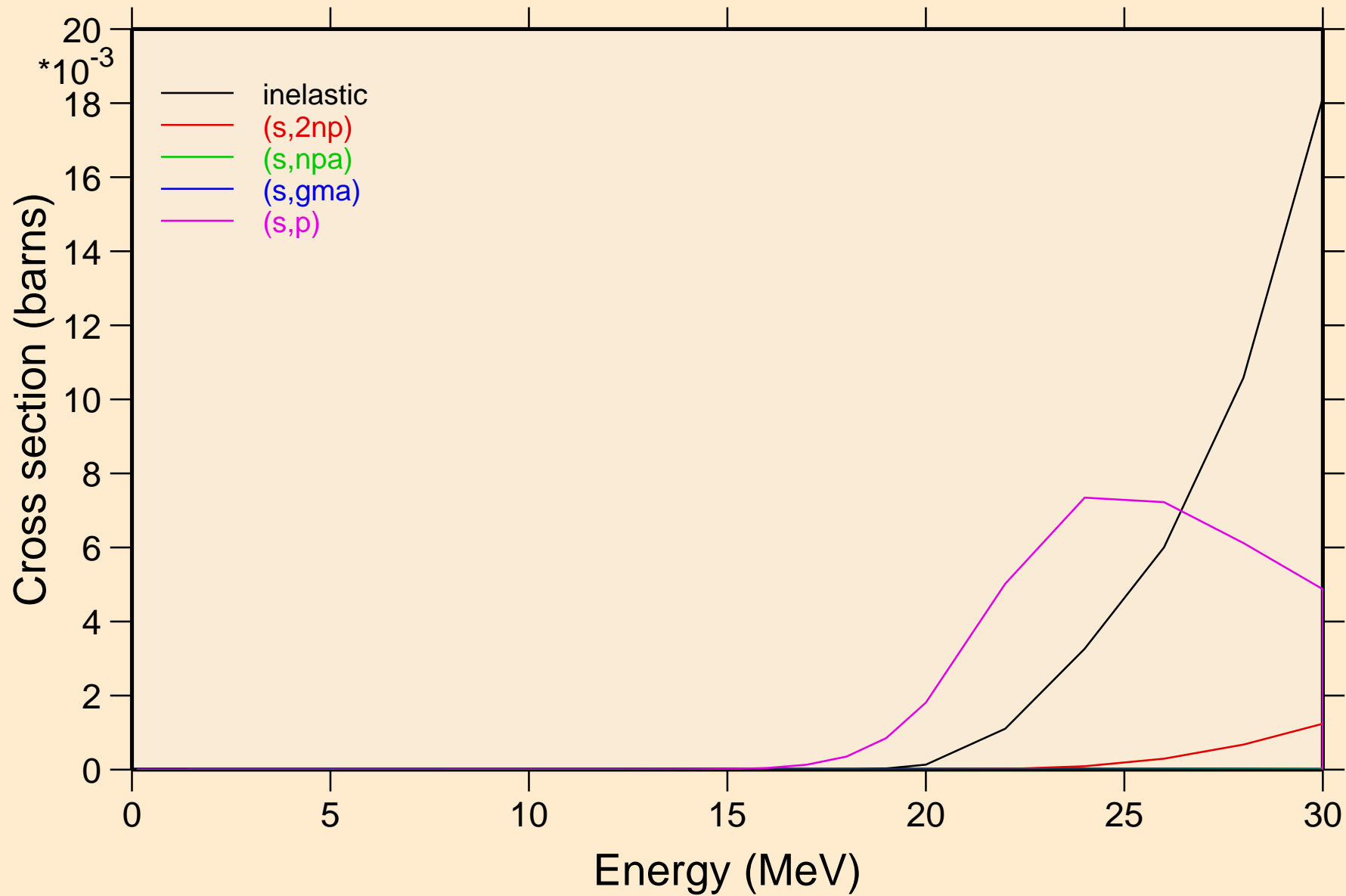

HG181 HELION ACER TENDL-2021 LIBRARY; T=0.K  
Threshold reactions

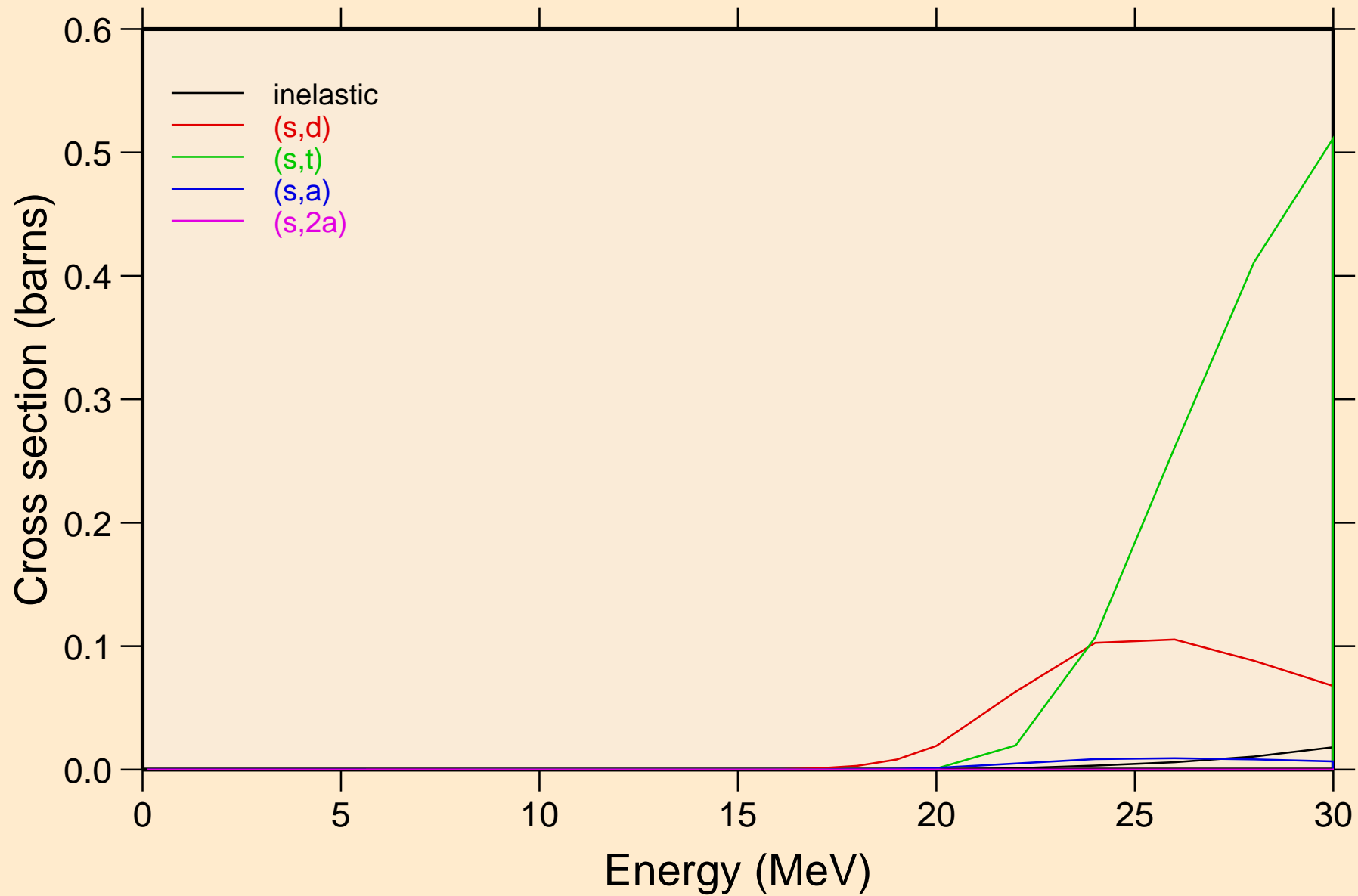

HG181 HELION ACER TENDL-2021 LIBRARY; T=0.K  
Threshold reactions

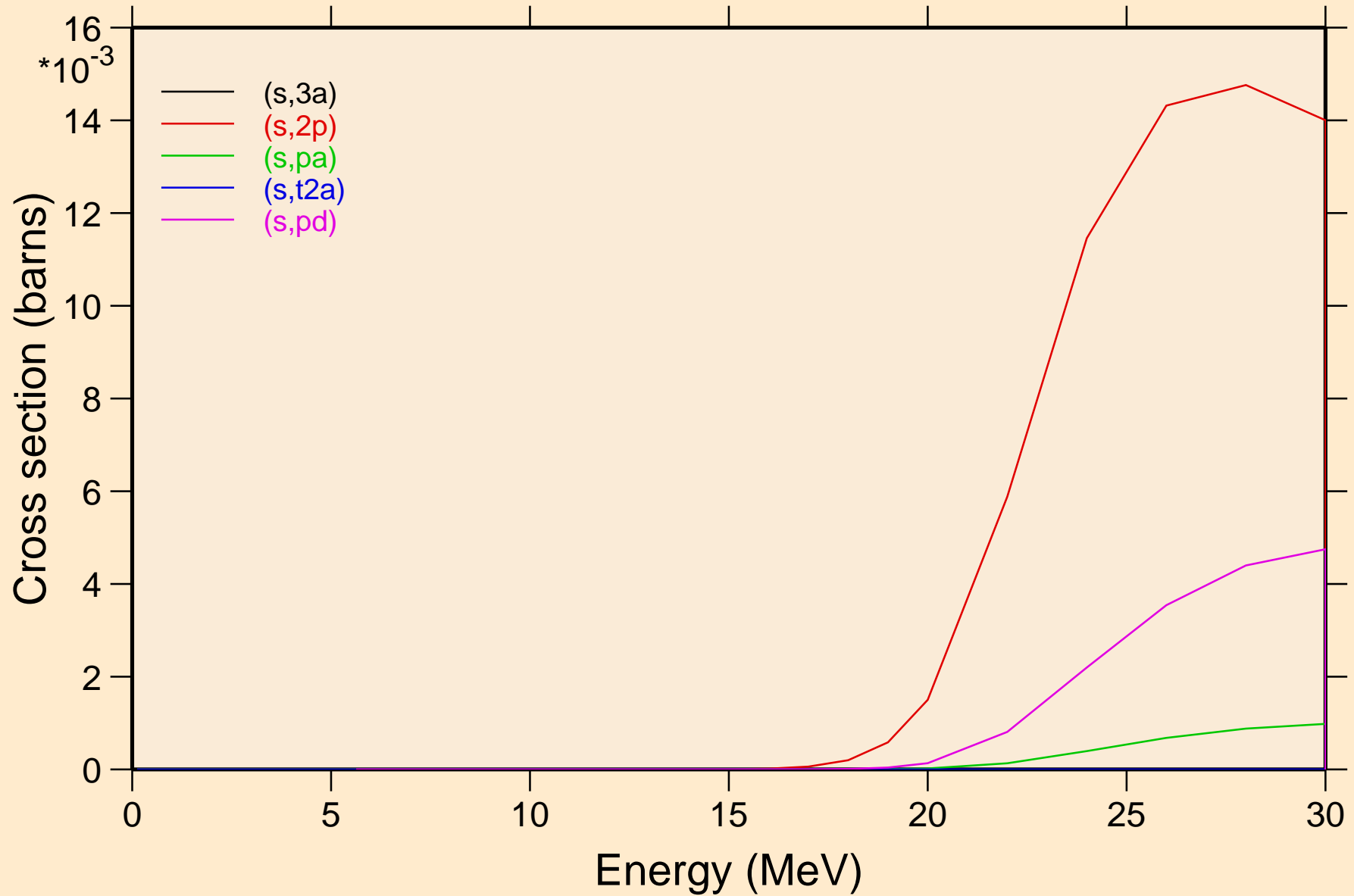

HG181 HELION ACER TENDL-2021 LIBRARY; T=0.K  
Threshold reactions

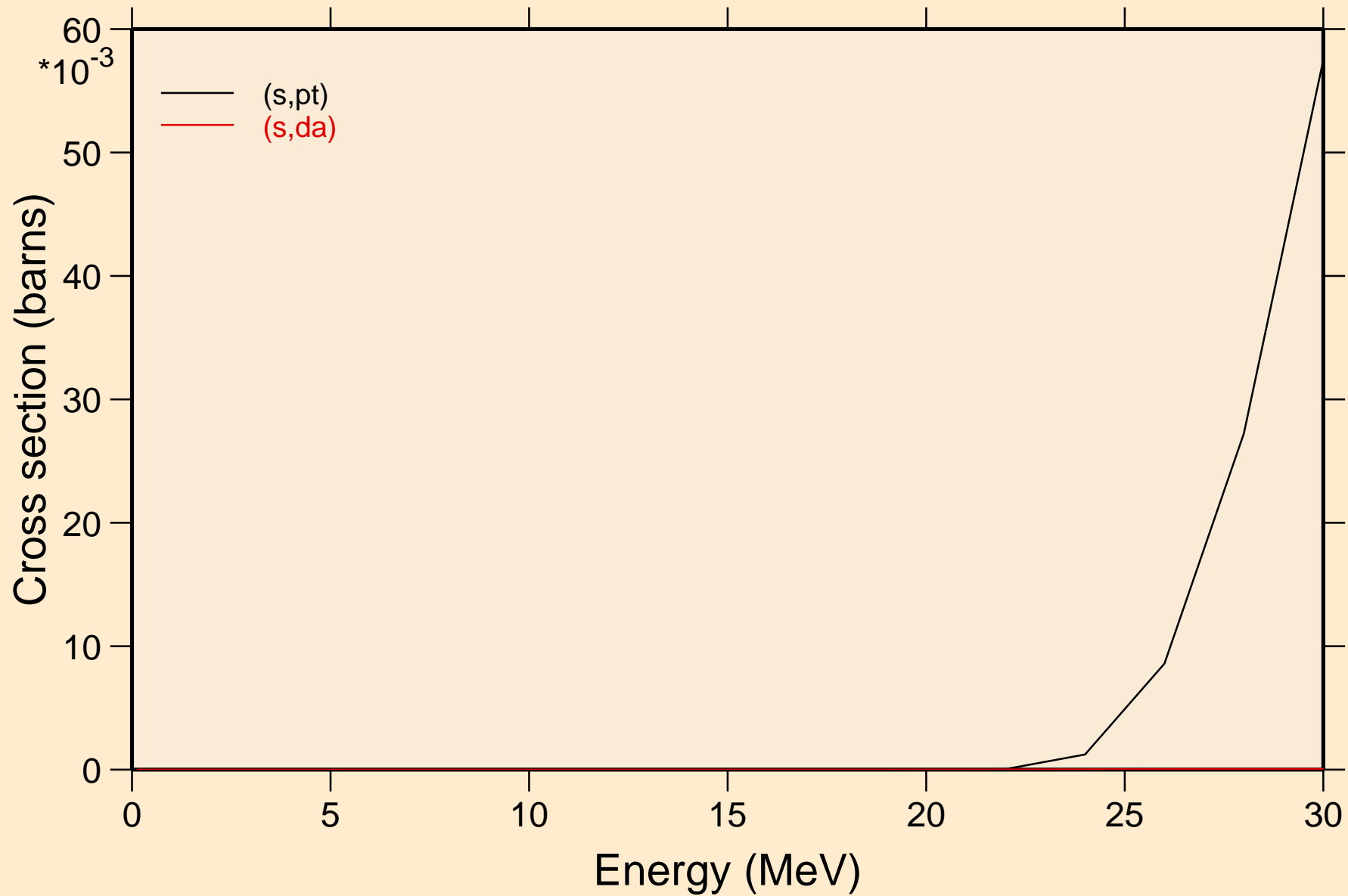

HG181 HELION ACER TENDL-2021 LIBRARY; T=0.K  
angular distribution for elastic

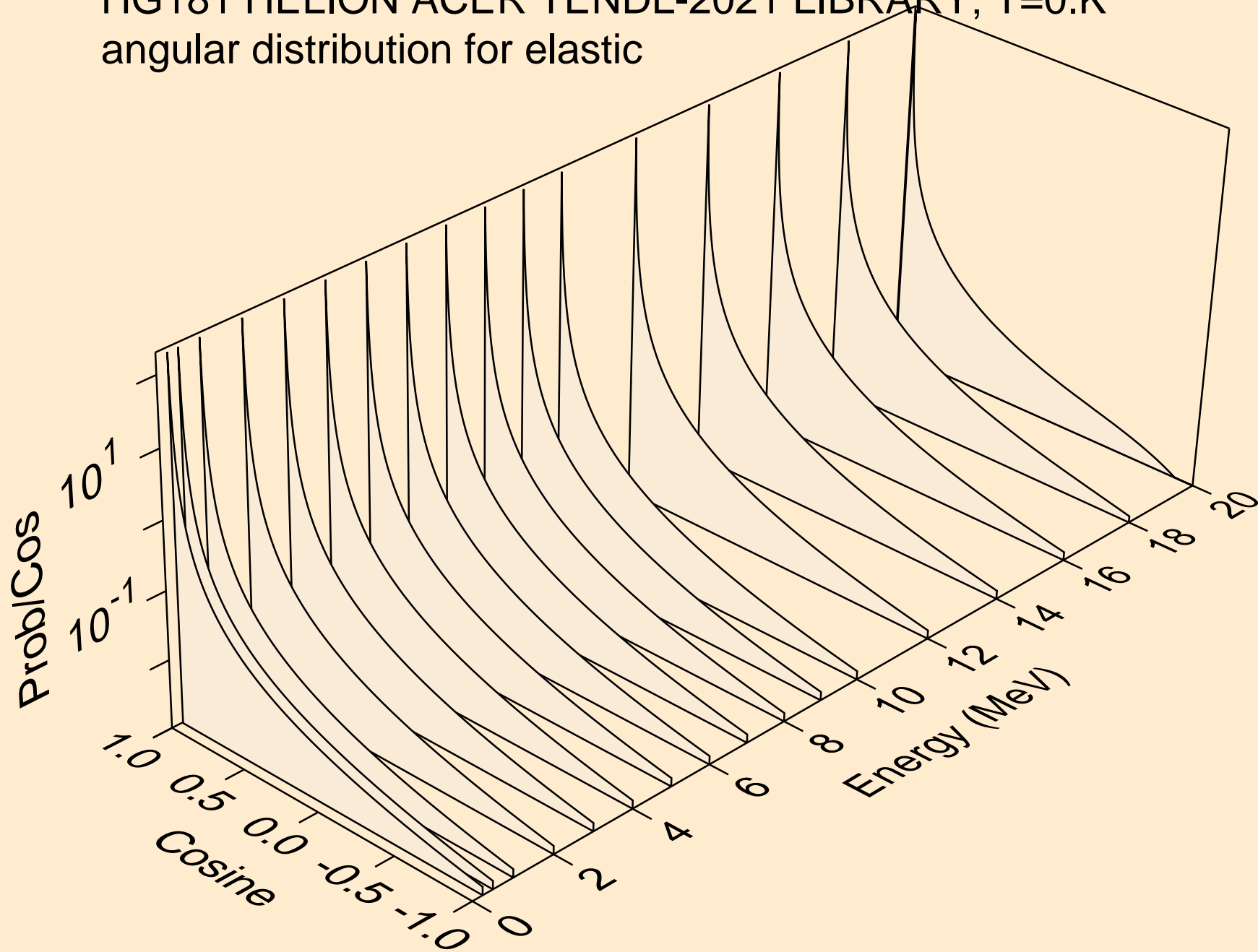

HG181 HELION ACER TENDL-2021 LIBRARY; T=0.K  
angular distribution for elastic

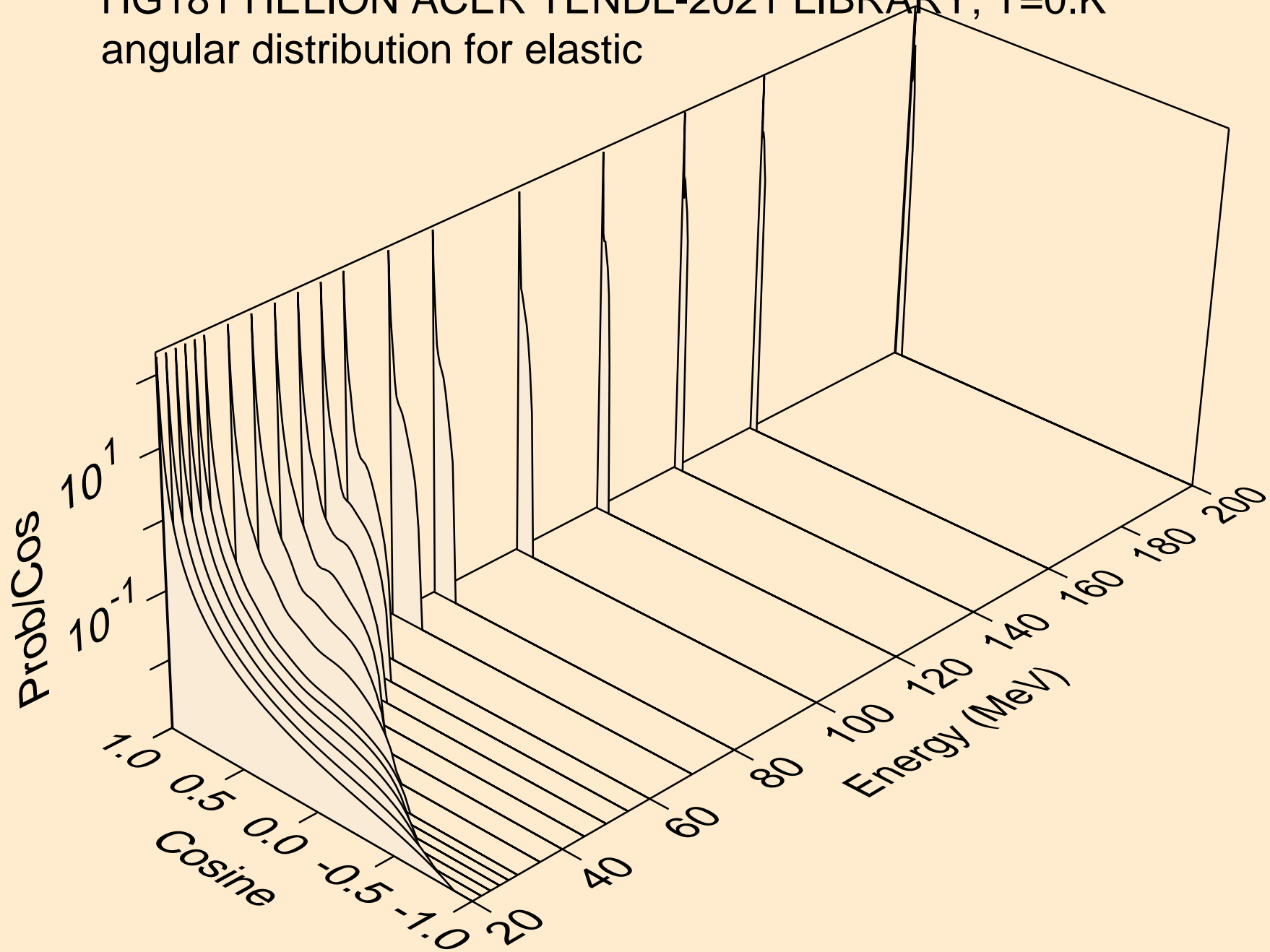

HG181 HELION ACER TENDL-2021 LIBRARY; T=0.K  
He-3 emission for (s,x)

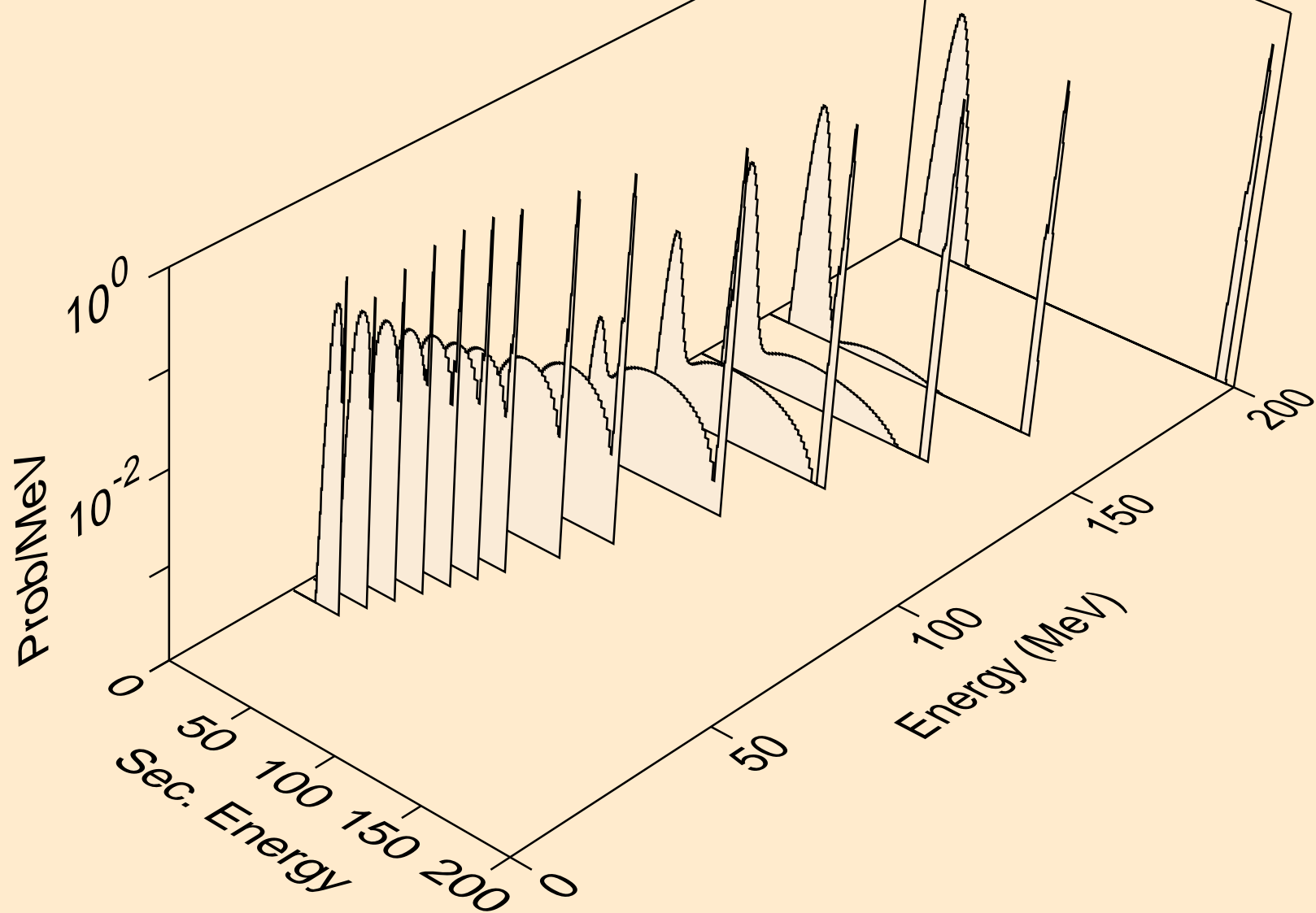

HG181 HELION ACER TENDL-2021 LIBRARY; T=0.K  
He-3 emission for (s,n\*)he3

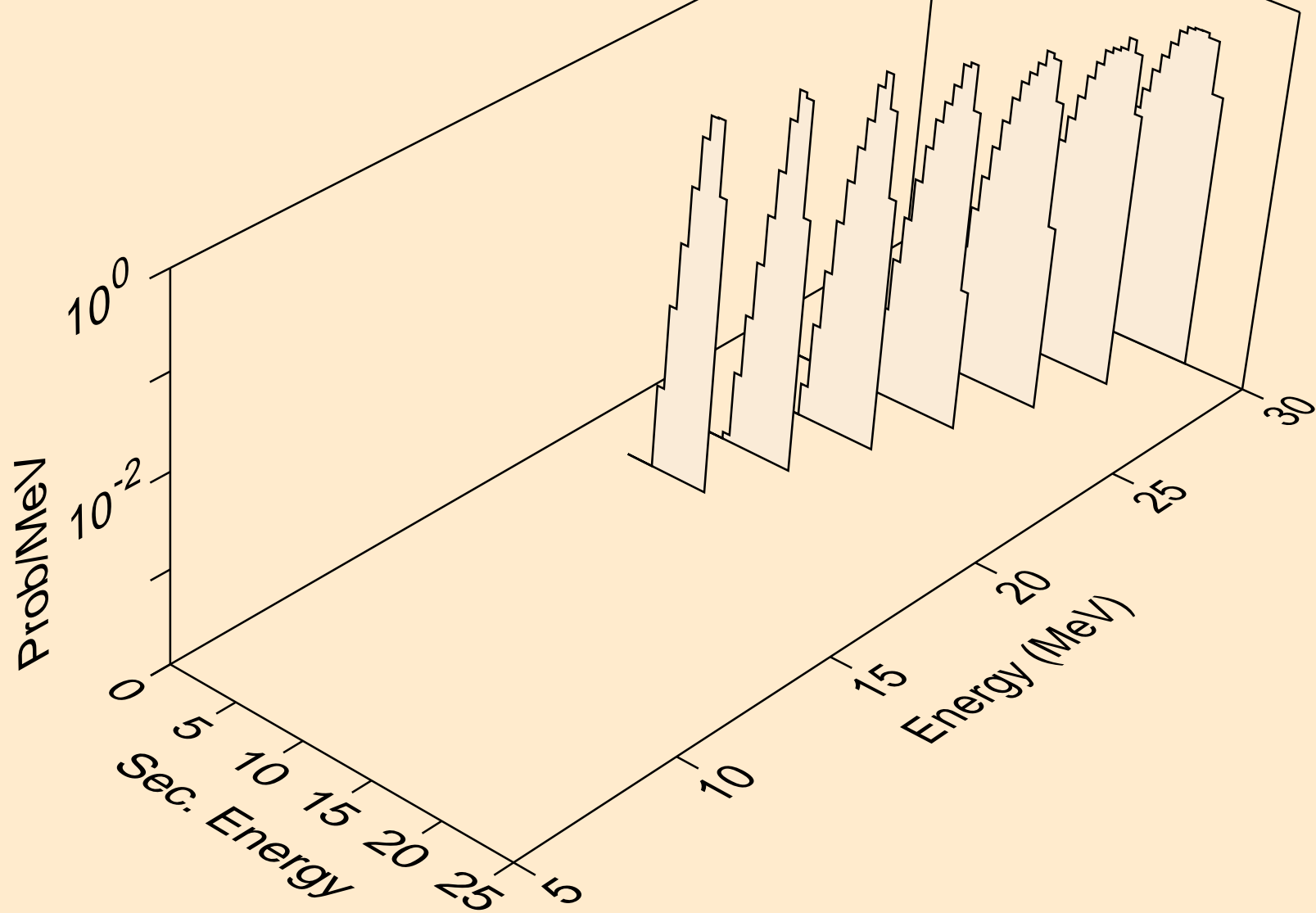



HG181 HELION ACER TENDL-2021 LIBRARY; T=0.K  
He-3 emission for inelastic

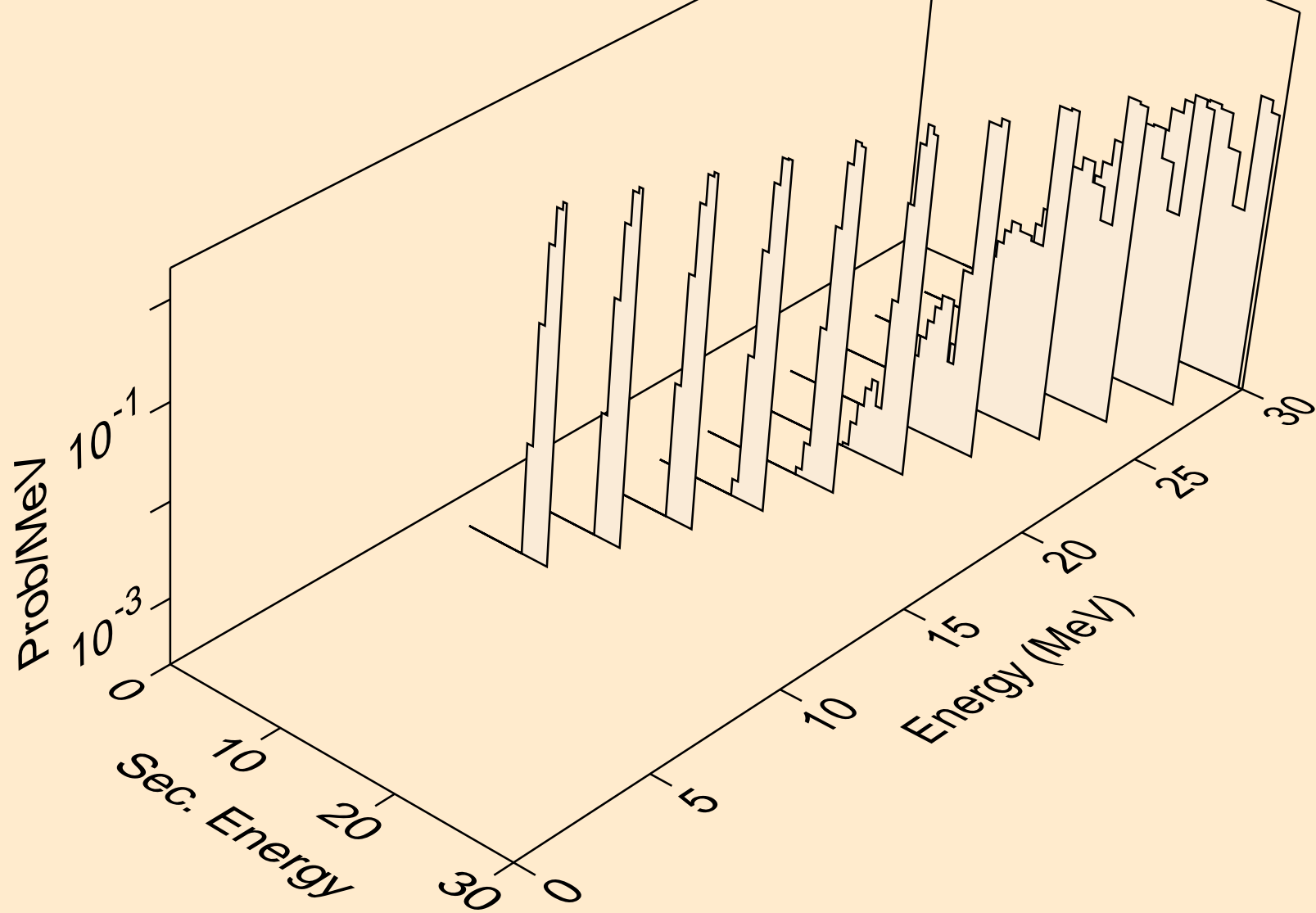

HG181 HELION ACER TENDL-2021 LIBRARY; T=0.K  
Photon emission for (z,n)

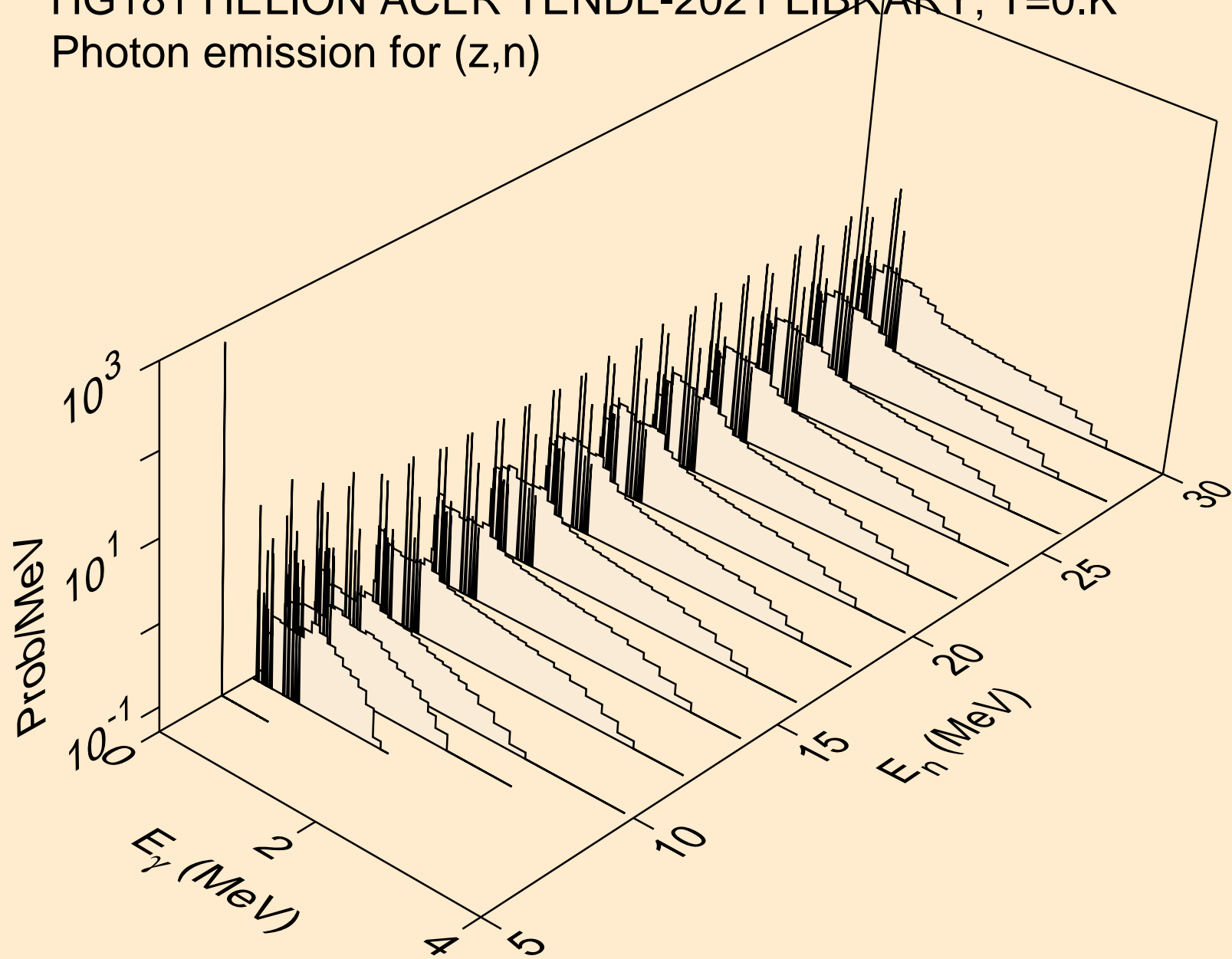

HG181 HELION ACER TENDL-2021 LIBRARY; T=0.K  
Photon emission for (n,x)

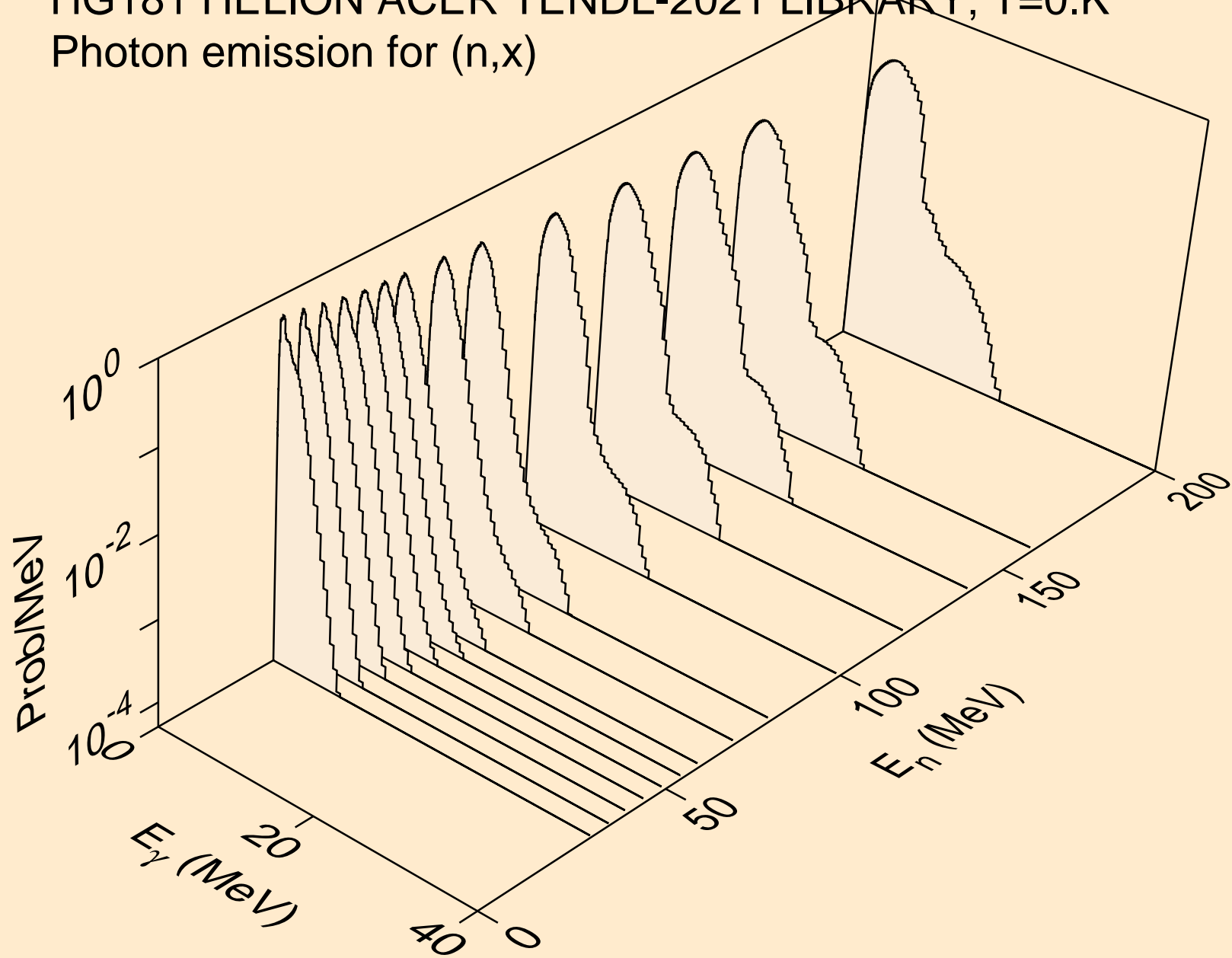

HG181 HELION ACER TENDL-2021 LIBRARY; T=0.K  
Photon emission for (n,2n)

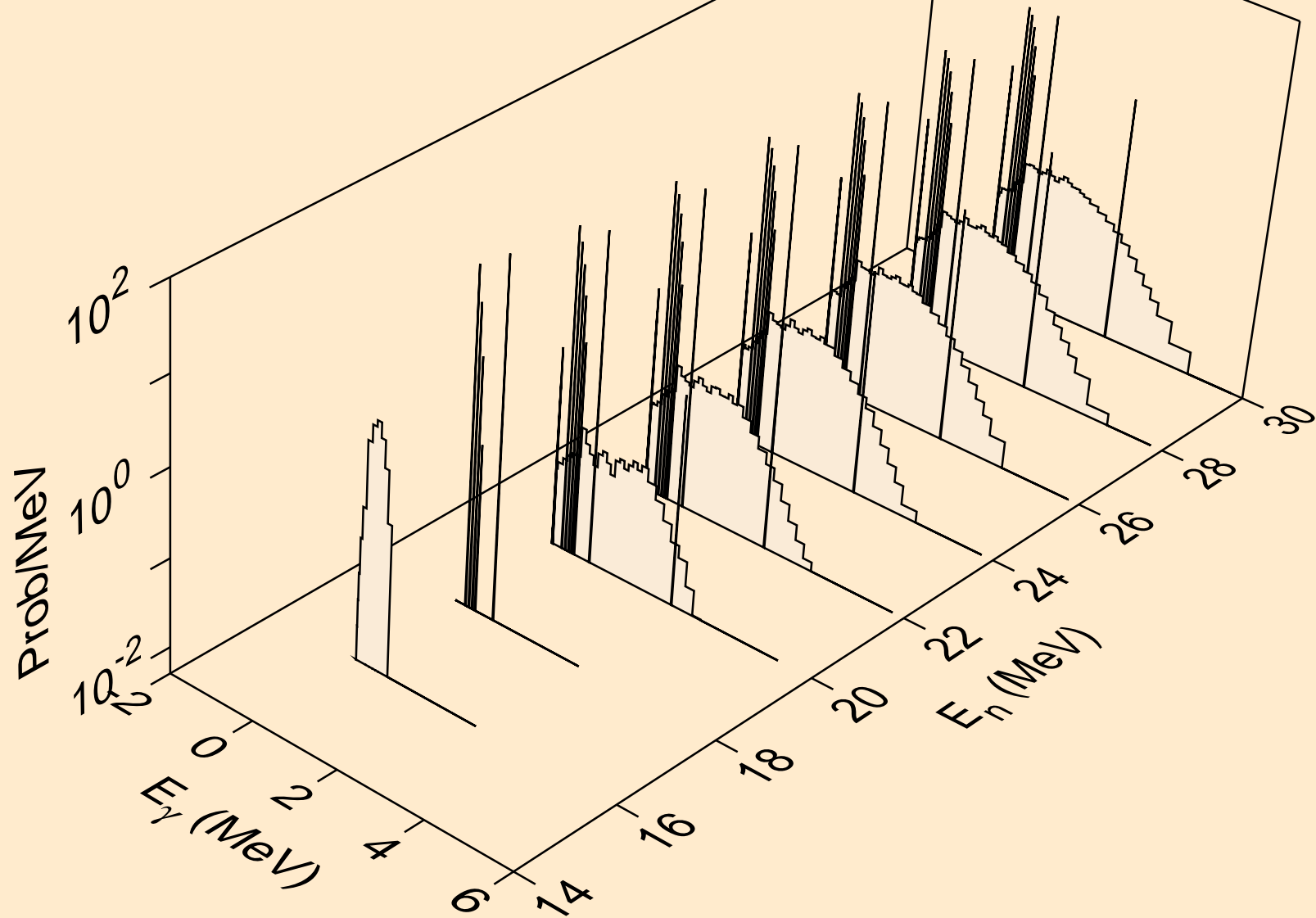

HG181 HELION ACER TENDL-2021 LIBRARY; T=0.K  
Photon emission for (n,3n)

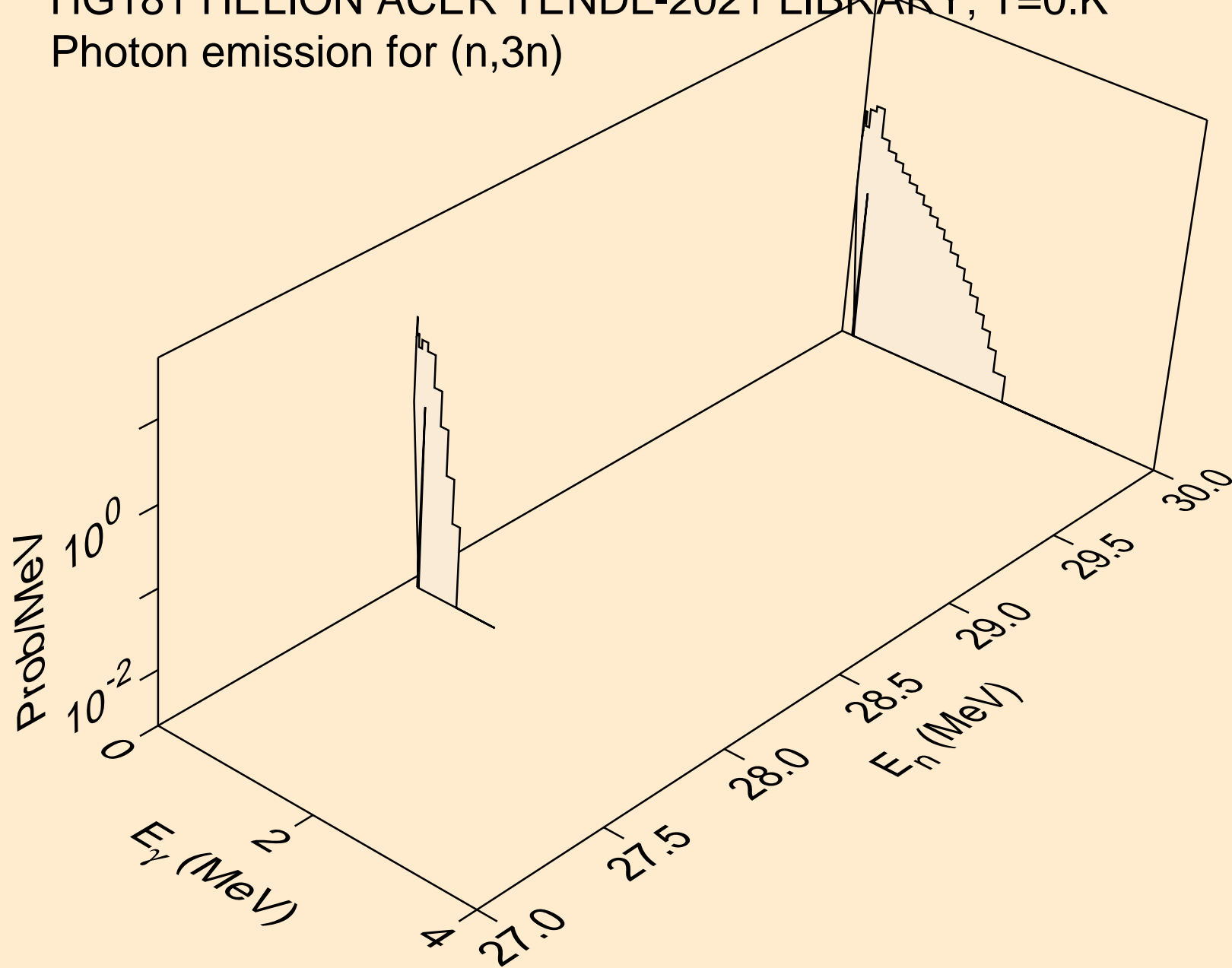

HG181 HELION ACER TENDL-2021 LIBRARY; T=0.K  
Photon emission for (n,n\*)a

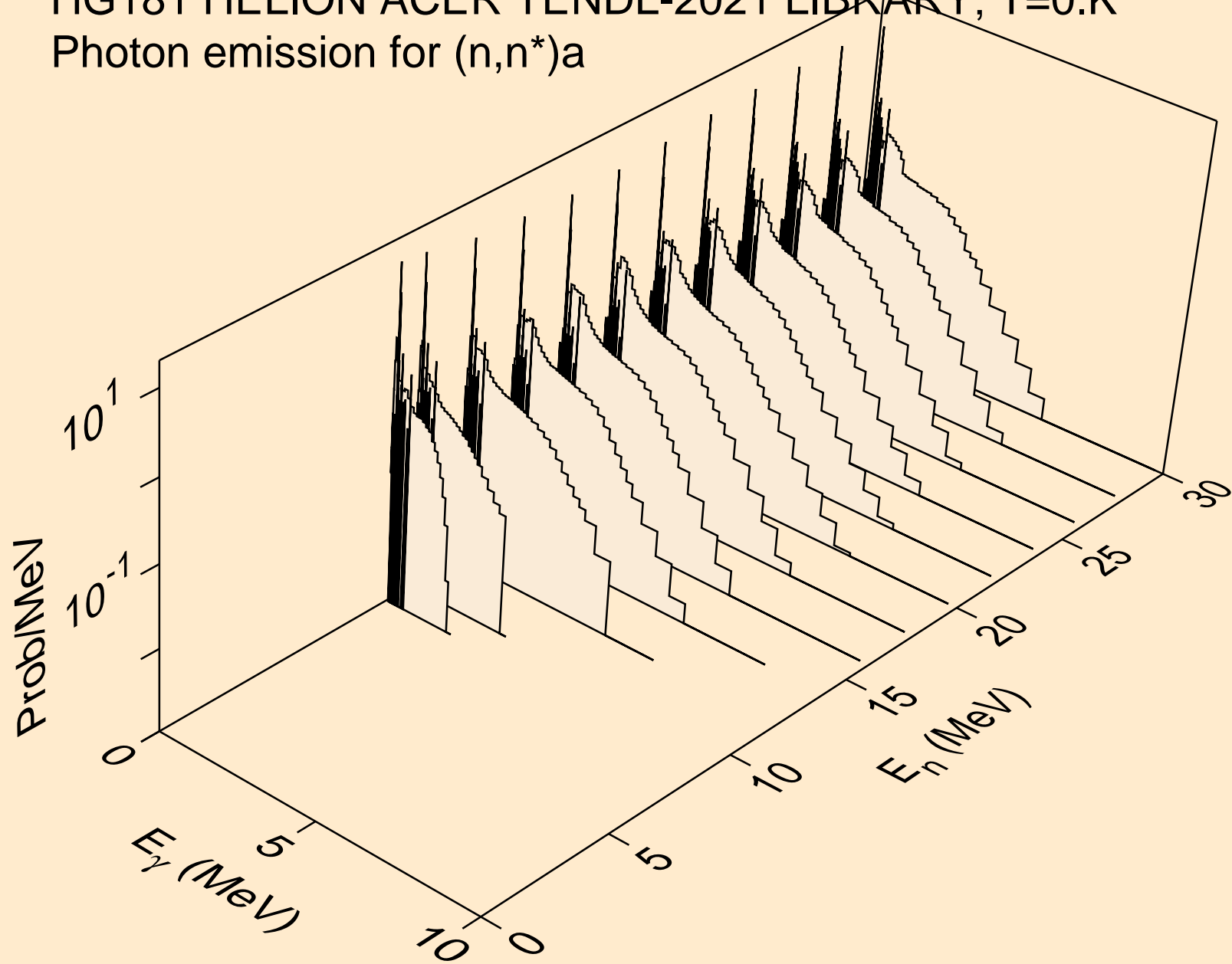

HG181 HELION ACER TENDL-2021 LIBRARY; T=0.K  
Photon emission for (n,2n)a

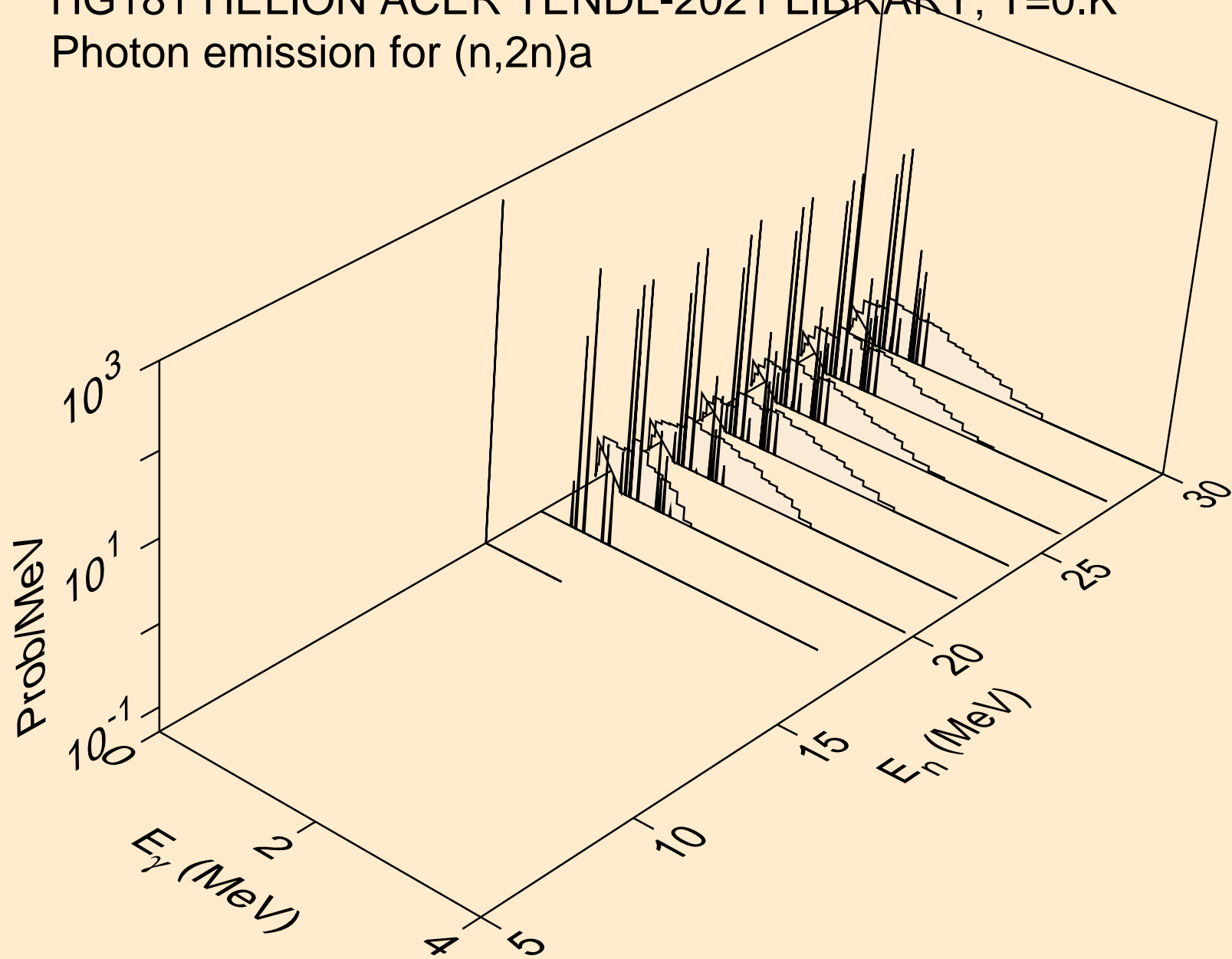

HG181 HELION ACER TENDL-2021 LIBRARY; T=0.K  
Photon emission for (n,3n)a

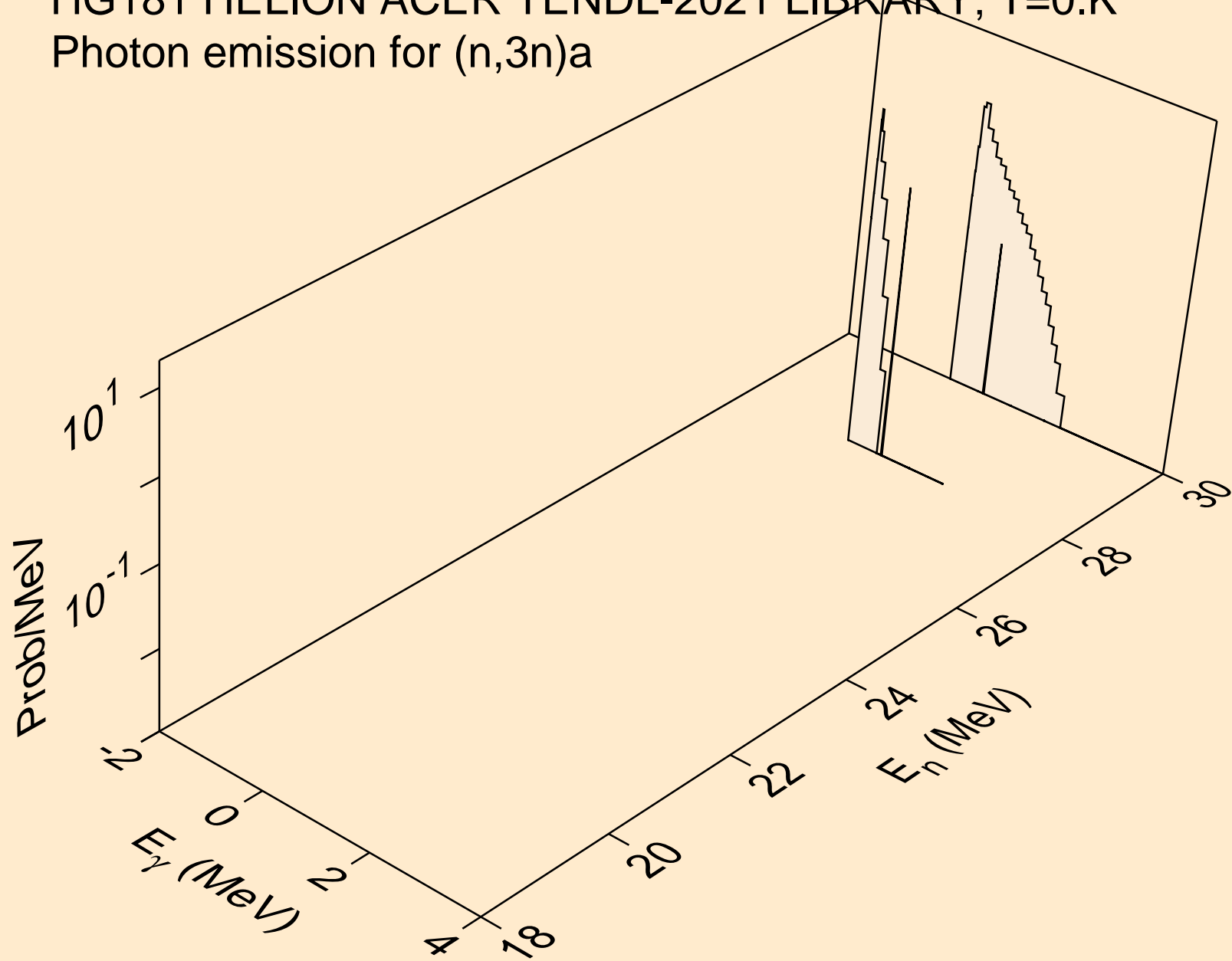



HG181 HELION ACER TENDL-2021 LIBRARY; T=0.K  
Photon emission for (n,n\*)p

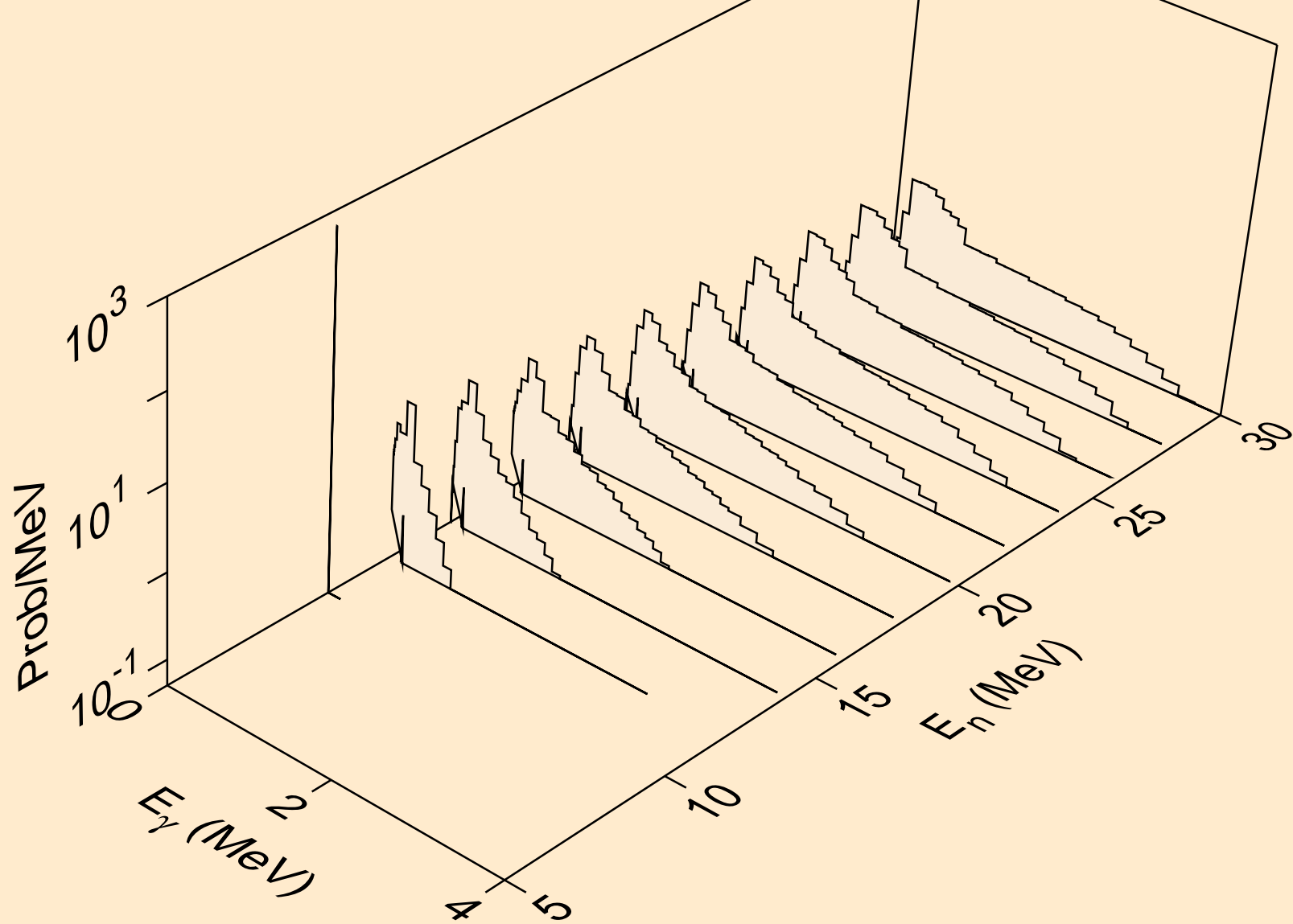

HG181 HELION ACER TENDL-2021 LIBRARY; T=0.K  
Photon emission for (n,n\*)2a

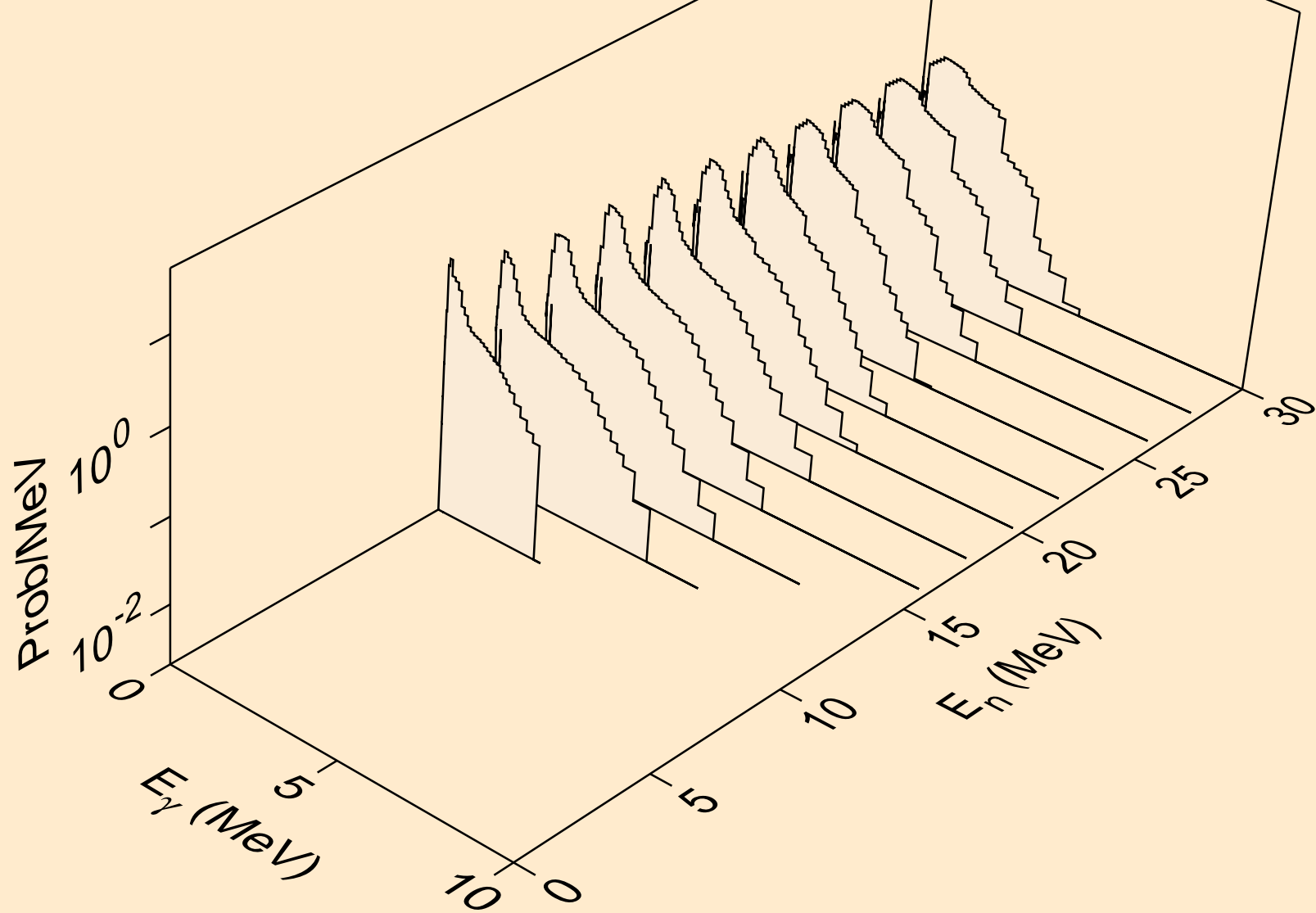

HG181 HELION ACER TENDL-2021 LIBRARY; T=0.K  
Photon emission for (n,2n)2a

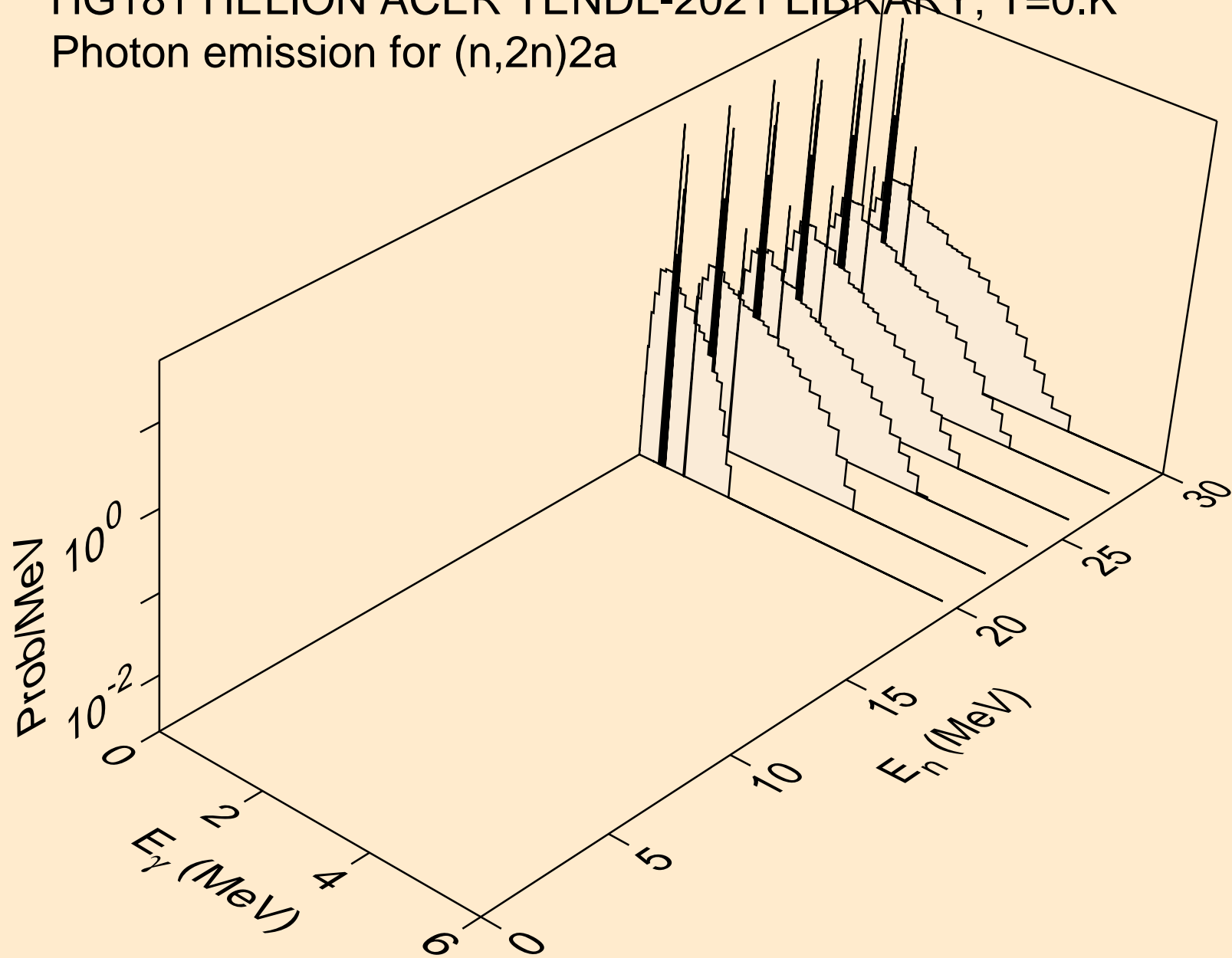

HG181 HELION ACER TENDL-2021 LIBRARY; T=0.K  
Photon emission for (n,n\*)d

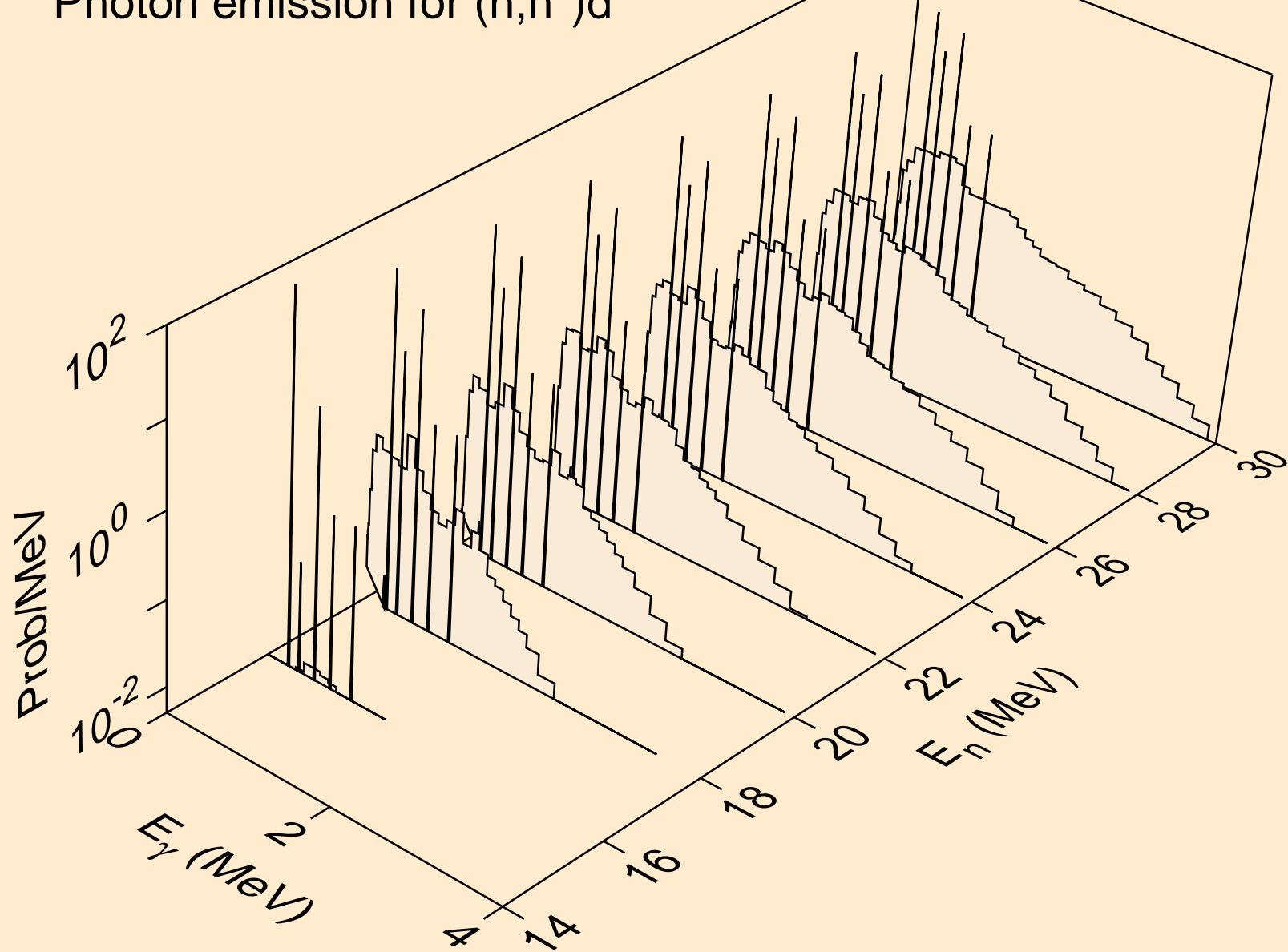

HG181 HELION ACER TENDL-2021 LIBRARY; T=0.K  
Photon emission for (n,n\*)t

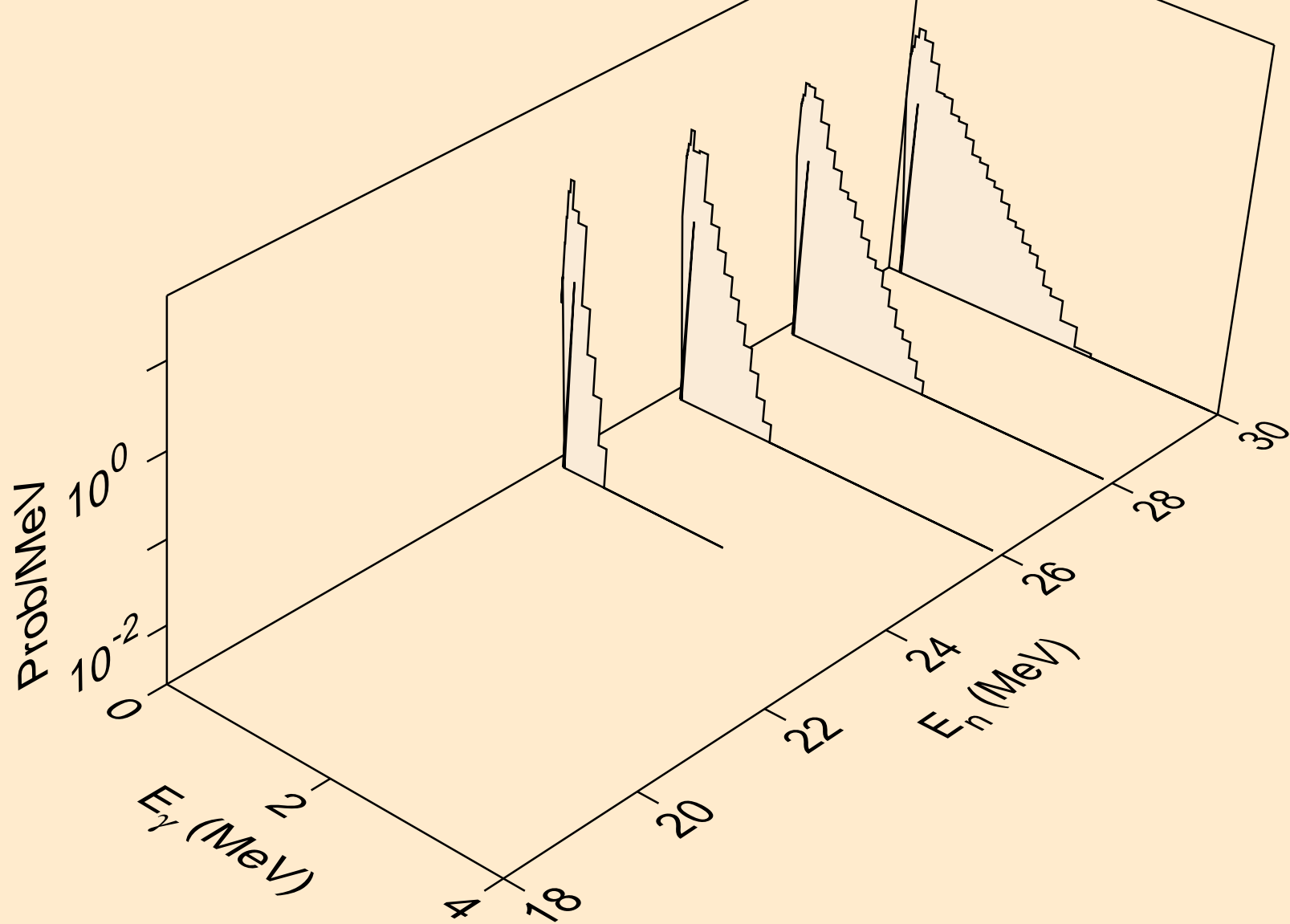

HG181 HELION ACER TENDL-2021 LIBRARY; T=0.K  
Photon emission for (n,n\*)he3

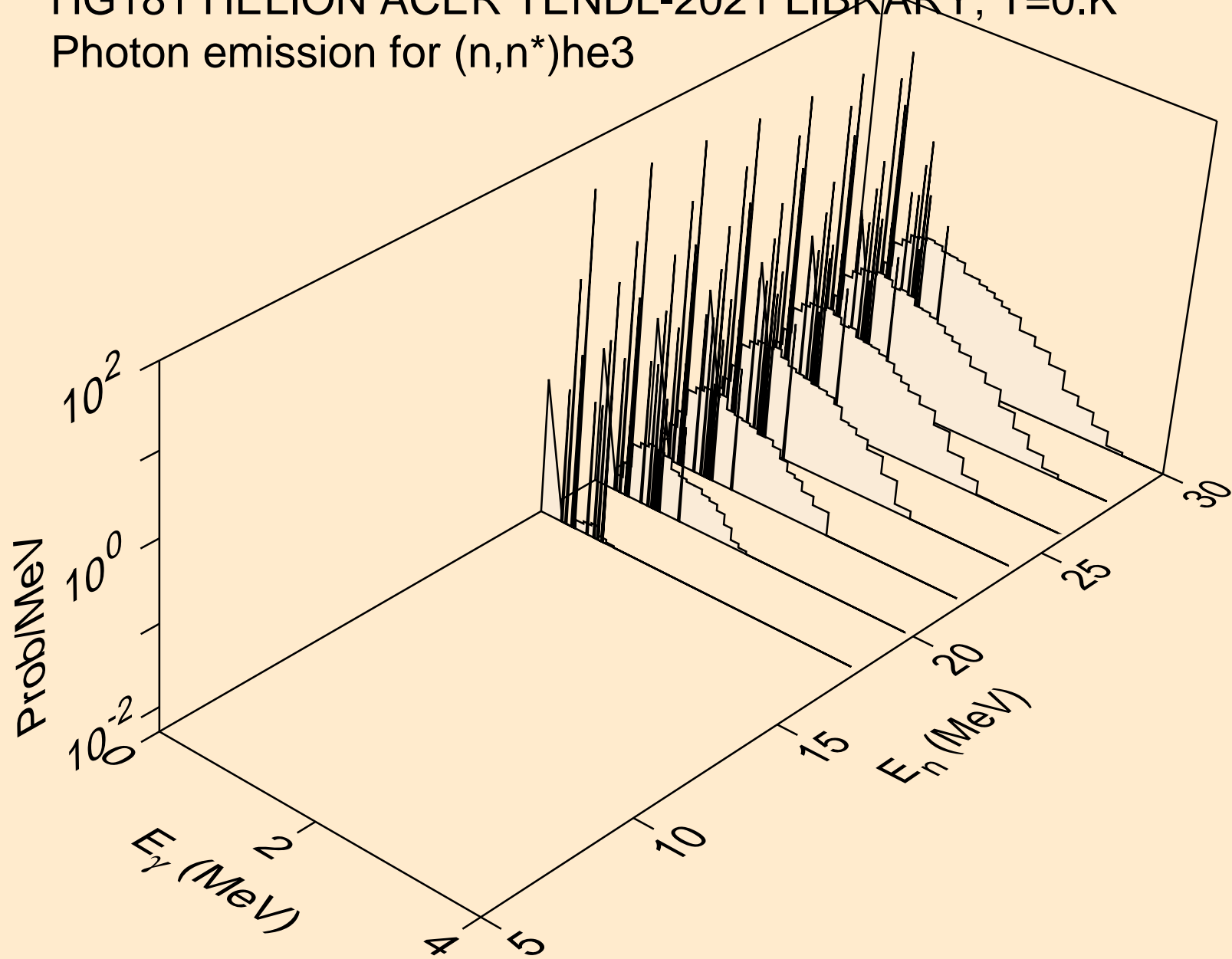

HG181 HELION ACER TENDL-2021 LIBRARY; T=0.K  
Photon emission for (n,2np)

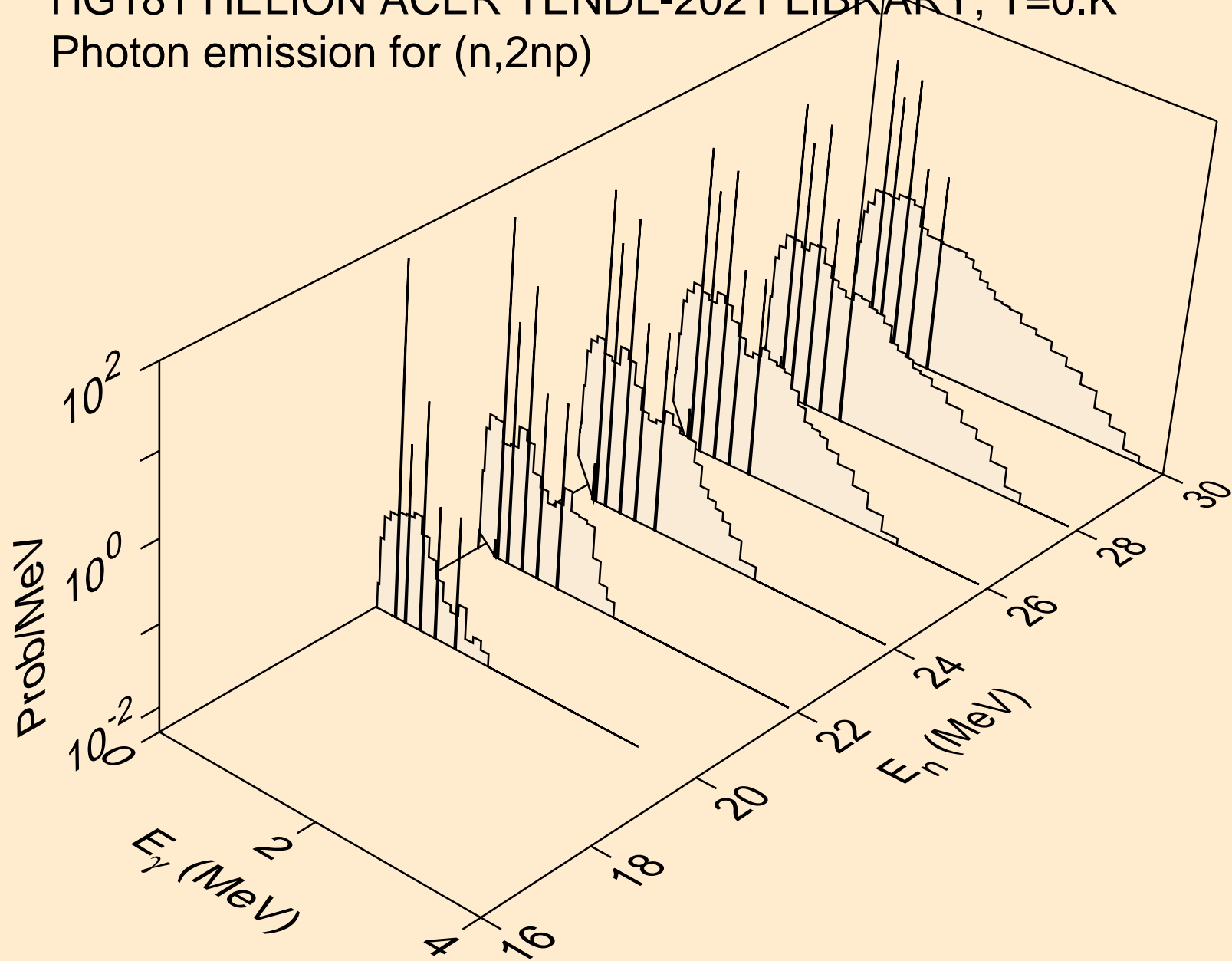

HG181 HELION ACER TENDL-2021 LIBRARY; T=0.K  
Photon emission for (n,2np)

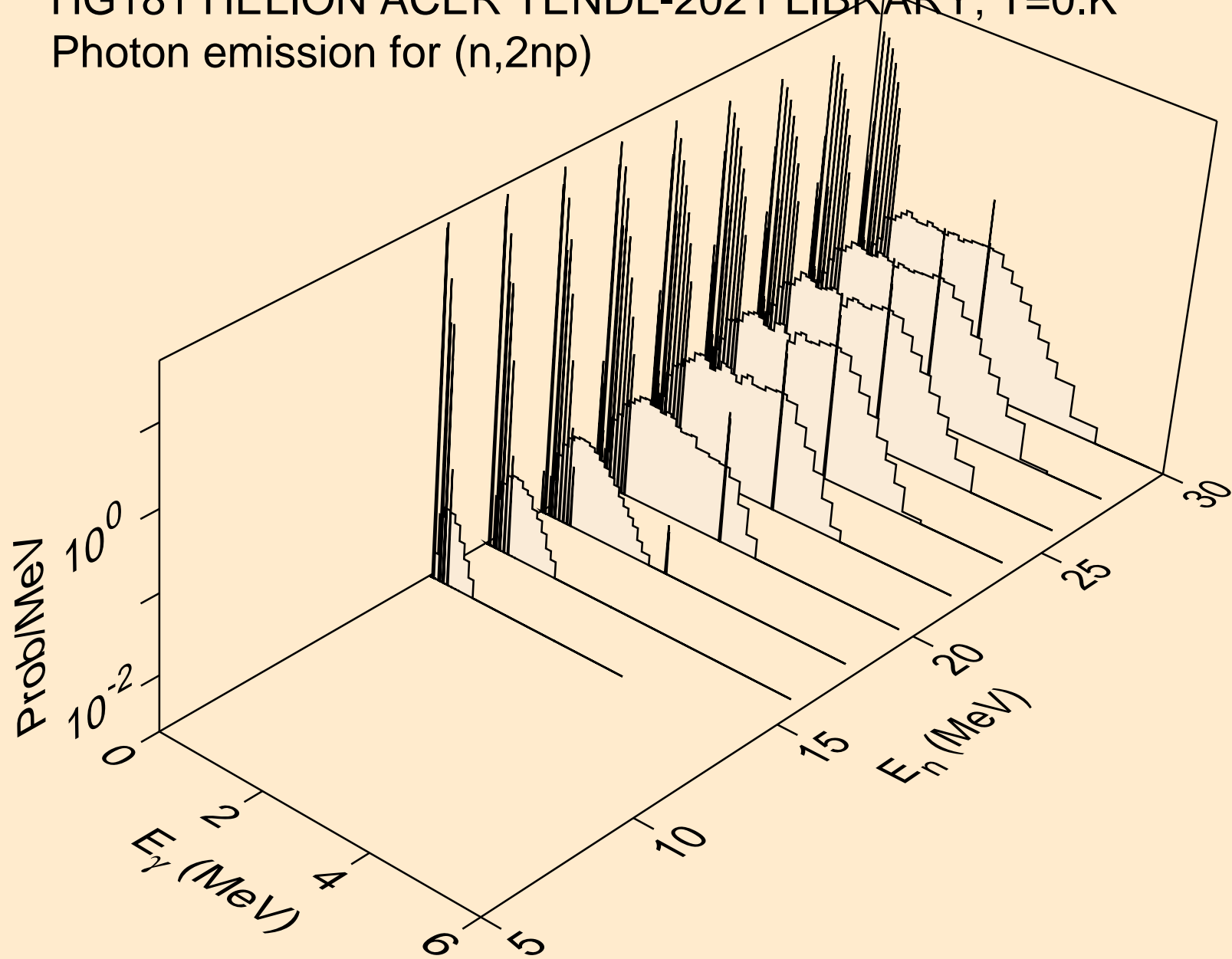



HG181 HELION ACER TENDL-2021 LIBRARY; T=0.K  
Photon emission for (n,npa)

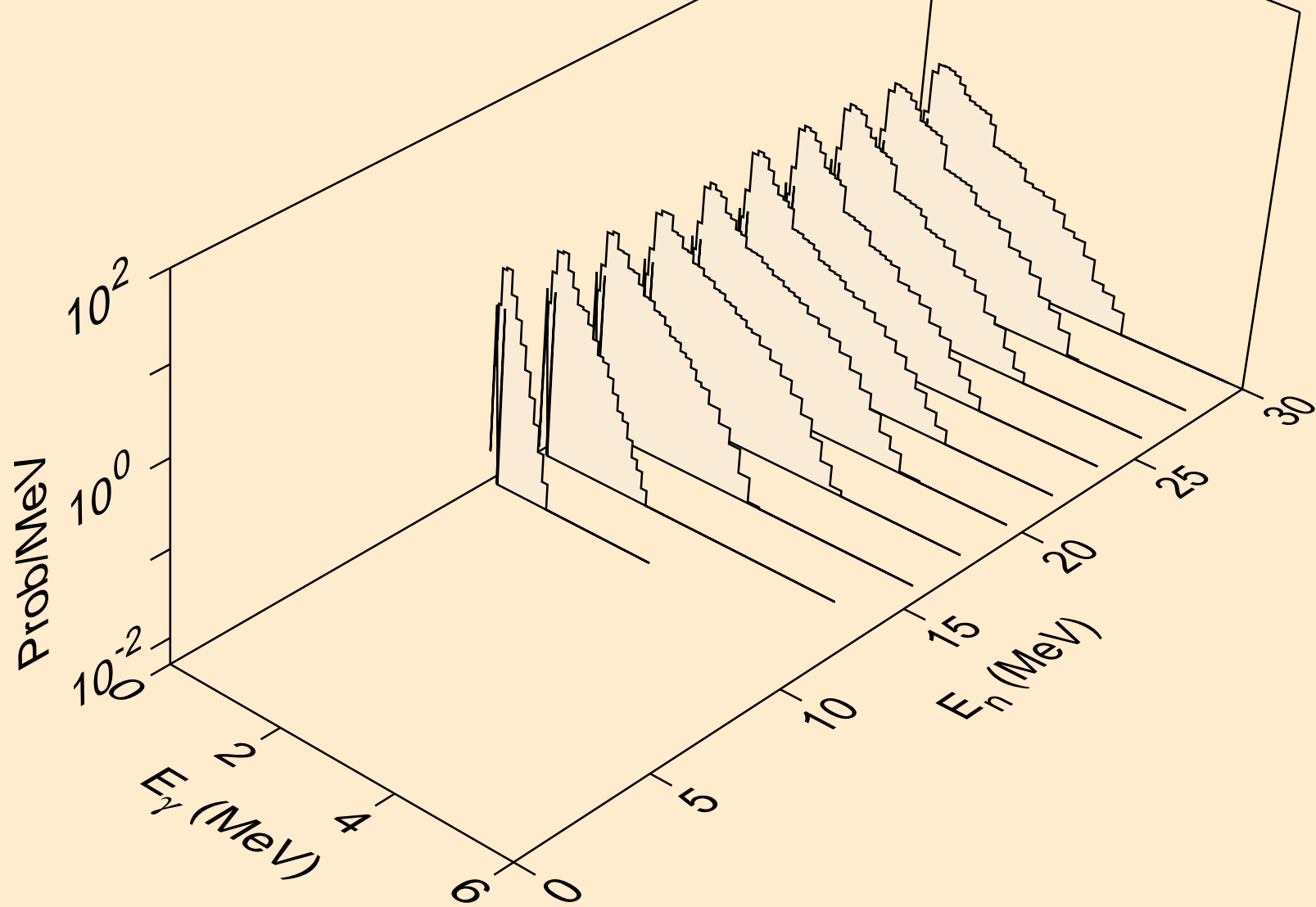

HG181 HELION ACER TENDL-2021 LIBRARY; T=0.K  
Photon emission for (n,gma)

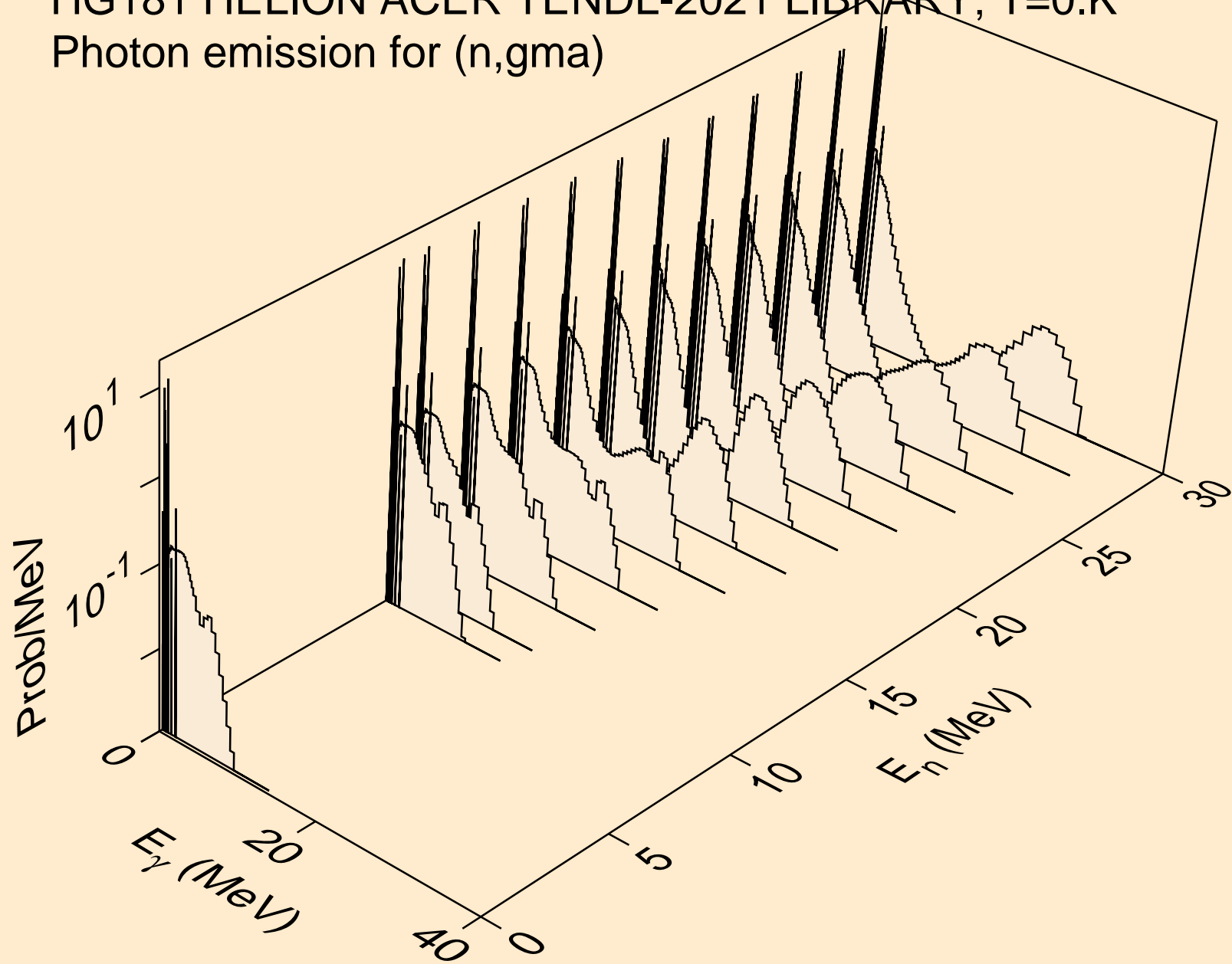

HG181 HELION ACER TENDL-2021 LIBRARY; T=0.K  
Photon emission for (n,p)

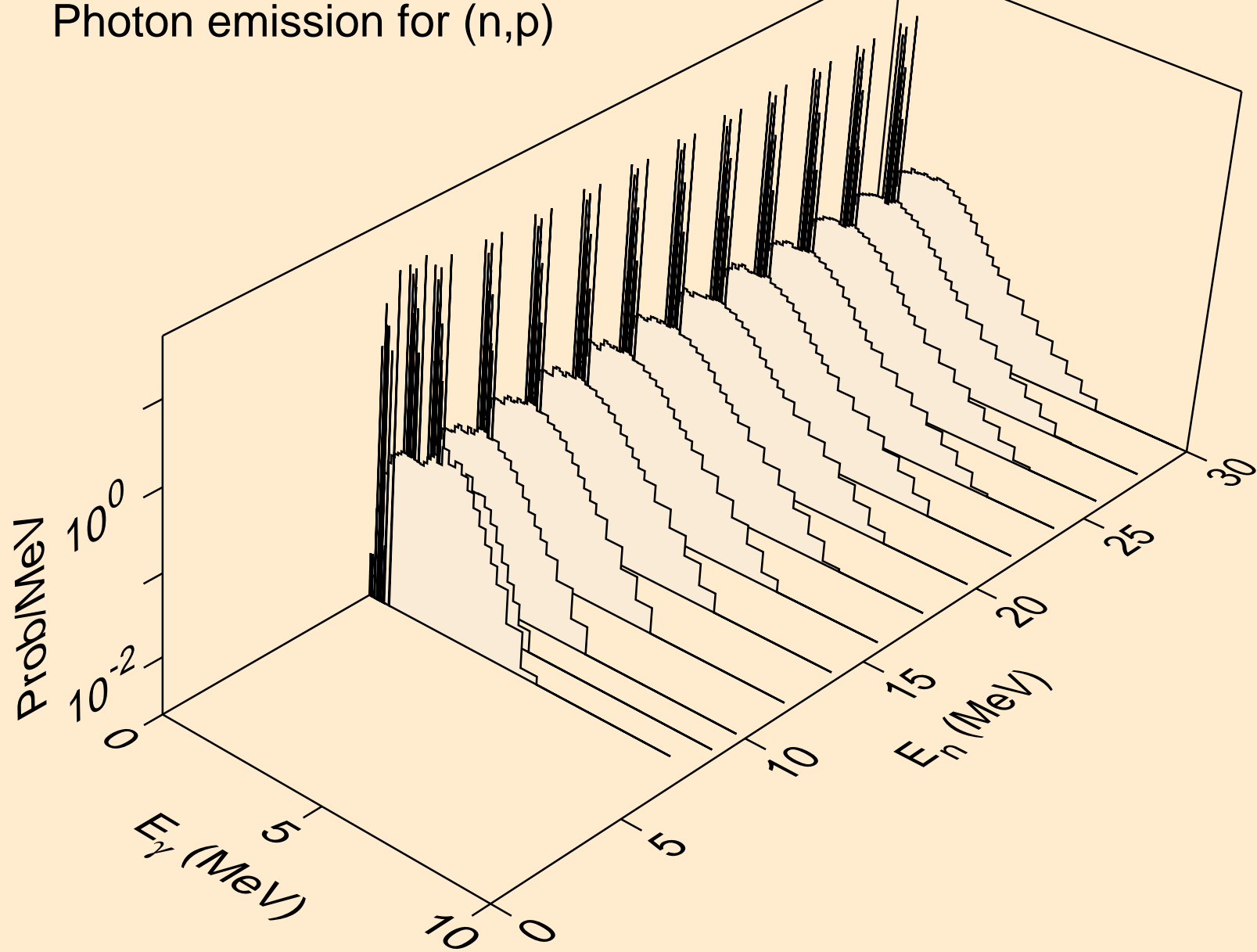

HG181 HELION ACER TENDL-2021 LIBRARY; T=0.K  
Photon emission for (n,d)

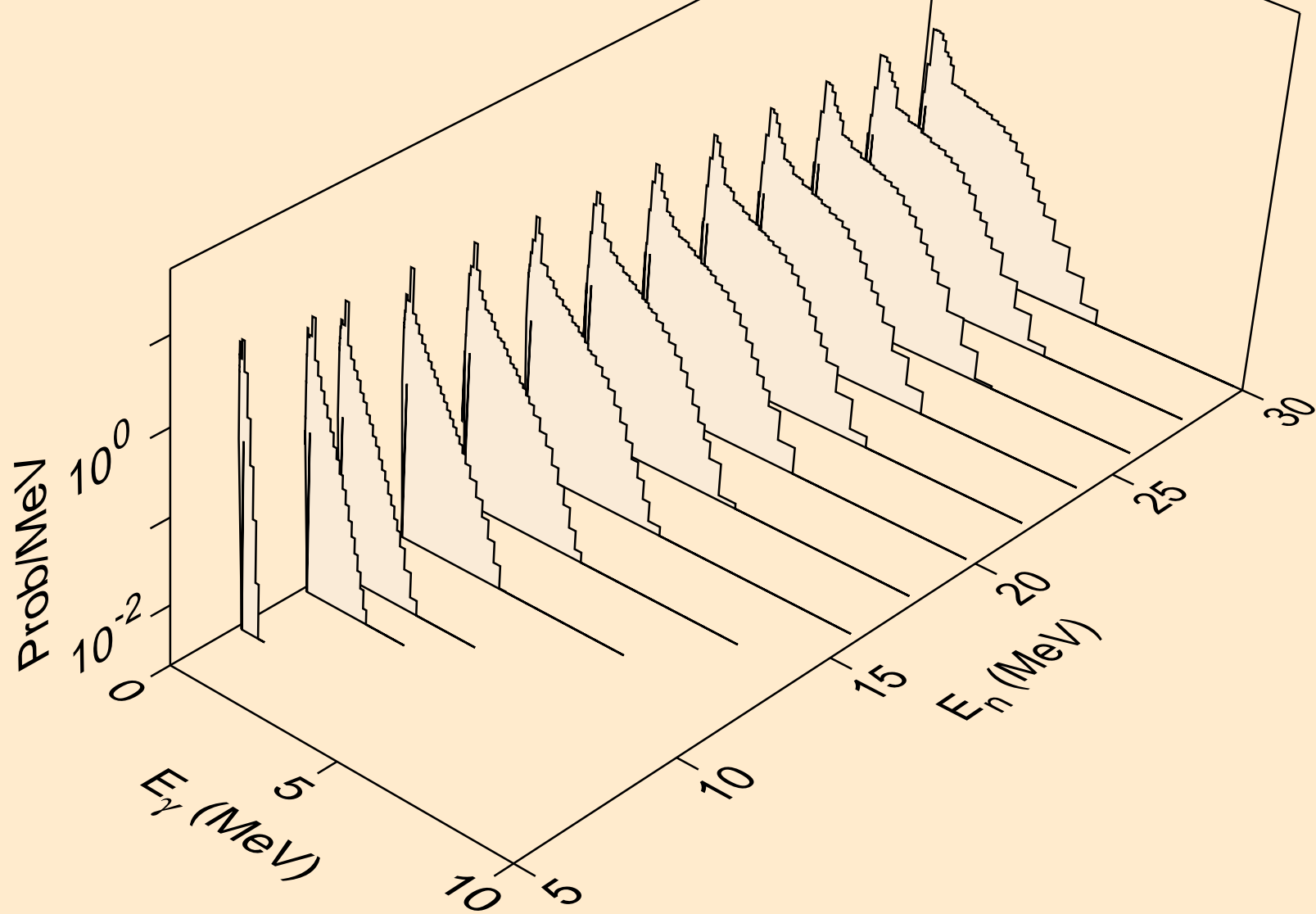

HG181 HELION ACER TENDL-2021 LIBRARY; T=0.K  
Photon emission for (n,t)

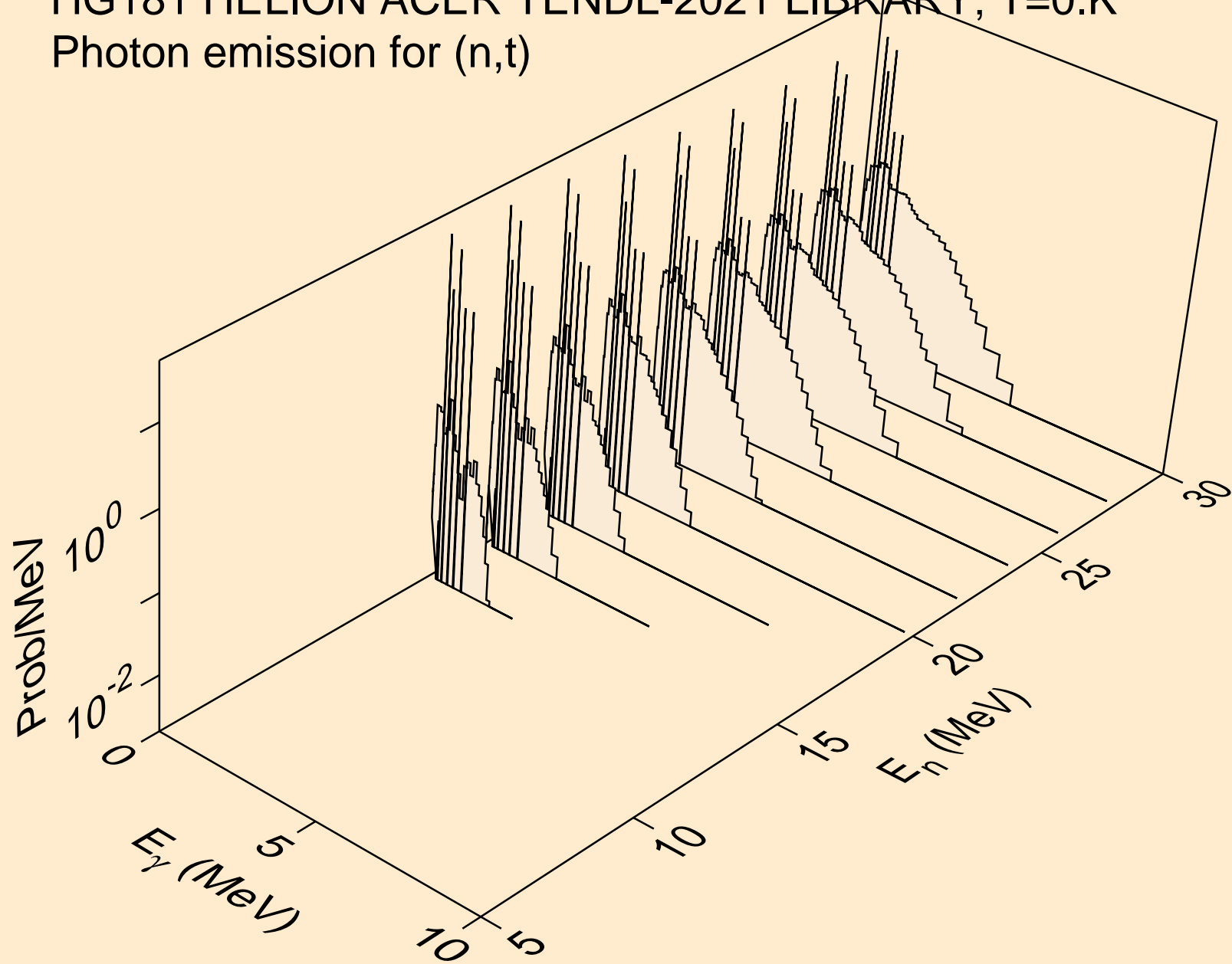

HG181 HELION ACER TENDL-2021 LIBRARY; T=0.K  
Photon emission for inelastic

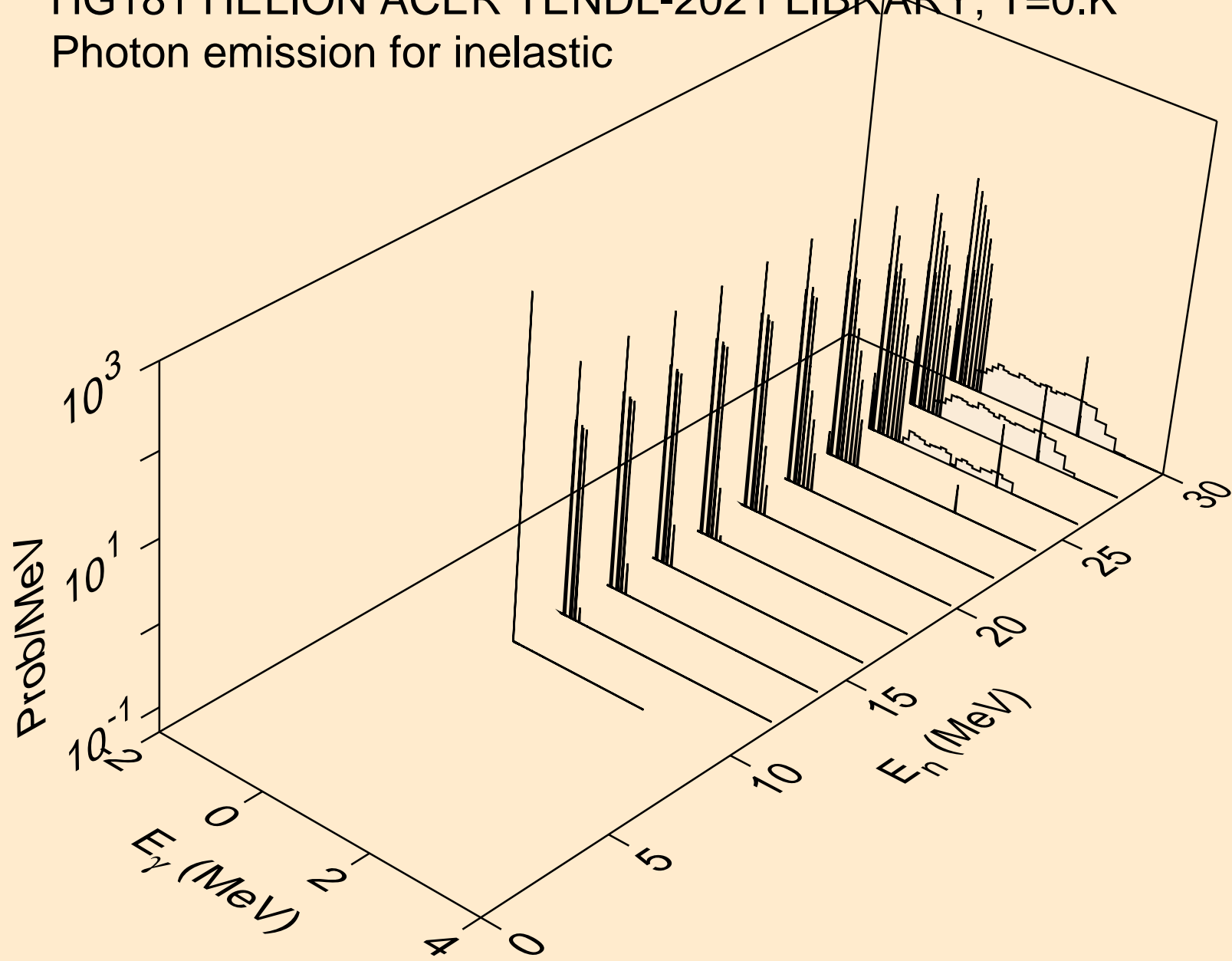

HG181 HELION ACER TENDL-2021 LIBRARY; T=0.K  
Photon emission for (n,a)

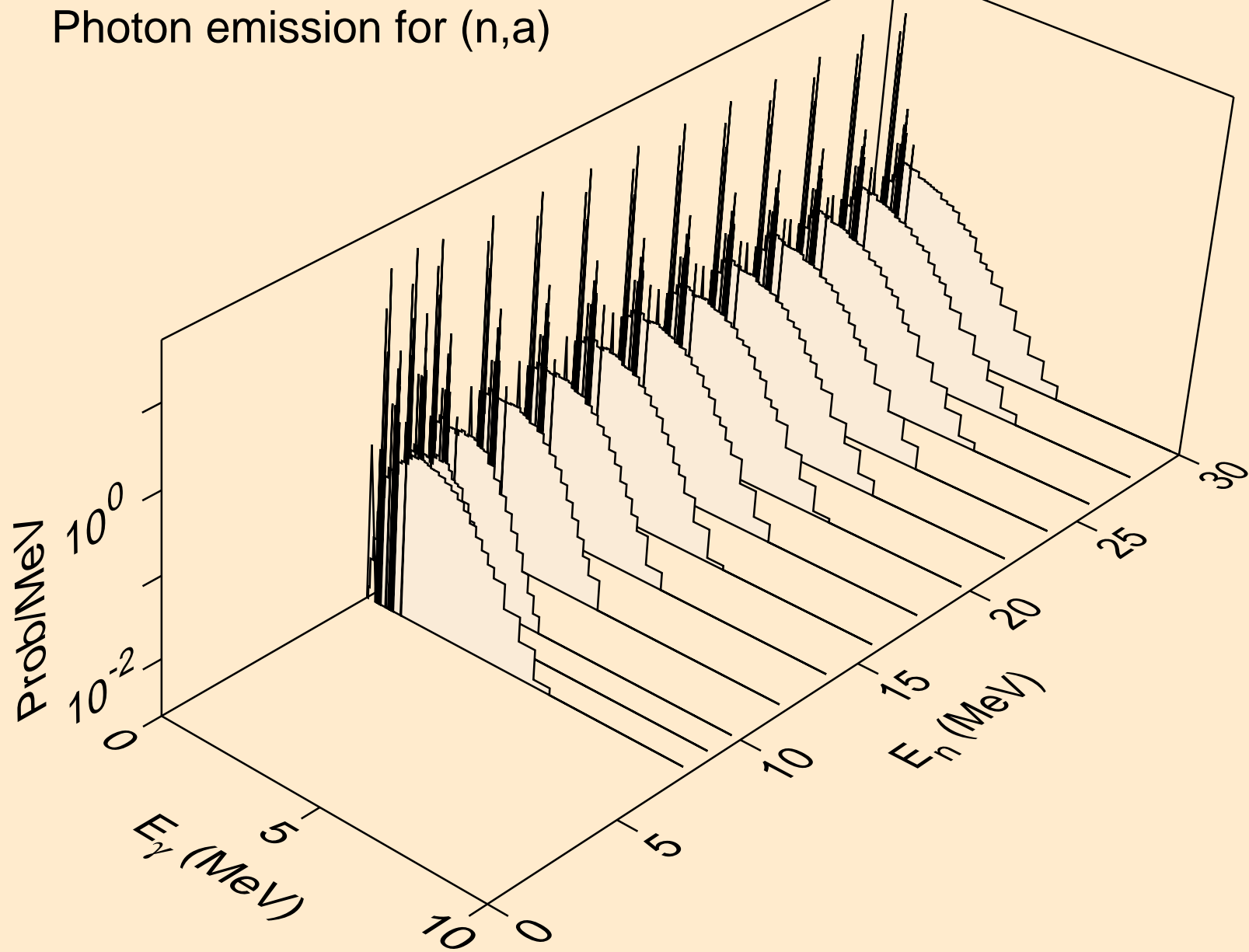

HG181 HELION ACER TENDL-2021 LIBRARY; T=0.K  
Photon emission for (n,2a)

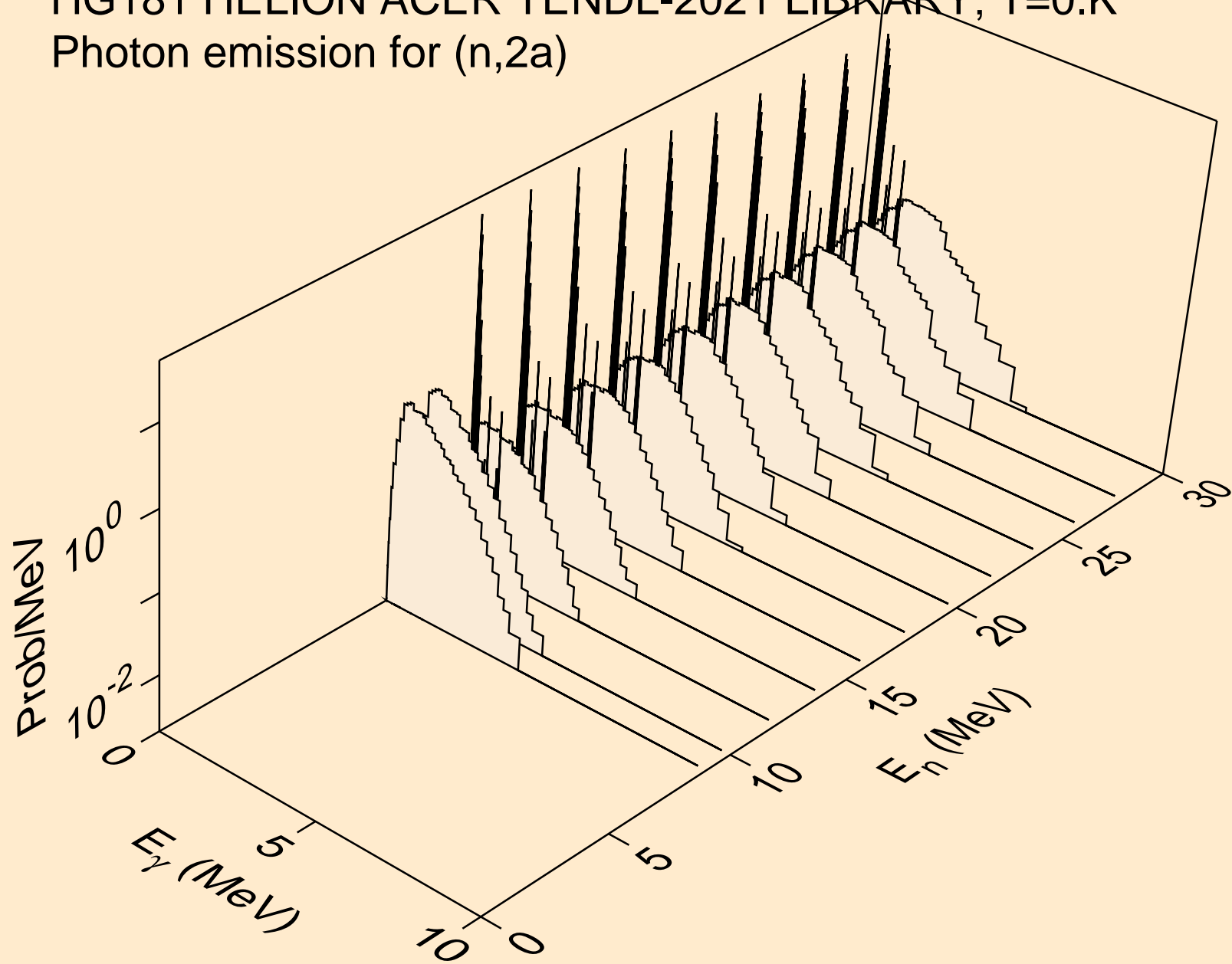



HG181 HELION ACER TENDL-2021 LIBRARY; T=0.K  
Photon emission for (n,3a)

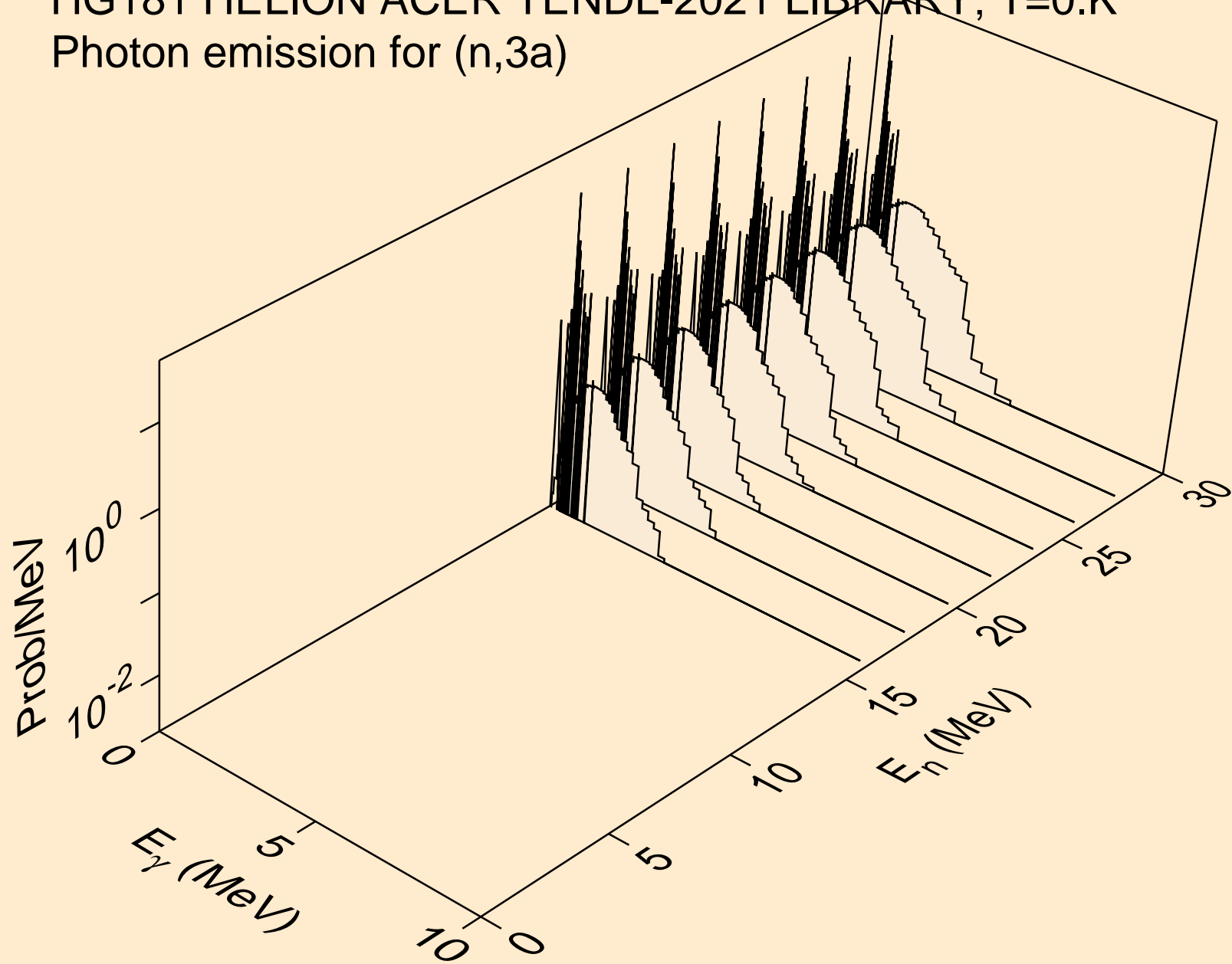

HG181 HELION ACER TENDL-2021 LIBRARY; T=0.K  
Photon emission for (n,2p)

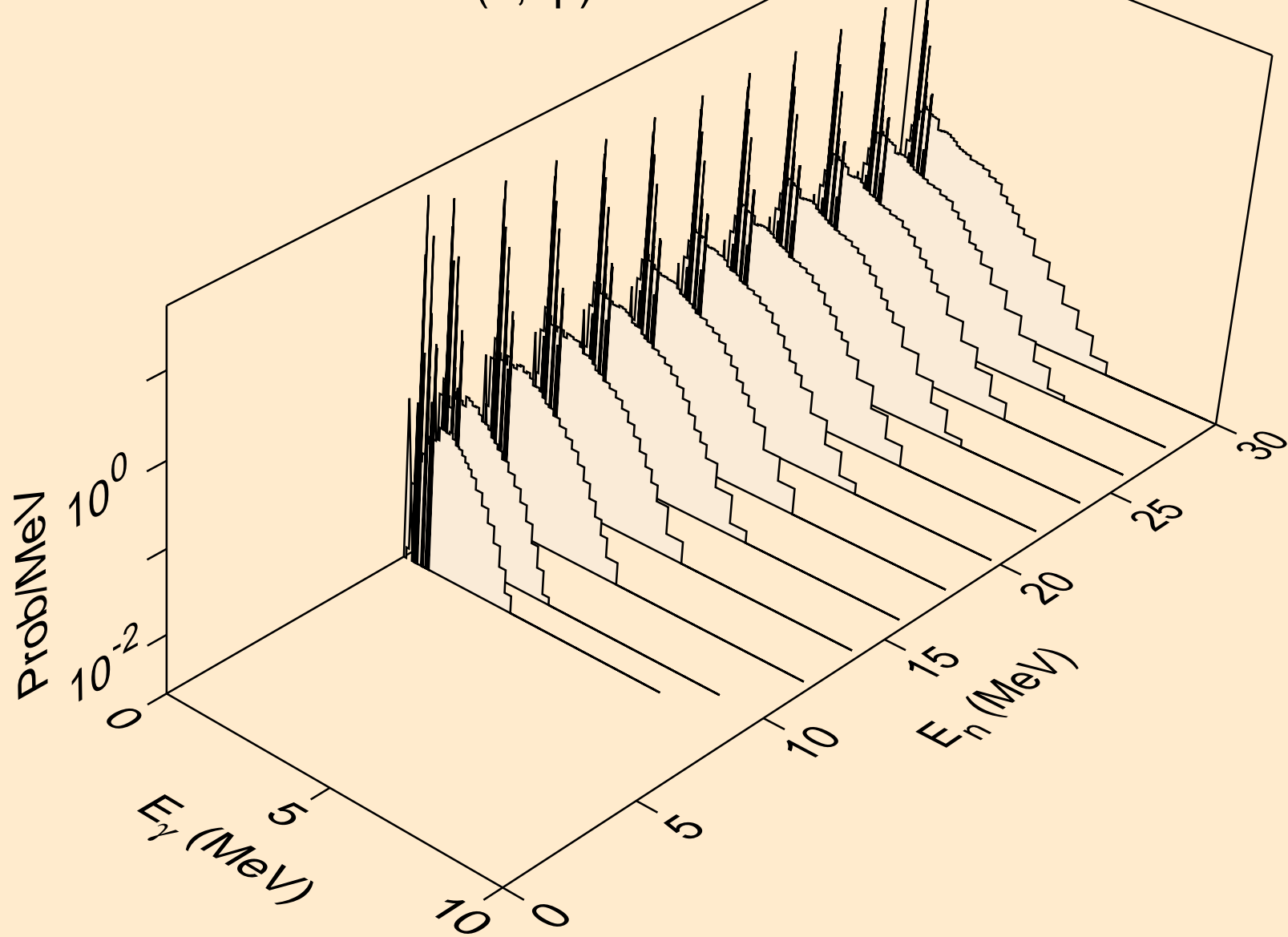

HG181 HELION ACER TENDL-2021 LIBRARY; T=0.K  
Photon emission for (n,pa)

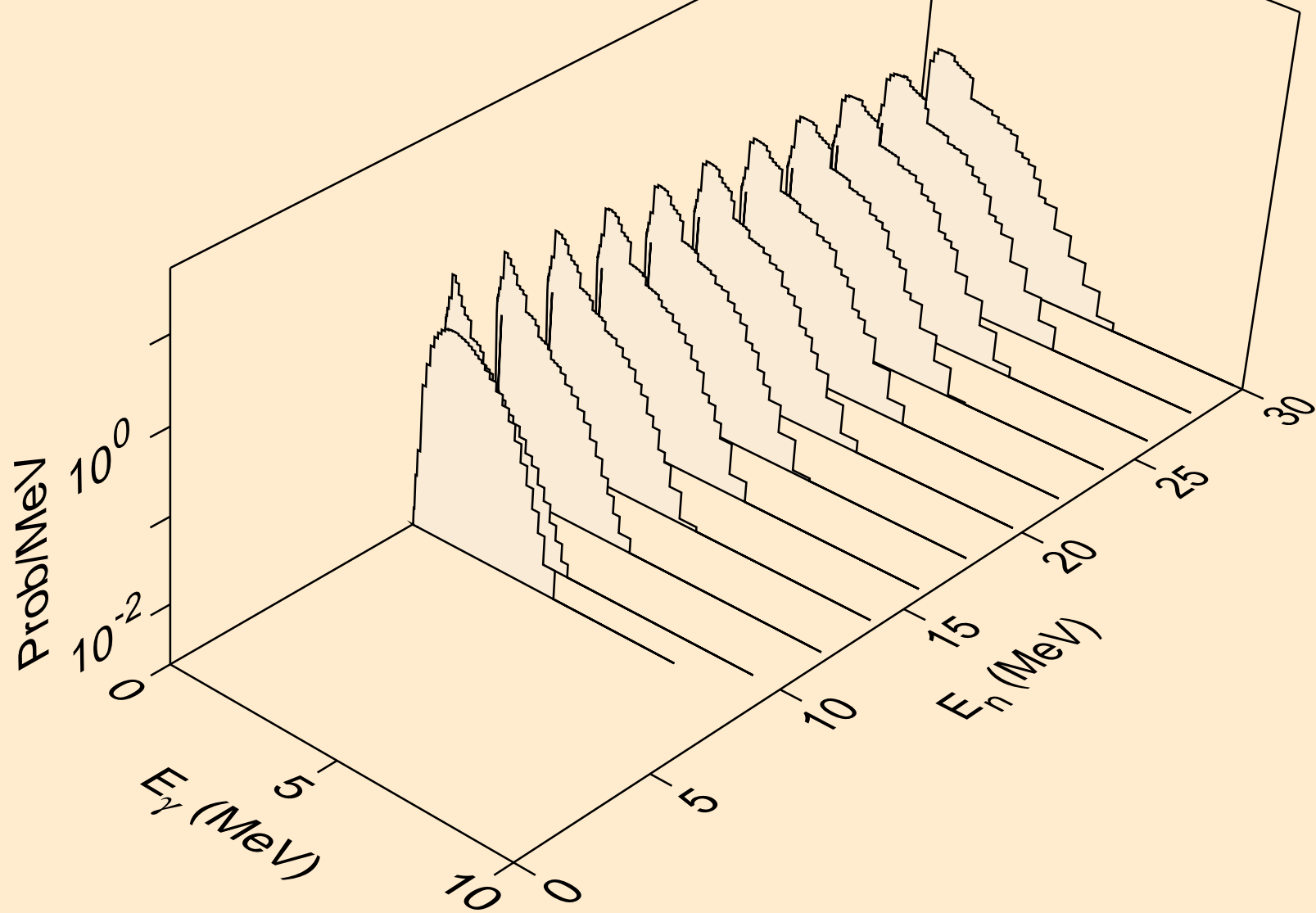

HG181 HELION ACER TENDL-2021 LIBRARY; T=0.K  
Photon emission for (n,t2a)

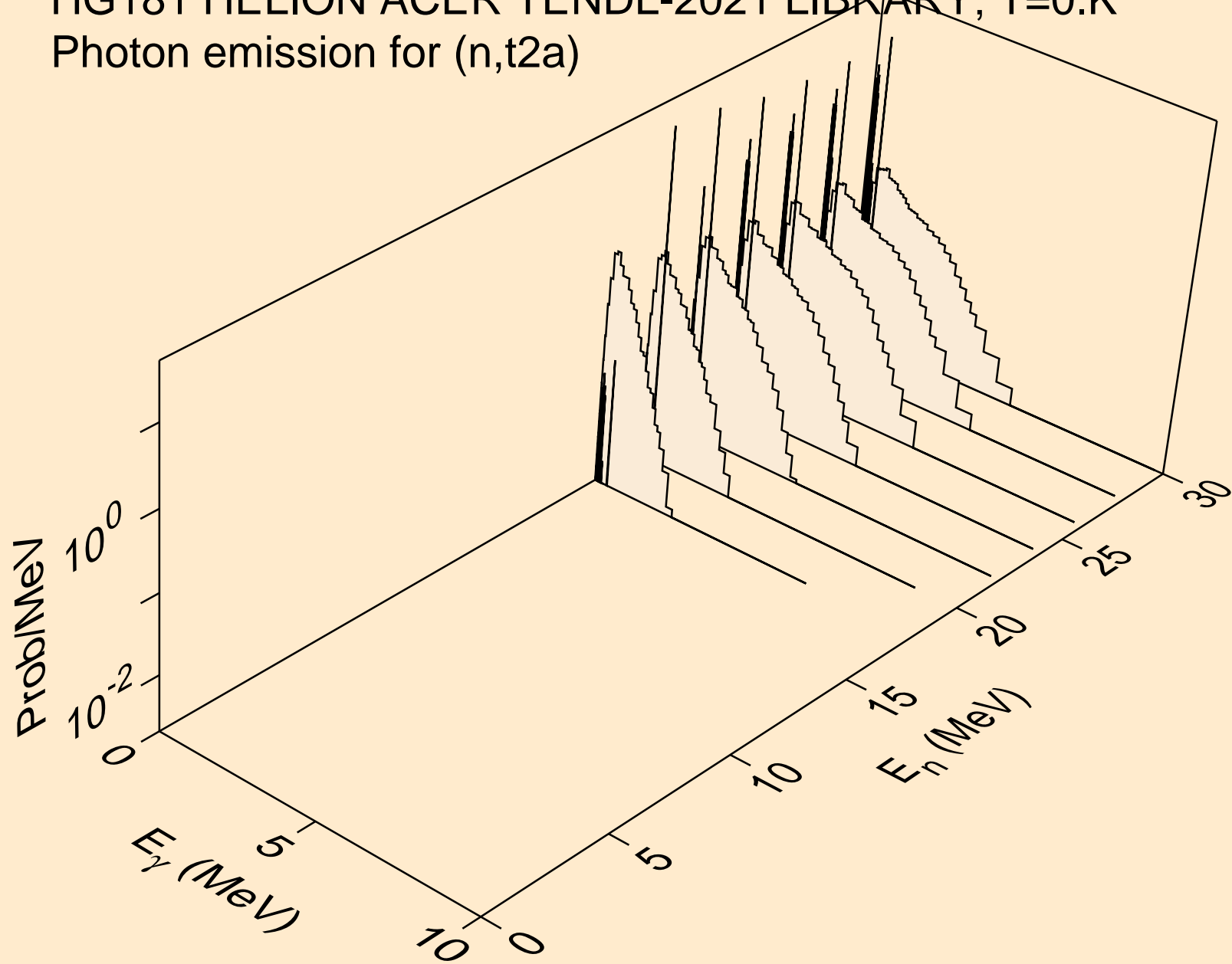

HG181 HELION ACER TENDL-2021 LIBRARY; T=0.K  
Photon emission for (n,pd)

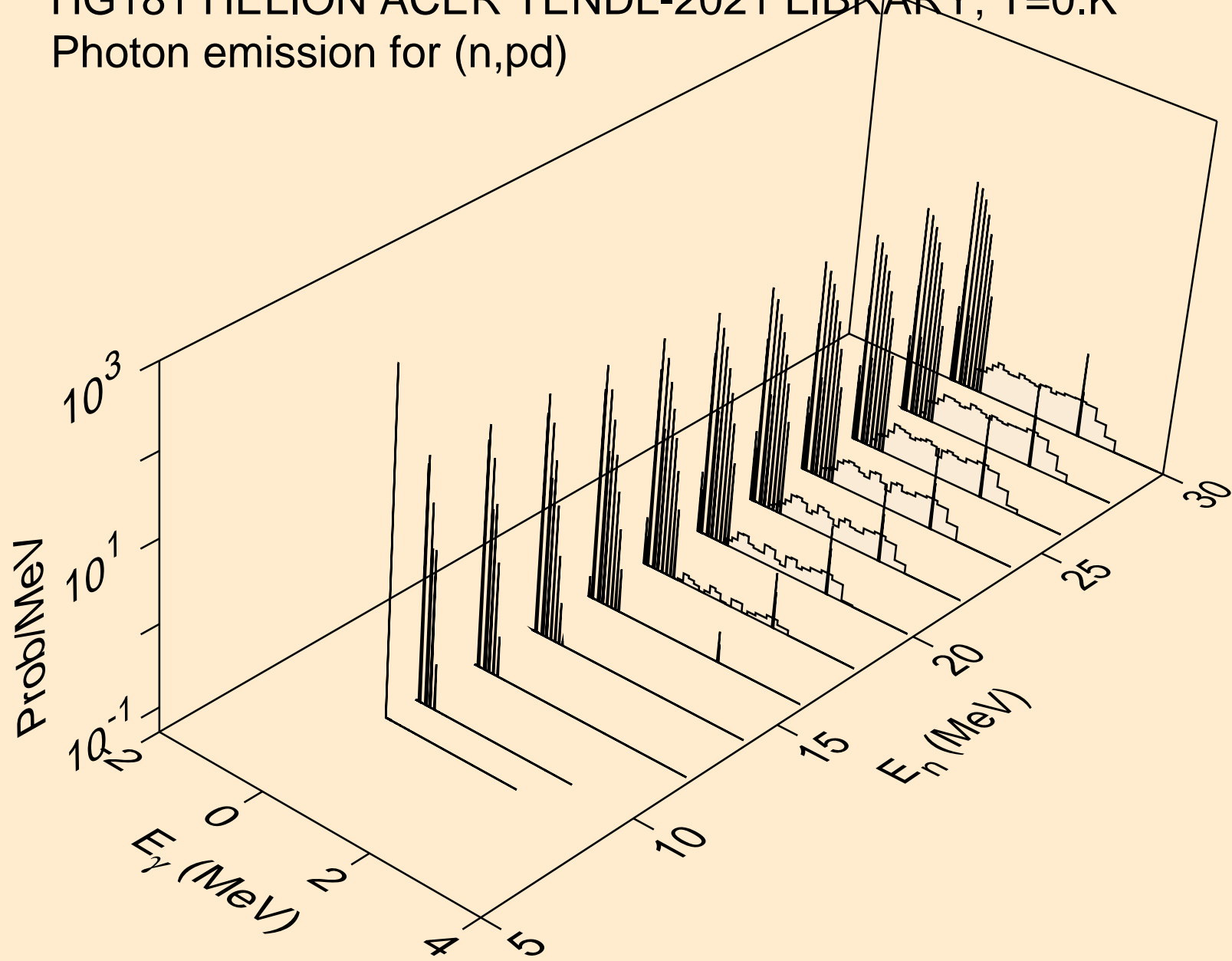

HG181 HELION ACER TENDL-2021 LIBRARY; T=0.K  
Photon emission for (n,pt)

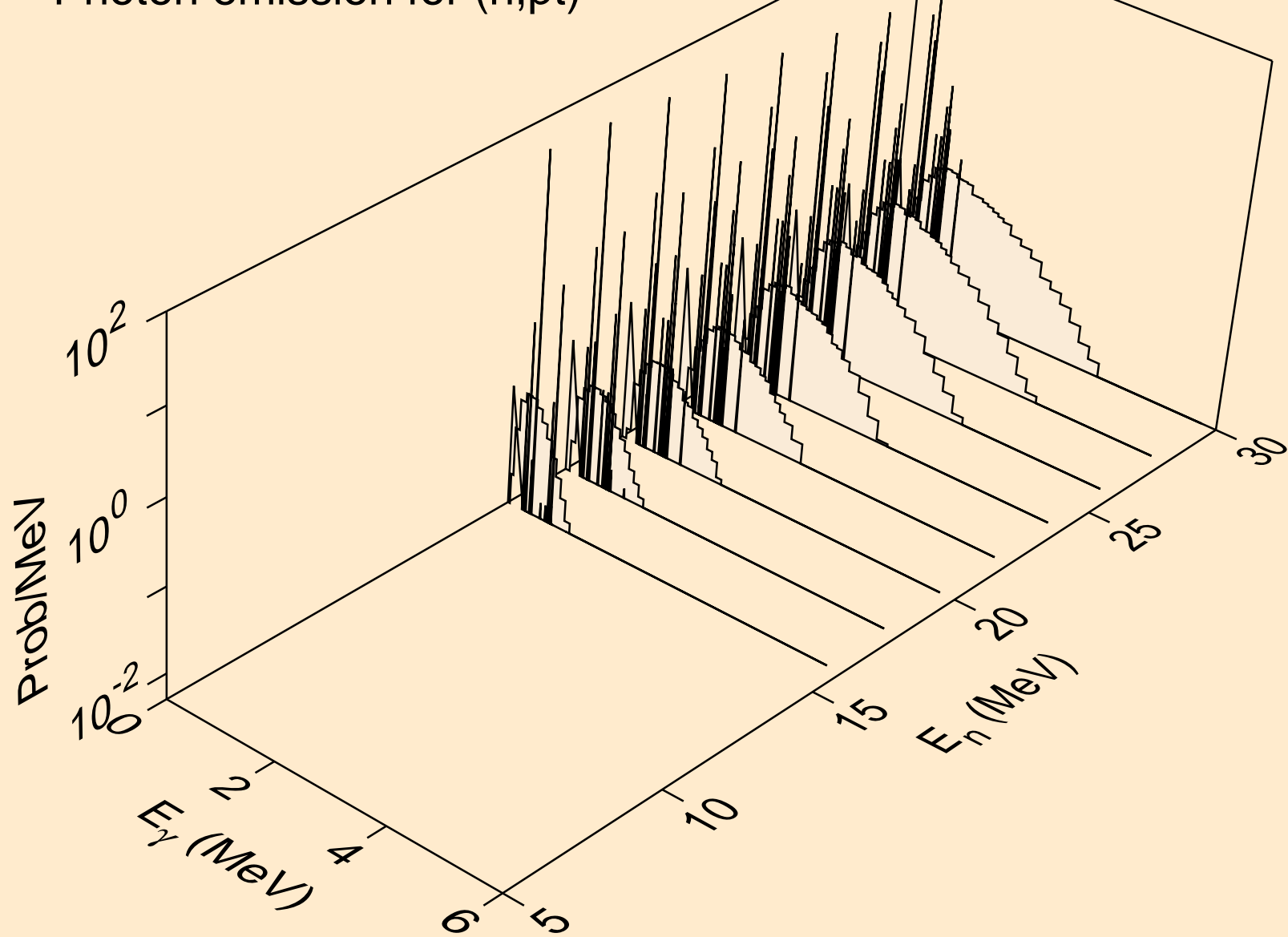

HG181 HELION ACER TENDL-2021 LIBRARY; T=0.K  
Photon emission for (n,da)

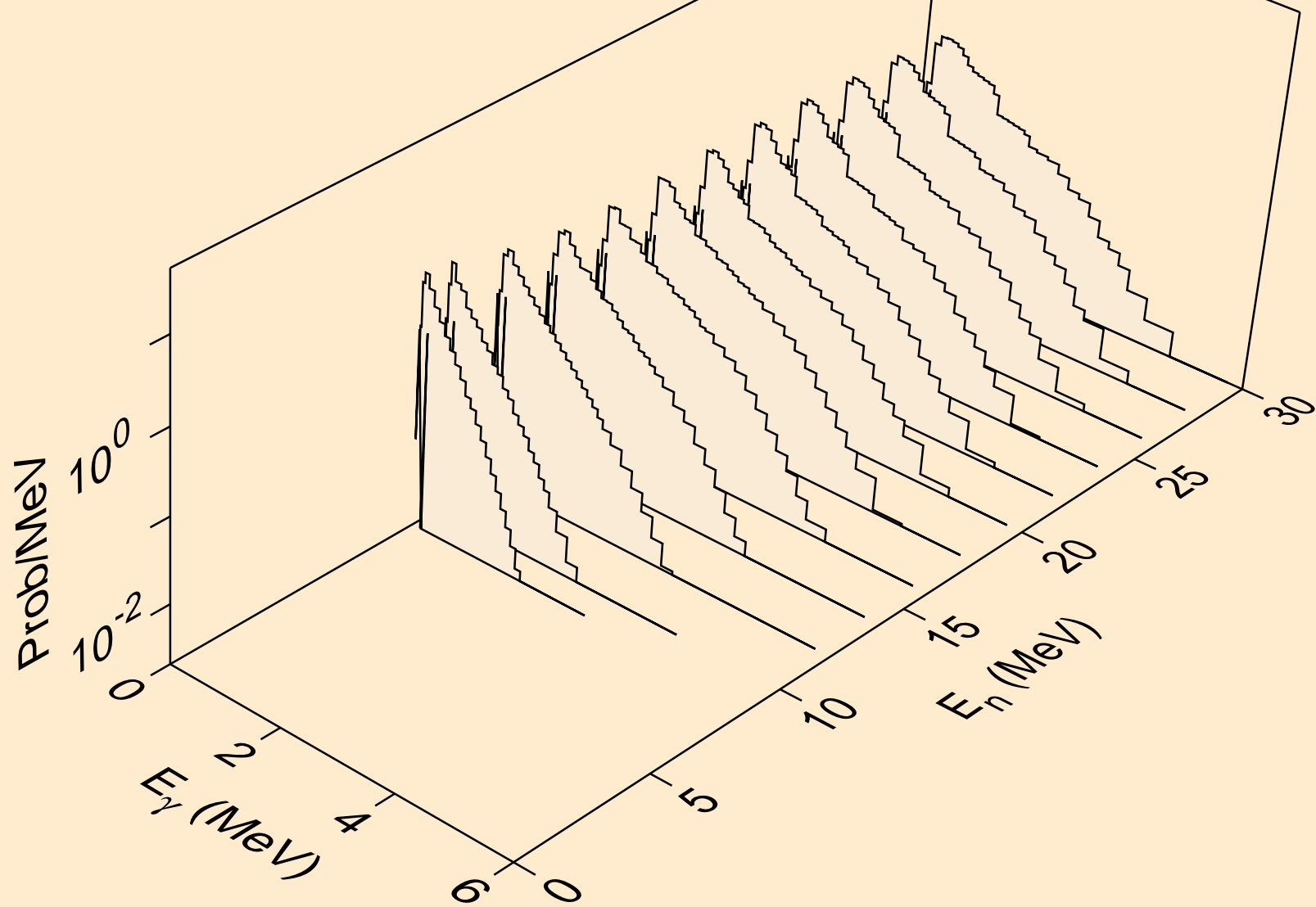

# HG181 HELION ACER TENDL-2021 LIBRARY; T=0.K

## Particle heating contributions

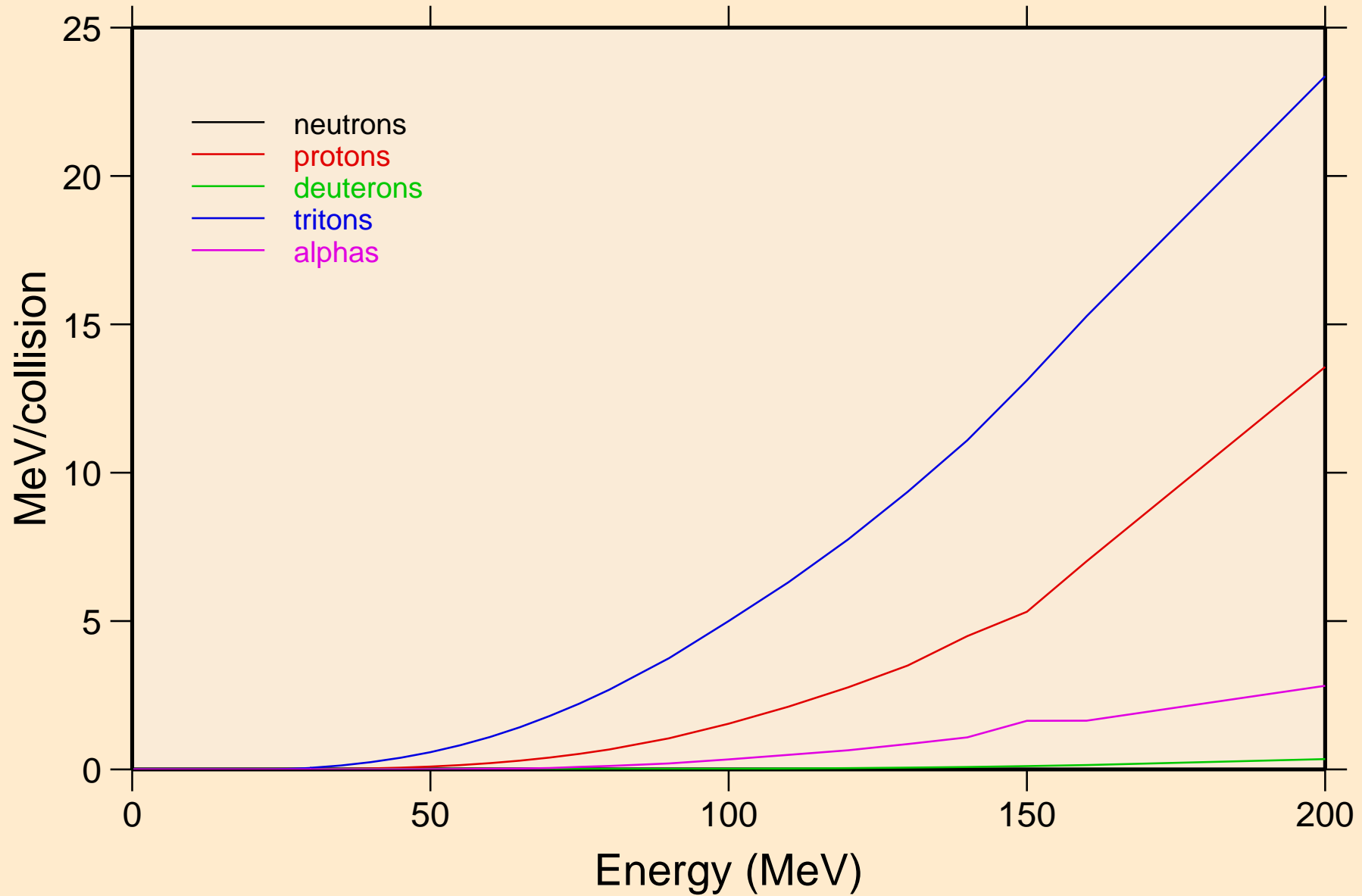



HG181 HELION ACER TENDL-2021 LIBRARY; T=0.K  
Recoil Heating

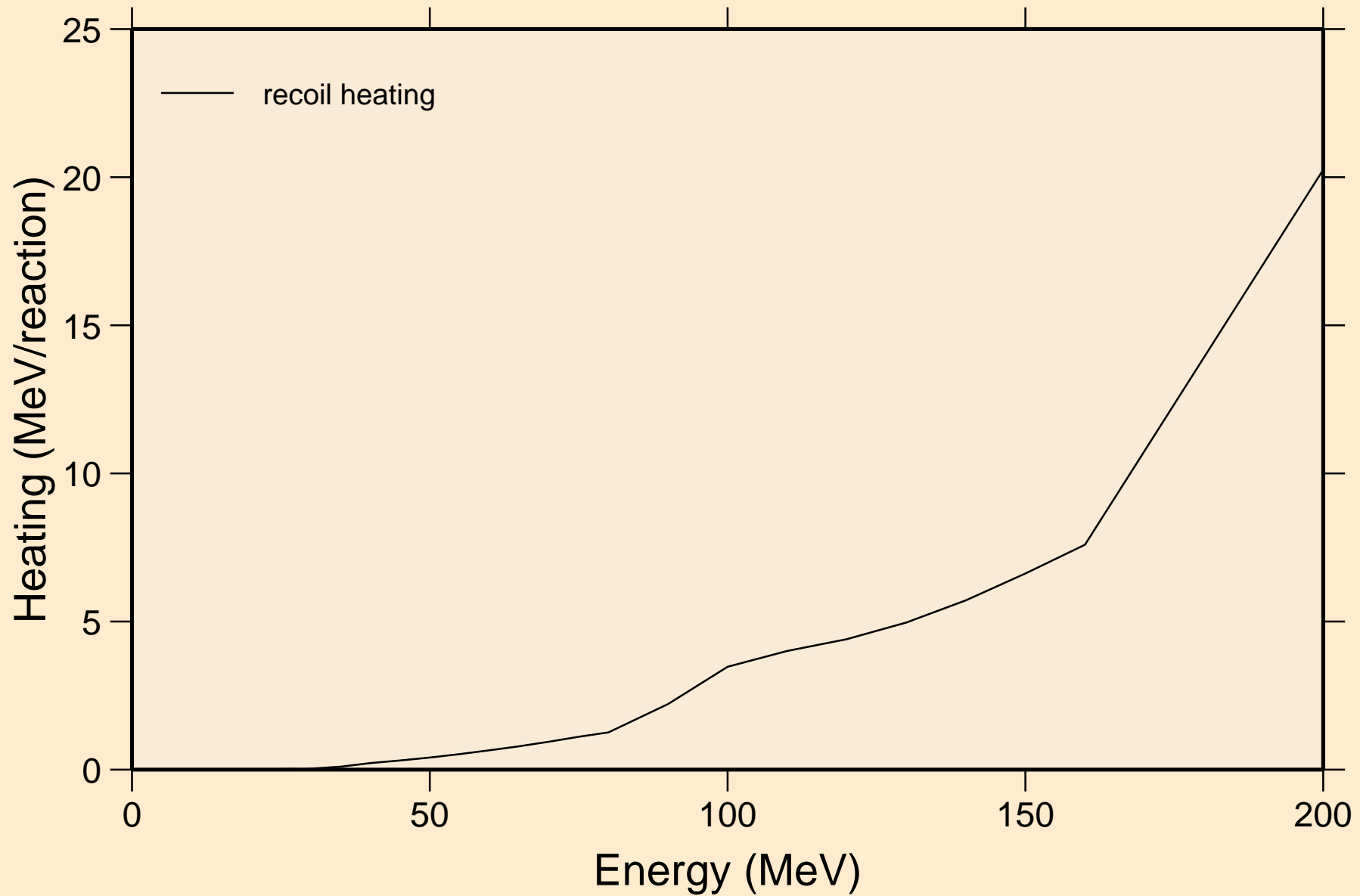

HG181 HELION ACER TENDL-2021 LIBRARY; T=0.K  
Particle production cross sections

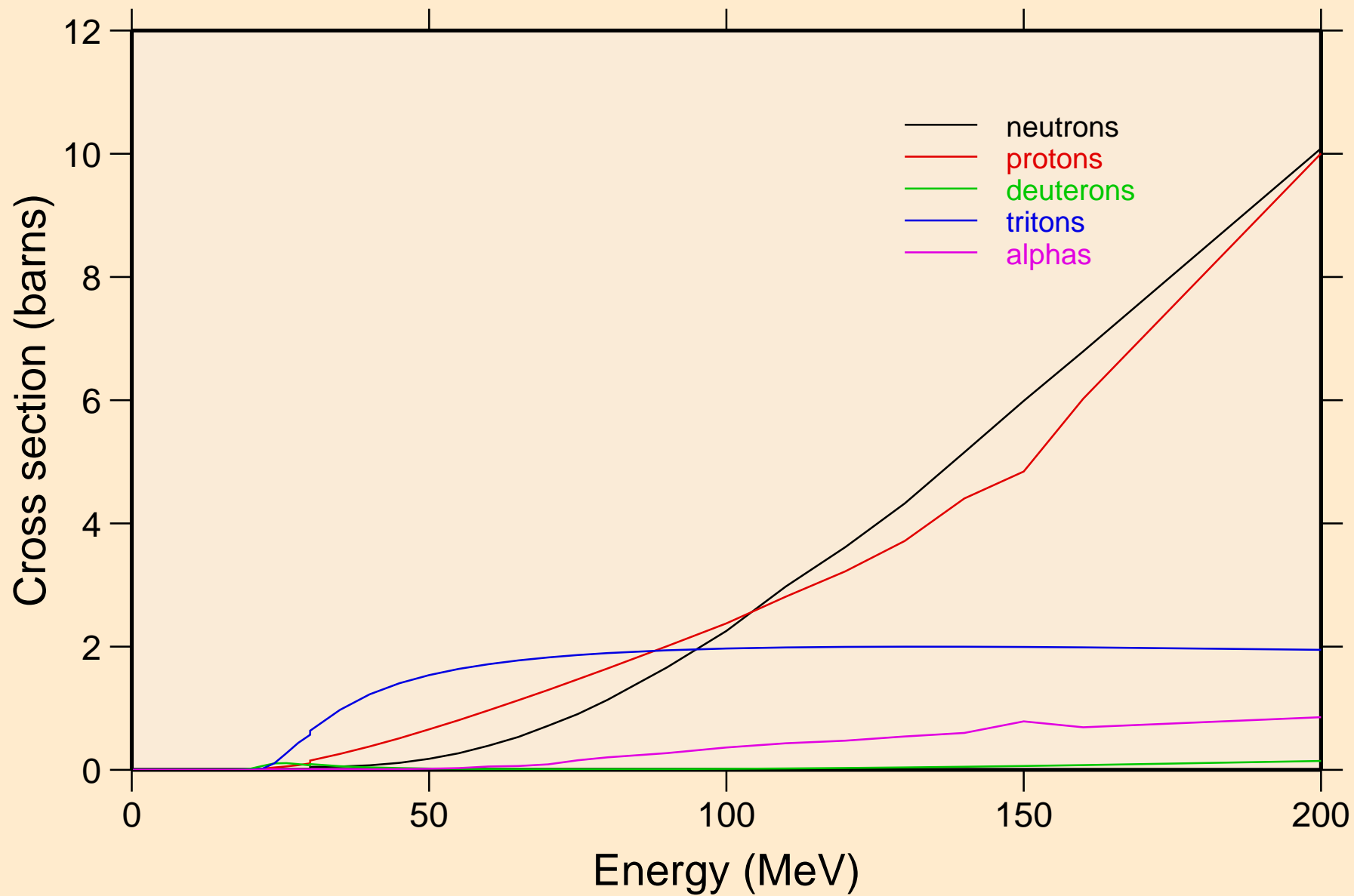

HG181 HELION ACER TENDL-2021 LIBRARY; T=0.K  
neutrons from (s,n)

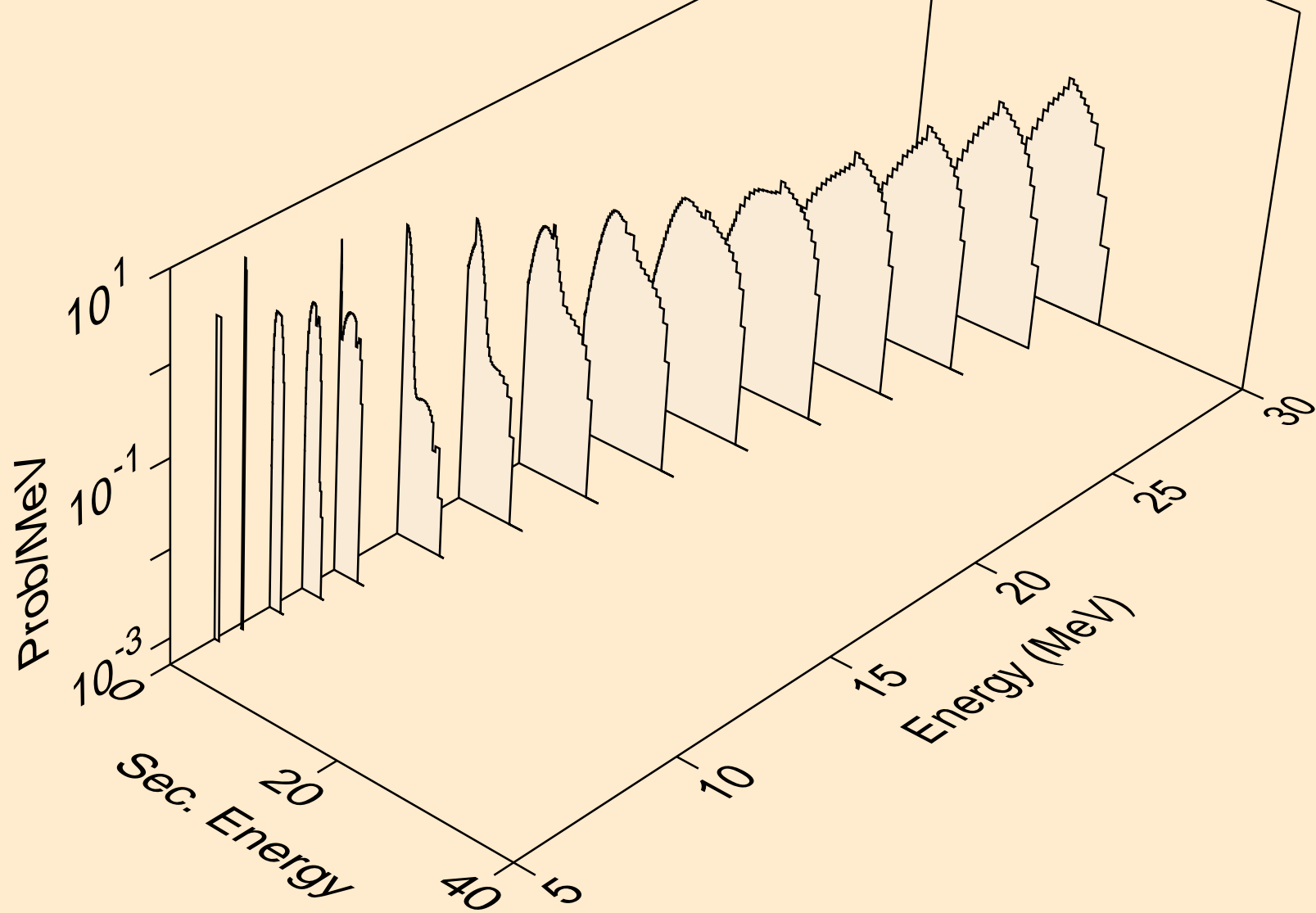

HG181 HELION ACER TENDL-2021 LIBRARY; T=0.K  
neutrons from (s,x)

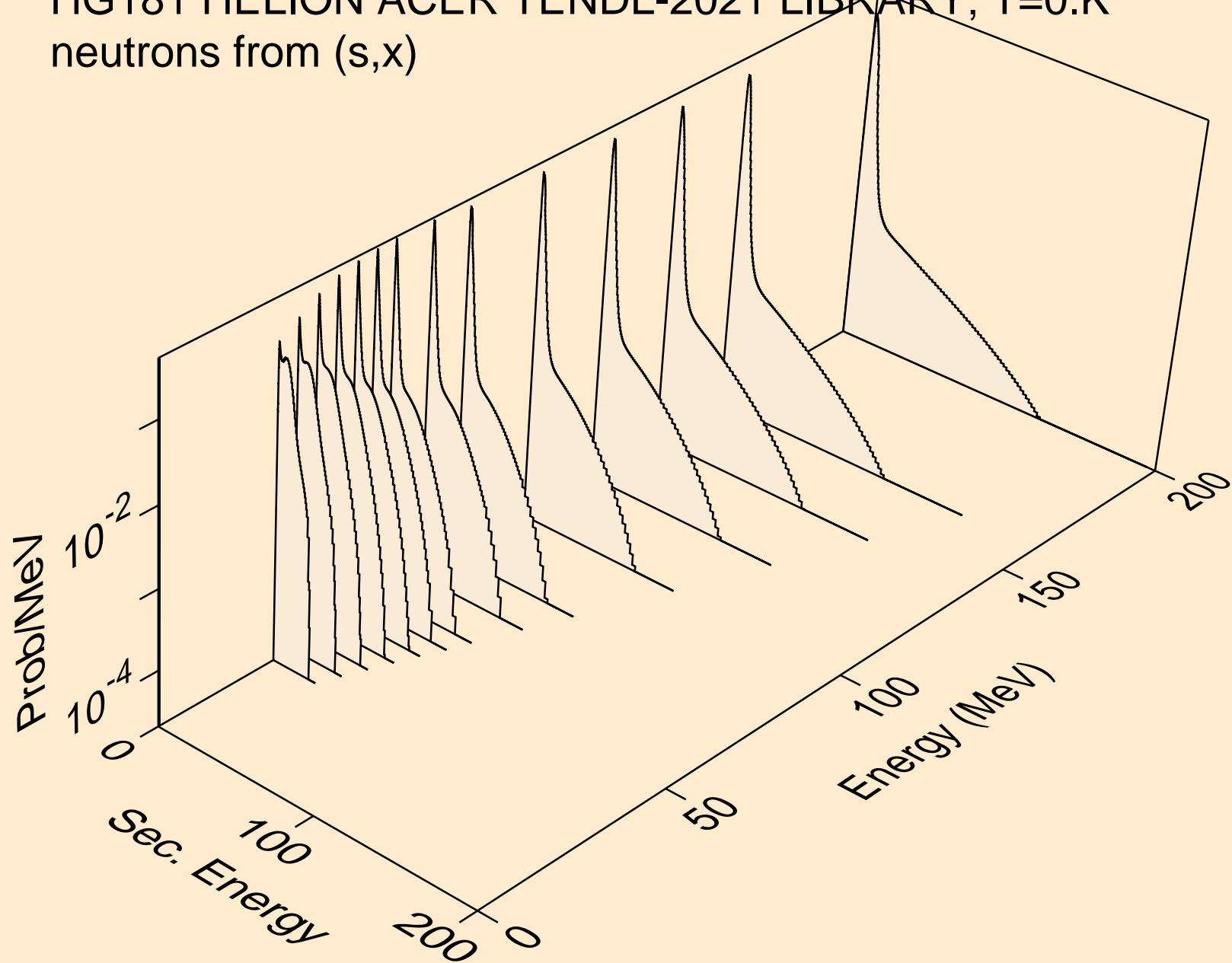

HG181 HELION ACER TENDL-2021 LIBRARY; T=0.K  
neutrons from (s,2n)

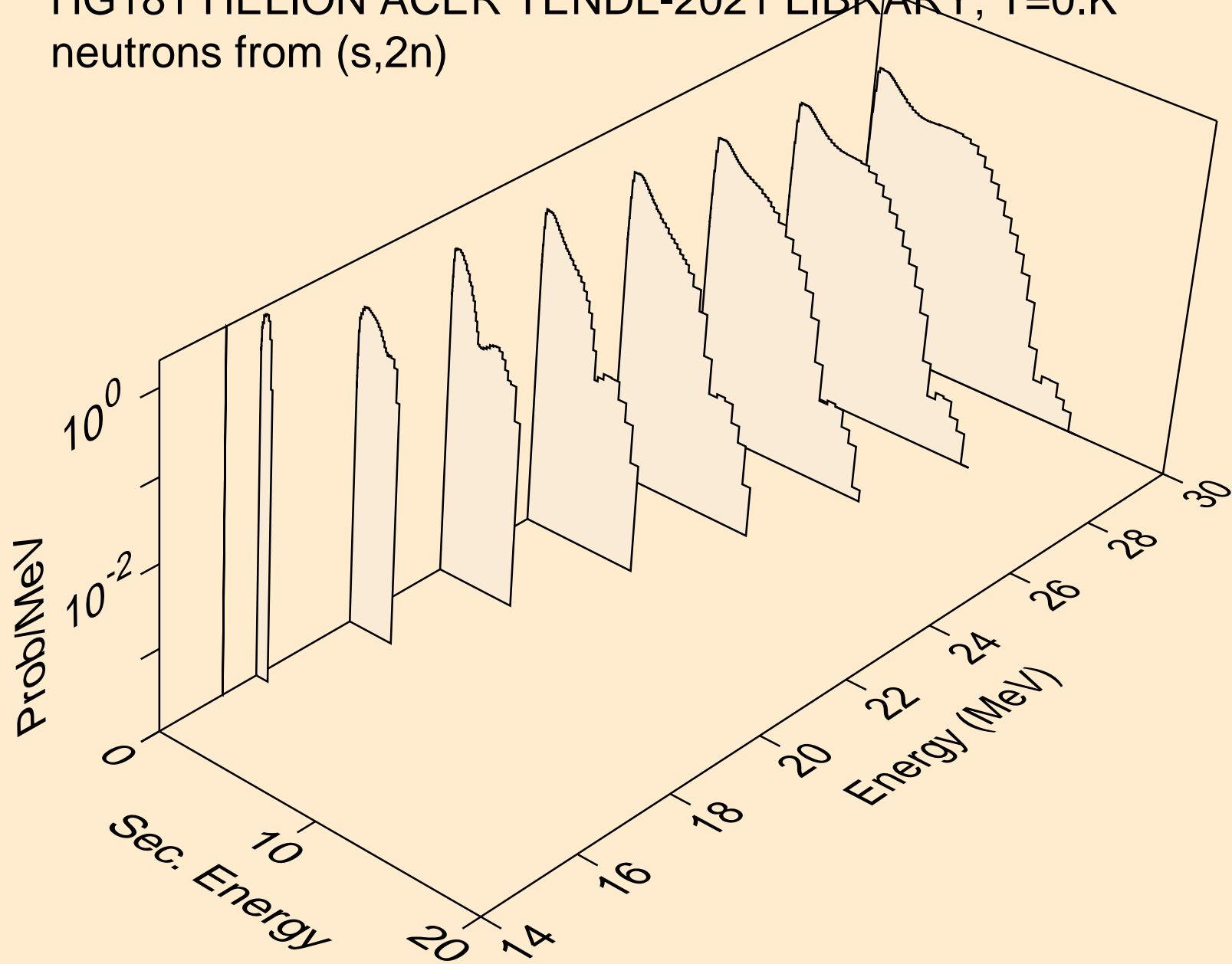

HG181 HELION ACER TENDL-2021 LIBRARY; T=0.K  
neutrons from (s,3n)

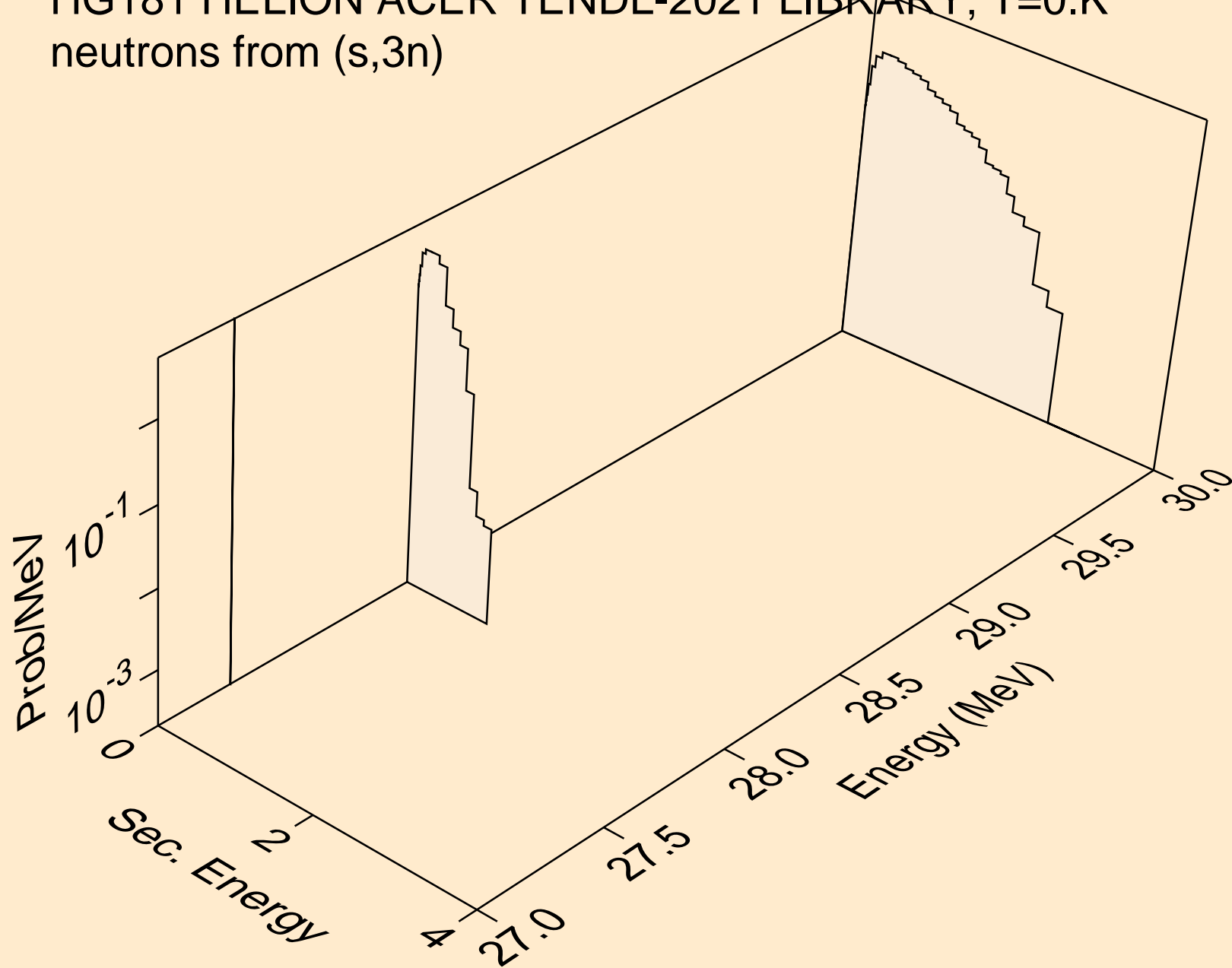

HG181 HELION ACER TENDL-2021 LIBRARY; T=0.K  
neutrons from (s,n\*)a

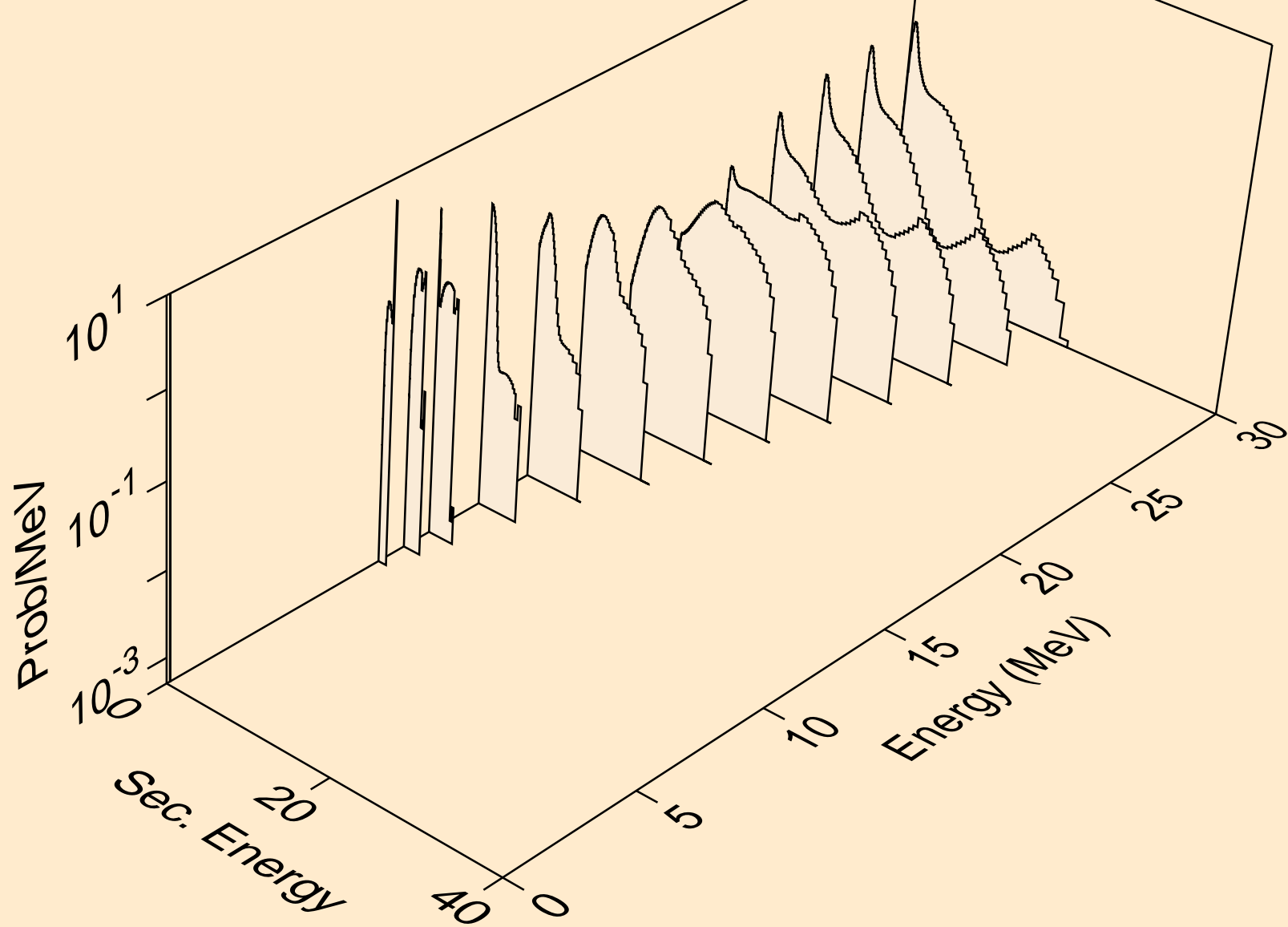

HG181 HELION ACER TENDL-2021 LIBRARY; T=0.K  
neutrons from (s,2n)a

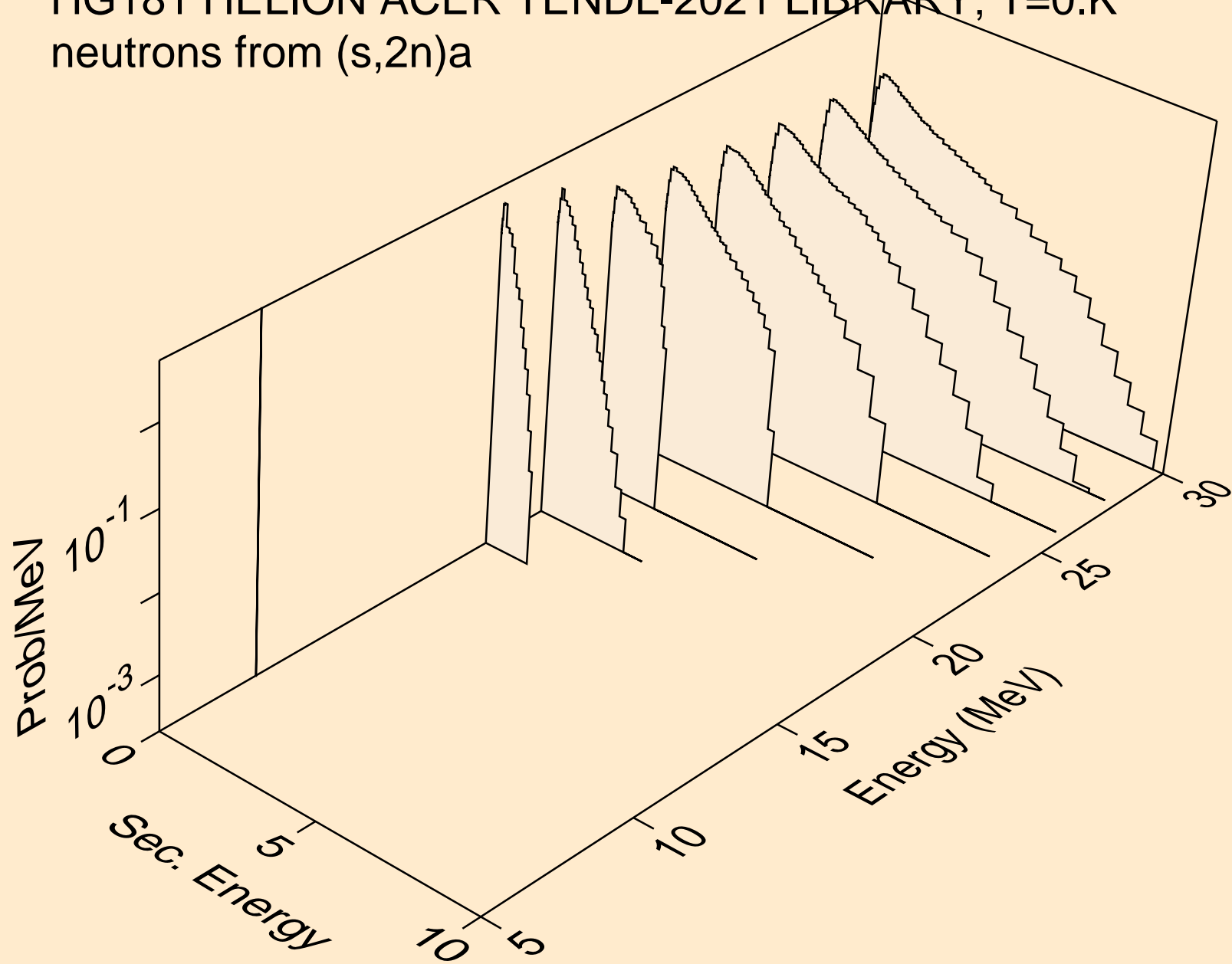



HG181 HELION ACER TENDL-2021 LIBRARY; T=0.K  
neutrons from (s,3n)a

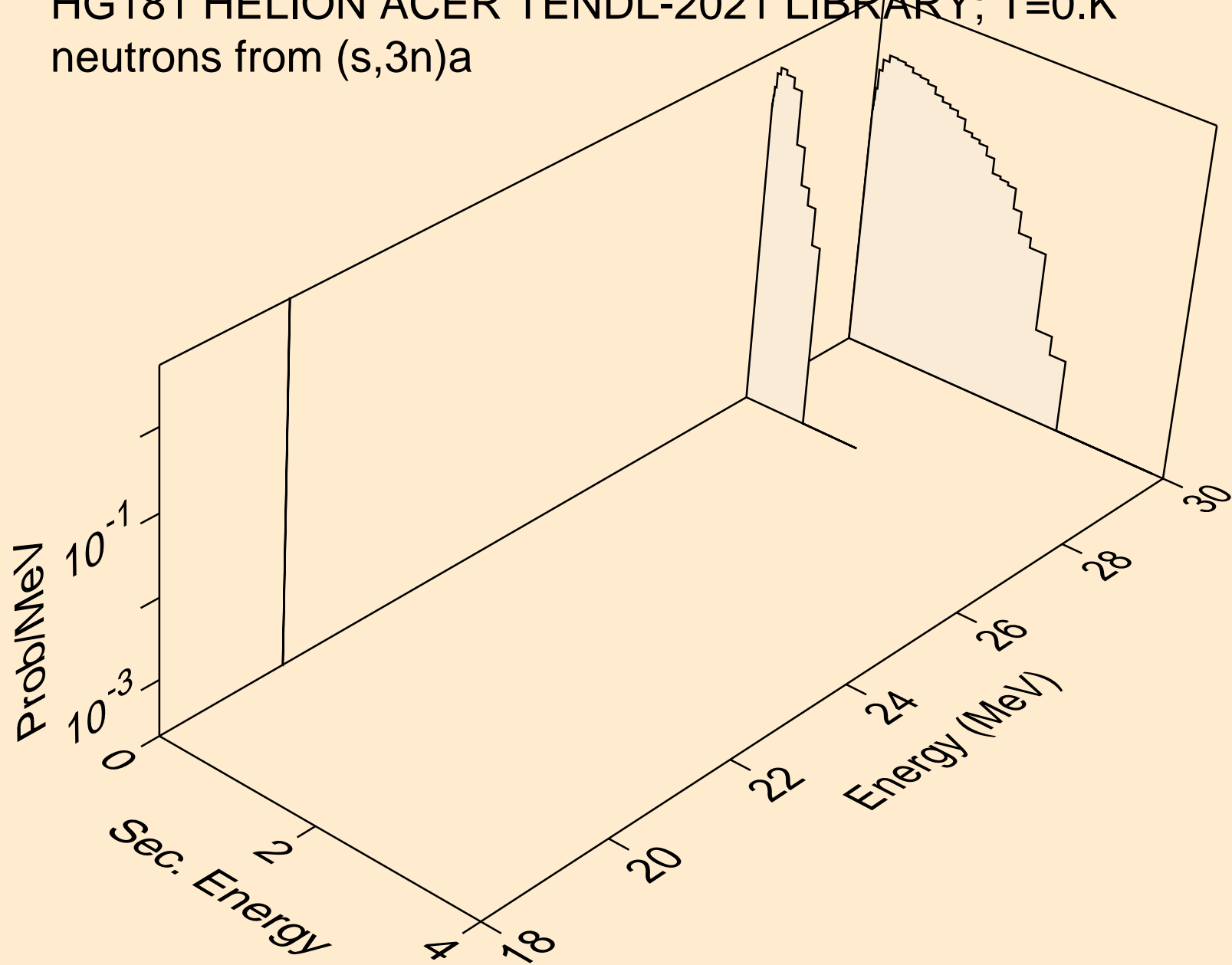

HG181 HELION ACER TENDL-2021 LIBRARY; T=0.K  
neutrons from (s,n\*)p

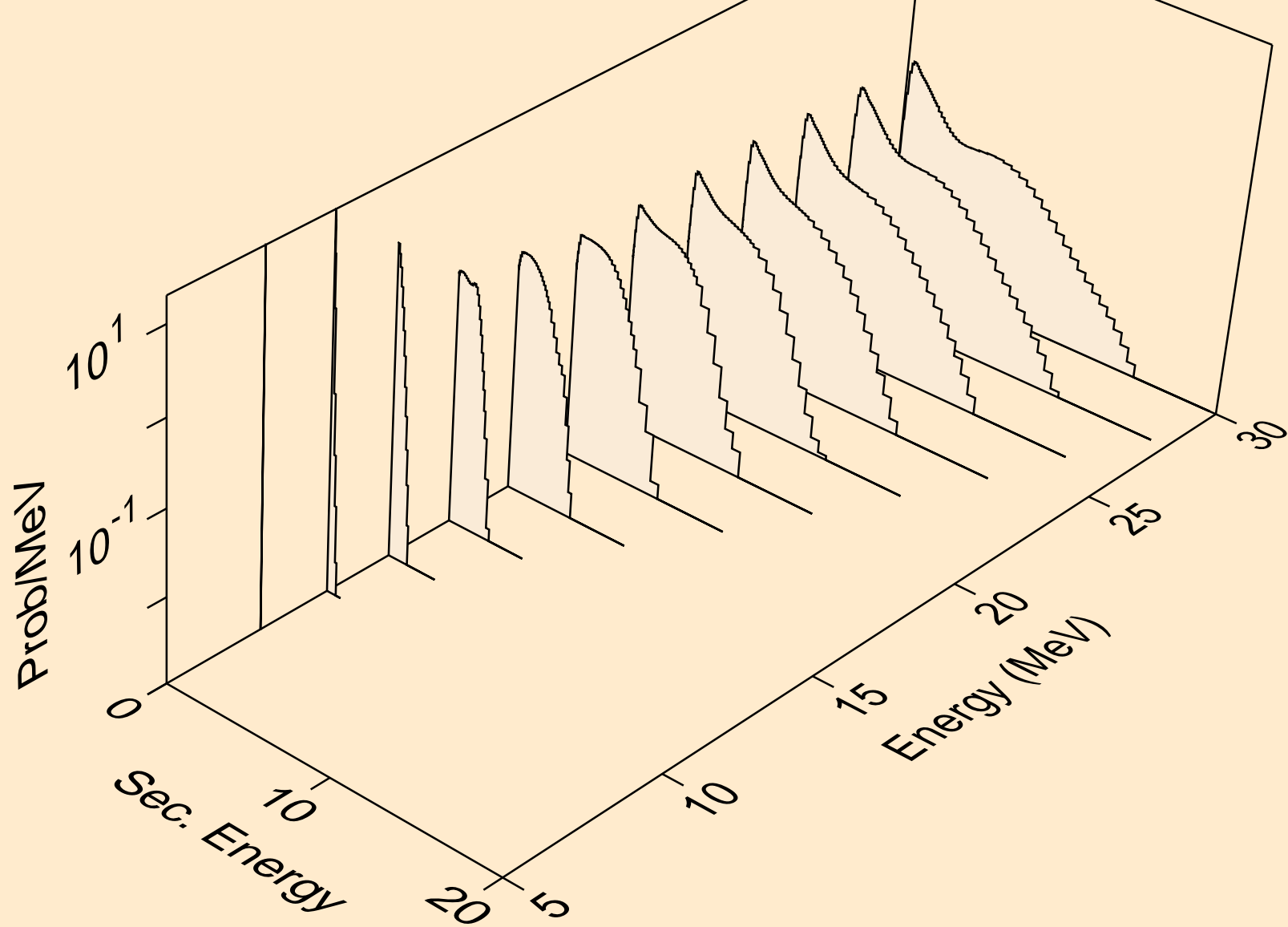

HG181 HELION ACER TENDL-2021 LIBRARY; T=0.K  
neutrons from (s,n\*)2a

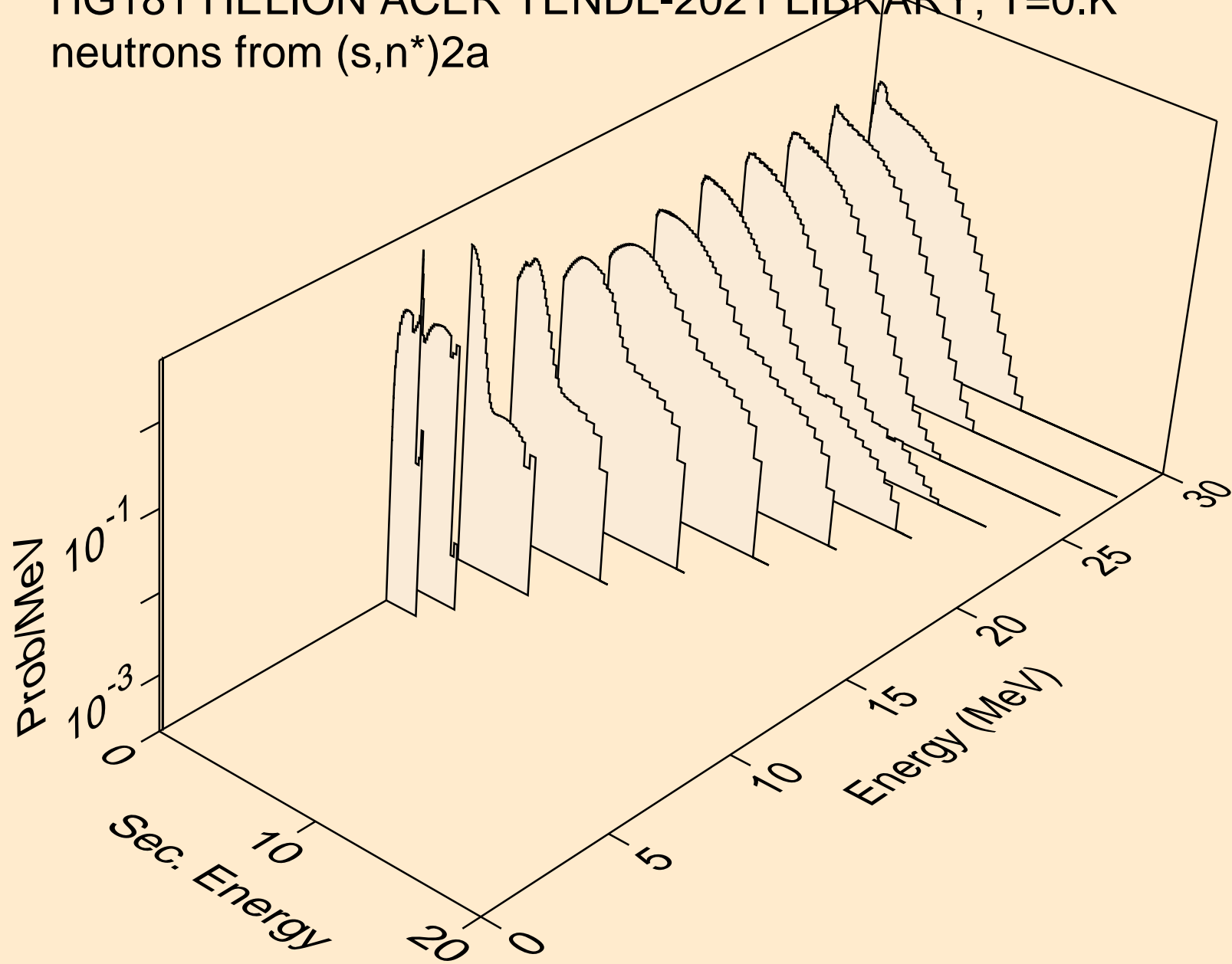

HG181 HELION ACER TENDL-2021 LIBRARY; T=0.K  
neutrons from (s,2n)2a

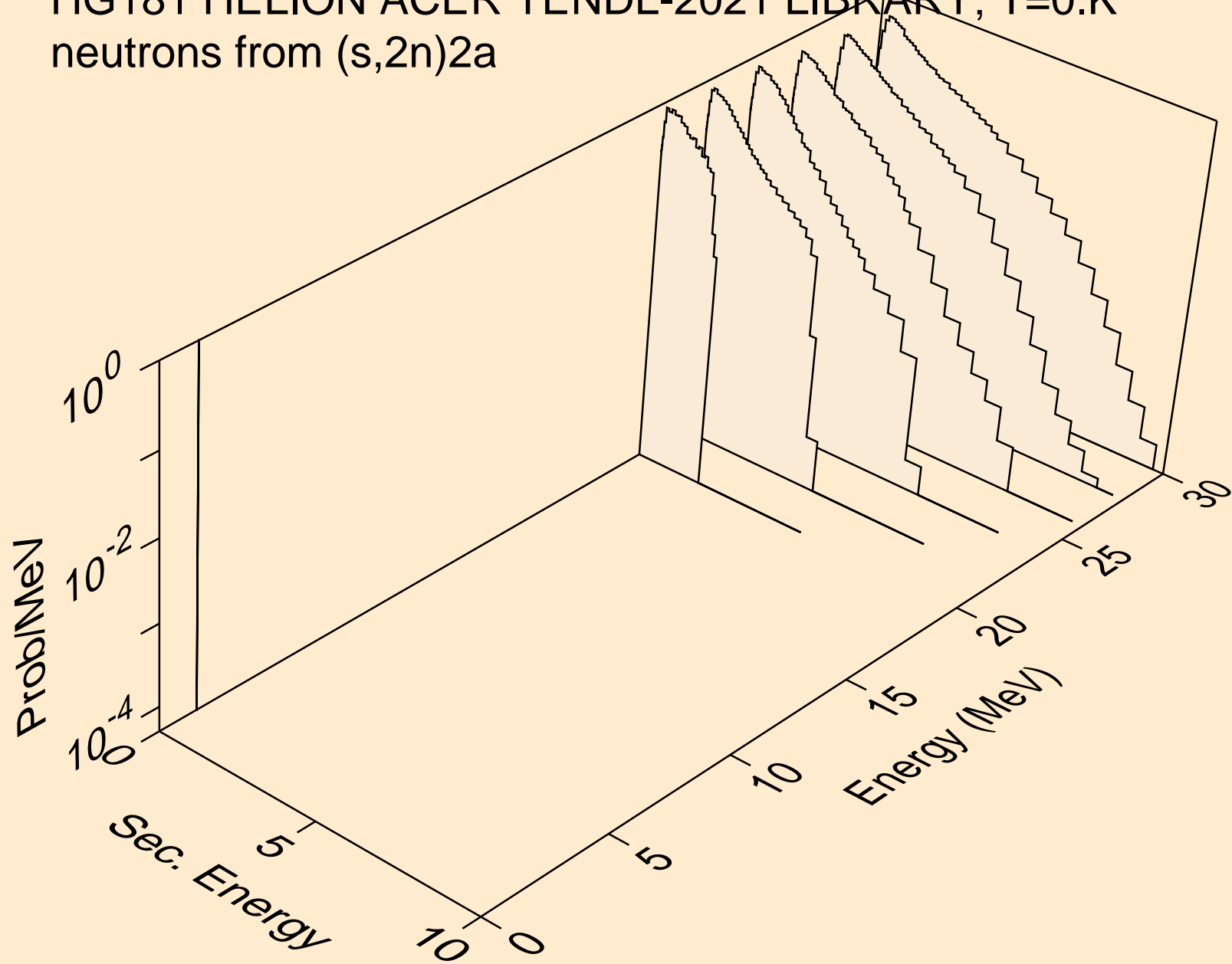

HG181 HELION ACER TENDL-2021 LIBRARY; T=0.K  
neutrons from (s,n\*)d

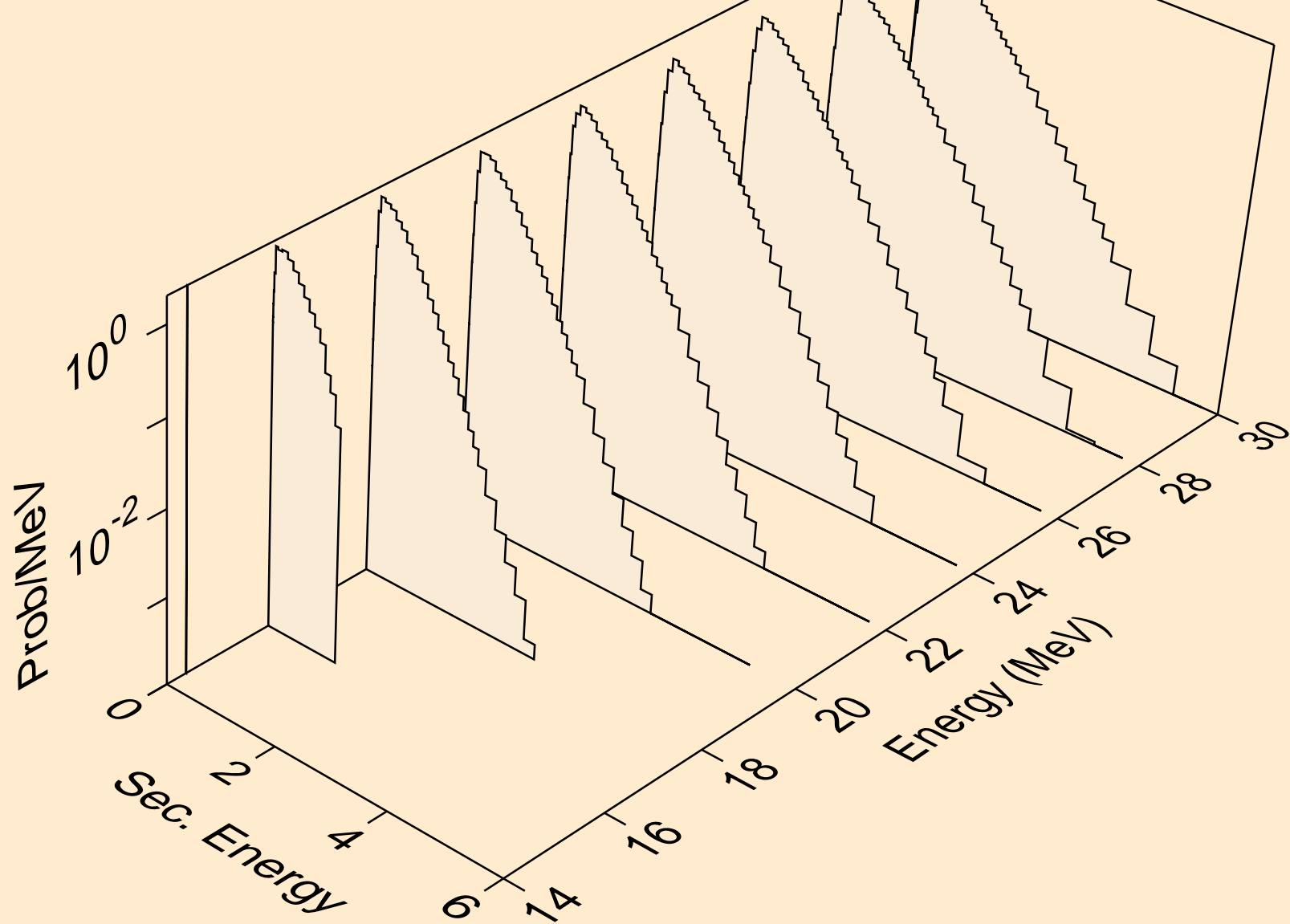

HG181 HELION ACER TENDL-2021 LIBRARY; T=0.K  
neutrons from (s,n\*)t

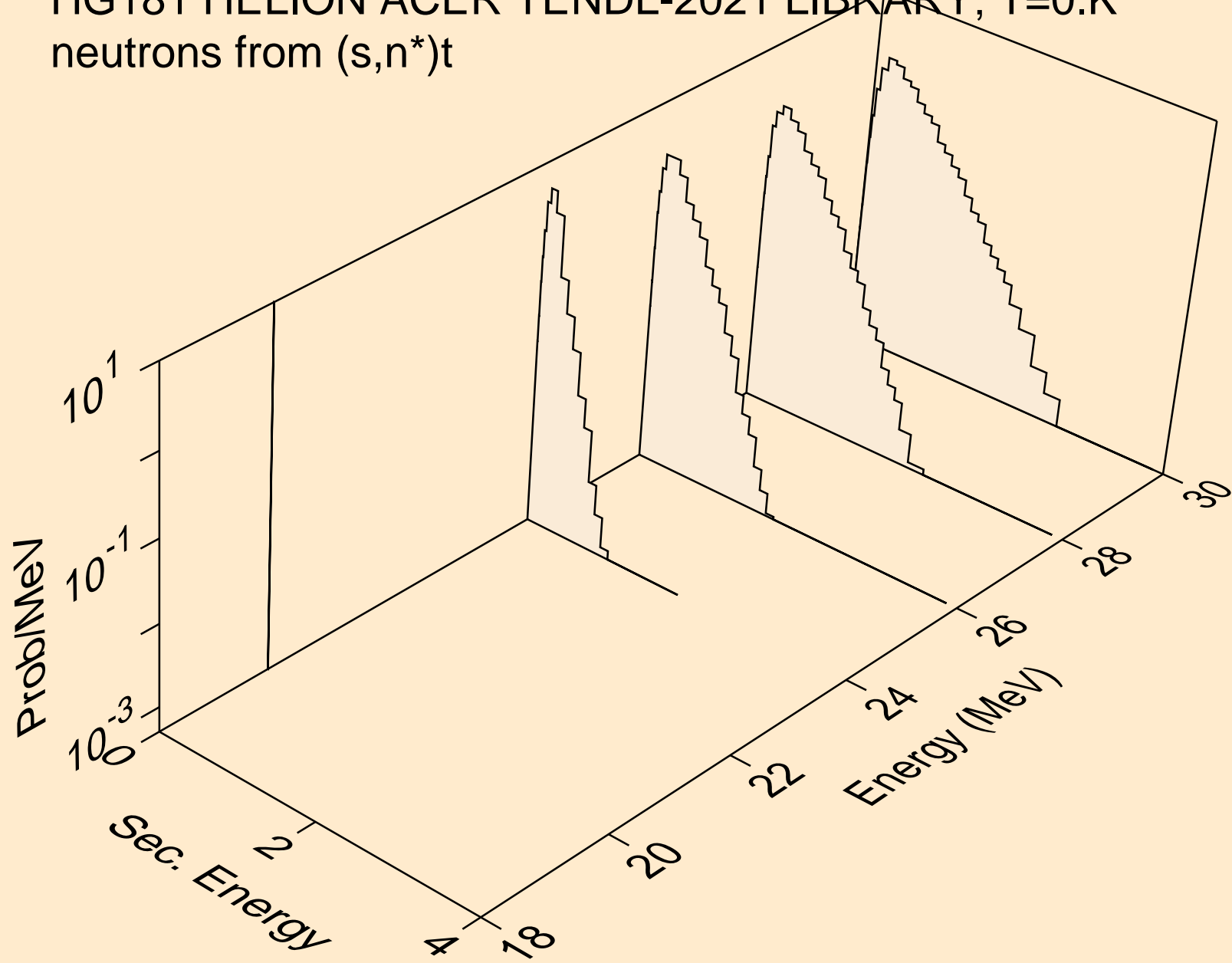

HG181 HELION ACER TENDL-2021 LIBRARY; T=0.K  
neutrons from (s,n\*)he3

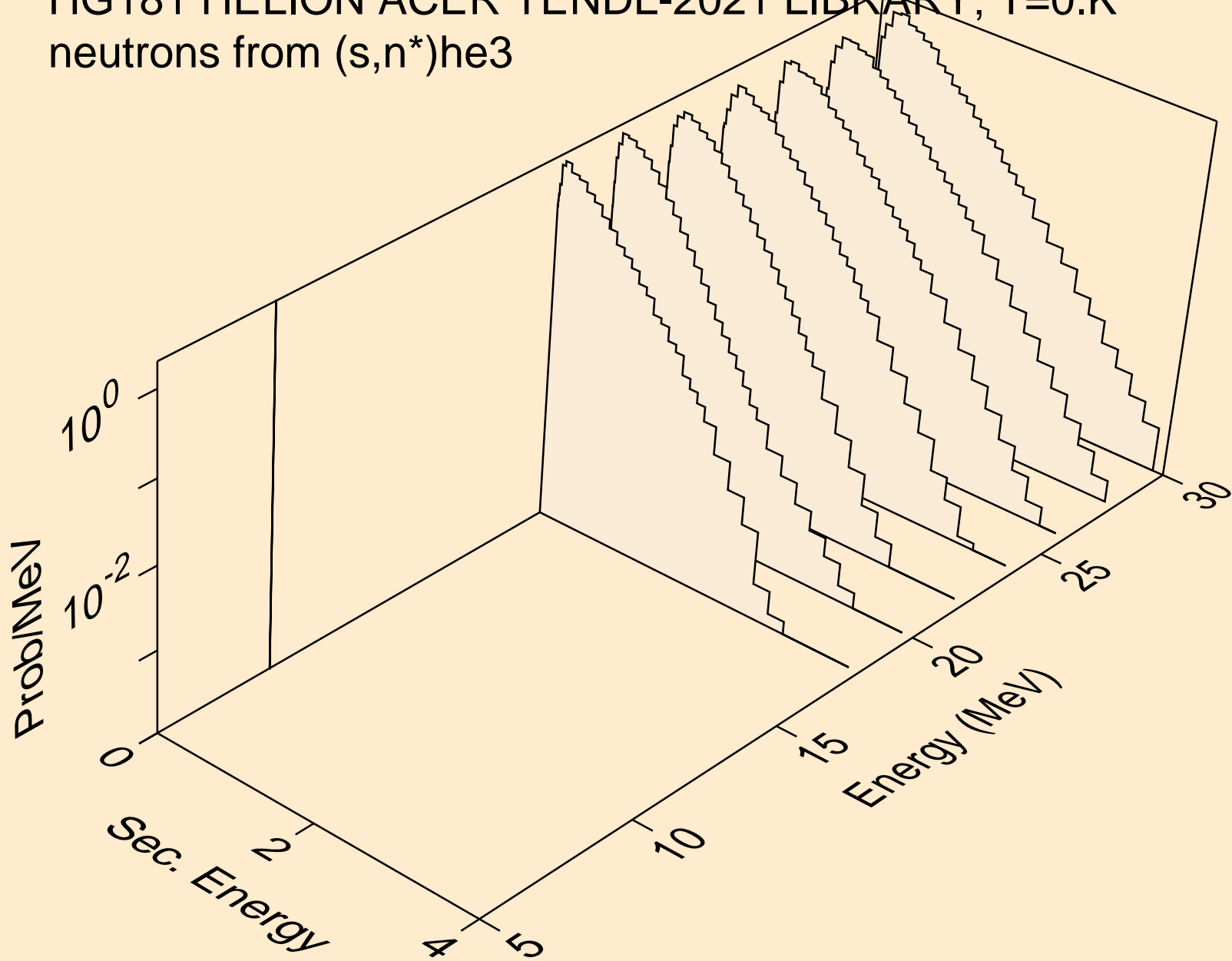

HG181 HELION ACER TENDL-2021 LIBRARY; T=0.K  
neutrons from (s,2np)

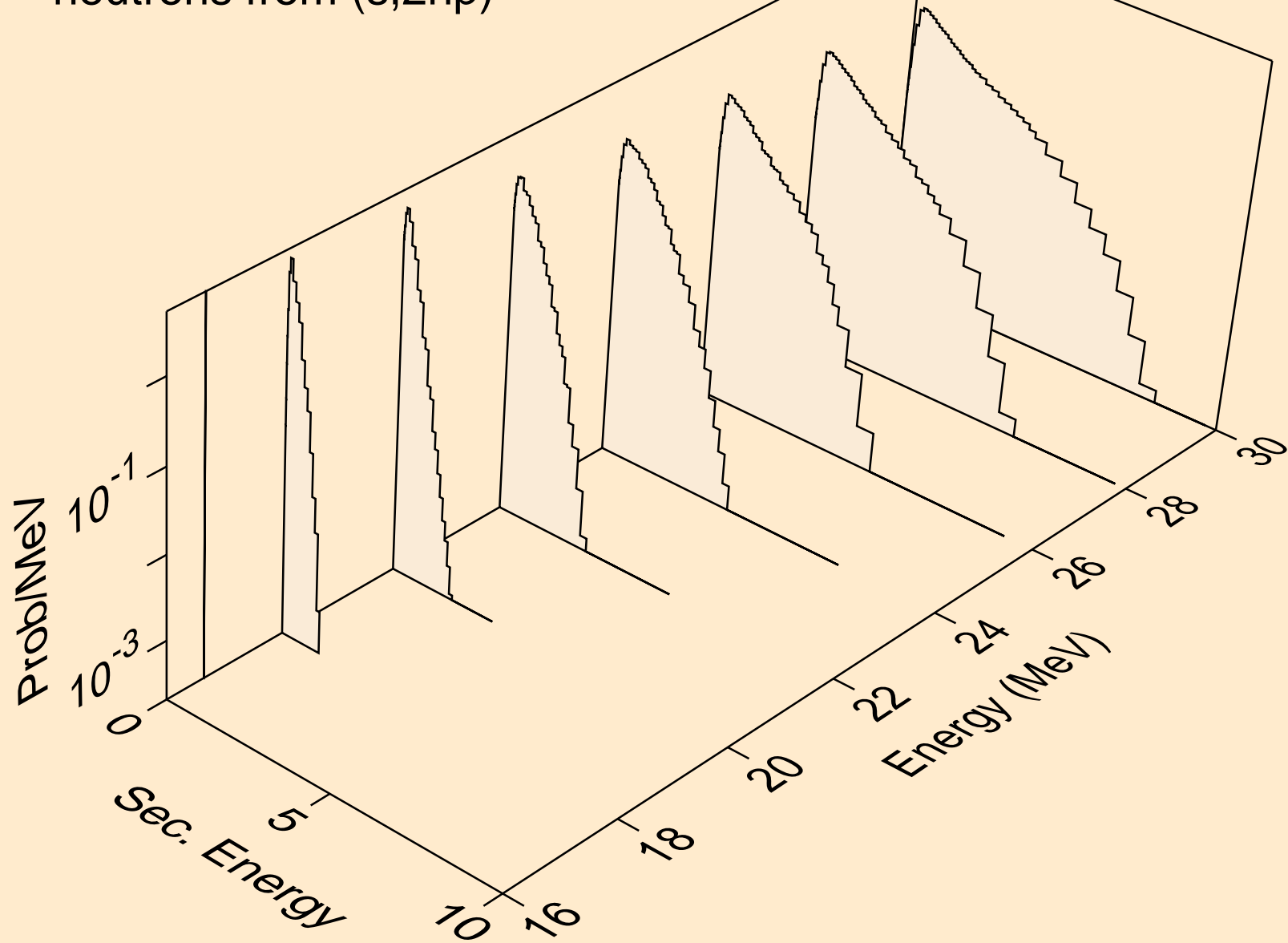



HG181 HELION ACER TENDL-2021 LIBRARY; T=0.K  
neutrons from (s,2np)

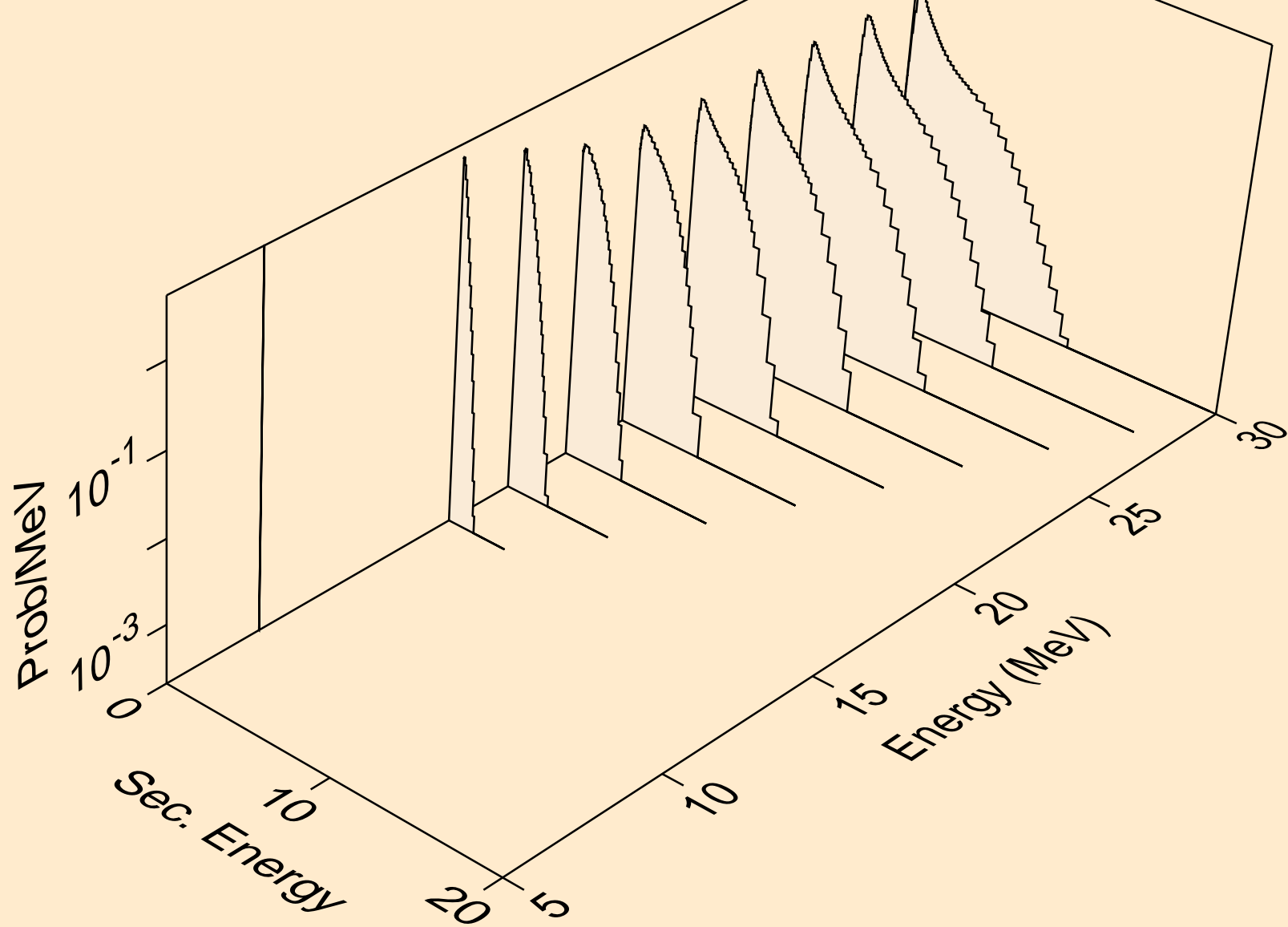

HG181 HELION ACER TENDL-2021 LIBRARY; T=0.K  
neutrons from (s,npa)

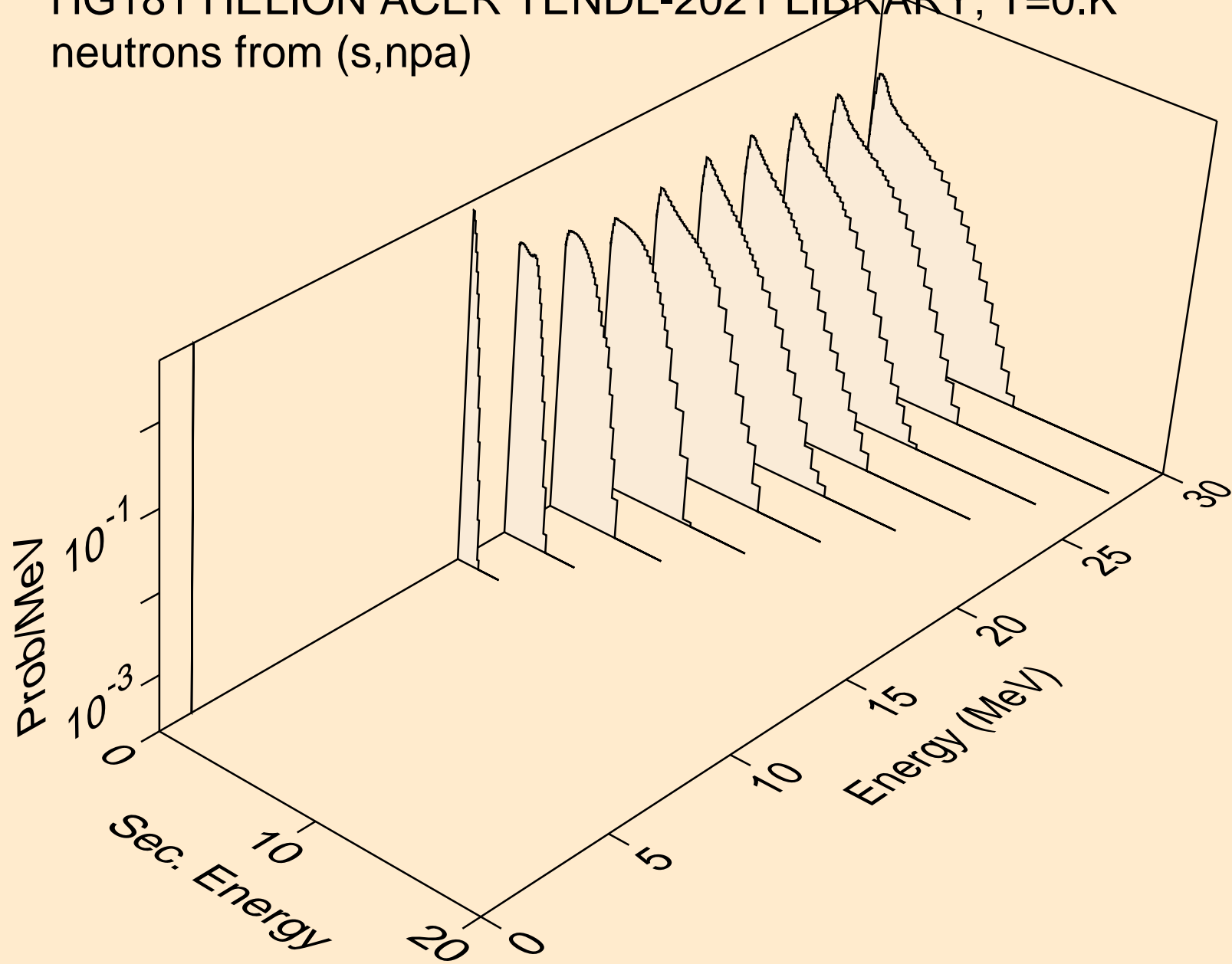

HG181 HELION ACER TENDL-2021 LIBRARY; T=0.K  
protons from (s,x)

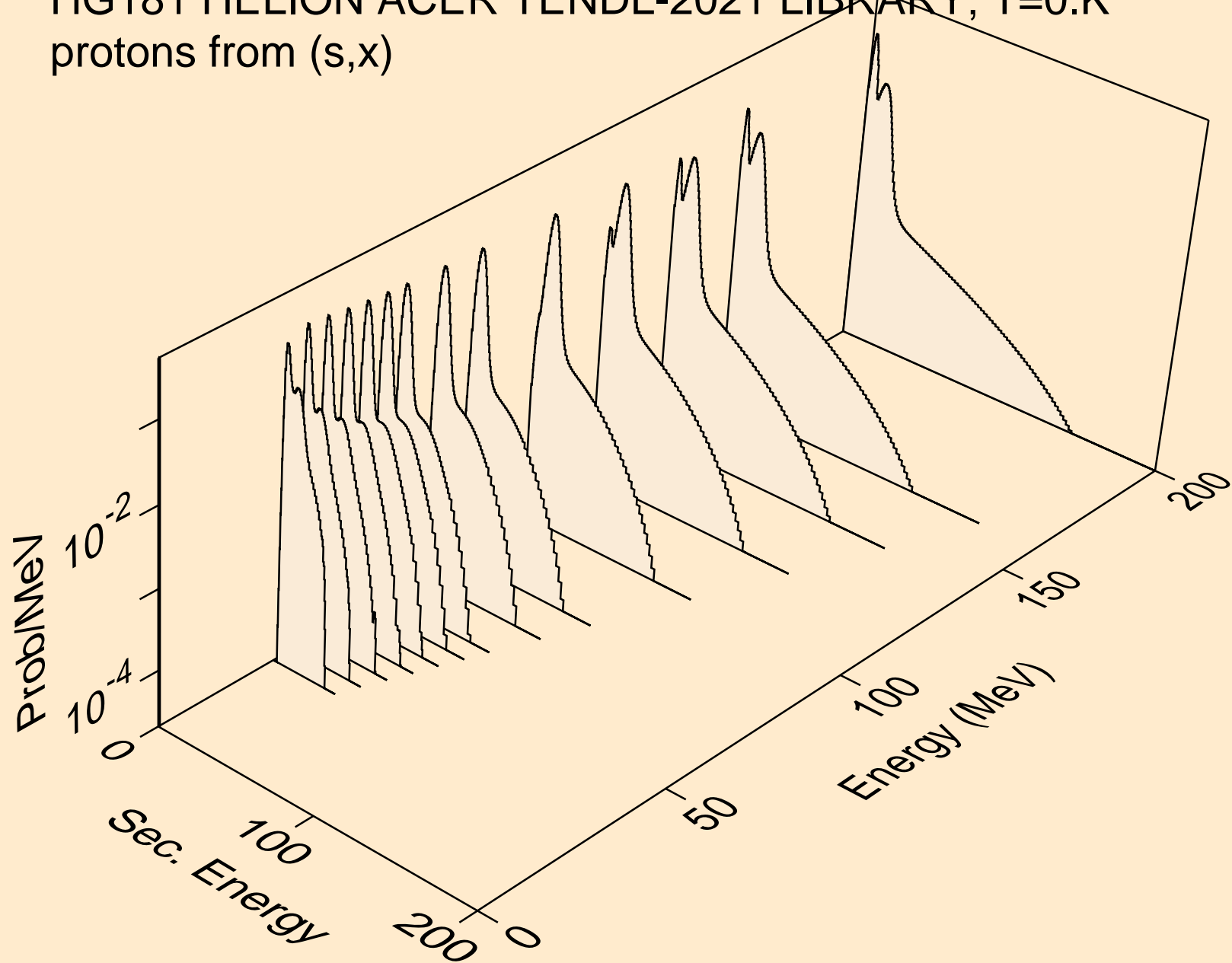

HG181 HELION ACER TENDL-2021 LIBRARY; T=0.K  
protons from (s,n\*)p

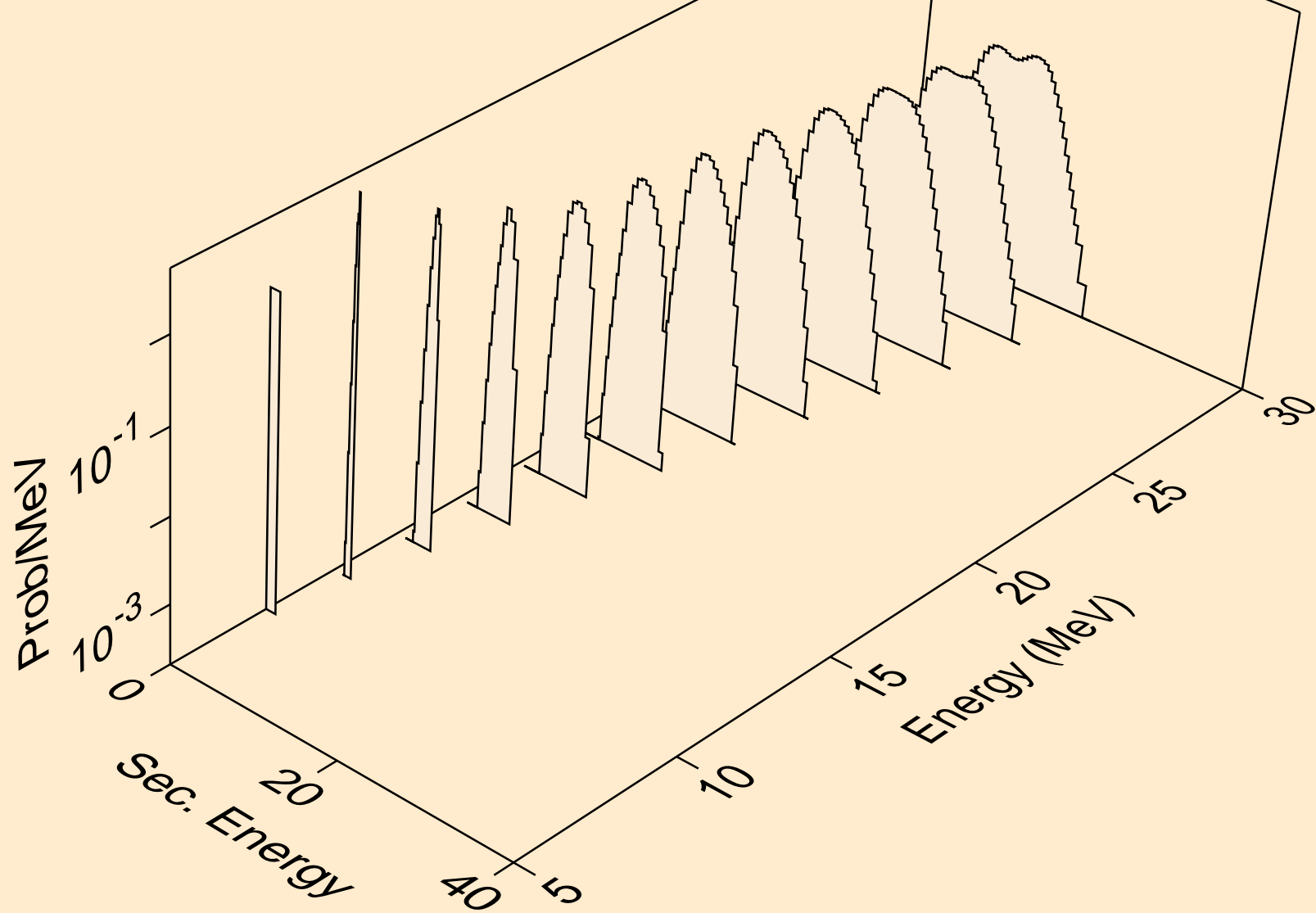

HG181 HELION ACER TENDL-2021 LIBRARY; T=0.K  
protons from (s,2np)

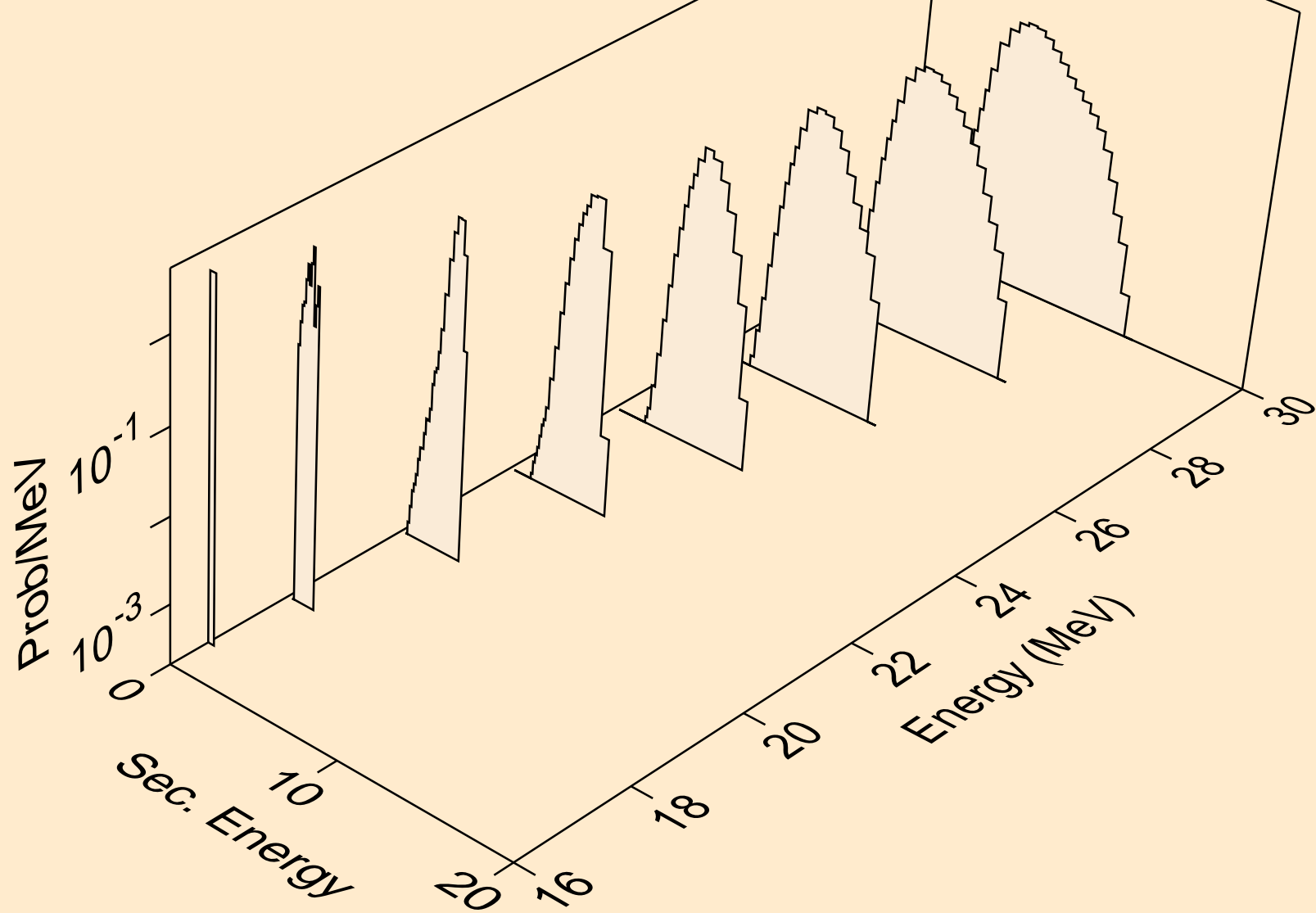

HG181 HELION ACER TENDL-2021 LIBRARY; T=0.K  
protons from (s,2np)

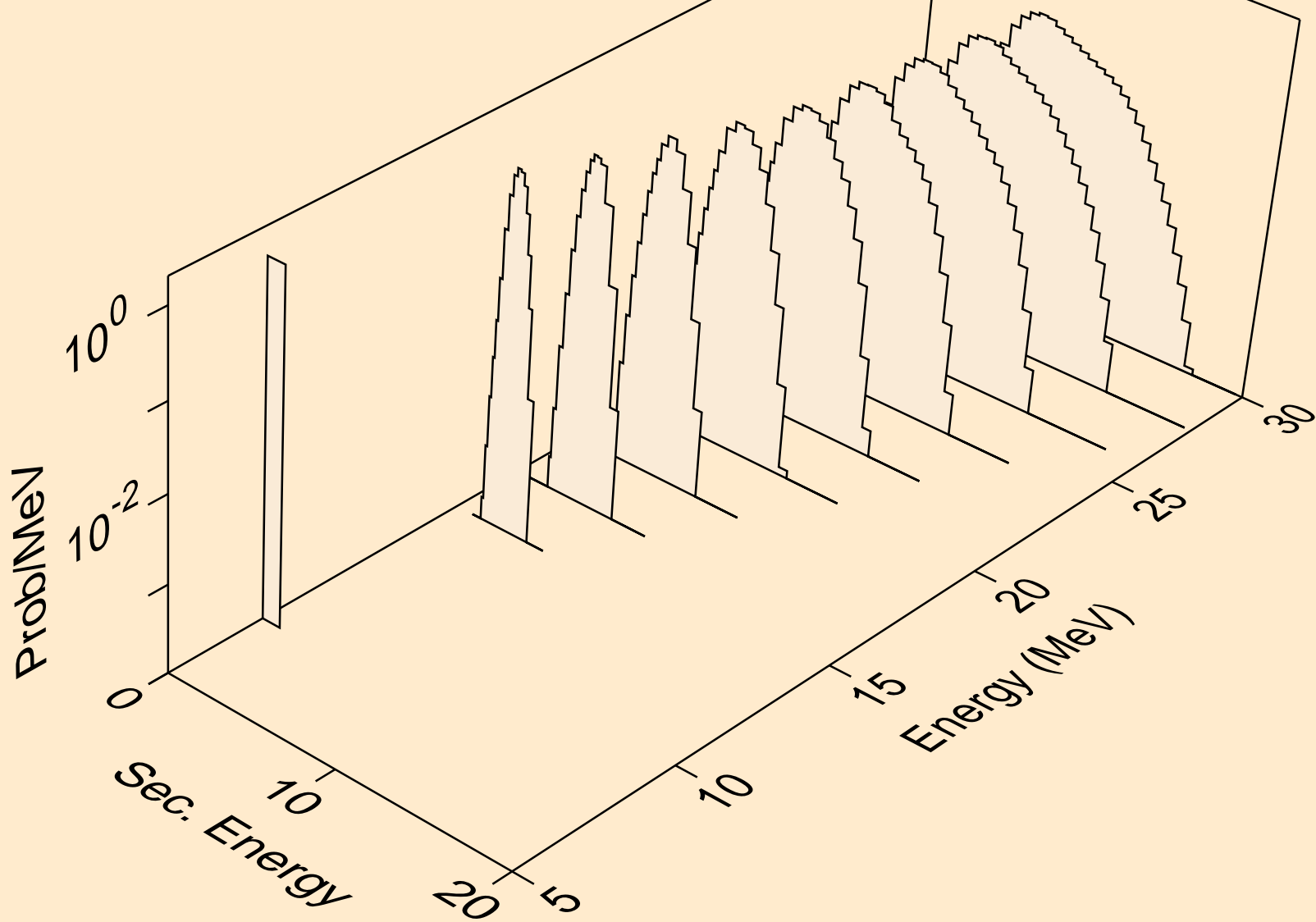

HG181 HELION ACER TENDL-2021 LIBRARY; T=0.K  
protons from (s,npa)

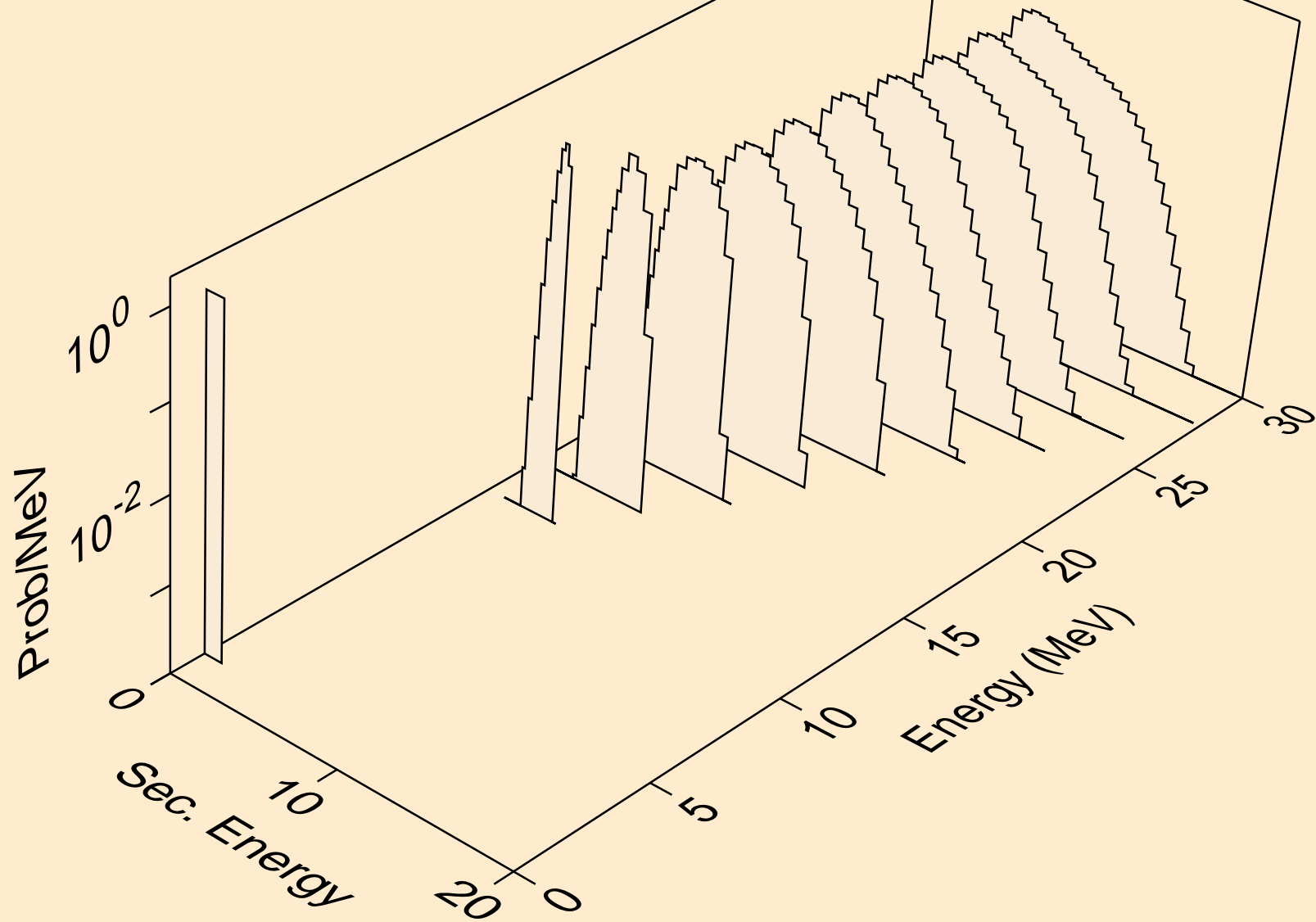

HG181 HELION ACER TENDL-2021 LIBRARY; T=0.K  
protons from (s,p)

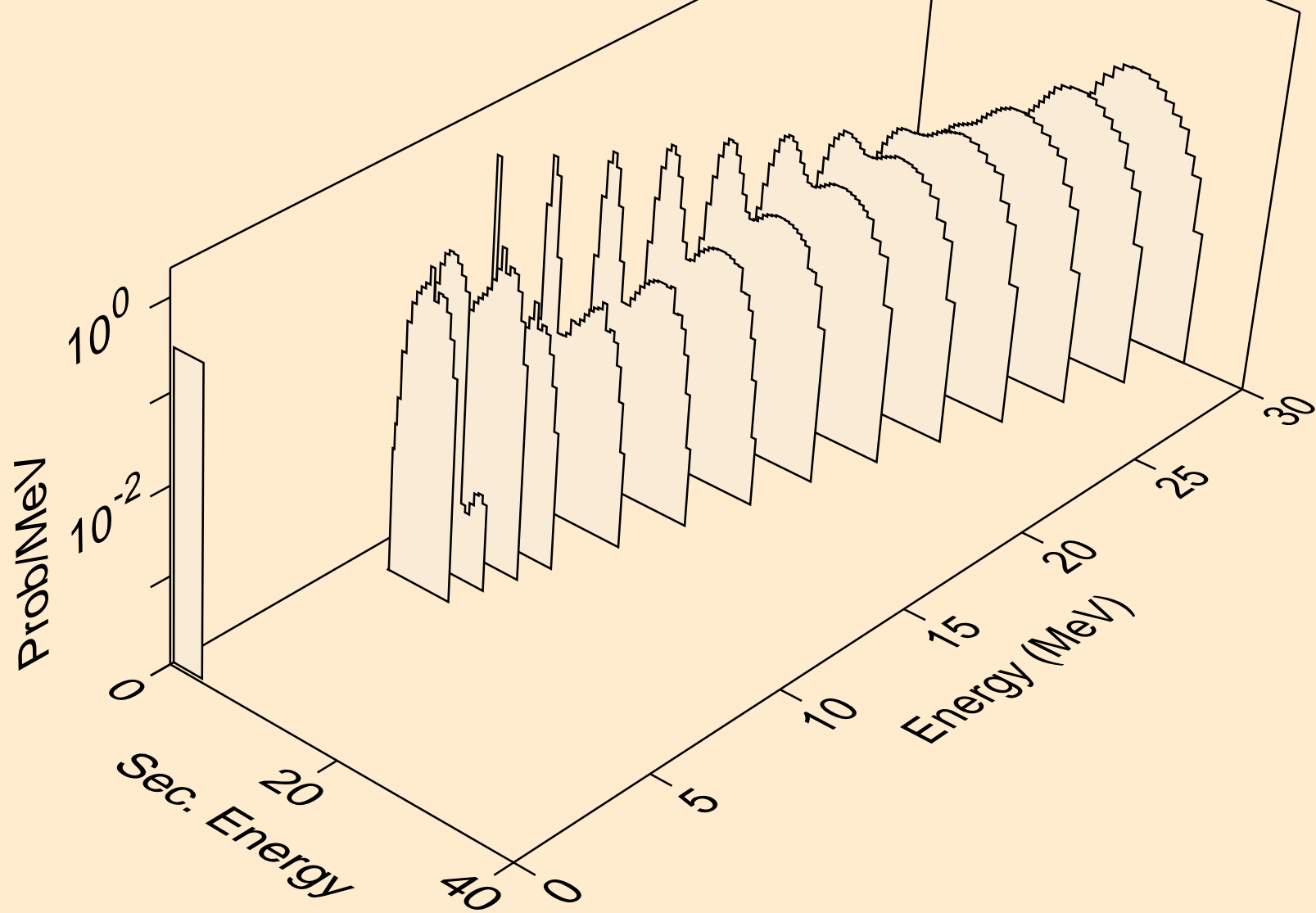



HG181 HELION ACER TENDL-2021 LIBRARY; T=0.K  
protons from (s,2p)

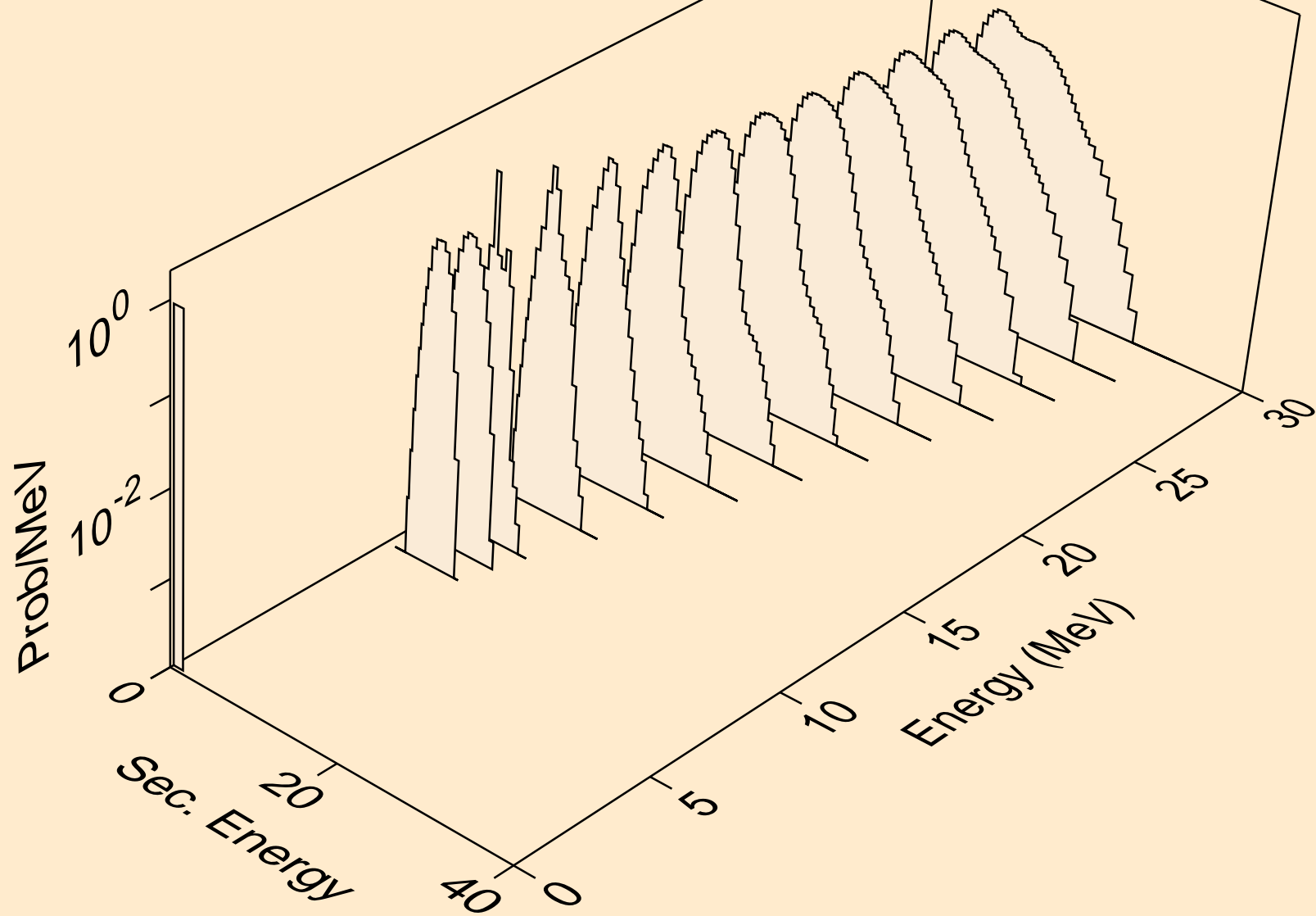

HG181 HELION ACER TENDL-2021 LIBRARY; T=0.K  
protons from (s,pa)

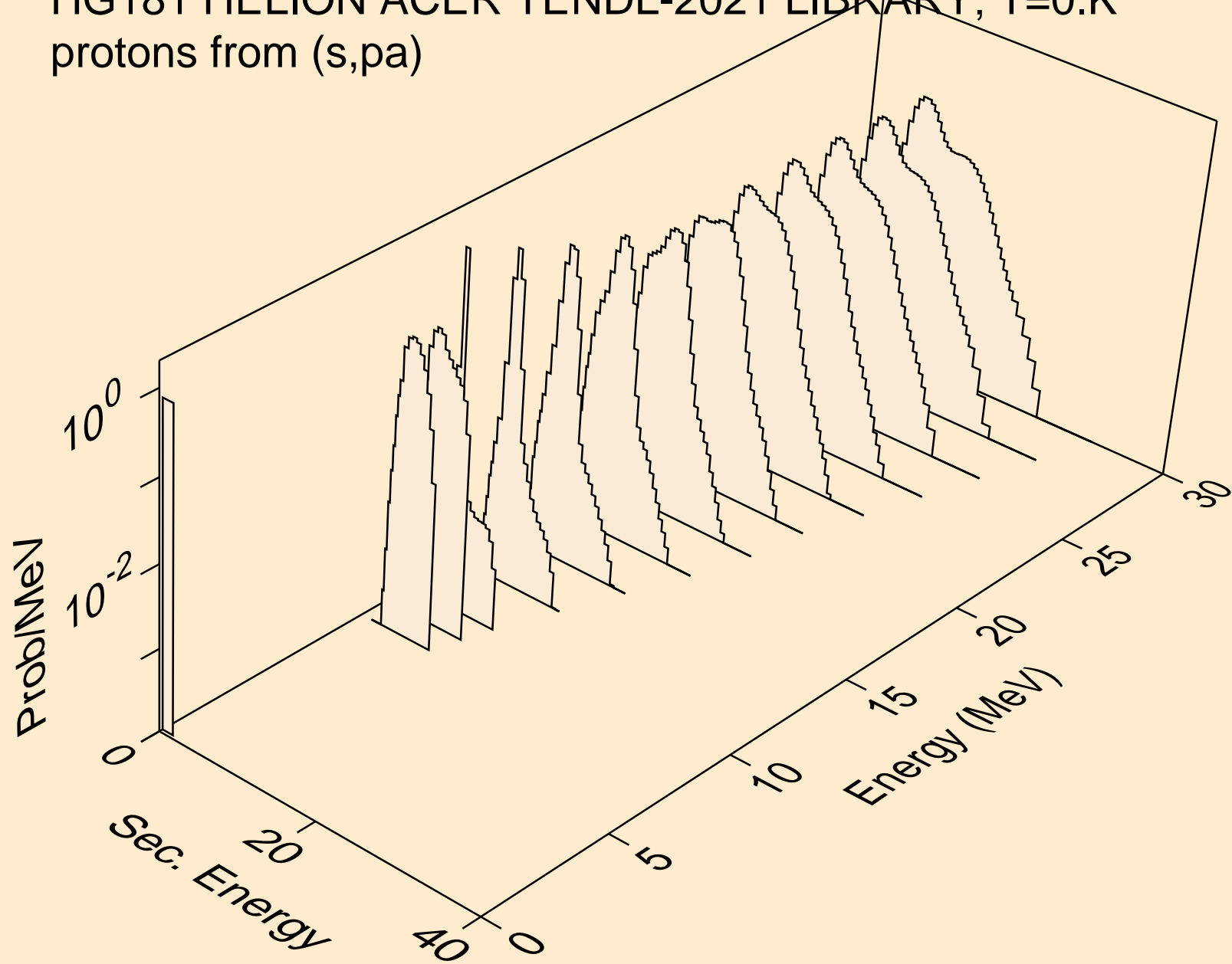

HG181 HELION ACER TENDL-2021 LIBRARY; T=0.K  
protons from (s,pd)

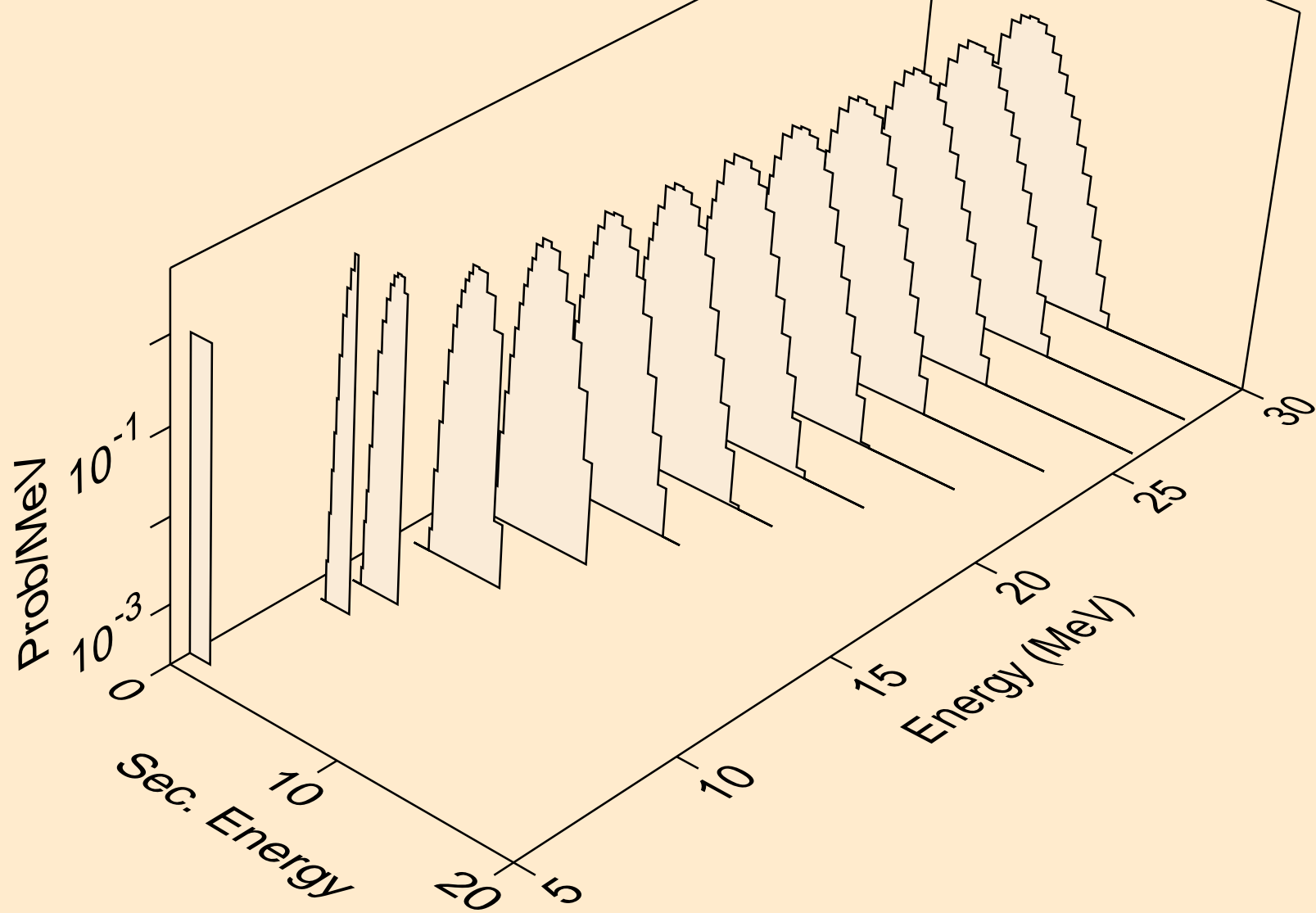

HG181 HELION ACER TENDL-2021 LIBRARY; T=0.K  
protons from (s,pt)

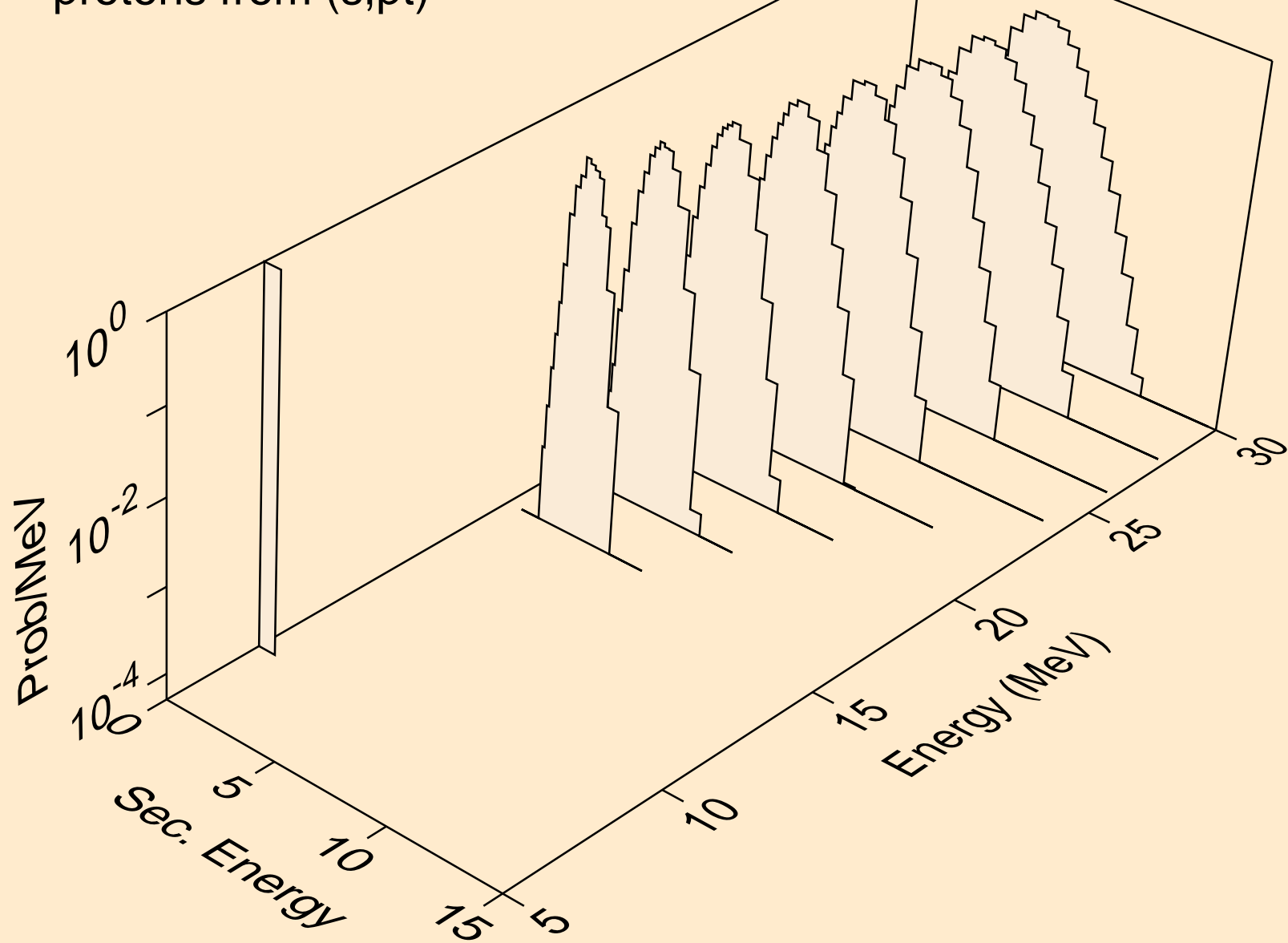

HG181 HELION ACER TENDL-2021 LIBRARY; T=0.K  
deuterons from (s,x)

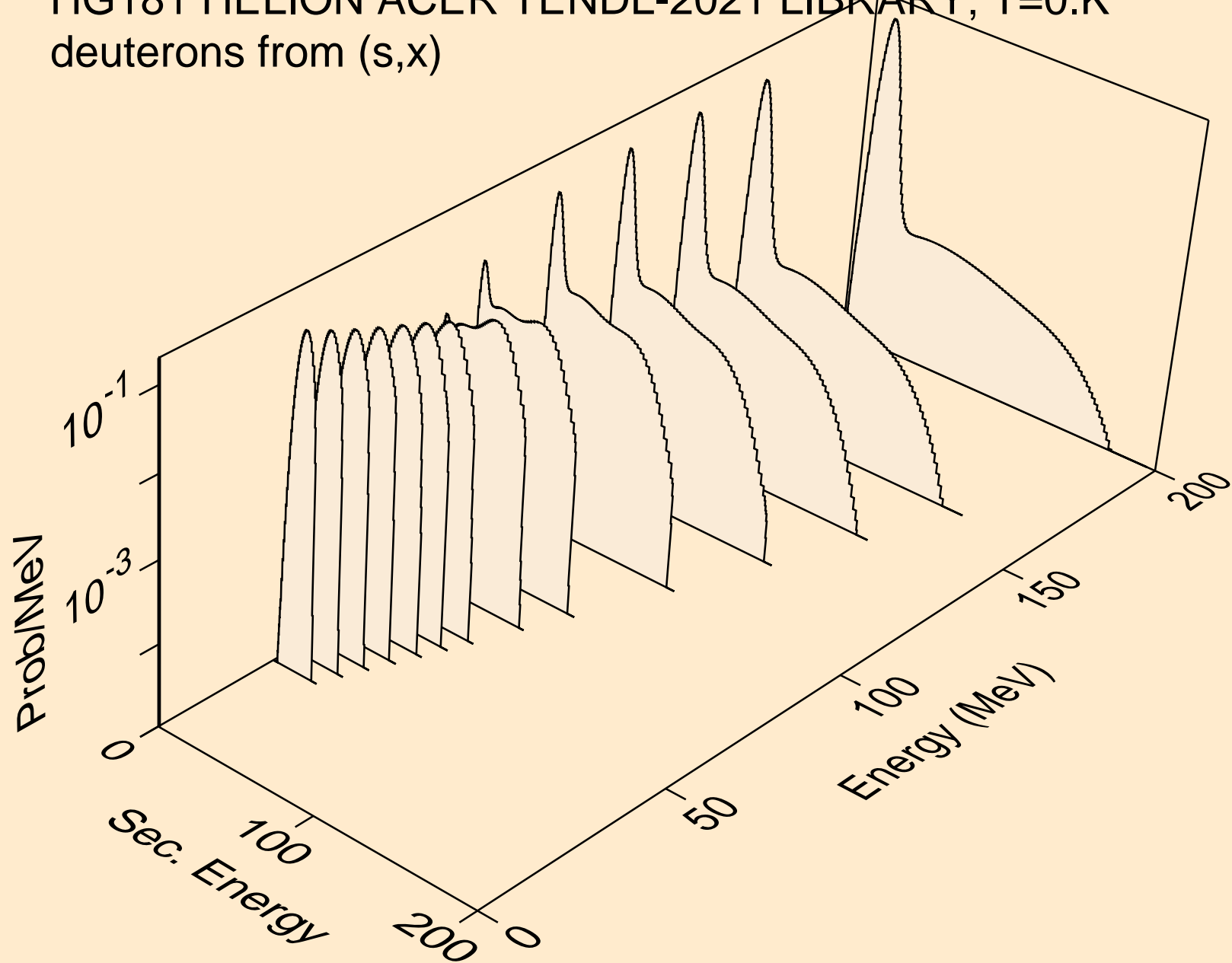

HG181 HELION ACER TENDL-2021 LIBRARY; T=0.K  
deuterons from (s,n\*)d

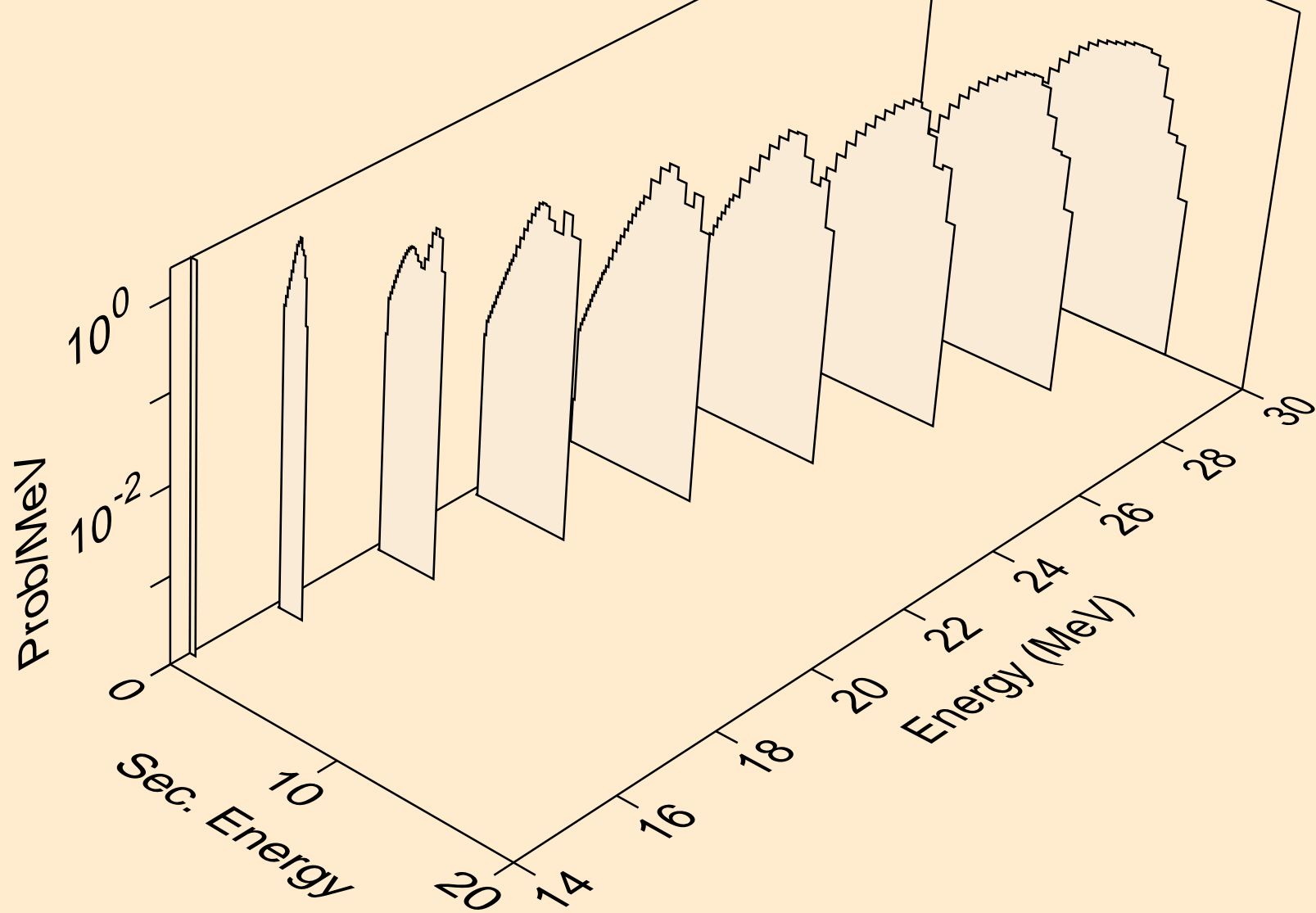

HG181 HELION ACER TENDL-2021 LIBRARY; T=0.K  
deuterons from (s,d)

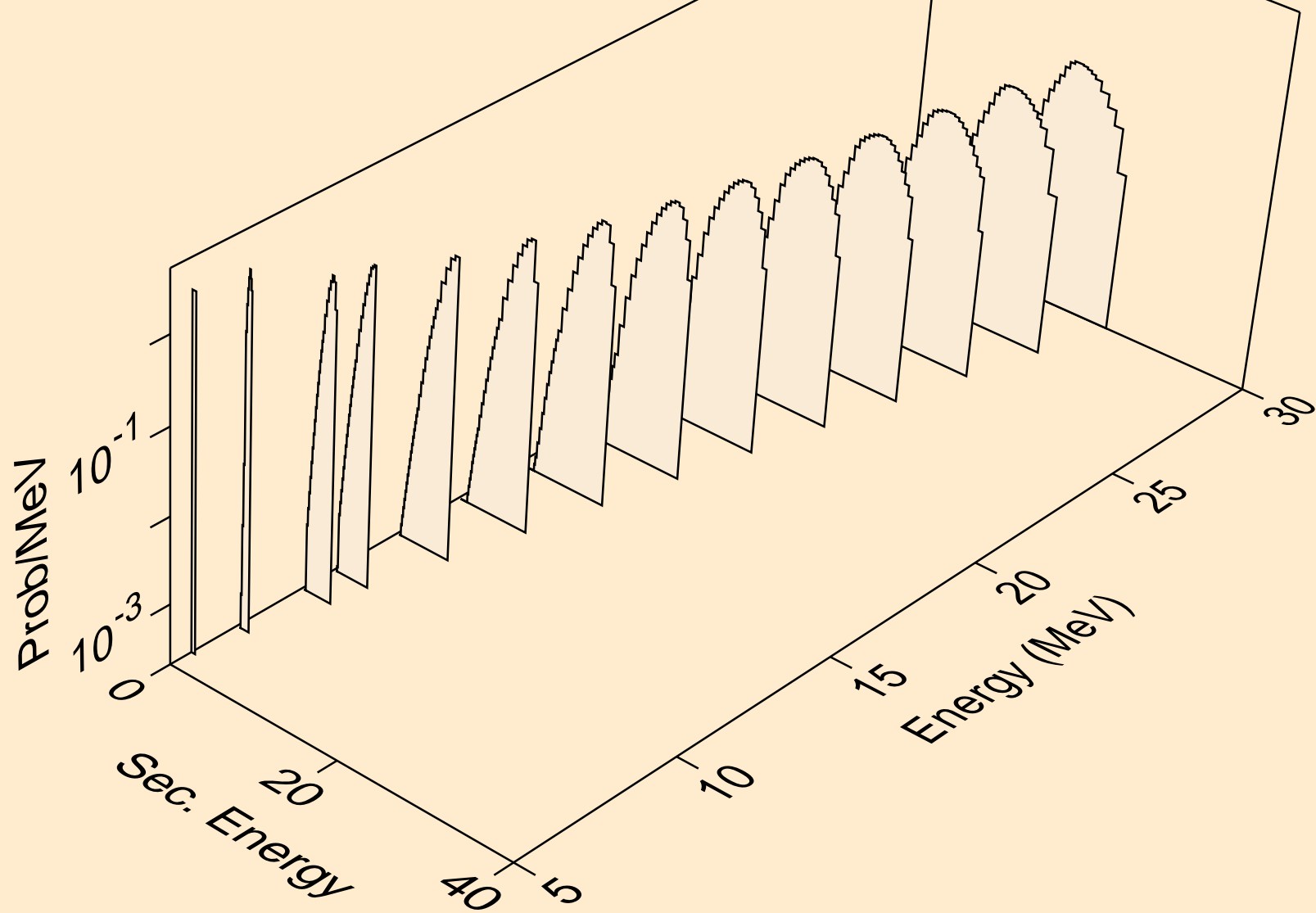

HG181 HELION ACER TENDL-2021 LIBRARY; T=0.K  
deuterons from (s,pd)

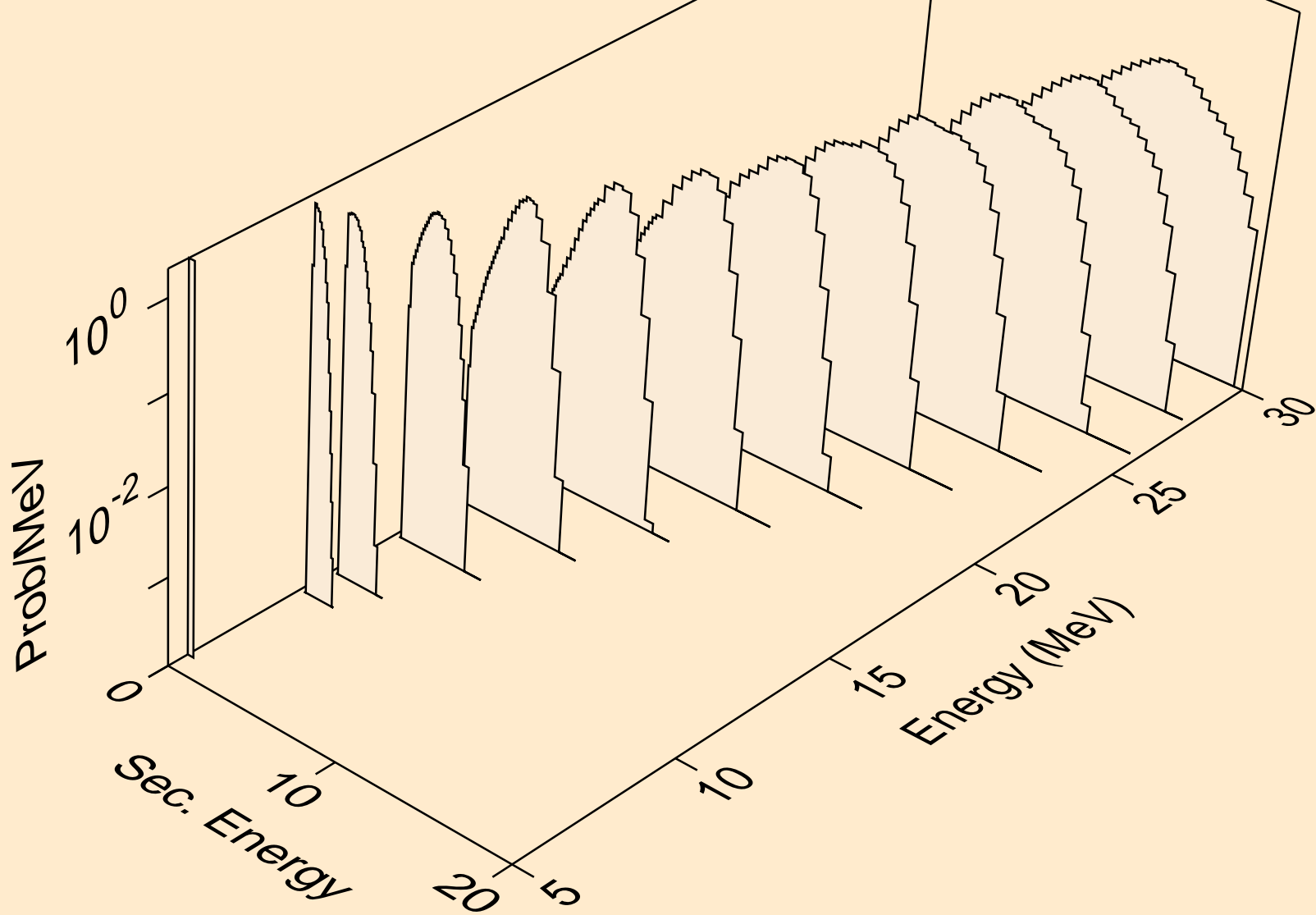



HG181 HELION ACER TENDL-2021 LIBRARY; T=0.K  
deuterons from (s,da)

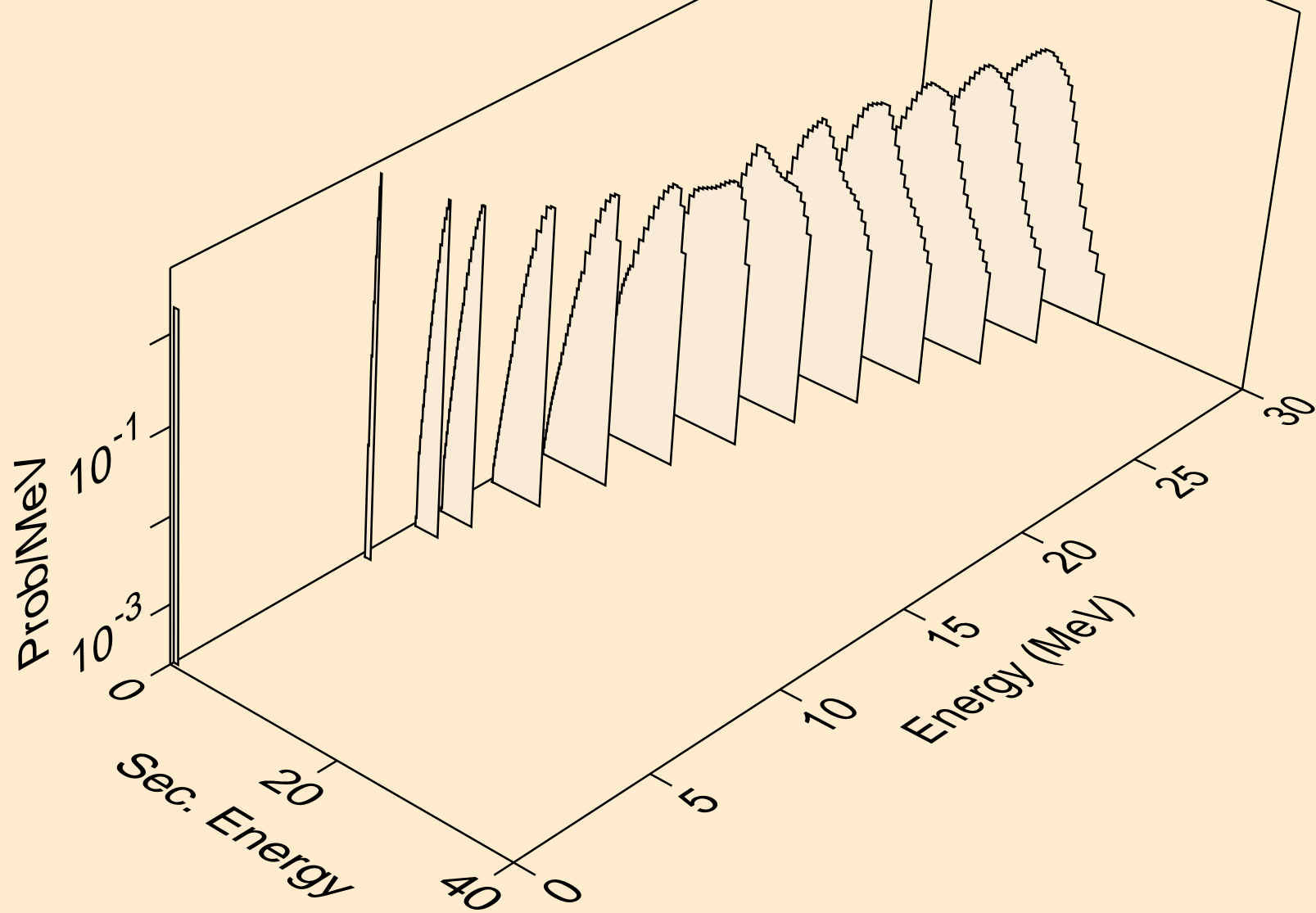

HG181 HELION ACER TENDL-2021 LIBRARY; T=0.K  
tritons from (s,x)

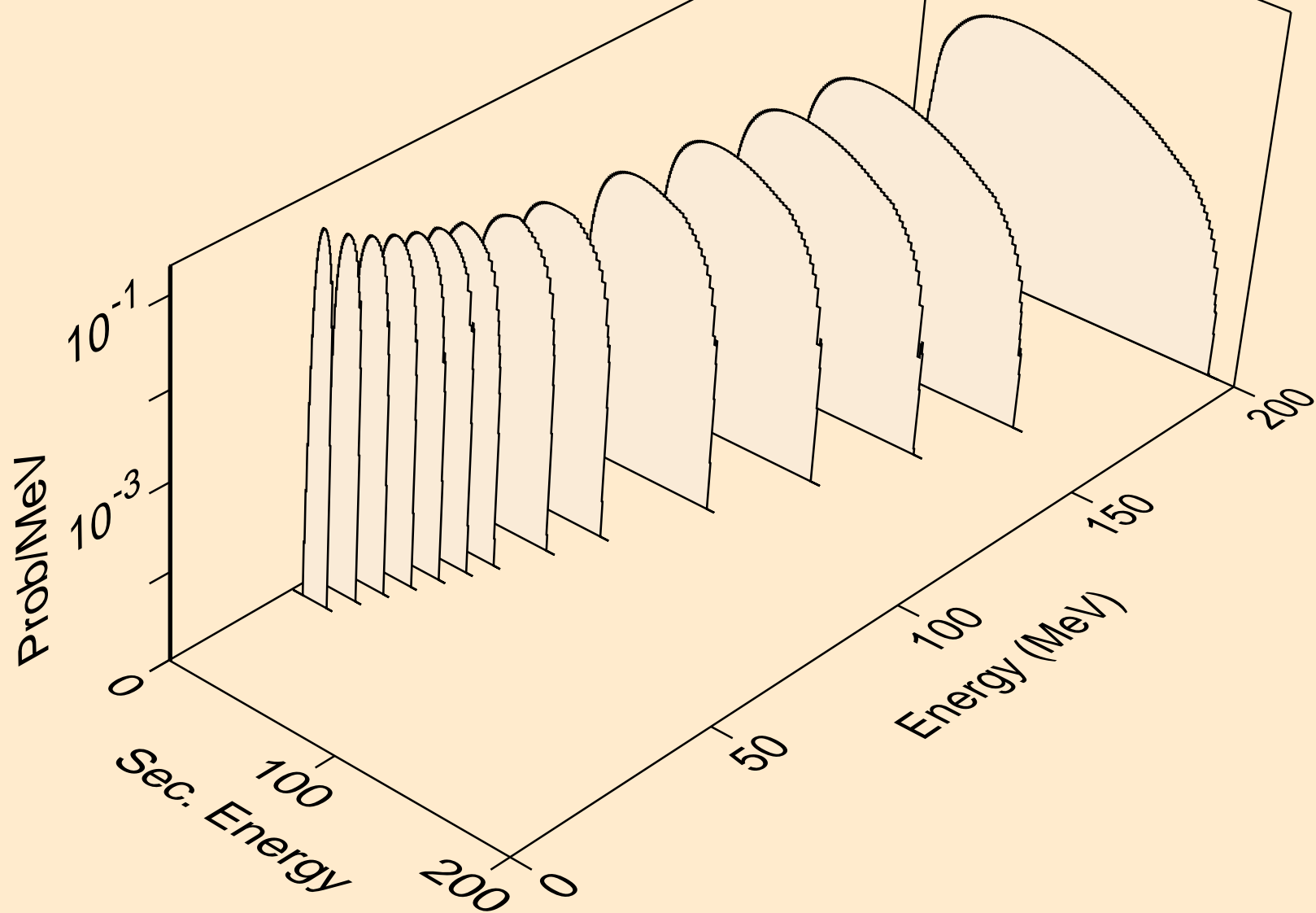

HG181 HELION ACER TENDL-2021 LIBRARY; T=0.K  
tritons from (s,n\*)t

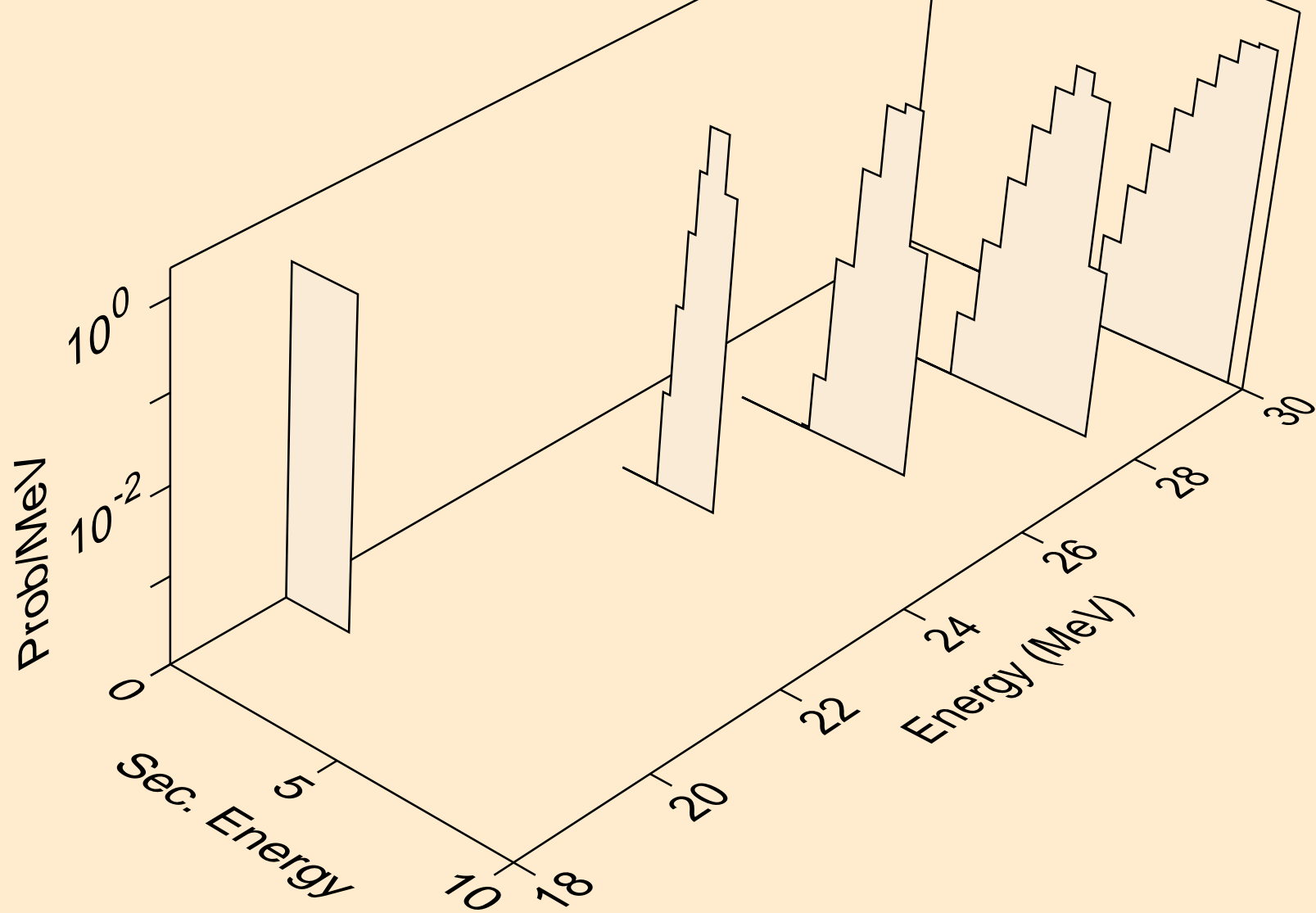

HG181 HELION ACER TENDL-2021 LIBRARY; T=0.K  
tritons from (s,t)

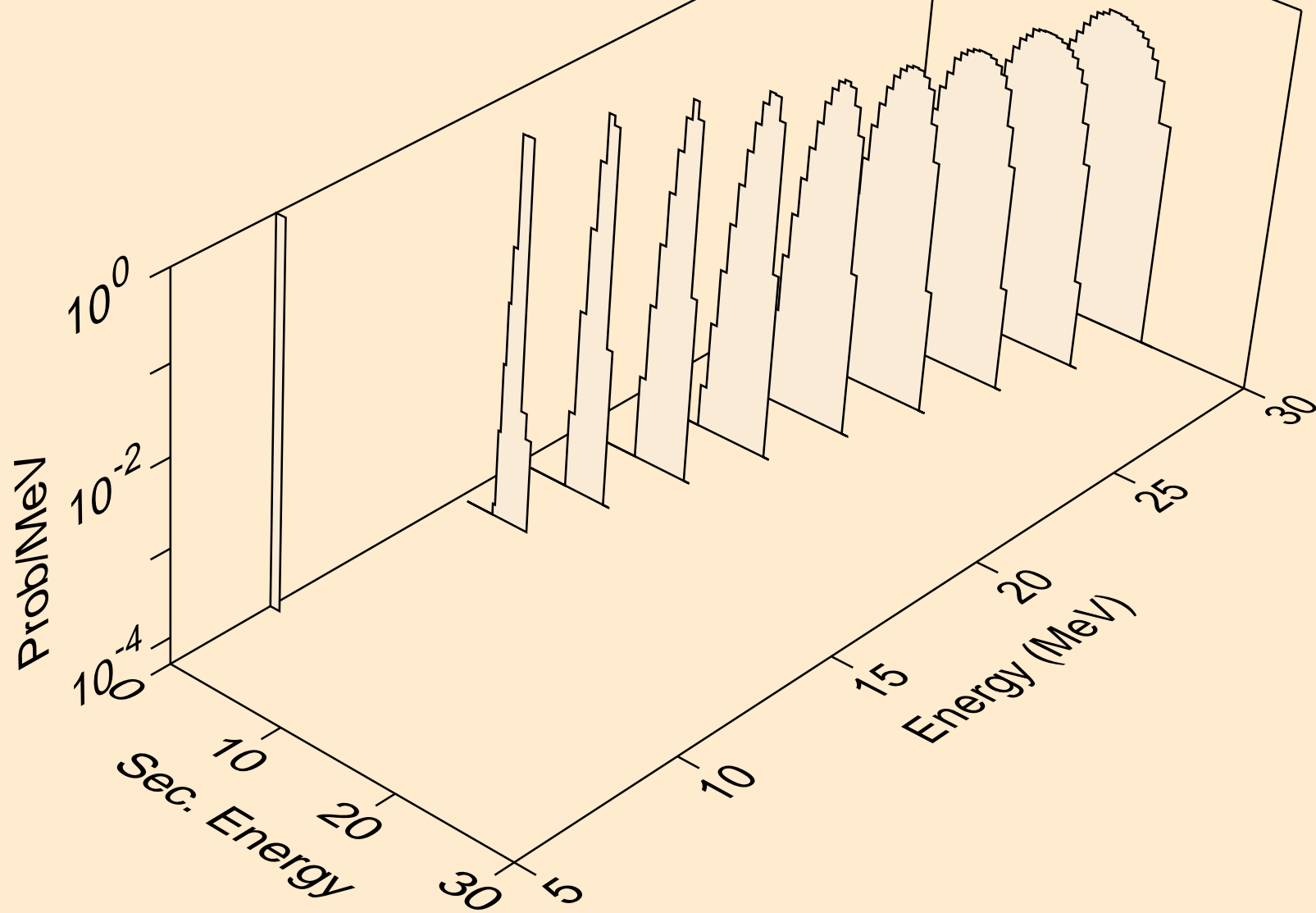

HG181 HELION ACER TENDL-2021 LIBRARY; T=0.K  
tritons from (s,t2a)

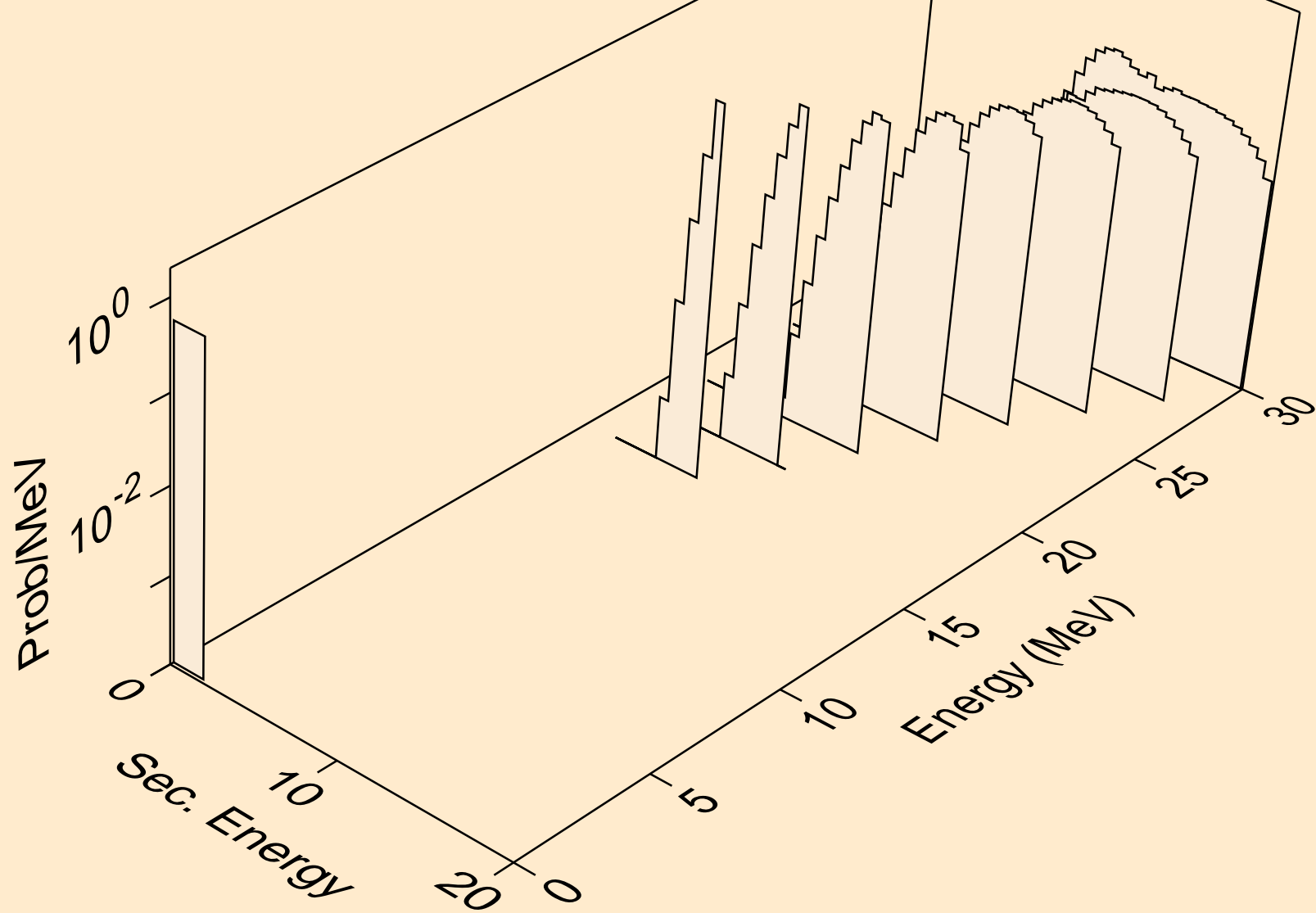

HG181 HELION ACER TENDL-2021 LIBRARY; T=0.K  
tritons from (s,pt)

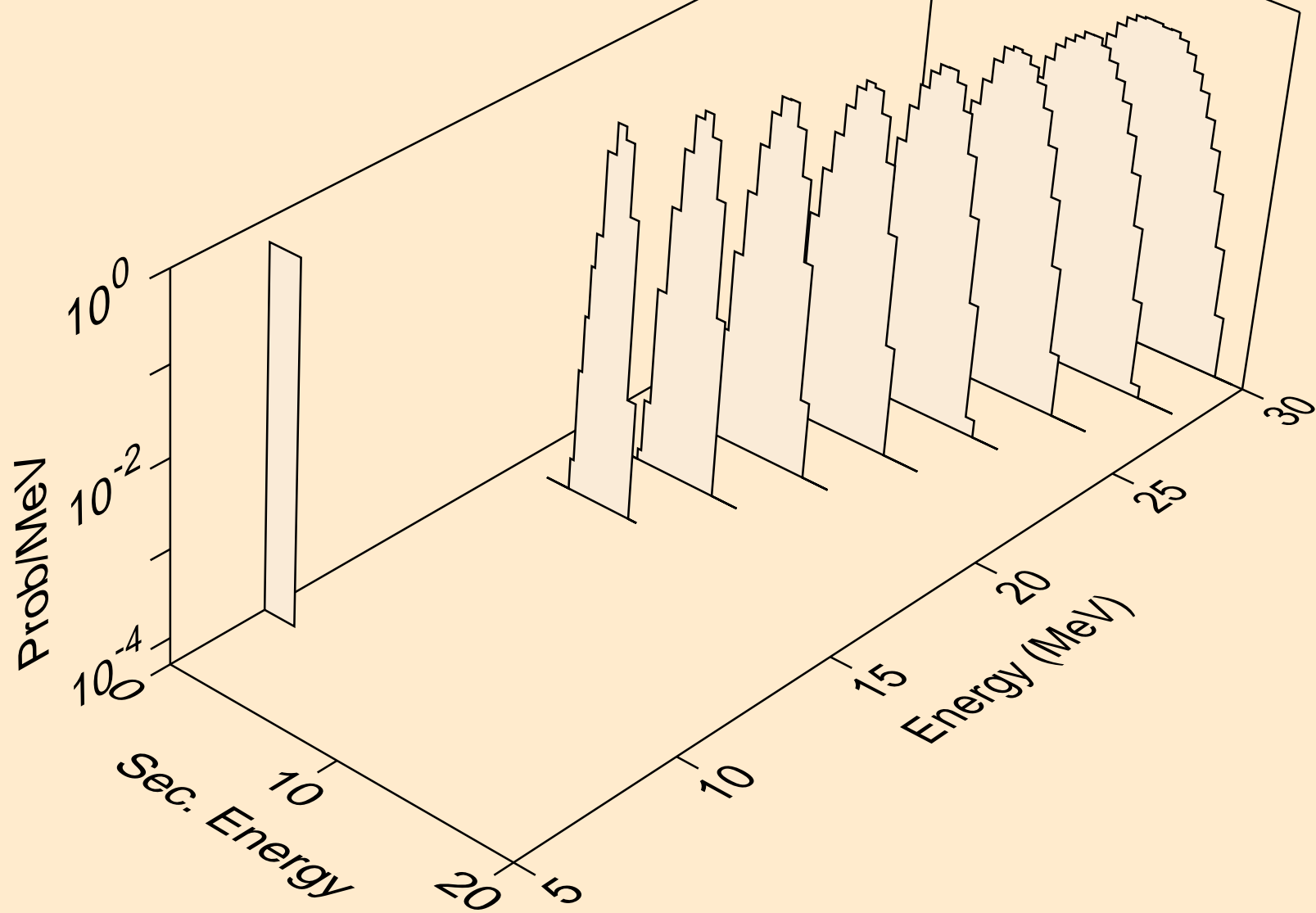

HG181 HELION ACER TENDL-2021 LIBRARY; T=0.K  
alphas from (s,x)

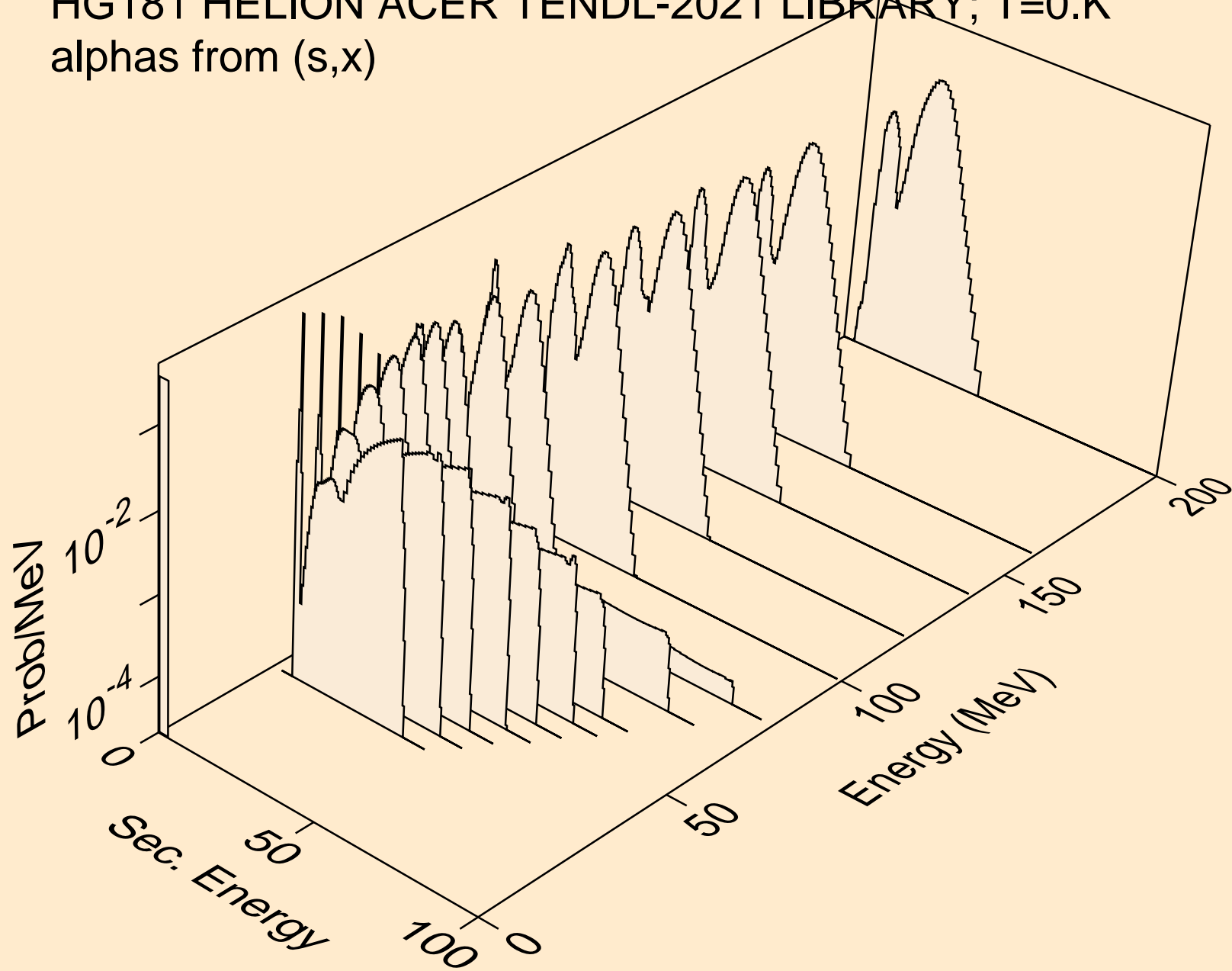

HG181 HELION ACER TENDL-2021 LIBRARY; T=0.K  
alphas from (s,n\*)a

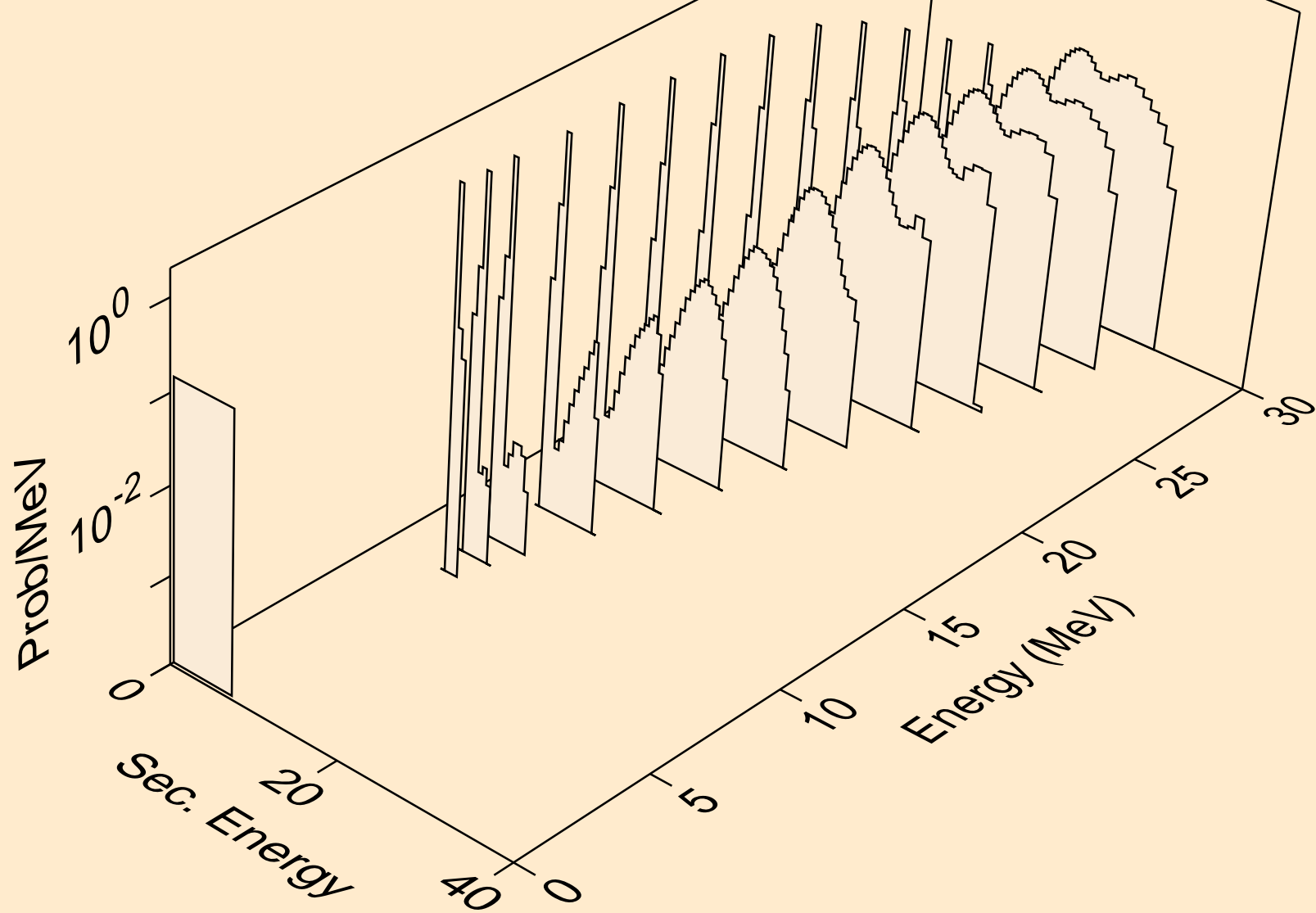



HG181 HELION ACER TENDL-2021 LIBRARY; T=0.K  
alphas from (s,2n)a

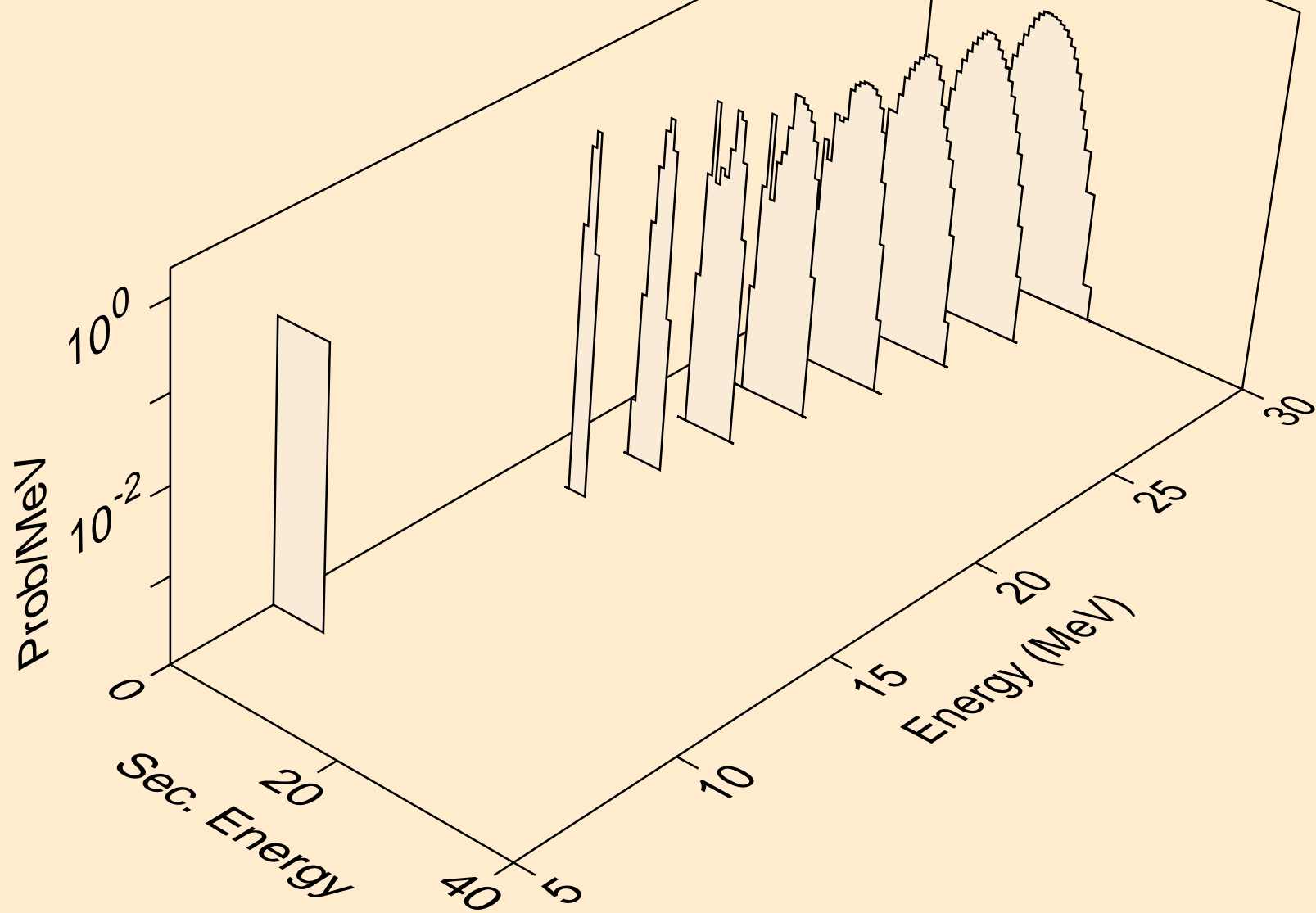

HG181 HELION ACER TENDL-2021 LIBRARY; T=0.K  
alphas from (s,3n)a

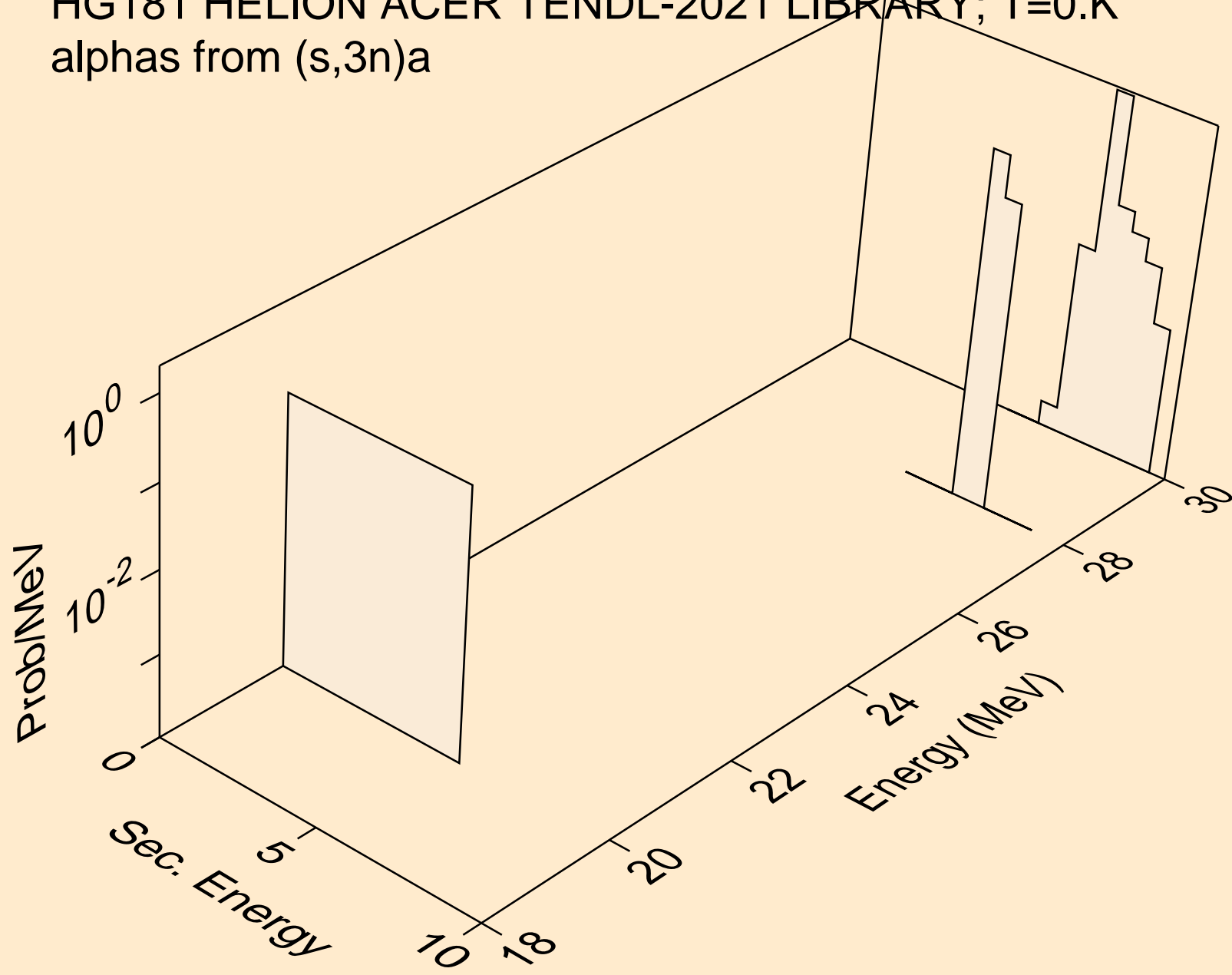

HG181 HELION ACER TENDL-2021 LIBRARY; T=0.K  
alphas from (s,n\*)2a

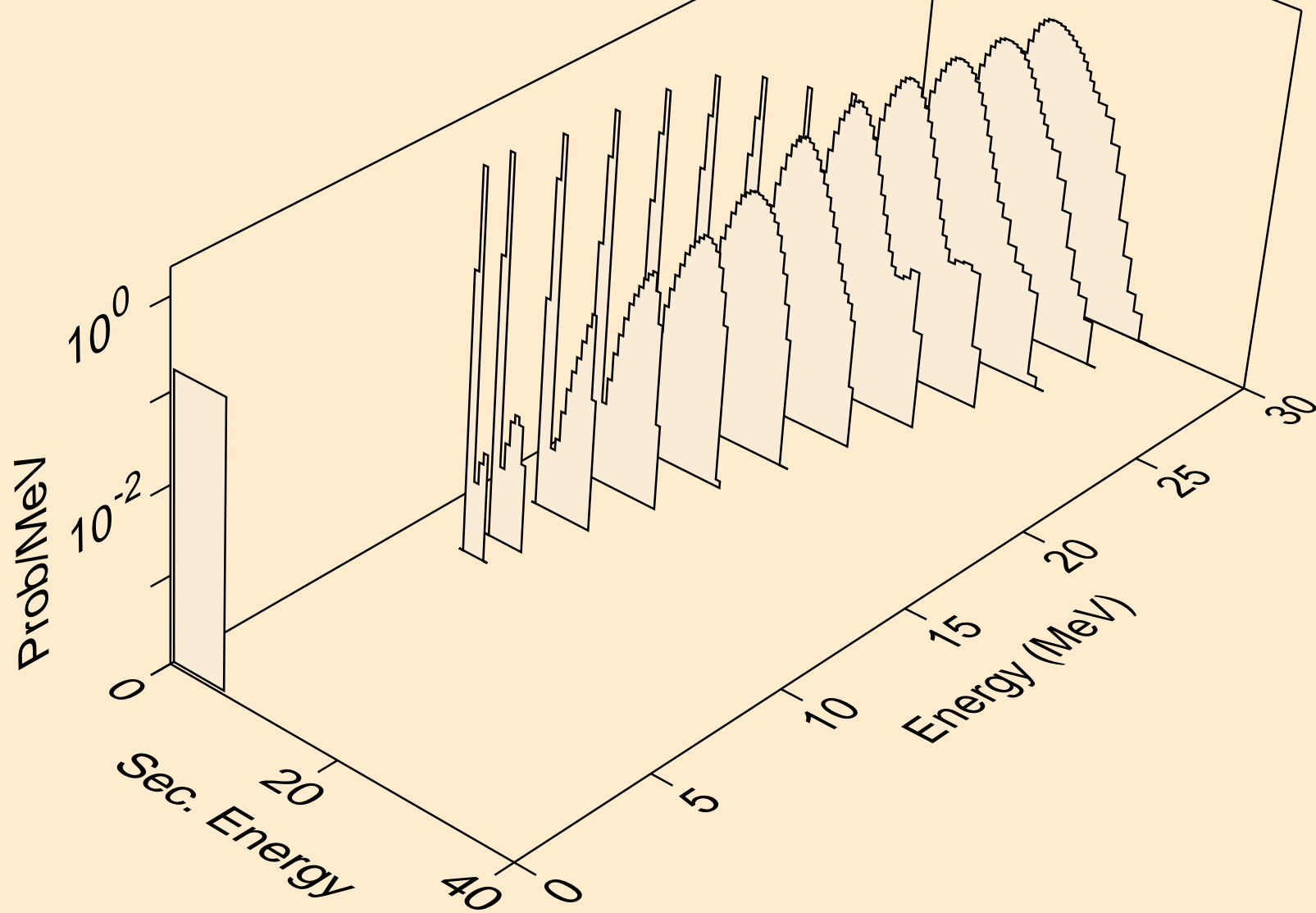

HG181 HELION ACER TENDL-2021 LIBRARY; T=0.K  
alphas from (s,2n)2a

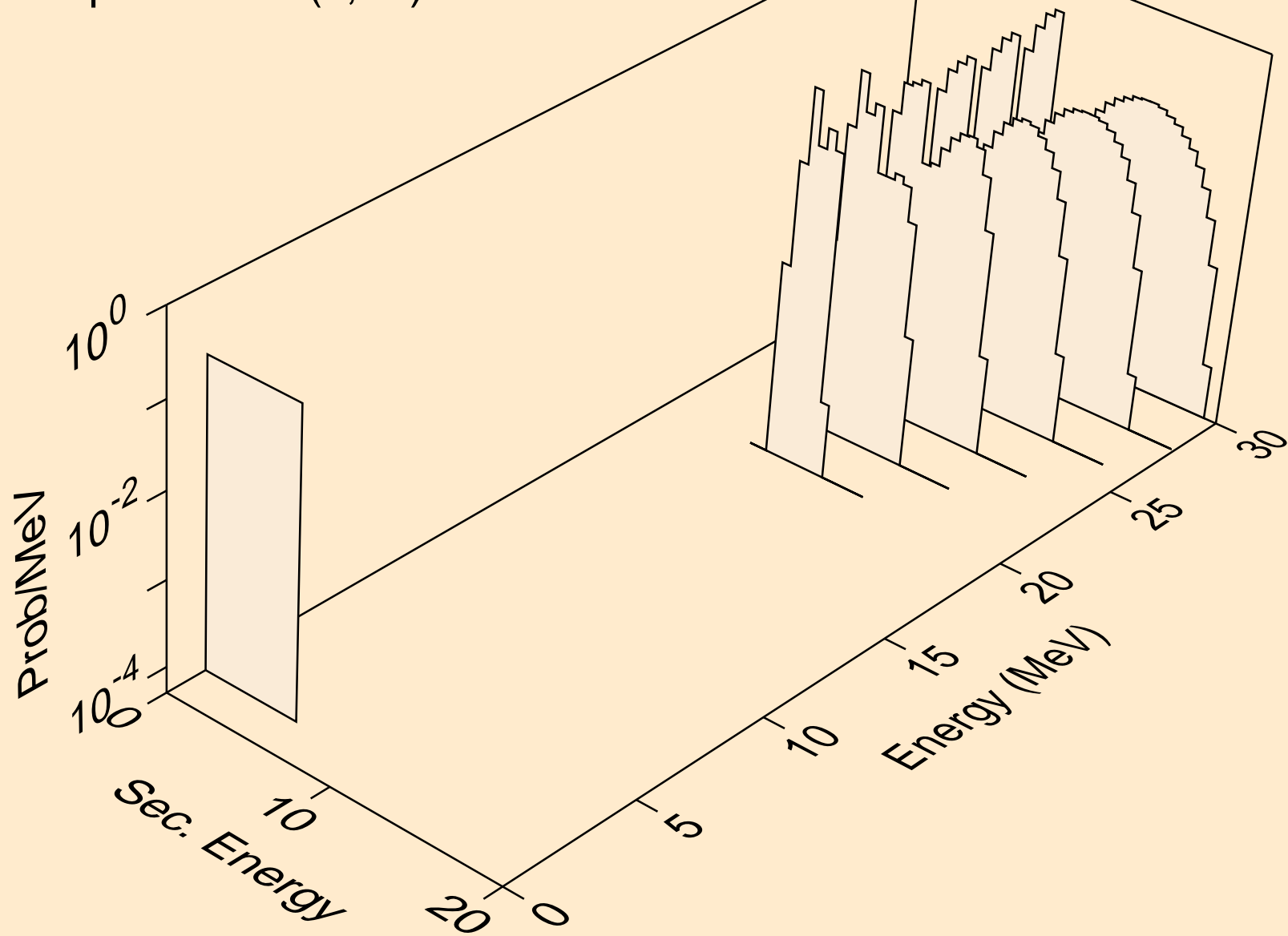

HG181 HELION ACER TENDL-2021 LIBRARY; T=0.K  
alphas from (s,npa)

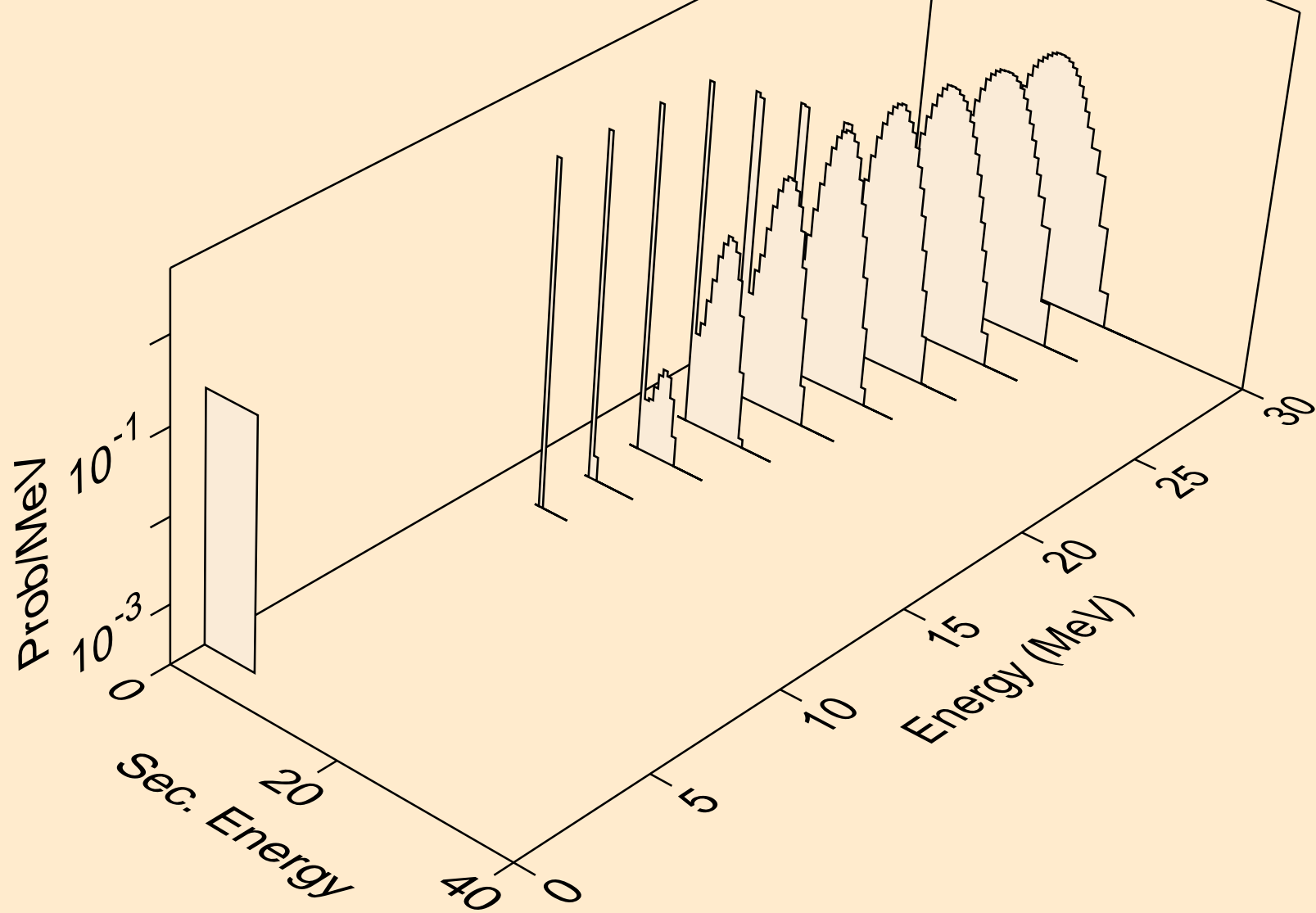

HG181 HELION ACER TENDL-2021 LIBRARY; T=0.K  
alphas from (s,a)

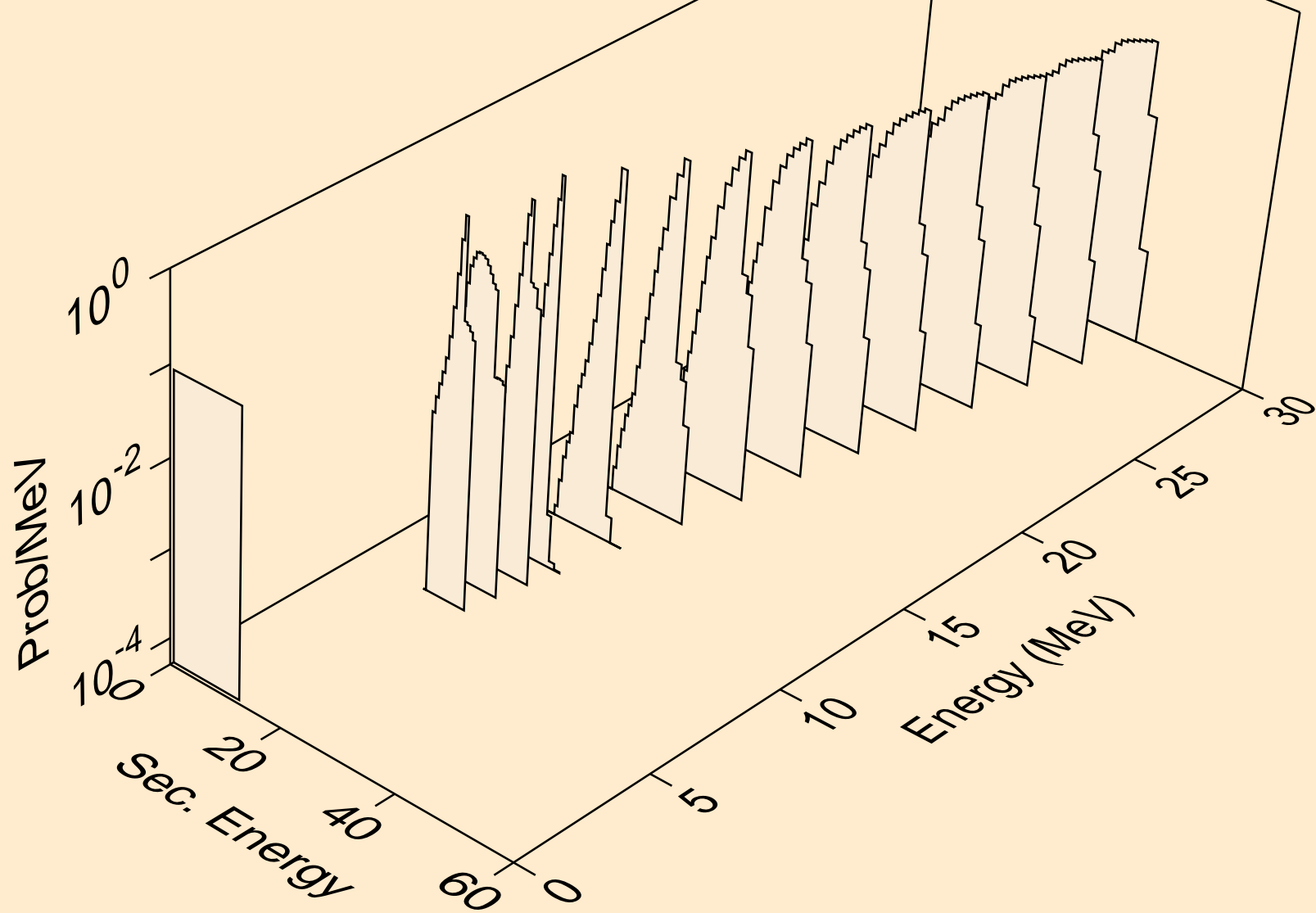

HG181 HELION ACER TENDL-2021 LIBRARY; T=0.K  
alphas from (s,2a)

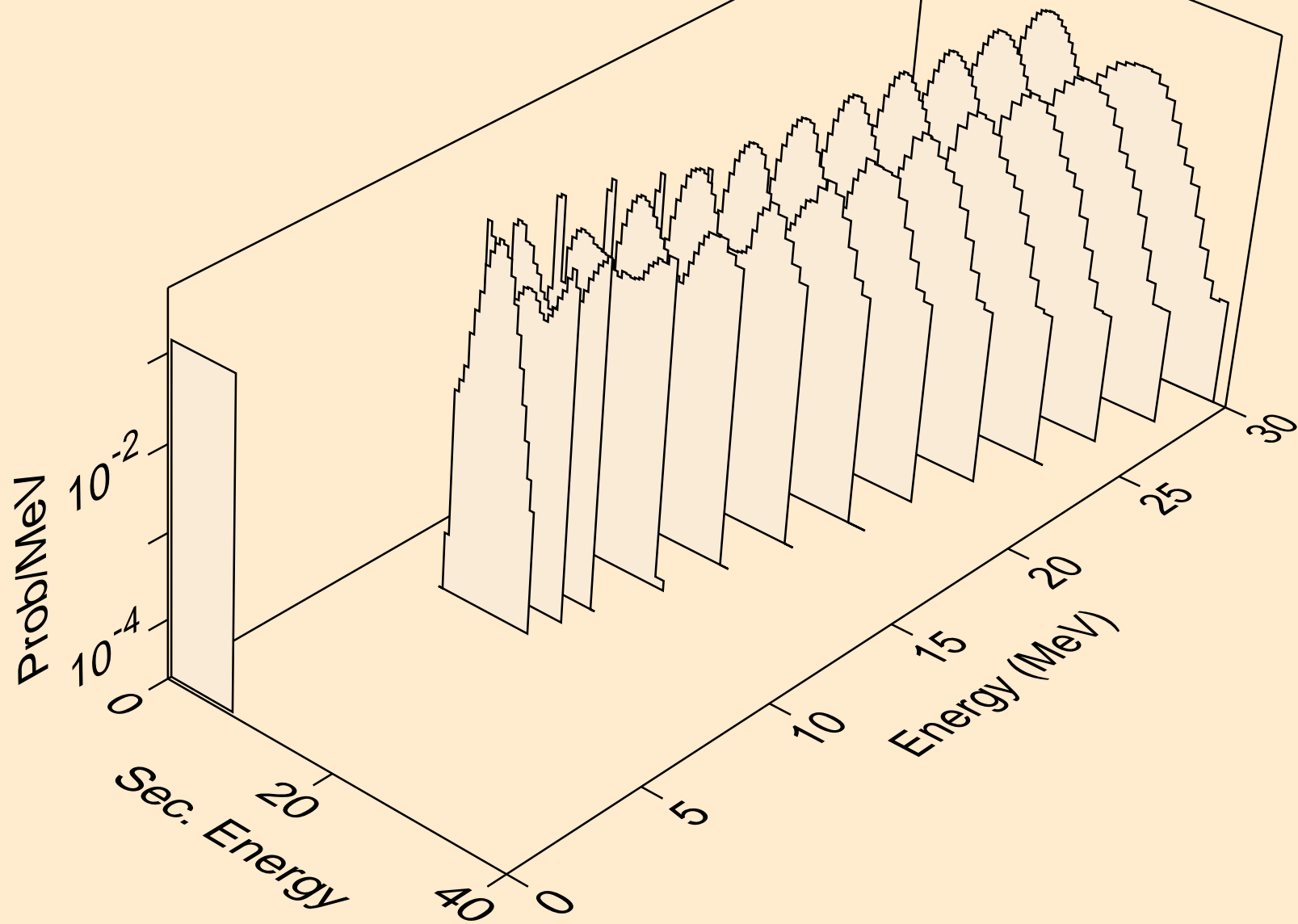

HG181 HELION ACER TENDL-2021 LIBRARY; T=0.K  
alphas from (s,3a)

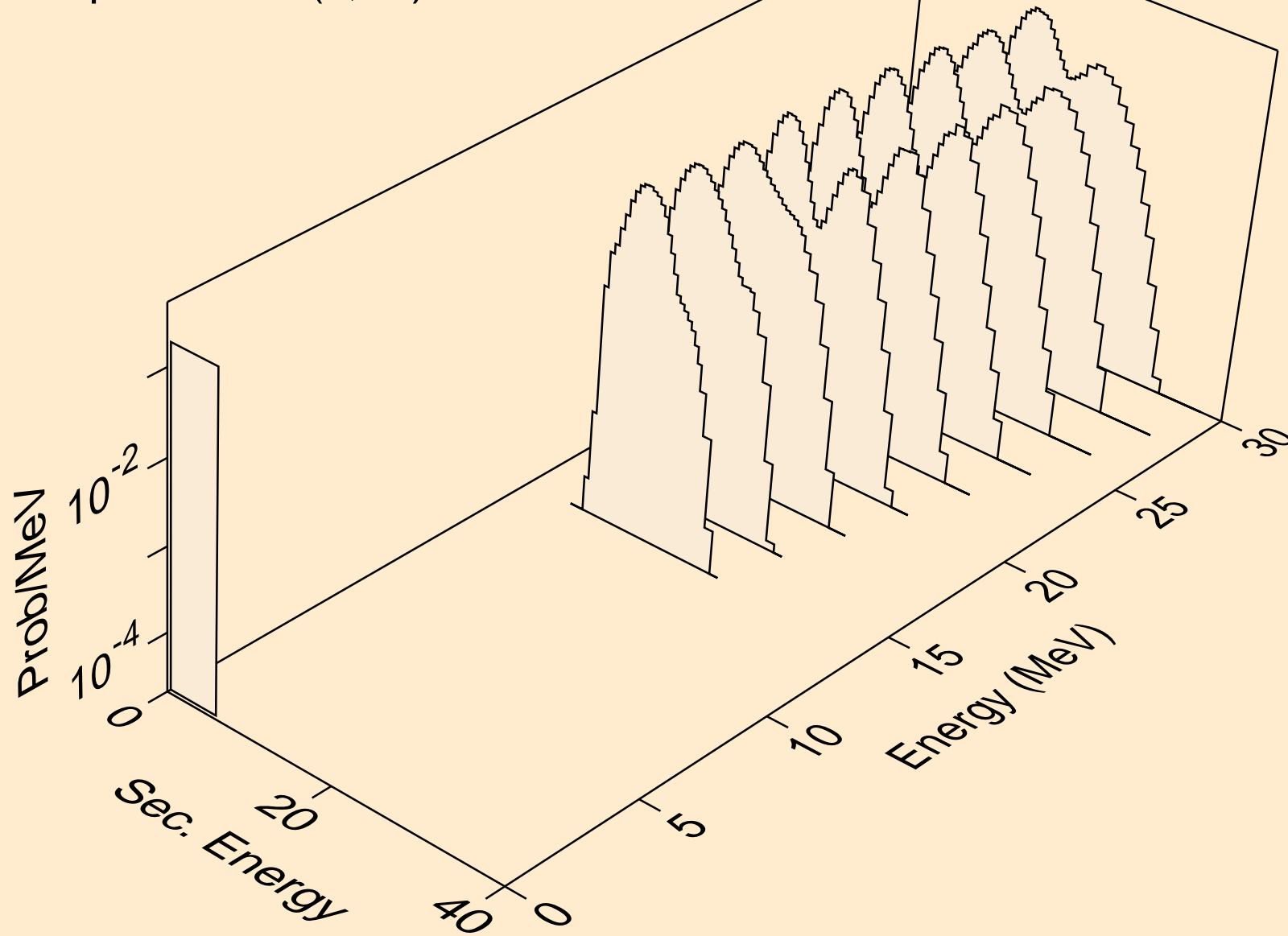



HG181 HELION ACER TENDL-2021 LIBRARY; T=0.K  
alphas from (s,pa)

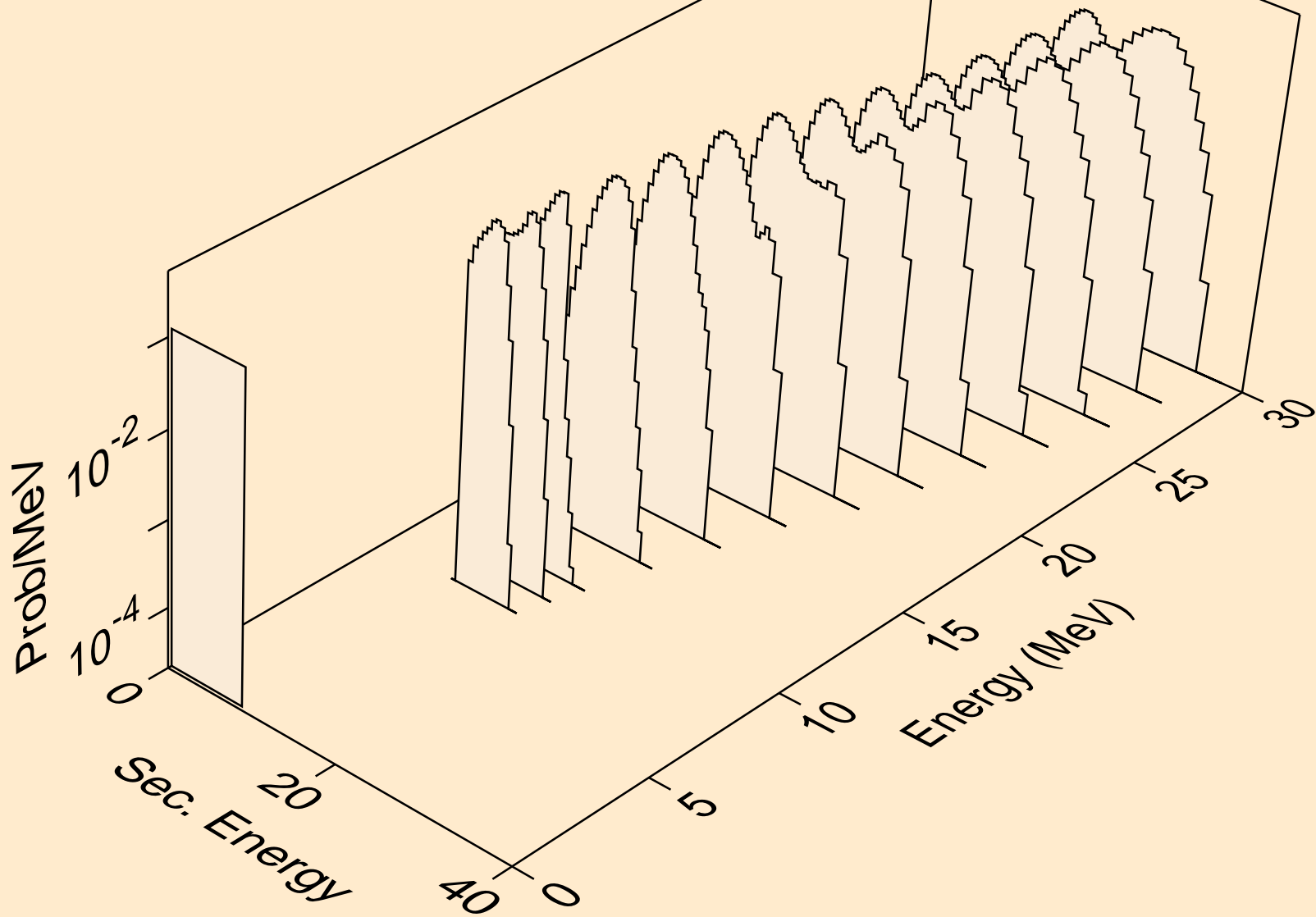

HG181 HELION ACER TENDL-2021 LIBRARY; T=0.K  
alphas from (s,t2a)

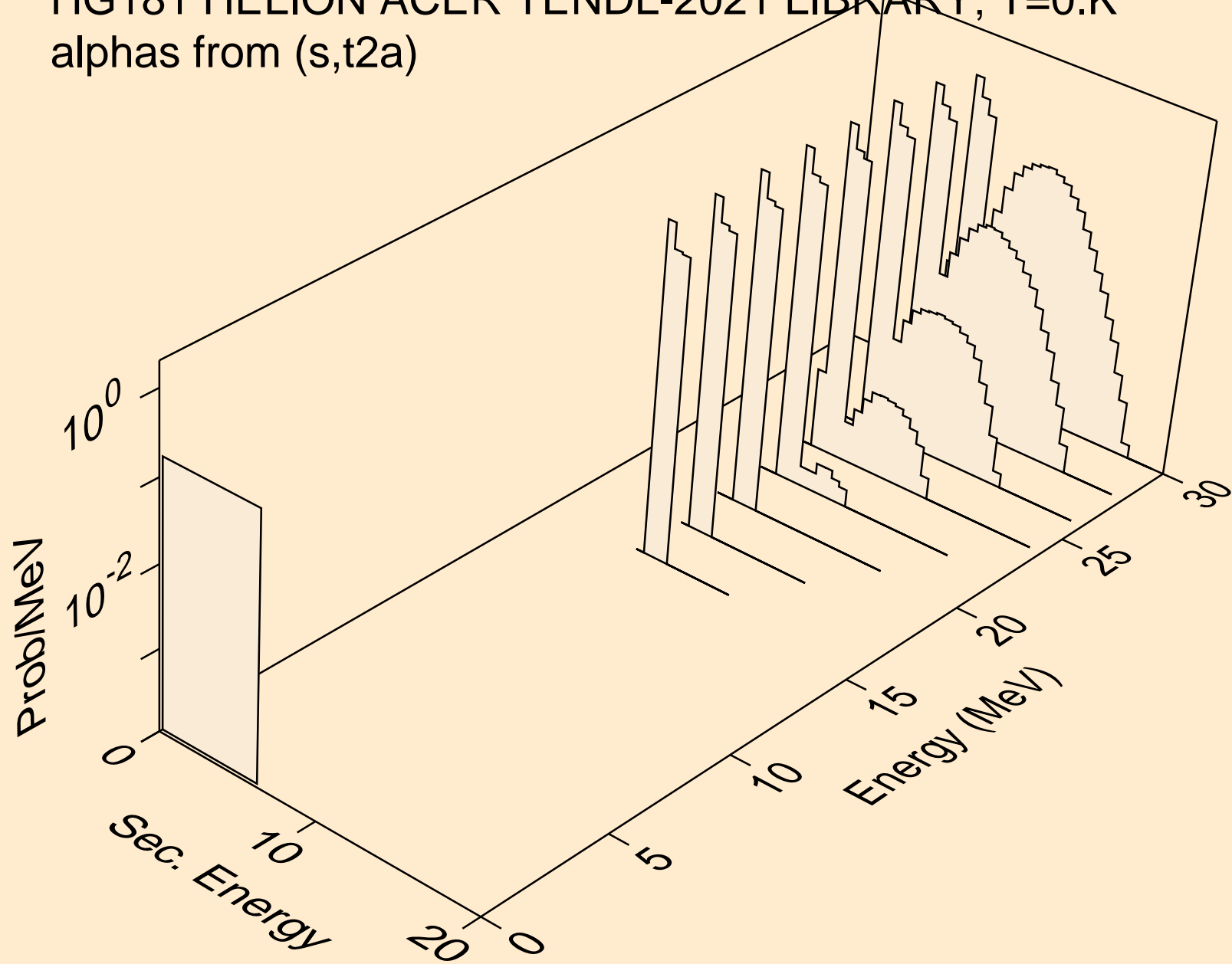

HG181 HELION ACER TENDL-2021 LIBRARY; T=0.K  
alphas from (s,da)

