

# HG198 HELION ACER TENDL-2021 LIBRARY; T=0.K

## Principal cross sections

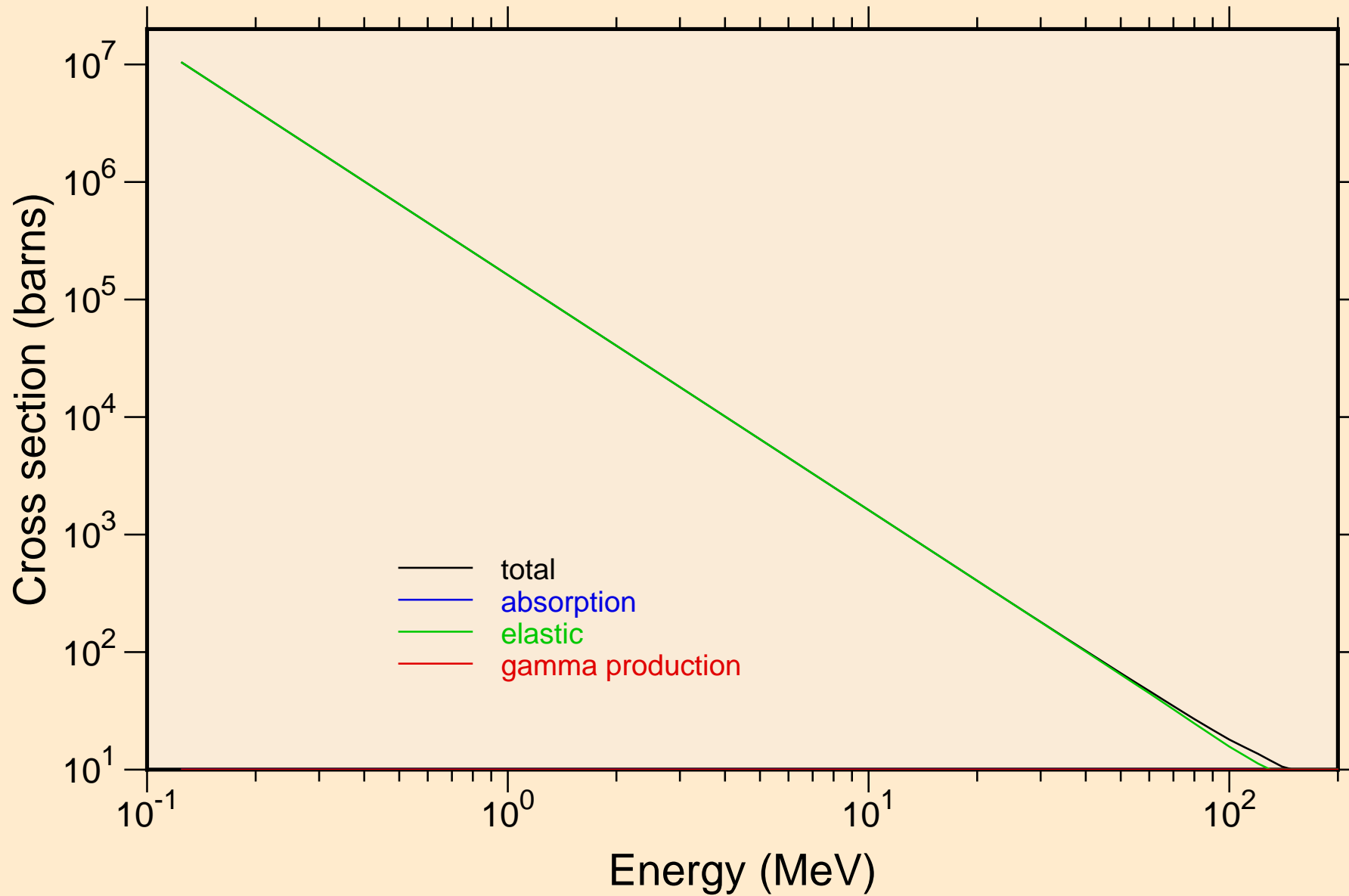

HG198 HELION ACER TENDL-2021 LIBRARY; T=0.K  
Heating

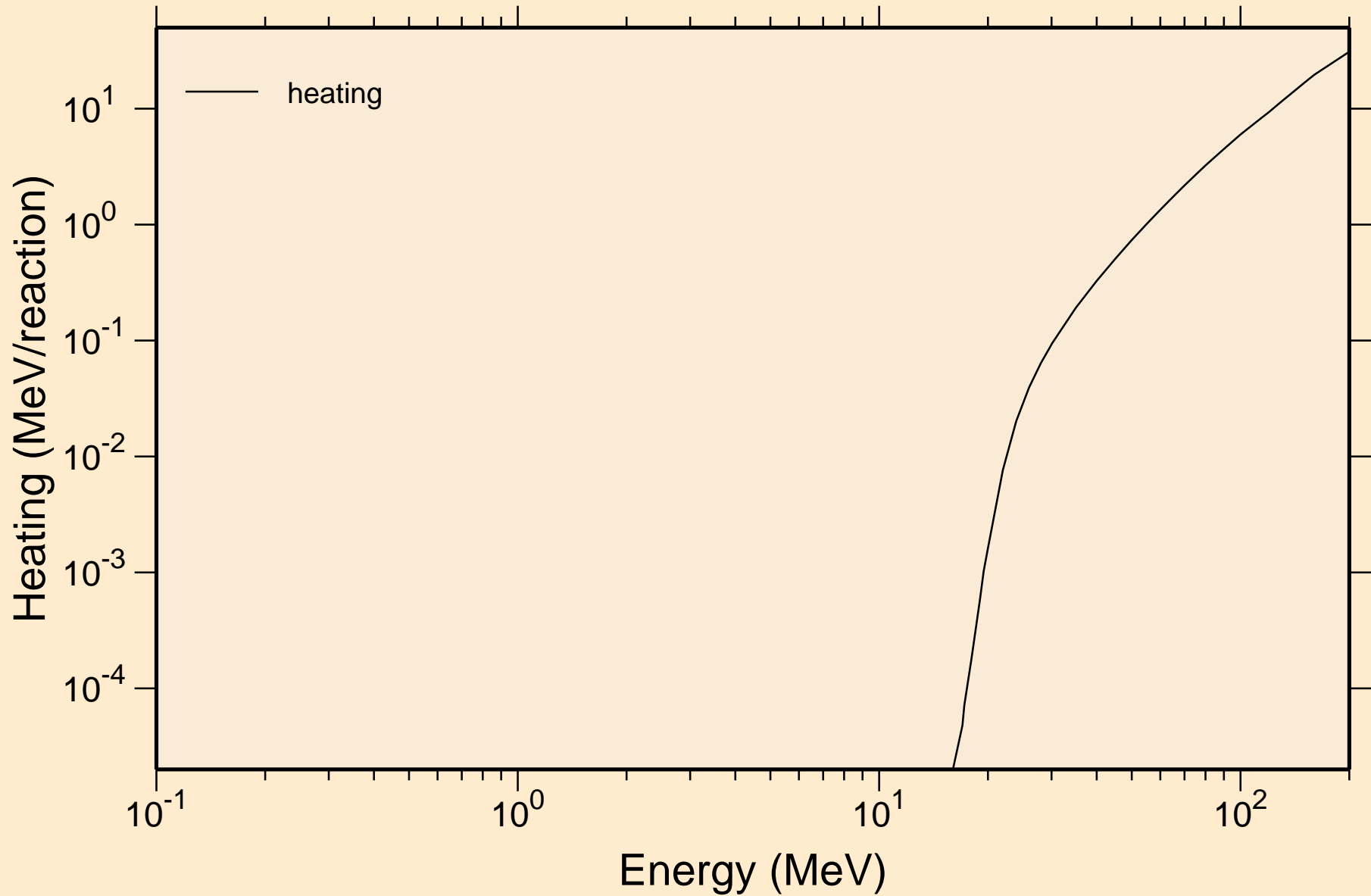

# HG198 HELION ACER TENDL-2021 LIBRARY; T=0.K

## Principal cross sections

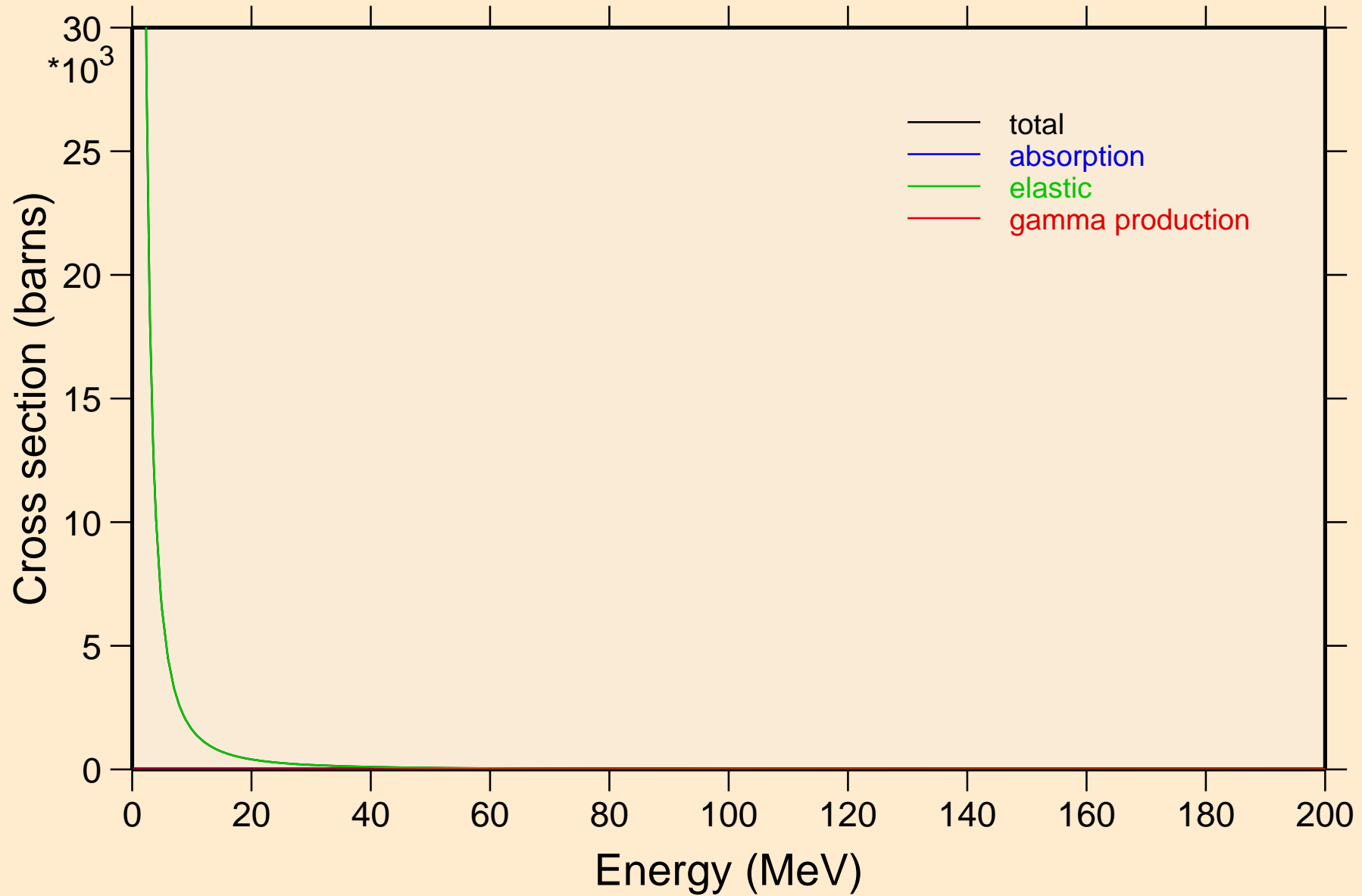

# HG198 HELION ACER TENDL-2021 LIBRARY; T=0.K

## Heating

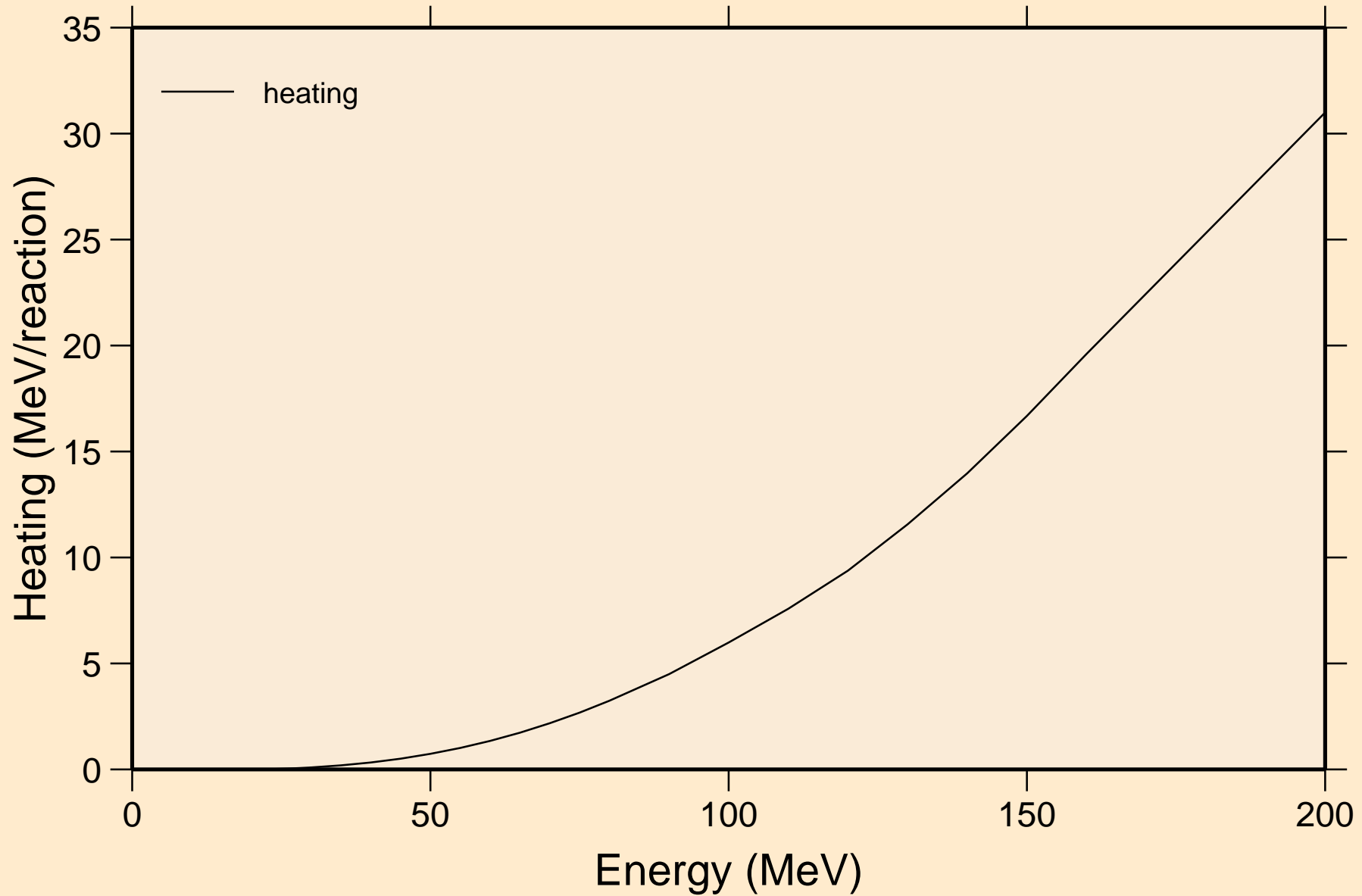

# HG198 HELION ACER TENDL-2021 LIBRARY; T=0.K

## Threshold reactions

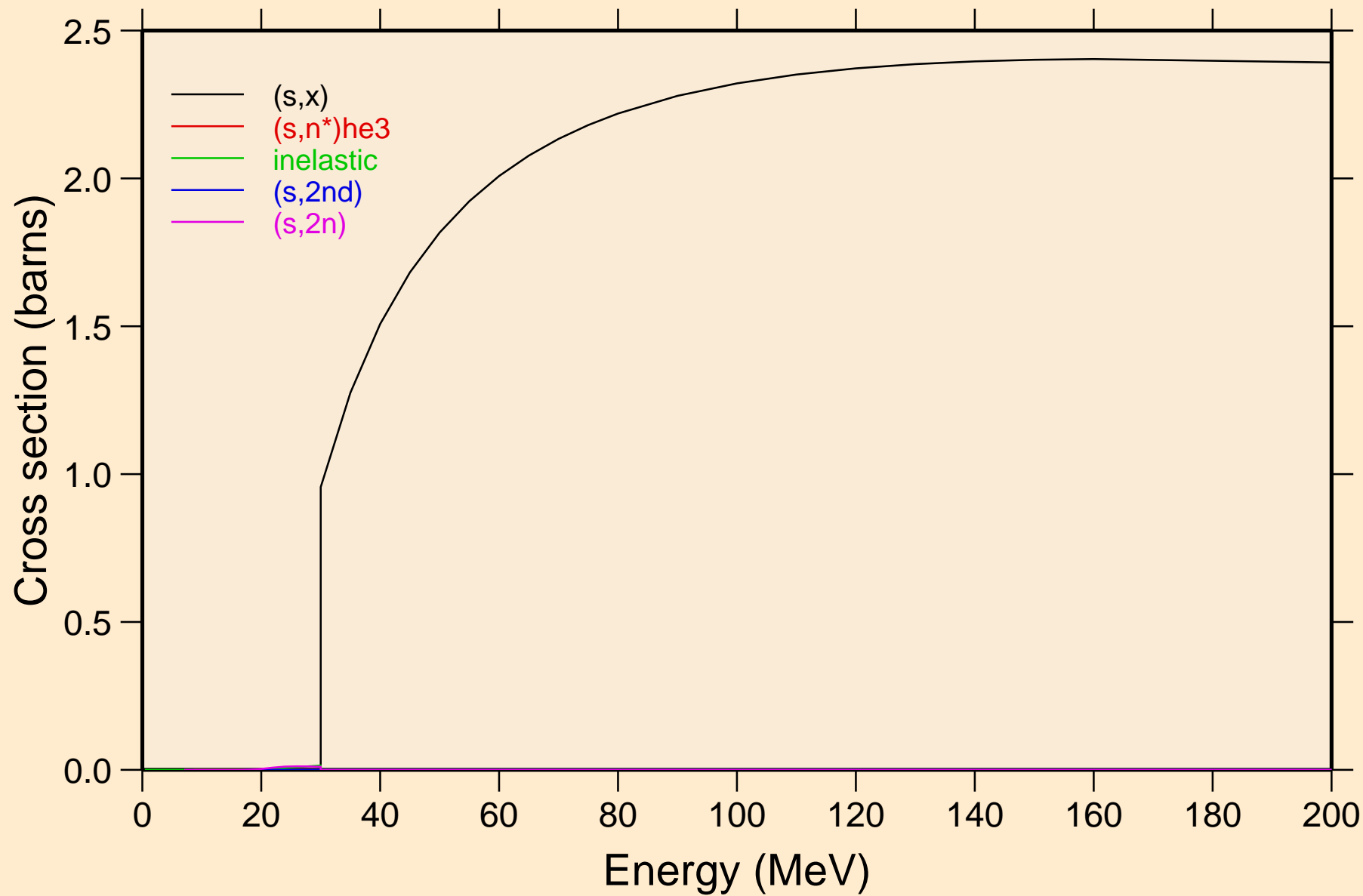

HG198 HELION ACER TENDL-2021 LIBRARY; T=0.K  
Threshold reactions

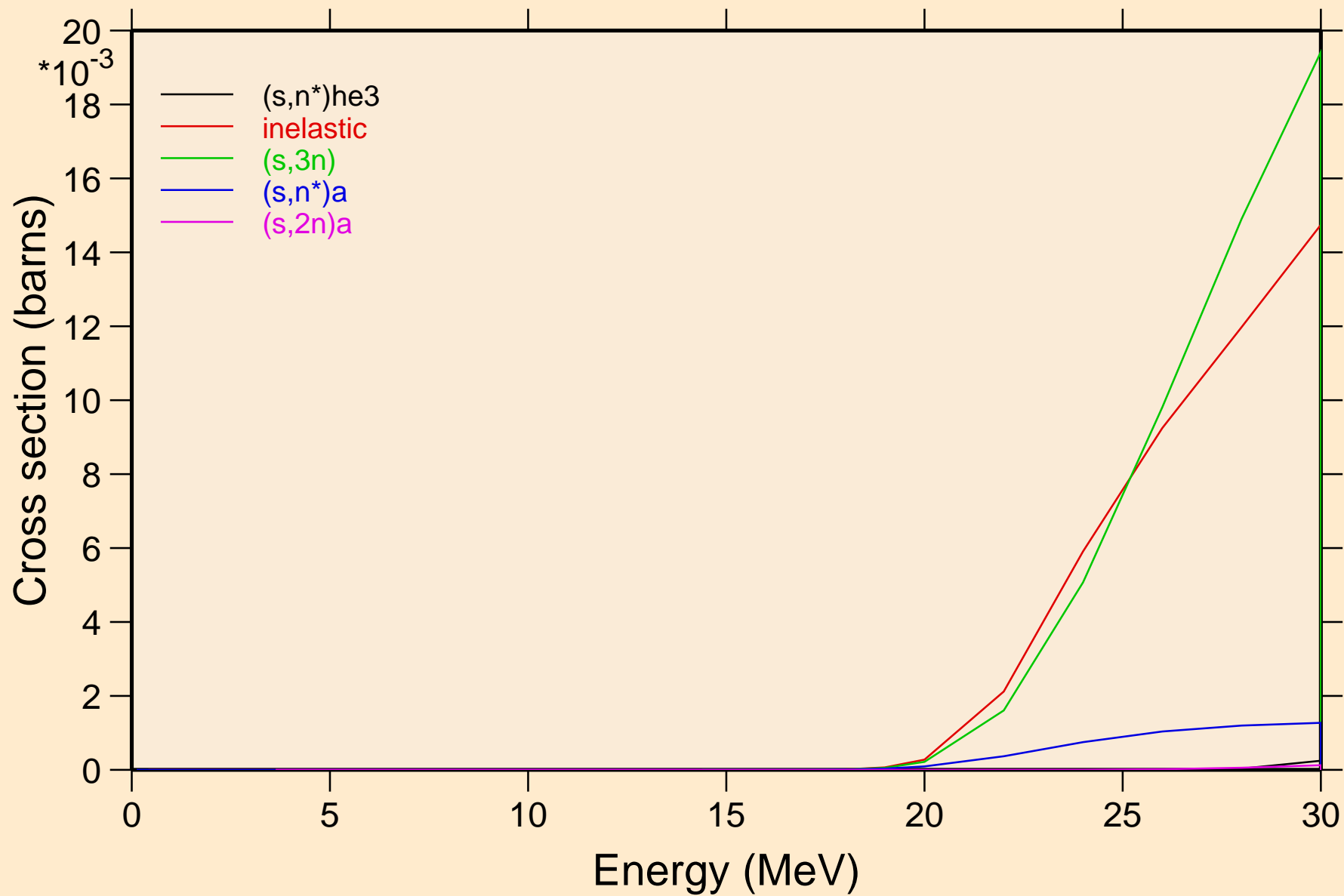

# HG198 HELION ACER TENDL-2021 LIBRARY; T=0.K

## Threshold reactions

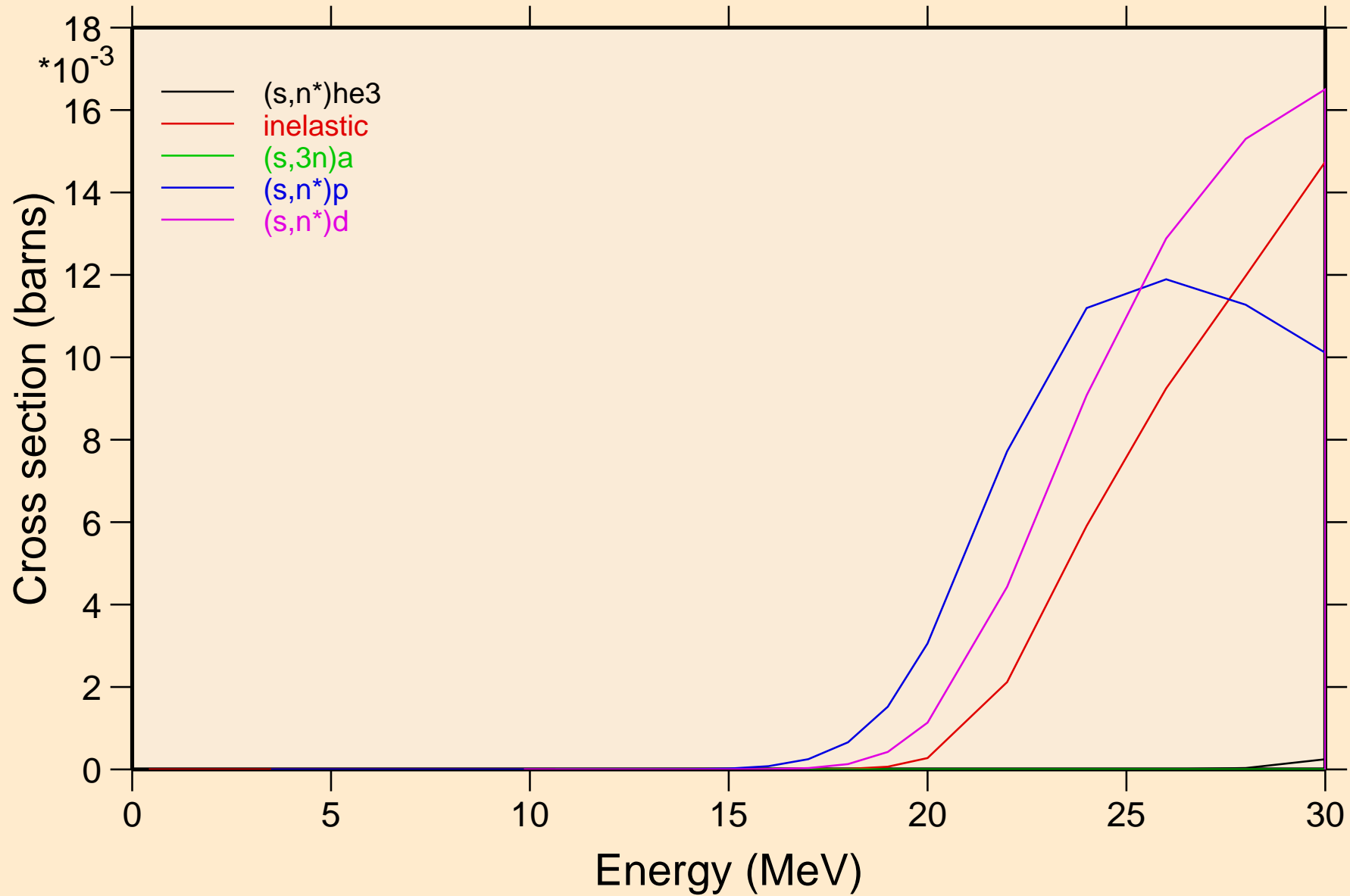

HG198 HELION ACER TENDL-2021 LIBRARY; T=0.K  
Threshold reactions

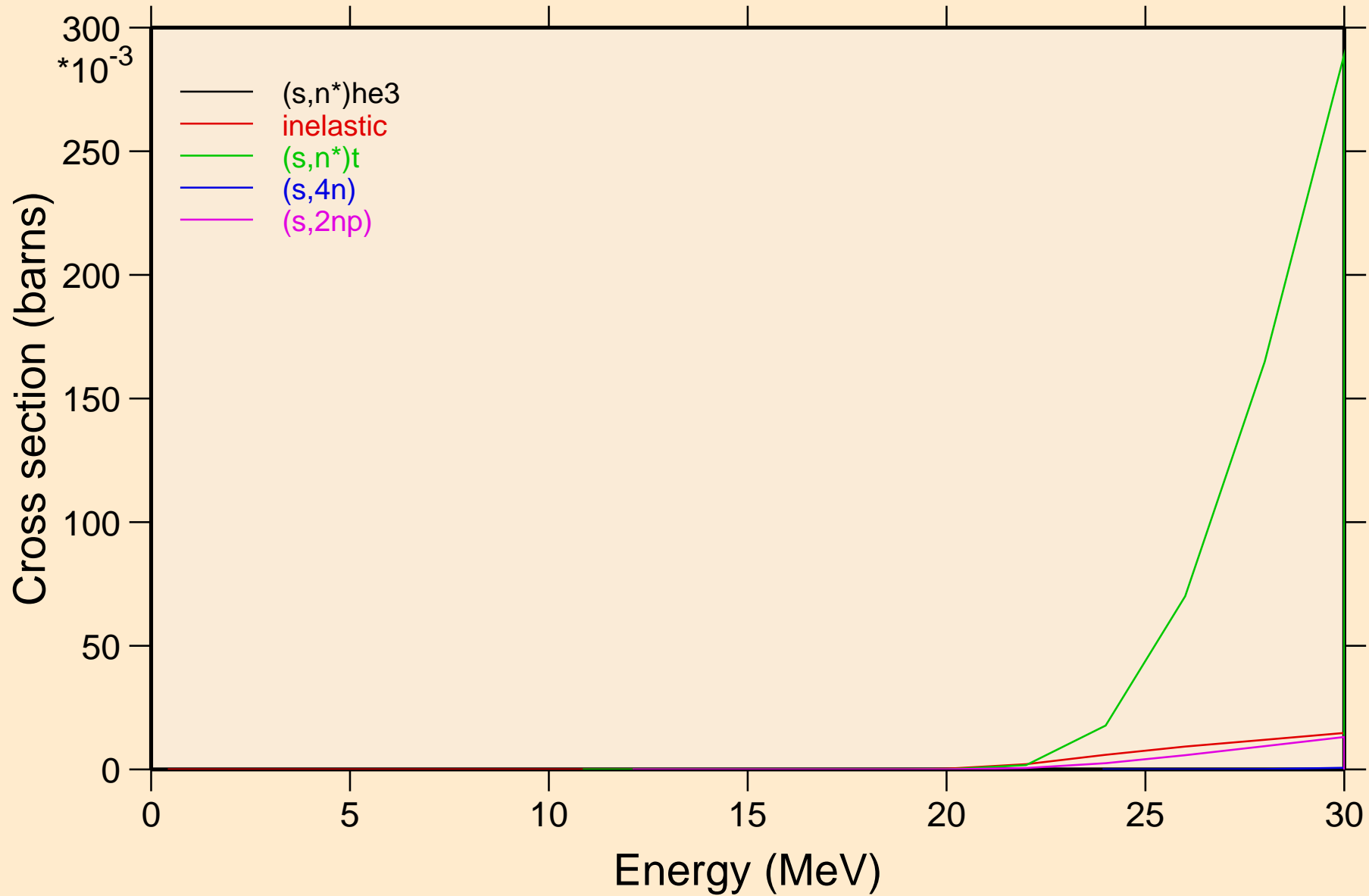



# HG198 HELION ACER TENDL-2021 LIBRARY; T=0.K

## Threshold reactions

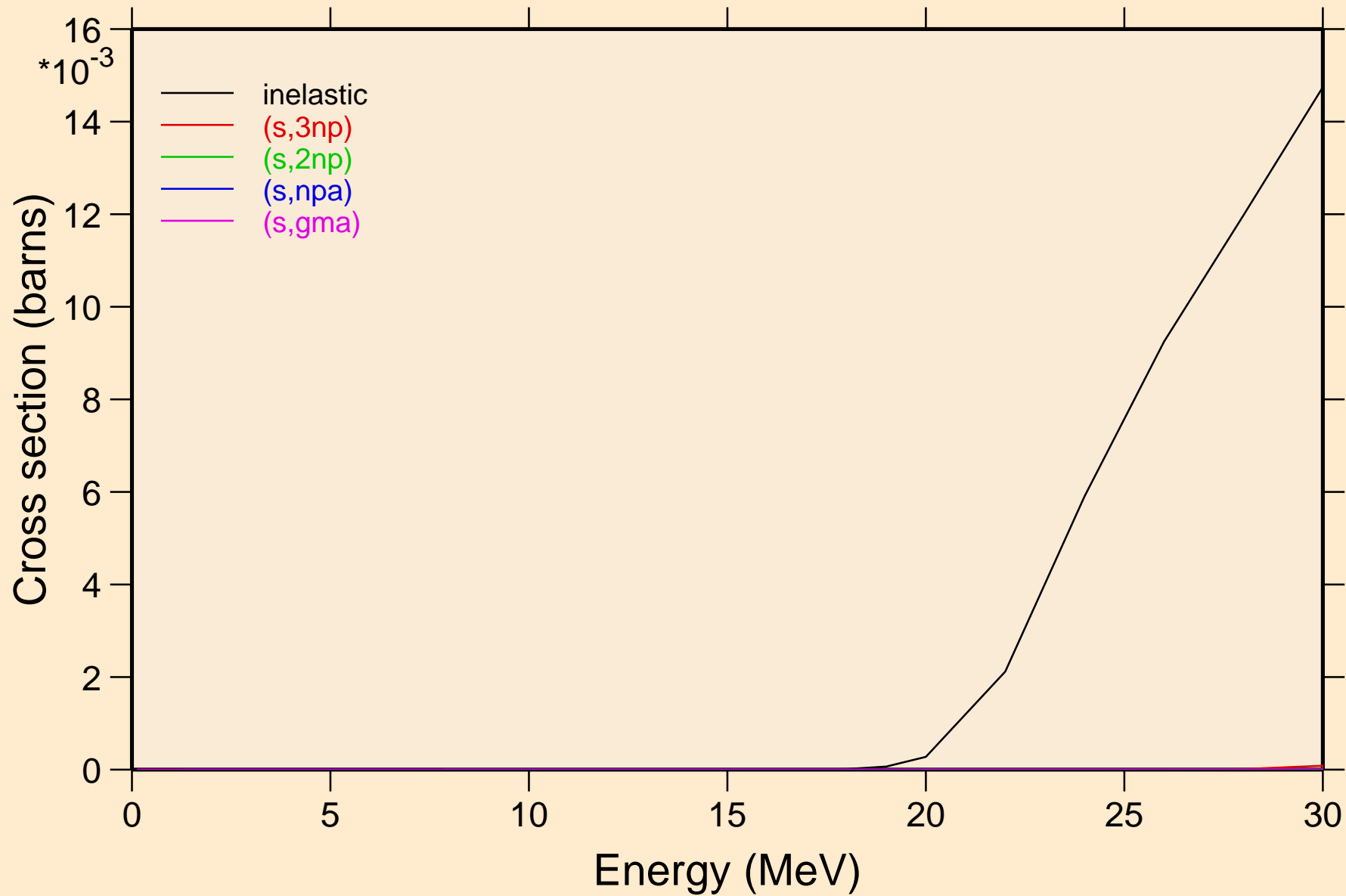

# HG198 HELION ACER TENDL-2021 LIBRARY; T=0.K

## Threshold reactions

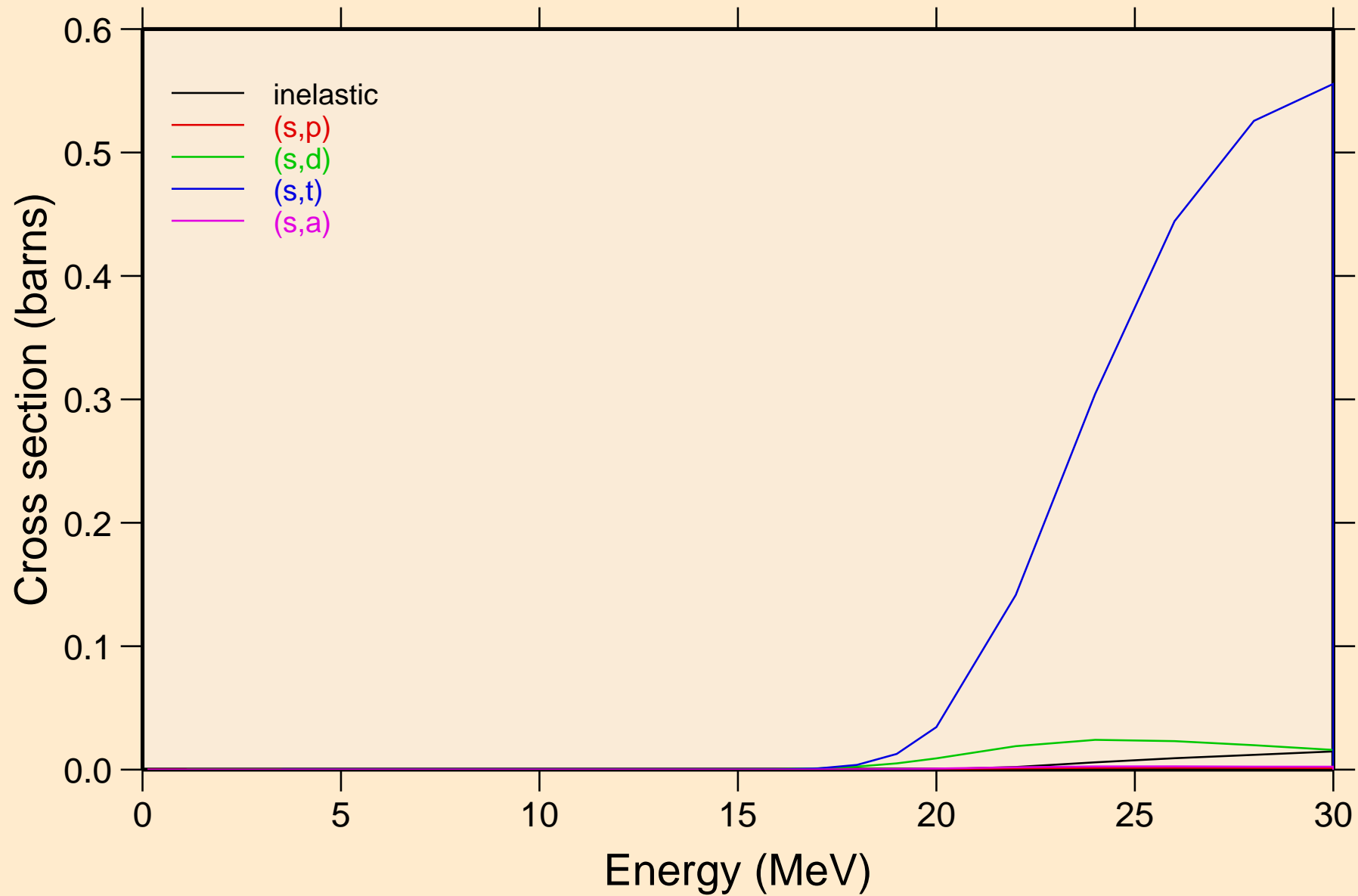

# HG198 HELION ACER TENDL-2021 LIBRARY; T=0.K

## Threshold reactions

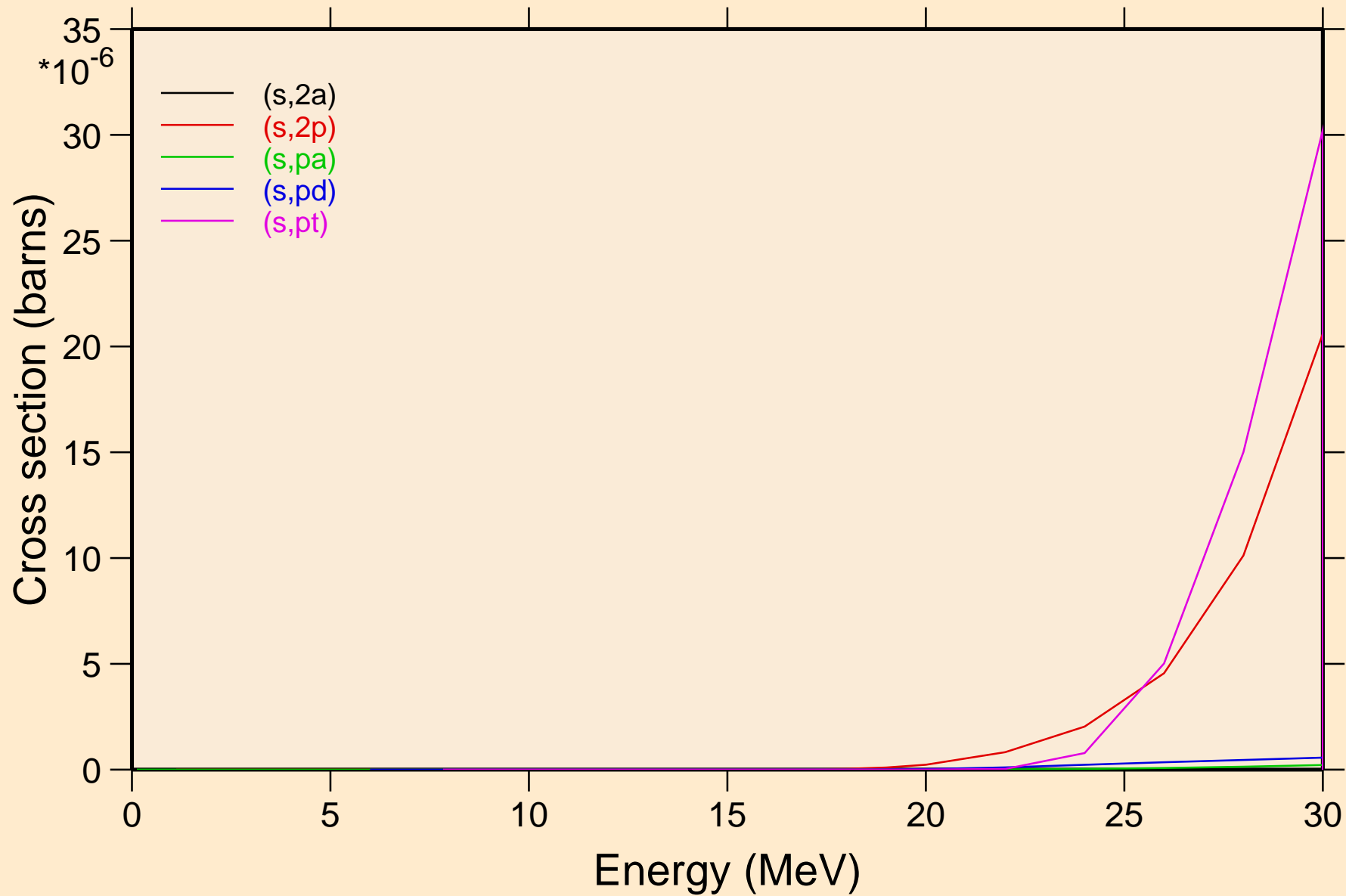

HG198 HELION ACER TENDL-2021 LIBRARY; T=0.K  
Threshold reactions

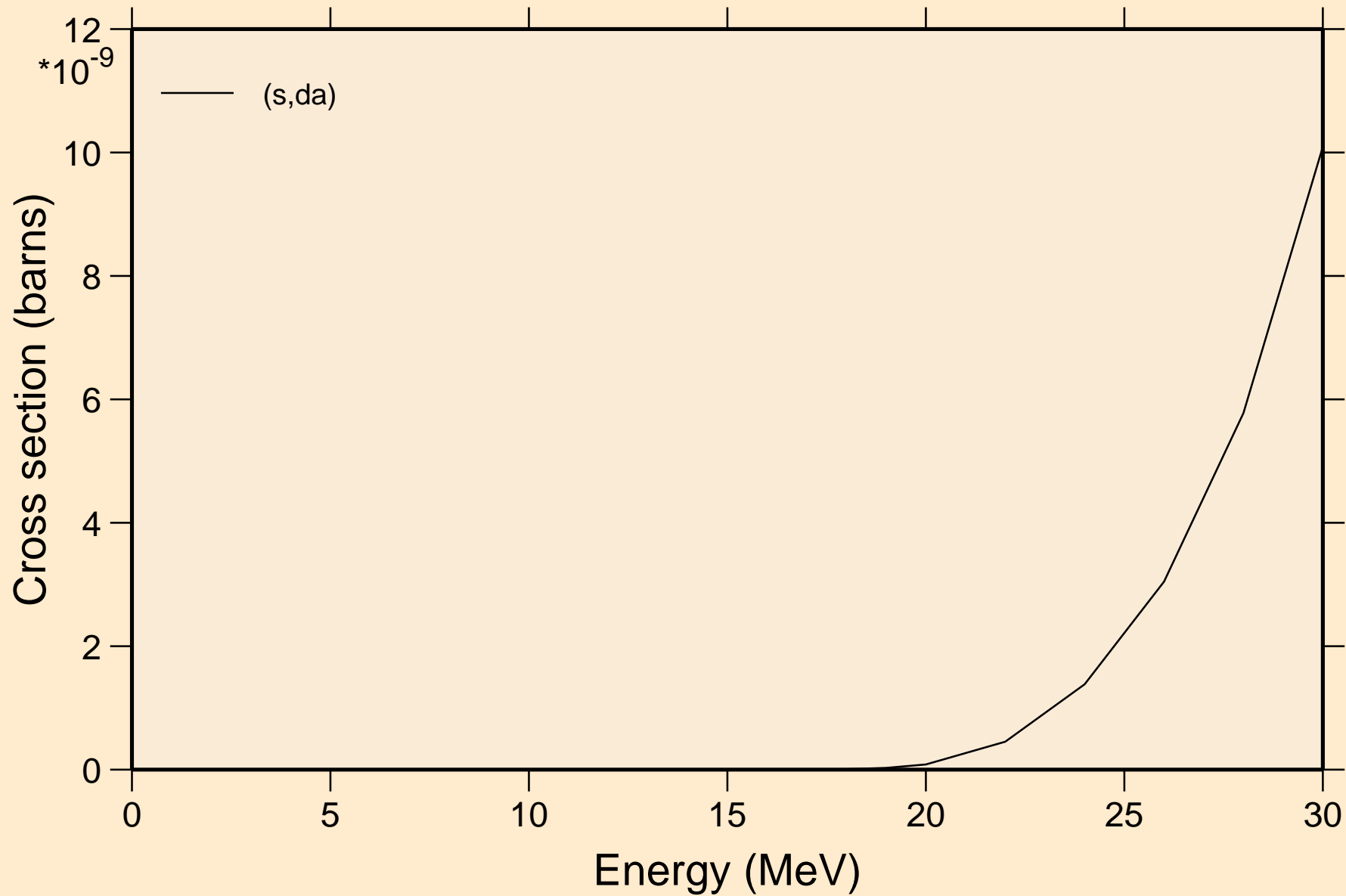

HG198 HELION ACER TENDL-2021 LIBRARY; T=0.K  
angular distribution for elastic

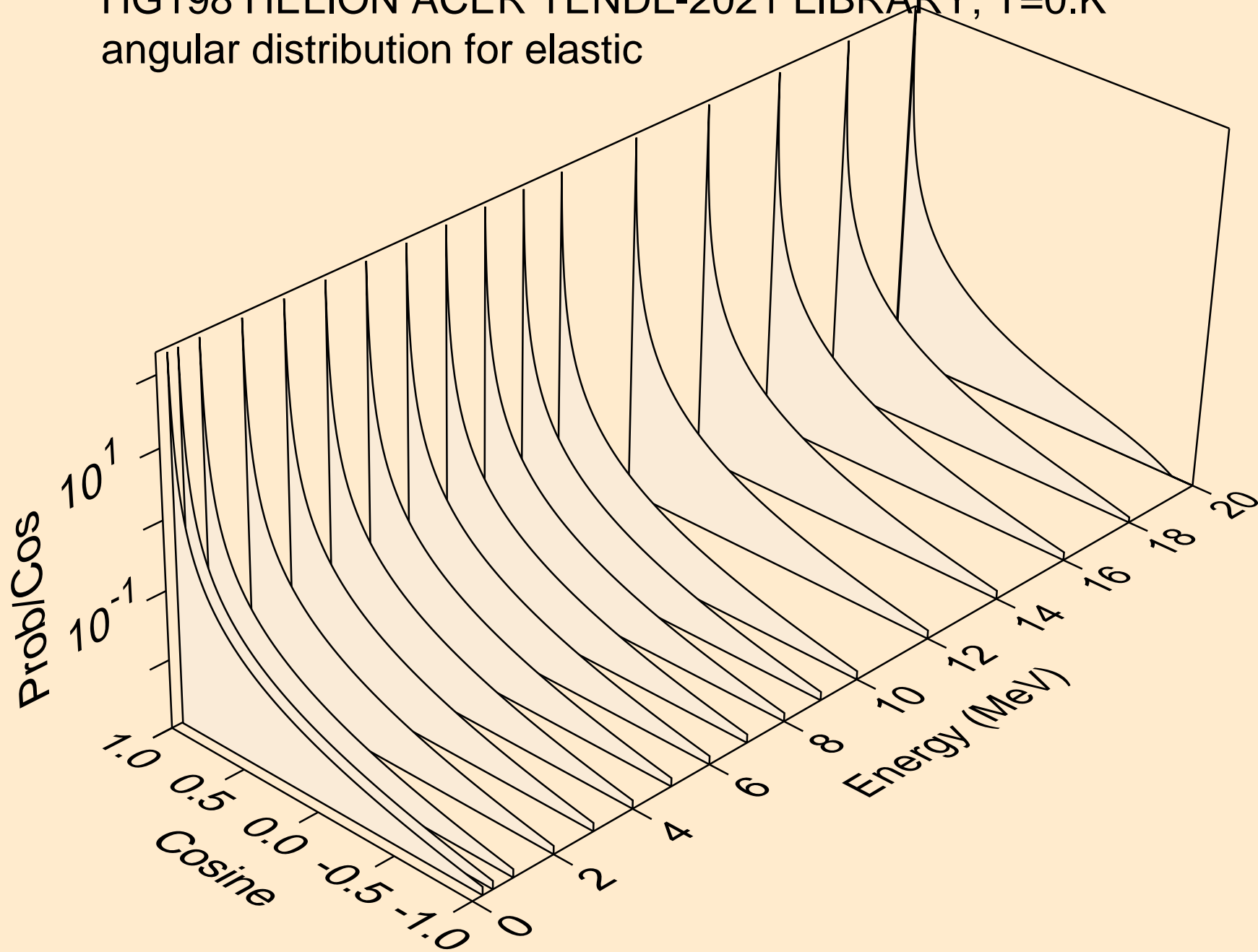

HG198 HELION ACER TENDL-2021 LIBRARY; T=0.K  
angular distribution for elastic

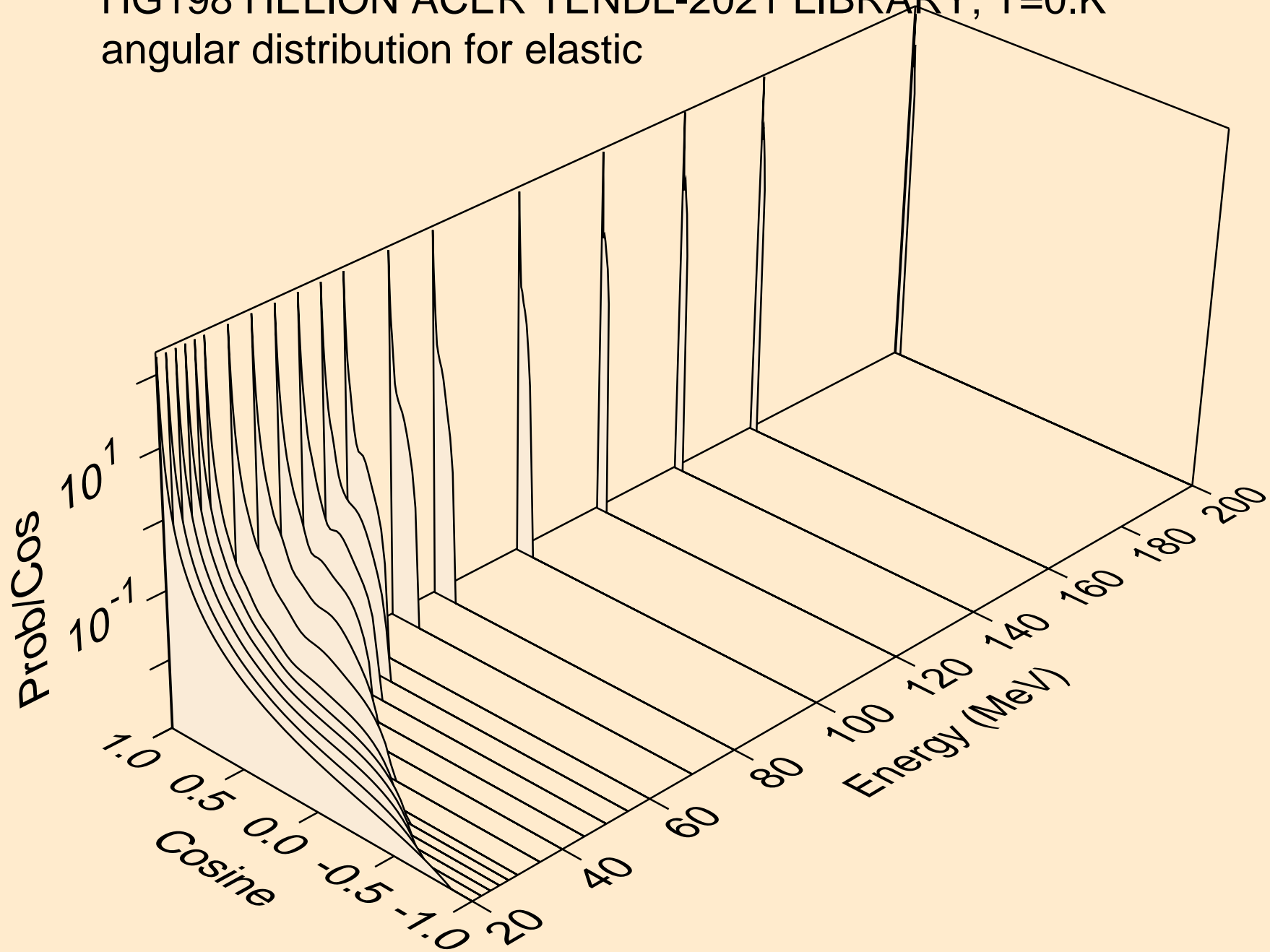

HG198 HELION ACER TENDL-2021 LIBRARY; T=0.K  
He-3 emission for (s,x)

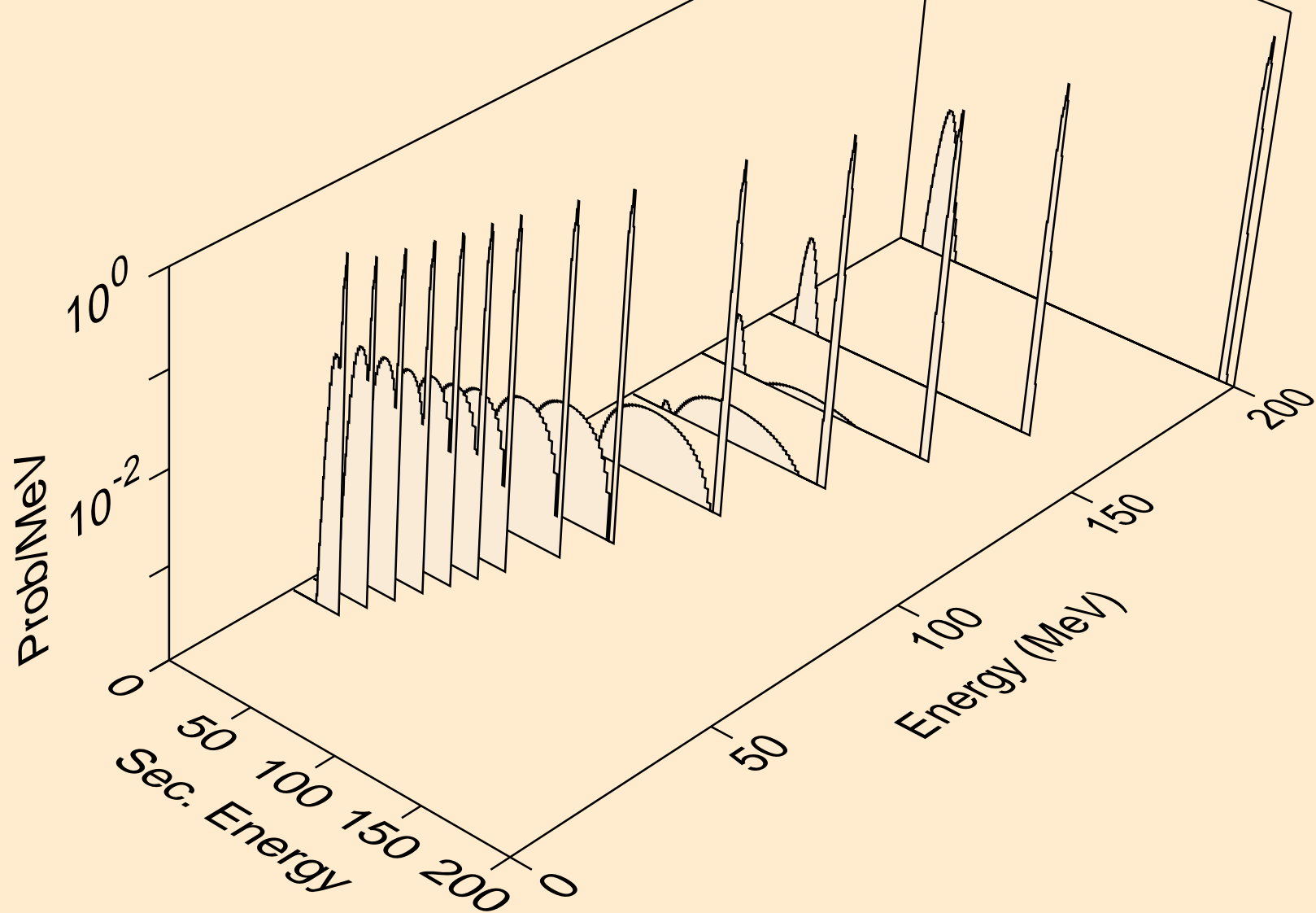

HG198 HELION ACER TENDL-2021 LIBRARY; T=0.K  
He-3 emission for (s,n\*)he3

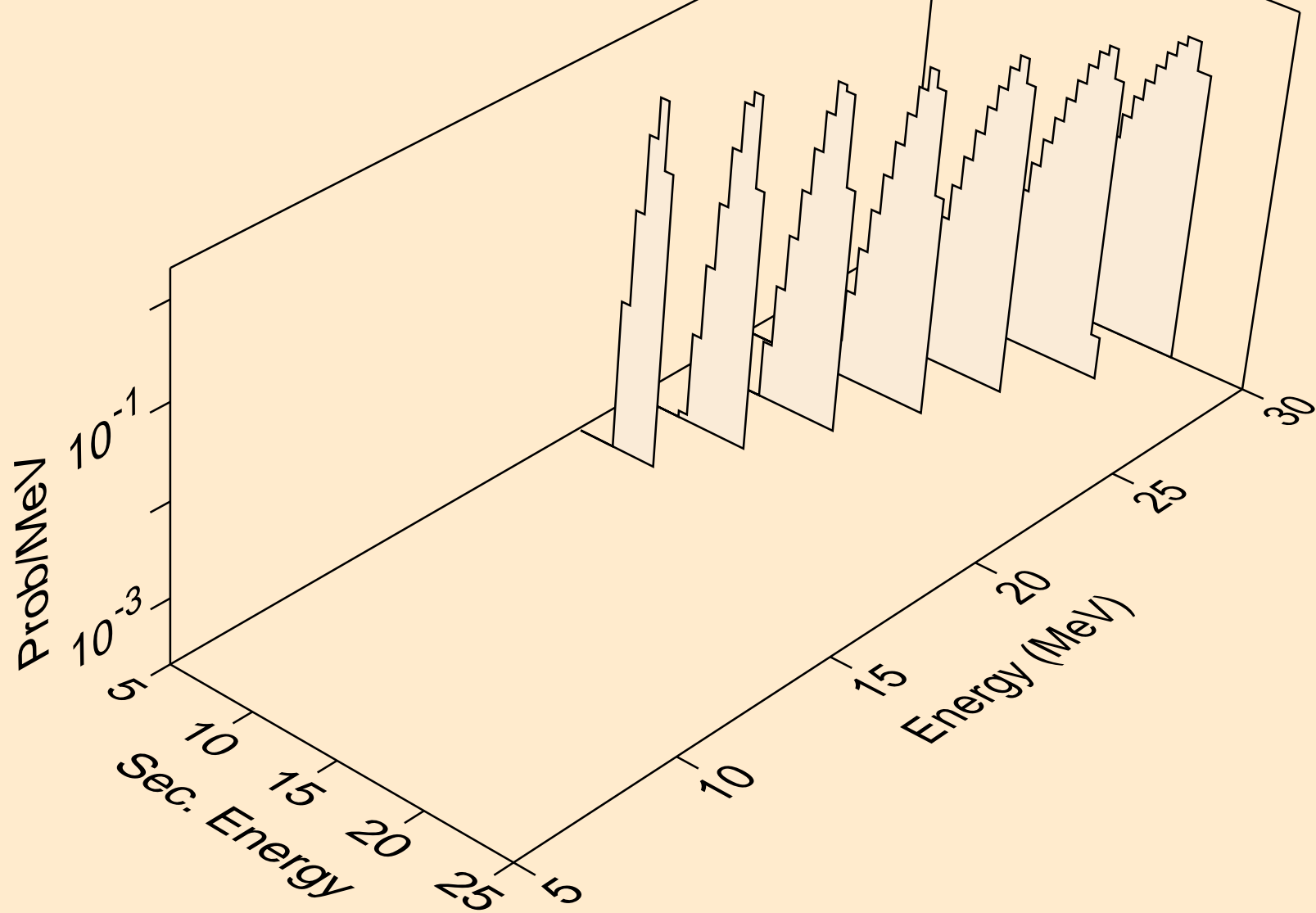



HG198 HELION ACER TENDL-2021 LIBRARY; T=0.K  
He-3 emission for inelastic

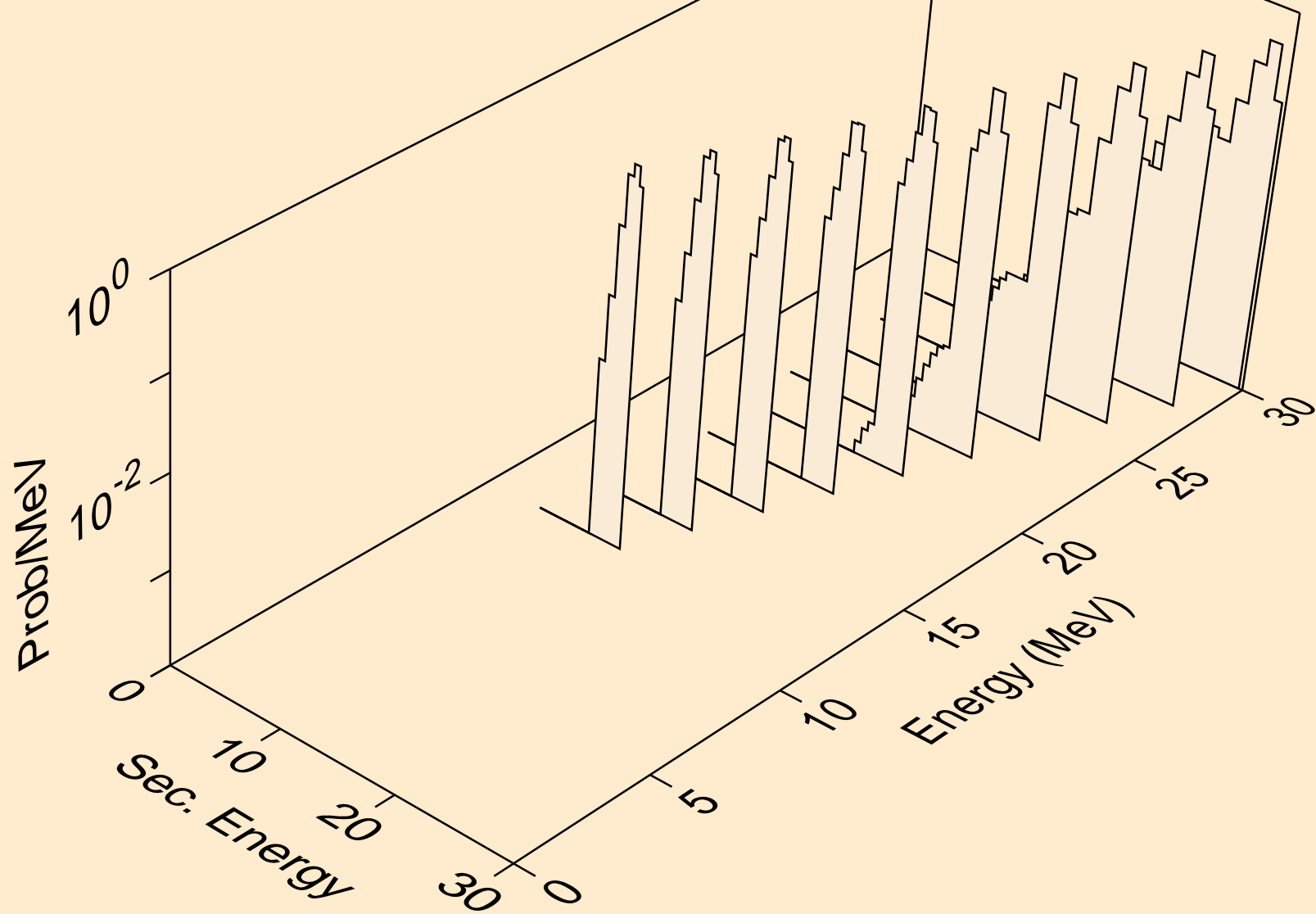

HG198 HELION ACER TENDL-2021 LIBRARY; T=0.K  
Photon emission for (z,n)

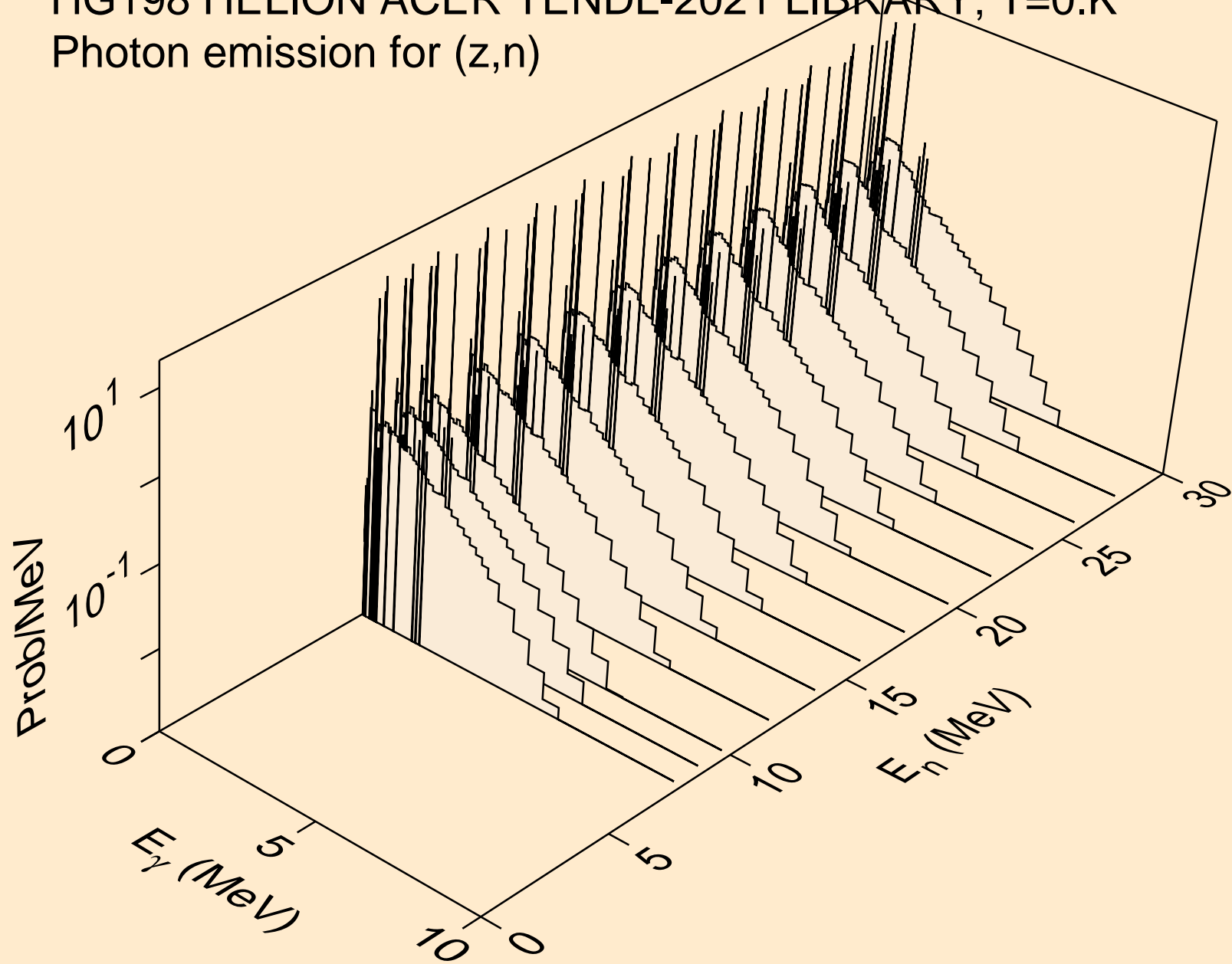

HG198 HELION ACER TENDL-2021 LIBRARY; T=0.K  
Photon emission for (n,x)

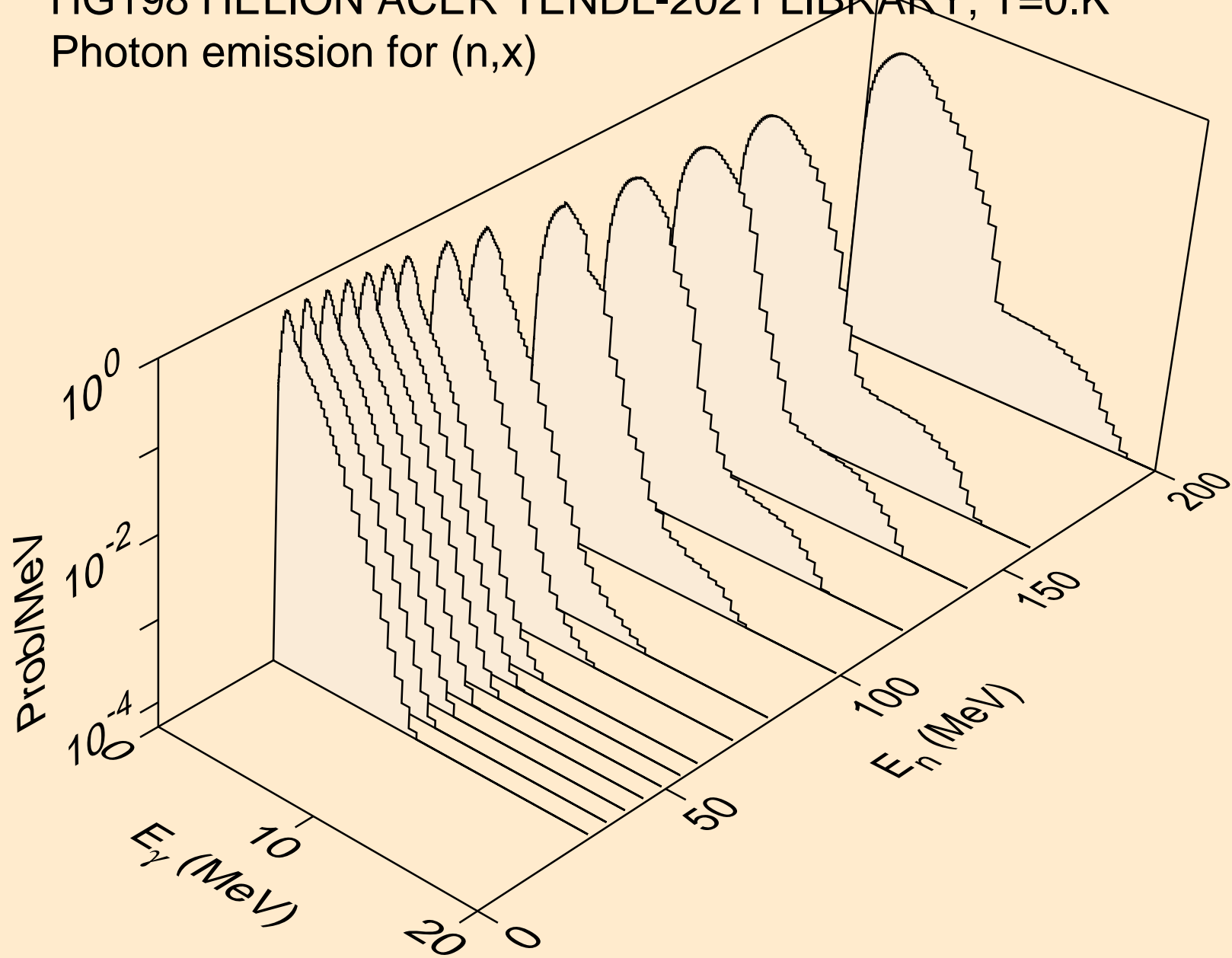

HG198 HELION ACER TENDL-2021 LIBRARY; T=0.K  
Photon emission for (n,2nd)

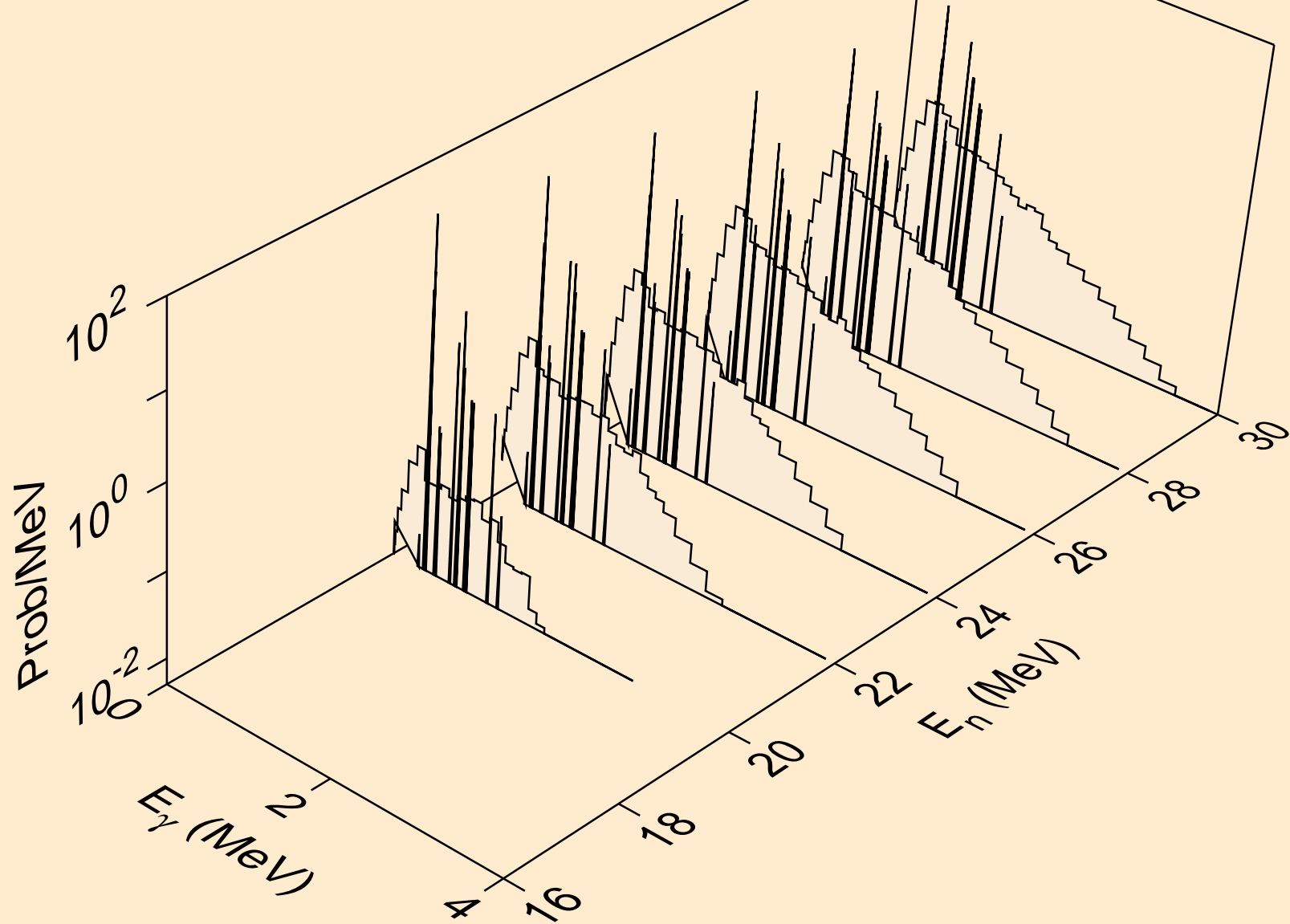

HG198 HELION ACER TENDL-2021 LIBRARY; T=0.K  
Photon emission for (n,2n)

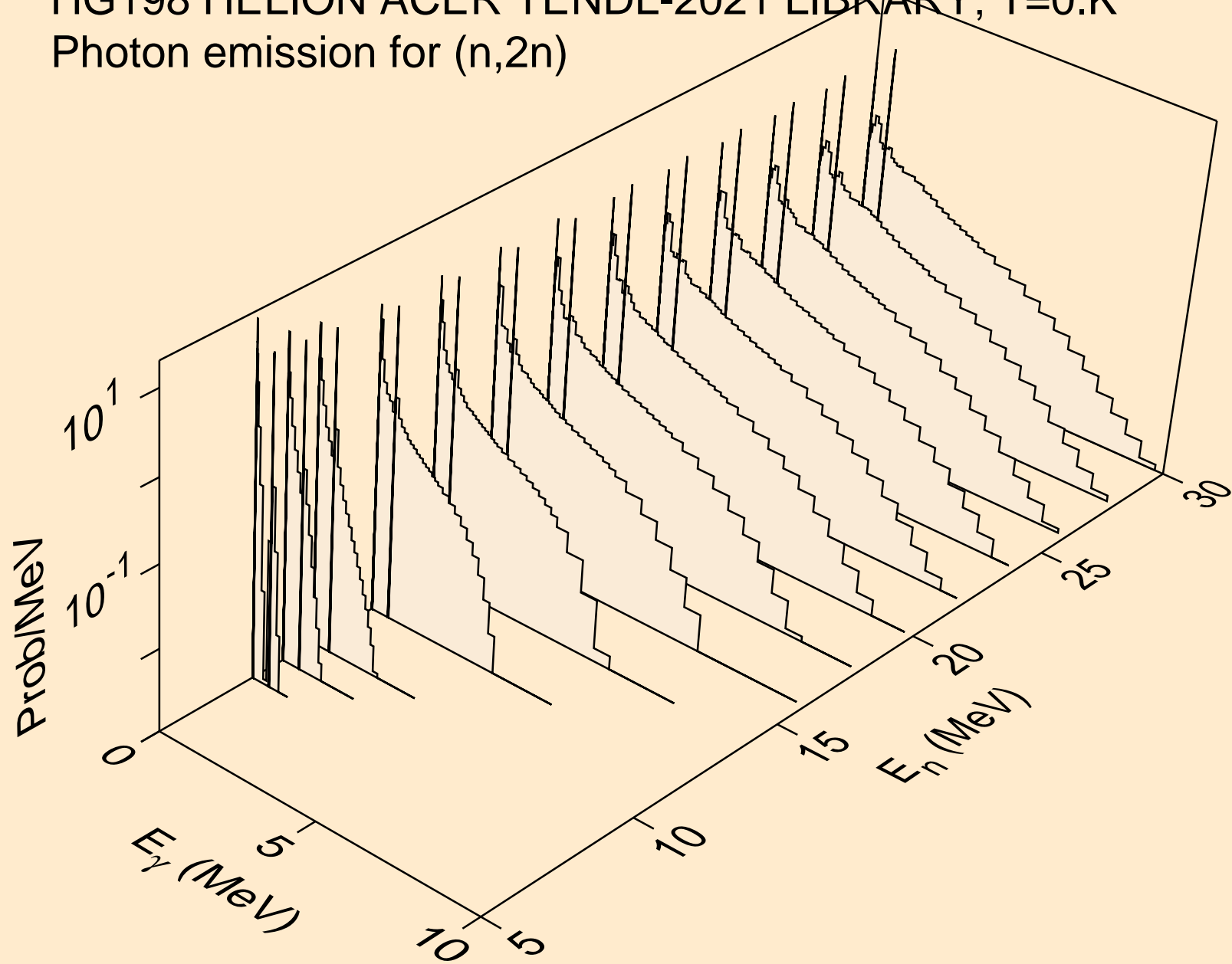

HG198 HELION ACER TENDL-2021 LIBRARY; T=0.K  
Photon emission for (n,3n)

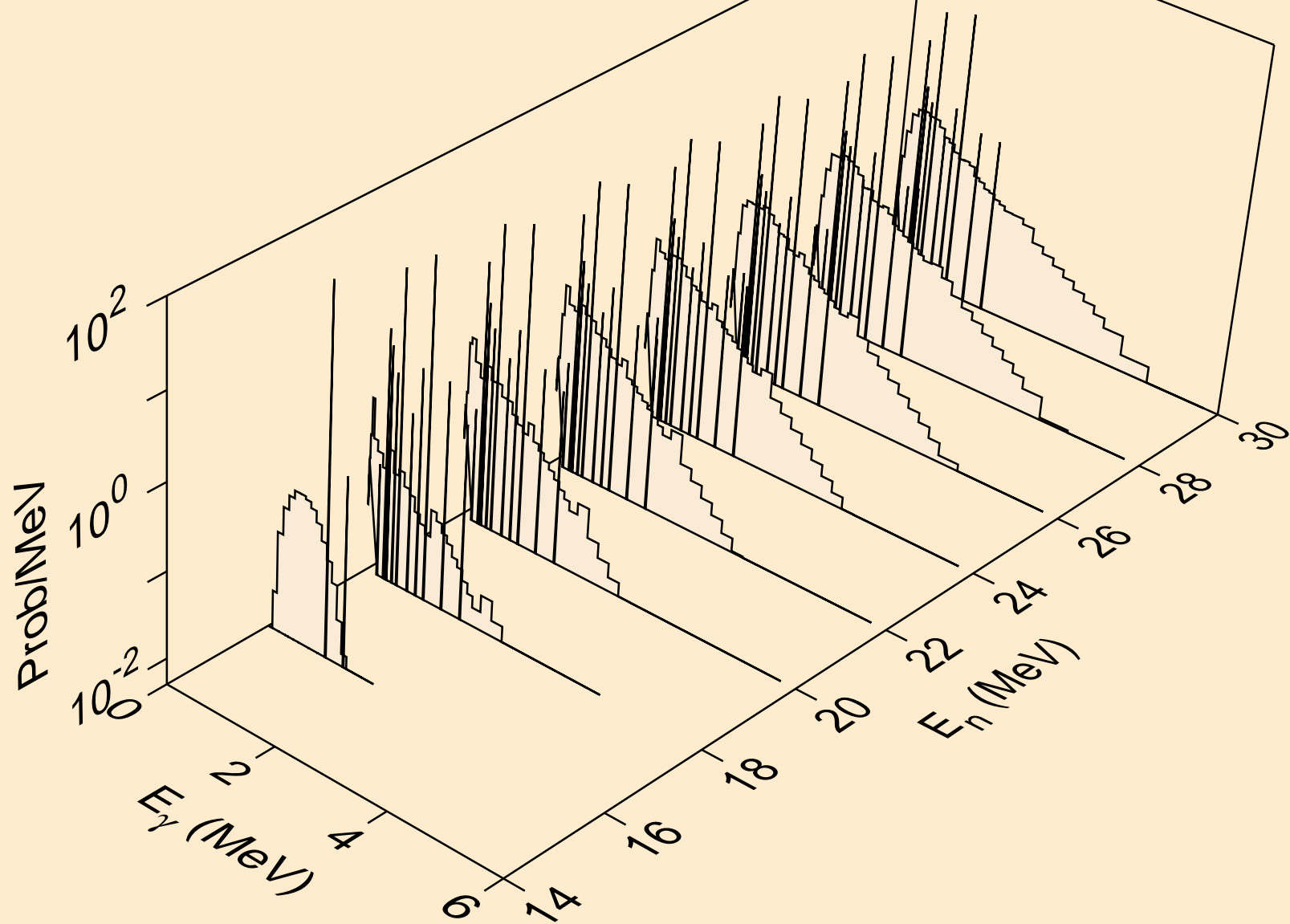

HG198 HELION ACER TENDL-2021 LIBRARY; T=0.K  
Photon emission for (n,n\*)a

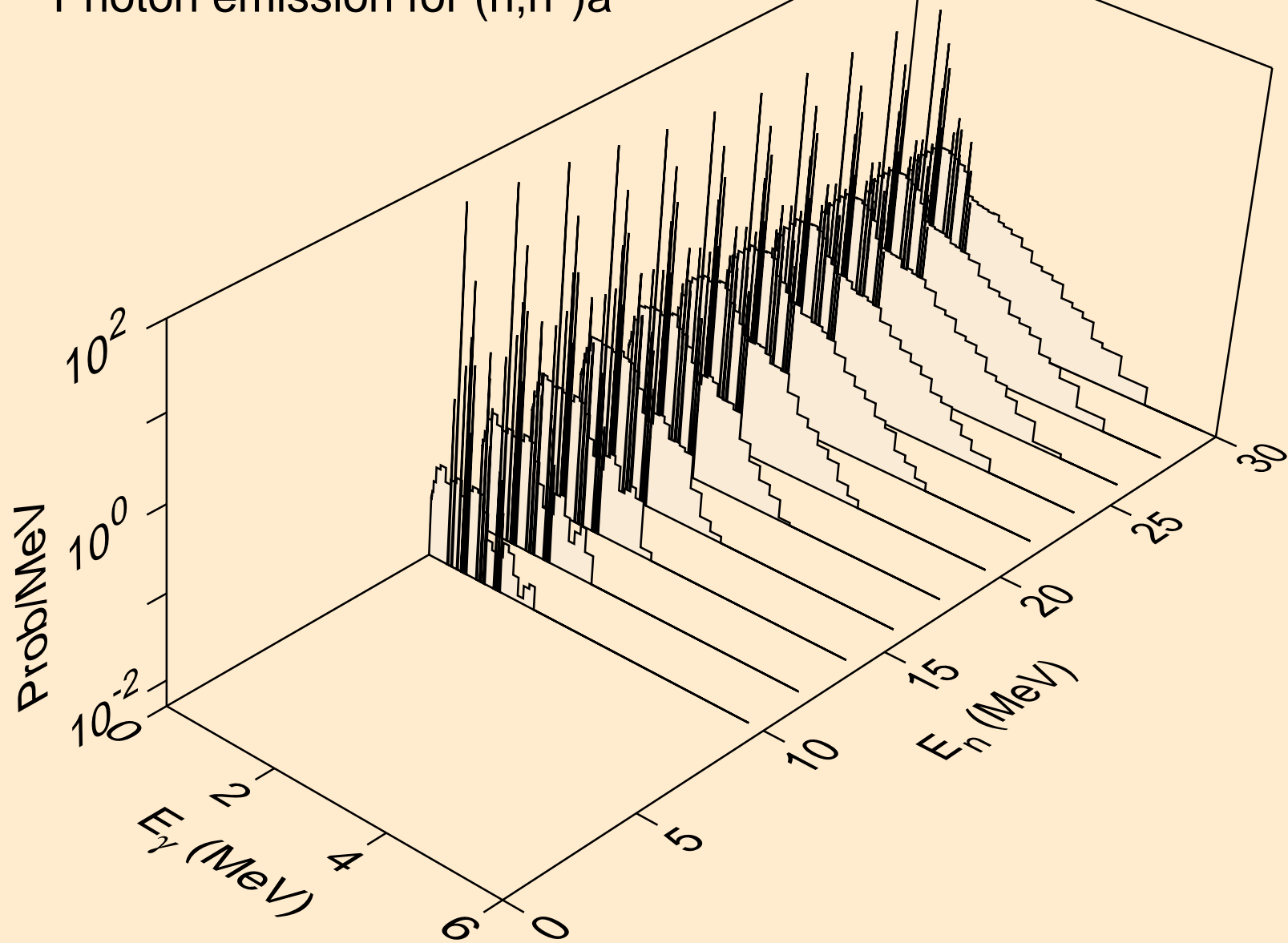

HG198 HELION ACER TENDL-2021 LIBRARY; T=0.K  
Photon emission for (n,2n)a

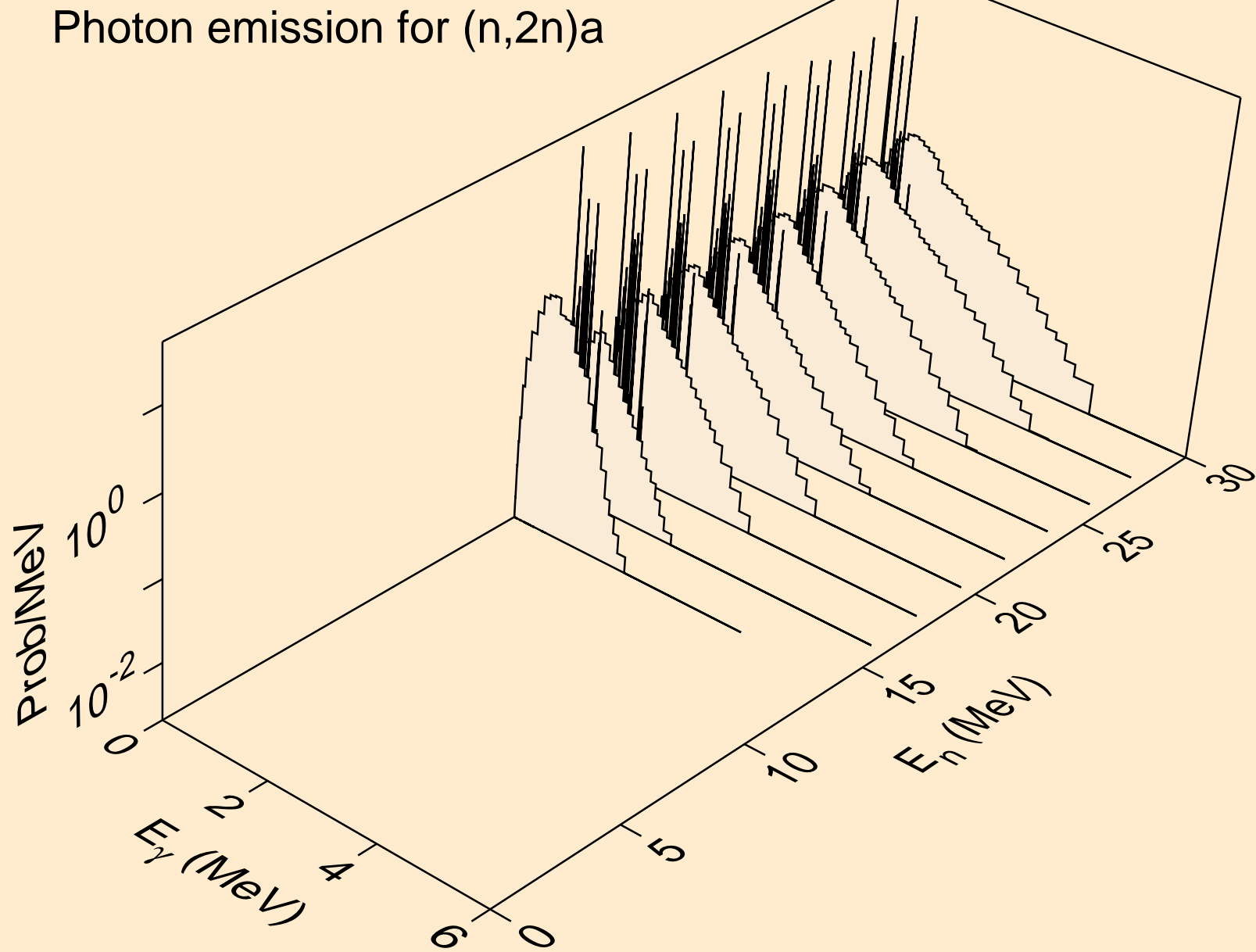



HG198 HELION ACER TENDL-2021 LIBRARY; T=0.K  
Photon emission for (n,3n)a

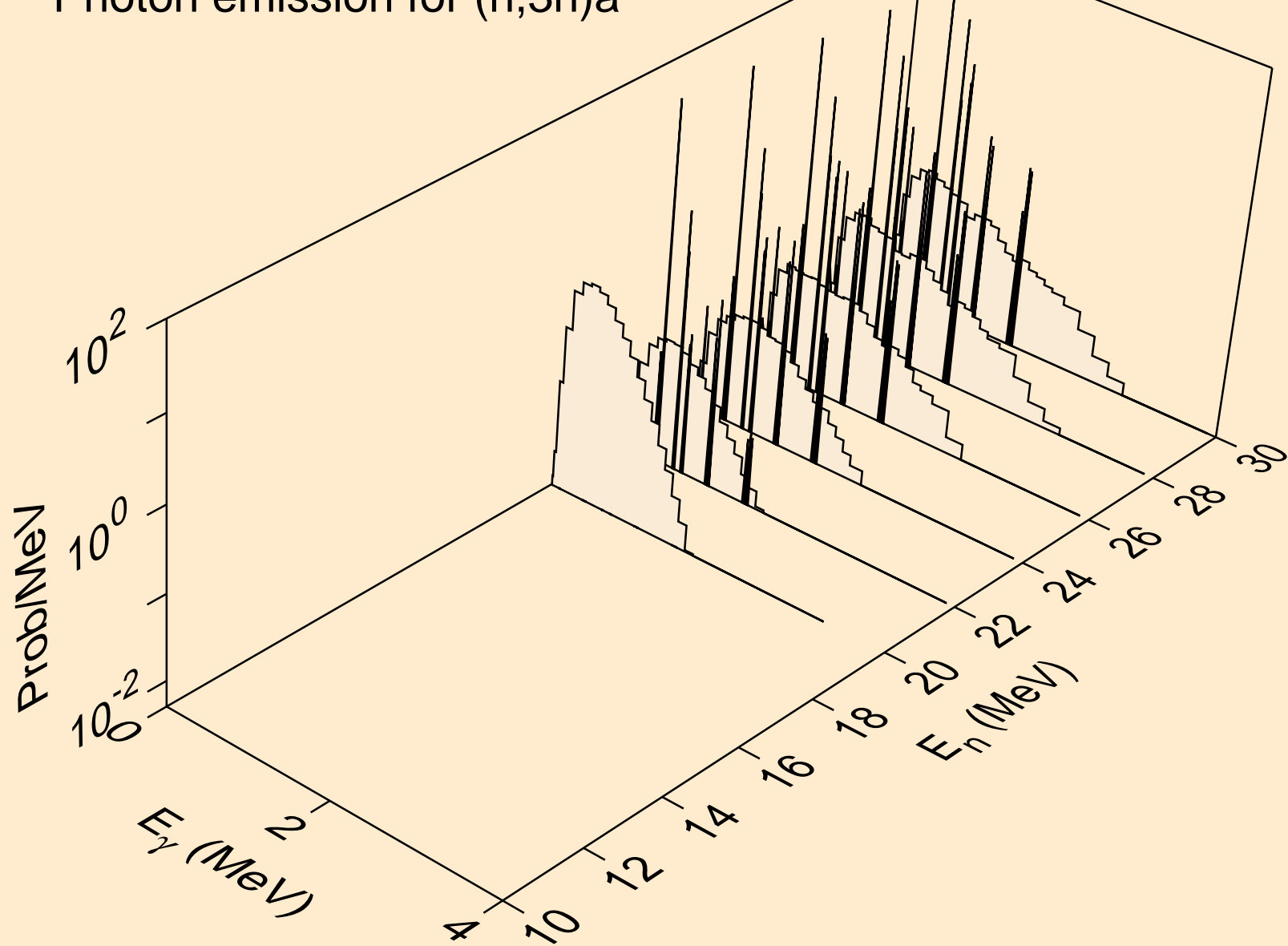

HG198 HELION ACER TENDL-2021 LIBRARY; T=0.K  
Photon emission for (n,n\*)p

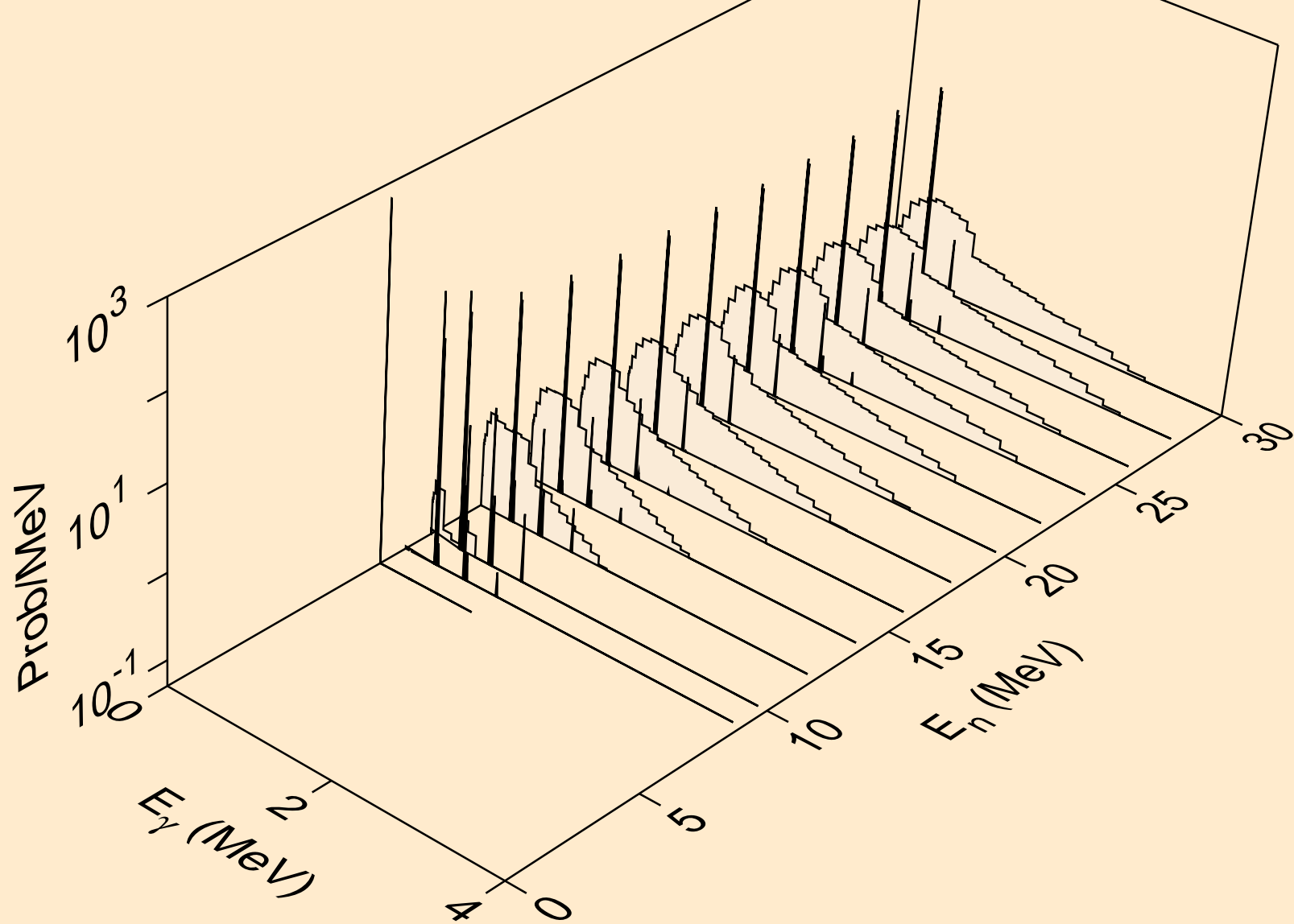

HG198 HELION ACER TENDL-2021 LIBRARY; T=0.K  
Photon emission for (n,n\*)d

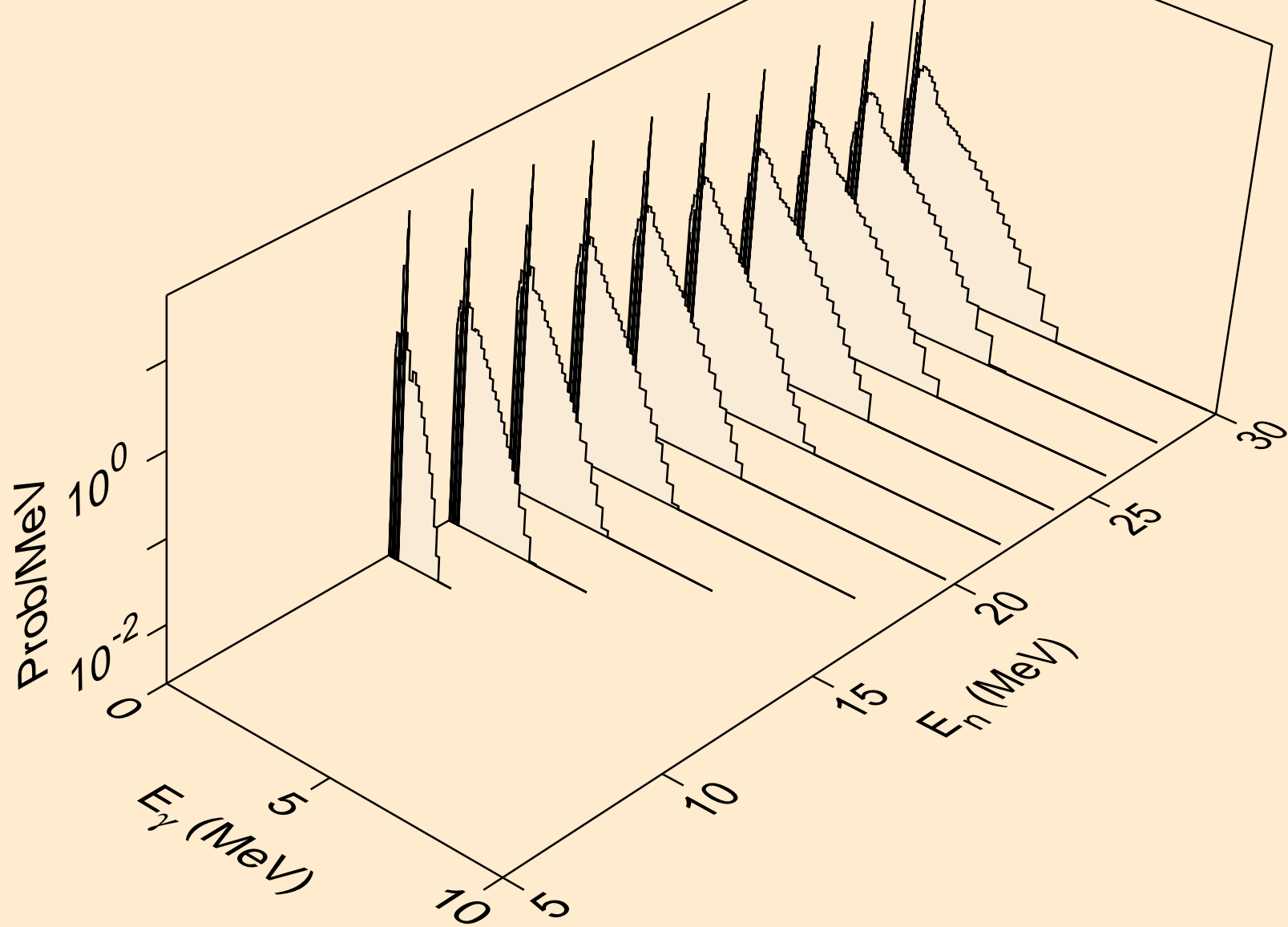

HG198 HELION ACER TENDL-2021 LIBRARY; T=0.K  
Photon emission for (n,n\*)t

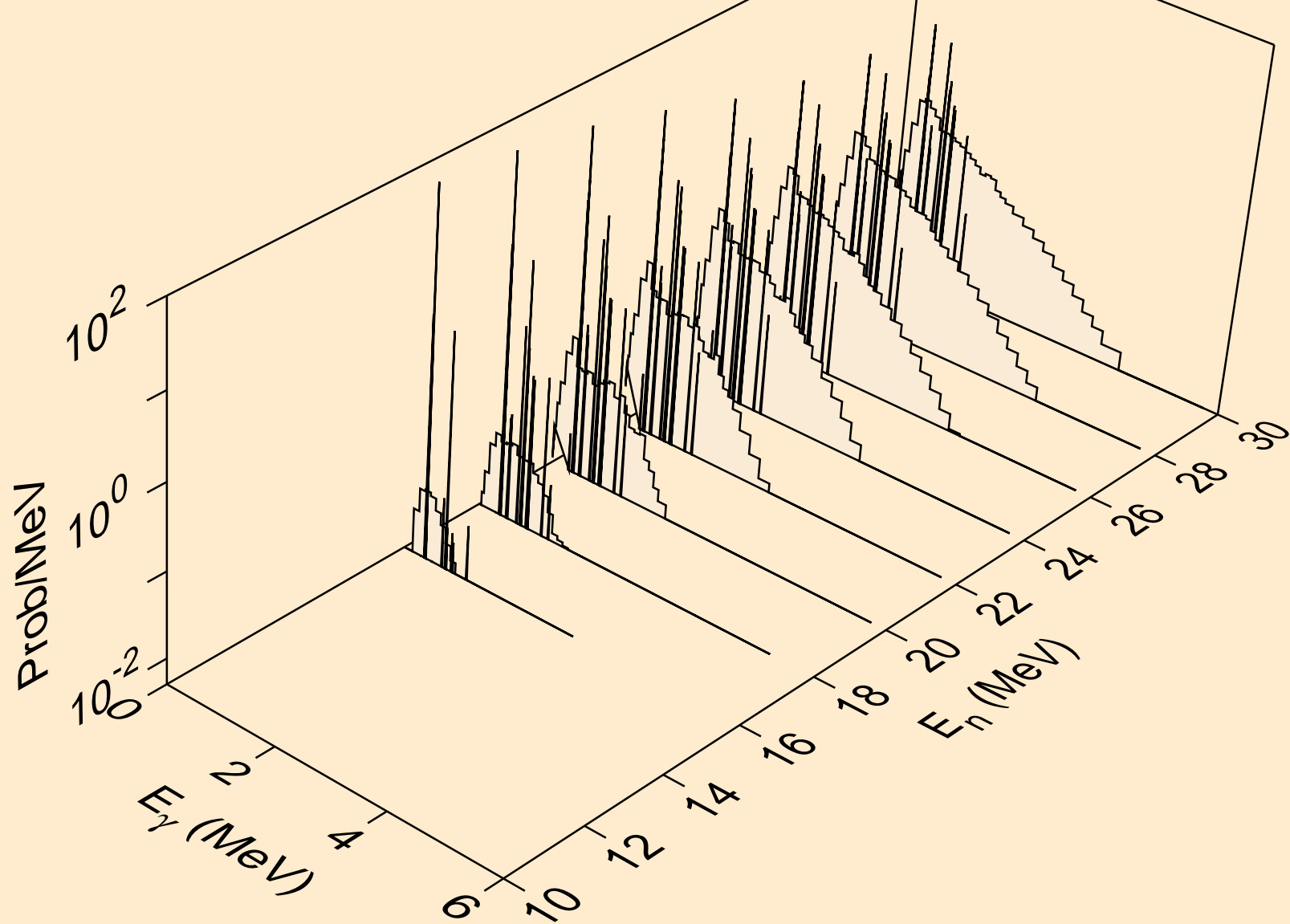

HG198 HELION ACER TENDL-2021 LIBRARY; T=0.K  
Photon emission for (n,n\*)he3

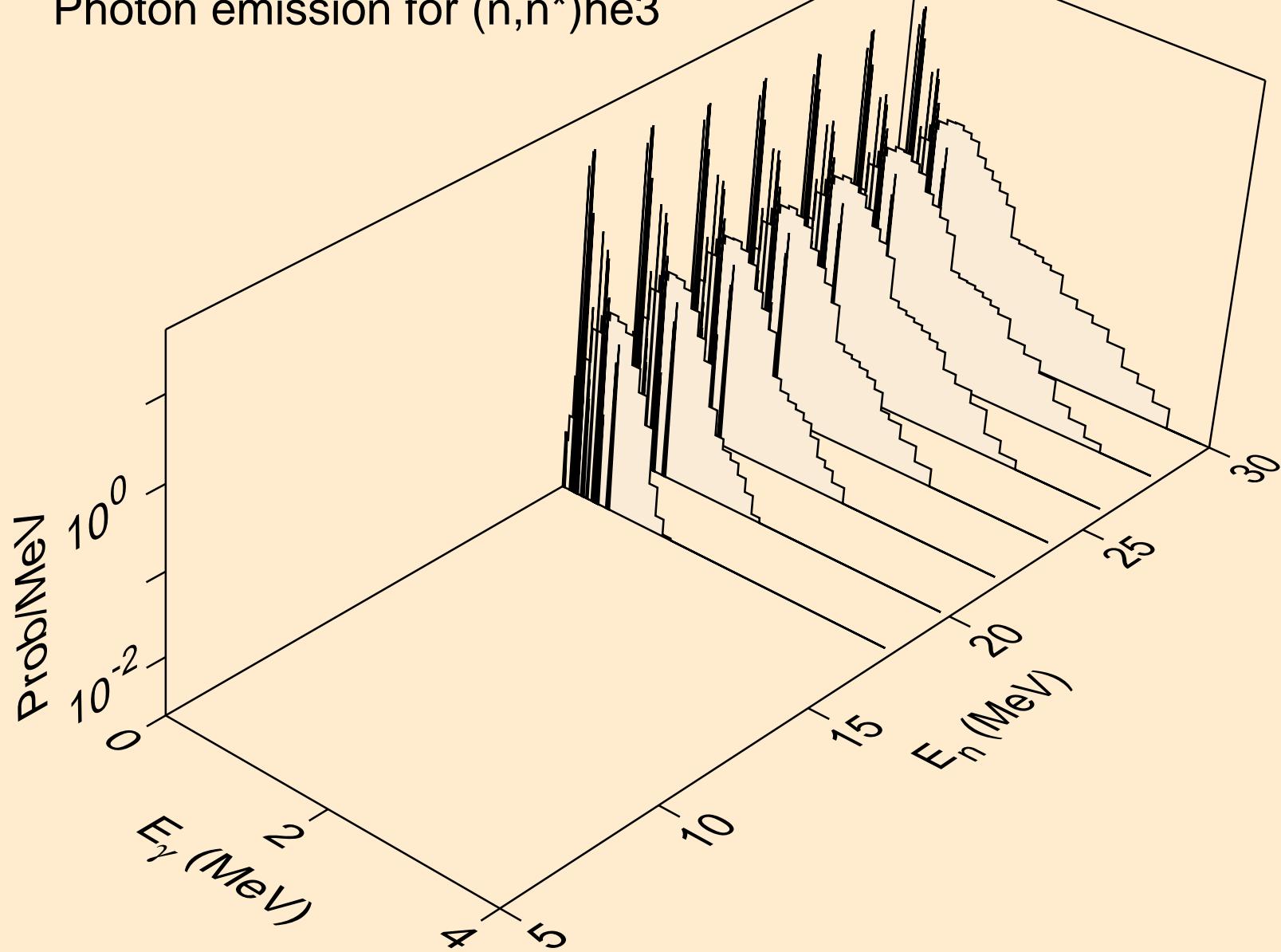

HG198 HELION ACER TENDL-2021 LIBRARY; T=0.K  
Photon emission for (n,4n)

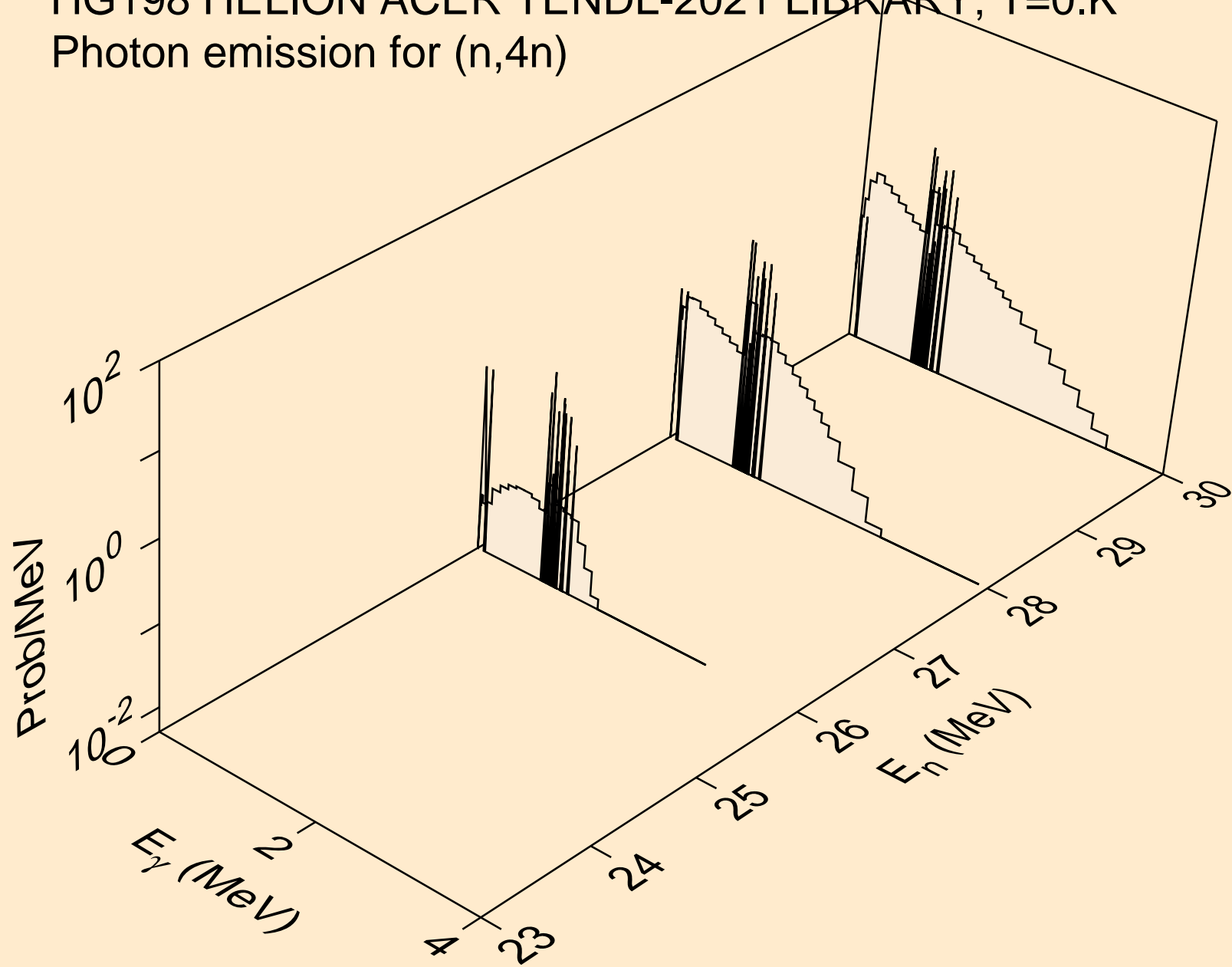

HG198 HELION ACER TENDL-2021 LIBRARY; T=0.K  
Photon emission for (n,2np)

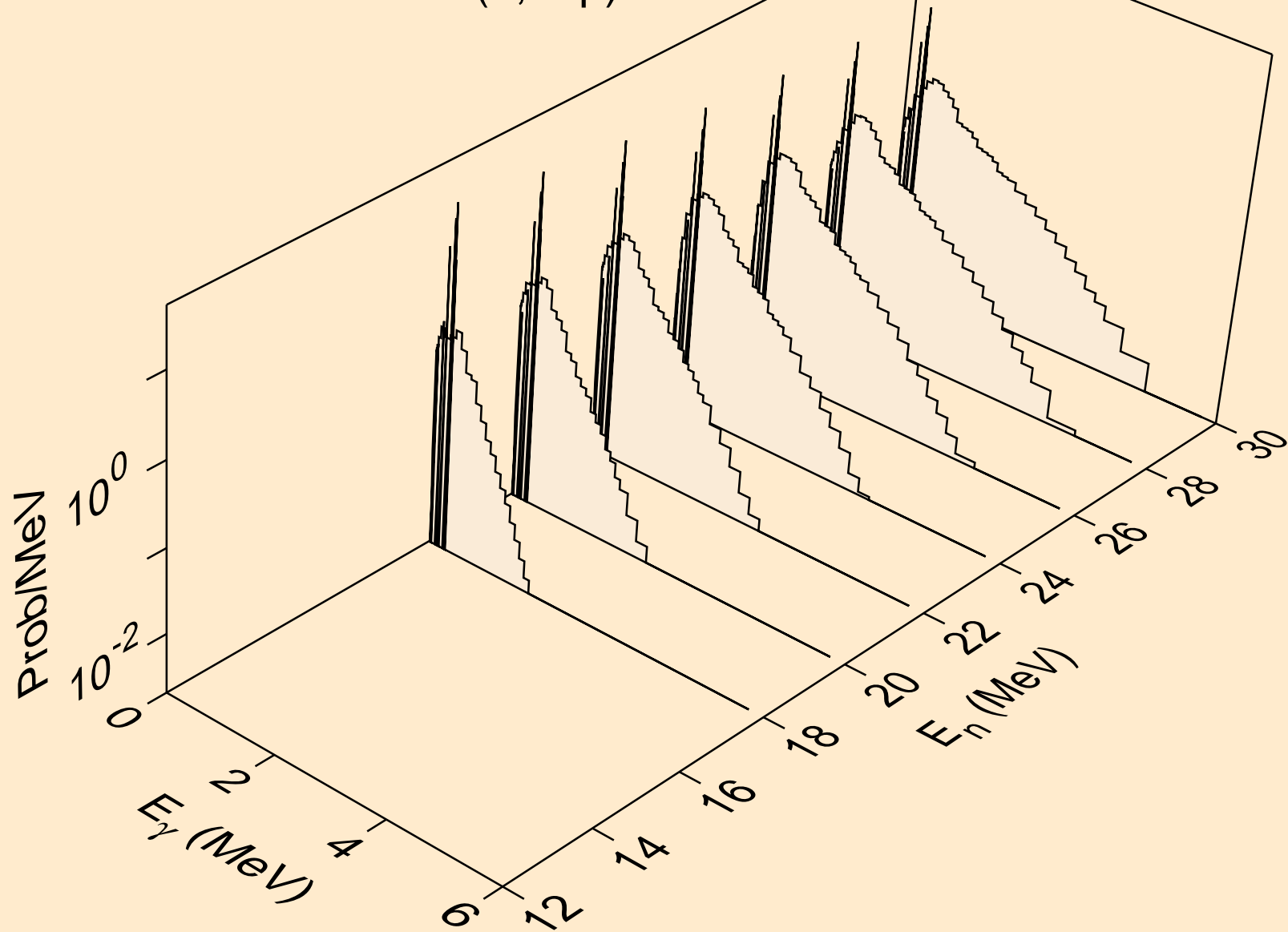

HG198 HELION ACER TENDL-2021 LIBRARY; T=0.K  
Photon emission for (n,3np)

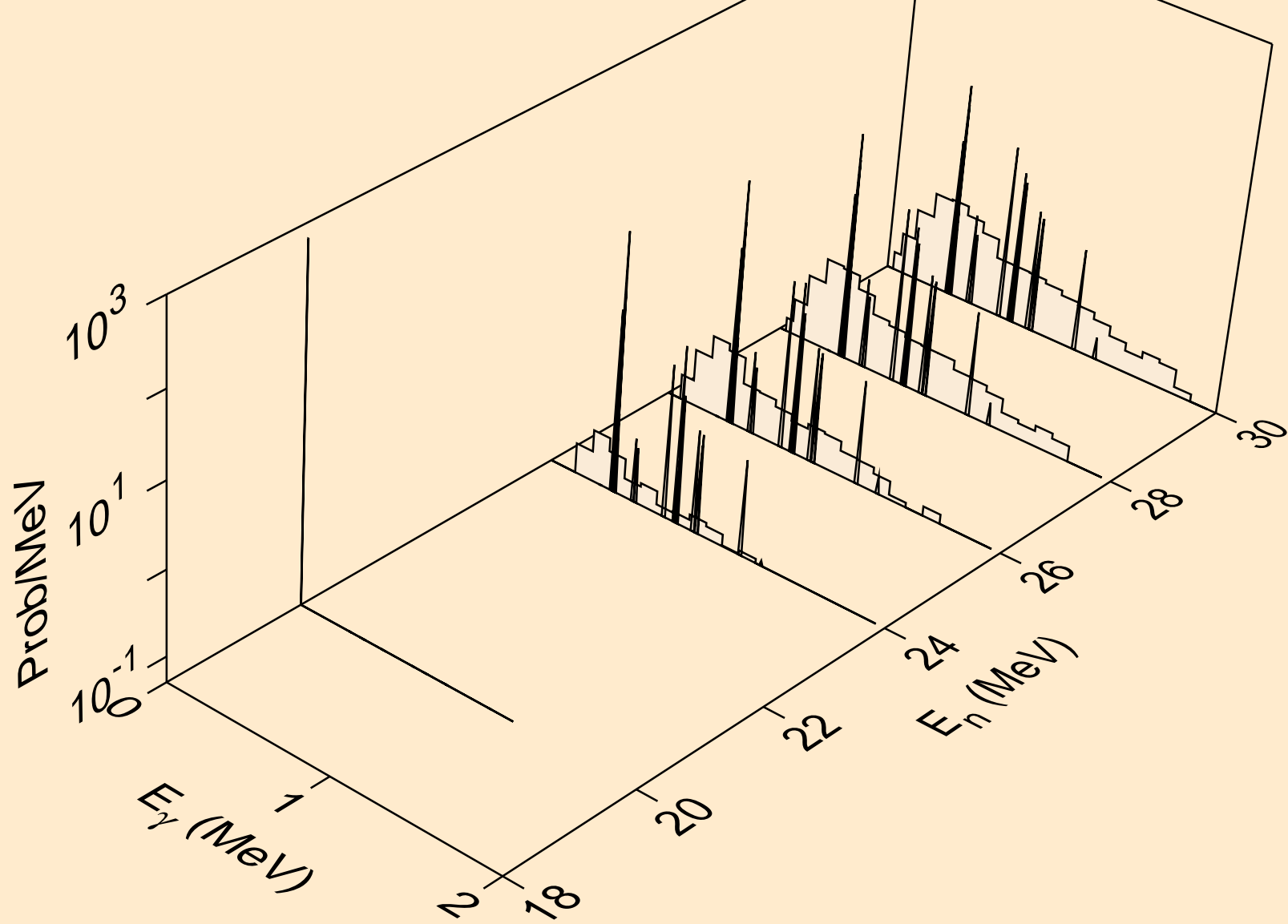



HG198 HELION ACER TENDL-2021 LIBRARY; T=0.K  
Photon emission for (n,2np)

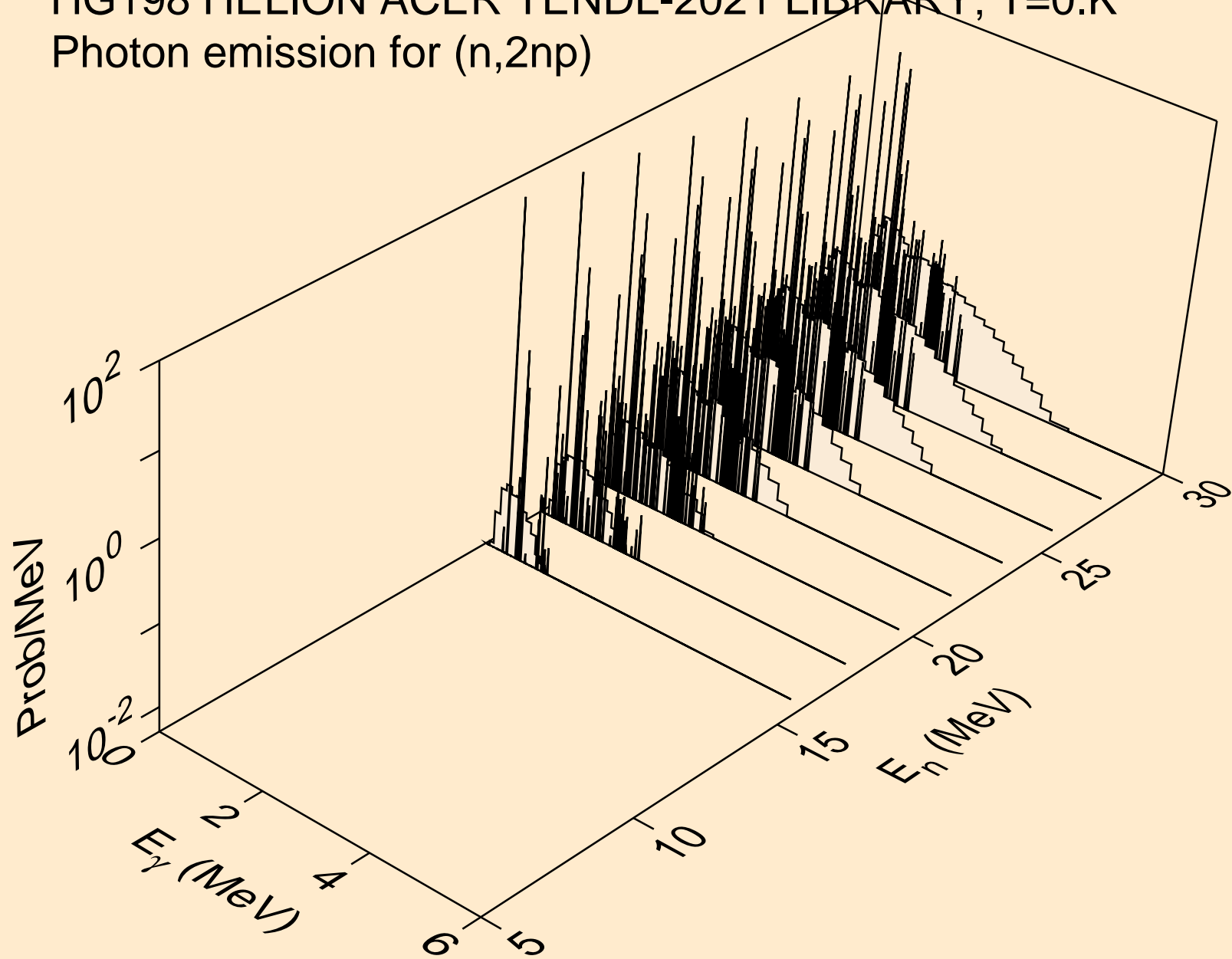

HG198 HELION ACER TENDL-2021 LIBRARY; T=0.K  
Photon emission for (n,npa)

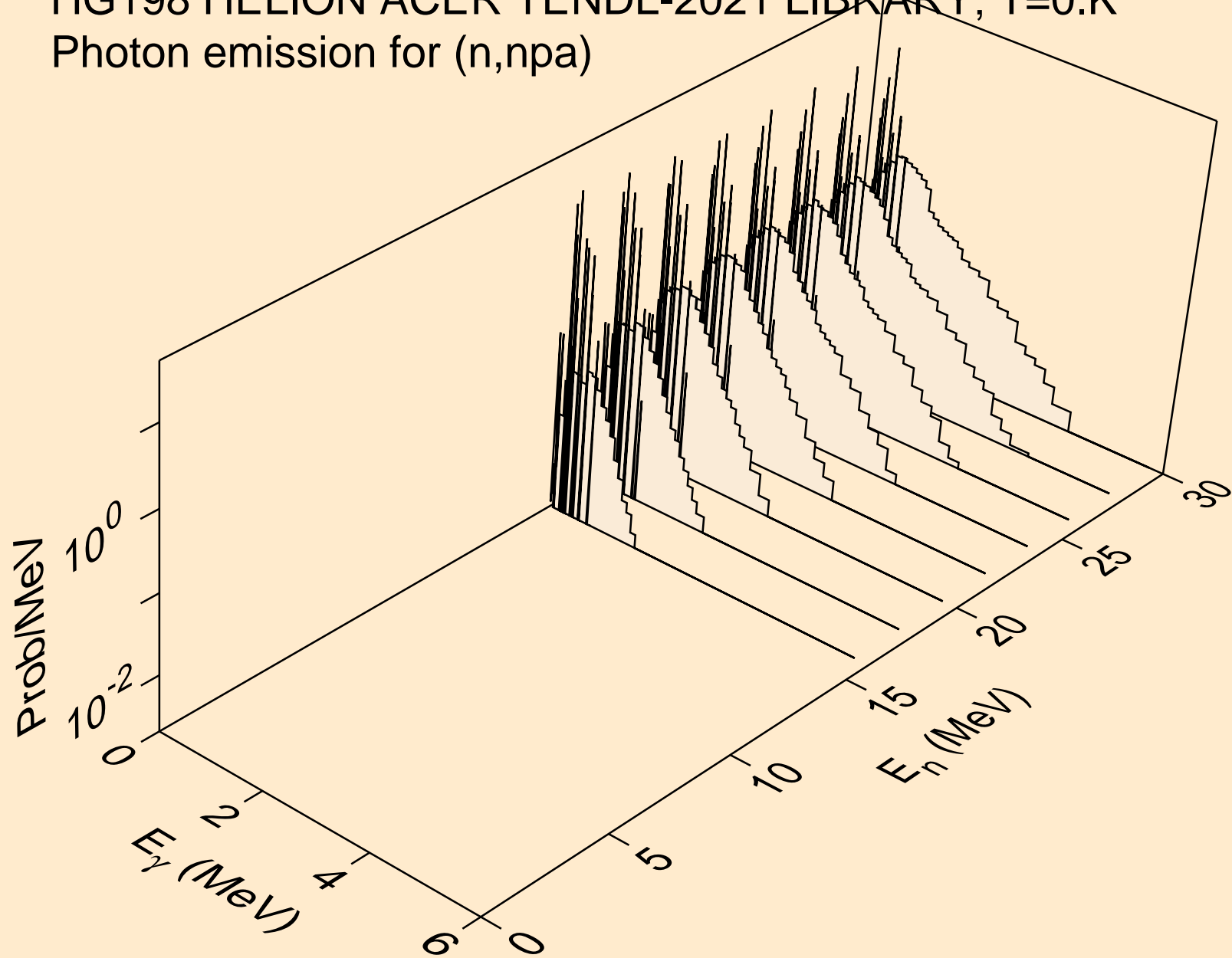

HG198 HELION ACER TENDL-2021 LIBRARY; T=0.K  
Photon emission for (n,gma)

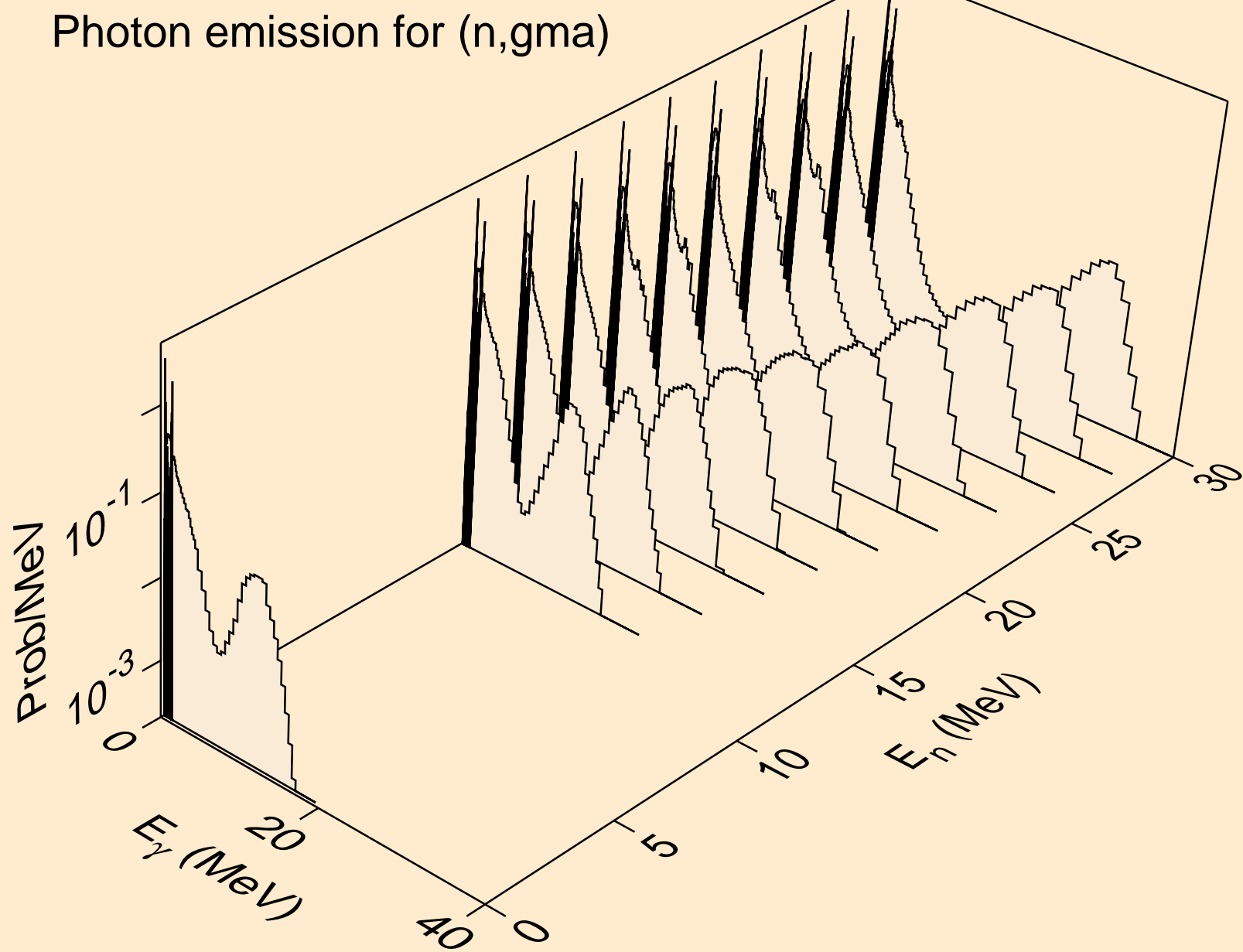

HG198 HELION ACER TENDL-2021 LIBRARY; T=0.K  
Photon emission for (n,p)

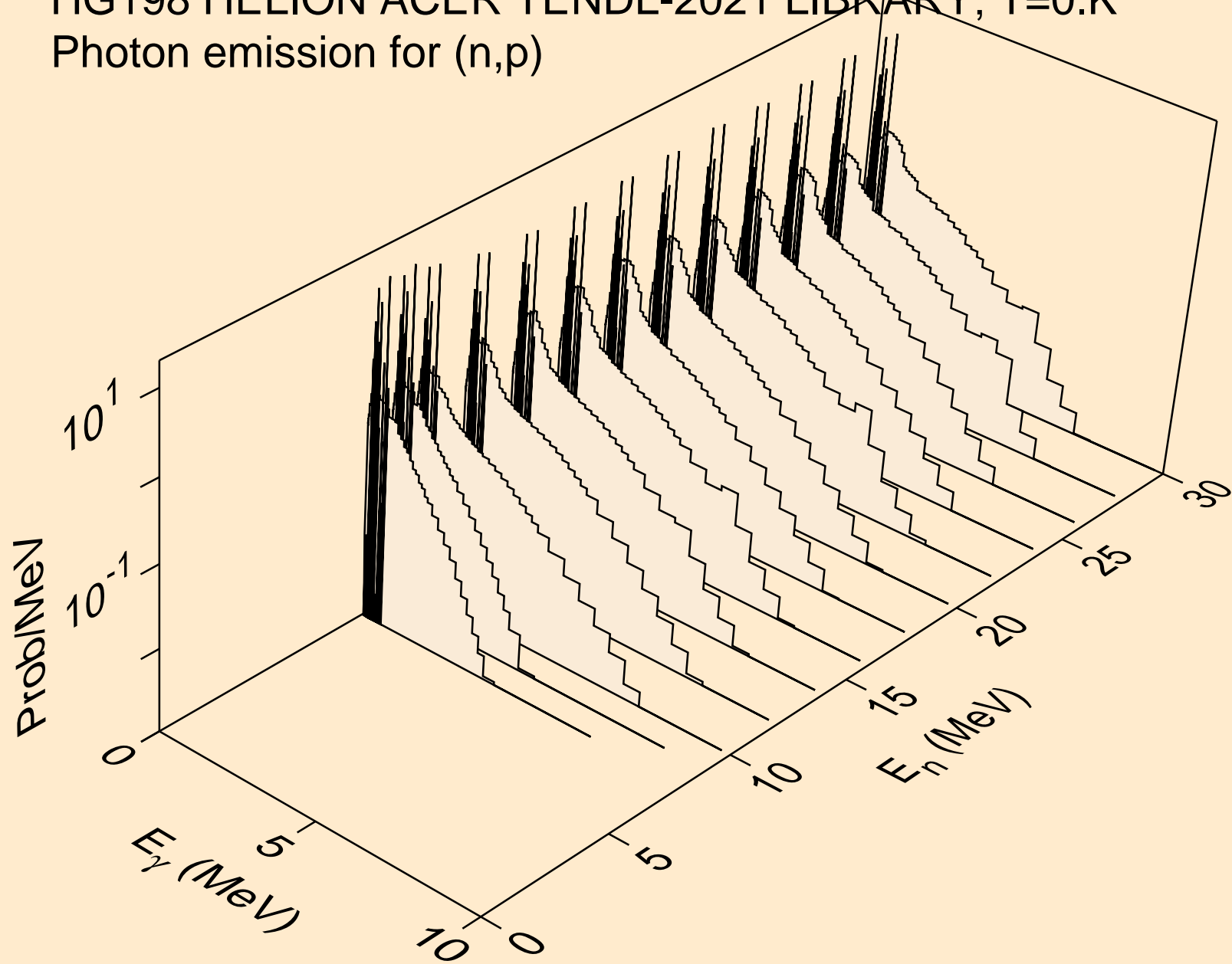

HG198 HELION ACER TENDL-2021 LIBRARY; T=0.K  
Photon emission for (n,d)

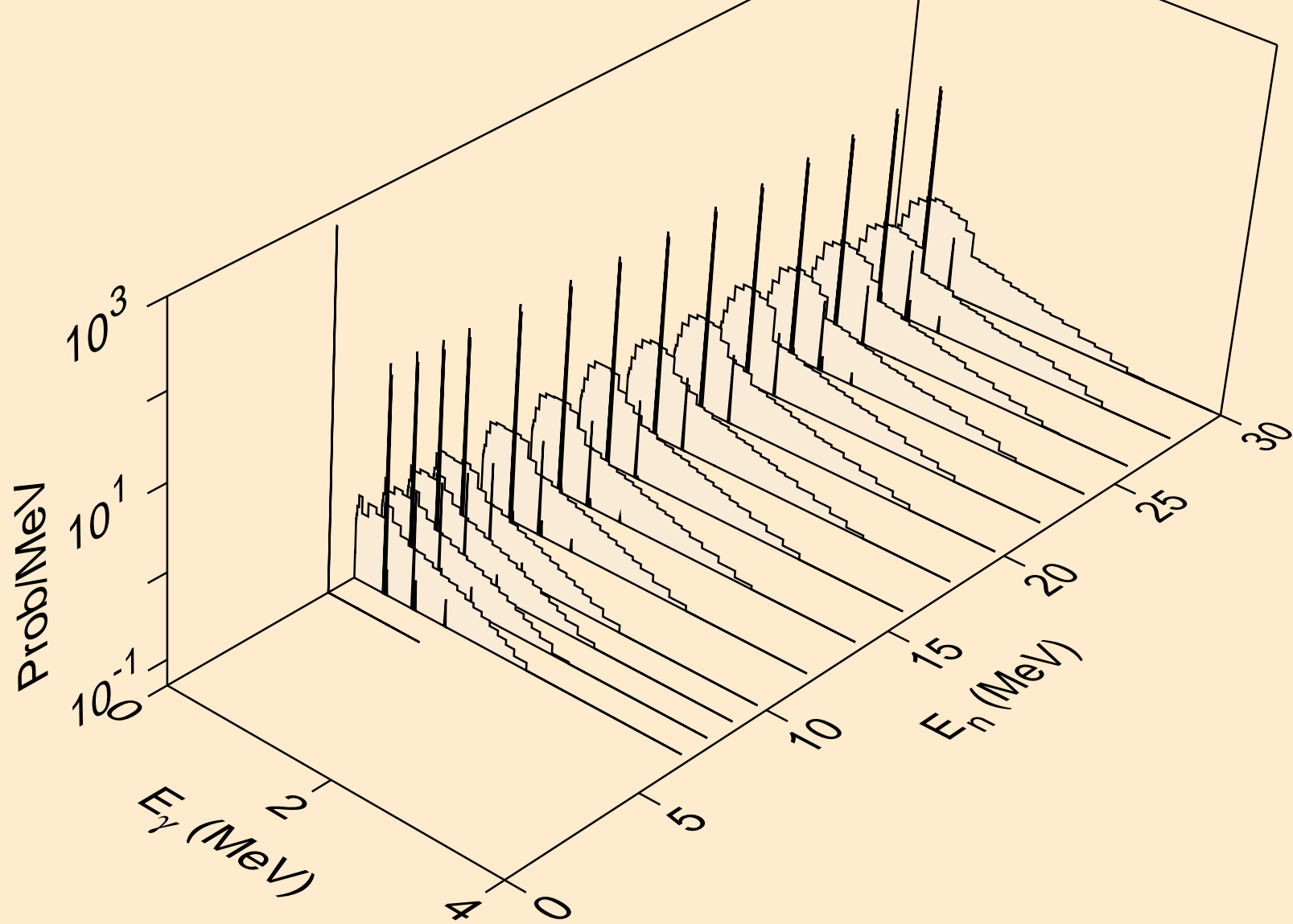

HG198 HELION ACER TENDL-2021 LIBRARY; T=0.K  
Photon emission for (n,t)

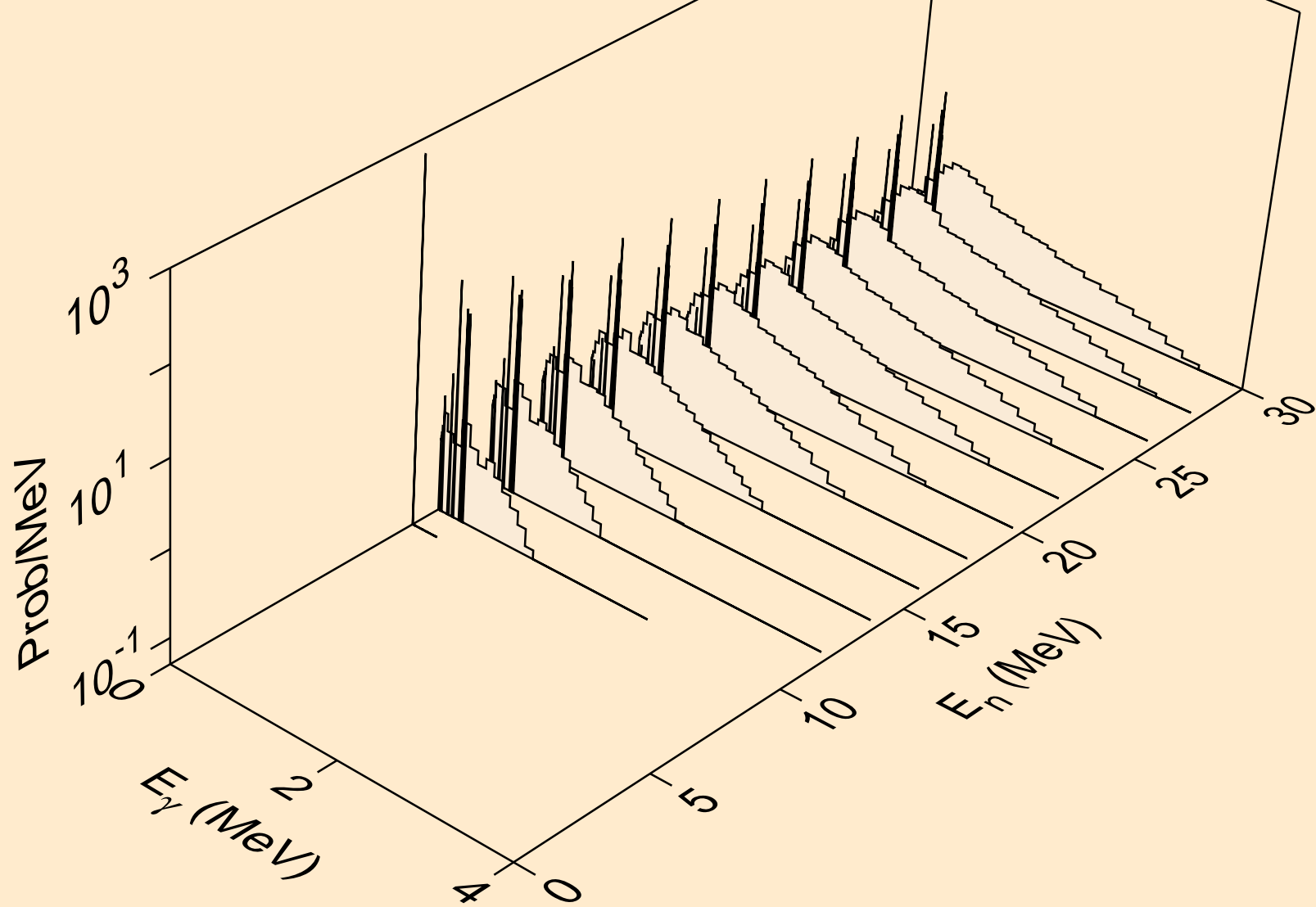

HG198 HELION ACER TENDL-2021 LIBRARY; T=0.K  
Photon emission for inelastic

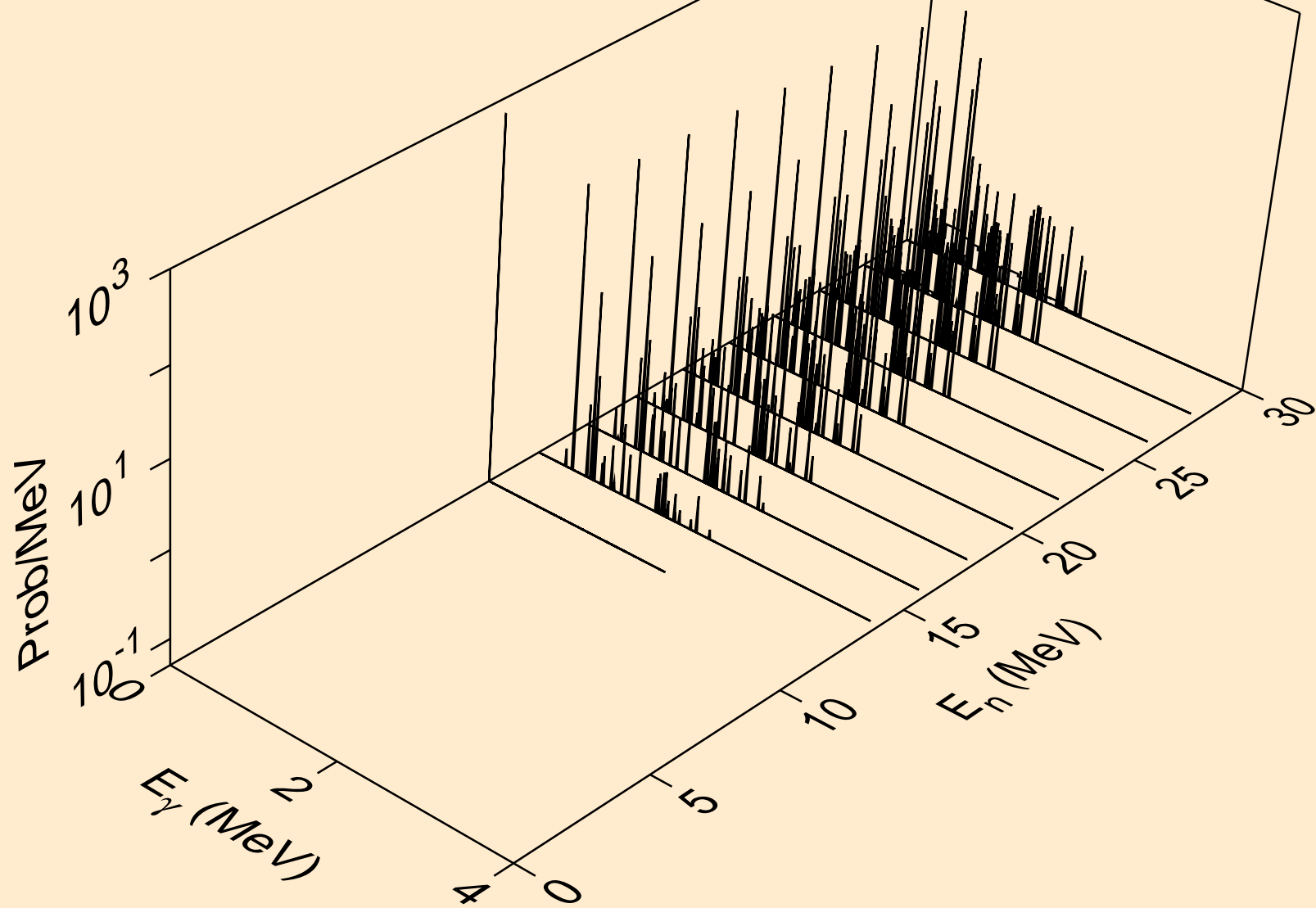

HG198 HELION ACER TENDL-2021 LIBRARY; T=0.K  
Photon emission for (n,a)

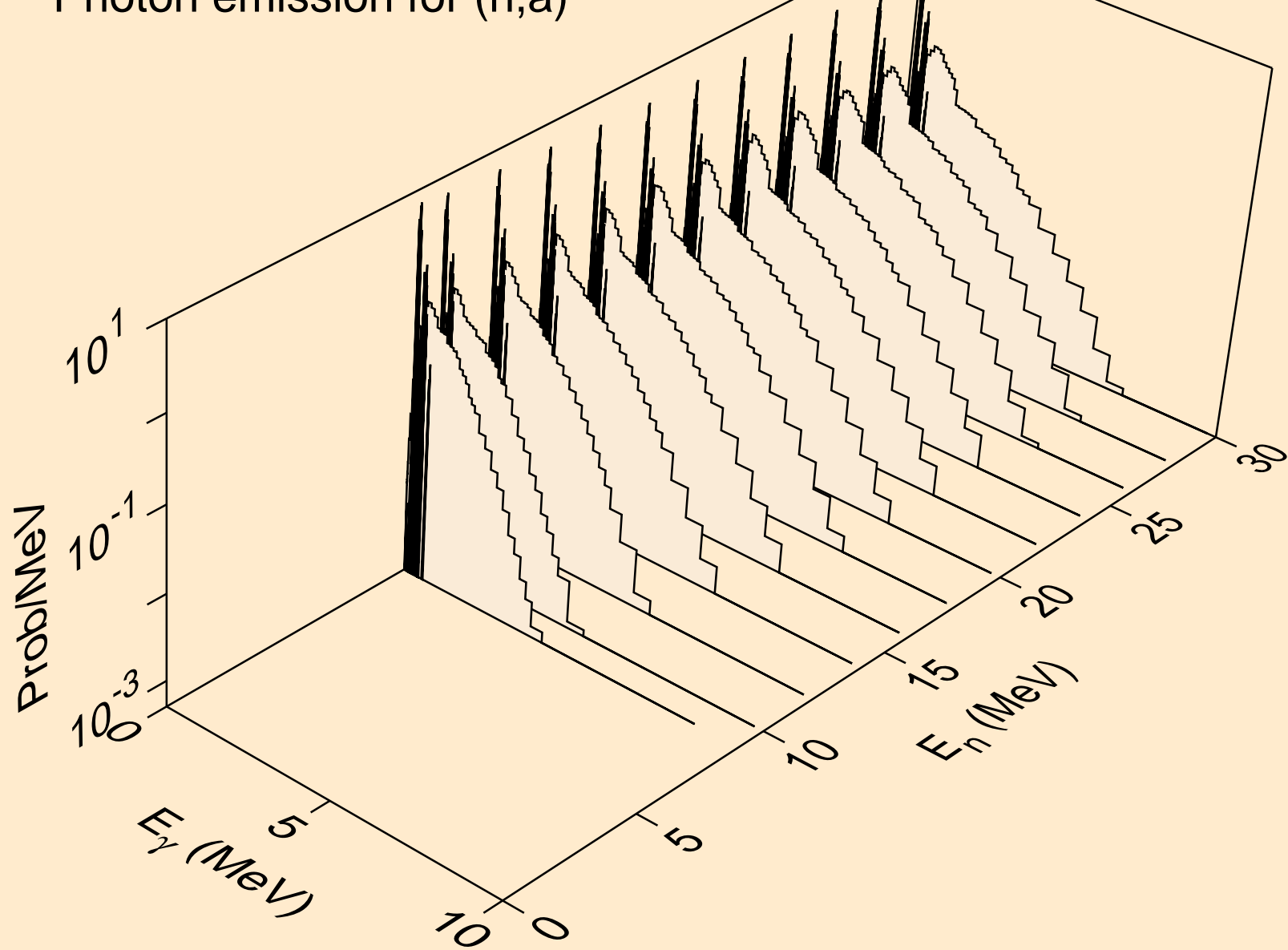



HG198 HELION ACER TENDL-2021 LIBRARY; T=0.K  
Photon emission for (n,2a)

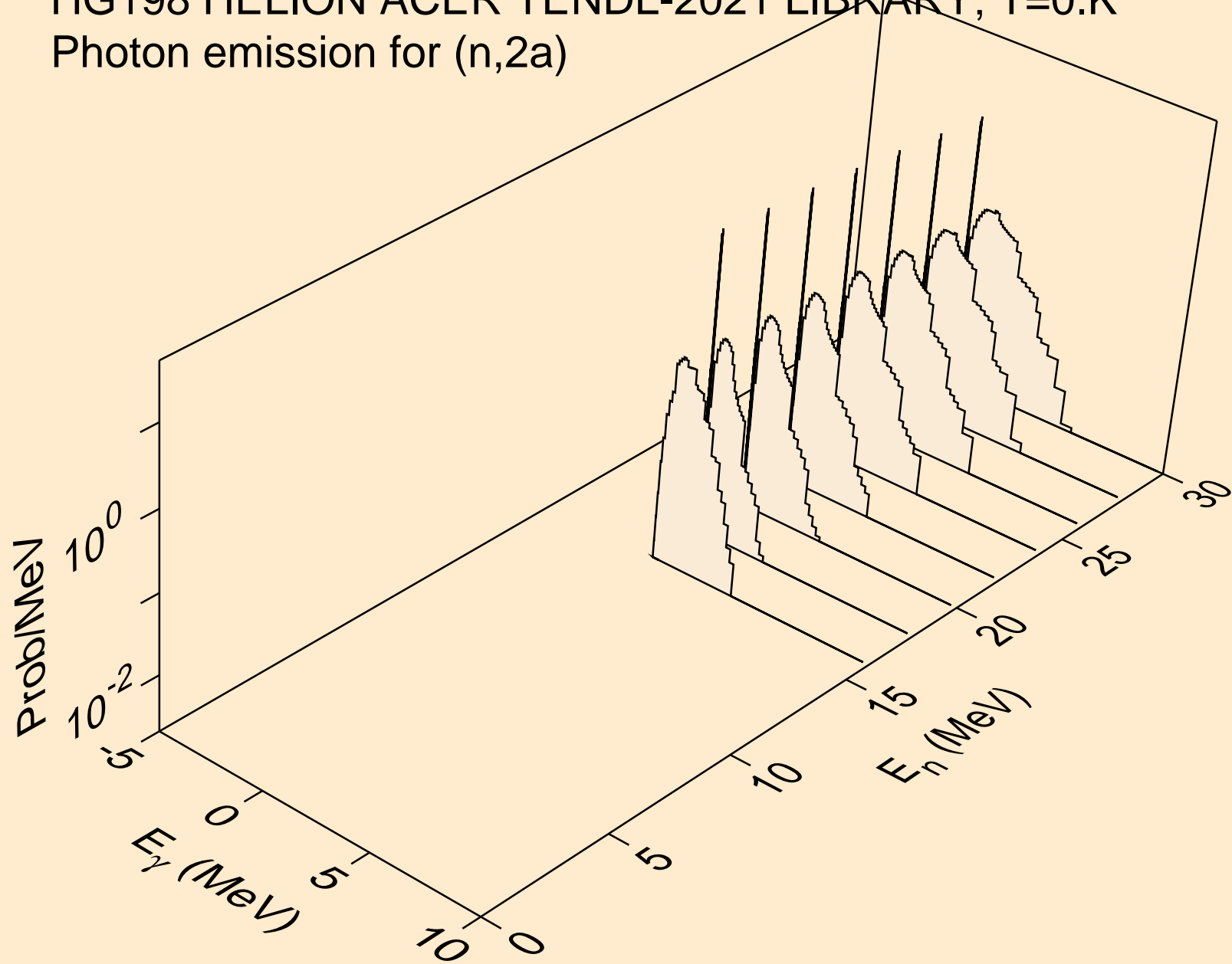

HG198 HELION ACER TENDL-2021 LIBRARY; T=0.K  
Photon emission for (n,2p)

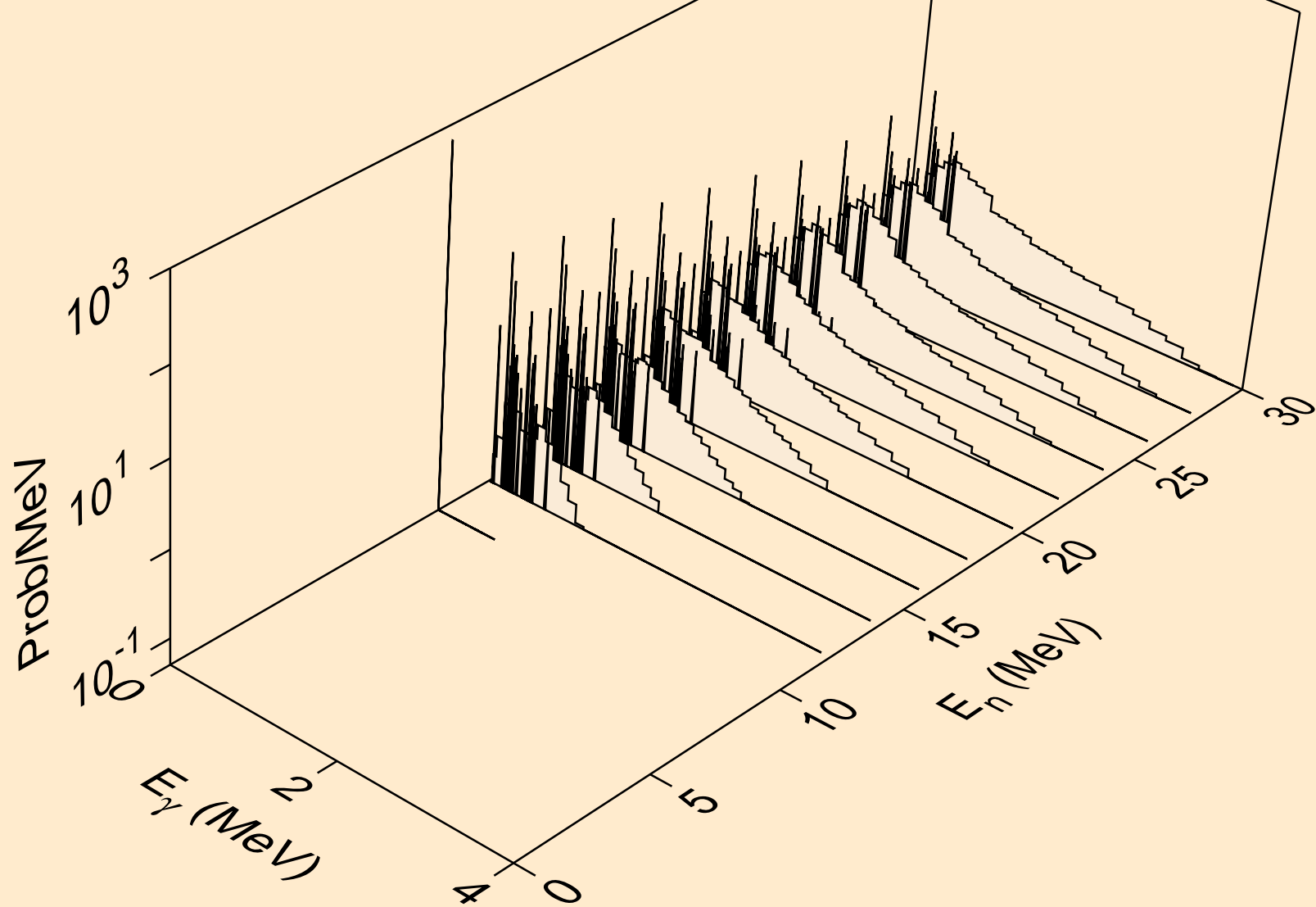

HG198 HELION ACER TENDL-2021 LIBRARY; T=0.K  
Photon emission for (n,pa)

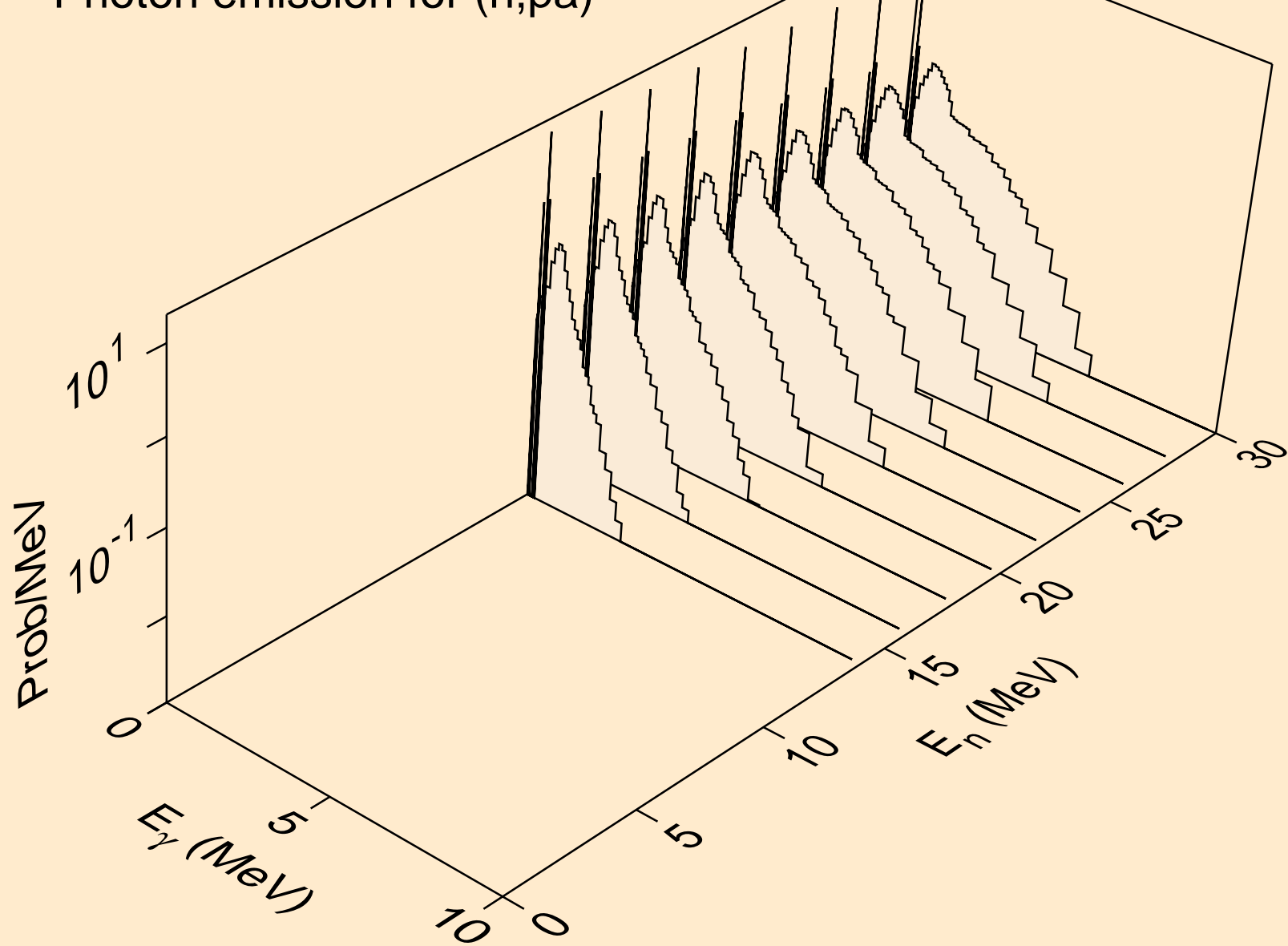

HG198 HELION ACER TENDL-2021 LIBRARY; T=0.K  
Photon emission for (n,pd)

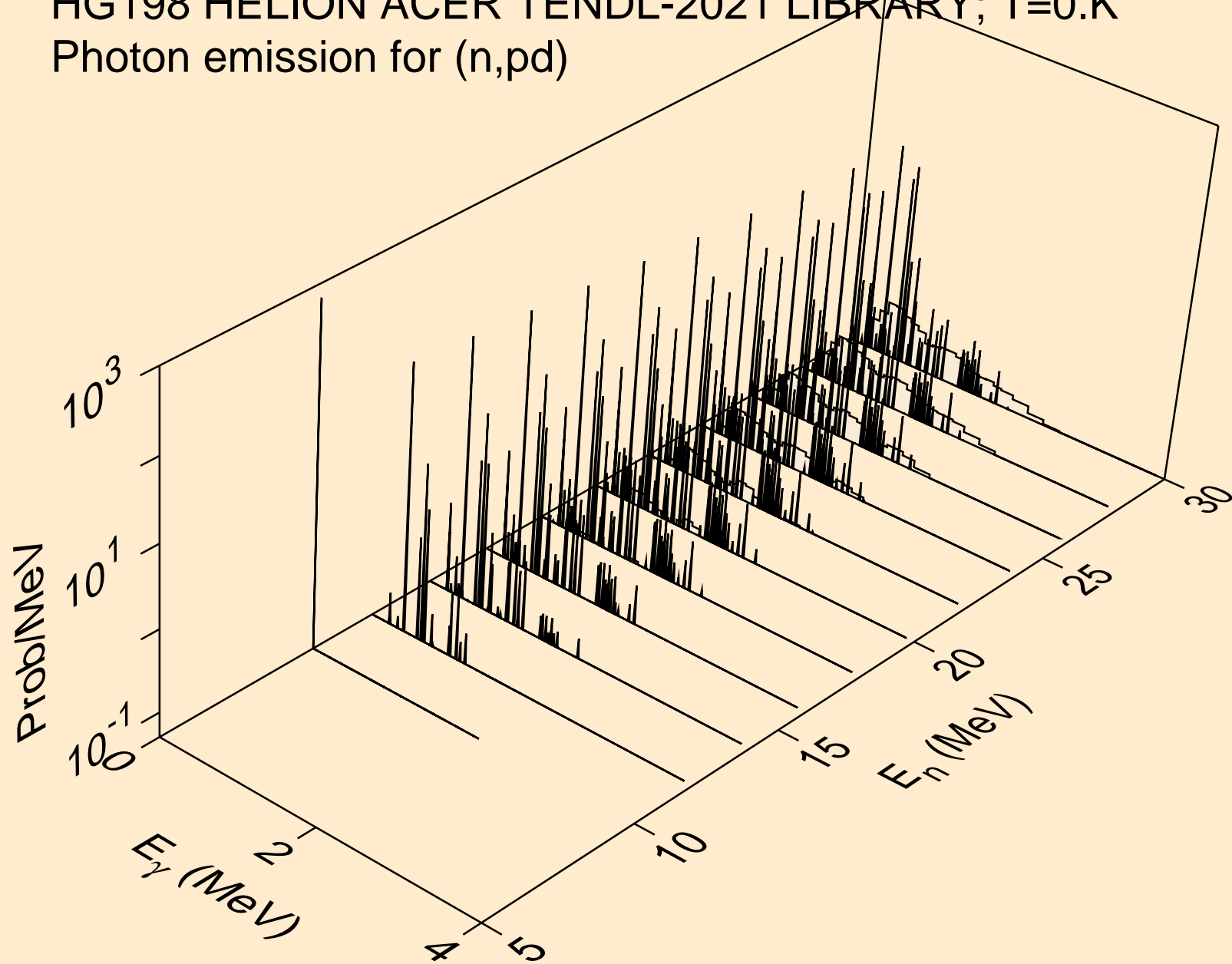

HG198 HELION ACER TENDL-2021 LIBRARY; T=0.K  
Photon emission for (n,pt)

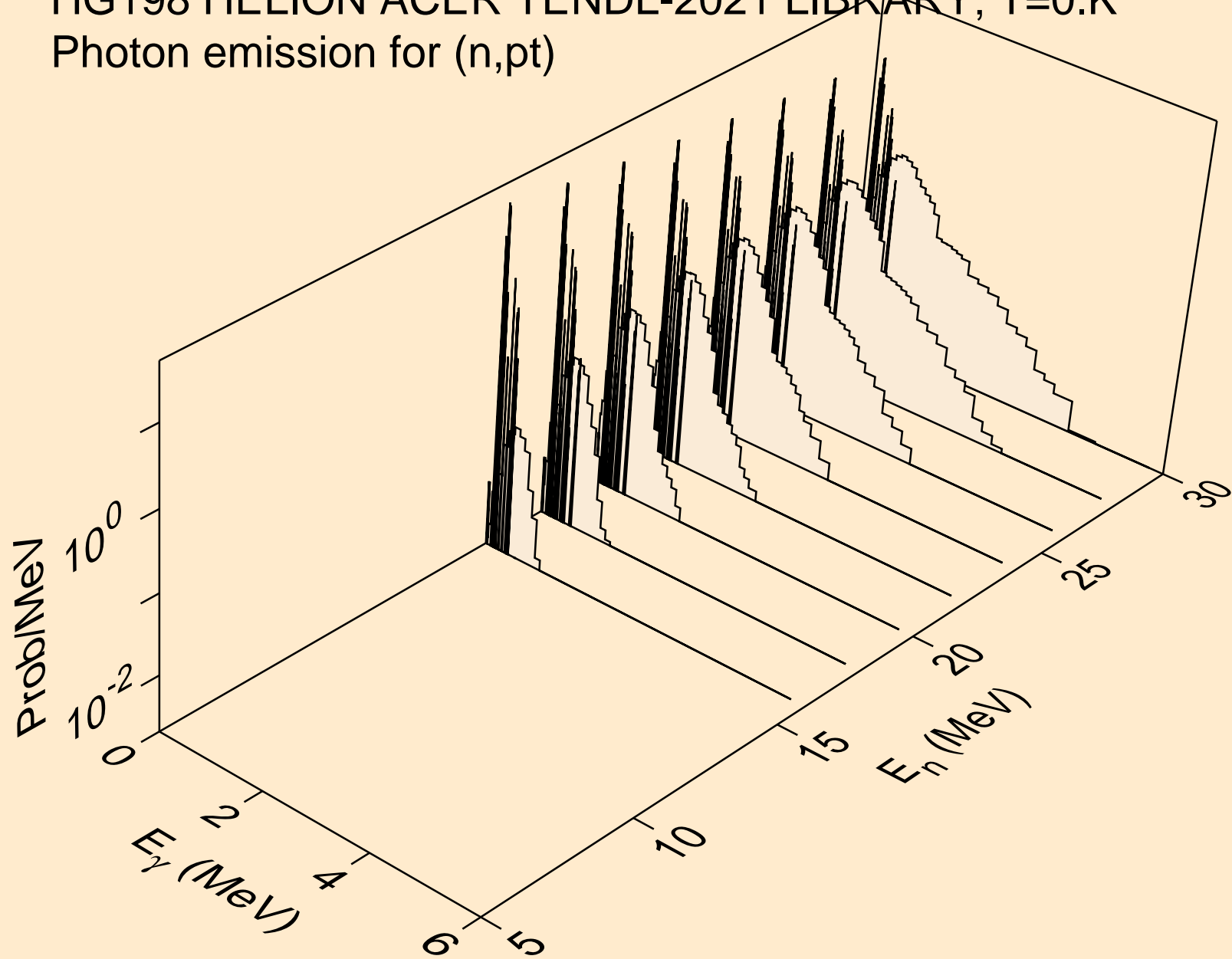

HG198 HELION ACER TENDL-2021 LIBRARY; T=0.K  
Photon emission for (n,da)

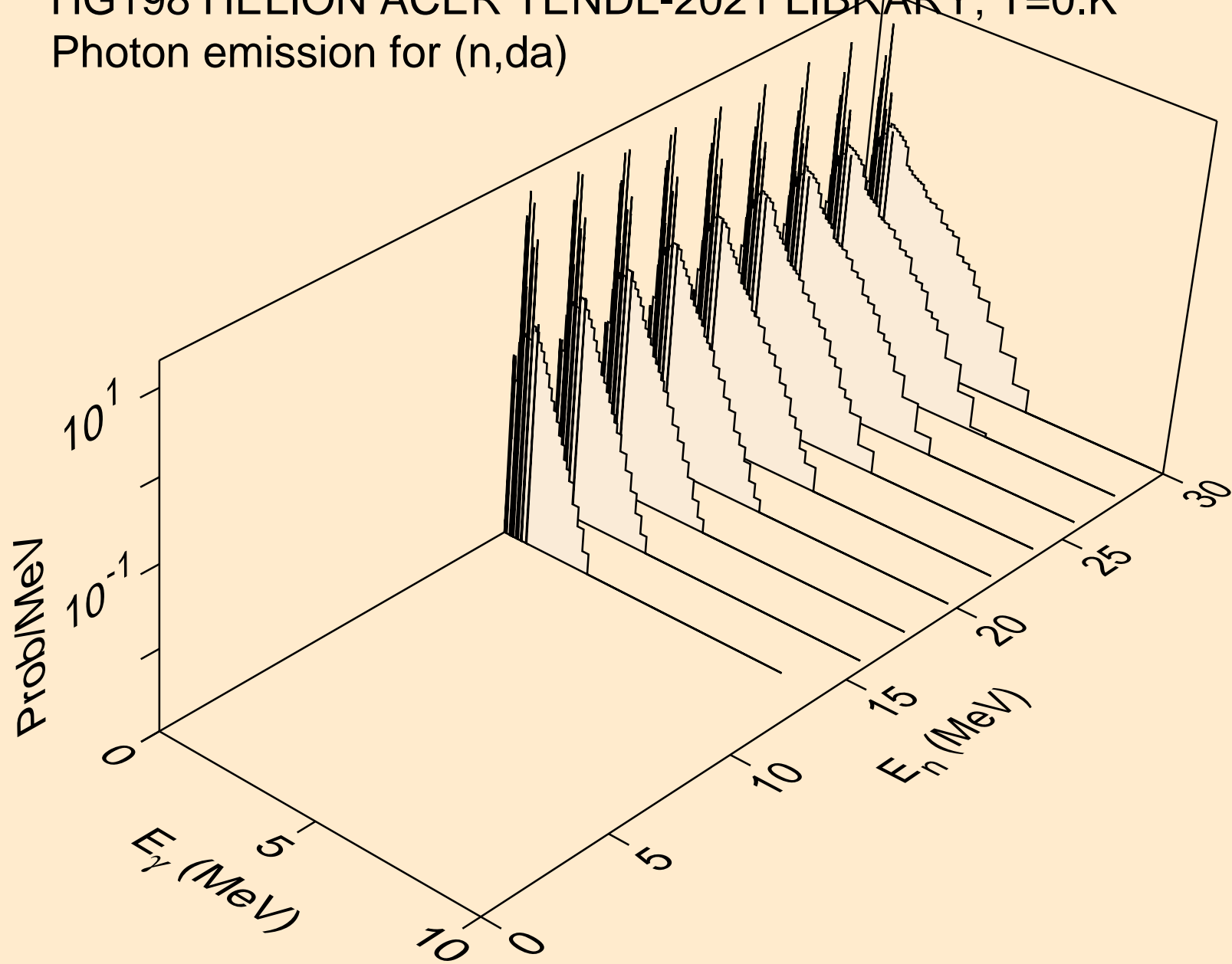

# HG198 HELION ACER TENDL-2021 LIBRARY; T=0.K

## Particle heating contributions

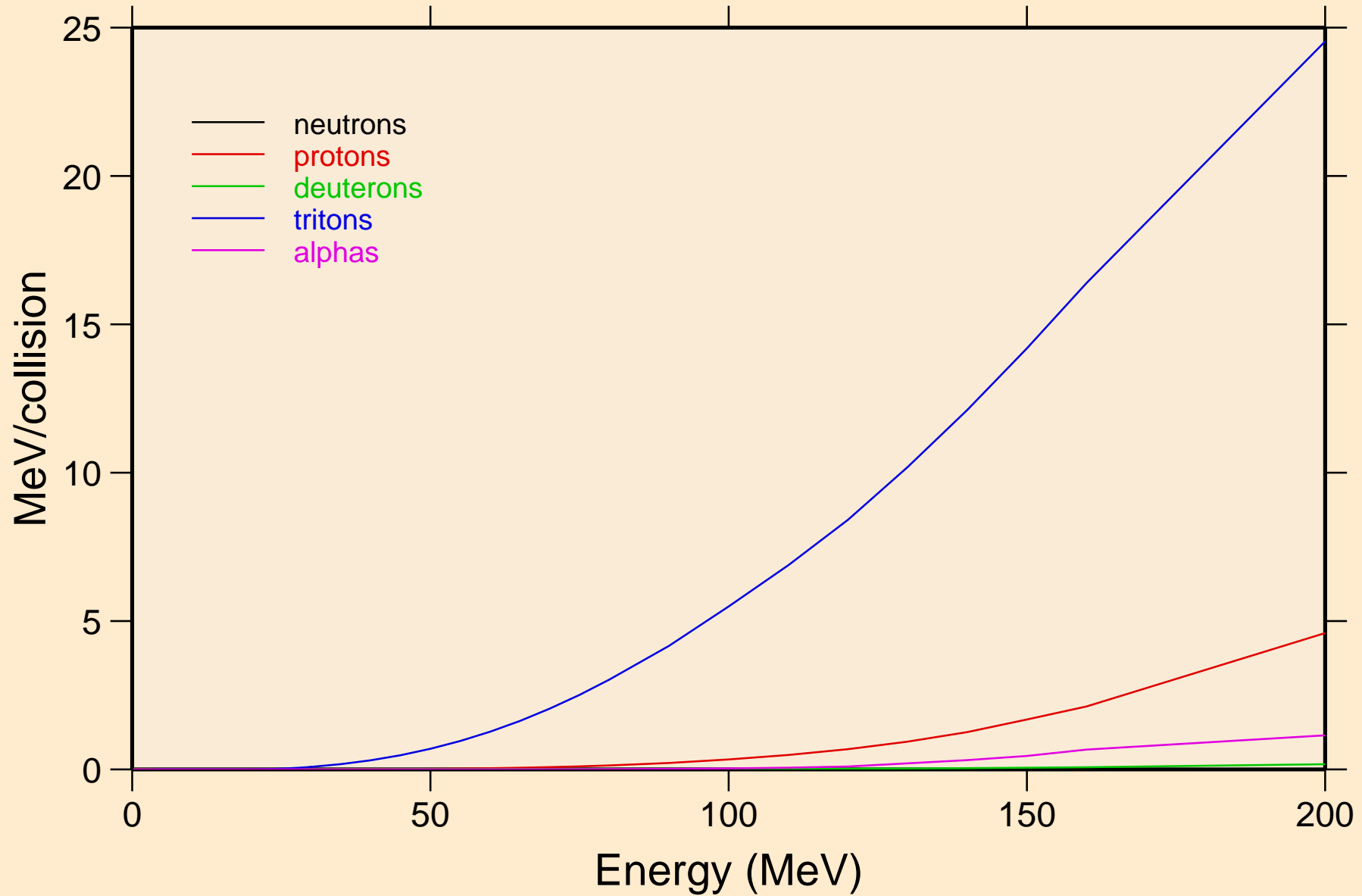

HG198 HELION ACER TENDL-2021 LIBRARY; T=0.K  
Recoil Heating

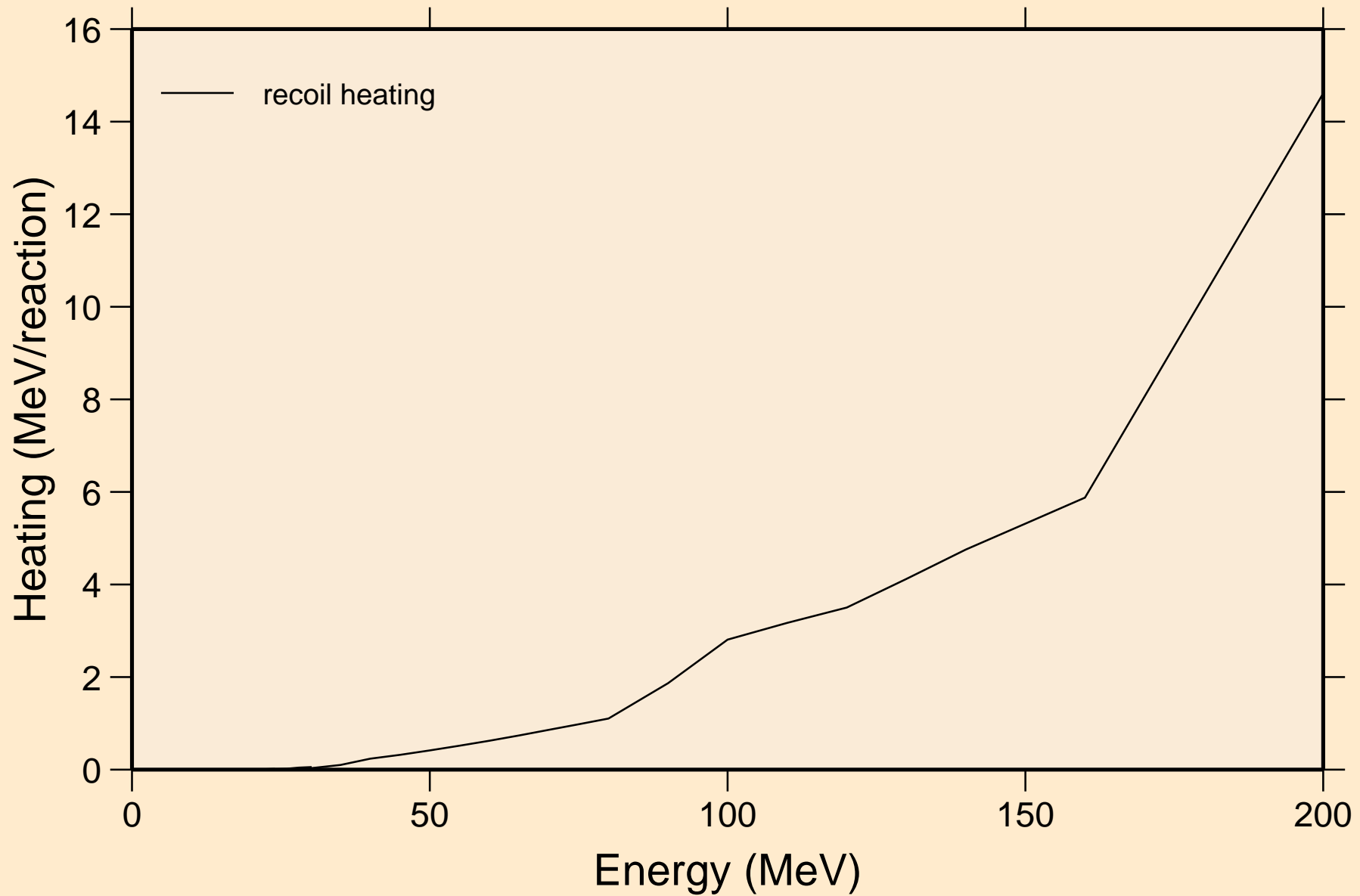



HG198 HELION ACER TENDL-2021 LIBRARY; T=0.K  
Particle production cross sections

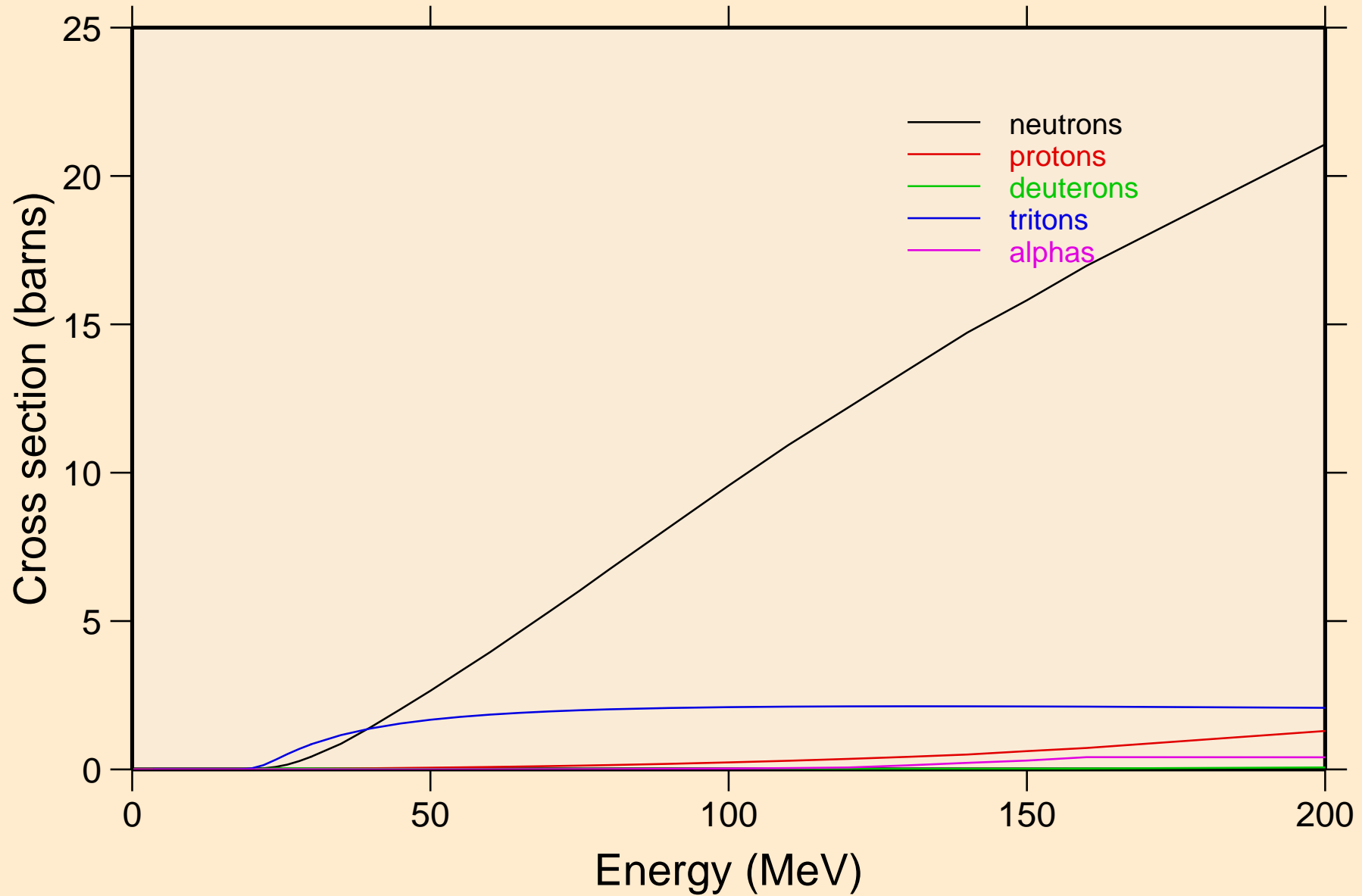

HG198 HELION ACER TENDL-2021 LIBRARY; T=0.K  
neutrons from (s,n)

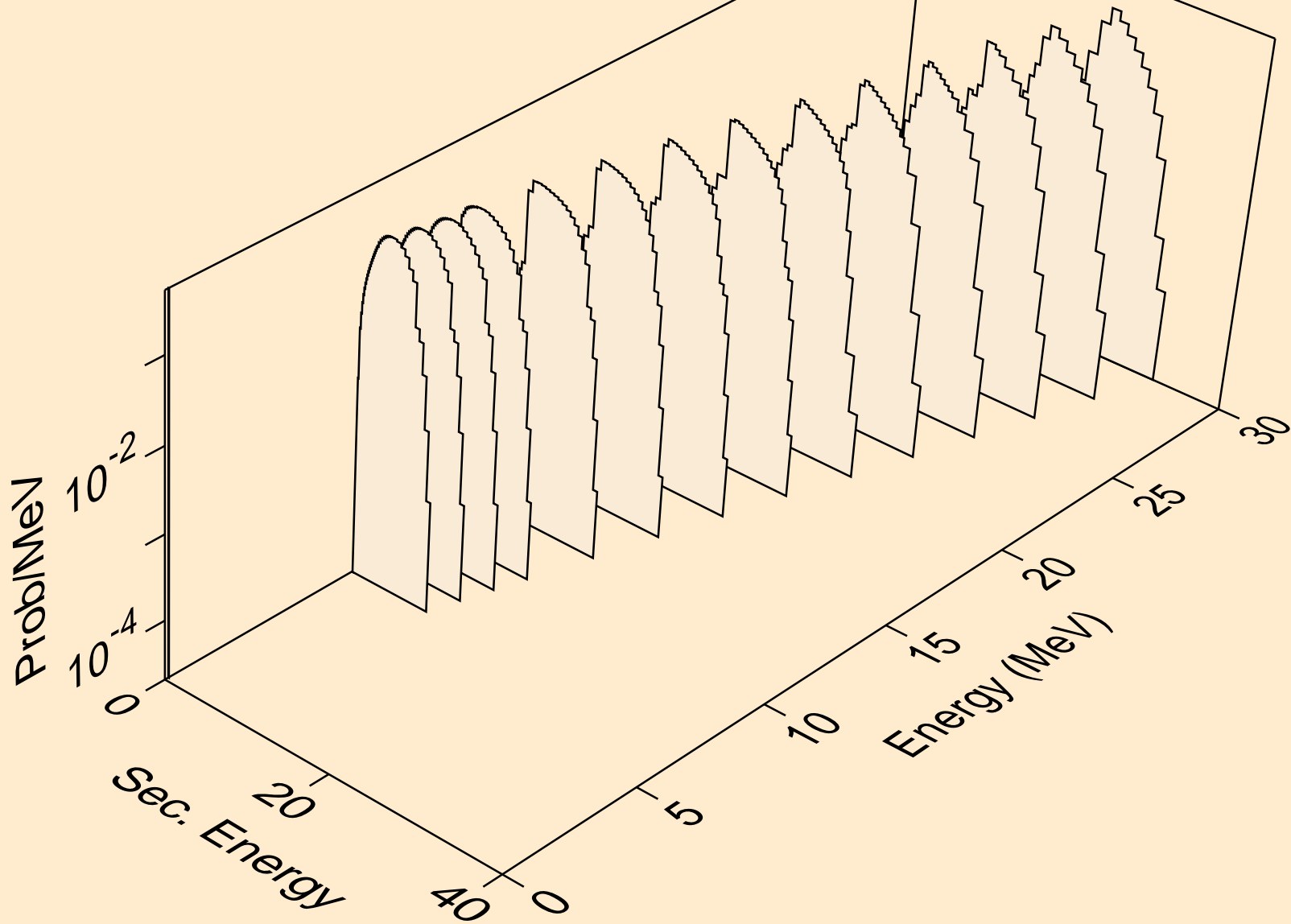

HG198 HELION ACER TENDL-2021 LIBRARY; T=0.K  
neutrons from (s,x)

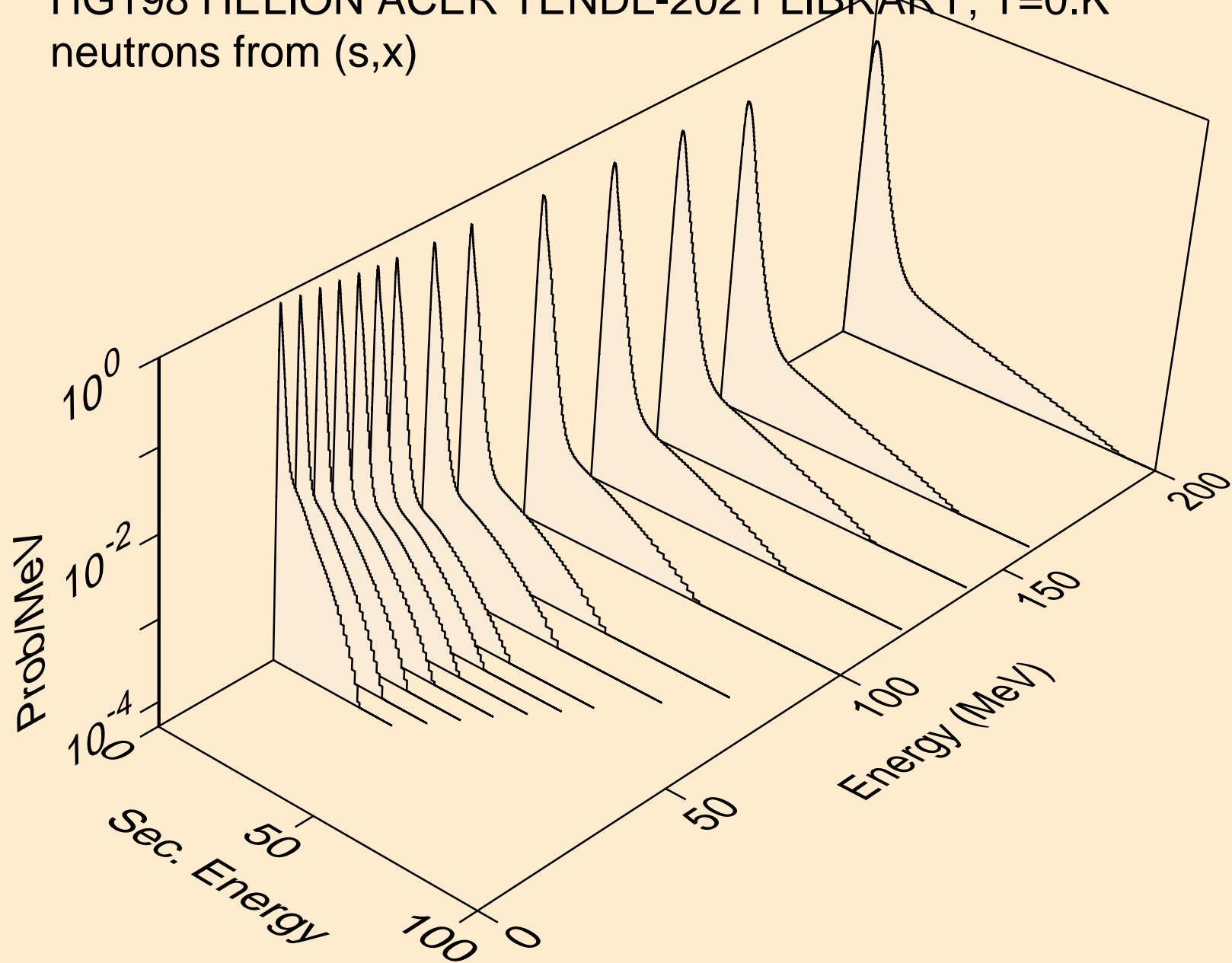

HG198 HELION ACER TENDL-2021 LIBRARY; T=0.K  
neutrons from (s,2nd)

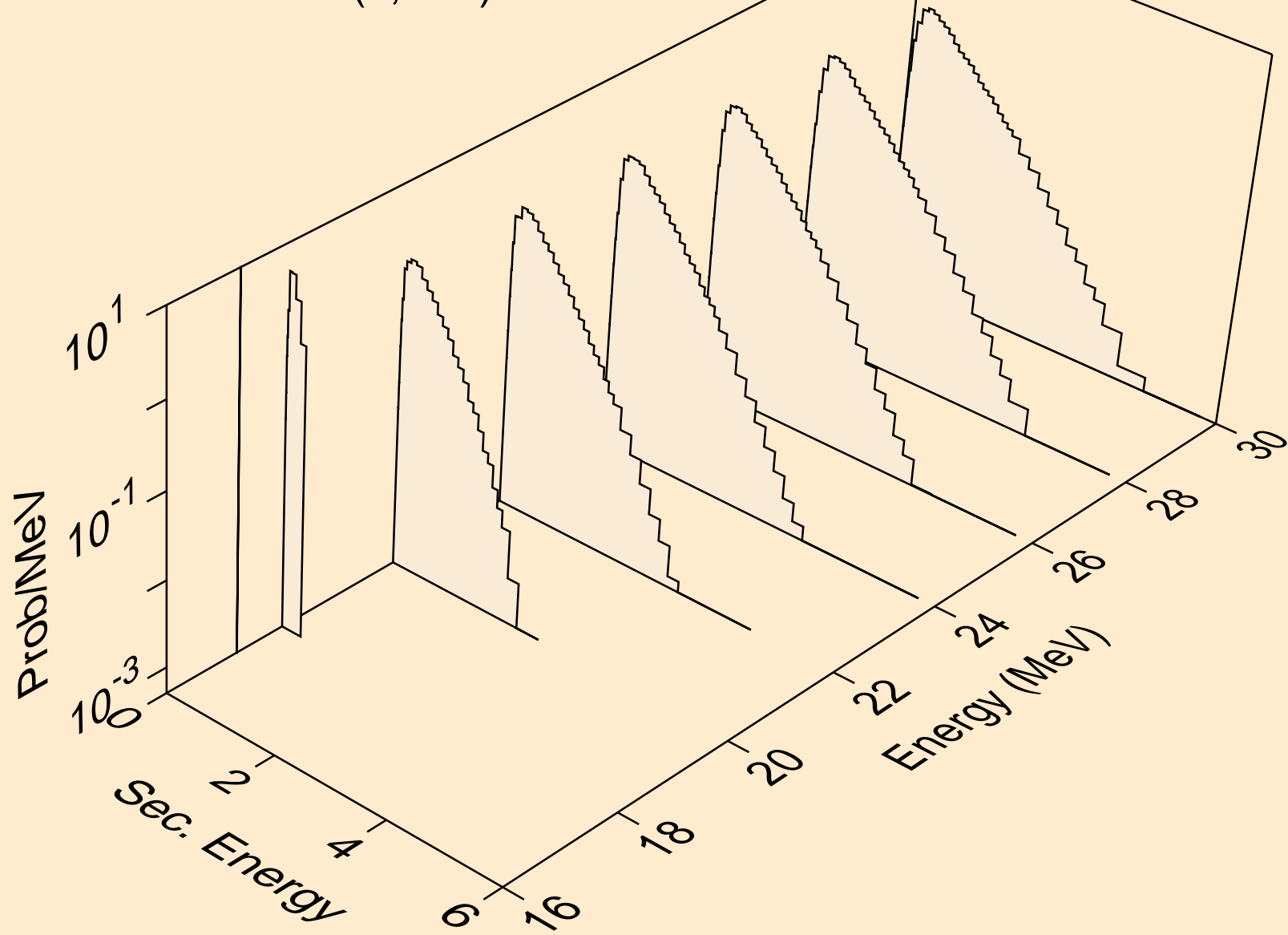

HG198 HELION ACER TENDL-2021 LIBRARY; T=0.K  
neutrons from (s,2n)

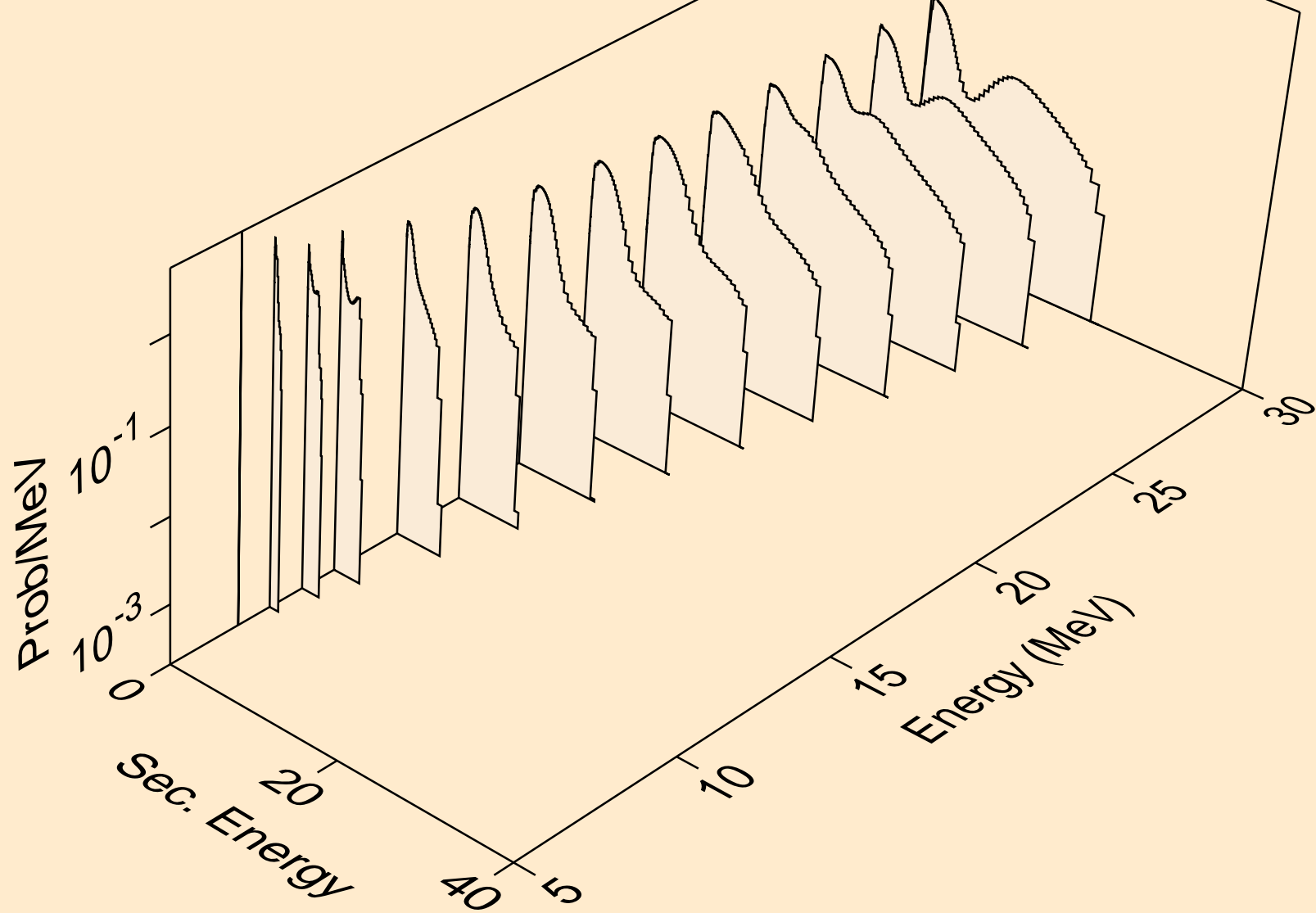

HG198 HELION ACER TENDL-2021 LIBRARY; T=0.K  
neutrons from (s,3n)

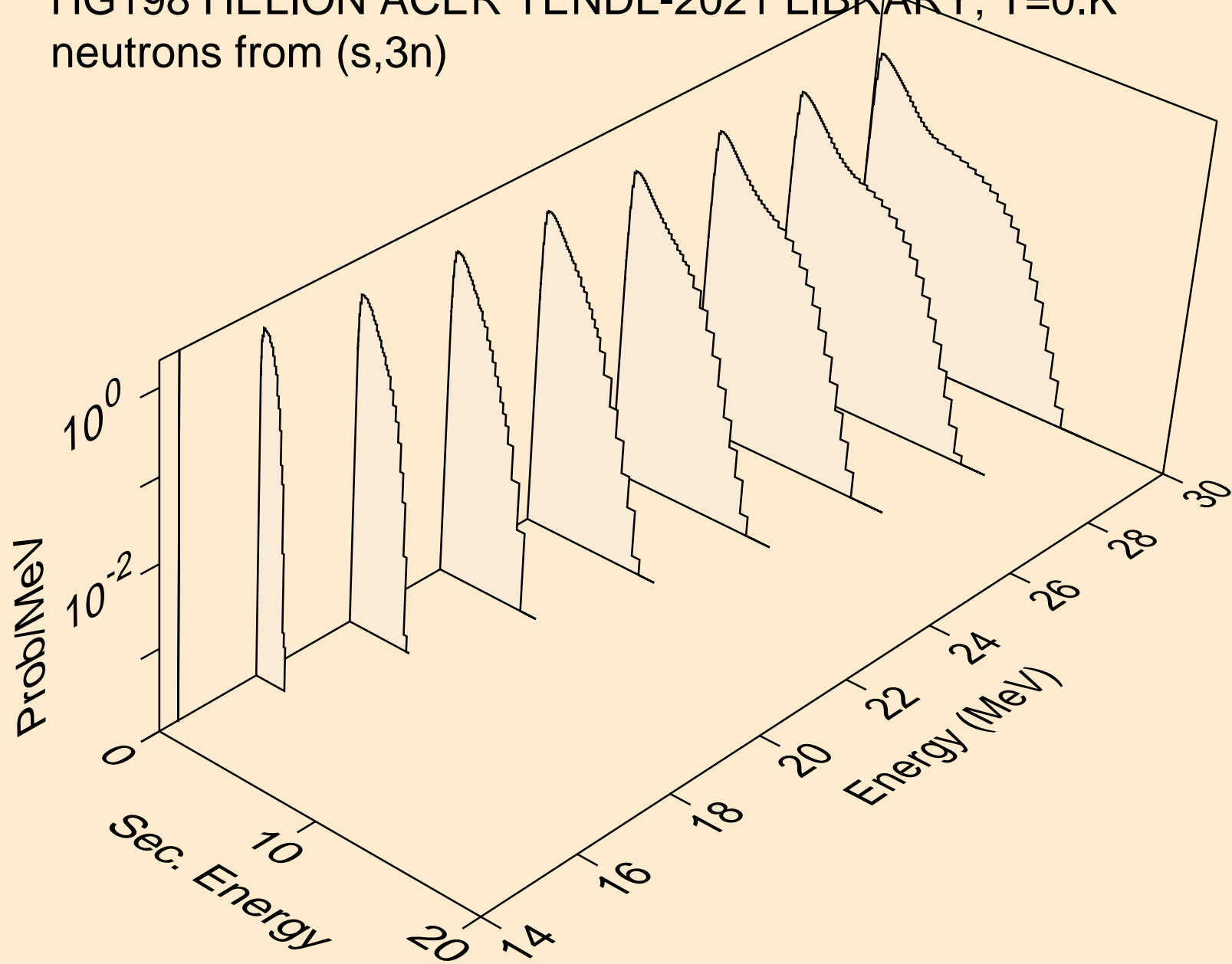

HG198 HELION ACER TENDL-2021 LIBRARY; T=0.K  
neutrons from (s,n\*)a

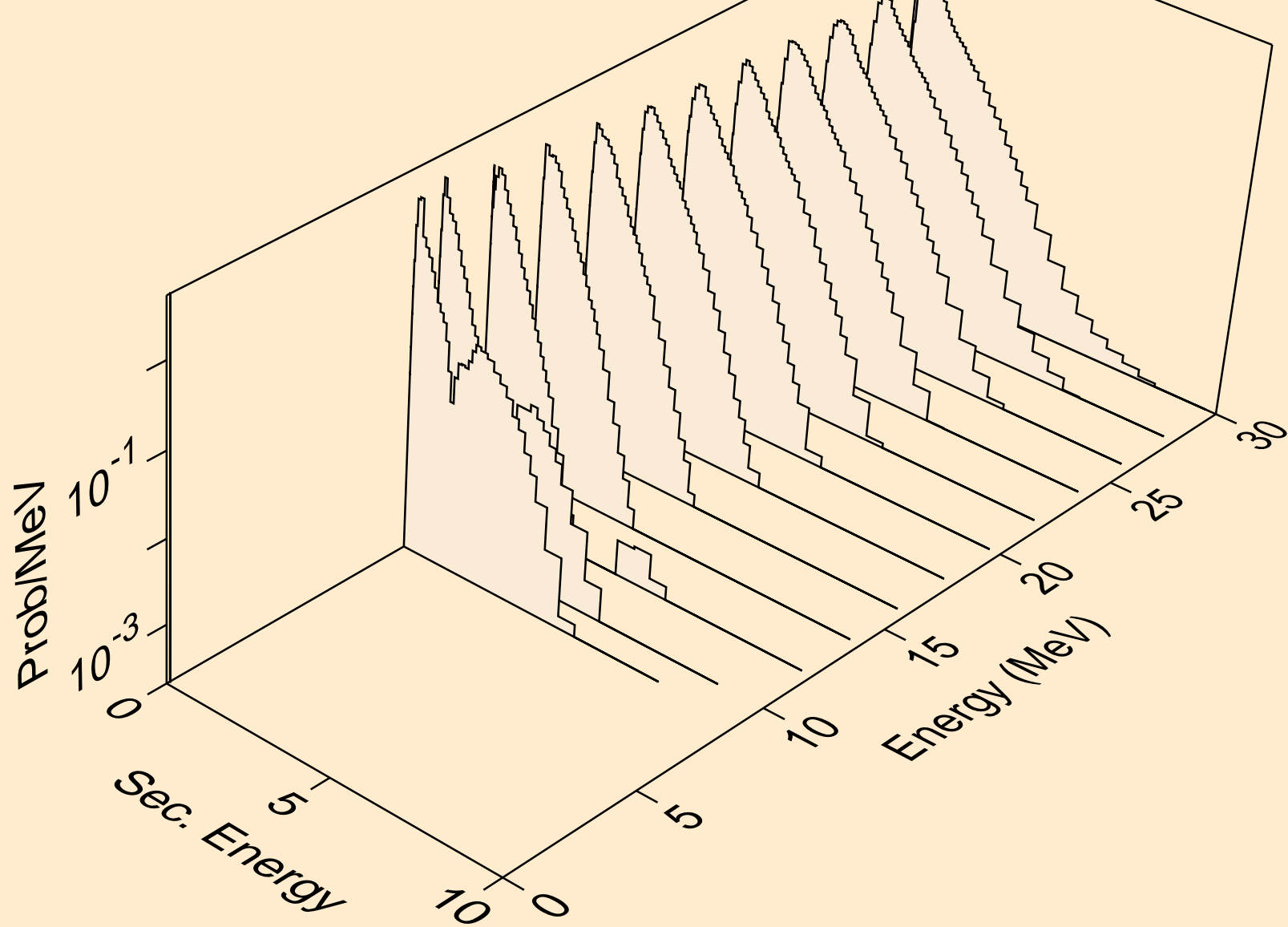

HG198 HELION ACER TENDL-2021 LIBRARY; T=0.K  
neutrons from (s,2n)a

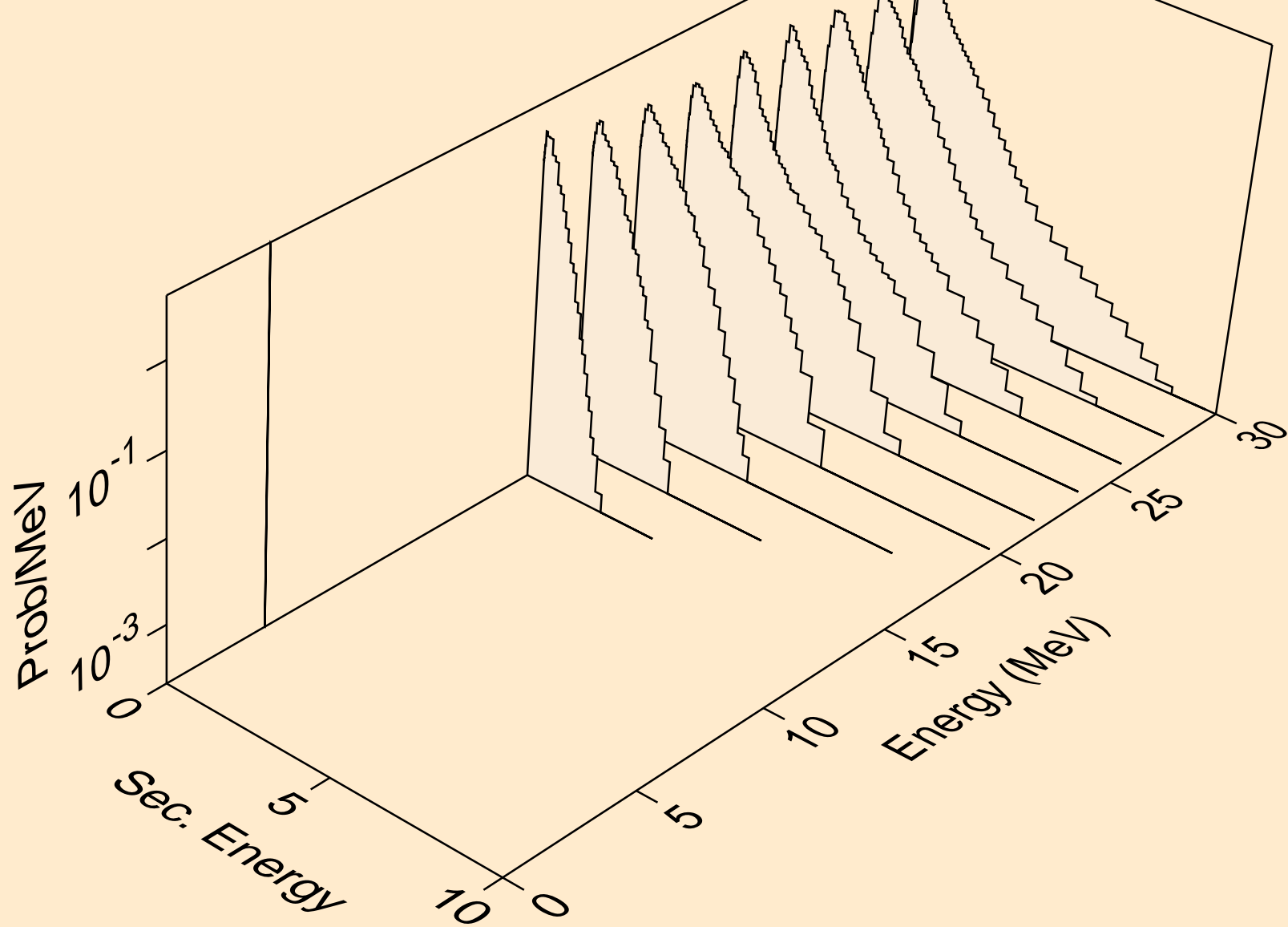



HG198 HELION ACER TENDL-2021 LIBRARY; T=0.K  
neutrons from (s,3n)a

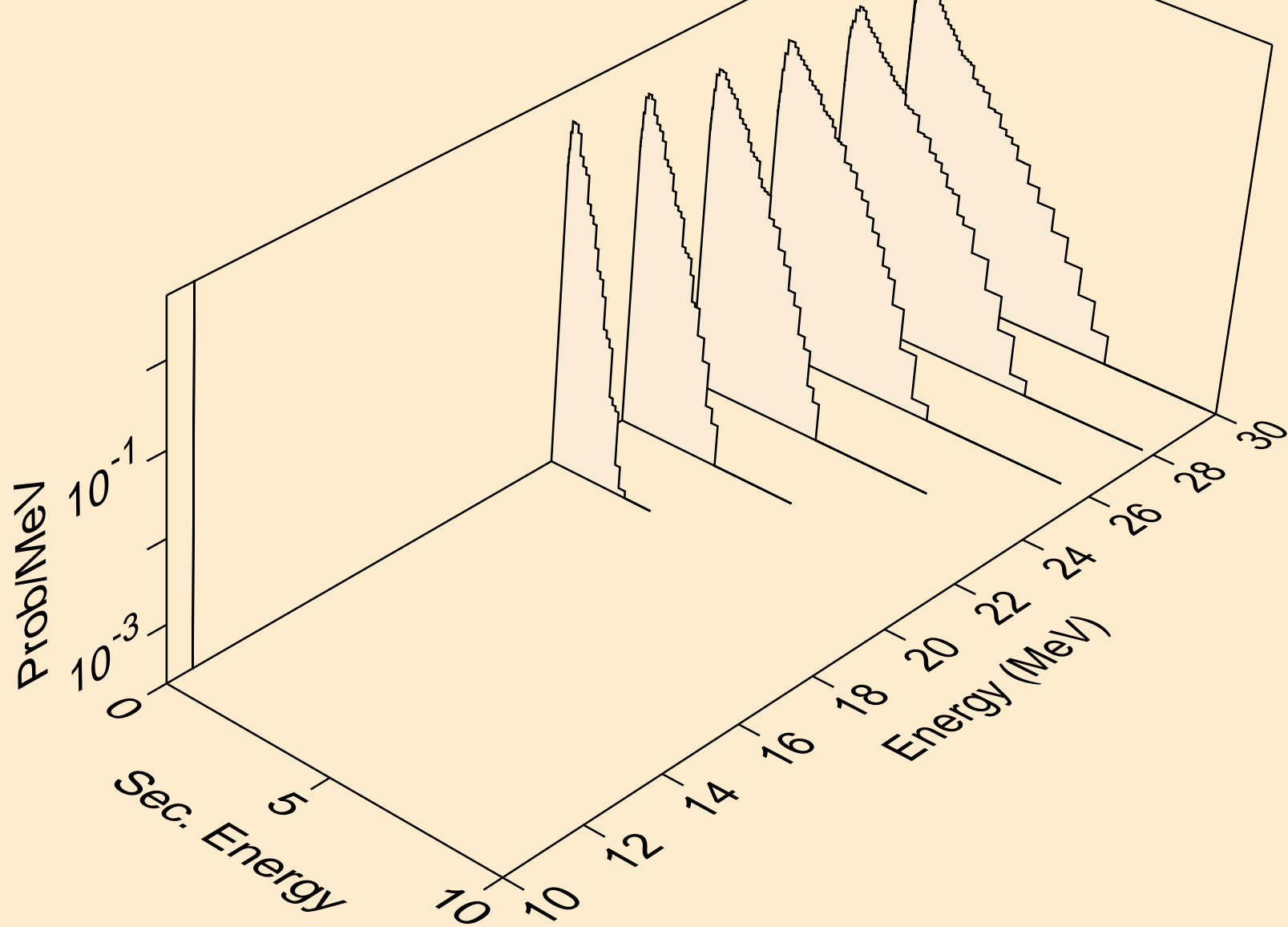

HG198 HELION ACER TENDL-2021 LIBRARY; T=0.K  
neutrons from (s,n\*)p

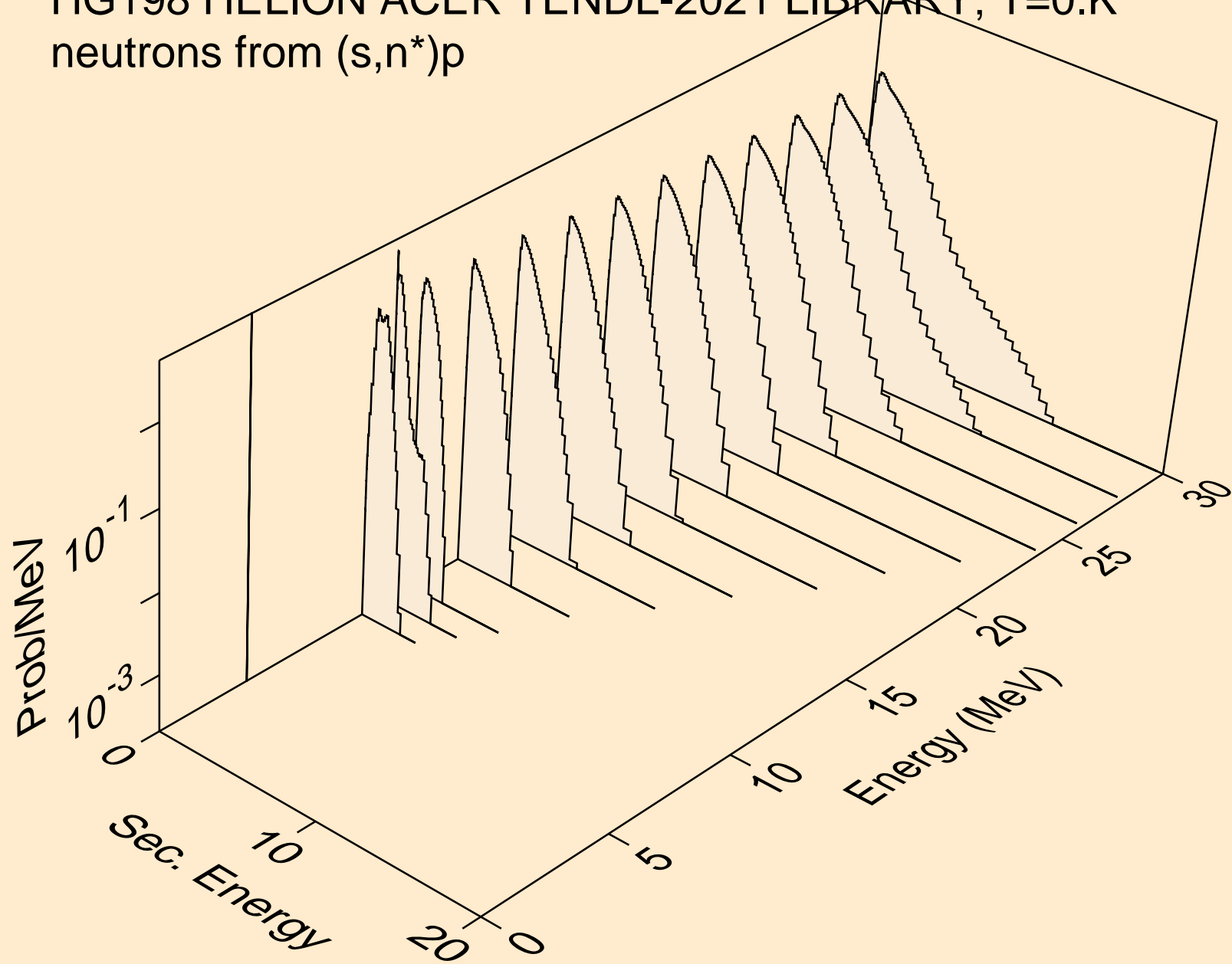

HG198 HELION ACER TENDL-2021 LIBRARY; T=0.K  
neutrons from (s,n\*)d

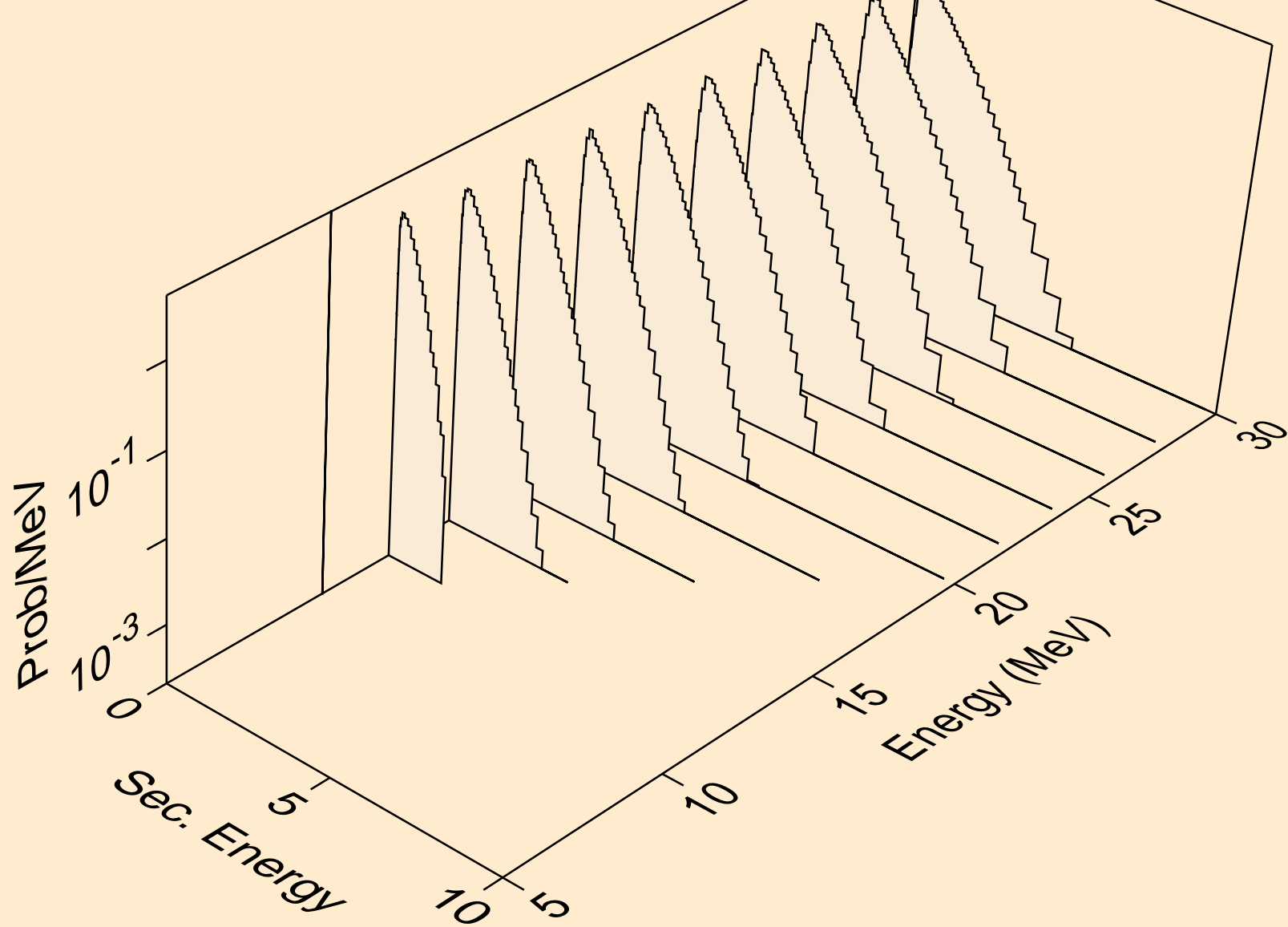

HG198 HELION ACER TENDL-2021 LIBRARY; T=0.K  
neutrons from (s,n\*)t

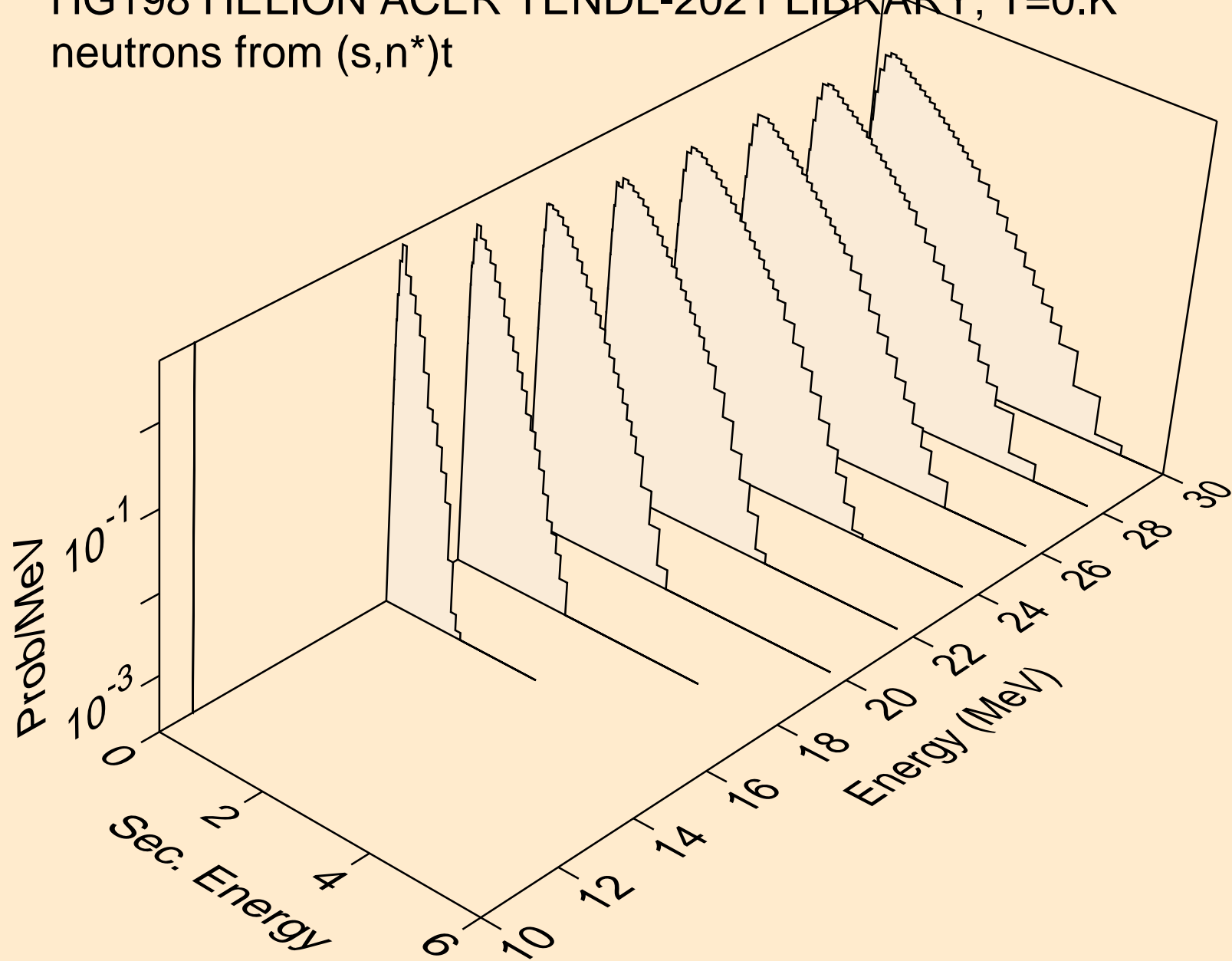

HG198 HELION ACER TENDL-2021 LIBRARY; T=0.K  
neutrons from (s,n\*)he3

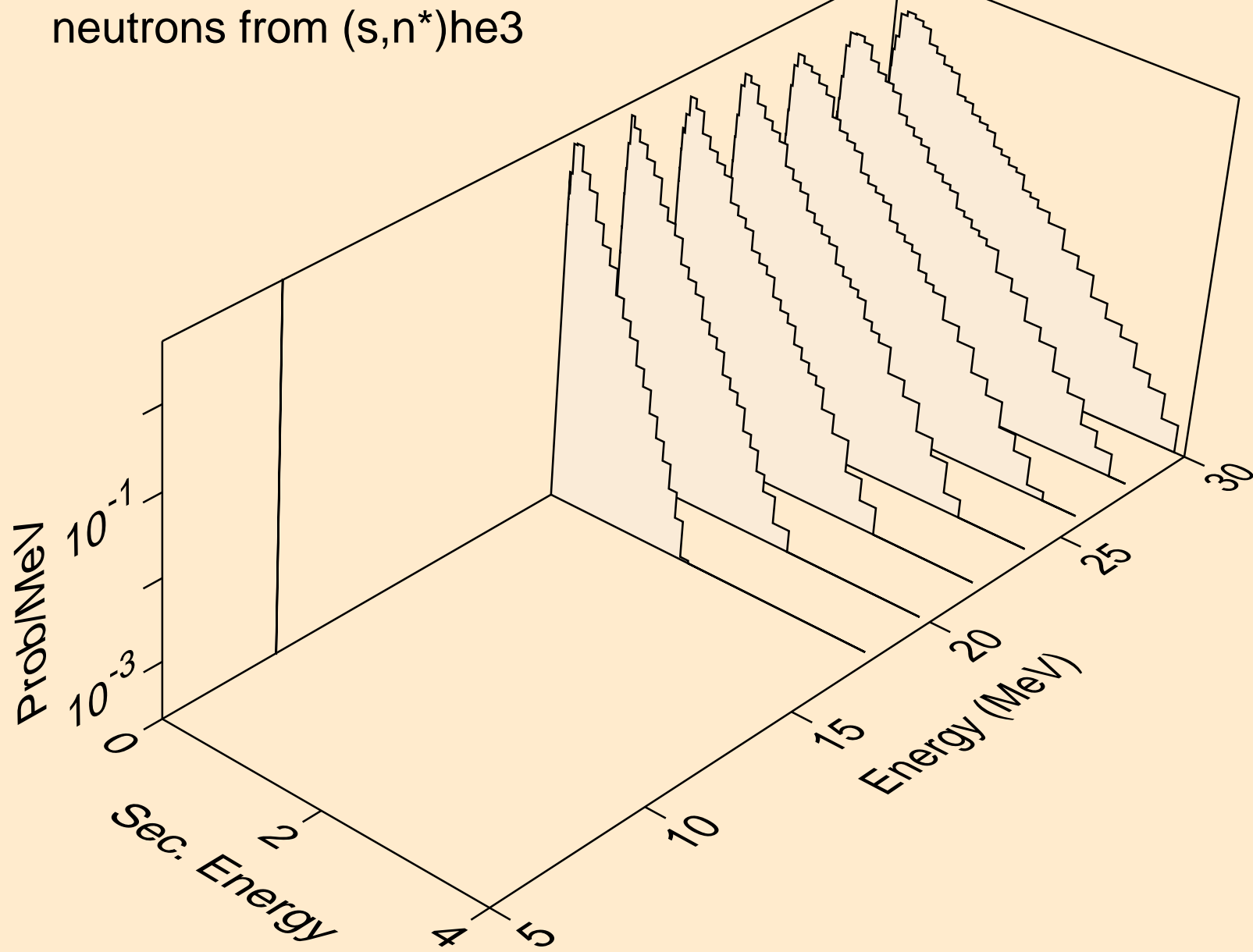

HG198 HELION ACER TENDL-2021 LIBRARY; T=0.K  
neutrons from (s,4n)

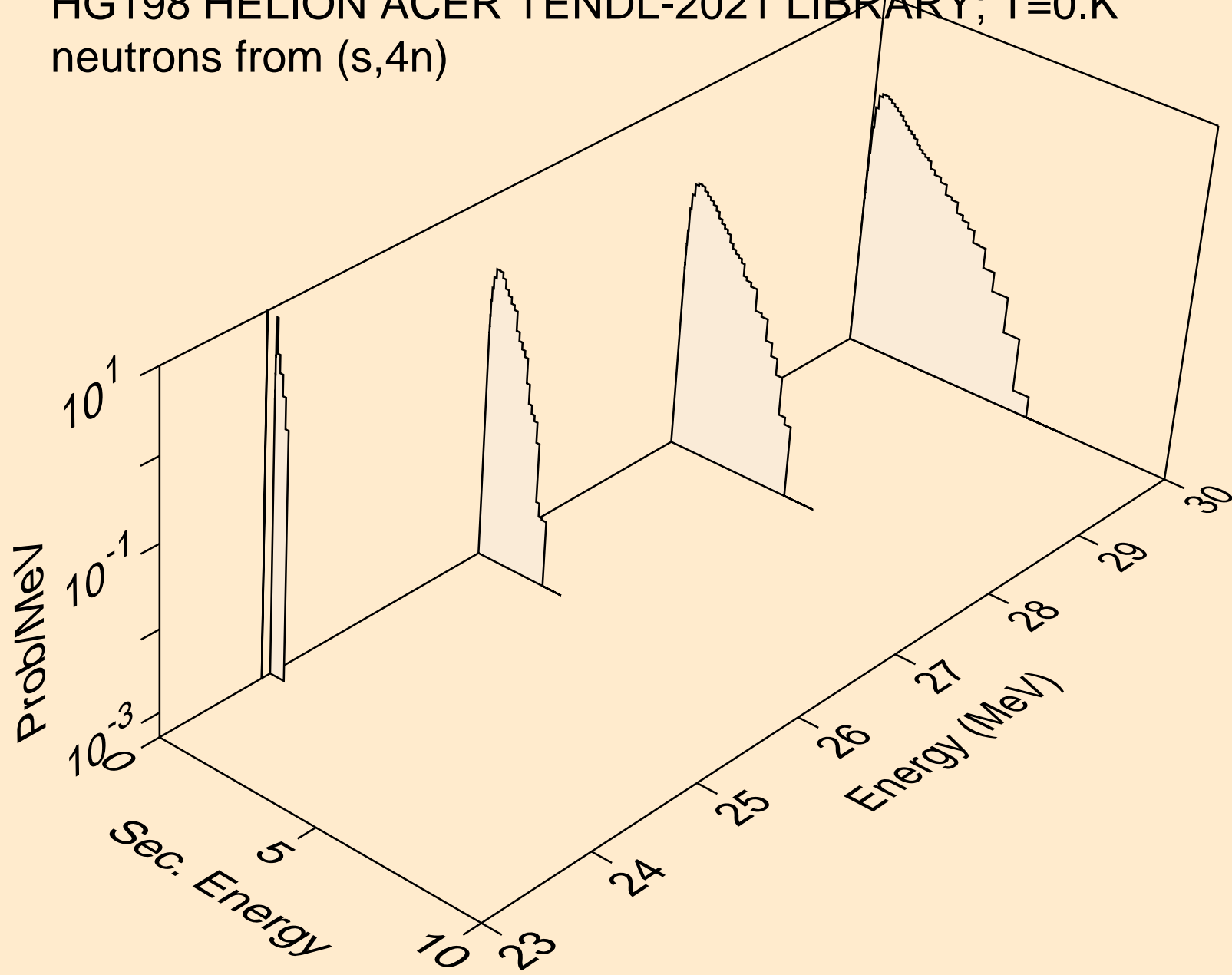

HG198 HELION ACER TENDL-2021 LIBRARY; T=0.K  
neutrons from (s,2np)

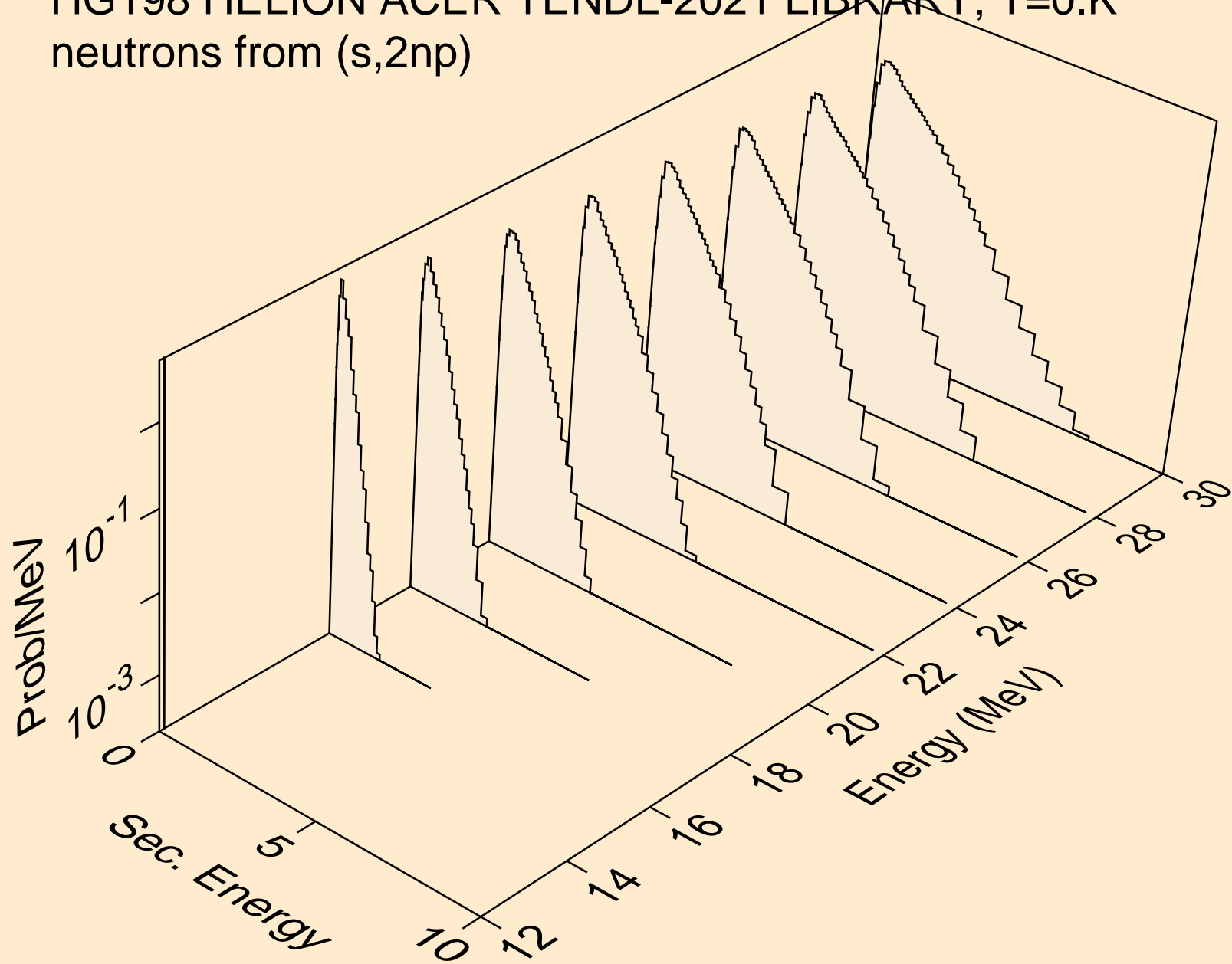

HG198 HELION ACER TENDL-2021 LIBRARY; T=0.K  
neutrons from (s,3np)

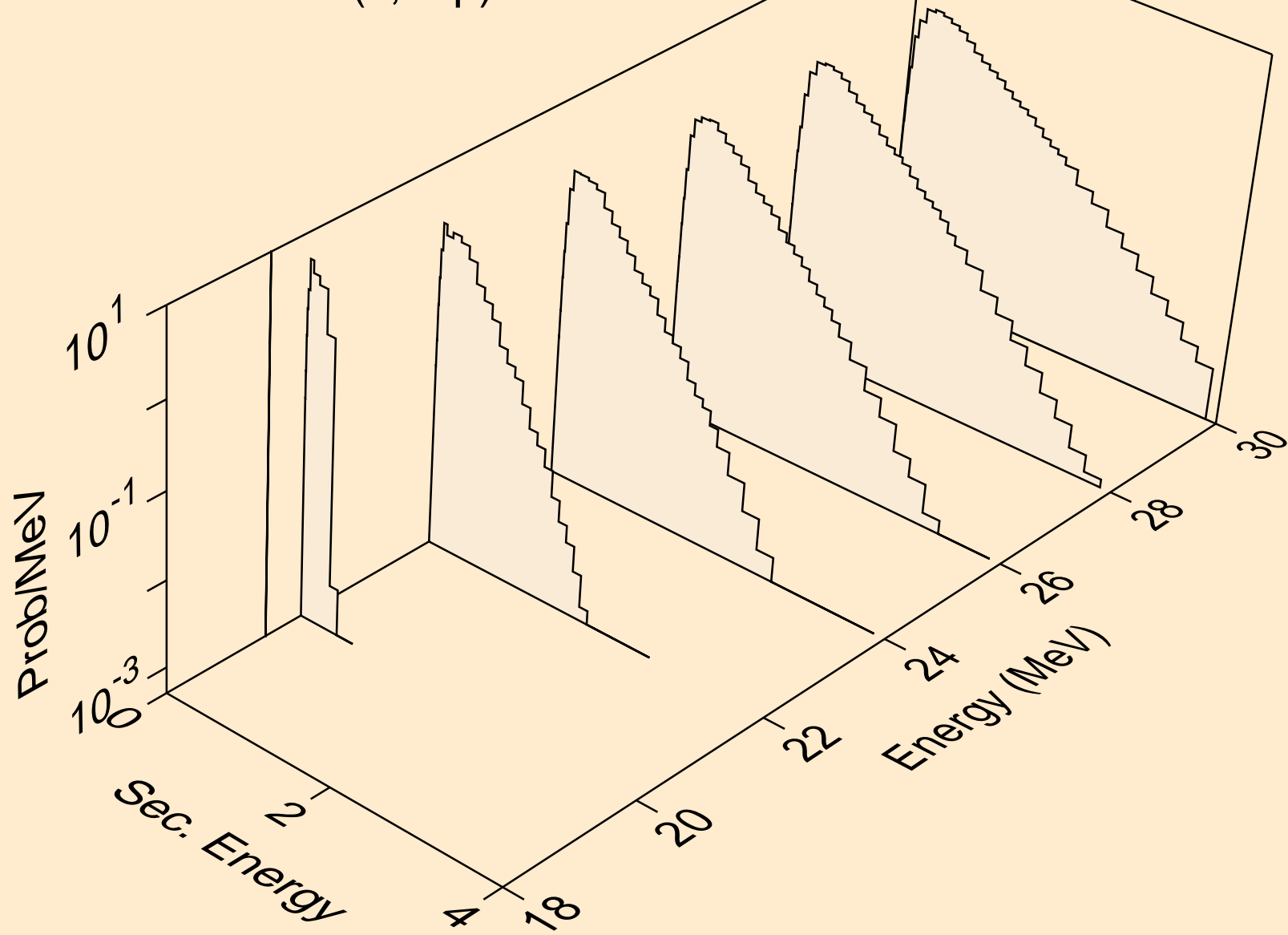



HG198 HELION ACER TENDL-2021 LIBRARY; T=0.K  
neutrons from (s,2np)

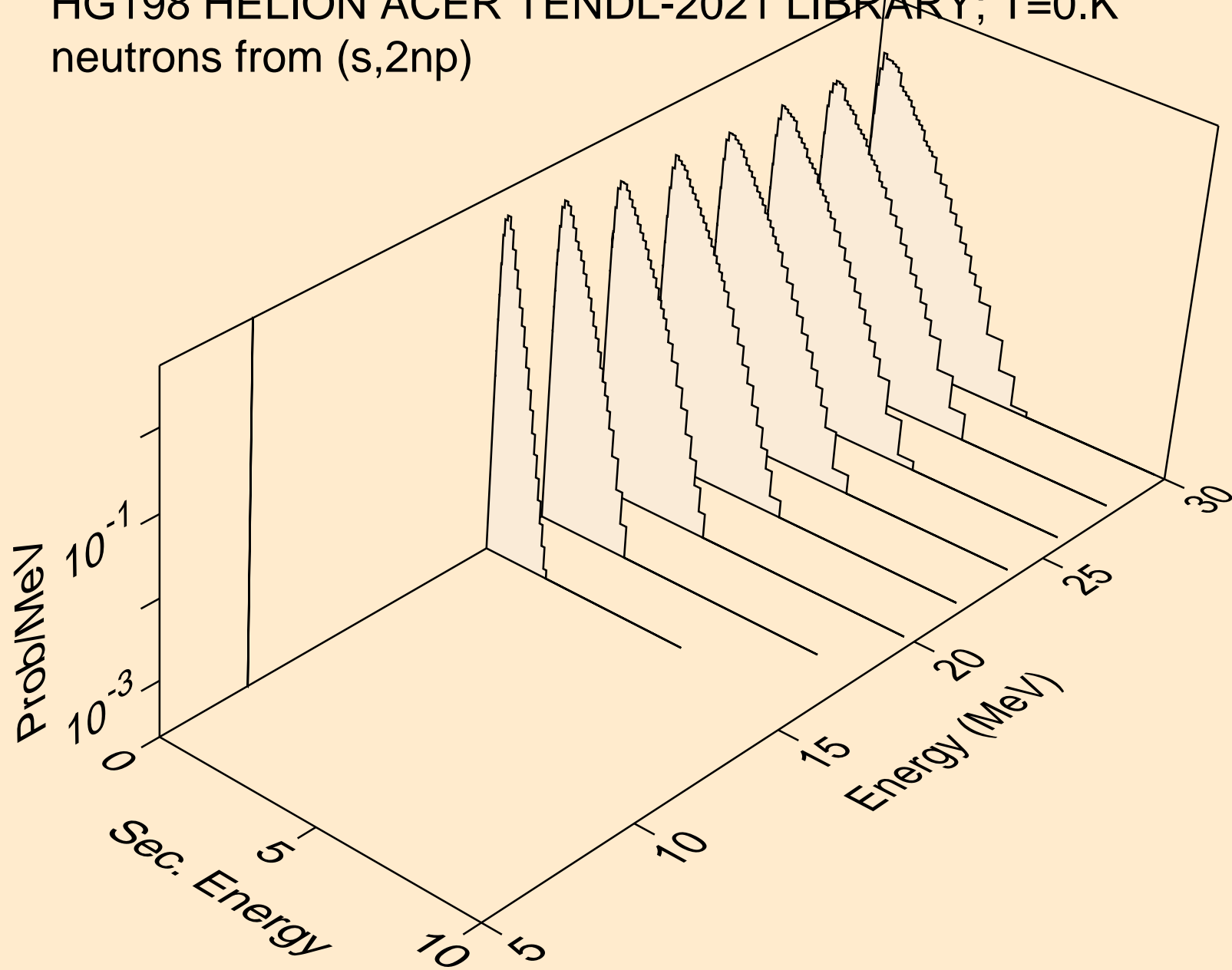

HG198 HELION ACER TENDL-2021 LIBRARY; T=0.K  
neutrons from (s,npa)

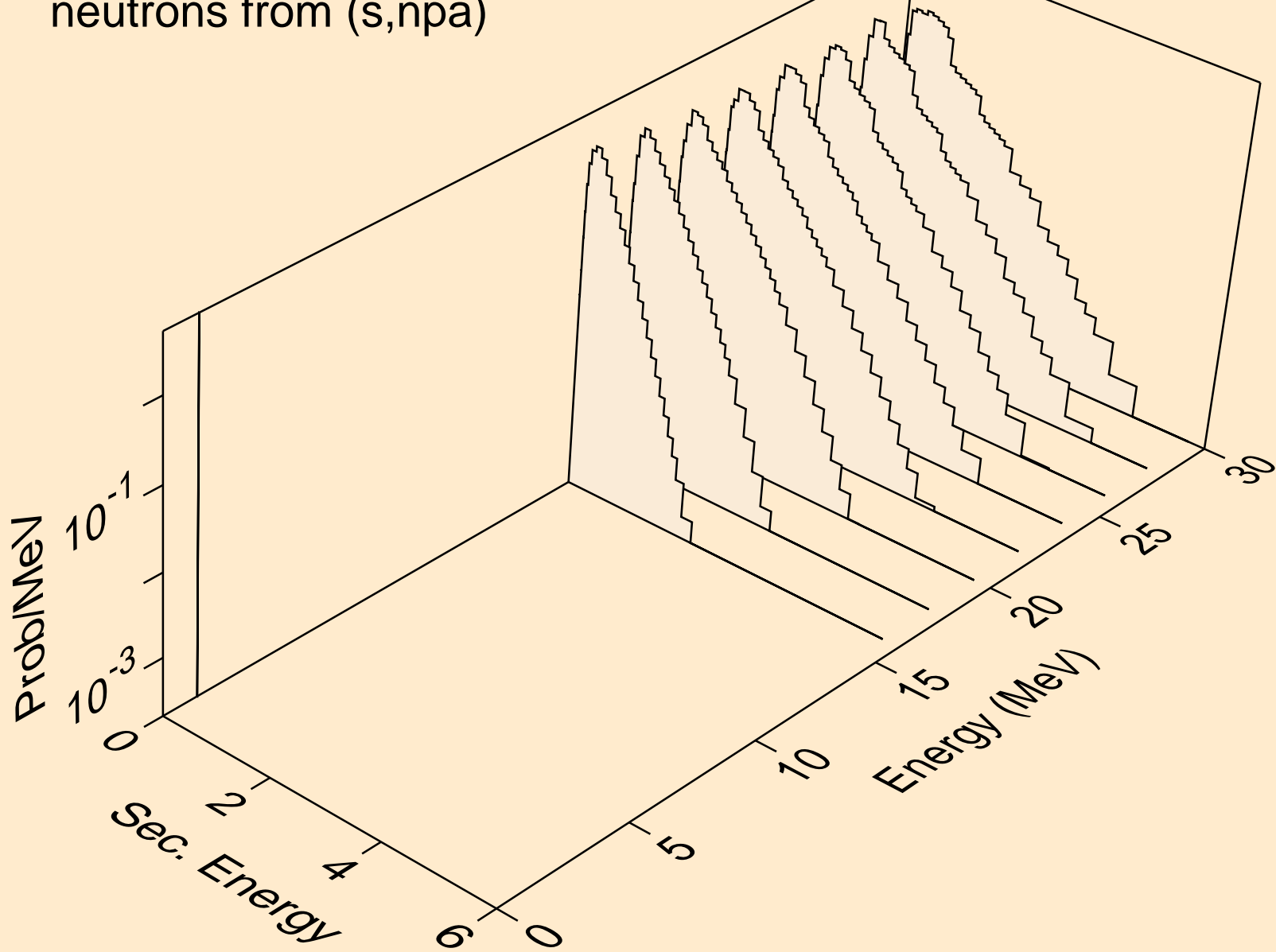

HG198 HELION ACER TENDL-2021 LIBRARY; T=0.K  
protons from (s,x)

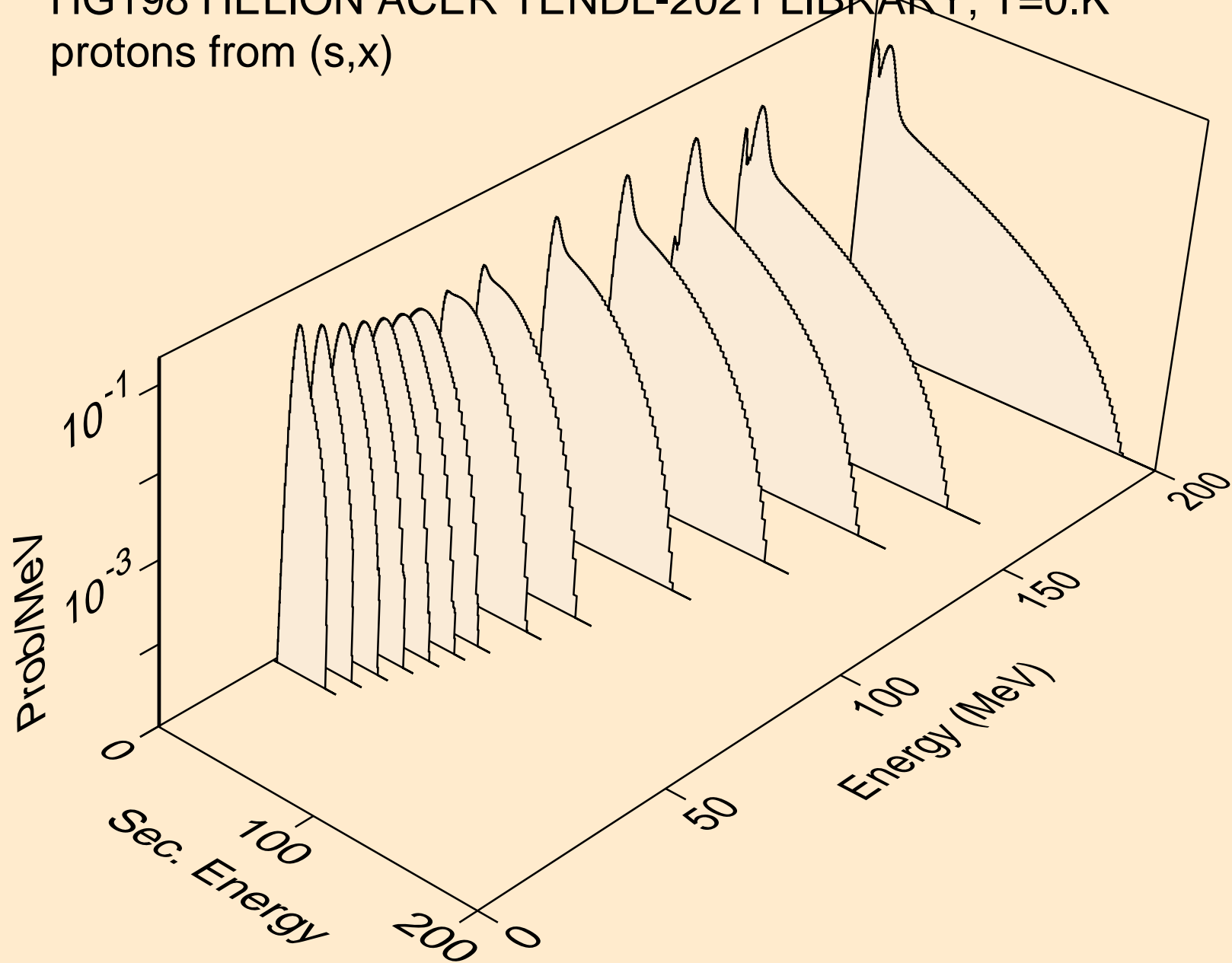

HG198 HELION ACER TENDL-2021 LIBRARY; T=0.K  
protons from (s,n\*)p

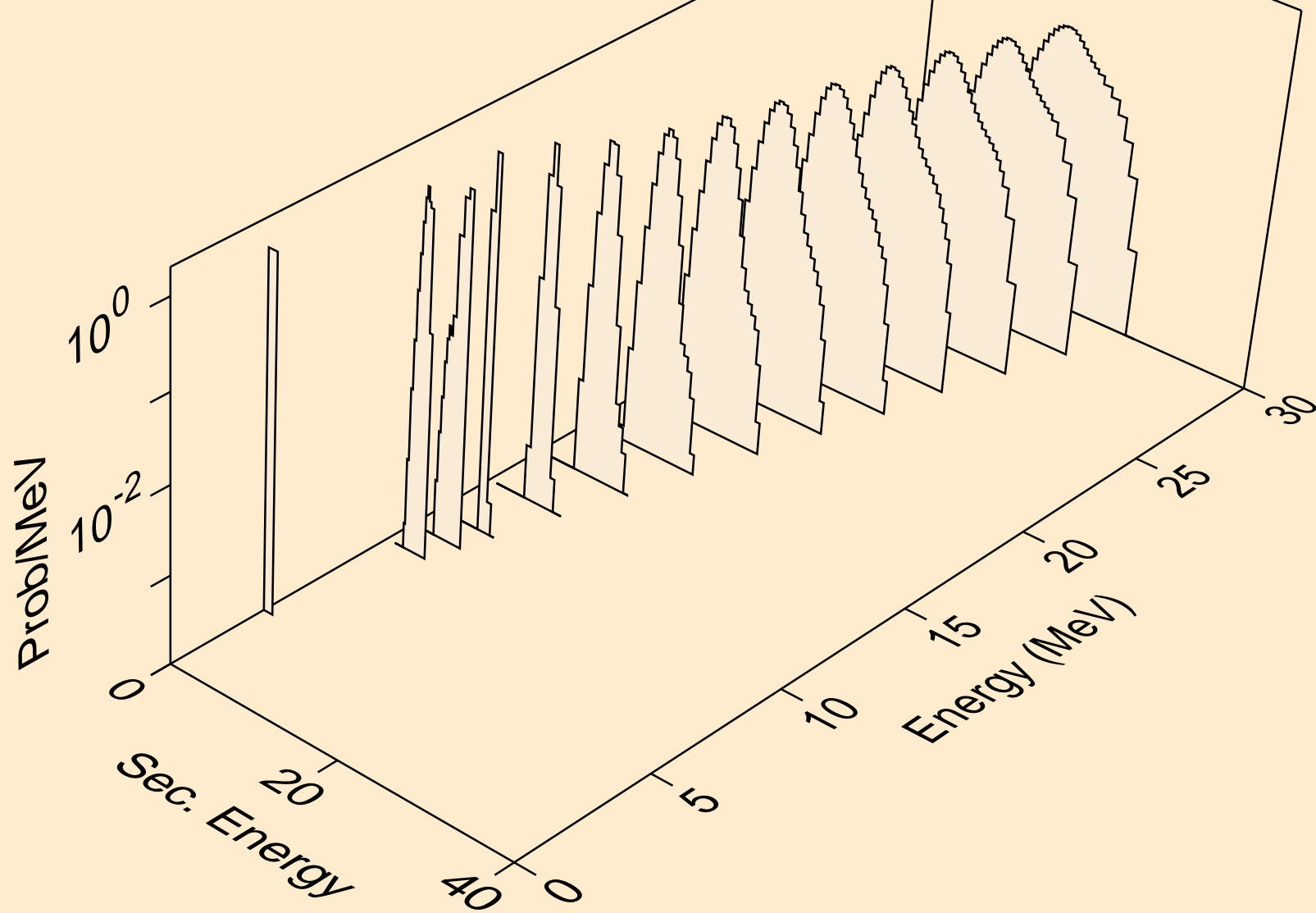

HG198 HELION ACER TENDL-2021 LIBRARY; T=0.K  
protons from (s,2np)

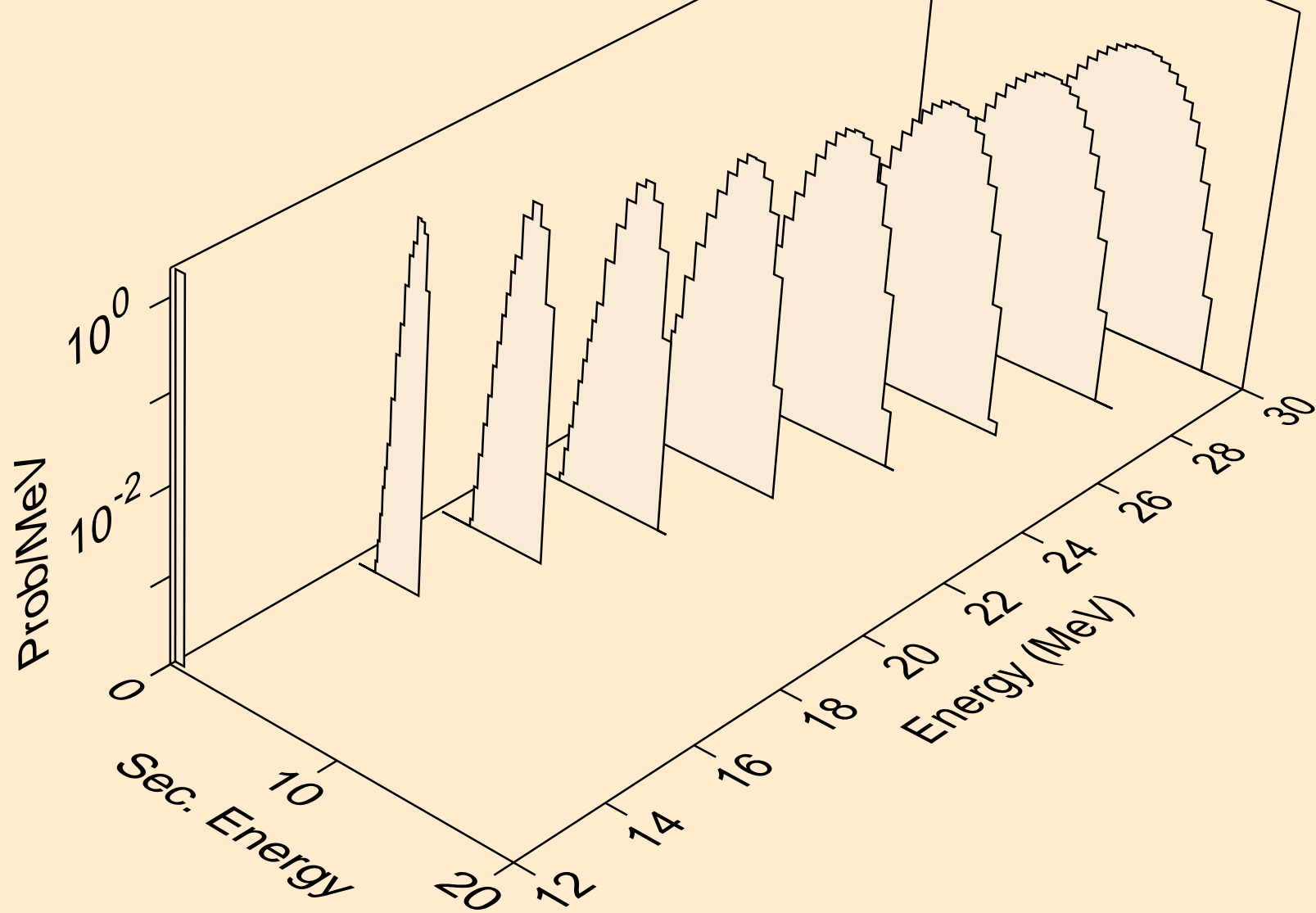

HG198 HELION ACER TENDL-2021 LIBRARY; T=0.K  
protons from (s,3np)

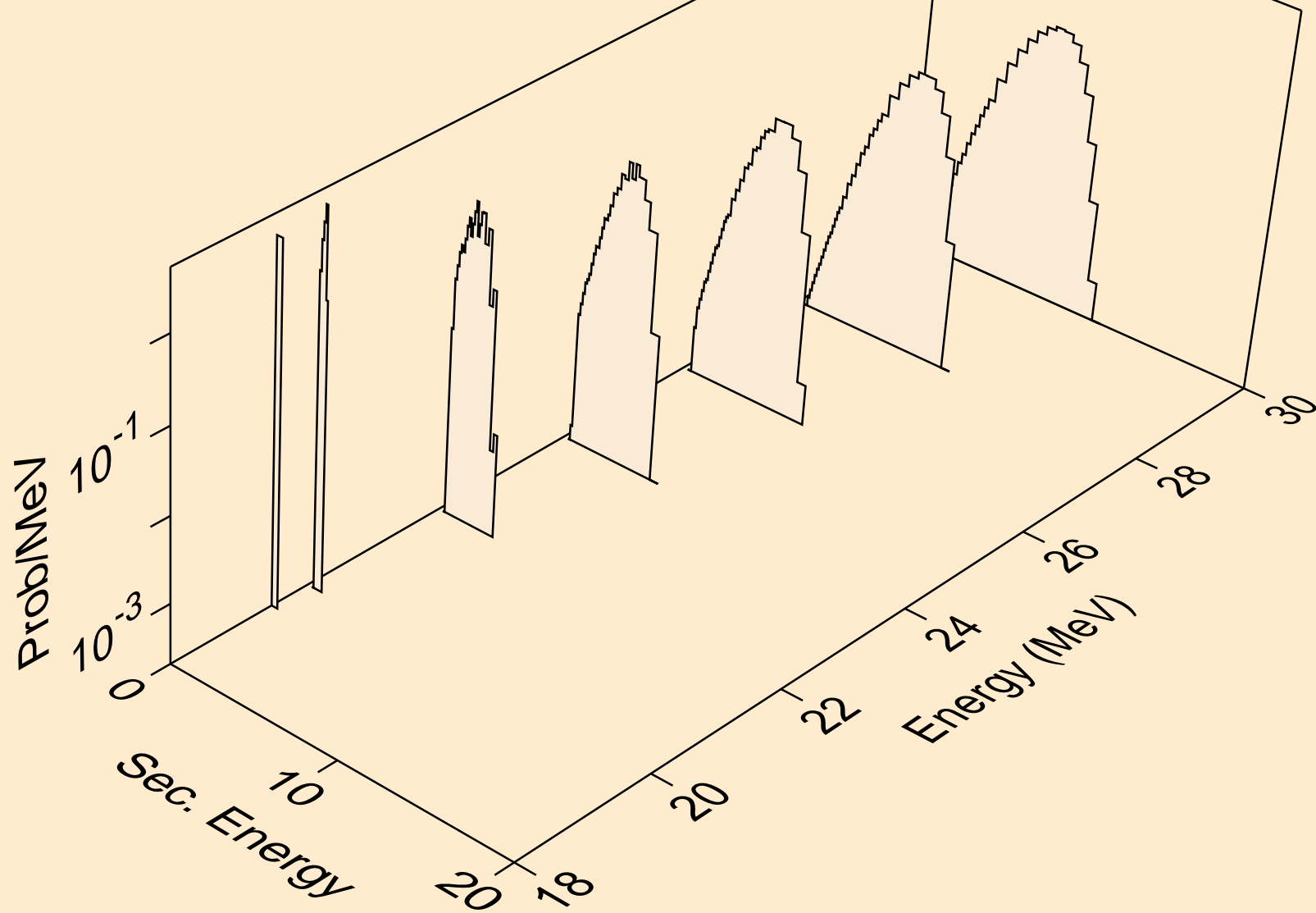

HG198 HELION ACER TENDL-2021 LIBRARY; T=0.K  
protons from (s,2np)

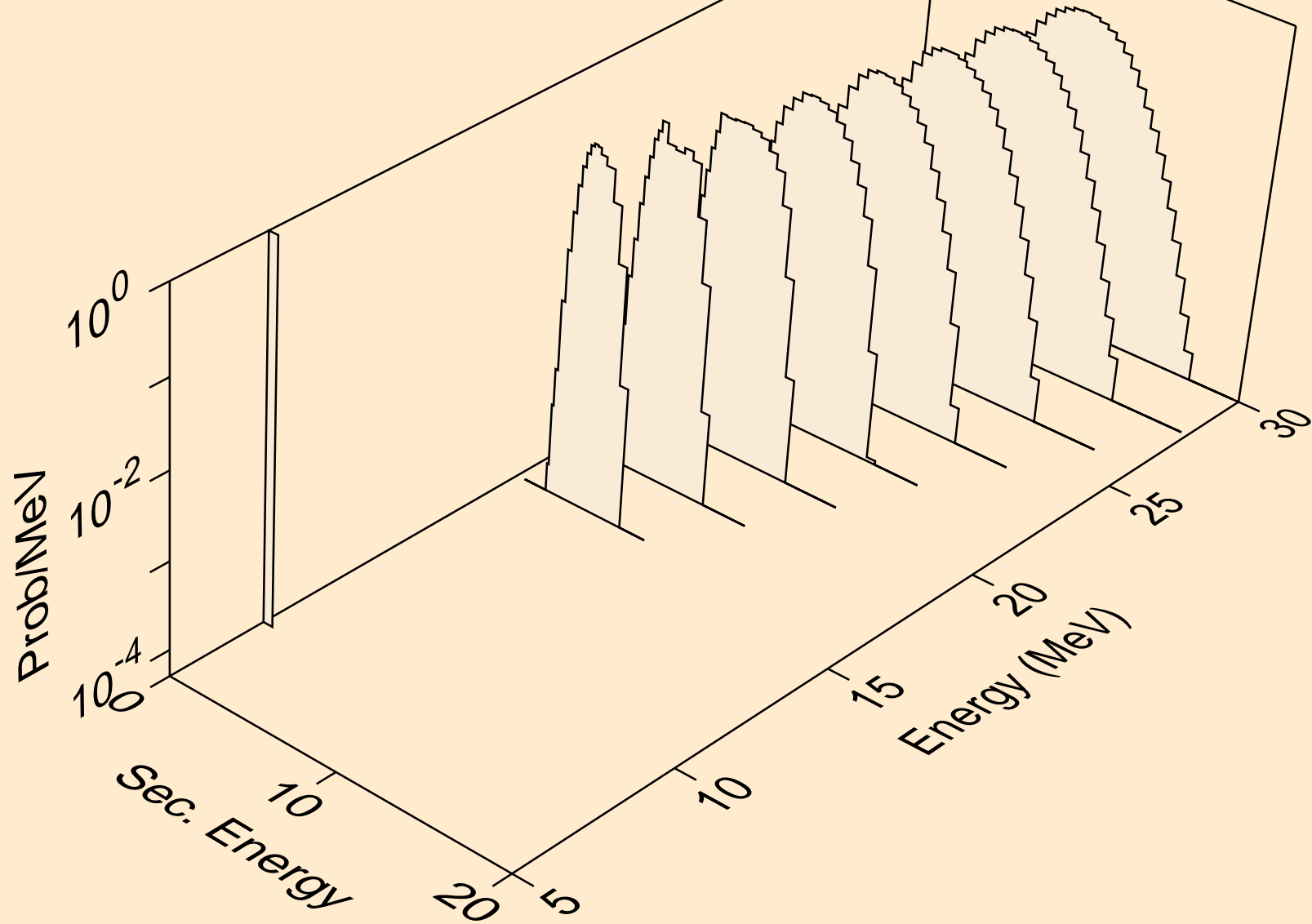

HG198 HELION ACER TENDL-2021 LIBRARY; T=0.K  
protons from (s,npa)

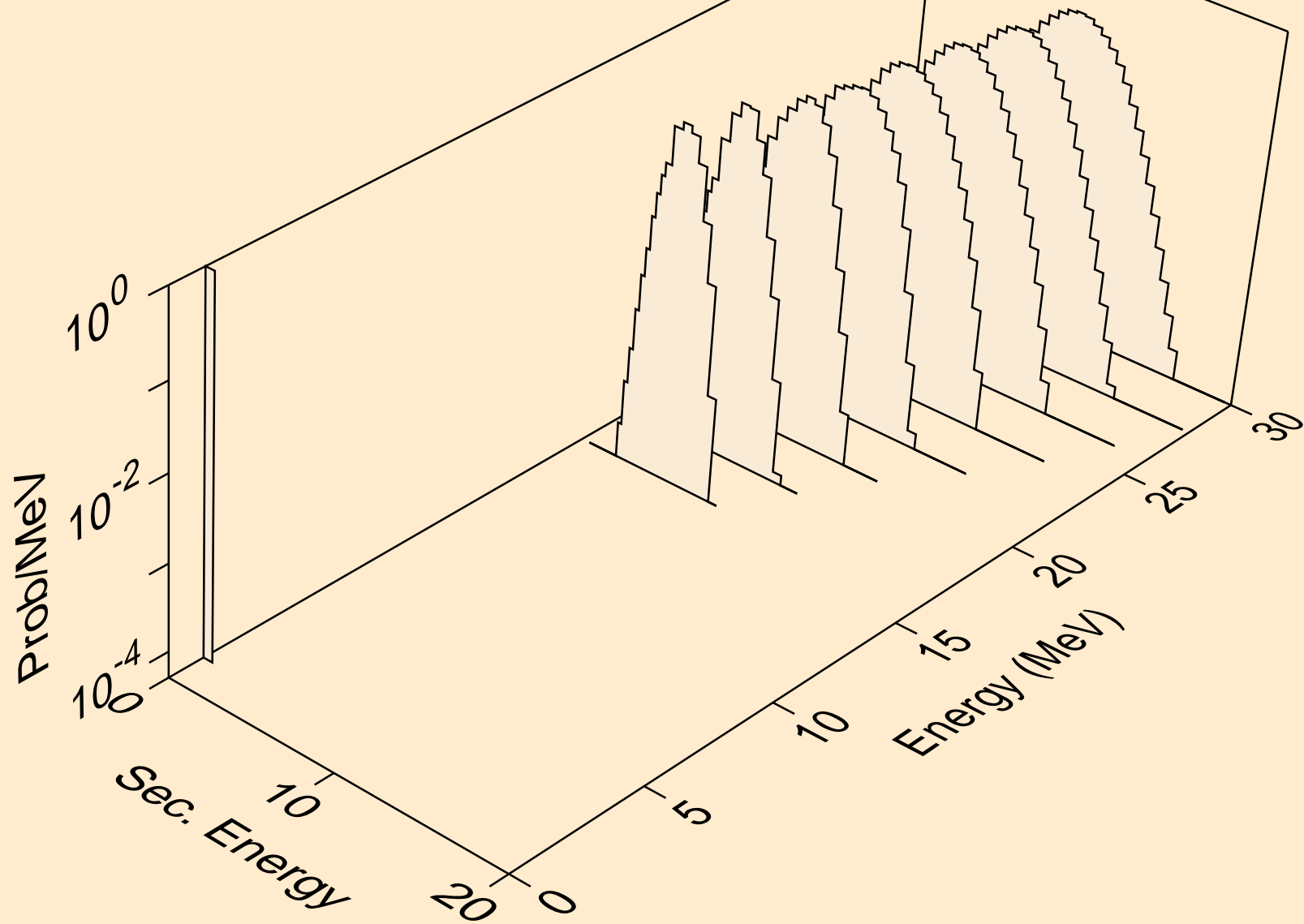



HG198 HELION ACER TENDL-2021 LIBRARY; T=0.K  
protons from (s,p)

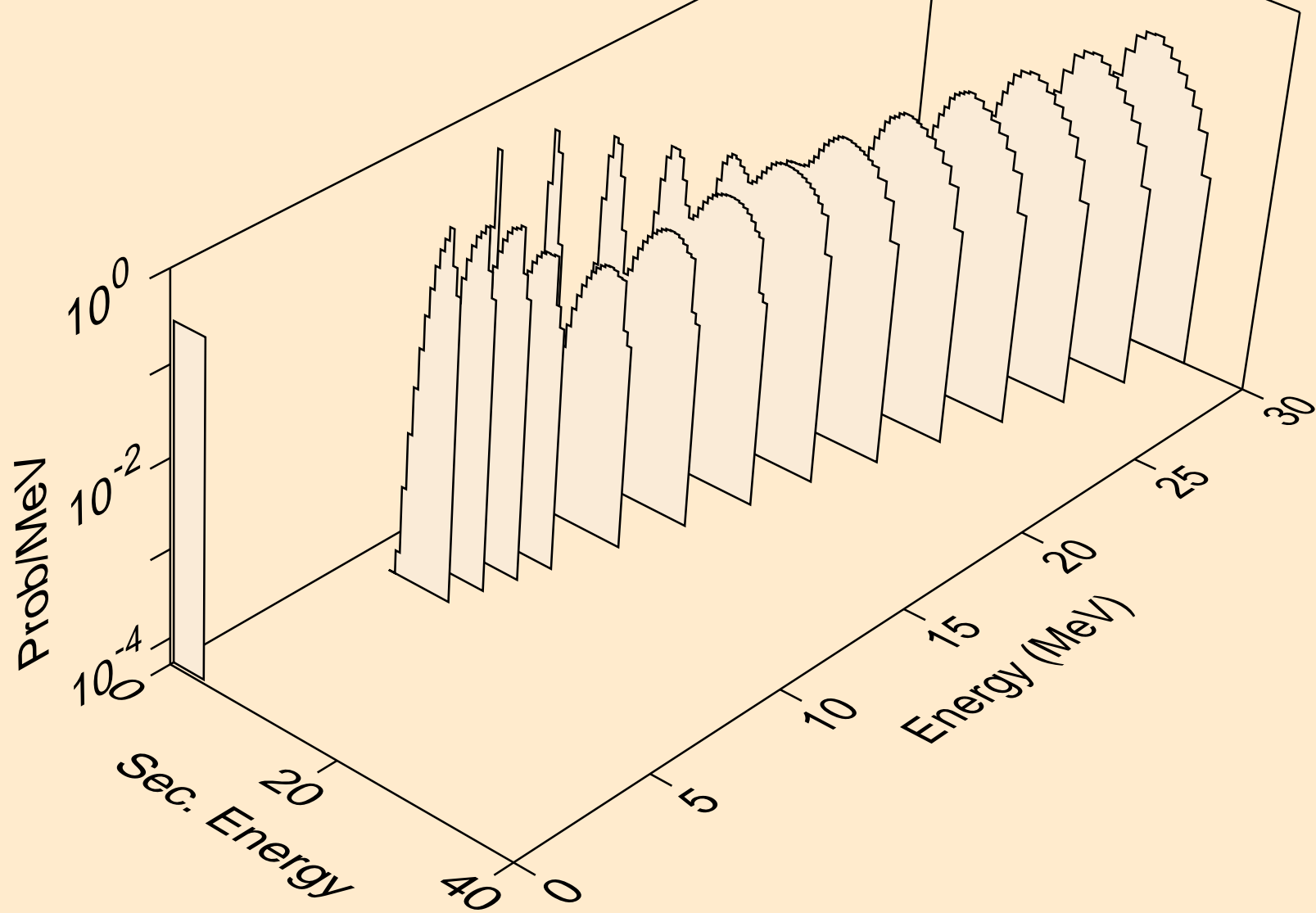

HG198 HELION ACER TENDL-2021 LIBRARY; T=0.K  
protons from (s,2p)

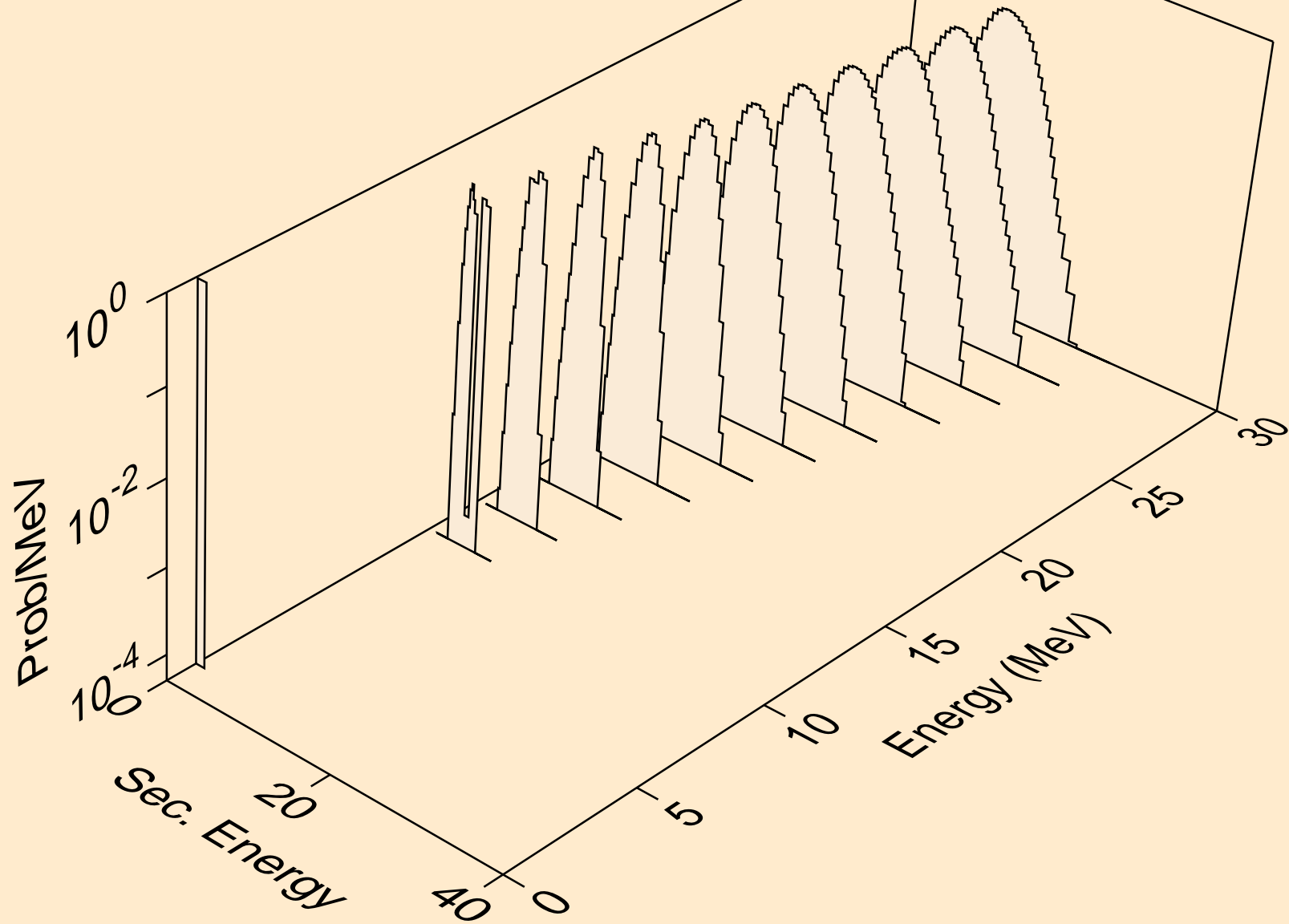

HG198 HELION ACER TENDL-2021 LIBRARY; T=0.K  
protons from (s,pa)

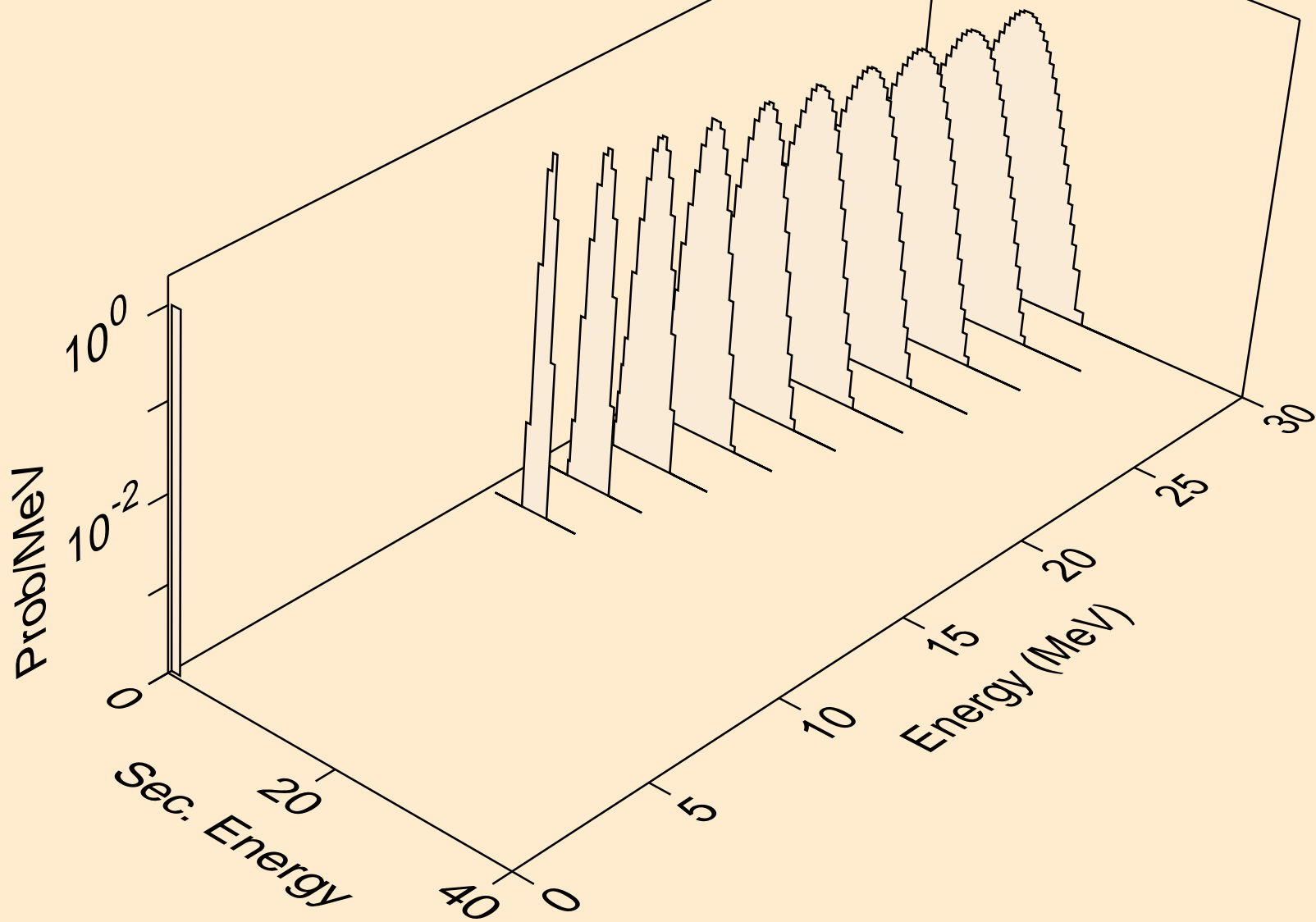

HG198 HELION ACER TENDL-2021 LIBRARY; T=0.K  
protons from (s,pd)

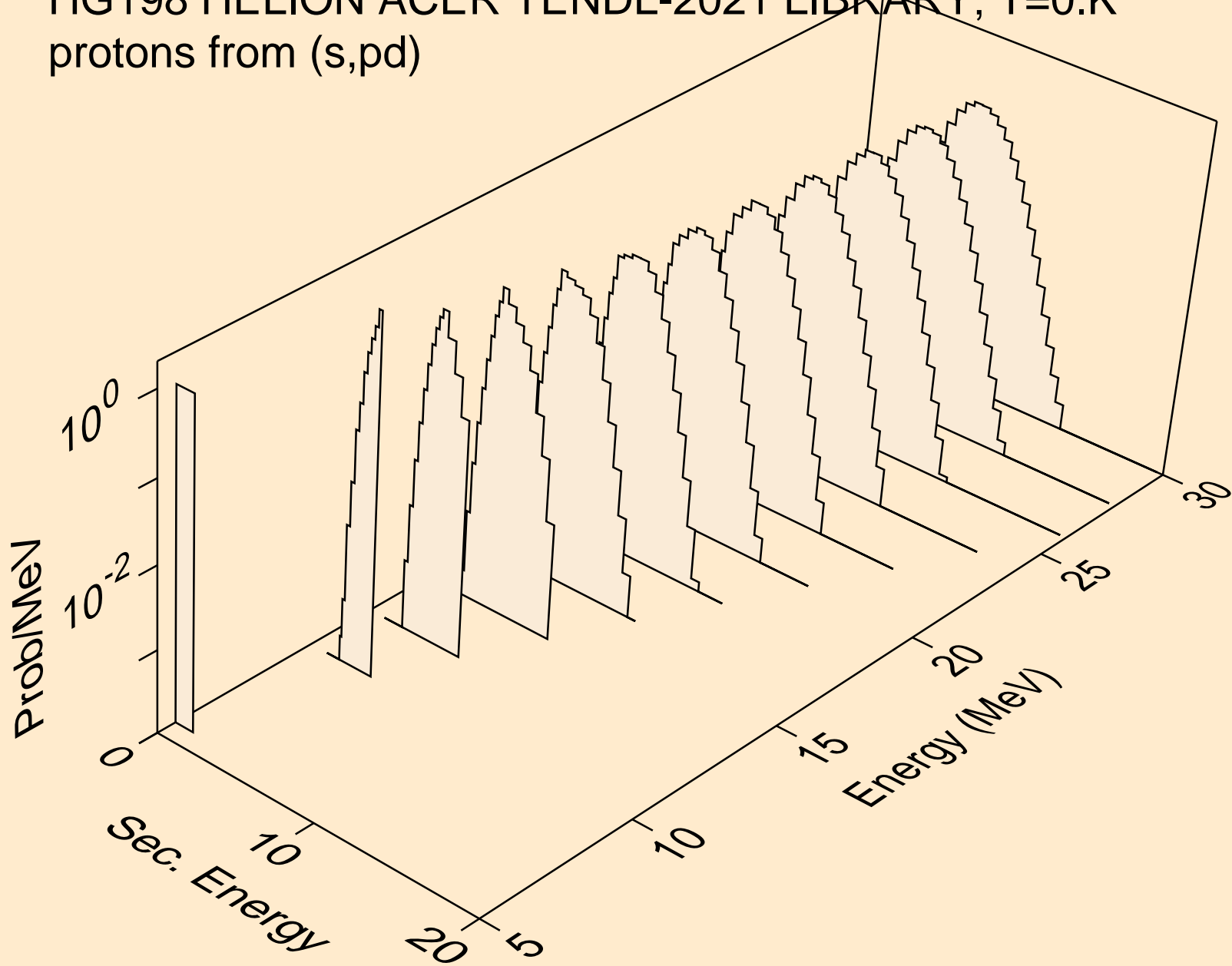

HG198 HELION ACER TENDL-2021 LIBRARY; T=0.K  
protons from (s,pt)

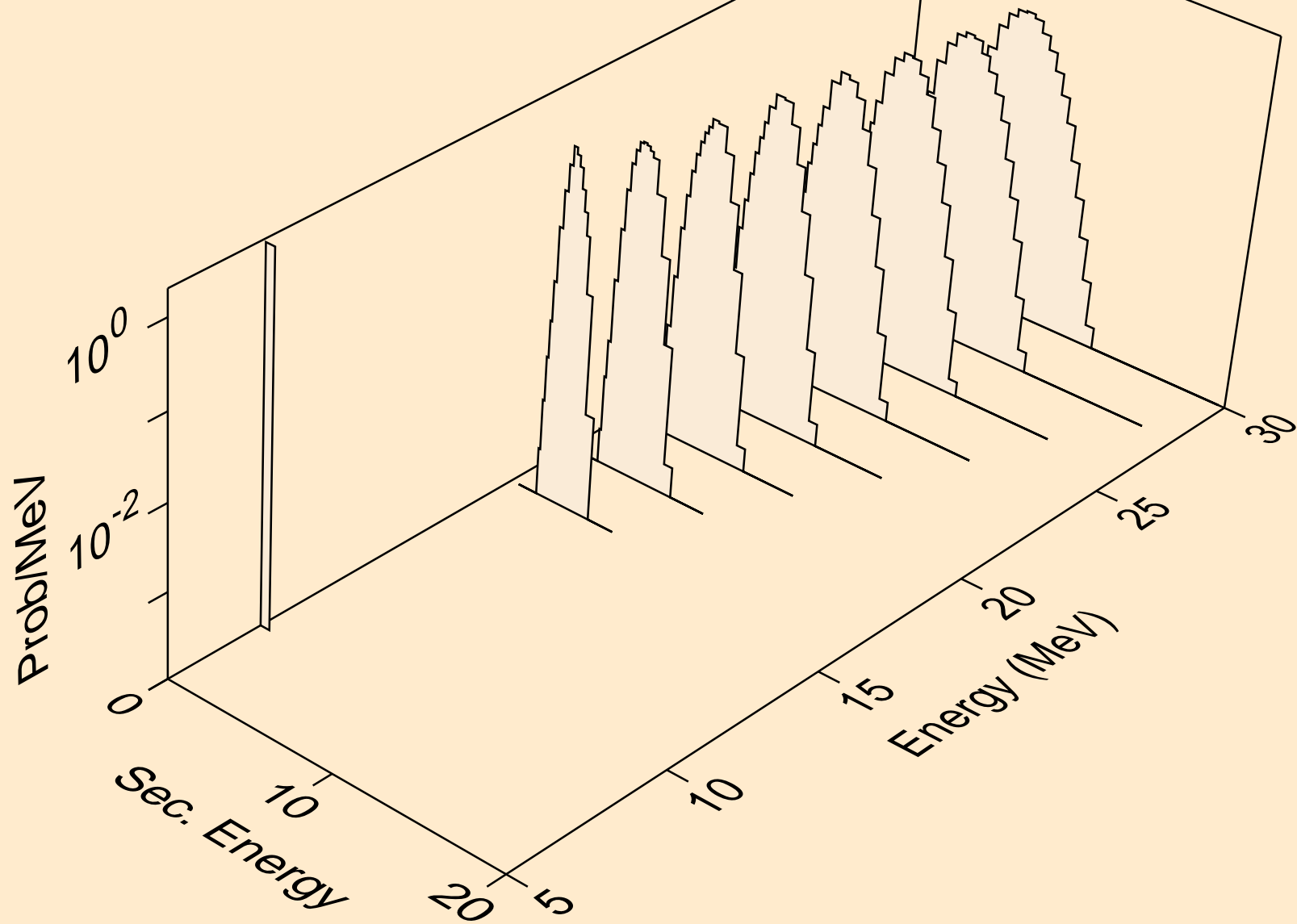

HG198 HELION ACER TENDL-2021 LIBRARY; T=0.K  
deuterons from (s,x)

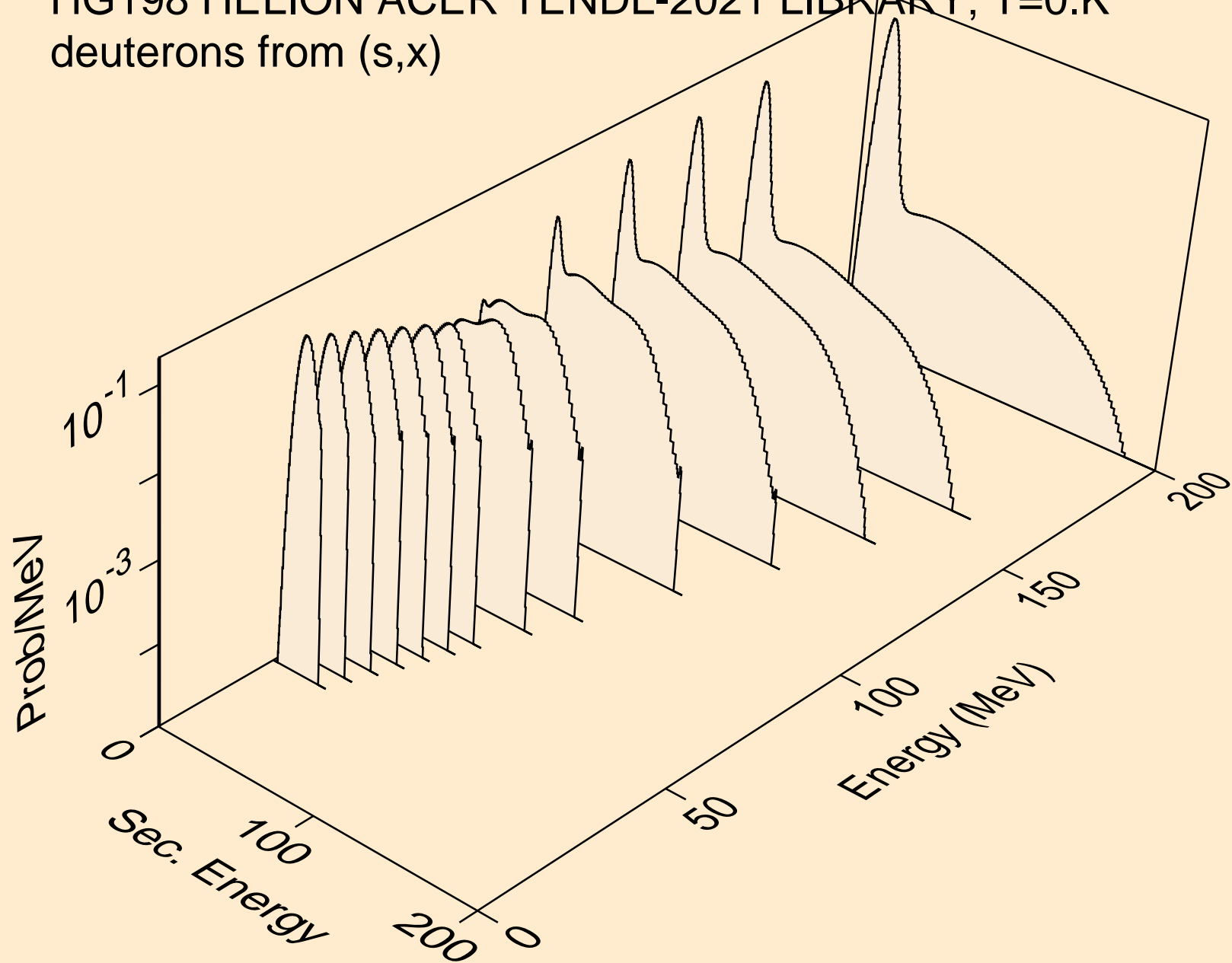

HG198 HELION ACER TENDL-2021 LIBRARY; T=0.K  
deuterons from (s,2nd)

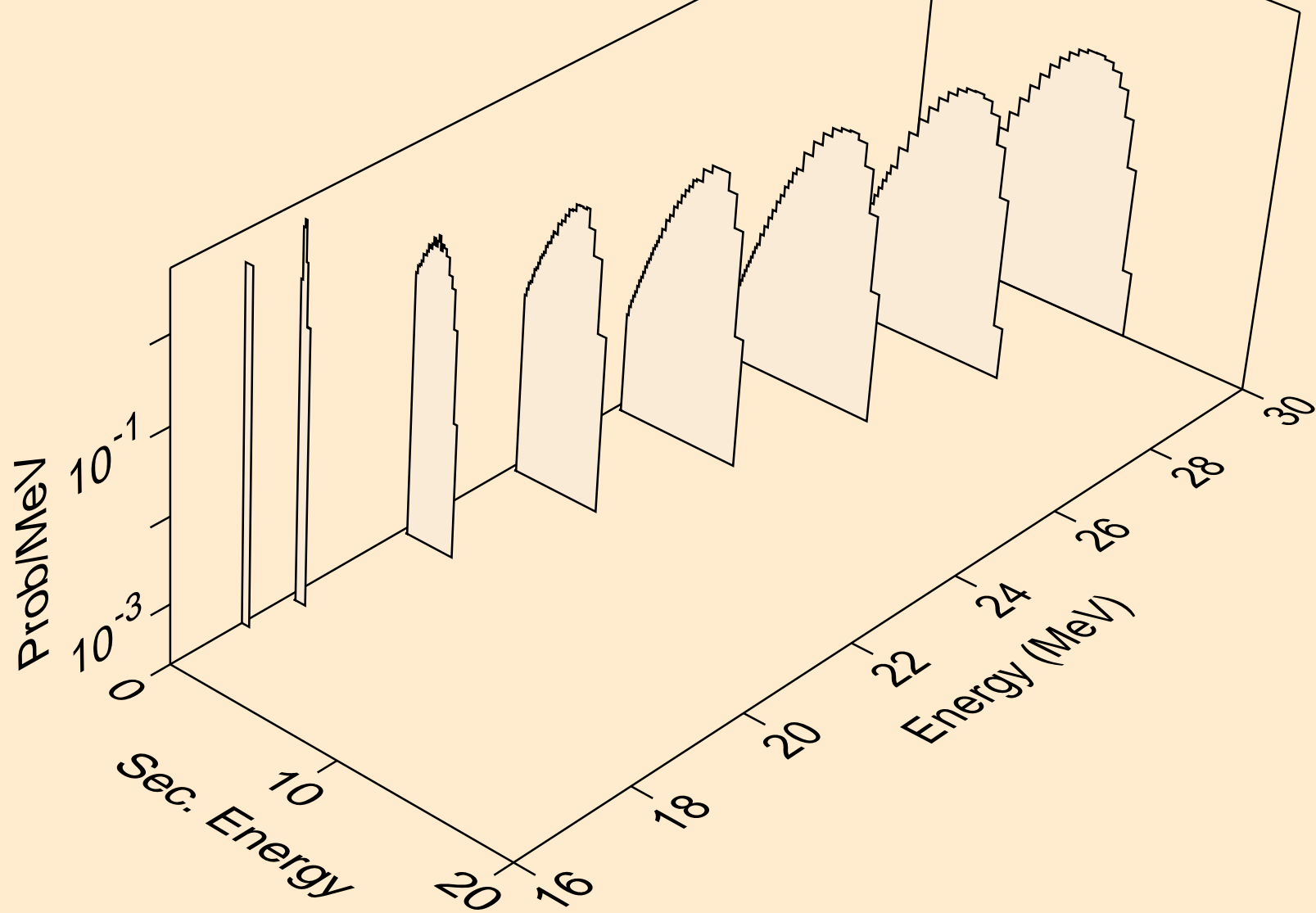

HG198 HELION ACER TENDL-2021 LIBRARY; T=0.K  
deuterons from (s,n\*)d

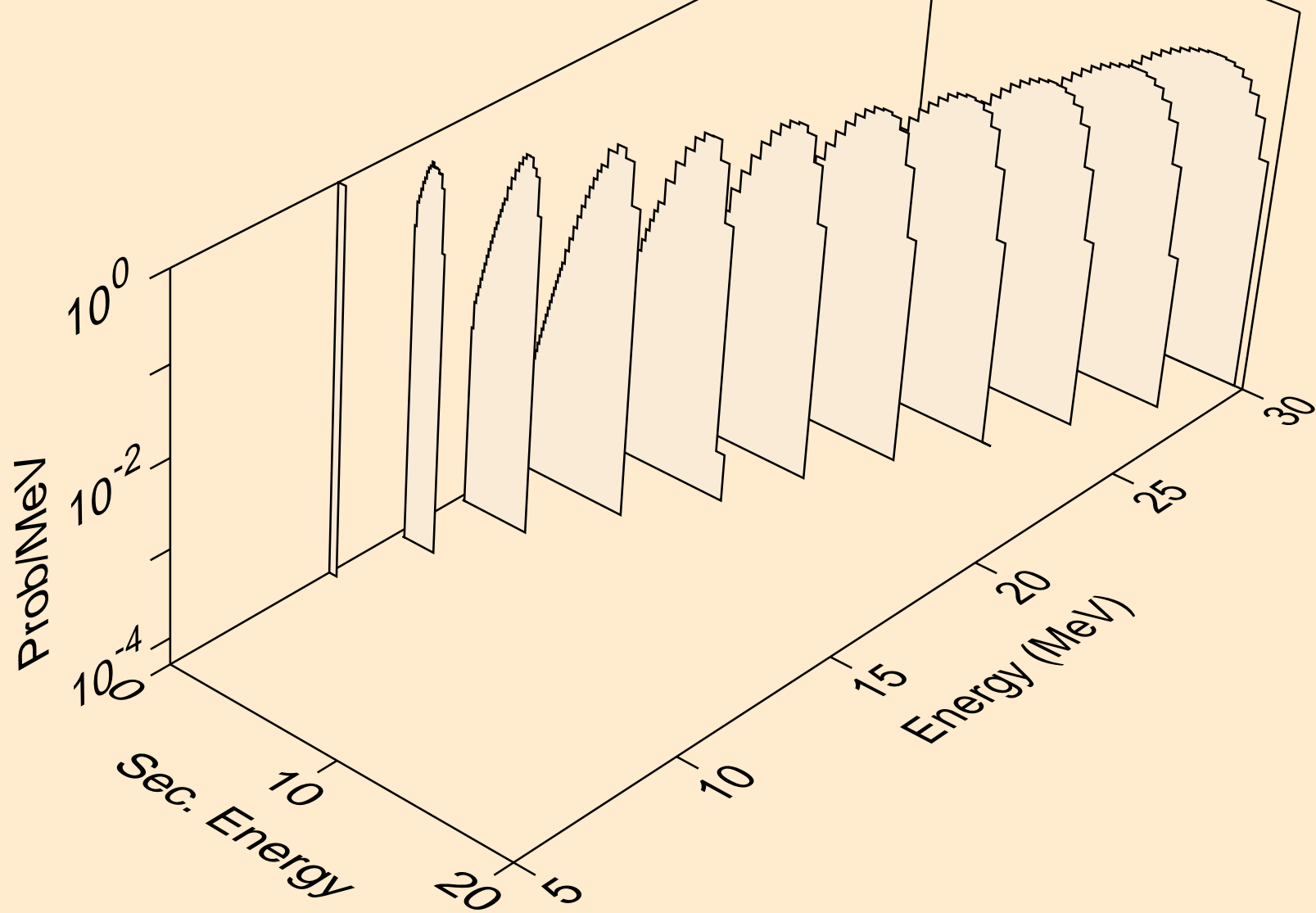



HG198 HELION ACER TENDL-2021 LIBRARY; T=0.K  
deuterons from (s,d)

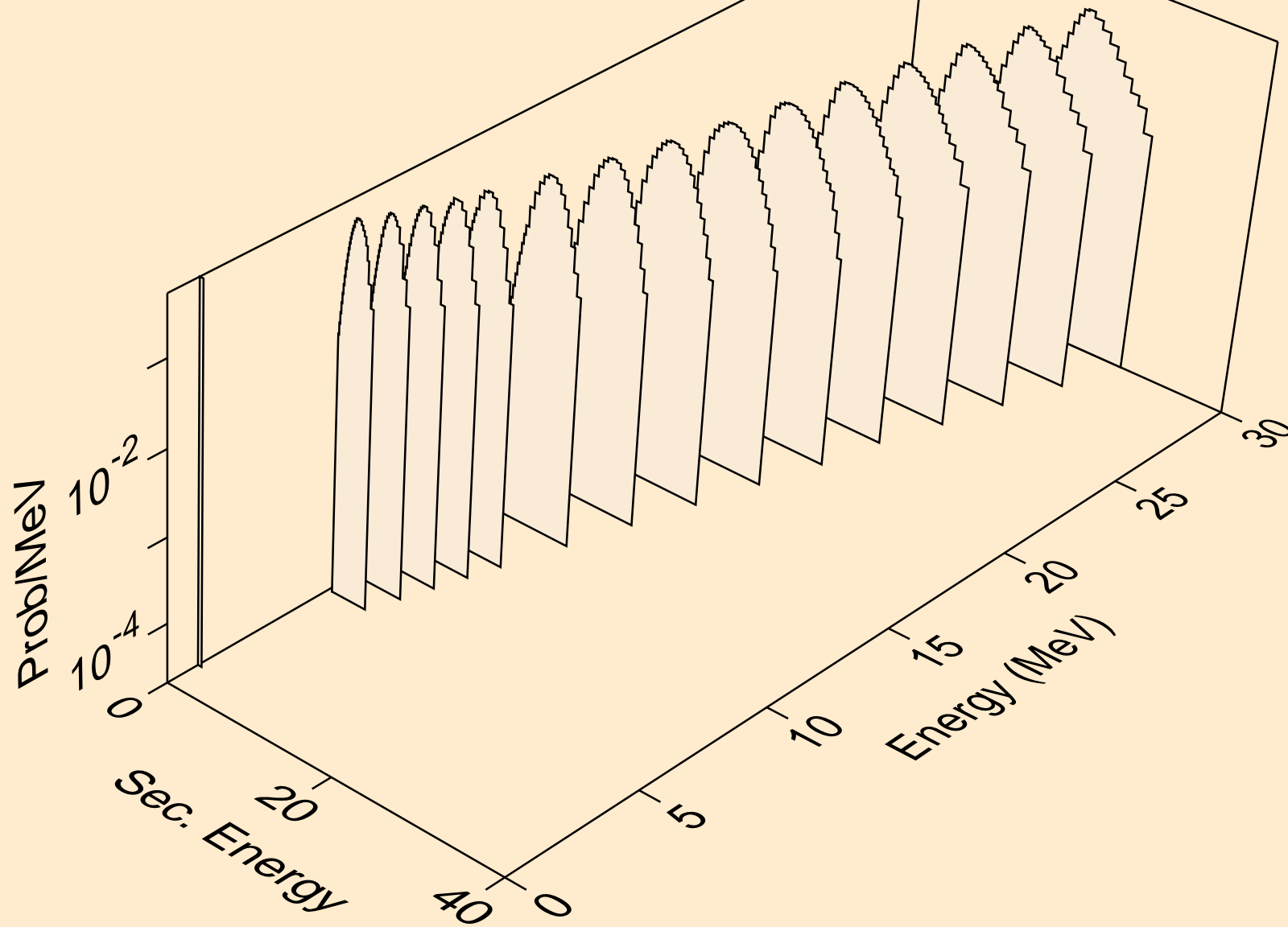

HG198 HELION ACER TENDL-2021 LIBRARY; T=0.K  
deuterons from (s,pd)

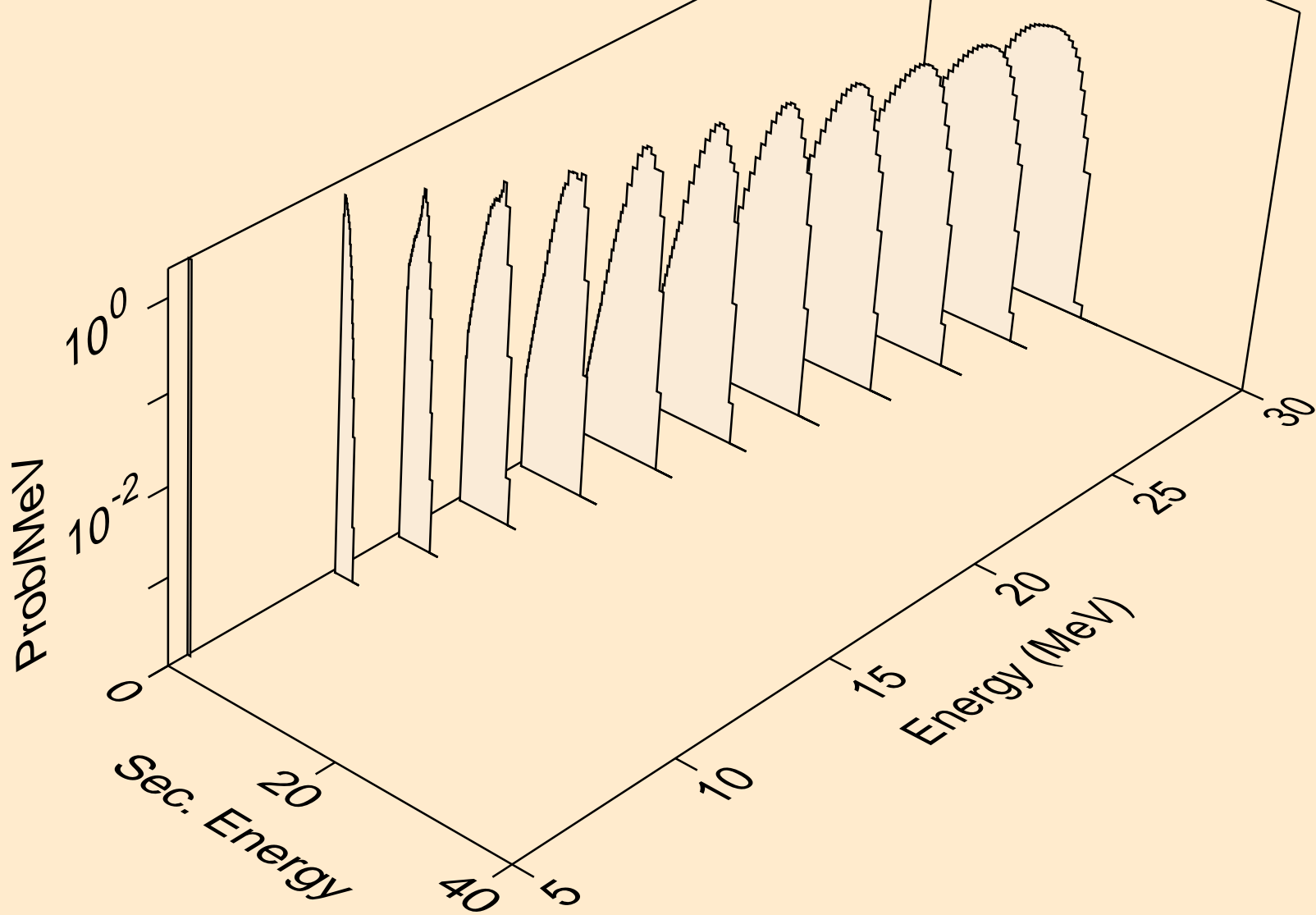

HG198 HELION ACER TENDL-2021 LIBRARY; T=0.K  
deuterons from (s,da)

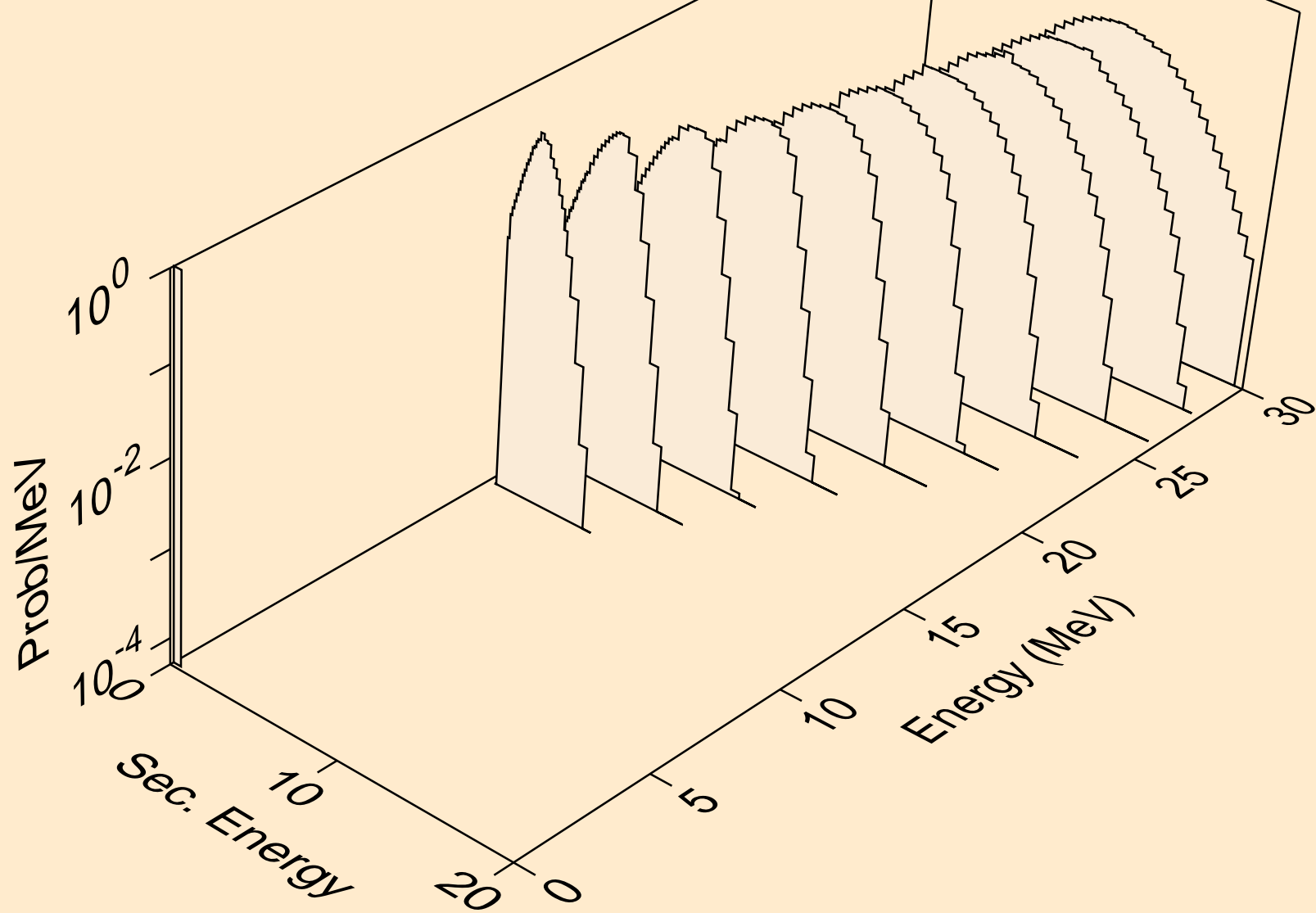

HG198 HELION ACER TENDL-2021 LIBRARY; T=0.K  
tritons from (s,x)

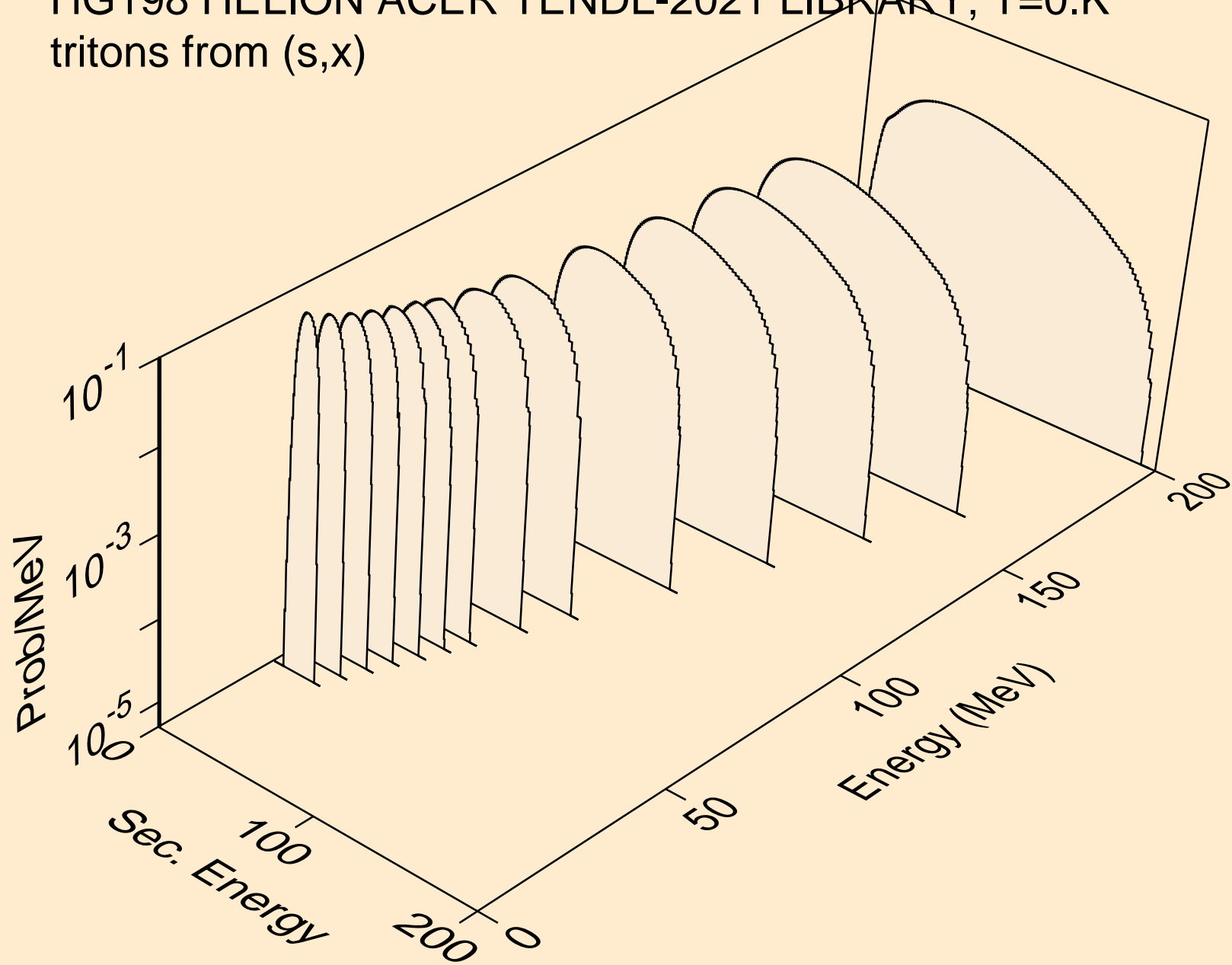

HG198 HELION ACER TENDL-2021 LIBRARY; T=0.K  
tritons from (s,n\*)t

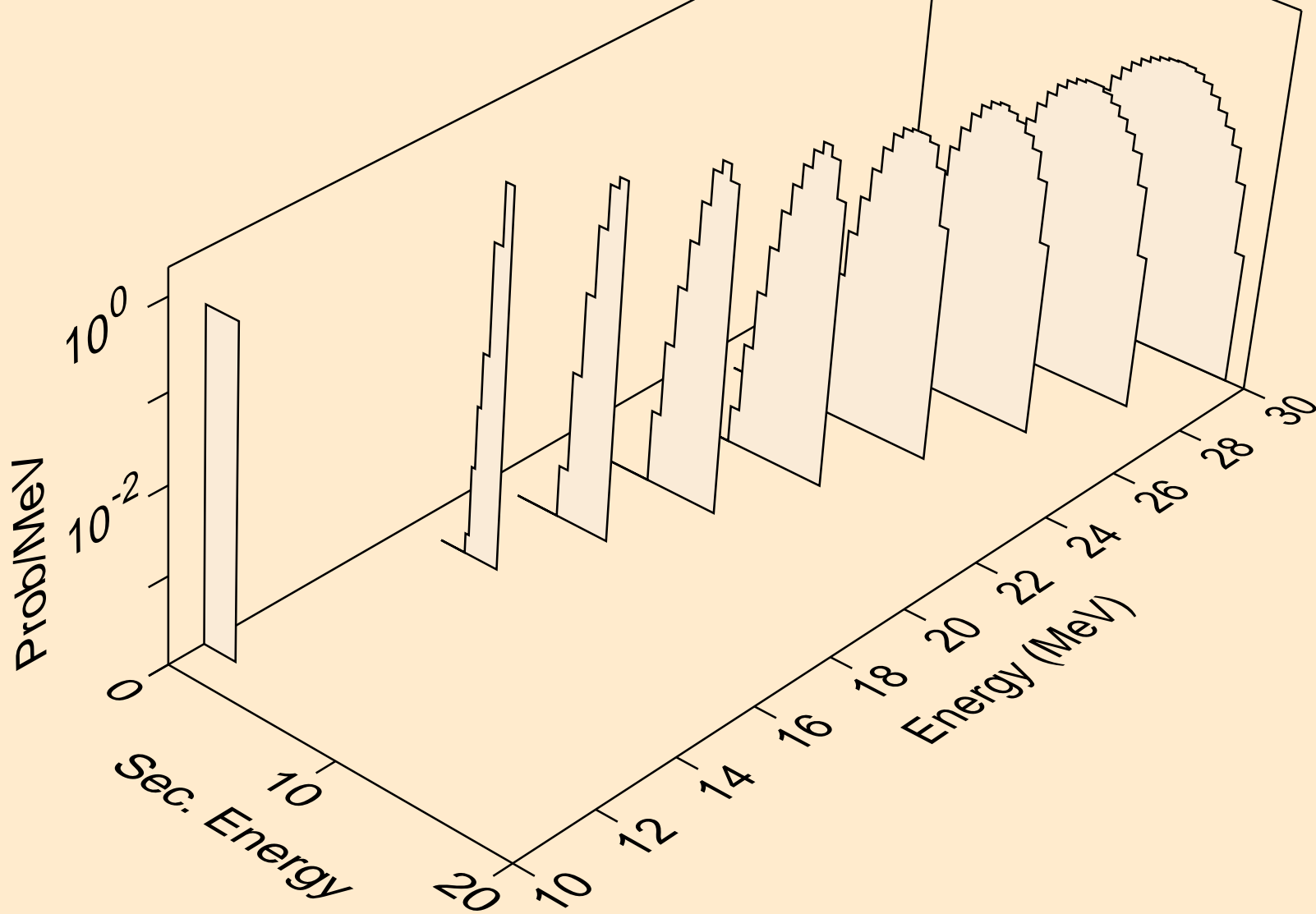

HG198 HELION ACER TENDL-2021 LIBRARY; T=0.K  
tritons from (s,t)

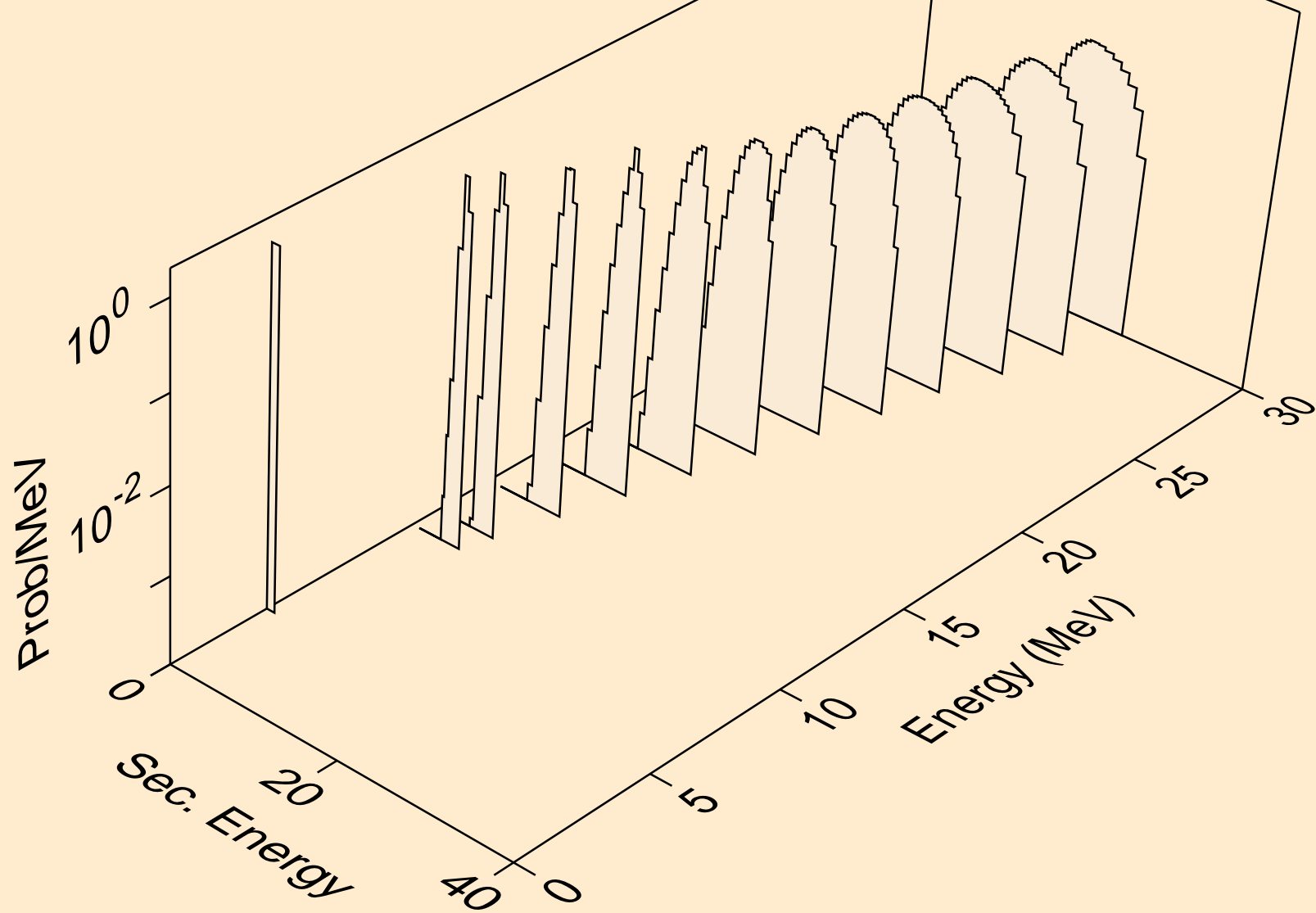

HG198 HELION ACER TENDL-2021 LIBRARY; T=0.K  
tritons from (s,pt)

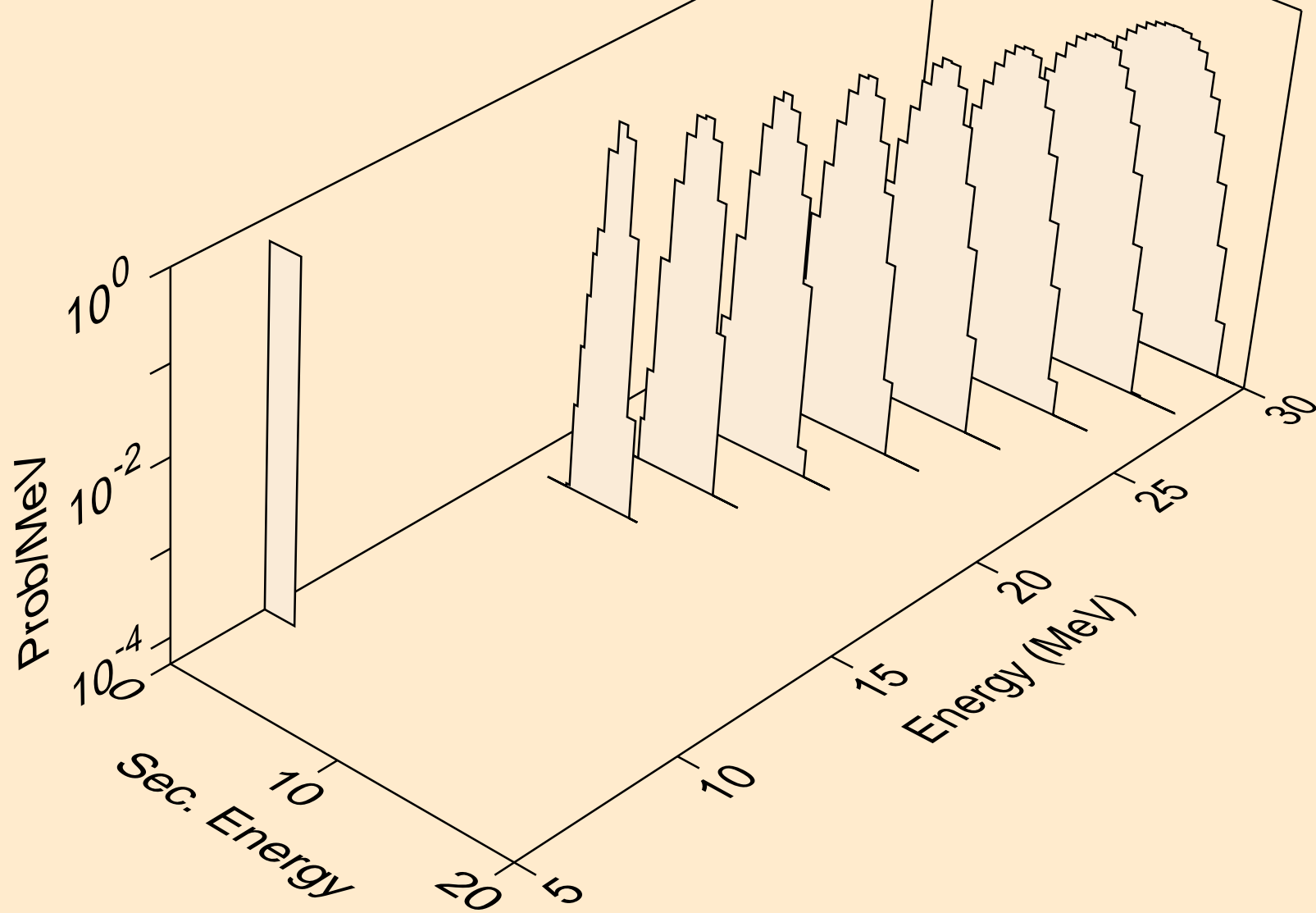

HG198 HELION ACER TENDL-2021 LIBRARY; T=0.K  
alphas from (s,x)

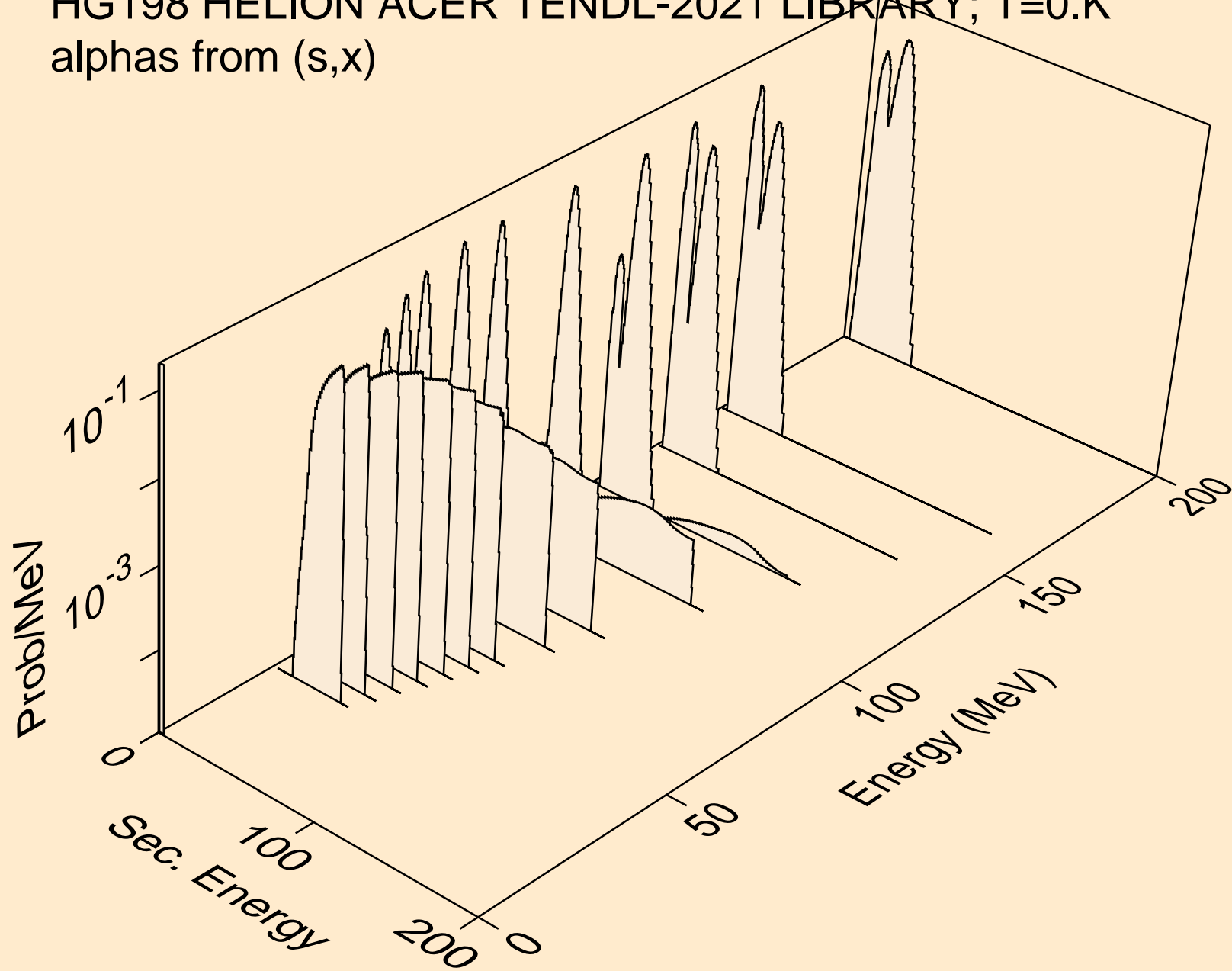



HG198 HELION ACER TENDL-2021 LIBRARY; T=0.K  
alphas from (s,n\*)a

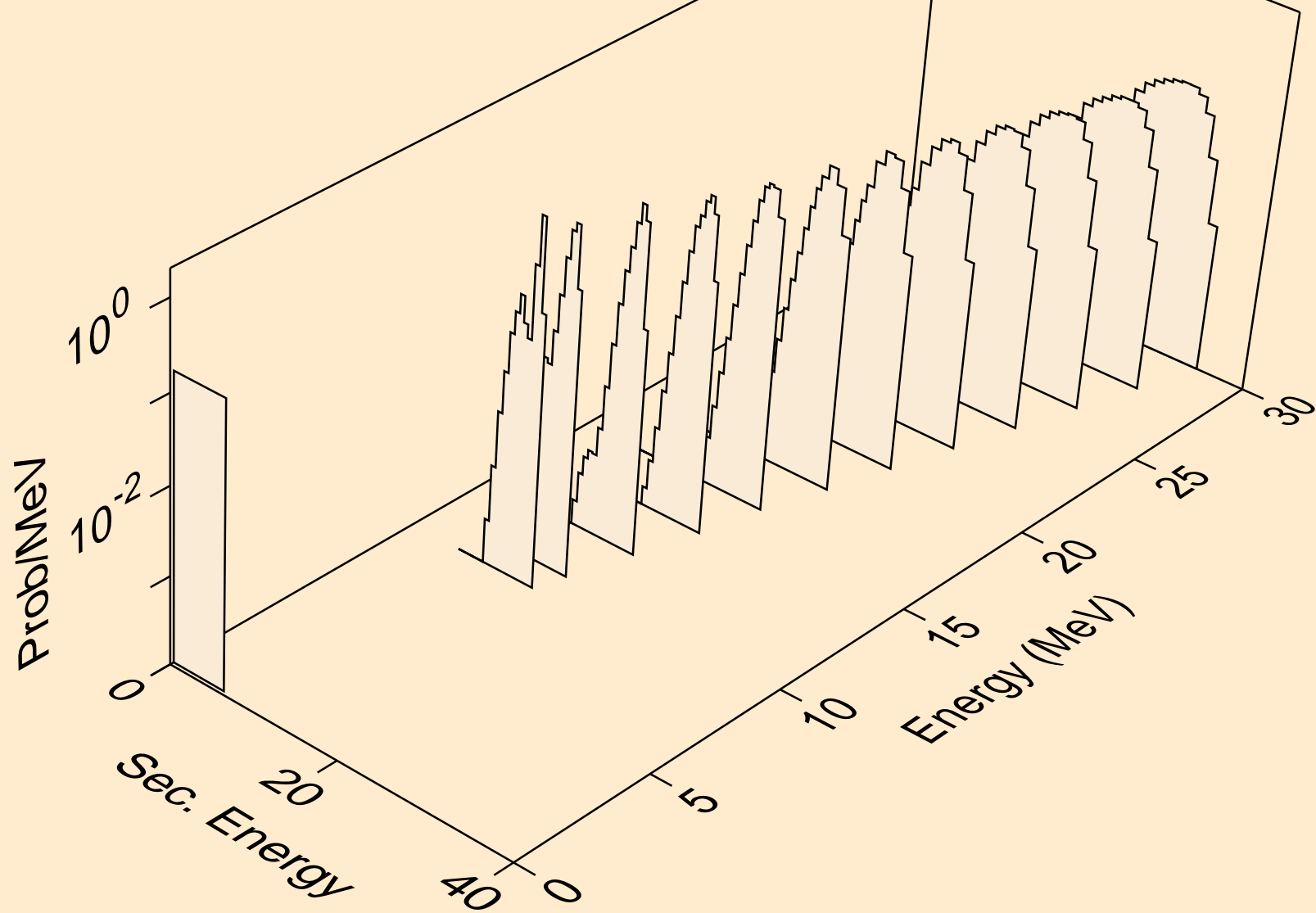

HG198 HELION ACER TENDL-2021 LIBRARY; T=0.K  
alphas from (s,2n)a

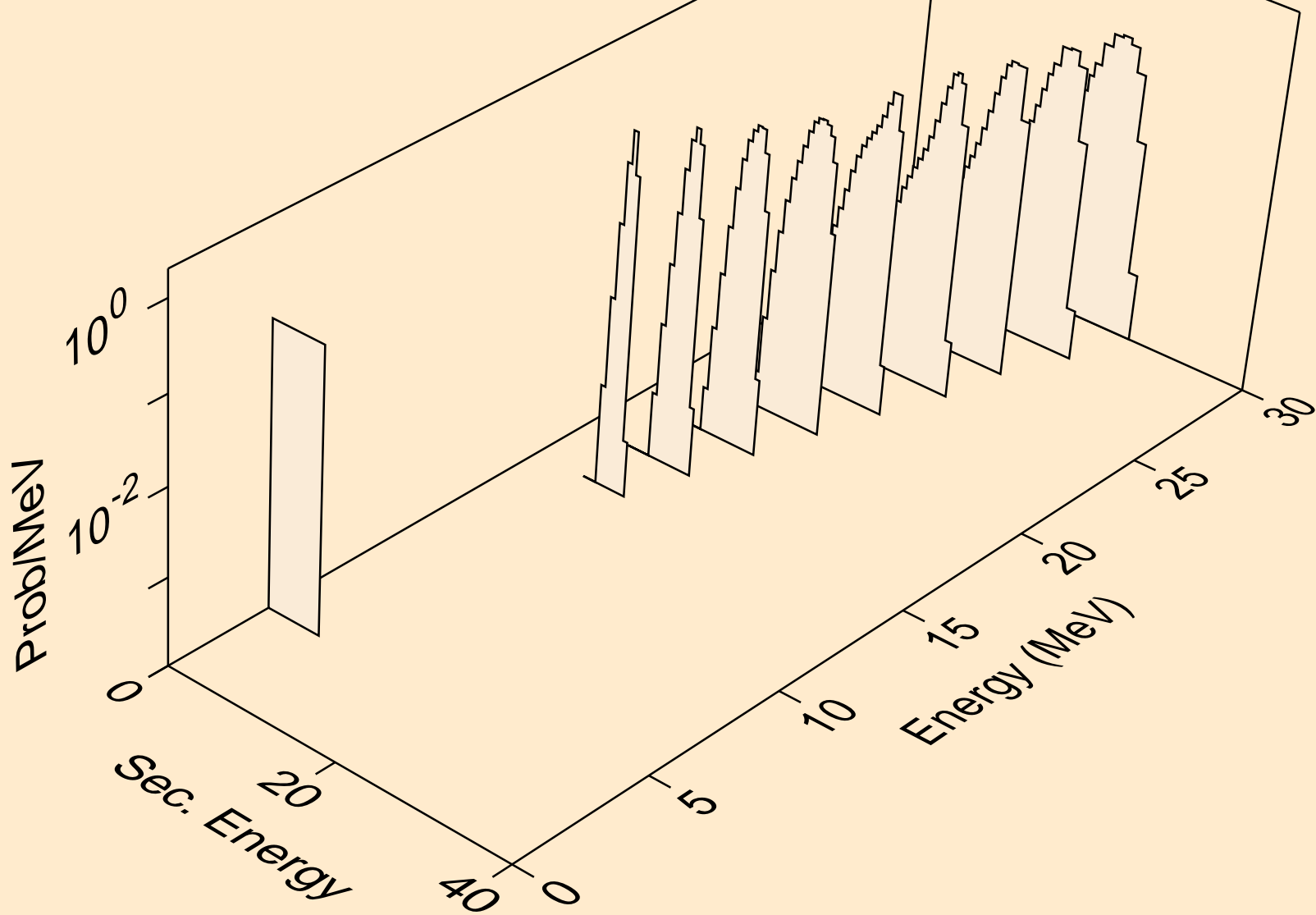

HG198 HELION ACER TENDL-2021 LIBRARY; T=0.K  
alphas from (s,3n)a

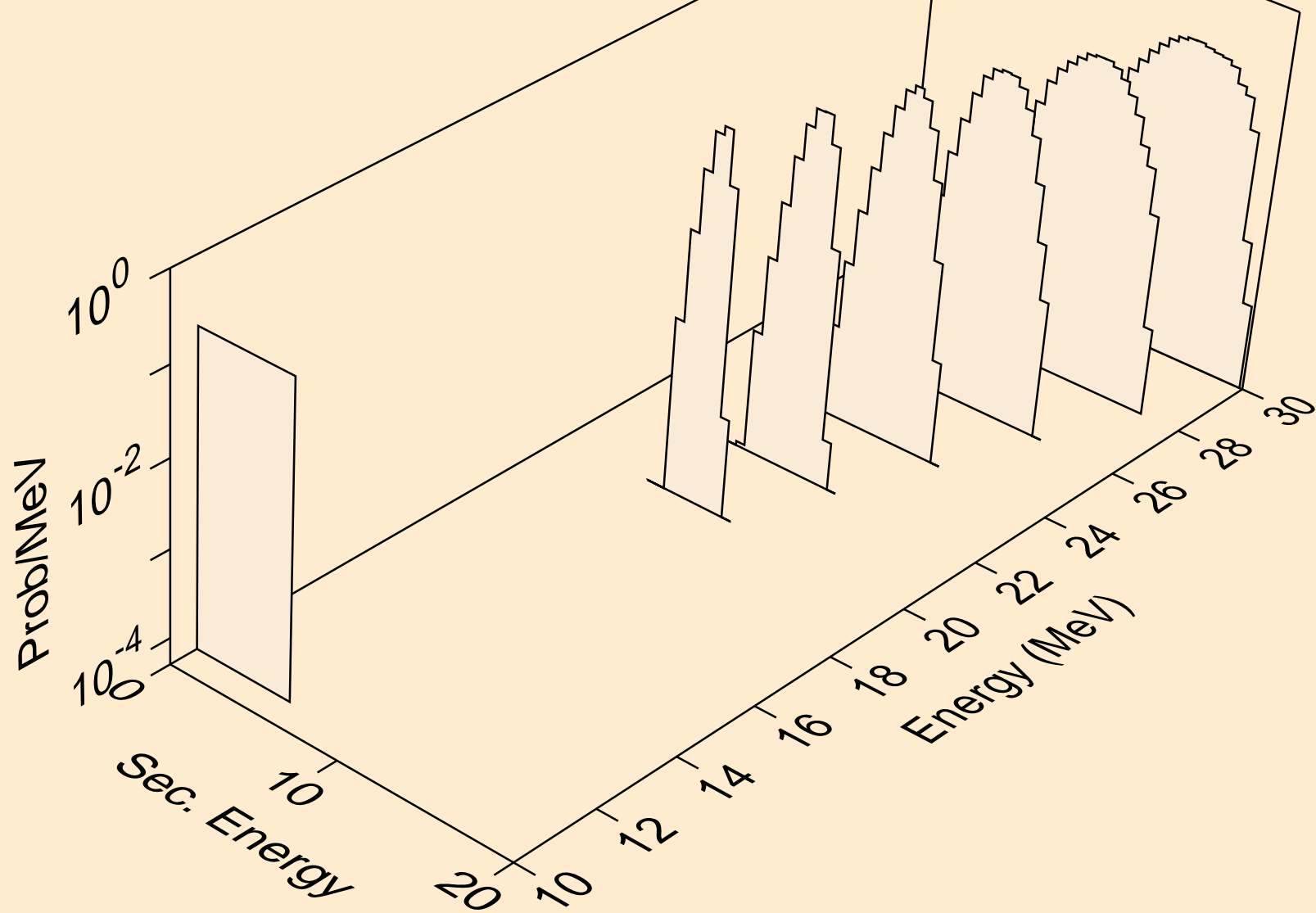

HG198 HELION ACER TENDL-2021 LIBRARY; T=0.K  
alphas from (s,npa)

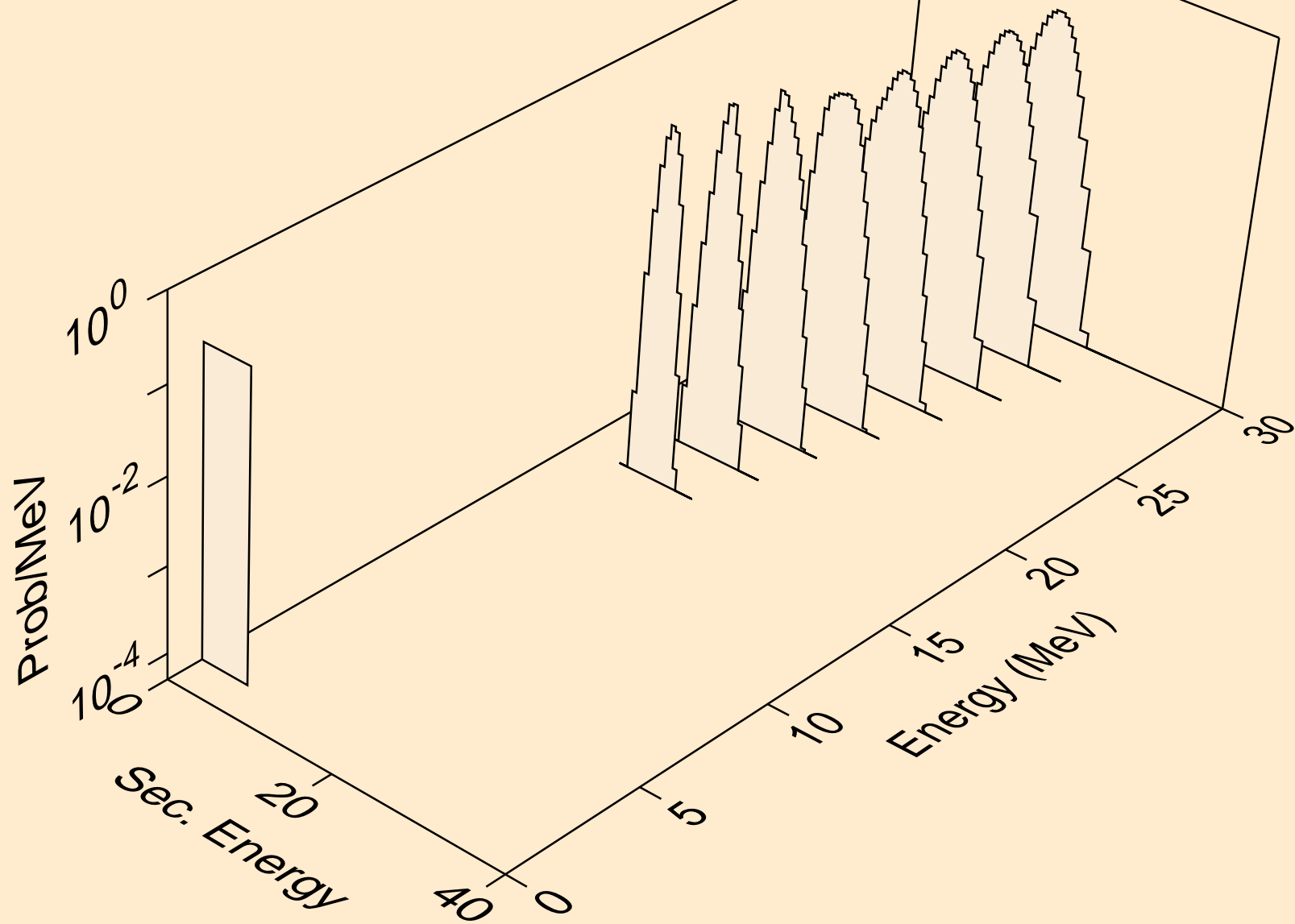

HG198 HELION ACER TENDL-2021 LIBRARY; T=0.K  
alphas from (s,a)

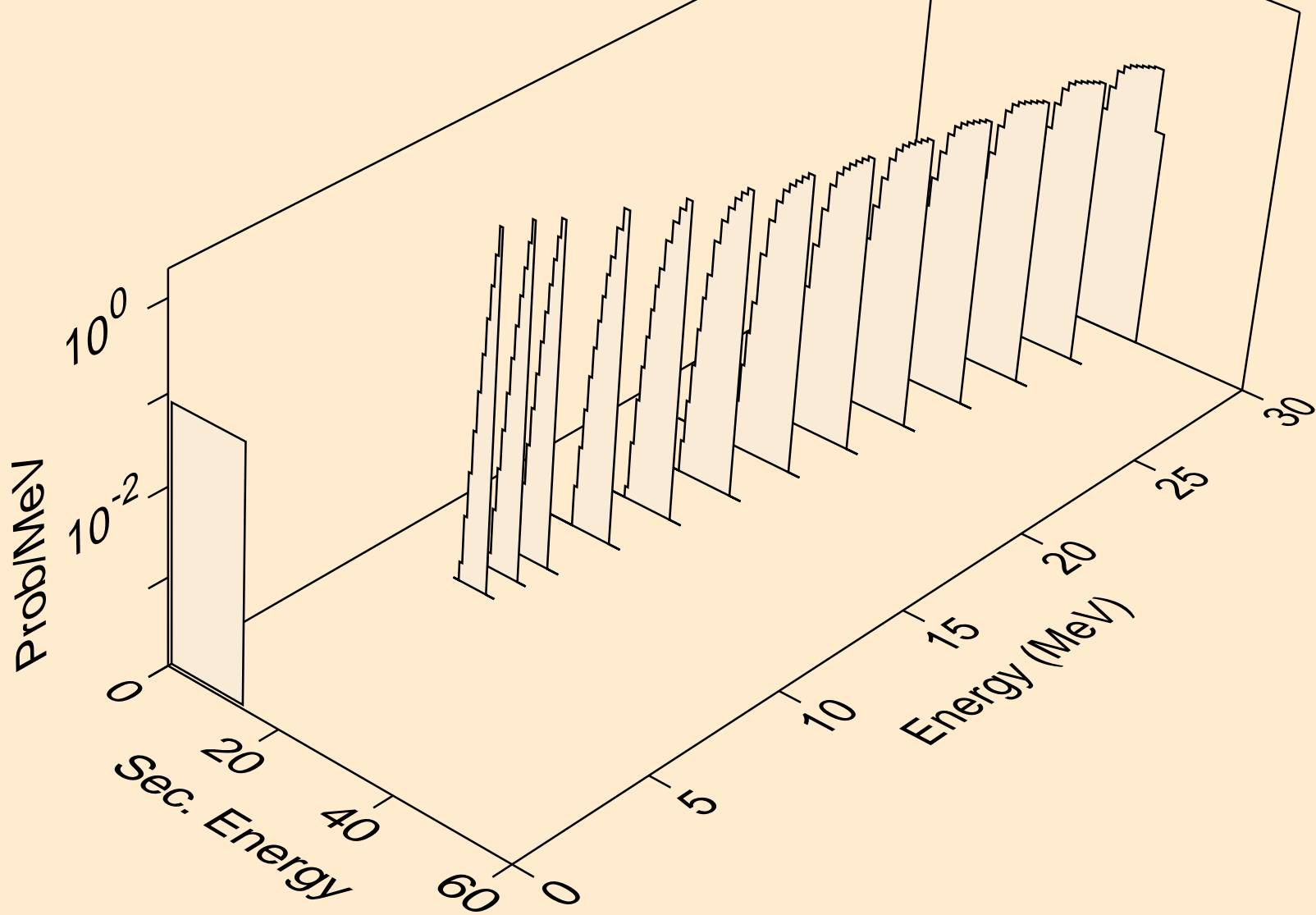

HG198 HELION ACER TENDL-2021 LIBRARY; T=0.K  
alphas from (s,2a)

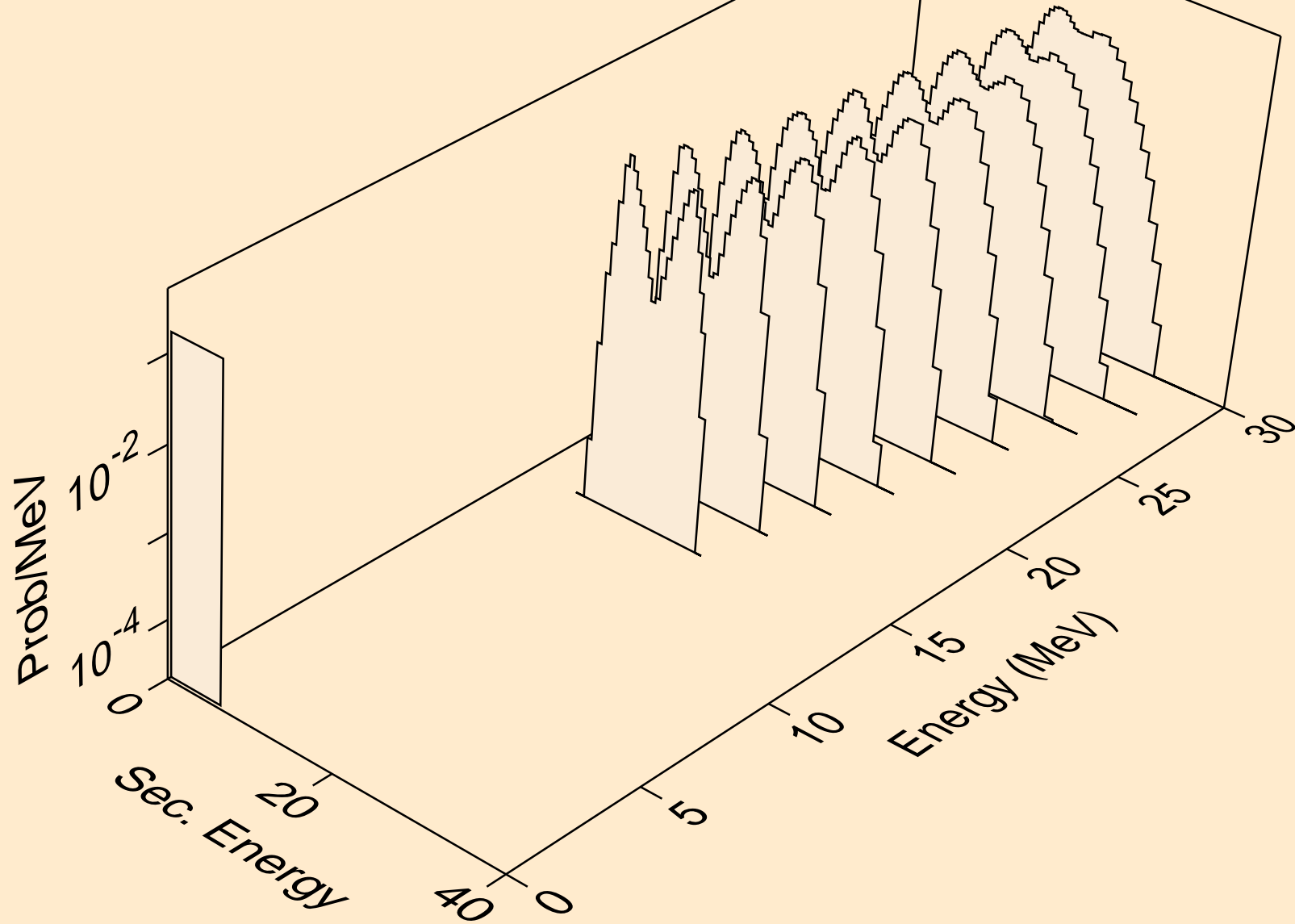

HG198 HELION ACER TENDL-2021 LIBRARY; T=0.K  
alphas from (s,pa)

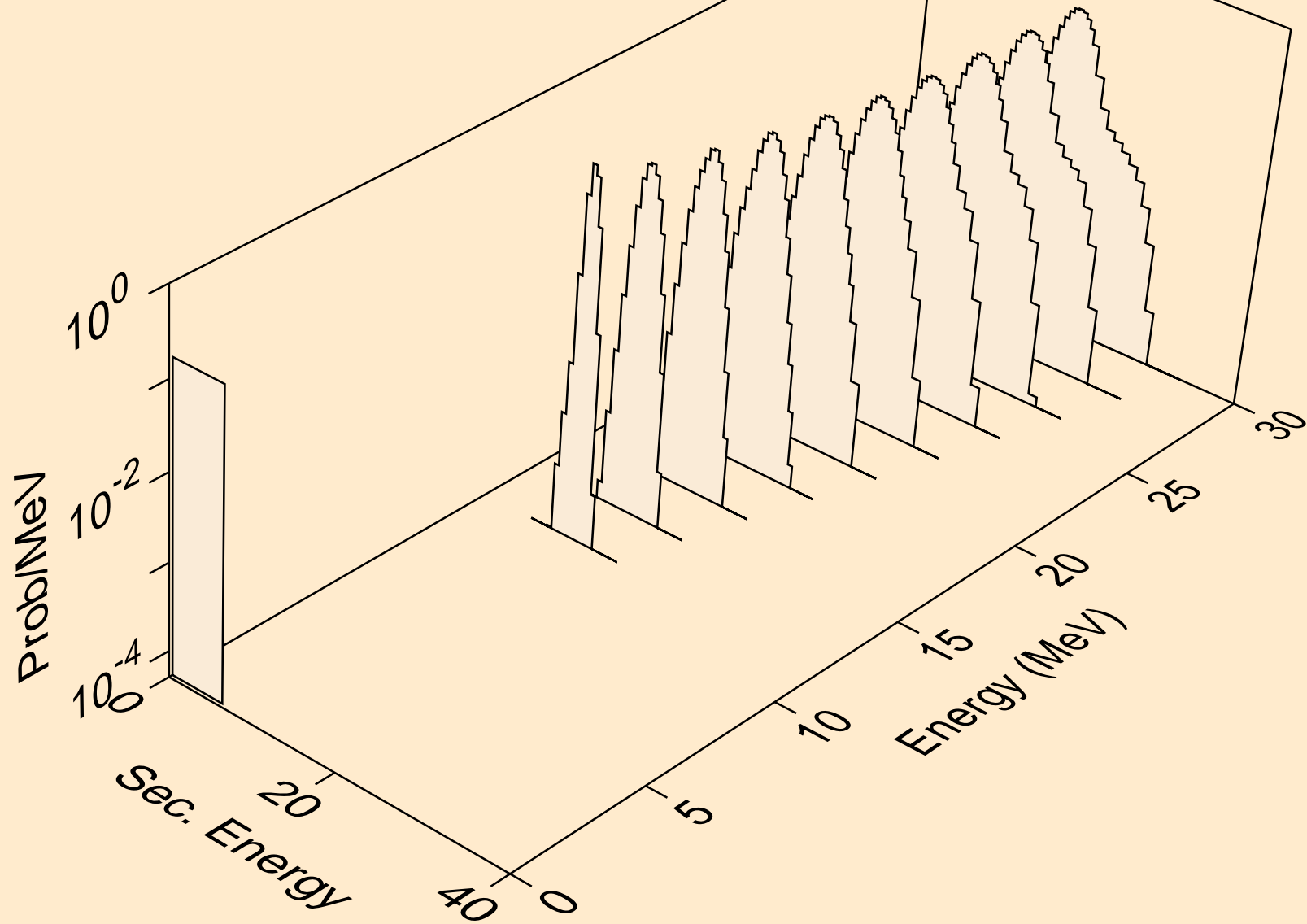

HG198 HELION ACER TENDL-2021 LIBRARY; T=0.K  
alphas from (s,da)

