

HO150 HELION ACER TENDL-2021 LIBRARY; T=0.K  
Principal cross sections

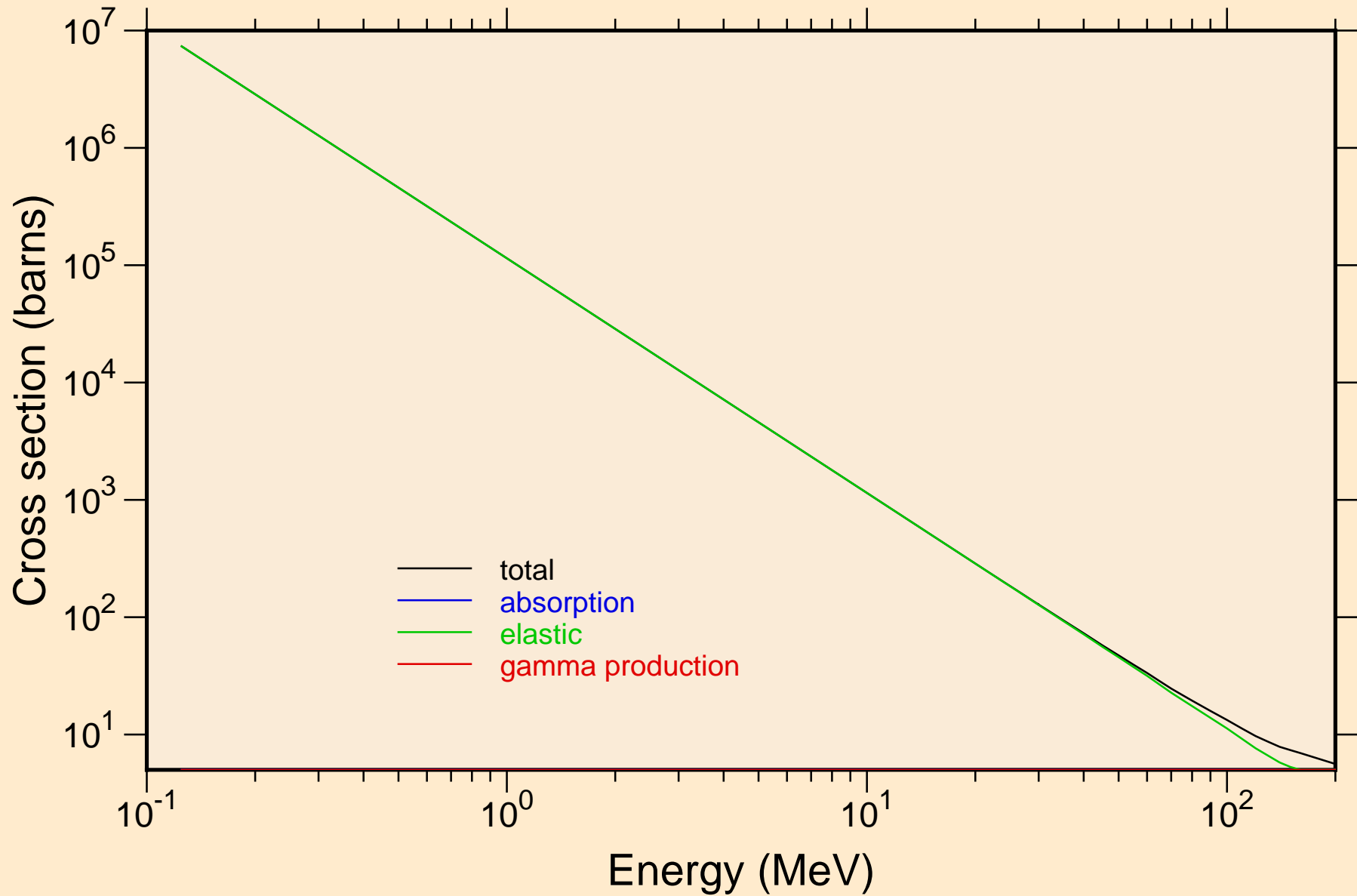

HO150 HELION ACER TENDL-2021 LIBRARY; T=0.K  
Heating

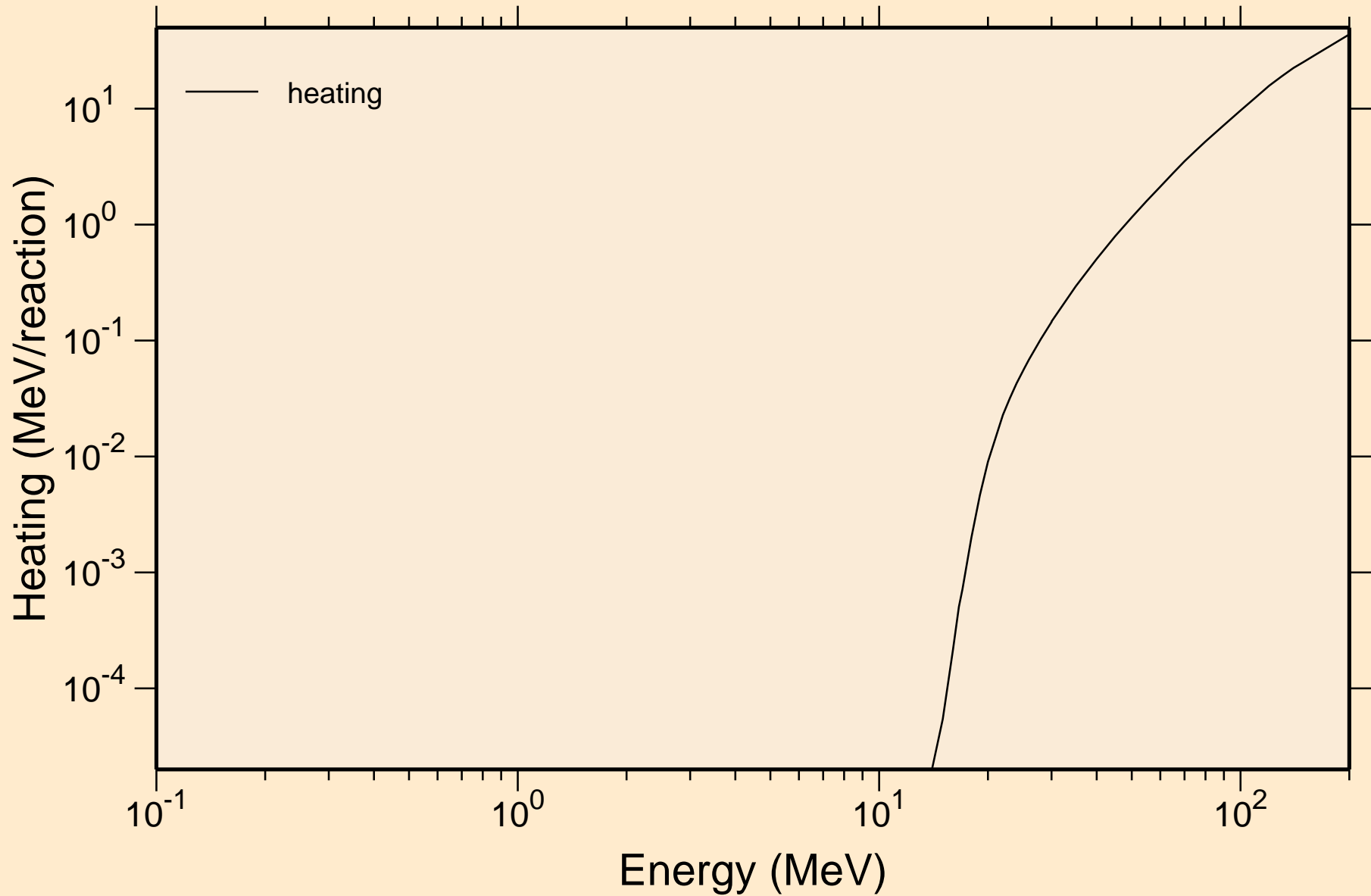

# HO150 HELION ACER TENDL-2021 LIBRARY; T=0.K

## Principal cross sections

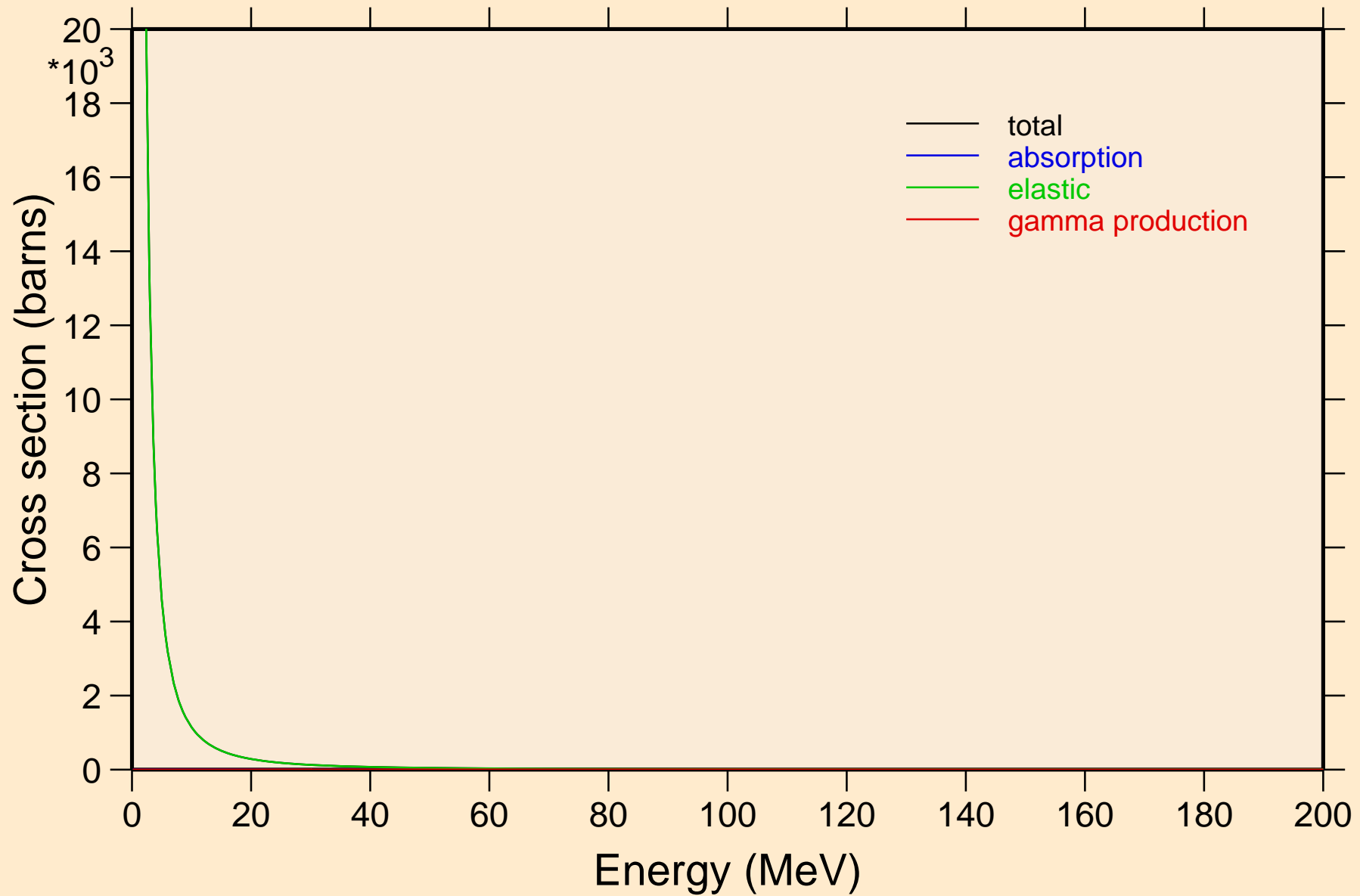

HO150 HELION ACER TENDL-2021 LIBRARY; T=0.K

Heating

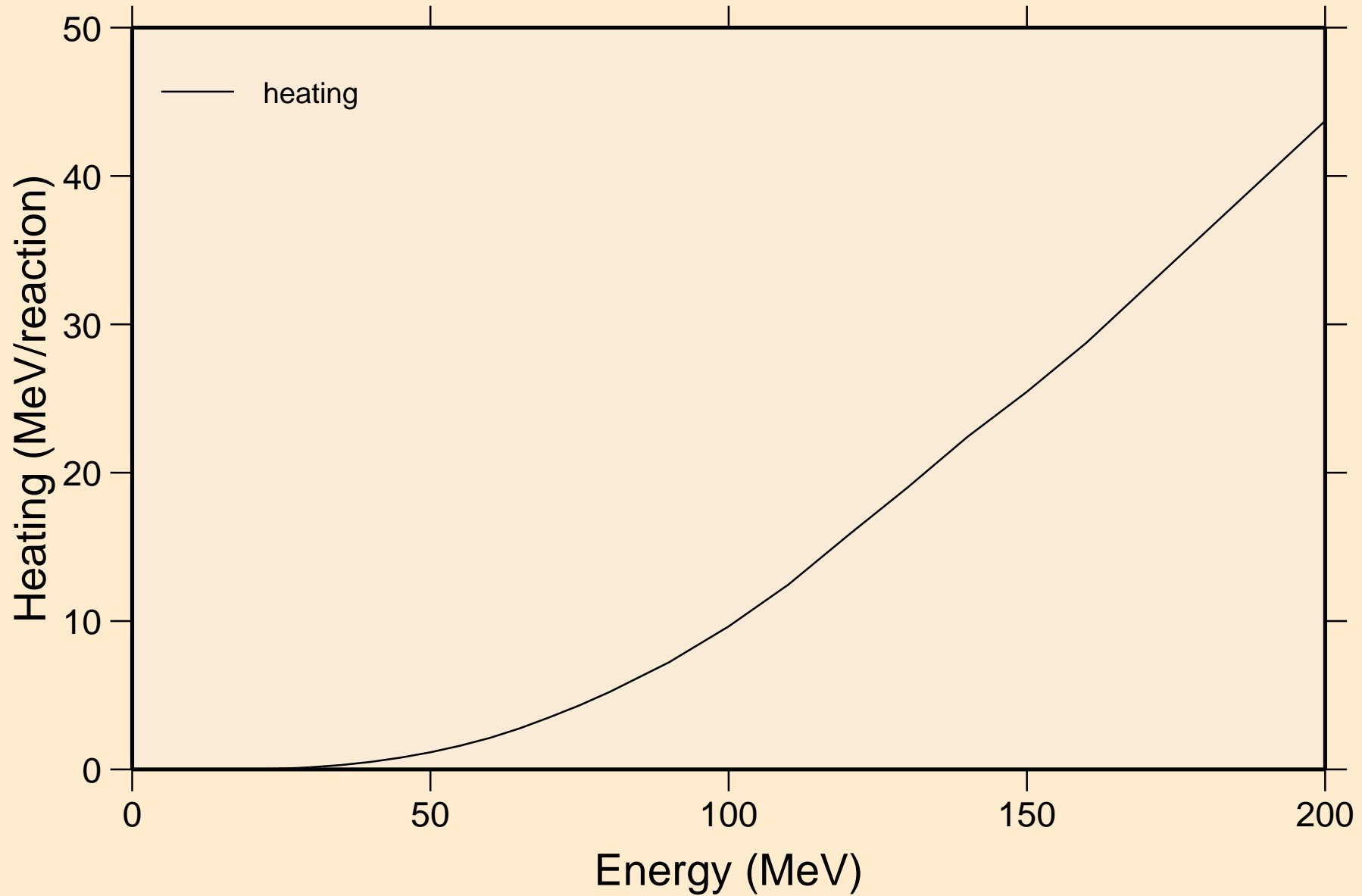

# HO150 HELION ACER TENDL-2021 LIBRARY; T=0.K

## Threshold reactions

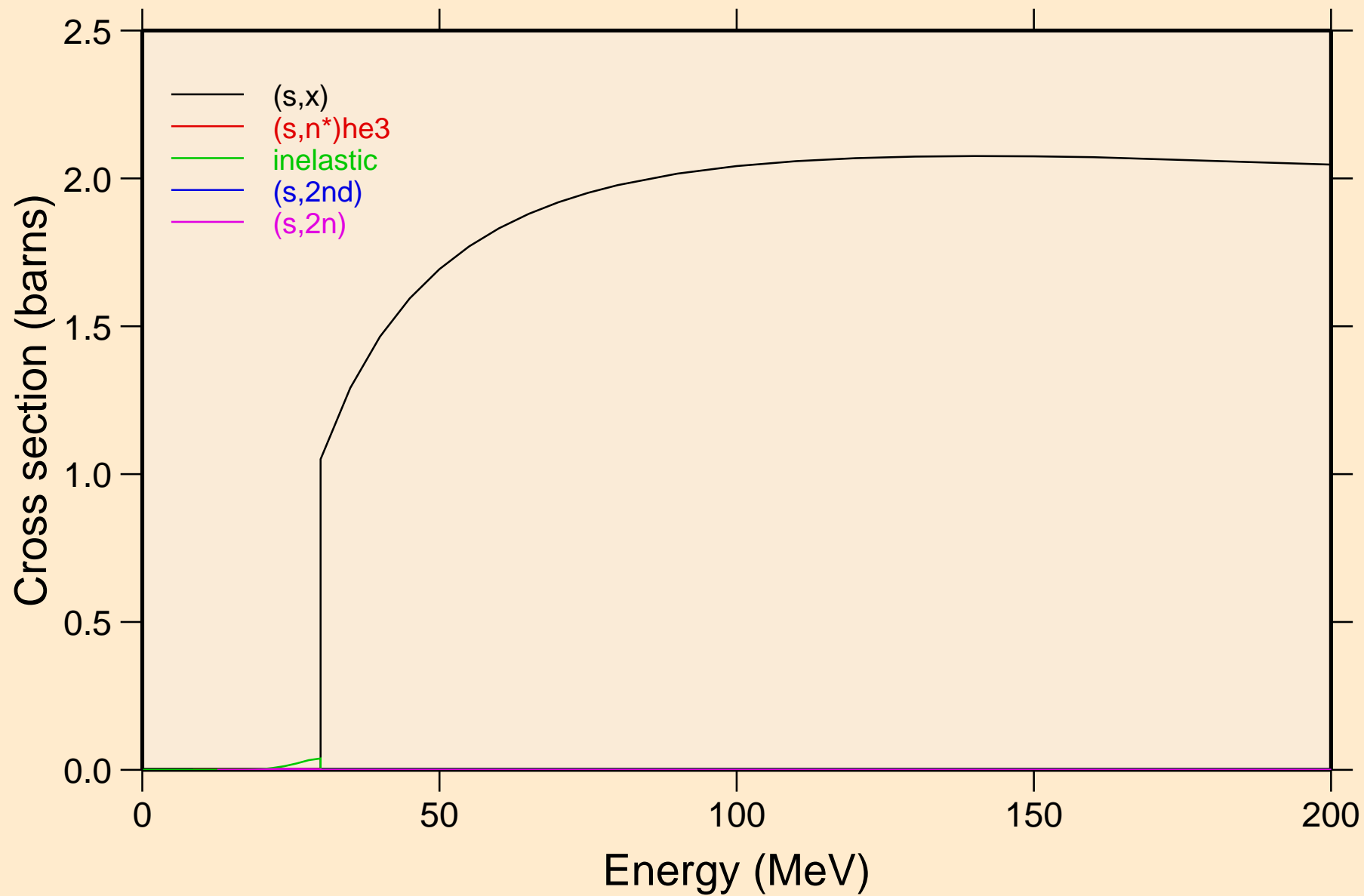

HO150 HELION ACER TENDL-2021 LIBRARY; T=0.K  
Threshold reactions

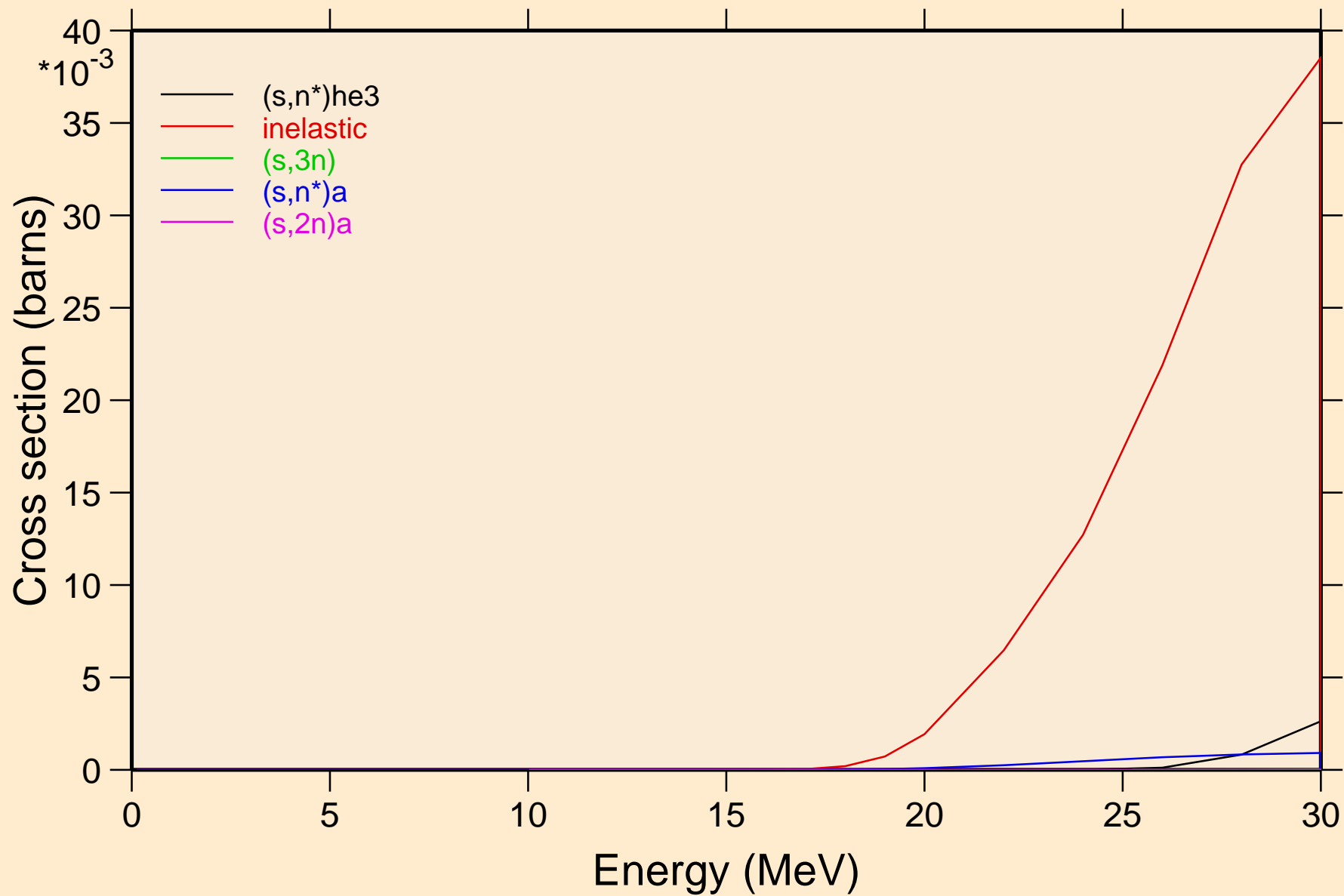

# HO150 HELION ACER TENDL-2021 LIBRARY; T=0.K

## Threshold reactions

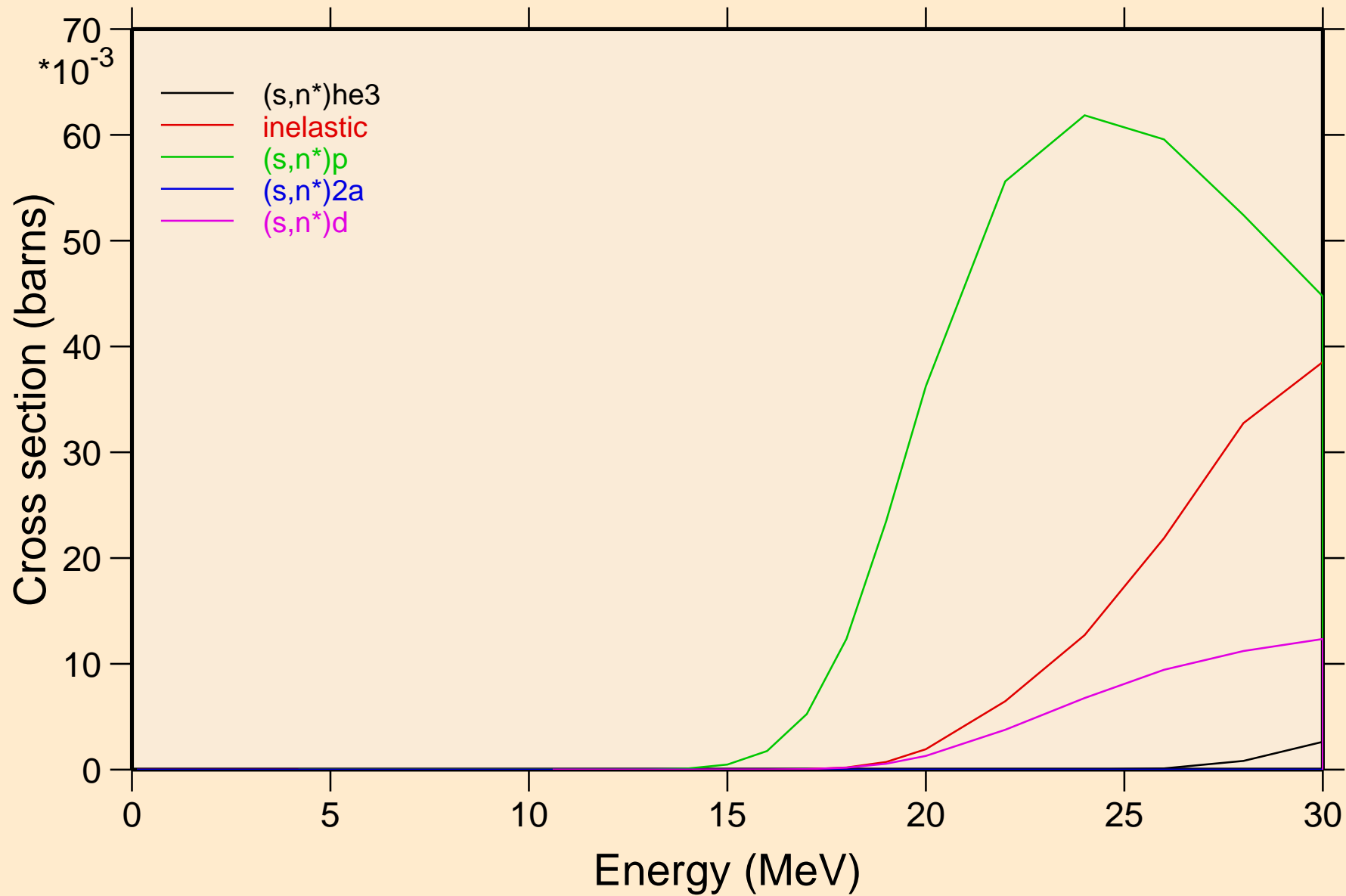

HO150 HELION ACER TENDL-2021 LIBRARY; T=0.K  
Threshold reactions

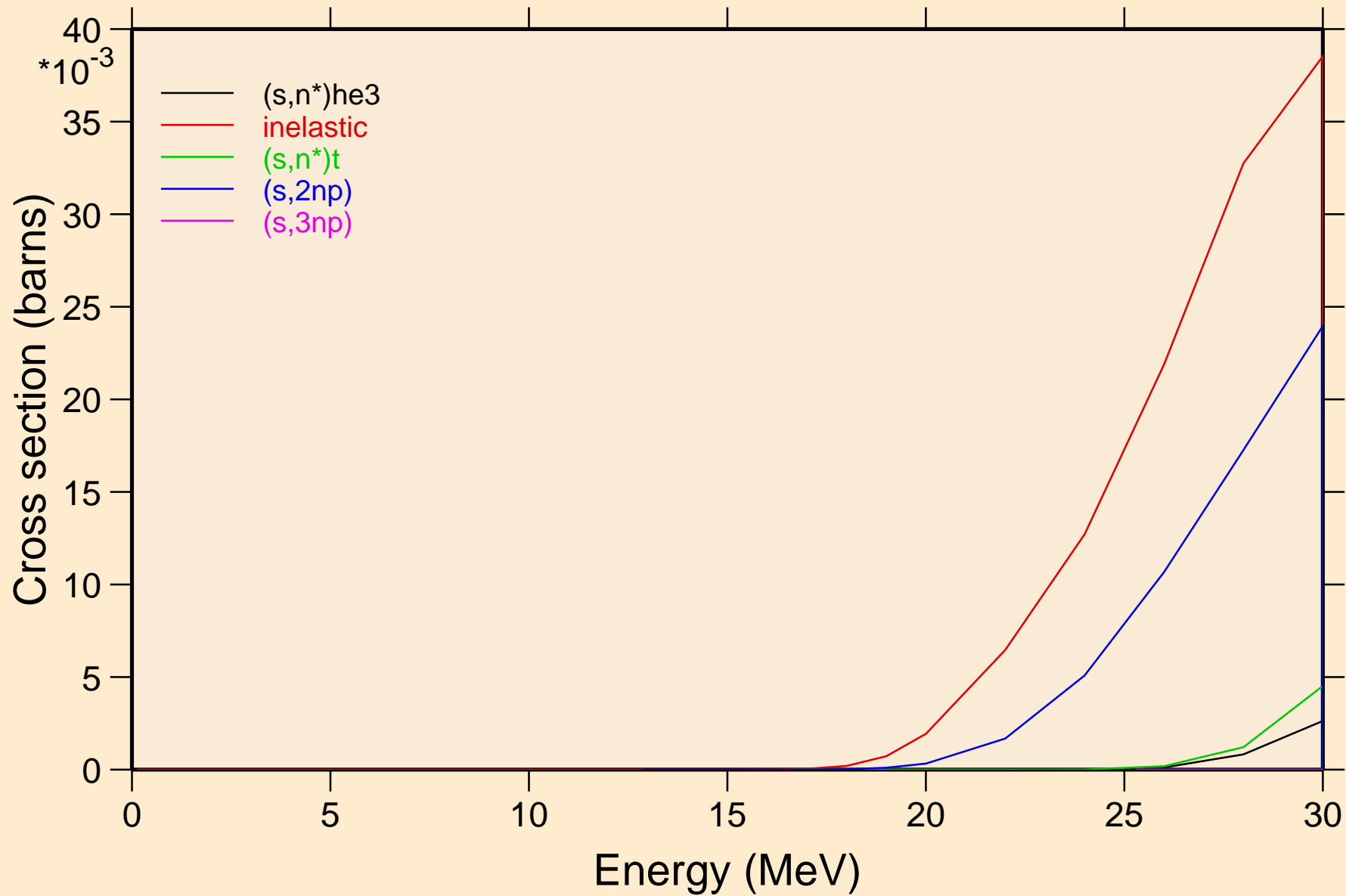



# HO150 HELION ACER TENDL-2021 LIBRARY; T=0.K

## Threshold reactions

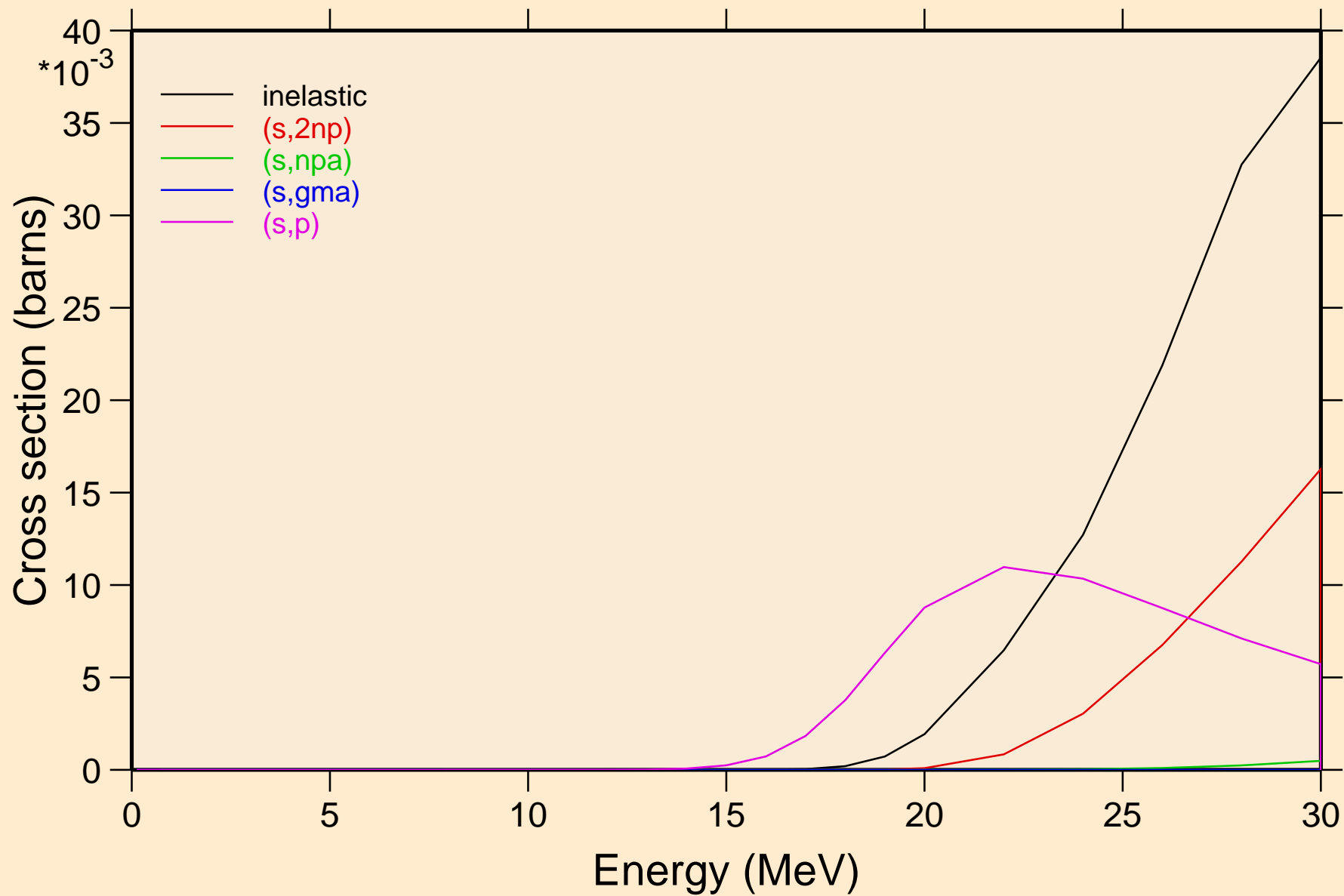

HO150 HELION ACER TENDL-2021 LIBRARY; T=0.K  
Threshold reactions

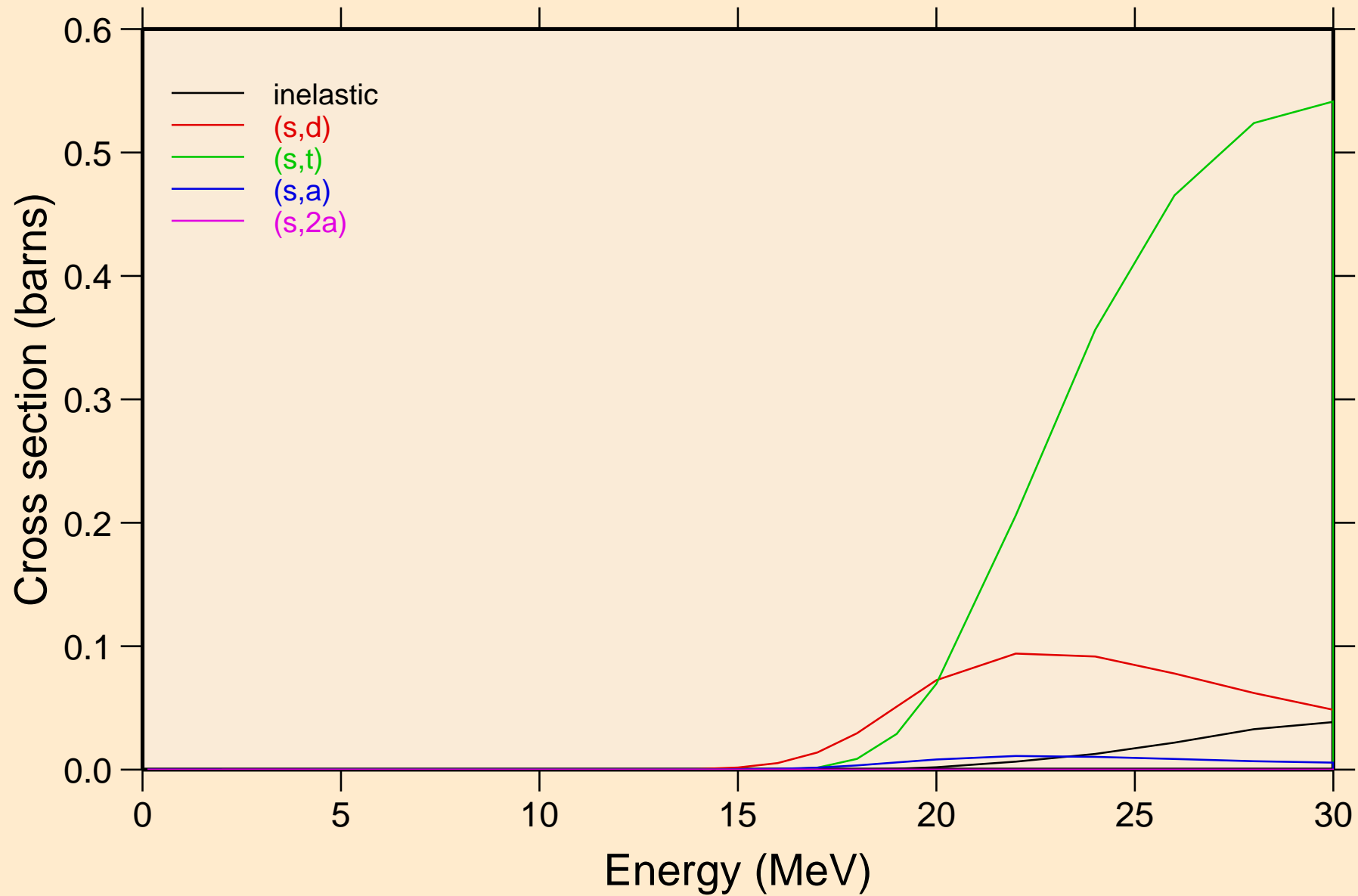

HO150 HELION ACER TENDL-2021 LIBRARY; T=0.K  
Threshold reactions

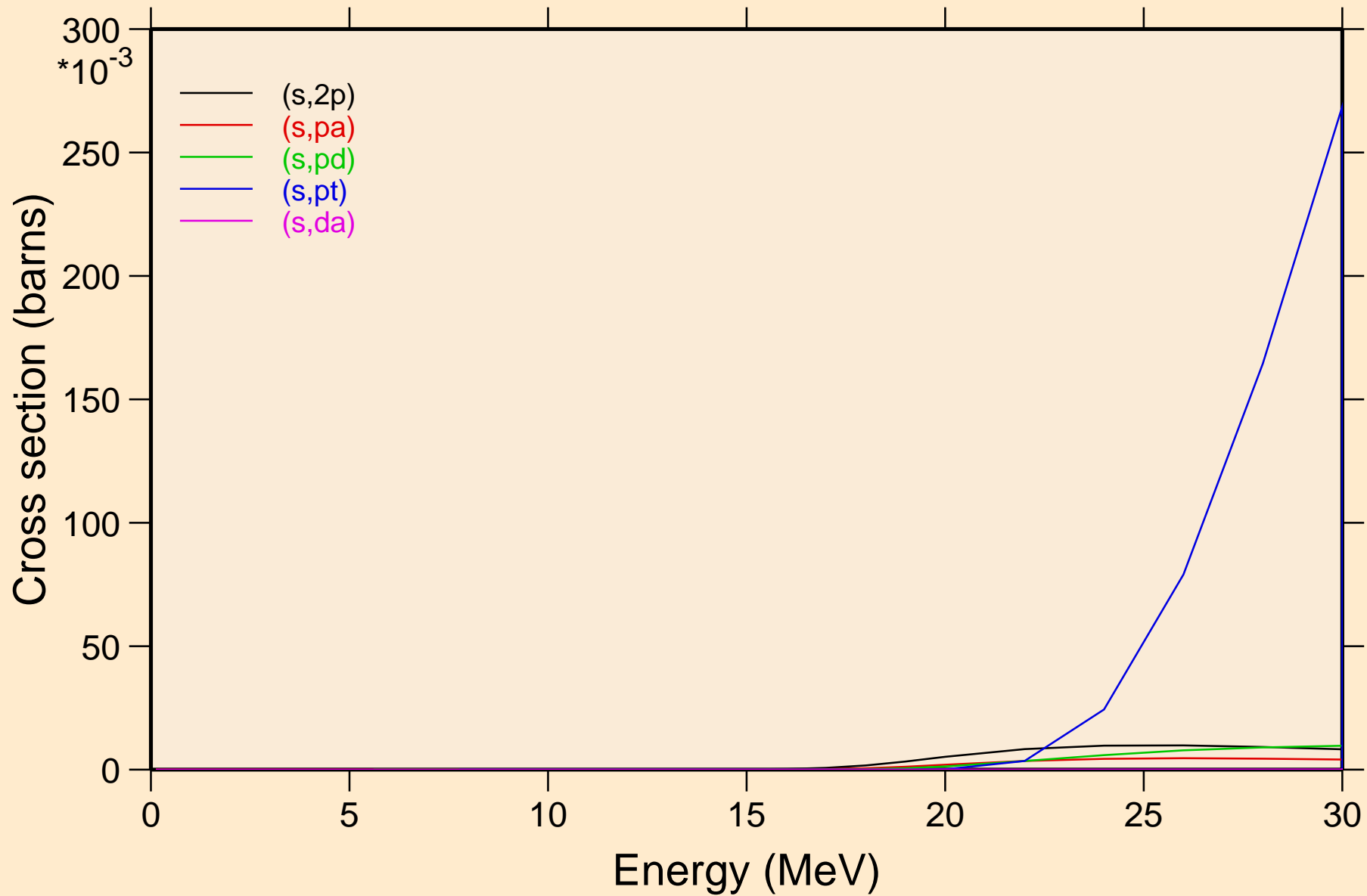

HO150 HELION ACER TENDL-2021 LIBRARY; T=0.K  
angular distribution for elastic

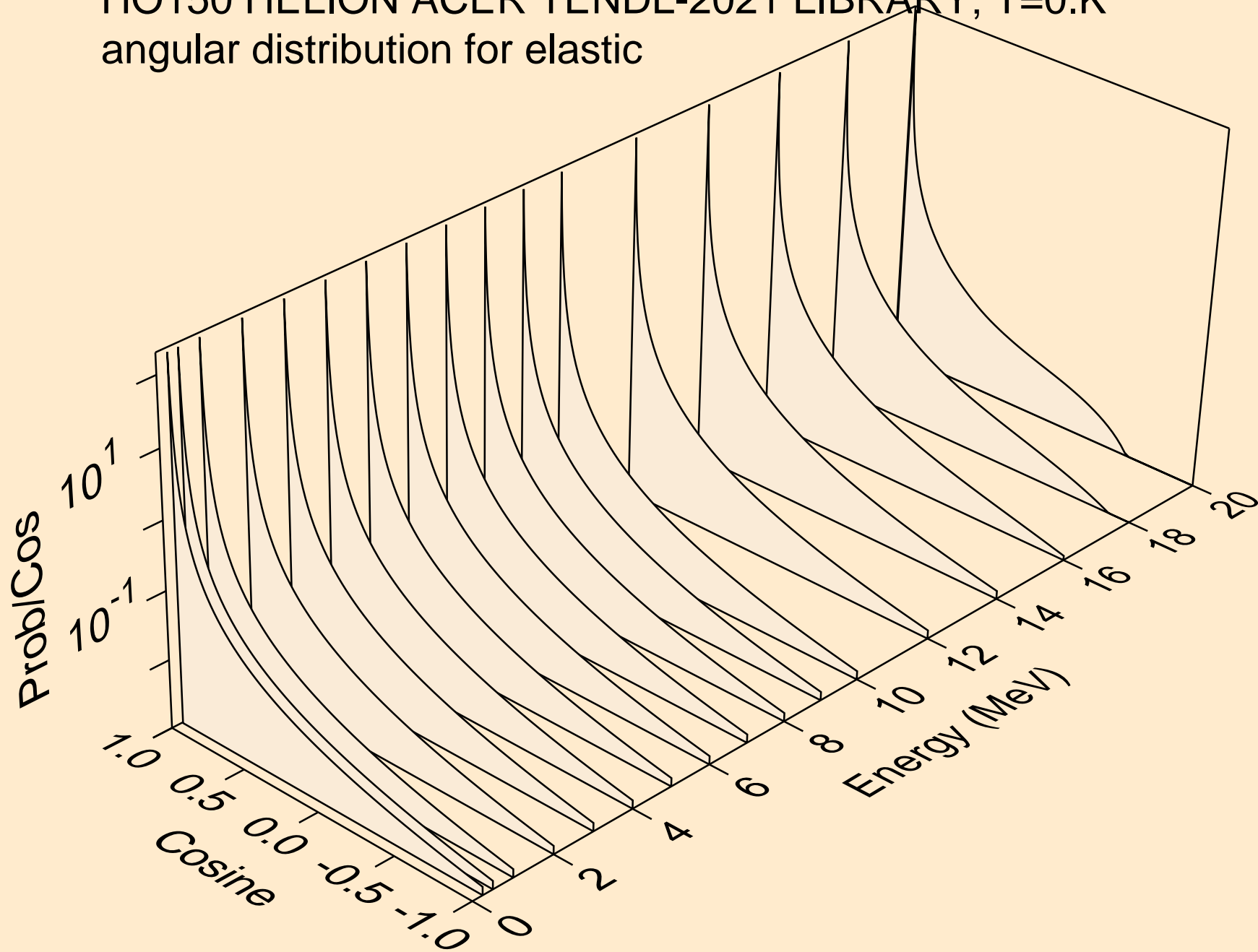

HO150 HELION ACER TENDL-2021 LIBRARY; T=0.K  
angular distribution for elastic

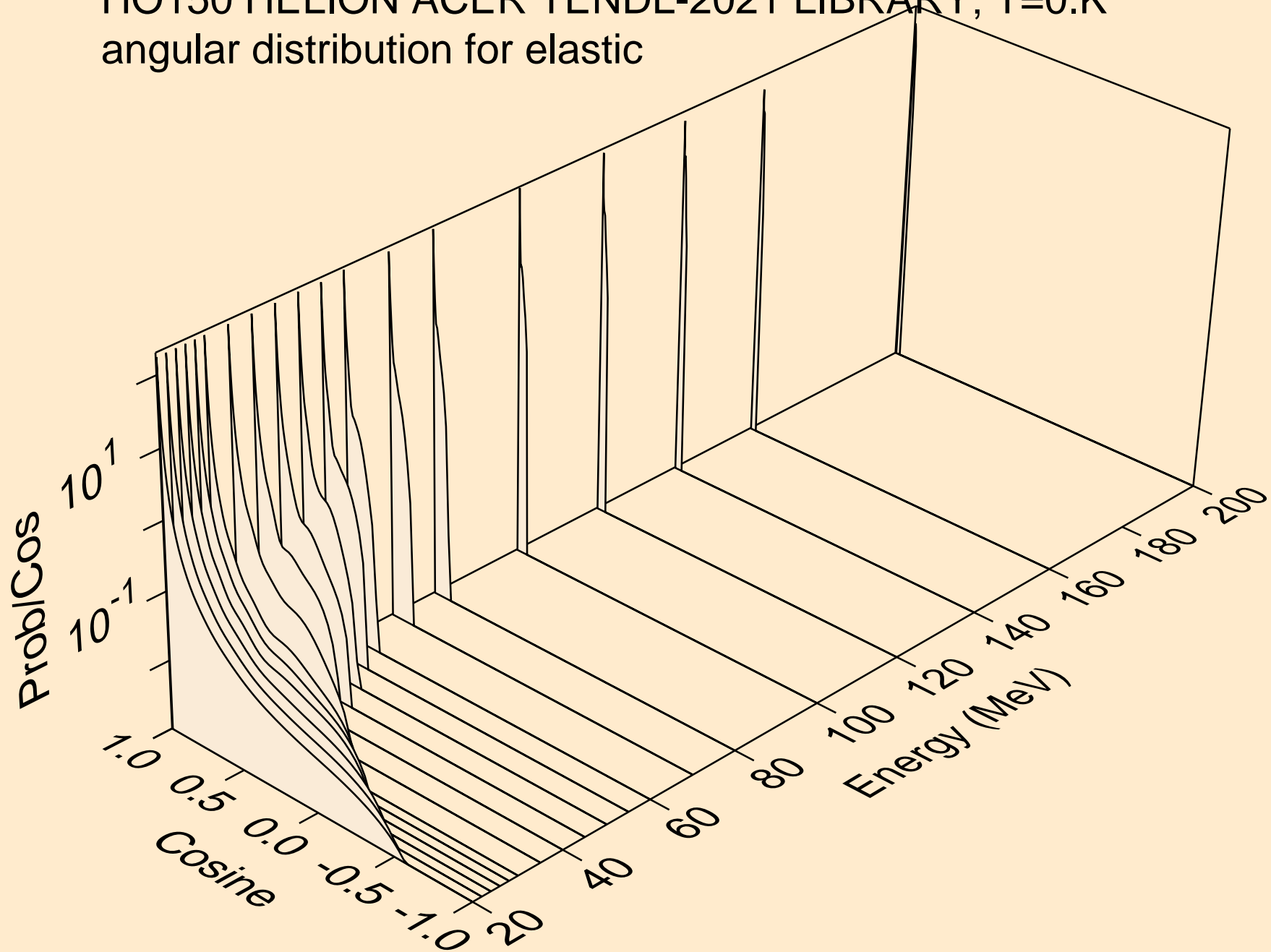

HO150 HELION ACER TENDL-2021 LIBRARY; T=0.K  
He-3 emission for (s,x)

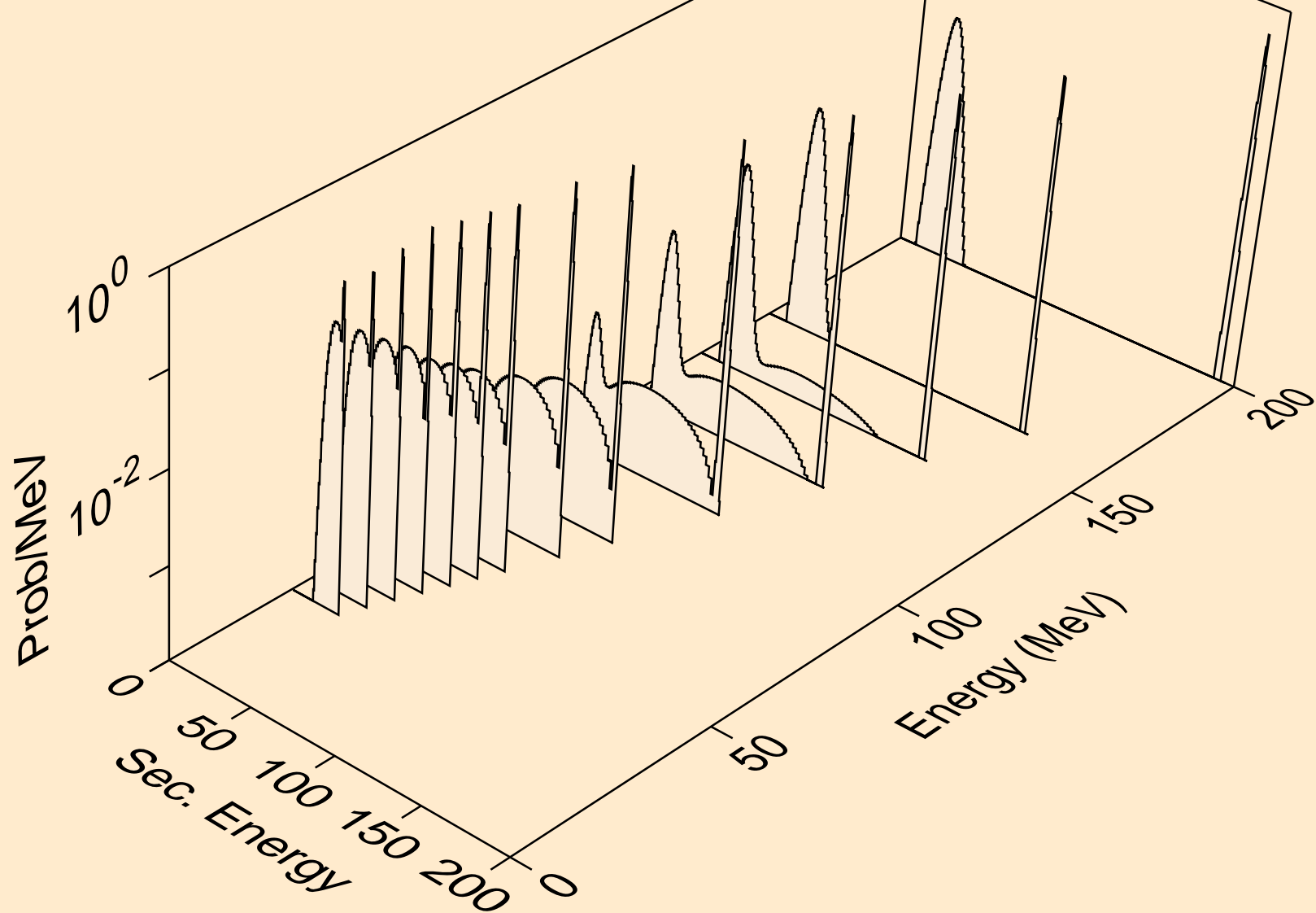

HO150 HELION ACER TENDL-2021 LIBRARY; T=0.K  
He-3 emission for (s,n\*)he3

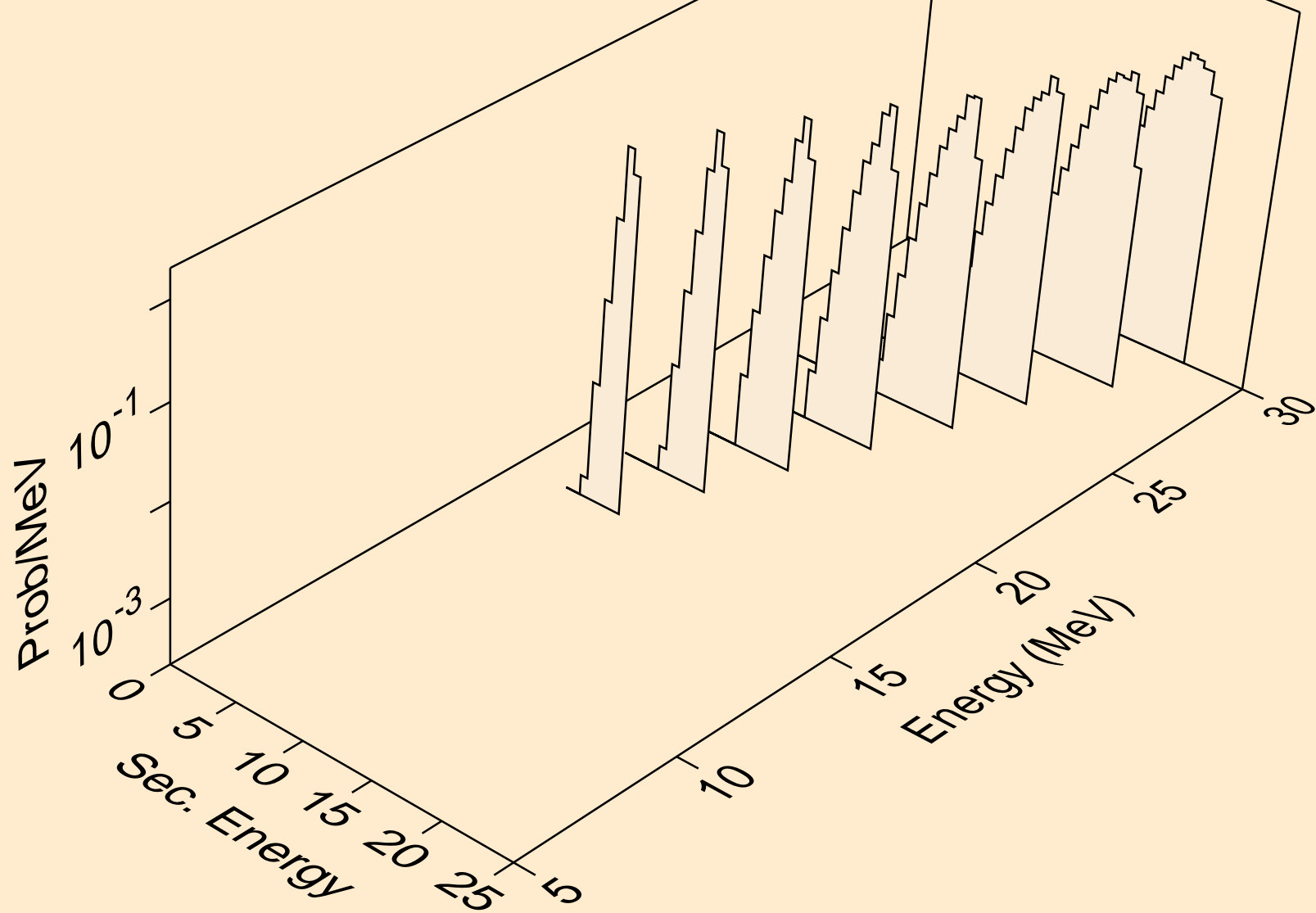

HO150 HELION ACER TENDL-2021 LIBRARY; T=0.K  
He-3 emission for inelastic

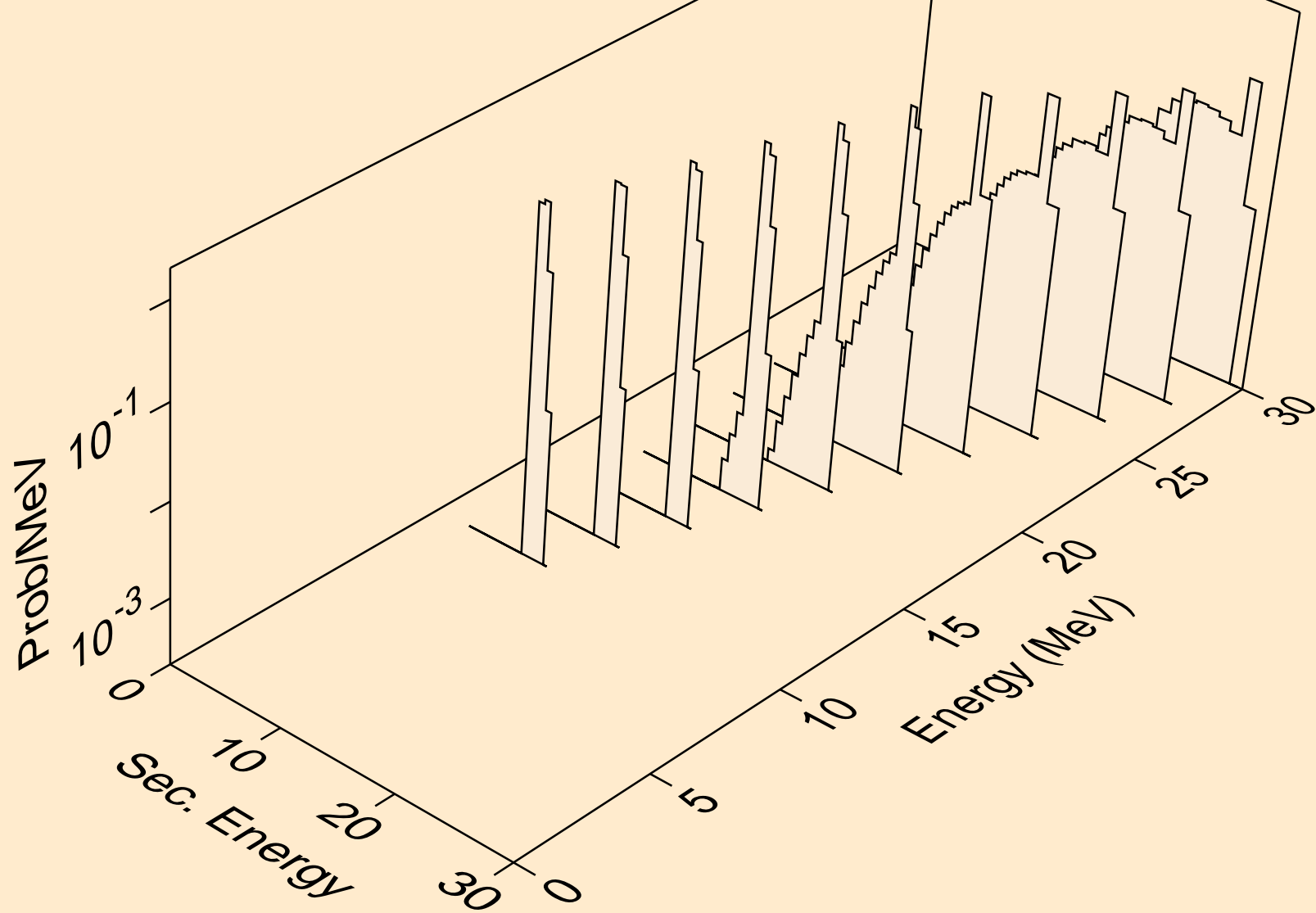



HO150 HELION ACER TENDL-2021 LIBRARY; T=0.K  
Photon emission for (z,n)

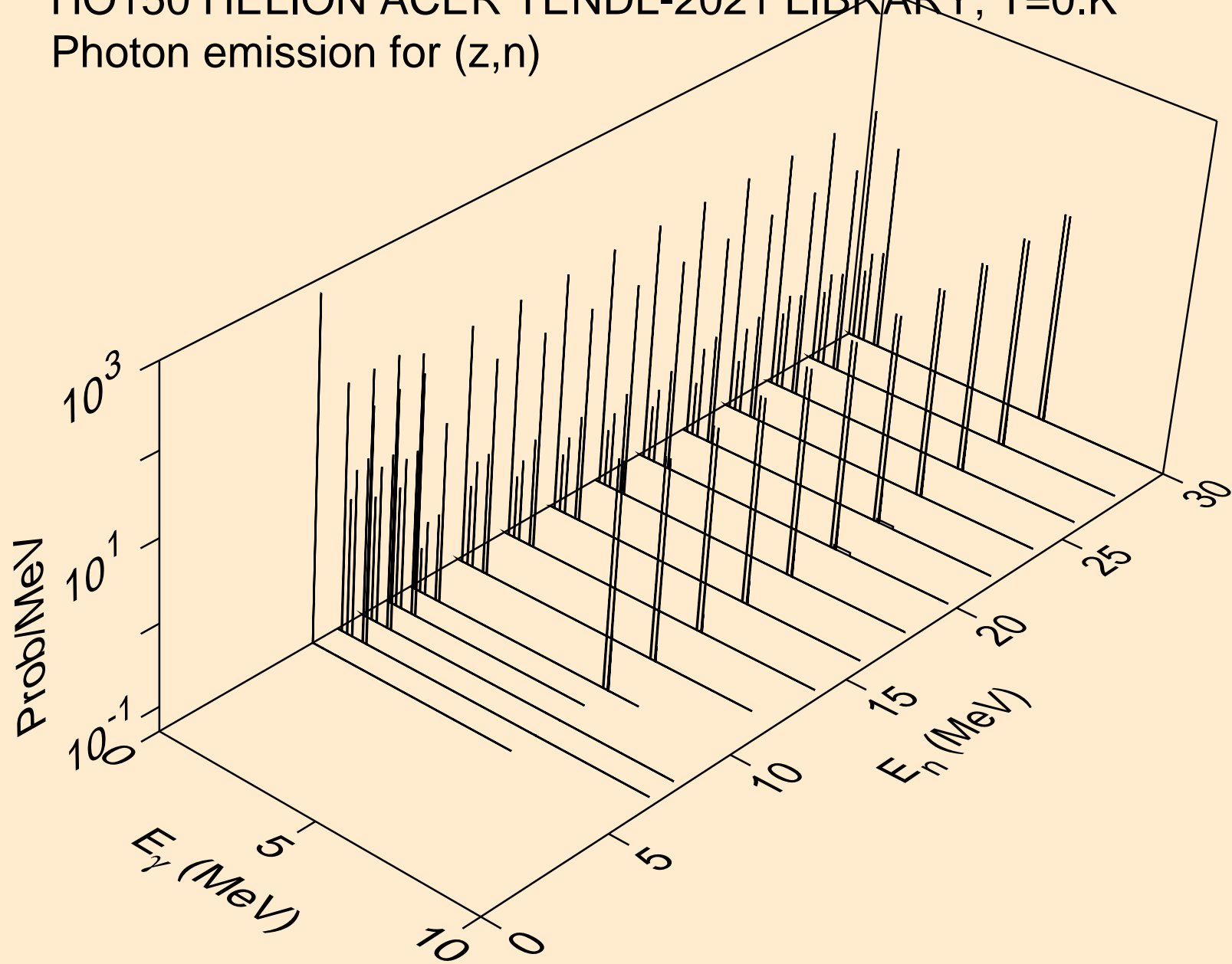

HO150 HELION ACER TENDL-2021 LIBRARY; T=0.K  
Photon emission for (n,x)

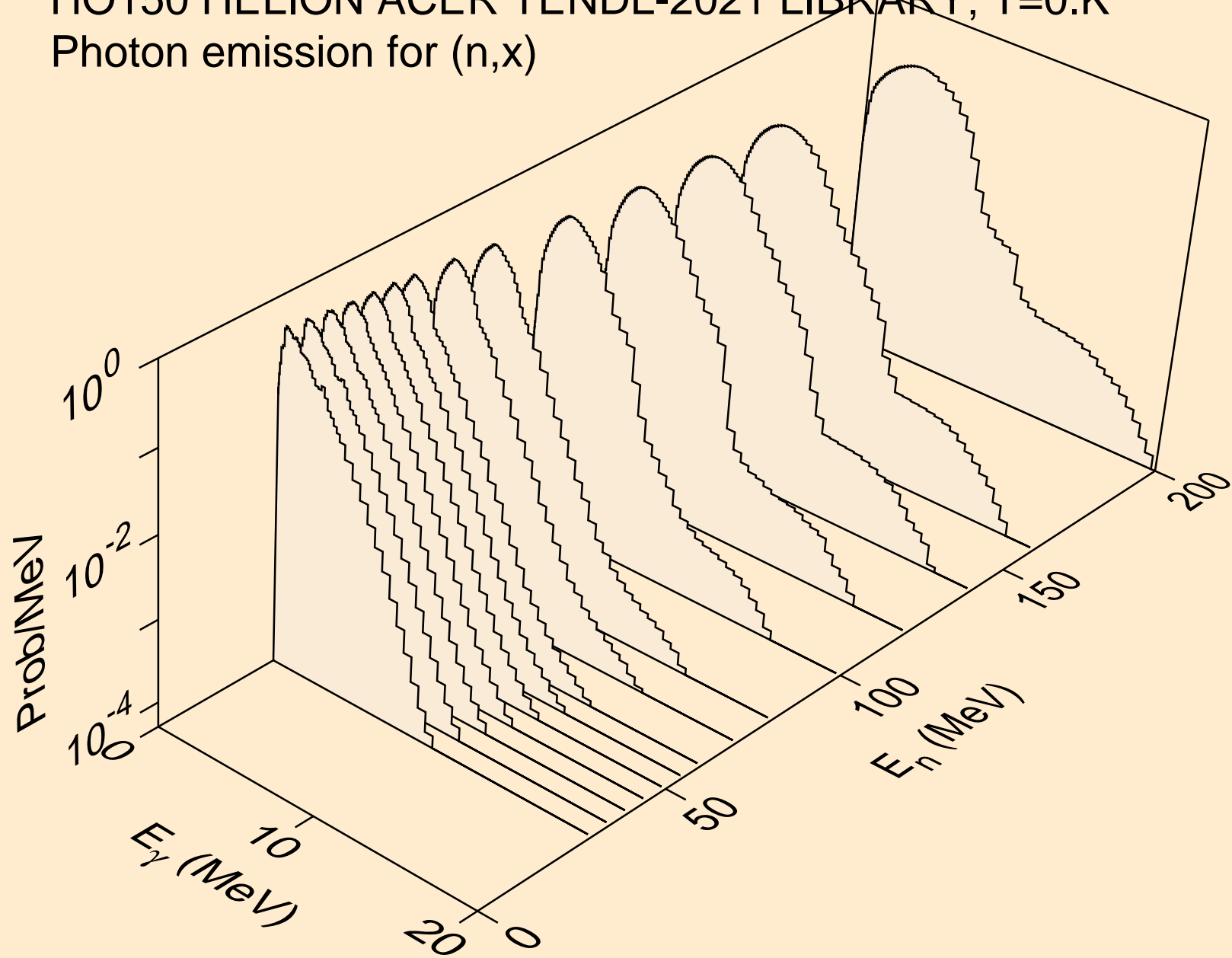

HO150 HELION ACER TENDL-2021 LIBRARY; T=0.K  
Photon emission for (n,2nd)

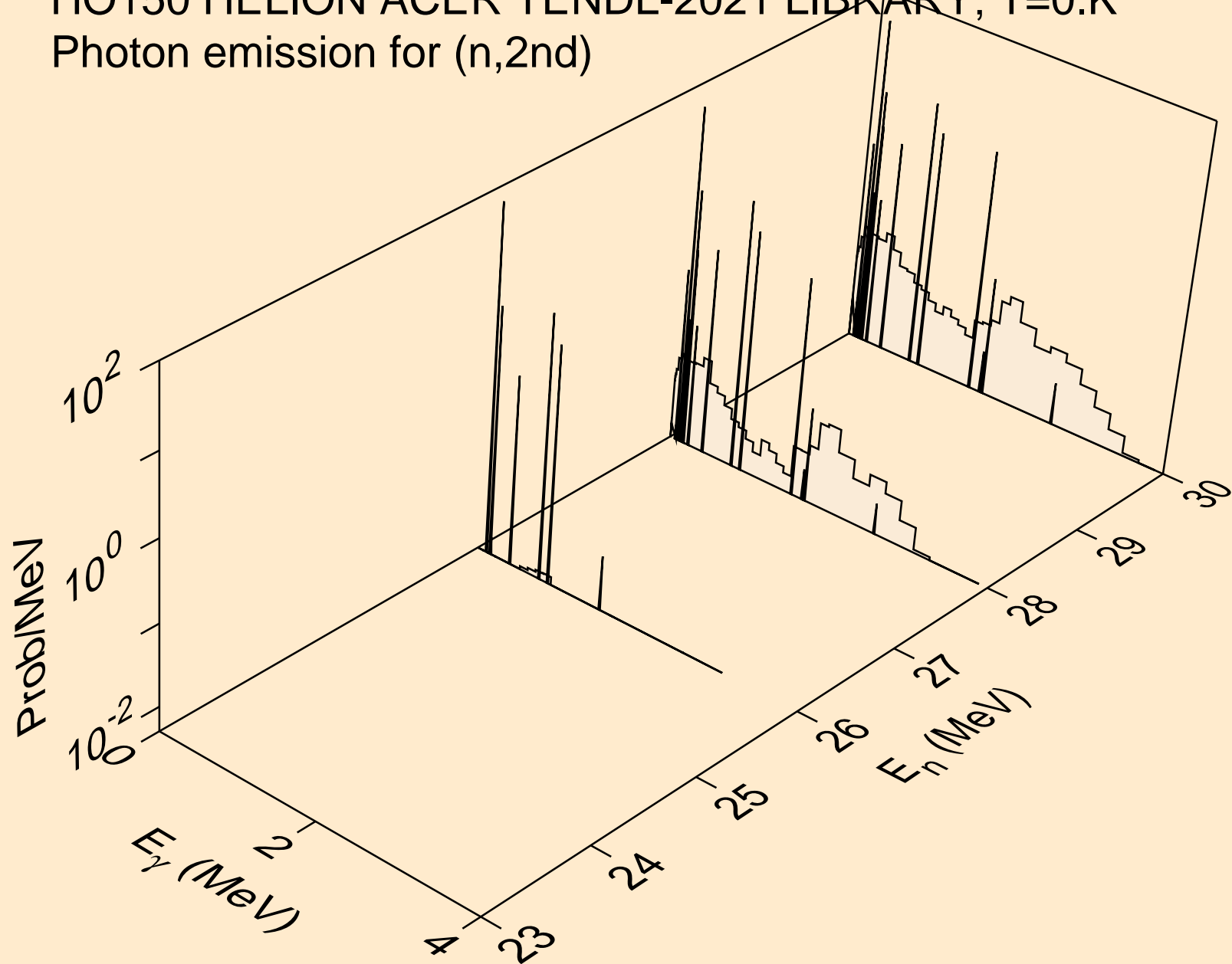

HO150 HELION ACER TENDL-2021 LIBRARY; T=0.K  
Photon emission for (n,2n)

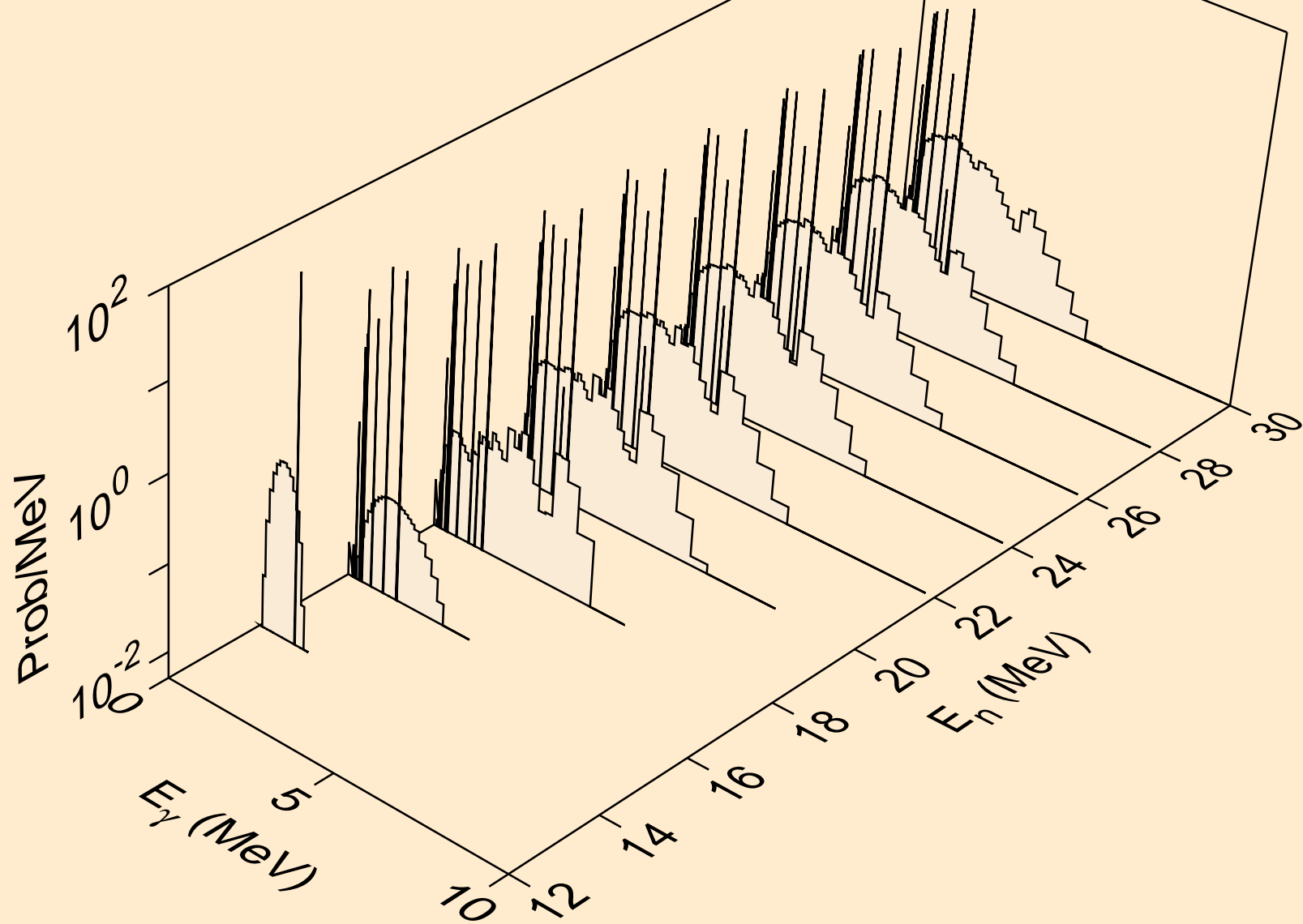

HO150 HELION ACER TENDL-2021 LIBRARY; T=0.K  
Photon emission for (n,3n)

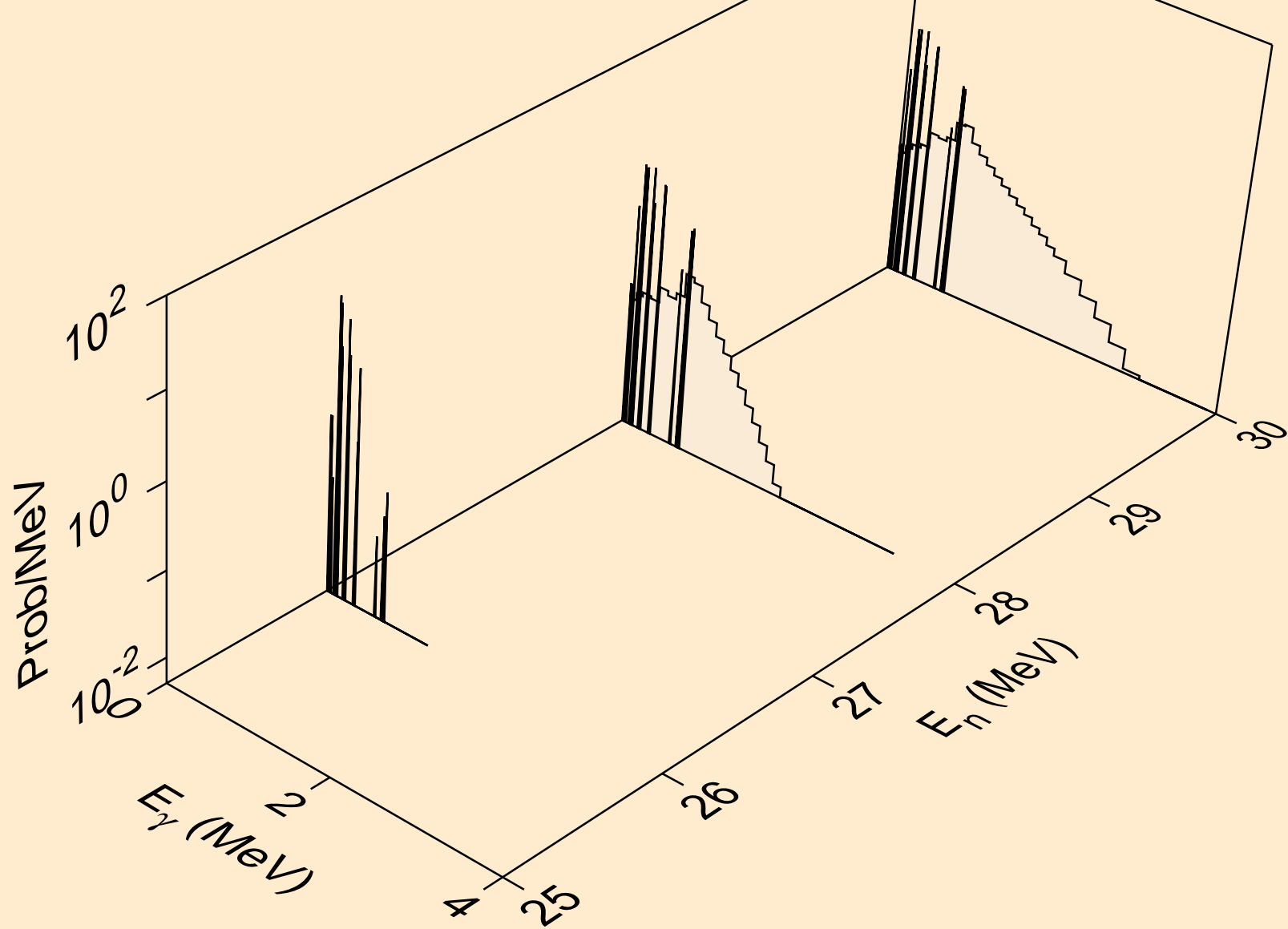

HO150 HELION ACER TENDL-2021 LIBRARY; T=0.K  
Photon emission for (n,n\*)a

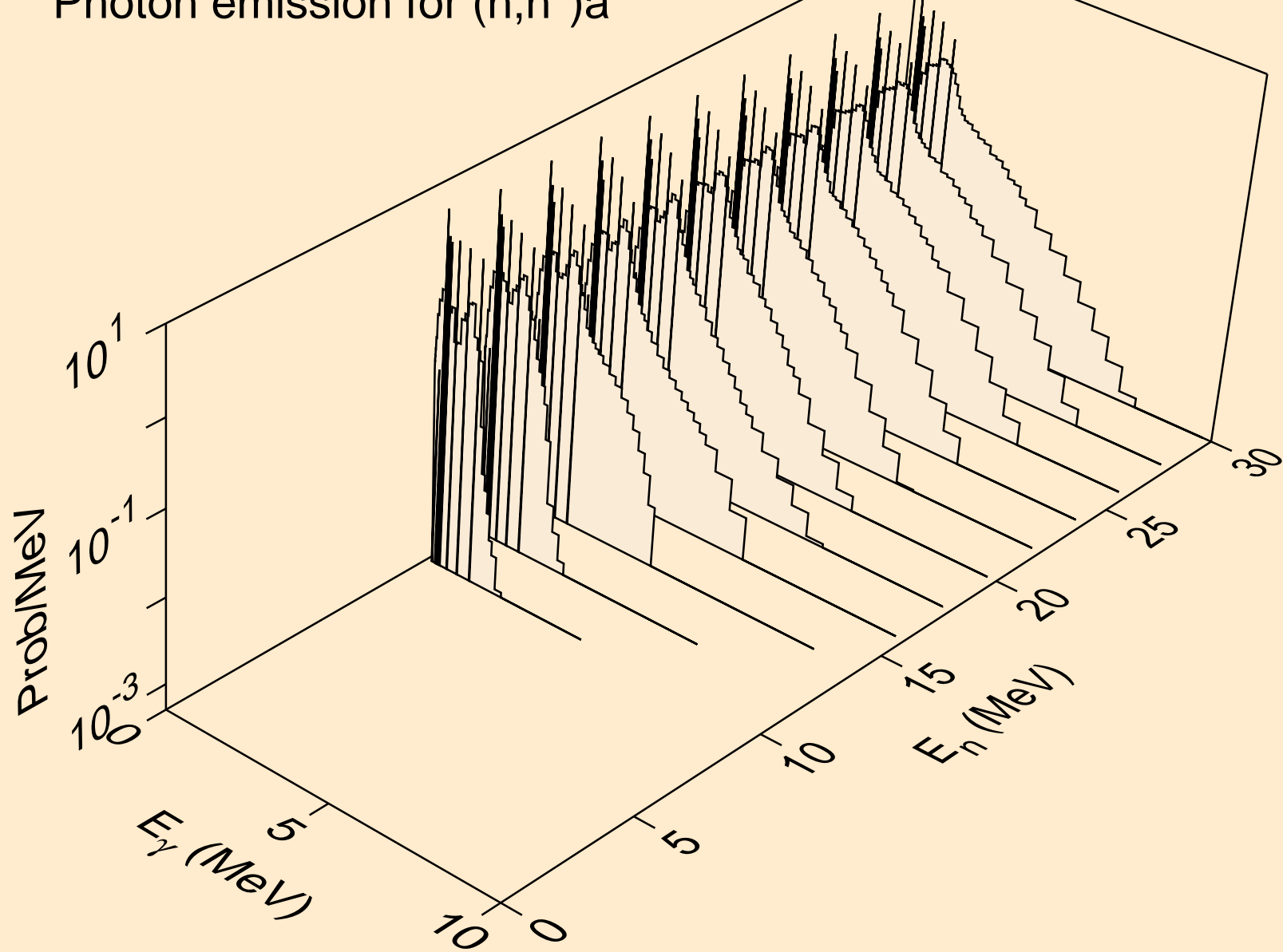

HO150 HELION ACER TENDL-2021 LIBRARY; T=0.K  
Photon emission for (n,2n)a

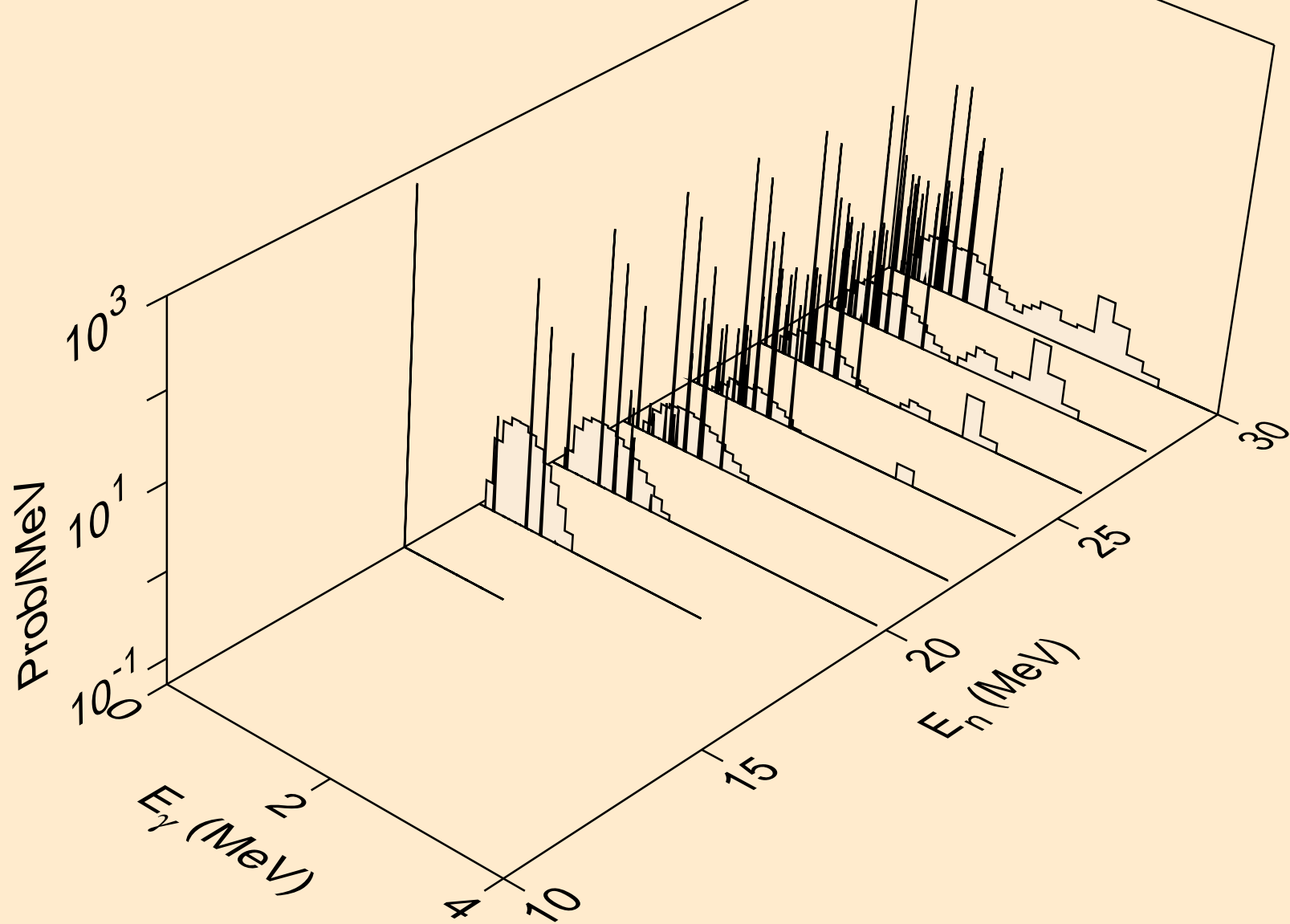

HO150 HELION ACER TENDL-2021 LIBRARY; T=0.K  
Photon emission for (n,n\*)p

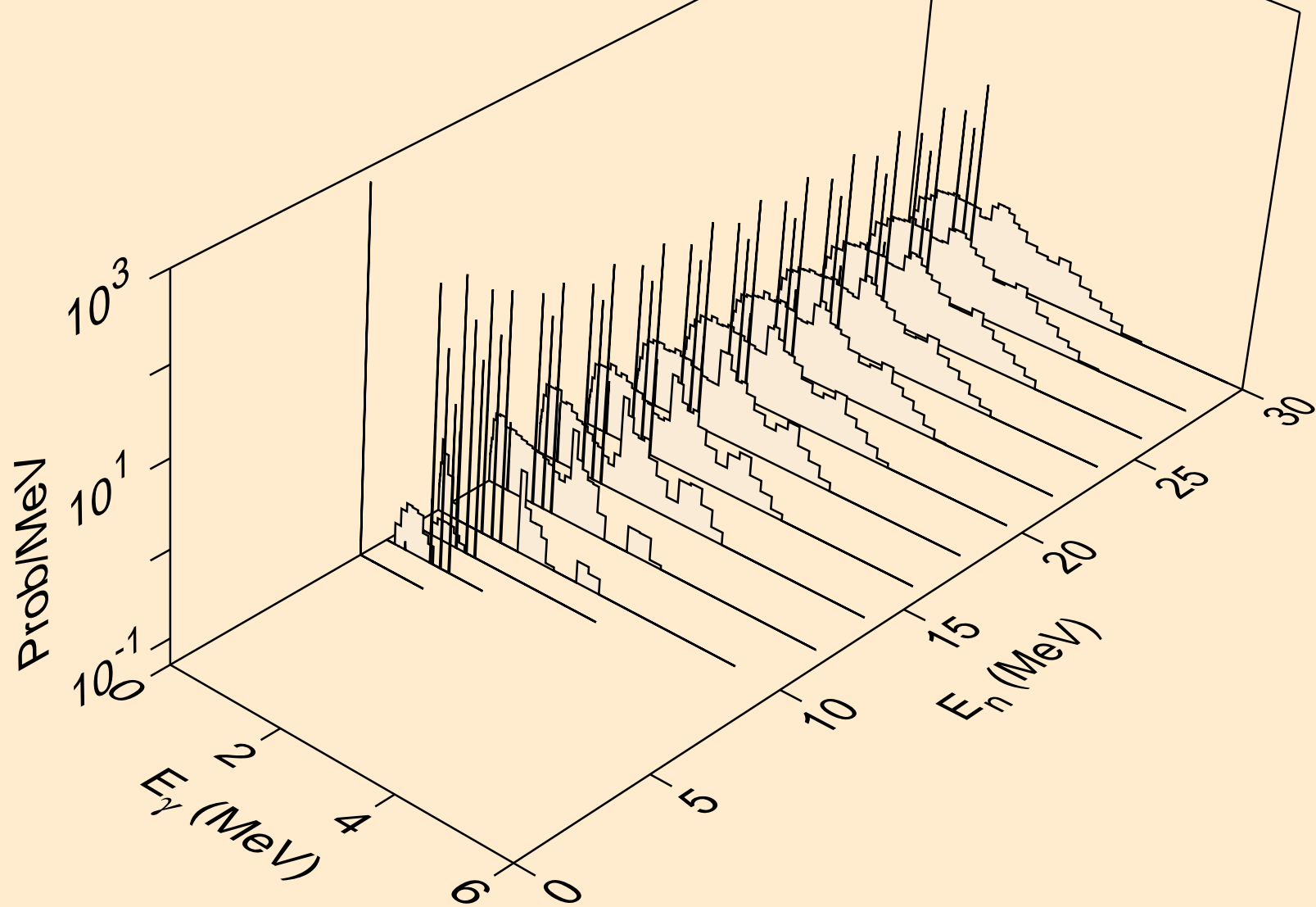



HO150 HELION ACER TENDL-2021 LIBRARY; T=0.K  
Photon emission for (n,n\*)2a

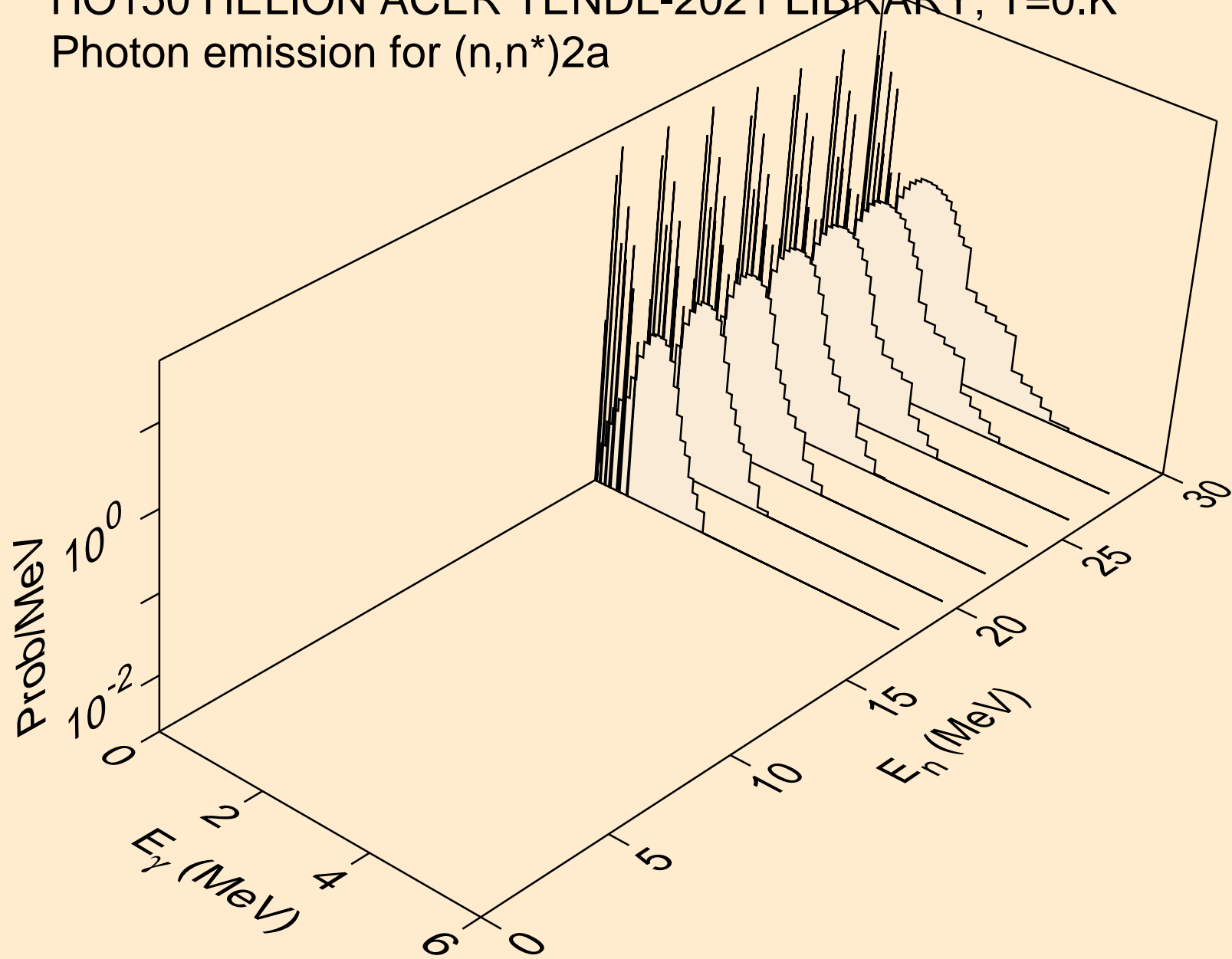

HO150 HELION ACER TENDL-2021 LIBRARY; T=0.K  
Photon emission for (n,n\*)d

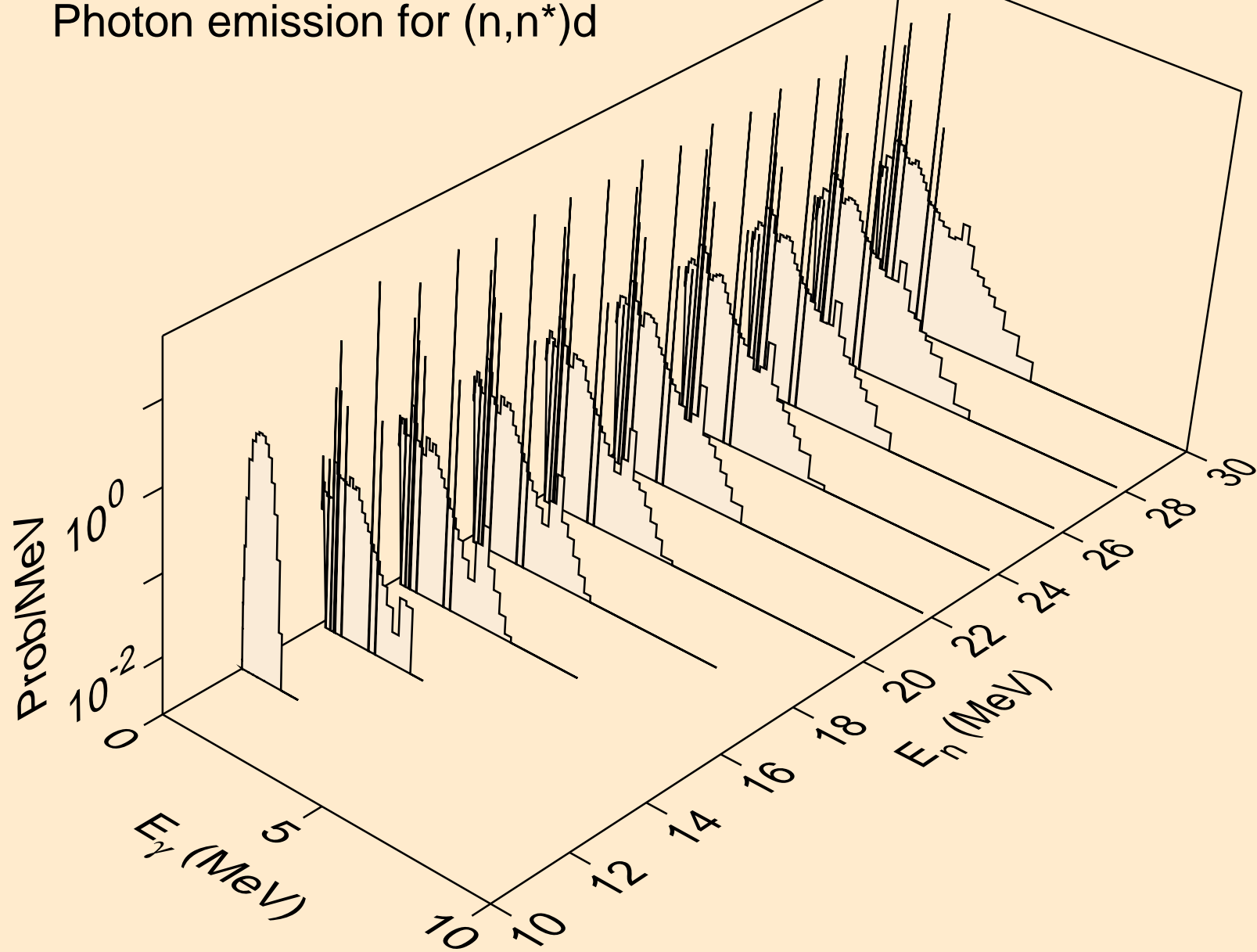

HO150 HELION ACER TENDL-2021 LIBRARY; T=0.K  
Photon emission for (n,n\*)t

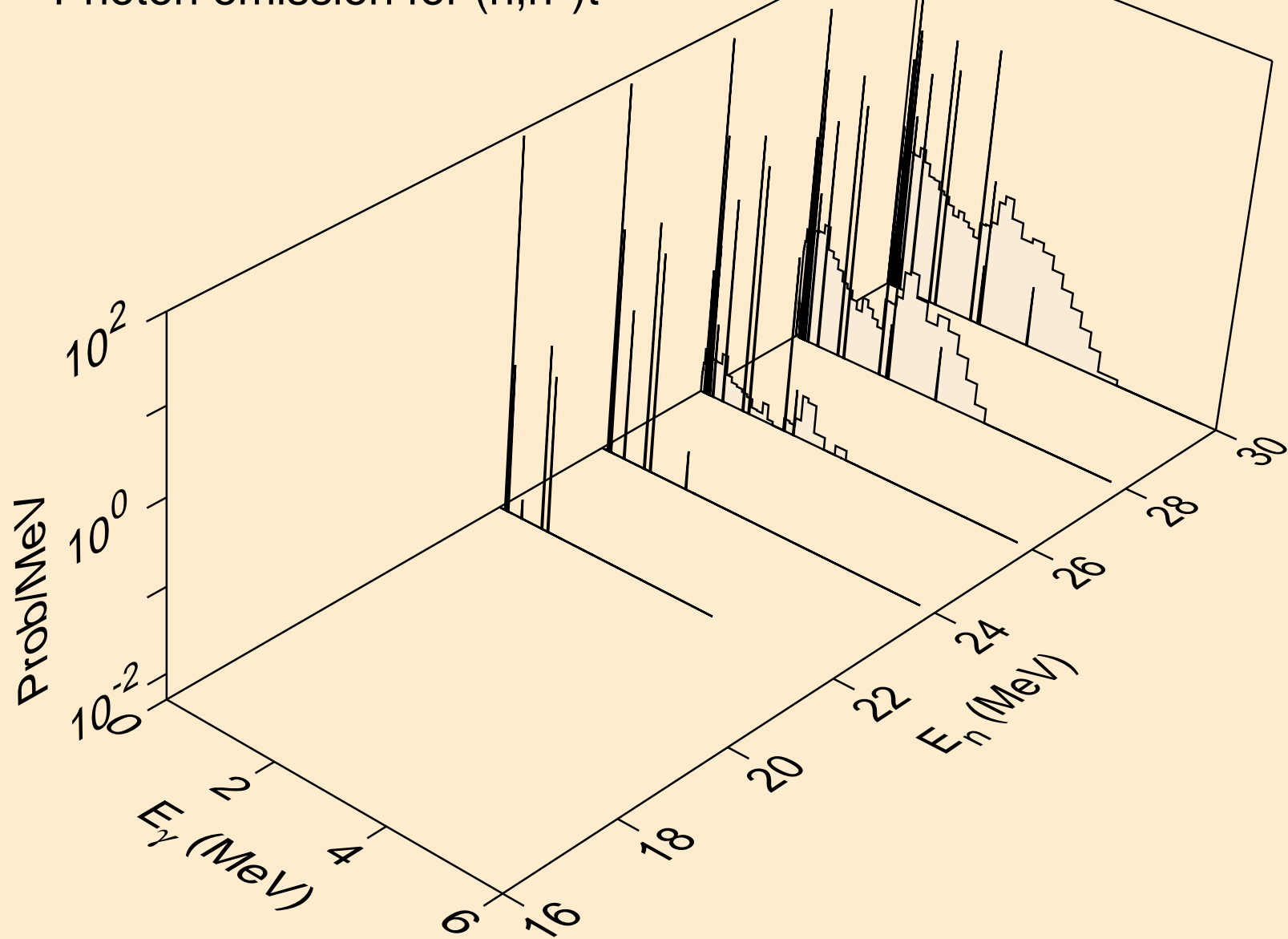

HO150 HELION ACER TENDL-2021 LIBRARY; T=0.K  
Photon emission for (n,n\*)he3

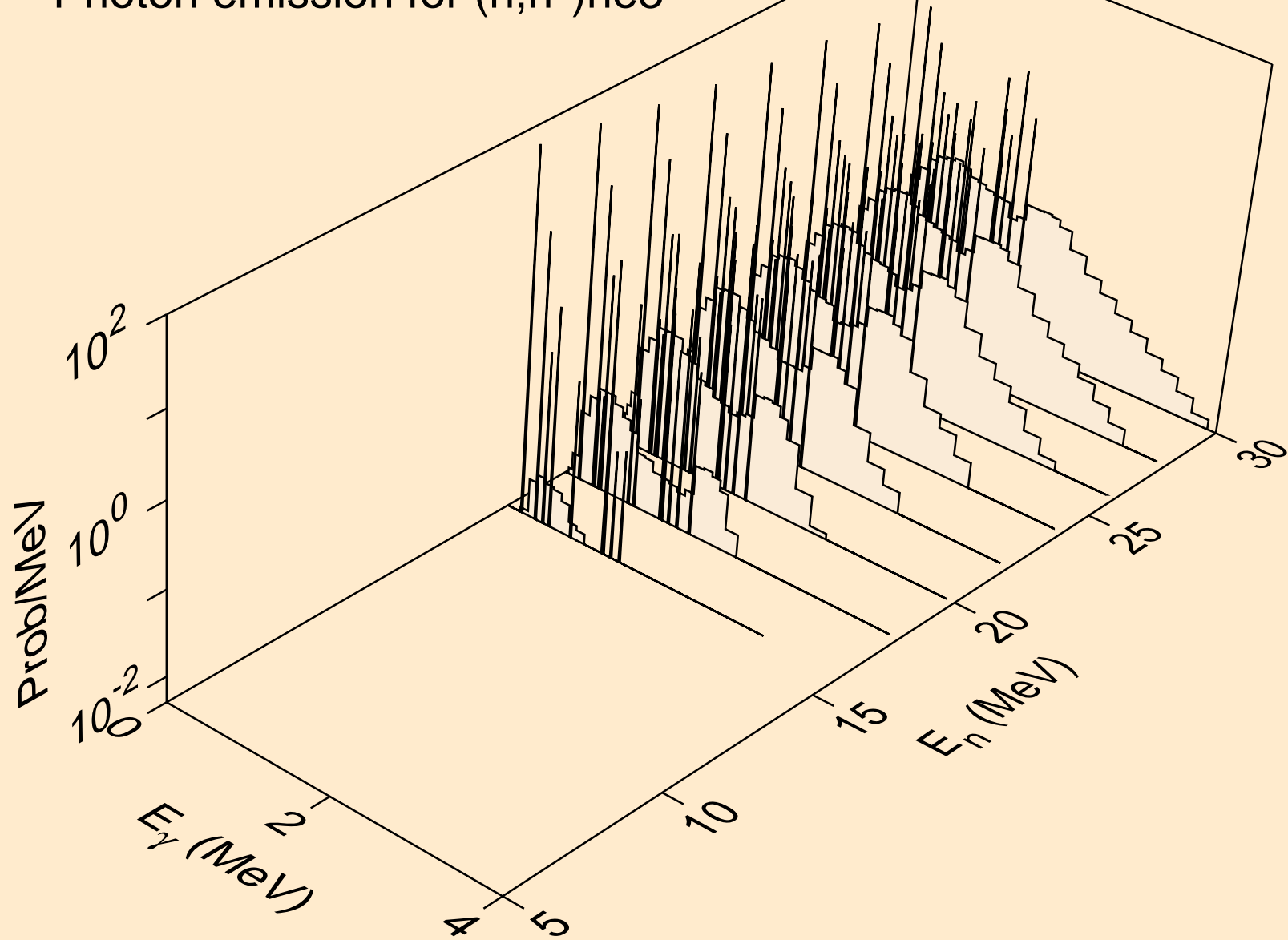

HO150 HELION ACER TENDL-2021 LIBRARY; T=0.K  
Photon emission for (n,2np)

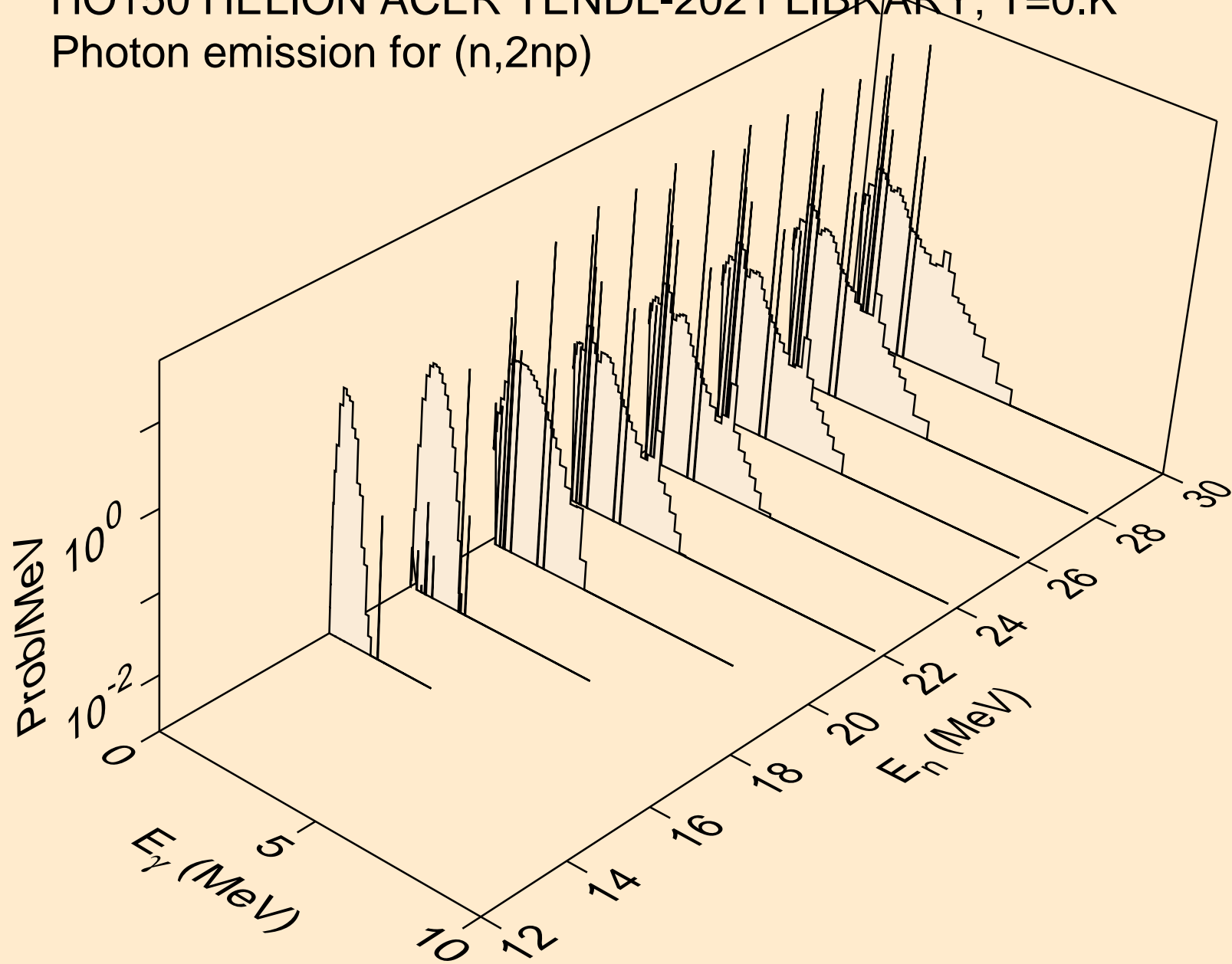

HO150 HELION ACER TENDL-2021 LIBRARY; T=0.K  
Photon emission for (n,3np)

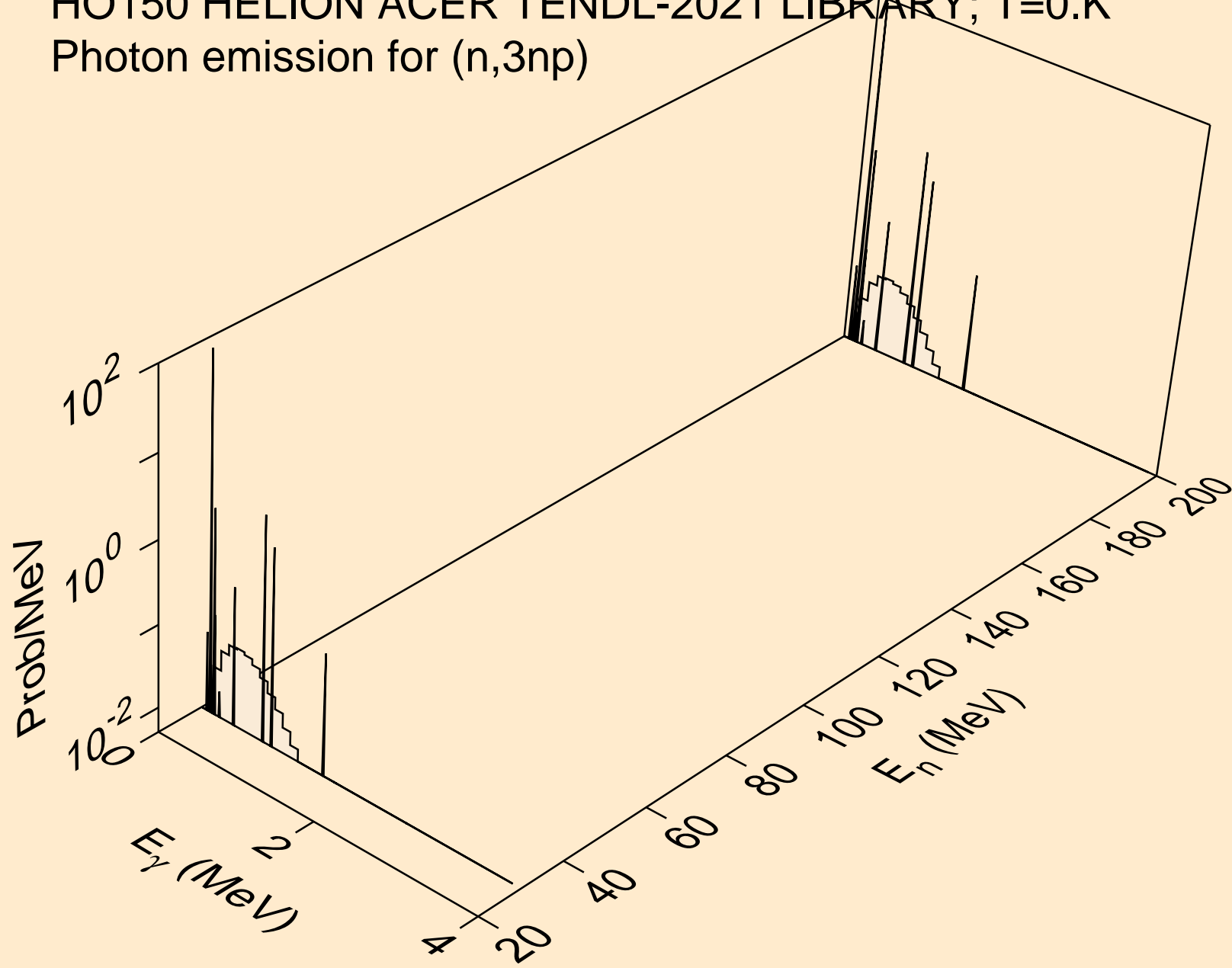

HO150 HELION ACER TENDL-2021 LIBRARY; T=0.K  
Photon emission for (n,2np)

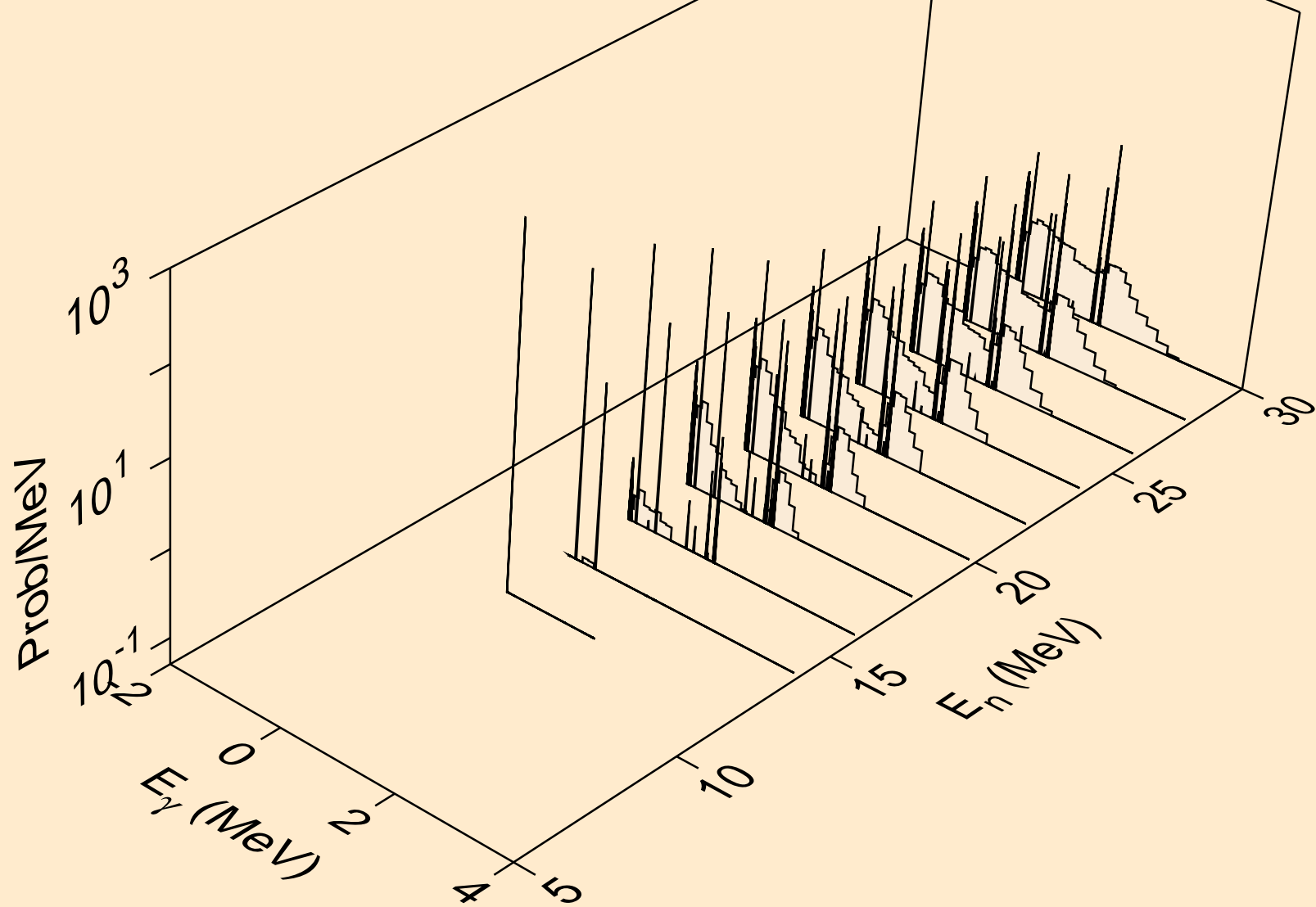

HO150 HELION ACER TENDL-2021 LIBRARY; T=0.K  
Photon emission for (n,npa)

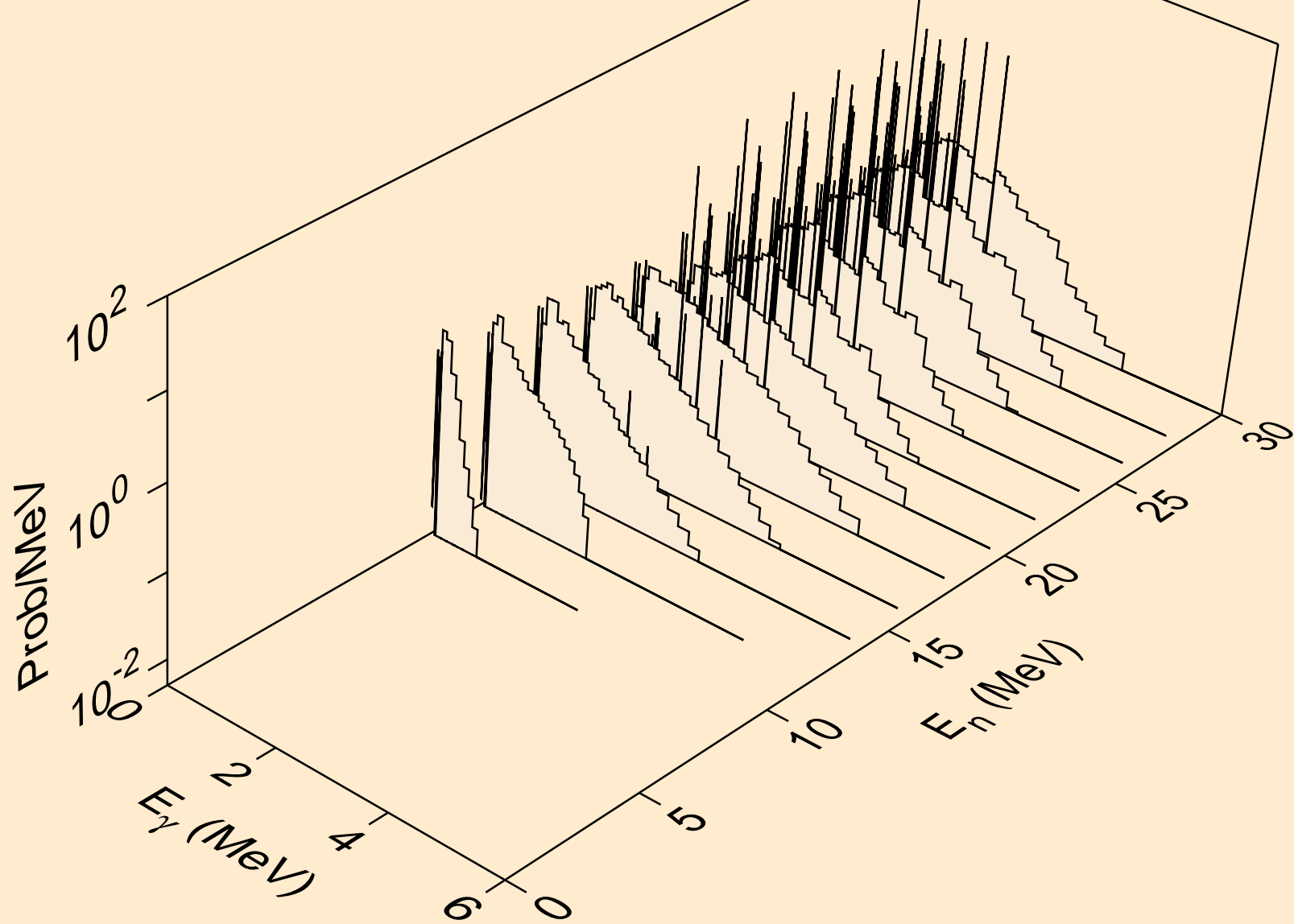



HO150 HELION ACER TENDL-2021 LIBRARY; T=0.K  
Photon emission for (n,gma)

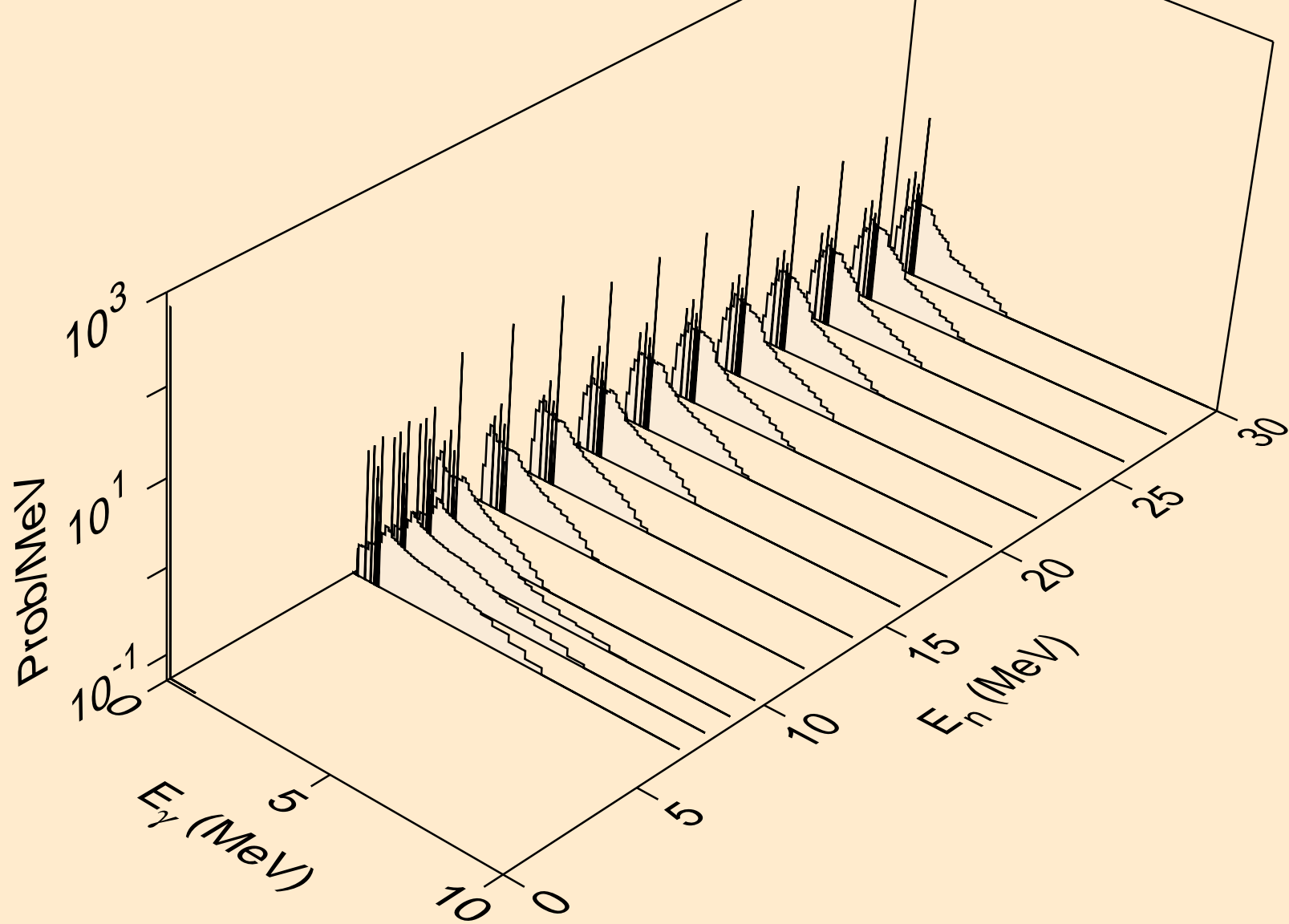

HO150 HELION ACER TENDL-2021 LIBRARY; T=0.K  
Photon emission for (n,p)

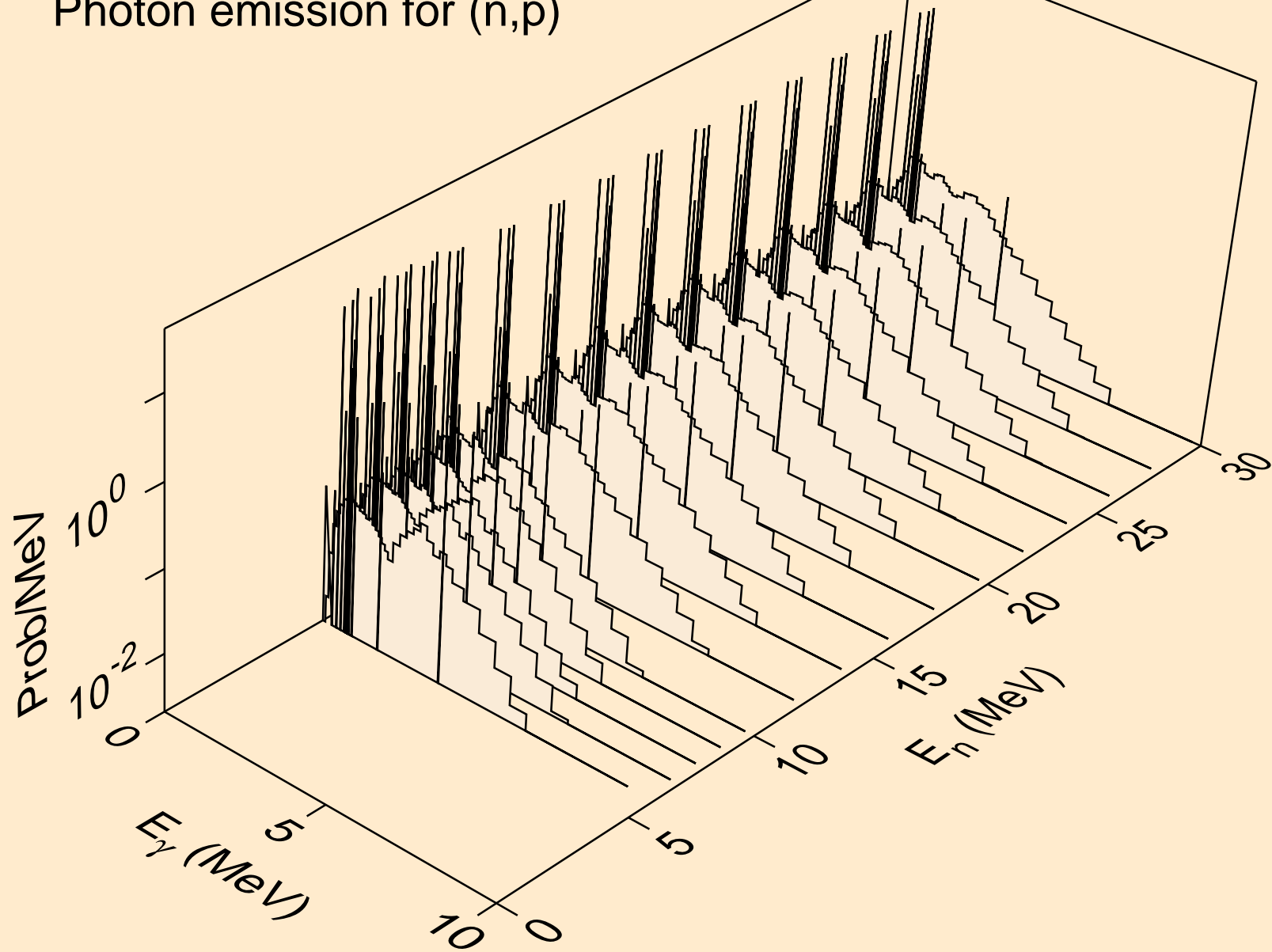

HO150 HELION ACER TENDL-2021 LIBRARY; T=0.K  
Photon emission for (n,d)

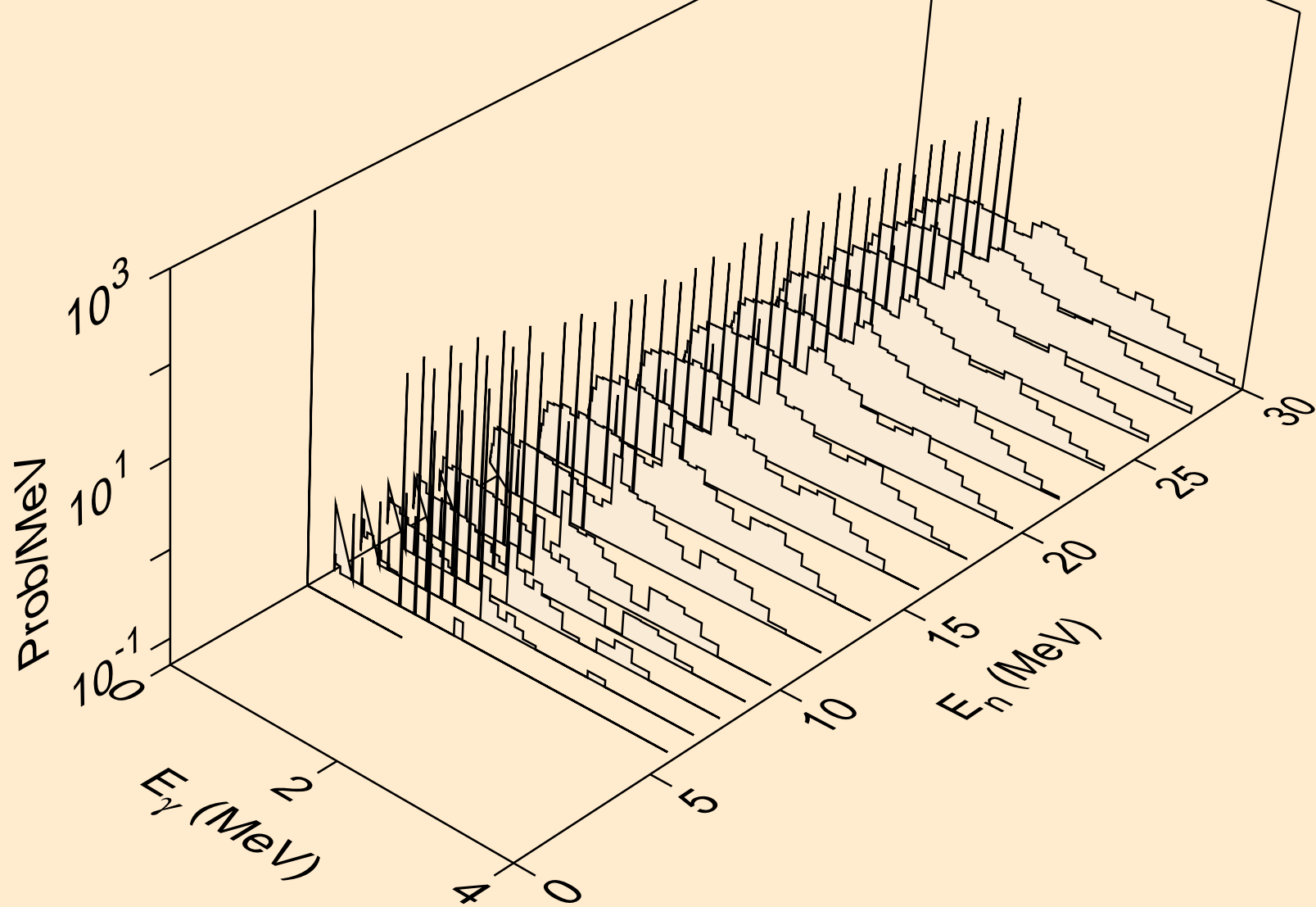

HO150 HELION ACER TENDL-2021 LIBRARY; T=0.K  
Photon emission for (n,t)

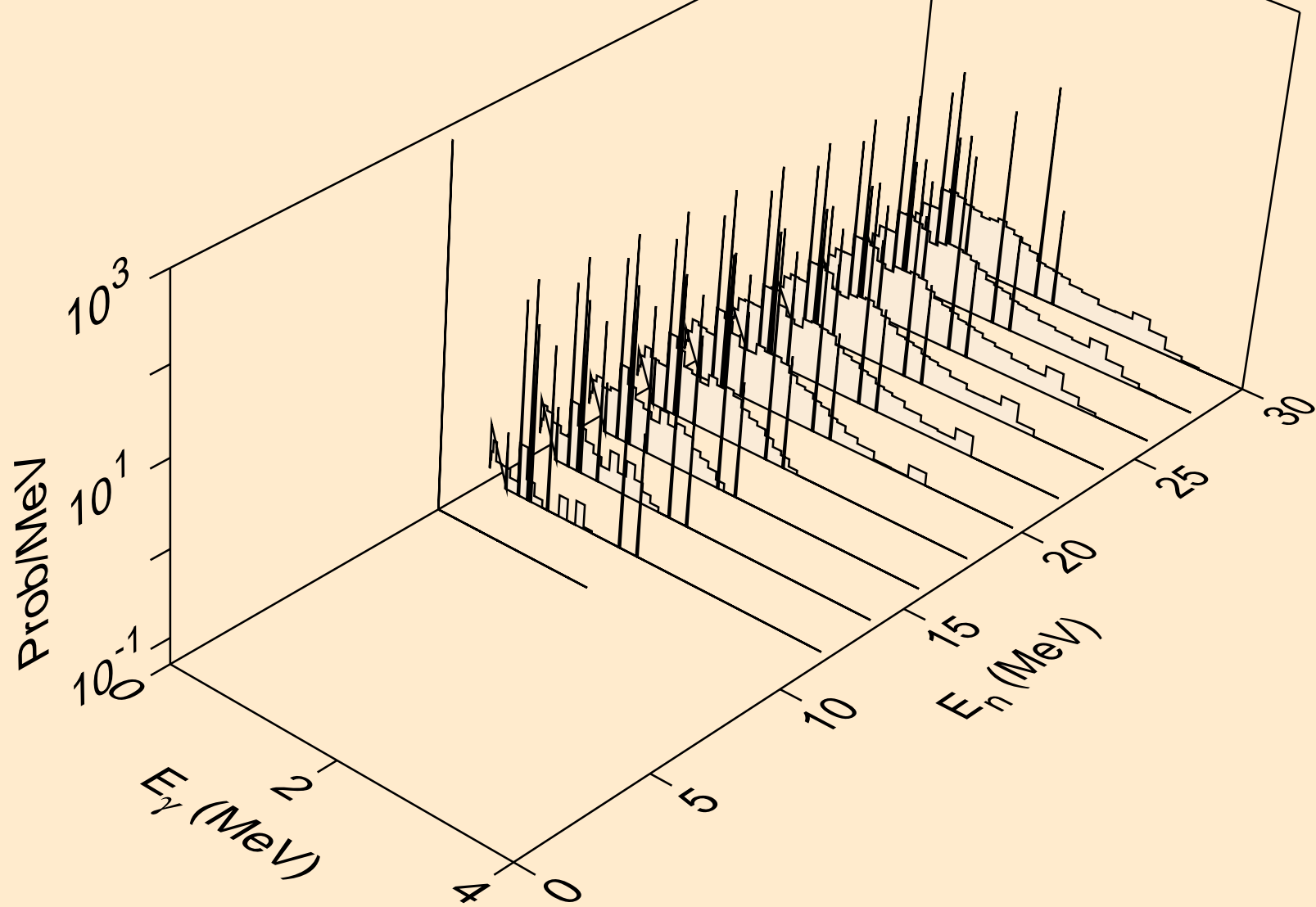

HO150 HELION ACER TENDL-2021 LIBRARY; T=0.K  
Photon emission for inelastic

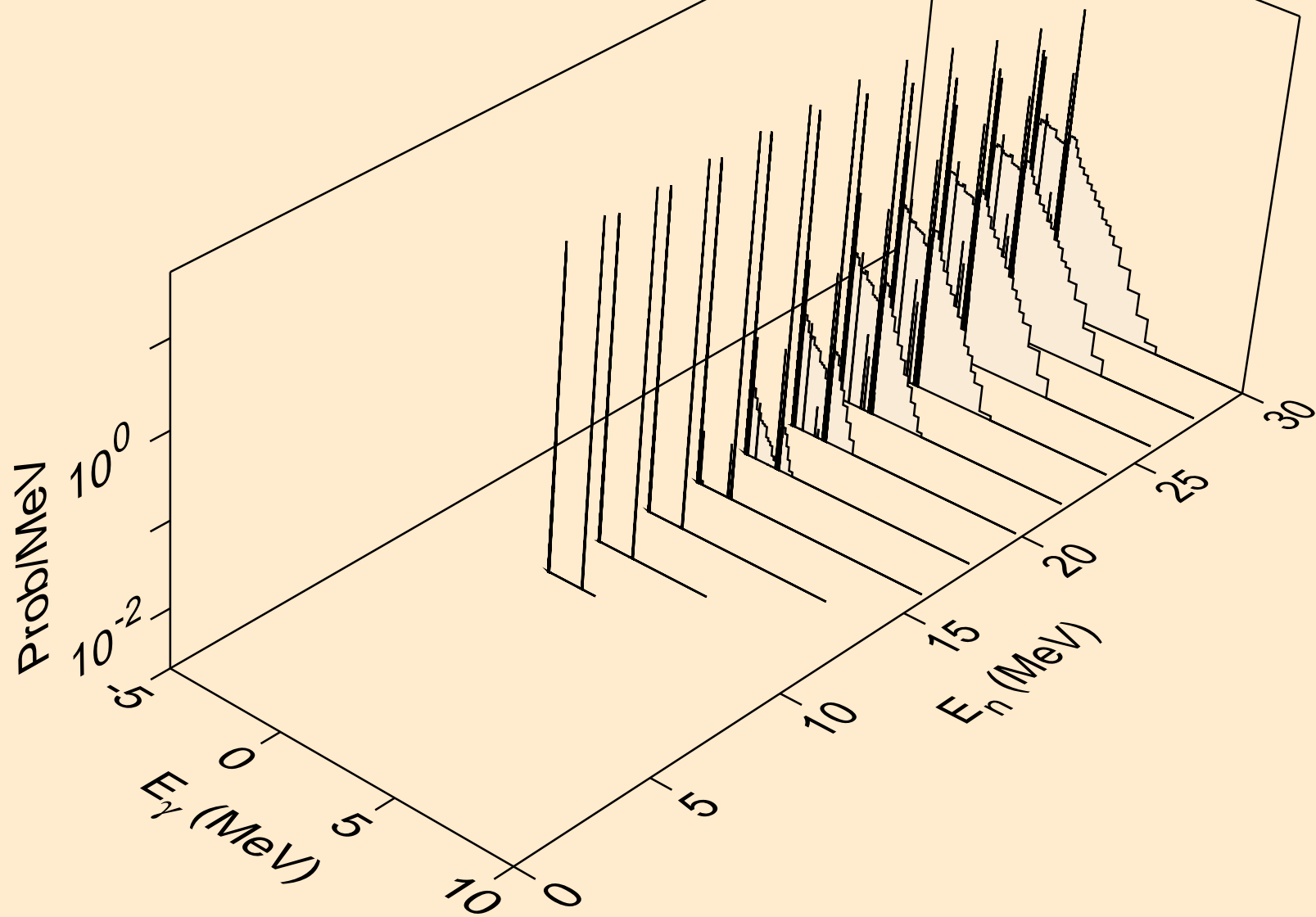

HO150 HELION ACER TENDL-2021 LIBRARY; T=0.K  
Photon emission for (n,a)

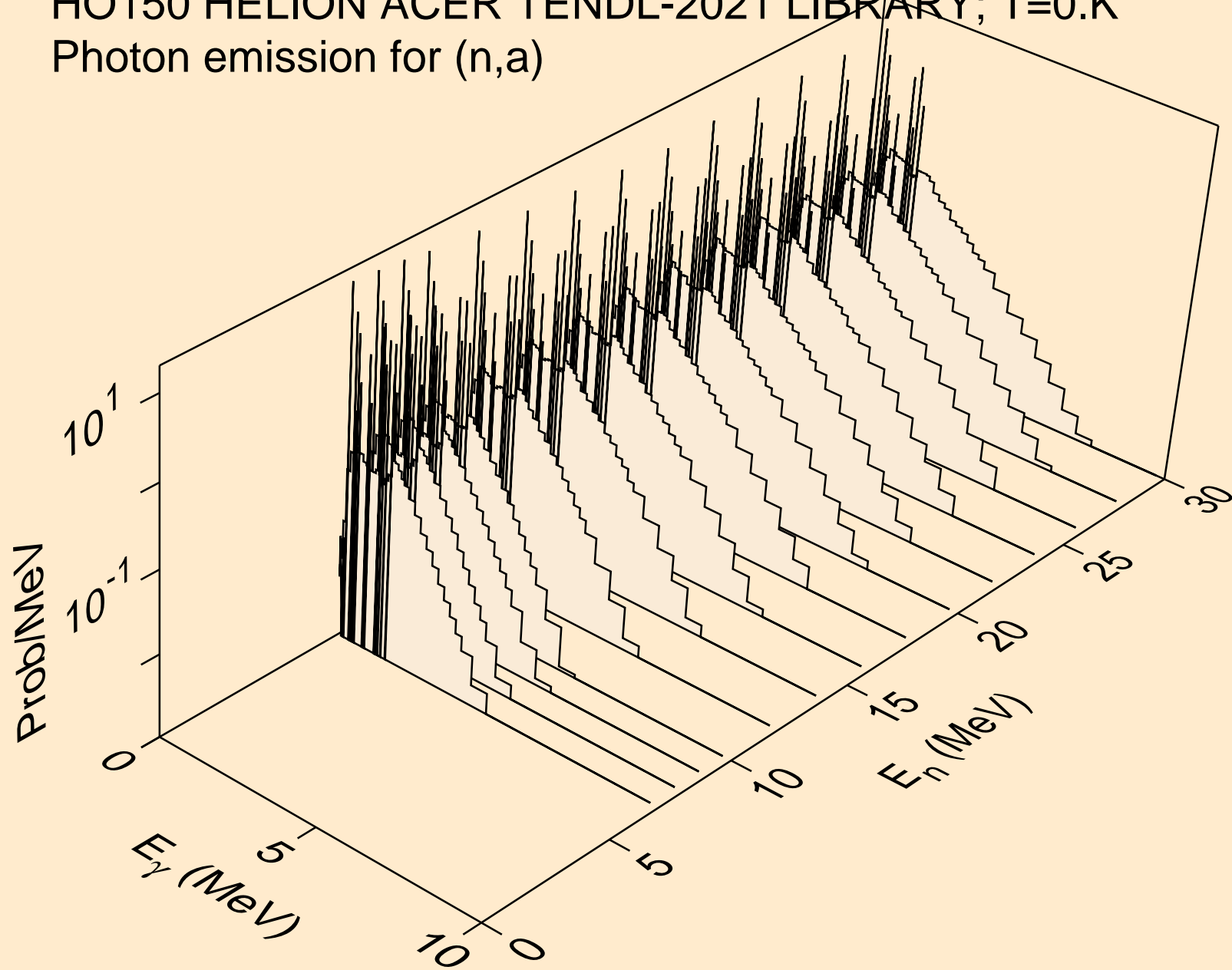

HO150 HELION ACER TENDL-2021 LIBRARY; T=0.K  
Photon emission for (n,2a)

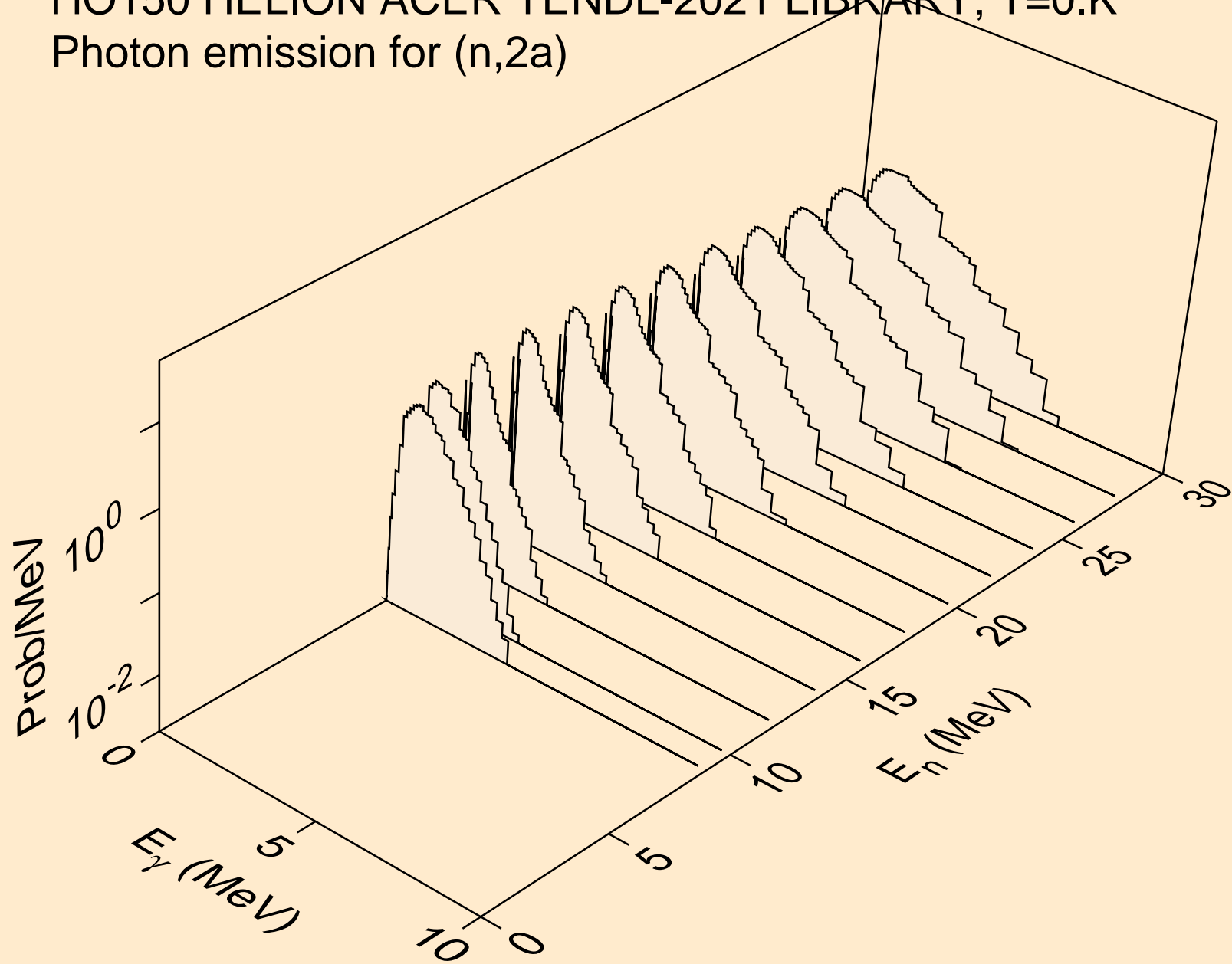

HO150 HELION ACER TENDL-2021 LIBRARY; T=0.K  
Photon emission for (n,2p)

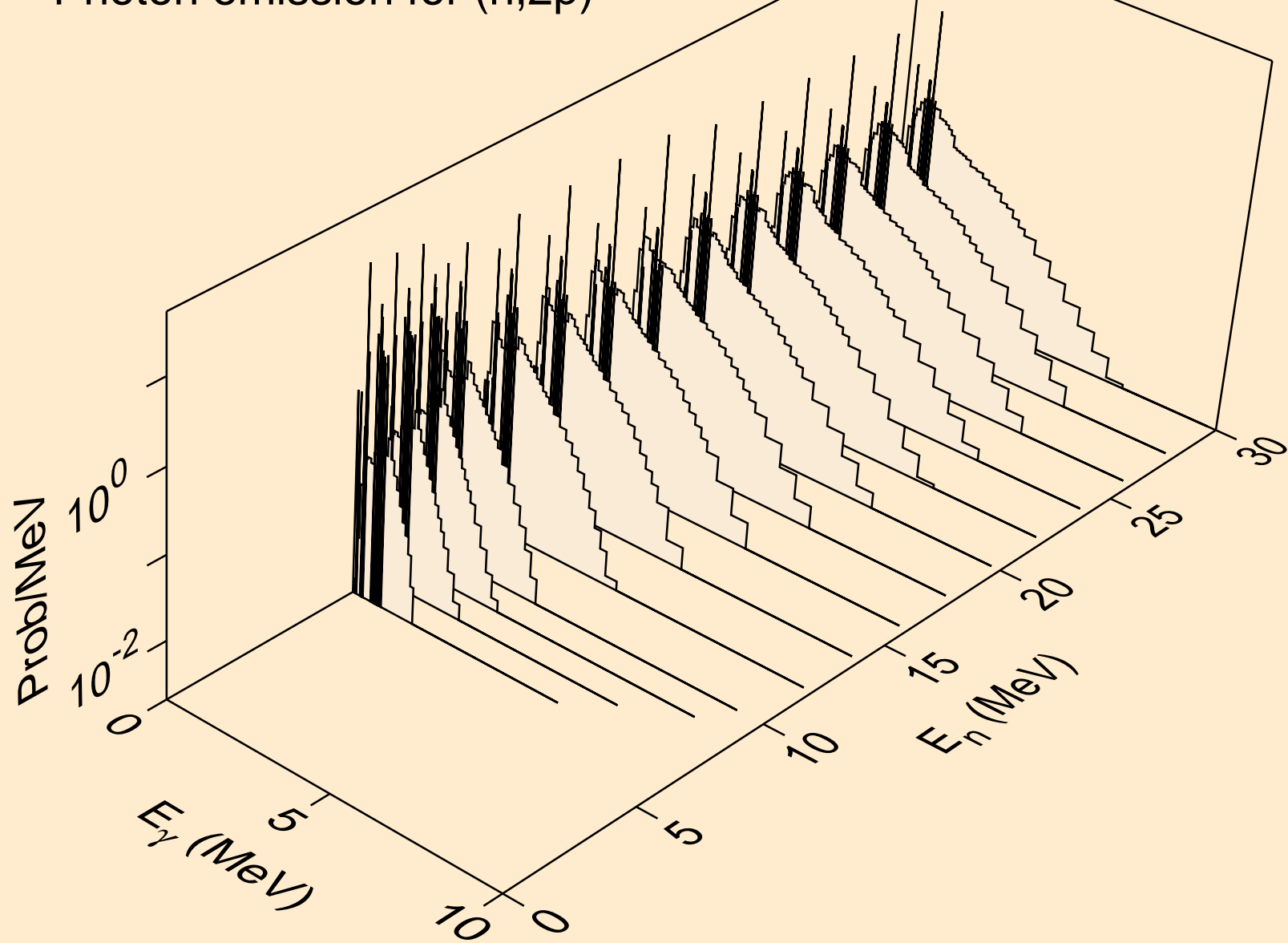



HO150 HELION ACER TENDL-2021 LIBRARY; T=0.K  
Photon emission for (n,pa)

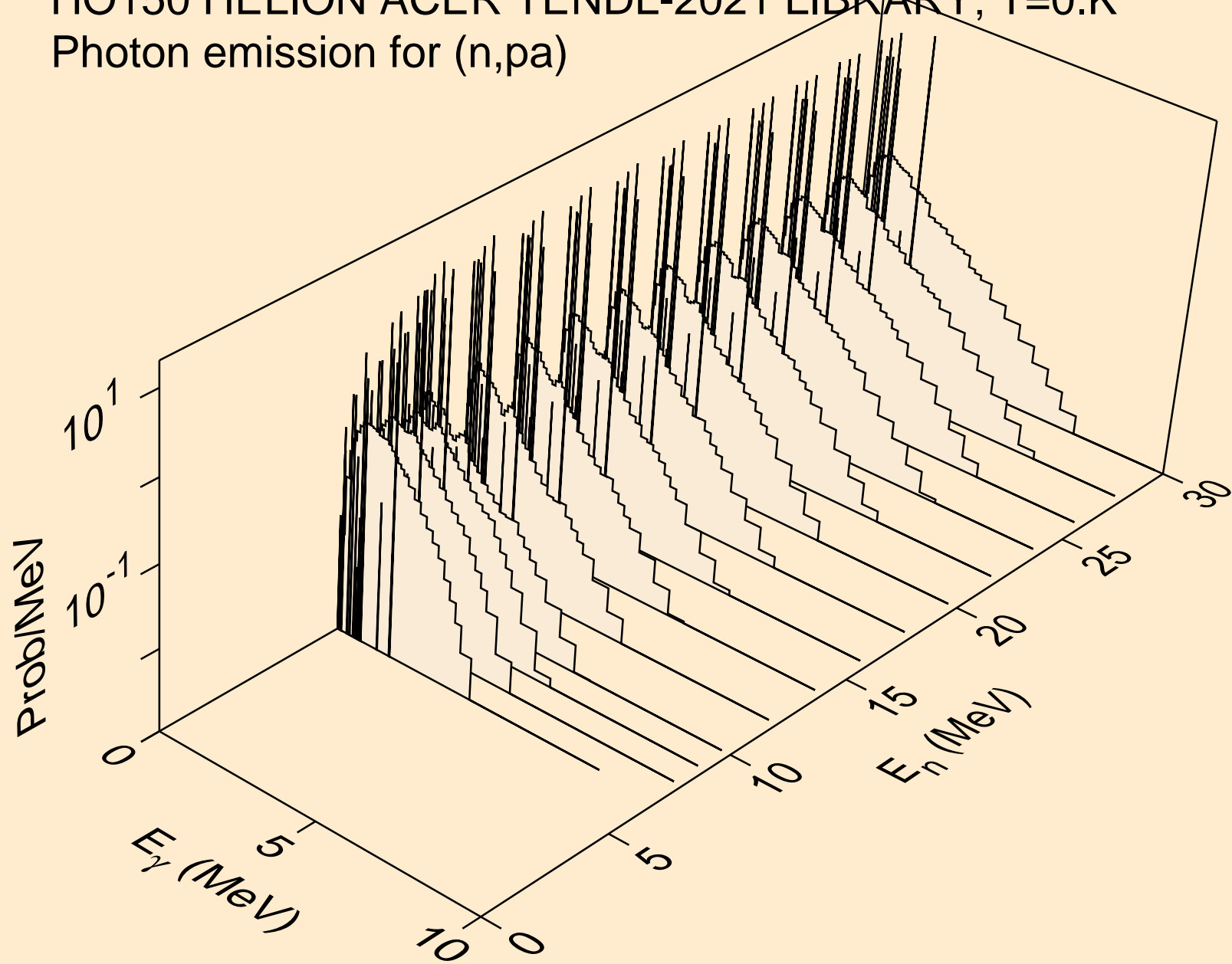

HO150 HELION ACER TENDL-2021 LIBRARY; T=0.K  
Photon emission for (n,pd)

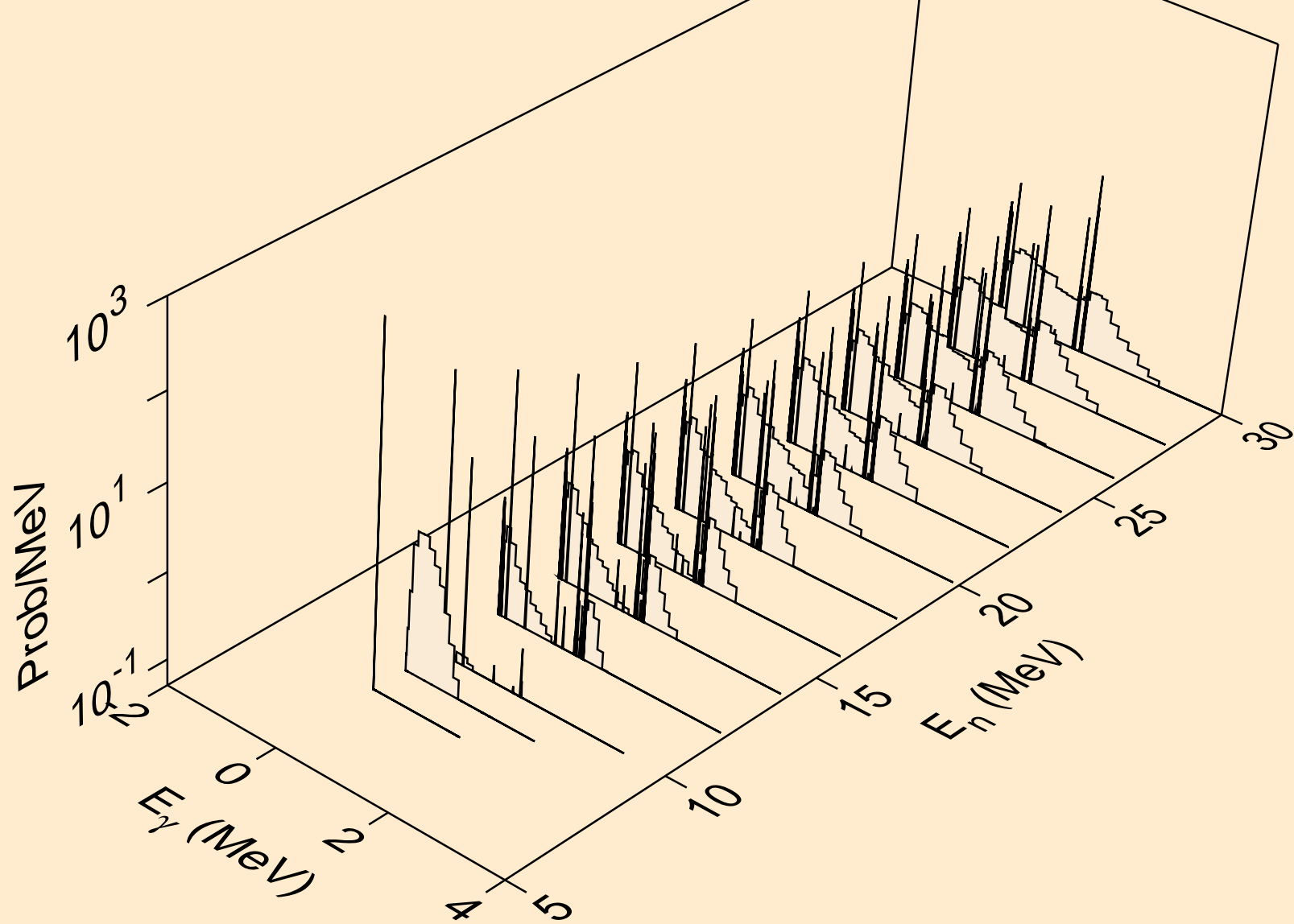

HO150 HELION ACER TENDL-2021 LIBRARY; T=0.K  
Photon emission for (n,pt)

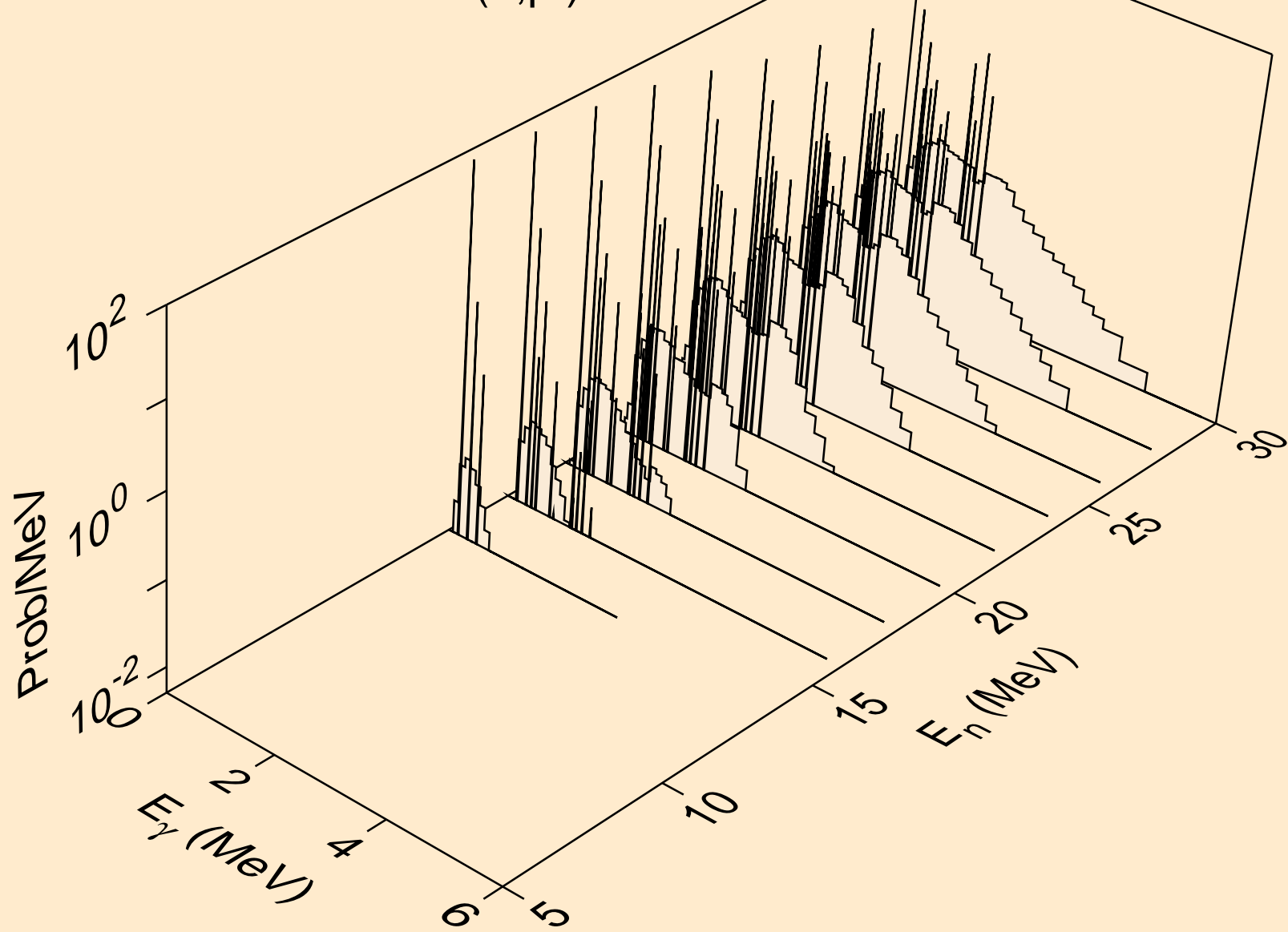

HO150 HELION ACER TENDL-2021 LIBRARY; T=0.K  
Photon emission for (n,da)

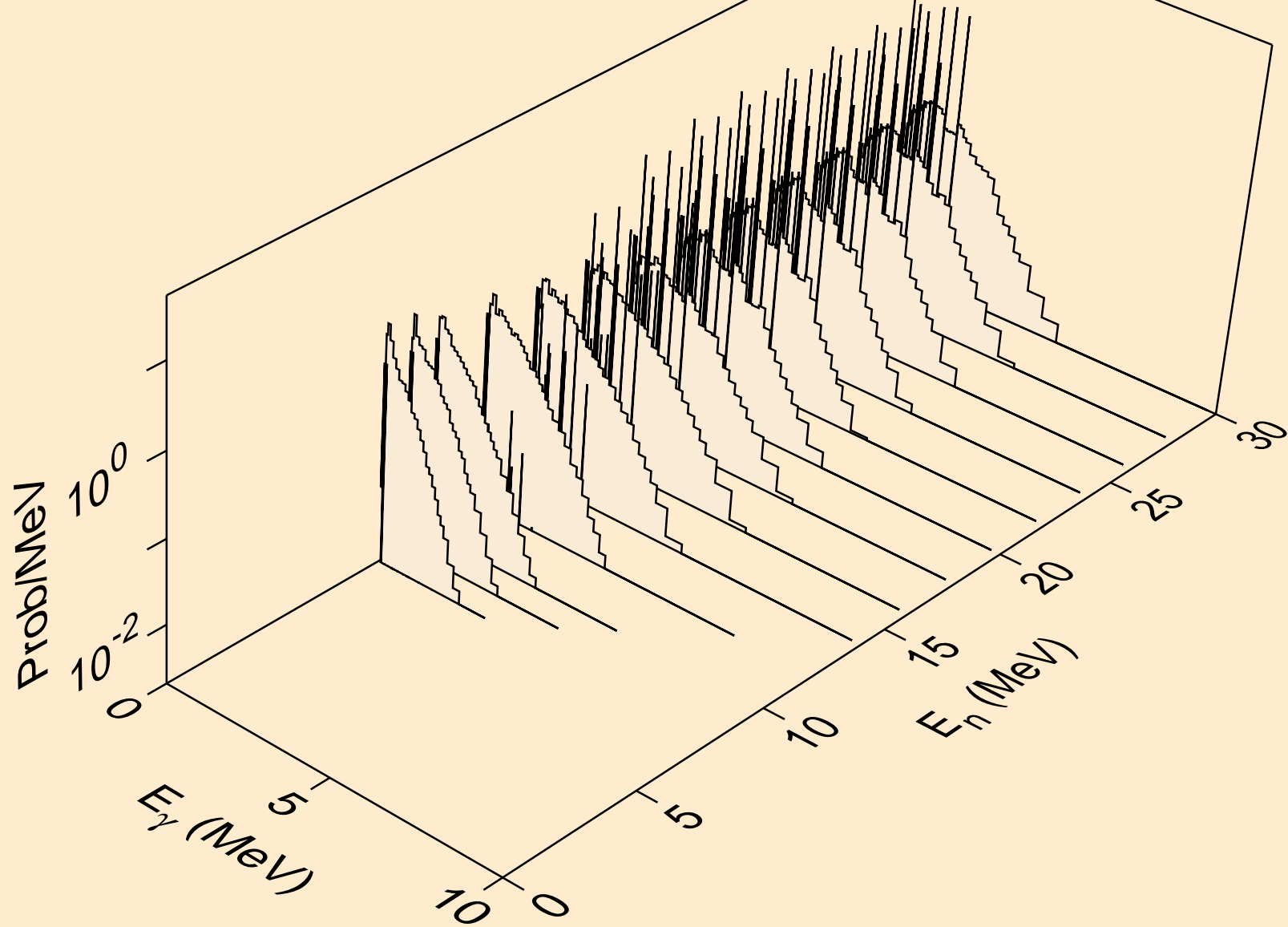

HO150 HELION ACER TENDL-2021 LIBRARY; T=0.K  
Particle heating contributions

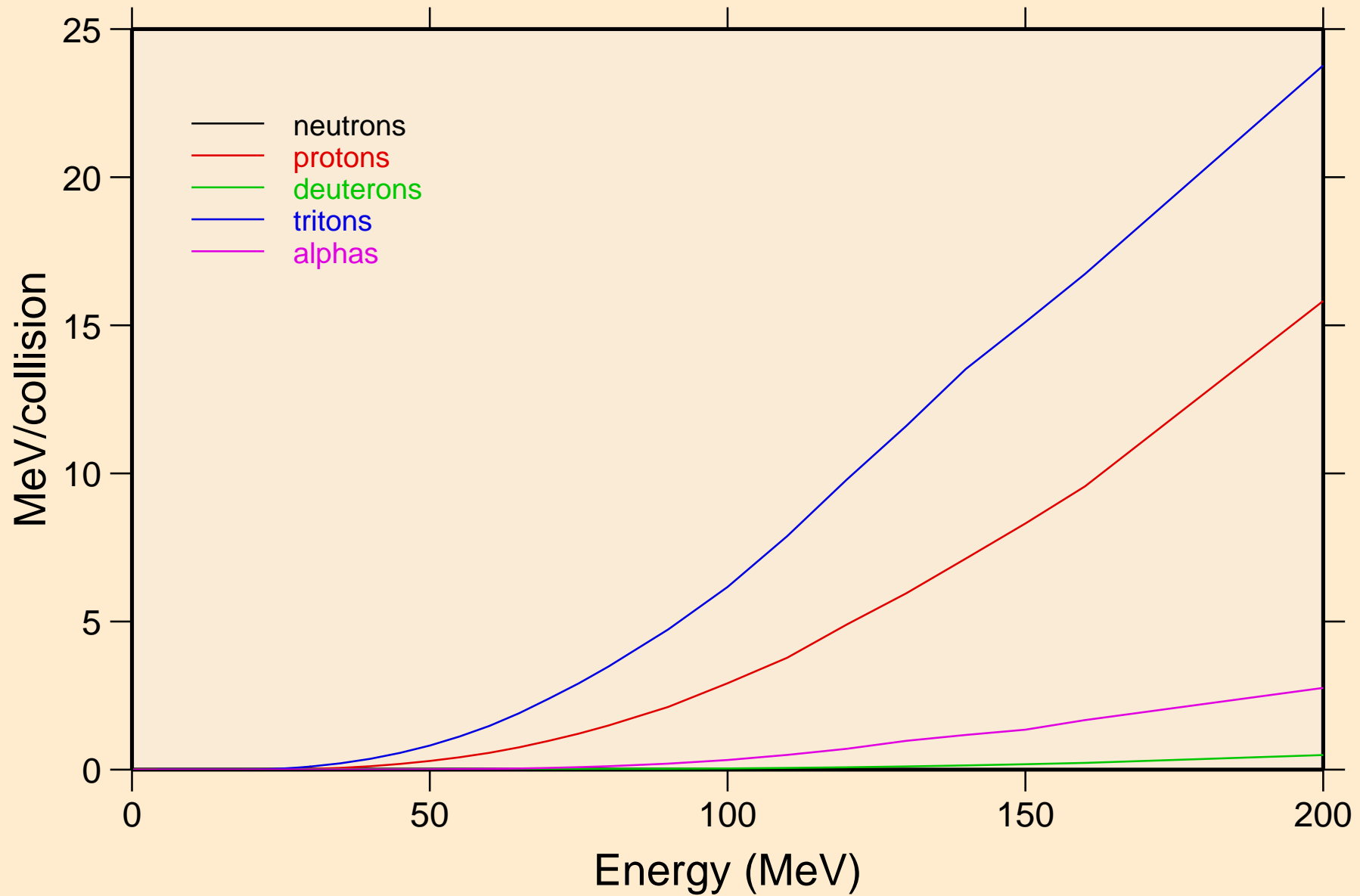

HO150 HELION ACER TENDL-2021 LIBRARY; T=0.K  
Recoil Heating

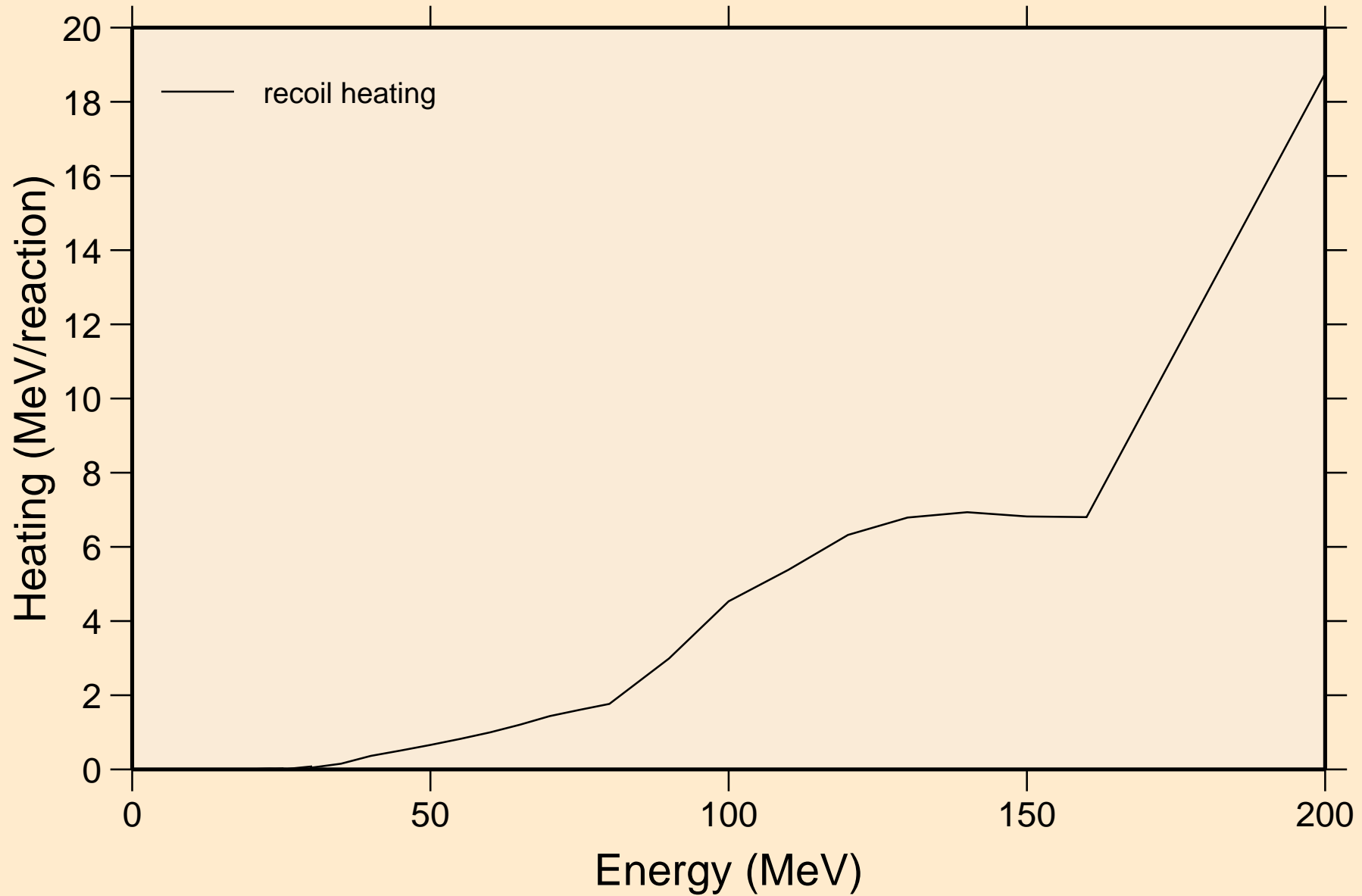

HO150 HELION ACER TENDL-2021 LIBRARY; T=0.K  
Particle production cross sections

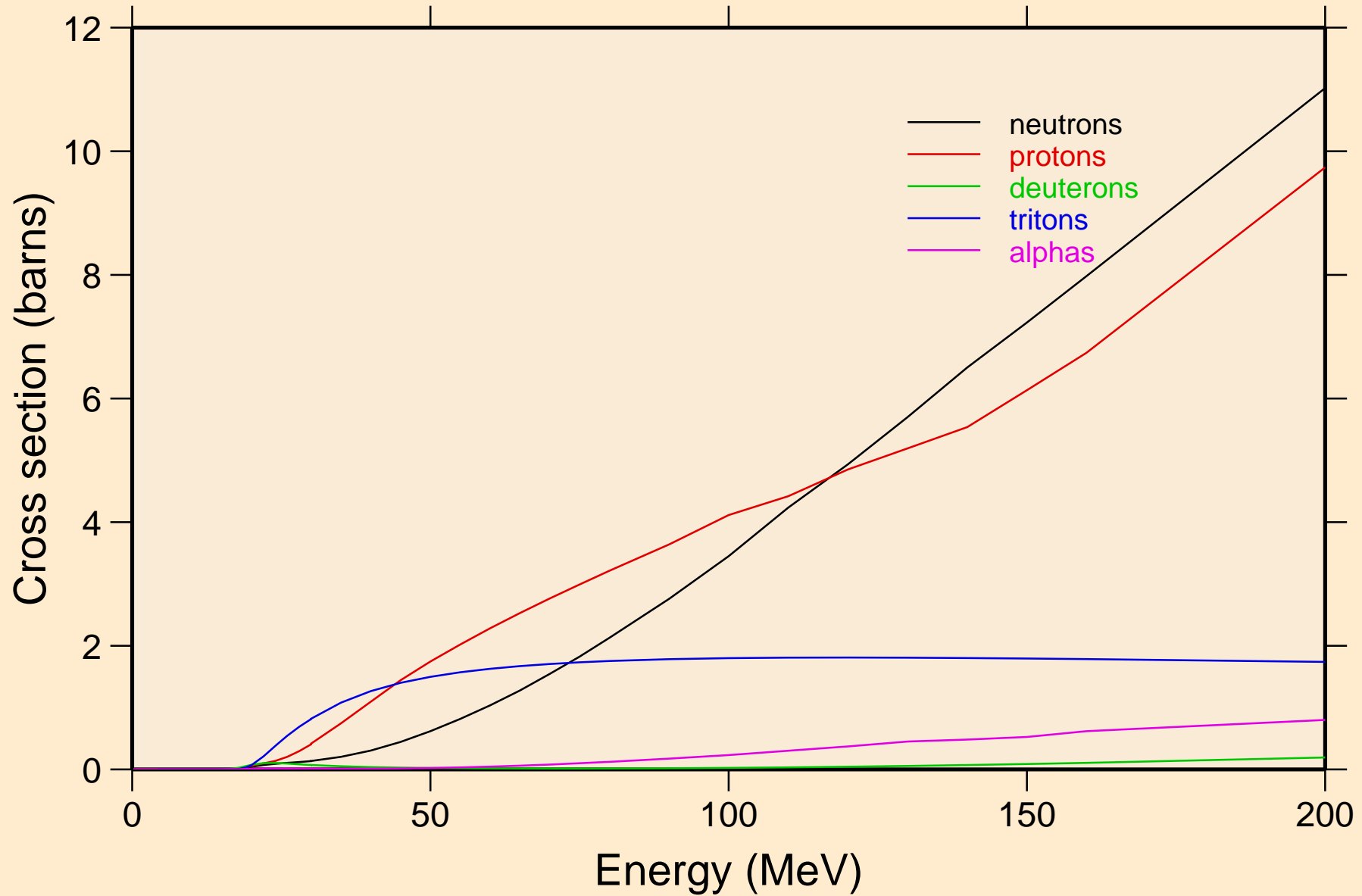

HO150 HELION ACER TENDL-2021 LIBRARY; T=0.K  
neutrons from (s,n)

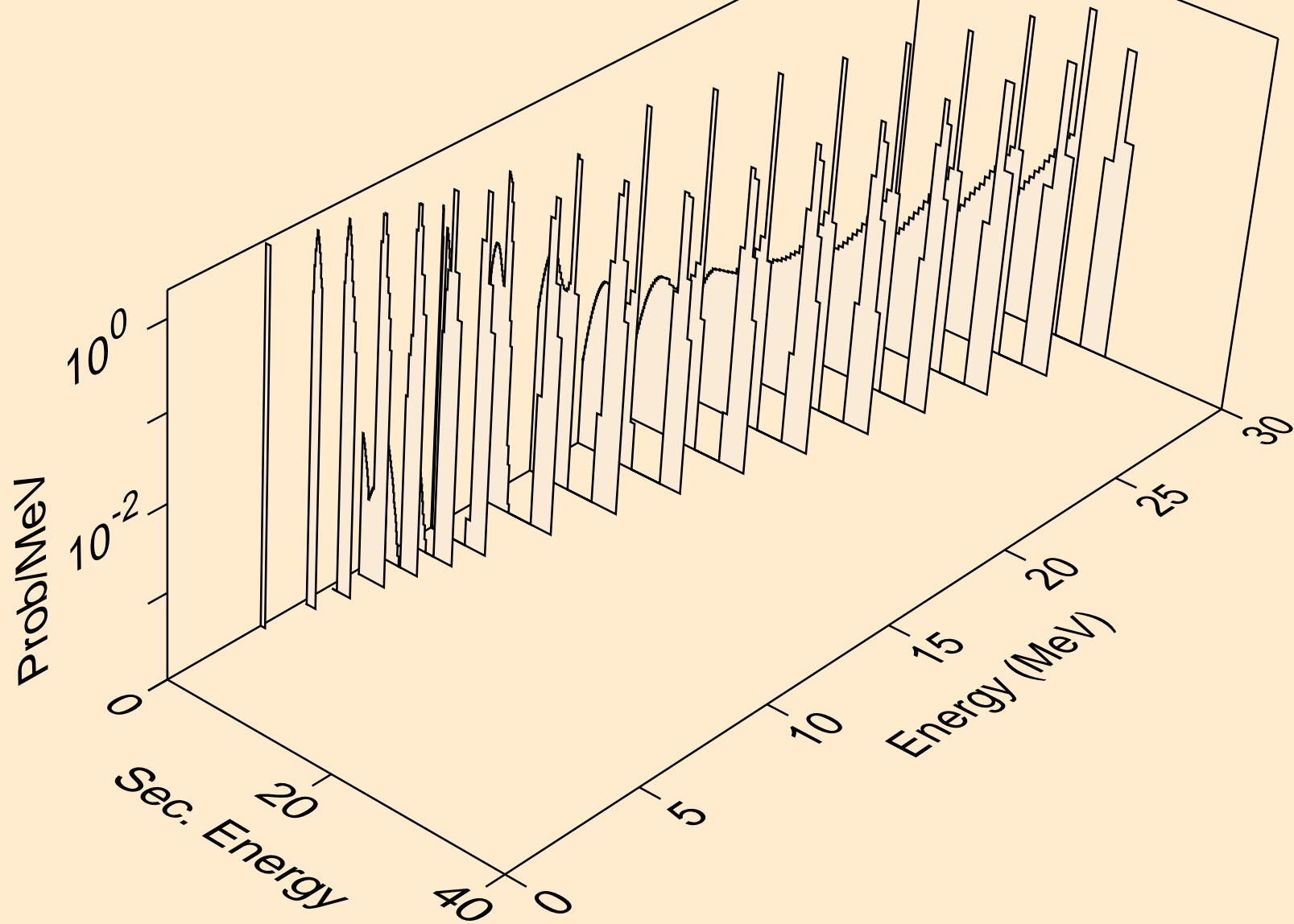



HO150 HELION ACER TENDL-2021 LIBRARY; T=0.K  
neutrons from (s,x)

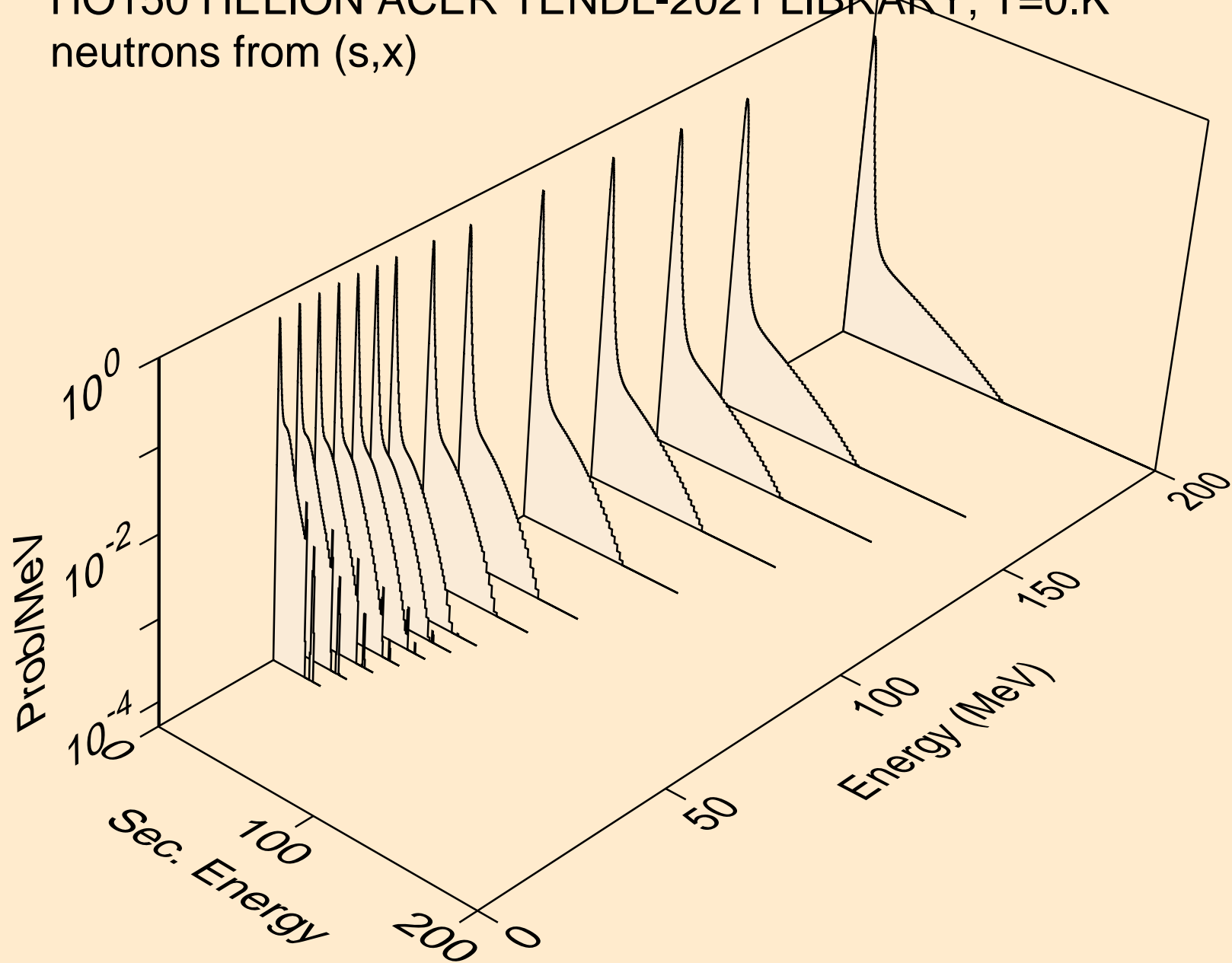

HO150 HELION ACER TENDL-2021 LIBRARY; T=0.K  
neutrons from (s,2nd)

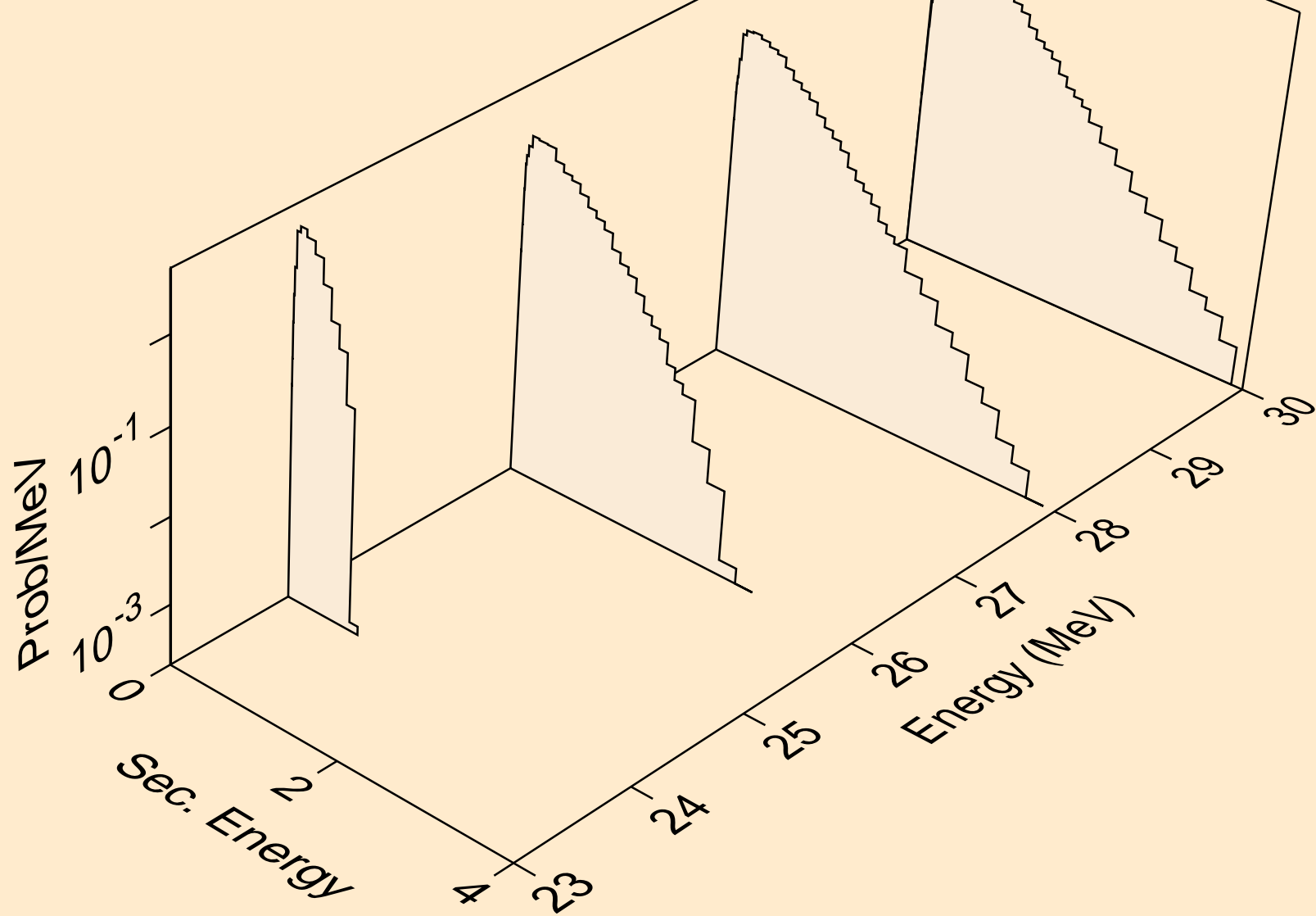

HO150 HELION ACER TENDL-2021 LIBRARY; T=0.K  
neutrons from (s,2n)

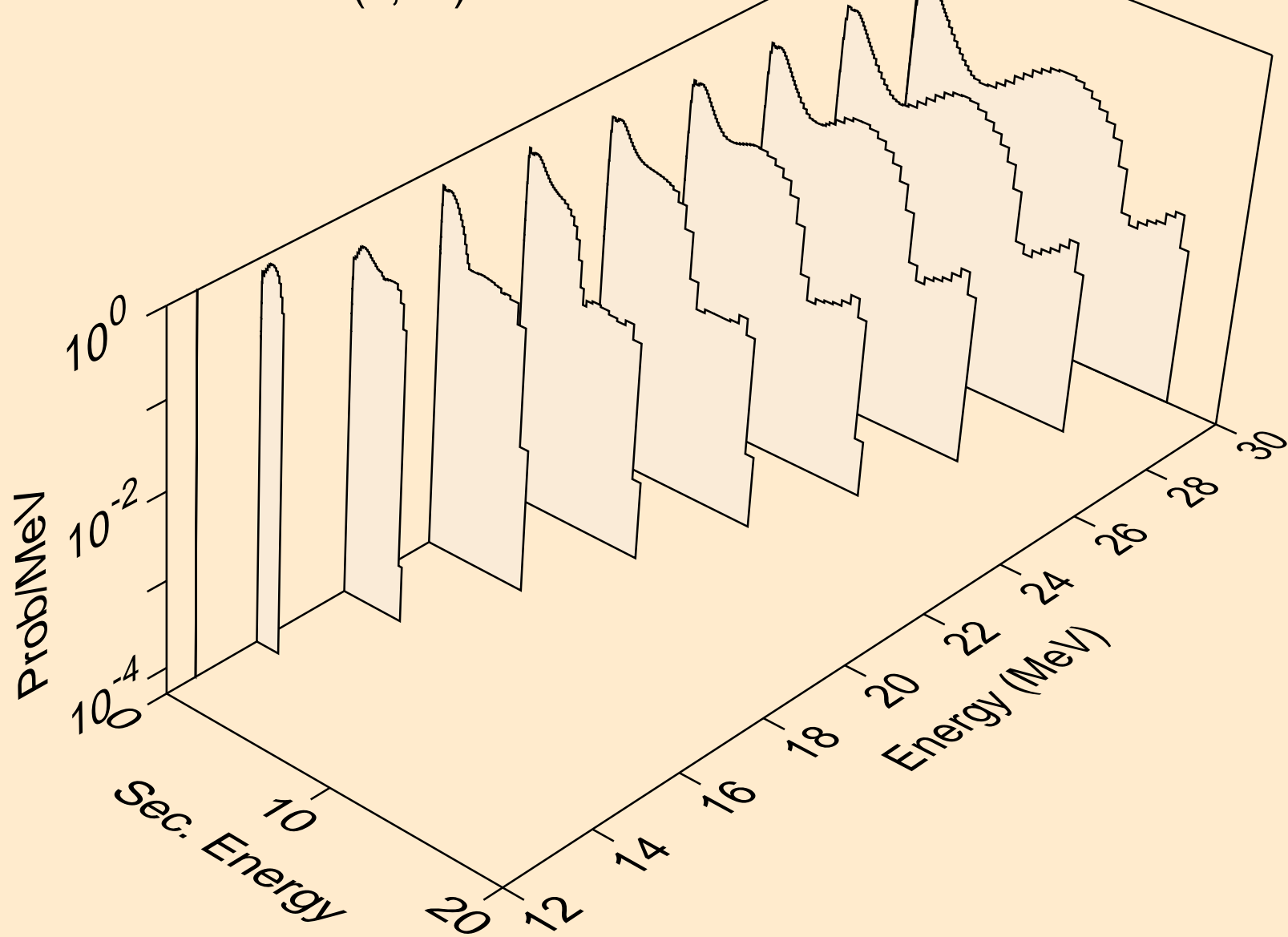

HO150 HELION ACER TENDL-2021 LIBRARY; T=0.K  
neutrons from (s,3n)

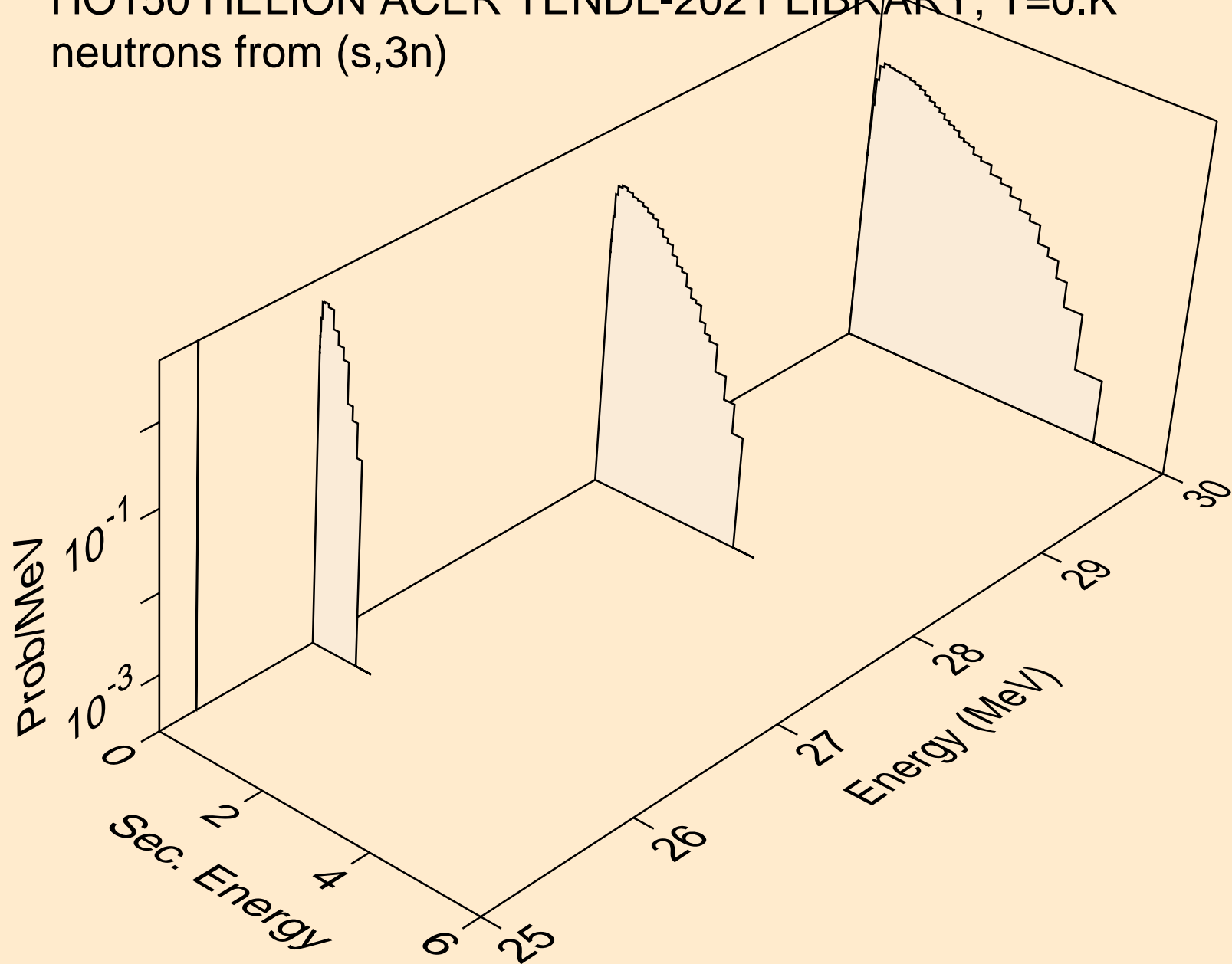

HO150 HELION ACER TENDL-2021 LIBRARY; T=0.K  
neutrons from (s,n\*)a

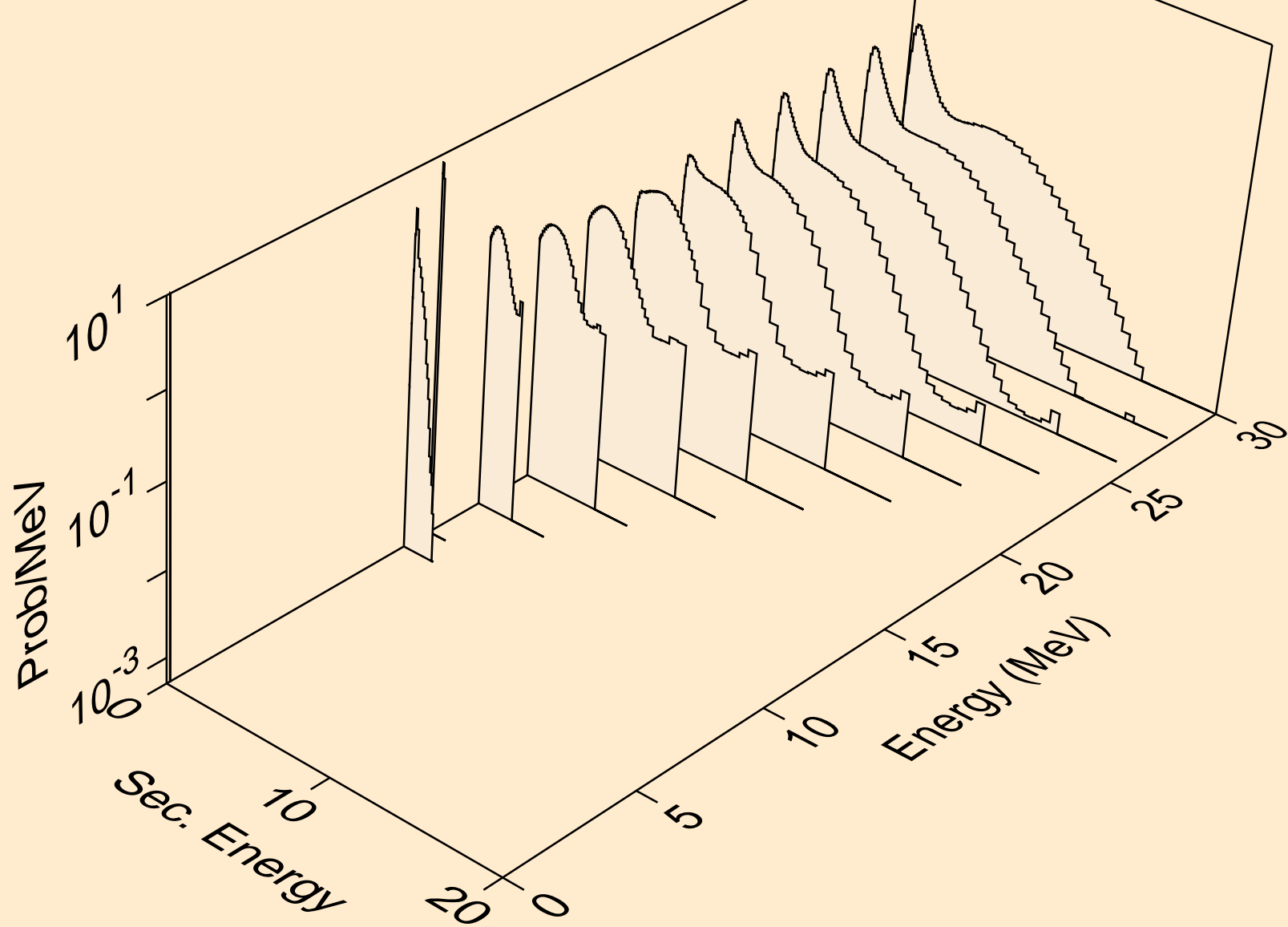

HO150 HELION ACER TENDL-2021 LIBRARY; T=0.K  
neutrons from (s,2n)a

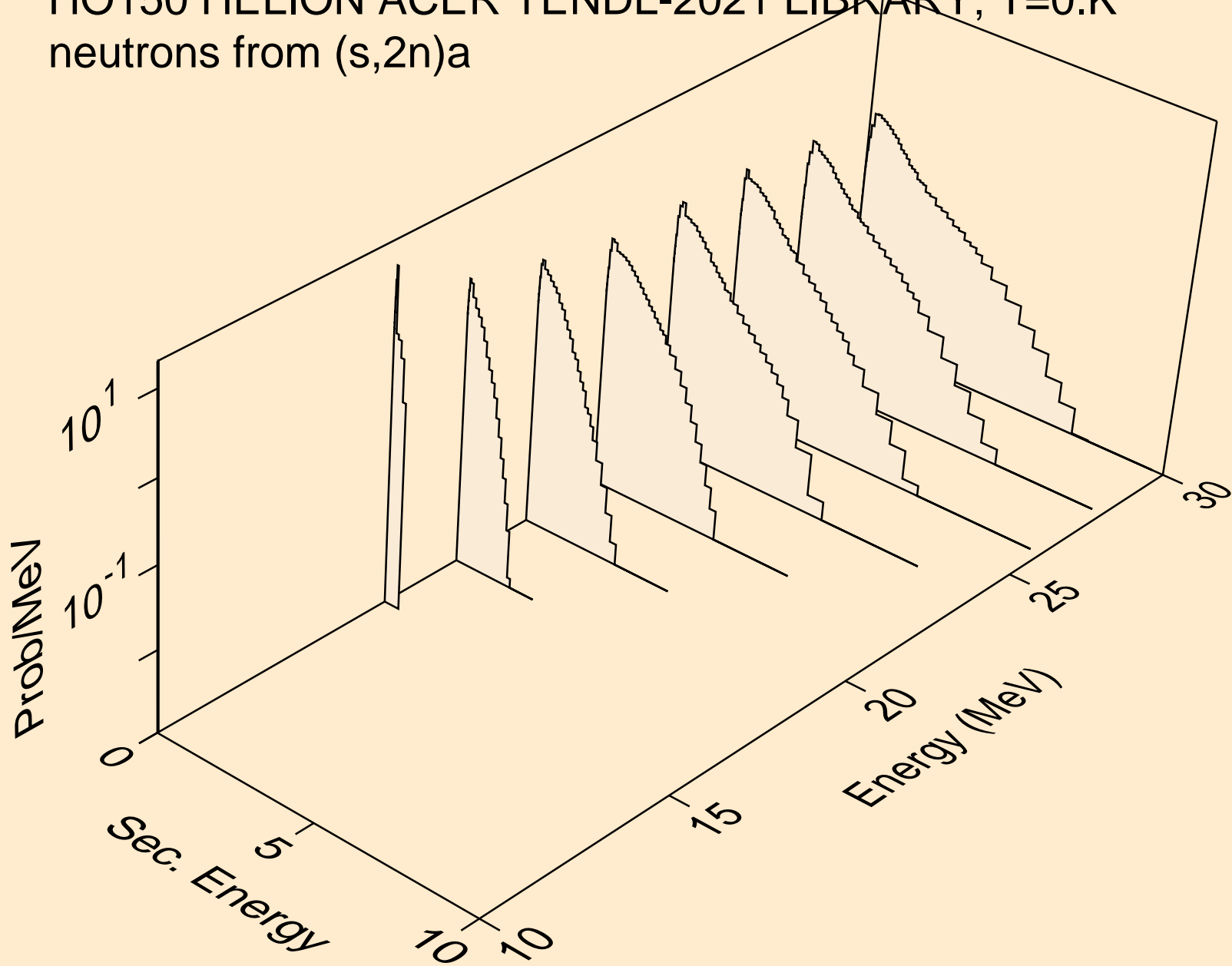

HO150 HELION ACER TENDL-2021 LIBRARY; T=0.K  
neutrons from (s,n\*)p

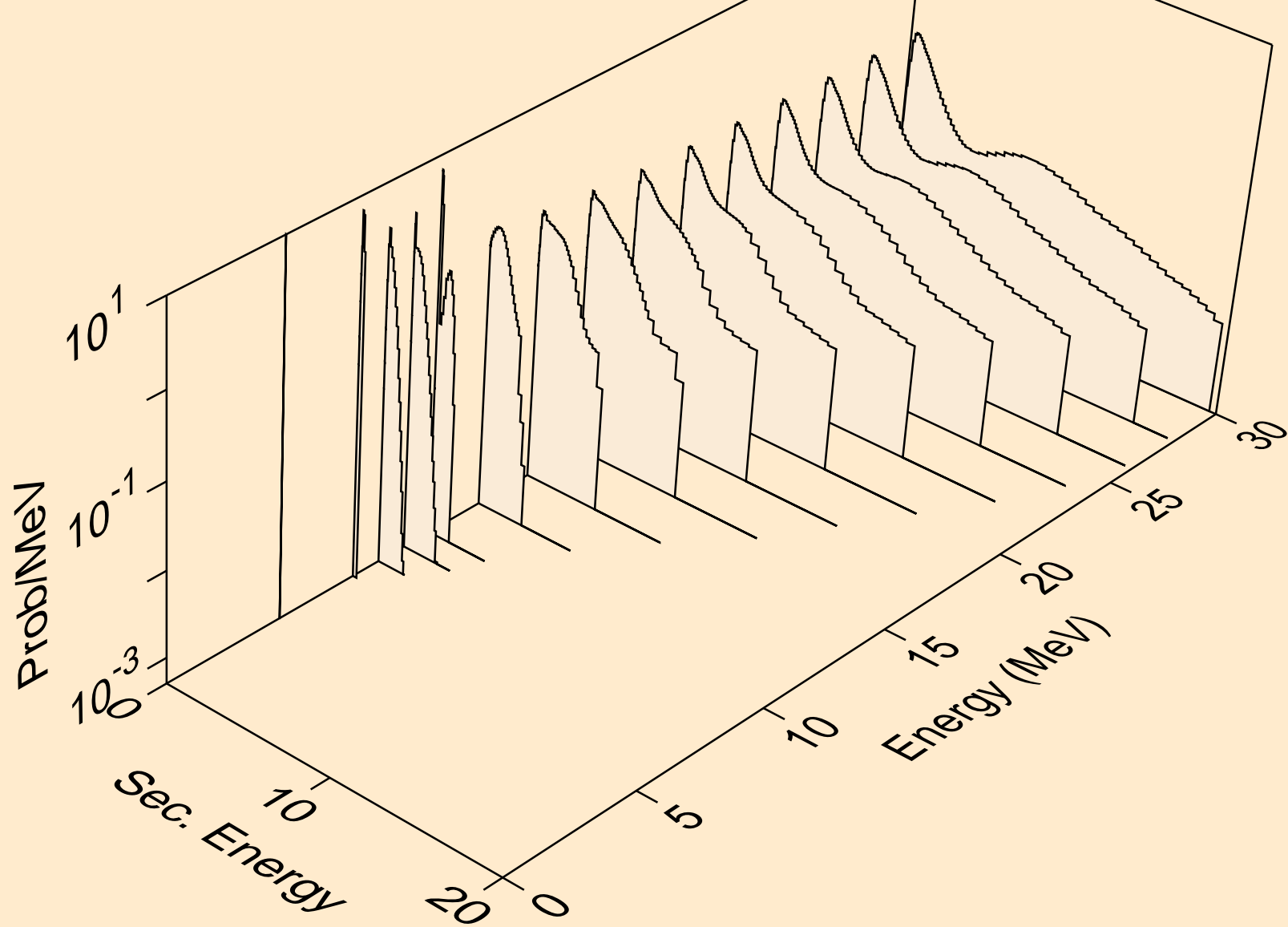

HO150 HELION ACER TENDL-2021 LIBRARY; T=0.K  
neutrons from (s,n\*)2a

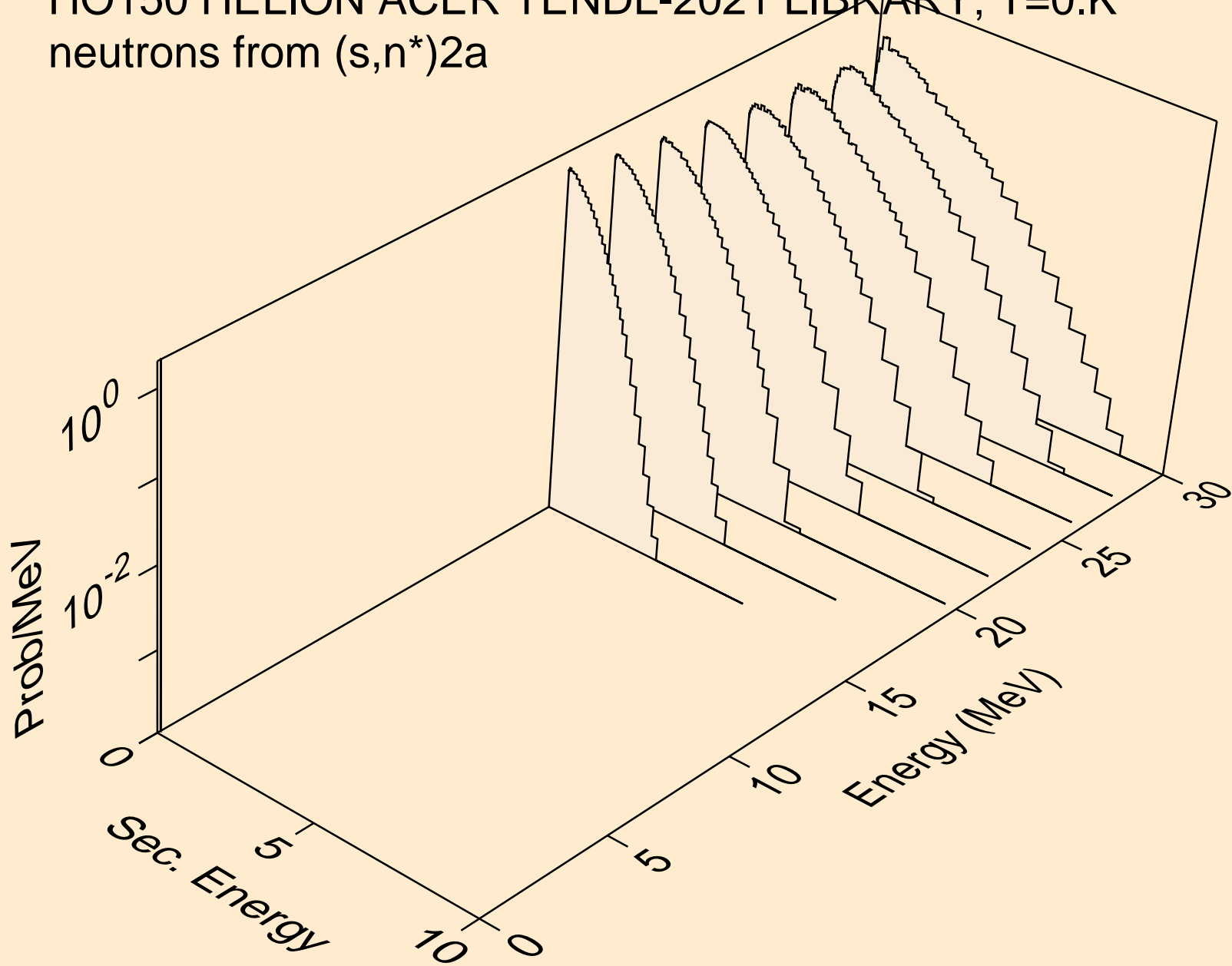



HO150 HELION ACER TENDL-2021 LIBRARY; T=0.K  
neutrons from (s,n\*)d

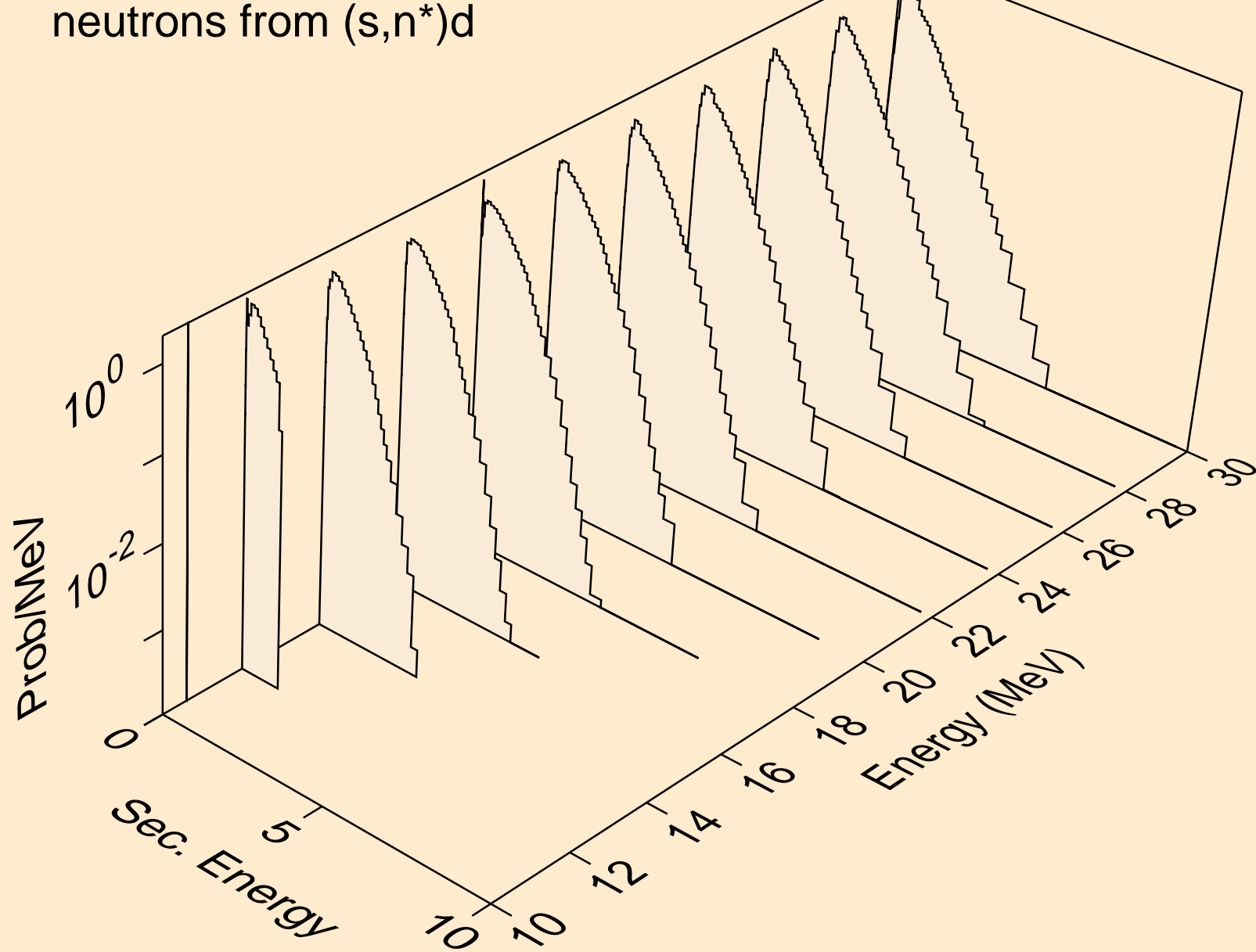

HO150 HELION ACER TENDL-2021 LIBRARY; T=0.K  
neutrons from (s,n\*)t

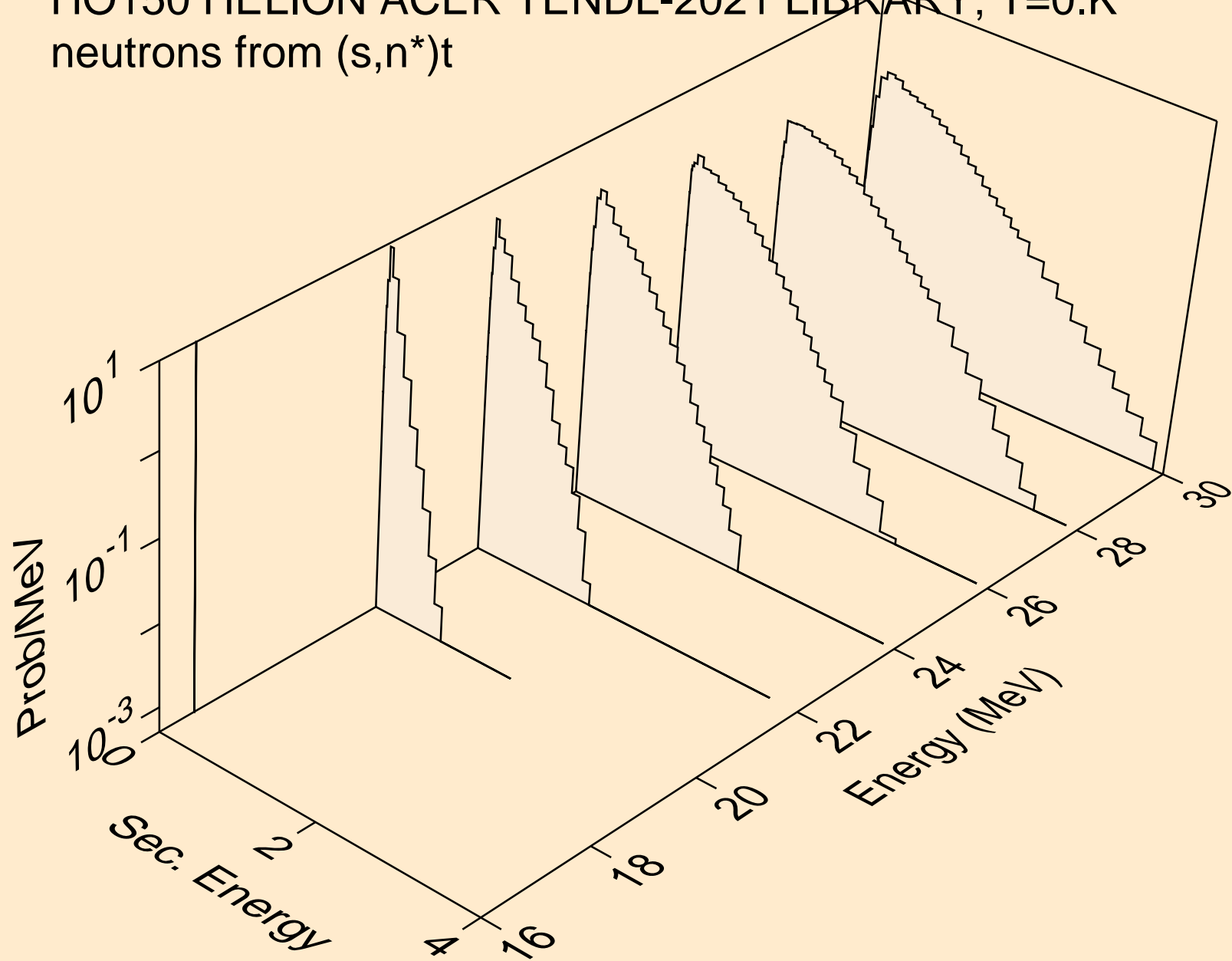

HO150 HELION ACER TENDL-2021 LIBRARY; T=0.K  
neutrons from (s,n\*)he3

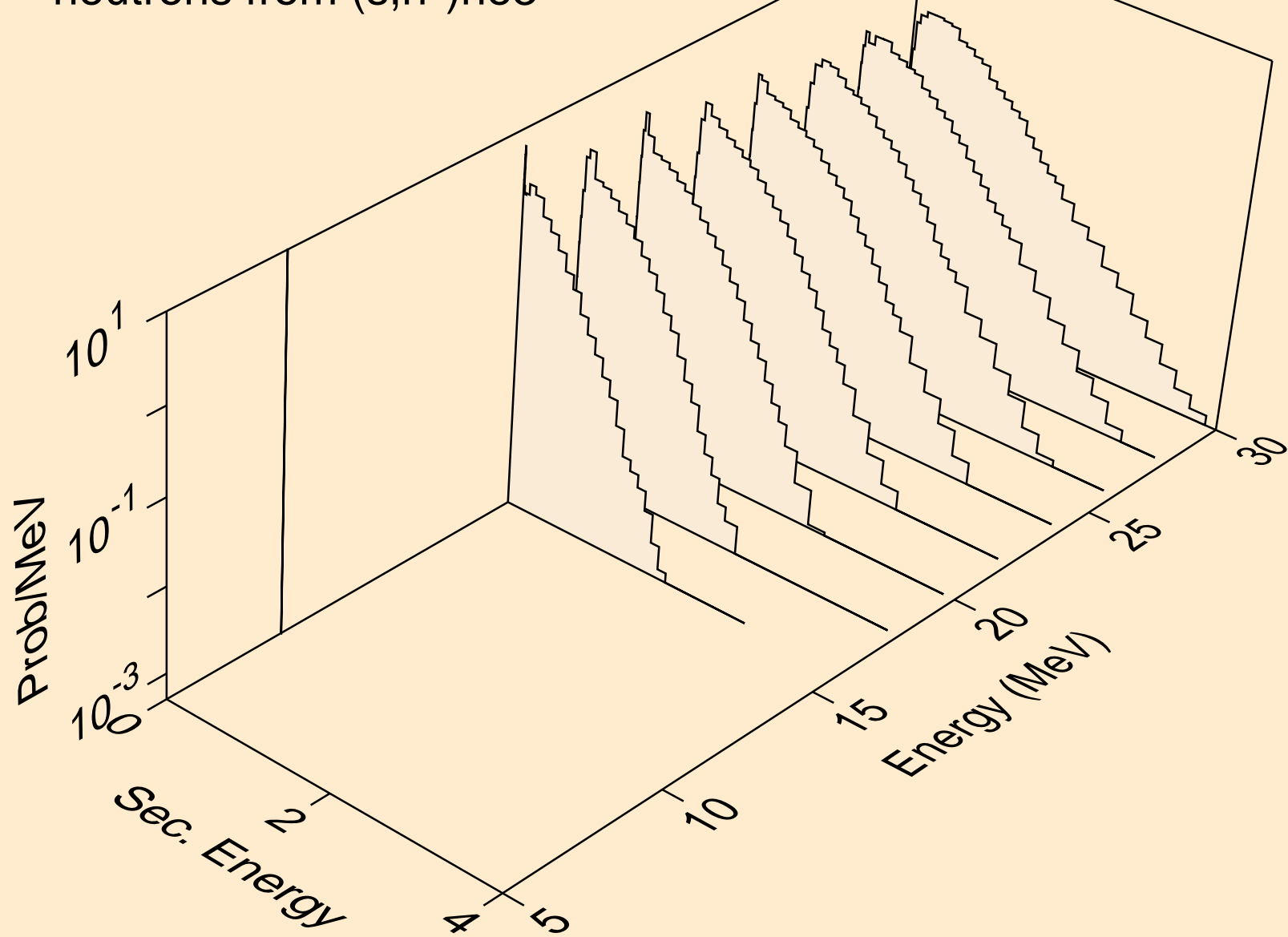

HO150 HELION ACER TENDL-2021 LIBRARY; T=0.K  
neutrons from (s,2np)

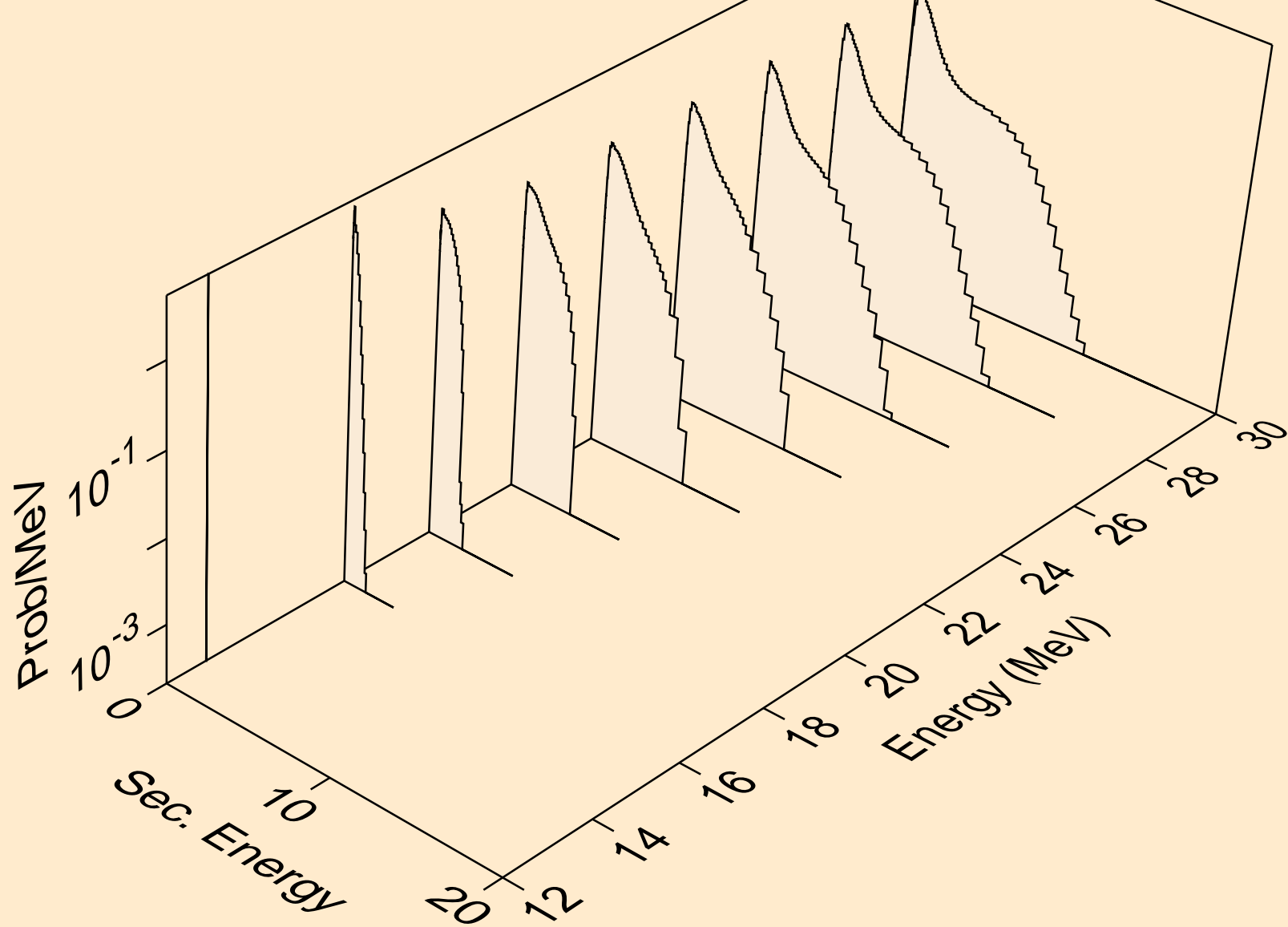

HO150 HELION ACER TENDL-2021 LIBRARY; T=0.K  
neutrons from (s,3np)

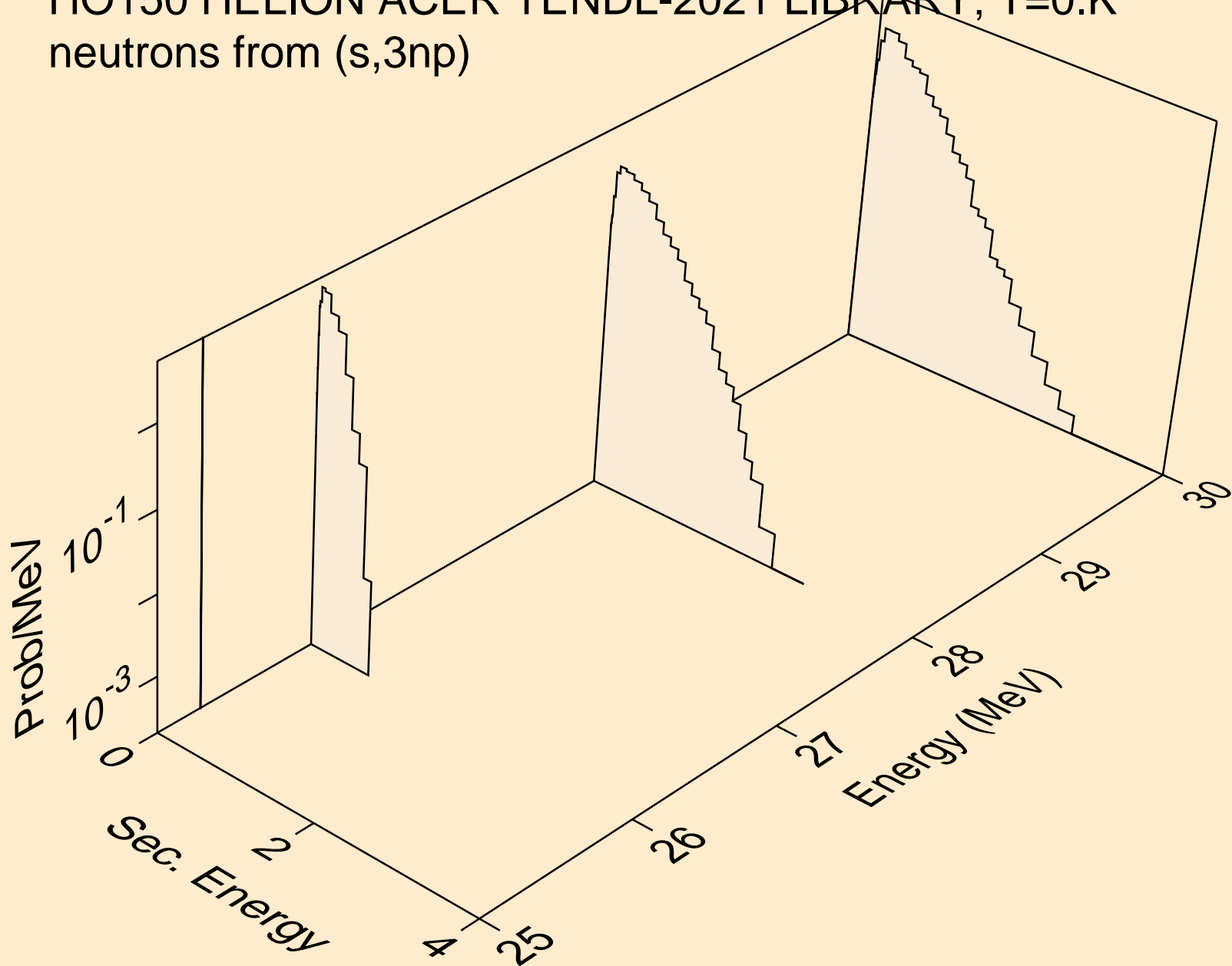

HO150 HELION ACER TENDL-2021 LIBRARY; T=0.K  
neutrons from (s,2np)

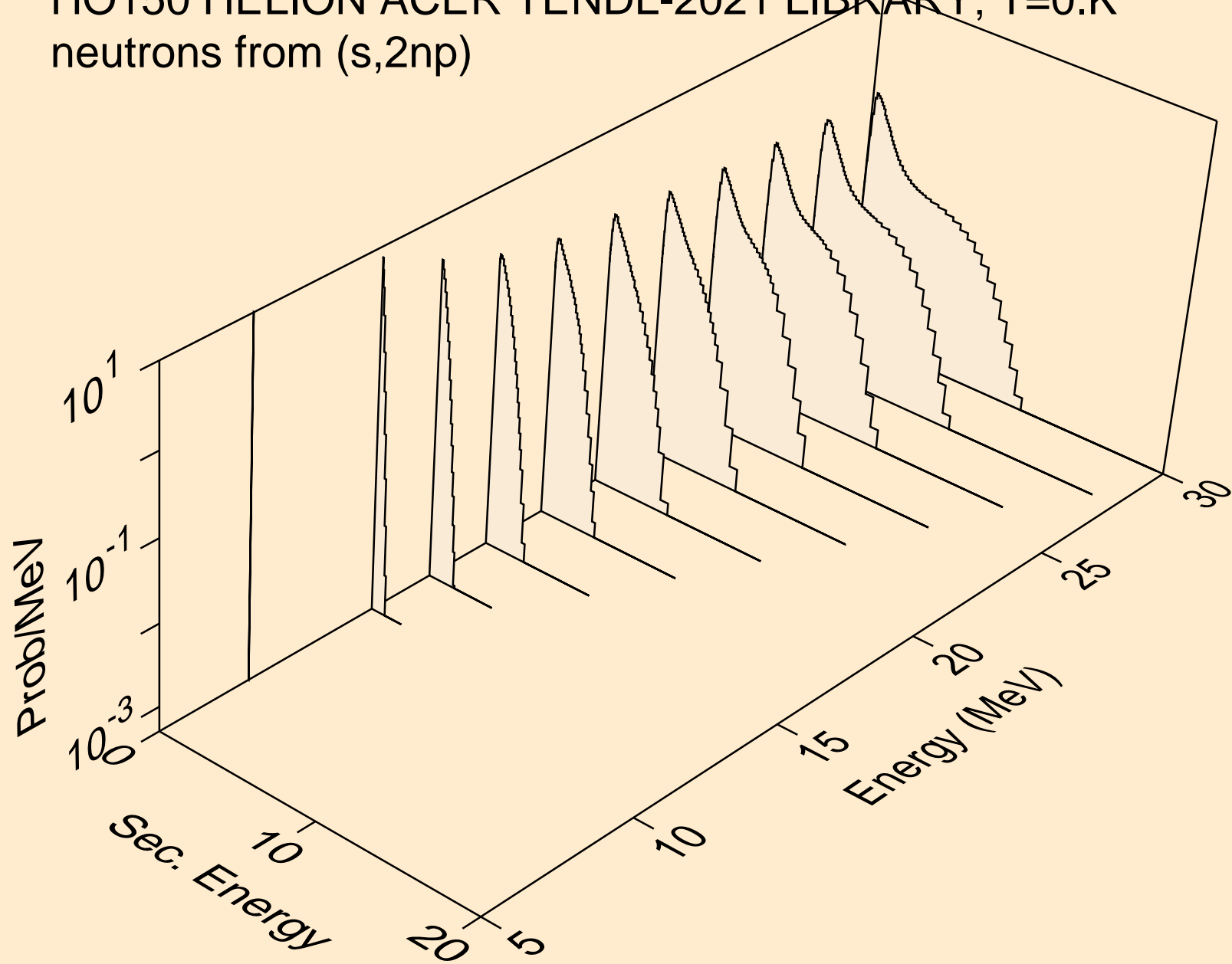

HO150 HELION ACER TENDL-2021 LIBRARY; T=0.K  
neutrons from (s,npa)

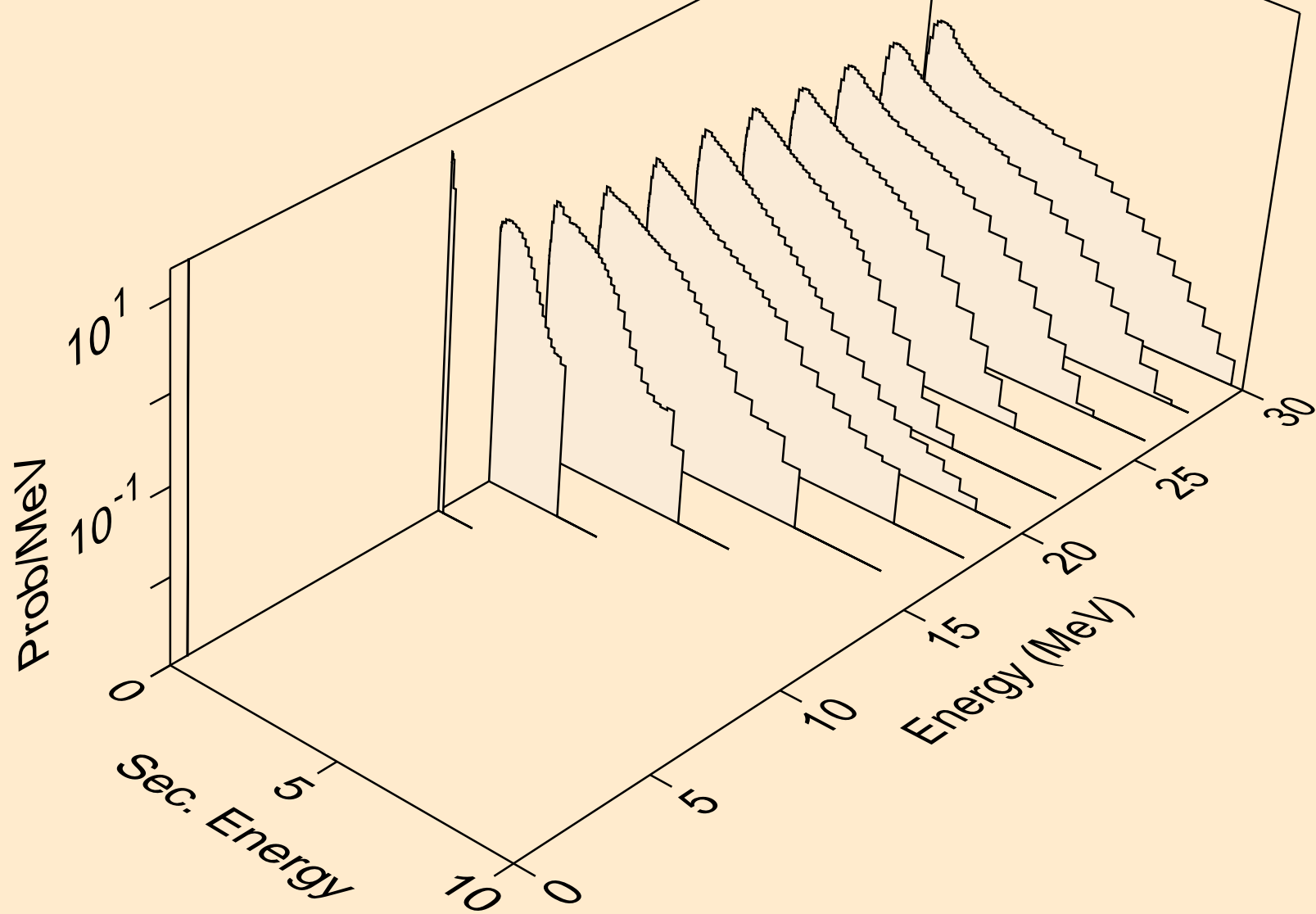

HO150 HELION ACER TENDL-2021 LIBRARY; T=0.K  
protons from (s,x)

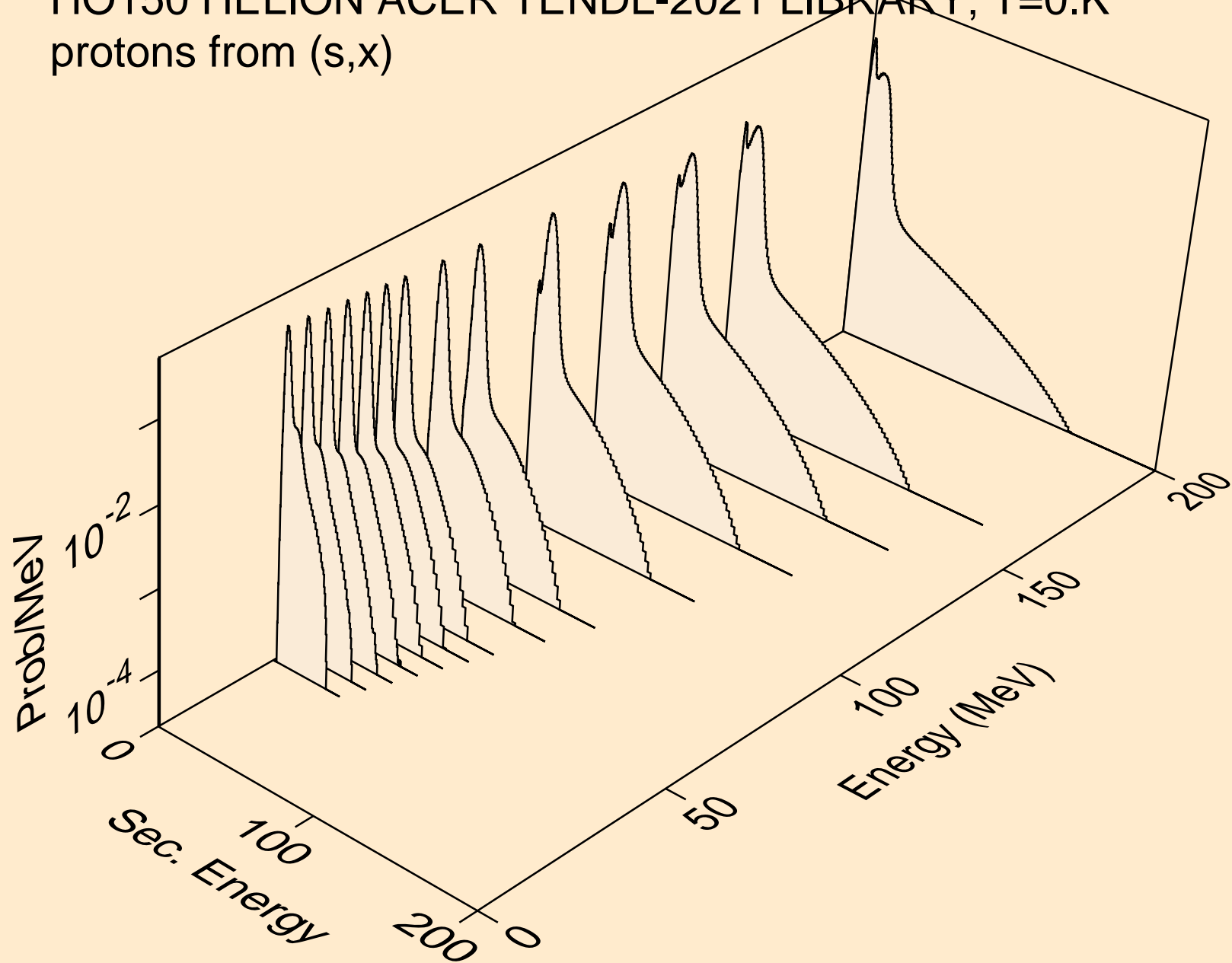



HO150 HELION ACER TENDL-2021 LIBRARY; T=0.K  
protons from (s,n\*)p

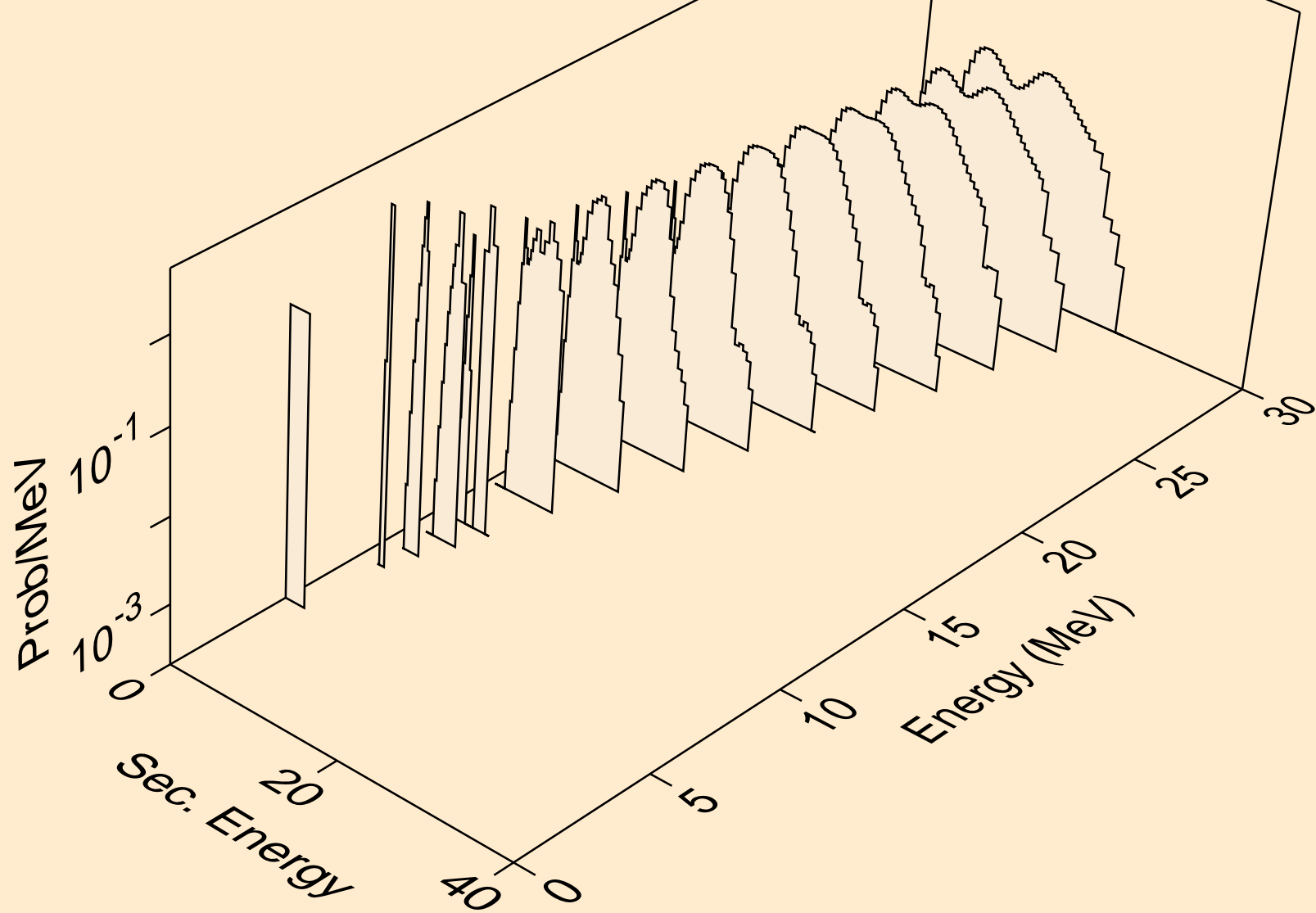

HO150 HELION ACER TENDL-2021 LIBRARY; T=0.K  
protons from (s,2np)

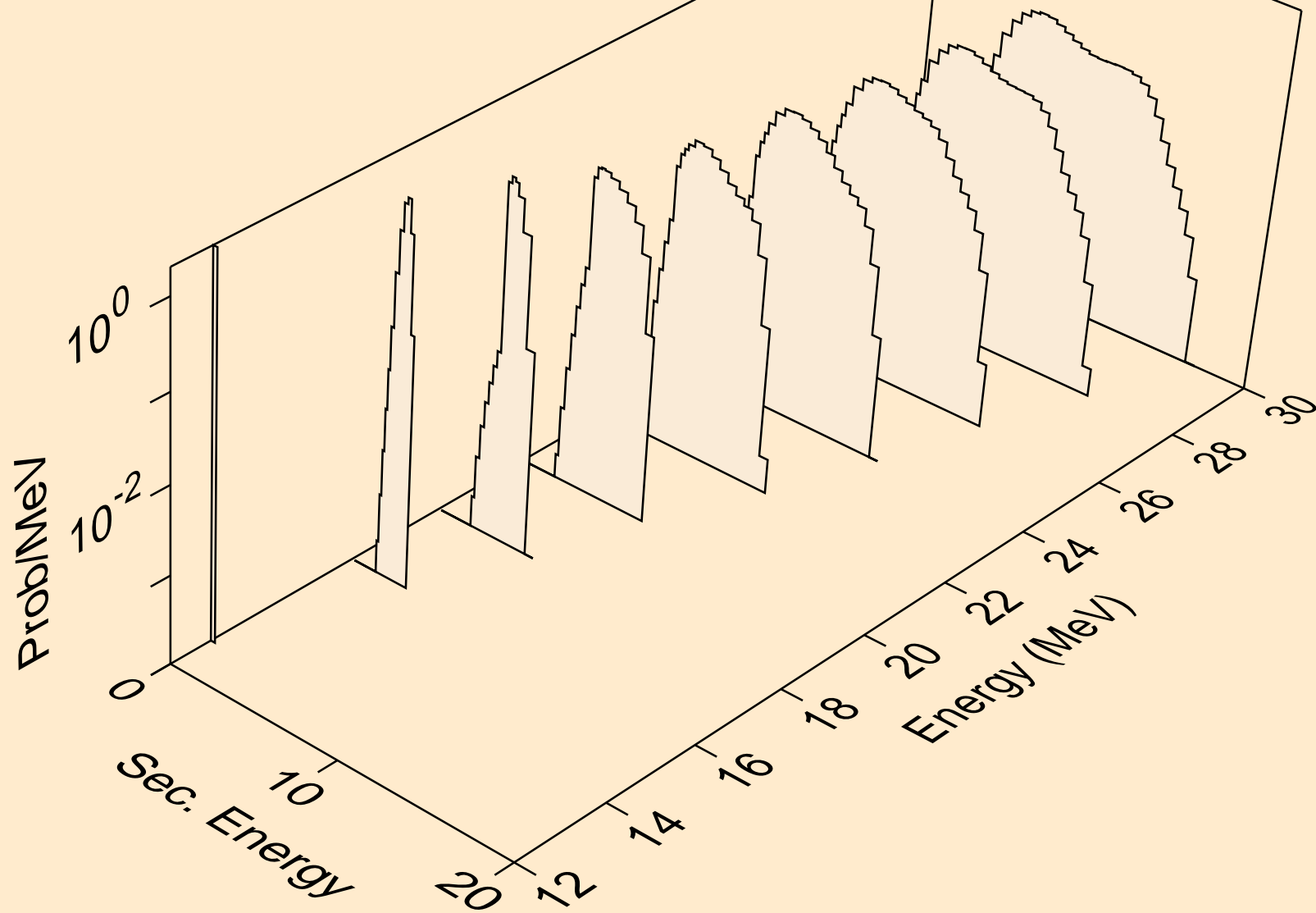

HO150 HELION ACER TENDL-2021 LIBRARY; T=0.K  
protons from (s,3np)

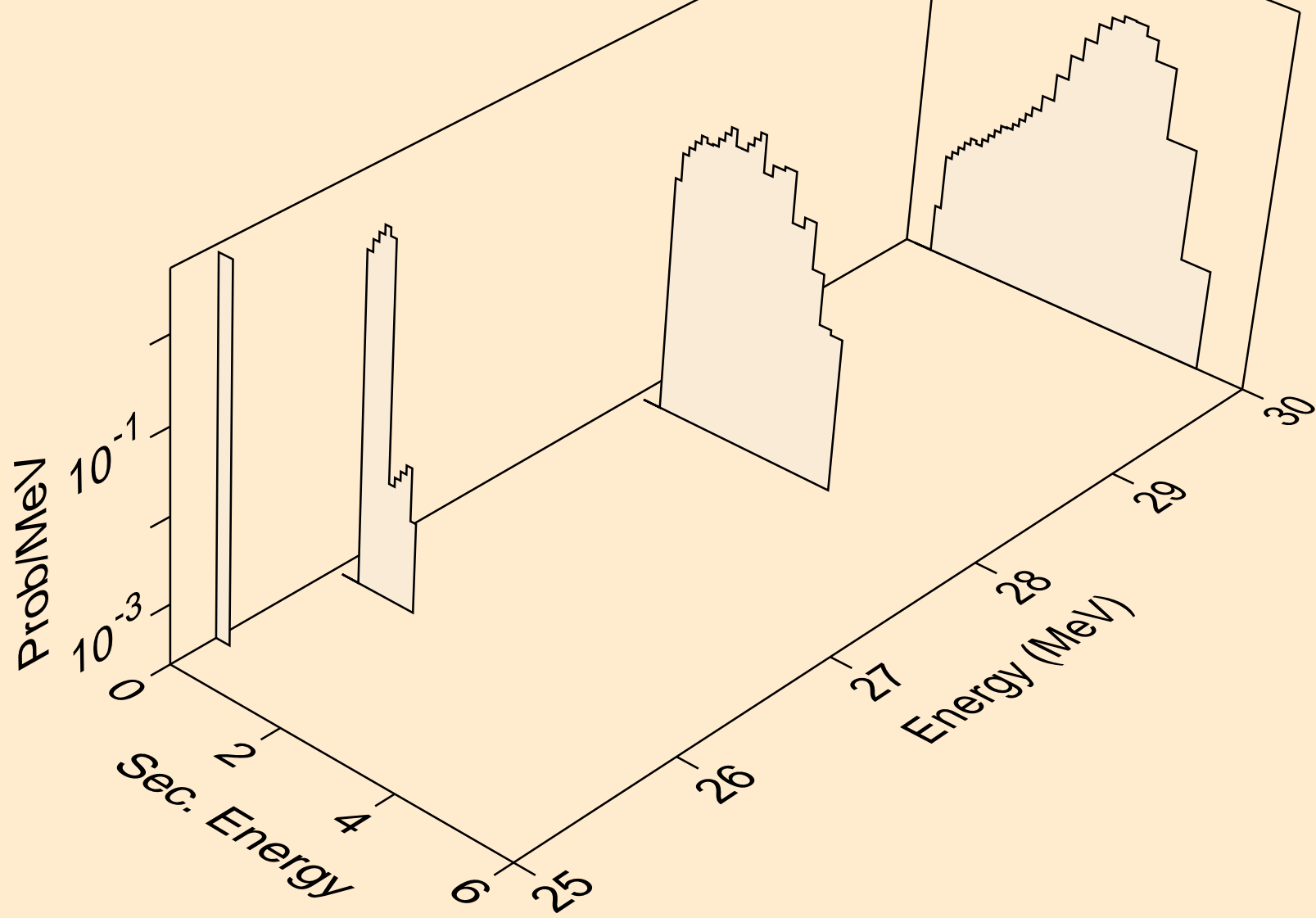

HO150 HELION ACER TENDL-2021 LIBRARY; T=0.K  
protons from (s,2np)

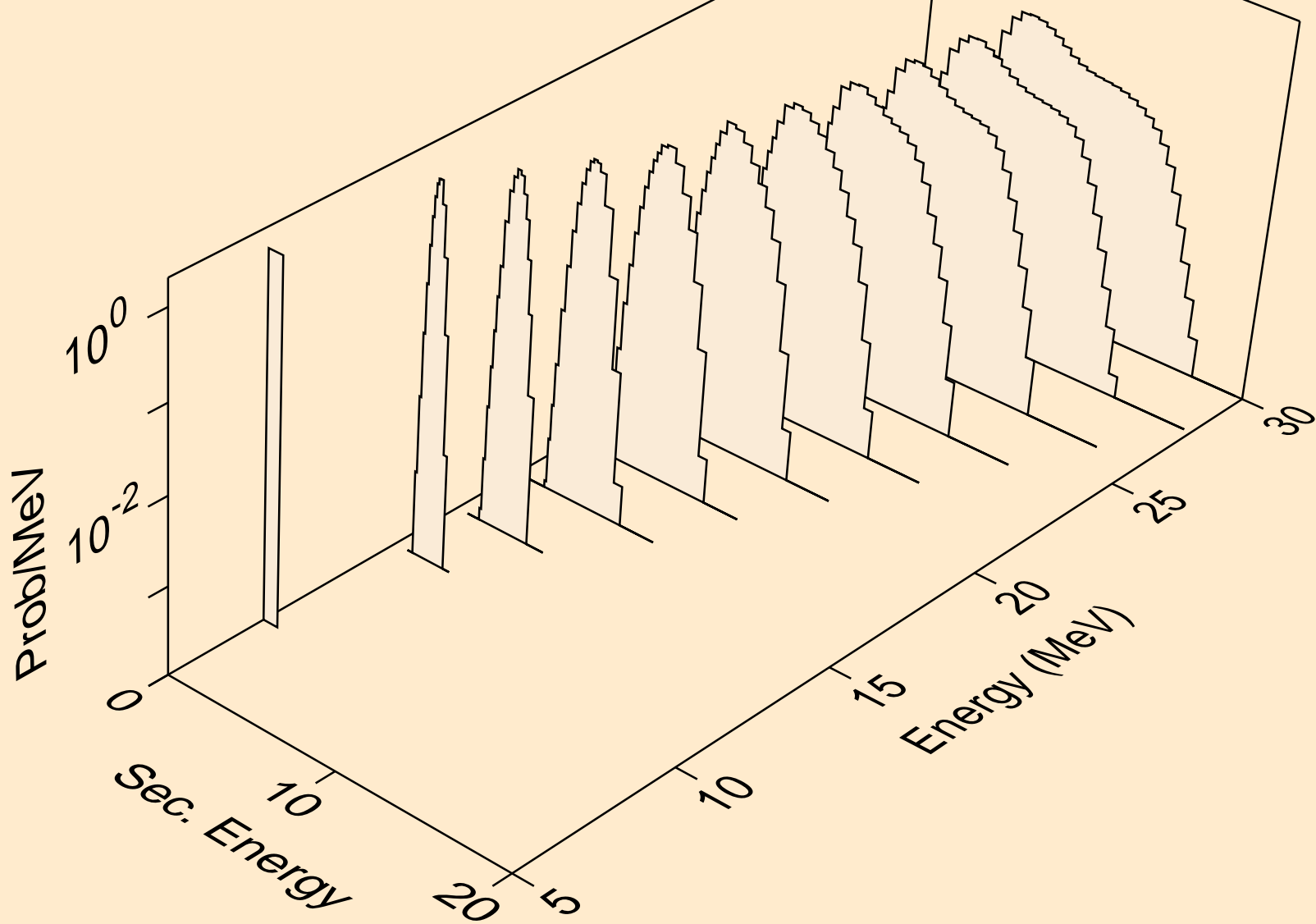

HO150 HELION ACER TENDL-2021 LIBRARY; T=0.K  
protons from (s,npa)

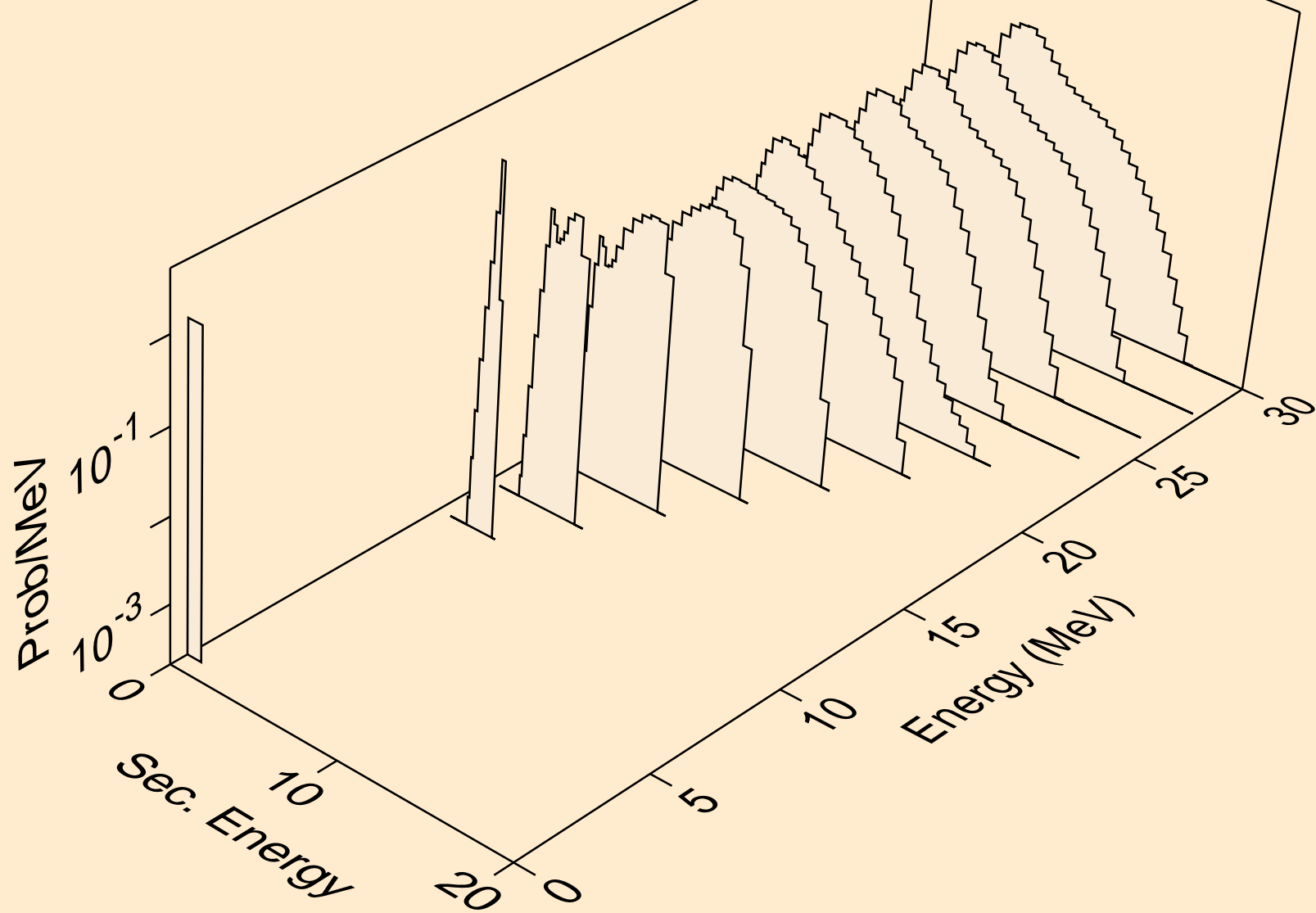

HO150 HELION ACER TENDL-2021 LIBRARY; T=0.K  
protons from (s,p)

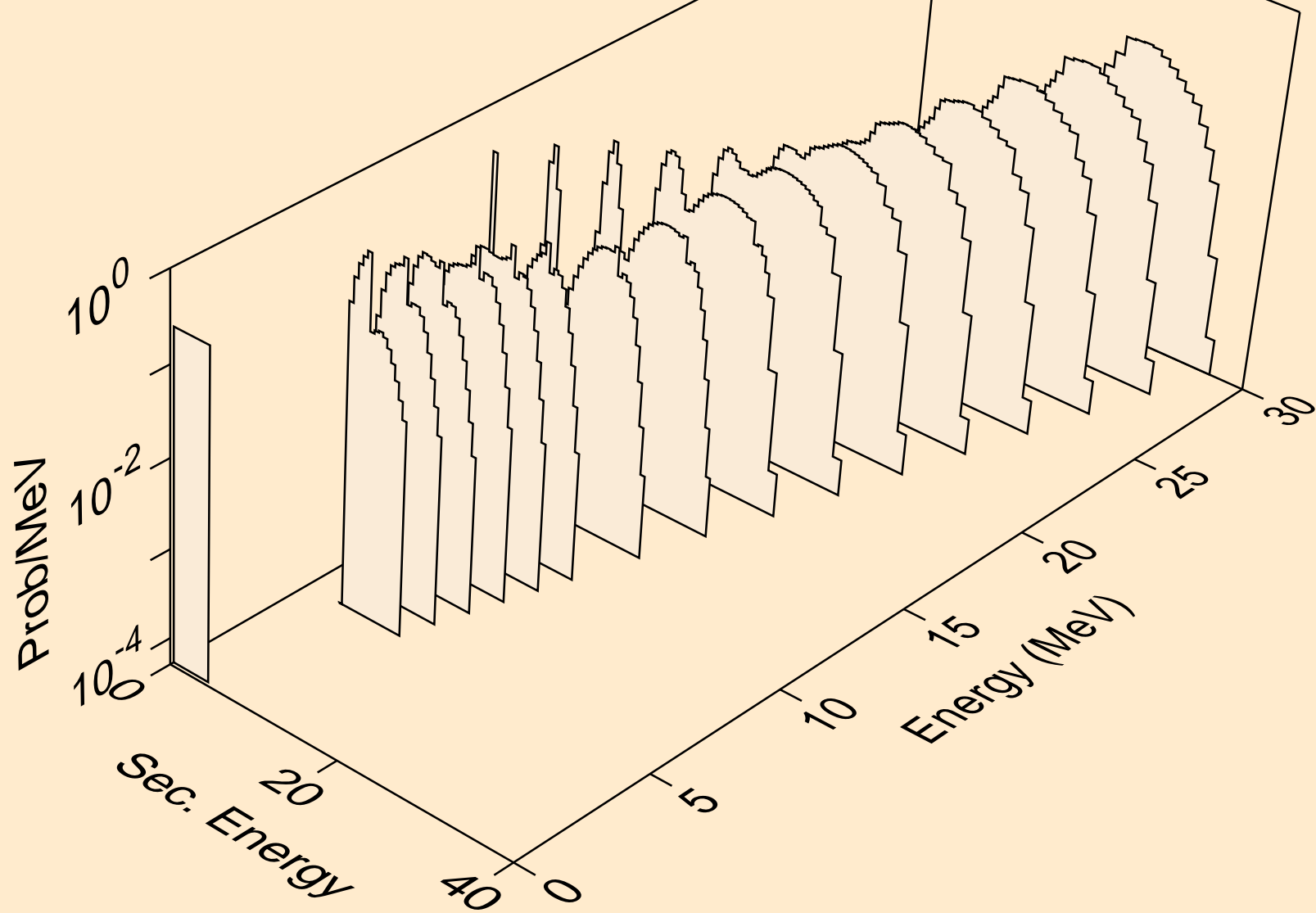

HO150 HELION ACER TENDL-2021 LIBRARY; T=0.K  
protons from (s,2p)

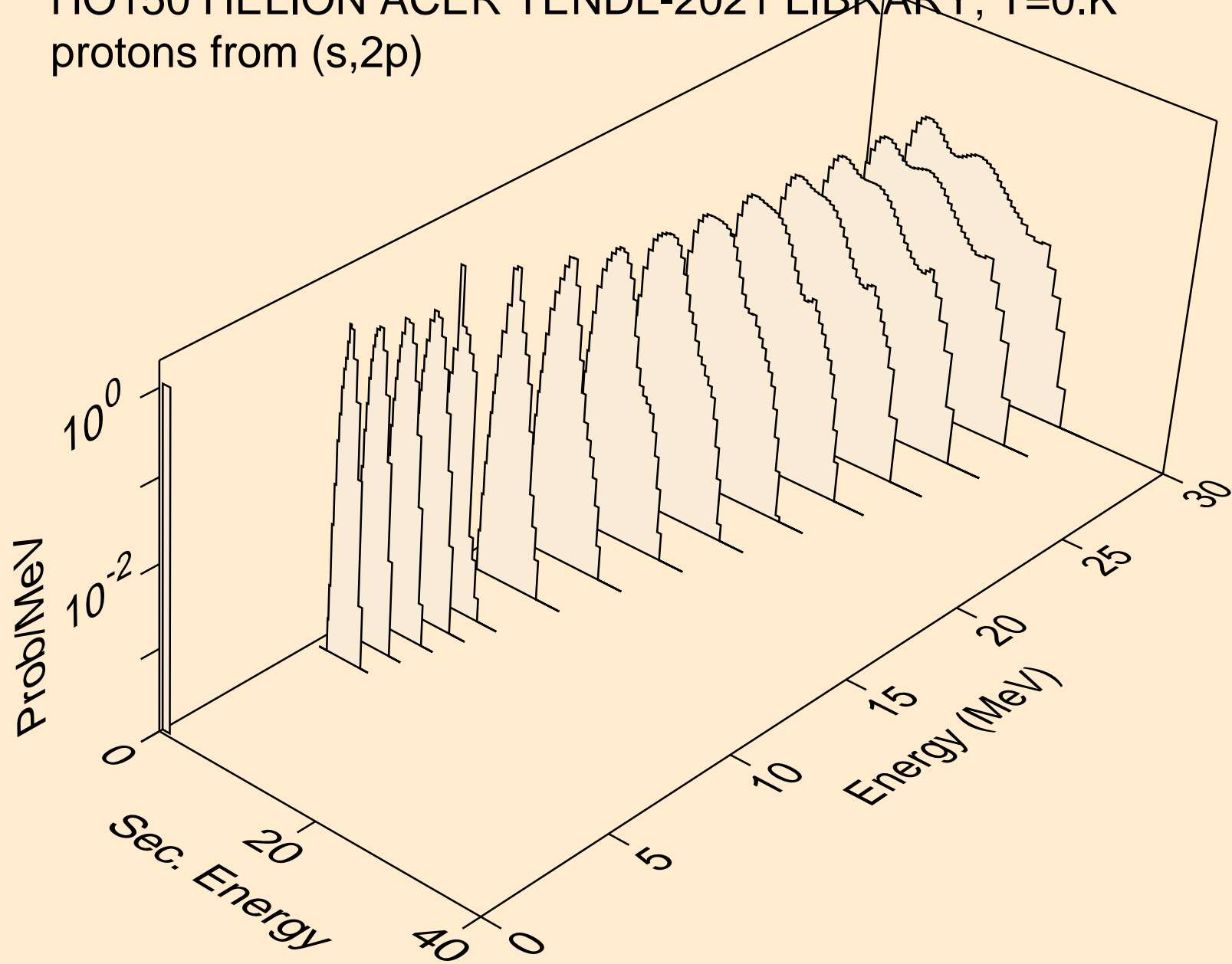

HO150 HELION ACER TENDL-2021 LIBRARY; T=0.K  
protons from (s,pa)

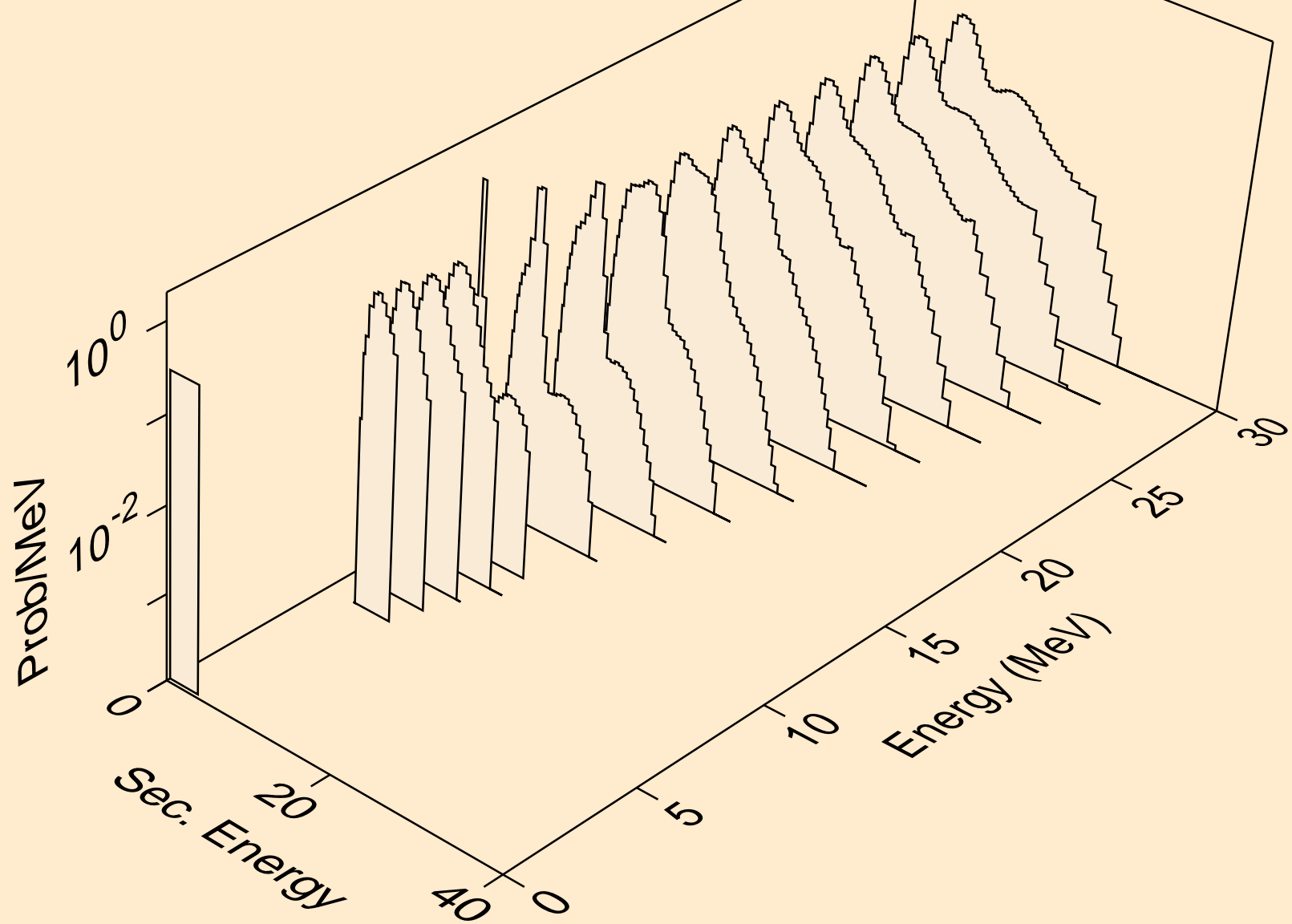



HO150 HELION ACER TENDL-2021 LIBRARY; T=0.K  
protons from (s,pd)

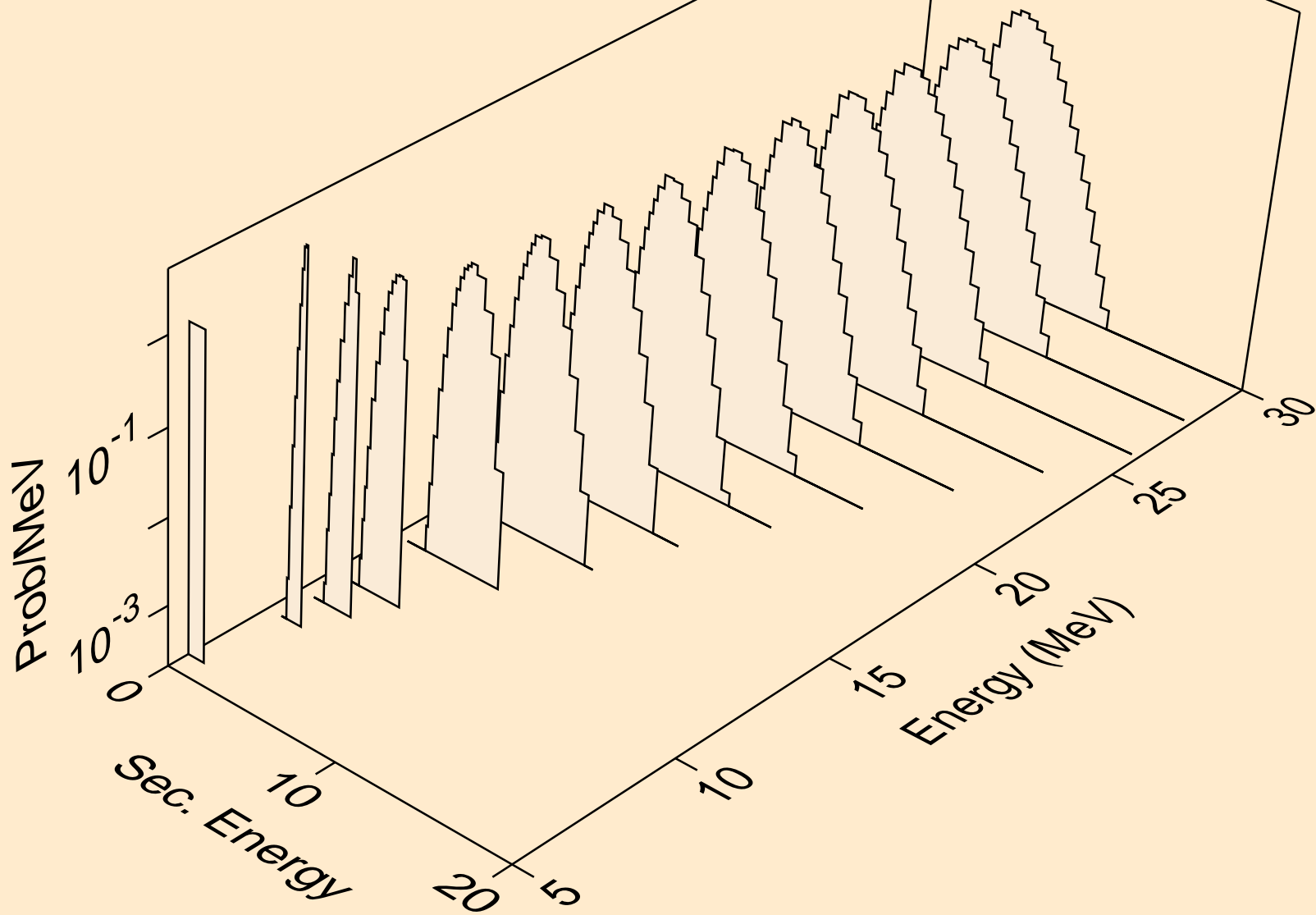

HO150 HELION ACER TENDL-2021 LIBRARY; T=0.K  
protons from (s,pt)

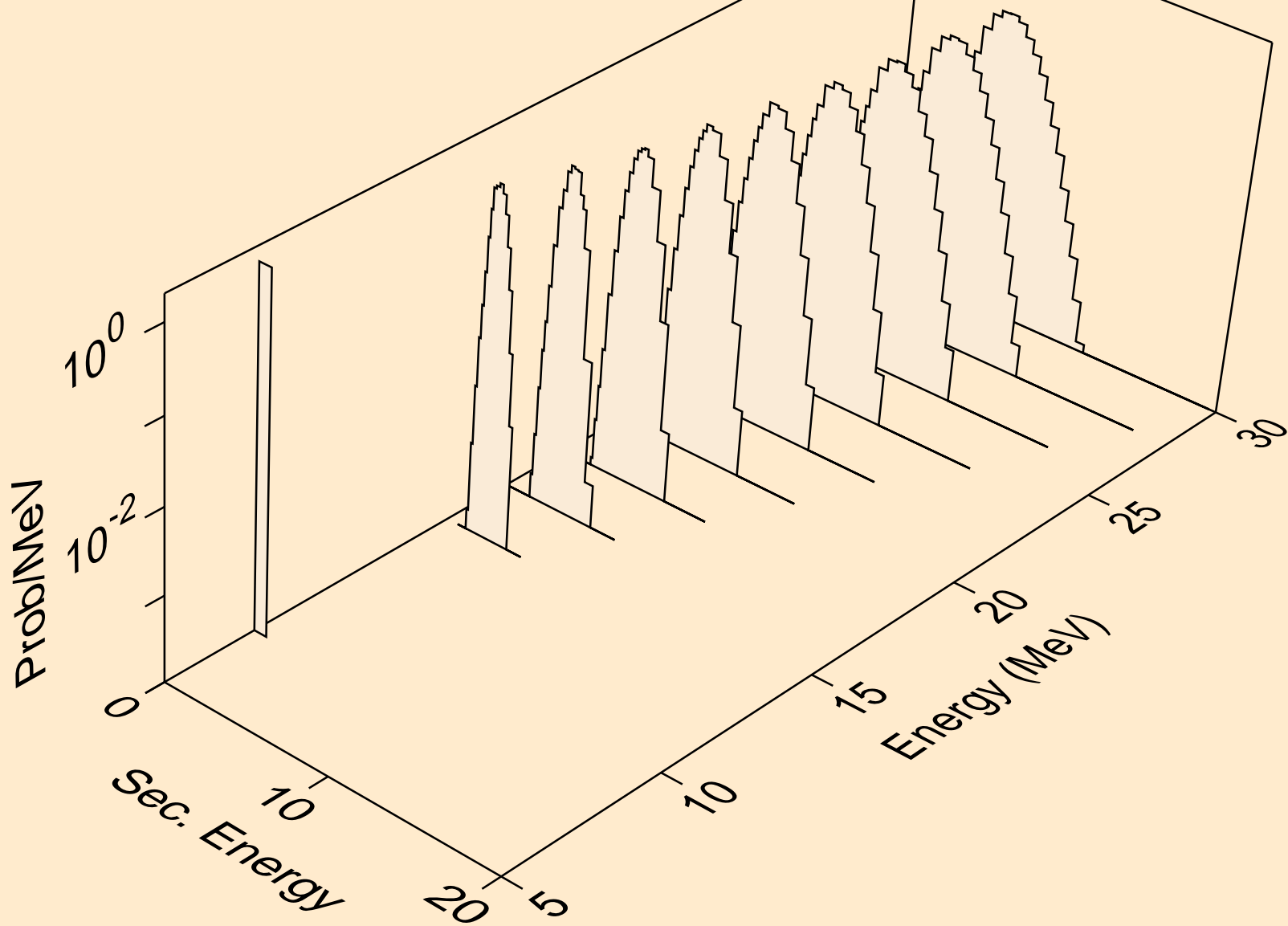

HO150 HELION ACER TENDL-2021 LIBRARY; T=0.K  
deuterons from (s,x)

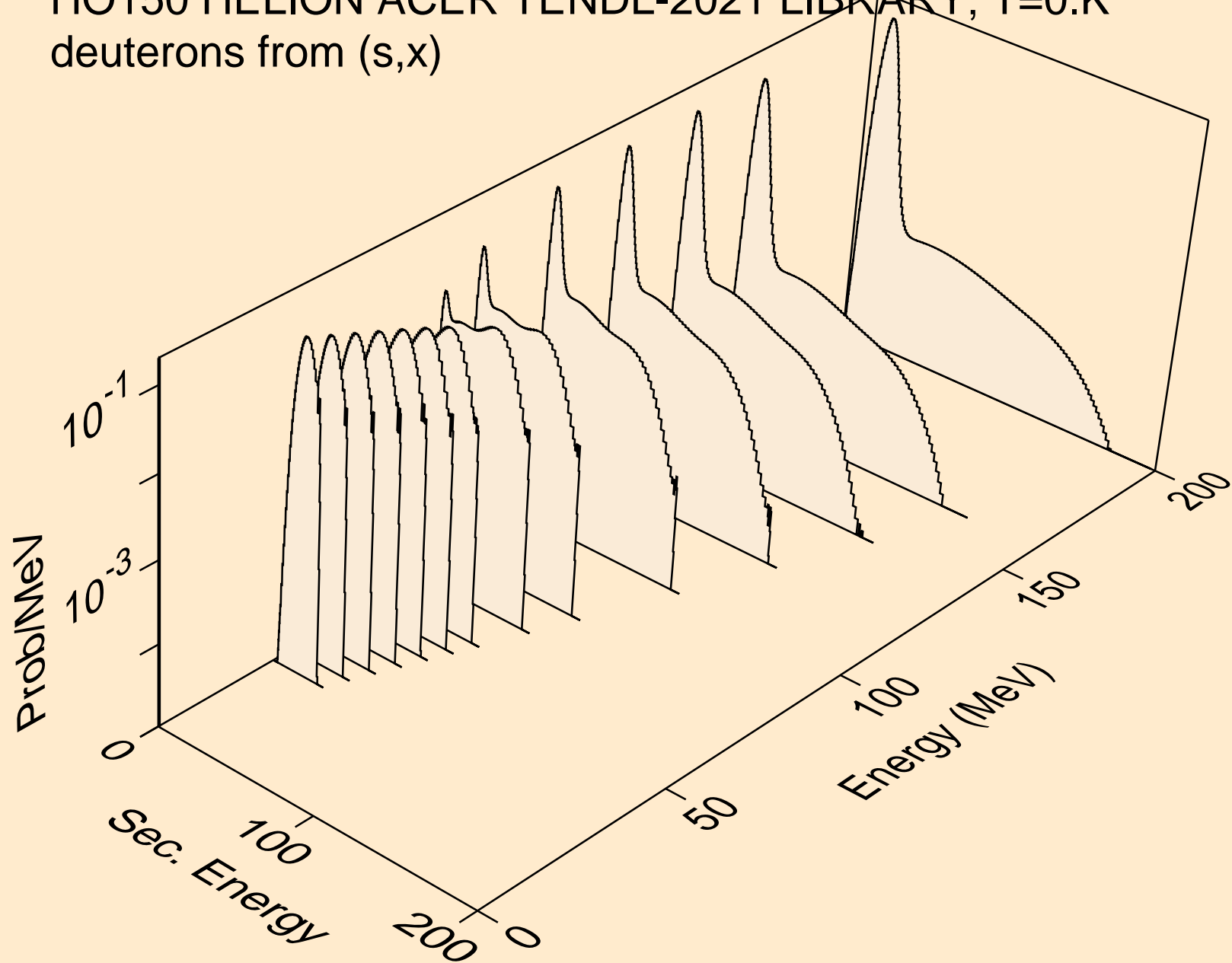

HO150 HELION ACER TENDL-2021 LIBRARY; T=0.K  
deuterons from (s,2nd)

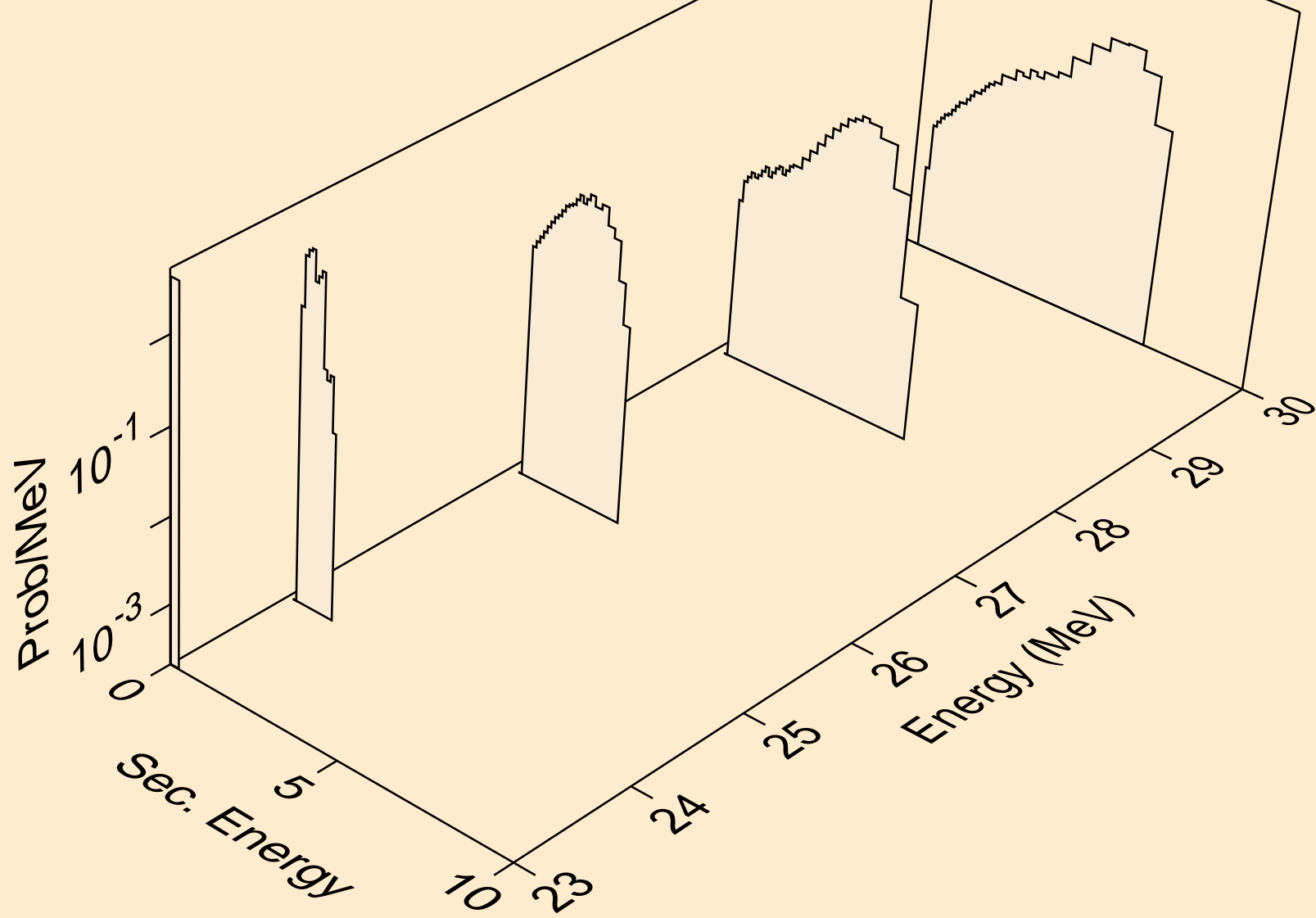

HO150 HELION ACER TENDL-2021 LIBRARY; T=0.K  
deuterons from (s,n\*)d

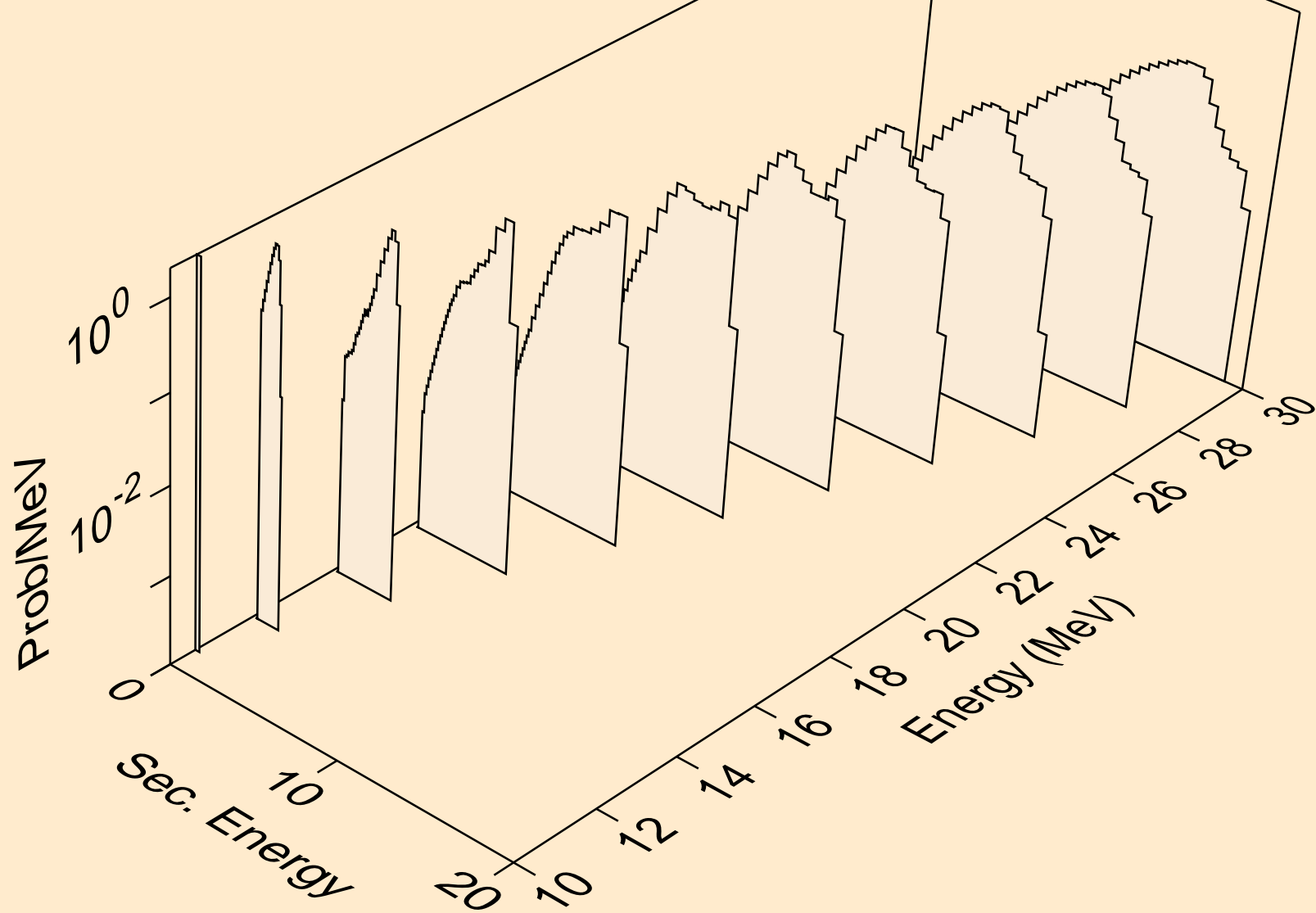

HO150 HELION ACER TENDL-2021 LIBRARY; T=0.K  
deuterons from (s,d)

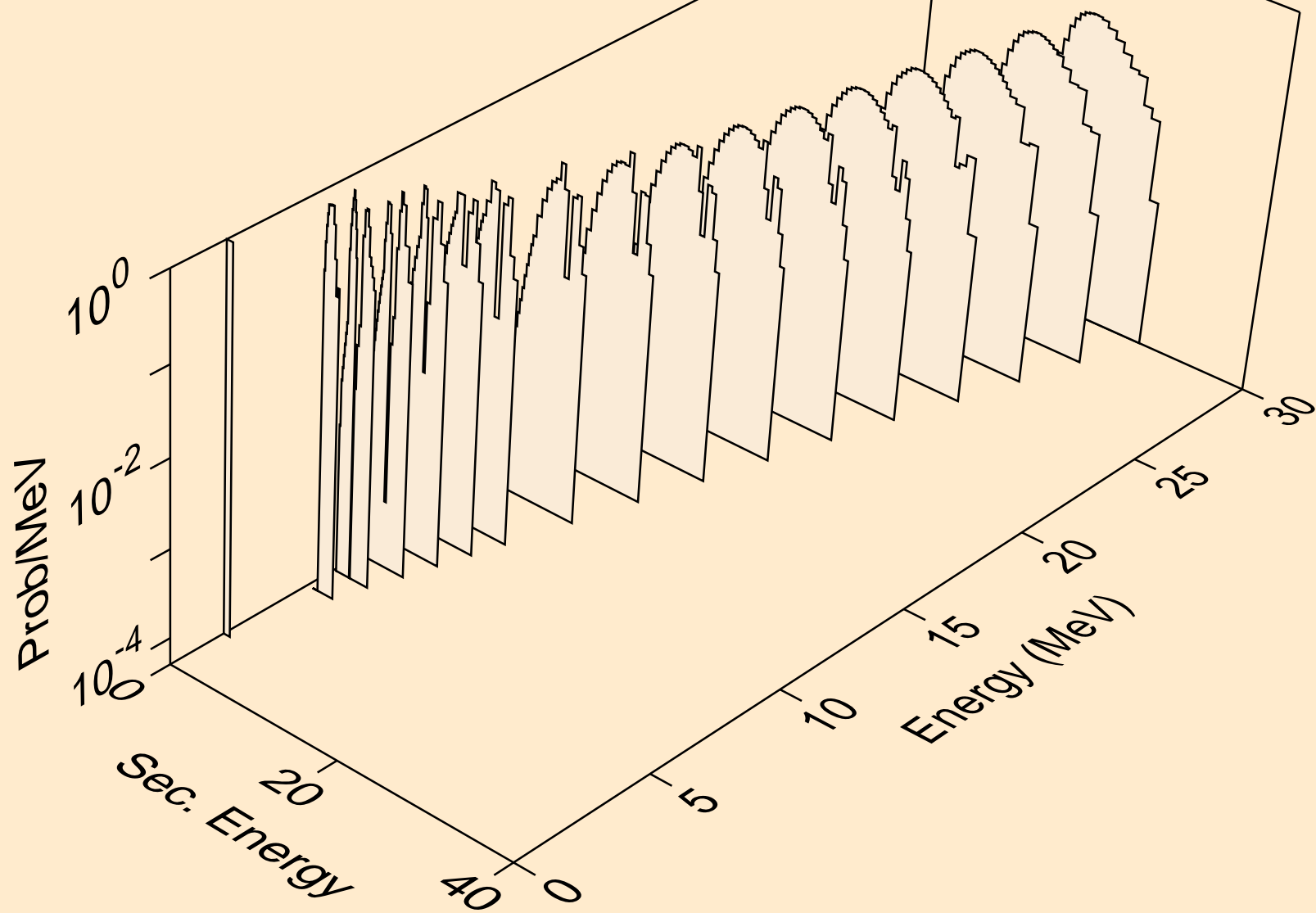

HO150 HELION ACER TENDL-2021 LIBRARY; T=0.K  
deuterons from (s,pd)

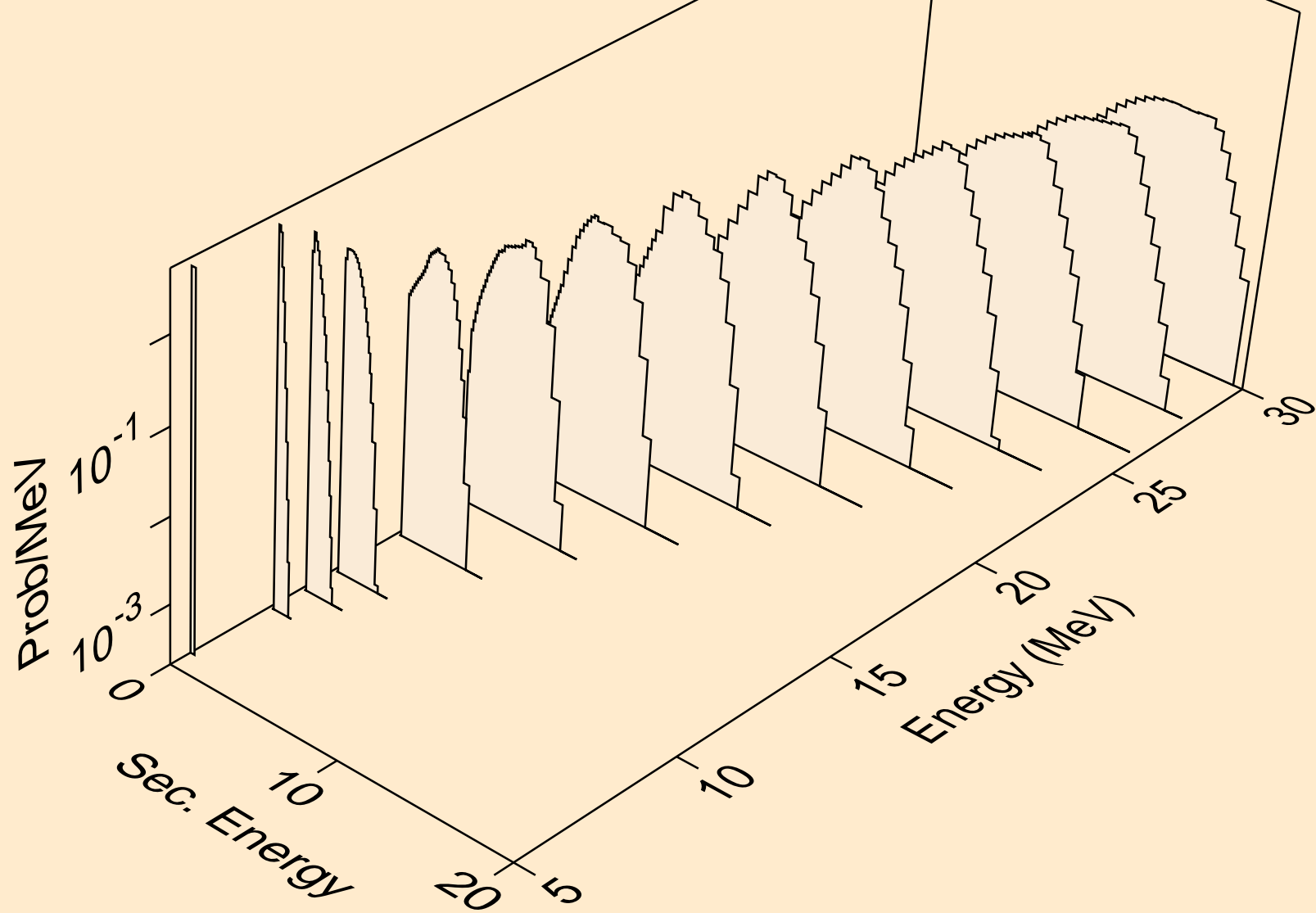

HO150 HELION ACER TENDL-2021 LIBRARY; T=0.K  
deuterons from (s,da)

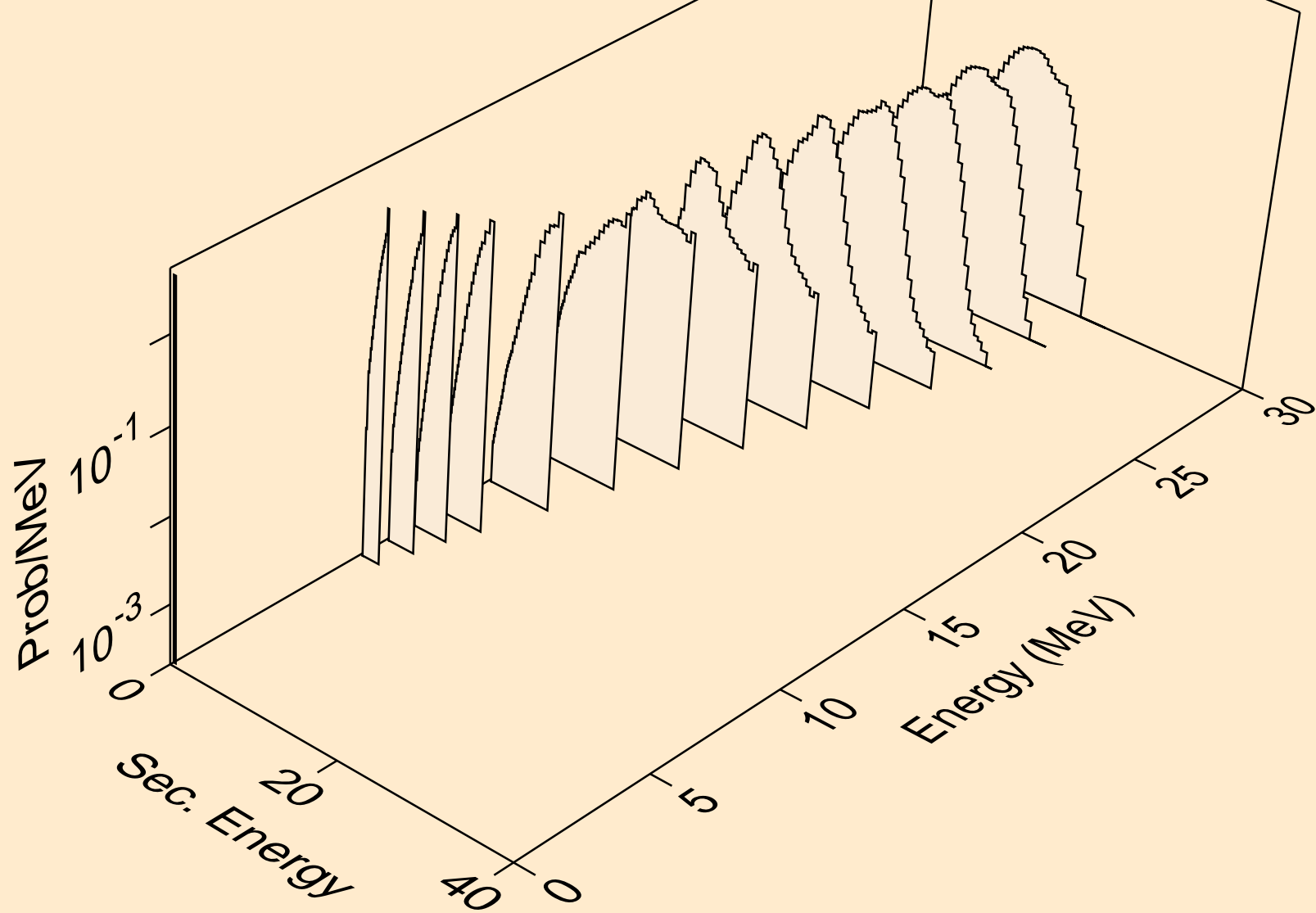



HO150 HELION ACER TENDL-2021 LIBRARY; T=0.K  
tritons from (s,x)

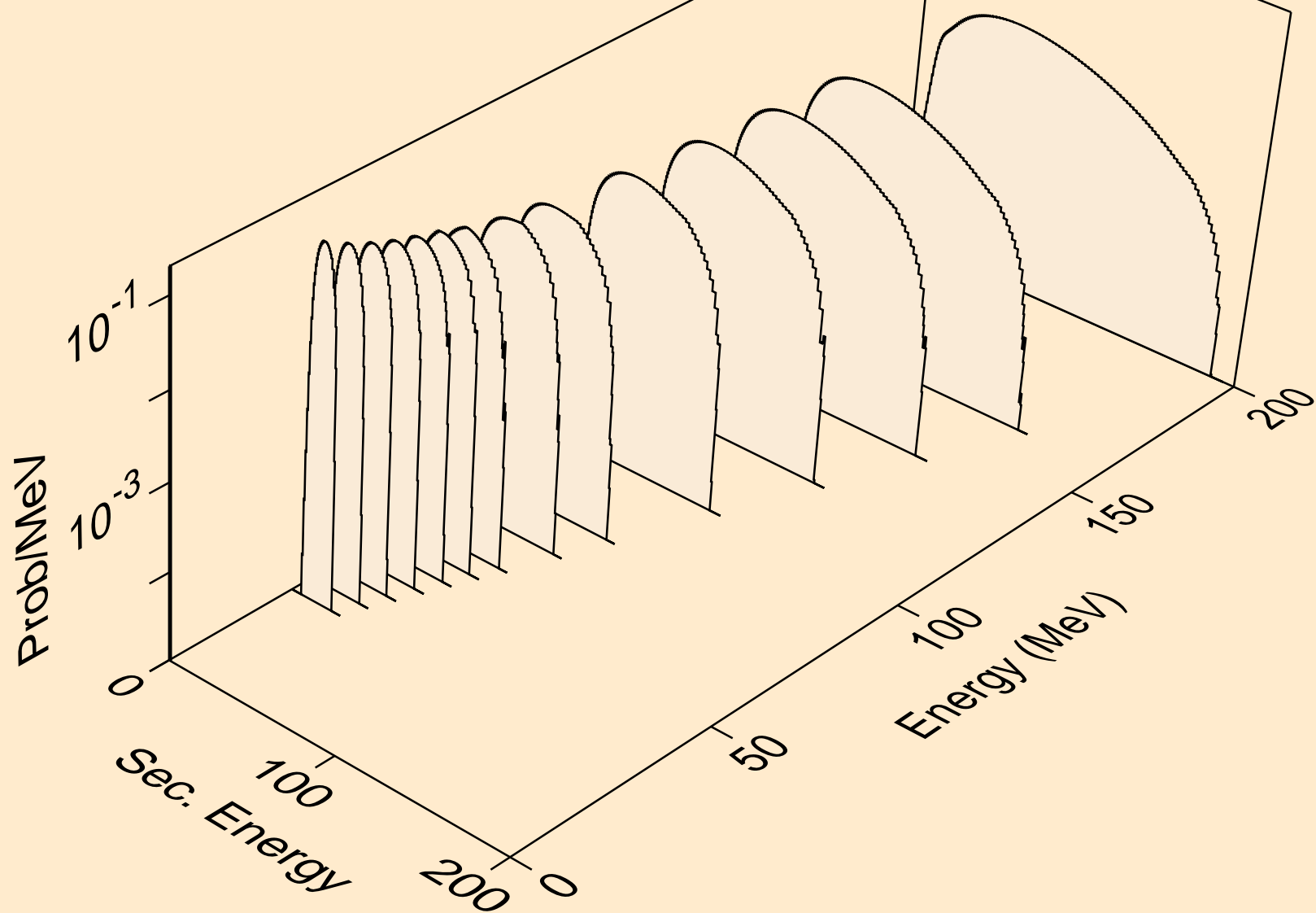

HO150 HELION ACER TENDL-2021 LIBRARY; T=0.K  
tritons from (s,n\*)t

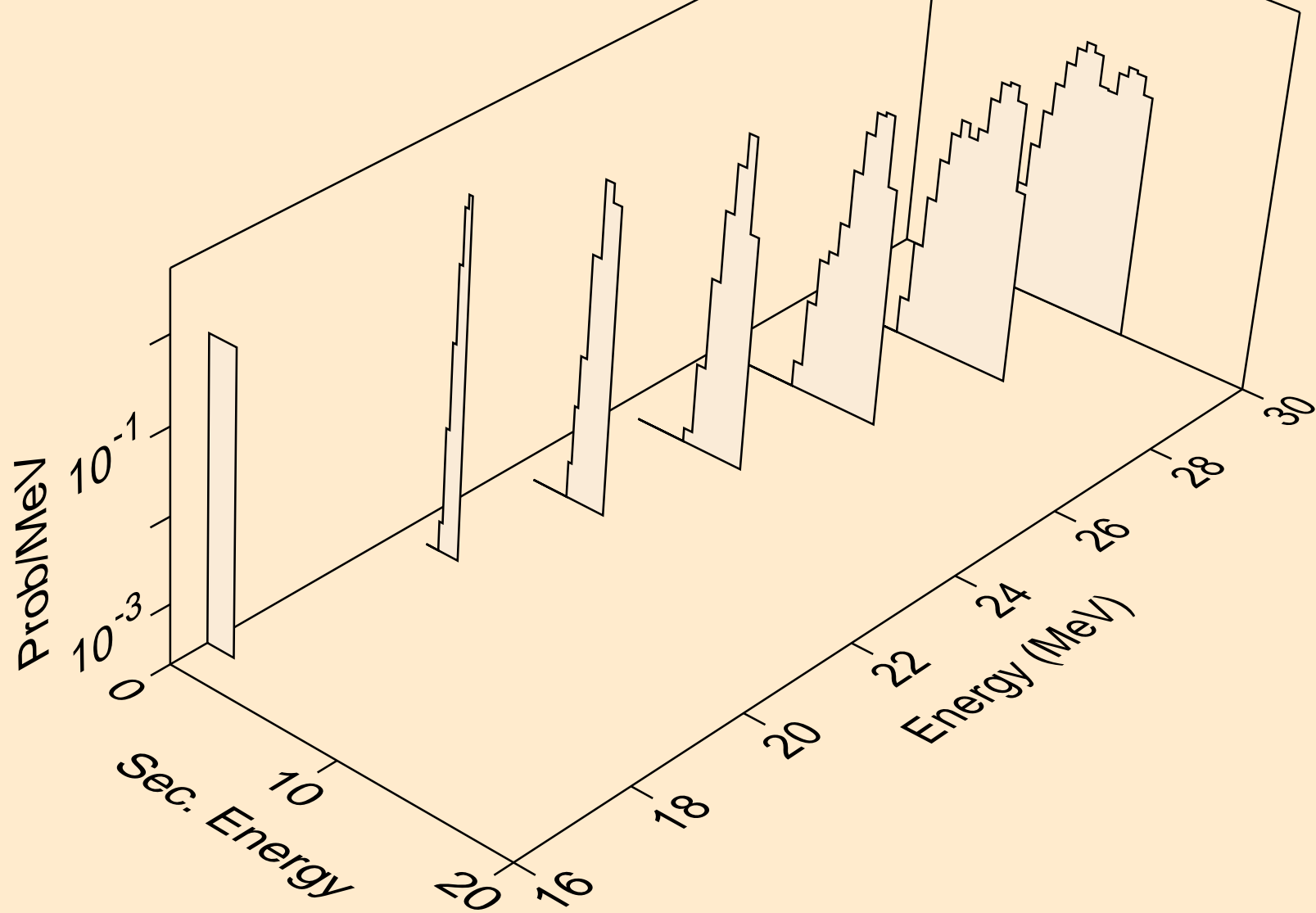

HO150 HELION ACER TENDL-2021 LIBRARY; T=0.K  
tritons from (s,t)

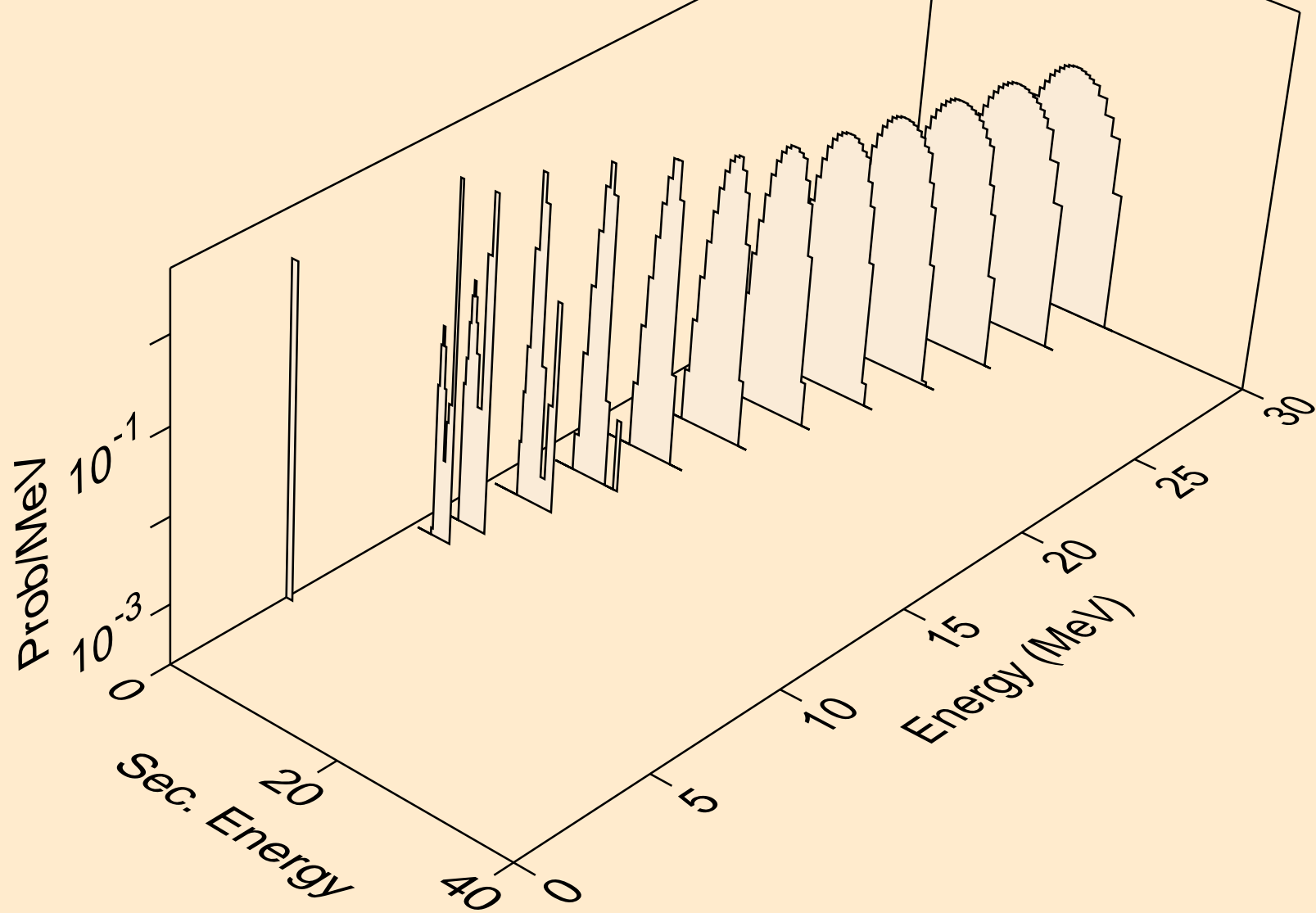

HO150 HELION ACER TENDL-2021 LIBRARY; T=0.K  
tritons from (s,pt)

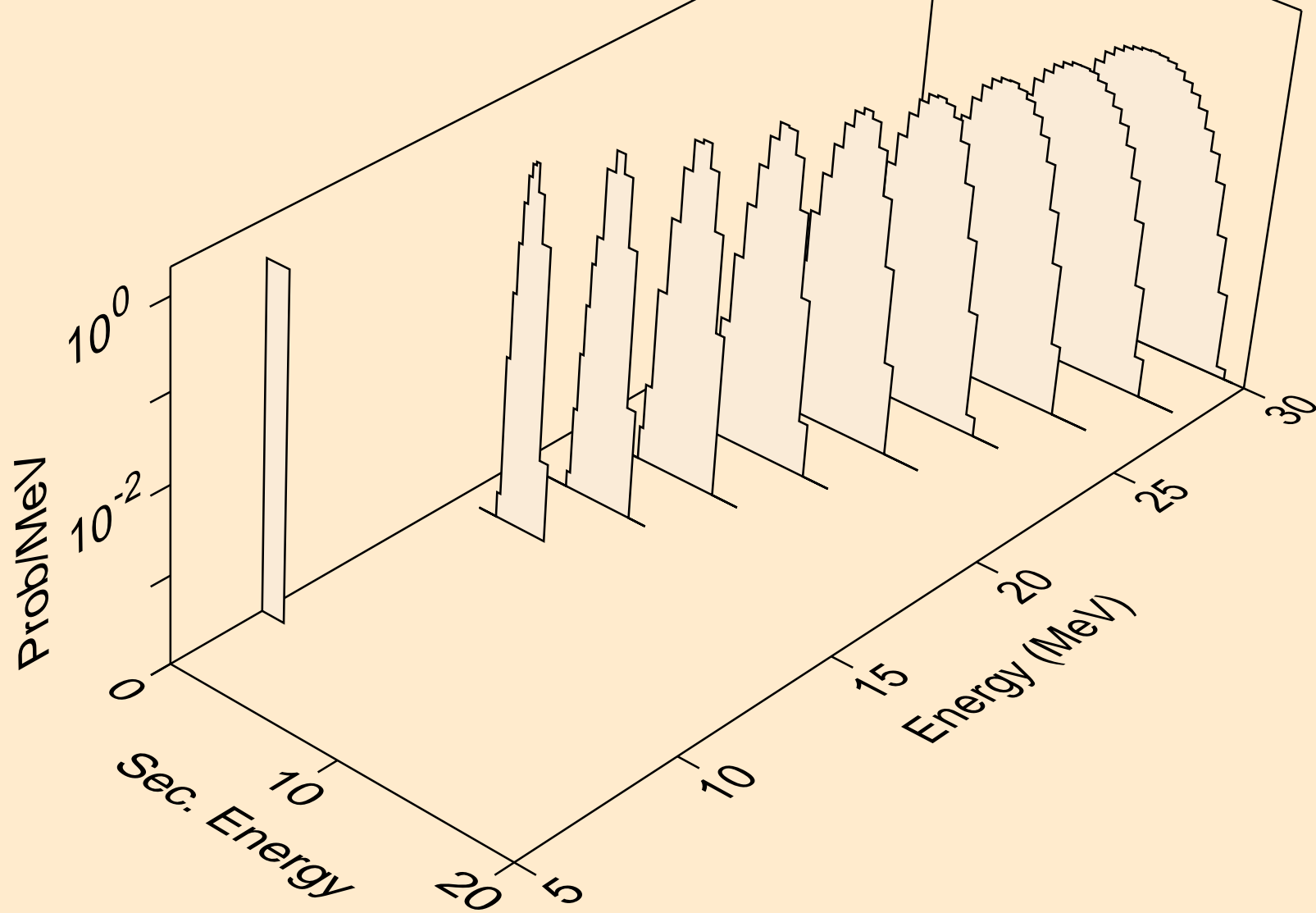

HO150 HELION ACER TENDL-2021 LIBRARY; T=0.K  
alphas from (s,x)

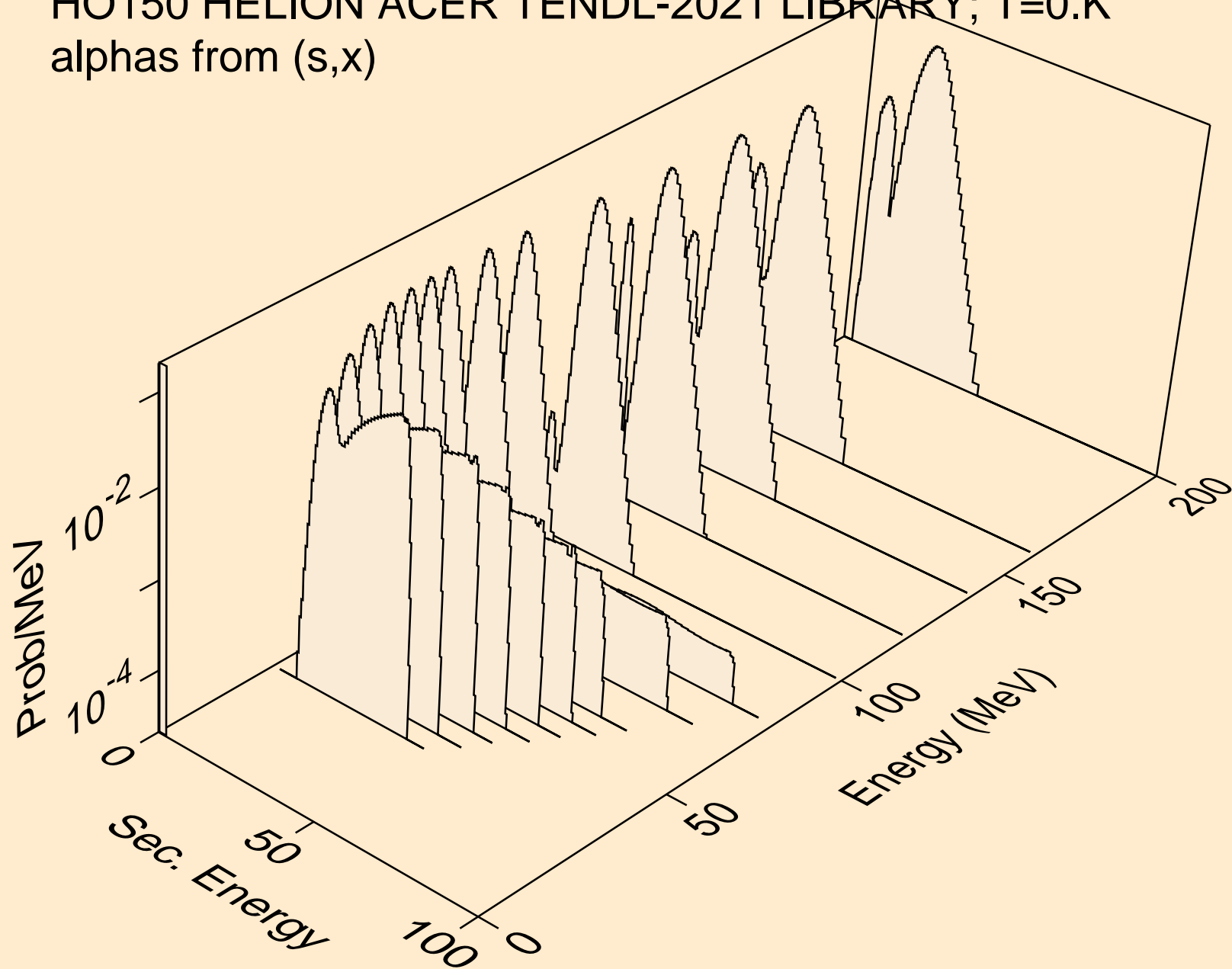

HO150 HELION ACER TENDL-2021 LIBRARY; T=0.K  
alphas from (s,n\*)a

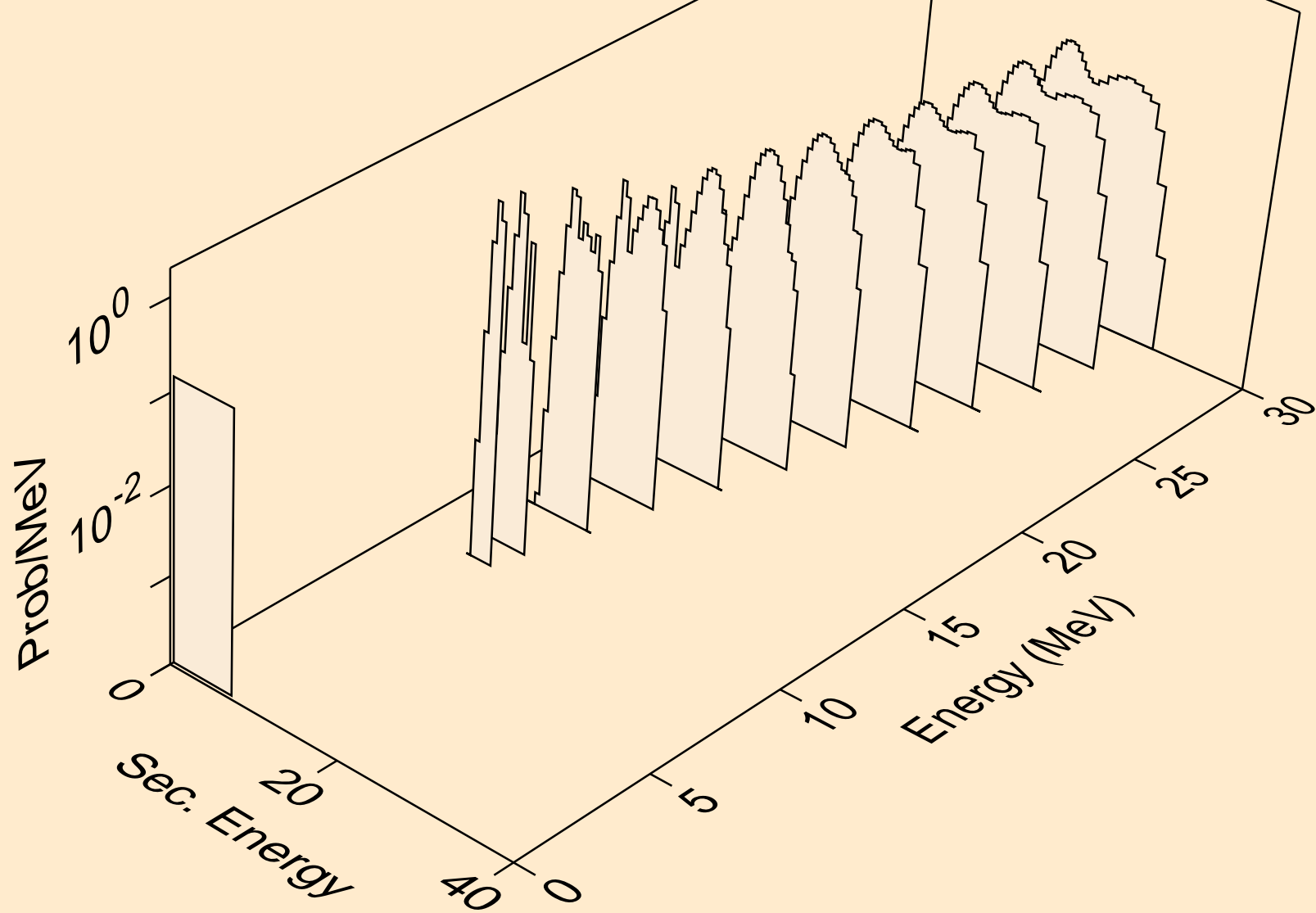

HO150 HELION ACER TENDL-2021 LIBRARY; T=0.K  
alphas from (s,2n)a

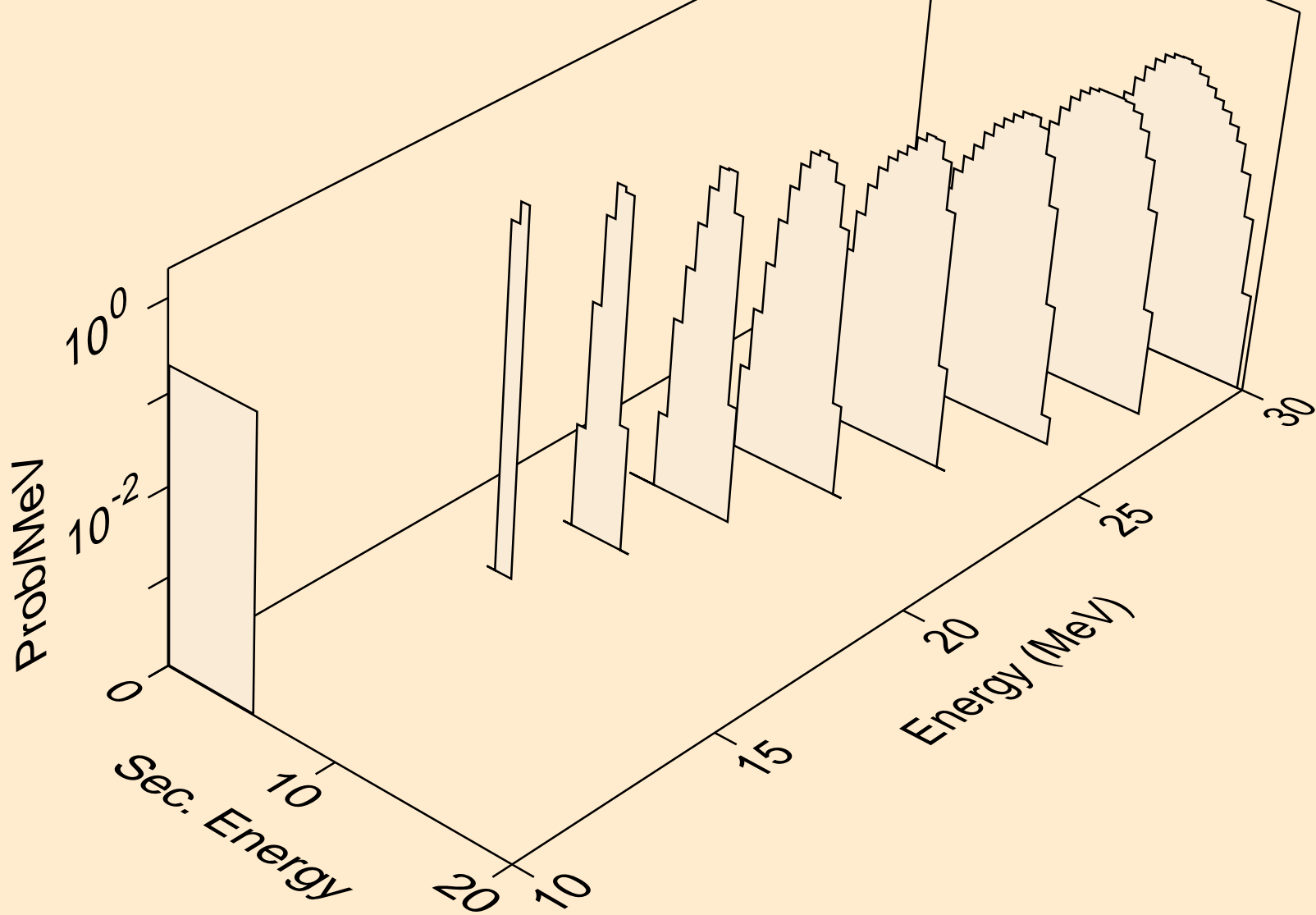

HO150 HELION ACER TENDL-2021 LIBRARY; T=0.K  
alphas from (s,n\*)2a

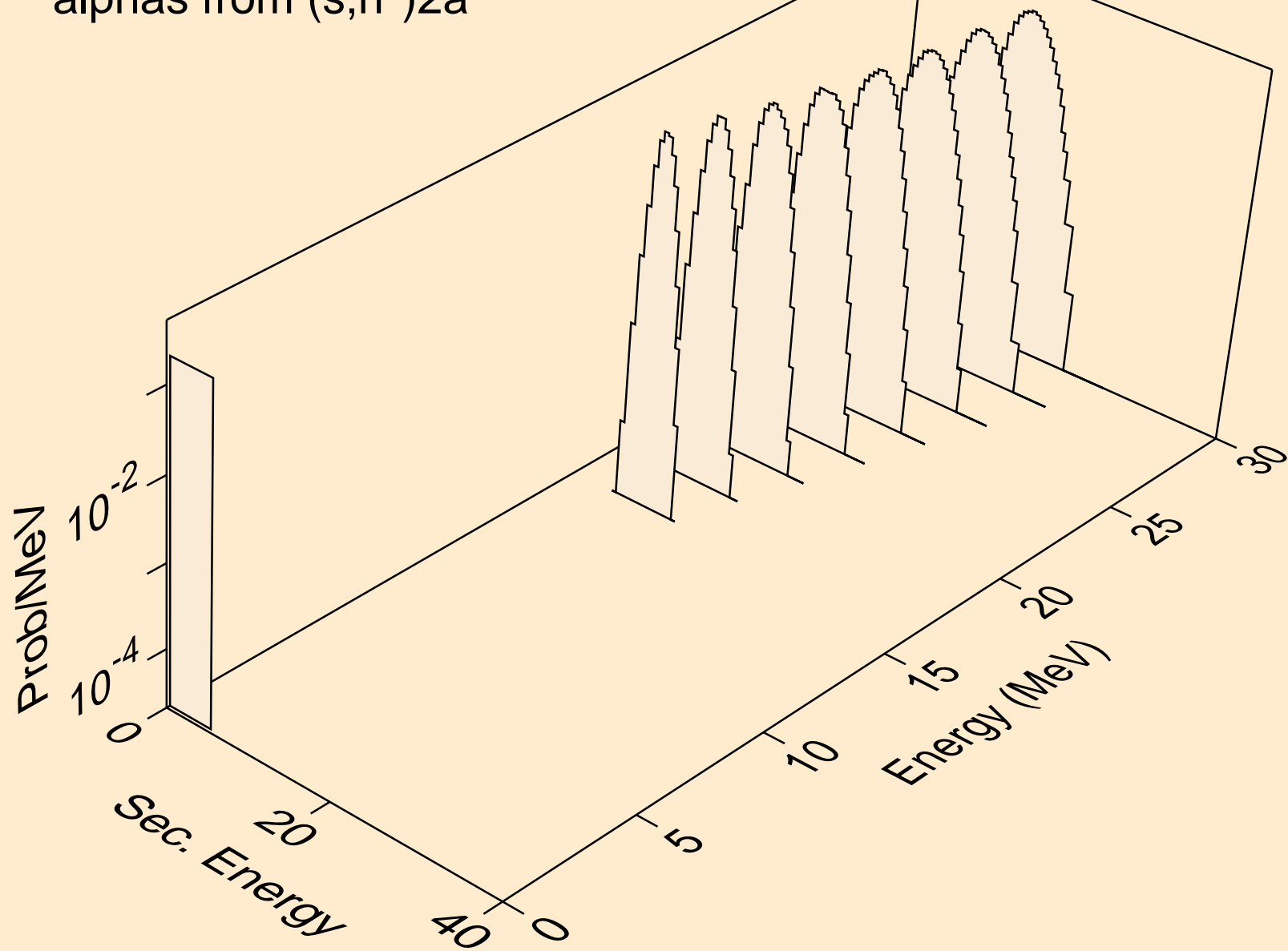



HO150 HELION ACER TENDL-2021 LIBRARY; T=0.K  
alphas from (s,npa)

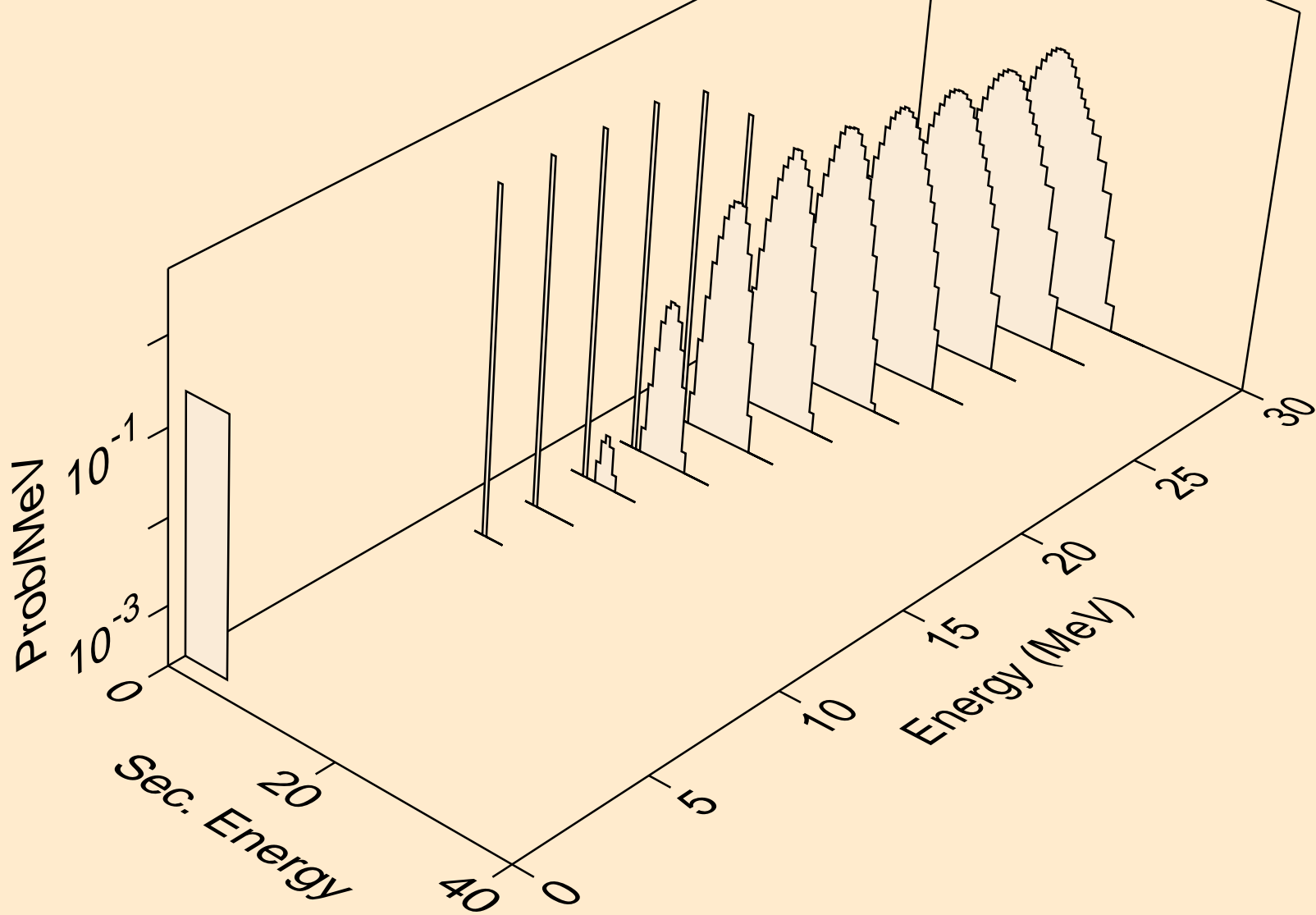

HO150 HELION ACER TENDL-2021 LIBRARY; T=0.K  
alphas from (s,a)

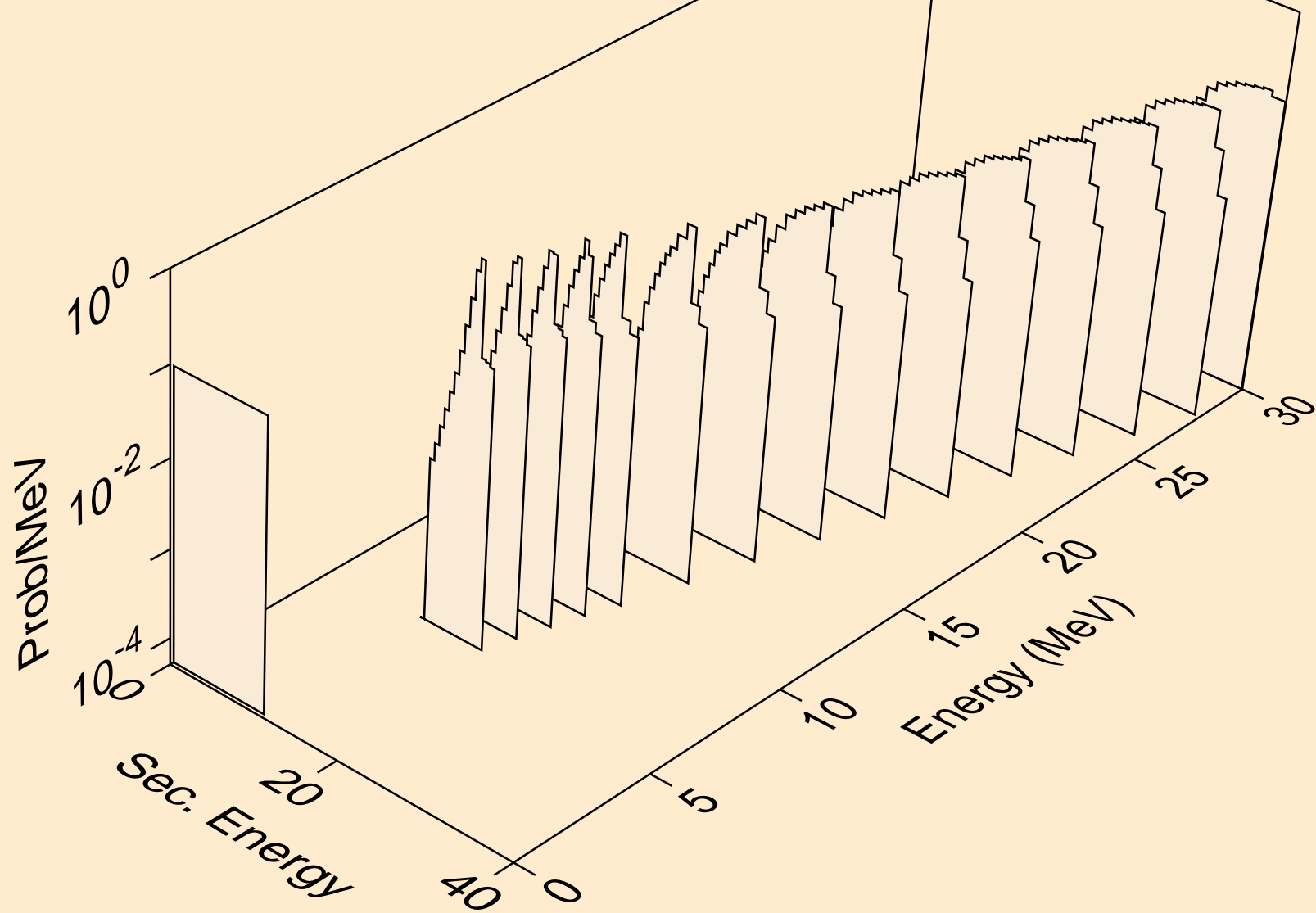

HO150 HELION ACER TENDL-2021 LIBRARY; T=0.K  
alphas from (s,2a)

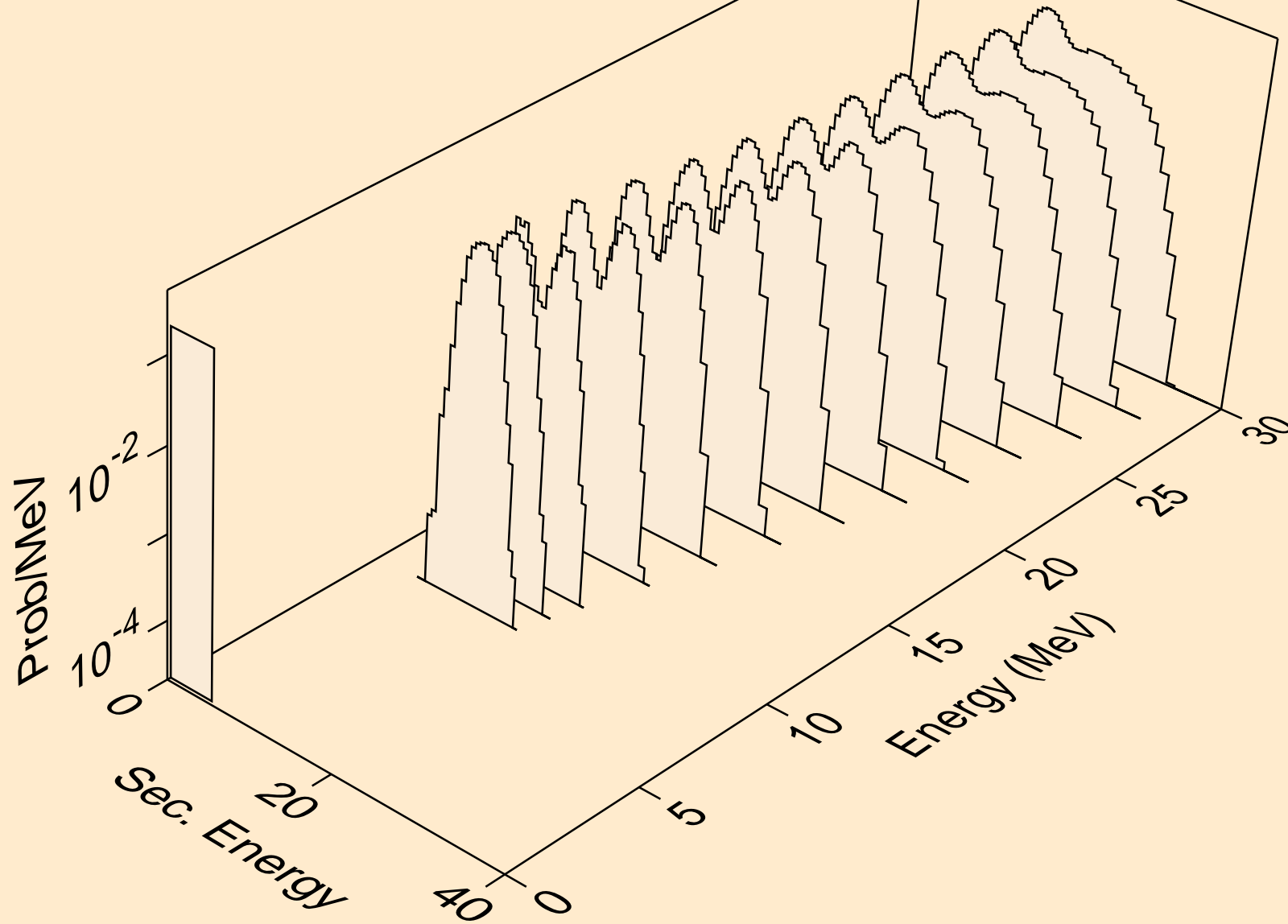

HO150 HELION ACER TENDL-2021 LIBRARY; T=0.K  
alphas from (s,pa)

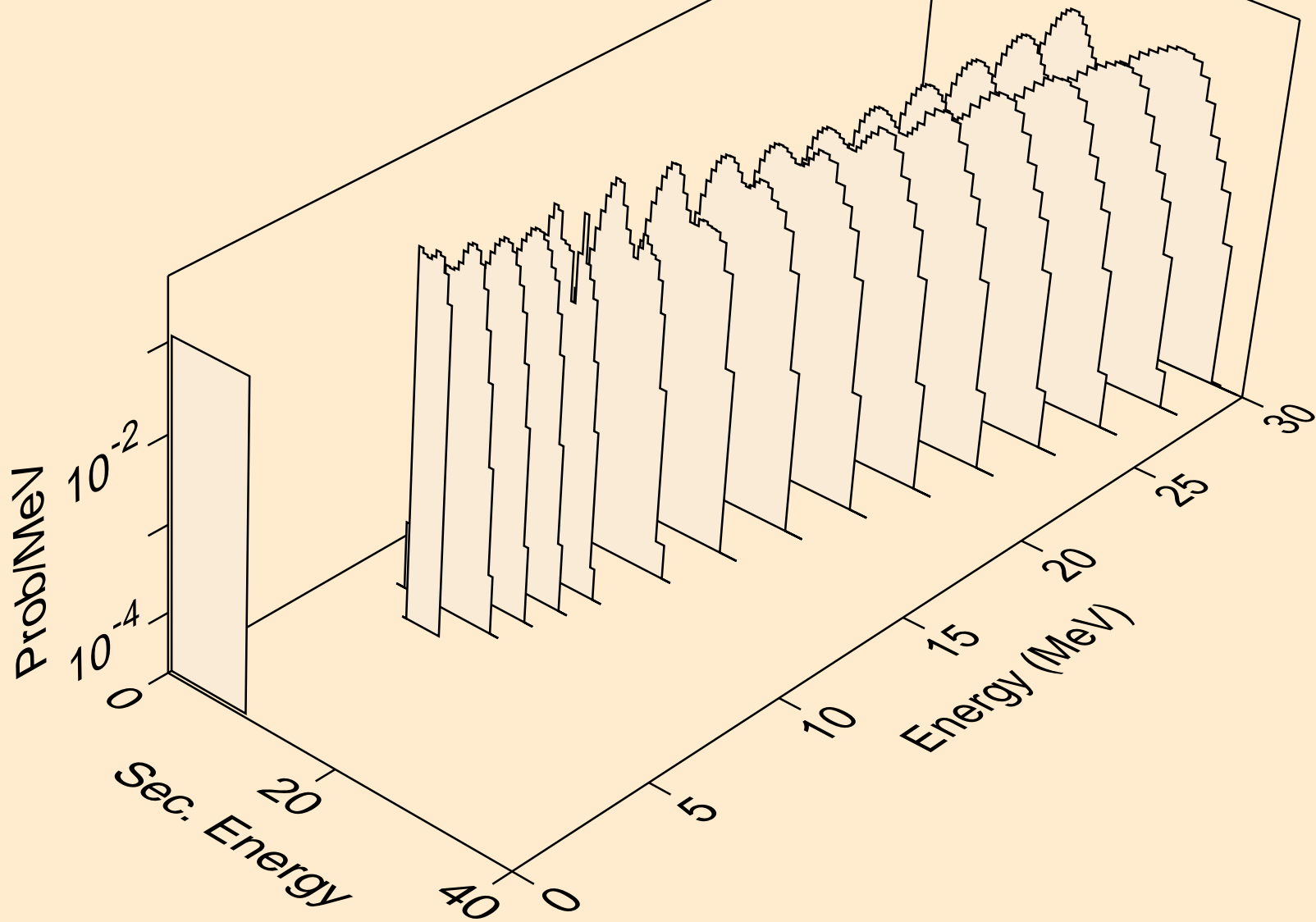

HO150 HELION ACER TENDL-2021 LIBRARY; T=0.K  
alphas from (s,da)

