

HO161 HELION ACER TENDL-2021 LIBRARY; T=0.K  
Principal cross sections

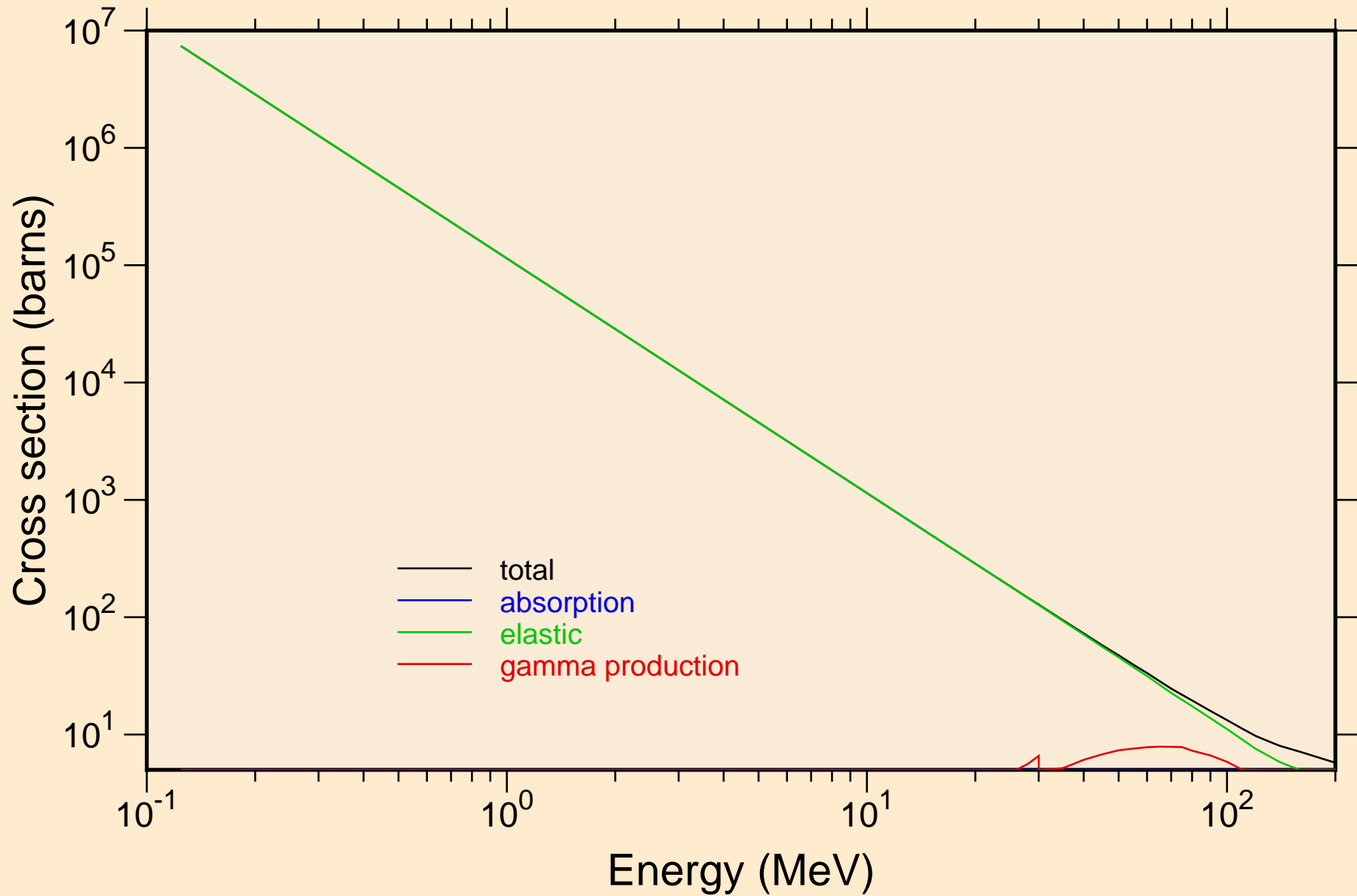

HO161 HELION ACER TENDL-2021 LIBRARY; T=0.K  
Heating

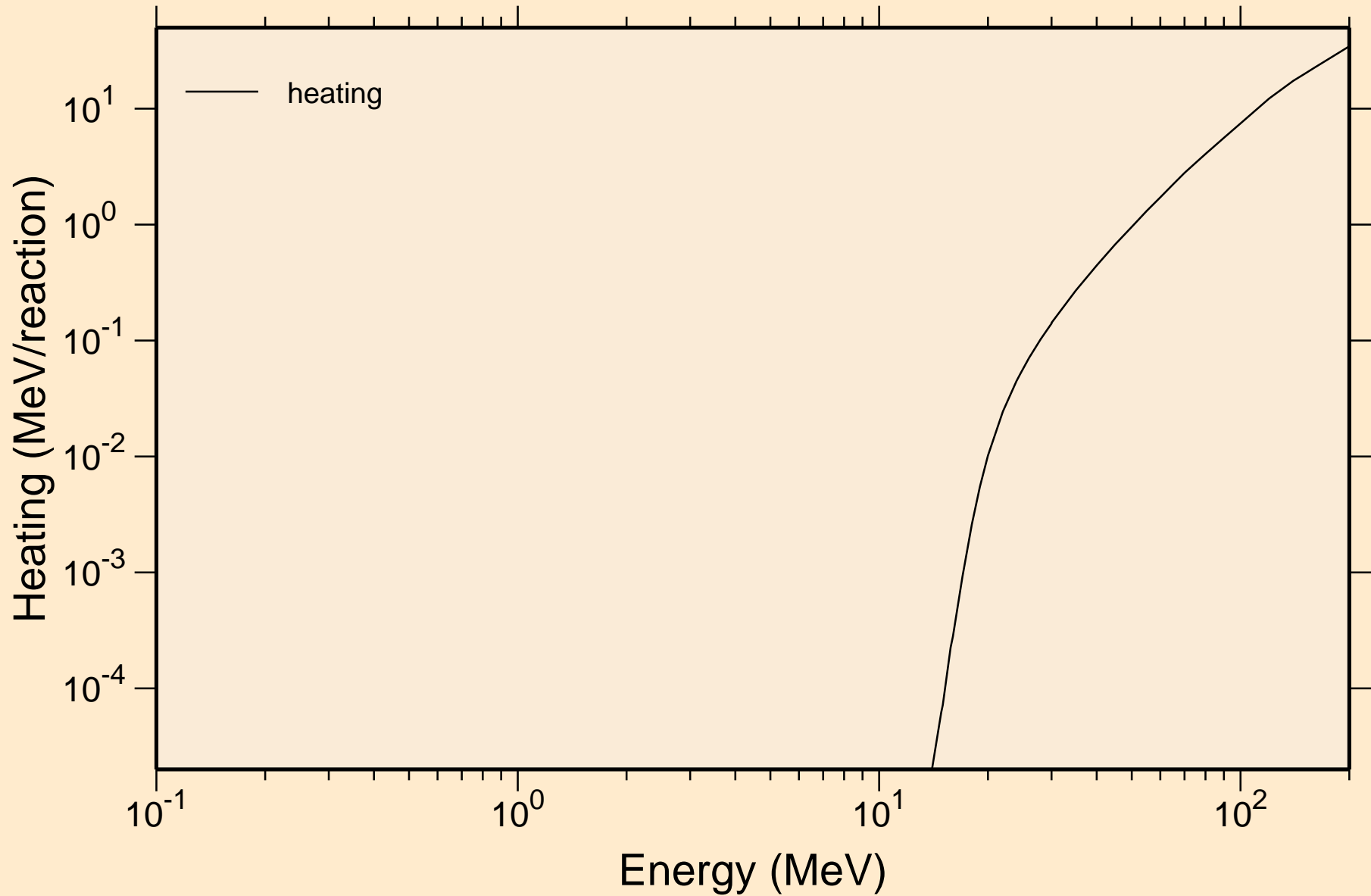

# HO161 HELION ACER TENDL-2021 LIBRARY; T=0.K

## Principal cross sections

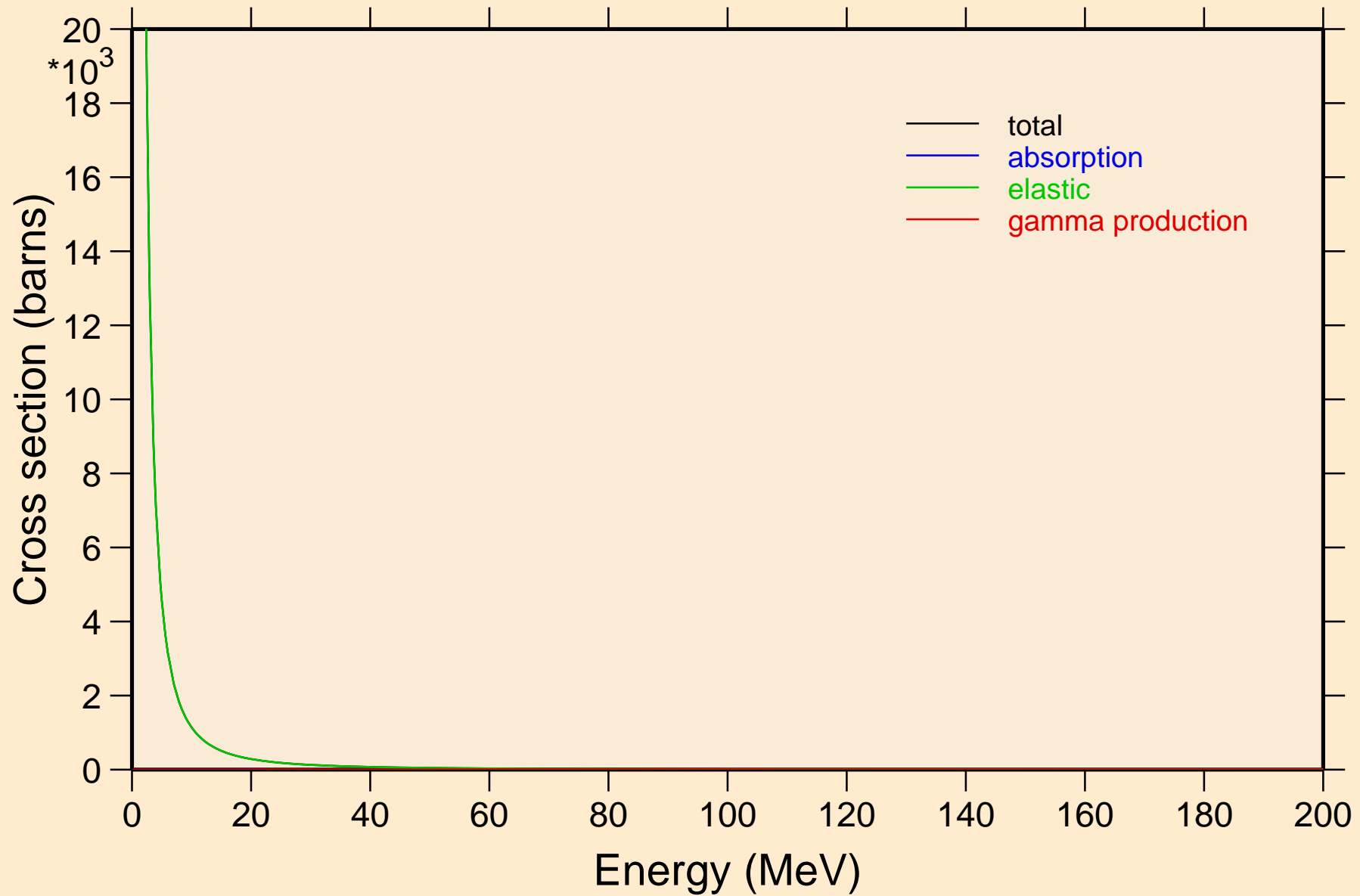

HO161 HELION ACER TENDL-2021 LIBRARY; T=0.K

Heating

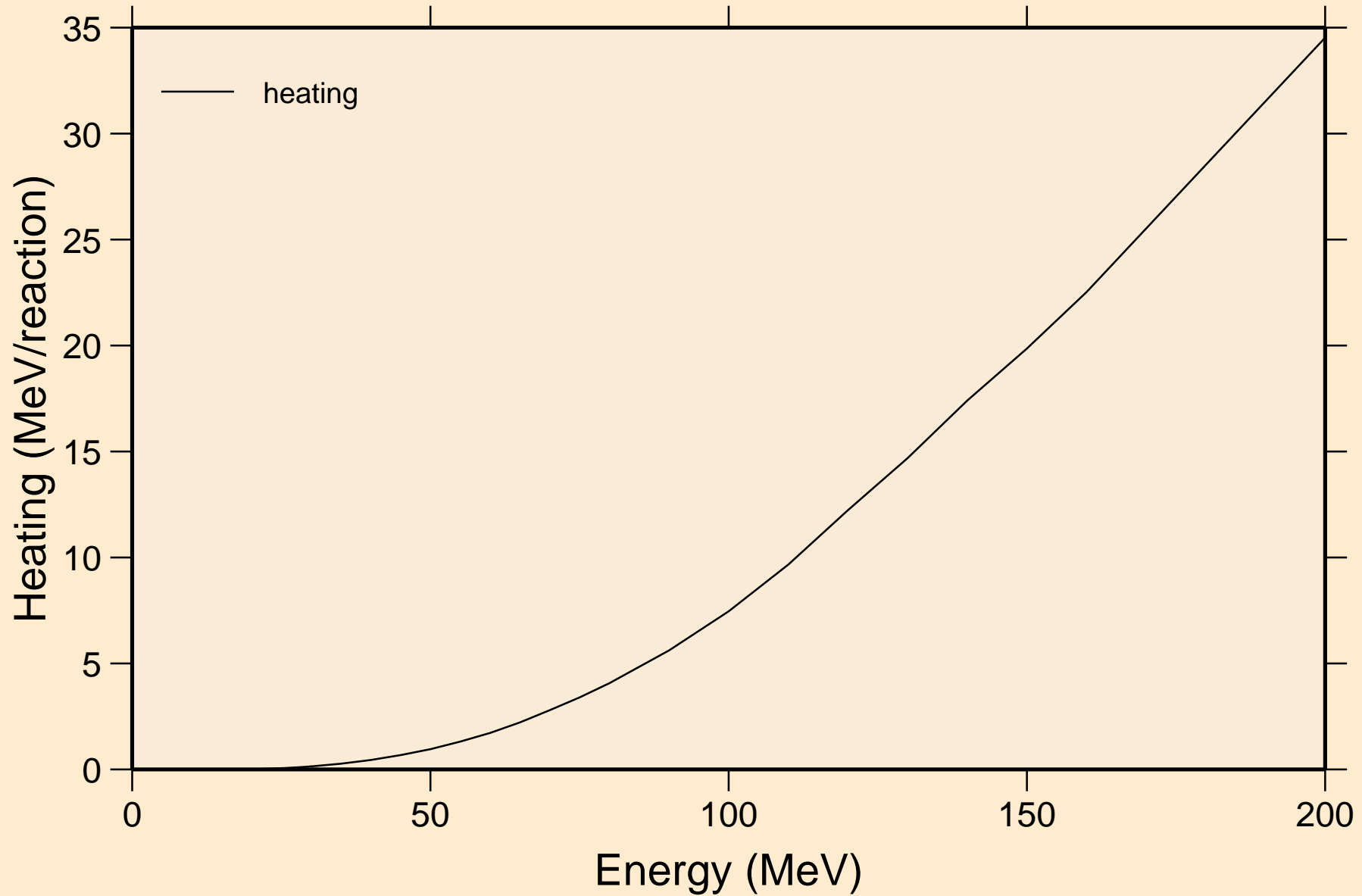

# HO161 HELION ACER TENDL-2021 LIBRARY; T=0.K

## Threshold reactions

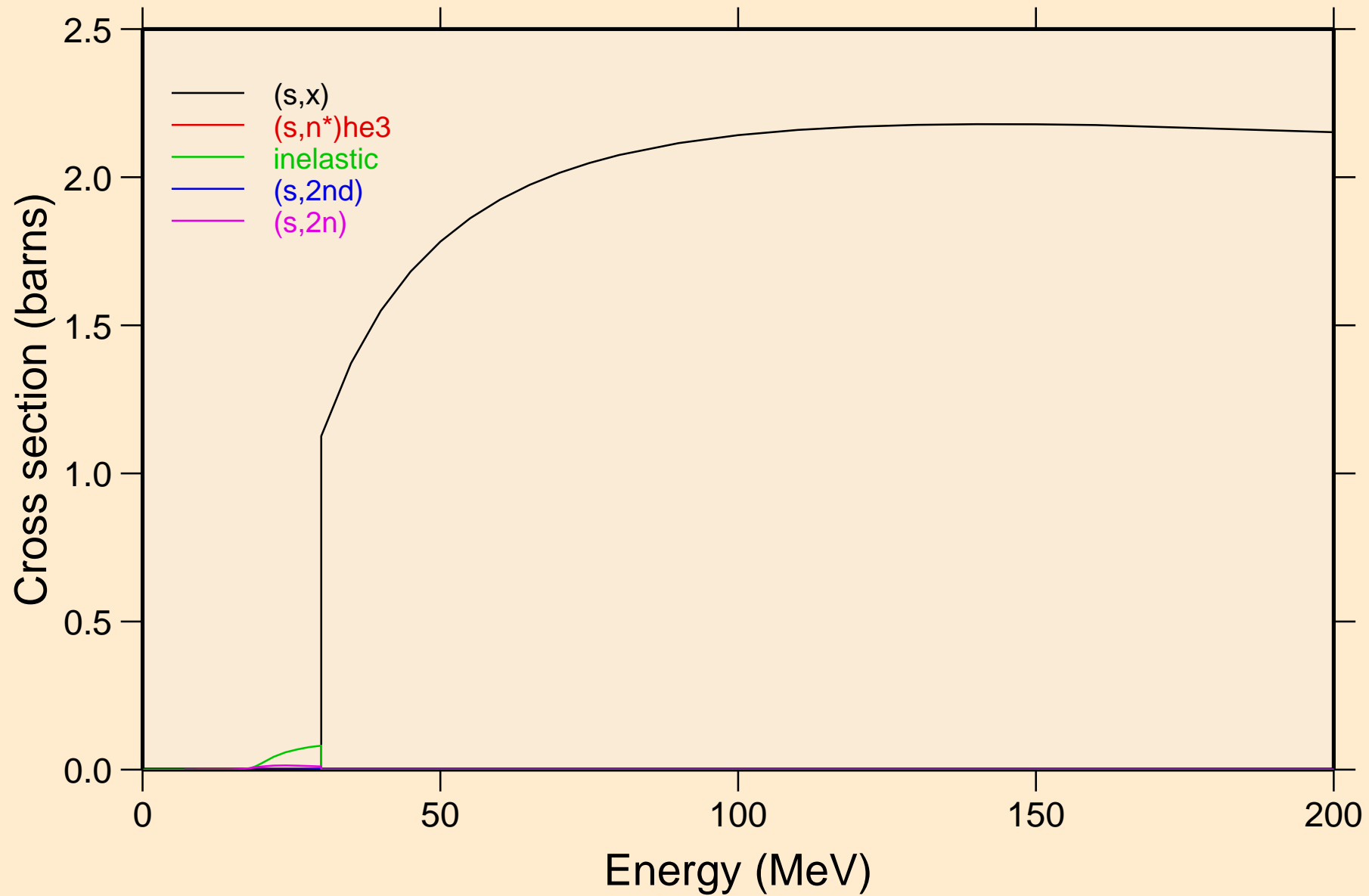

# HO161 HELION ACER TENDL-2021 LIBRARY; T=0.K

## Threshold reactions

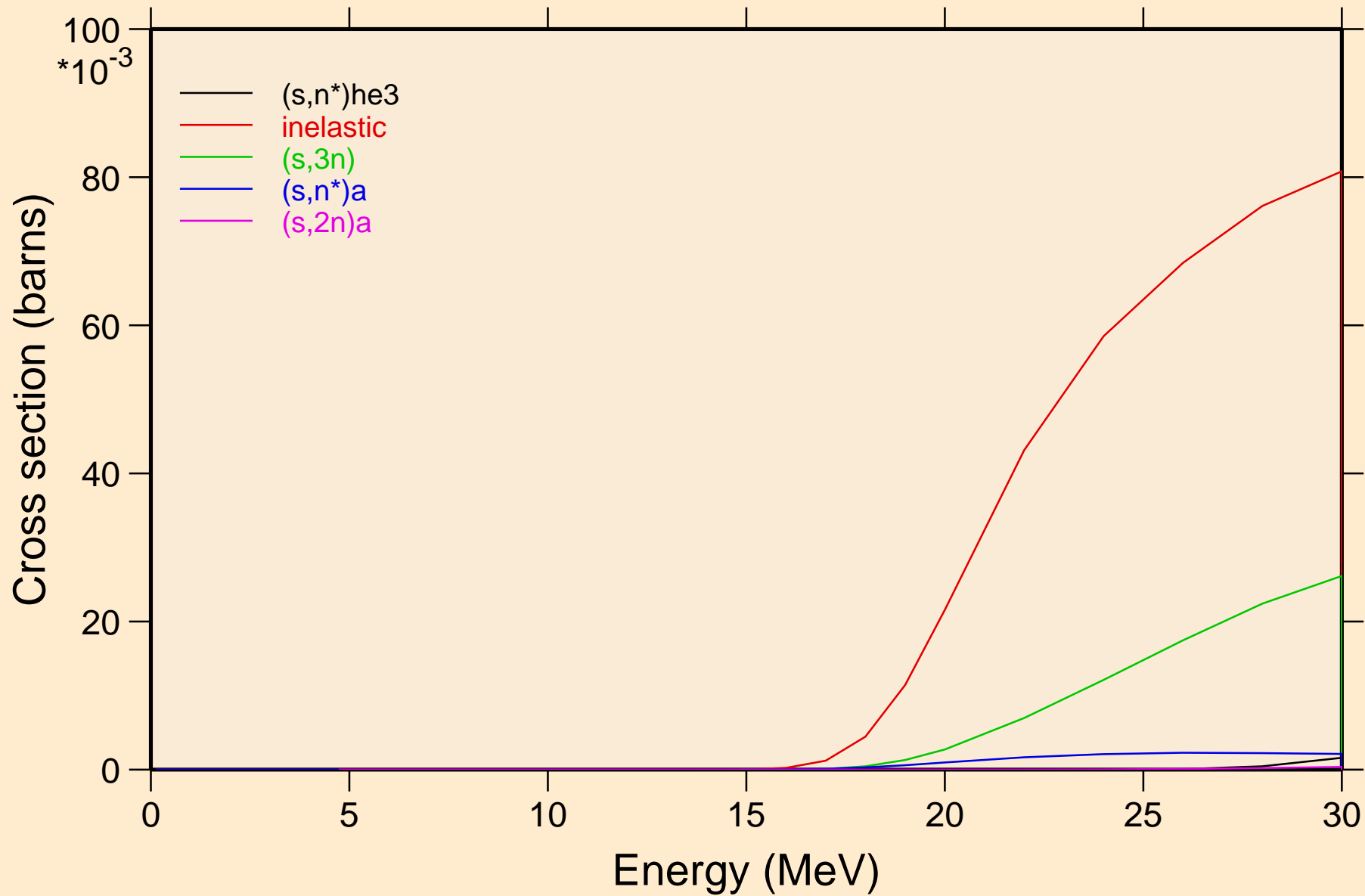

HO161 HELION ACER TENDL-2021 LIBRARY; T=0.K  
Threshold reactions

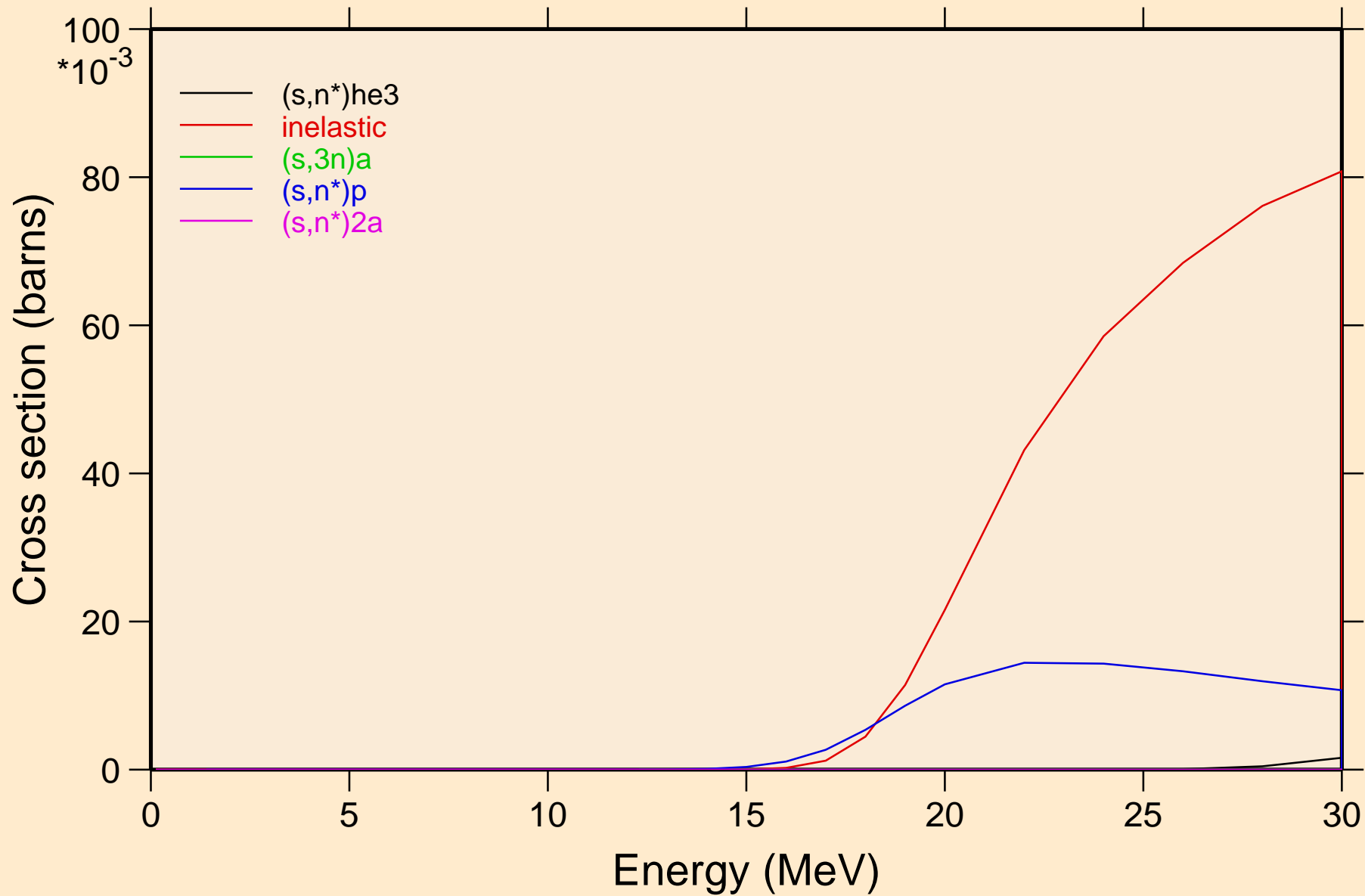

HO161 HELION ACER TENDL-2021 LIBRARY; T=0.K  
Threshold reactions

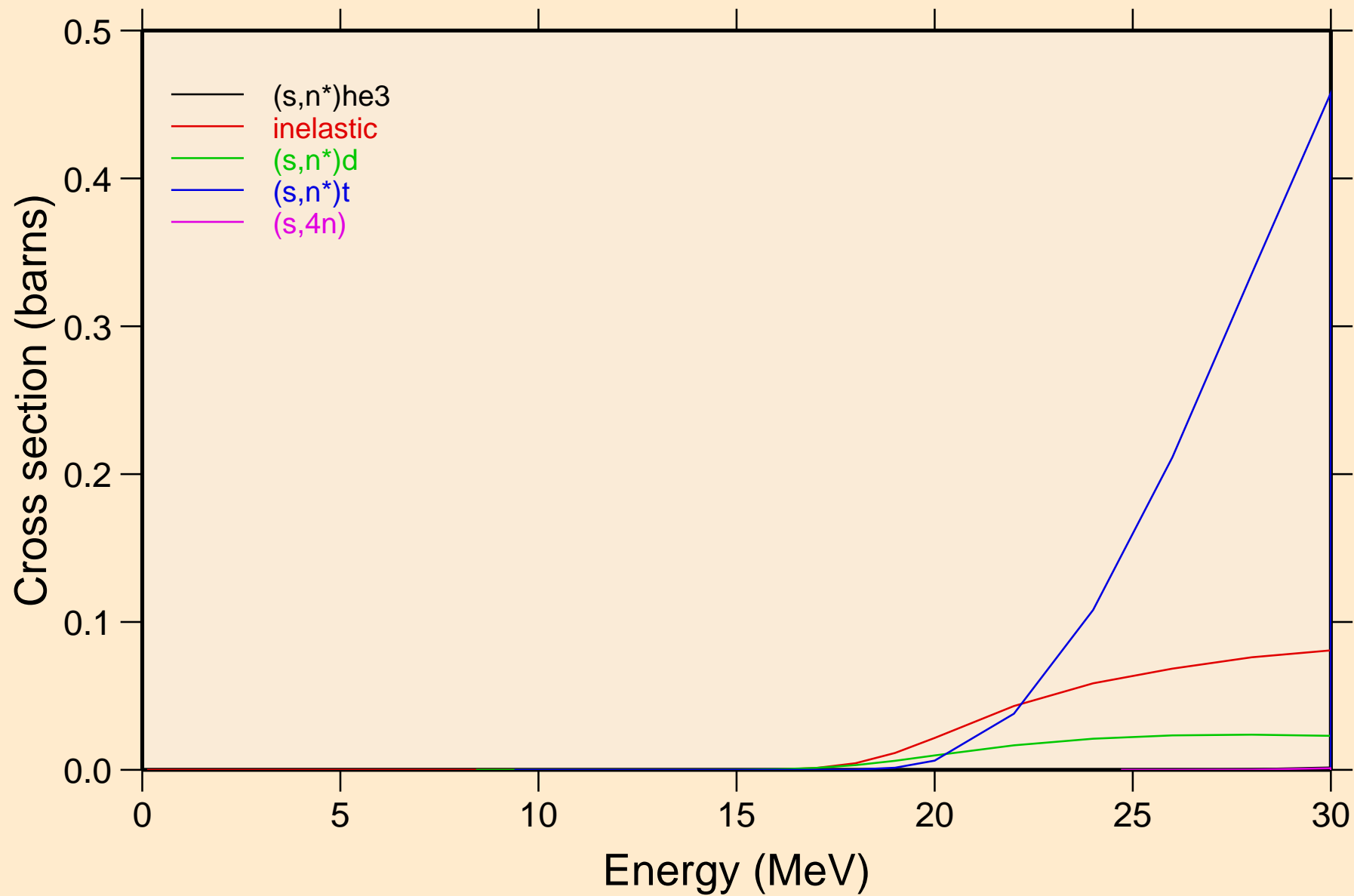



# HO161 HELION ACER TENDL-2021 LIBRARY; T=0.K

## Threshold reactions

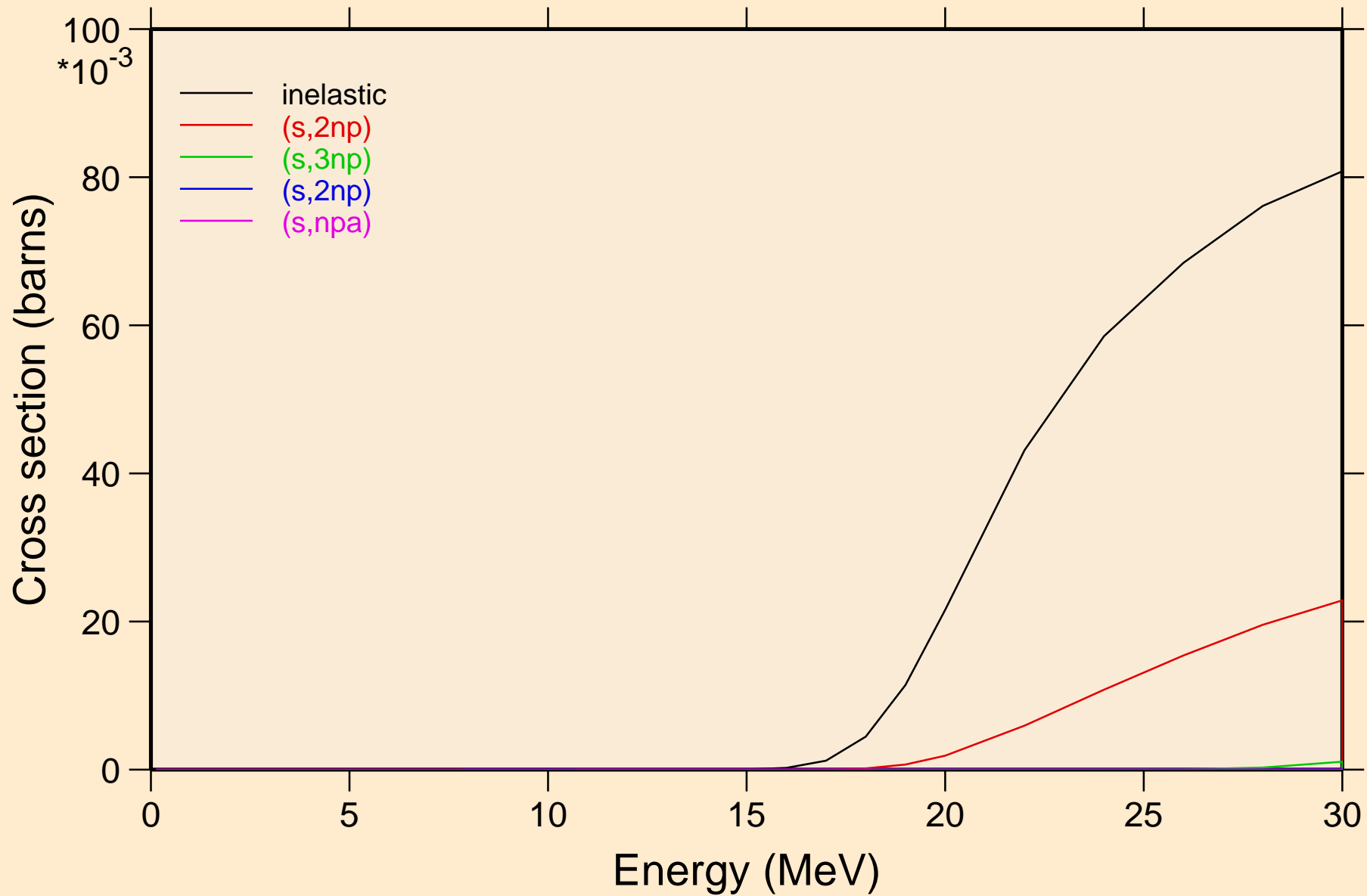

HO161 HELION ACER TENDL-2021 LIBRARY; T=0.K  
Threshold reactions

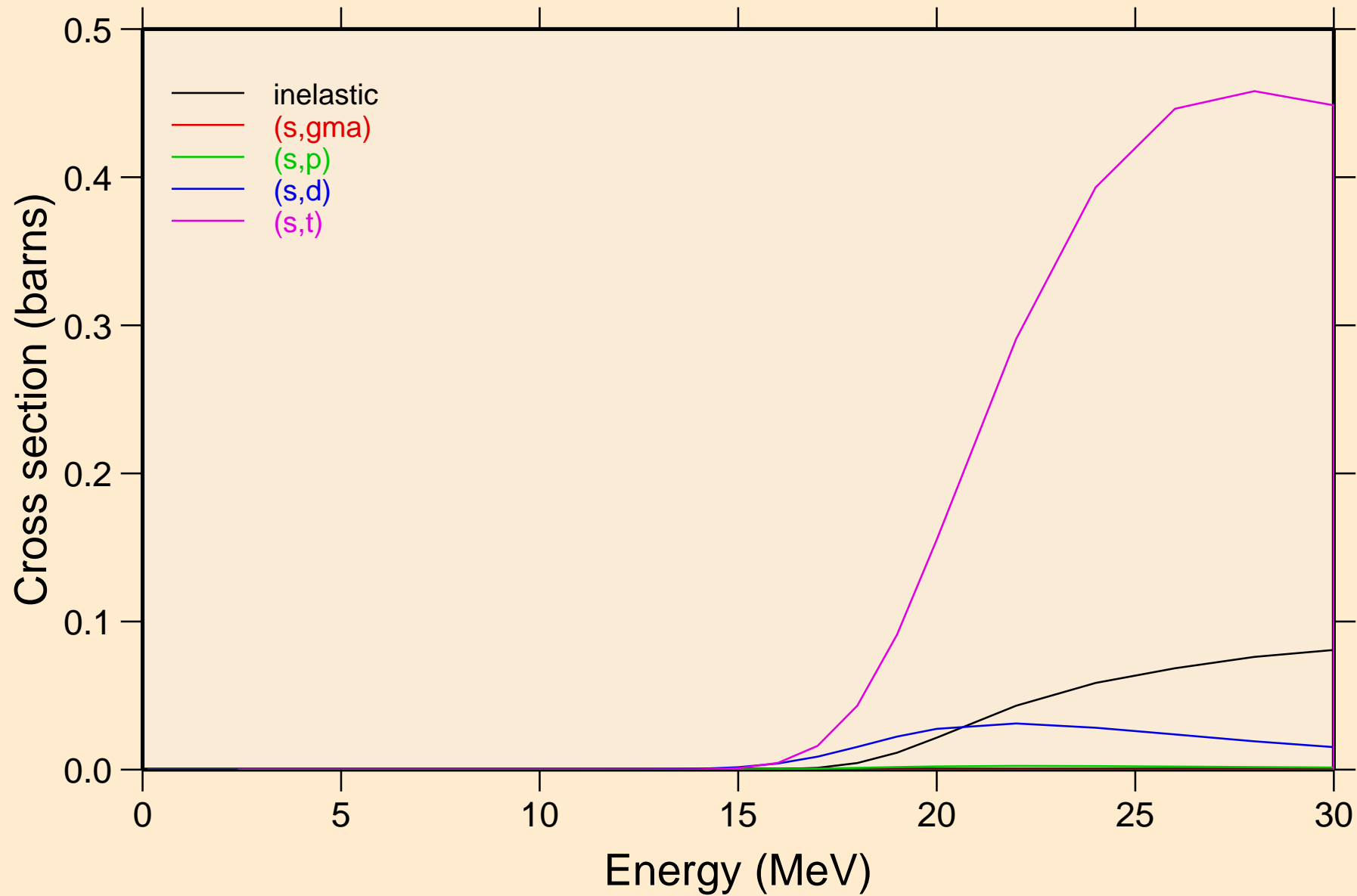

HO161 HELION ACER TENDL-2021 LIBRARY; T=0.K  
Threshold reactions

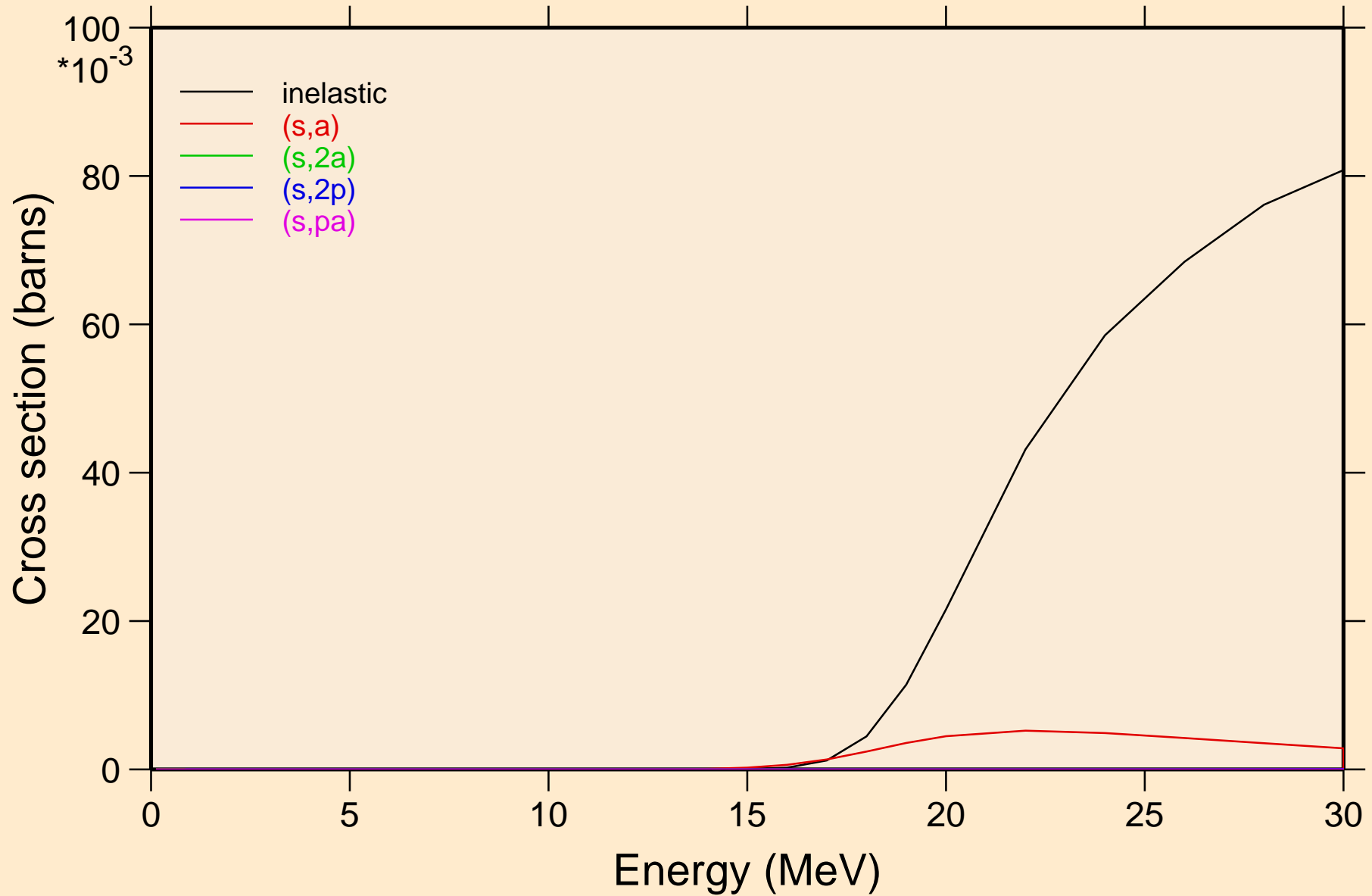

HO161 HELION ACER TENDL-2021 LIBRARY; T=0.K  
Threshold reactions

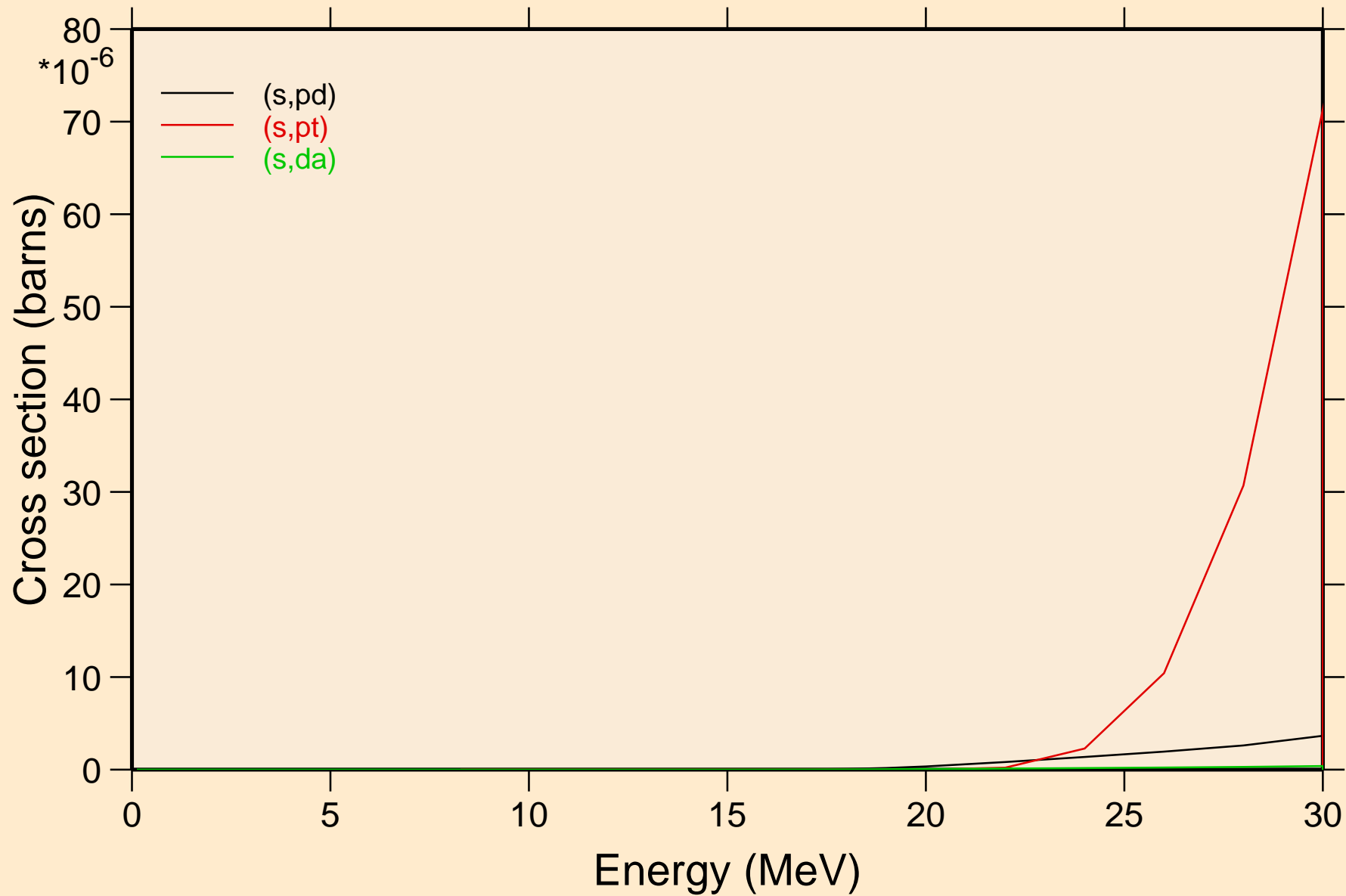

HO161 HELION ACER TENDL-2021 LIBRARY; T=0.K  
angular distribution for elastic

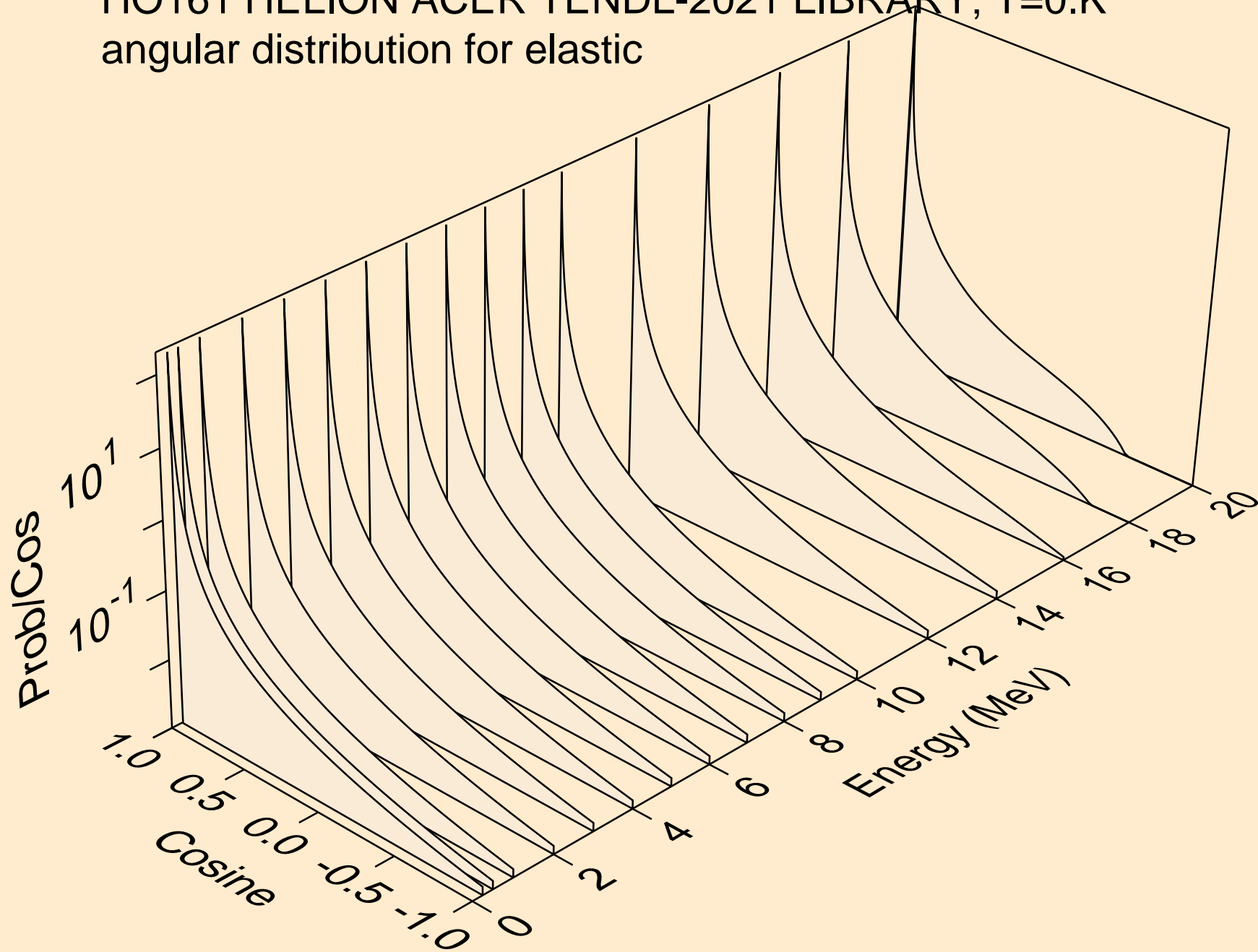

HO161 HELION ACER TENDL-2021 LIBRARY; T=0.K  
angular distribution for elastic

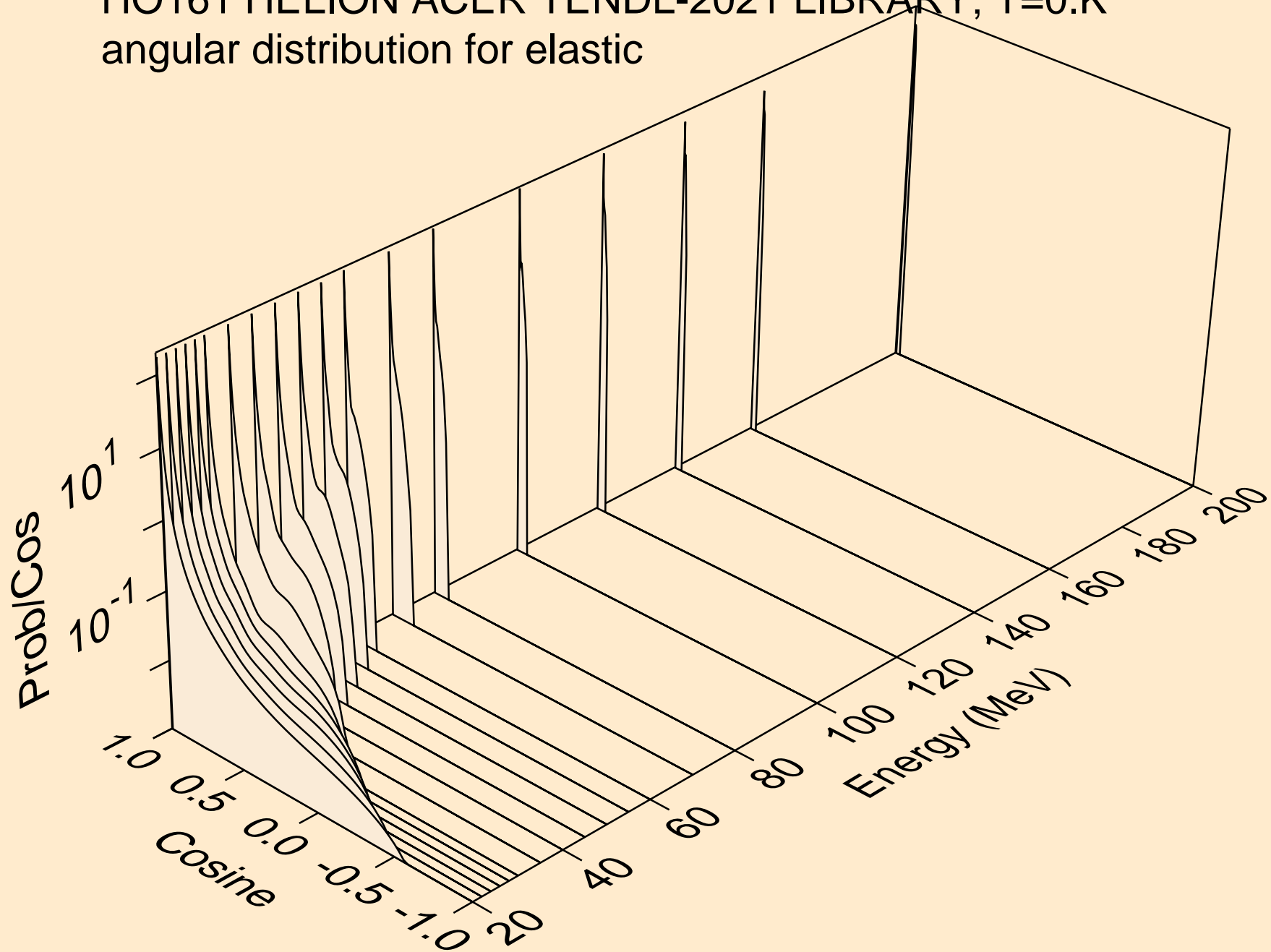

HO161 HELION ACER TENDL-2021 LIBRARY; T=0.K  
He-3 emission for (s,x)

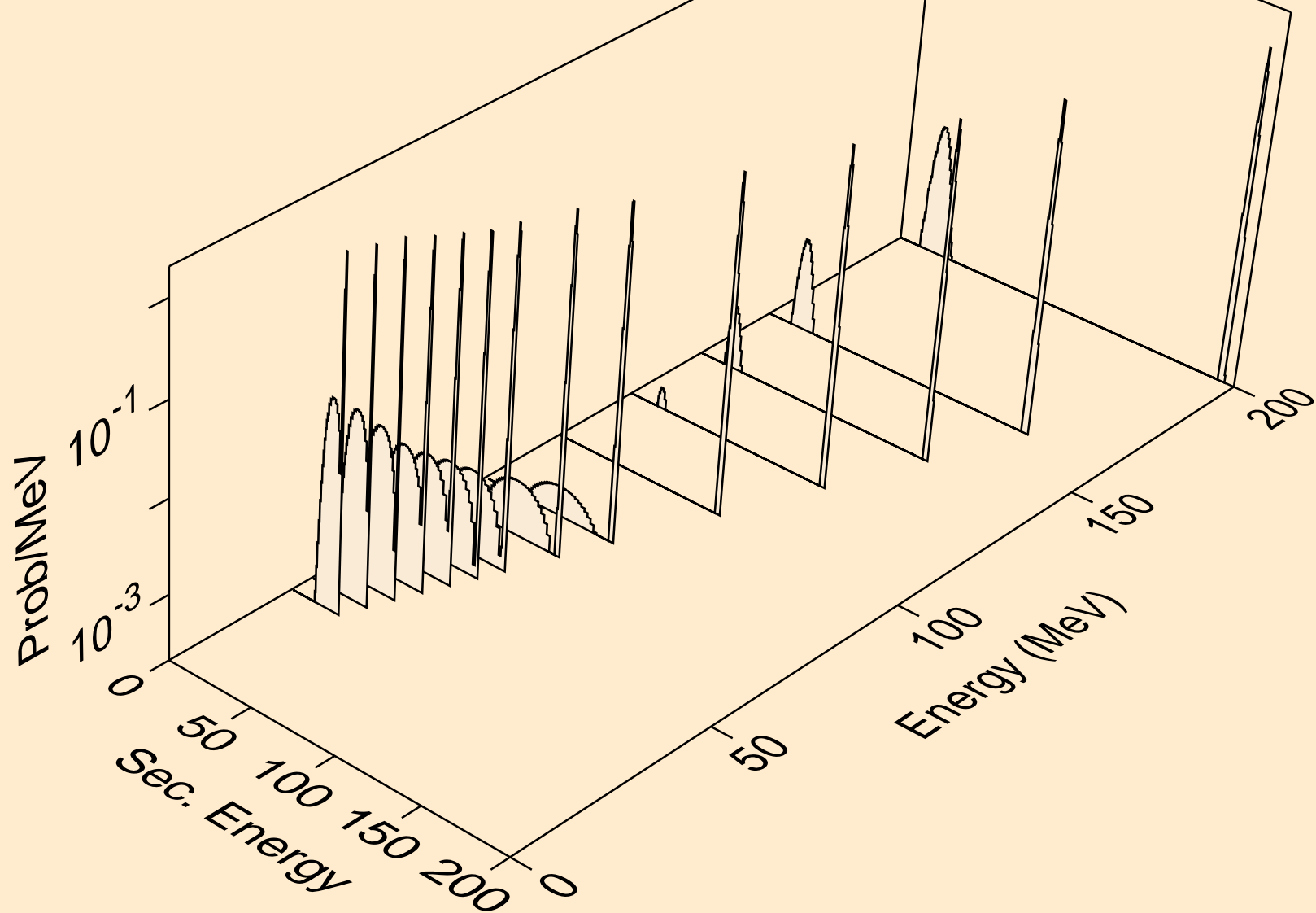

HO161 HELION ACER TENDL-2021 LIBRARY; T=0.K  
He-3 emission for (s,n\*)he3

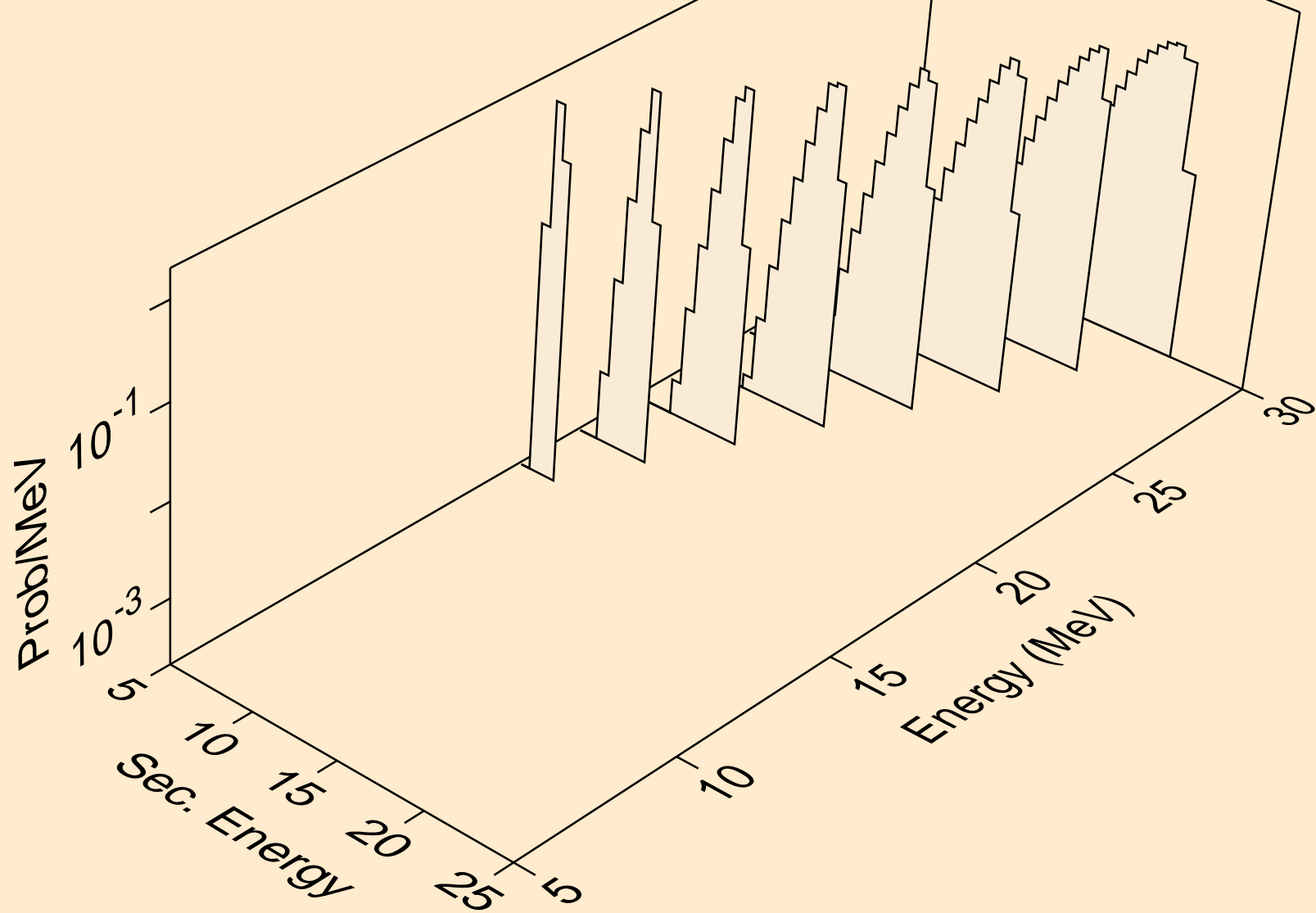



HO161 HELION ACER TENDL-2021 LIBRARY; T=0.K  
He-3 emission for inelastic

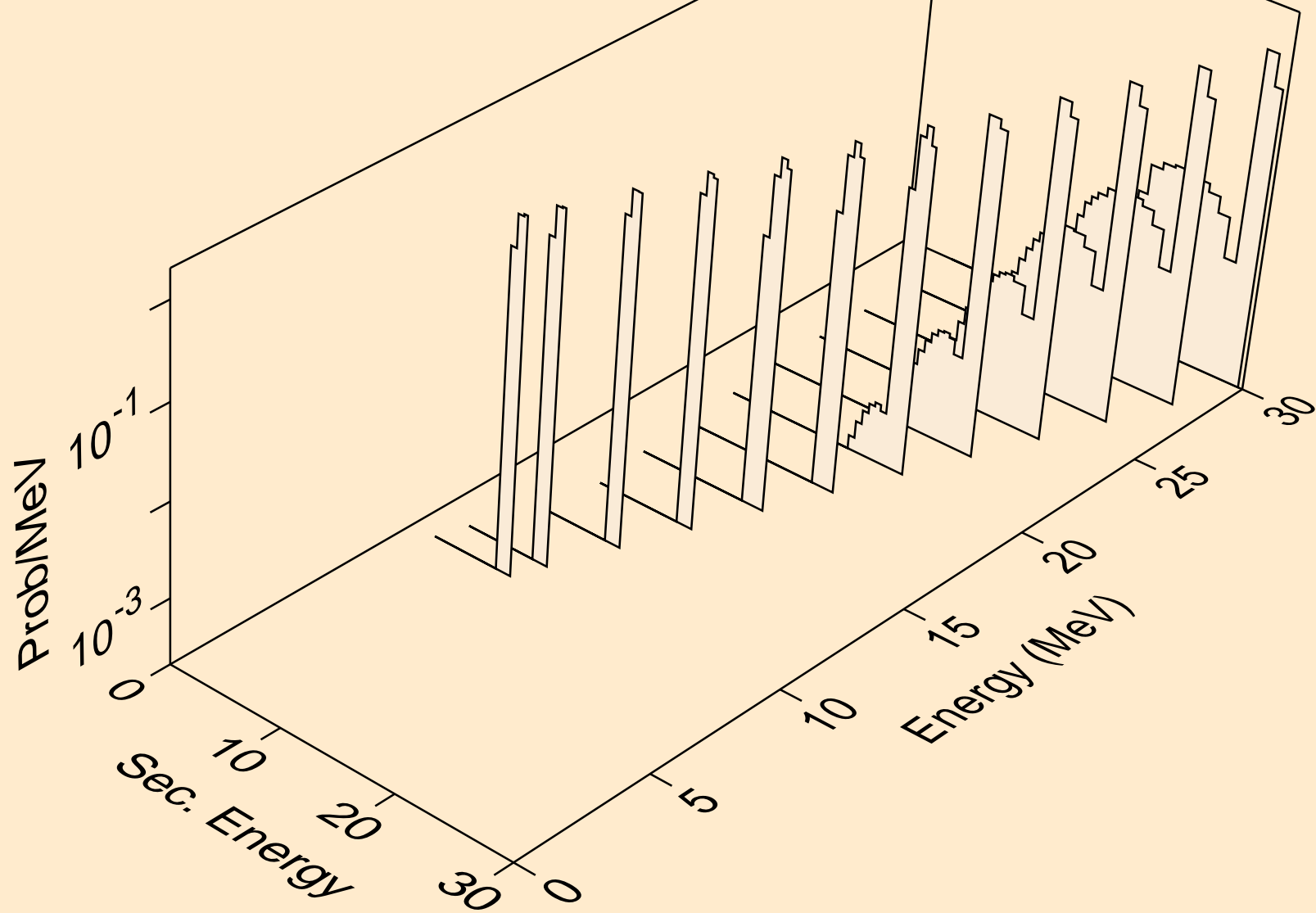

HO161 HELION ACER TENDL-2021 LIBRARY; T=0.K  
Photon emission for (z,n)

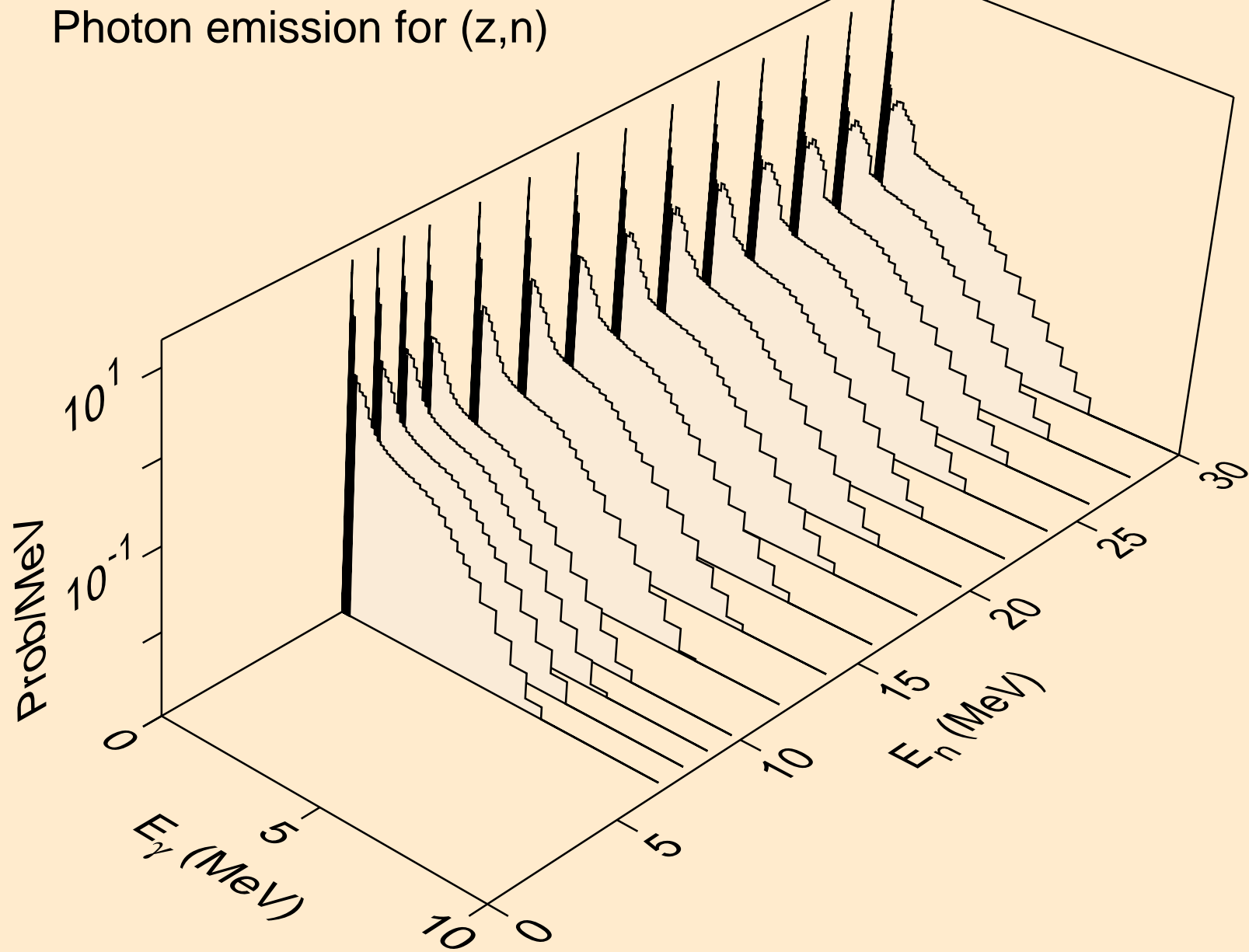

HO161 HELION ACER TENDL-2021 LIBRARY; T=0.K  
Photon emission for (n,x)

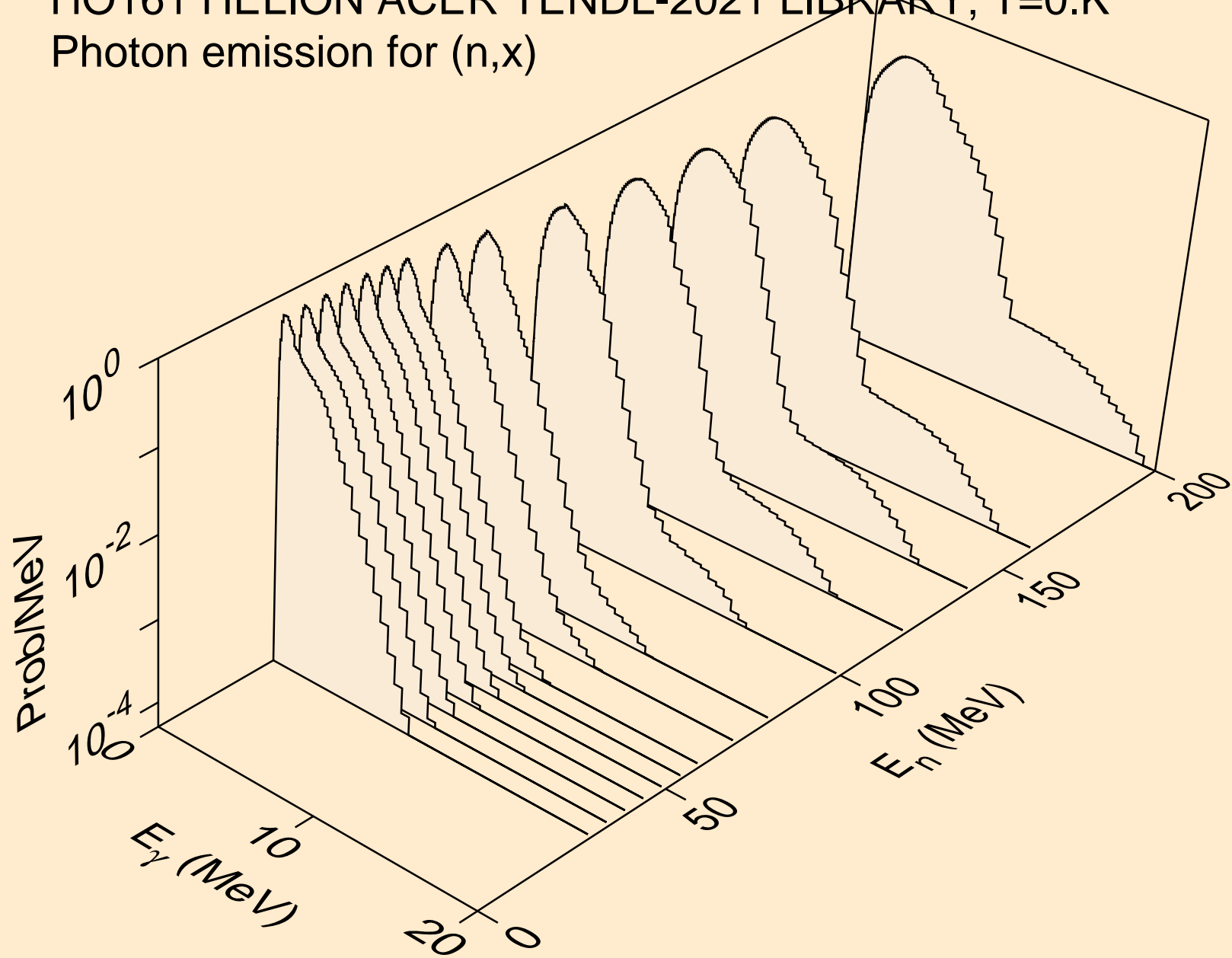

HO161 HELION ACER TENDL-2021 LIBRARY; T=0.K  
Photon emission for (n,2nd)

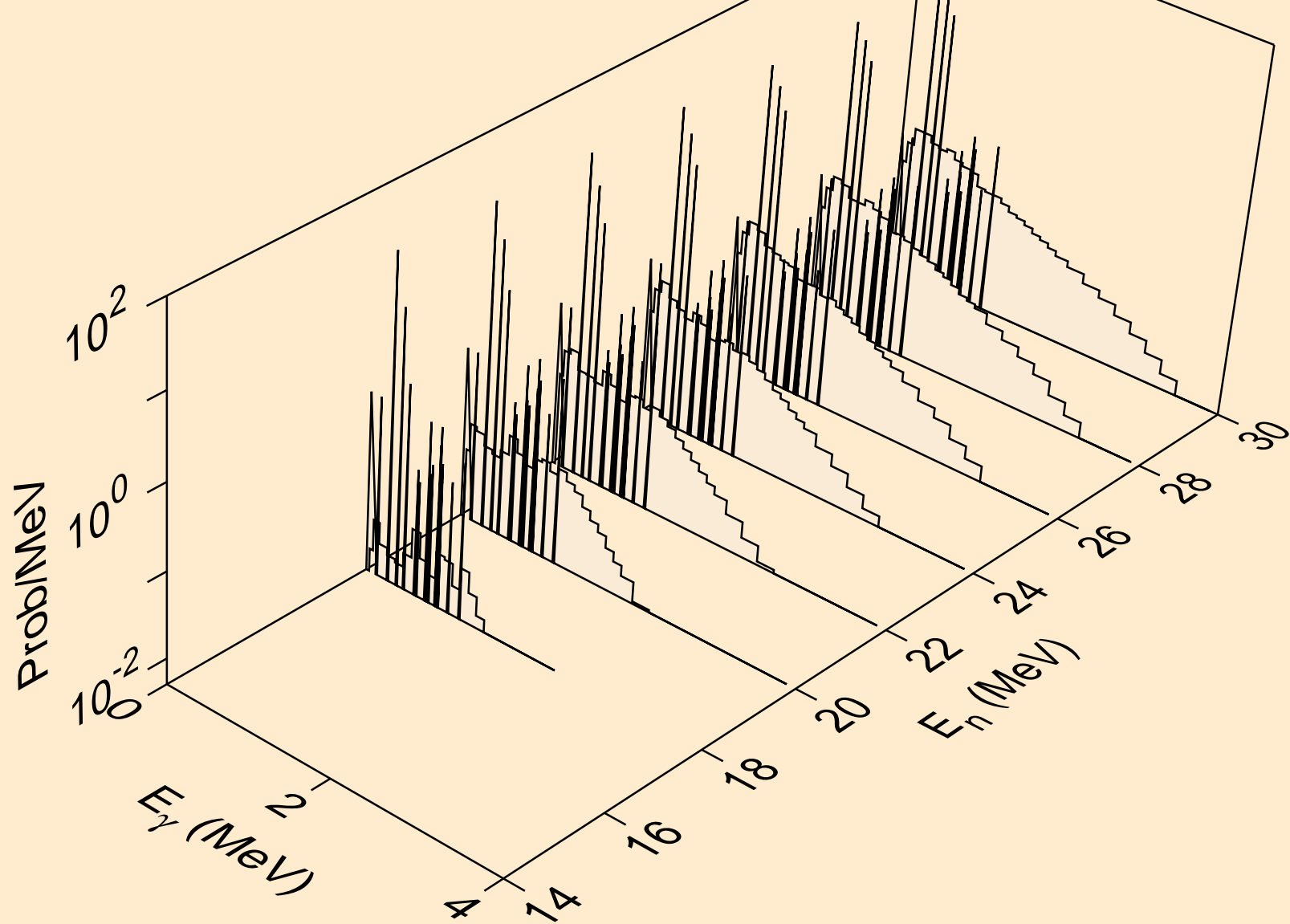

HO161 HELION ACER TENDL-2021 LIBRARY; T=0.K  
Photon emission for (n,2n)

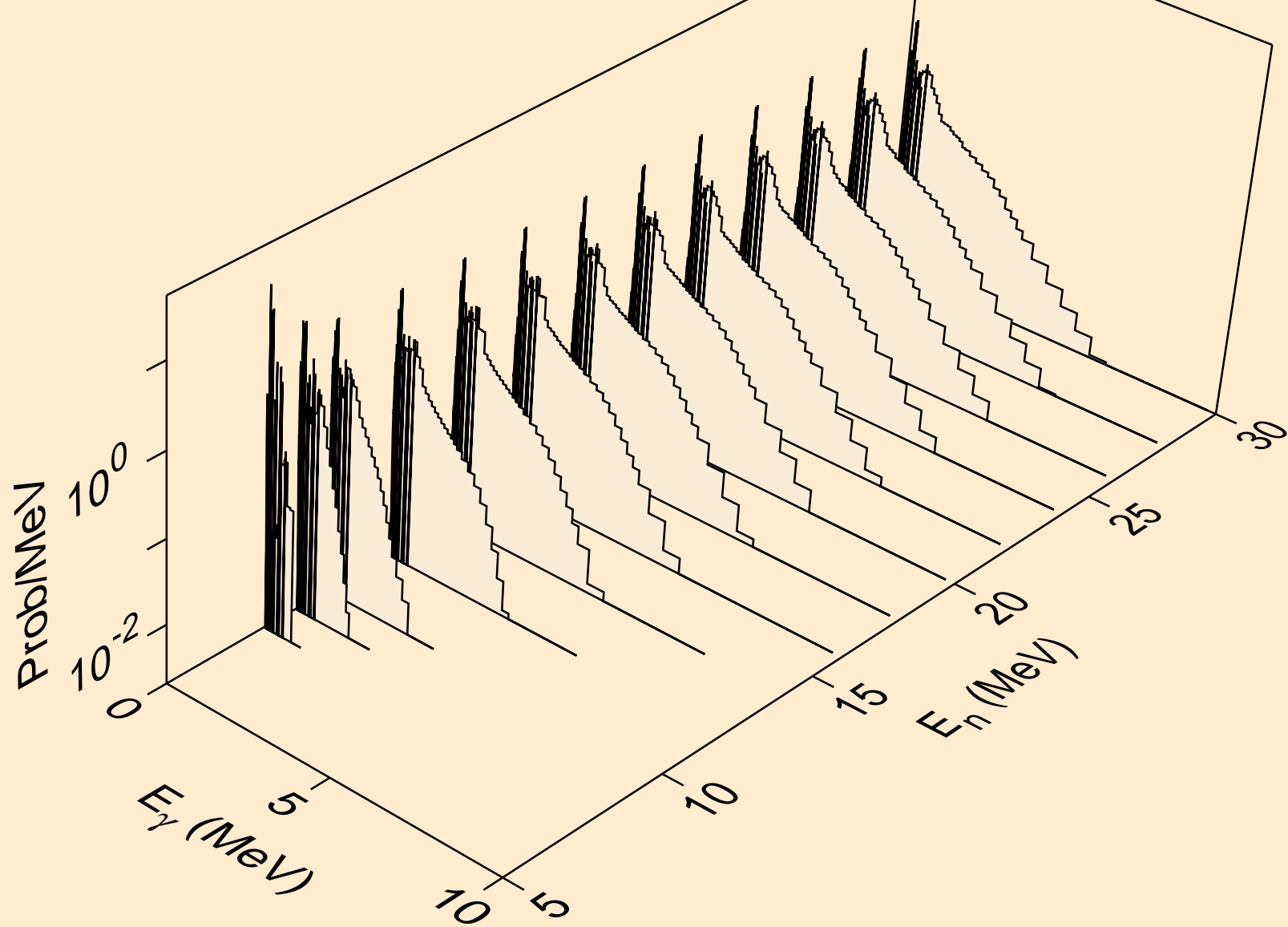

HO161 HELION ACER TENDL-2021 LIBRARY; T=0.K  
Photon emission for (n,3n)

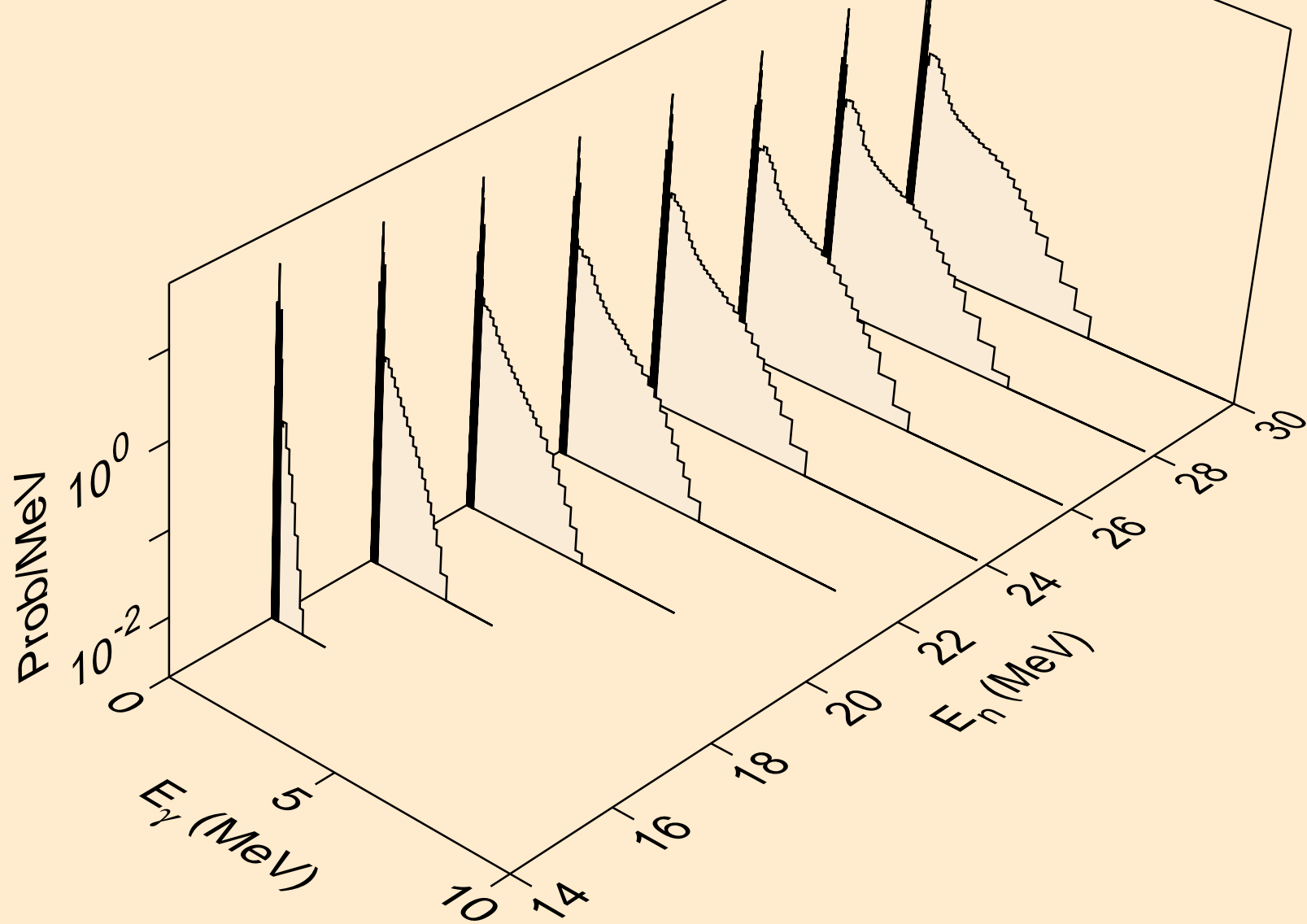

HO161 HELION ACER TENDL-2021 LIBRARY; T=0.K  
Photon emission for (n,n\*)a

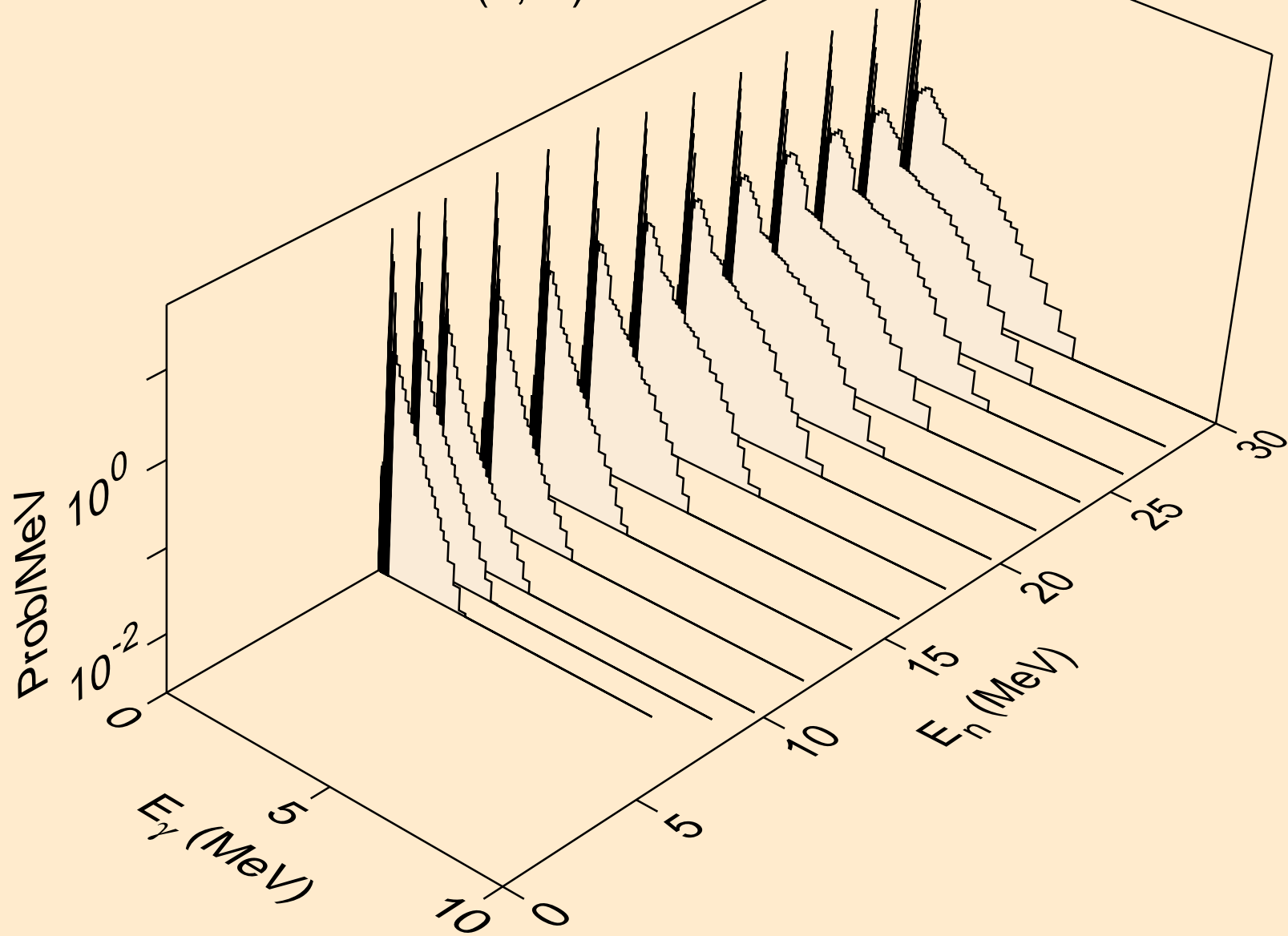

HO161 HELION ACER TENDL-2021 LIBRARY; T=0.K  
Photon emission for (n,2n)a

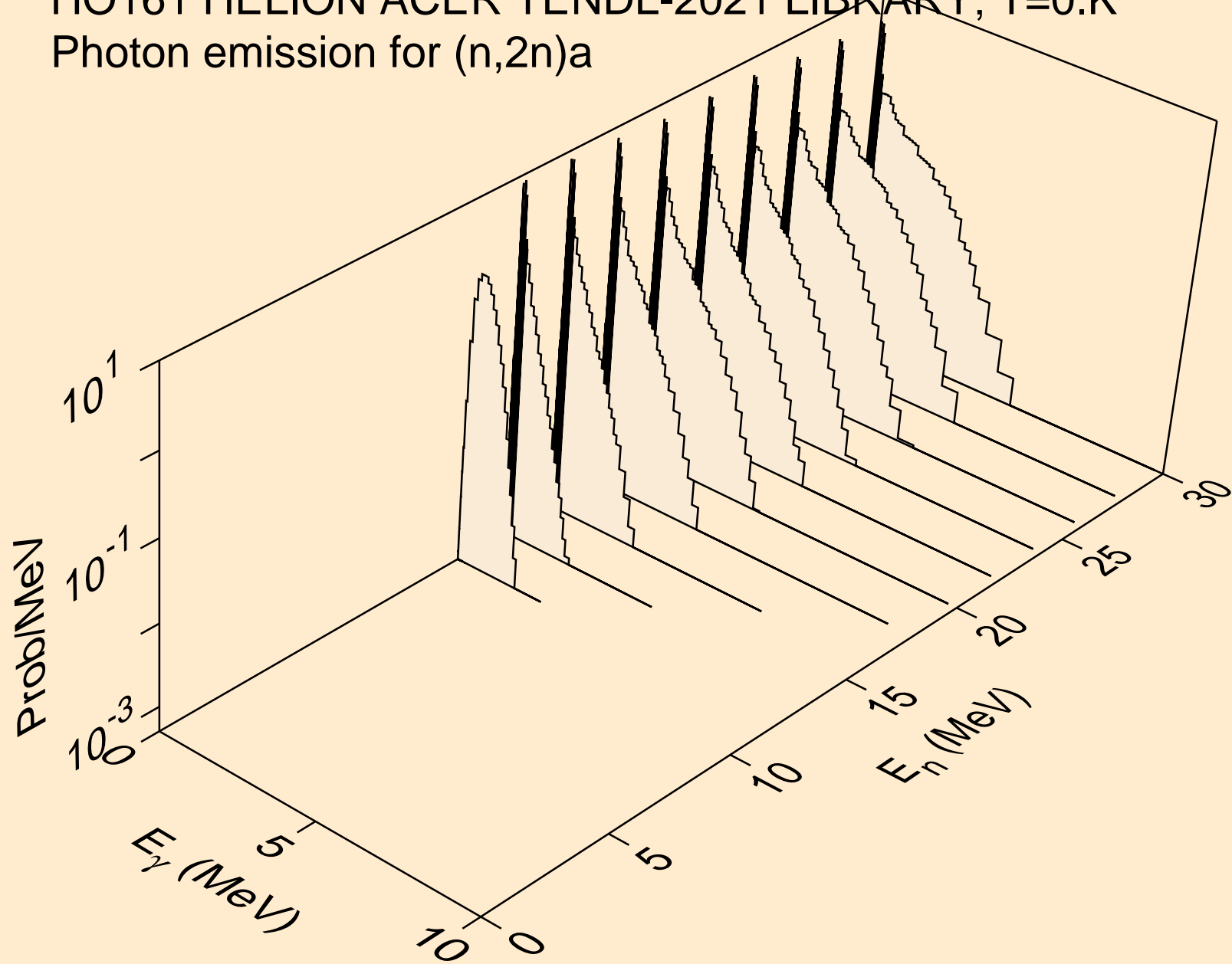



HO161 HELION ACER TENDL-2021 LIBRARY; T=0.K  
Photon emission for (n,3n)a

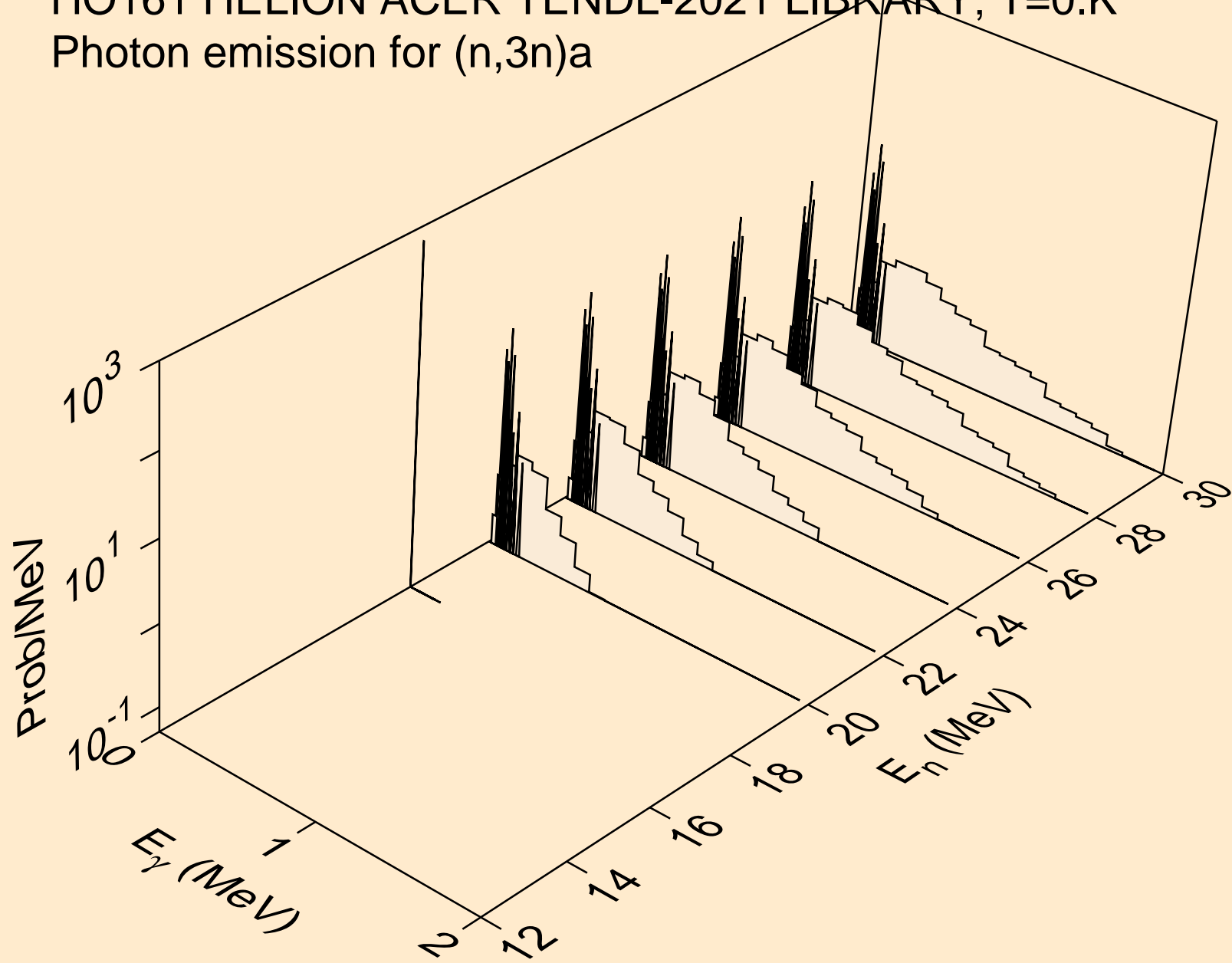

HO161 HELION ACER TENDL-2021 LIBRARY; T=0.K  
Photon emission for (n,n\*)p

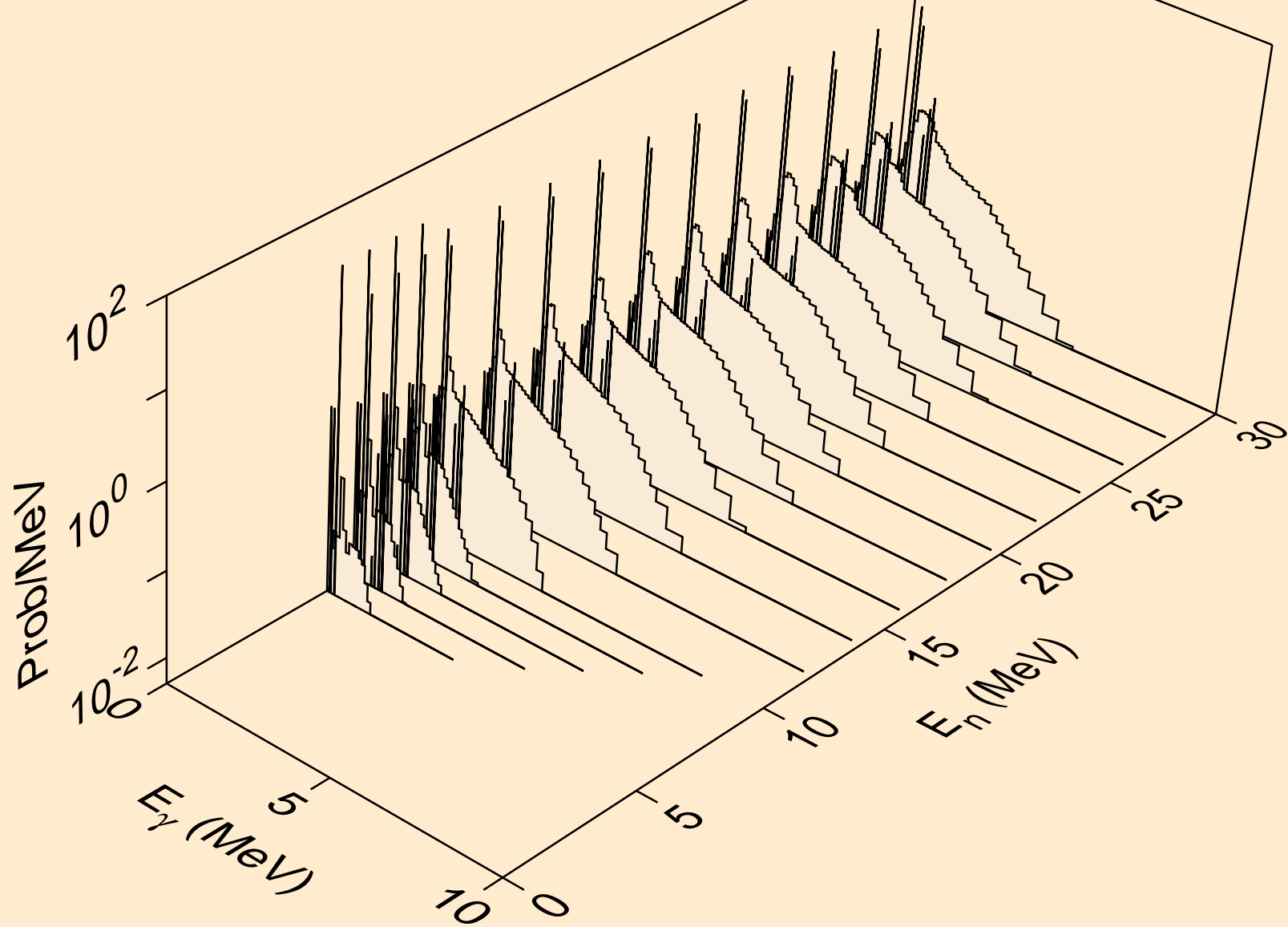

HO161 HELION ACER TENDL-2021 LIBRARY; T=0.K  
Photon emission for (n,n\*)2a

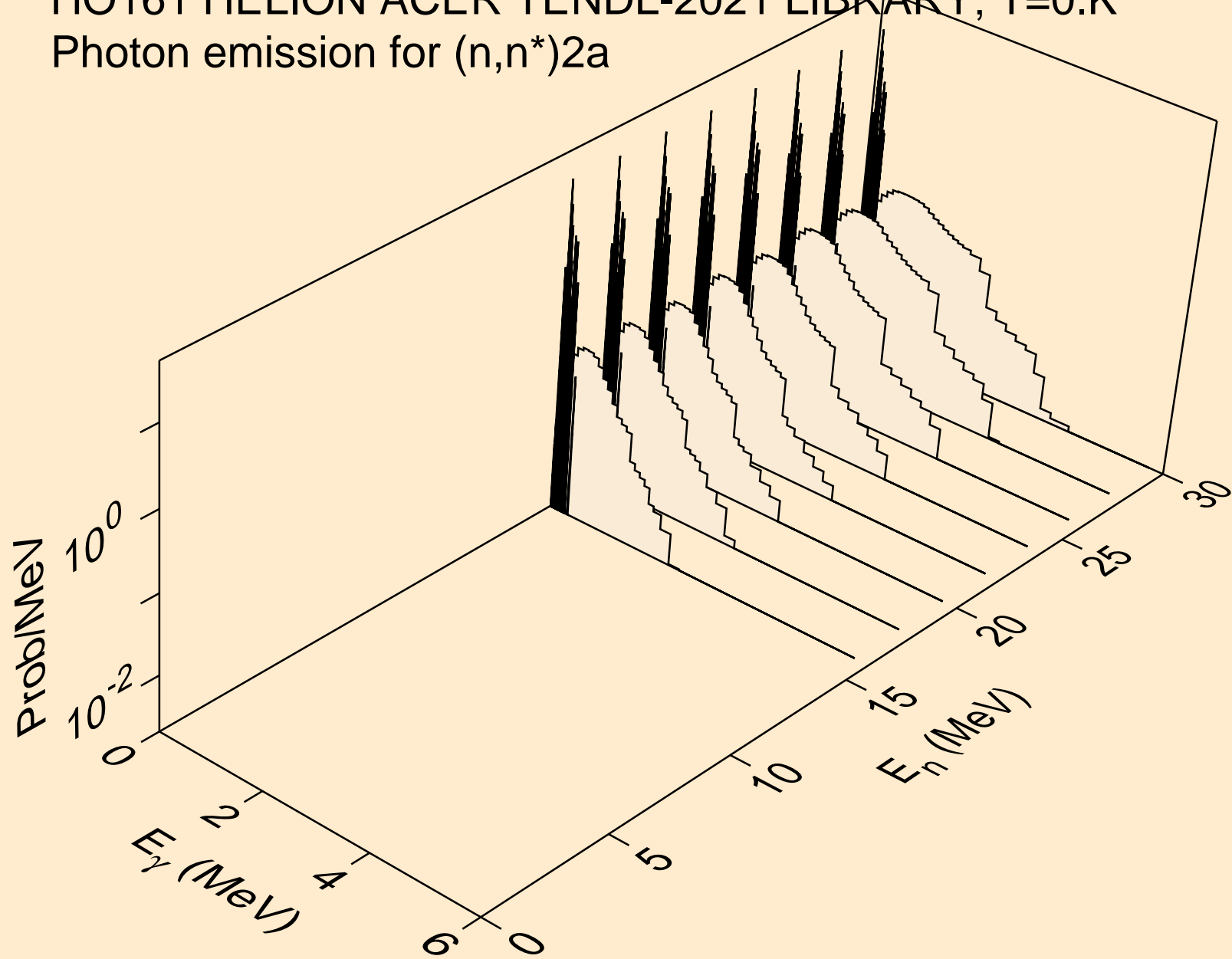

HO161 HELION ACER TENDL-2021 LIBRARY; T=0.K  
Photon emission for (n,n\*)d

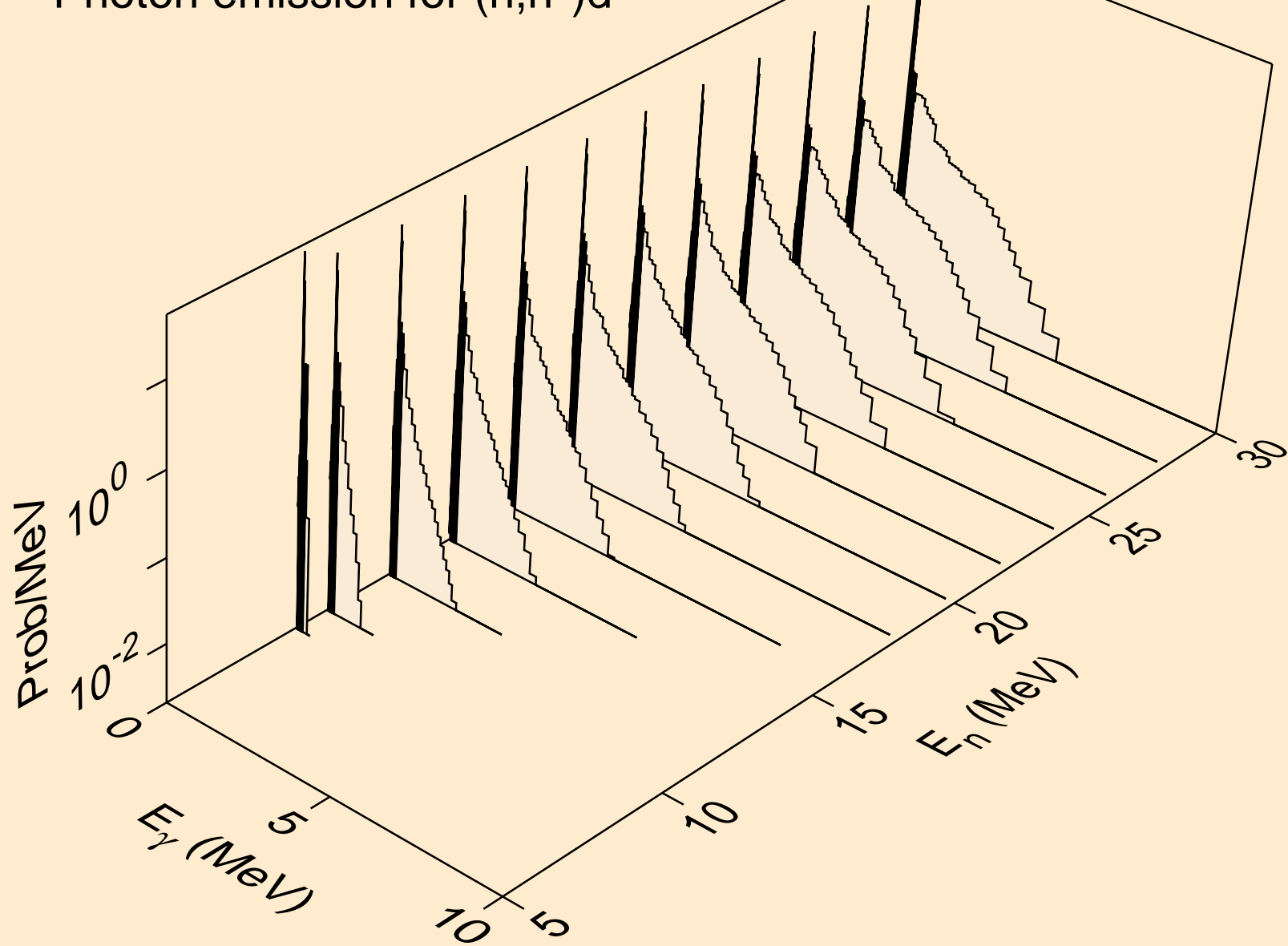

HO161 HELION ACER TENDL-2021 LIBRARY; T=0.K  
Photon emission for (n,n\*)t

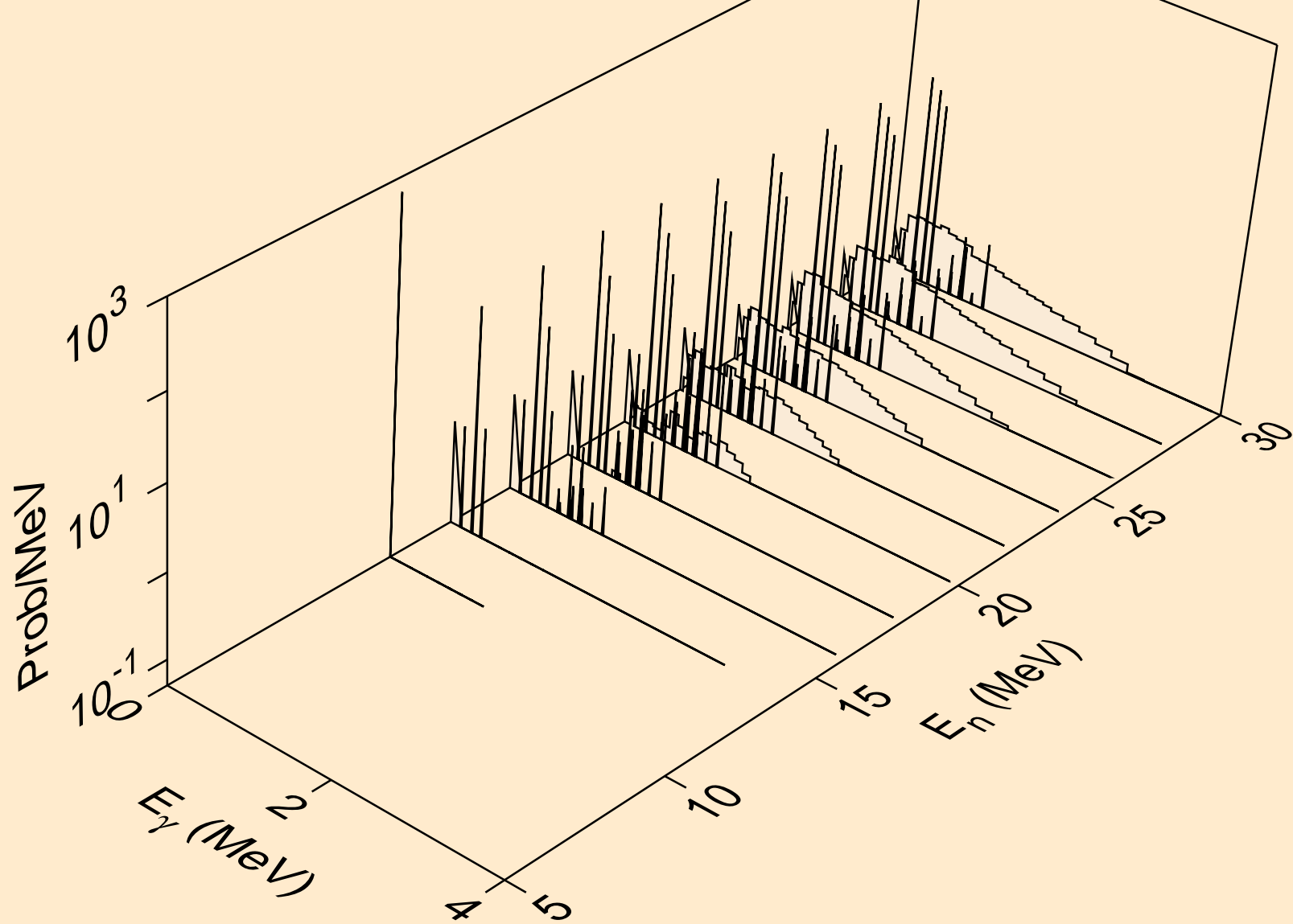

HO161 HELION ACER TENDL-2021 LIBRARY; T=0.K  
Photon emission for (n,n\*)he3

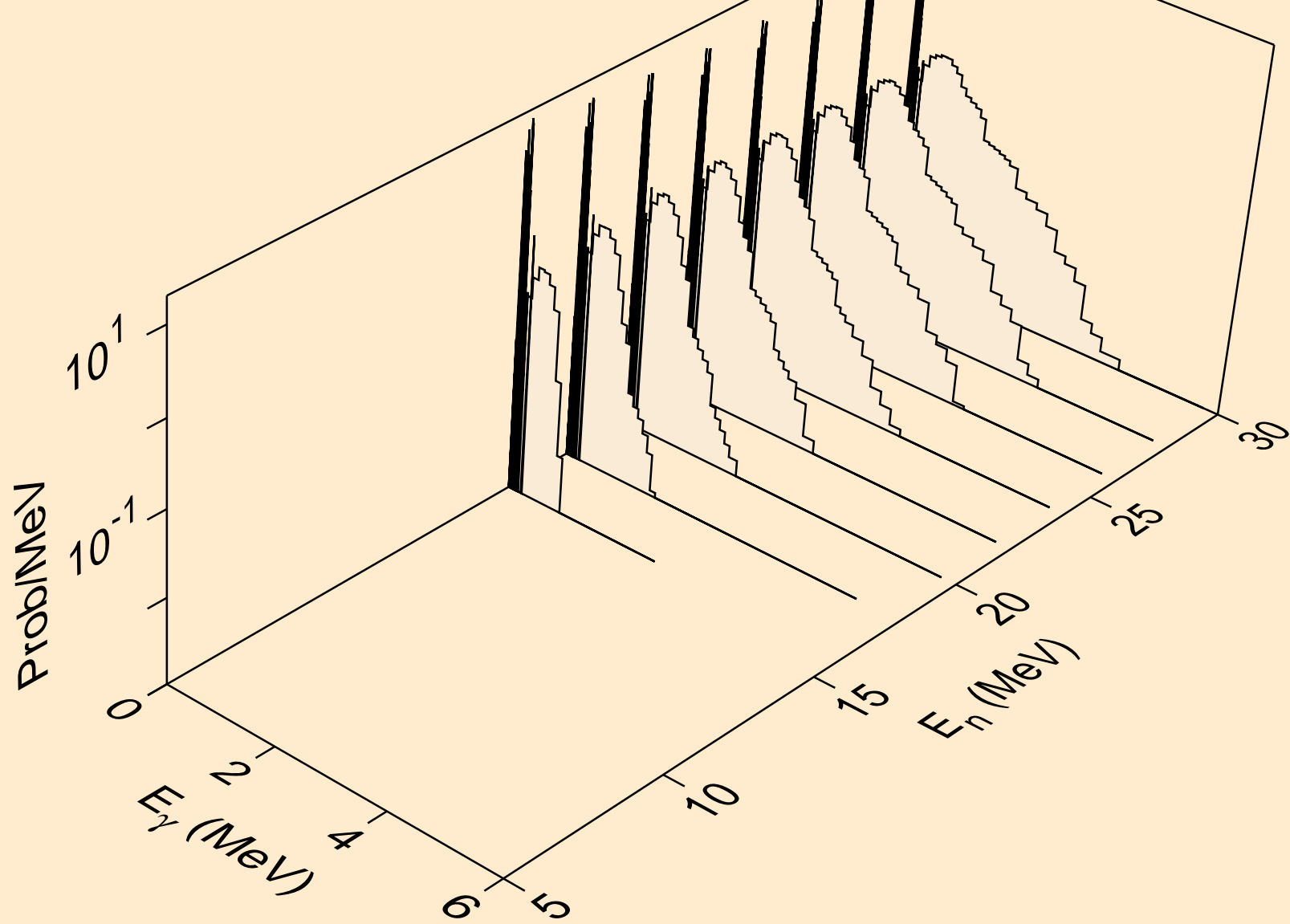

HO161 HELION ACER TENDL-2021 LIBRARY; T=0.K  
Photon emission for (n,4n)

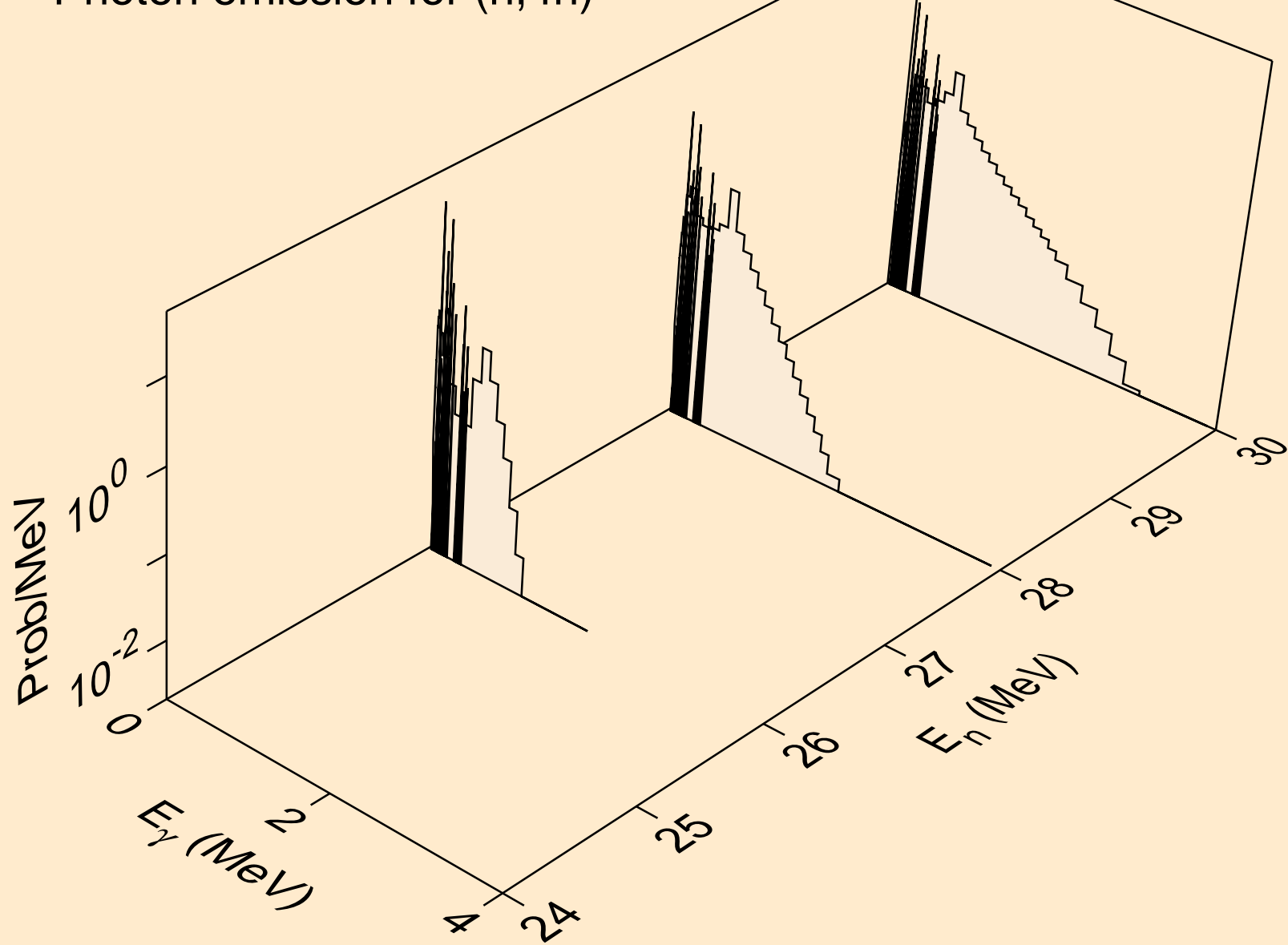

HO161 HELION ACER TENDL-2021 LIBRARY; T=0.K  
Photon emission for (n,2np)

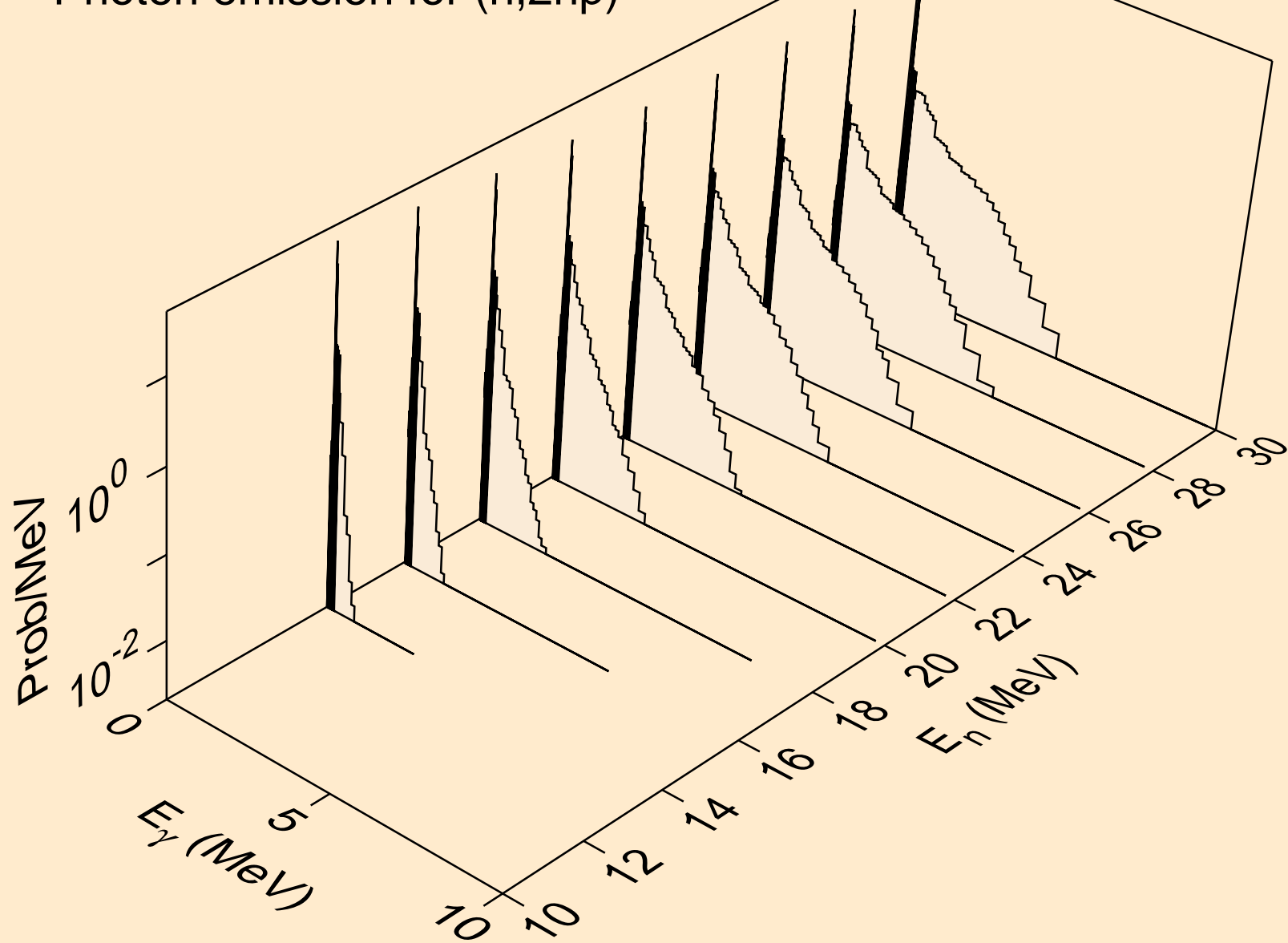



HO161 HELION ACER TENDL-2021 LIBRARY; T=0.K  
Photon emission for (n,3np)

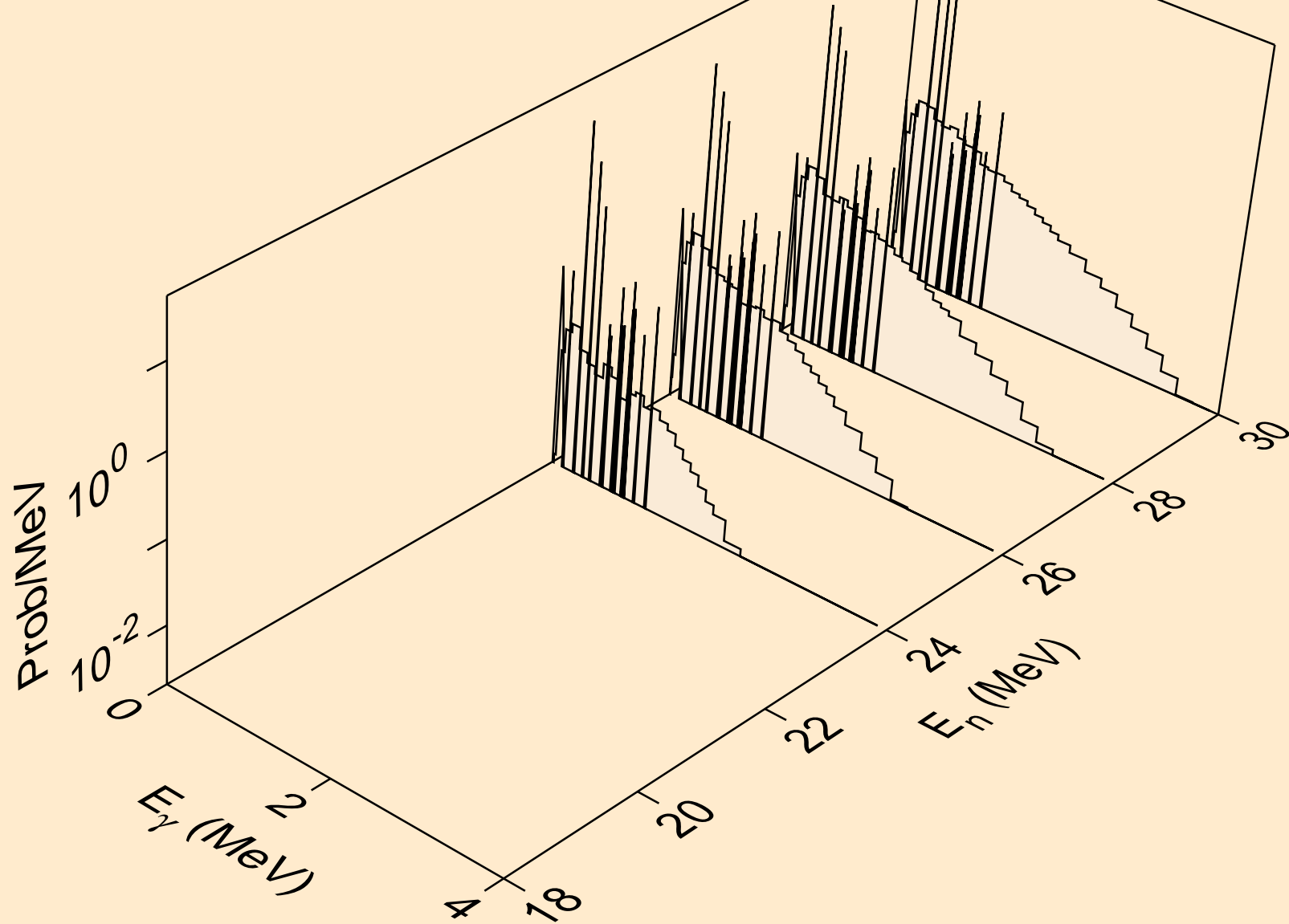

HO161 HELION ACER TENDL-2021 LIBRARY; T=0.K  
Photon emission for (n,2np)

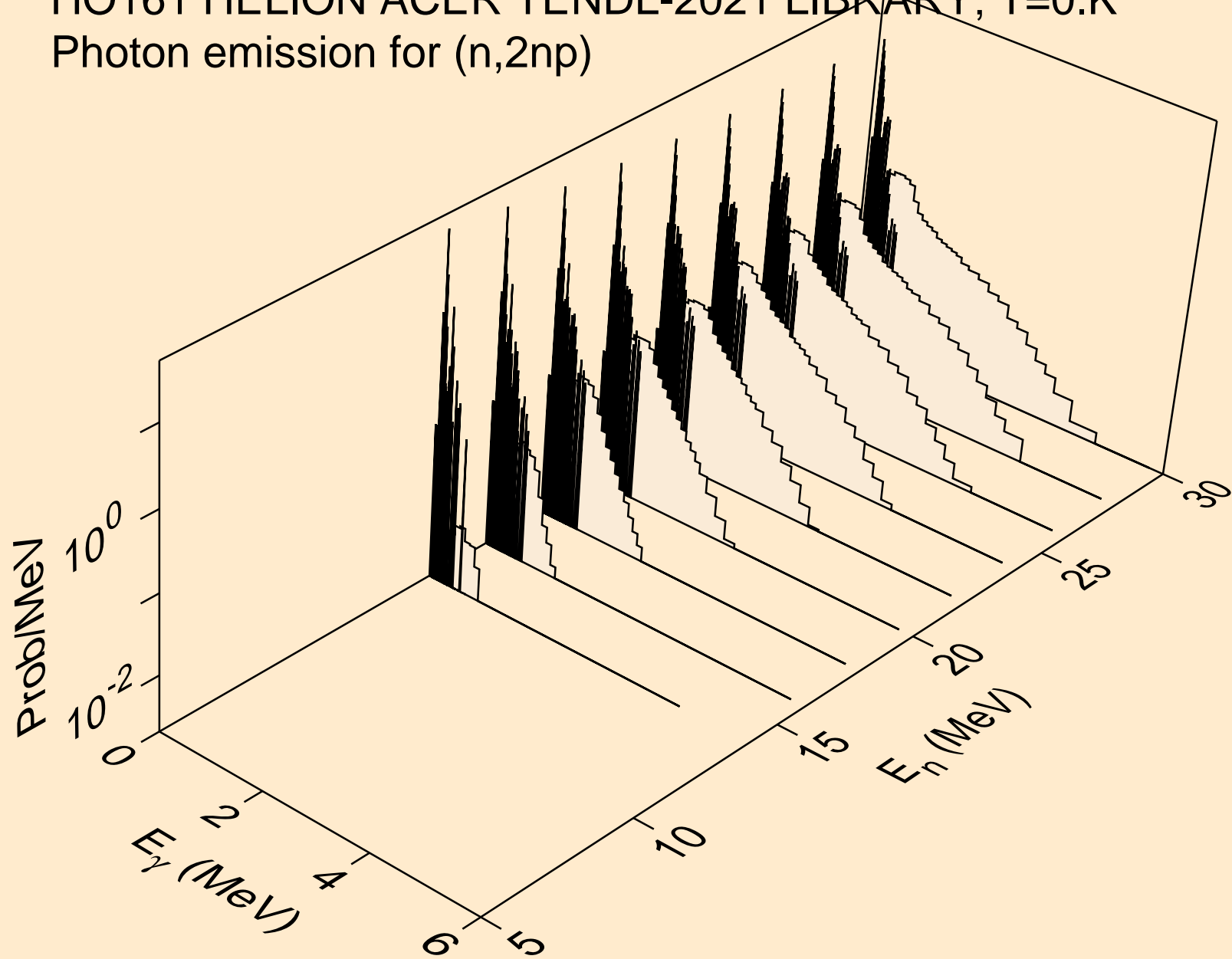

HO161 HELION ACER TENDL-2021 LIBRARY; T=0.K  
Photon emission for (n,npa)

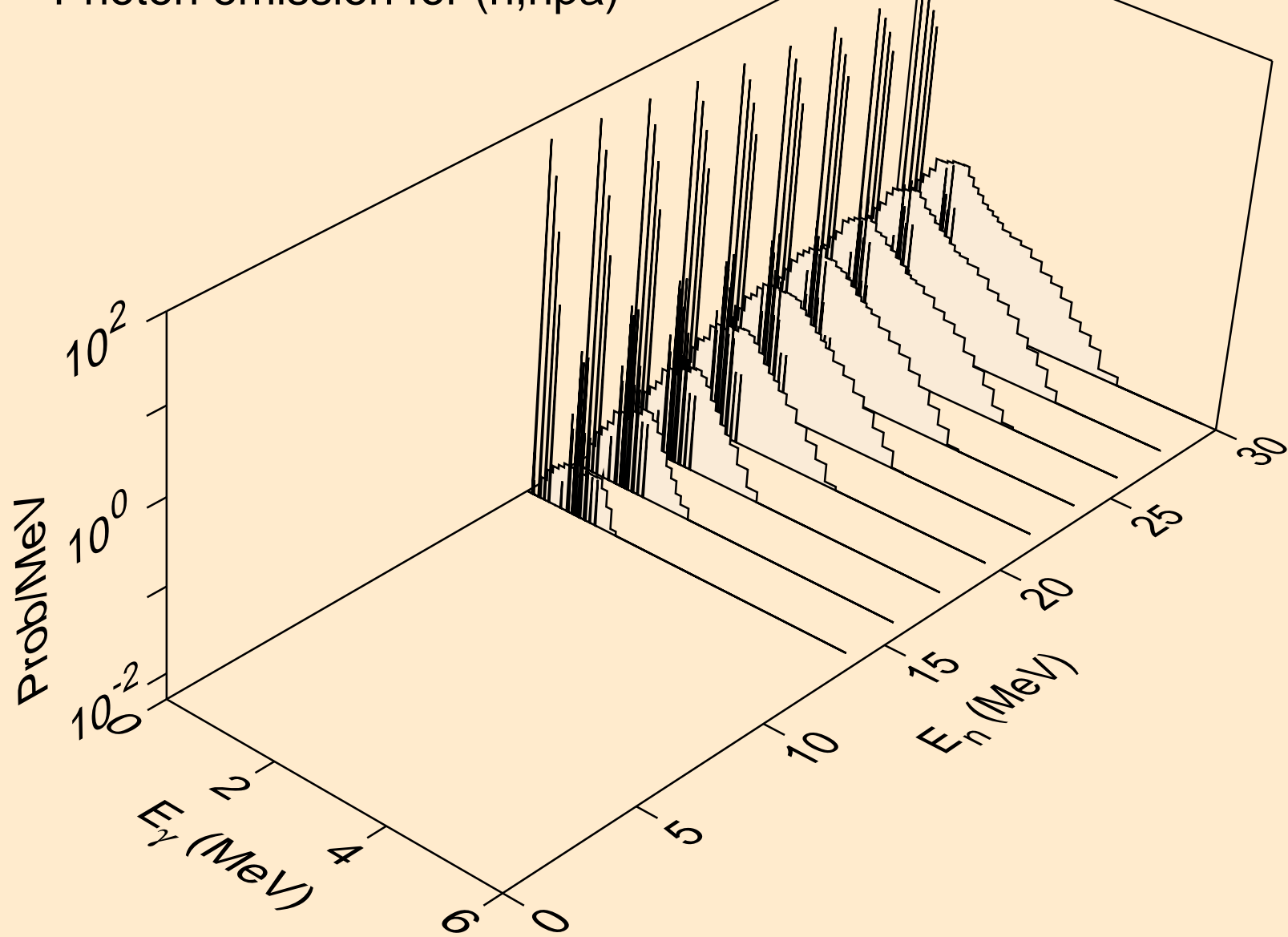

HO161 HELION ACER TENDL-2021 LIBRARY; T=0.K  
Photon emission for (n,gma)

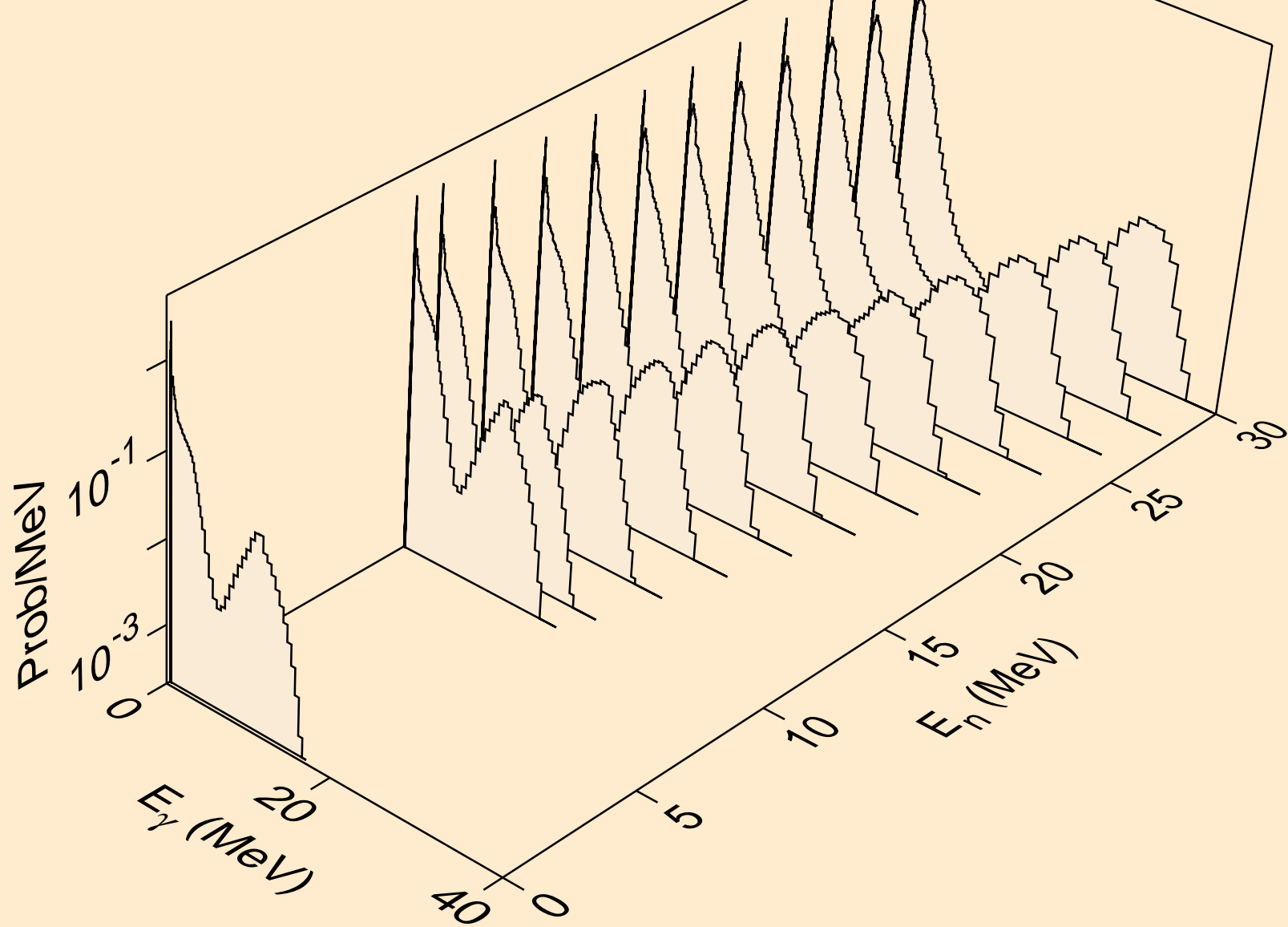

HO161 HELION ACER TENDL-2021 LIBRARY; T=0.K  
Photon emission for (n,p)

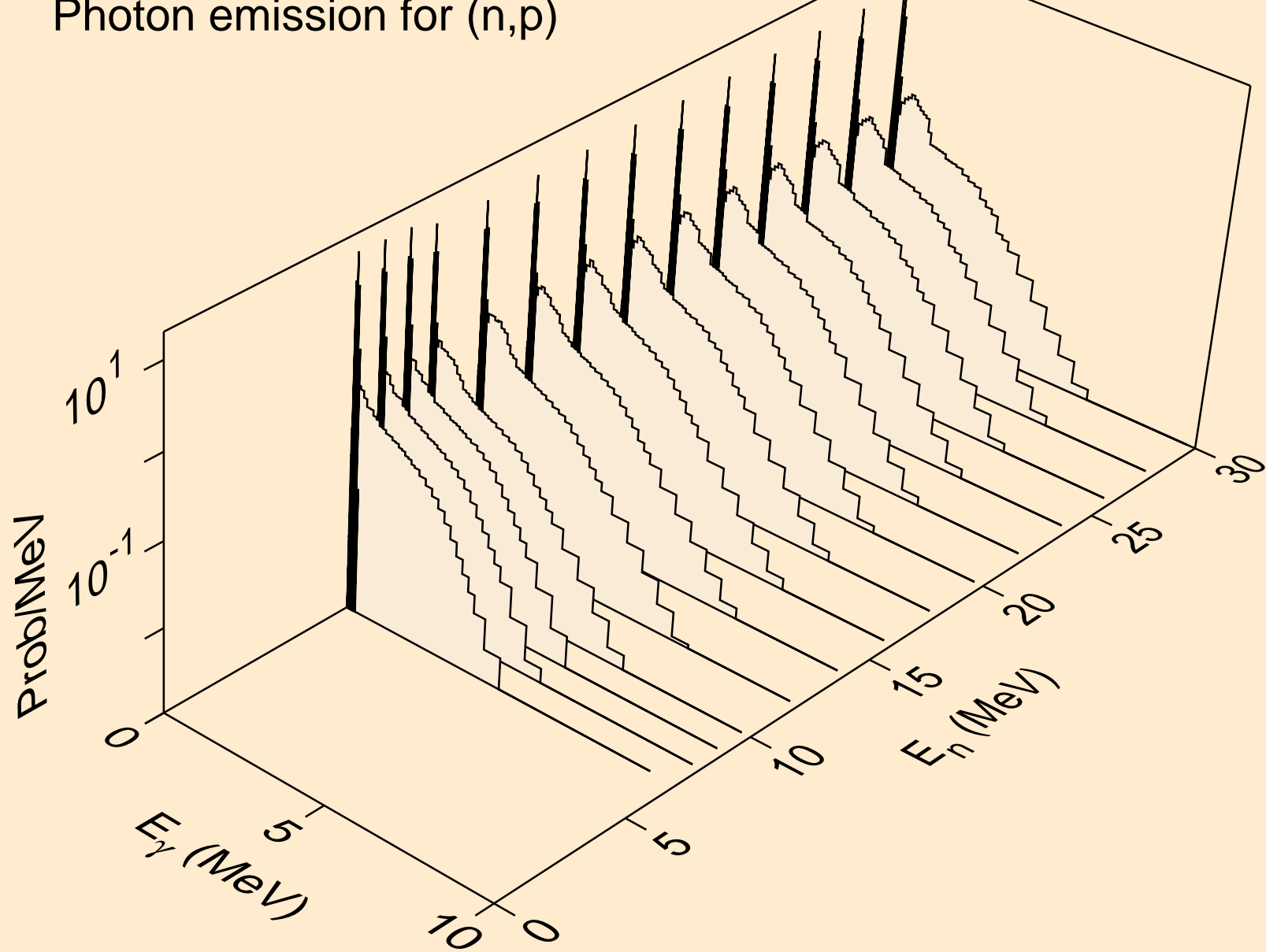

HO161 HELION ACER TENDL-2021 LIBRARY; T=0.K  
Photon emission for (n,d)

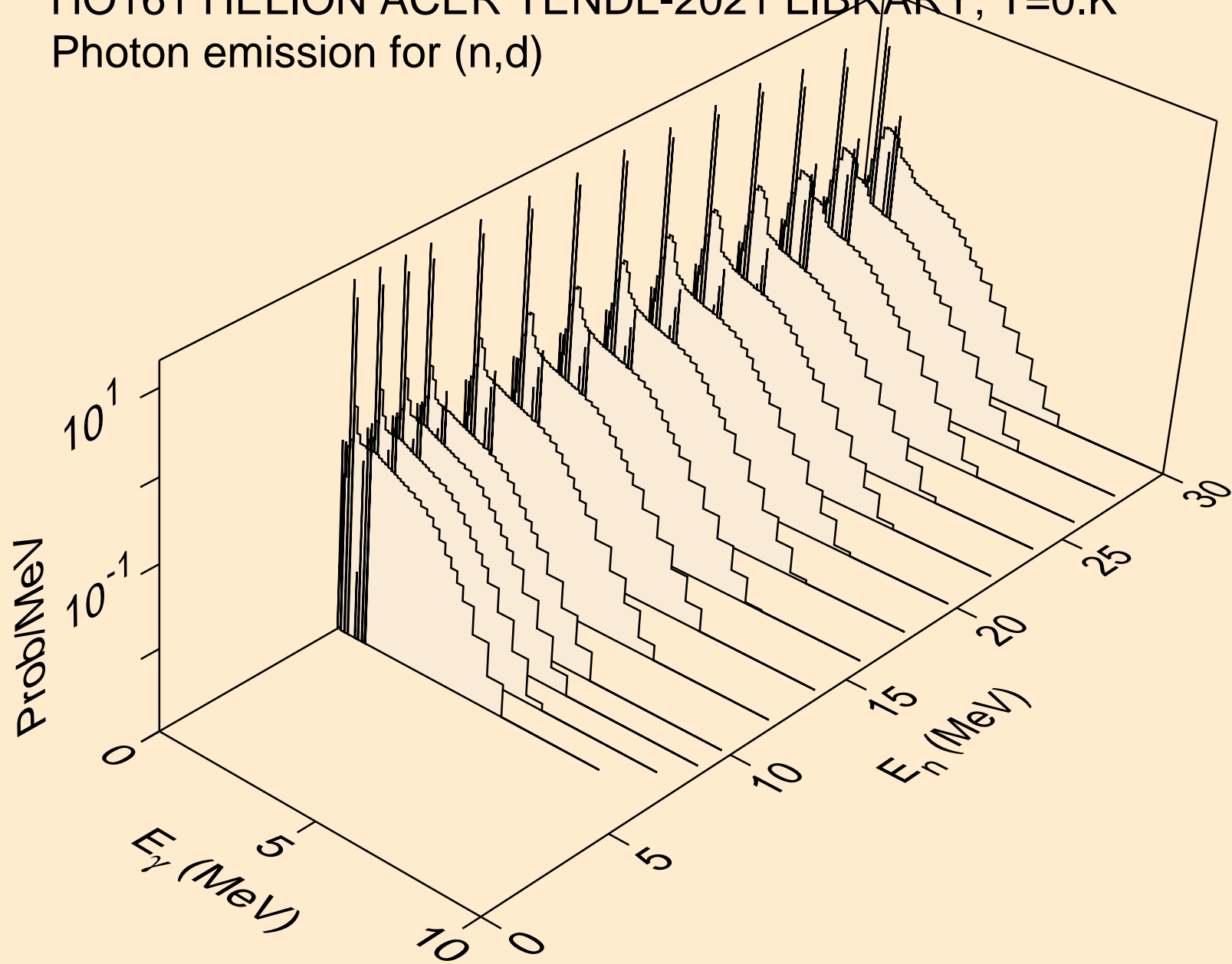

HO161 HELION ACER TENDL-2021 LIBRARY; T=0.K  
Photon emission for (n,t)

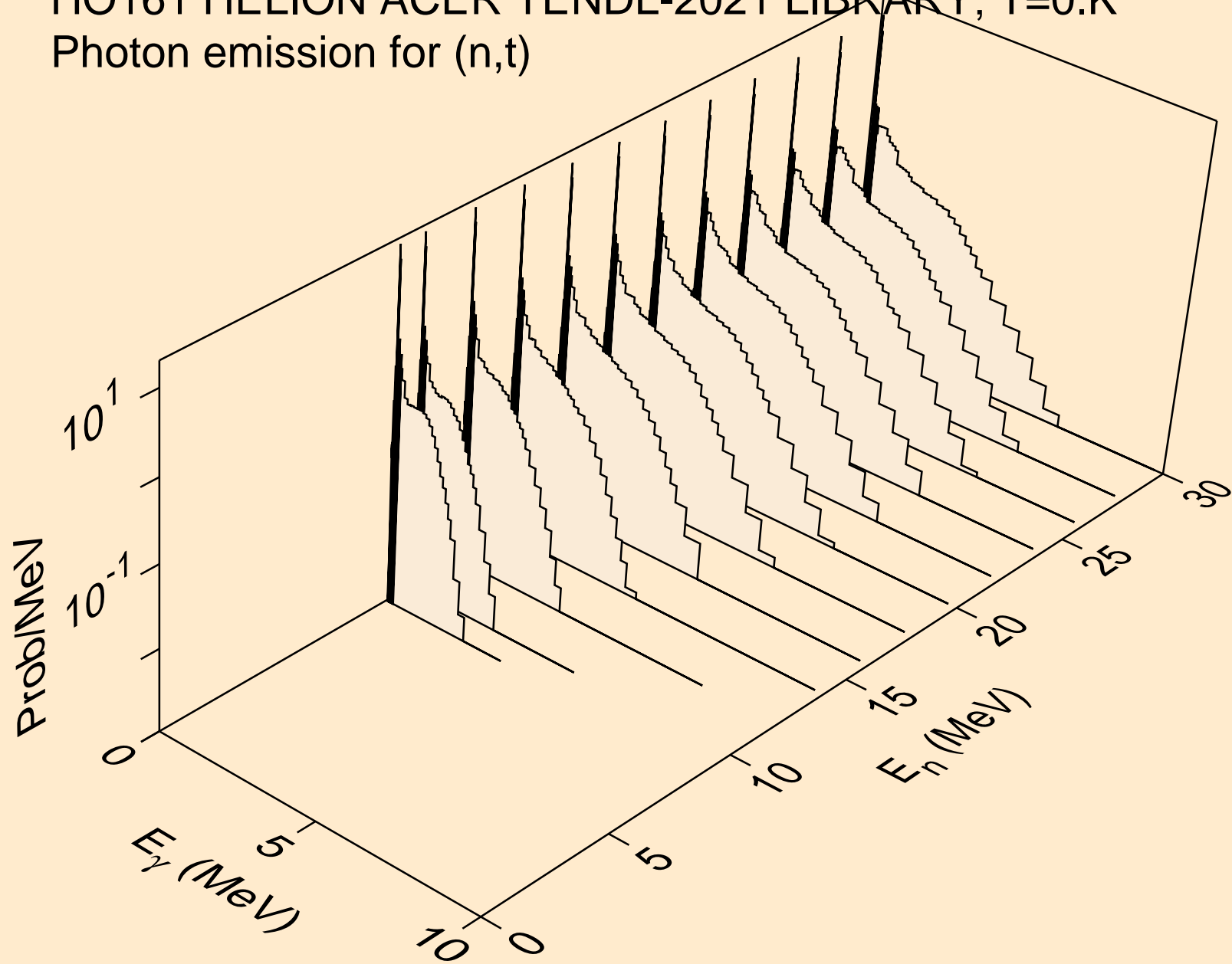

HO161 HELION ACER TENDL-2021 LIBRARY; T=0.K  
Photon emission for inelastic

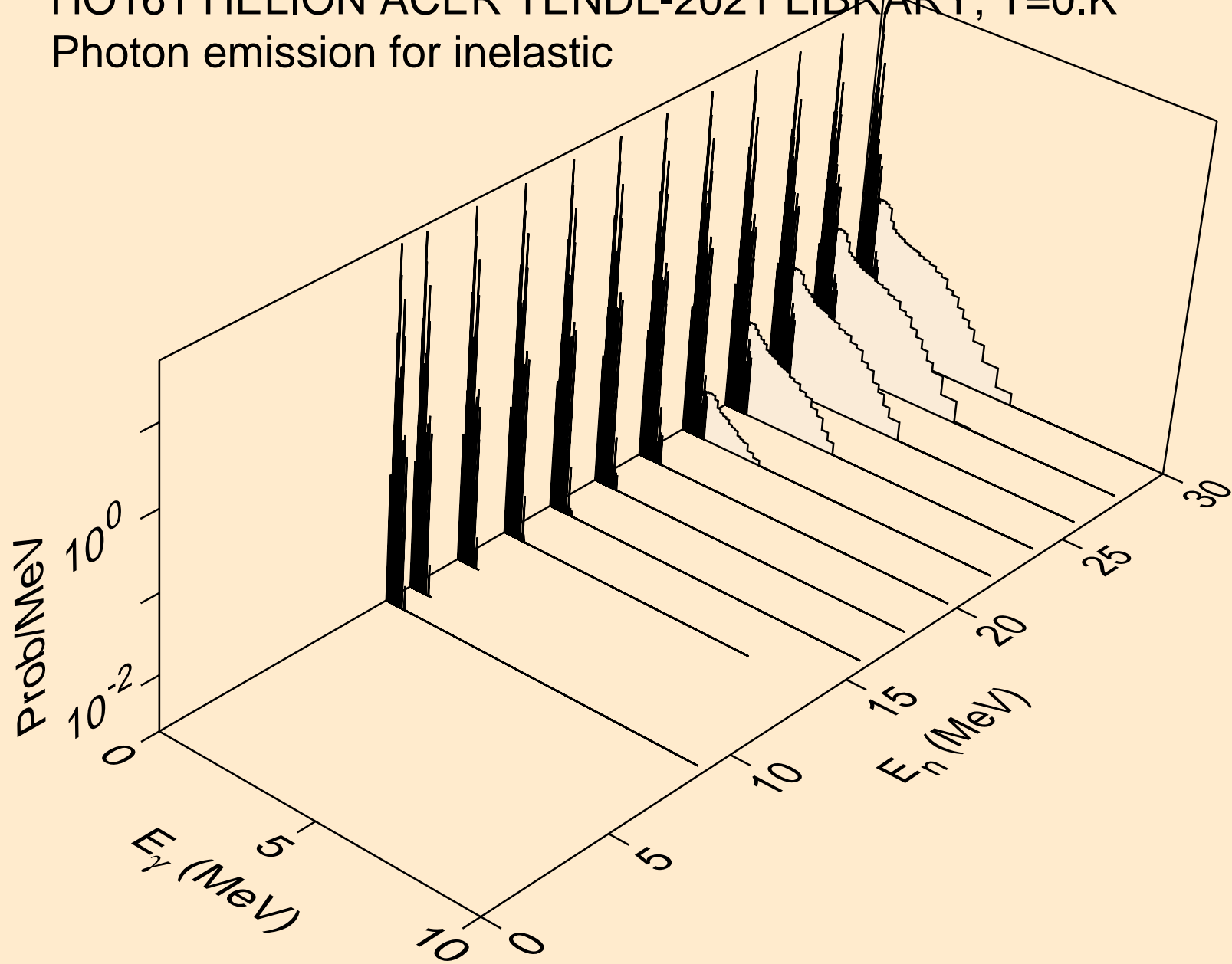



HO161 HELION ACER TENDL-2021 LIBRARY; T=0.K  
Photon emission for (n,a)

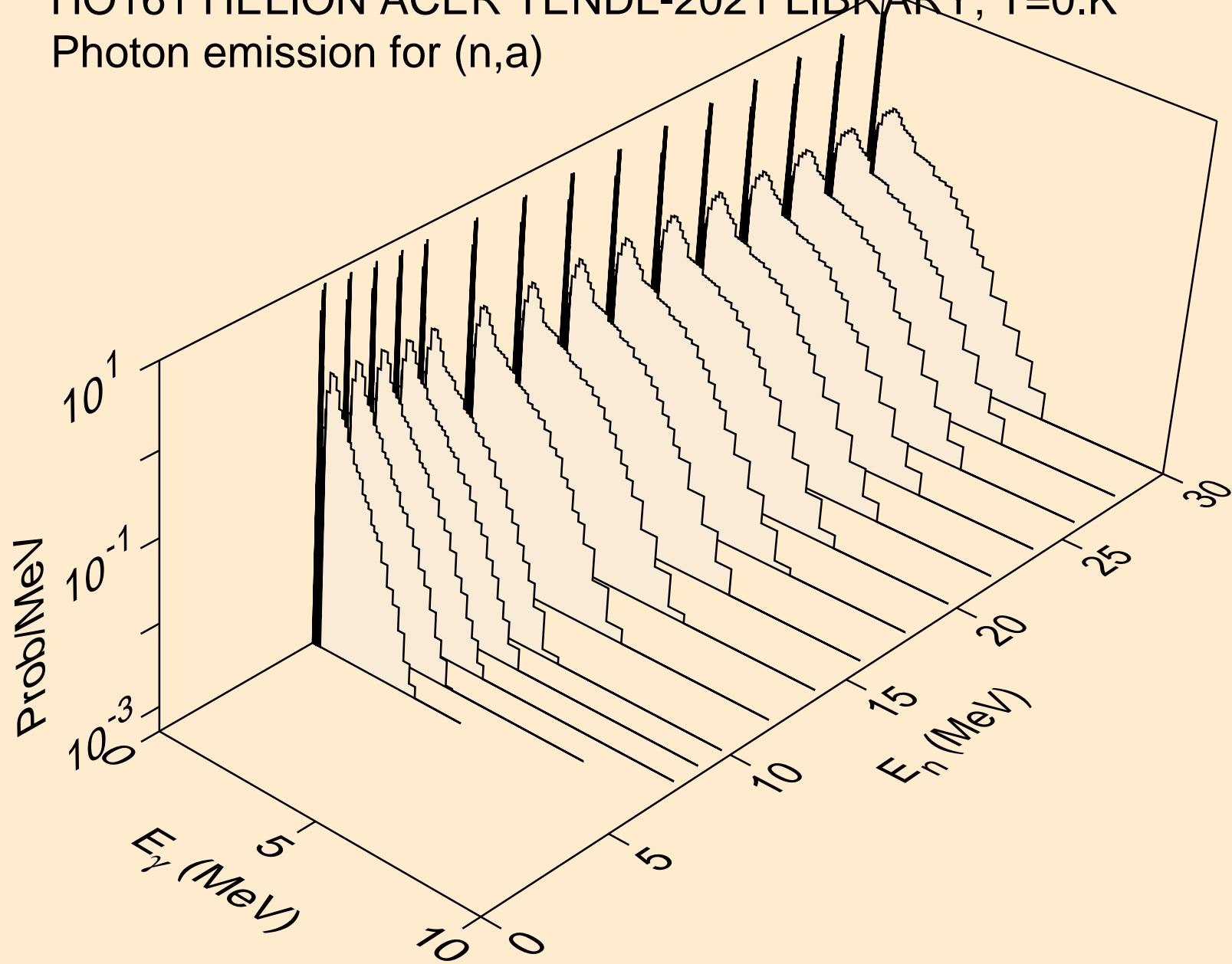

HO161 HELION ACER TENDL-2021 LIBRARY; T=0.K  
Photon emission for (n,2a)

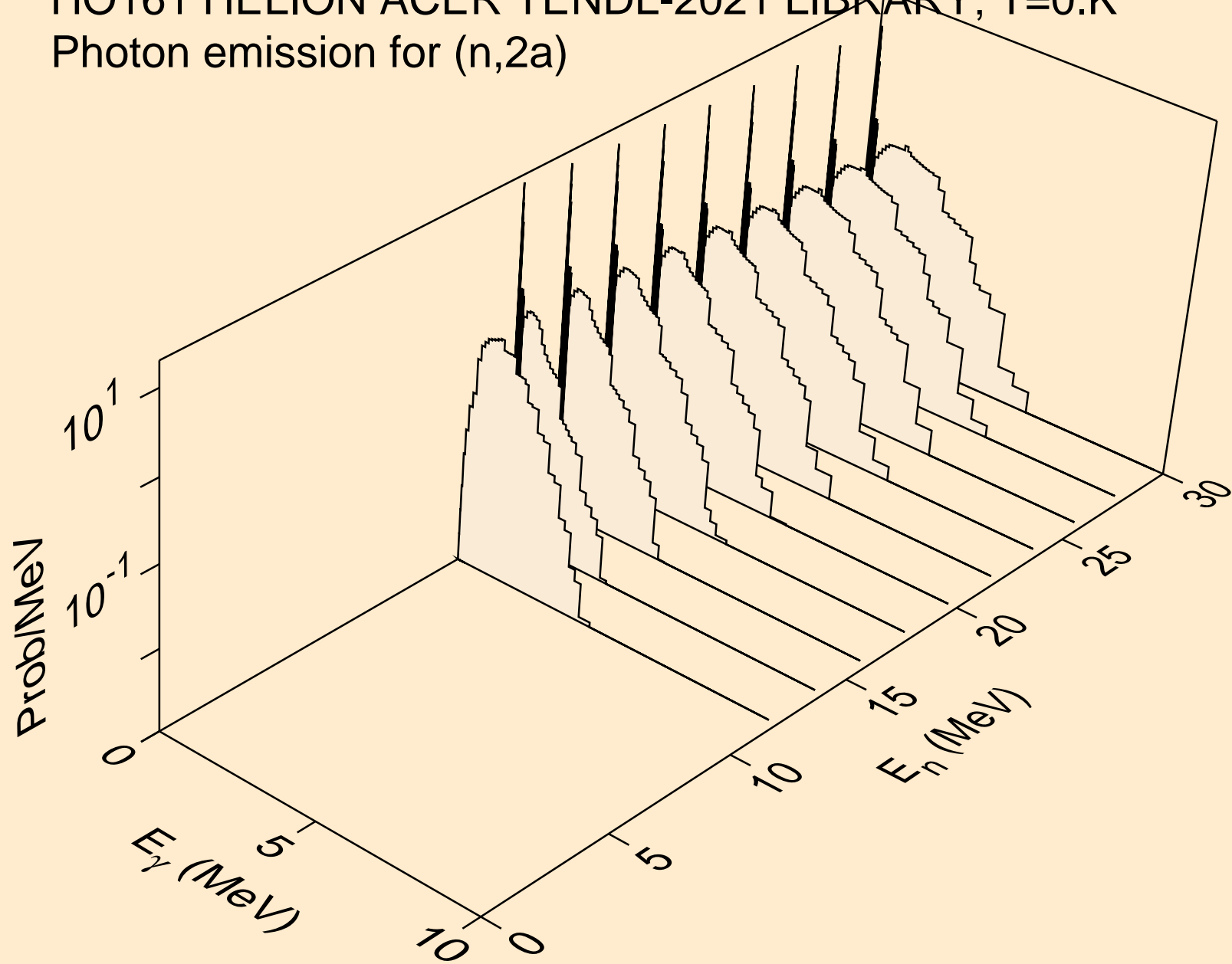

HO161 HELION ACER TENDL-2021 LIBRARY; T=0.K  
Photon emission for (n,2p)

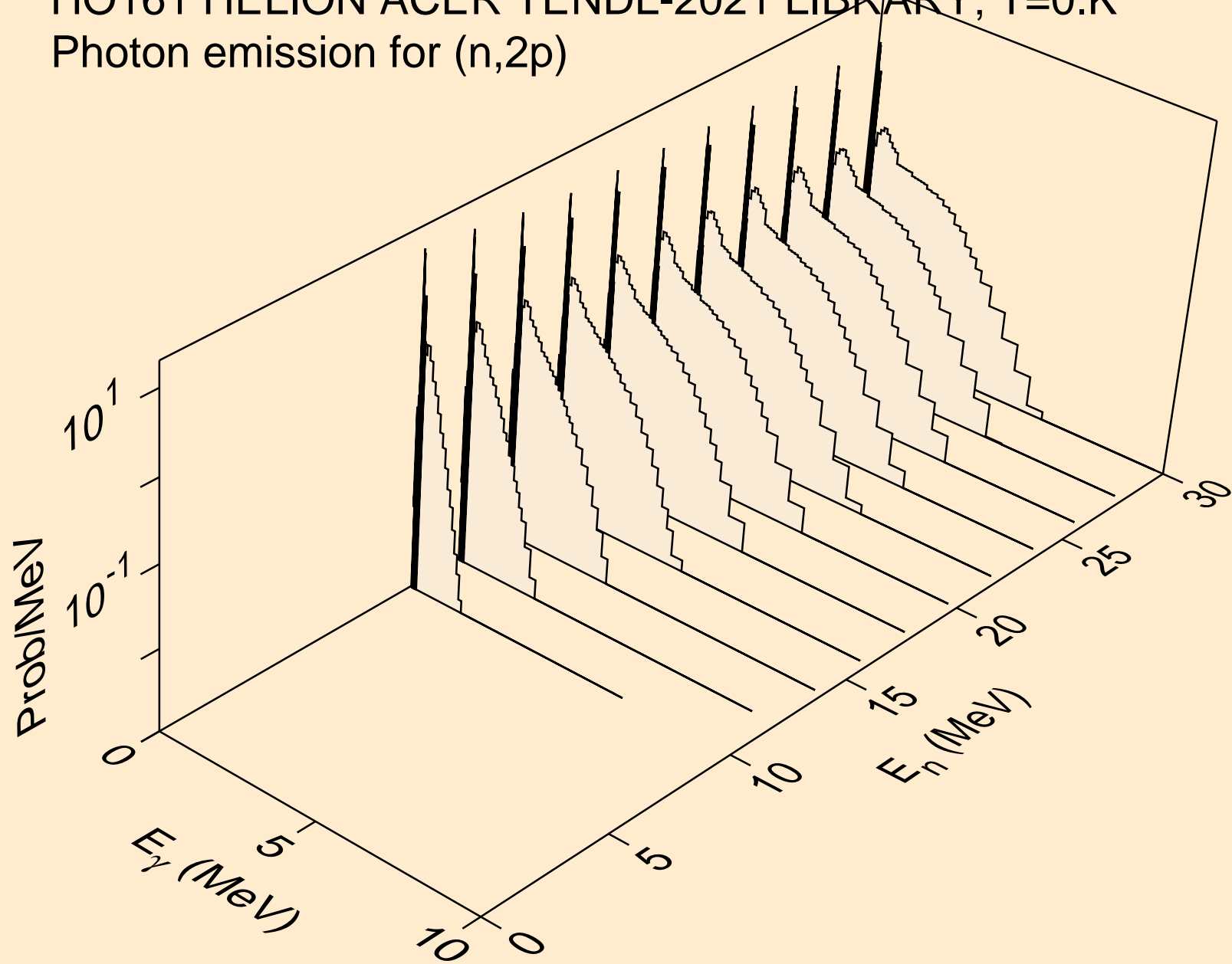

HO161 HELION ACER TENDL-2021 LIBRARY; T=0.K  
Photon emission for (n,pa)

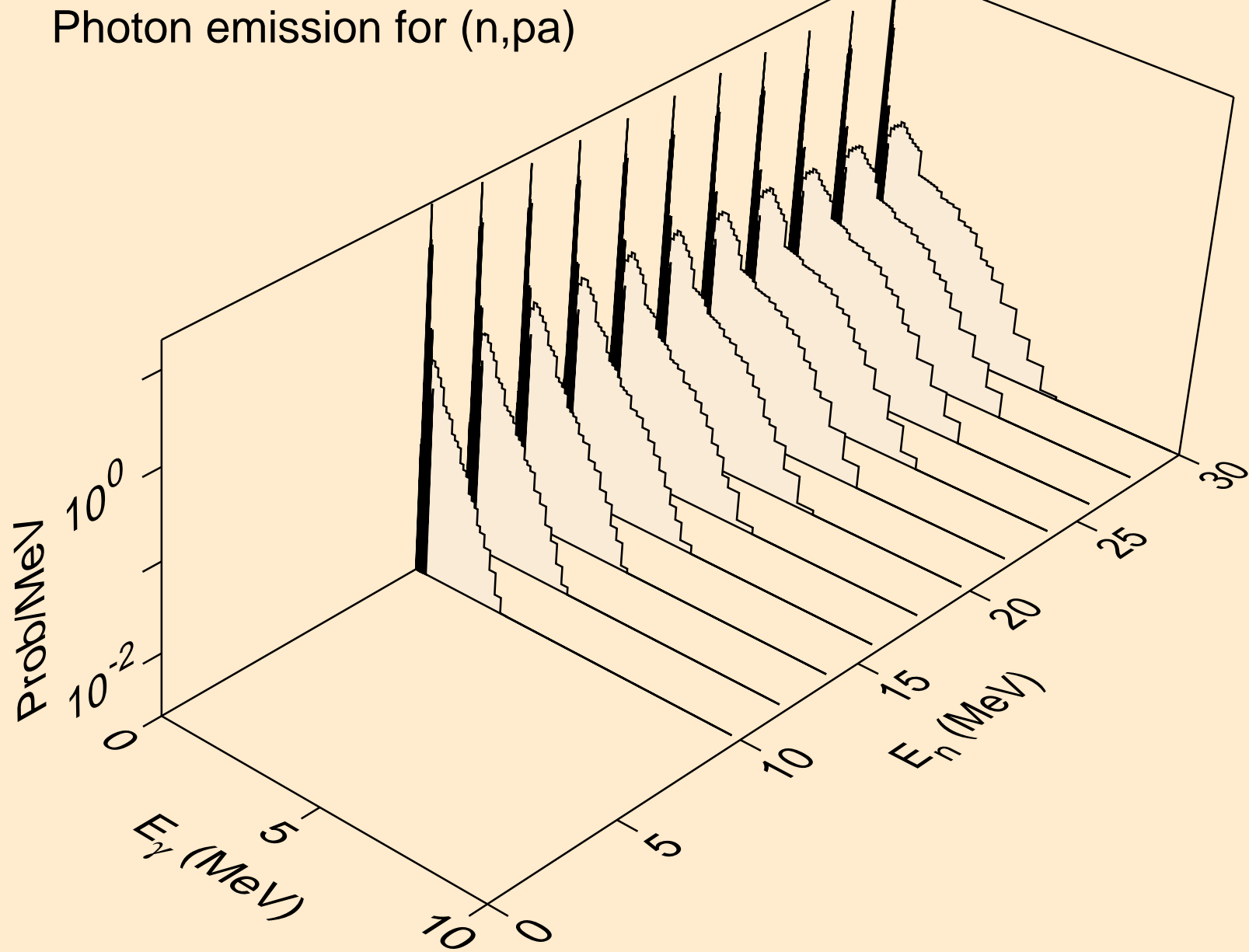

HO161 HELION ACER TENDL-2021 LIBRARY; T=0.K  
Photon emission for (n,pd)

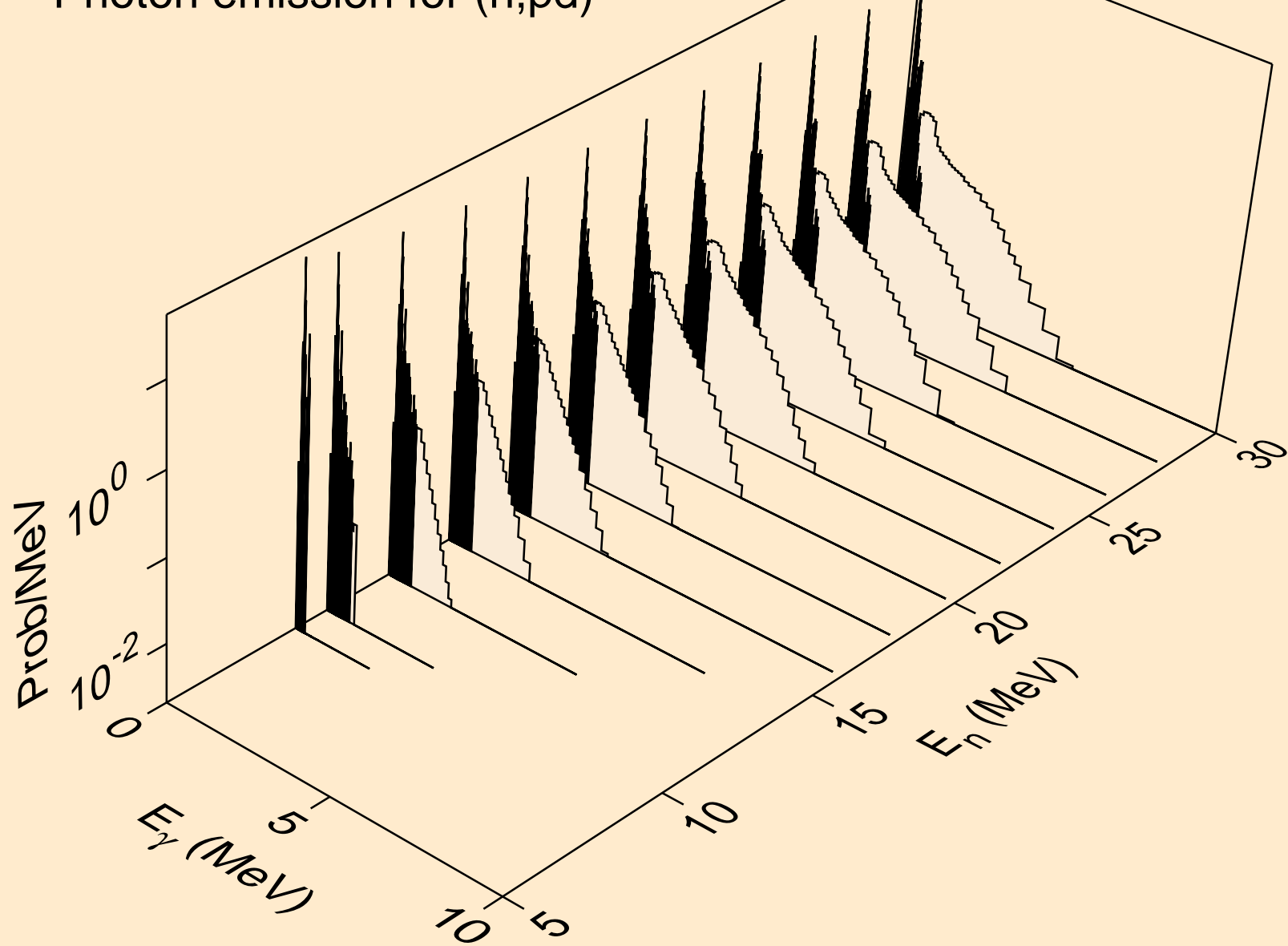

HO161 HELION ACER TENDL-2021 LIBRARY; T=0.K  
Photon emission for (n,pt)

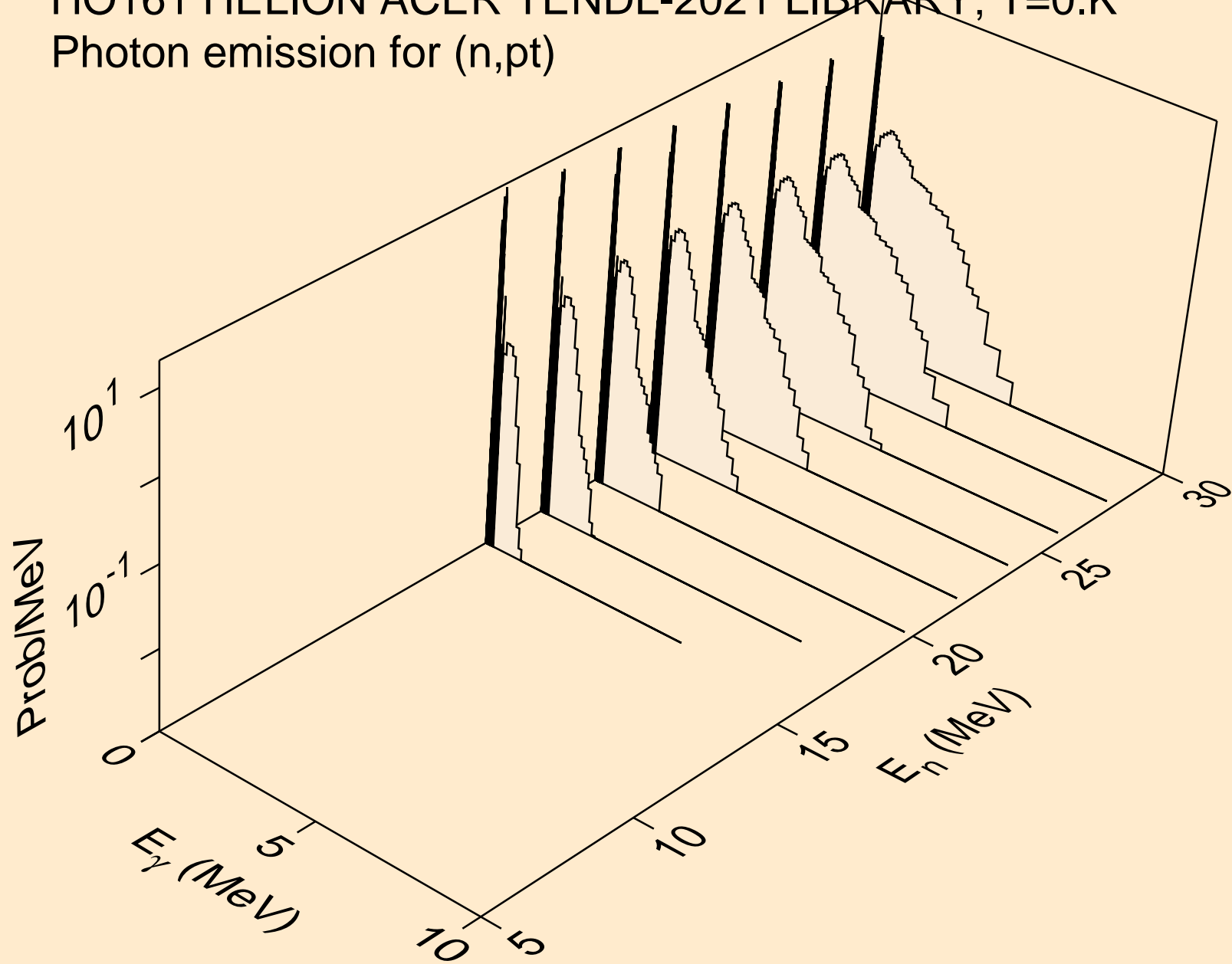

HO161 HELION ACER TENDL-2021 LIBRARY; T=0.K  
Photon emission for (n,da)

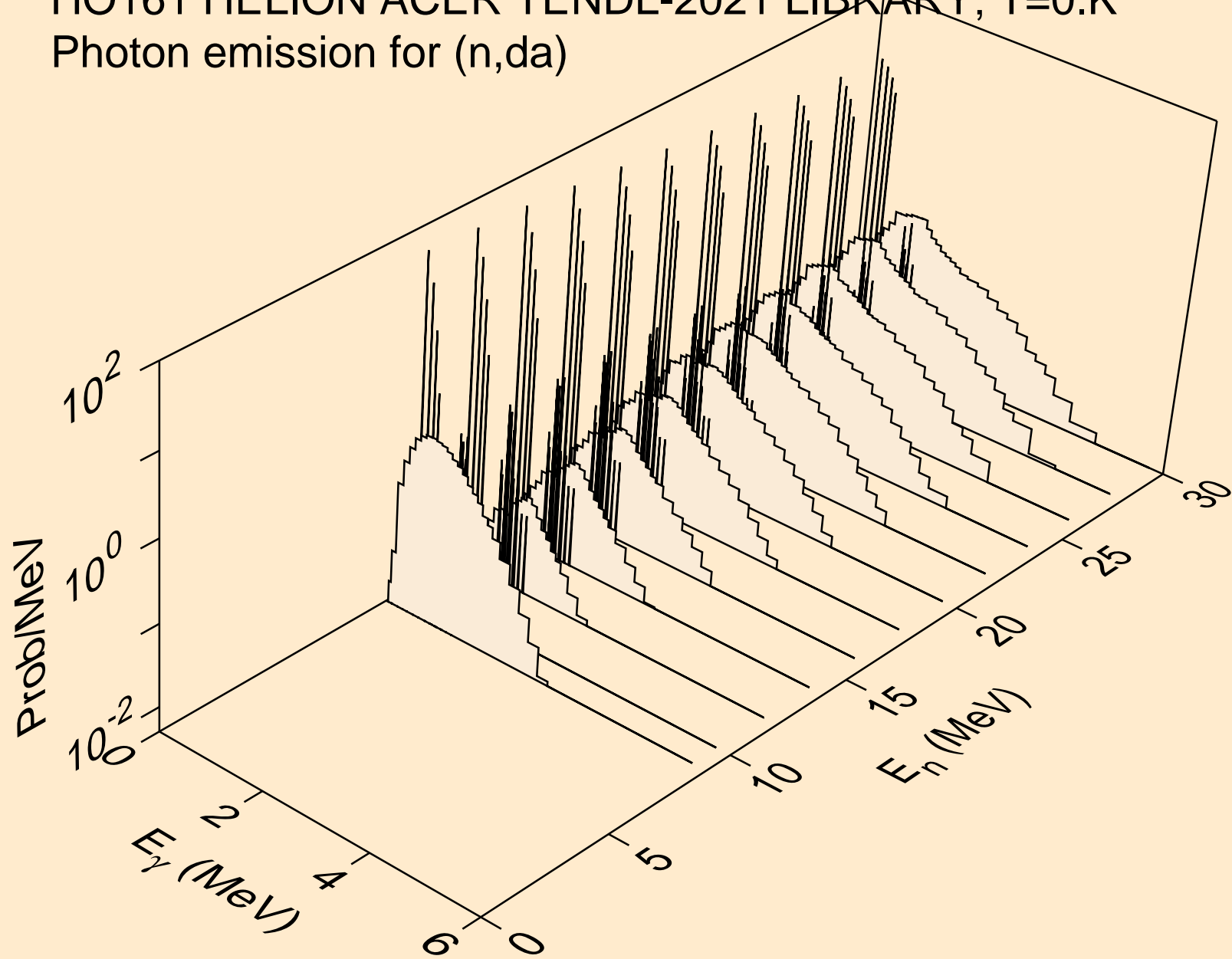

HO161 HELION ACER TENDL-2021 LIBRARY; T=0.K  
Particle heating contributions

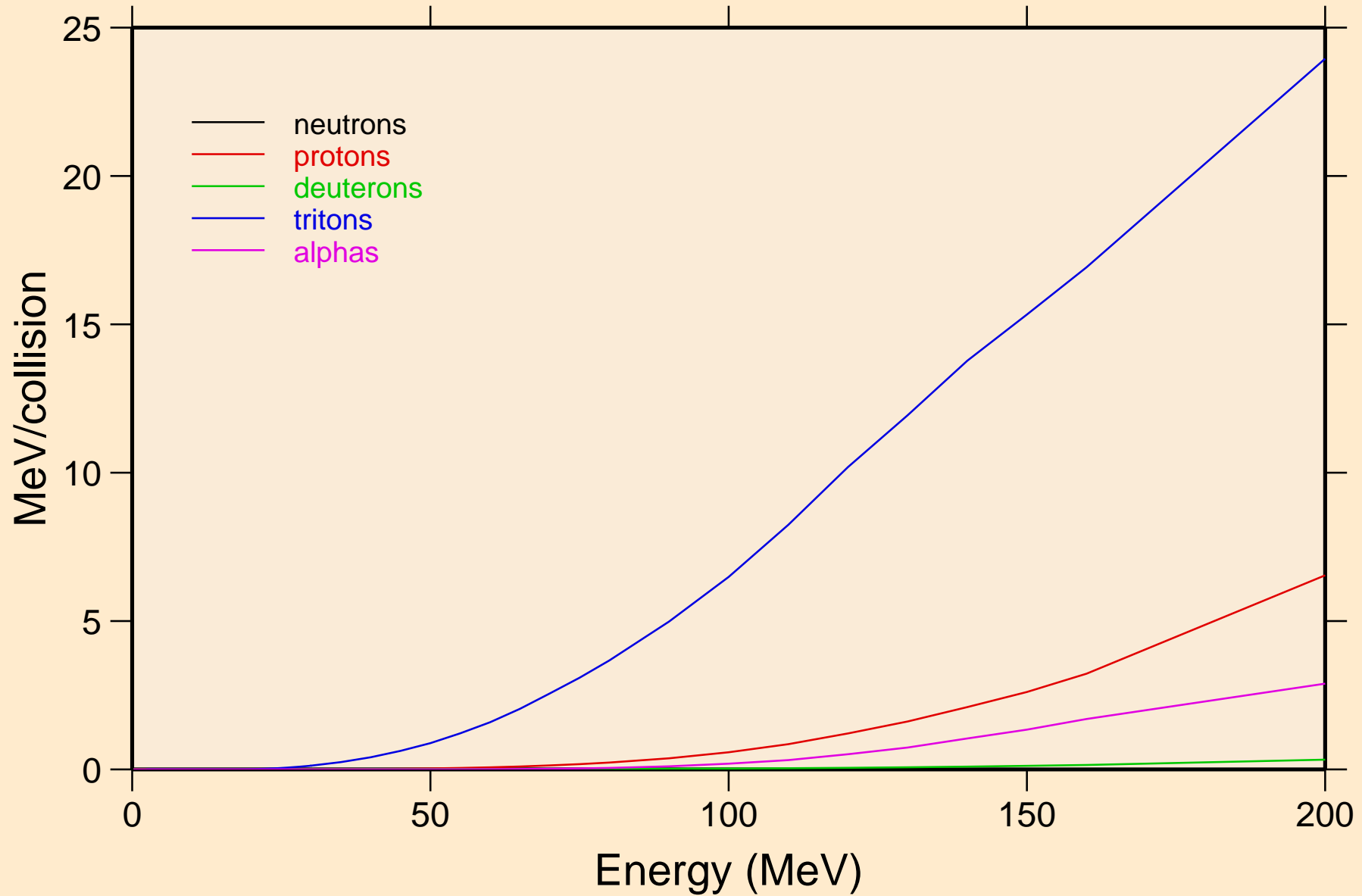



HO161 HELION ACER TENDL-2021 LIBRARY; T=0.K  
Recoil Heating

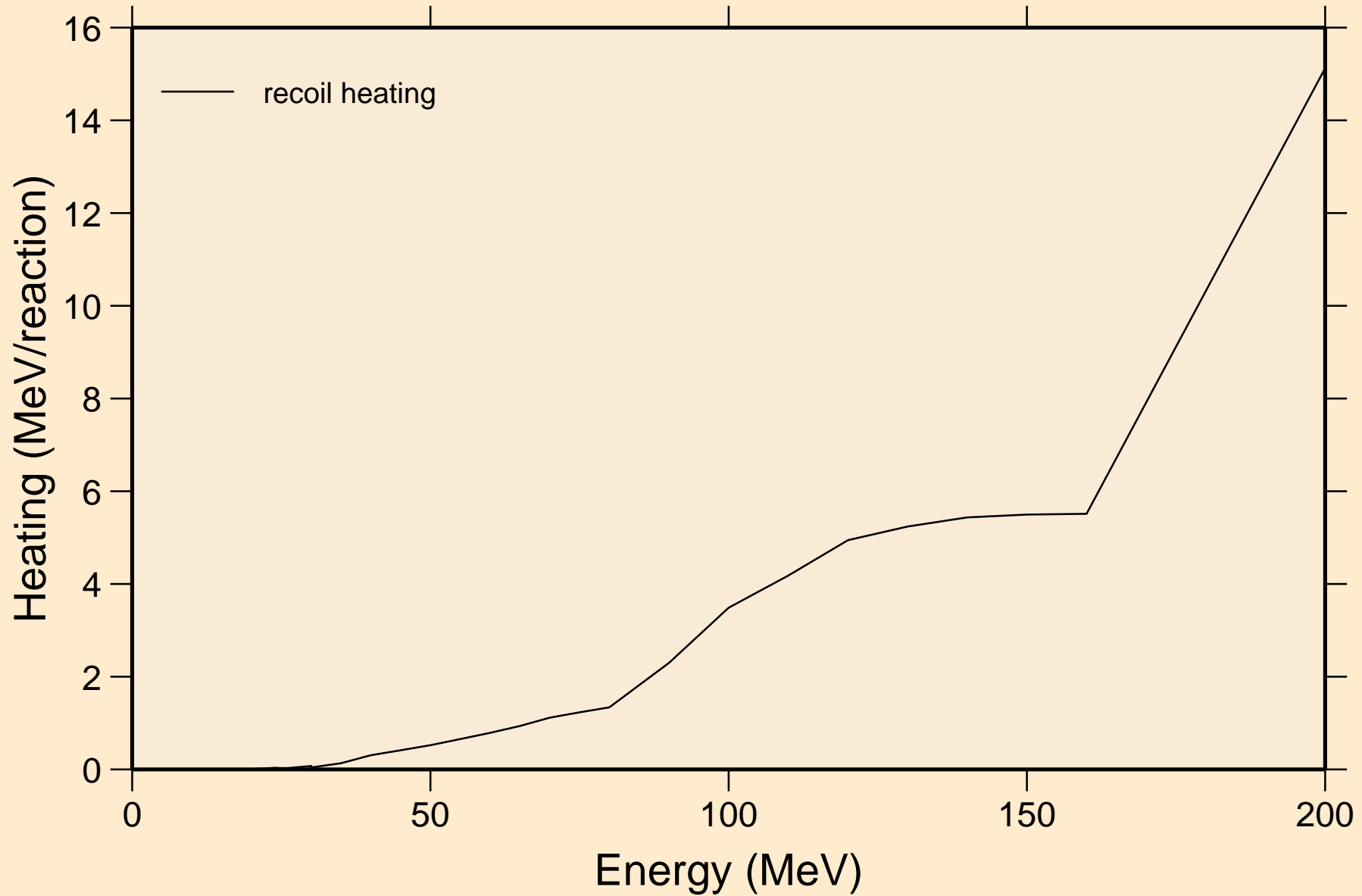

HO161 HELION ACER TENDL-2021 LIBRARY; T=0.K  
Particle production cross sections

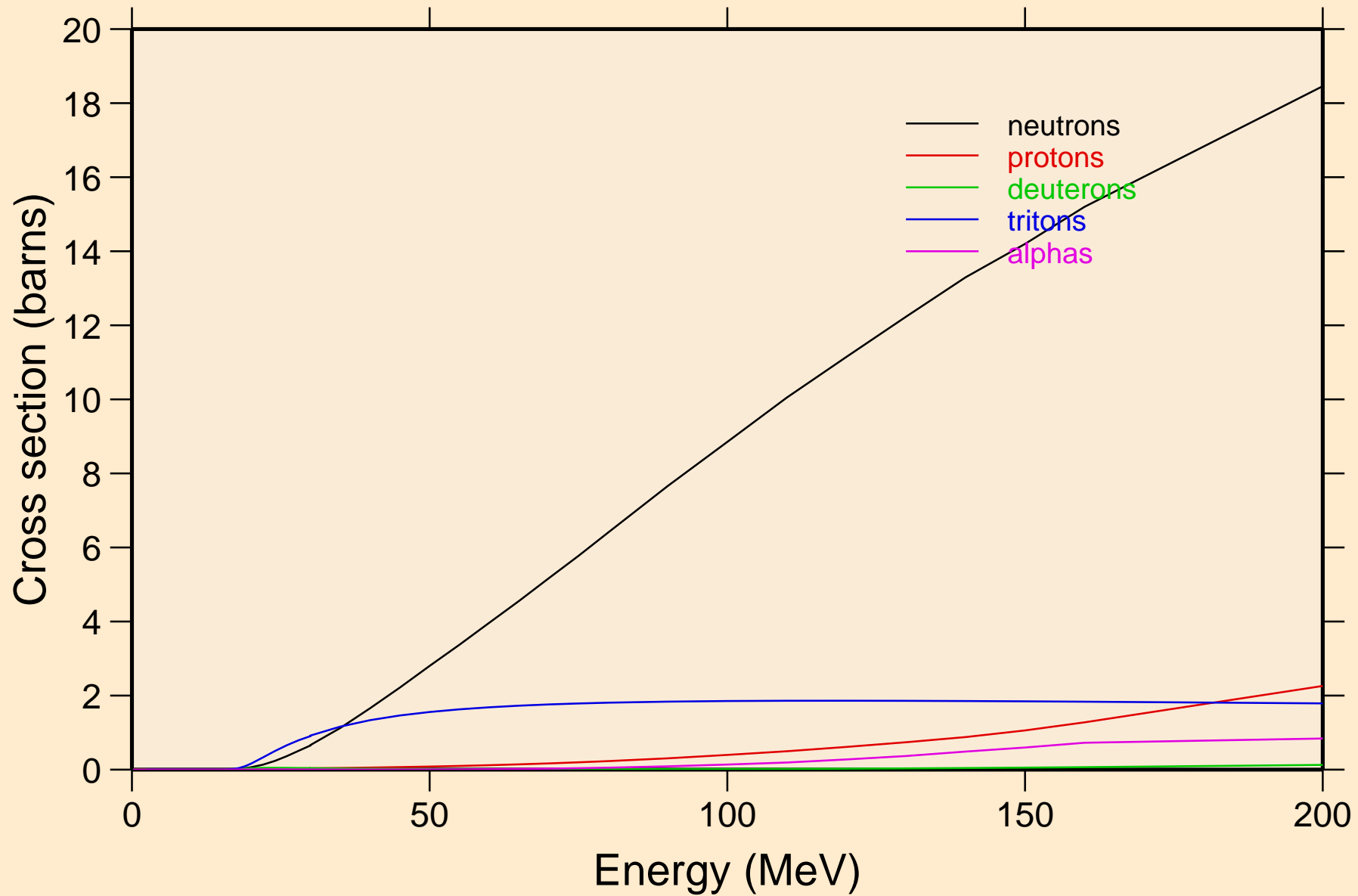

HO161 HELION ACER TENDL-2021 LIBRARY; T=0.K  
neutrons from (s,n)

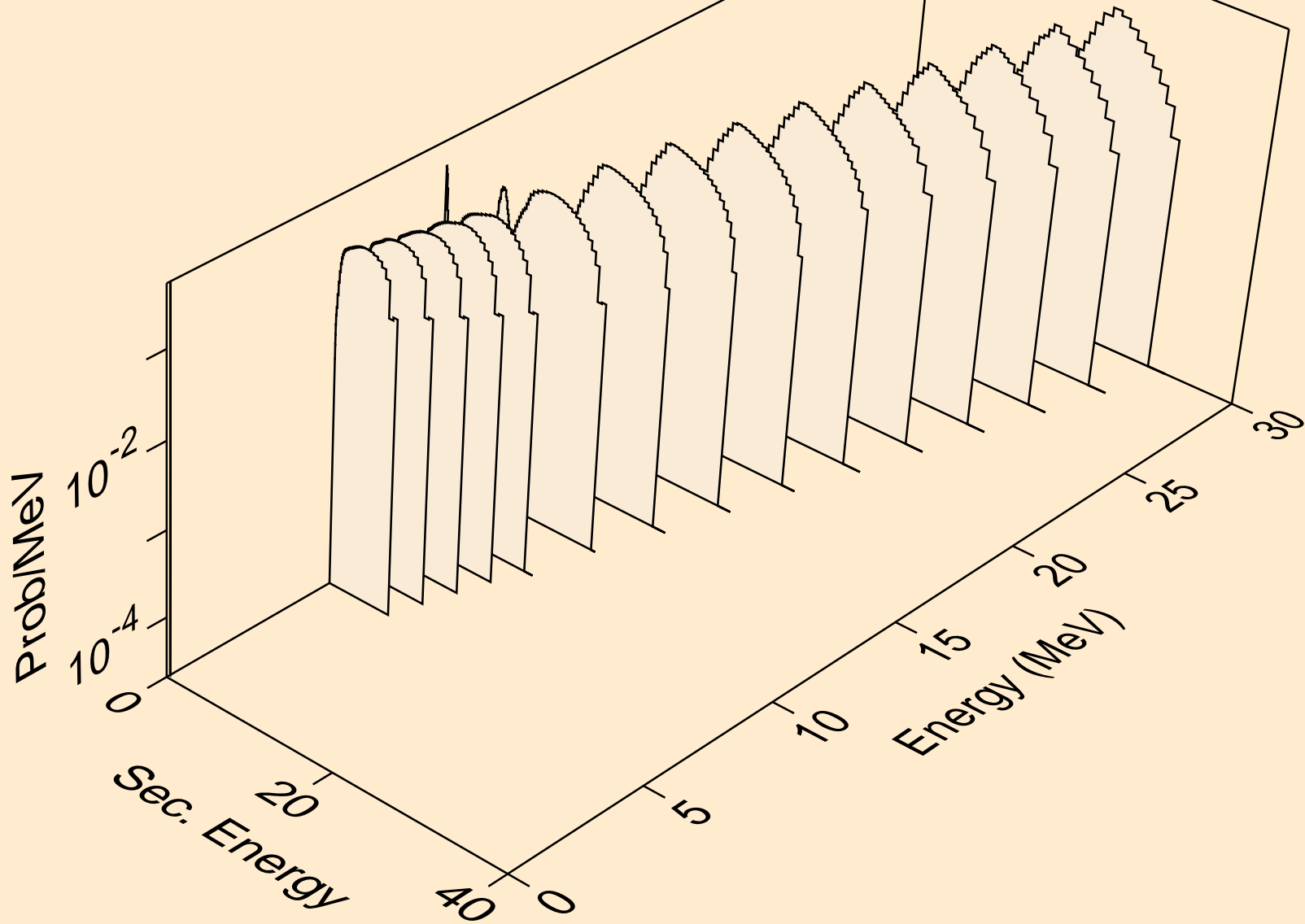

HO161 HELION ACER TENDL-2021 LIBRARY; T=0.K  
neutrons from (s,x)

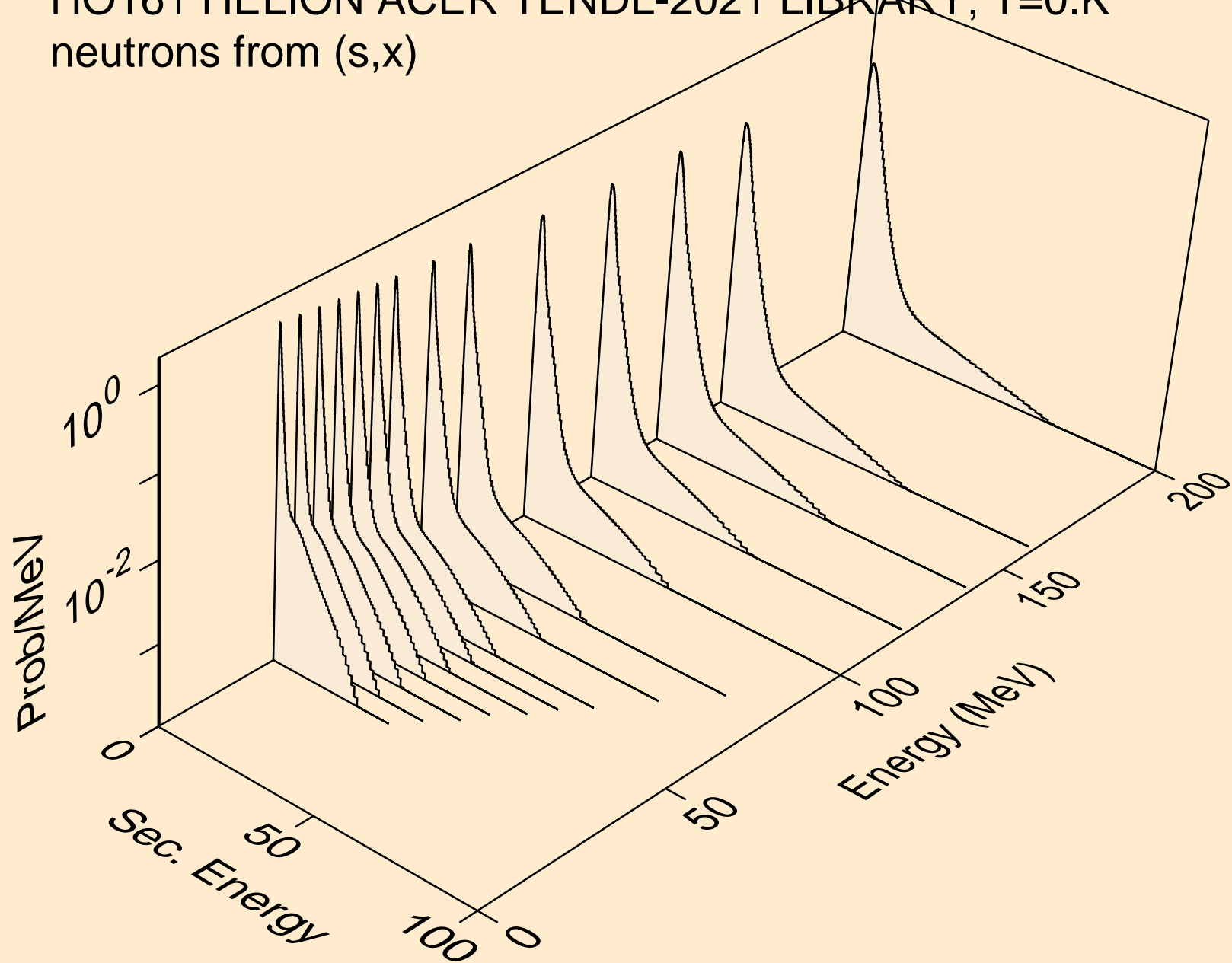

HO161 HELION ACER TENDL-2021 LIBRARY; T=0.K  
neutrons from (s,2nd)

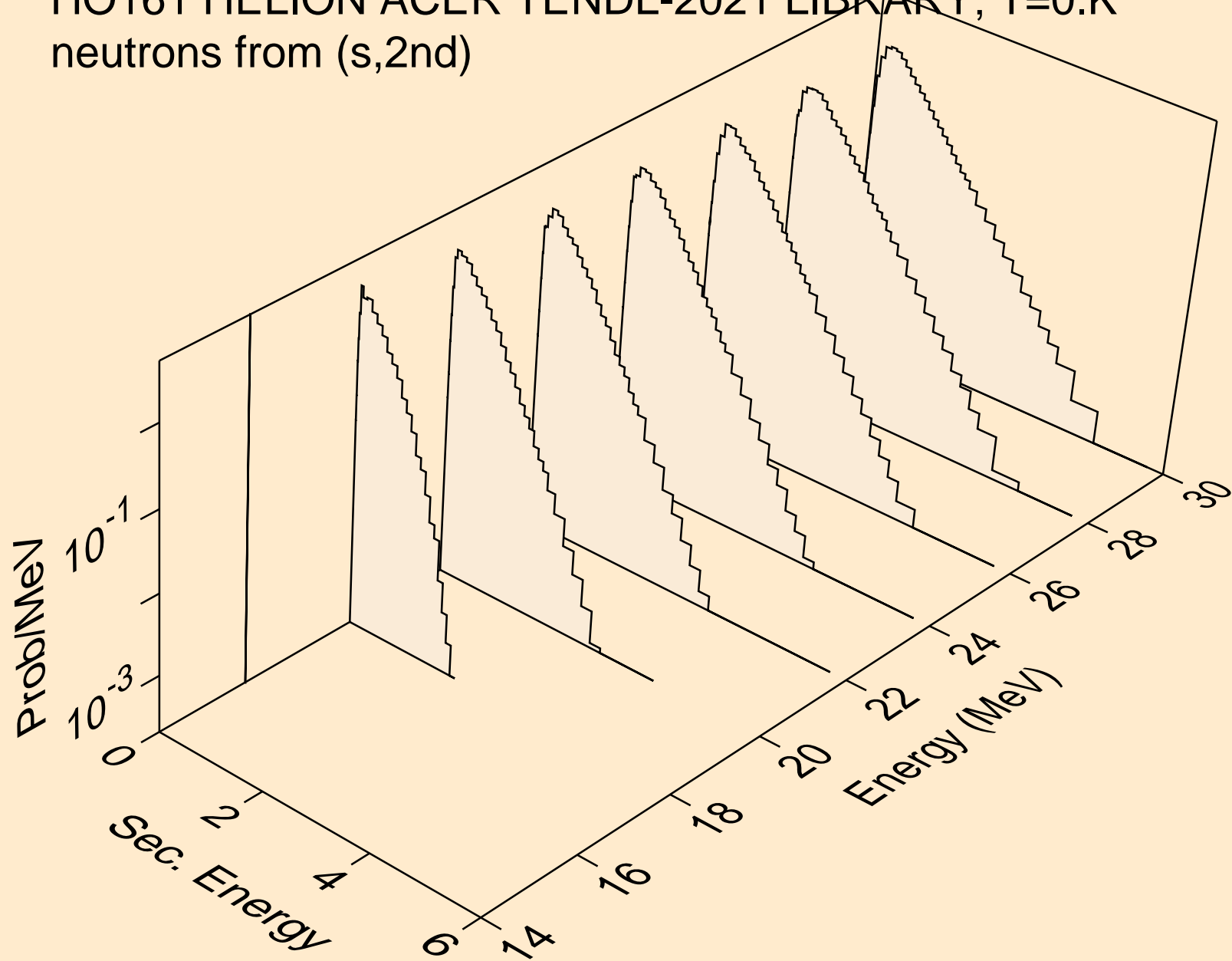

HO161 HELION ACER TENDL-2021 LIBRARY; T=0.K  
neutrons from (s,2n)

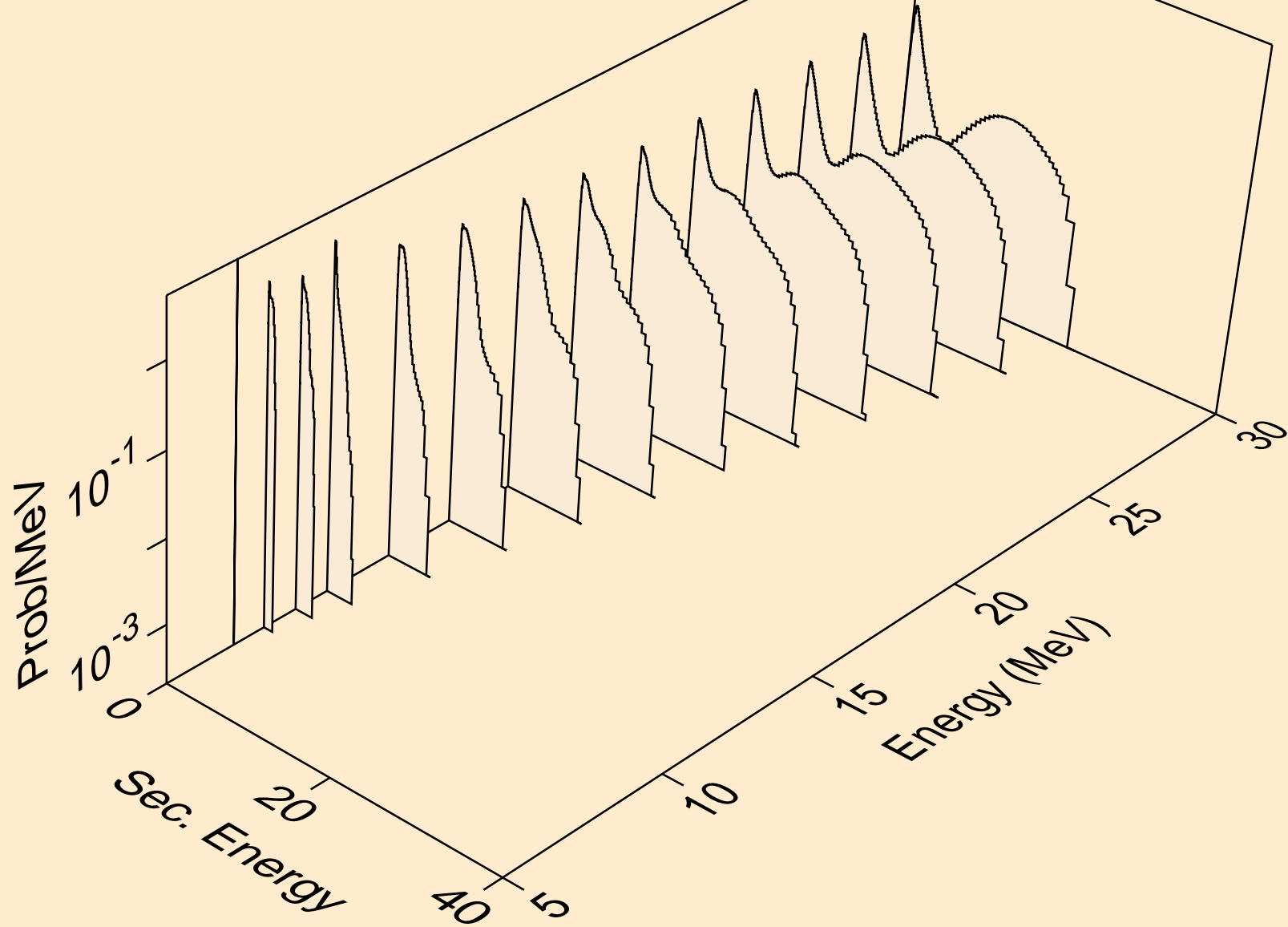

HO161 HELION ACER TENDL-2021 LIBRARY; T=0.K  
neutrons from (s,3n)

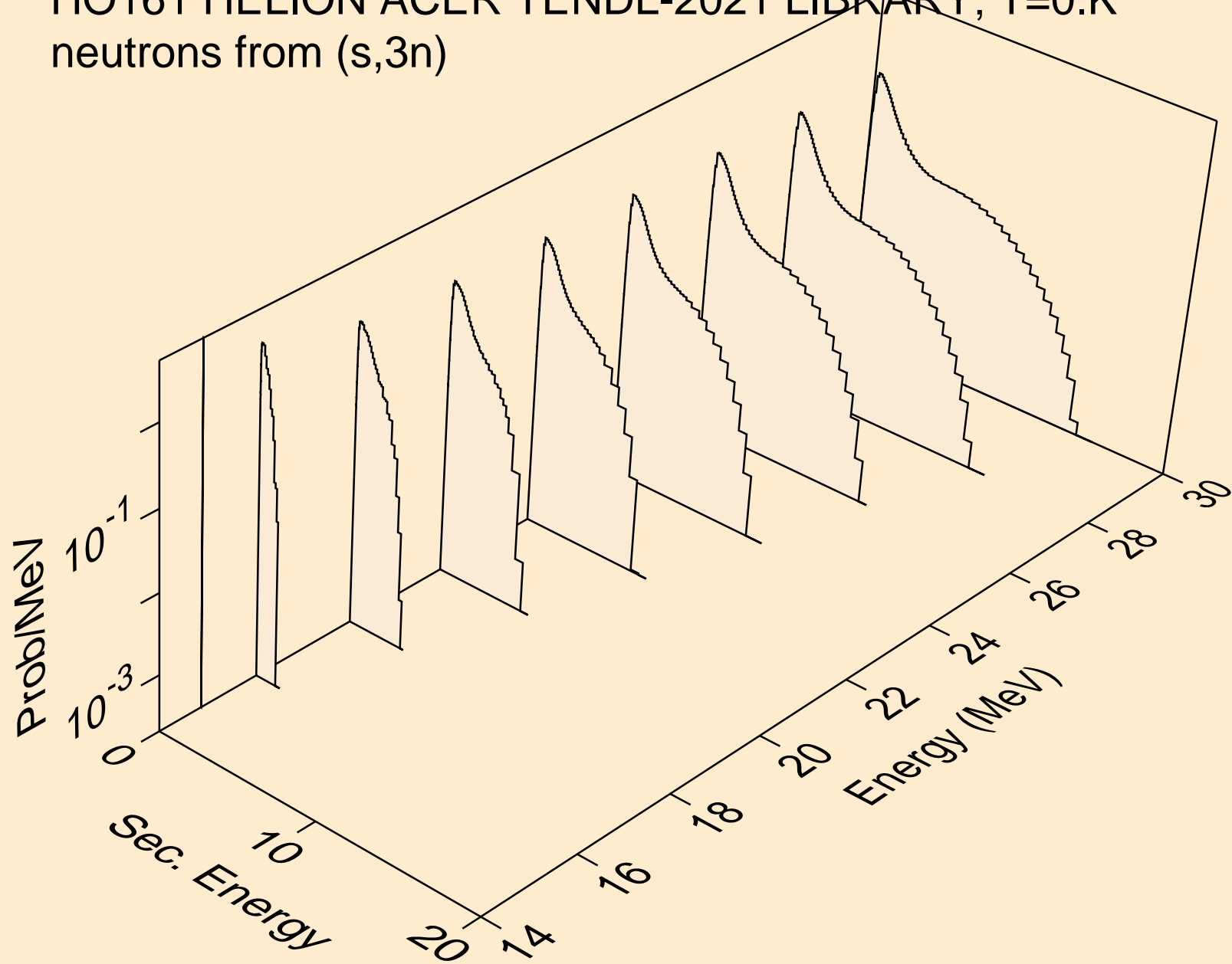

HO161 HELION ACER TENDL-2021 LIBRARY; T=0.K  
neutrons from (s,n\*)a

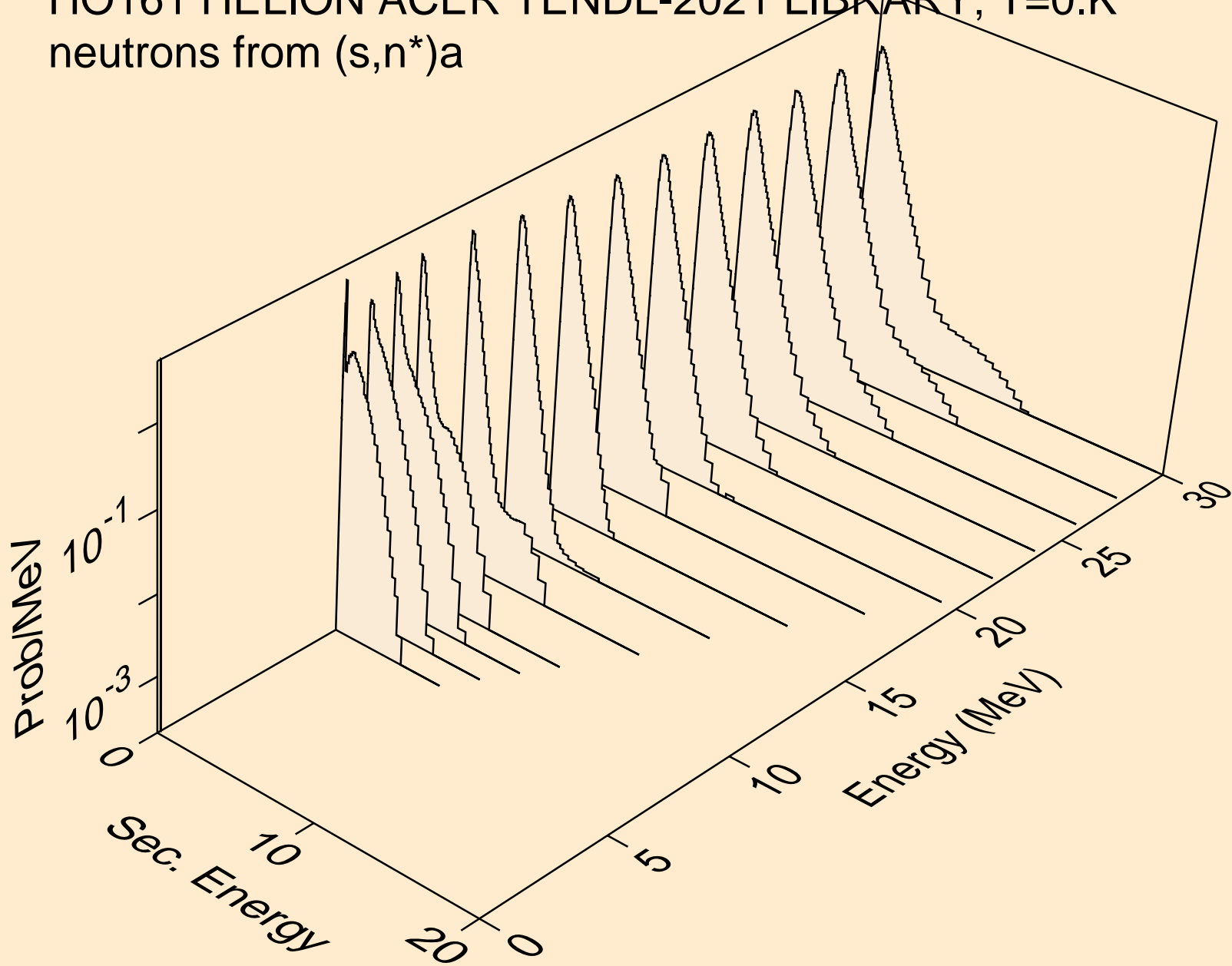



HO161 HELION ACER TENDL-2021 LIBRARY; T=0.K  
neutrons from (s,2n)a

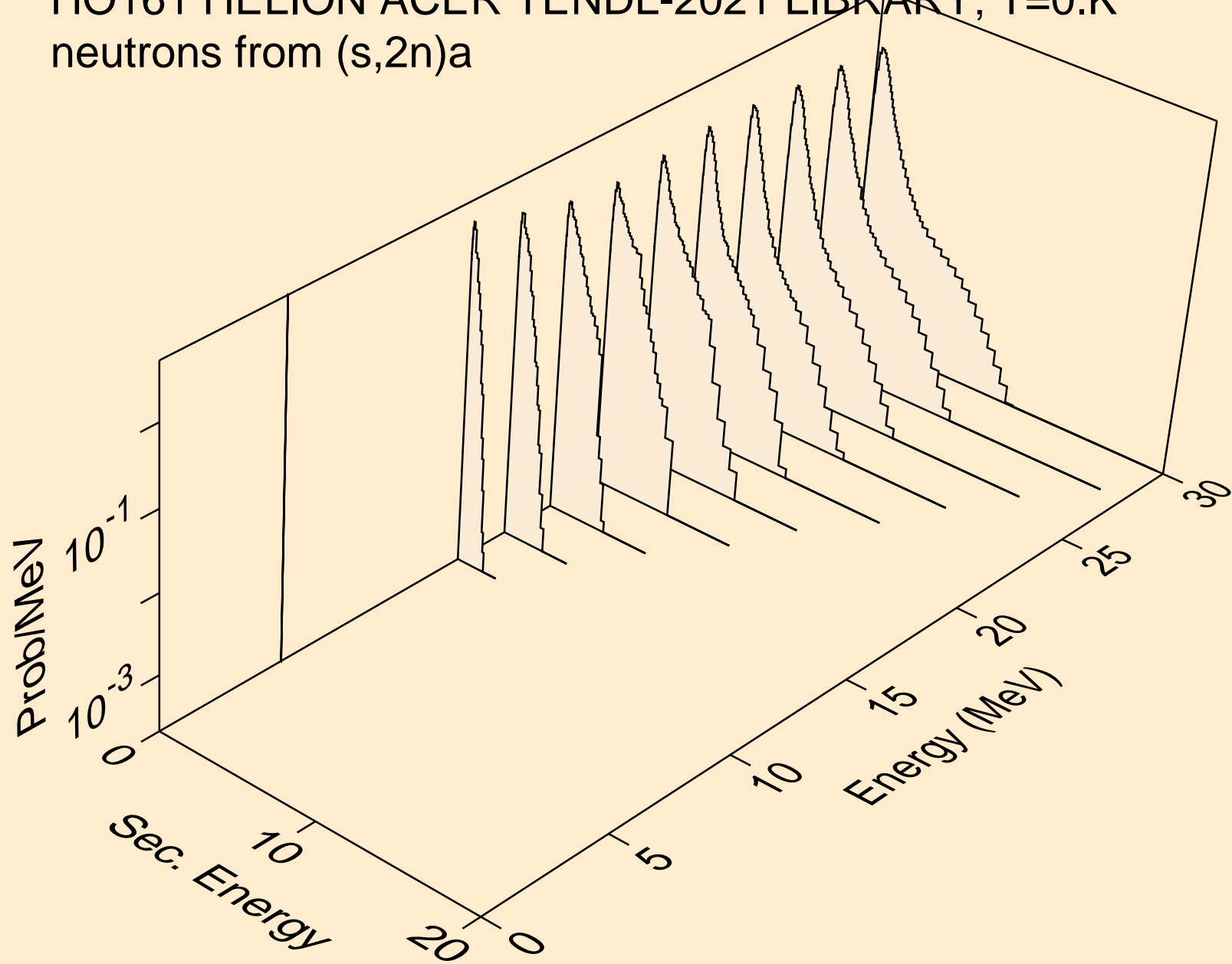

HO161 HELION ACER TENDL-2021 LIBRARY; T=0.K  
neutrons from (s,3n)a

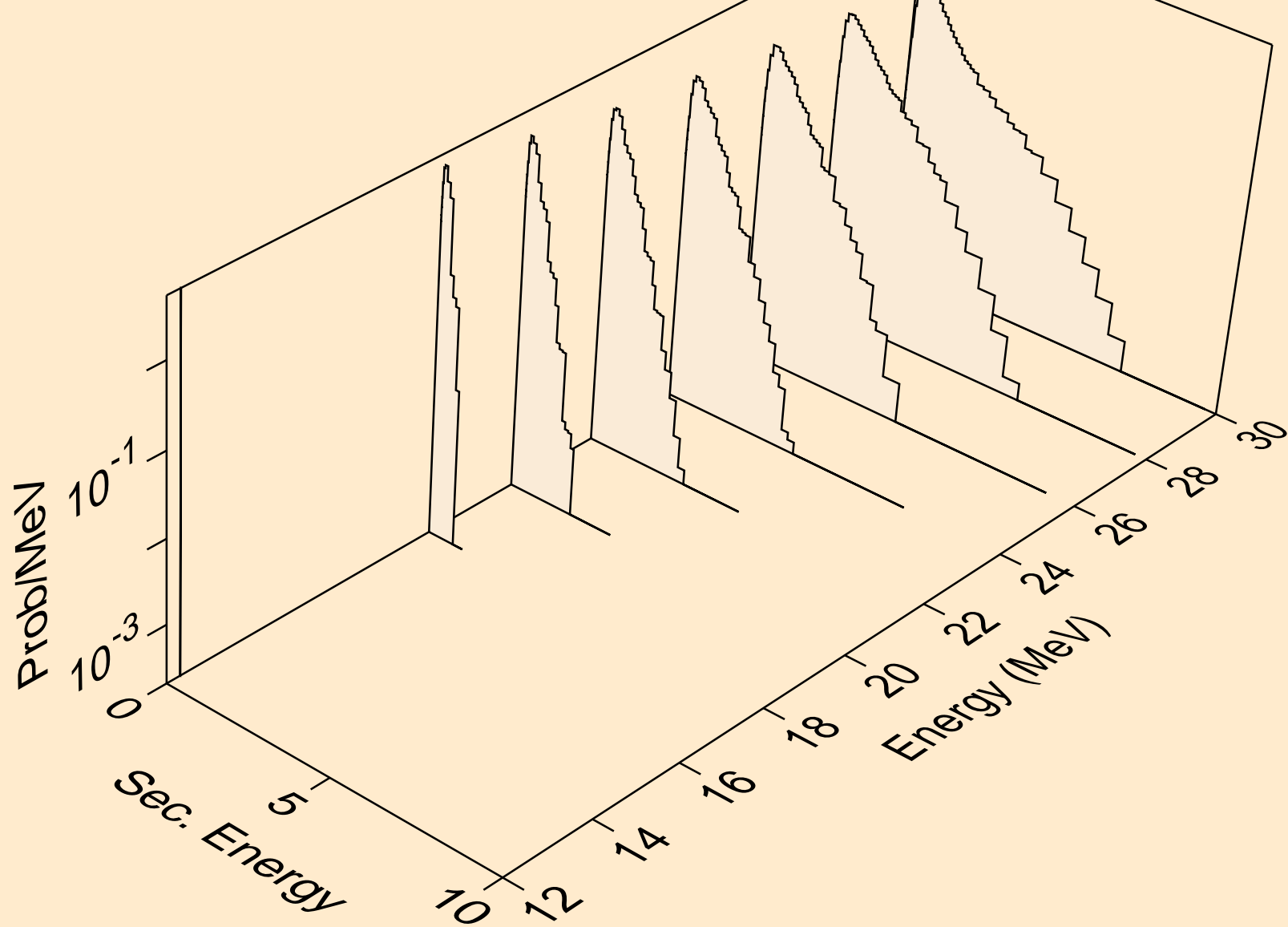

HO161 HELION ACER TENDL-2021 LIBRARY; T=0.K  
neutrons from (s,n\*)p

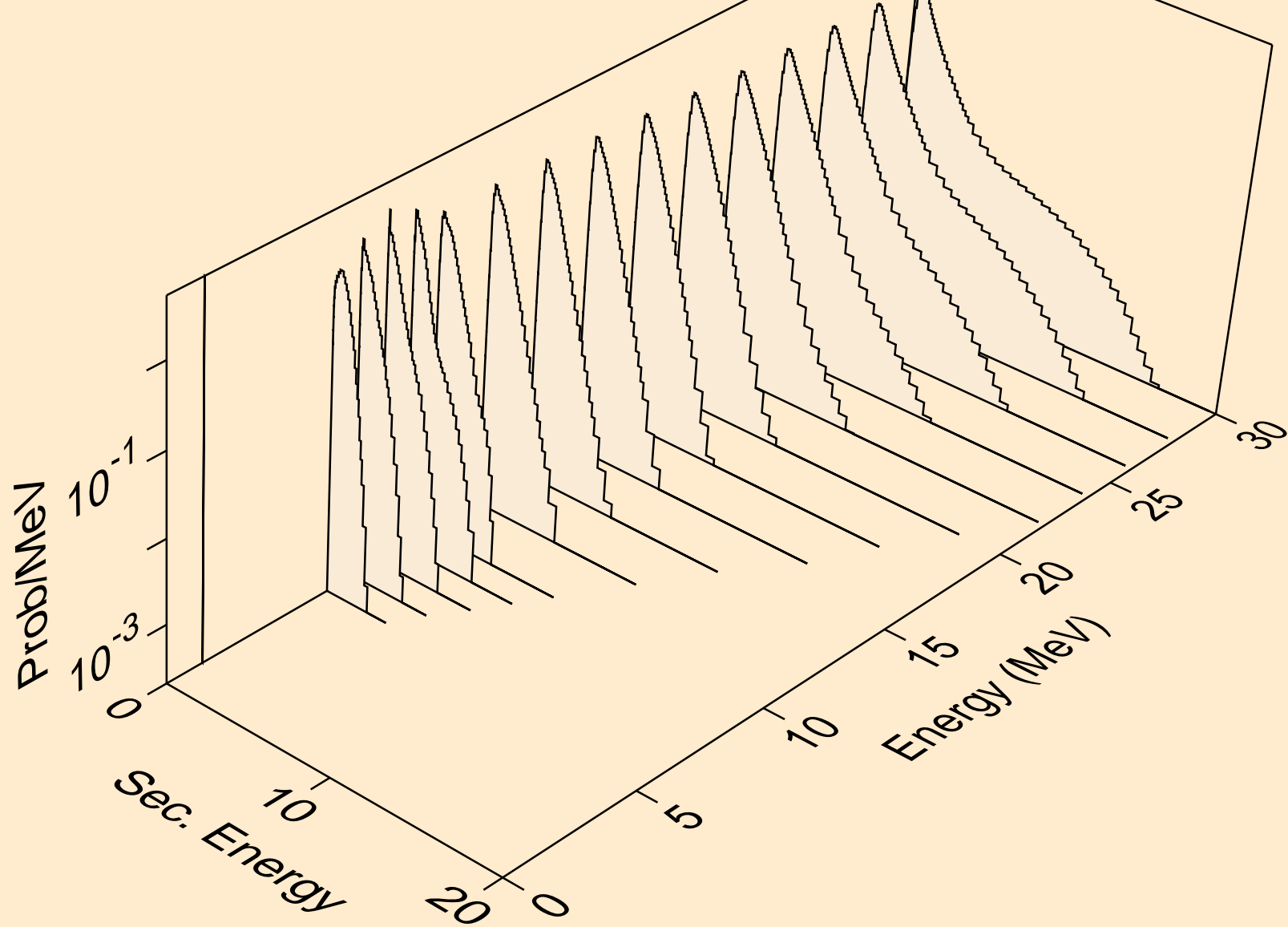

HO161 HELION ACER TENDL-2021 LIBRARY; T=0.K  
neutrons from (s,n\*)2a

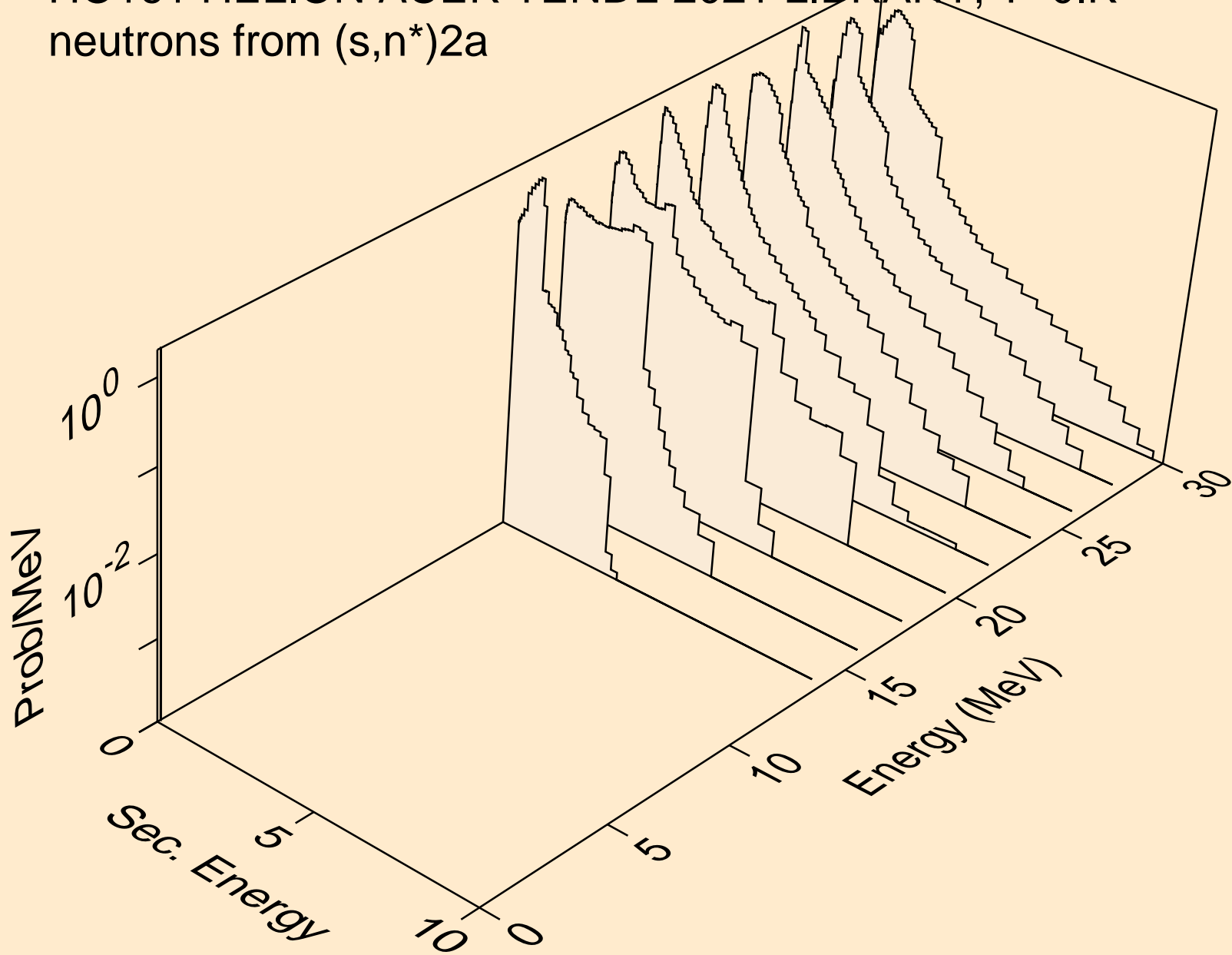

HO161 HELION ACER TENDL-2021 LIBRARY; T=0.K  
neutrons from (s,n\*)d

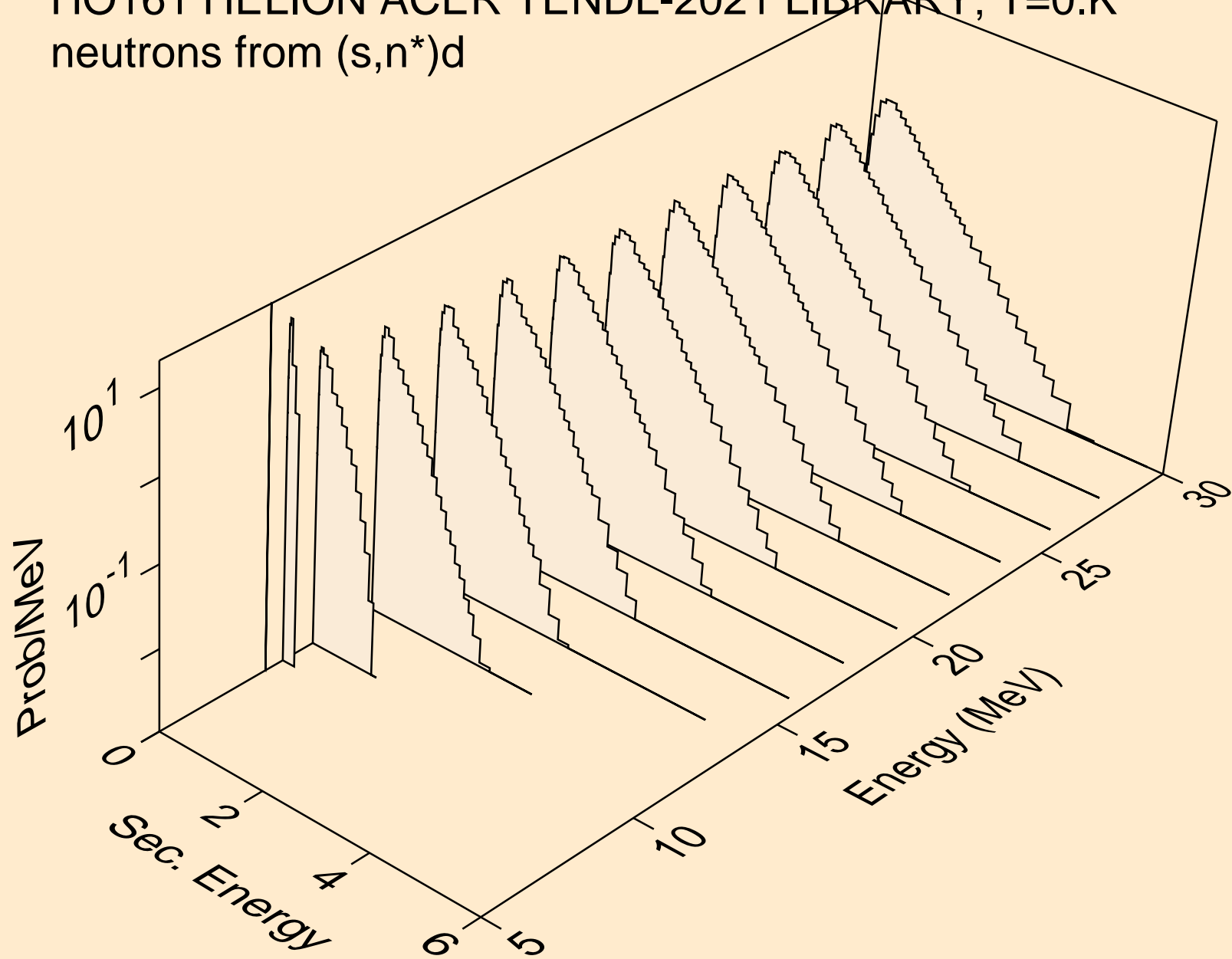

HO161 HELION ACER TENDL-2021 LIBRARY; T=0.K  
neutrons from (s,n\*)t

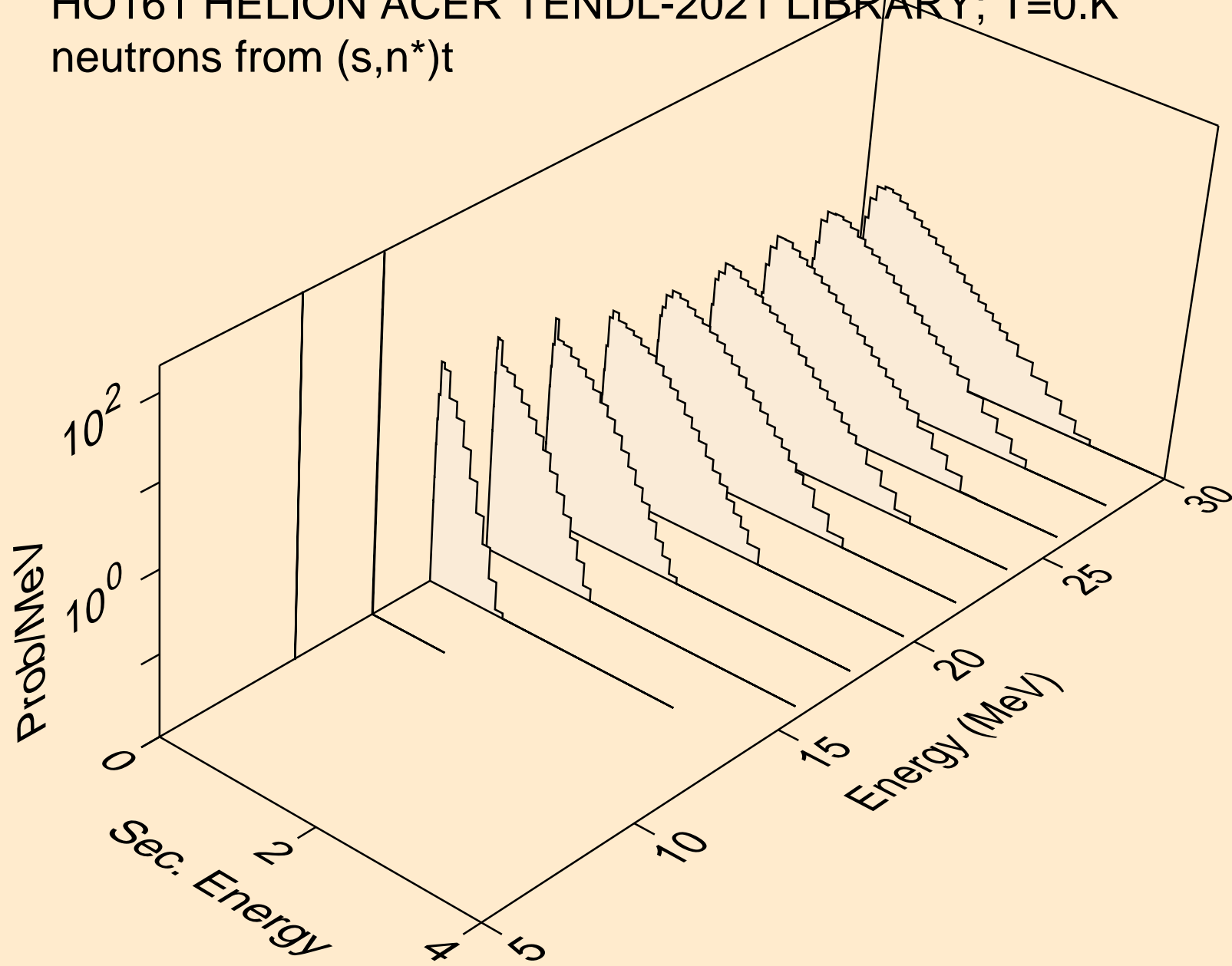

HO161 HELION ACER TENDL-2021 LIBRARY; T=0.K  
neutrons from (s,n\*)he3

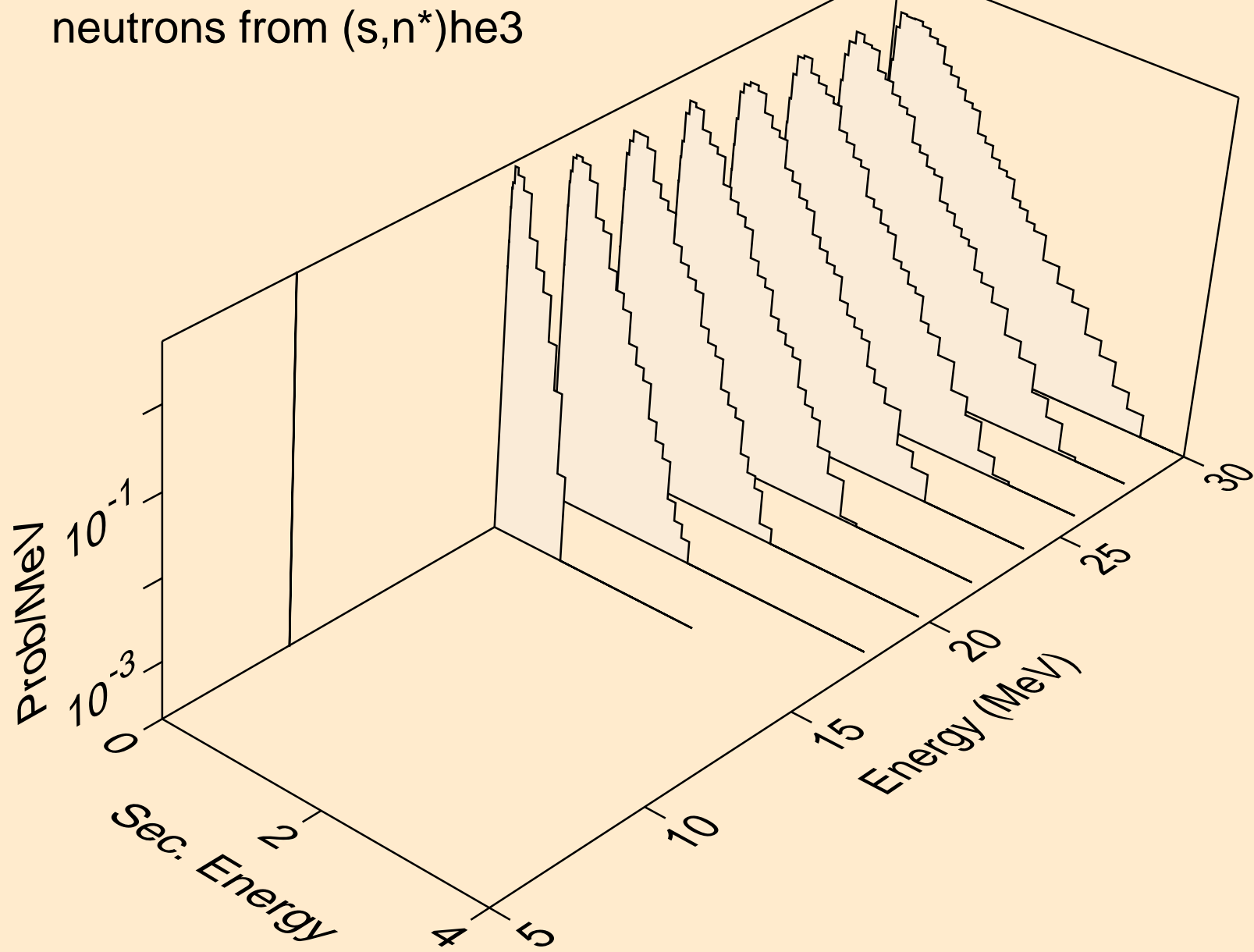

HO161 HELION ACER TENDL-2021 LIBRARY; T=0.K  
neutrons from (s,4n)

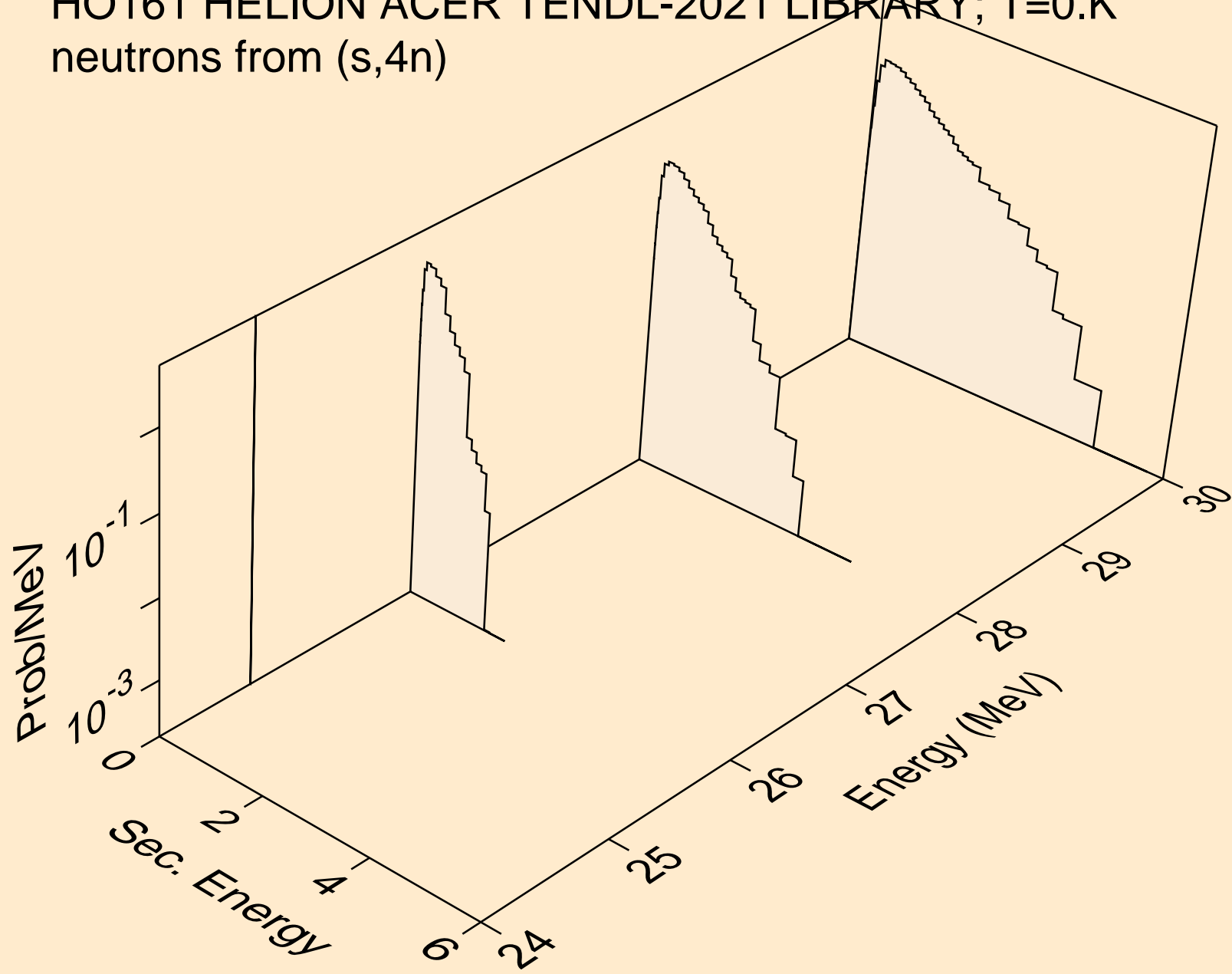



HO161 HELION ACER TENDL-2021 LIBRARY; T=0.K  
neutrons from (s,2np)

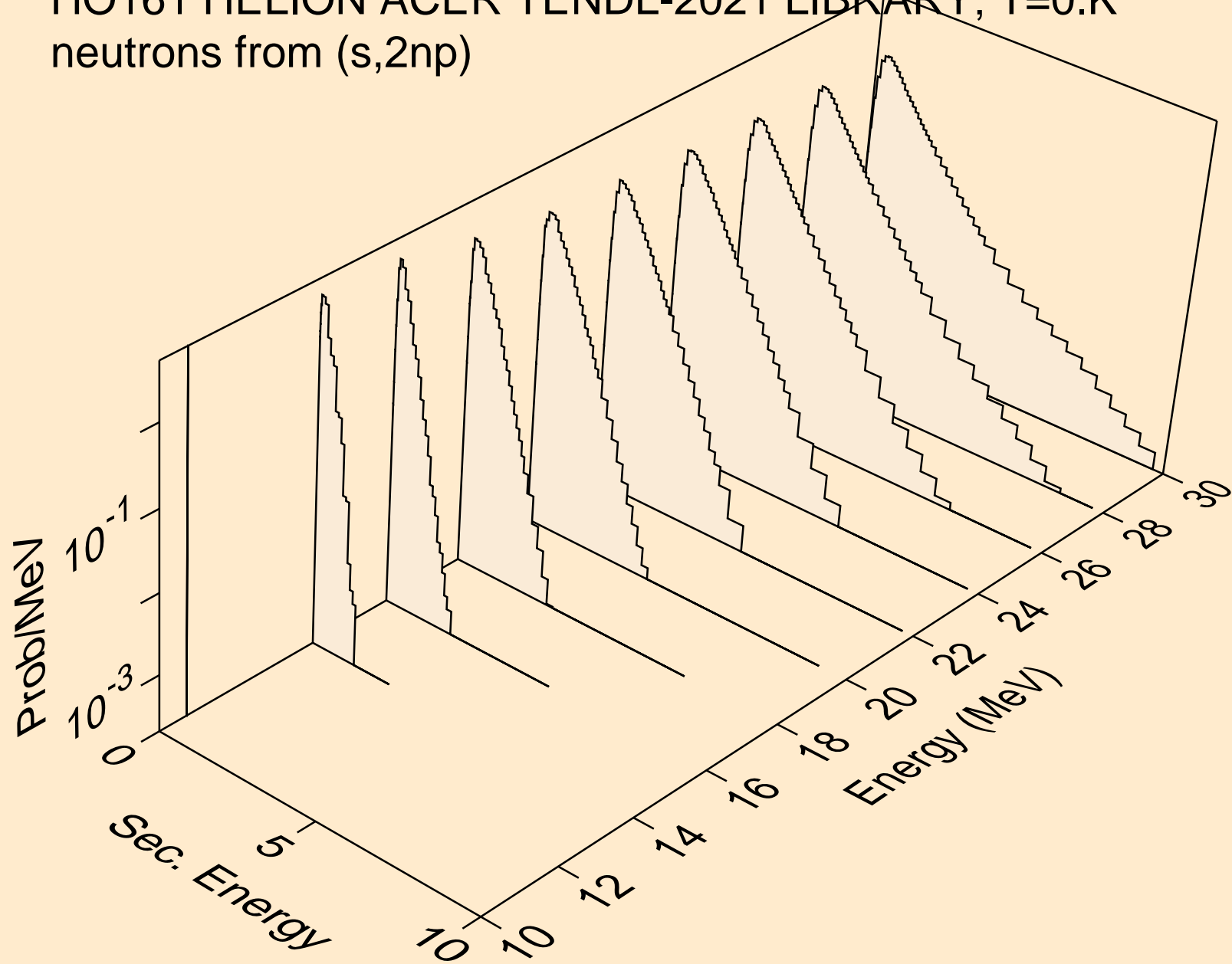

HO161 HELION ACER TENDL-2021 LIBRARY; T=0.K  
neutrons from (s,3np)

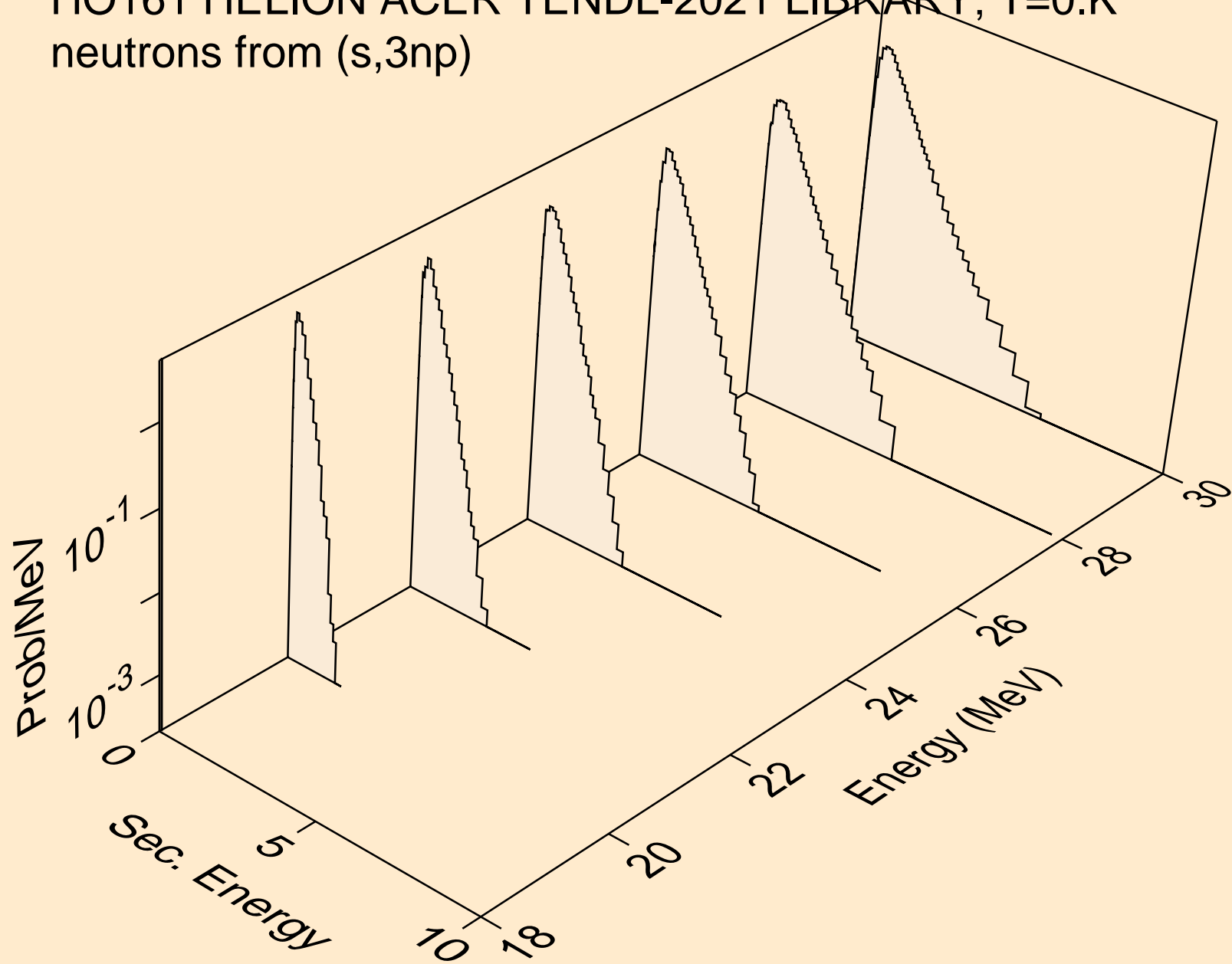

HO161 HELION ACER TENDL-2021 LIBRARY; T=0.K  
neutrons from (s,2np)

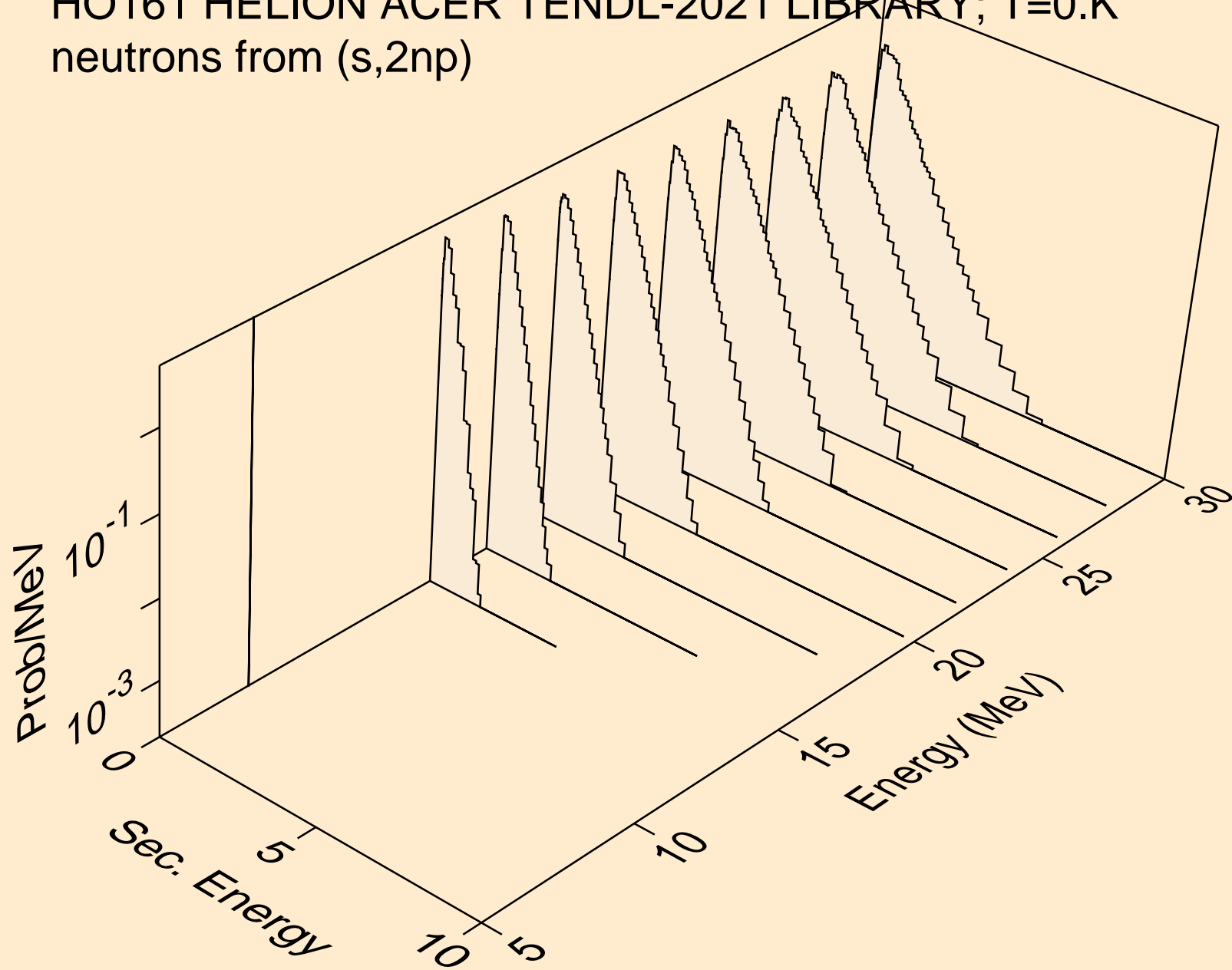

HO161 HELION ACER TENDL-2021 LIBRARY; T=0.K  
neutrons from (s,npa)

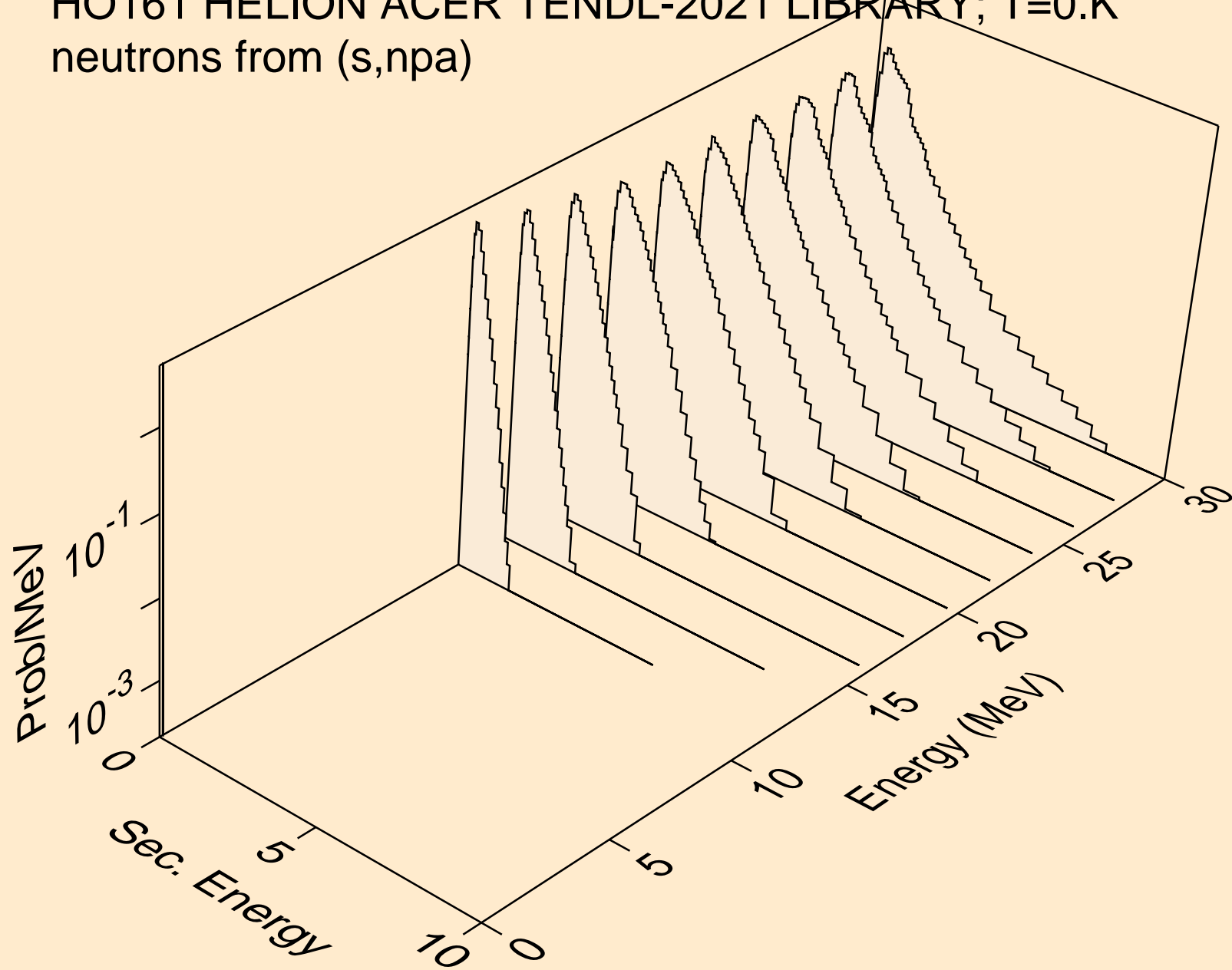

HO161 HELION ACER TENDL-2021 LIBRARY; T=0.K  
protons from (s,x)

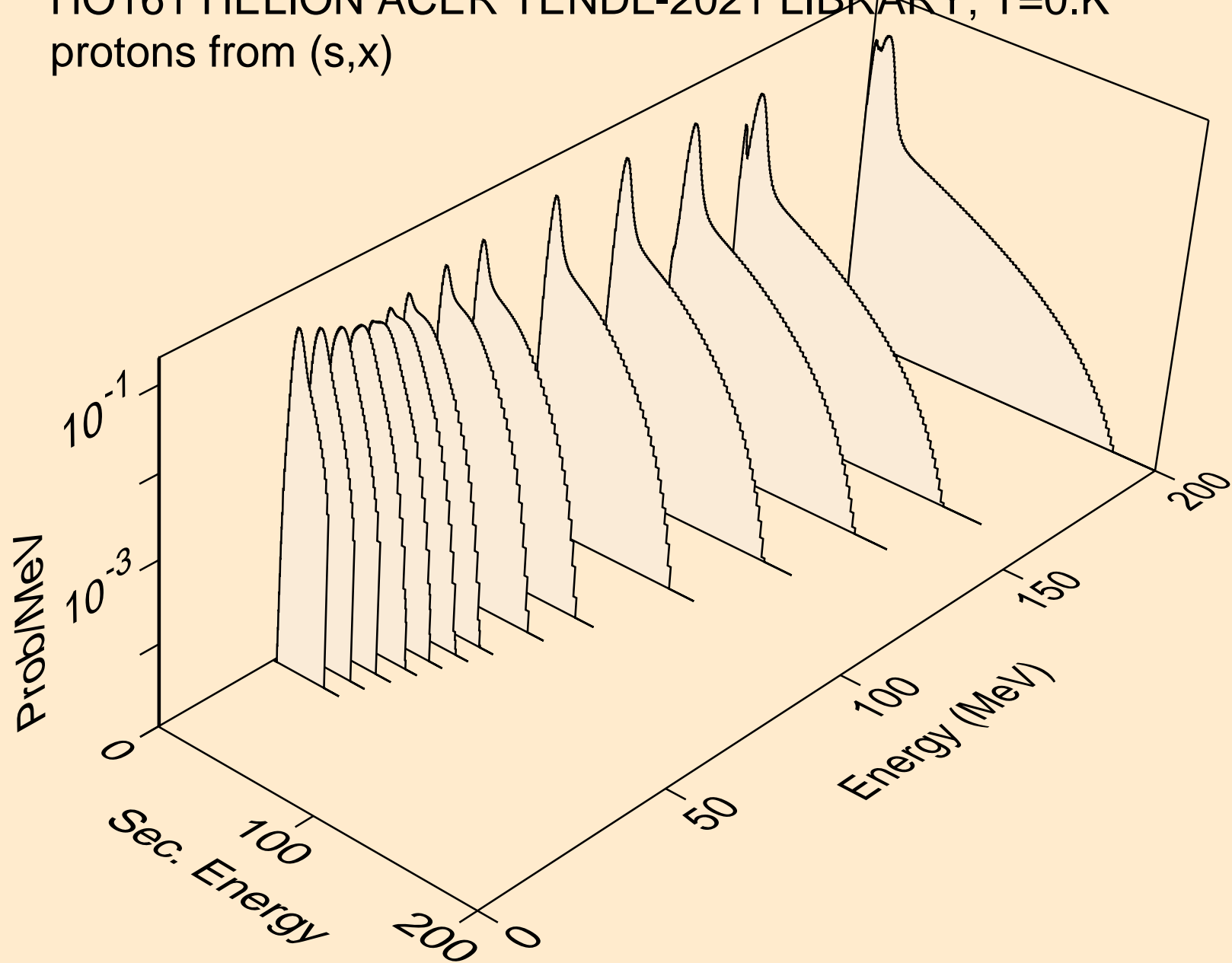

HO161 HELION ACER TENDL-2021 LIBRARY; T=0.K  
protons from (s,n\*)p

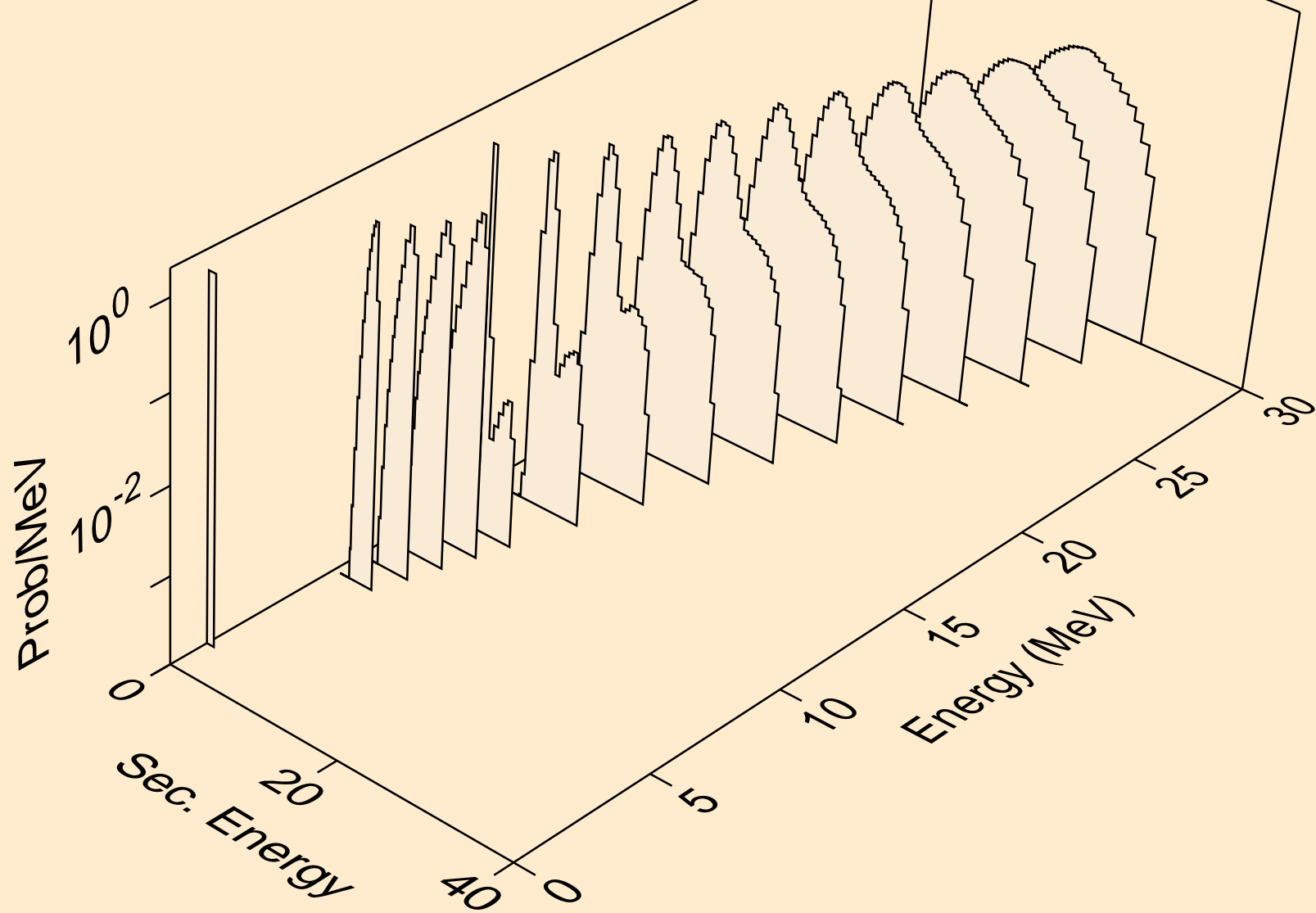

HO161 HELION ACER TENDL-2021 LIBRARY; T=0.K  
protons from (s,2np)

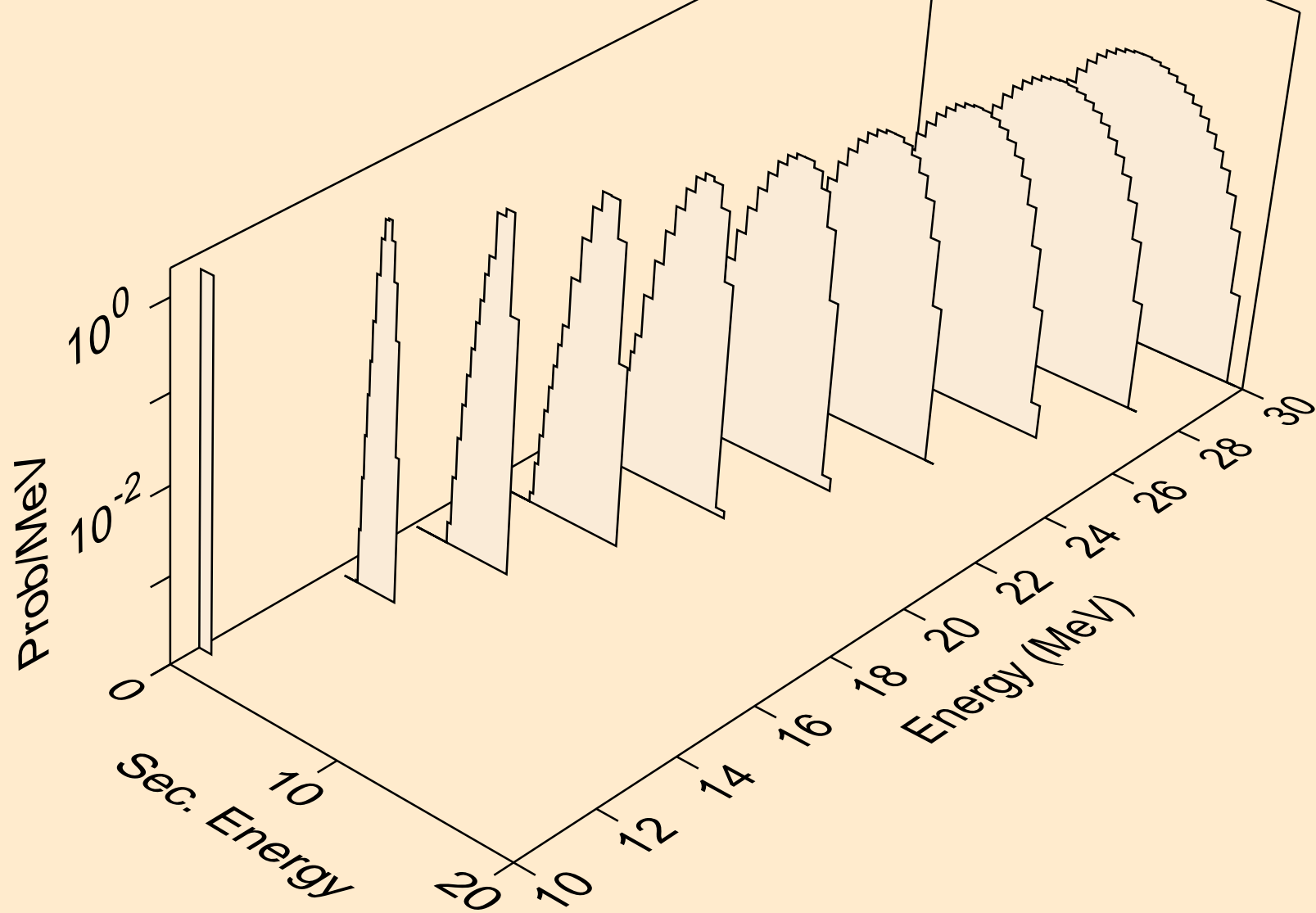

HO161 HELION ACER TENDL-2021 LIBRARY; T=0.K  
protons from (s,3np)

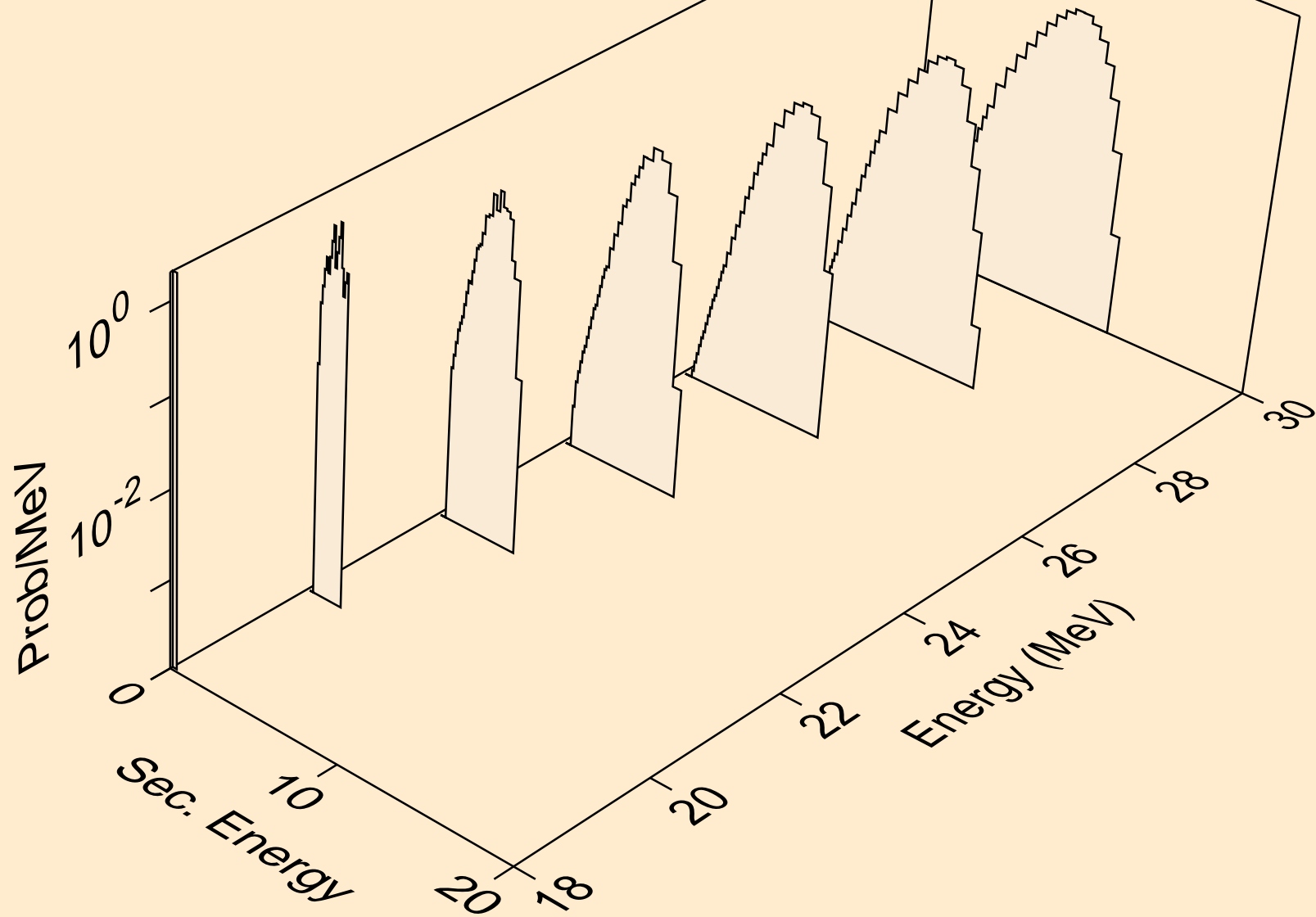



HO161 HELION ACER TENDL-2021 LIBRARY; T=0.K  
protons from (s,2np)

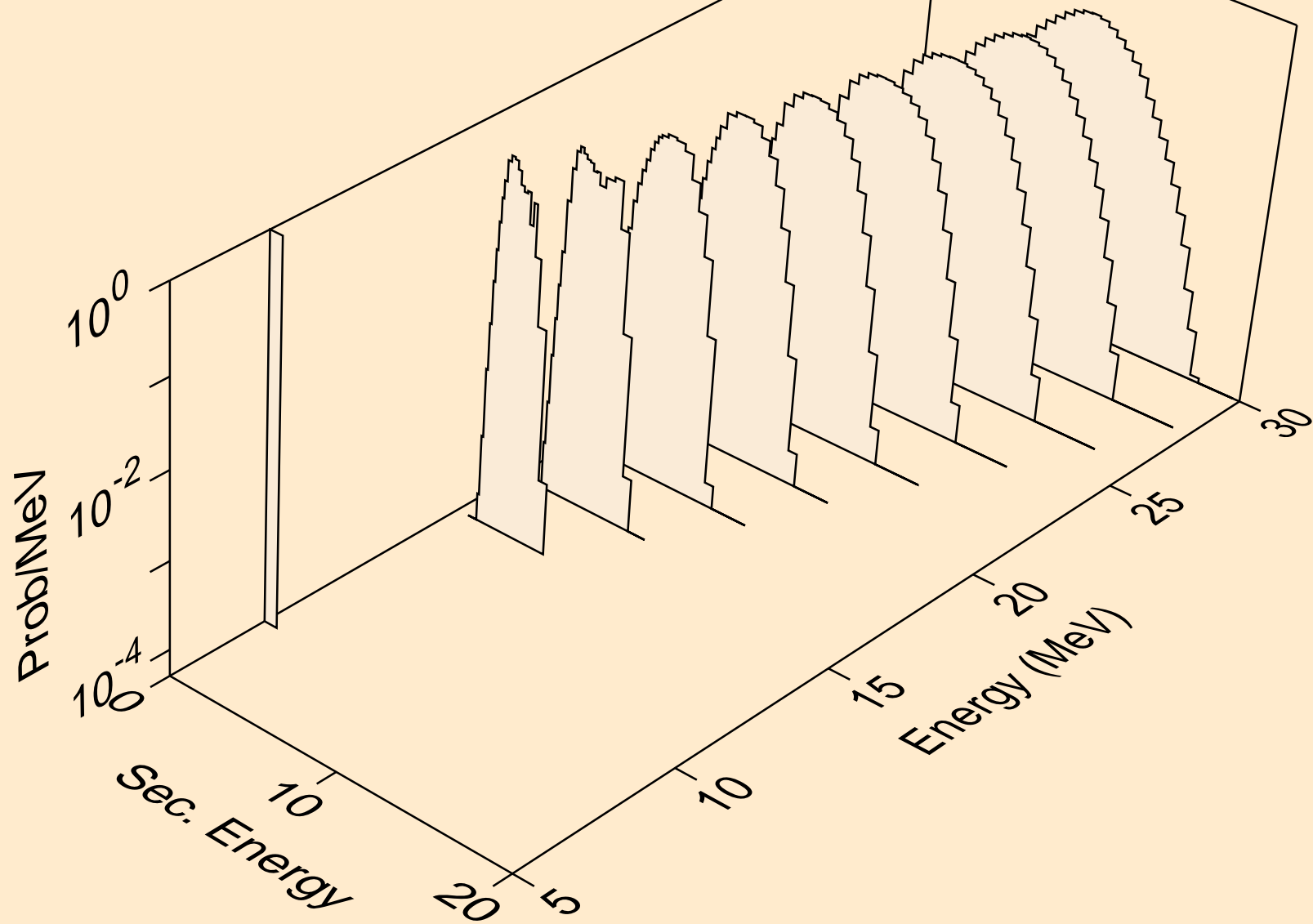

HO161 HELION ACER TENDL-2021 LIBRARY; T=0.K  
protons from (s,npa)

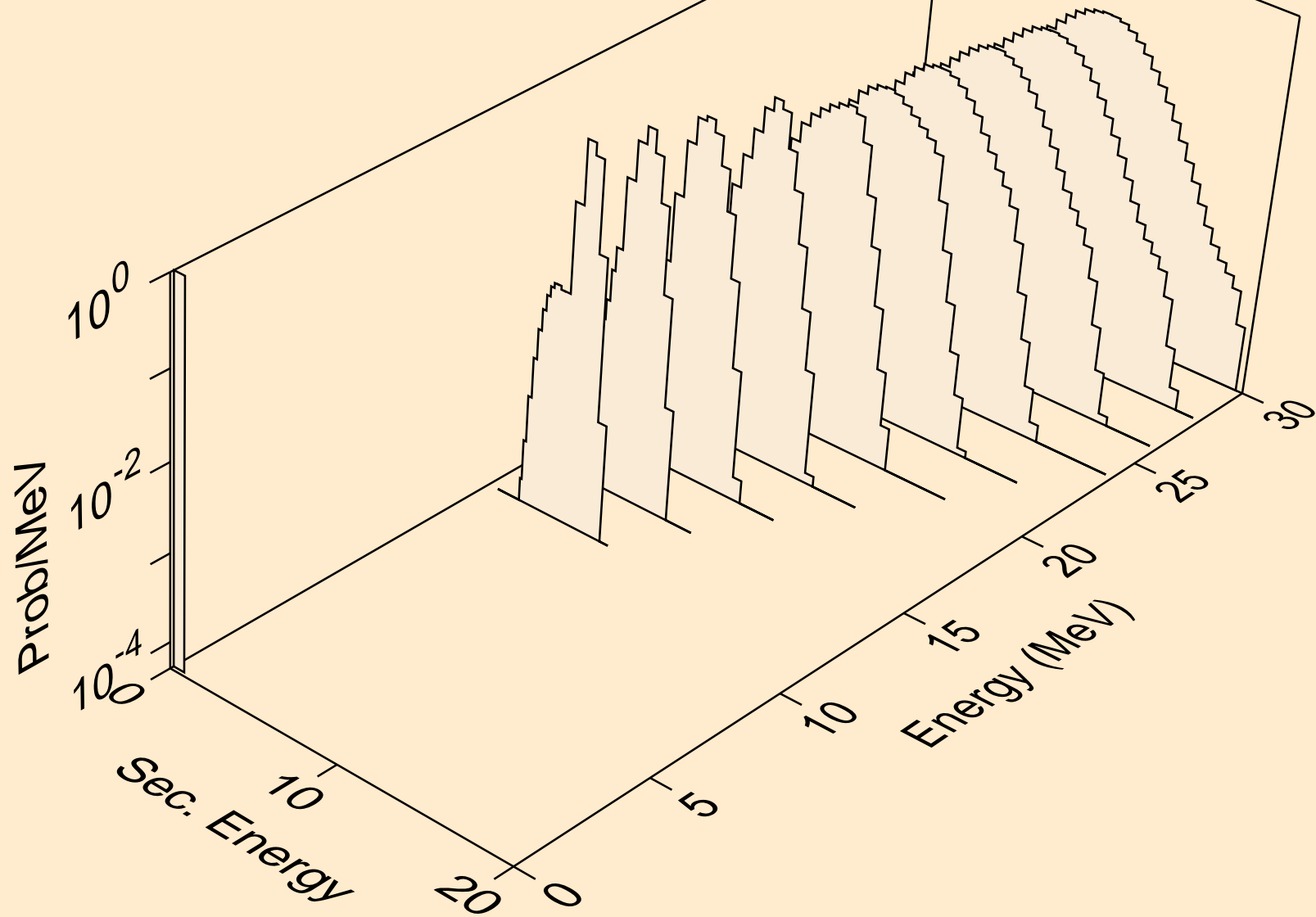

HO161 HELION ACER TENDL-2021 LIBRARY; T=0.K  
protons from (s,p)

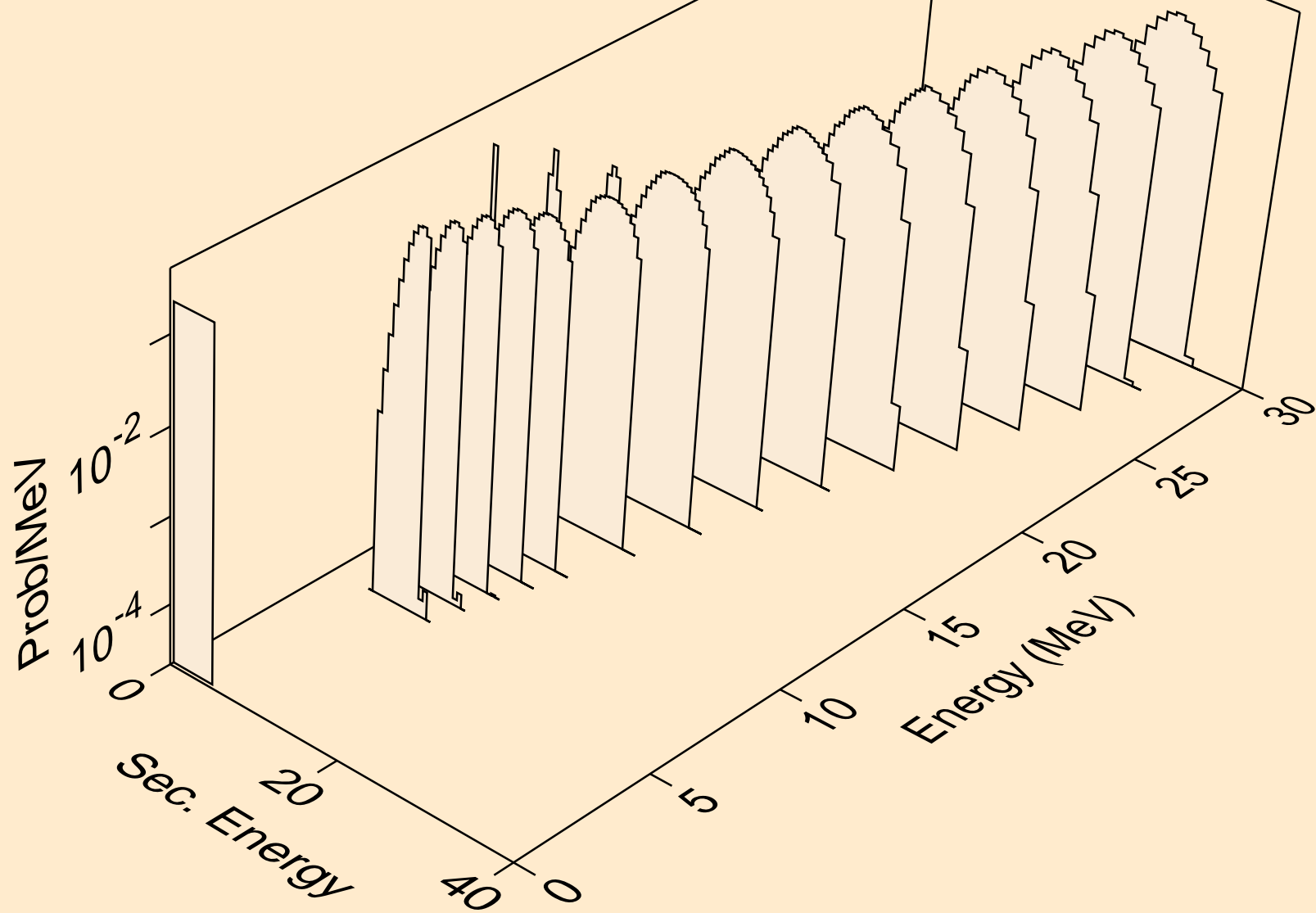

HO161 HELION ACER TENDL-2021 LIBRARY; T=0.K  
protons from (s,2p)

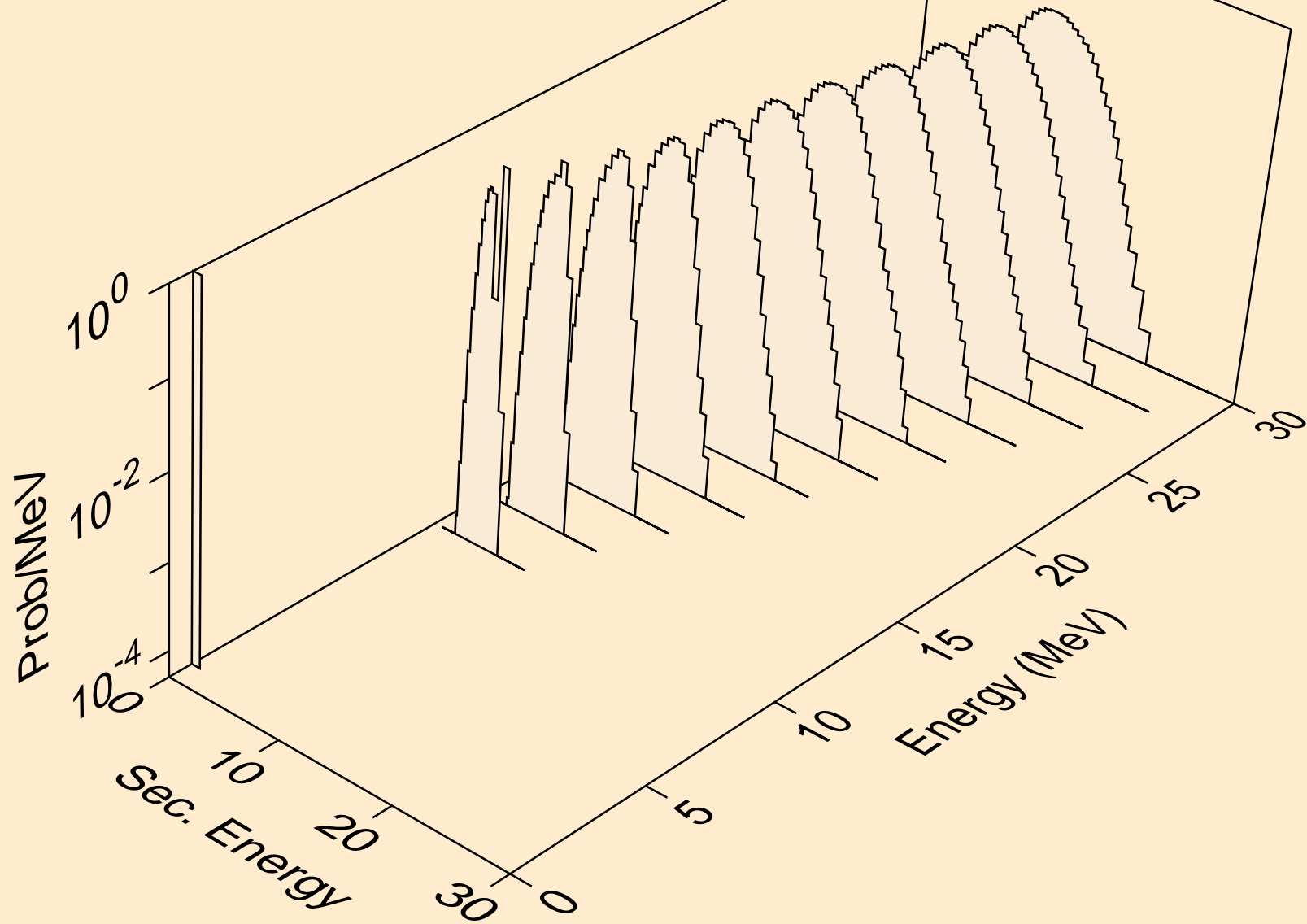

HO161 HELION ACER TENDL-2021 LIBRARY; T=0.K  
protons from (s,pa)

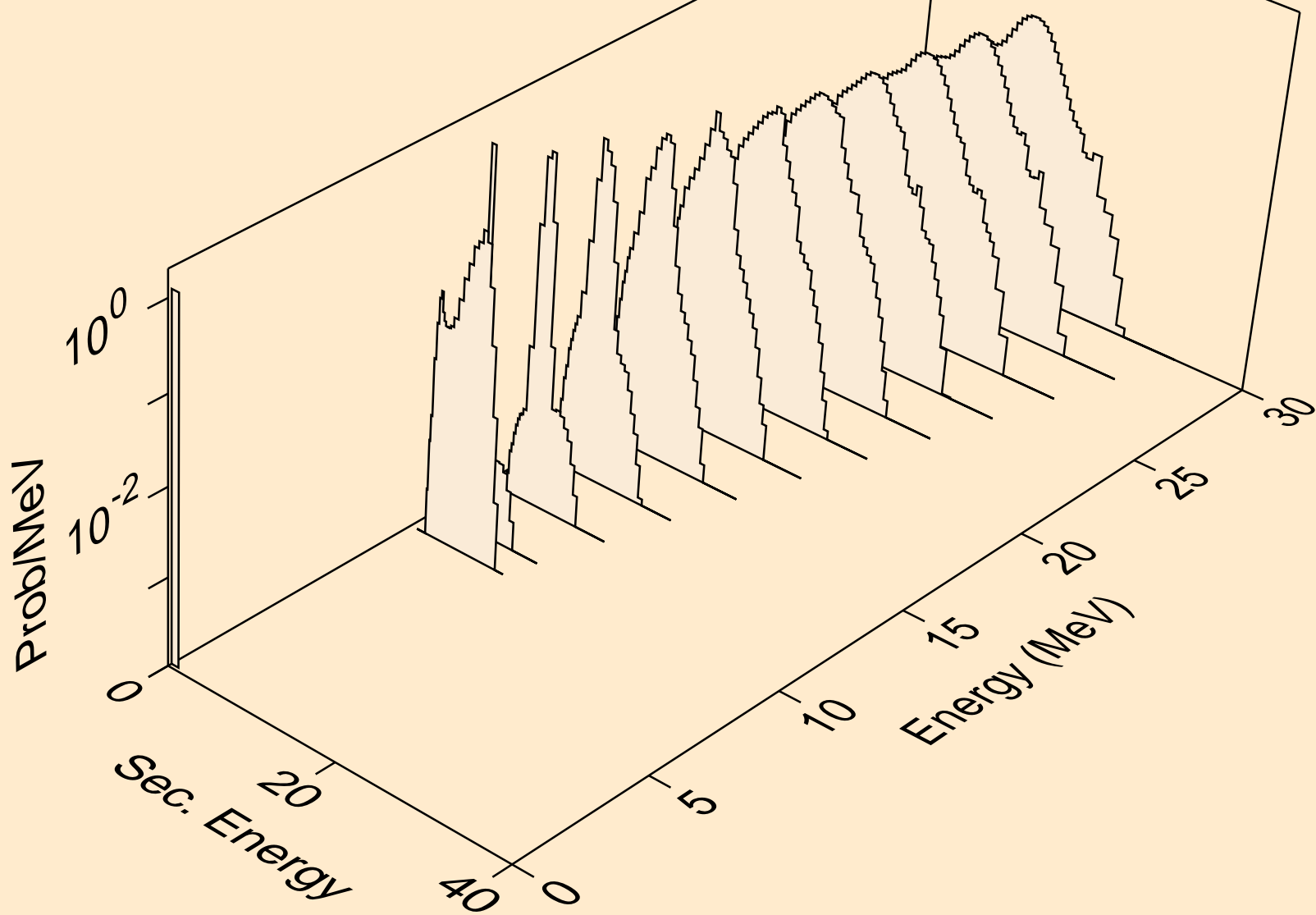

HO161 HELION ACER TENDL-2021 LIBRARY; T=0.K  
protons from (s,pd)

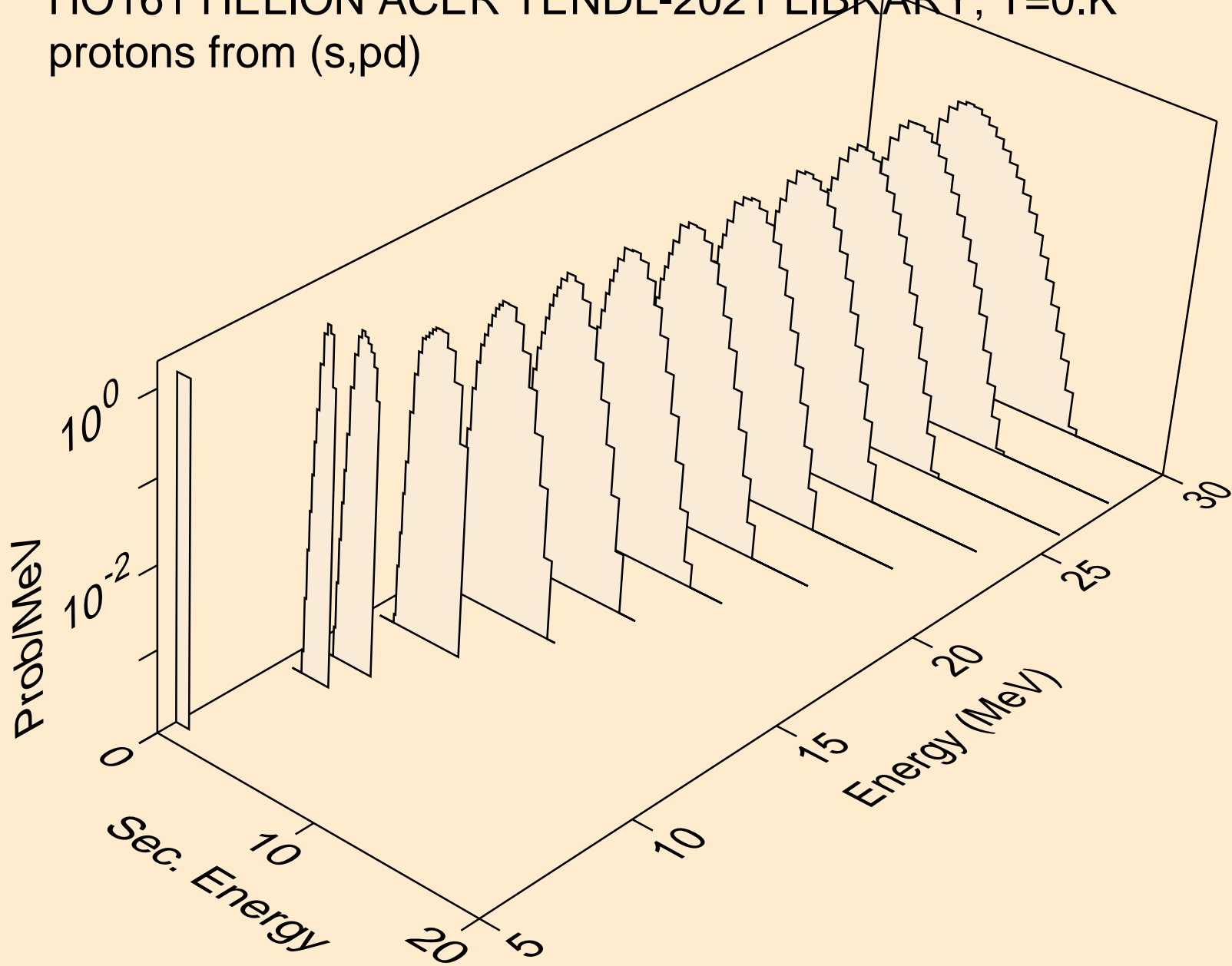

HO161 HELION ACER TENDL-2021 LIBRARY; T=0.K  
protons from (s,pt)

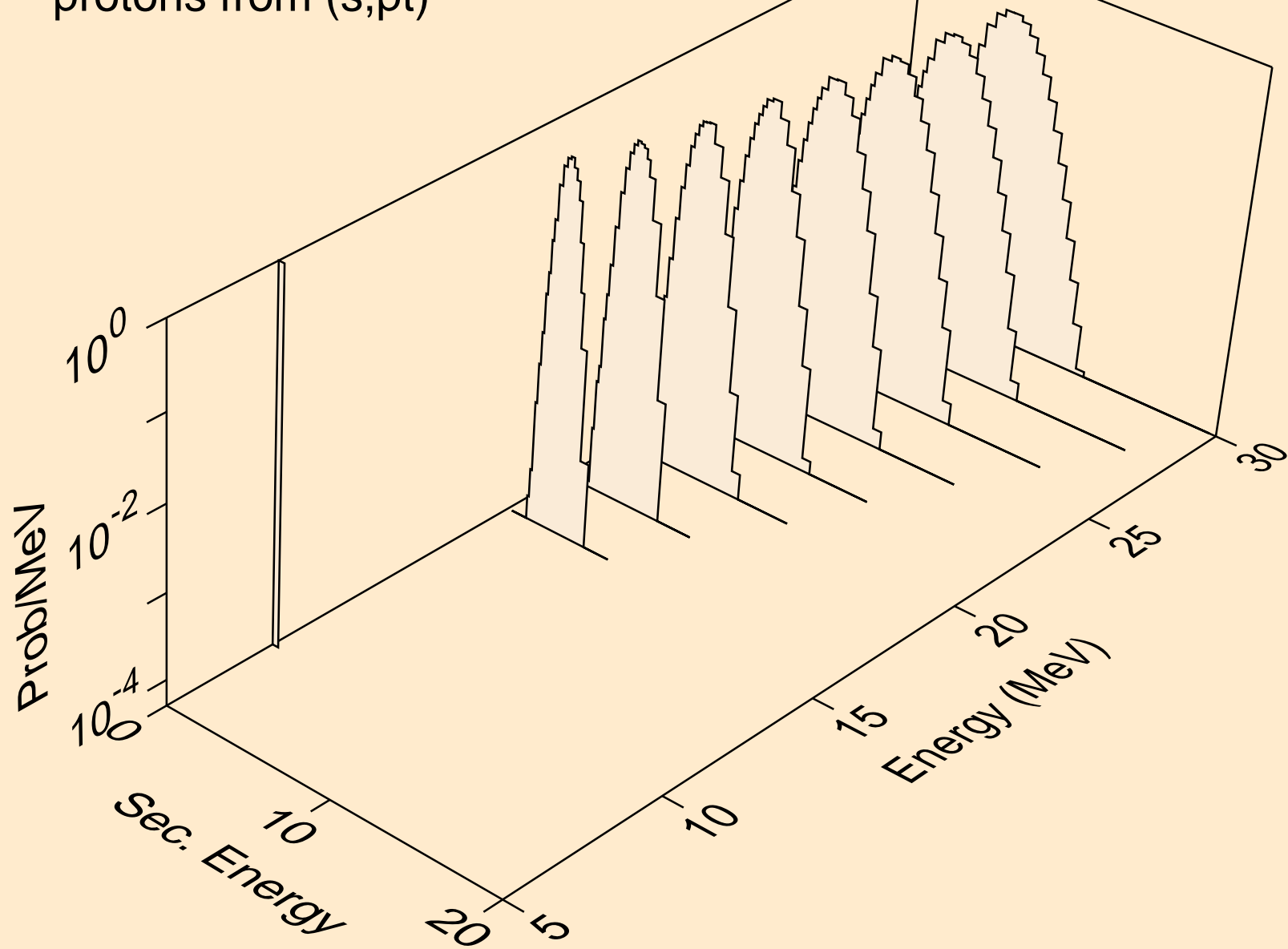

HO161 HELION ACER TENDL-2021 LIBRARY; T=0.K  
deuterons from (s,x)

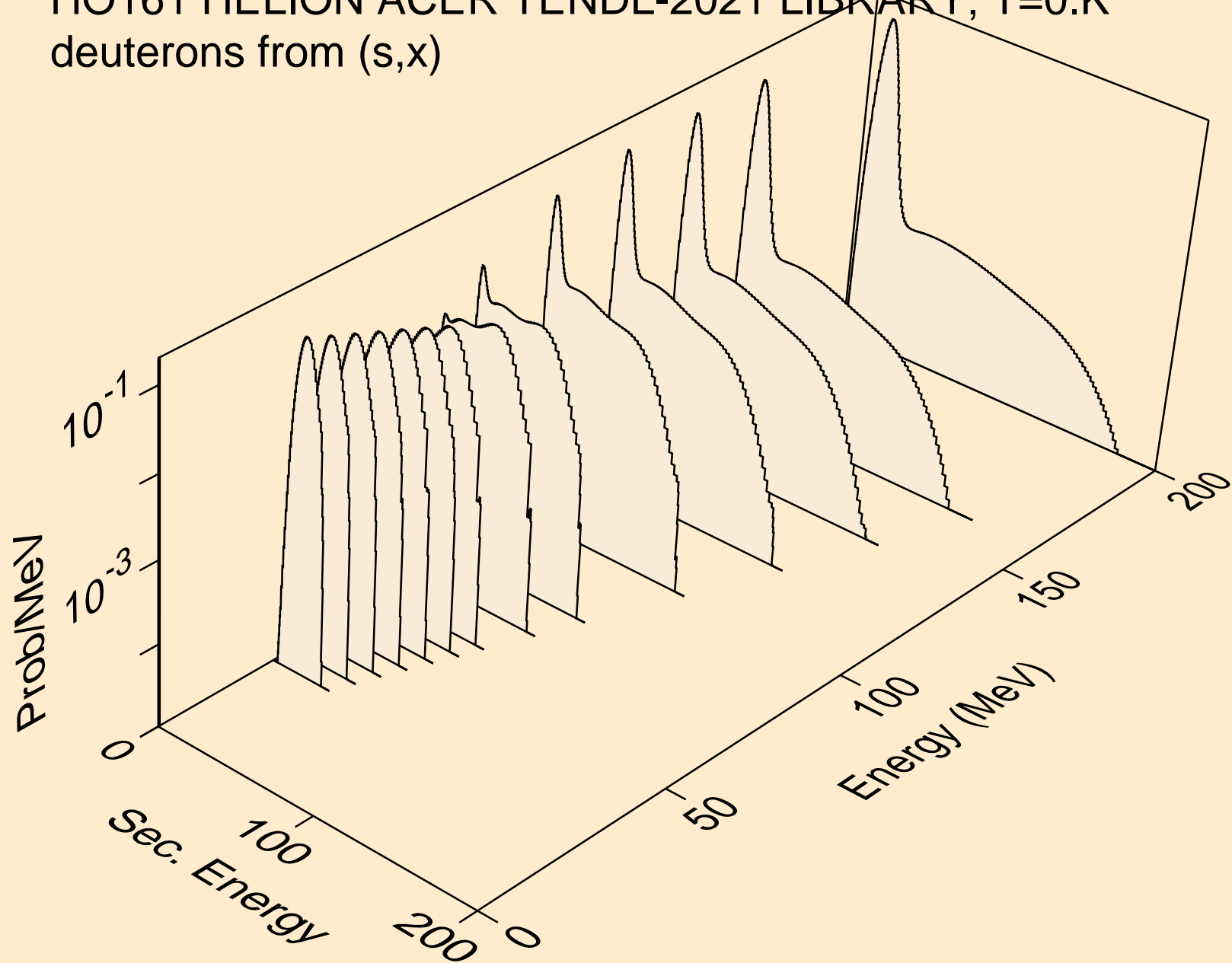



HO161 HELION ACER TENDL-2021 LIBRARY; T=0.K  
deuterons from (s,2nd)

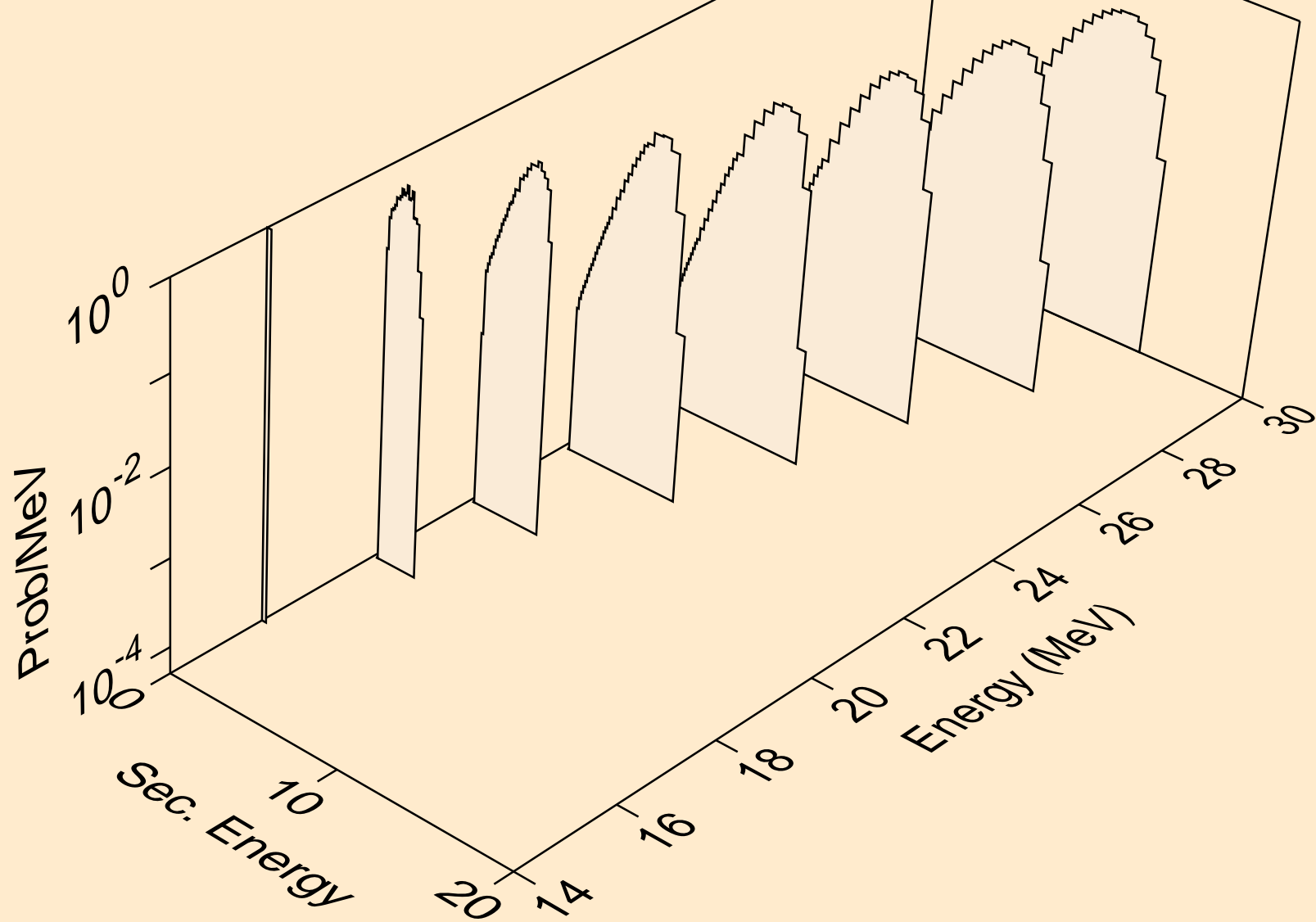

HO161 HELION ACER TENDL-2021 LIBRARY; T=0.K  
deuterons from (s,n\*)d

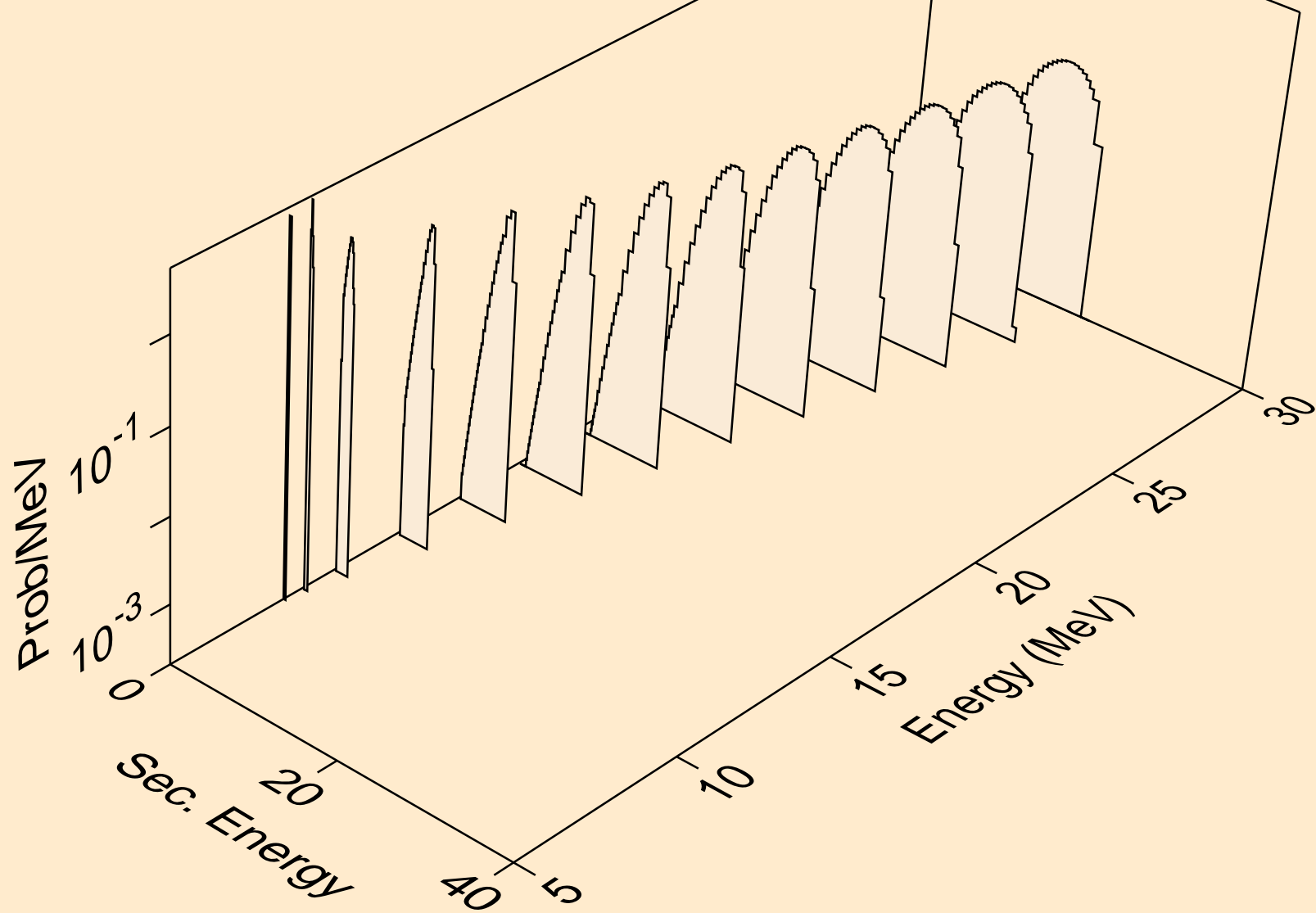

HO161 HELION ACER TENDL-2021 LIBRARY; T=0.K  
deuterons from (s,d)

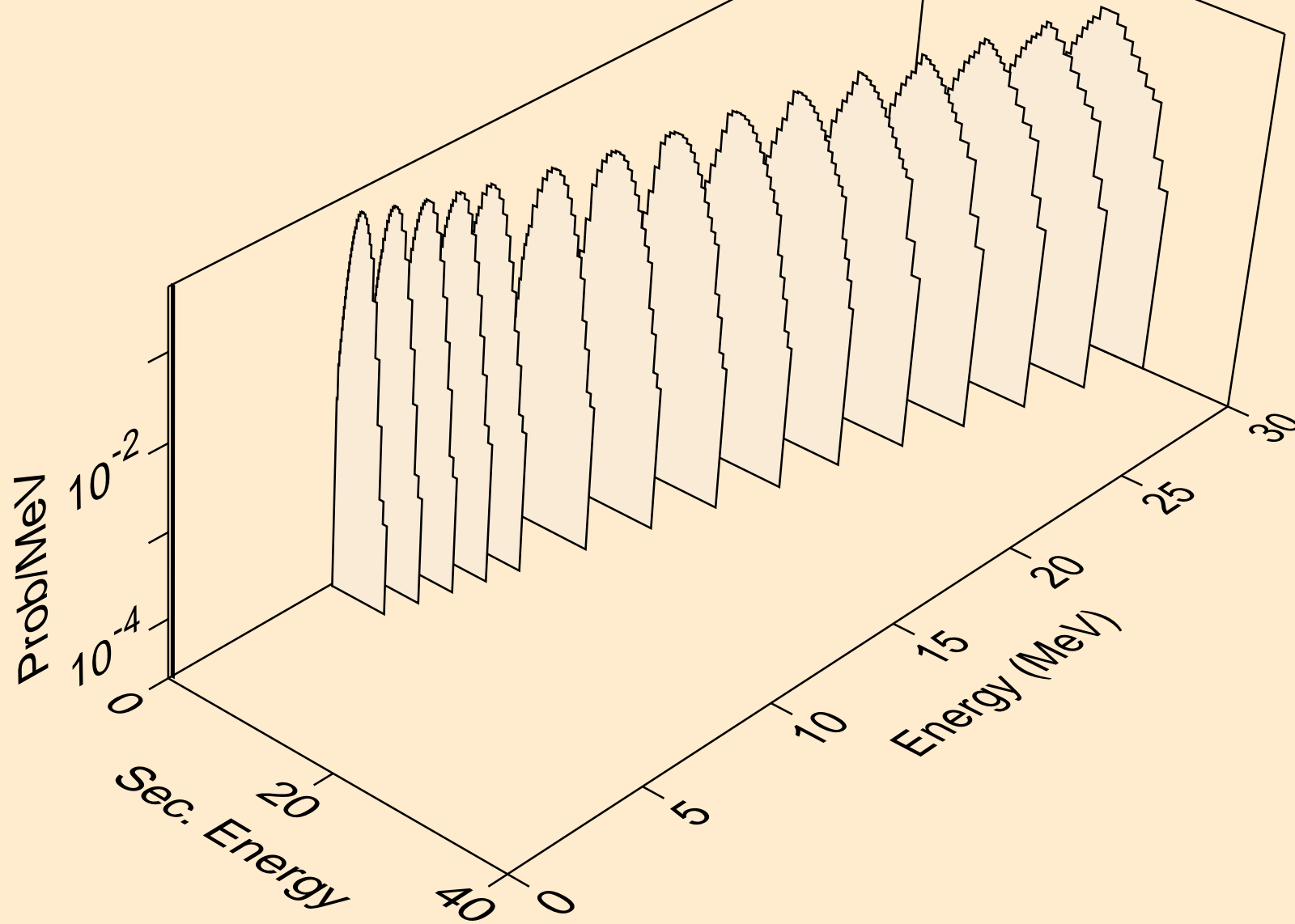

HO161 HELION ACER TENDL-2021 LIBRARY; T=0.K  
deuterons from (s,pd)

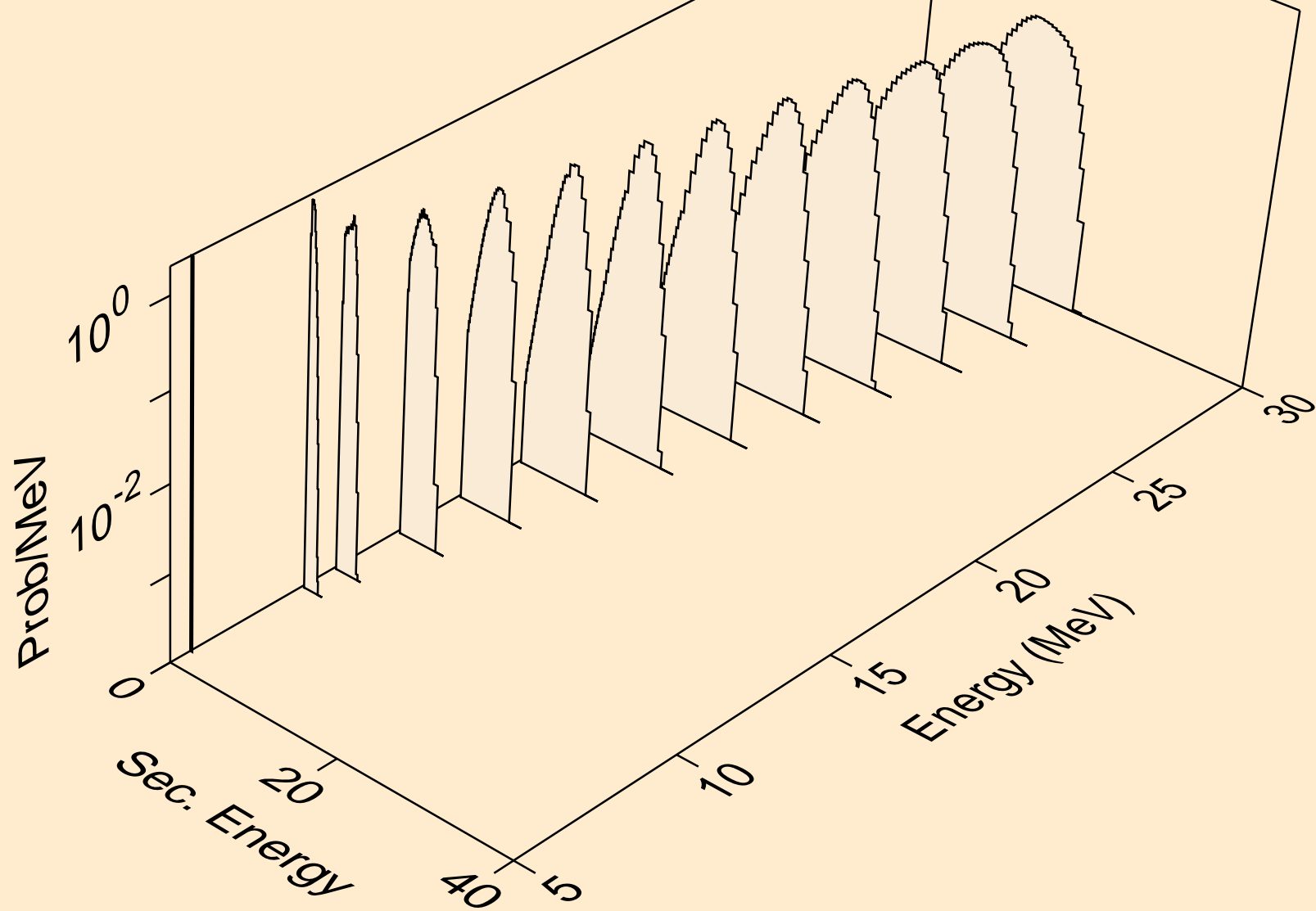

HO161 HELION ACER TENDL-2021 LIBRARY; T=0.K  
deuterons from (s,da)

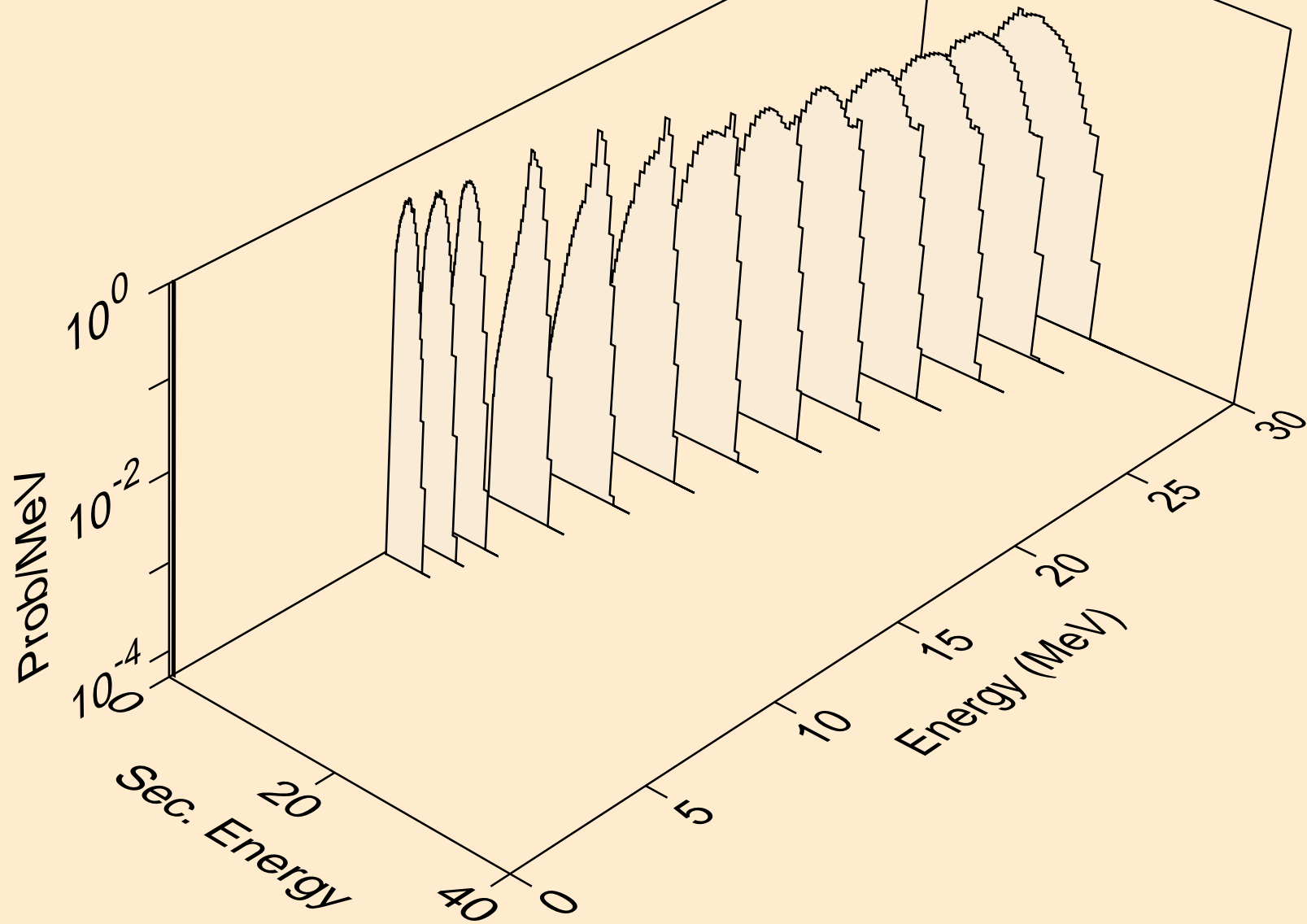

HO161 HELION ACER TENDL-2021 LIBRARY; T=0.K  
tritons from (s,x)

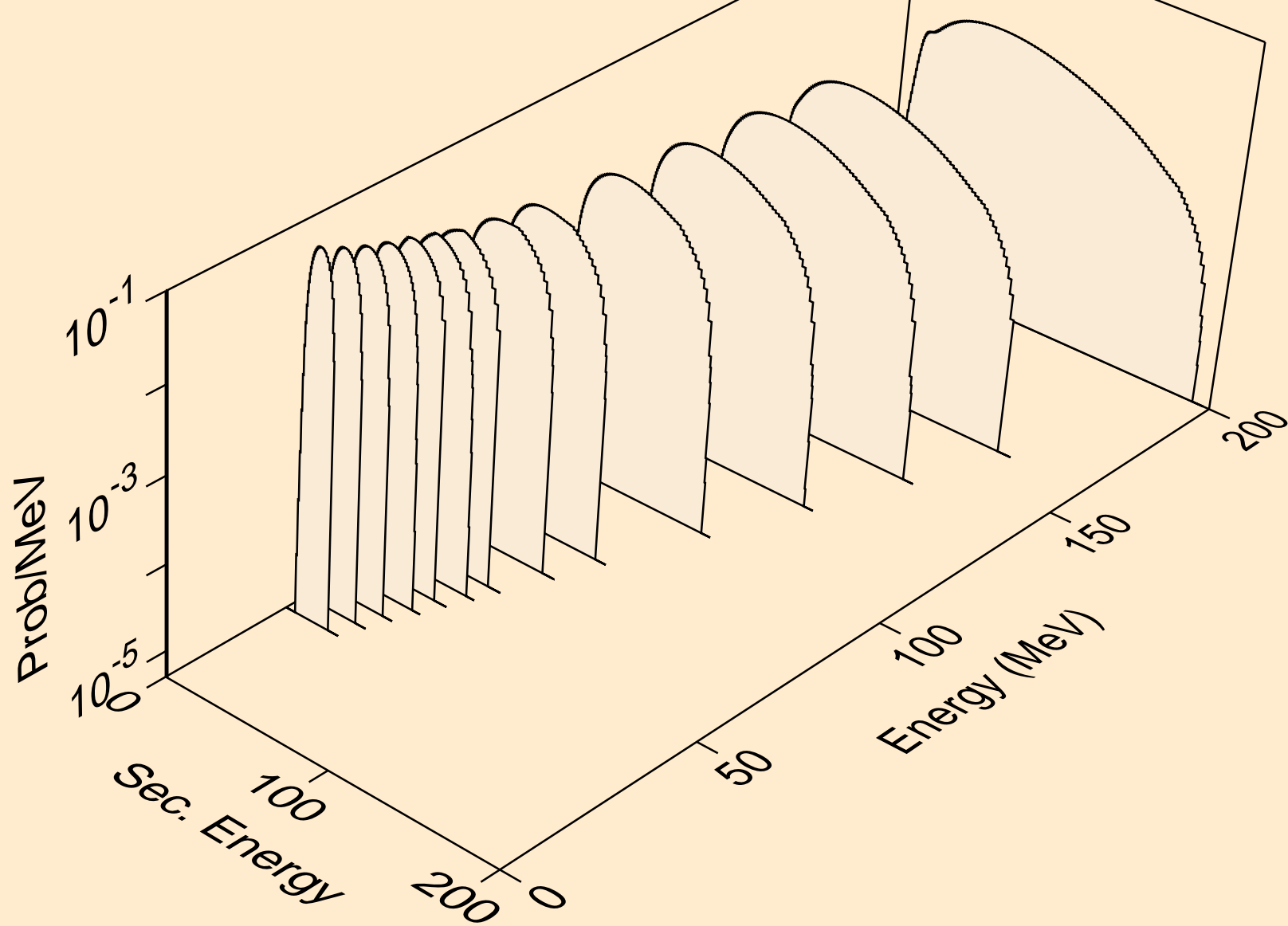

HO161 HELION ACER TENDL-2021 LIBRARY; T=0.K  
tritons from (s,n\*)t

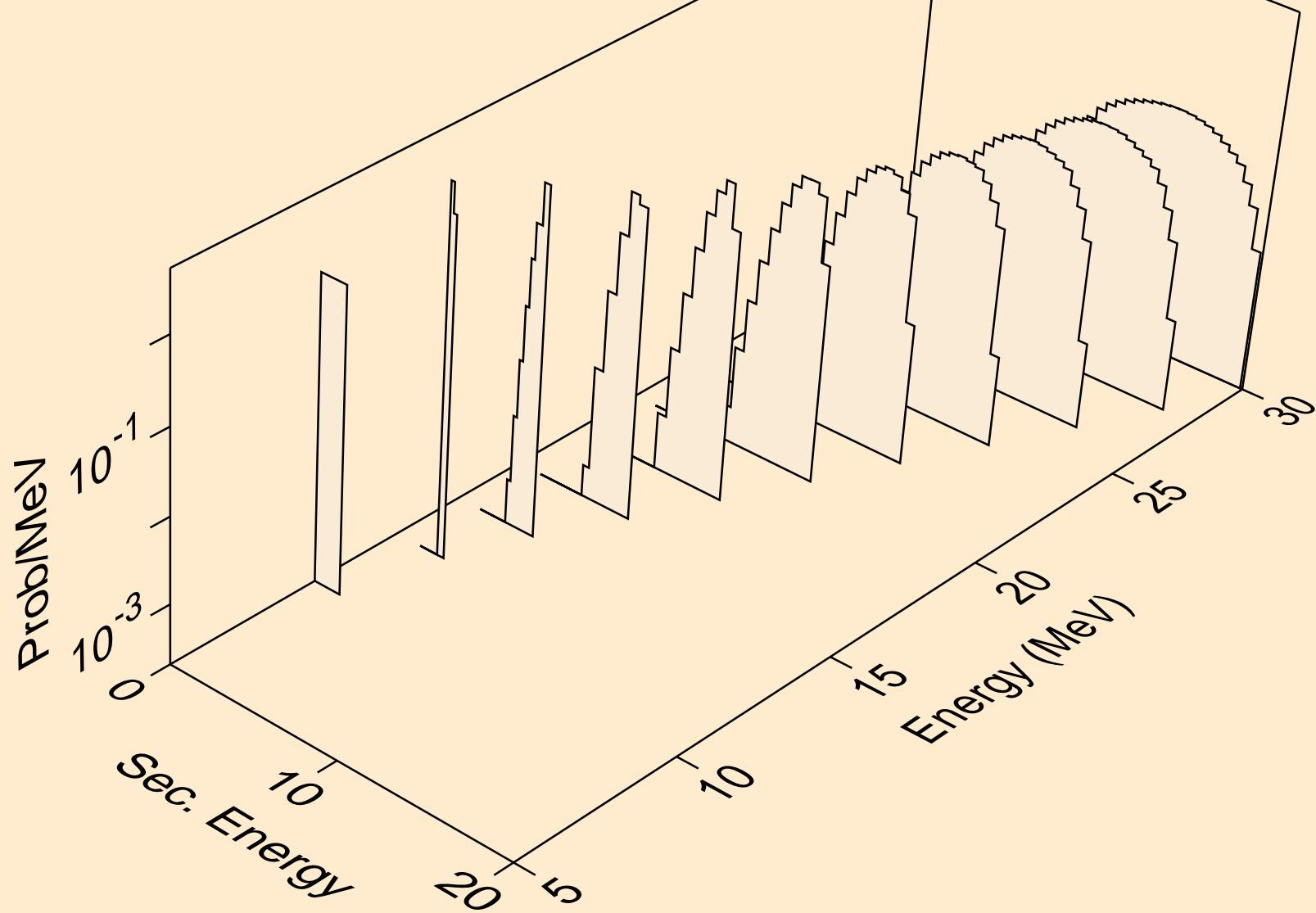

HO161 HELION ACER TENDL-2021 LIBRARY; T=0.K  
tritons from (s,t)

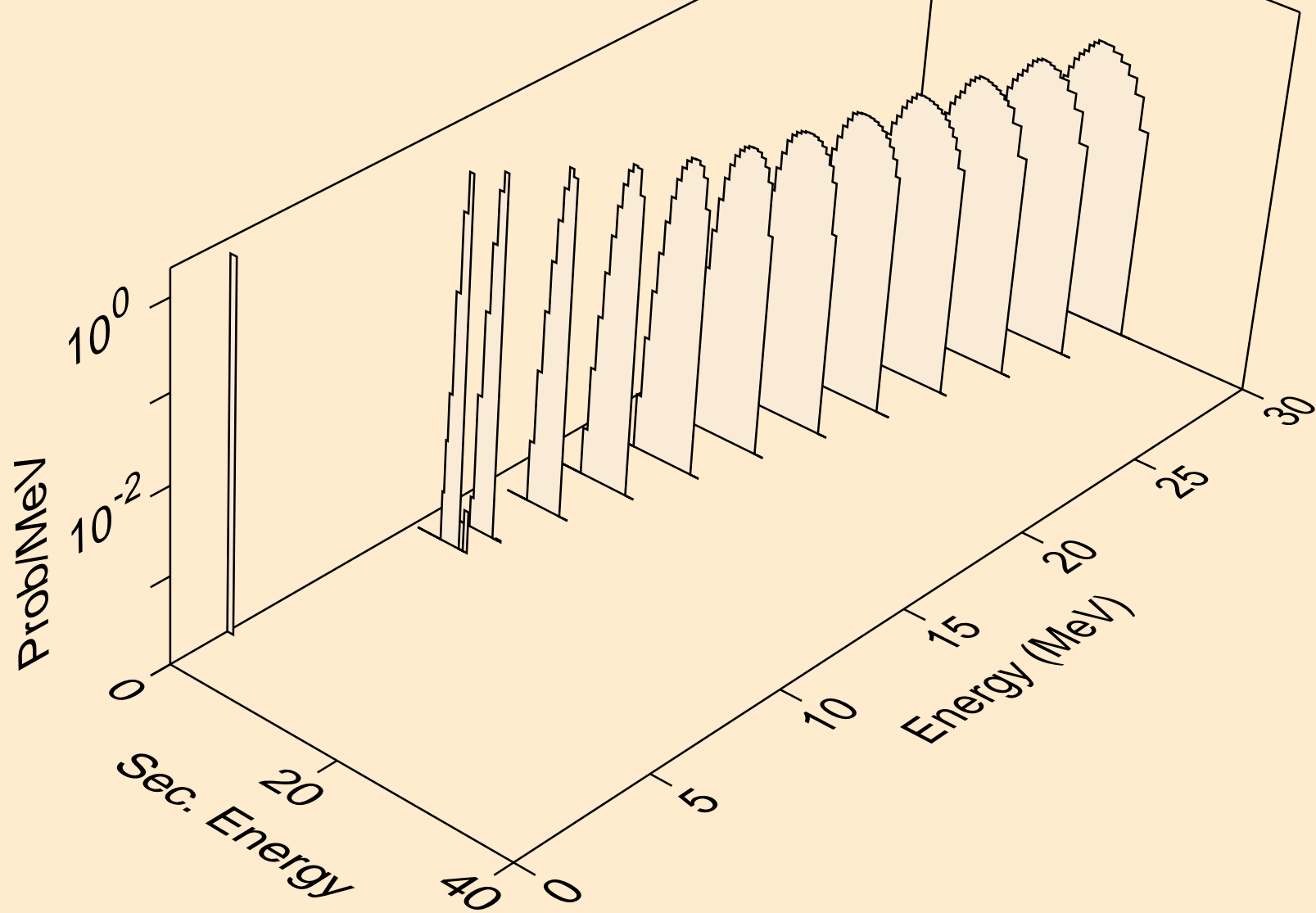



HO161 HELION ACER TENDL-2021 LIBRARY; T=0.K  
tritons from (s,pt)

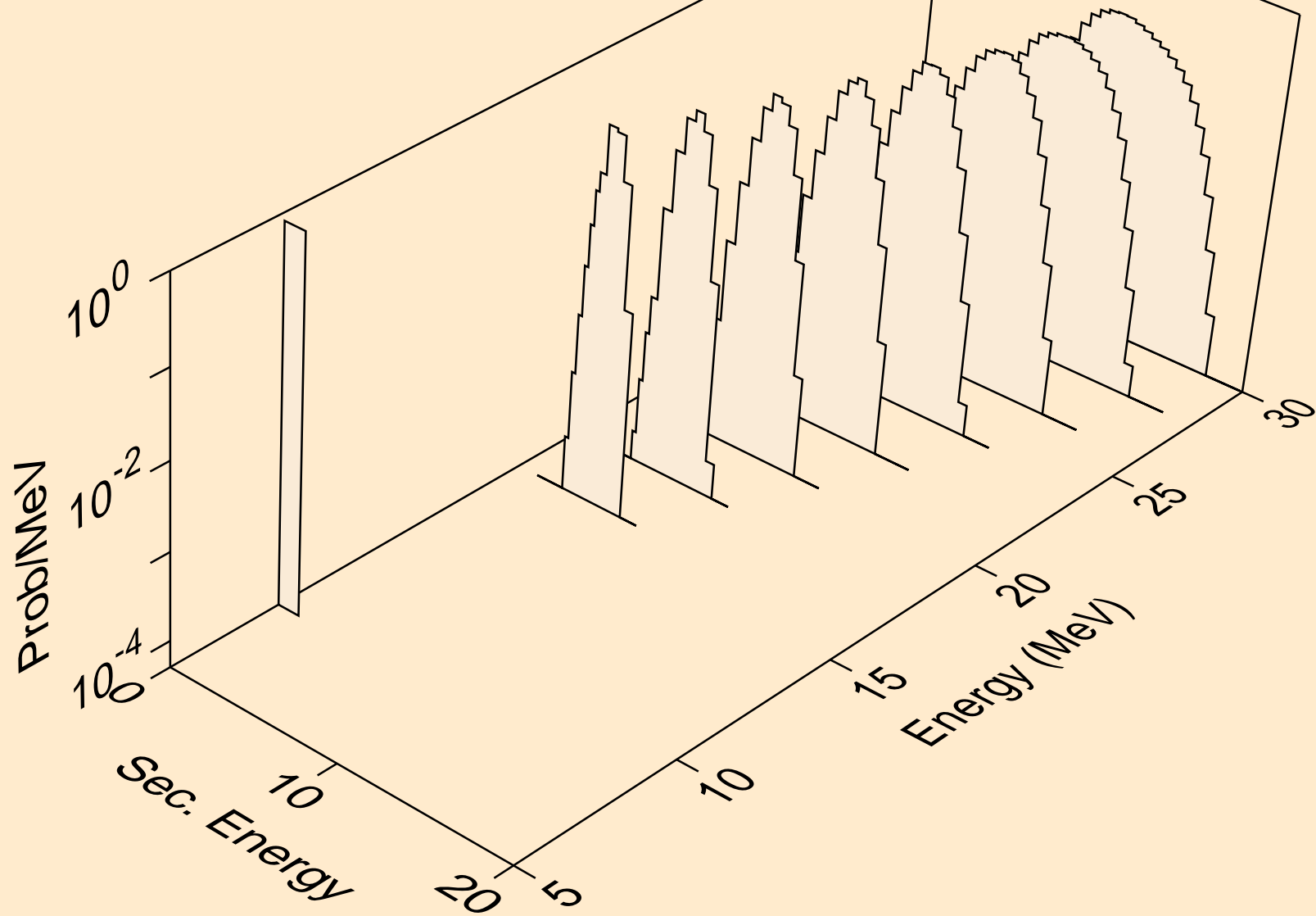

HO161 HELION ACER TENDL-2021 LIBRARY; T=0.K  
alphas from (s,x)

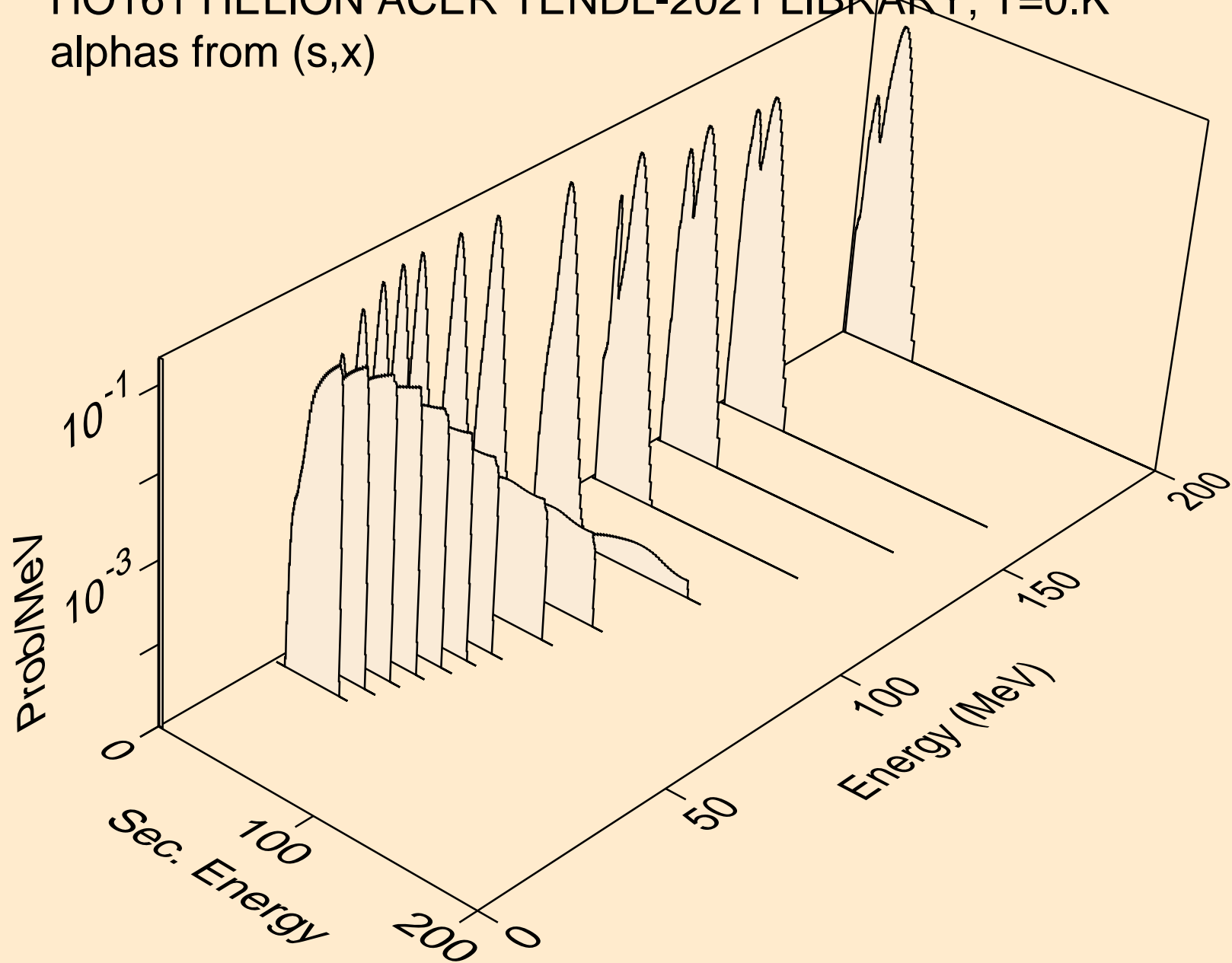

HO161 HELION ACER TENDL-2021 LIBRARY; T=0.K  
alphas from (s,n\*)a

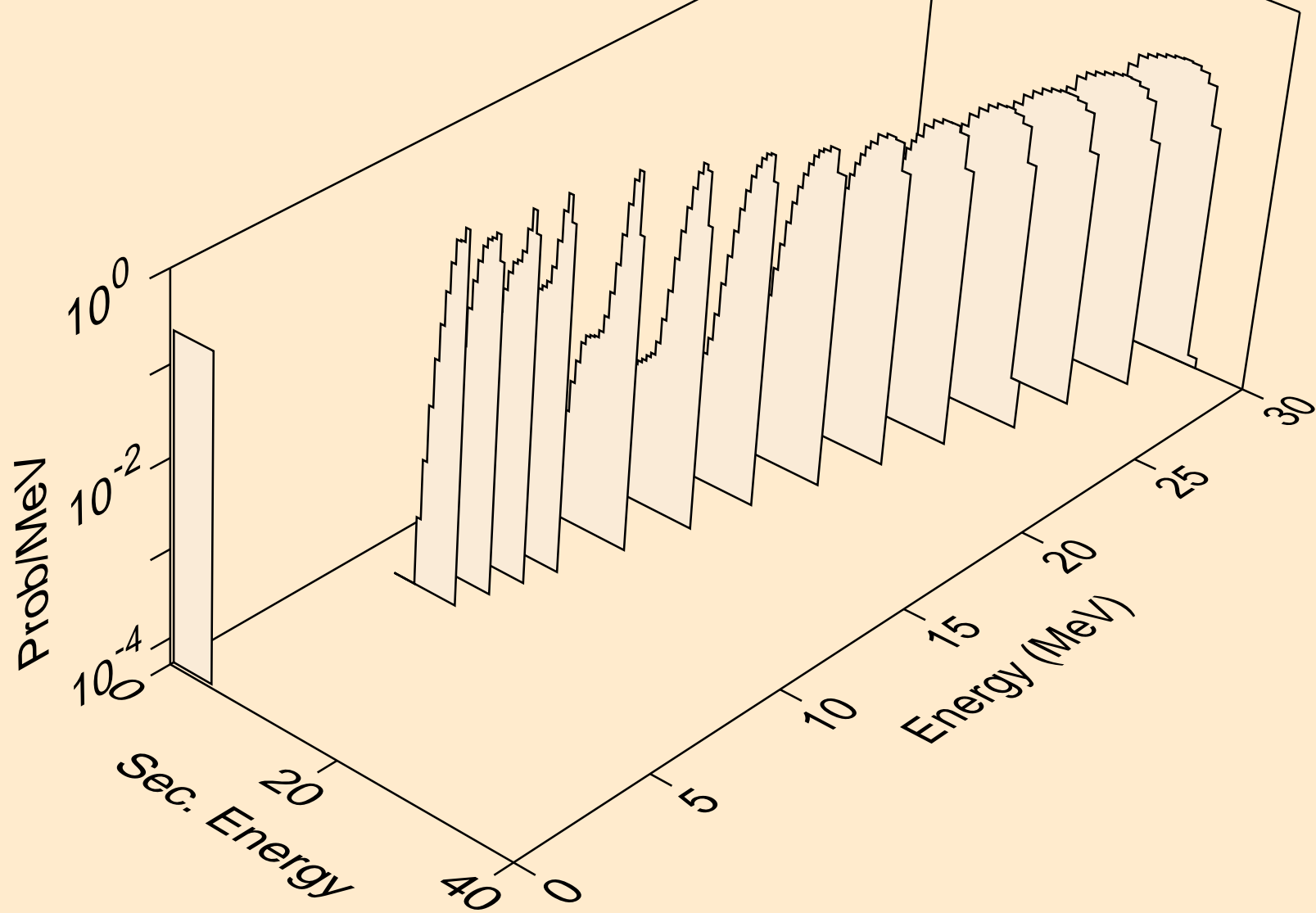

HO161 HELION ACER TENDL-2021 LIBRARY; T=0.K  
alphas from (s,2n)a

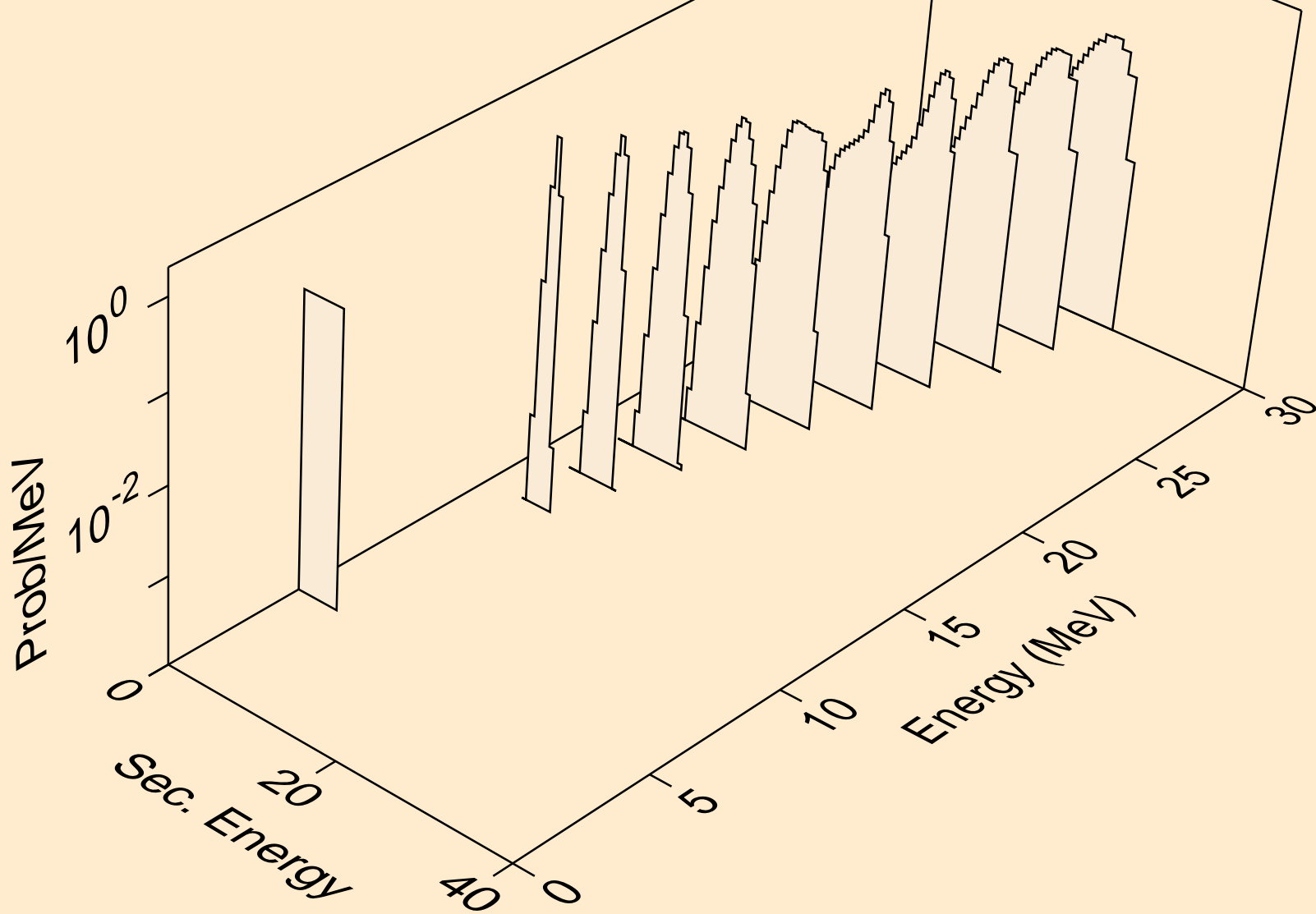

HO161 HELION ACER TENDL-2021 LIBRARY; T=0.K  
alphas from (s,3n)a

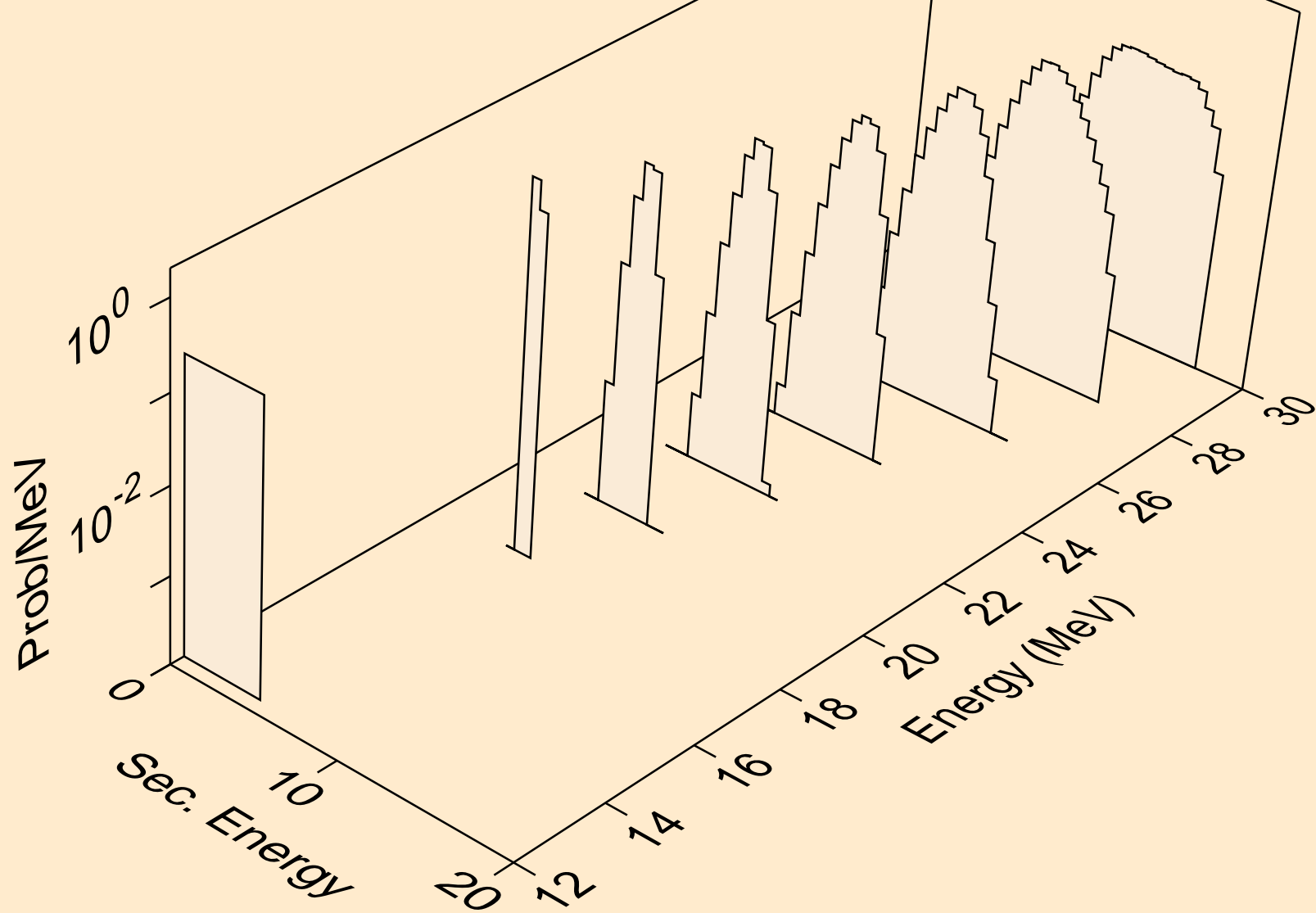

HO161 HELION ACER TENDL-2021 LIBRARY; T=0.K  
alphas from (s,n\*)2a

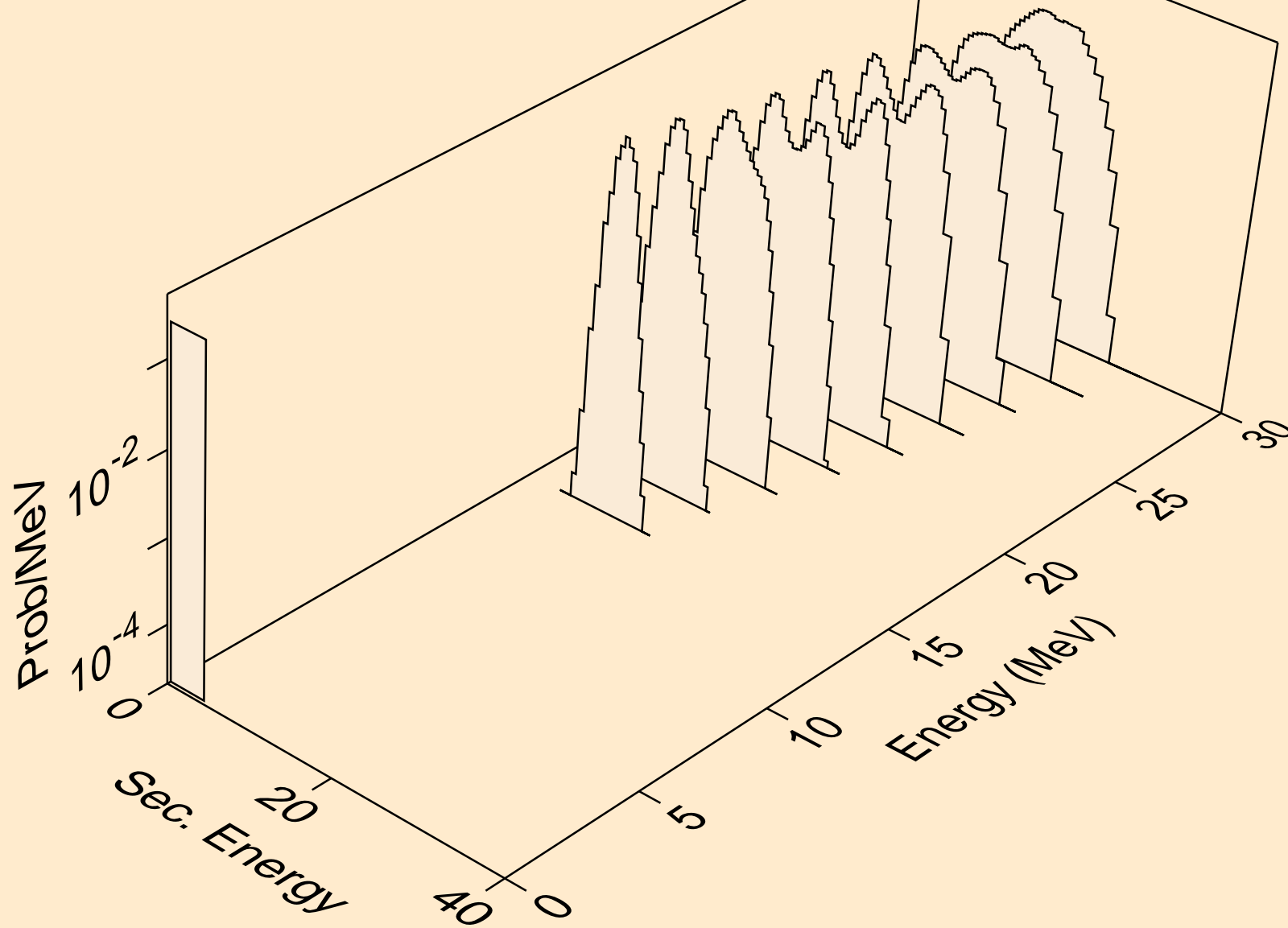

HO161 HELION ACER TENDL-2021 LIBRARY; T=0.K  
alphas from (s,npa)

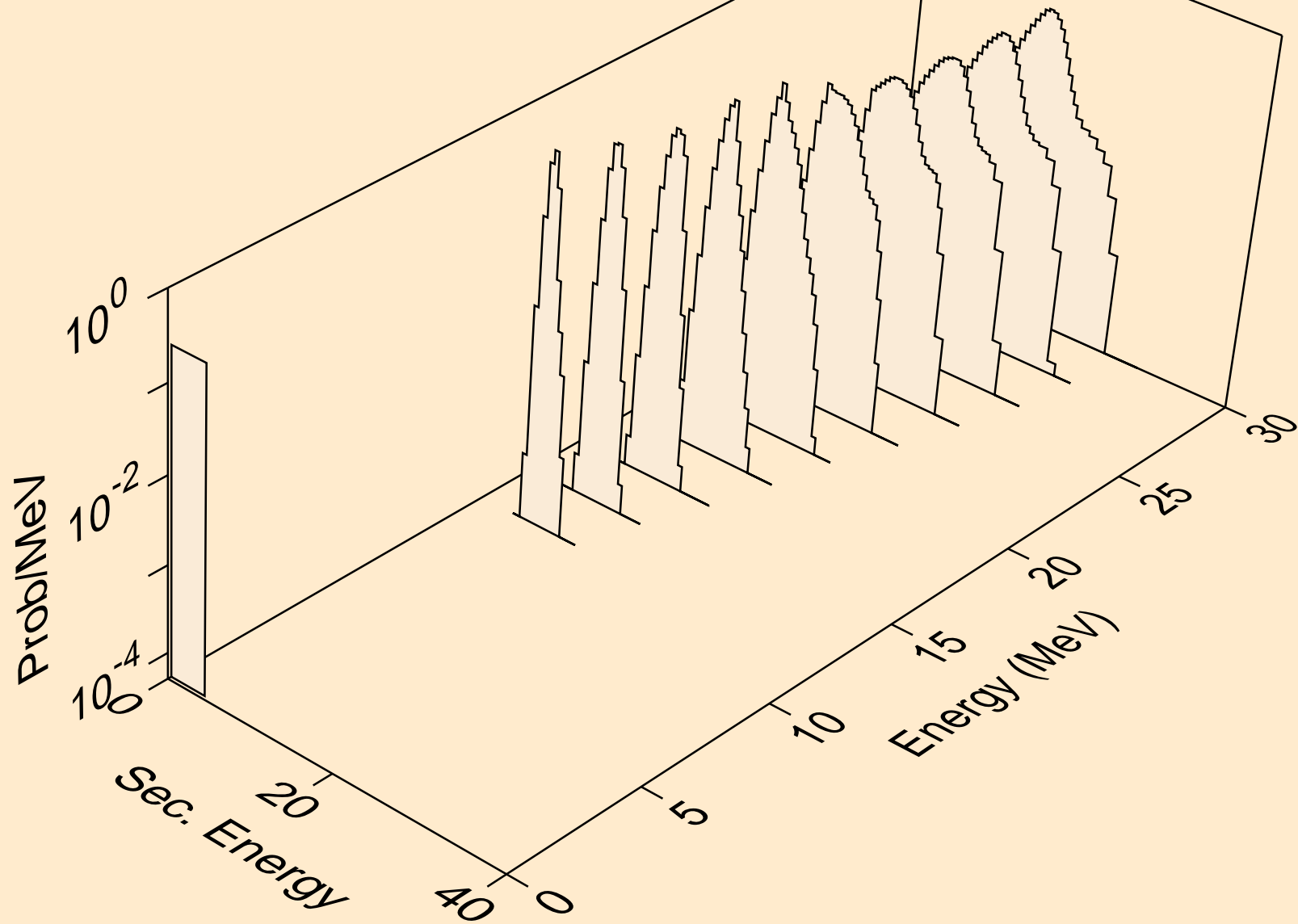

HO161 HELION ACER TENDL-2021 LIBRARY; T=0.K  
alphas from (s,a)

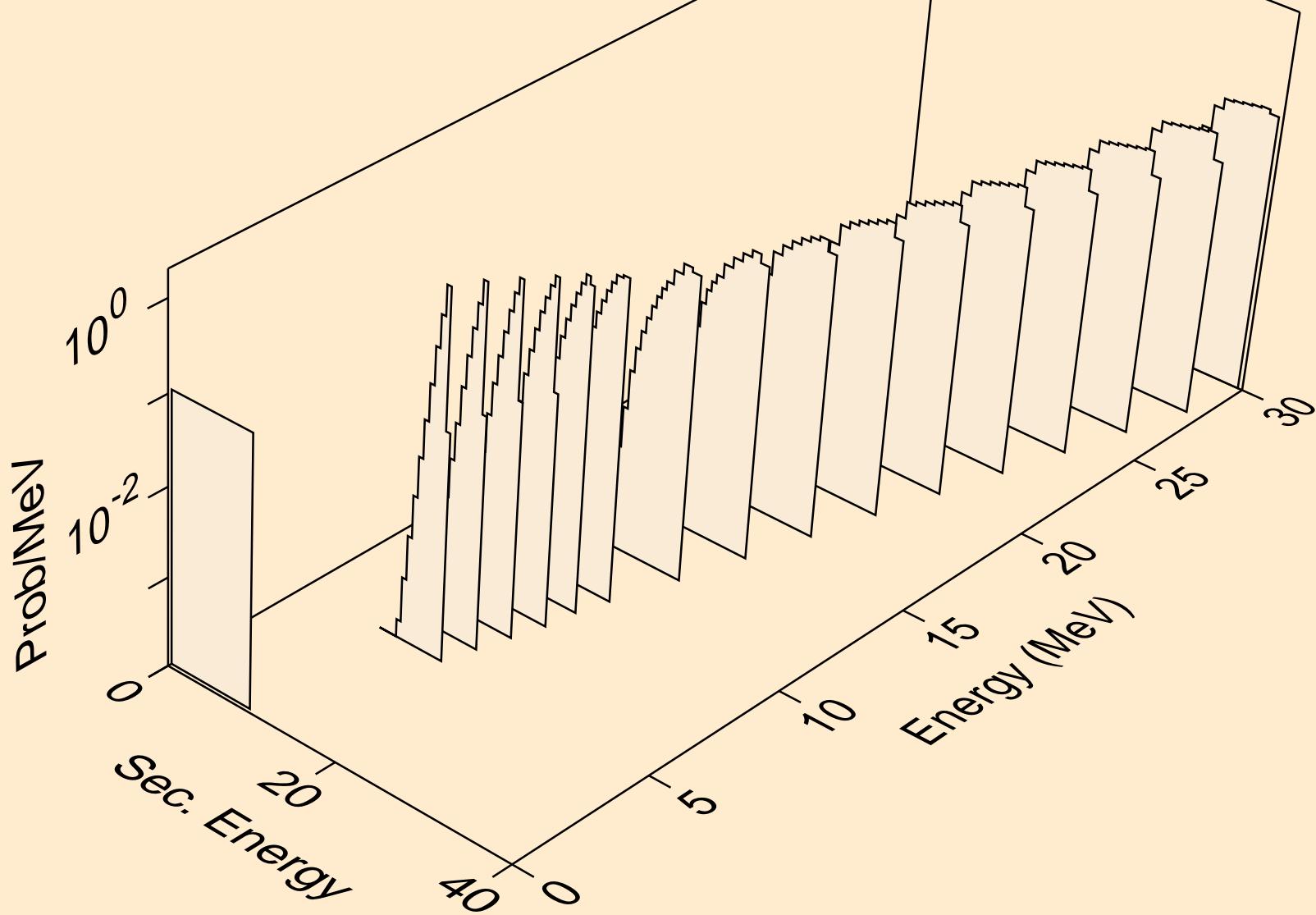



HO161 HELION ACER TENDL-2021 LIBRARY; T=0.K  
alphas from (s,2a)

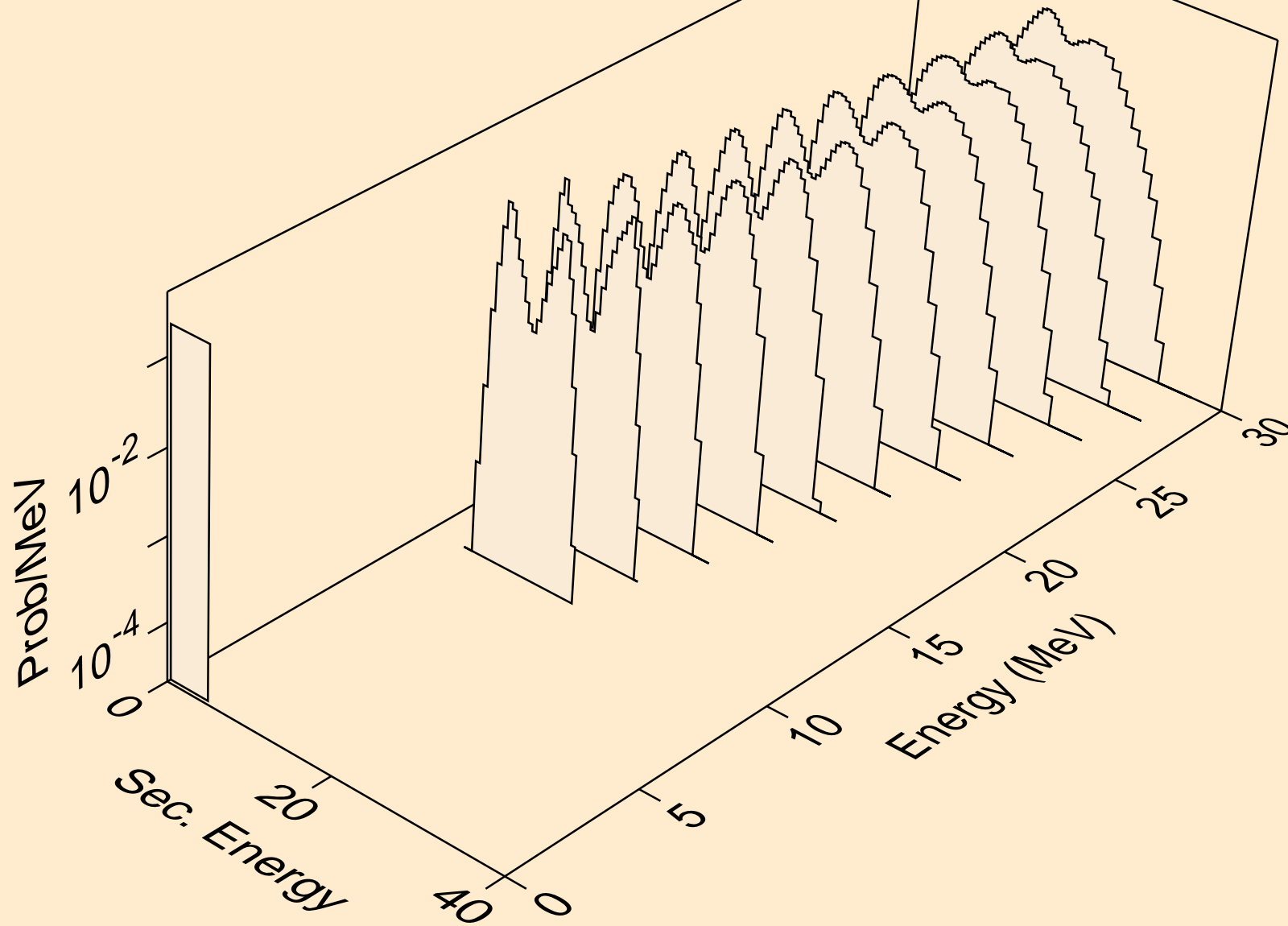

HO161 HELION ACER TENDL-2021 LIBRARY; T=0.K  
alphas from (s,pa)

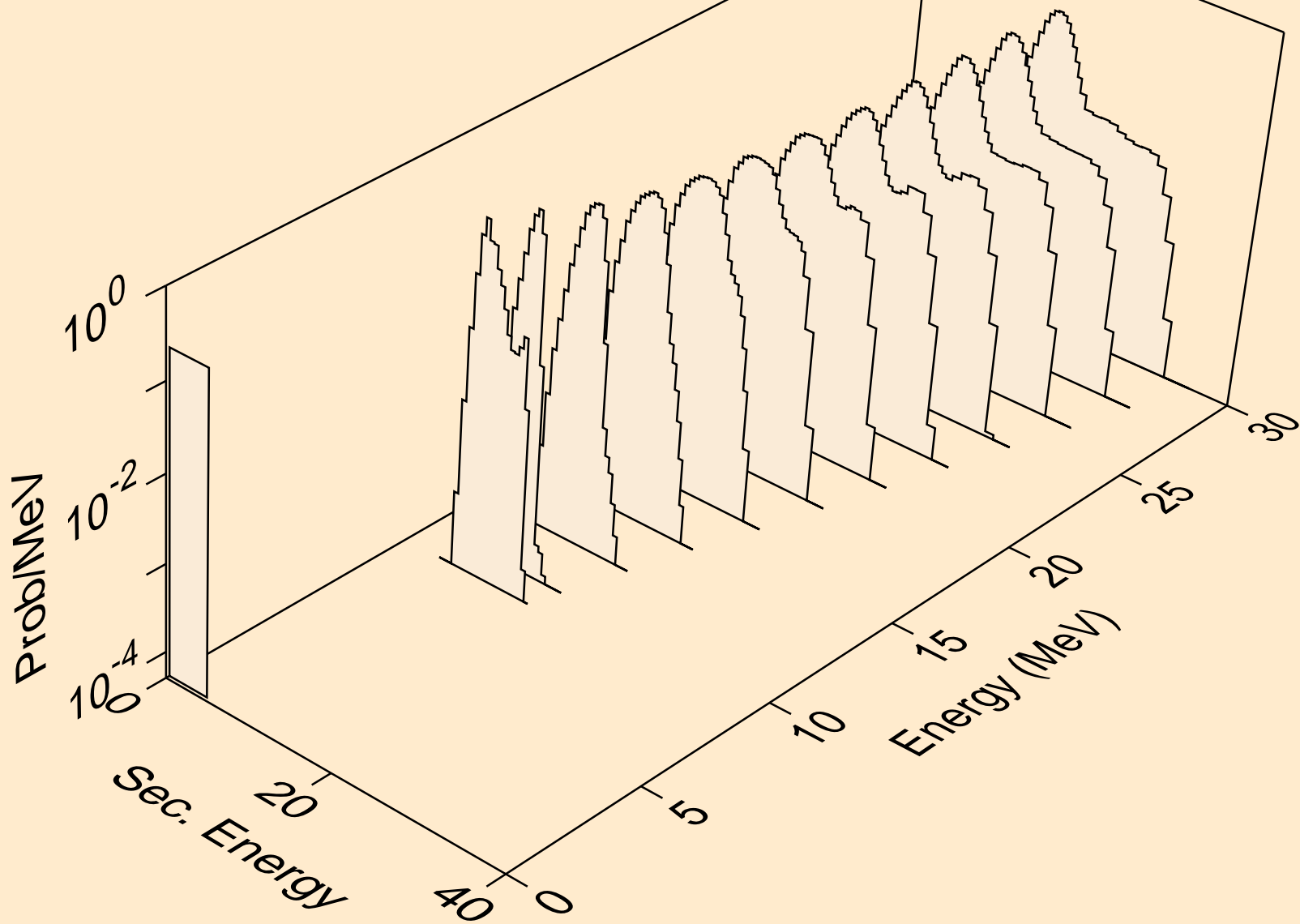

HO161 HELION ACER TENDL-2021 LIBRARY; T=0.K  
alphas from (s,da)

