

HO163 HELION ACER TENDL-2021 LIBRARY; T=0.K  
Principal cross sections

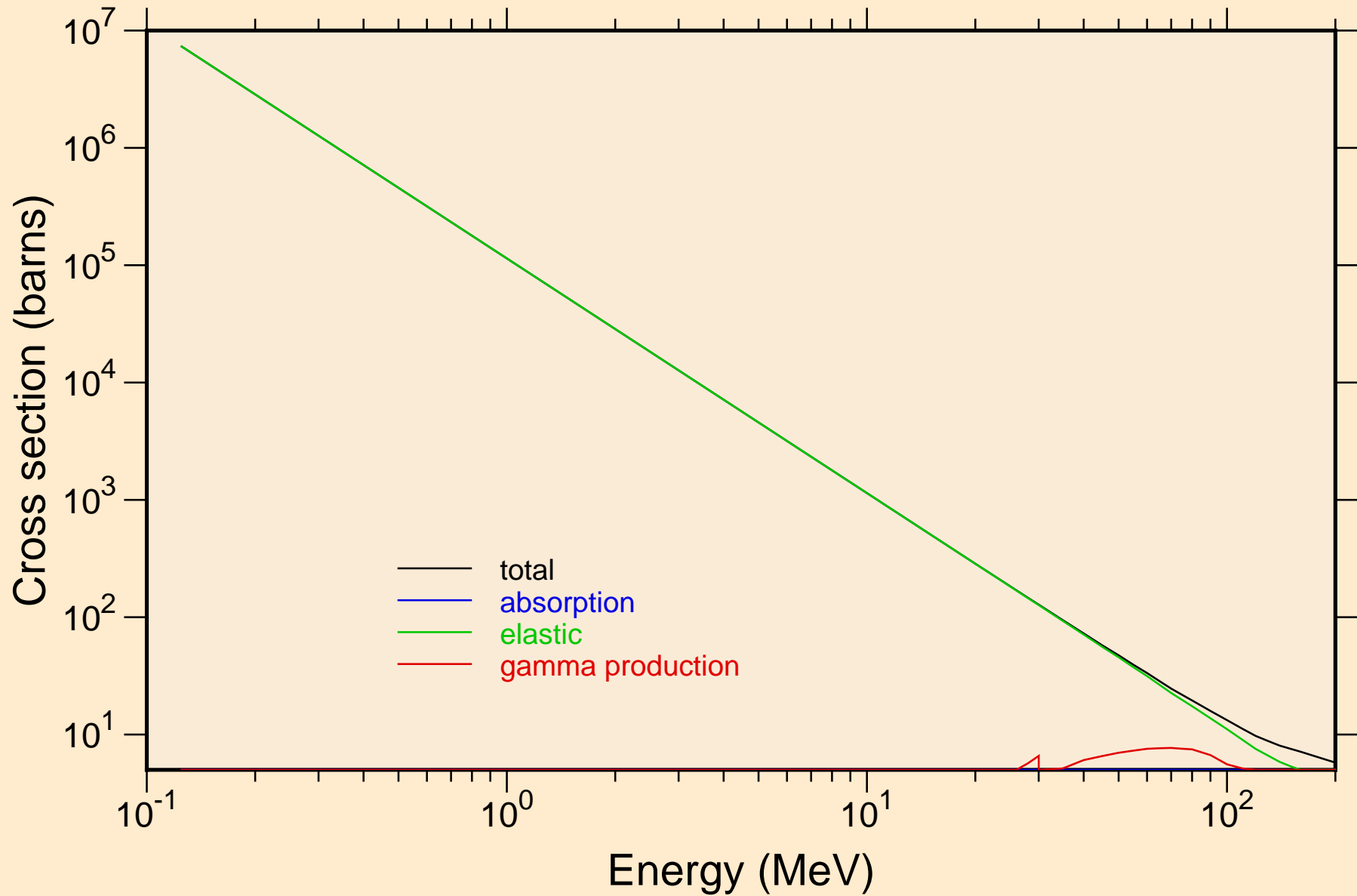

HO163 HELION ACER TENDL-2021 LIBRARY; T=0.K

Heating

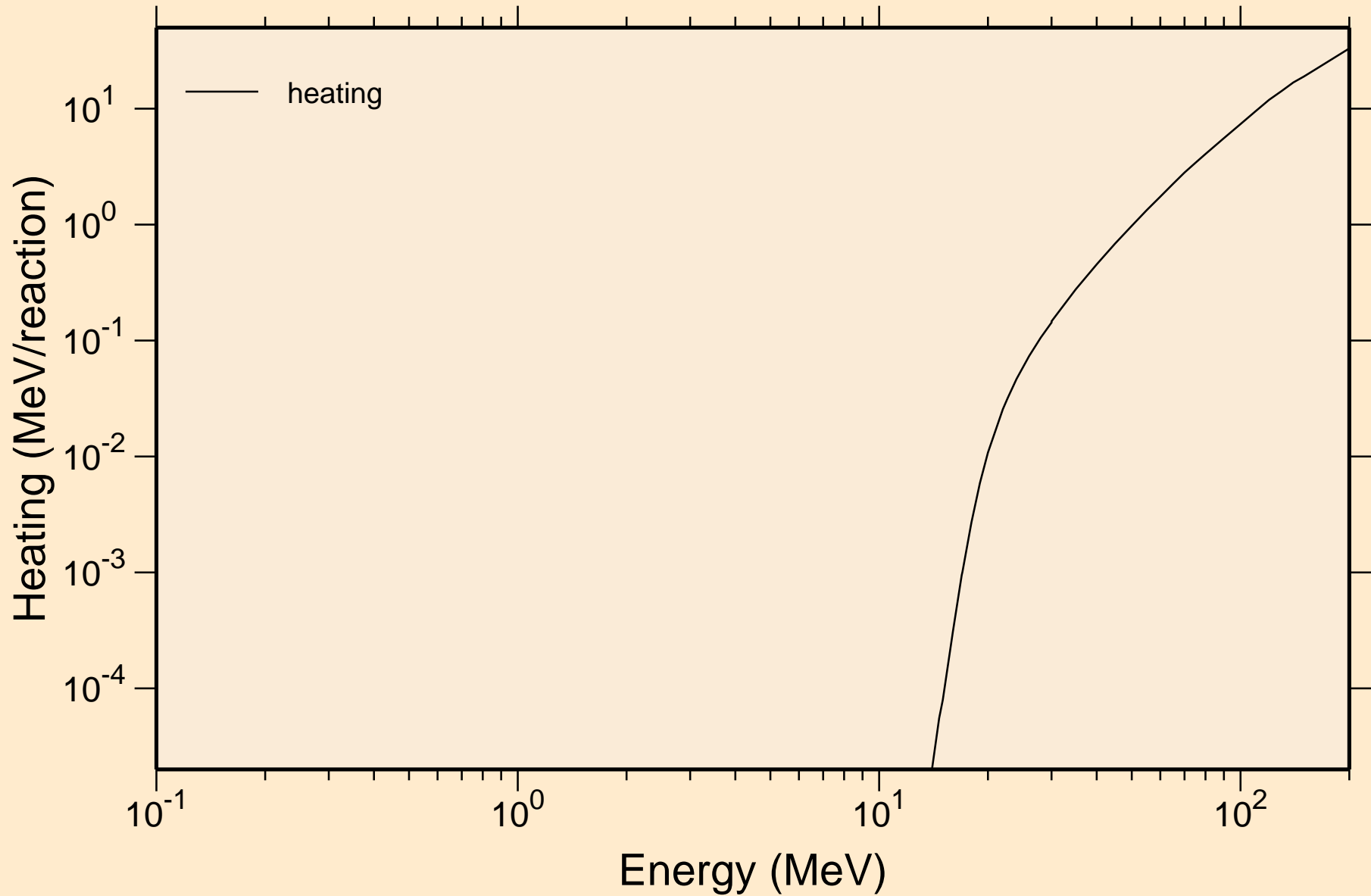

# HO163 HELION ACER TENDL-2021 LIBRARY; T=0.K

## Principal cross sections

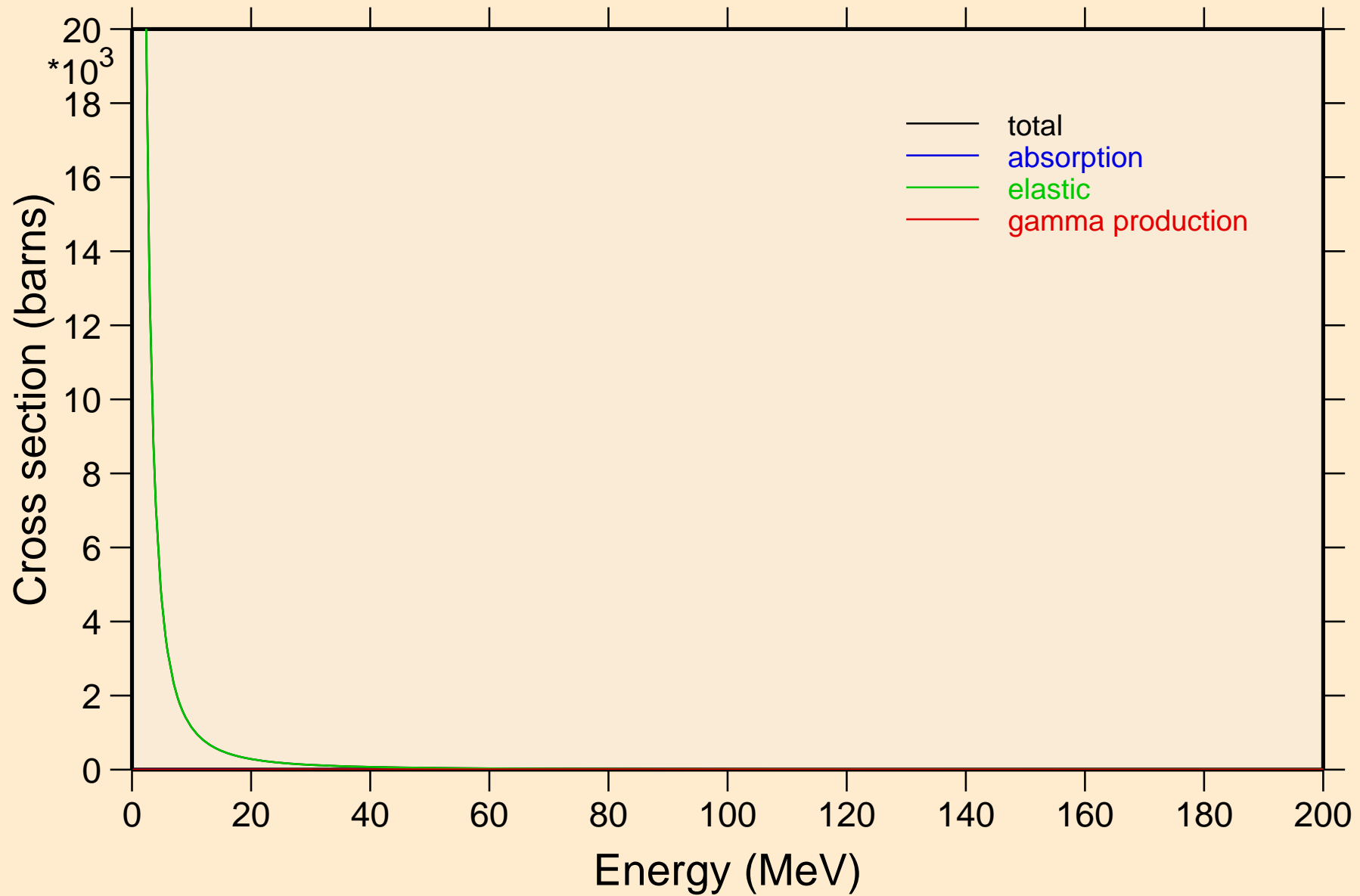

HO163 HELION ACER TENDL-2021 LIBRARY; T=0.K

Heating

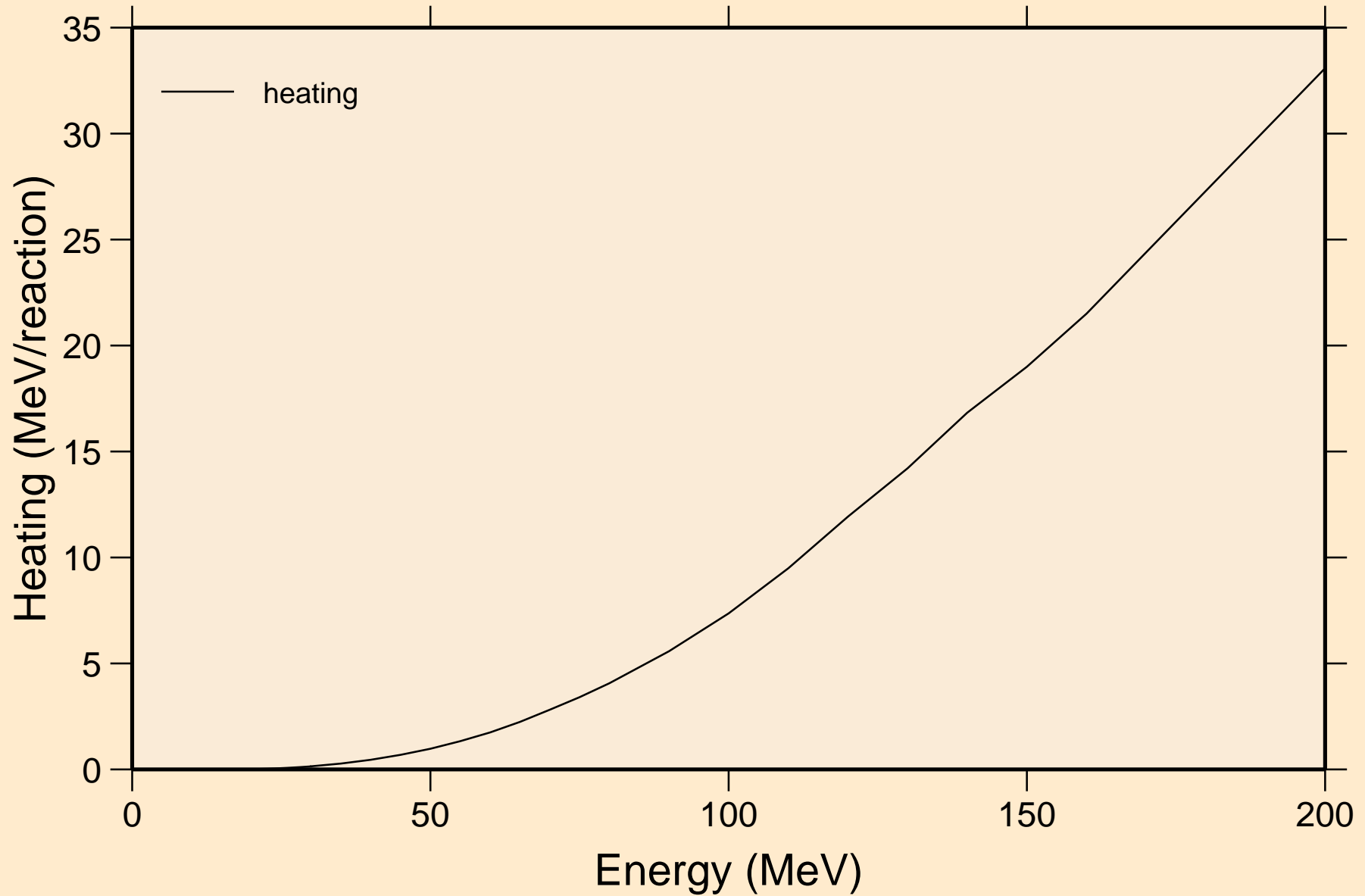

HO163 HELION ACER TENDL-2021 LIBRARY; T=0.K  
Threshold reactions

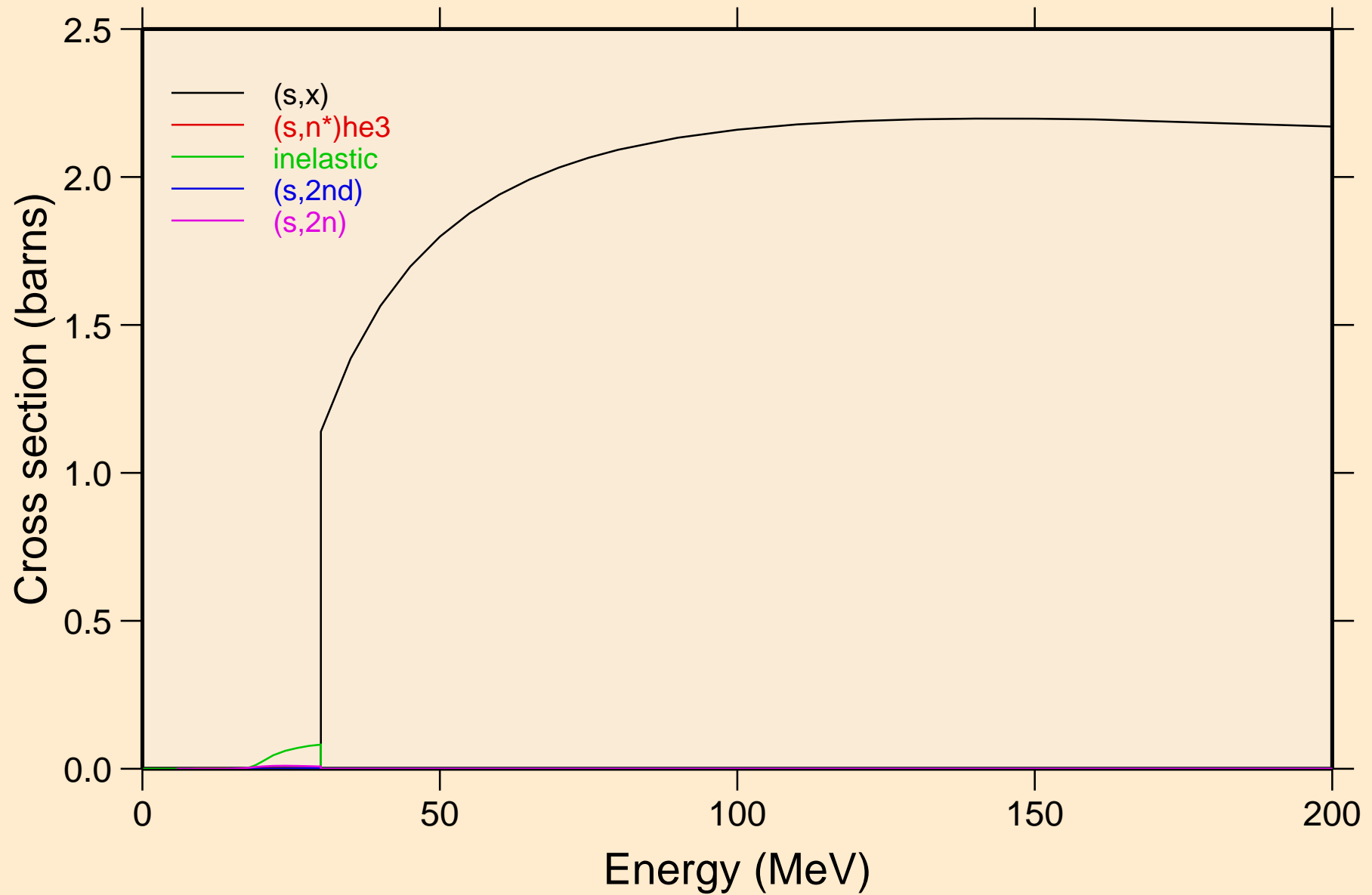

# HO163 HELION ACER TENDL-2021 LIBRARY; T=0.K

## Threshold reactions

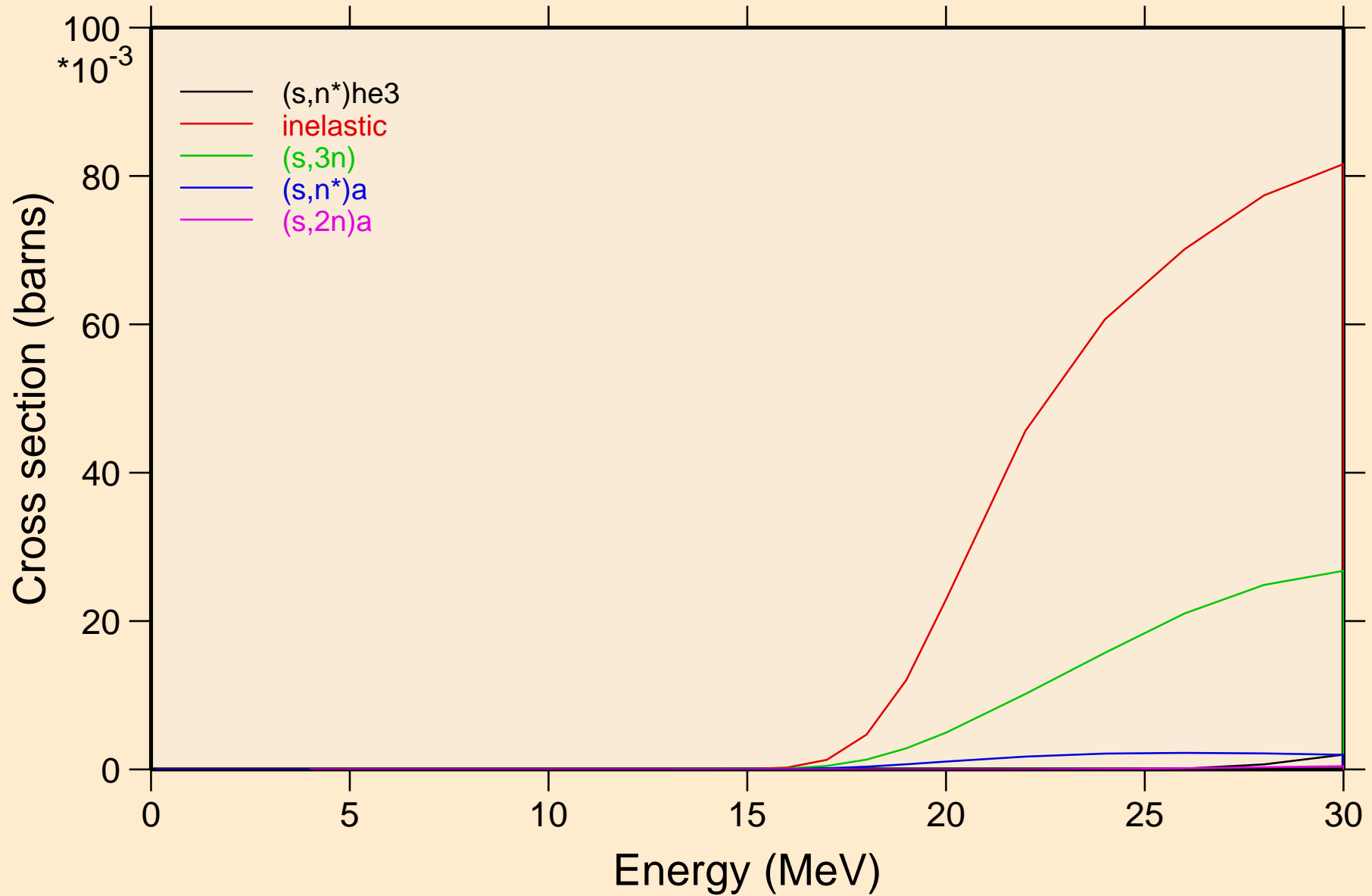

HO163 HELION ACER TENDL-2021 LIBRARY; T=0.K  
Threshold reactions

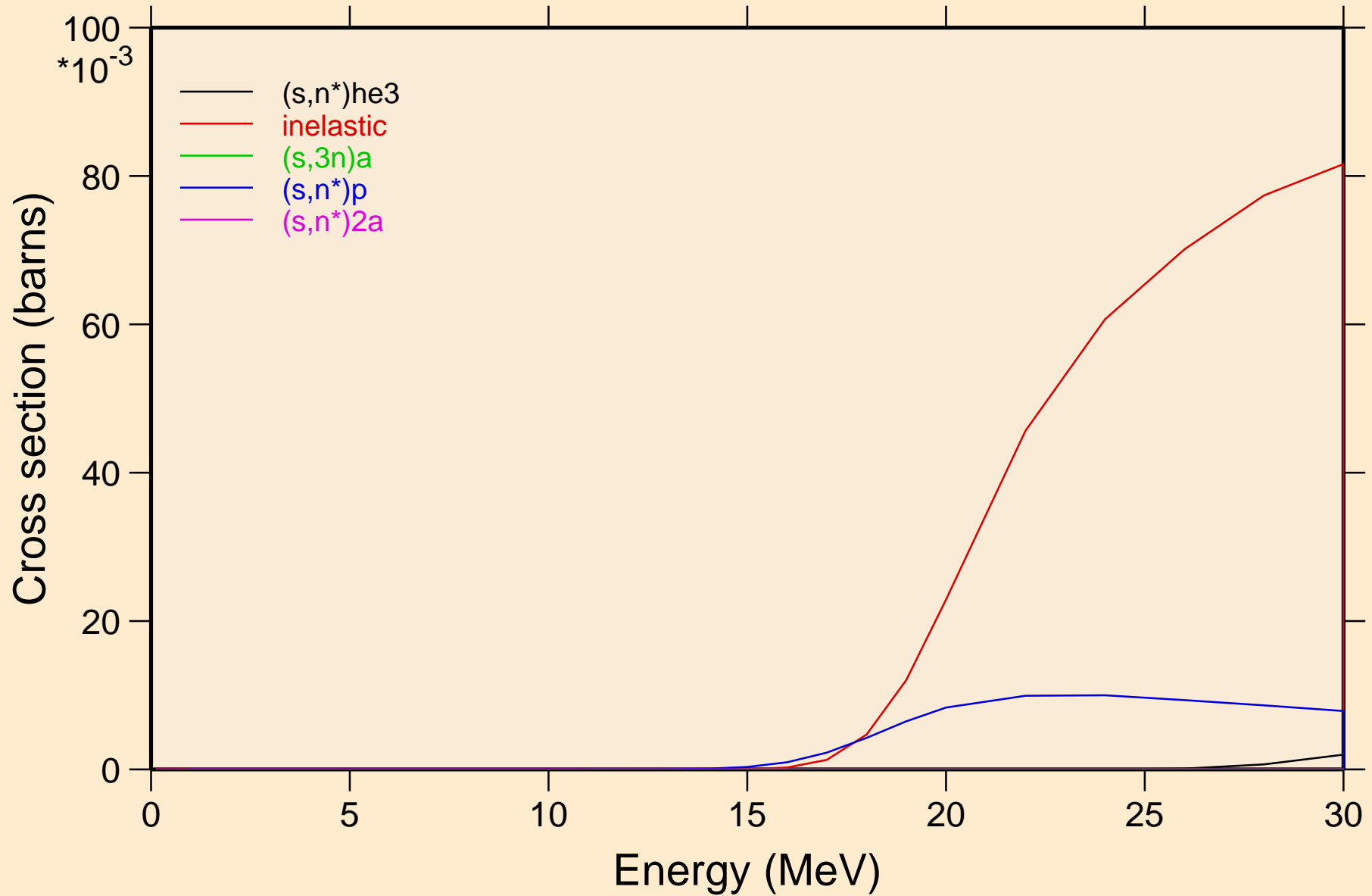

HO163 HELION ACER TENDL-2021 LIBRARY; T=0.K  
Threshold reactions

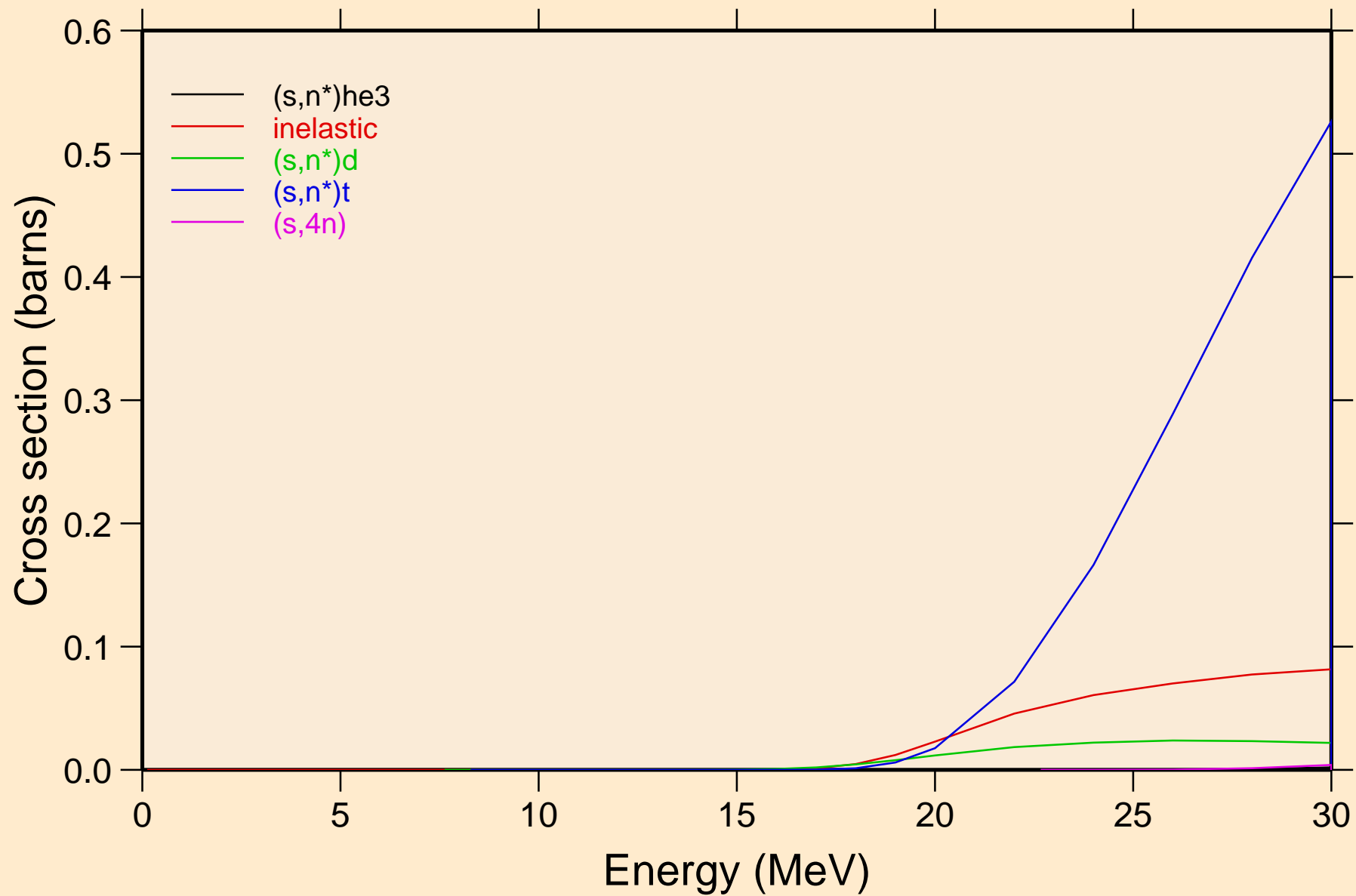



HO163 HELION ACER TENDL-2021 LIBRARY; T=0.K  
Threshold reactions

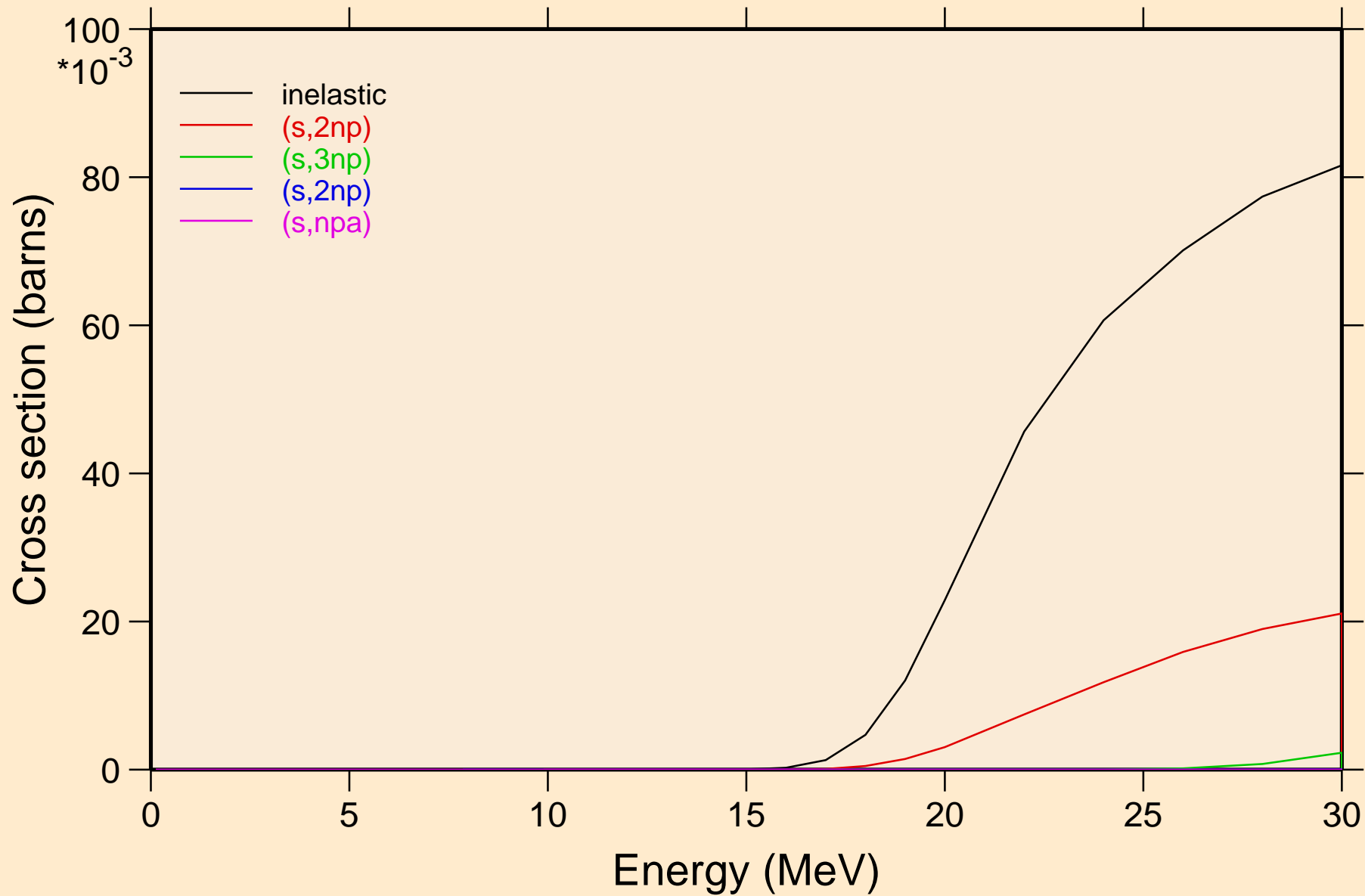

# HO163 HELION ACER TENDL-2021 LIBRARY; T=0.K

## Threshold reactions

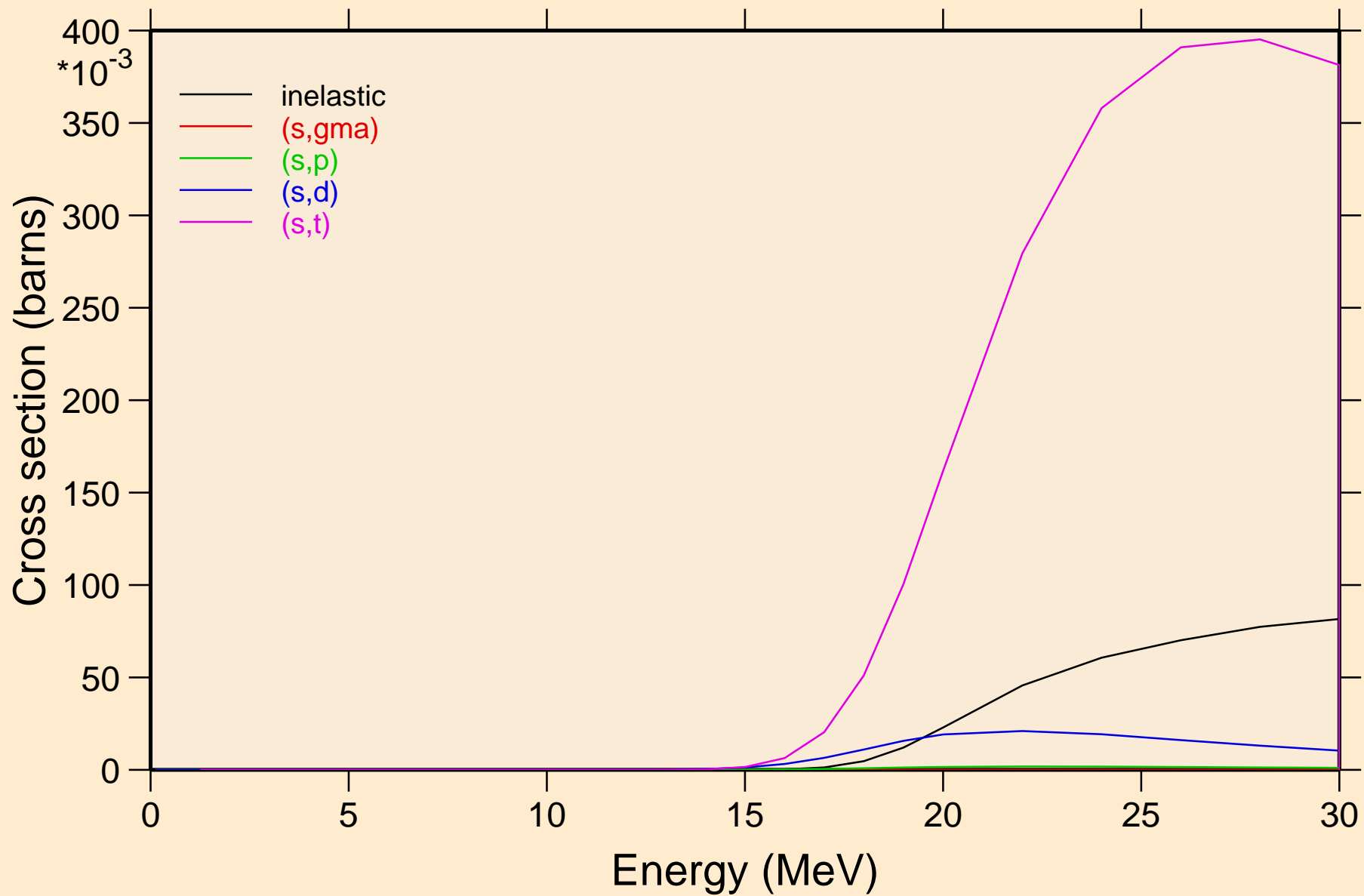

# HO163 HELION ACER TENDL-2021 LIBRARY; T=0.K

## Threshold reactions

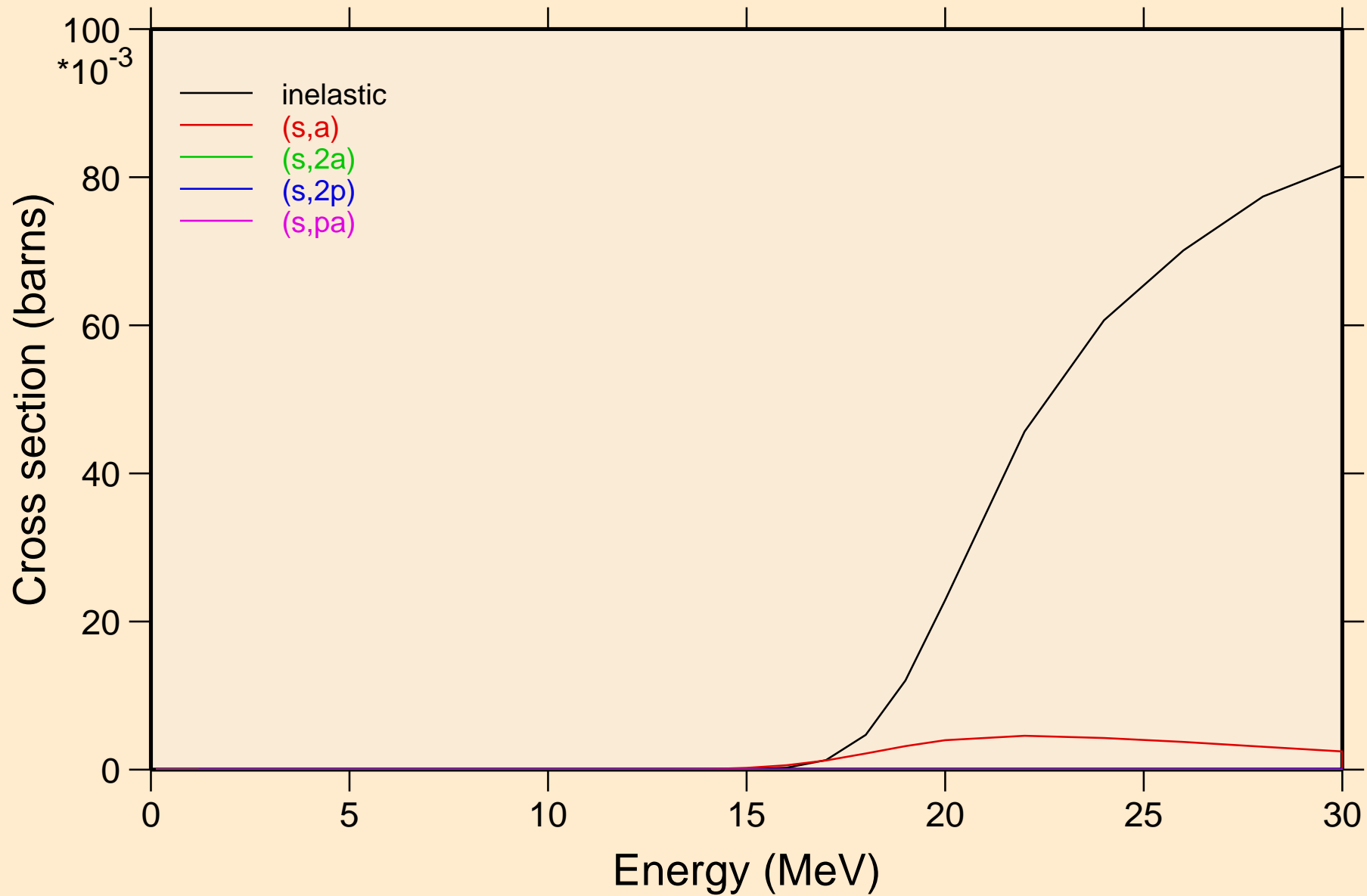

HO163 HELION ACER TENDL-2021 LIBRARY; T=0.K  
Threshold reactions

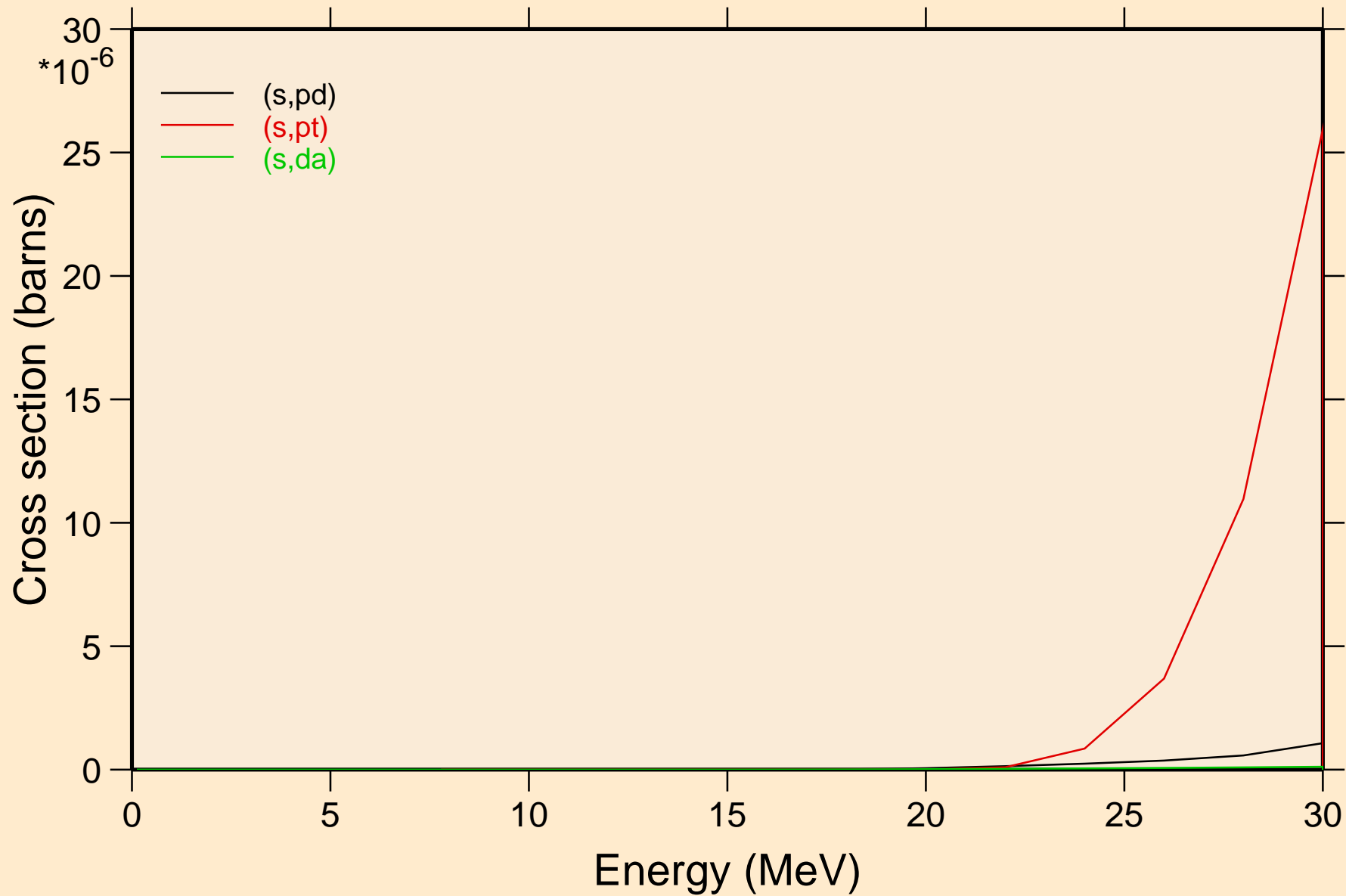

HO163 HELION ACER TENDL-2021 LIBRARY; T=0.K  
angular distribution for elastic

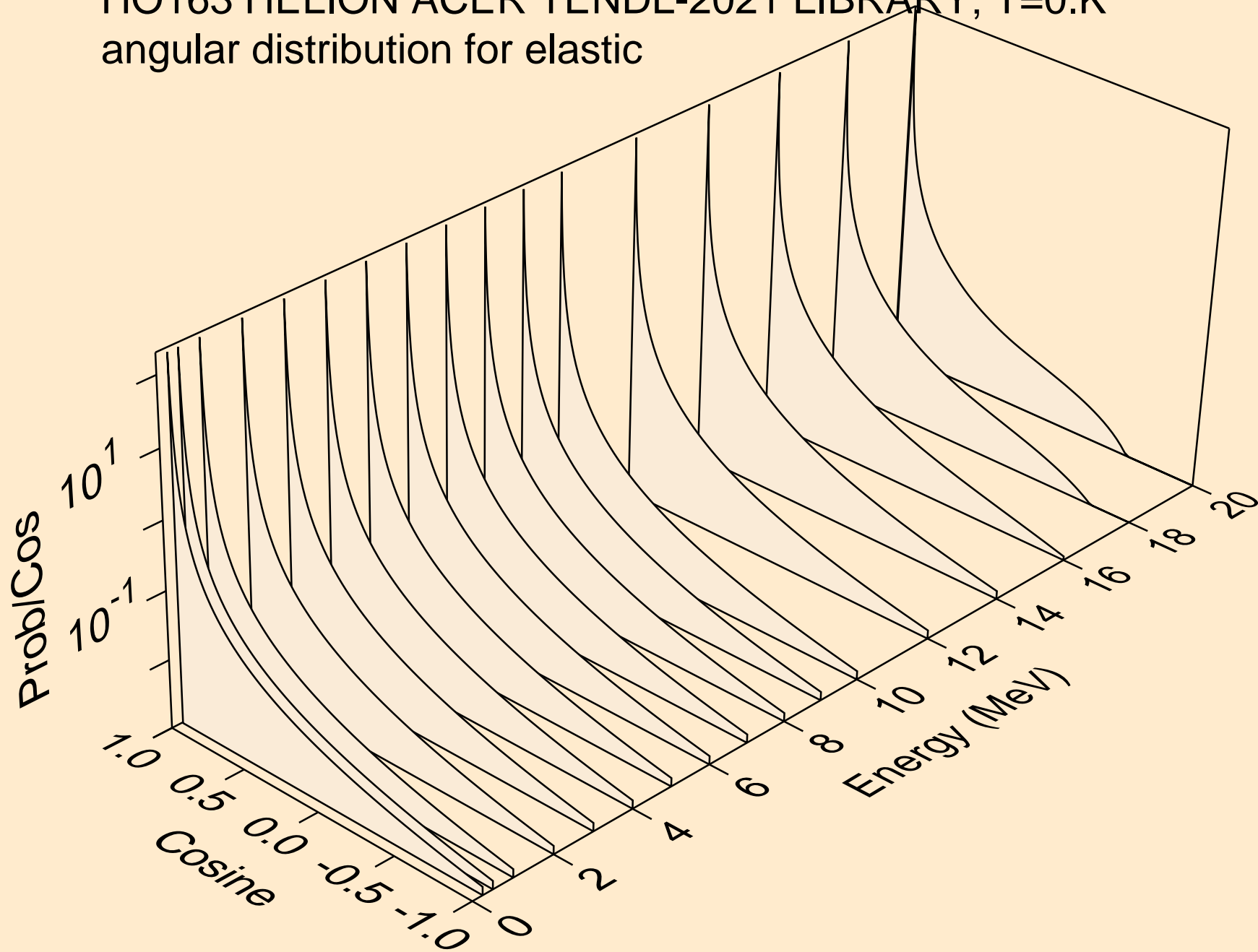

HO163 HELION ACER TENDL-2021 LIBRARY; T=0.K  
angular distribution for elastic

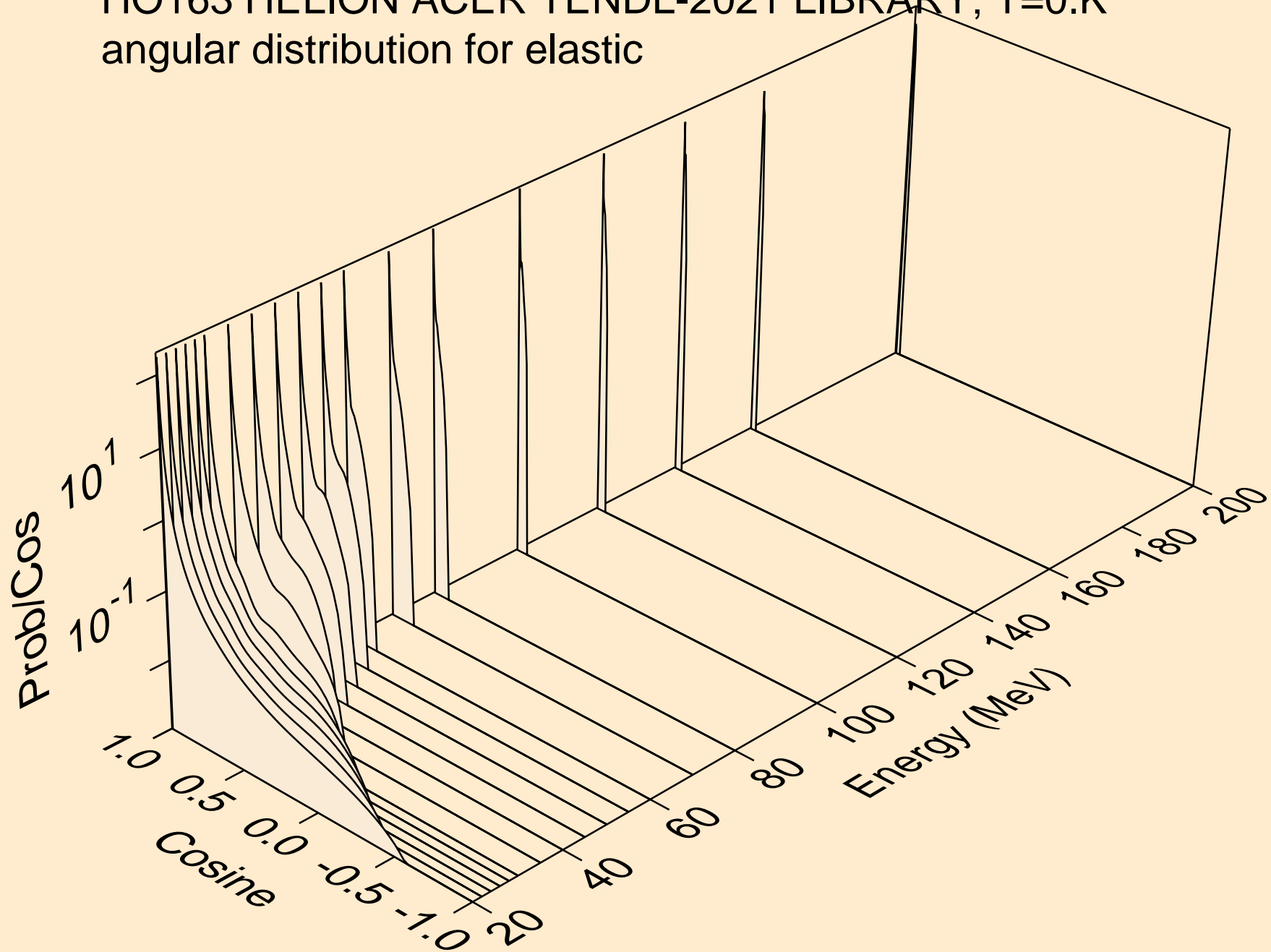

HO163 HELION ACER TENDL-2021 LIBRARY; T=0.K  
He-3 emission for (s,x)

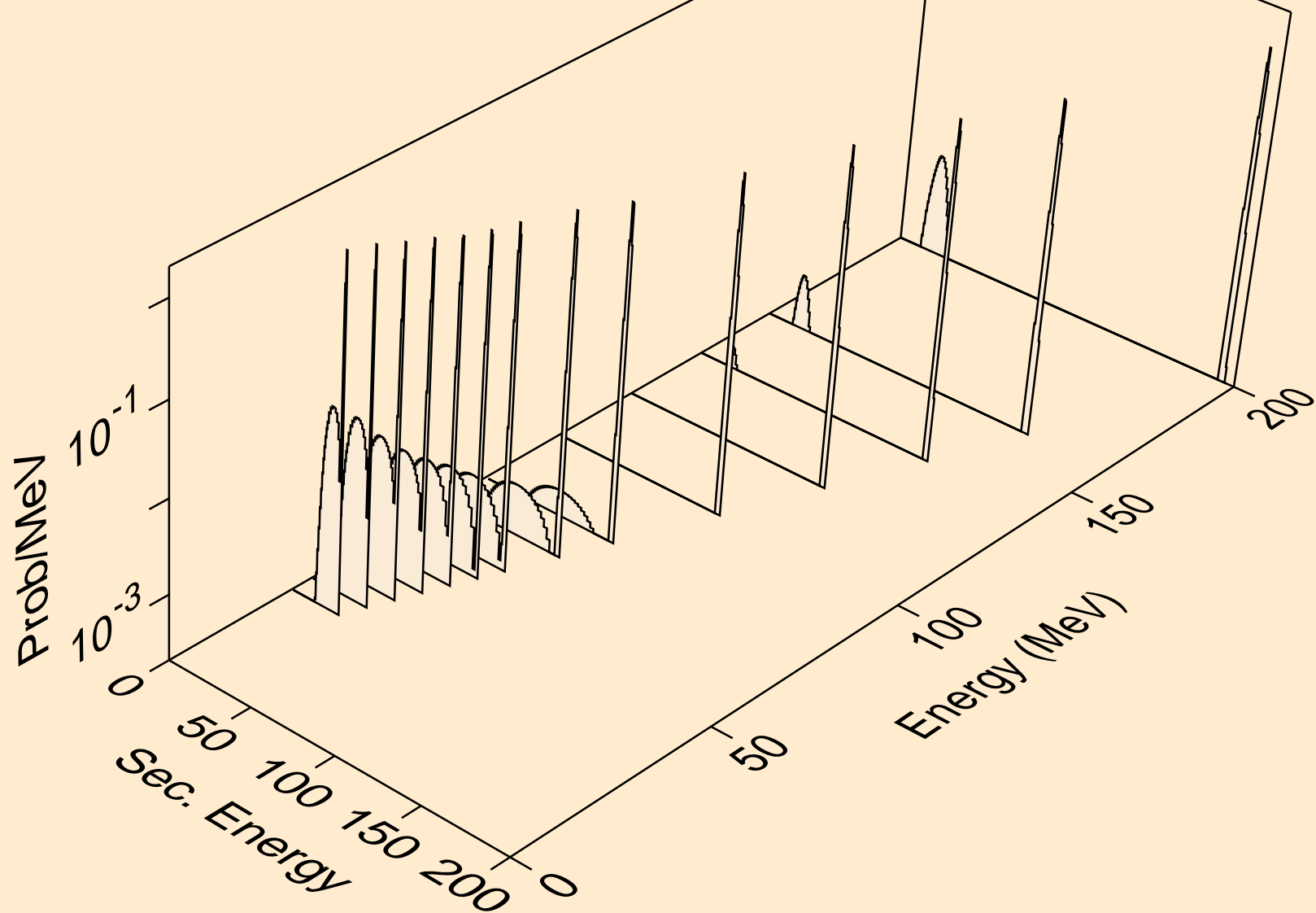

HO163 HELION ACER TENDL-2021 LIBRARY; T=0.K  
He-3 emission for (s,n\*)he3

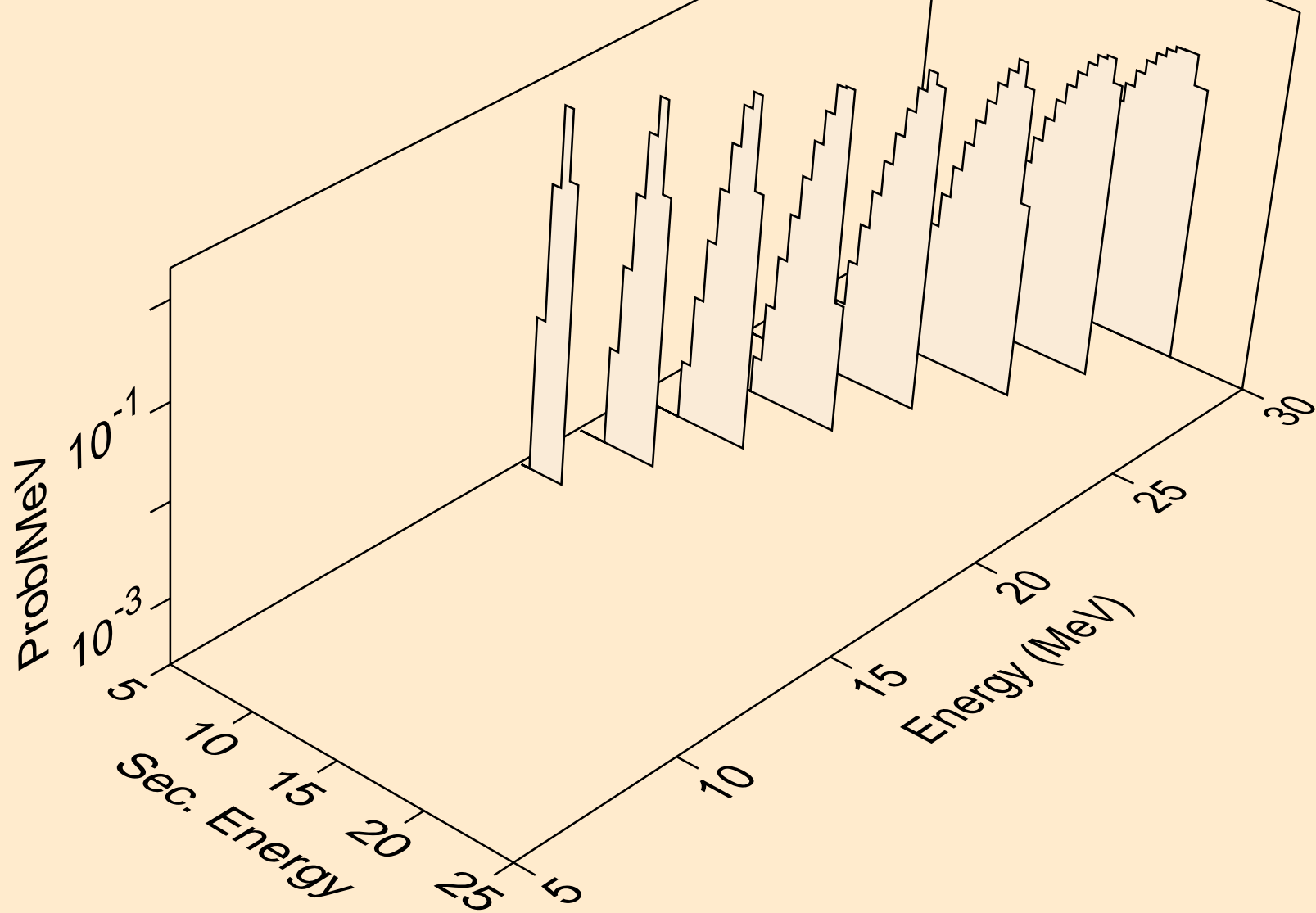



HO163 HELION ACER TENDL-2021 LIBRARY; T=0.K  
He-3 emission for inelastic

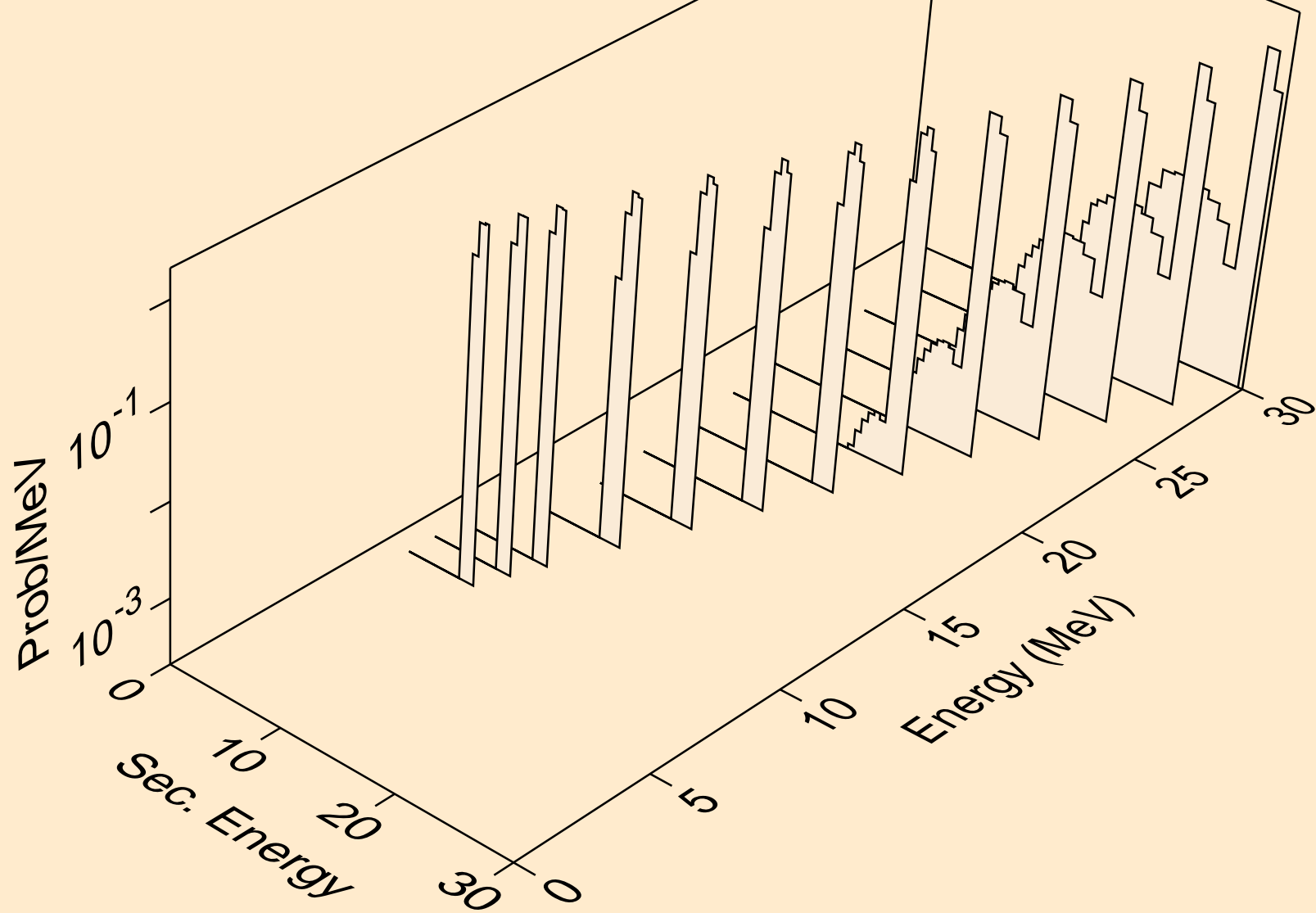

HO163 HELION ACER TENDL-2021 LIBRARY; T=0.K  
Photon emission for (z,n)

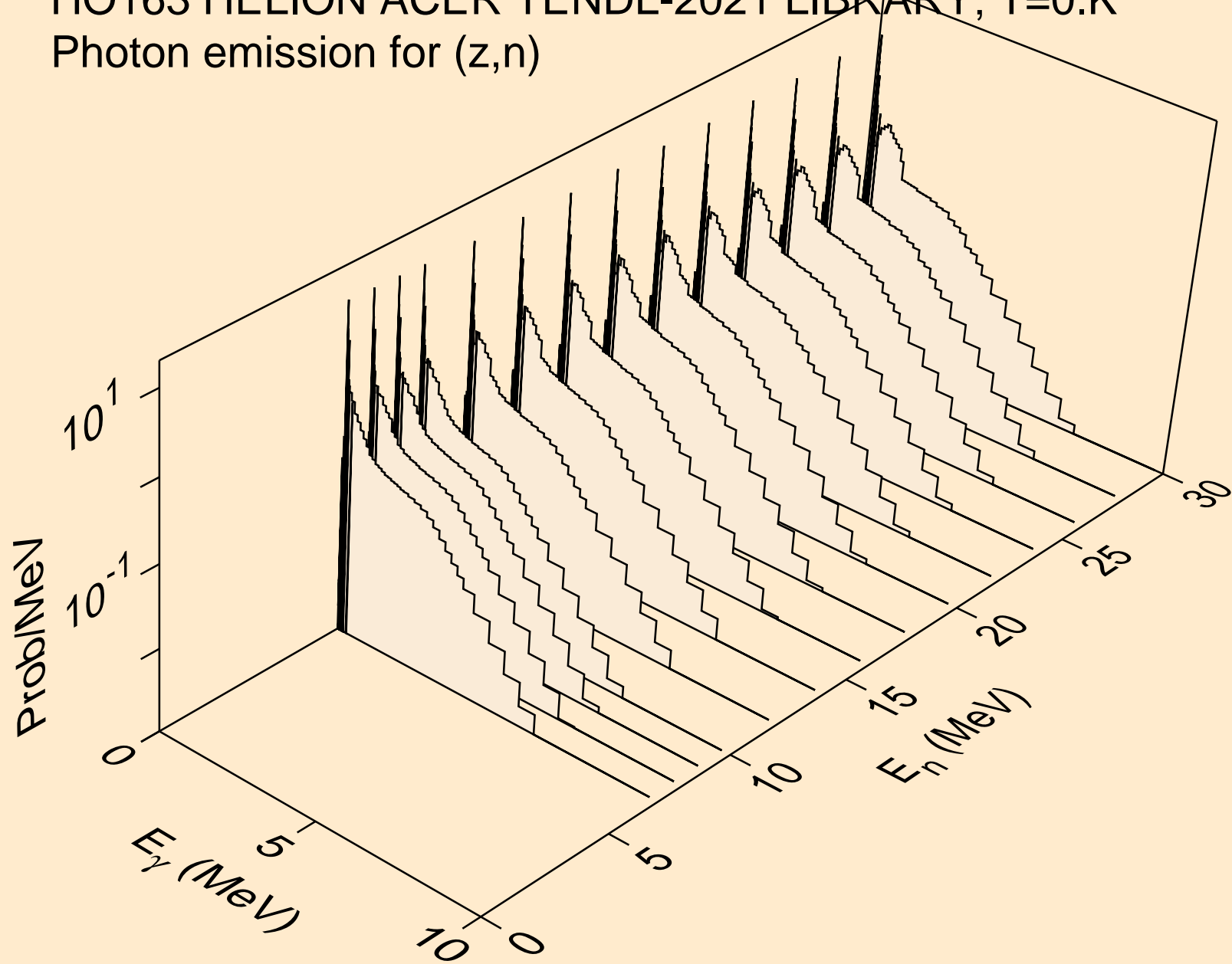

HO163 HELION ACER TENDL-2021 LIBRARY; T=0.K  
Photon emission for (n,x)

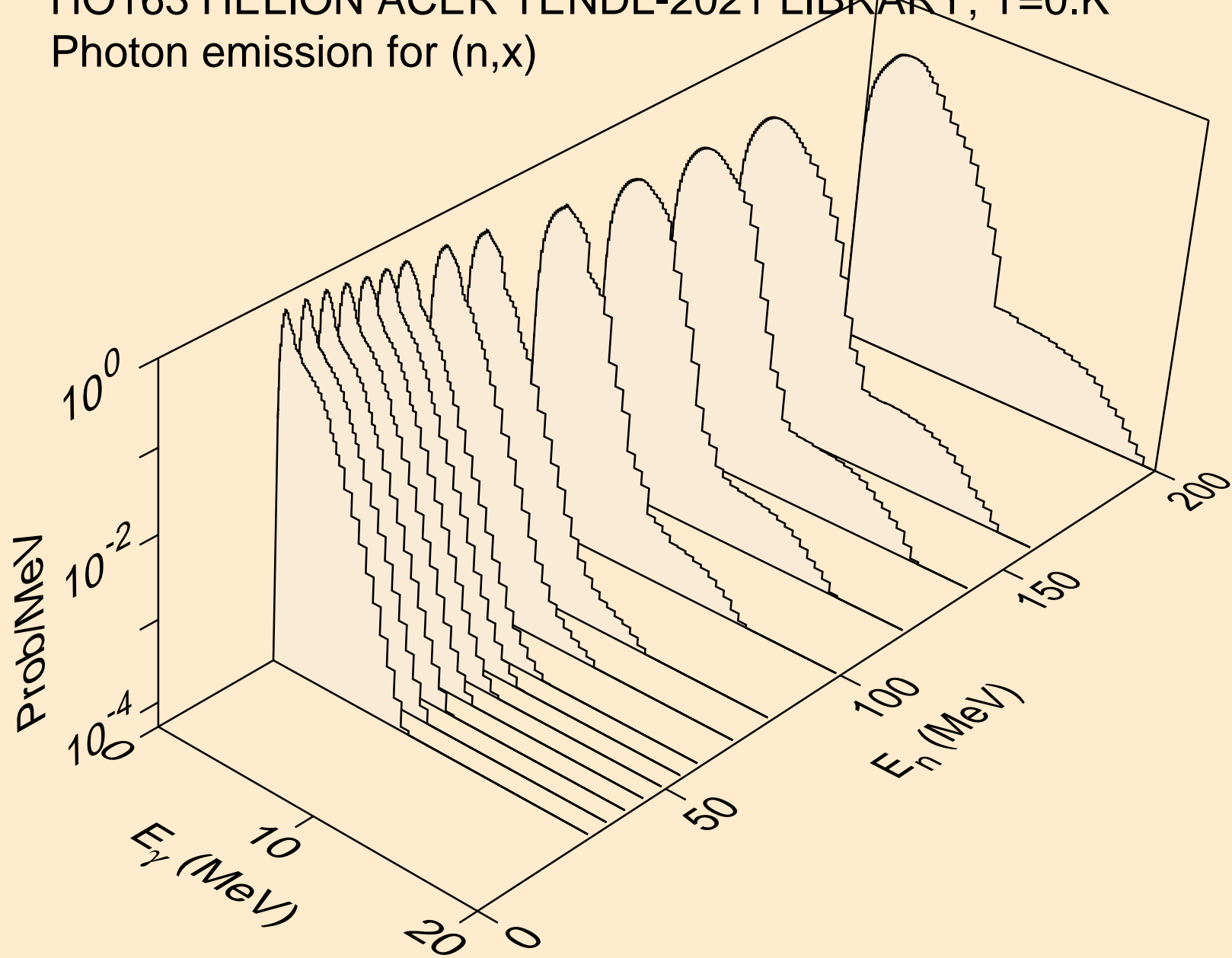

HO163 HELION ACER TENDL-2021 LIBRARY; T=0.K  
Photon emission for (n,2nd)

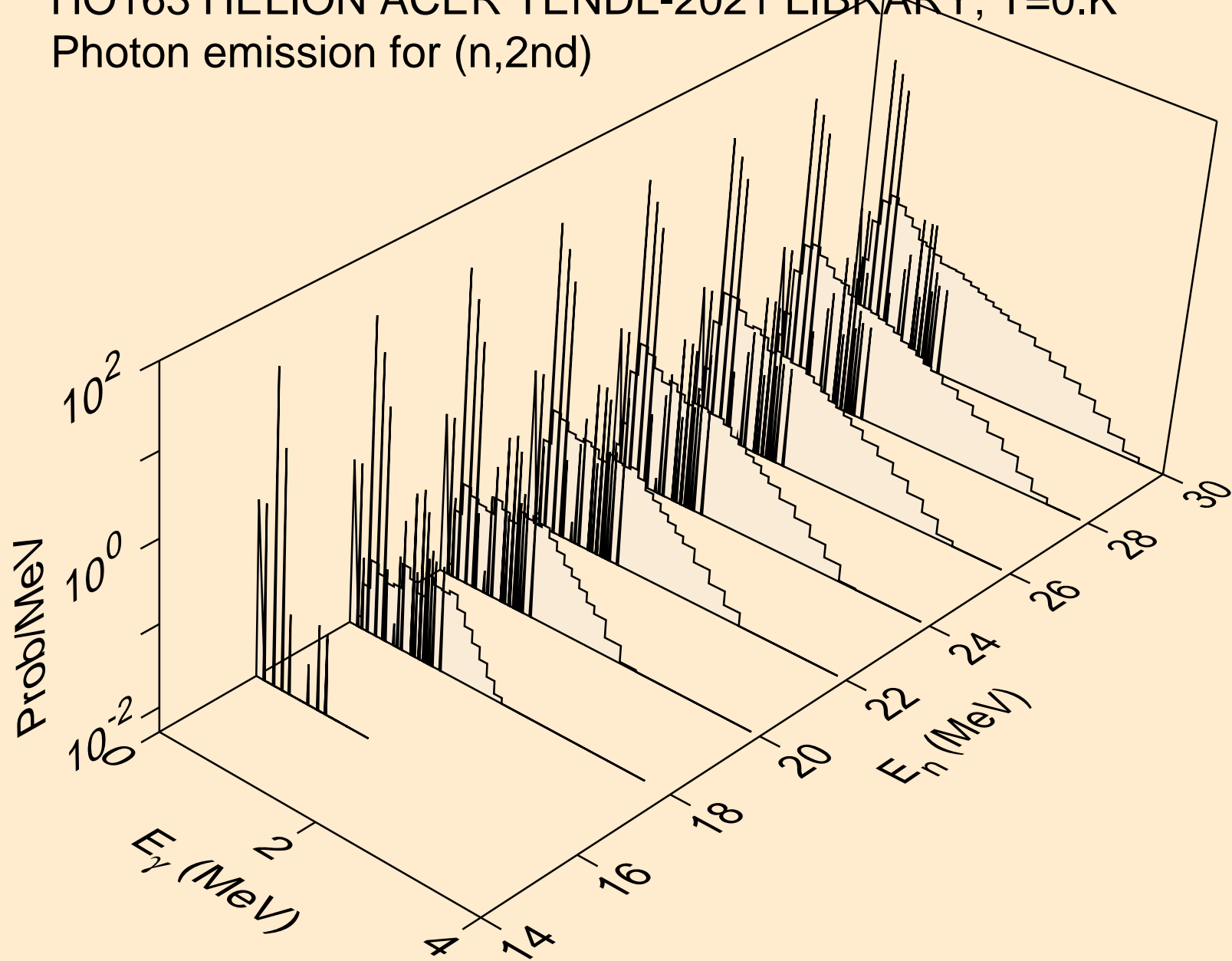

HO163 HELION ACER TENDL-2021 LIBRARY; T=0.K  
Photon emission for (n,2n)

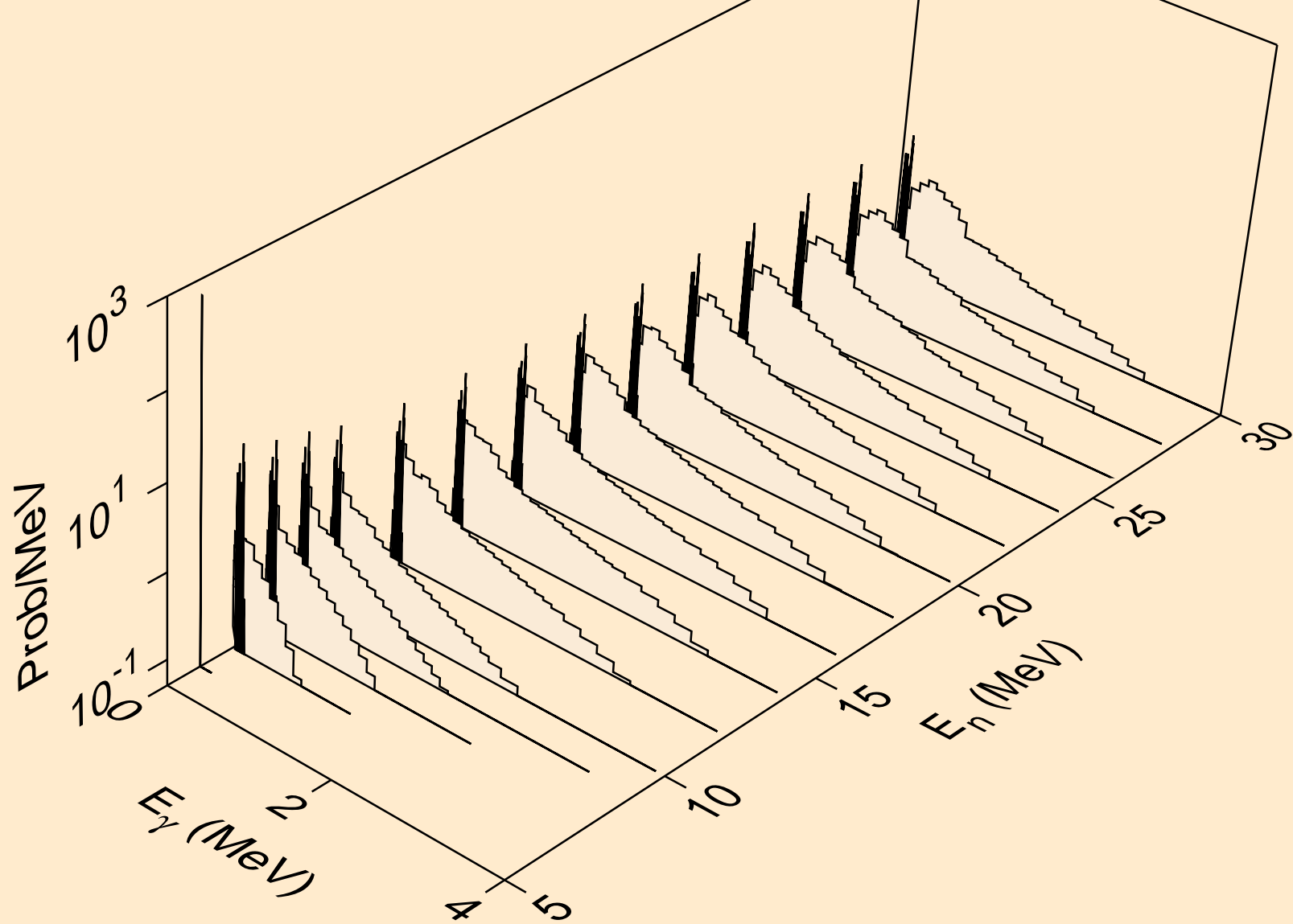

HO163 HELION ACER TENDL-2021 LIBRARY; T=0.K  
Photon emission for (n,3n)

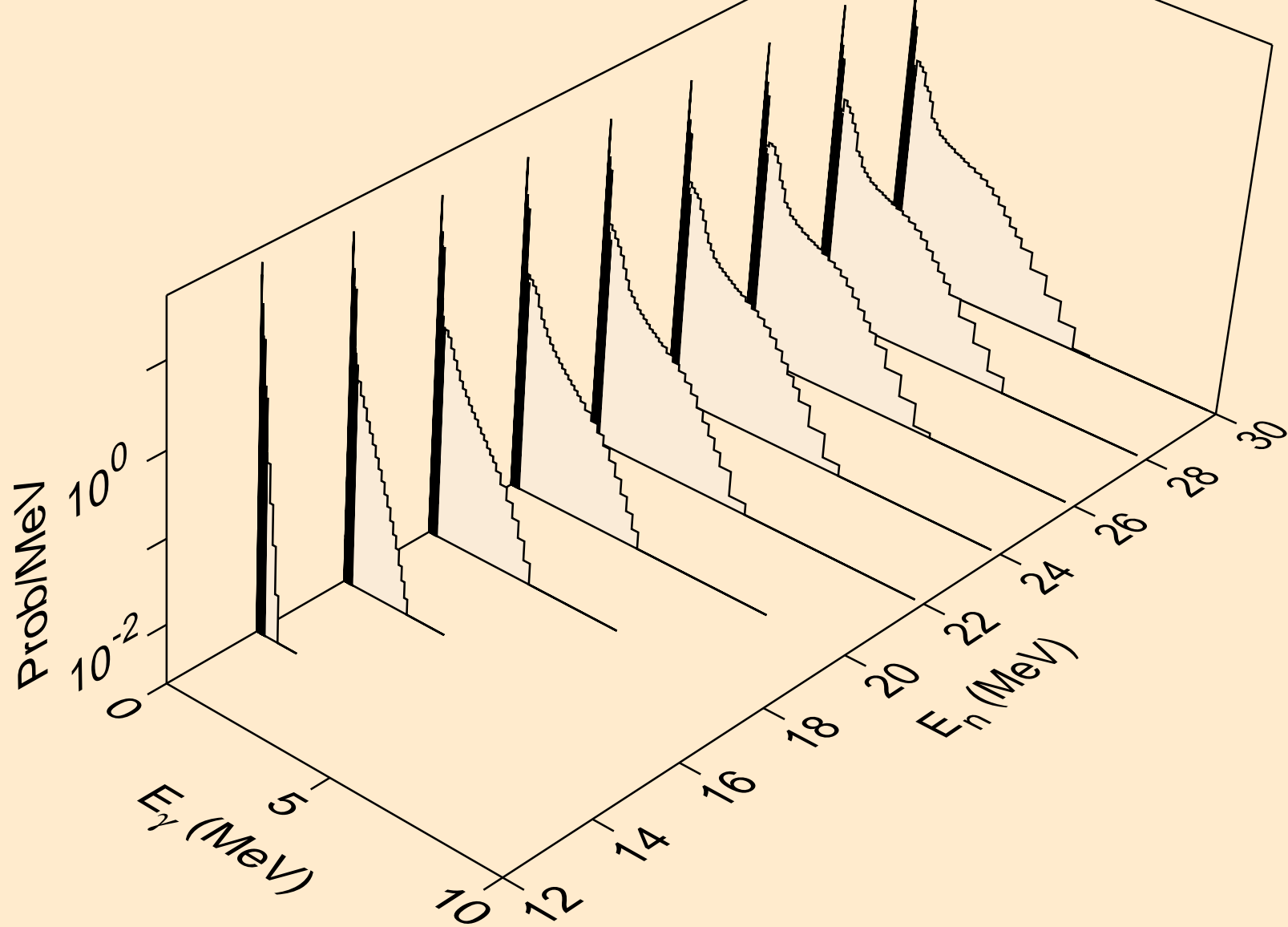

HO163 HELION ACER TENDL-2021 LIBRARY; T=0.K  
Photon emission for (n,n\*)a

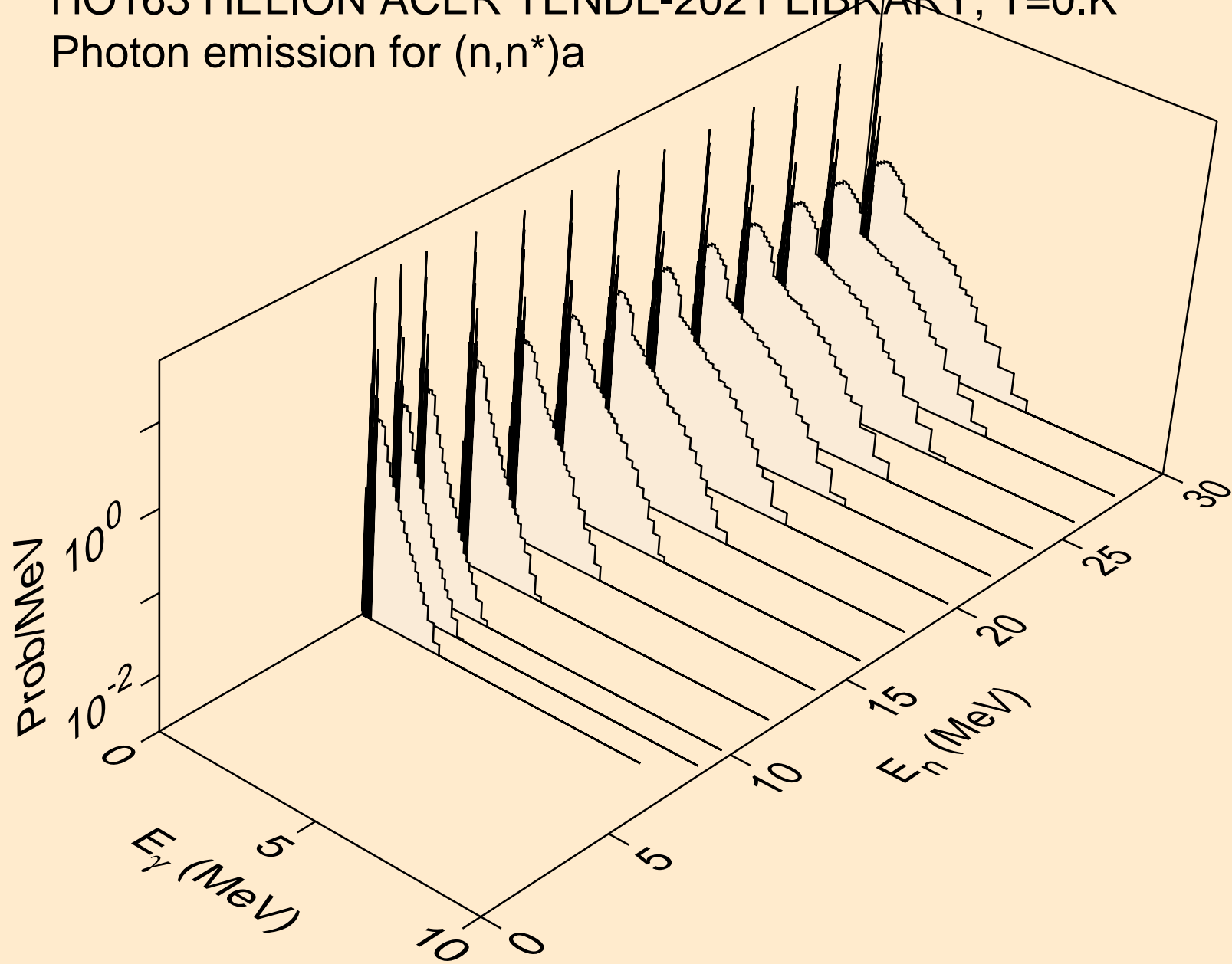

HO163 HELION ACER TENDL-2021 LIBRARY; T=0.K  
Photon emission for (n,2n)a

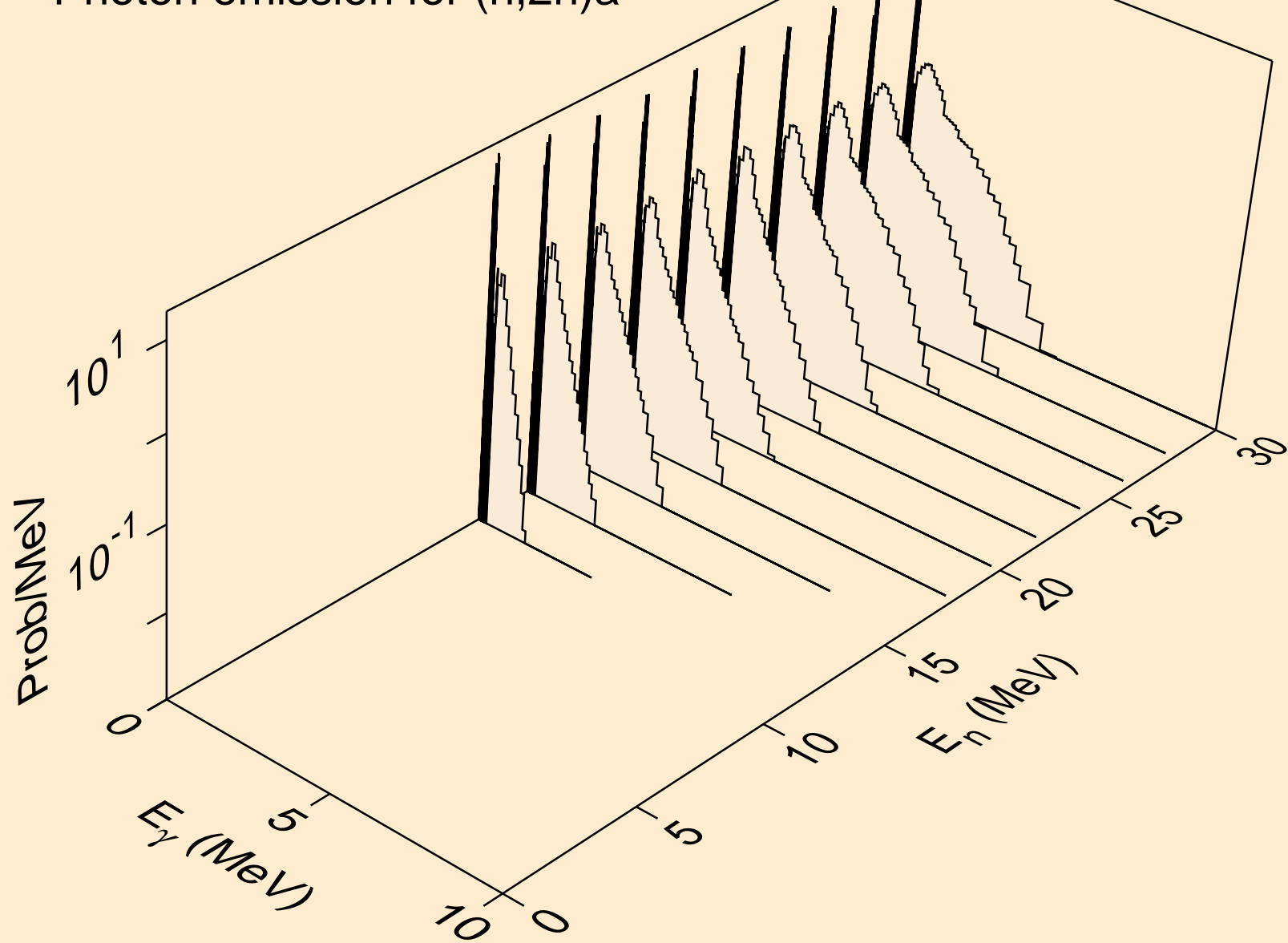



HO163 HELION ACER TENDL-2021 LIBRARY; T=0.K  
Photon emission for (n,3n)a

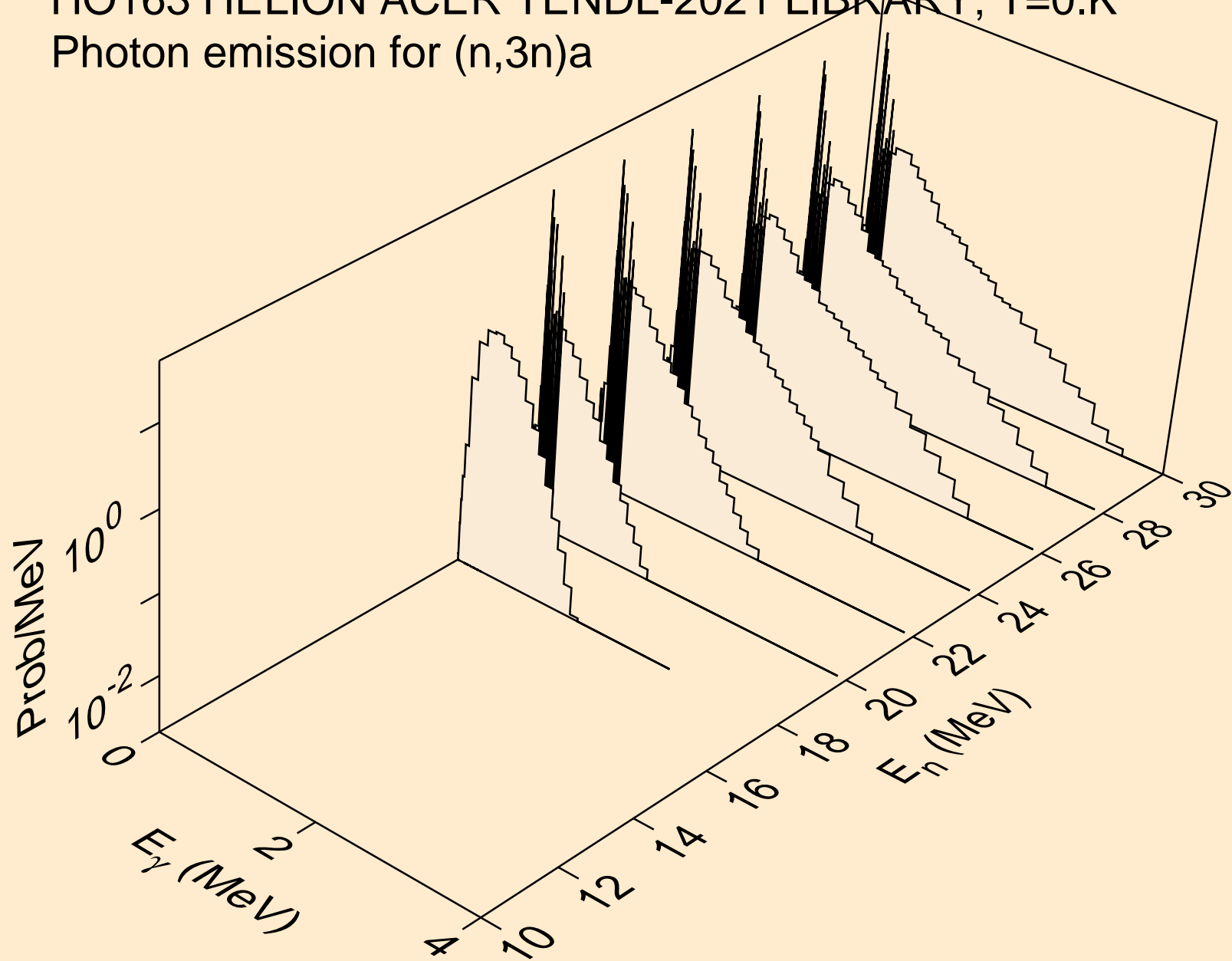

HO163 HELION ACER TENDL-2021 LIBRARY; T=0.K  
Photon emission for (n,n\*)p

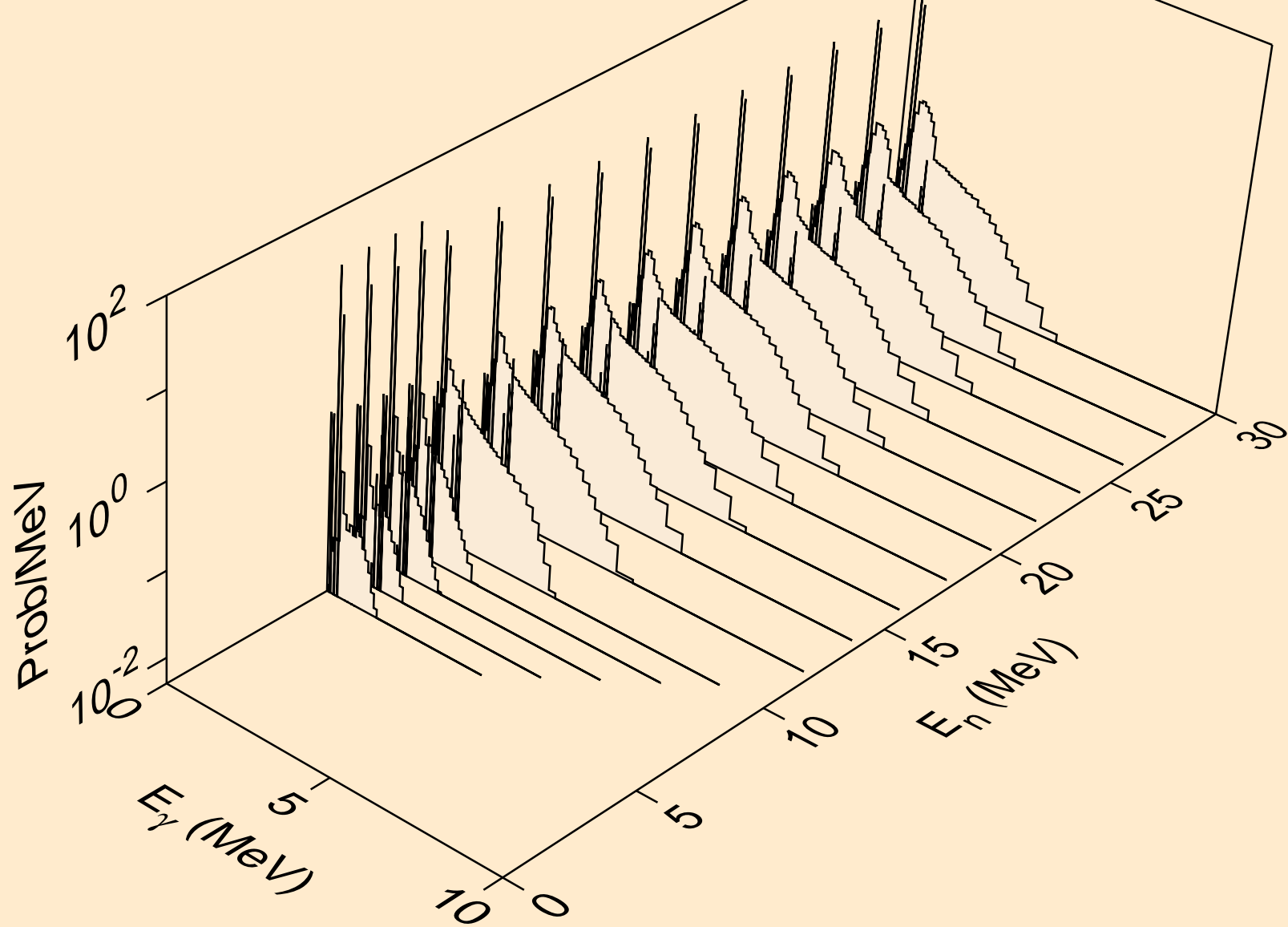

HO163 HELION ACER TENDL-2021 LIBRARY; T=0.K  
Photon emission for (n,n\*)2a

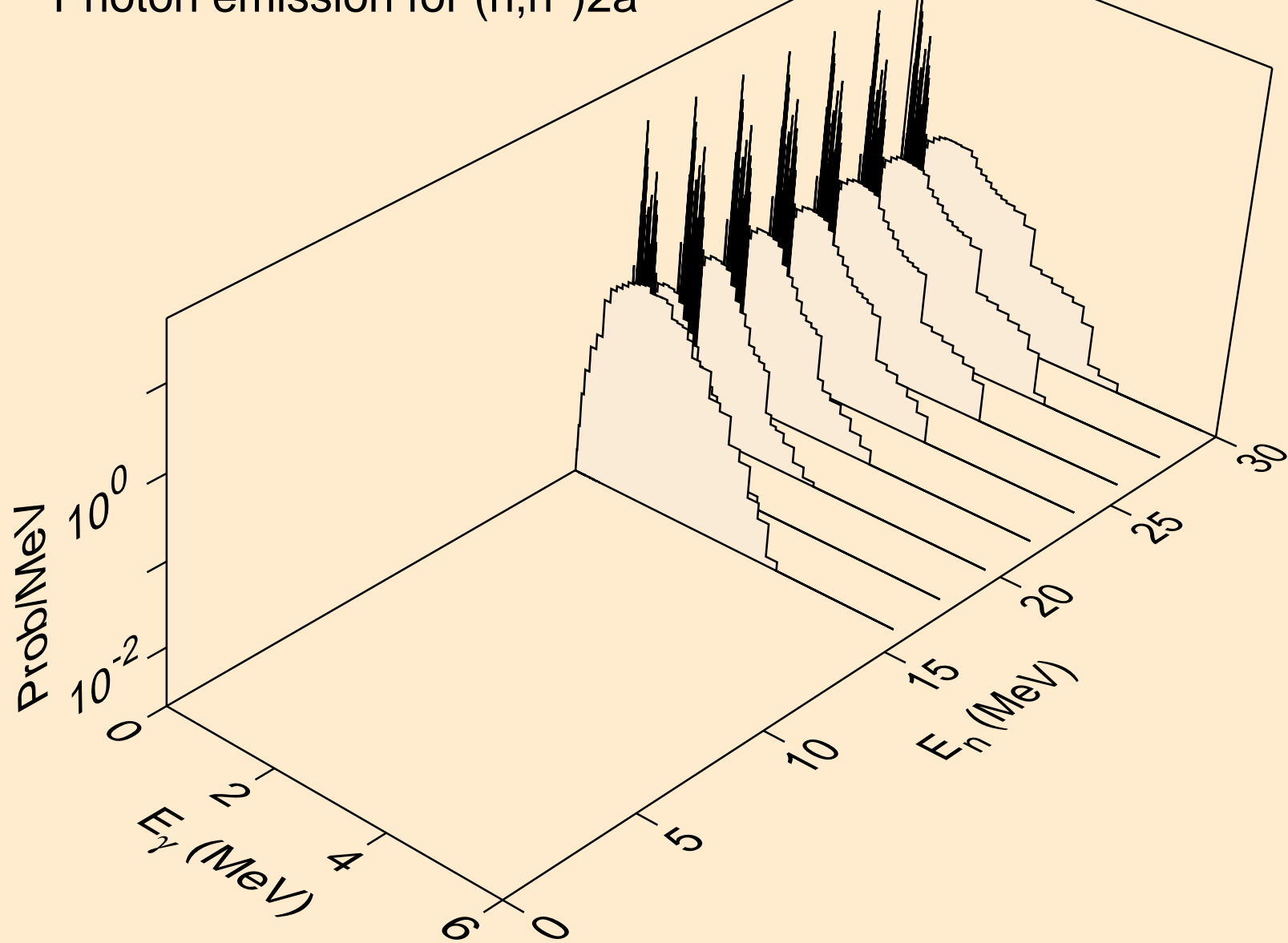

HO163 HELION ACER TENDL-2021 LIBRARY; T=0.K  
Photon emission for (n,n\*)d

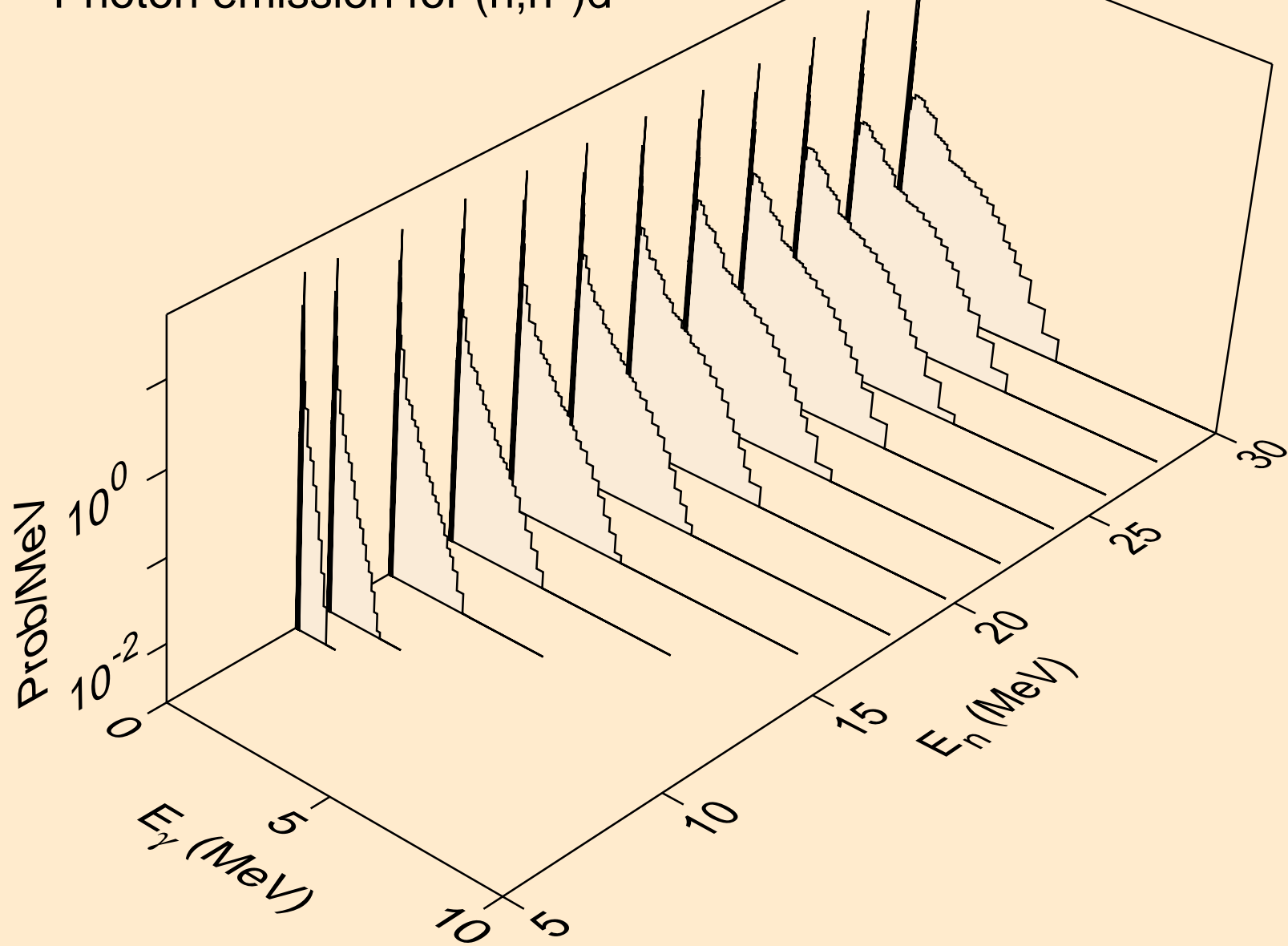

HO163 HELION ACER TENDL-2021 LIBRARY; T=0.K  
Photon emission for (n,n\*)t

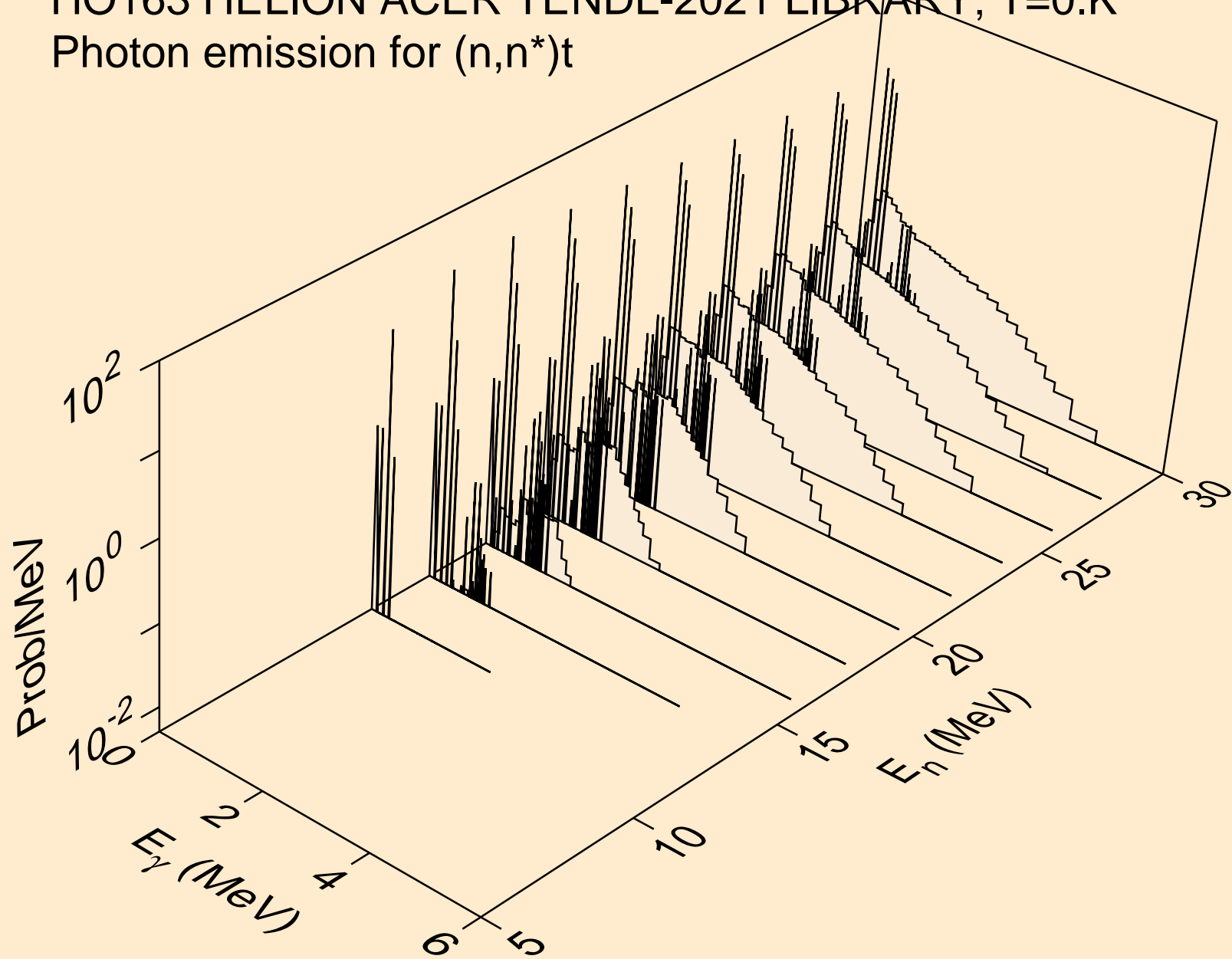

HO163 HELION ACER TENDL-2021 LIBRARY; T=0.K  
Photon emission for (n,n\*)he3

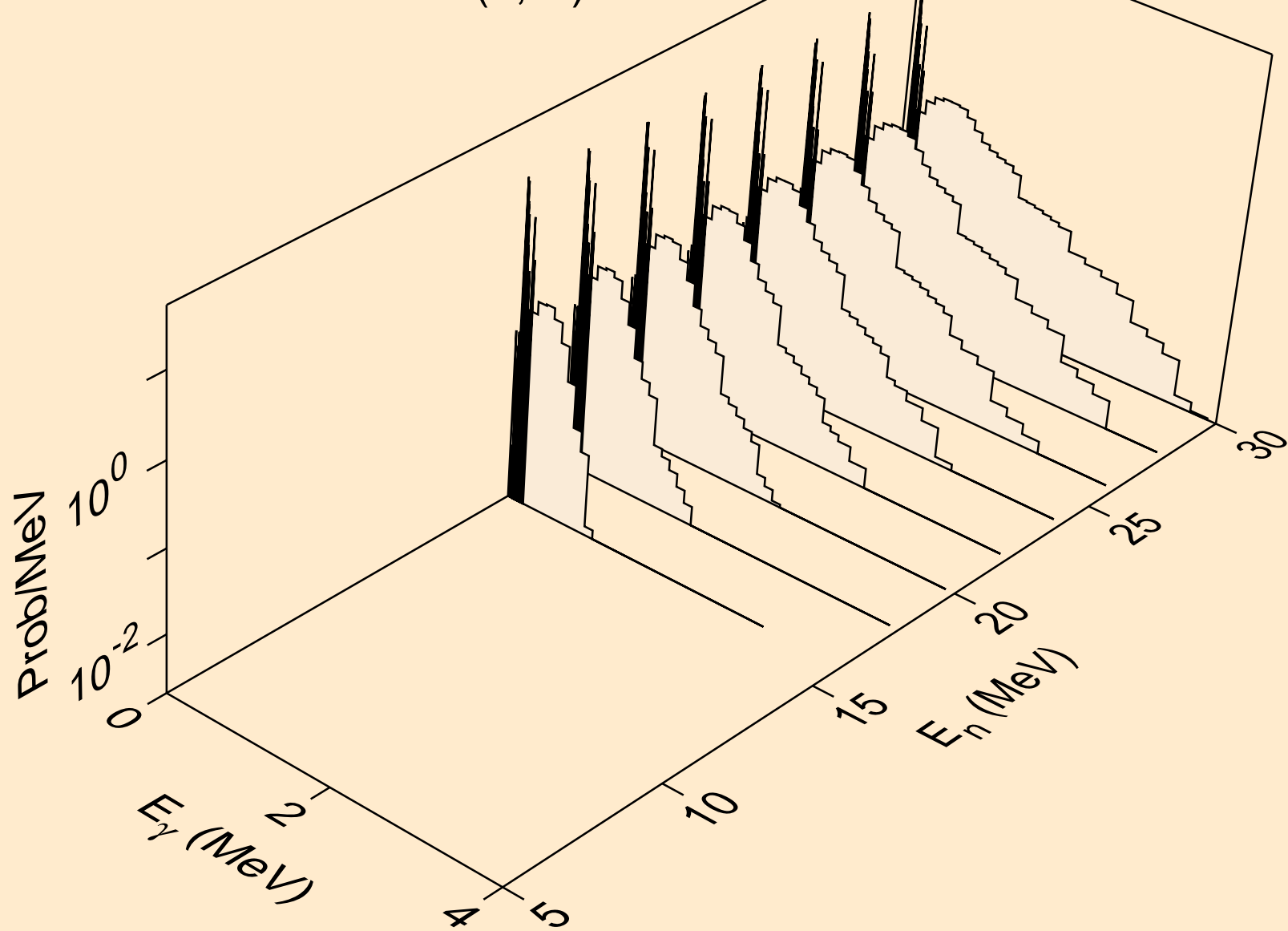

HO163 HELION ACER TENDL-2021 LIBRARY; T=0.K  
Photon emission for (n,4n)

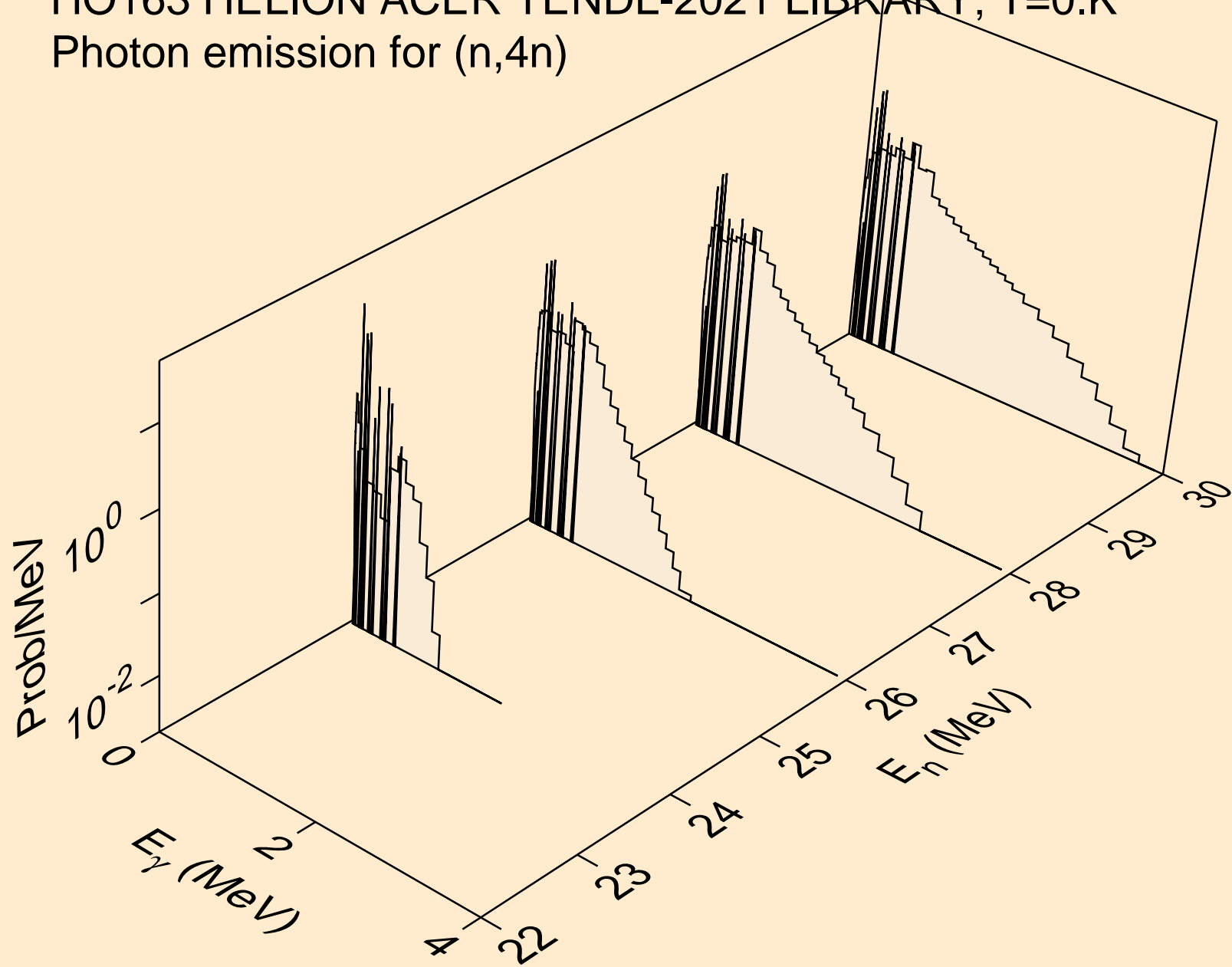

HO163 HELION ACER TENDL-2021 LIBRARY; T=0.K  
Photon emission for (n,2np)

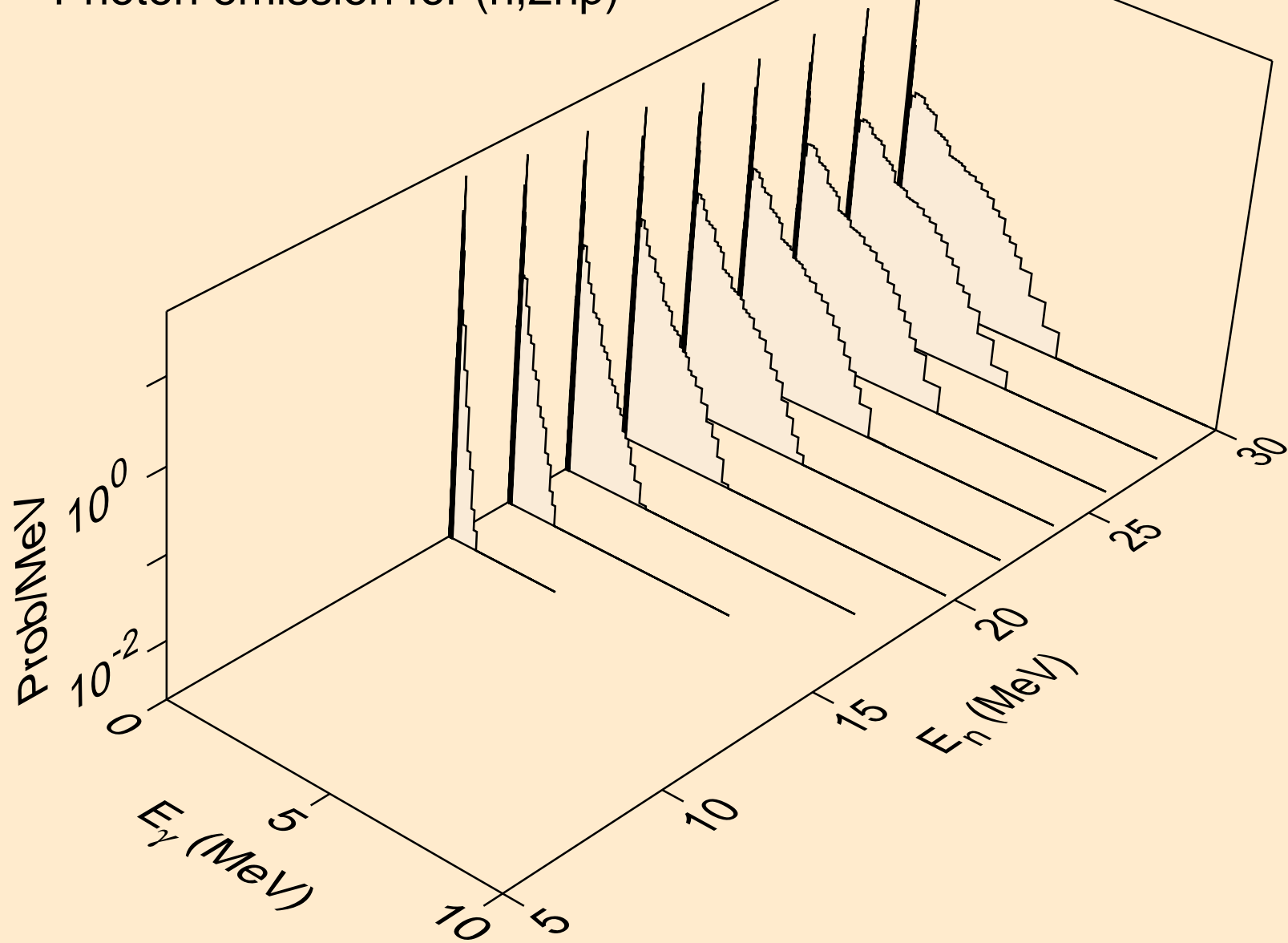



HO163 HELION ACER TENDL-2021 LIBRARY; T=0.K  
Photon emission for (n,3np)

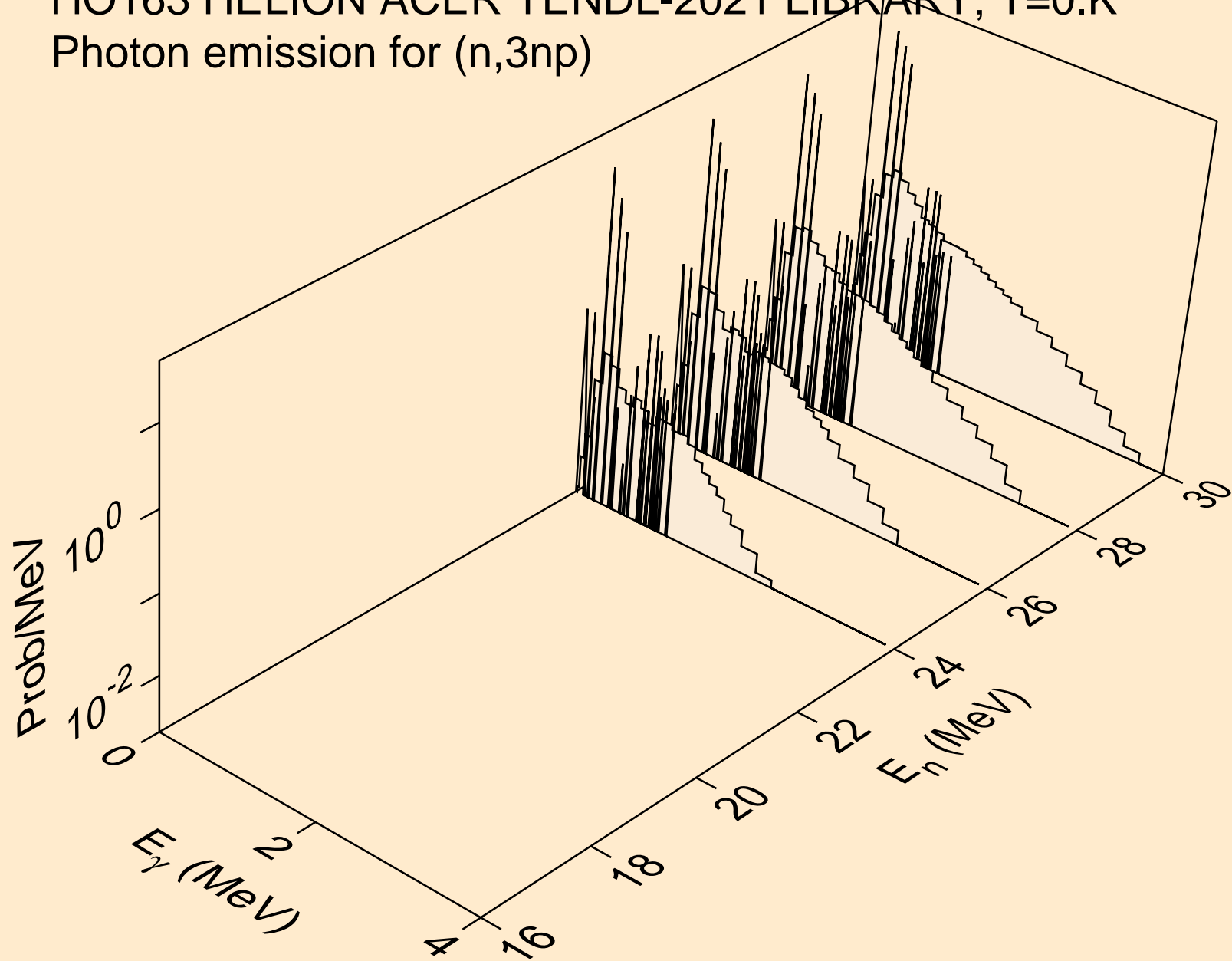

HO163 HELION ACER TENDL-2021 LIBRARY; T=0.K  
Photon emission for (n,2np)

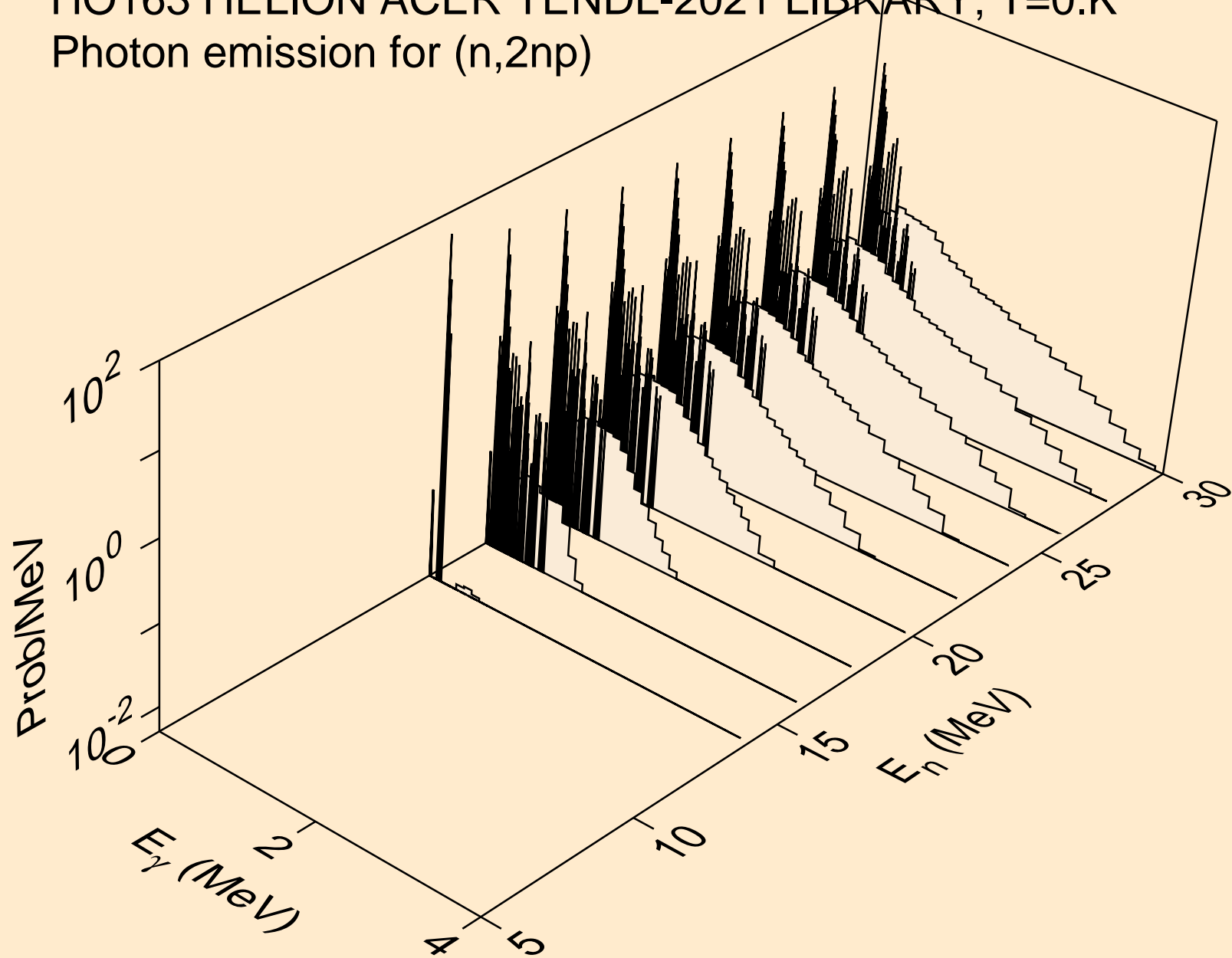

HO163 HELION ACER TENDL-2021 LIBRARY; T=0.K  
Photon emission for (n,npa)

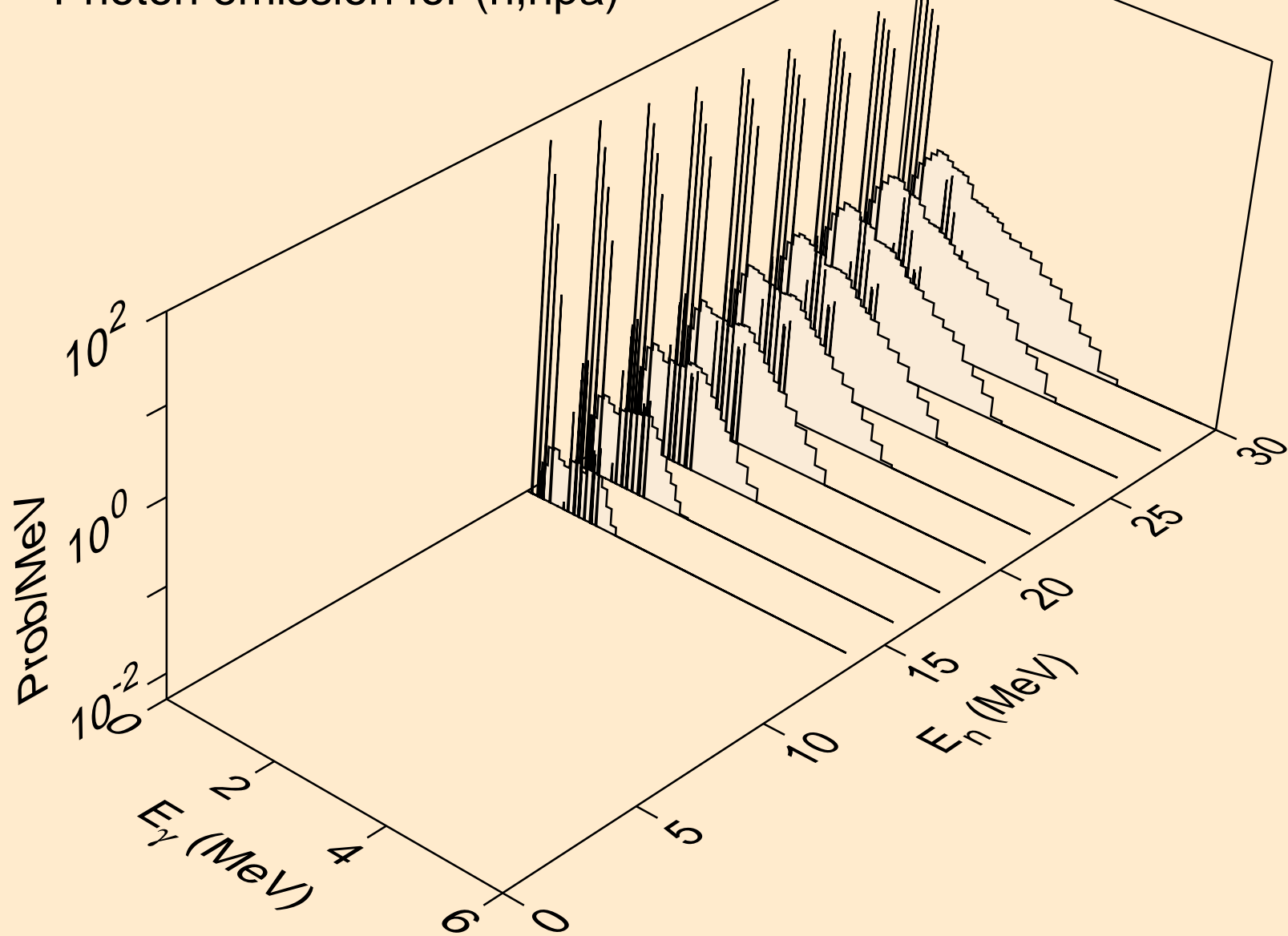

HO163 HELION ACER TENDL-2021 LIBRARY; T=0.K  
Photon emission for (n,gma)

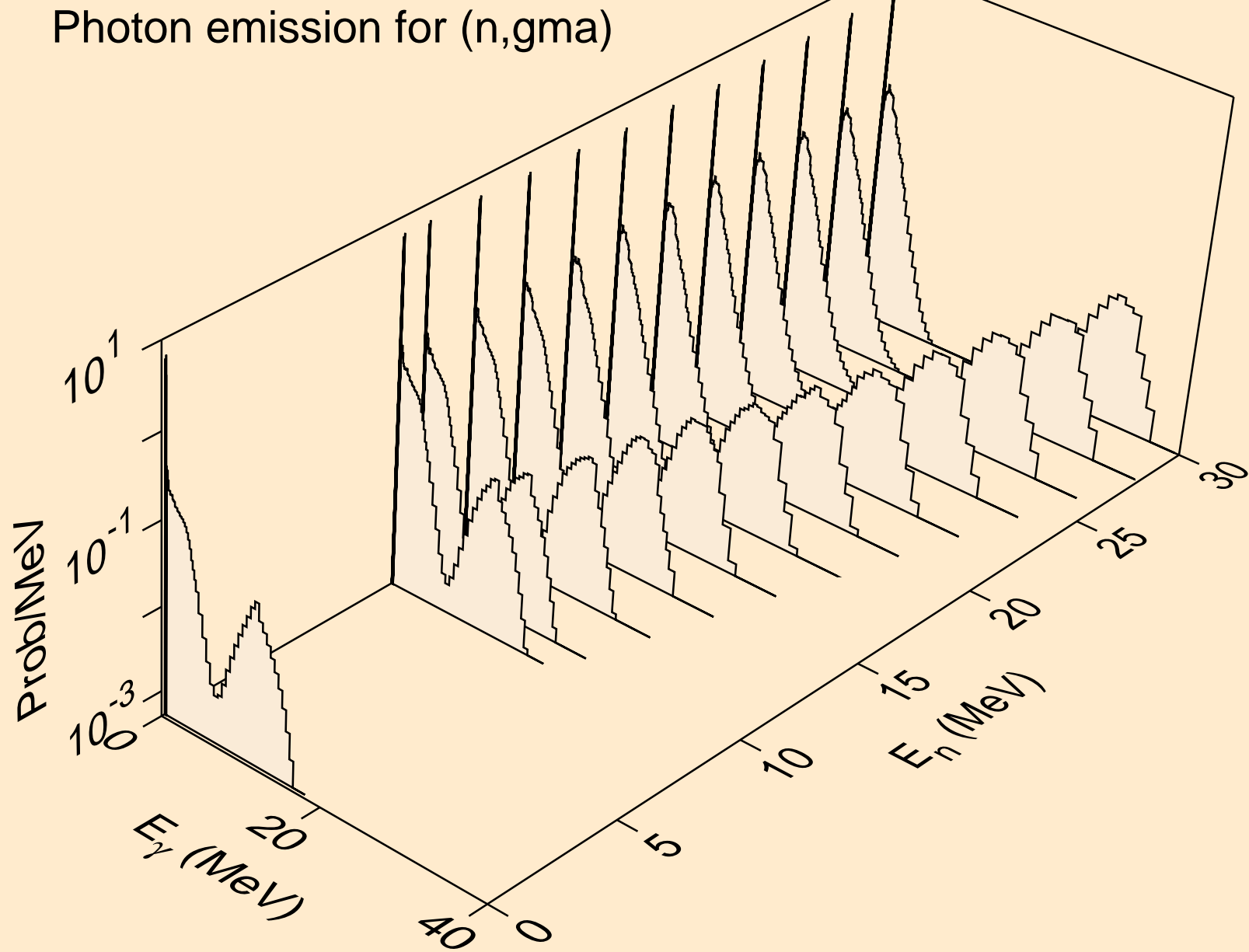

HO163 HELION ACER TENDL-2021 LIBRARY; T=0.K  
Photon emission for (n,p)

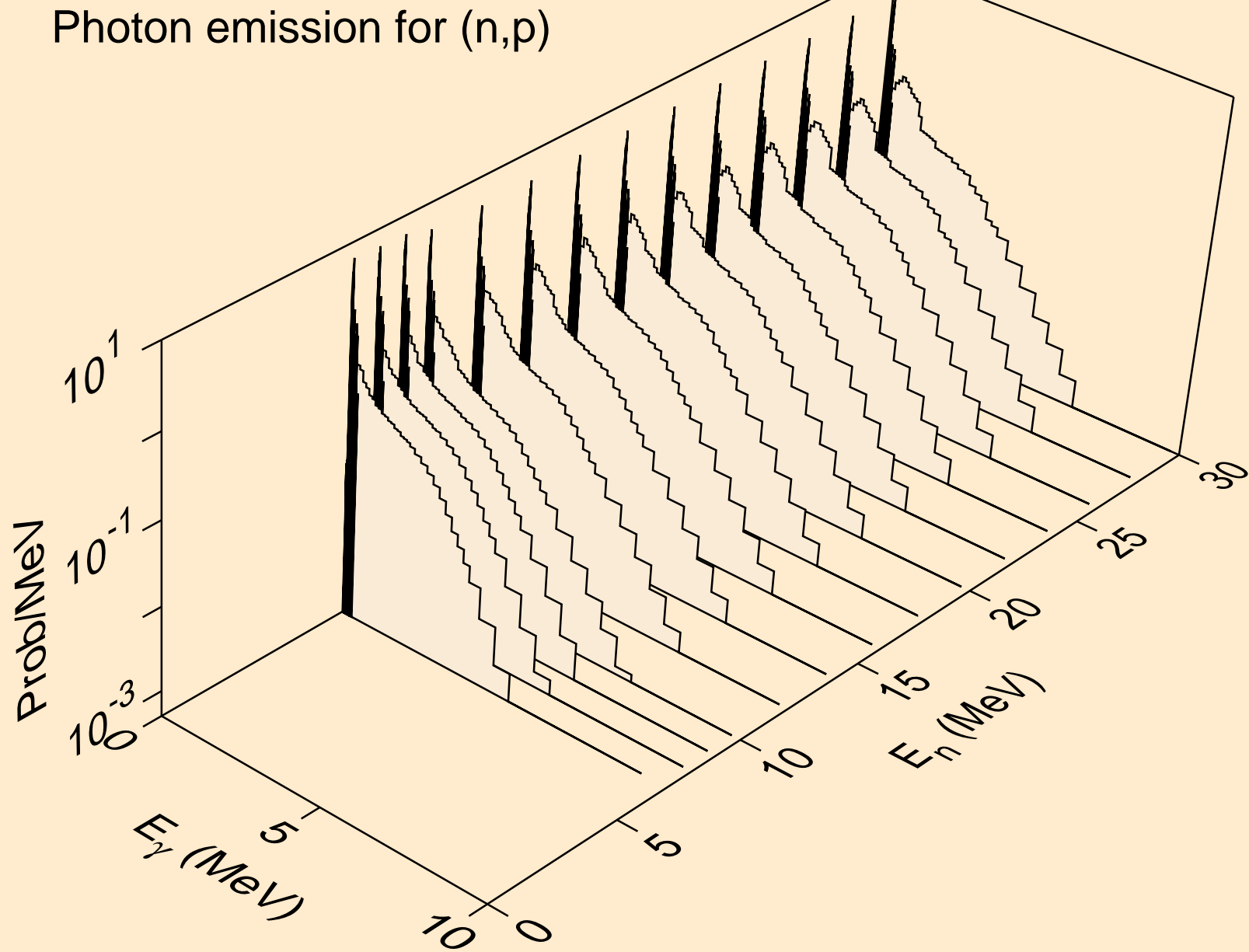

HO163 HELION ACER TENDL-2021 LIBRARY; T=0.K  
Photon emission for (n,d)

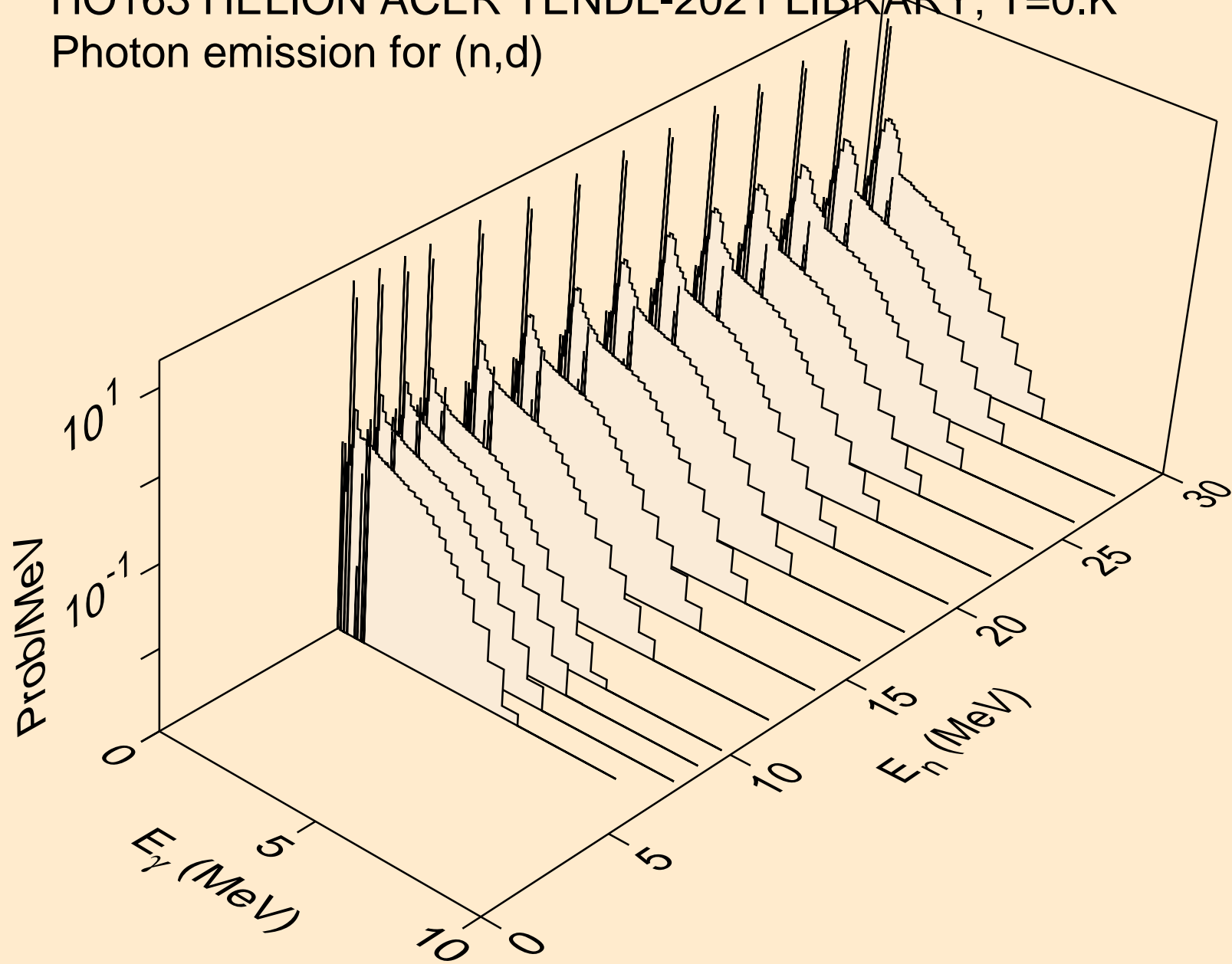

HO163 HELION ACER TENDL-2021 LIBRARY; T=0.K  
Photon emission for (n,t)

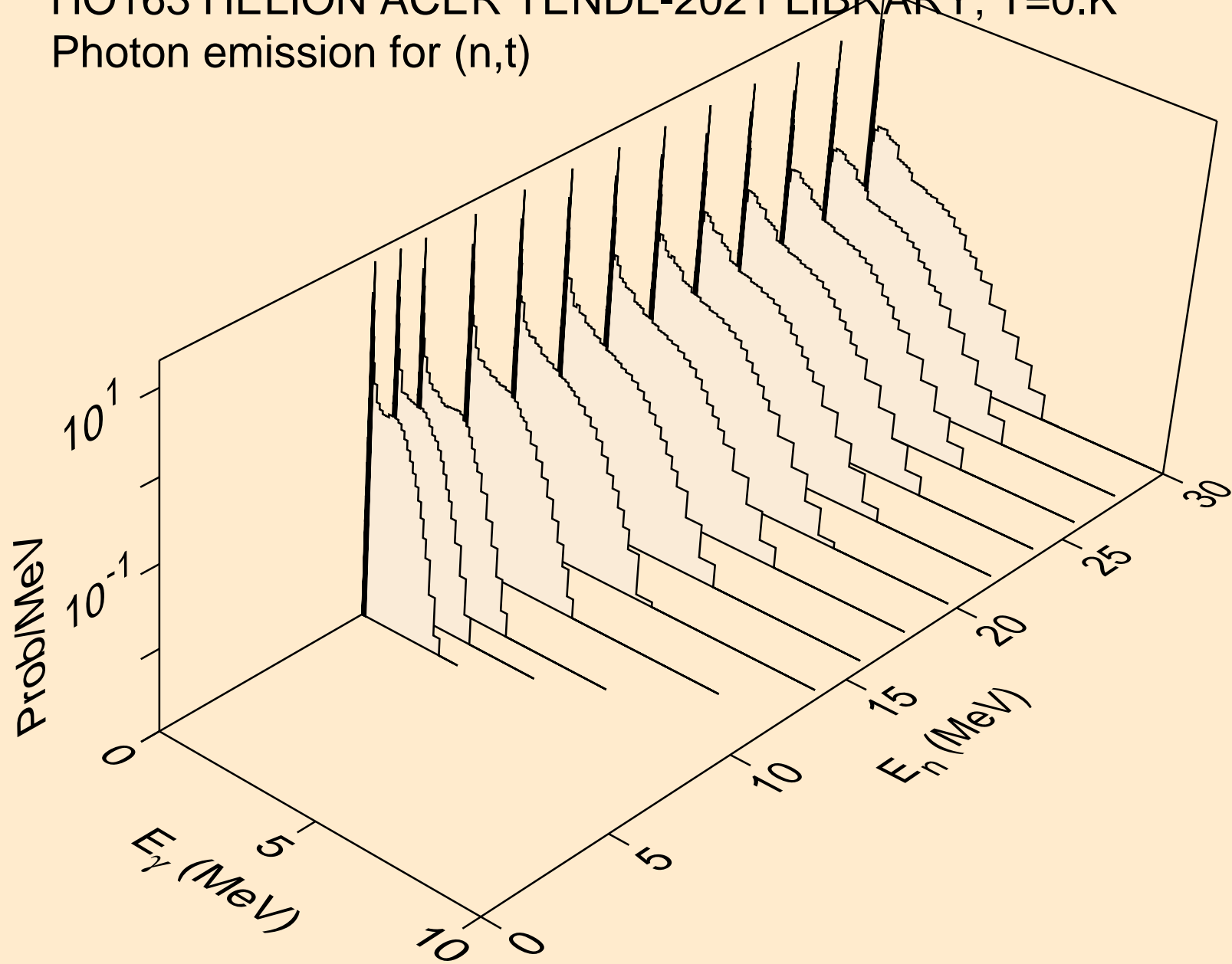

HO163 HELION ACER TENDL-2021 LIBRARY; T=0.K  
Photon emission for inelastic

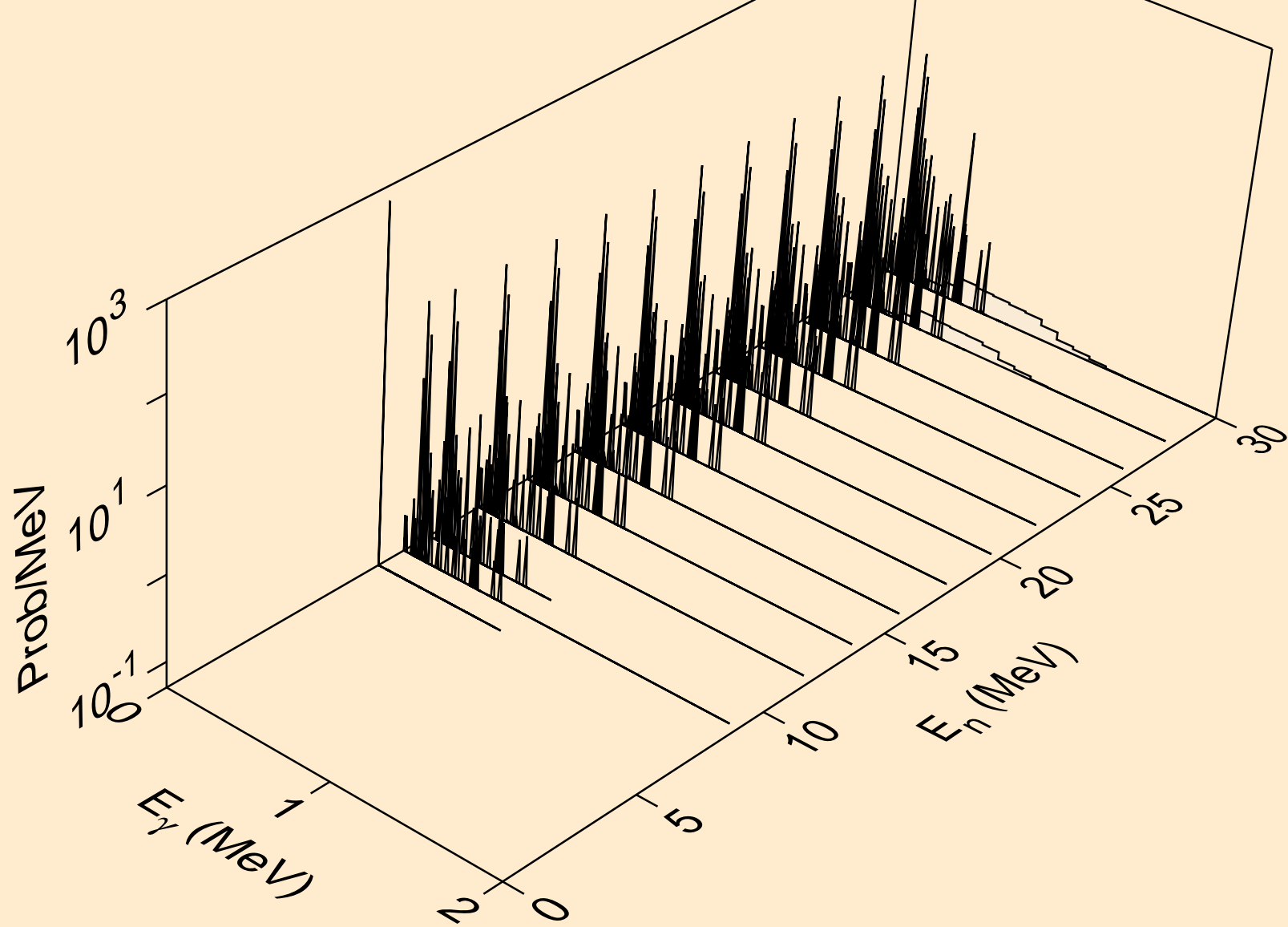



HO163 HELION ACER TENDL-2021 LIBRARY; T=0.K  
Photon emission for (n,a)

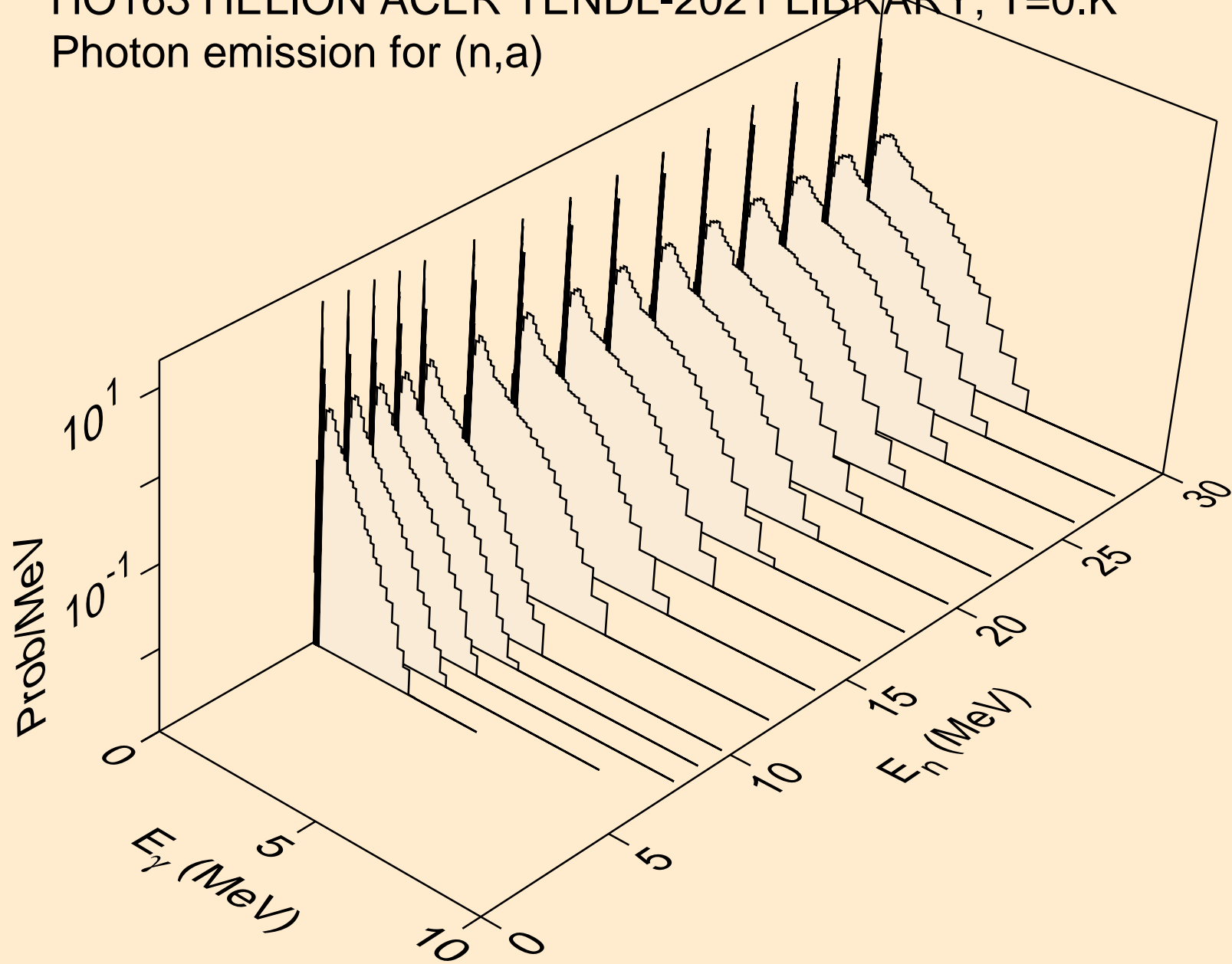

HO163 HELION ACER TENDL-2021 LIBRARY; T=0.K  
Photon emission for (n,2a)

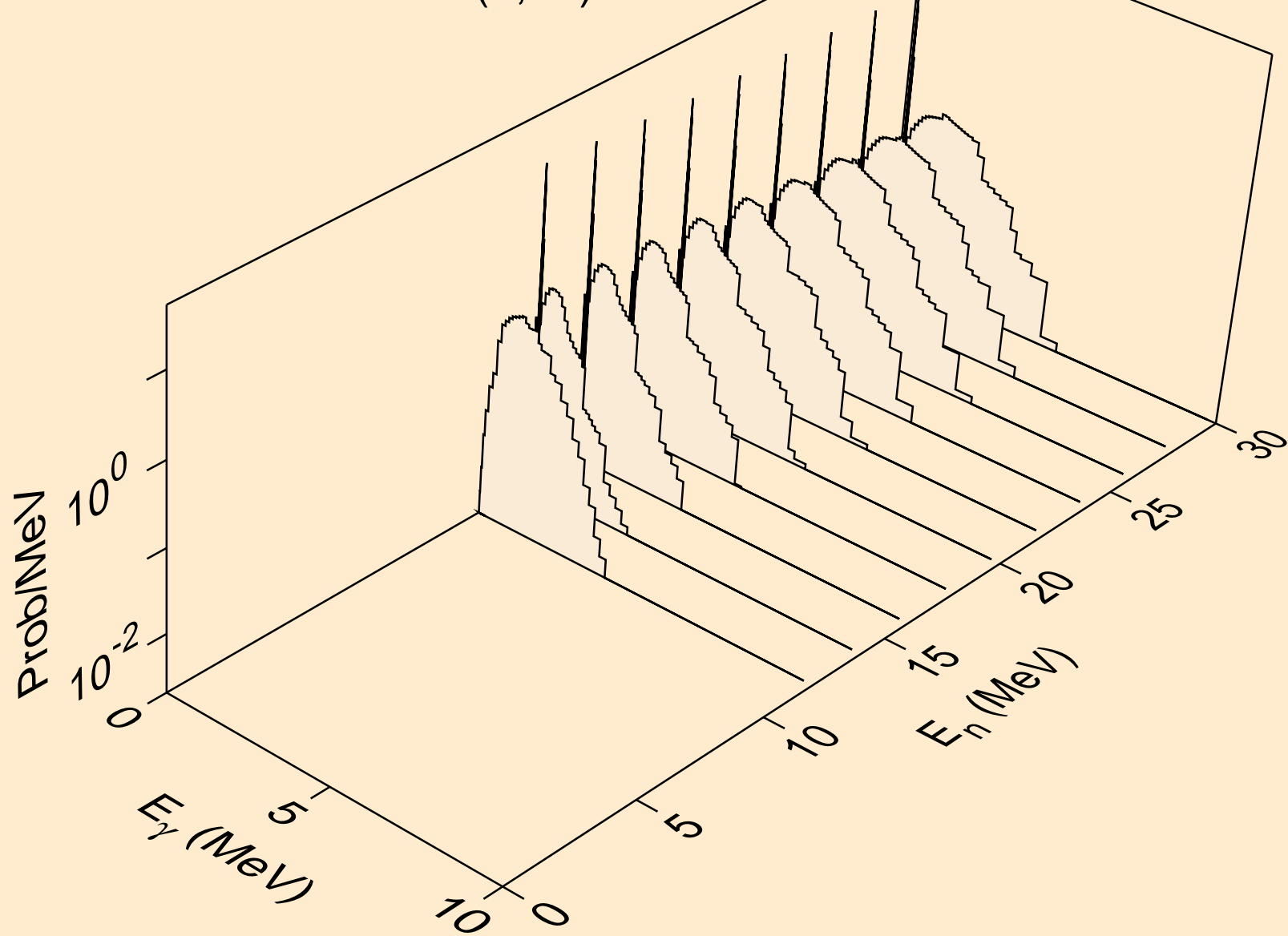

HO163 HELION ACER TENDL-2021 LIBRARY; T=0.K  
Photon emission for (n,2p)

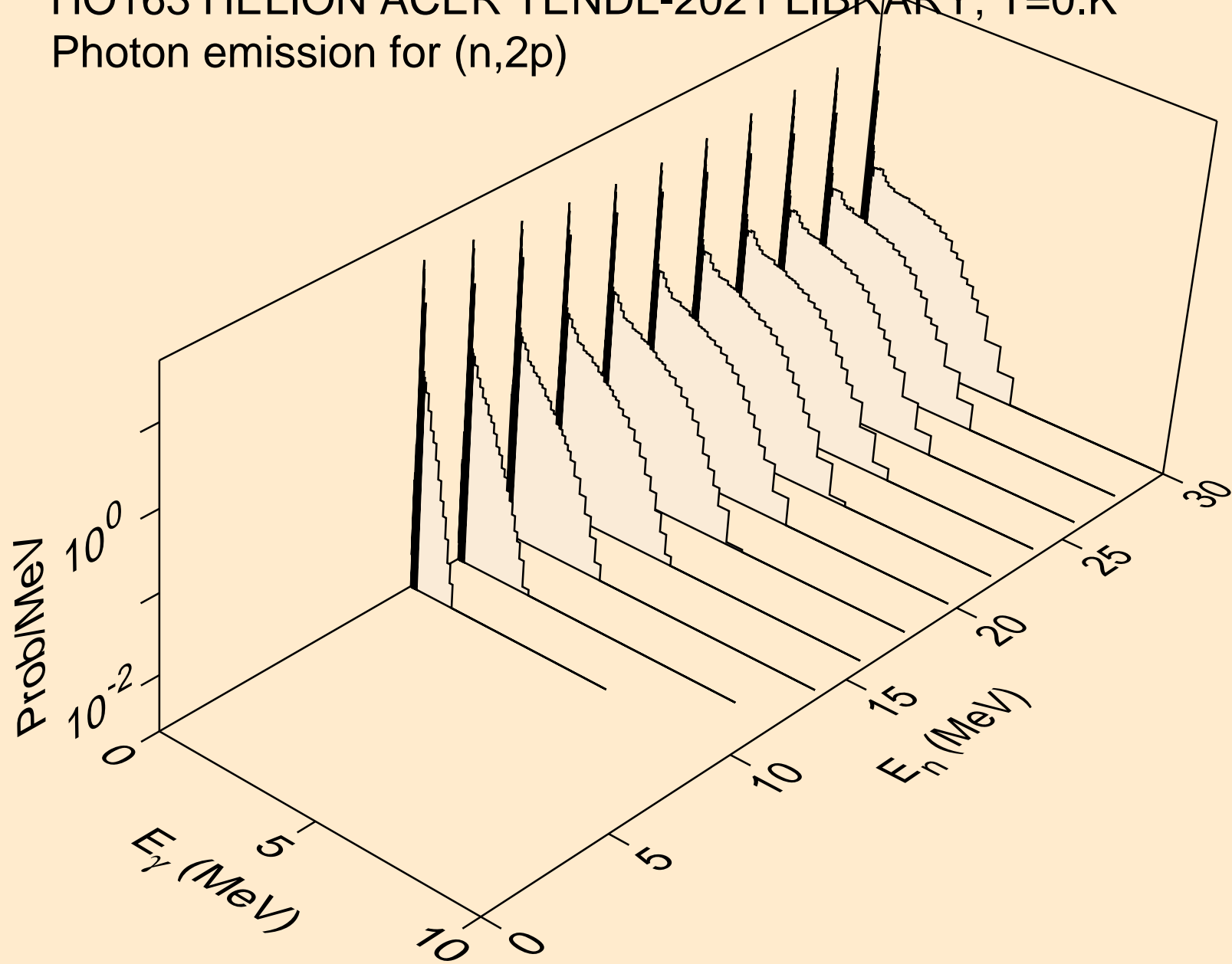

HO163 HELION ACER TENDL-2021 LIBRARY; T=0.K  
Photon emission for (n,pa)

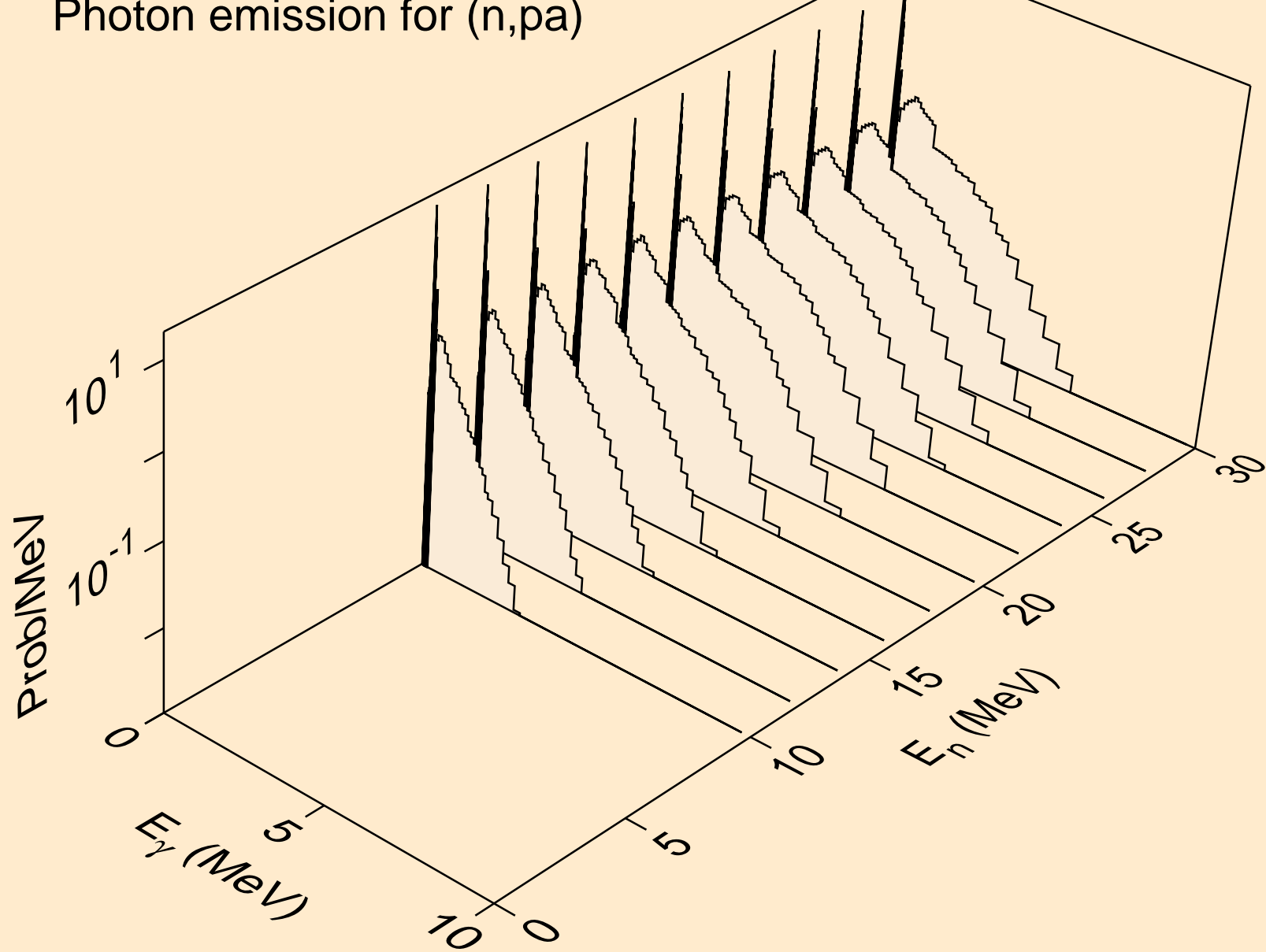

HO163 HELION ACER TENDL-2021 LIBRARY; T=0.K  
Photon emission for (n,pd)

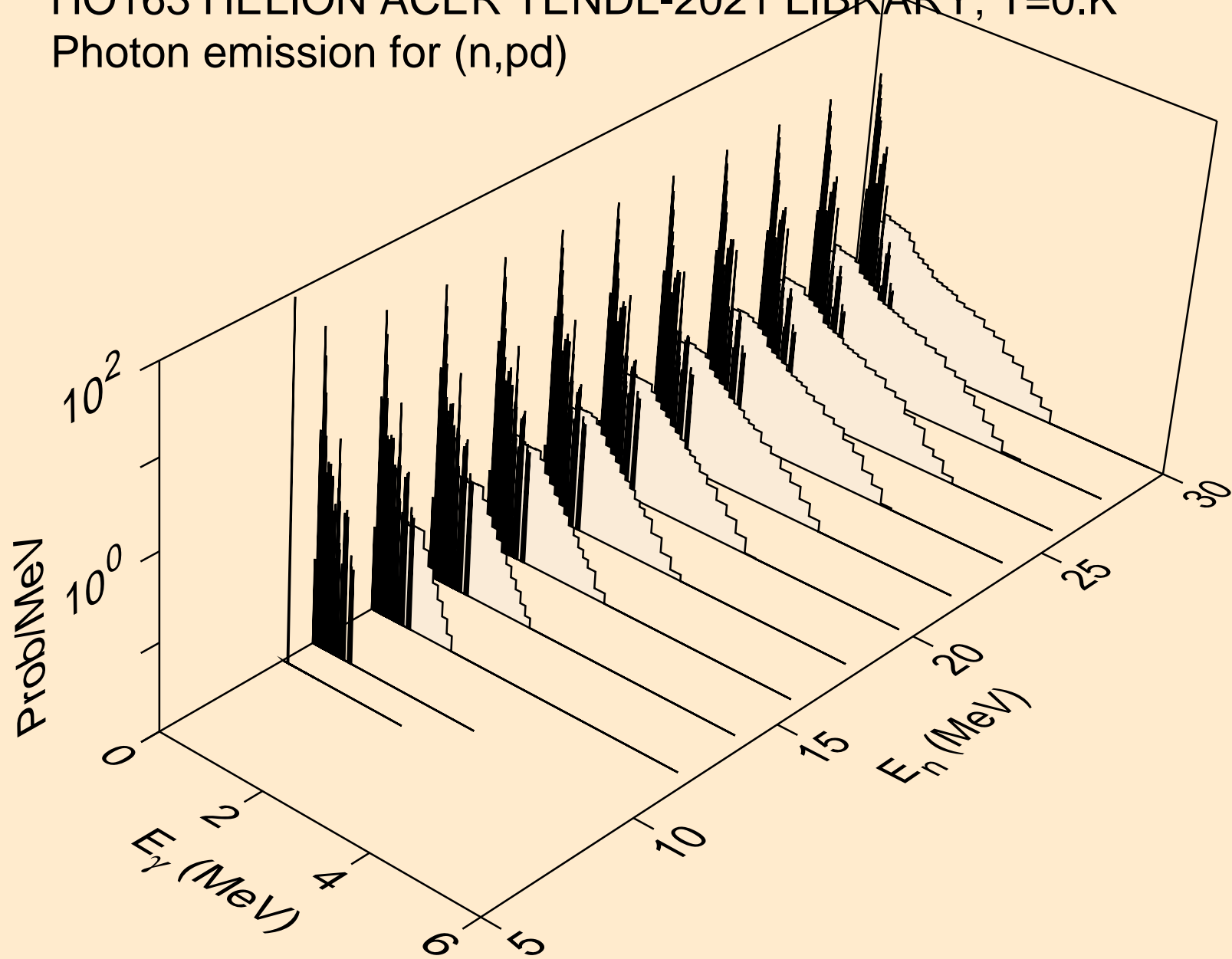

HO163 HELION ACER TENDL-2021 LIBRARY; T=0.K  
Photon emission for (n,pt)

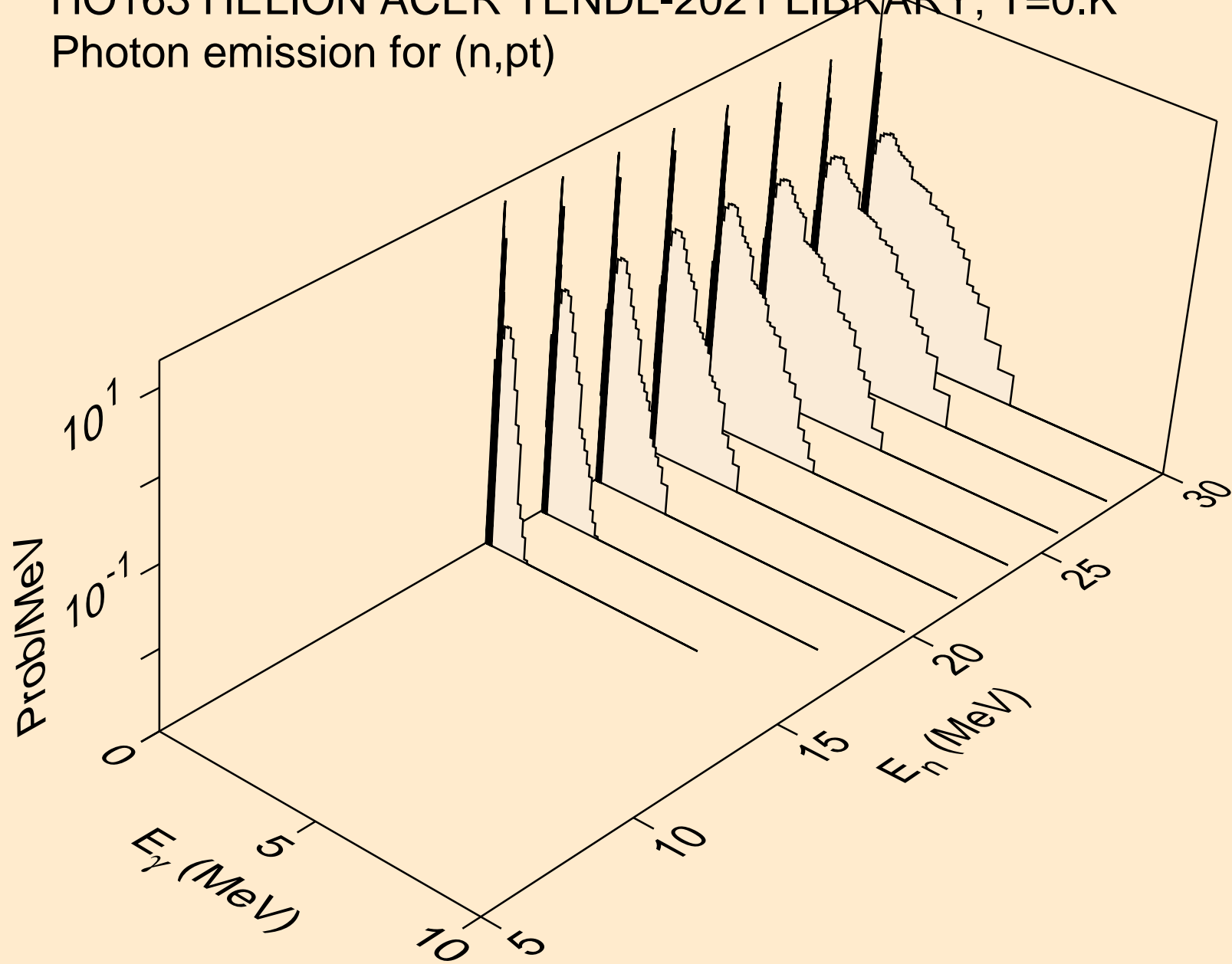

HO163 HELION ACER TENDL-2021 LIBRARY; T=0.K  
Photon emission for (n,da)

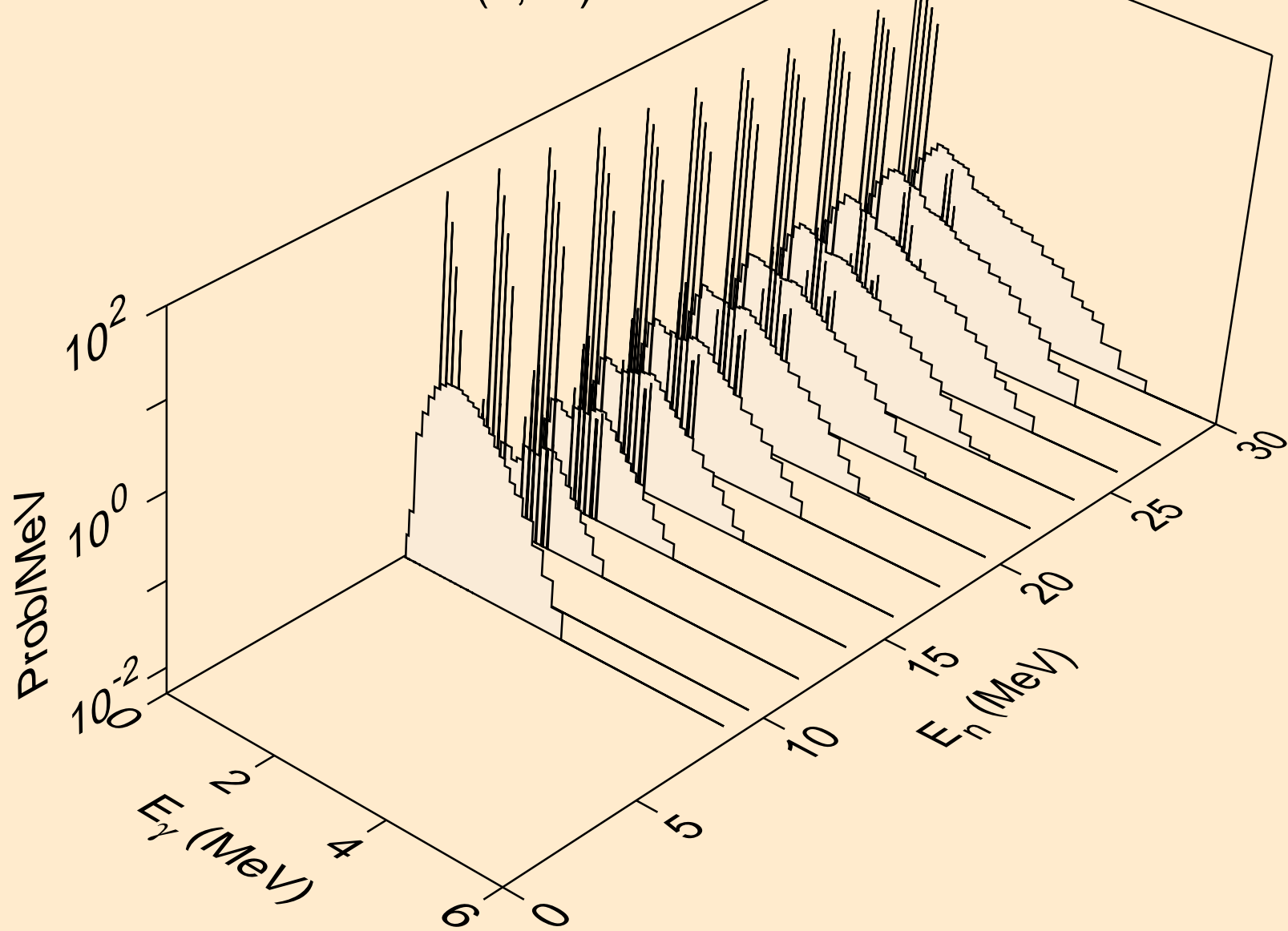

HO163 HELION ACER TENDL-2021 LIBRARY; T=0.K  
Particle heating contributions

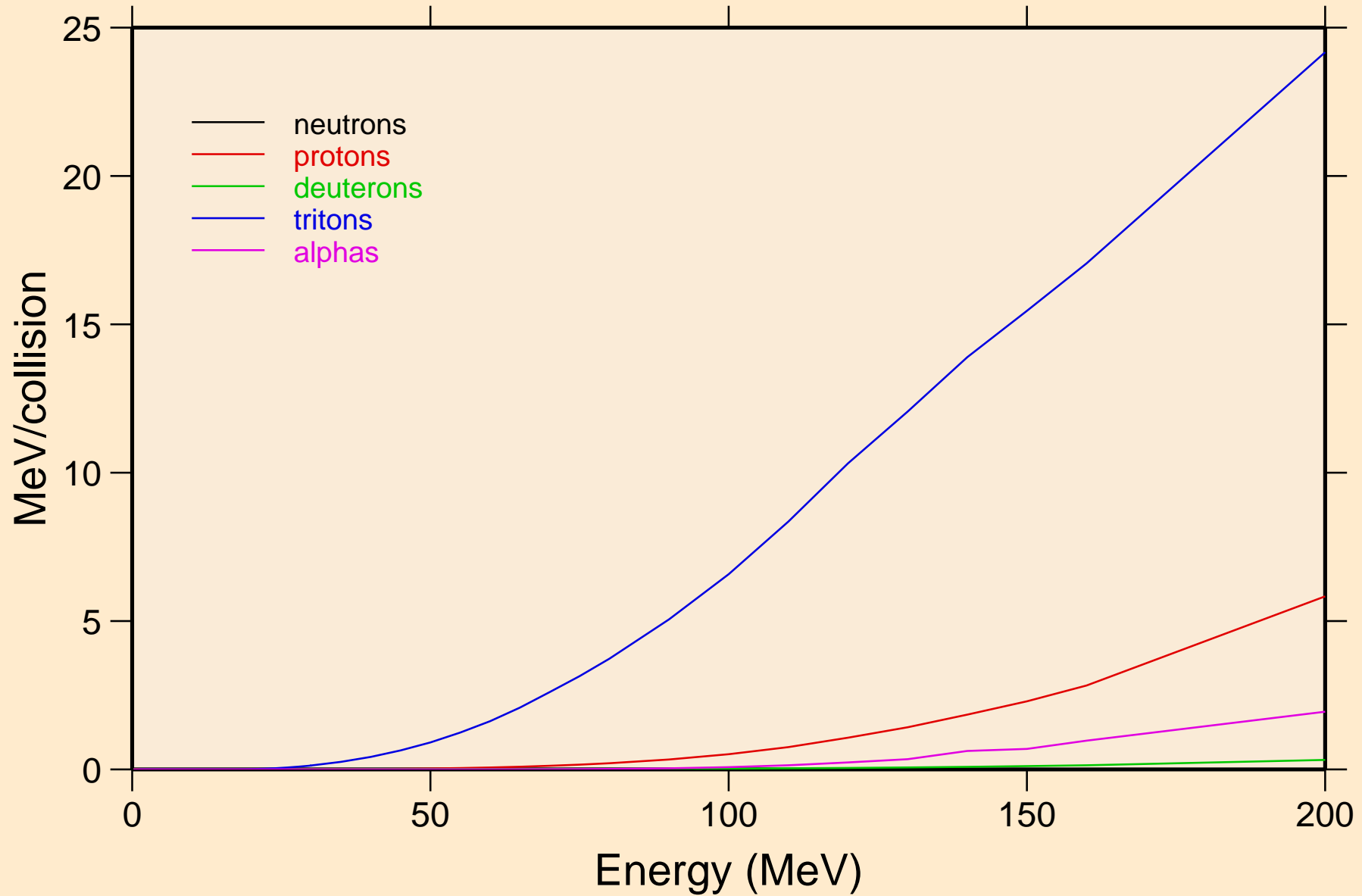



HO163 HELION ACER TENDL-2021 LIBRARY; T=0.K  
Recoil Heating

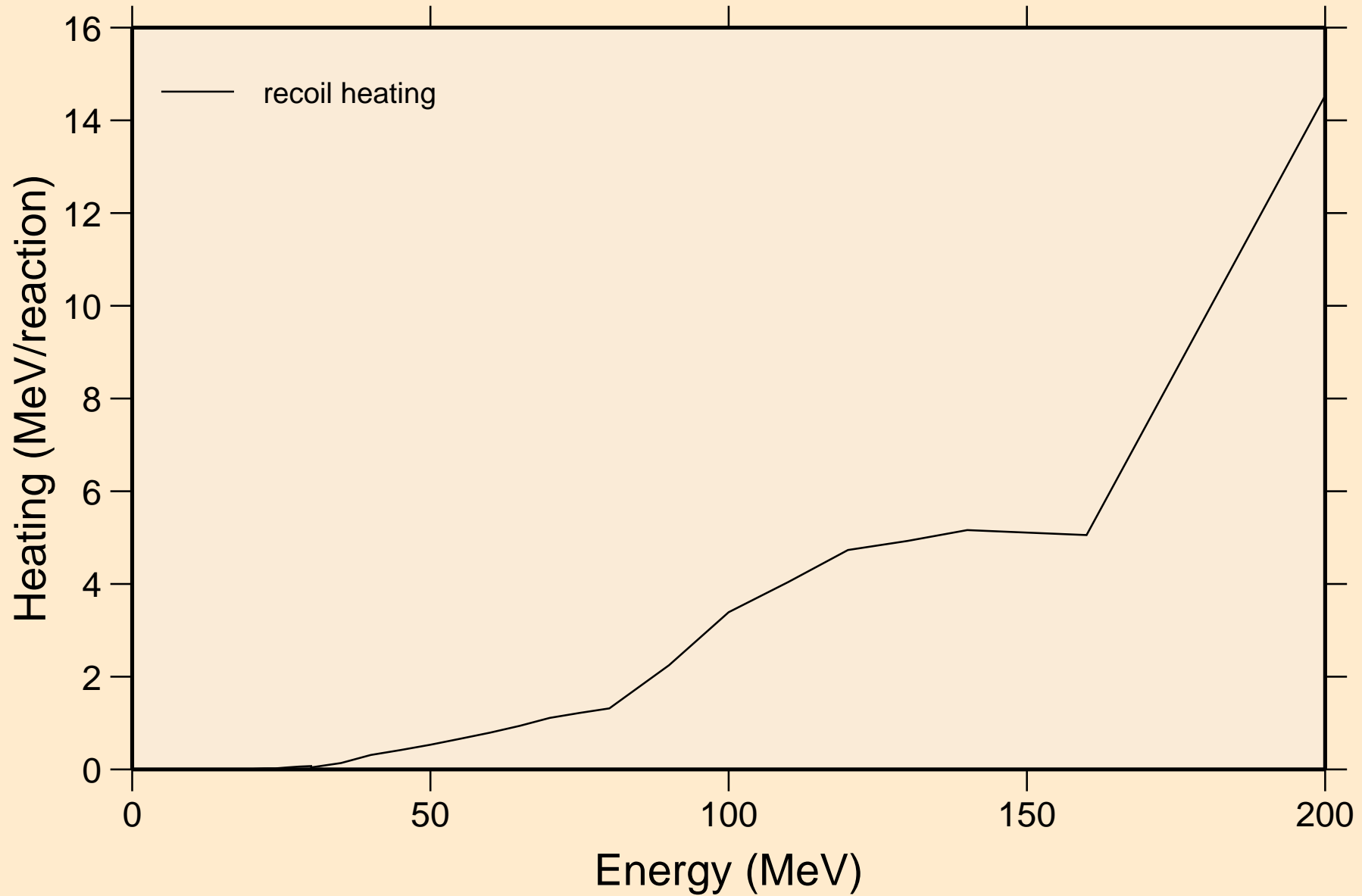

HO163 HELION ACER TENDL-2021 LIBRARY; T=0.K  
Particle production cross sections

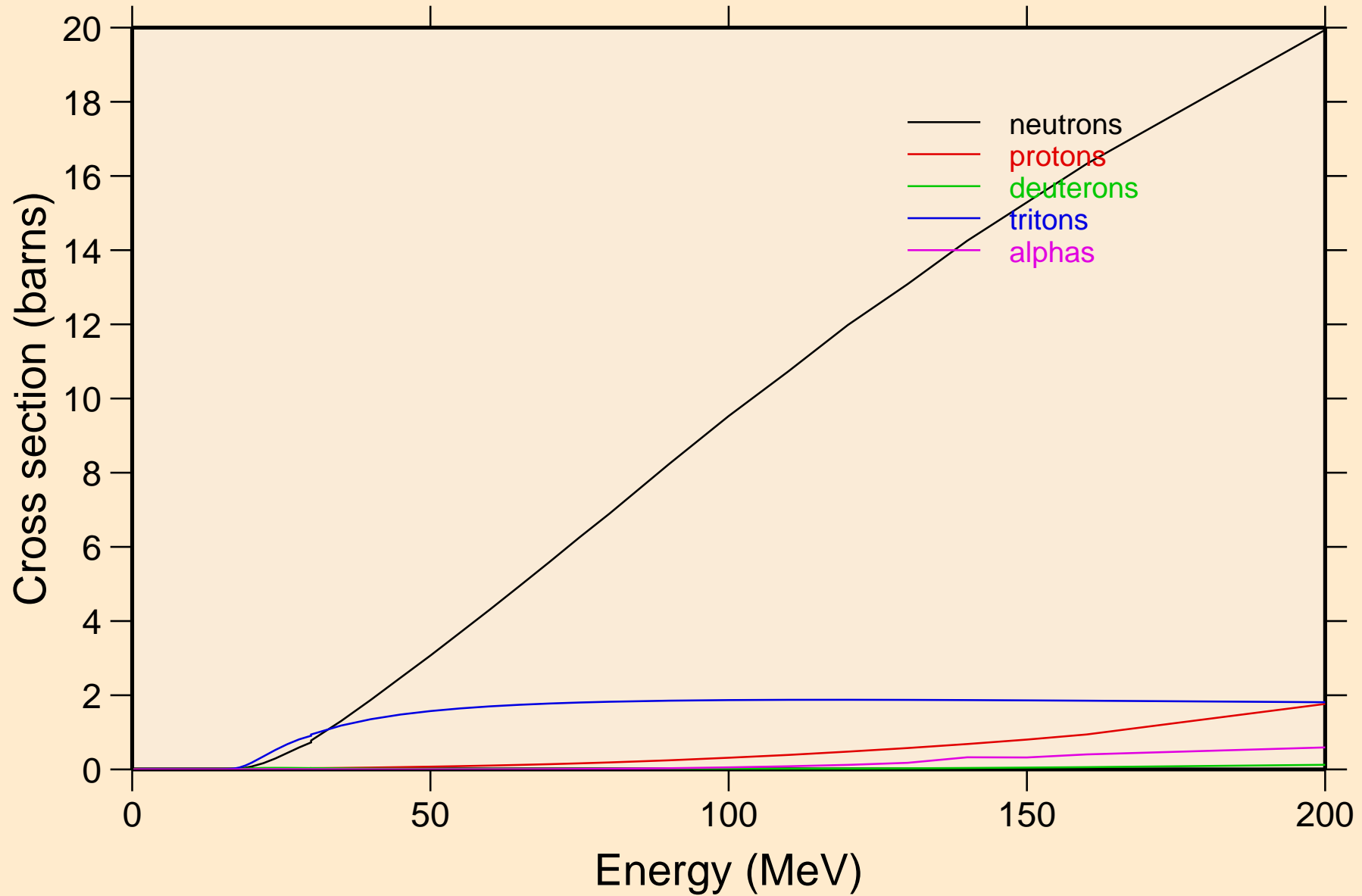

HO163 HELION ACER TENDL-2021 LIBRARY; T=0.K  
neutrons from (s,n)

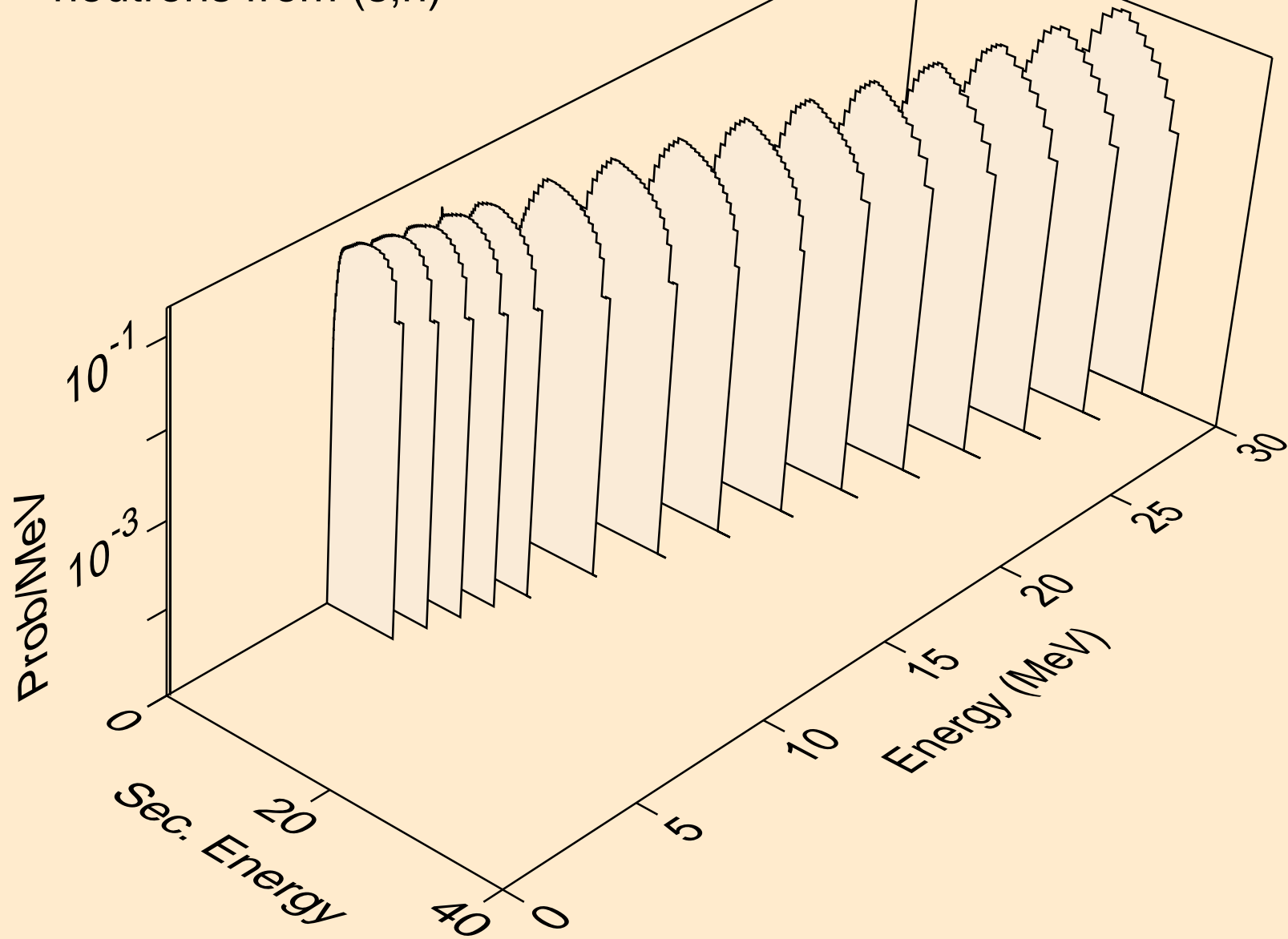

HO163 HELION ACER TENDL-2021 LIBRARY; T=0.K  
neutrons from (s,x)

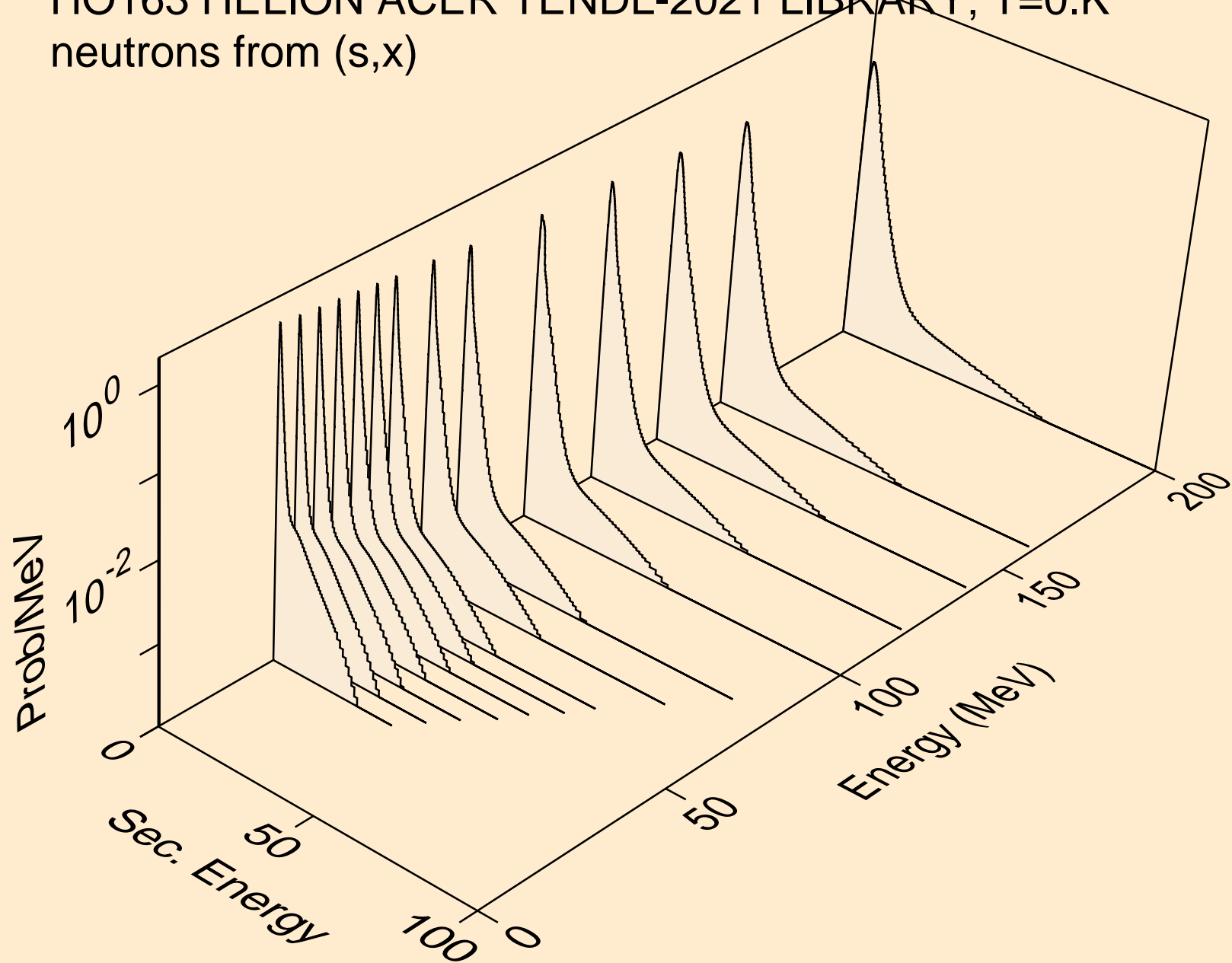

HO163 HELION ACER TENDL-2021 LIBRARY; T=0.K  
neutrons from (s,2nd)

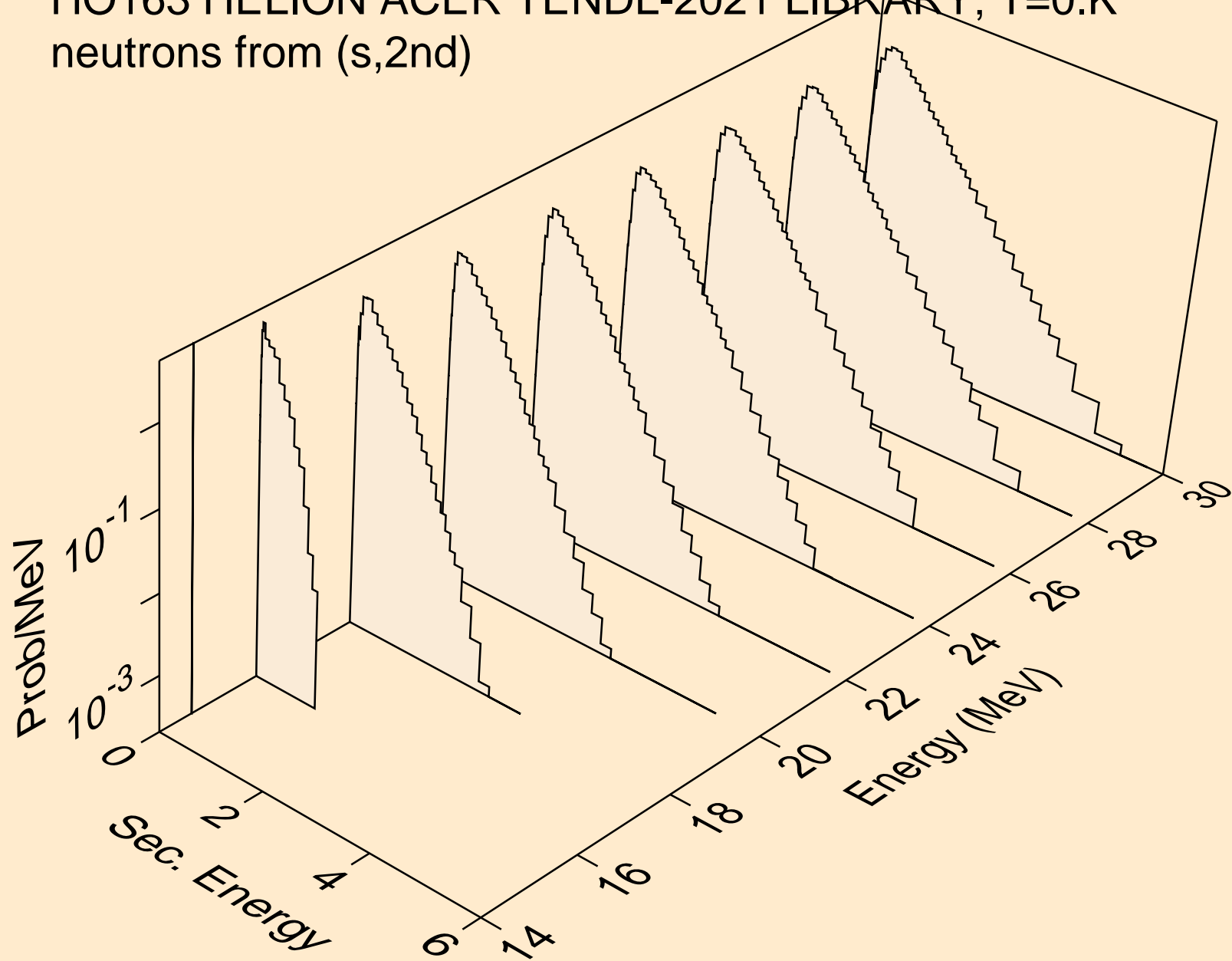

HO163 HELION ACER TENDL-2021 LIBRARY; T=0.K  
neutrons from (s,2n)

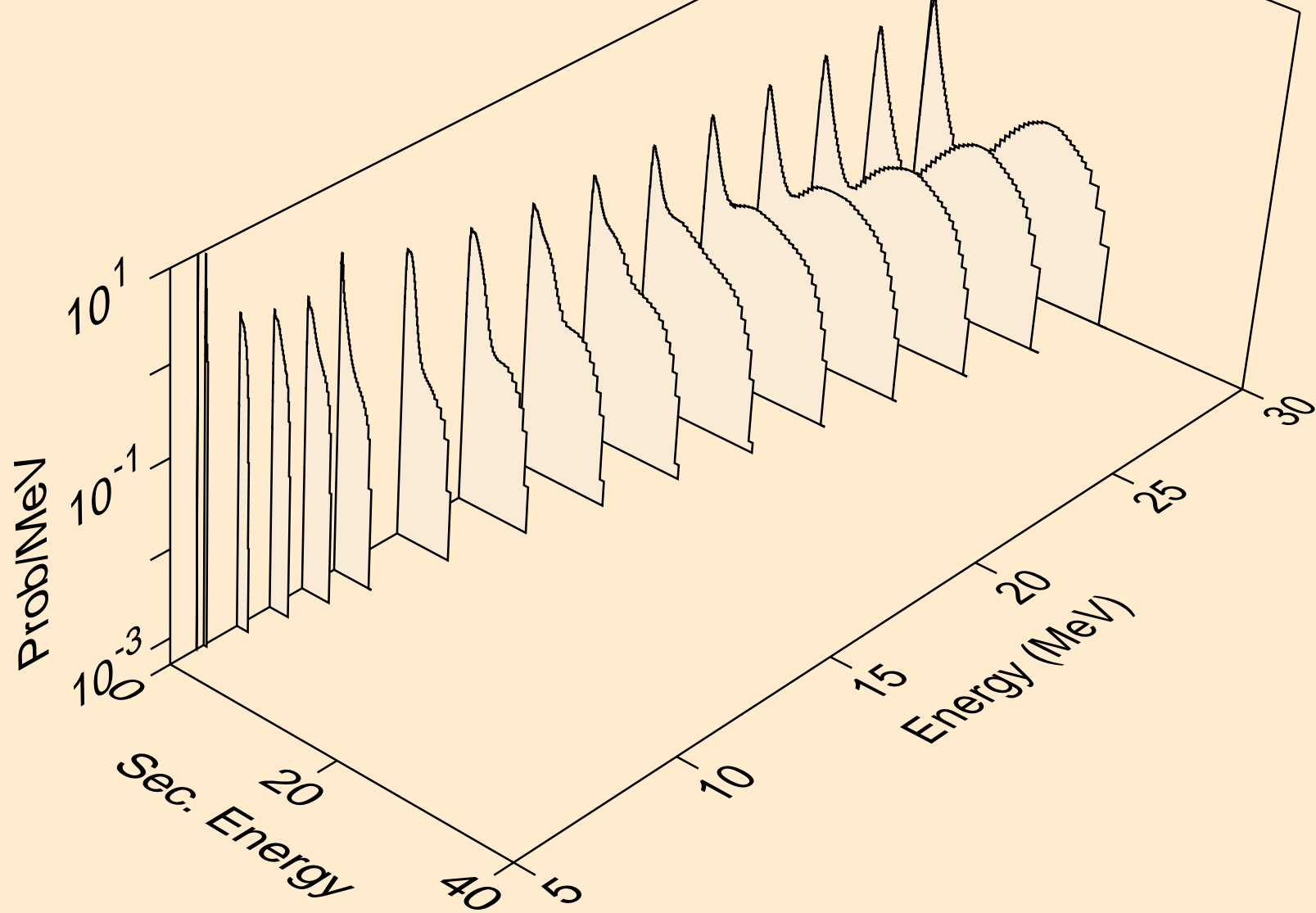

HO163 HELION ACER TENDL-2021 LIBRARY; T=0.K  
neutrons from (s,3n)

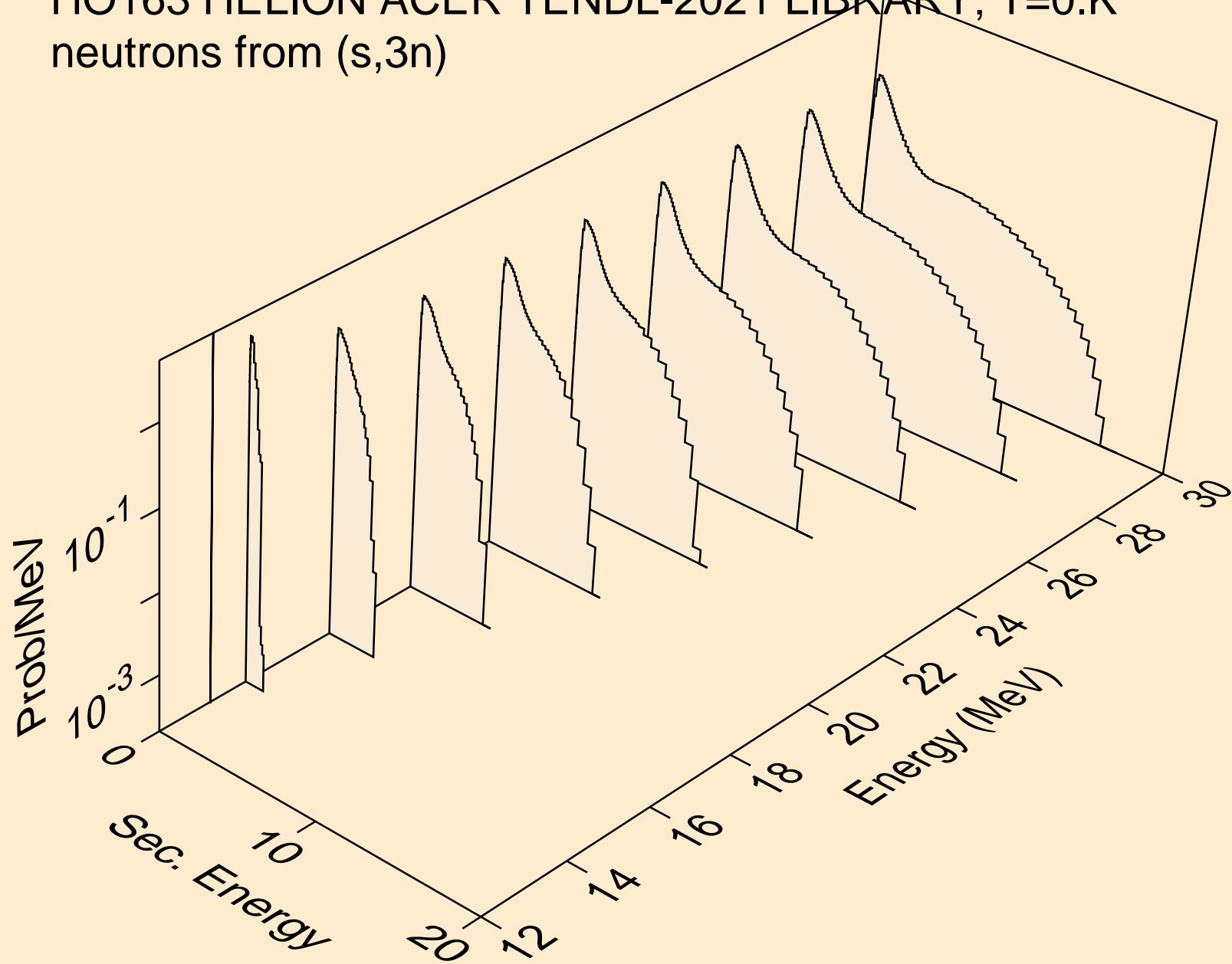

HO163 HELION ACER TENDL-2021 LIBRARY; T=0.K  
neutrons from (s,n\*)a

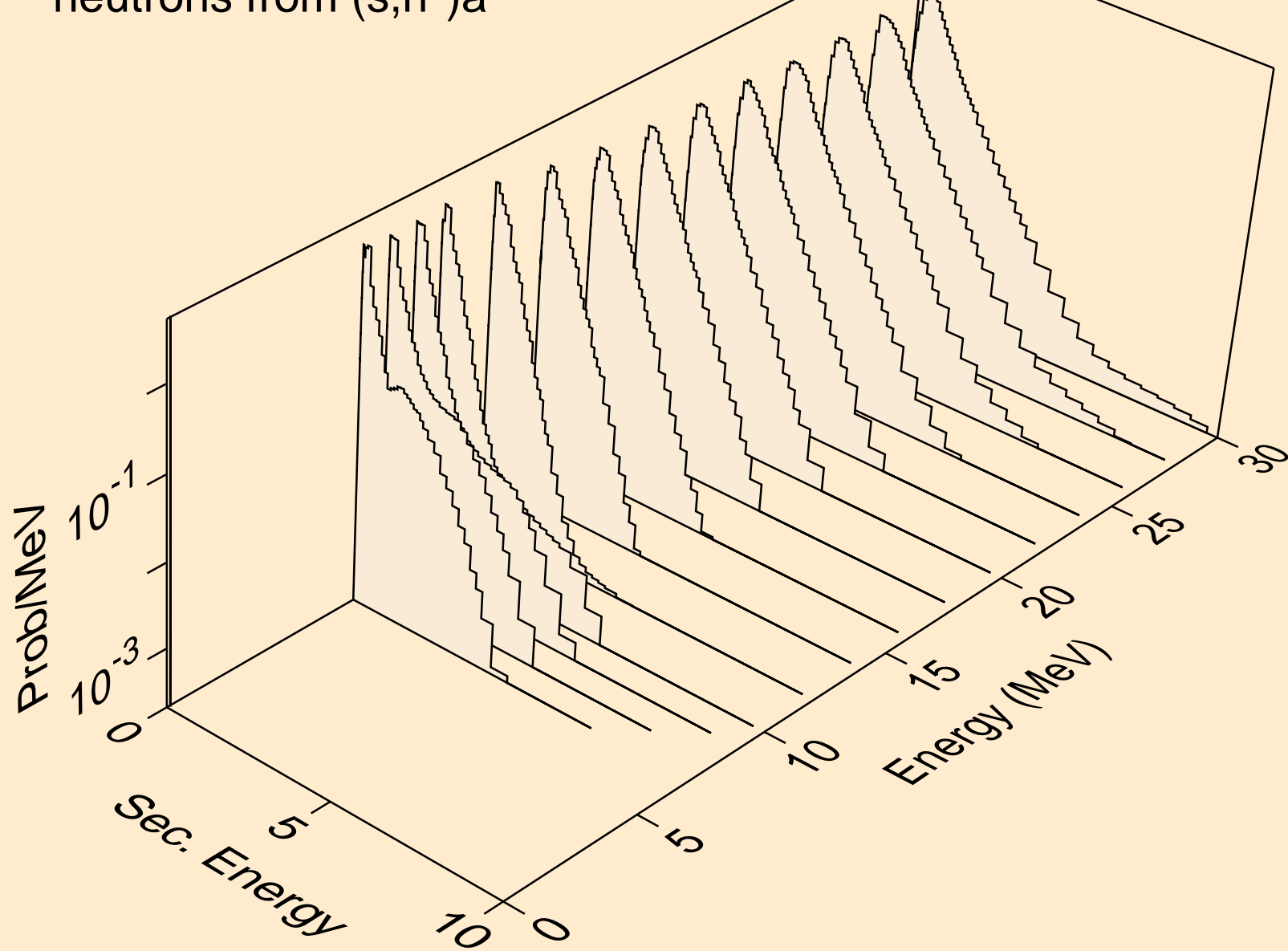



HO163 HELION ACER TENDL-2021 LIBRARY; T=0.K  
neutrons from (s,2n)a

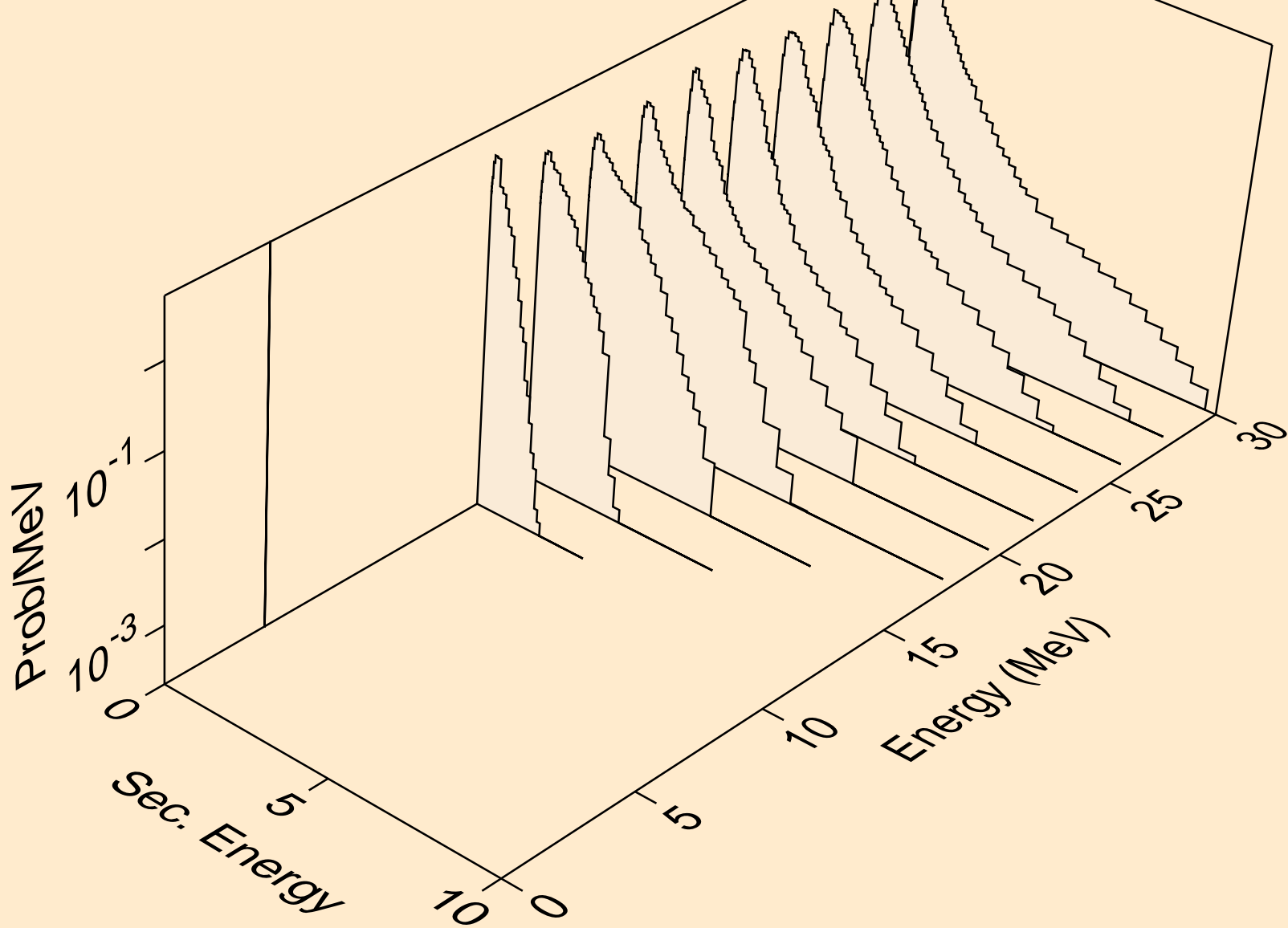

HO163 HELION ACER TENDL-2021 LIBRARY; T=0.K  
neutrons from (s,3n)a

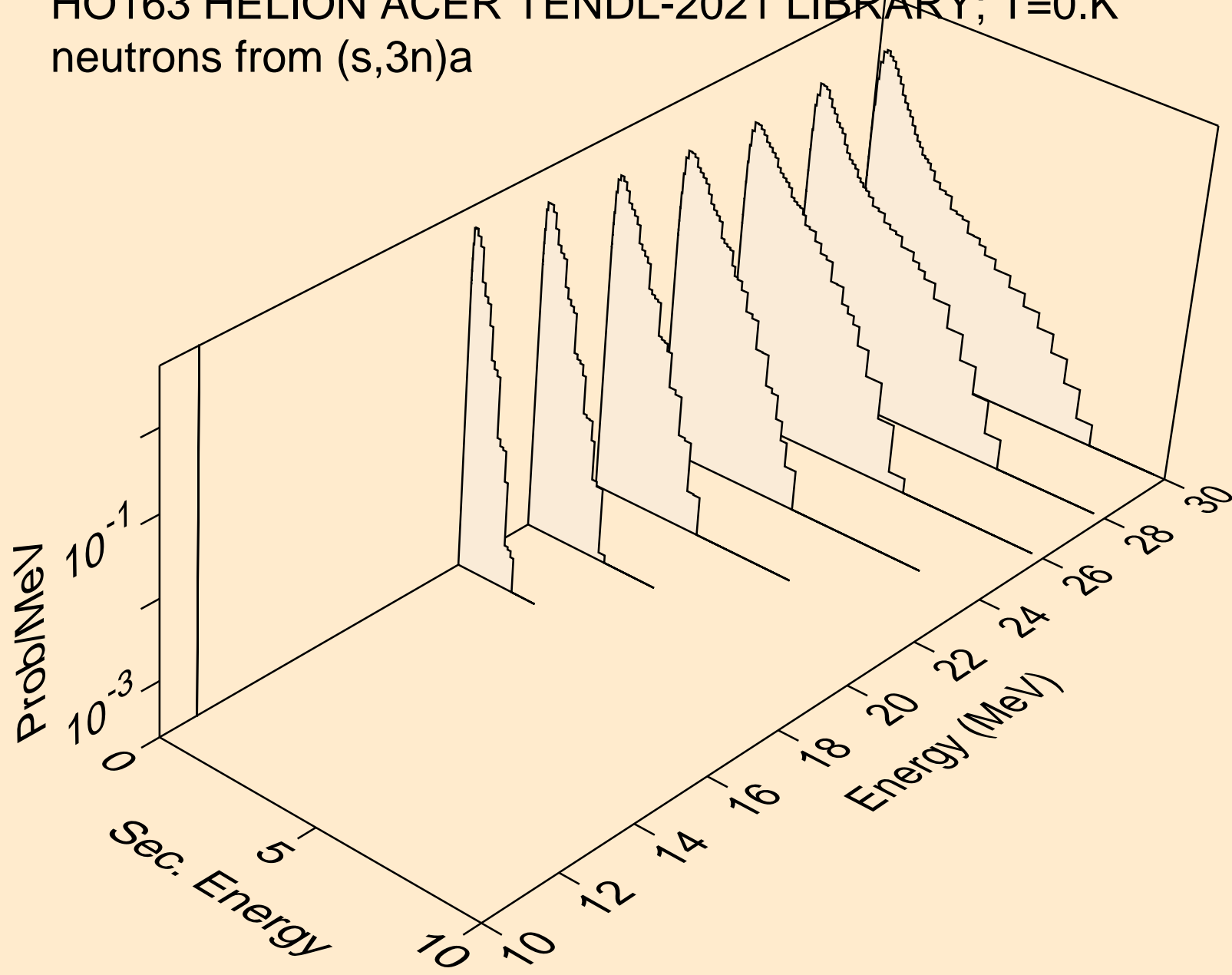

HO163 HELION ACER TENDL-2021 LIBRARY; T=0.K  
neutrons from (s,n\*)p

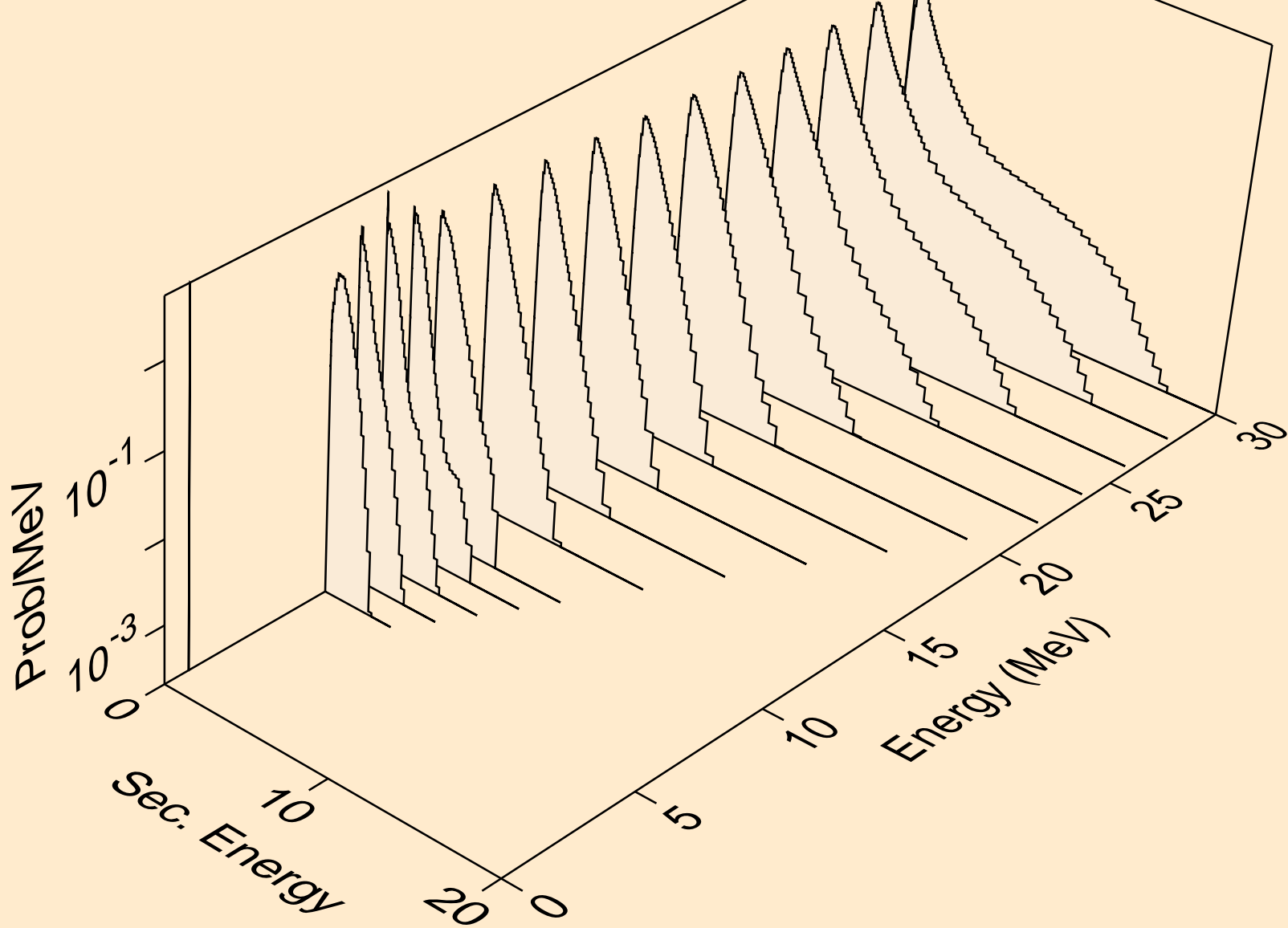

HO163 HELION ACER TENDL-2021 LIBRARY; T=0.K  
neutrons from (s,n\*)2a

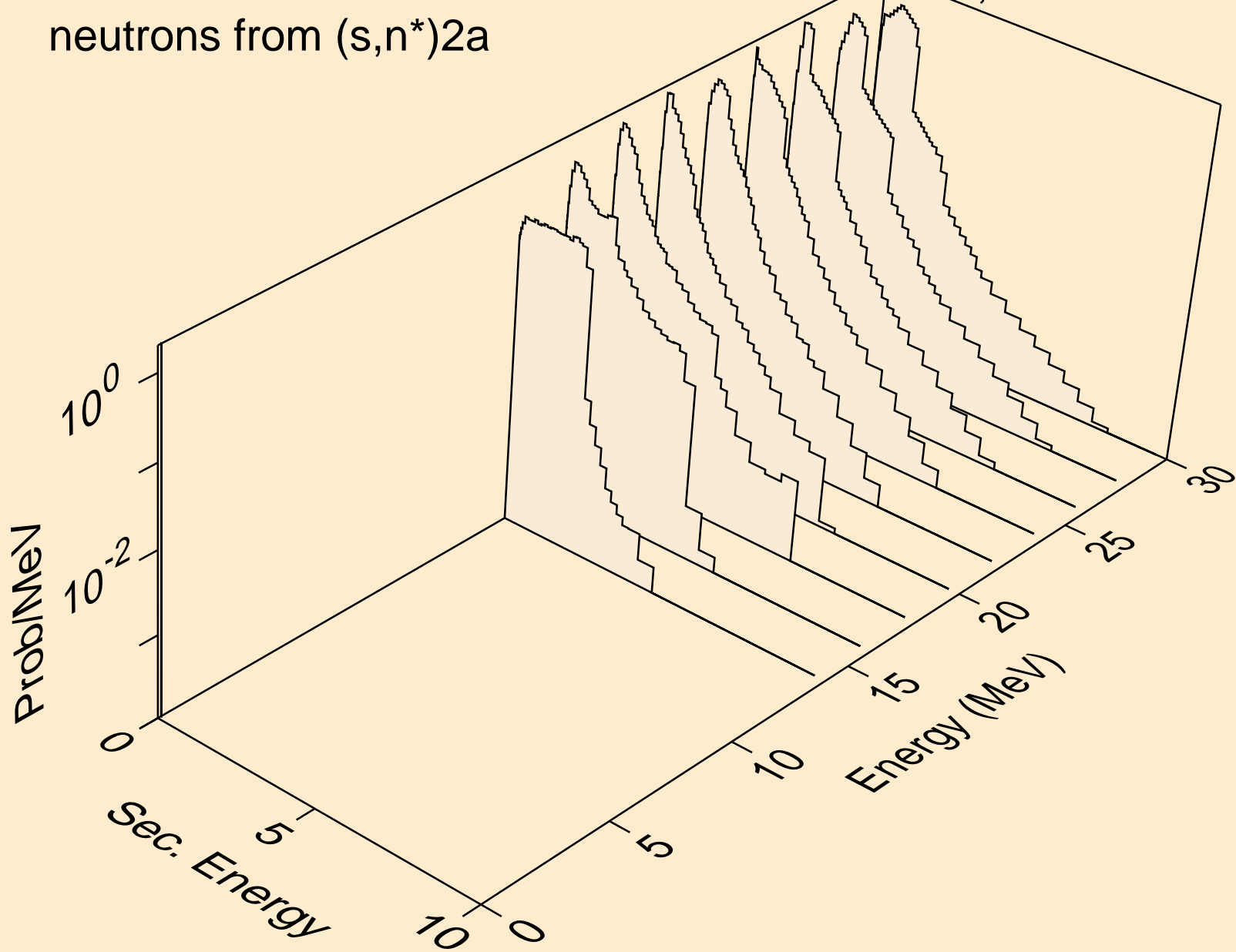

HO163 HELION ACER TENDL-2021 LIBRARY; T=0.K  
neutrons from (s,n\*)d

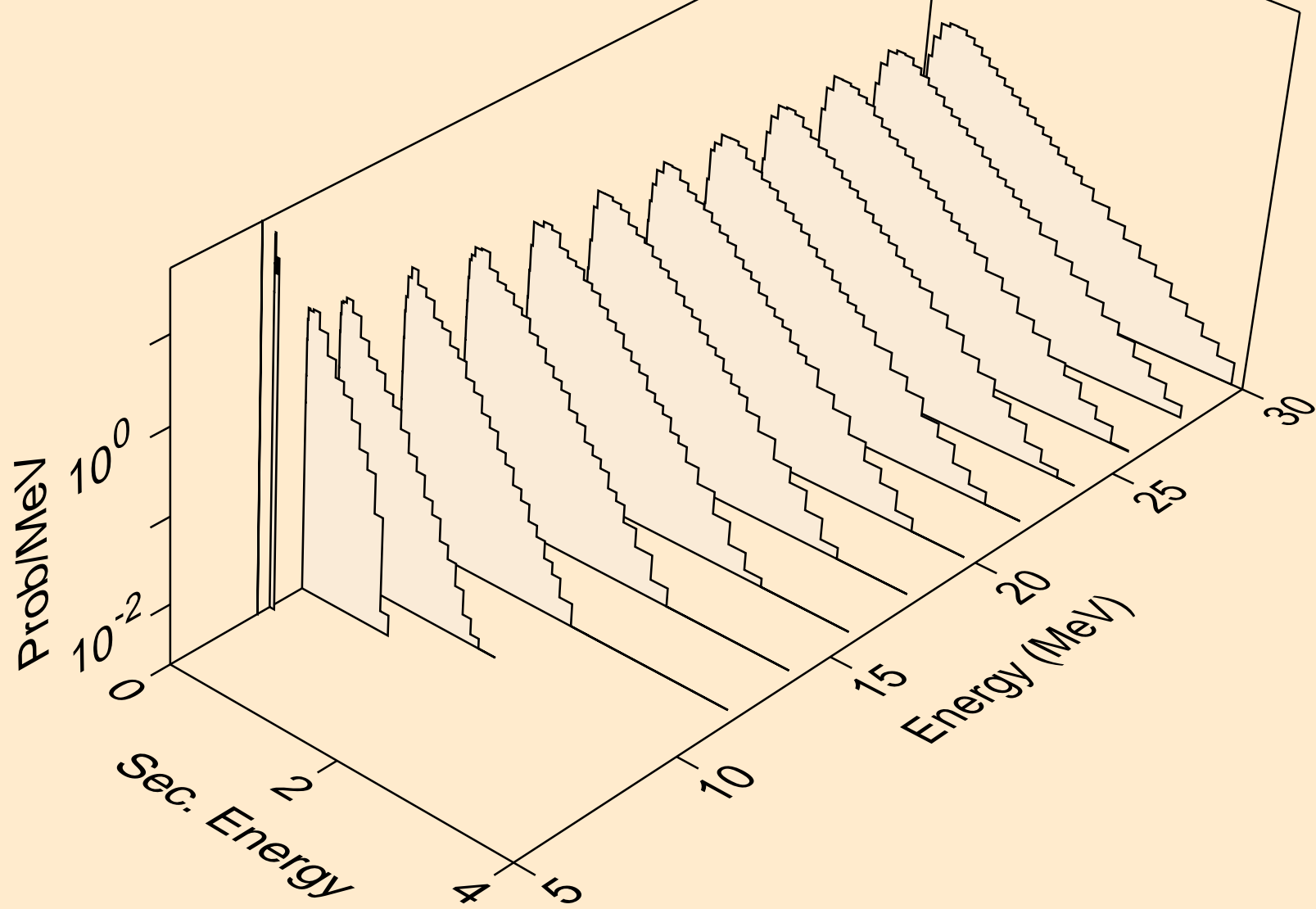

HO163 HELION ACER TENDL-2021 LIBRARY; T=0.K  
neutrons from (s,n\*)t

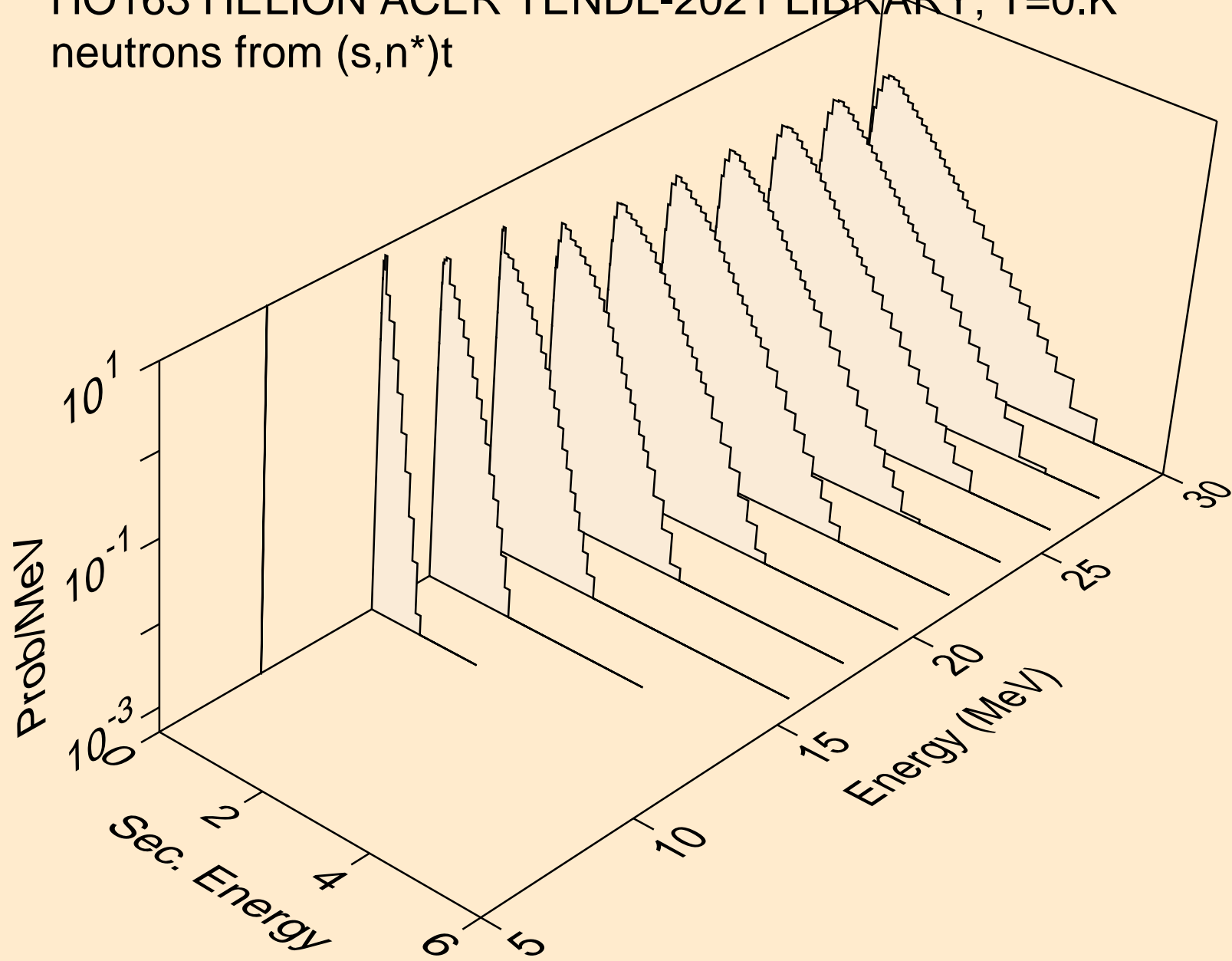

HO163 HELION ACER TENDL-2021 LIBRARY; T=0.K  
neutrons from (s,n\*)he3

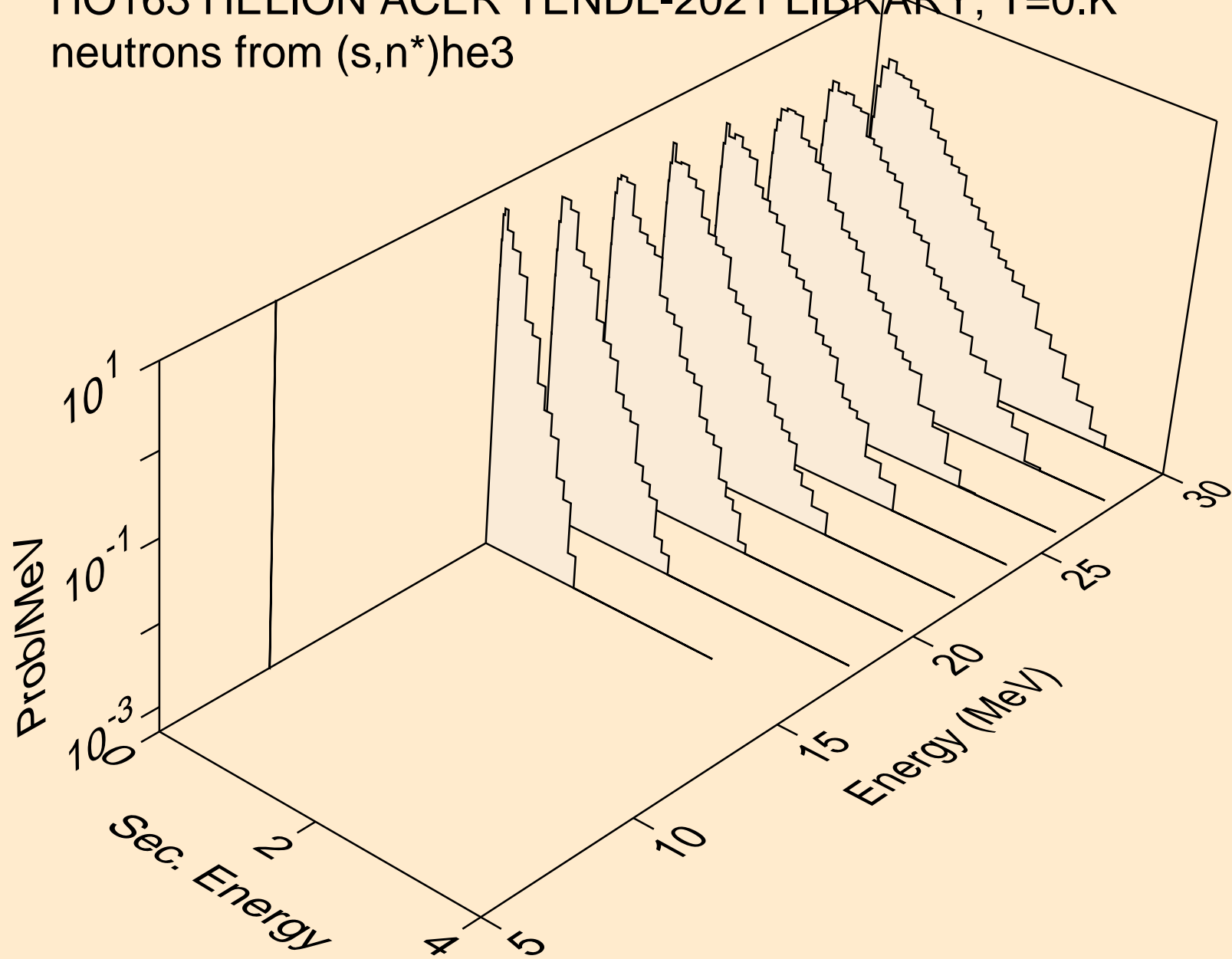

HO163 HELION ACER TENDL-2021 LIBRARY; T=0.K  
neutrons from (s,4n)

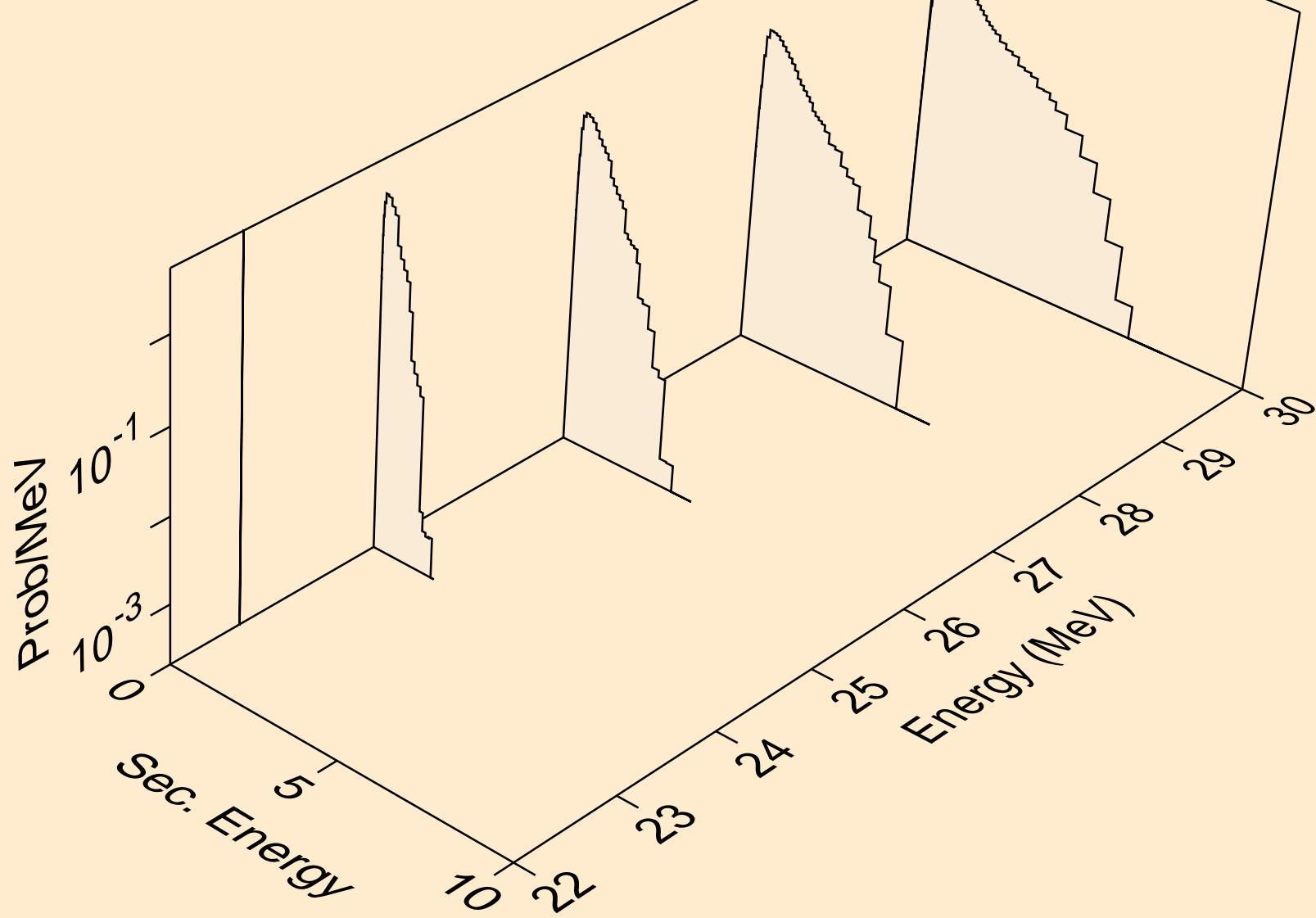



HO163 HELION ACER TENDL-2021 LIBRARY; T=0.K  
neutrons from (s,2np)

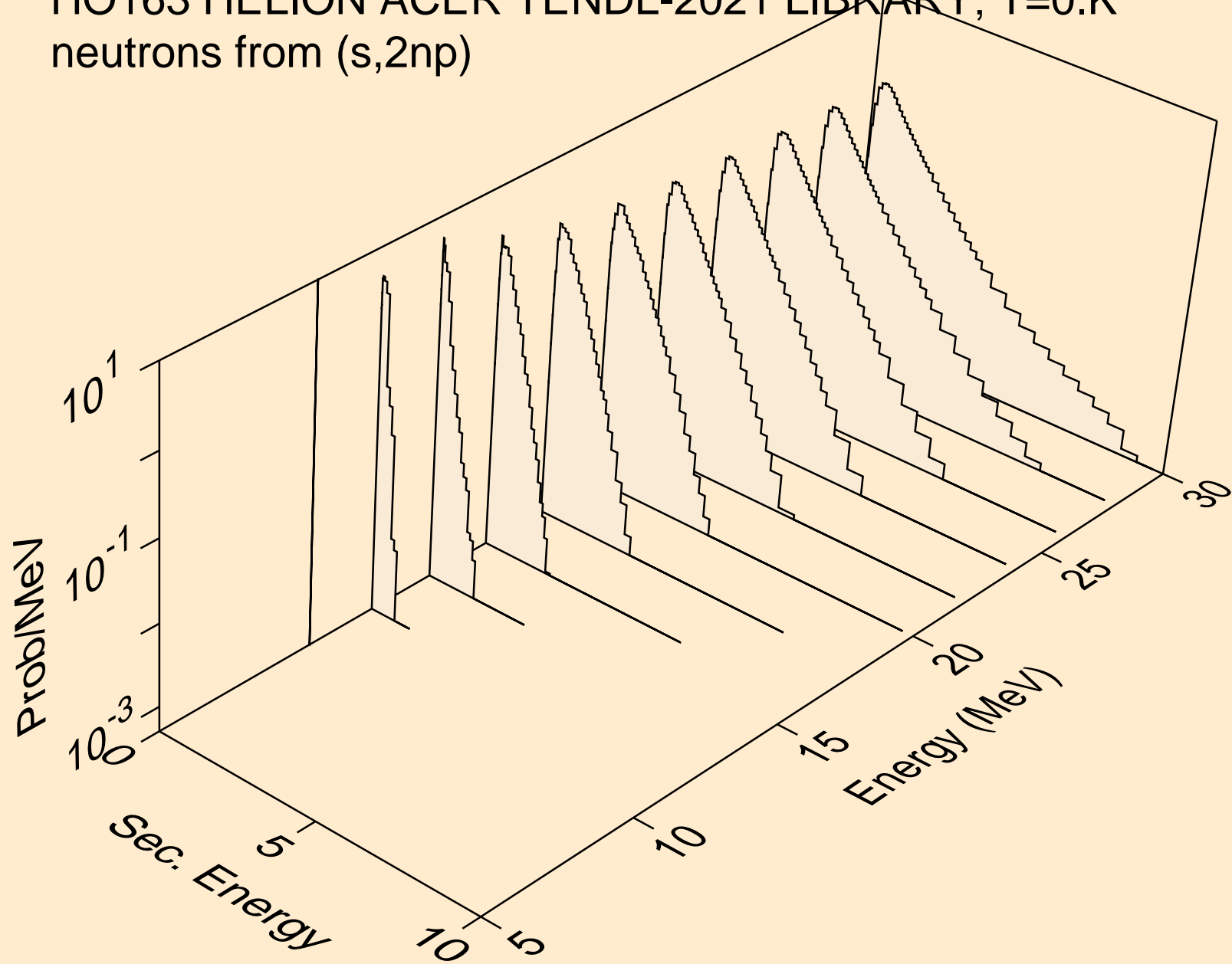

HO163 HELION ACER TENDL-2021 LIBRARY; T=0.K  
neutrons from (s,3np)

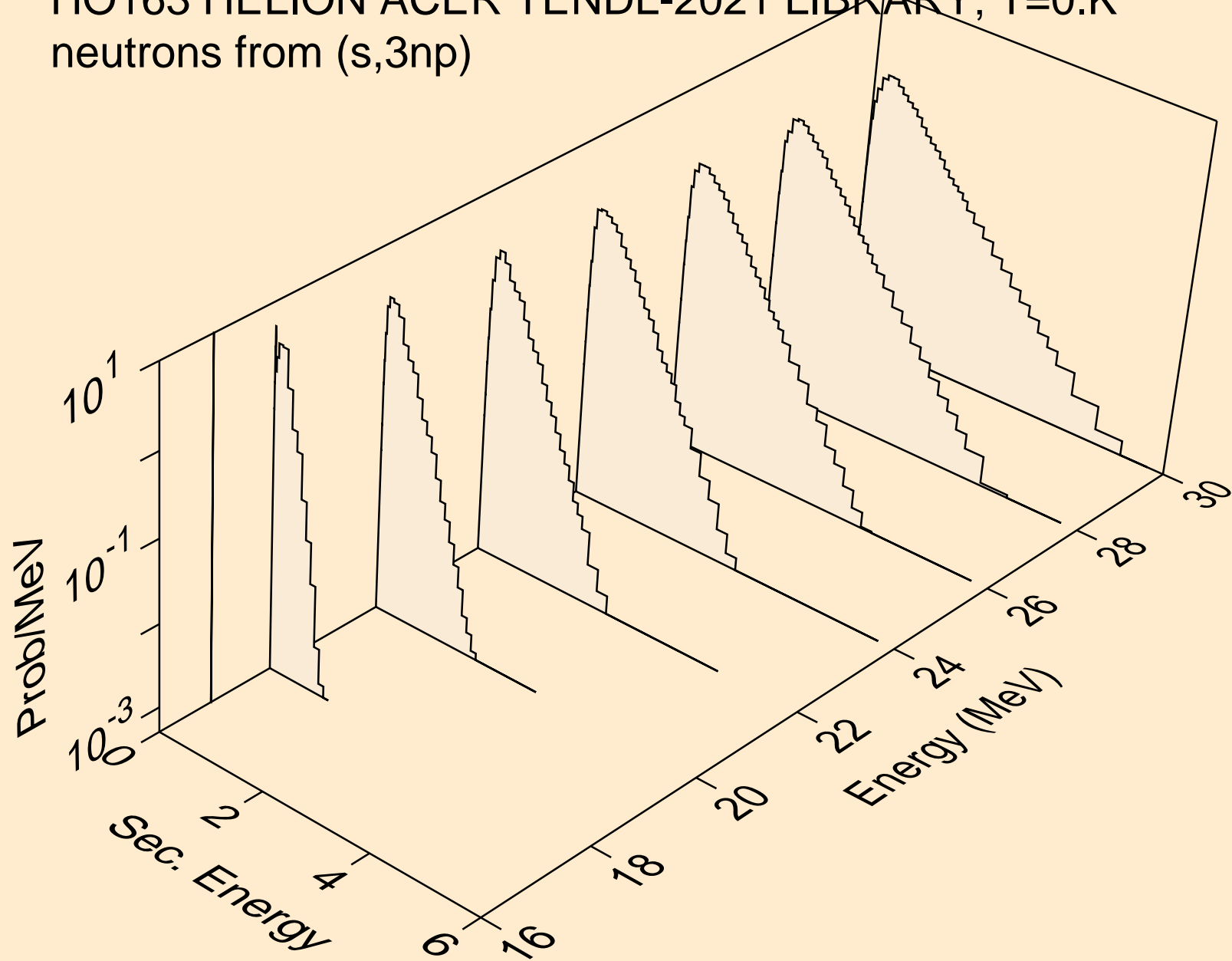

HO163 HELION ACER TENDL-2021 LIBRARY; T=0.K  
neutrons from (s,2np)

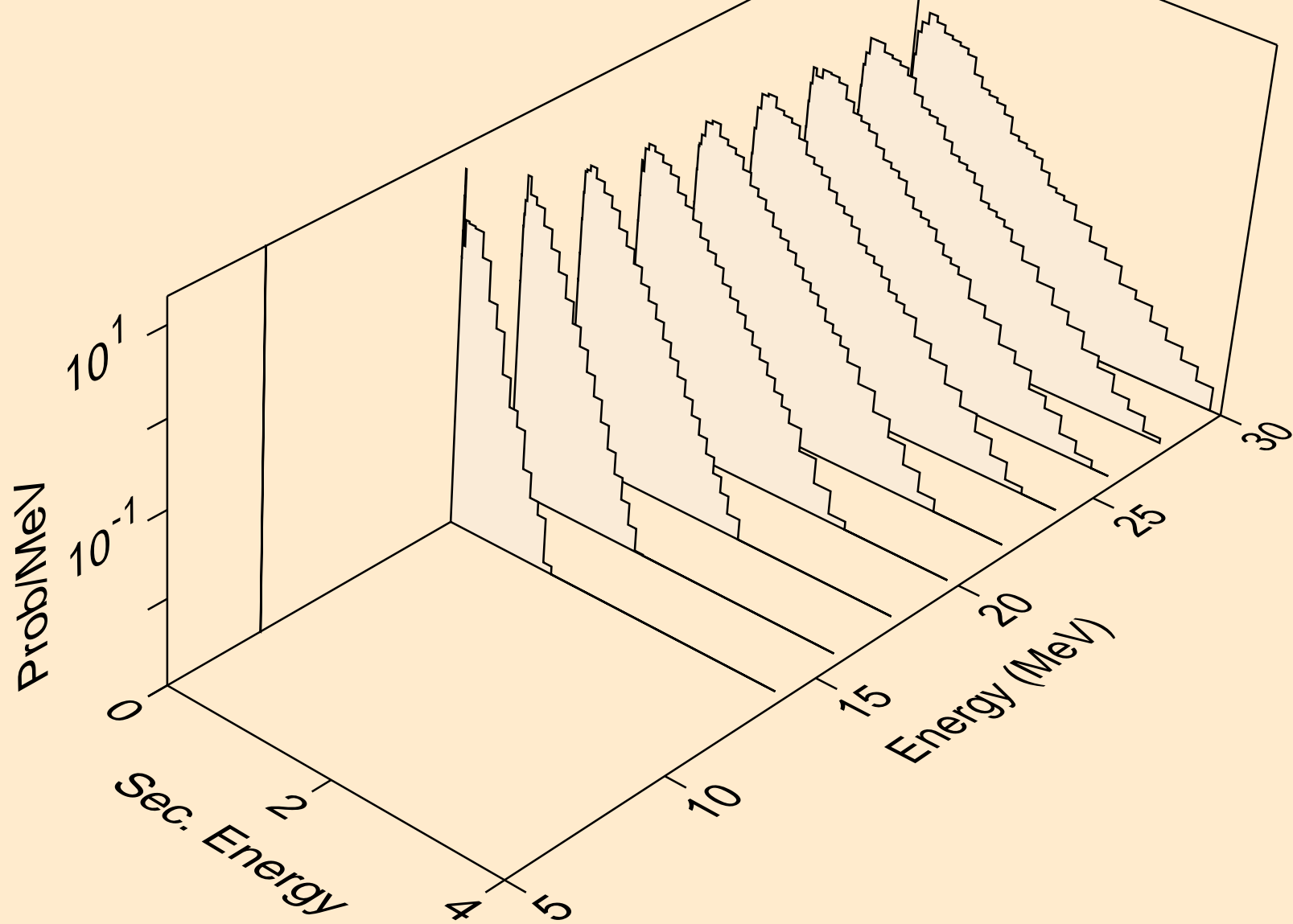

HO163 HELION ACER TENDL-2021 LIBRARY; T=0.K  
neutrons from (s,npa)

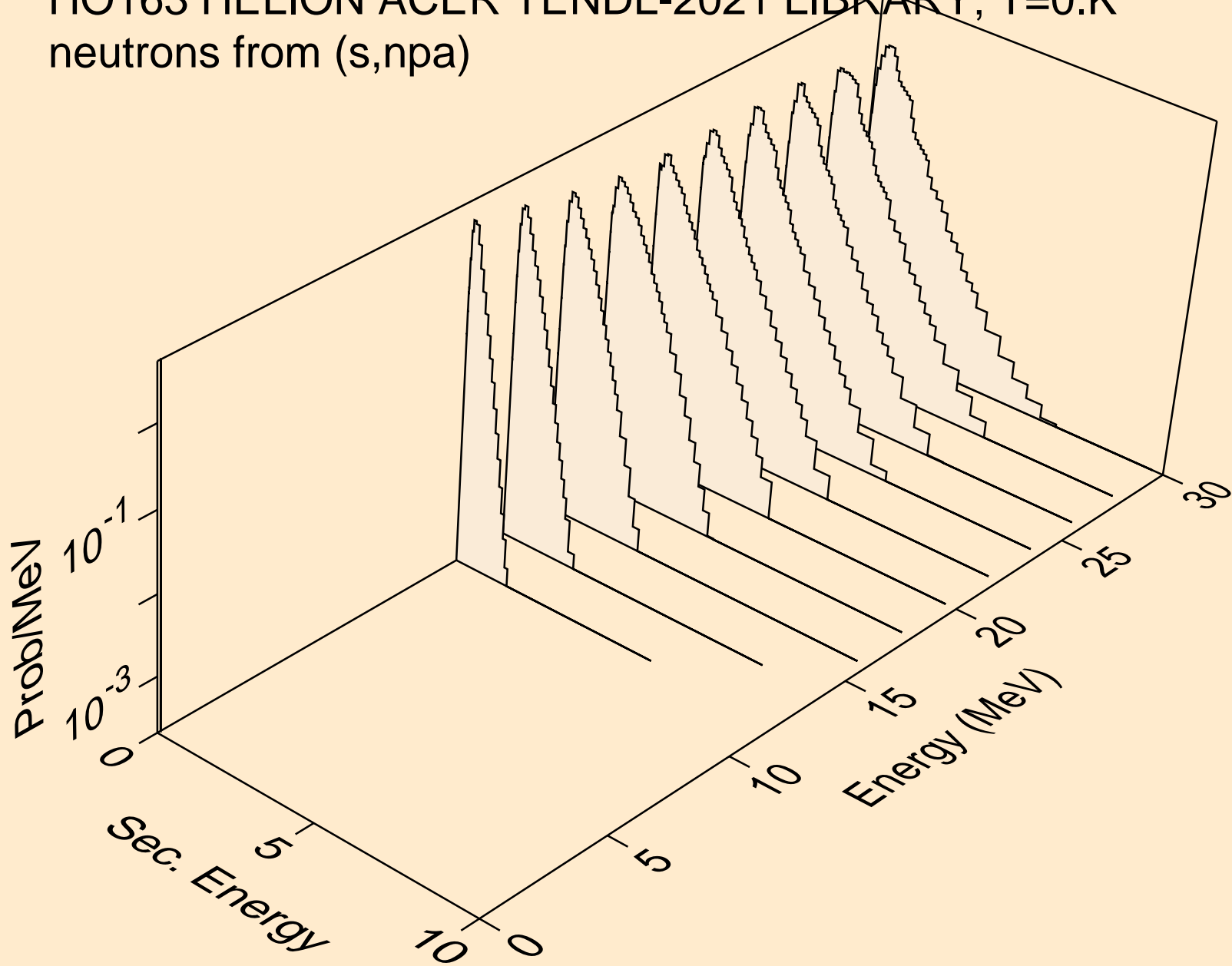

HO163 HELION ACER TENDL-2021 LIBRARY; T=0.K  
protons from (s,x)

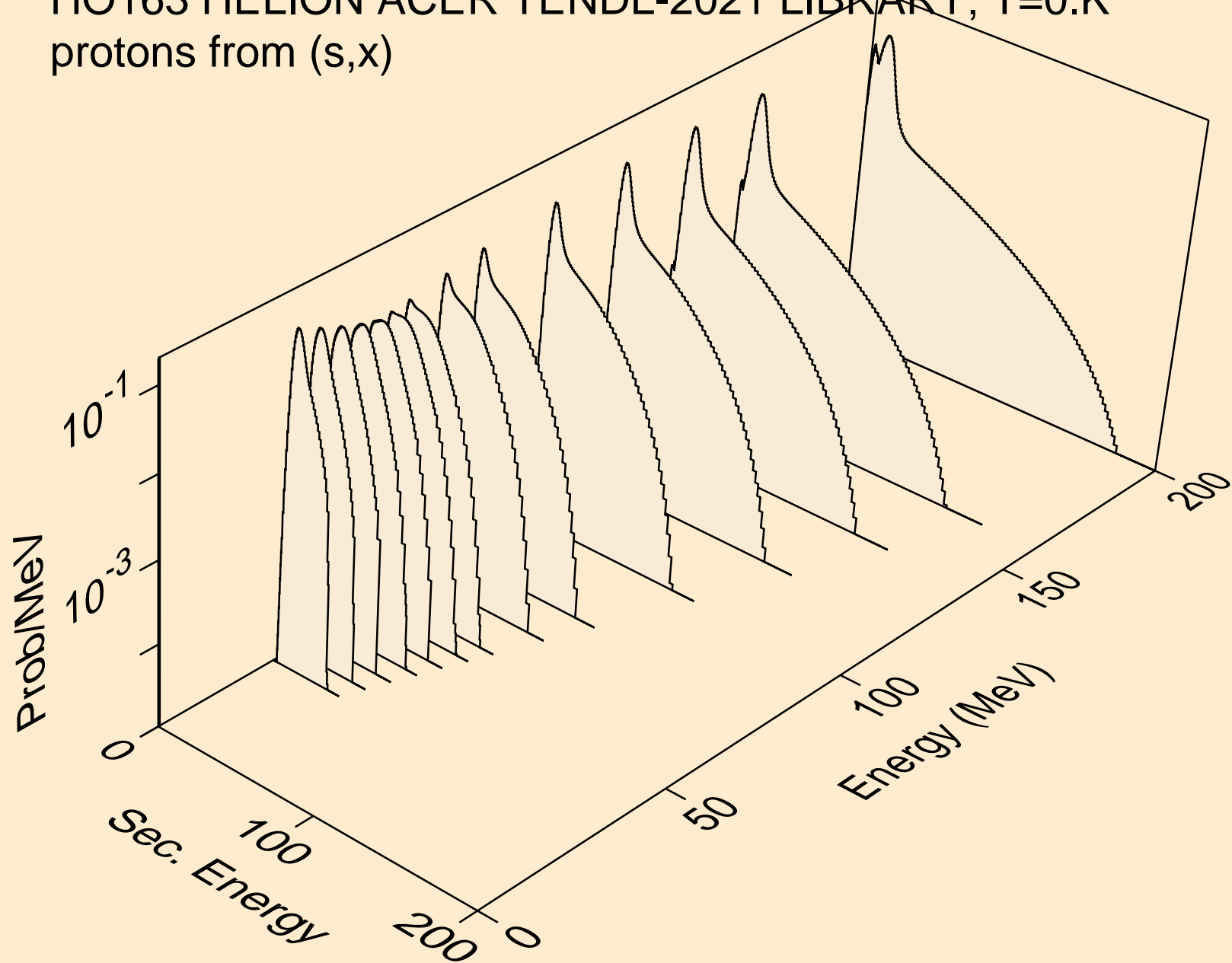

HO163 HELION ACER TENDL-2021 LIBRARY; T=0.K  
protons from (s,n\*)p

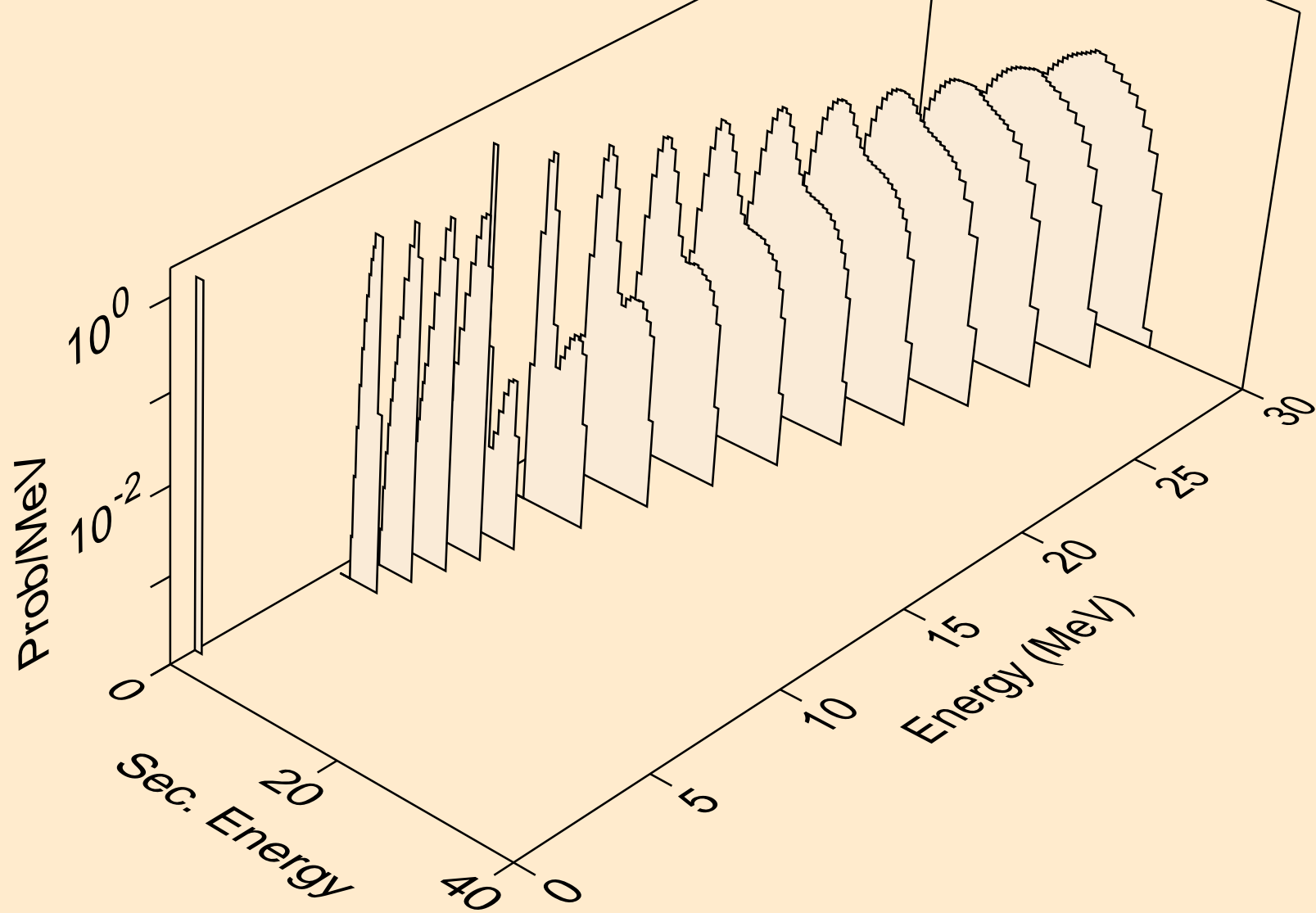

HO163 HELION ACER TENDL-2021 LIBRARY; T=0.K  
protons from (s,2np)

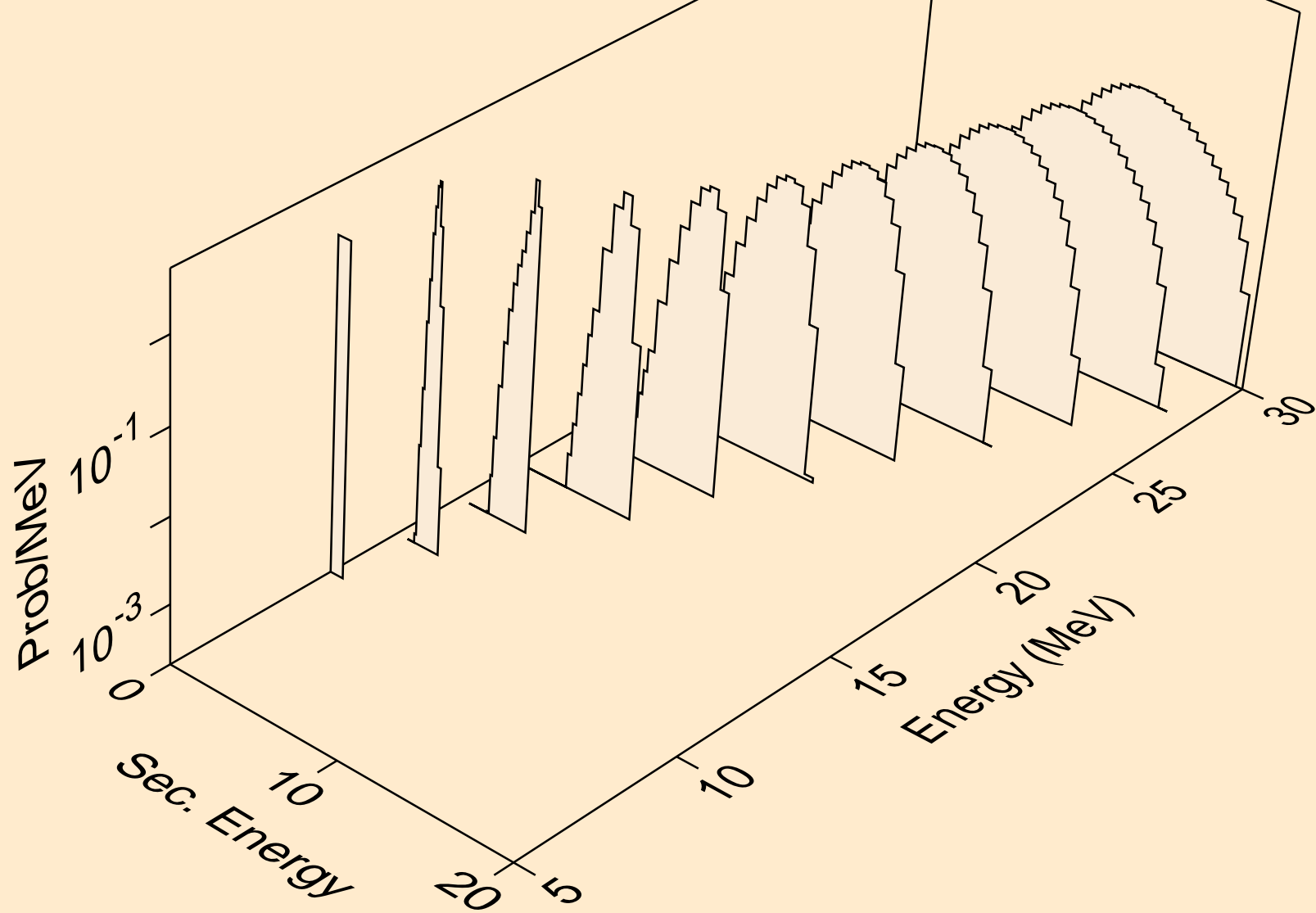

HO163 HELION ACER TENDL-2021 LIBRARY; T=0.K  
protons from (s,3np)

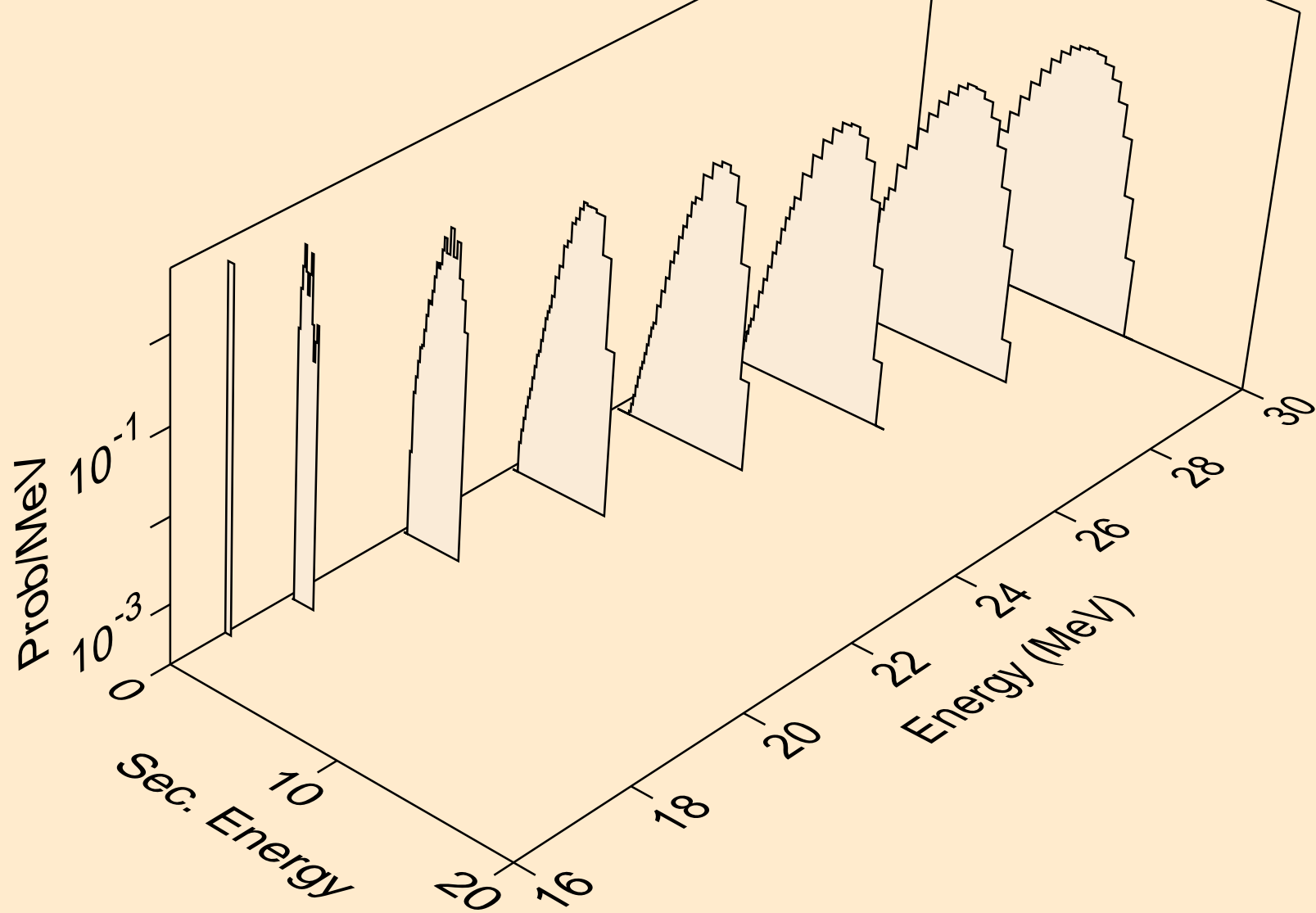



HO163 HELION ACER TENDL-2021 LIBRARY; T=0.K  
protons from (s,2np)

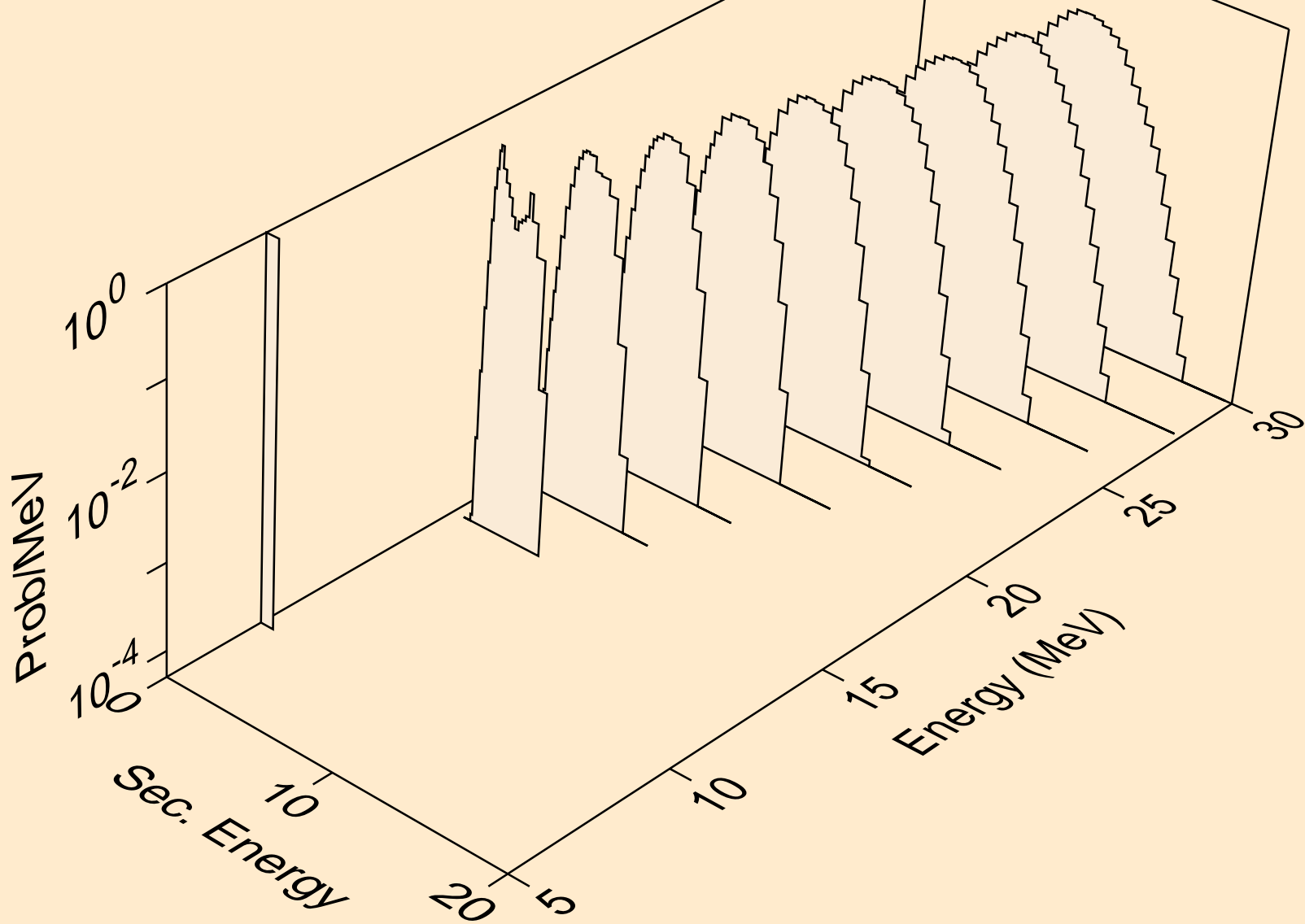

HO163 HELION ACER TENDL-2021 LIBRARY; T=0.K  
protons from (s,npa)

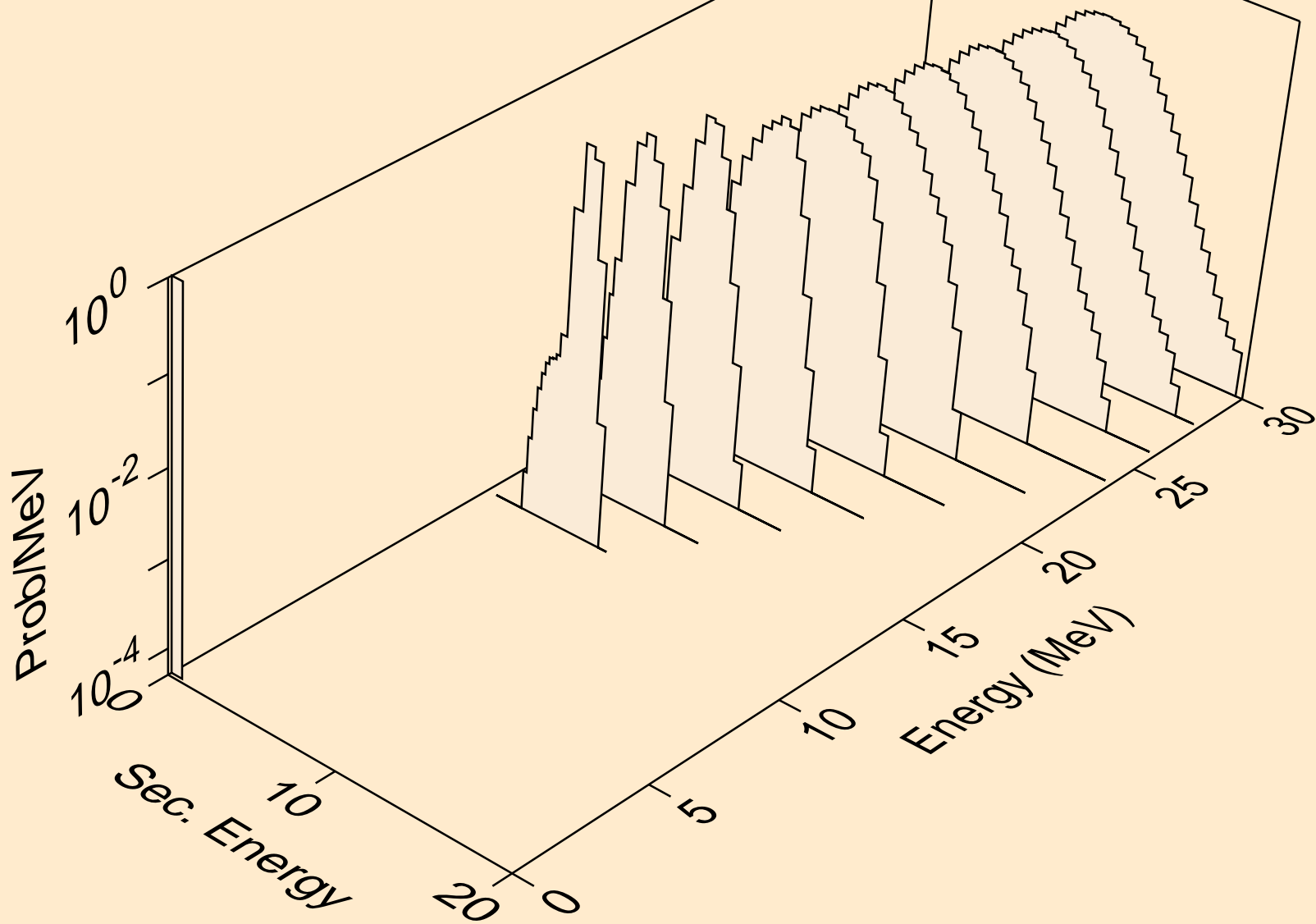

HO163 HELION ACER TENDL-2021 LIBRARY; T=0.K  
protons from (s,p)

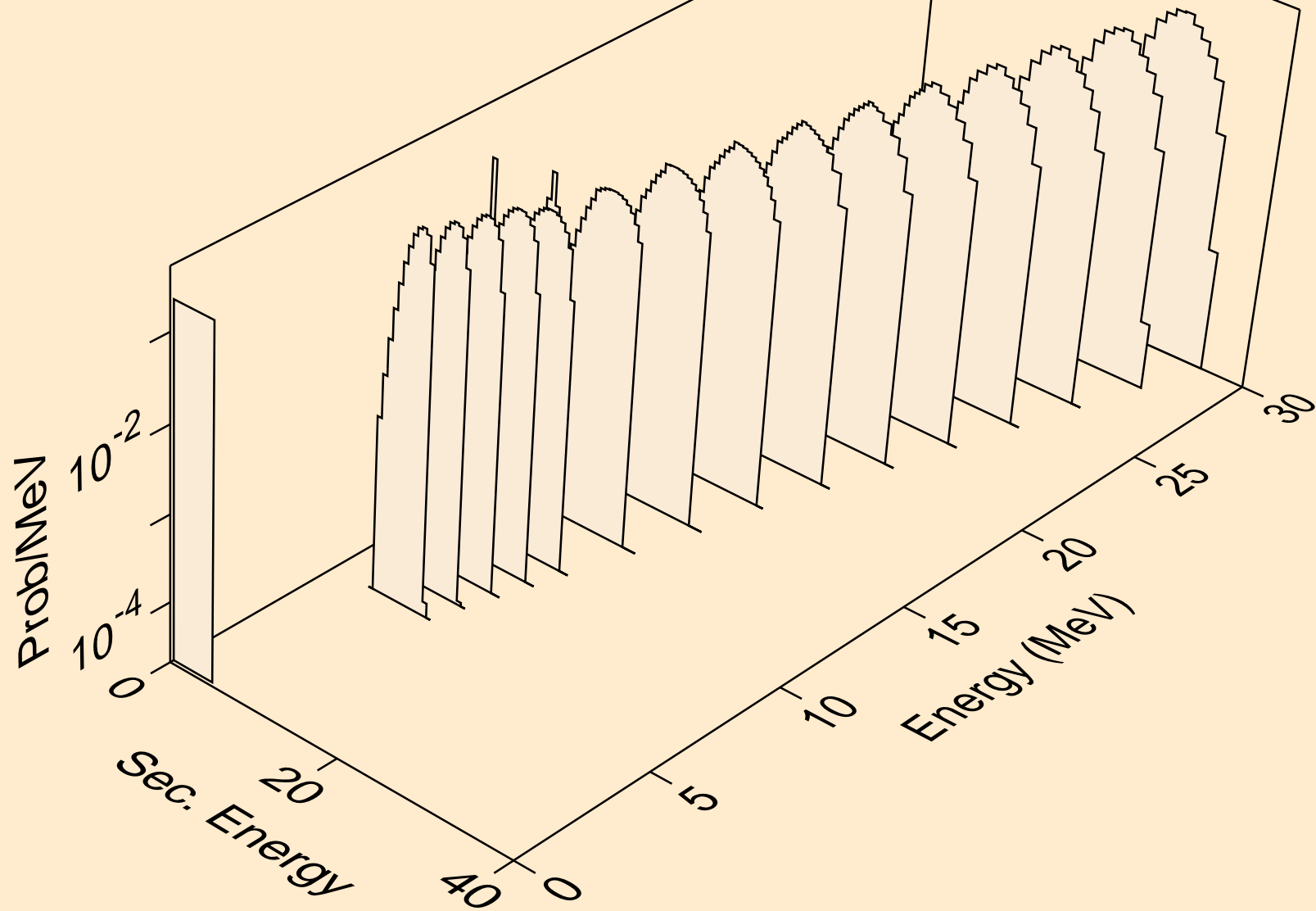

HO163 HELION ACER TENDL-2021 LIBRARY; T=0.K  
protons from (s,2p)

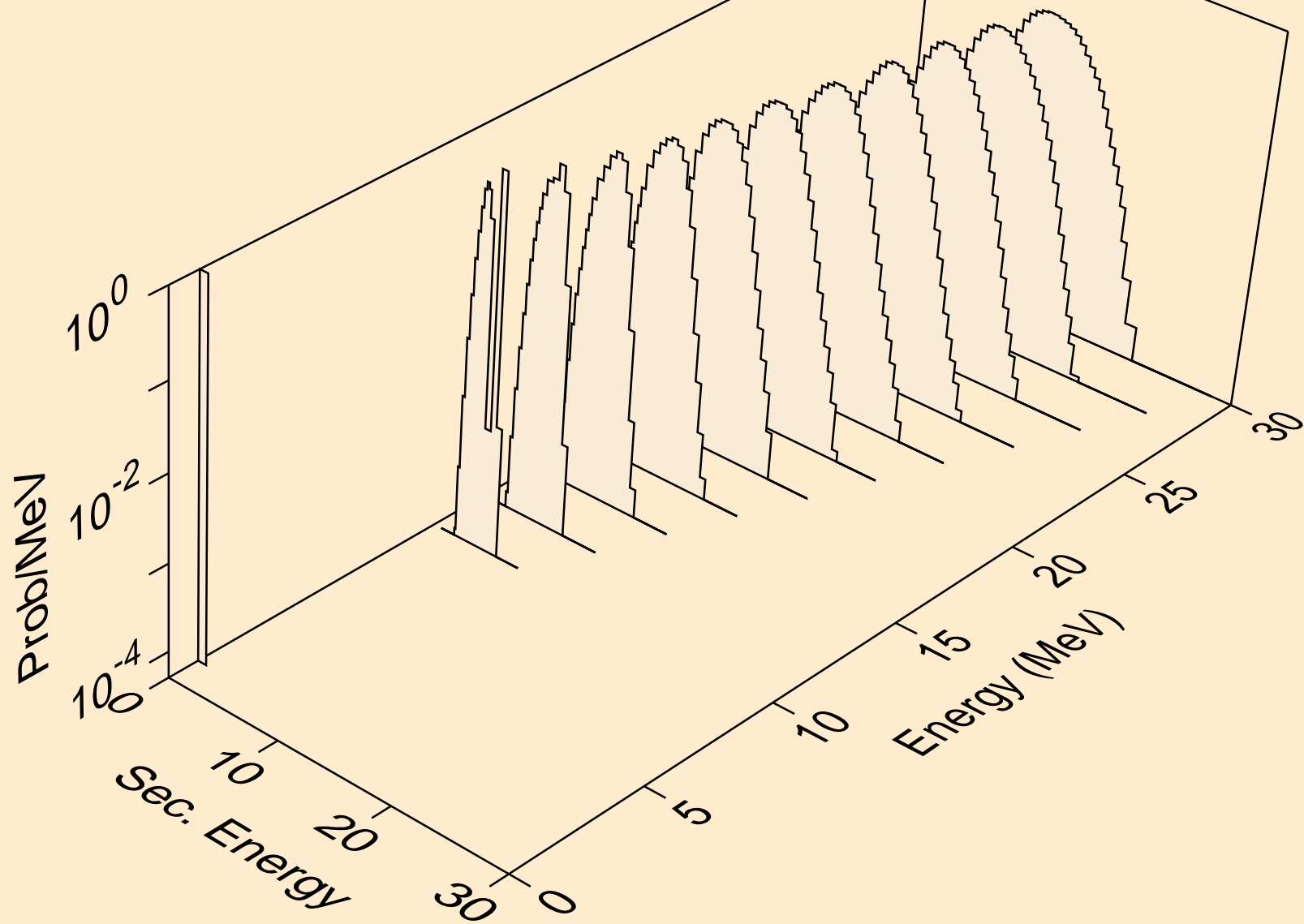

HO163 HELION ACER TENDL-2021 LIBRARY; T=0.K  
protons from (s,pa)

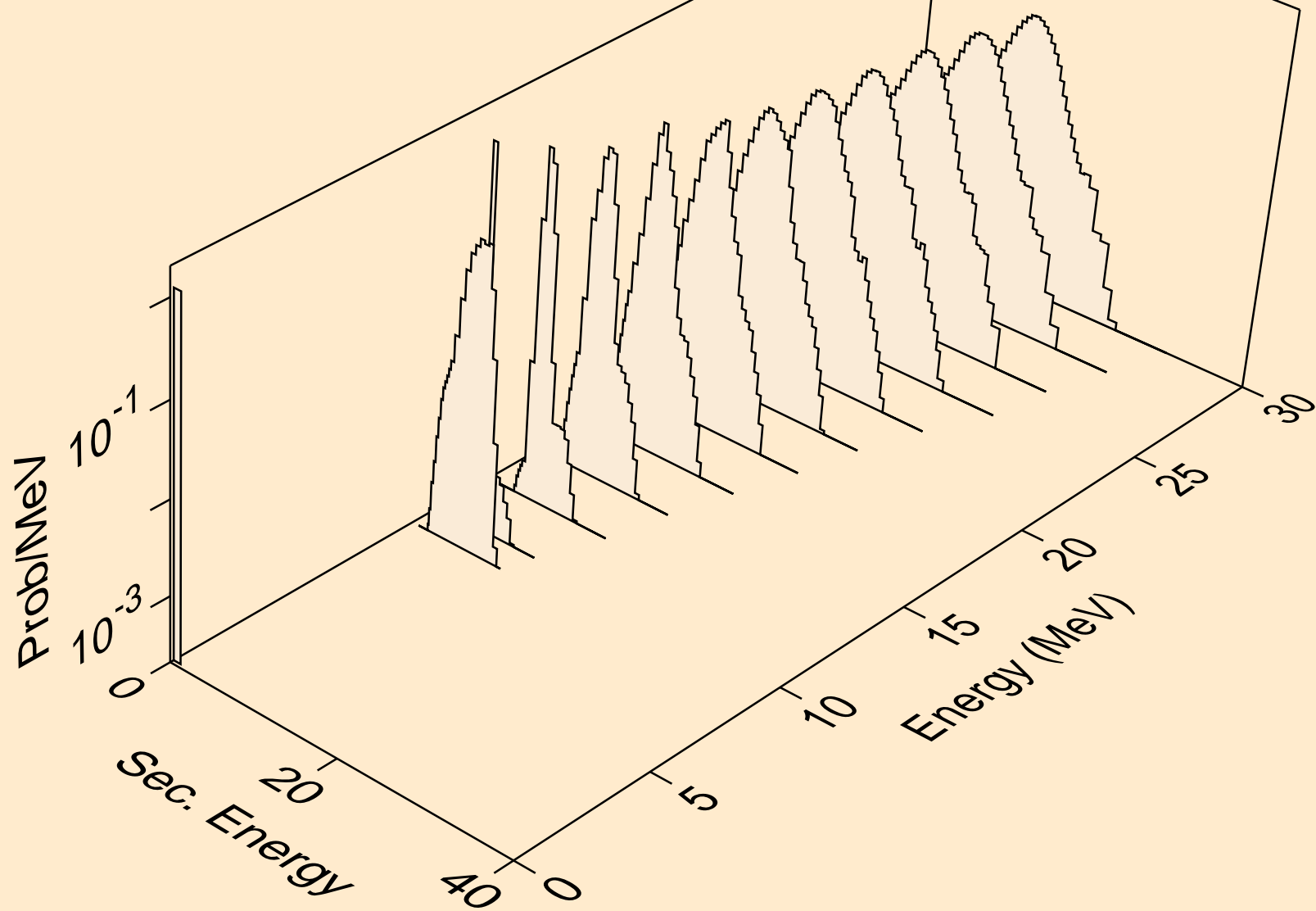

HO163 HELION ACER TENDL-2021 LIBRARY; T=0.K  
protons from (s,pd)

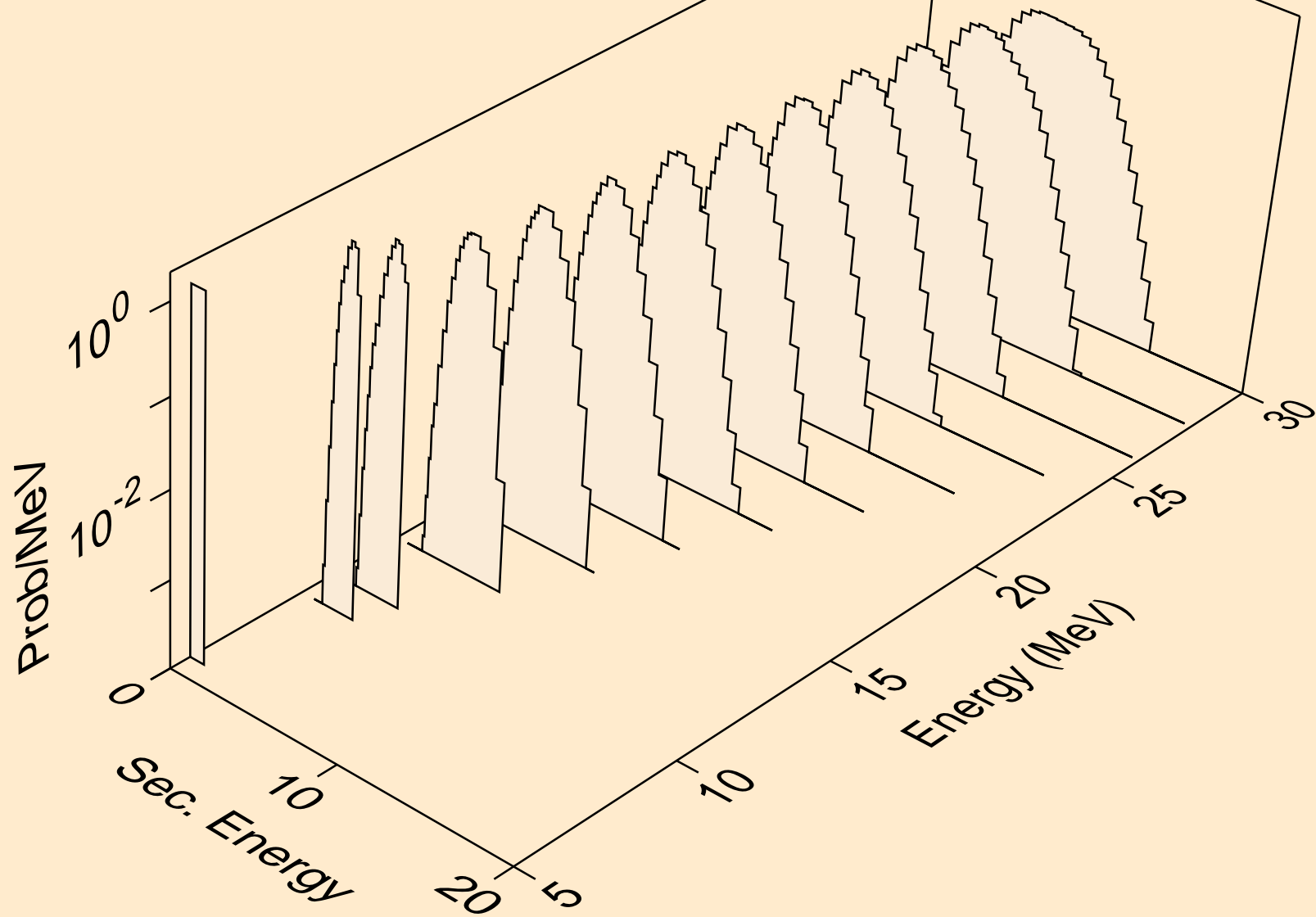

HO163 HELION ACER TENDL-2021 LIBRARY; T=0.K  
protons from (s,pt)

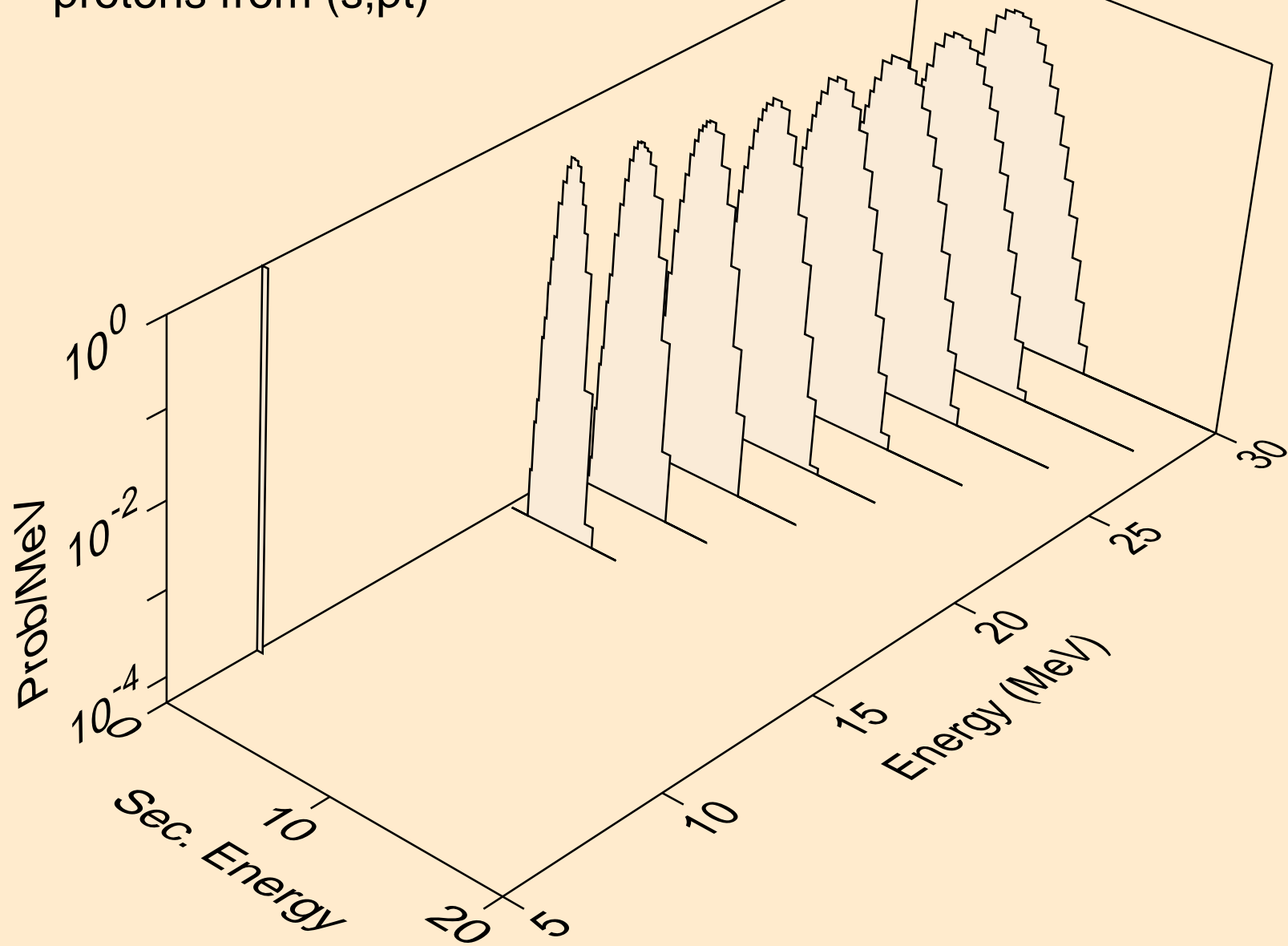

HO163 HELION ACER TENDL-2021 LIBRARY; T=0.K  
deuterons from (s,x)

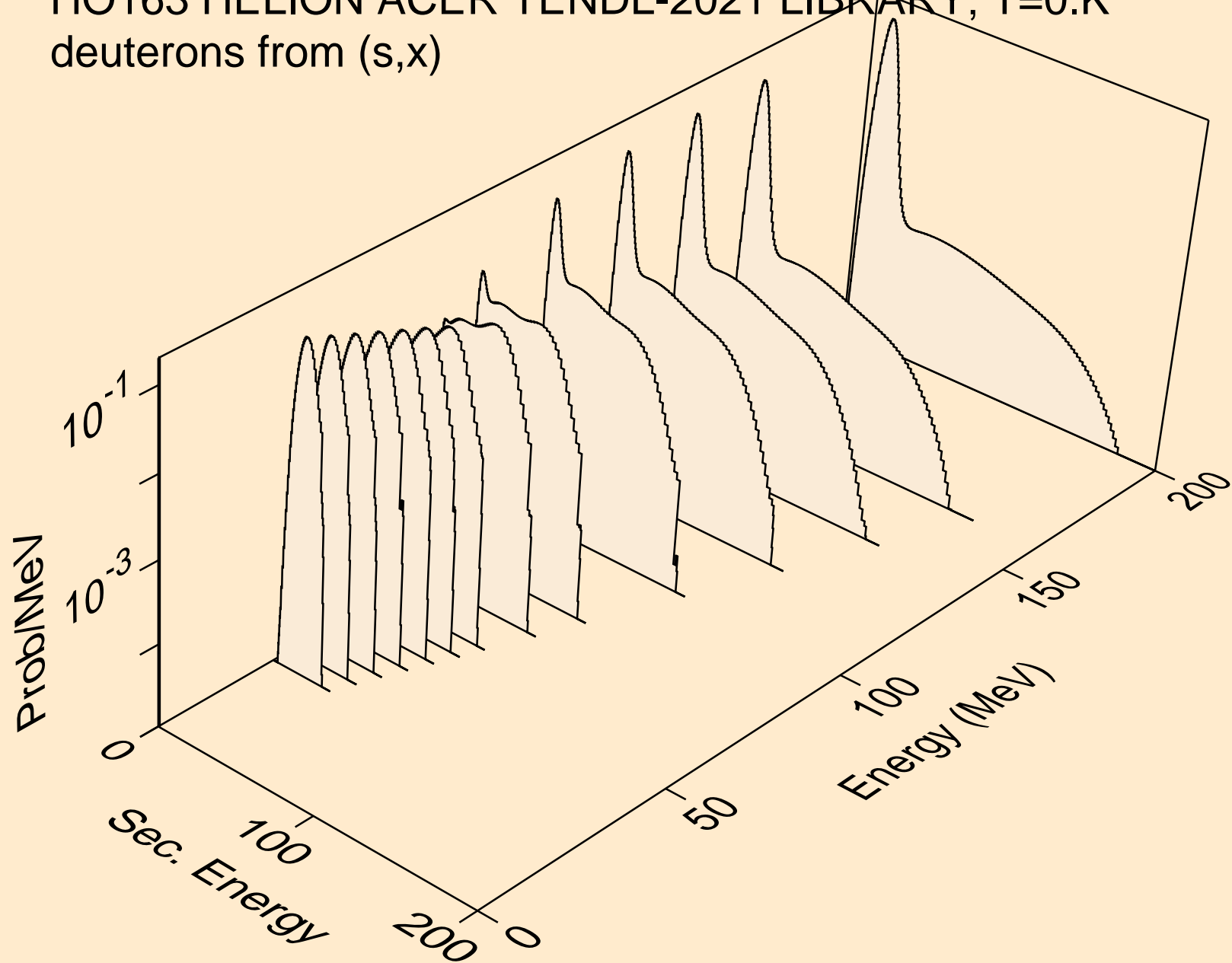



HO163 HELION ACER TENDL-2021 LIBRARY; T=0.K  
deuterons from (s,2nd)

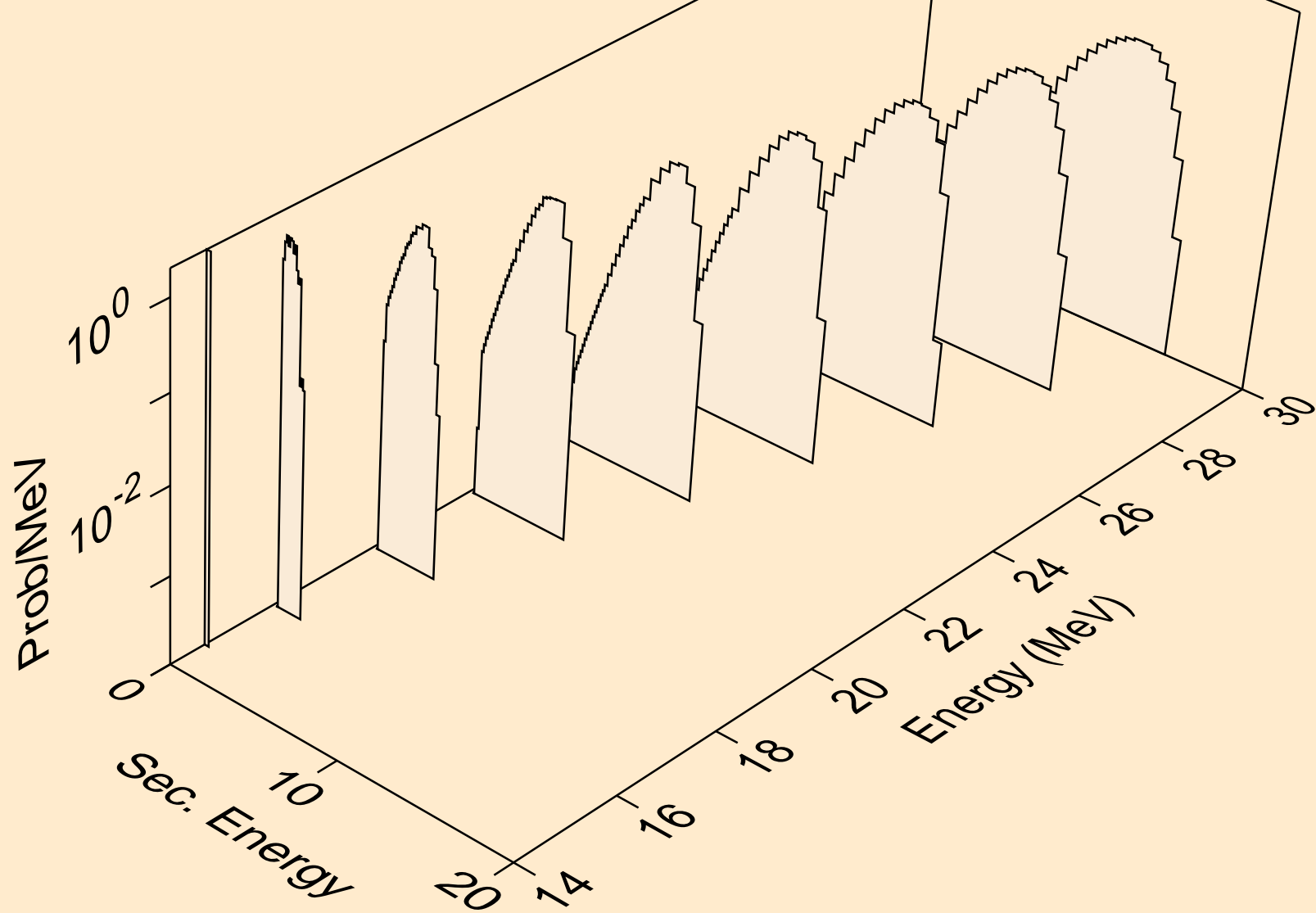

HO163 HELION ACER TENDL-2021 LIBRARY; T=0.K  
deuterons from (s,n\*)d

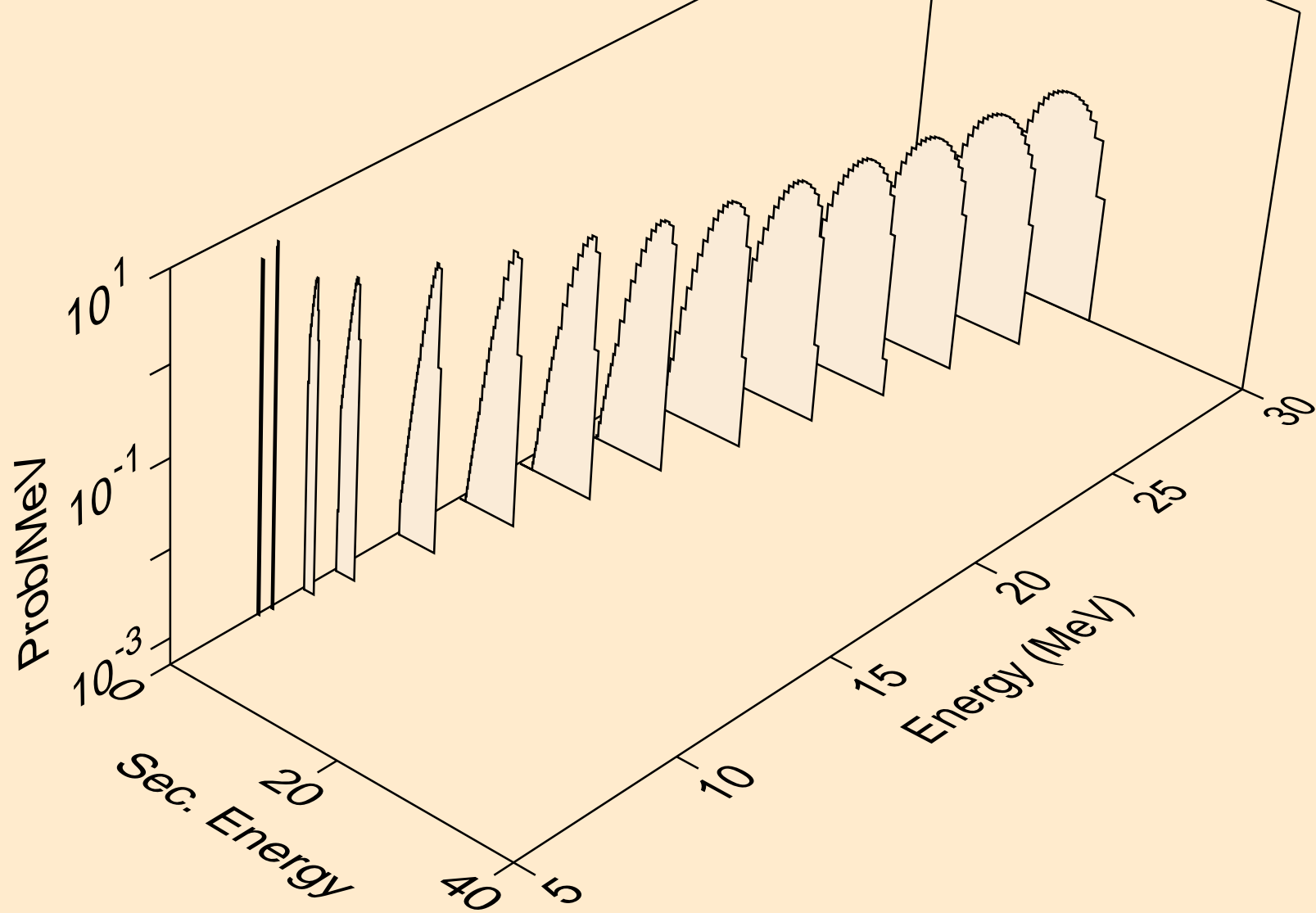

HO163 HELION ACER TENDL-2021 LIBRARY; T=0.K  
deuterons from (s,d)

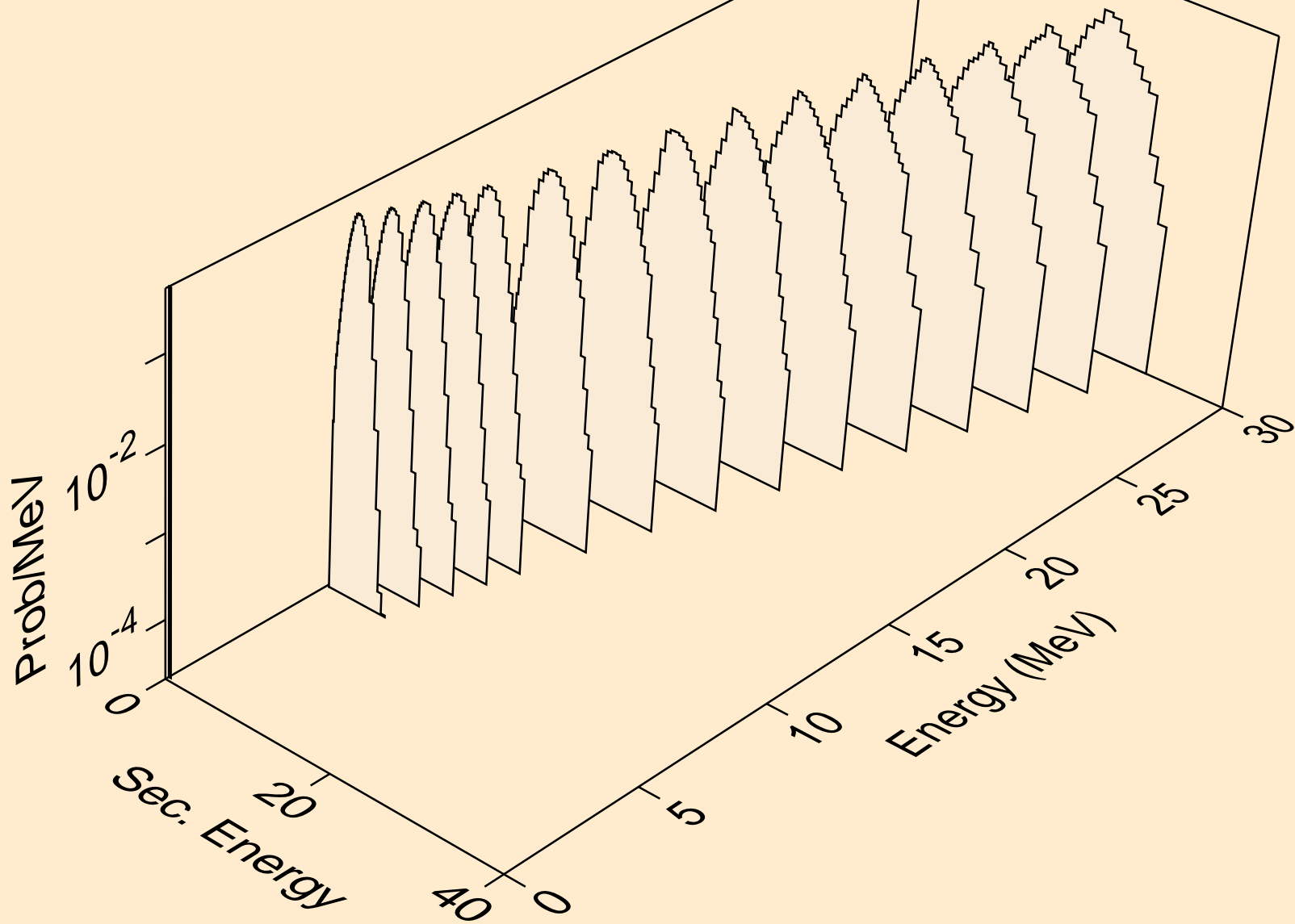

HO163 HELION ACER TENDL-2021 LIBRARY; T=0.K  
deuterons from (s,pd)

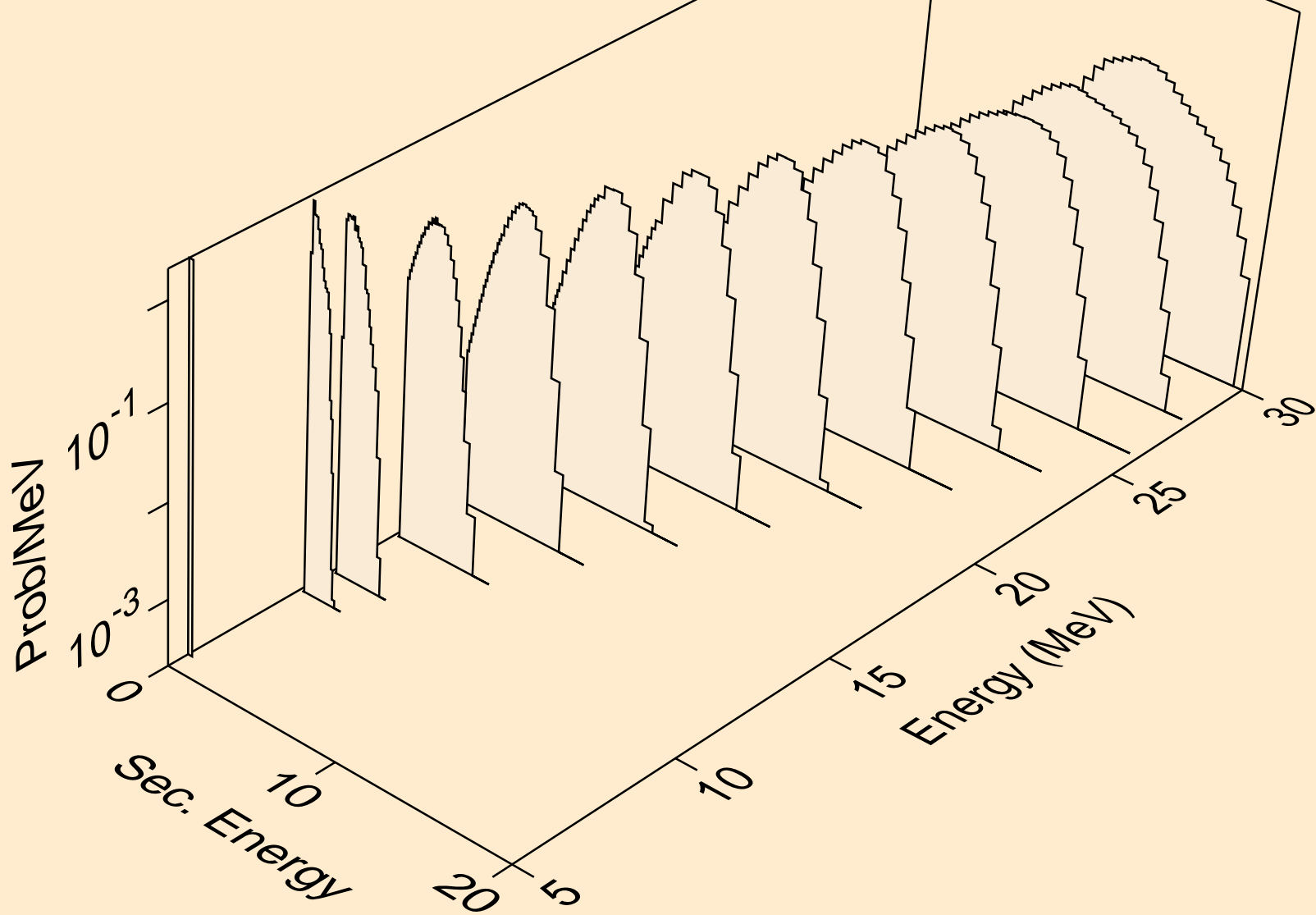

HO163 HELION ACER TENDL-2021 LIBRARY; T=0.K  
deuterons from (s,da)

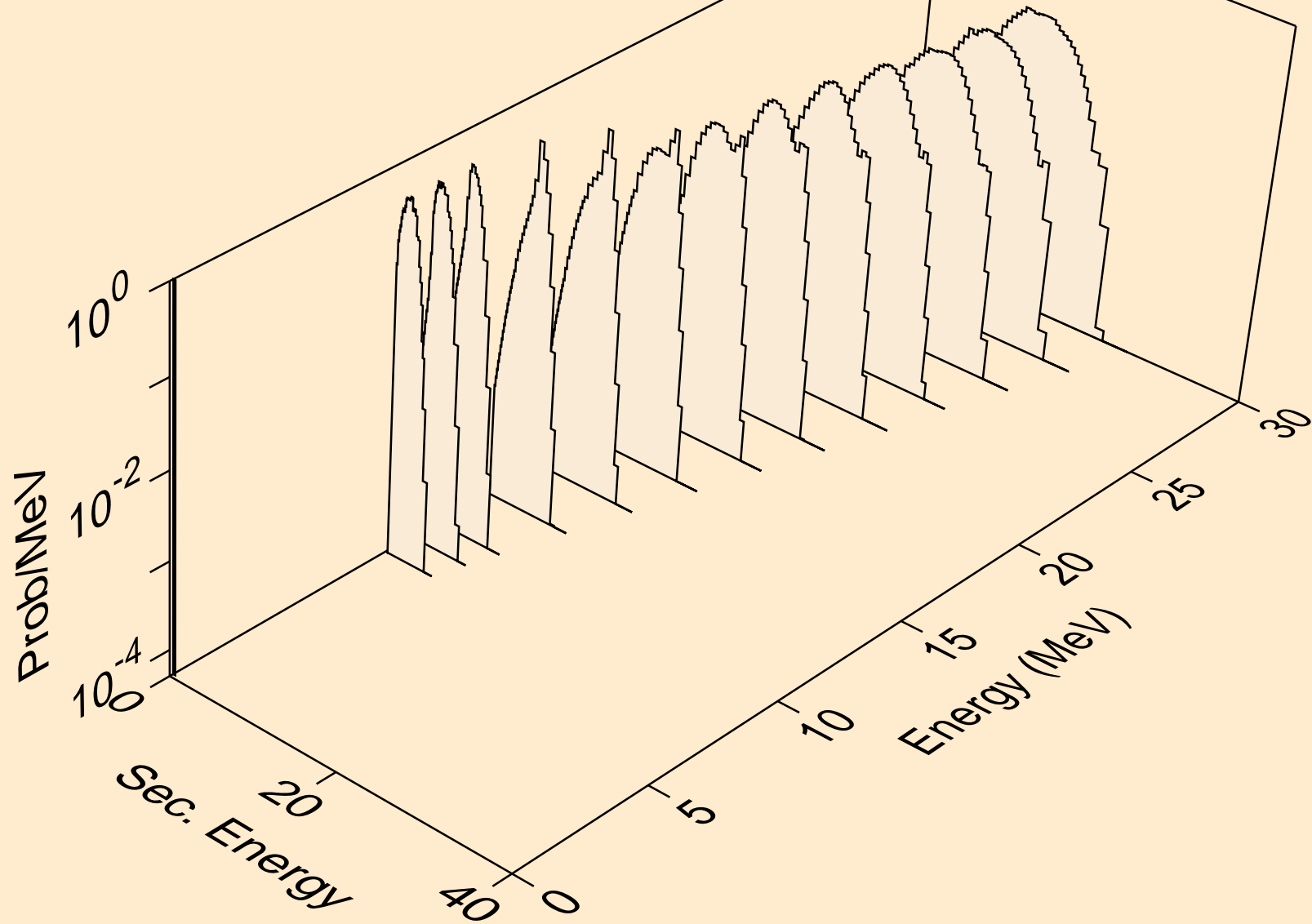

HO163 HELION ACER TENDL-2021 LIBRARY; T=0.K  
tritons from (s,x)

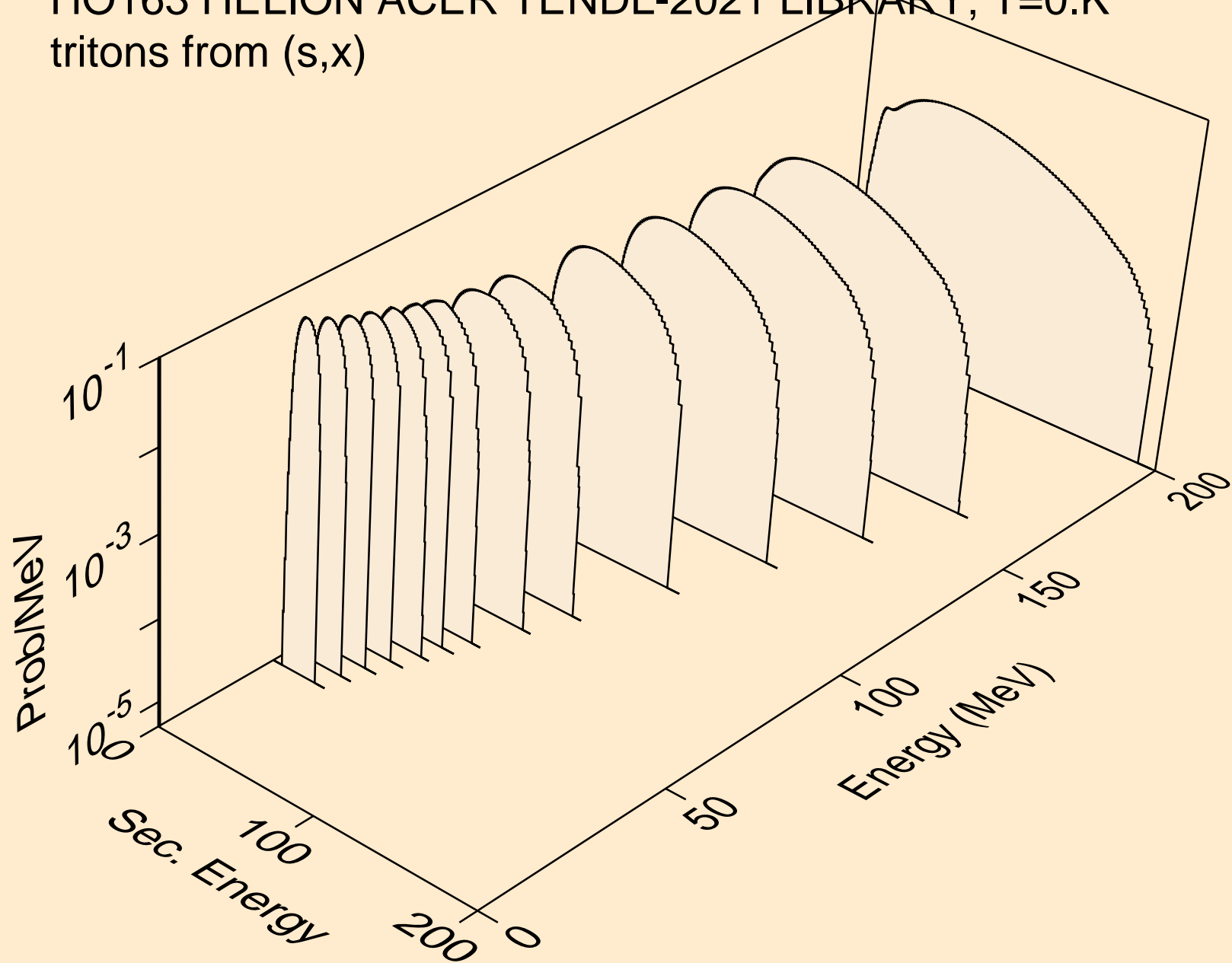

HO163 HELION ACER TENDL-2021 LIBRARY; T=0.K  
tritons from (s,n\*)t

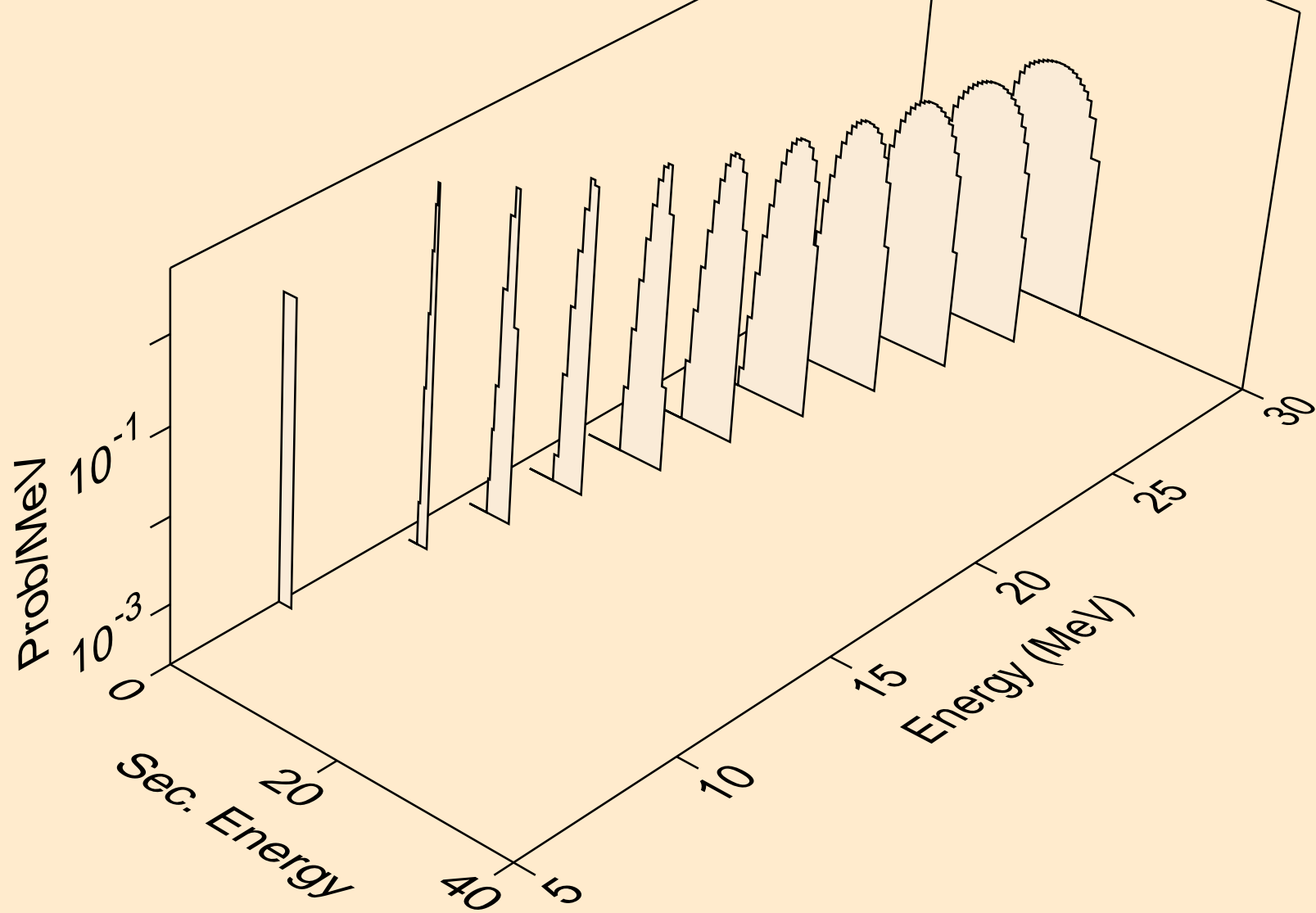

HO163 HELION ACER TENDL-2021 LIBRARY; T=0.K  
tritons from (s,t)

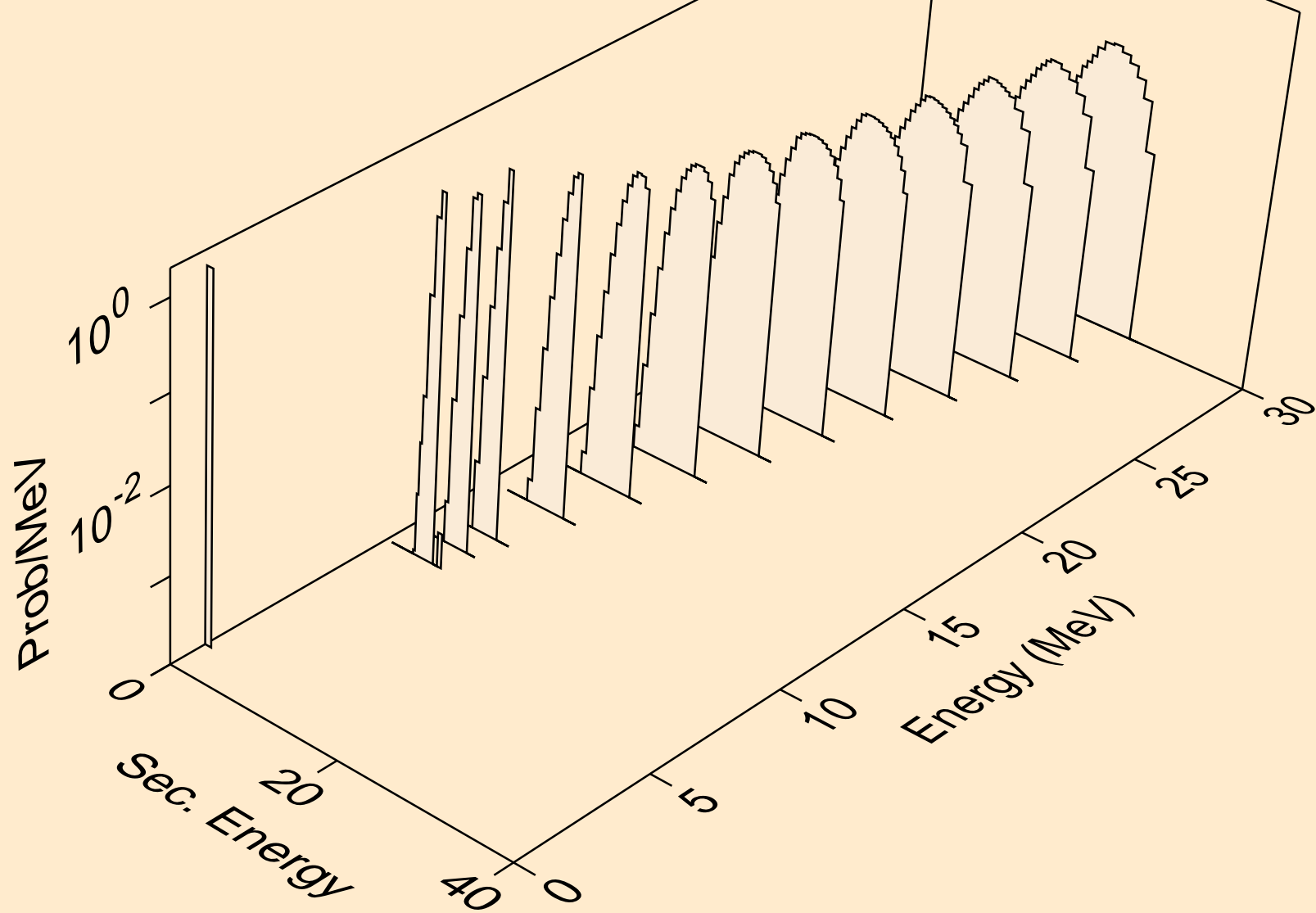



HO163 HELION ACER TENDL-2021 LIBRARY; T=0.K  
tritons from (s,pt)

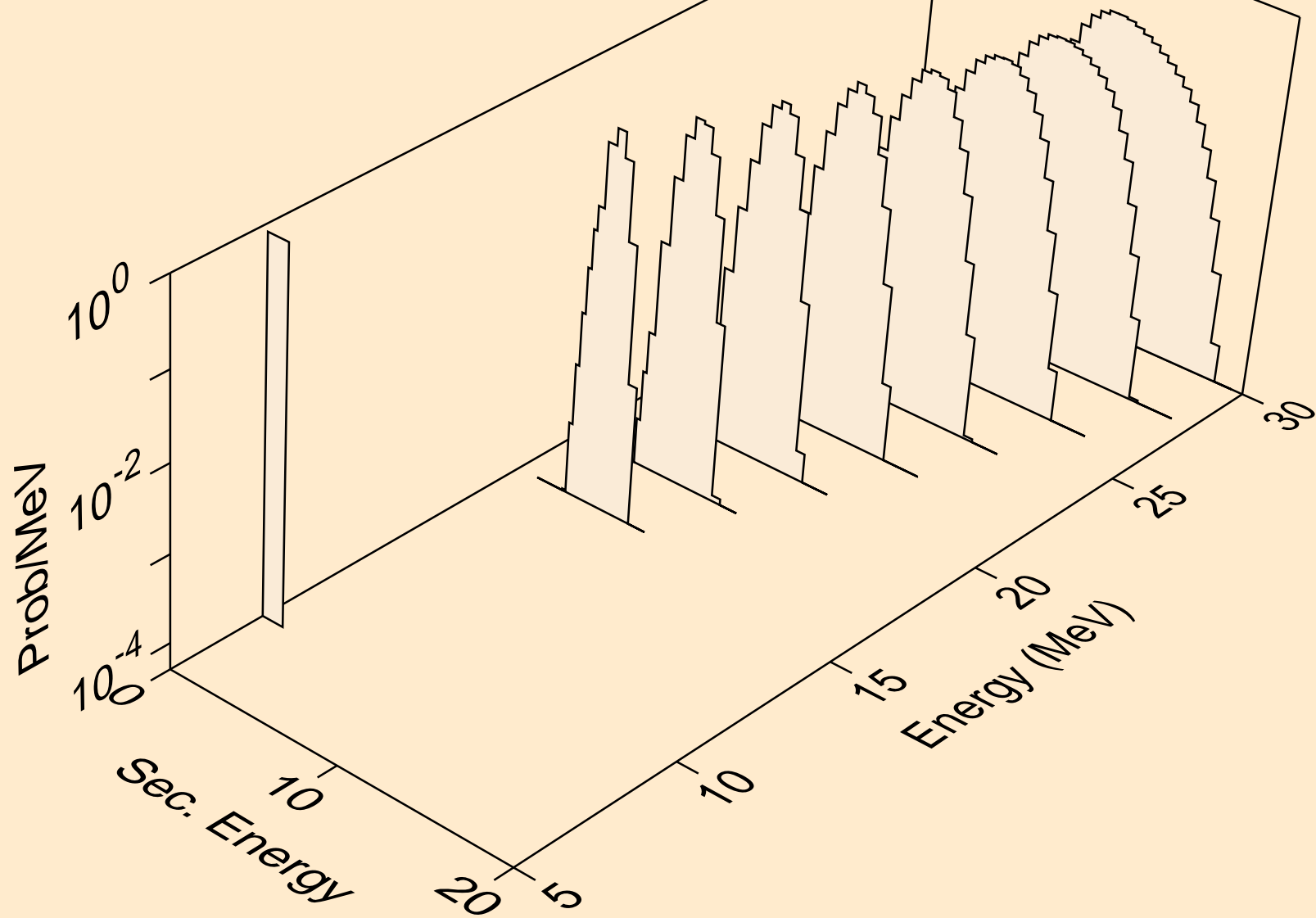

HO163 HELION ACER TENDL-2021 LIBRARY; T=0.K  
alphas from (s,x)

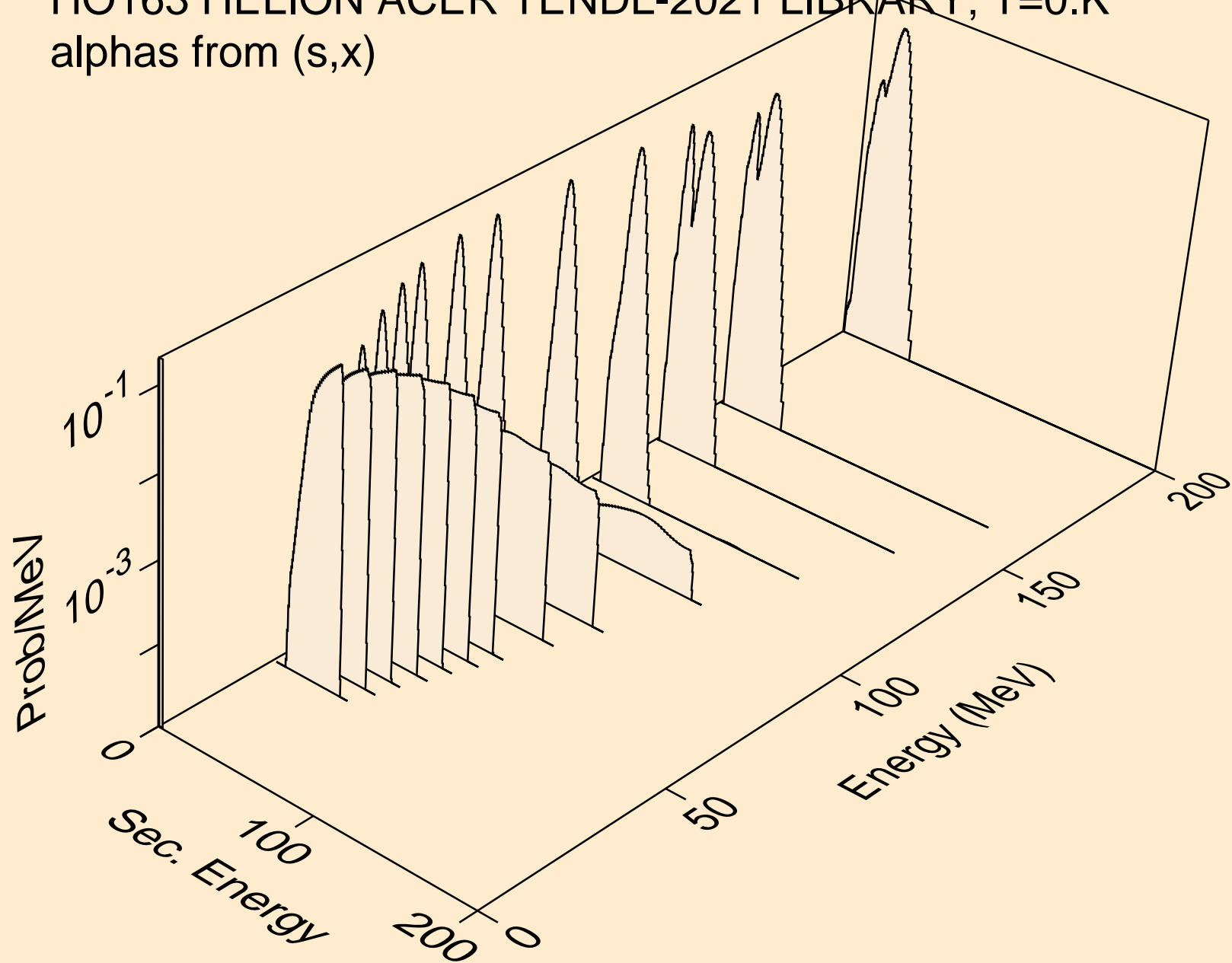

HO163 HELION ACER TENDL-2021 LIBRARY; T=0.K  
alphas from (s,n\*)a

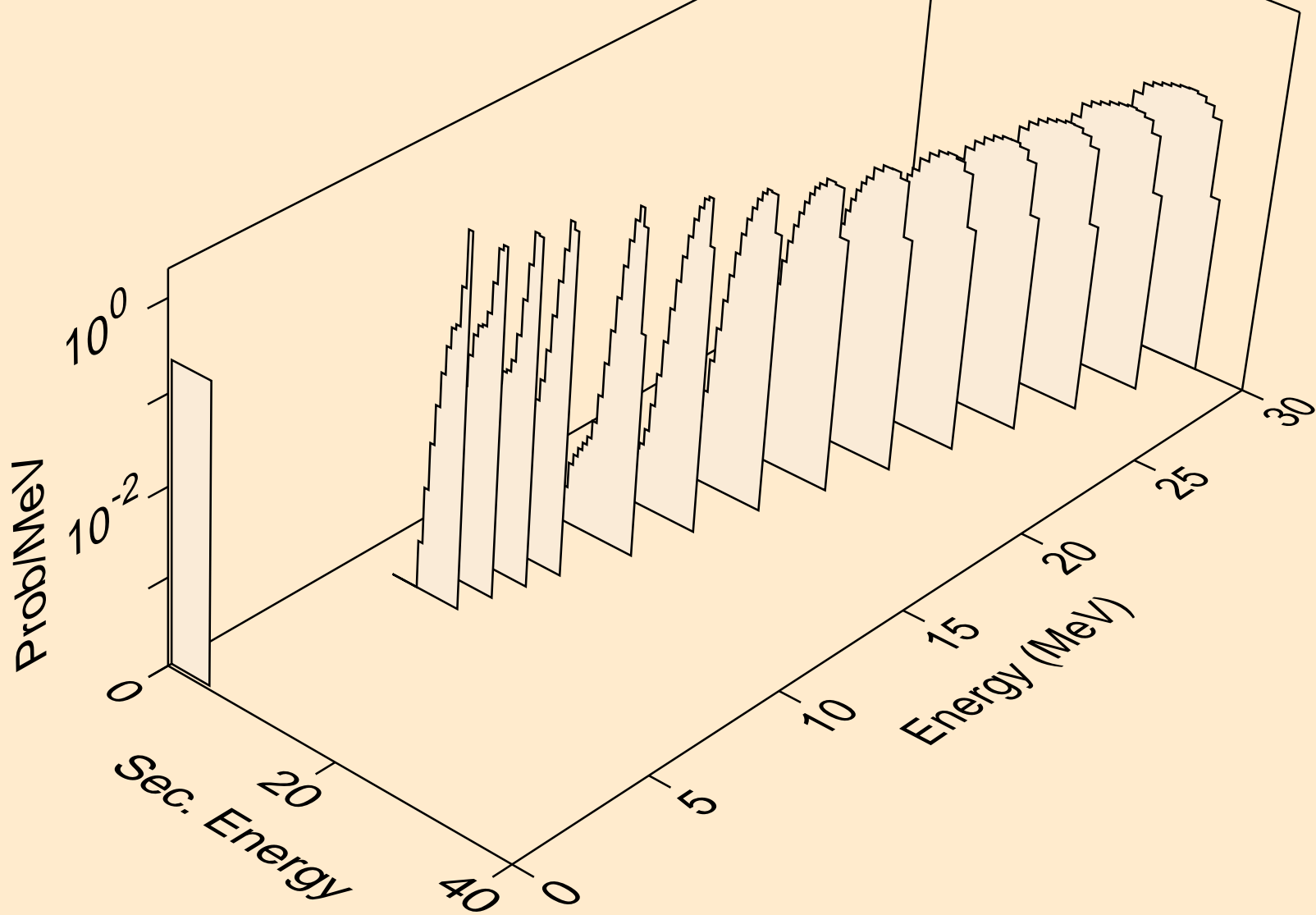

HO163 HELION ACER TENDL-2021 LIBRARY; T=0.K  
alphas from (s,2n)a

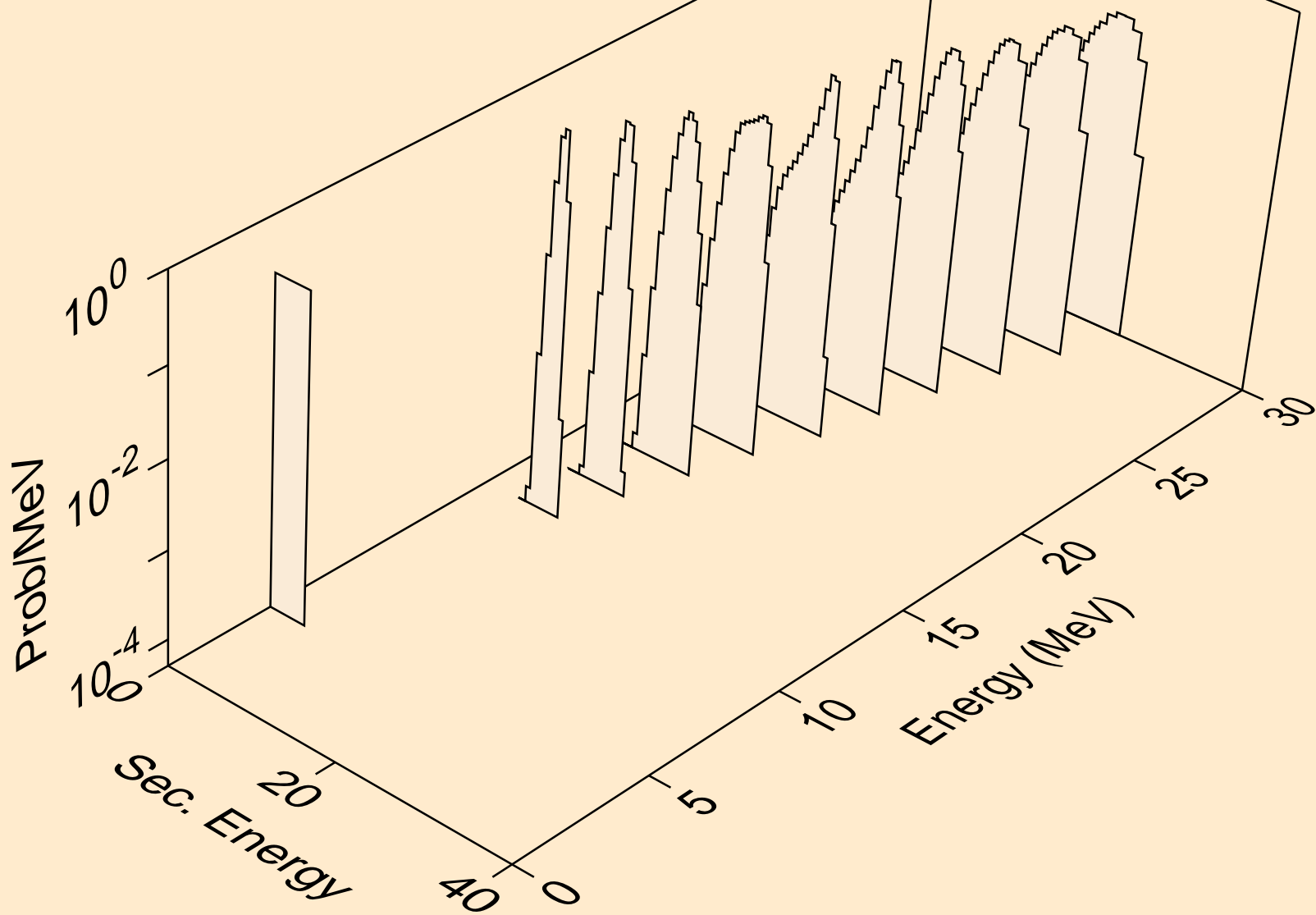

HO163 HELION ACER TENDL-2021 LIBRARY; T=0.K  
alphas from (s,3n)a

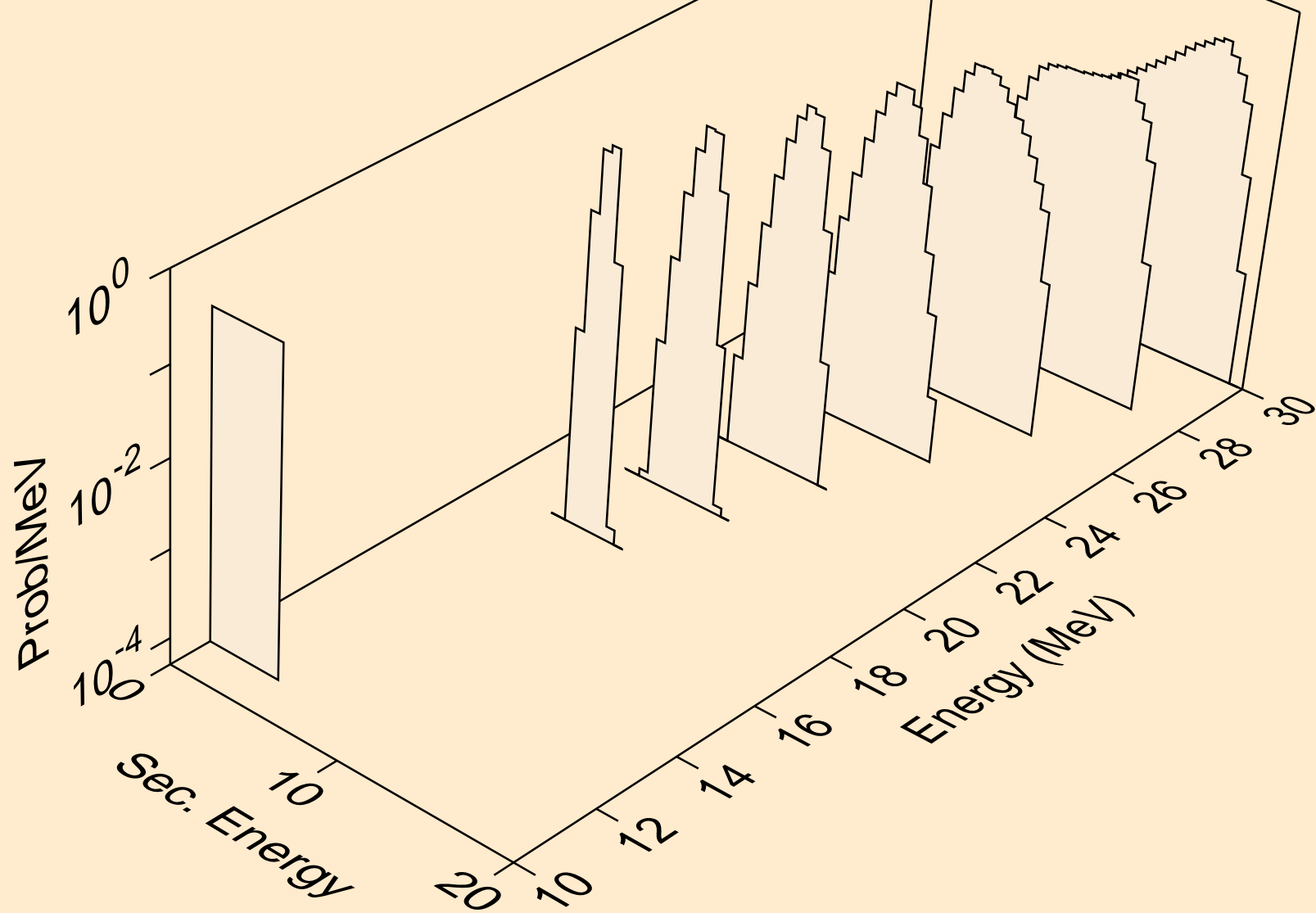

HO163 HELION ACER TENDL-2021 LIBRARY; T=0.K  
alphas from (s,n\*)2a

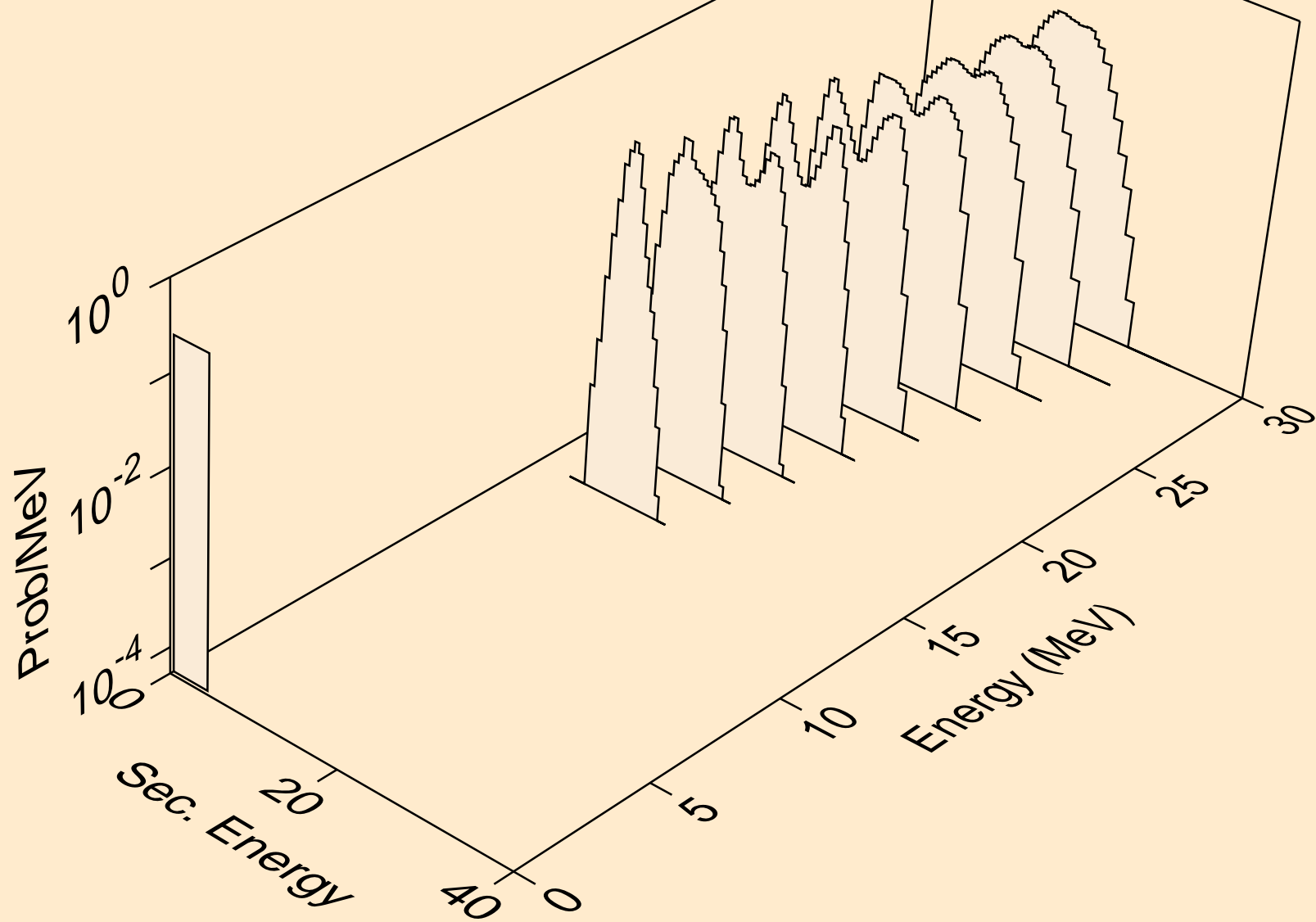

HO163 HELION ACER TENDL-2021 LIBRARY; T=0.K  
alphas from (s,npa)

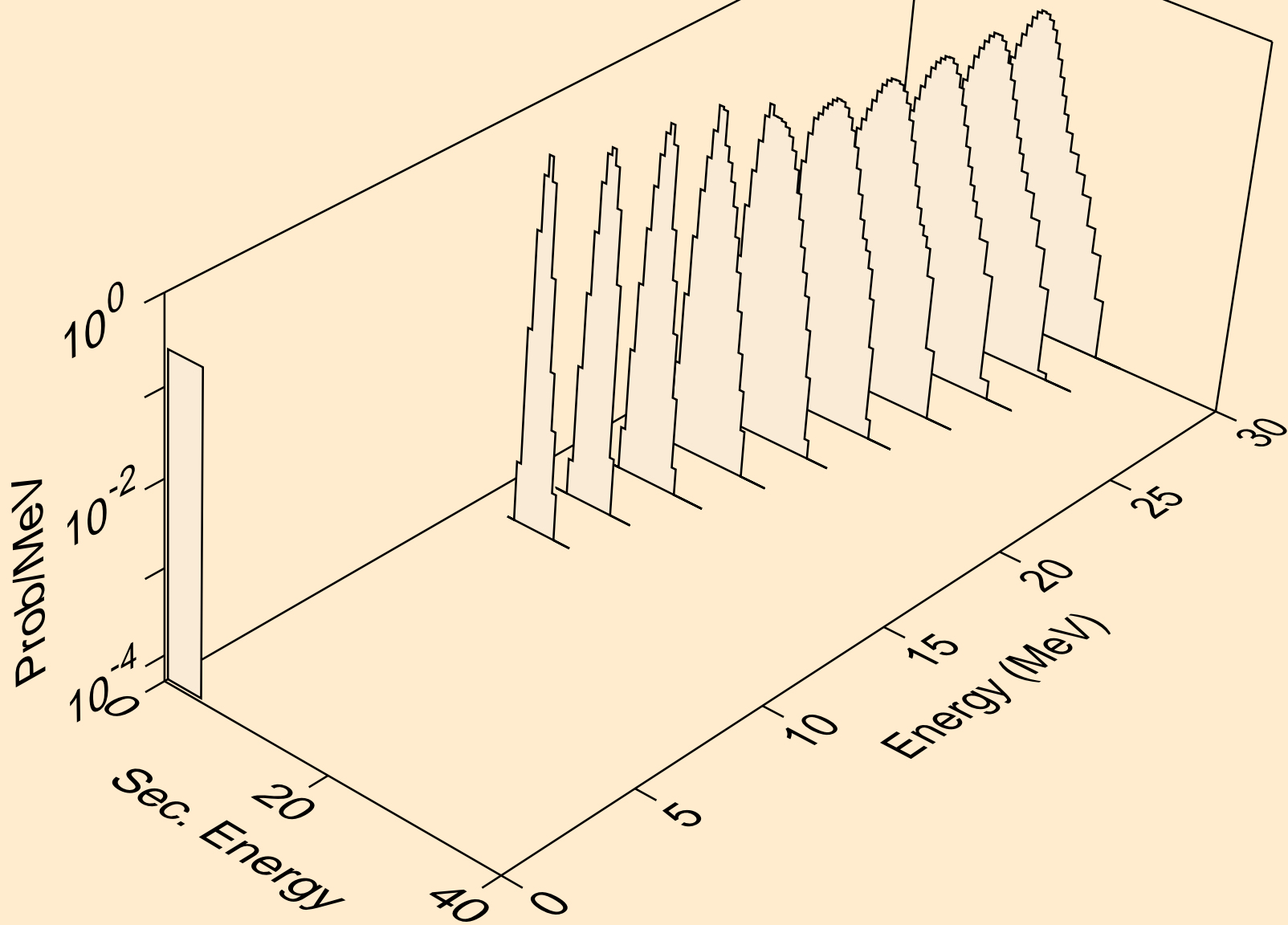

HO163 HELION ACER TENDL-2021 LIBRARY; T=0.K  
alphas from (s,a)

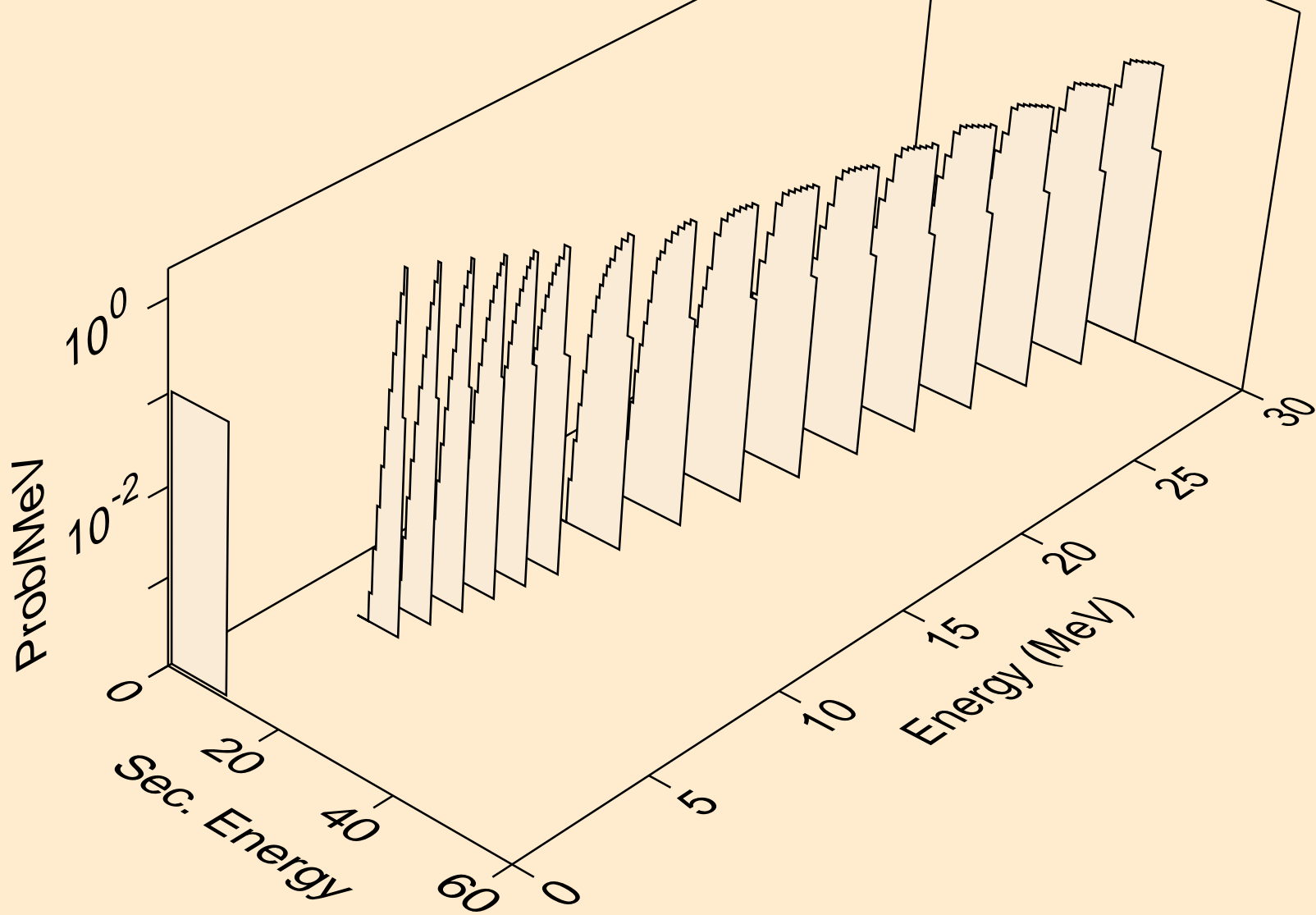



HO163 HELION ACER TENDL-2021 LIBRARY; T=0.K  
alphas from (s,2a)

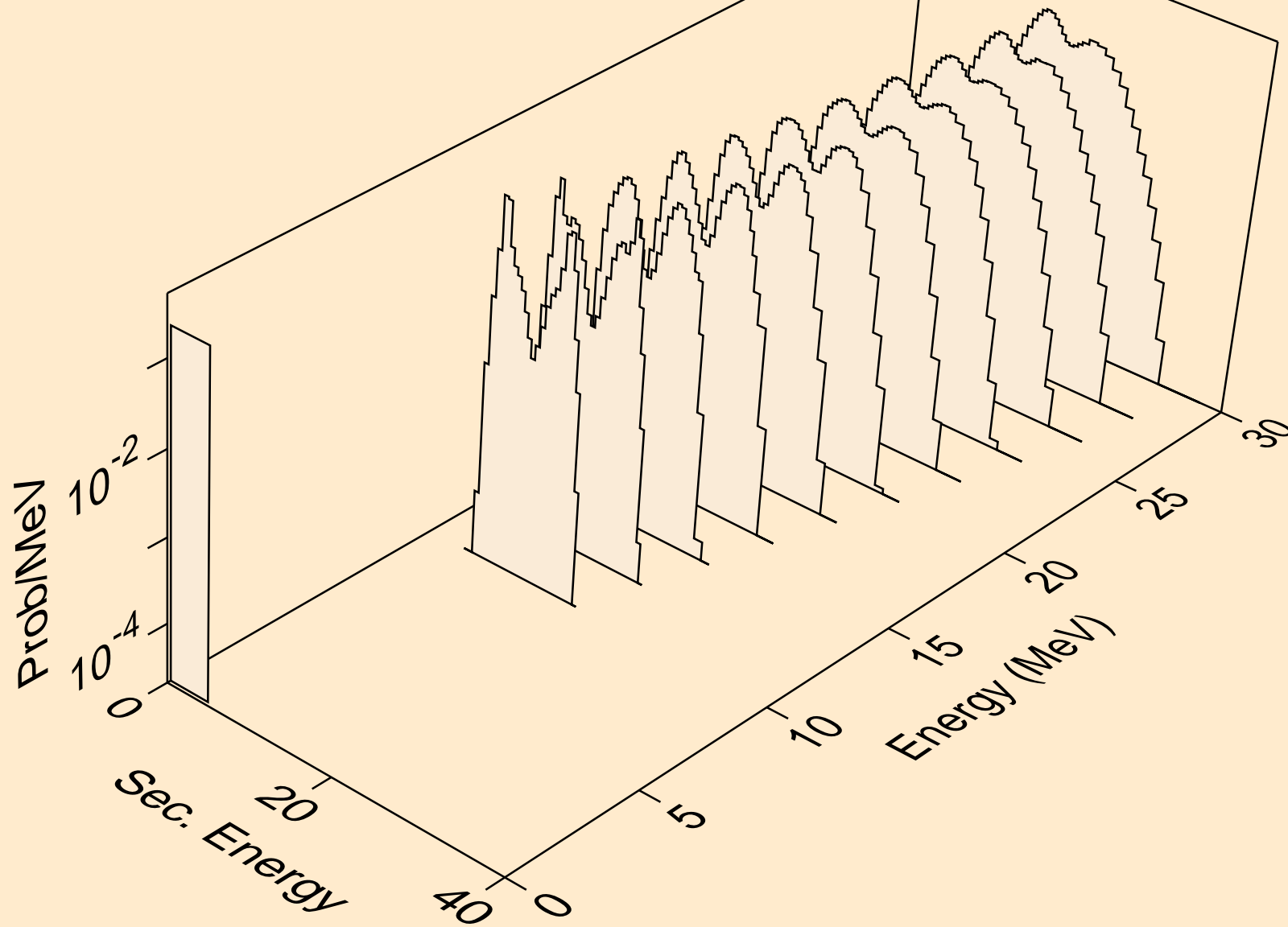

HO163 HELION ACER TENDL-2021 LIBRARY; T=0.K  
alphas from (s,pa)

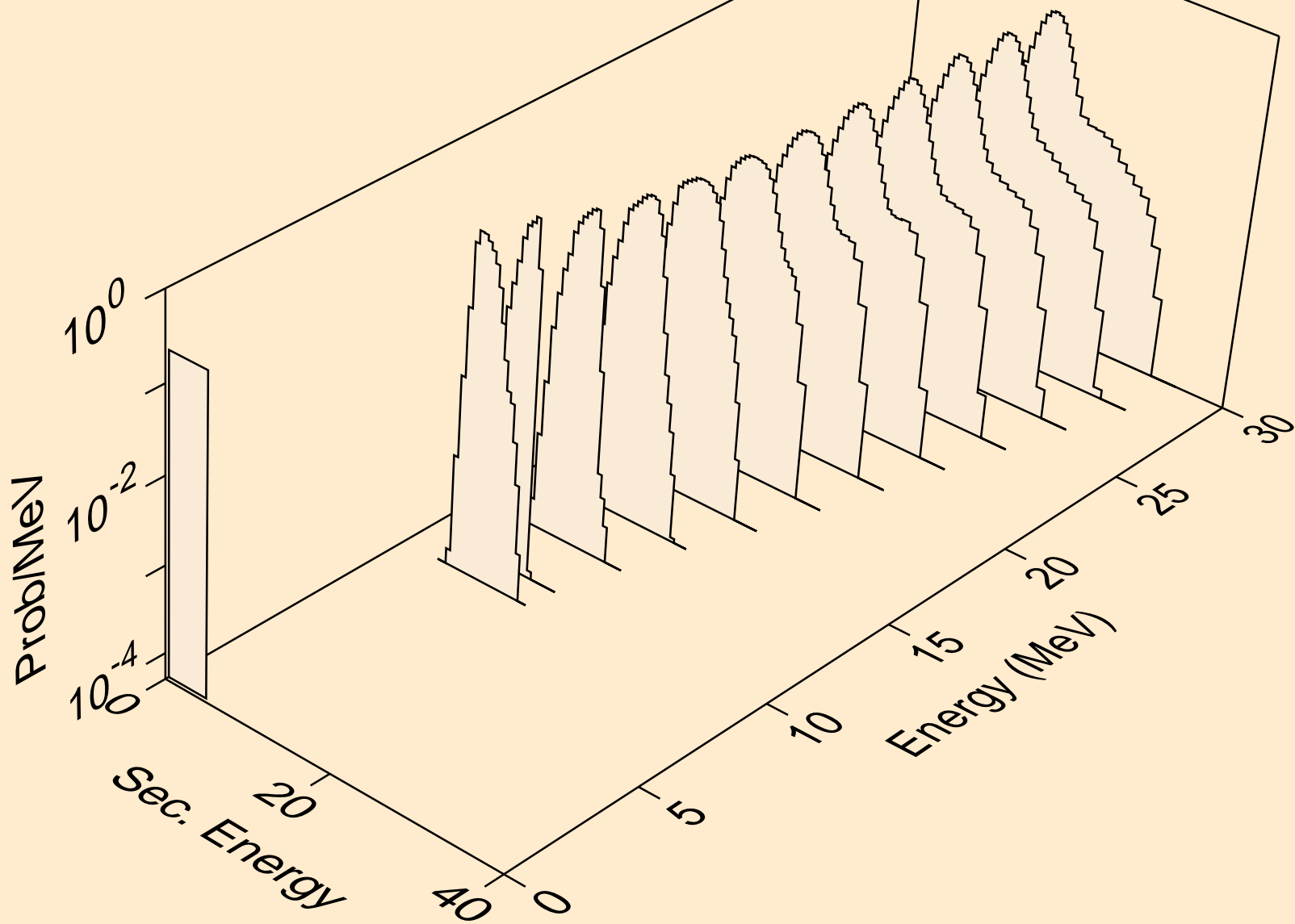

HO163 HELION ACER TENDL-2021 LIBRARY; T=0.K  
alphas from (s,da)

