

HS269 HELION ACER TENDL-2021 LIBRARY; T=0.K  
Principal cross sections

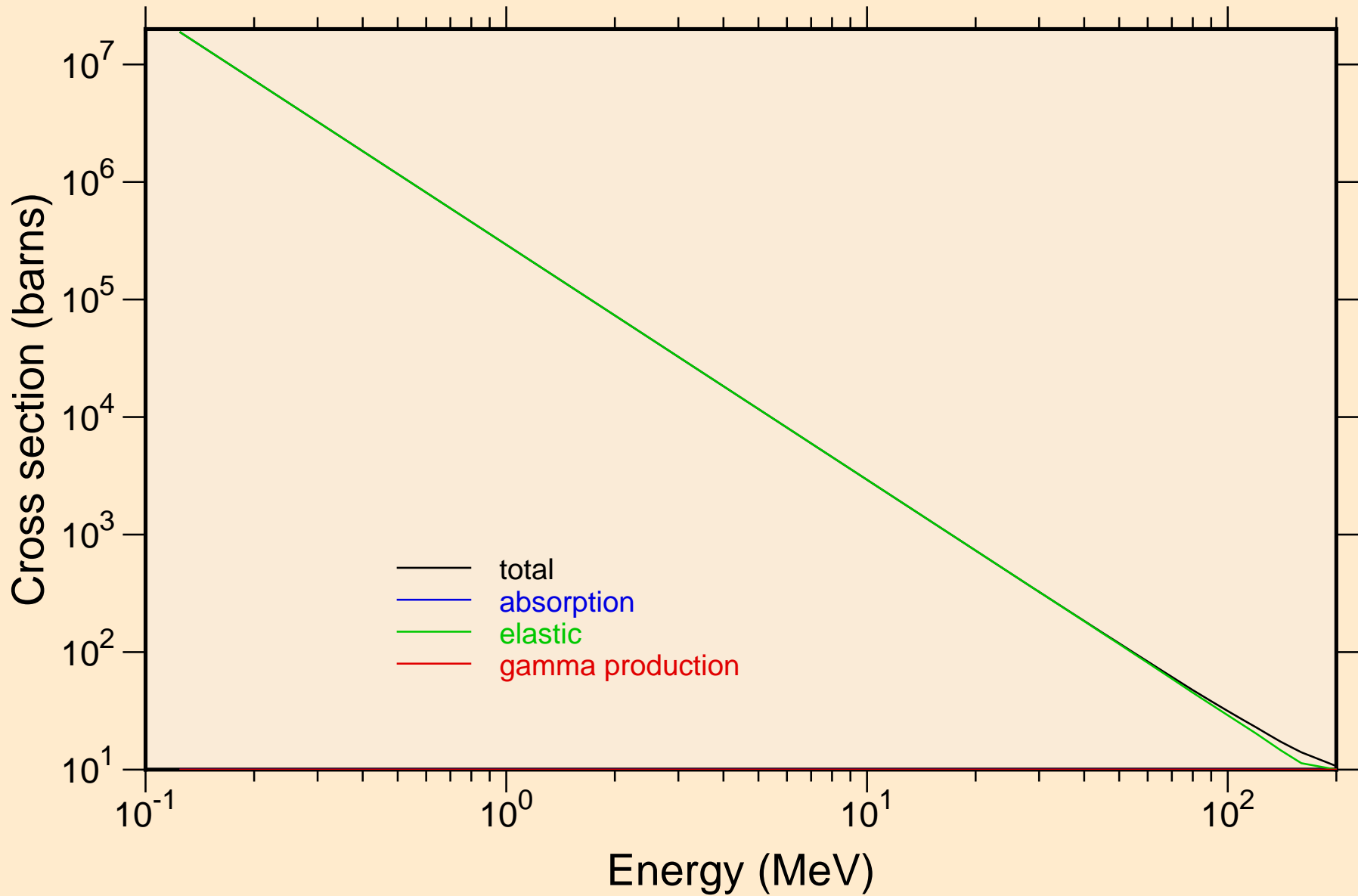

HS269 HELION ACER TENDL-2021 LIBRARY; T=0.K  
Heating

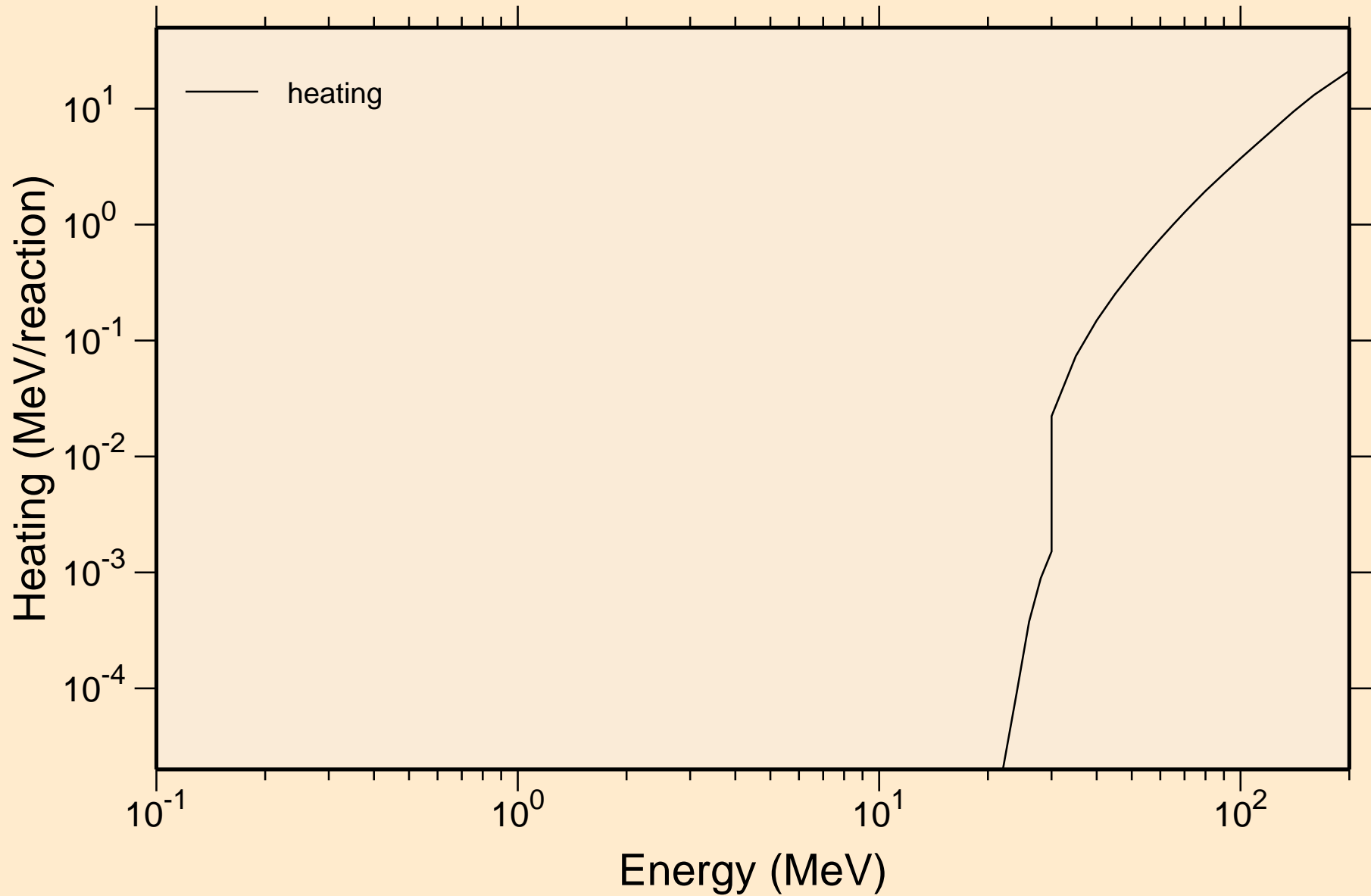

# HS269 HELION ACER TENDL-2021 LIBRARY; T=0.K

## Principal cross sections

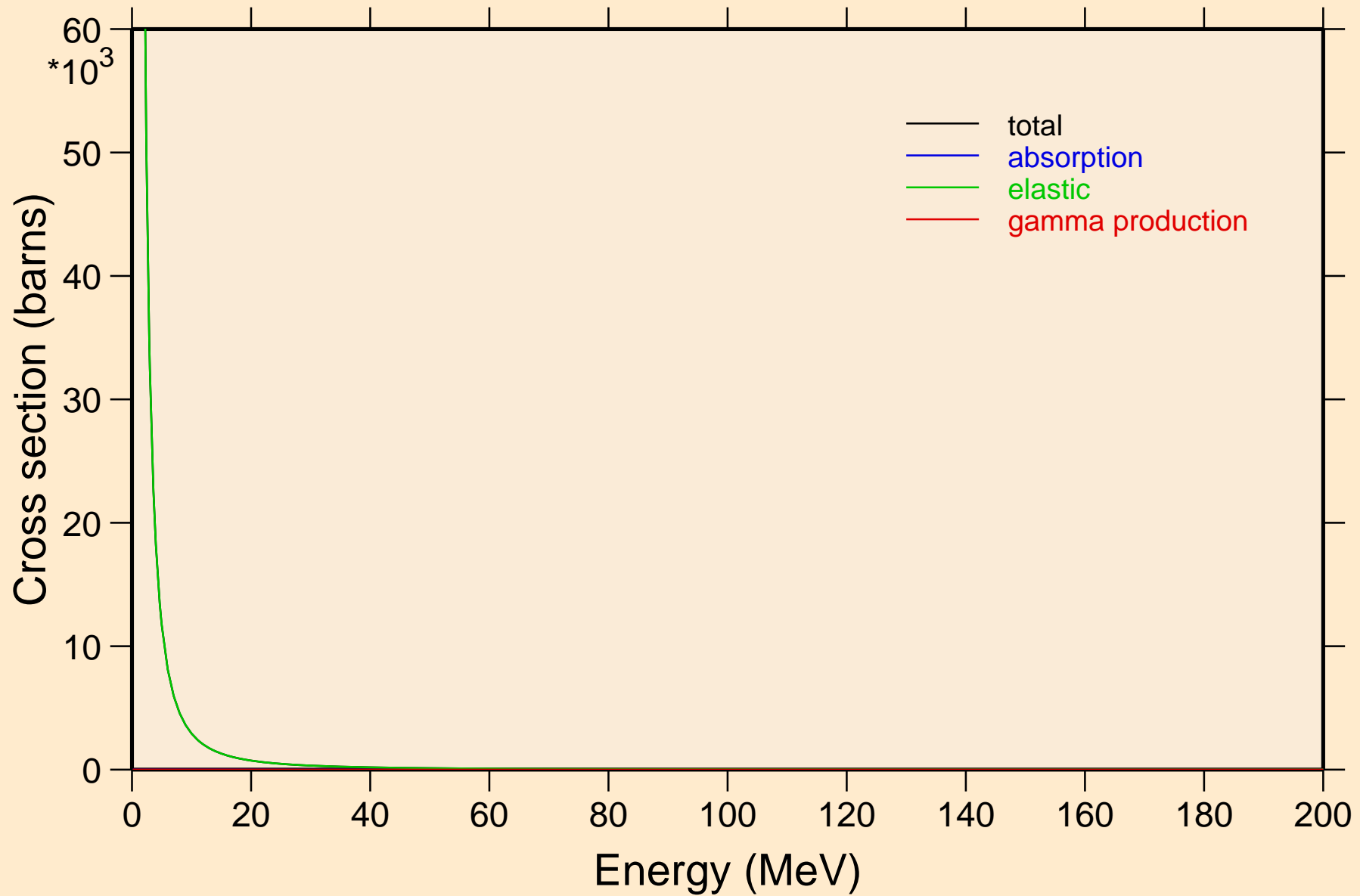

HS269 HELION ACER TENDL-2021 LIBRARY; T=0.K

Heating

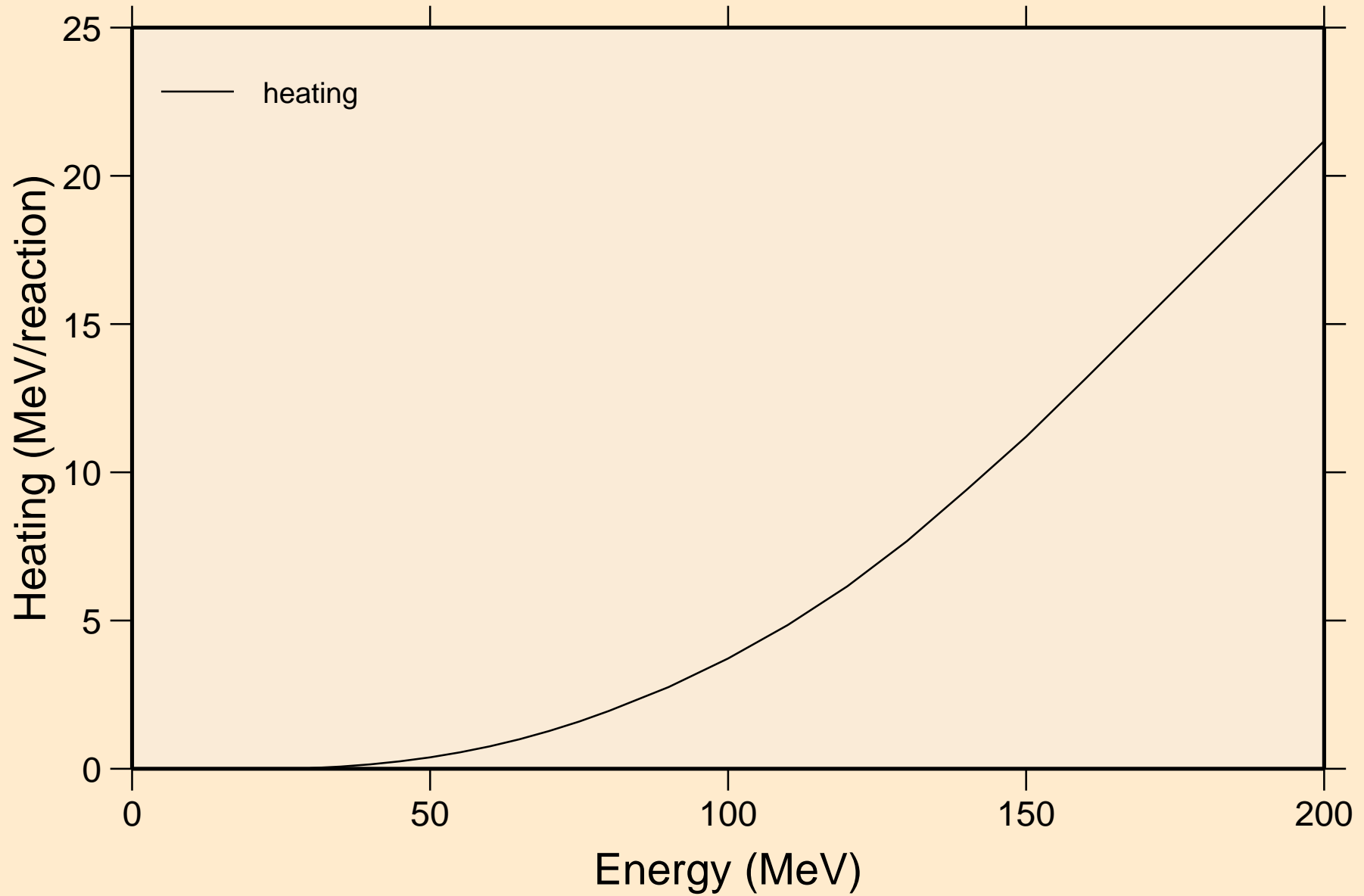

HS269 HELION ACER TENDL-2021 LIBRARY; T=0.K  
Threshold reactions

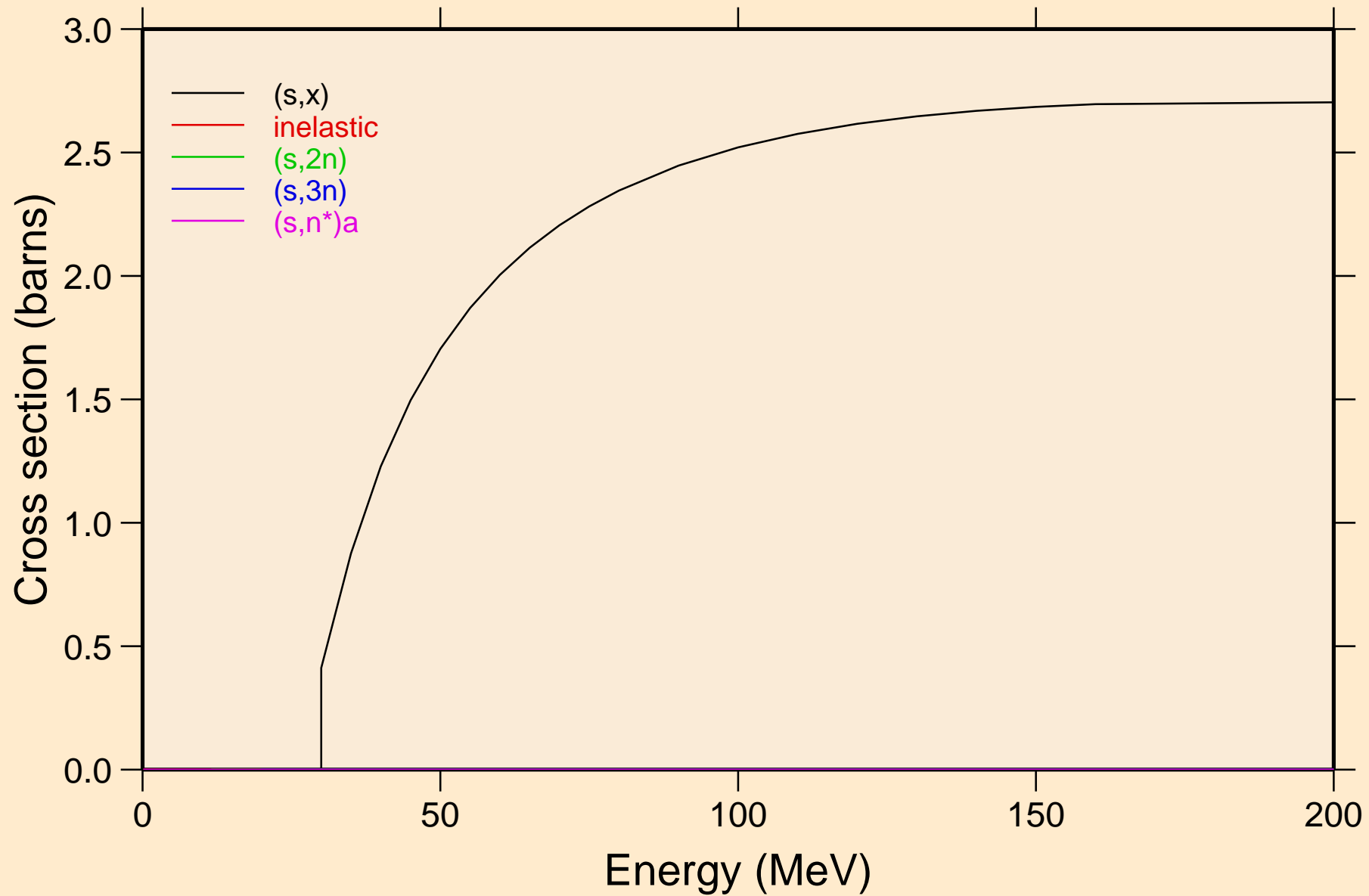

# HS269 HELION ACER TENDL-2021 LIBRARY; T=0.K

## Threshold reactions

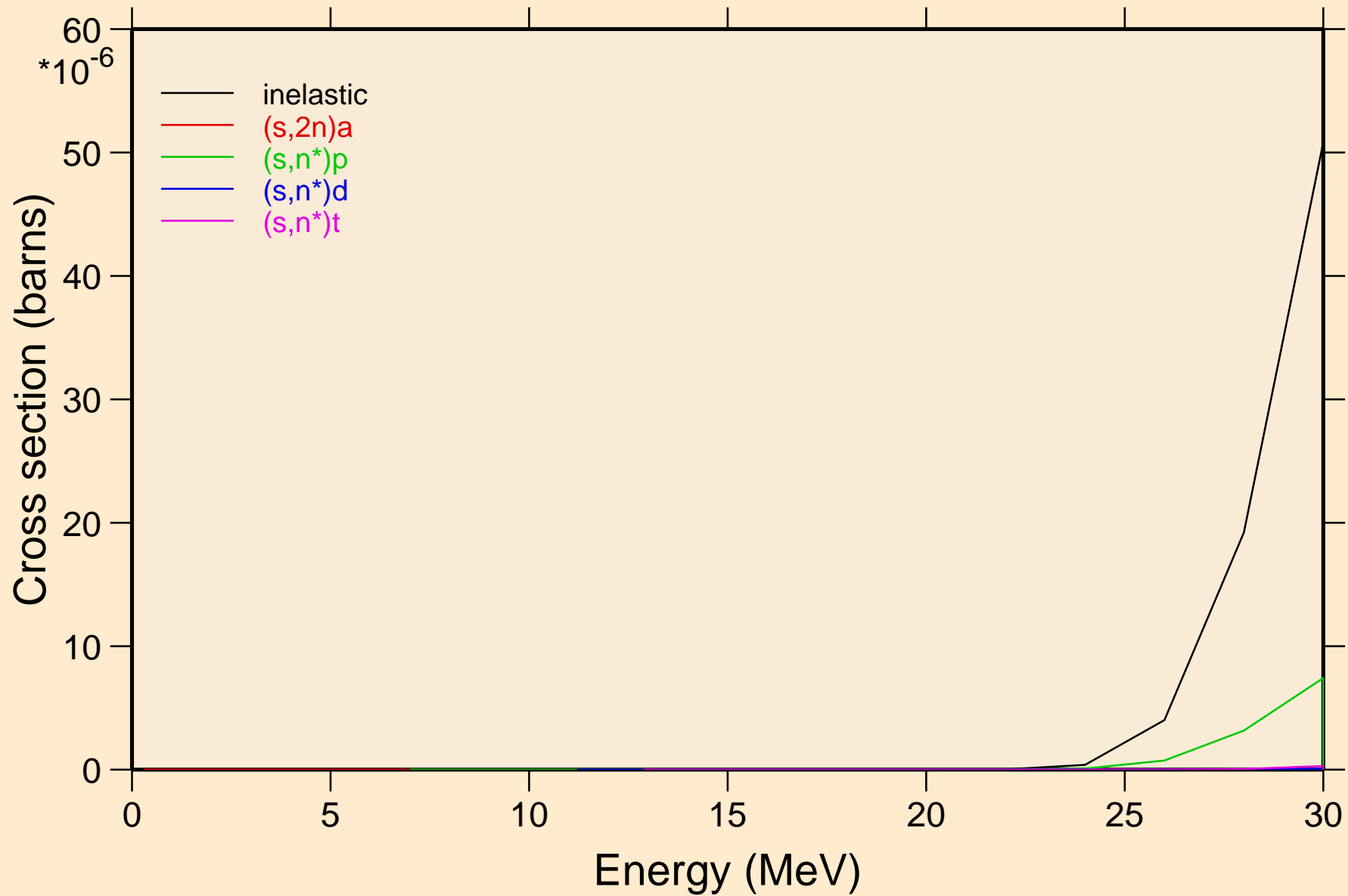

# HS269 HELION ACER TENDL-2021 LIBRARY; T=0.K

## Threshold reactions

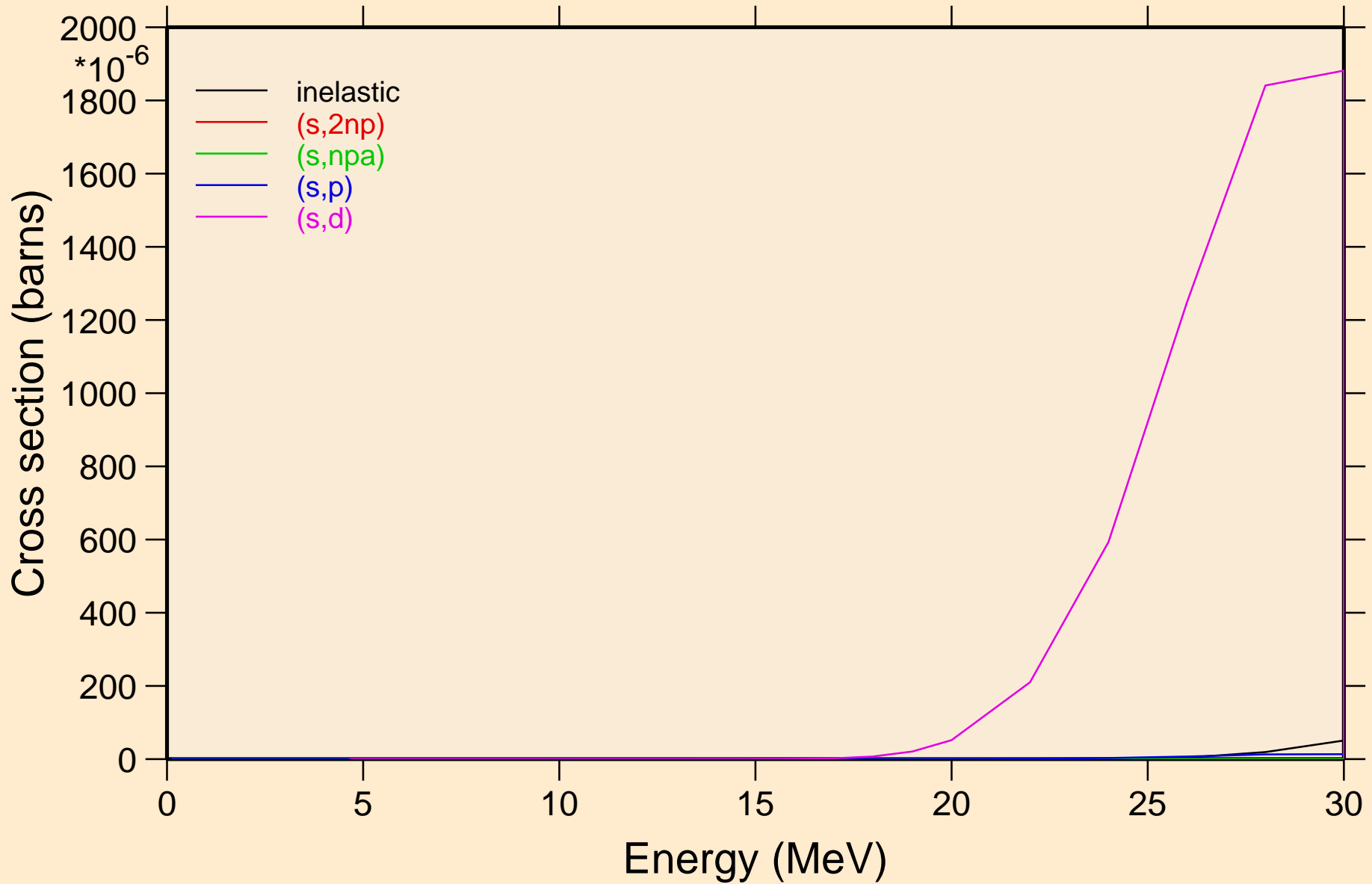

HS269 HELION ACER TENDL-2021 LIBRARY; T=0.K  
Threshold reactions

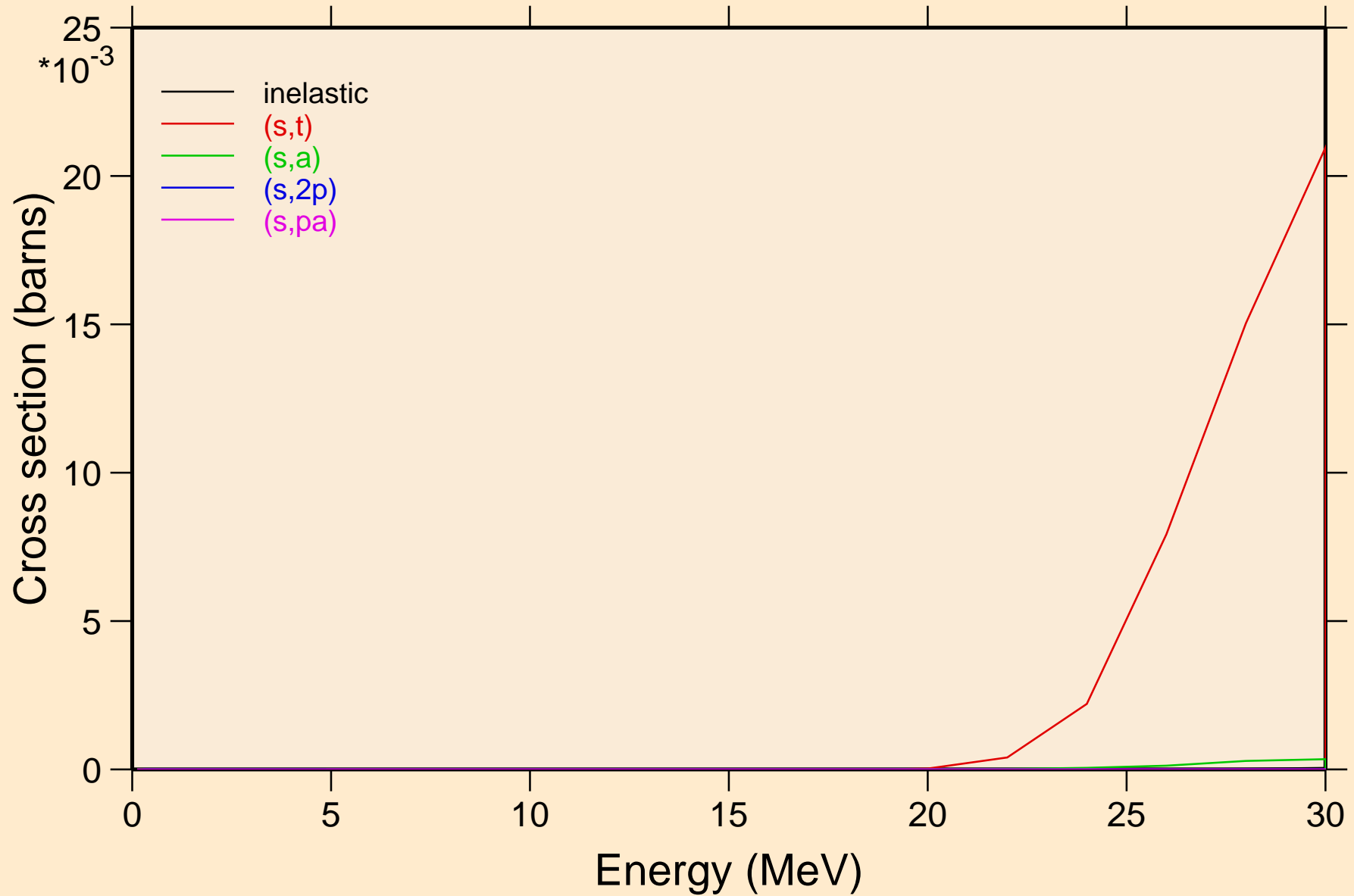



HS269 HELION ACER TENDL-2021 LIBRARY; T=0.K  
Threshold reactions

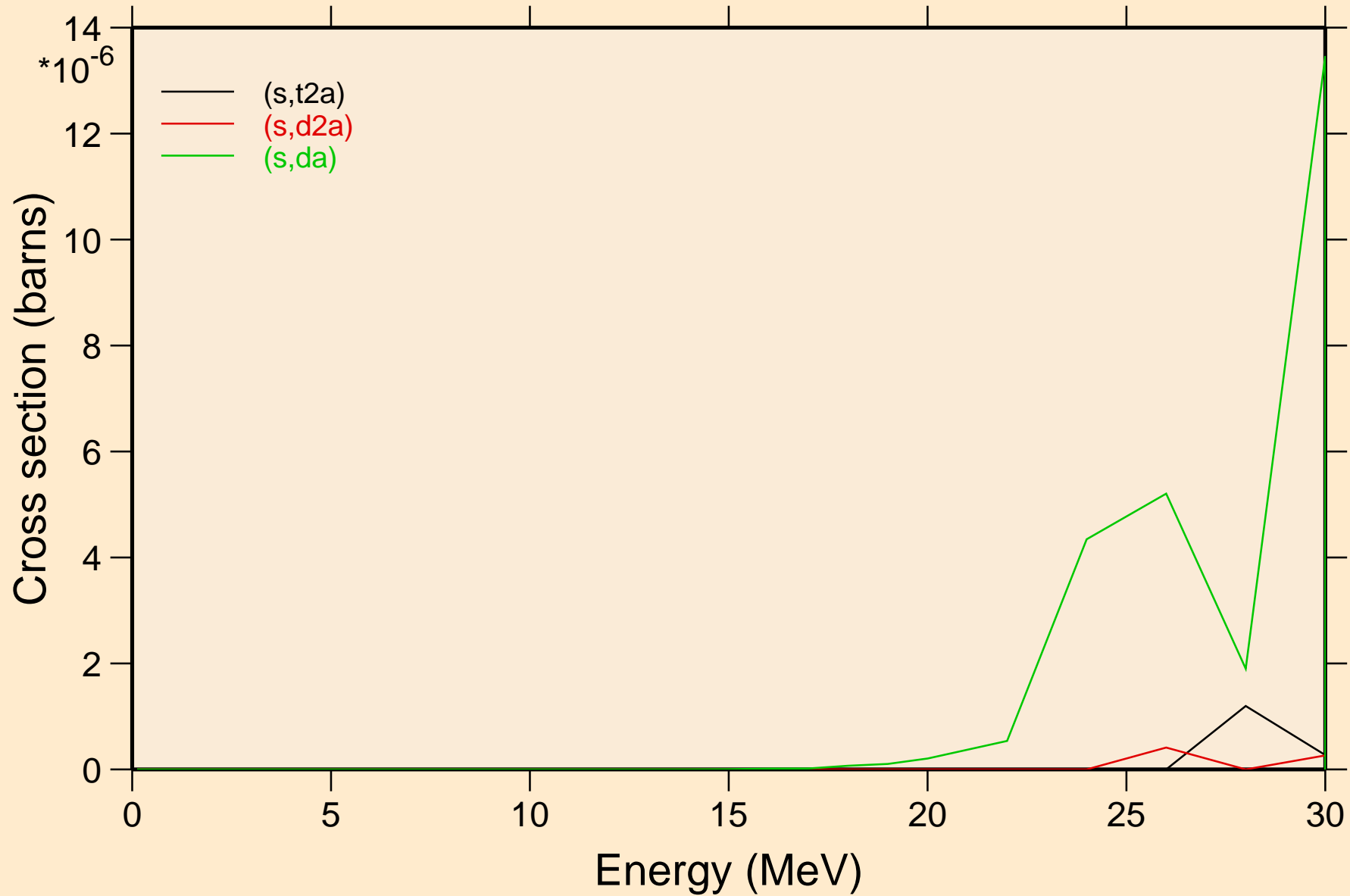

HS269 HELION ACER TENDL-2021 LIBRARY; T=0.K  
angular distribution for elastic

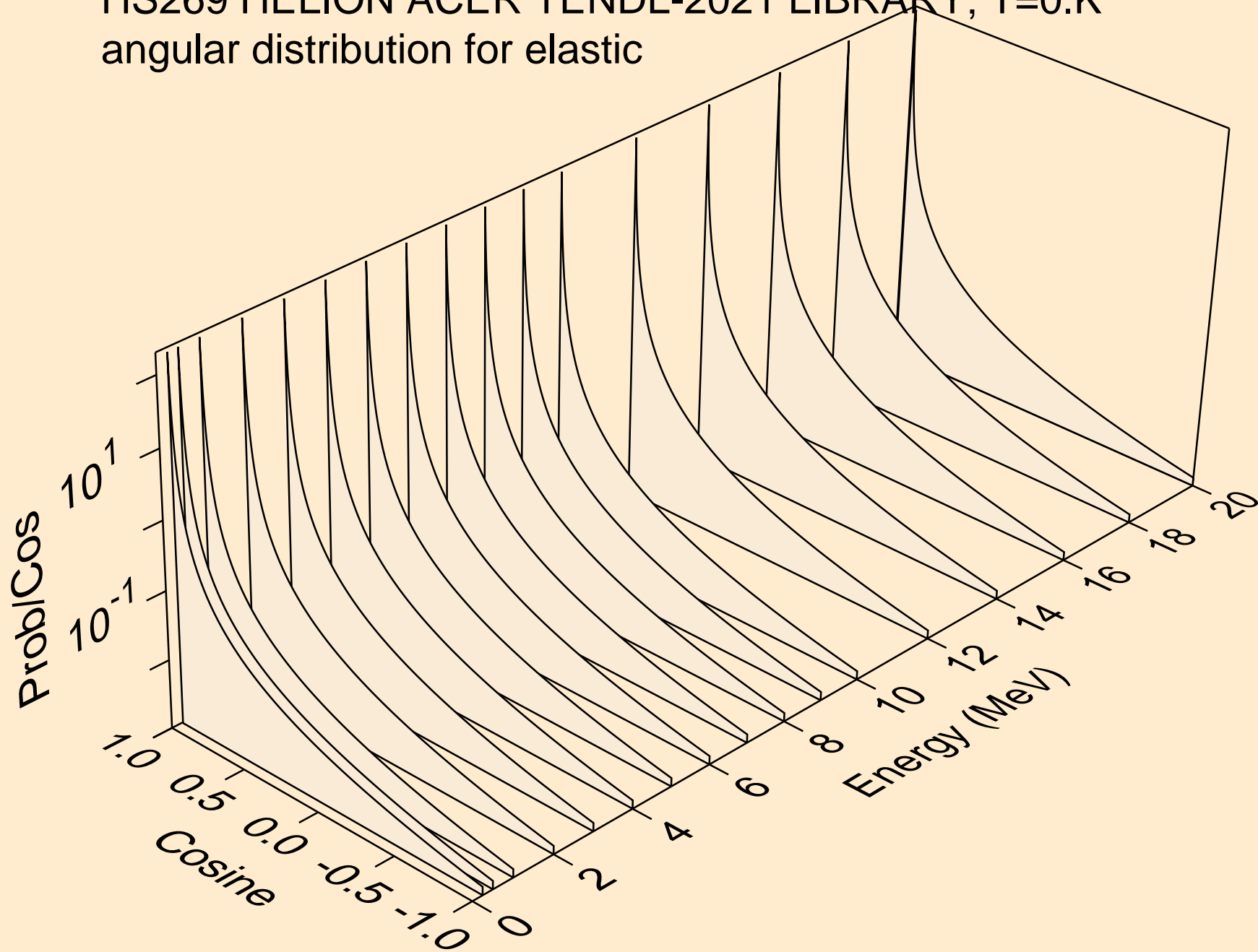

HS269 HELION ACER TENDL-2021 LIBRARY; T=0.K  
angular distribution for elastic

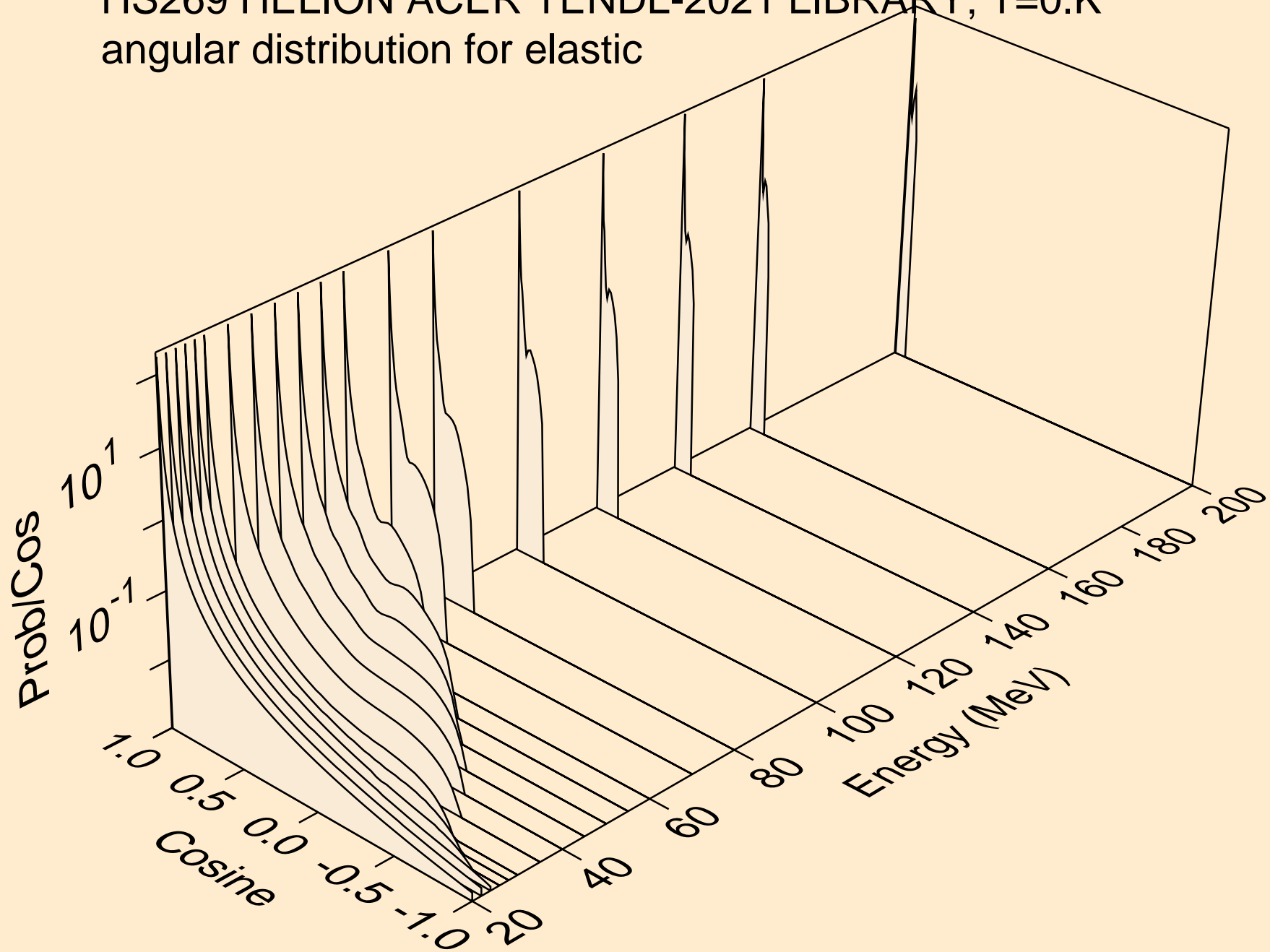

HS269 HELION ACER TENDL-2021 LIBRARY; T=0.K  
He-3 emission for (s,x)

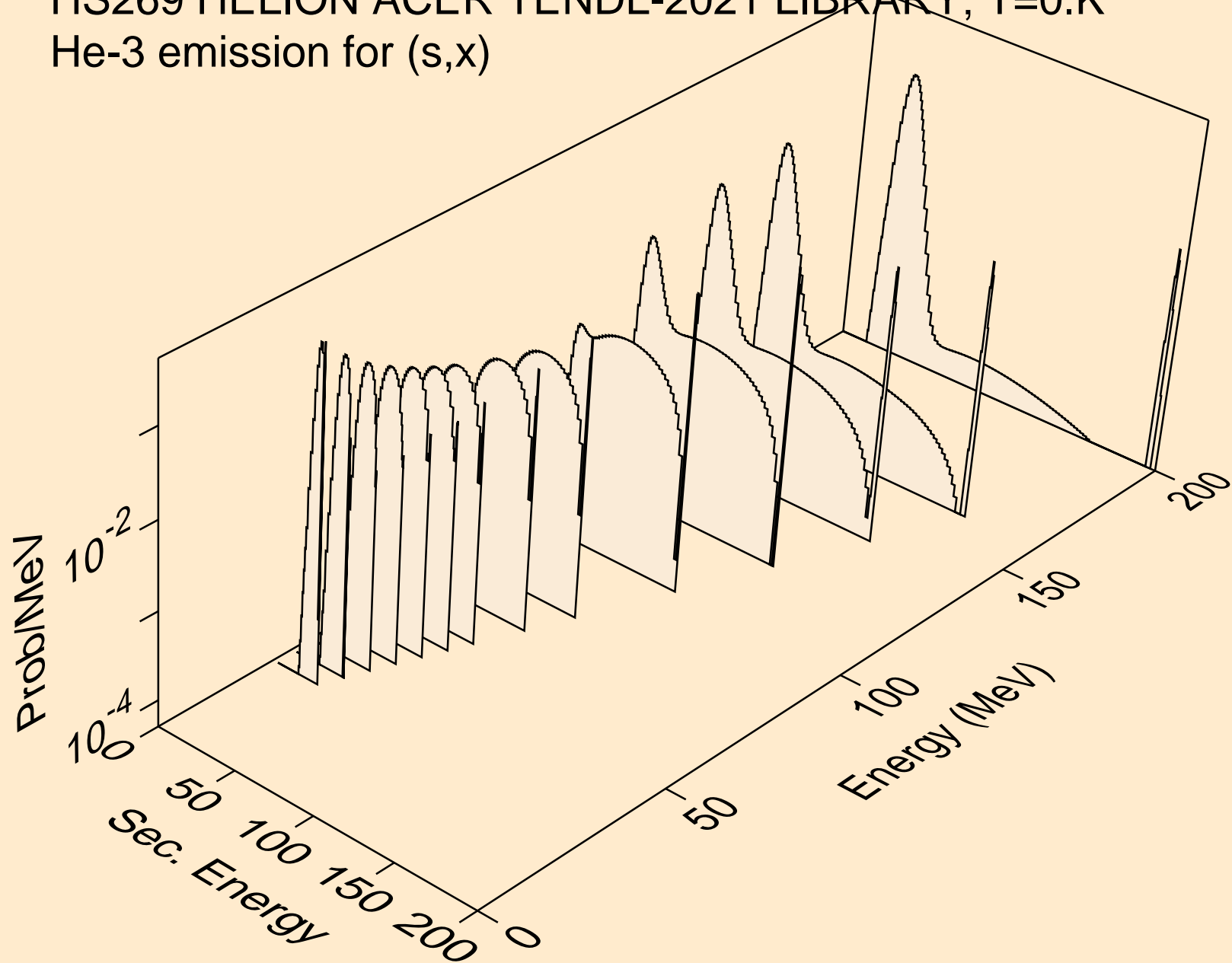

HS269 HELION ACER TENDL-2021 LIBRARY; T=0.K  
He-3 emission for inelastic

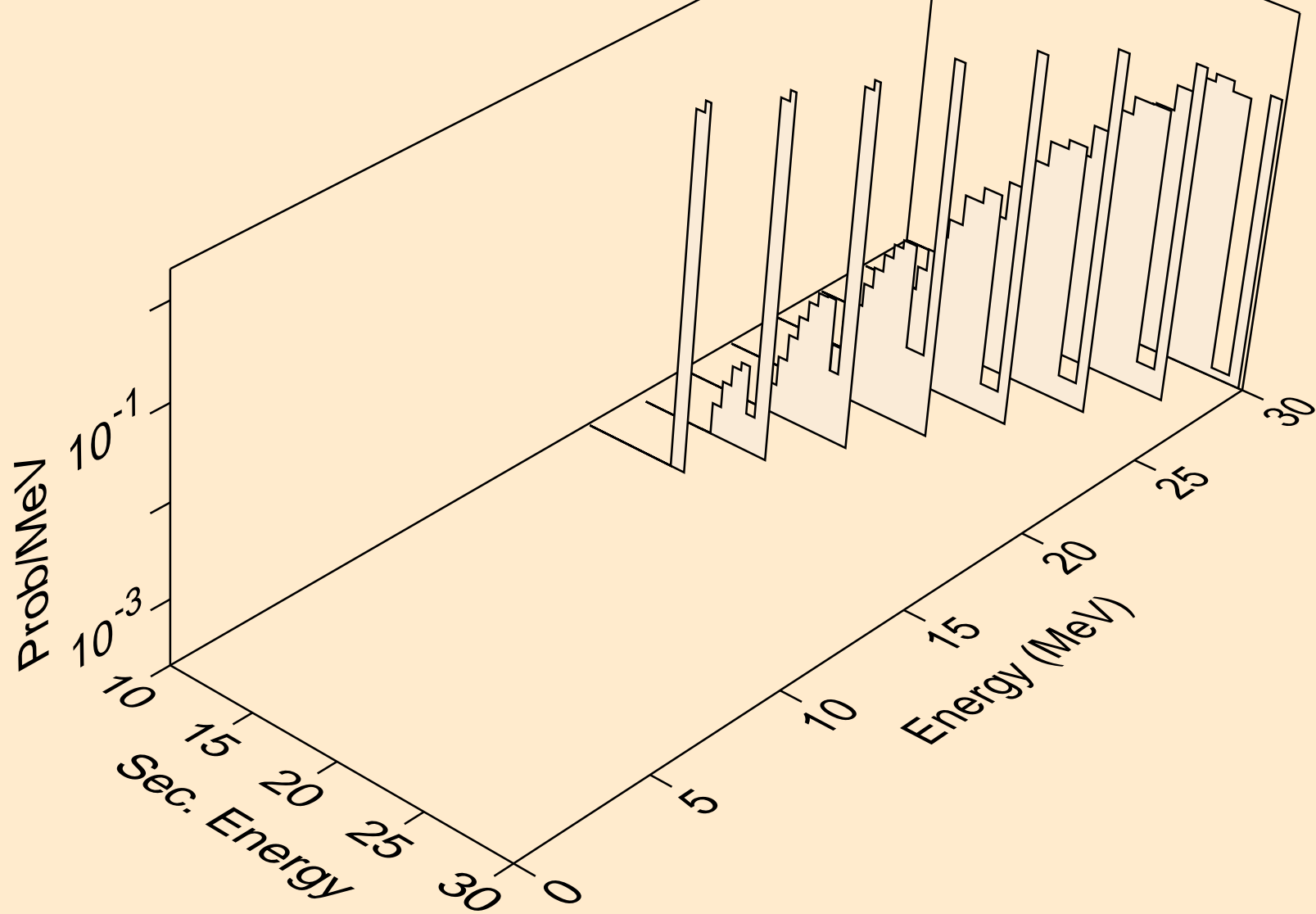

HS269 HELION ACER TENDL-2021 LIBRARY; T=0.K  
Photon emission for (z,n)

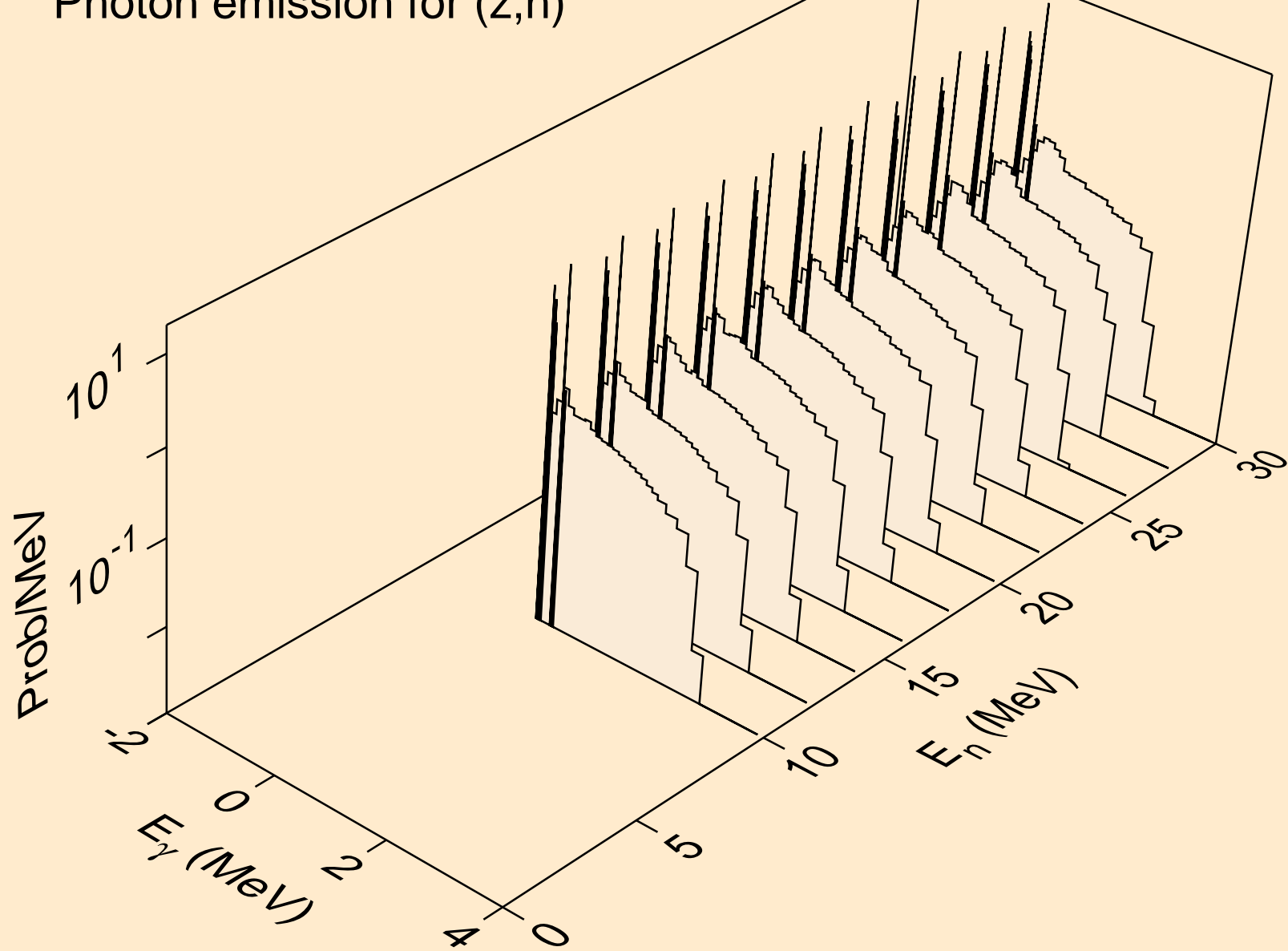

HS269 HELION ACER TENDL-2021 LIBRARY; T=0.K  
Photon emission for (n,x)

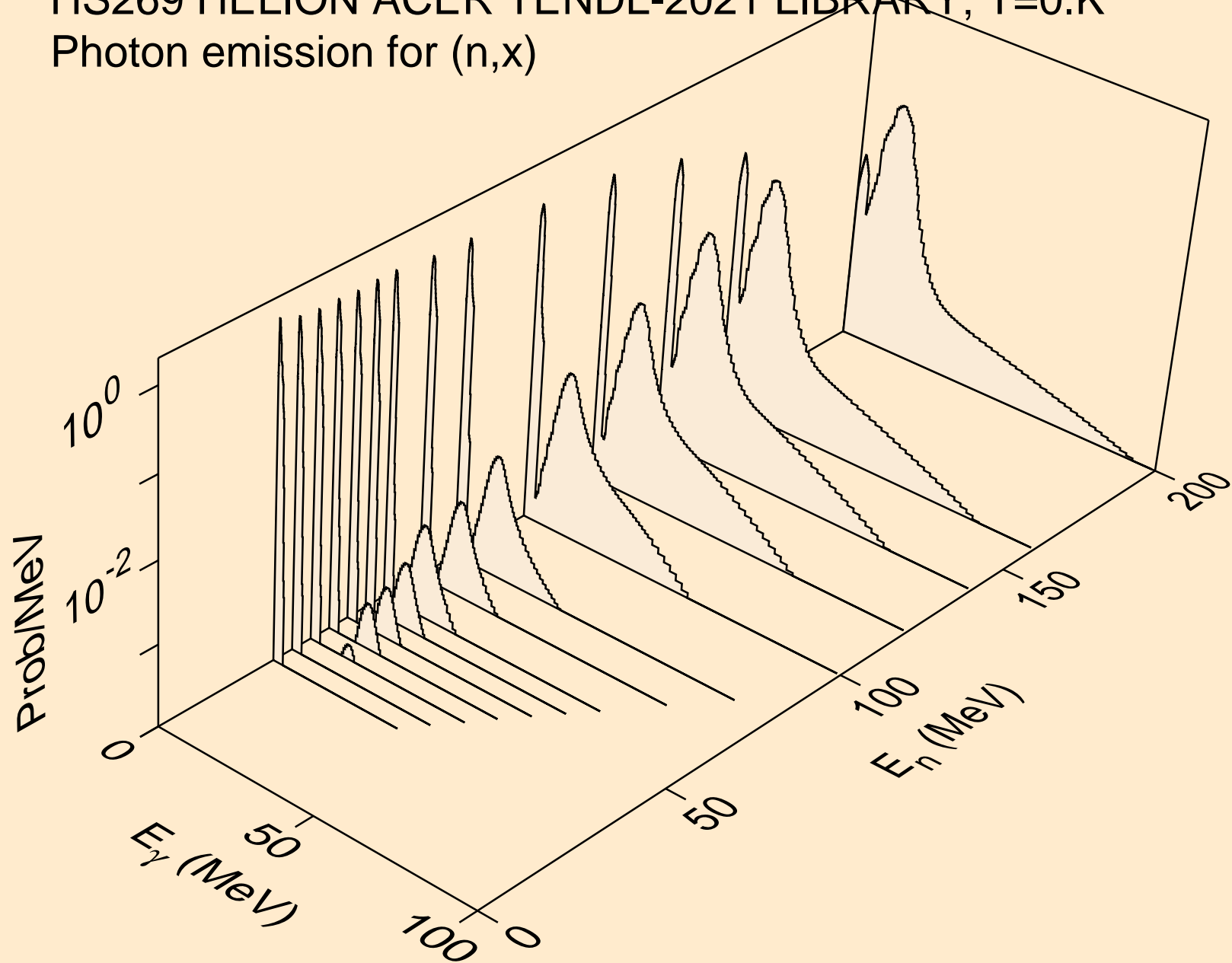

HS269 HELION ACER TENDL-2021 LIBRARY; T=0.K  
Photon emission for (n,2n)

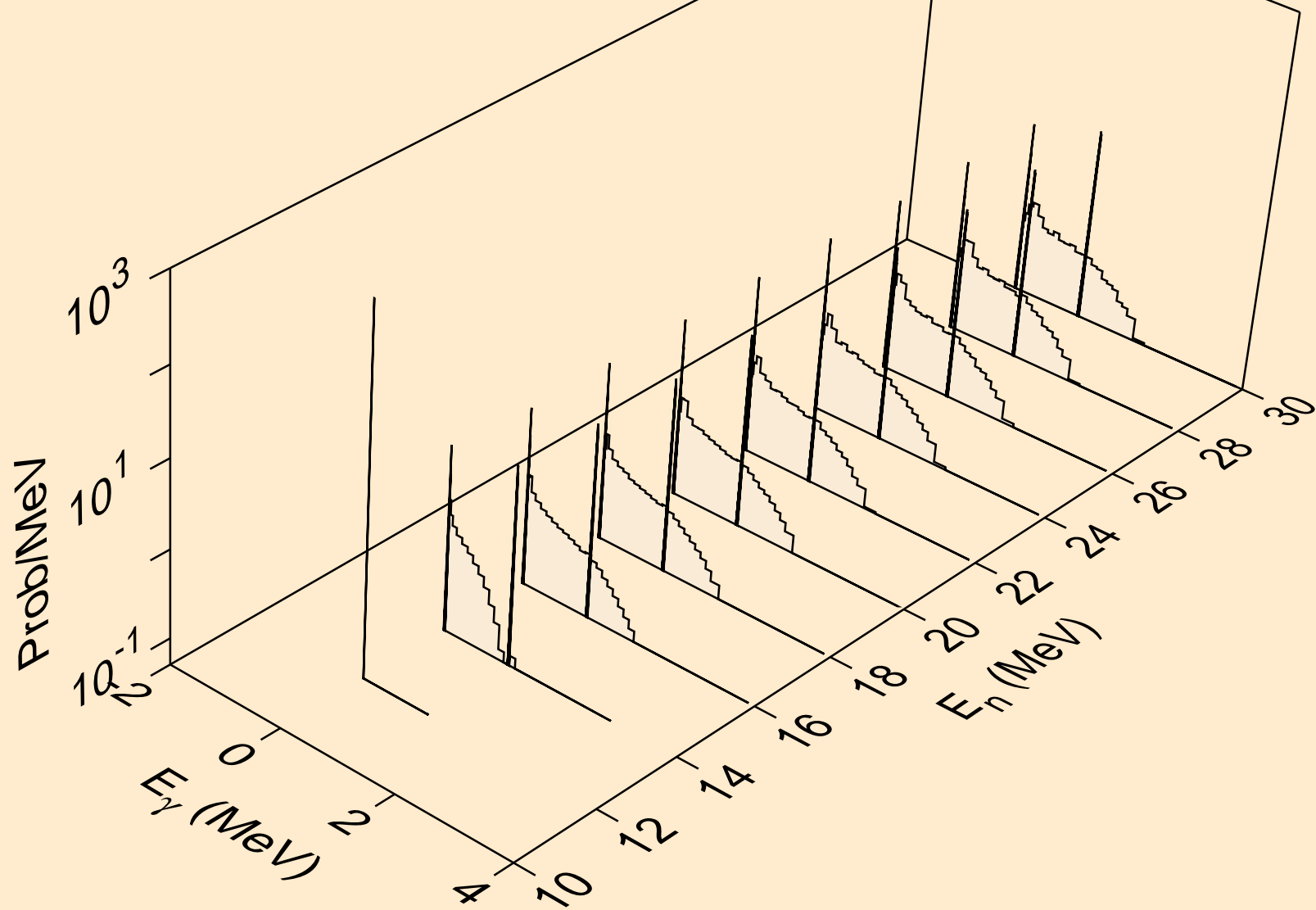



HS269 HELION ACER TENDL-2021 LIBRARY; T=0.K  
Photon emission for (n,3n)

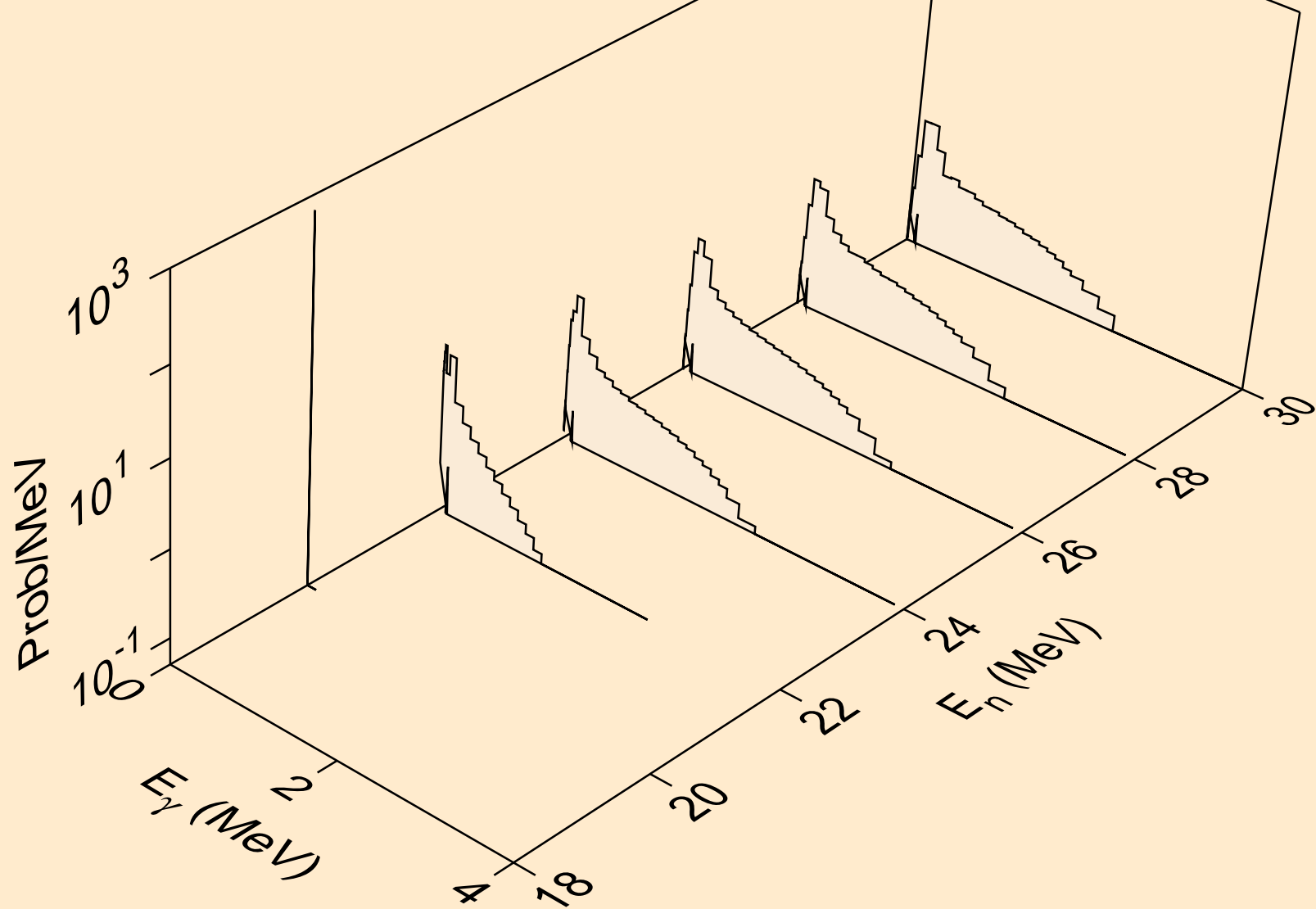

HS269 HELION ACER TENDL-2021 LIBRARY; T=0.K  
Photon emission for (n,n\*)a

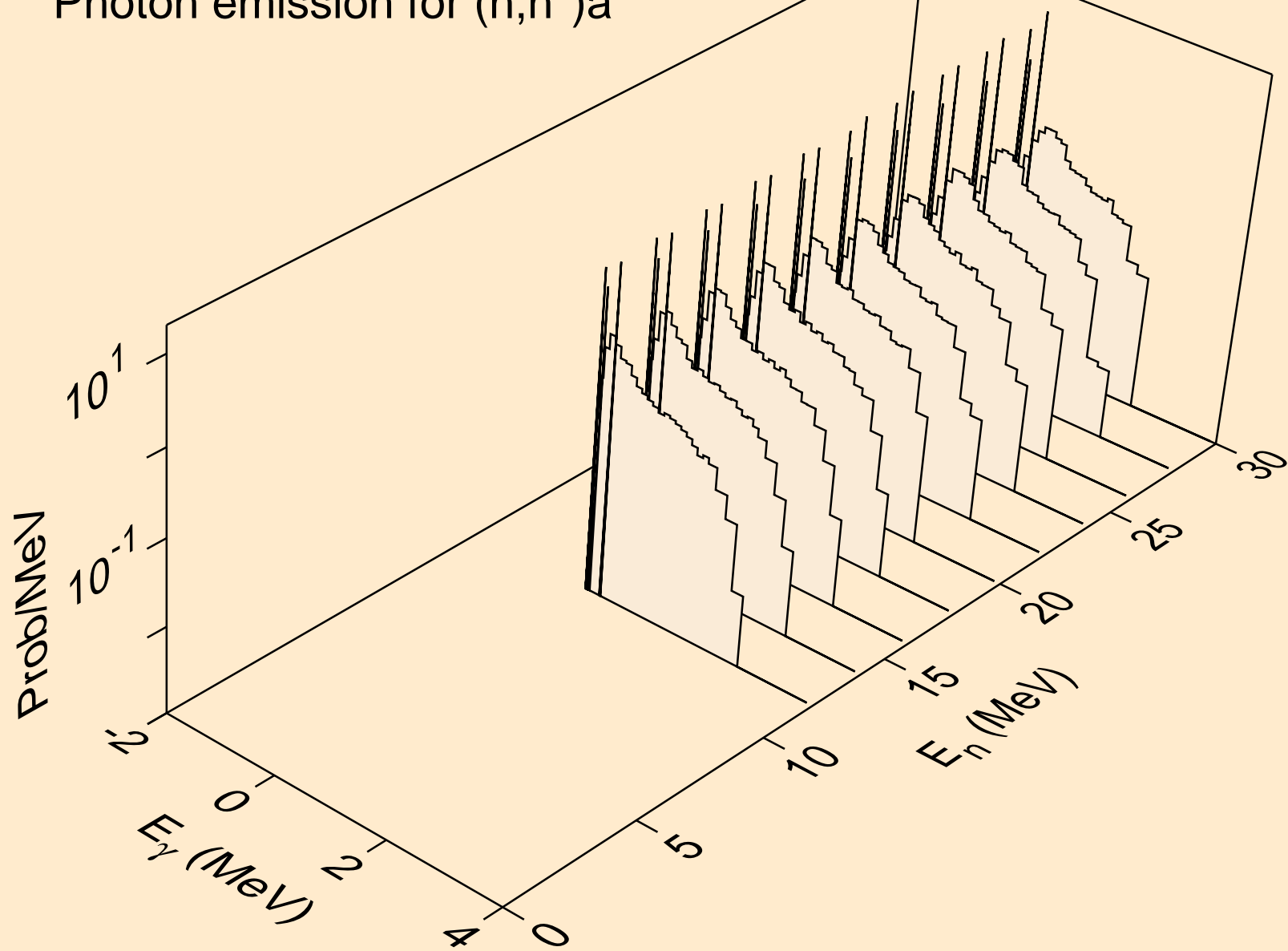

HS269 HELION ACER TENDL-2021 LIBRARY; T=0.K  
Photon emission for (n,2n)a

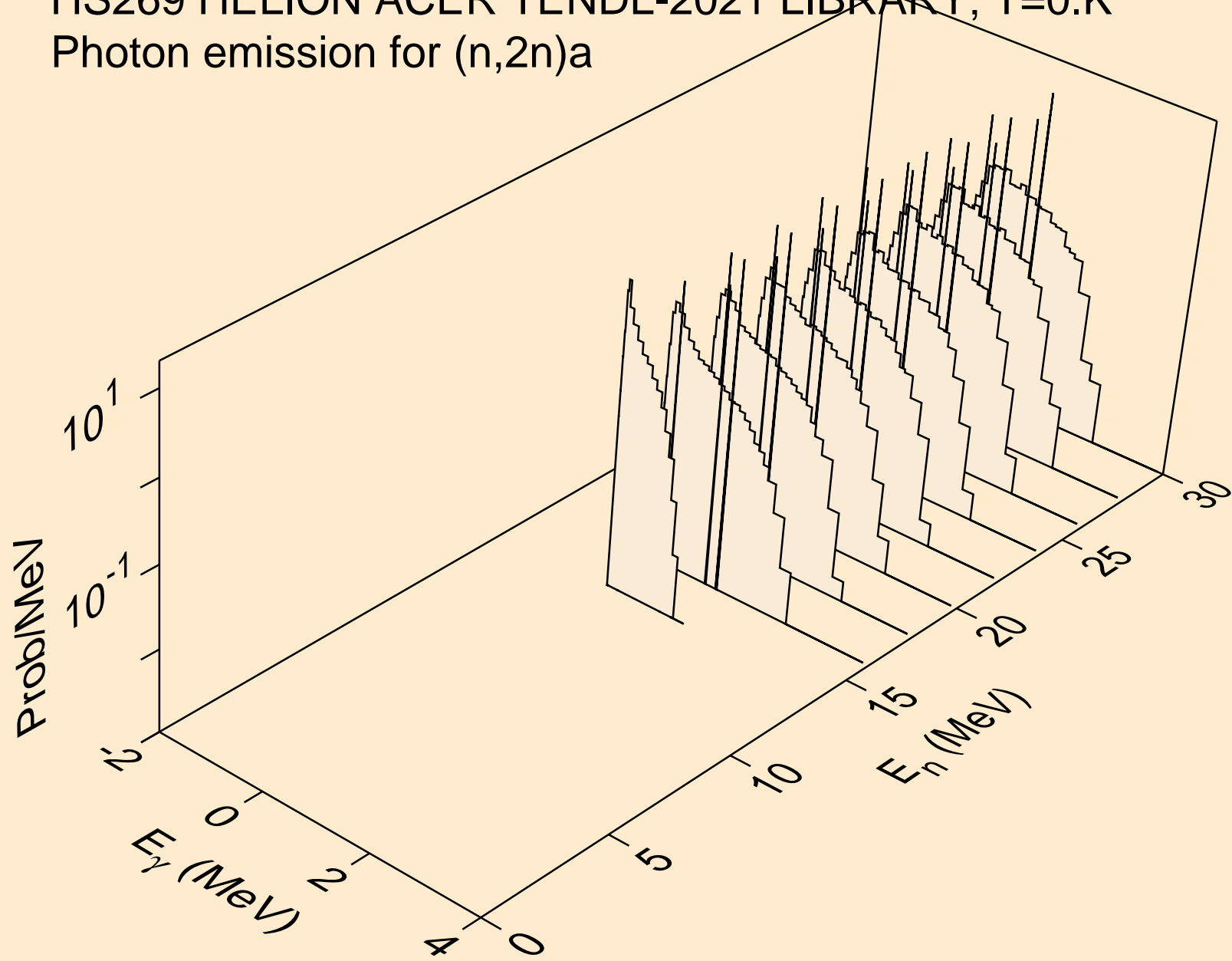

HS269 HELION ACER TENDL-2021 LIBRARY; T=0.K  
Photon emission for (n,n\*)p

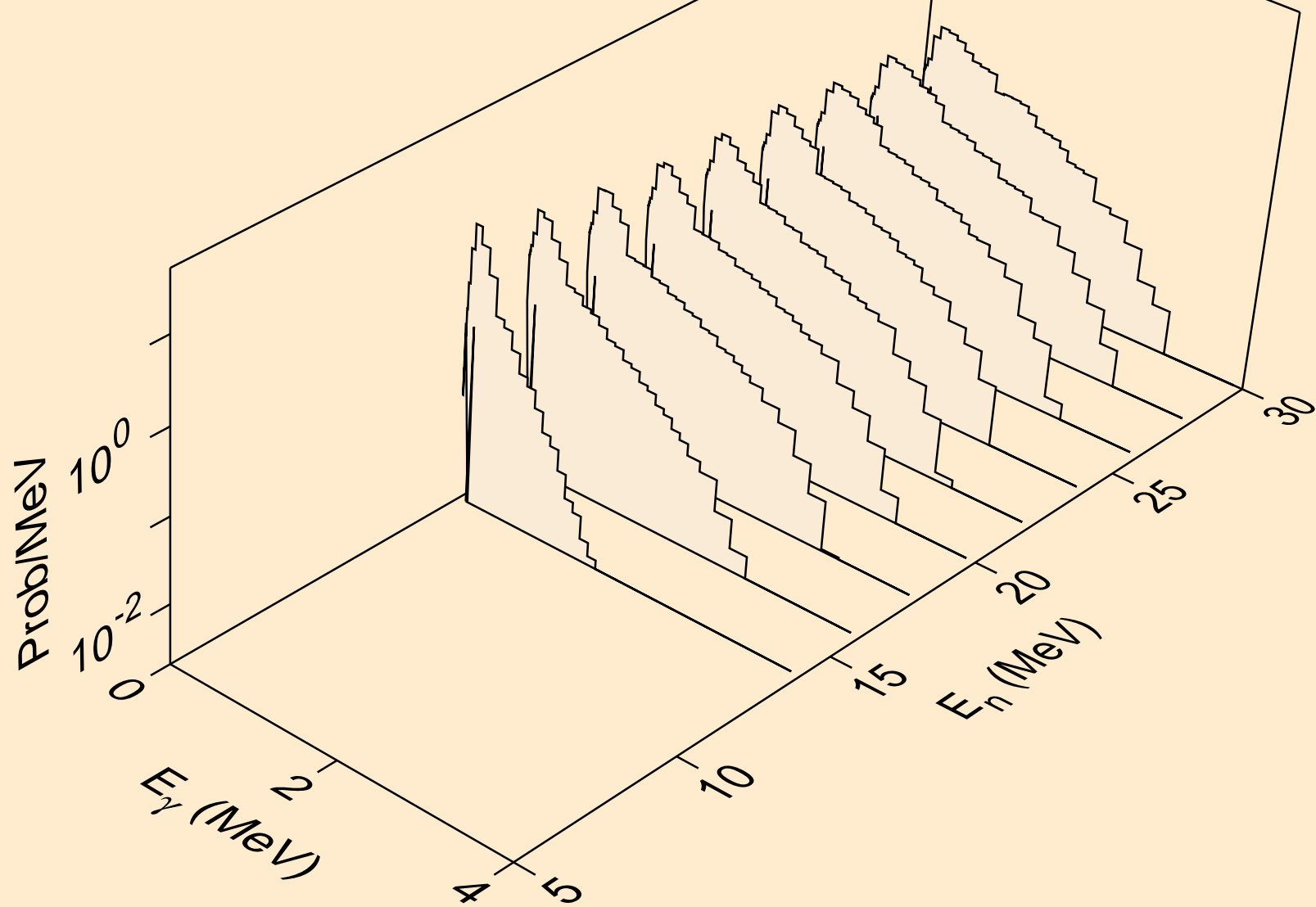

HS269 HELION ACER TENDL-2021 LIBRARY; T=0.K  
Photon emission for (n,n\*)d

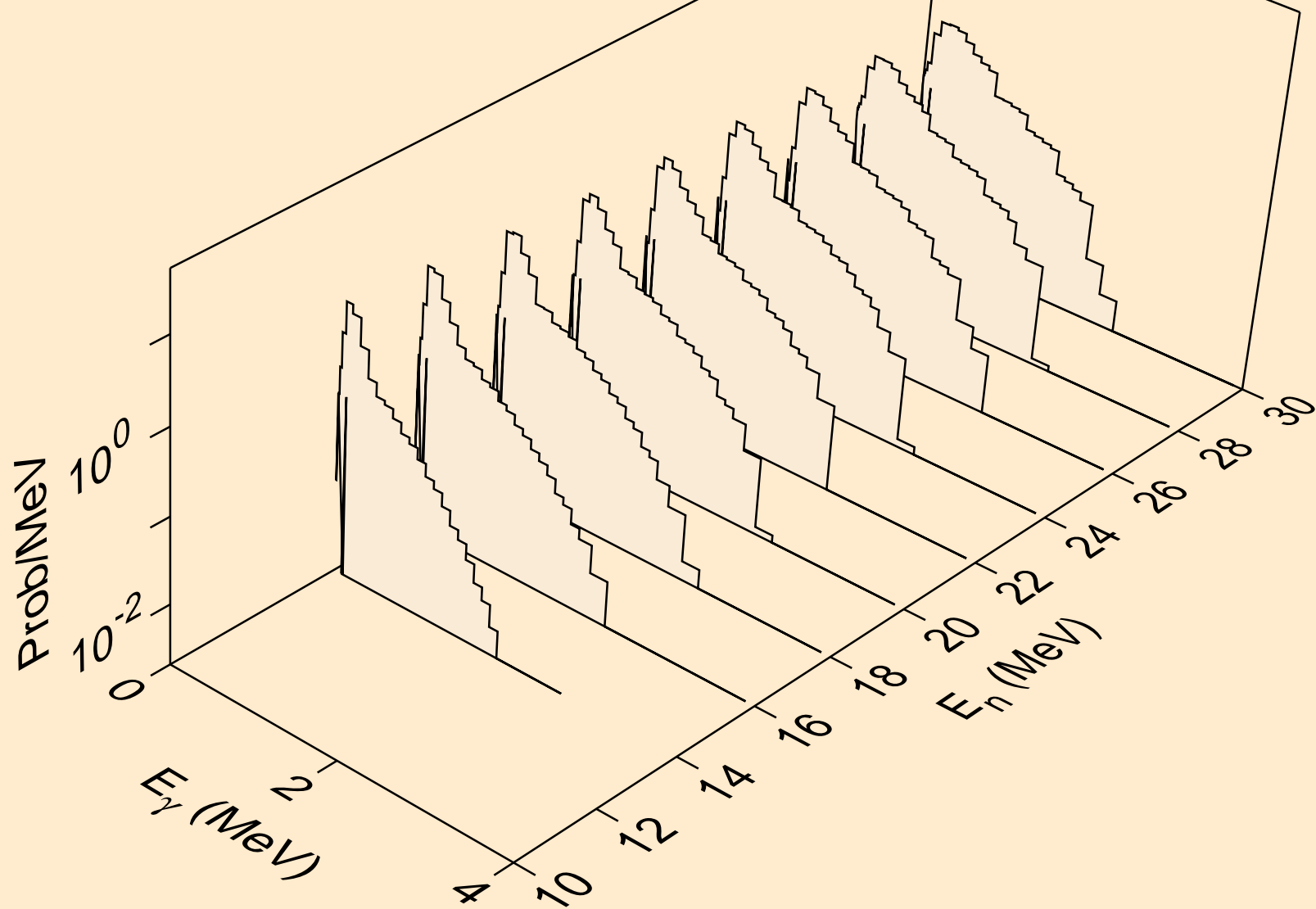

HS269 HELION ACER TENDL-2021 LIBRARY; T=0.K  
Photon emission for (n,n\*)t

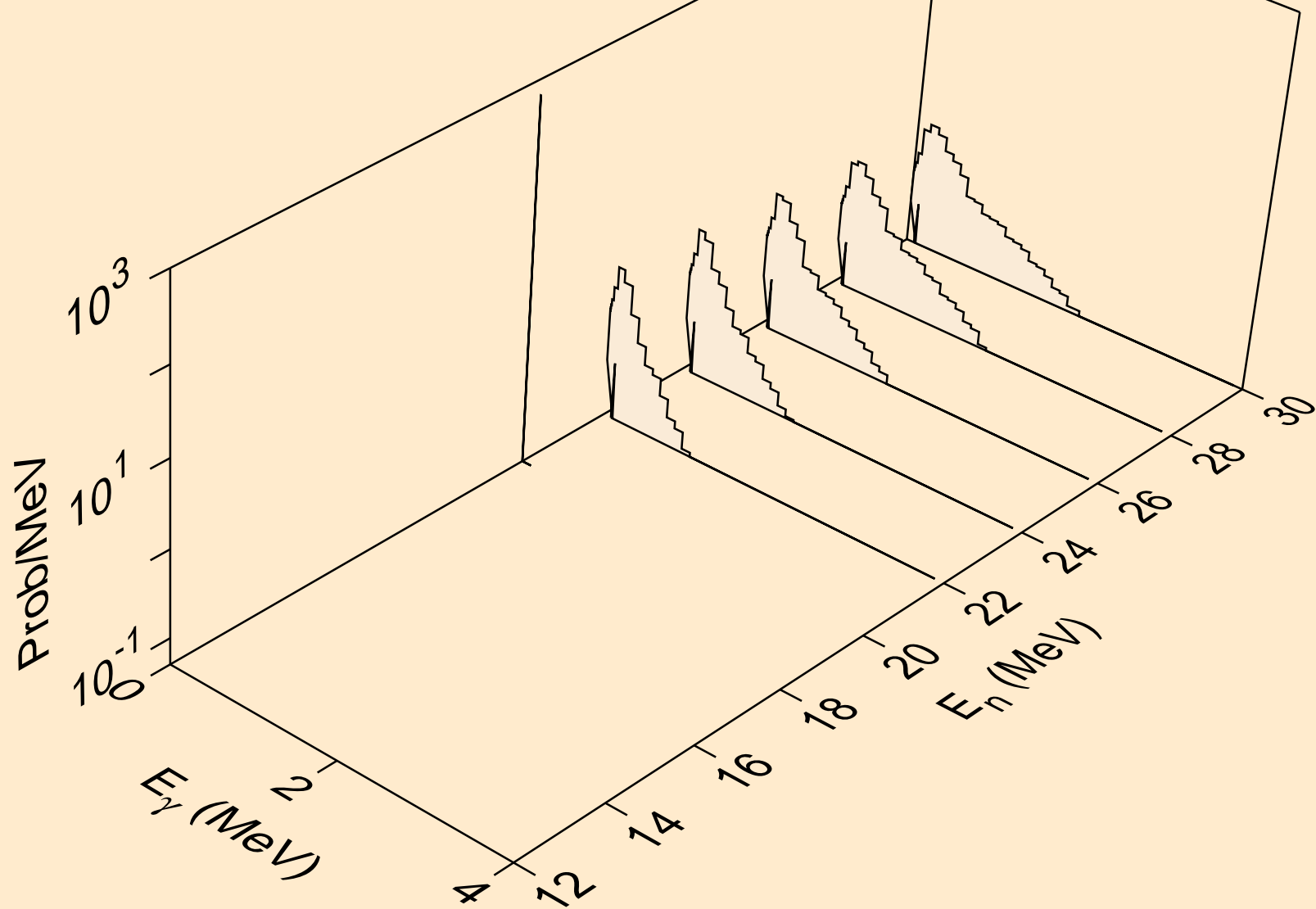

HS269 HELION ACER TENDL-2021 LIBRARY; T=0.K  
Photon emission for (n,2np)

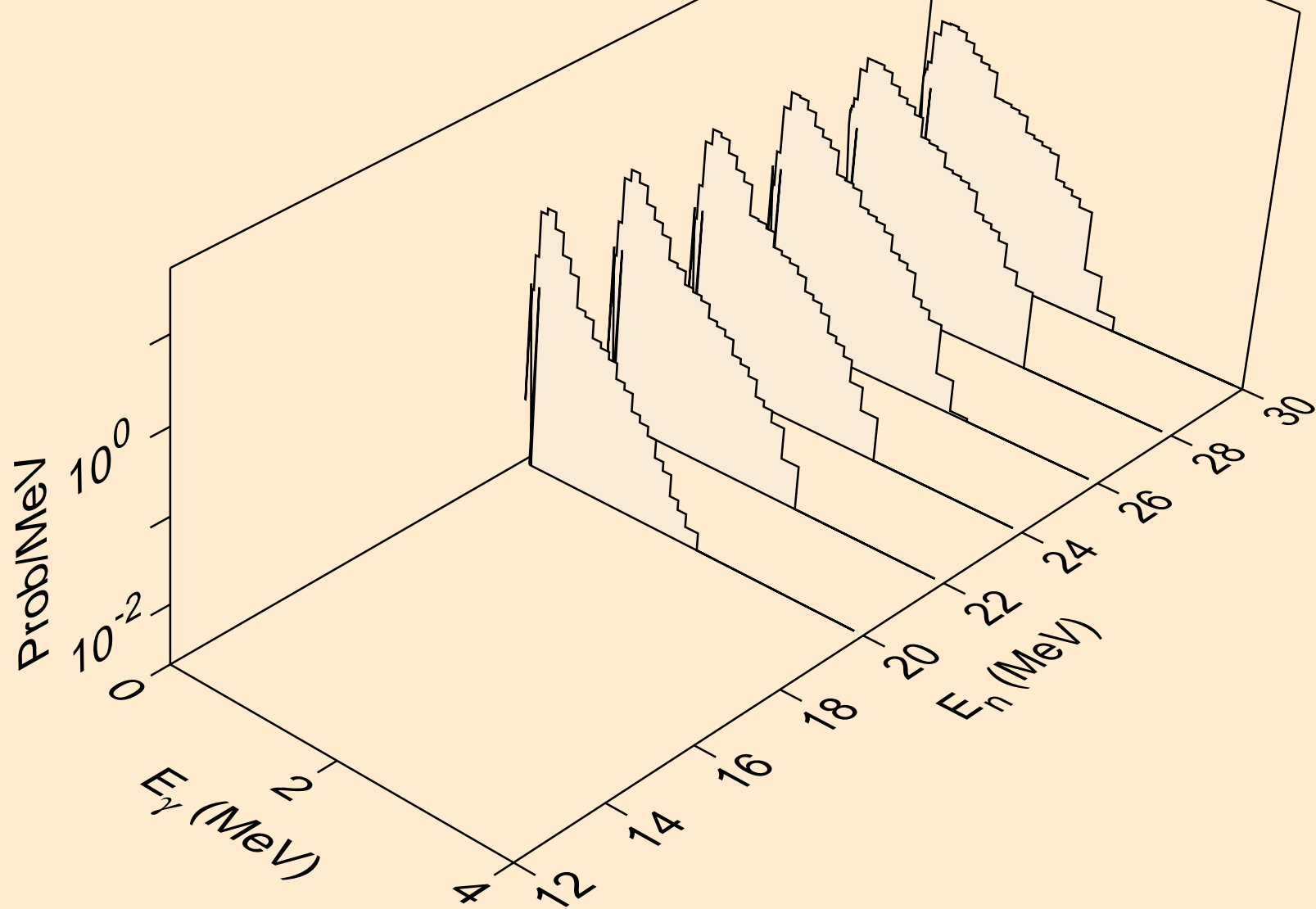

HS269 HELION ACER TENDL-2021 LIBRARY; T=0.K  
Photon emission for (n,npa)

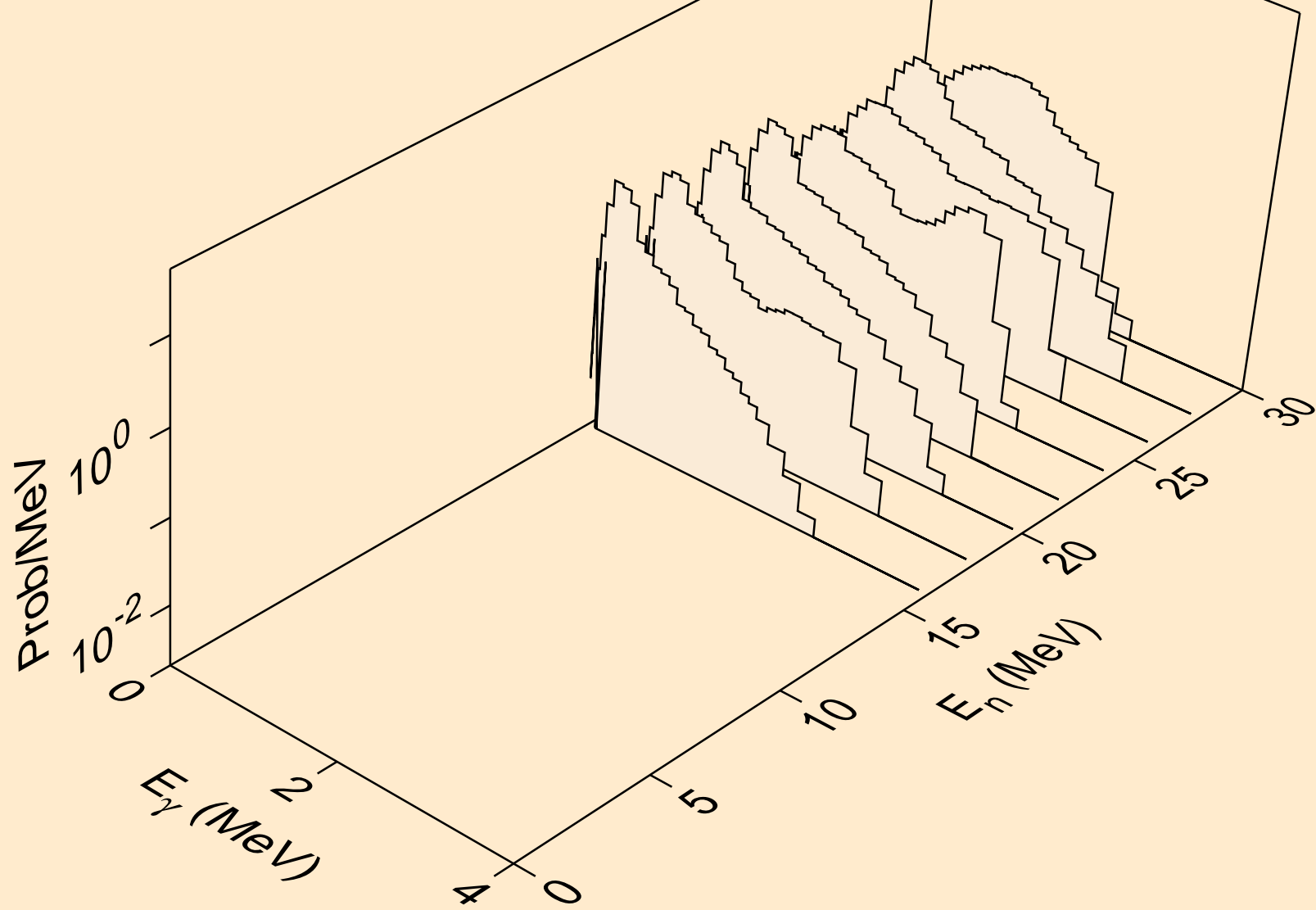



HS269 HELION ACER TENDL-2021 LIBRARY; T=0.K  
Photon emission for (n,p)

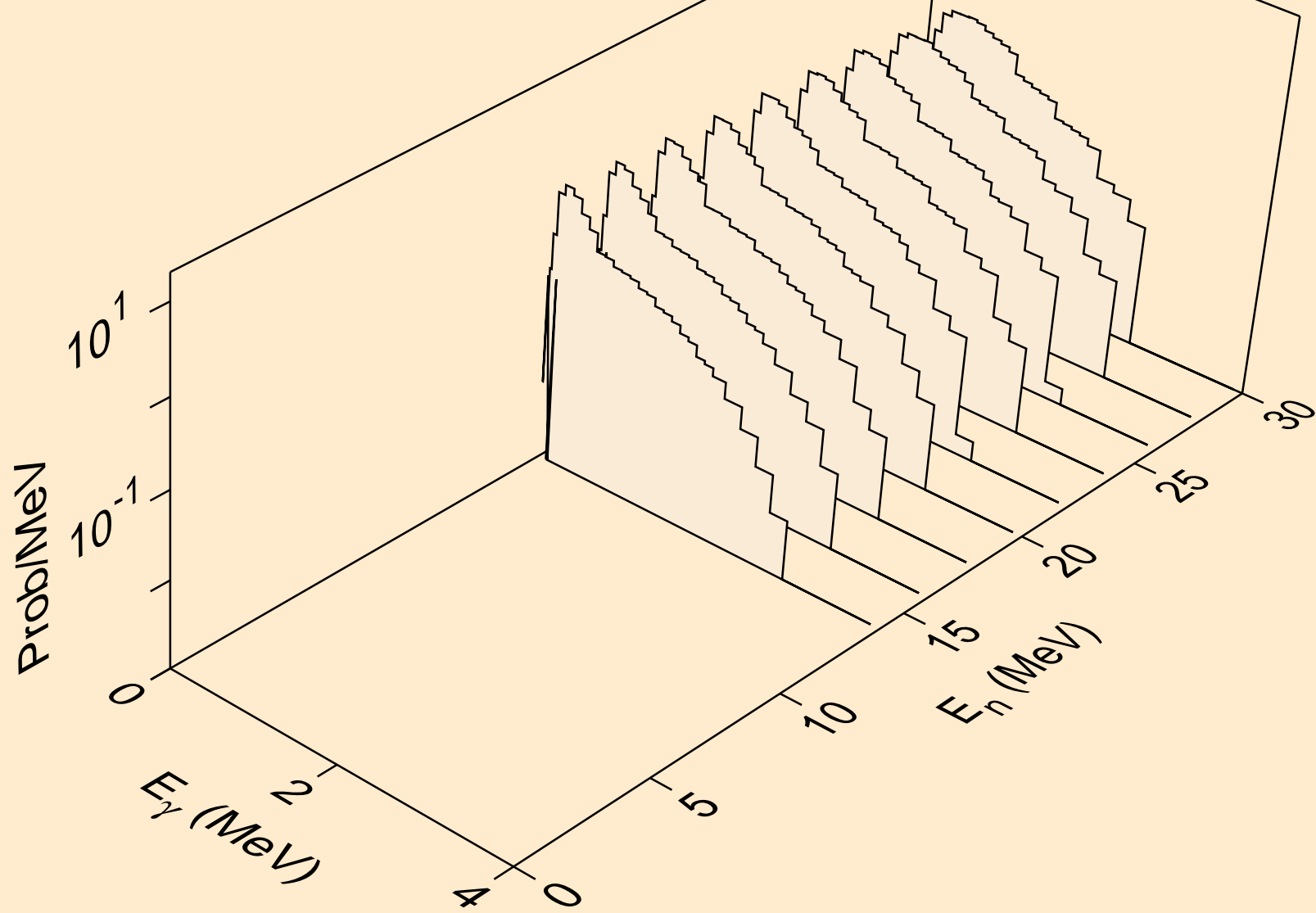

HS269 HELION ACER TENDL-2021 LIBRARY; T=0.K  
Photon emission for (n,d)

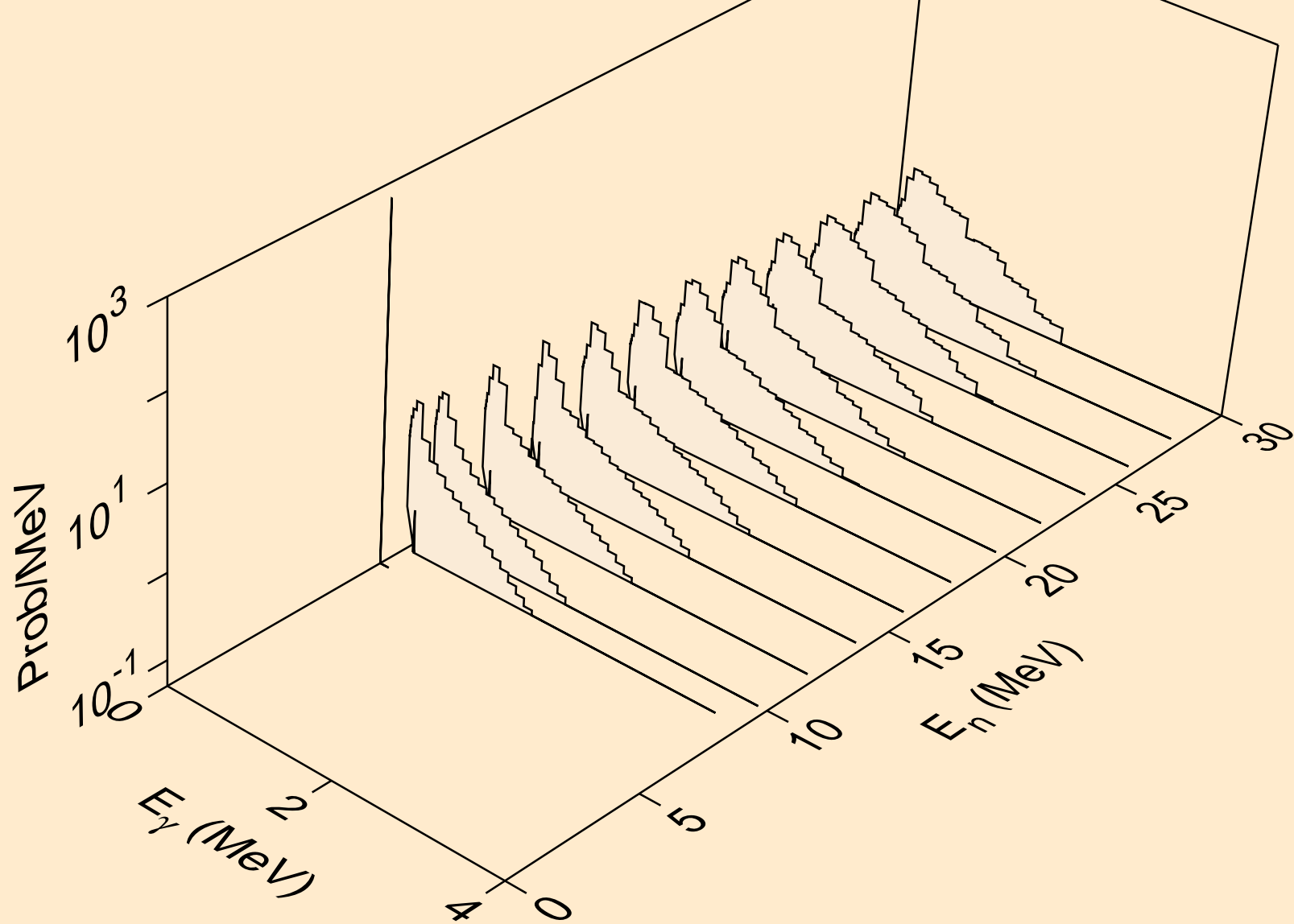

HS269 HELION ACER TENDL-2021 LIBRARY; T=0.K  
Photon emission for (n,t)

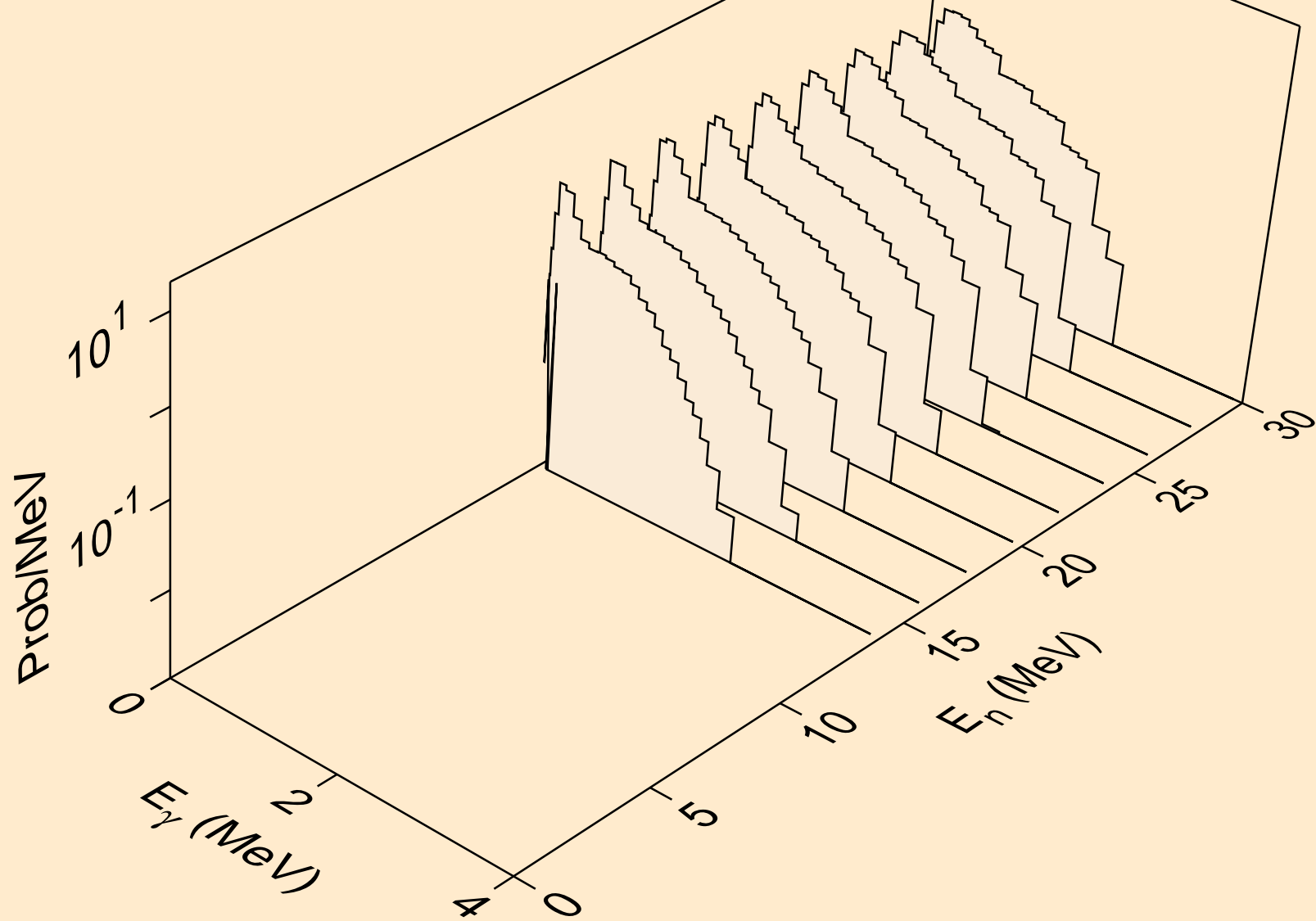

HS269 HELION ACER TENDL-2021 LIBRARY; T=0.K  
Photon emission for inelastic

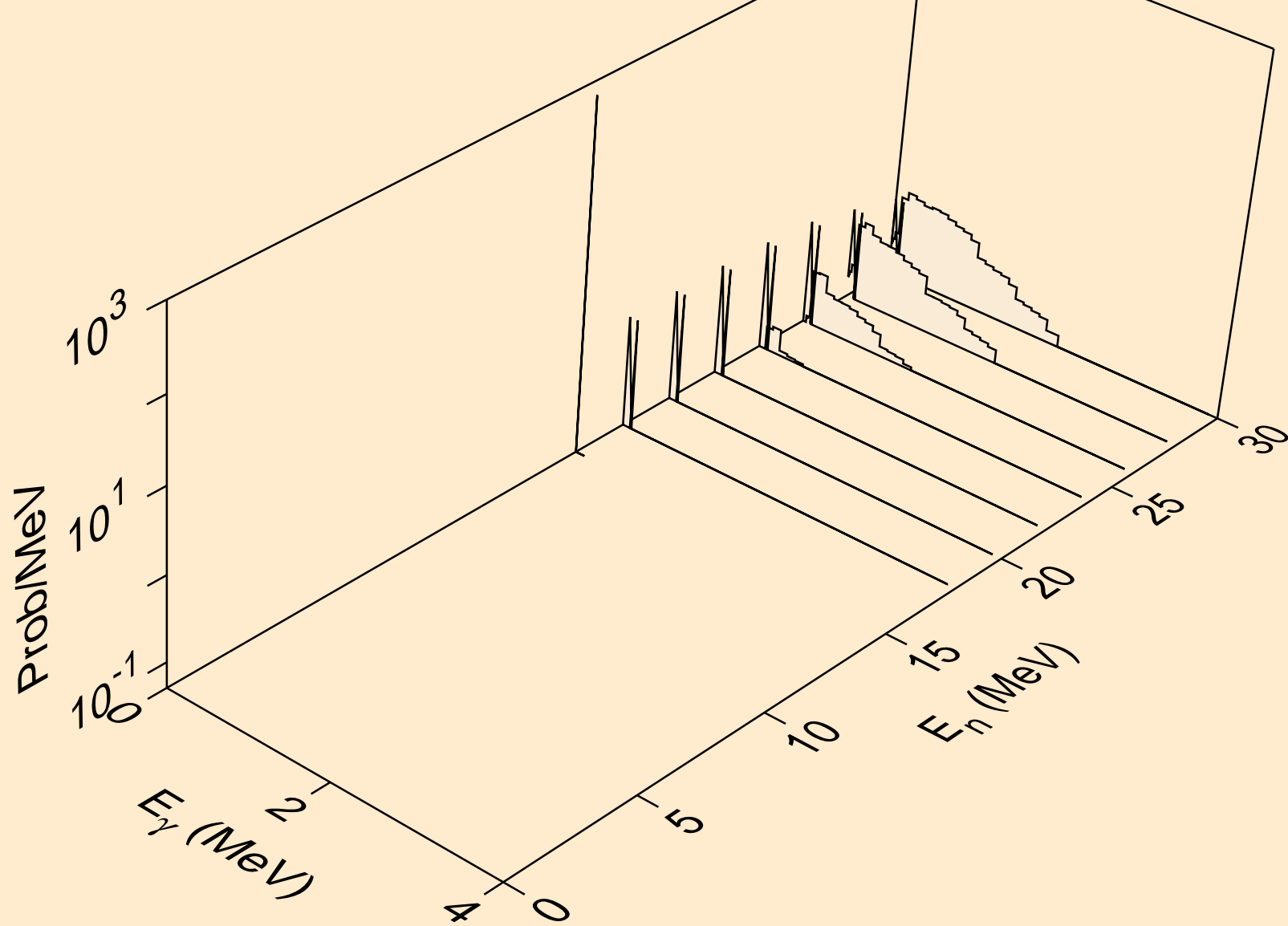

HS269 HELION ACER TENDL-2021 LIBRARY; T=0.K  
Photon emission for (n,a)

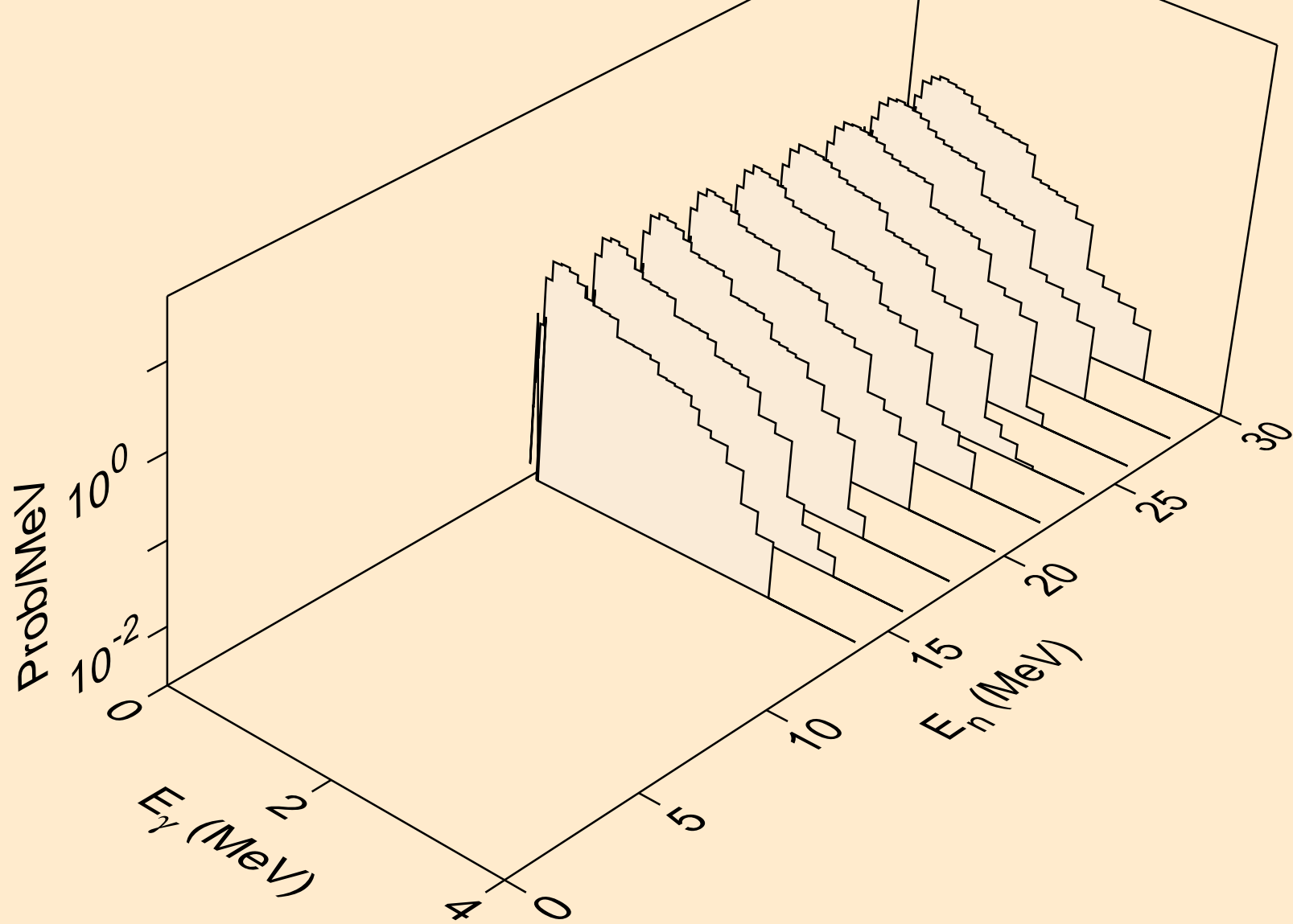

HS269 HELION ACER TENDL-2021 LIBRARY; T=0.K  
Photon emission for (n,2p)

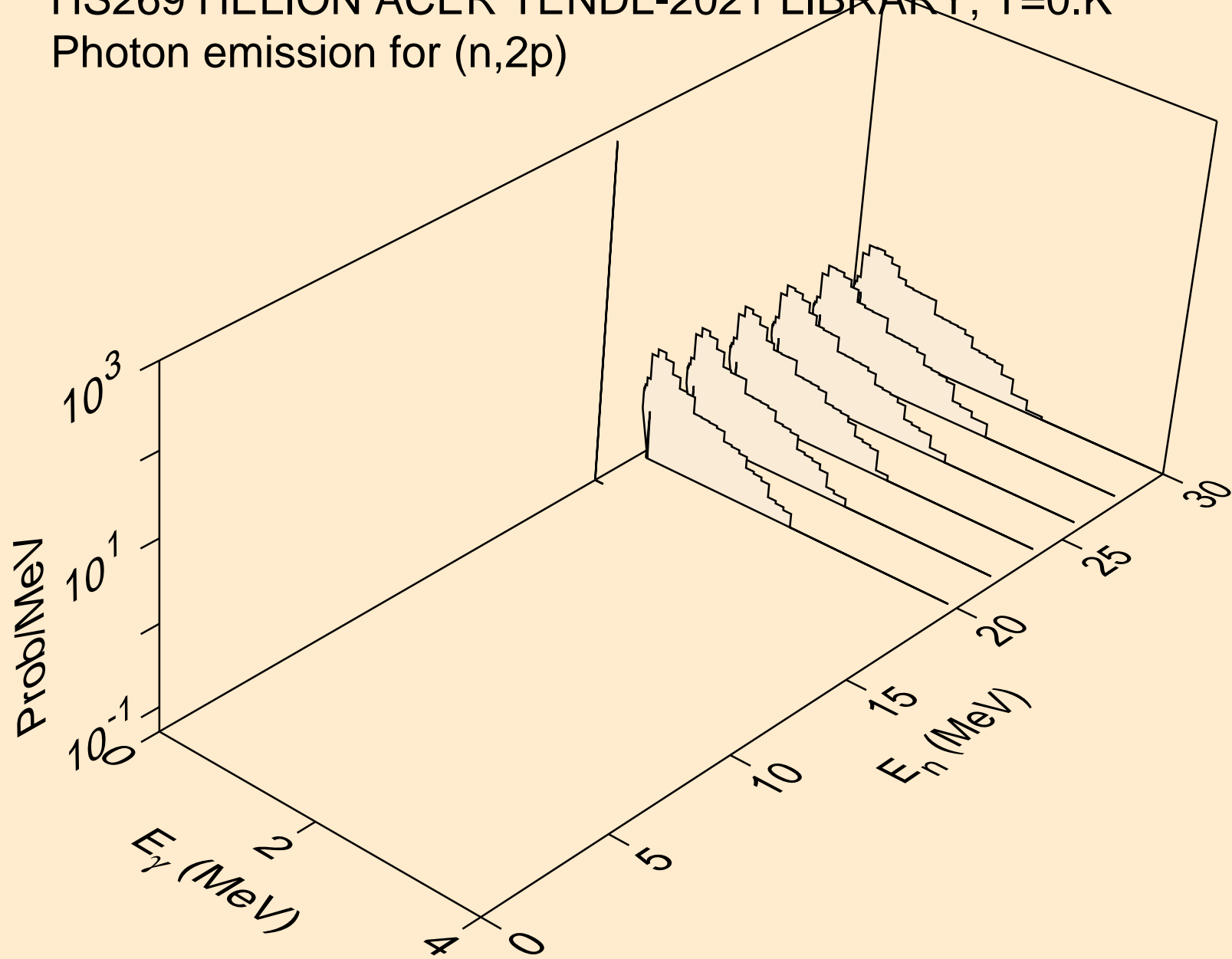

HS269 HELION ACER TENDL-2021 LIBRARY; T=0.K  
Photon emission for (n,pa)

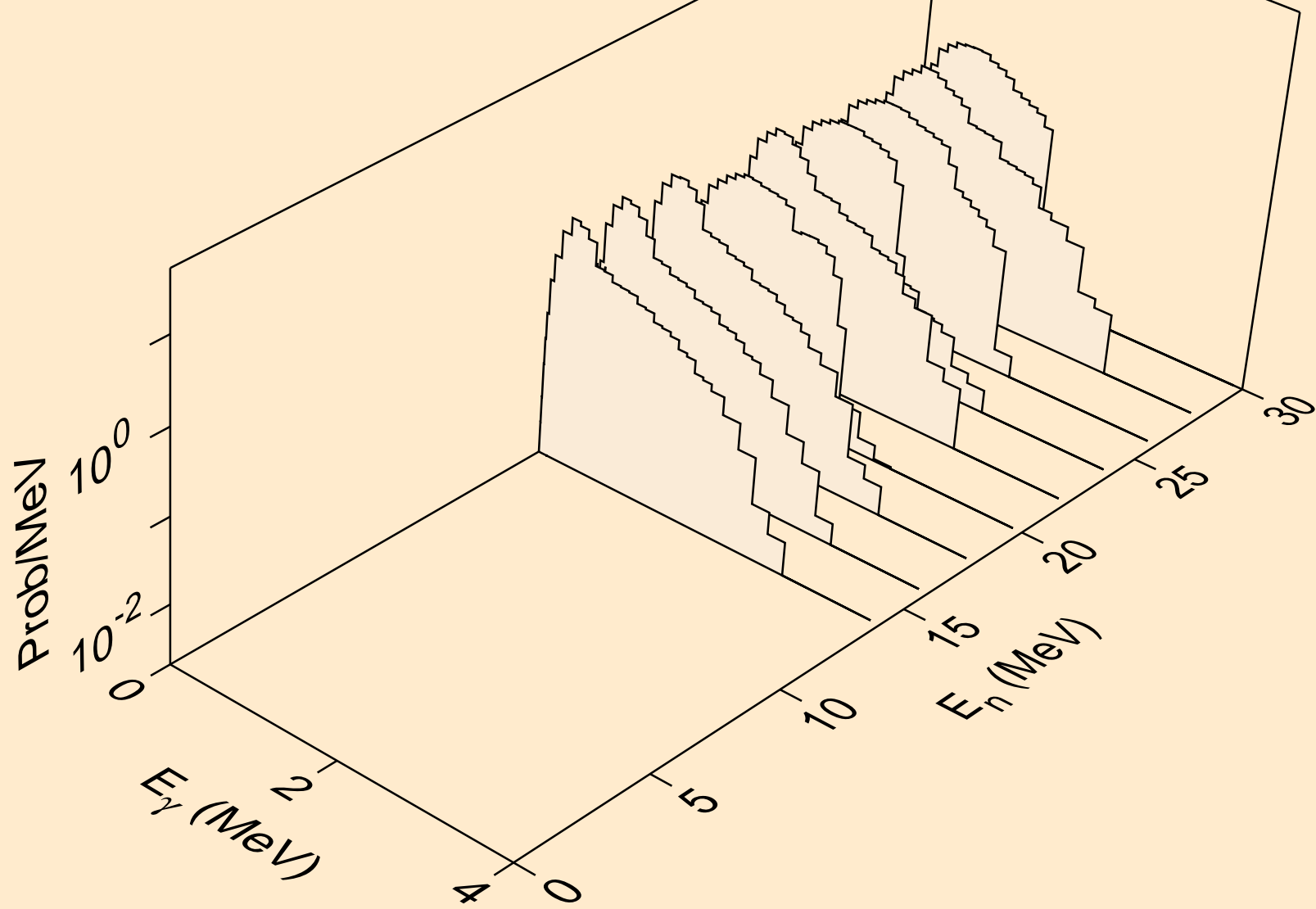

HS269 HELION ACER TENDL-2021 LIBRARY; T=0.K  
Photon emission for (n,t2a)

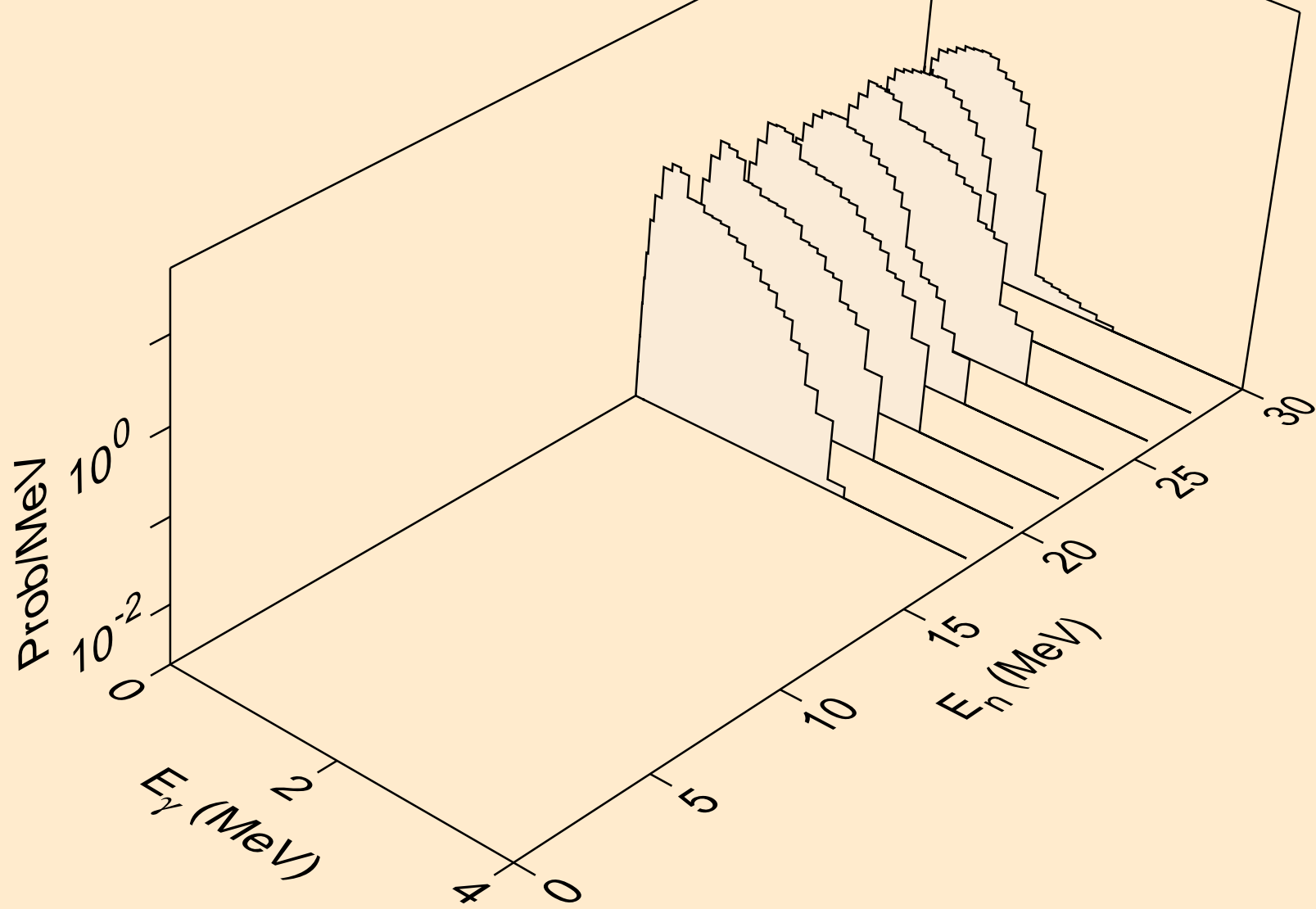



HS269 HELION ACER TENDL-2021 LIBRARY; T=0.K  
Photon emission for (n,d2a)

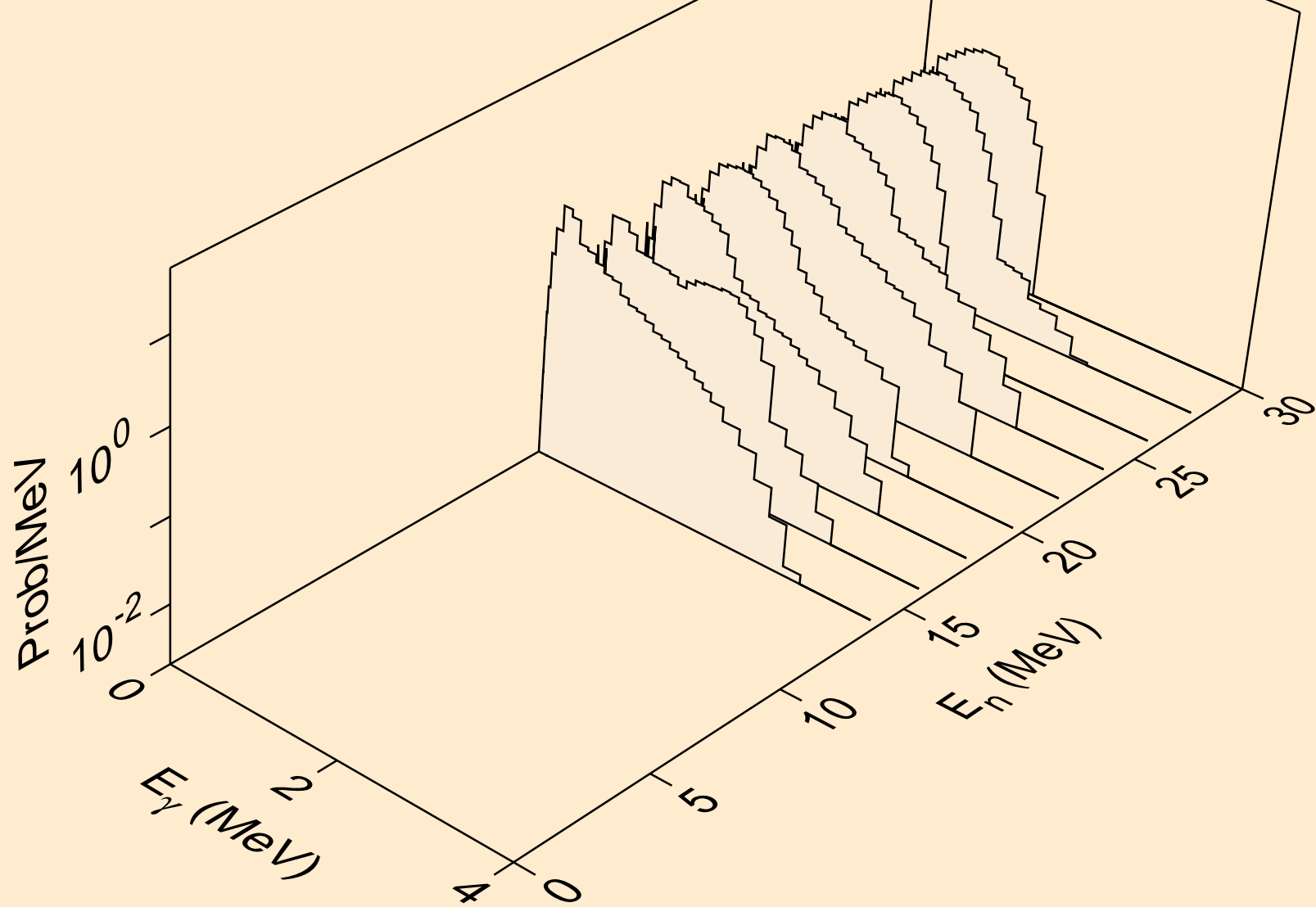

HS269 HELION ACER TENDL-2021 LIBRARY; T=0.K  
Photon emission for (n,da)

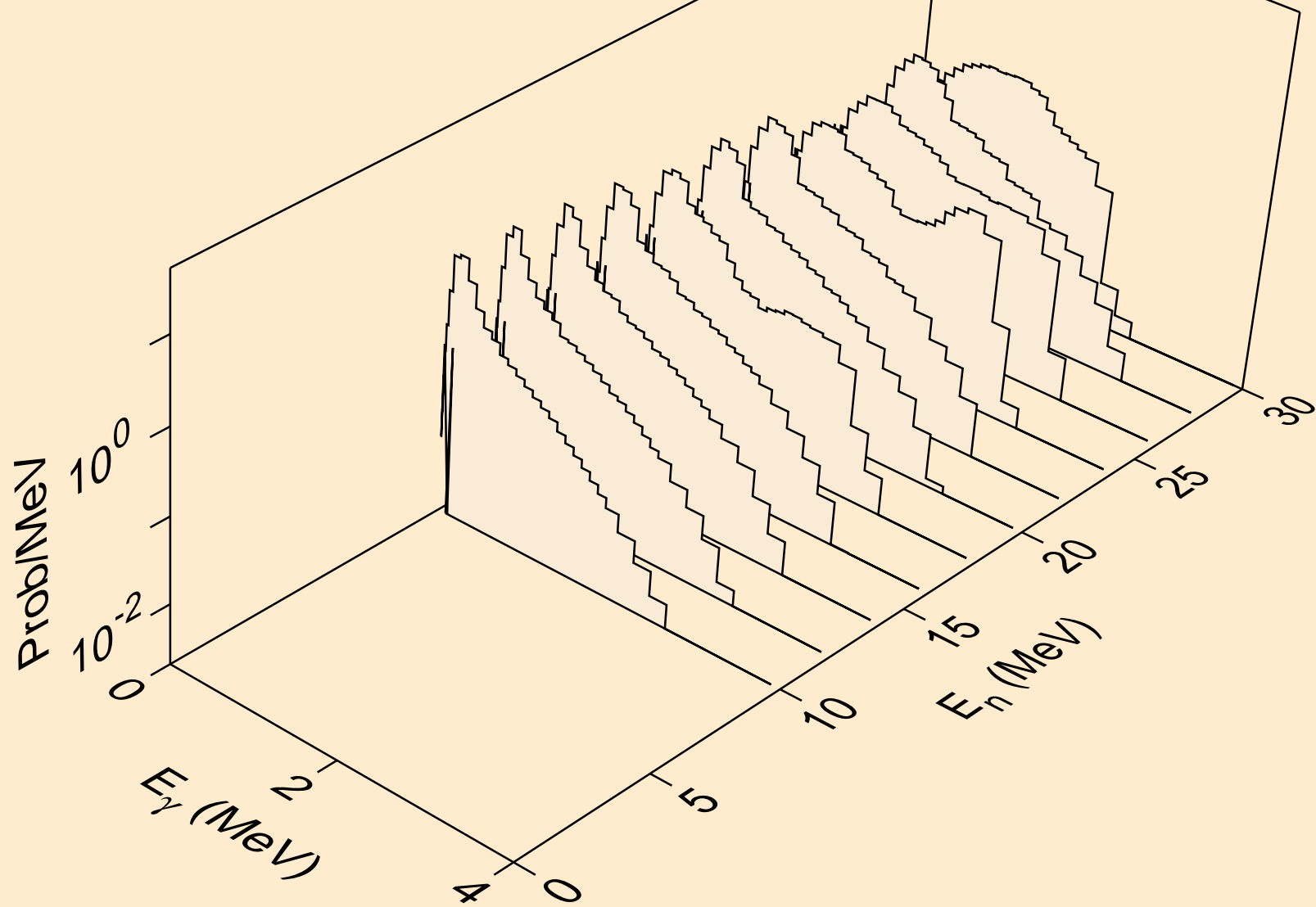

HS269 HELION ACER TENDL-2021 LIBRARY; T=0.K  
Particle heating contributions

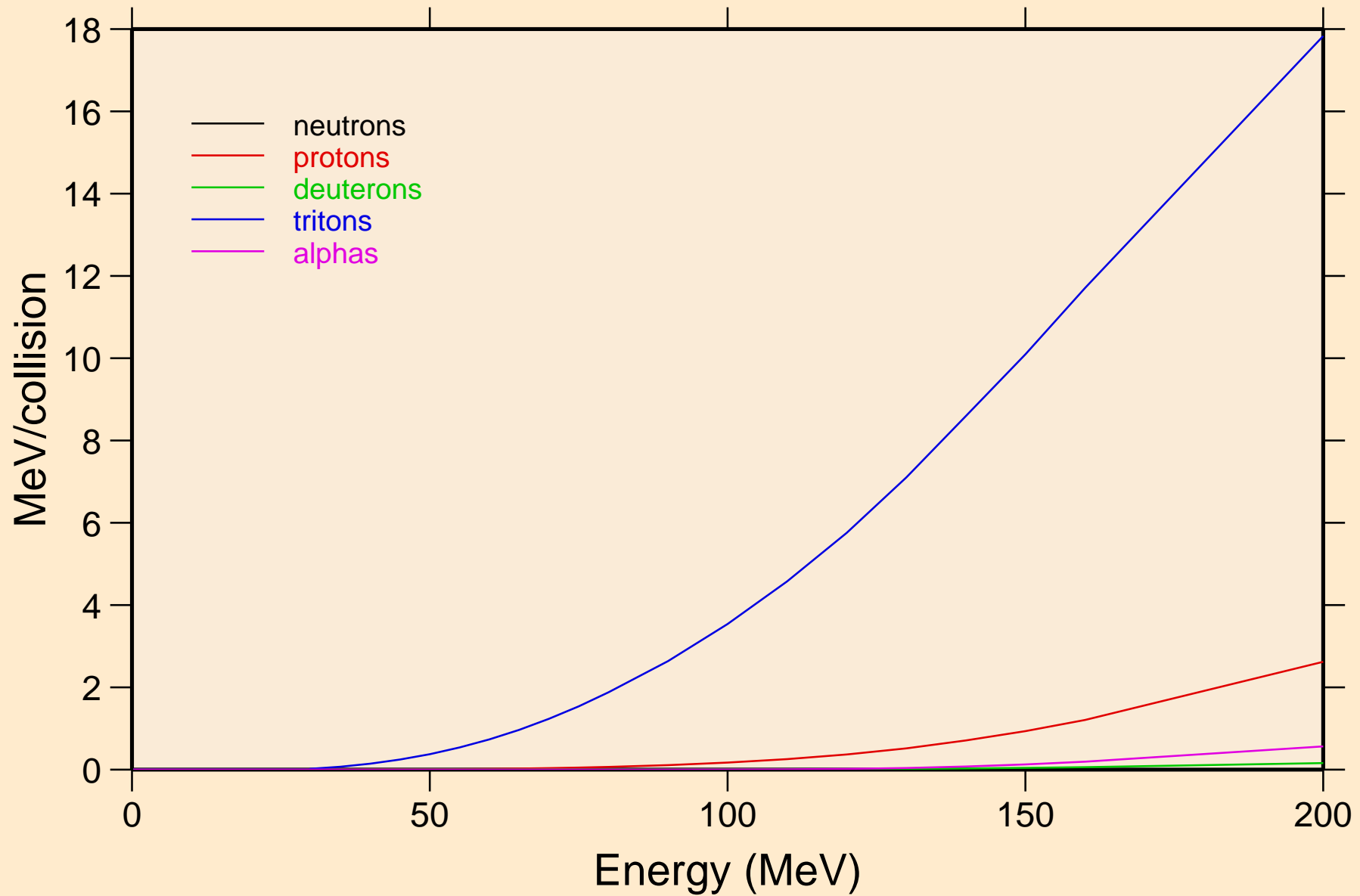

HS269 HELION ACER TENDL-2021 LIBRARY; T=0.K  
Recoil Heating

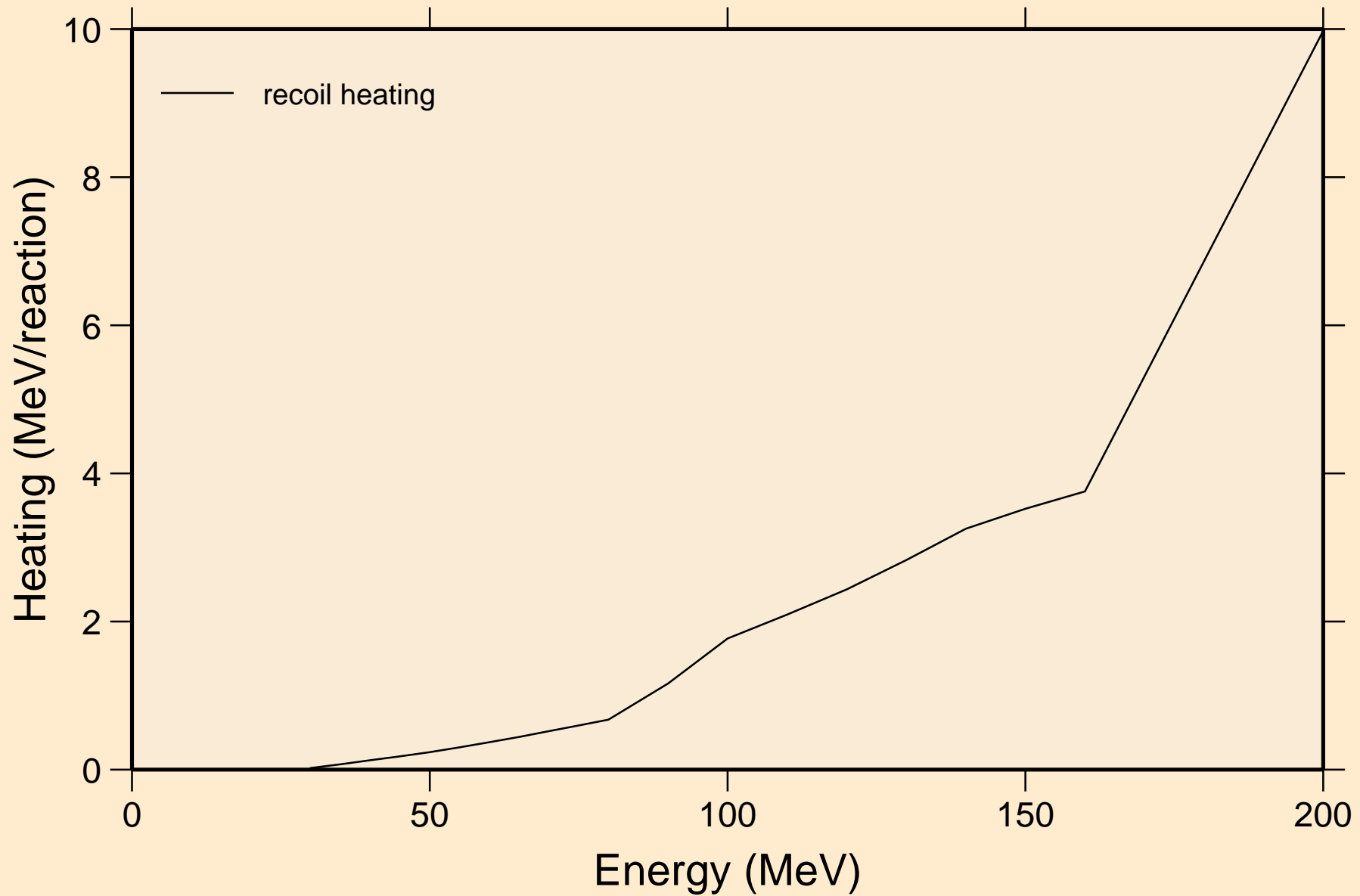

HS269 HELION ACER TENDL-2021 LIBRARY; T=0.K  
Particle production cross sections

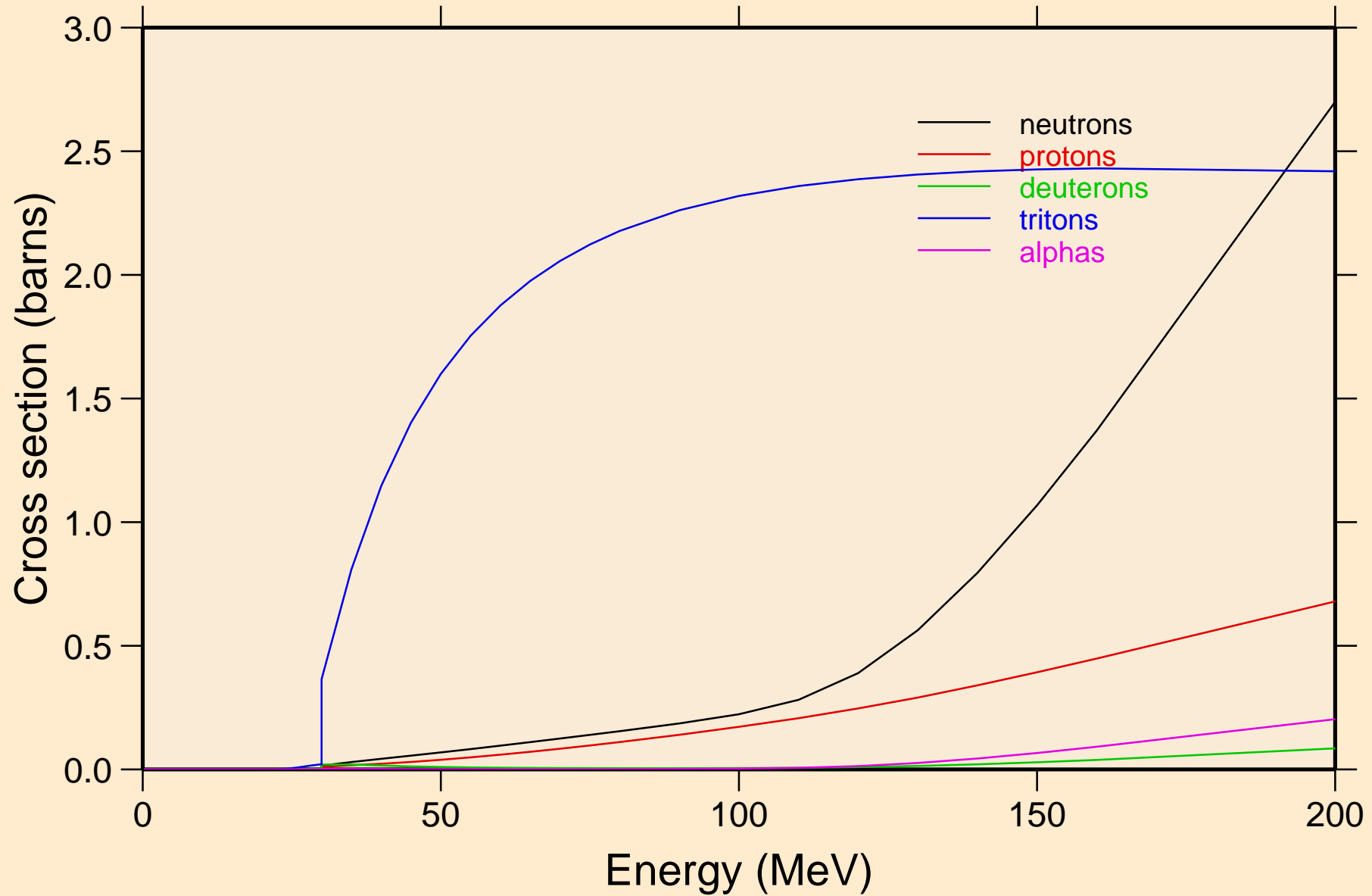

HS269 HELION ACER TENDL-2021 LIBRARY; T=0.K  
neutrons from (s,n)

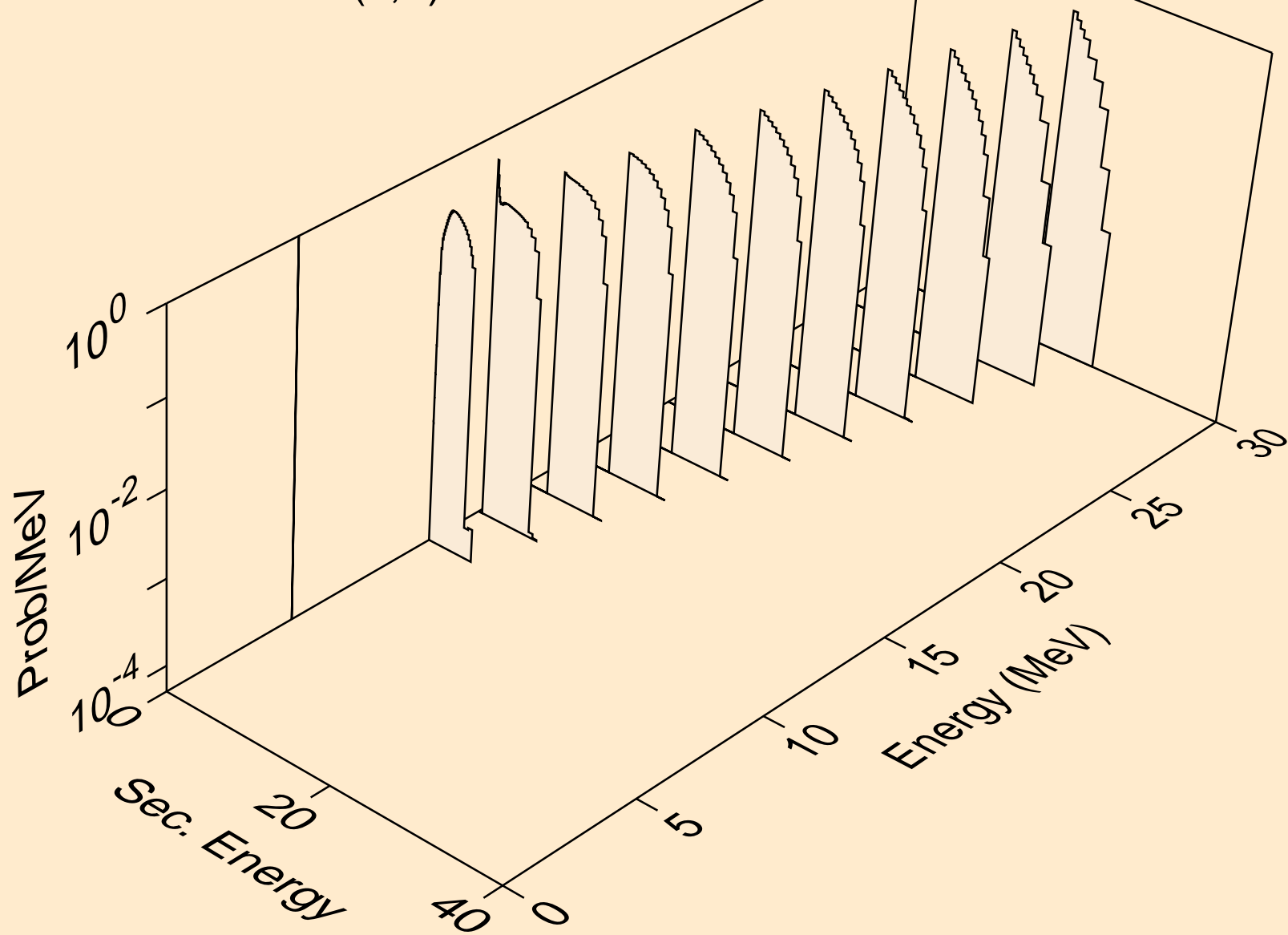

HS269 HELION ACER TENDL-2021 LIBRARY; T=0.K  
neutrons from (s,x)

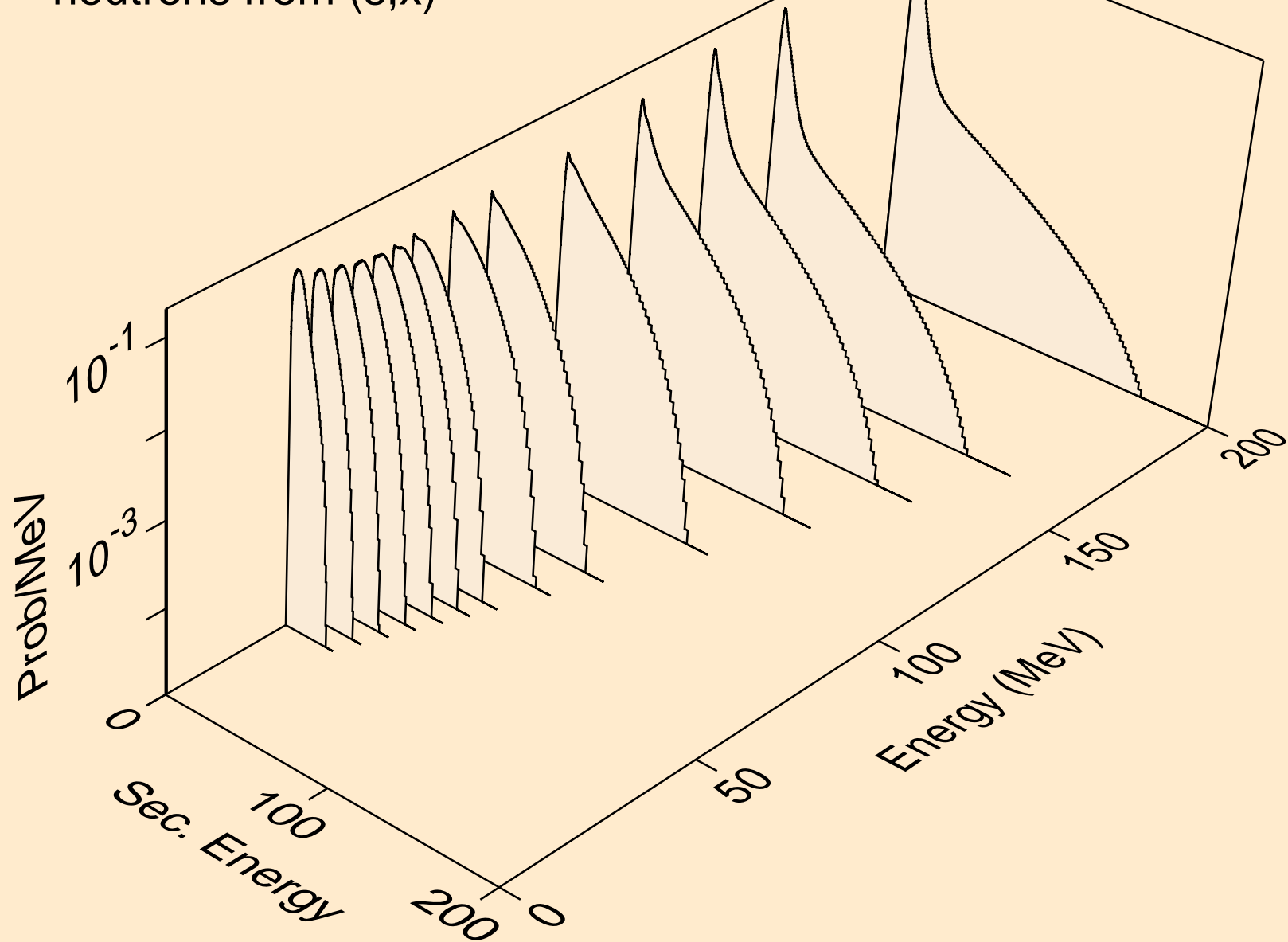

HS269 HELION ACER TENDL-2021 LIBRARY; T=0.K  
neutrons from (s,2n)

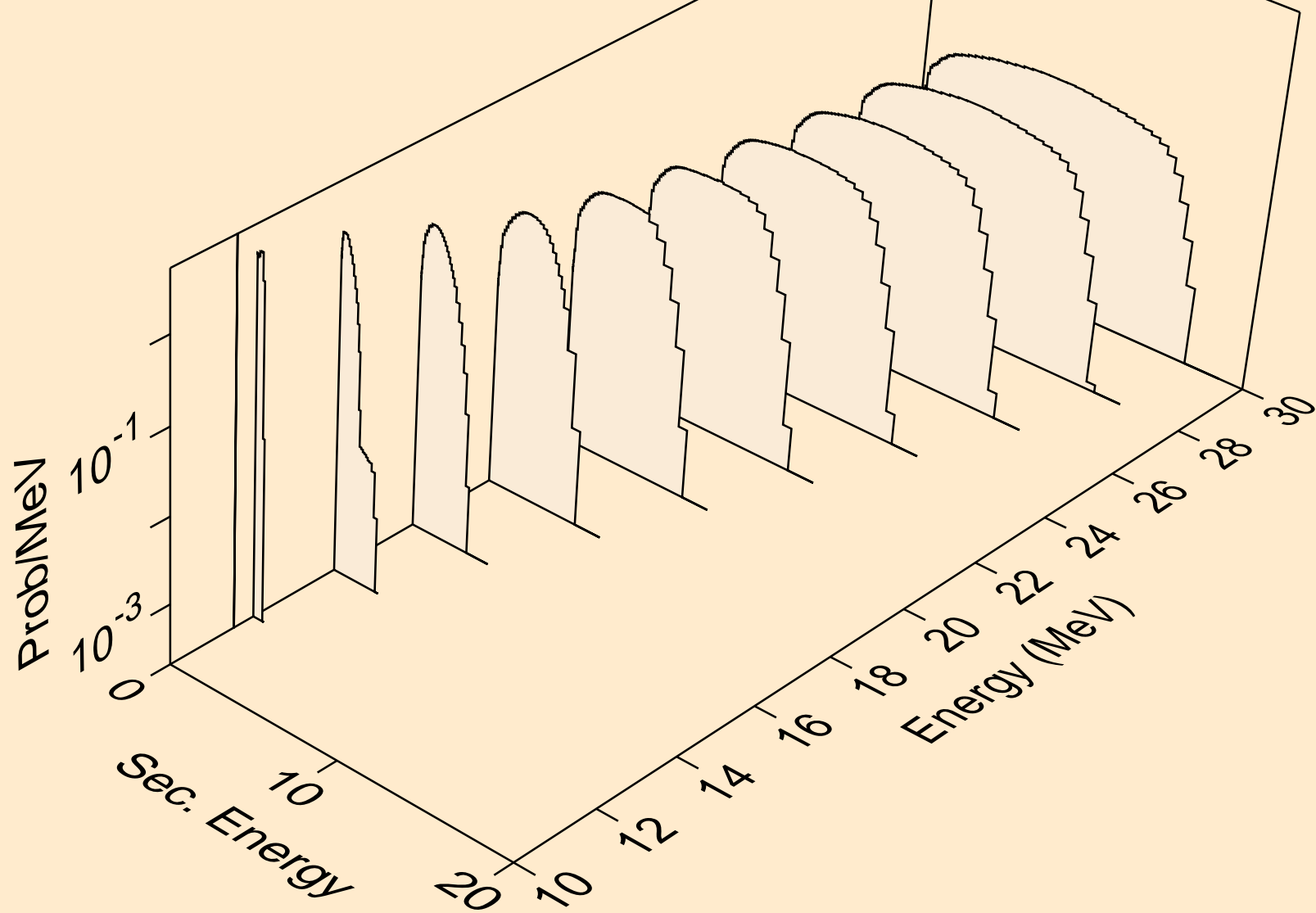



HS269 HELION ACER TENDL-2021 LIBRARY; T=0.K  
neutrons from (s,3n)

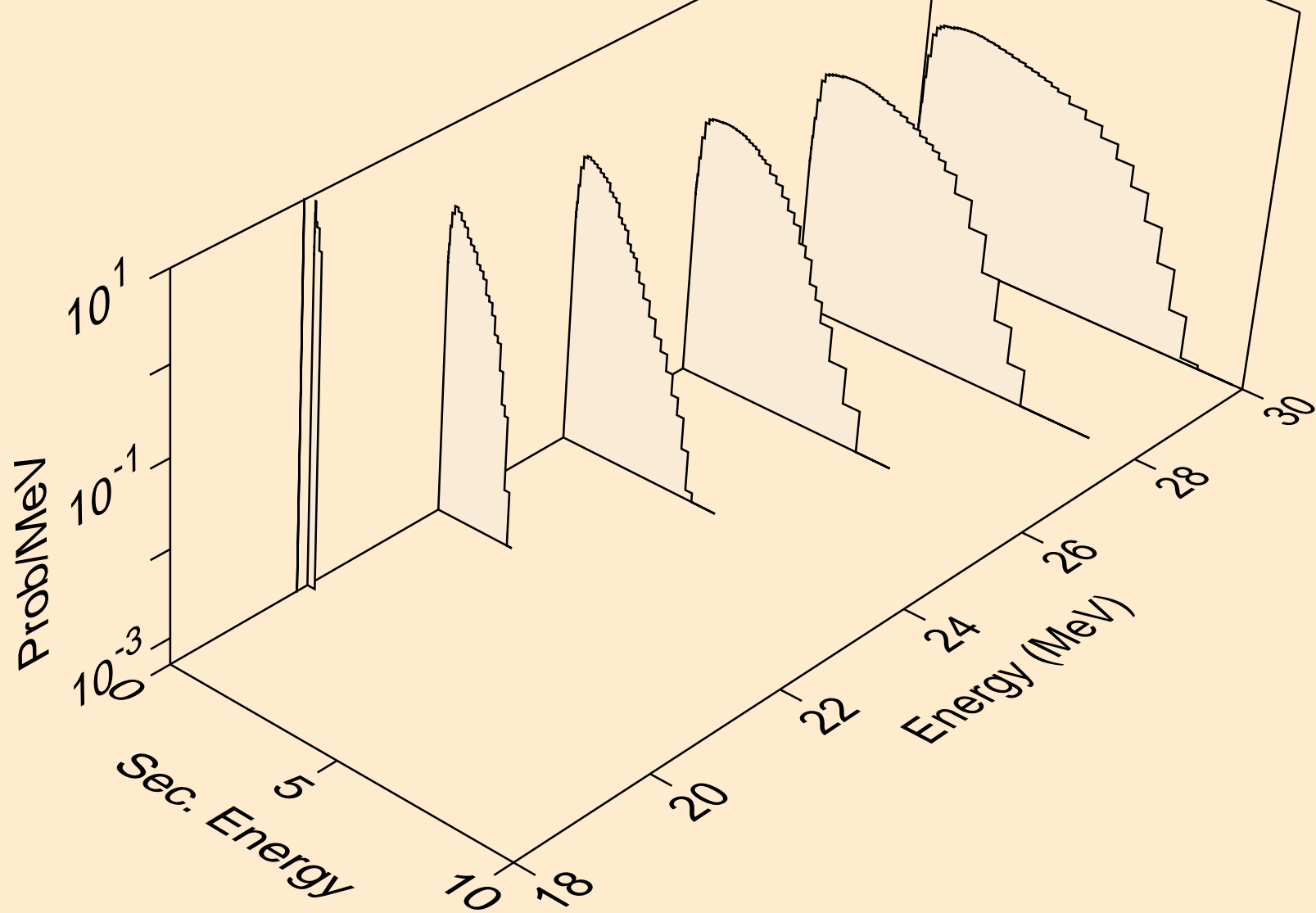

HS269 HELION ACER TENDL-2021 LIBRARY; T=0.K  
neutrons from (s,n\*)a

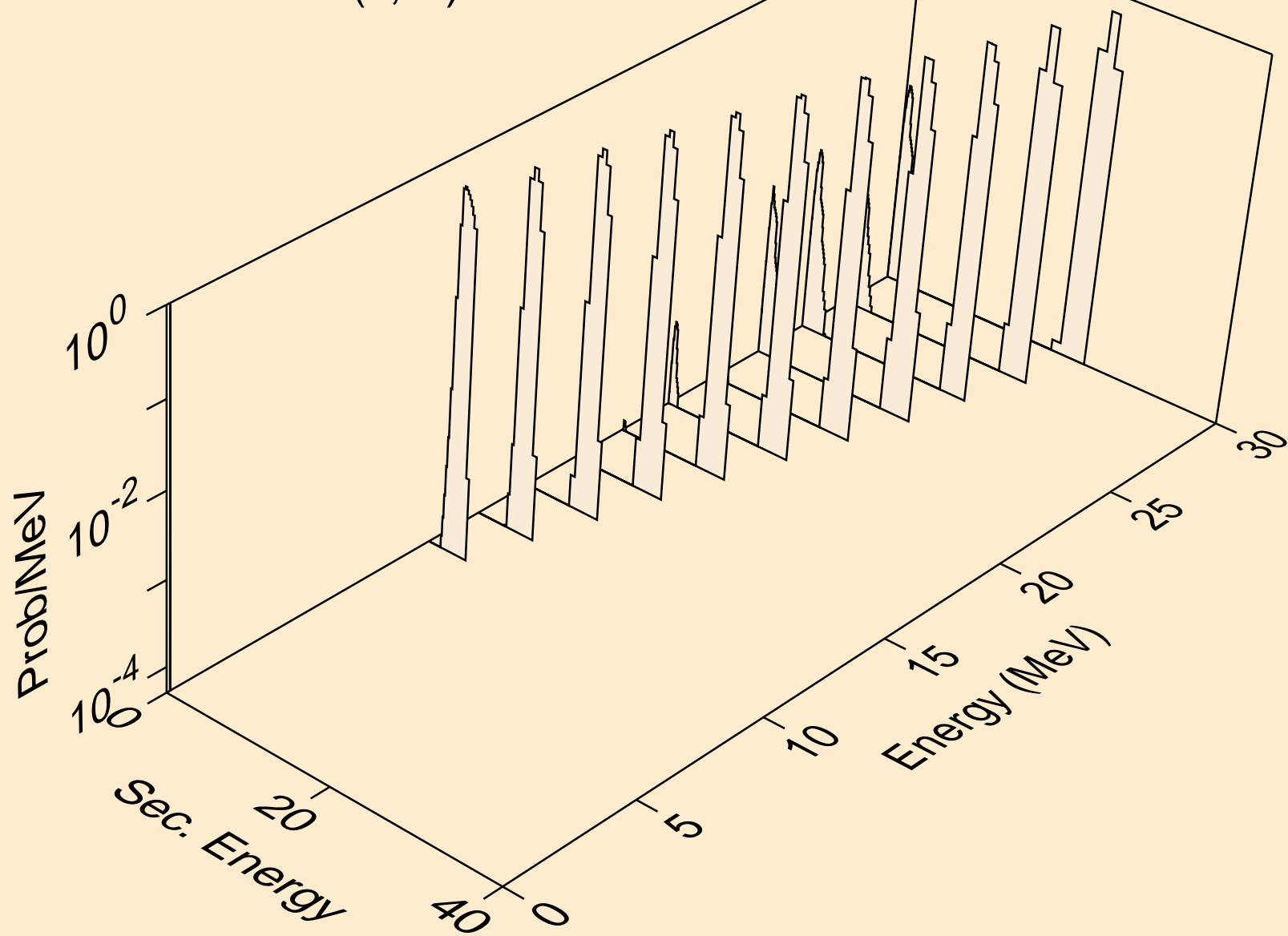

HS269 HELION ACER TENDL-2021 LIBRARY; T=0.K  
neutrons from (s,2n)a

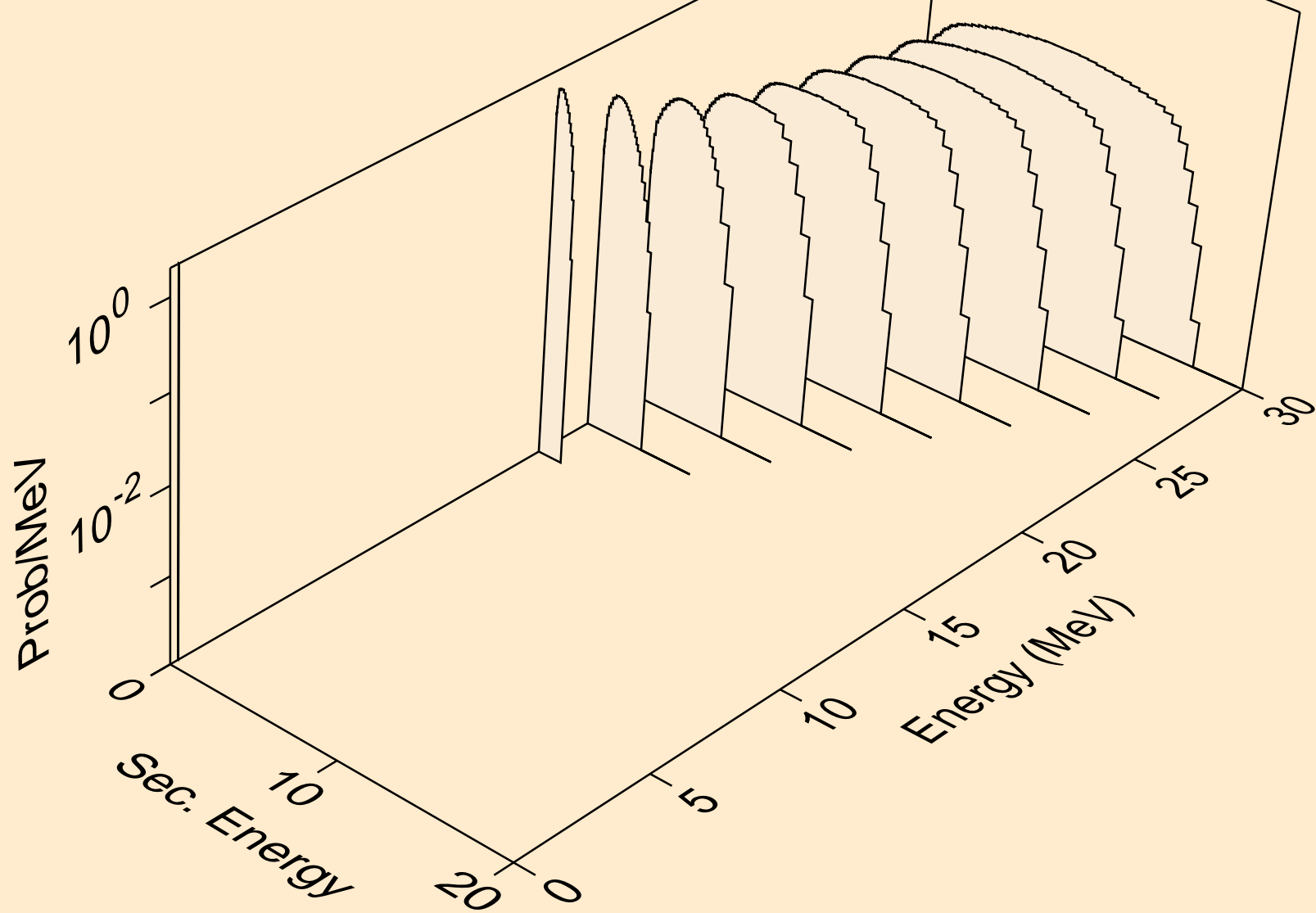

HS269 HELION ACER TENDL-2021 LIBRARY; T=0.K  
neutrons from (s,n\*)p

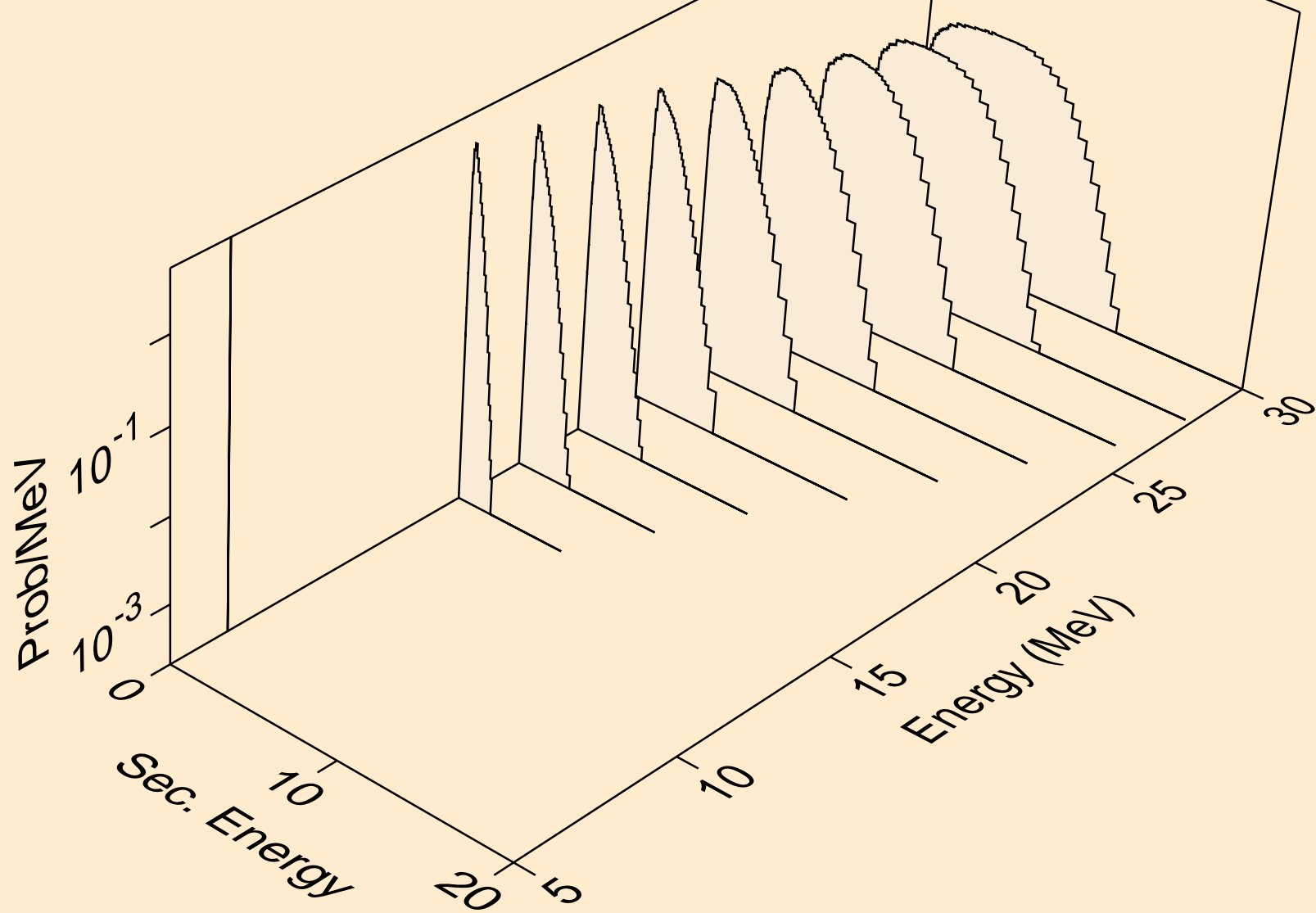

HS269 HELION ACER TENDL-2021 LIBRARY; T=0.K  
neutrons from (s,n\*)d

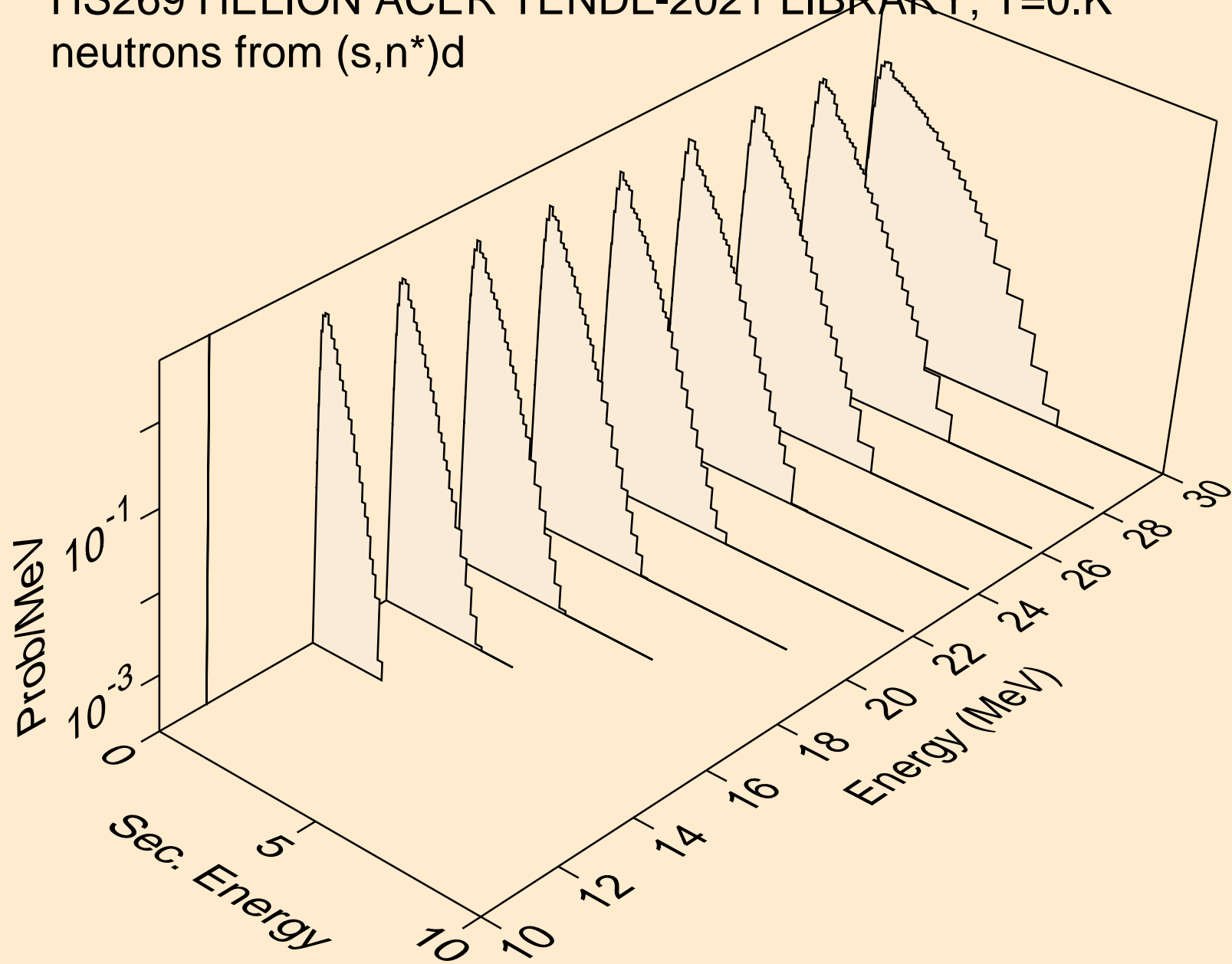

HS269 HELION ACER TENDL-2021 LIBRARY; T=0.K  
neutrons from (s,n\*)t

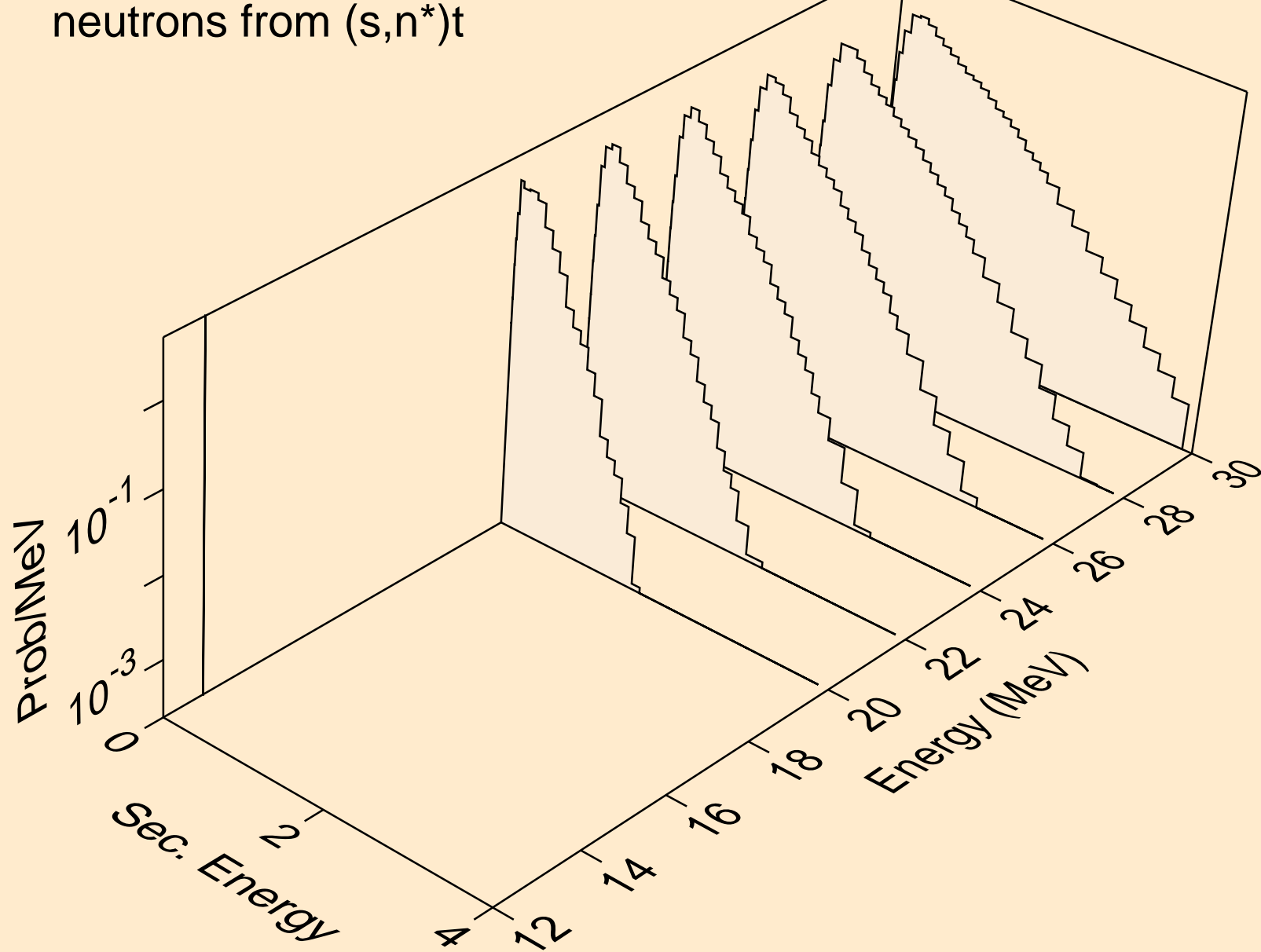

HS269 HELION ACER TENDL-2021 LIBRARY; T=0.K  
neutrons from (s,2np)

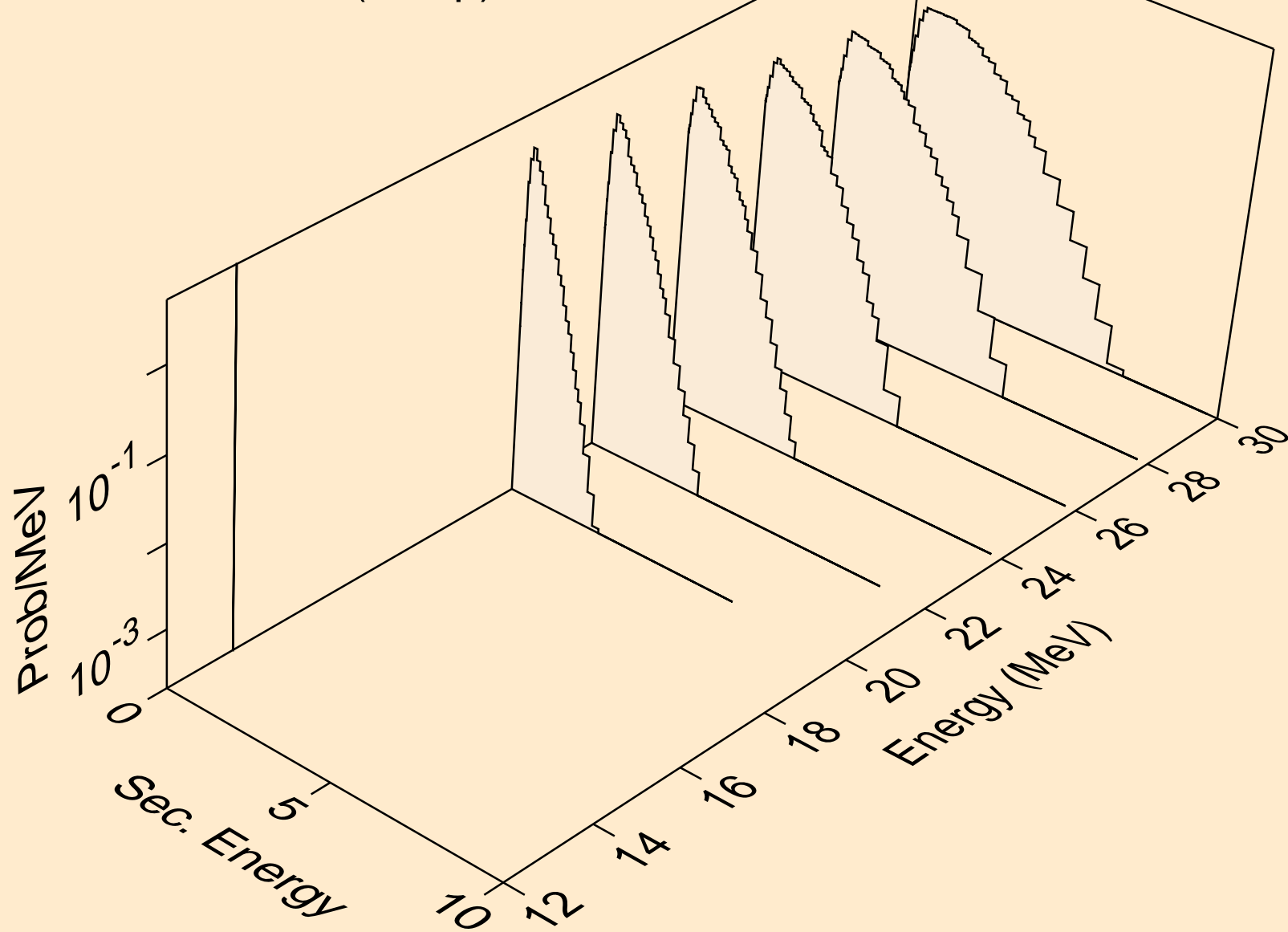

HS269 HELION ACER TENDL-2021 LIBRARY; T=0.K  
neutrons from (s,npa)

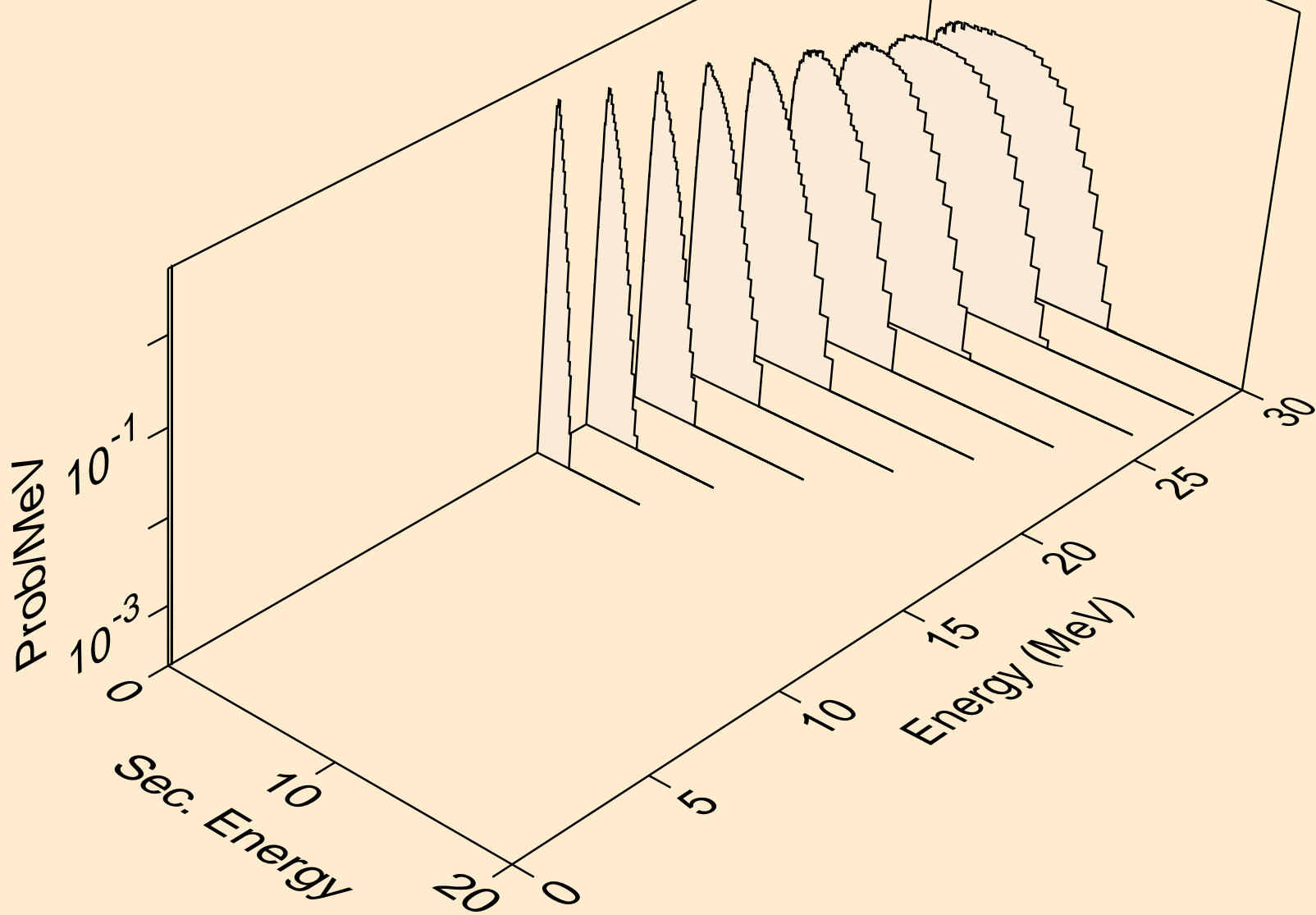



HS269 HELION ACER TENDL-2021 LIBRARY; T=0.K  
protons from (s,x)

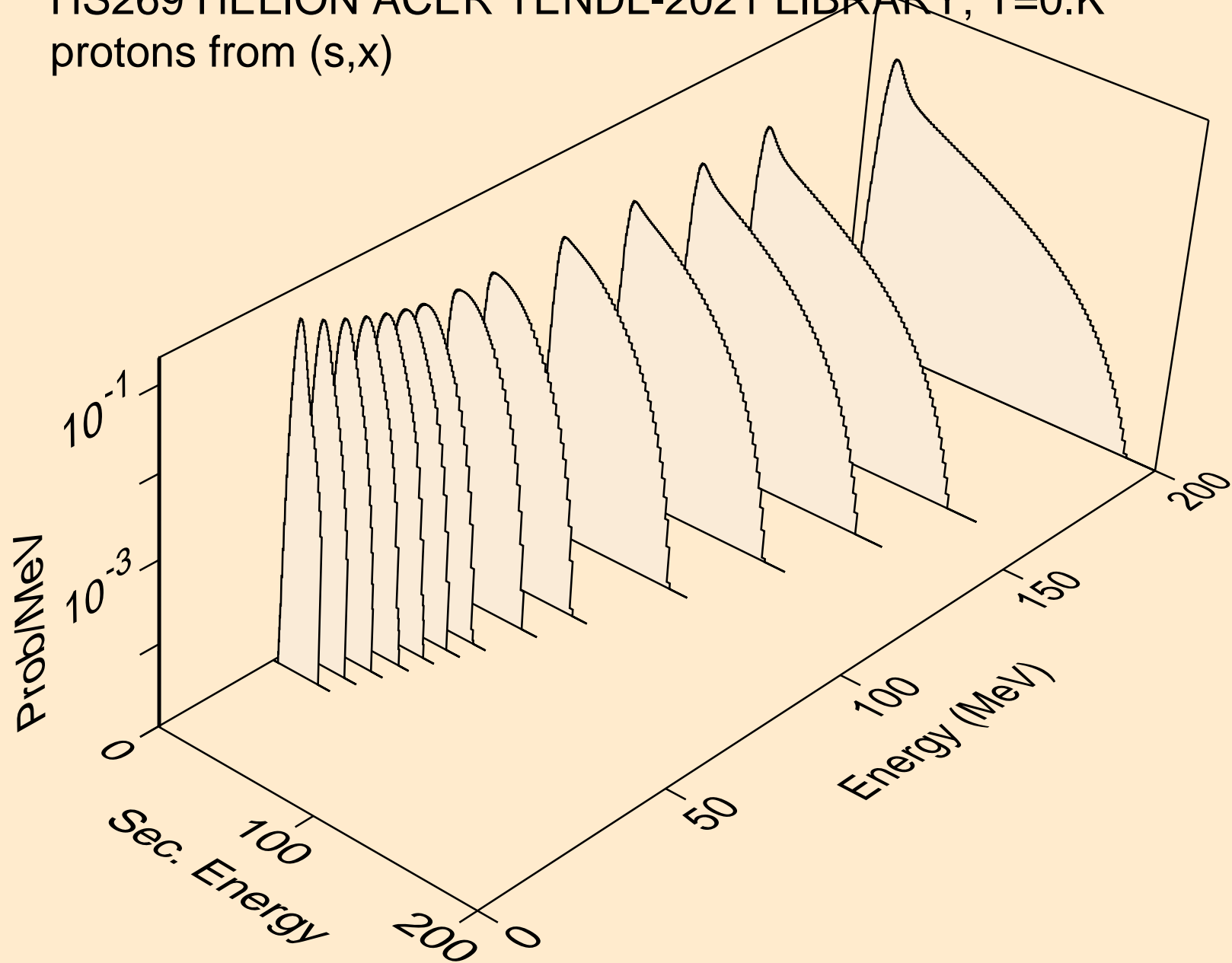

HS269 HELION ACER TENDL-2021 LIBRARY; T=0.K  
protons from (s,n\*)p

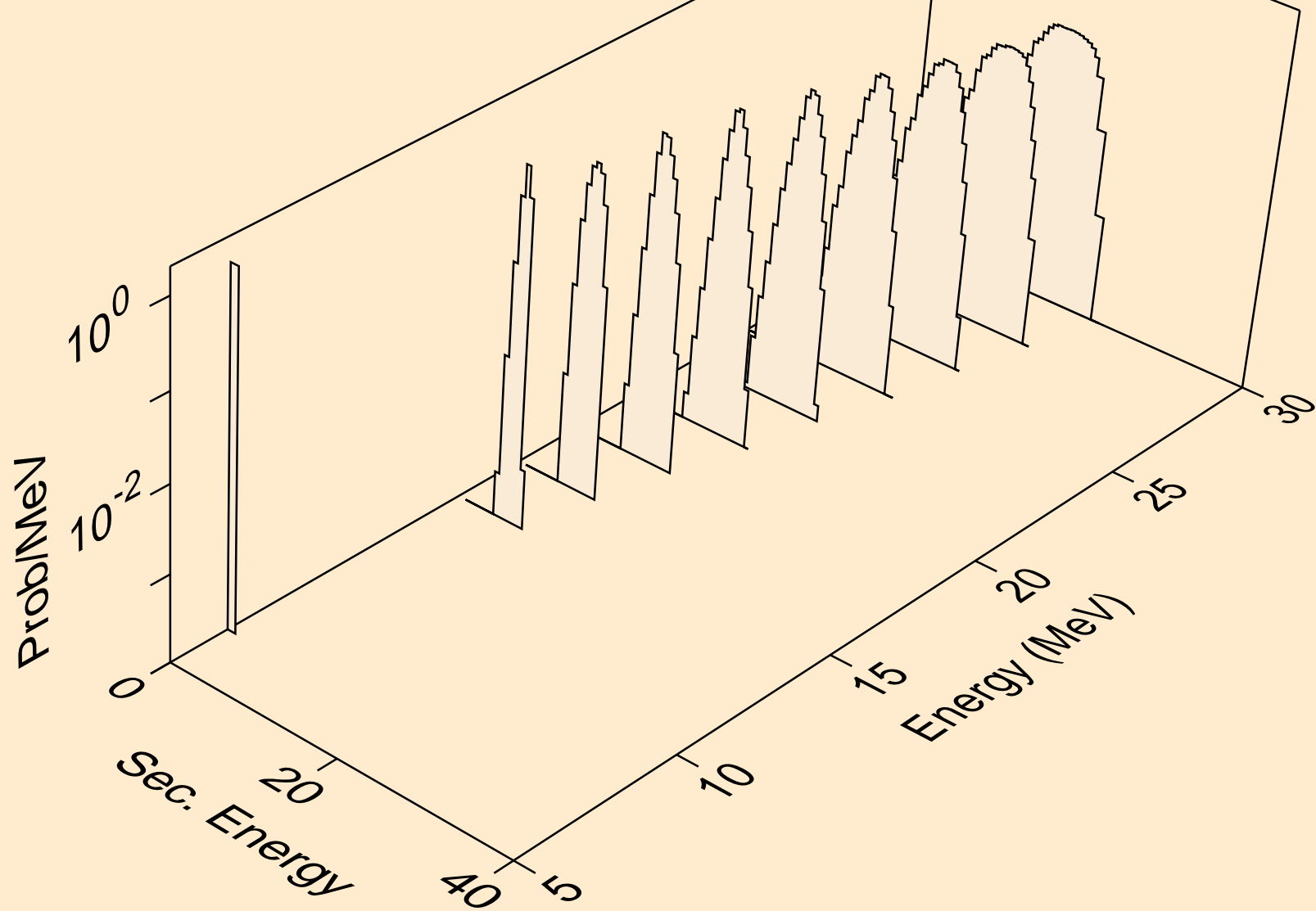

HS269 HELION ACER TENDL-2021 LIBRARY; T=0.K  
protons from (s,2np)

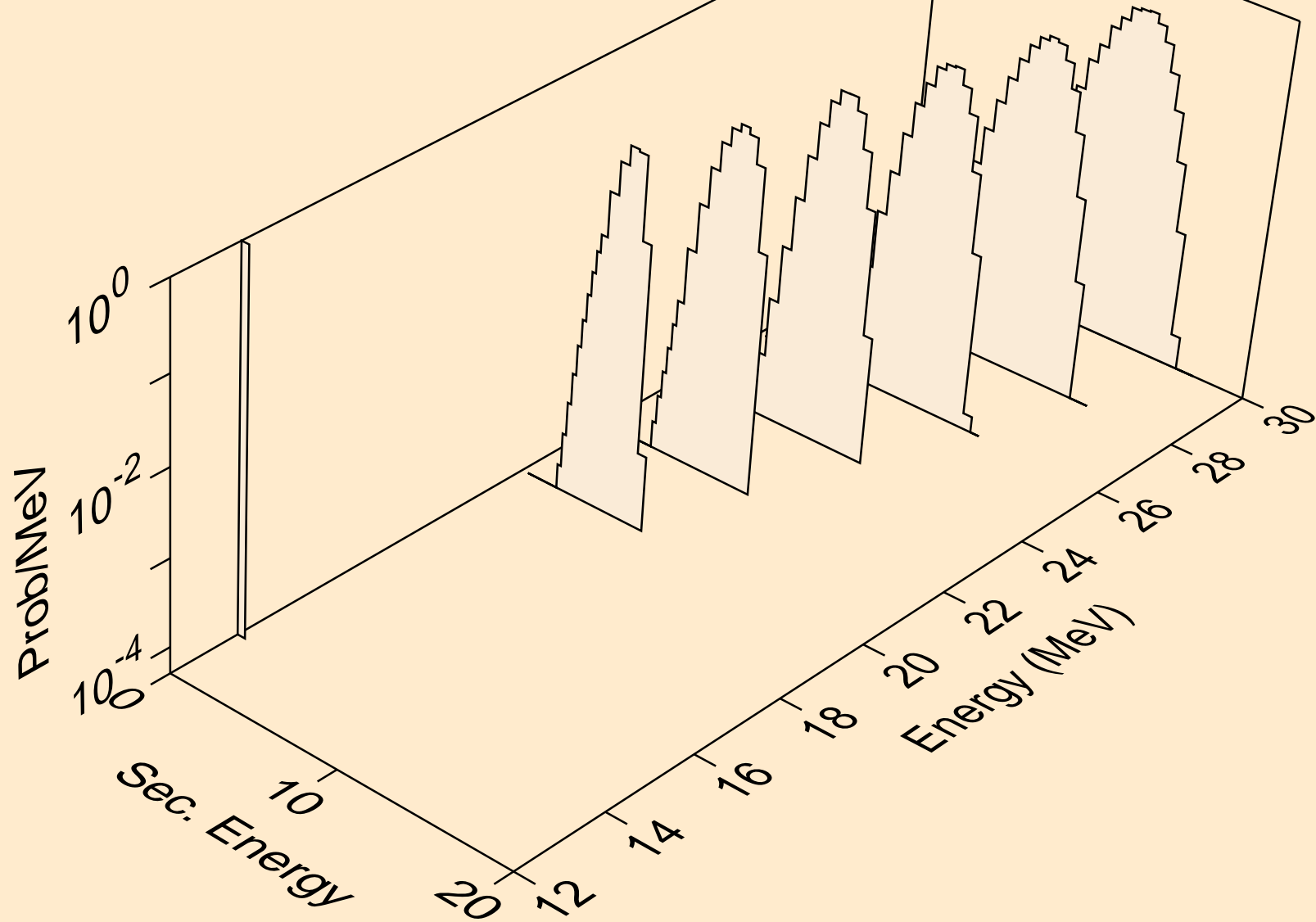

HS269 HELION ACER TENDL-2021 LIBRARY; T=0.K  
protons from (s,npa)

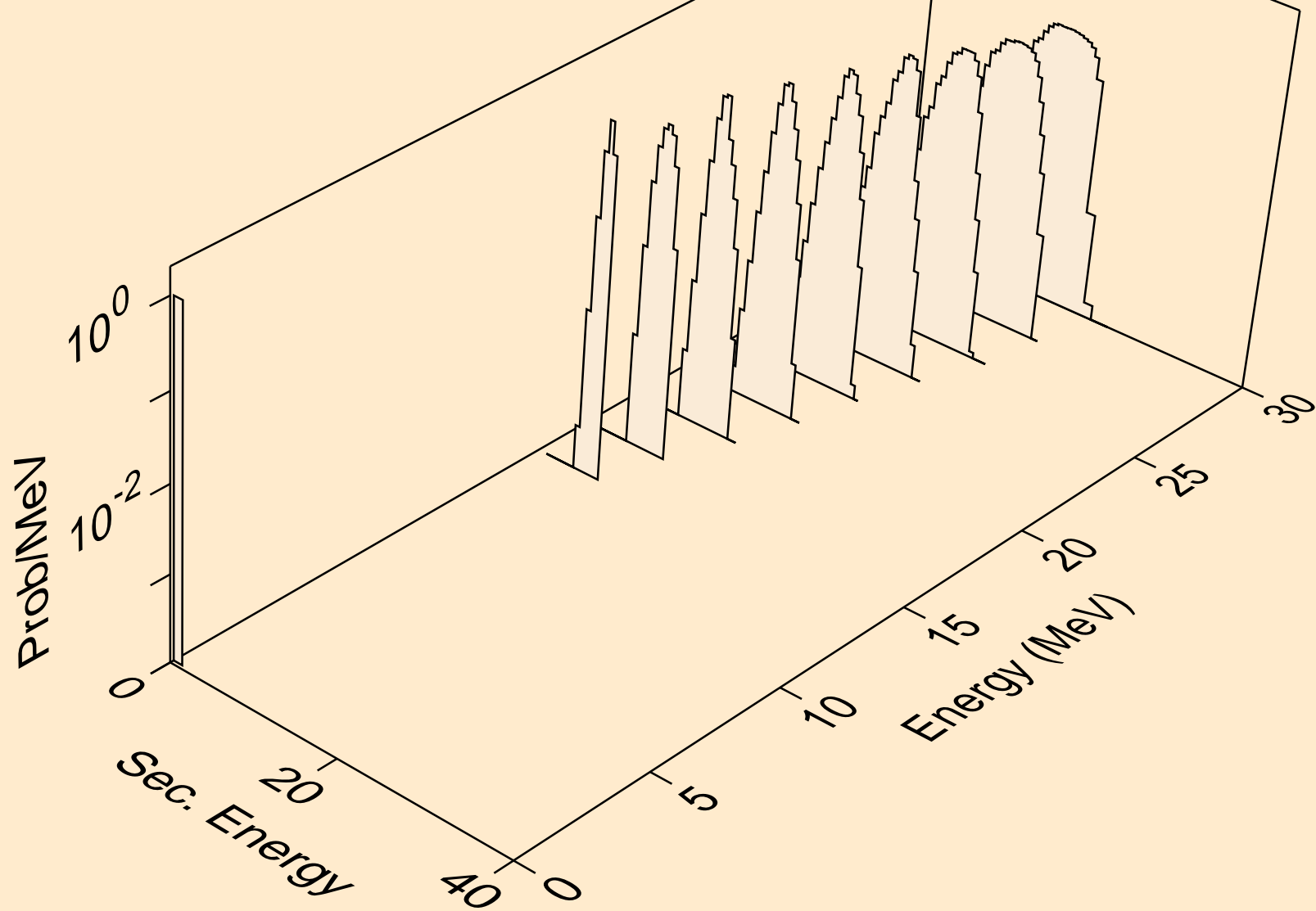

HS269 HELION ACER TENDL-2021 LIBRARY; T=0.K  
protons from (s,p)

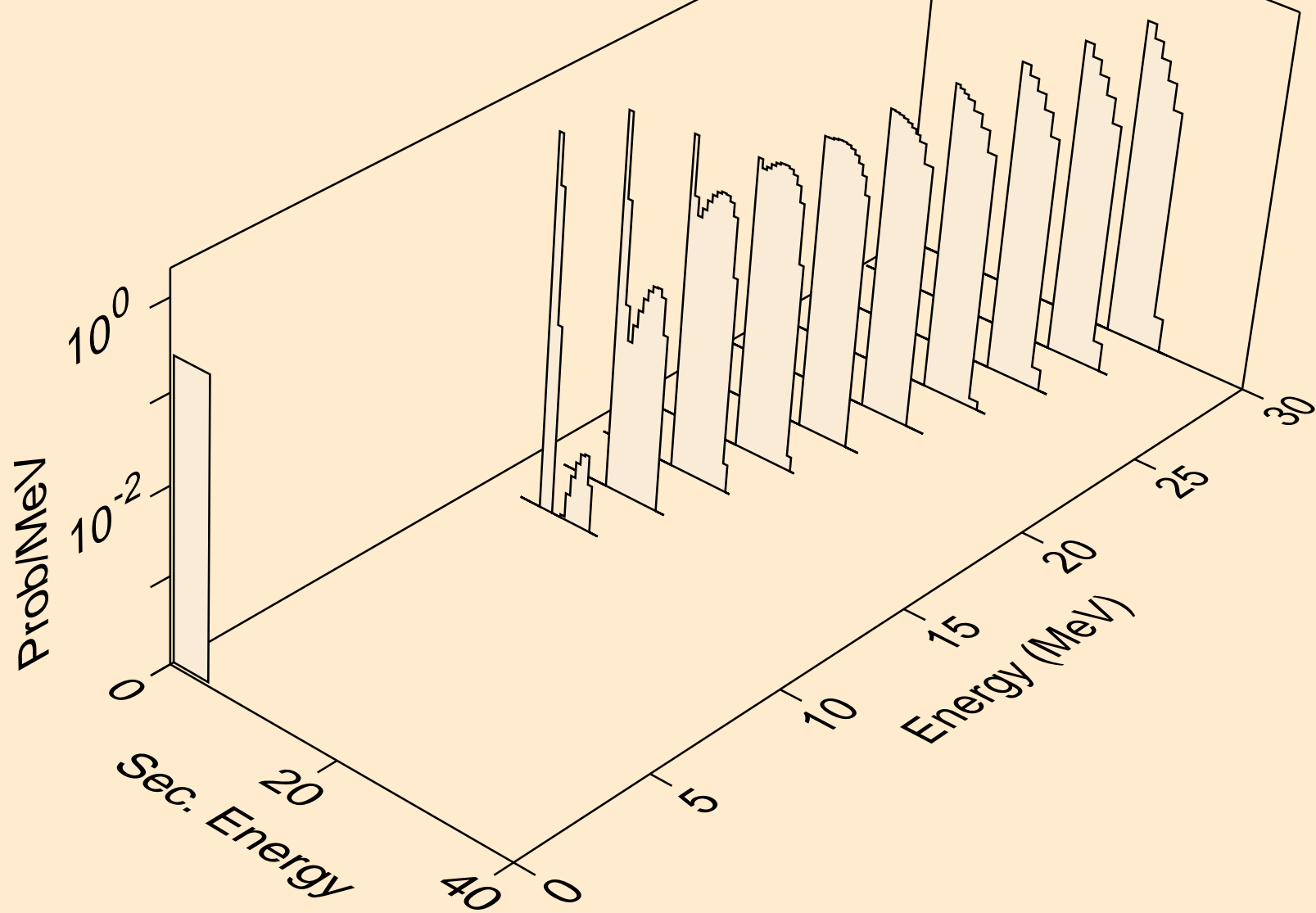

HS269 HELION ACER TENDL-2021 LIBRARY; T=0.K  
protons from (s,2p)

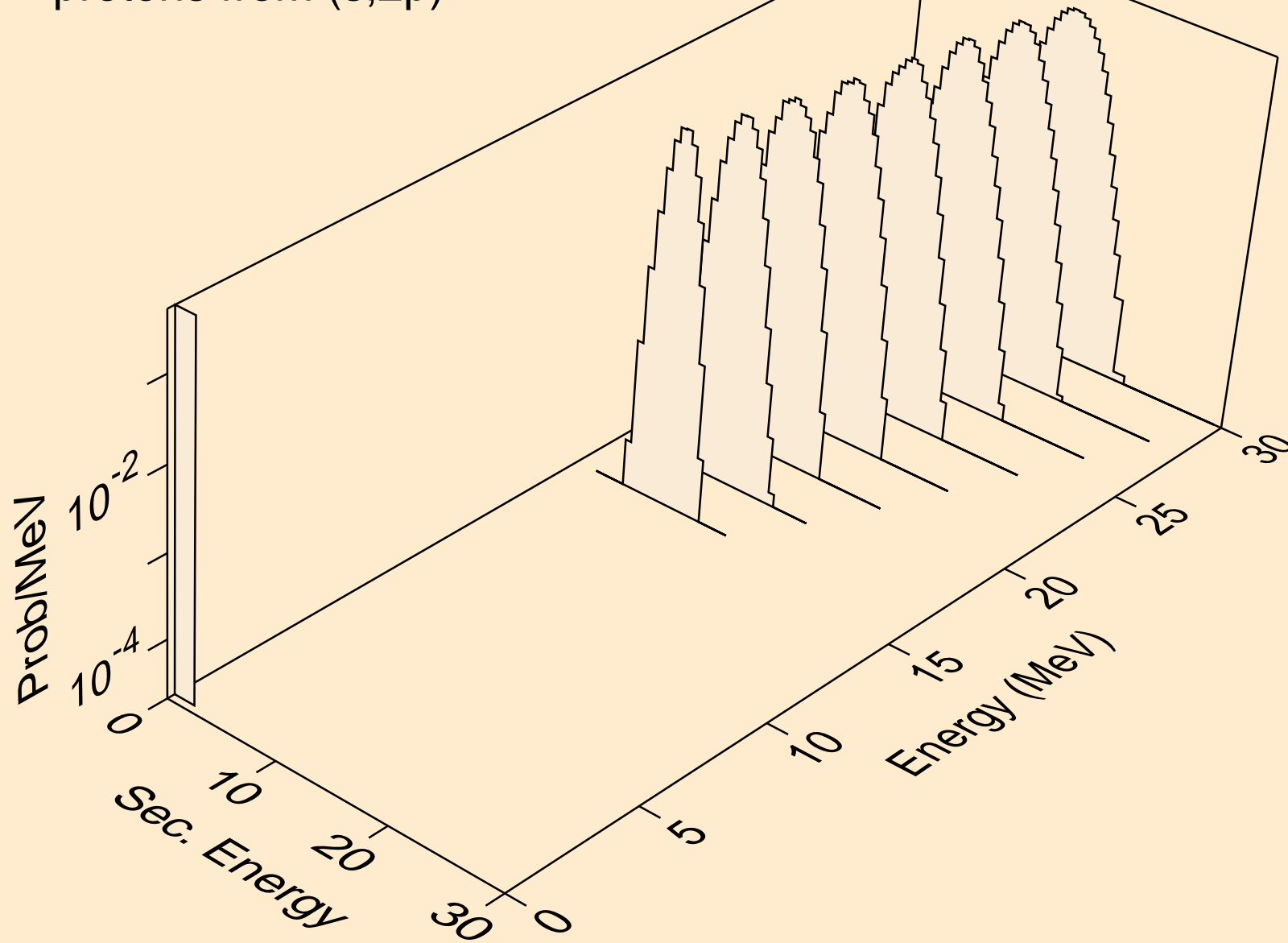

HS269 HELION ACER TENDL-2021 LIBRARY; T=0.K  
protons from (s,pa)

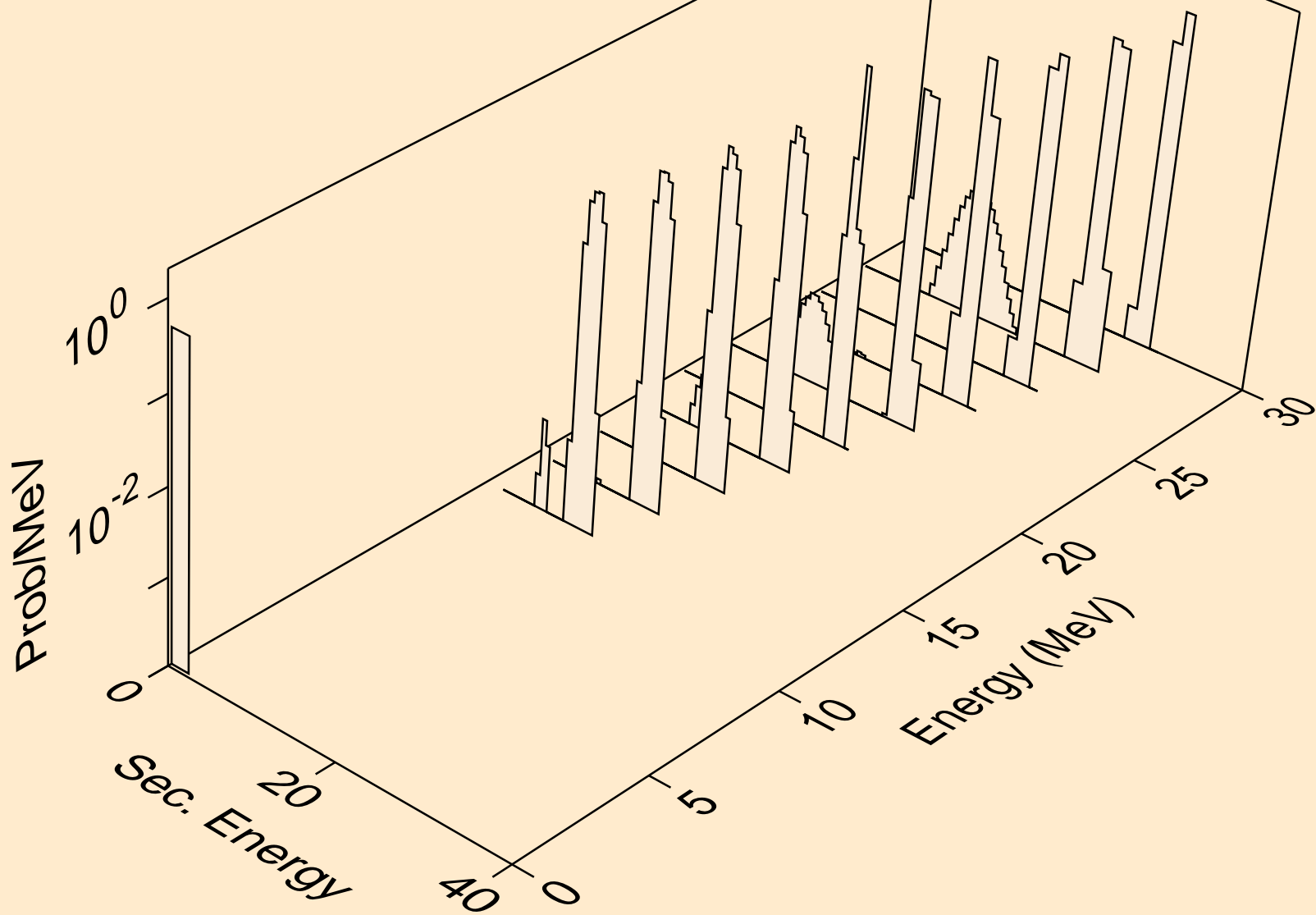

HS269 HELION ACER TENDL-2021 LIBRARY; T=0.K  
deuterons from (s,x)

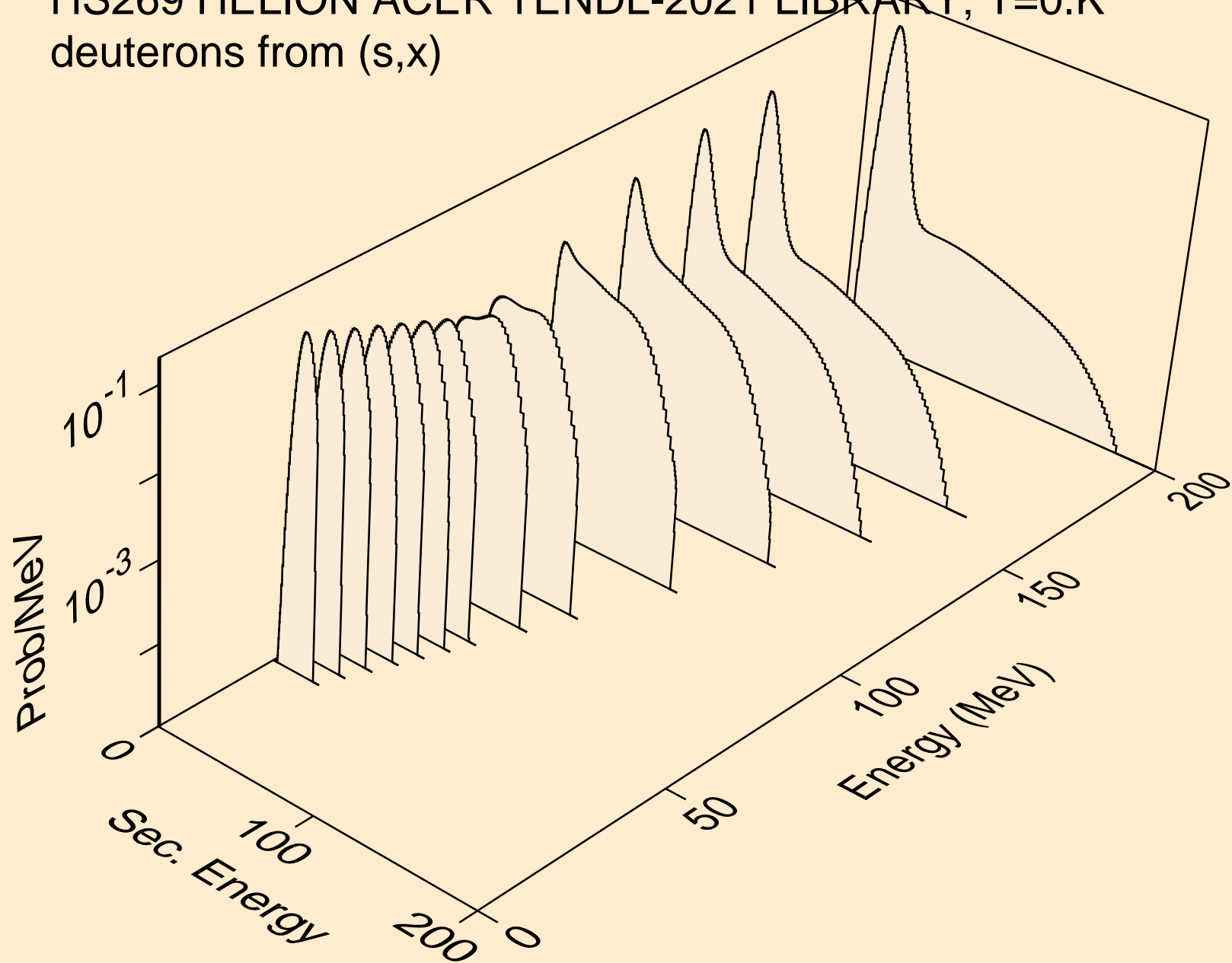



HS269 HELION ACER TENDL-2021 LIBRARY; T=0.K  
deuterons from (s,n\*)d

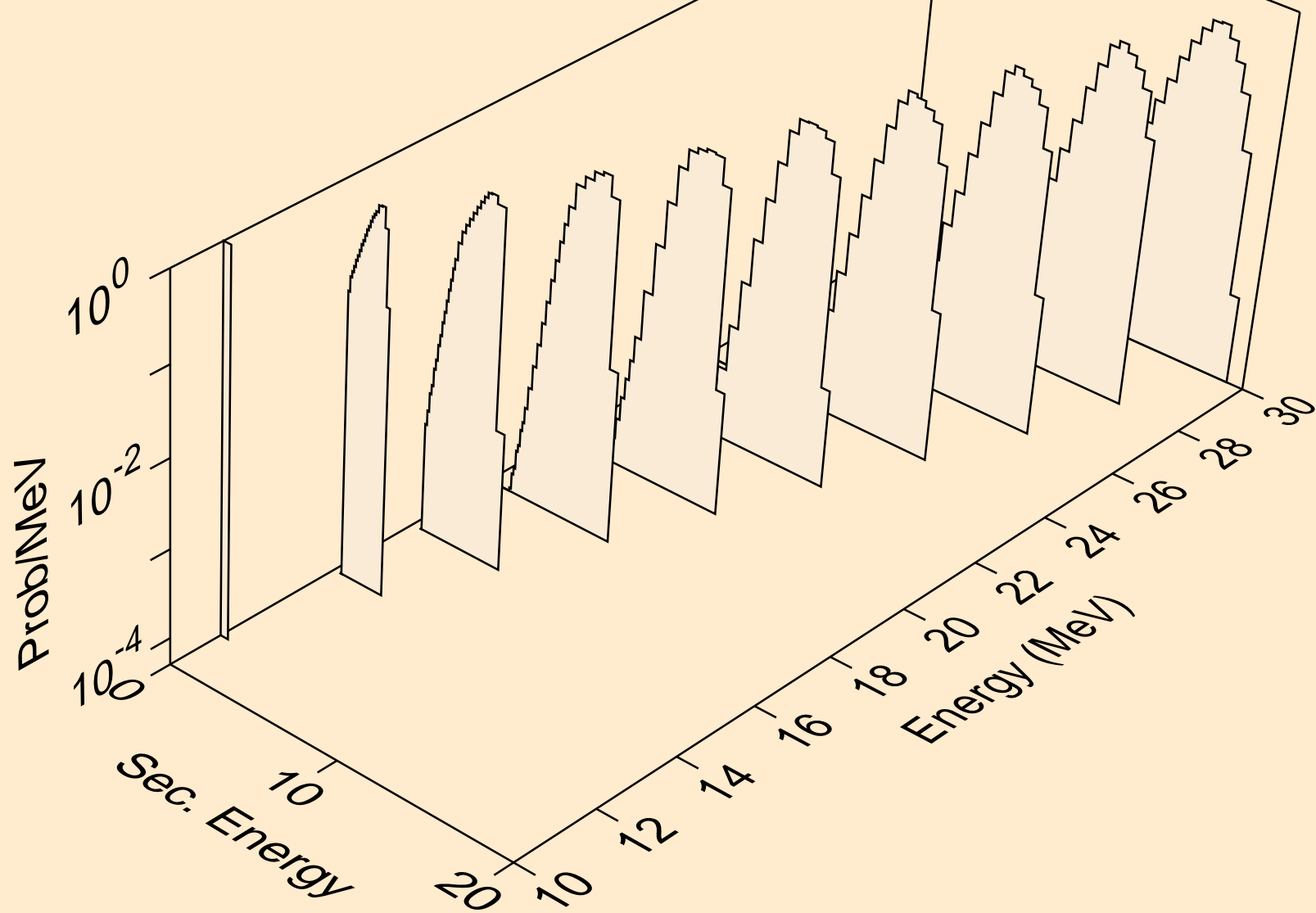

HS269 HELION ACER TENDL-2021 LIBRARY; T=0.K  
deuterons from (s,d)

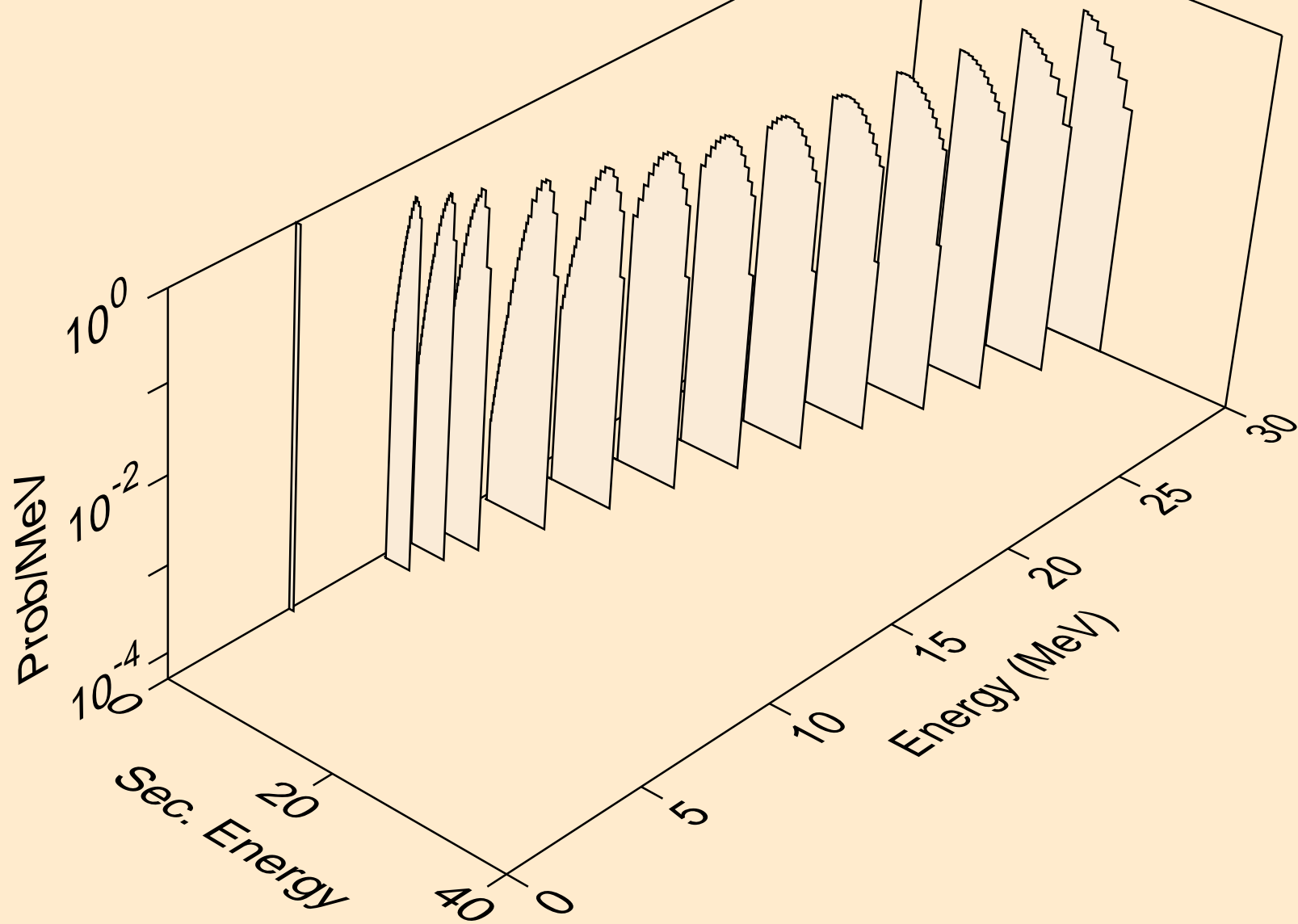

HS269 HELION ACER TENDL-2021 LIBRARY; T=0.K  
deuterons from (s,d2a)

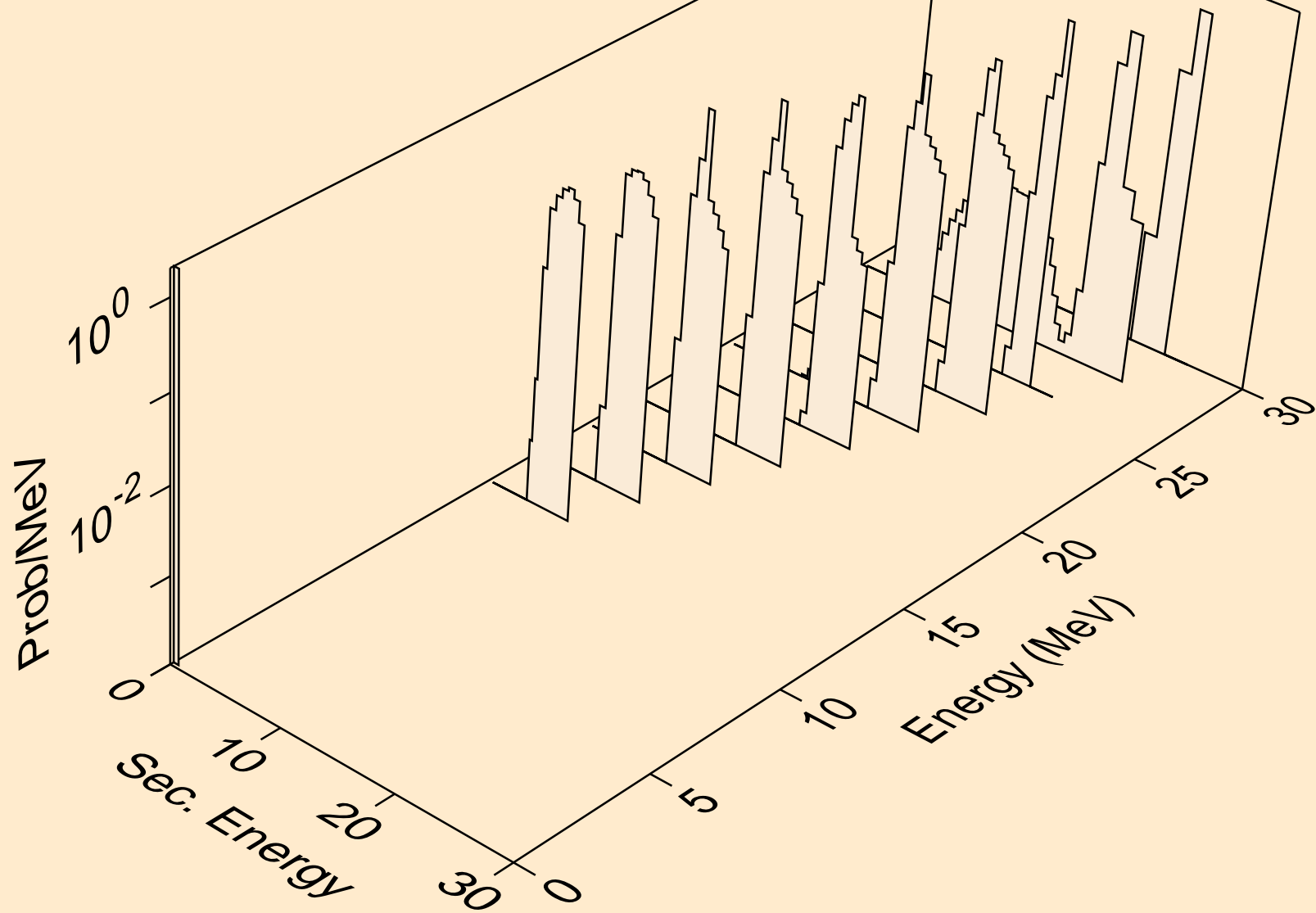

HS269 HELION ACER TENDL-2021 LIBRARY; T=0.K  
deuterons from (s,da)

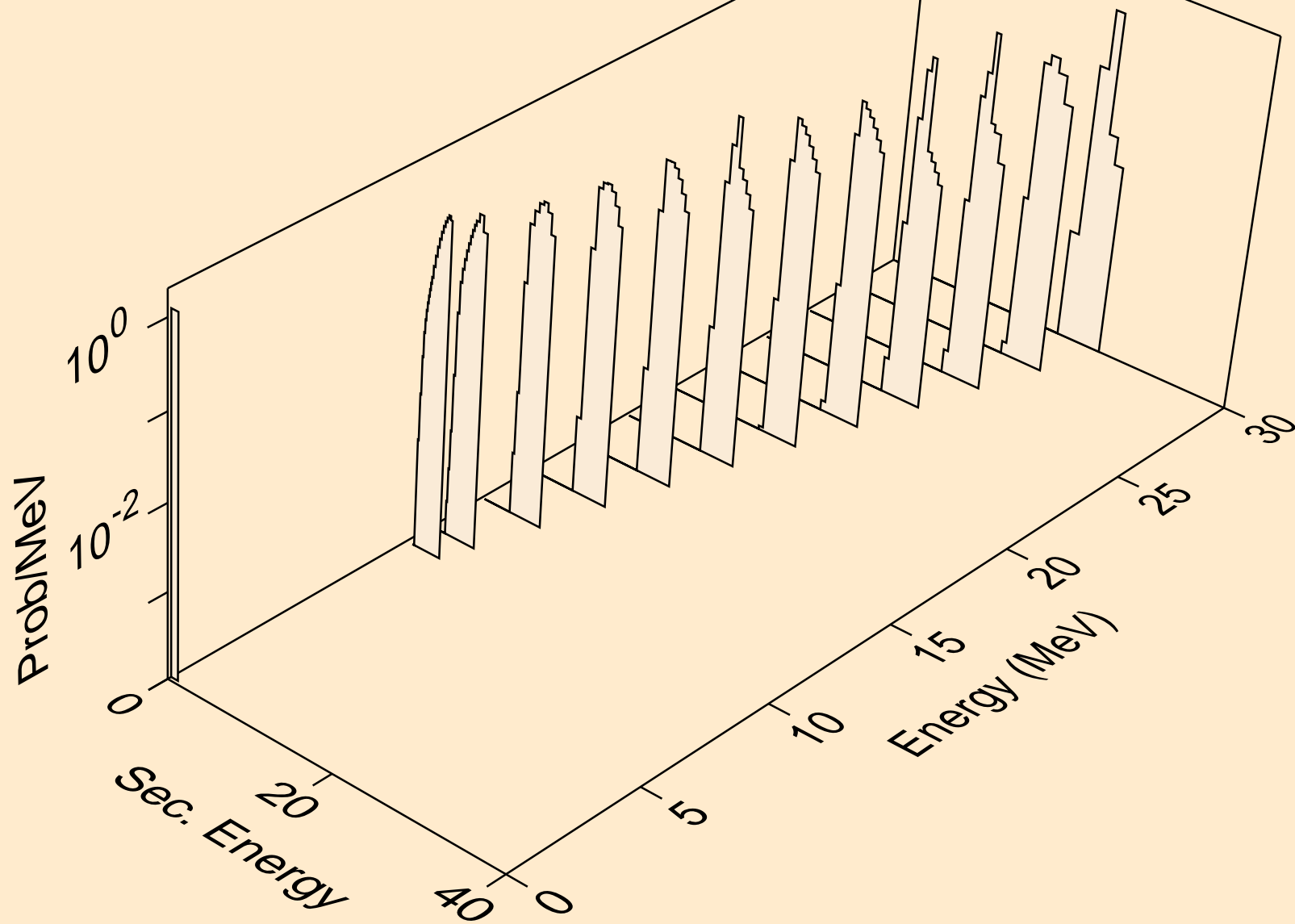

HS269 HELION ACER TENDL-2021 LIBRARY; T=0.K  
tritons from (s,x)

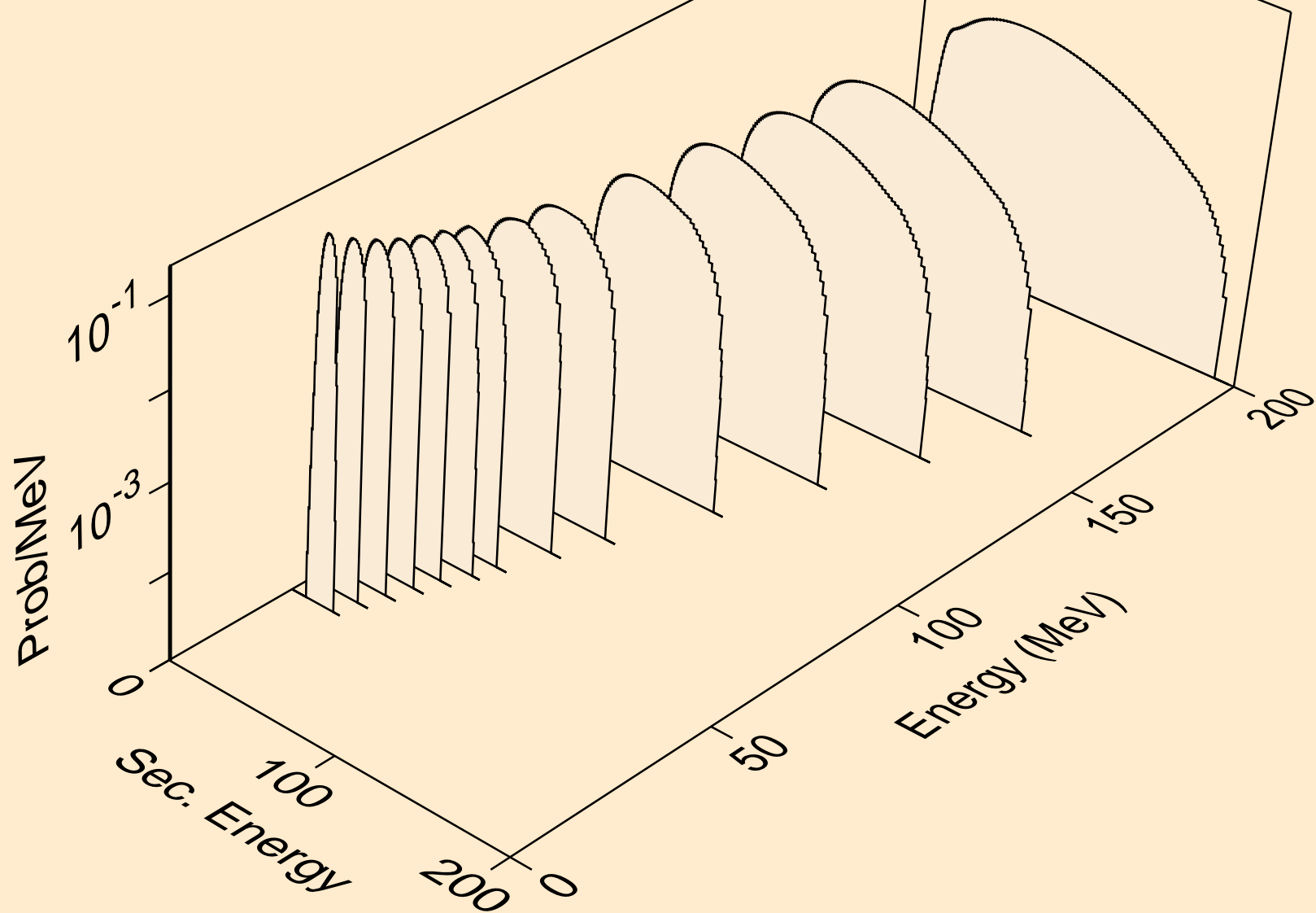

HS269 HELION ACER TENDL-2021 LIBRARY; T=0.K  
tritons from (s,n\*)t

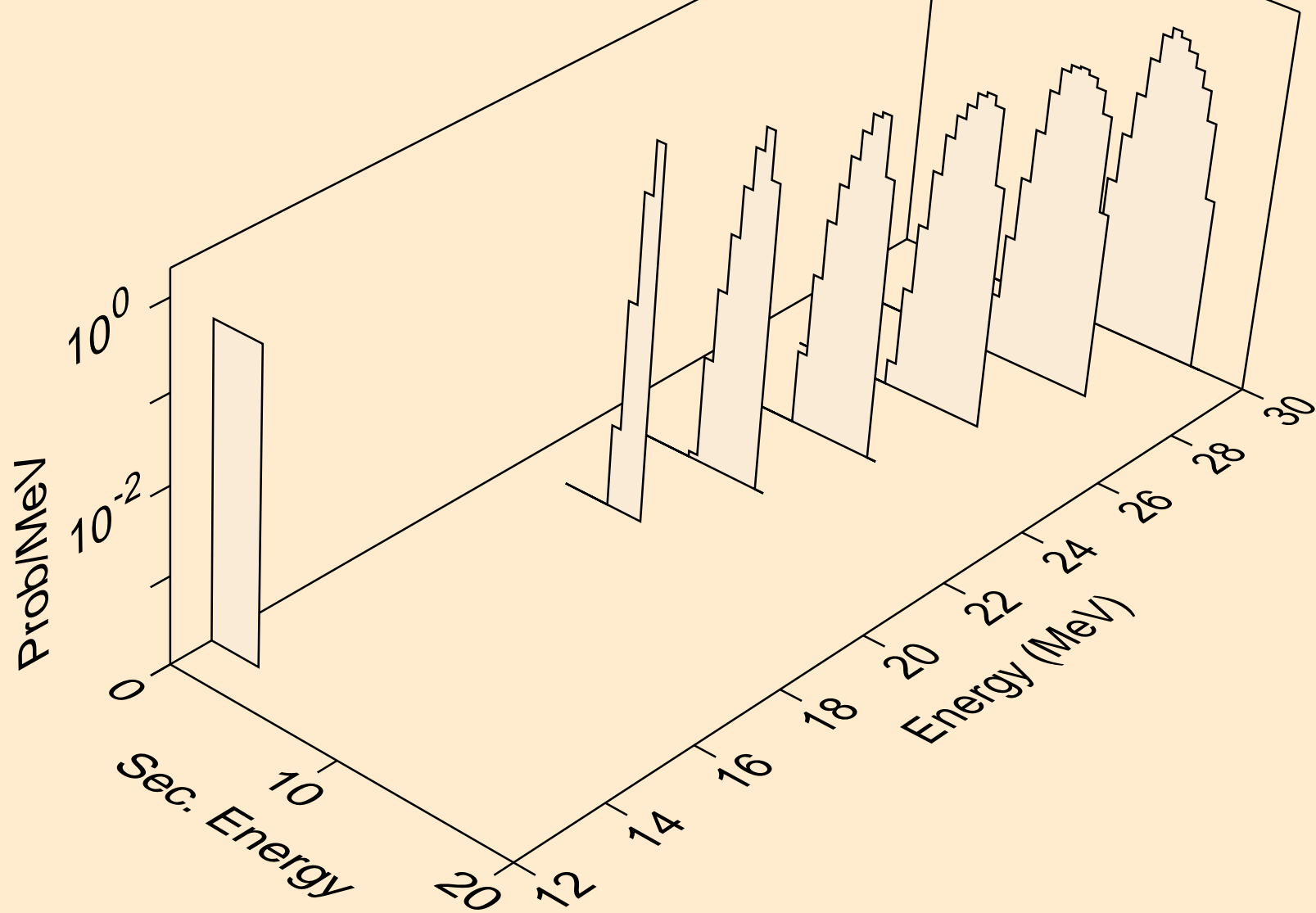

HS269 HELION ACER TENDL-2021 LIBRARY; T=0.K  
tritons from (s,t)

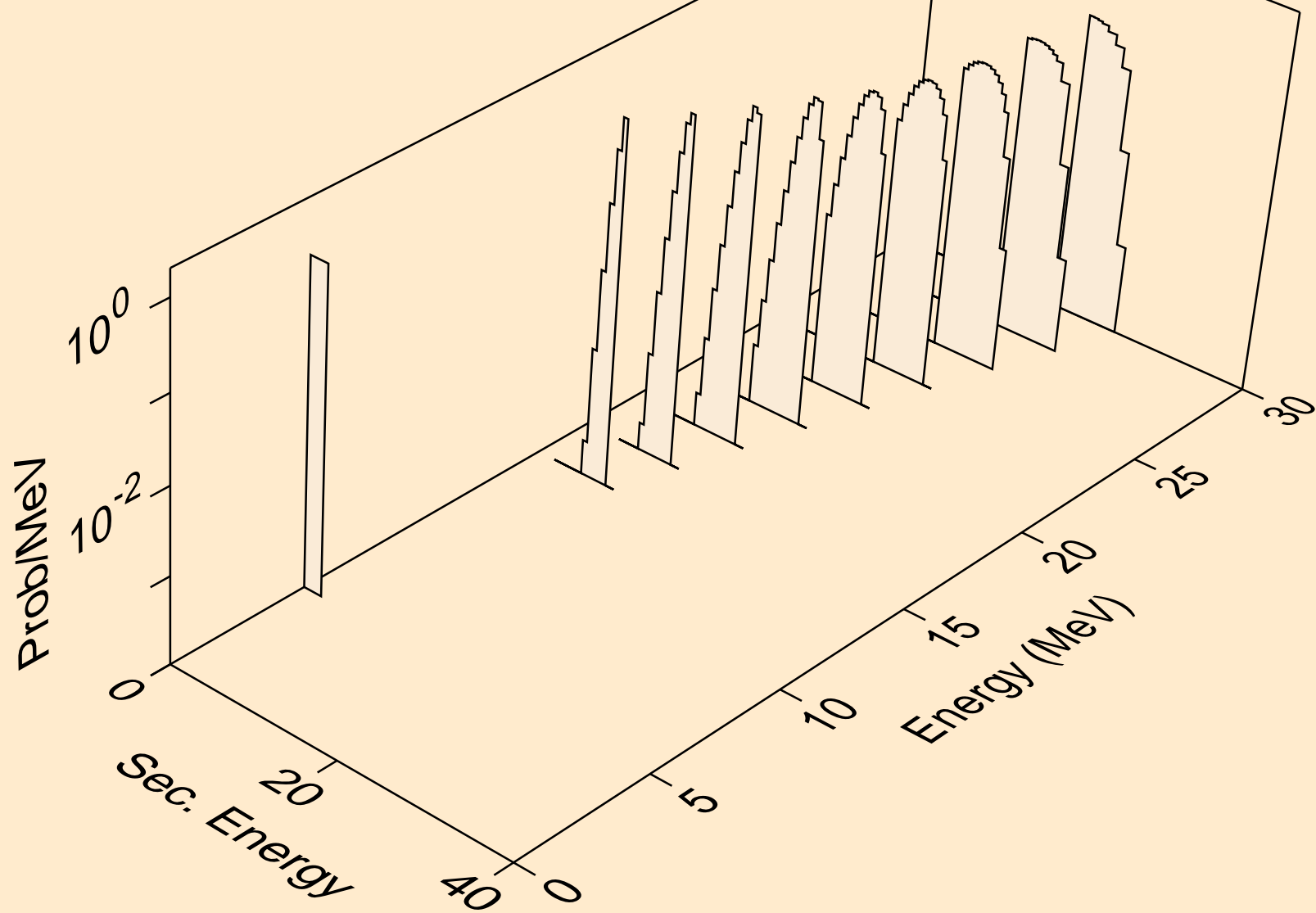

HS269 HELION ACER TENDL-2021 LIBRARY; T=0.K  
tritons from (s,t2a)

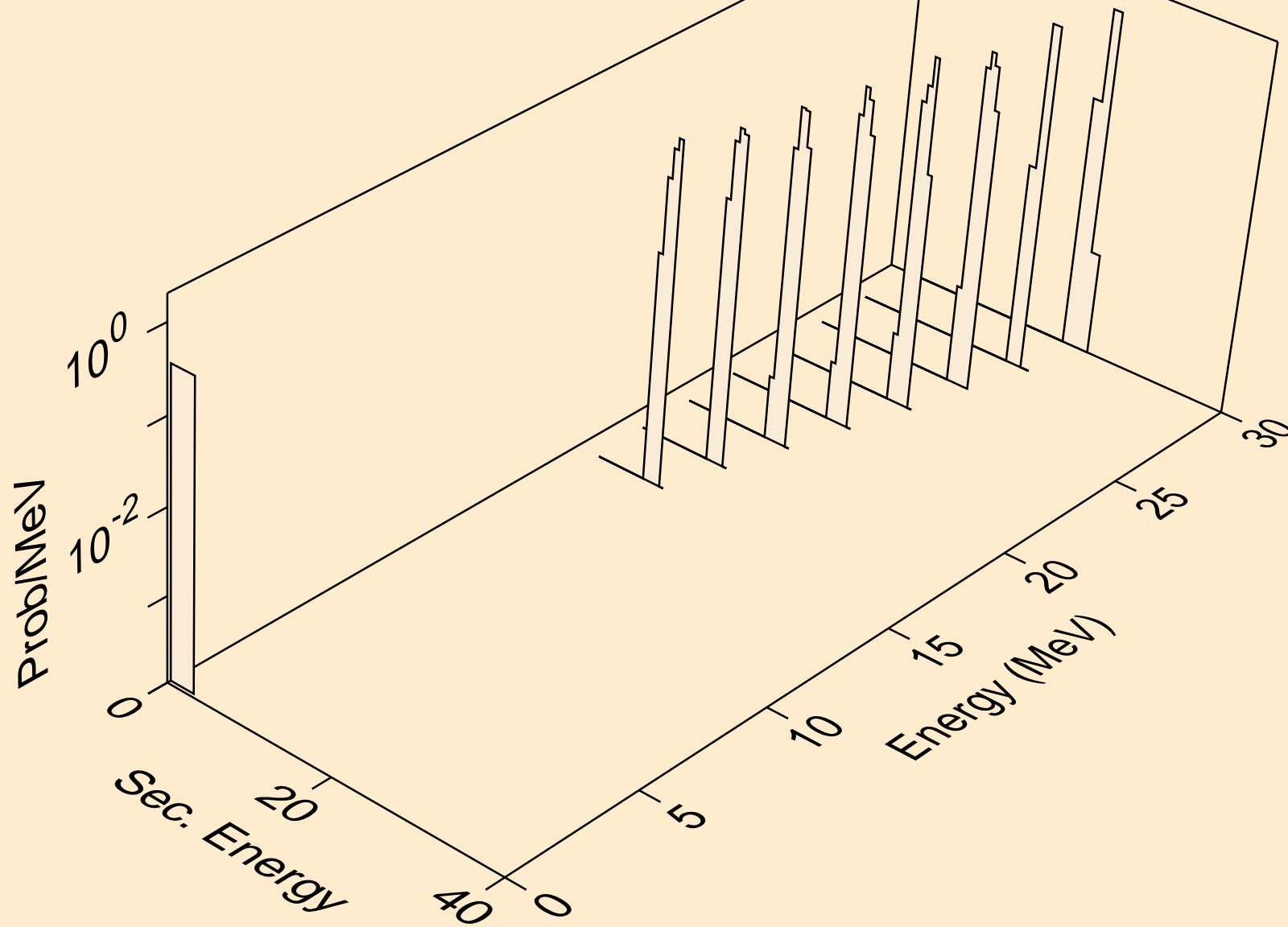



HS269 HELION ACER TENDL-2021 LIBRARY; T=0.K  
alphas from (s,x)

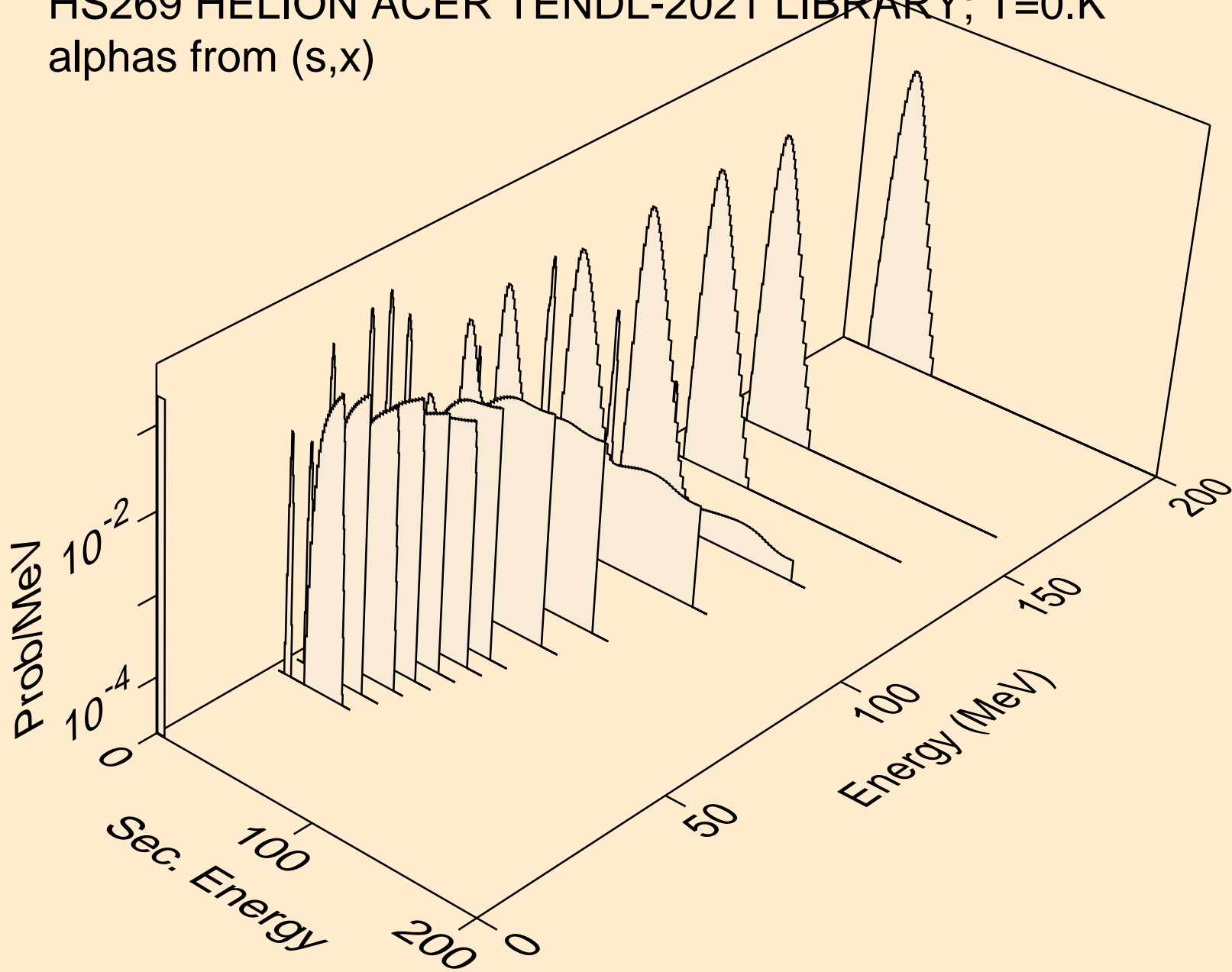

HS269 HELION ACER TENDL-2021 LIBRARY; T=0.K  
alphas from (s,n\*)a

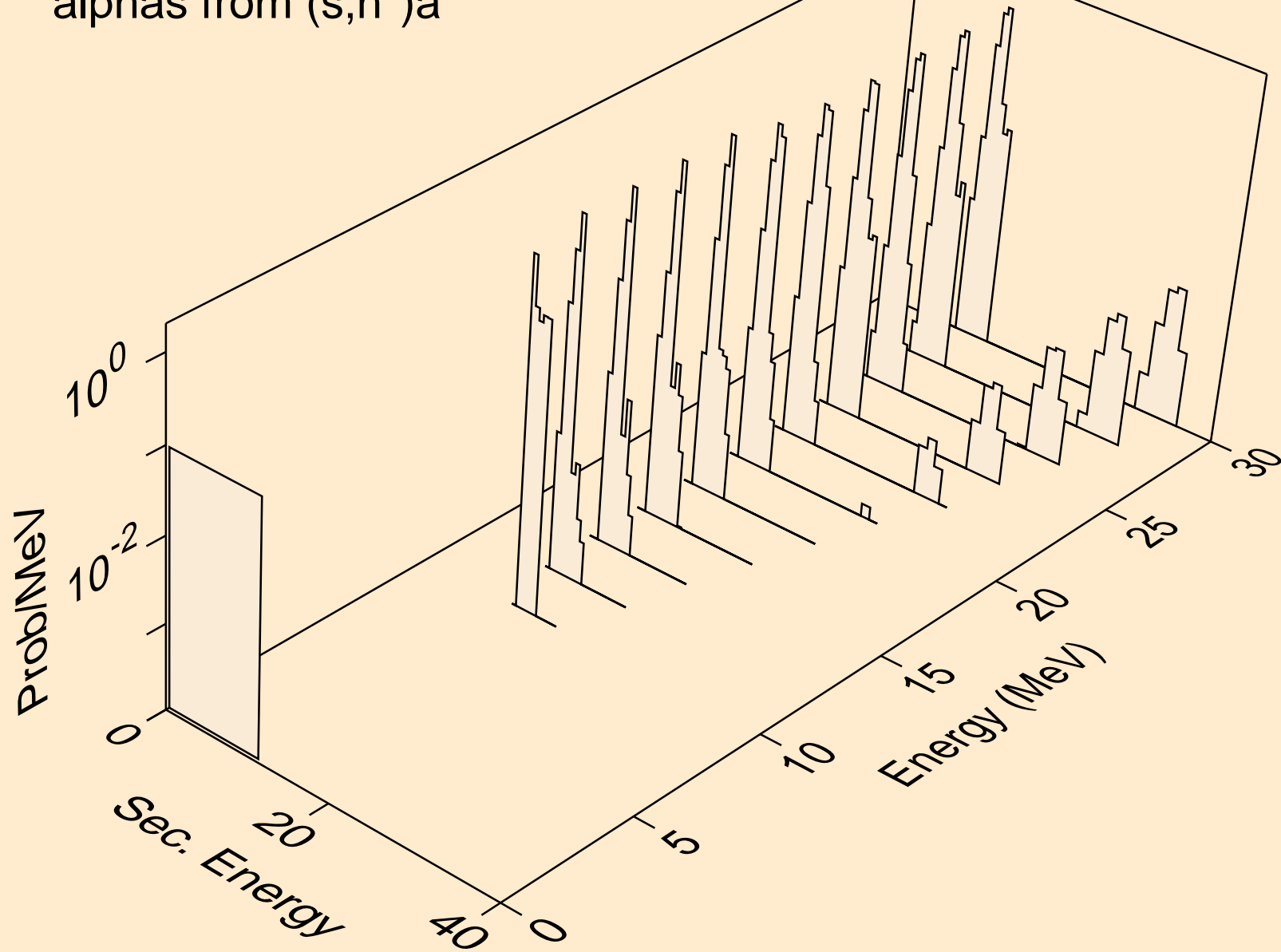

HS269 HELION ACER TENDL-2021 LIBRARY; T=0.K  
alphas from (s,2n)a

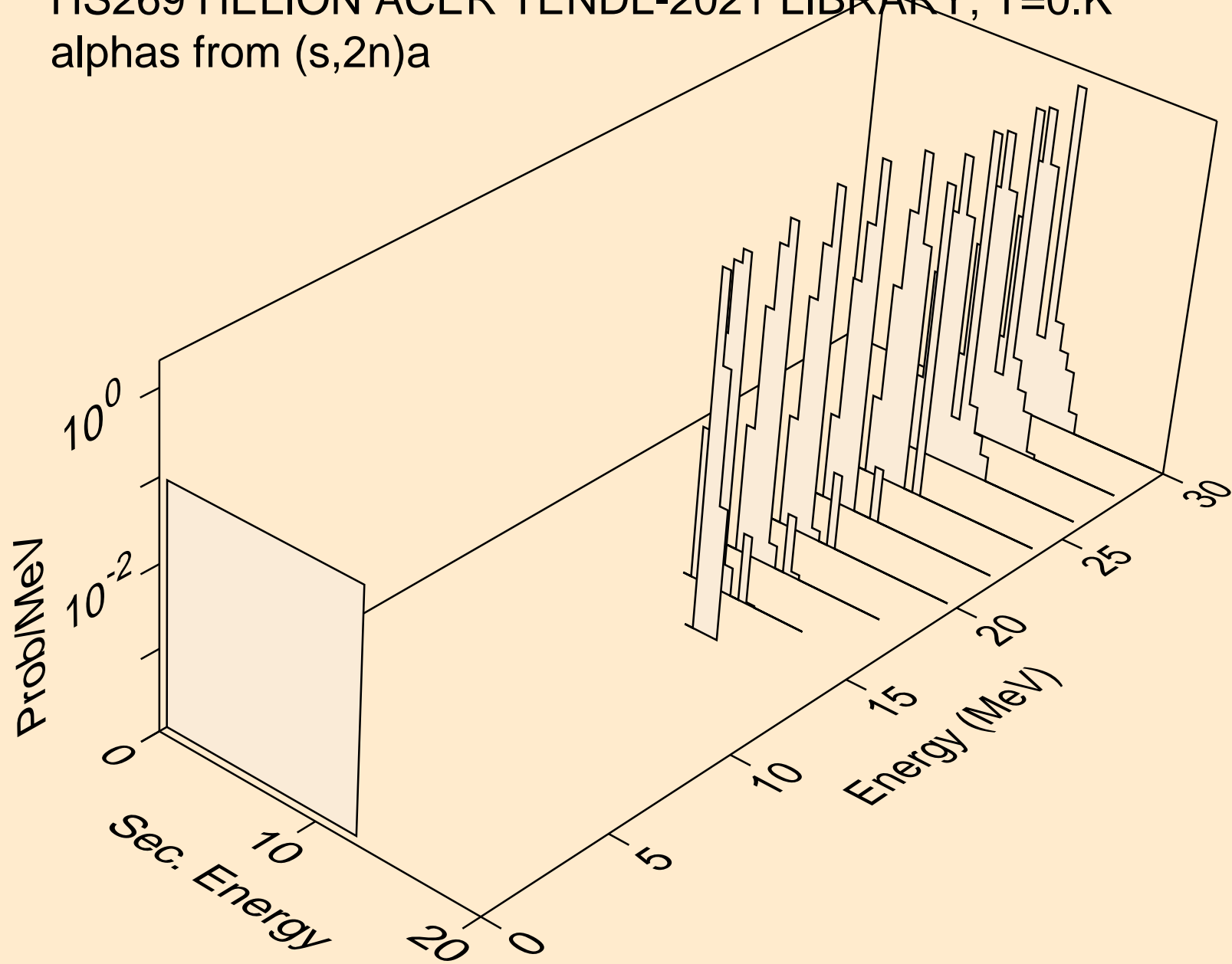

HS269 HELION ACER TENDL-2021 LIBRARY; T=0.K  
alphas from (s,npa)

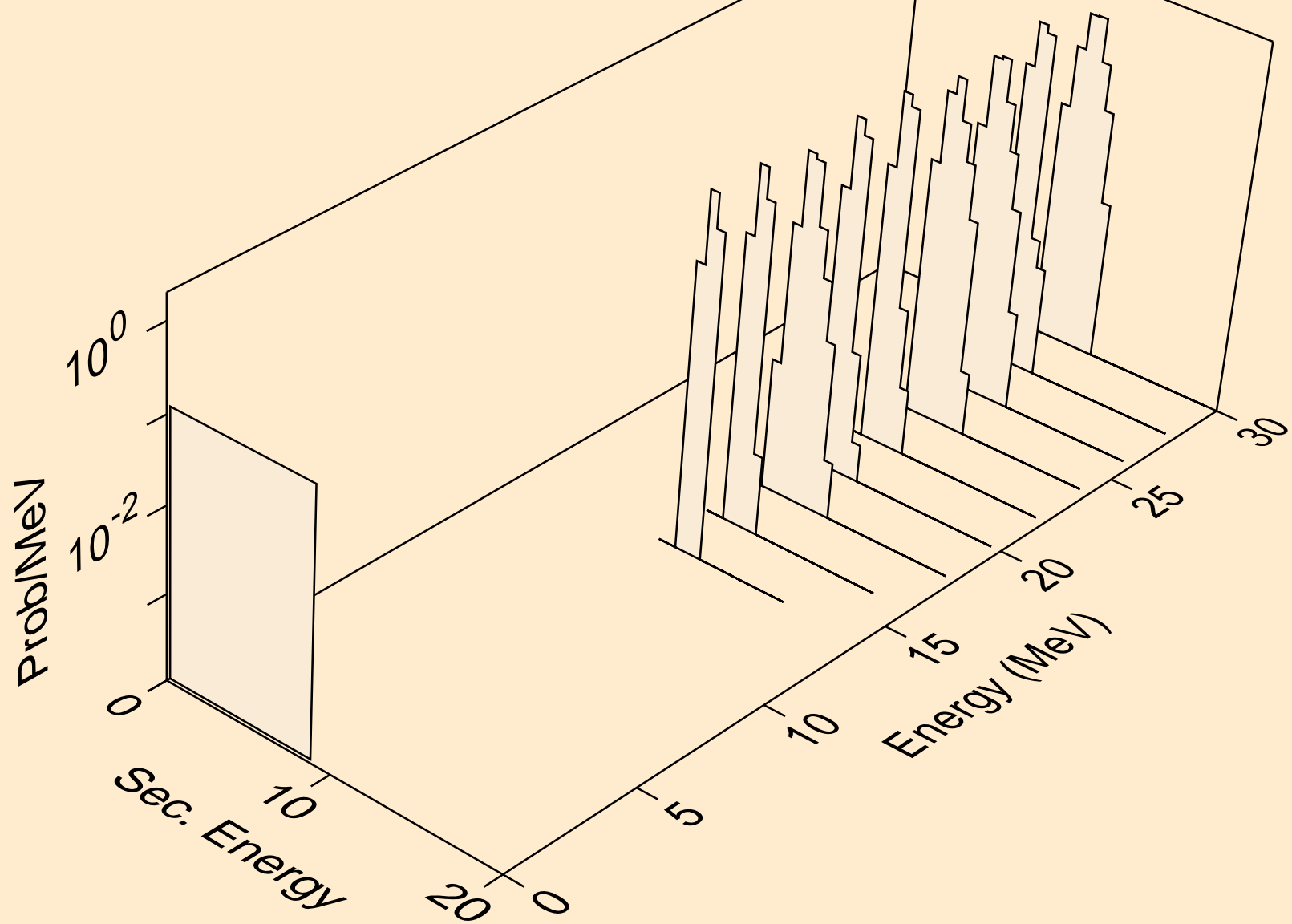

HS269 HELION ACER TENDL-2021 LIBRARY; T=0.K  
alphas from (s,a)

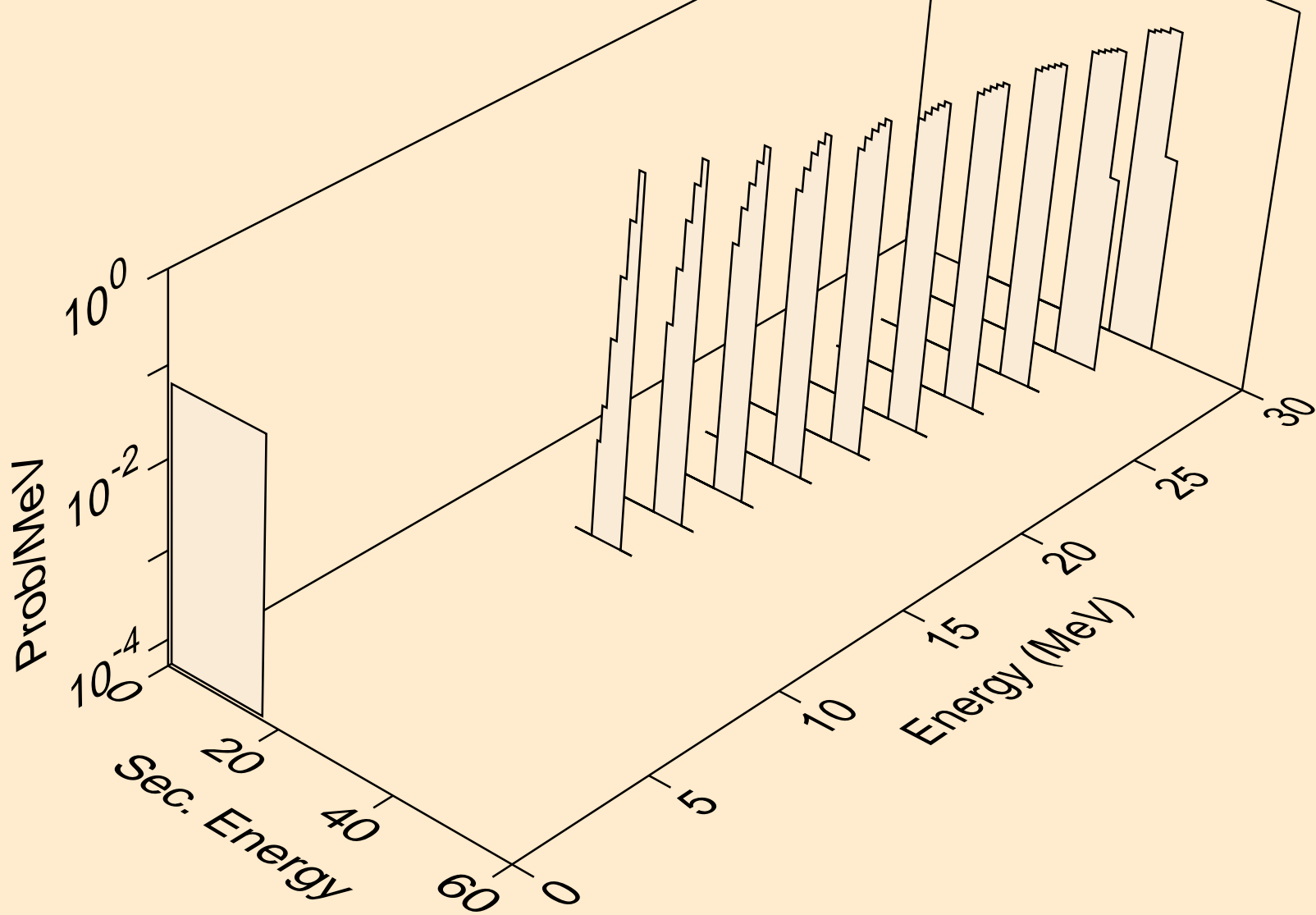

HS269 HELION ACER TENDL-2021 LIBRARY; T=0.K  
alphas from (s,pa)

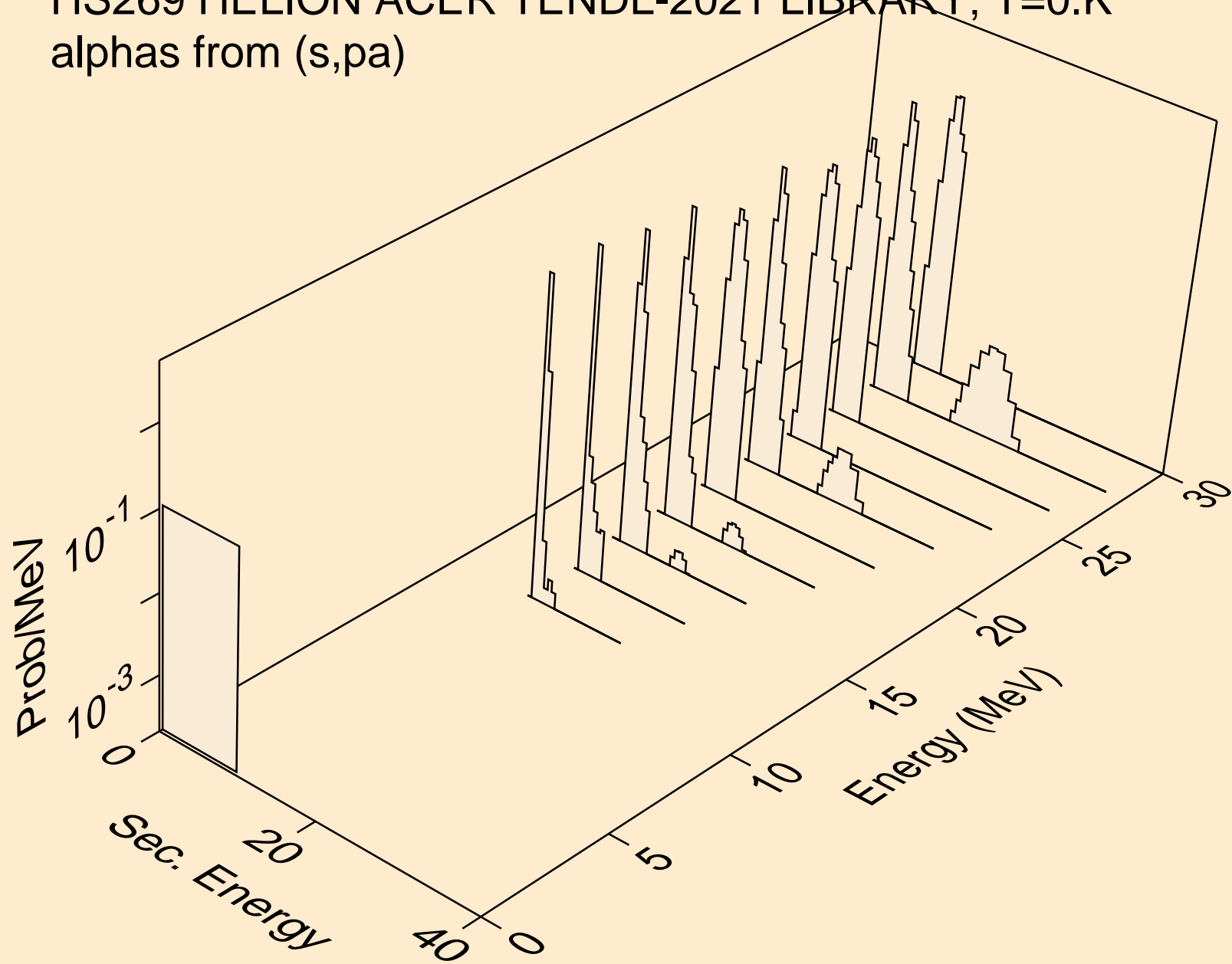

HS269 HELION ACER TENDL-2021 LIBRARY; T=0.K  
alphas from (s,t2a)

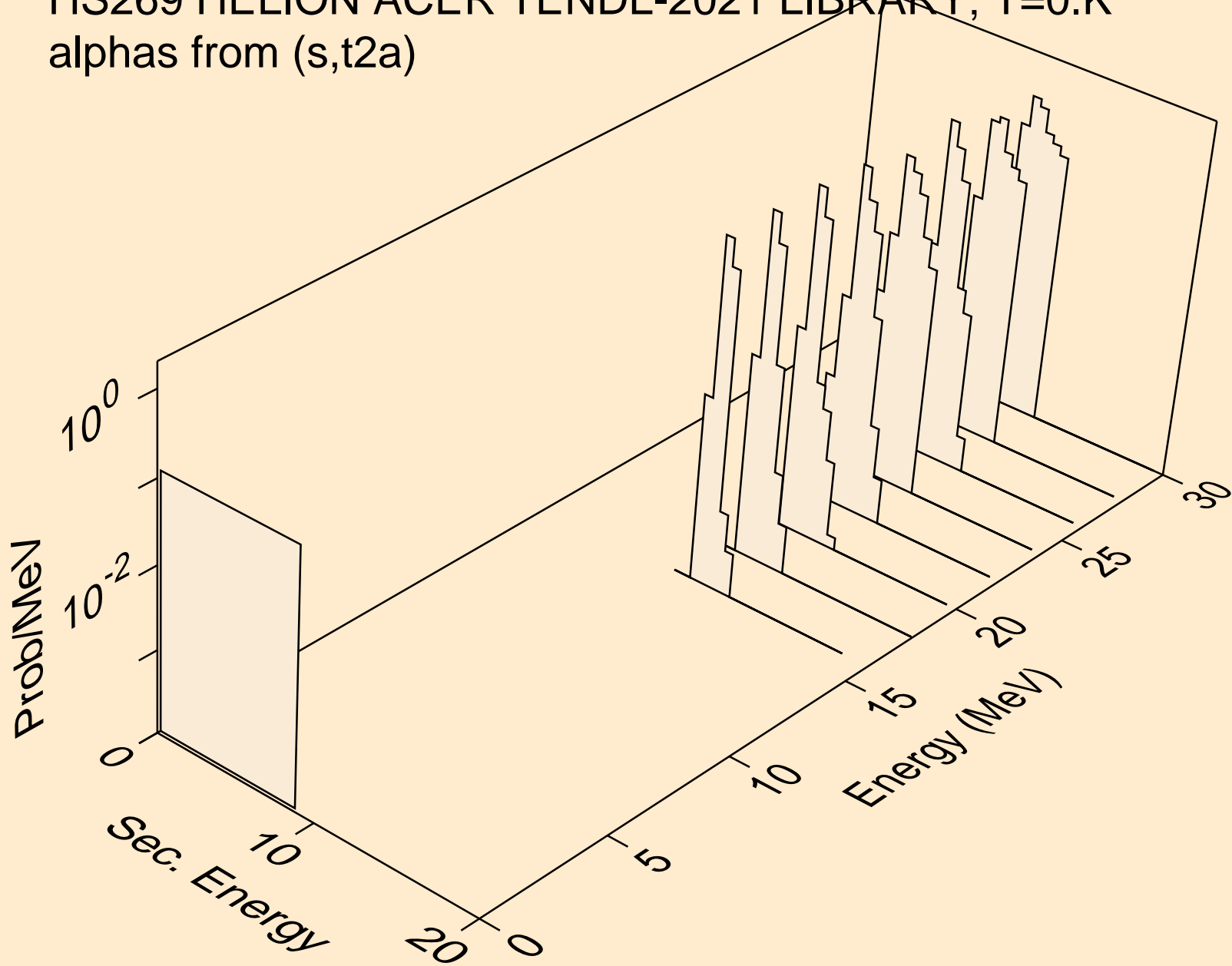

HS269 HELION ACER TENDL-2021 LIBRARY; T=0.K  
alphas from (s,d2a)

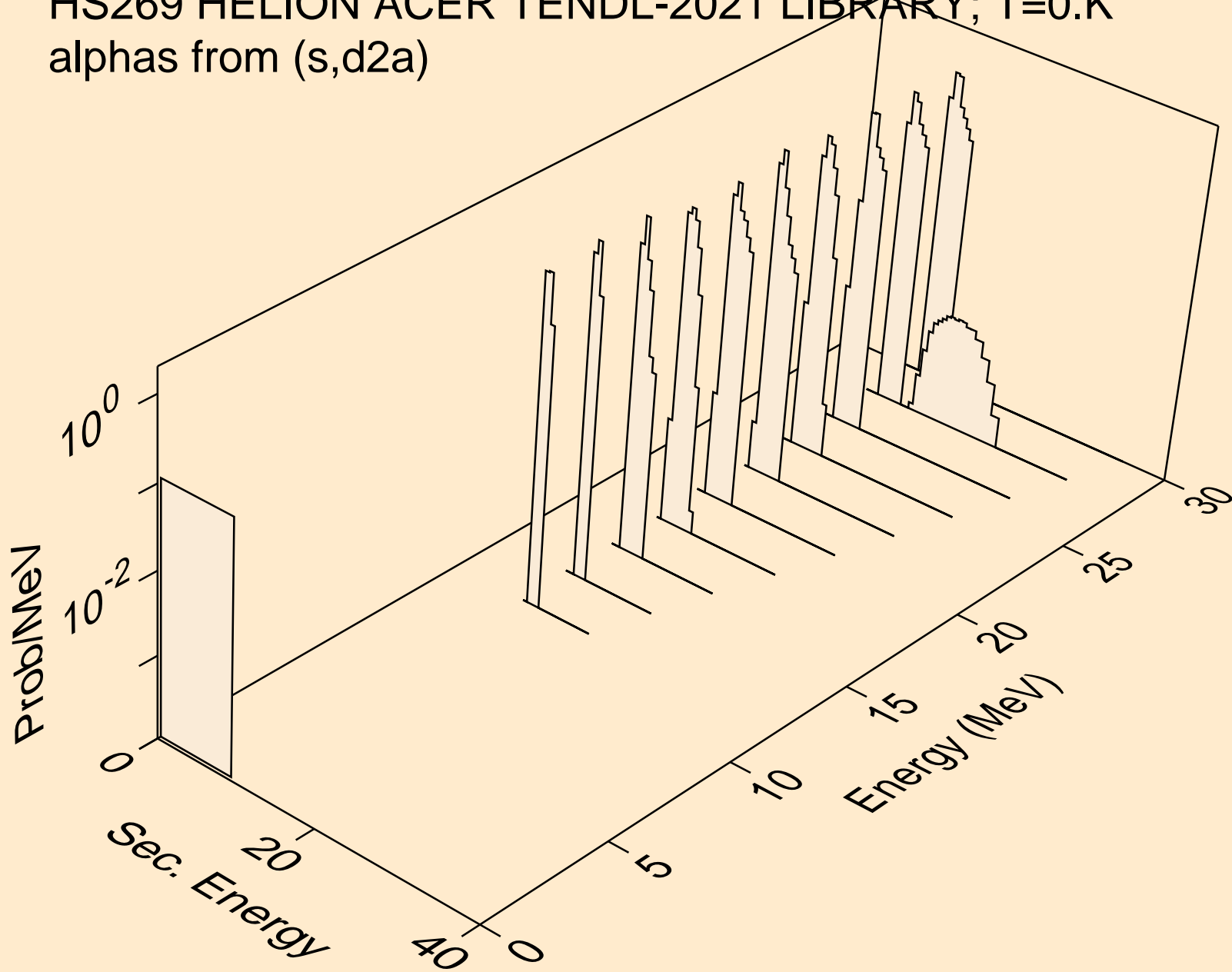



HS269 HELION ACER TENDL-2021 LIBRARY; T=0.K  
alphas from (s,da)

