

HS271 HELION ACER TENDL-2021 LIBRARY; T=0.K
Principal cross sections

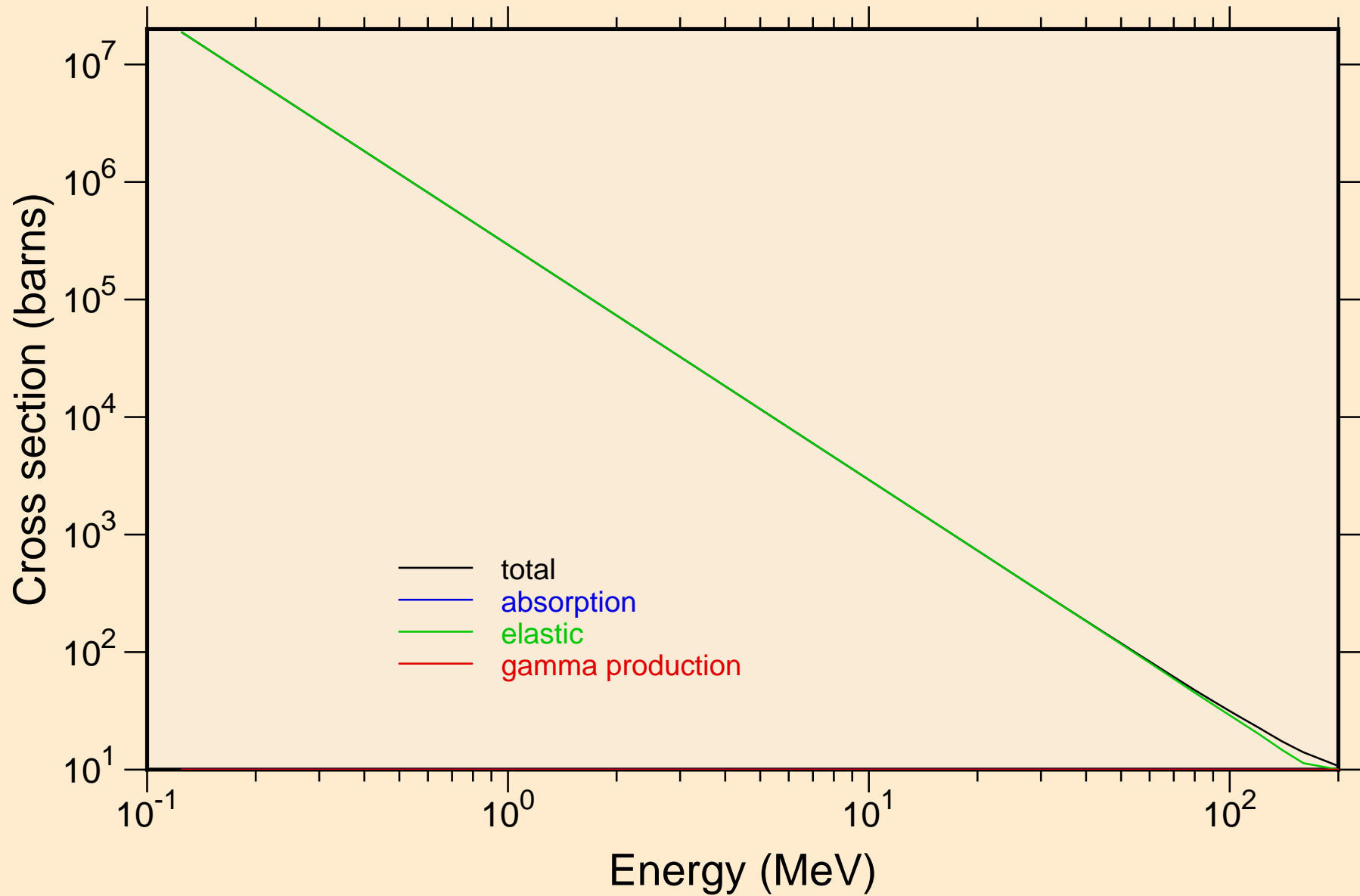

HS271 HELION ACER TENDL-2021 LIBRARY; T=0.K
Heating

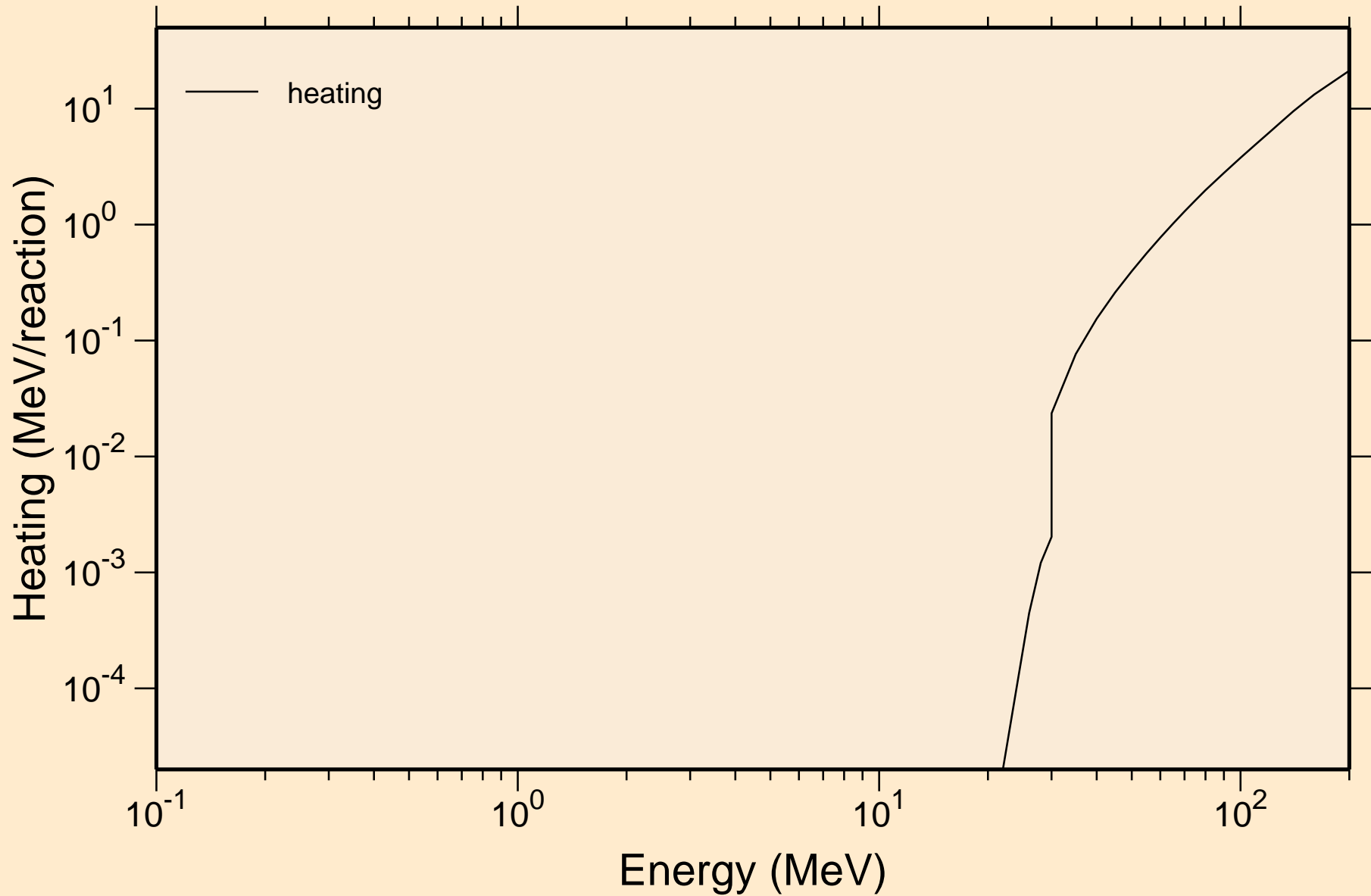

HS271 HELION ACER TENDL-2021 LIBRARY; T=0.K

Principal cross sections

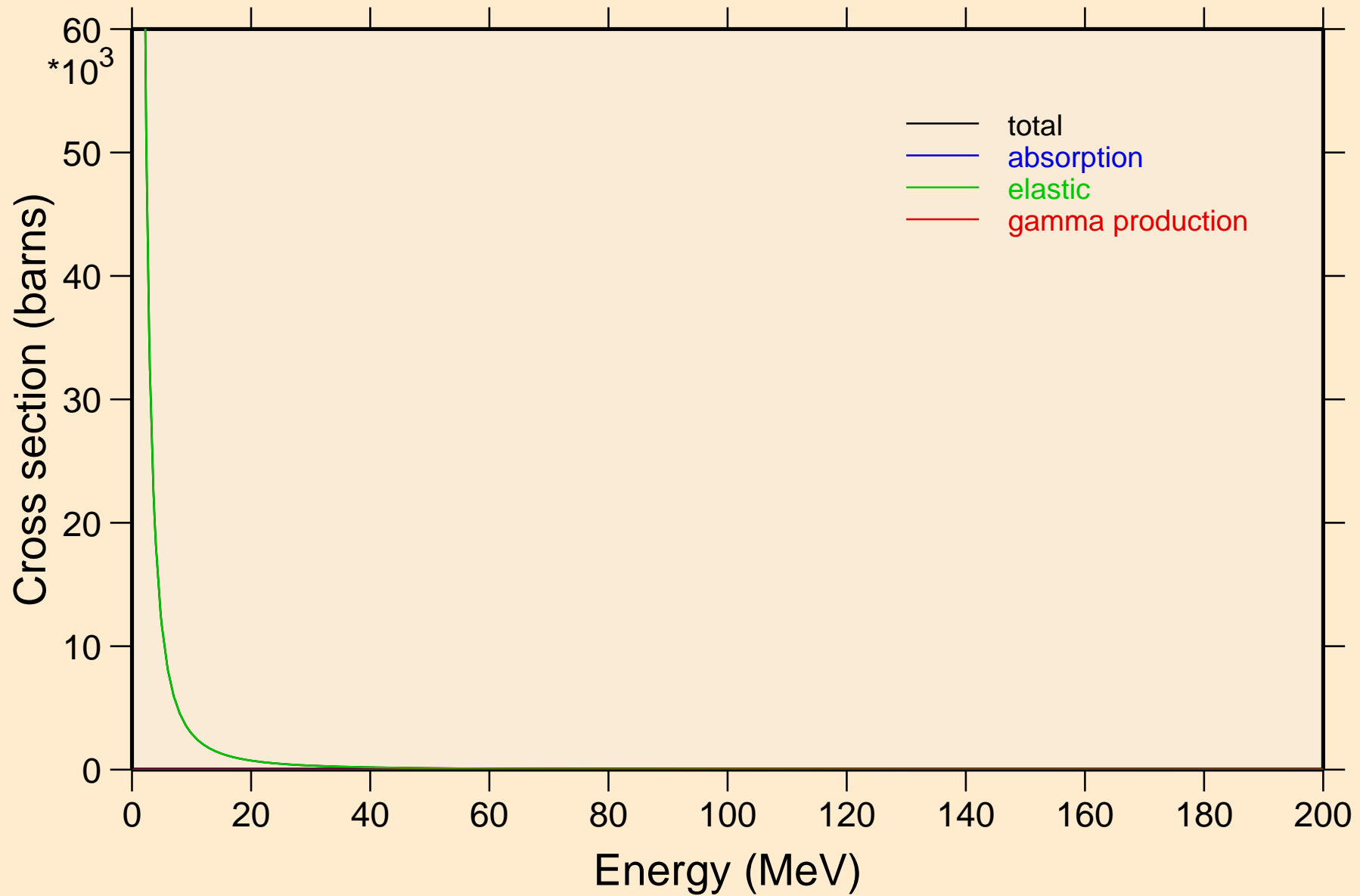

HS271 HELION ACER TENDL-2021 LIBRARY; T=0.K

Heating

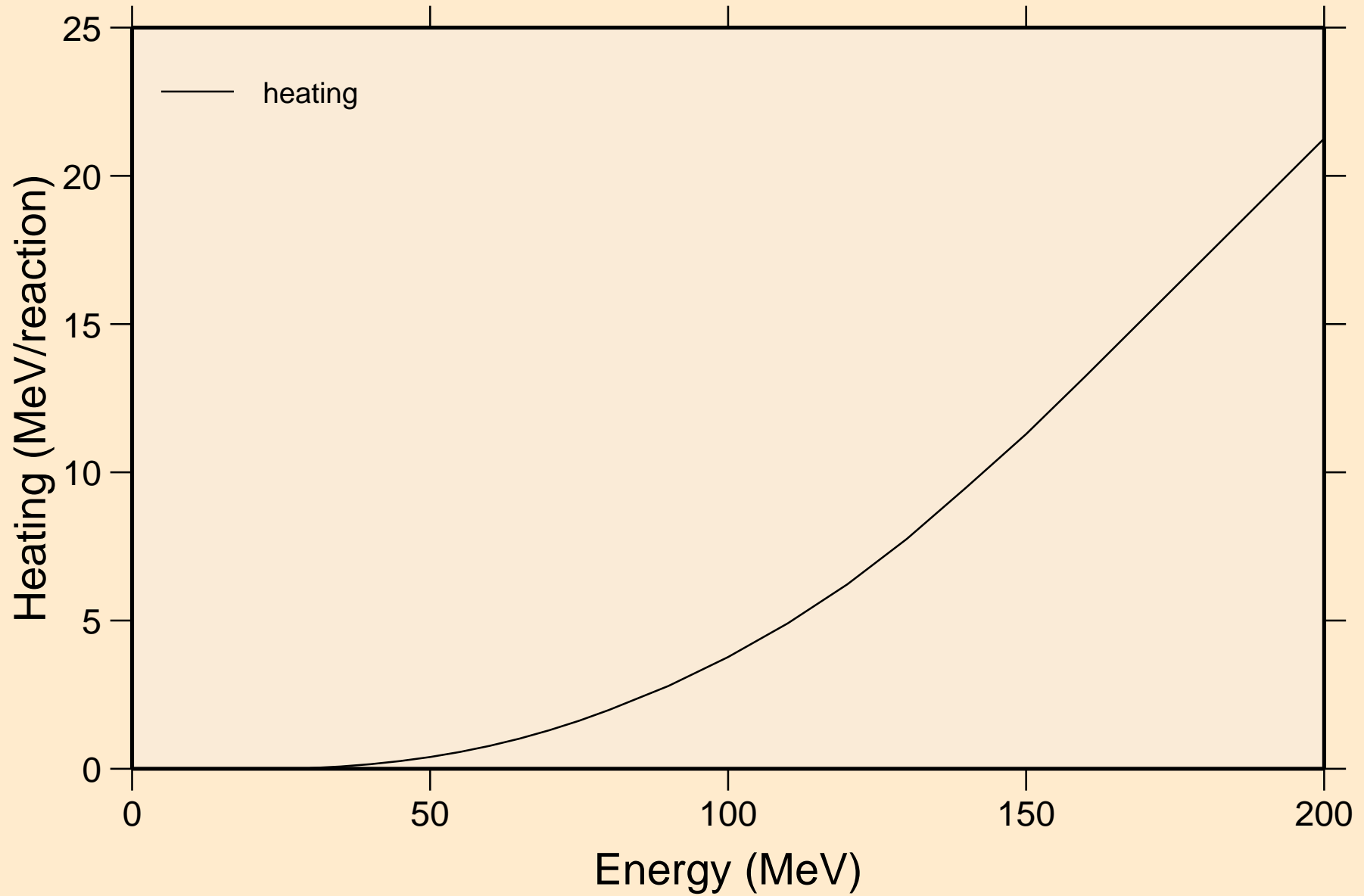

HS271 HELION ACER TENDL-2021 LIBRARY; T=0.K
Threshold reactions

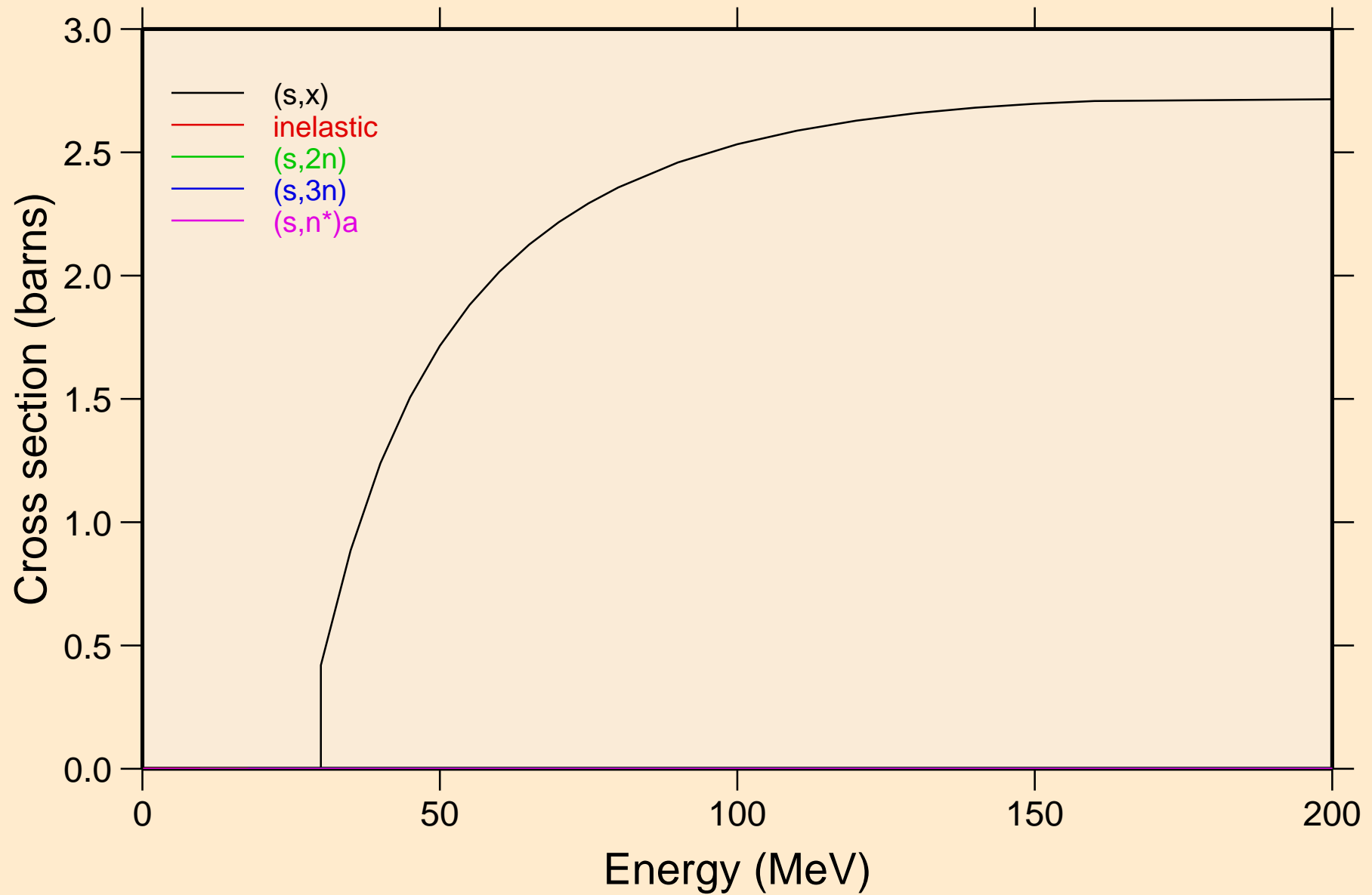

HS271 HELION ACER TENDL-2021 LIBRARY; T=0.K
Threshold reactions

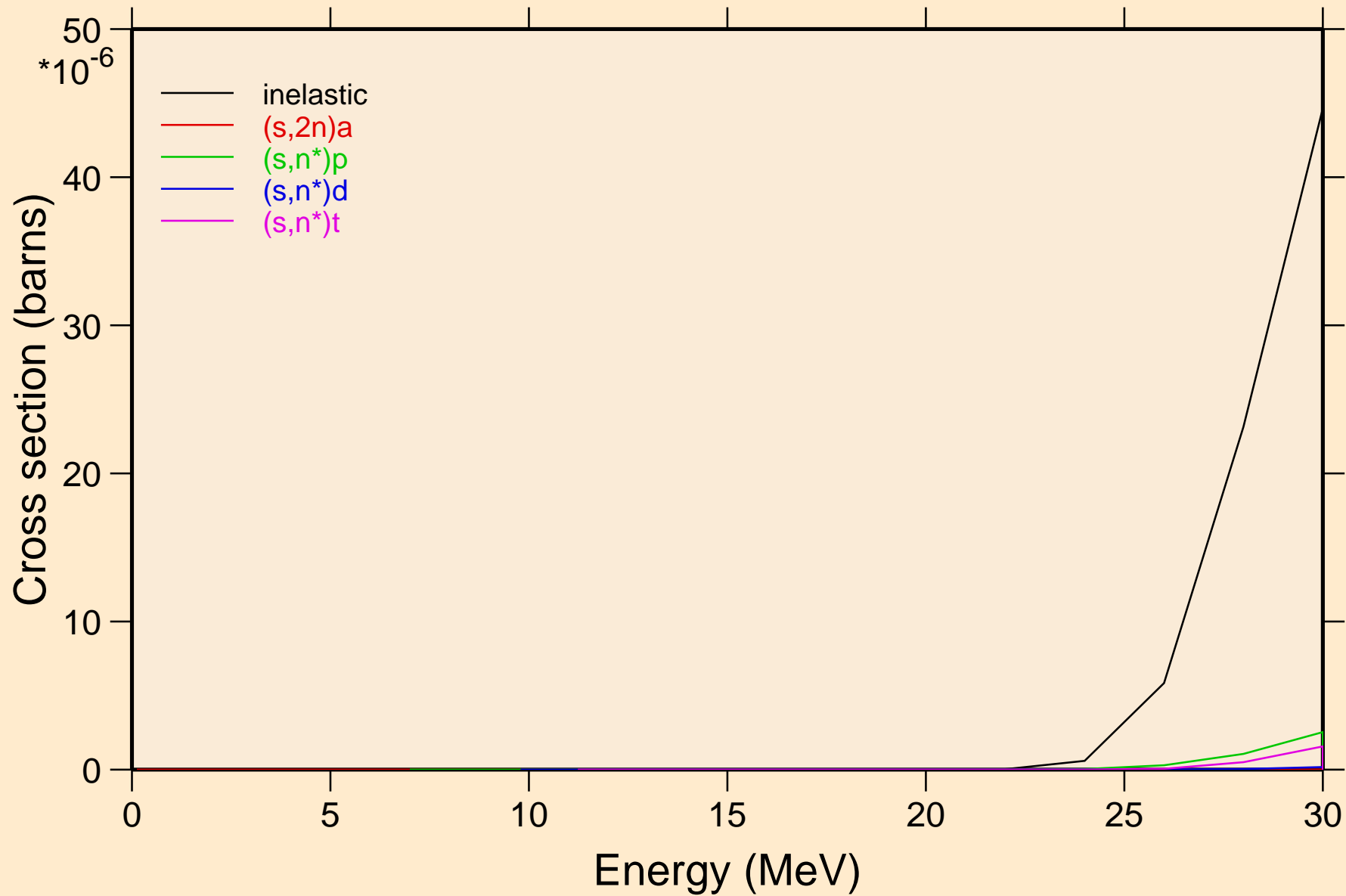

HS271 HELION ACER TENDL-2021 LIBRARY; T=0.K

Threshold reactions

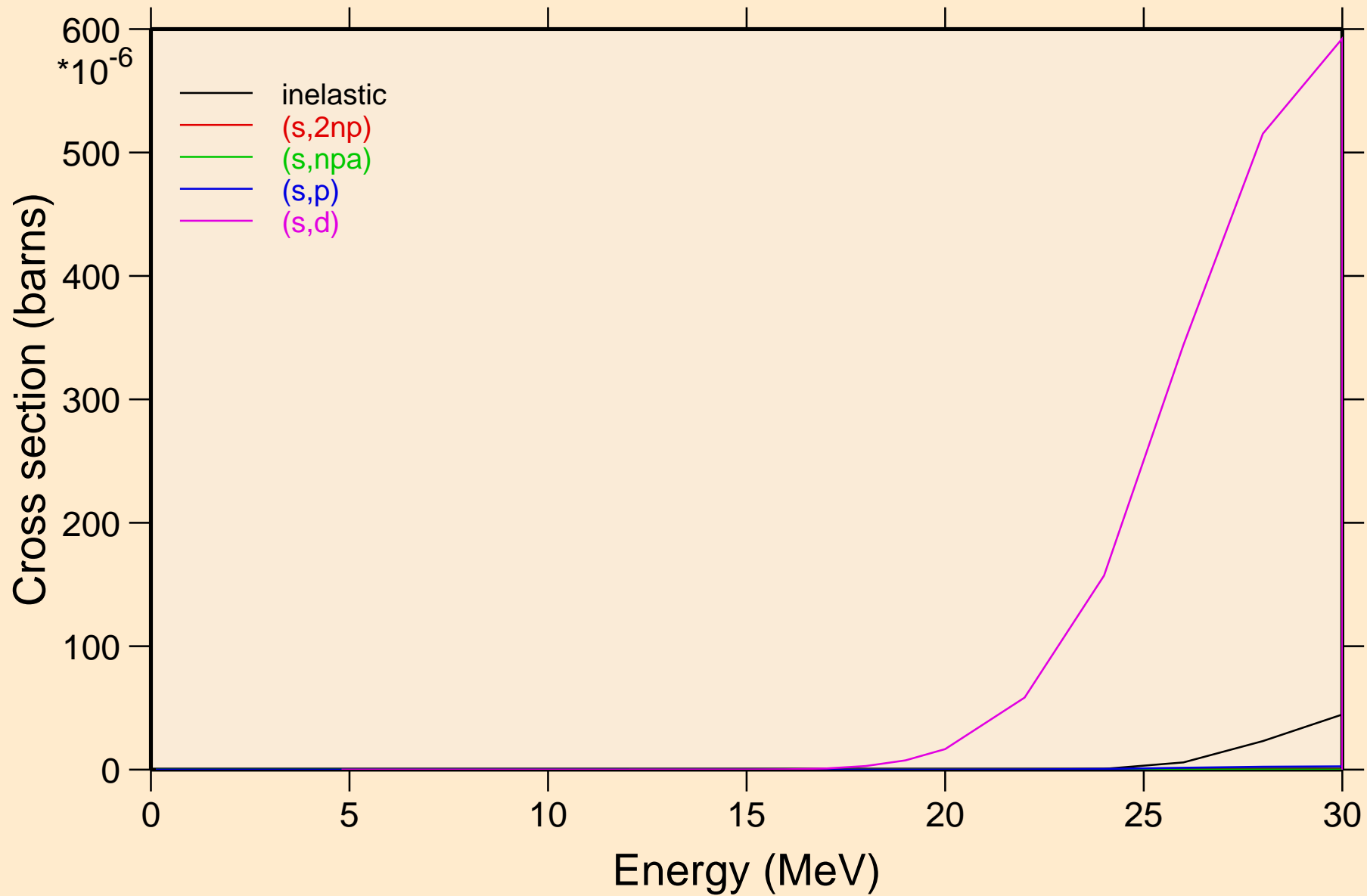

HS271 HELION ACER TENDL-2021 LIBRARY; T=0.K

Threshold reactions

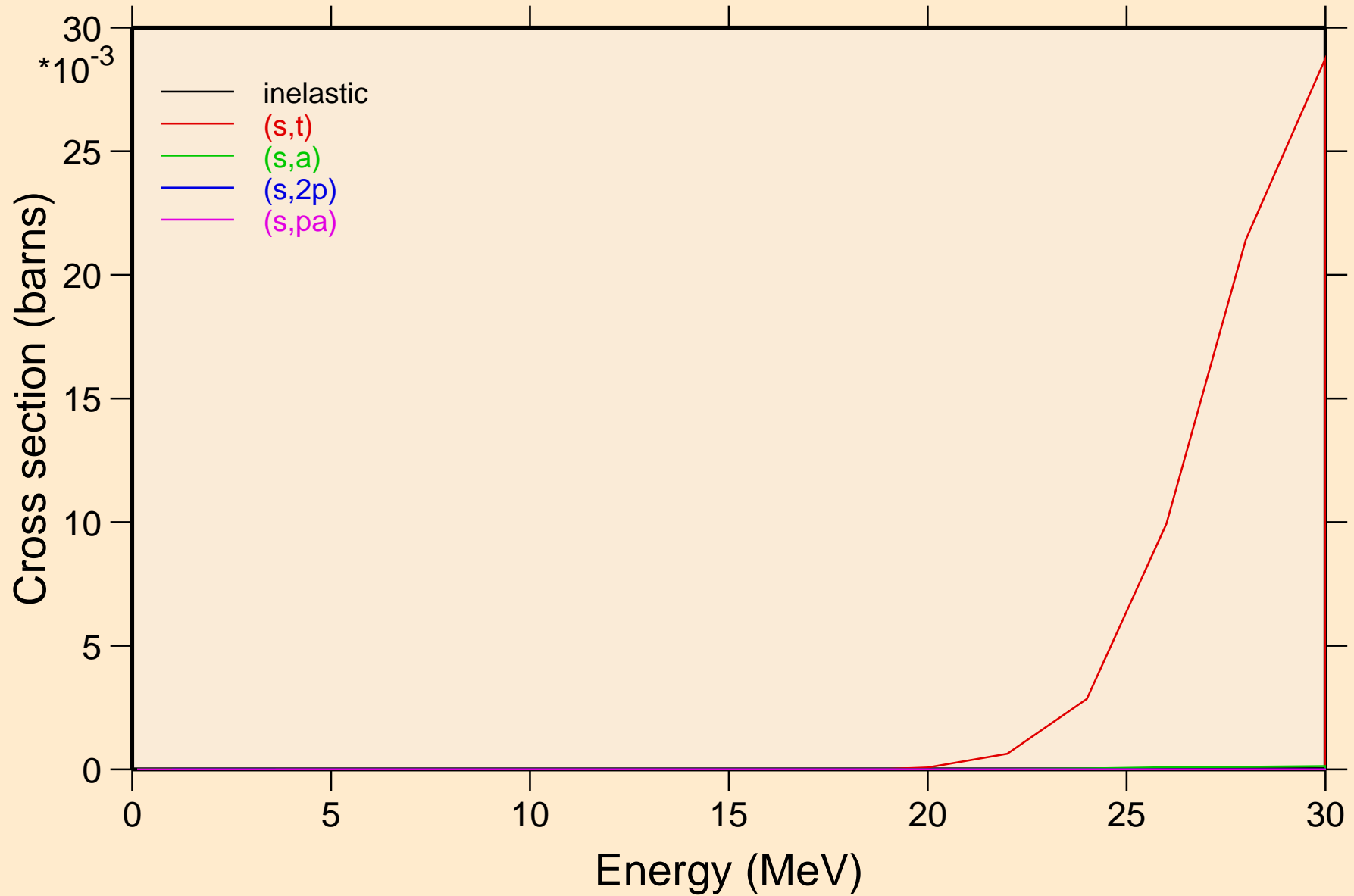

HS271 HELION ACER TENDL-2021 LIBRARY; T=0.K
Threshold reactions

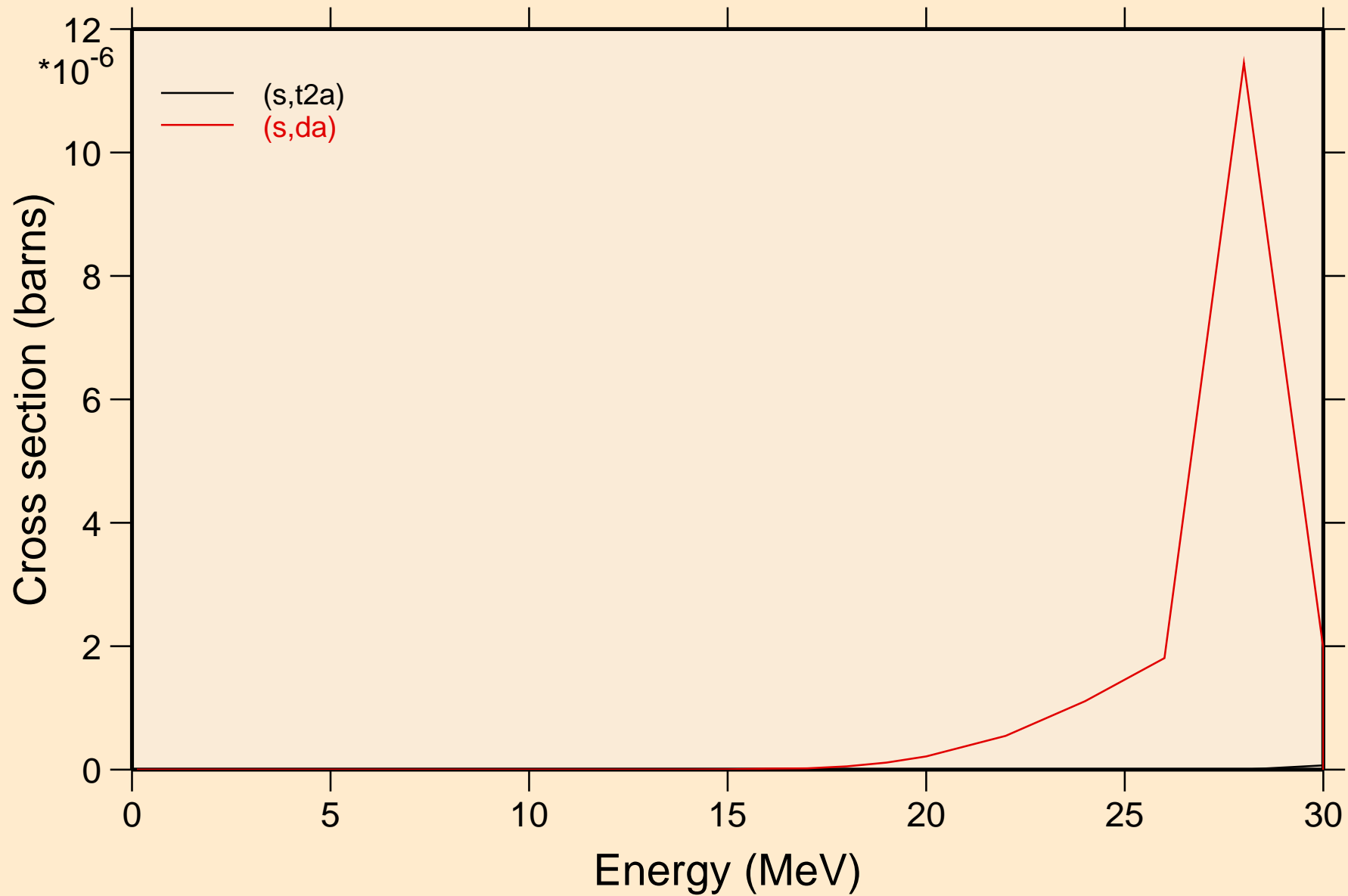

HS271 HELION ACER TENDL-2021 LIBRARY; T=0.K
angular distribution for elastic

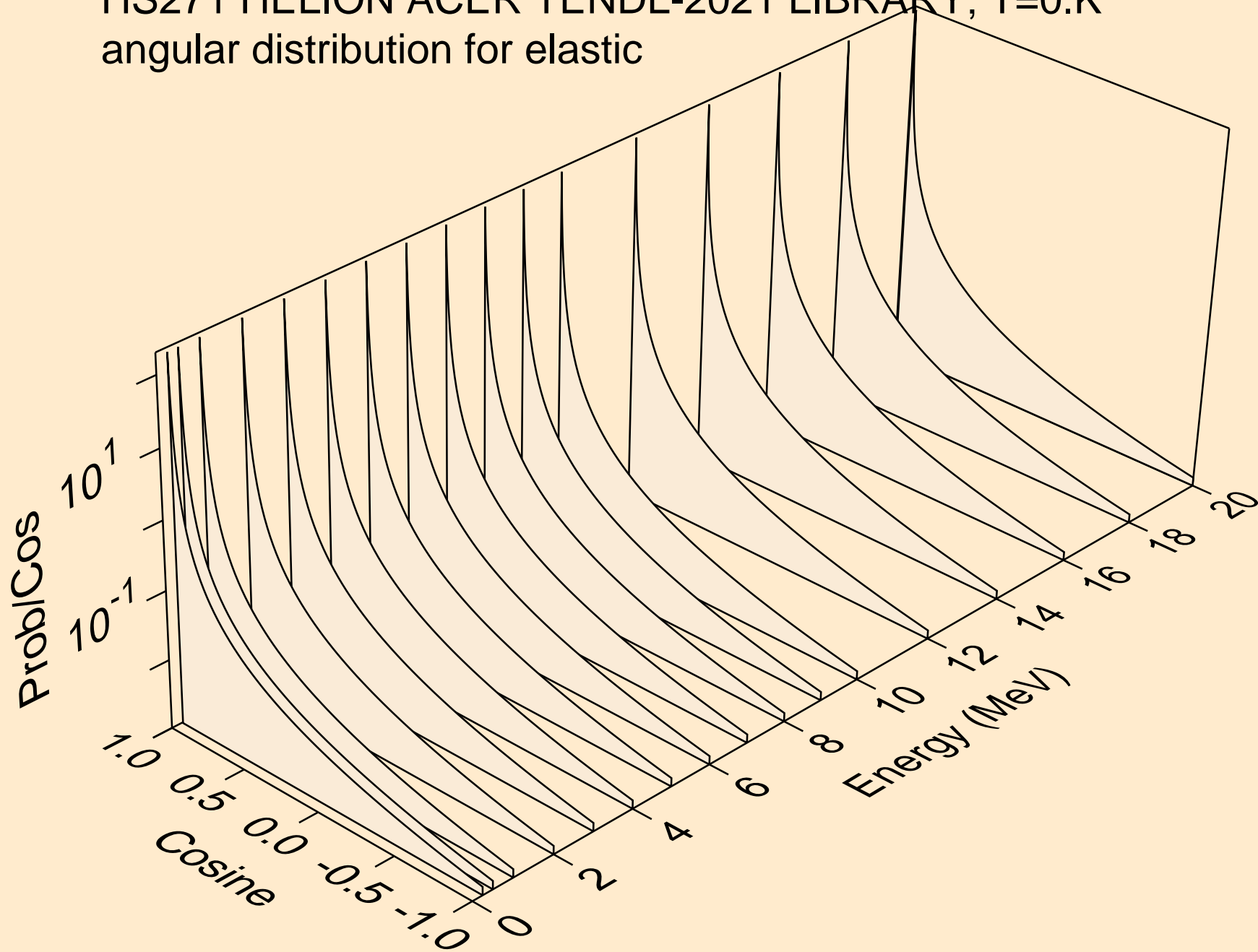

HS271 HELION ACER TENDL-2021 LIBRARY; T=0.K
angular distribution for elastic

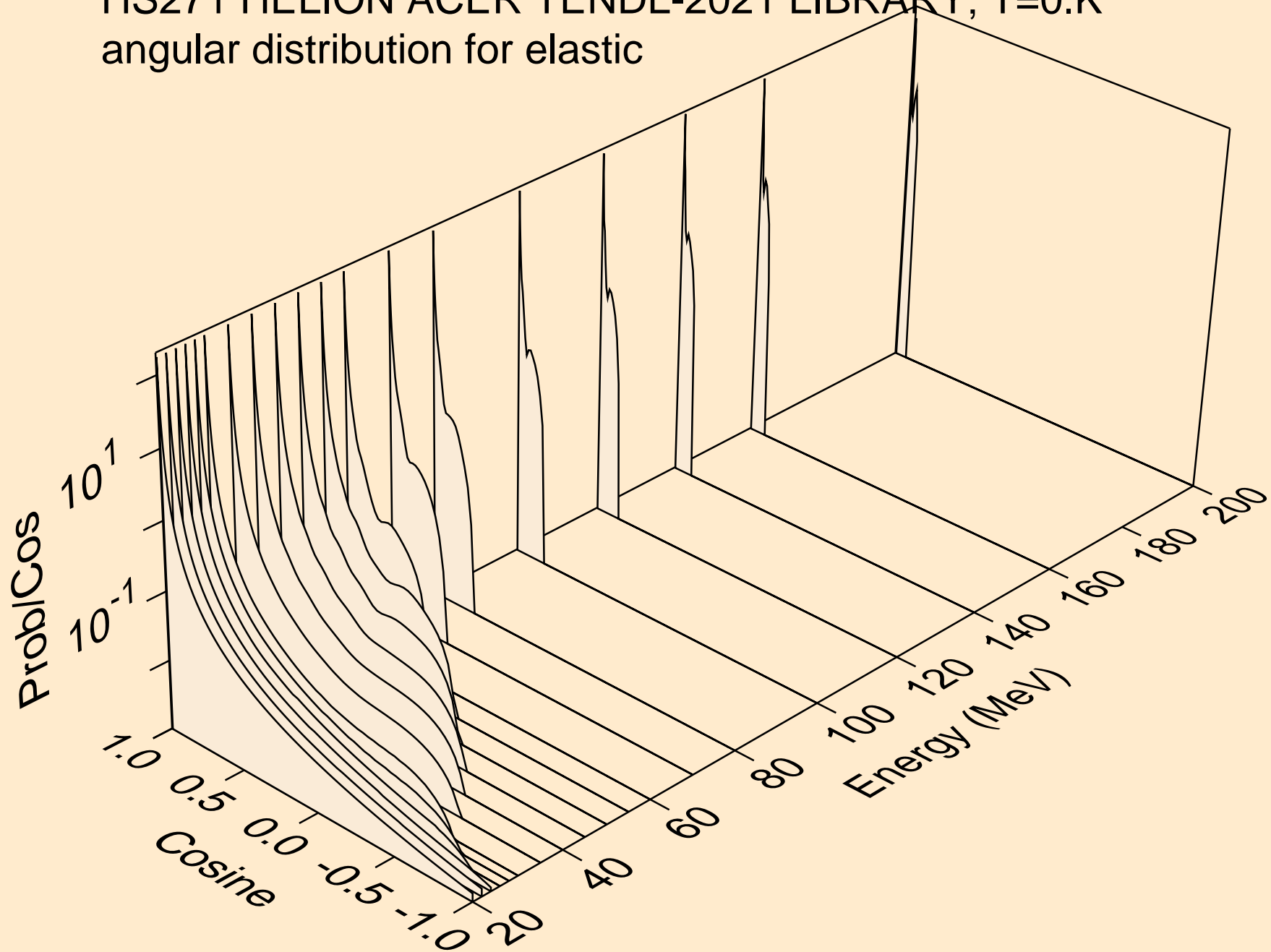

HS271 HELION ACER TENDL-2021 LIBRARY; T=0.K
He-3 emission for (s,x)

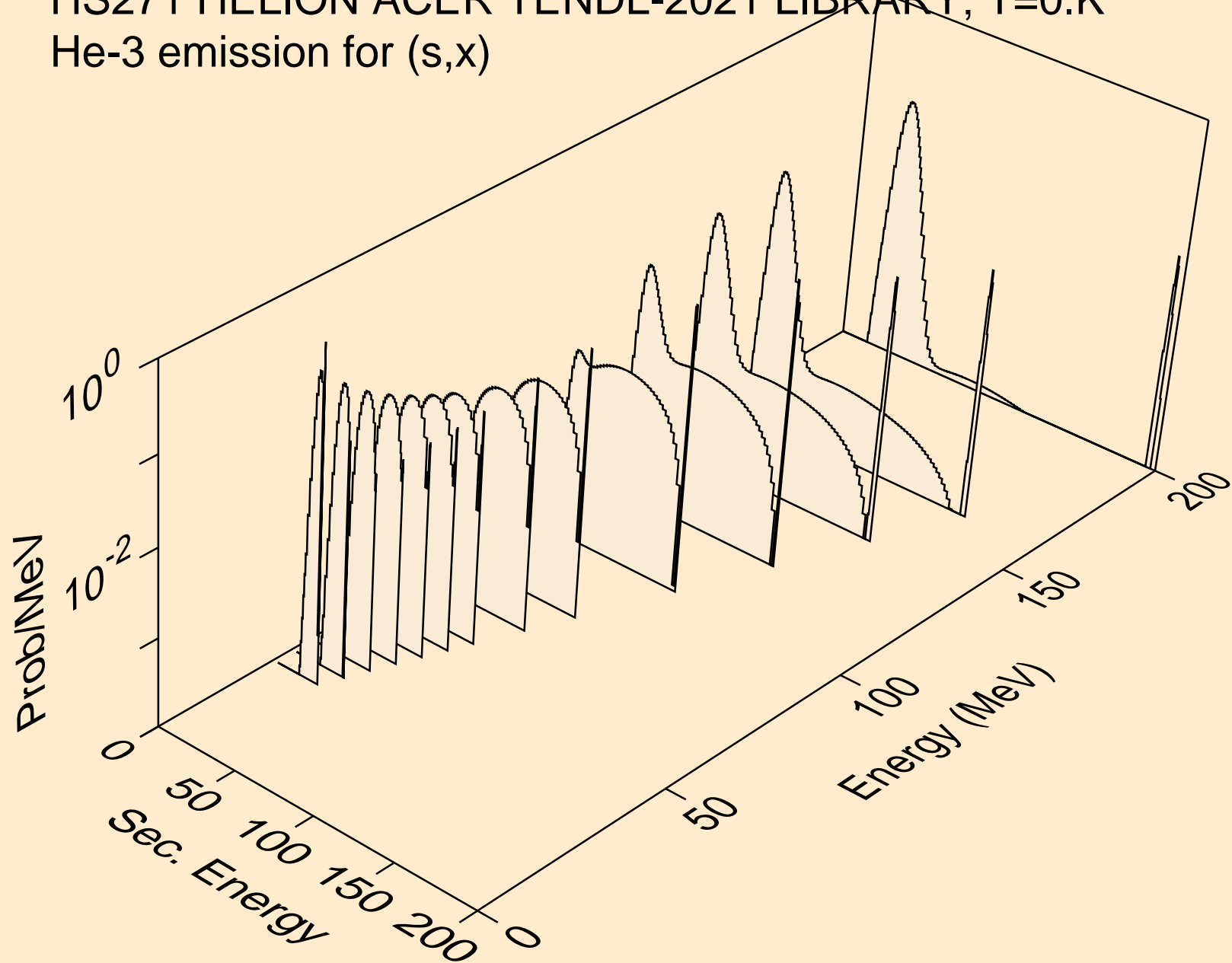

HS271 HELION ACER TENDL-2021 LIBRARY; T=0.K
He-3 emission for inelastic

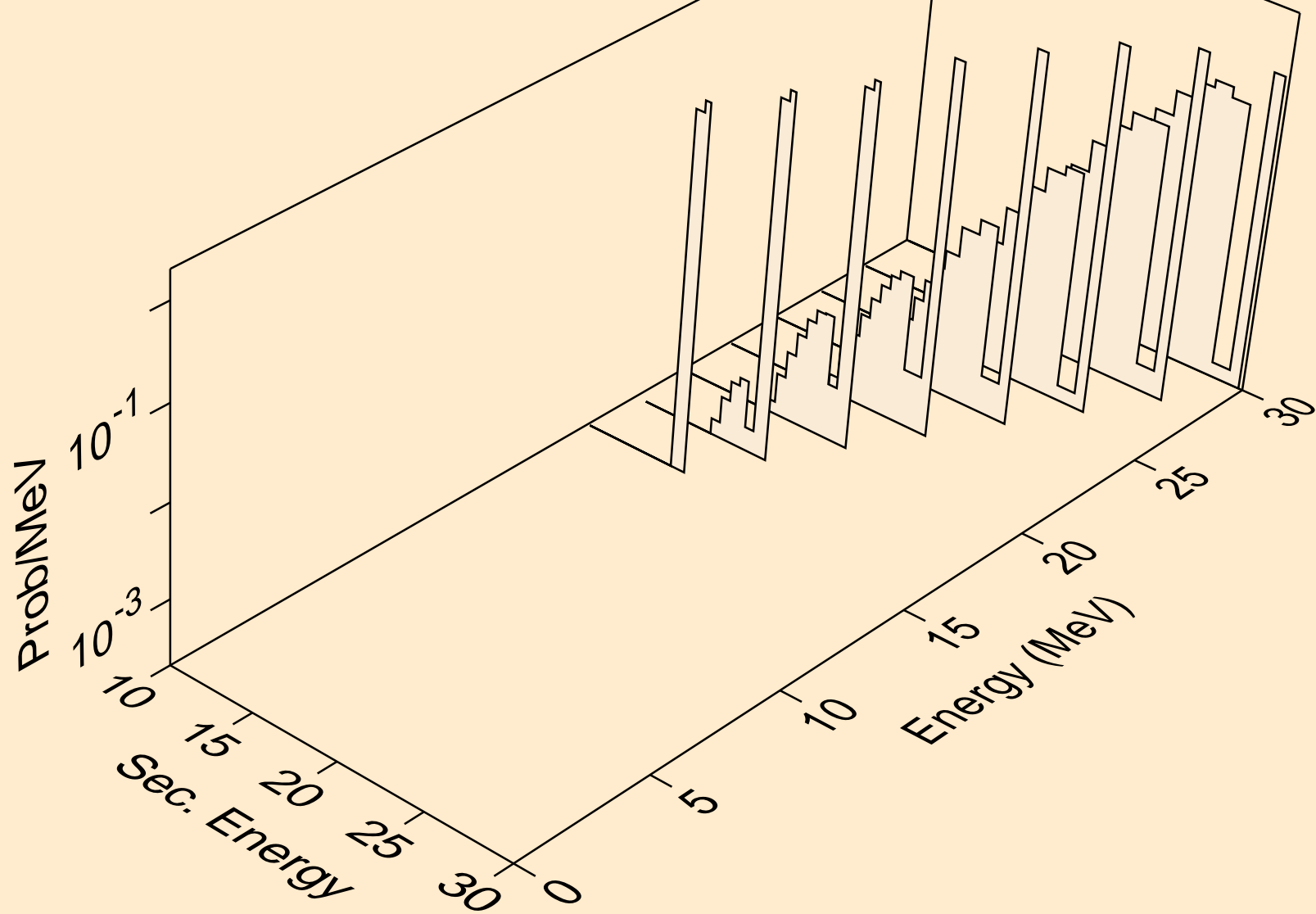

HS271 HELION ACER TENDL-2021 LIBRARY; T=0.K
Photon emission for (z,n)

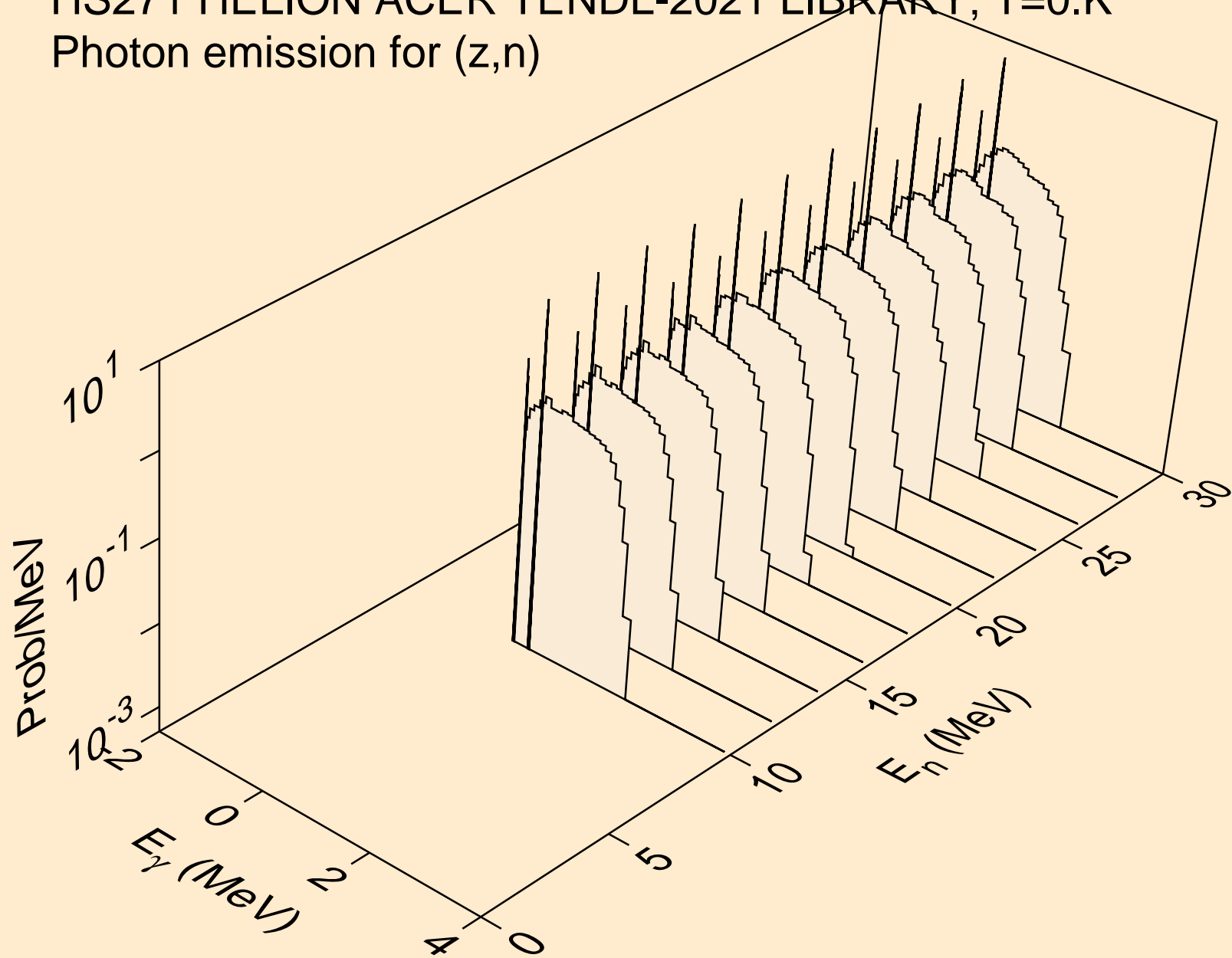

HS271 HELION ACER TENDL-2021 LIBRARY; T=0.K
Photon emission for (n,x)

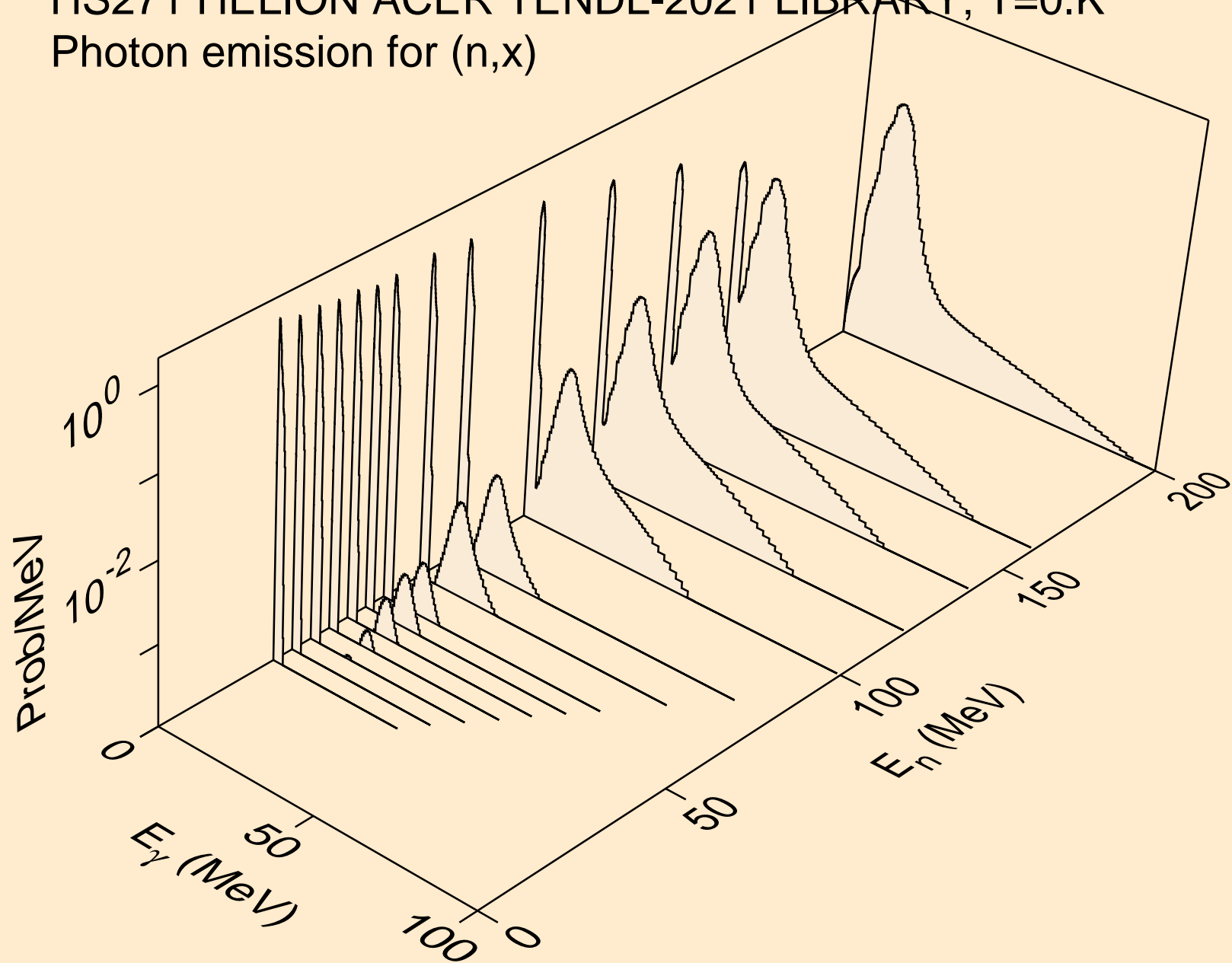

HS271 HELION ACER TENDL-2021 LIBRARY; T=0.K
Photon emission for (n,2n)

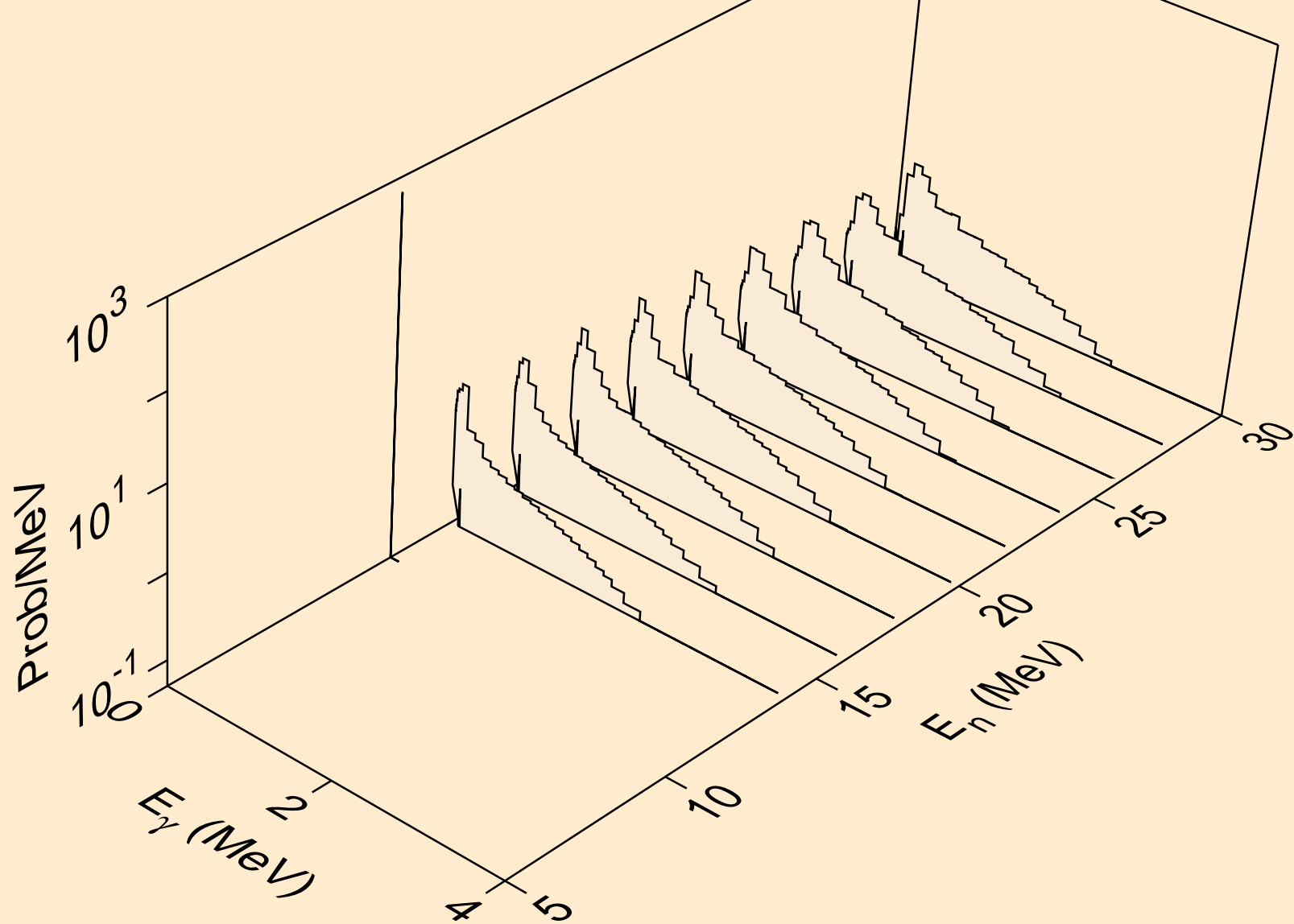

HS271 HELION ACER TENDL-2021 LIBRARY; T=0.K
Photon emission for (n,3n)

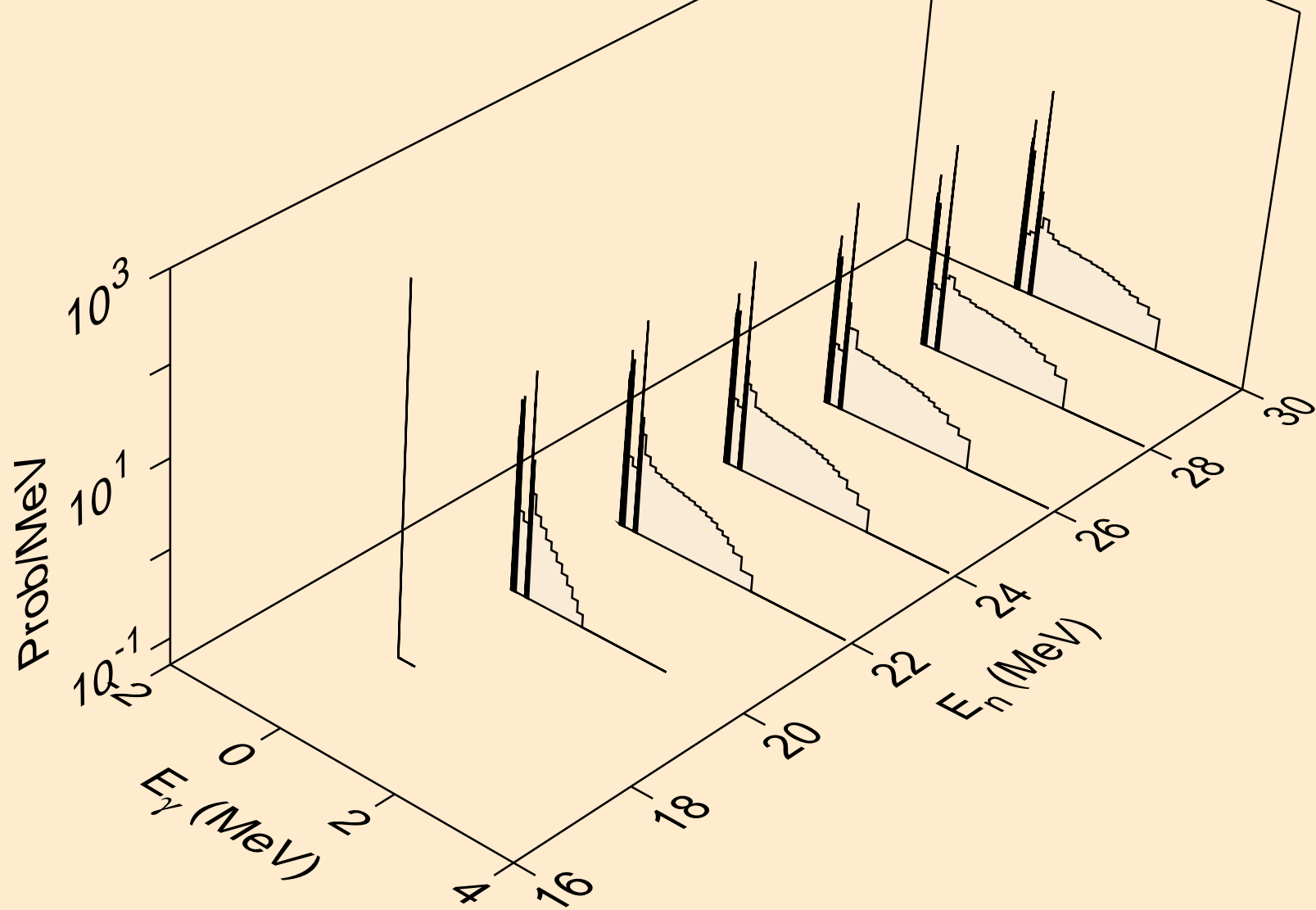

HS271 HELION ACER TENDL-2021 LIBRARY; T=0.K
Photon emission for (n,n*)a

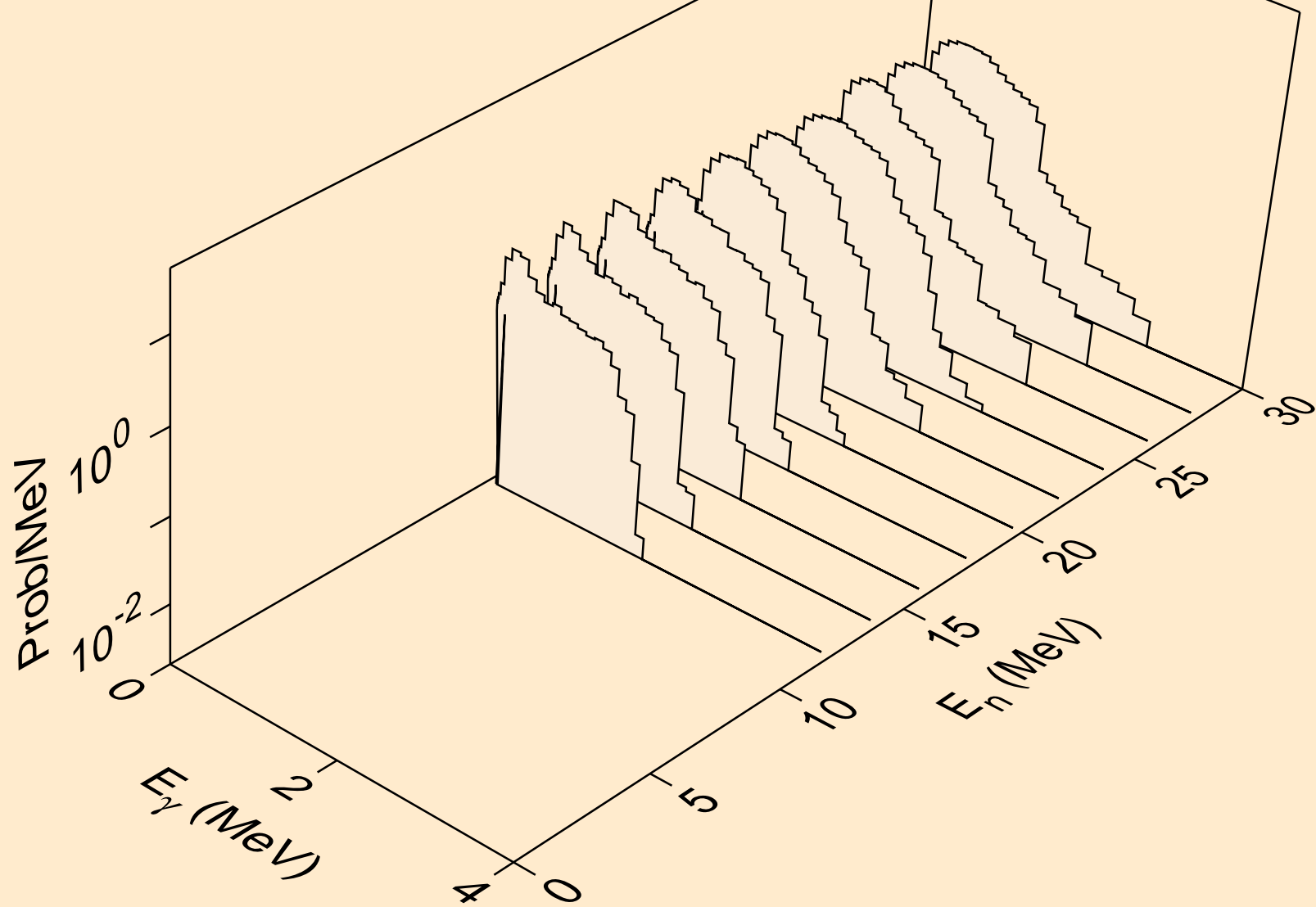

HS271 HELION ACER TENDL-2021 LIBRARY; T=0.K
Photon emission for (n,2n)a

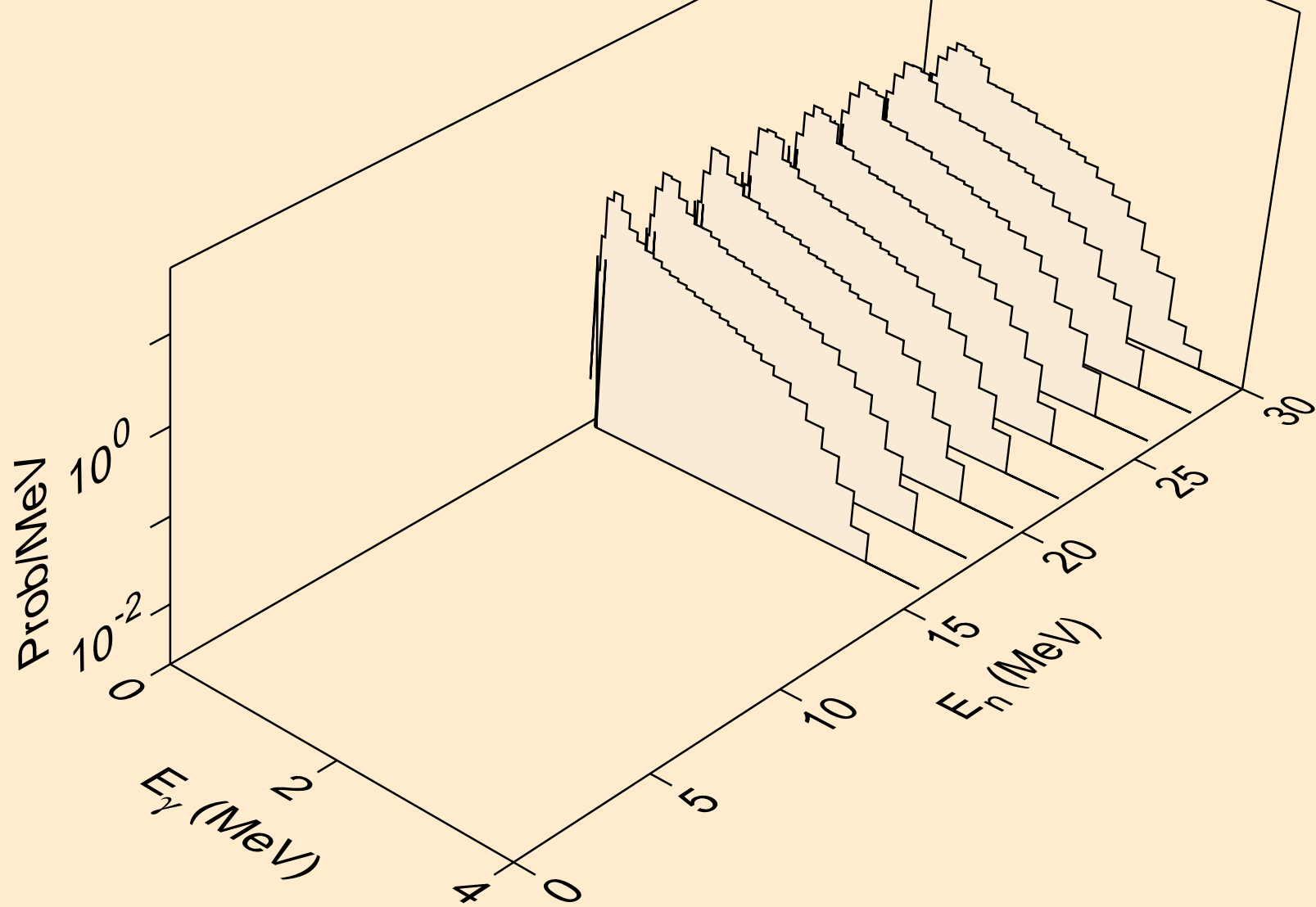

HS271 HELION ACER TENDL-2021 LIBRARY; T=0.K
Photon emission for (n,n*)p

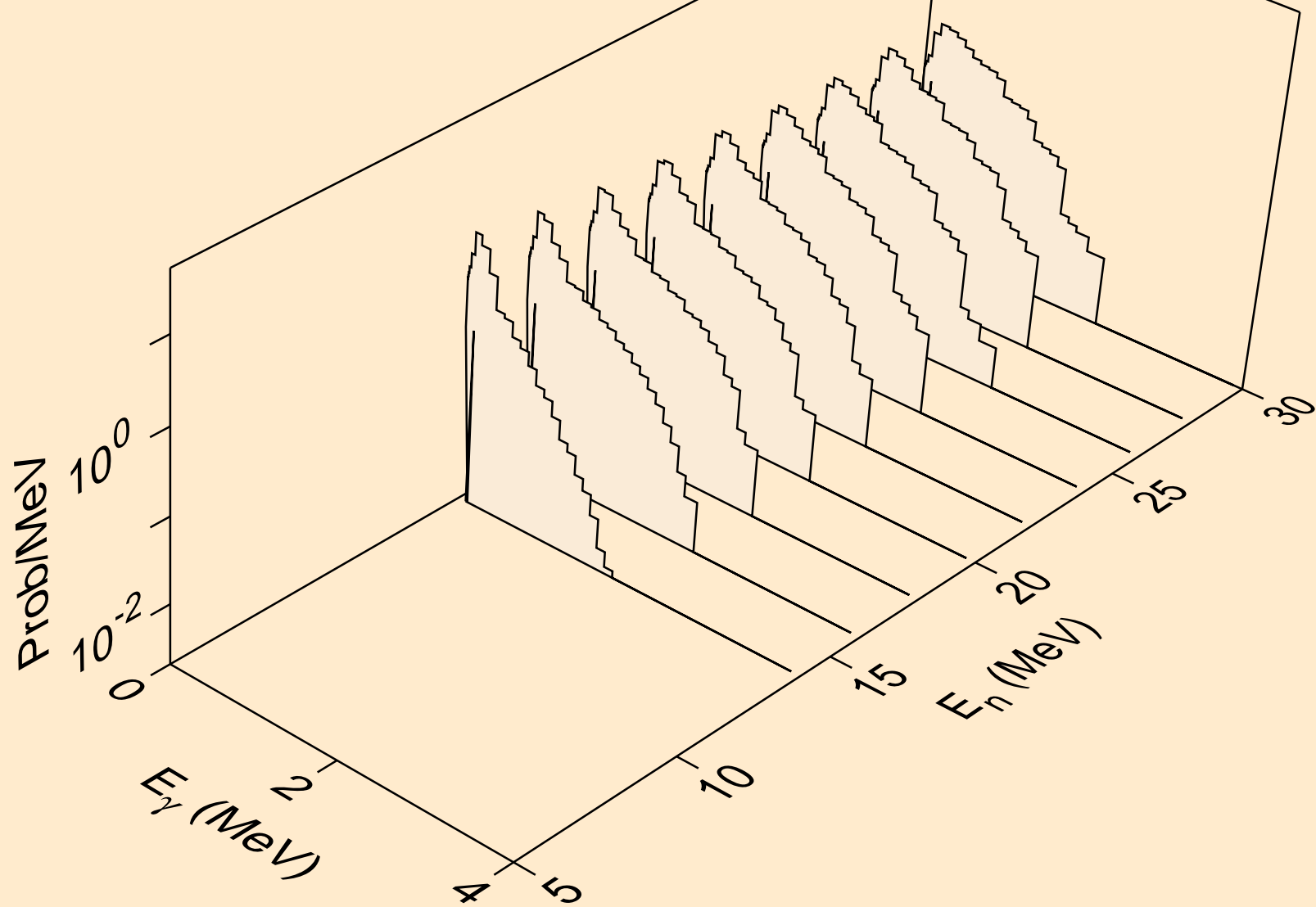

HS271 HELION ACER TENDL-2021 LIBRARY; T=0.K
Photon emission for (n,n*)d

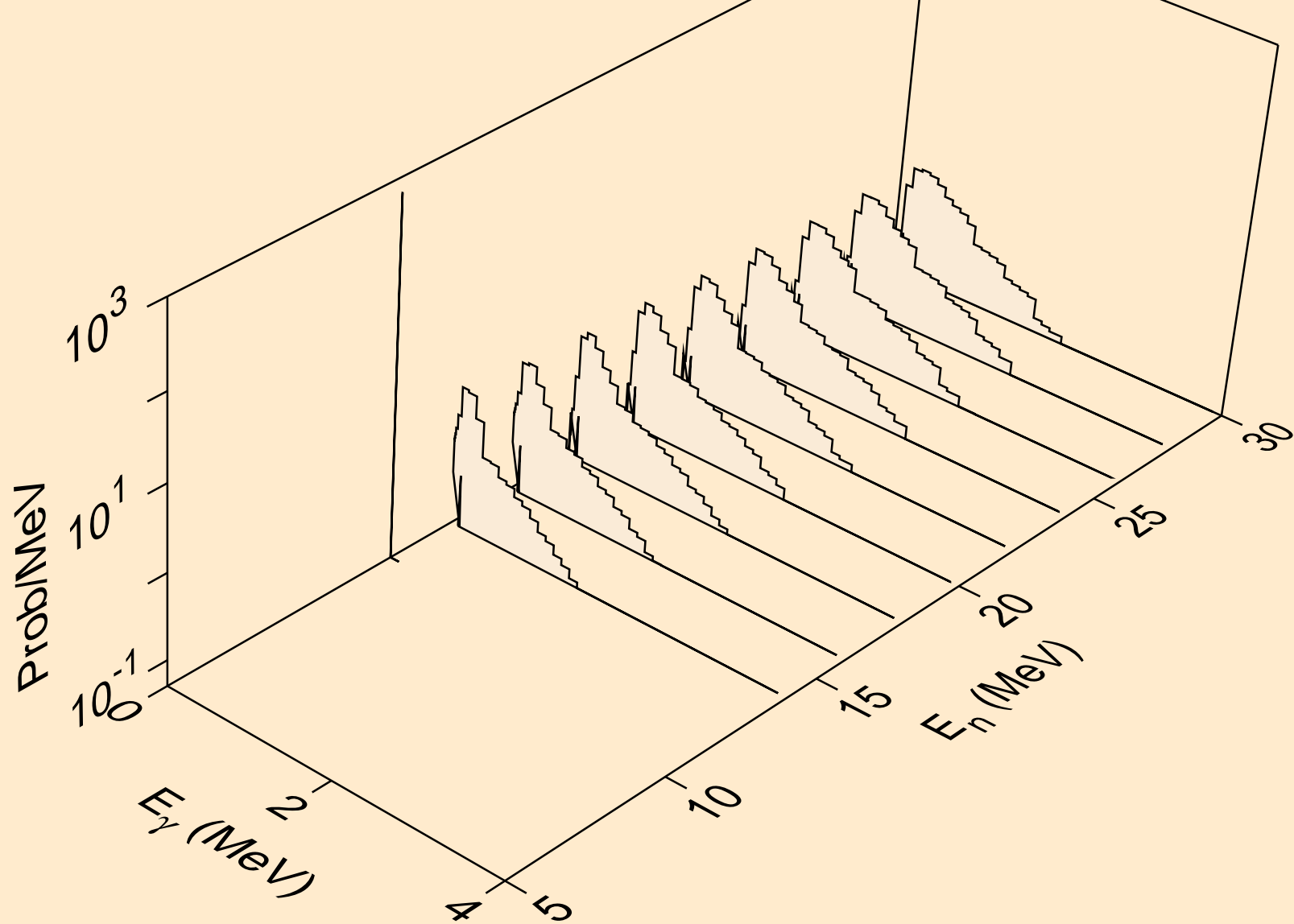

HS271 HELION ACER TENDL-2021 LIBRARY; T=0.K
Photon emission for (n,n*)t

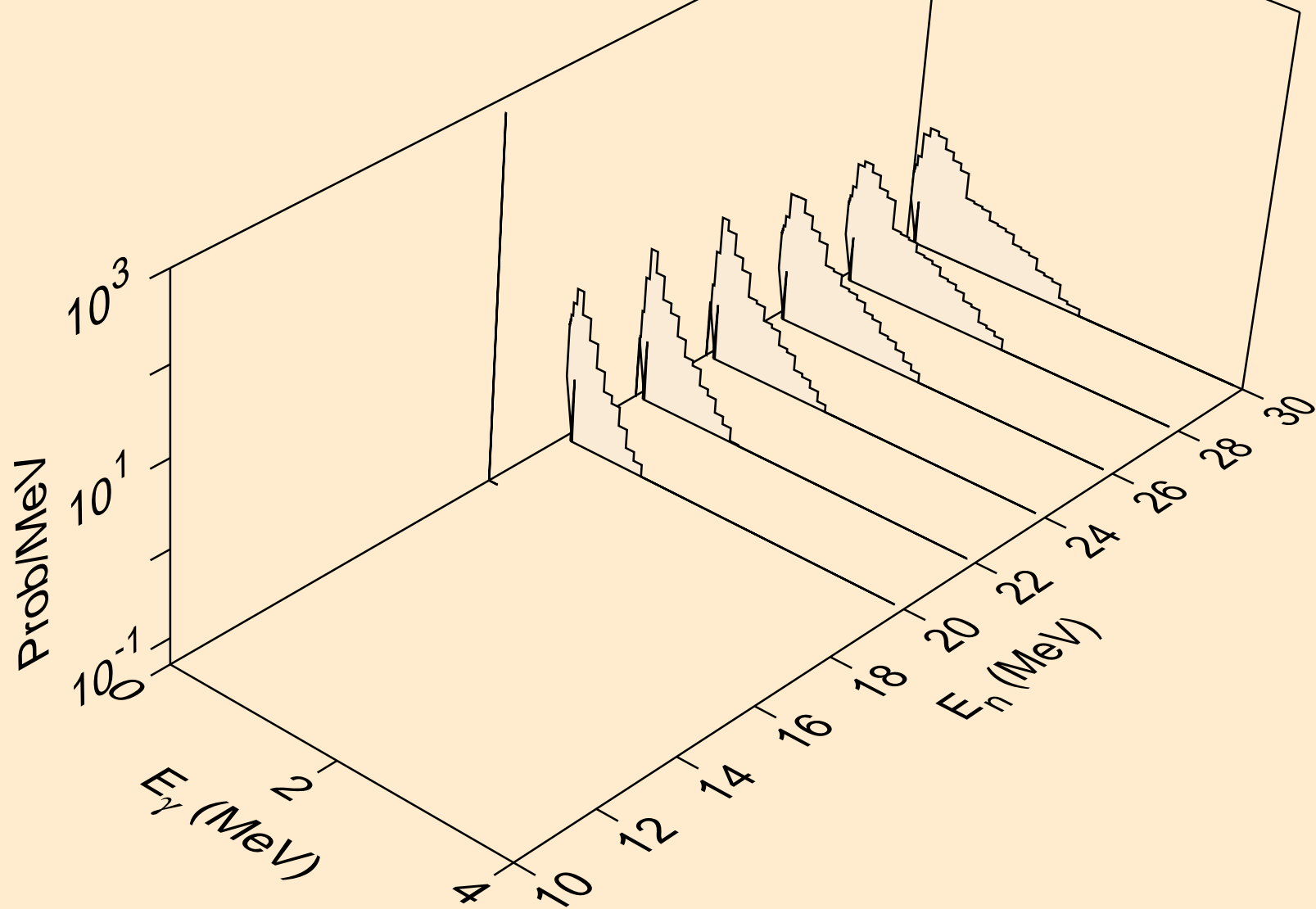

HS271 HELION ACER TENDL-2021 LIBRARY; T=0.K
Photon emission for (n,2np)

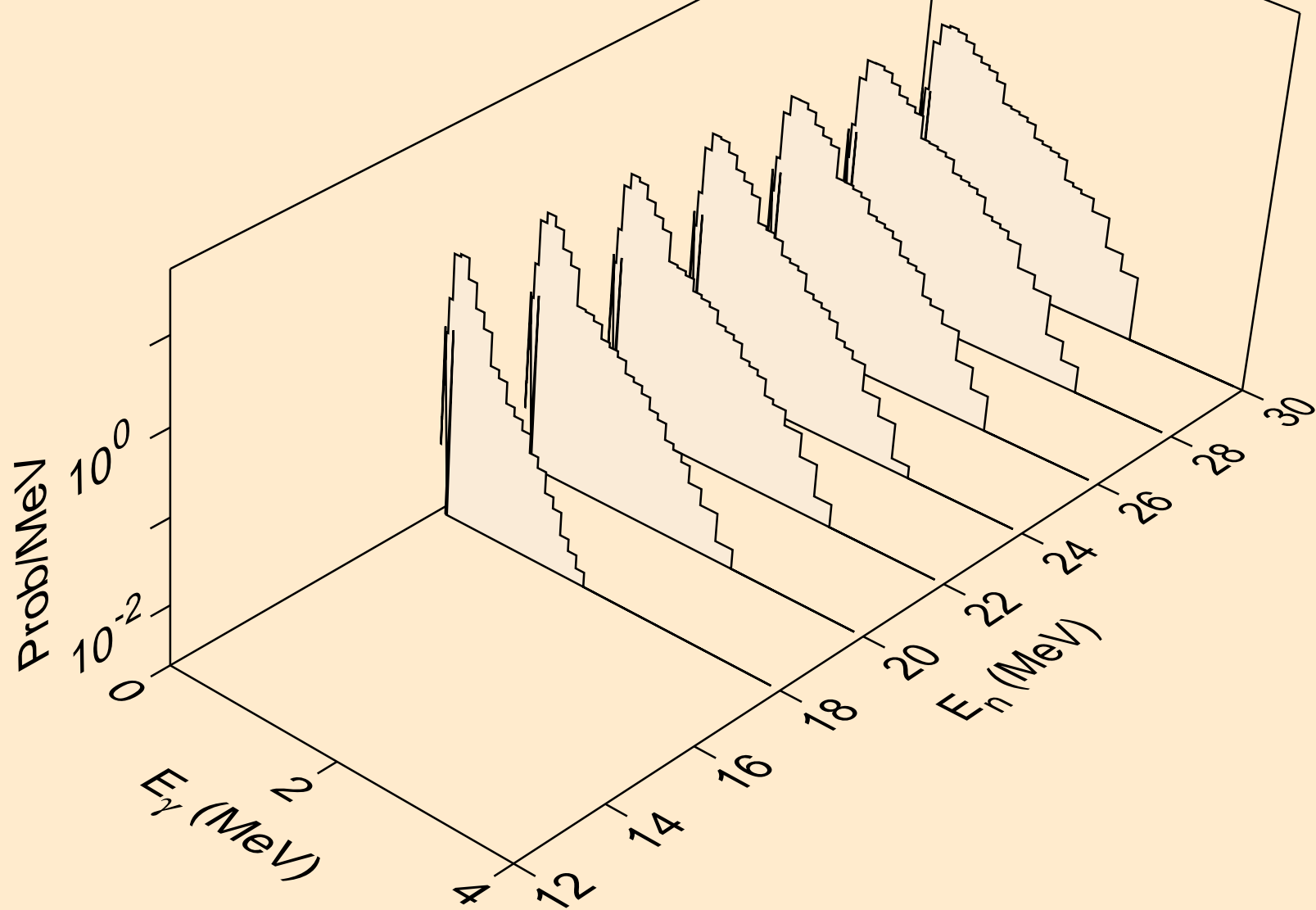

HS271 HELION ACER TENDL-2021 LIBRARY; T=0.K
Photon emission for (n,npa)

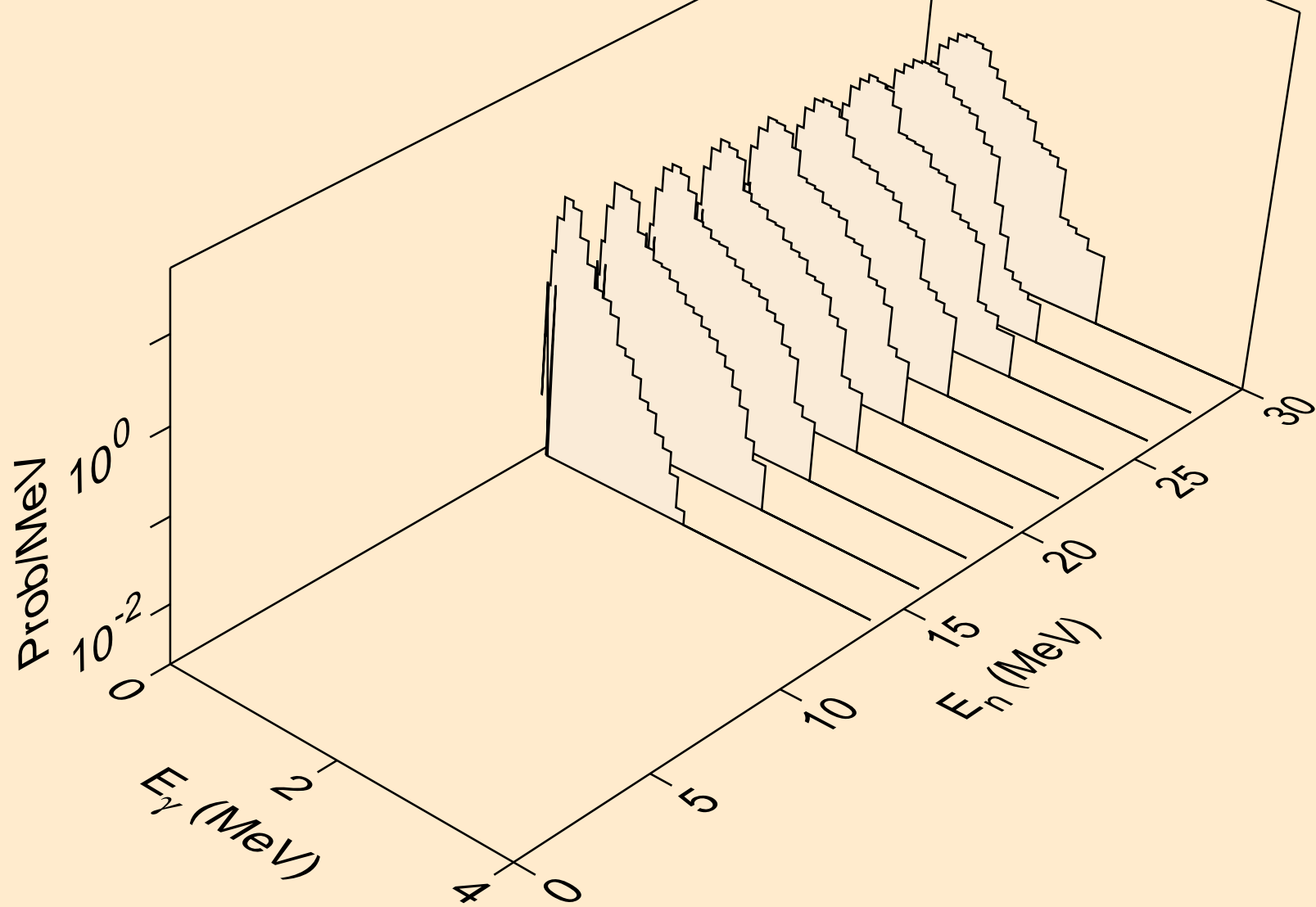

HS271 HELION ACER TENDL-2021 LIBRARY; T=0.K
Photon emission for (n,p)

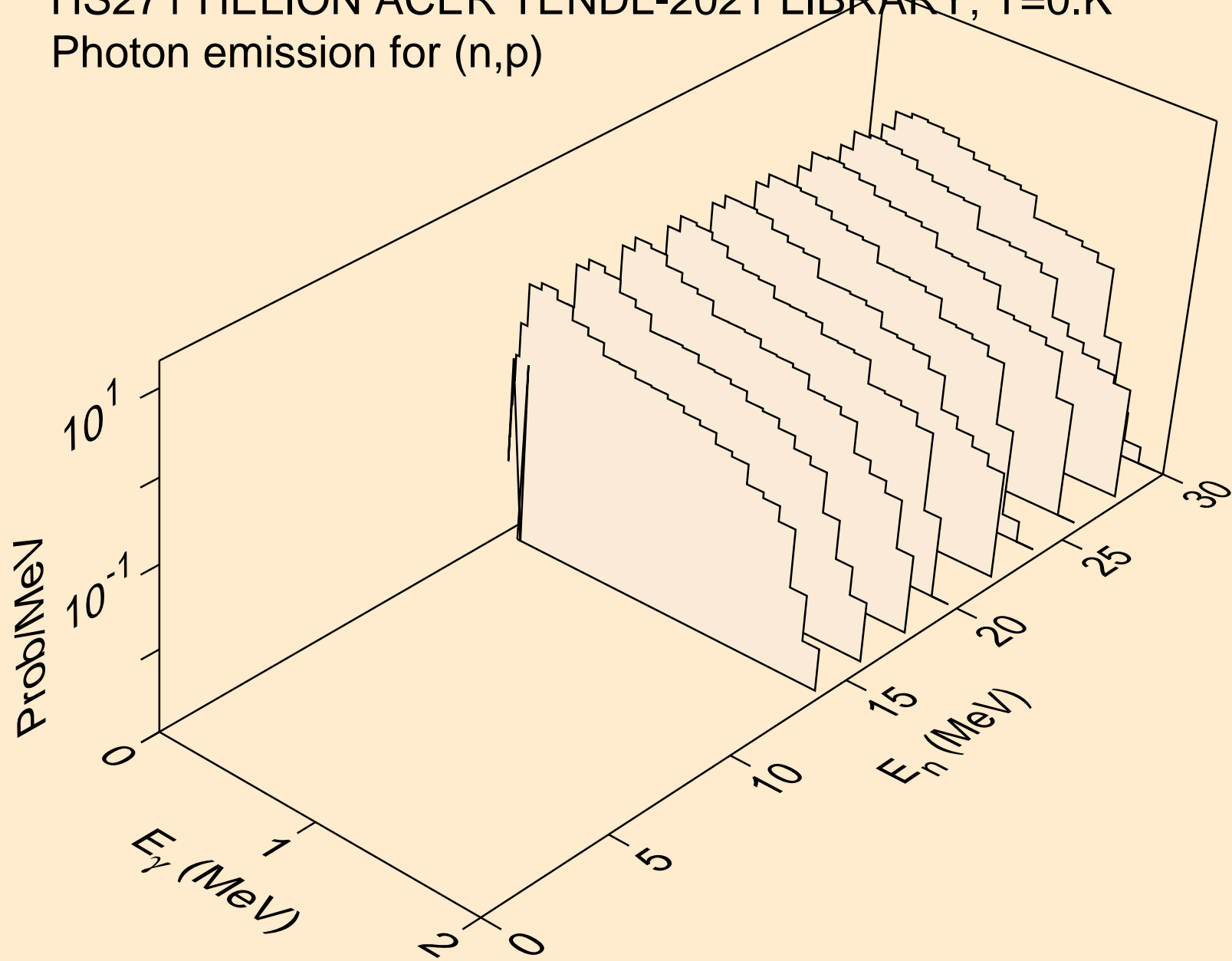

HS271 HELION ACER TENDL-2021 LIBRARY; T=0.K
Photon emission for (n,d)

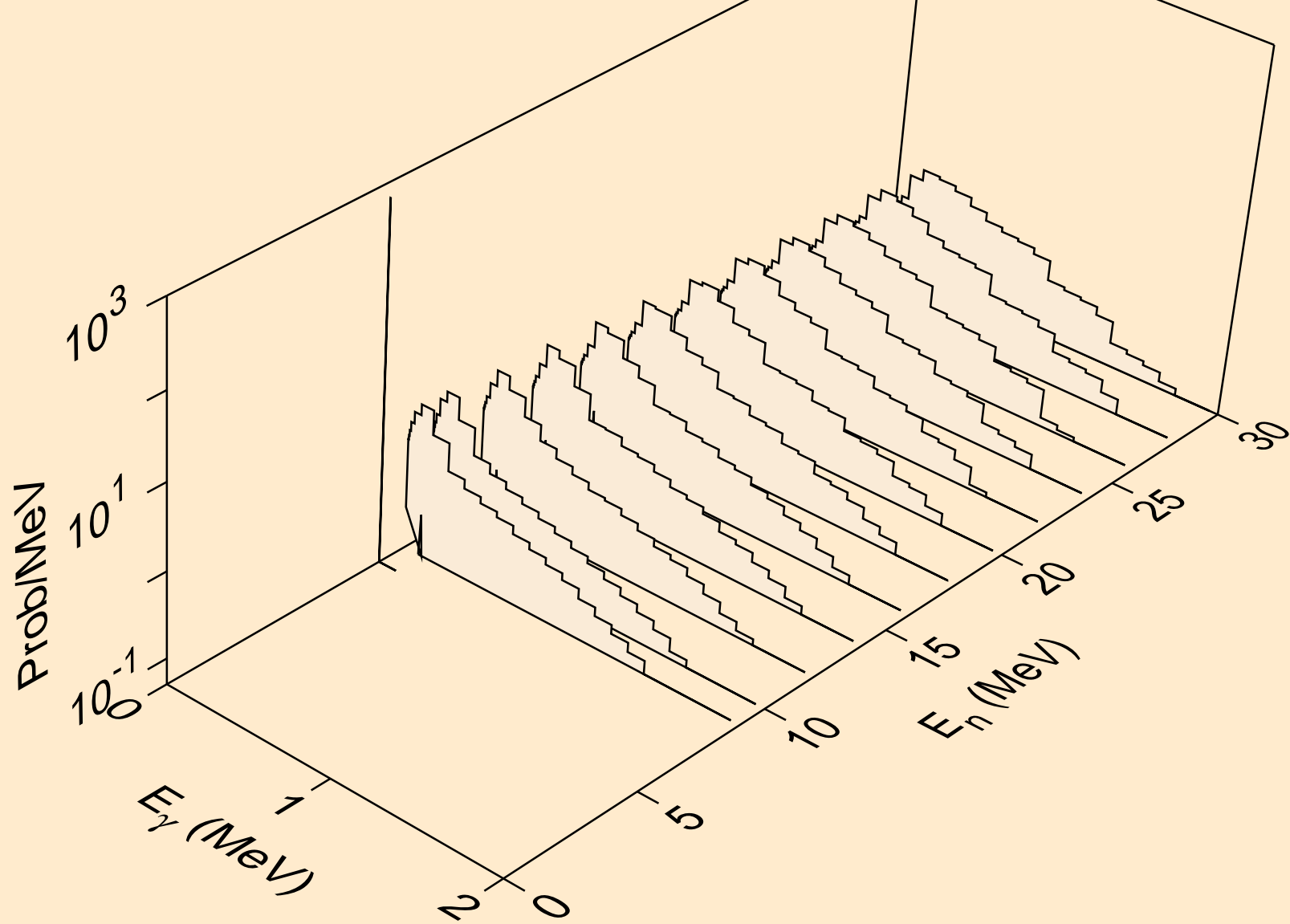

HS271 HELION ACER TENDL-2021 LIBRARY; T=0.K
Photon emission for (n,t)

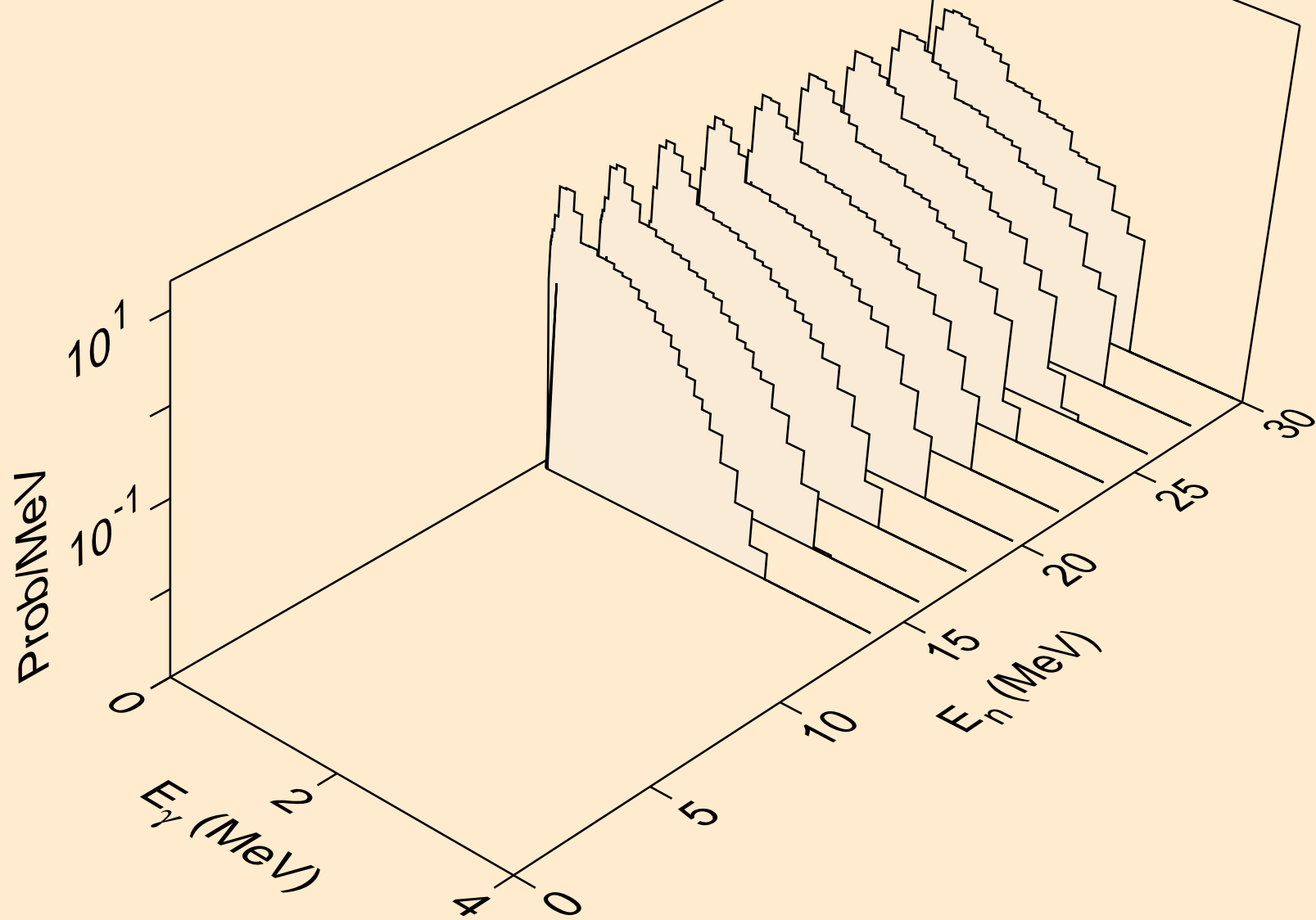

HS271 HELION ACER TENDL-2021 LIBRARY; T=0.K
Photon emission for inelastic

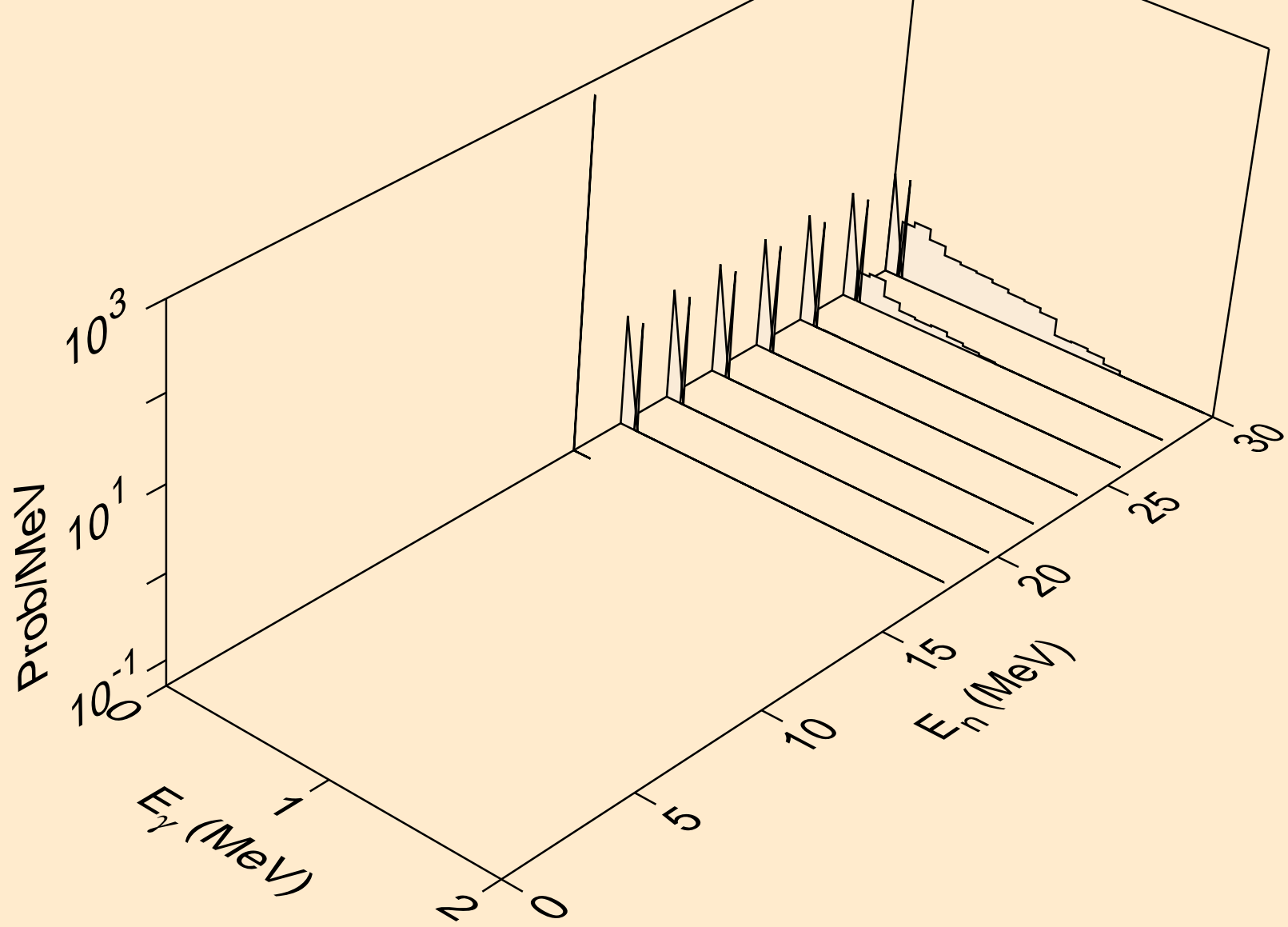

HS271 HELION ACER TENDL-2021 LIBRARY; T=0.K
Photon emission for (n,a)

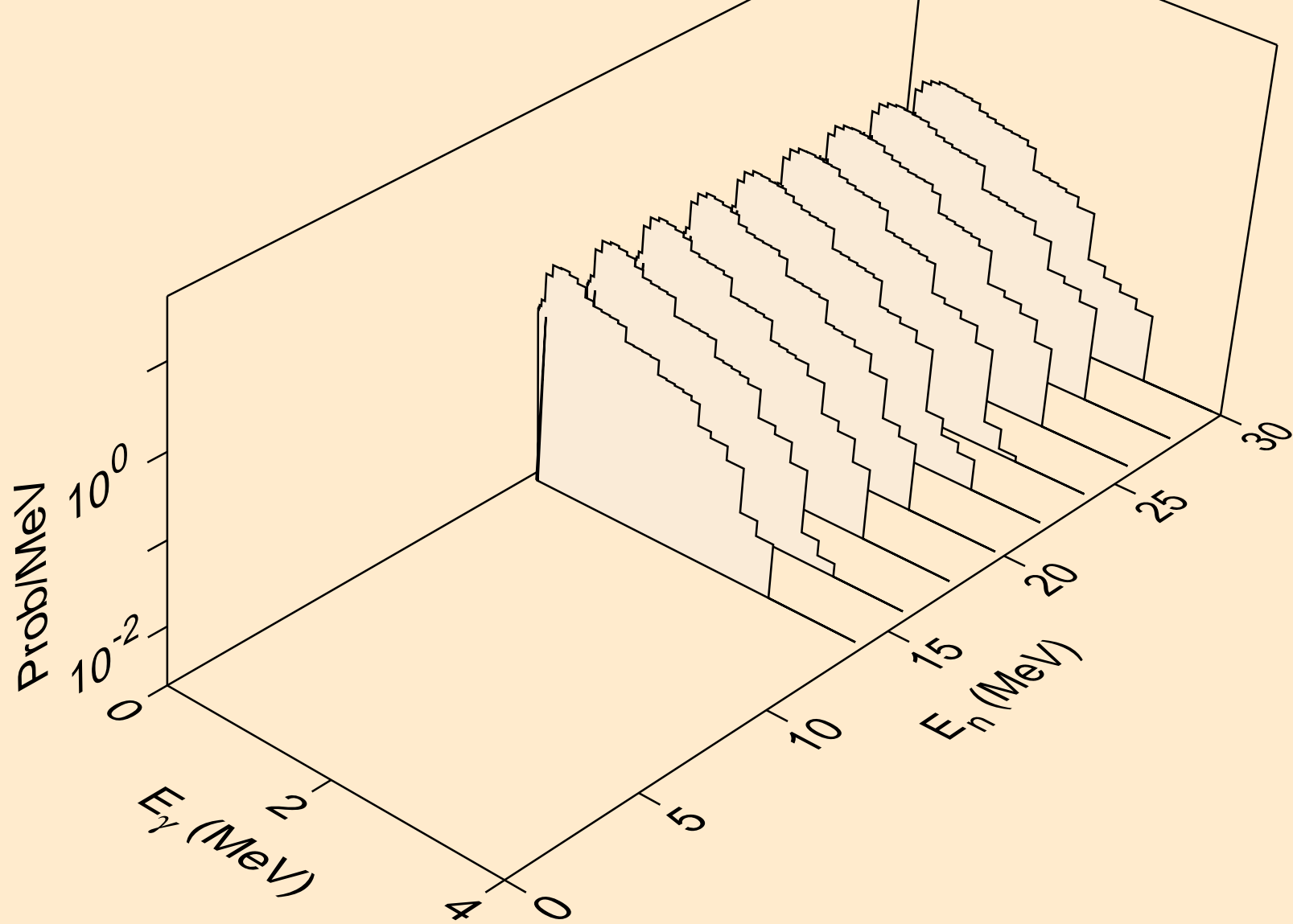

HS271 HELION ACER TENDL-2021 LIBRARY; T=0.K
Photon emission for (n,2p)

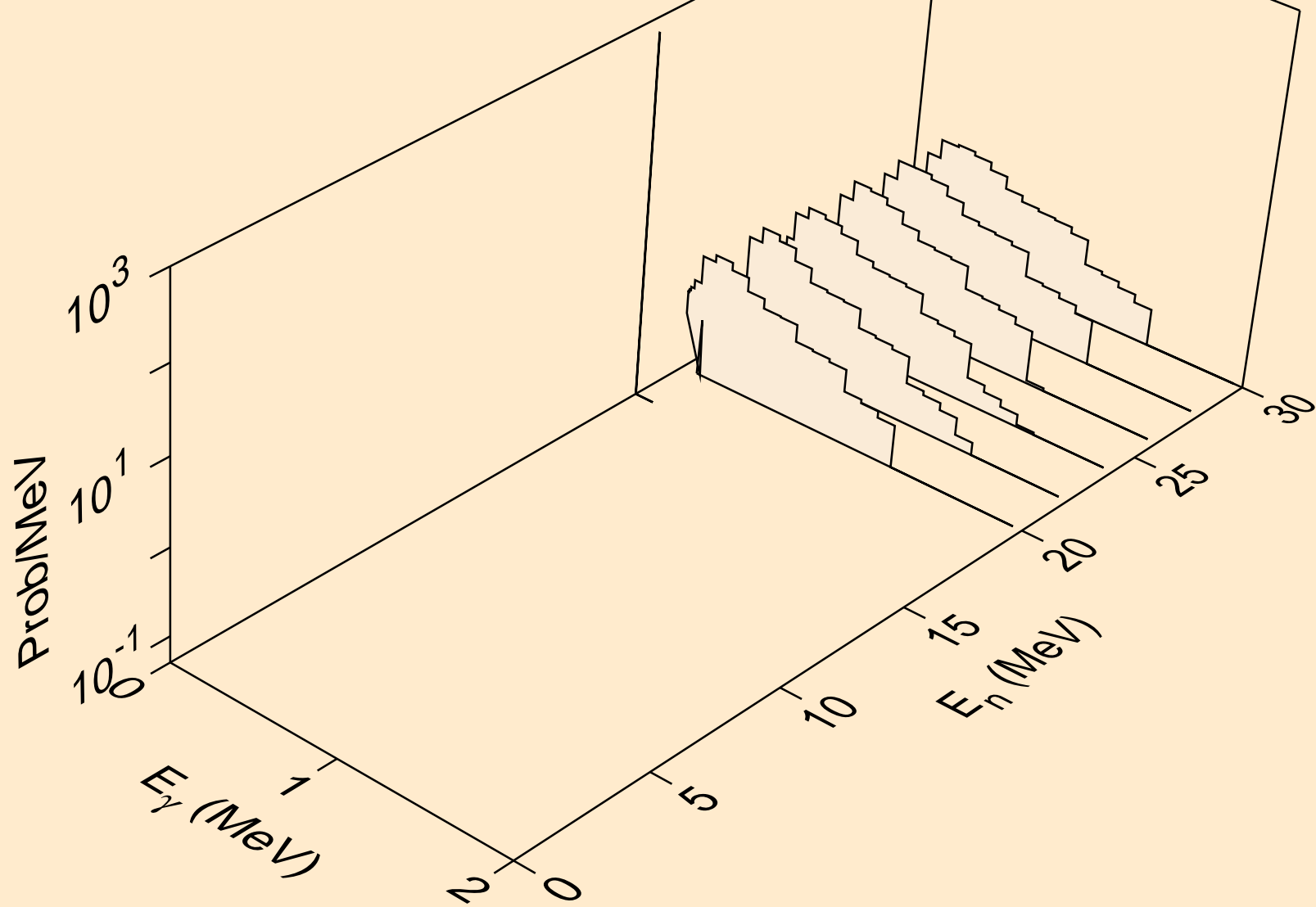

HS271 HELION ACER TENDL-2021 LIBRARY; T=0.K
Photon emission for (n,pa)

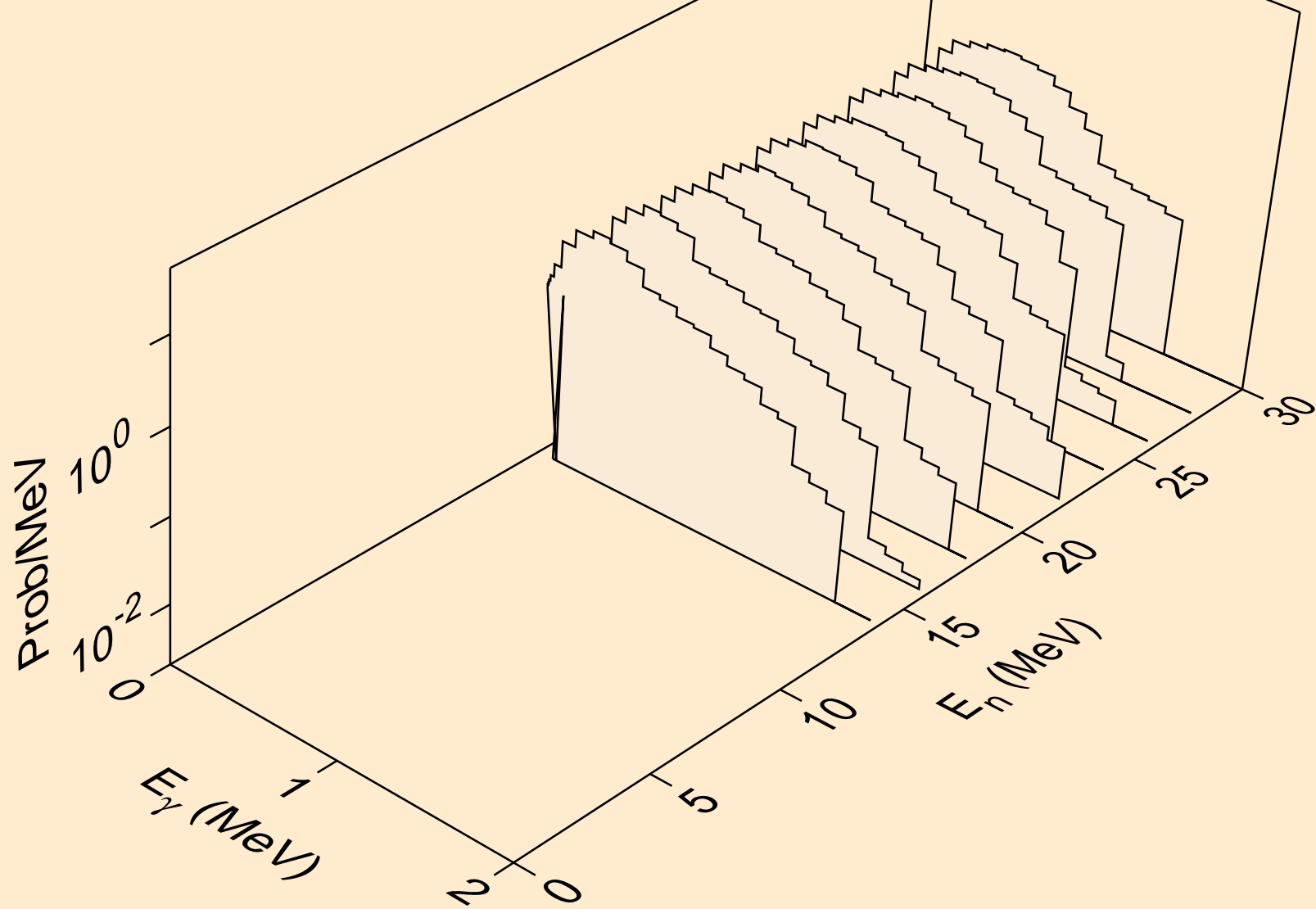

HS271 HELION ACER TENDL-2021 LIBRARY; T=0.K
Photon emission for (n,t2a)

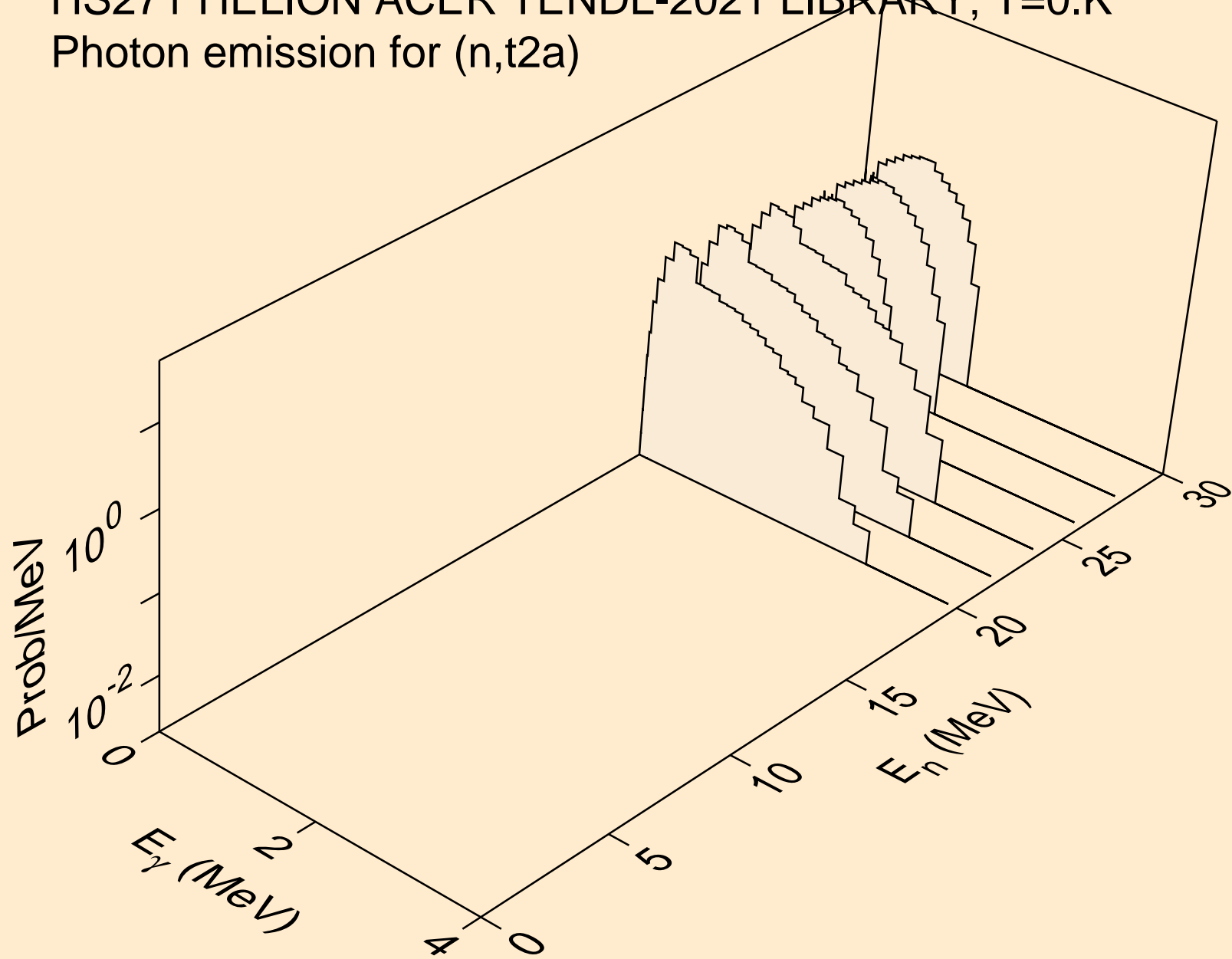

HS271 HELION ACER TENDL-2021 LIBRARY; T=0.K
Photon emission for (n,da)

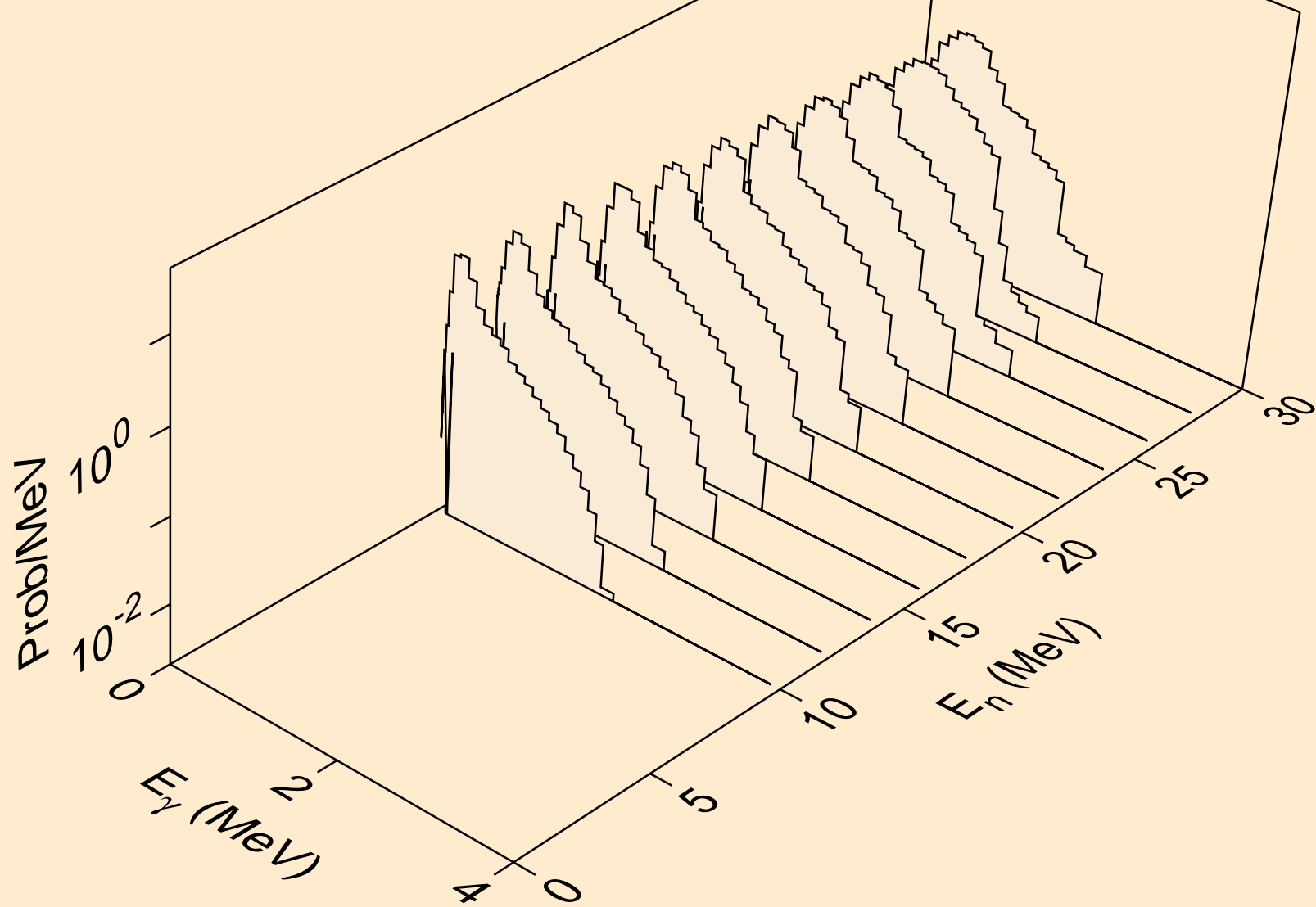

HS271 HELION ACER TENDL-2021 LIBRARY; T=0.K

Particle heating contributions

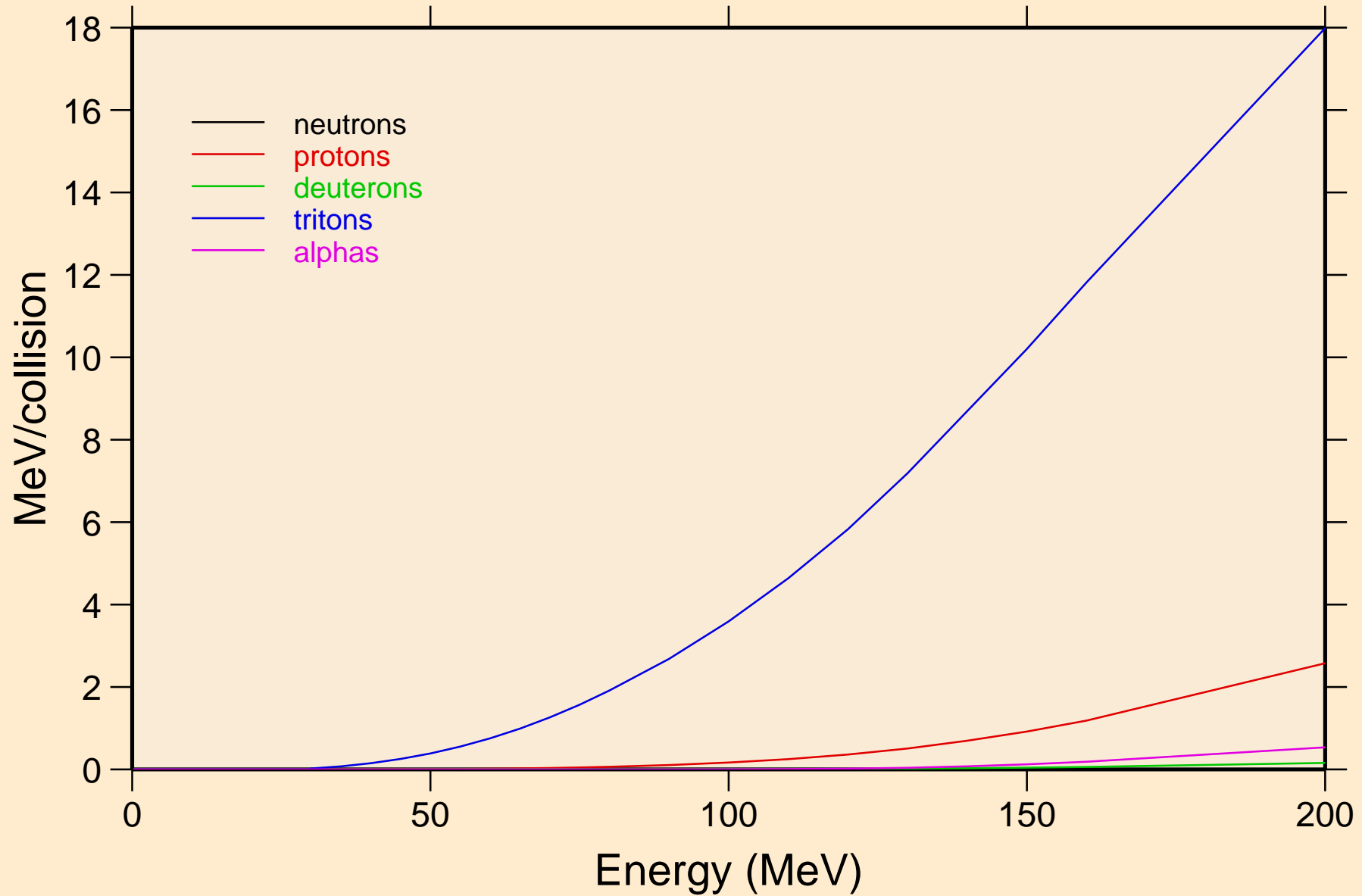

HS271 HELION ACER TENDL-2021 LIBRARY; T=0.K
Recoil Heating

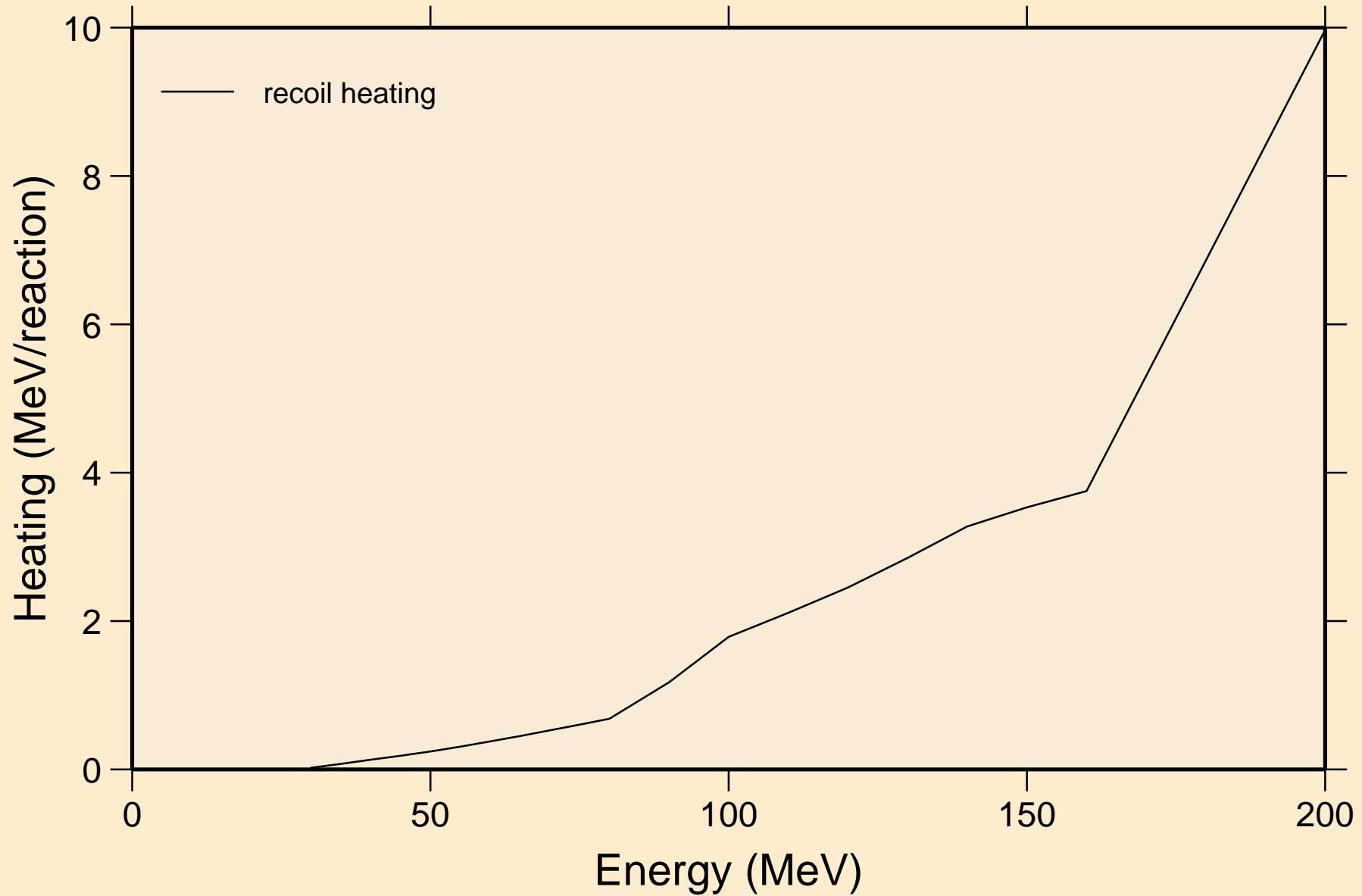

HS271 HELION ACER TENDL-2021 LIBRARY; T=0.K
Particle production cross sections

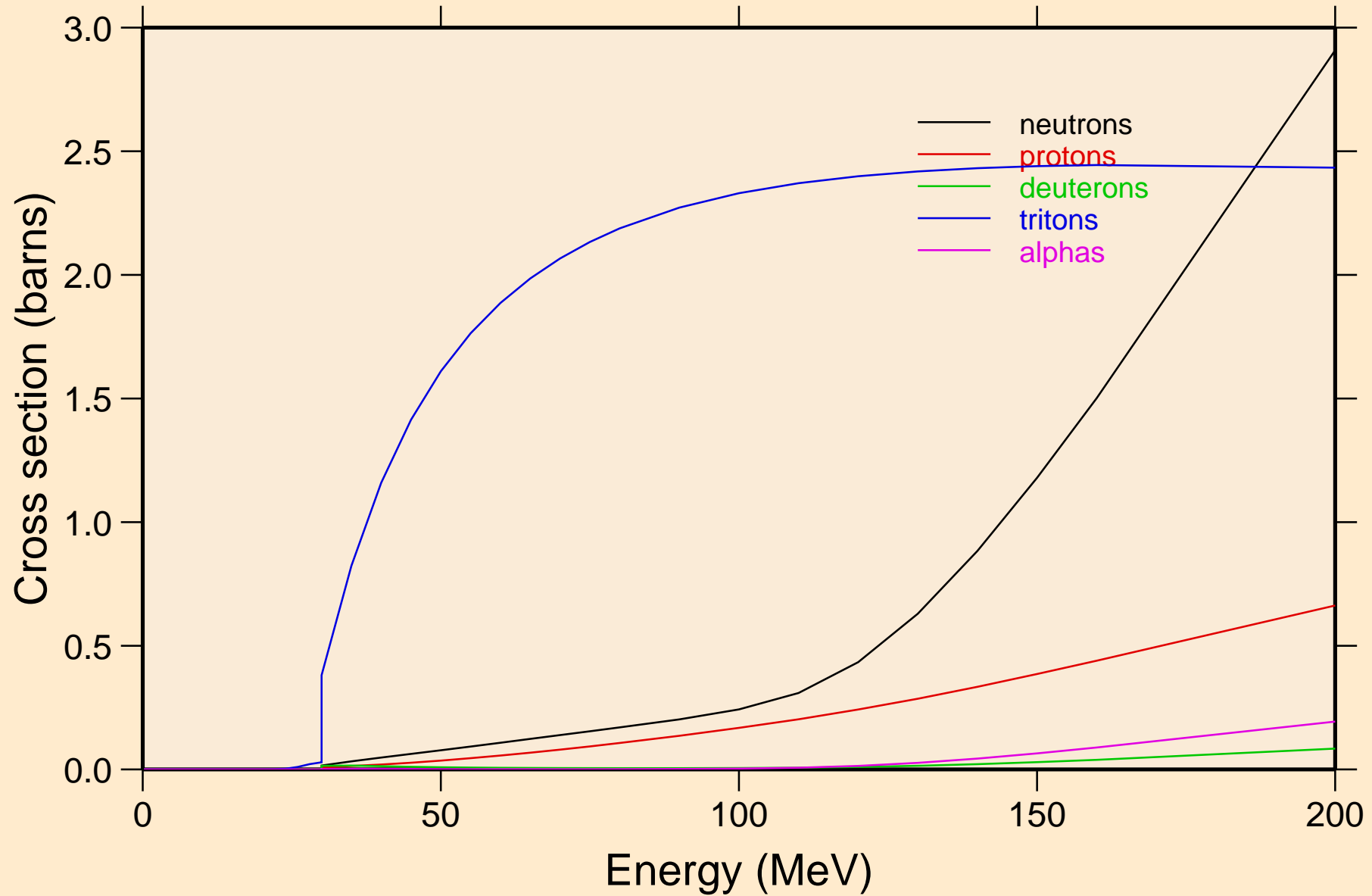

HS271 HELION ACER TENDL-2021 LIBRARY; T=0.K
neutrons from (s,n)

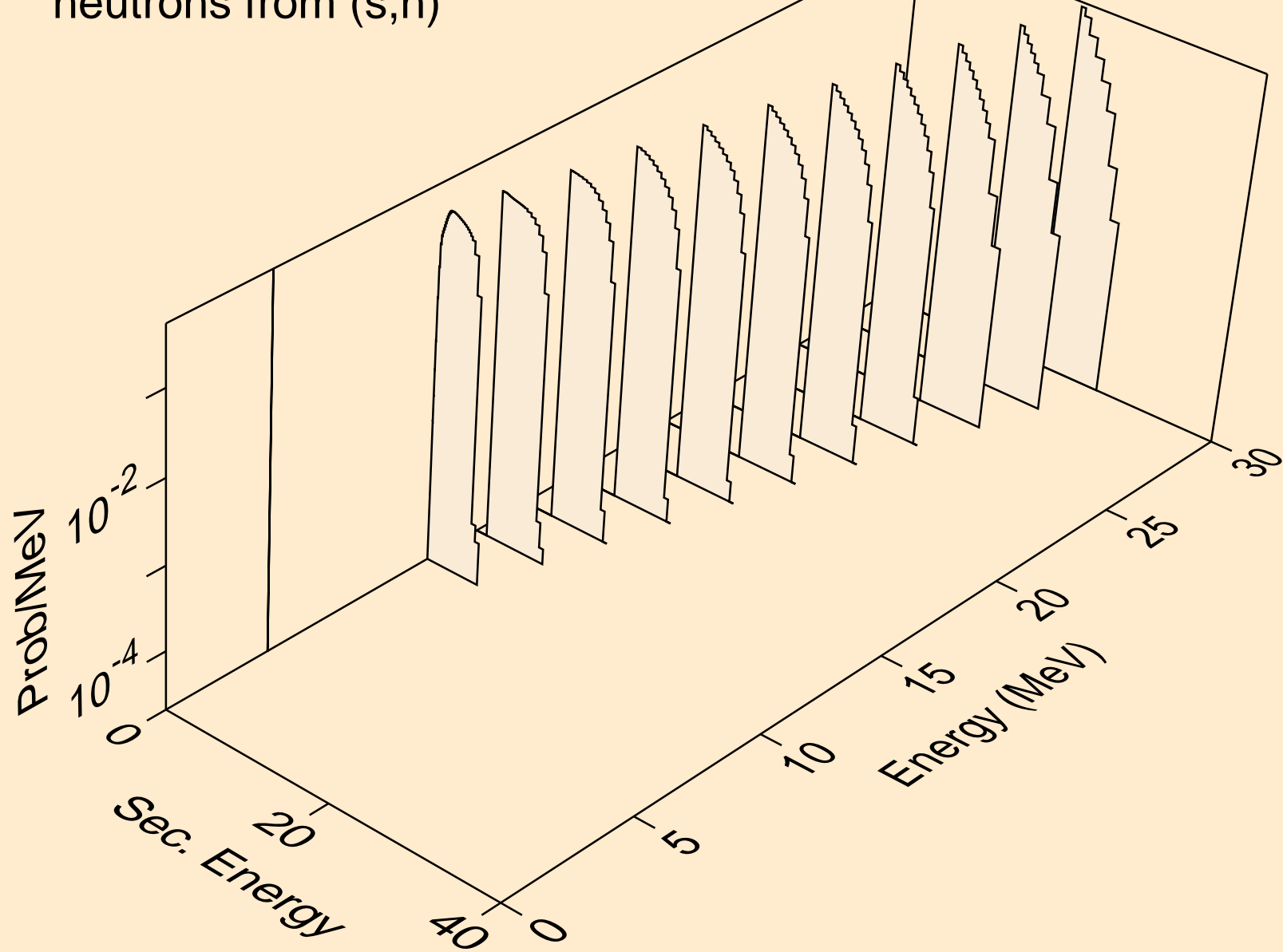

HS271 HELION ACER TENDL-2021 LIBRARY; T=0.K
neutrons from (s,x)

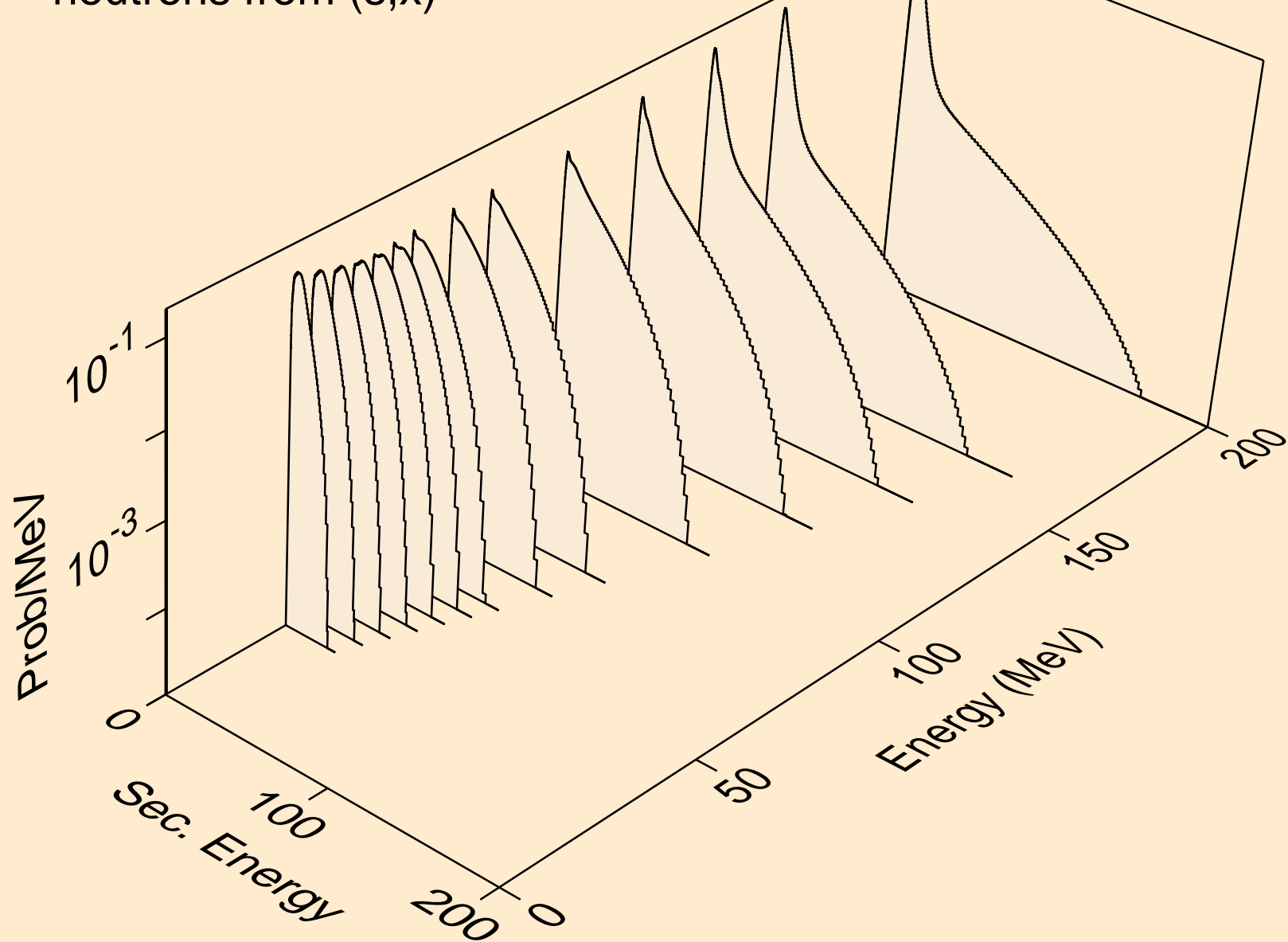

HS271 HELION ACER TENDL-2021 LIBRARY; T=0.K
neutrons from (s,2n)

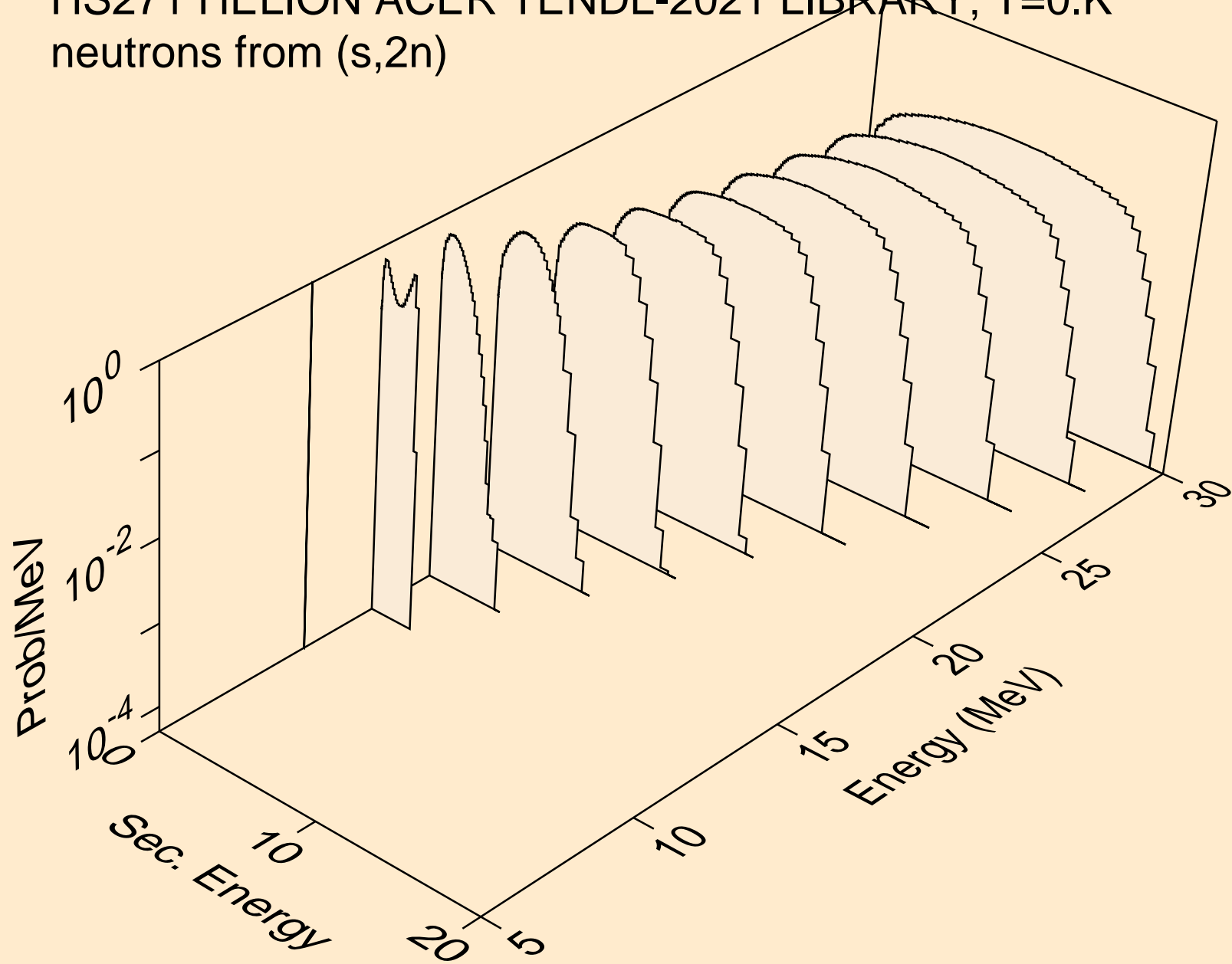

HS271 HELION ACER TENDL-2021 LIBRARY; T=0.K
neutrons from (s,3n)

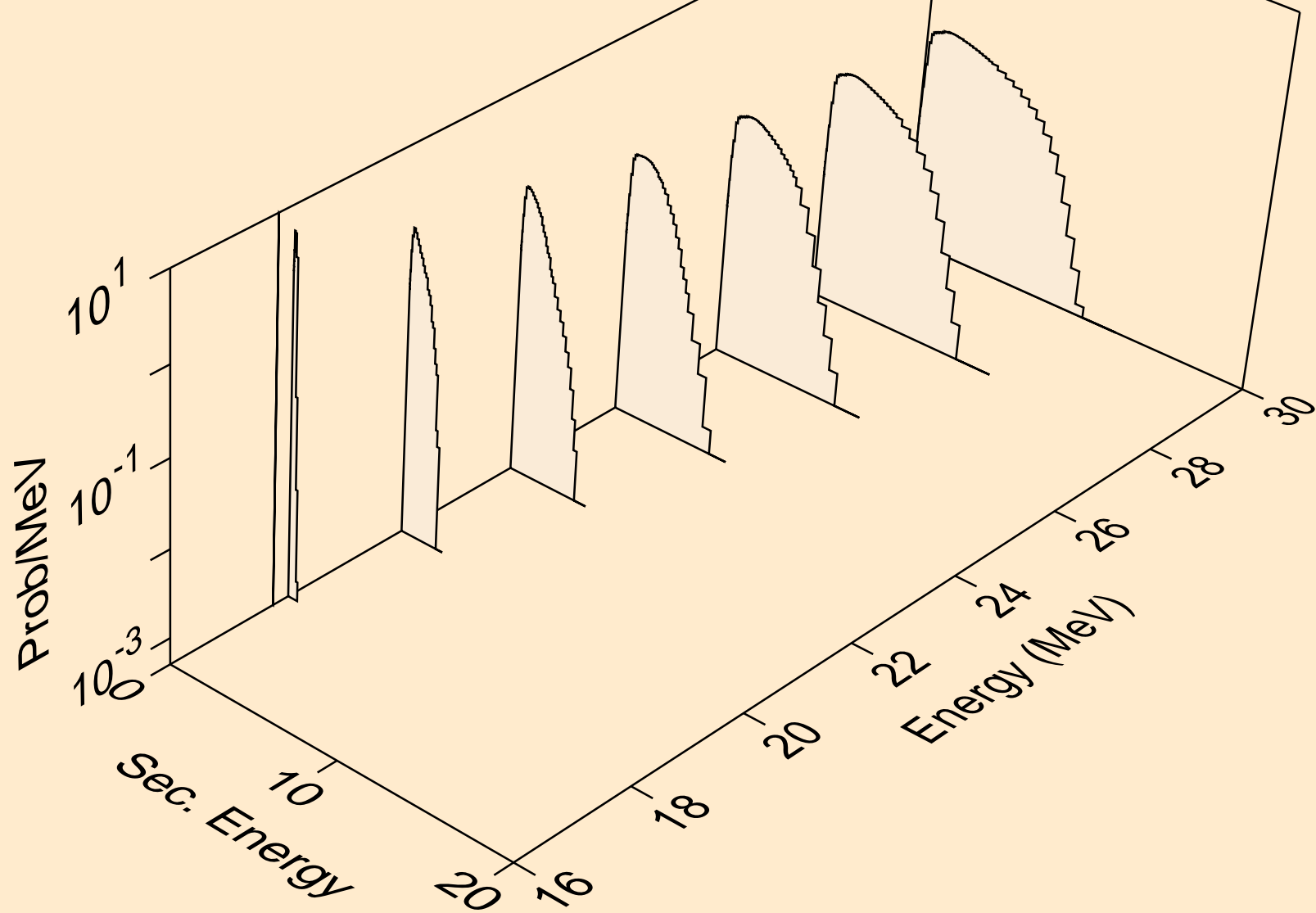

HS271 HELION ACER TENDL-2021 LIBRARY; T=0.K
neutrons from (s,n*)a

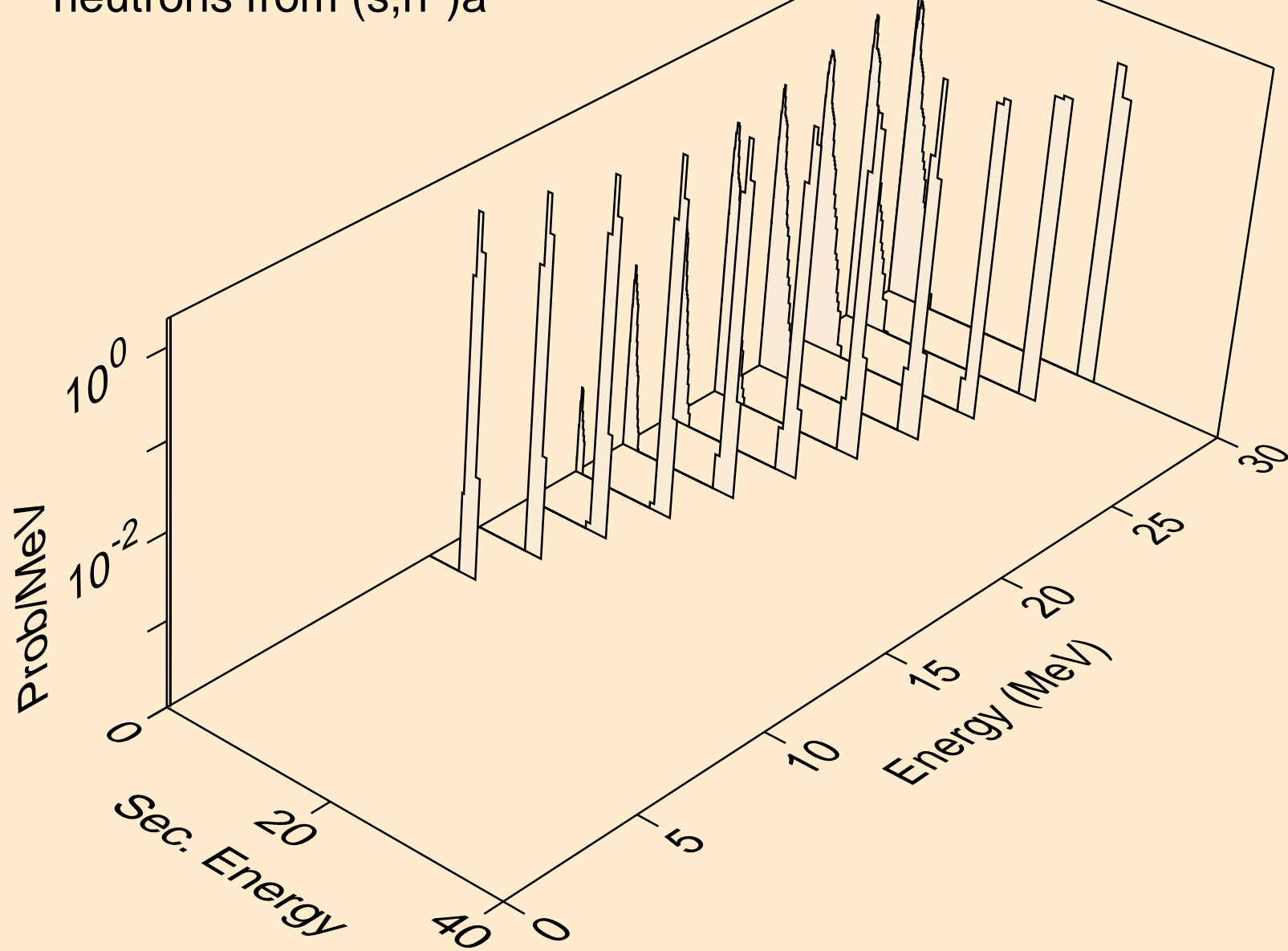

HS271 HELION ACER TENDL-2021 LIBRARY; T=0.K
neutrons from (s,2n)a

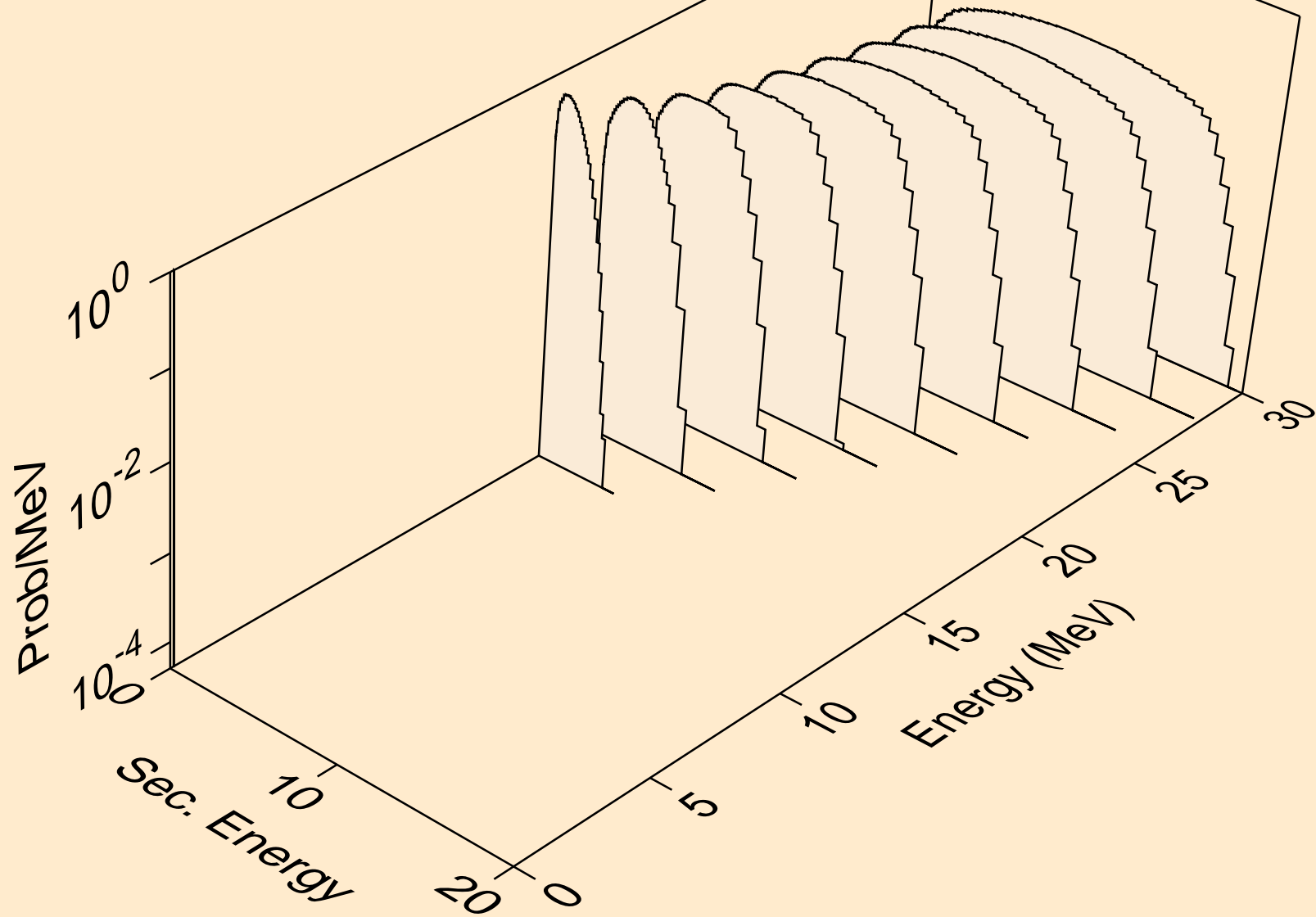

HS271 HELION ACER TENDL-2021 LIBRARY; T=0.K
neutrons from (s,n*)p

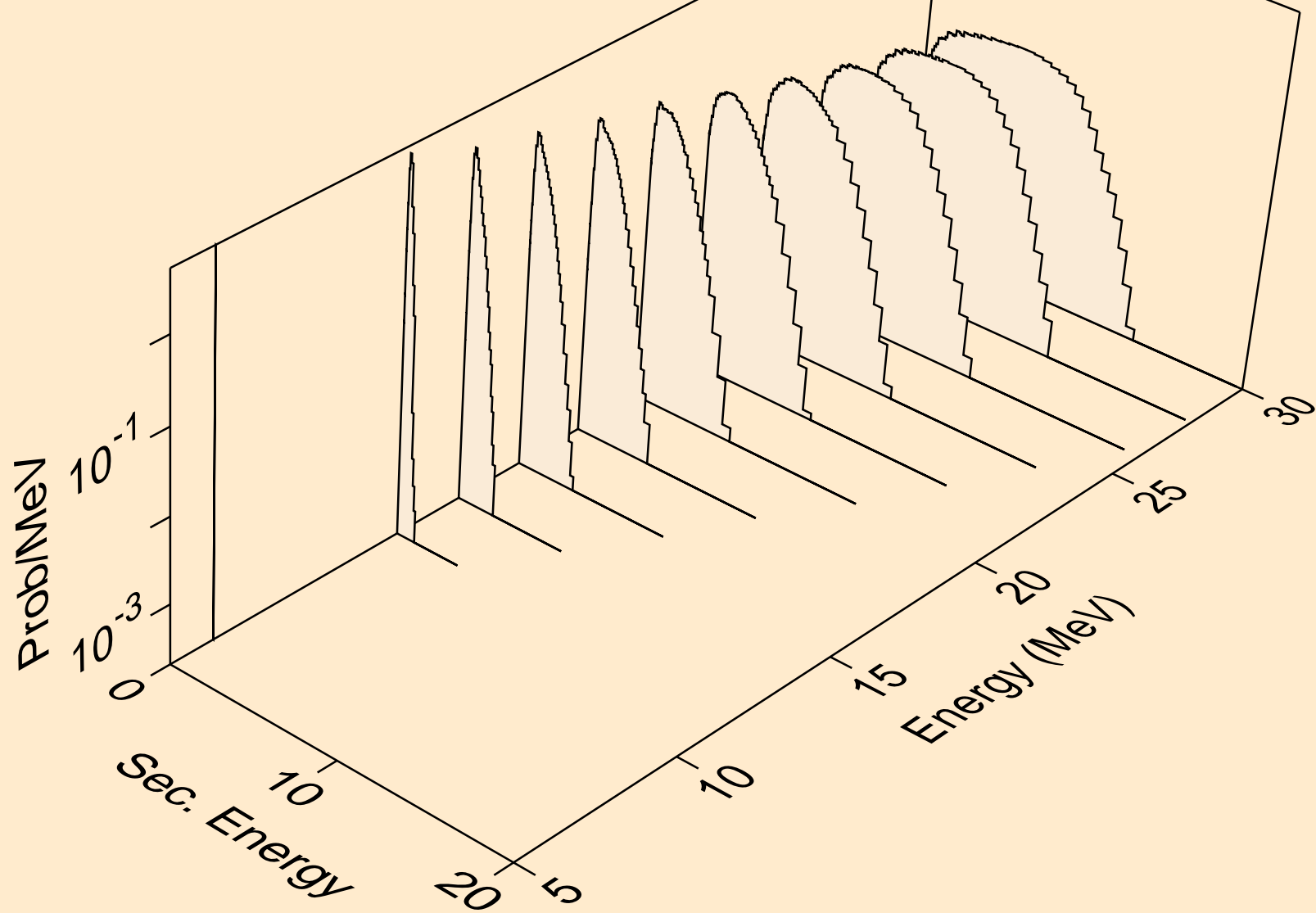

HS271 HELION ACER TENDL-2021 LIBRARY; T=0.K
neutrons from (s,n*)d

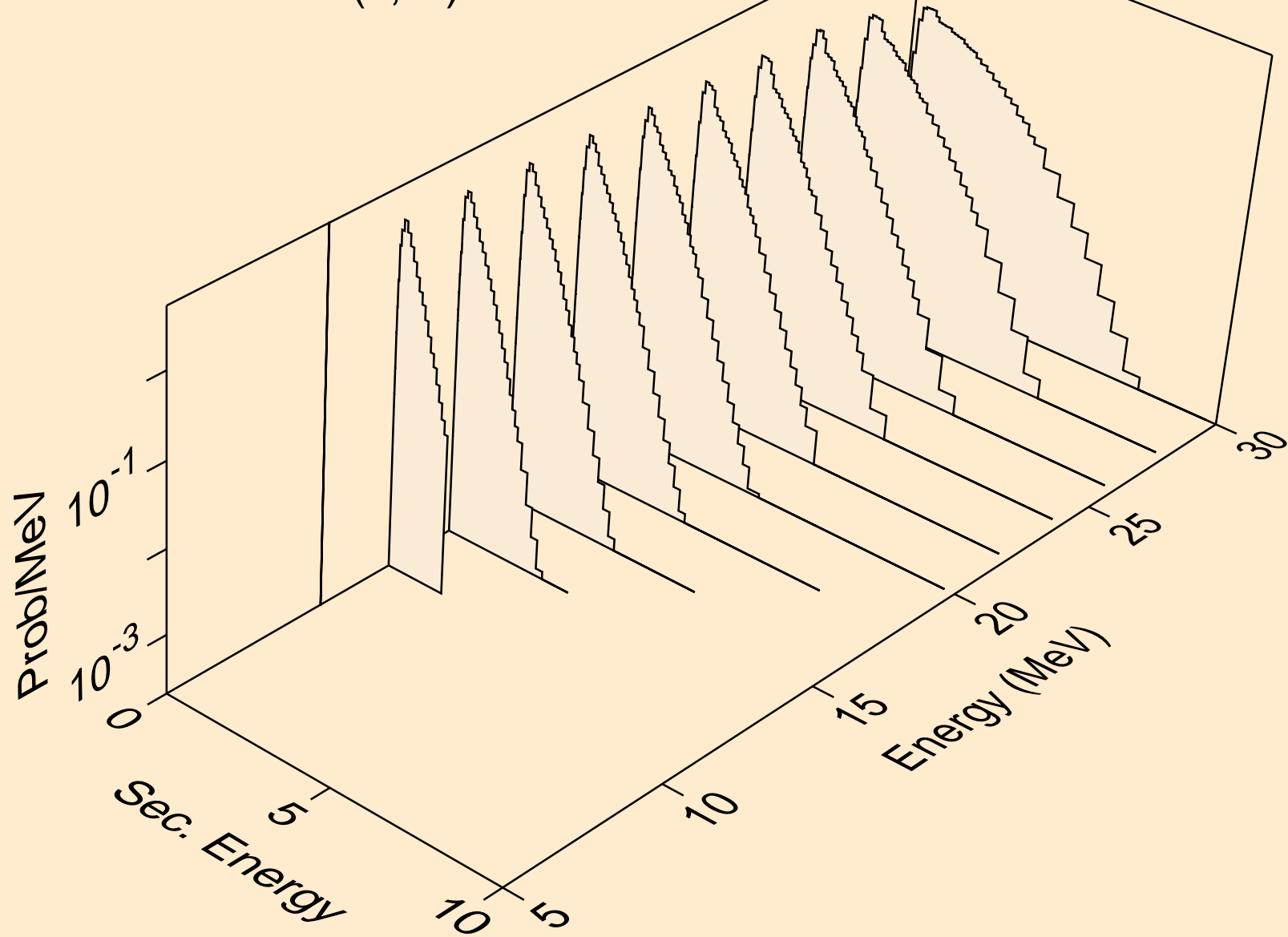

HS271 HELION ACER TENDL-2021 LIBRARY; T=0.K
neutrons from (s,n*)t

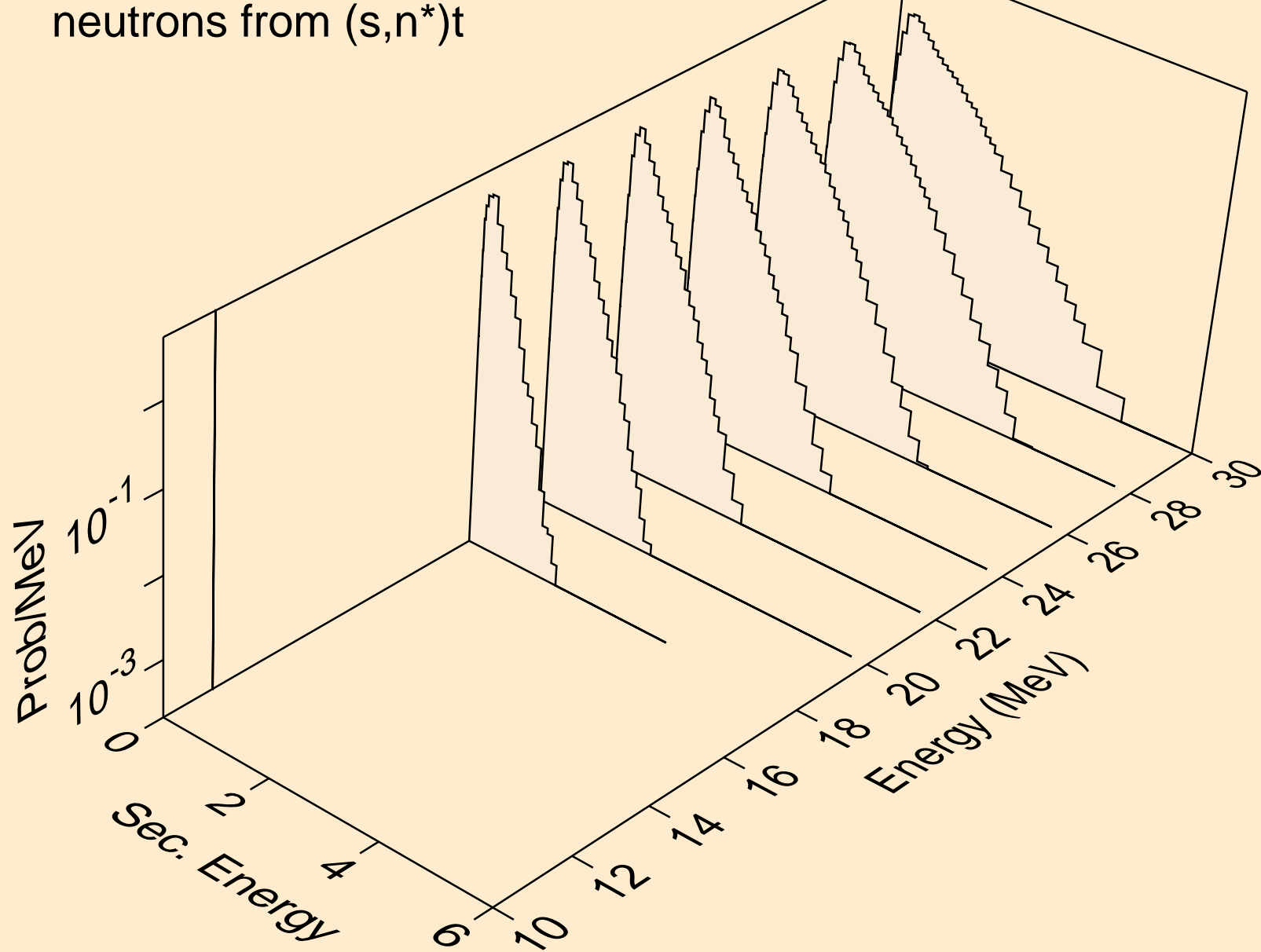

HS271 HELION ACER TENDL-2021 LIBRARY; T=0.K
neutrons from (s,2np)

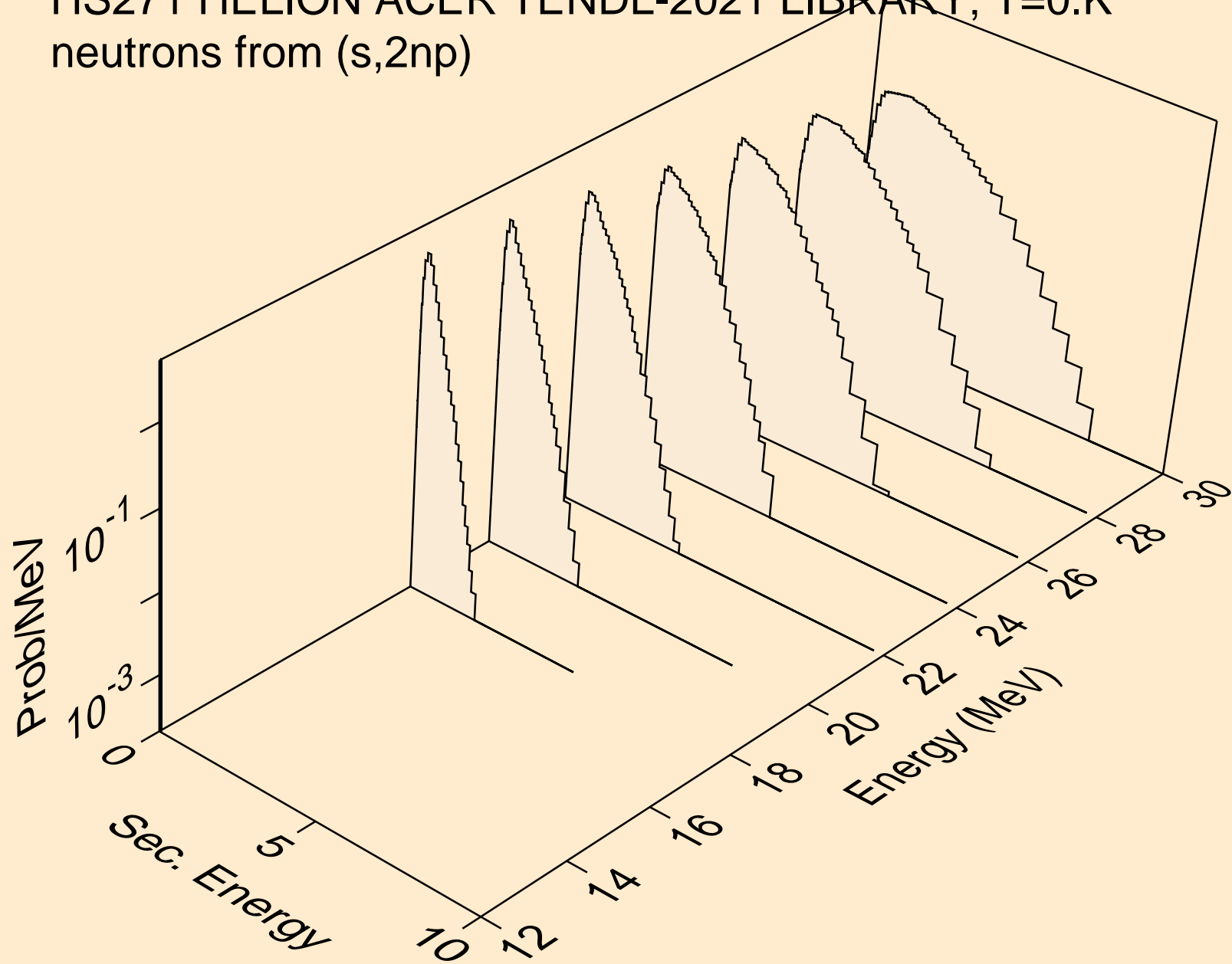

HS271 HELION ACER TENDL-2021 LIBRARY; T=0.K
neutrons from (s,npa)

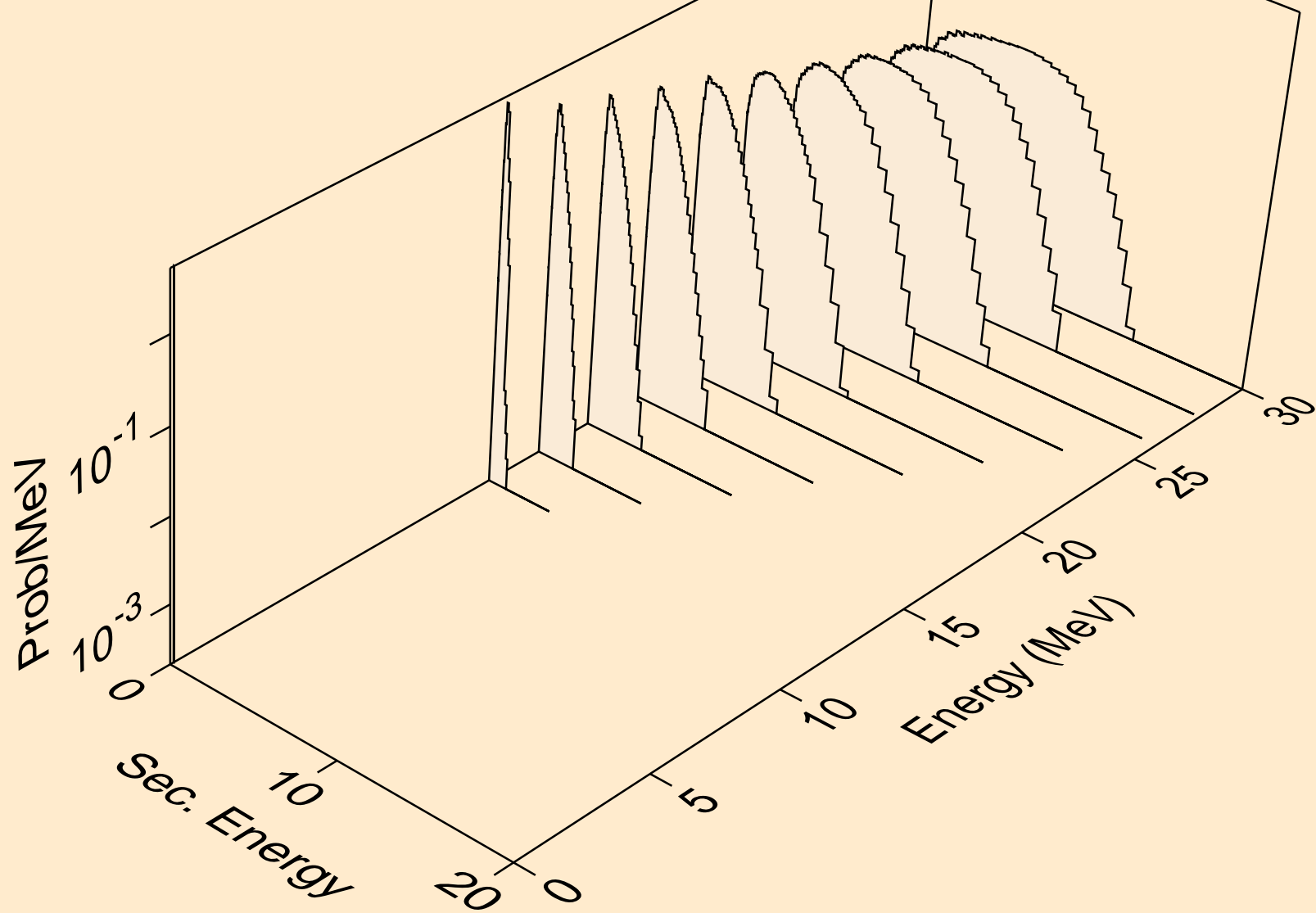

HS271 HELION ACER TENDL-2021 LIBRARY; T=0.K
protons from (s,x)

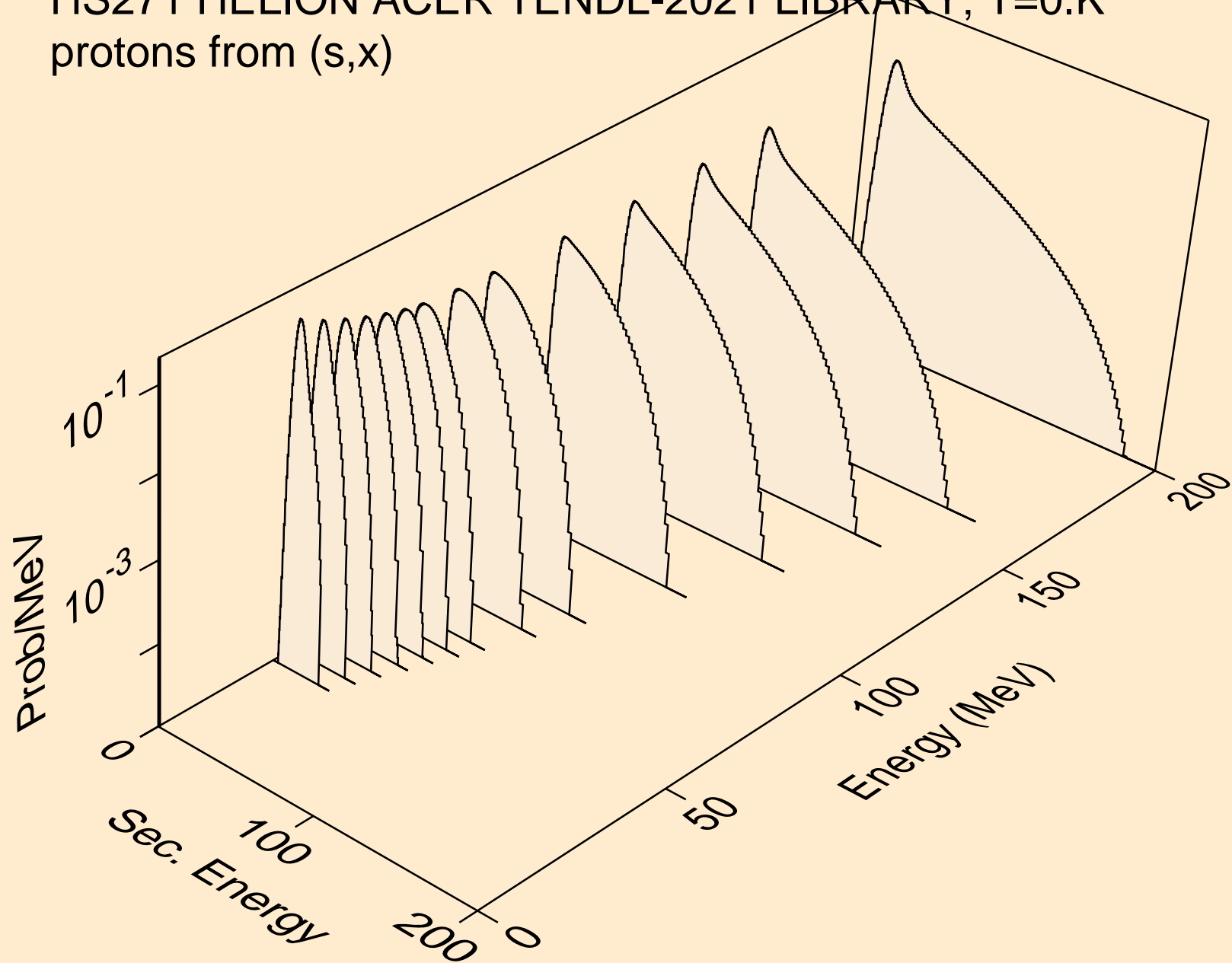

HS271 HELION ACER TENDL-2021 LIBRARY; T=0.K
protons from (s,n*)p

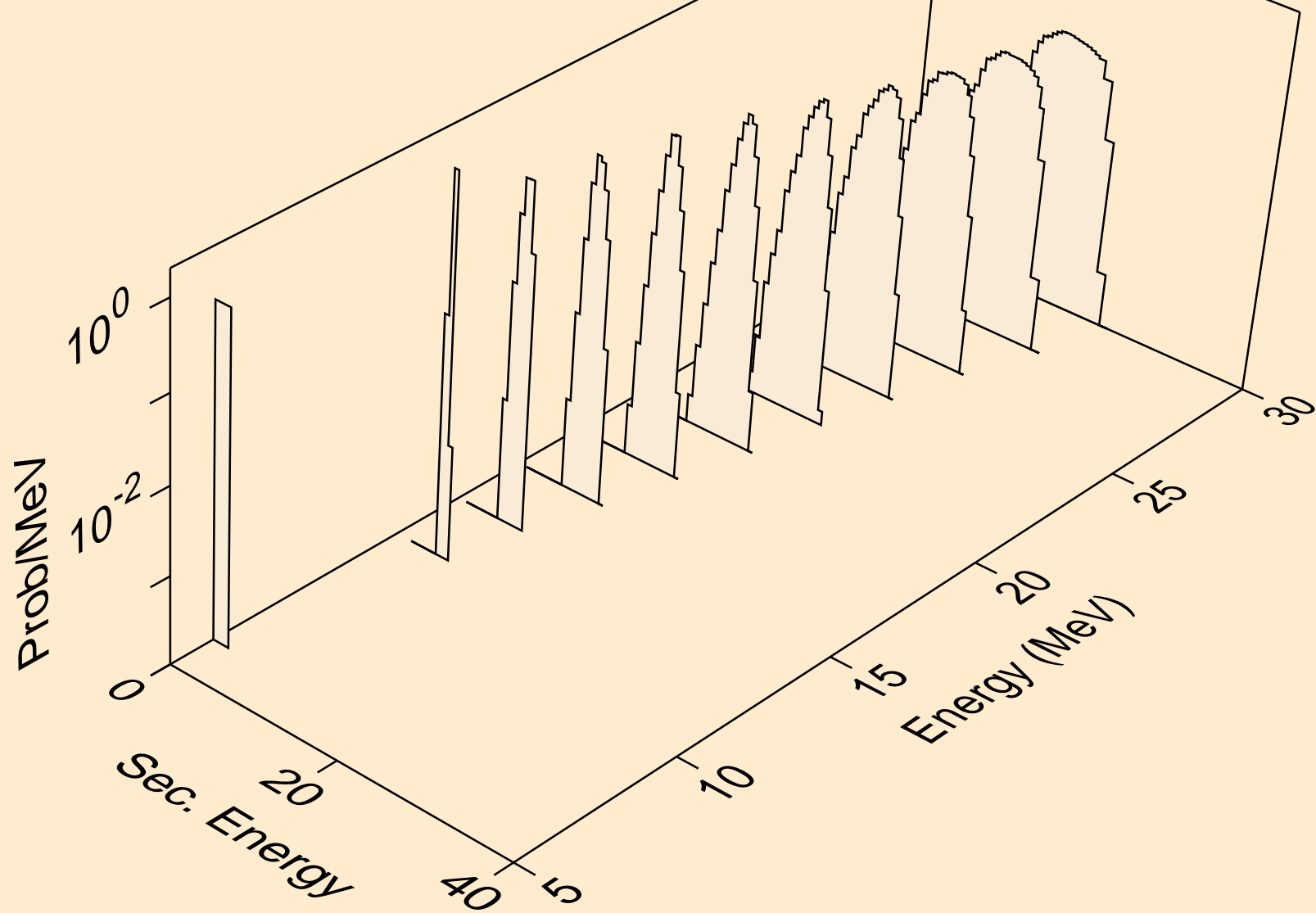

HS271 HELION ACER TENDL-2021 LIBRARY; T=0.K
protons from (s,2np)

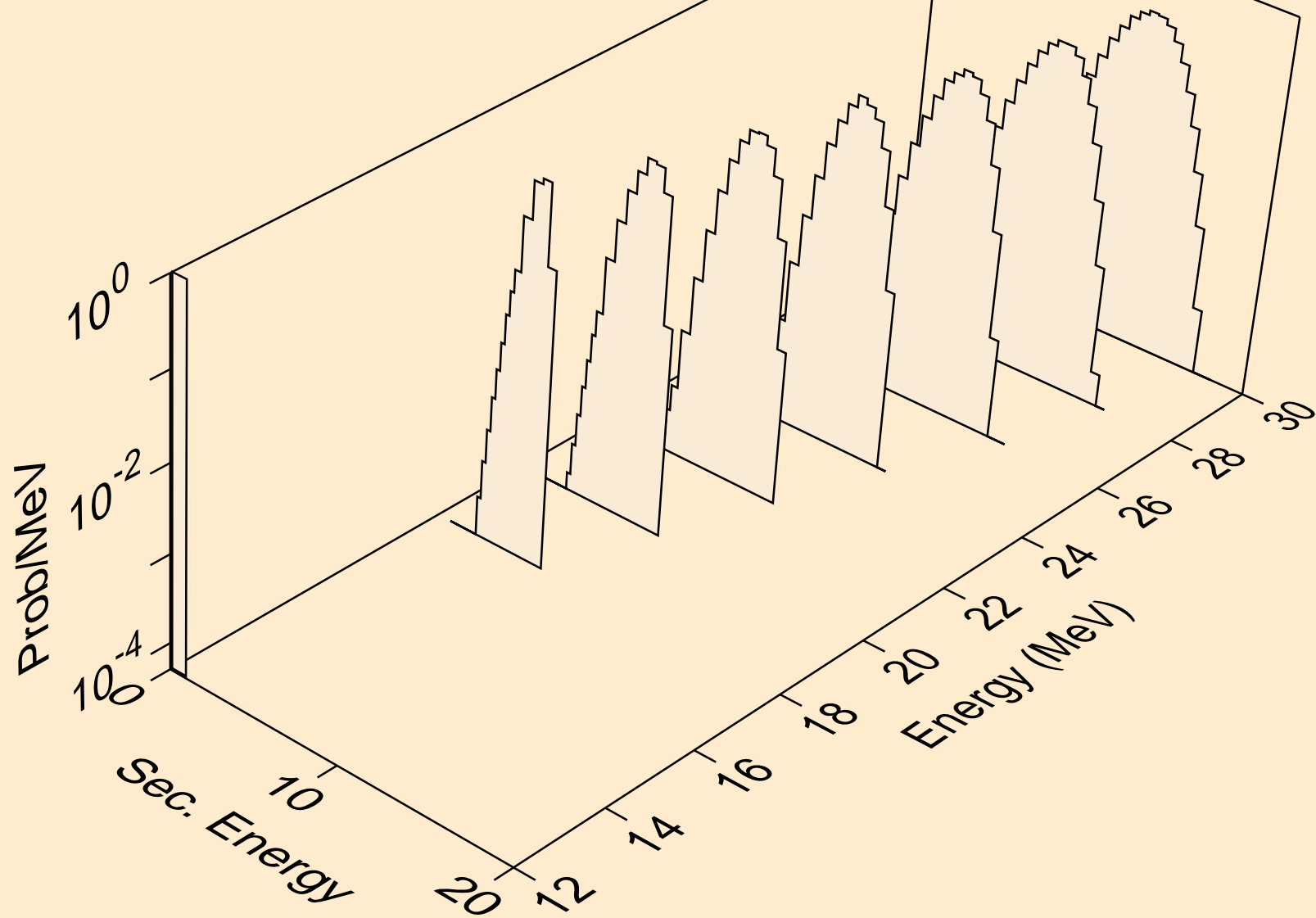

HS271 HELION ACER TENDL-2021 LIBRARY; T=0.K
protons from (s,npa)

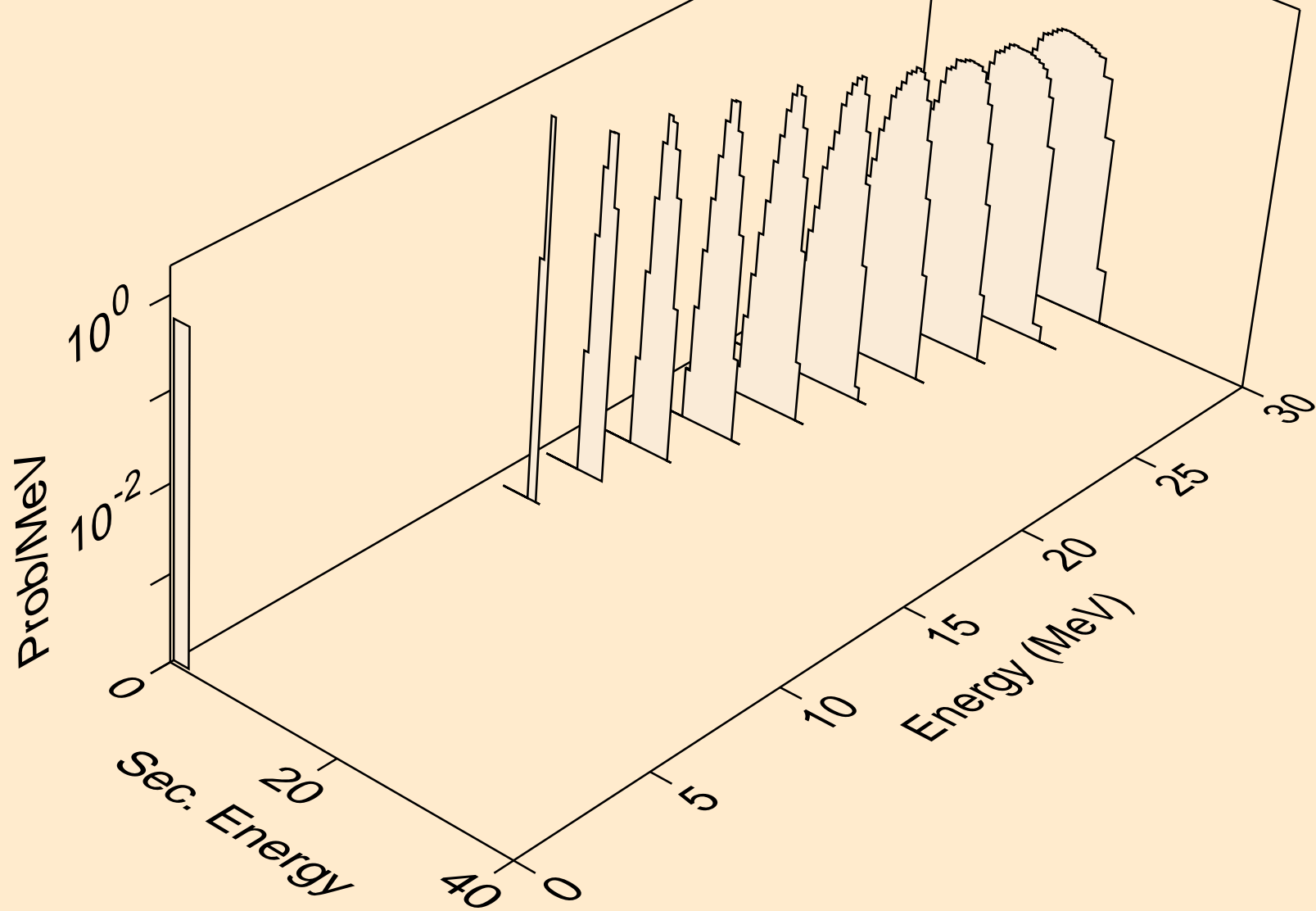

HS271 HELION ACER TENDL-2021 LIBRARY; T=0.K
protons from (s,p)

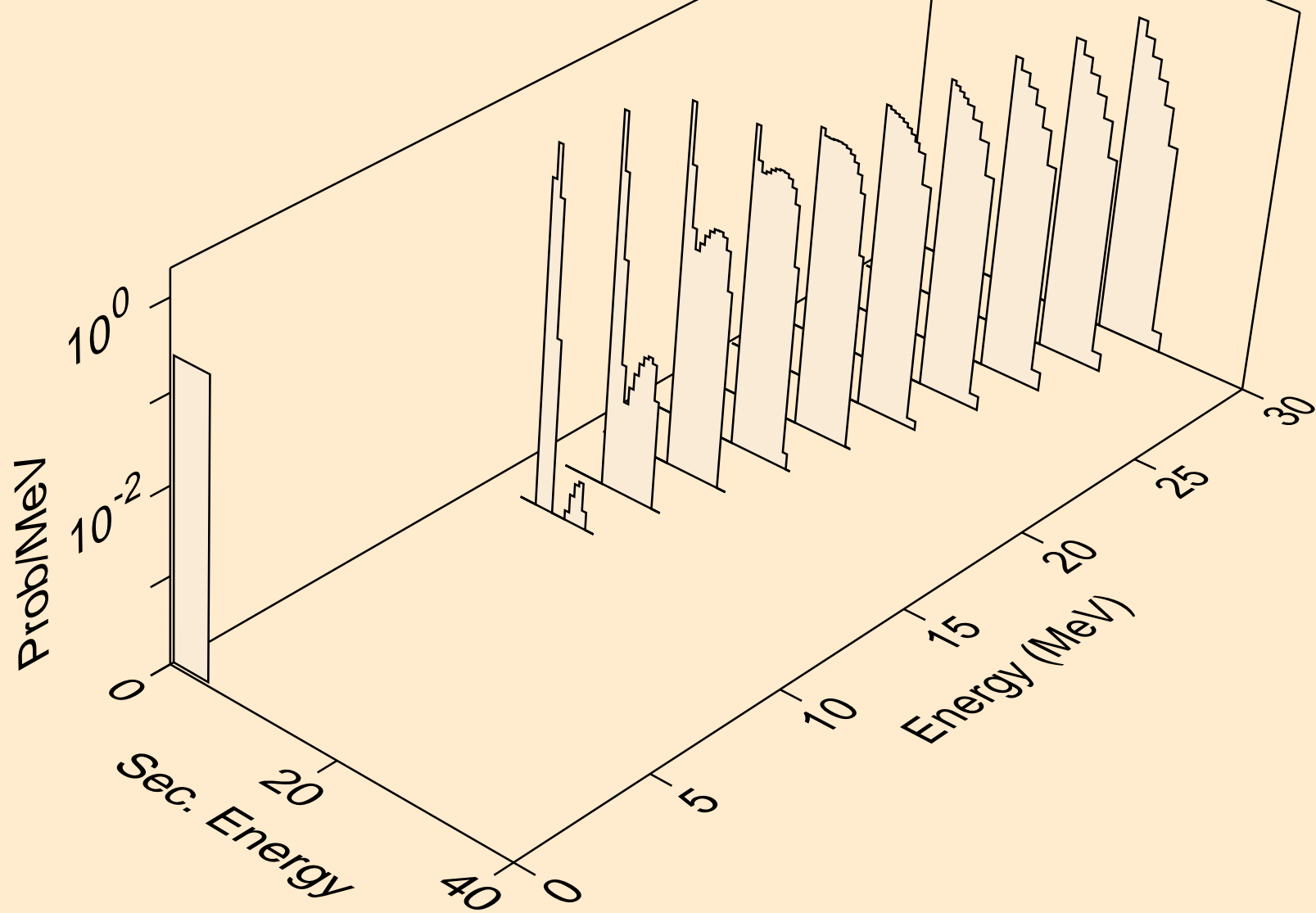

HS271 HELION ACER TENDL-2021 LIBRARY; T=0.K
protons from (s,2p)

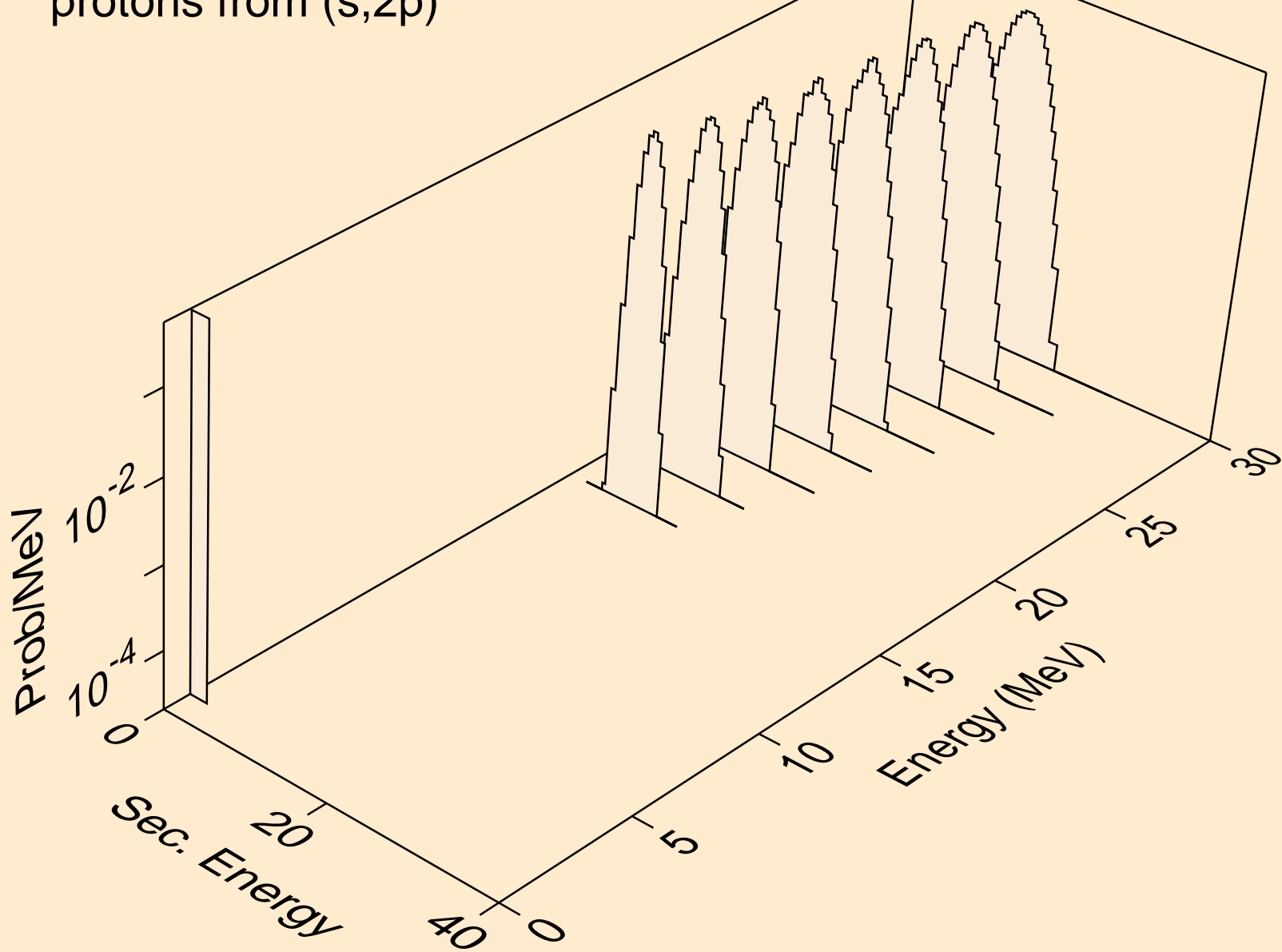

HS271 HELION ACER TENDL-2021 LIBRARY; T=0.K
protons from (s,pa)

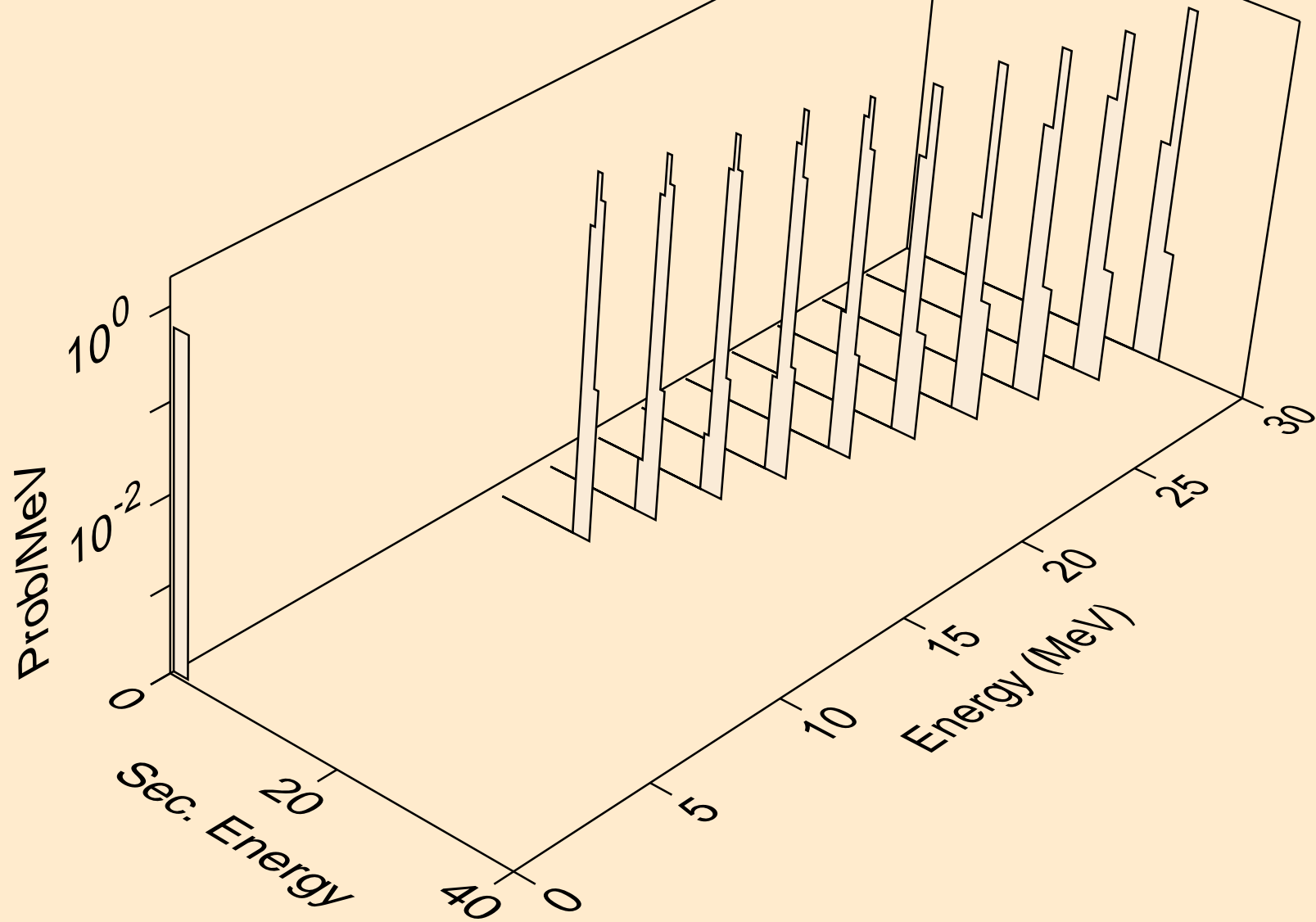

HS271 HELION ACER TENDL-2021 LIBRARY; T=0.K
deuterons from (s,x)

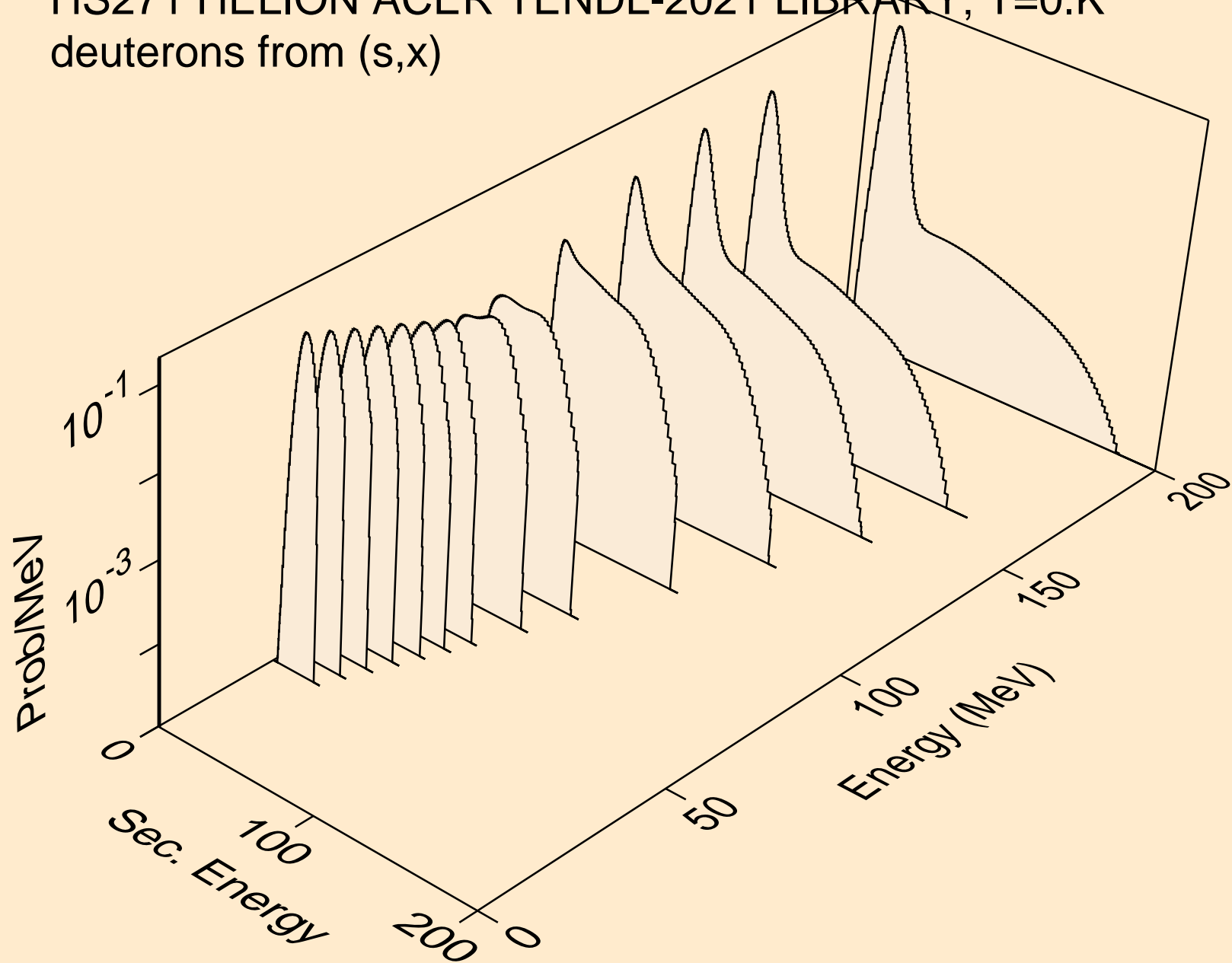

HS271 HELION ACER TENDL-2021 LIBRARY; T=0.K
deuterons from (s,n*)d

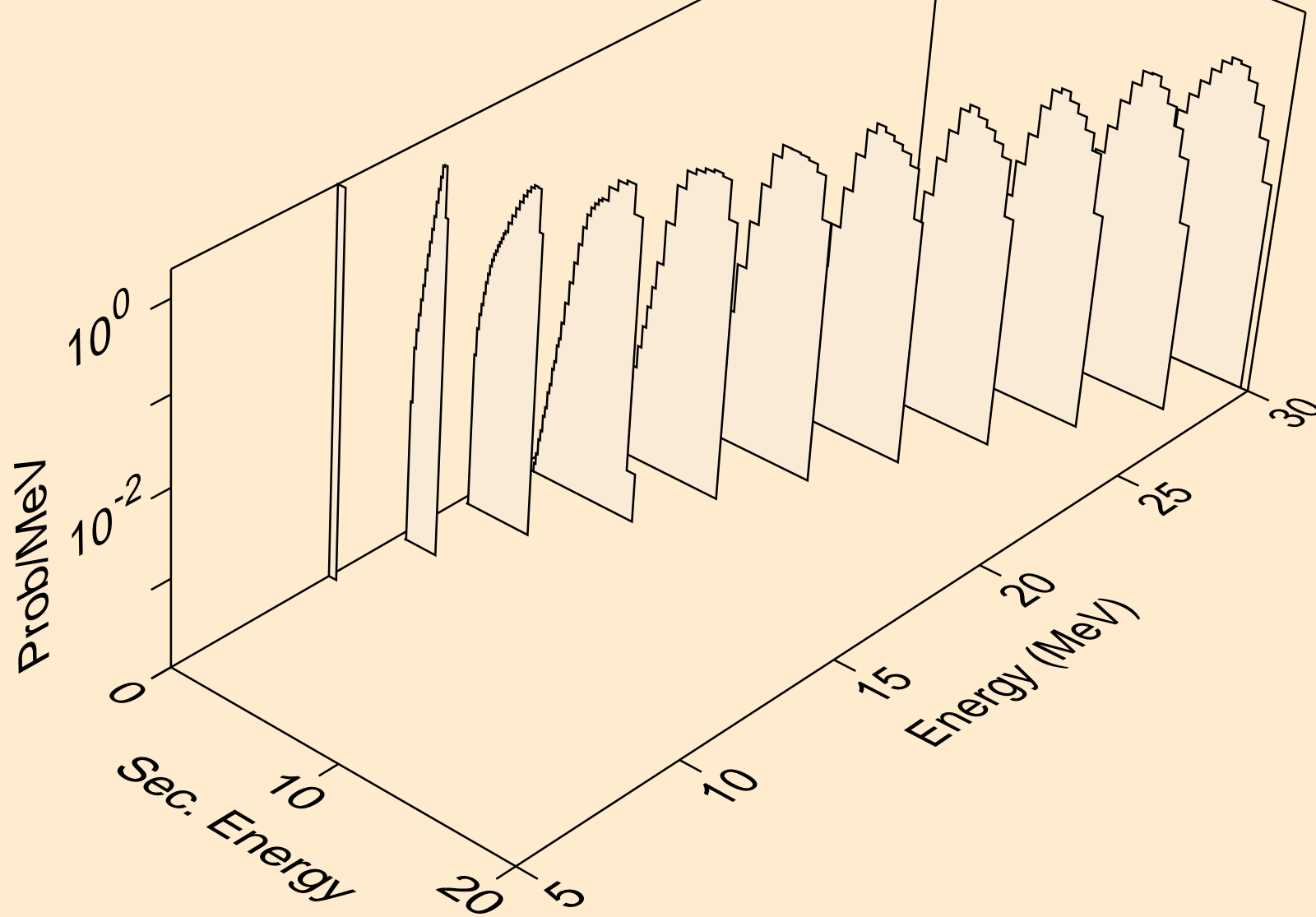

HS271 HELION ACER TENDL-2021 LIBRARY; T=0.K
deuterons from (s,d)

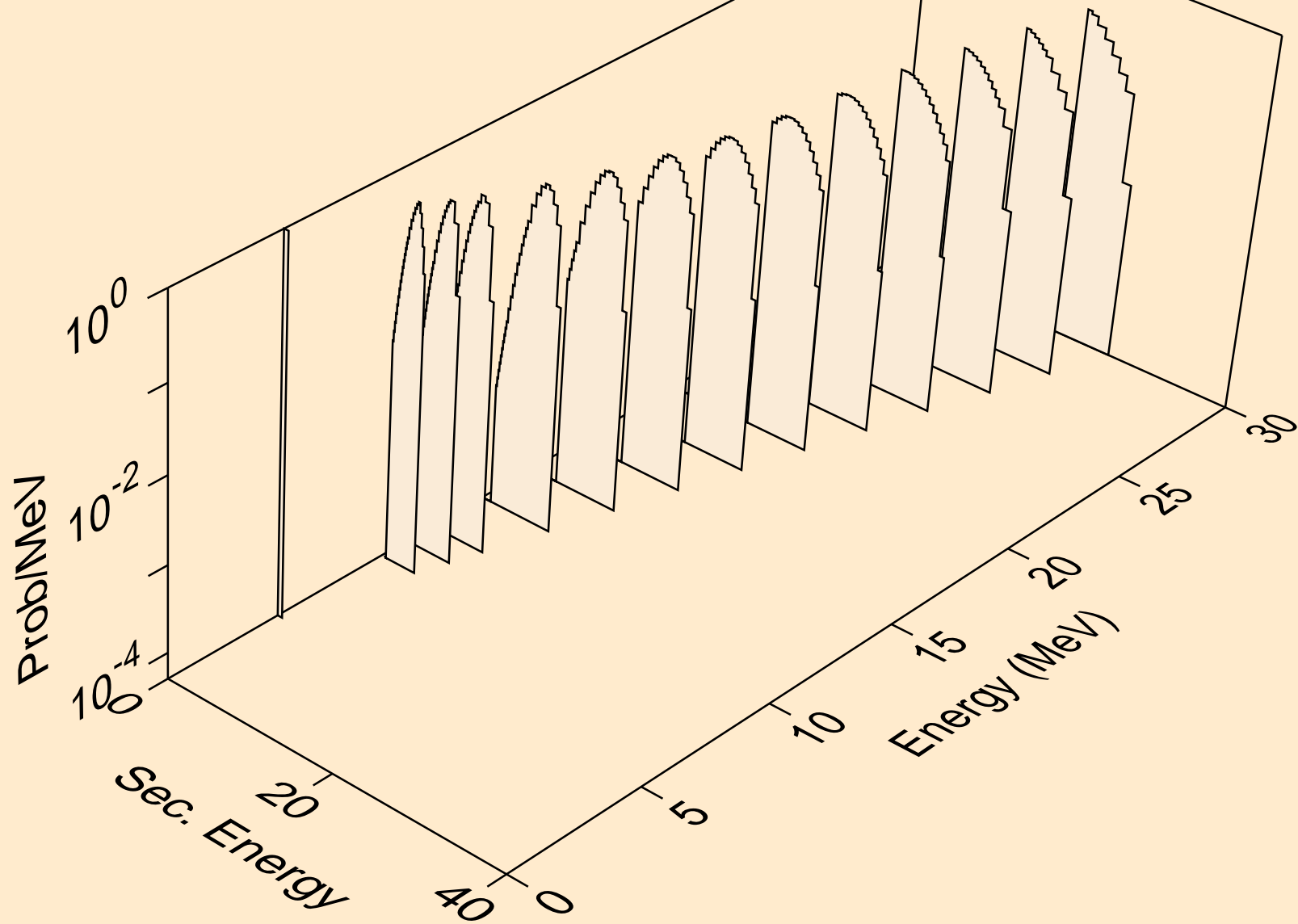

HS271 HELION ACER TENDL-2021 LIBRARY; T=0.K
deuterons from (s,da)

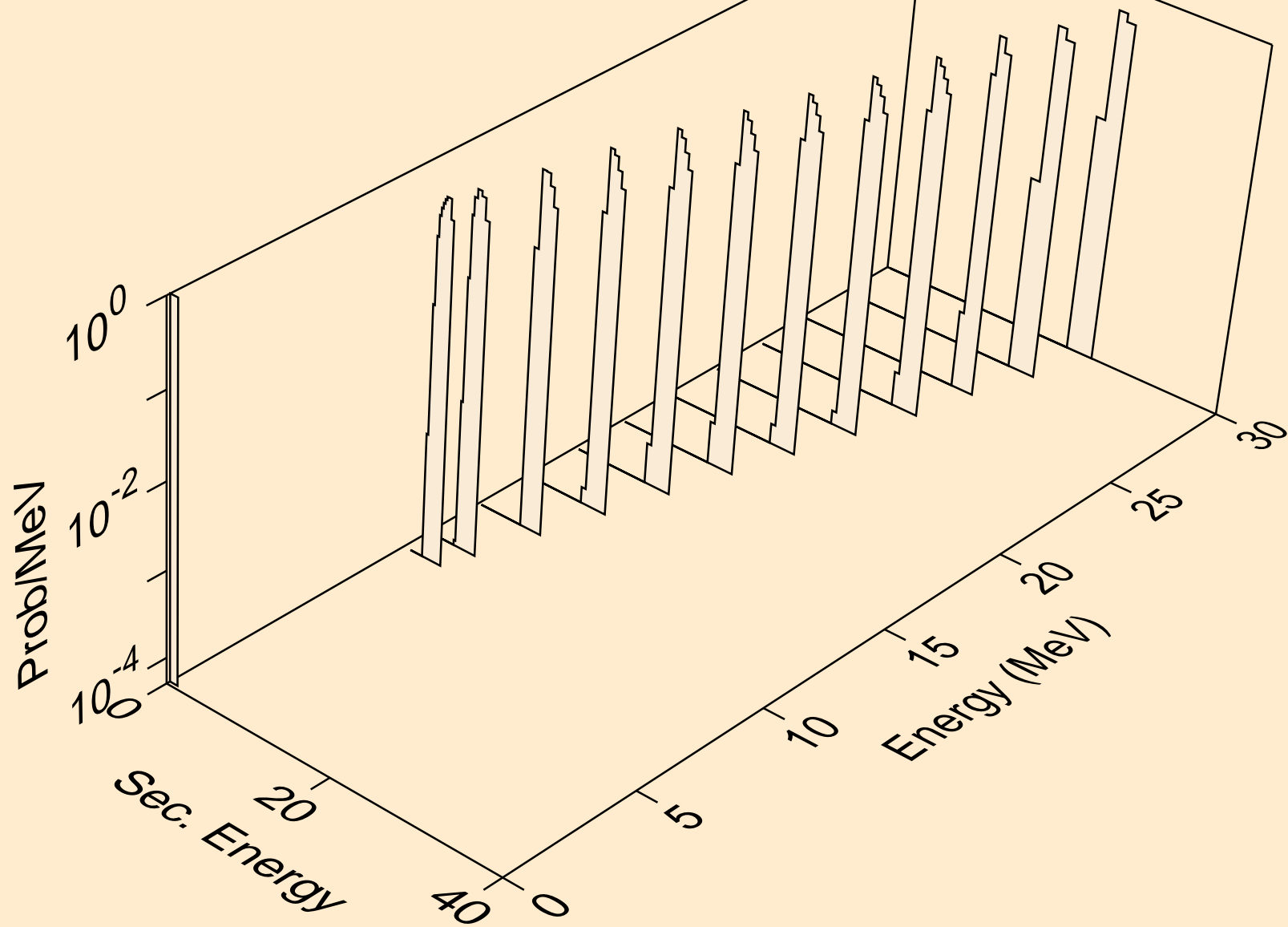

HS271 HELION ACER TENDL-2021 LIBRARY; T=0.K
tritons from (s,x)

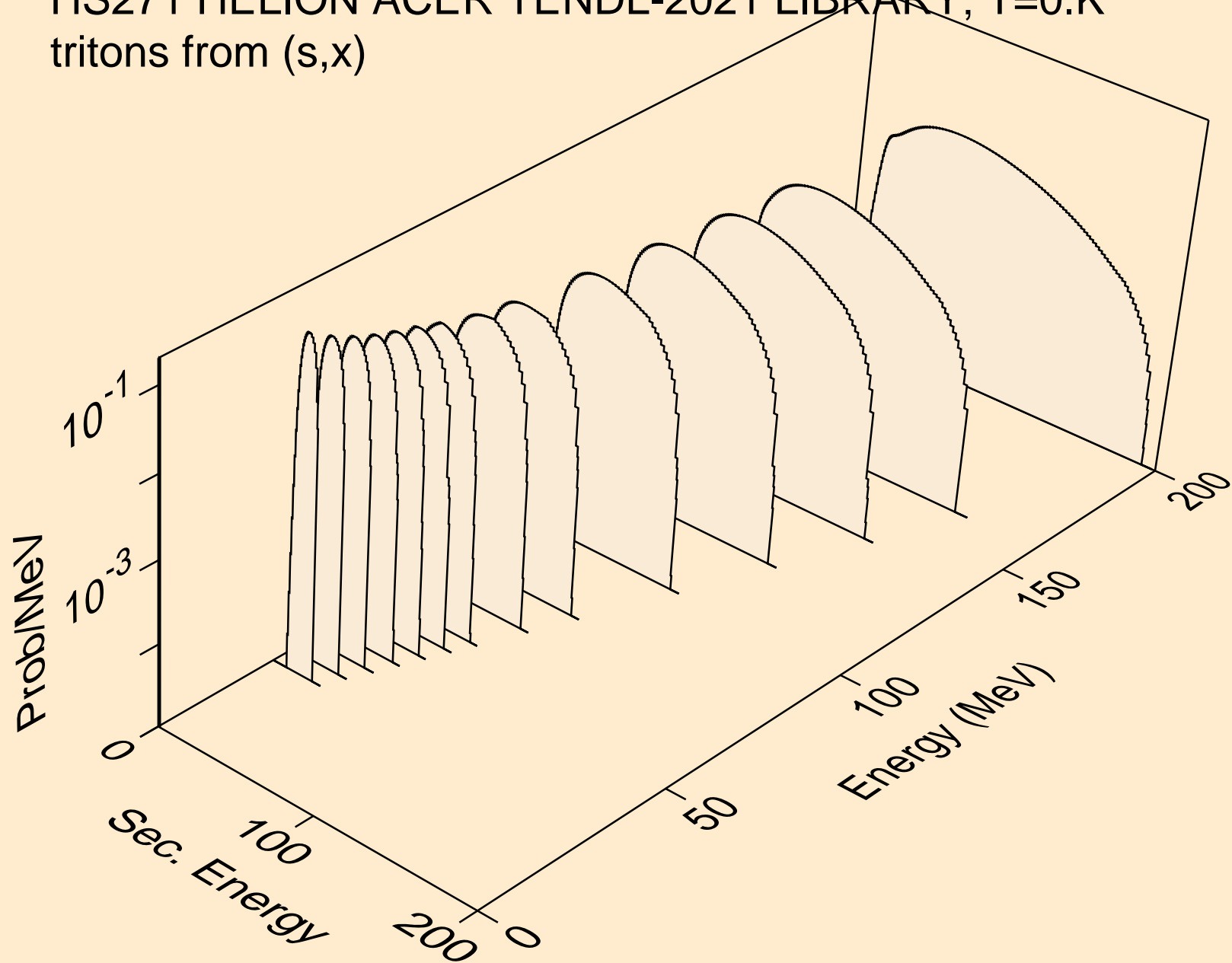

HS271 HELION ACER TENDL-2021 LIBRARY; T=0.K
tritons from (s,n*)t

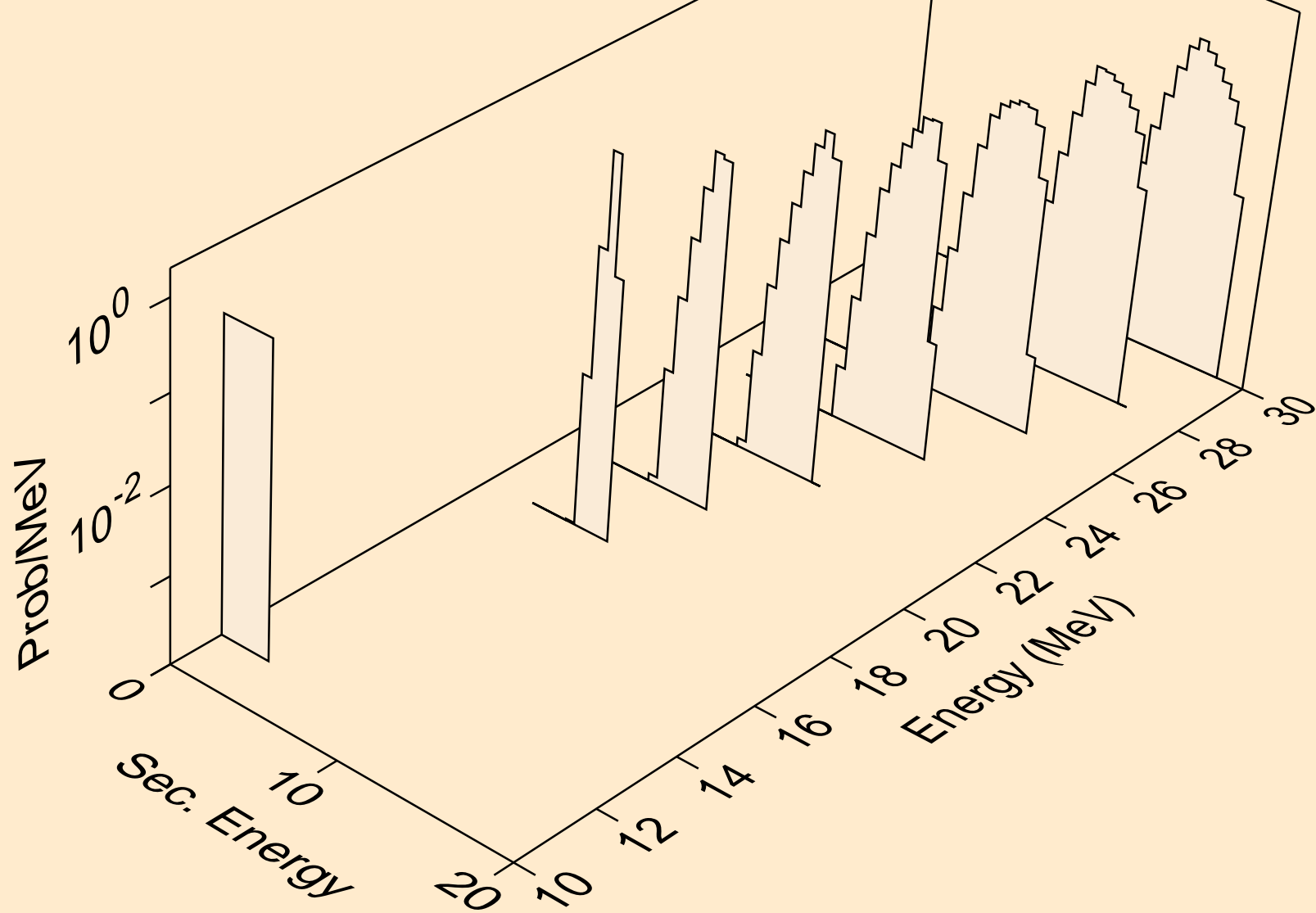

HS271 HELION ACER TENDL-2021 LIBRARY; T=0.K
tritons from (s,t)

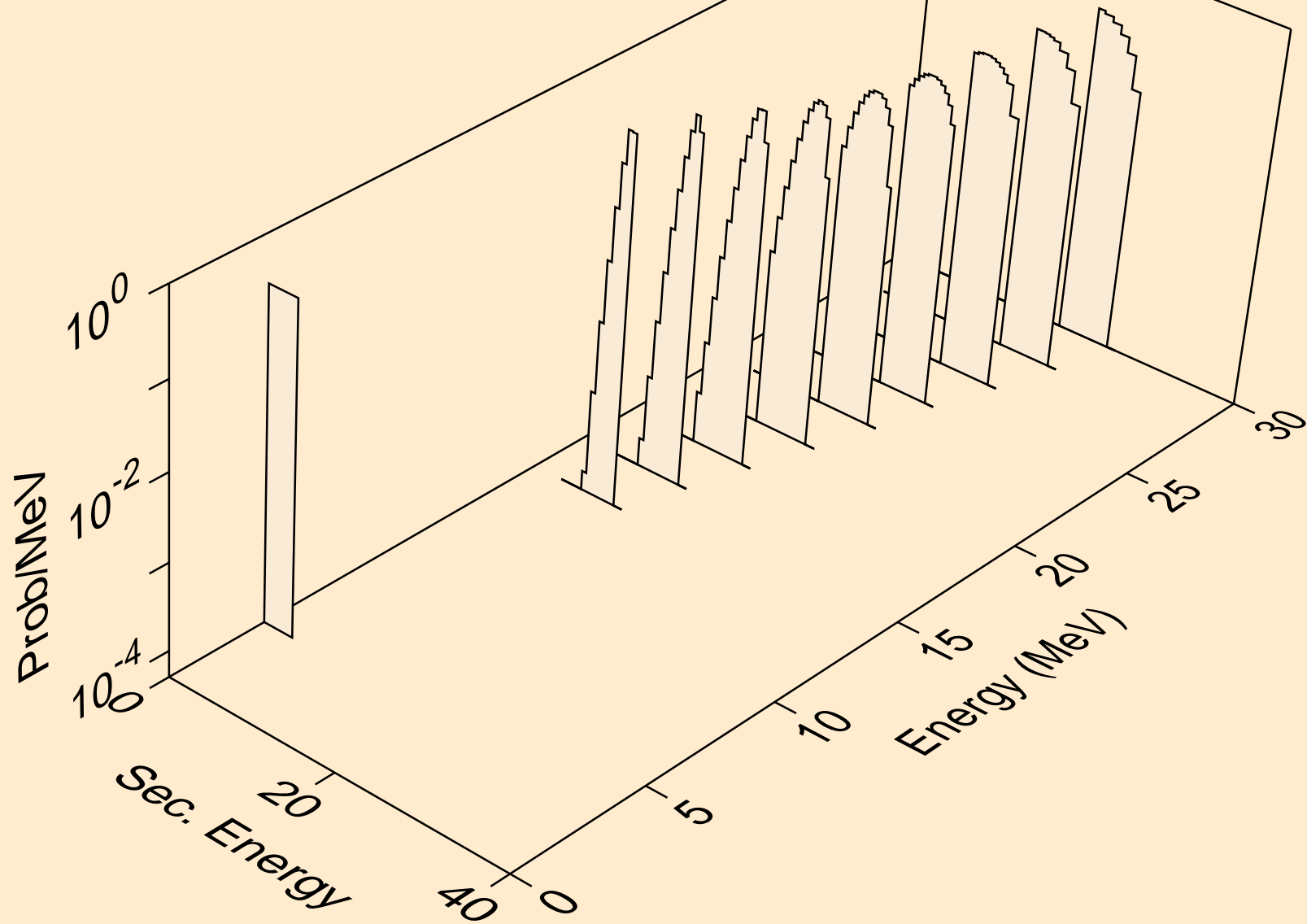

HS271 HELION ACER TENDL-2021 LIBRARY; T=0.K
tritons from (s,t2a)

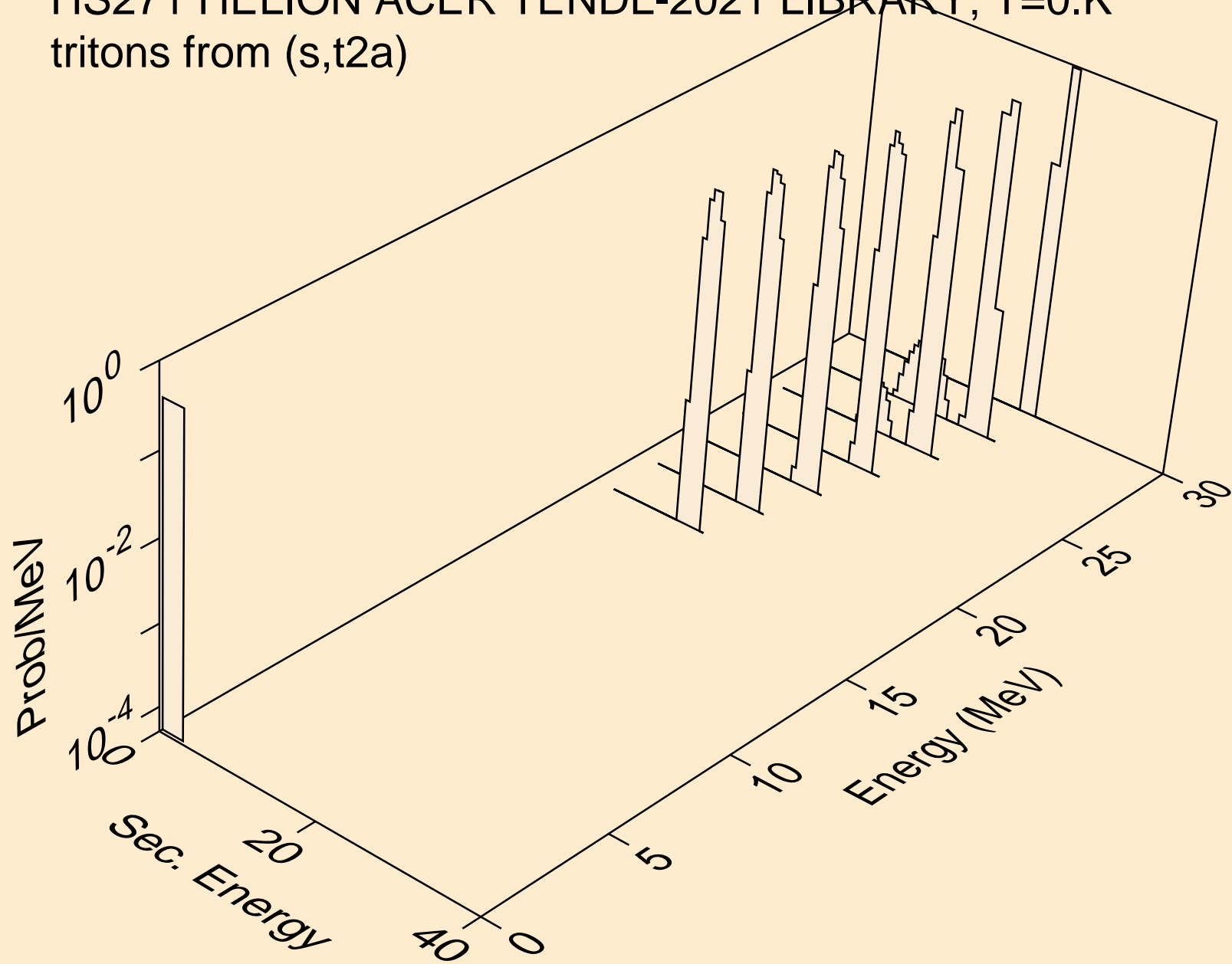

HS271 HELION ACER TENDL-2021 LIBRARY; T=0.K
alphas from (s,x)

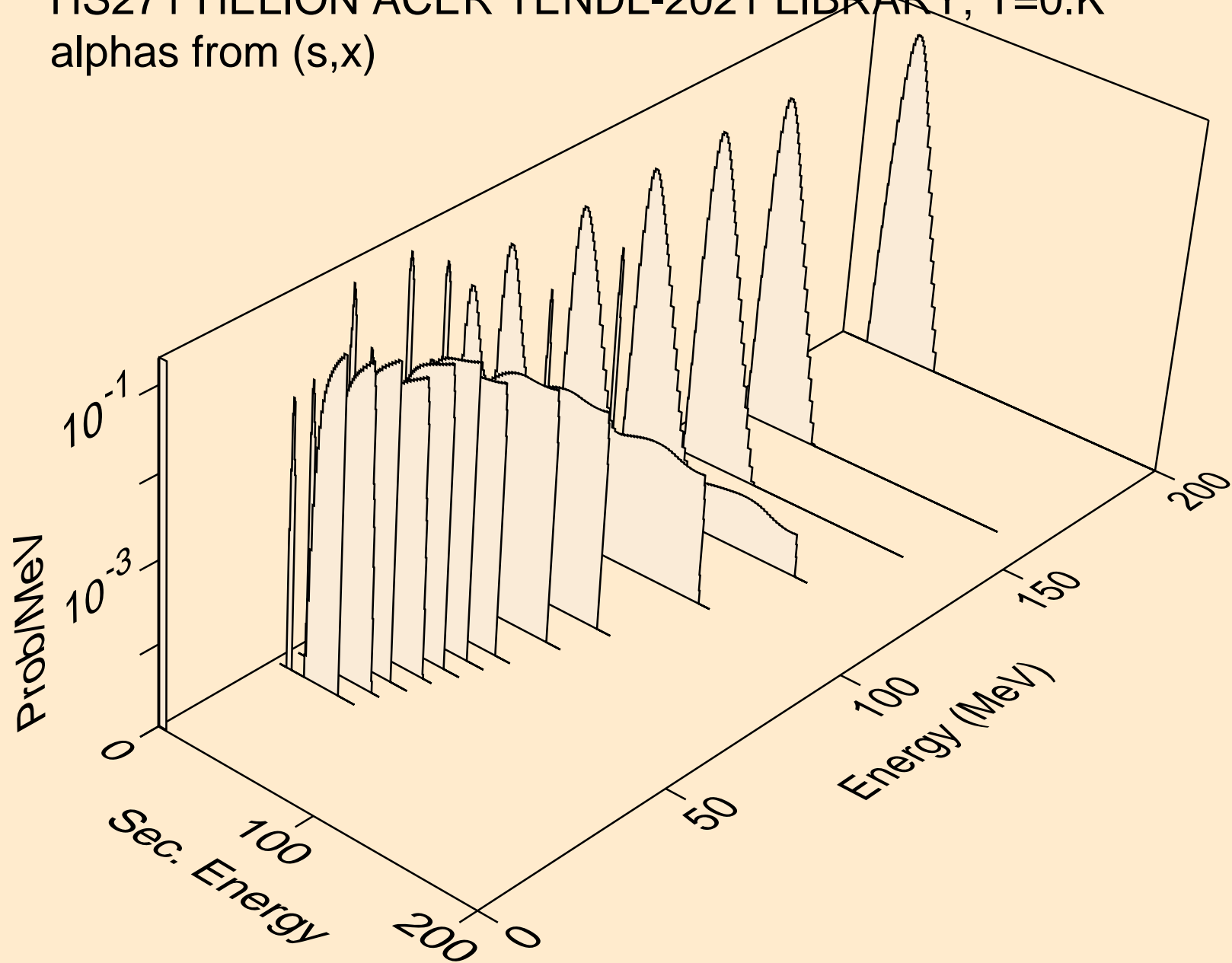

HS271 HELION ACER TENDL-2021 LIBRARY; T=0.K
alphas from (s,n*)a

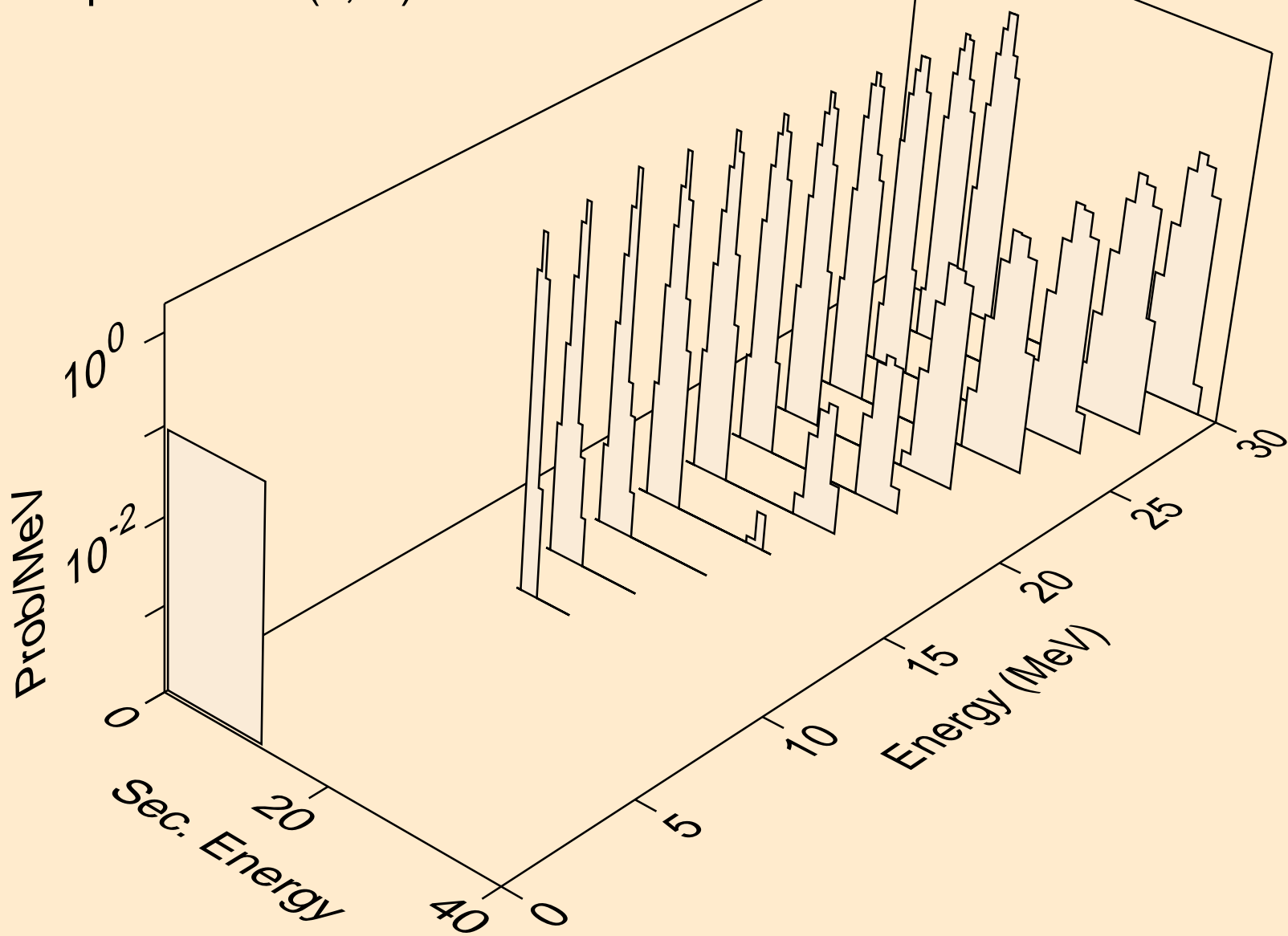

HS271 HELION ACER TENDL-2021 LIBRARY; T=0.K
alphas from (s,2n)a

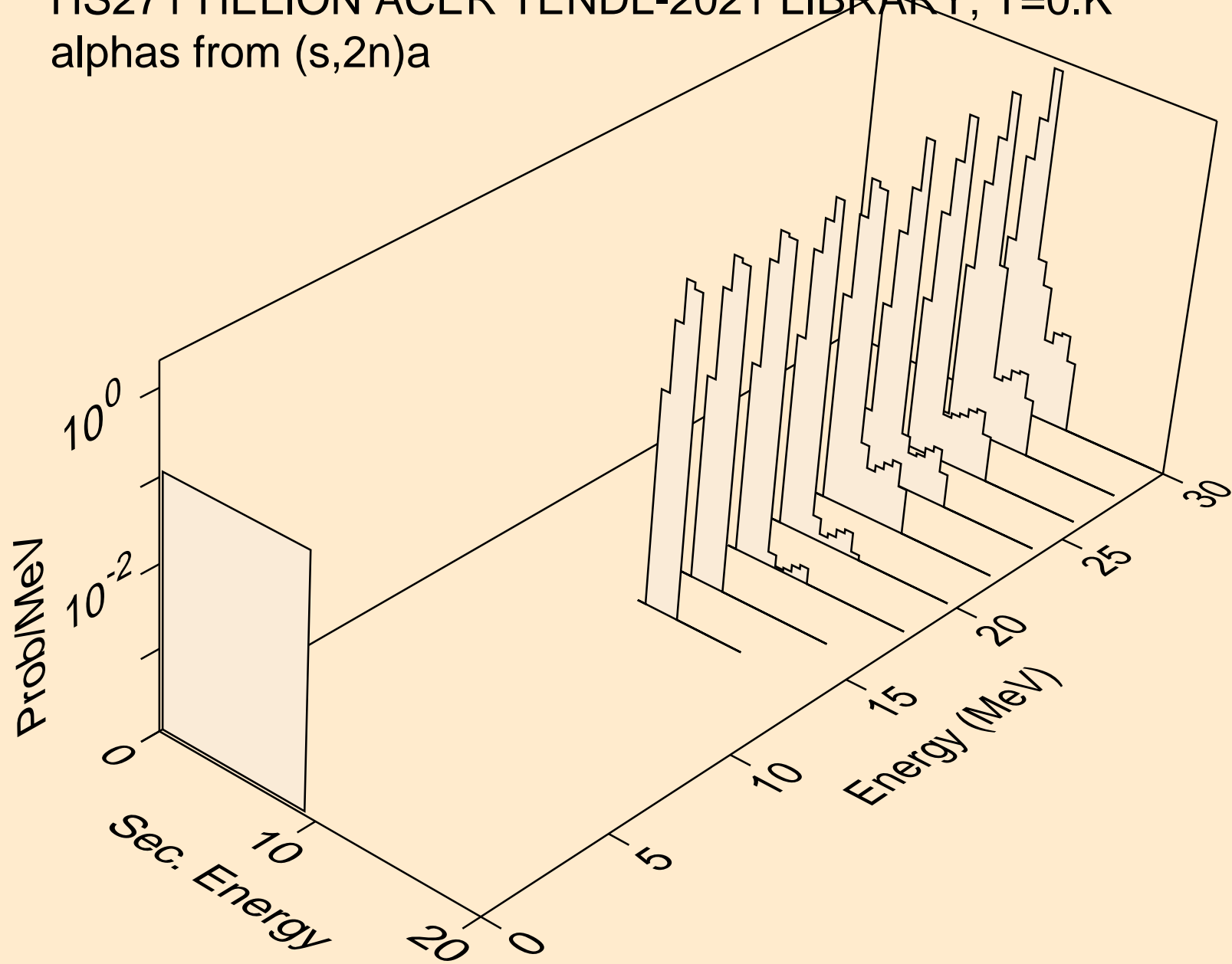

HS271 HELION ACER TENDL-2021 LIBRARY; T=0.K
alphas from (s,npa)

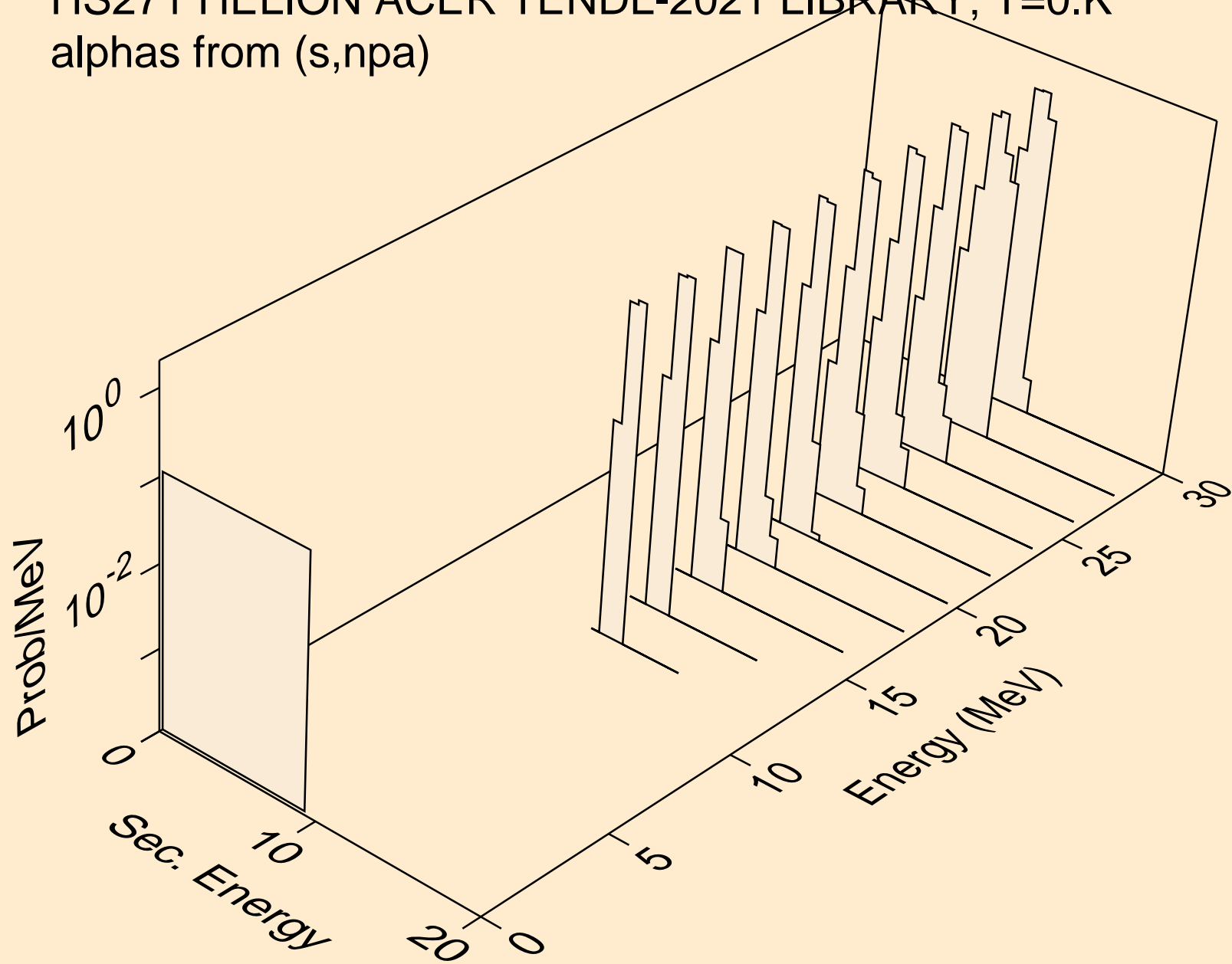

HS271 HELION ACER TENDL-2021 LIBRARY; T=0.K
alphas from (s,a)

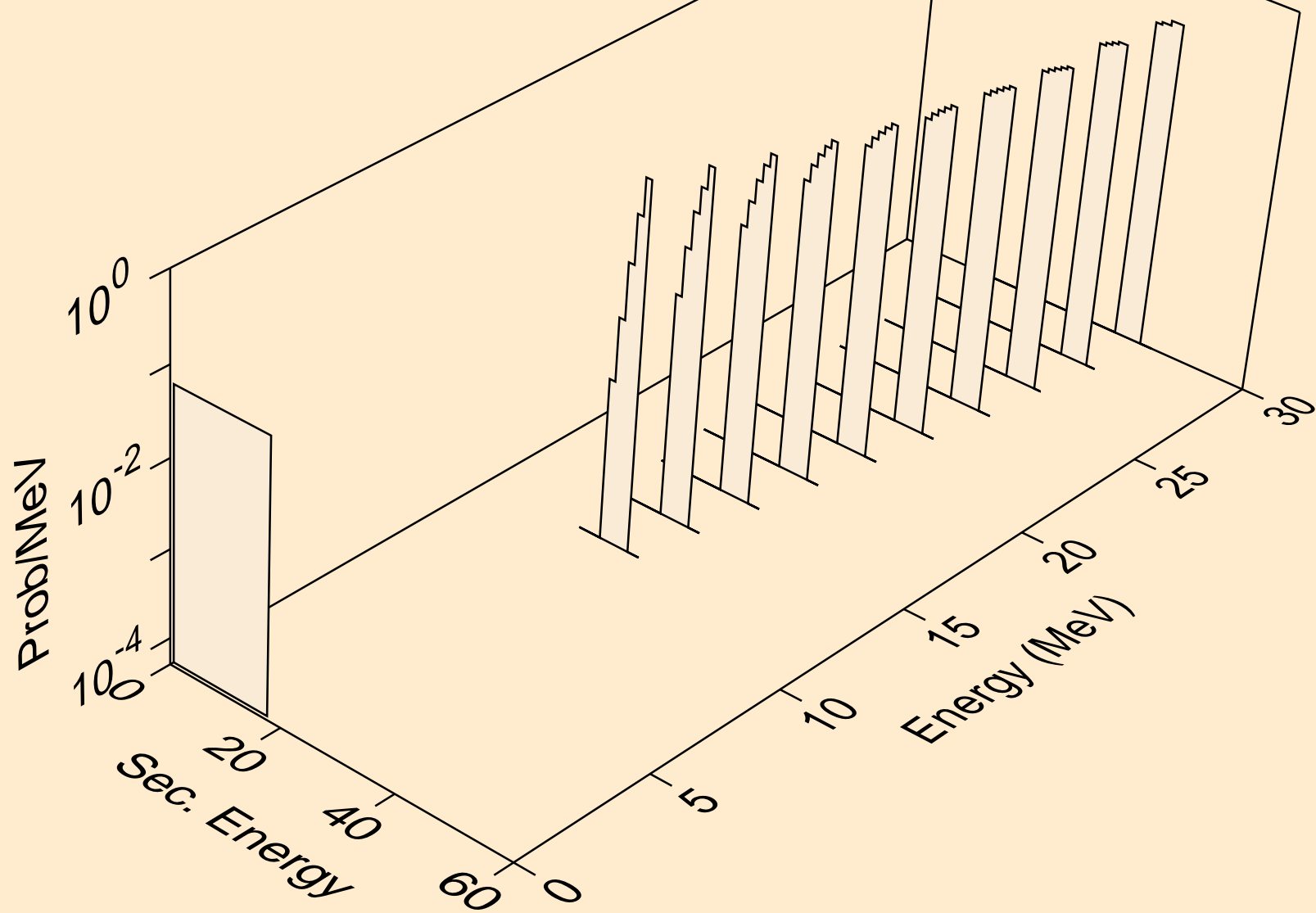

HS271 HELION ACER TENDL-2021 LIBRARY; T=0.K
alphas from (s,pa)

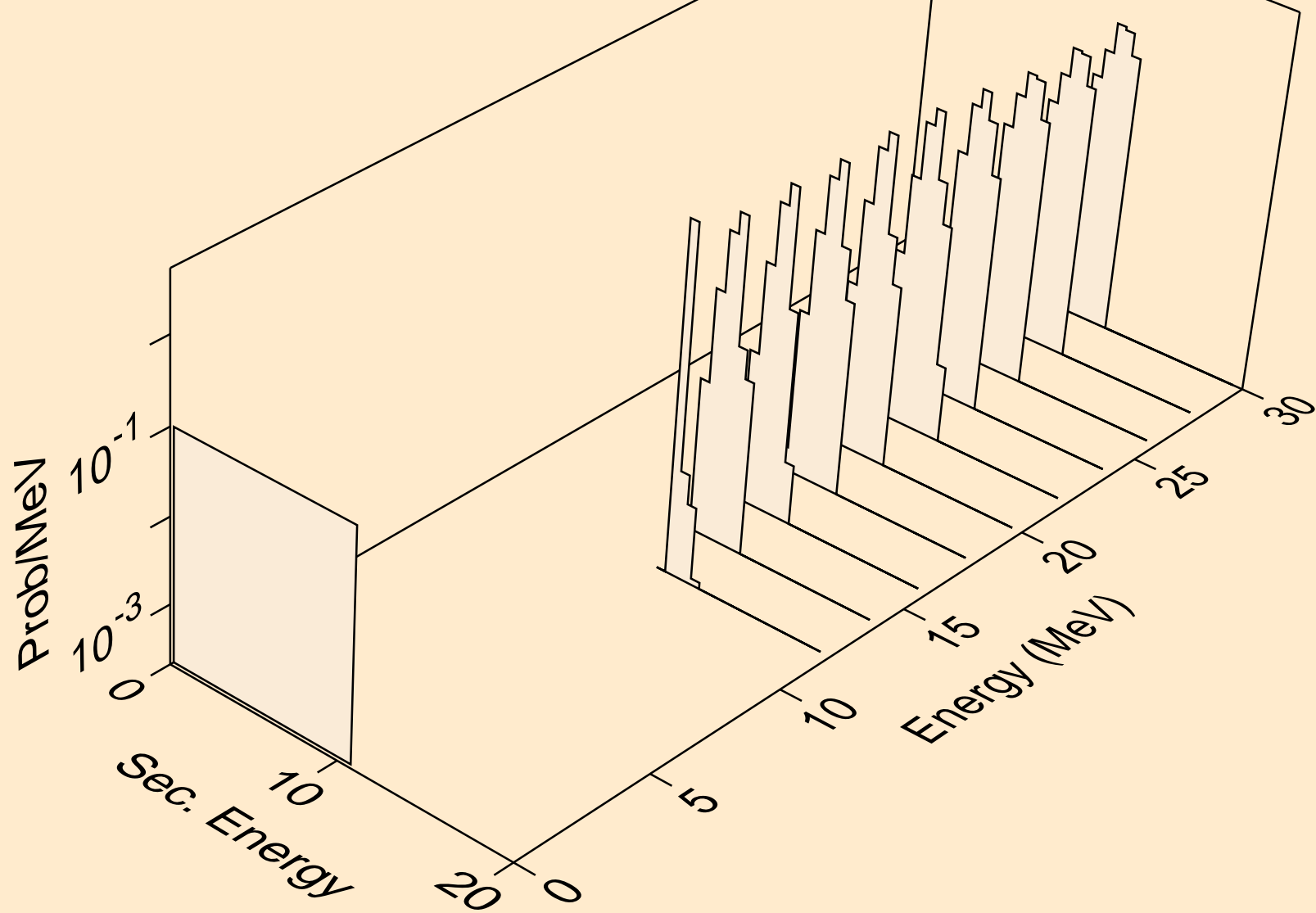

HS271 HELION ACER TENDL-2021 LIBRARY; T=0.K
alphas from (s,t2a)

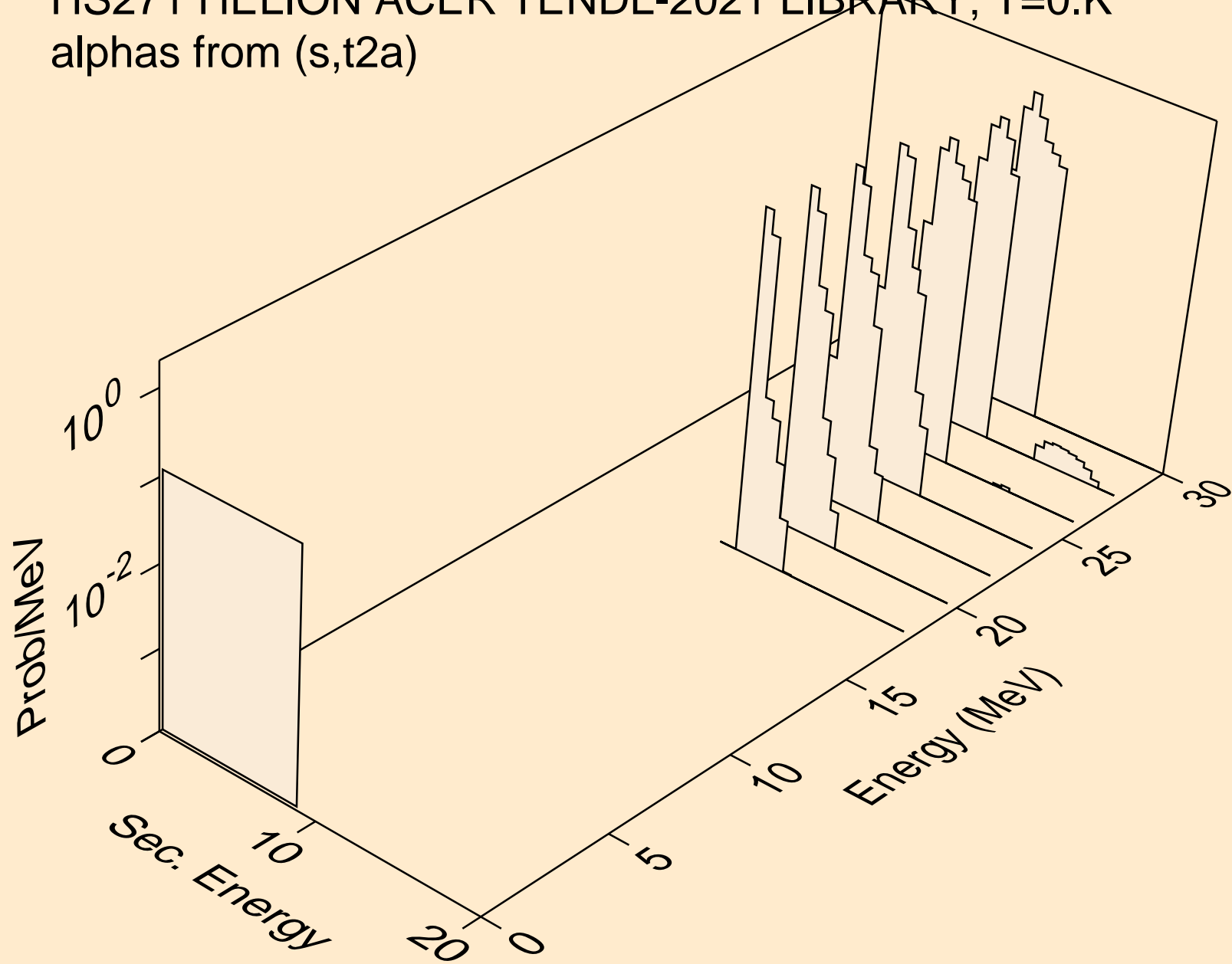

HS271 HELION ACER TENDL-2021 LIBRARY; T=0.K
alphas from (s,da)

