

I114 HELION ACER TENDL-2021 LIBRARY; T=0.K  
Principal cross sections

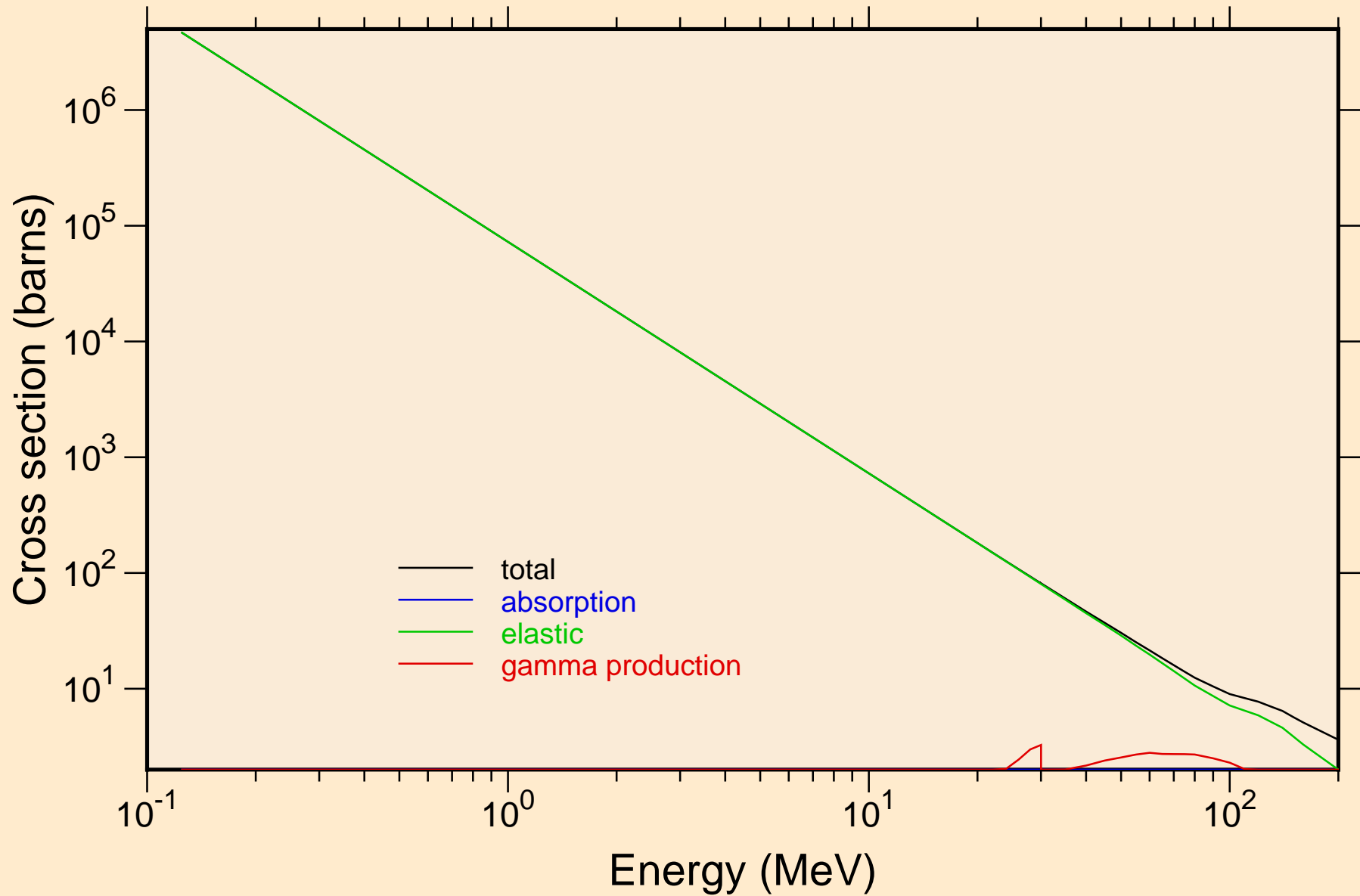

I114 HELION ACER TENDL-2021 LIBRARY; T=0.K

Heating

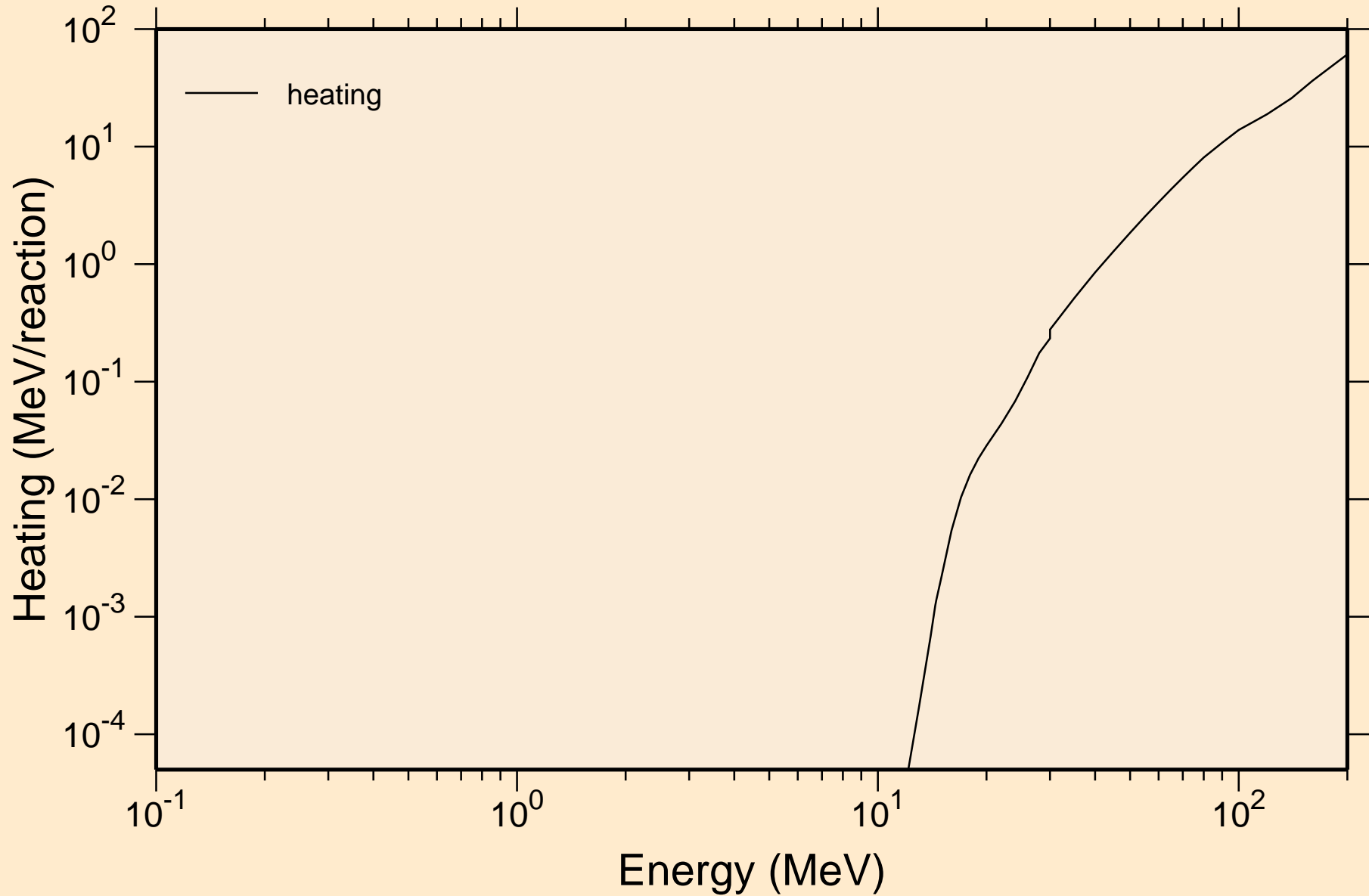

# I114 HELION ACER TENDL-2021 LIBRARY; T=0.K

## Principal cross sections

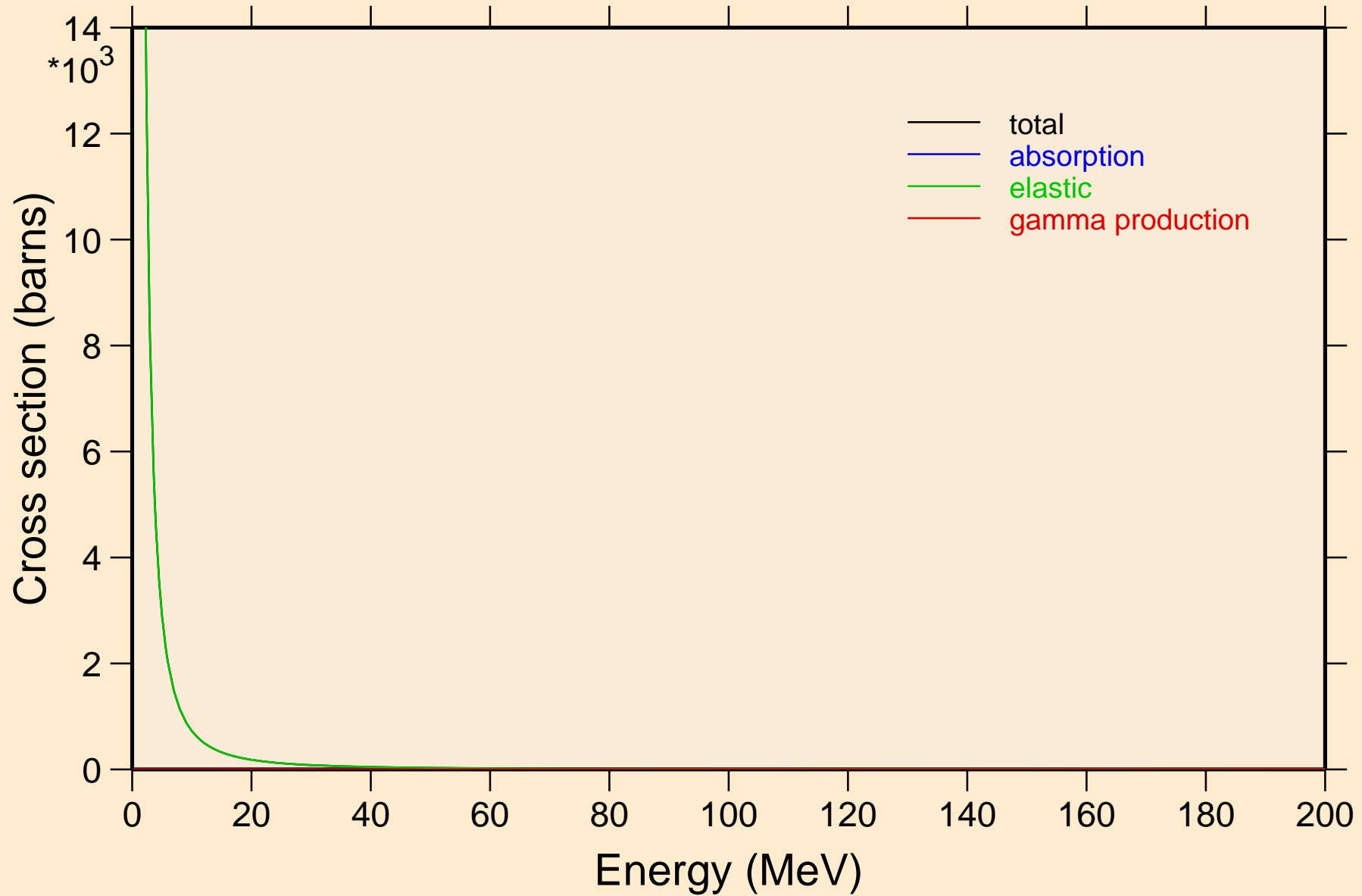

I114 HELION ACER TENDL-2021 LIBRARY; T=0.K

Heating

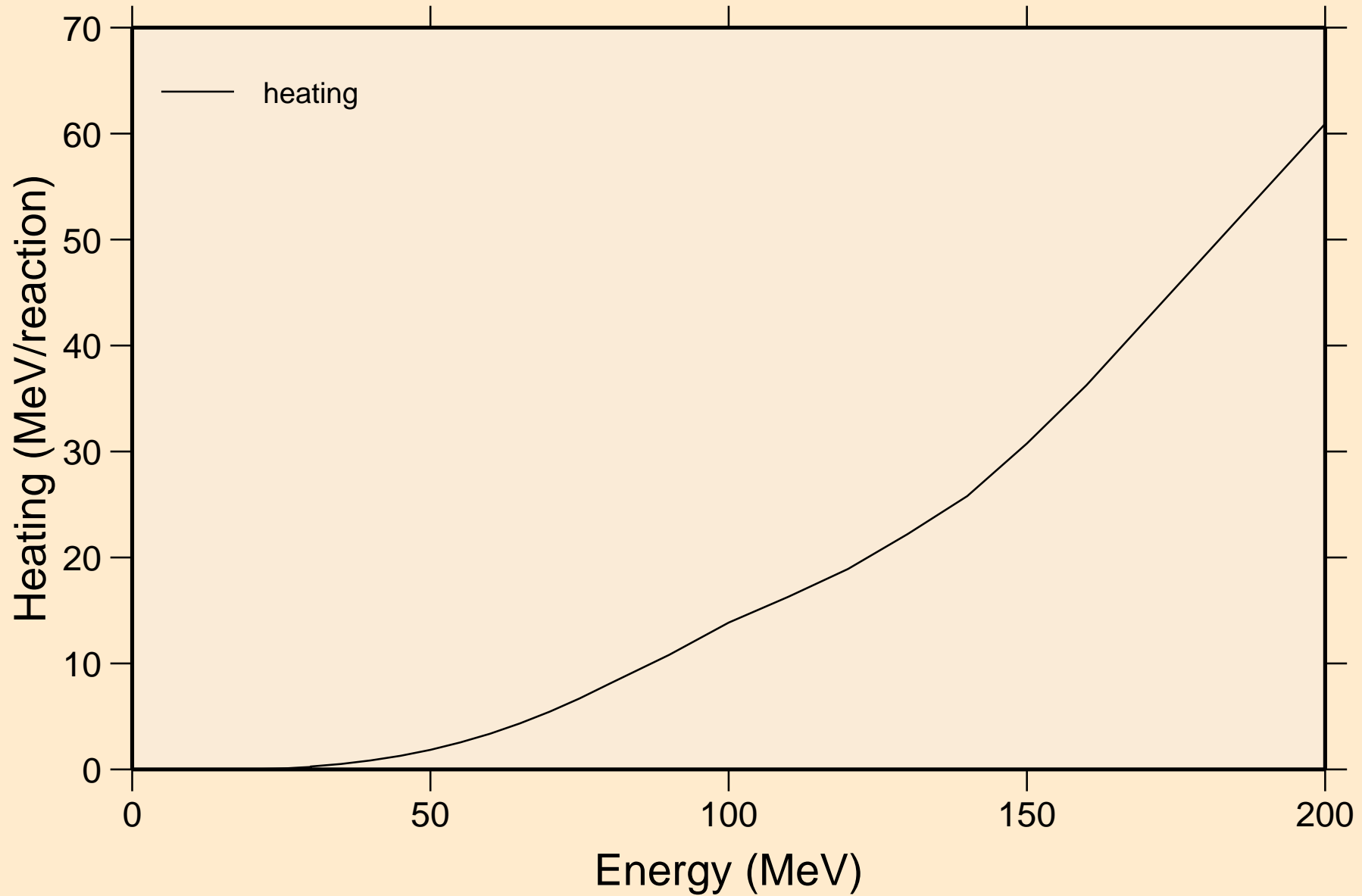

I114 HELION ACER TENDL-2021 LIBRARY; T=0.K  
Threshold reactions

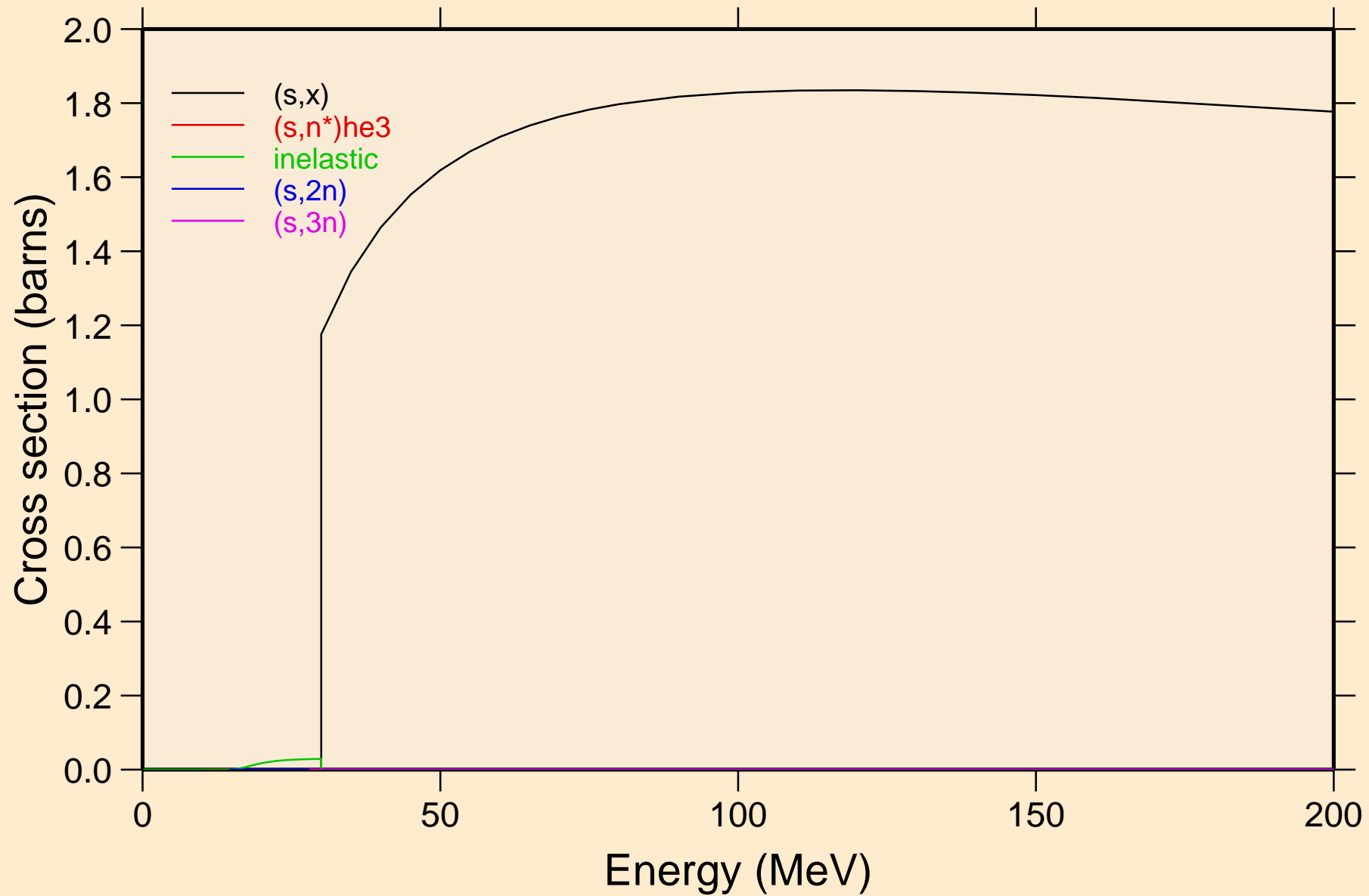

I114 HELION ACER TENDL-2021 LIBRARY; T=0.K  
Threshold reactions

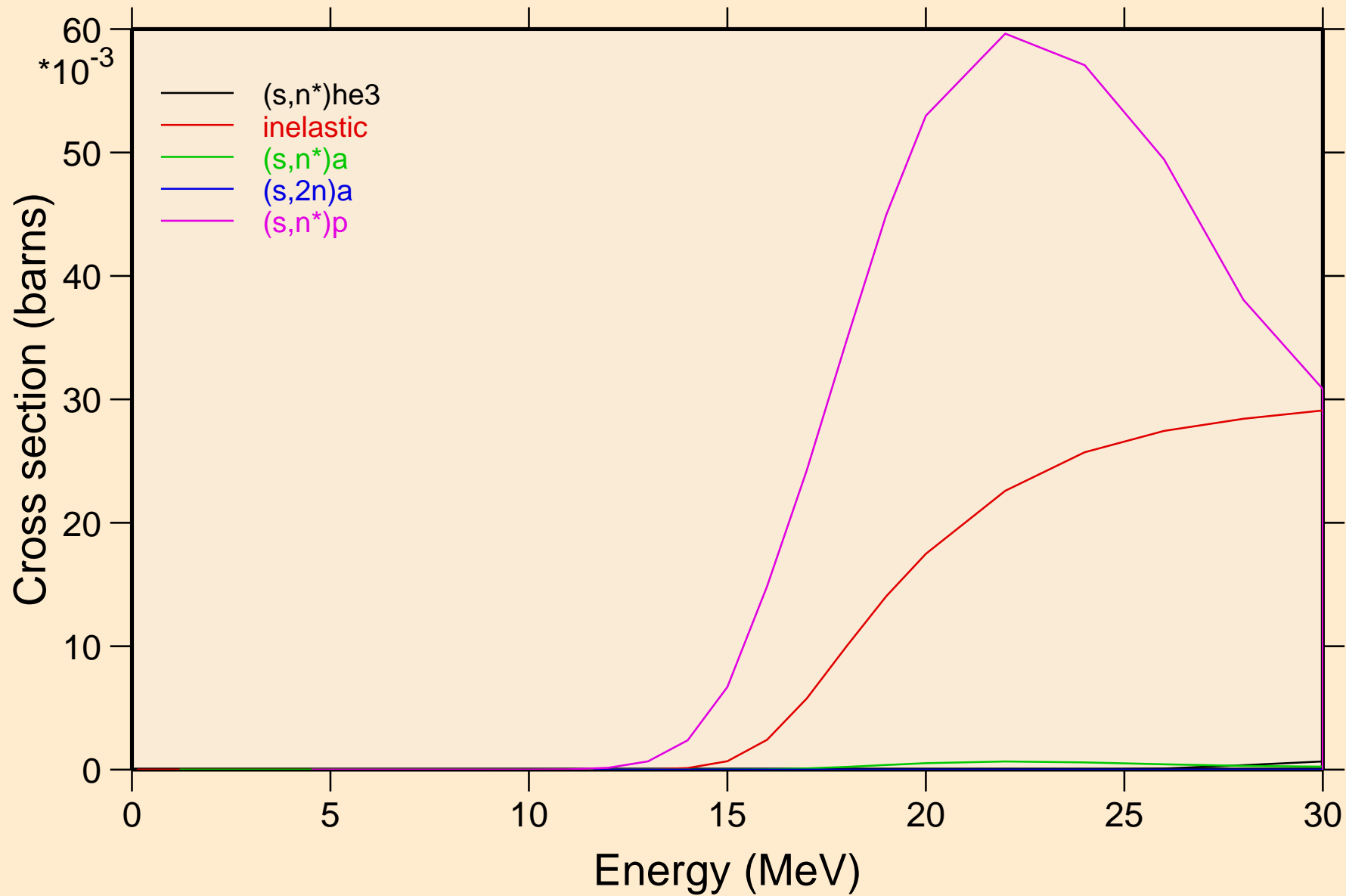

I114 HELION ACER TENDL-2021 LIBRARY; T=0.K  
Threshold reactions

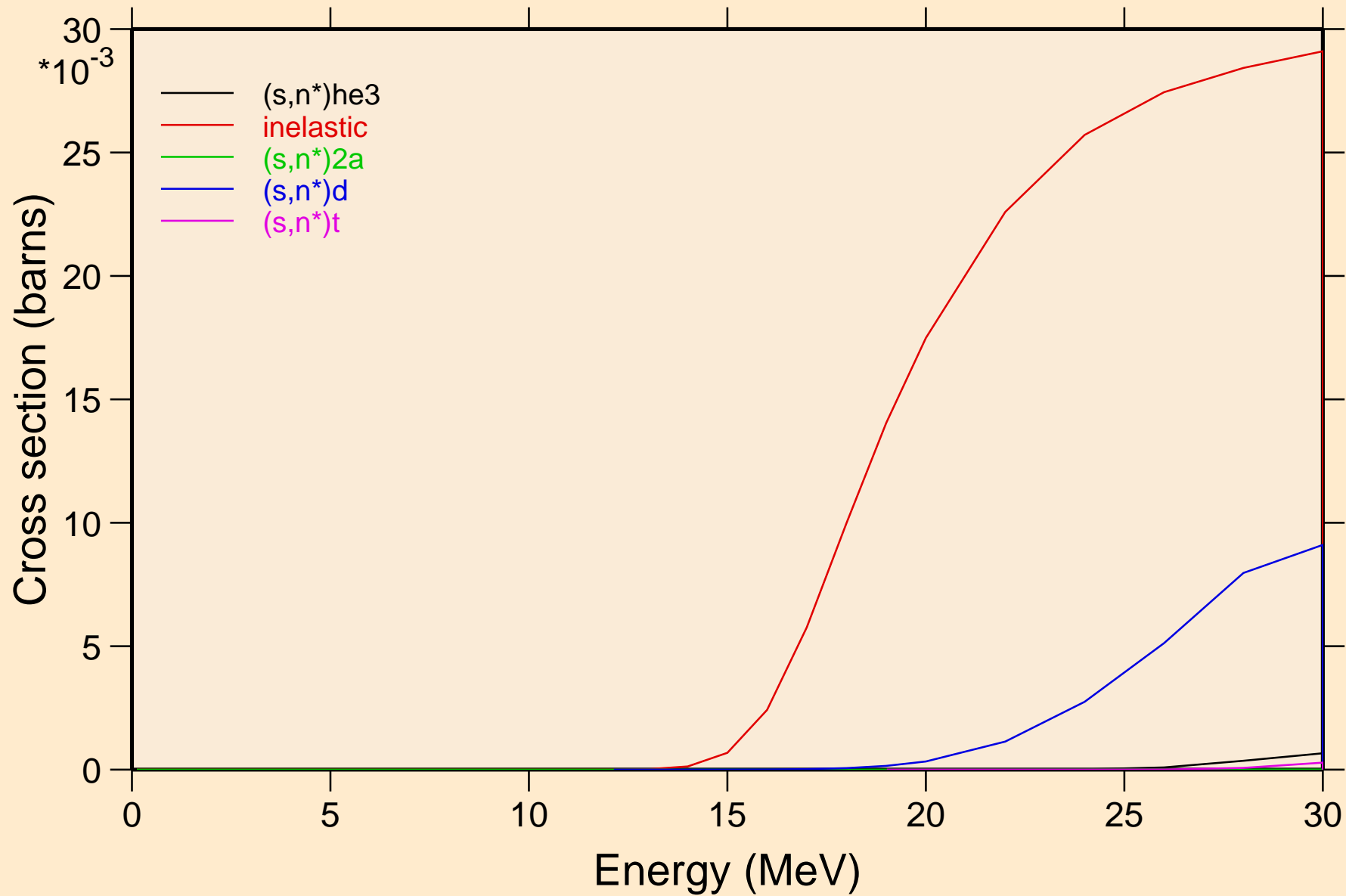

I114 HELION ACER TENDL-2021 LIBRARY; T=0.K  
Threshold reactions

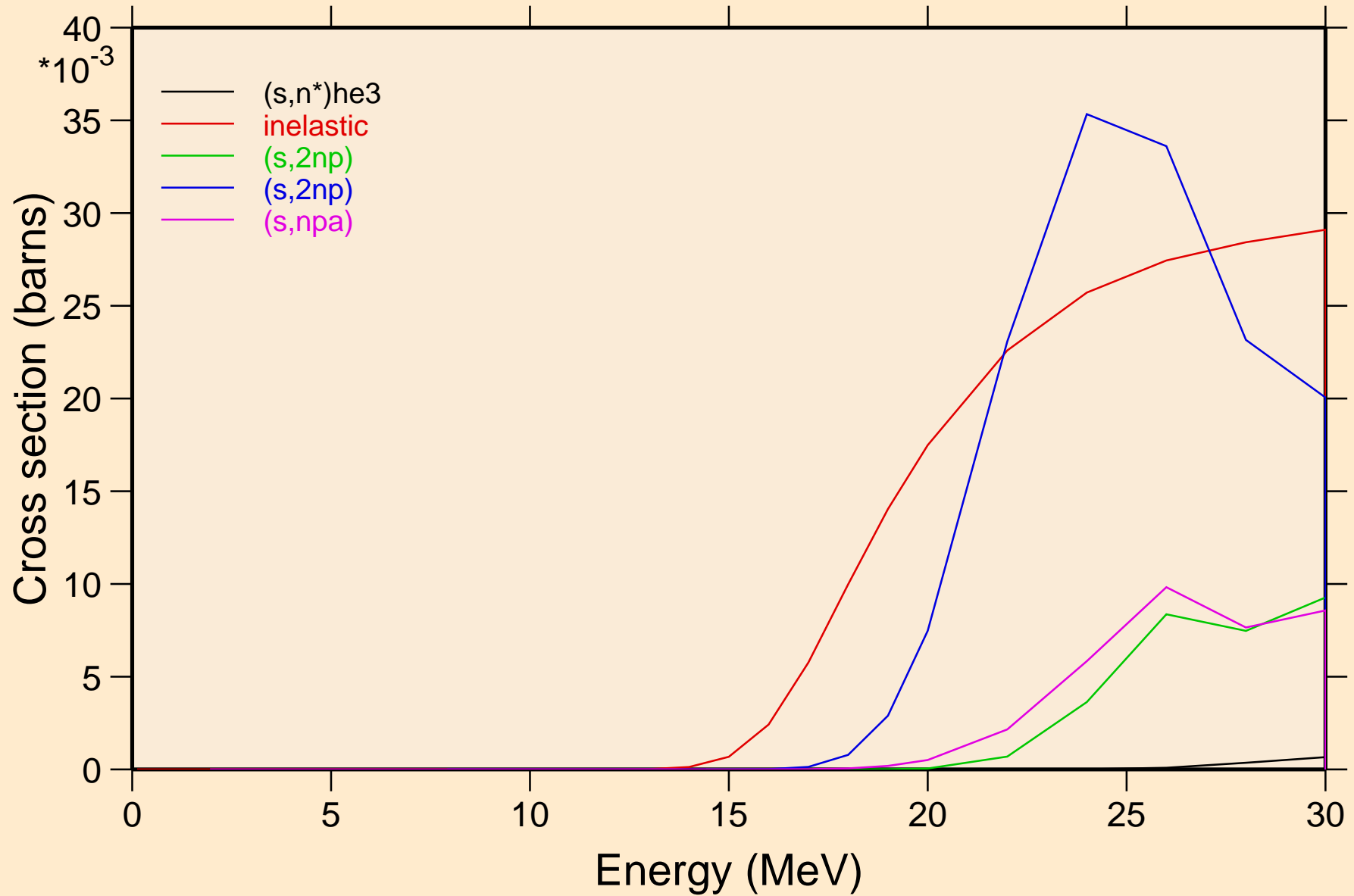



I114 HELION ACER TENDL-2021 LIBRARY; T=0.K  
Threshold reactions

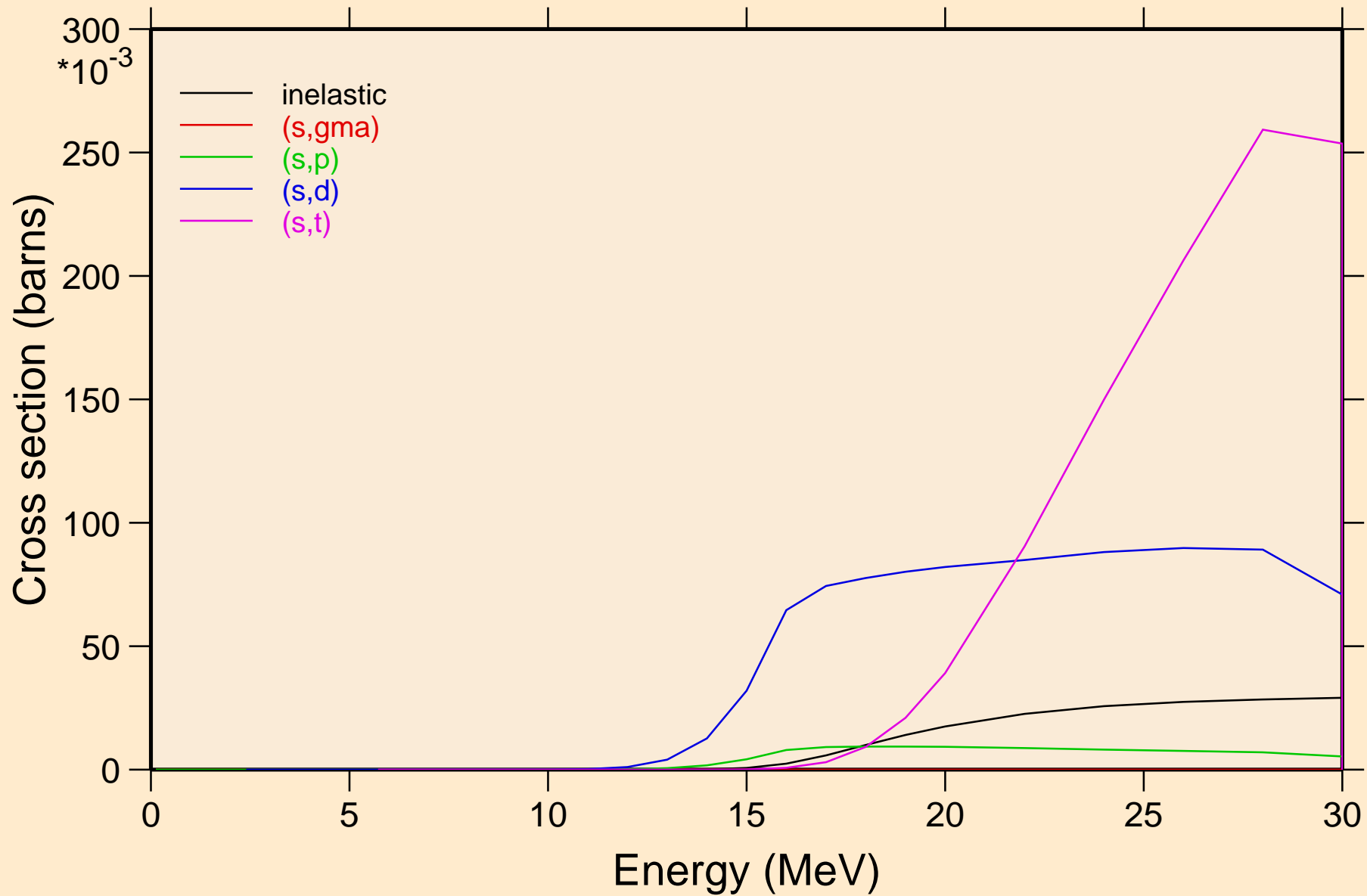

I114 HELION ACER TENDL-2021 LIBRARY; T=0.K  
Threshold reactions

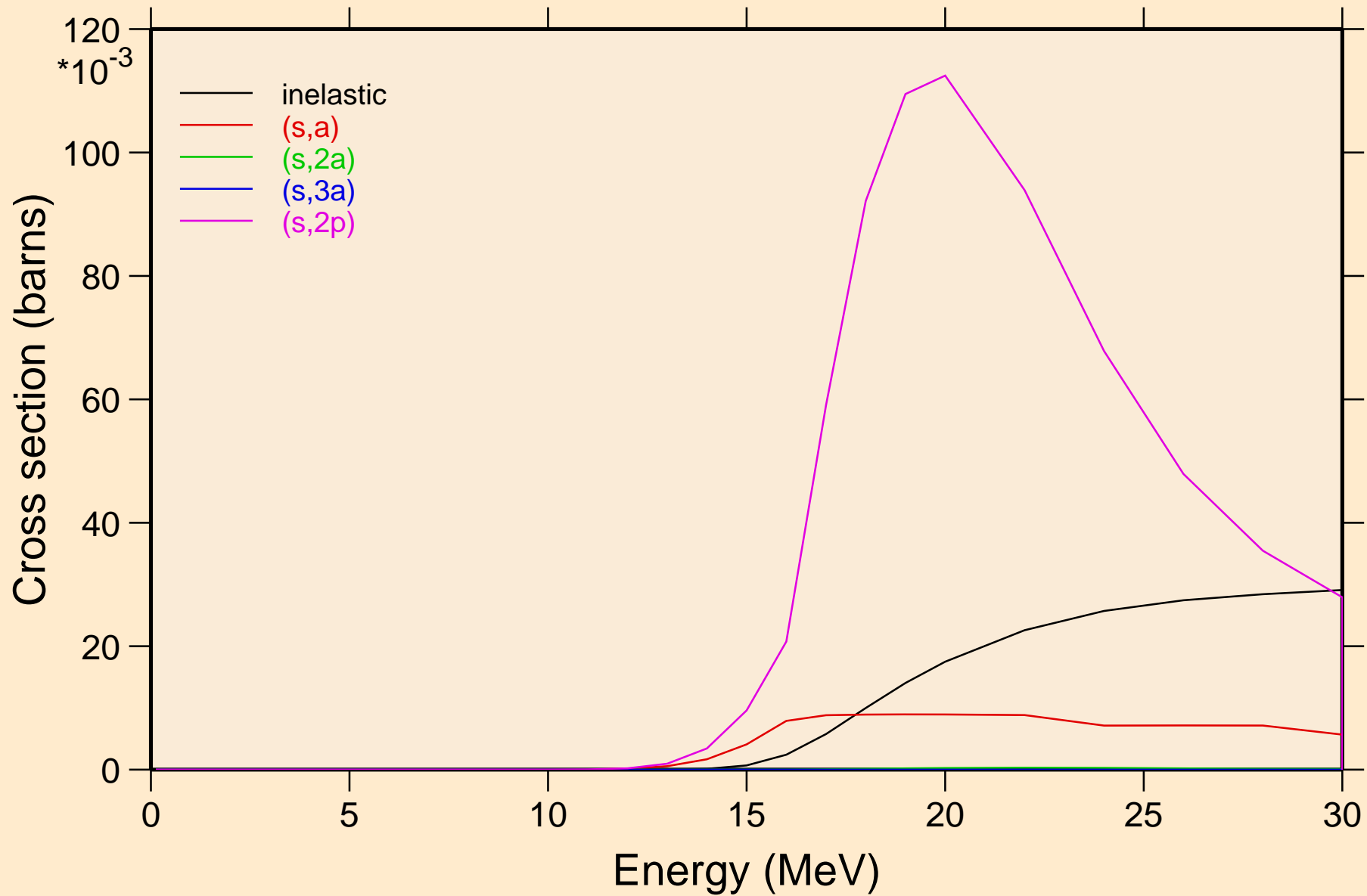

I114 HELION ACER TENDL-2021 LIBRARY; T=0.K  
Threshold reactions

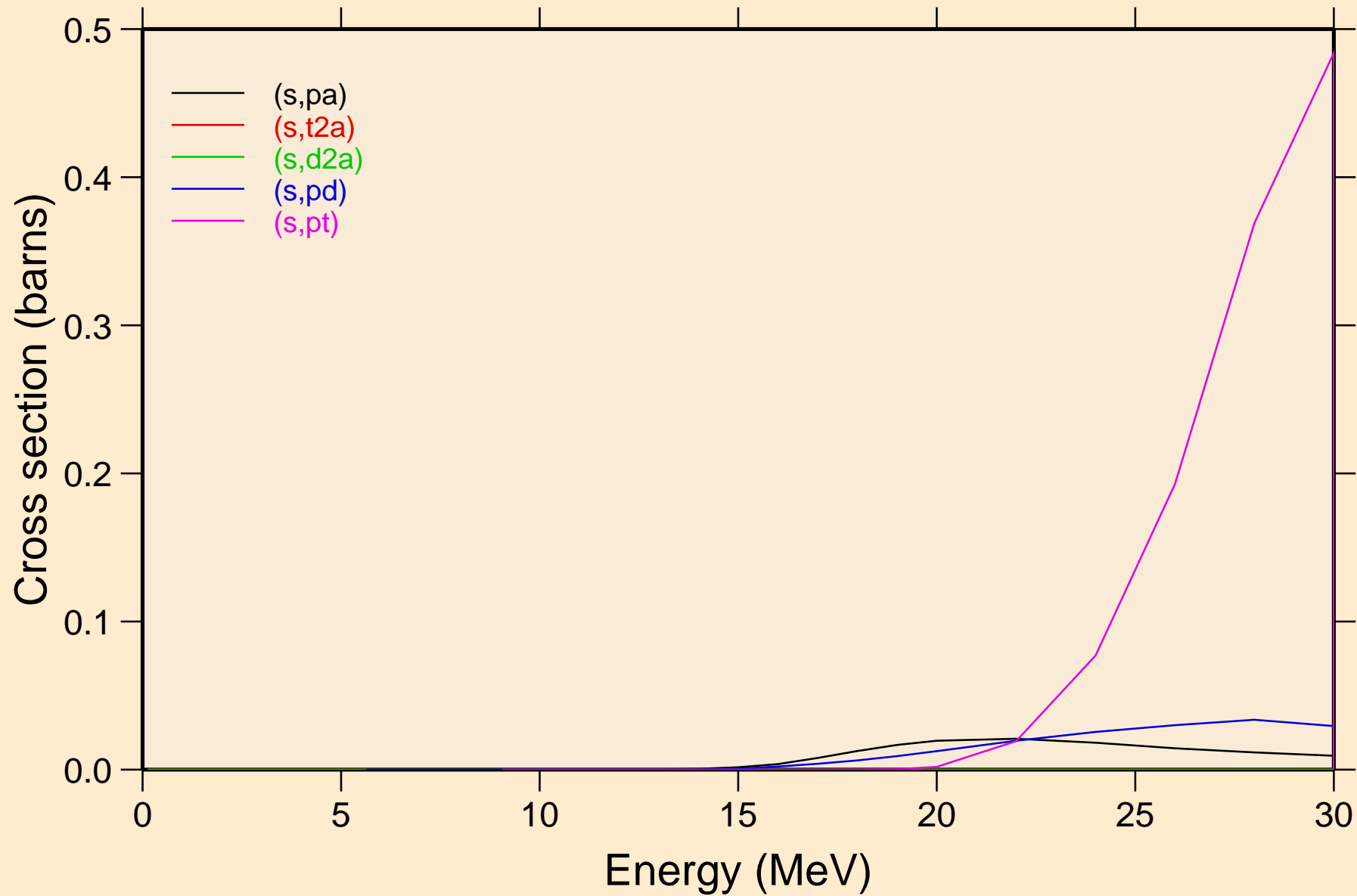

I114 HELION ACER TENDL-2021 LIBRARY; T=0.K  
Threshold reactions

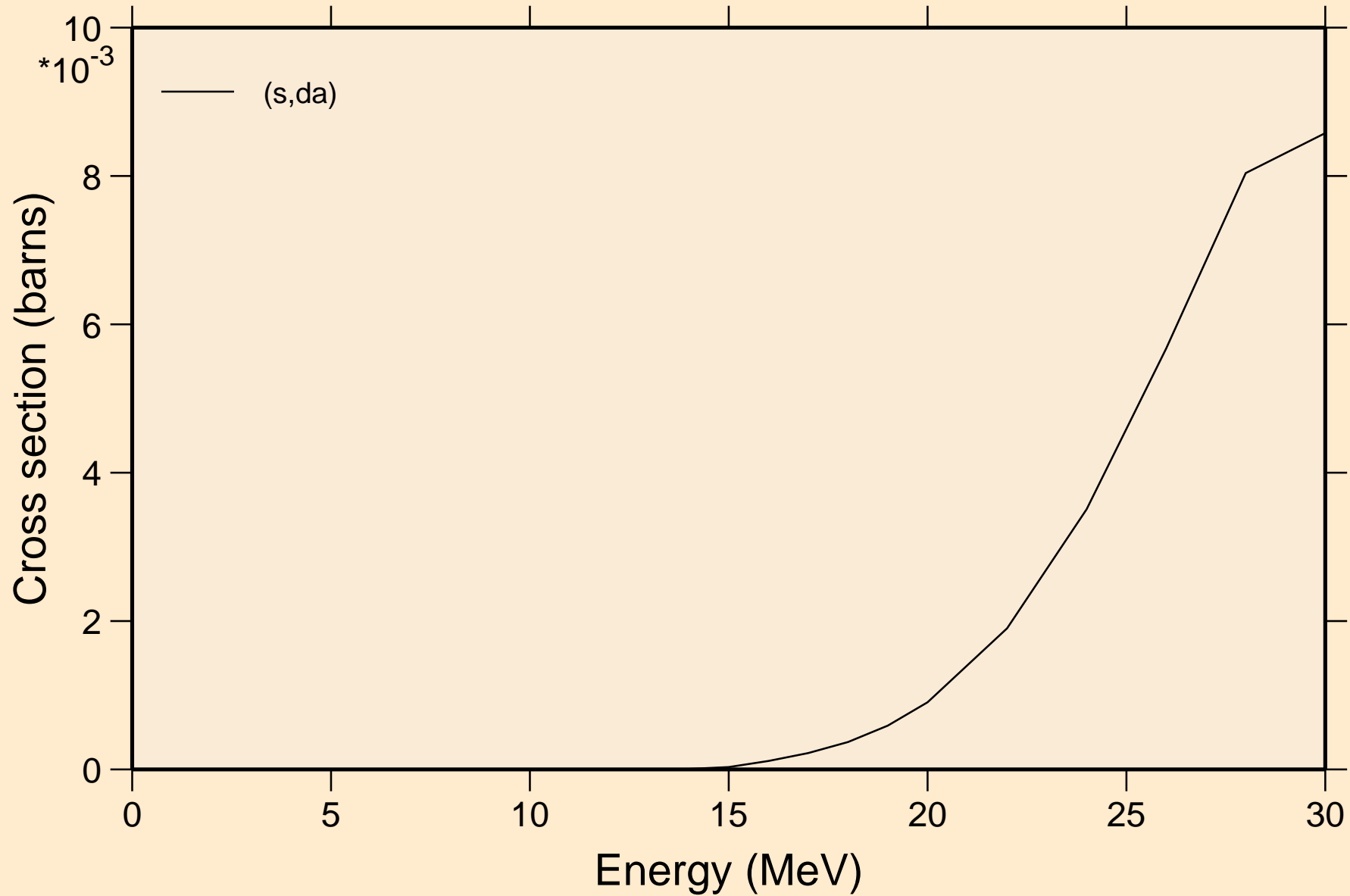

I114 HELION ACER TENDL-2021 LIBRARY; T=0.K  
angular distribution for elastic

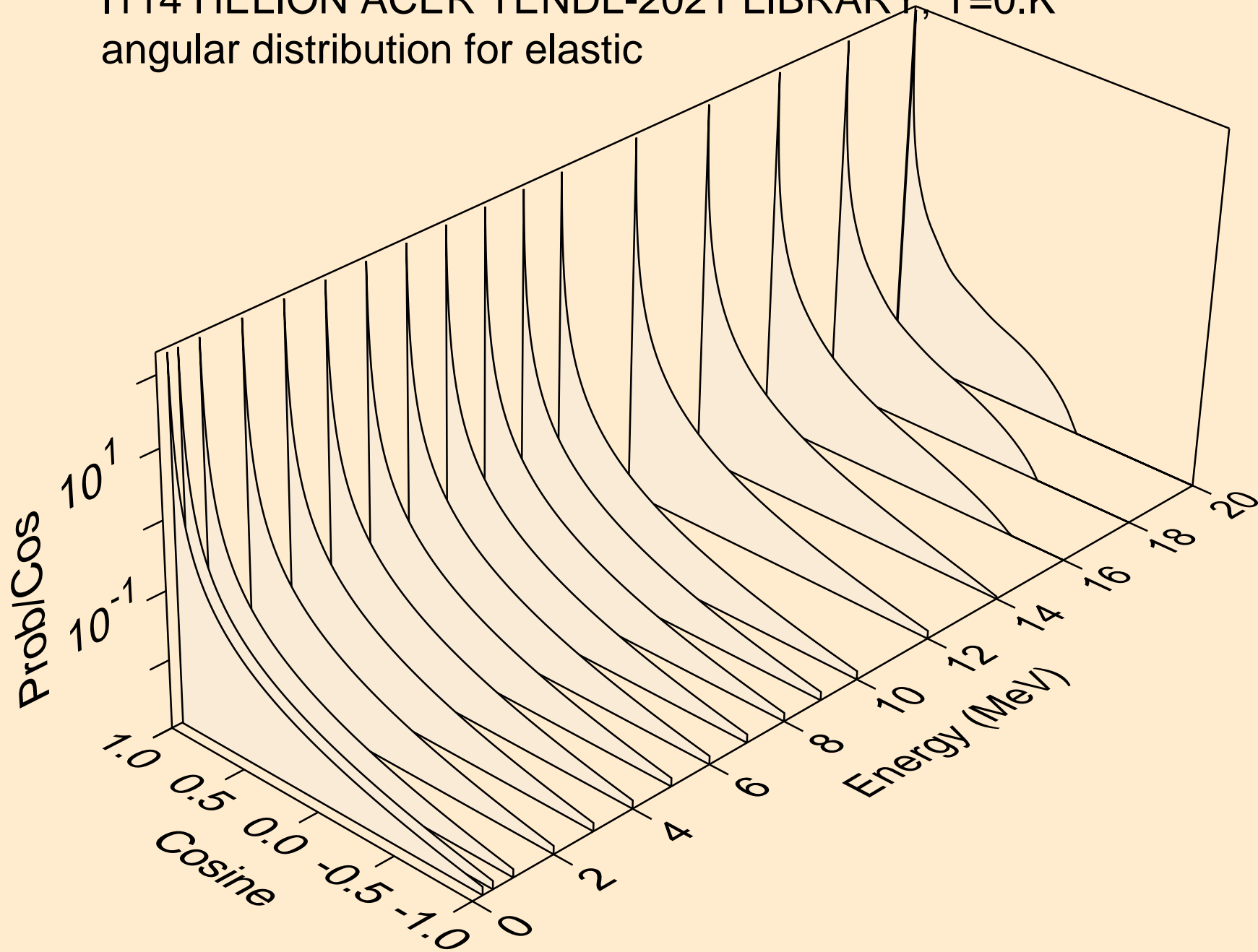

I114 HELION ACER TENDL-2021 LIBRARY; T=0.K  
angular distribution for elastic

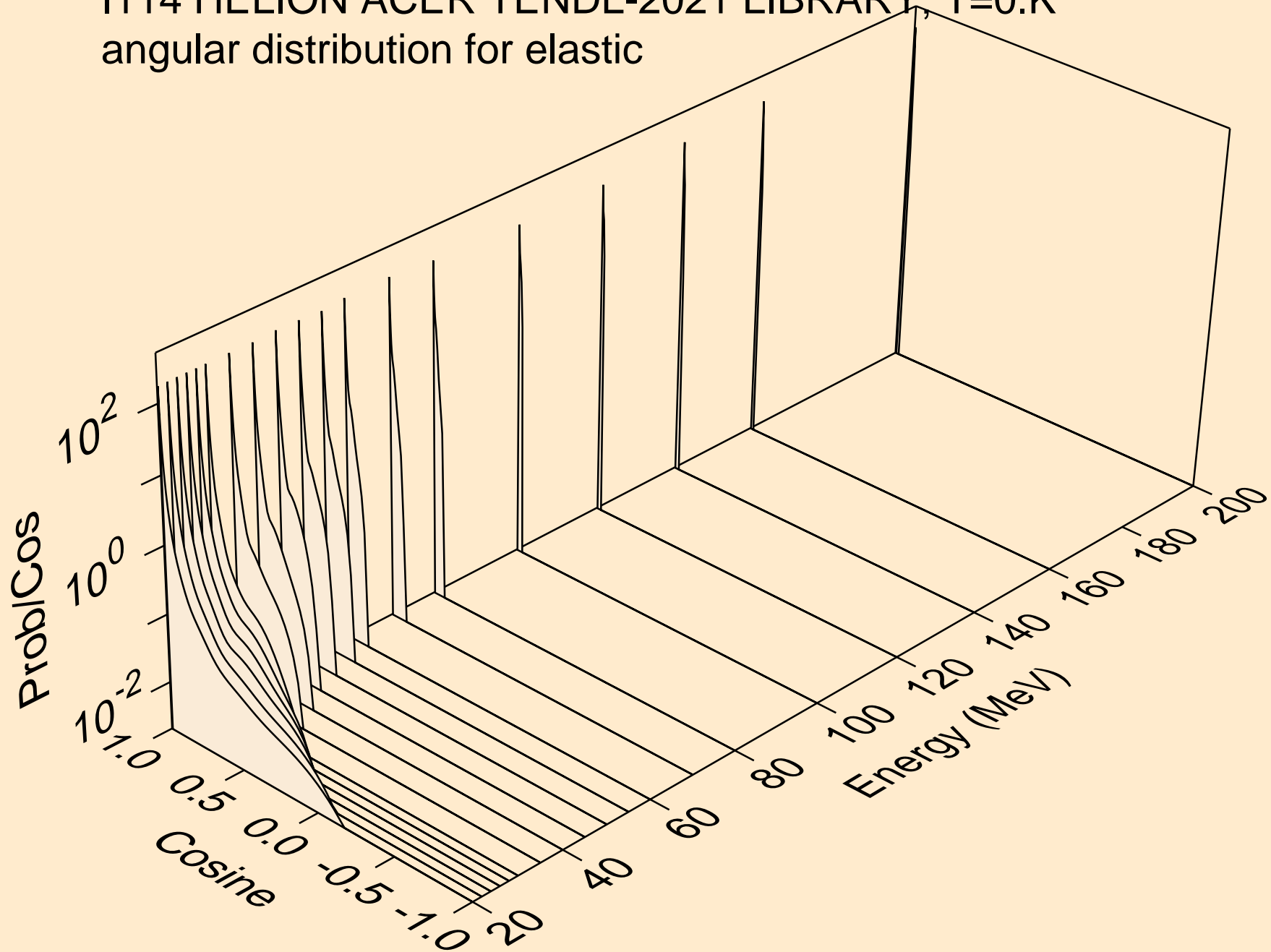

I114 HELION ACER TENDL-2021 LIBRARY; T=0.K  
He-3 emission for (s,x)

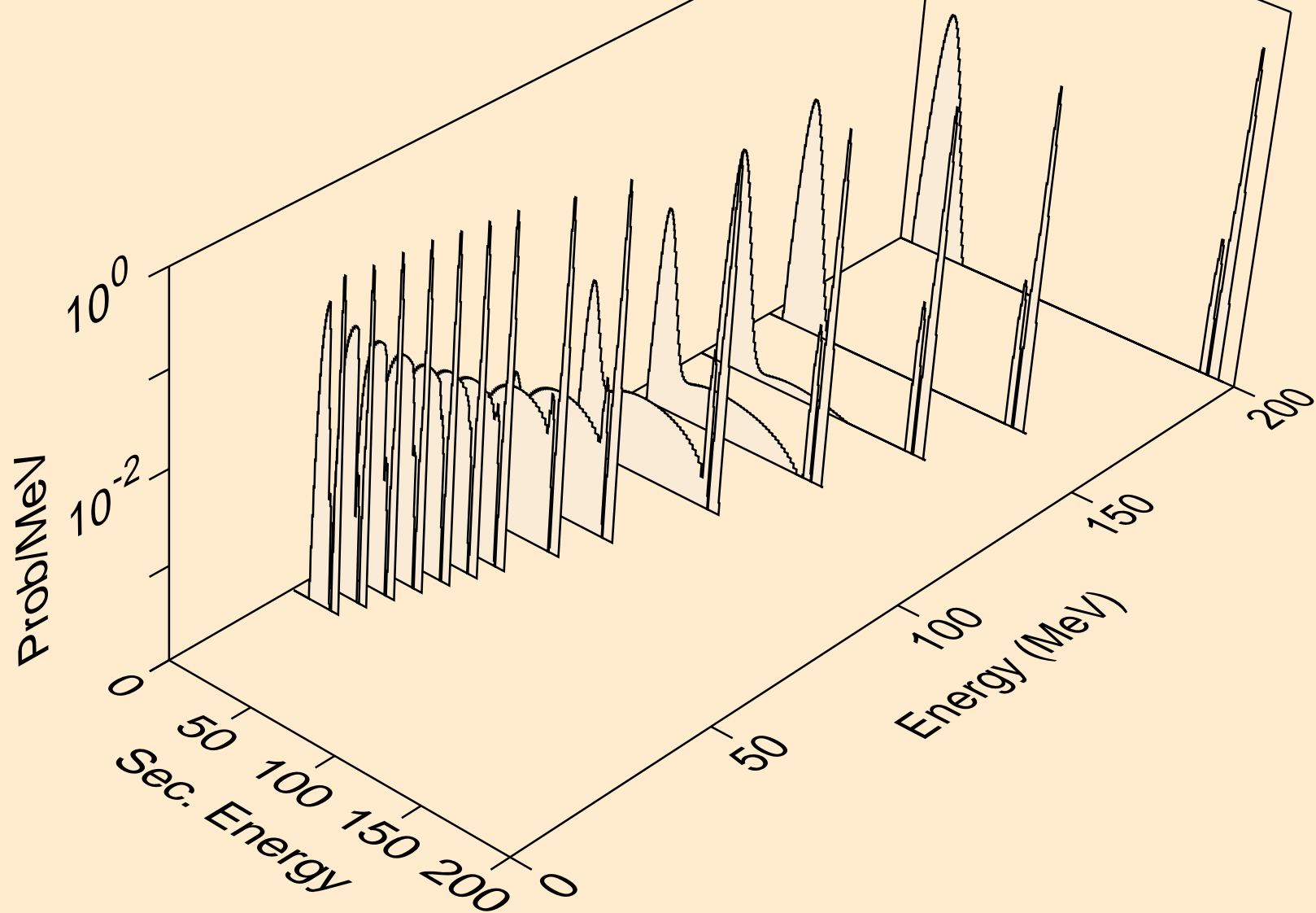

I114 HELION ACER TENDL-2021 LIBRARY; T=0.K  
He-3 emission for (s,n\*)he3

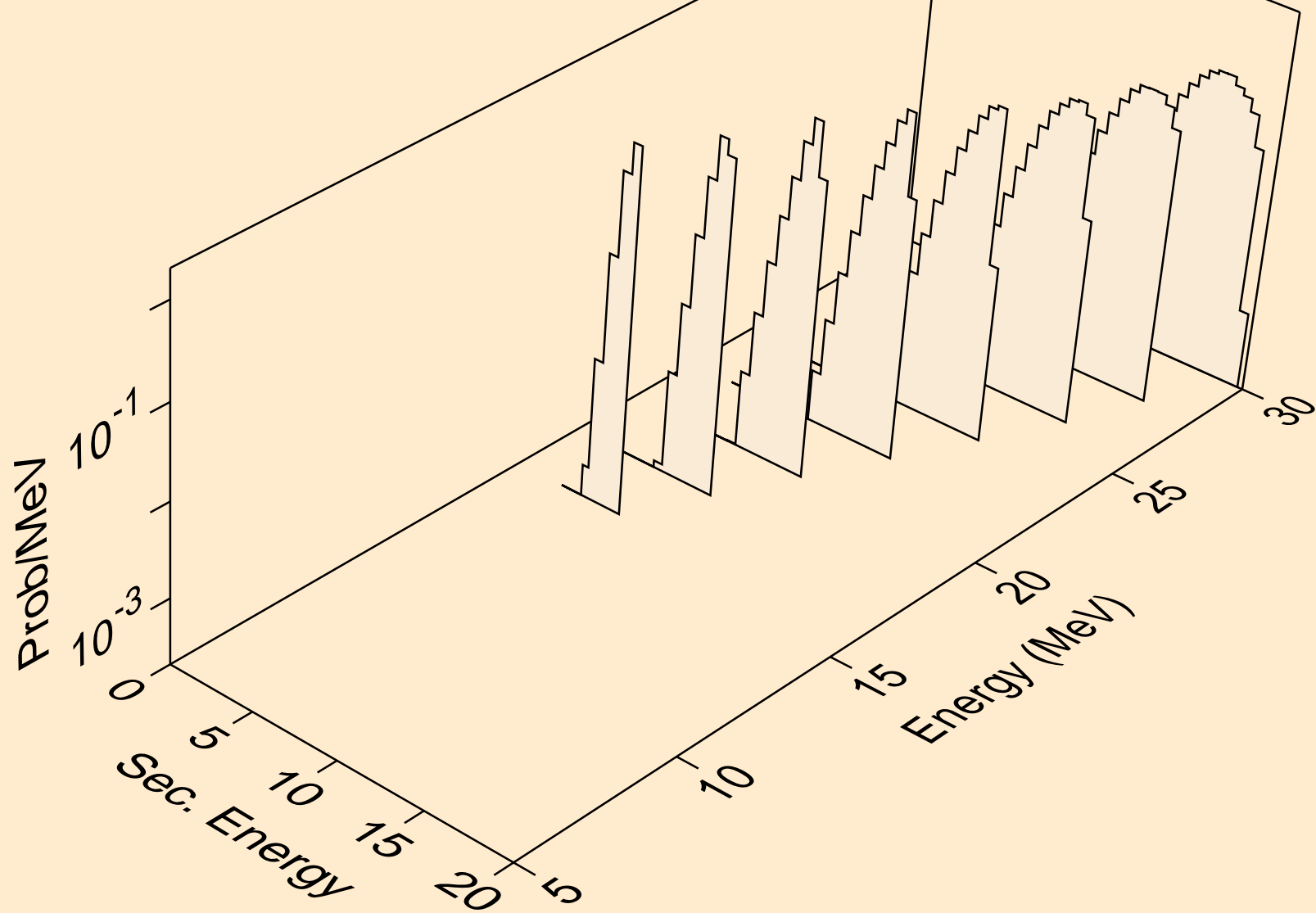



I114 HELION ACER TENDL-2021 LIBRARY; T=0.K  
He-3 emission for inelastic

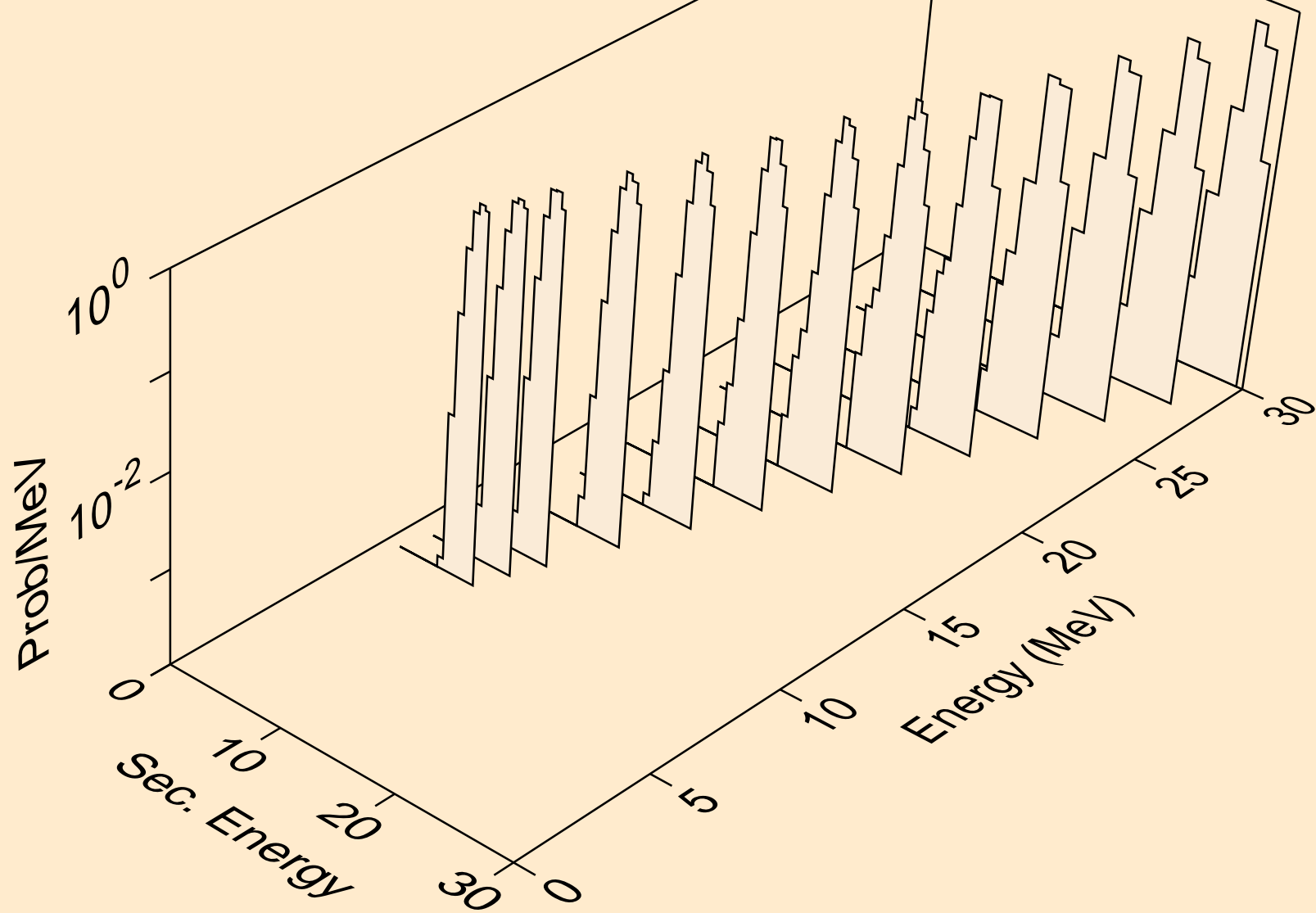

I114 HELION ACER TENDL-2021 LIBRARY; T=0.K  
Photon emission for (z,n)

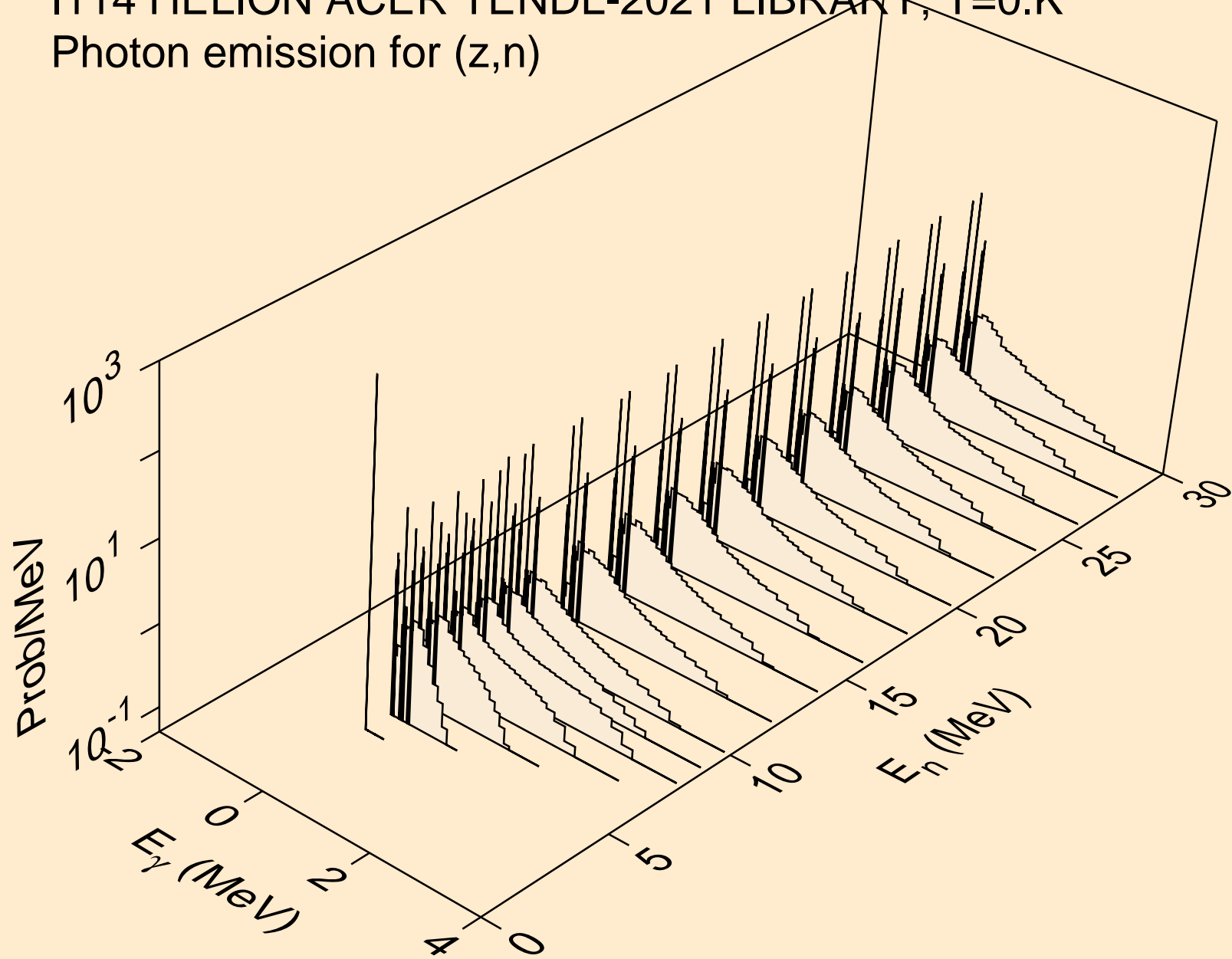

I114 HELION ACER TENDL-2021 LIBRARY; T=0.K  
Photon emission for (n,x)

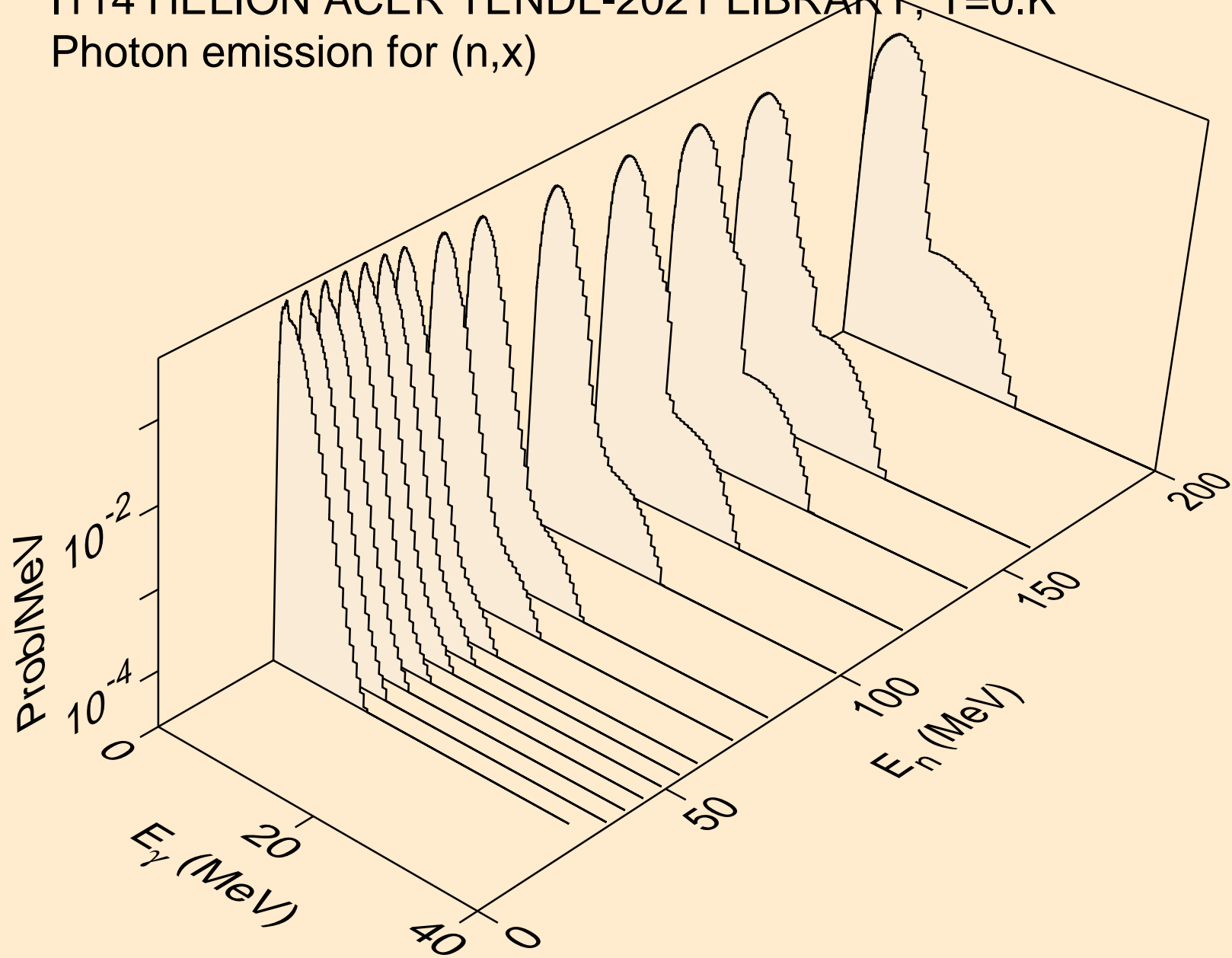

I114 HELION ACER TENDL-2021 LIBRARY; T=0.K  
Photon emission for (n,2n)

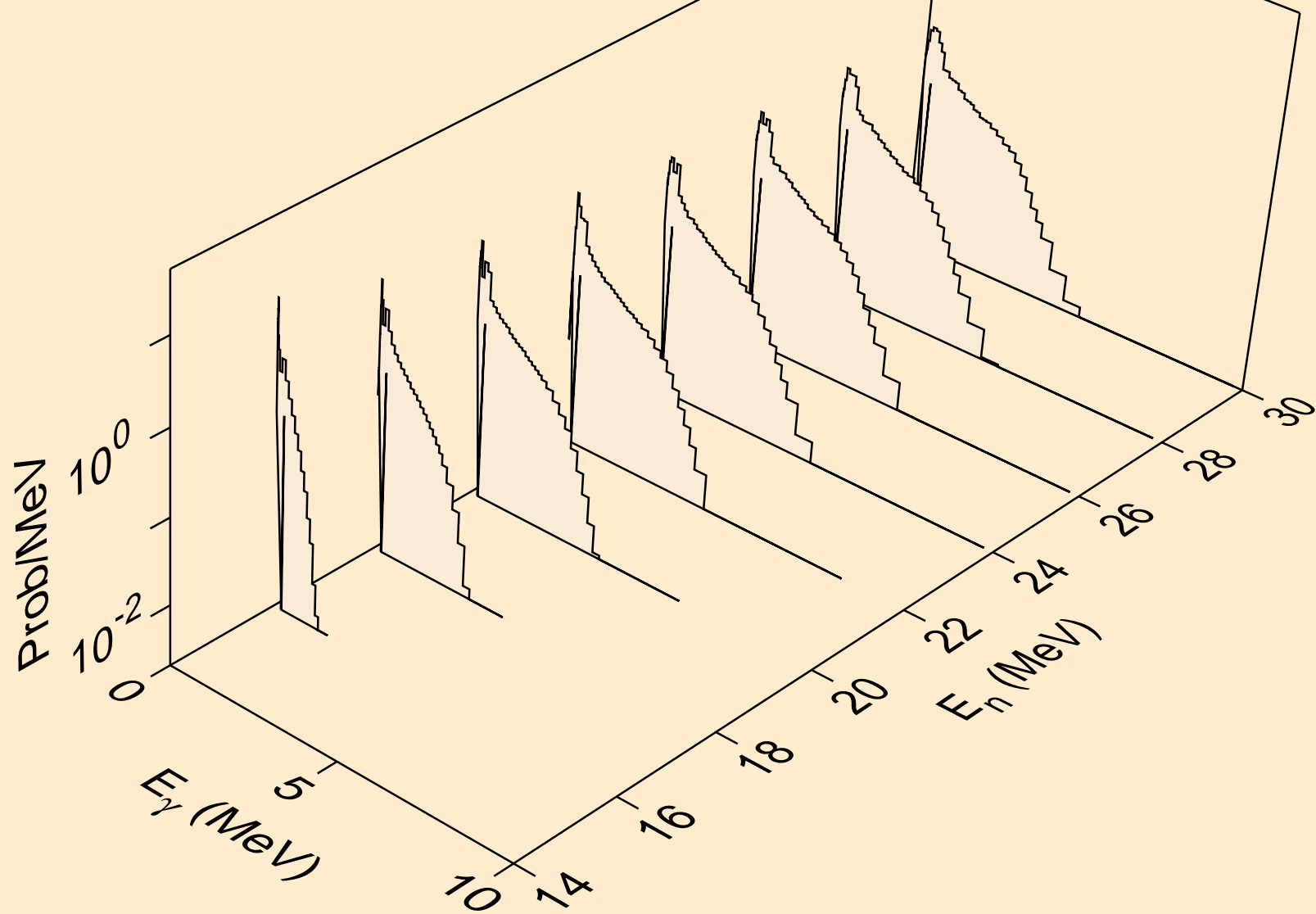

I114 HELION ACER TENDL-2021 LIBRARY; T=0.K  
Photon emission for (n,3n)

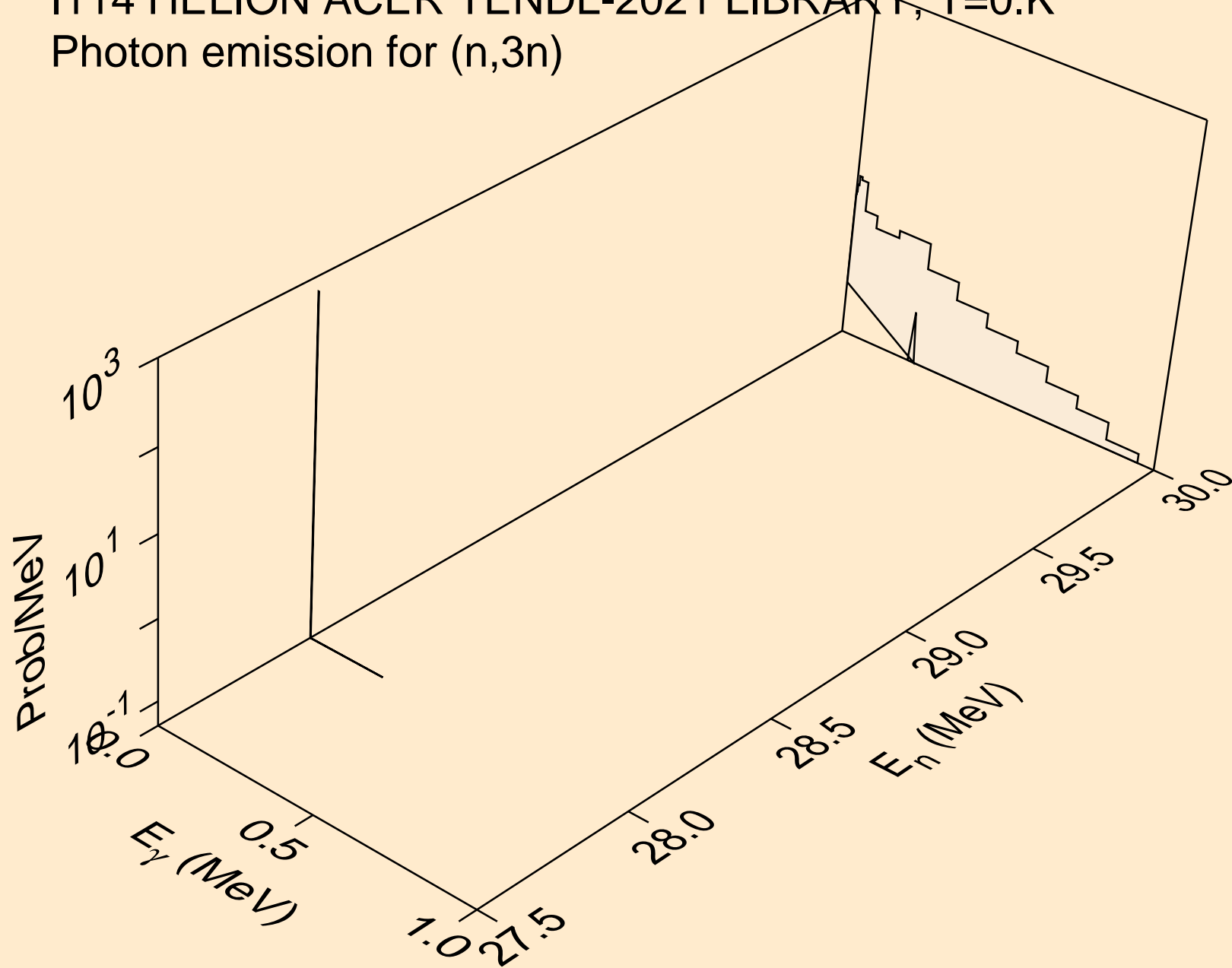

I114 HELION ACER TENDL-2021 LIBRARY; T=0.K  
Photon emission for (n,n\*)a

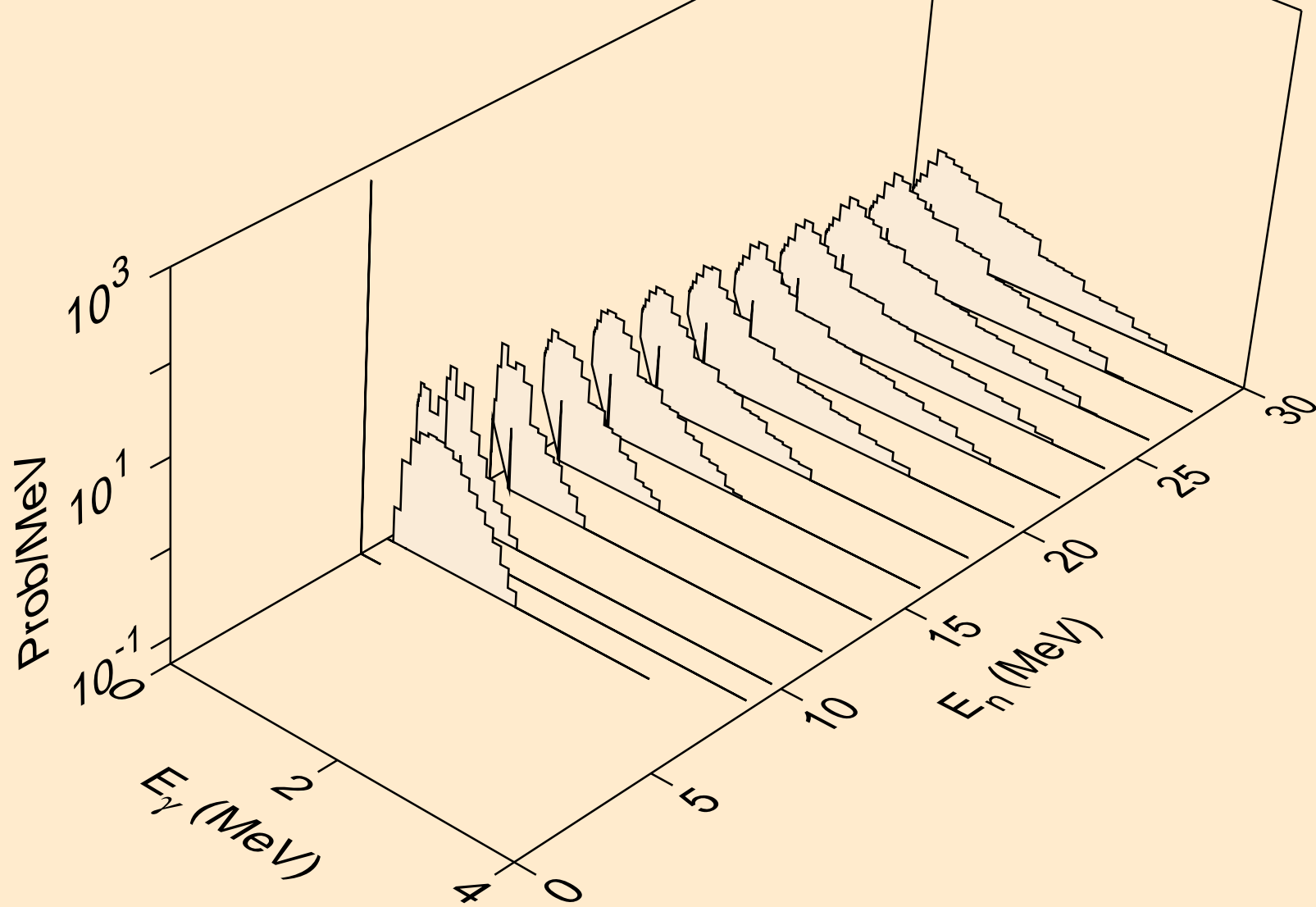

I114 HELION ACER TENDL-2021 LIBRARY; T=0.K  
Photon emission for (n,2n) $\alpha$

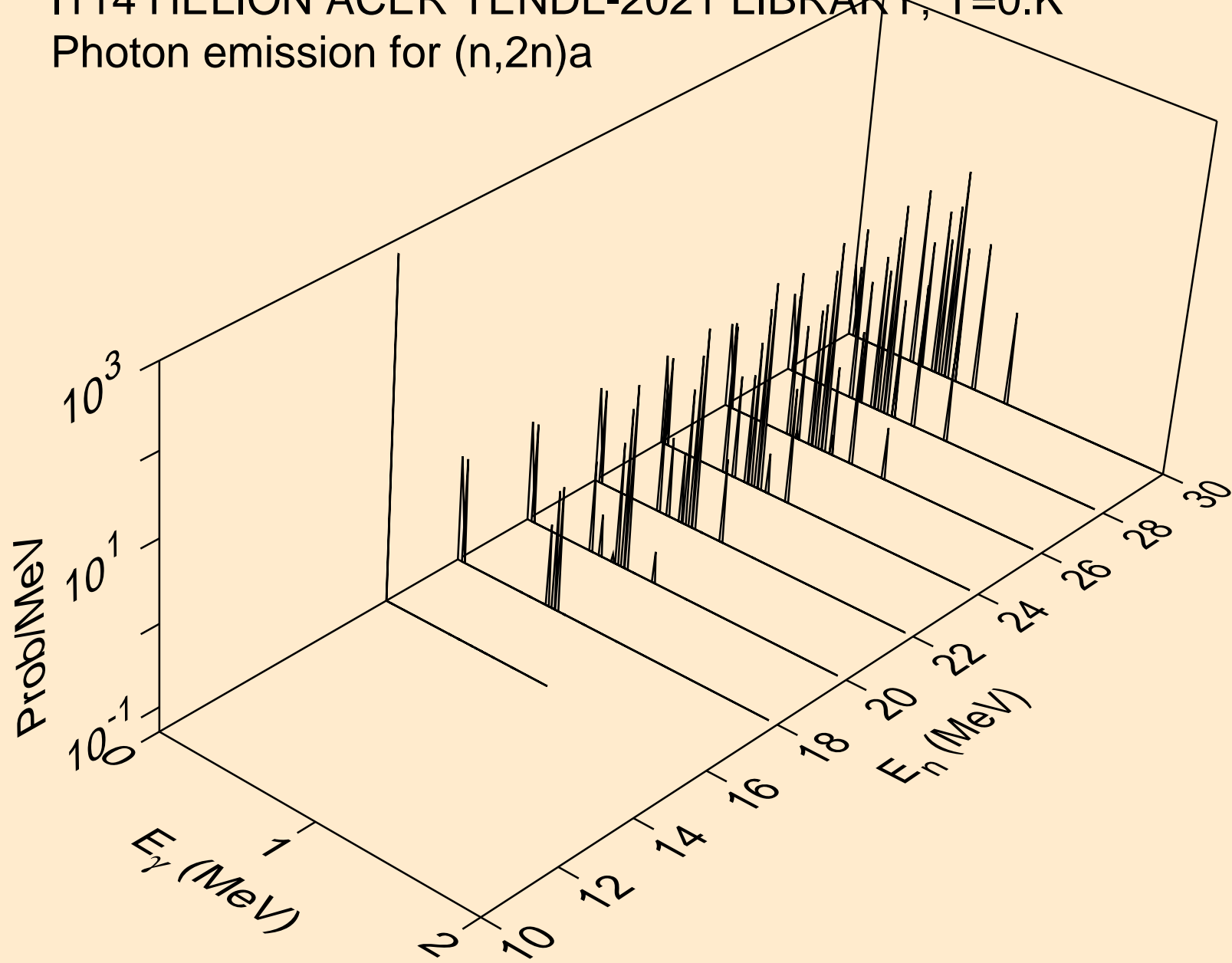

I114 HELION ACER TENDL-2021 LIBRARY; T=0.K  
Photon emission for (n,n\*)p

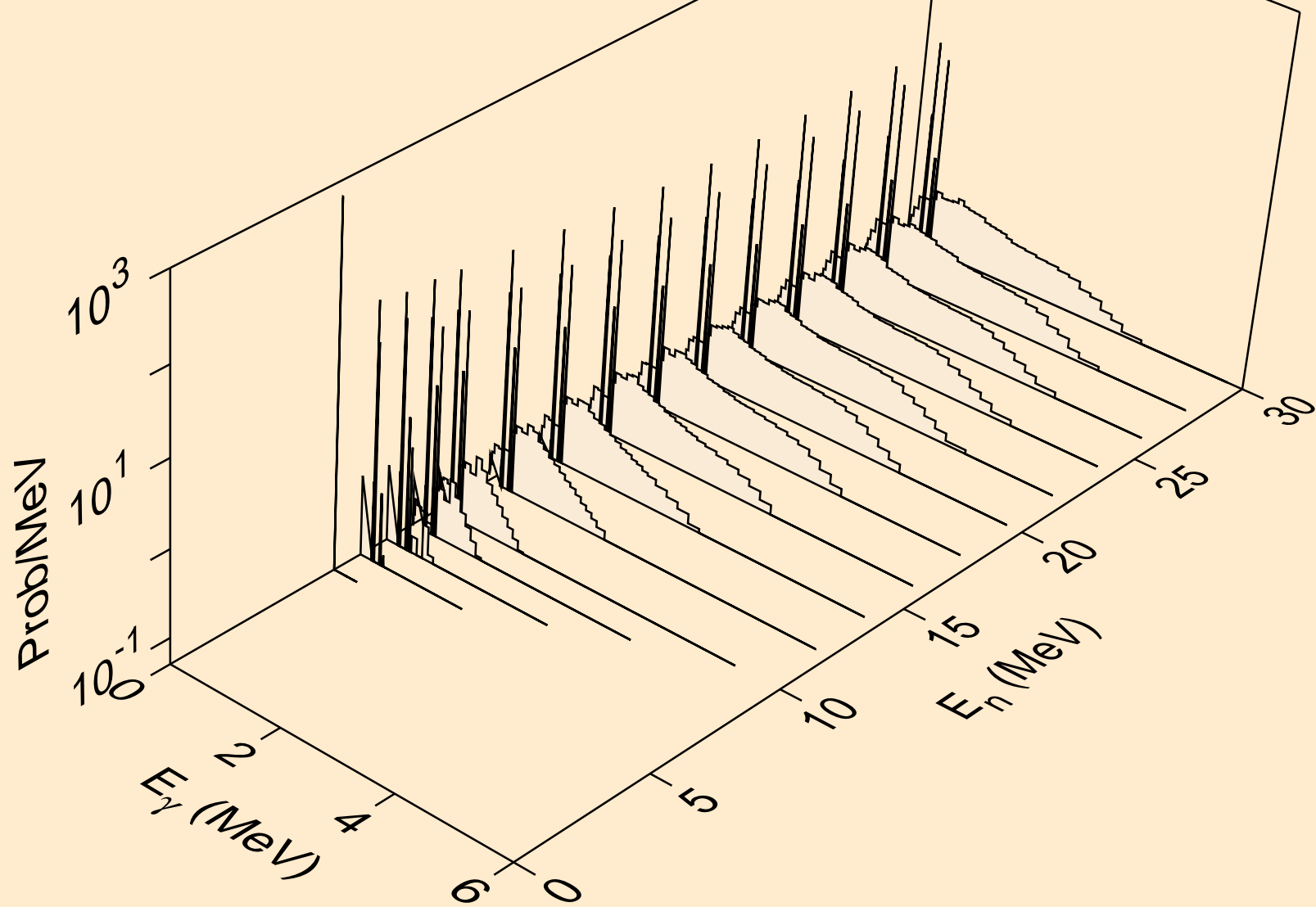



I114 HELION ACER TENDL-2021 LIBRARY; T=0.K  
Photon emission for (n,n\*)2a

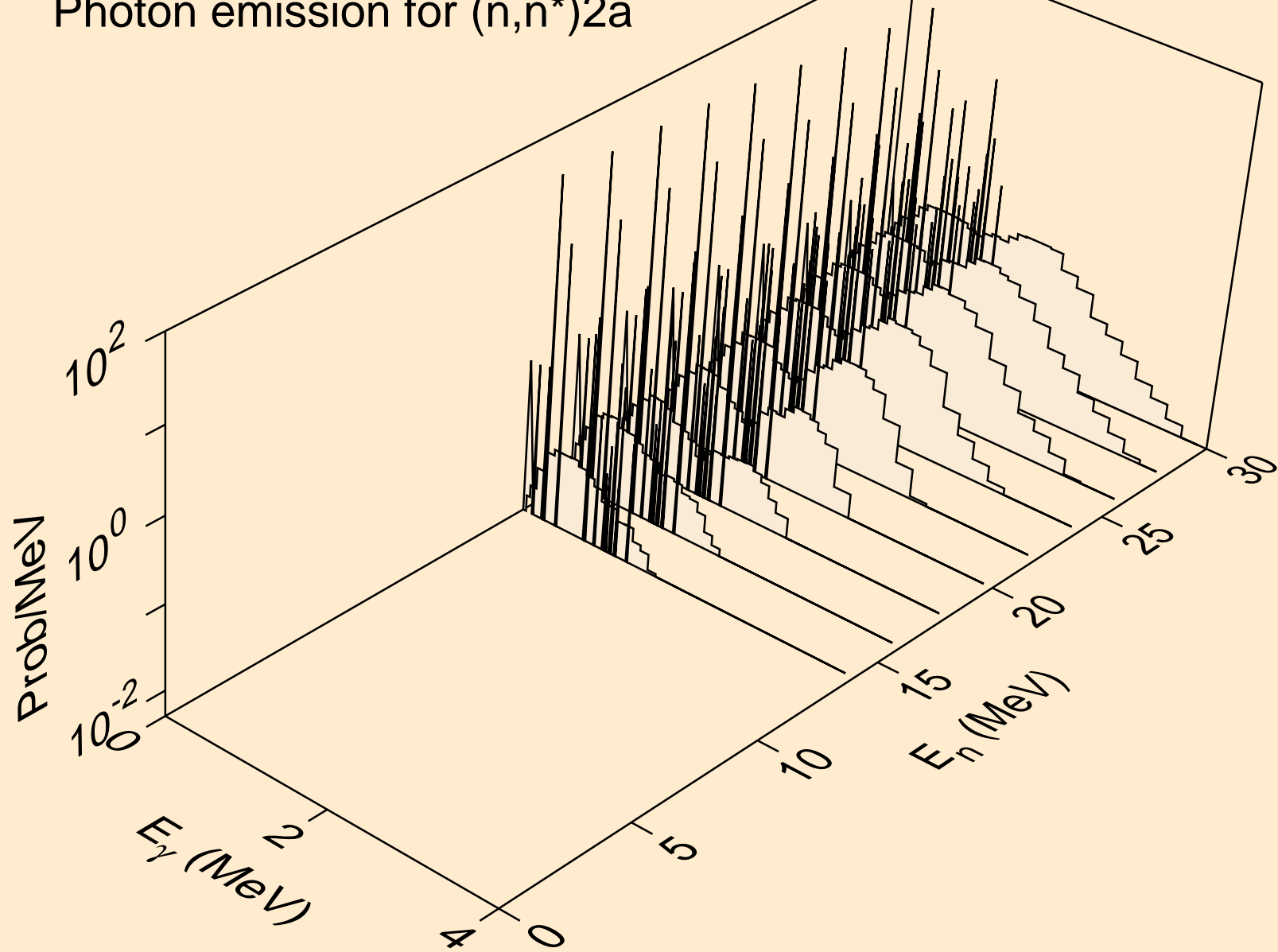

I114 HELION ACER TENDL-2021 LIBRARY; T=0.K  
Photon emission for (n,n\*)d

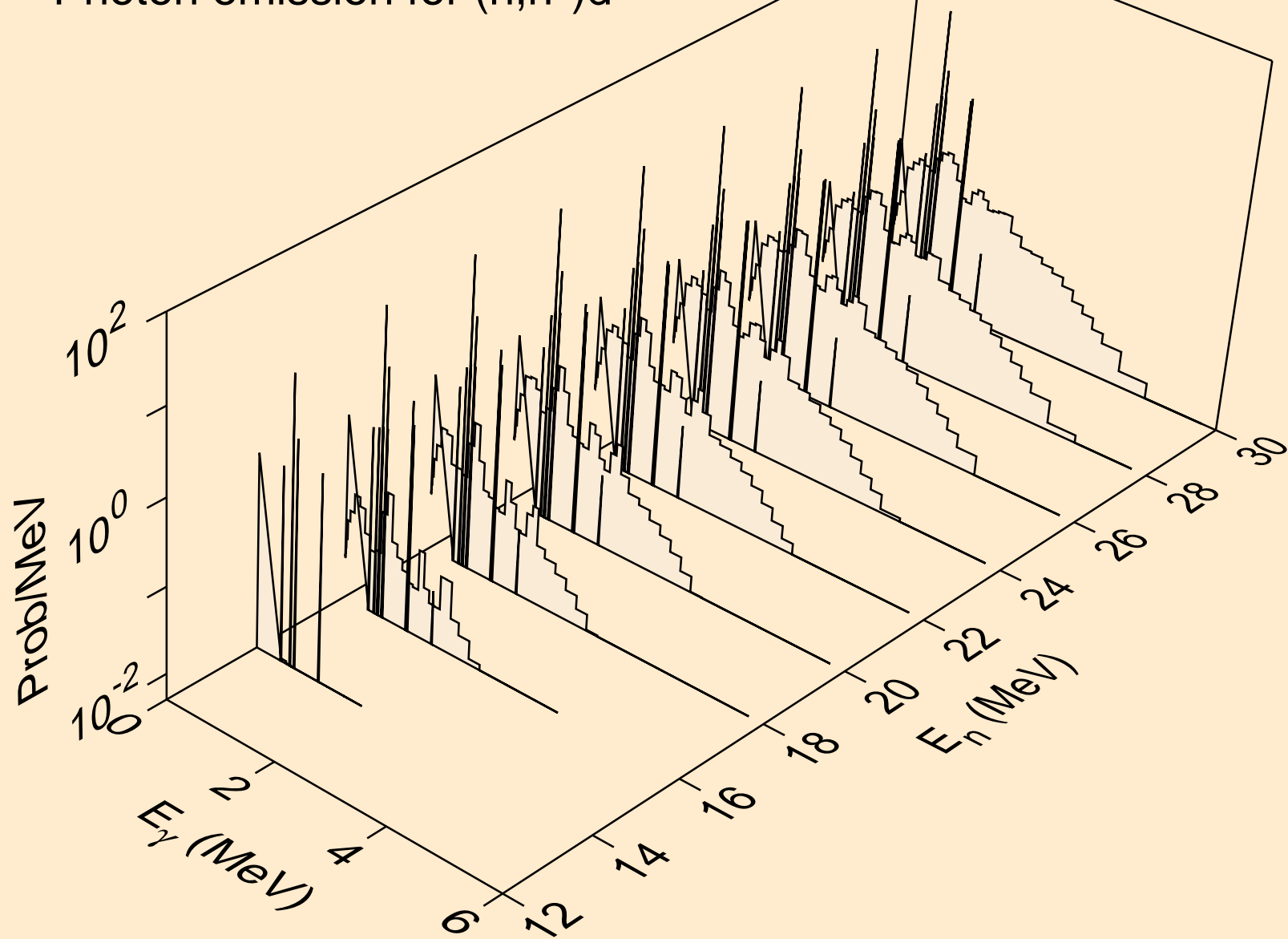

I114 HELION ACER TENDL-2021 LIBRARY; T=0.K  
Photon emission for (n,n\*)t

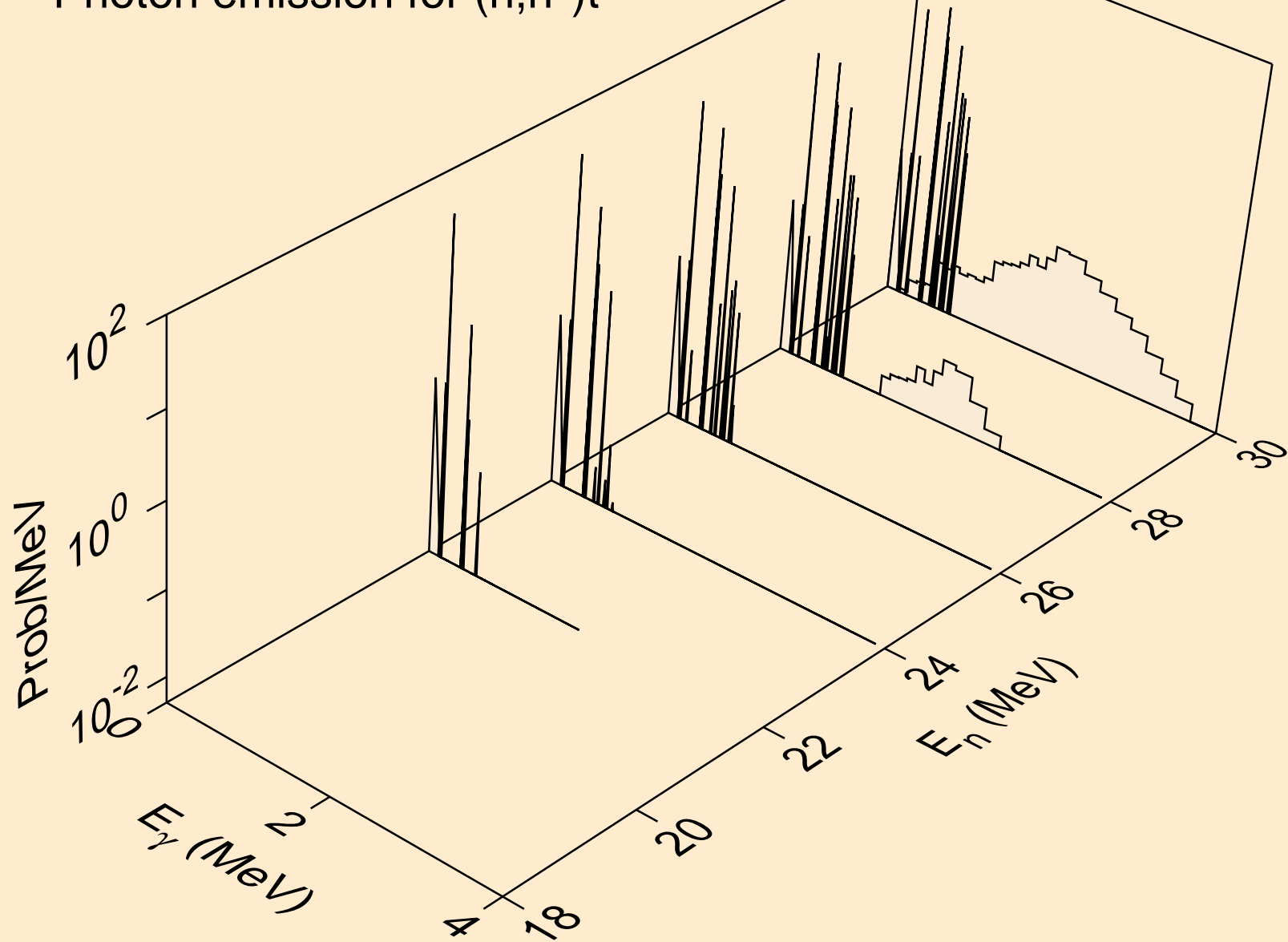

I114 HELION ACER TENDL-2021 LIBRARY; T=0.K  
Photon emission for (n,n\*)he3

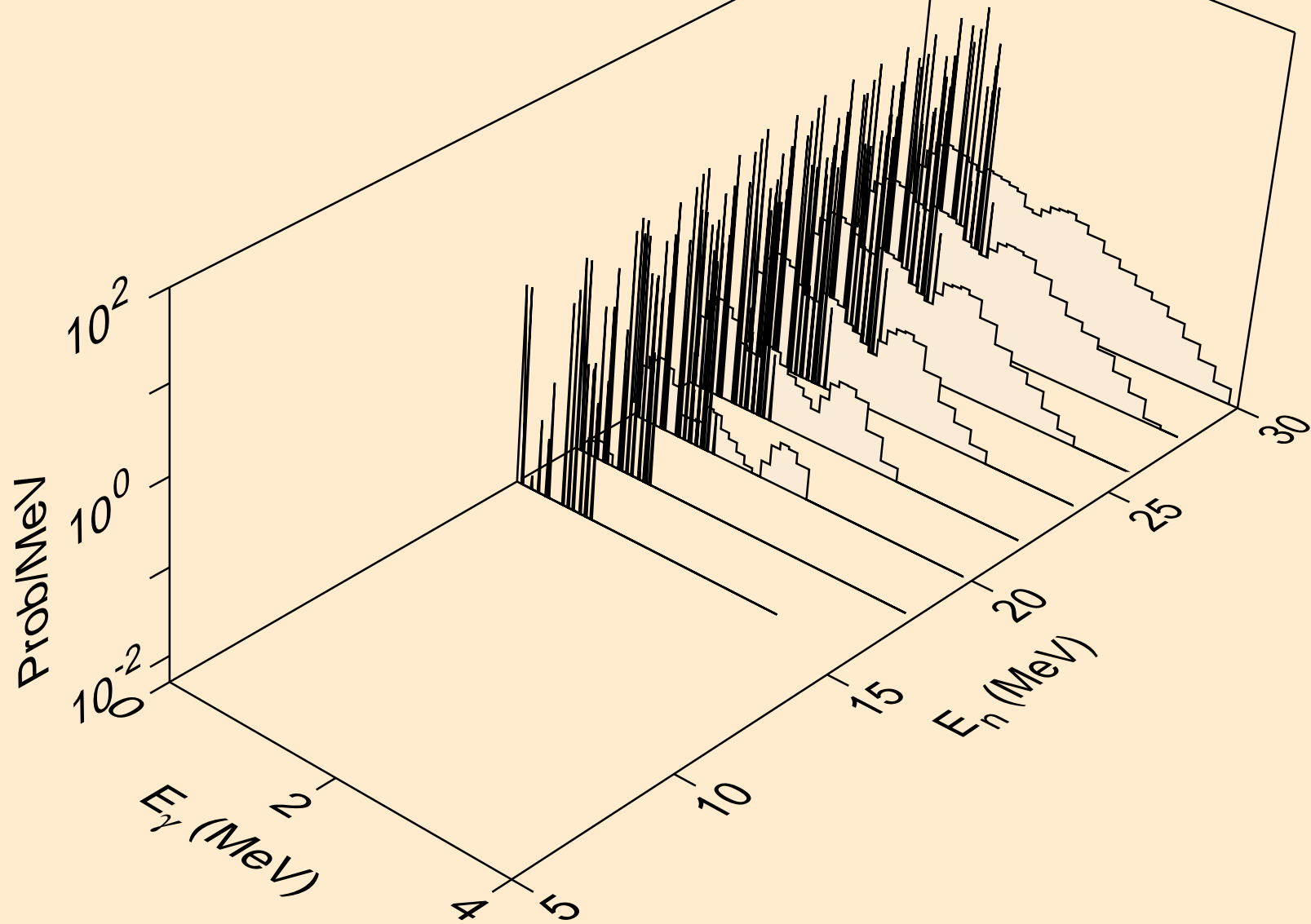

I114 HELION ACER TENDL-2021 LIBRARY; T=0.K  
Photon emission for (n,2np)

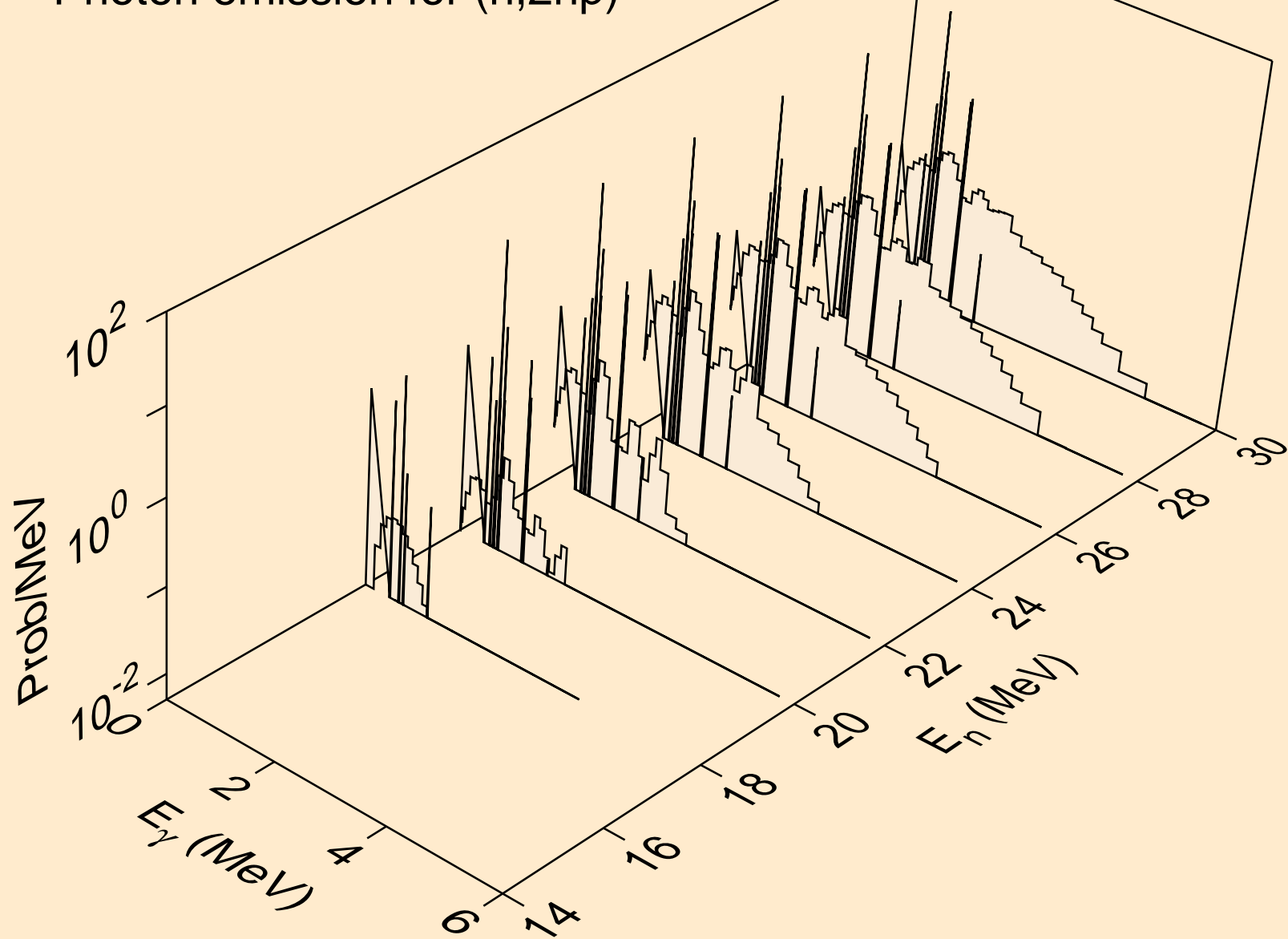

I114 HELION ACER TENDL-2021 LIBRARY; T=0.K  
Photon emission for (n,2np)

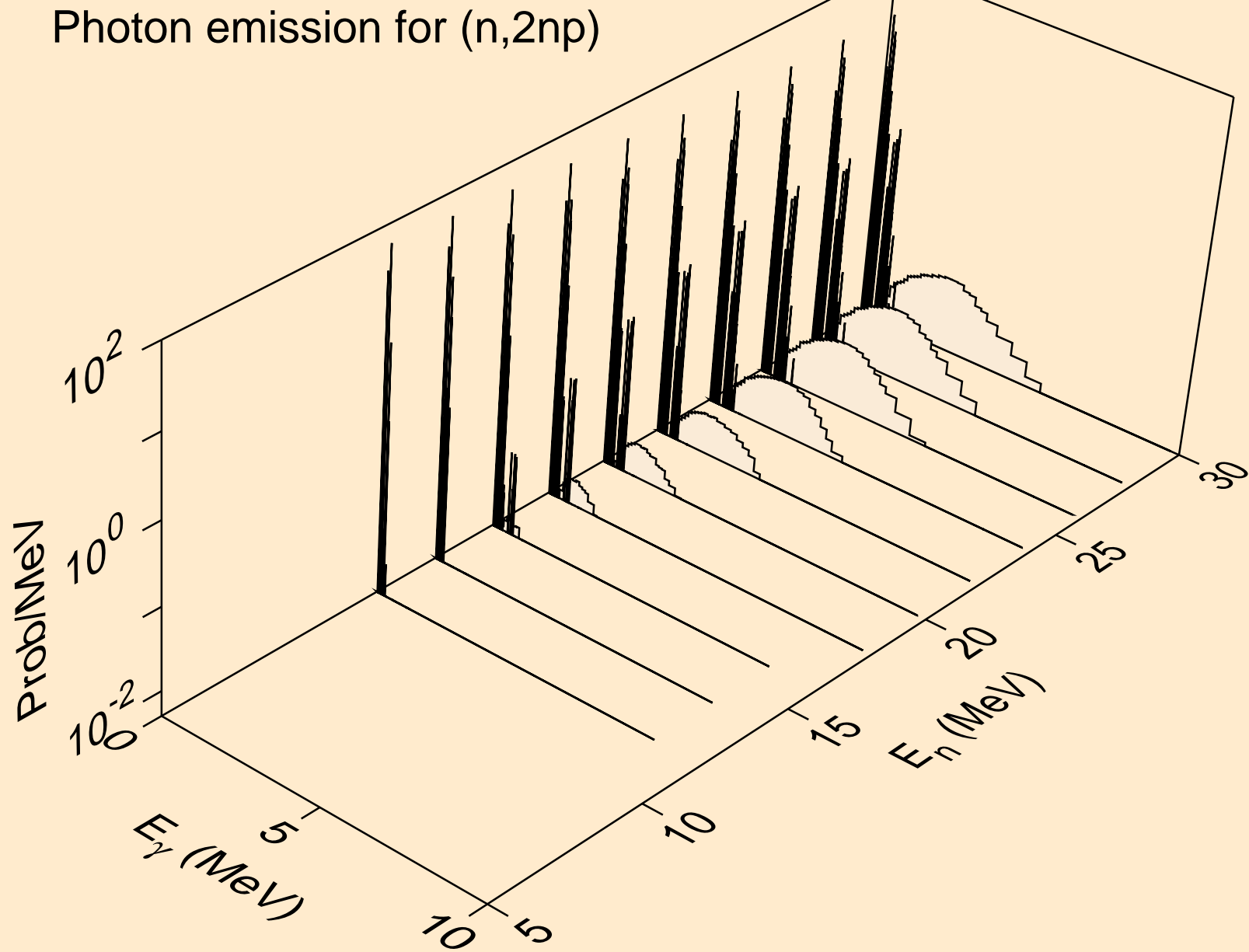

I114 HELION ACER TENDL-2021 LIBRARY; T=0.K  
Photon emission for (n,npa)

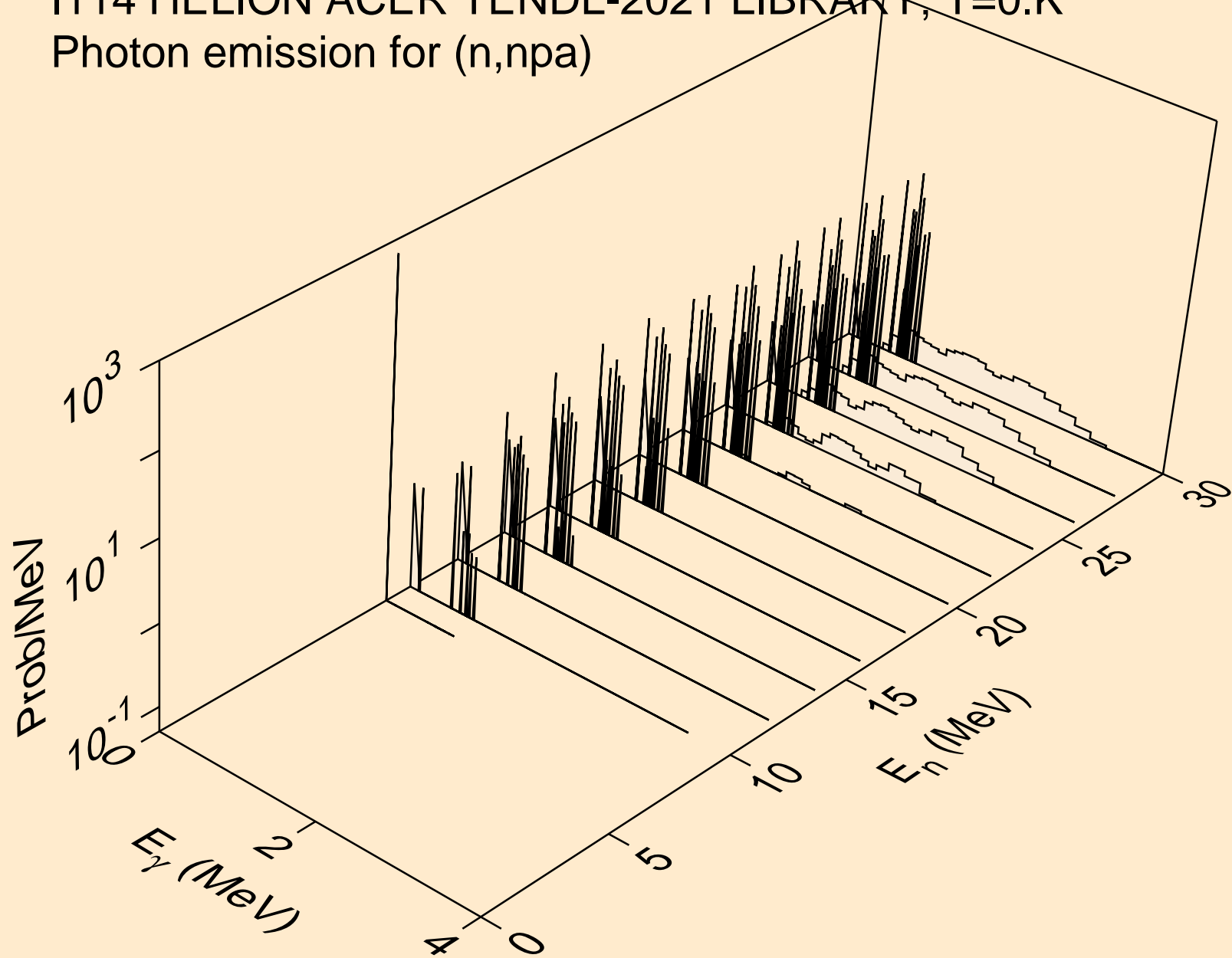

I114 HELION ACER TENDL-2021 LIBRARY; T=0.K  
Photon emission for (n,gma)

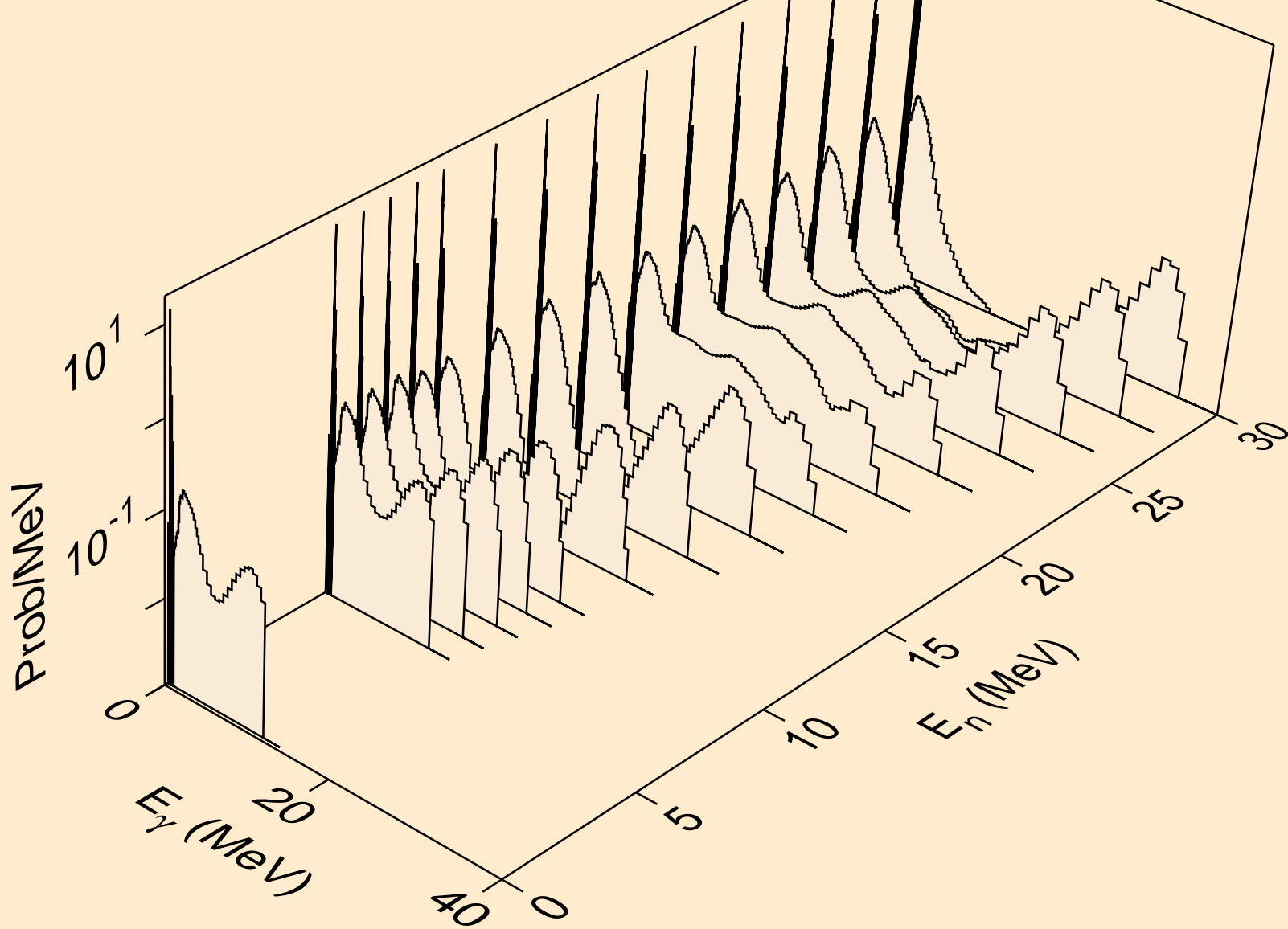



I114 HELION ACER TENDL-2021 LIBRARY; T=0.K  
Photon emission for (n,p)

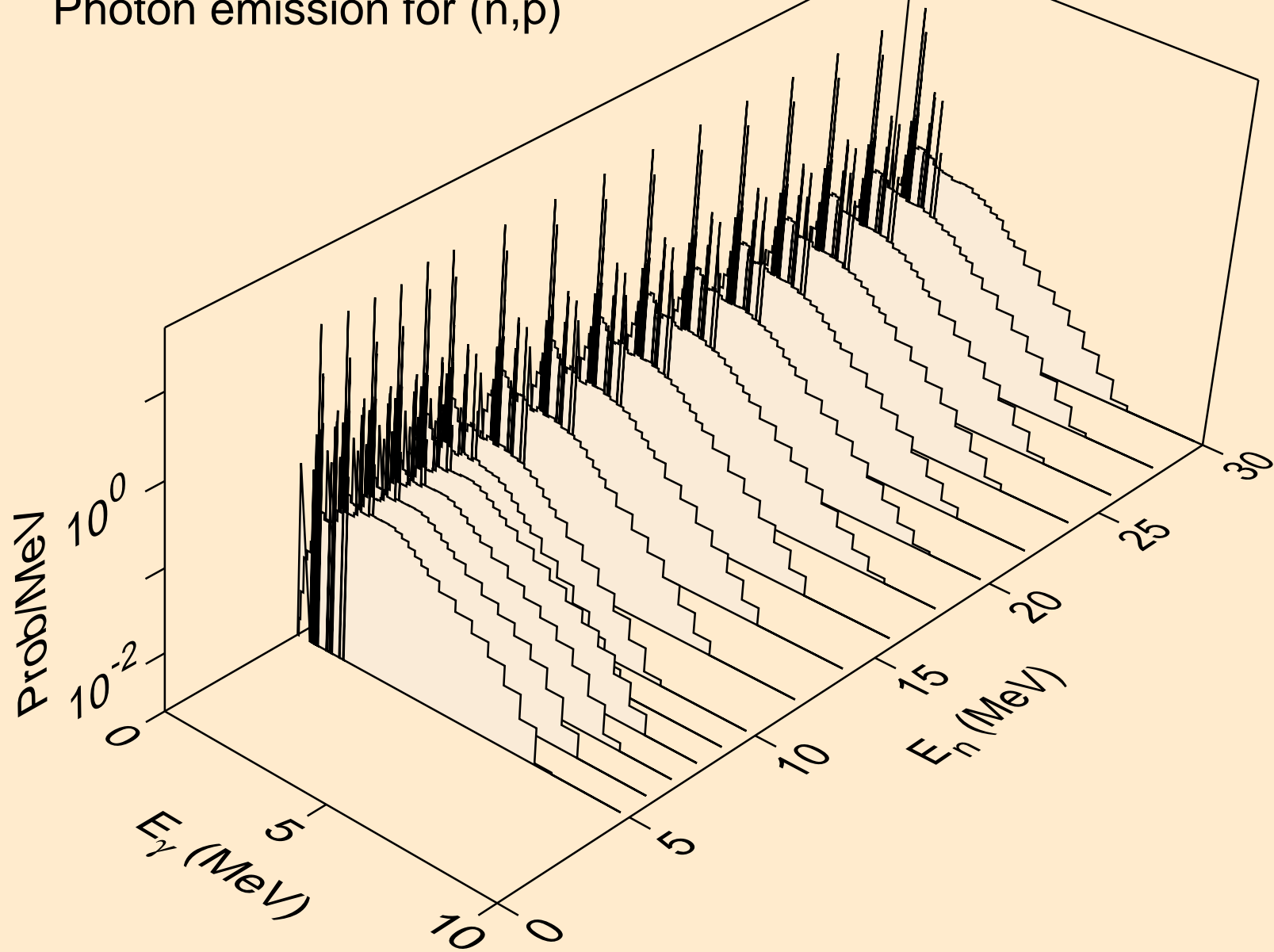

I114 HELION ACER TENDL-2021 LIBRARY; T=0.K  
Photon emission for (n,d)

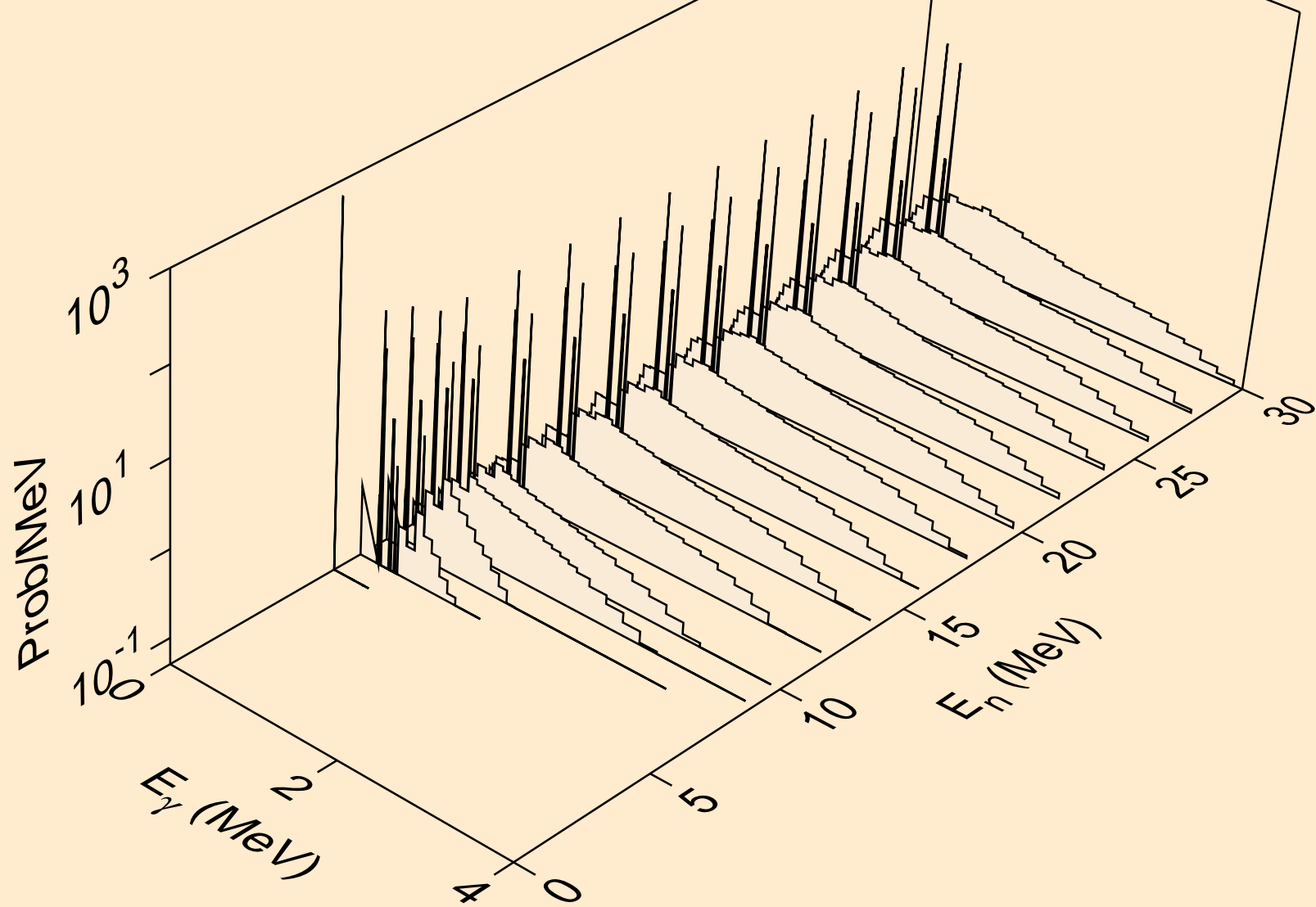

I114 HELION ACER TENDL-2021 LIBRARY; T=0.K  
Photon emission for (n,t)

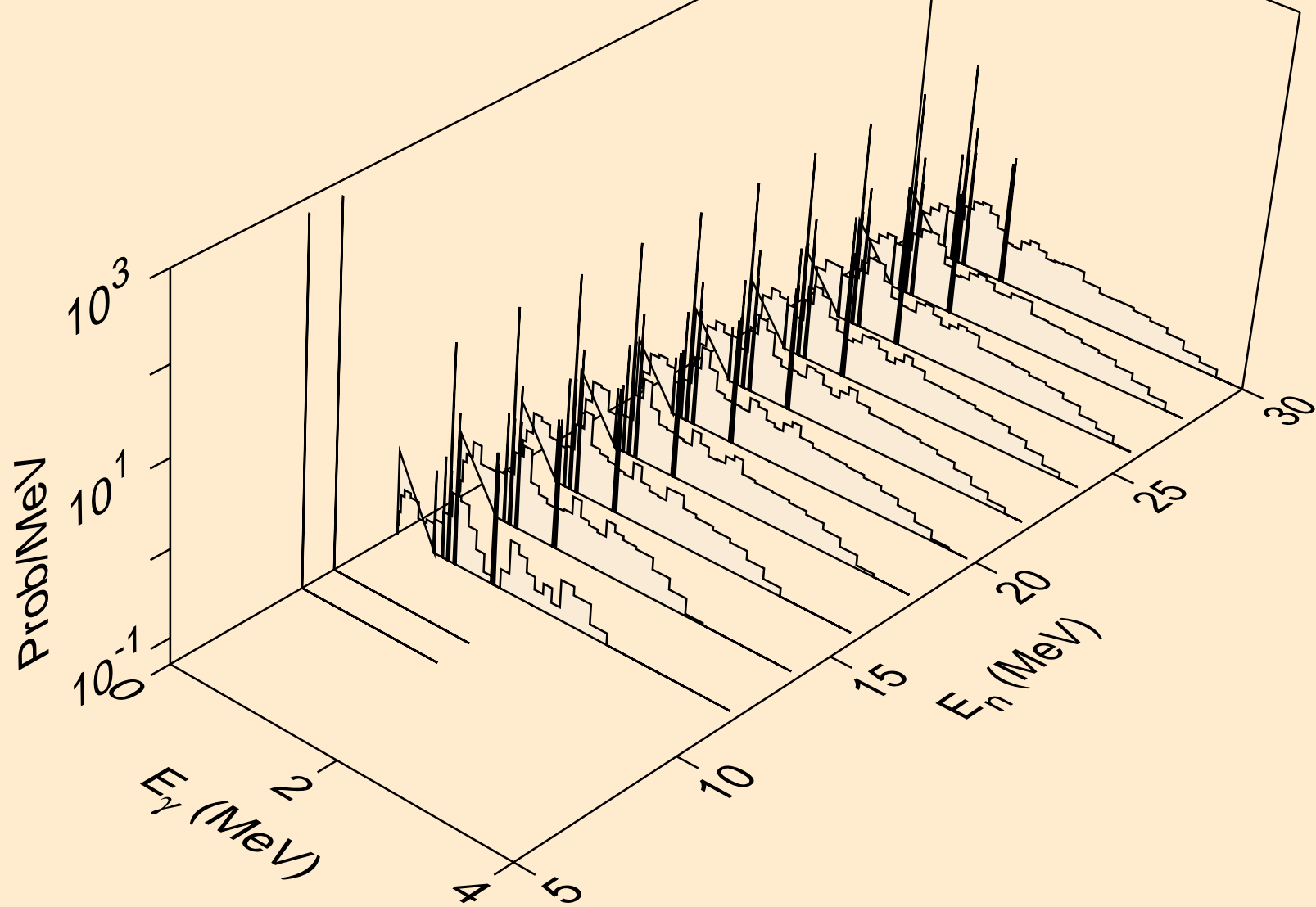

I114 HELION ACER TENDL-2021 LIBRARY; T=0.K  
Photon emission for inelastic

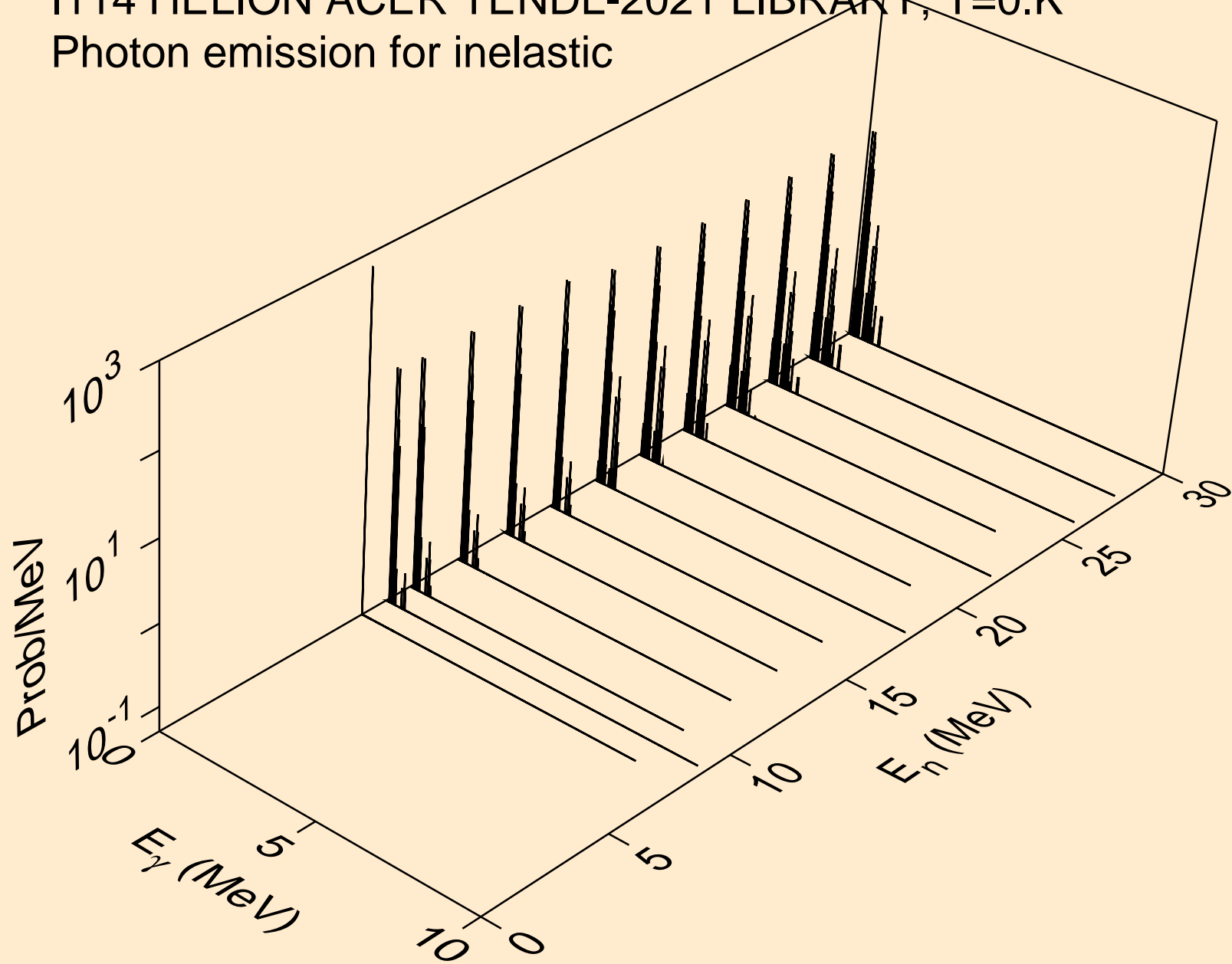

I114 HELION ACER TENDL-2021 LIBRARY; T=0.K  
Photon emission for (n,a)

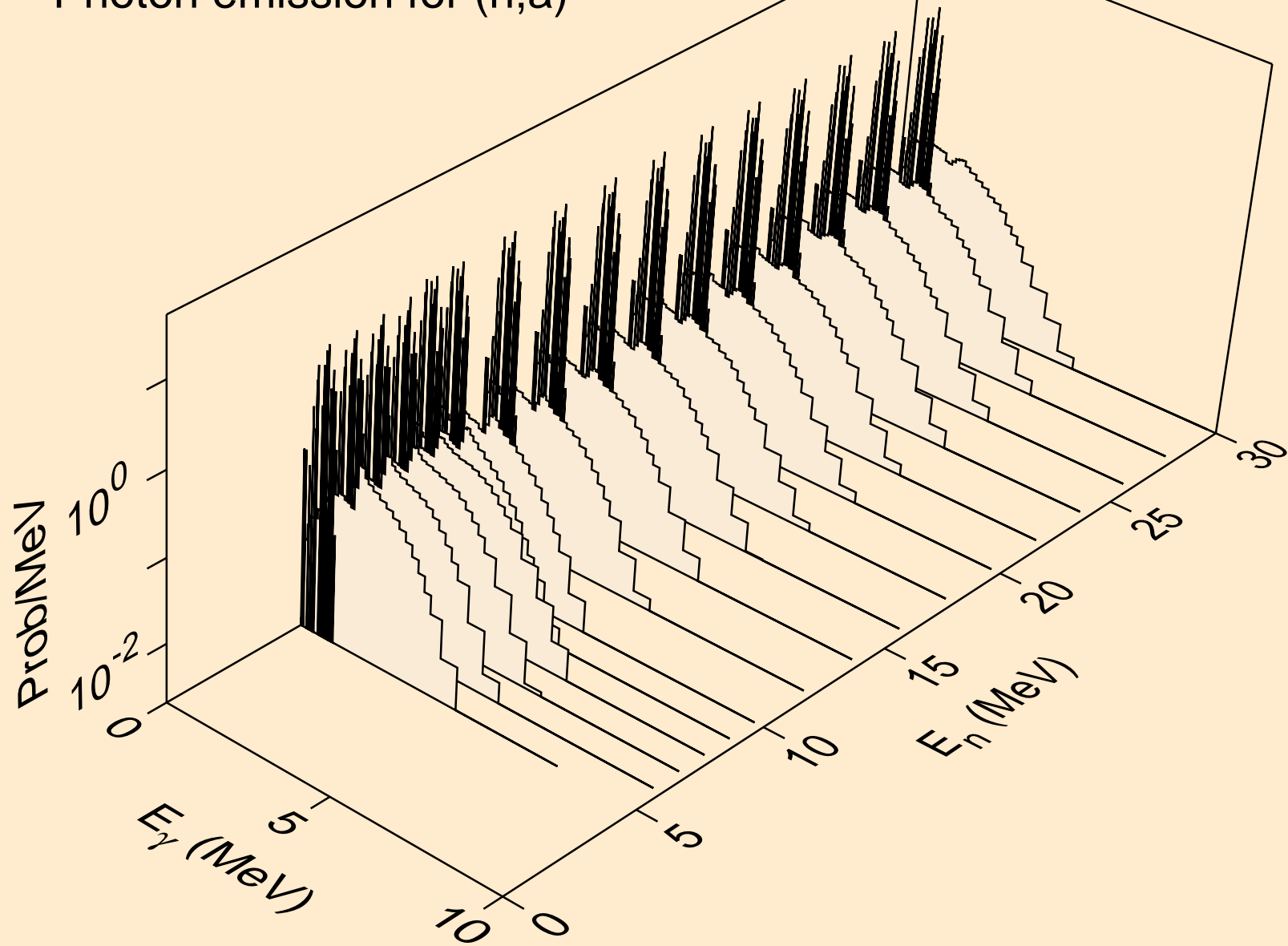

I114 HELION ACER TENDL-2021 LIBRARY; T=0.K  
Photon emission for (n,2a)

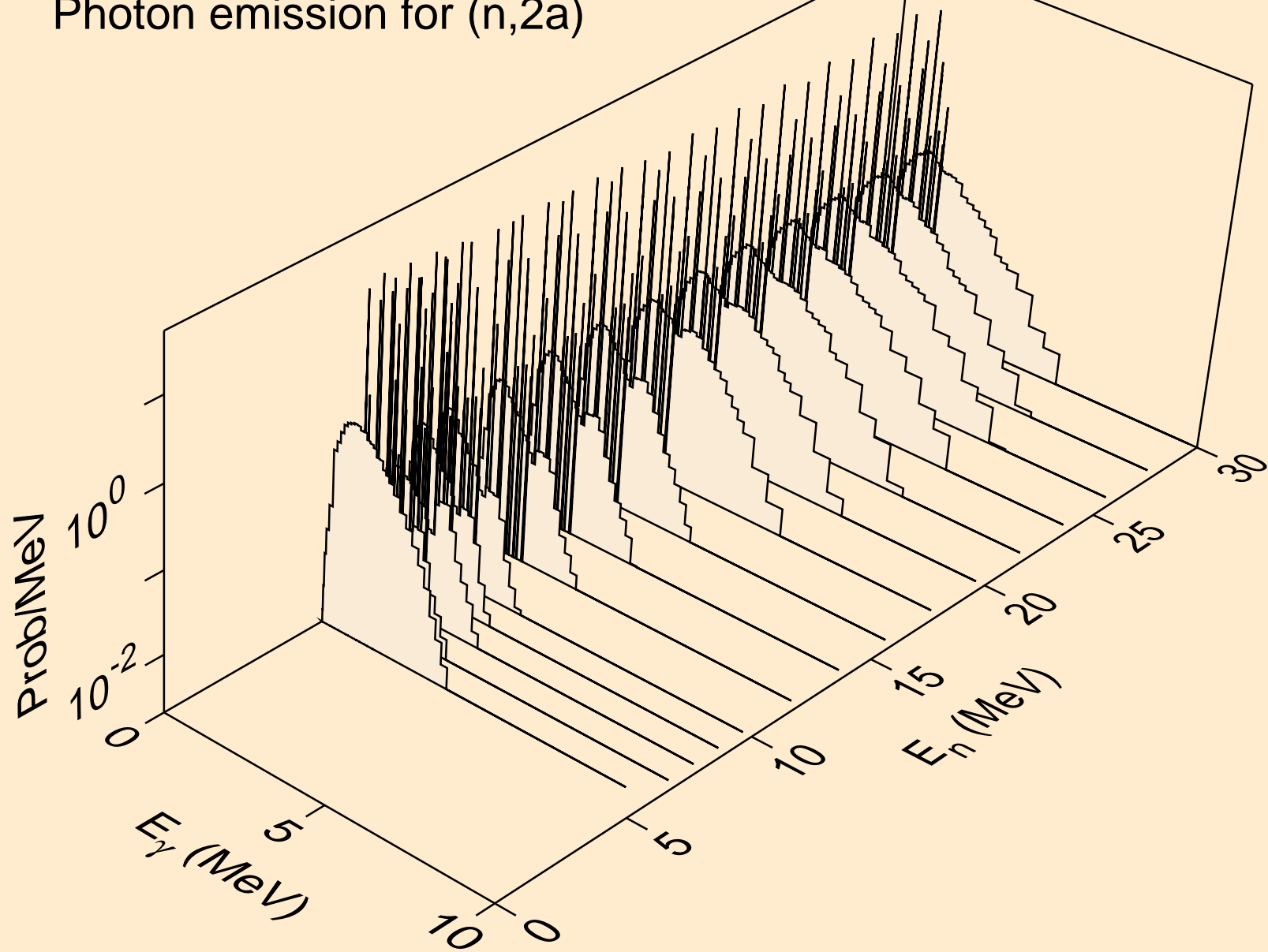

I114 HELION ACER TENDL-2021 LIBRARY; T=0.K  
Photon emission for (n,3a)

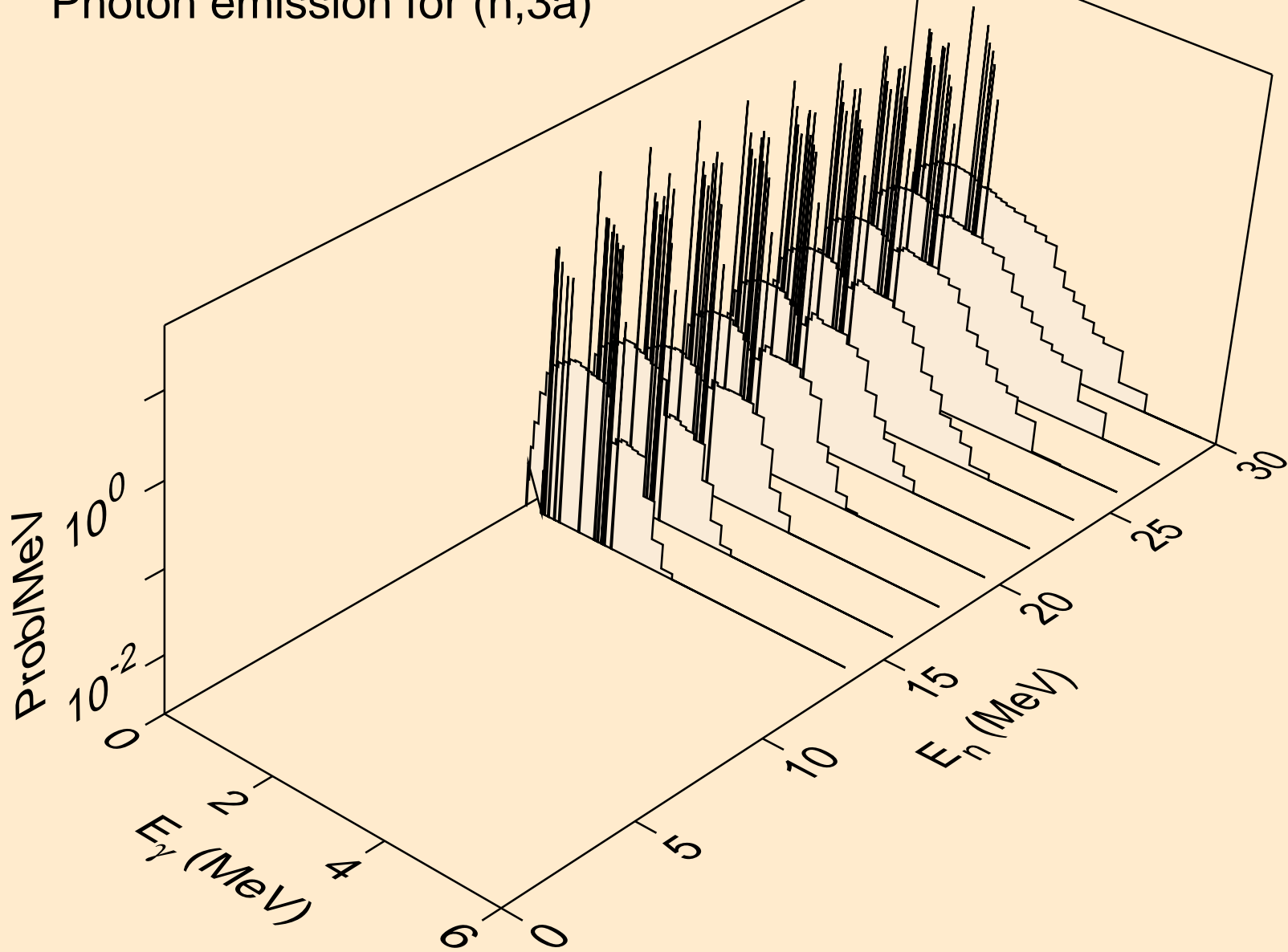

I114 HELION ACER TENDL-2021 LIBRARY; T=0.K  
Photon emission for (n,2p)

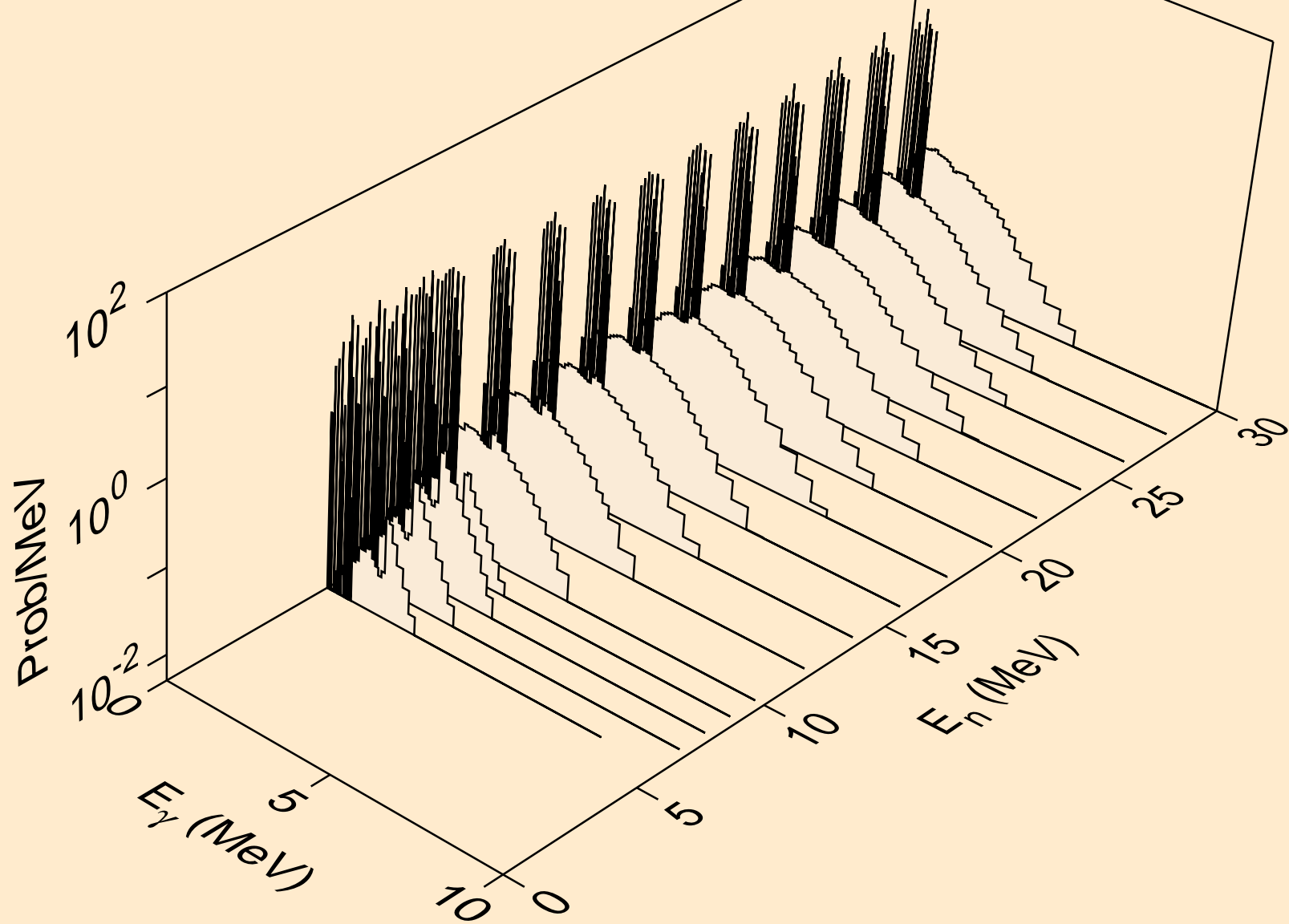



I114 HELION ACER TENDL-2021 LIBRARY; T=0.K  
Photon emission for (n,pa)

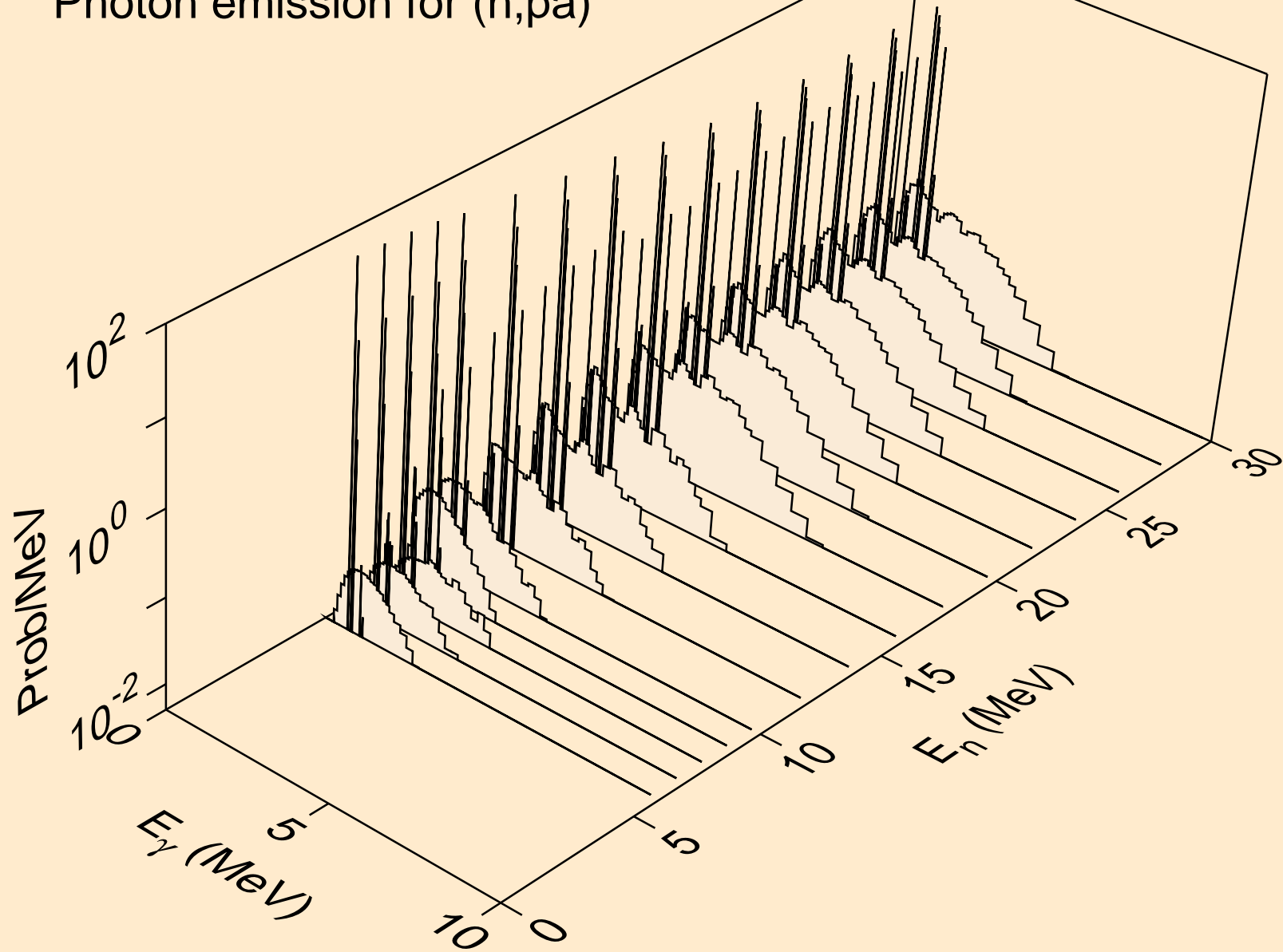

I114 HELION ACER TENDL-2021 LIBRARY; T=0.K  
Photon emission for (n,t2a)

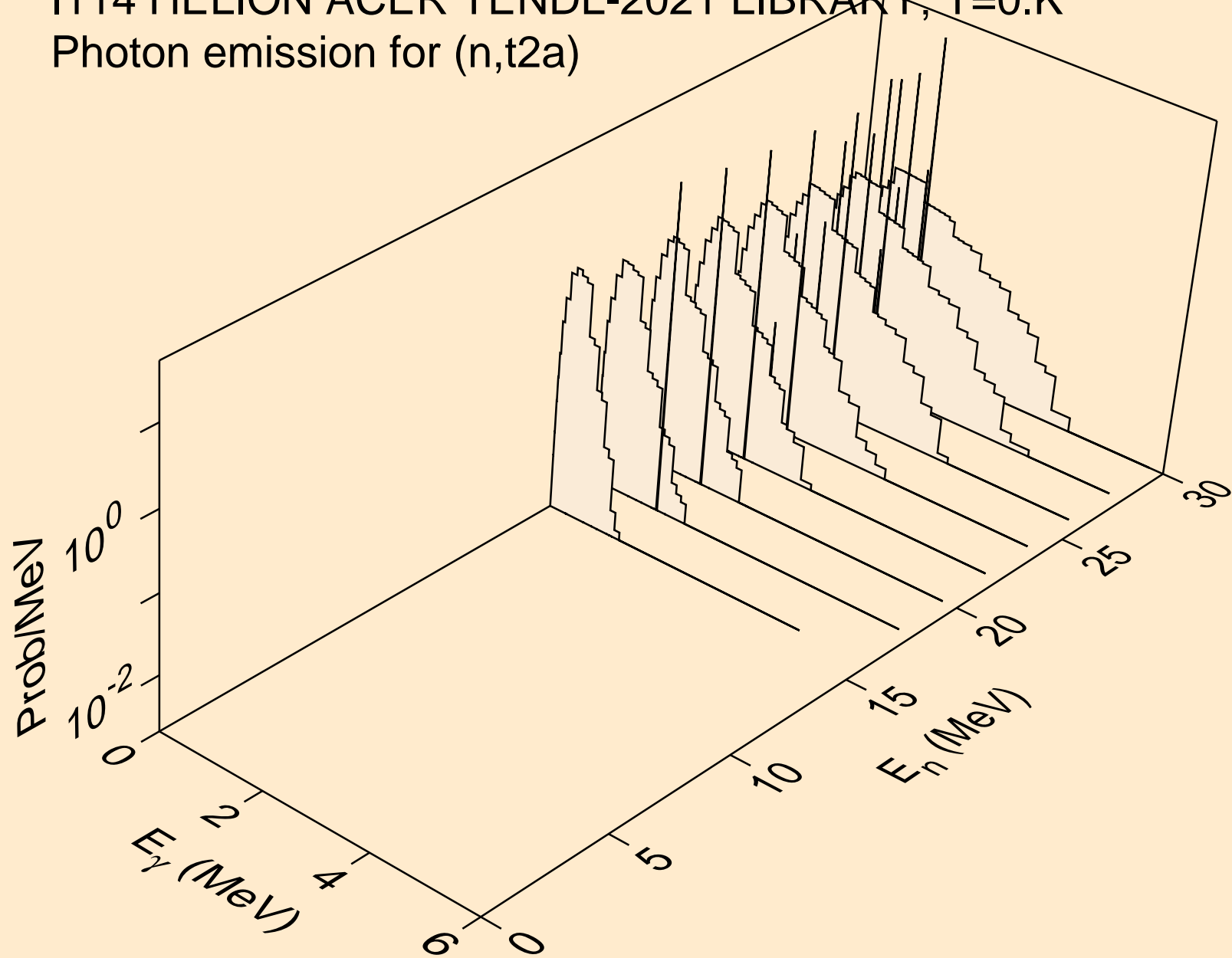

I114 HELION ACER TENDL-2021 LIBRARY; T=0.K  
Photon emission for (n,d2a)

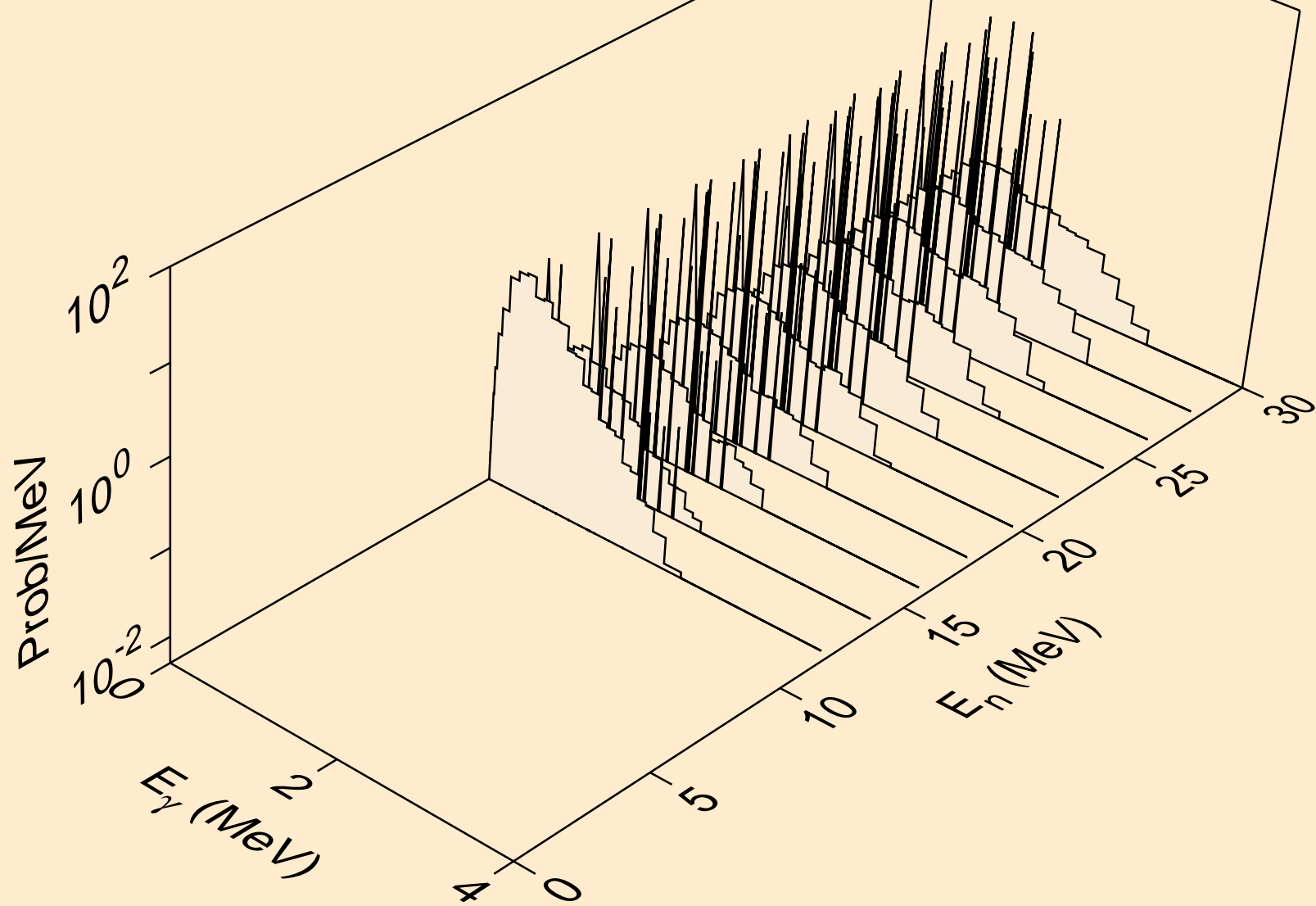

I114 HELION ACER TENDL-2021 LIBRARY; T=0.K  
Photon emission for (n,pd)

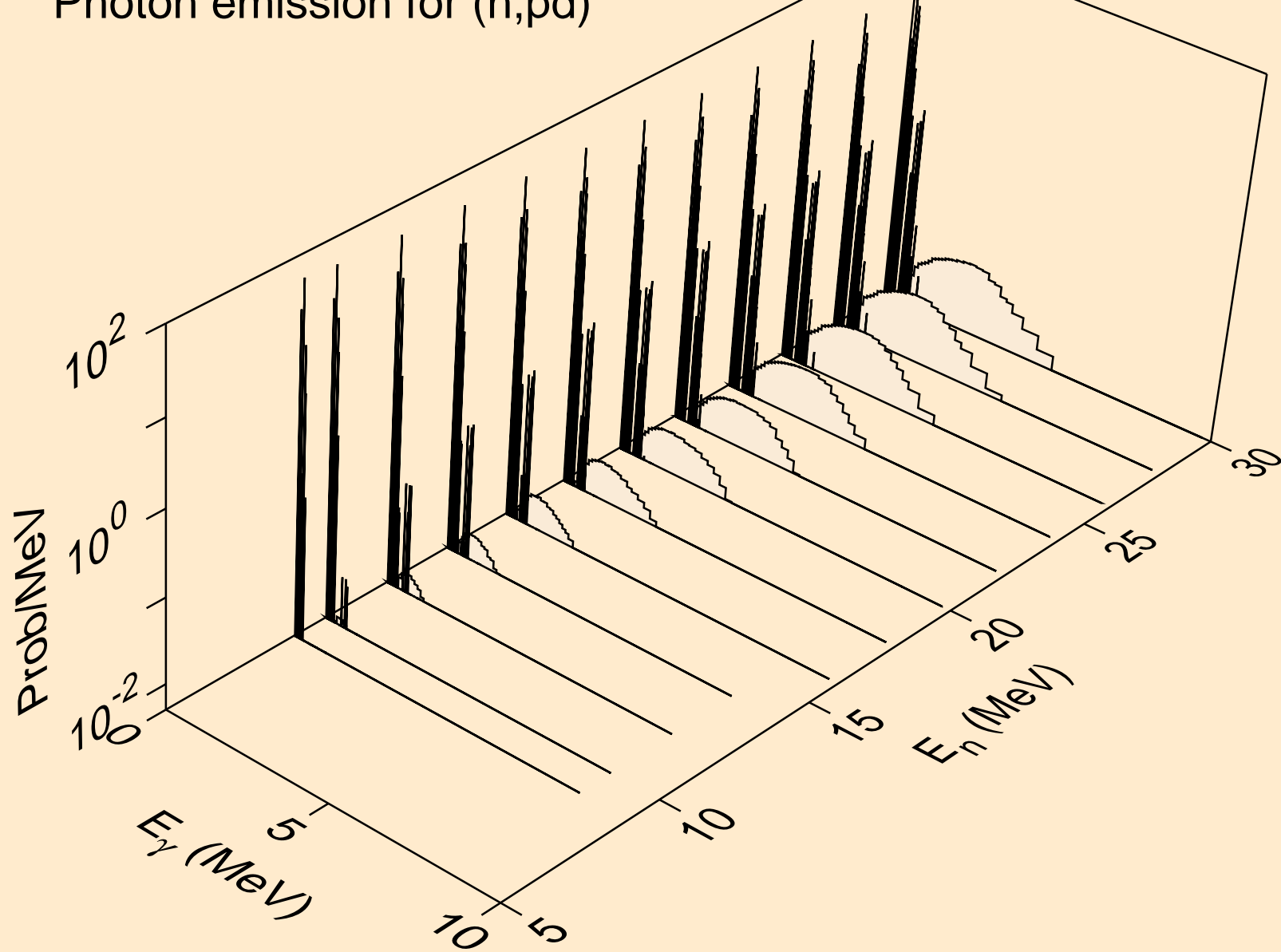

I114 HELION ACER TENDL-2021 LIBRARY; T=0.K  
Photon emission for (n,pt)

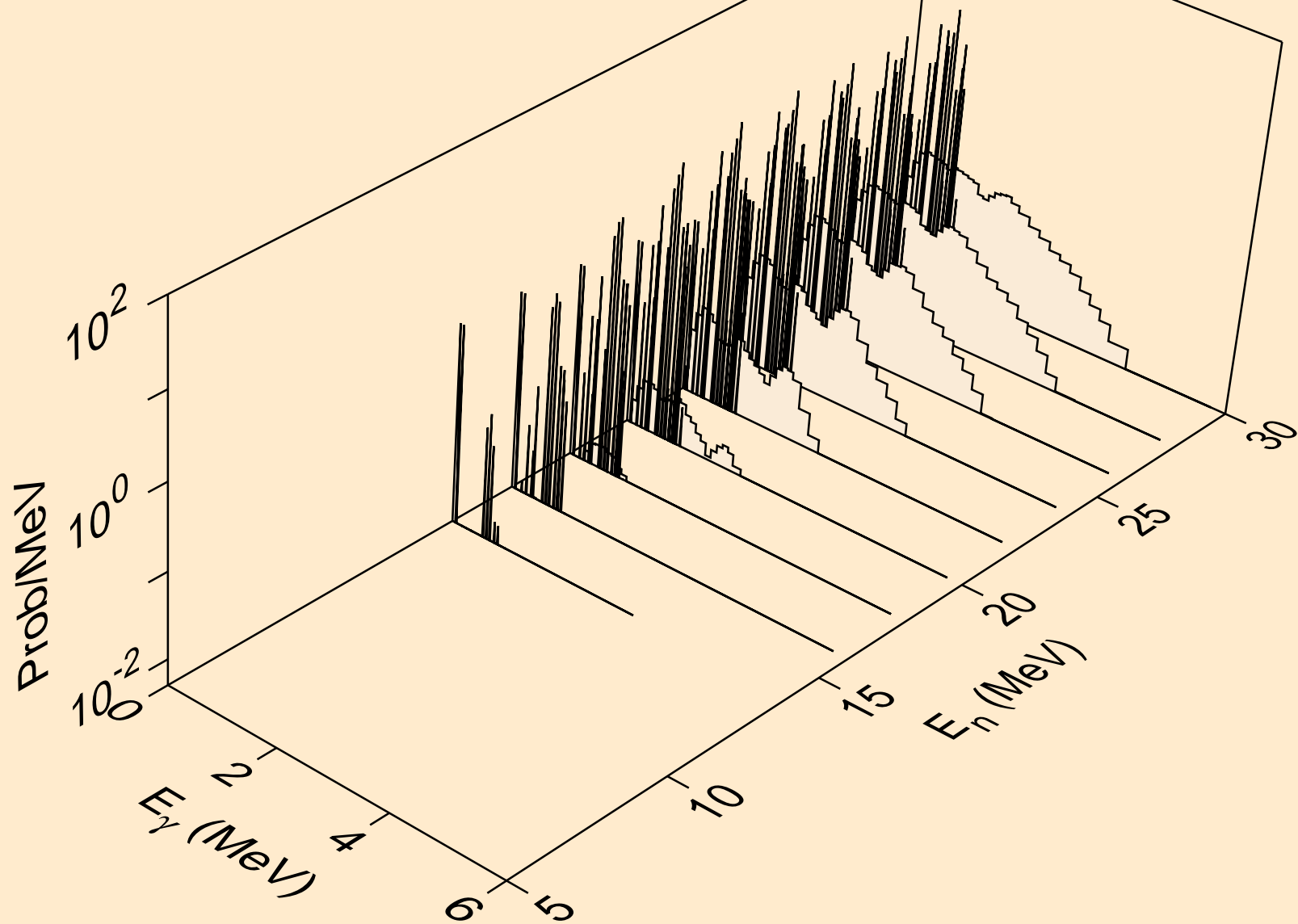

I114 HELION ACER TENDL-2021 LIBRARY; T=0.K  
Photon emission for (n,da)

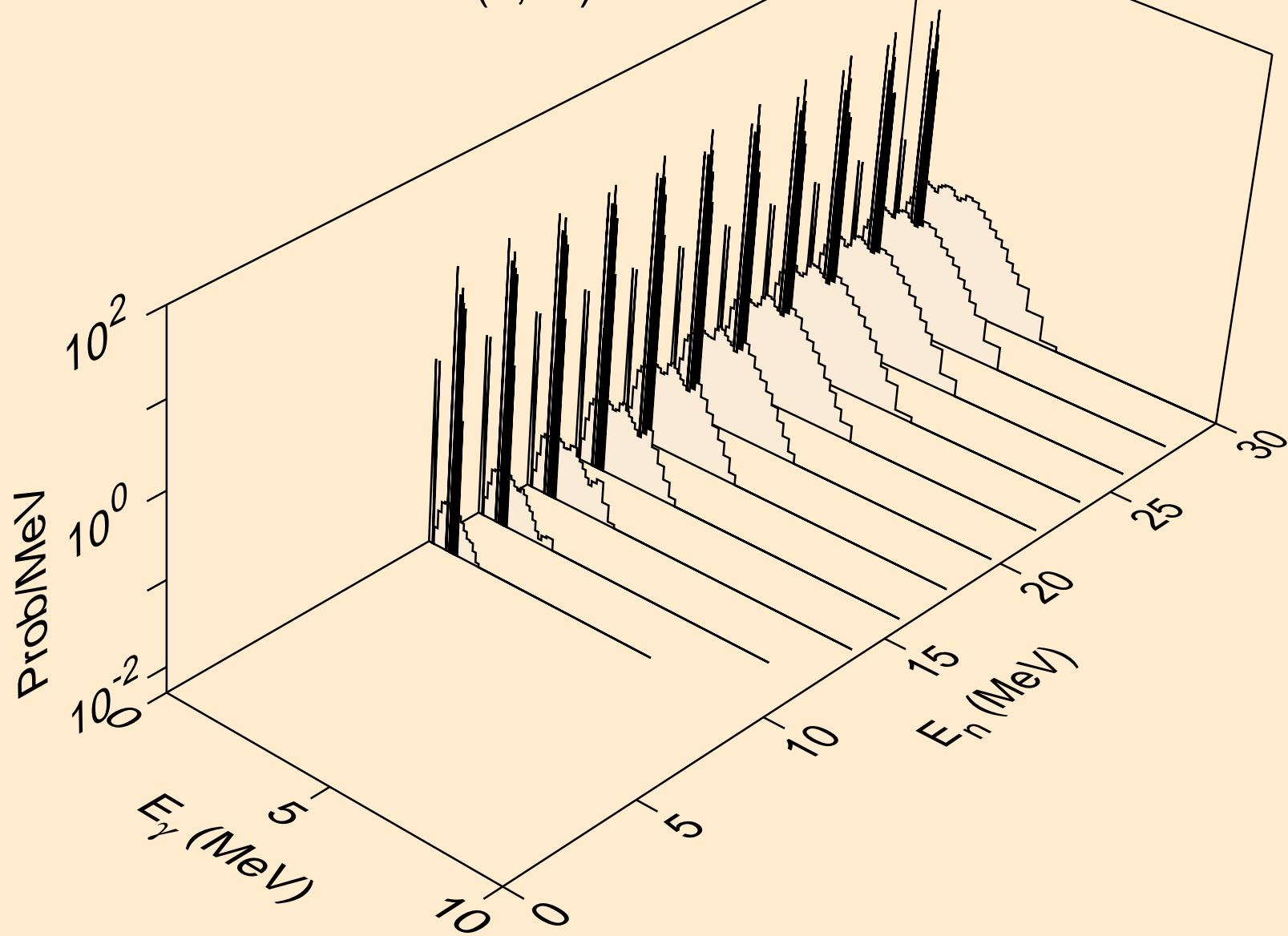

# I114 HELION ACER TENDL-2021 LIBRARY; T=0.K

## Particle heating contributions

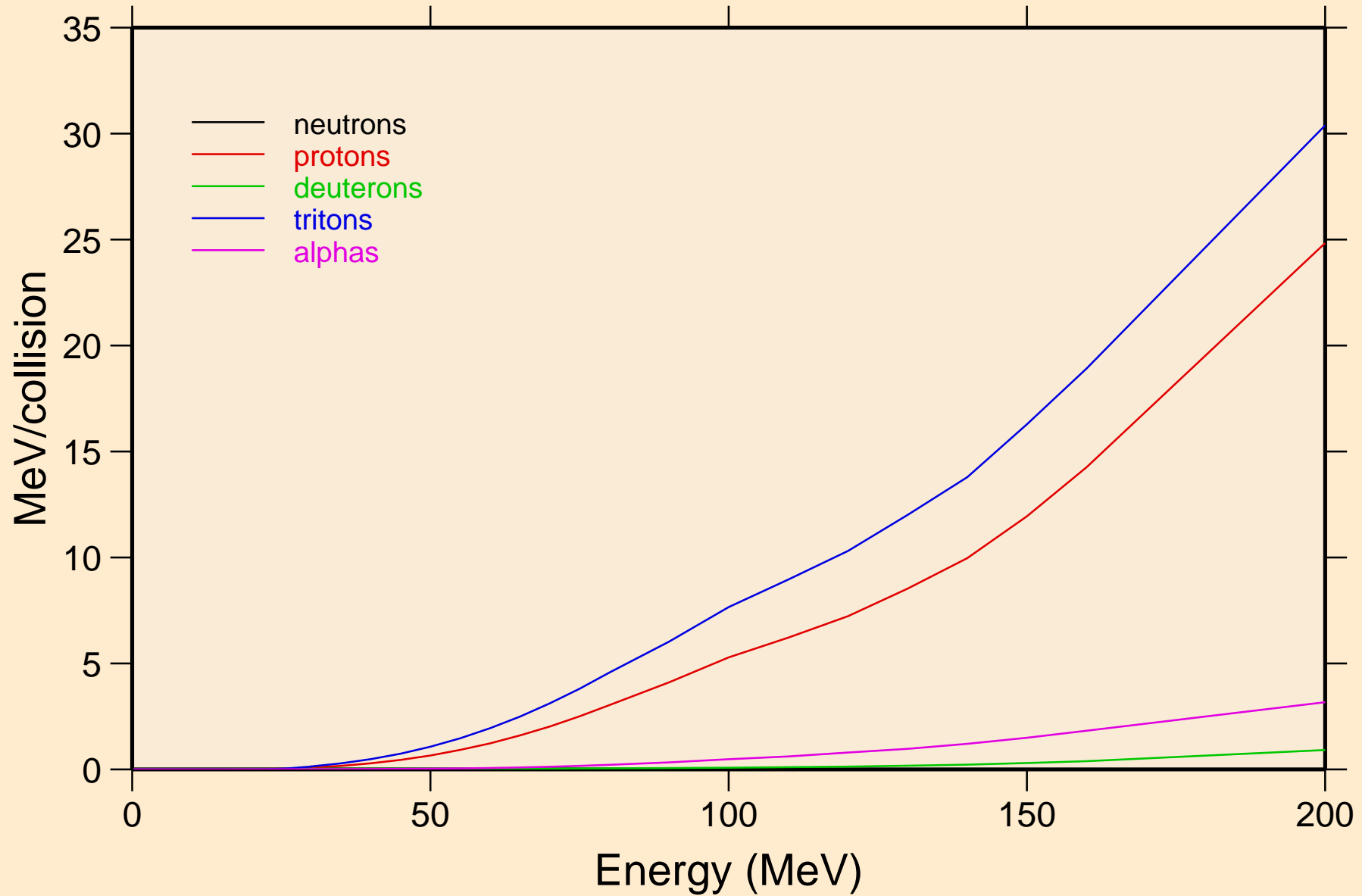

I114 HELION ACER TENDL-2021 LIBRARY; T=0.K  
Recoil Heating

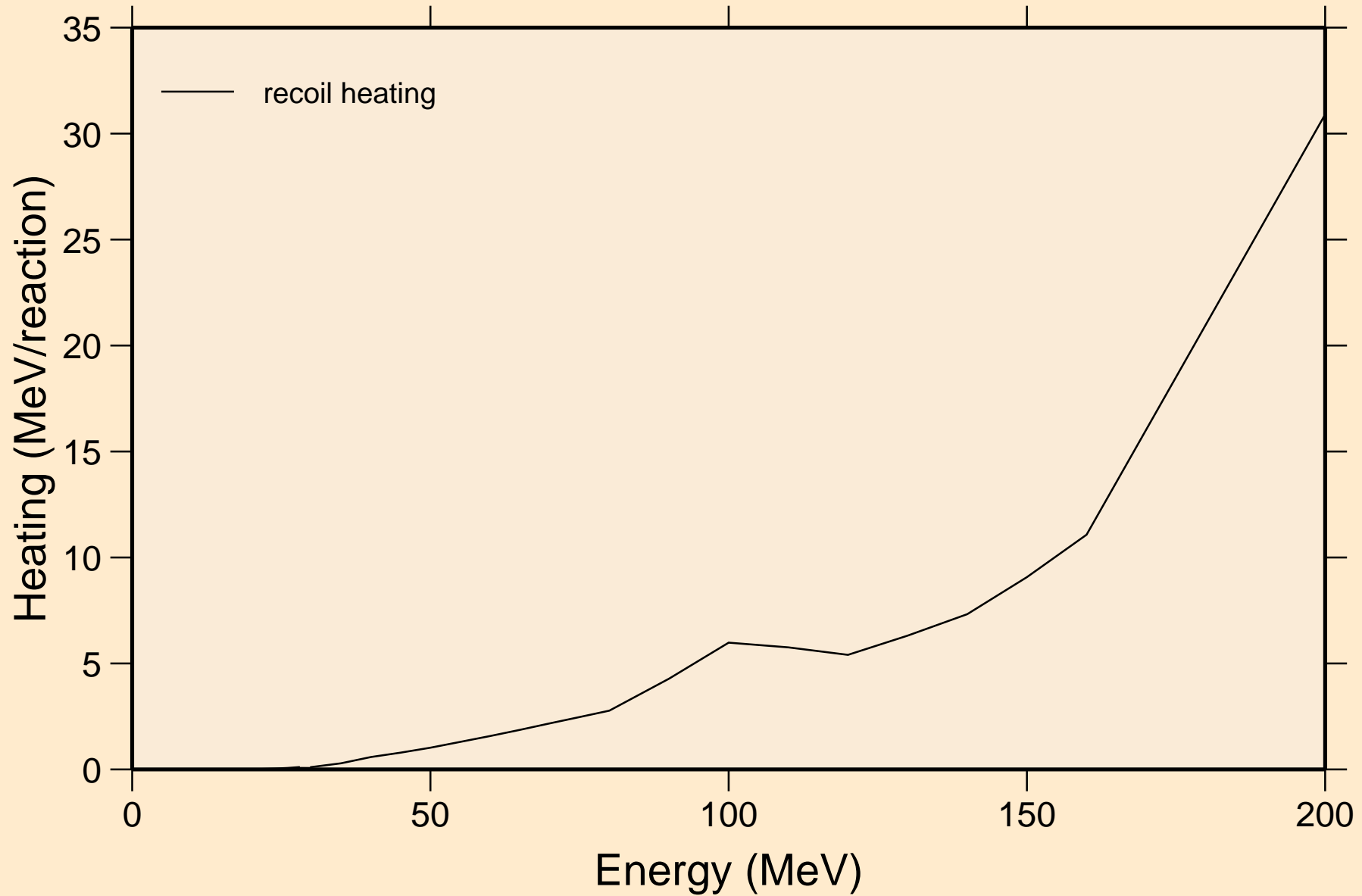



I114 HELION ACER TENDL-2021 LIBRARY; T=0.K  
Particle production cross sections

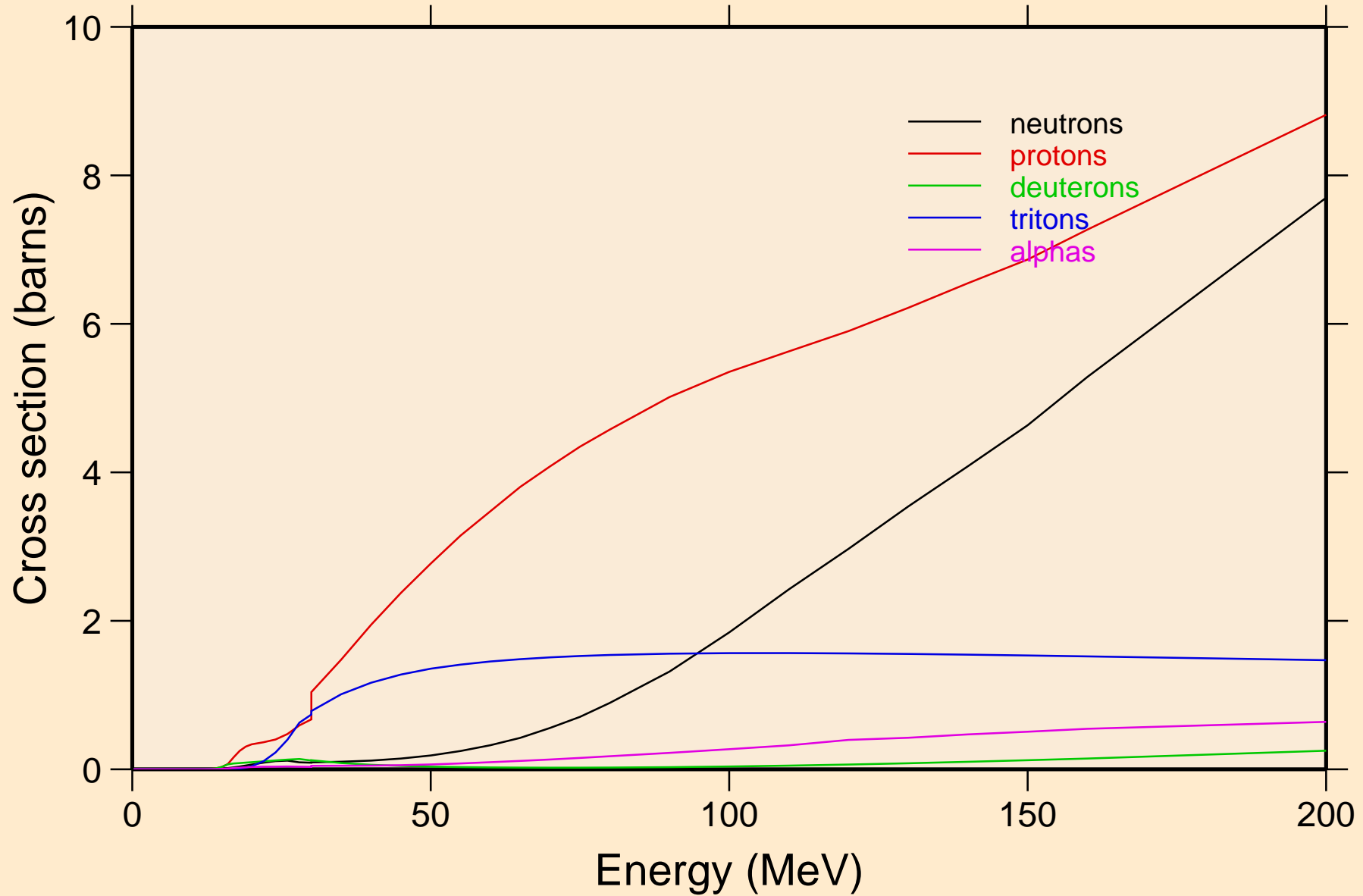

I114 HELION ACER TENDL-2021 LIBRARY; T=0.K  
neutrons from (s,n)

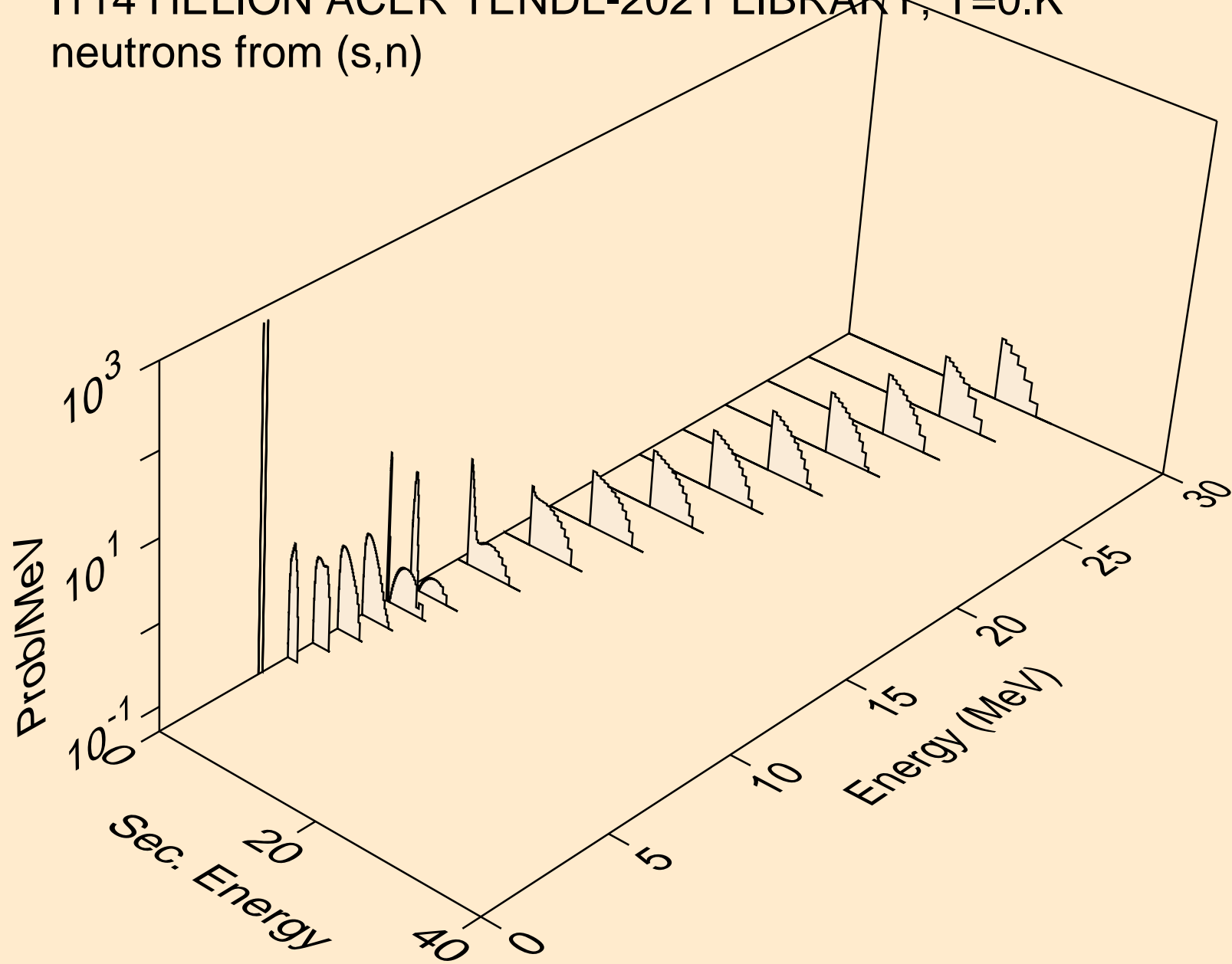

I114 HELION ACER TENDL-2021 LIBRARY; T=0.K  
neutrons from (s,x)

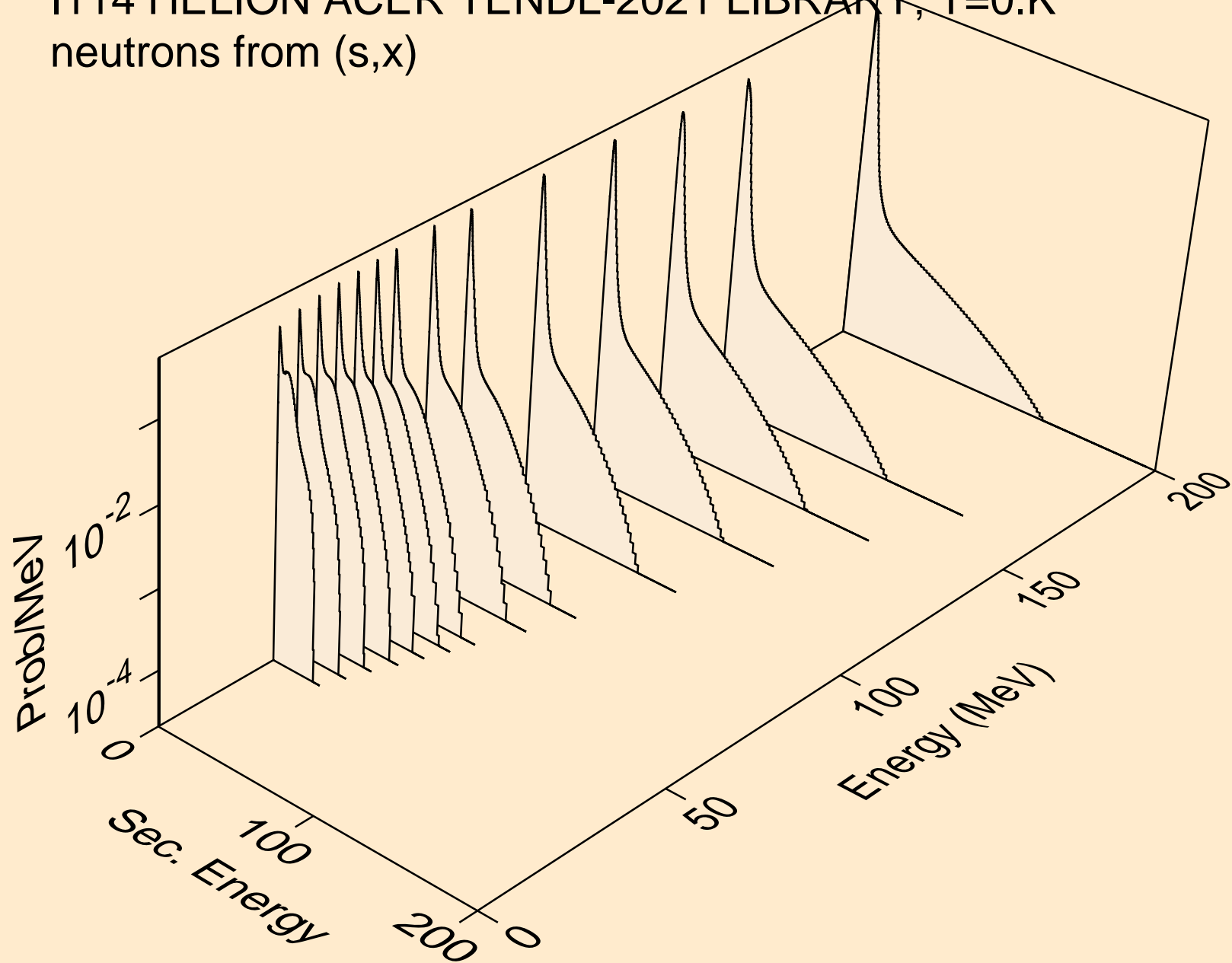

I114 HELION ACER TENDL-2021 LIBRARY; T=0.K  
neutrons from (s,2n)

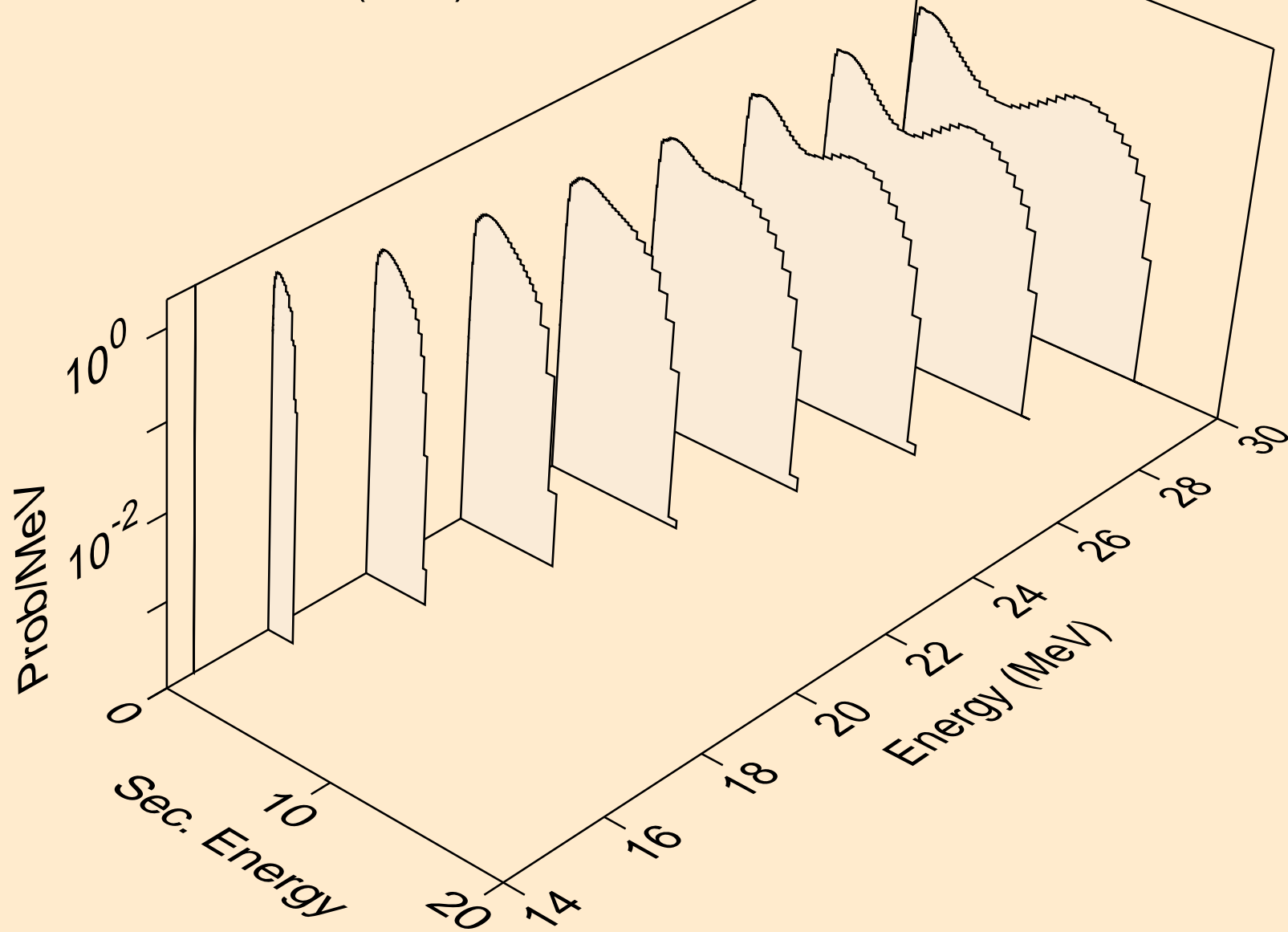

I114 HELION ACER TENDL-2021 LIBRARY; T=0.K  
neutrons from (s,3n)

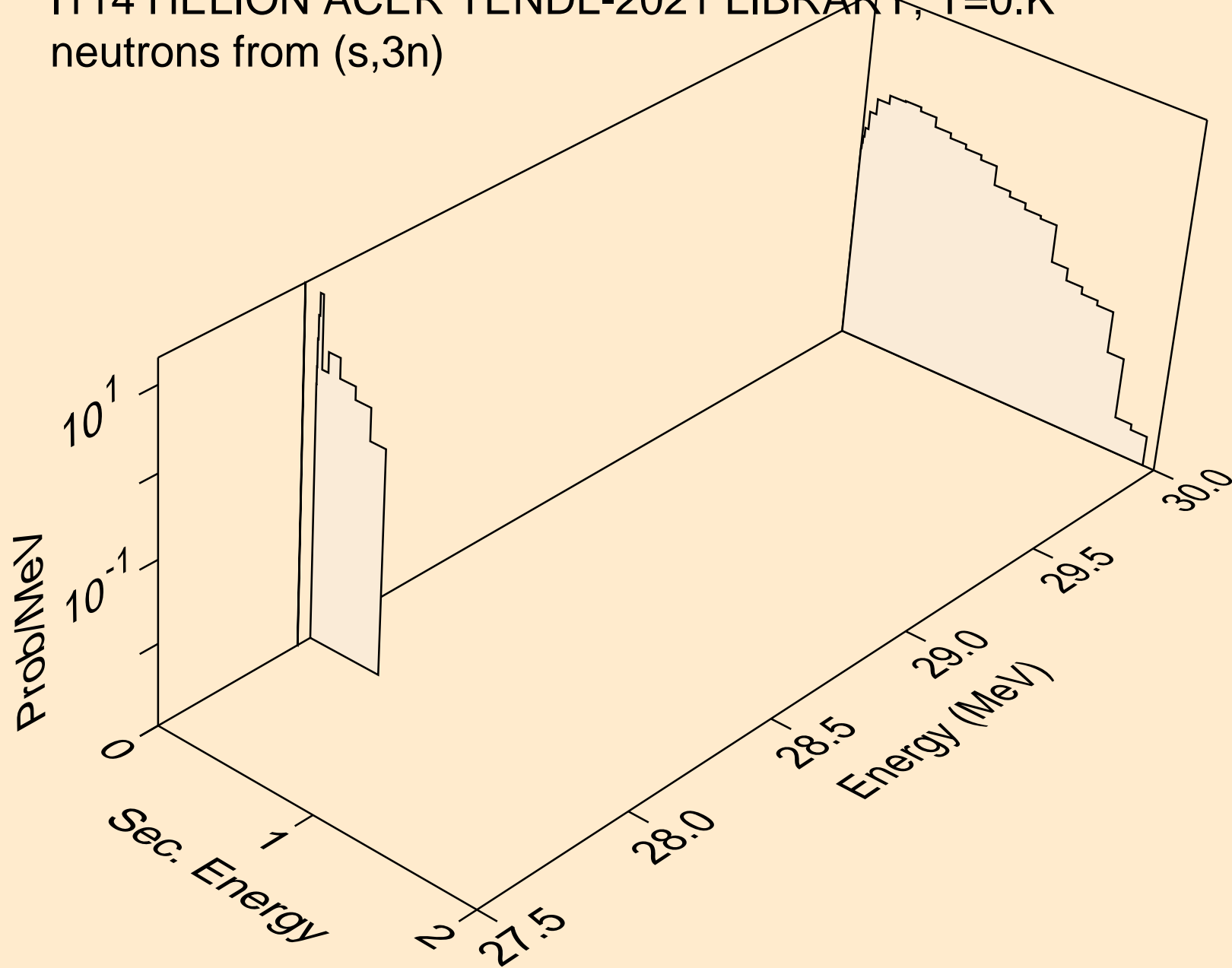

I114 HELION ACER TENDL-2021 LIBRARY; T=0.K  
neutrons from (s,n\*)a

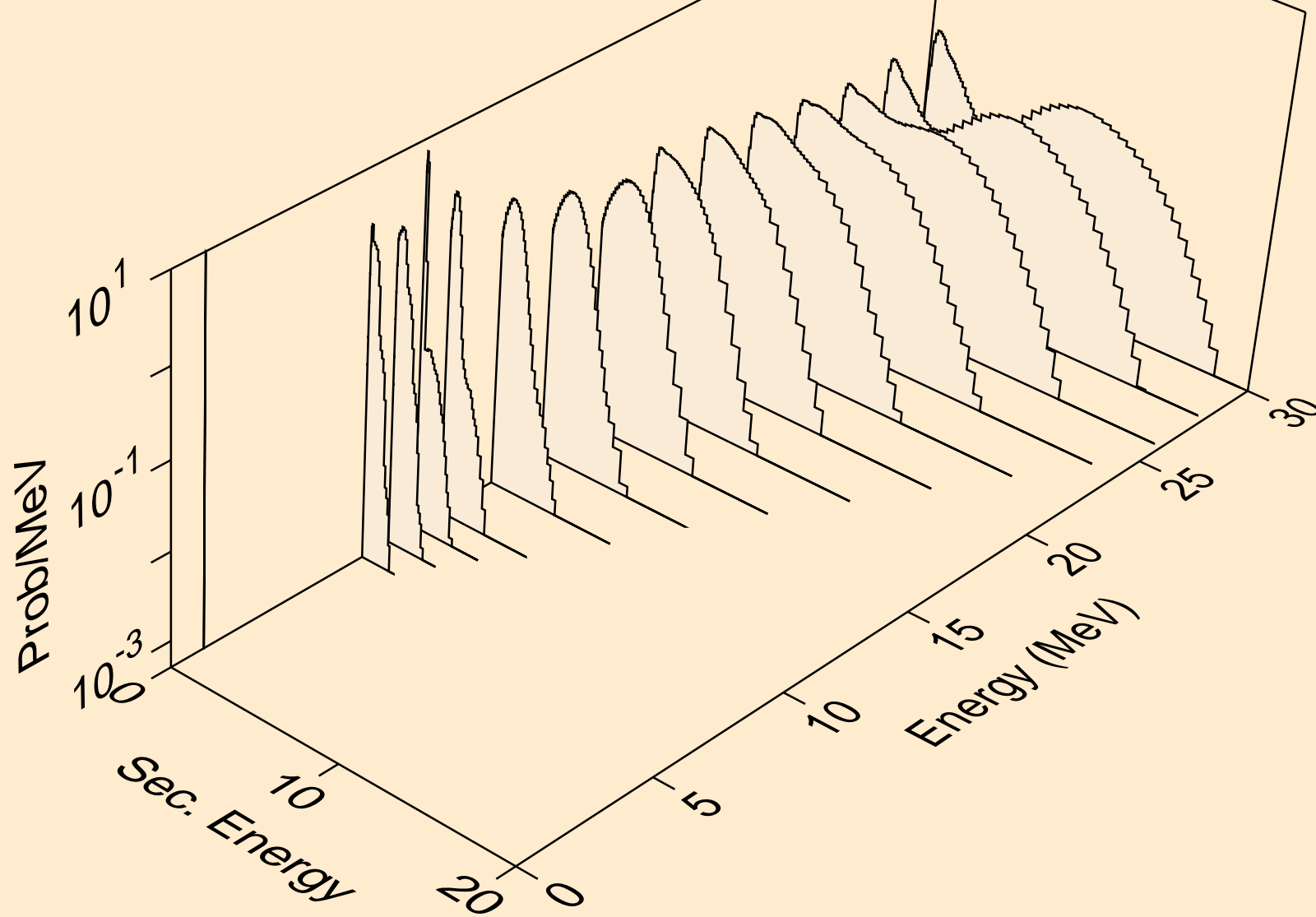

I114 HELION ACER TENDL-2021 LIBRARY; T=0.K  
neutrons from (s,2n)a

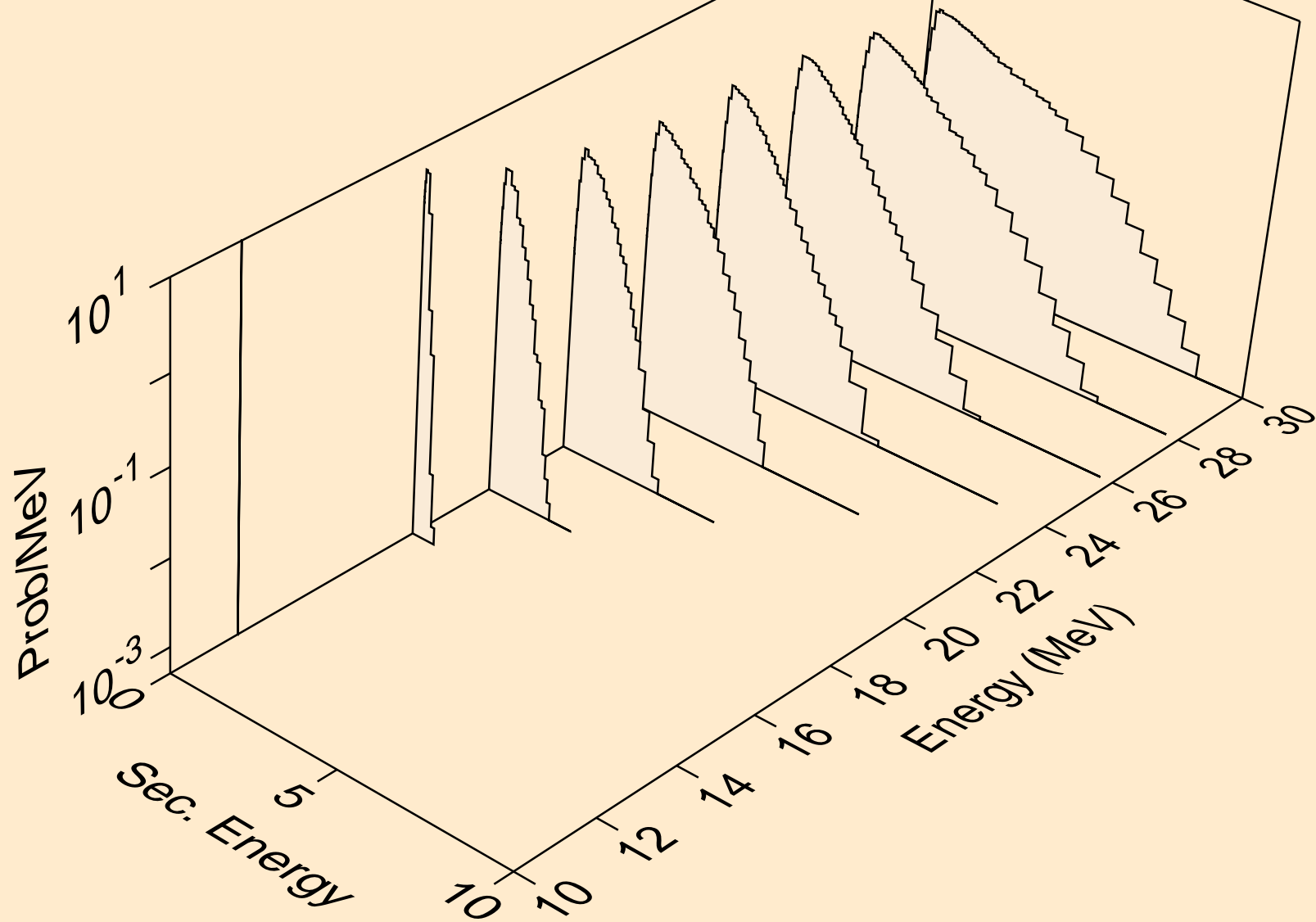

I114 HELION ACER TENDL-2021 LIBRARY; T=0.K  
neutrons from (s,n\*)p

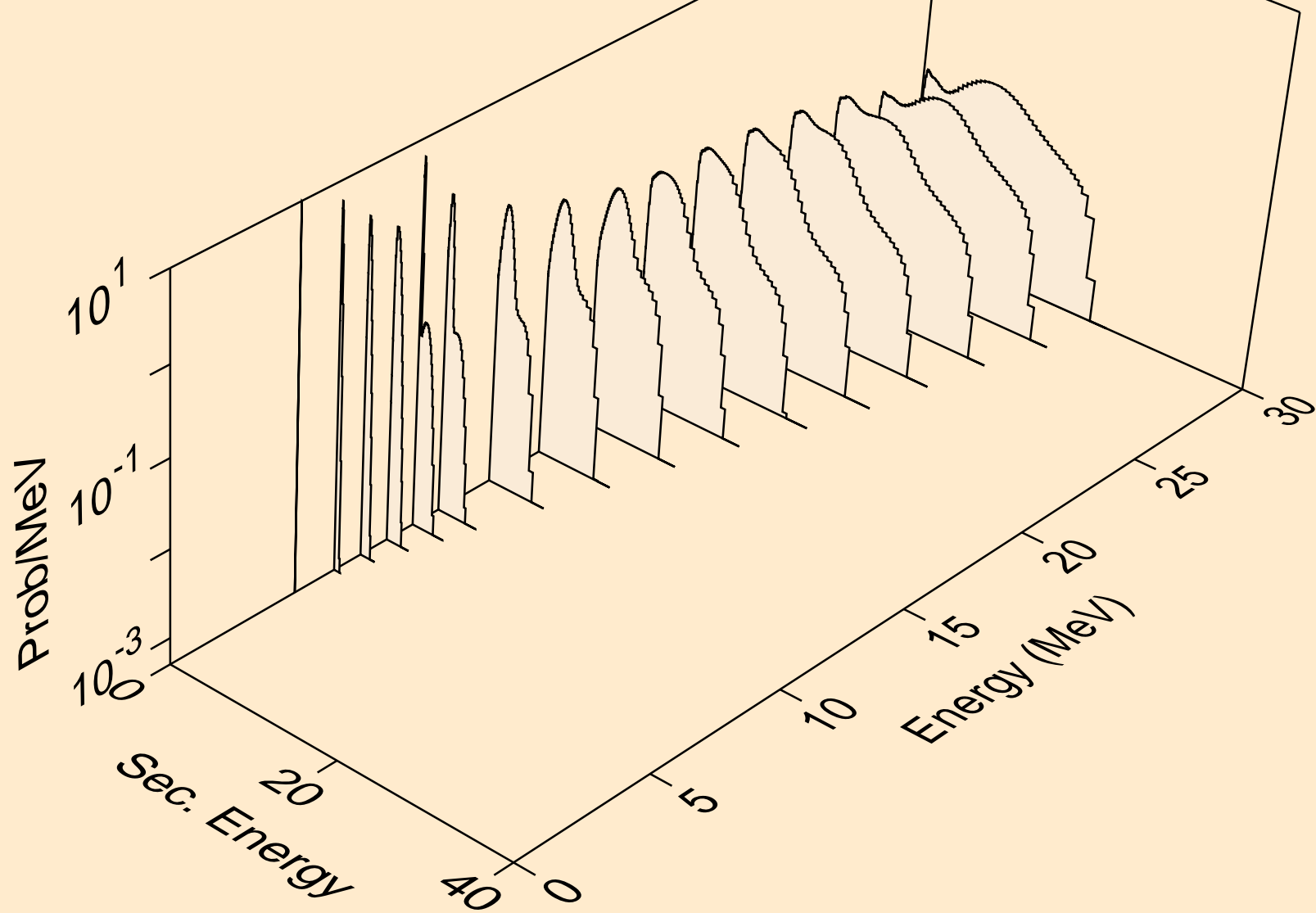



I114 HELION ACER TENDL-2021 LIBRARY; T=0.K  
neutrons from (s,n\*)2a

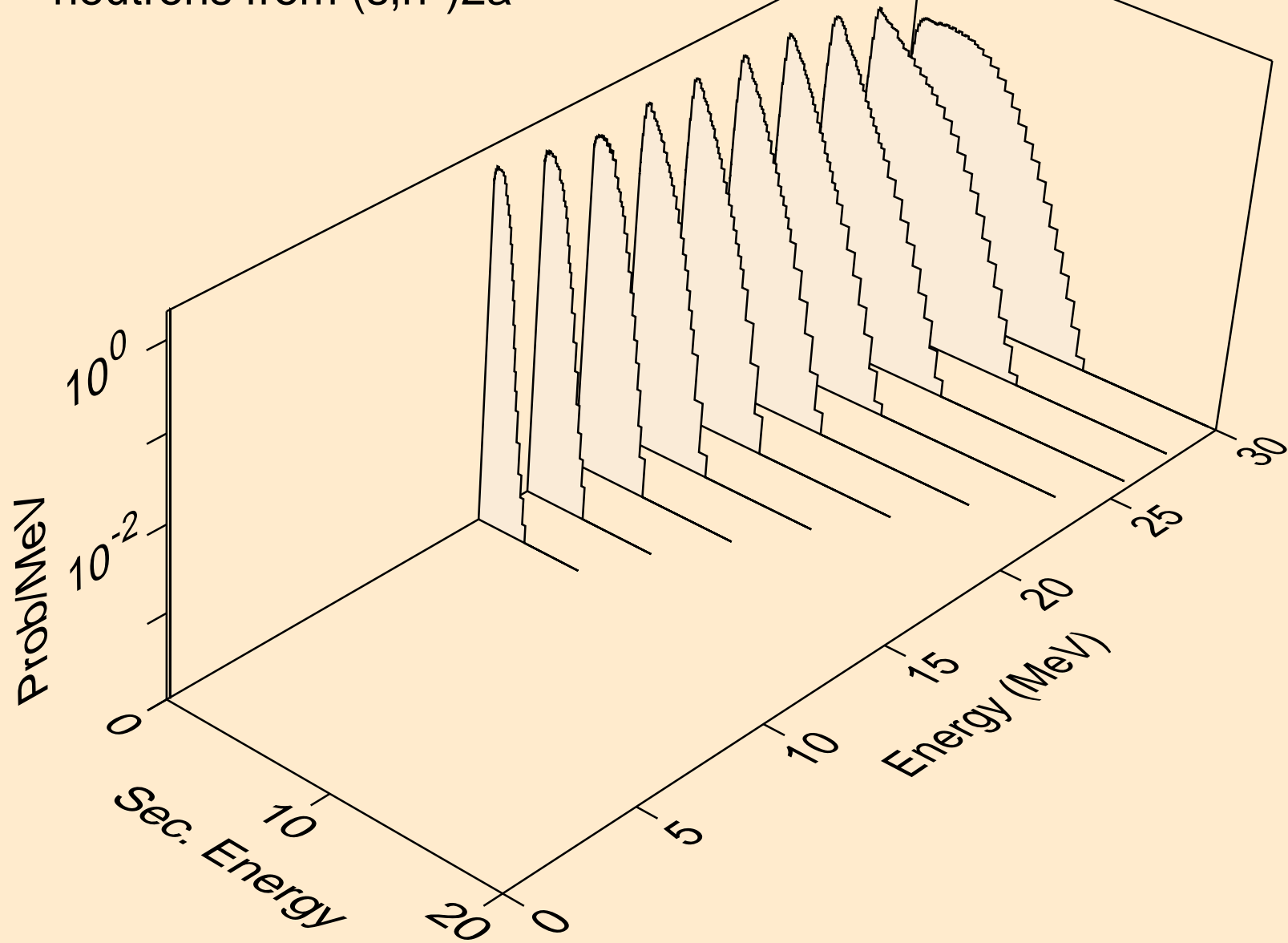

I114 HELION ACER TENDL-2021 LIBRARY; T=0.K  
neutrons from (s,n\*)d

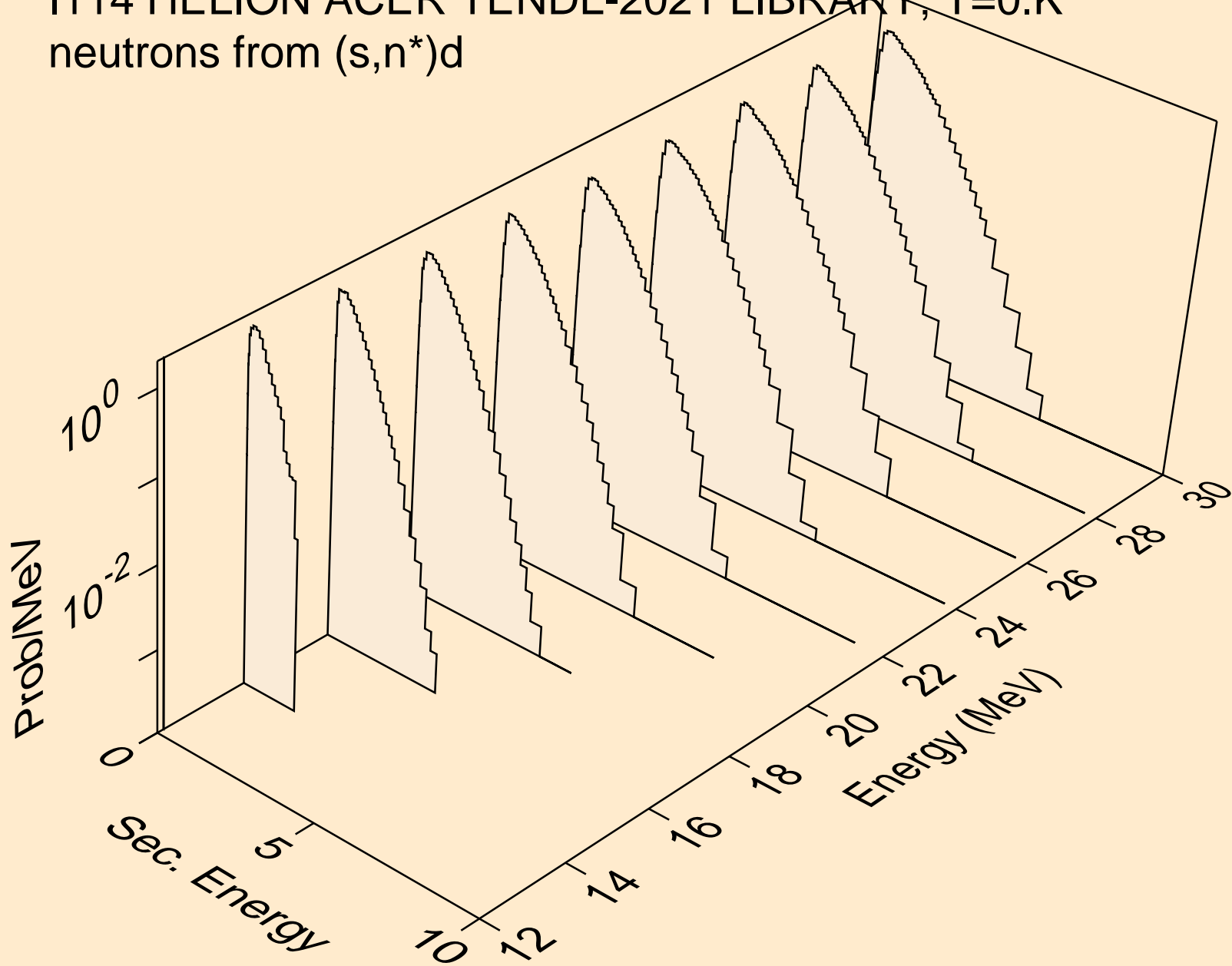

I114 HELION ACER TENDL-2021 LIBRARY; T=0.K  
neutrons from (s,n\*)t

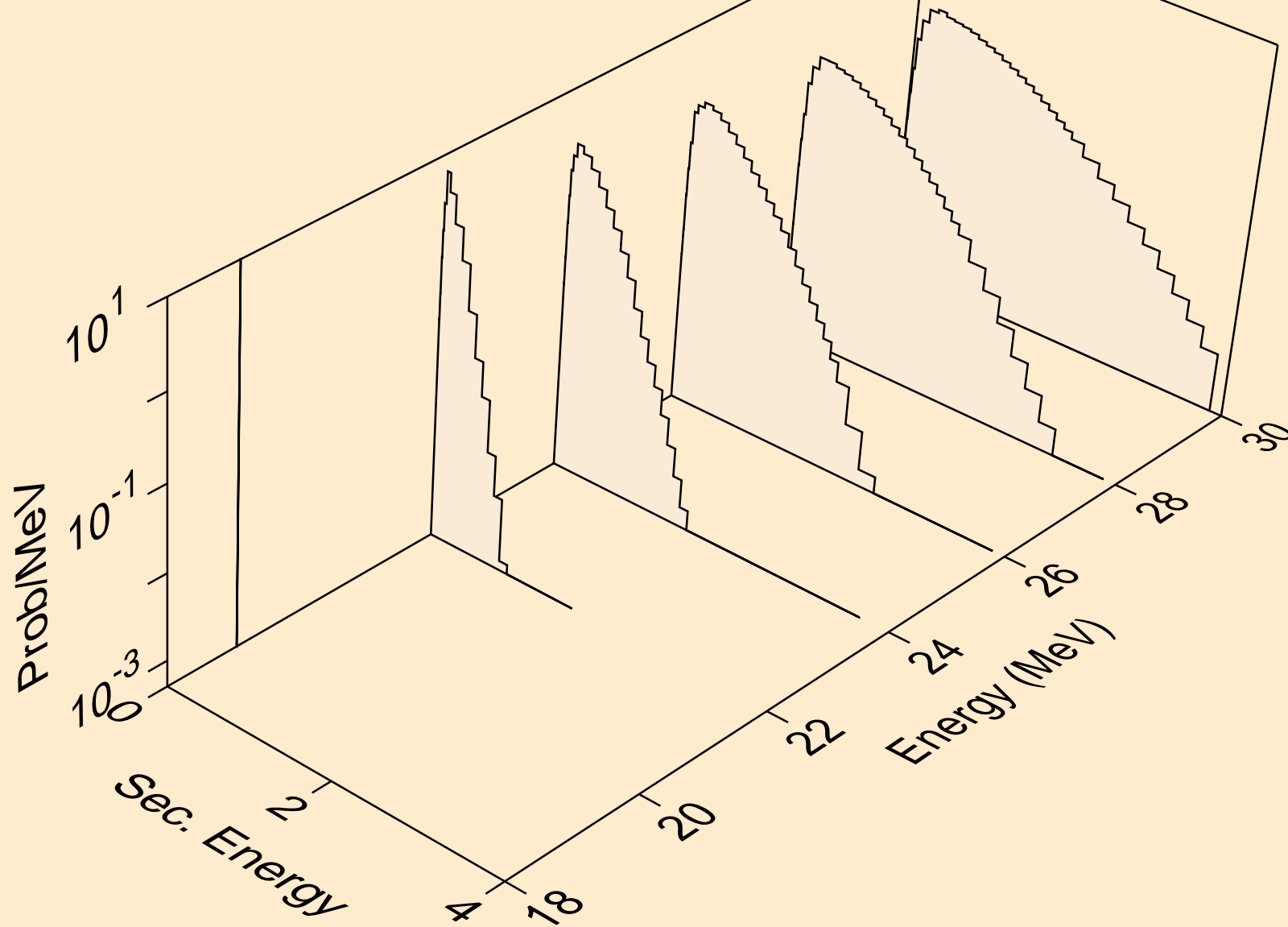

I114 HELION ACER TENDL-2021 LIBRARY; T=0.K  
neutrons from (s,n\*)he3

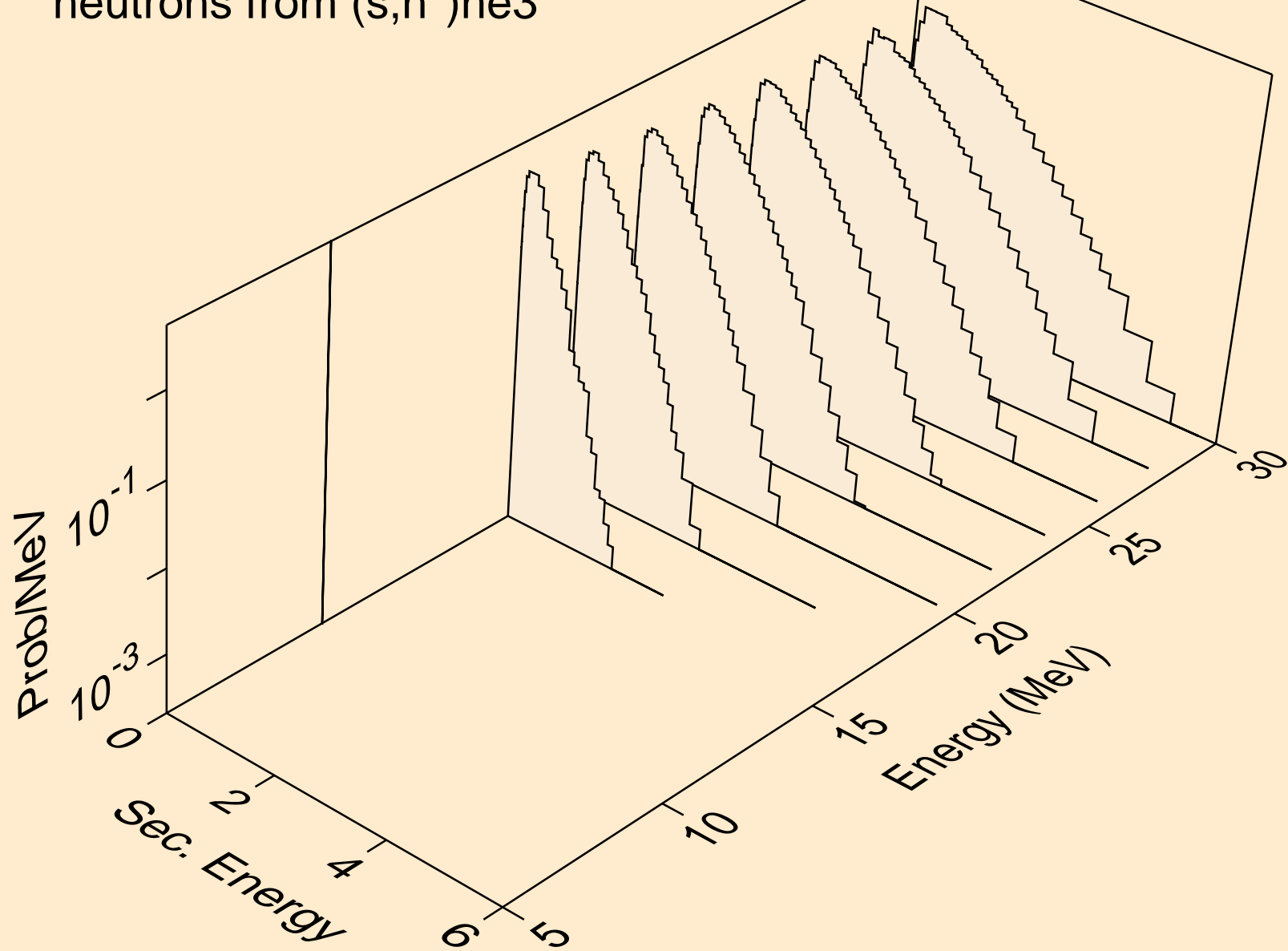

I114 HELION ACER TENDL-2021 LIBRARY; T=0.K  
neutrons from (s,2np)

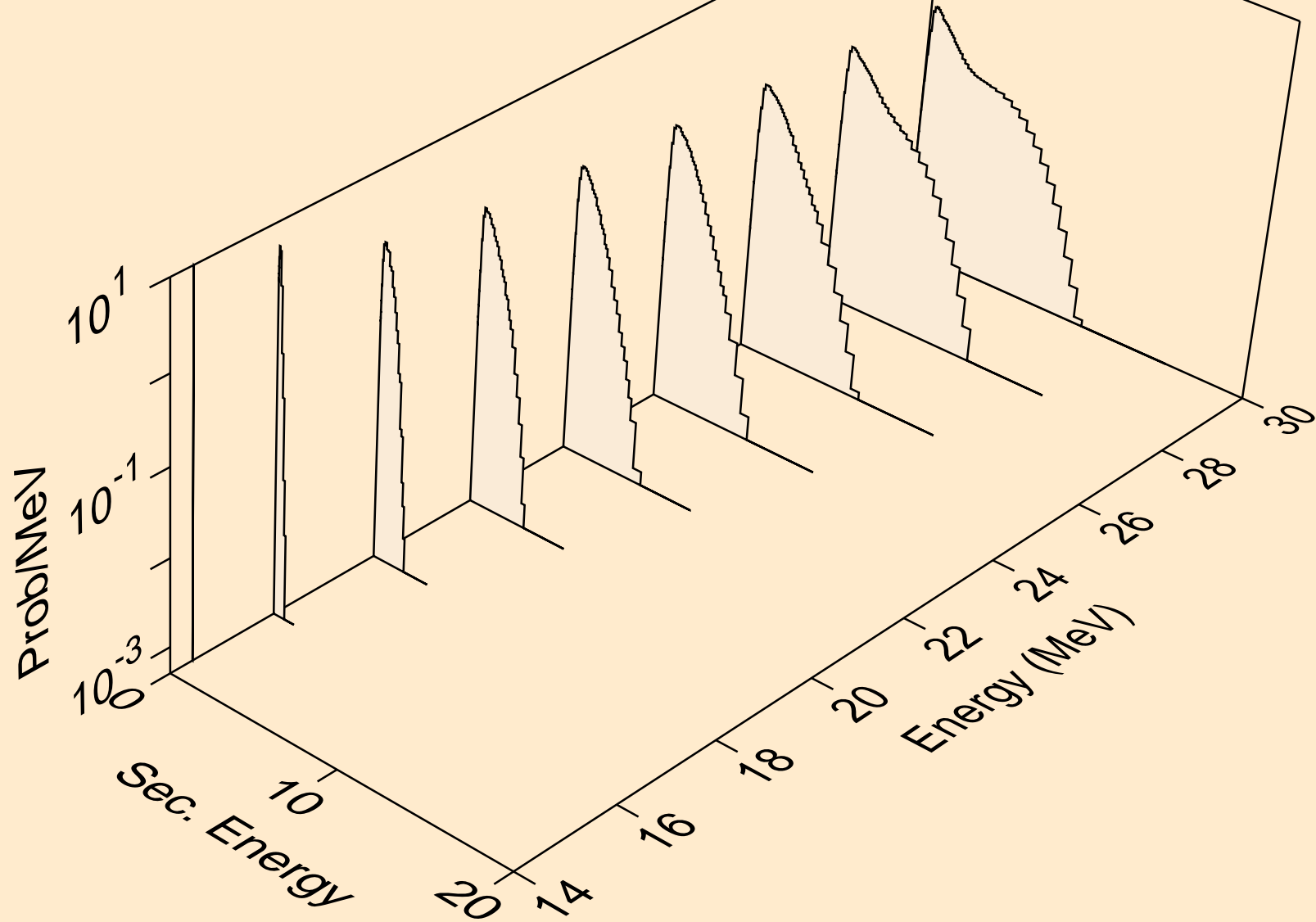

I114 HELION ACER TENDL-2021 LIBRARY; T=0.K  
neutrons from (s,2np)

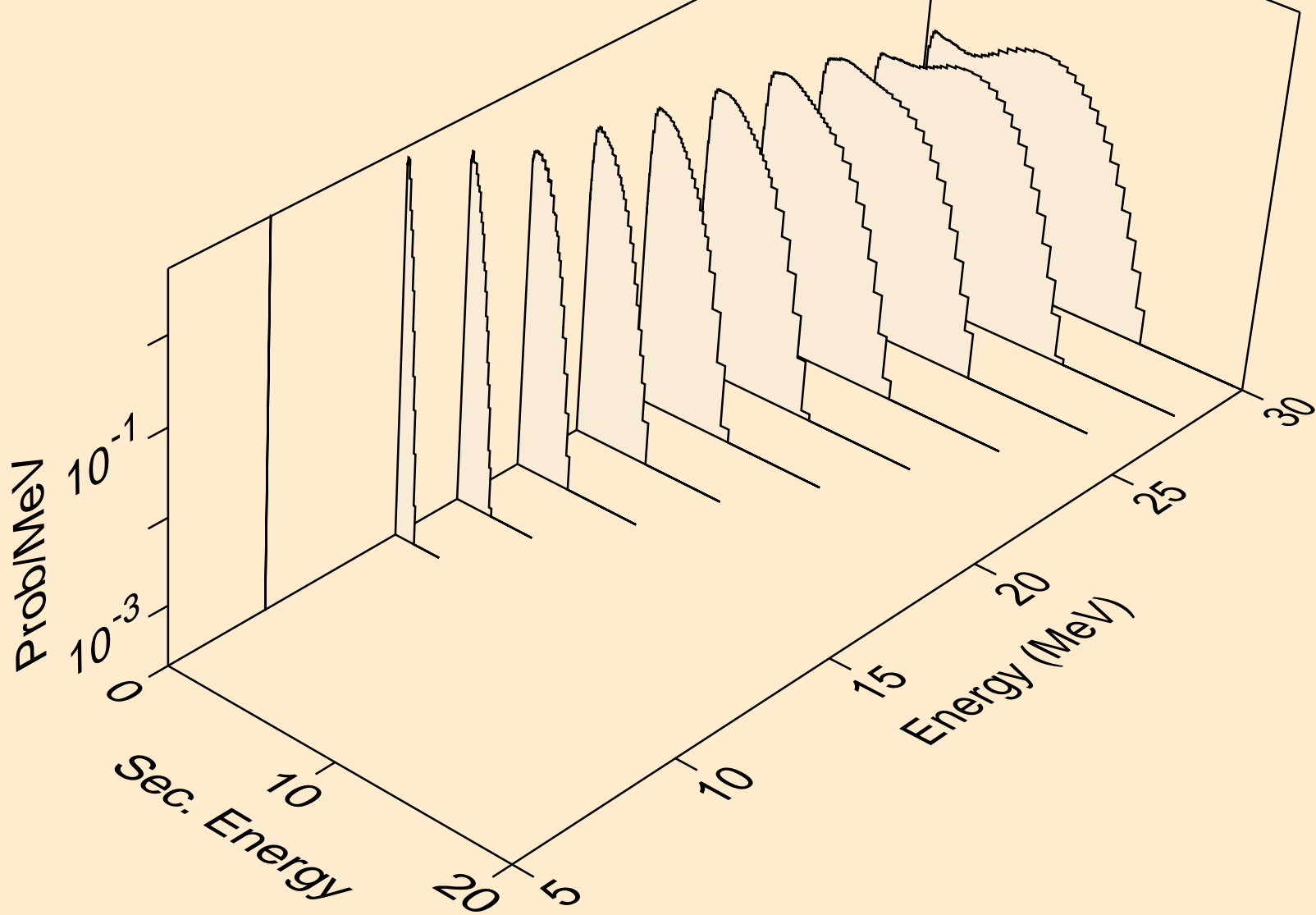

I114 HELION ACER TENDL-2021 LIBRARY; T=0.K  
neutrons from (s,npa)

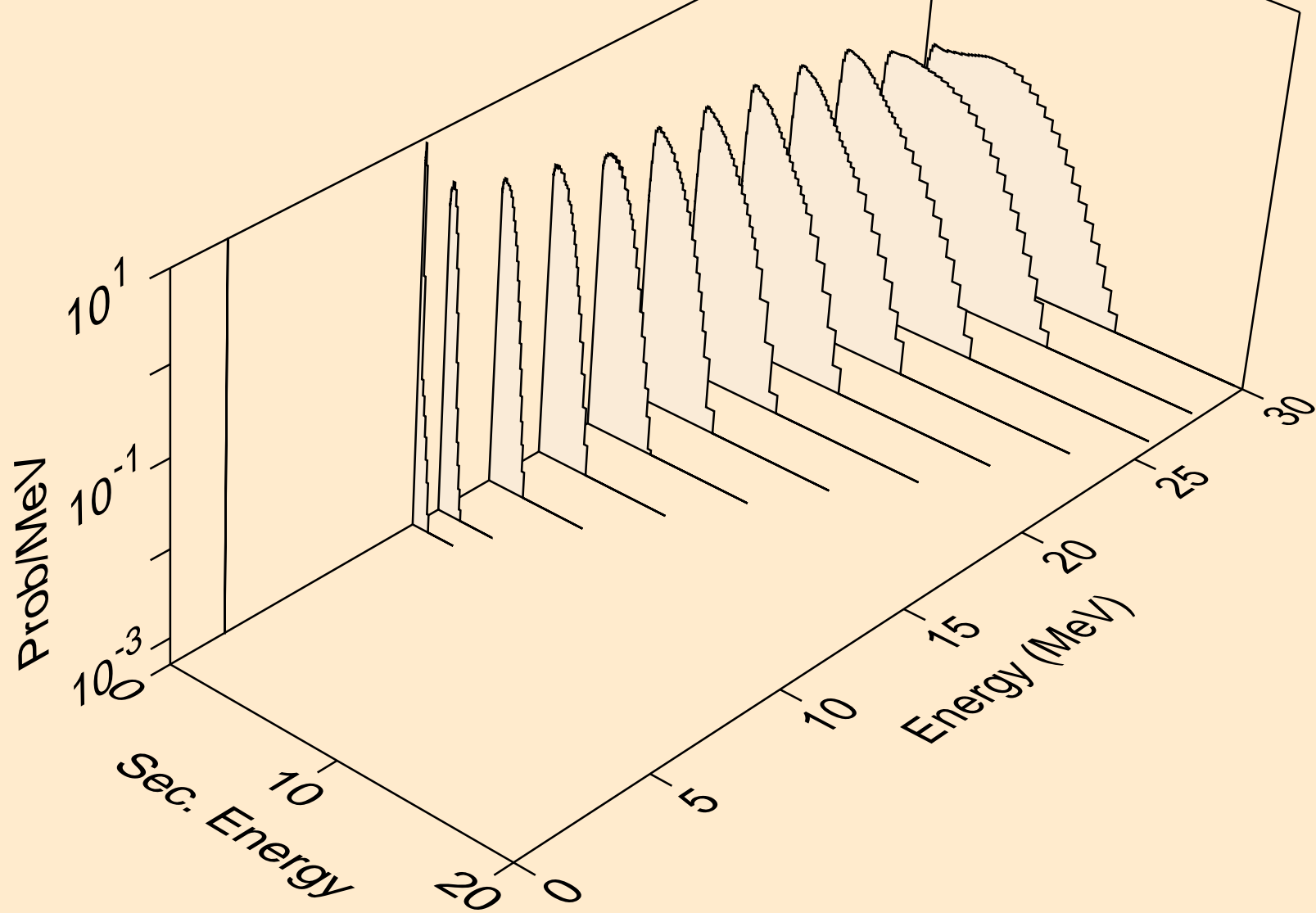

I114 HELION ACER TENDL-2021 LIBRARY; T=0.K  
protons from (s,x)

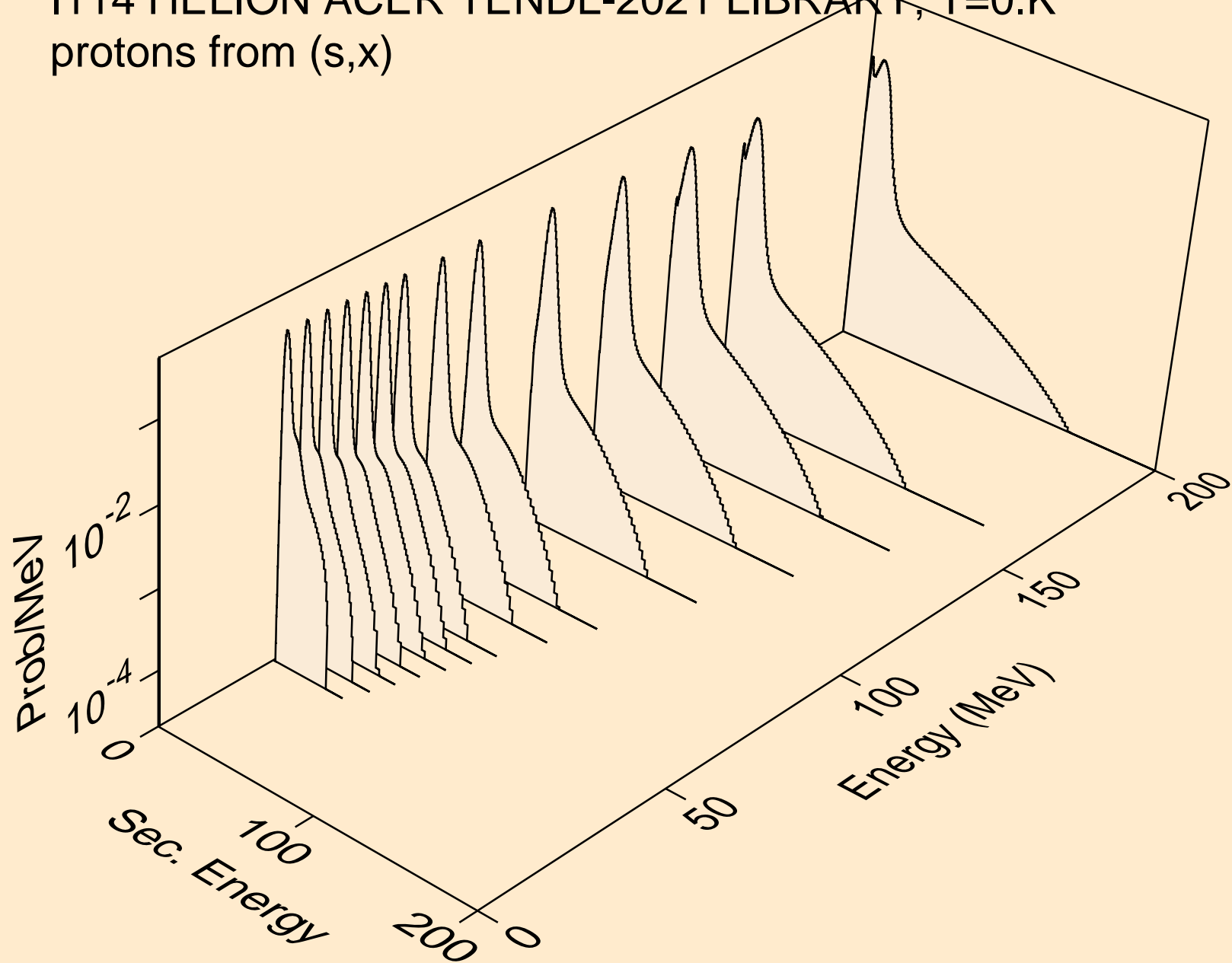



I114 HELION ACER TENDL-2021 LIBRARY; T=0.K  
protons from (s,n\*)p

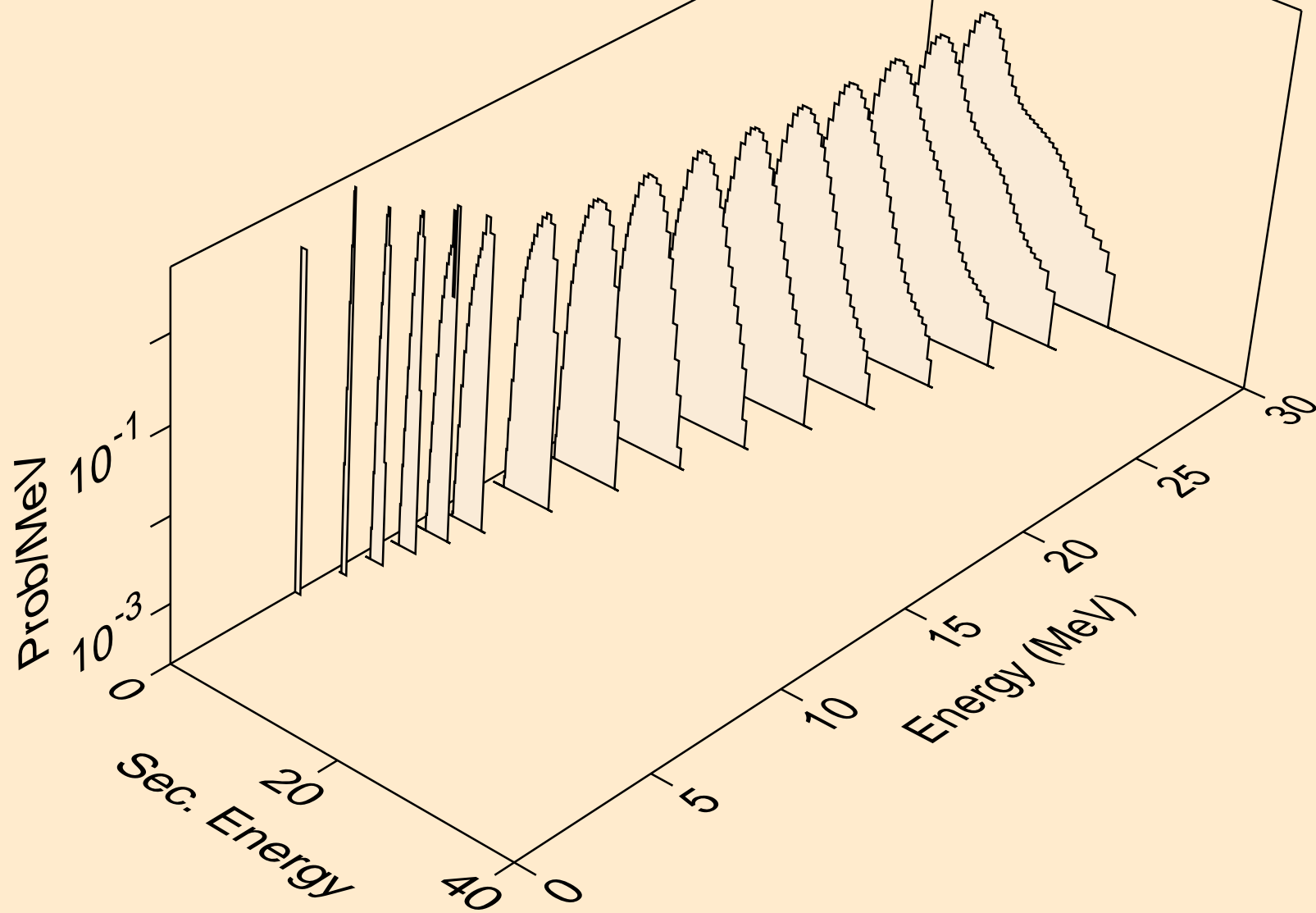

I114 HELION ACER TENDL-2021 LIBRARY; T=0.K  
protons from (s,2np)

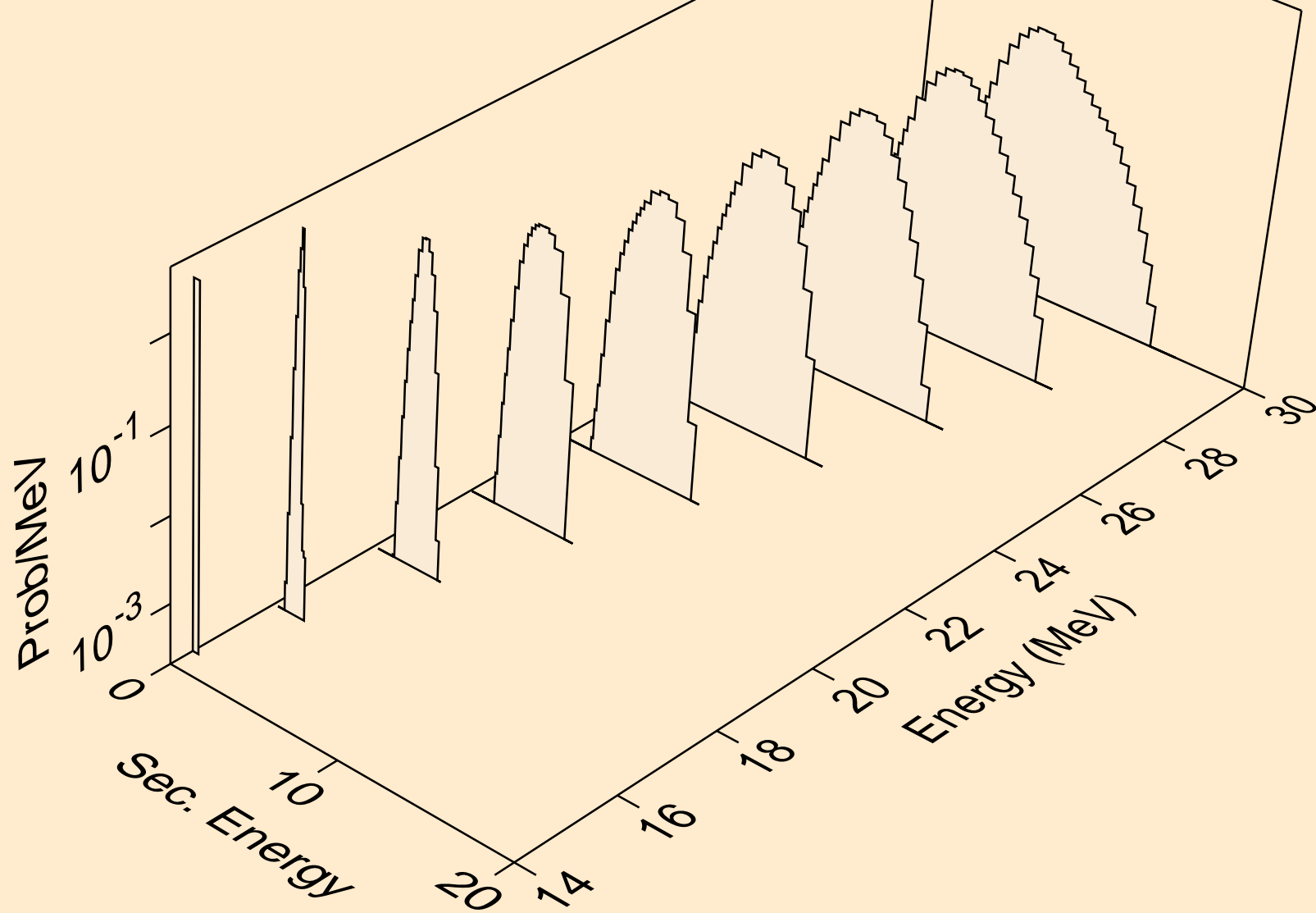

I114 HELION ACER TENDL-2021 LIBRARY; T=0.K  
protons from (s,2np)

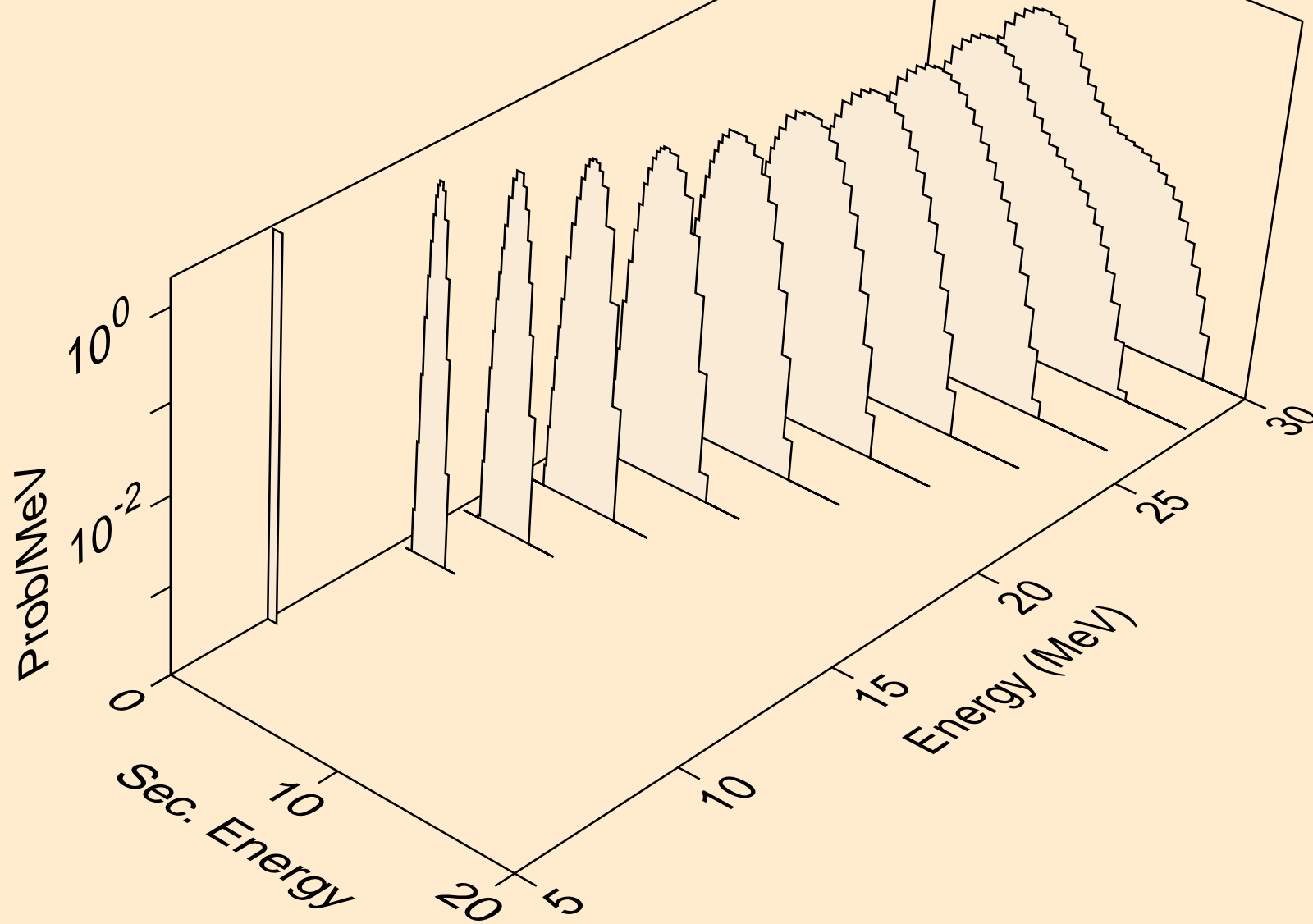

I114 HELION ACER TENDL-2021 LIBRARY; T=0.K  
protons from (s,npa)

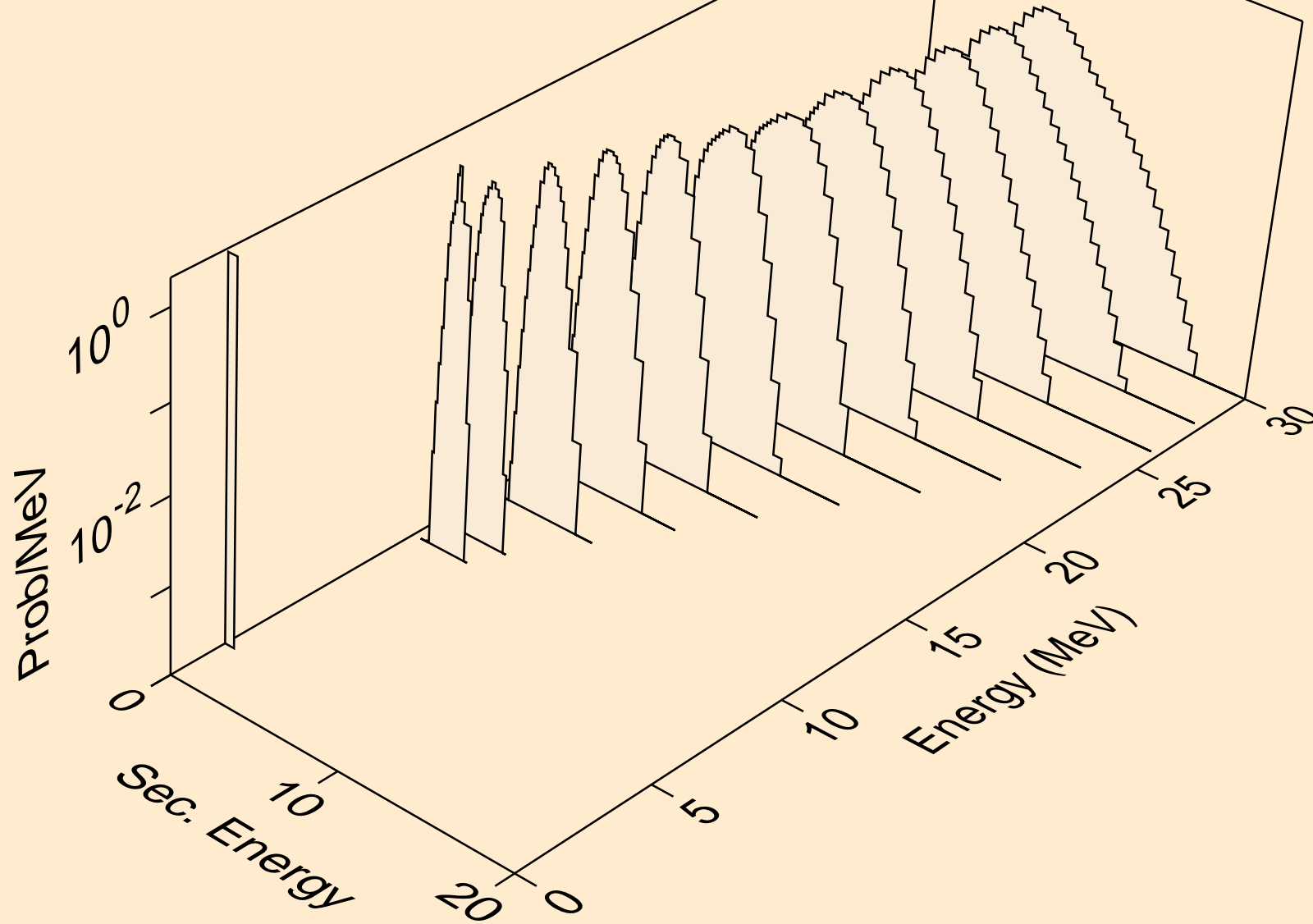

I114 HELION ACER TENDL-2021 LIBRARY; T=0.K  
protons from (s,p)

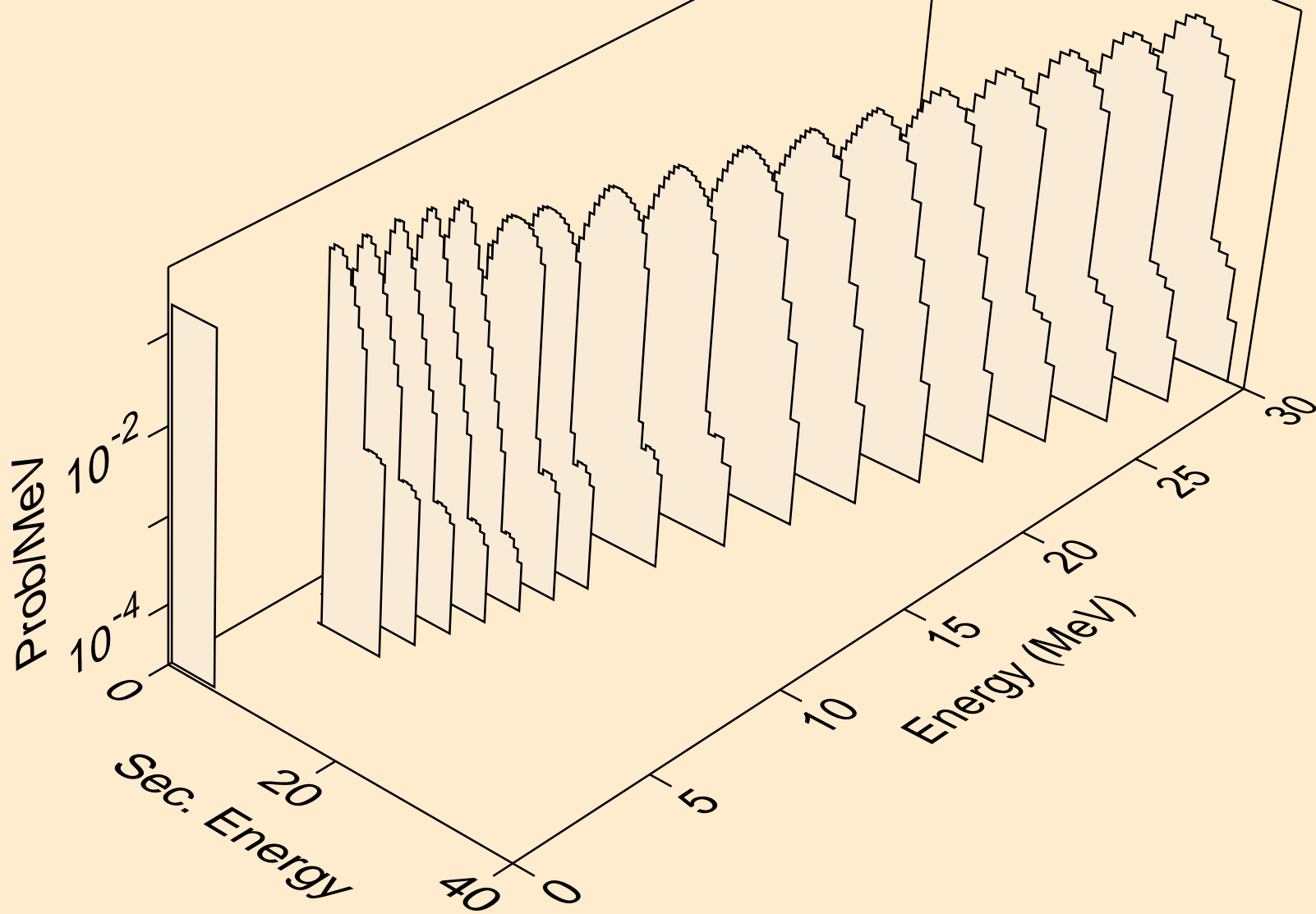

I114 HELION ACER TENDL-2021 LIBRARY; T=0.K  
protons from (s,2p)

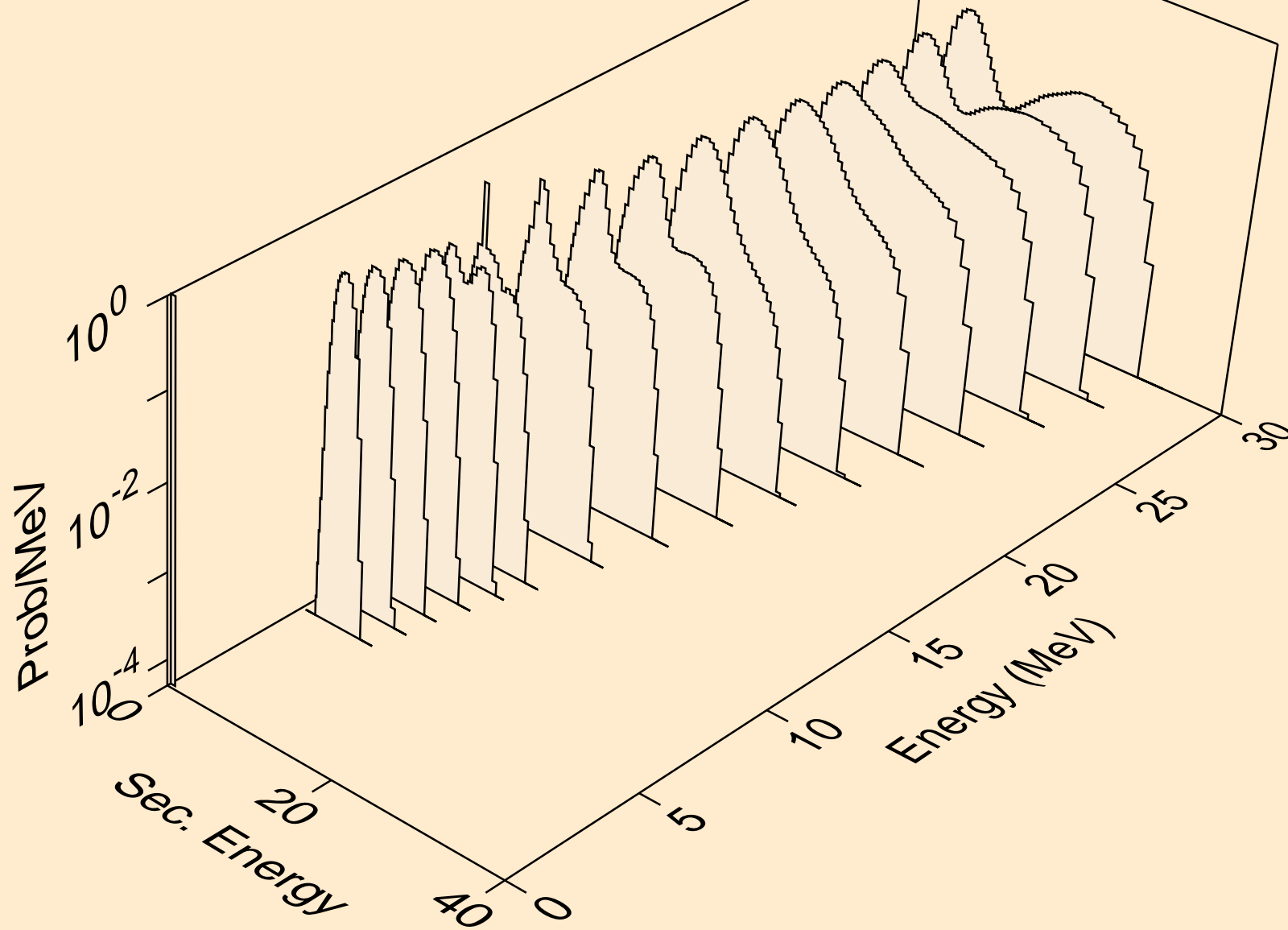

I114 HELION ACER TENDL-2021 LIBRARY; T=0.K  
protons from (s,pa)

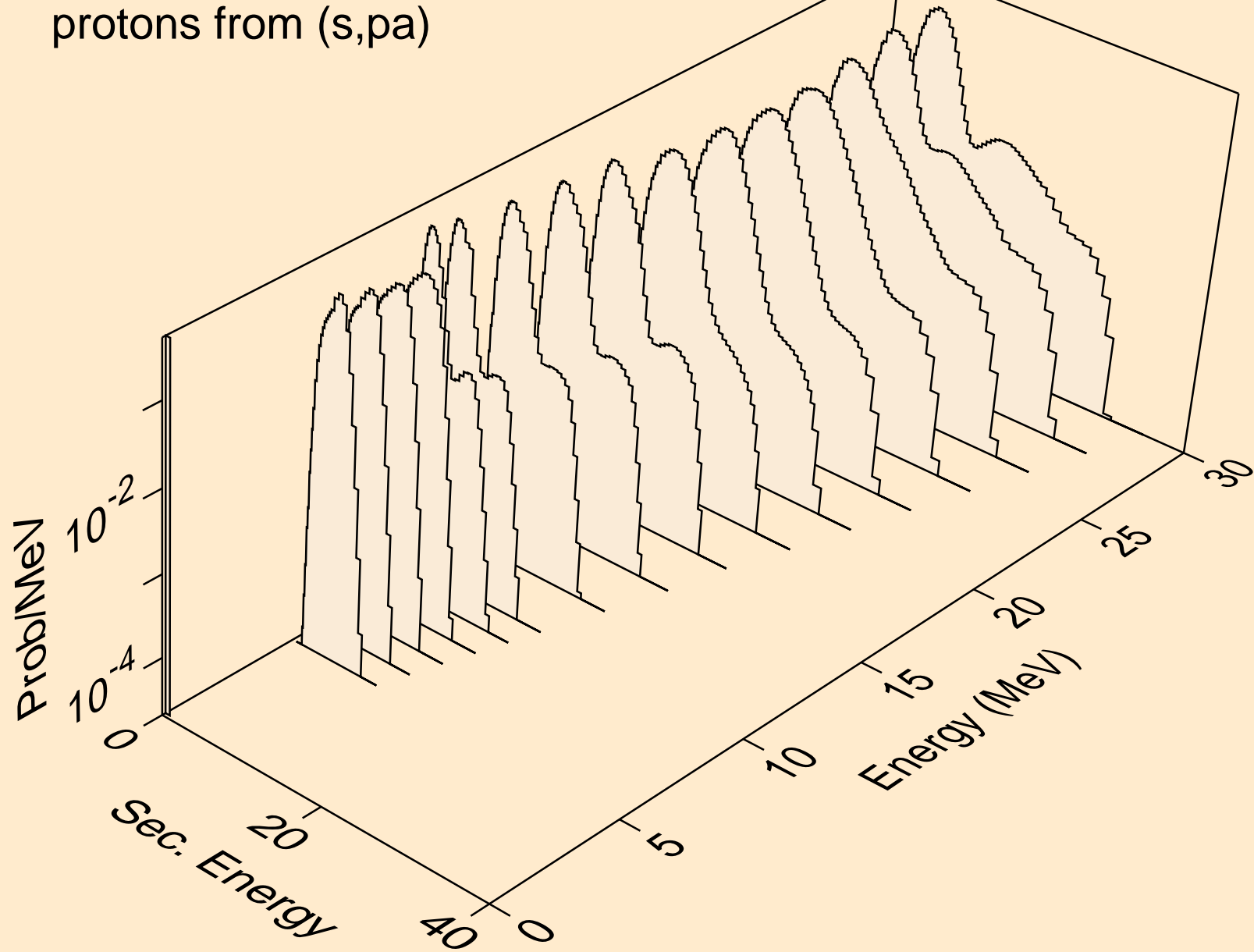

I114 HELION ACER TENDL-2021 LIBRARY; T=0.K  
protons from (s,pd)

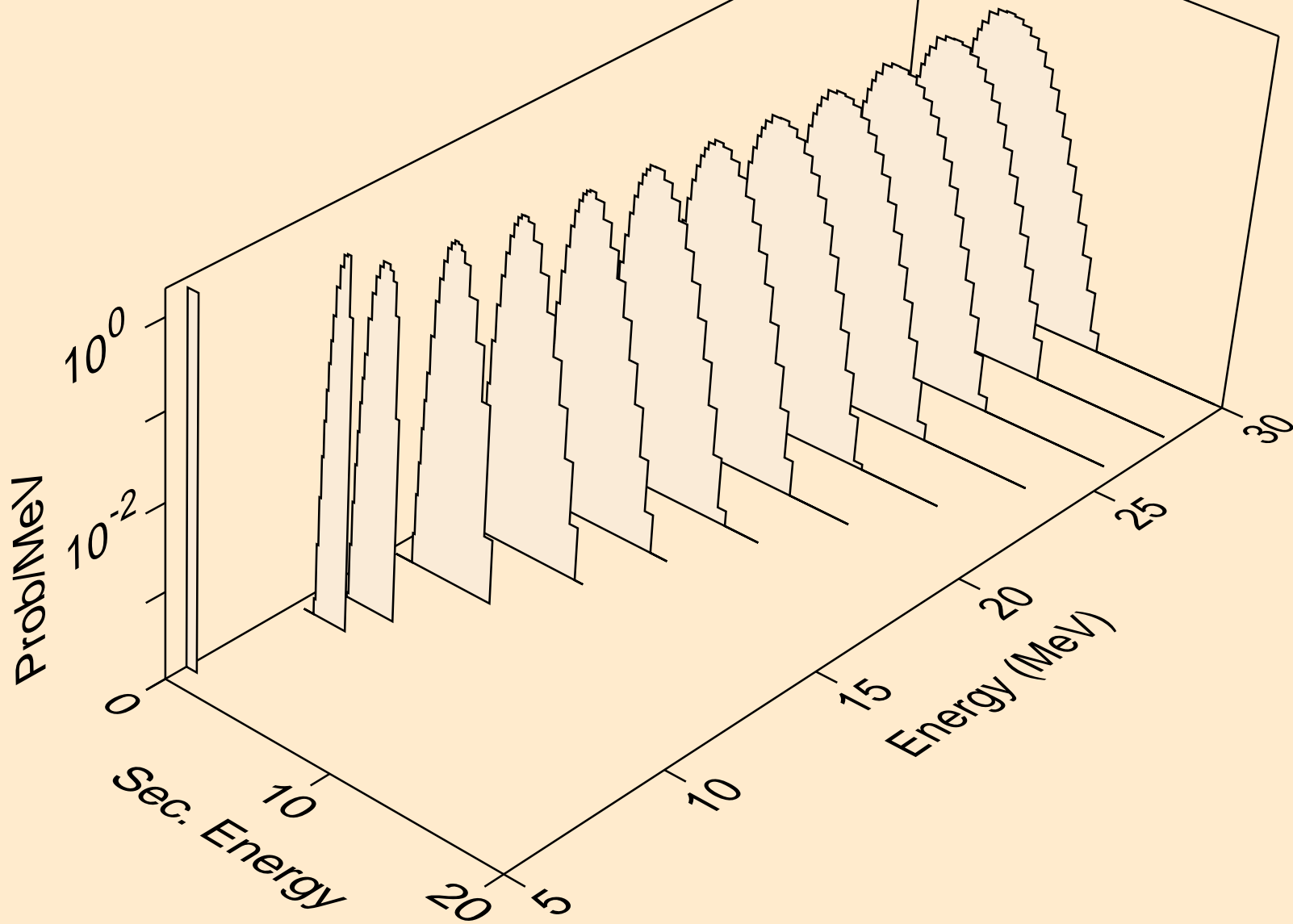



I114 HELION ACER TENDL-2021 LIBRARY; T=0.K  
protons from (s,pt)

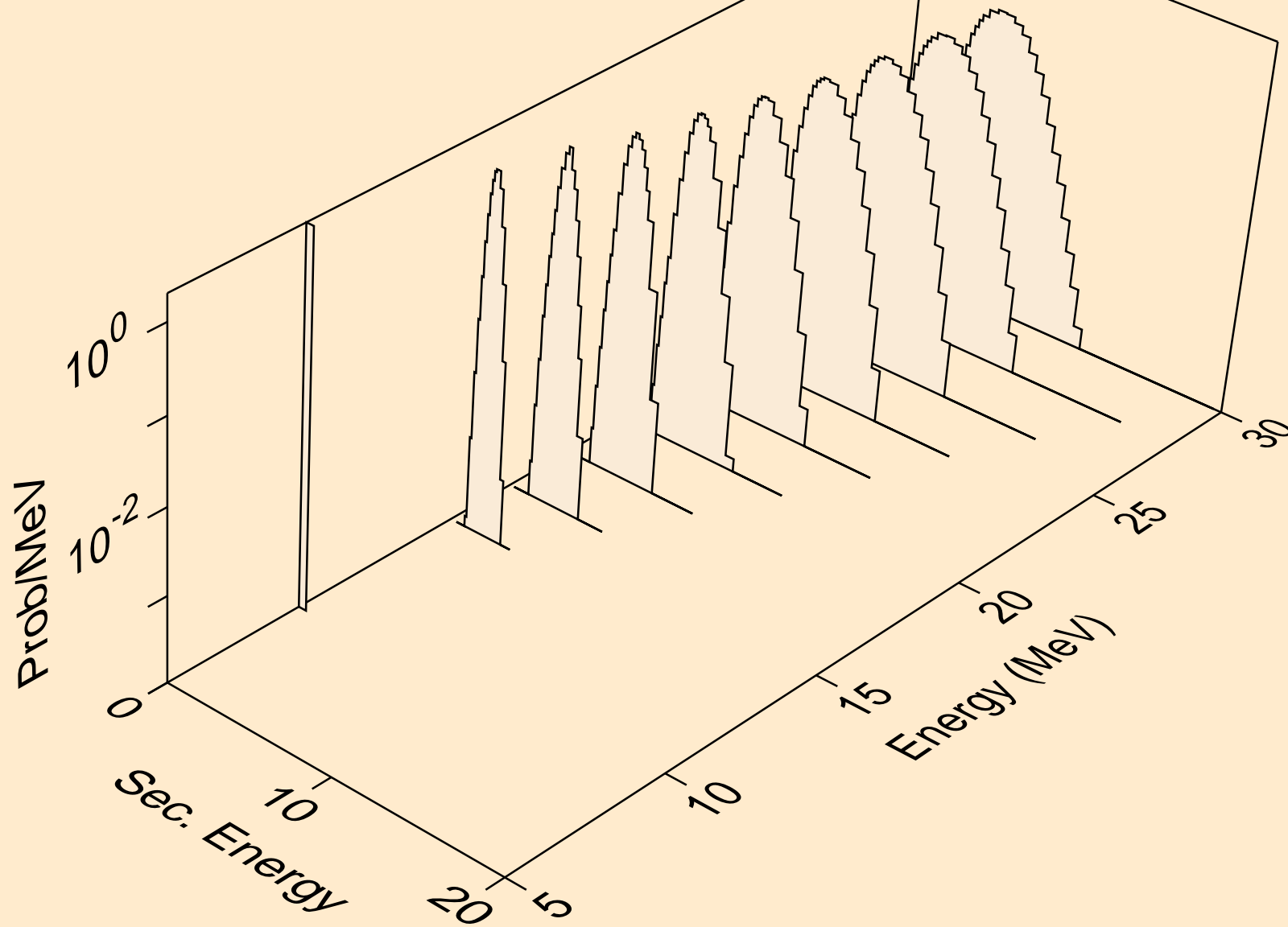

I114 HELION ACER TENDL-2021 LIBRARY; T=0.K  
deuterons from (s,x)

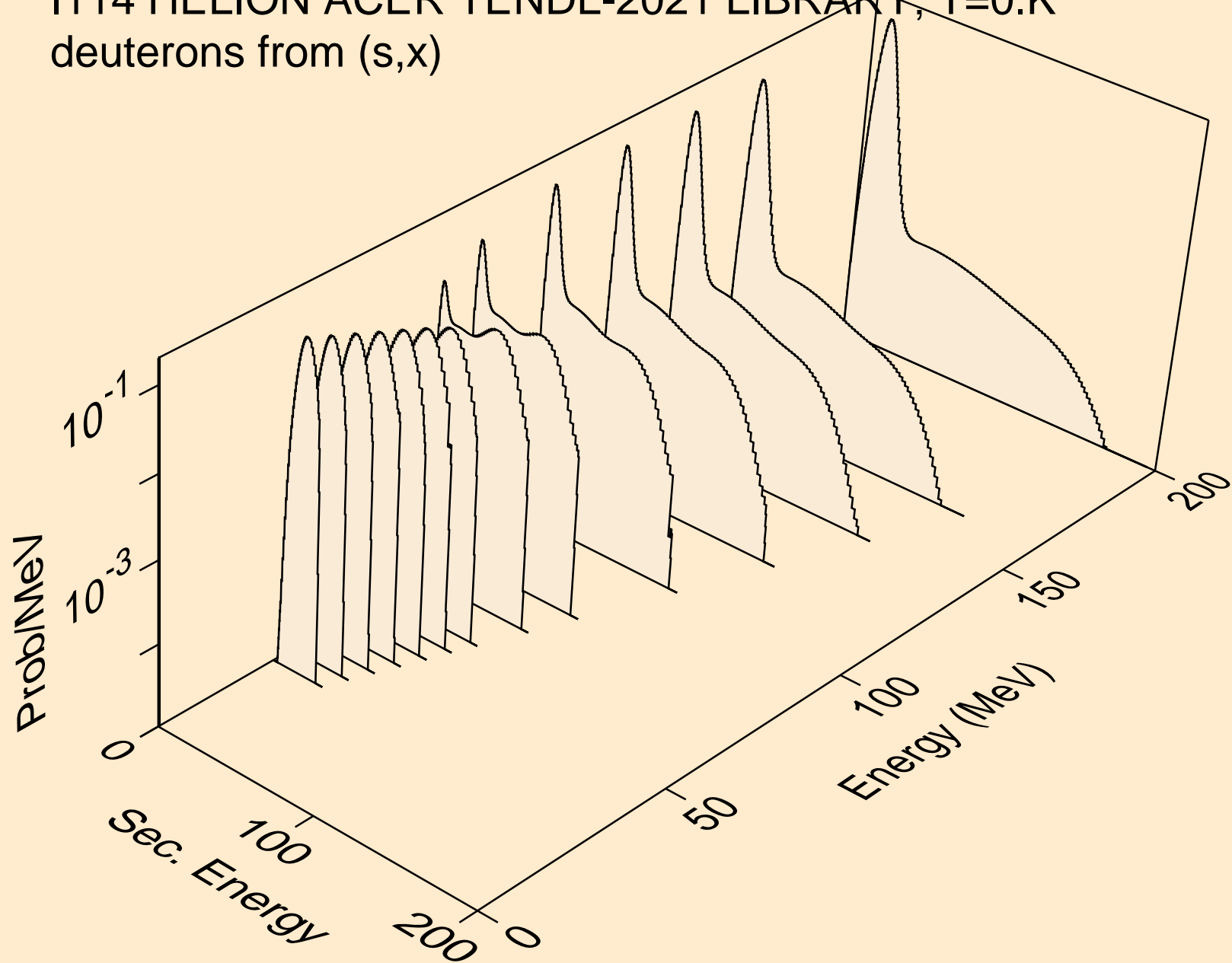

I114 HELION ACER TENDL-2021 LIBRARY; T=0.K  
deuterons from (s,n\*)d

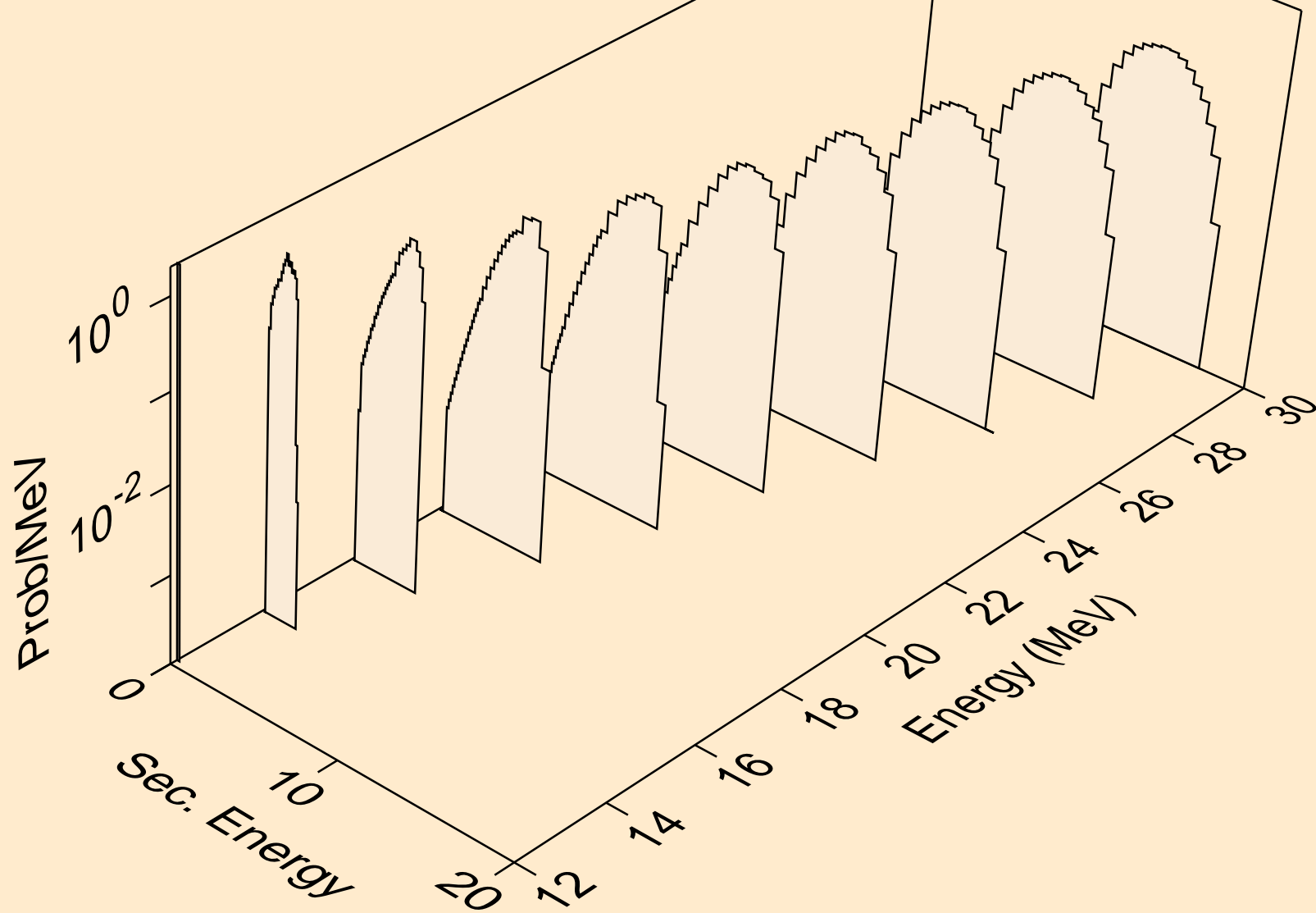

I114 HELION ACER TENDL-2021 LIBRARY; T=0.K  
deuterons from (s,d)

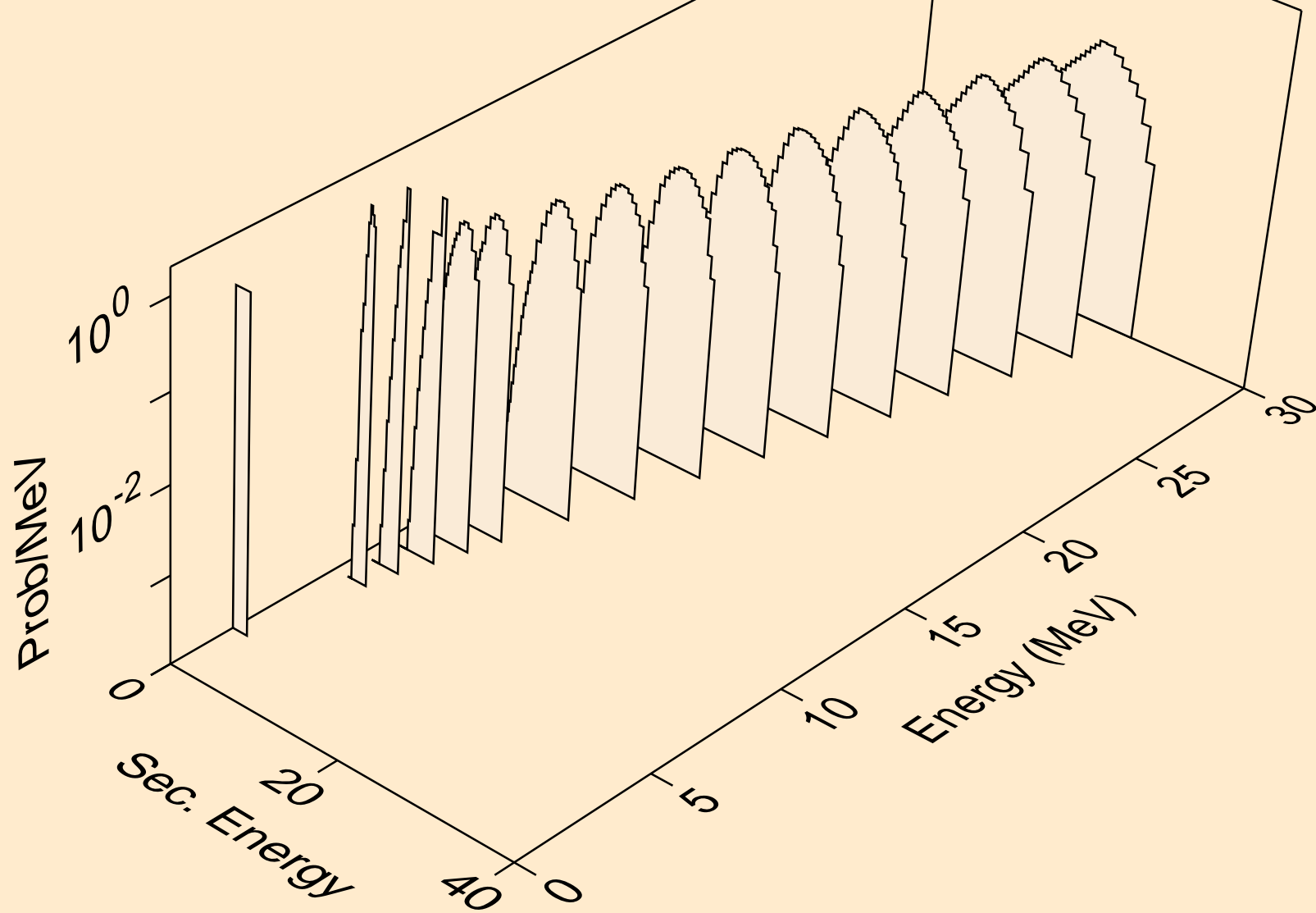

I114 HELION ACER TENDL-2021 LIBRARY; T=0.K  
deuterons from (s,d2a)

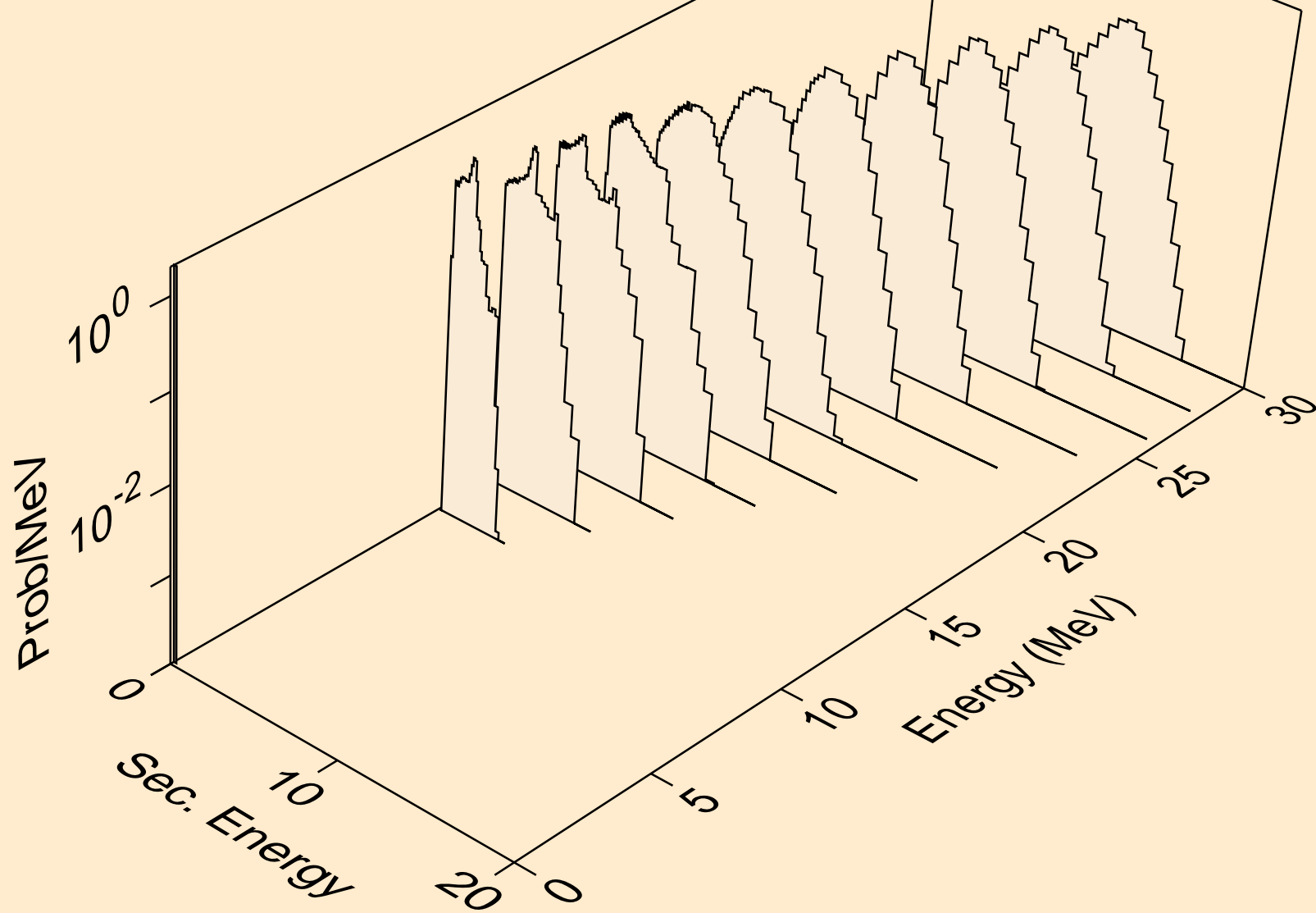

I114 HELION ACER TENDL-2021 LIBRARY; T=0.K  
deuterons from (s,pd)

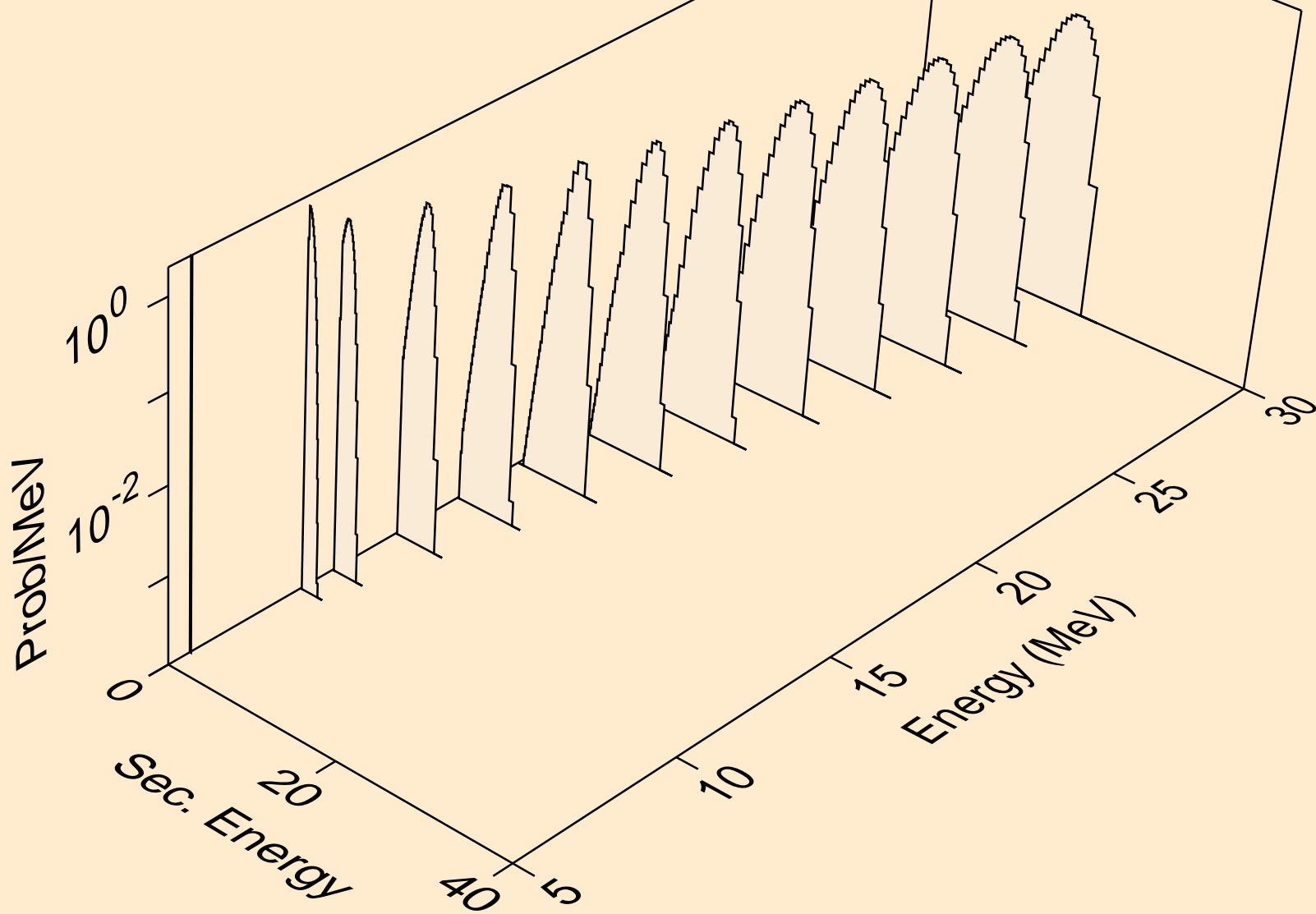

I114 HELION ACER TENDL-2021 LIBRARY; T=0.K  
deuterons from (s,da)

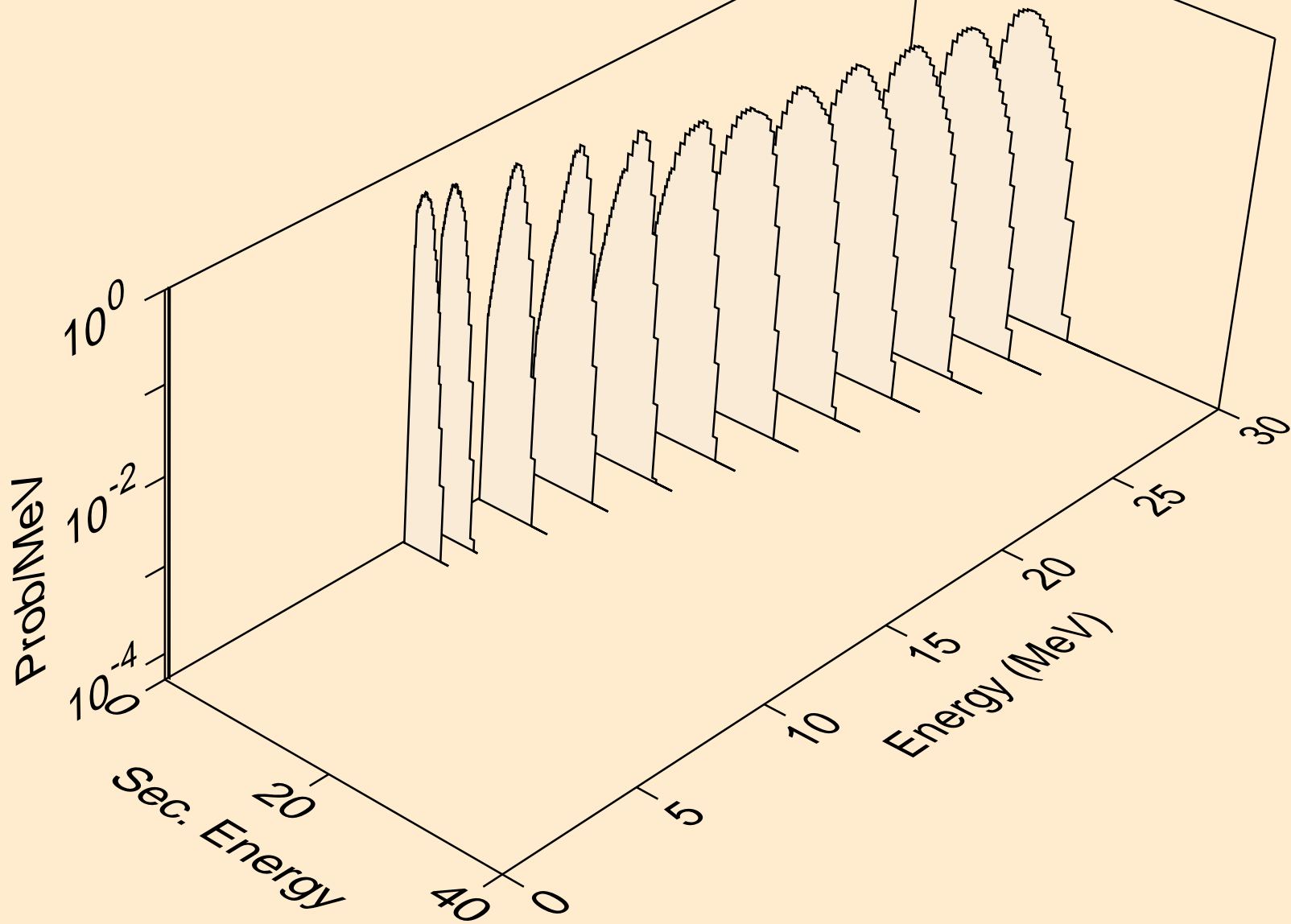

I114 HELION ACER TENDL-2021 LIBRARY; T=0.K  
tritons from (s,x)

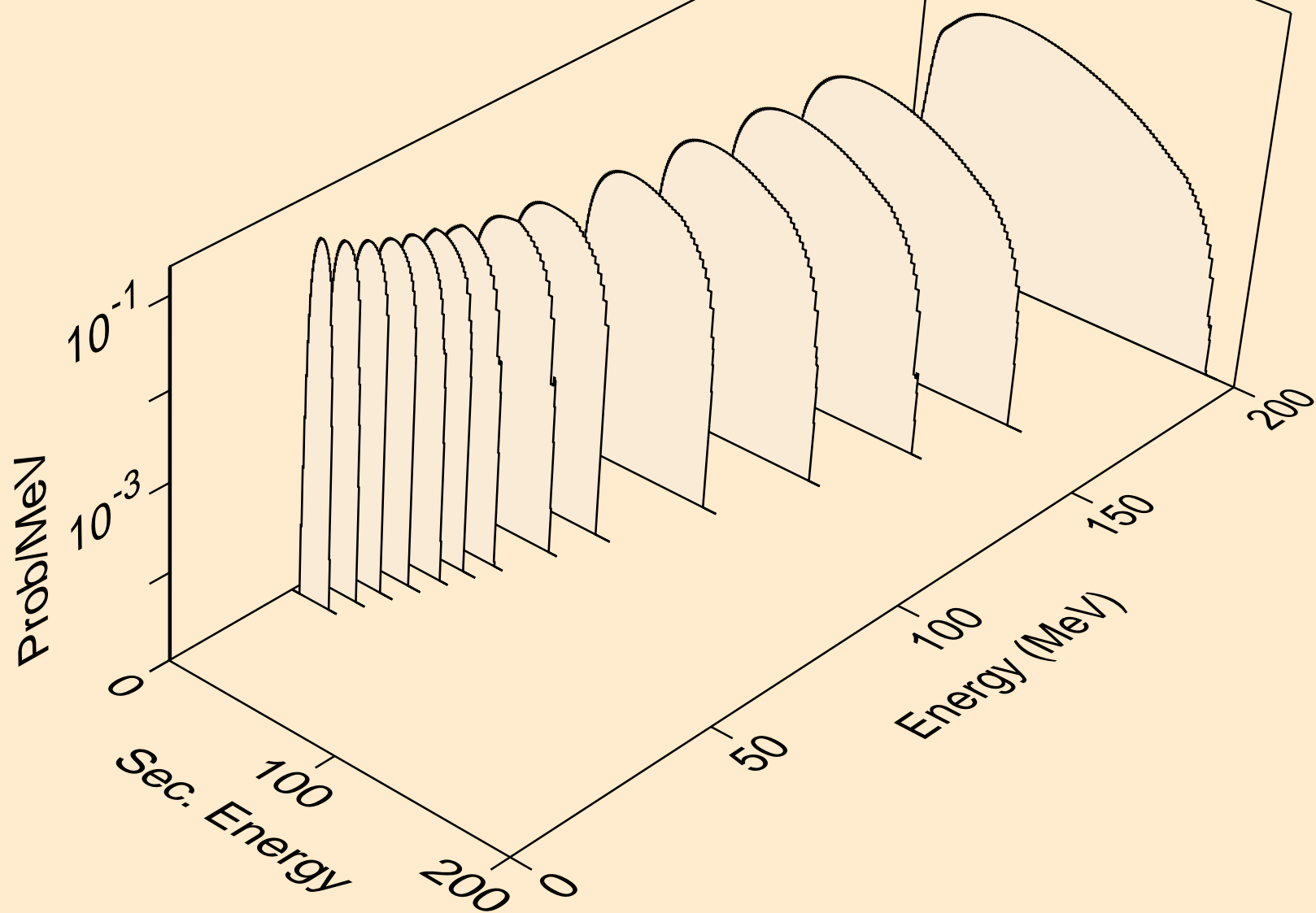



I114 HELION ACER TENDL-2021 LIBRARY; T=0.K  
tritons from (s,n\*)t

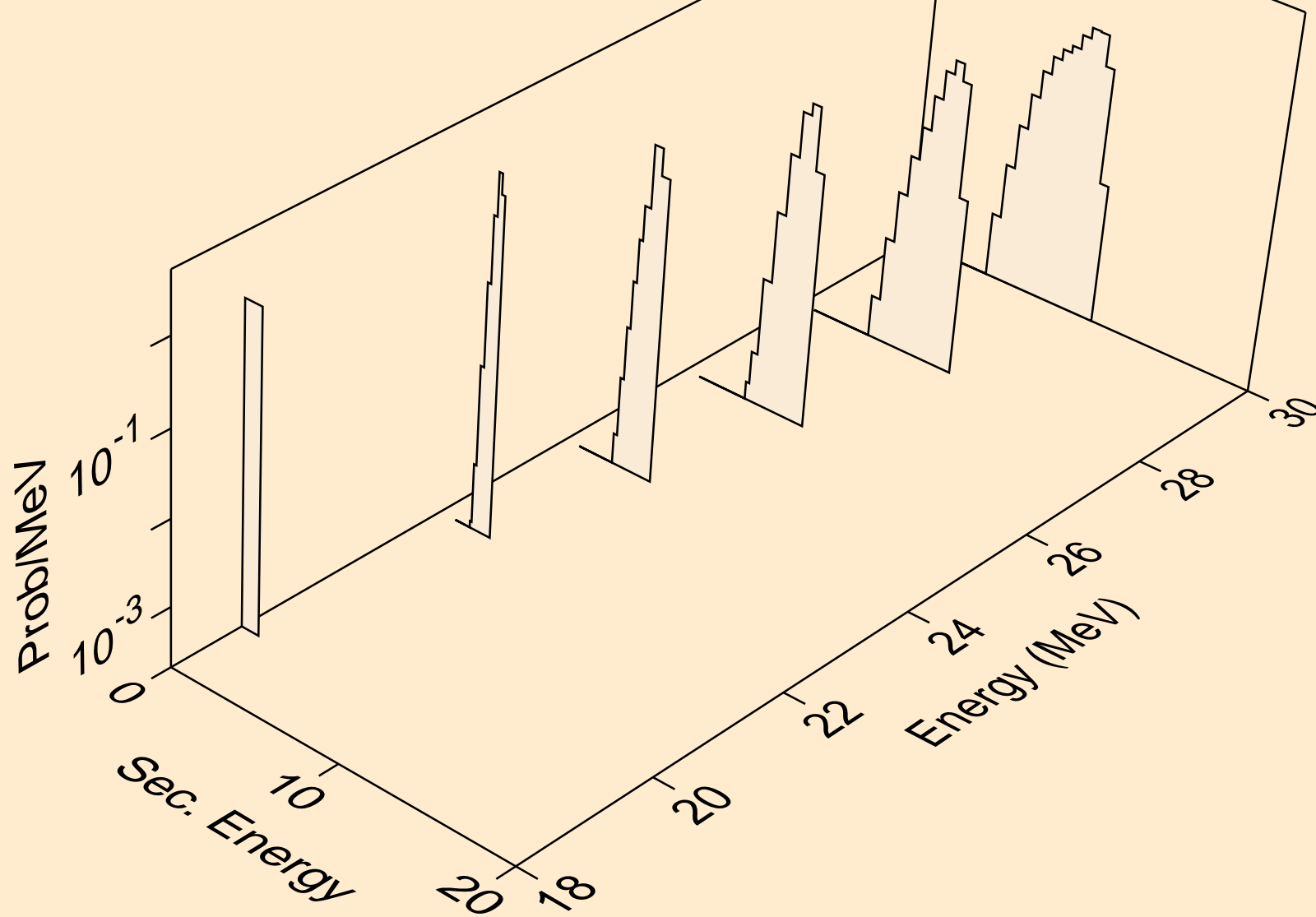

I114 HELION ACER TENDL-2021 LIBRARY; T=0.K  
tritons from (s,t)

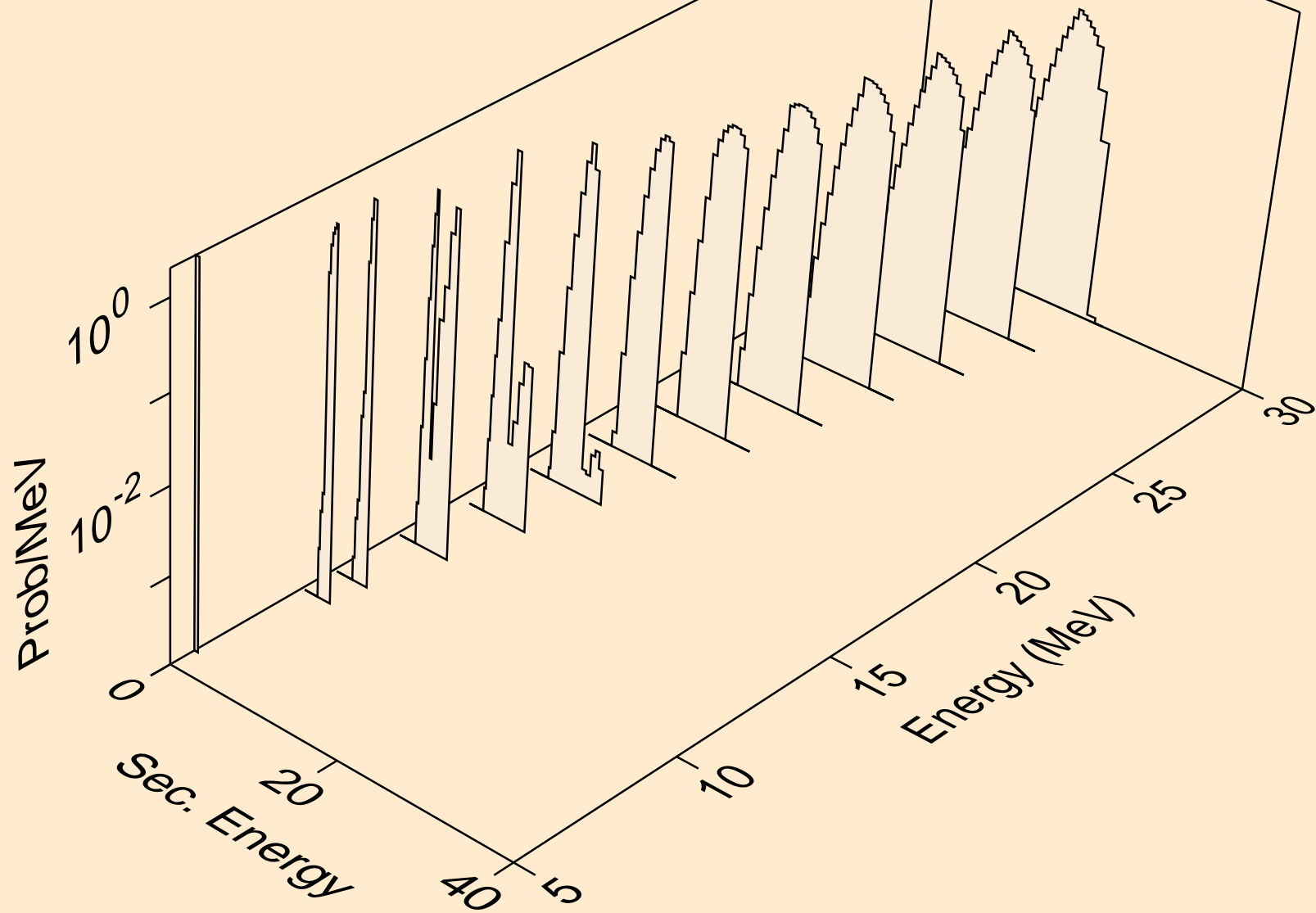

I114 HELION ACER TENDL-2021 LIBRARY; T=0.K  
tritons from (s,t2a)

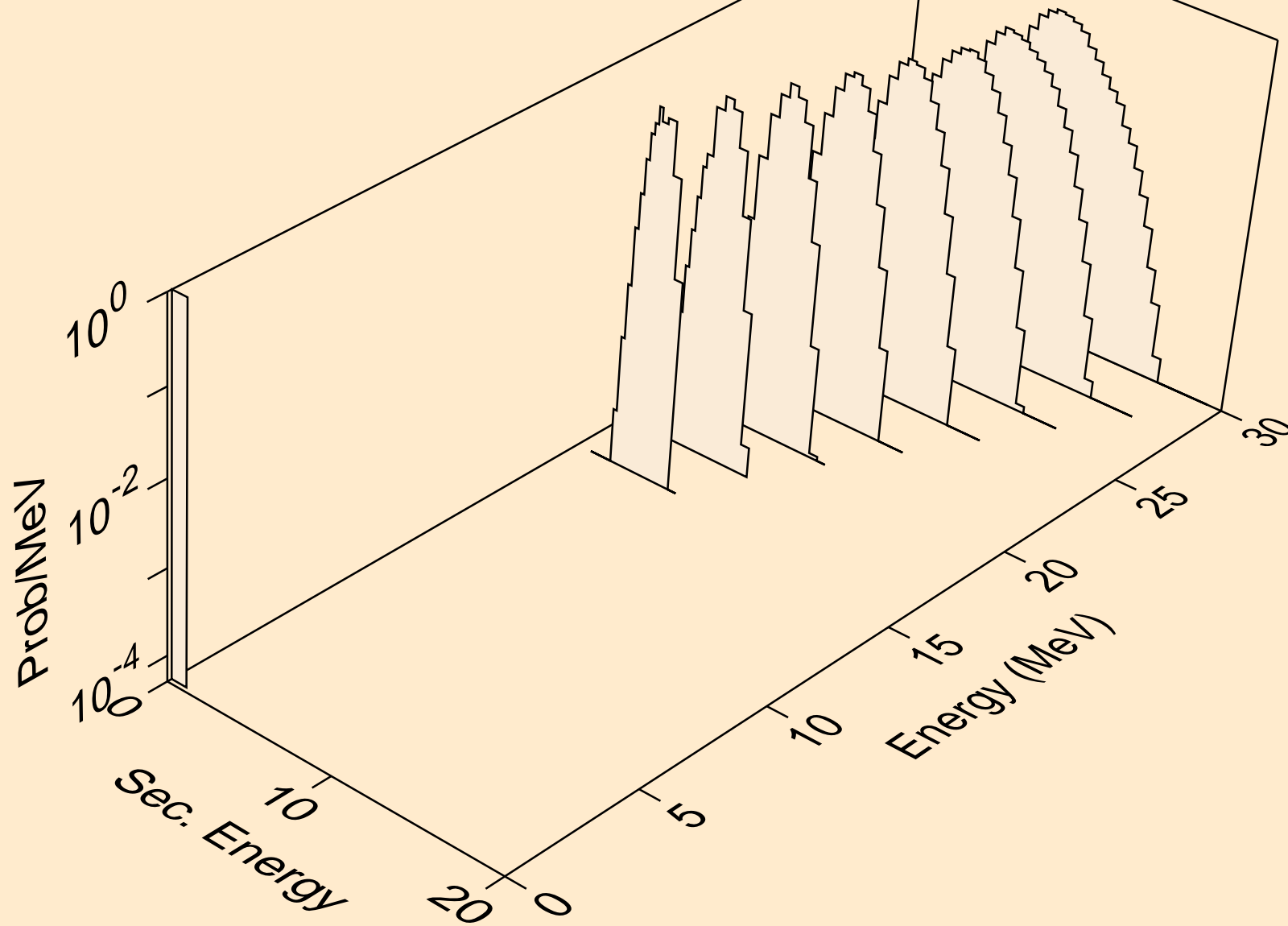

I114 HELION ACER TENDL-2021 LIBRARY; T=0.K  
tritons from (s,pt)

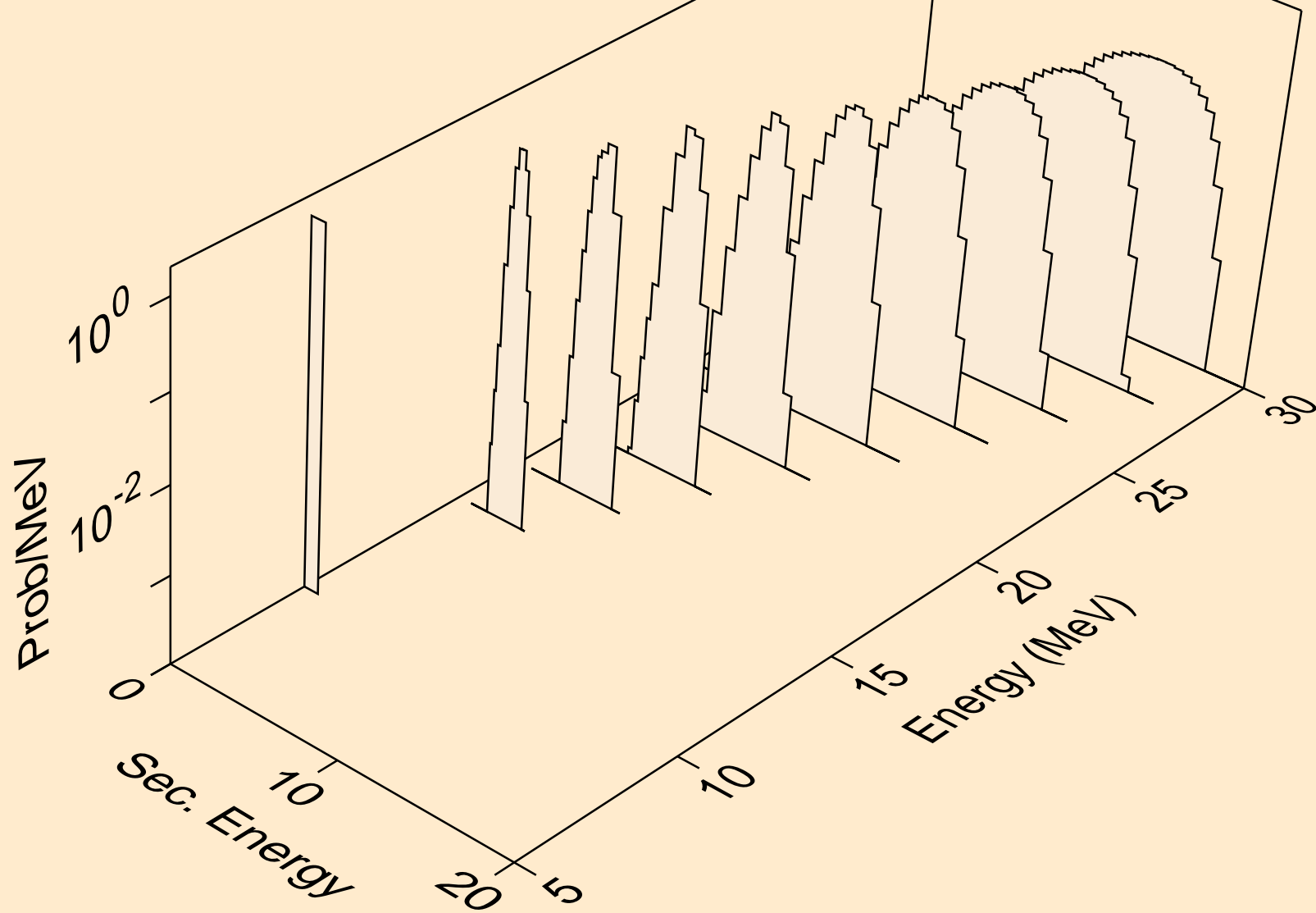

I114 HELION ACER TENDL-2021 LIBRARY; T=0.K  
alphas from (s,x)

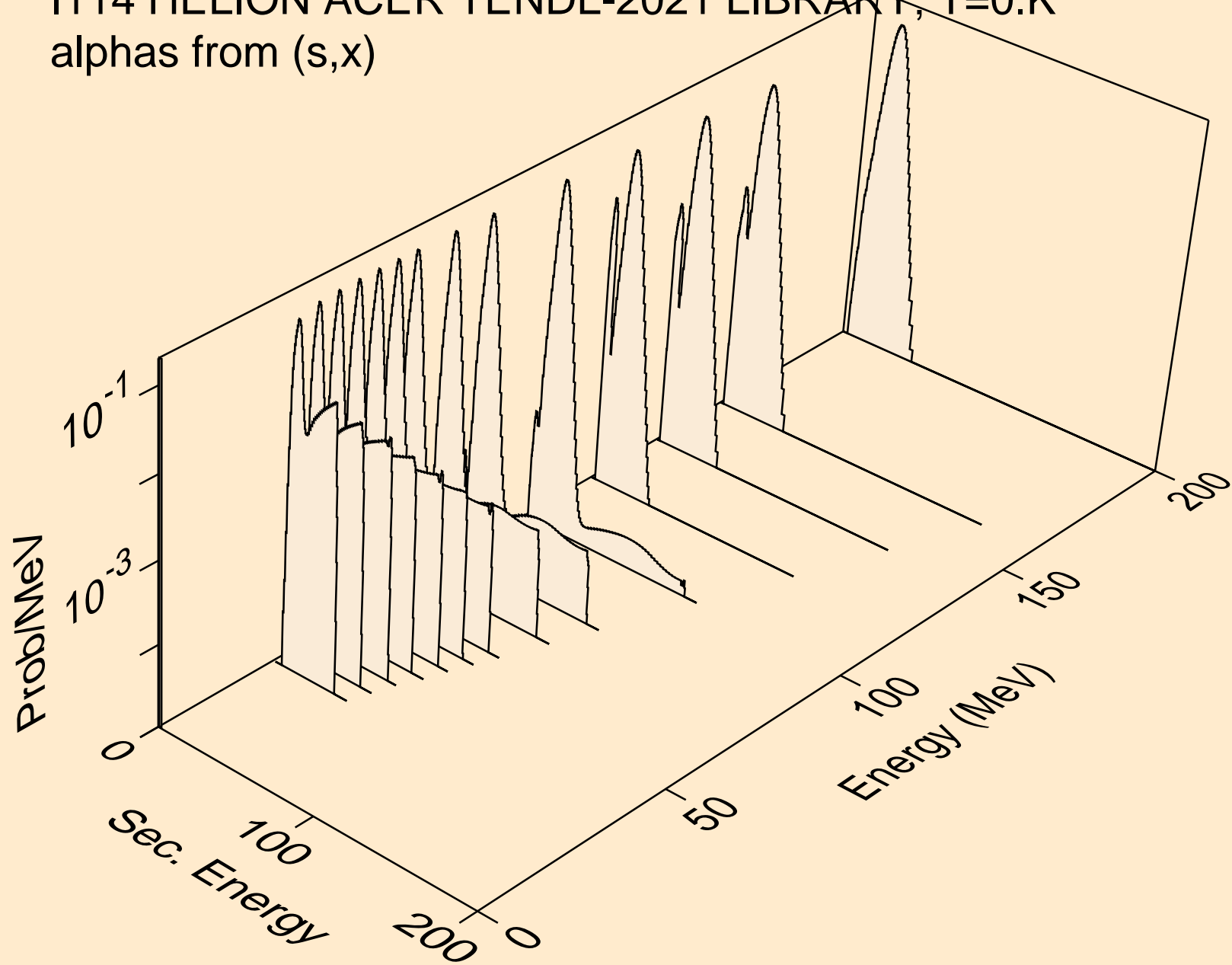

I114 HELION ACER TENDL-2021 LIBRARY; T=0.K  
alphas from (s,n\*)a

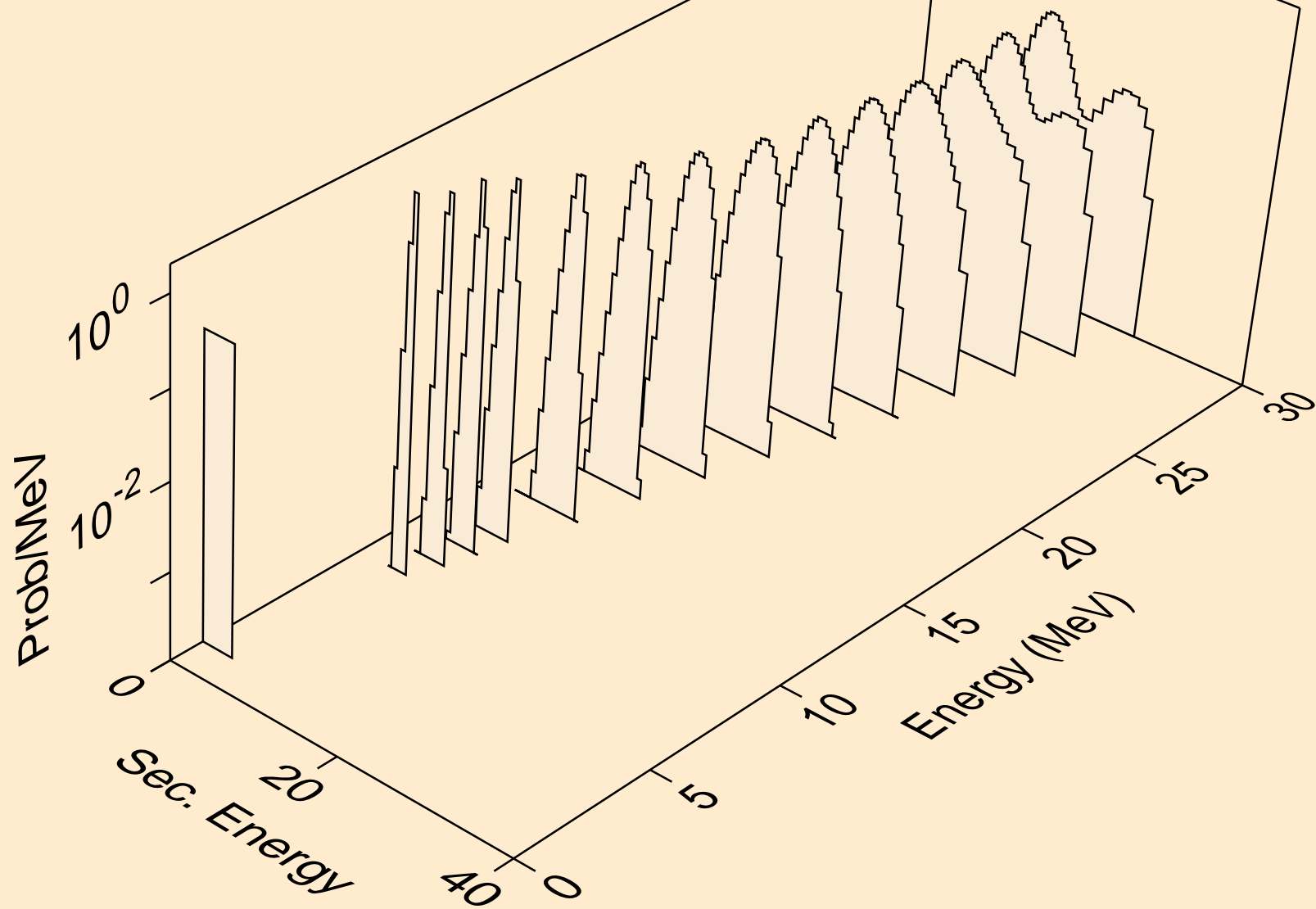

I114 HELION ACER TENDL-2021 LIBRARY; T=0.K  
alphas from (s,2n)a

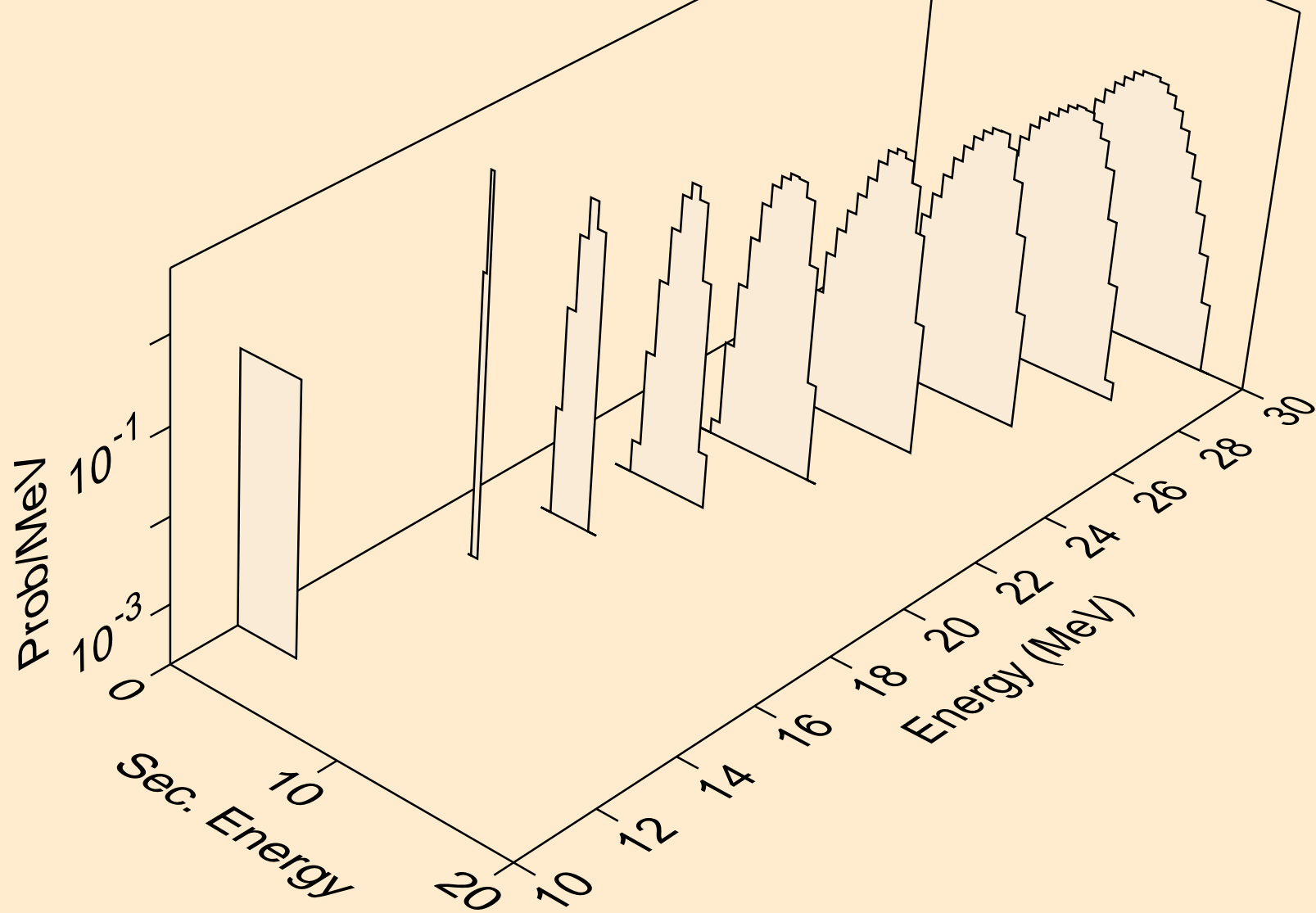

I114 HELION ACER TENDL-2021 LIBRARY; T=0.K  
alphas from (s,n\*)2a

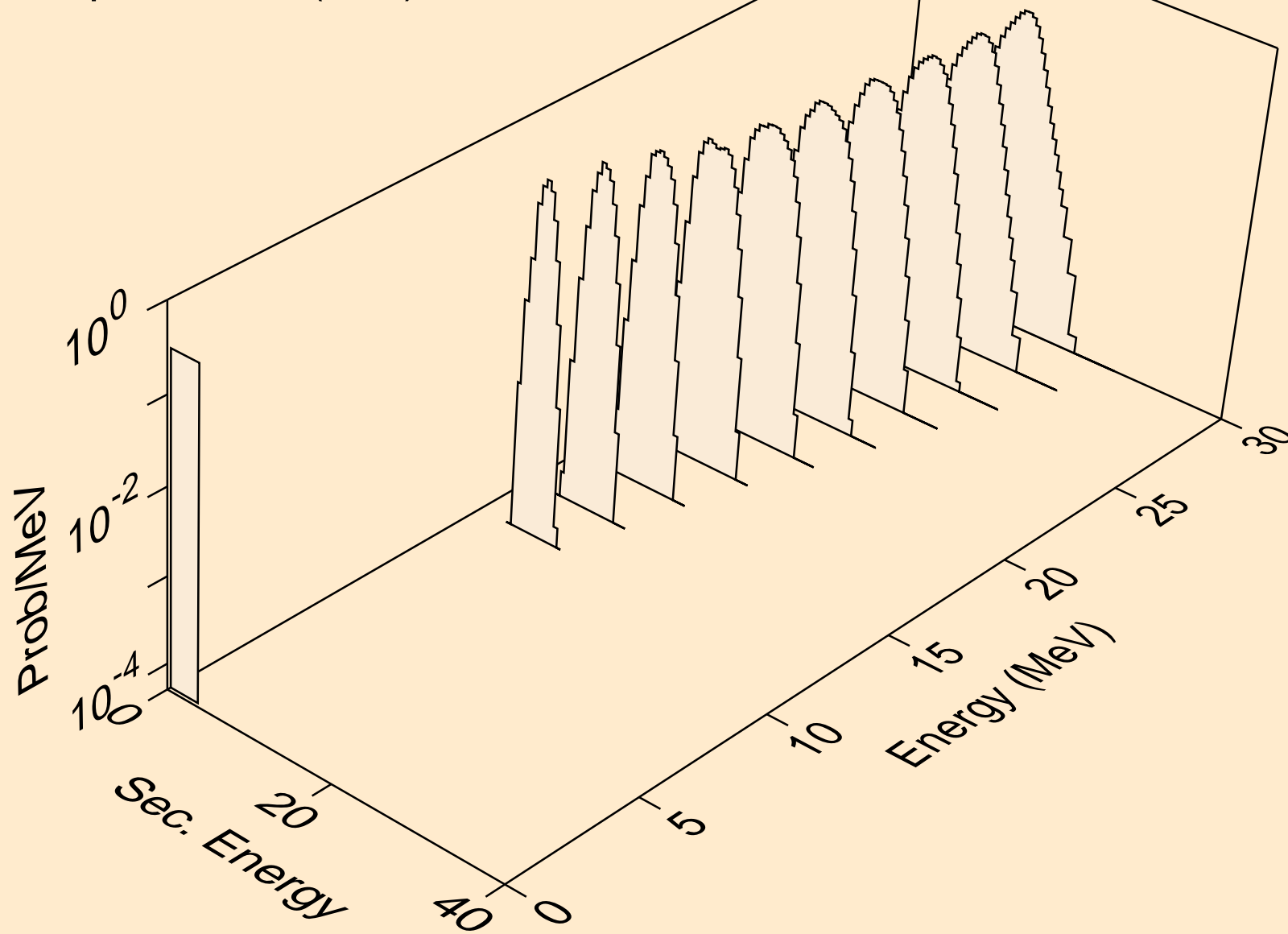



I114 HELION ACER TENDL-2021 LIBRARY; T=0.K  
alphas from (s,npa)

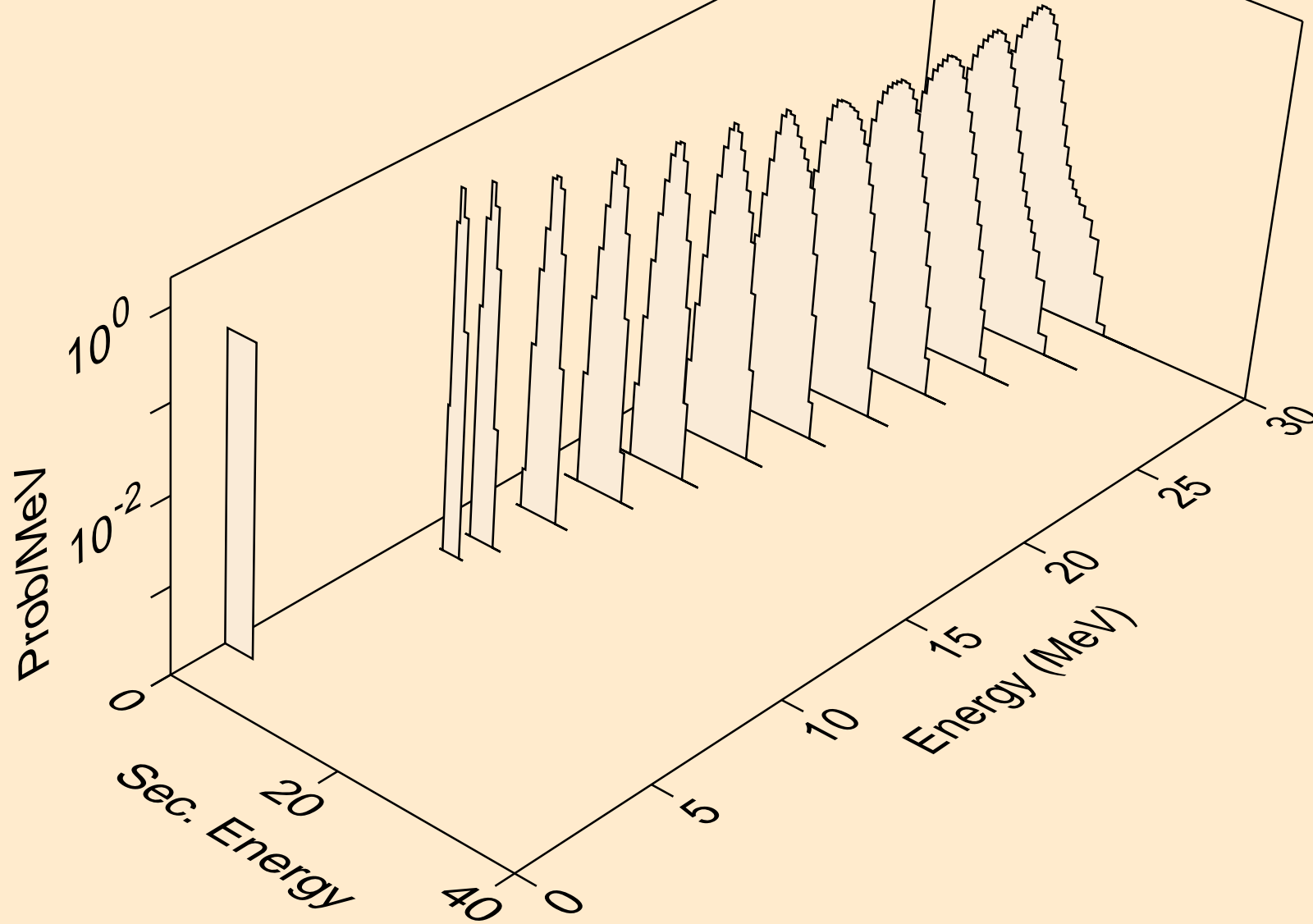

I114 HELION ACER TENDL-2021 LIBRARY; T=0.K  
alphas from (s,a)

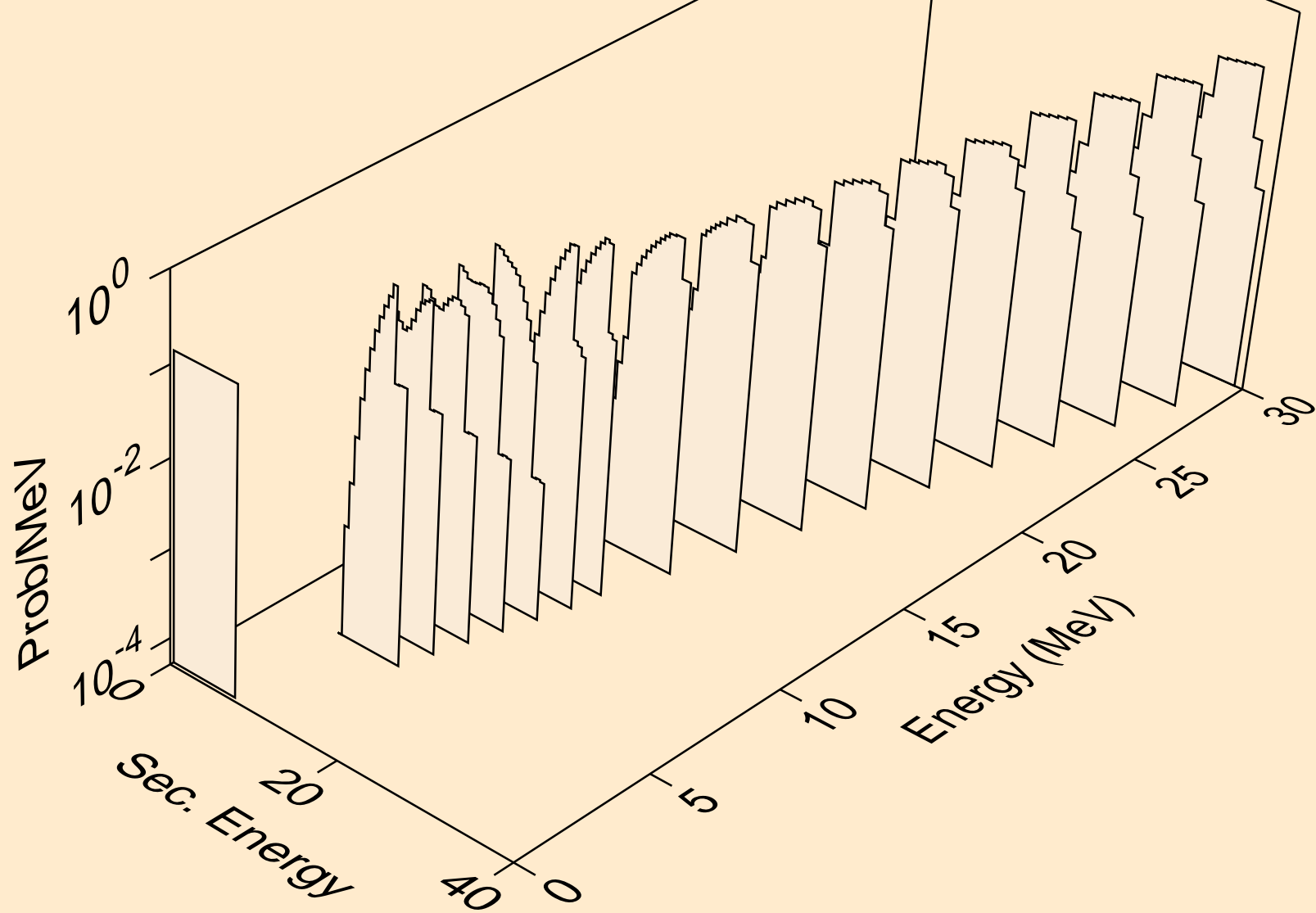

I114 HELION ACER TENDL-2021 LIBRARY; T=0.K  
alphas from (s,2a)

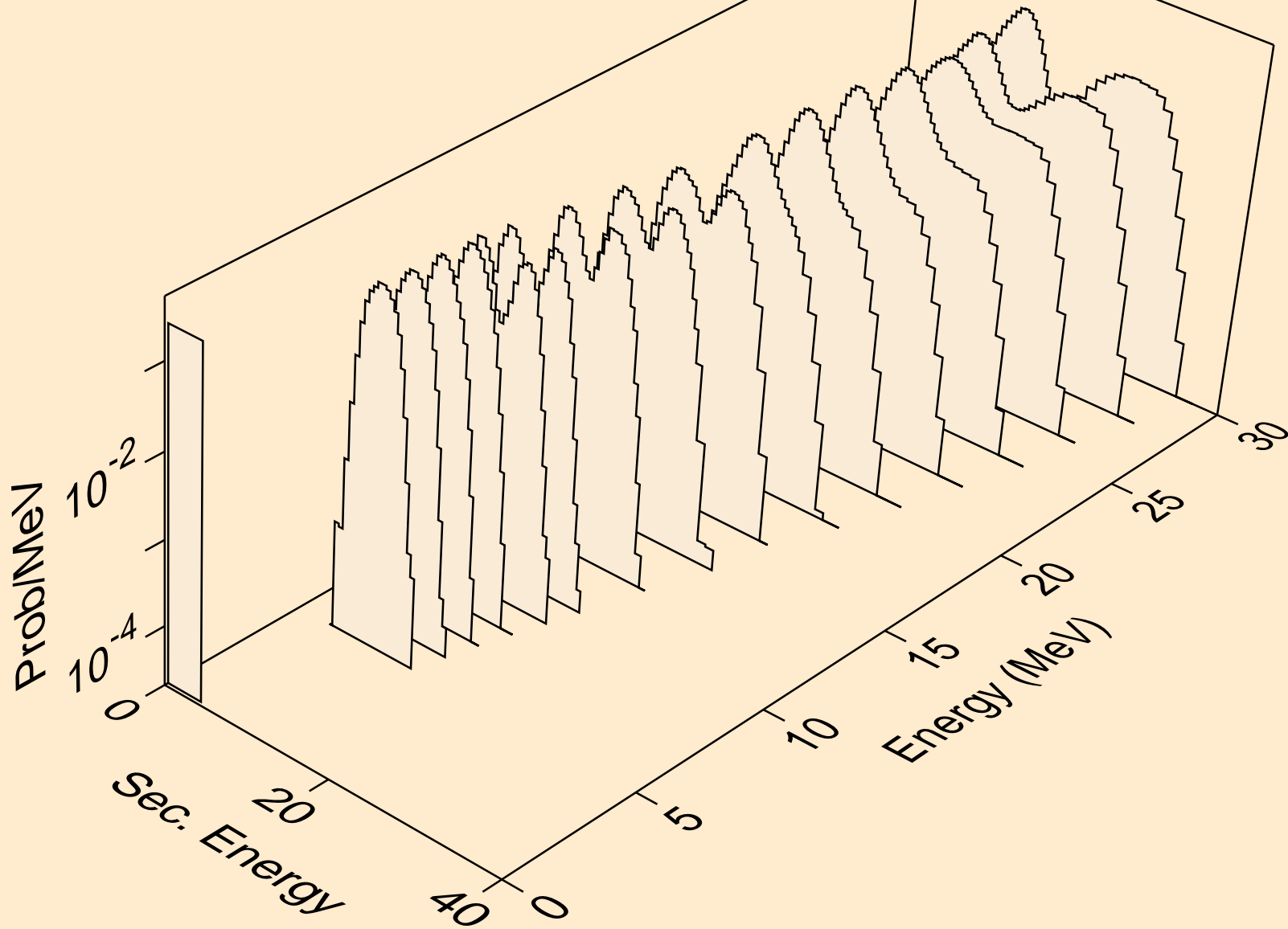

I114 HELION ACER TENDL-2021 LIBRARY; T=0.K  
alphas from (s,3a)

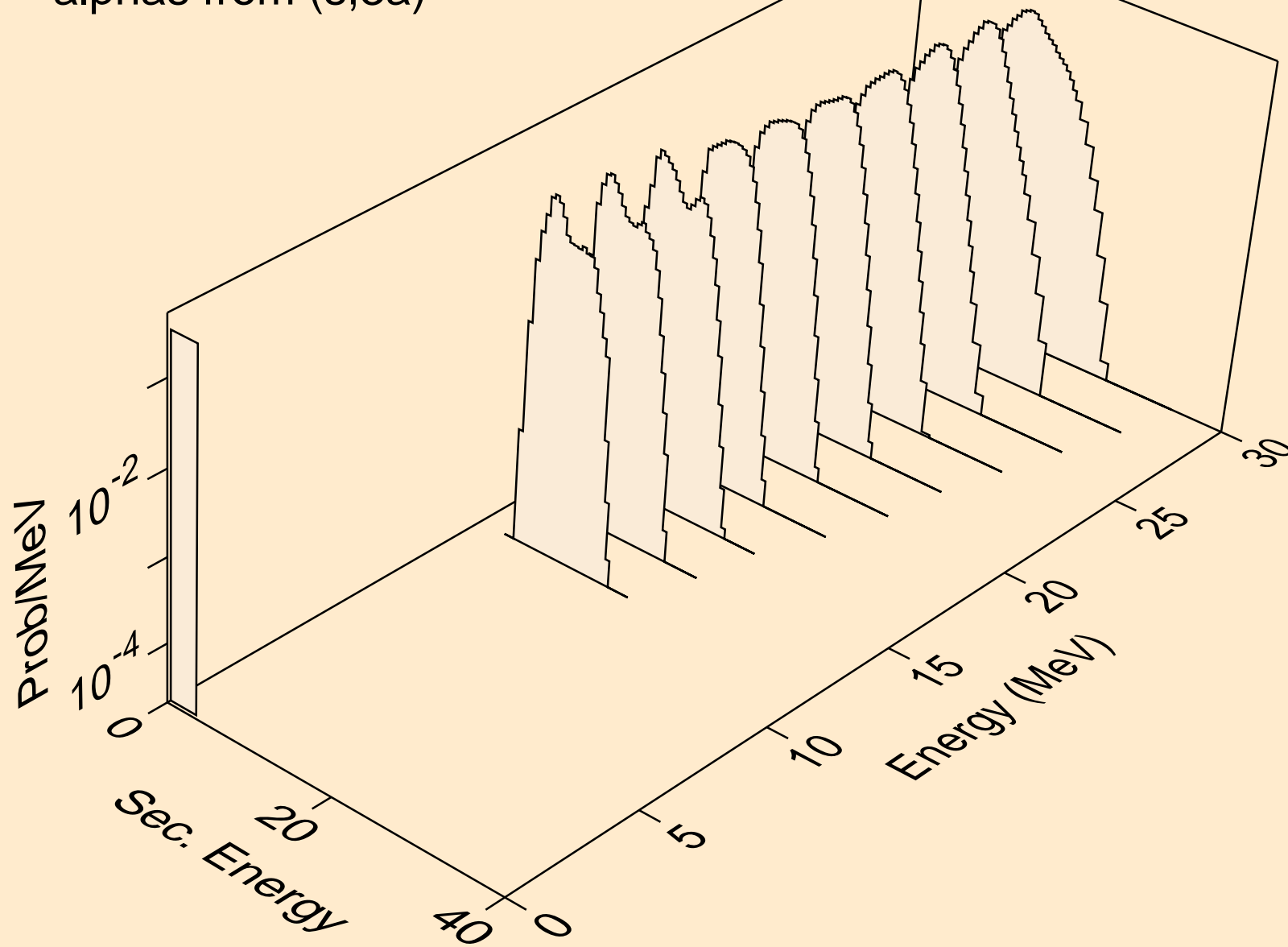

I114 HELION ACER TENDL-2021 LIBRARY; T=0.K  
alphas from (s,pa)

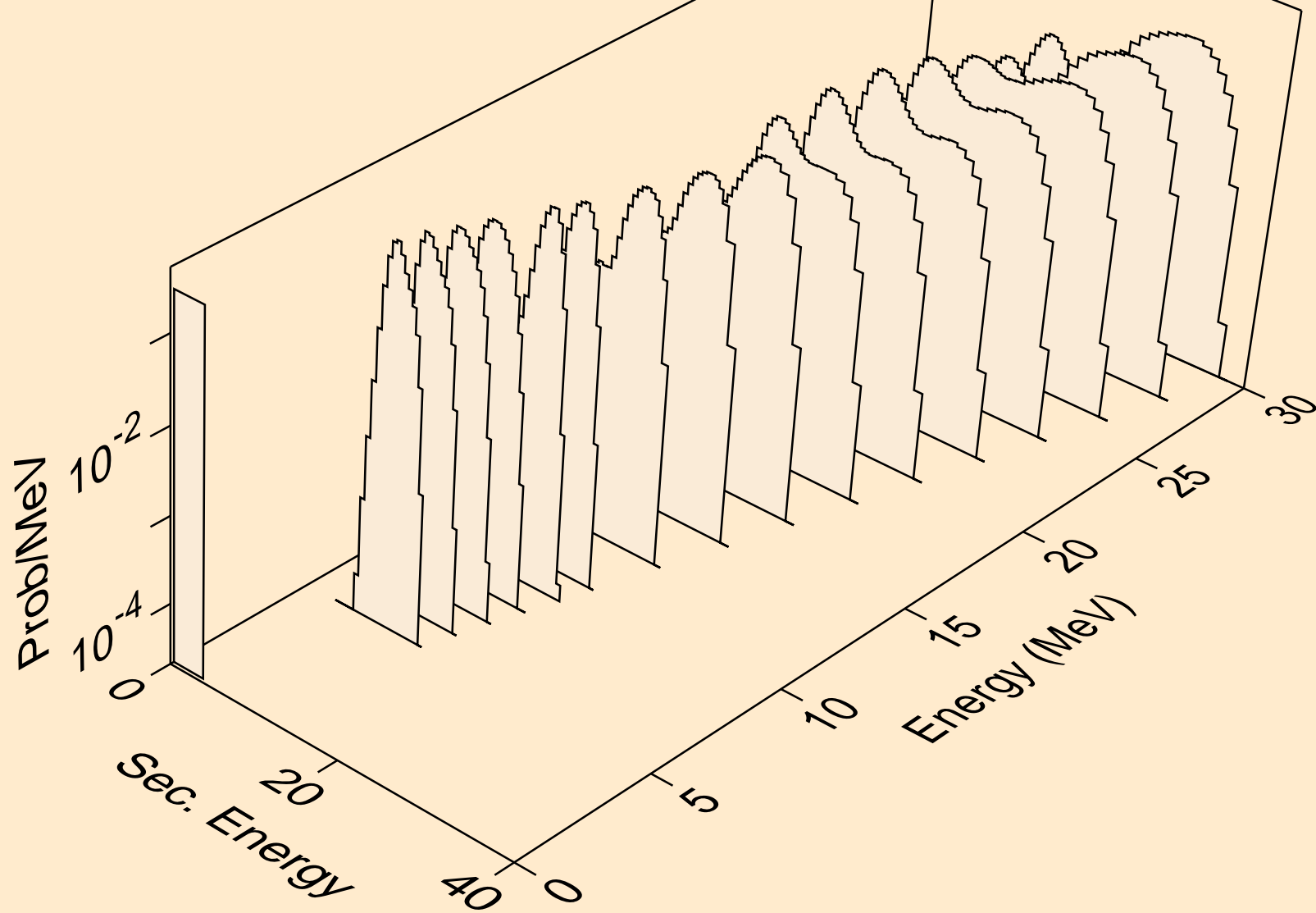

I114 HELION ACER TENDL-2021 LIBRARY; T=0.K  
alphas from (s,t2a)

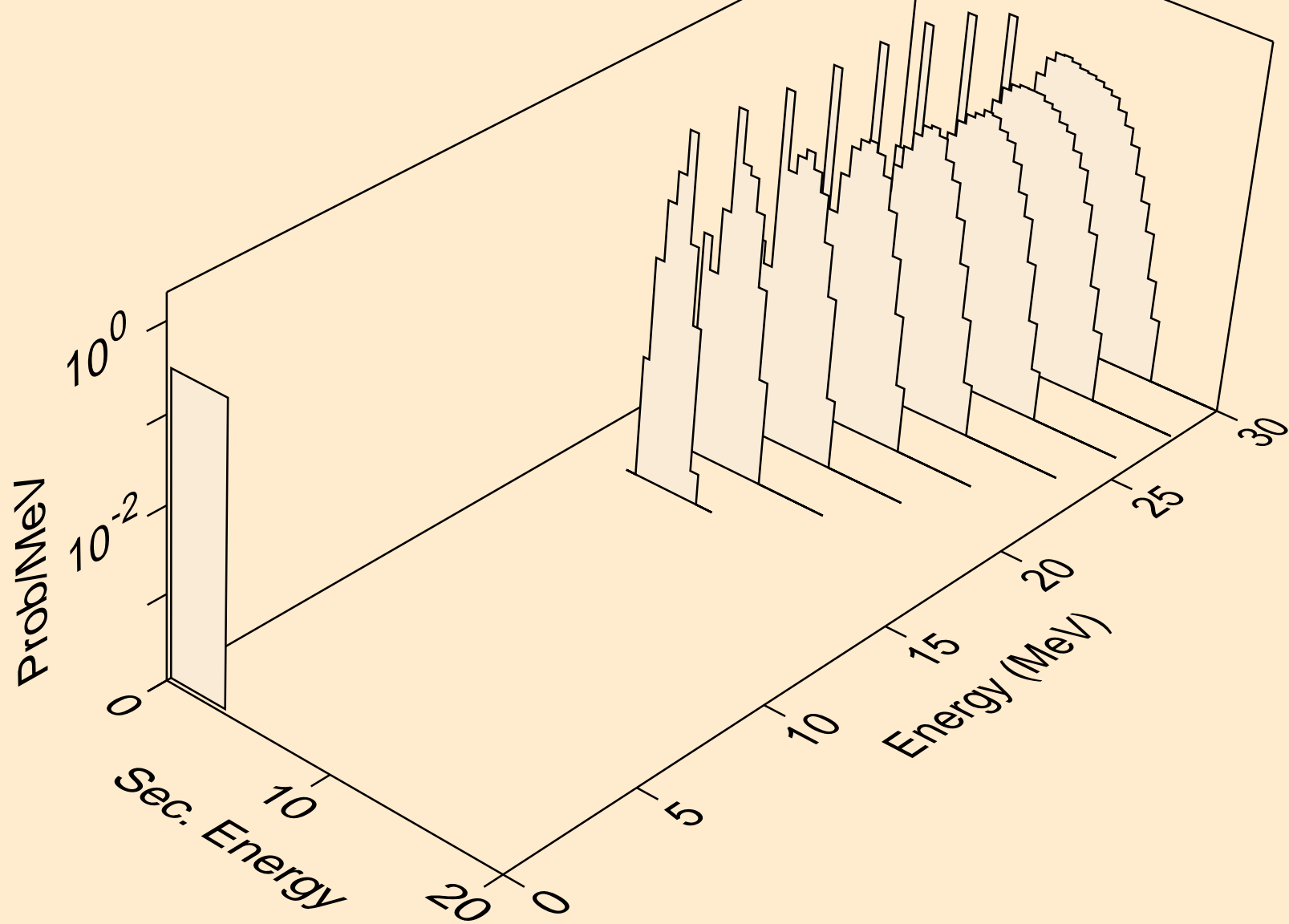

I114 HELION ACER TENDL-2021 LIBRARY; T=0.K  
alphas from (s,d2a)

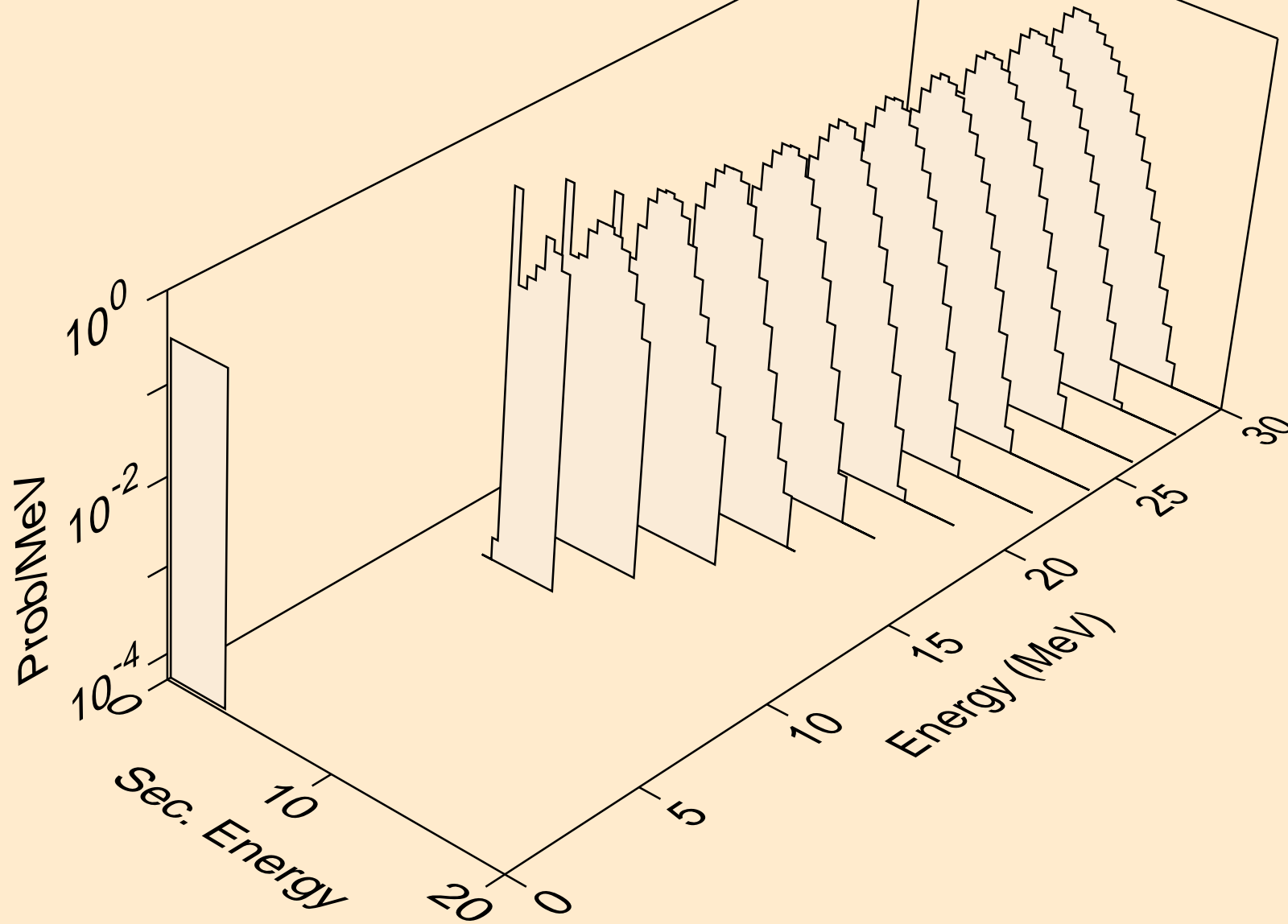

I114 HELION ACER TENDL-2021 LIBRARY; T=0.K  
alphas from (s,da)

