

I134 HELION ACER TENDL-2021 LIBRARY; T=0.K
Principal cross sections

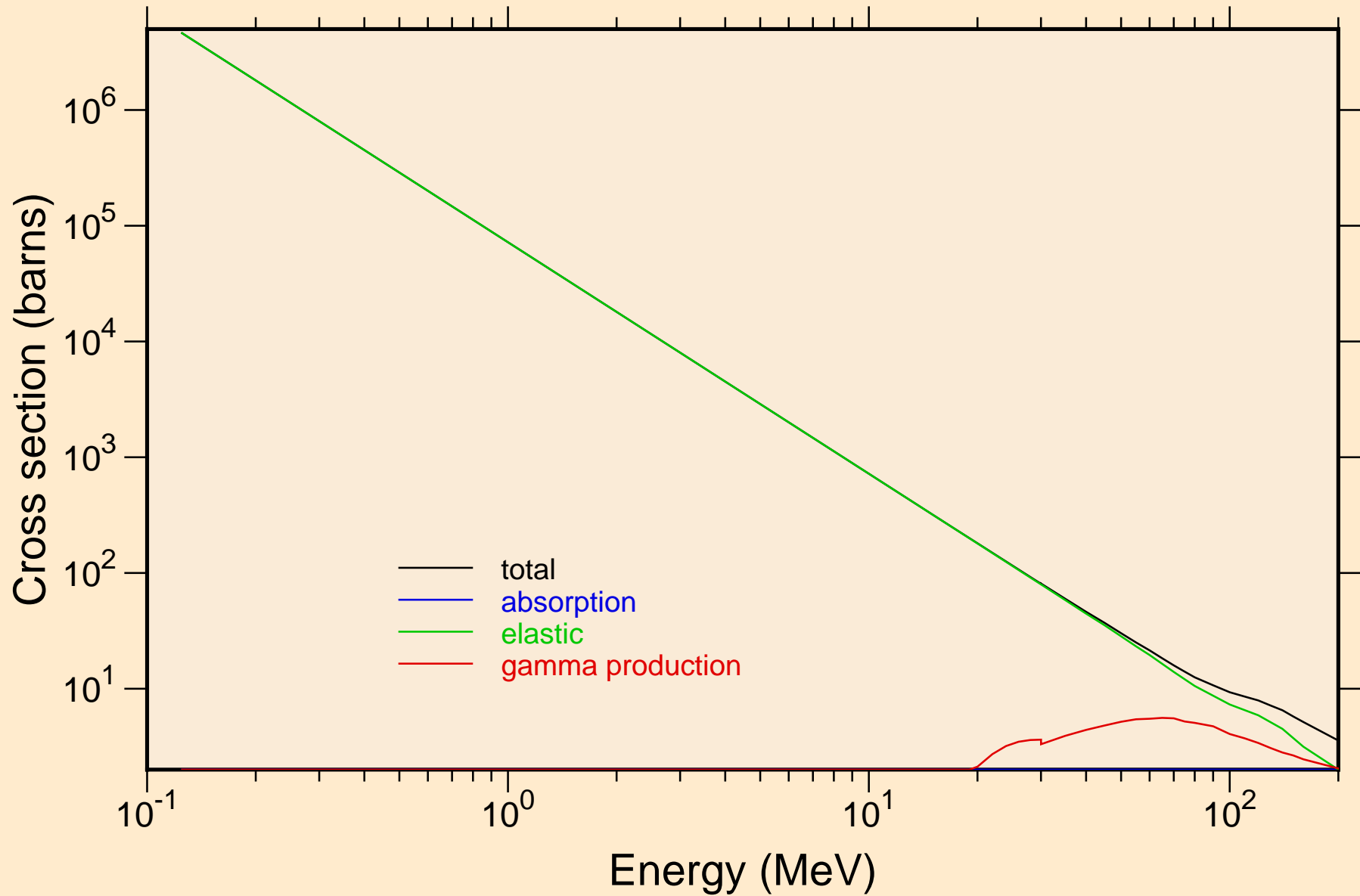

I134 HELION ACER TENDL-2021 LIBRARY; T=0.K

Heating

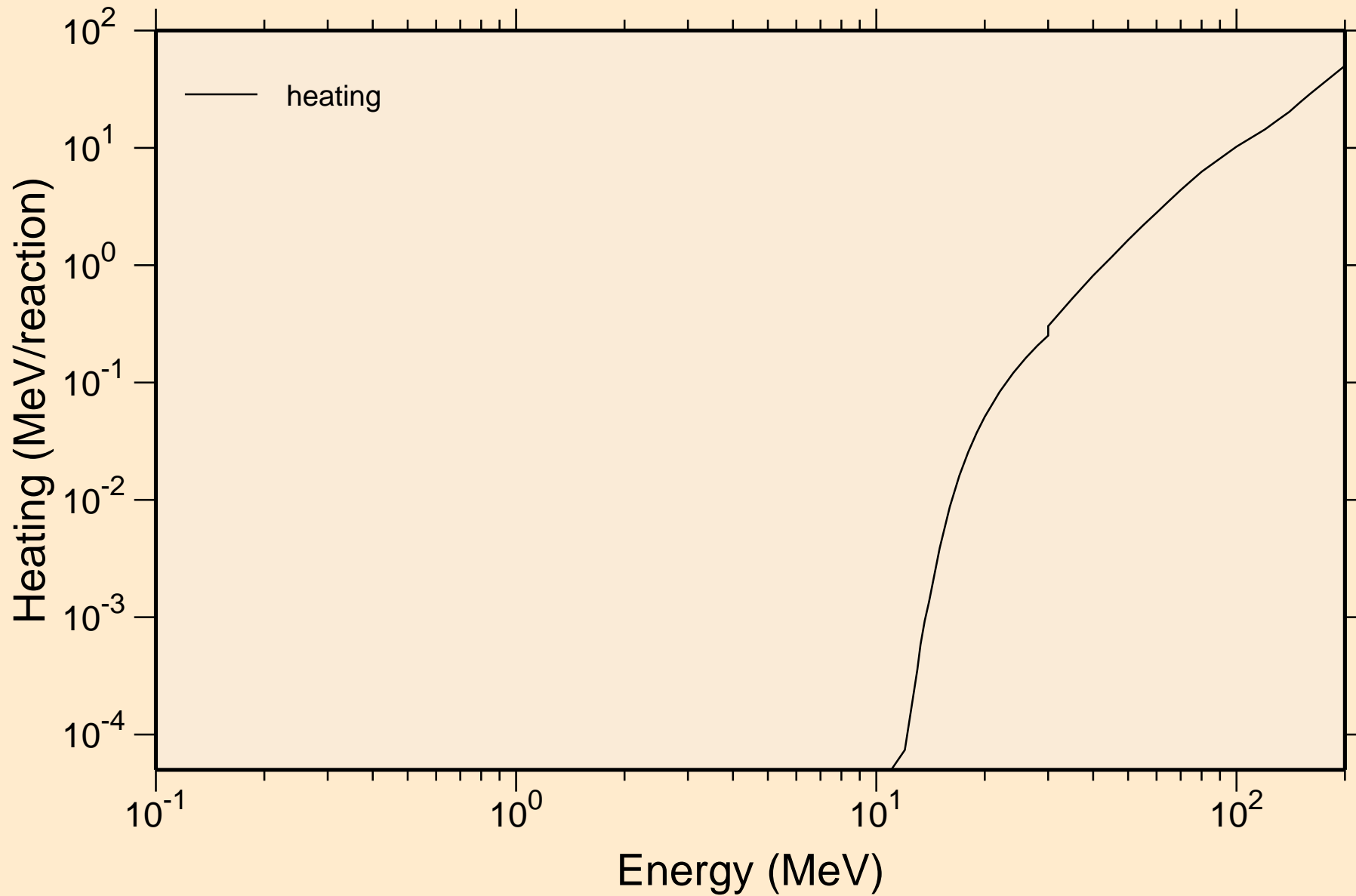

I134 HELION ACER TENDL-2021 LIBRARY; T=0.K

Principal cross sections

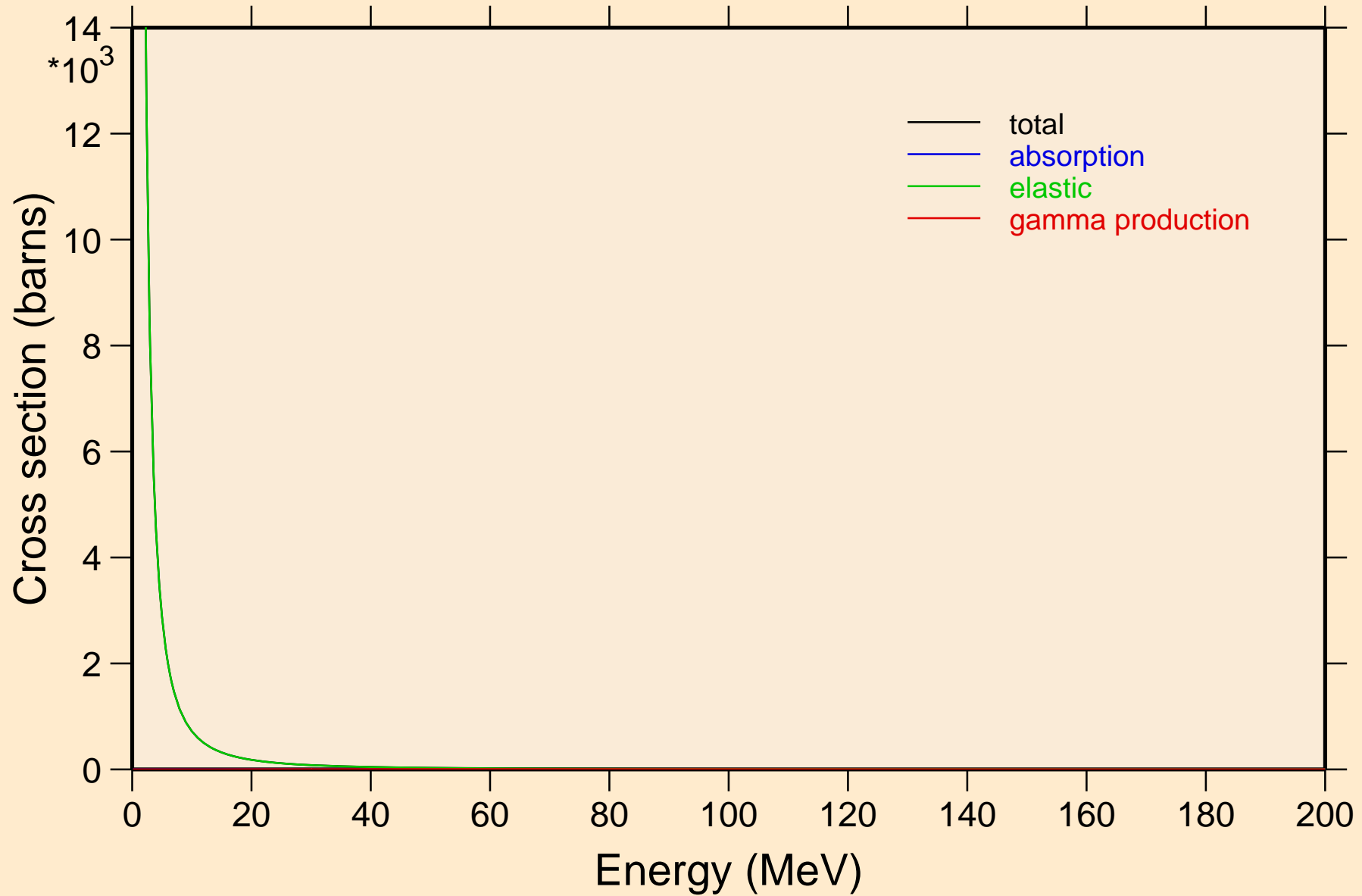

I134 HELION ACER TENDL-2021 LIBRARY; T=0.K

Heating

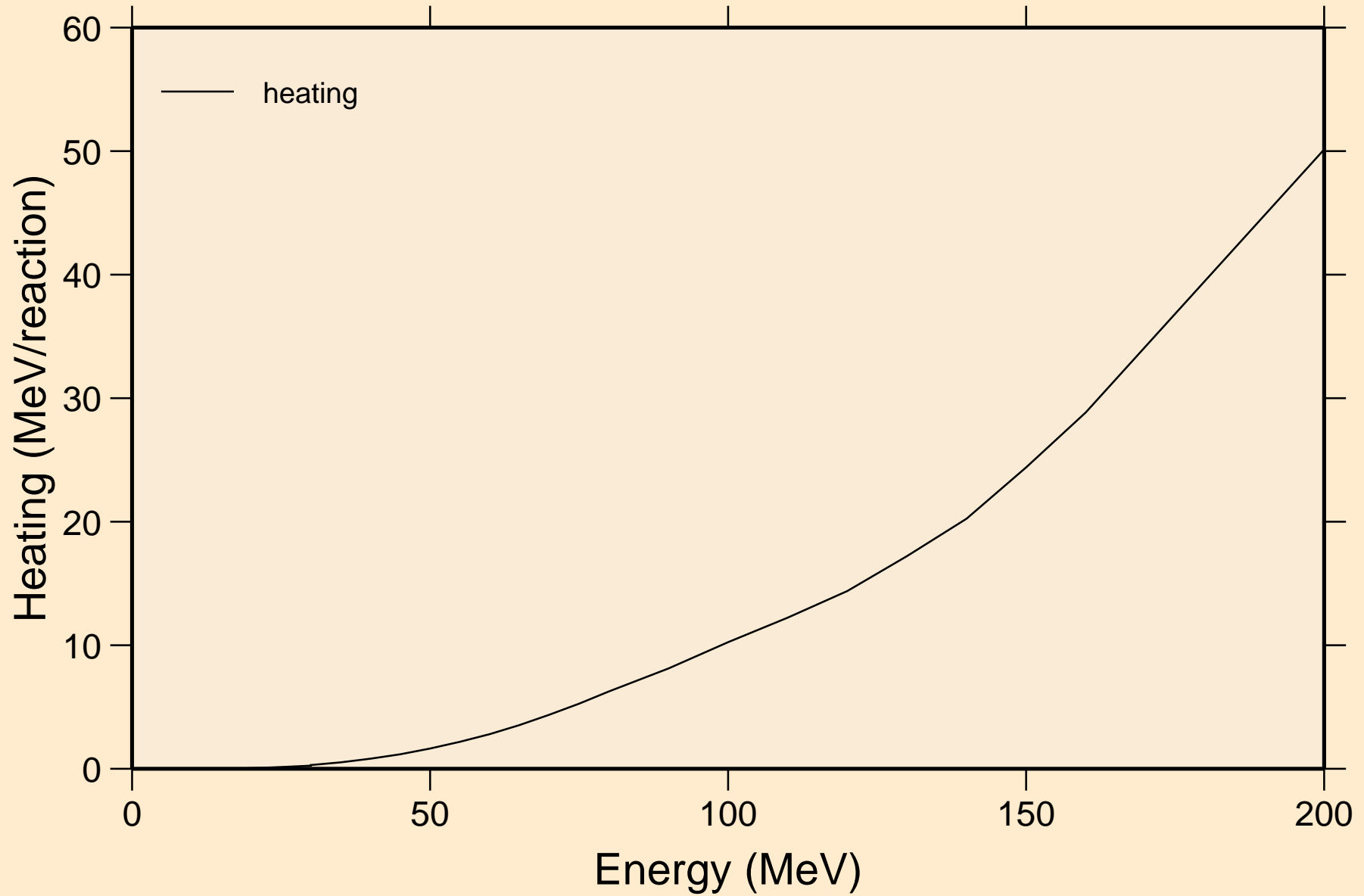

I134 HELION ACER TENDL-2021 LIBRARY; T=0.K
Threshold reactions

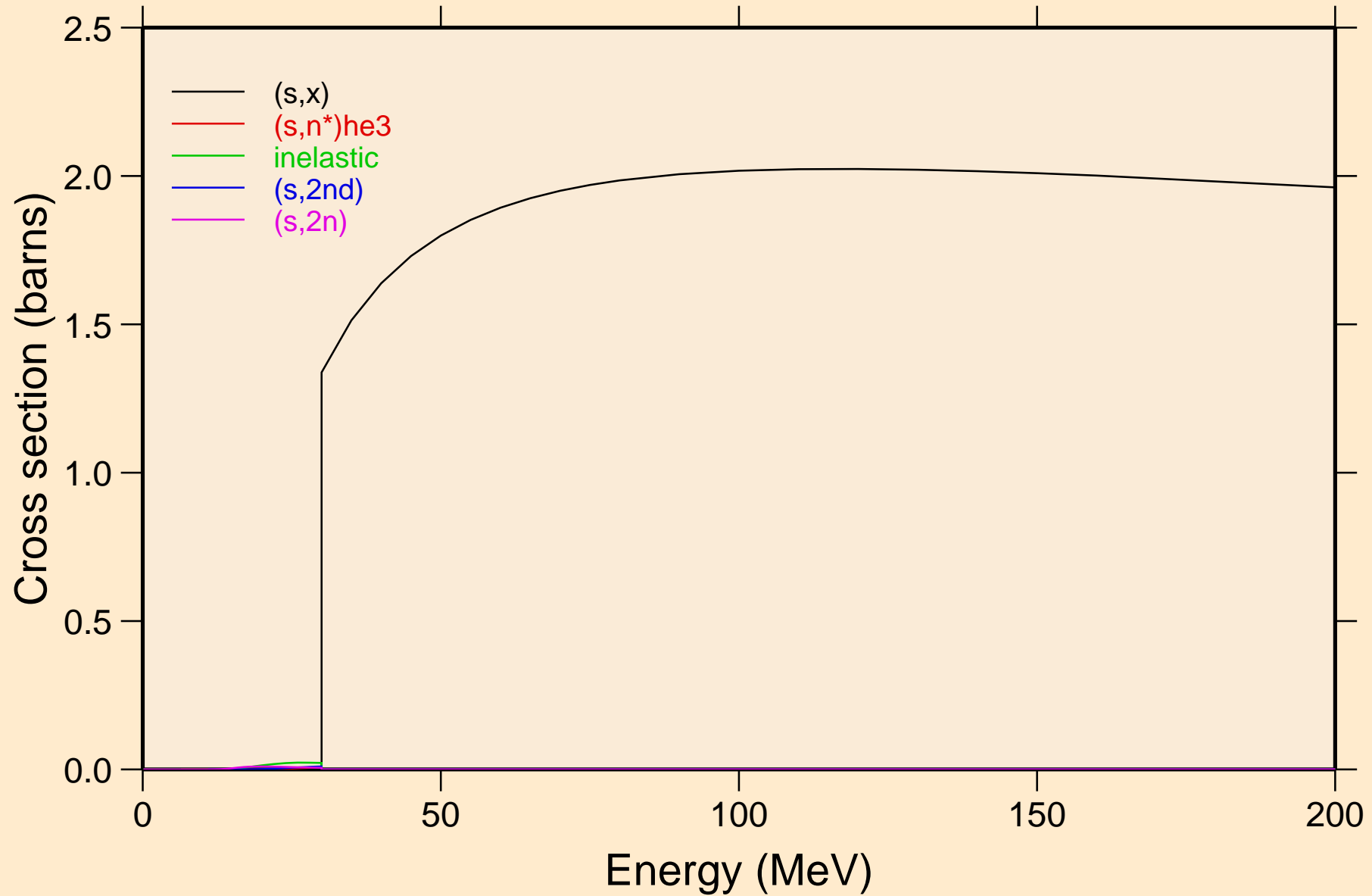

I134 HELION ACER TENDL-2021 LIBRARY; T=0.K

Threshold reactions

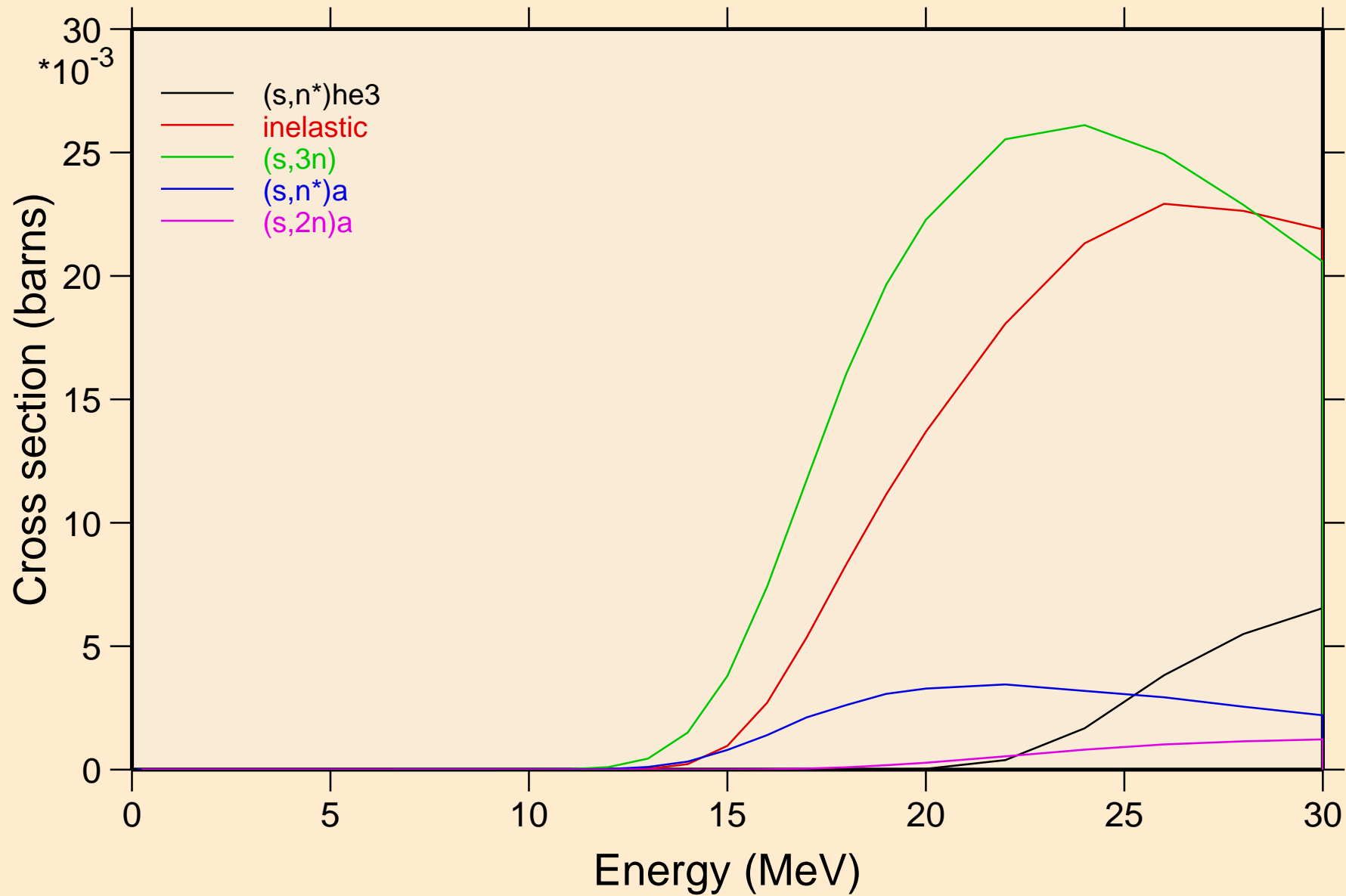

I134 HELION ACER TENDL-2021 LIBRARY; T=0.K

Threshold reactions

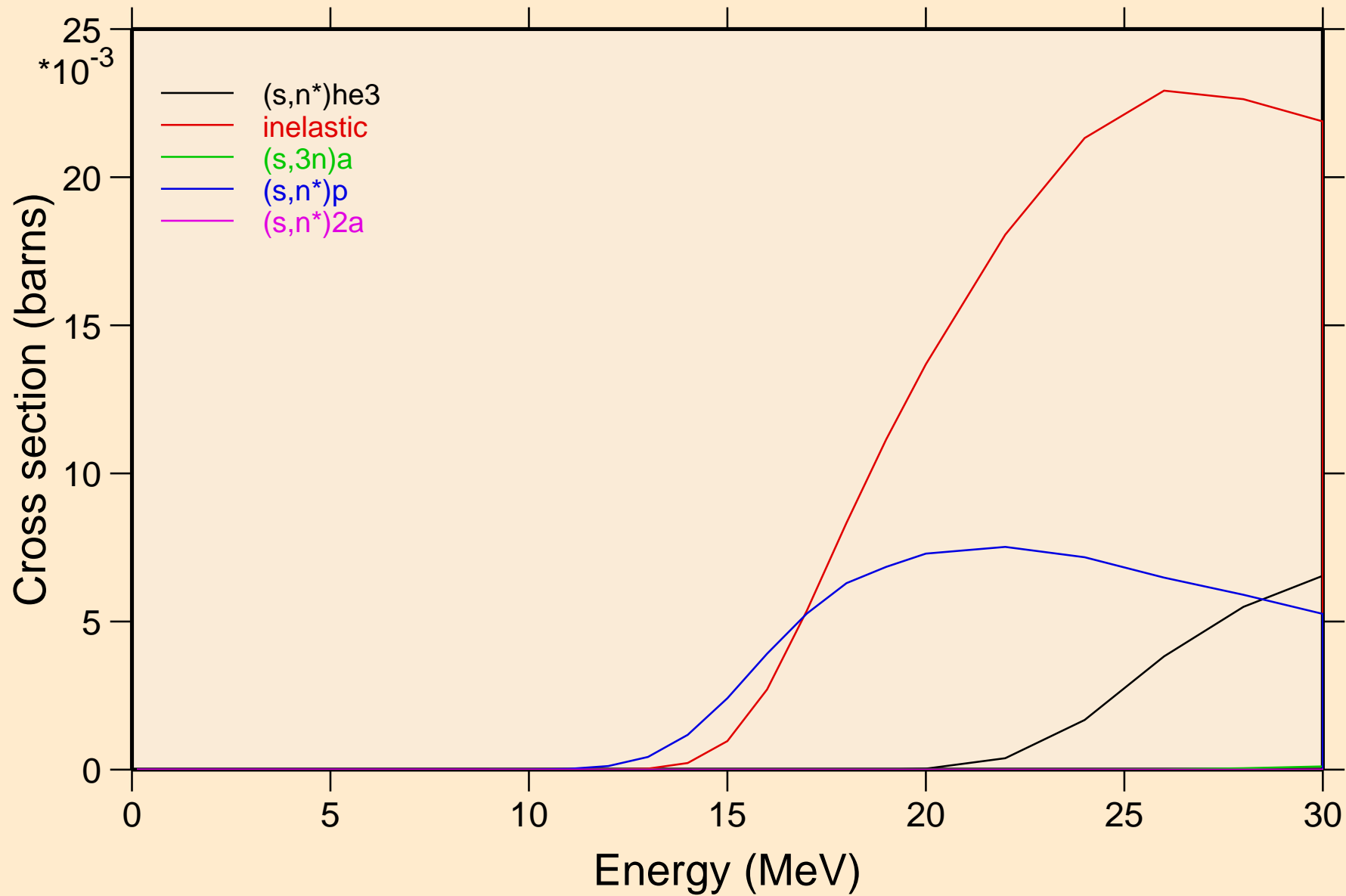

I134 HELION ACER TENDL-2021 LIBRARY; T=0.K
Threshold reactions

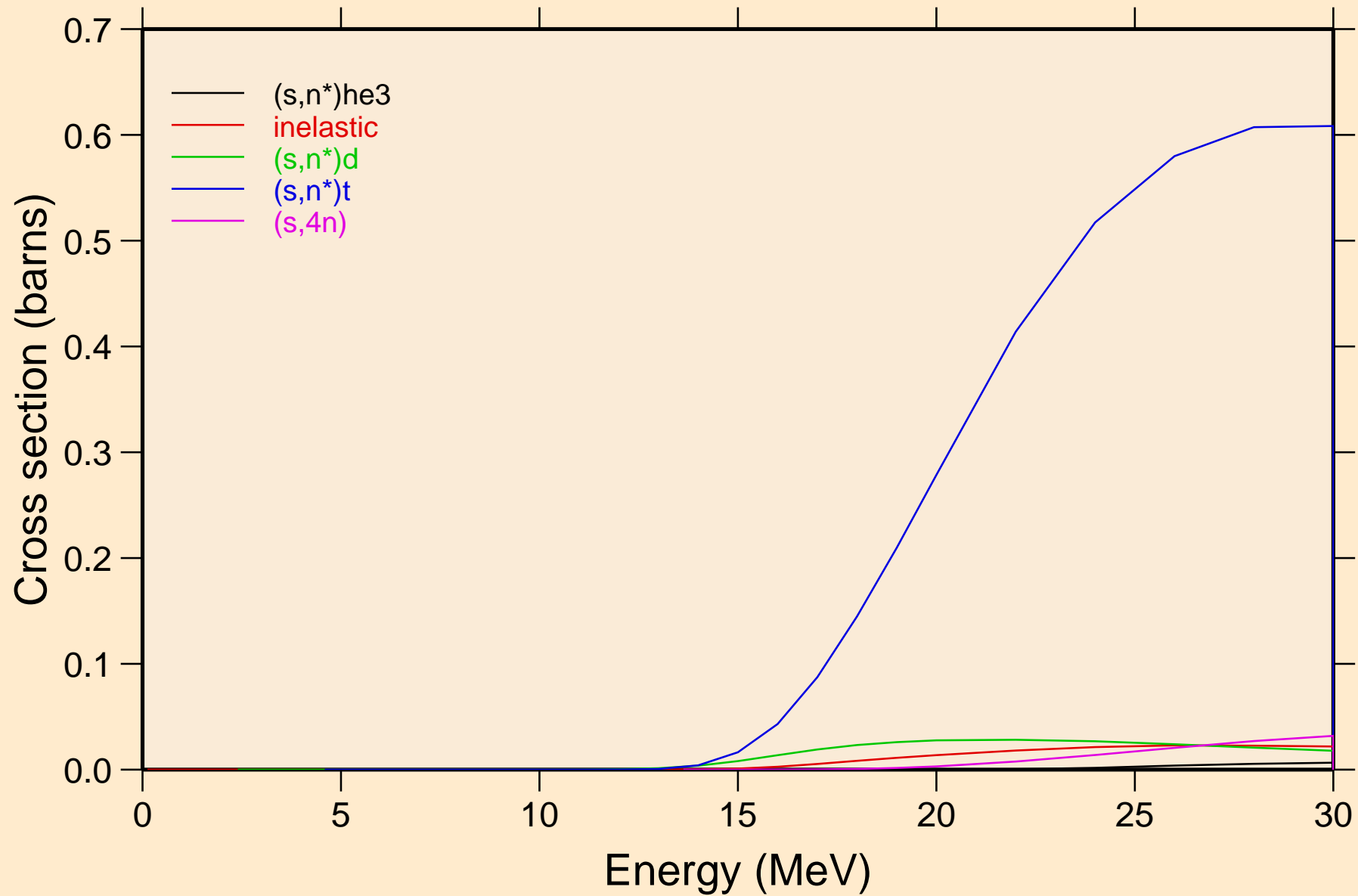

I134 HELION ACER TENDL-2021 LIBRARY; T=0.K
Threshold reactions

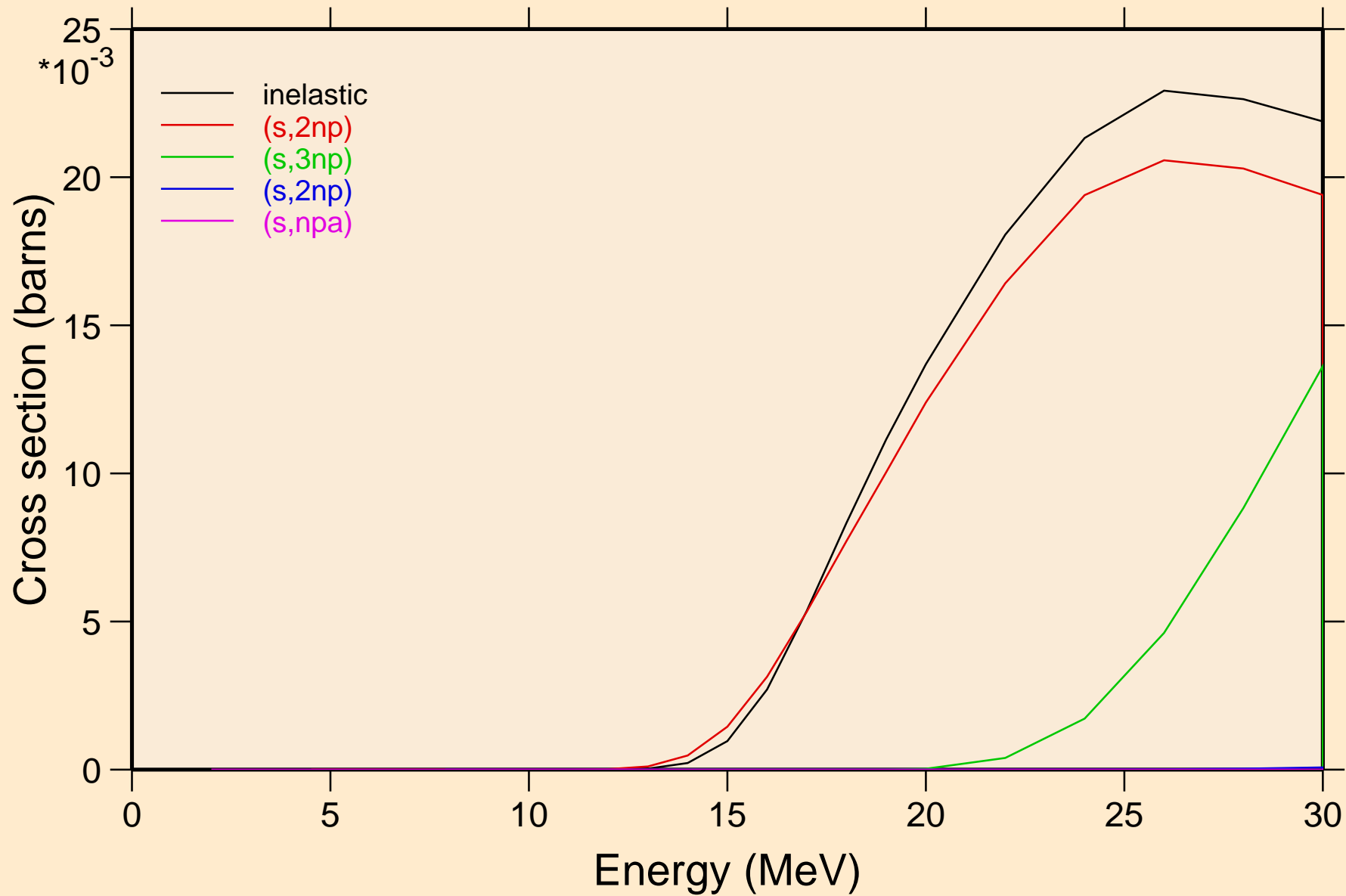

I134 HELION ACER TENDL-2021 LIBRARY; T=0.K
Threshold reactions

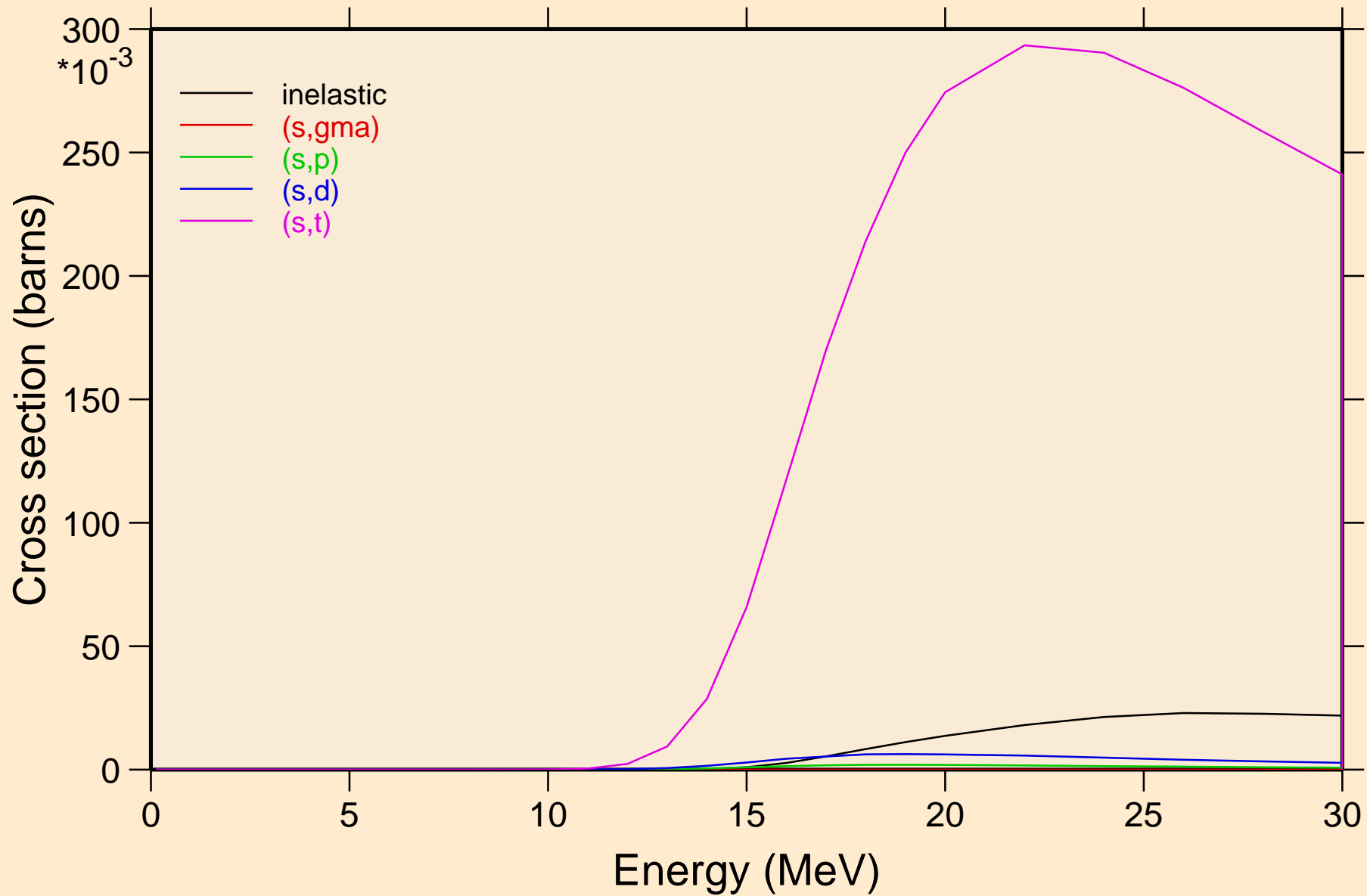

I134 HELION ACER TENDL-2021 LIBRARY; T=0.K
Threshold reactions

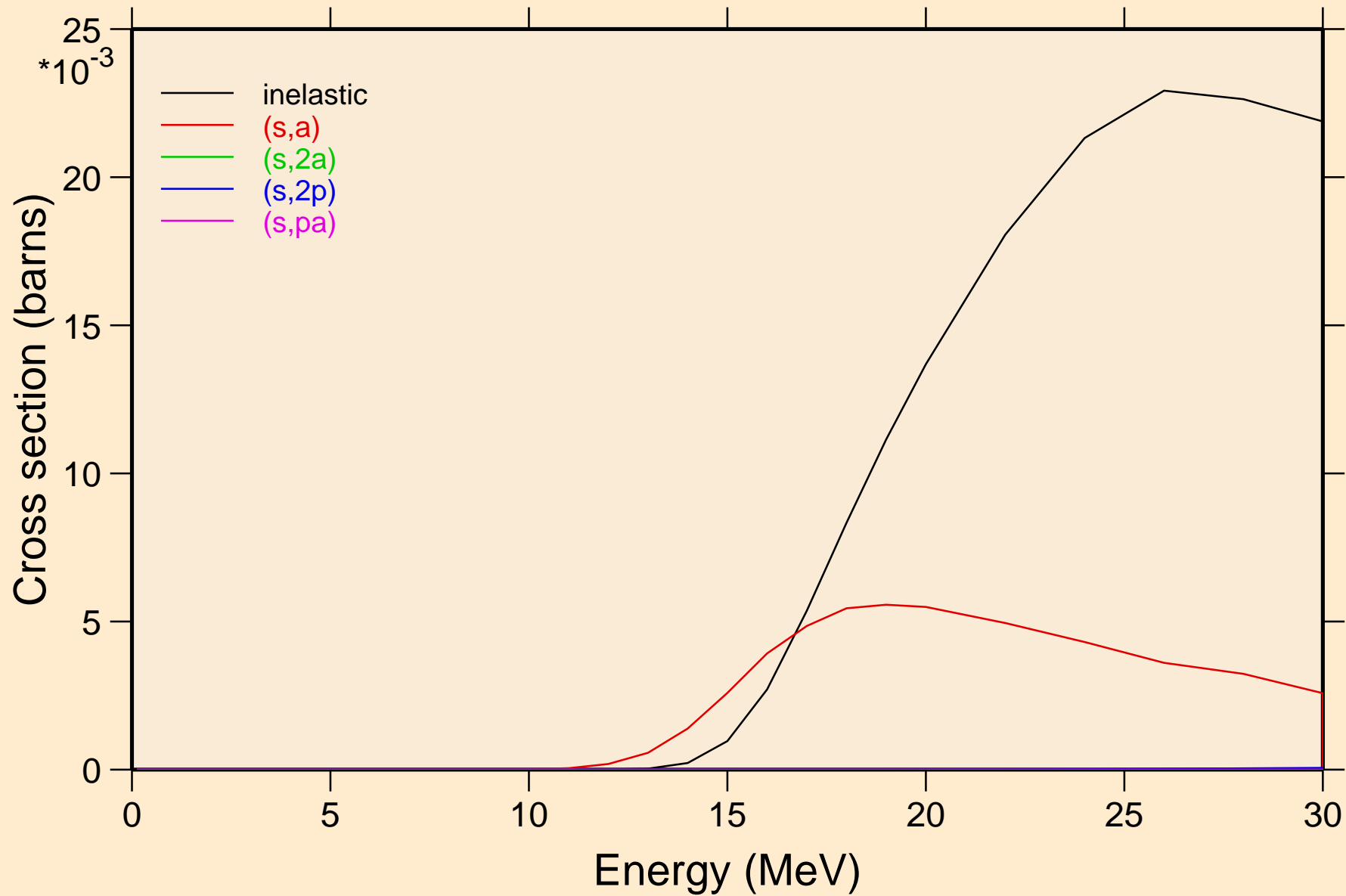

I134 HELION ACER TENDL-2021 LIBRARY; T=0.K
Threshold reactions

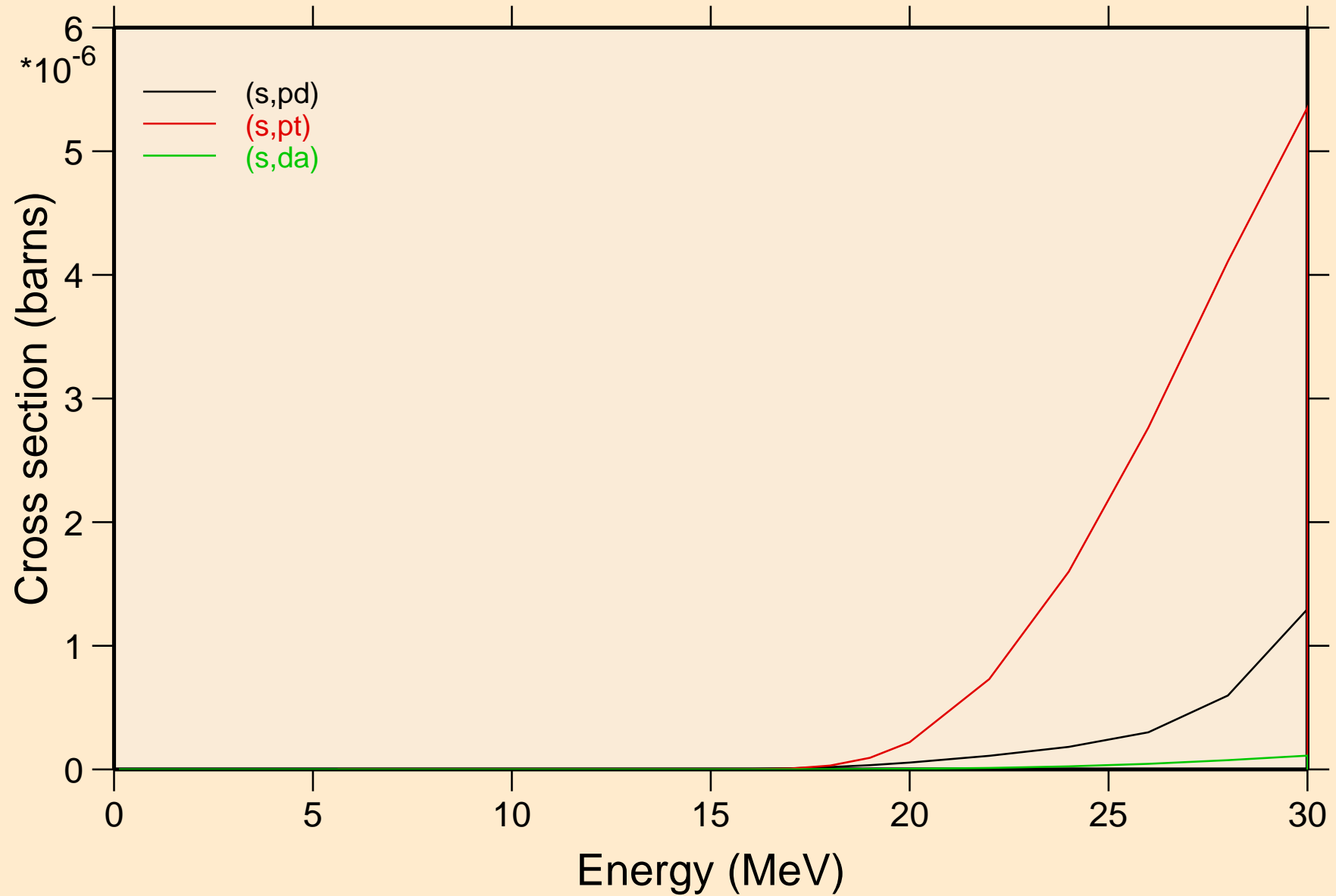

I134 HELION ACER TENDL-2021 LIBRARY; T=0.K
angular distribution for elastic

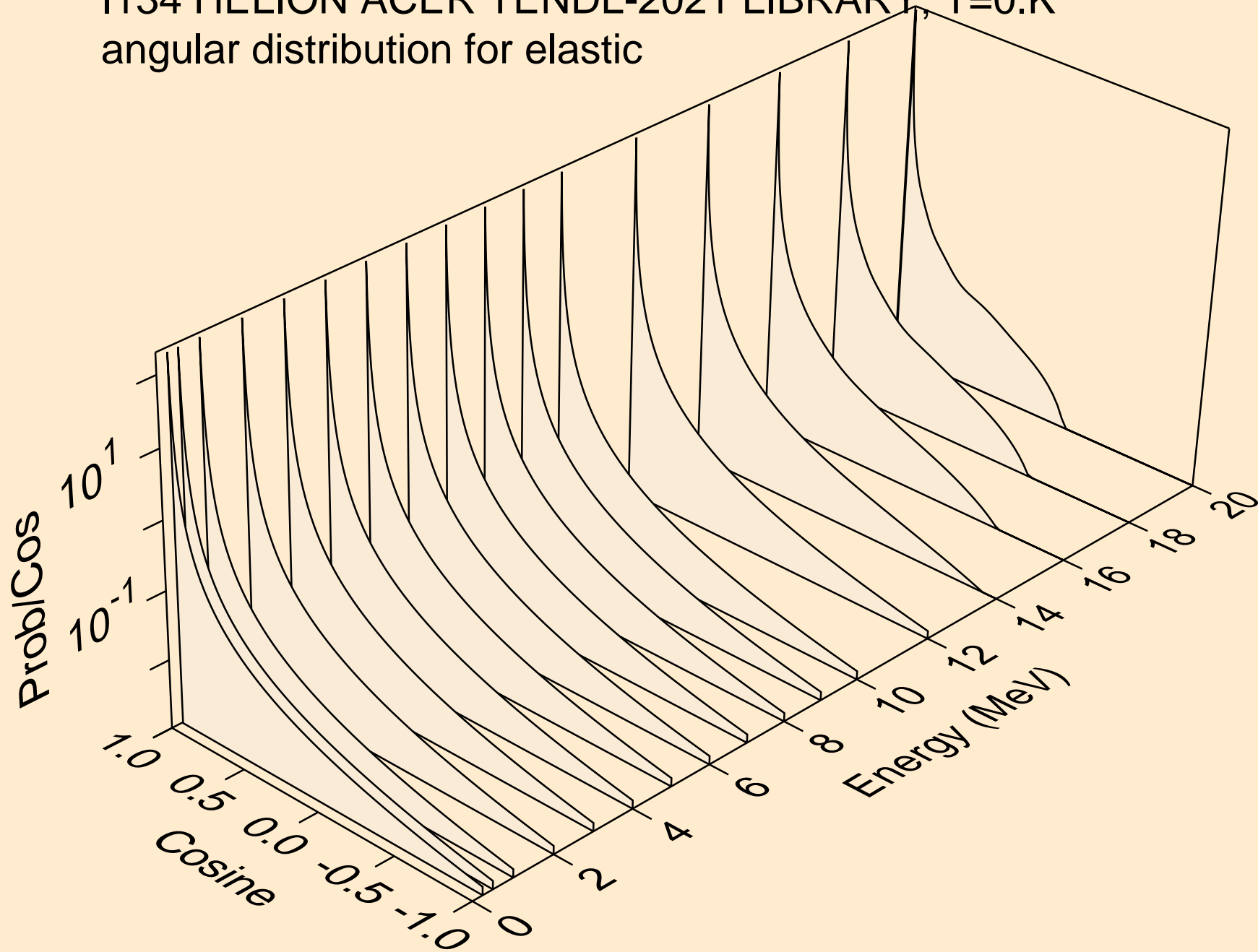

I134 HELION ACER TENDL-2021 LIBRARY; T=0.K
angular distribution for elastic

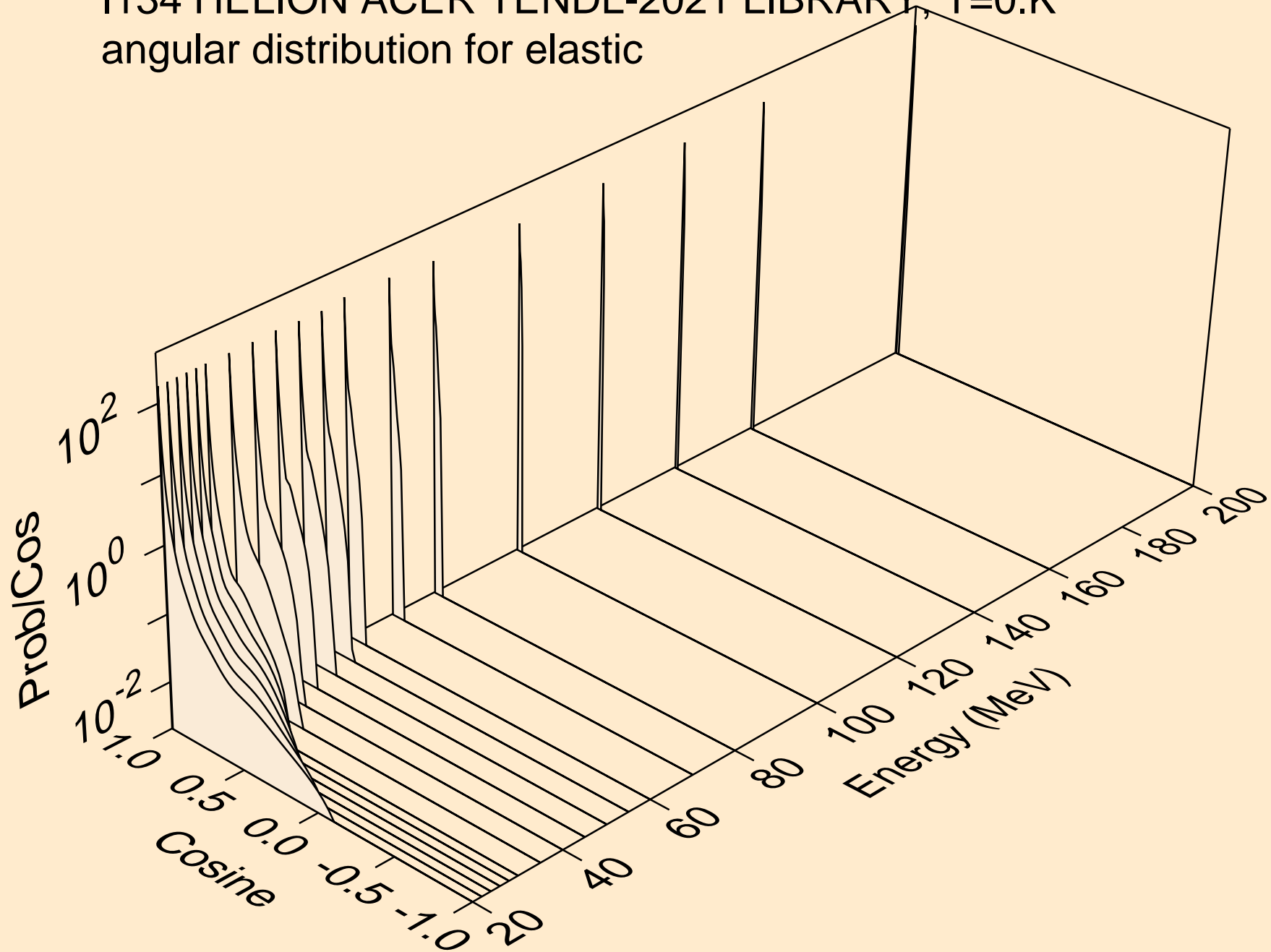

I134 HELION ACER TENDL-2021 LIBRARY; T=0.K
He-3 emission for (s,x)

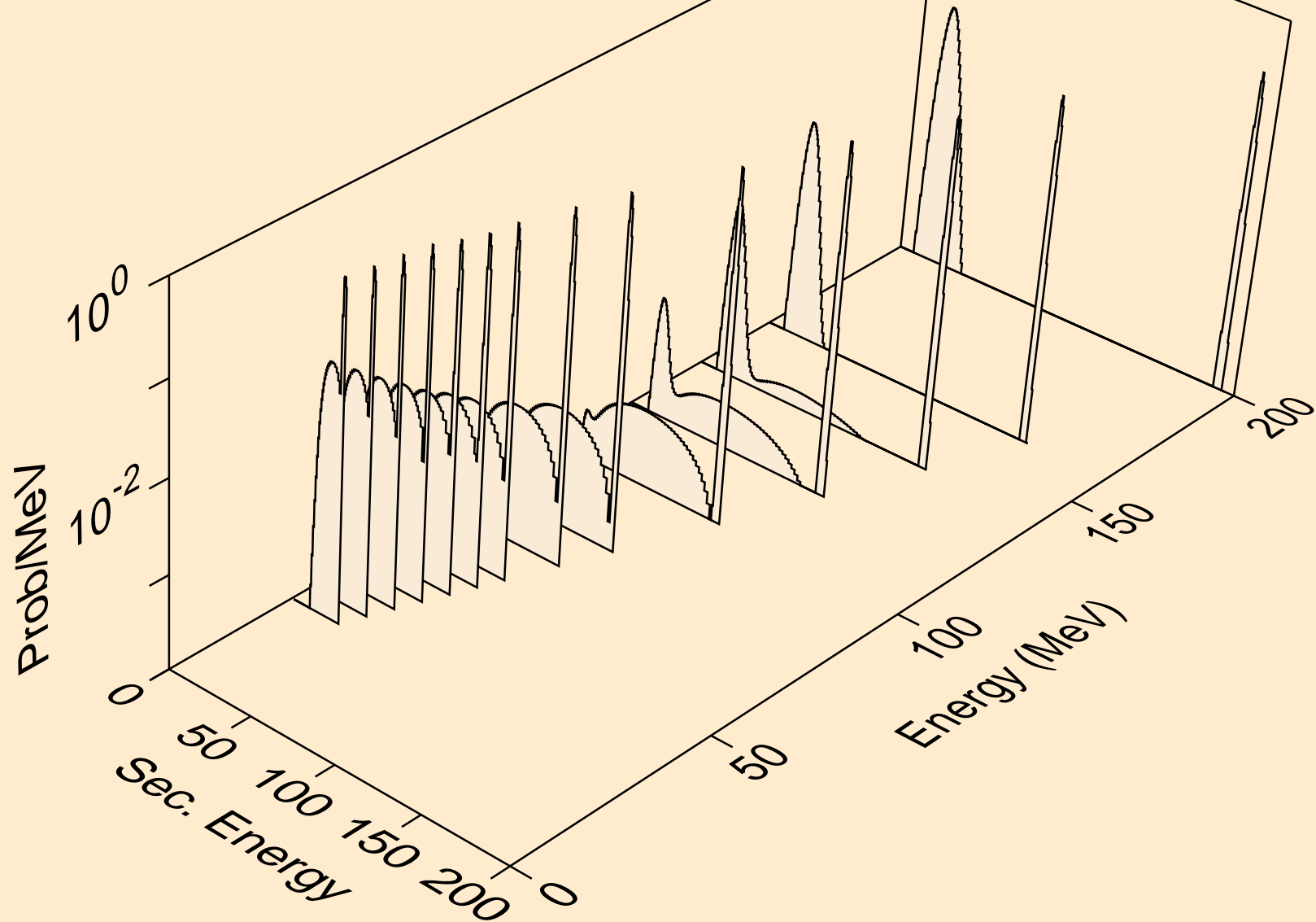

I134 HELION ACER TENDL-2021 LIBRARY; T=0.K
He-3 emission for (s,n*)he3

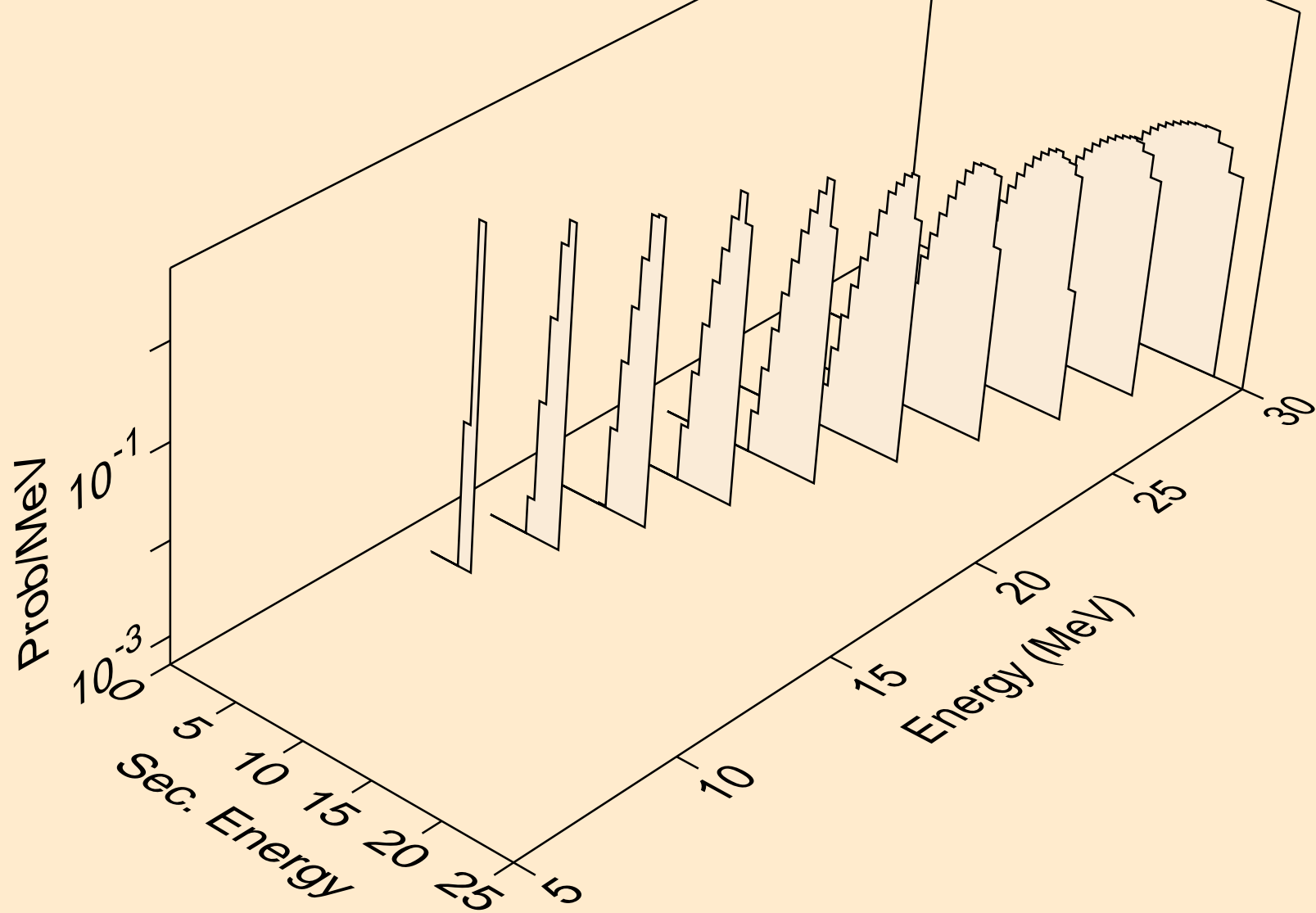

I134 HELION ACER TENDL-2021 LIBRARY; T=0.K
He-3 emission for inelastic

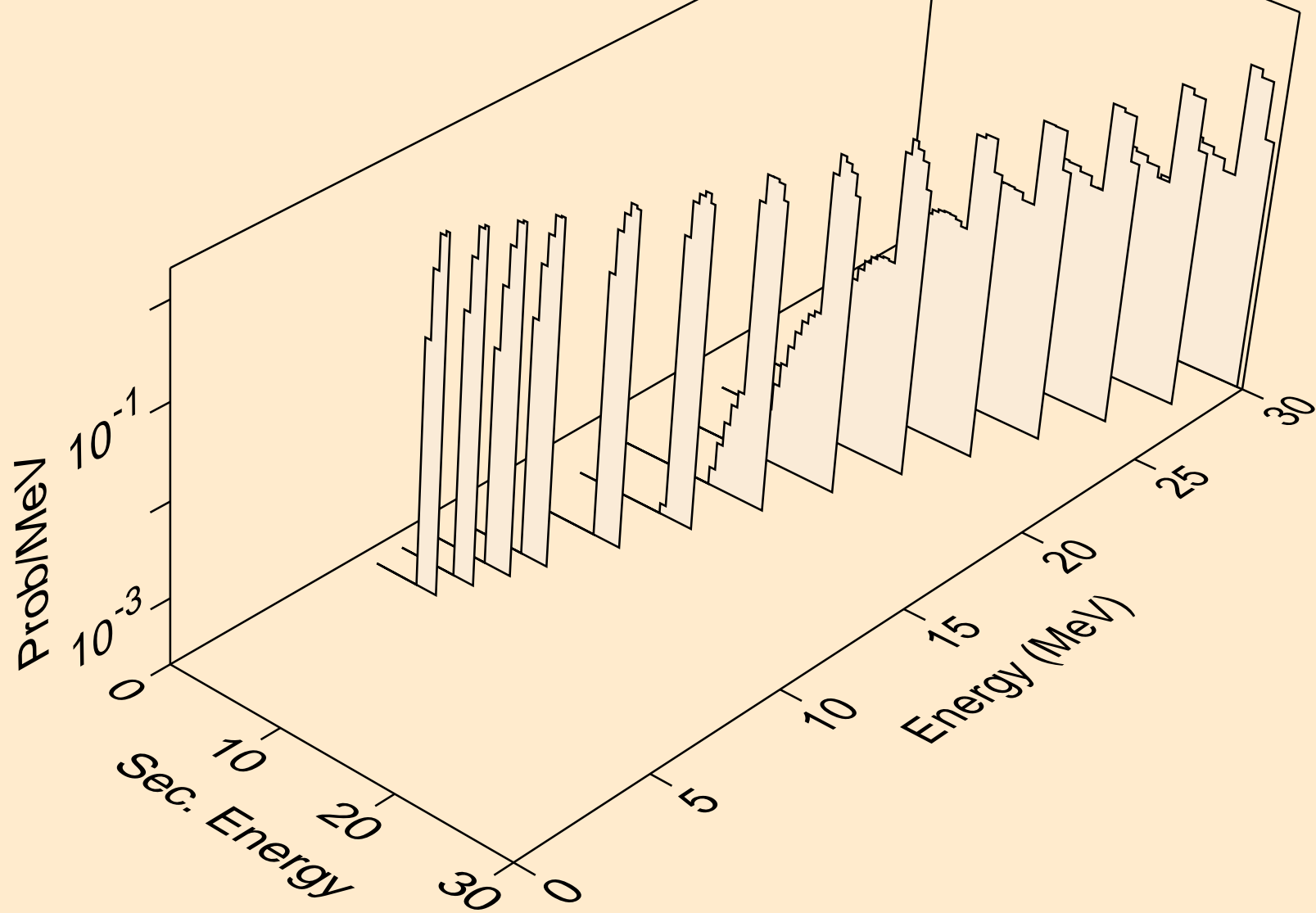

I134 HELION ACER TENDL-2021 LIBRARY; T=0.K
Photon emission for (z,n)

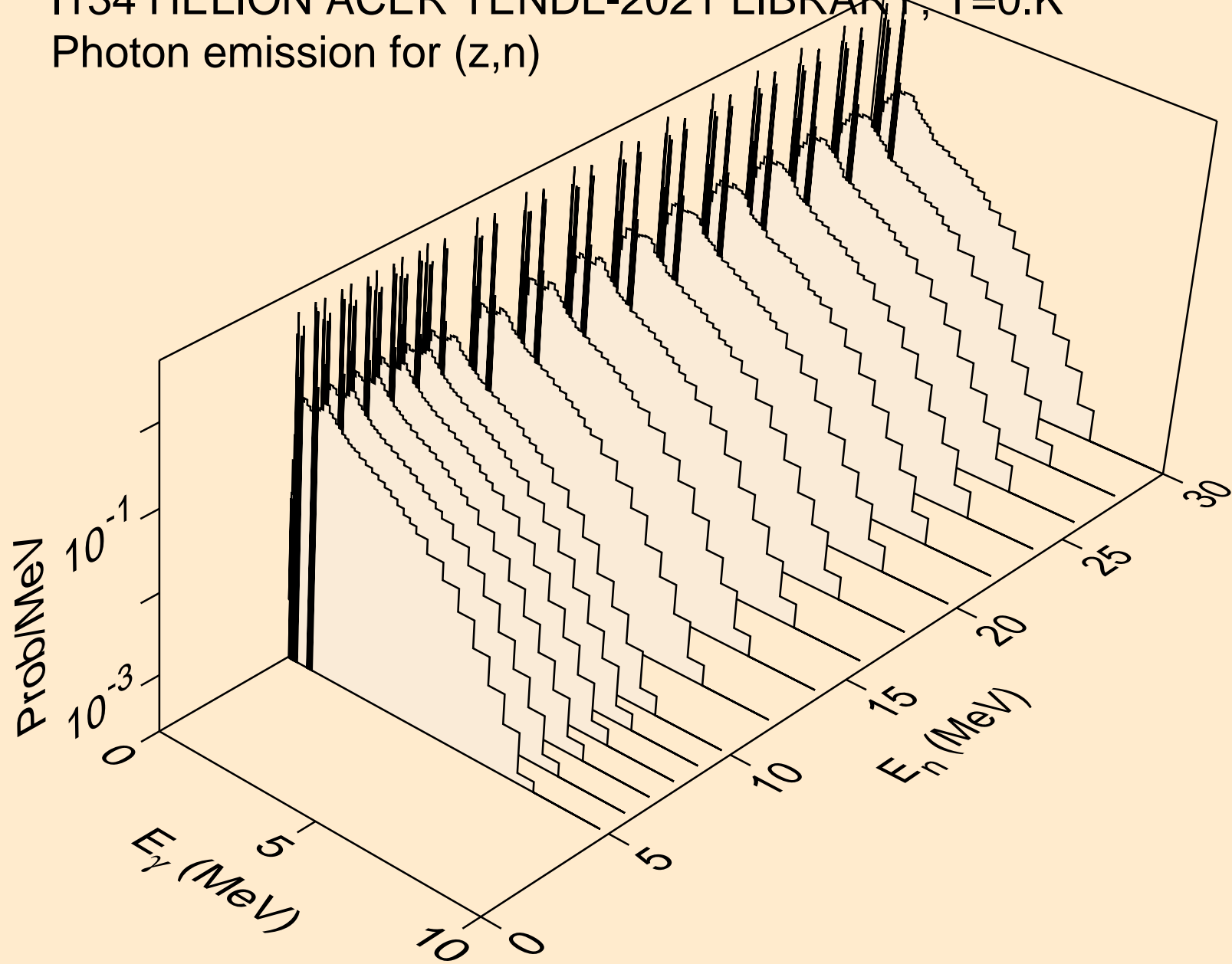

I134 HELION ACER TENDL-2021 LIBRARY; T=0.K
Photon emission for (n,x)

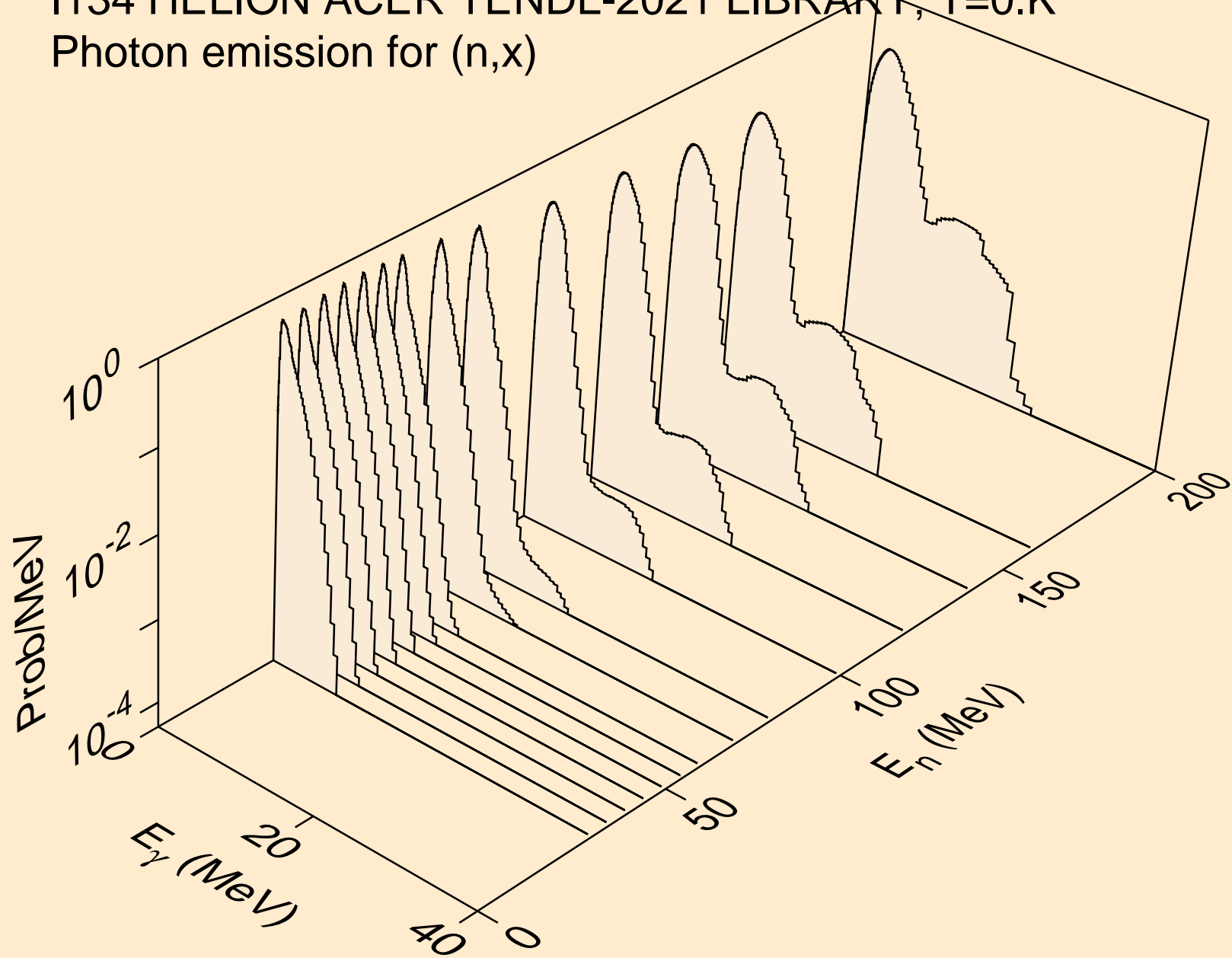

I134 HELION ACER TENDL-2021 LIBRARY; T=0.K
Photon emission for (n,2nd)

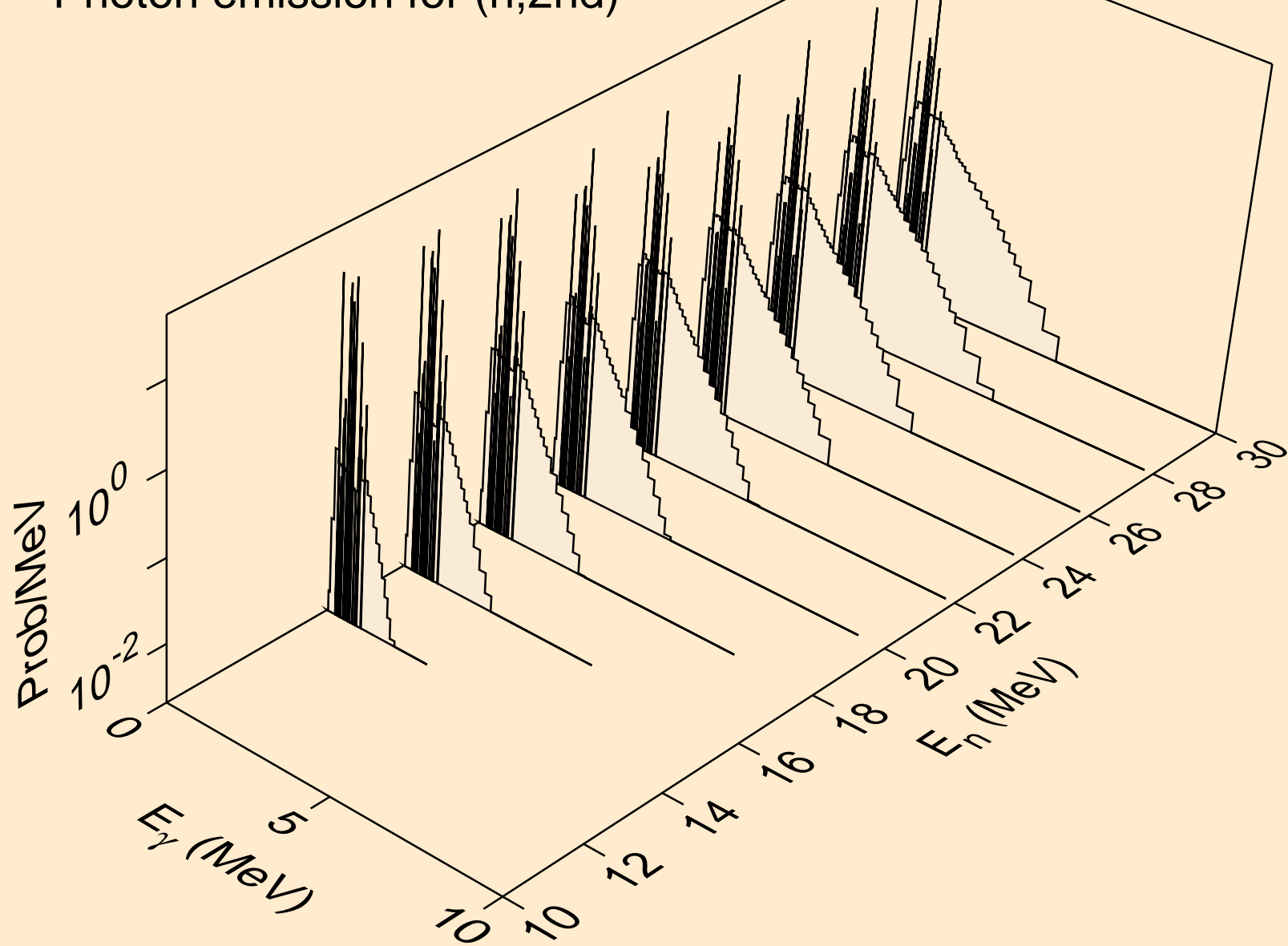

I134 HELION ACER TENDL-2021 LIBRARY; T=0.K
Photon emission for (n,2n)

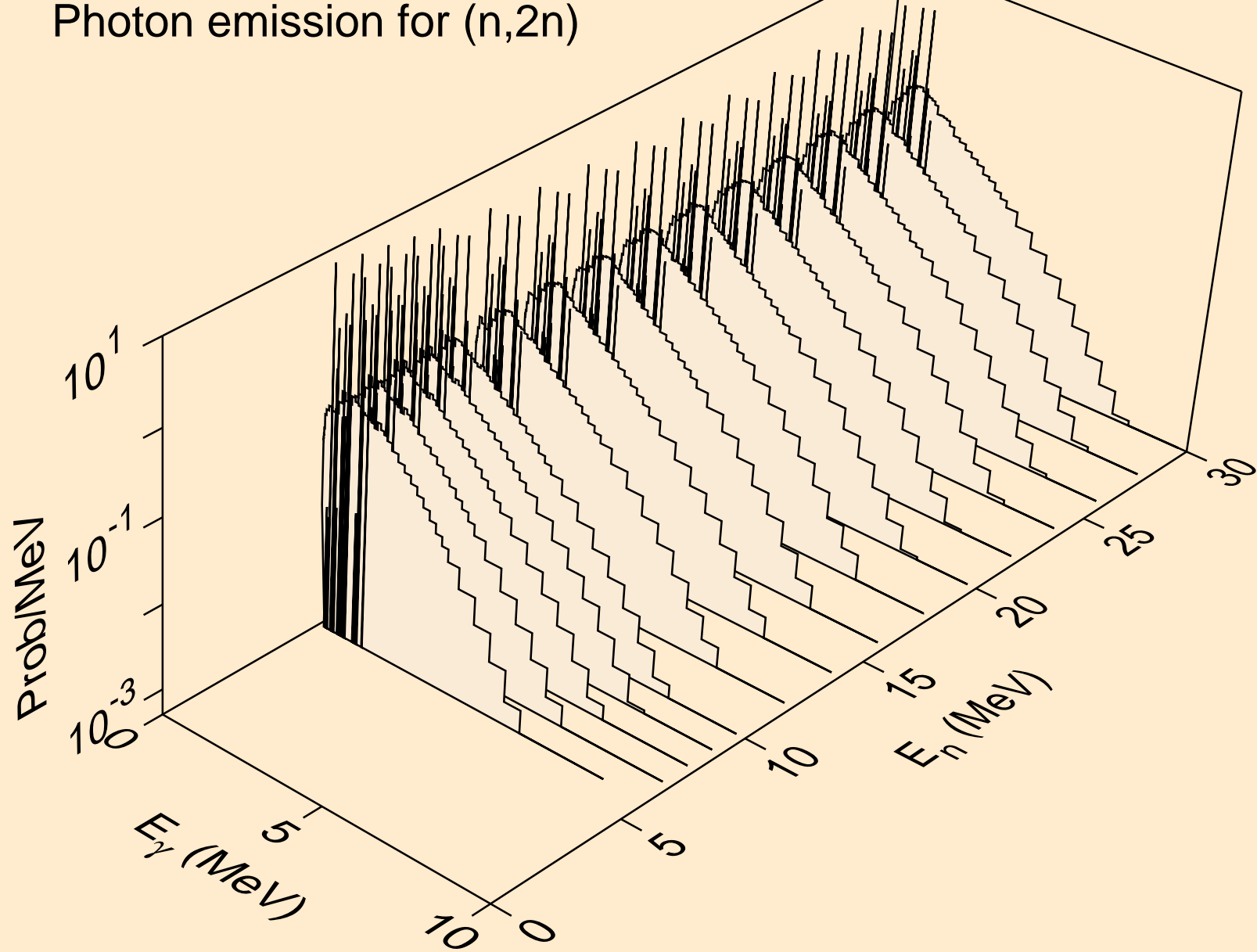

I134 HELION ACER TENDL-2021 LIBRARY; T=0.K
Photon emission for (n,3n)

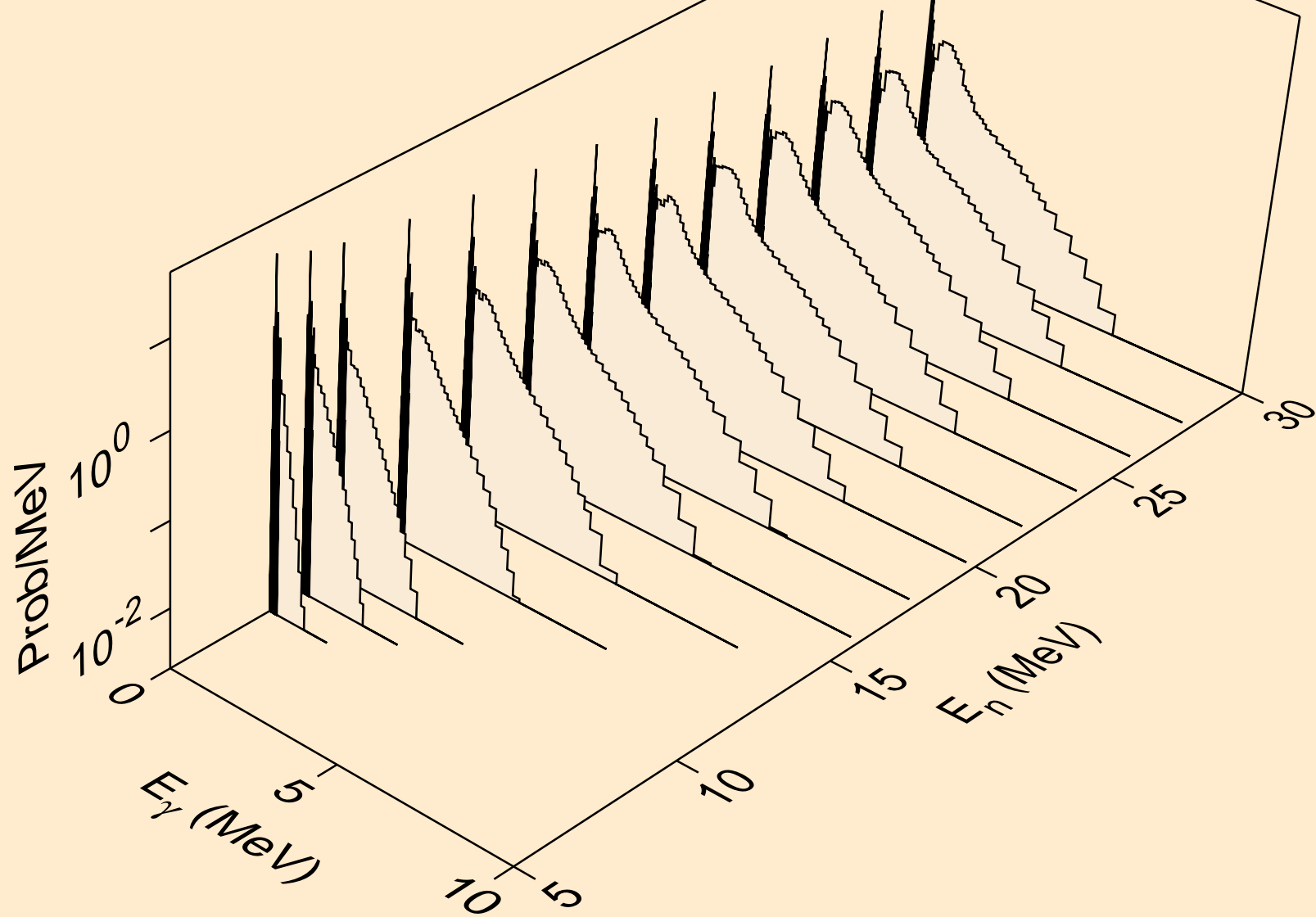

I134 HELION ACER TENDL-2021 LIBRARY; T=0.K
Photon emission for (n,n*)a

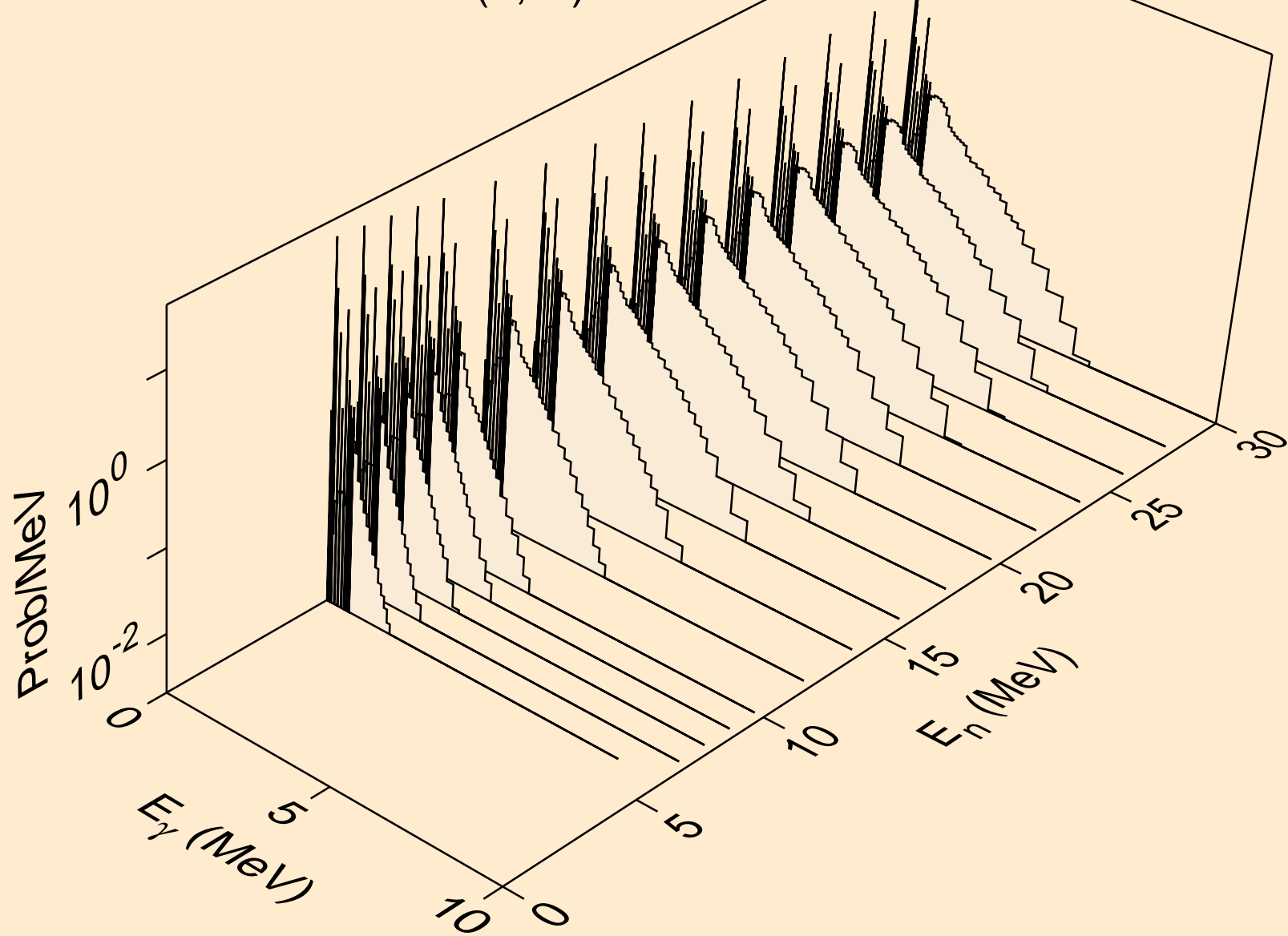

I134 HELION ACER TENDL-2021 LIBRARY; T=0.K
Photon emission for (n,2n)a

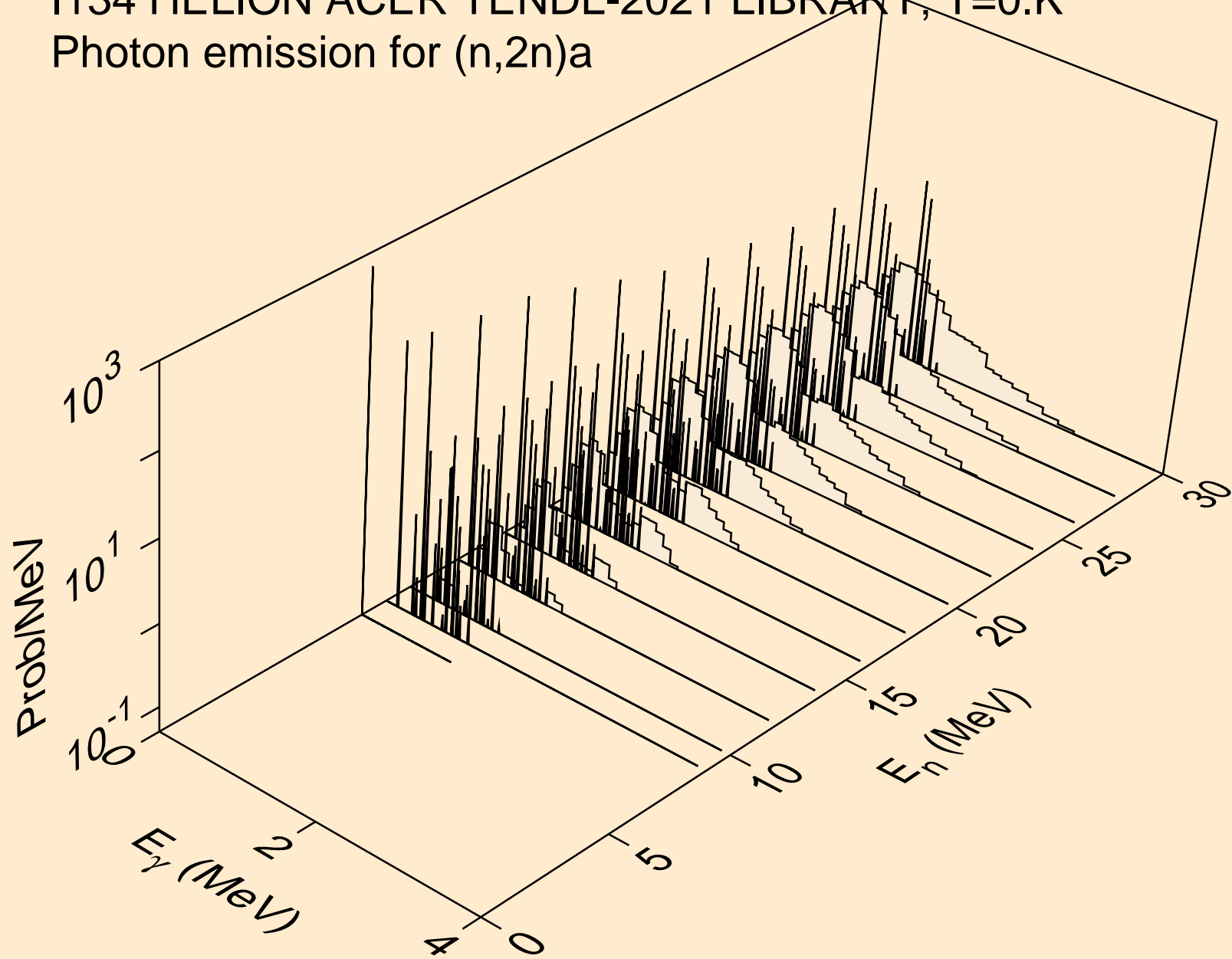

I134 HELION ACER TENDL-2021 LIBRARY; T=0.K
Photon emission for (n,3n)a

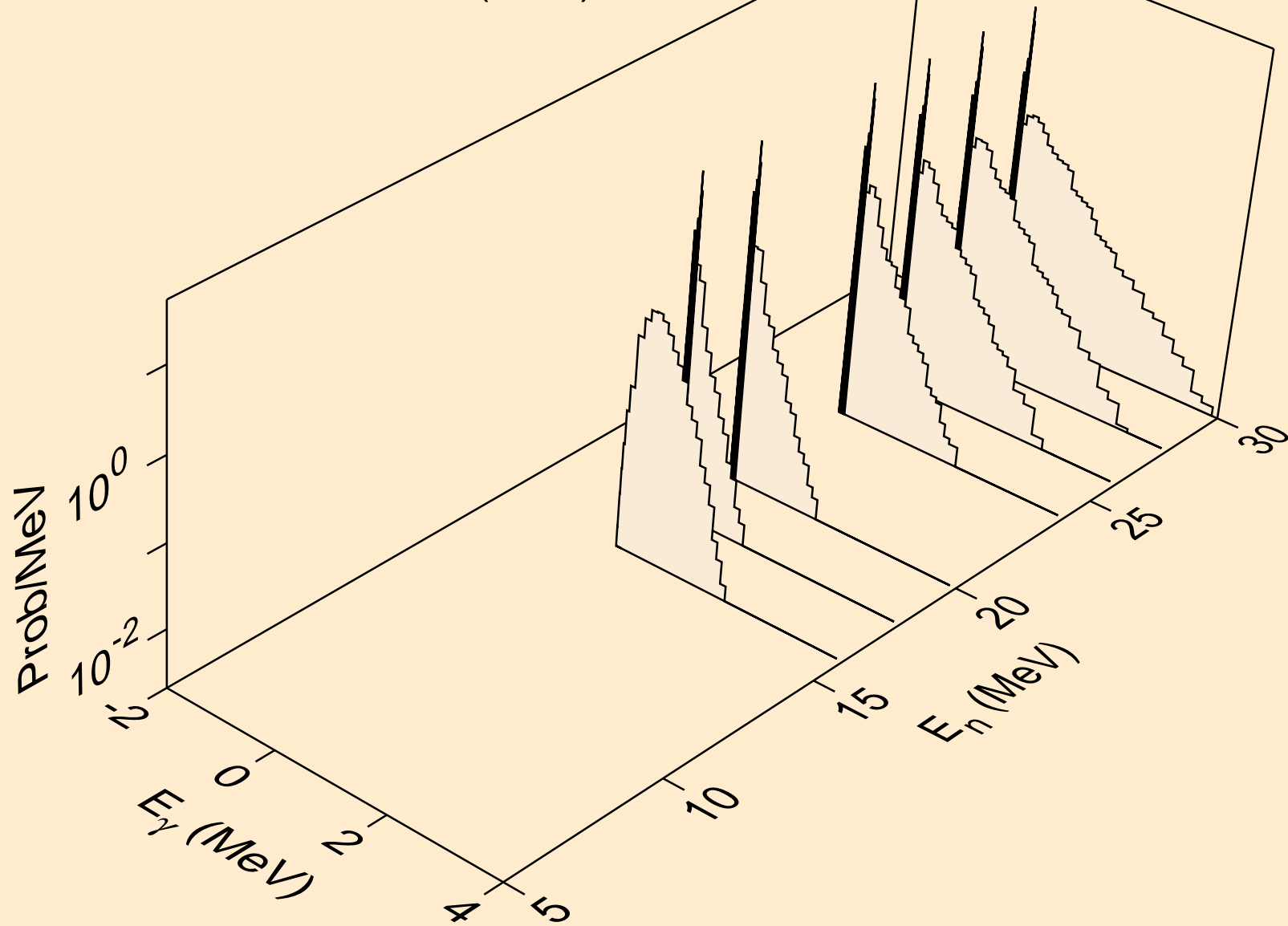

I134 HELION ACER TENDL-2021 LIBRARY; T=0.K
Photon emission for (n,n*)p

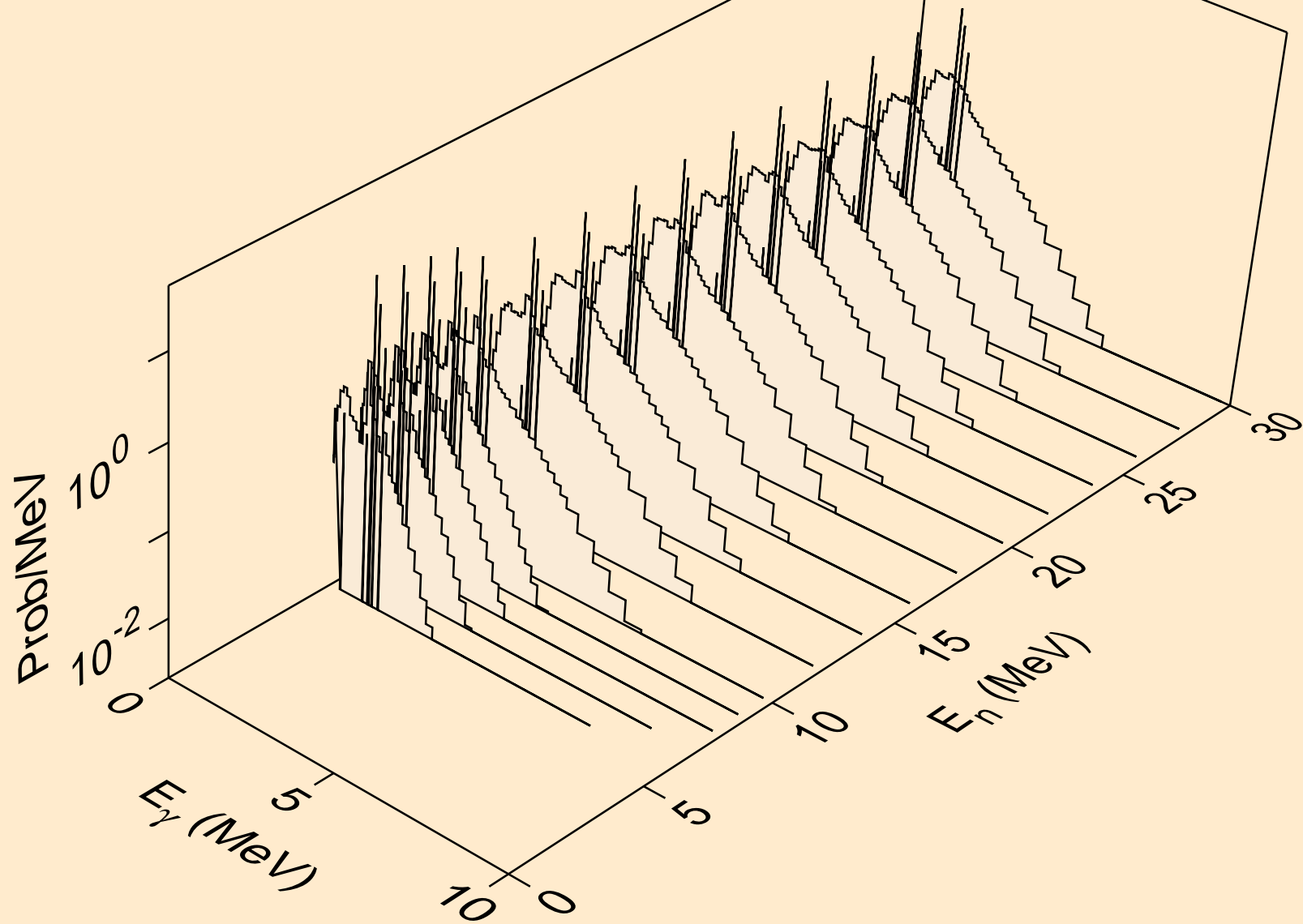

I134 HELION ACER TENDL-2021 LIBRARY; T=0.K
Photon emission for (n,n*)2a

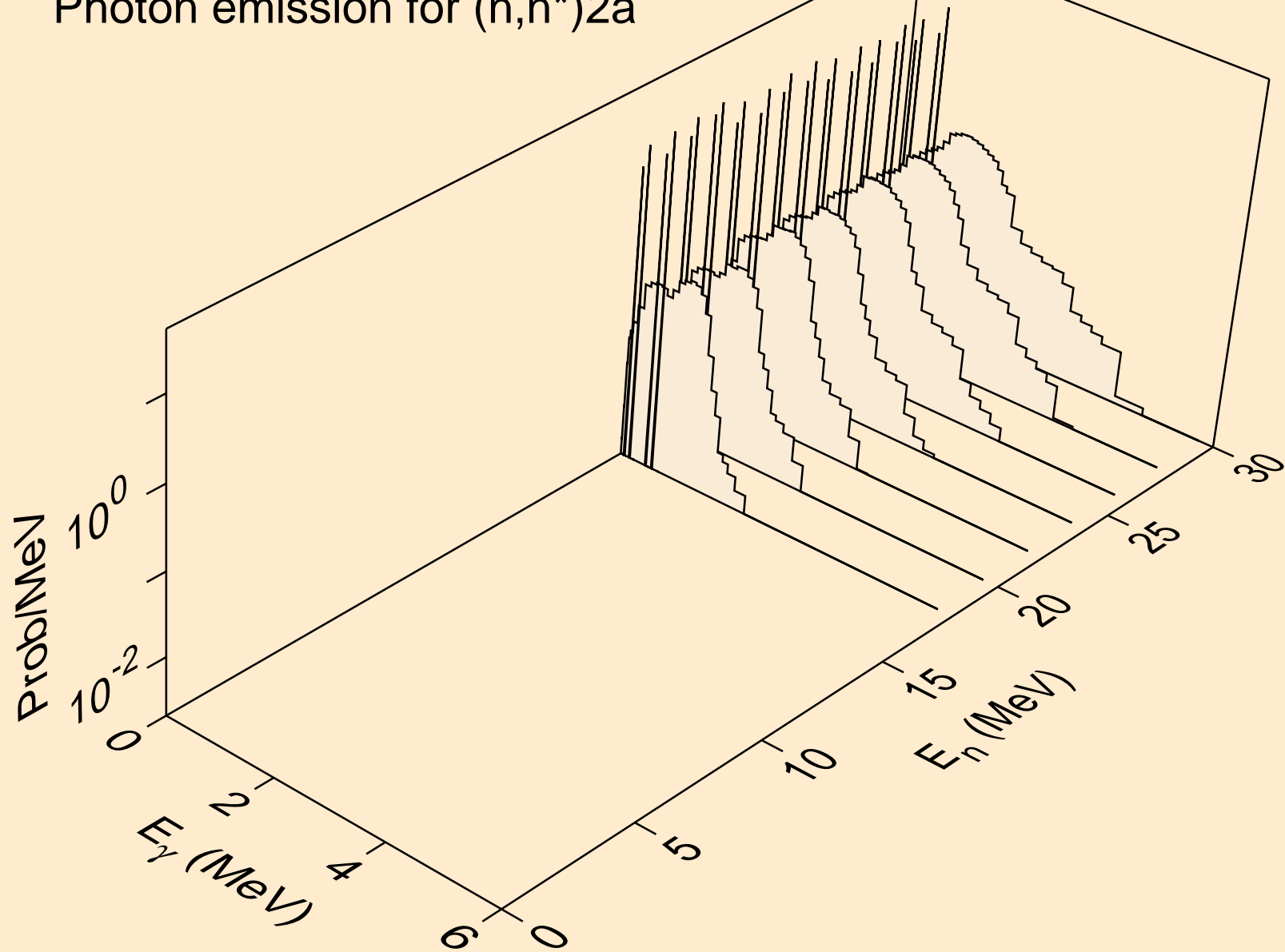

I134 HELION ACER TENDL-2021 LIBRARY; T=0.K
Photon emission for (n,n*)d

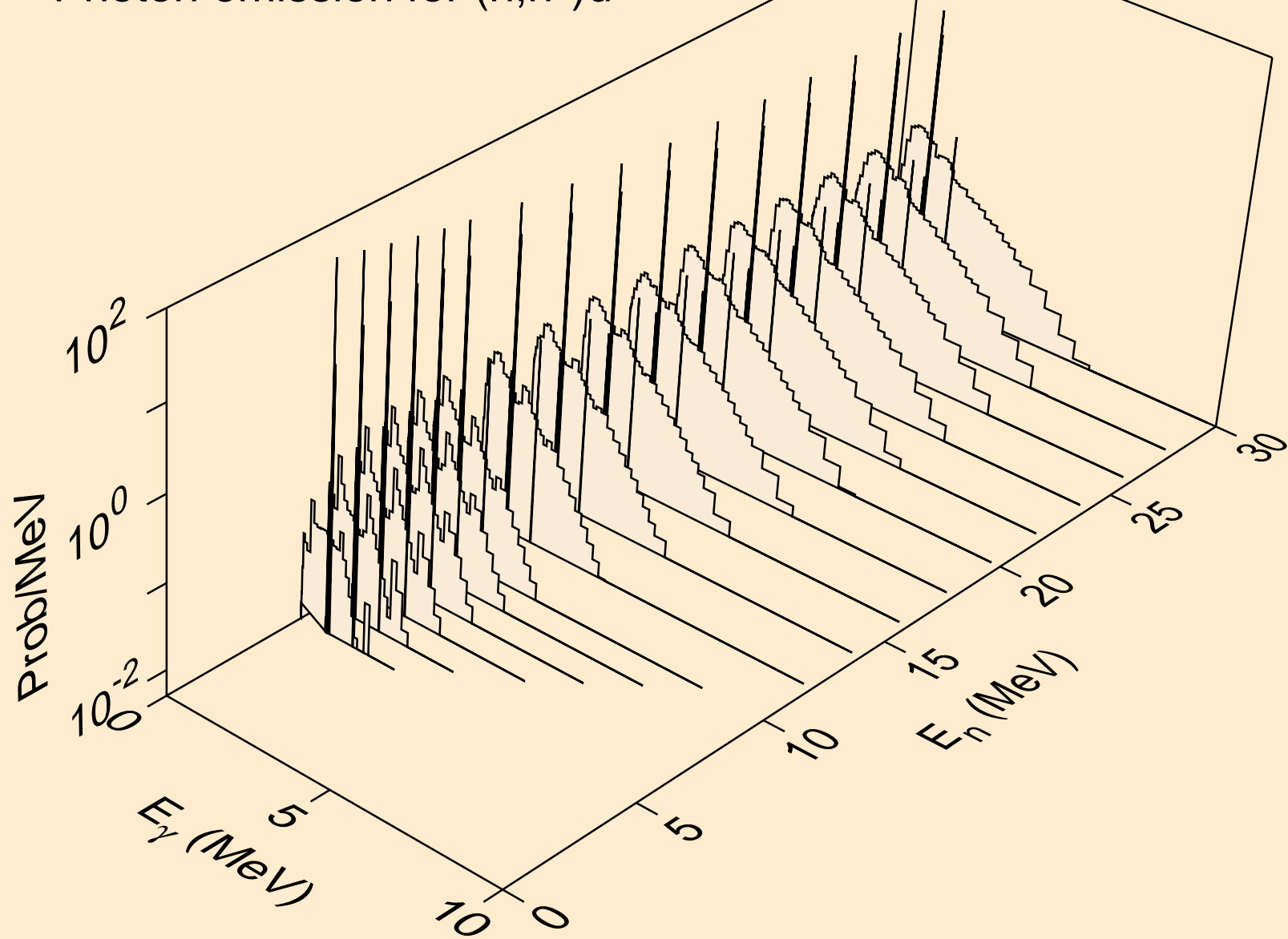

I134 HELION ACER TENDL-2021 LIBRARY; T=0.K
Photon emission for (n,n*)t

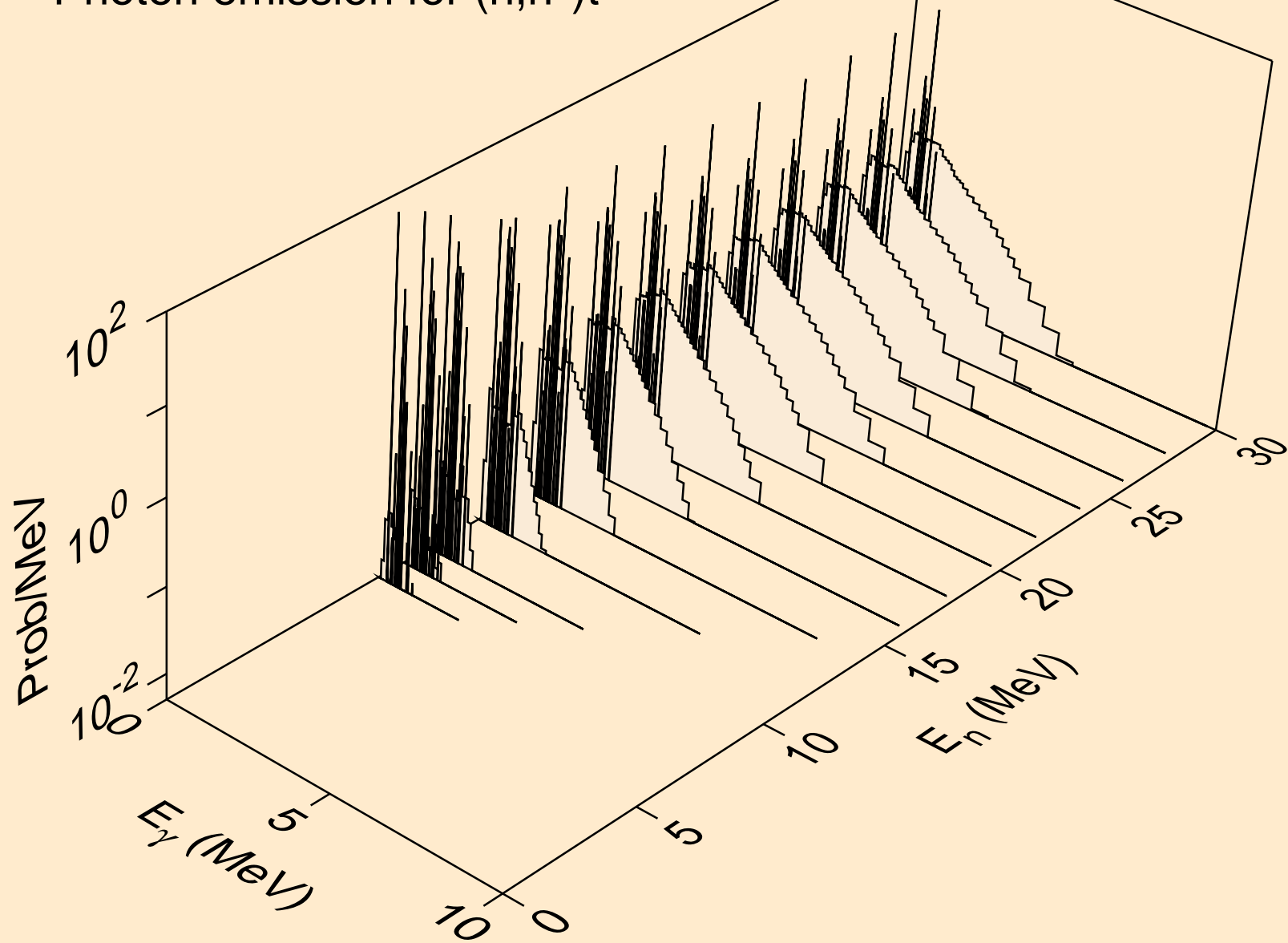

I134 HELION ACER TENDL-2021 LIBRARY; T=0.K
Photon emission for (n,n*)he3

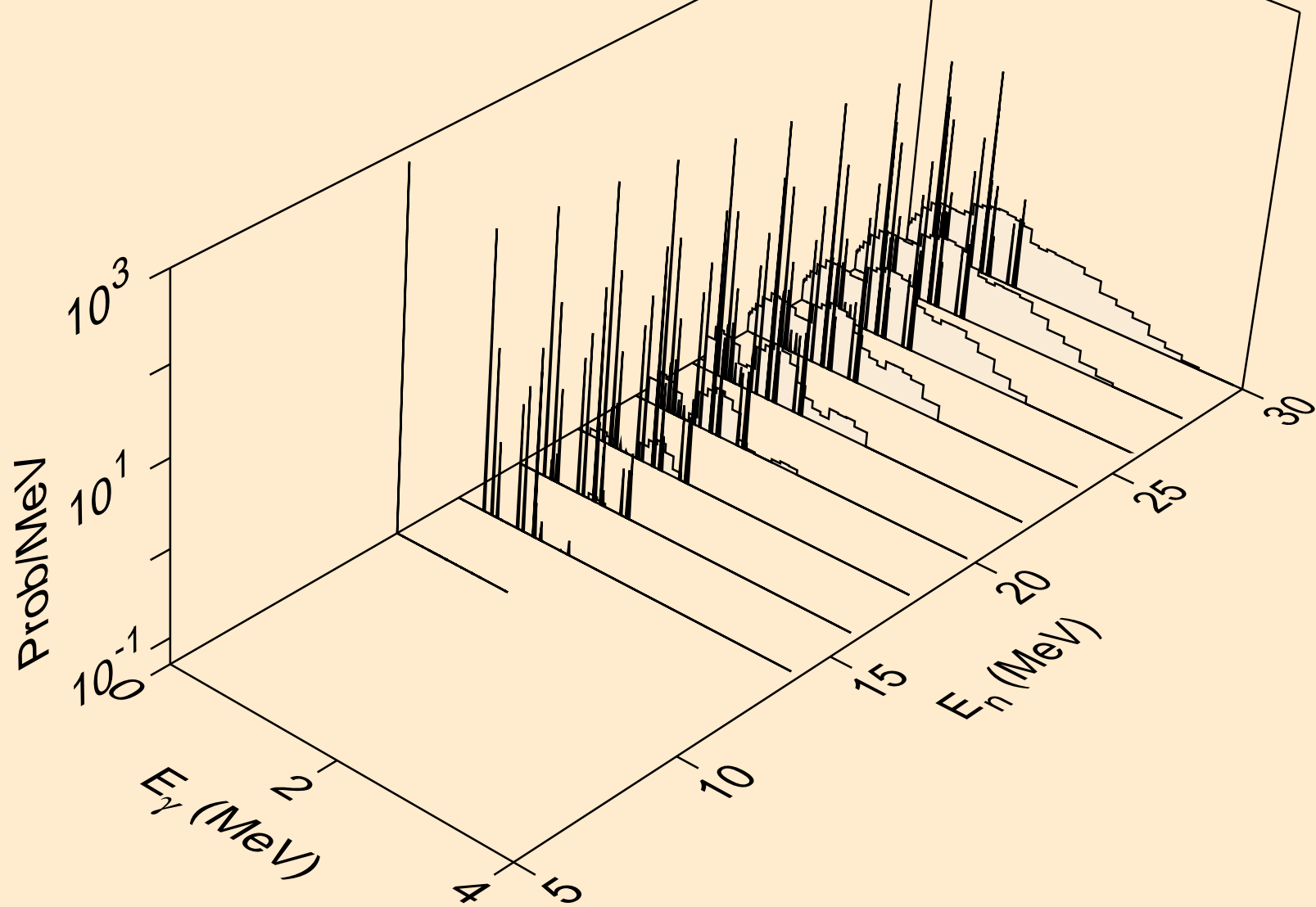

I134 HELION ACER TENDL-2021 LIBRARY; T=0.K
Photon emission for (n,4n)

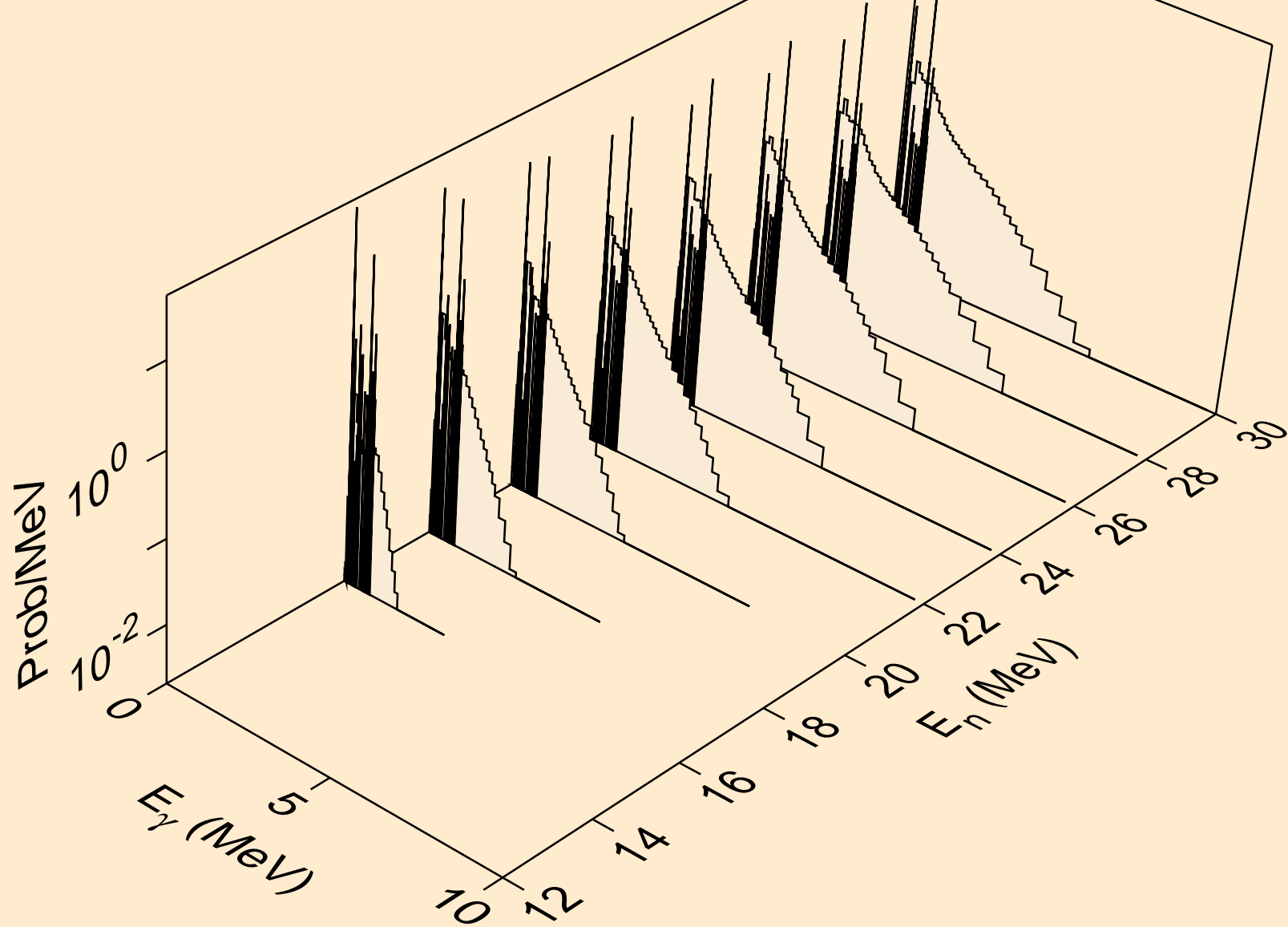

I134 HELION ACER TENDL-2021 LIBRARY; T=0.K
Photon emission for (n,2np)

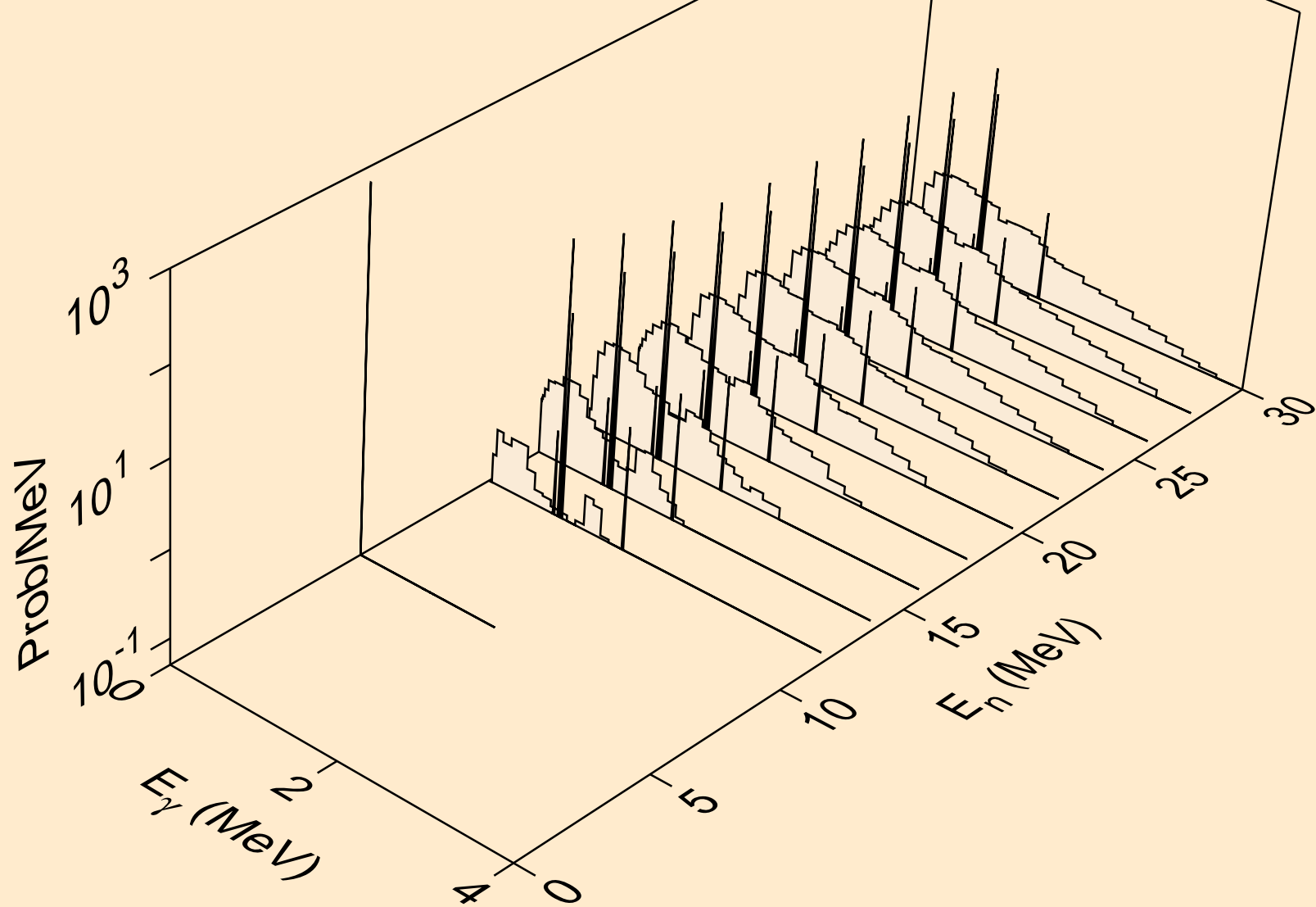

I134 HELION ACER TENDL-2021 LIBRARY; T=0.K
Photon emission for (n,3np)

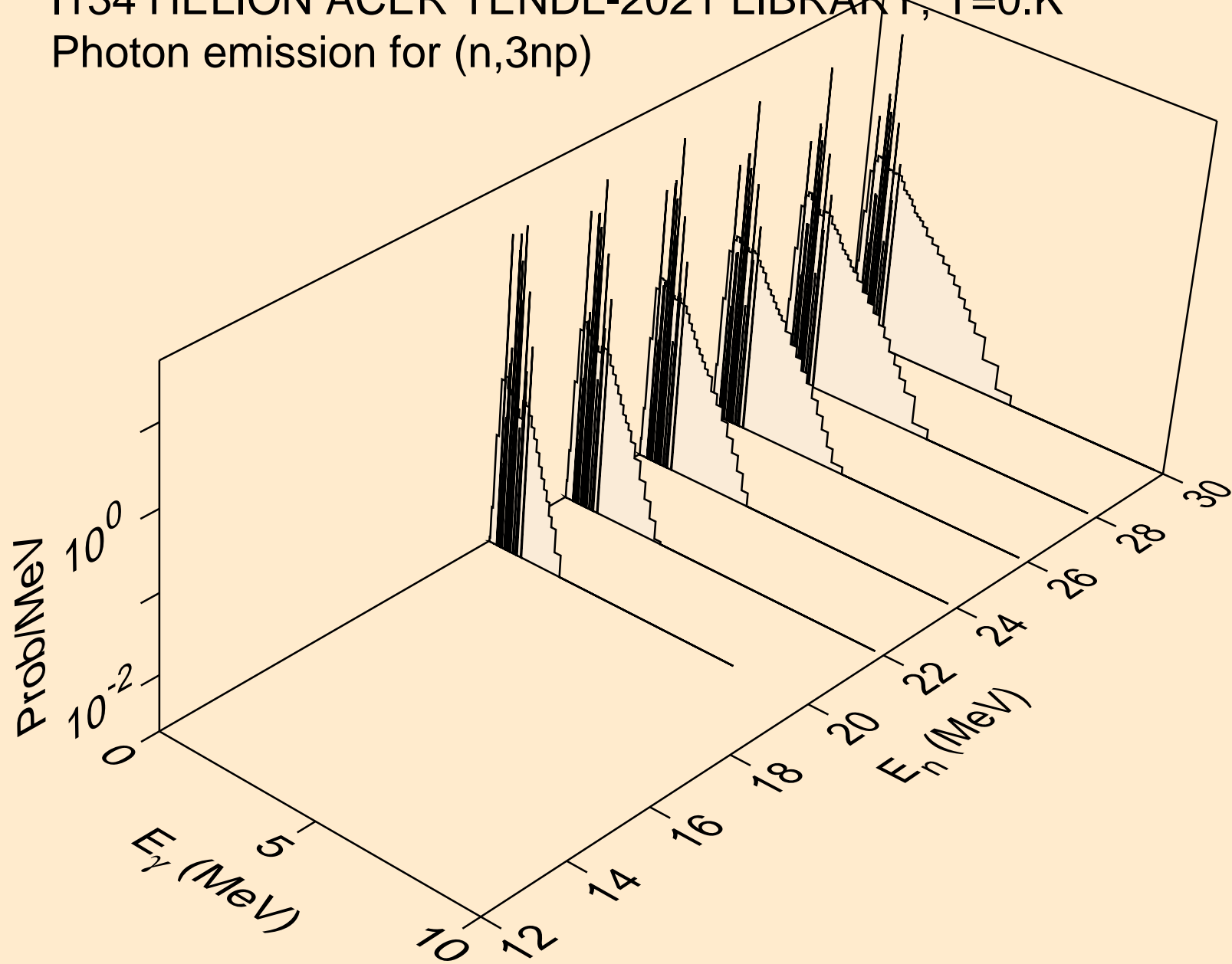

I134 HELION ACER TENDL-2021 LIBRARY; T=0.K
Photon emission for (n,2np)

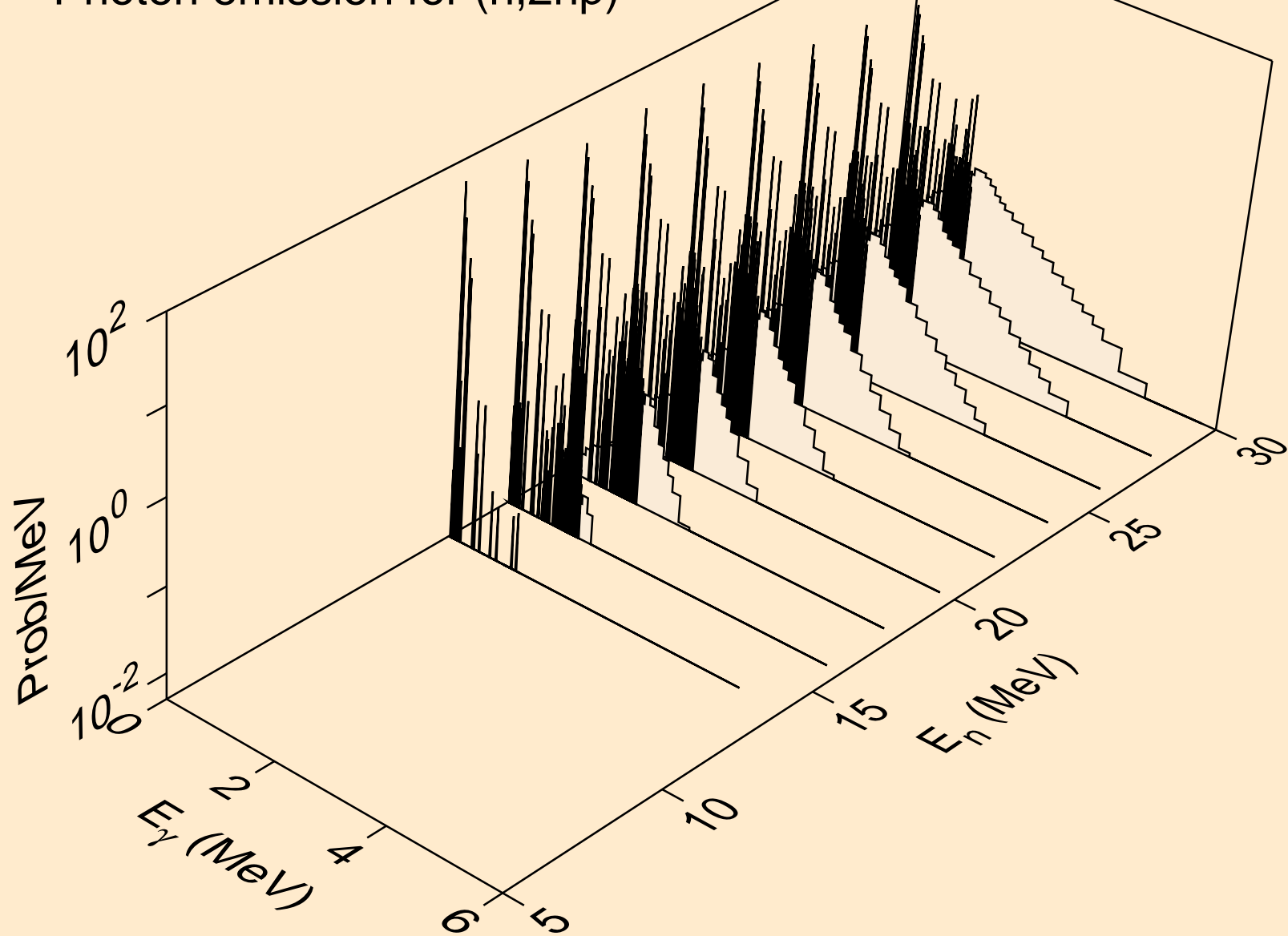

I134 HELION ACER TENDL-2021 LIBRARY; T=0.K
Photon emission for (n,npa)

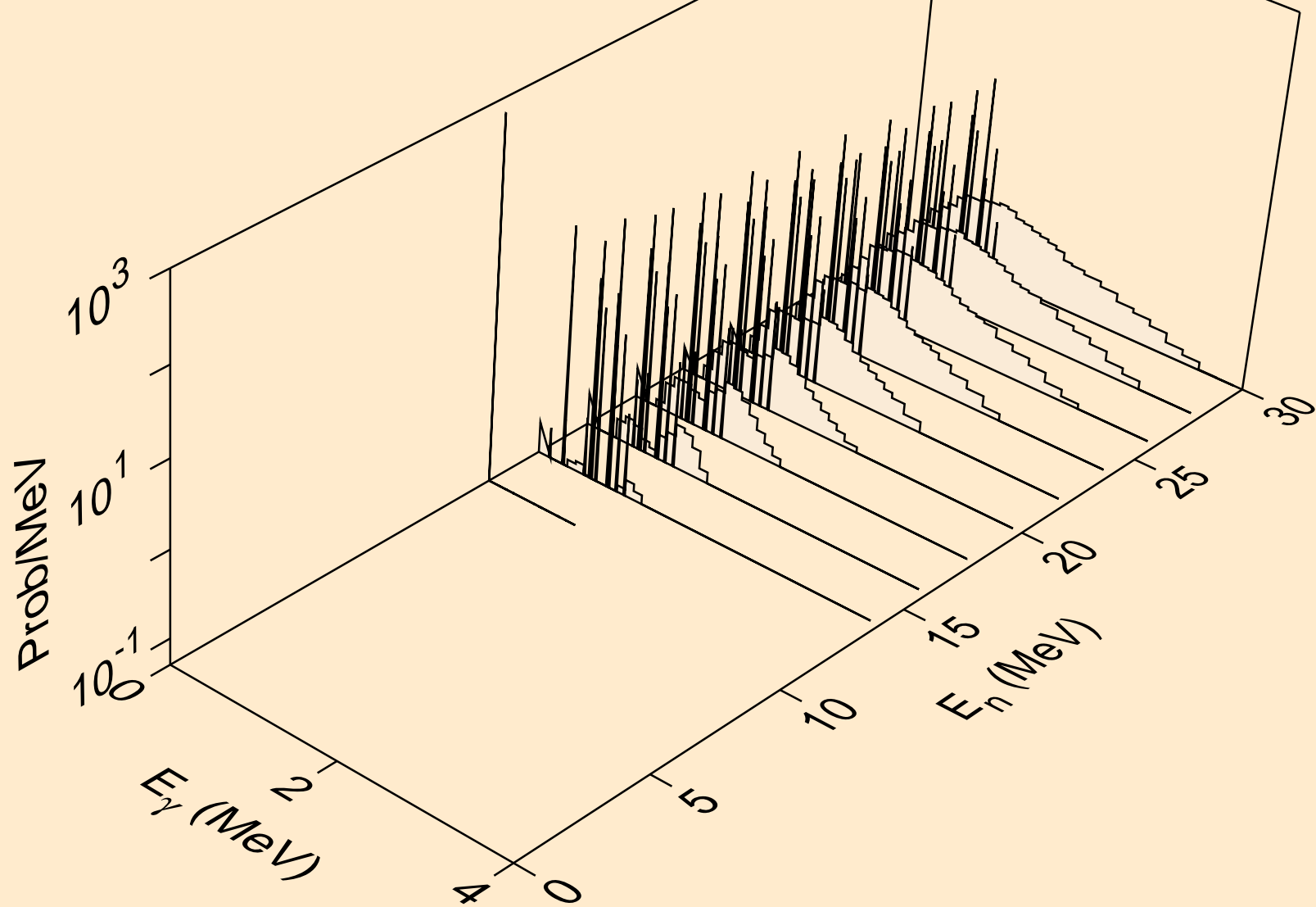

I134 HELION ACER TENDL-2021 LIBRARY; T=0.K
Photon emission for (n,gma)

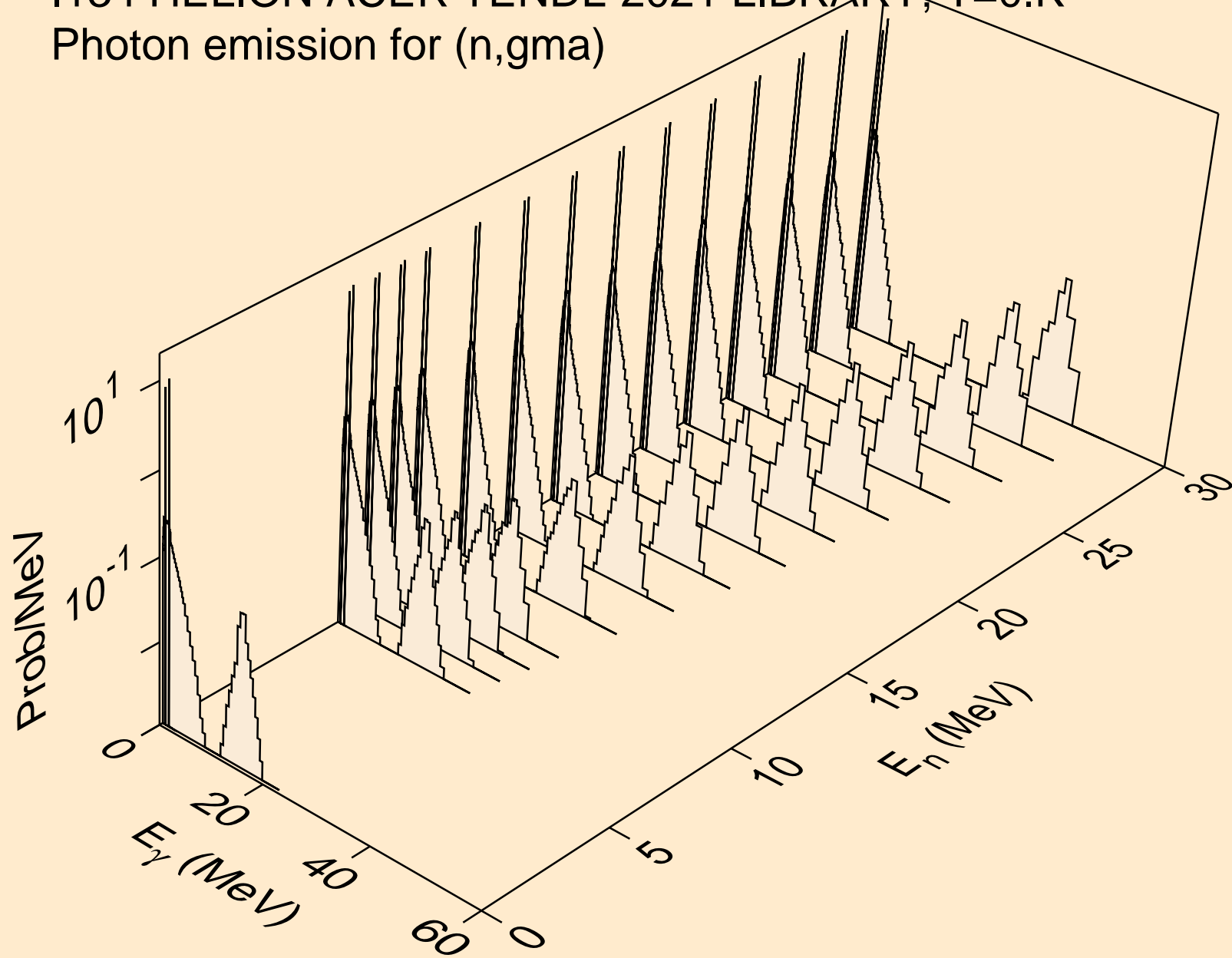

I134 HELION ACER TENDL-2021 LIBRARY; T=0.K
Photon emission for (n,p)

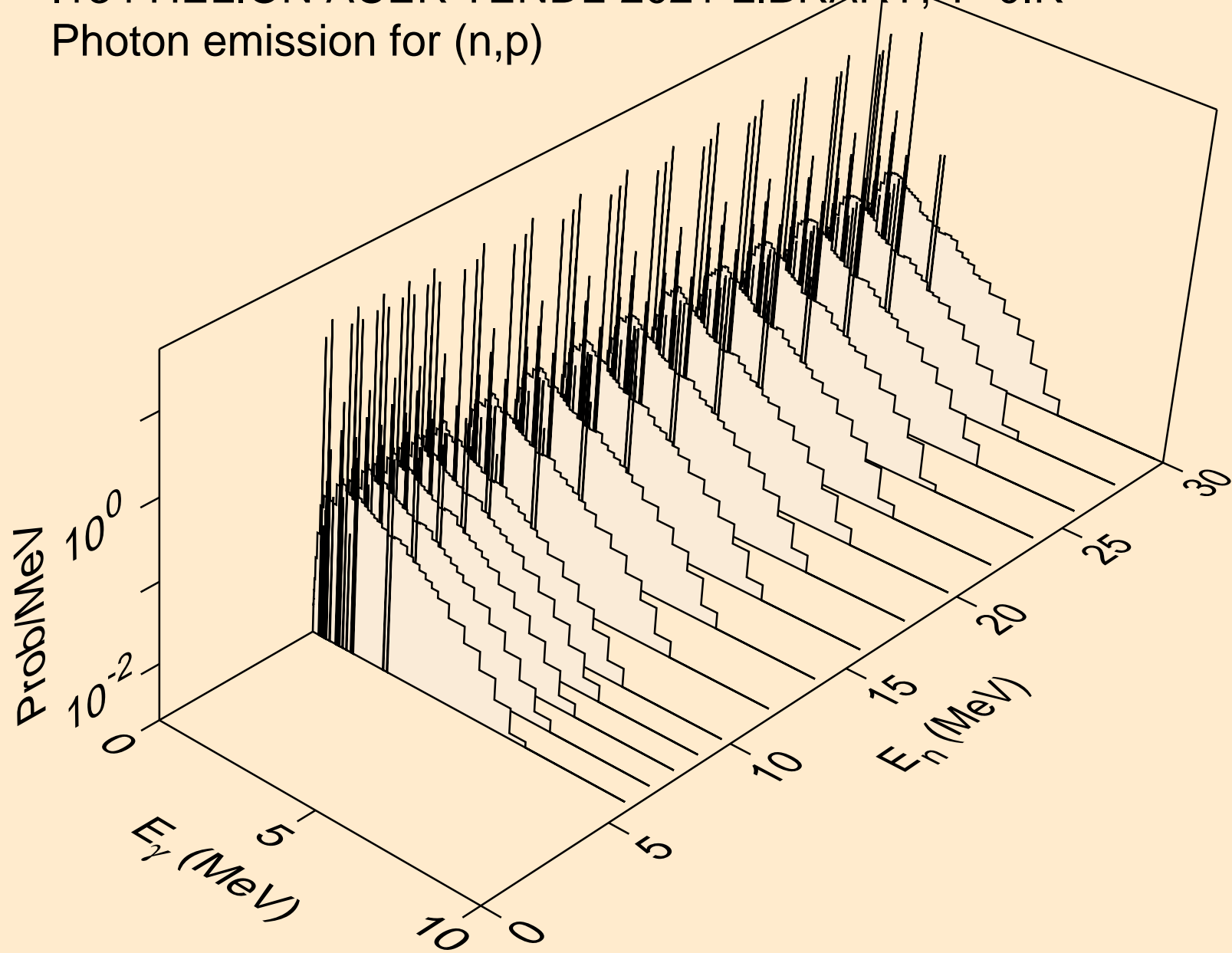

I134 HELION ACER TENDL-2021 LIBRARY: T=0.K
Photon emission for (n,d)

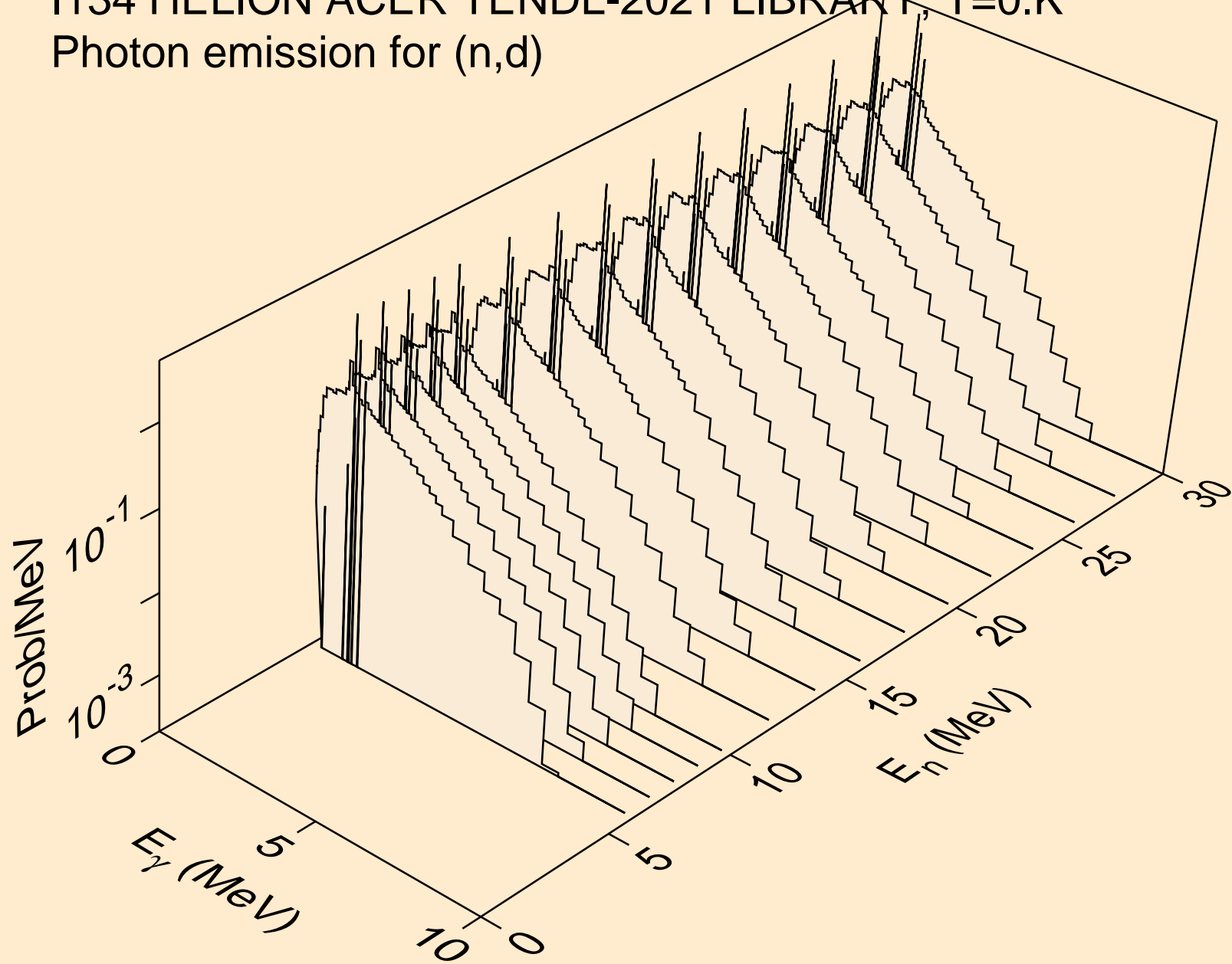

I134 HELION ACER TENDL-2021 LIBRARY; T=0.K
Photon emission for (n,t)

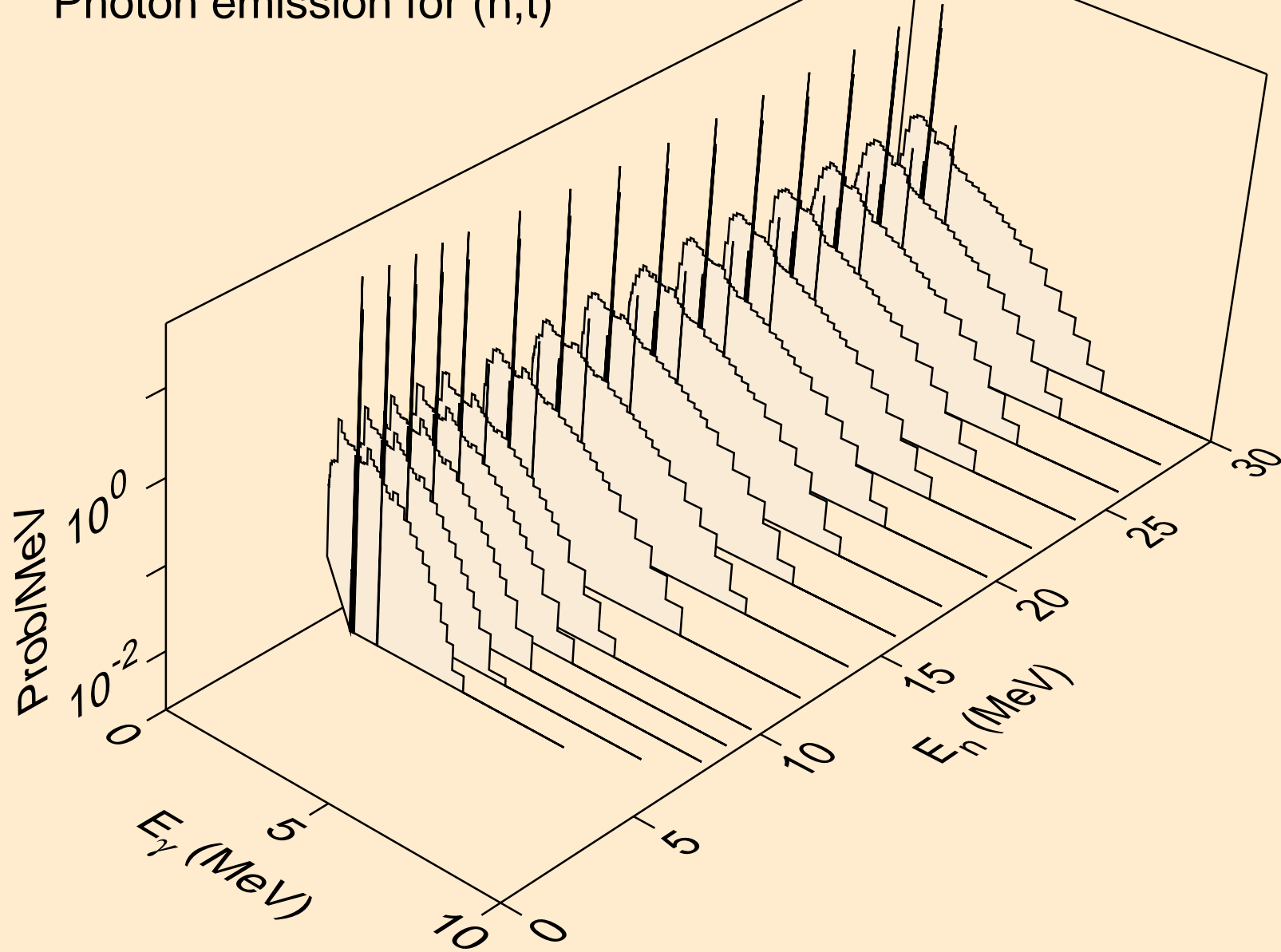

I134 HELION ACER TENDL-2021 LIBRARY; T=0.K
Photon emission for inelastic

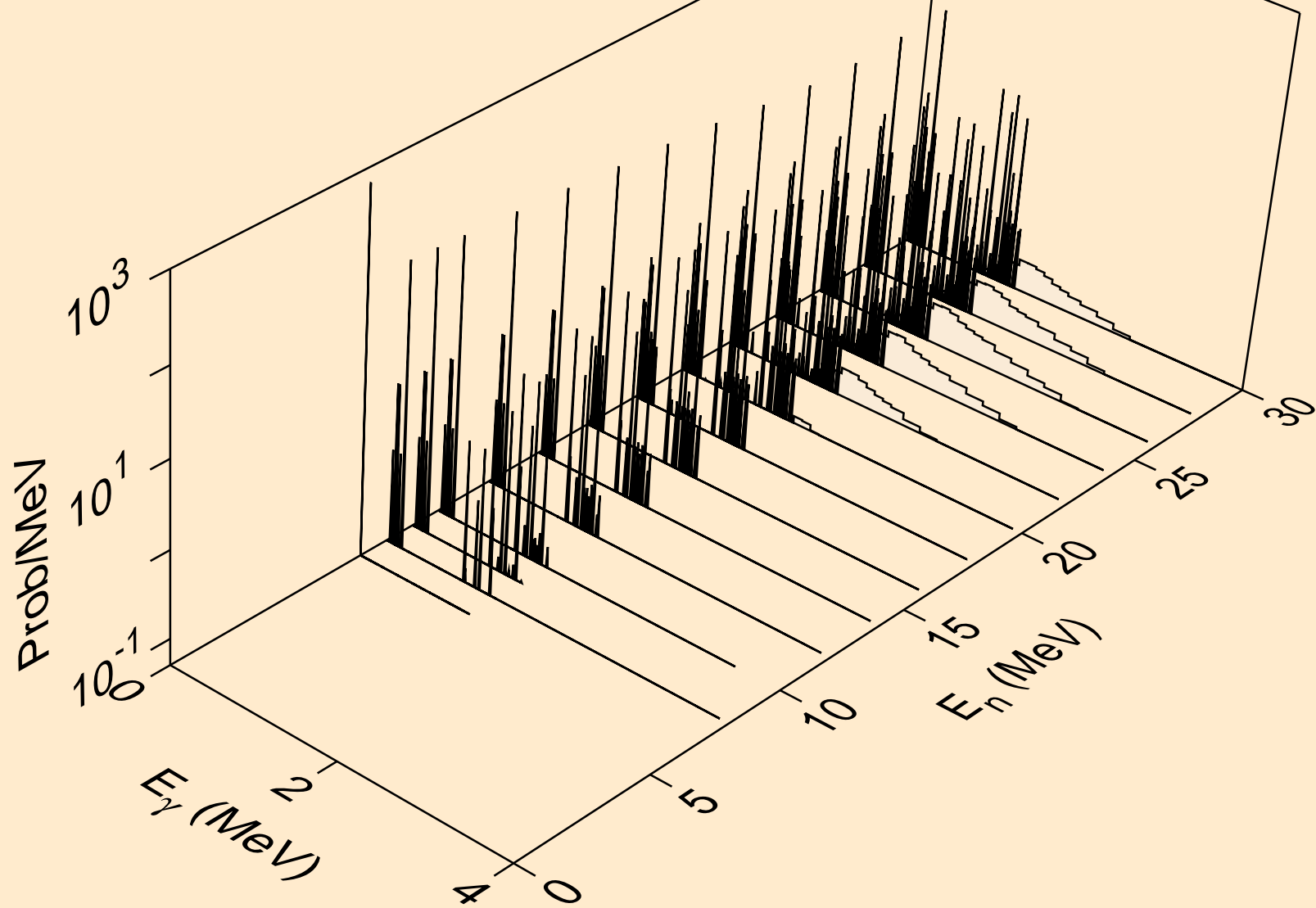

I134 HELION ACER TENDL-2021 LIBRARY; T=0.K
Photon emission for (n,a)

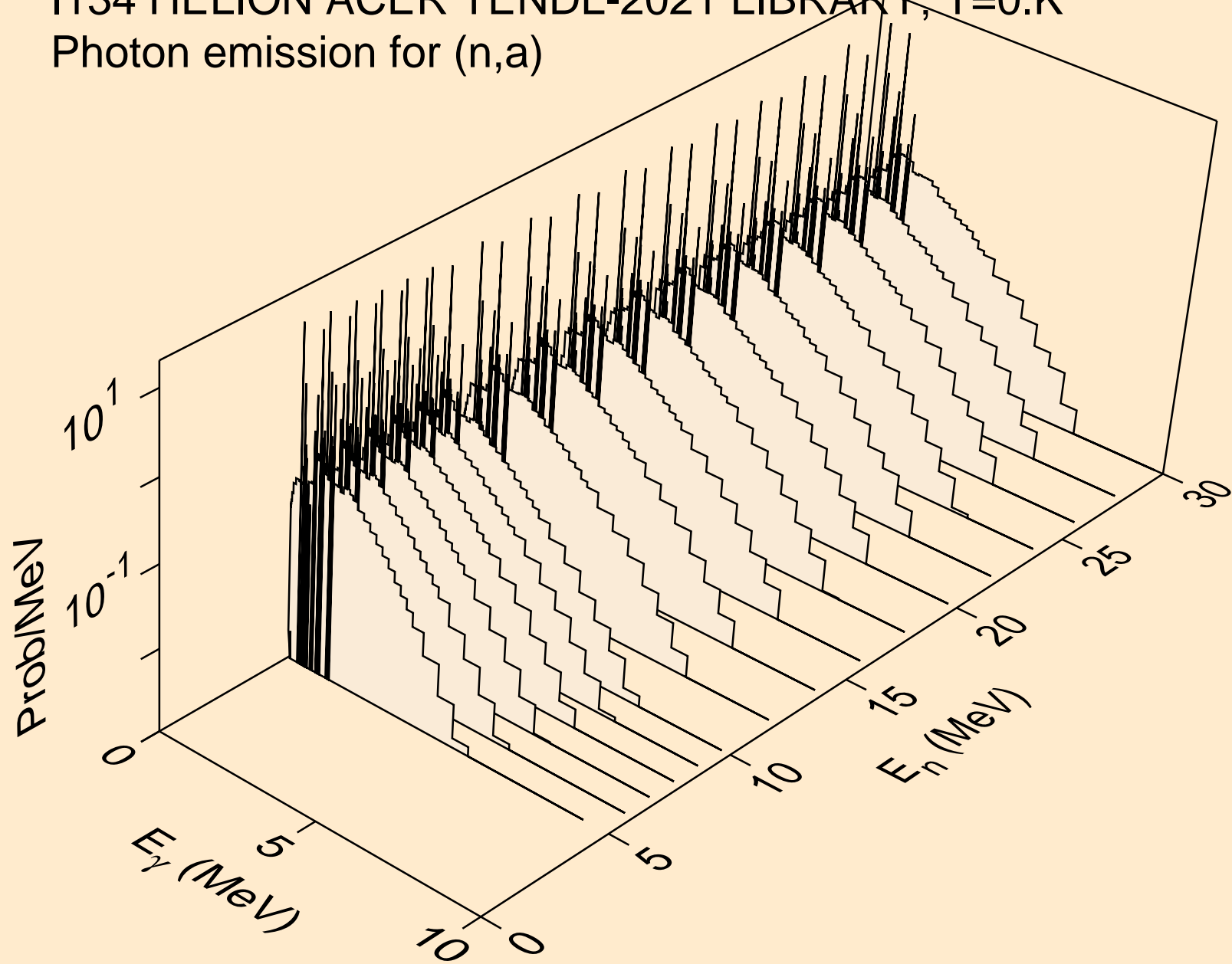

I134 HELION ACER TENDL-2021 LIBRARY; T=0.K
Photon emission for (n,2a)

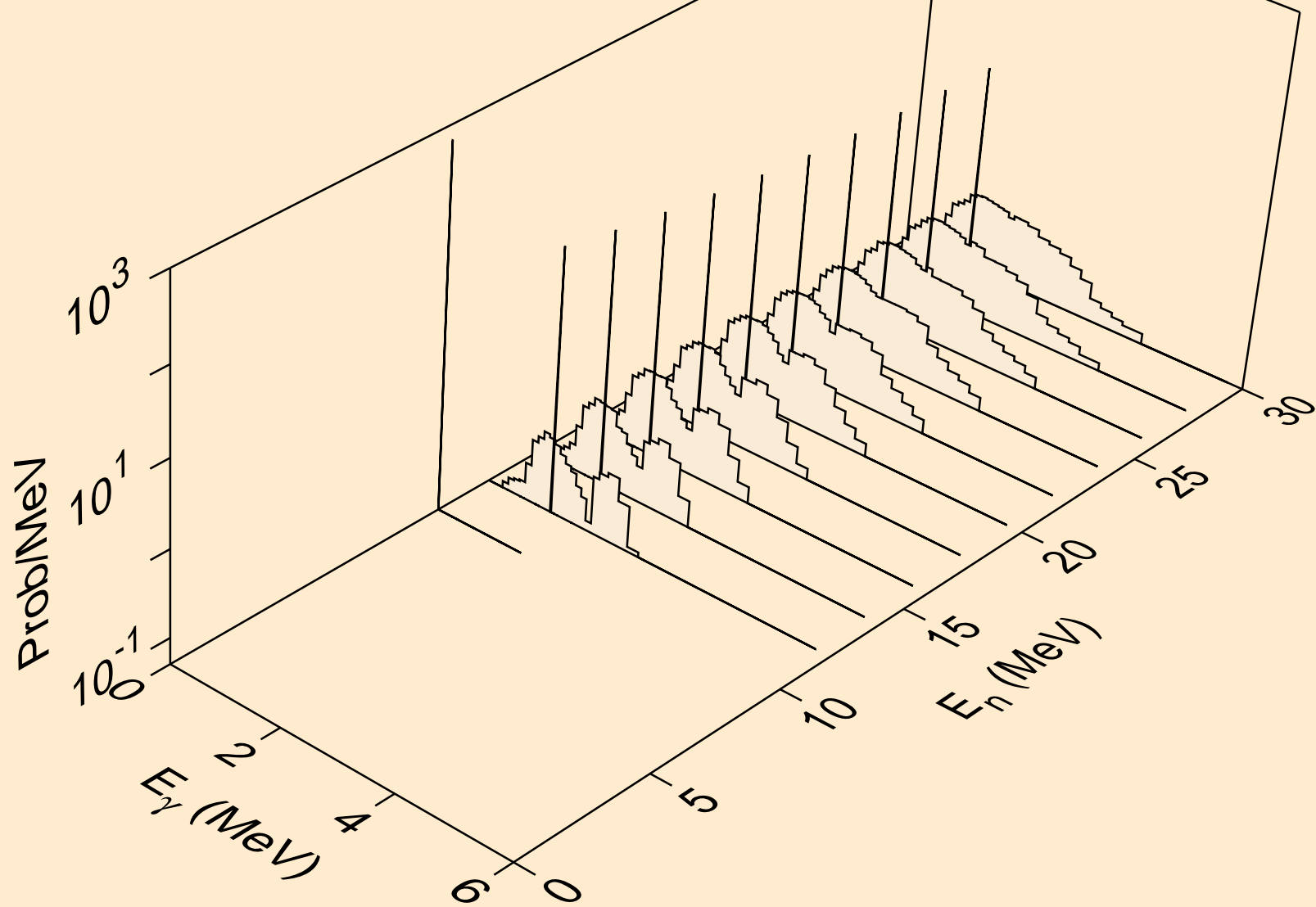

I134 HELION ACER TENDL-2021 LIBRARY; T=0.K
Photon emission for (n,2p)

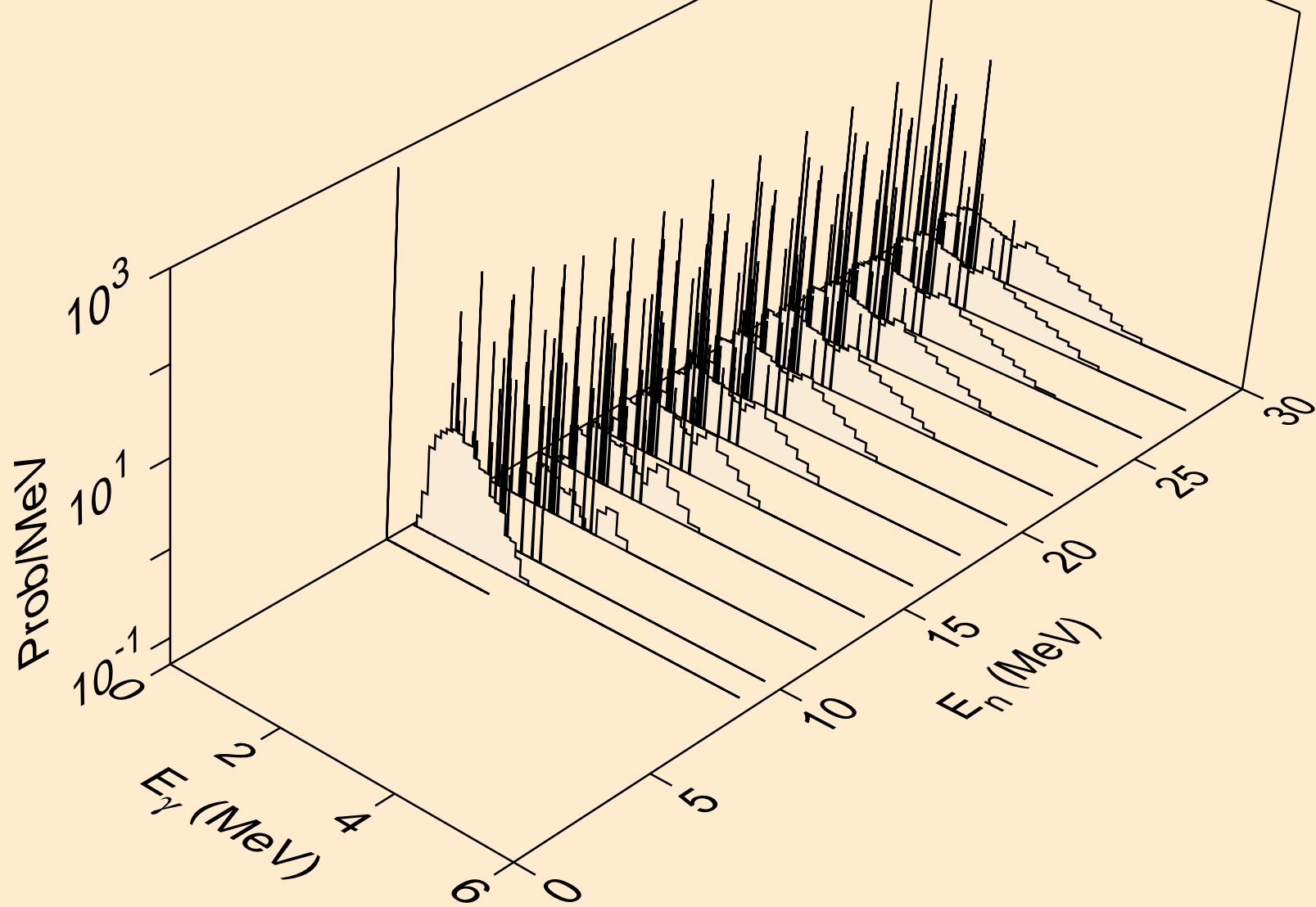

I134 HELION ACER TENDL-2021 LIBRARY; T=0.K
Photon emission for (n,pa)

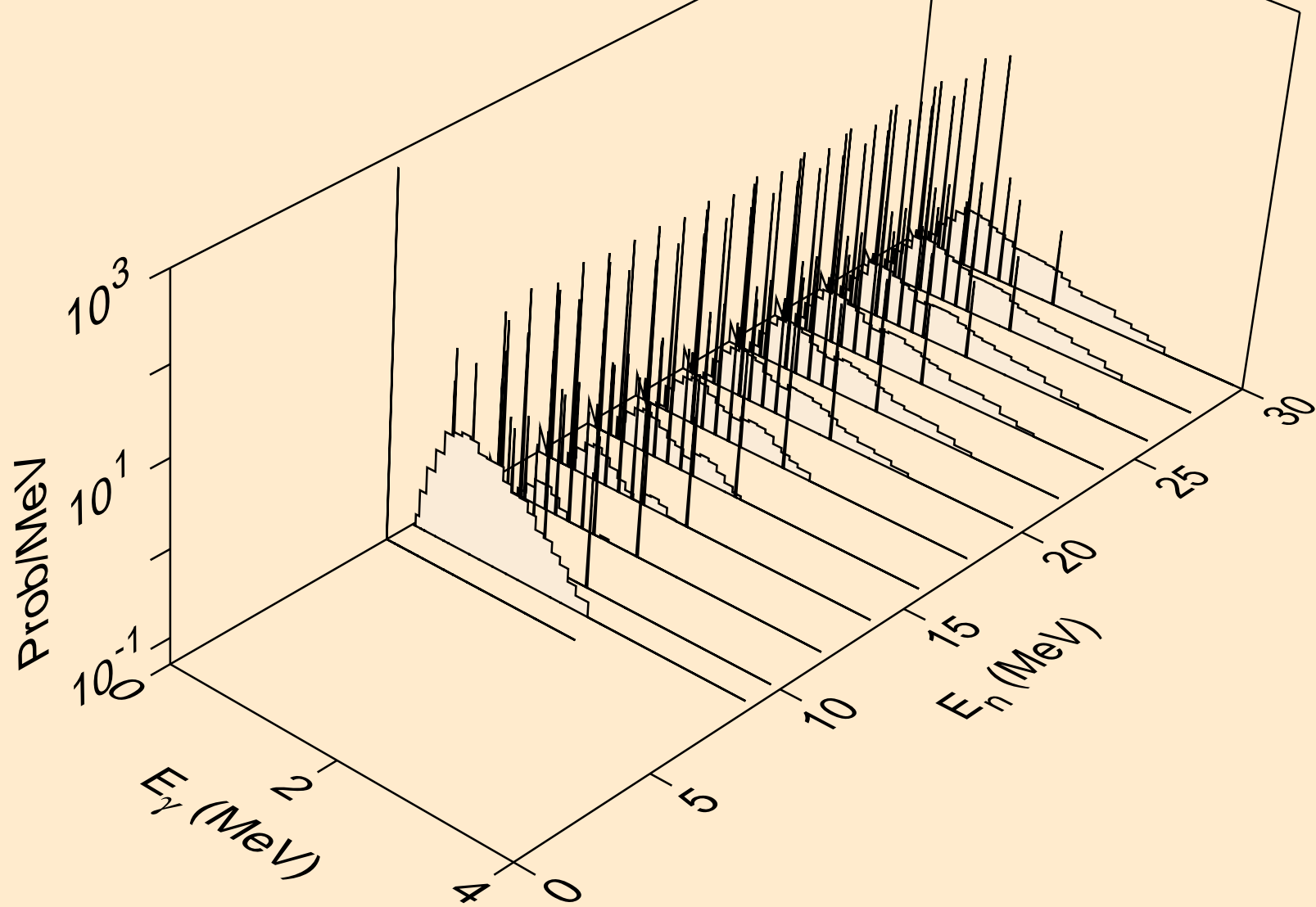

I134 HELION ACER TENDL-2021 LIBRARY; T=0.K
Photon emission for (n,pd)

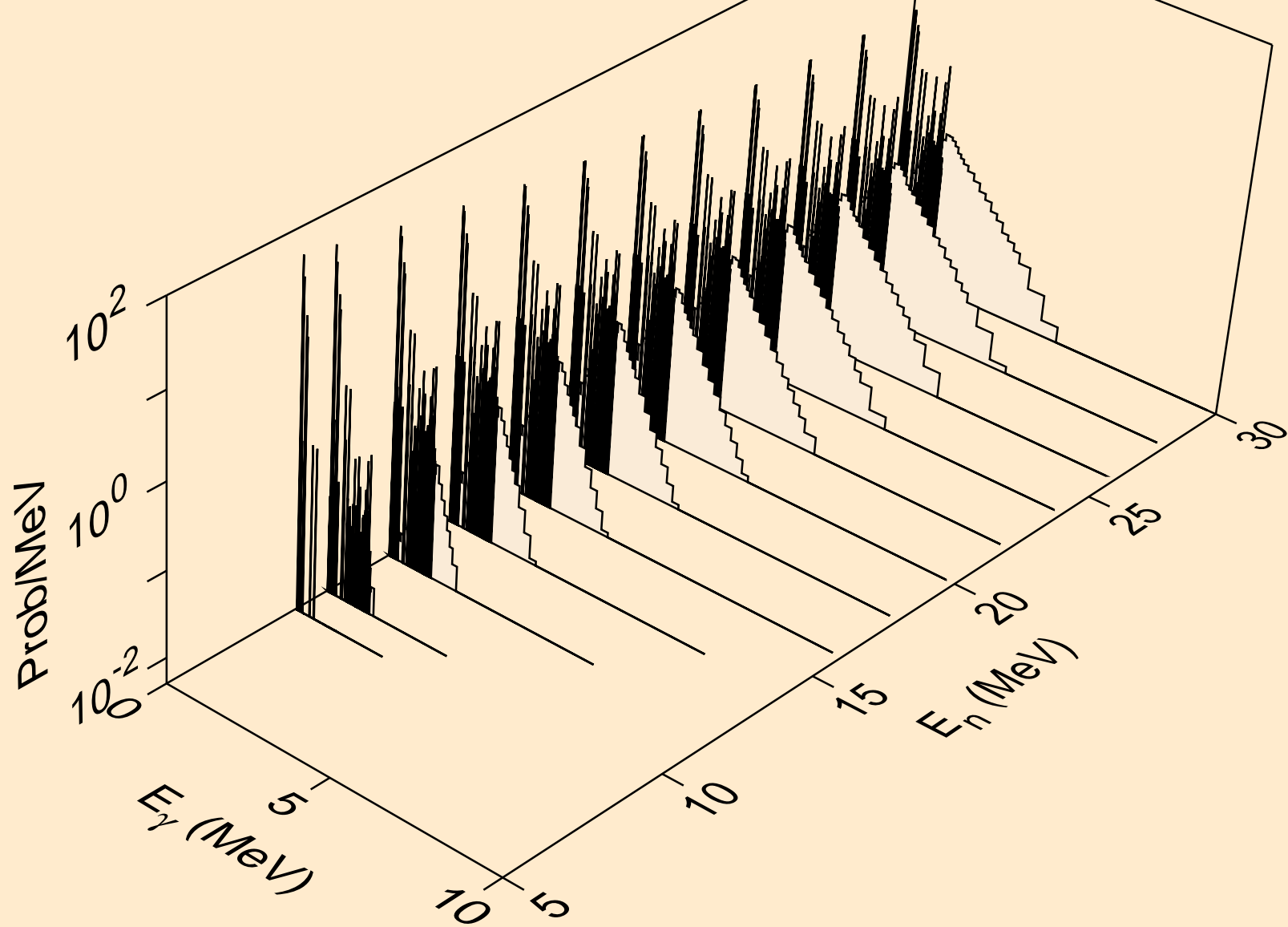

I134 HELION ACER TENDL-2021 LIBRARY; T=0.K
Photon emission for (n,pt)

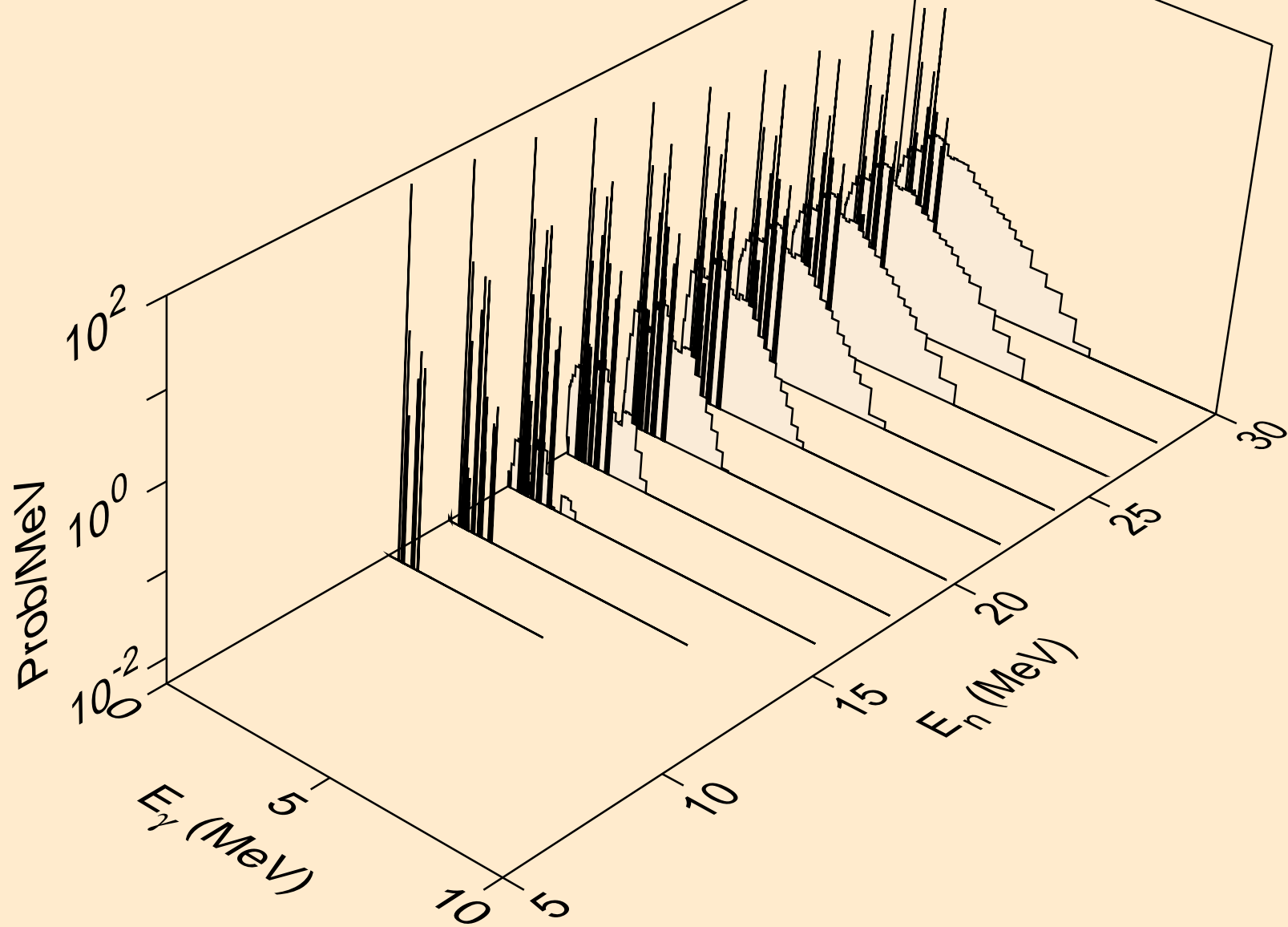

I134 HELION ACER TENDL-2021 LIBRARY; T=0.K
Photon emission for (n,da)

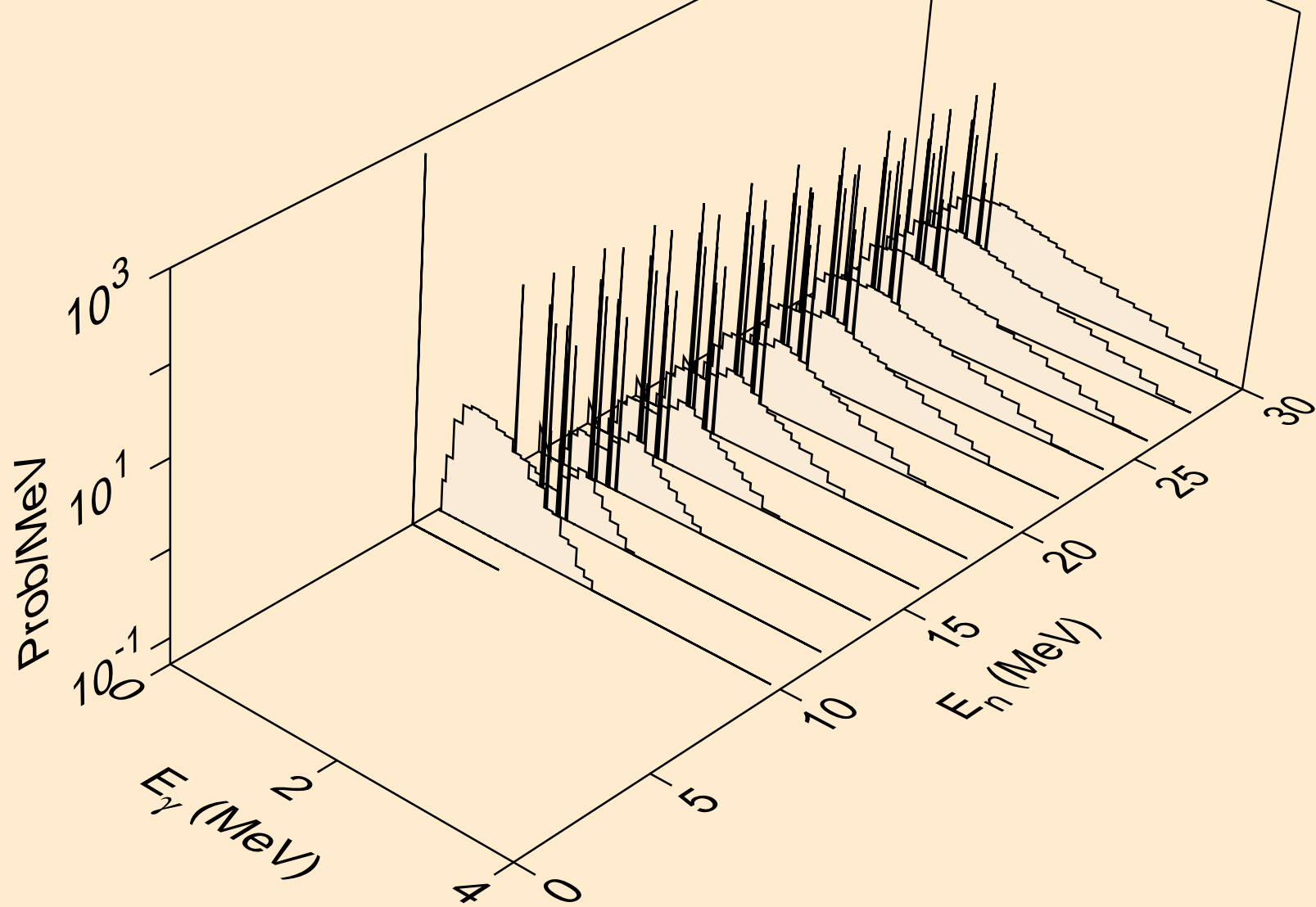

I134 HELION ACER TENDL-2021 LIBRARY; T=0.K

Particle heating contributions

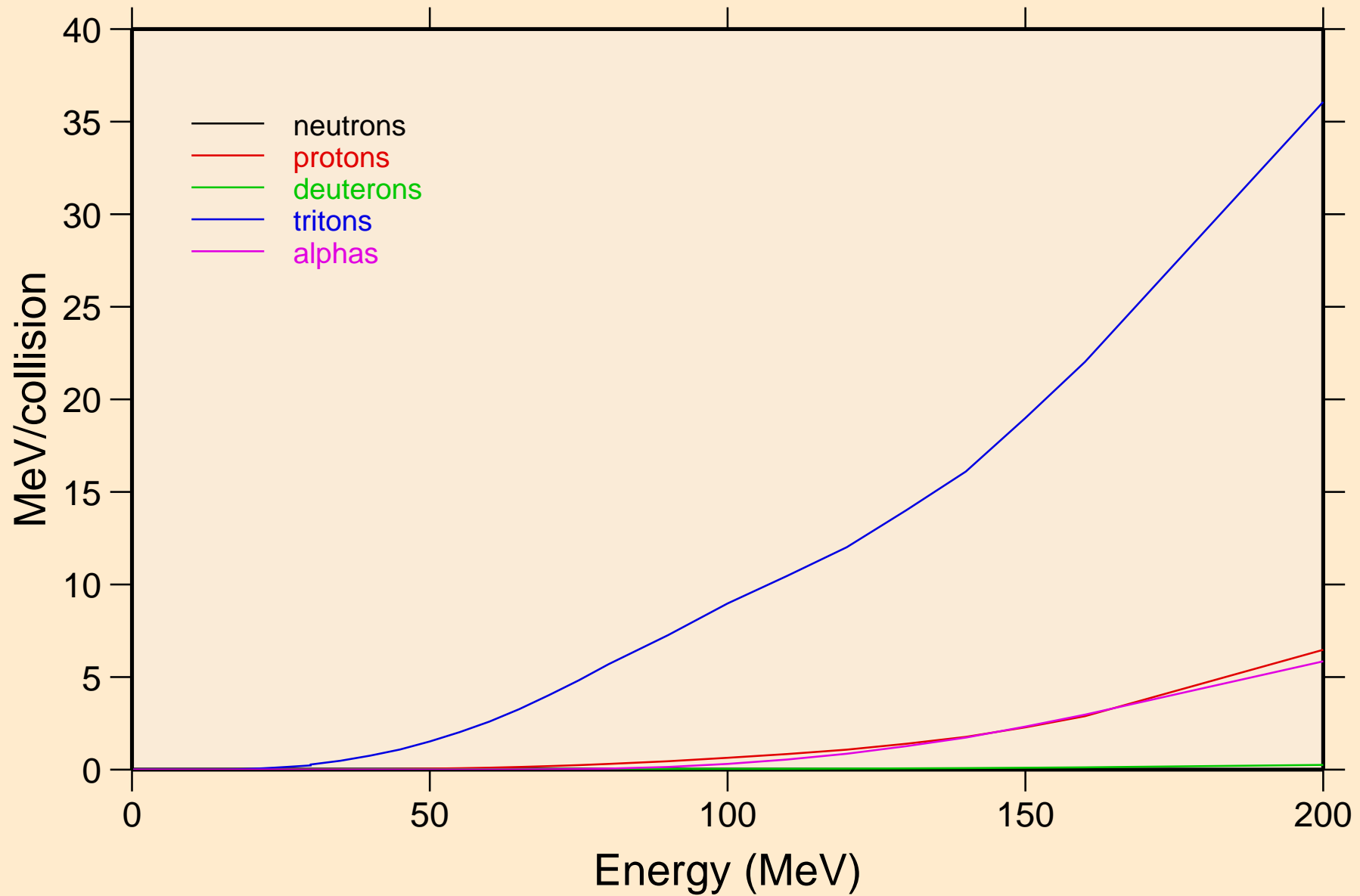

I134 HELION ACER TENDL-2021 LIBRARY; T=0.K
Recoil Heating

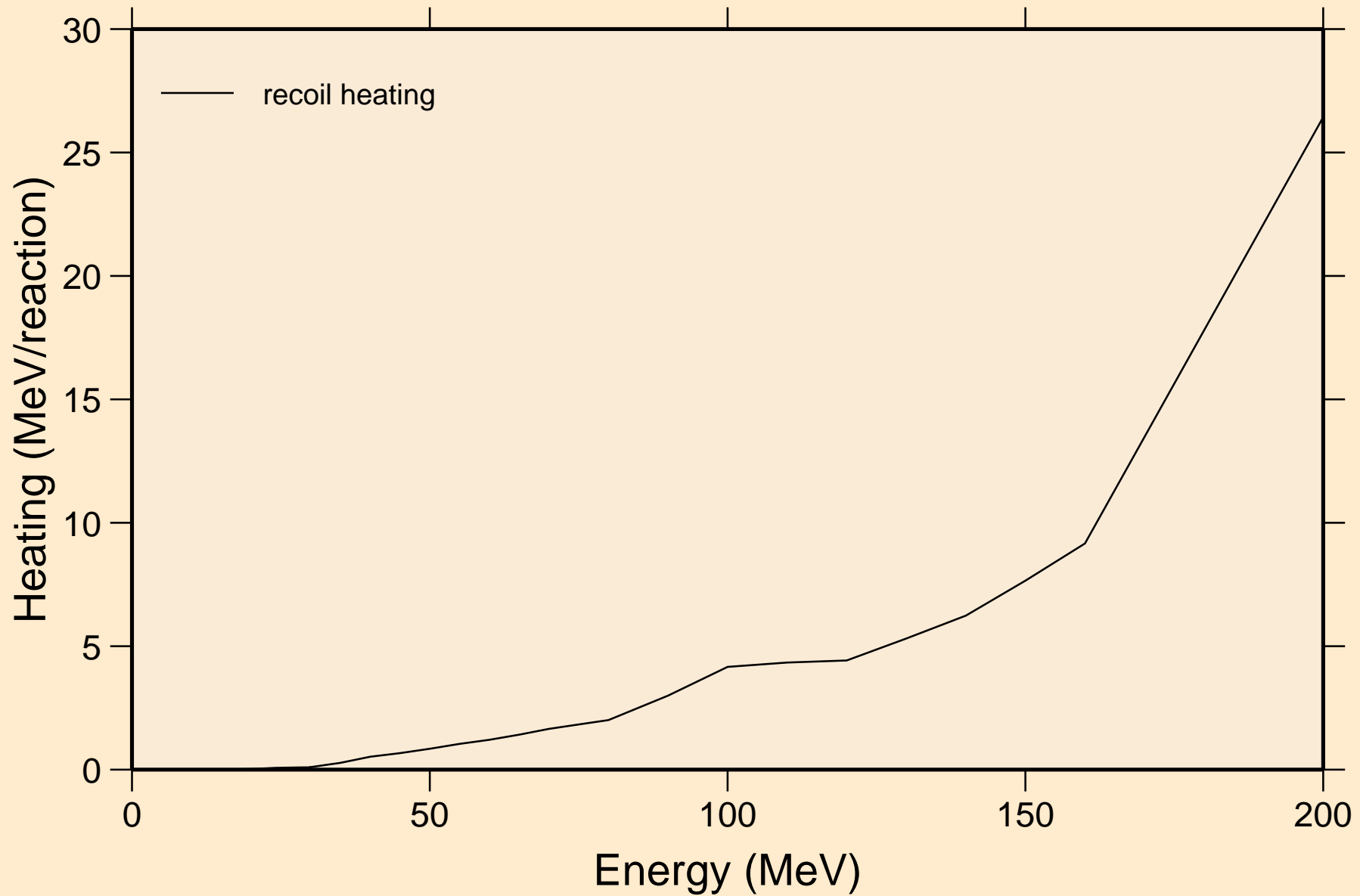

I134 HELION ACER TENDL-2021 LIBRARY; T=0.K
Particle production cross sections

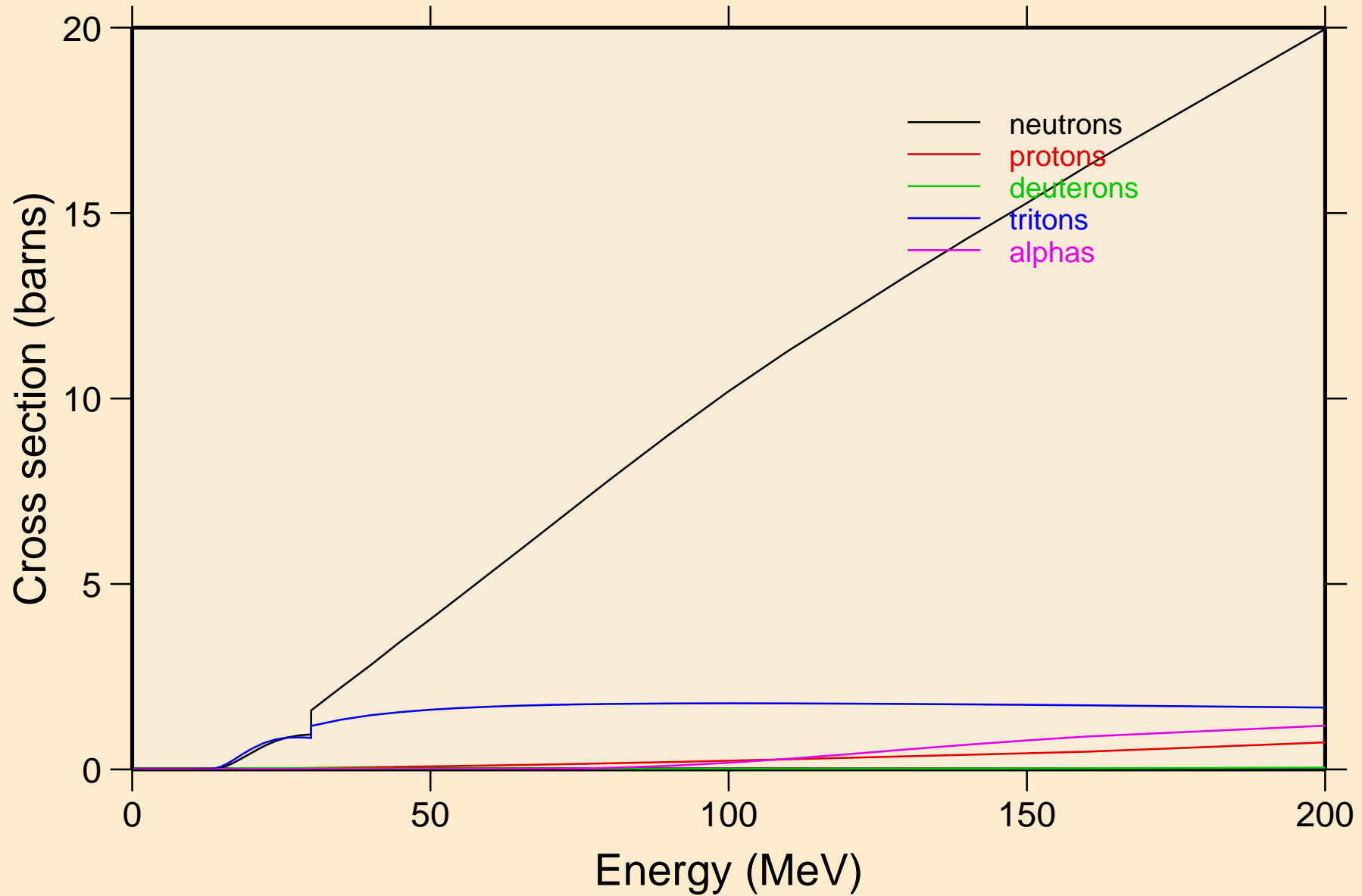

I134 HELION ACER TENDL-2021 LIBRARY; T=0.K
neutrons from (s,n)

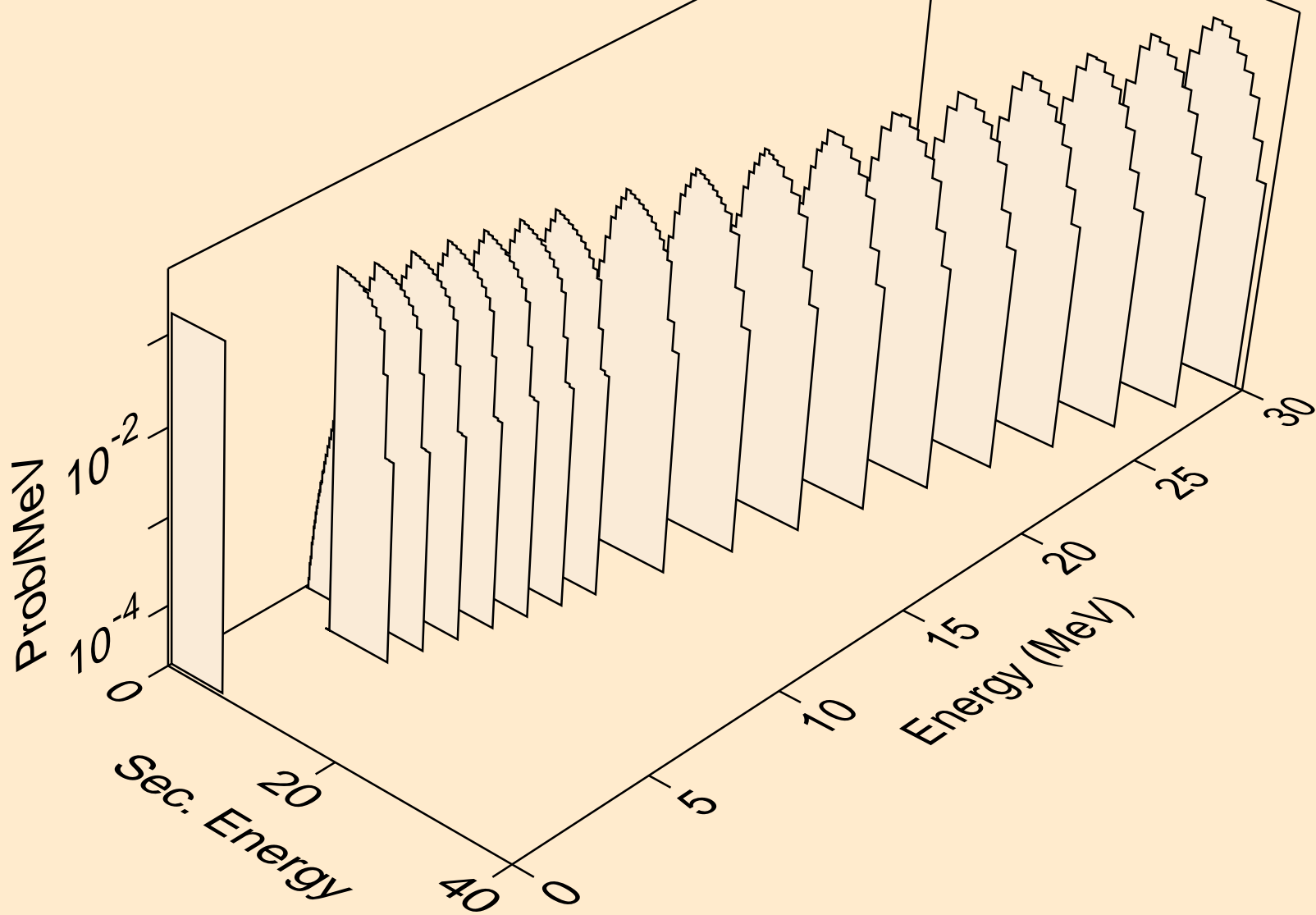

I134 HELION ACER TENDL-2021 LIBRARY; T=0.K
neutrons from (s,x)

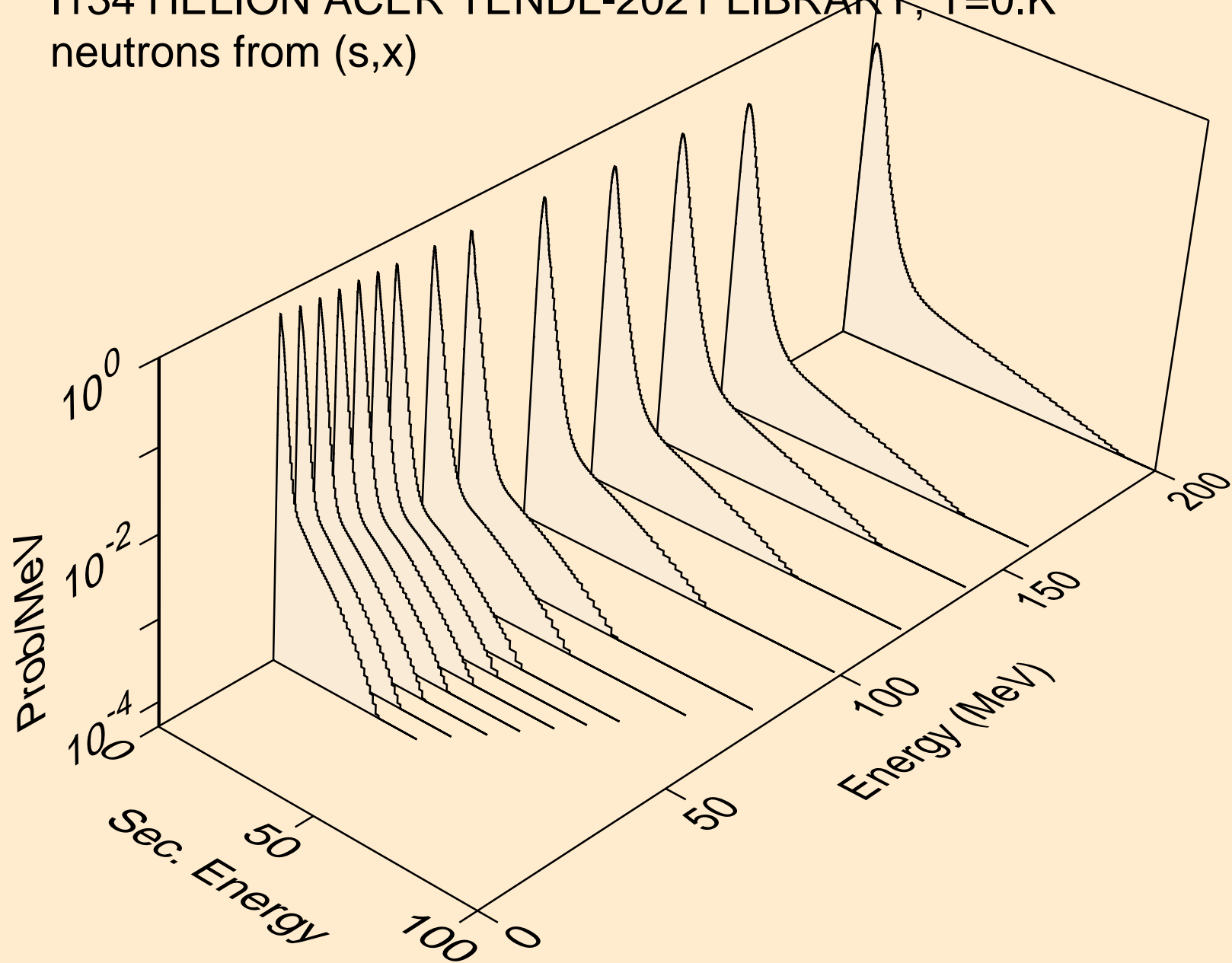

I134 HELION ACER TENDL-2021 LIBRARY; T=0.K
neutrons from (s,2nd)

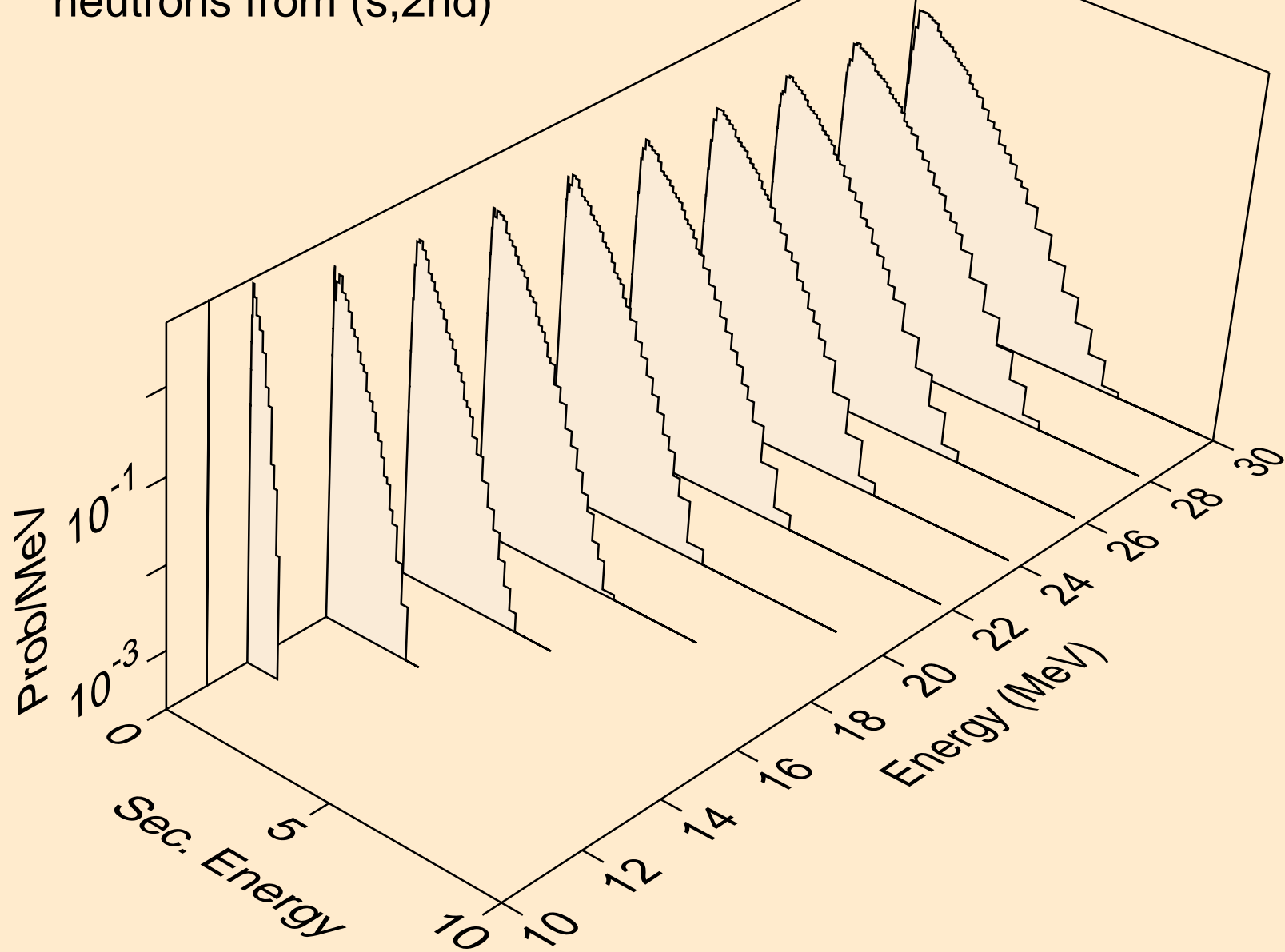

I134 HELION ACER TENDL-2021 LIBRARY; T=0.K
neutrons from (s,2n)

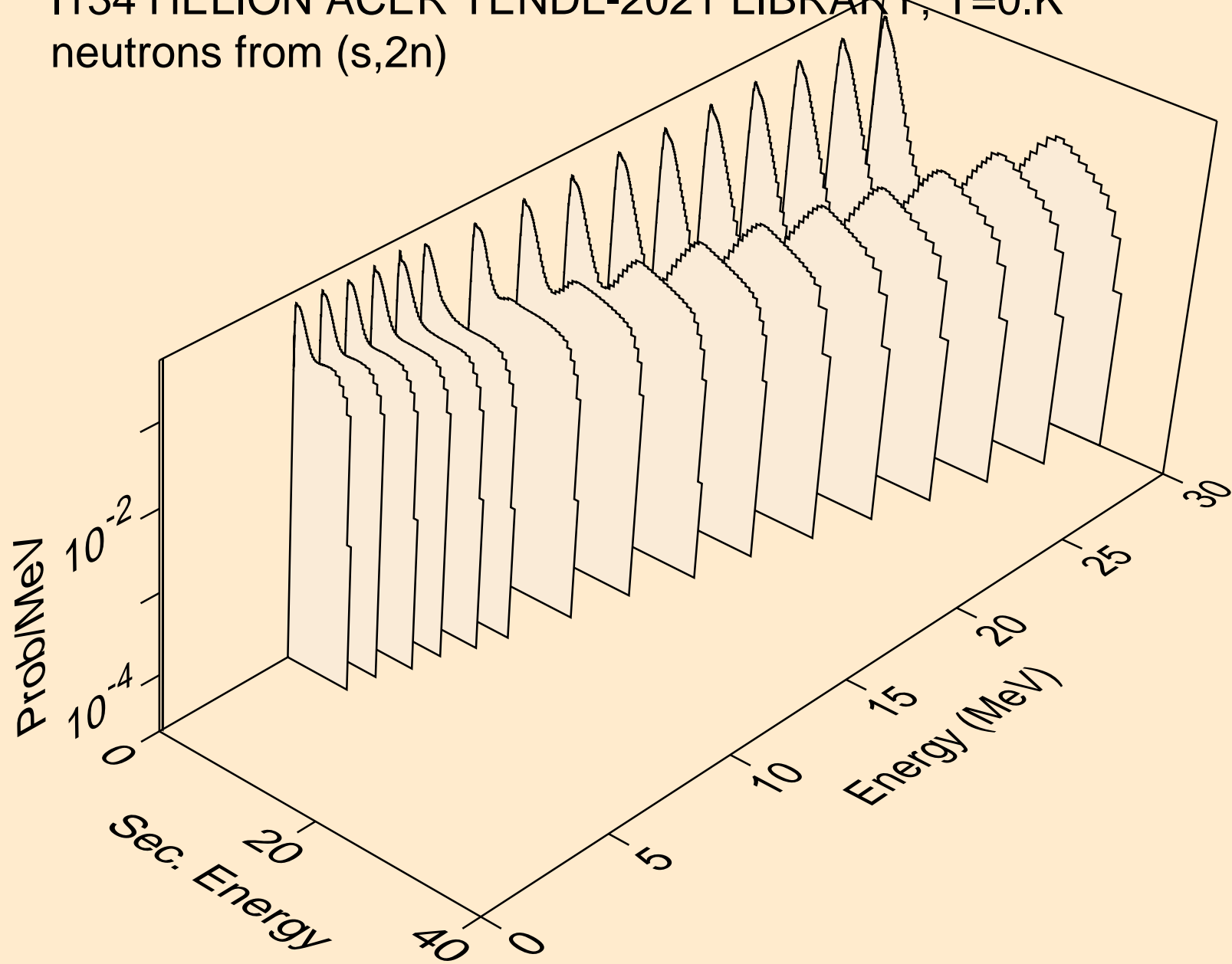

I134 HELION ACER TENDL-2021 LIBRARY; T=0.K
neutrons from (s,3n)

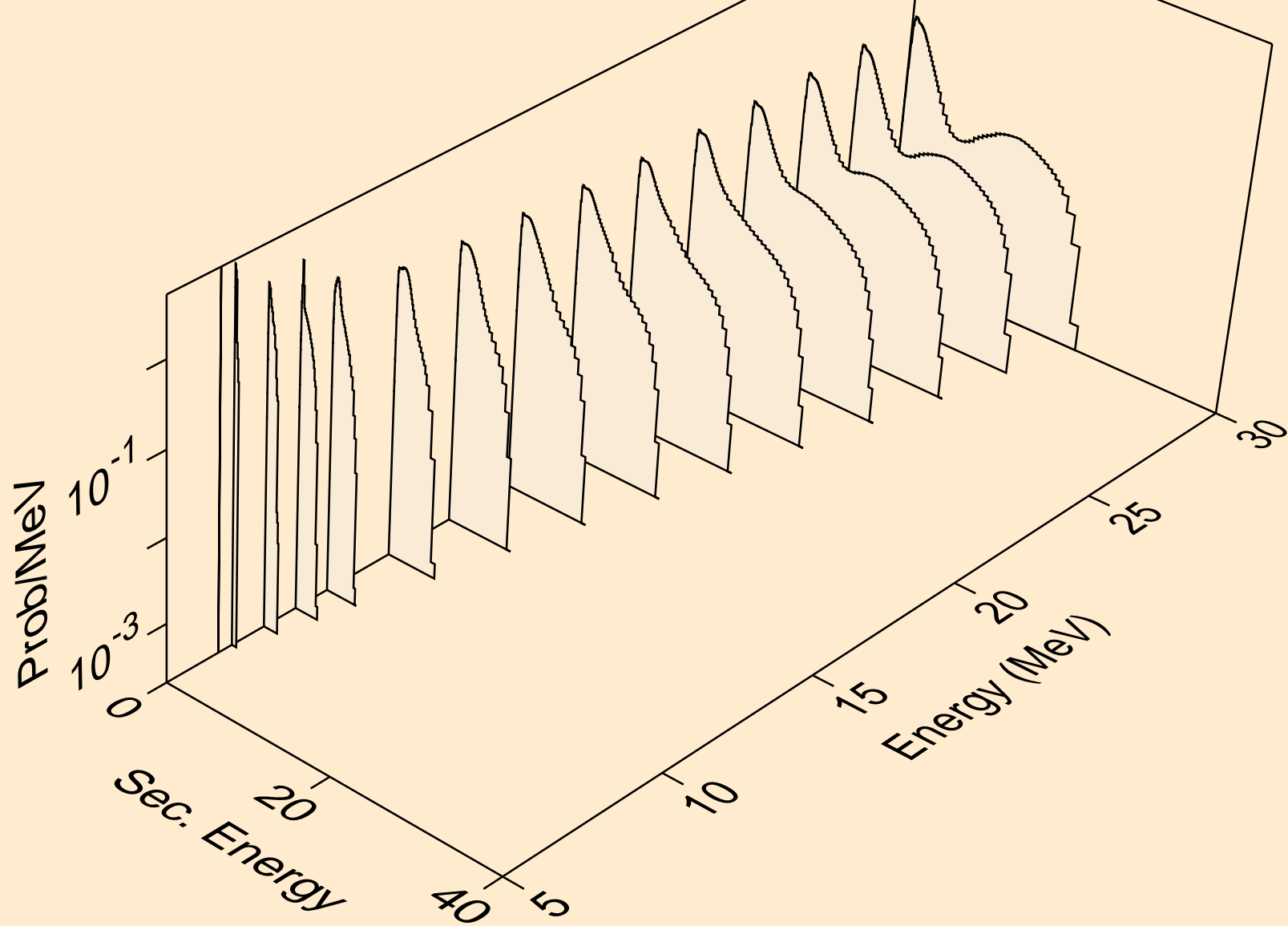

I134 HELION ACER TENDL-2021 LIBRARY; T=0.K
neutrons from (s,n*)a

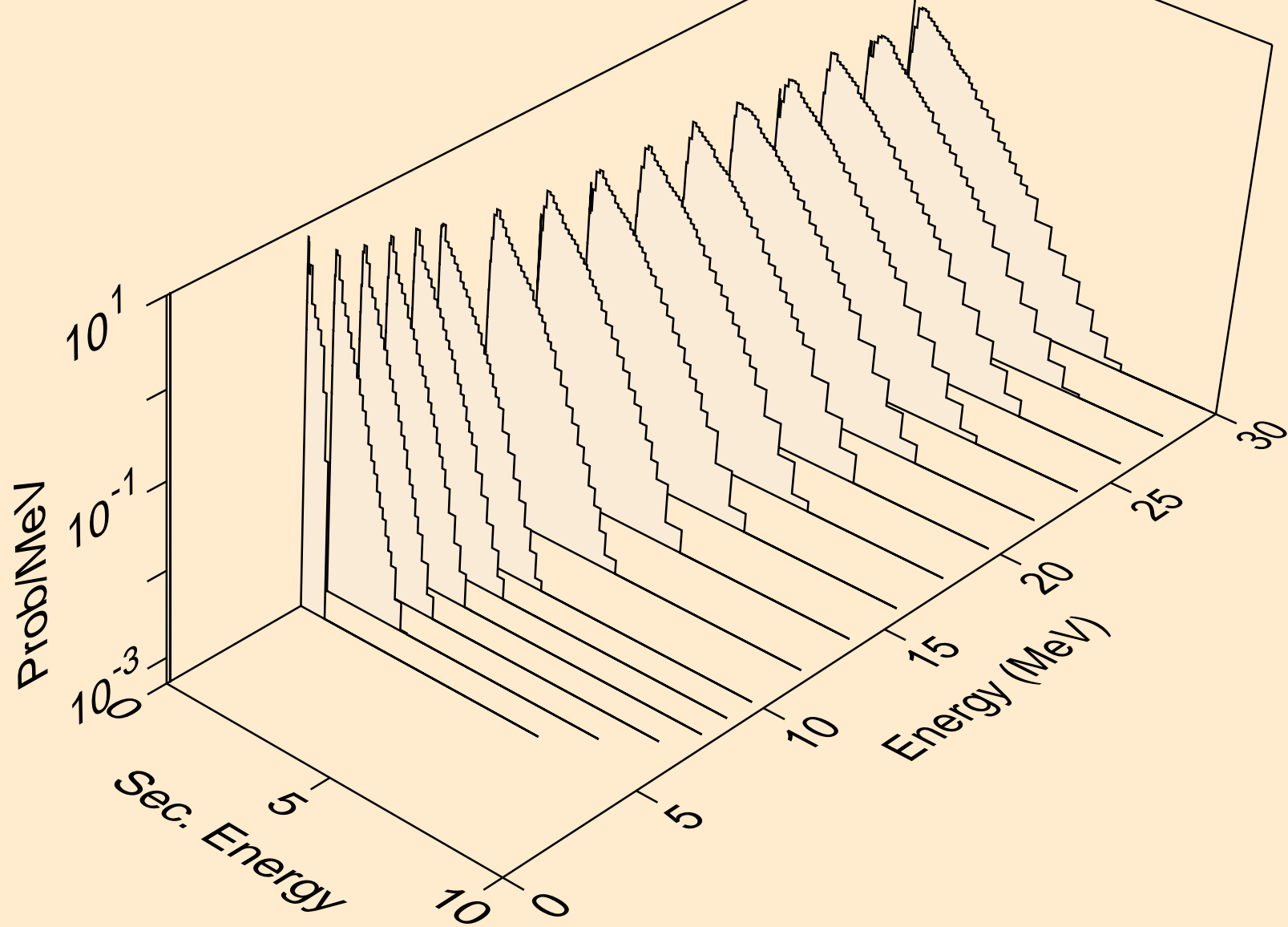

I134 HELION ACER TENDL-2021 LIBRARY; T=0.K
neutrons from (s,2n)a

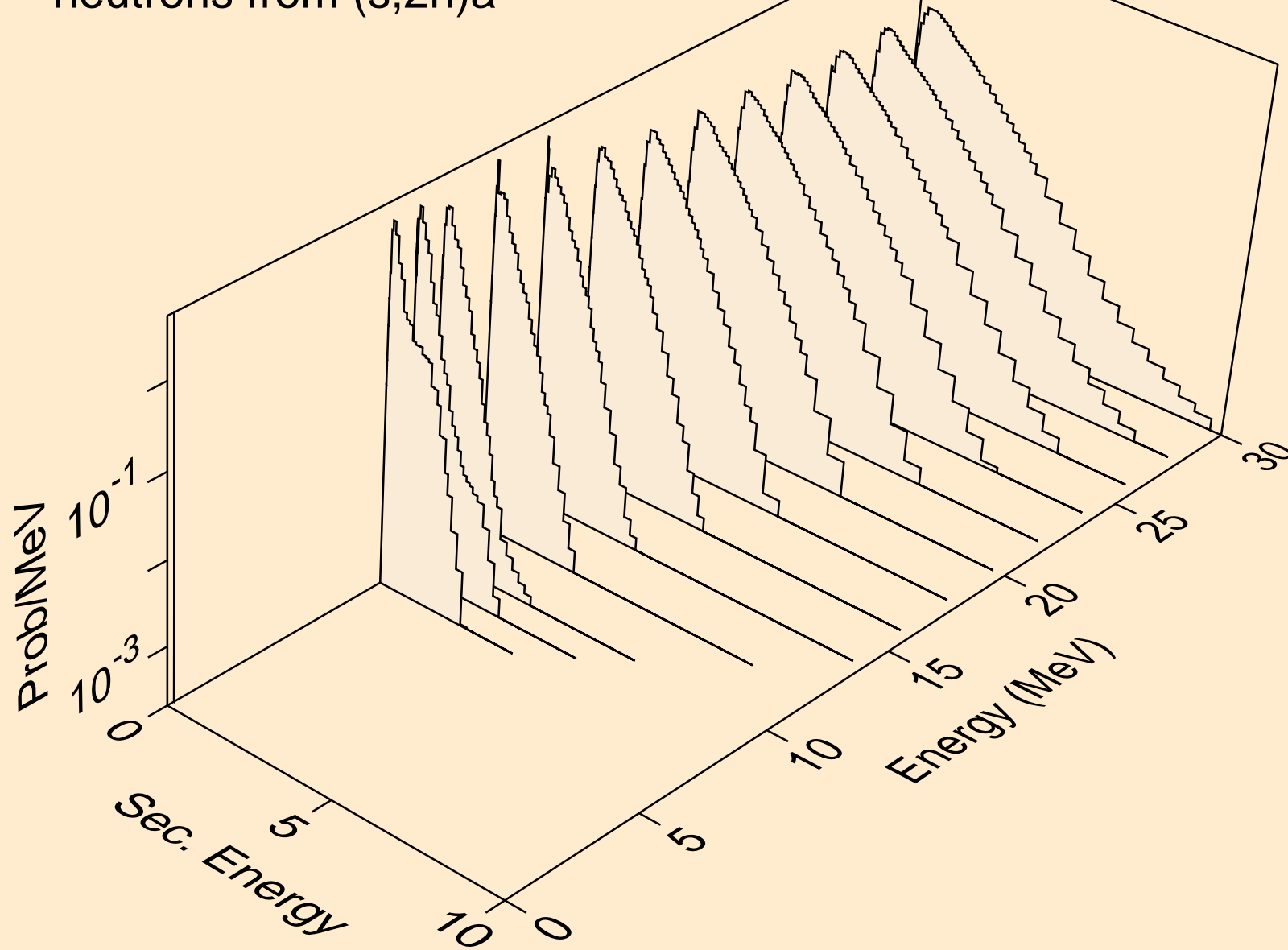

I134 HELION ACER TENDL-2021 LIBRARY; T=0.K
neutrons from (s,3n)a

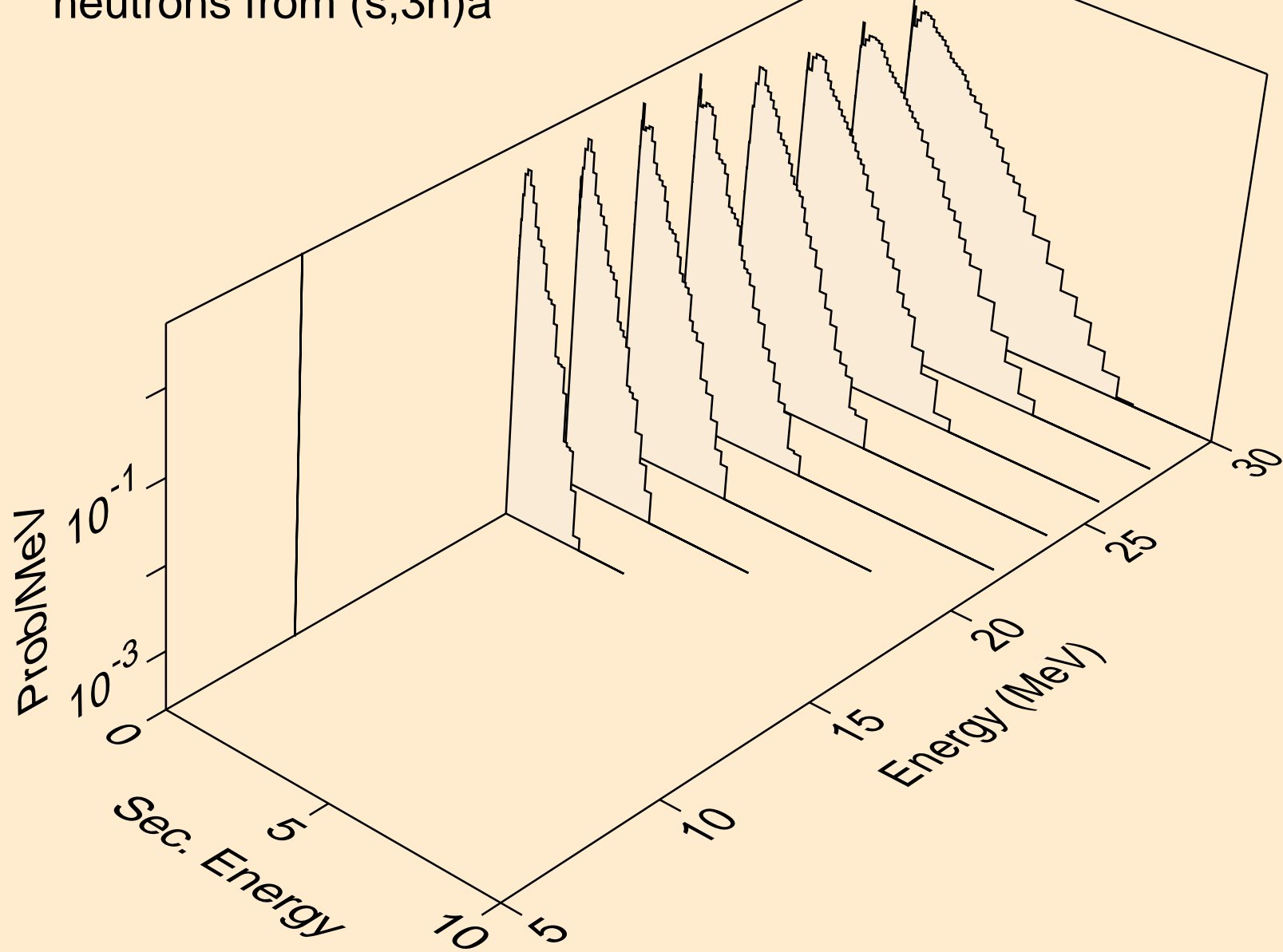

I134 HELION ACER TENDL-2021 LIBRARY; T=0.K
neutrons from (s,n*)p

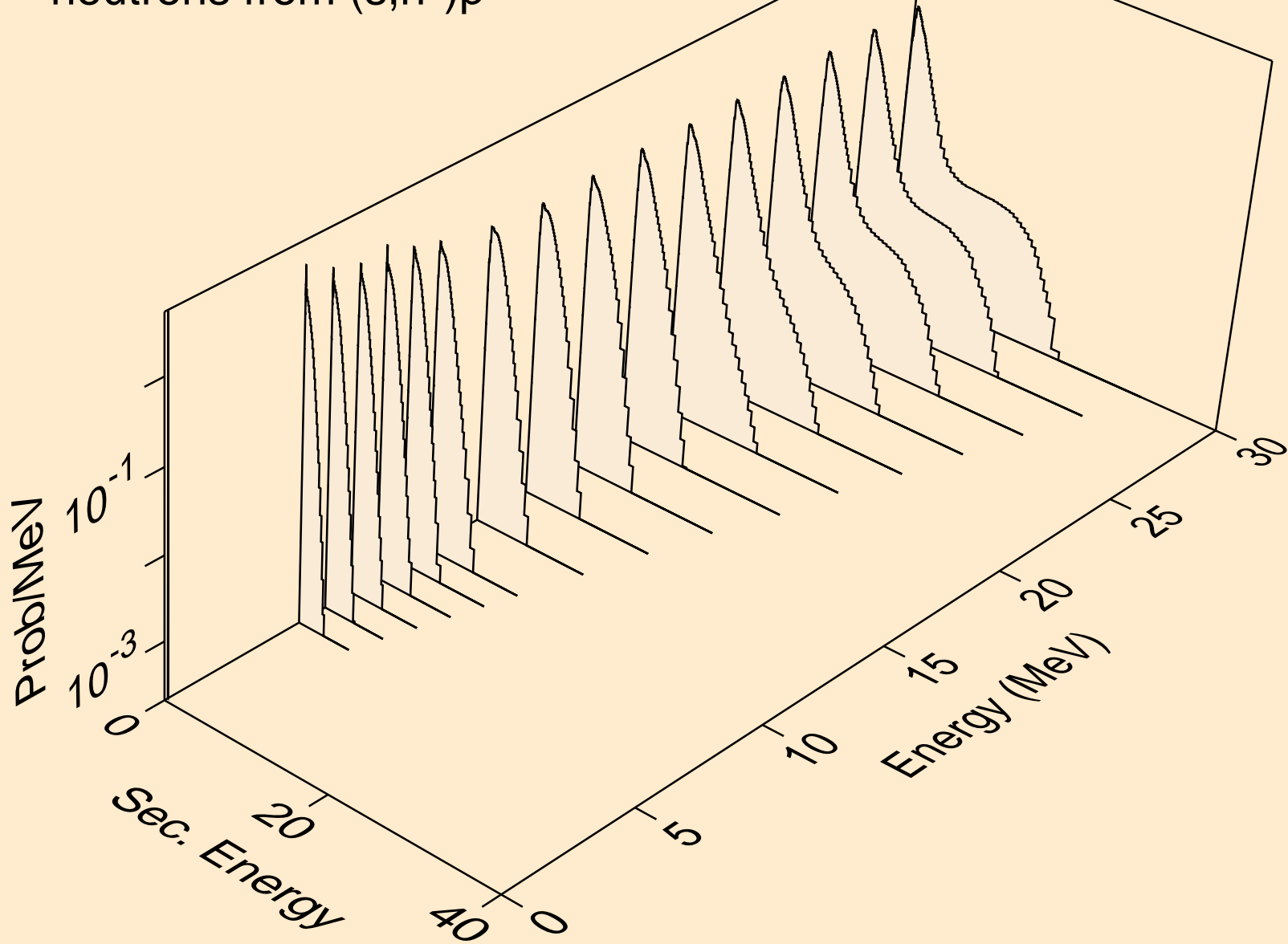

I134 HELION ACER TENDL-2021 LIBRARY; T=0.K
neutrons from (s,n*)2a

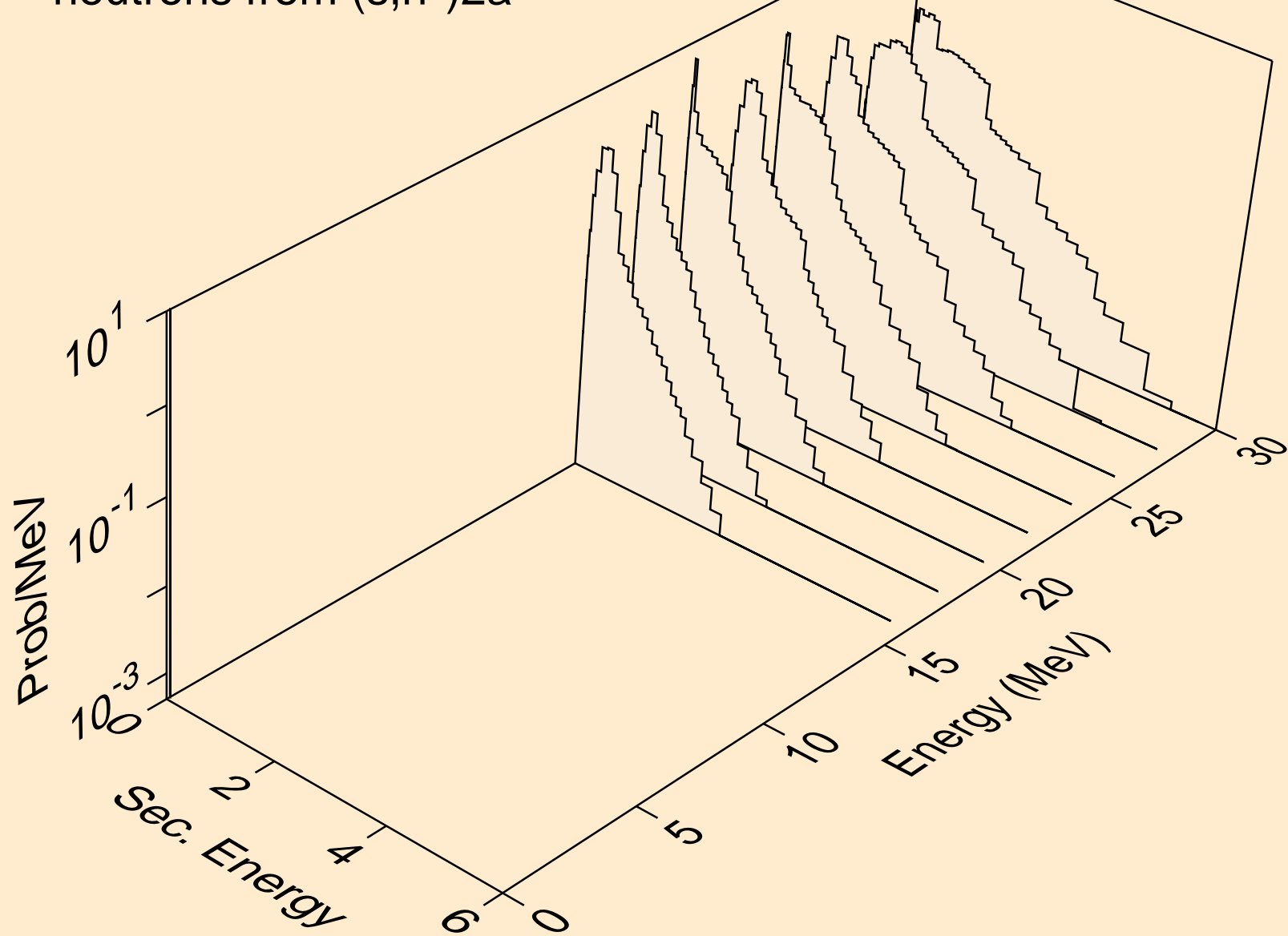

I134 HELION ACER TENDL-2021 LIBRARY; T=0.K
neutrons from (s,n*)d

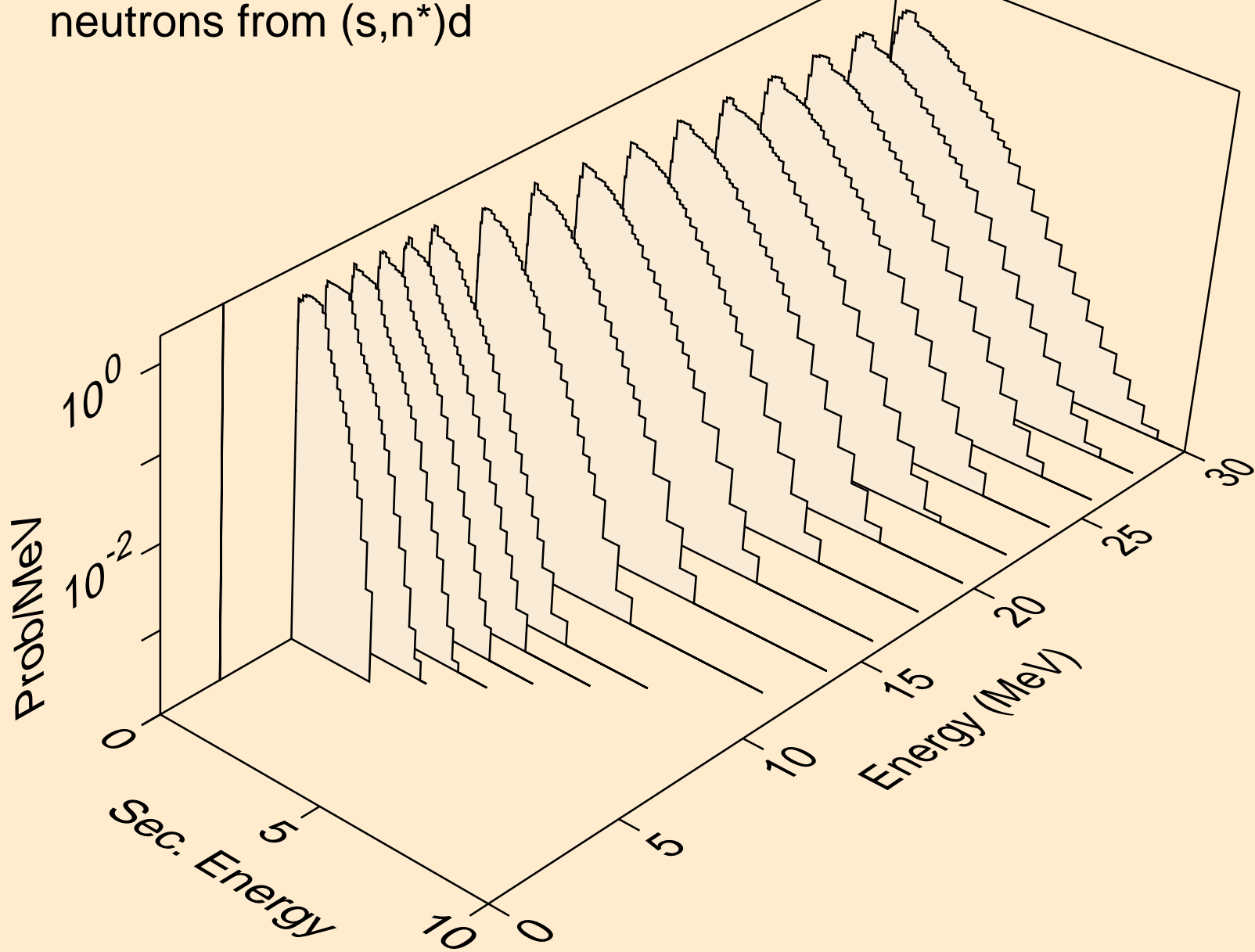

I134 HELION ACER TENDL-2021 LIBRARY; T=0.K
neutrons from (s,n*)t

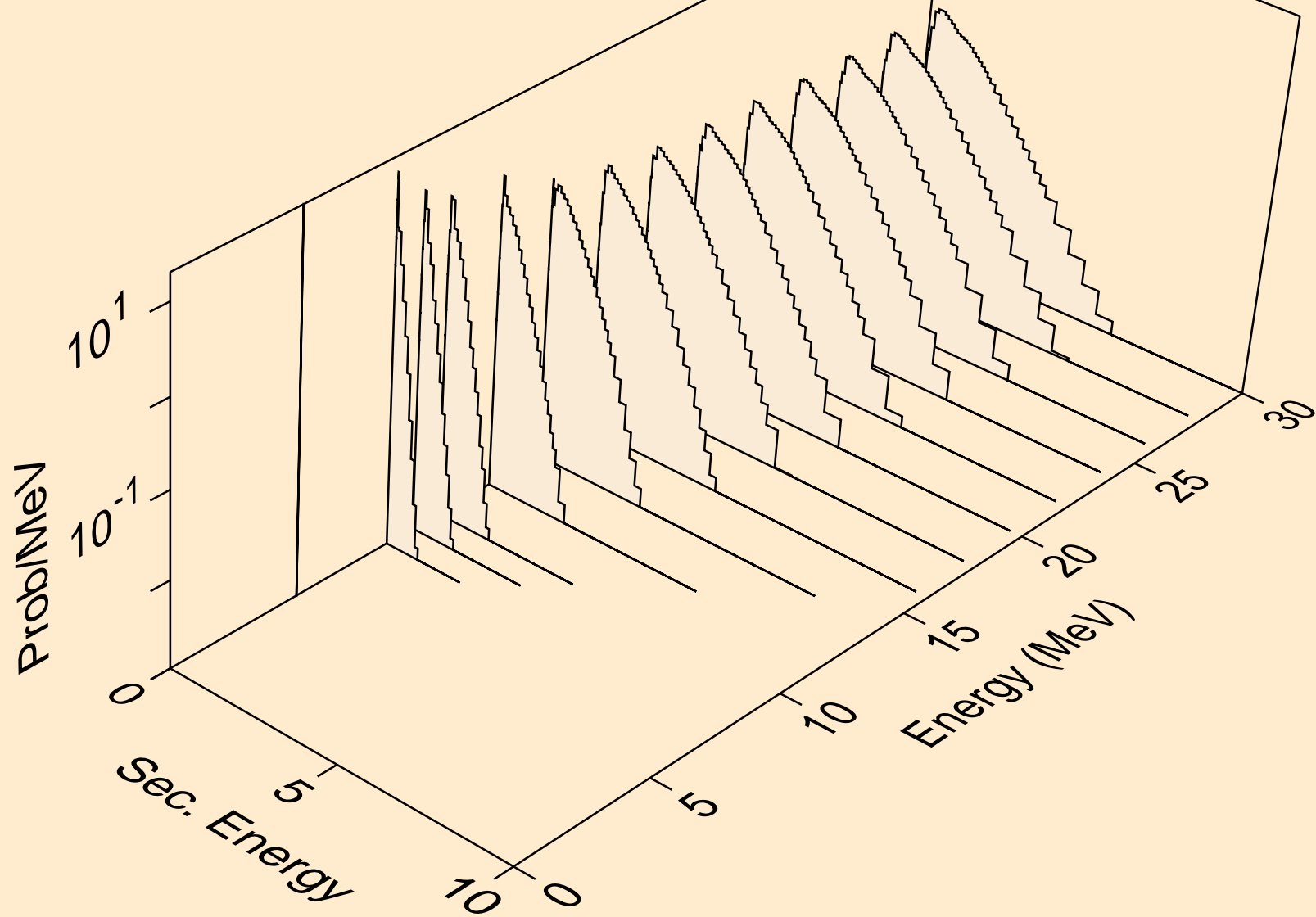

I134 HELION ACER TENDL-2021 LIBRARY; T=0.K
neutrons from (s,n*)he3

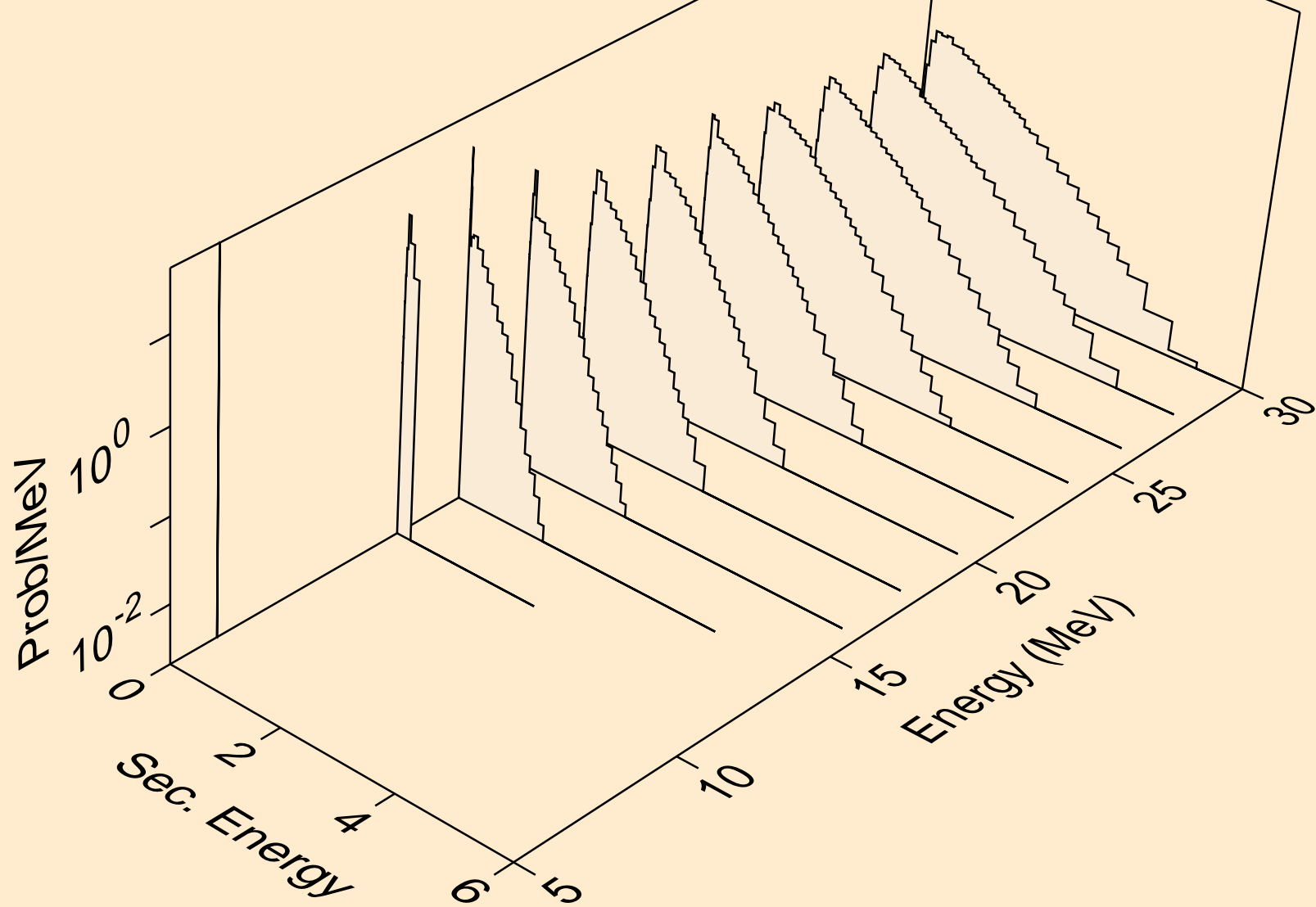

I134 HELION ACER TENDL-2021 LIBRARY; T=0.K
neutrons from (s,4n)

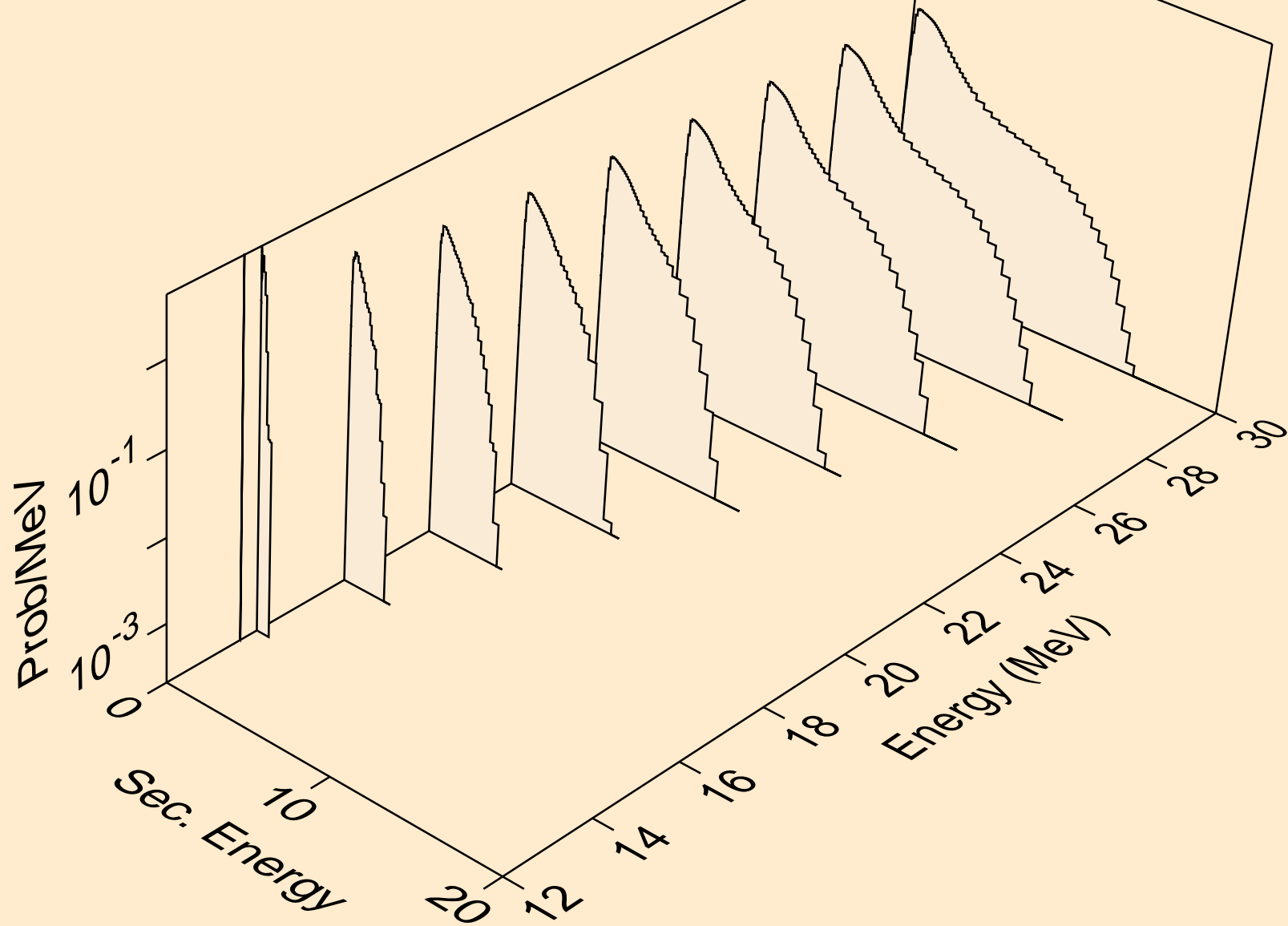

I134 HELION ACER TENDL-2021 LIBRARY; T=0.K
neutrons from (s,2np)

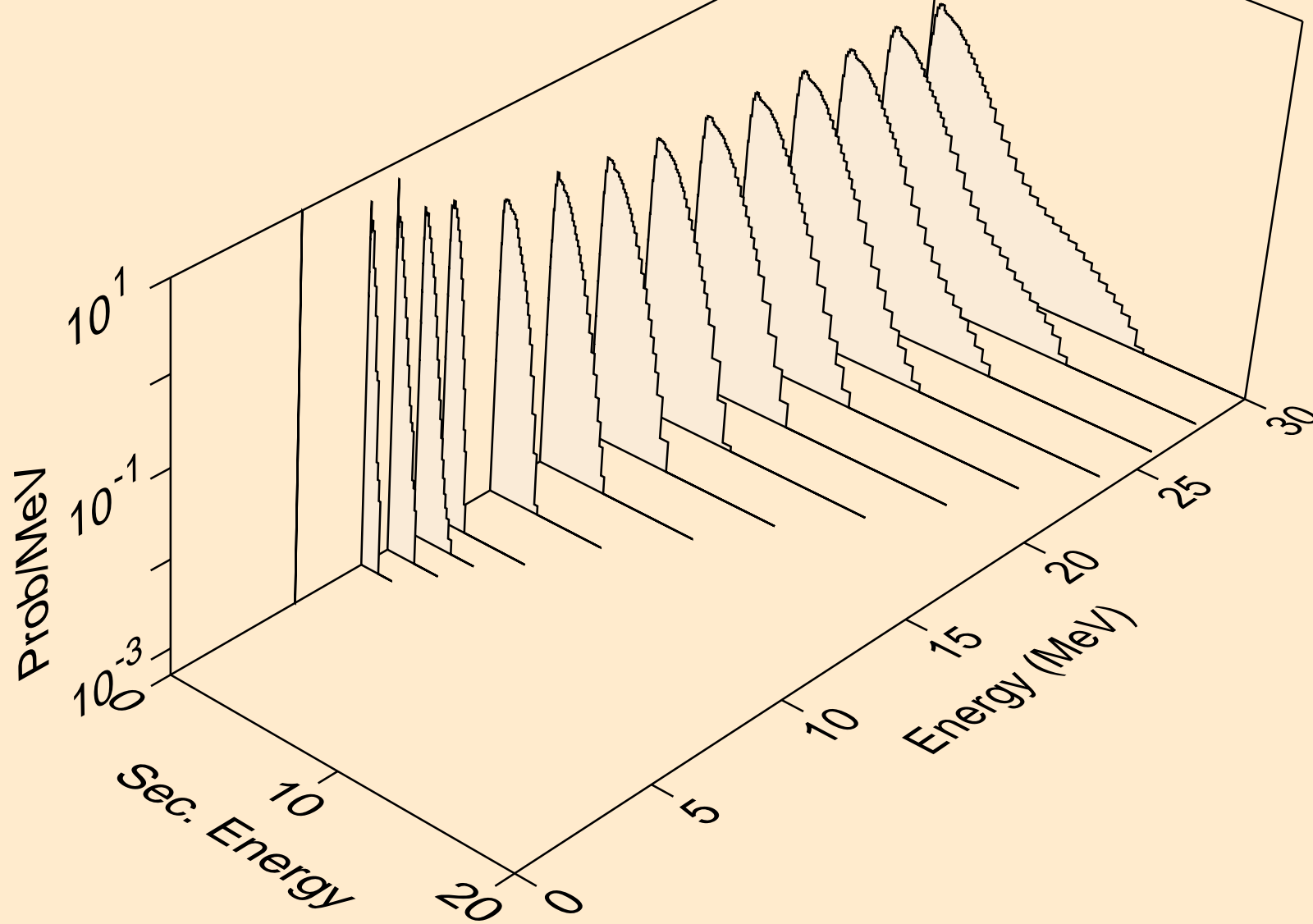

I134 HELION ACER TENDL-2021 LIBRARY; T=0.K
neutrons from (s,3np)

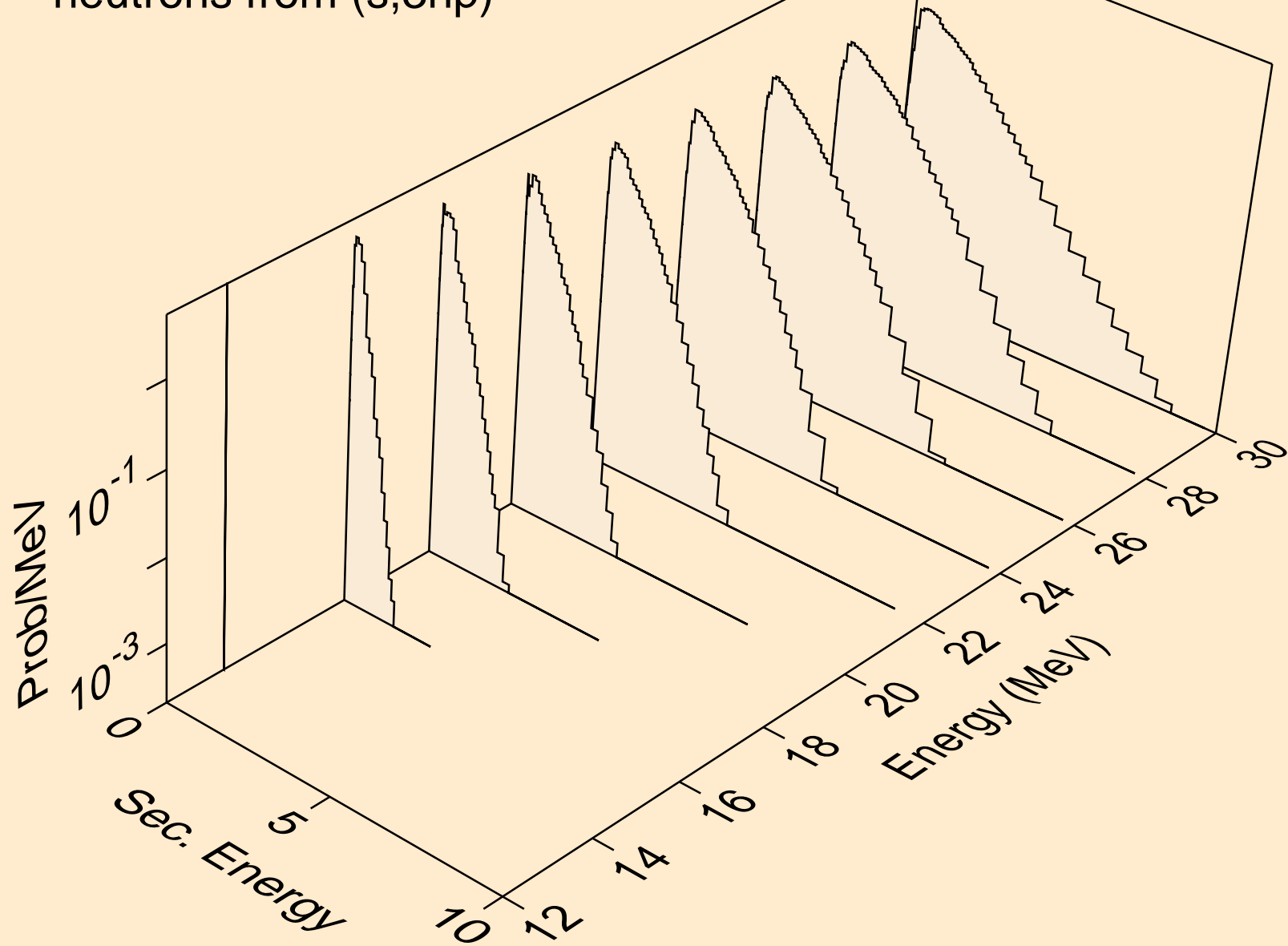

I134 HELION ACER TENDL-2021 LIBRARY; T=0.K
neutrons from (s,2np)

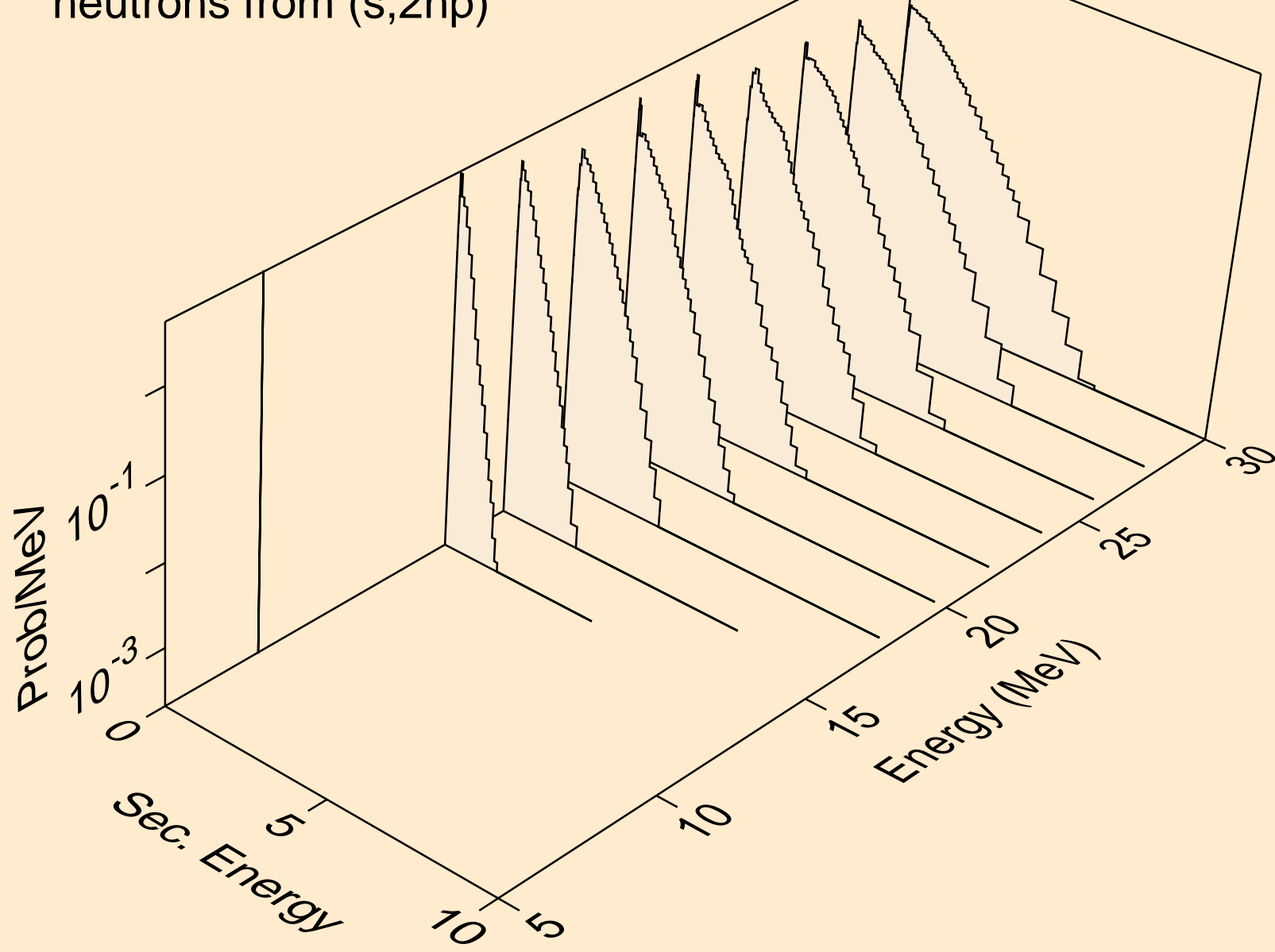

I134 HELION ACER TENDL-2021 LIBRARY; T=0.K
neutrons from (s,npa)

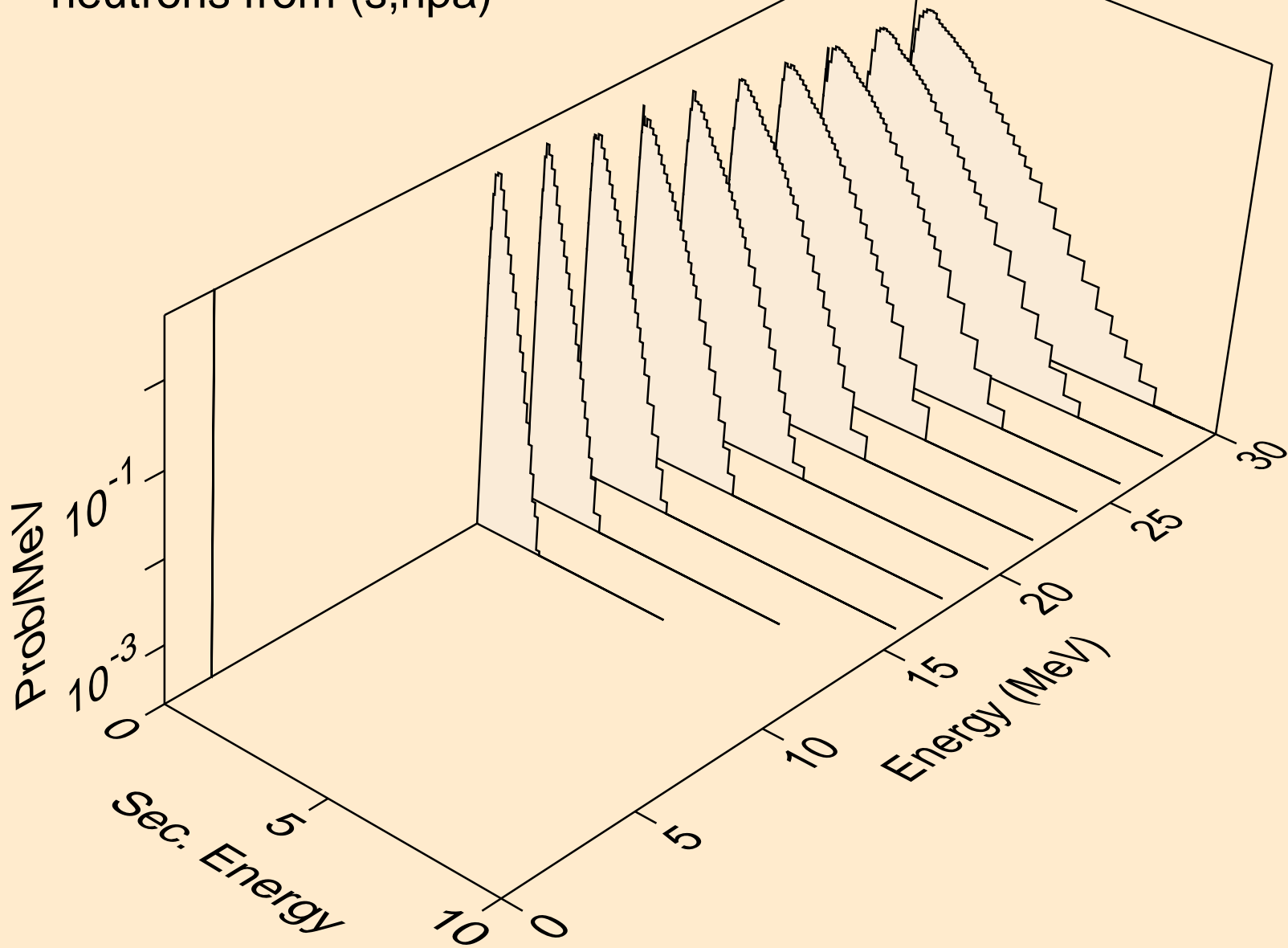

I134 HELION ACER TENDL-2021 LIBRARY; T=0.K
protons from (s,x)

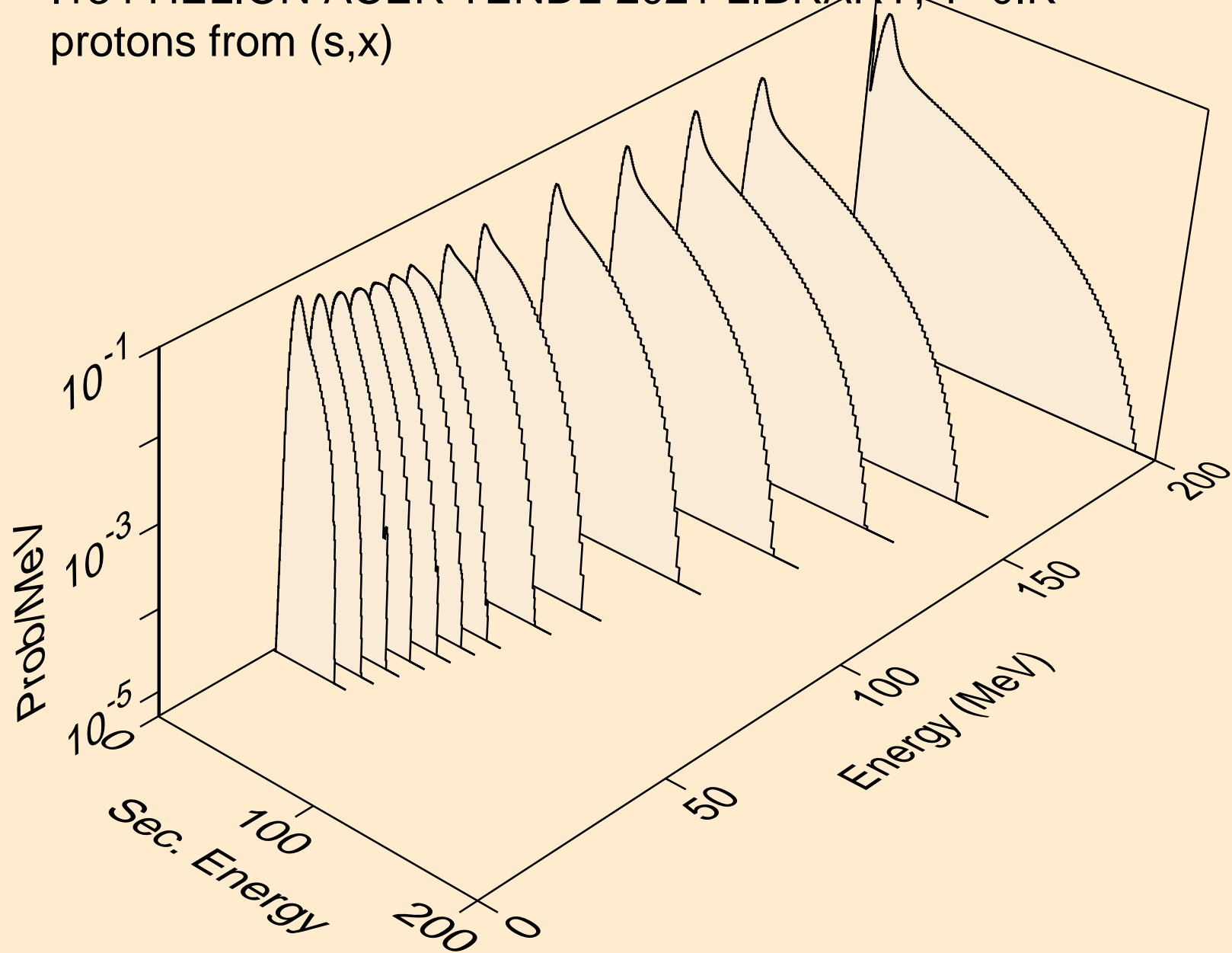

I134 HELION ACER TENDL-2021 LIBRARY; T=0.K
protons from (s,n*)p

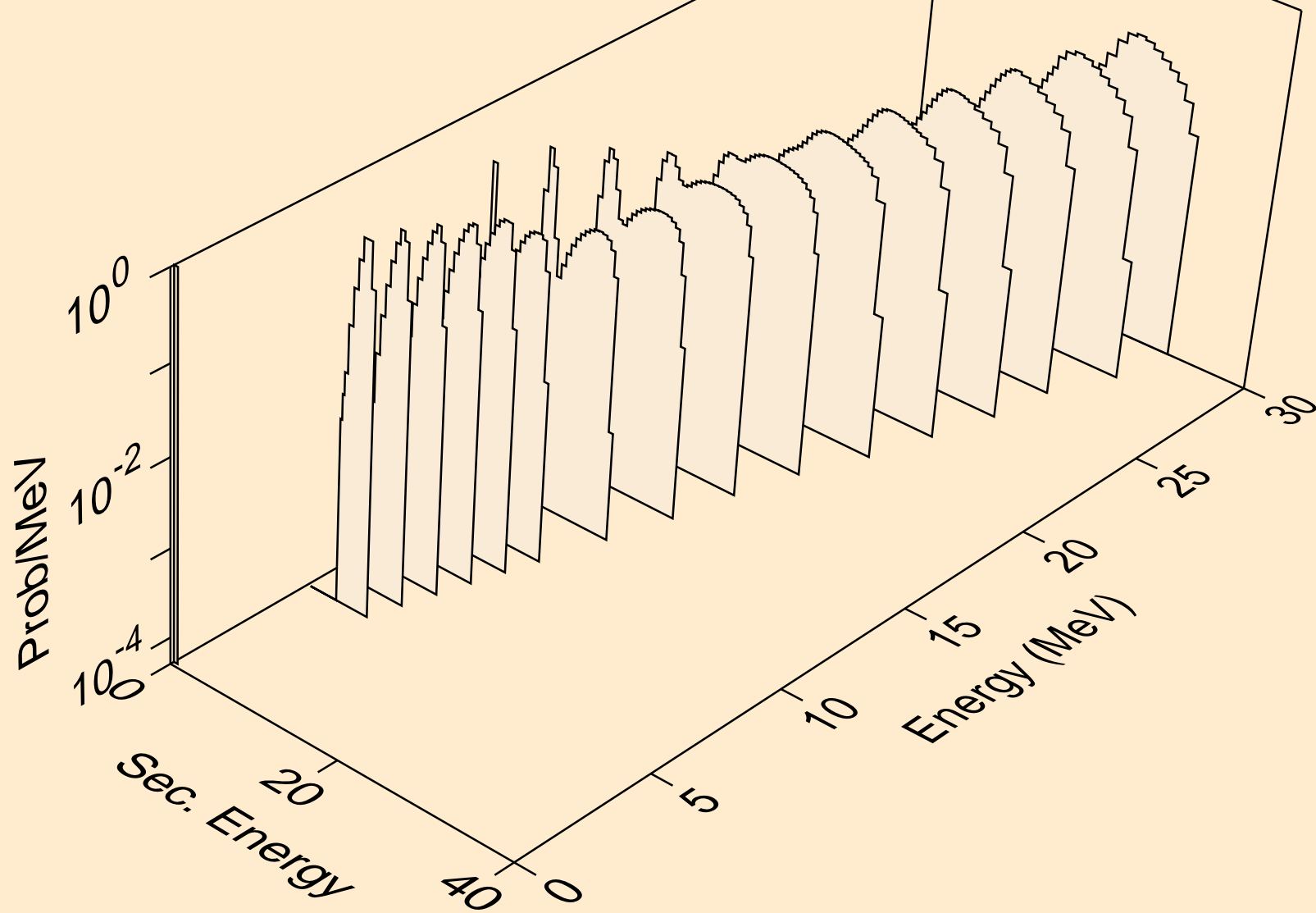

I134 HELION ACER TENDL-2021 LIBRARY; T=0.K
protons from (s,2np)

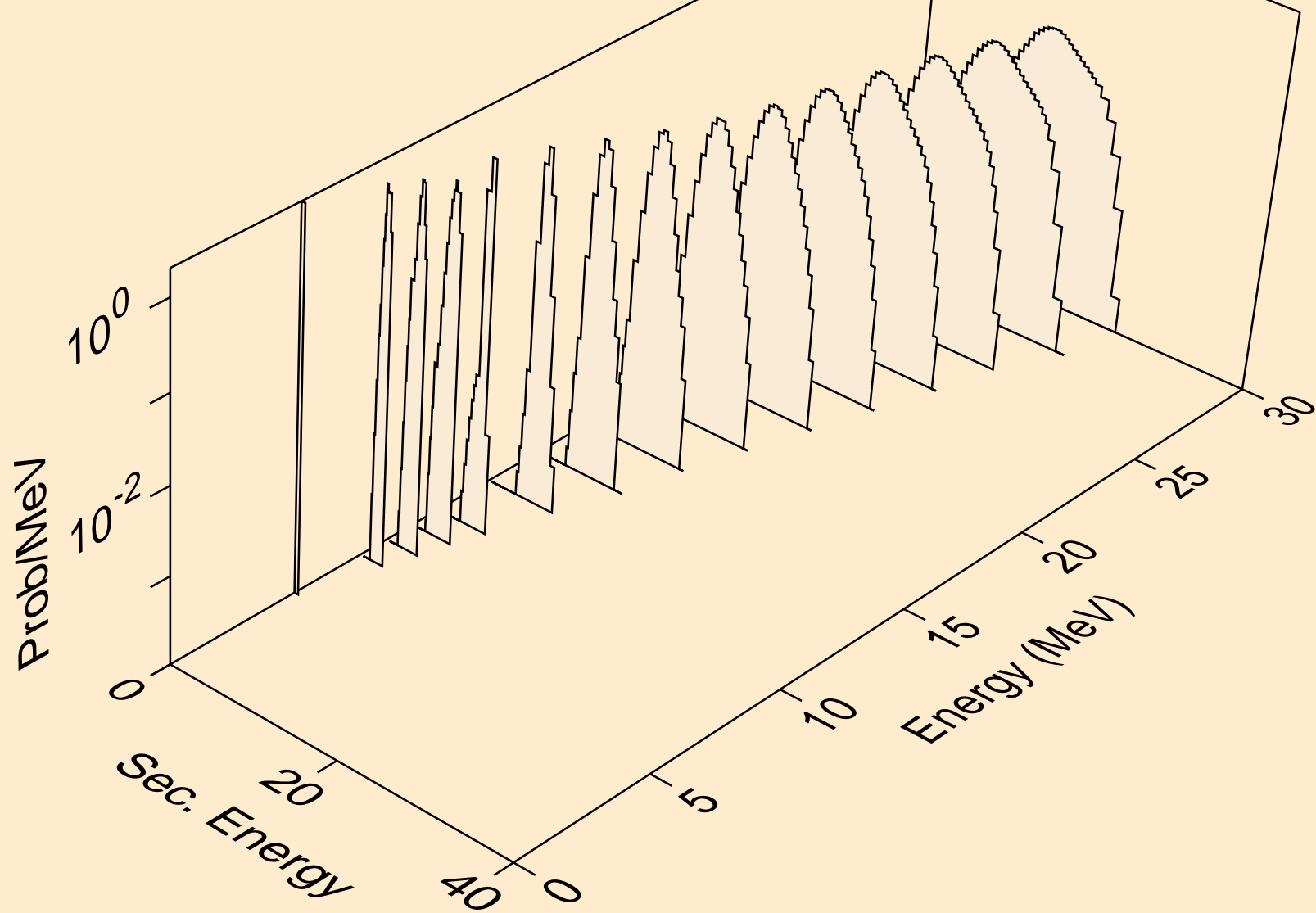

I134 HELION ACER TENDL-2021 LIBRARY; T=0.K
protons from (s,3np)

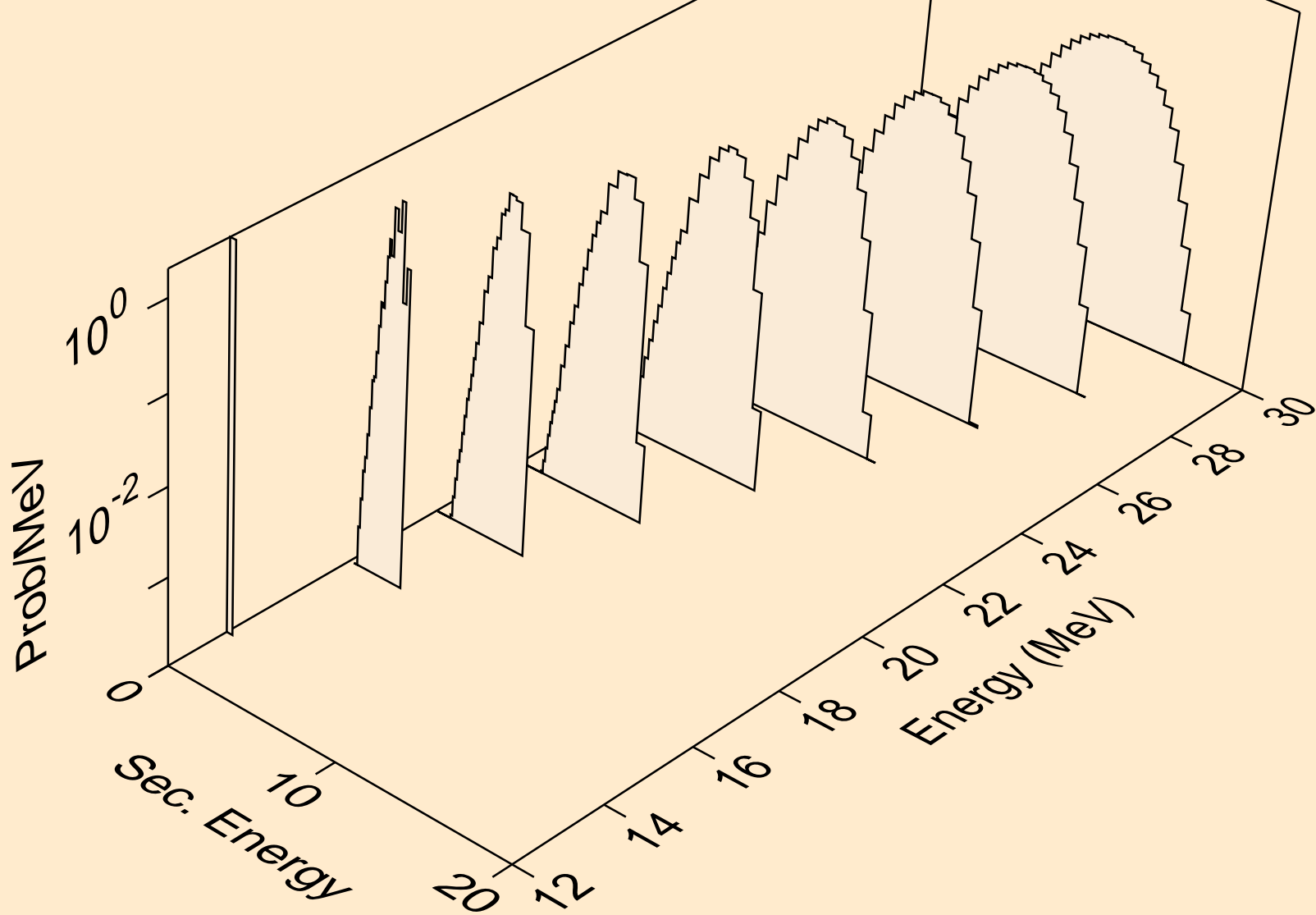

I134 HELION ACER TENDL-2021 LIBRARY; T=0.K
protons from (s,2np)

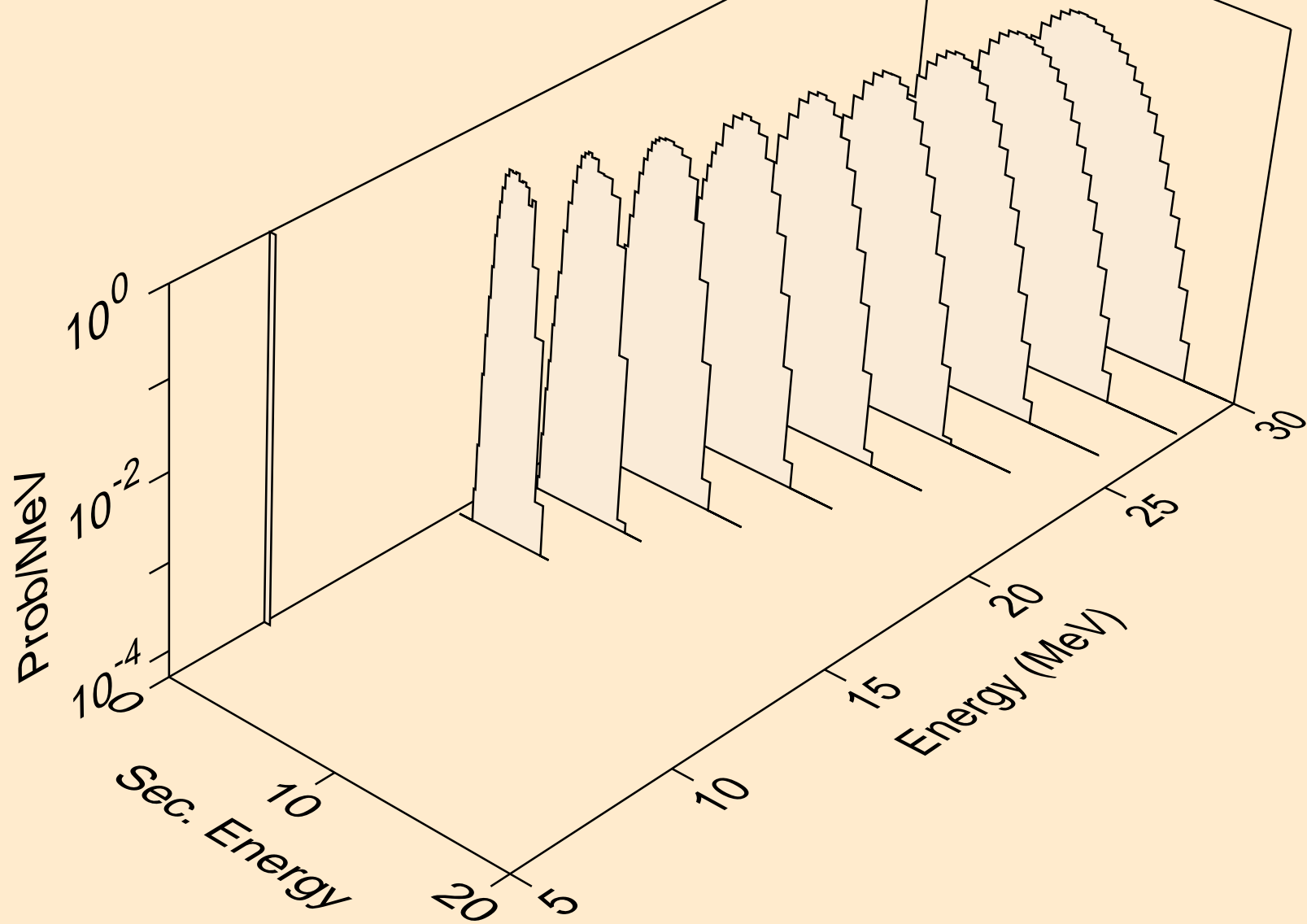

I134 HELION ACER TENDL-2021 LIBRARY; T=0.K
protons from (s,npa)

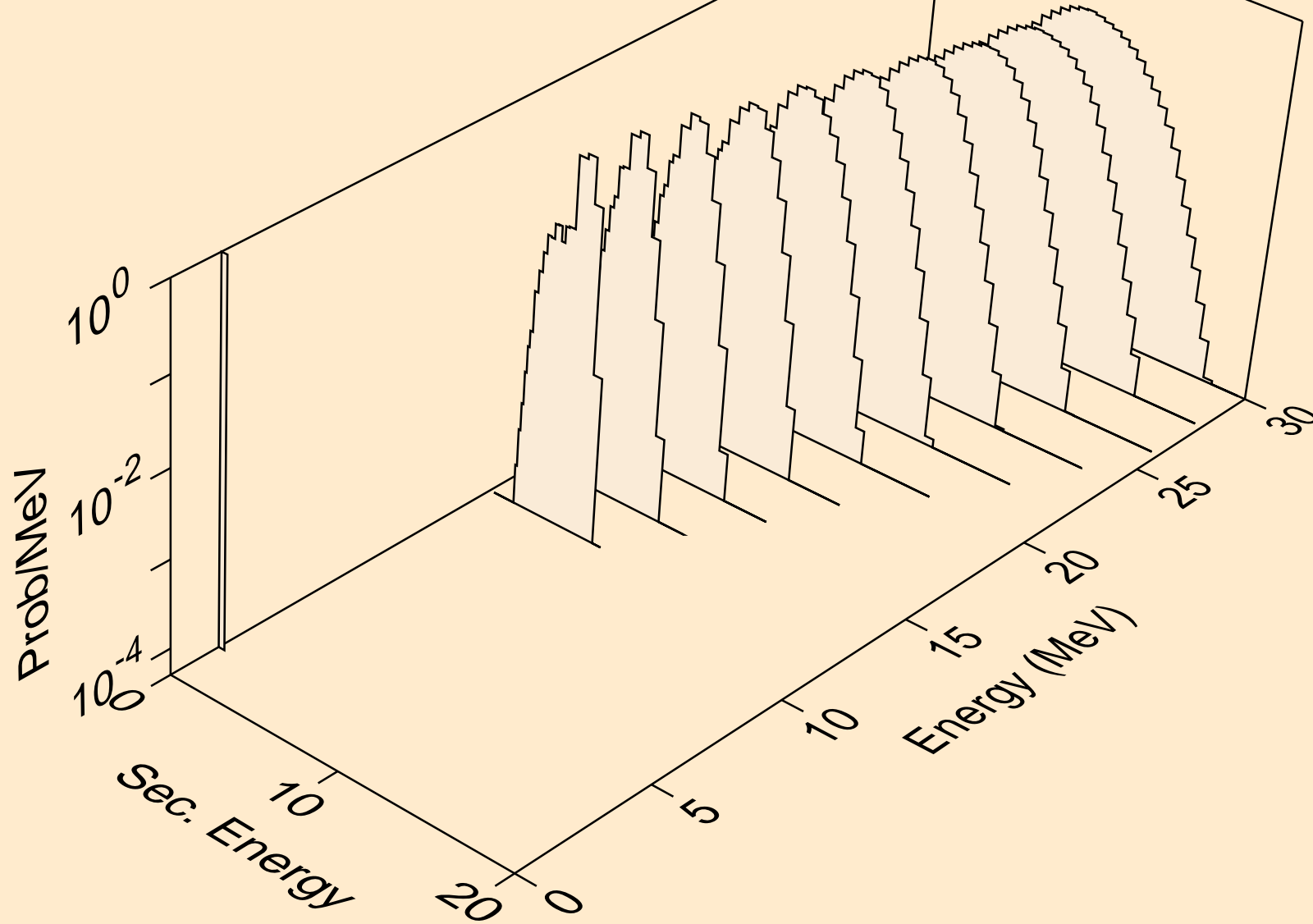

I134 HELION ACER TENDL-2021 LIBRARY; T=0.K
protons from (s,p)

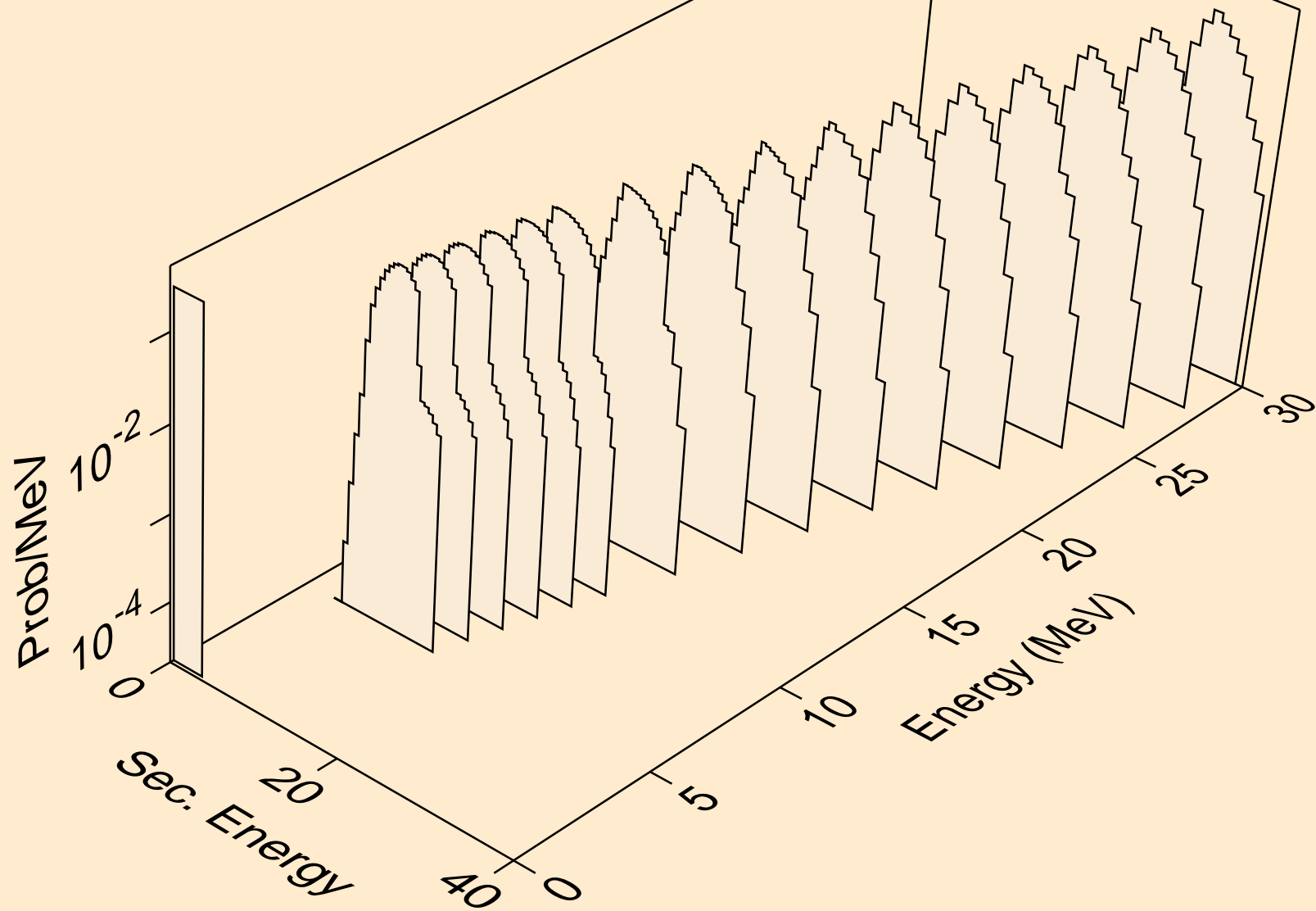

I134 HELION ACER TENDL-2021 LIBRARY; T=0.K
protons from (s,2p)

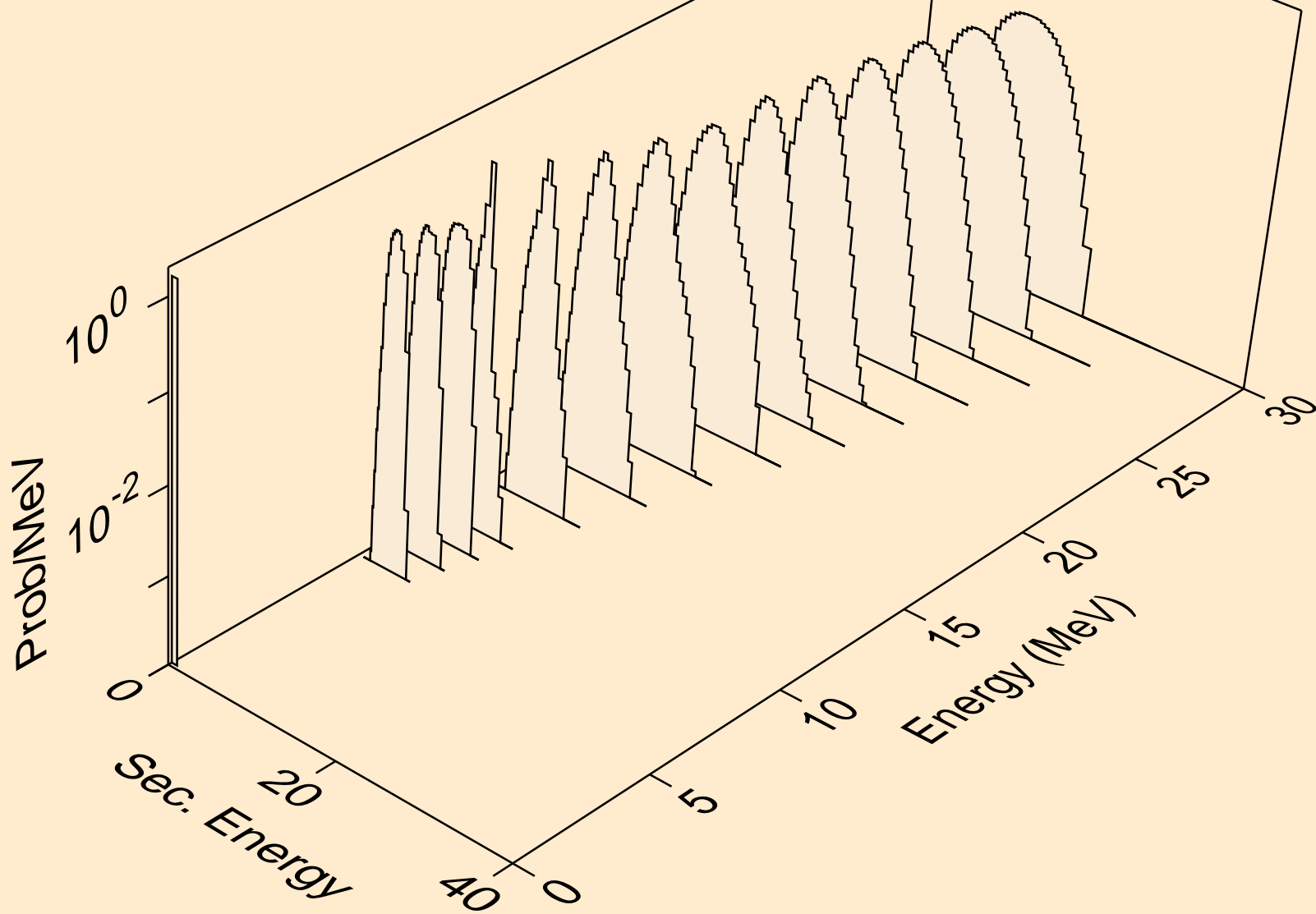

I134 HELION ACER TENDL-2021 LIBRARY; T=0.K
protons from (s,pa)

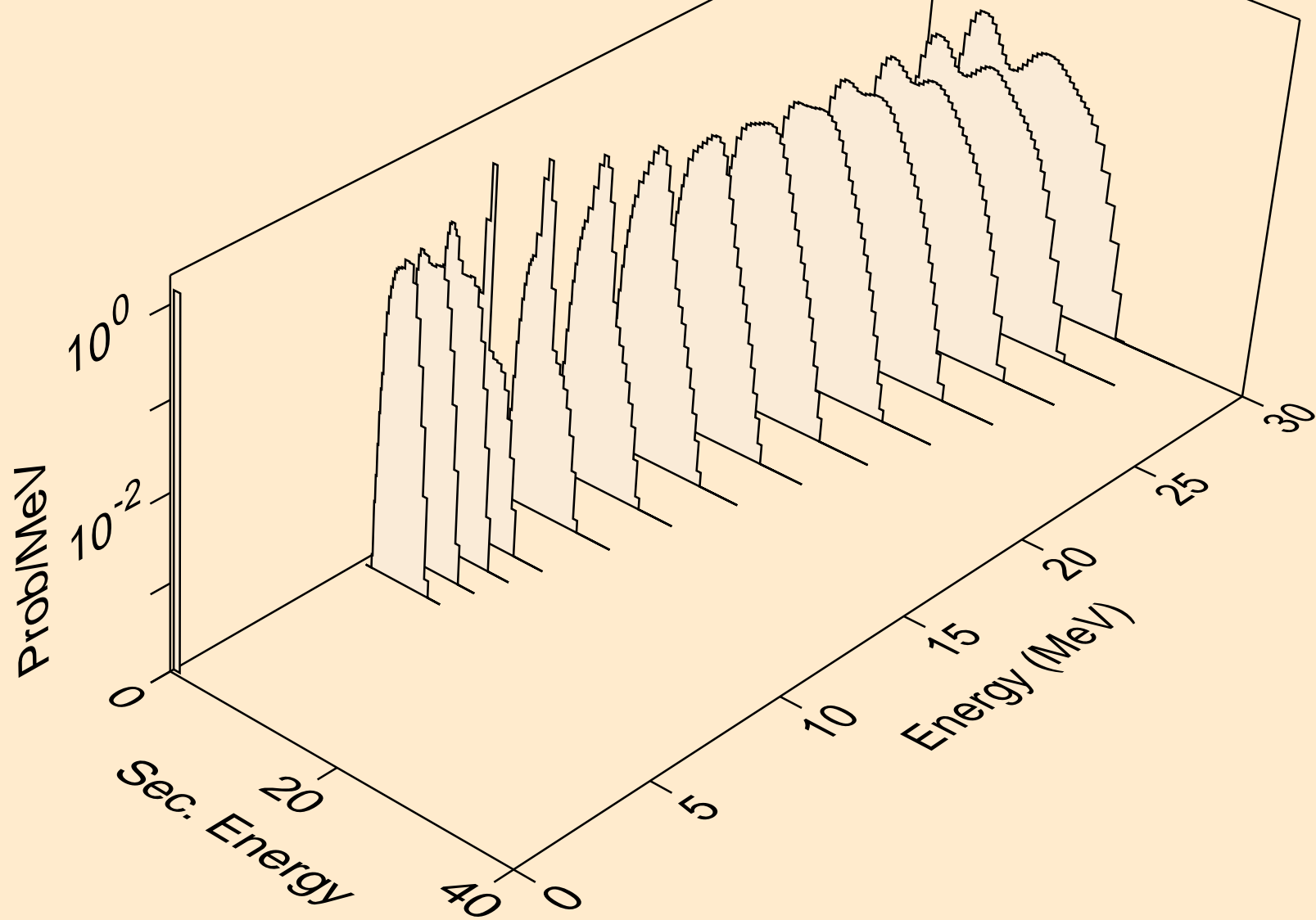

I134 HELION ACER TENDL-2021 LIBRARY; T=0.K
protons from (s,pd)

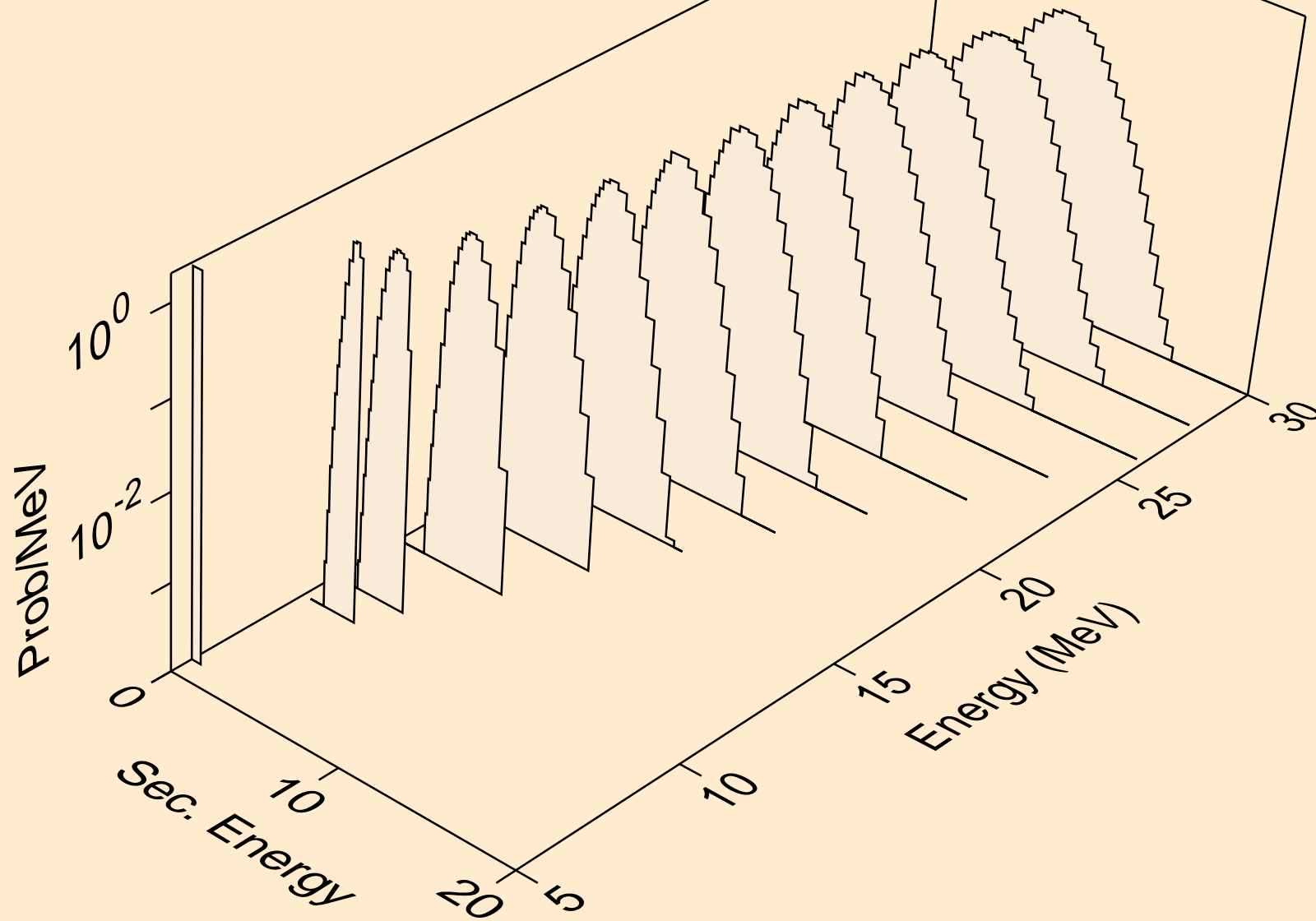

I134 HELION ACER TENDL-2021 LIBRARY; T=0.K
protons from (s,pt)

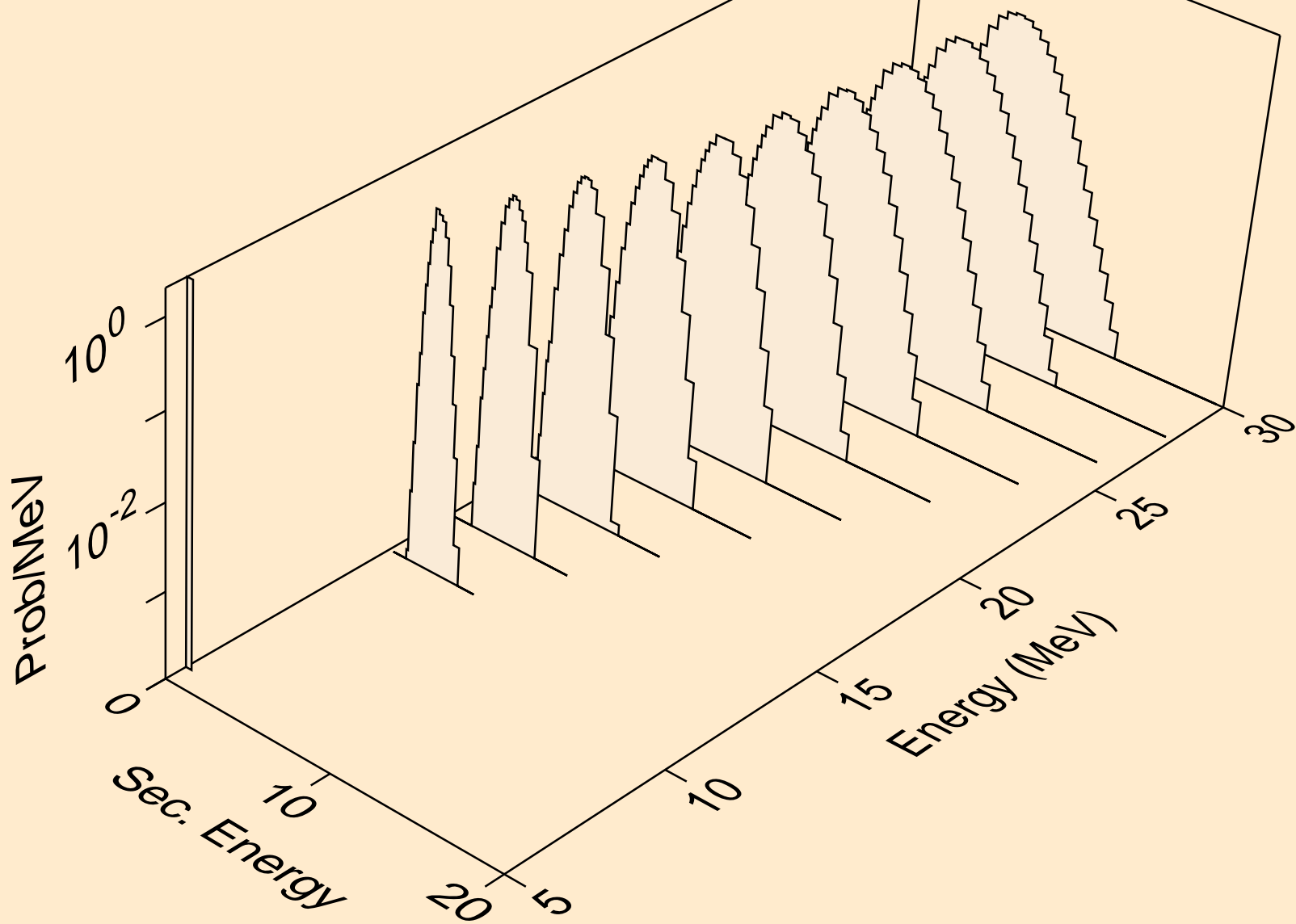

I134 HELION ACER TENDL-2021 LIBRARY; T=0.K
deuterons from (s,x)

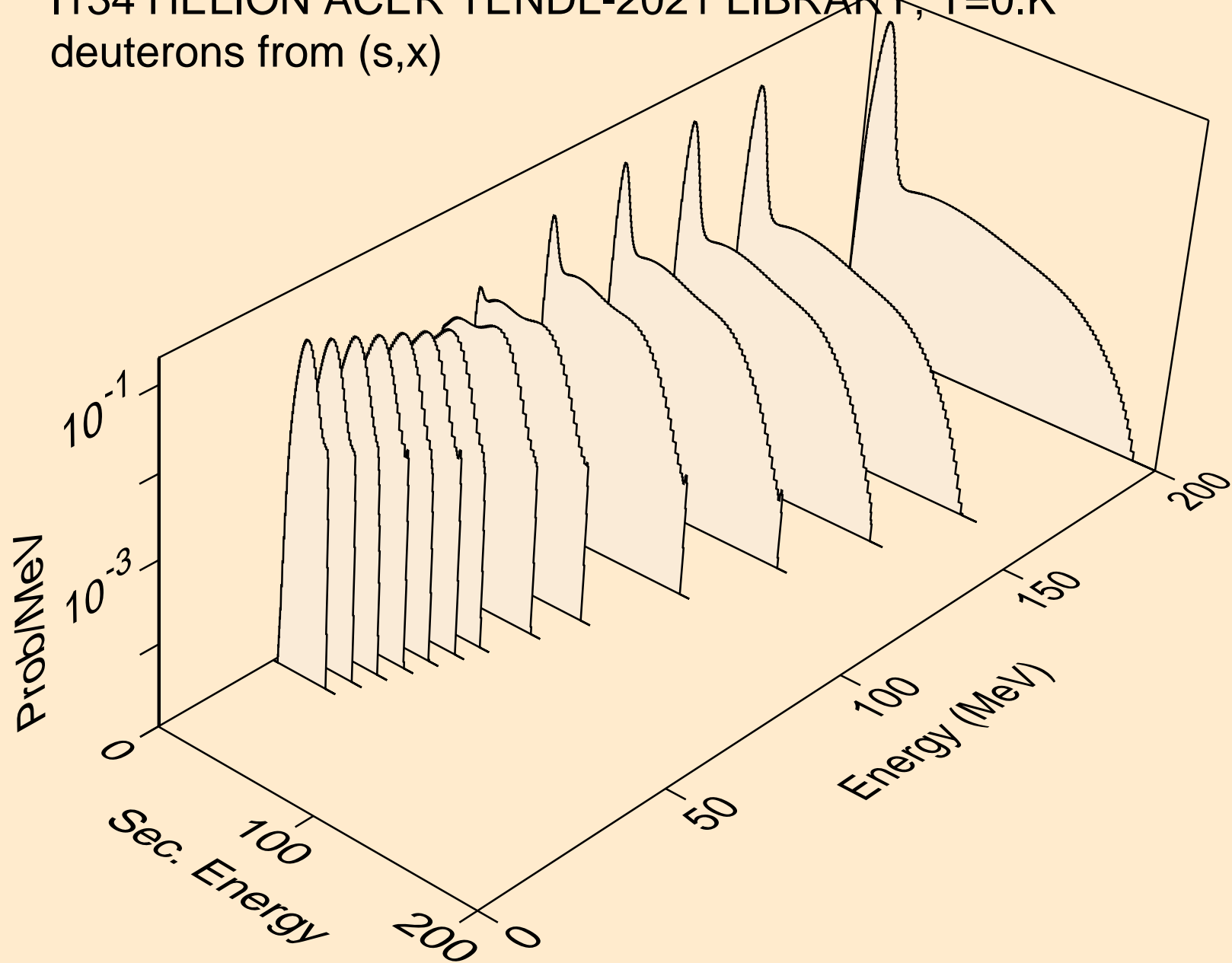

I134 HELION ACER TENDL-2021 LIBRARY; T=0.K
deuterons from (s,2nd)

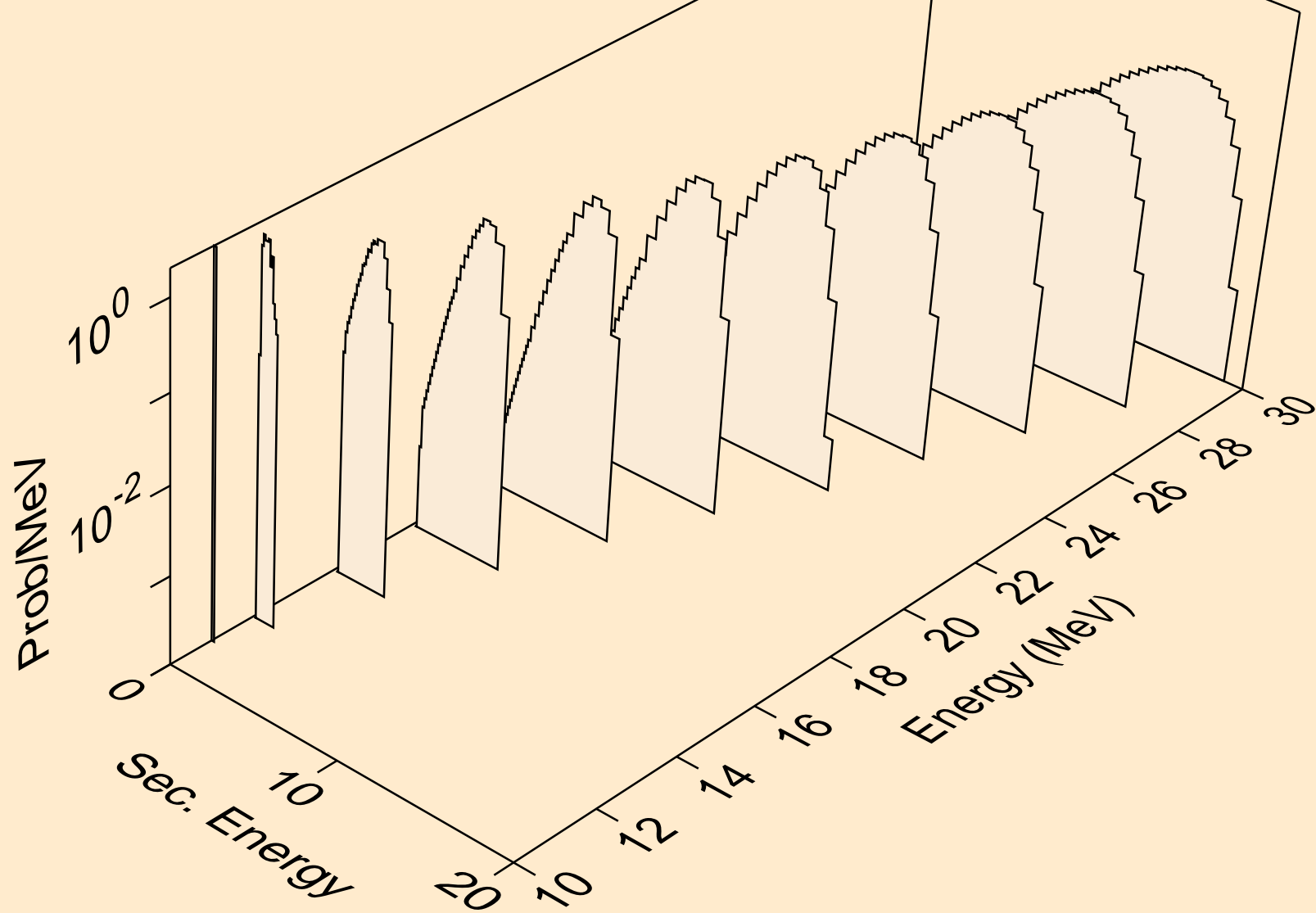

I134 HELION ACER TENDL-2021 LIBRARY; T=0.K
deuterons from (s,n*)d

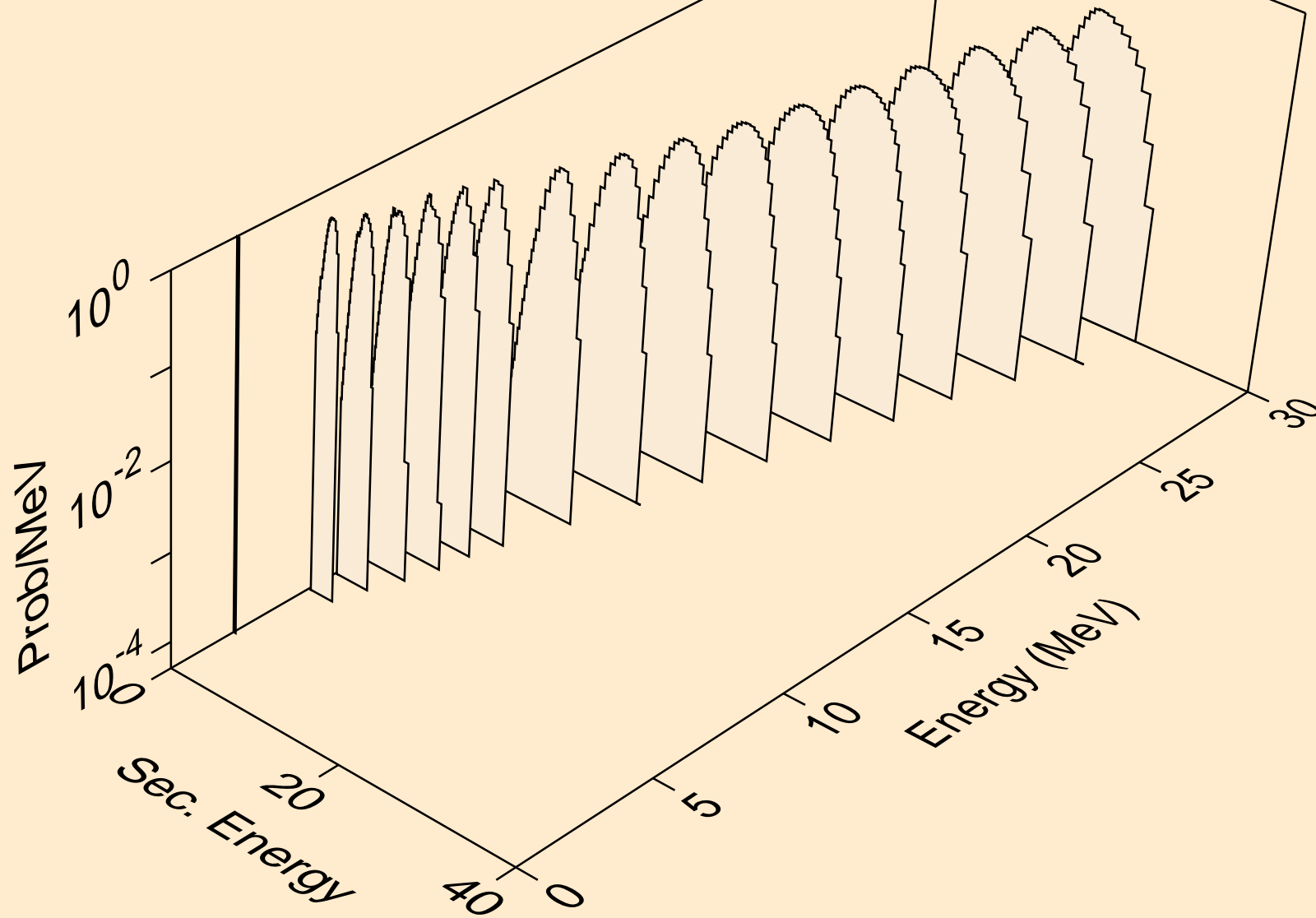

I134 HELION ACER TENDL-2021 LIBRARY; T=0.K
deuterons from (s,d)

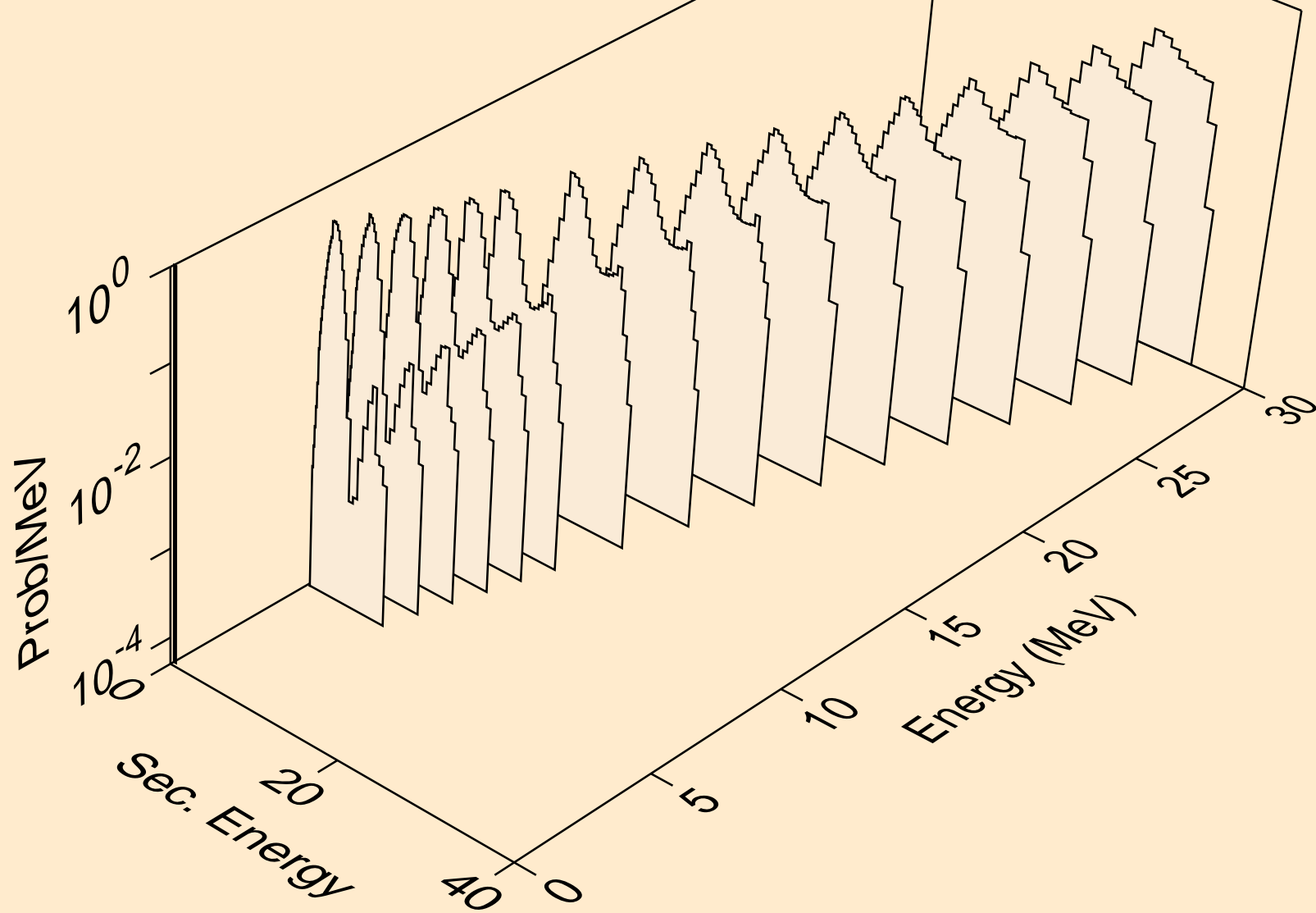

I134 HELION ACER TENDL-2021 LIBRARY; T=0.K
deuterons from (s,pd)

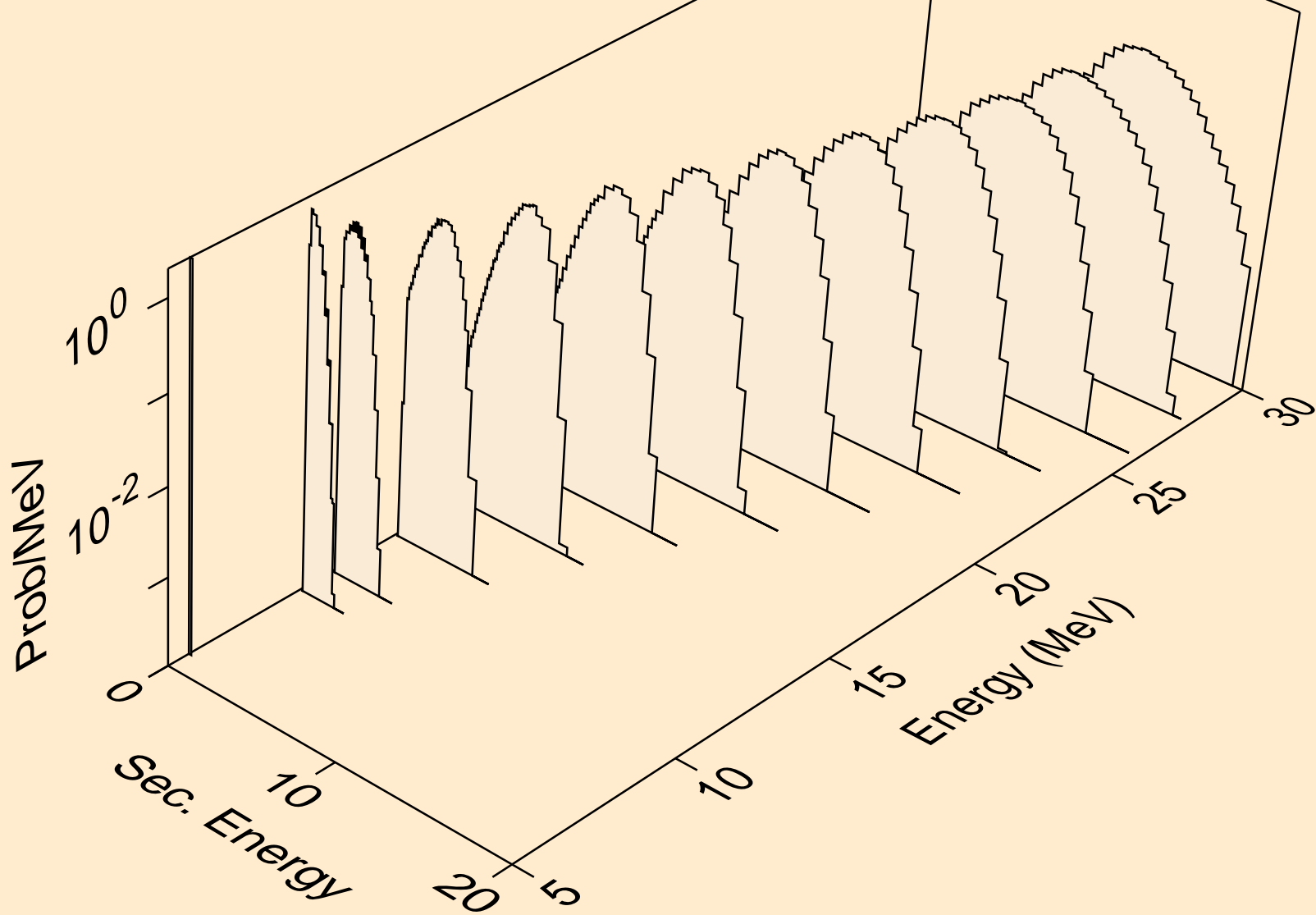

I134 HELION ACER TENDL-2021 LIBRARY; T=0.K
deuterons from (s,da)

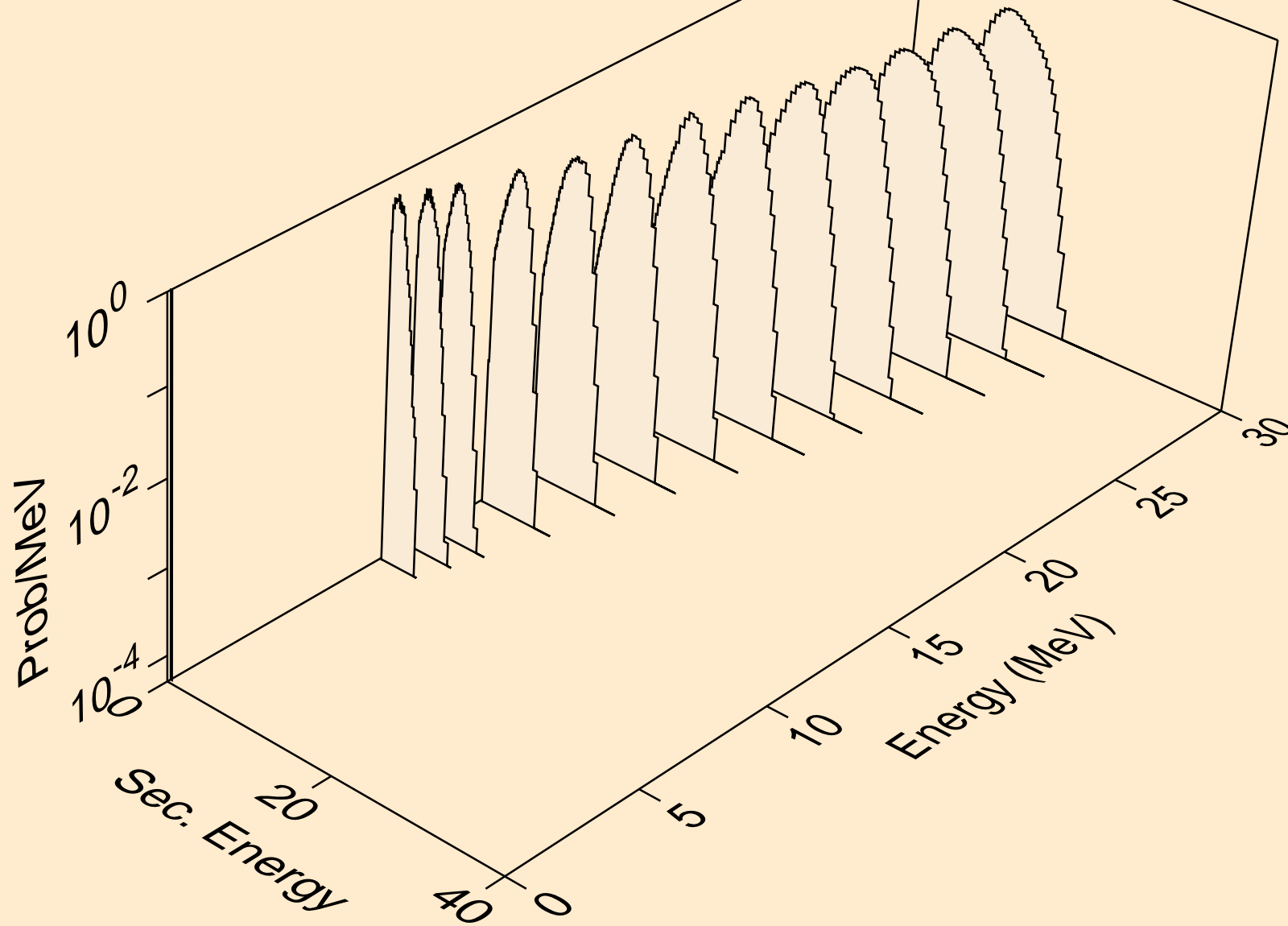

I134 HELION ACER TENDL-2021 LIBRARY; T=0.K
tritons from (s,x)

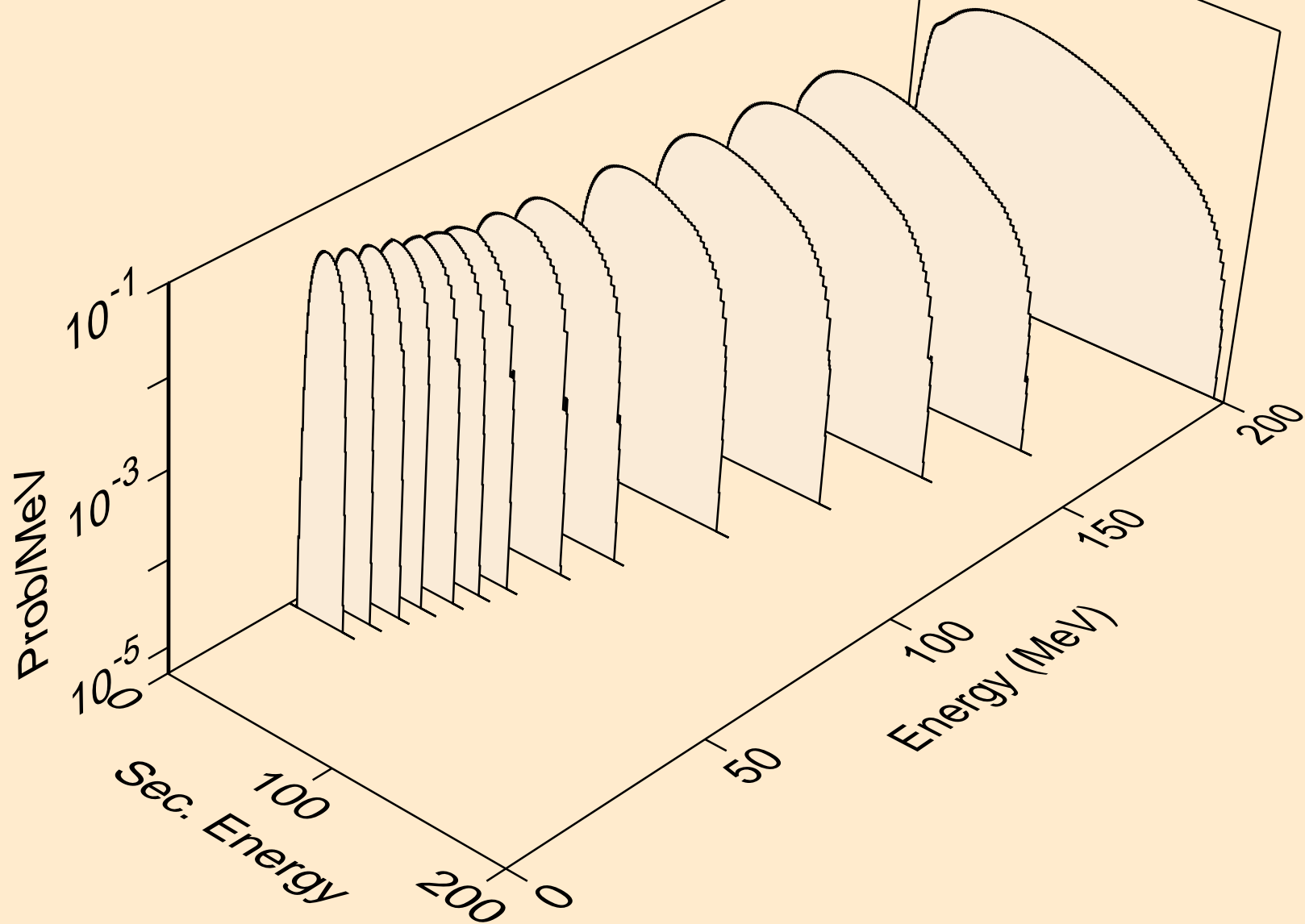

I134 HELION ACER TENDL-2021 LIBRARY; T=0.K
tritons from (s,n*)t

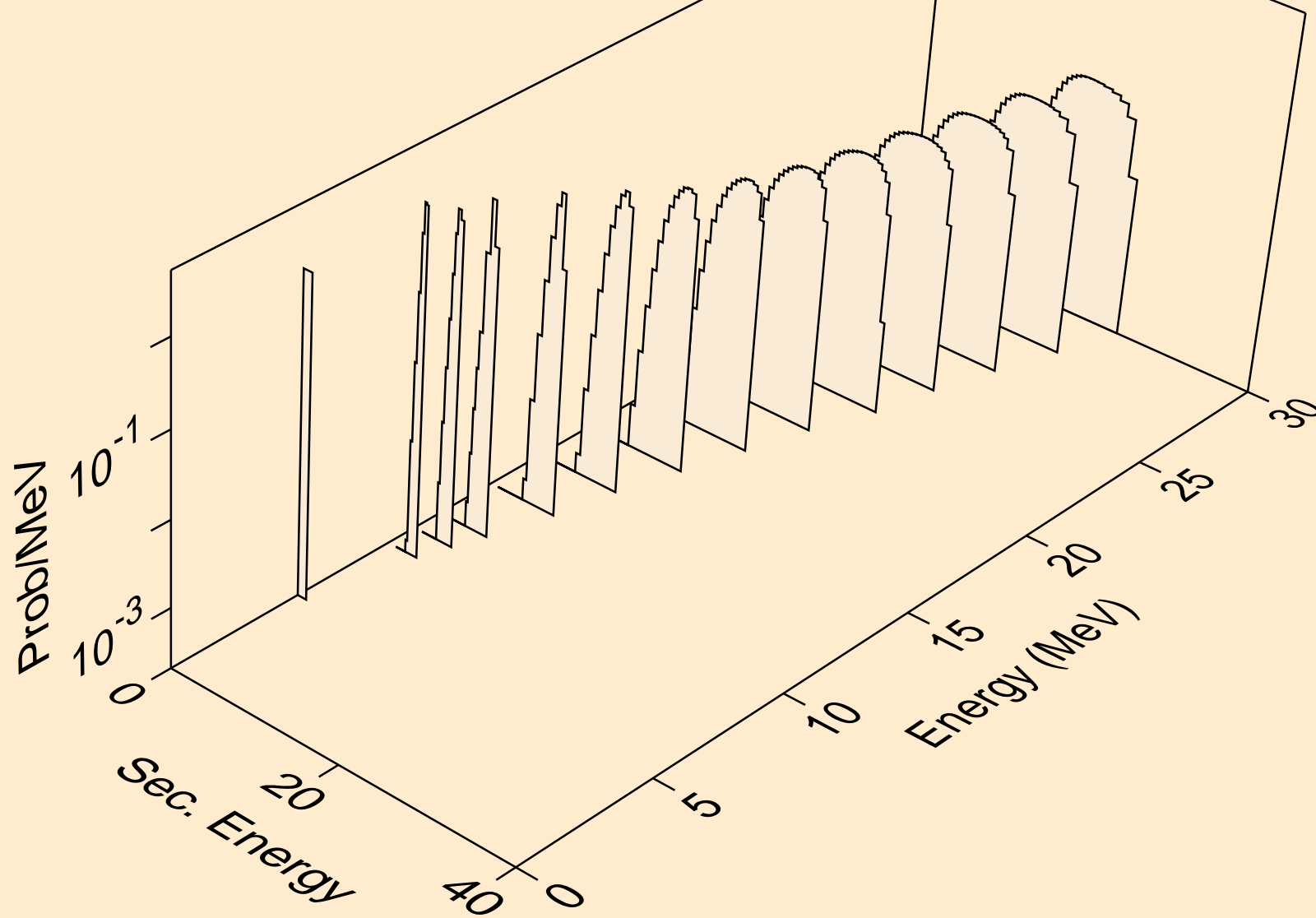

I134 HELION ACER TENDL-2021 LIBRARY; T=0.K
tritons from (s,t)

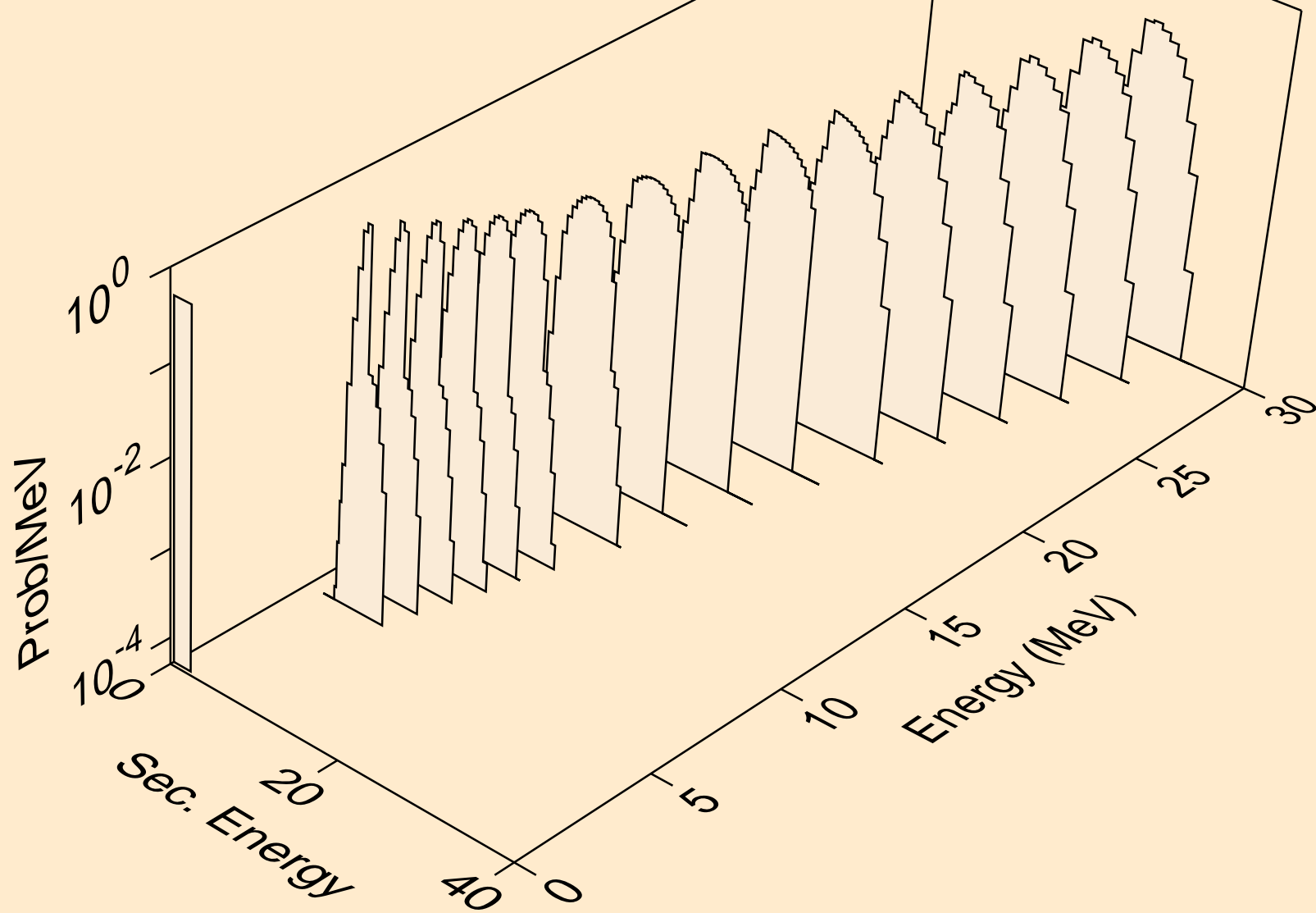

I134 HELION ACER TENDL-2021 LIBRARY; T=0.K
tritons from (s,pt)

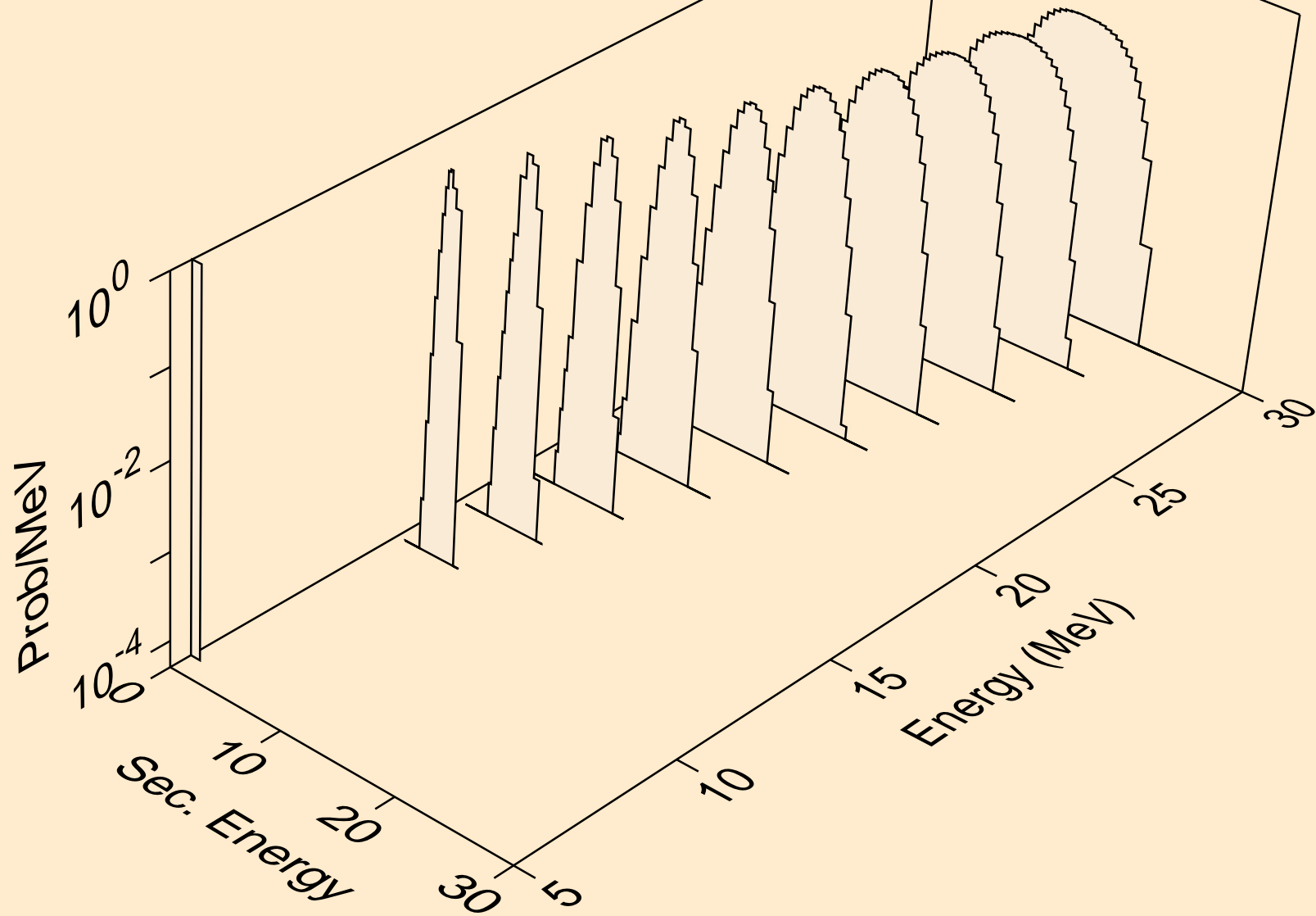

I134 HELION ACER TENDL-2021 LIBRARY; T=0.K
alphas from (s,x)

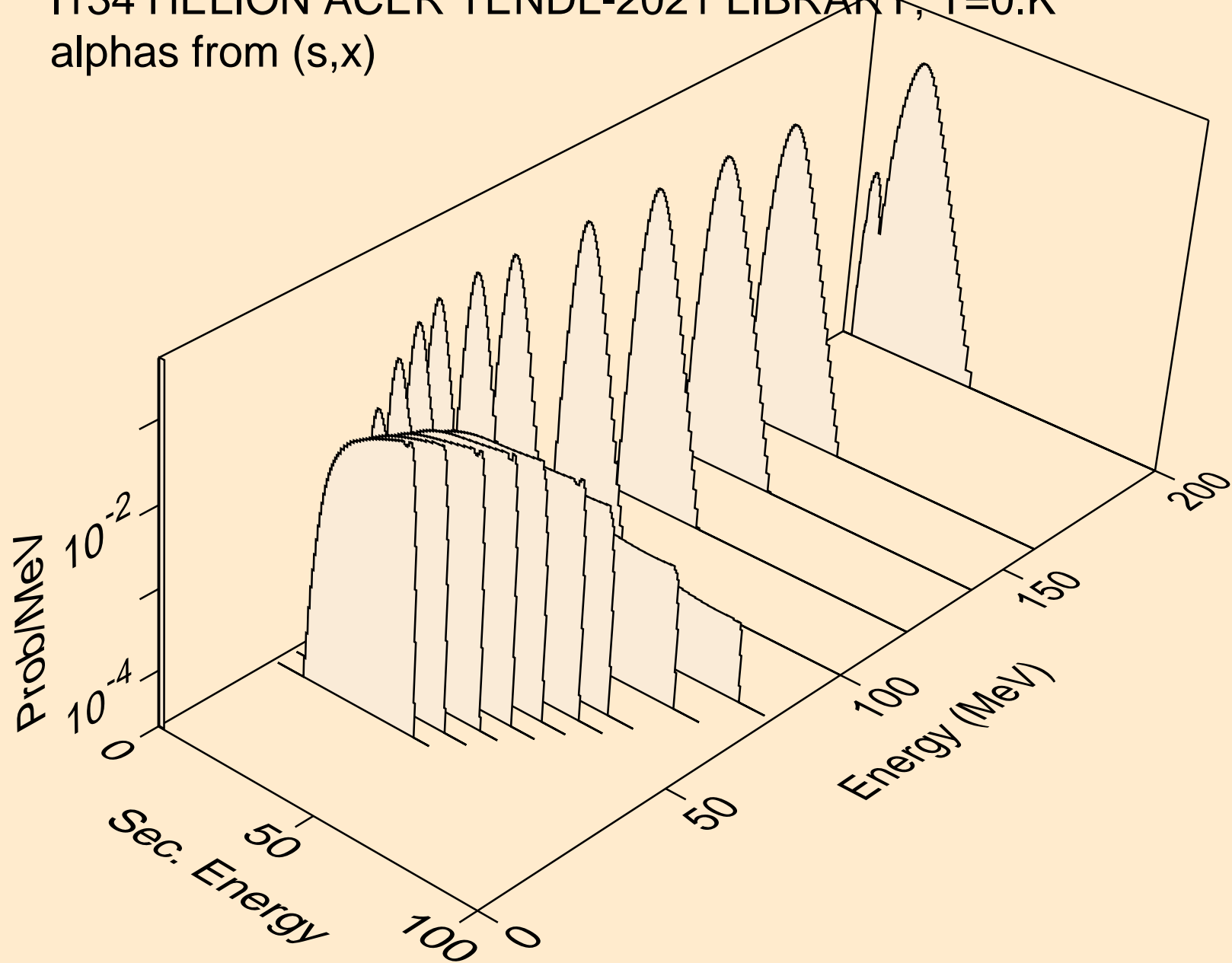

I134 HELION ACER TENDL-2021 LIBRARY; T=0.K
alphas from (s,n*)a

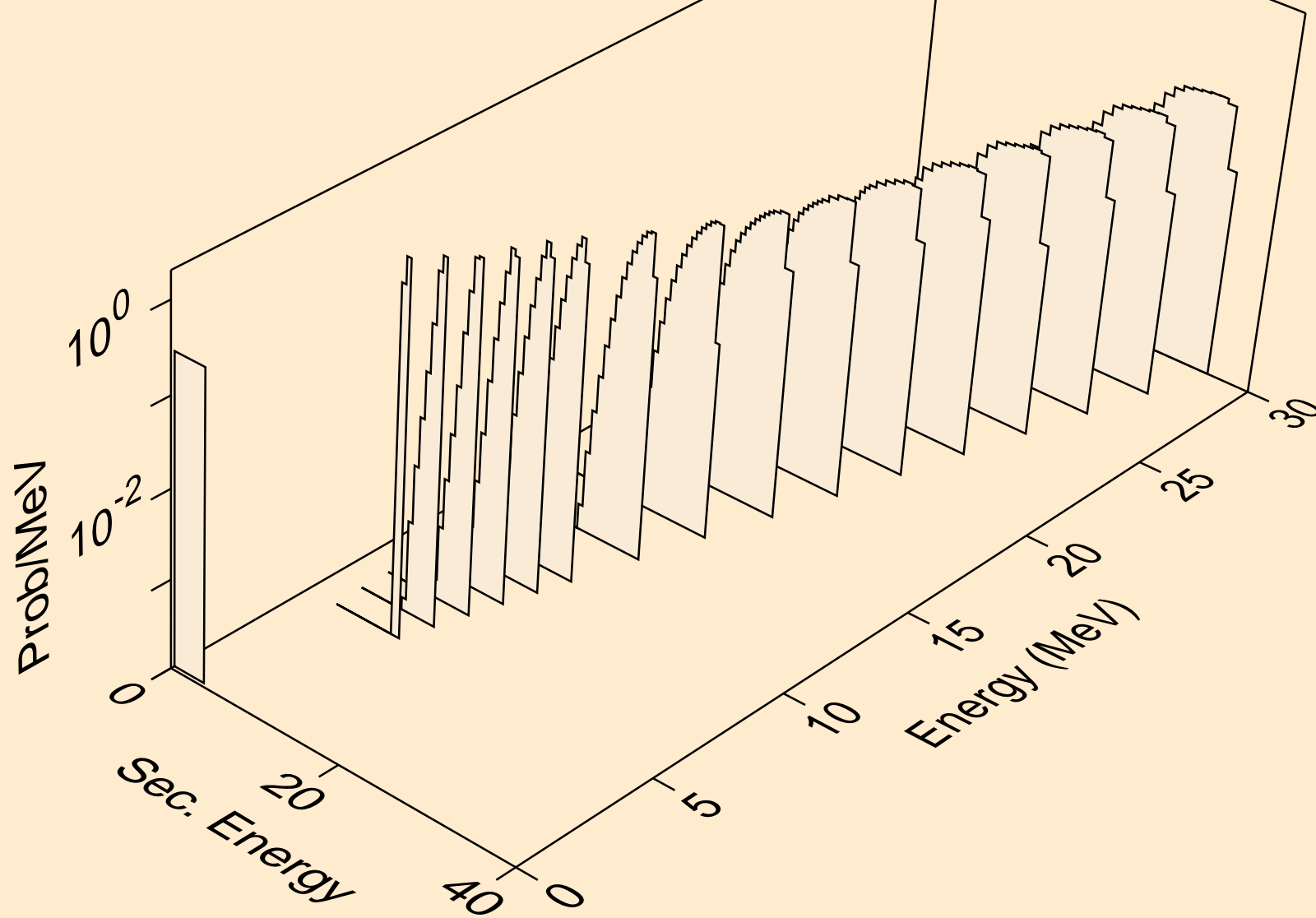

I134 HELION ACER TENDL-2021 LIBRARY; T=0.K
alphas from (s,2n)a

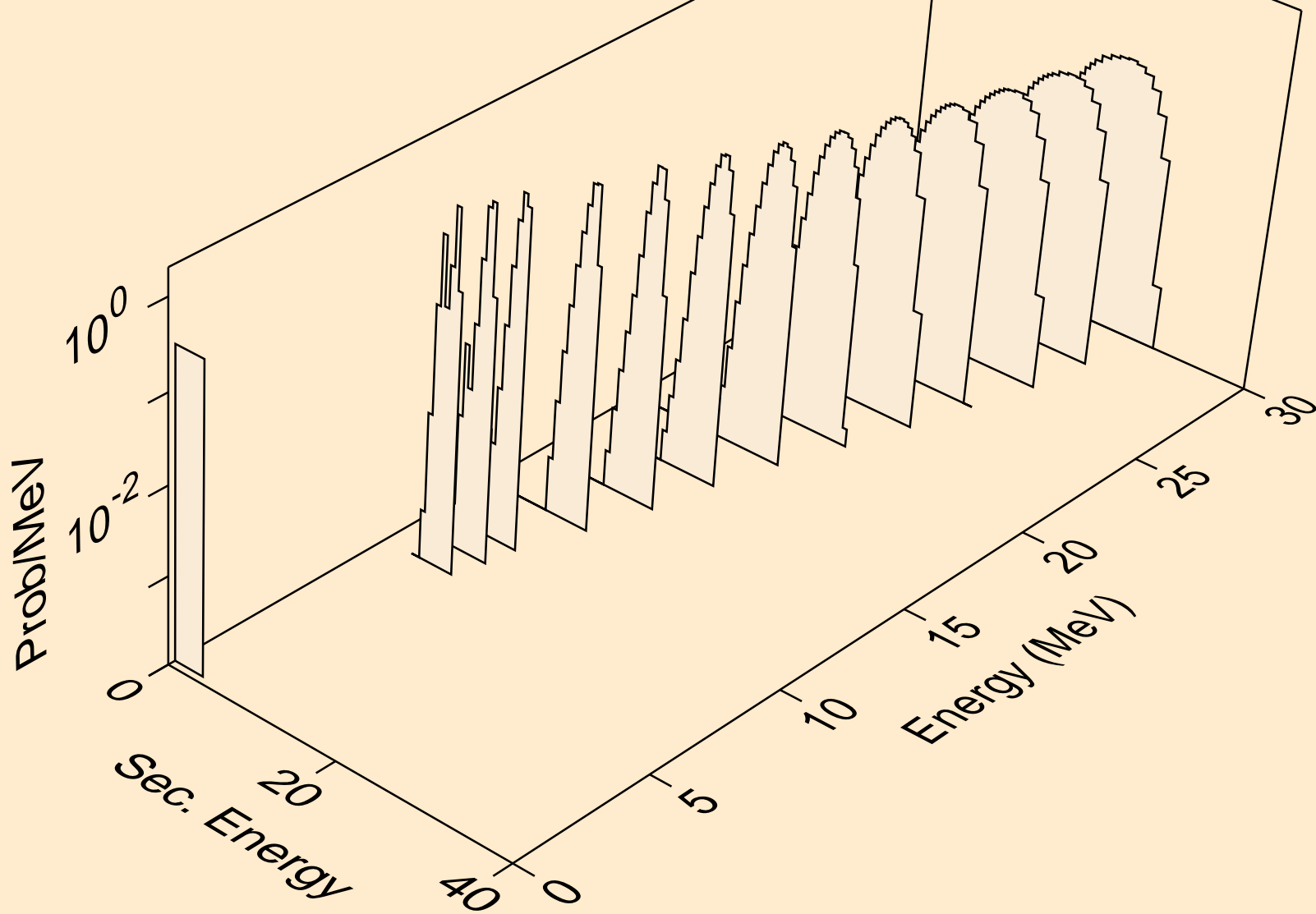

I134 HELION ACER TENDL-2021 LIBRARY; T=0.K
alphas from (s,3n)a

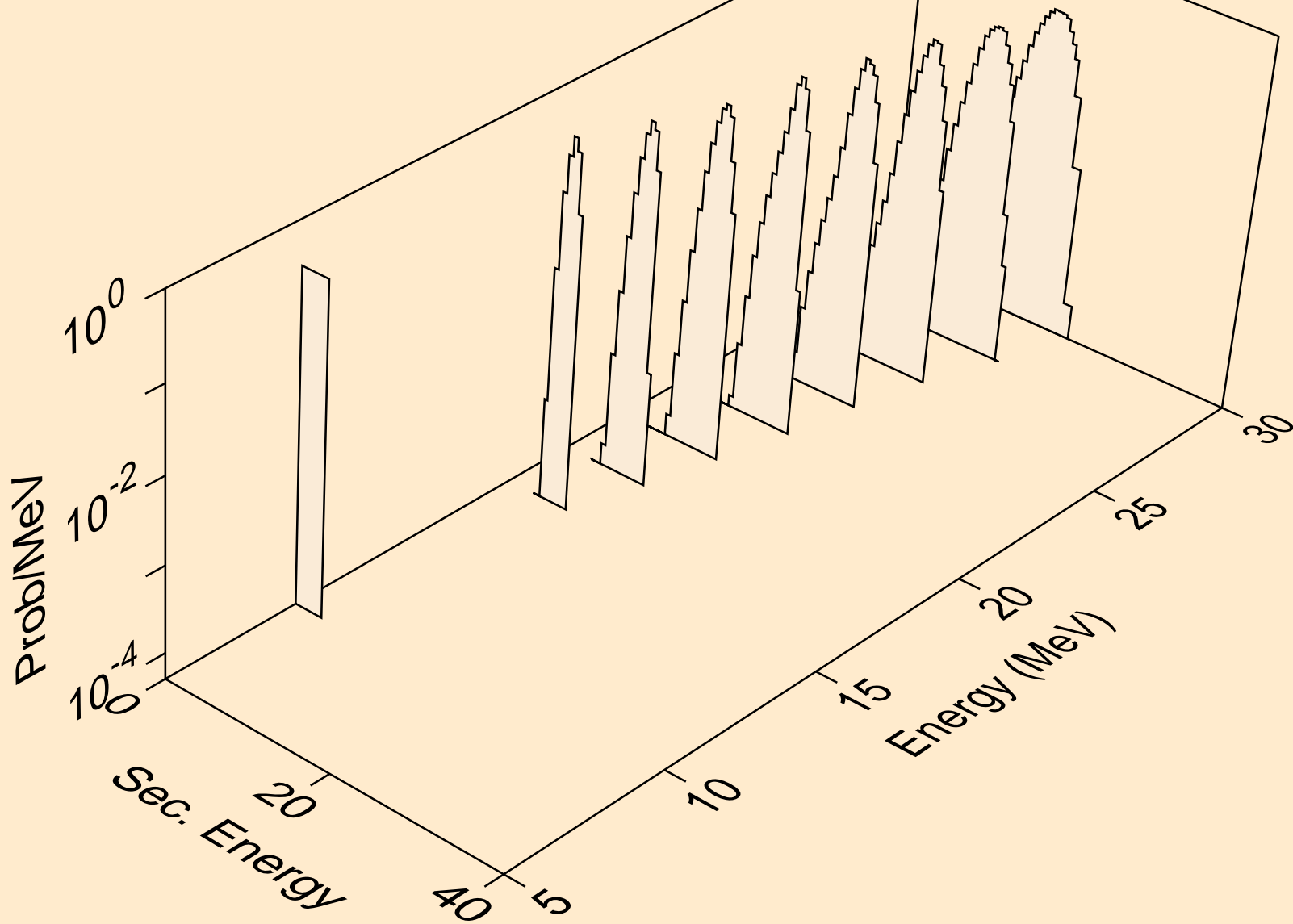

I134 HELION ACER TENDL-2021 LIBRARY; T=0.K
alphas from (s,n*)2a

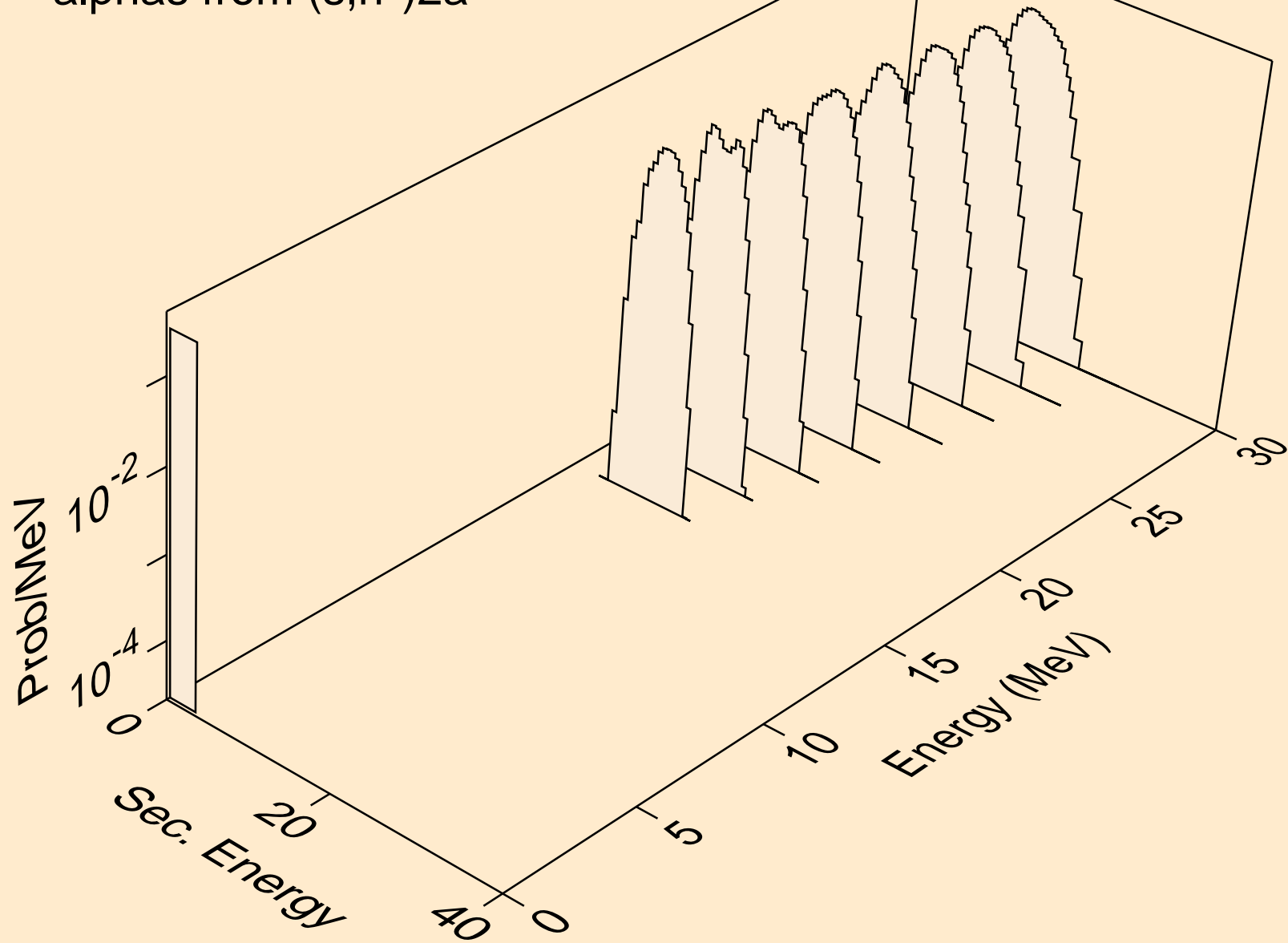

I134 HELION ACER TENDL-2021 LIBRARY; T=0.K
alphas from (s,npa)

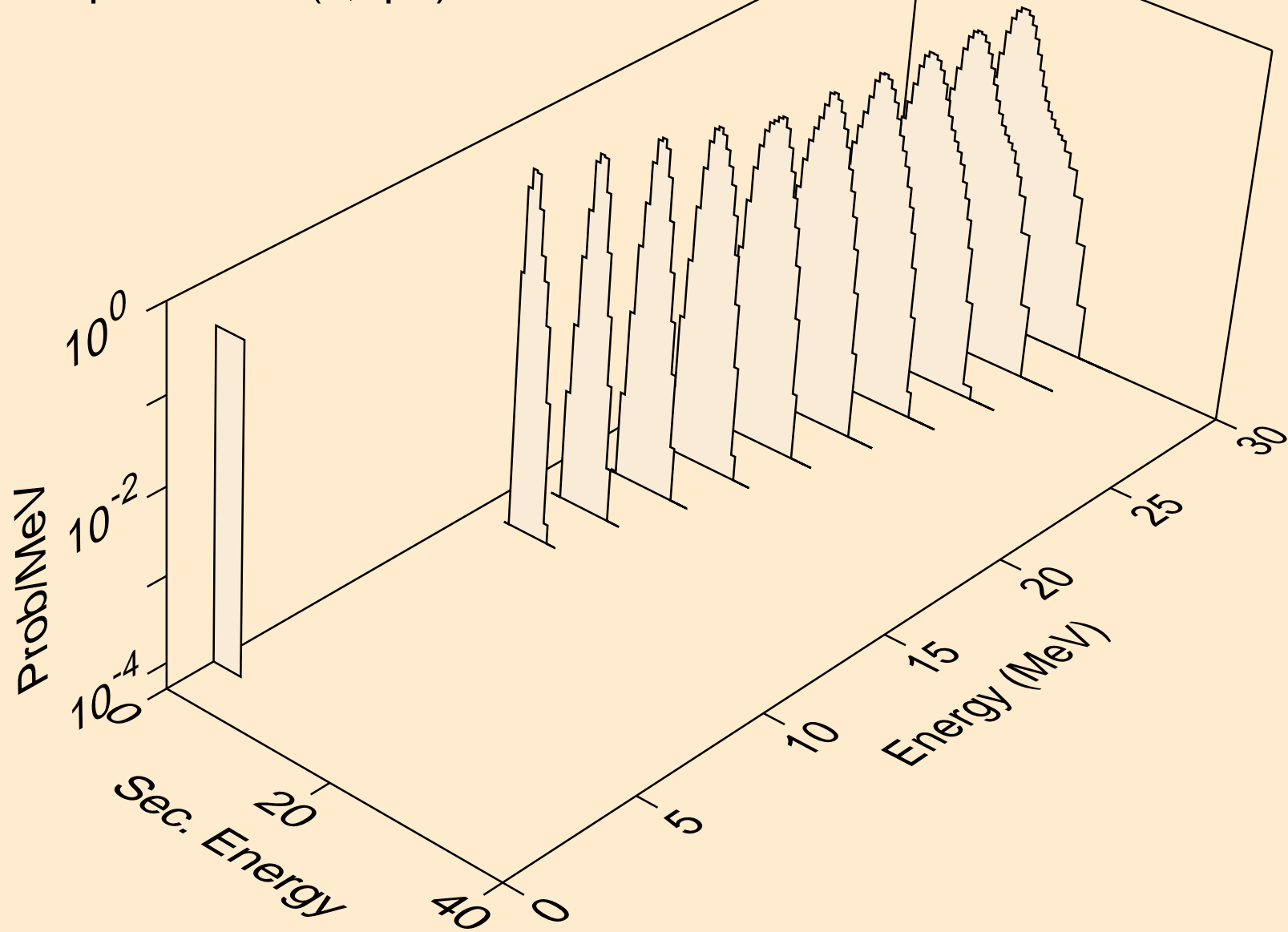

I134 HELION ACER TENDL-2021 LIBRARY; T=0.K
alphas from (s,a)

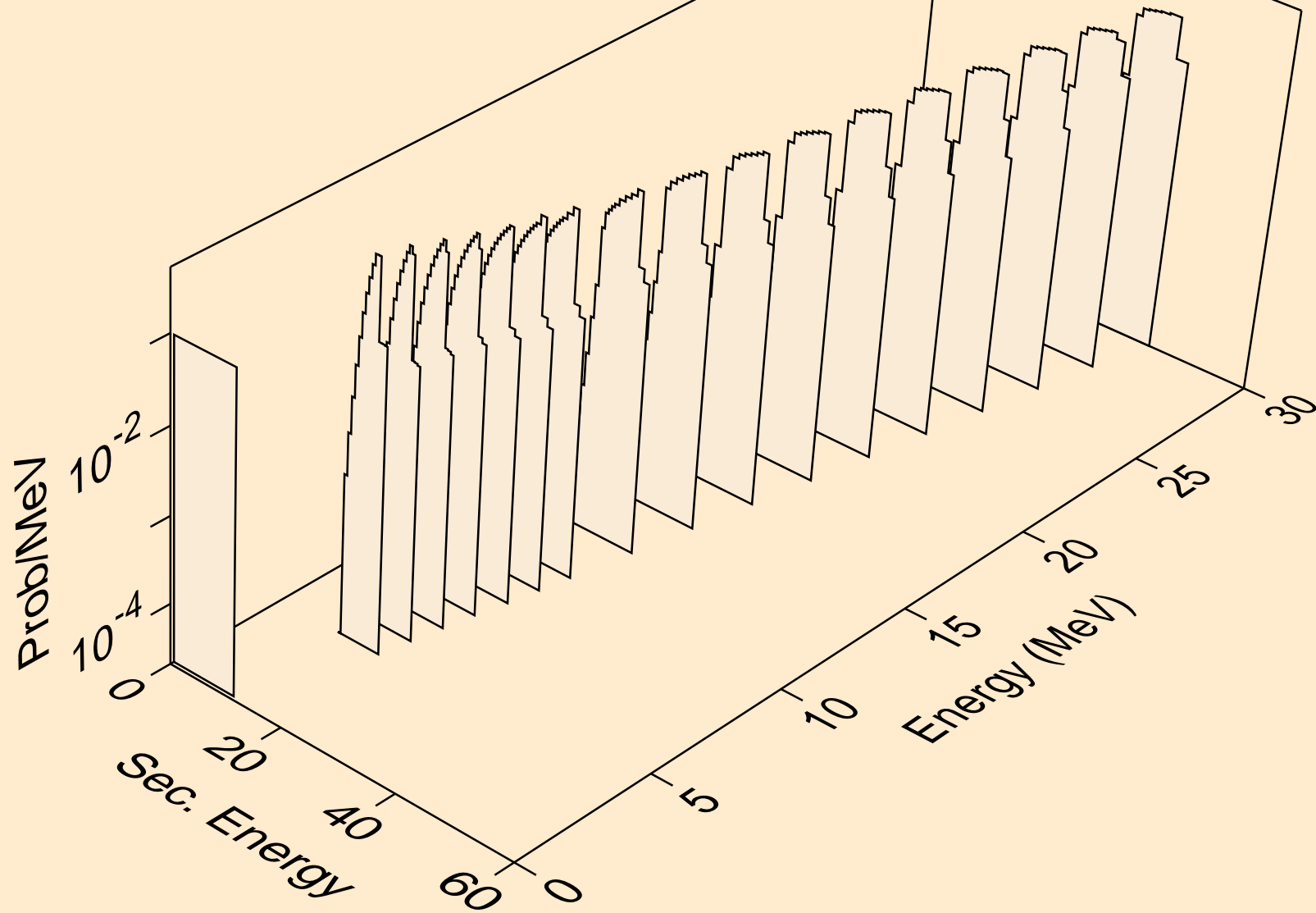

I134 HELION ACER TENDL-2021 LIBRARY; T=0.K
alphas from (s,2a)

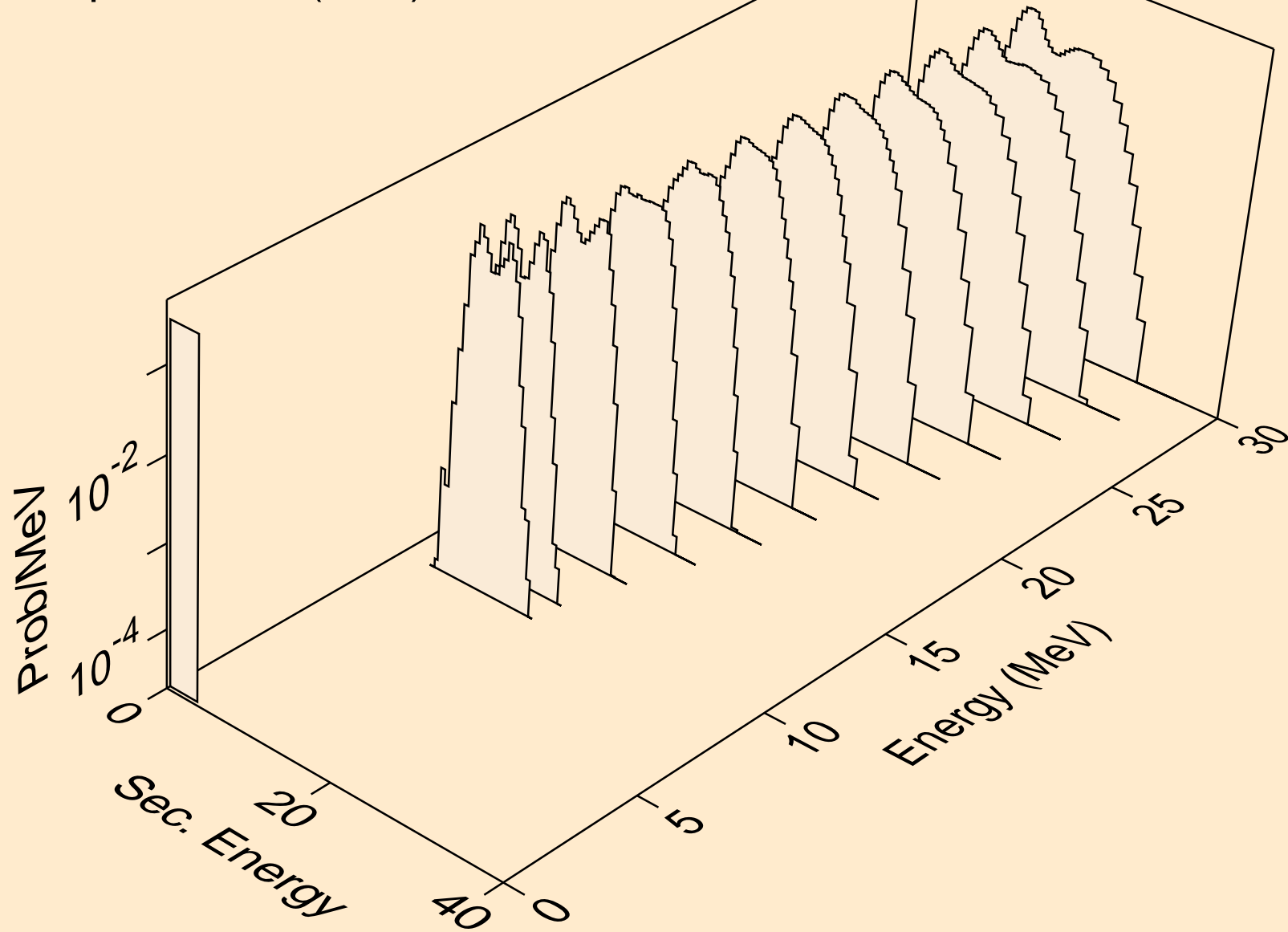

I134 HELION ACER TENDL-2021 LIBRARY; T=0.K
alphas from (s,pa)

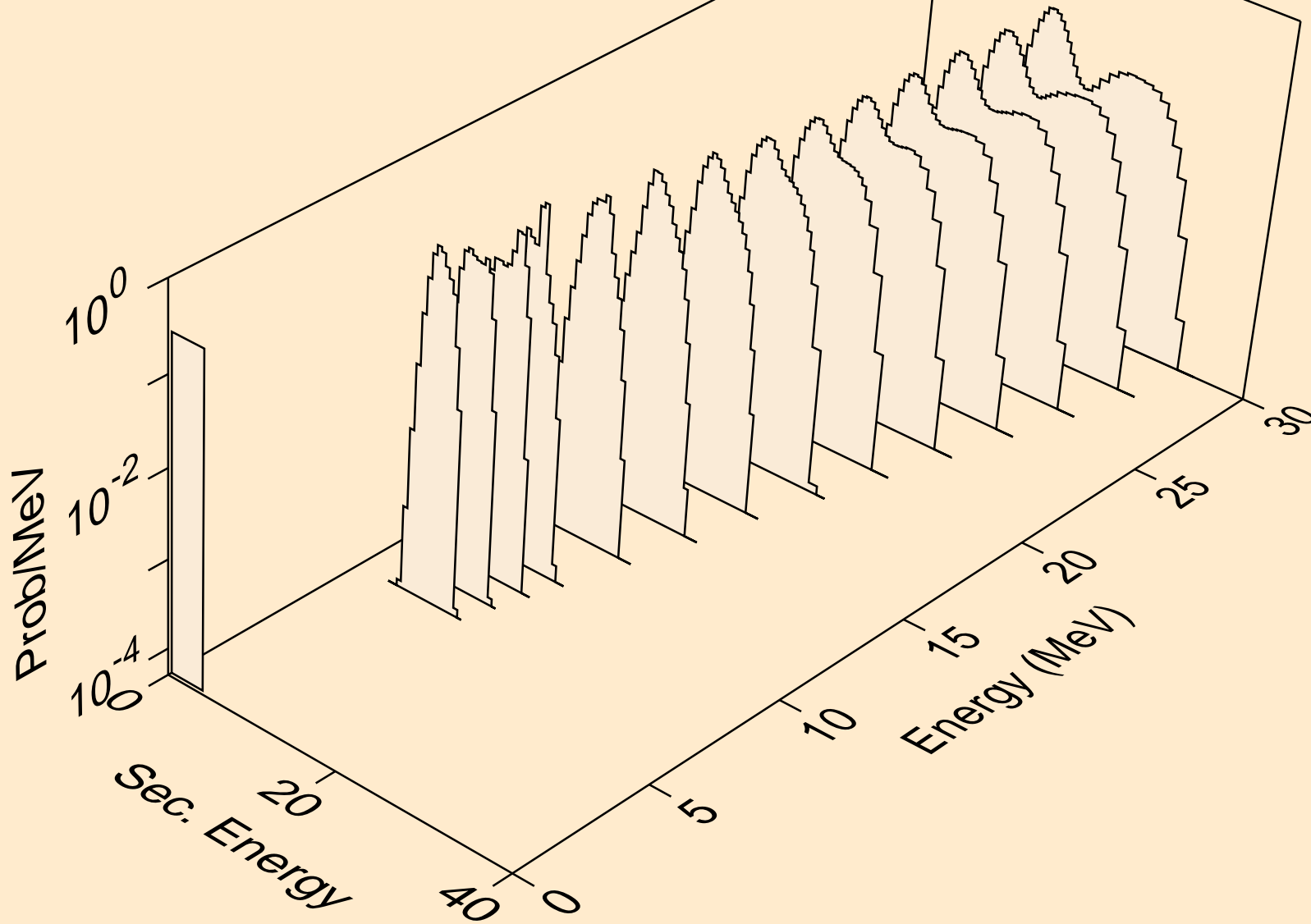

I134 HELION ACER TENDL-2021 LIBRARY; T=0.K
alphas from (s,da)

