

IR192N HELION ACER TENDL-2021 LIBRARY; T=0.K  
Principal cross sections

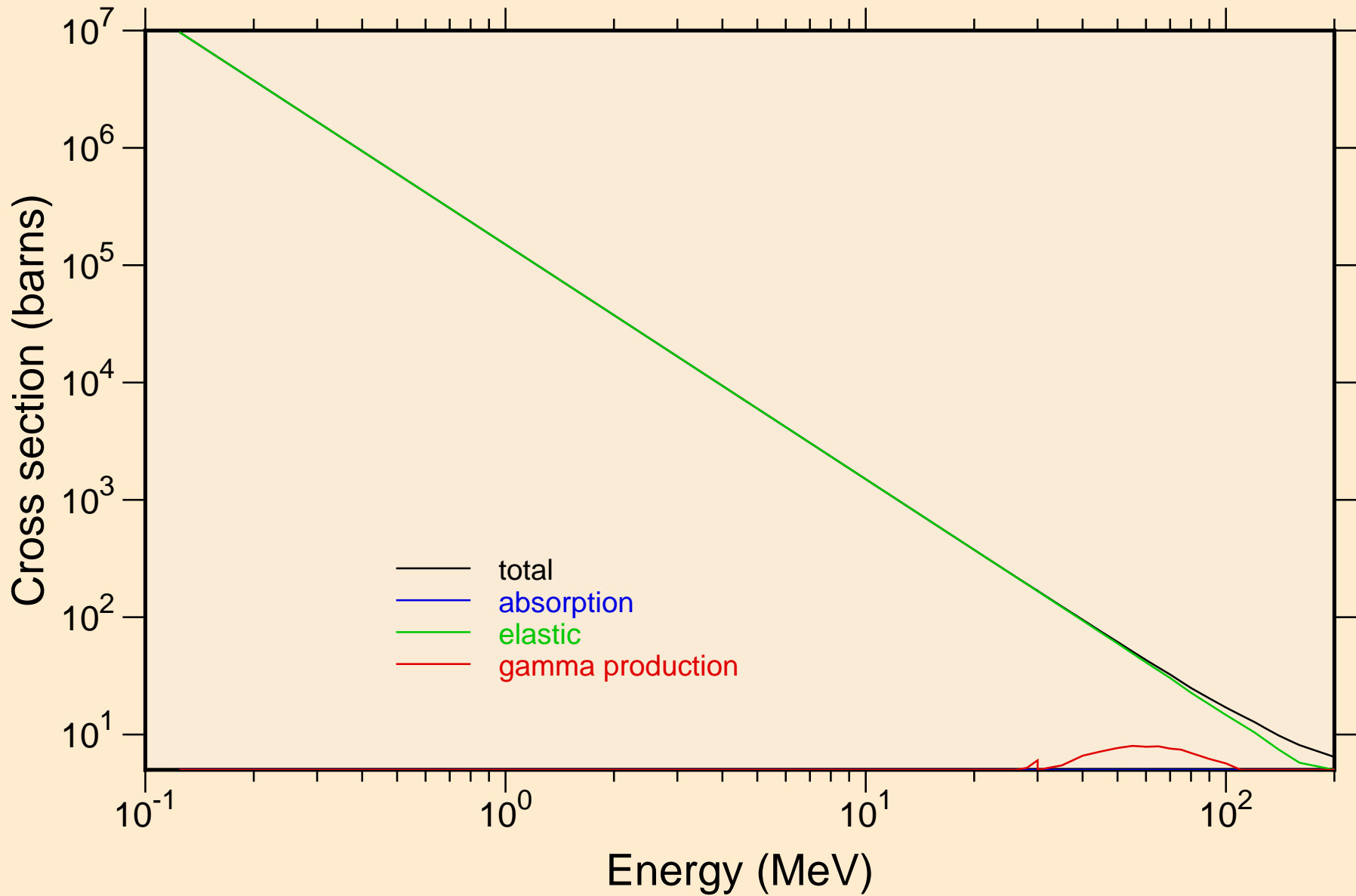

IR192N HELION ACER TENDL-2021 LIBRARY; T=0.K

Heating

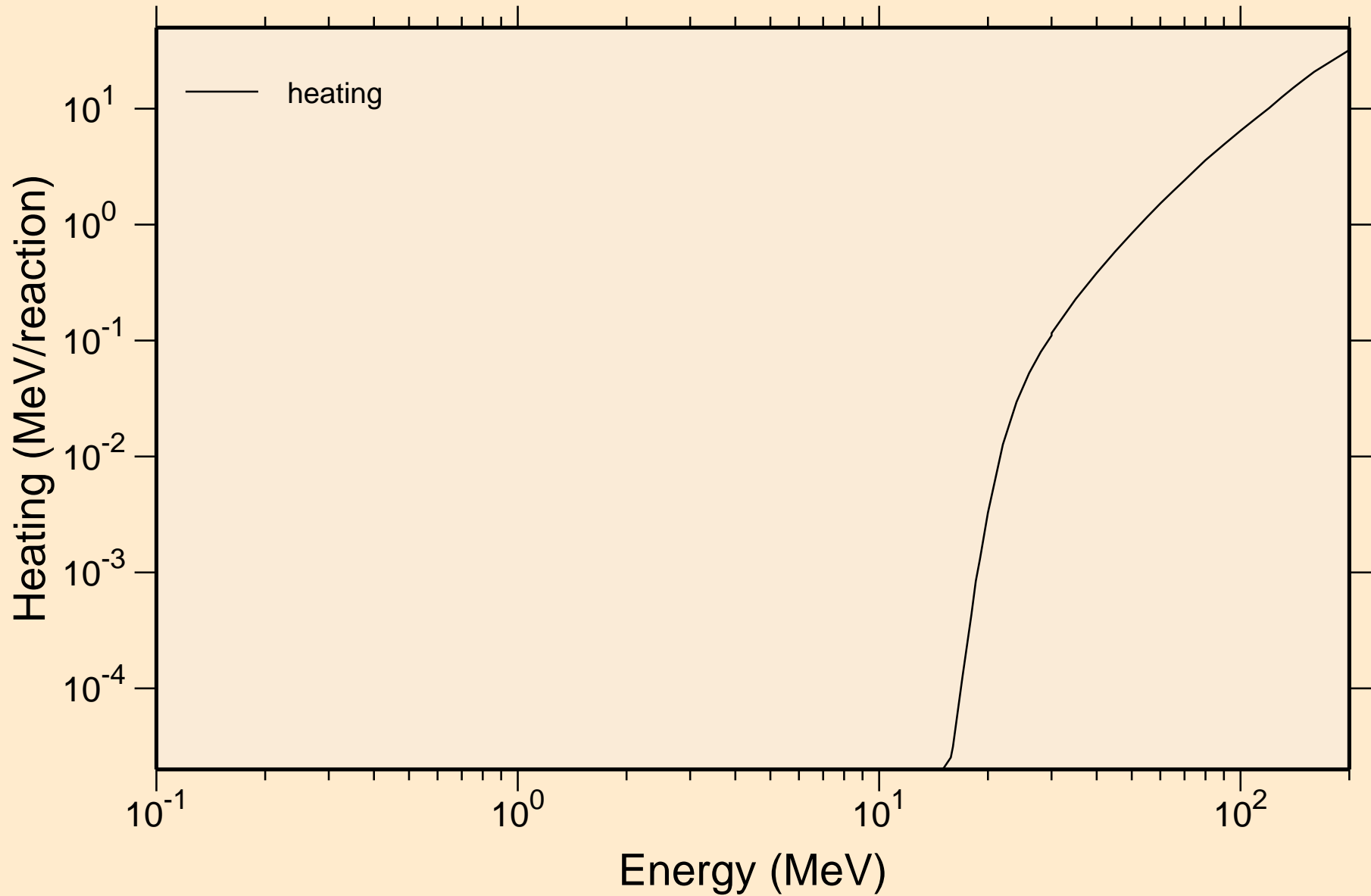

# IR192N HELION ACER TENDL-2021 LIBRARY; T=0.K

## Principal cross sections

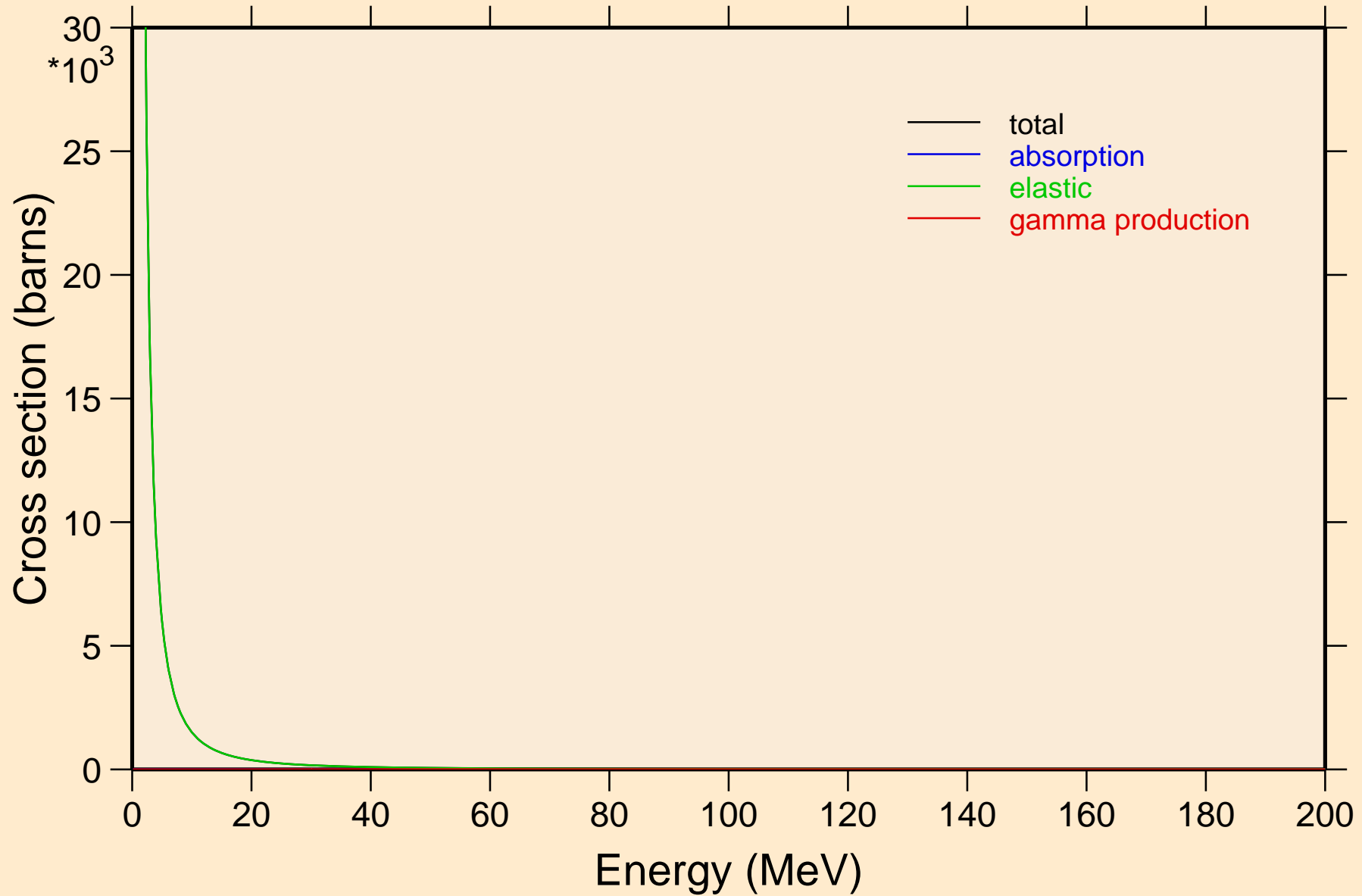

IR192N HELION ACER TENDL-2021 LIBRARY; T=0.K

Heating

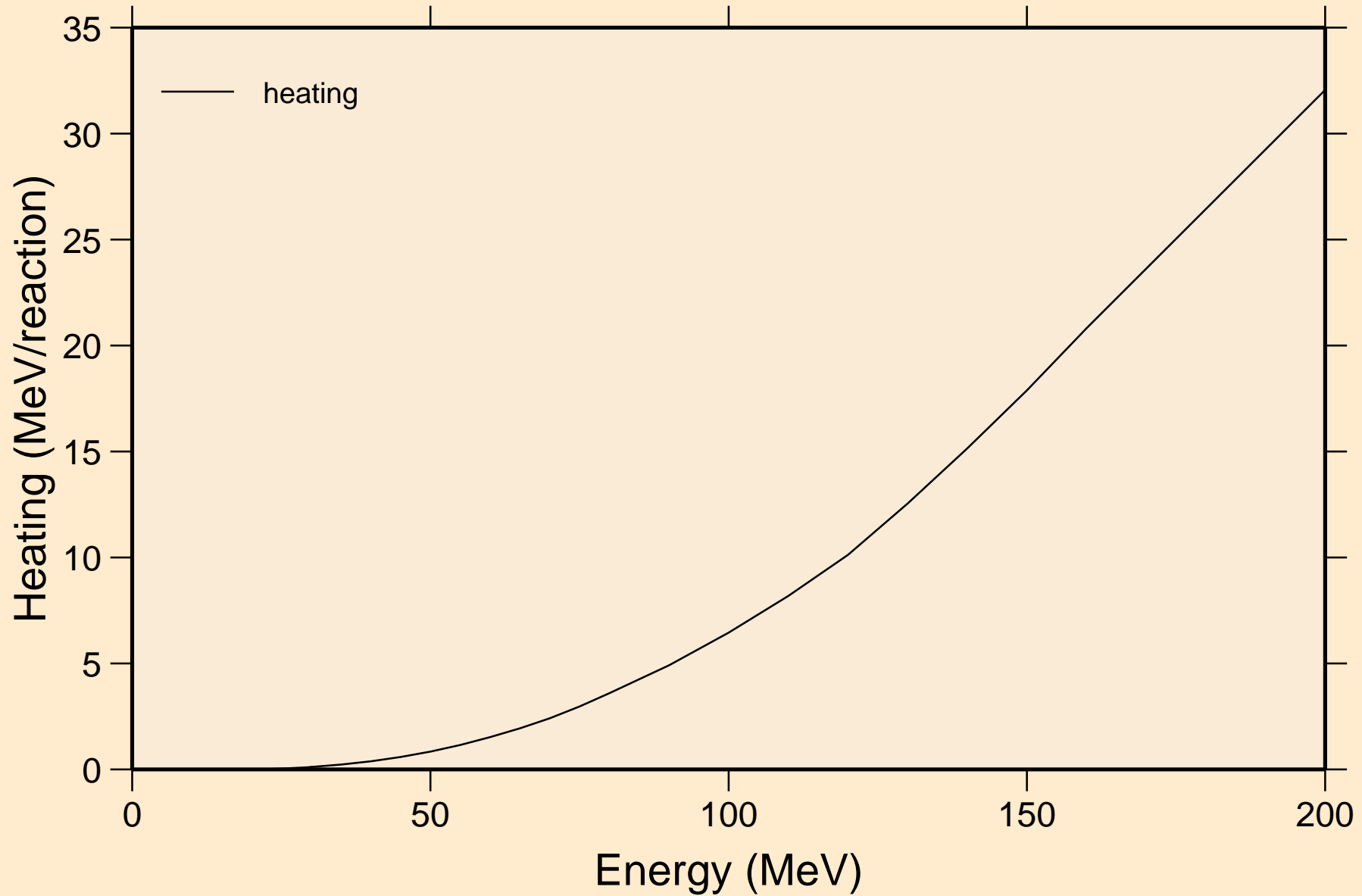

IR192N HELION ACER TENDL-2021 LIBRARY; T=0.K  
Threshold reactions

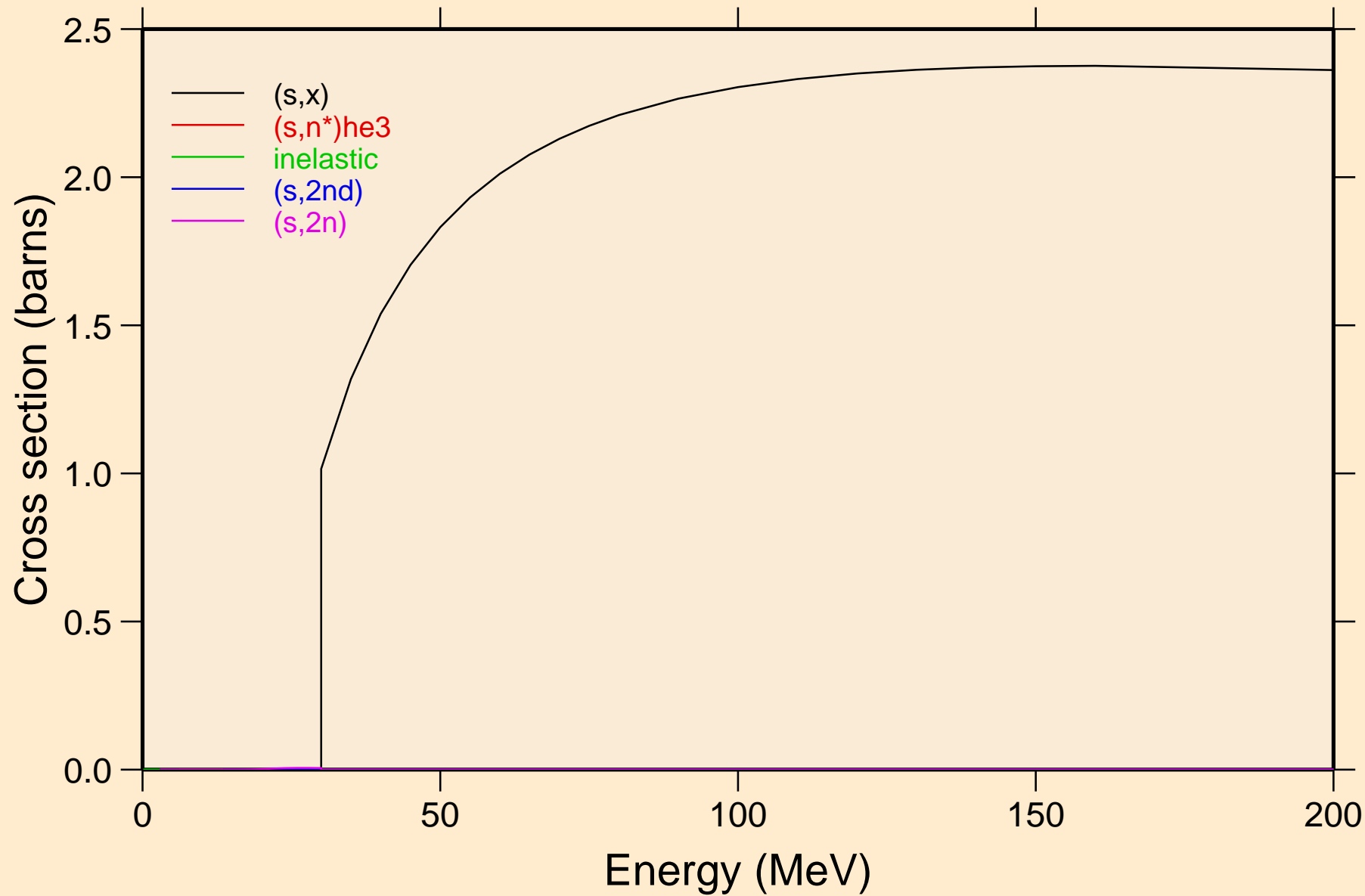

IR192N HELION ACER TENDL-2021 LIBRARY; T=0.K  
Threshold reactions

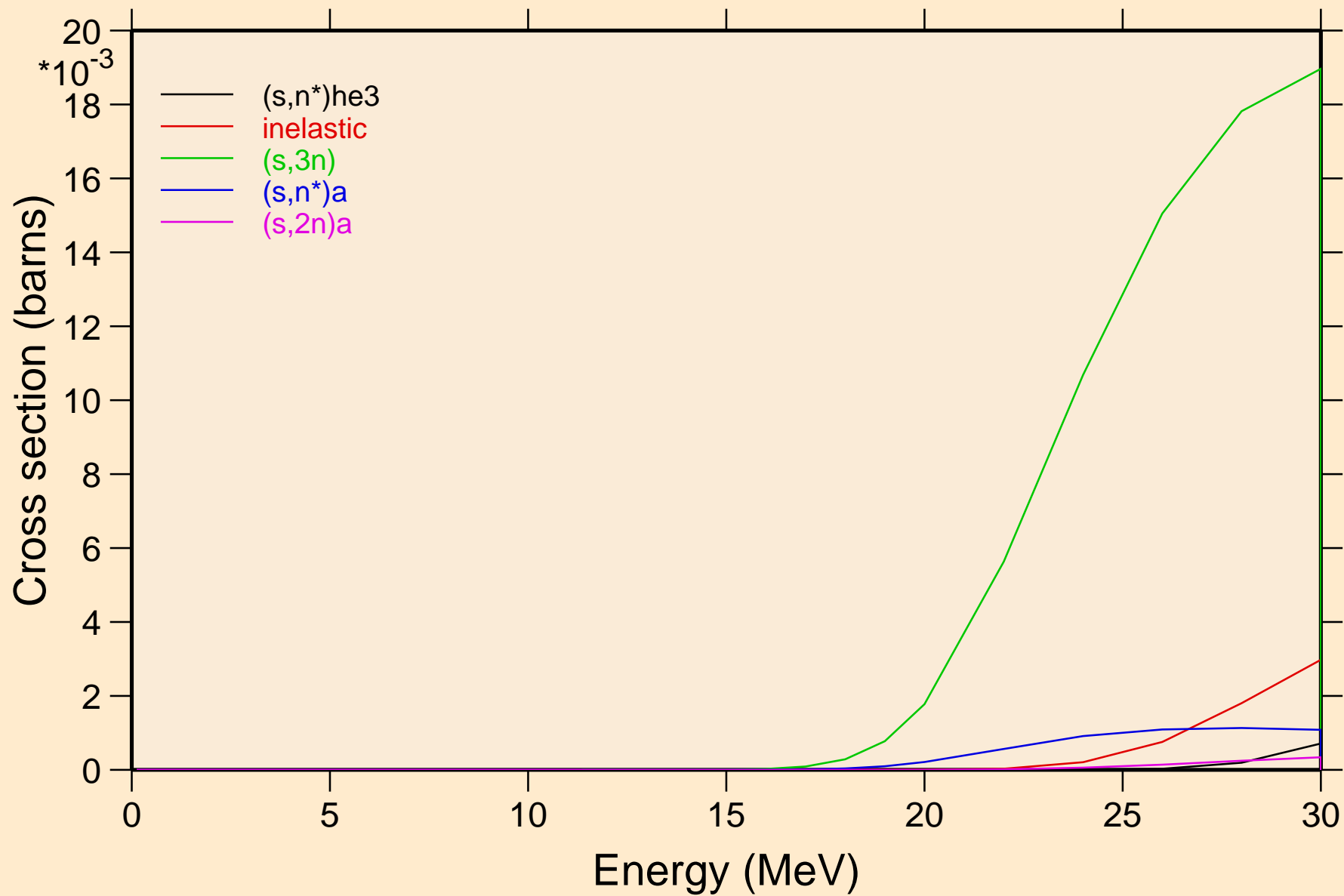

IR192N HELION ACER TENDL-2021 LIBRARY; T=0.K  
Threshold reactions

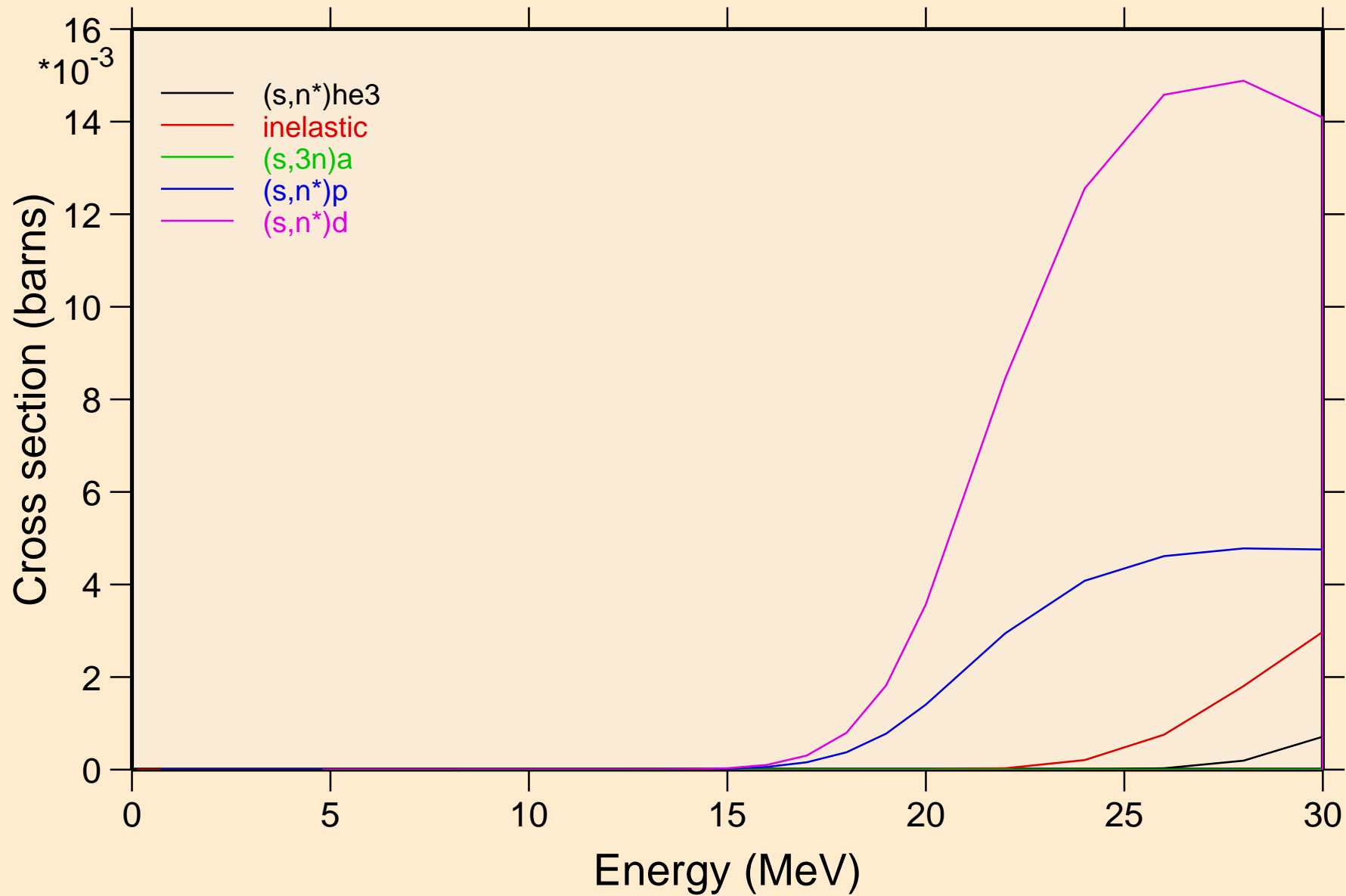

IR192N HELION ACER TENDL-2021 LIBRARY; T=0.K  
Threshold reactions

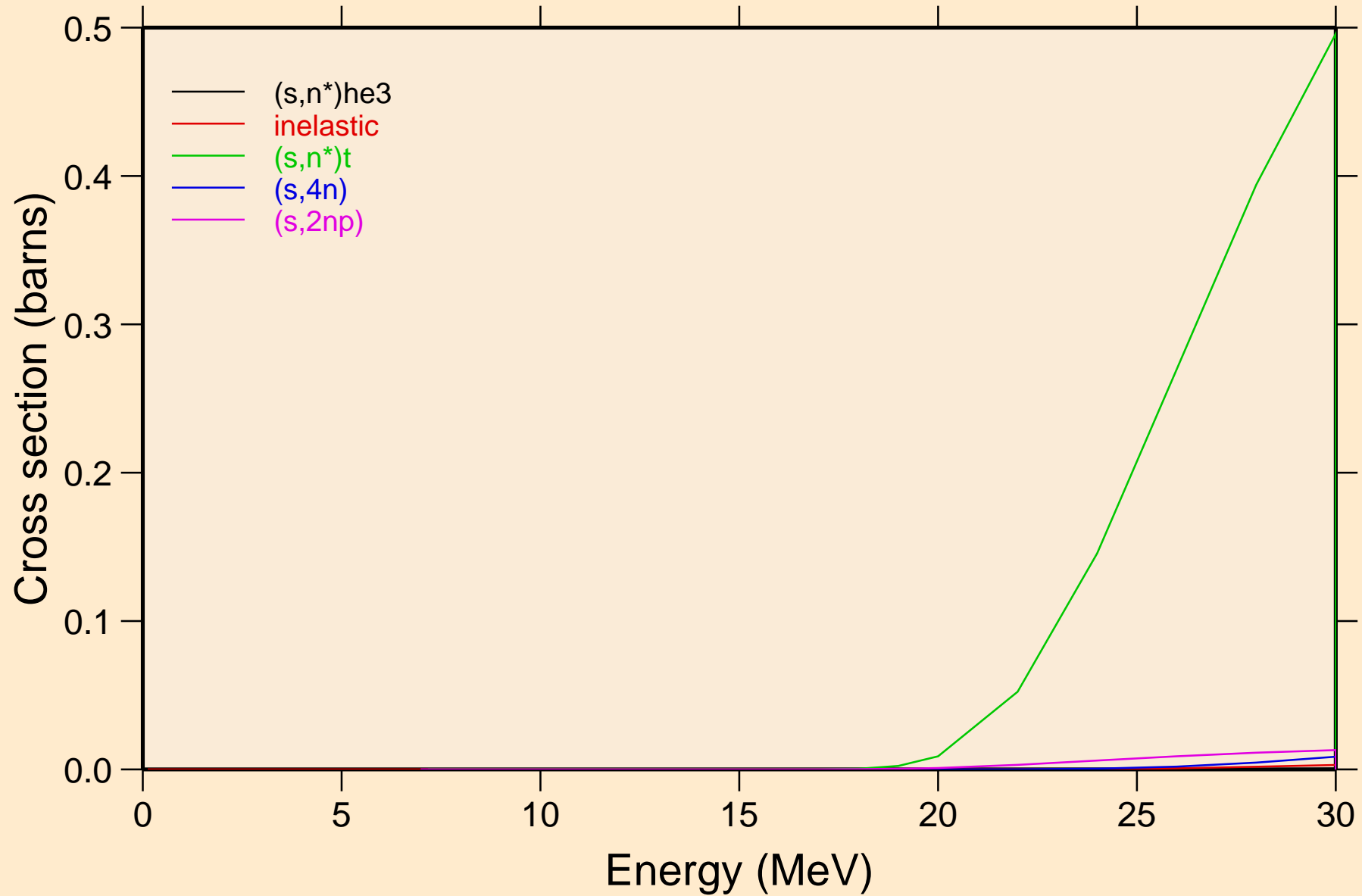



IR192N HELION ACER TENDL-2021 LIBRARY; T=0.K  
Threshold reactions

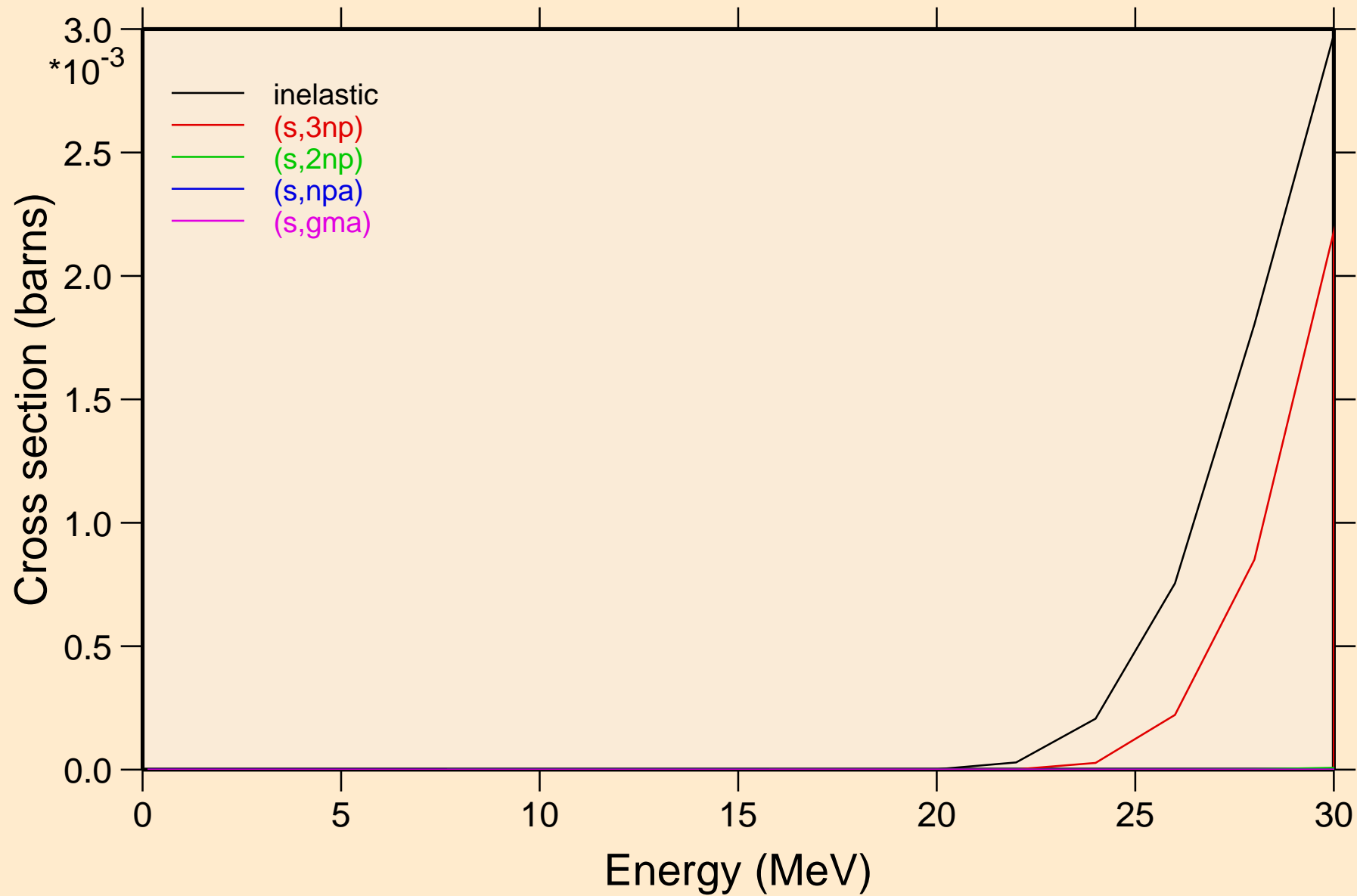

IR192N HELION ACER TENDL-2021 LIBRARY; T=0.K  
Threshold reactions

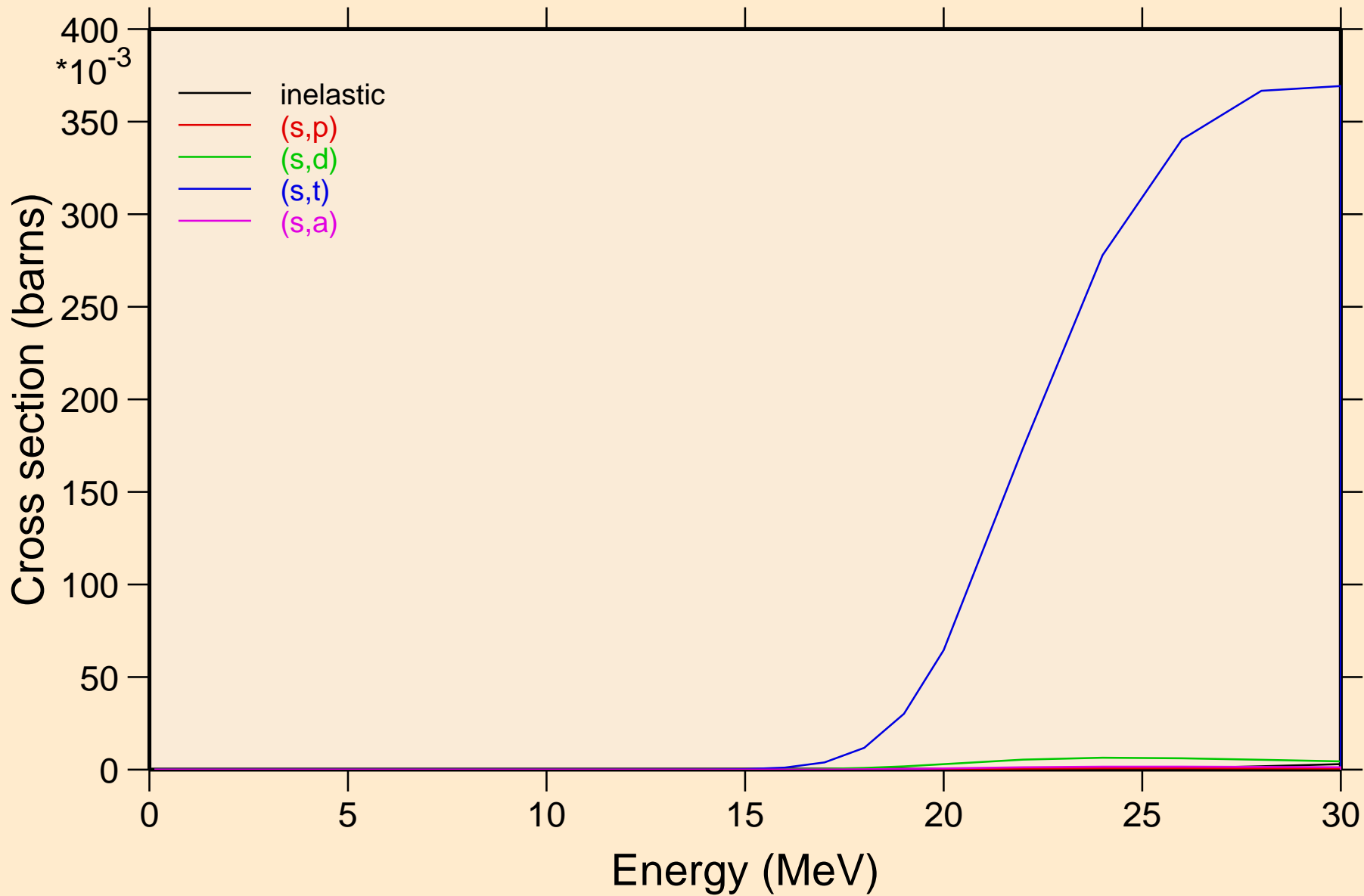

IR192N HELION ACER TENDL-2021 LIBRARY; T=0.K  
Threshold reactions

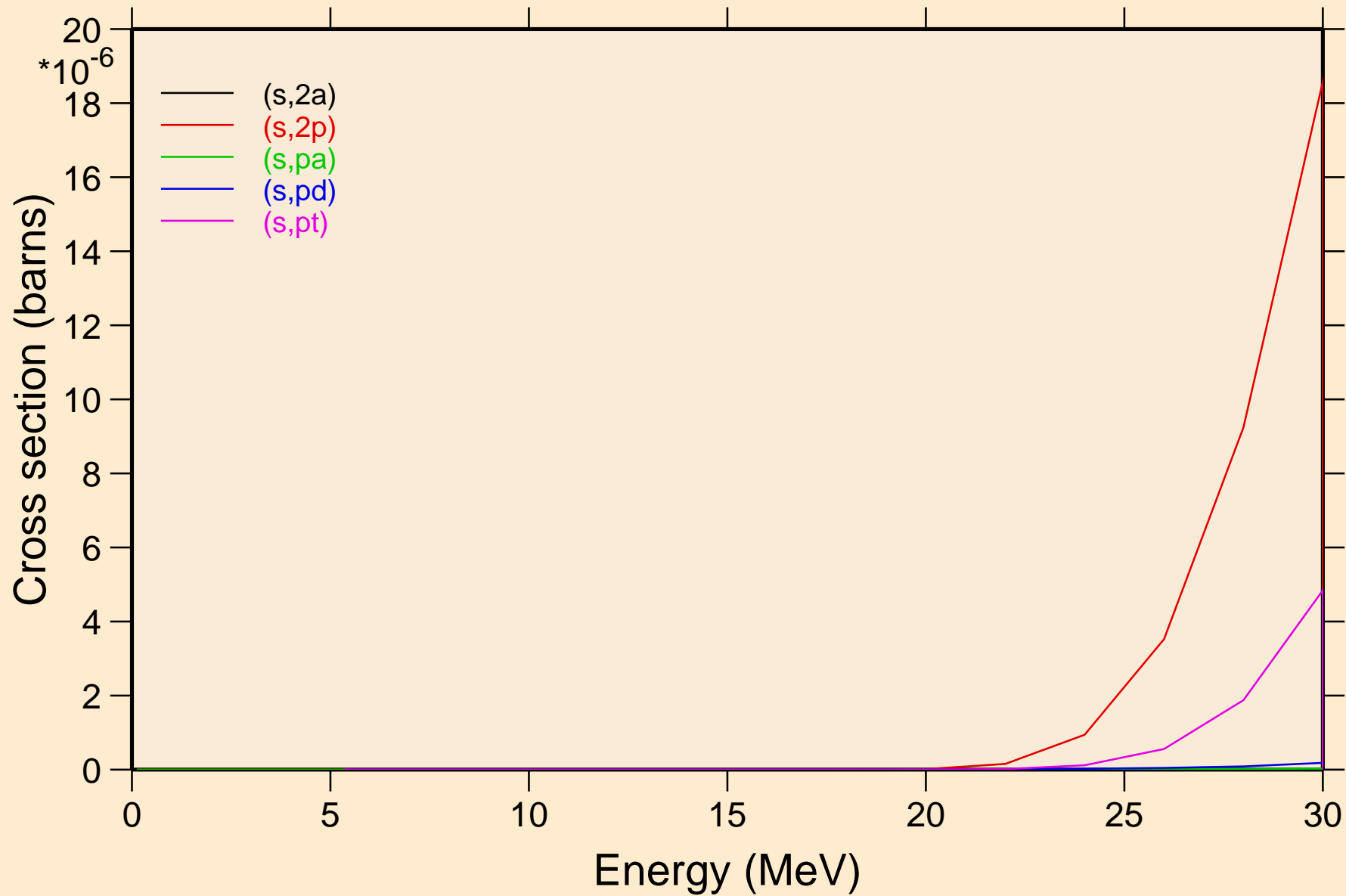

IR192N HELION ACER TENDL-2021 LIBRARY; T=0.K  
Threshold reactions

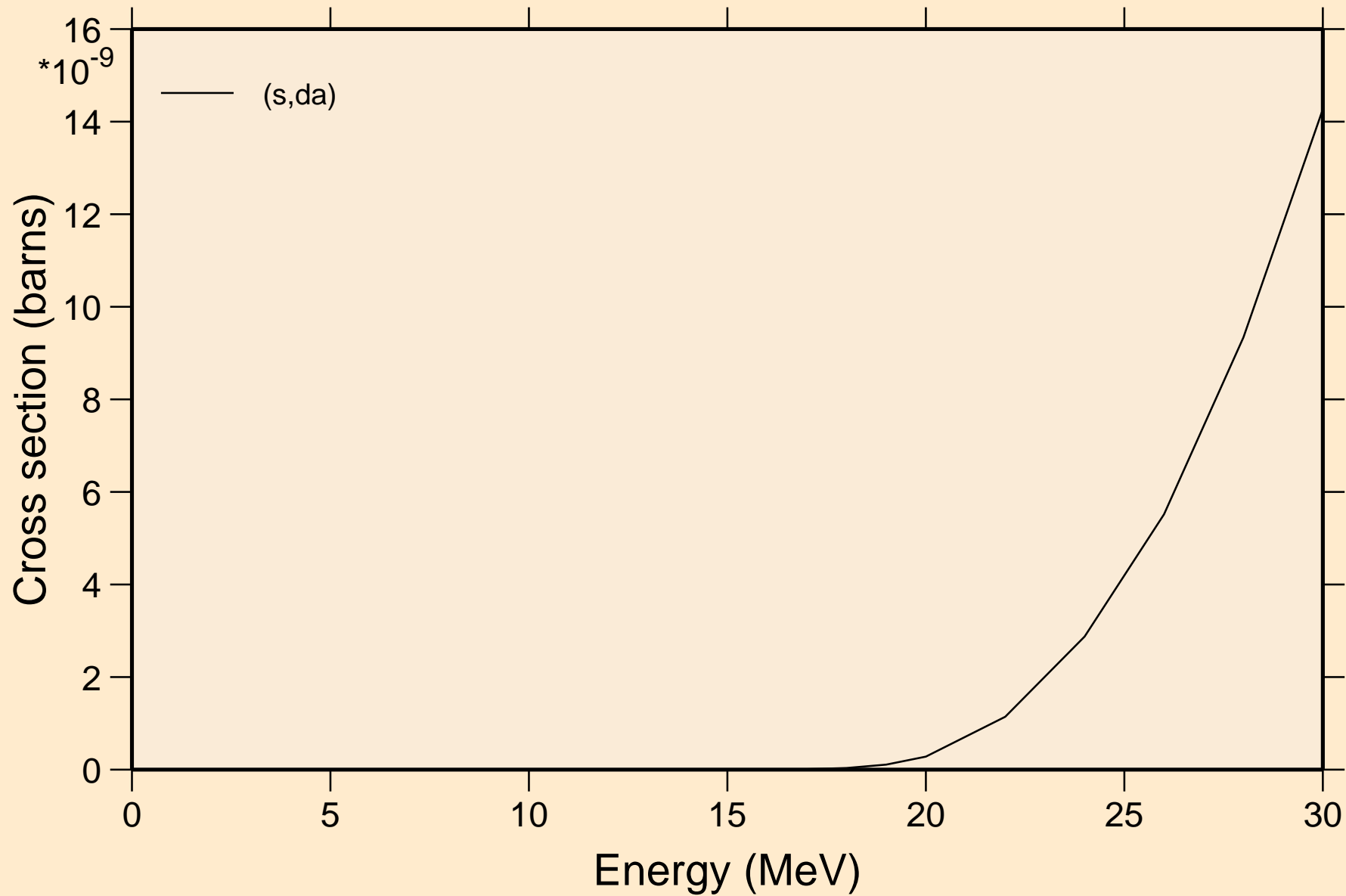

IR192N HELION ACER TENDL-2021 LIBRARY; T=0.K  
angular distribution for elastic

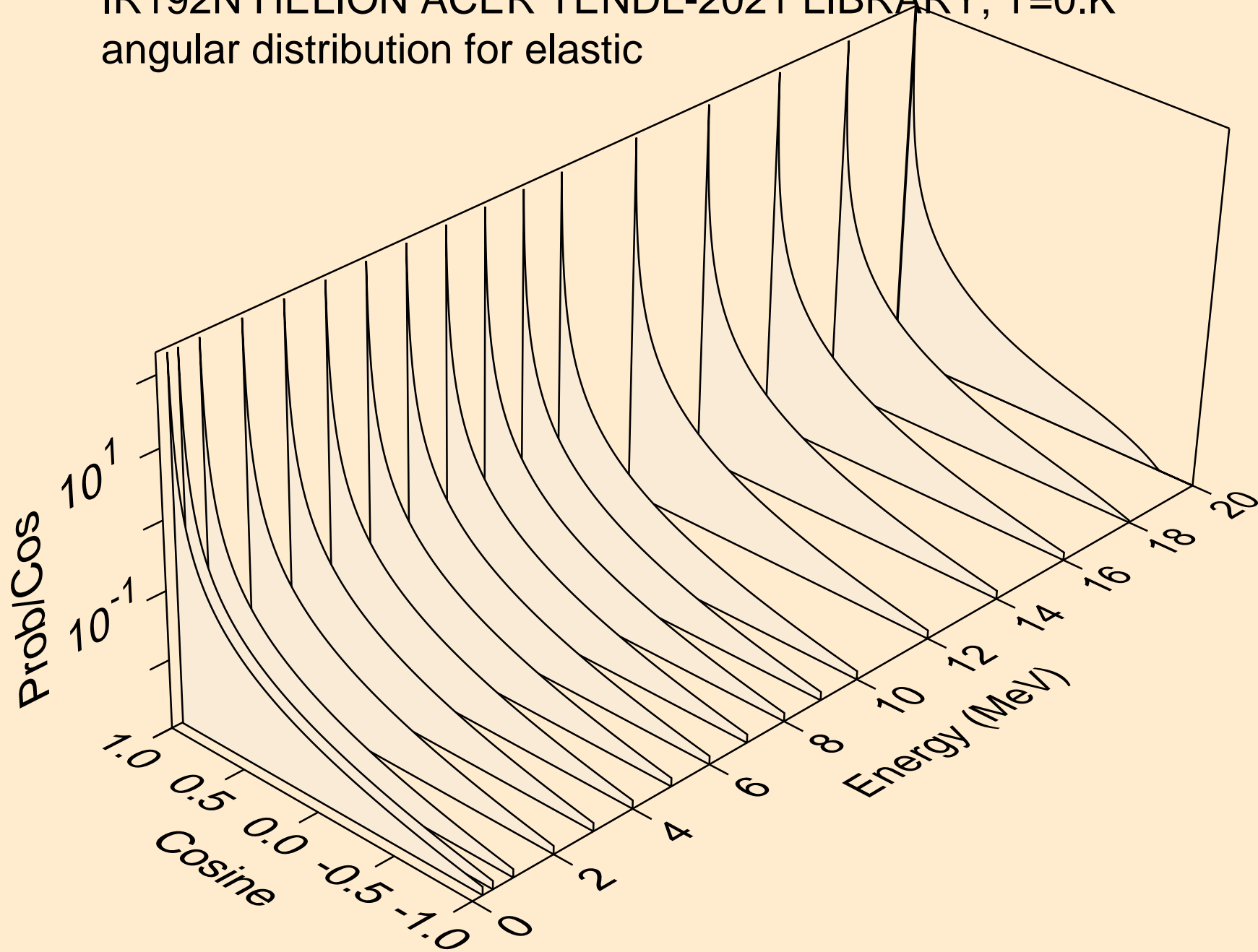

IR192N HELION ACER TENDL-2021 LIBRARY; T=0.K  
angular distribution for elastic

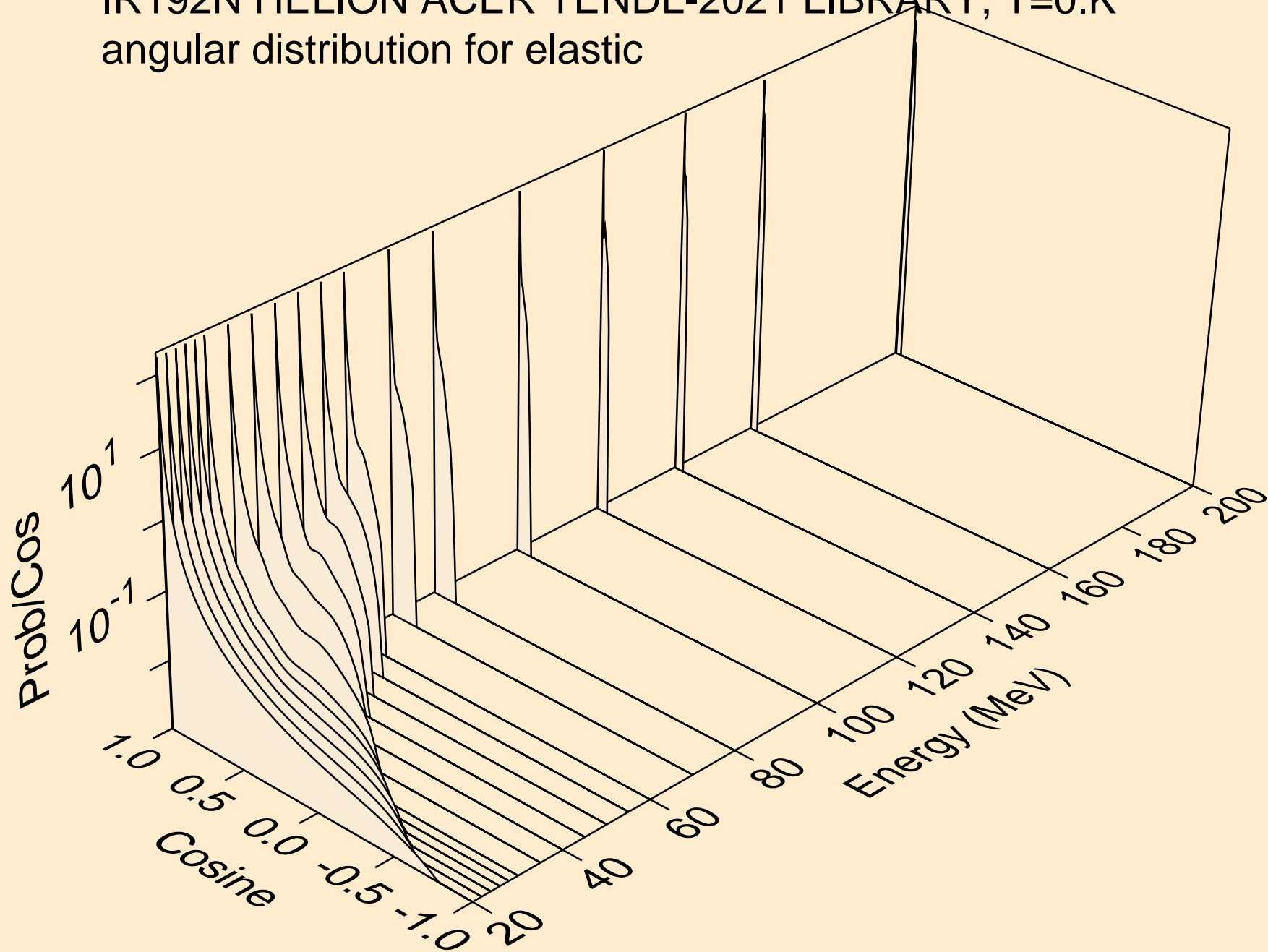

IR192N HELION ACER TENDL-2021 LIBRARY; T=0.K  
He-3 emission for (s,x)

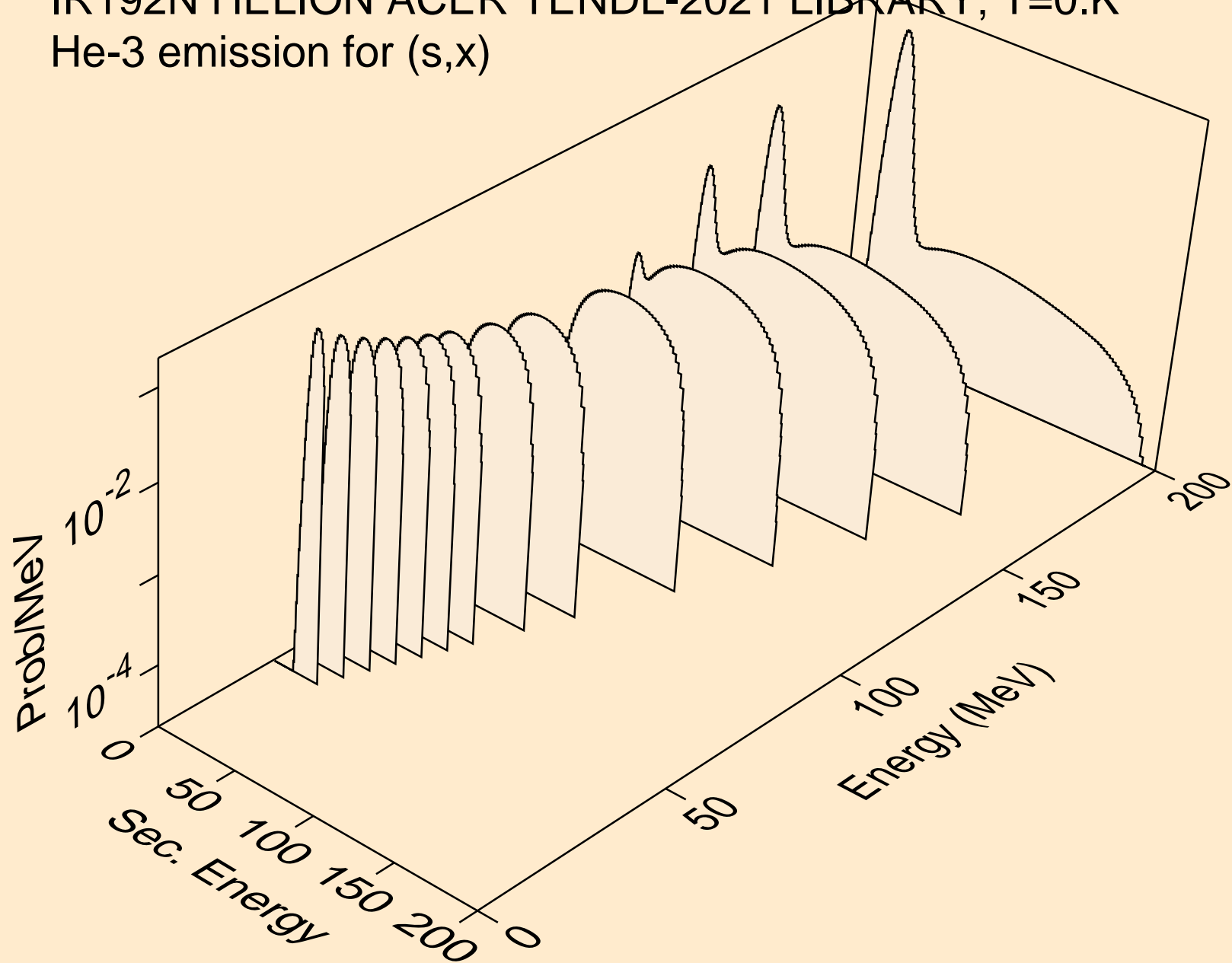

IR192N HELION ACER TENDL-2021 LIBRARY; T=0.K  
He-3 emission for (s,n\*)he3

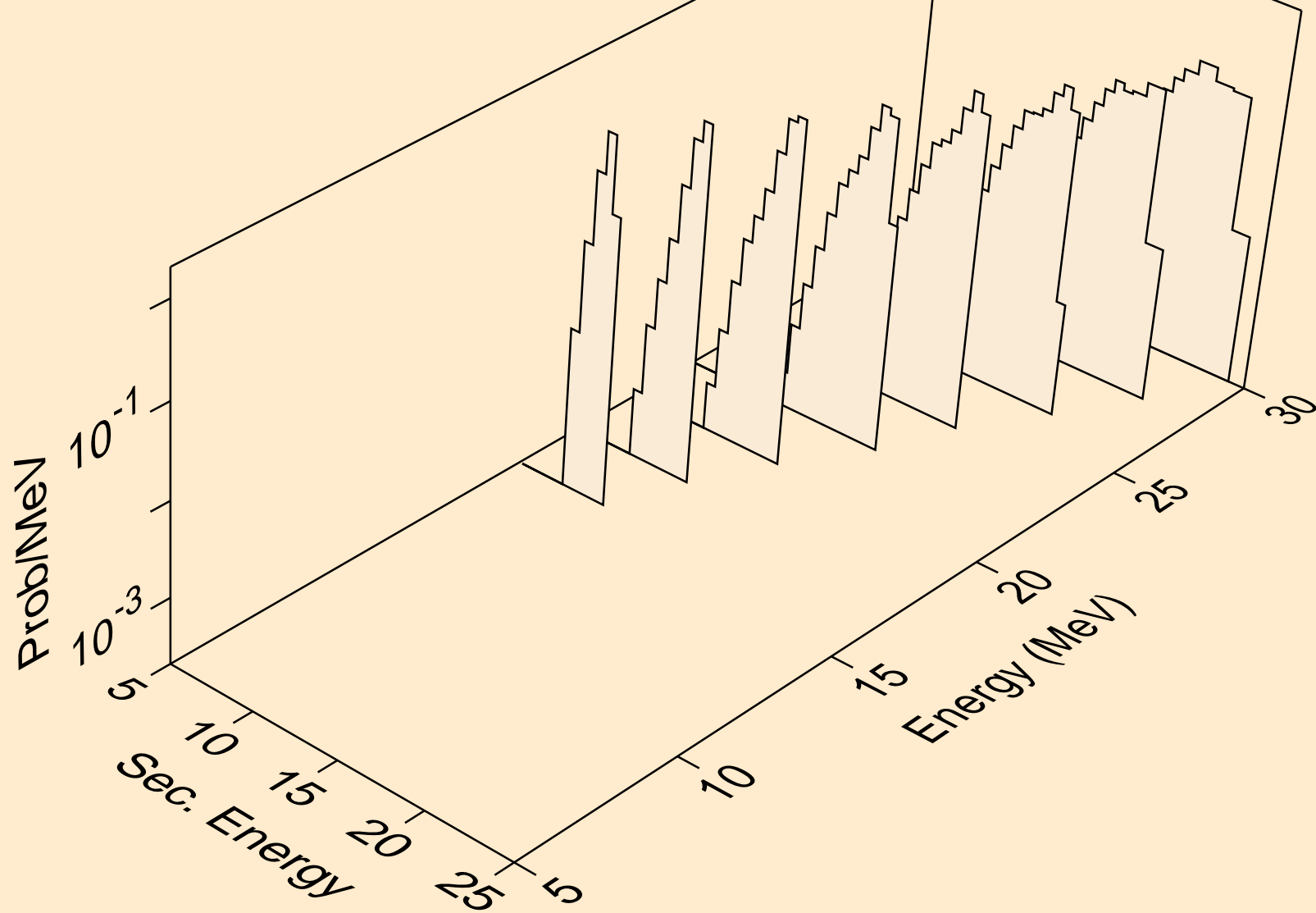



IR192N HELION ACER TENDL-2021 LIBRARY; T=0.K  
He-3 emission for inelastic

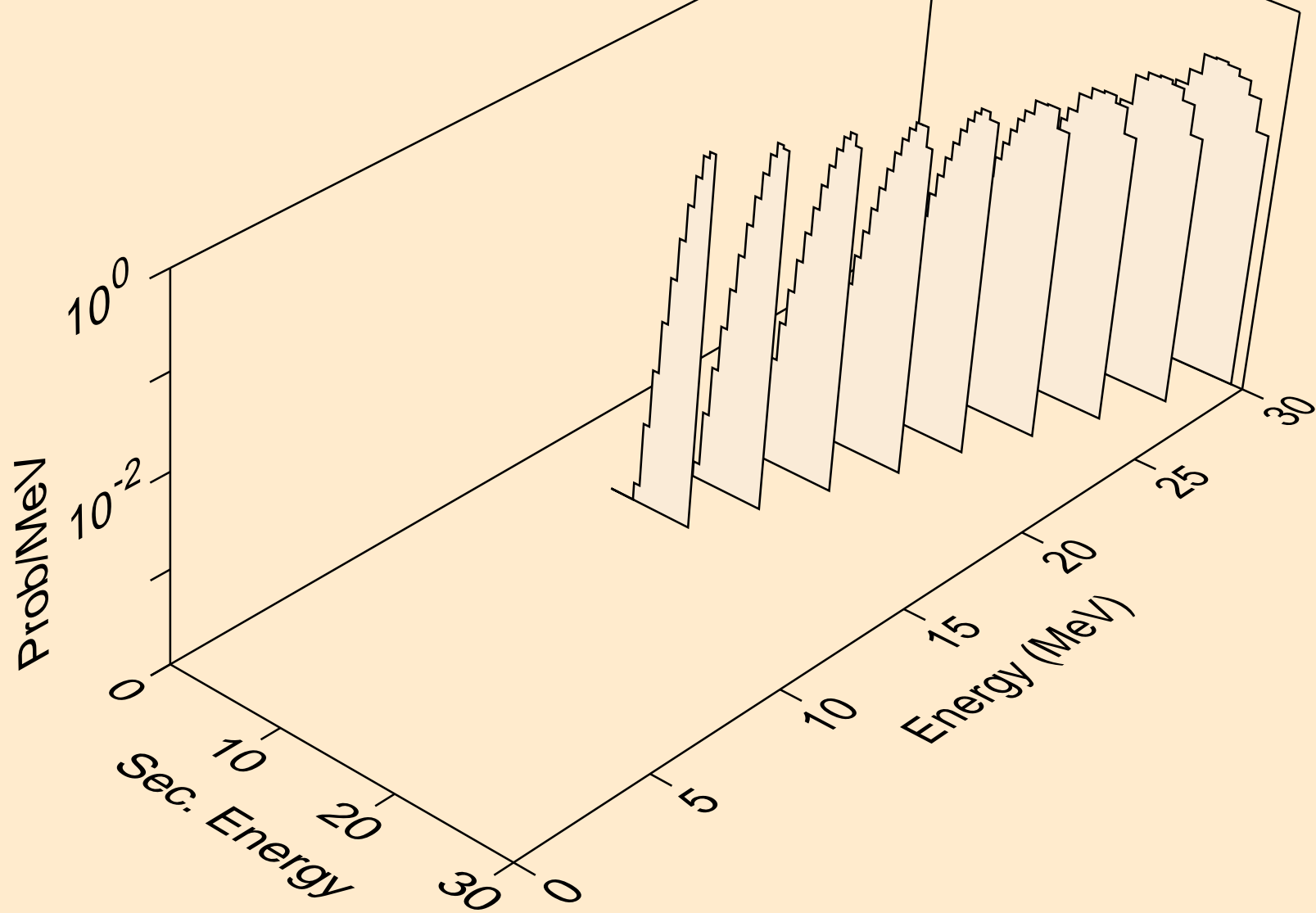

IR192N HELION ACER TENDL-2021 LIBRARY; T=0.K  
Photon emission for (z,n)

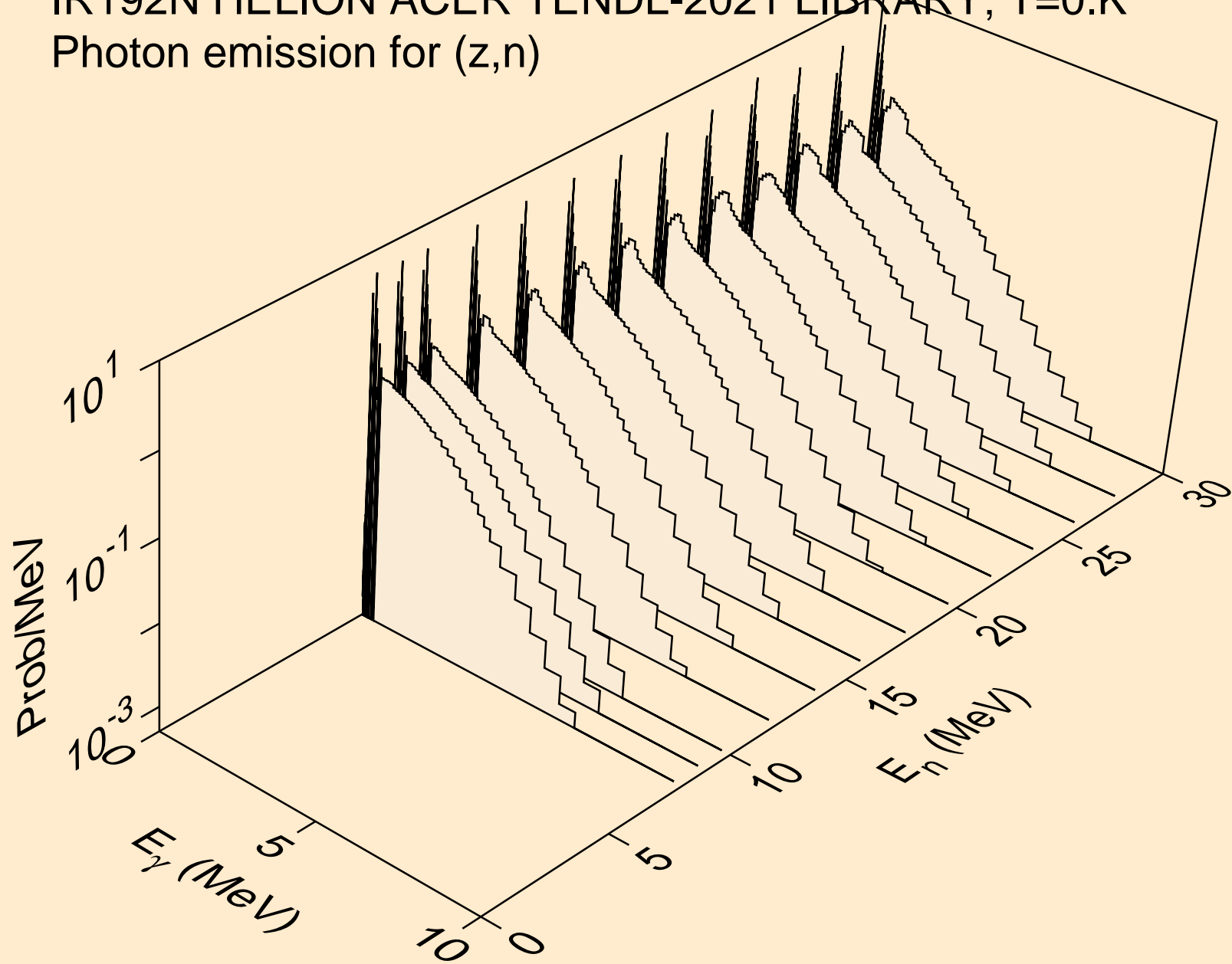

IR192N HELION ACER TENDL-2021 LIBRARY; T=0.K  
Photon emission for (n,x)

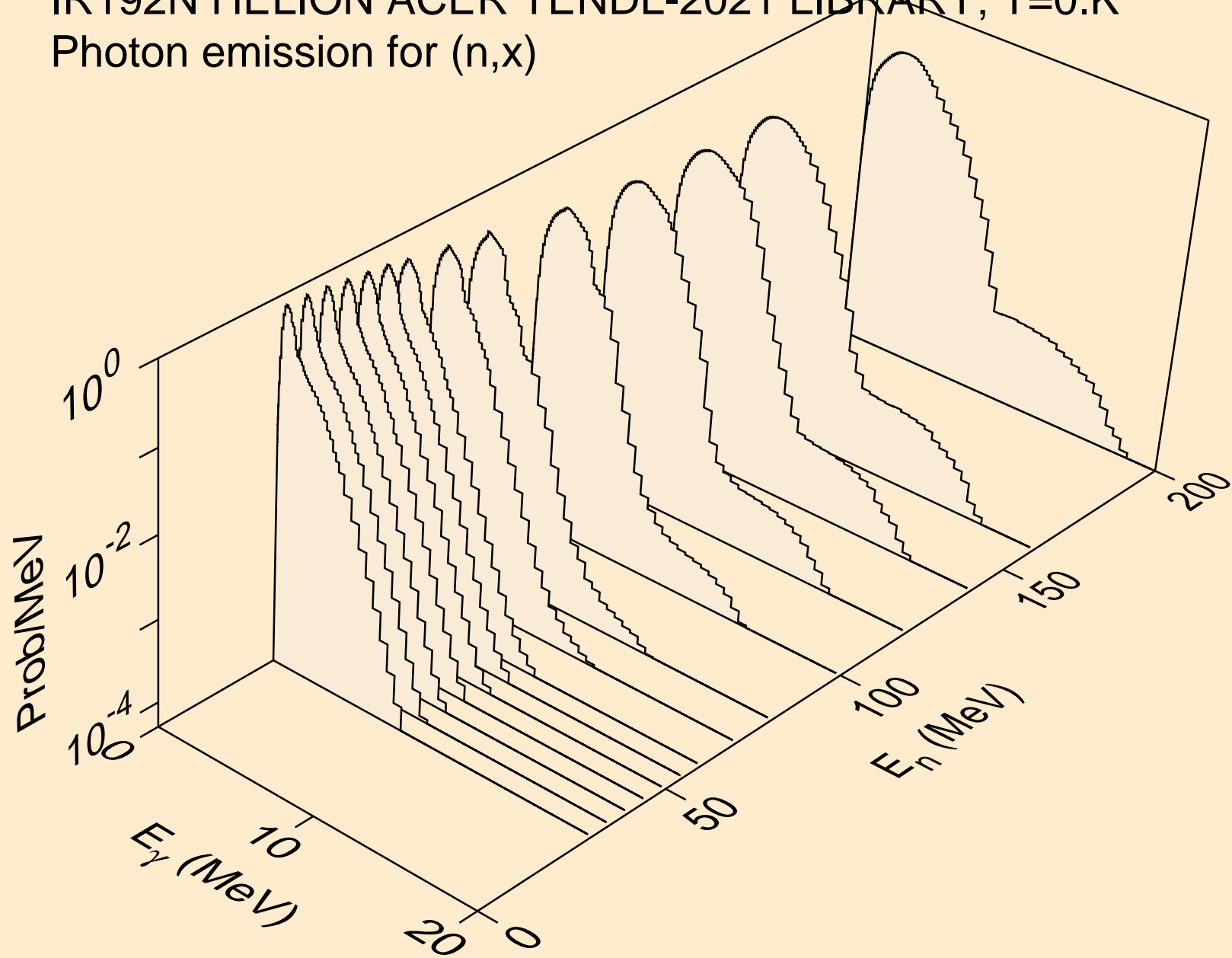

IR192N HELION ACER TENDL-2021 LIBRARY; T=0.K  
Photon emission for (n,2nd)

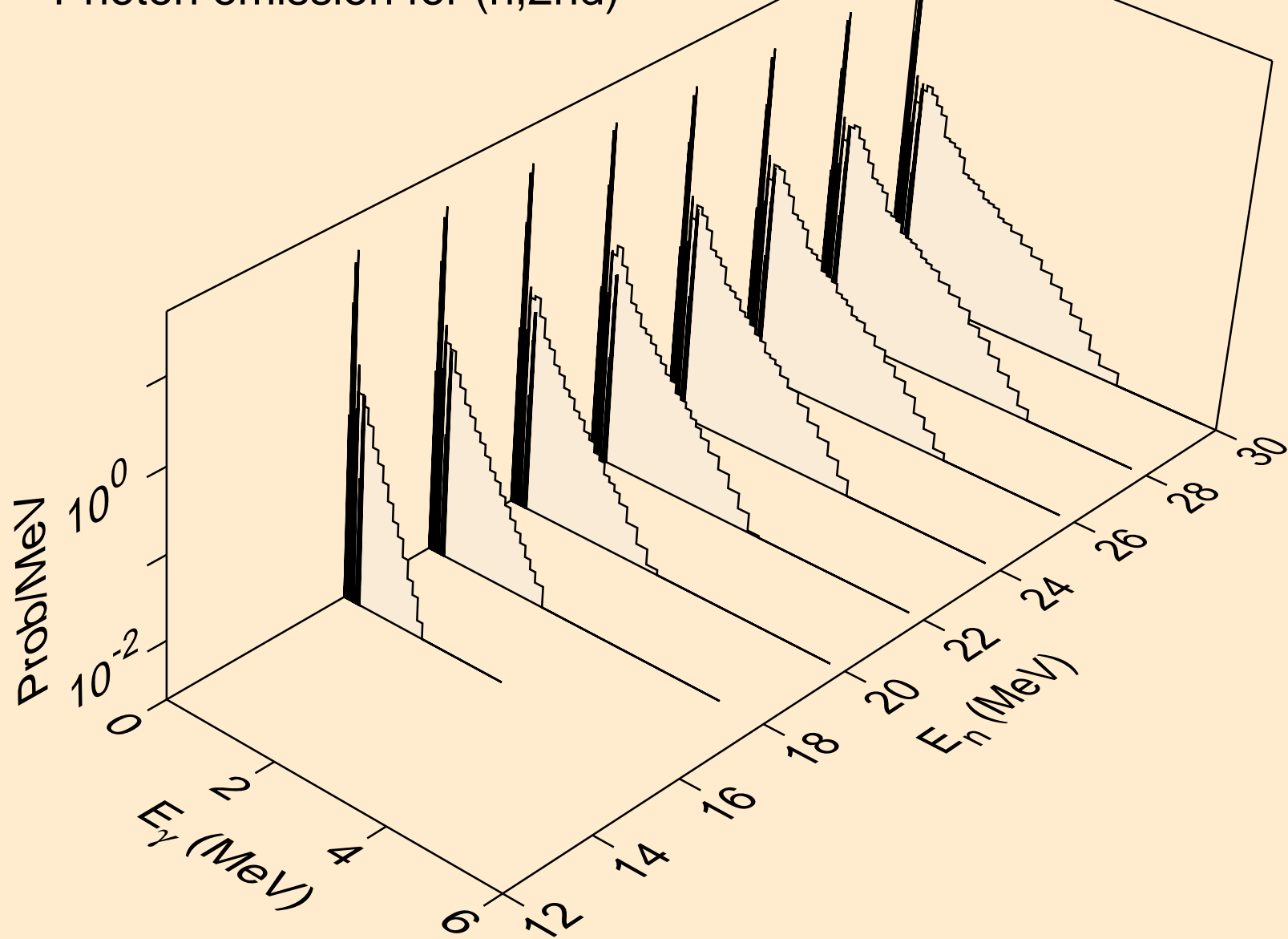

IR192N HELION ACER TENDL-2021 LIBRARY; T=0.K  
Photon emission for (n,2n)

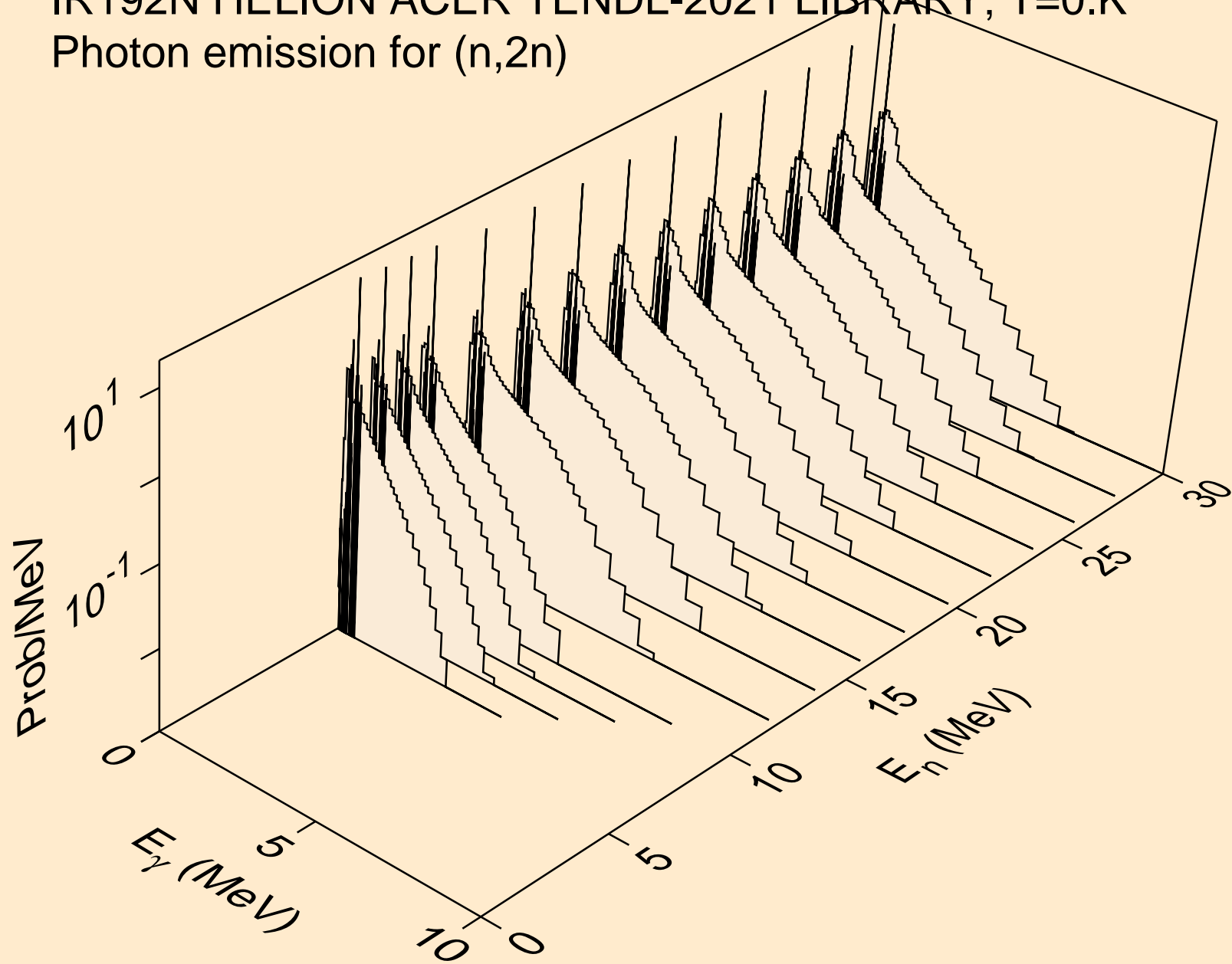

IR192N HELION ACER TENDL-2021 LIBRARY; T=0.K  
Photon emission for (n,3n)

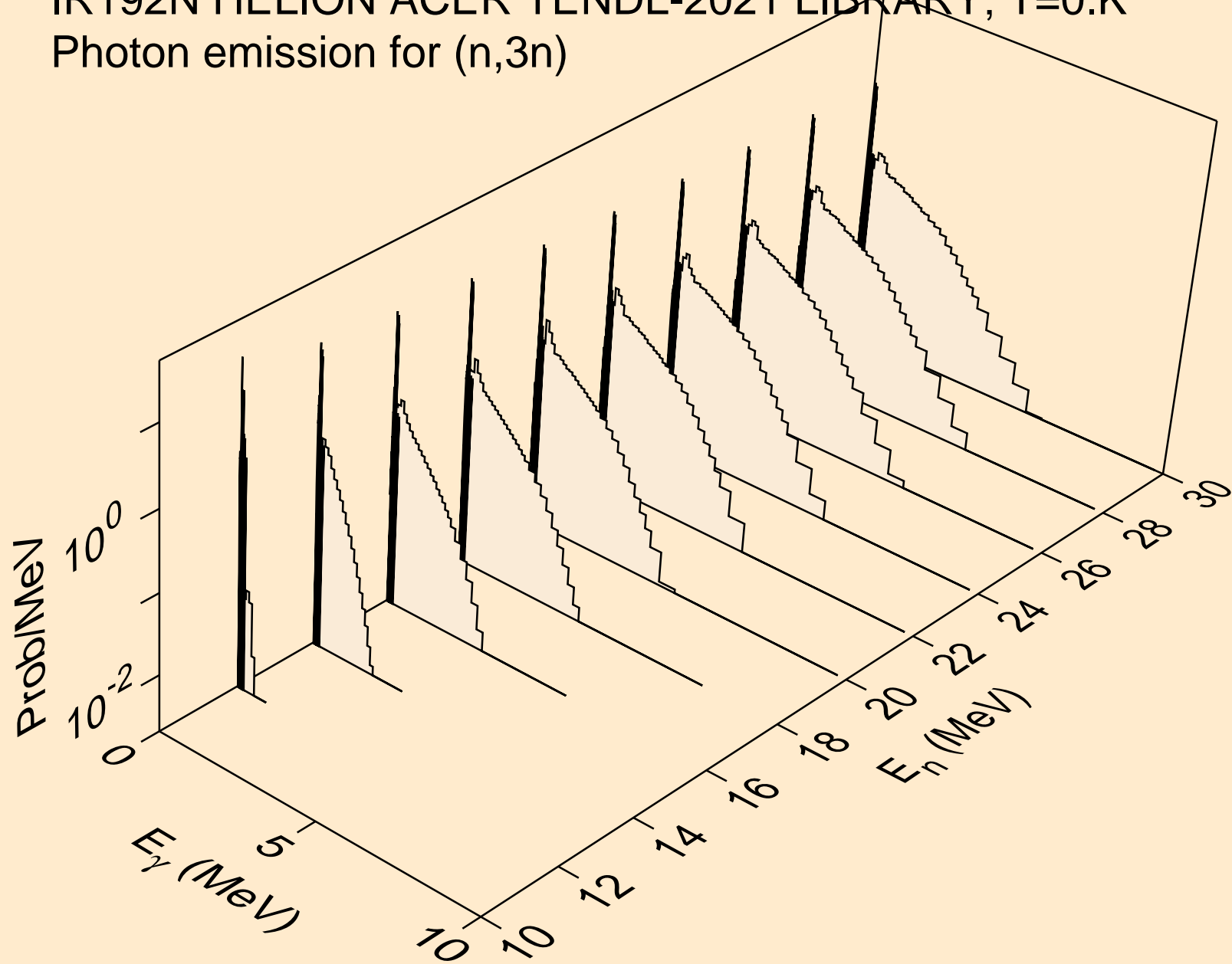

IR192N HELION ACER TENDL-2021 LIBRARY; T=0.K  
Photon emission for (n,n\*)a

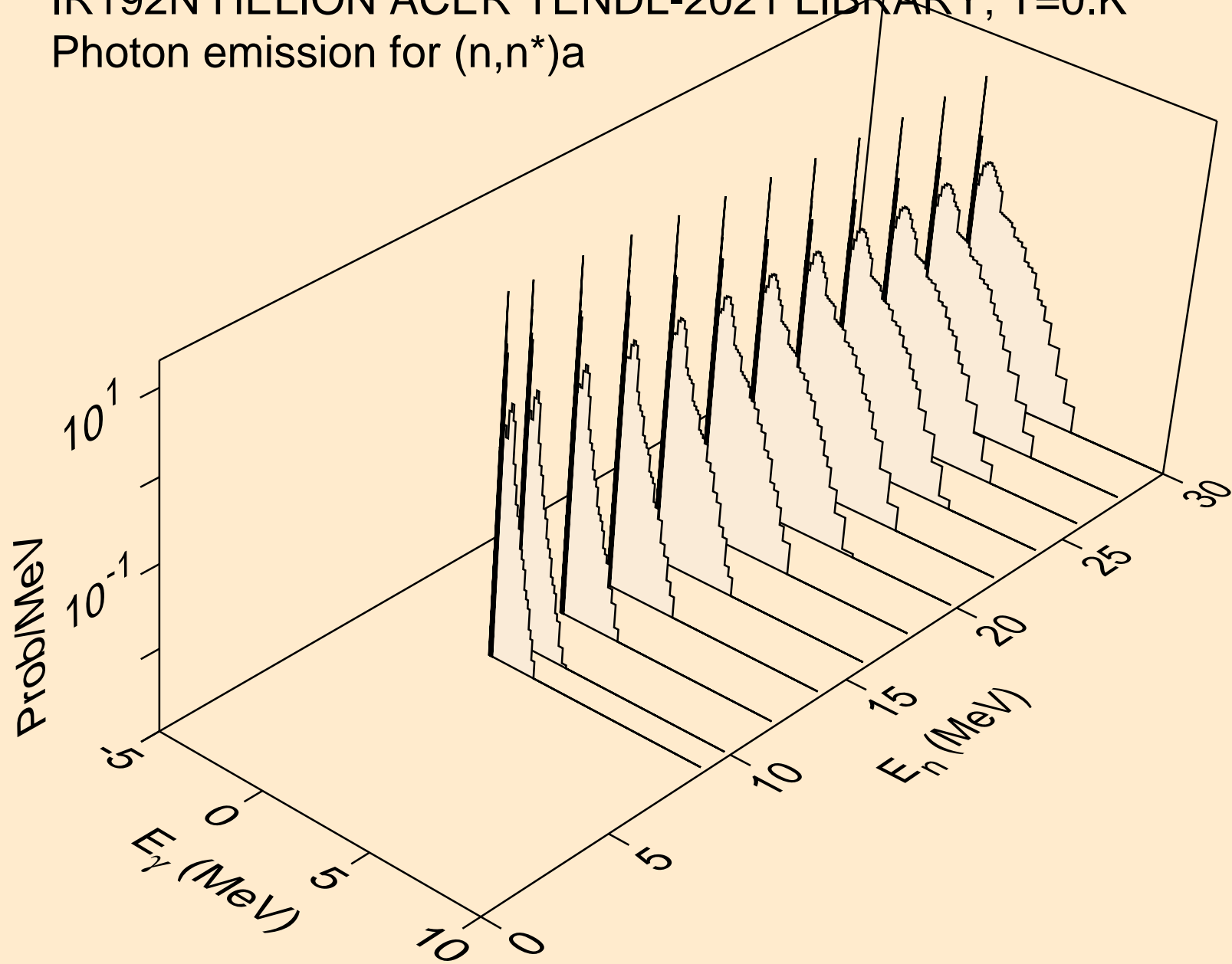

IR192N HELION ACER TENDL-2021 LIBRARY; T=0.K  
Photon emission for (n,2n)a

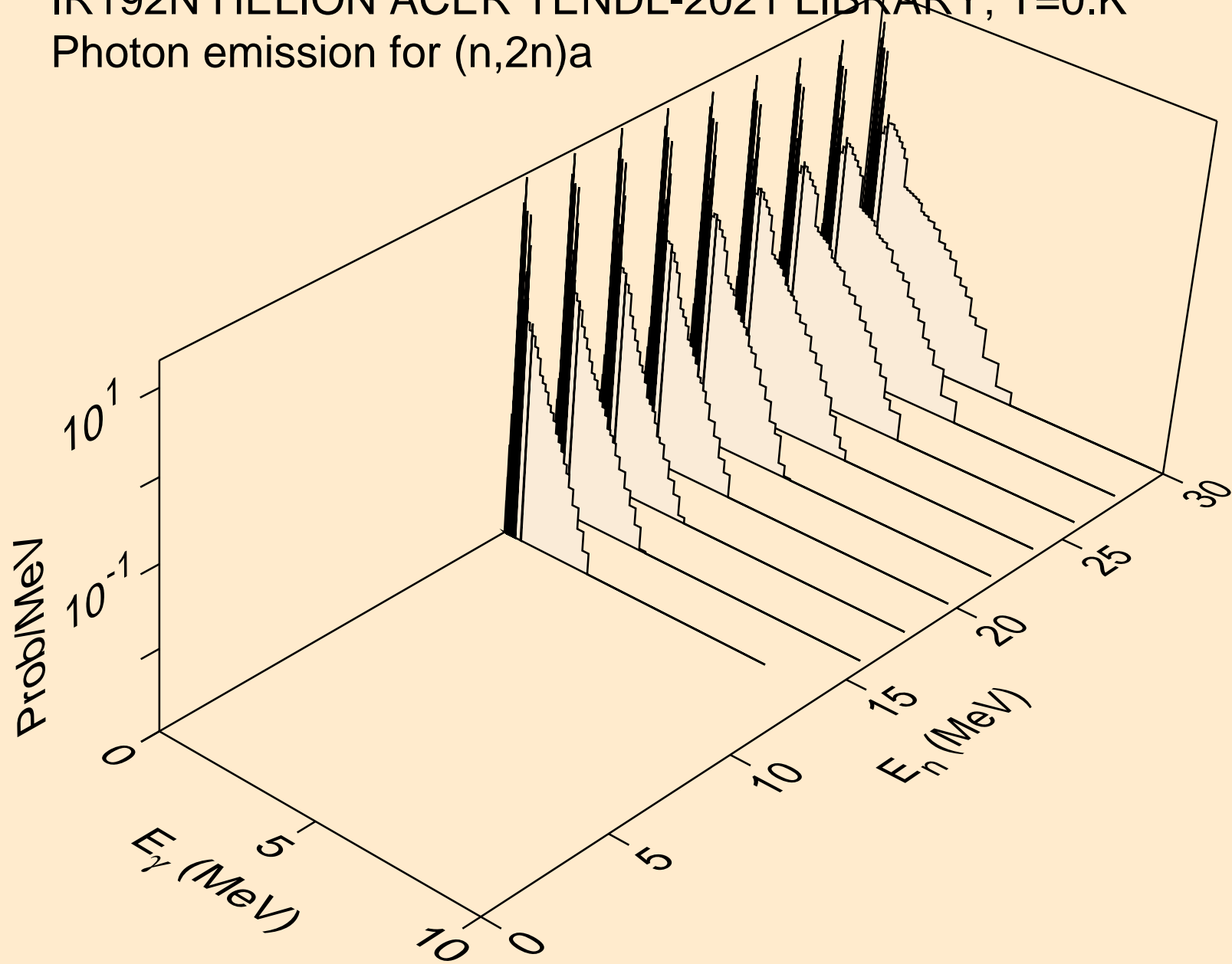



IR192N HELION ACER TENDL-2021 LIBRARY; T=0.K  
Photon emission for (n,3n)a

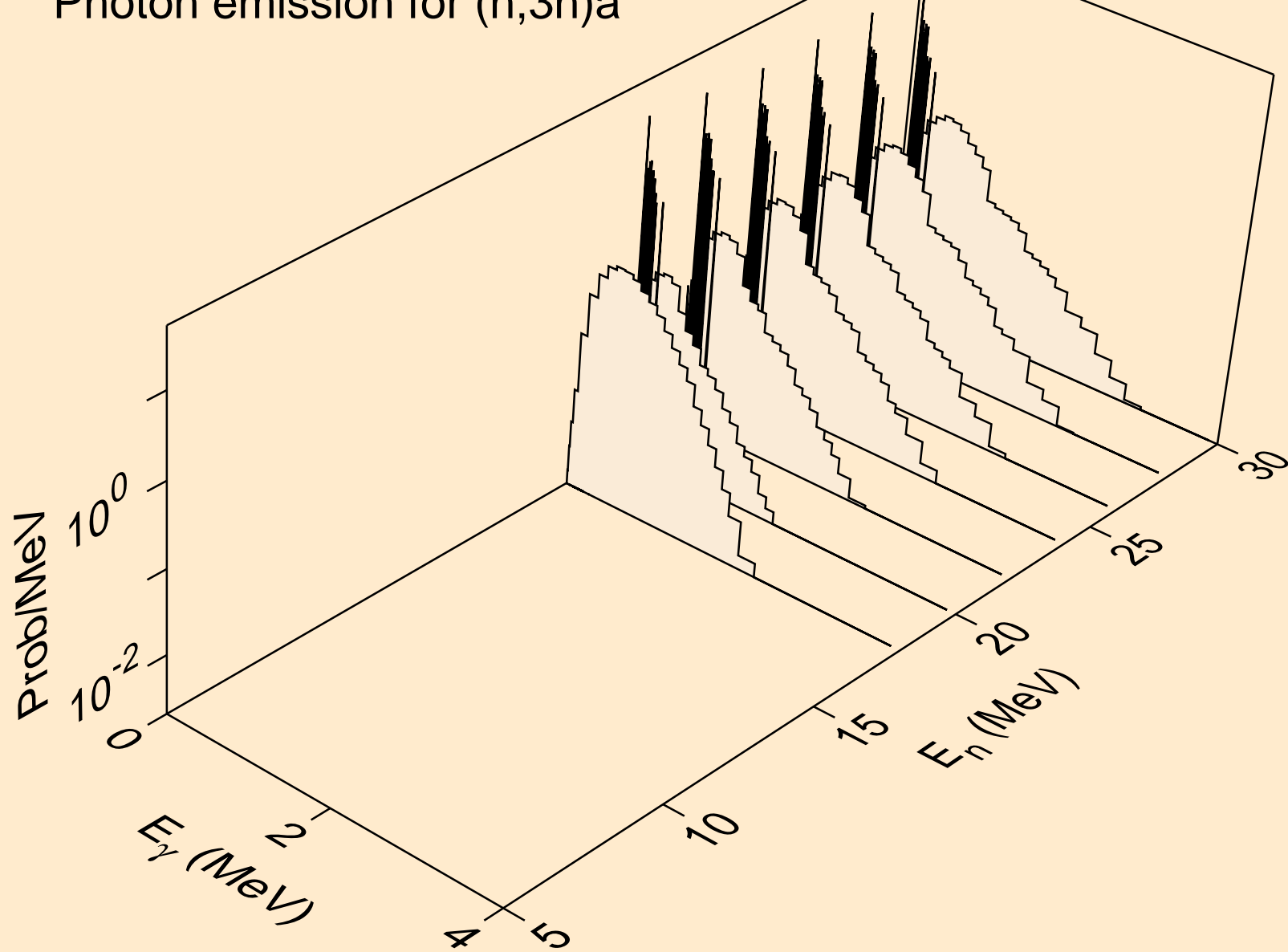

IR192N HELION ACER TENDL-2021 LIBRARY; T=0.K  
Photon emission for (n,n\*)p

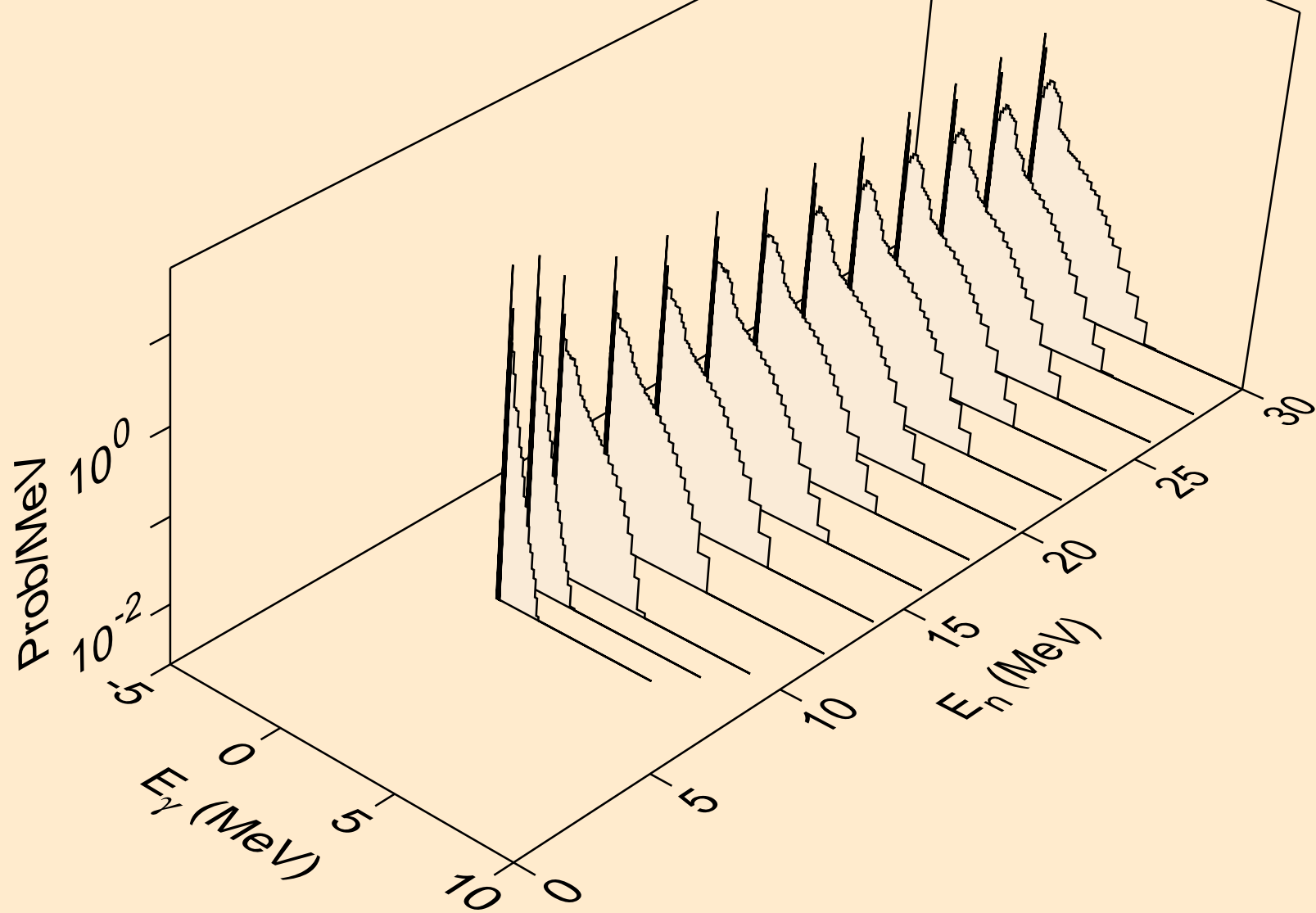

IR192N HELION ACER TENDL-2021 LIBRARY; T=0.K  
Photon emission for (n,n\*)d

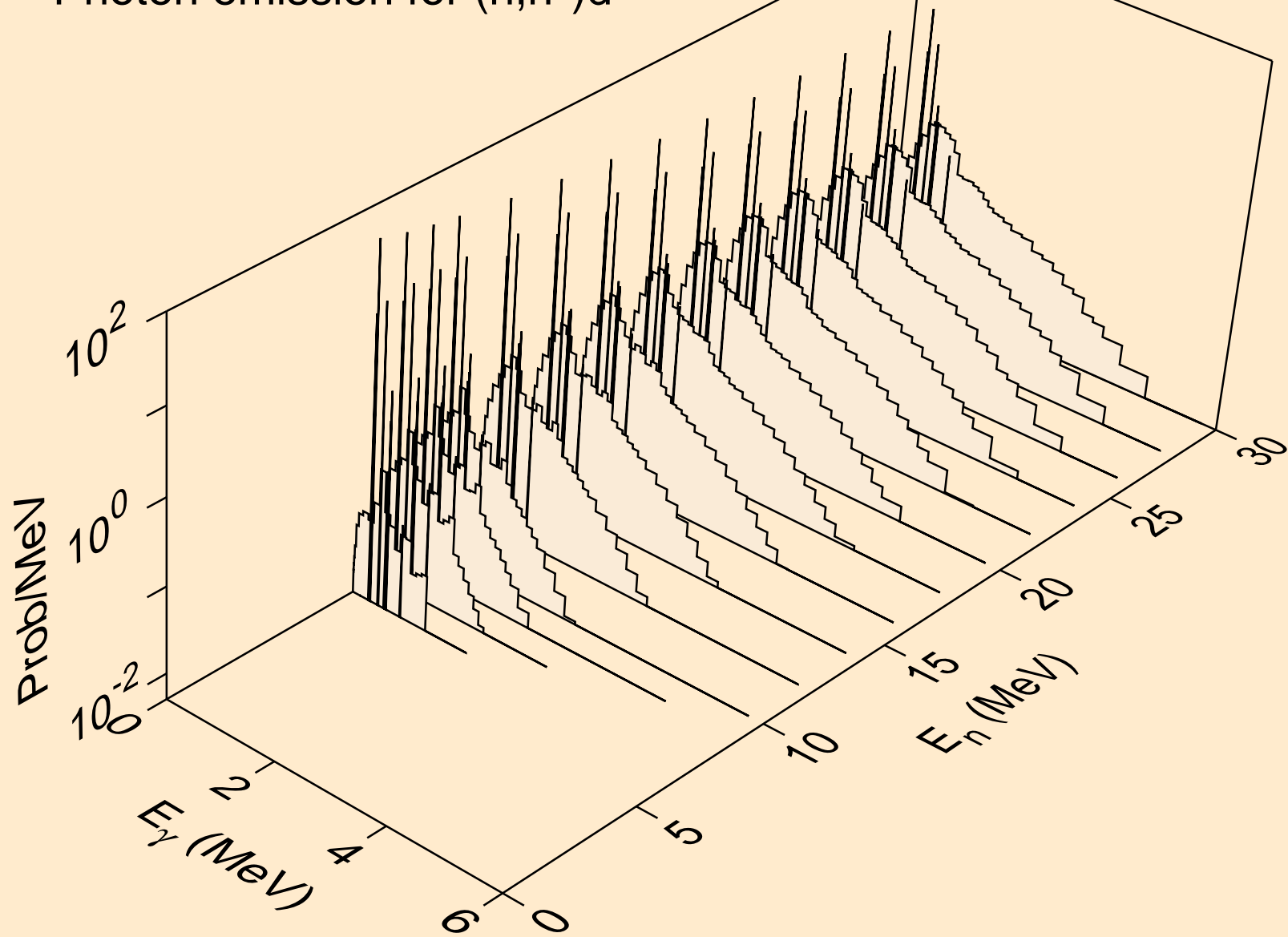

IR192N HELION ACER TENDL-2021 LIBRARY; T=0.K  
Photon emission for (n,n\*)t

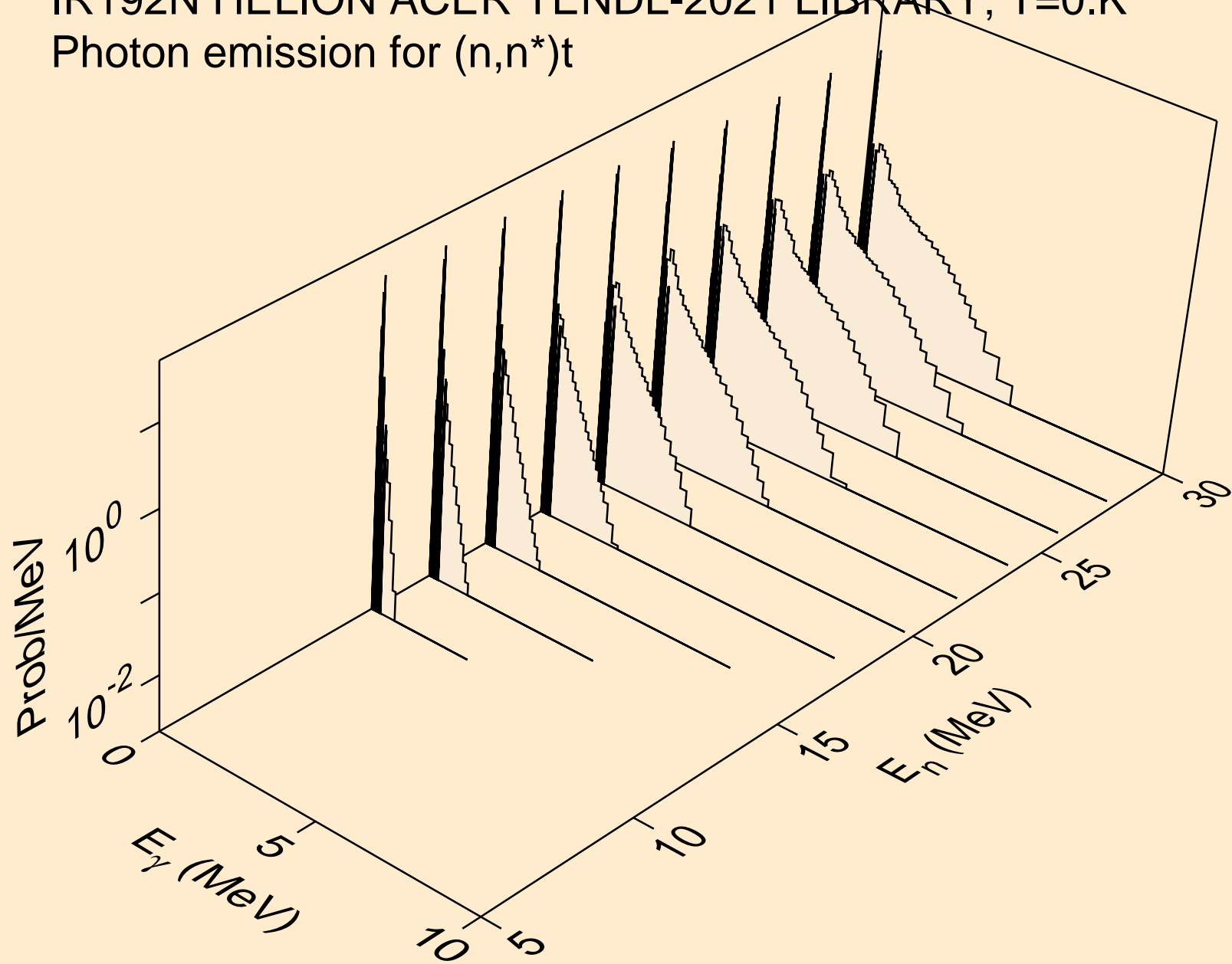

IR192N HELION ACER TENDL-2021 LIBRARY; T=0.K  
Photon emission for (n,n\*)he3

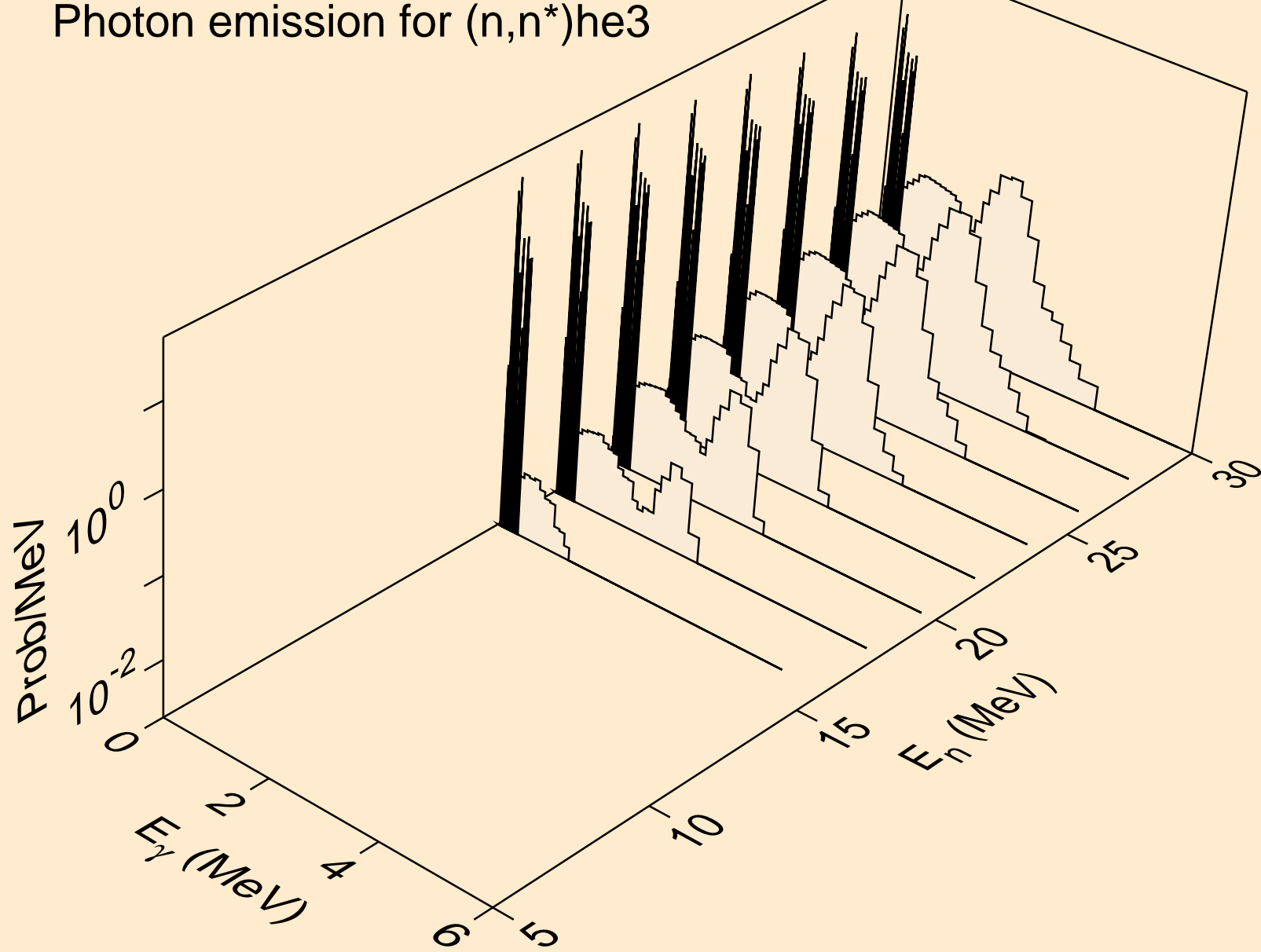

IR192N HELION ACER TENDL-2021 LIBRARY; T=0.K  
Photon emission for (n,4n)

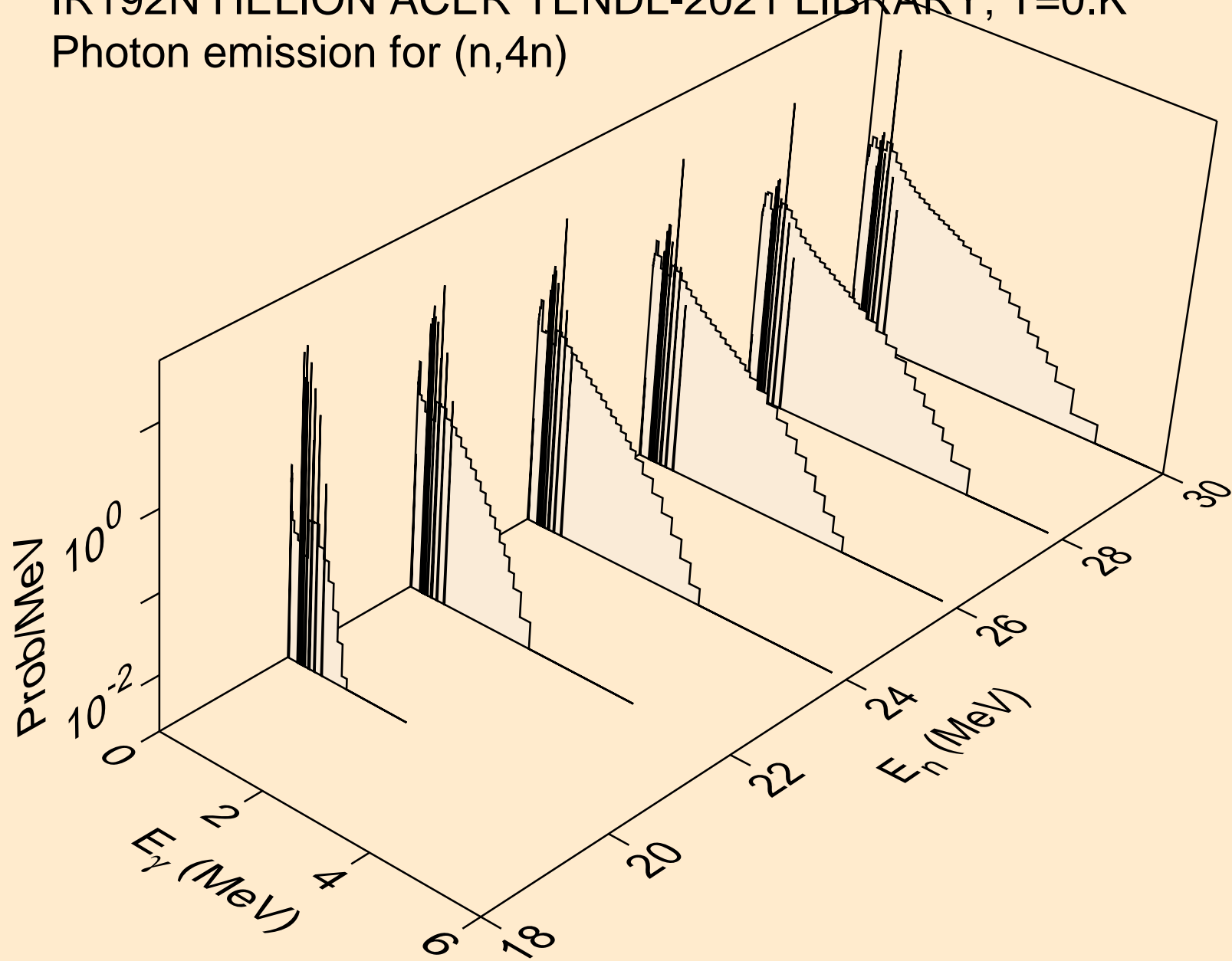

IR192N HELION ACER TENDL-2021 LIBRARY; T=0.K  
Photon emission for (n,2np)

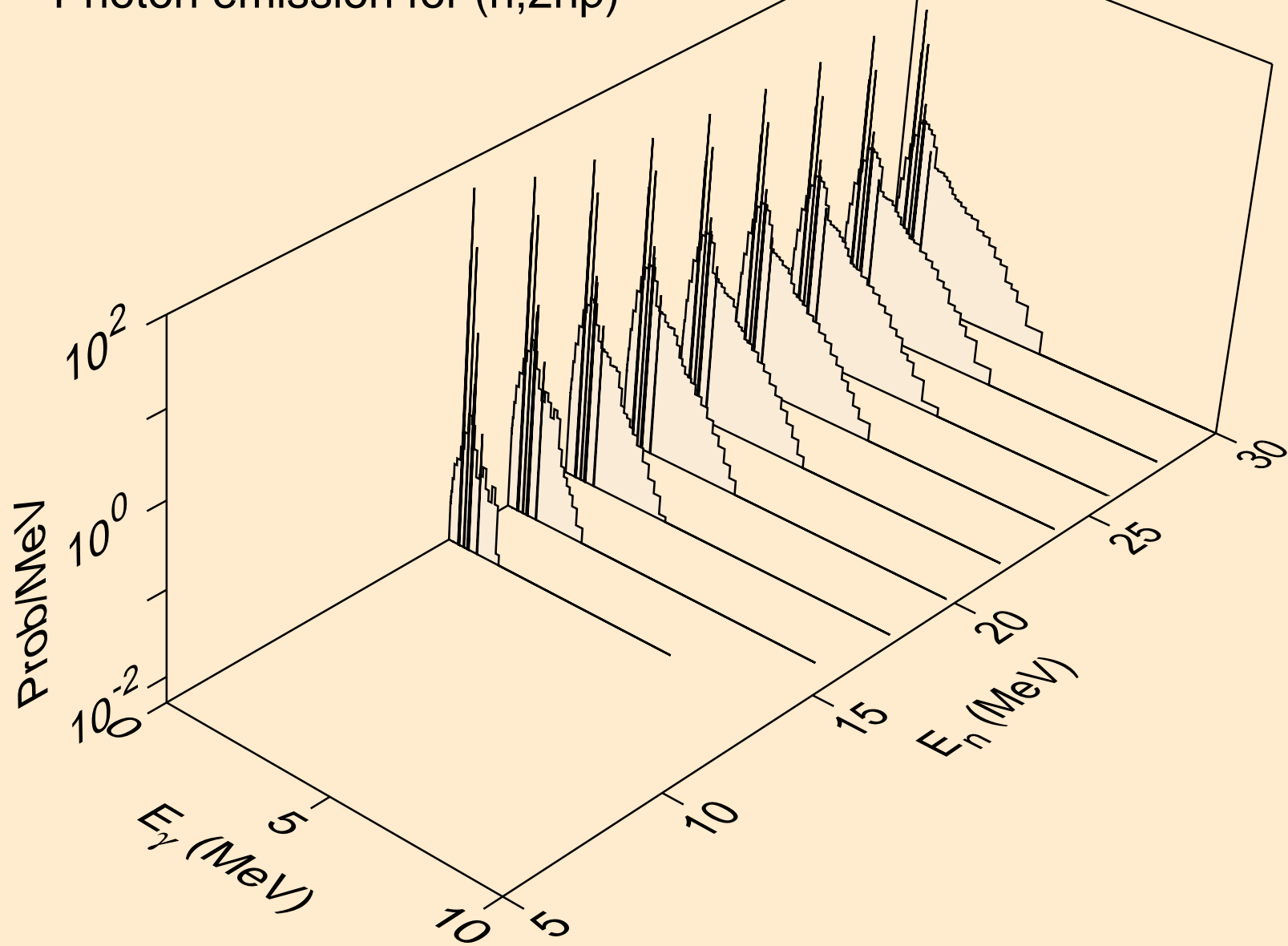

IR192N HELION ACER TENDL-2021 LIBRARY; T=0.K  
Photon emission for (n,3np)

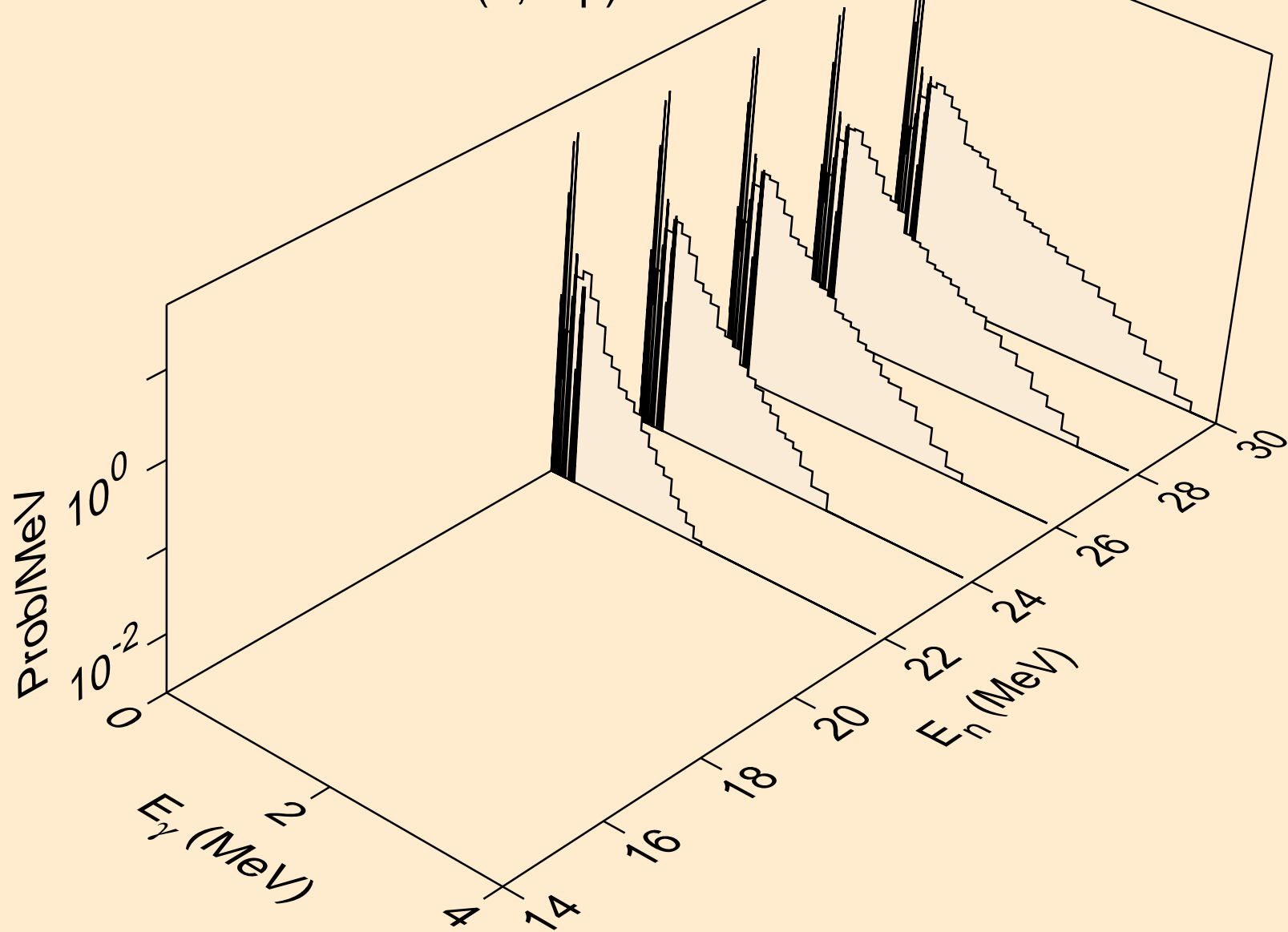



IR192N HELION ACER TENDL-2021 LIBRARY; T=0.K  
Photon emission for (n,2np)

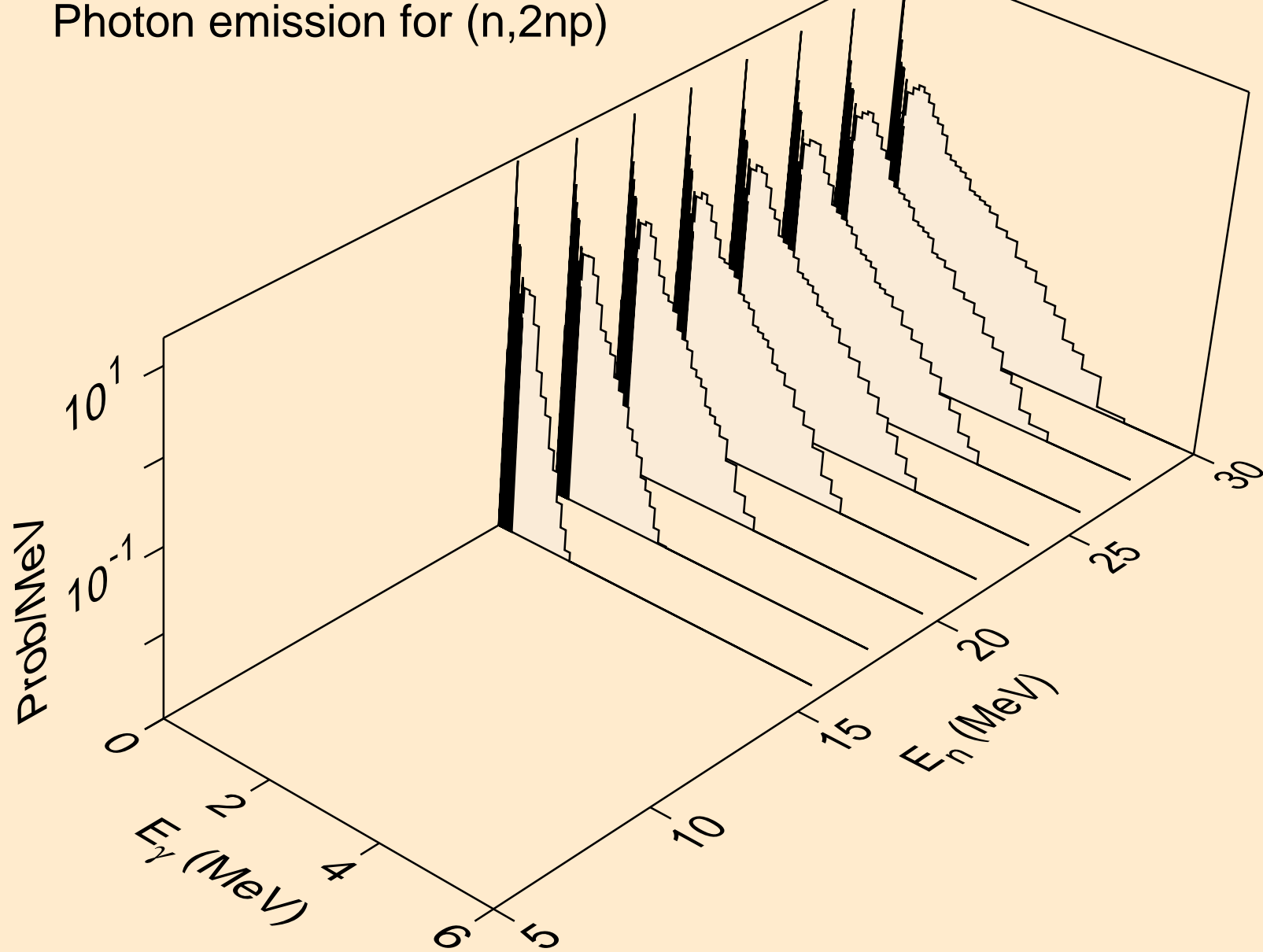

IR192N HELION ACER TENDL-2021 LIBRARY; T=0.K  
Photon emission for (n,npa)

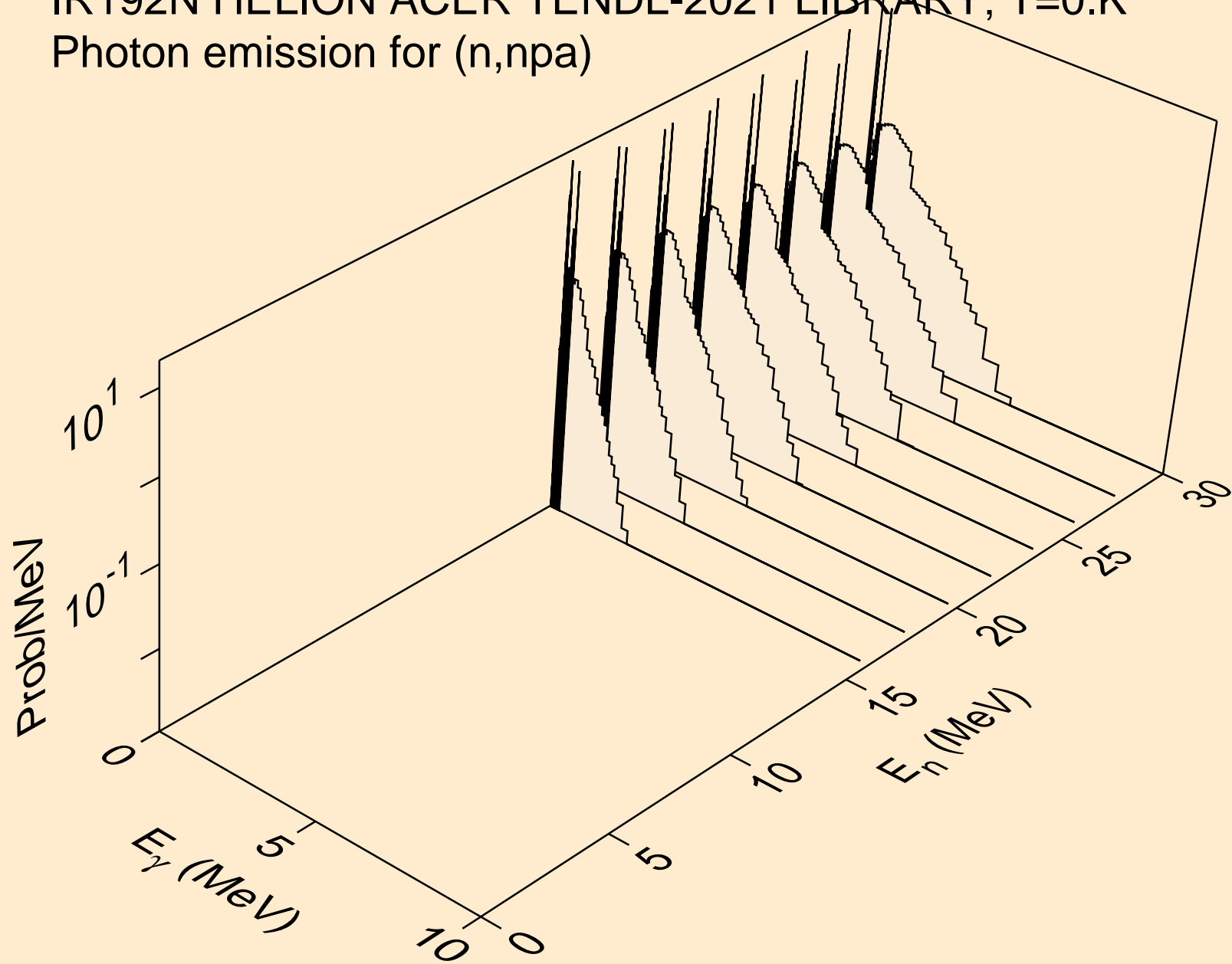

IR192N HELION ACER TENDL-2021 LIBRARY; T=0.K  
Photon emission for (n,gma)

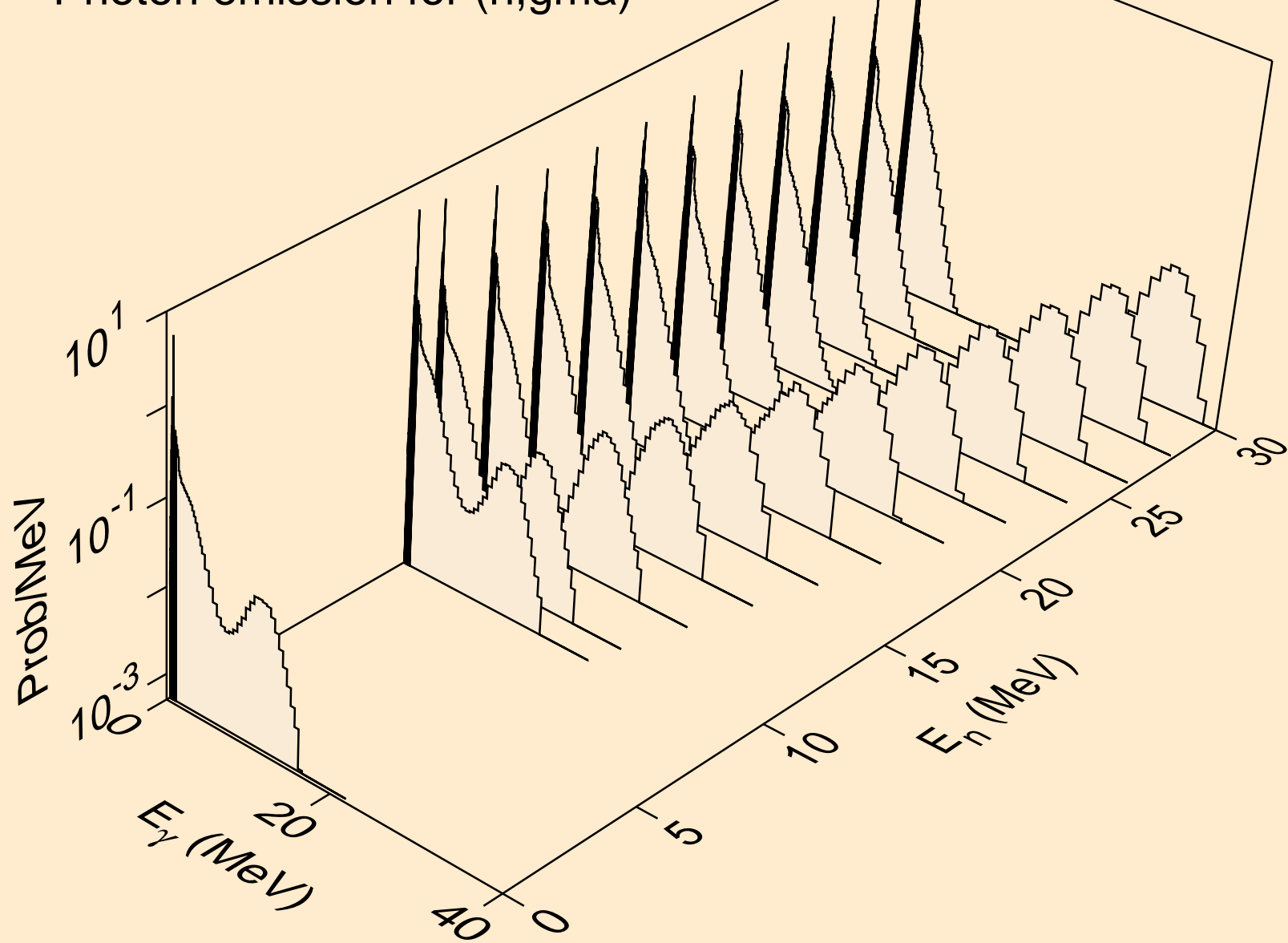

IR192N HELION ACER TENDL-2021 LIBRARY; T=0.K  
Photon emission for (n,p)

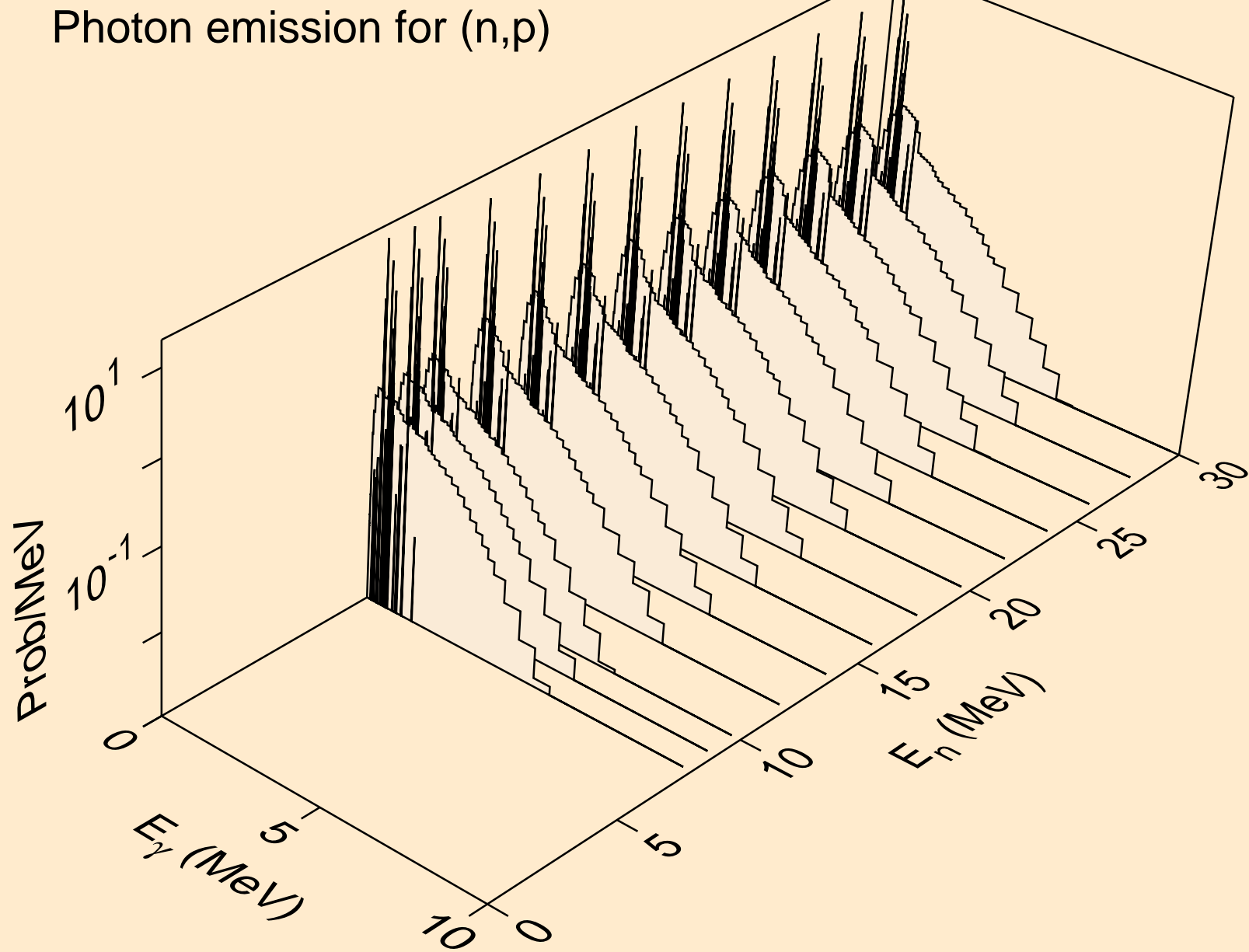

IR192N HELION ACER TENDL-2021 LIBRARY; T=0.K  
Photon emission for (n,d)

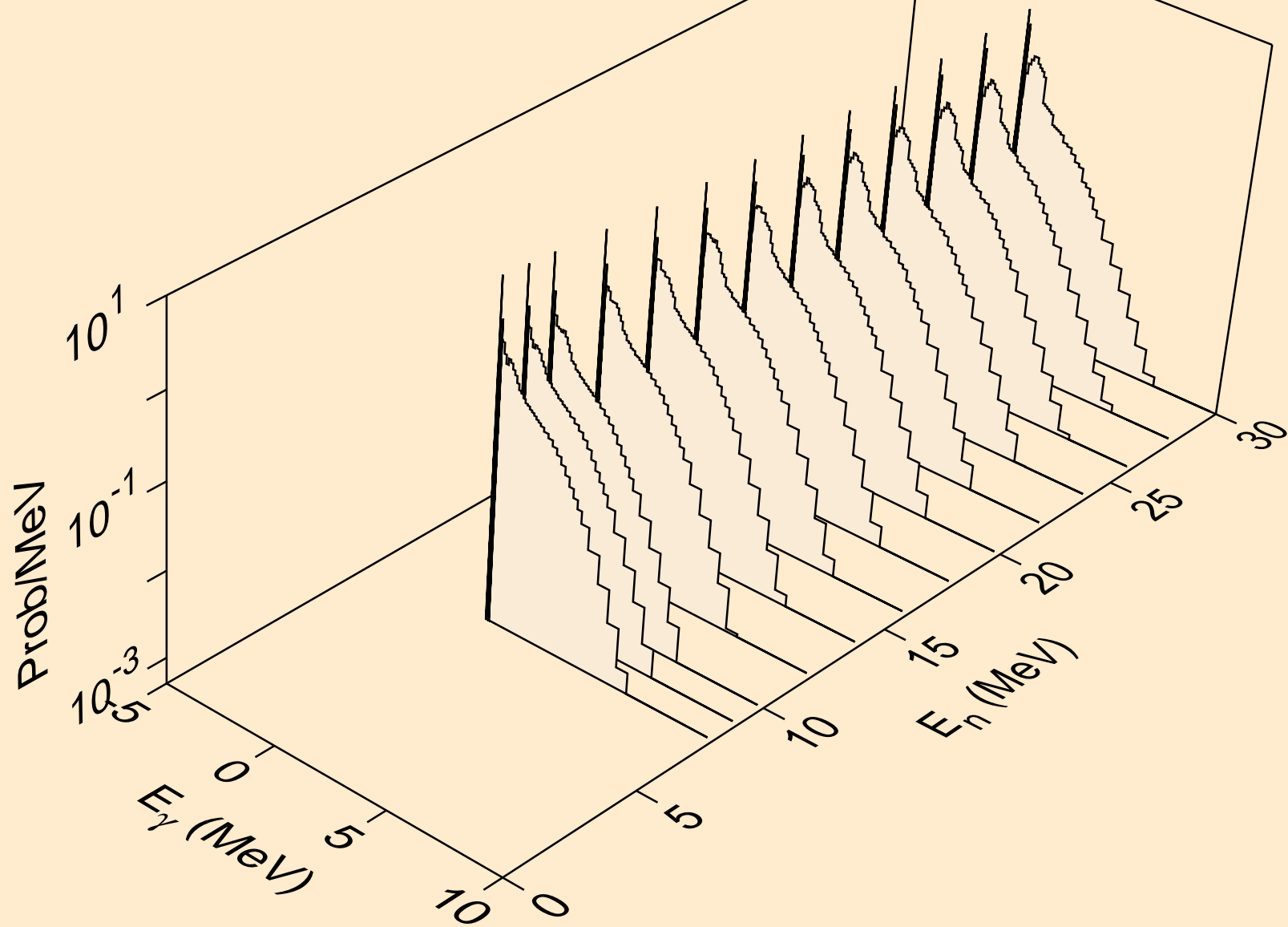

IR192N HELION ACER TENDL-2021 LIBRARY; T=0.K  
Photon emission for (n,t)

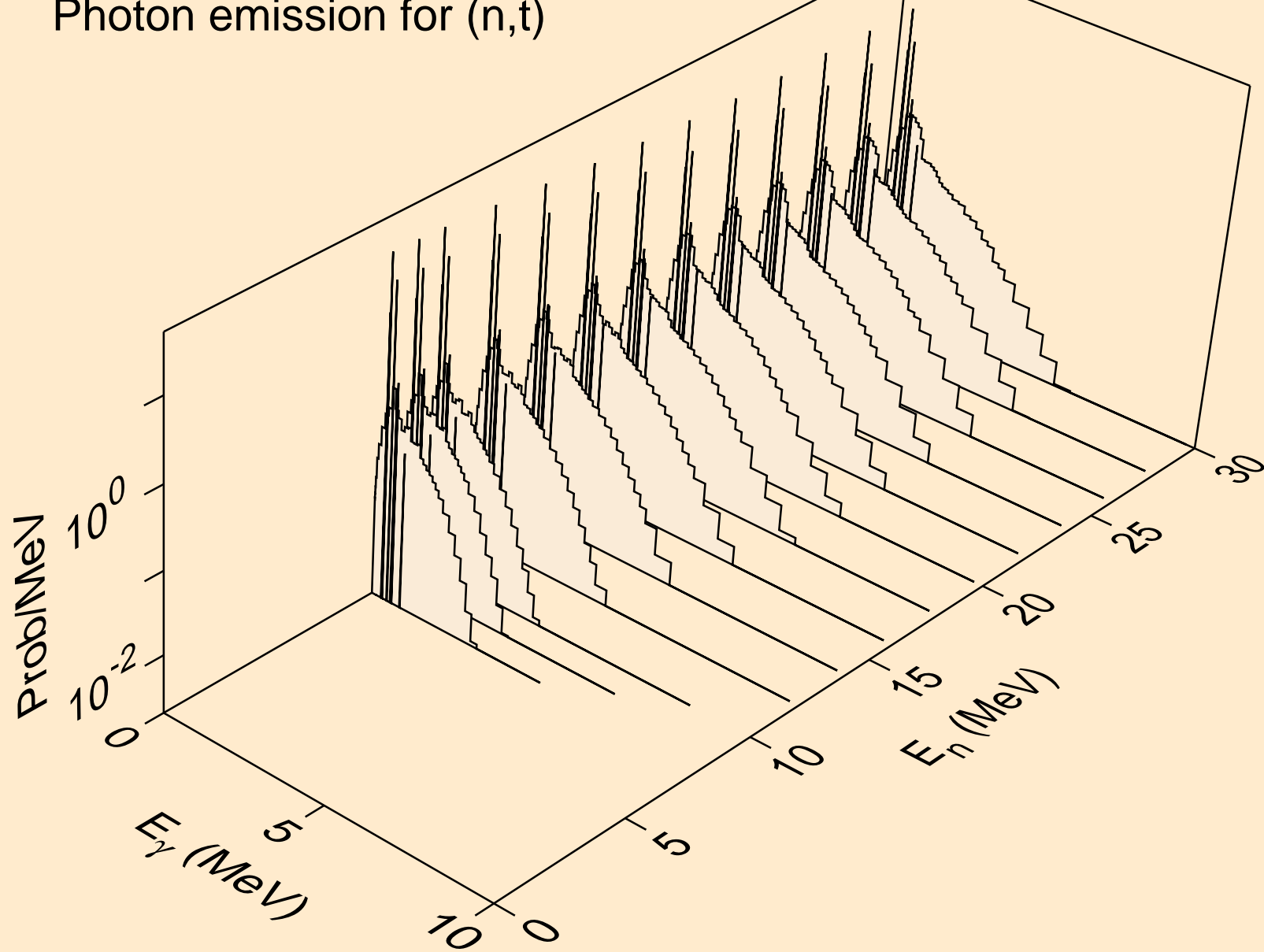

IR192N HELION ACER TENDL-2021 LIBRARY; T=0.K  
Photon emission for inelastic

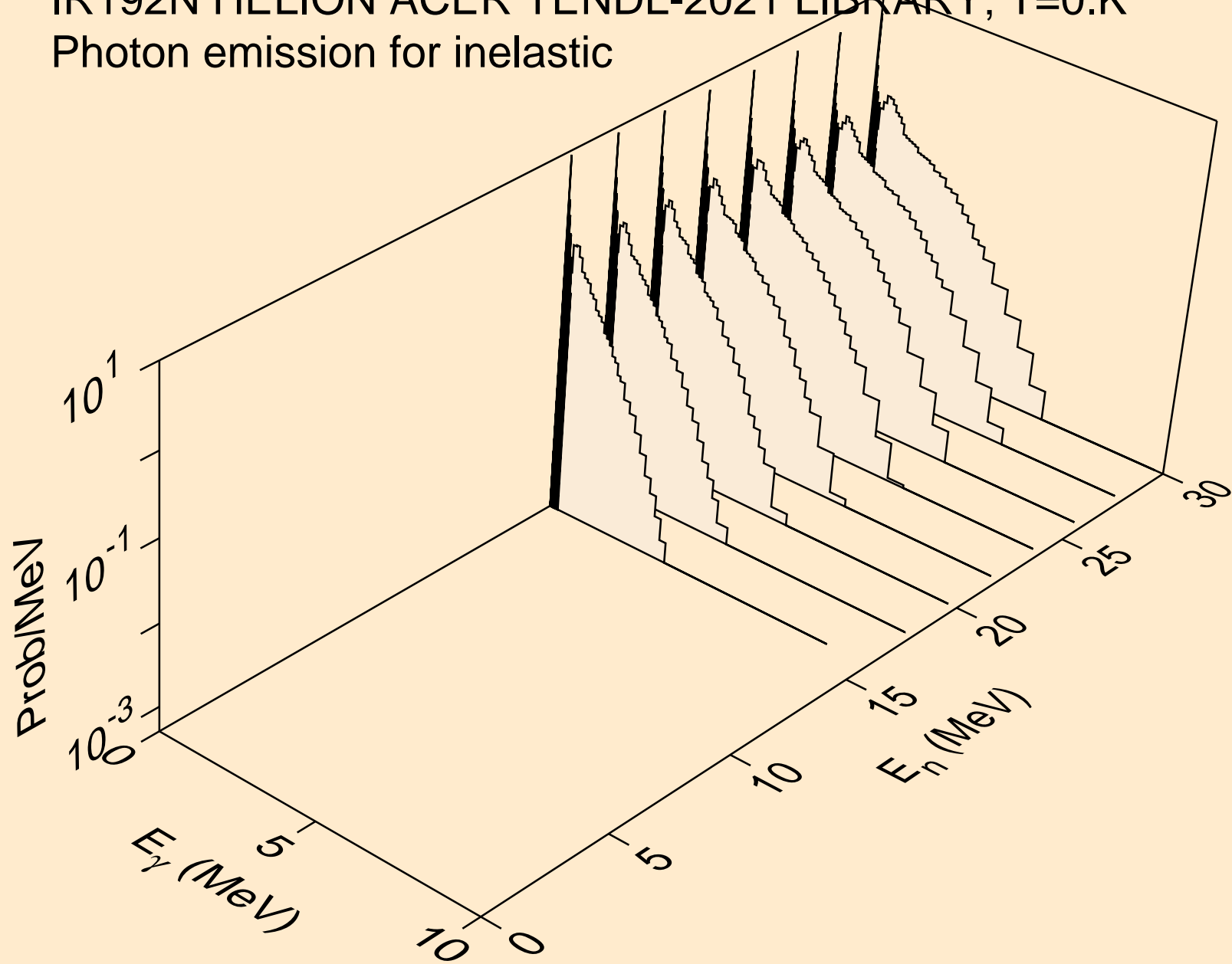

IR192N HELION ACER TENDL-2021 LIBRARY; T=0.K  
Photon emission for (n,a)

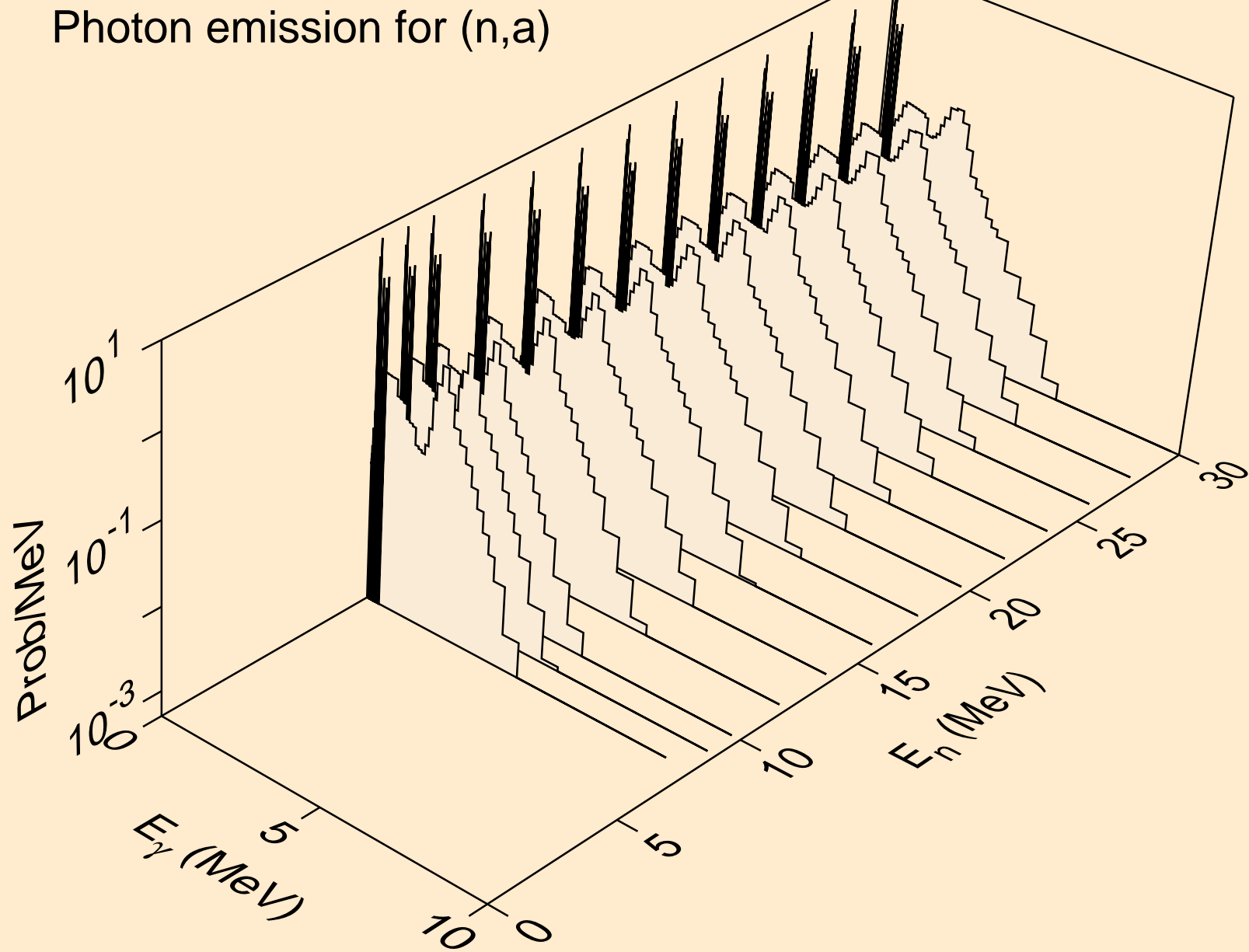



IR192N HELION ACER TENDL-2021 LIBRARY; T=0.K  
Photon emission for (n,2a)

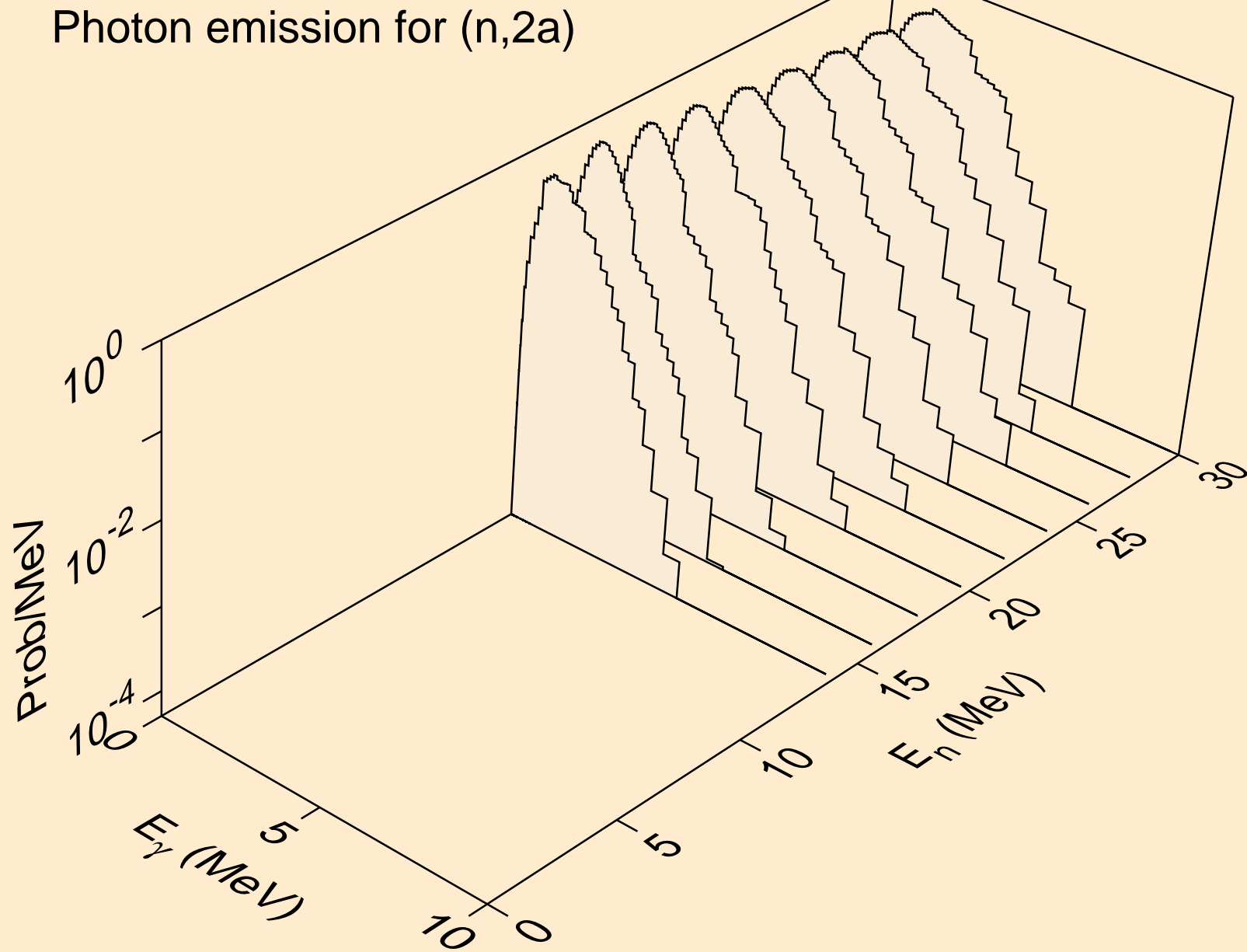

IR192N HELION ACER TENDL-2021 LIBRARY; T=0.K  
Photon emission for (n,2p)

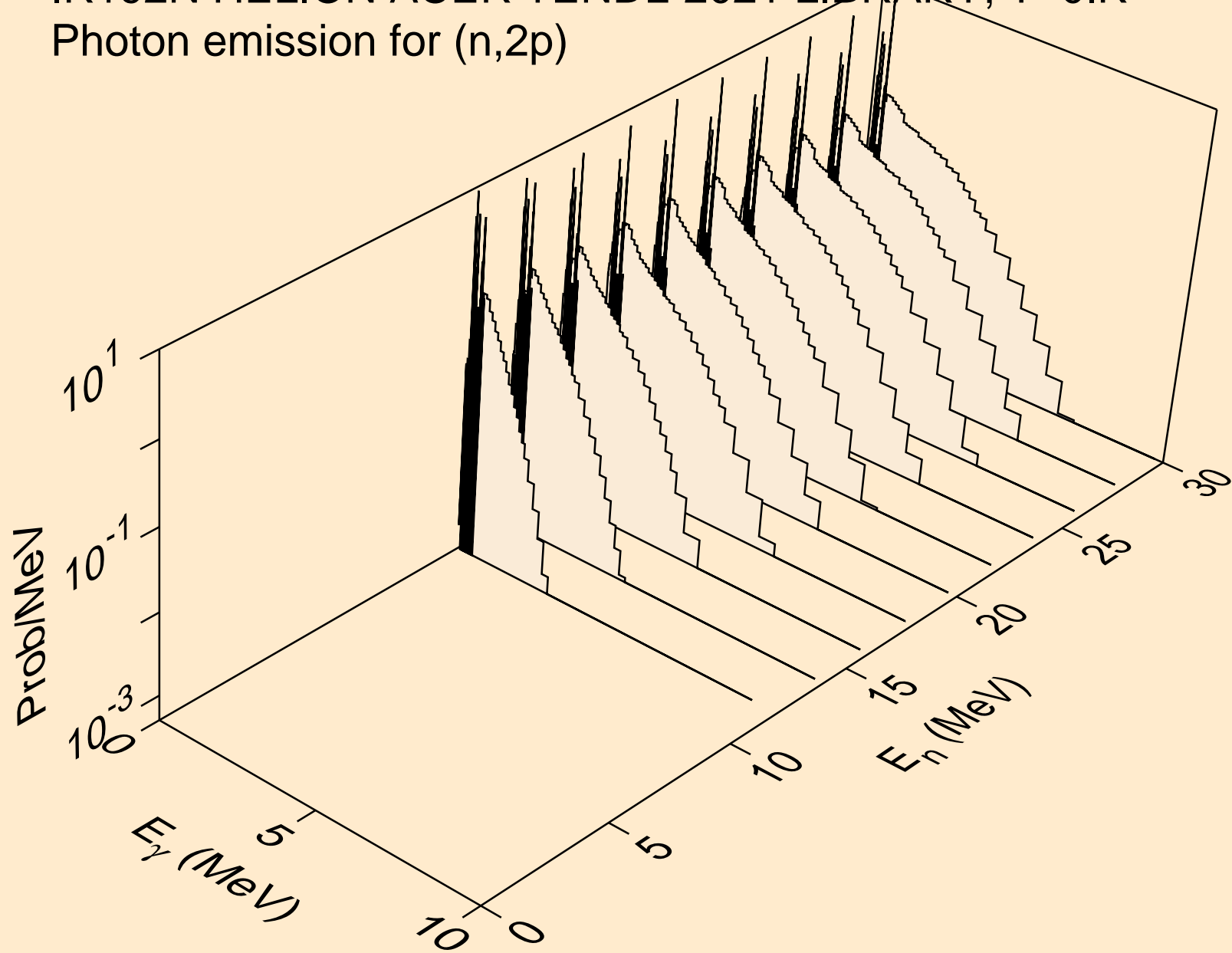

IR192N HELION ACER TENDL-2021 LIBRARY; T=0.K  
Photon emission for (n,pa)

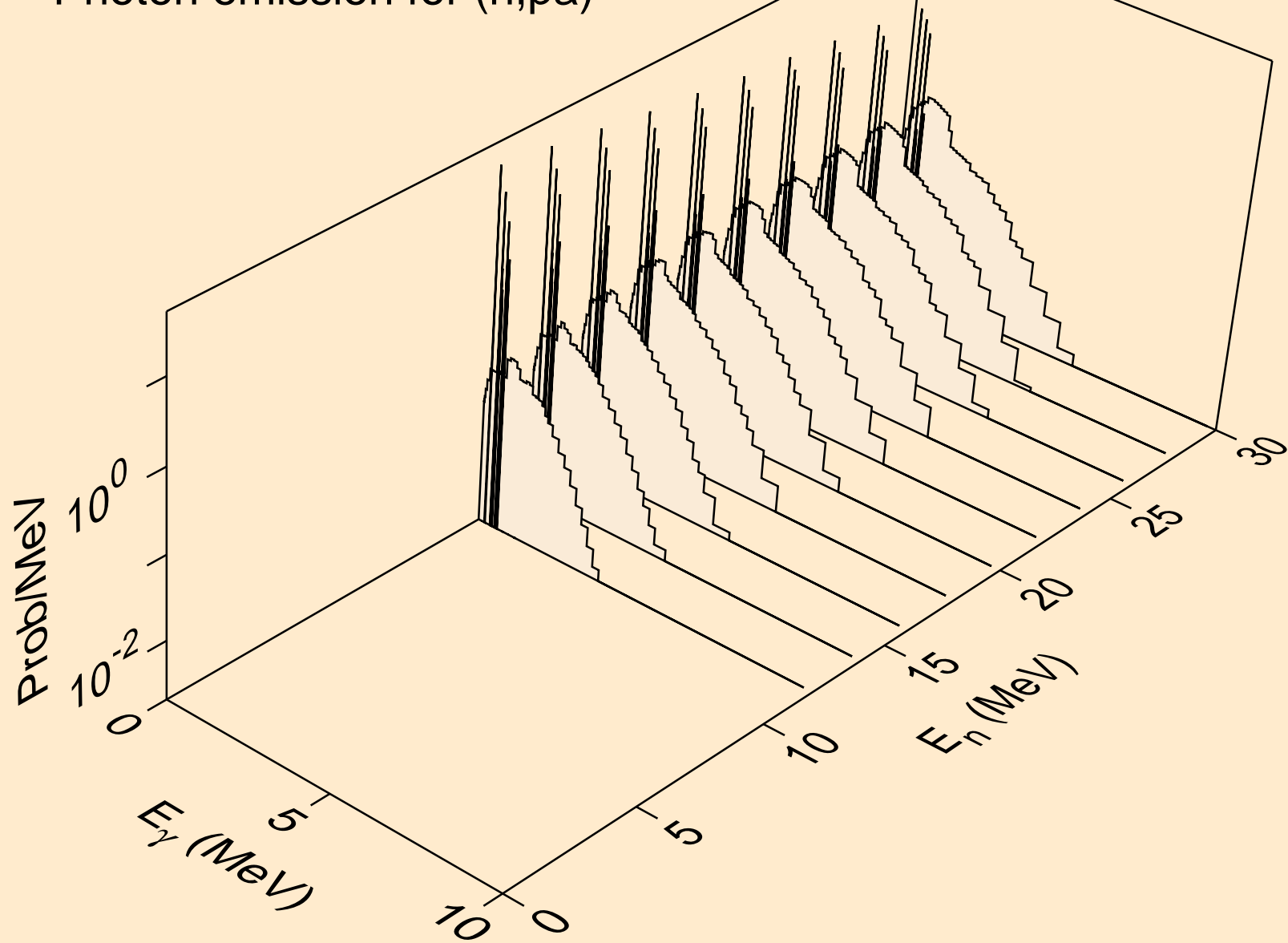

IR192N HELION ACER TENDL-2021 LIBRARY; T=0.K  
Photon emission for (n,pd)

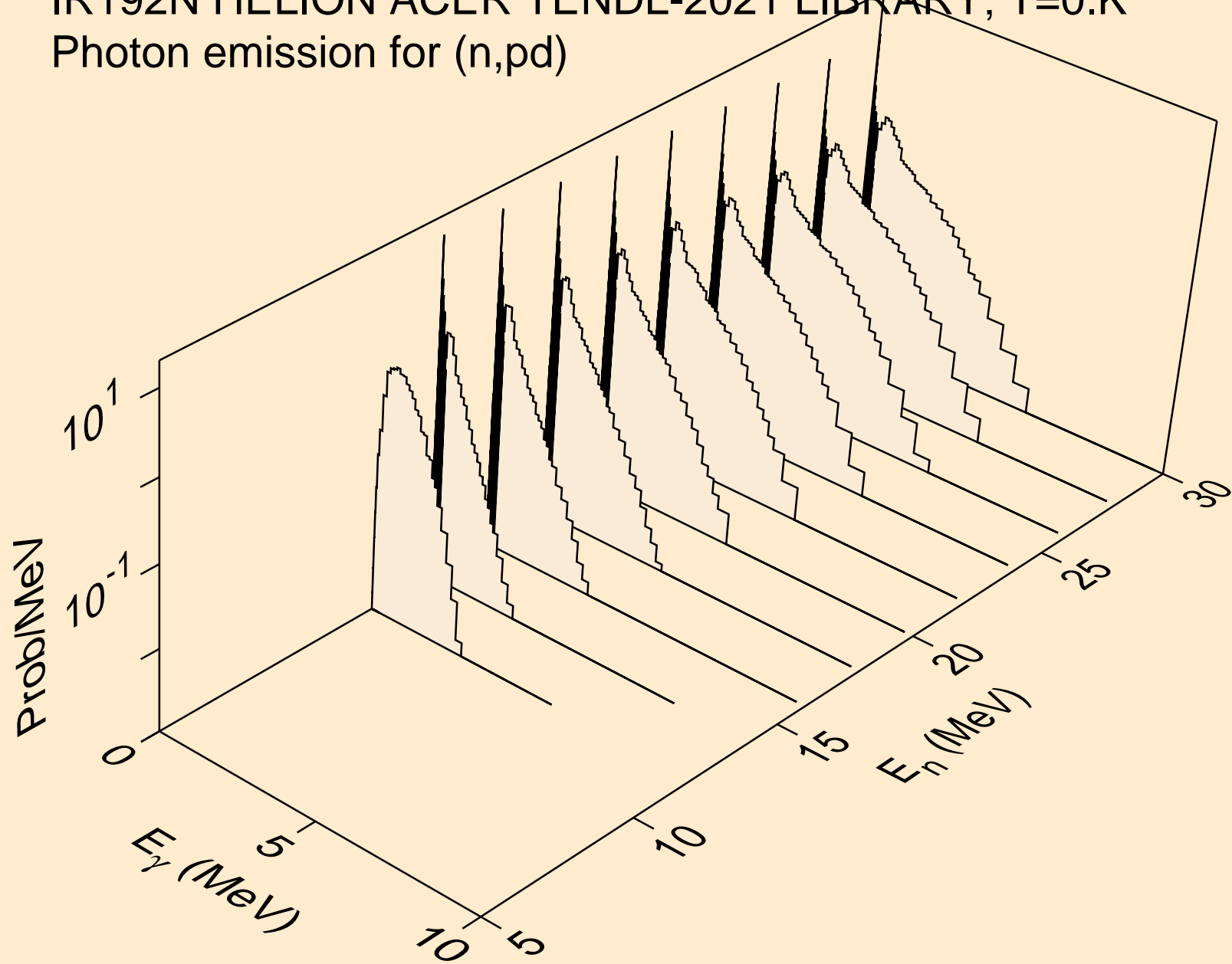

IR192N HELION ACER TENDL-2021 LIBRARY; T=0.K  
Photon emission for (n,pt)

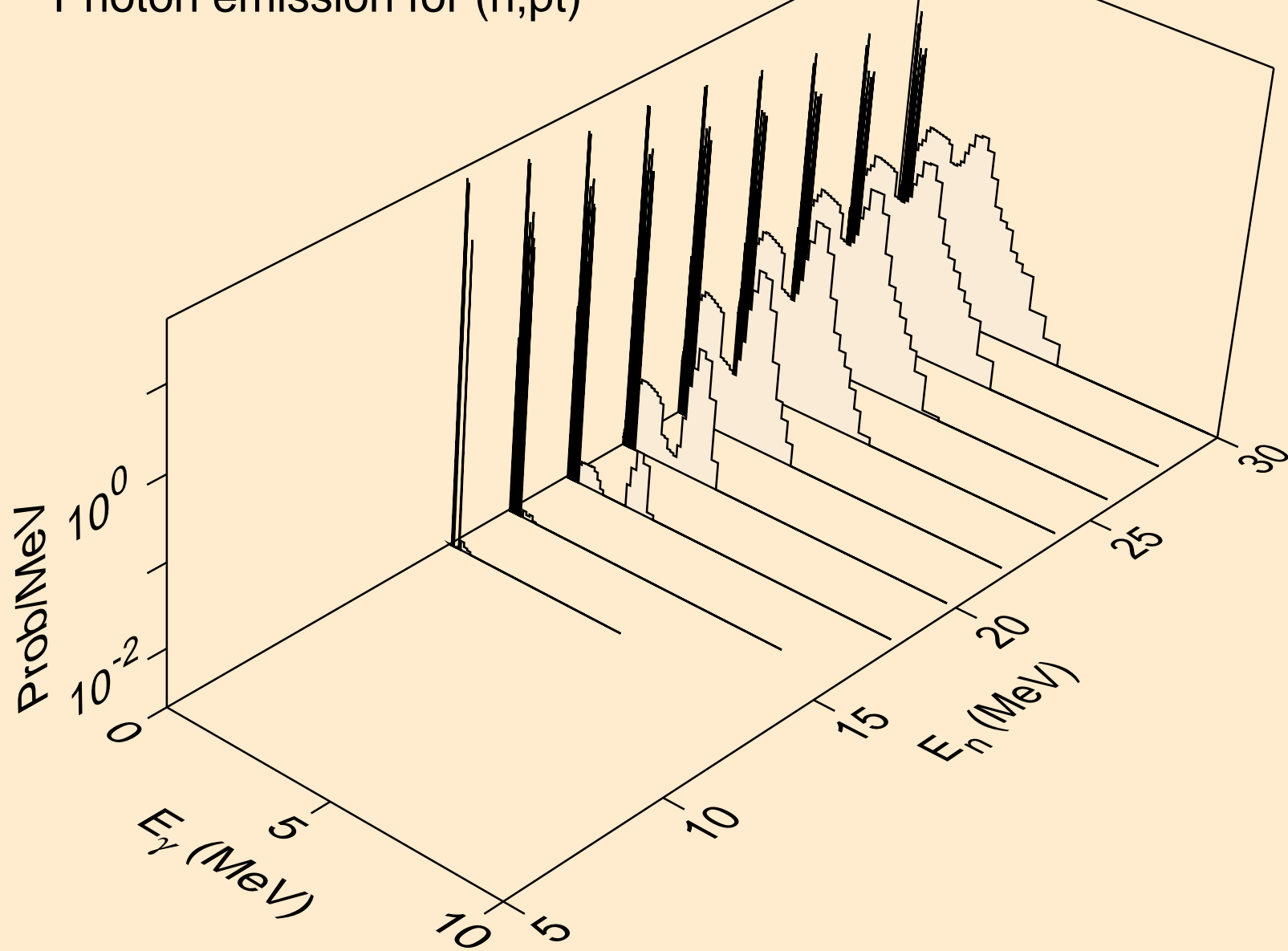

IR192N HELION ACER TENDL-2021 LIBRARY; T=0.K  
Photon emission for (n,da)

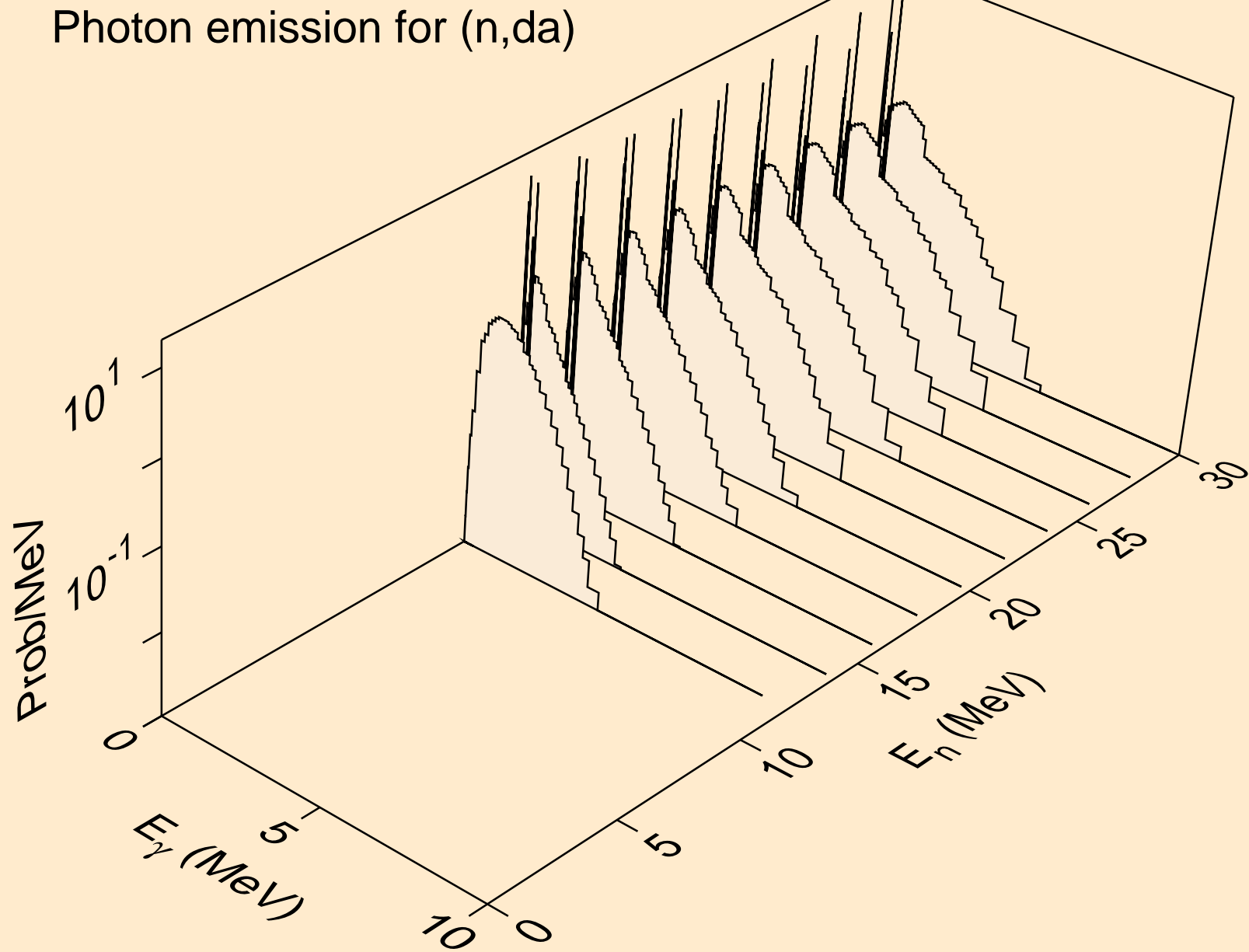

IR192N HELION ACER TENDL-2021 LIBRARY; T=0.K  
Particle heating contributions

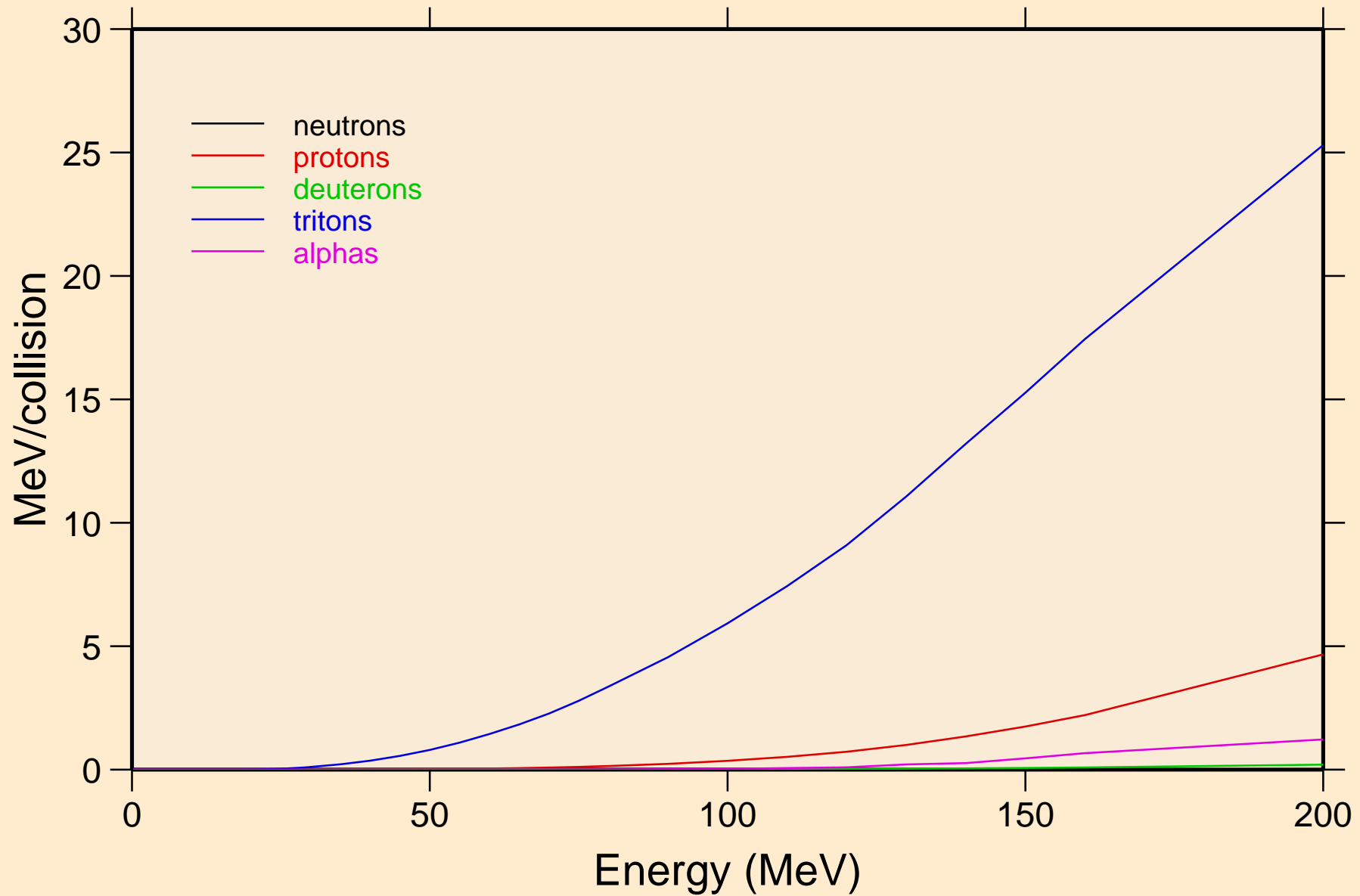

IR192N HELION ACER TENDL-2021 LIBRARY; T=0.K  
Recoil Heating

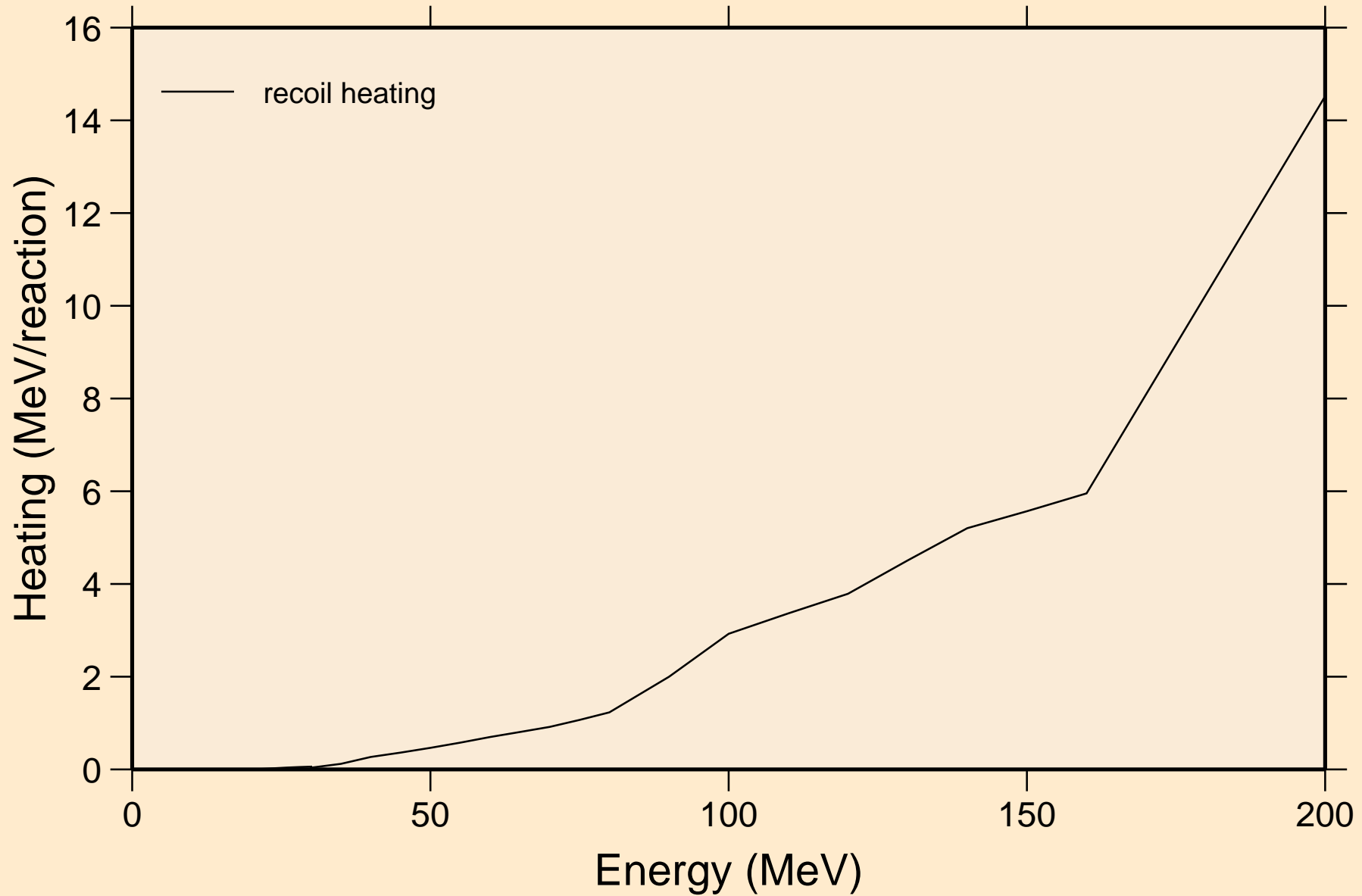



IR192N HELION ACER TENDL-2021 LIBRARY; T=0.K  
Particle production cross sections

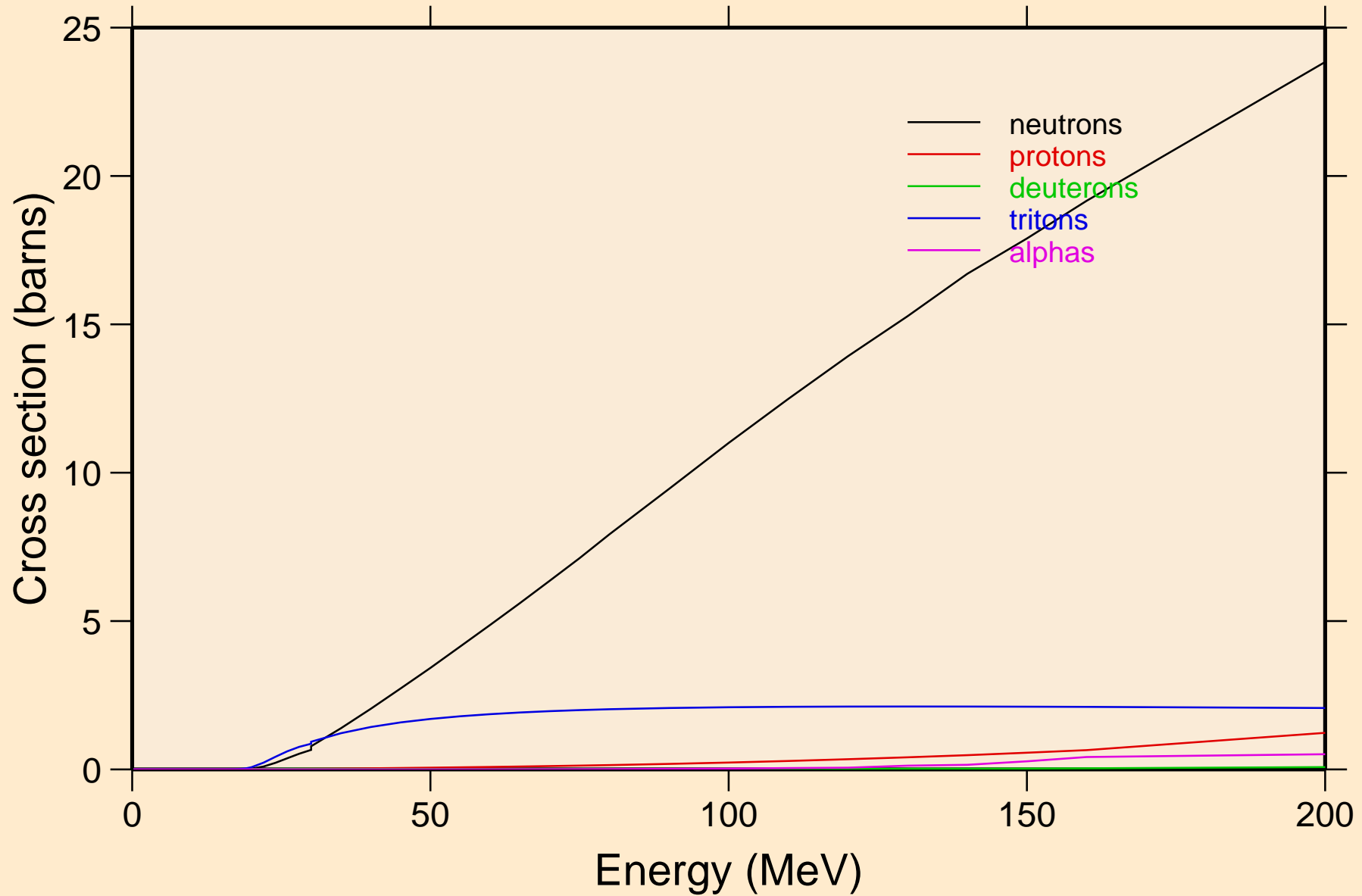

IR192N HELION ACER TENDL-2021 LIBRARY; T=0.K  
neutrons from (s,n)

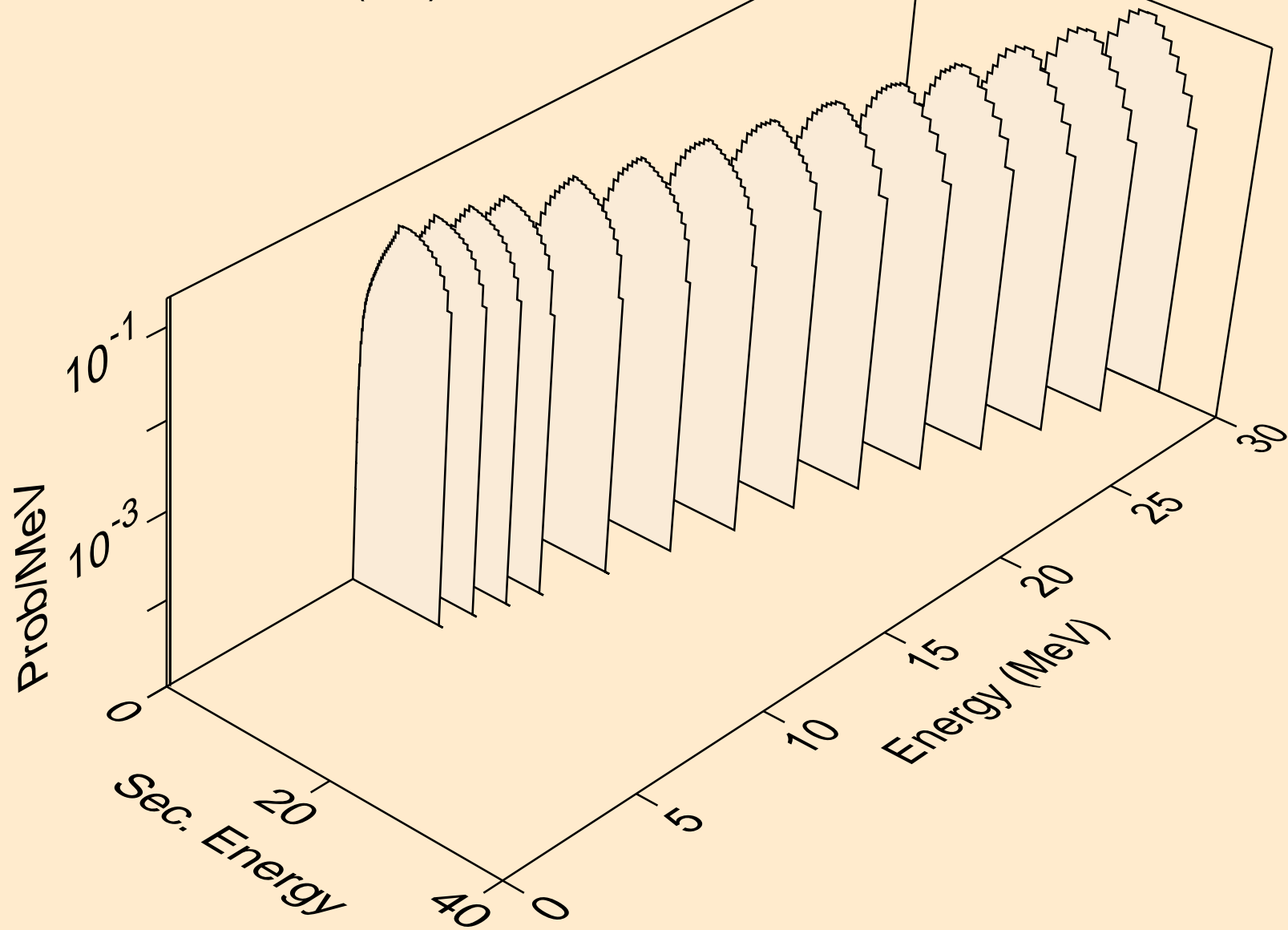

IR192N HELION ACER TENDL-2021 LIBRARY; T=0.K  
neutrons from (s,x)

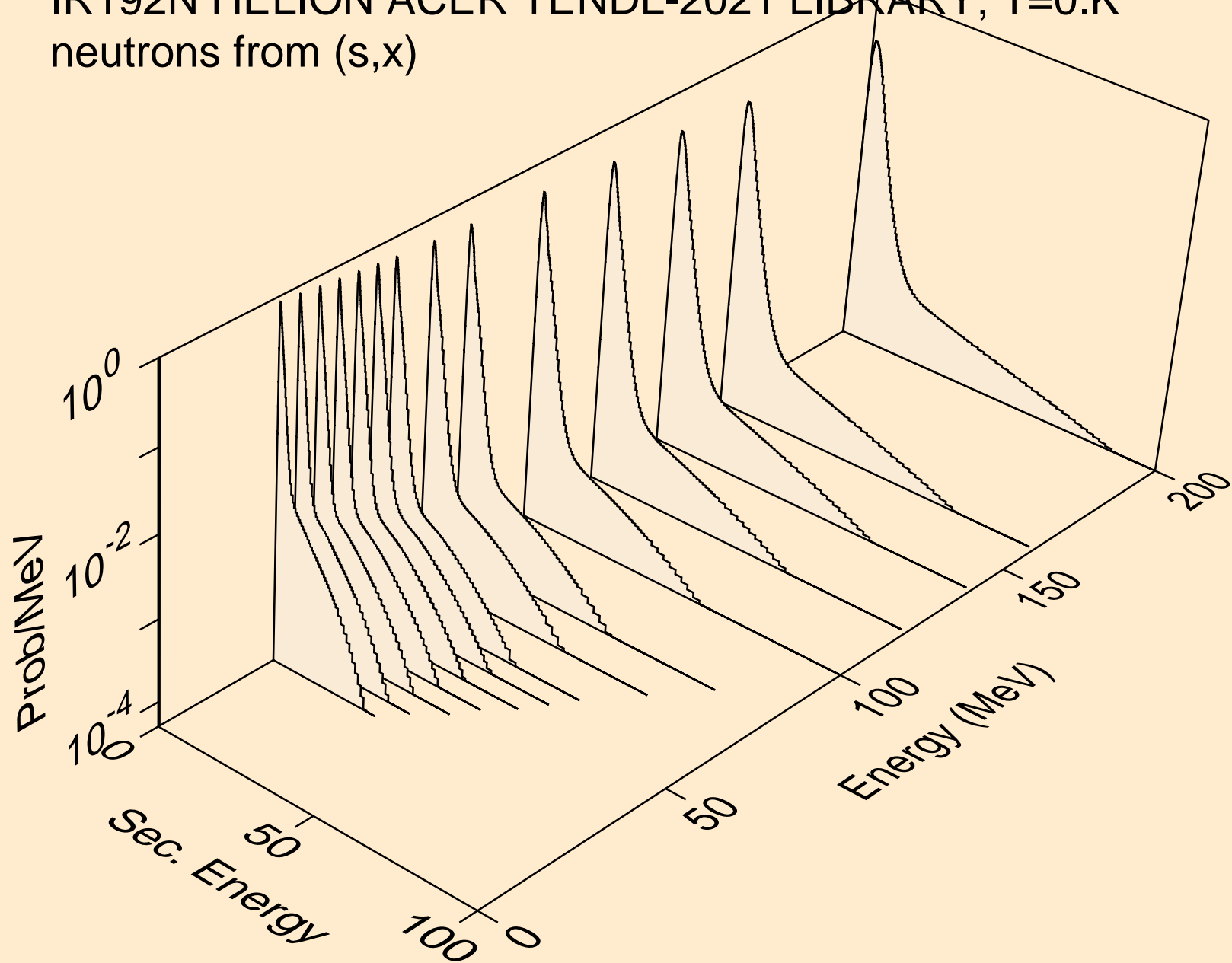

IR192N HELION ACER TENDL-2021 LIBRARY; T=0.K  
neutrons from (s,2nd)

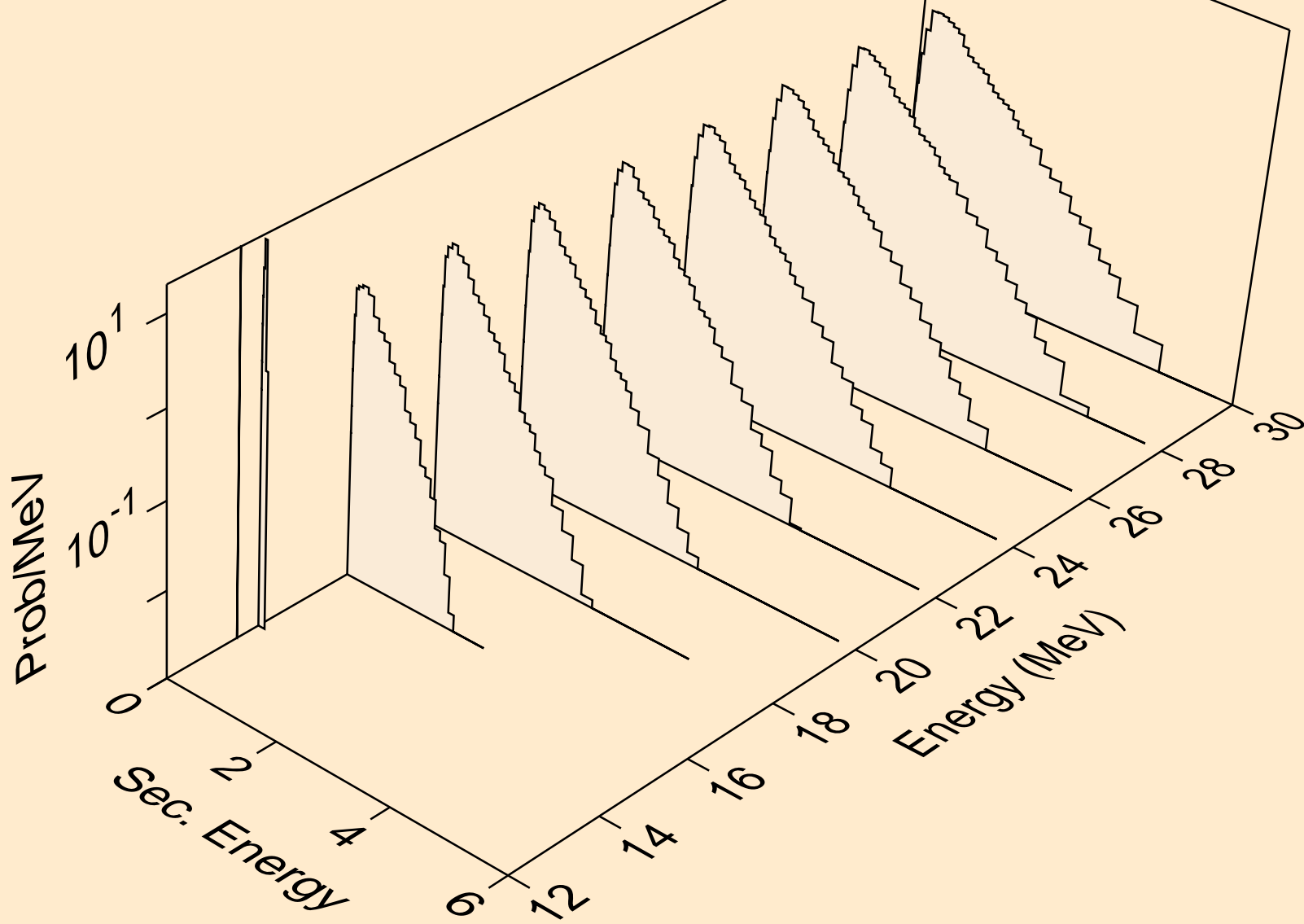

IR192N HELION ACER TENDL-2021 LIBRARY; T=0.K  
neutrons from (s,2n)

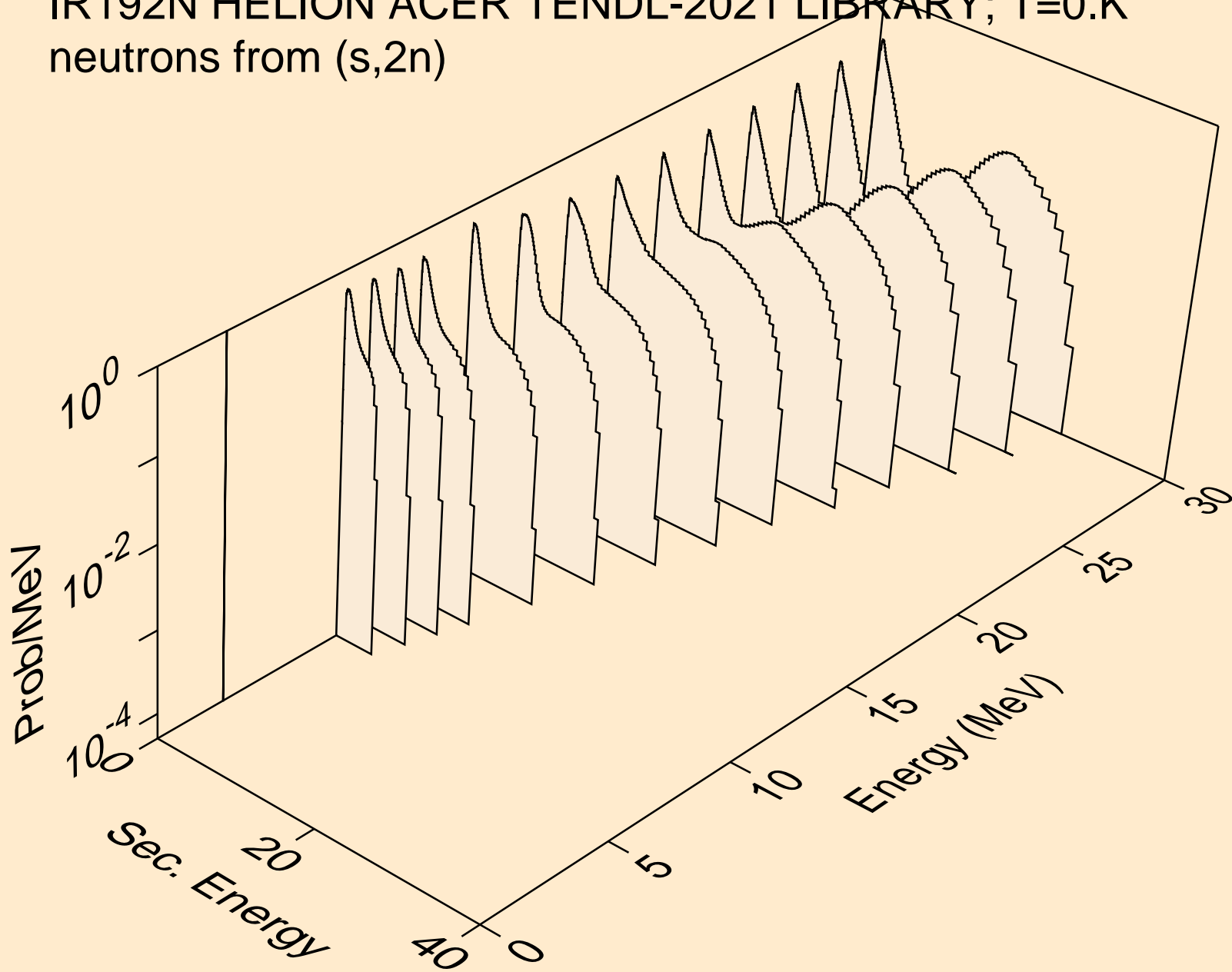

IR192N HELION ACER TENDL-2021 LIBRARY; T=0.K  
neutrons from (s,3n)

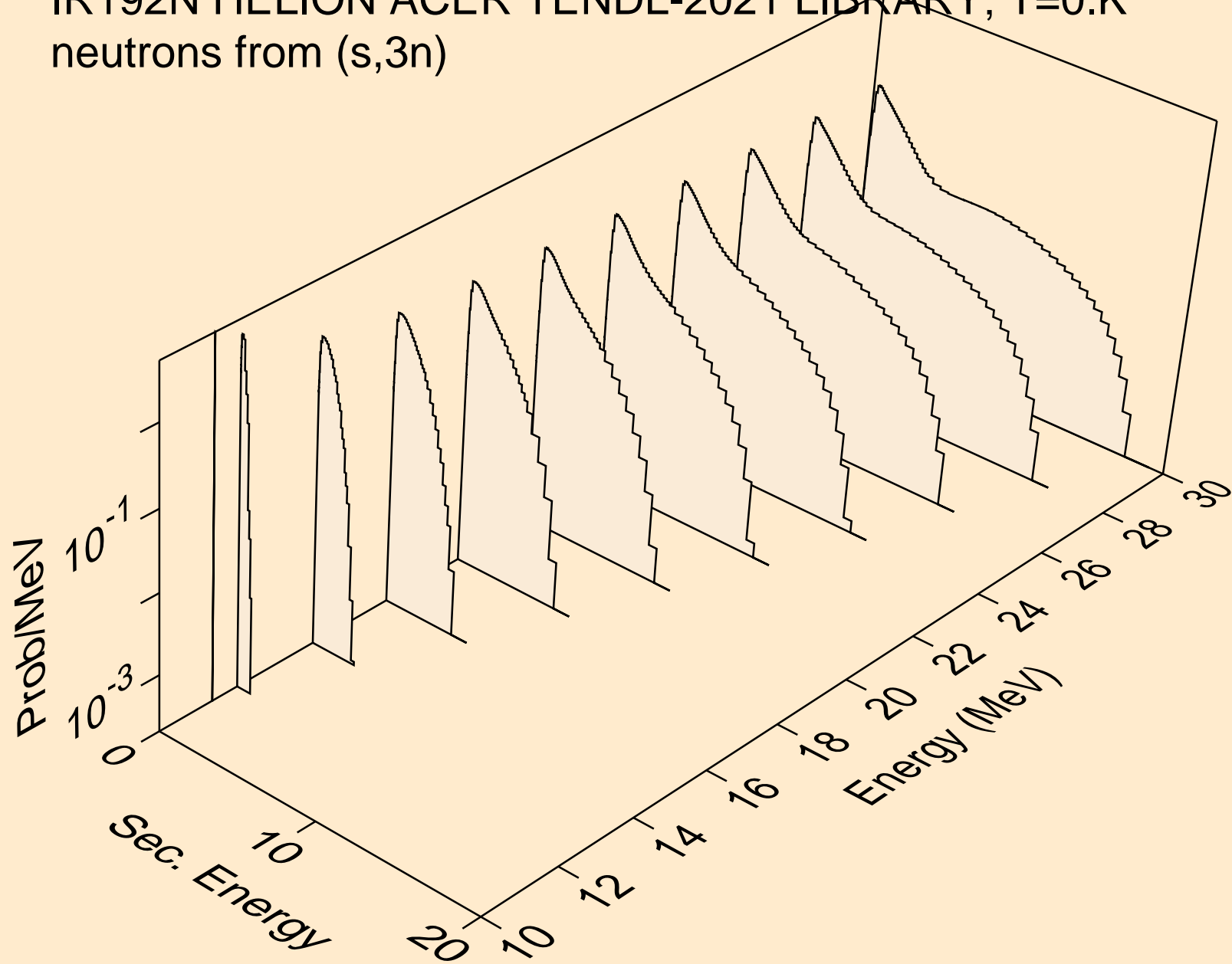

IR192N HELION ACER TENDL-2021 LIBRARY; T=0.K  
neutrons from (s,n\*)a

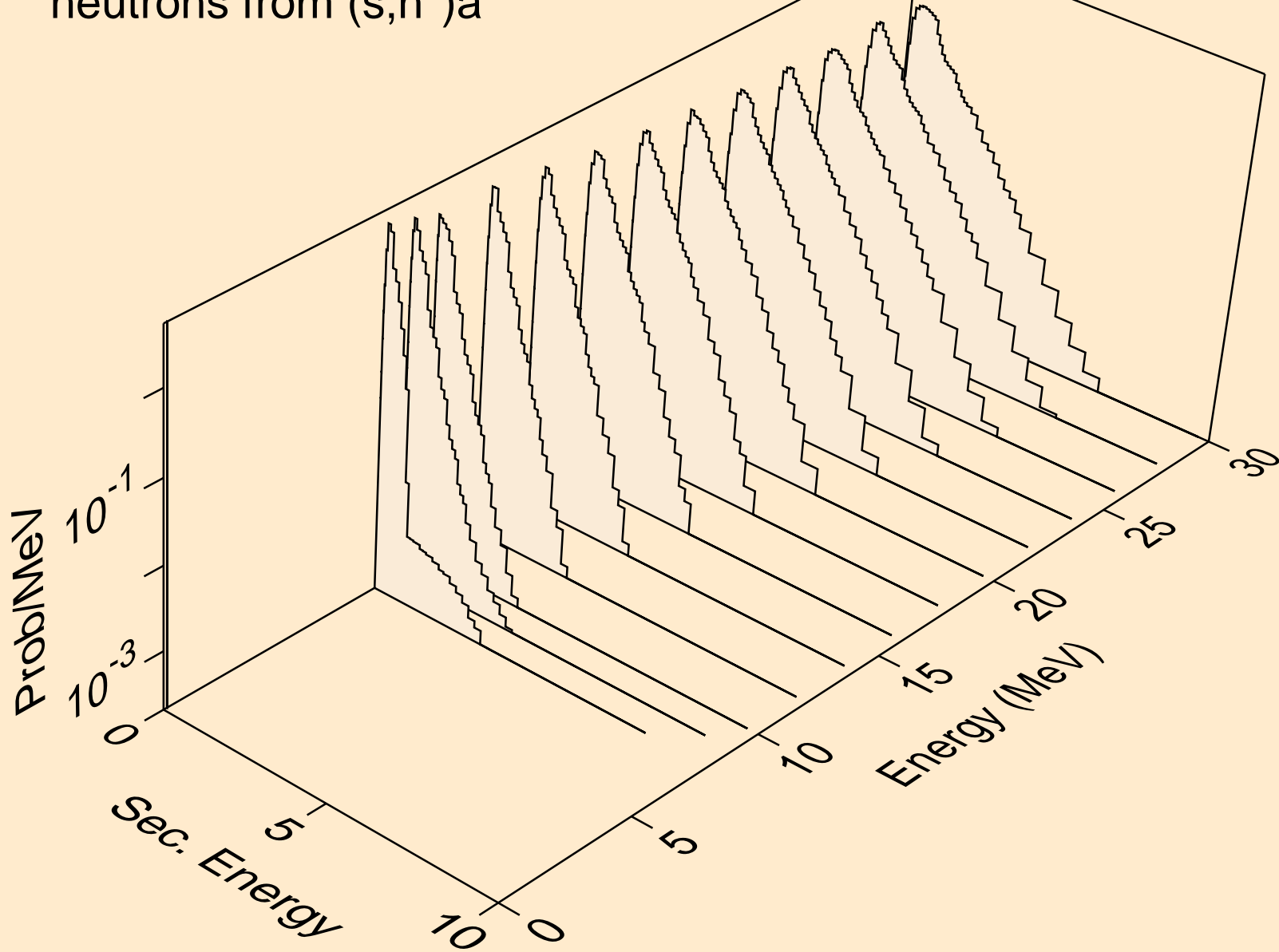

IR192N HELION ACER TENDL-2021 LIBRARY; T=0.K  
neutrons from (s,2n)a

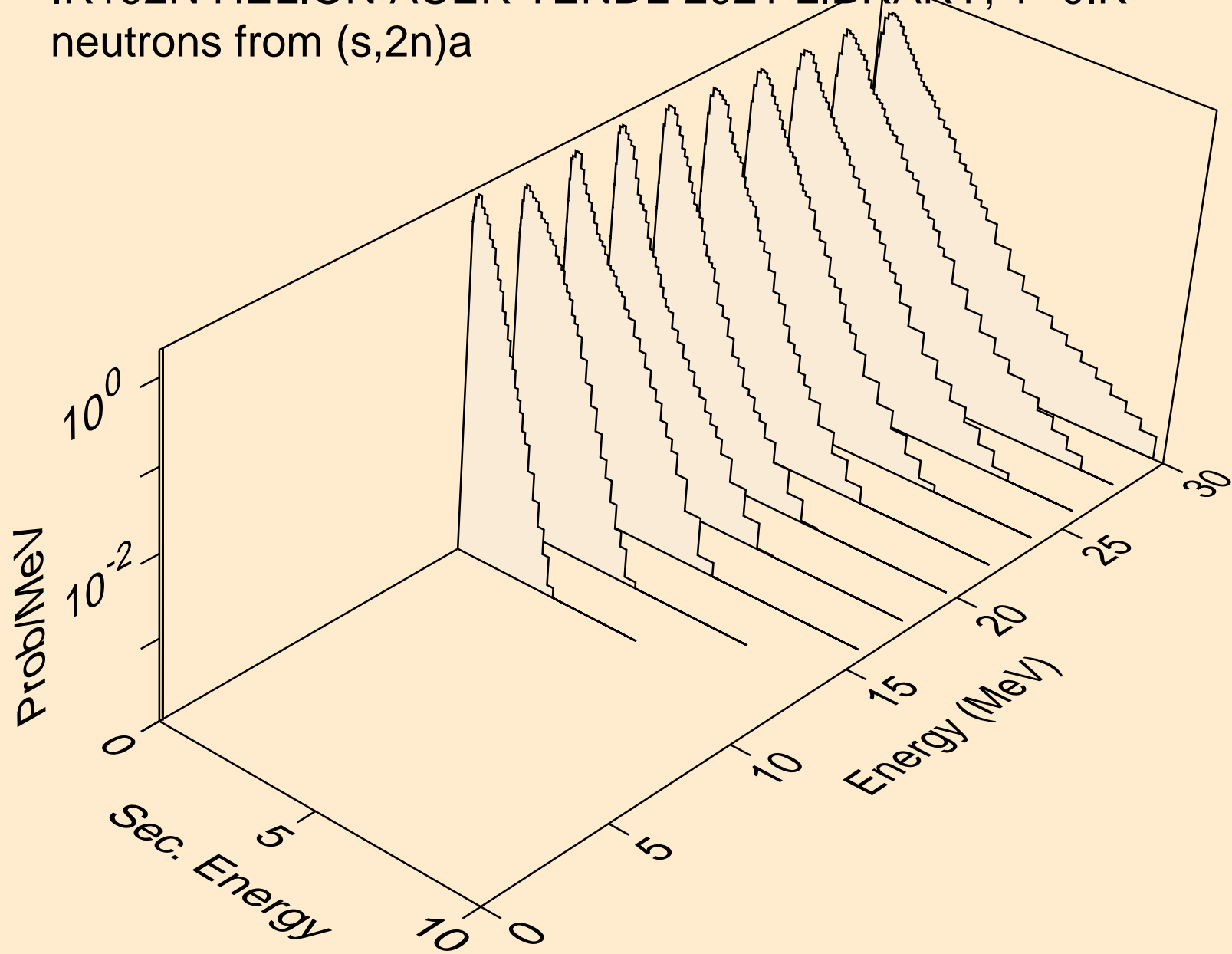



IR192N HELION ACER TENDL-2021 LIBRARY; T=0.K  
neutrons from (s,3n)a

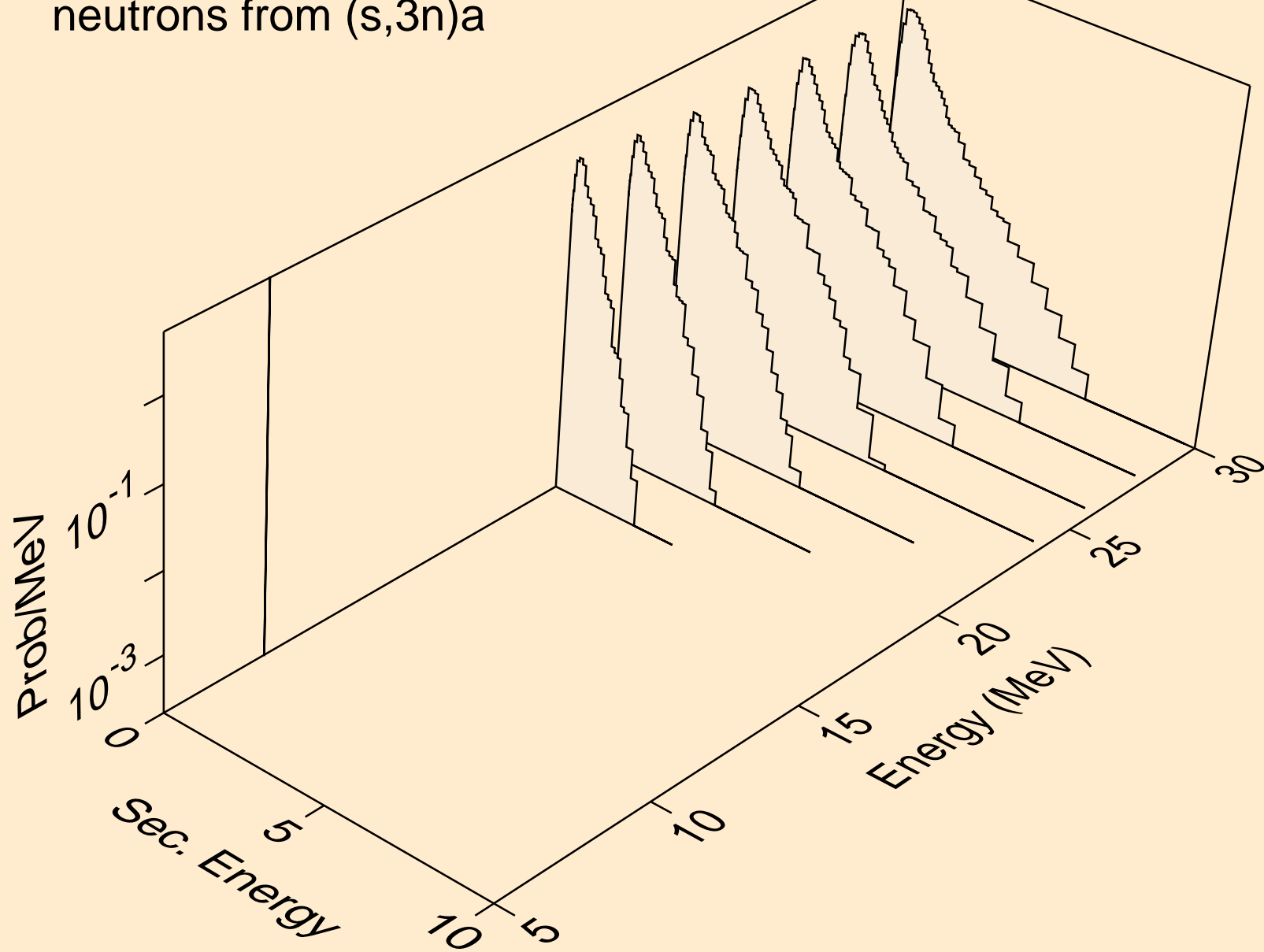

IR192N HELION ACER TENDL-2021 LIBRARY; T=0.K  
neutrons from (s,n\*)p

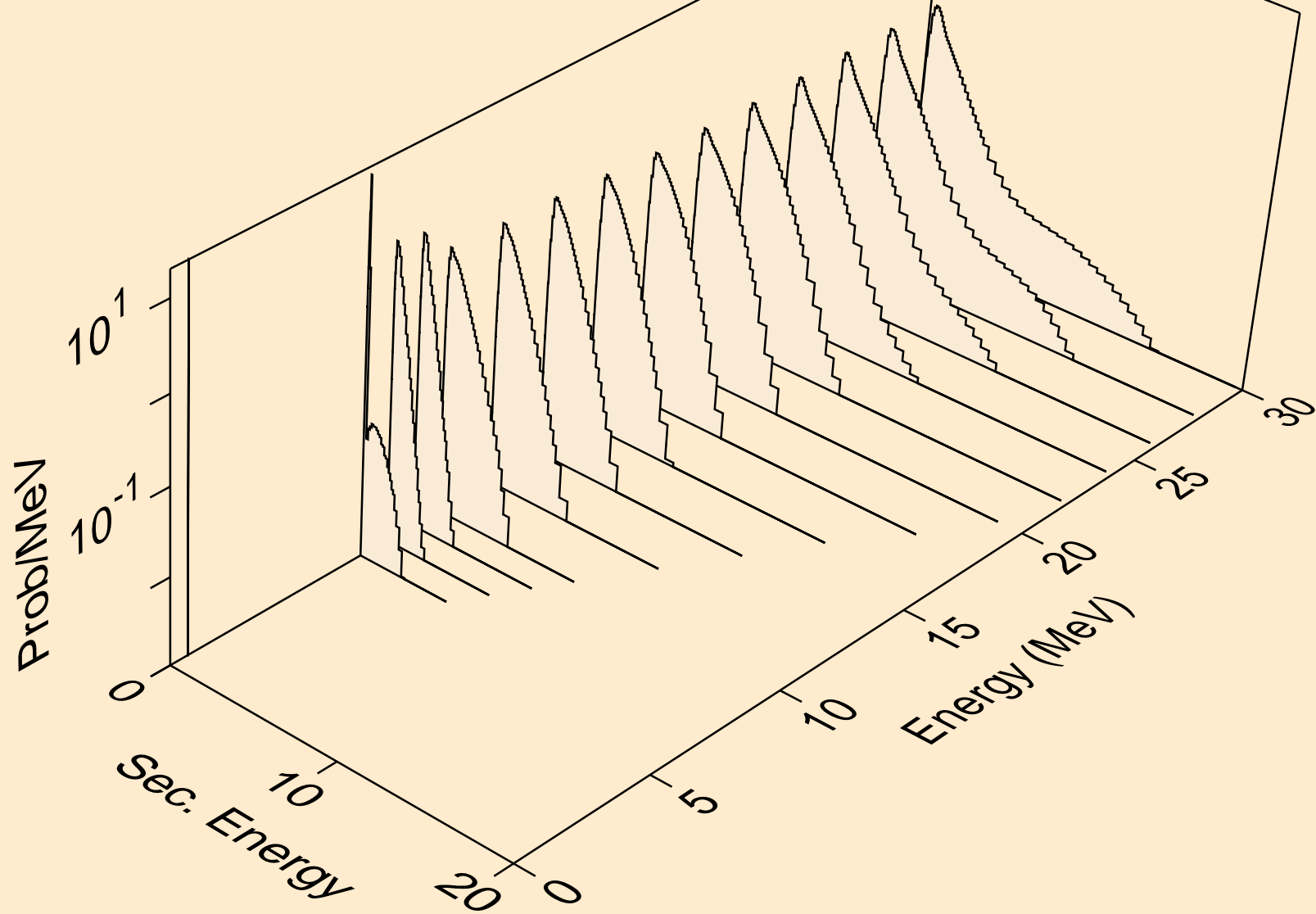

IR192N HELION ACER TENDL-2021 LIBRARY; T=0.K  
neutrons from (s,n\*)d

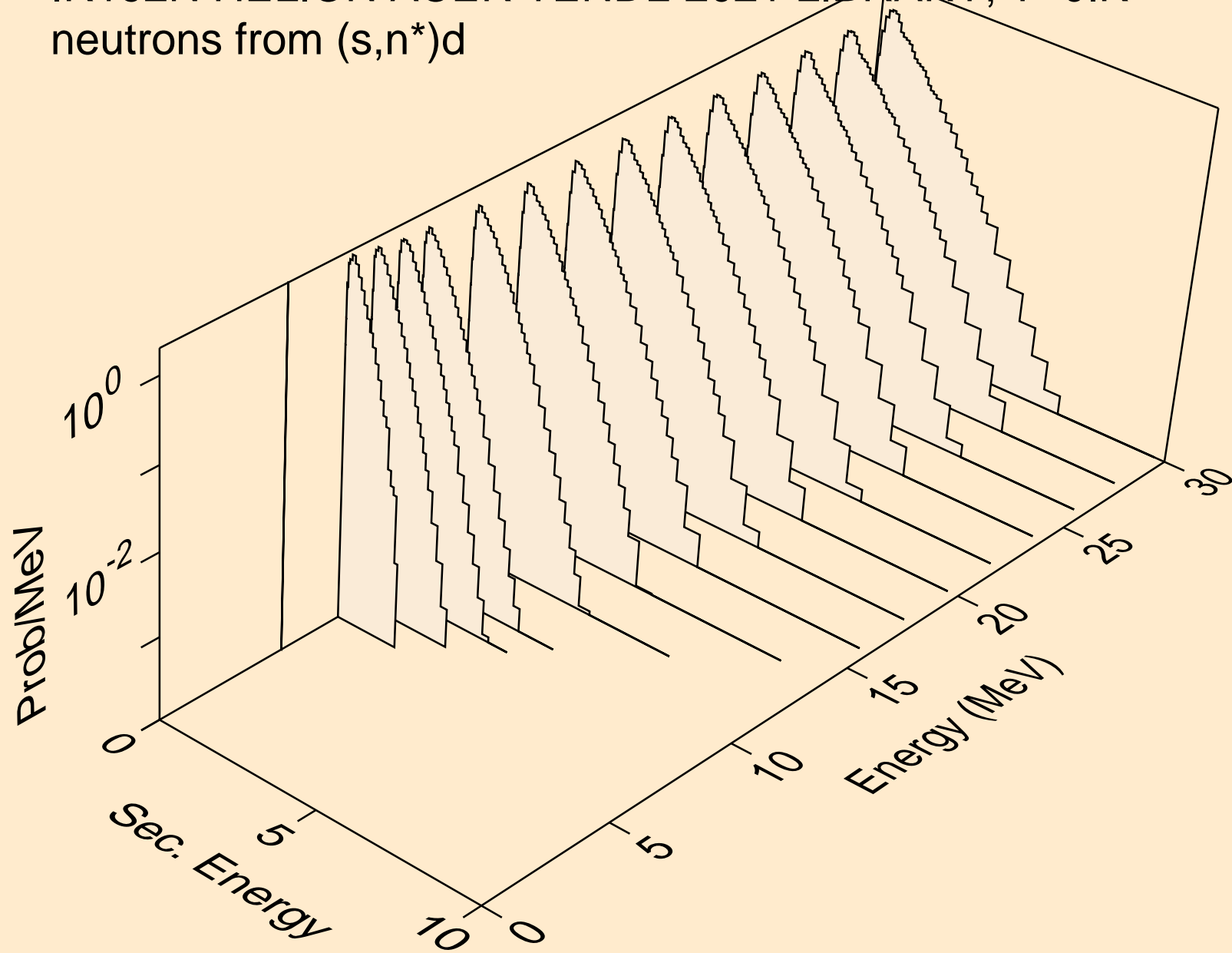

IR192N HELION ACER TENDL-2021 LIBRARY; T=0.K  
neutrons from (s,n\*)t

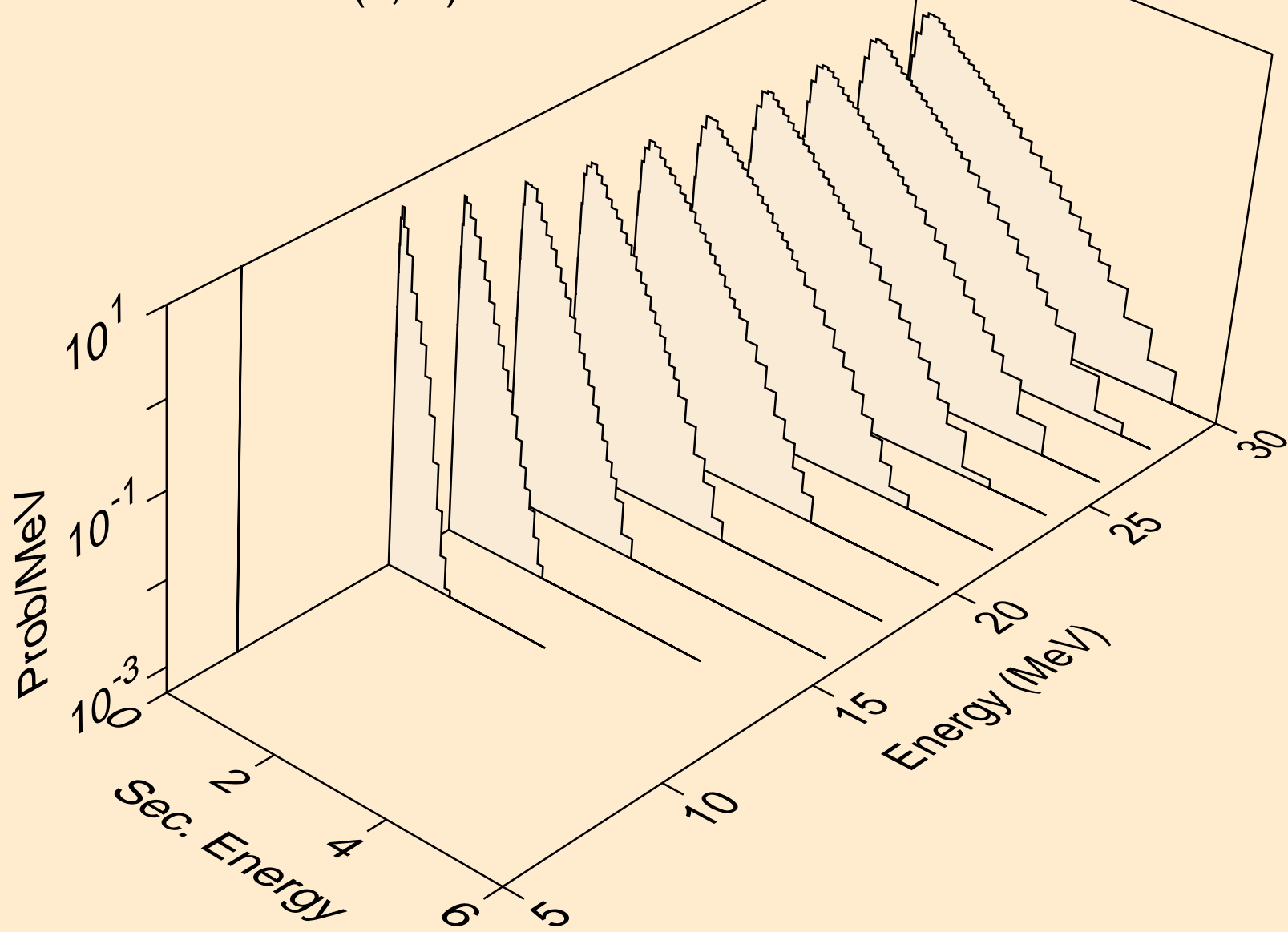

IR192N HELION ACER TENDL-2021 LIBRARY; T=0.K  
neutrons from (s,n\*)he3

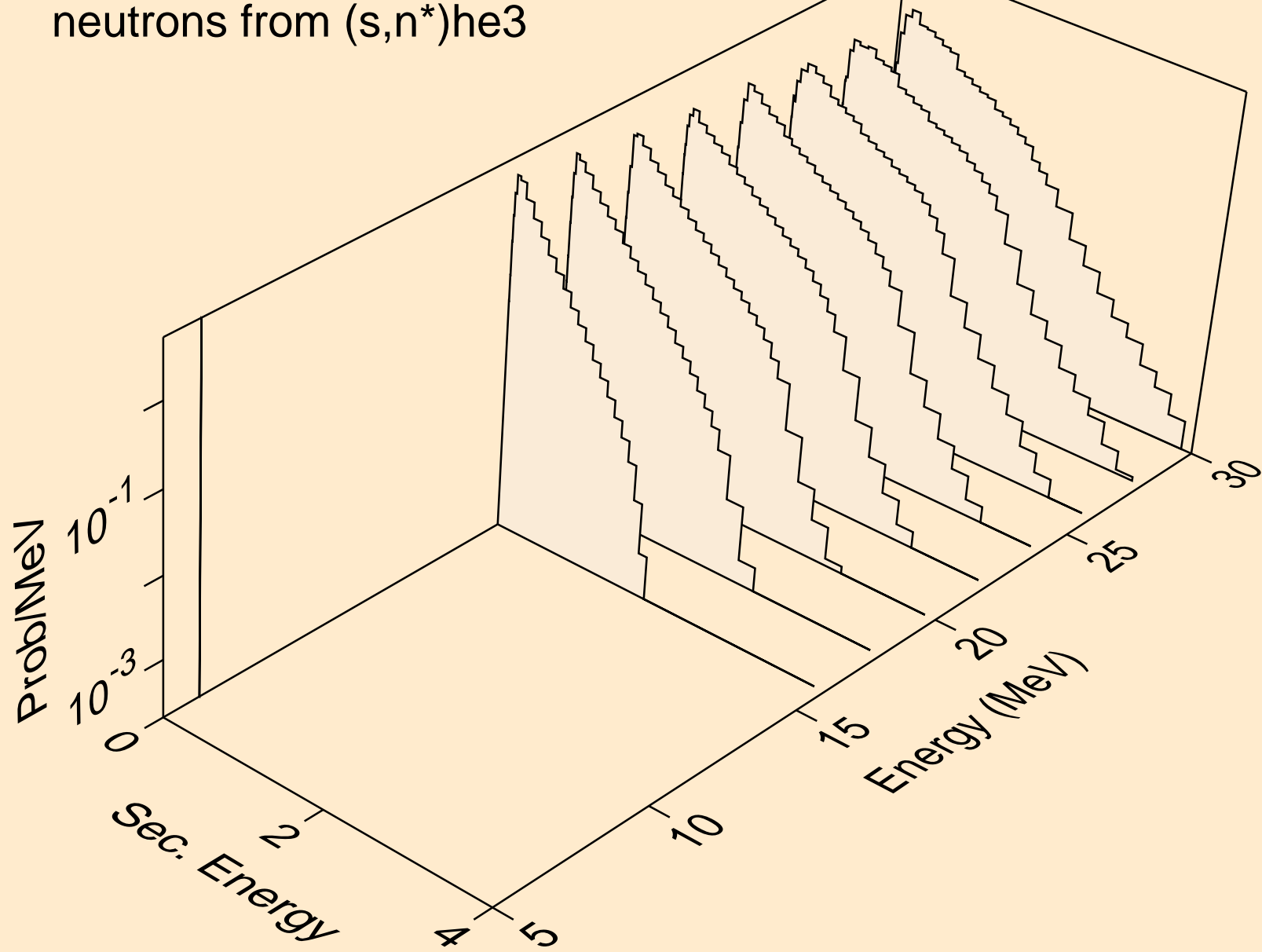

IR192N HELION ACER TENDL-2021 LIBRARY; T=0.K  
neutrons from (s,4n)

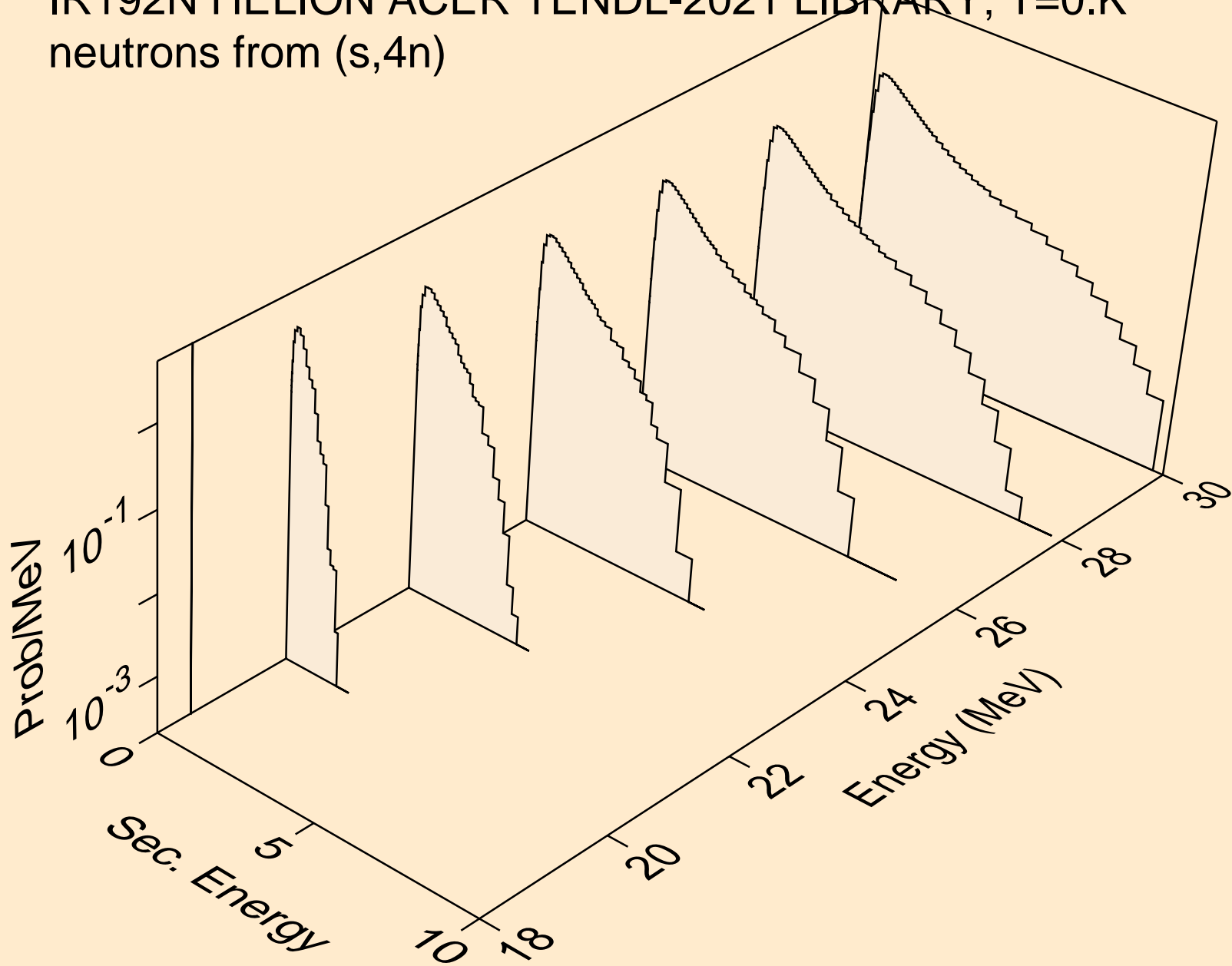

IR192N HELION ACER TENDL-2021 LIBRARY; T=0.K  
neutrons from (s,2np)

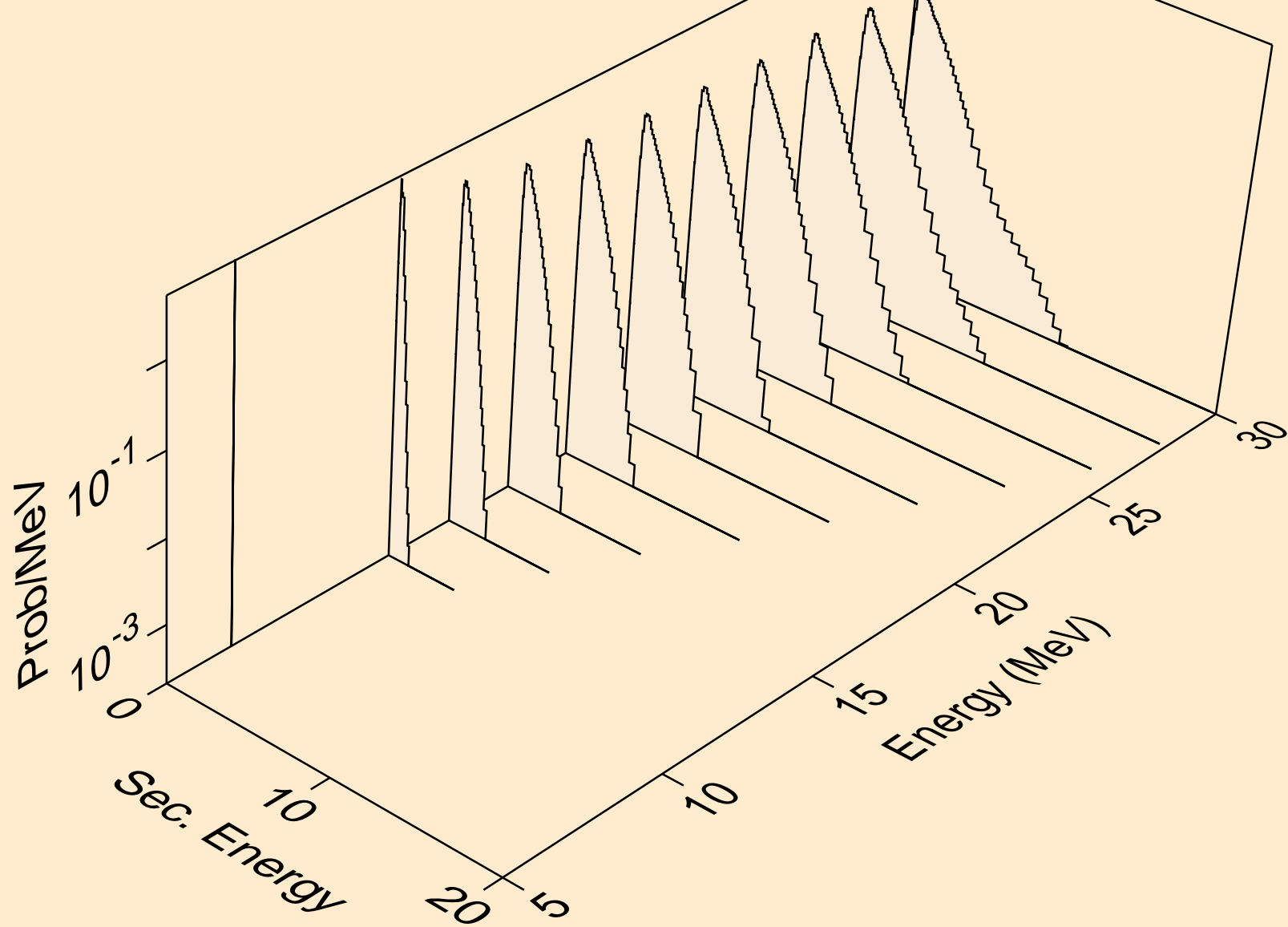

IR192N HELION ACER TENDL-2021 LIBRARY; T=0.K  
neutrons from (s,3np)

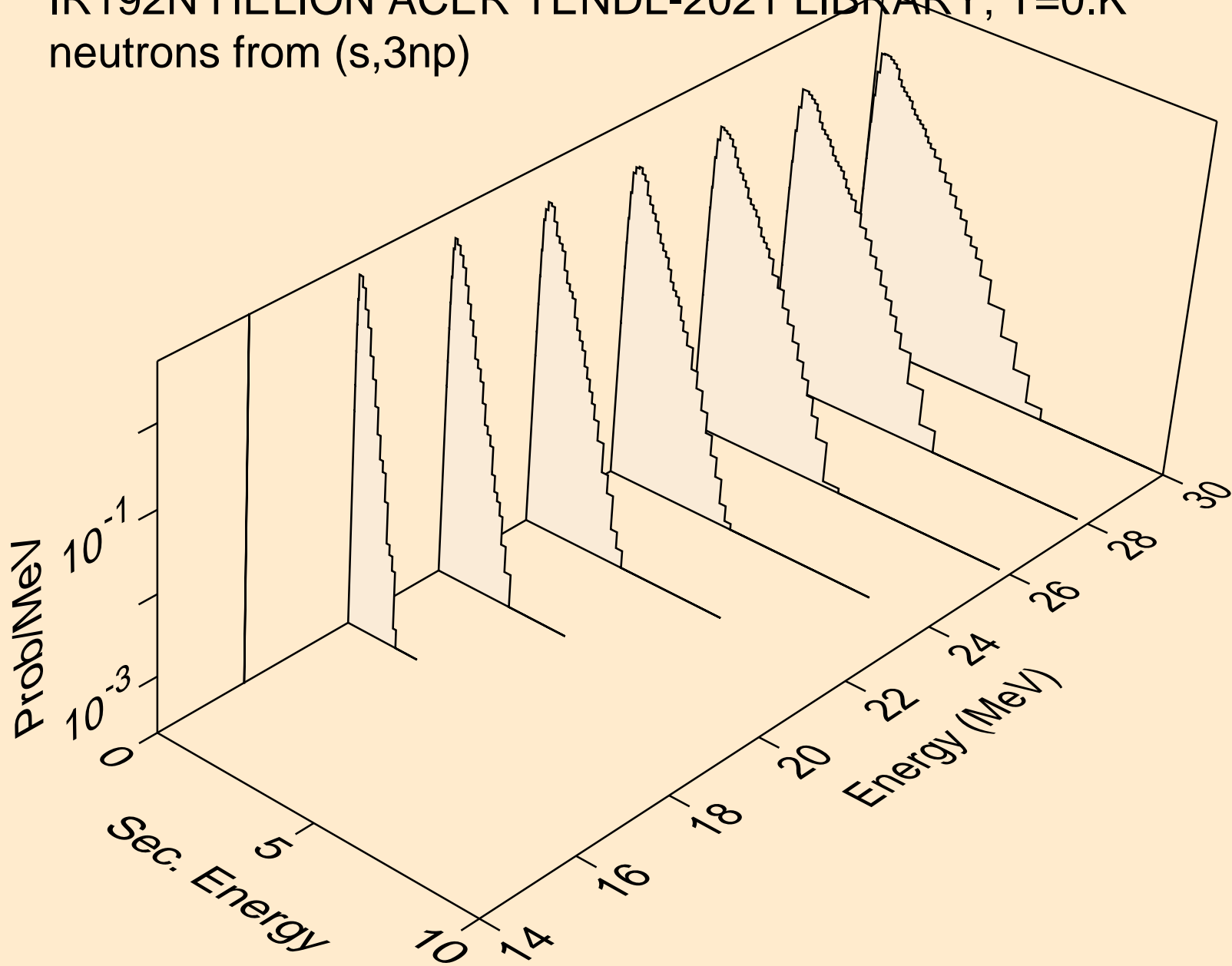



IR192N HELION ACER TENDL-2021 LIBRARY; T=0.K  
neutrons from (s,2np)

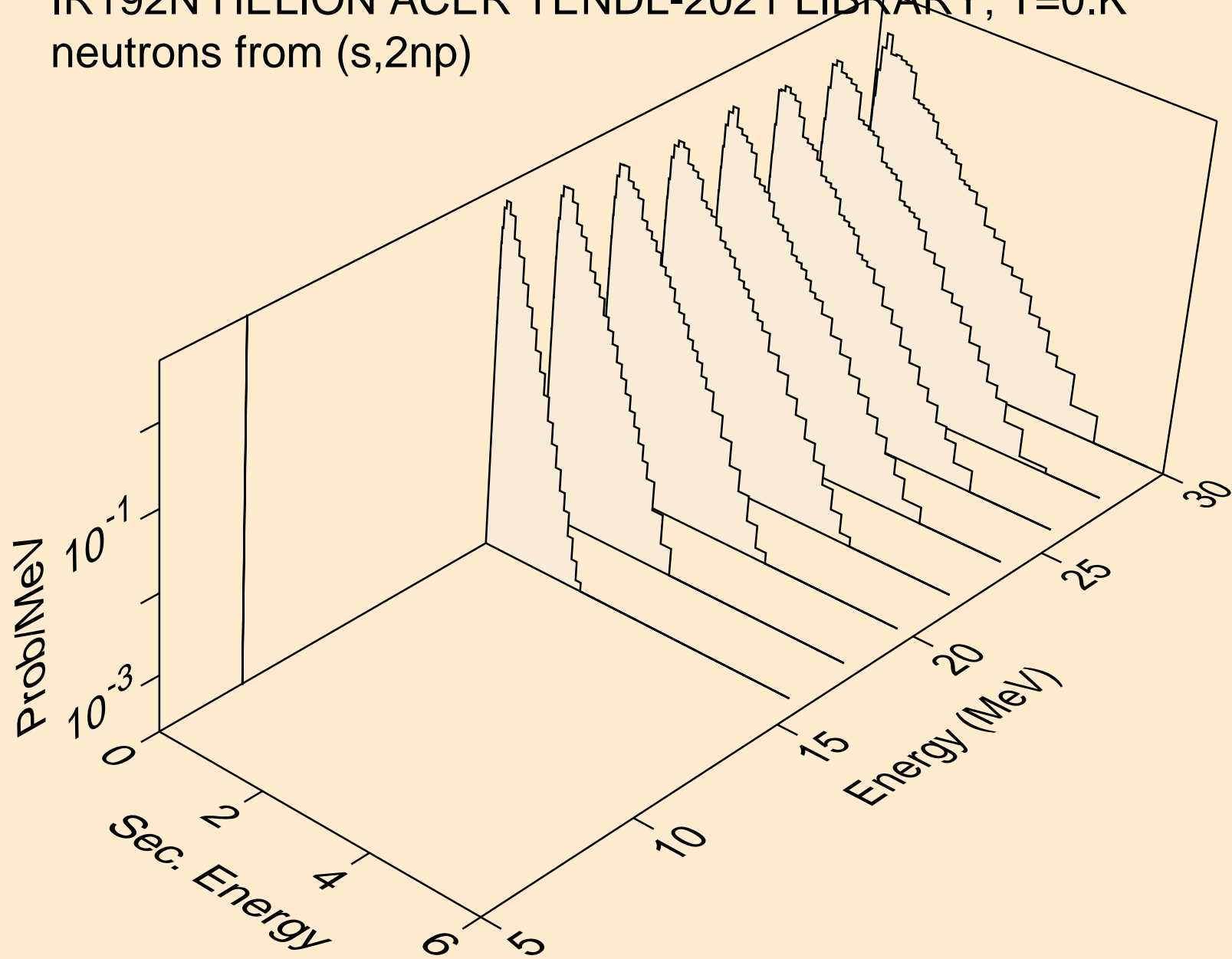

IR192N HELION ACER TENDL-2021 LIBRARY; T=0.K  
neutrons from (s,npa)

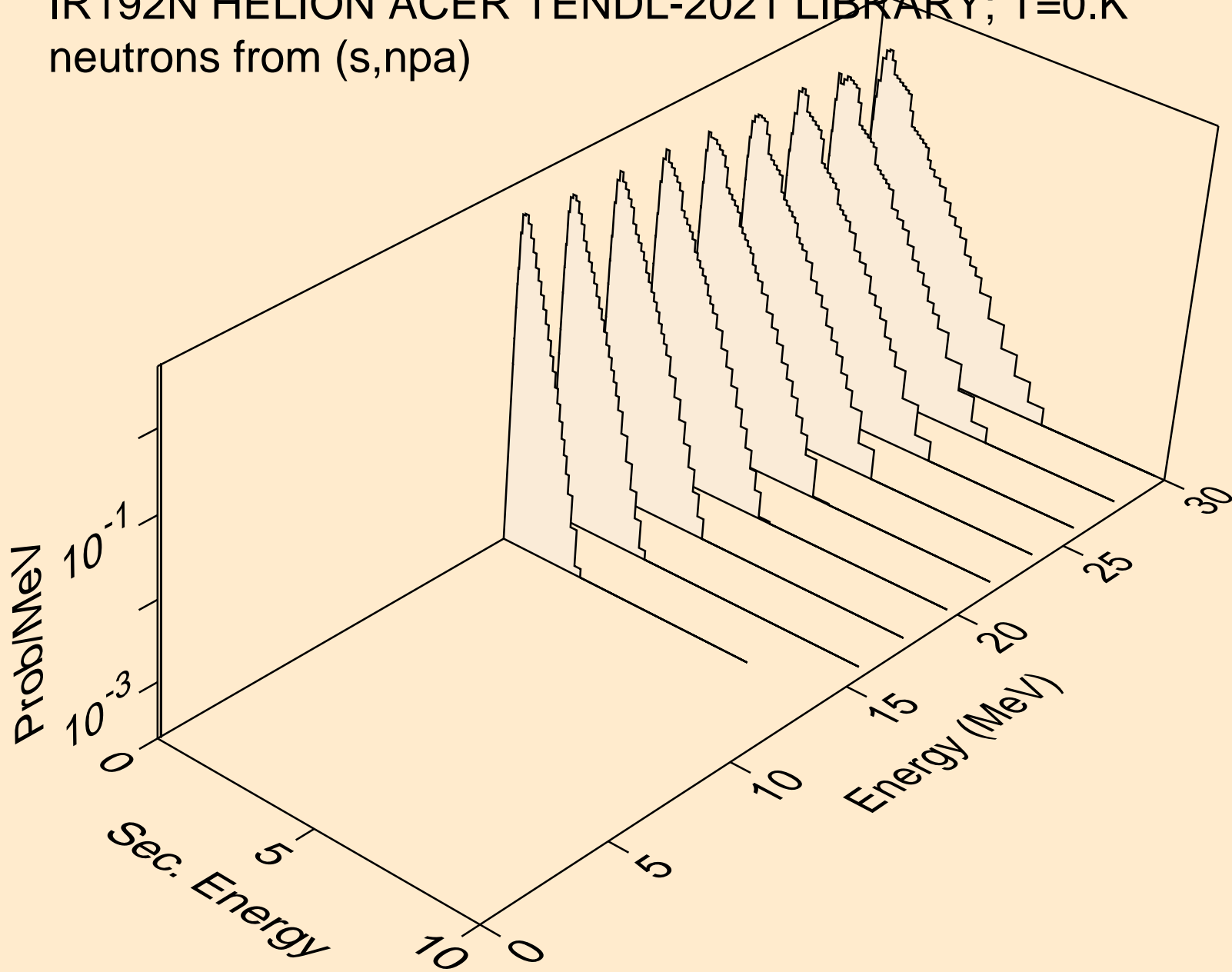

IR192N HELION ACER TENDL-2021 LIBRARY; T=0.K  
protons from (s,x)

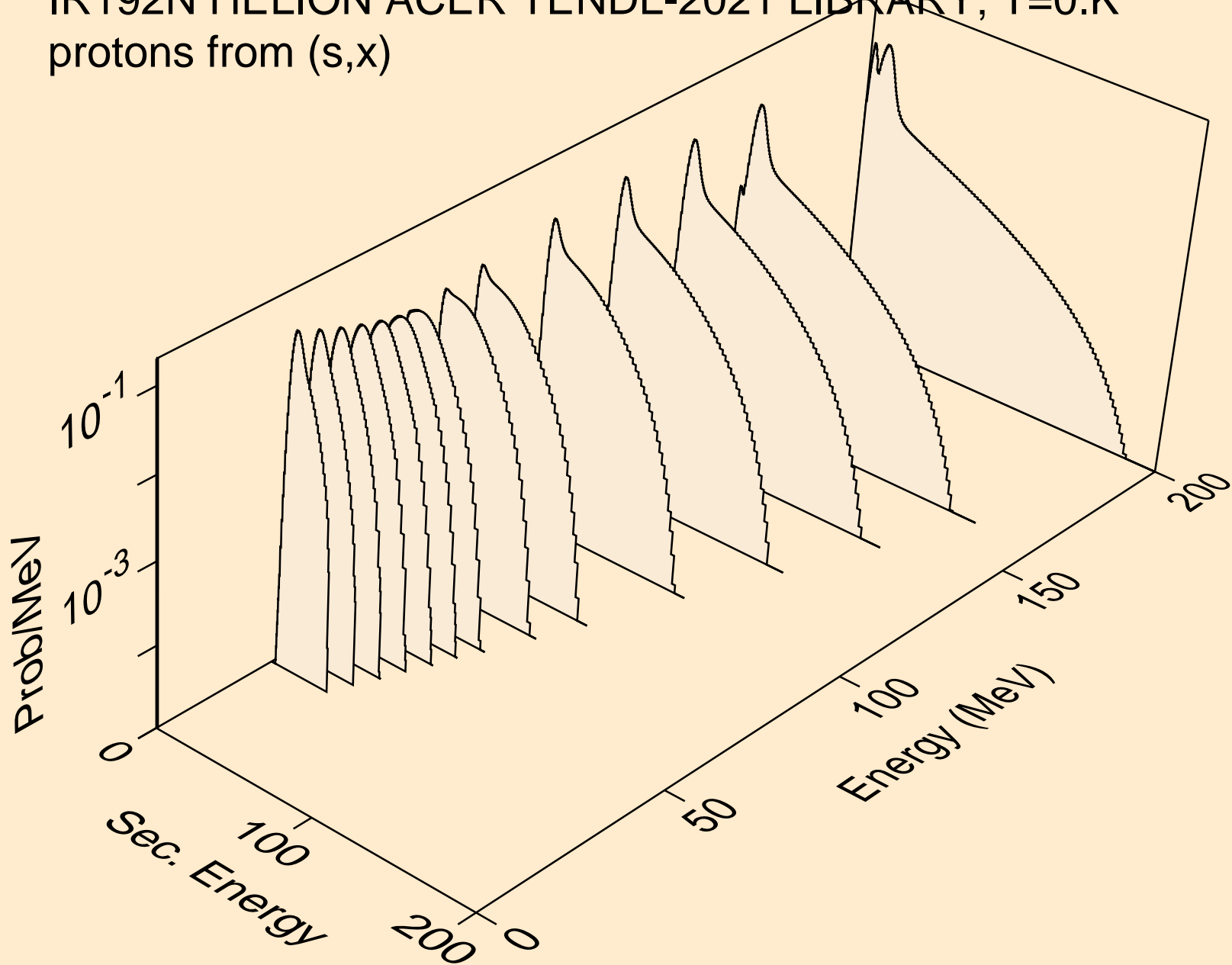

IR192N HELION ACER TENDL-2021 LIBRARY; T=0.K  
protons from (s,n\*)p

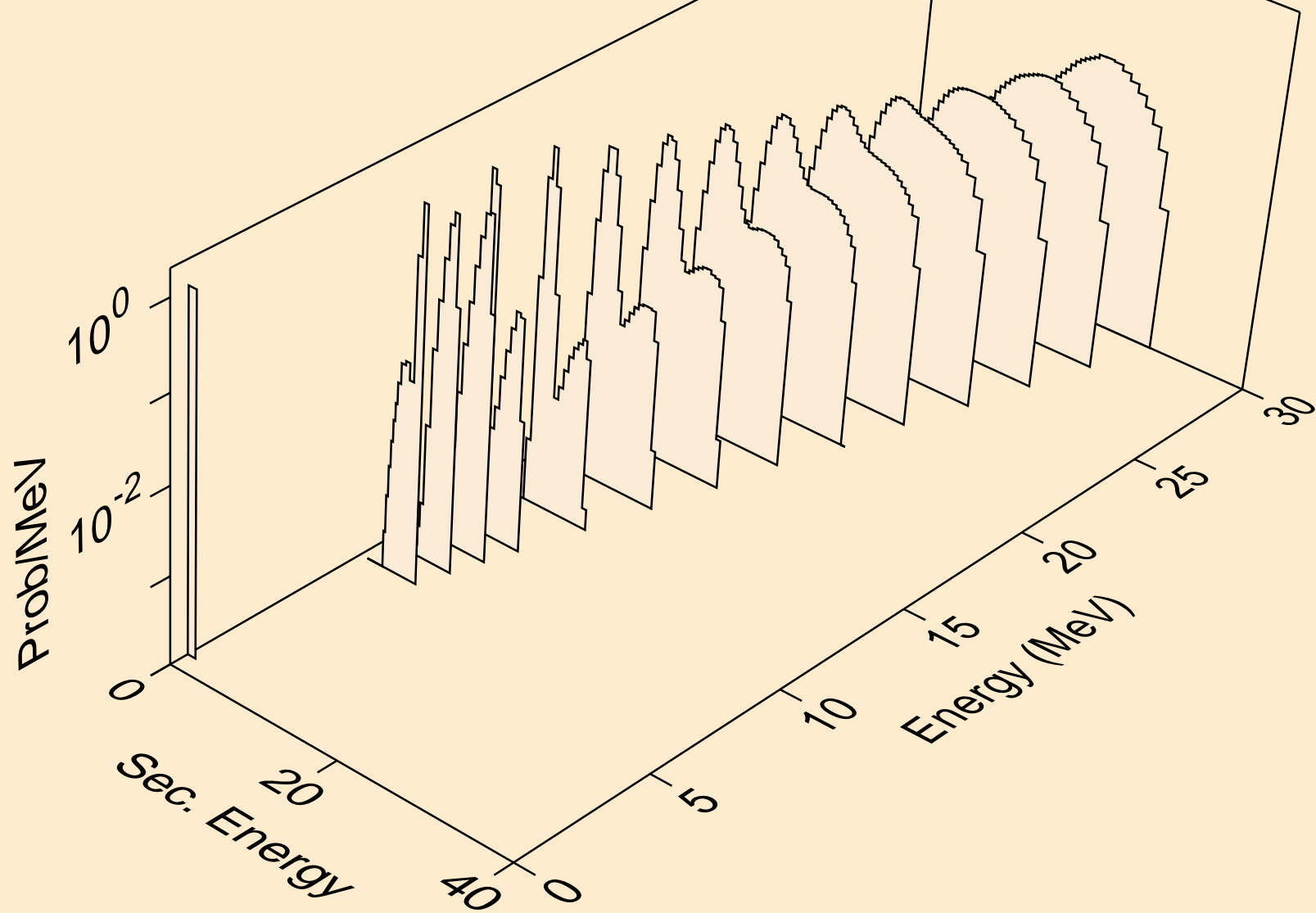

IR192N HELION ACER TENDL-2021 LIBRARY; T=0.K  
protons from (s,2np)

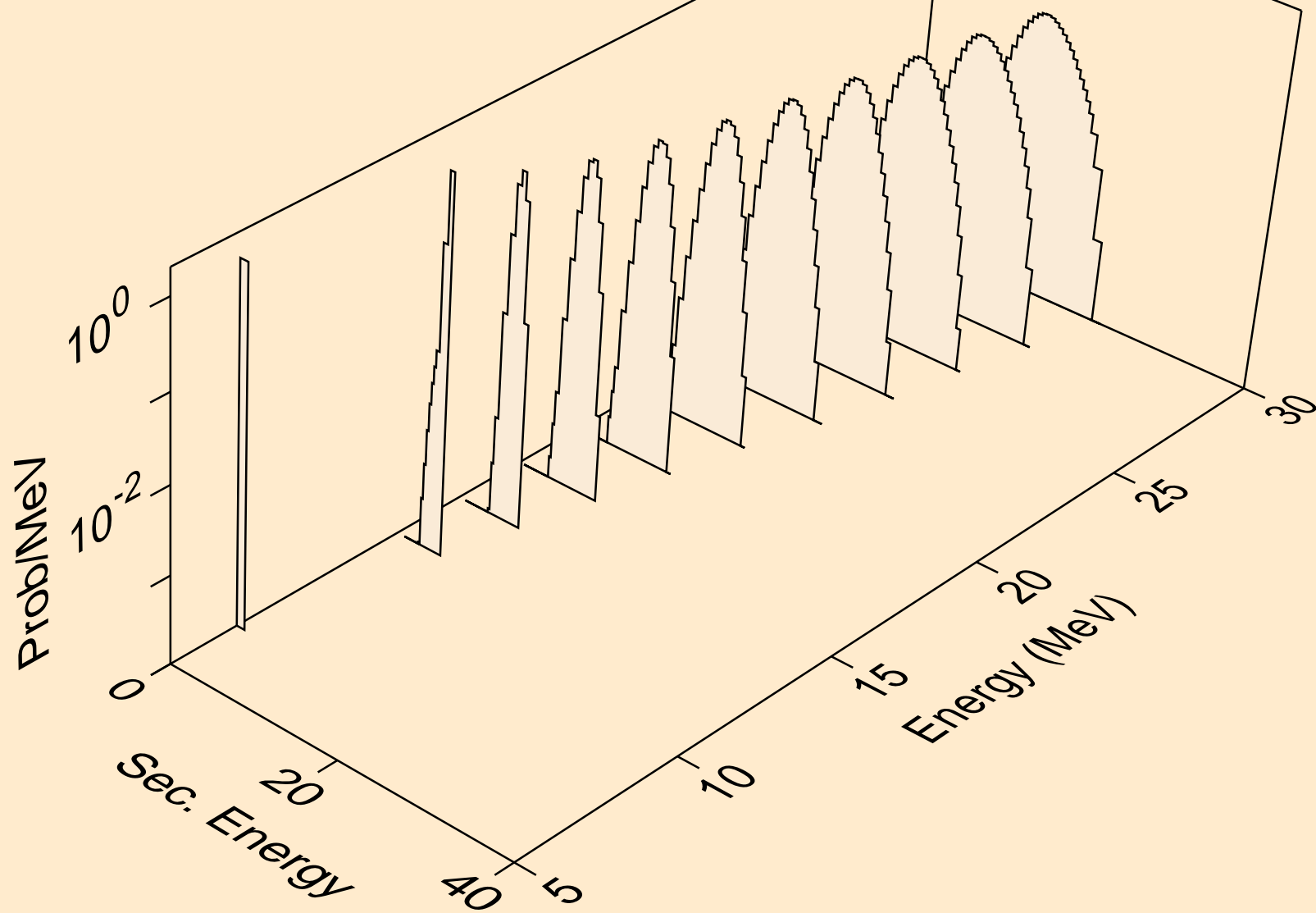

IR192N HELION ACER TENDL-2021 LIBRARY; T=0.K  
protons from (s,3np)

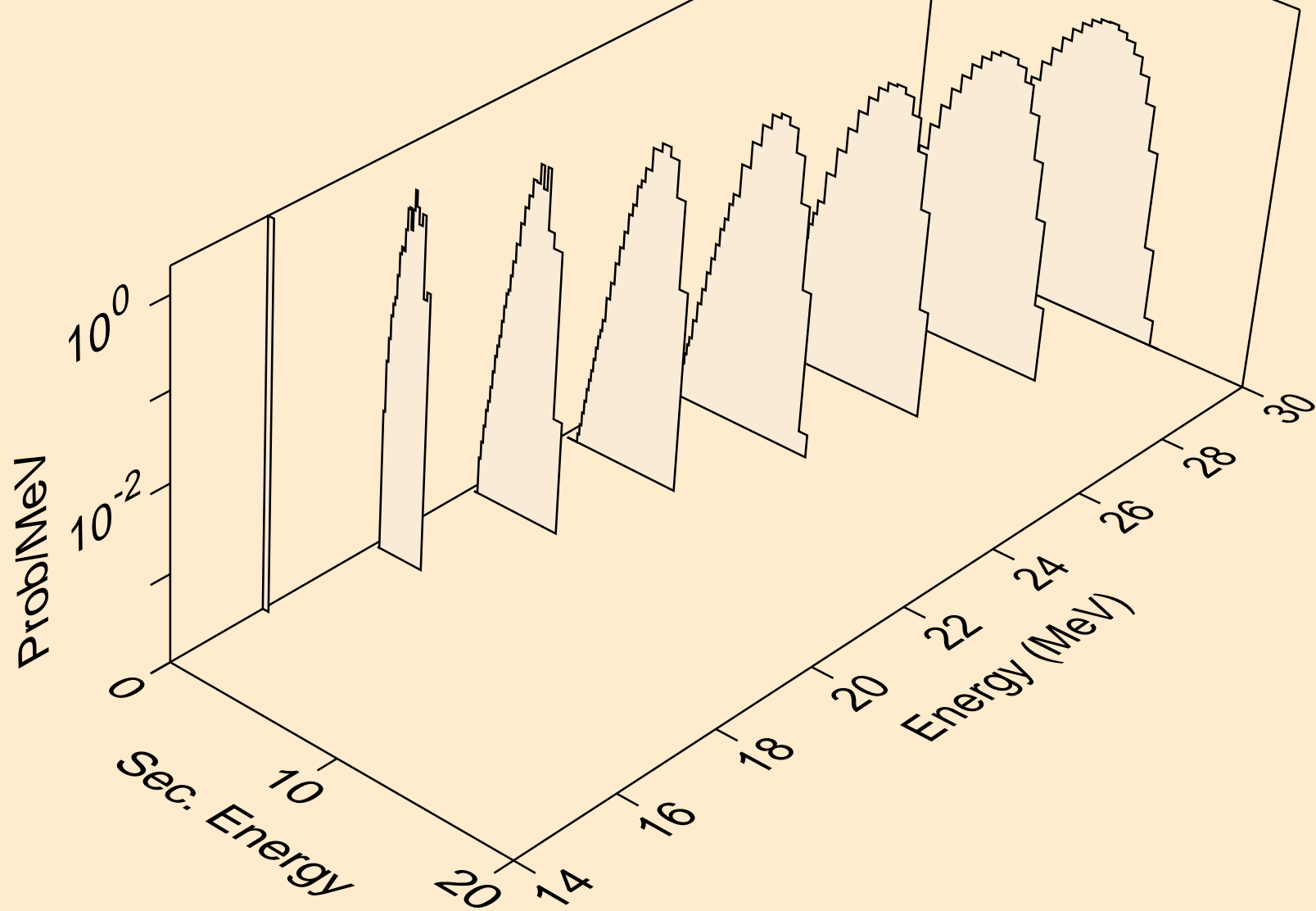

IR192N HELION ACER TENDL-2021 LIBRARY; T=0.K  
protons from (s,2np)

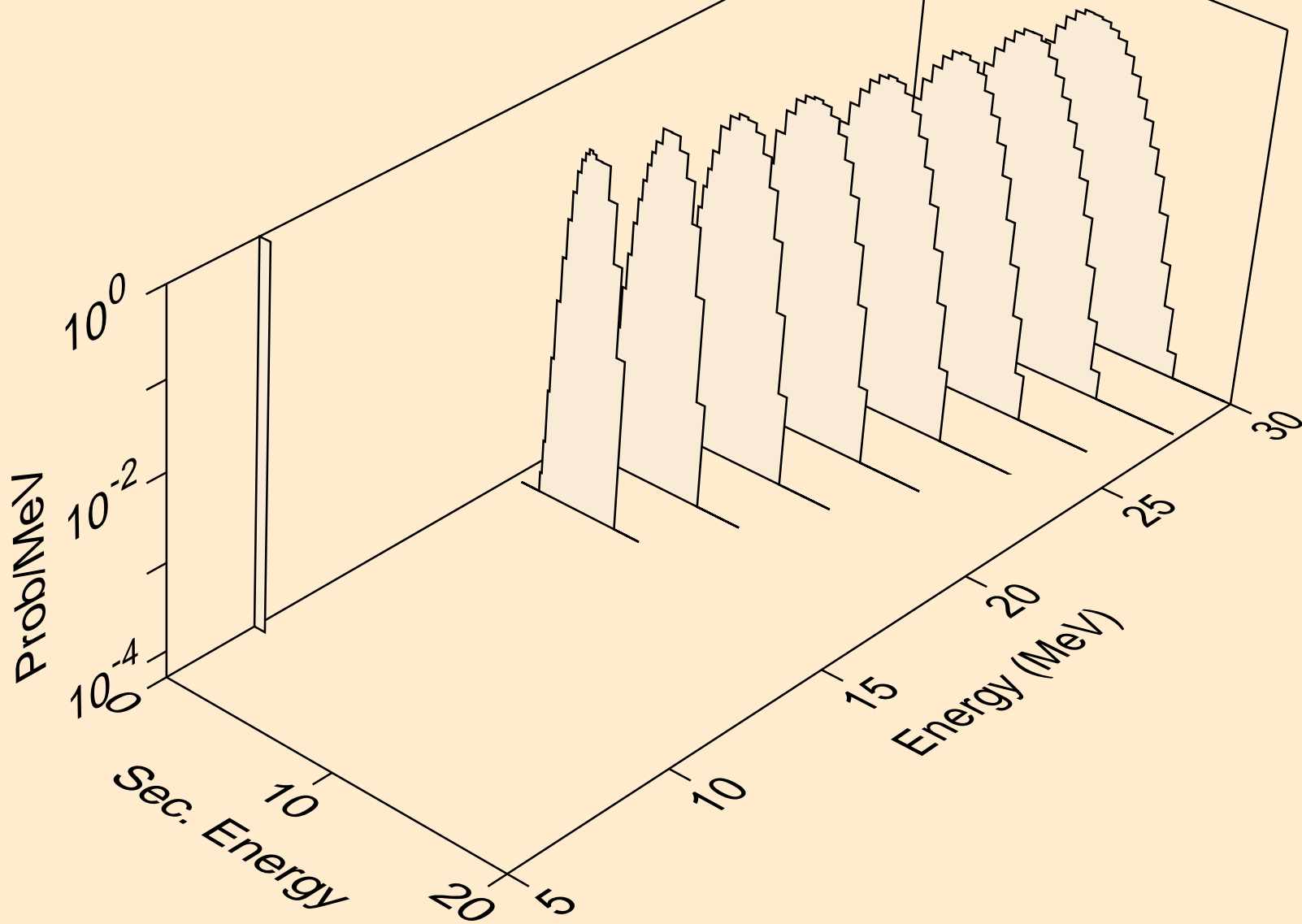

IR192N HELION ACER TENDL-2021 LIBRARY; T=0.K  
protons from (s,npa)

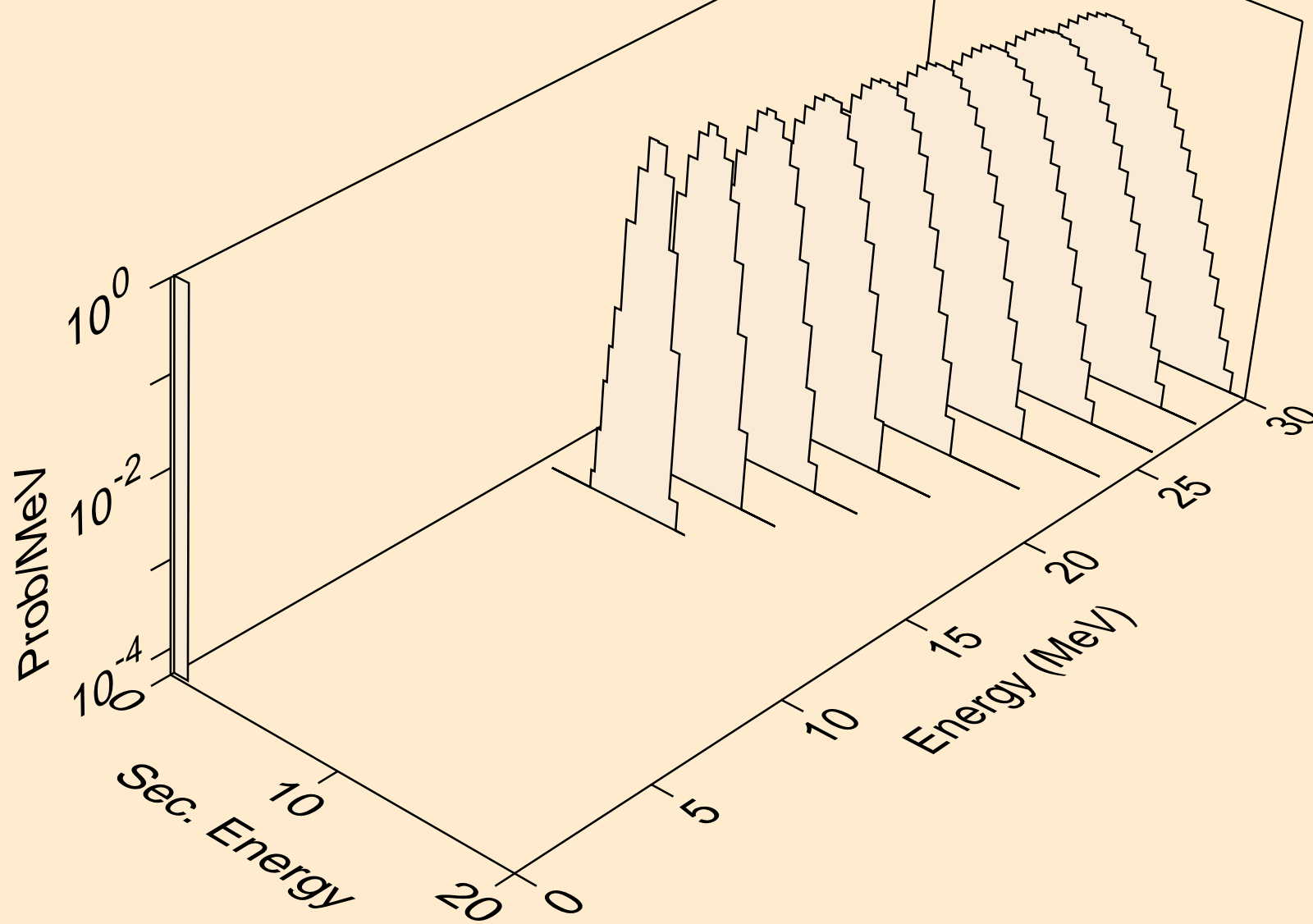



IR192N HELION ACER TENDL-2021 LIBRARY; T=0.K  
protons from (s,p)

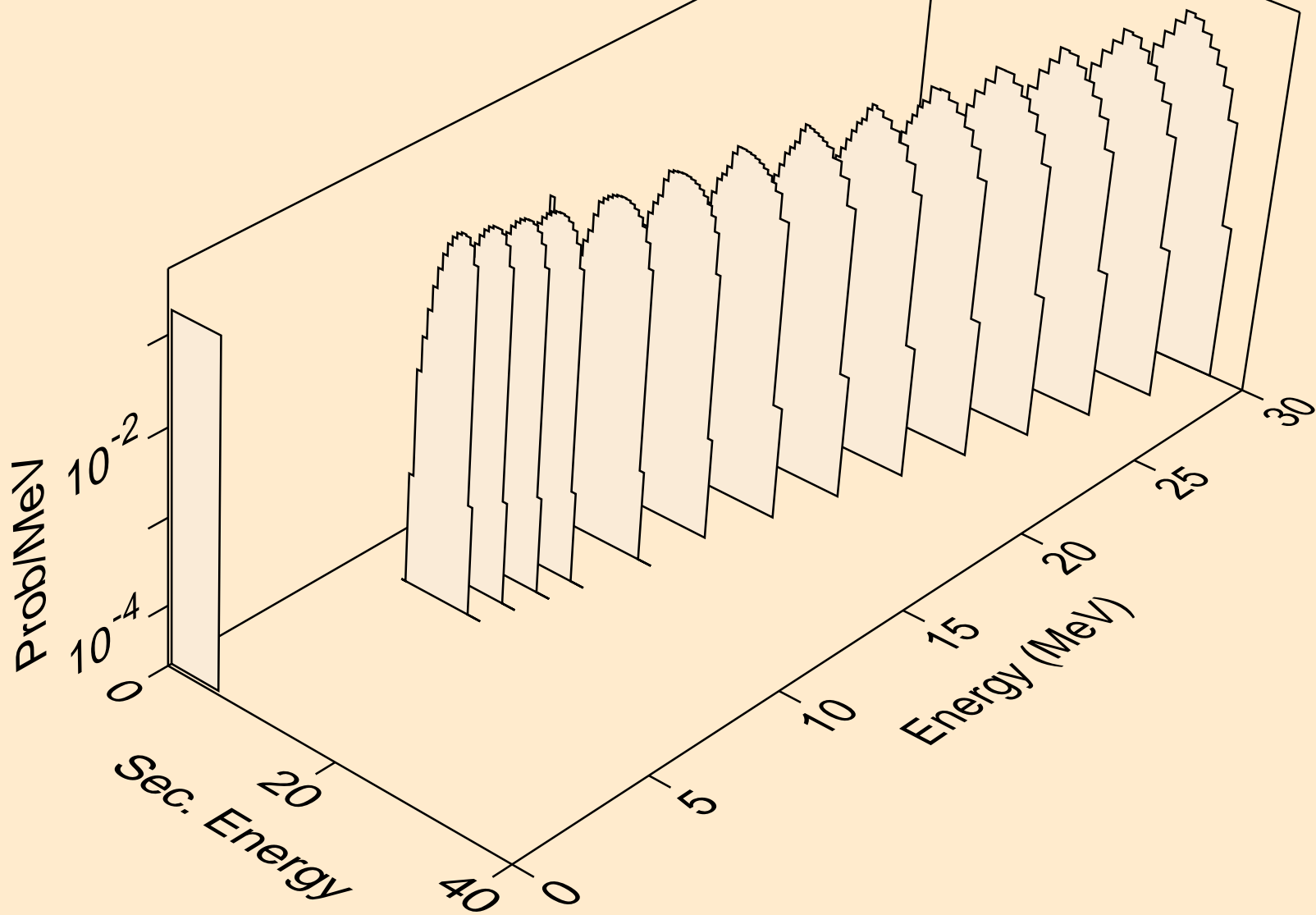

IR192N HELION ACER TENDL-2021 LIBRARY; T=0.K  
protons from (s,2p)

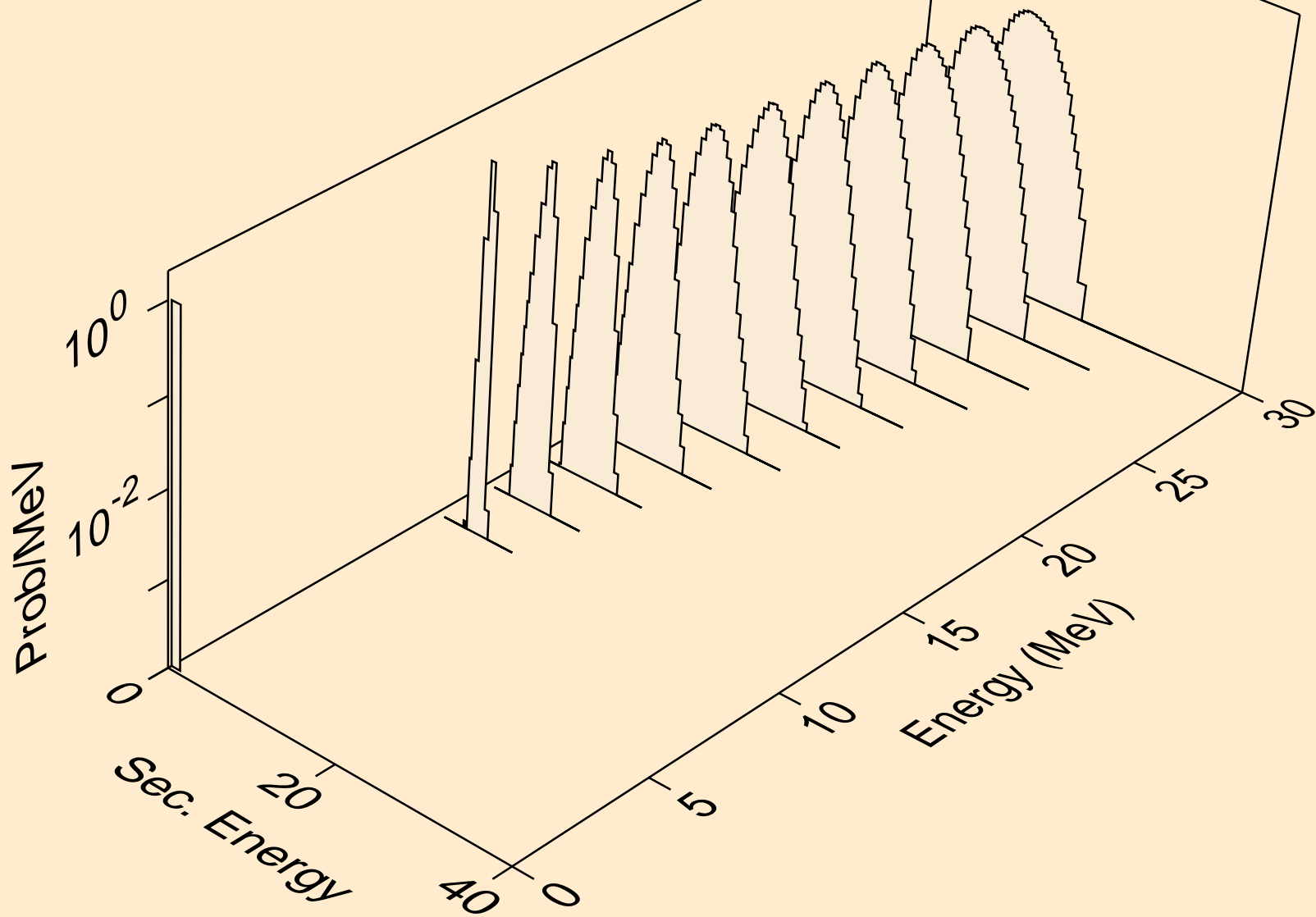

IR192N HELION ACER TENDL-2021 LIBRARY; T=0.K  
protons from (s,pa)

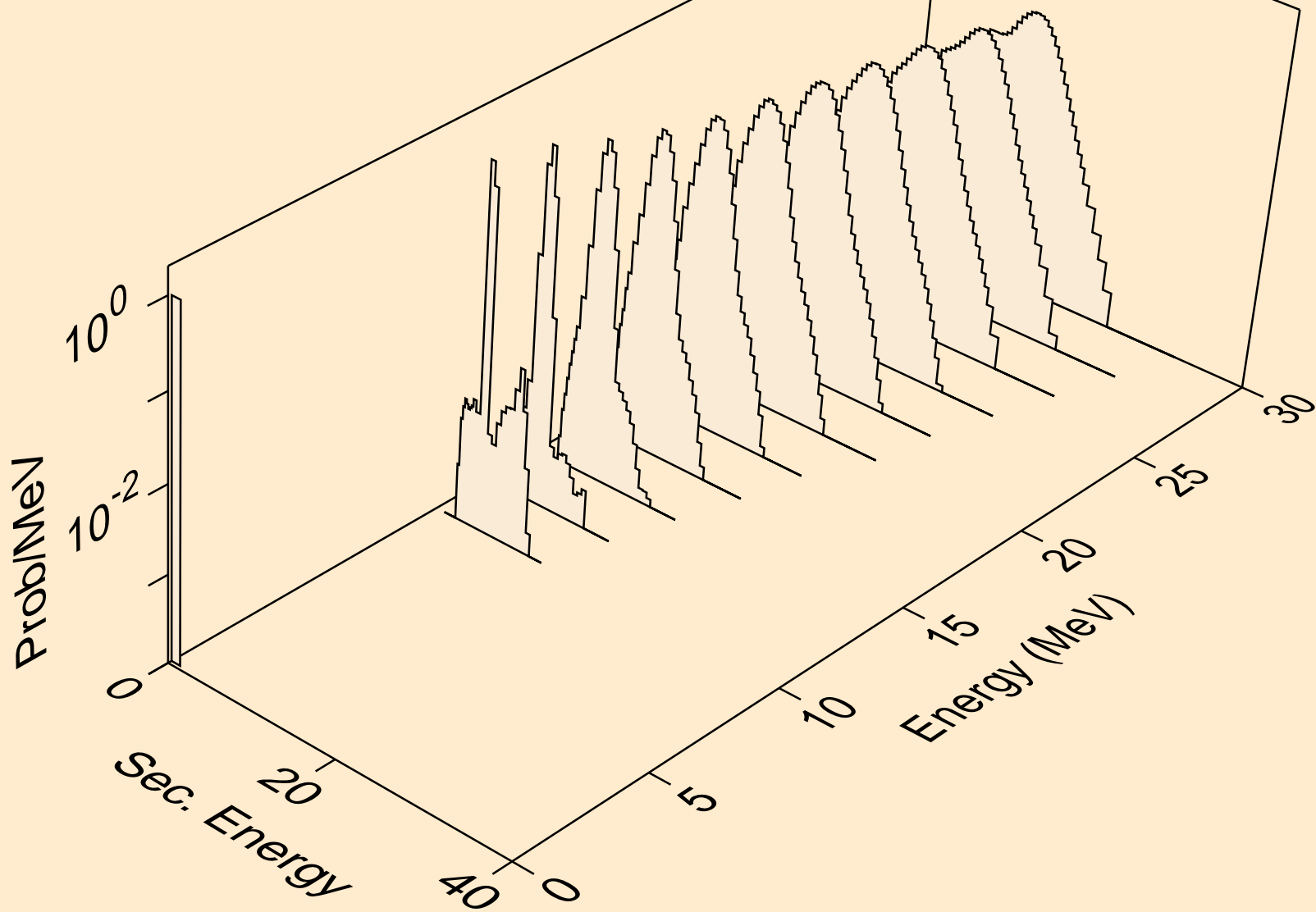

IR192N HELION ACER TENDL-2021 LIBRARY; T=0.K  
protons from (s,pd)

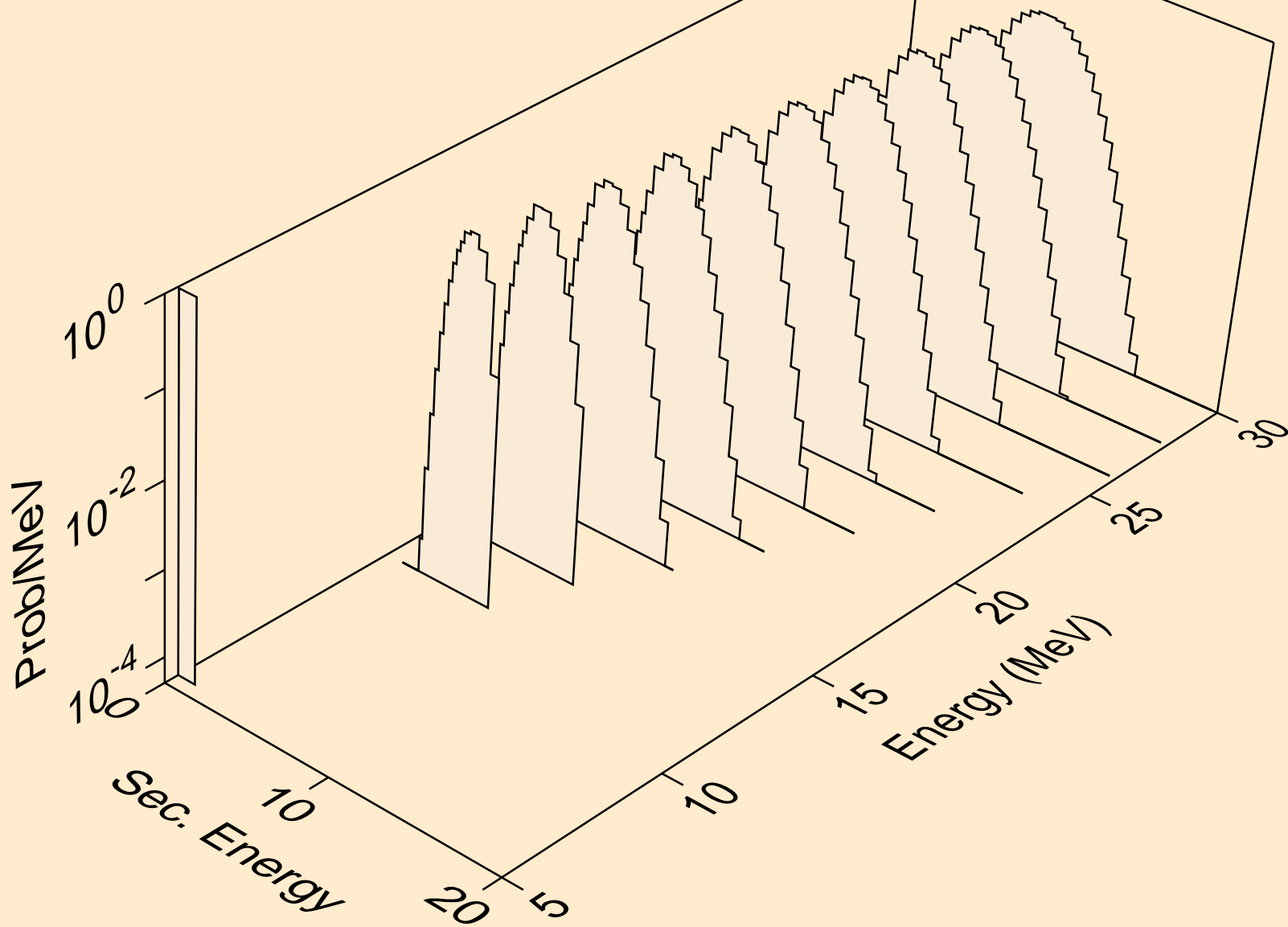

IR192N HELION ACER TENDL-2021 LIBRARY; T=0.K  
protons from (s,pt)

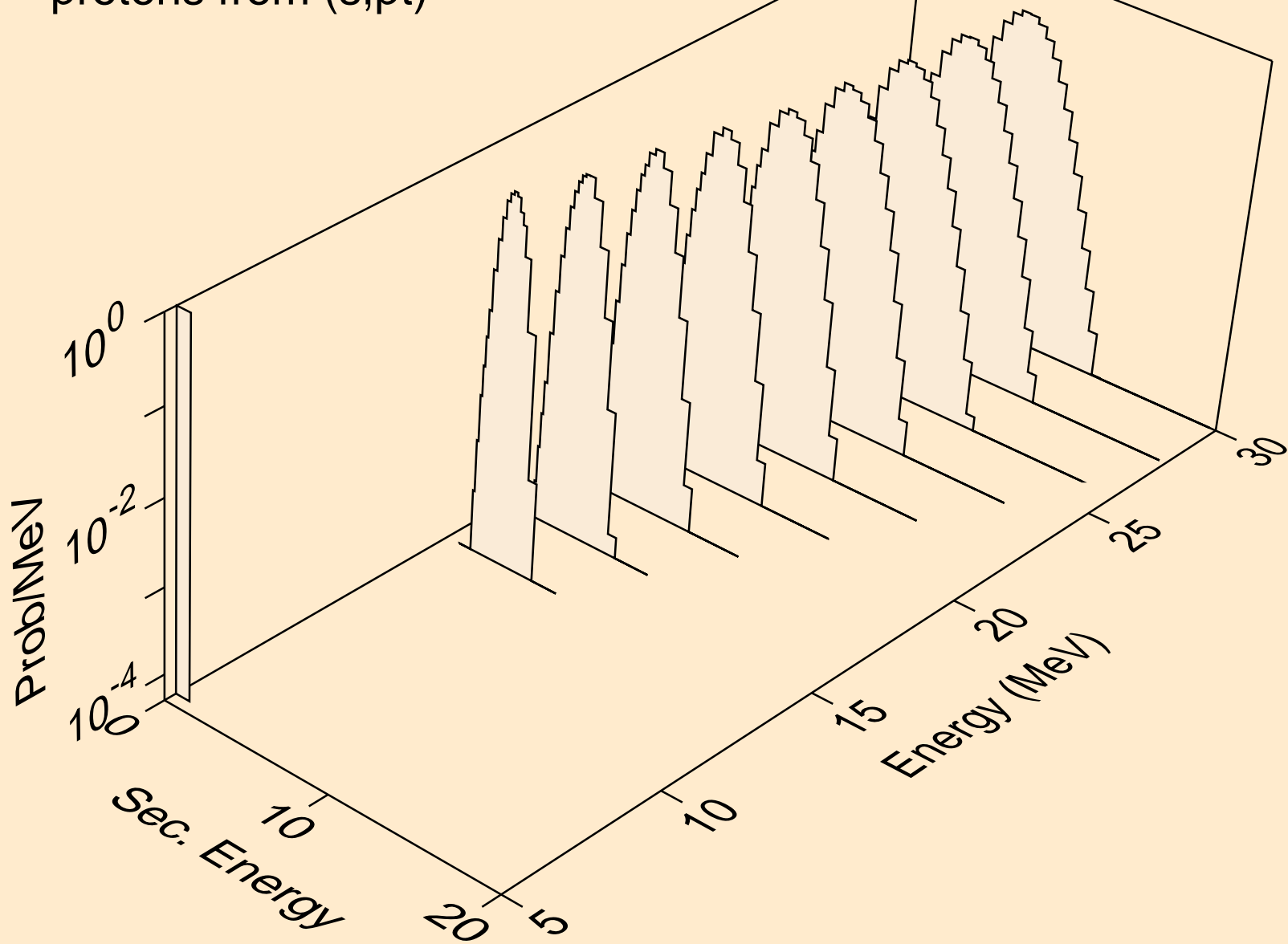

IR192N HELION ACER TENDL-2021 LIBRARY; T=0.K  
deuterons from (s,x)

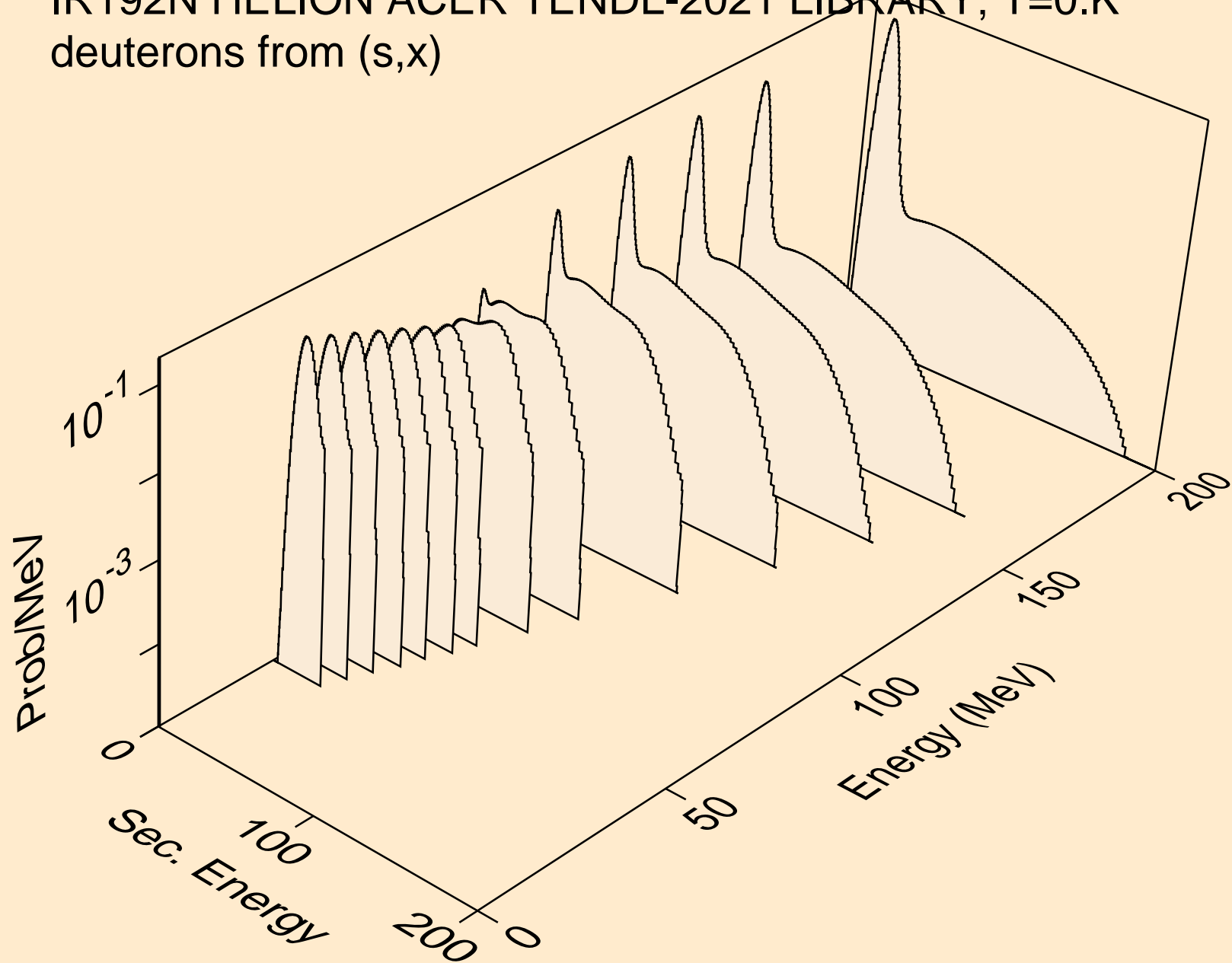

IR192N HELION ACER TENDL-2021 LIBRARY; T=0.K  
deuterons from (s,2nd)

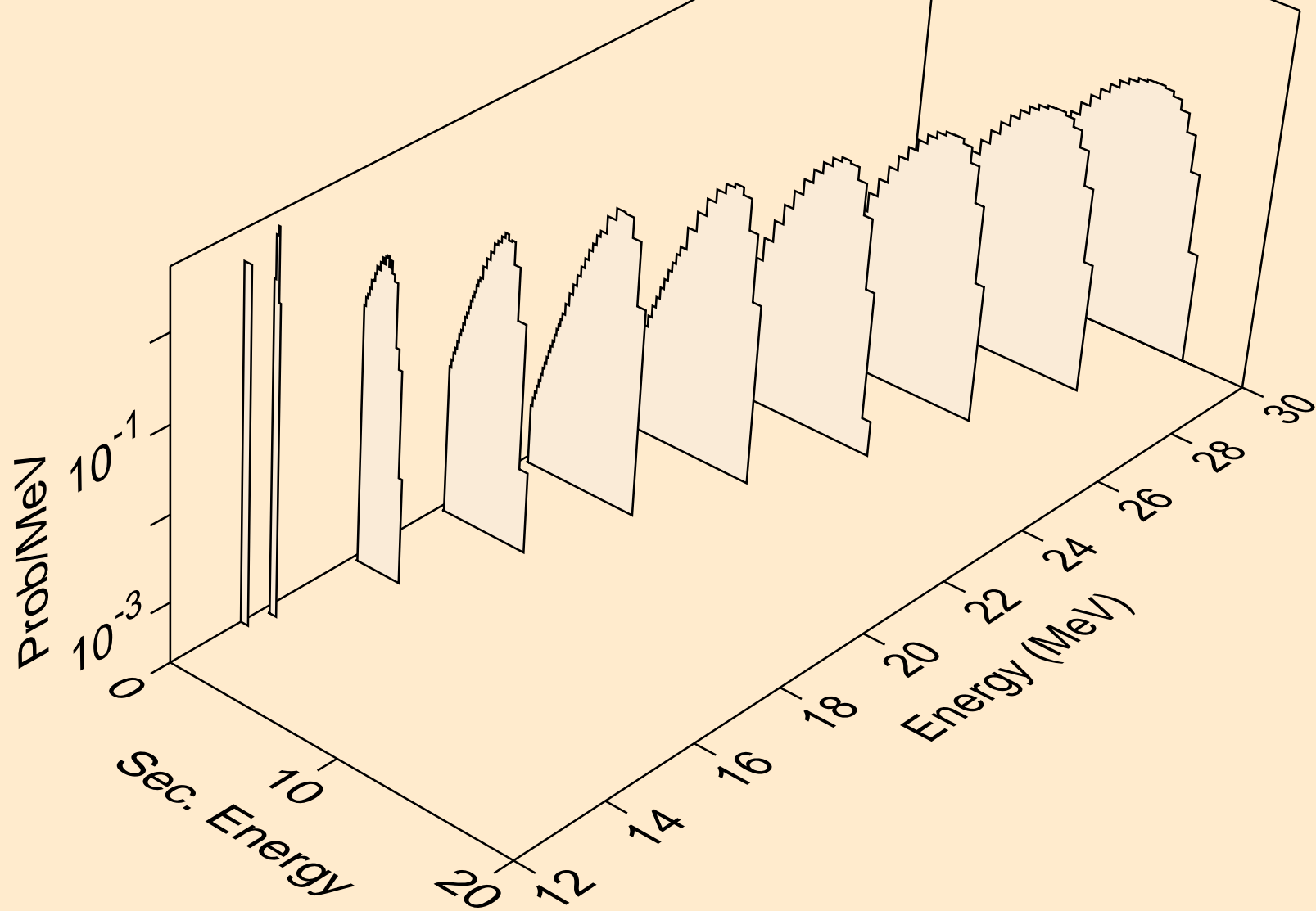

IR192N HELION ACER TENDL-2021 LIBRARY; T=0.K  
deuterons from (s,n\*)d

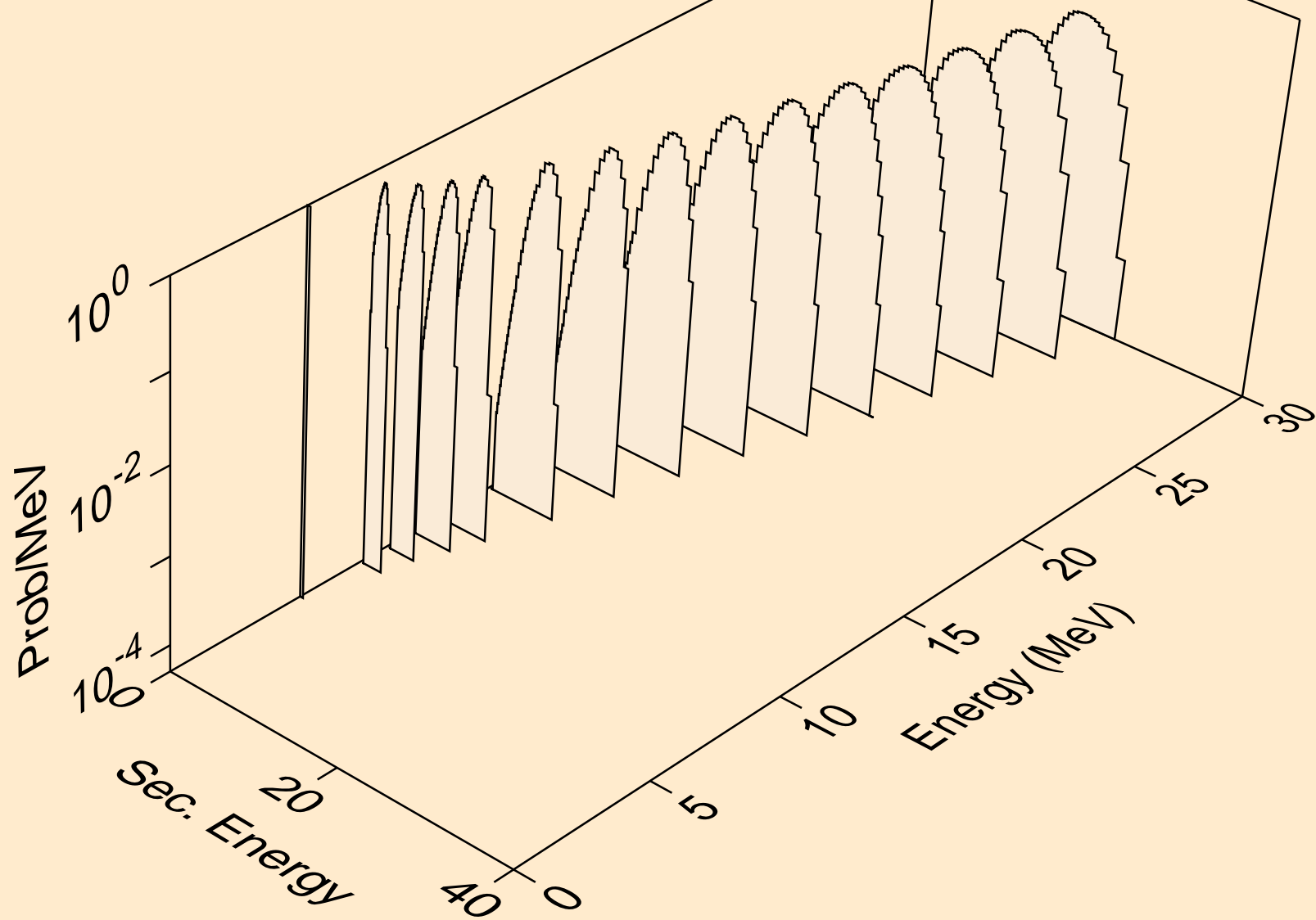



IR192N HELION ACER TENDL-2021 LIBRARY; T=0.K  
deuterons from (s,d)

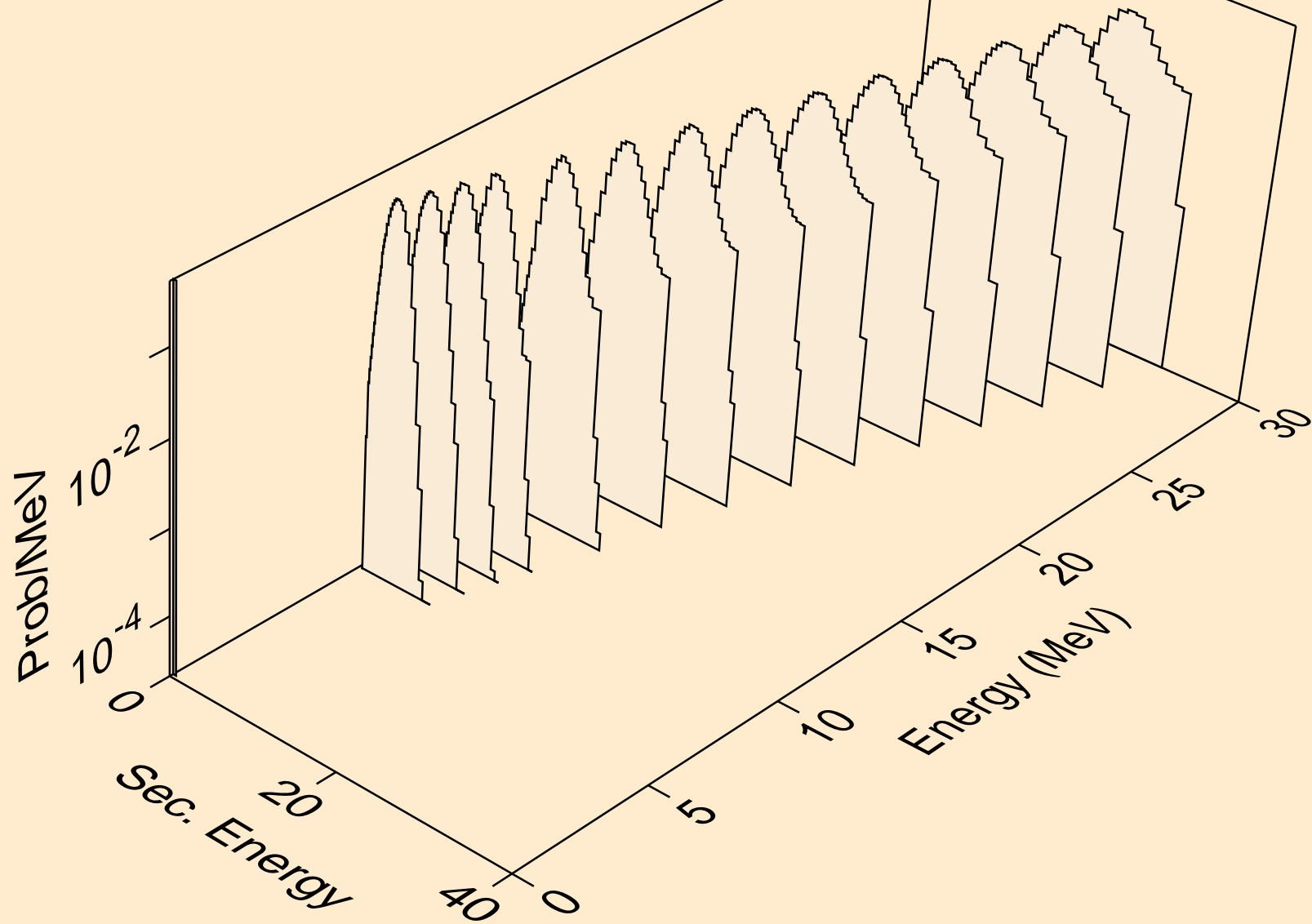

IR192N HELION ACER TENDL-2021 LIBRARY; T=0.K  
deuterons from (s,pd)

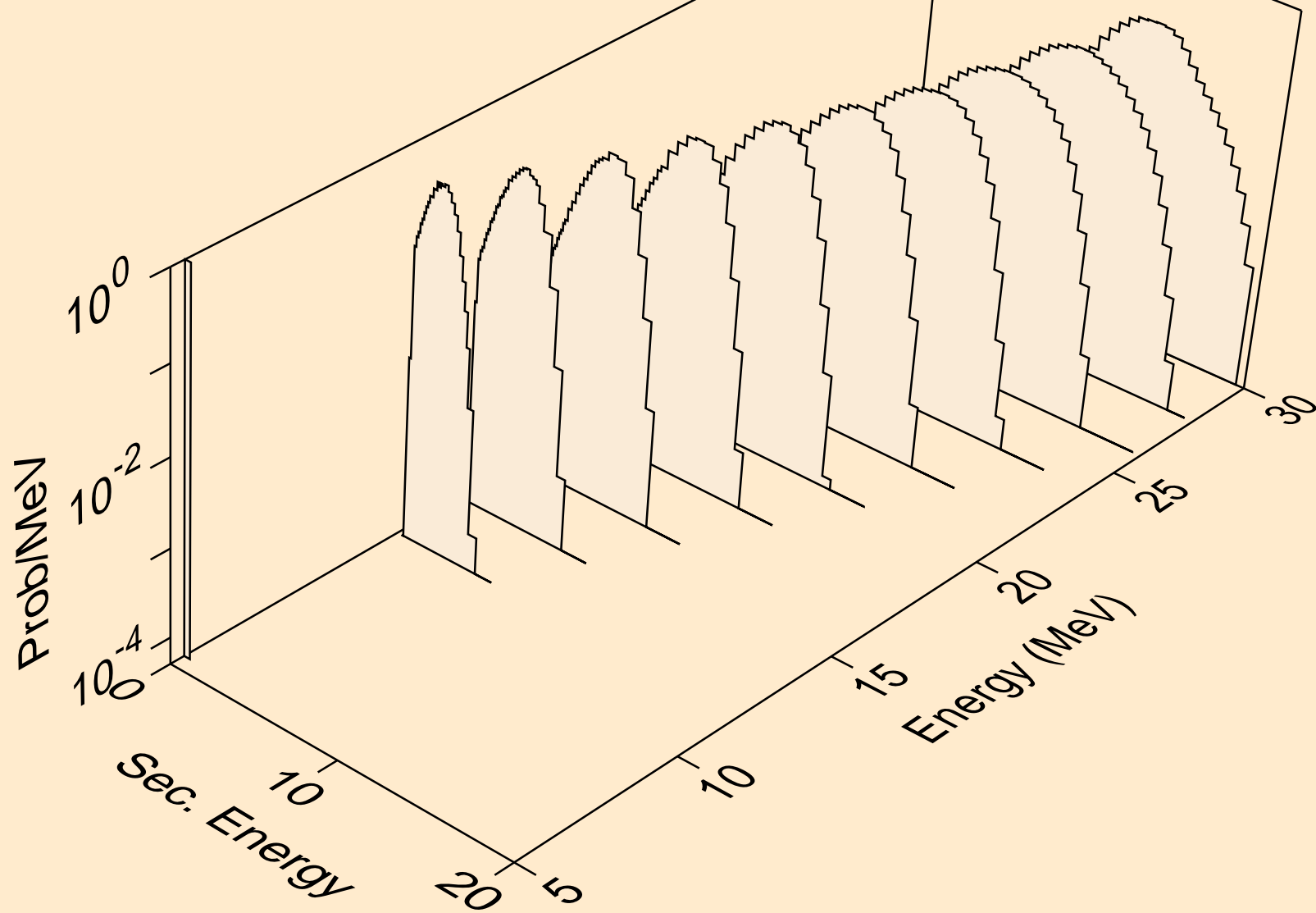

IR192N HELION ACER TENDL-2021 LIBRARY; T=0.K  
deuterons from (s,da)

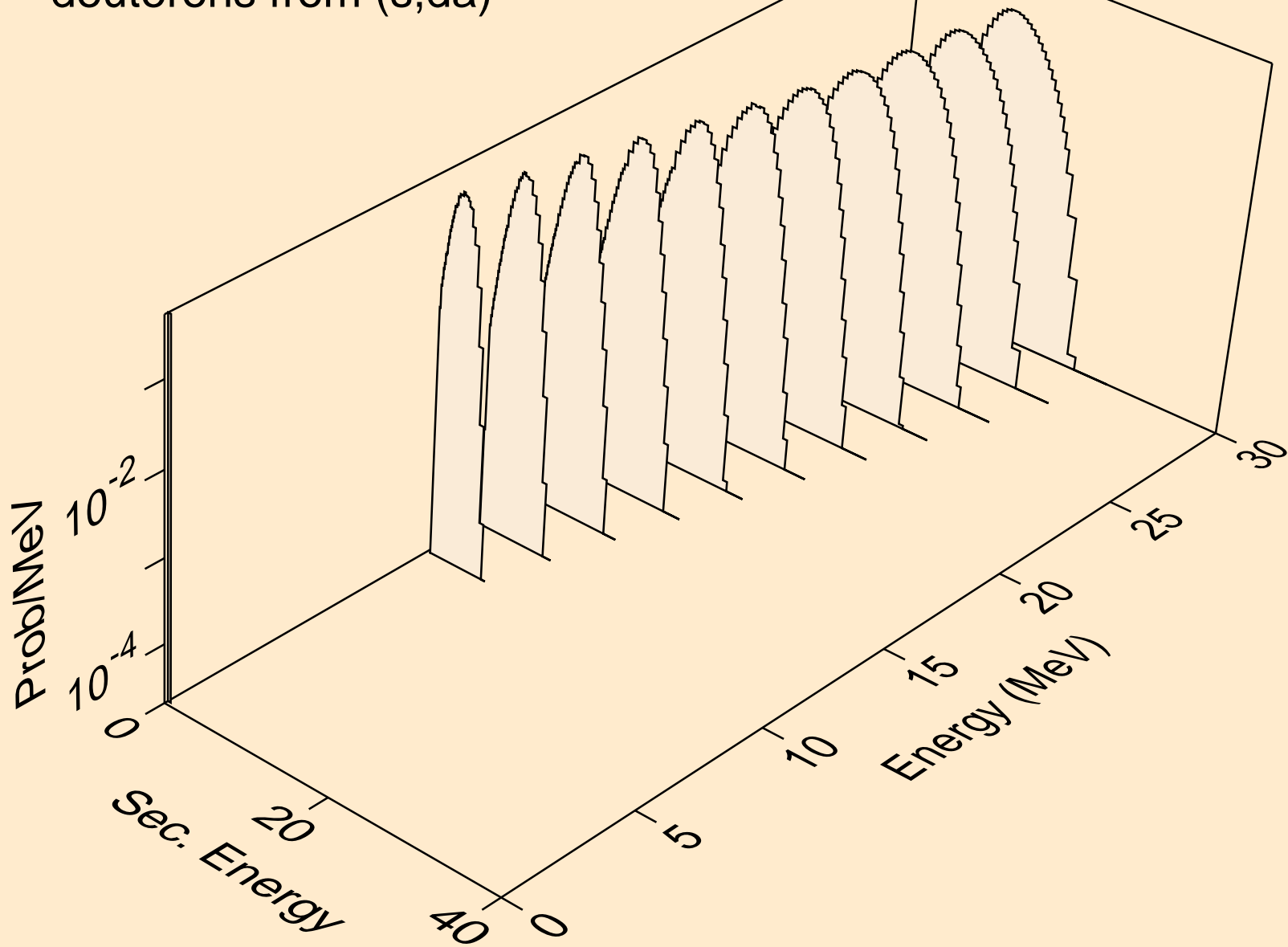

IR192N HELION ACER TENDL-2021 LIBRARY; T=0.K  
tritons from (s,x)

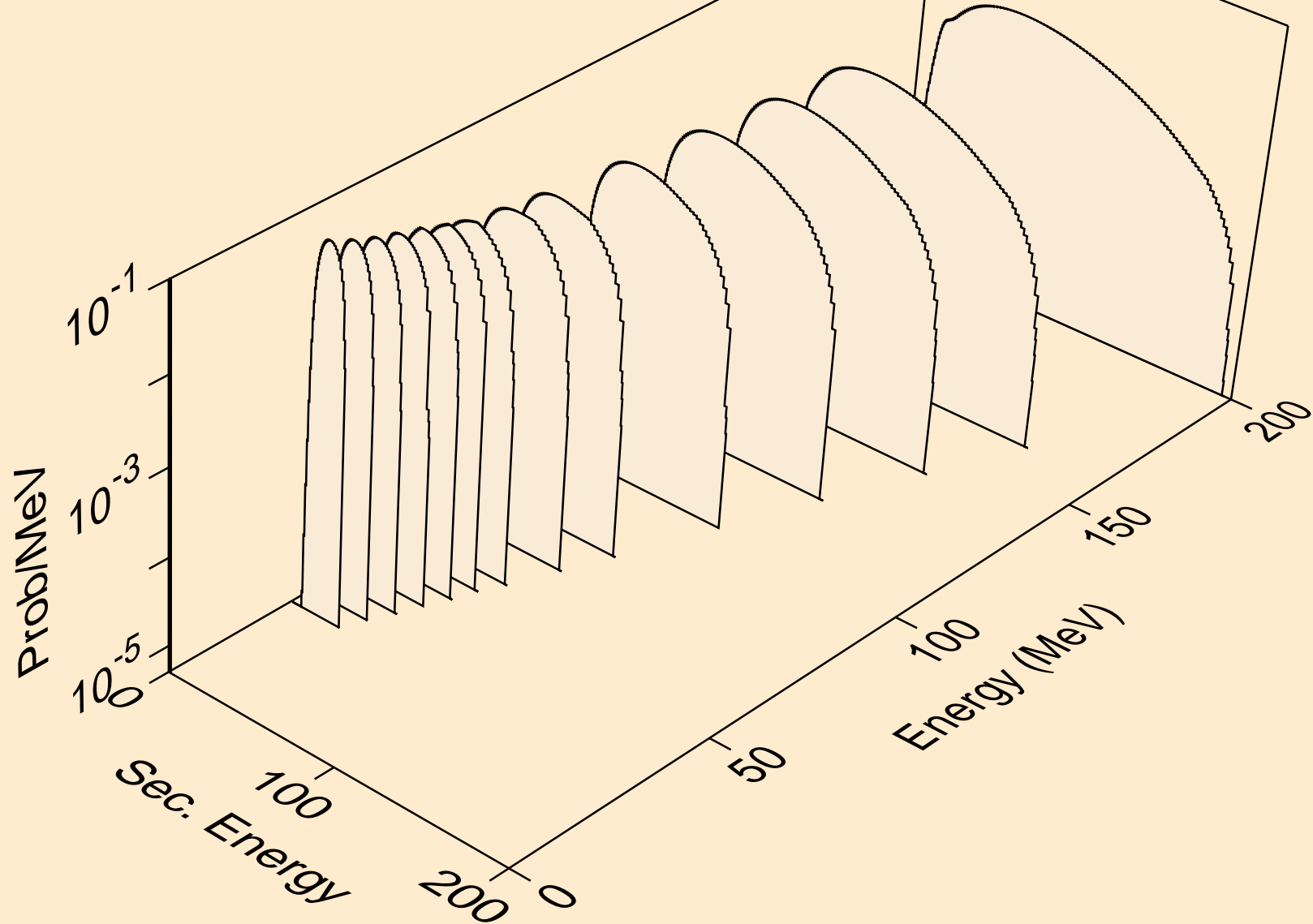

IR192N HELION ACER TENDL-2021 LIBRARY; T=0.K  
tritons from (s,n\*)t

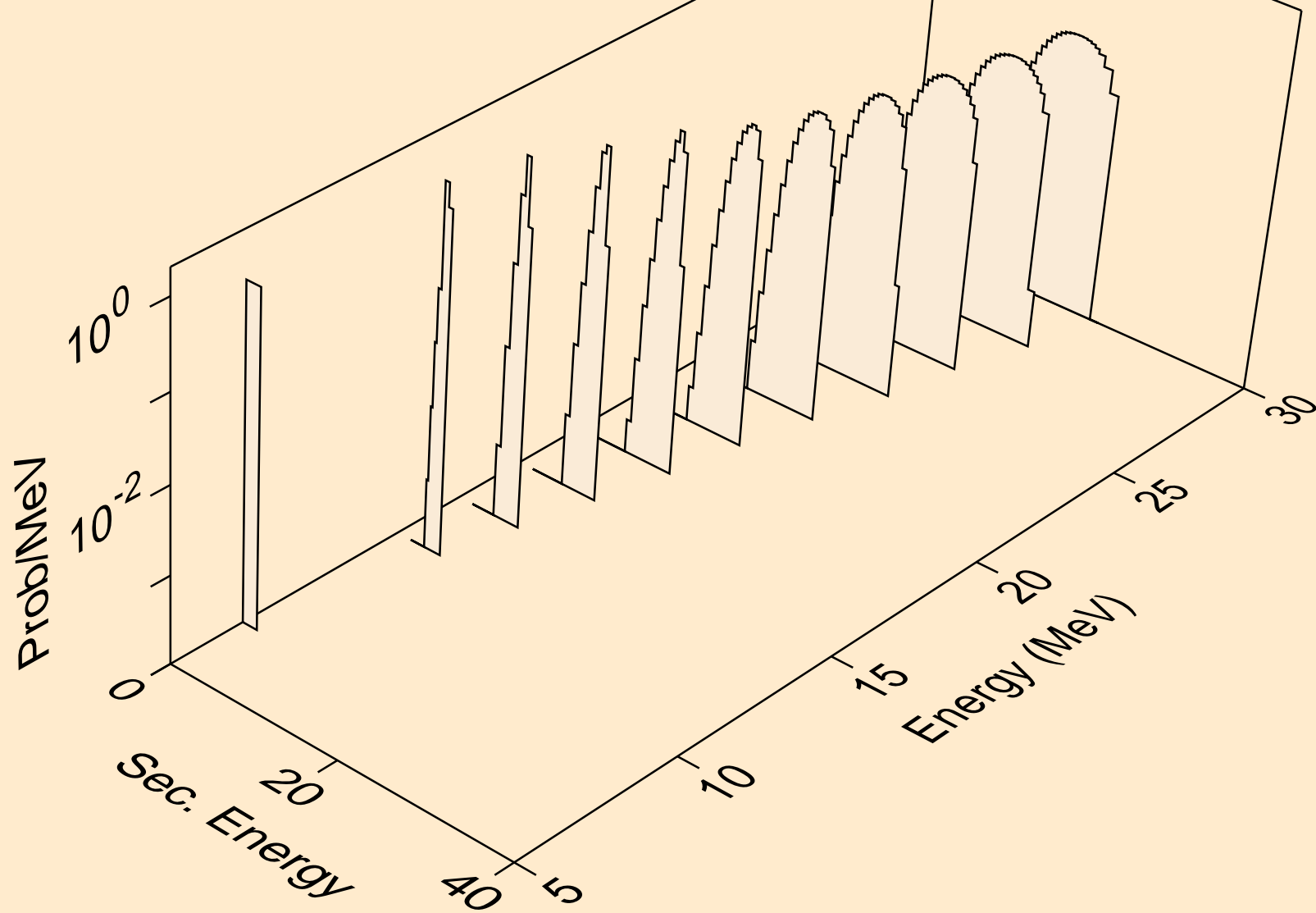

IR192N HELION ACER TENDL-2021 LIBRARY; T=0.K  
tritons from (s,t)

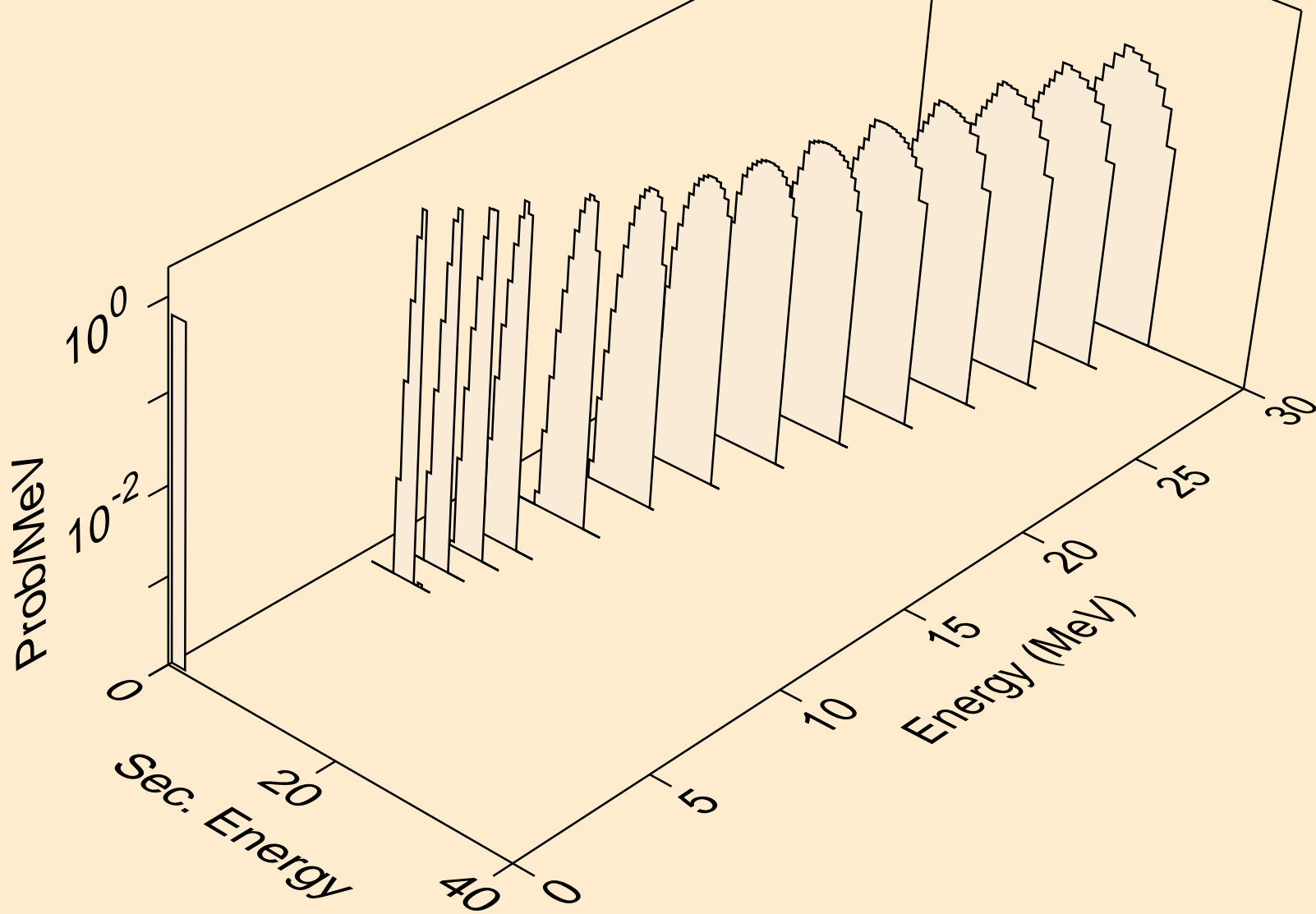

IR192N HELION ACER TENDL-2021 LIBRARY; T=0.K  
tritons from (s,pt)

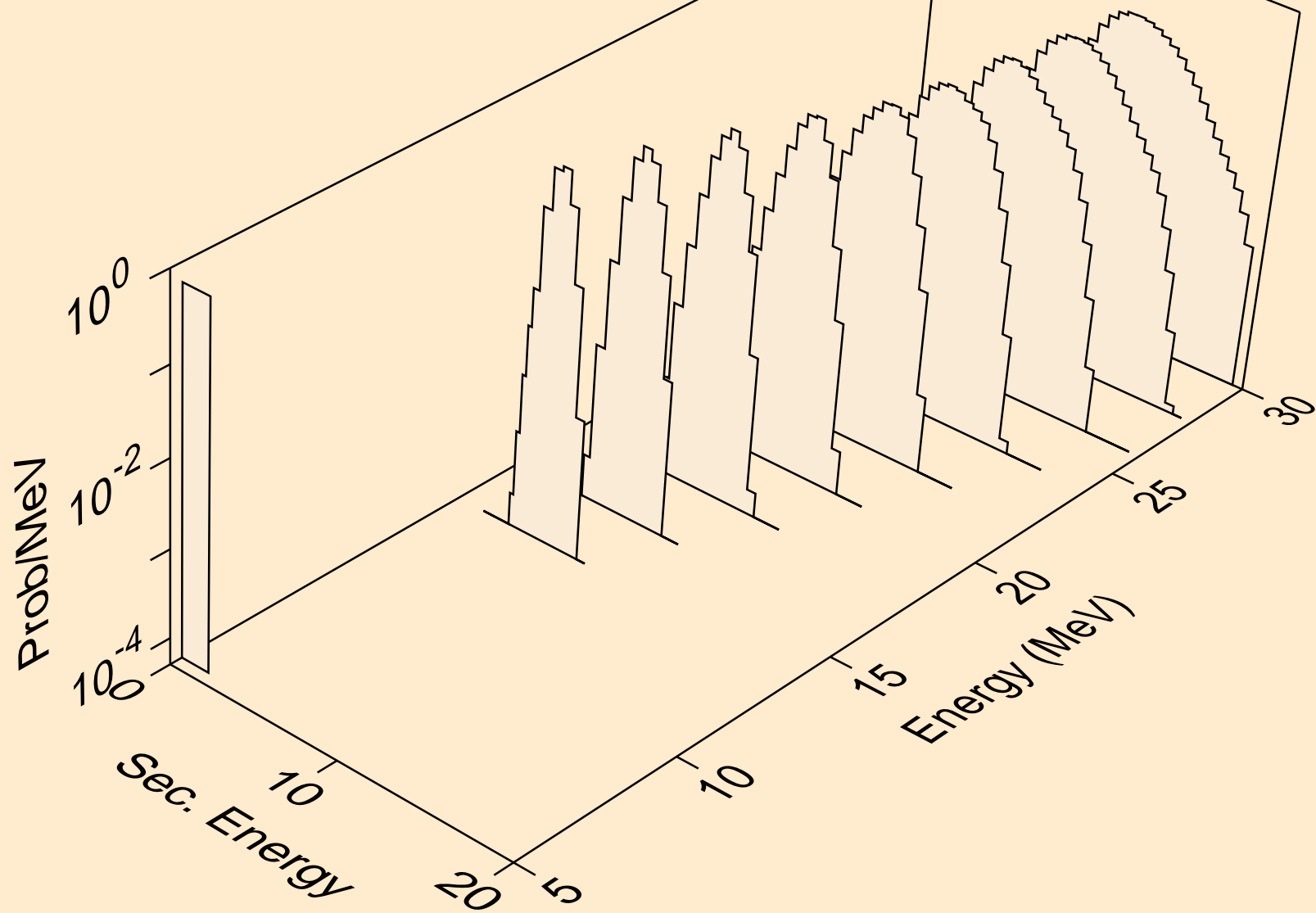

IR192N HELION ACER TENDL-2021 LIBRARY; T=0.K  
alphas from (s,x)

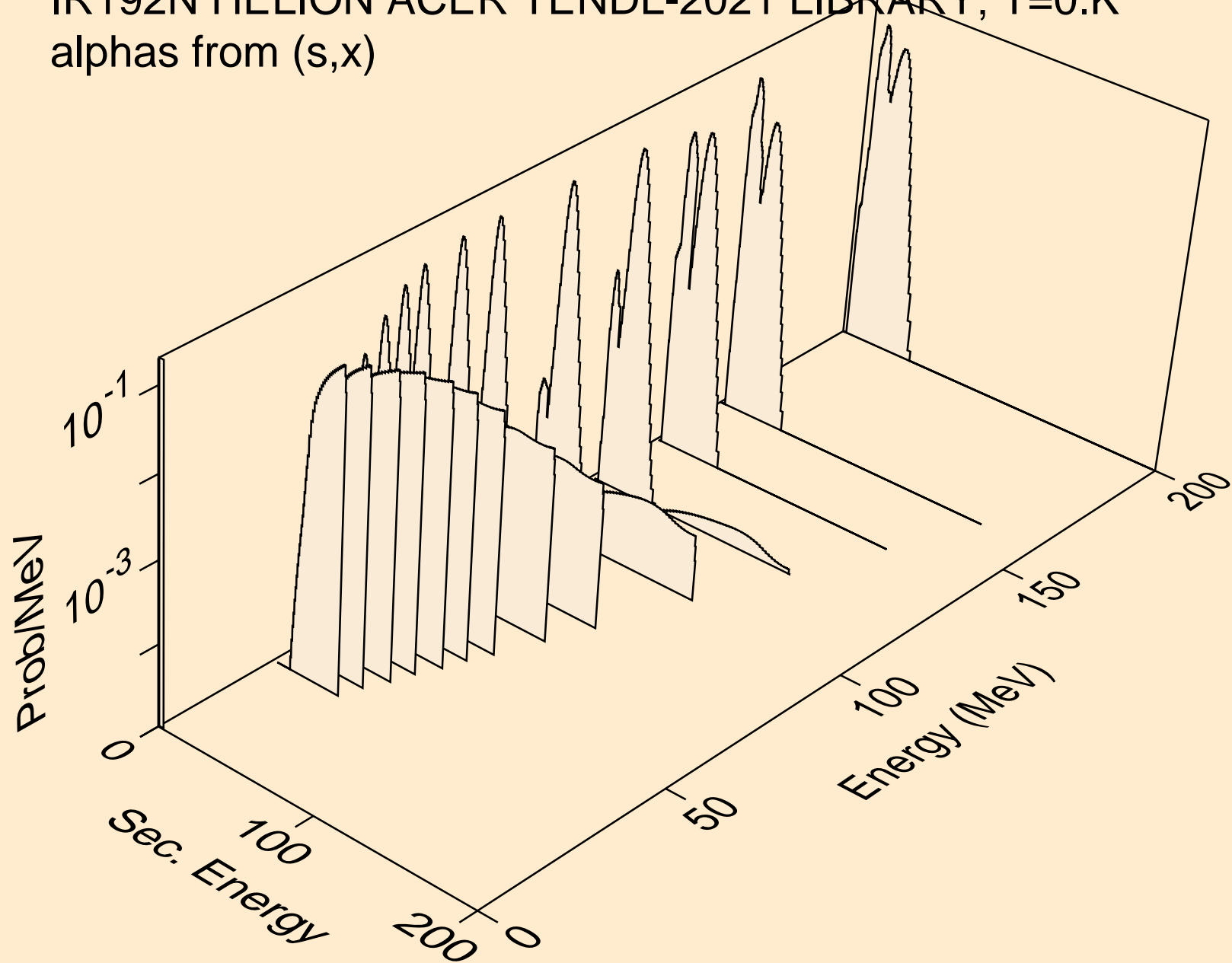



IR192N HELION ACER TENDL-2021 LIBRARY; T=0.K  
alphas from (s,n\*)a

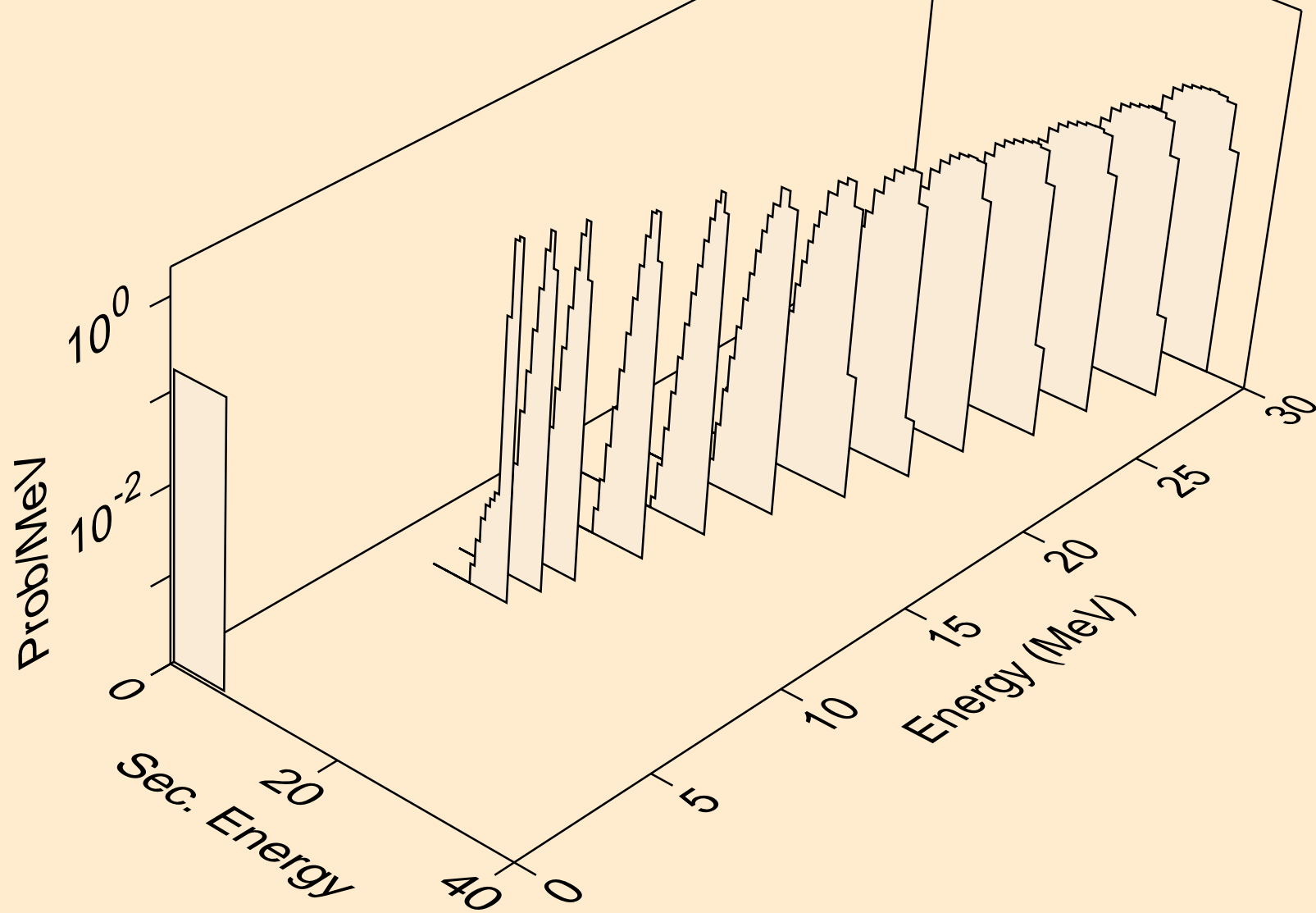

IR192N HELION ACER TENDL-2021 LIBRARY; T=0.K  
alphas from (s,2n)a

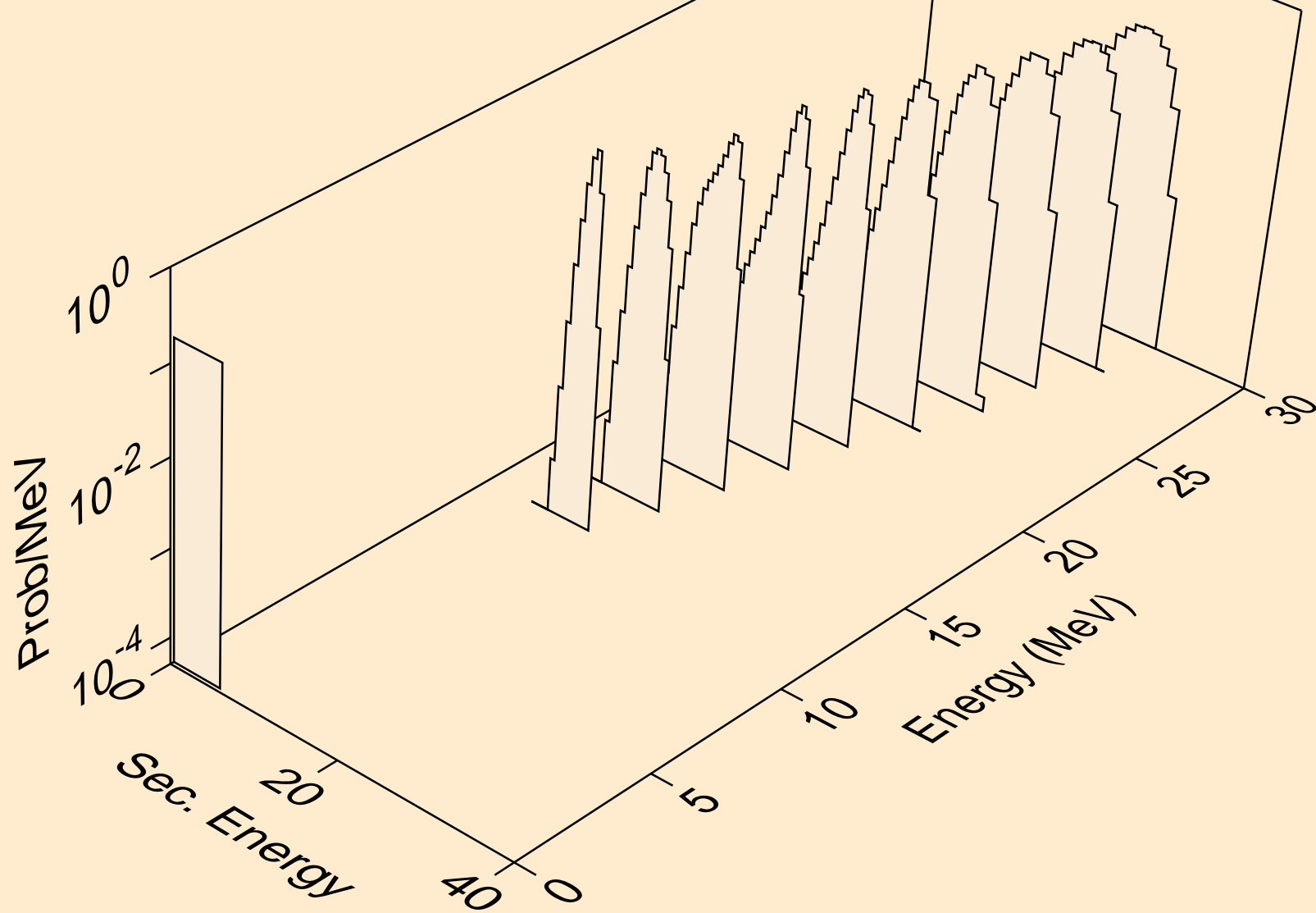

IR192N HELION ACER TENDL-2021 LIBRARY; T=0.K  
alphas from (s,3n)a

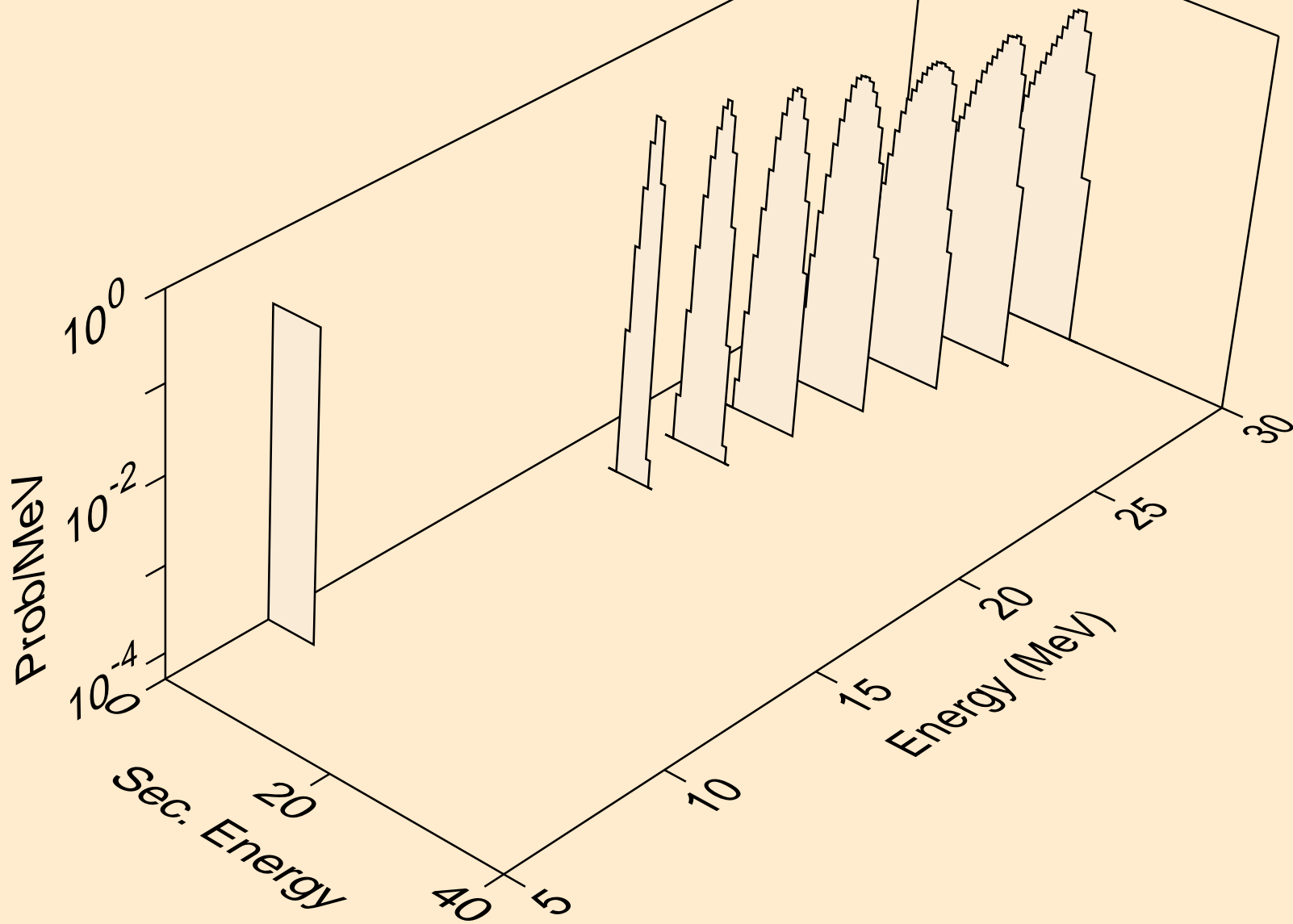

IR192N HELION ACER TENDL-2021 LIBRARY; T=0.K  
alphas from (s,npa)

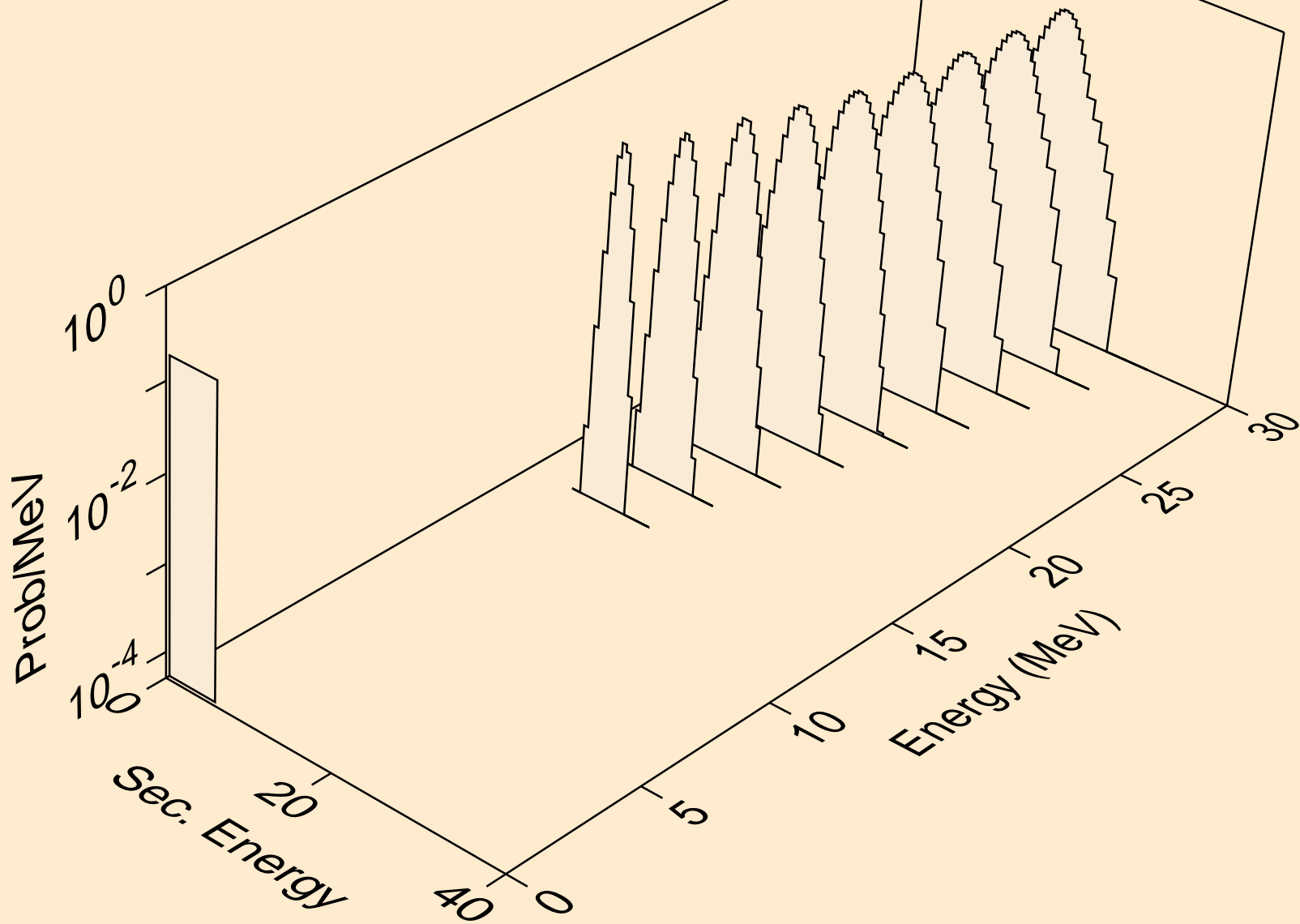

IR192N HELION ACER TENDL-2021 LIBRARY; T=0.K  
alphas from (s,a)

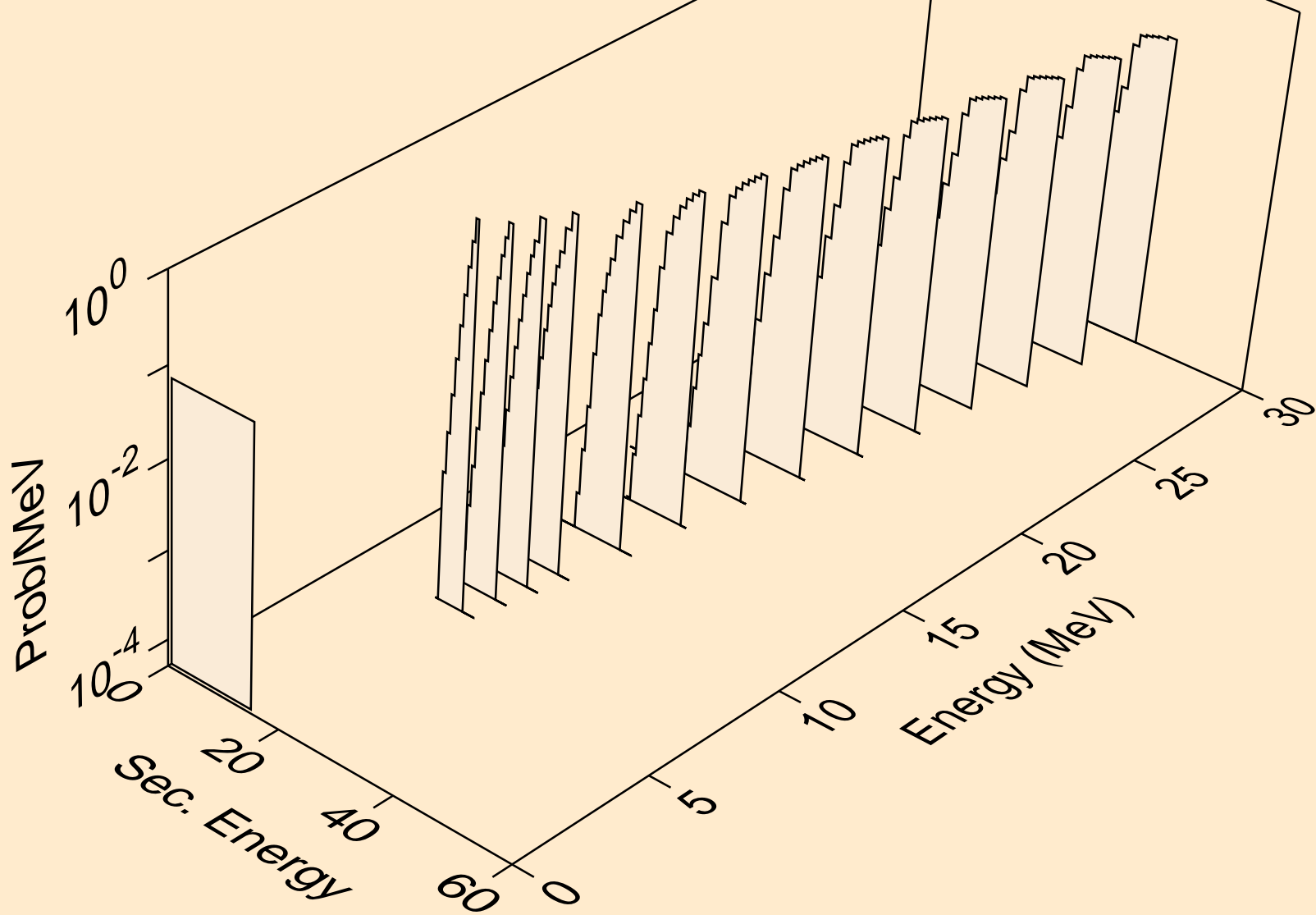

IR192N HELION ACER TENDL-2021 LIBRARY; T=0.K  
alphas from (s,2a)

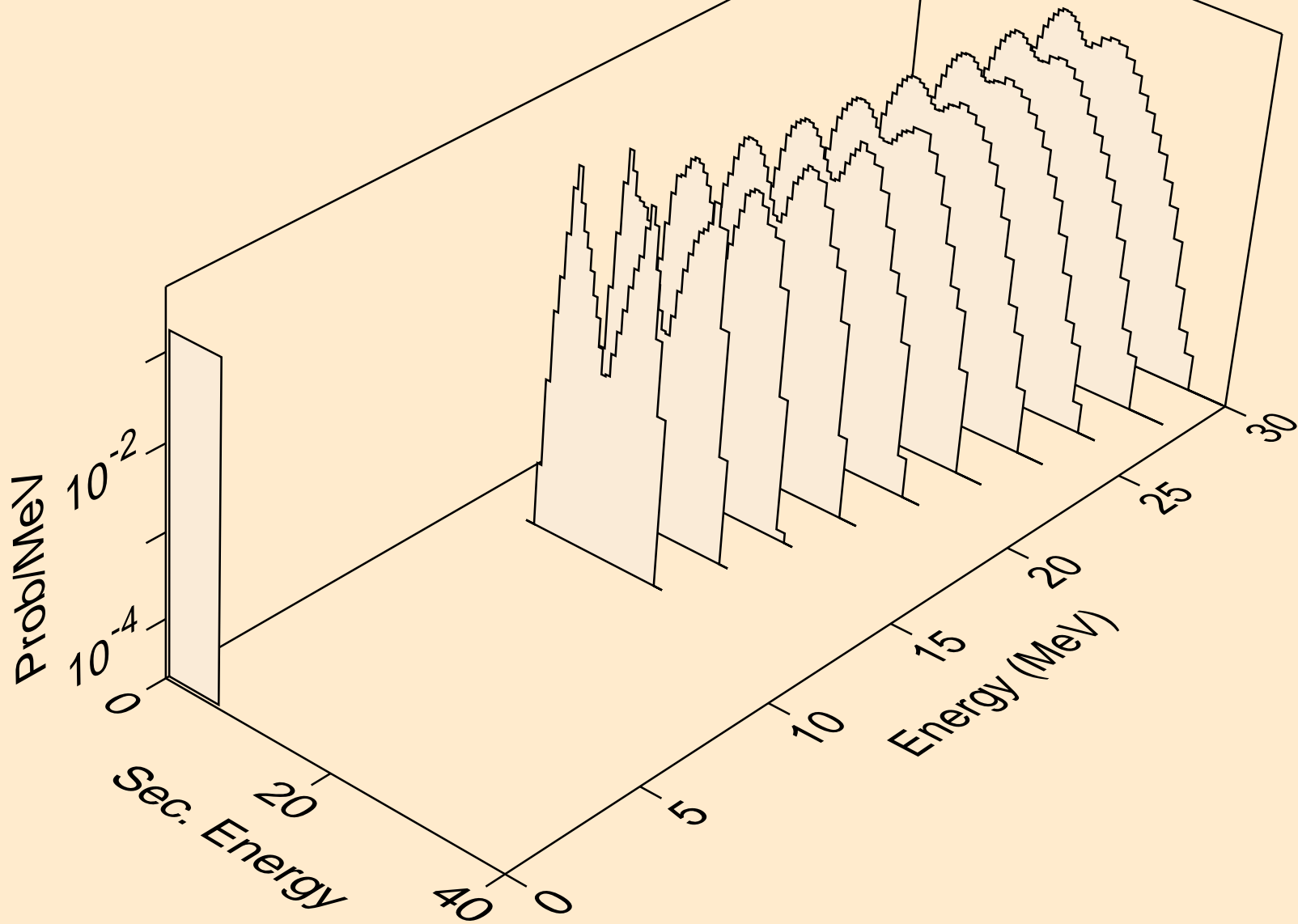

IR192N HELION ACER TENDL-2021 LIBRARY; T=0.K  
alphas from (s,pa)

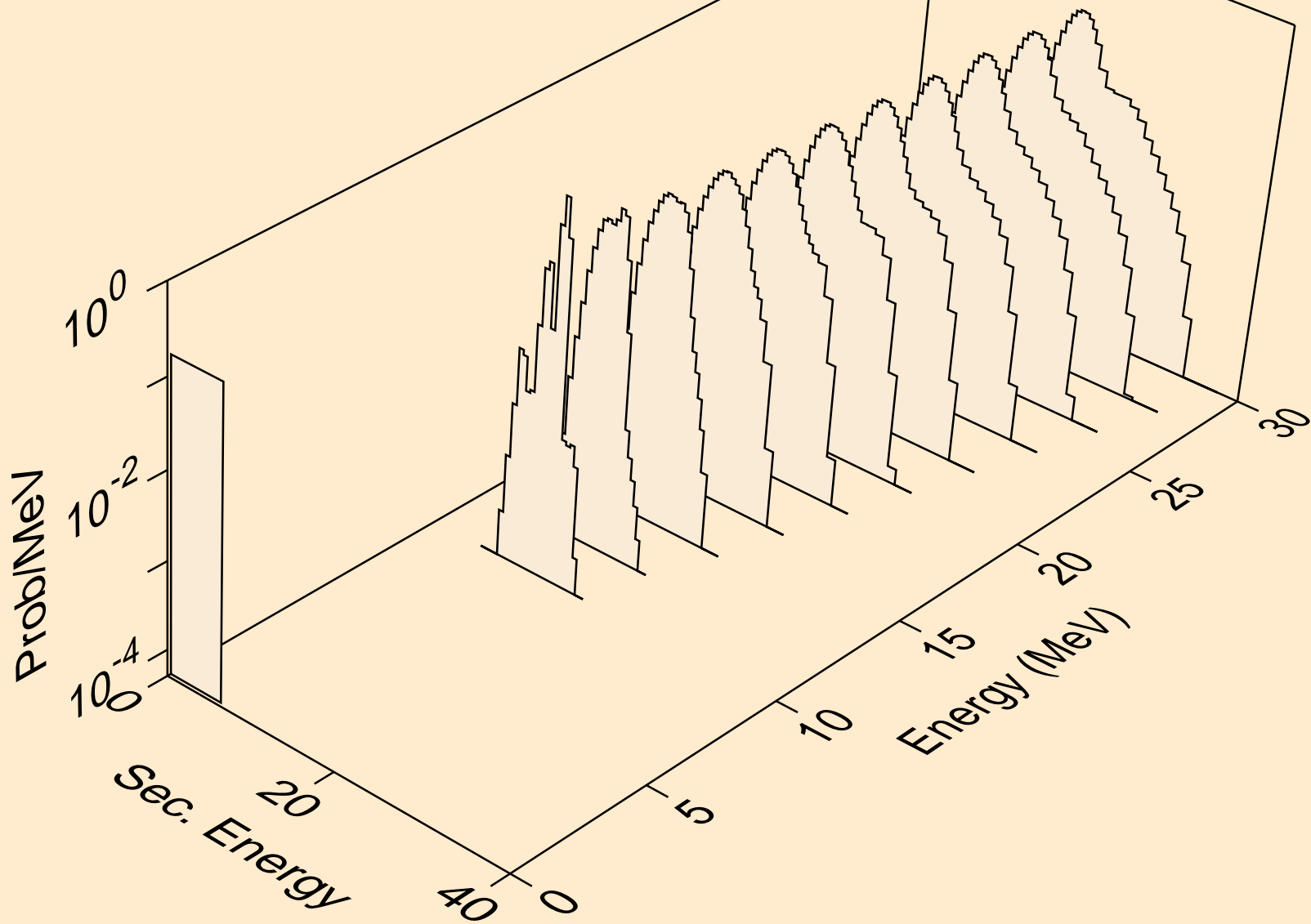

IR192N HELION ACER TENDL-2021 LIBRARY; T=0.K  
alphas from (s,da)

