

KR093 HELION ACER TENDL-2021 LIBRARY; T=0.K  
Principal cross sections

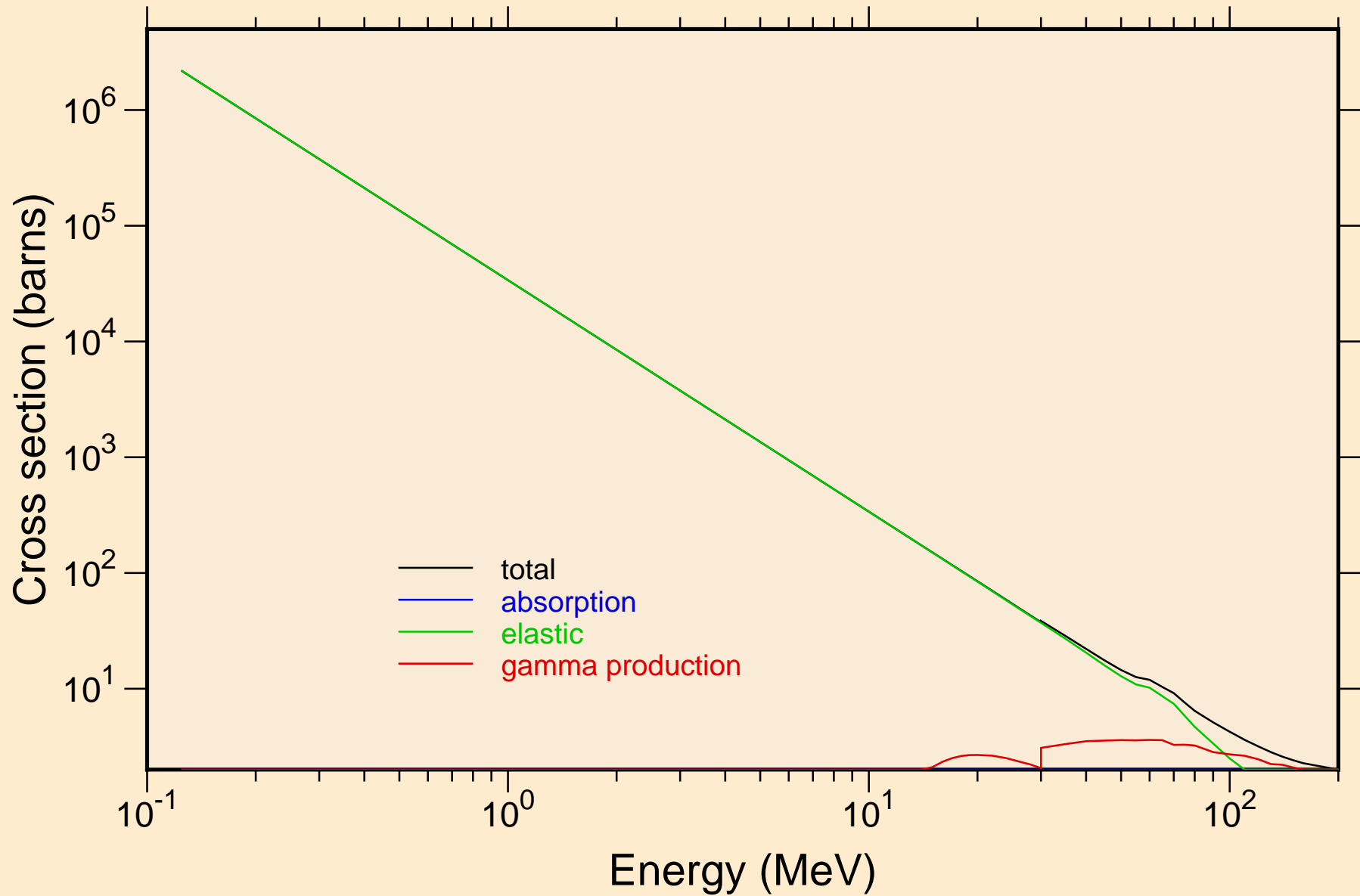

KR093 HELION ACER TENDL-2021 LIBRARY; T=0.K

Heating

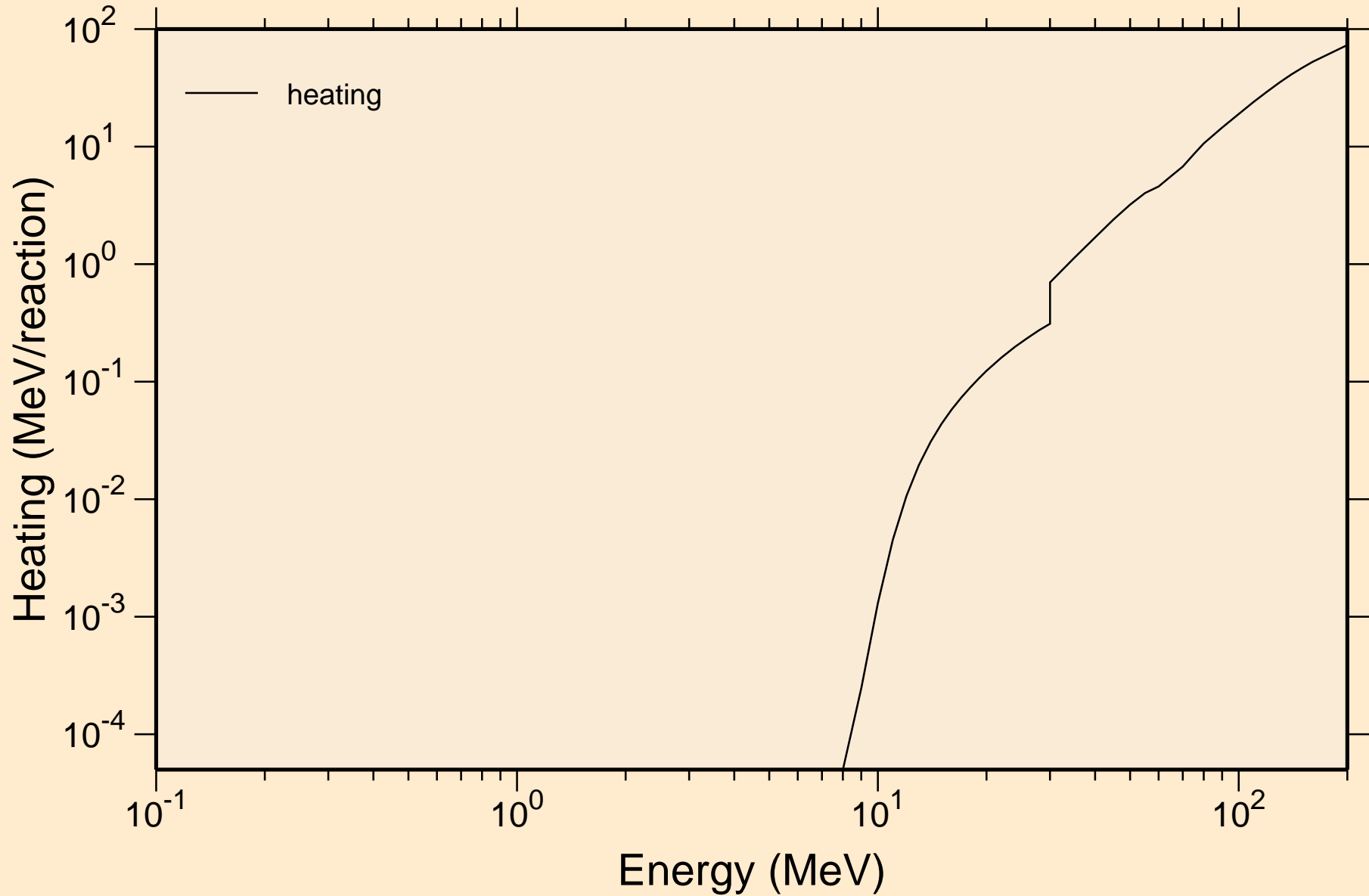

# KR093 HELION ACER TENDL-2021 LIBRARY; T=0.K

## Principal cross sections

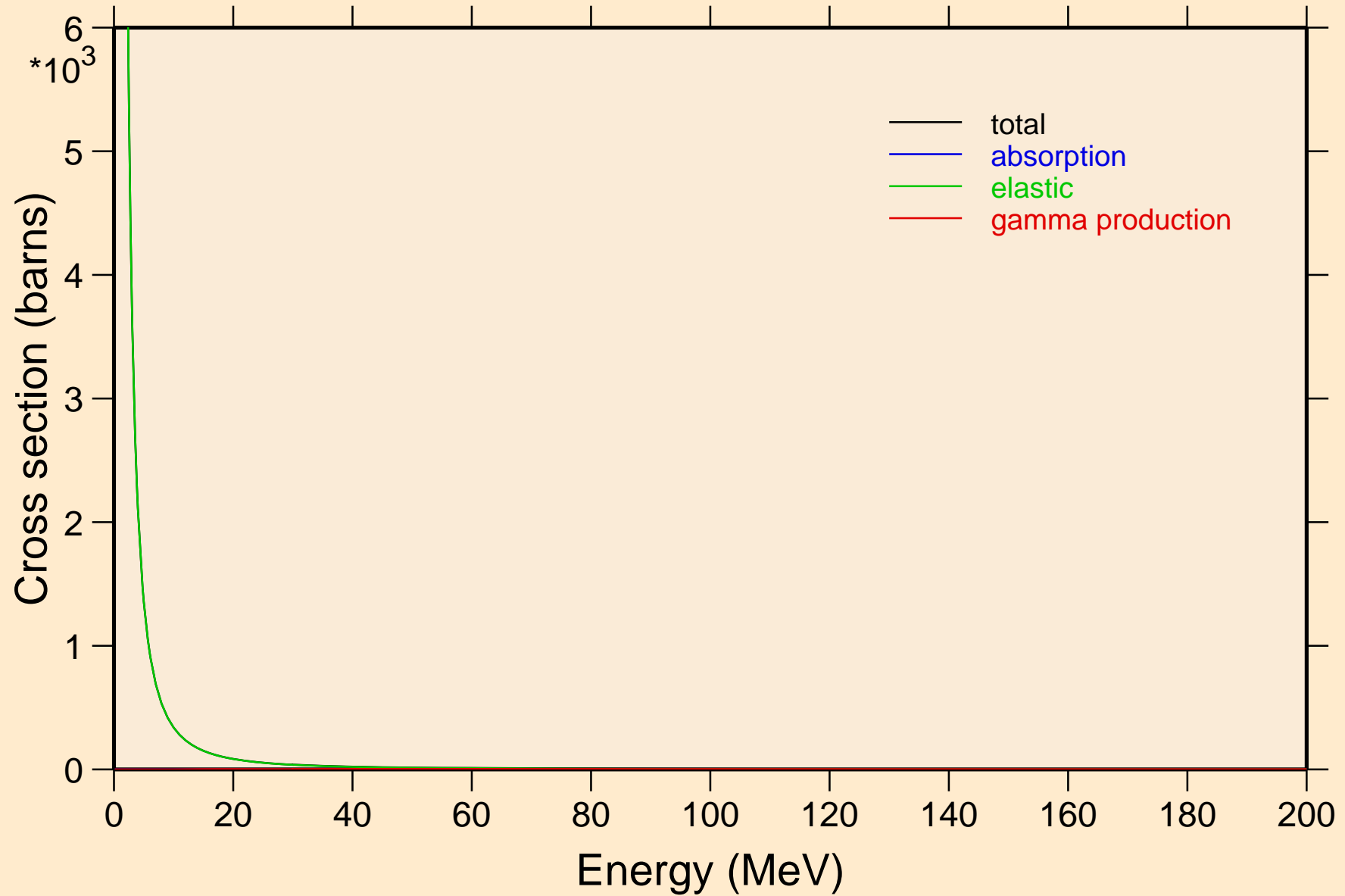

KR093 HELION ACER TENDL-2021 LIBRARY; T=0.K

Heating

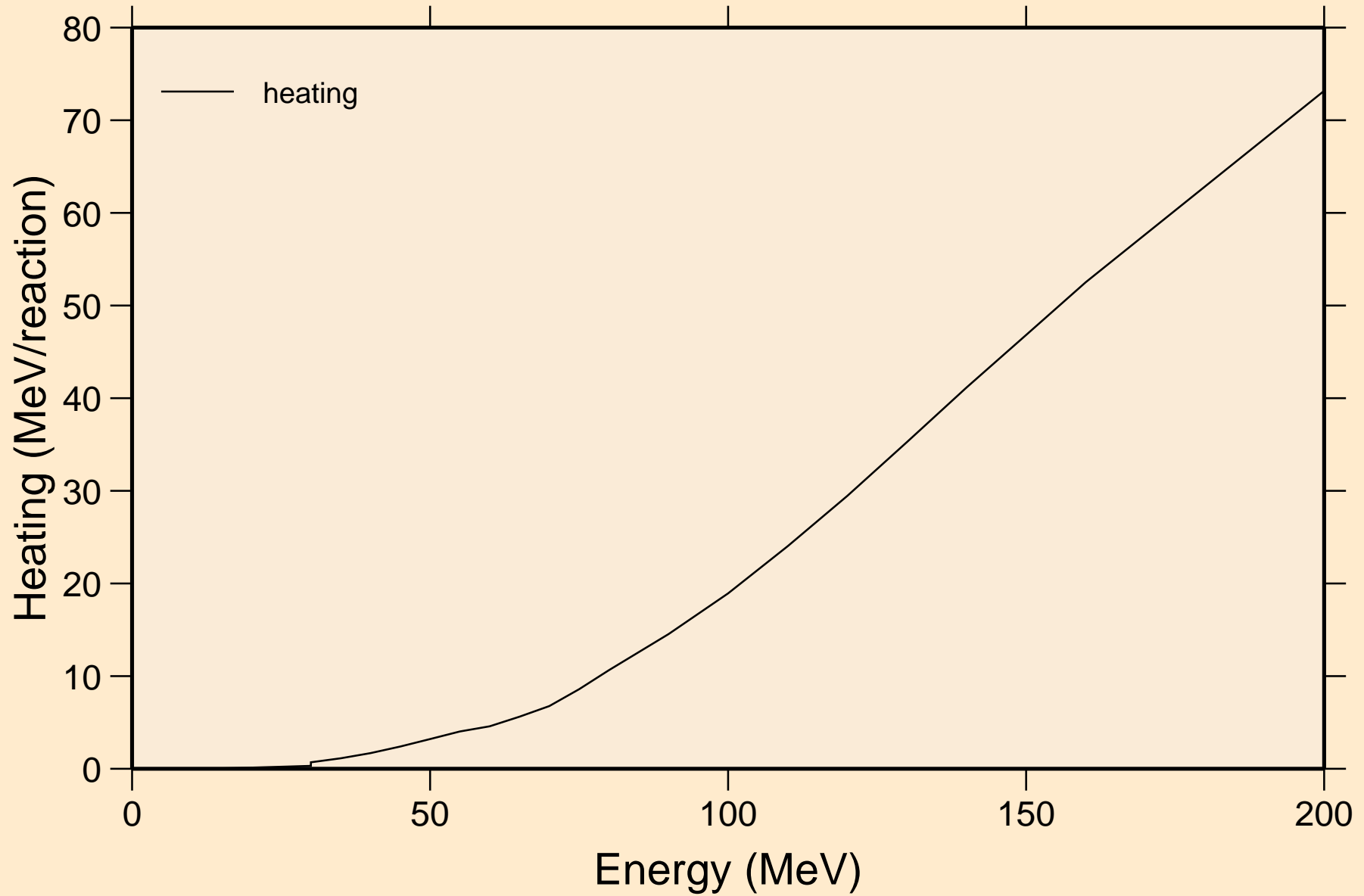

KR093 HELION ACER TENDL-2021 LIBRARY; T=0.K  
Threshold reactions

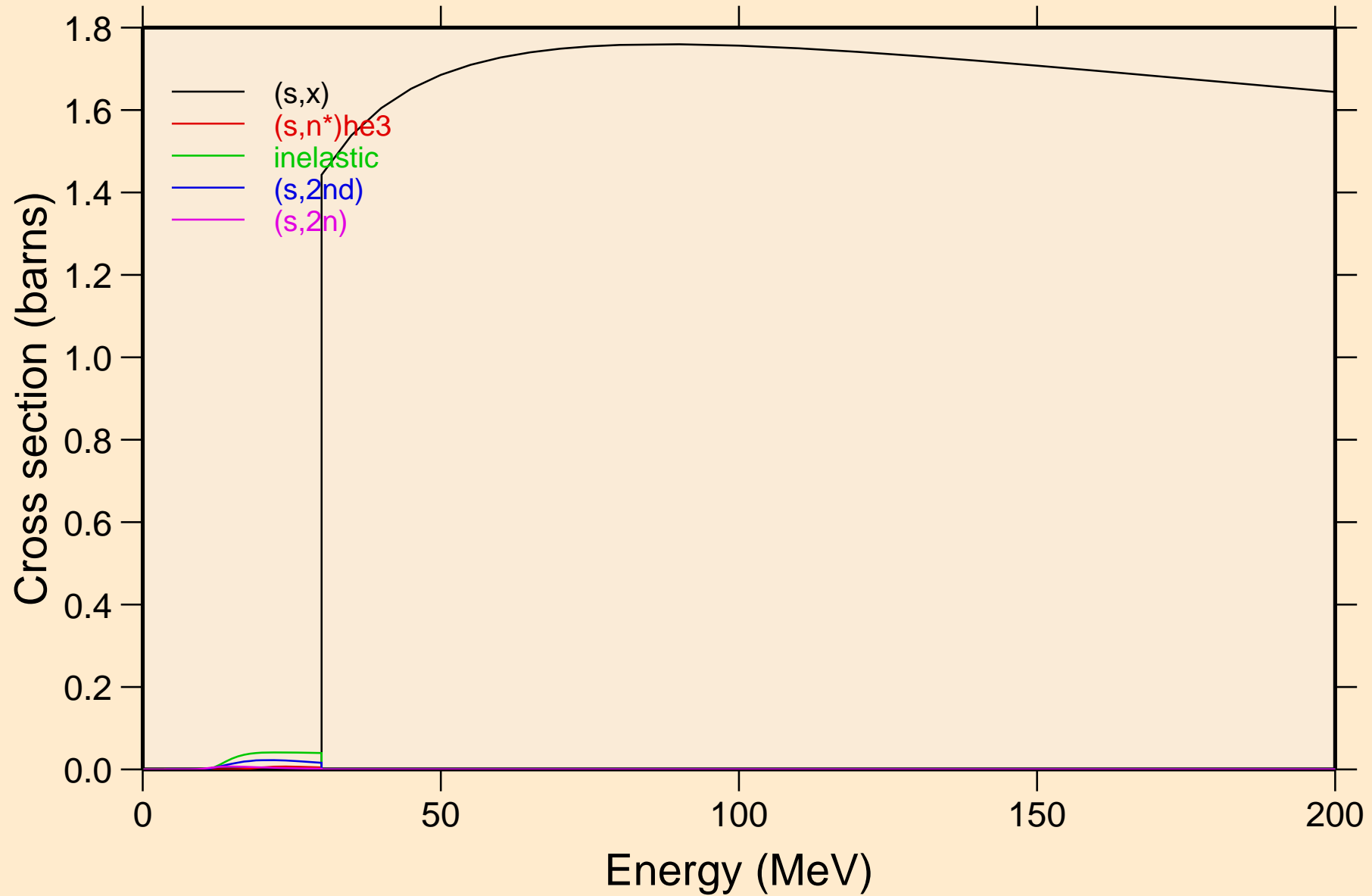

KR093 HELION ACER TENDL-2021 LIBRARY; T=0.K  
Threshold reactions

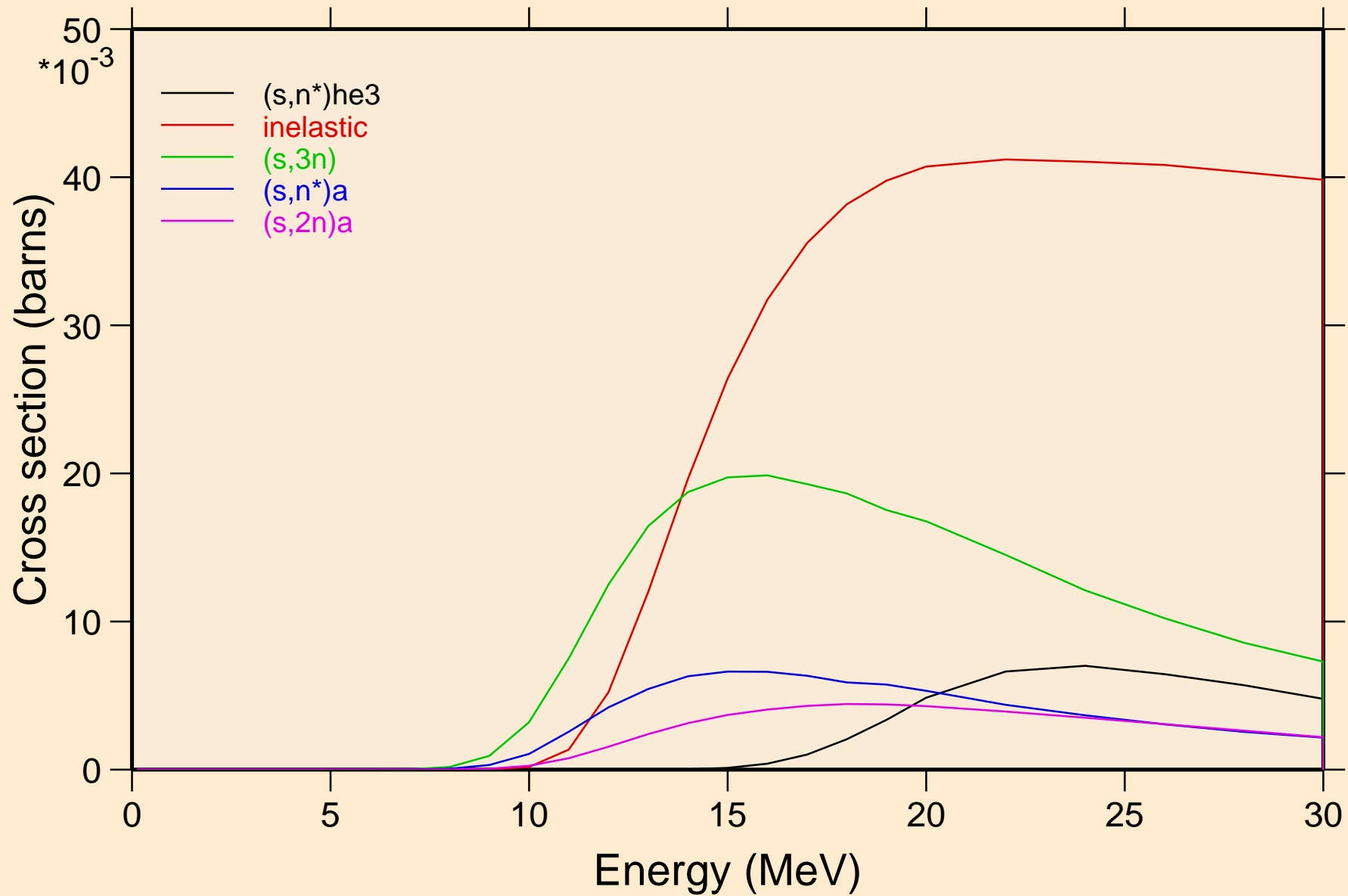

KR093 HELION ACER TENDL-2021 LIBRARY; T=0.K  
Threshold reactions

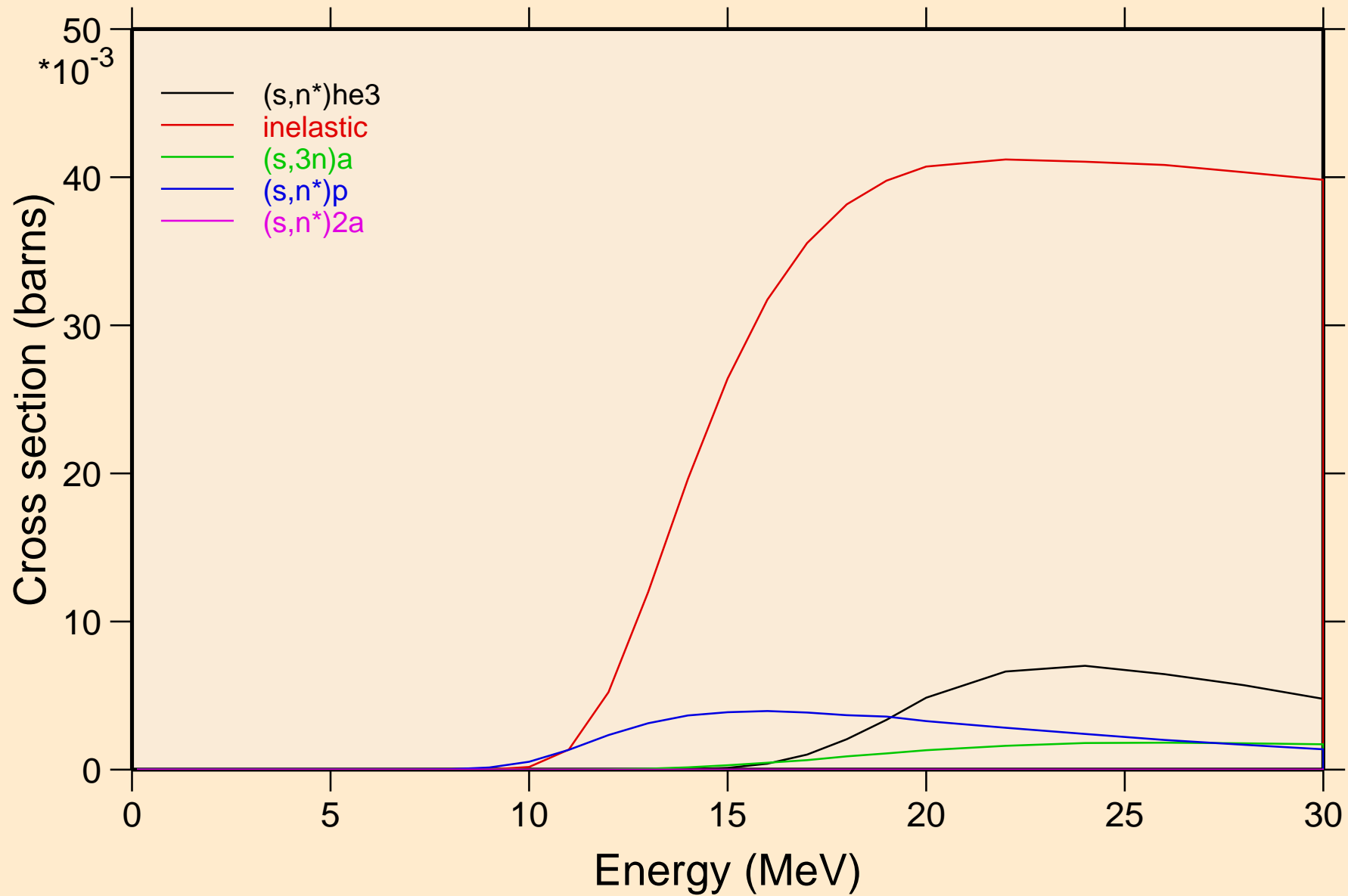

# KR093 HELION ACER TENDL-2021 LIBRARY; T=0.K

## Threshold reactions

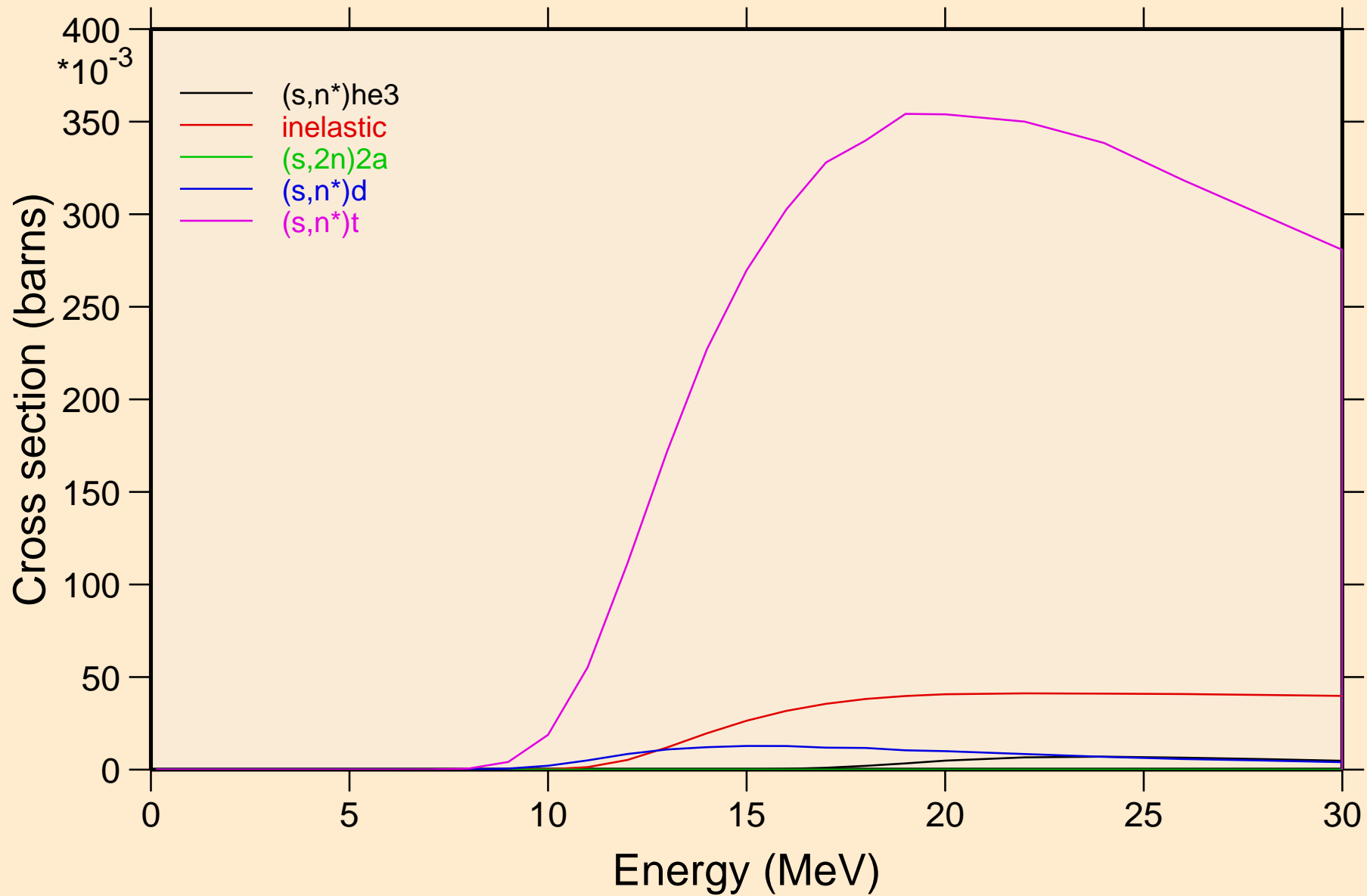



KR093 HELION ACER TENDL-2021 LIBRARY; T=0.K  
Threshold reactions

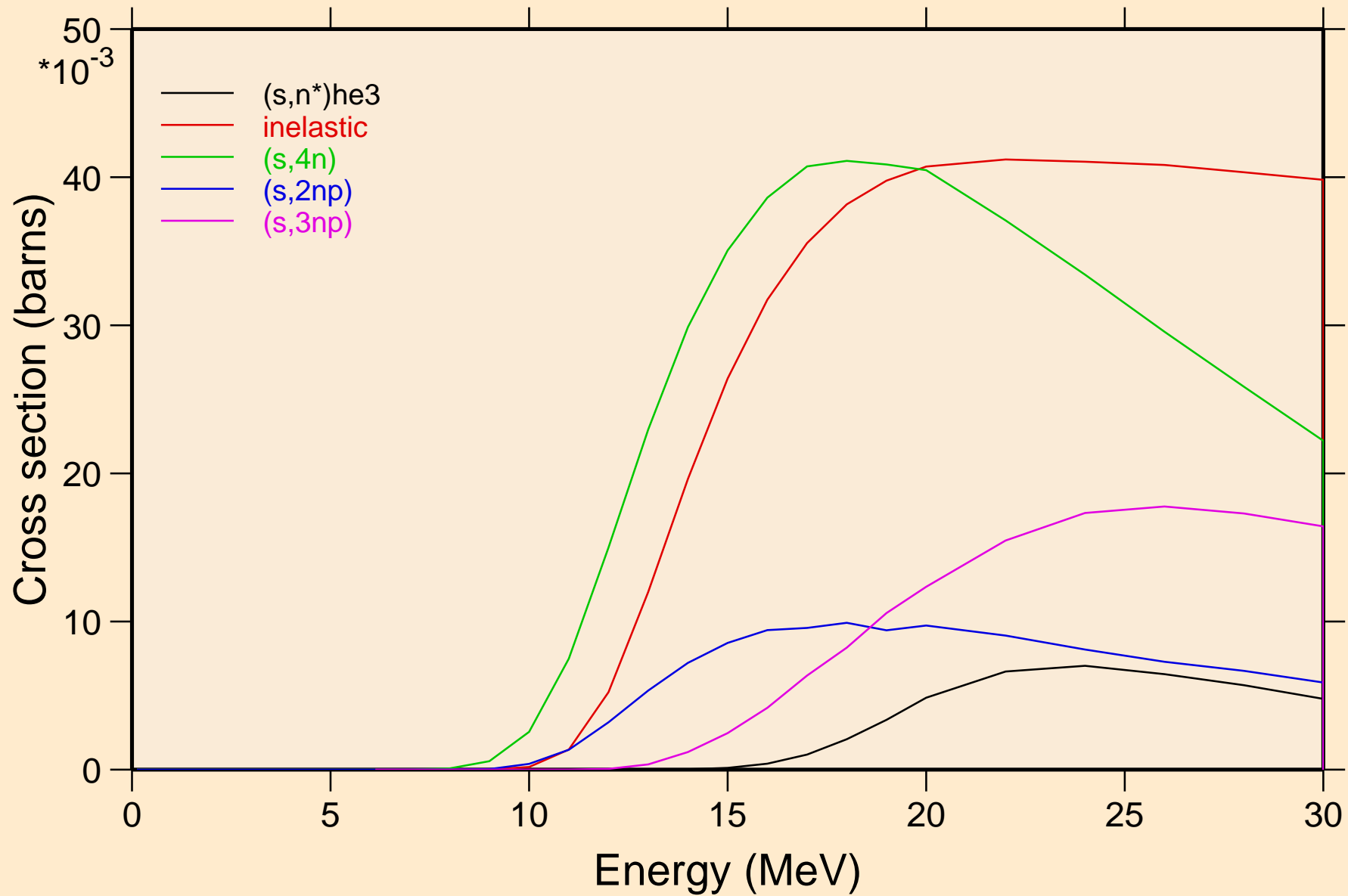

KR093 HELION ACER TENDL-2021 LIBRARY; T=0.K  
Threshold reactions

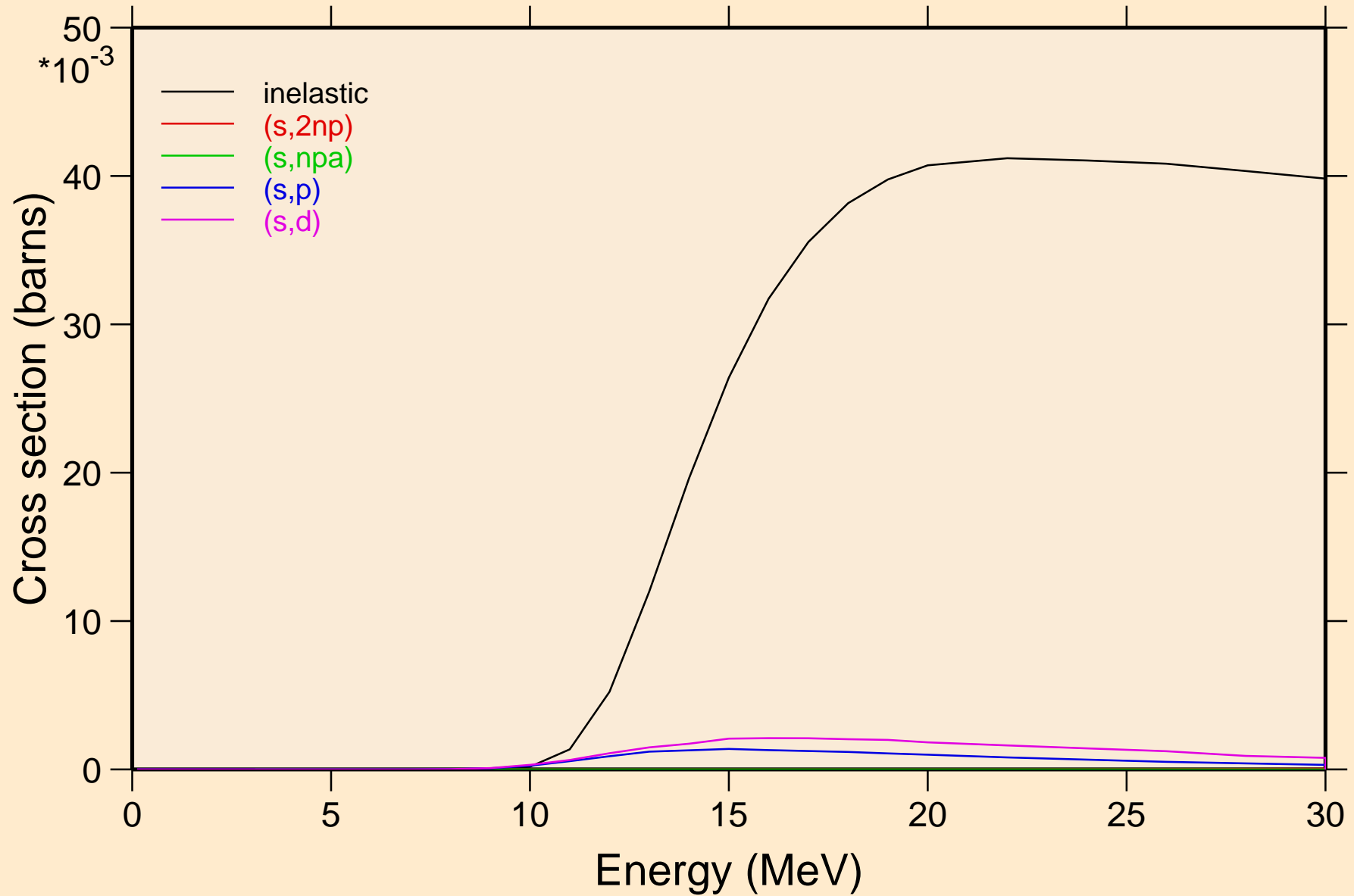

KR093 HELION ACER TENDL-2021 LIBRARY; T=0.K  
Threshold reactions

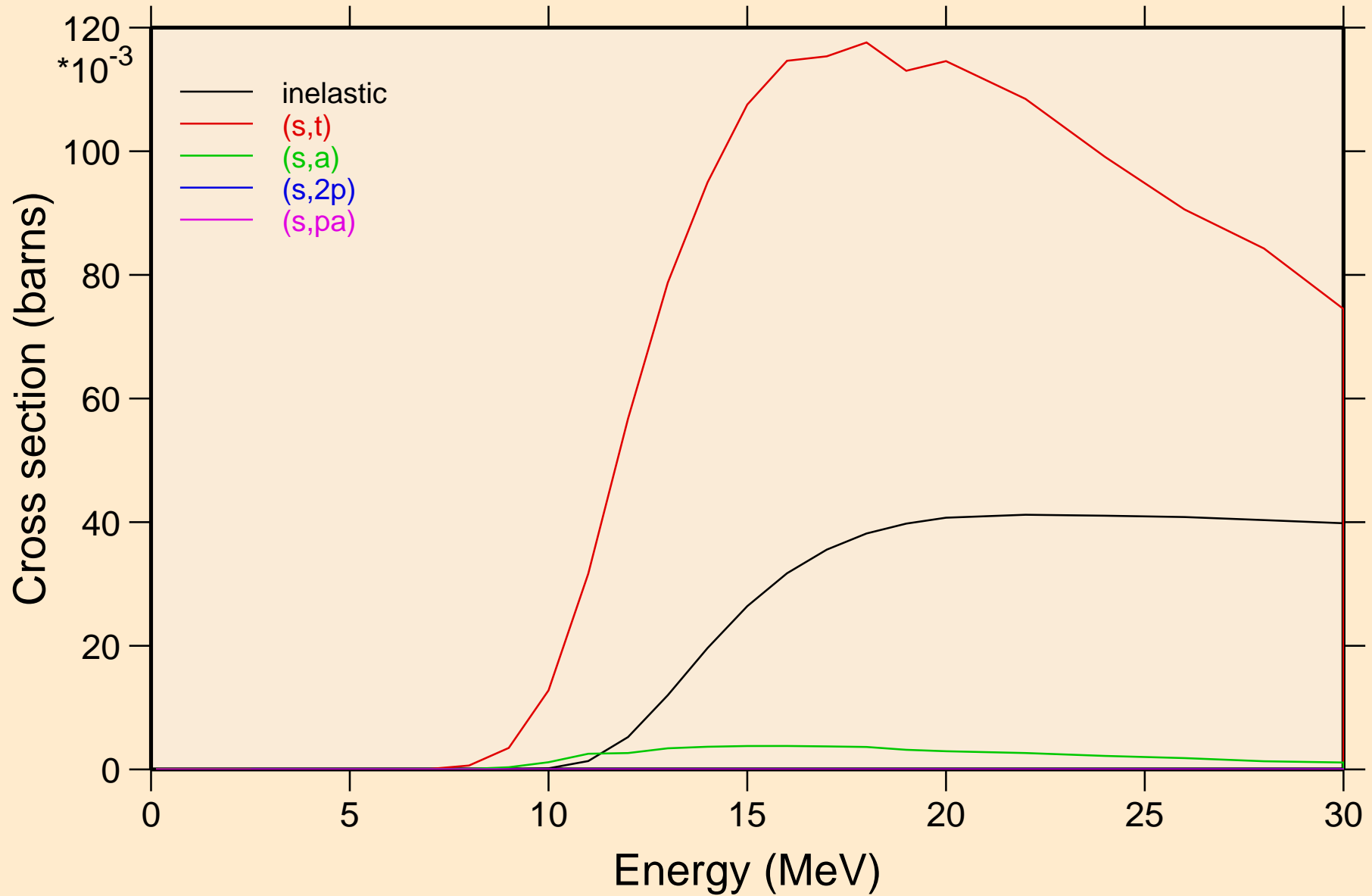

KR093 HELION ACER TENDL-2021 LIBRARY; T=0.K  
Threshold reactions

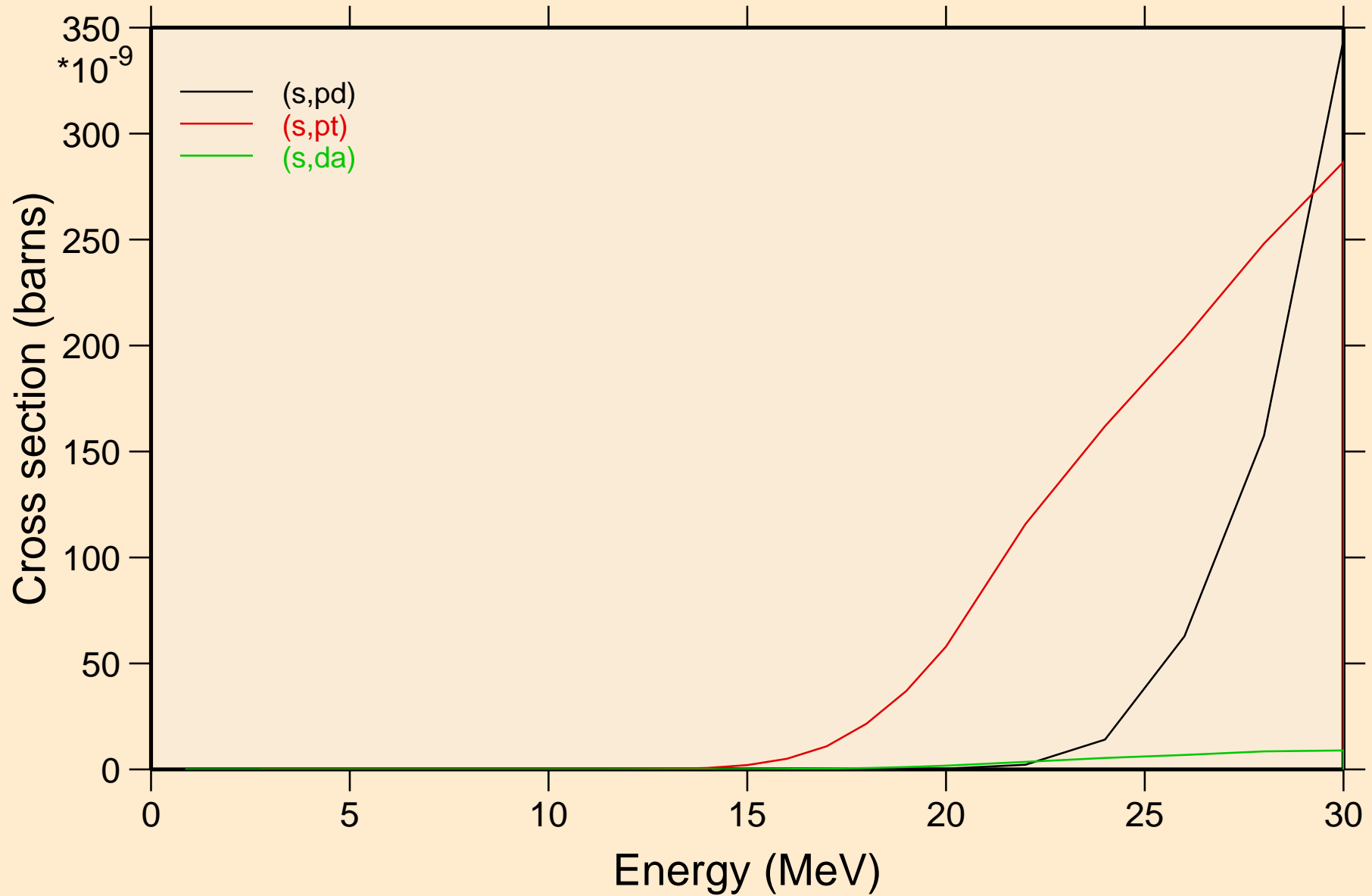

KR093 HELION ACER TENDL-2021 LIBRARY; T=0.K  
angular distribution for elastic

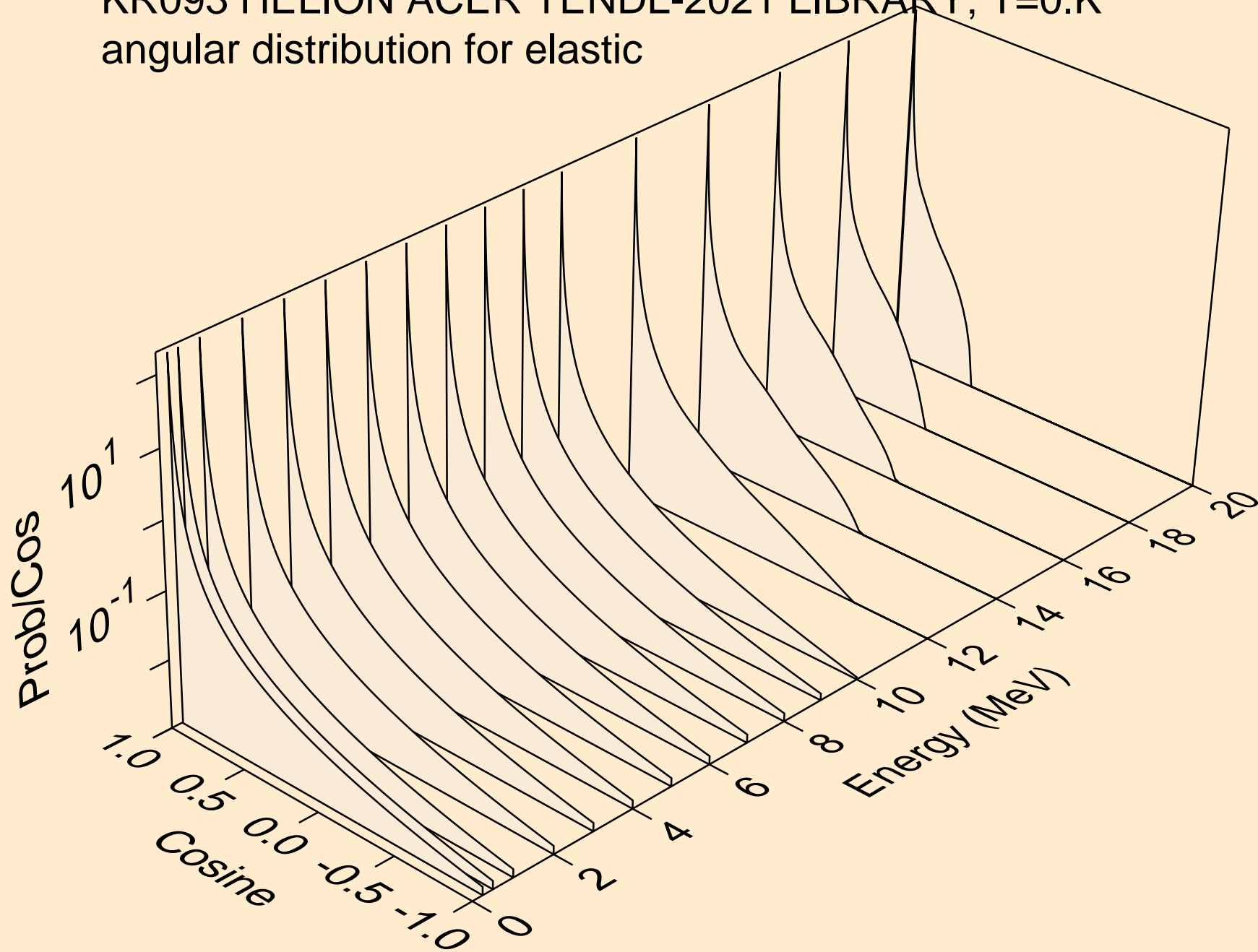

KR093 HELION ACER TENDL-2021 LIBRARY; T=0.K  
angular distribution for elastic

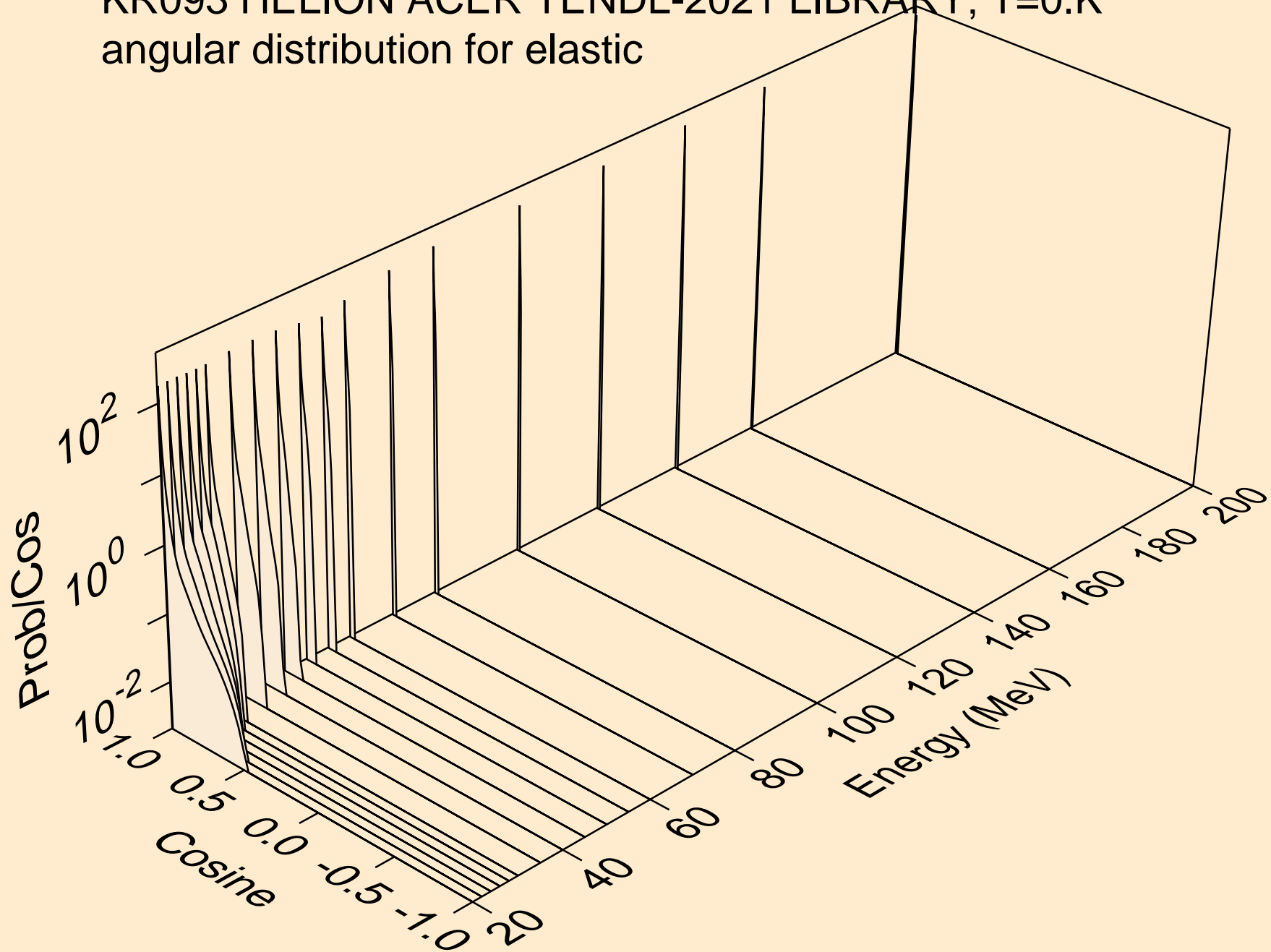

KR093 HELION ACER TENDL-2021 LIBRARY; T=0.K  
He-3 emission for (s,x)

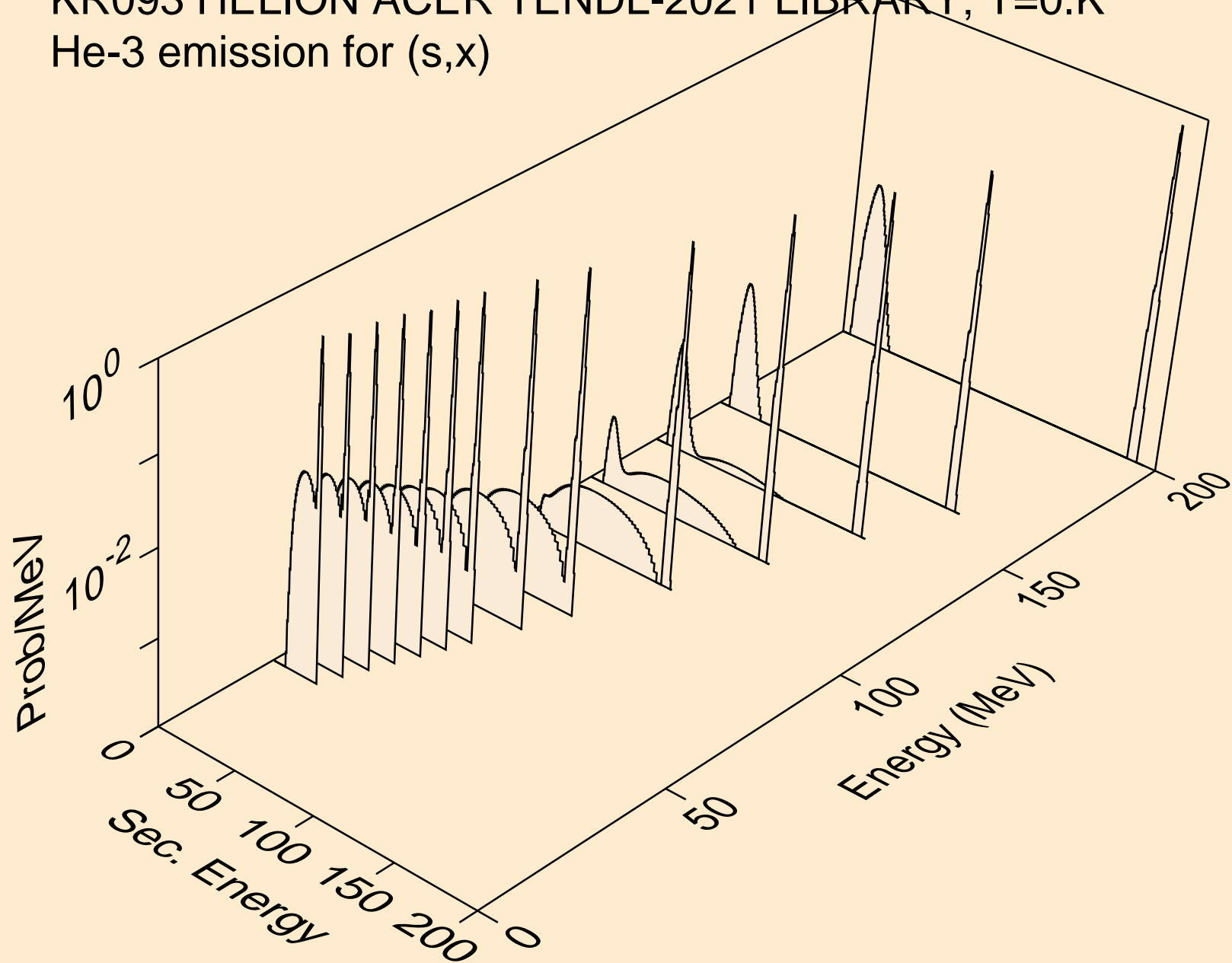

KR093 HELION ACER TENDL-2021 LIBRARY; T=0.K  
He-3 emission for (s,n\*)he3

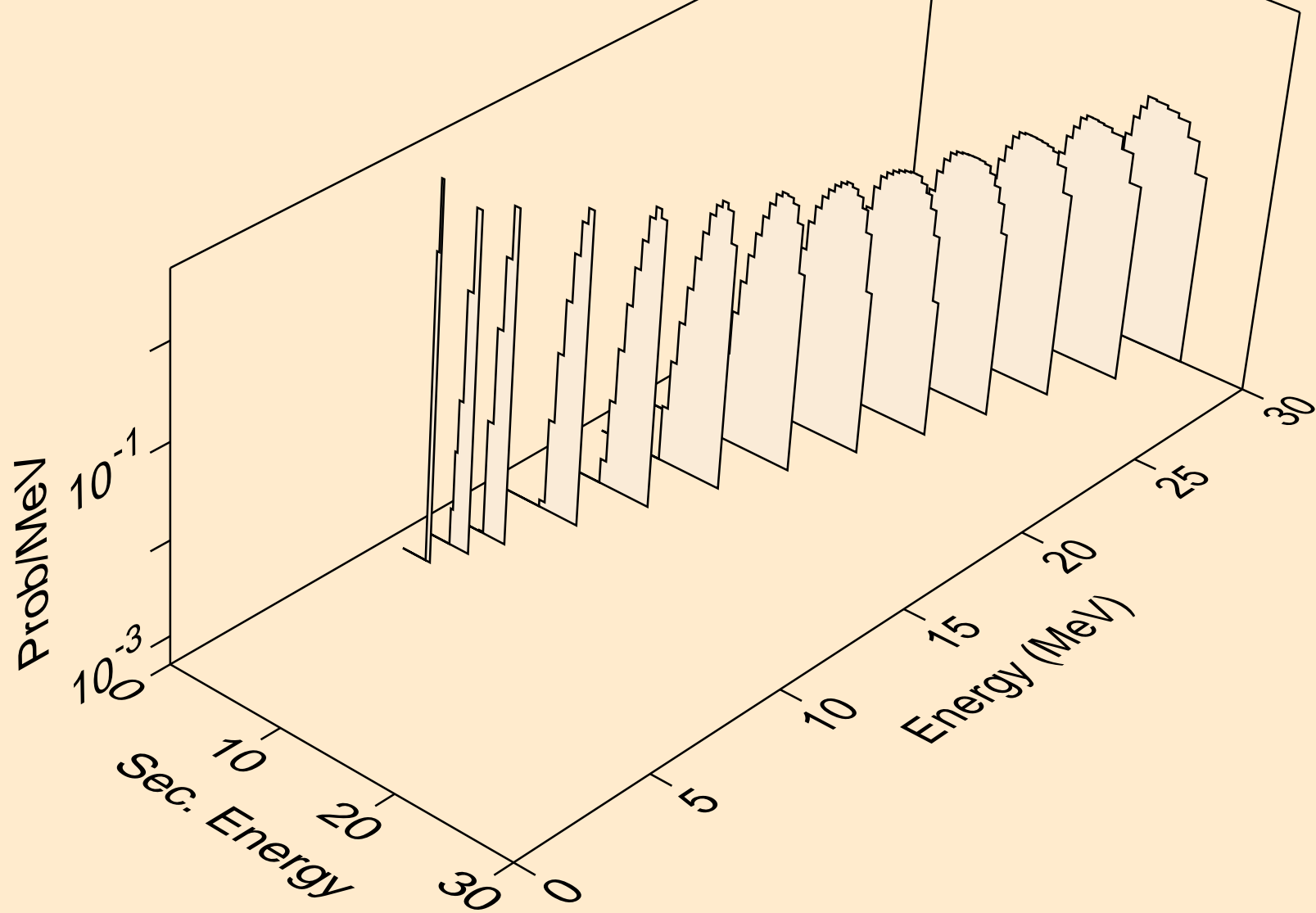



KR093 HELION ACER TENDL-2021 LIBRARY; T=0.K  
He-3 emission for inelastic

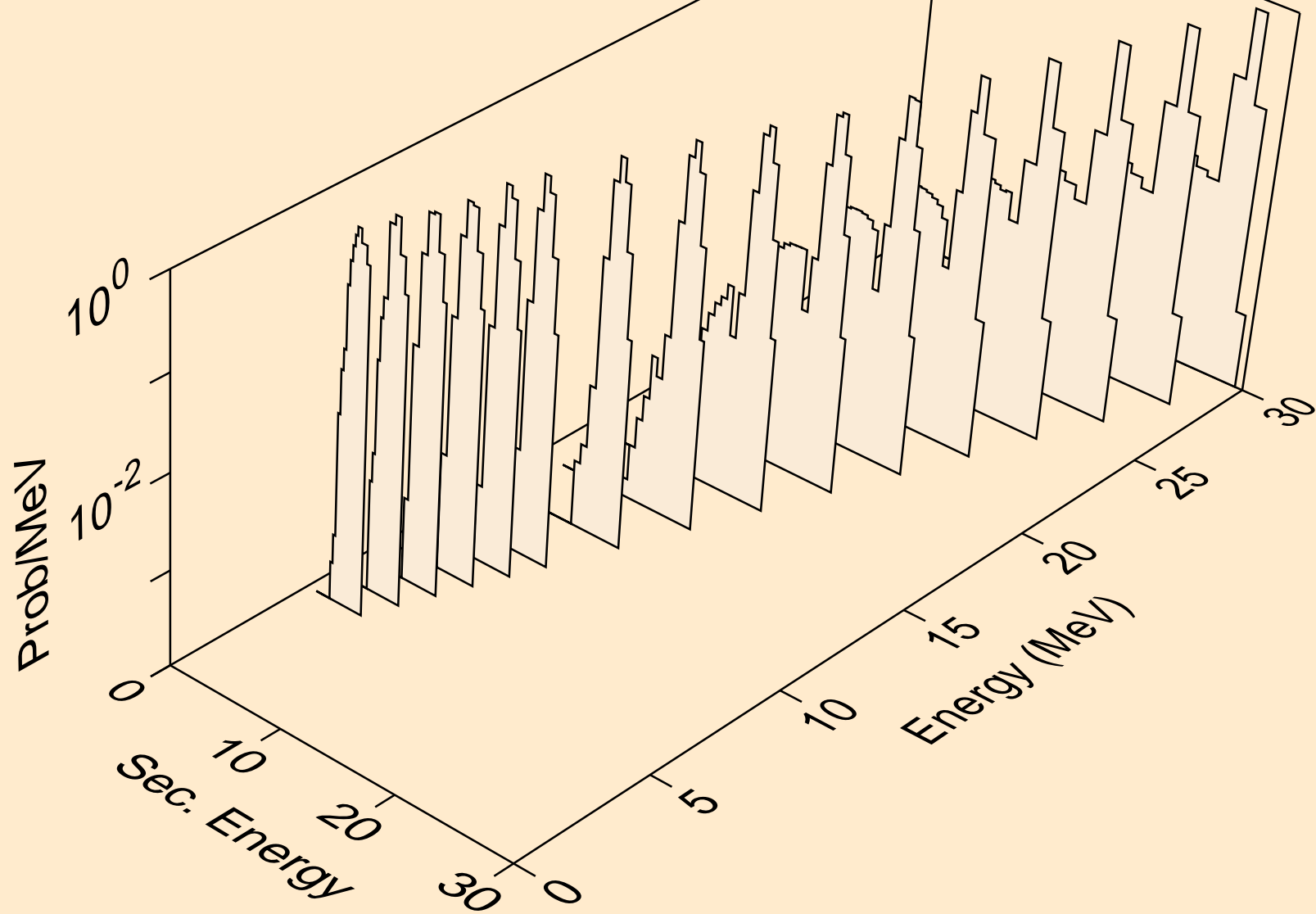

KR093 HELION ACER TENDL-2021 LIBRARY; T=0.K  
Photon emission for (z,n)

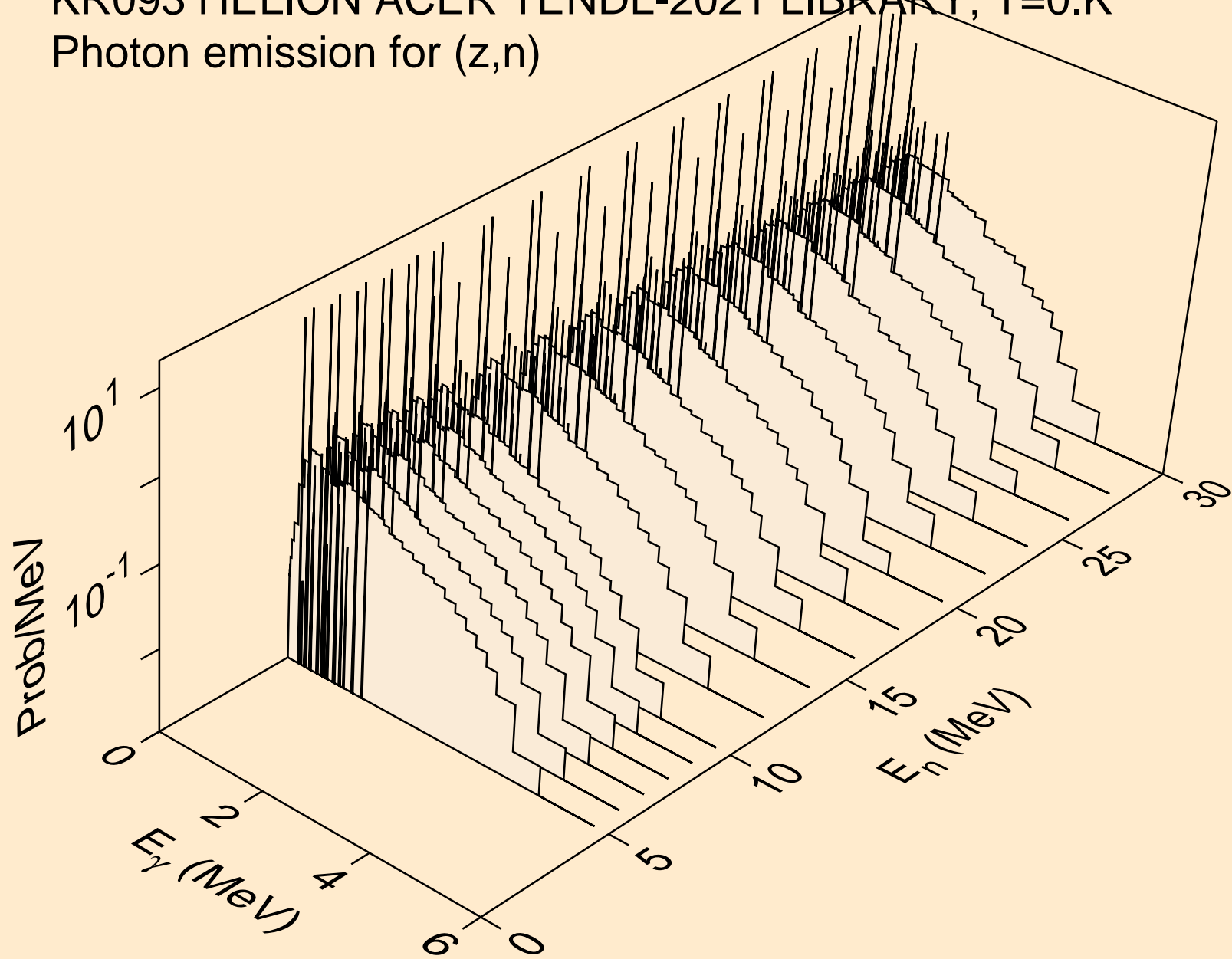

KR093 HELION ACER TENDL-2021 LIBRARY; T=0.K  
Photon emission for (n,x)

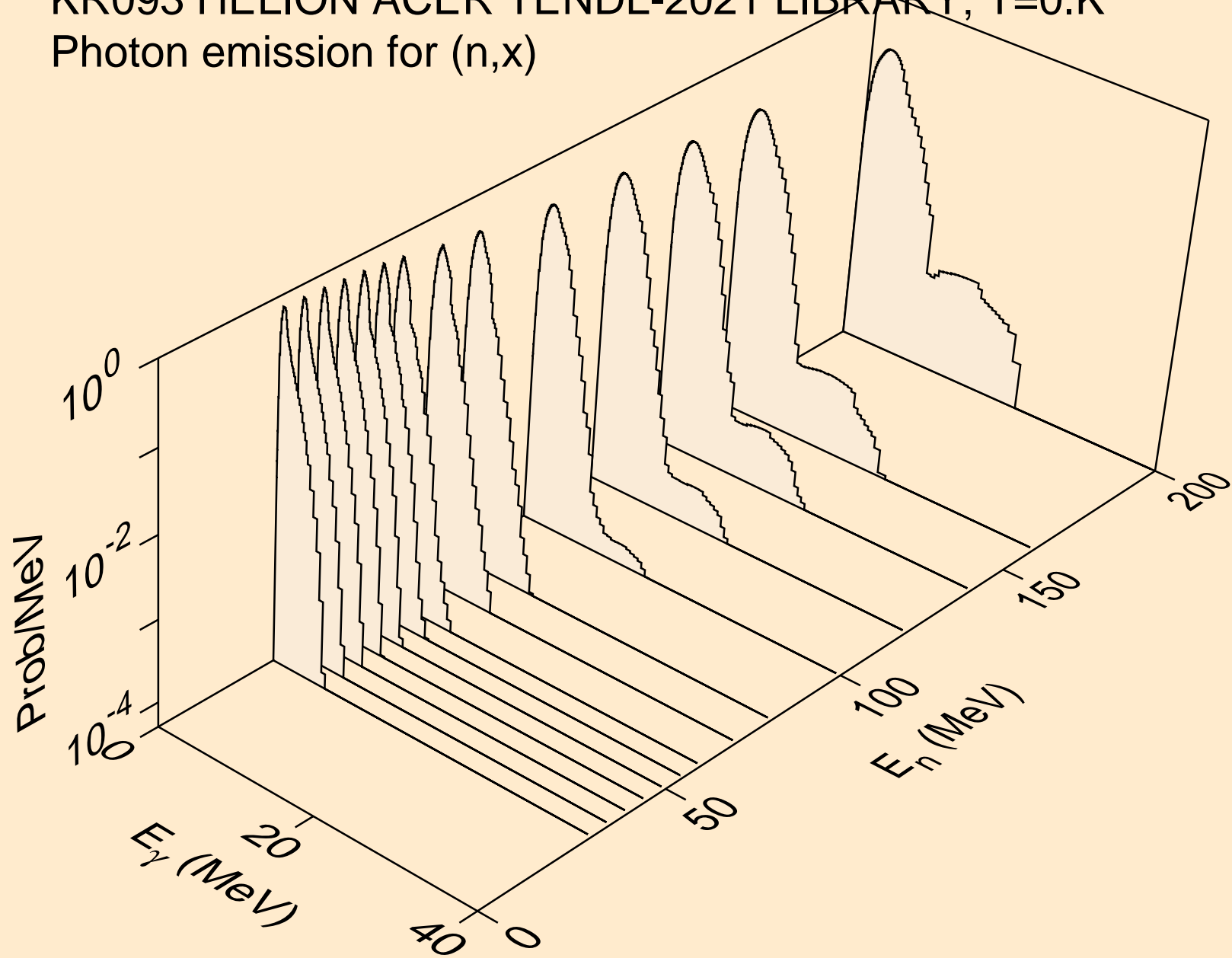

KR093 HELION ACER TENDL-2021 LIBRARY; T=0.K  
Photon emission for (n,2nd)

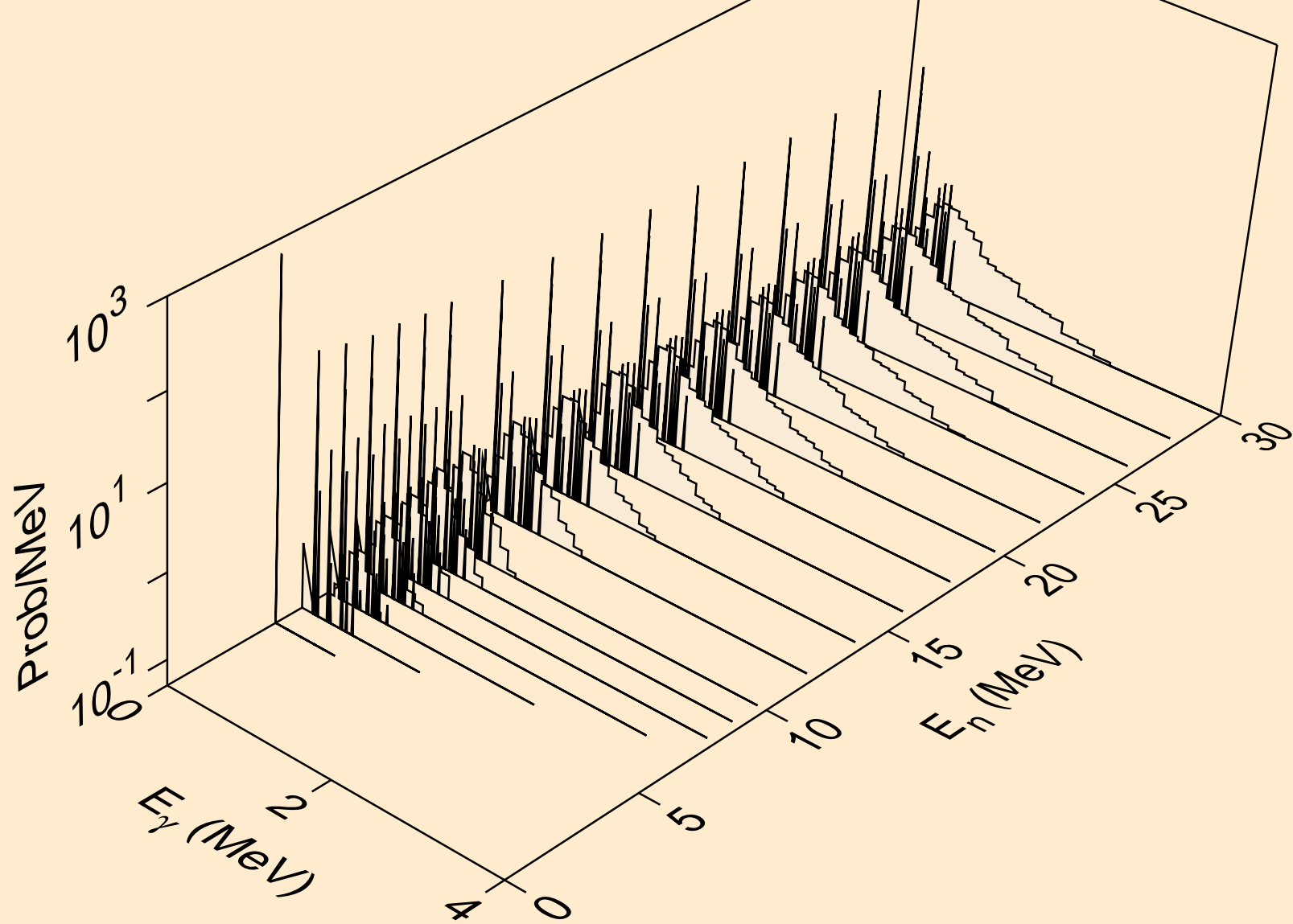

KR093 HELION ACER TENDL-2021 LIBRARY; T=0.K  
Photon emission for (n,2n)

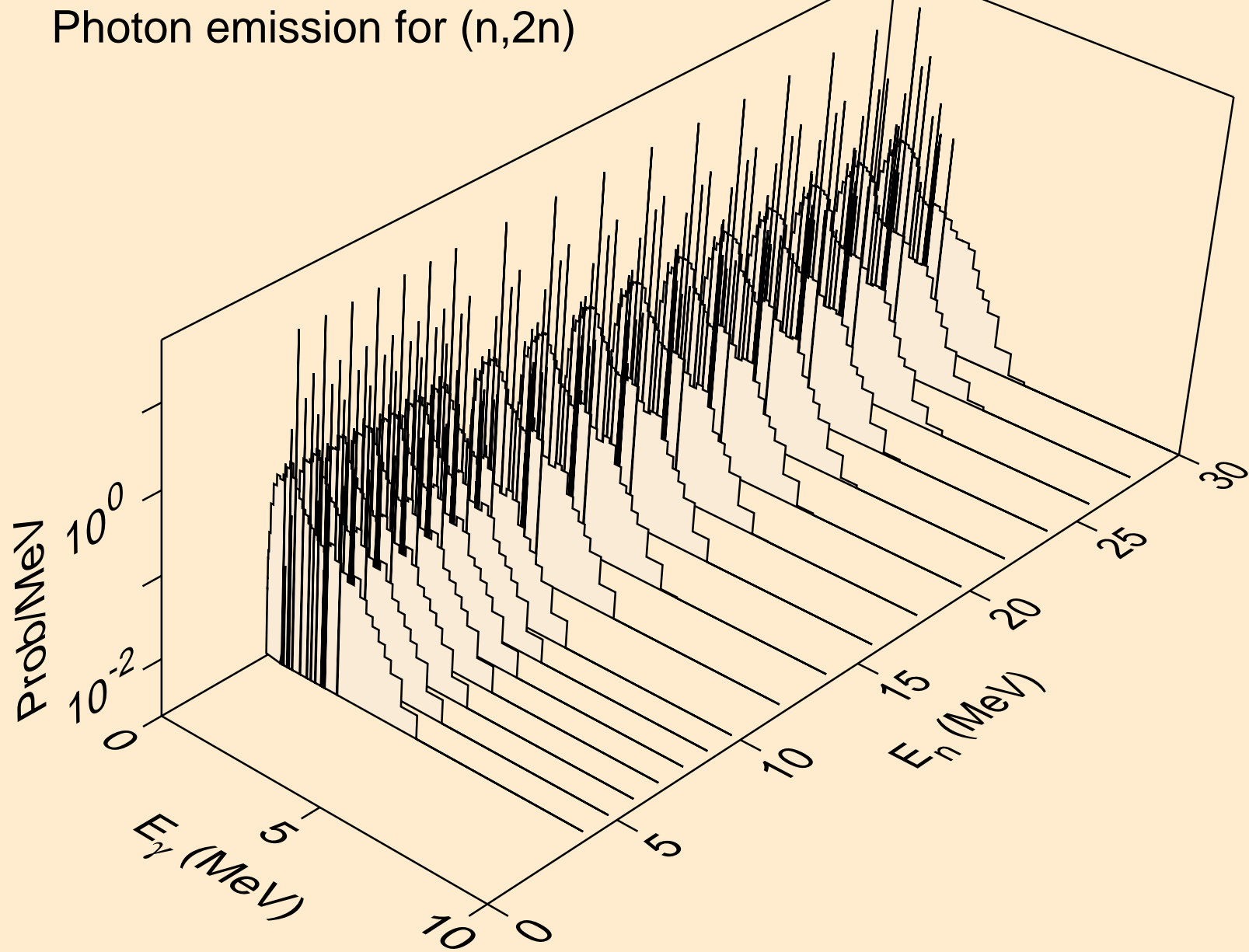

KR093 HELION ACER TENDL-2021 LIBRARY; T=0.K  
Photon emission for (n,3n)

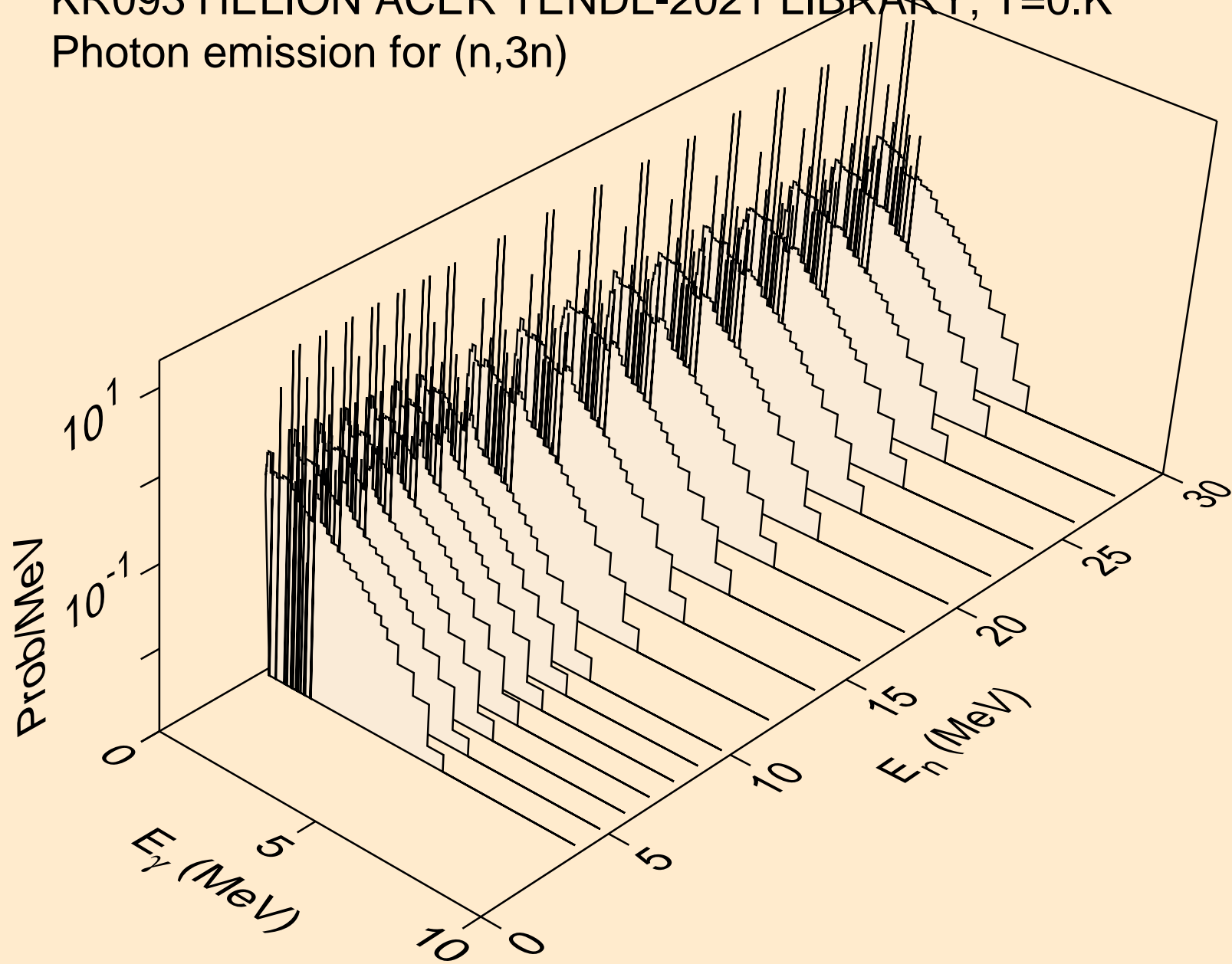

KR093 HELION ACER TENDL-2021 LIBRARY; T=0.K  
Photon emission for (n,n\*)a

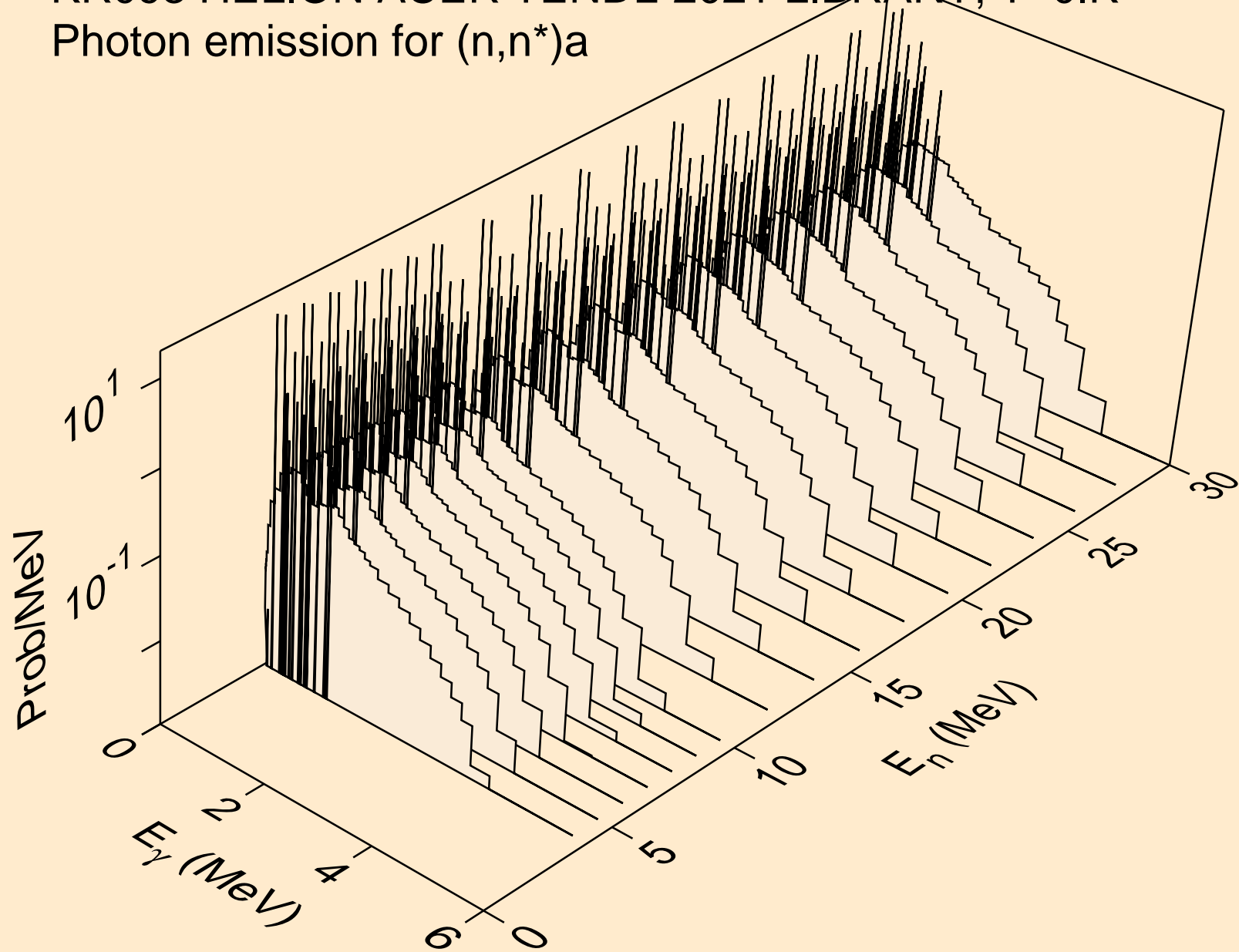

KR093 HELION ACER TENDL-2021 LIBRARY; T=0.K  
Photon emission for (n,2n)a

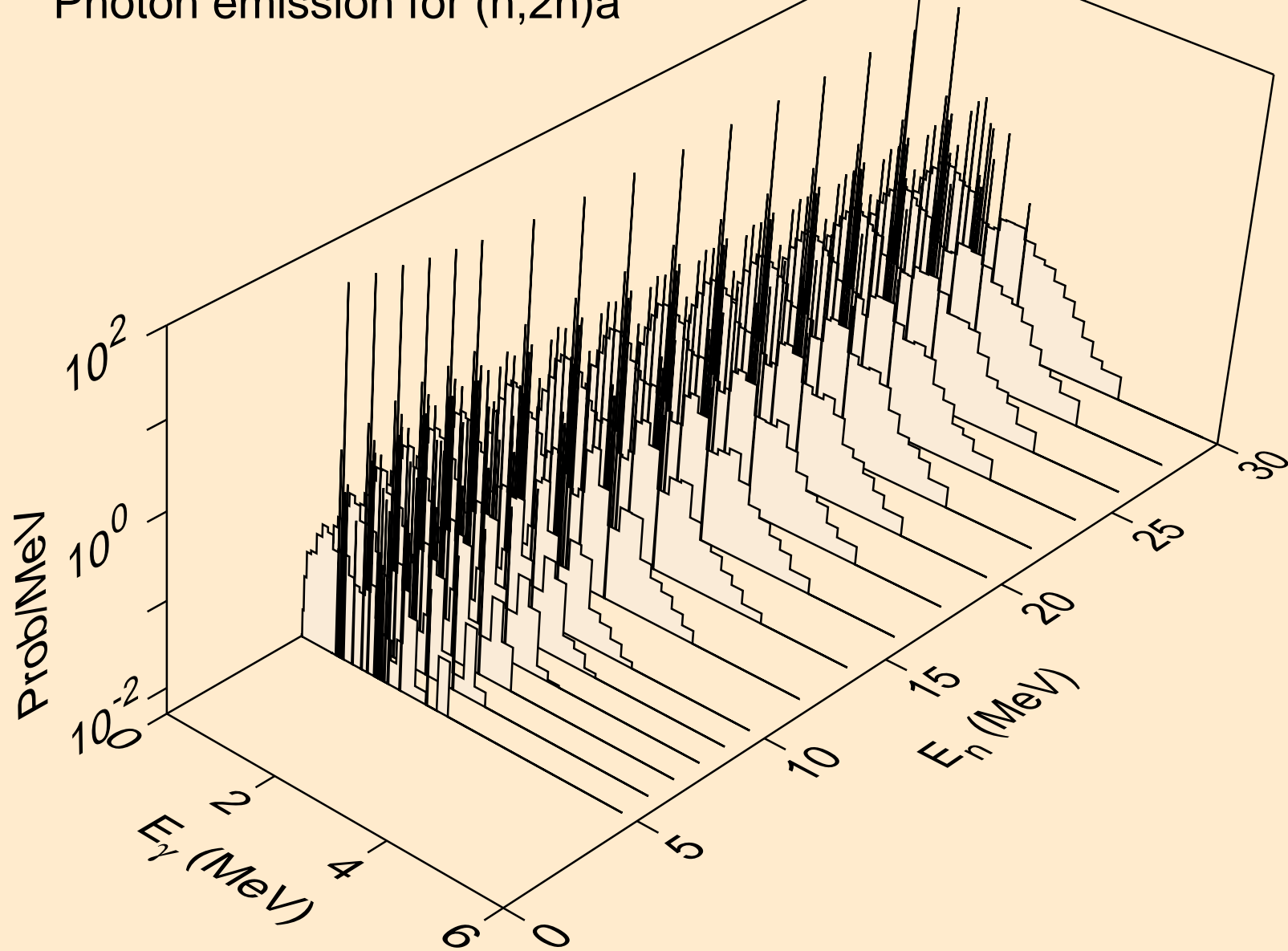



KR093 HELION ACER TENDL-2021 LIBRARY; T=0.K  
Photon emission for (n,3n)a

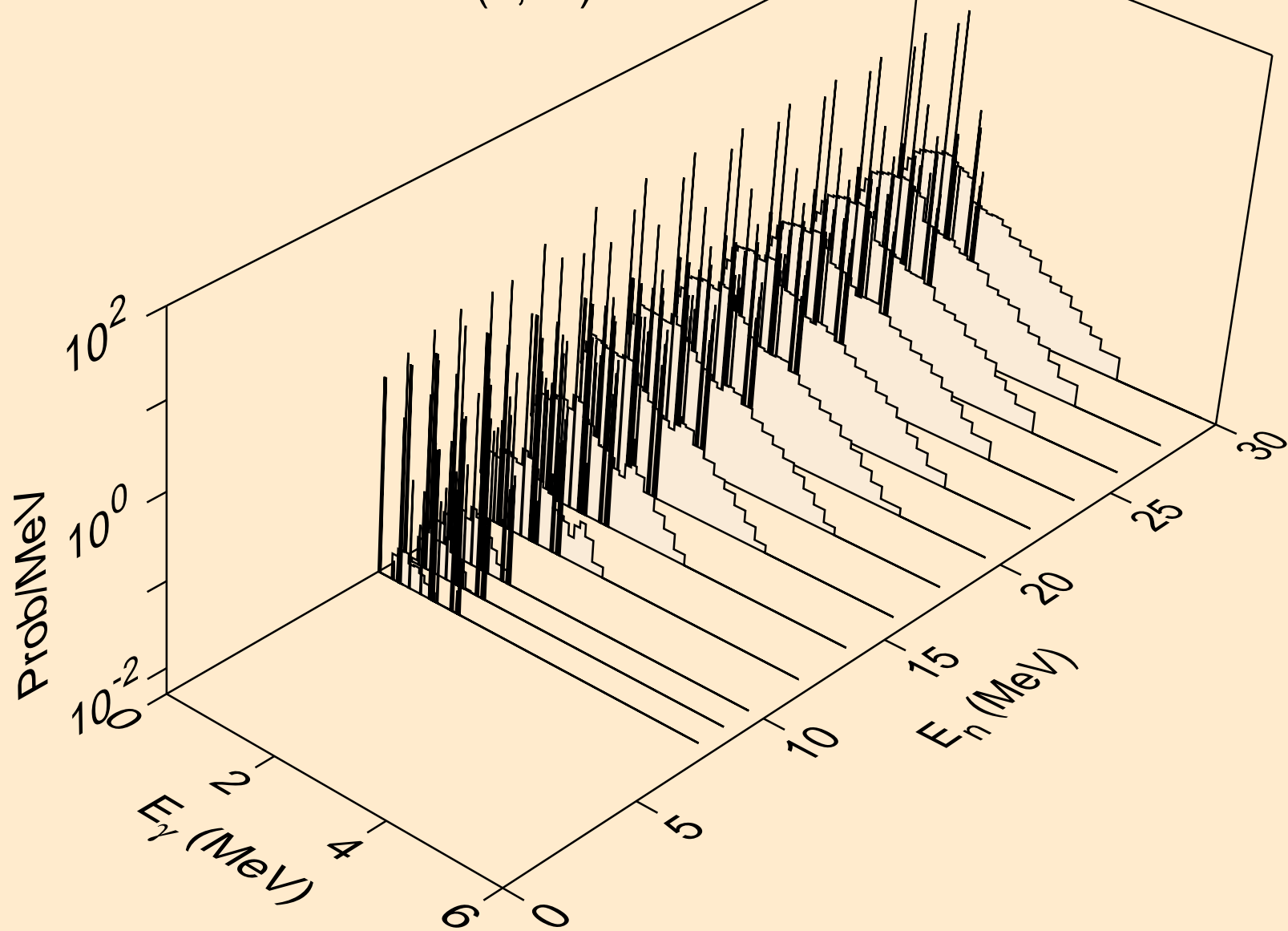

KR093 HELION ACER TENDL-2021 LIBRARY; T=0.K  
Photon emission for (n,n\*)p

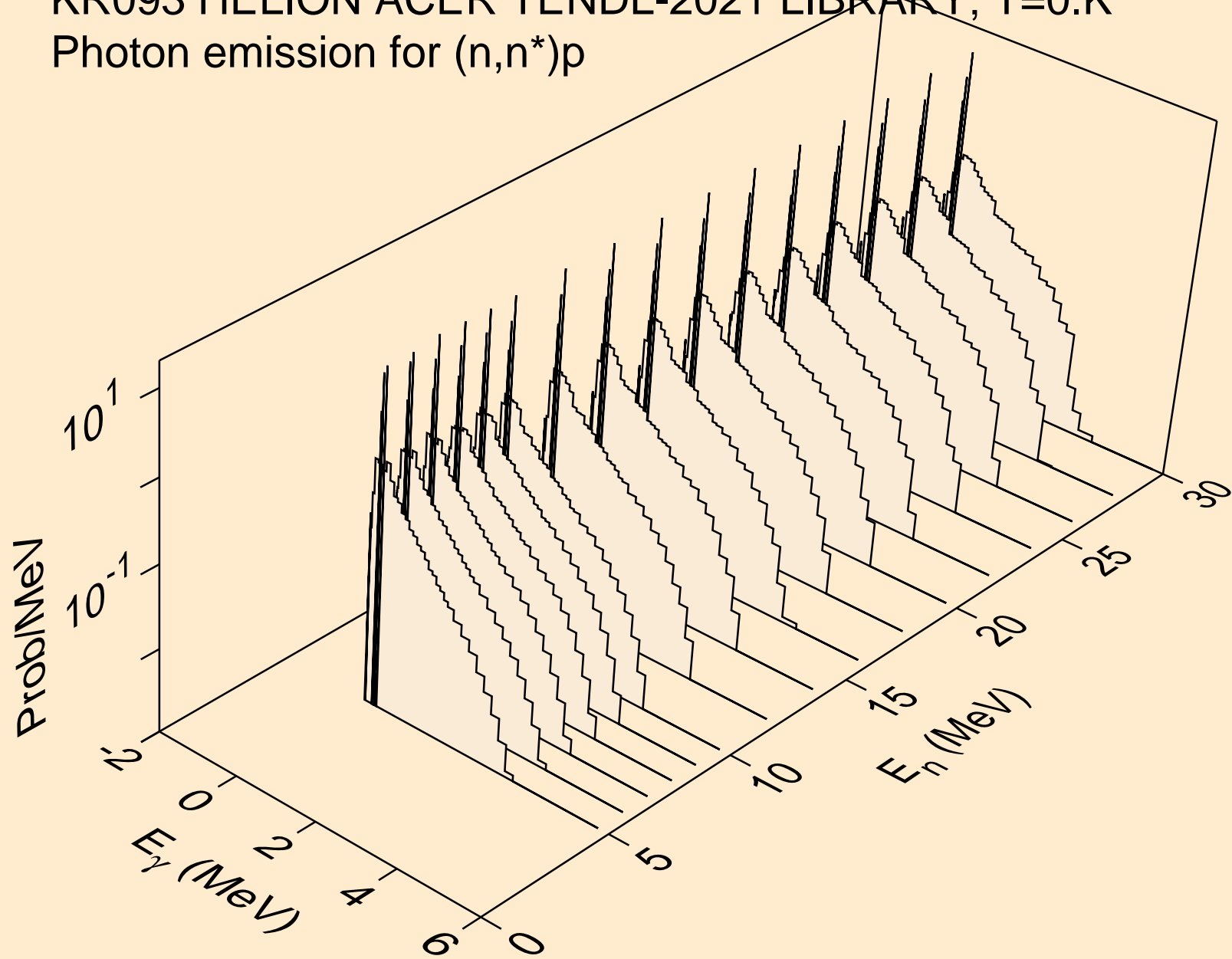

KR093 HELION ACER TENDL-2021 LIBRARY; T=0.K  
Photon emission for (n,n\*)2a

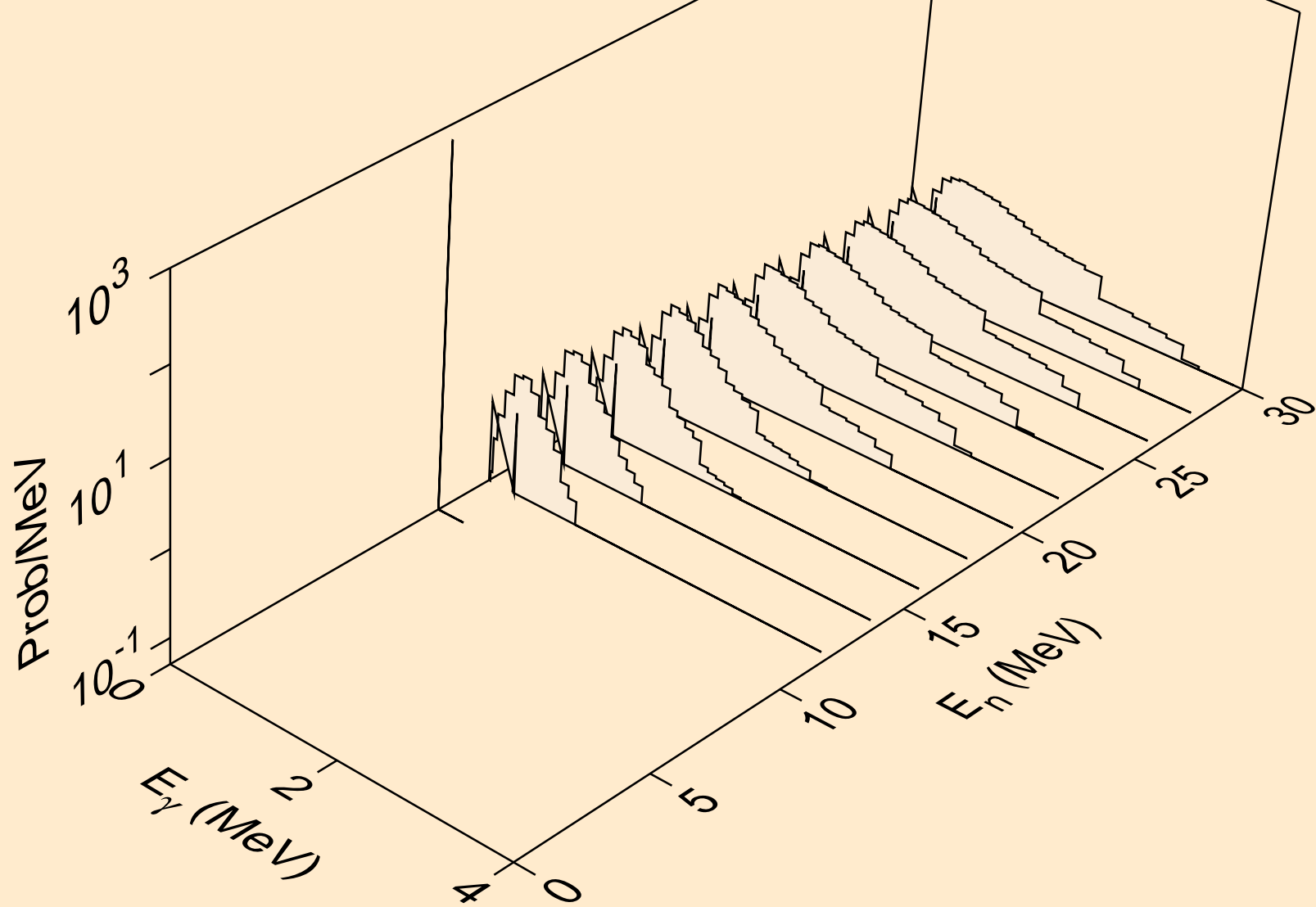

KR093 HELION ACER TENDL-2021 LIBRARY; T=0.K  
Photon emission for (n,2n)2a

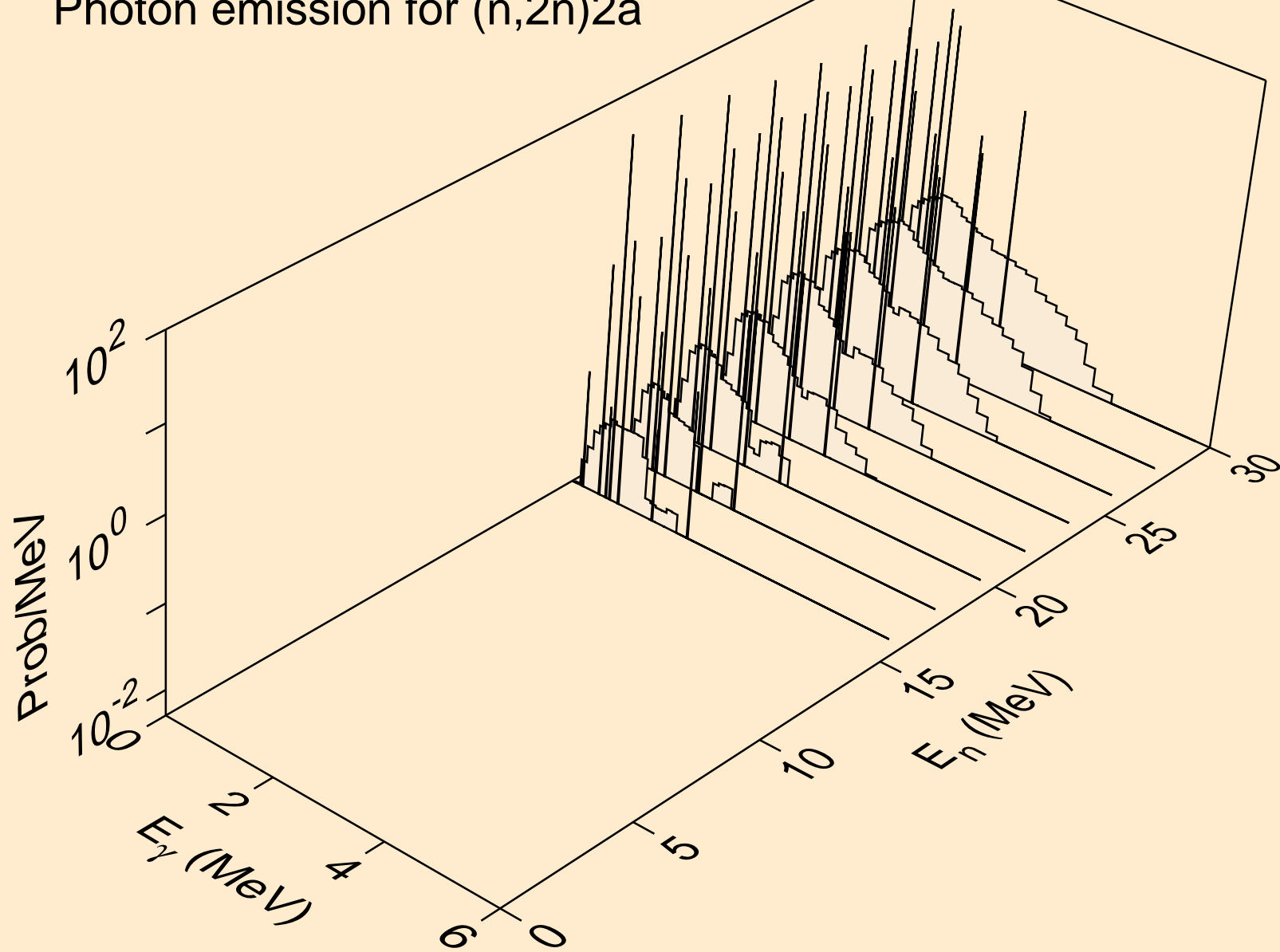

KR093 HELION ACER TENDL-2021 LIBRARY; T=0.K  
Photon emission for (n,n\*)d

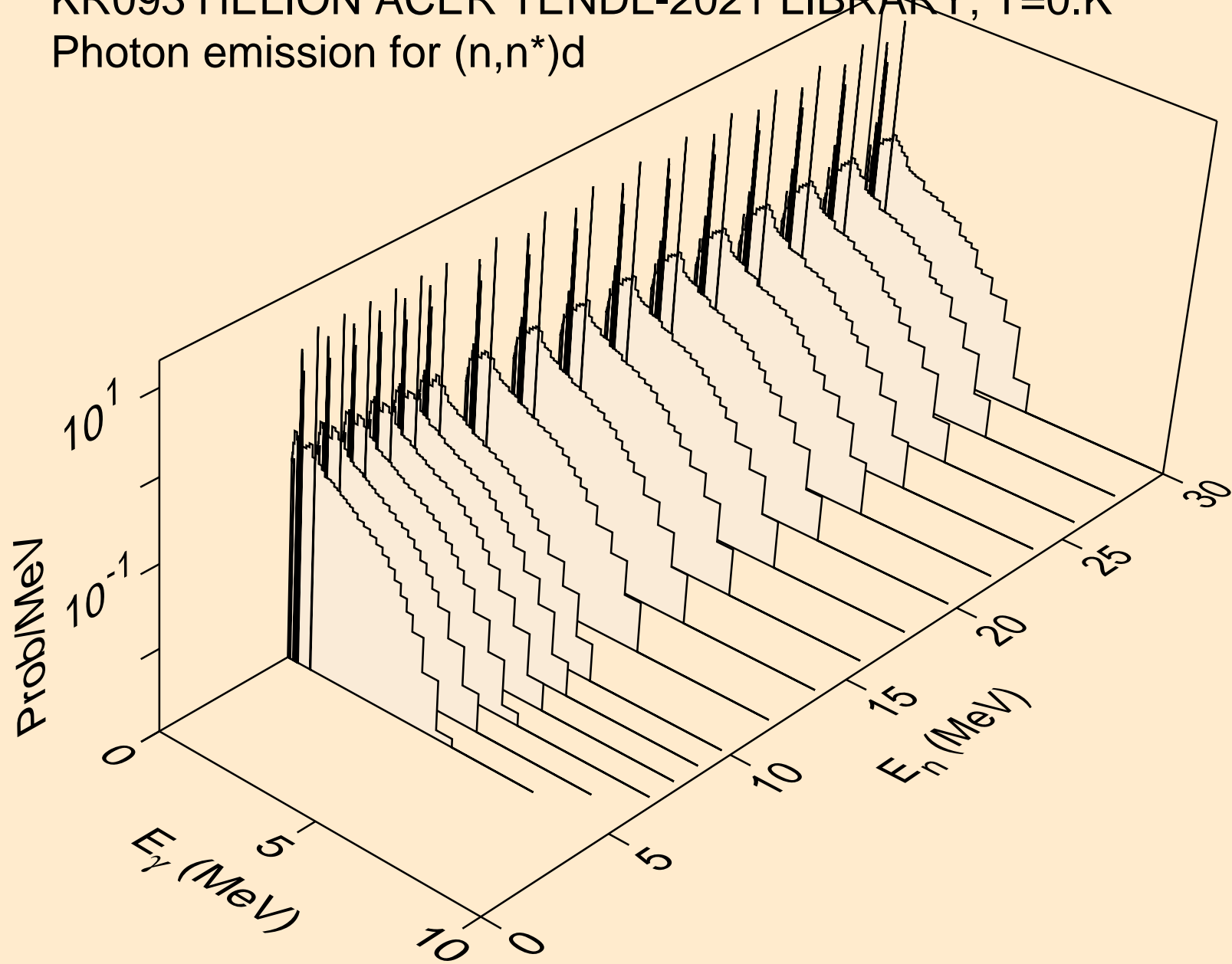

KR093 HELION ACER TENDL-2021 LIBRARY; T=0.K  
Photon emission for (n,n\*)t

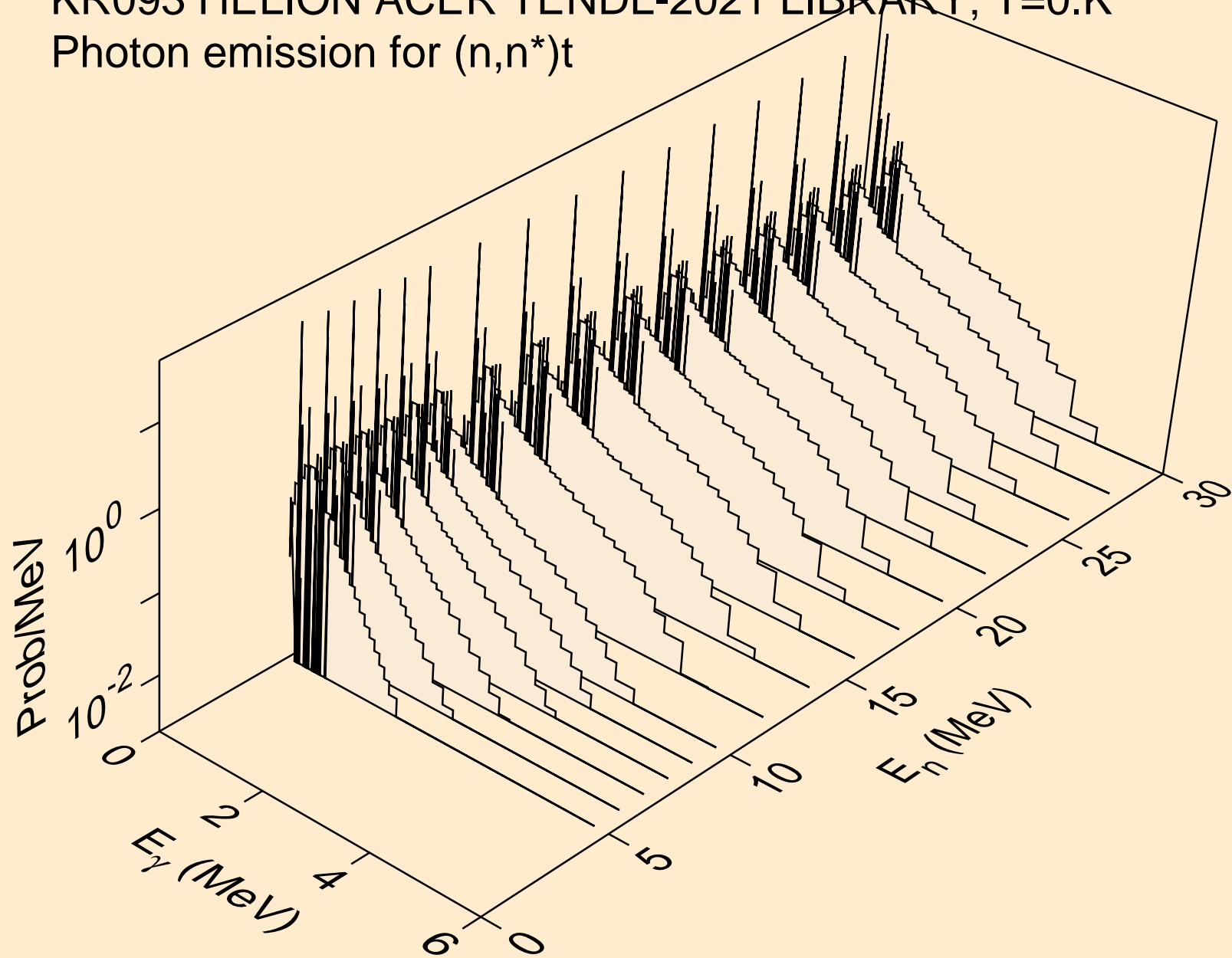

KR093 HELION ACER TENDL-2021 LIBRARY; T=0.K  
Photon emission for (n,n\*)he3

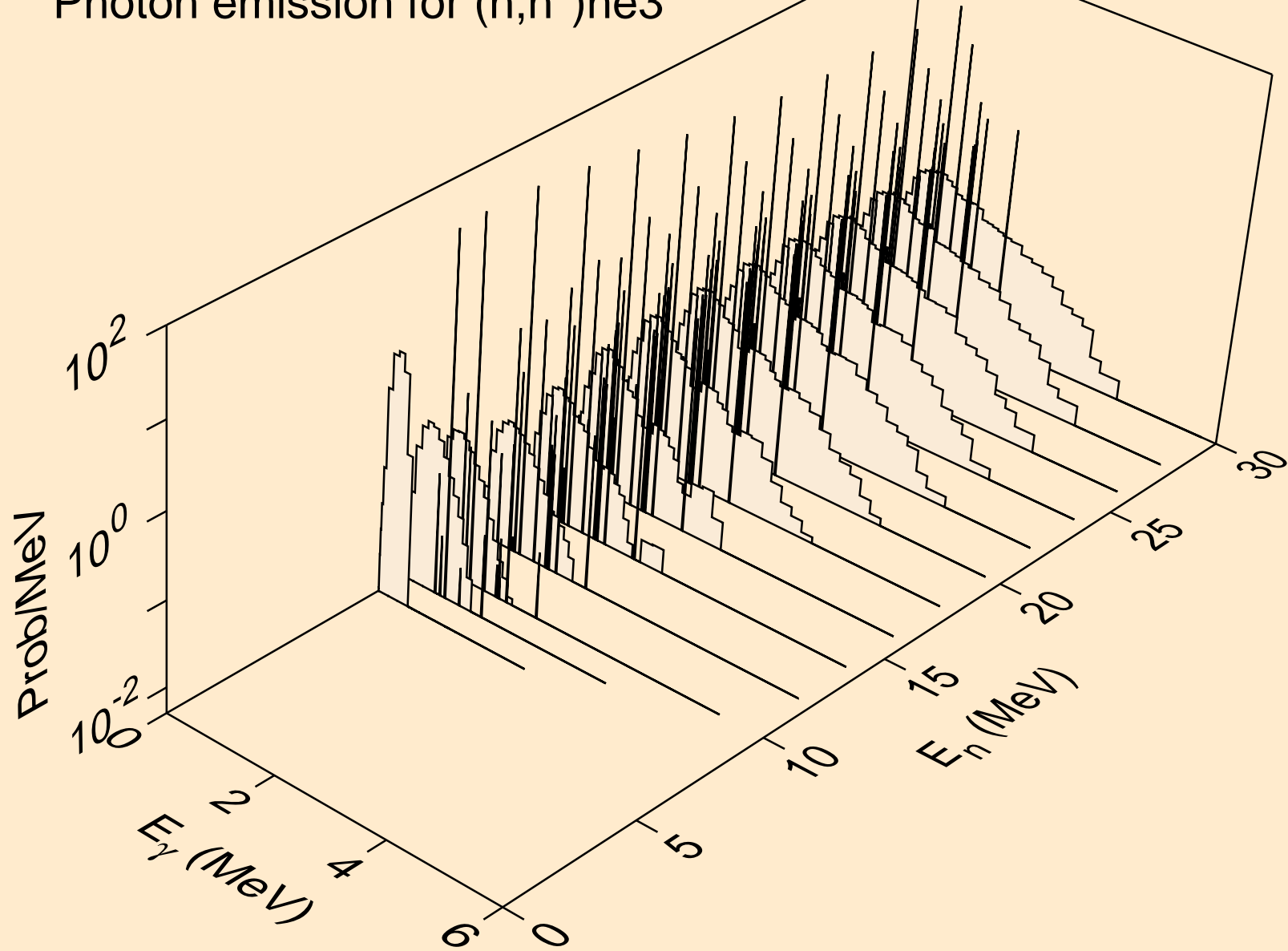

KR093 HELION ACER TENDL-2021 LIBRARY; T=0.K  
Photon emission for (n,4n)

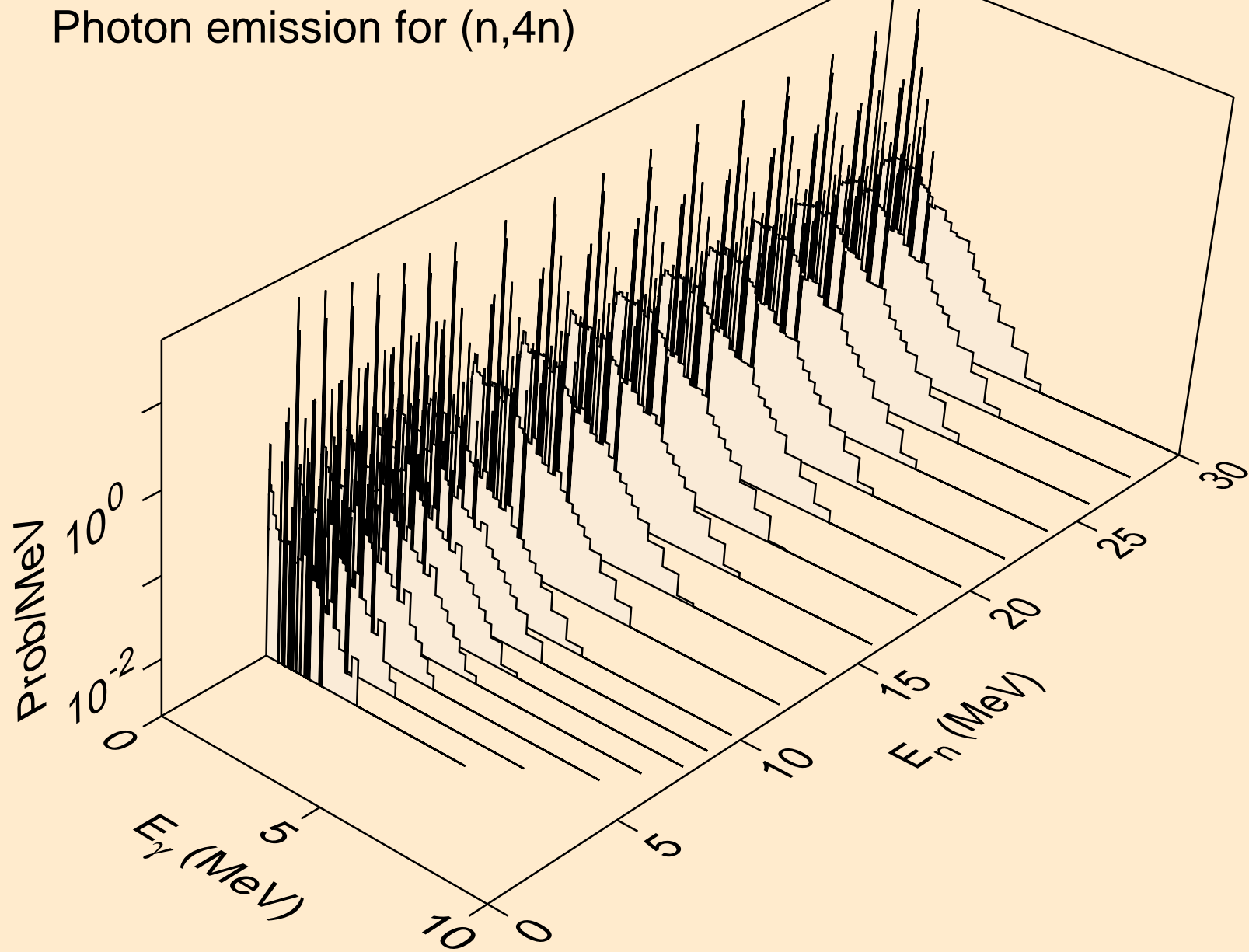



KR093 HELION ACER TENDL-2021 LIBRARY; T=0.K  
Photon emission for (n,2np)

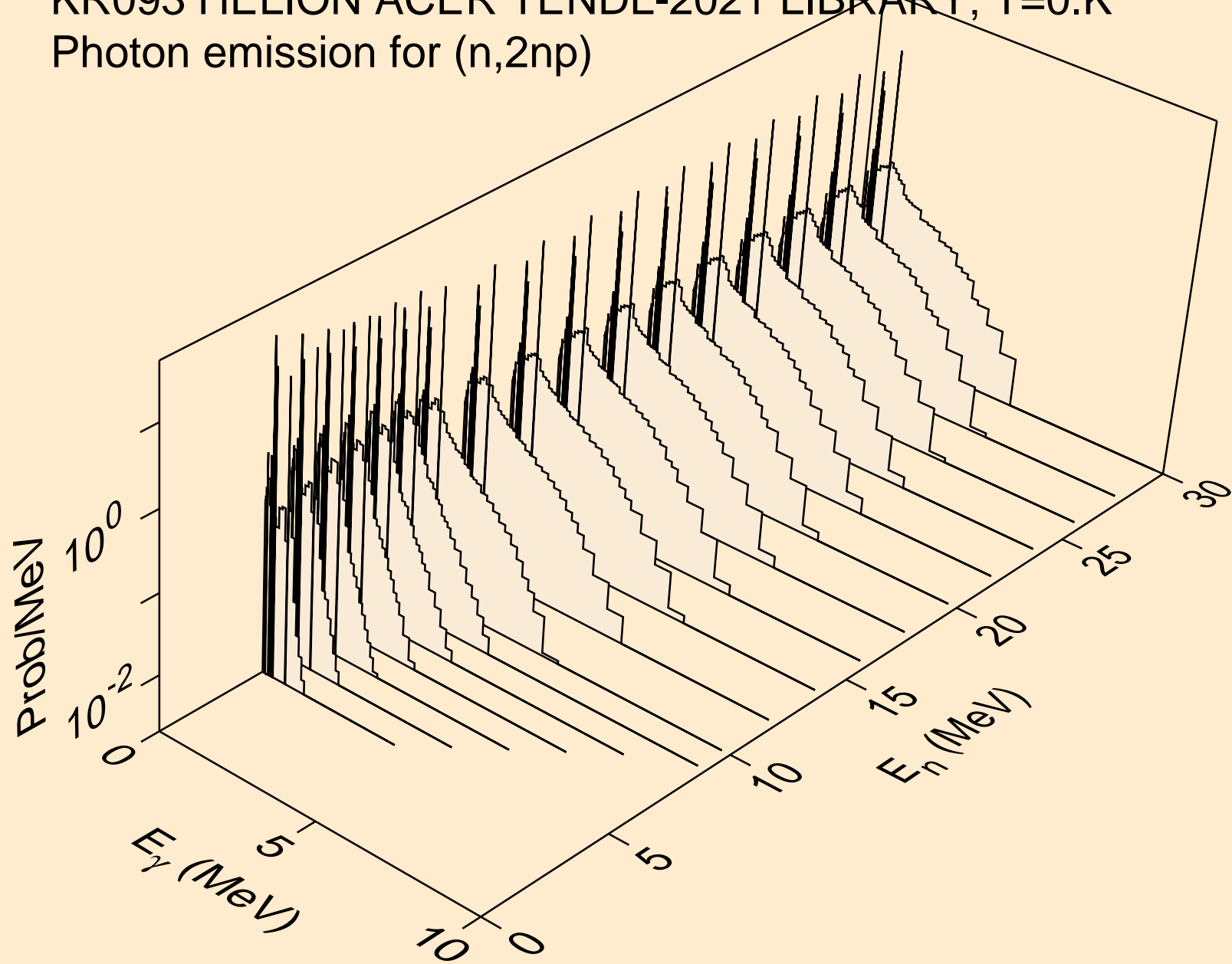

KR093 HELION ACER TENDL-2021 LIBRARY; T=0.K  
Photon emission for (n,3np)

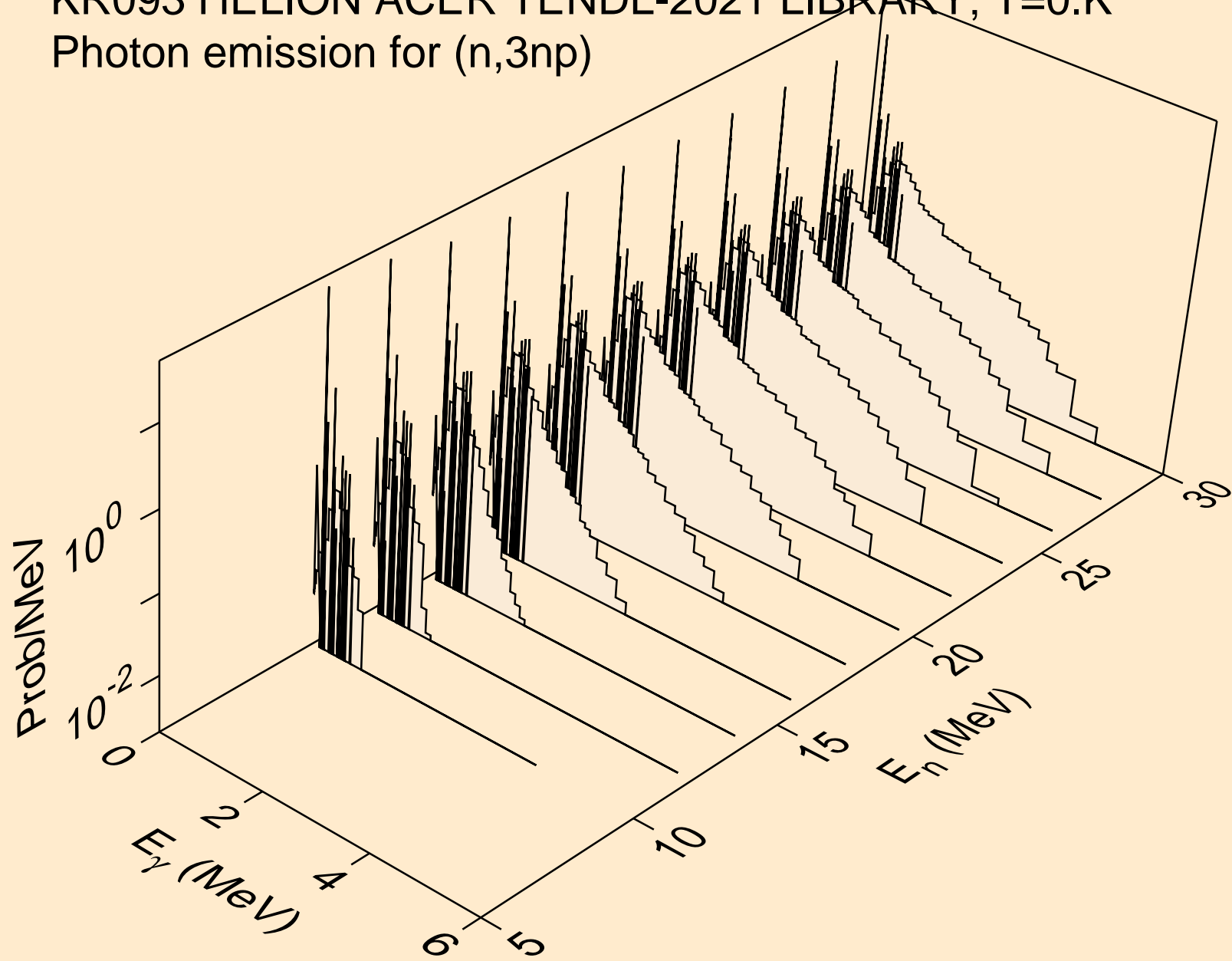

KR093 HELION ACER TENDL-2021 LIBRARY; T=0.K  
Photon emission for (n,2np)

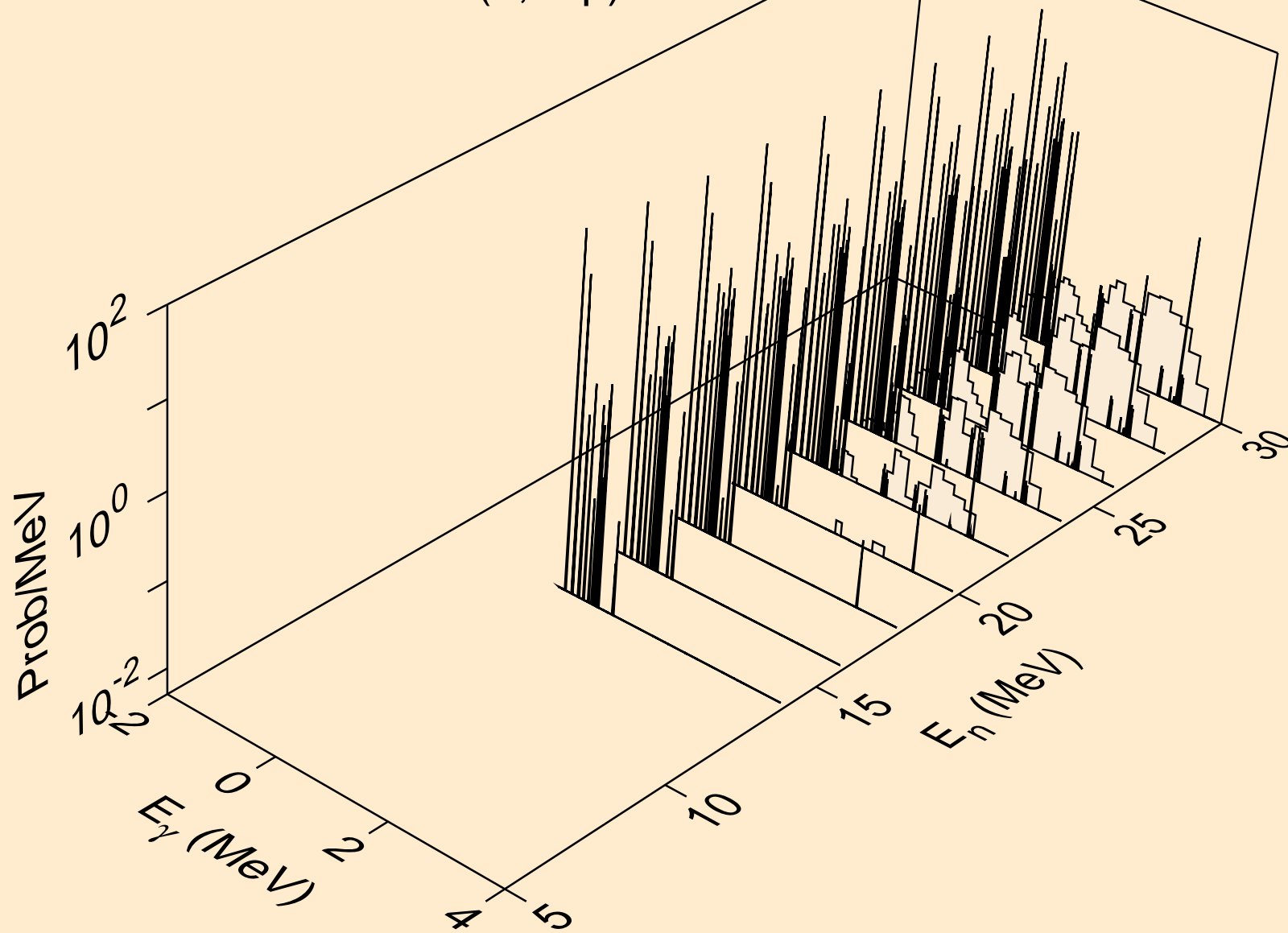

KR093 HELION ACER TENDL-2021 LIBRARY; T=0.K  
Photon emission for (n,npa)

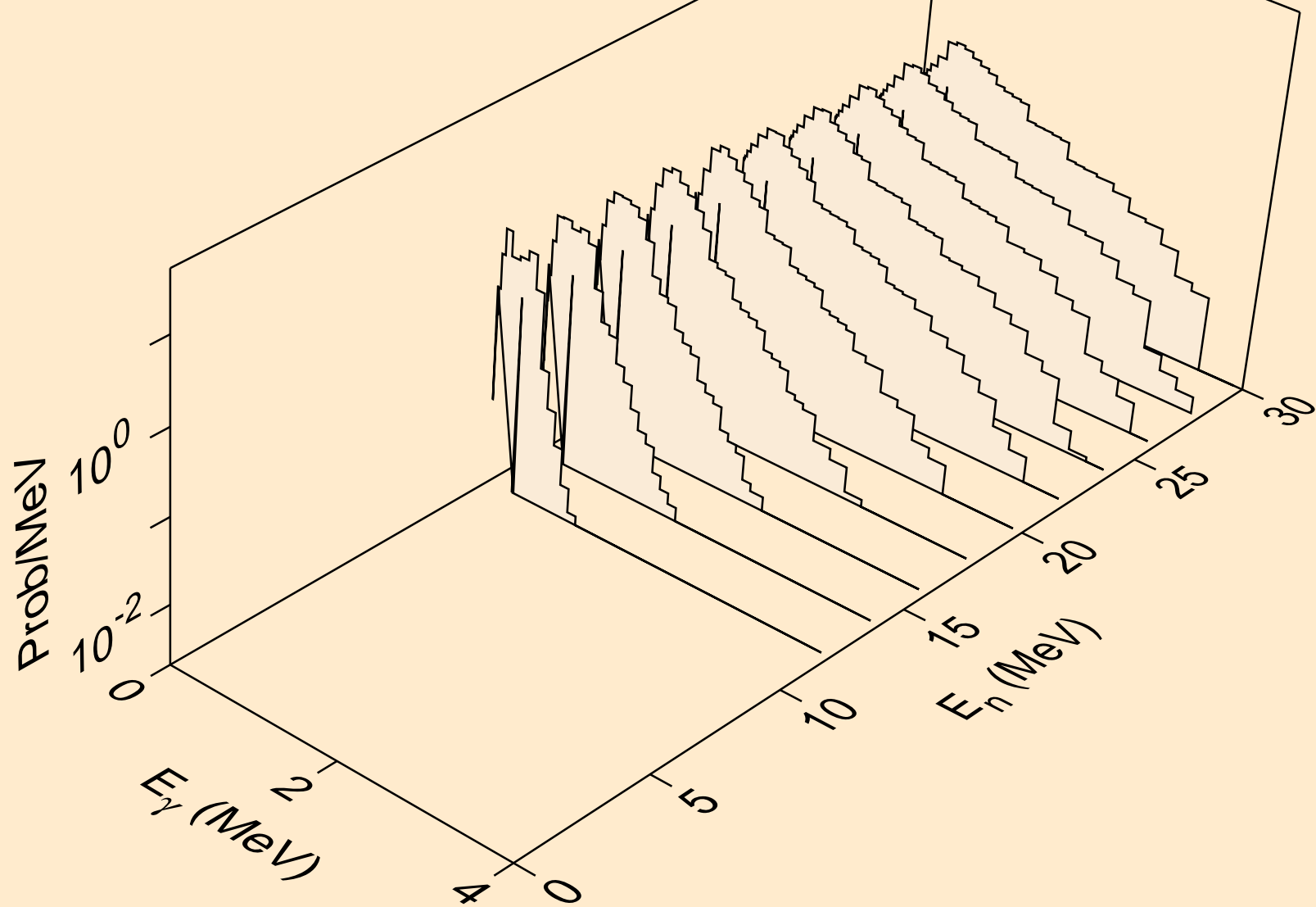

KR093 HELION ACER TENDL-2021 LIBRARY; T=0.K  
Photon emission for (n,p)

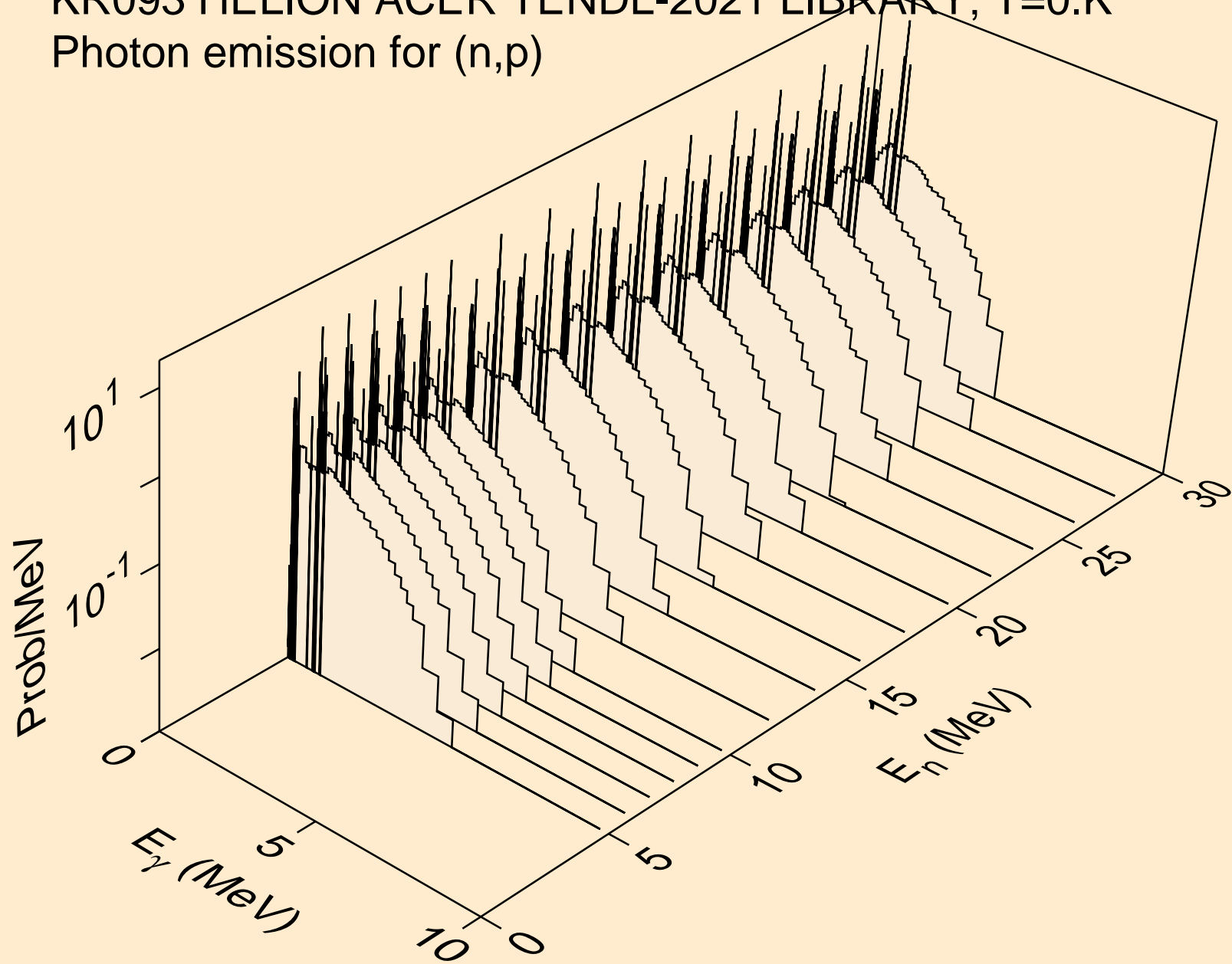

KR093 HELION ACER TENDL-2021 LIBRARY; T=0.K  
Photon emission for (n,d)

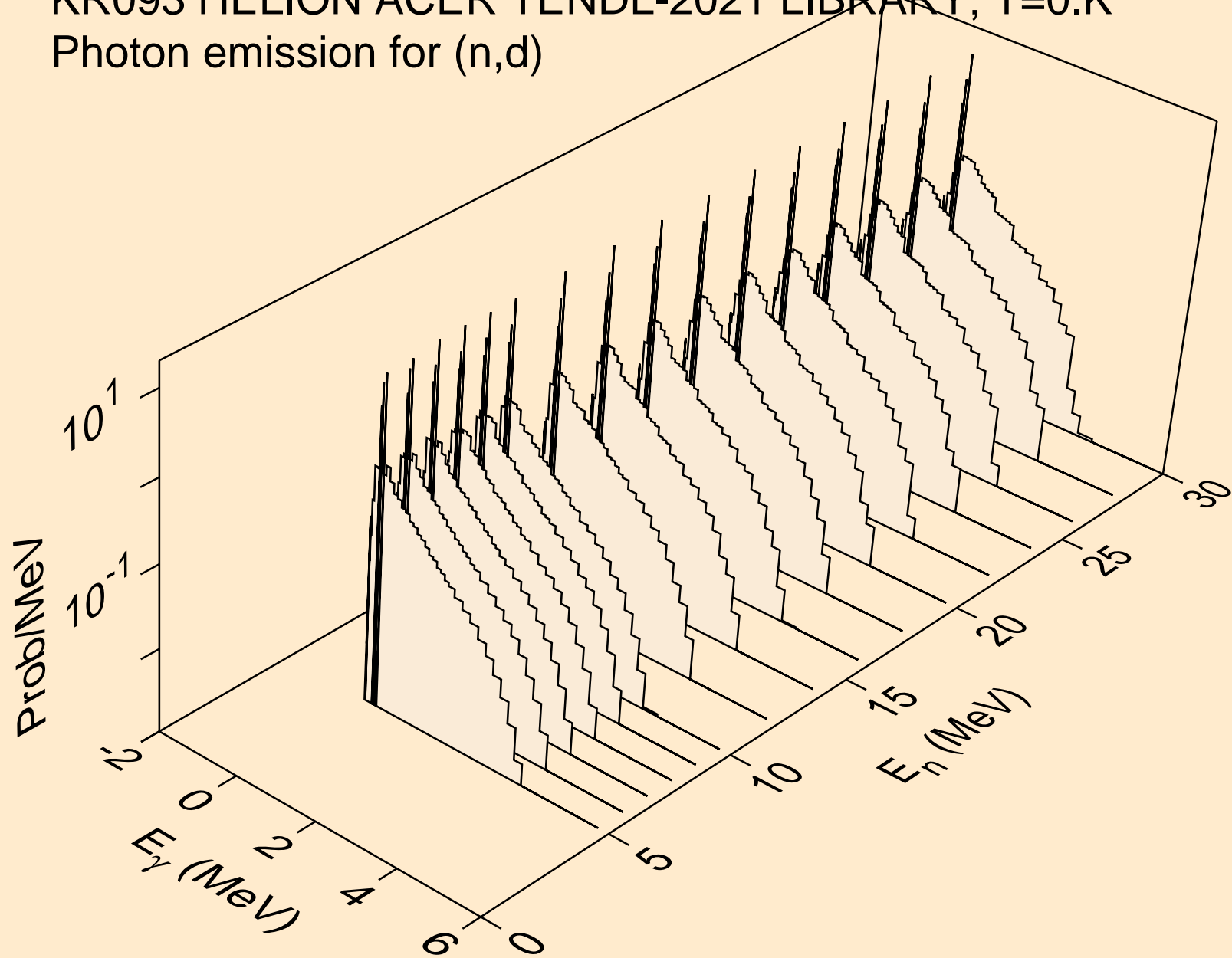

KR093 HELION ACER TENDL-2021 LIBRARY; T=0.K  
Photon emission for (n,t)

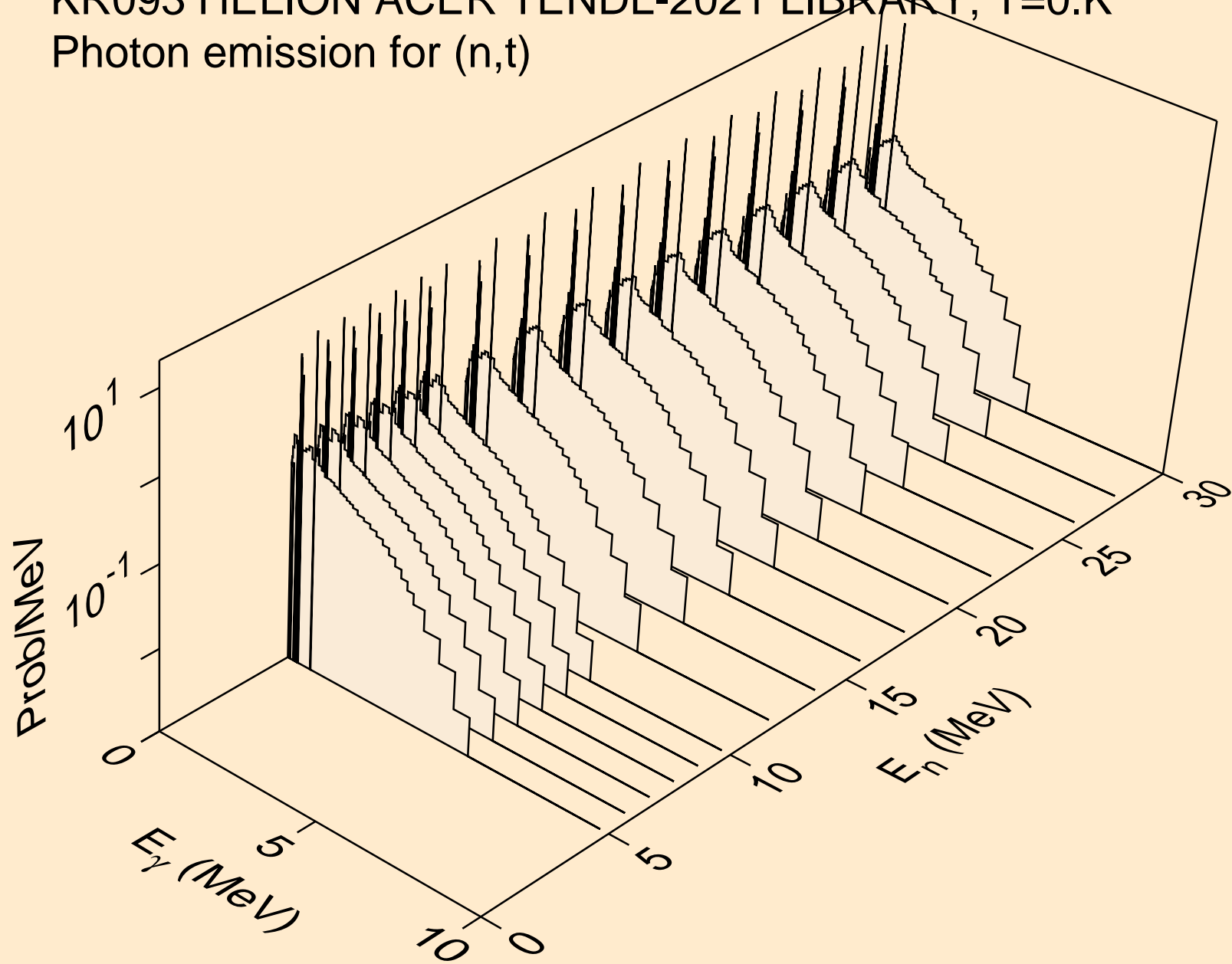

KR093 HELION ACER TENDL-2021 LIBRARY; T=0.K  
Photon emission for inelastic

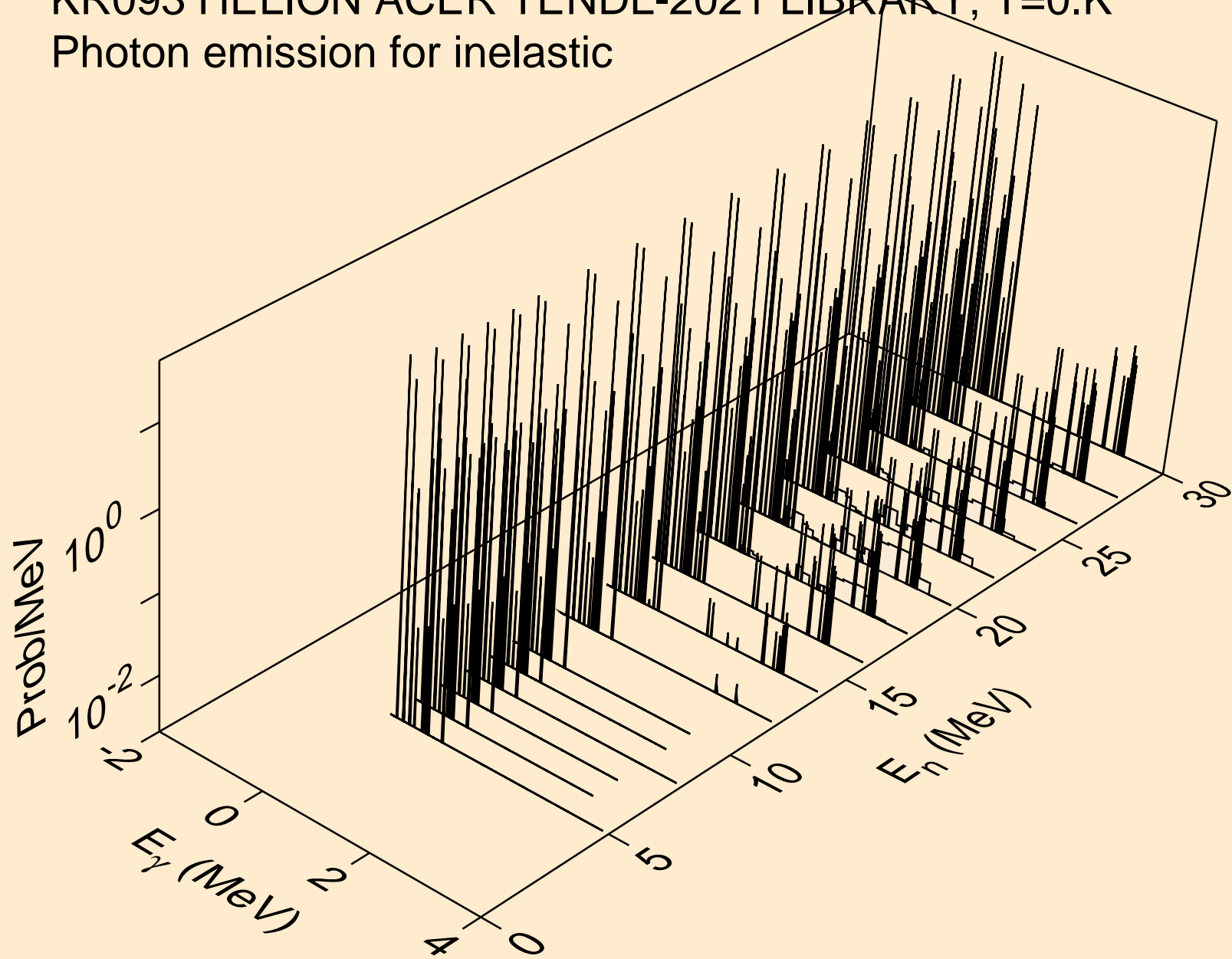



KR093 HELION ACER TENDL-2021 LIBRARY; T=0.K  
Photon emission for (n,a)

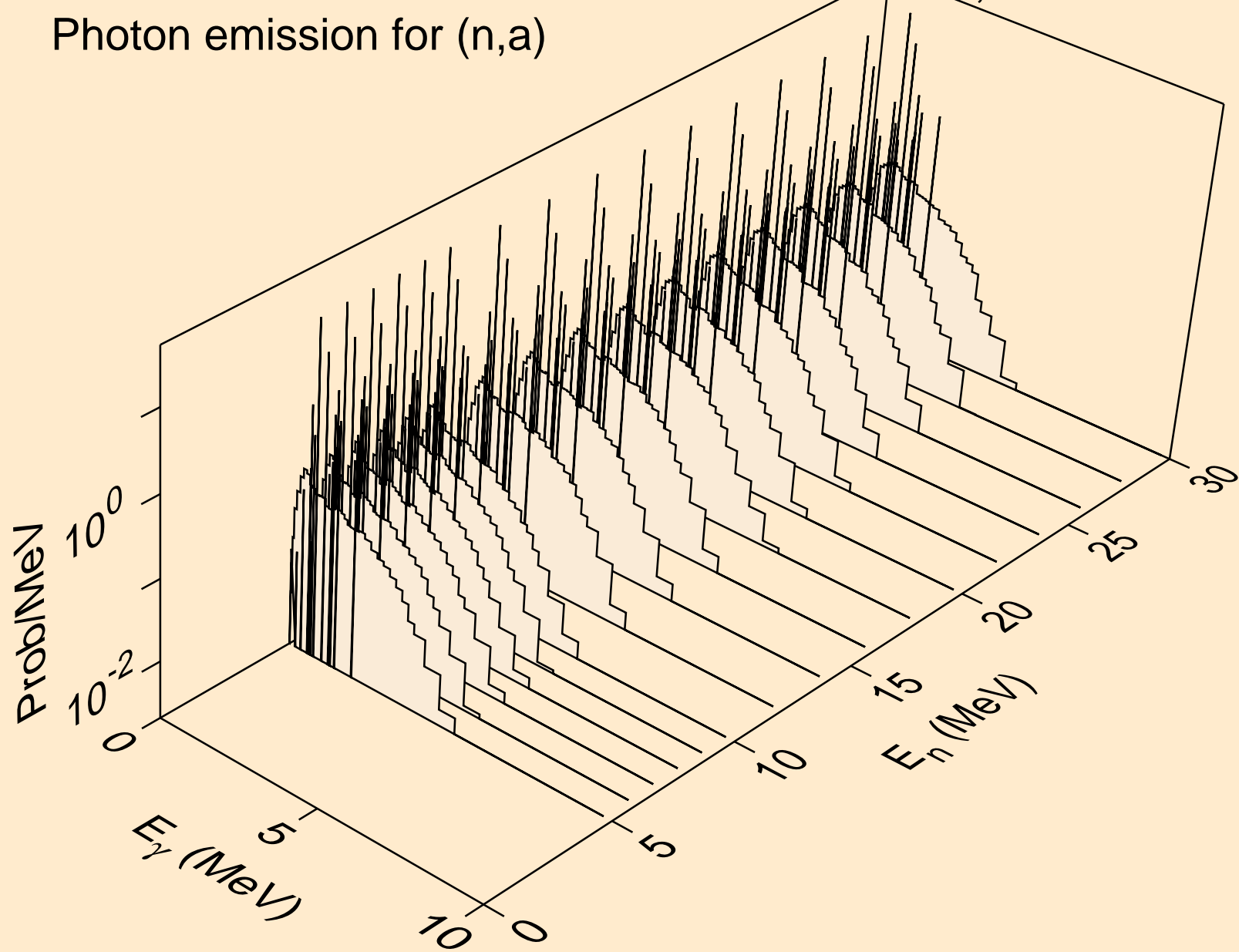

KR093 HELION ACER TENDL-2021 LIBRARY; T=0.K  
Photon emission for (n,2p)

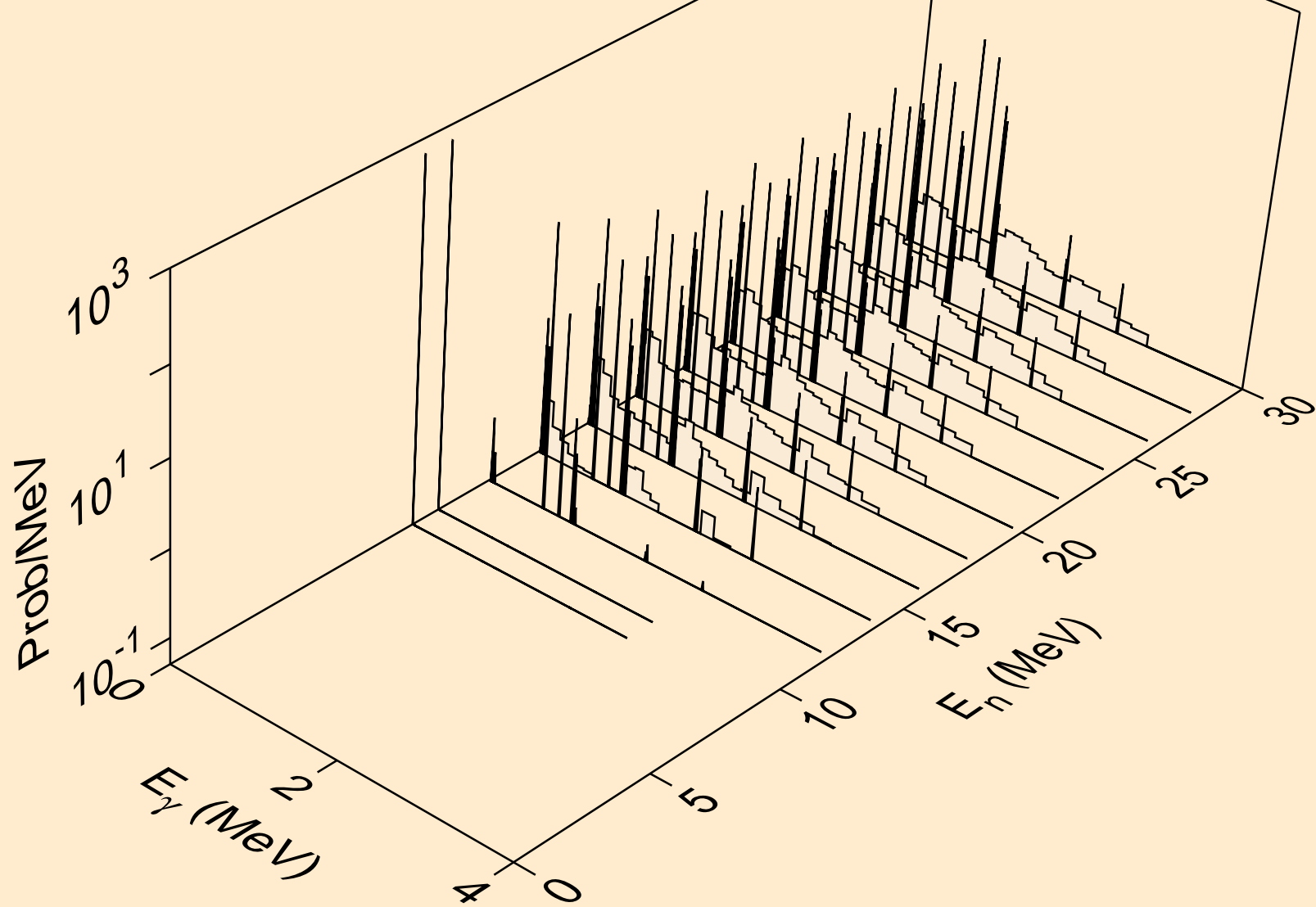

KR093 HELION ACER TENDL-2021 LIBRARY; T=0.K  
Photon emission for (n,pa)

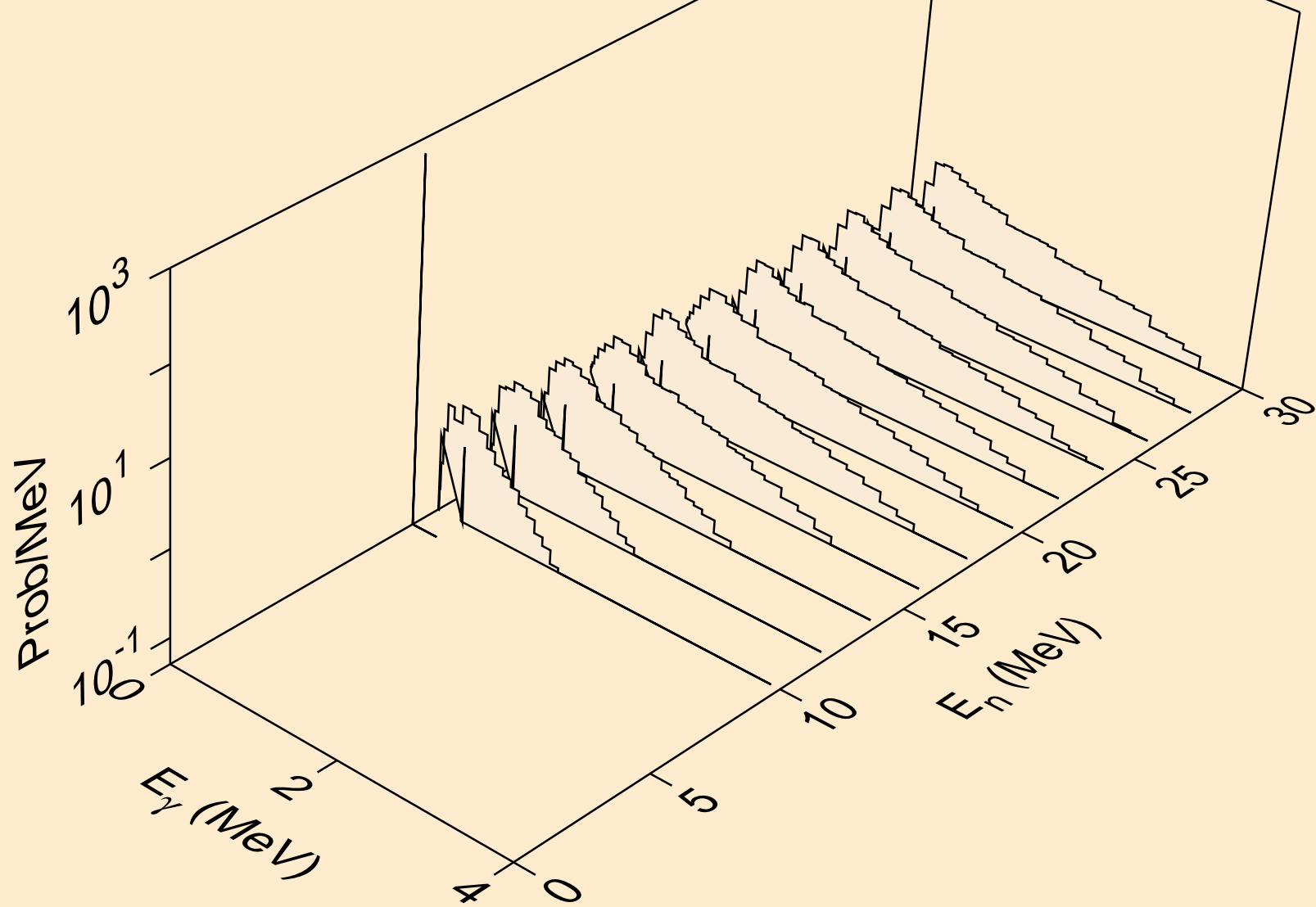

KR093 HELION ACER TENDL-2021 LIBRARY; T=0.K  
Photon emission for (n,pd)

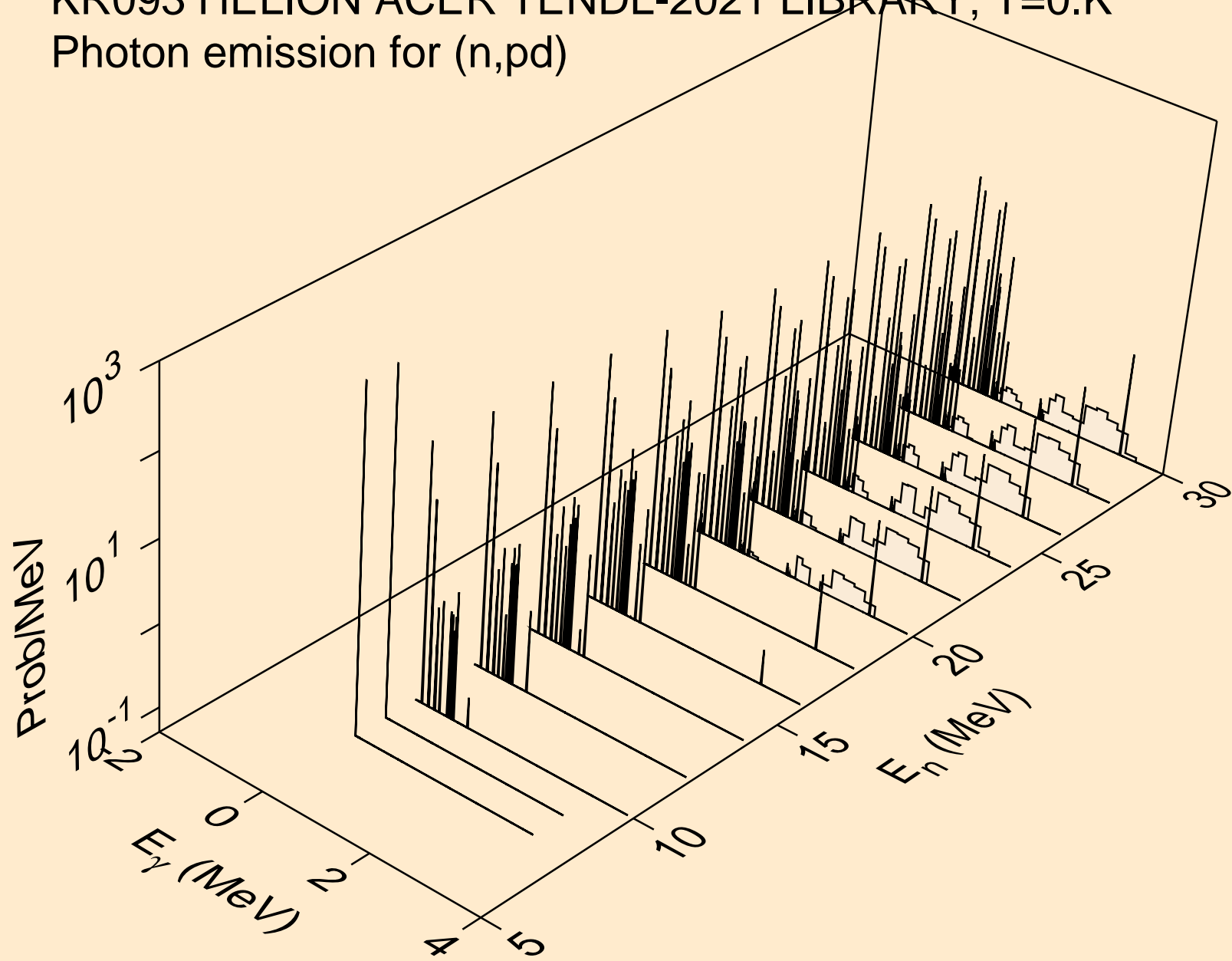

KR093 HELION ACER TENDL-2021 LIBRARY; T=0.K  
Photon emission for (n,pt)

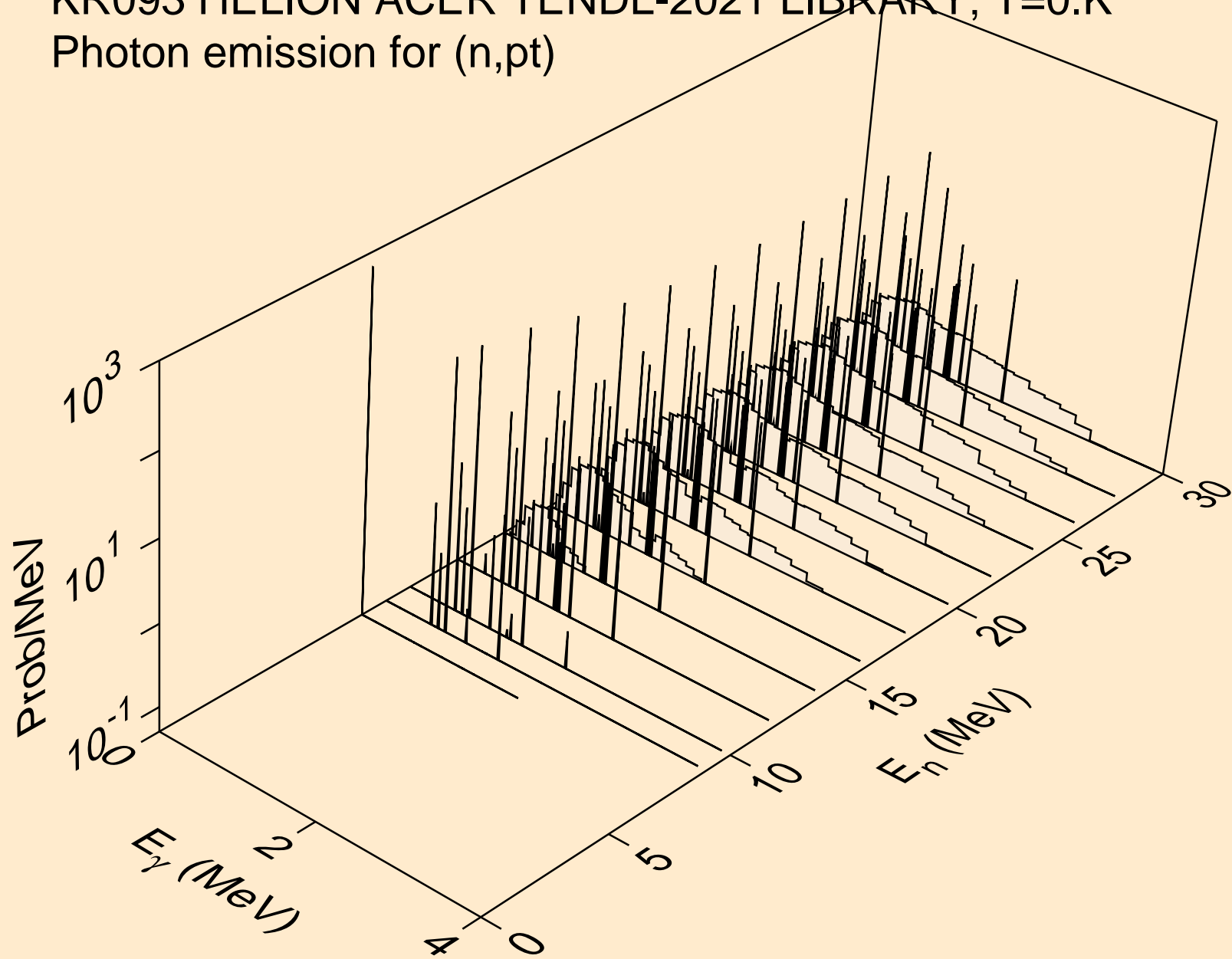

KR093 HELION ACER TENDL-2021 LIBRARY; T=0.K  
Photon emission for (n,da)

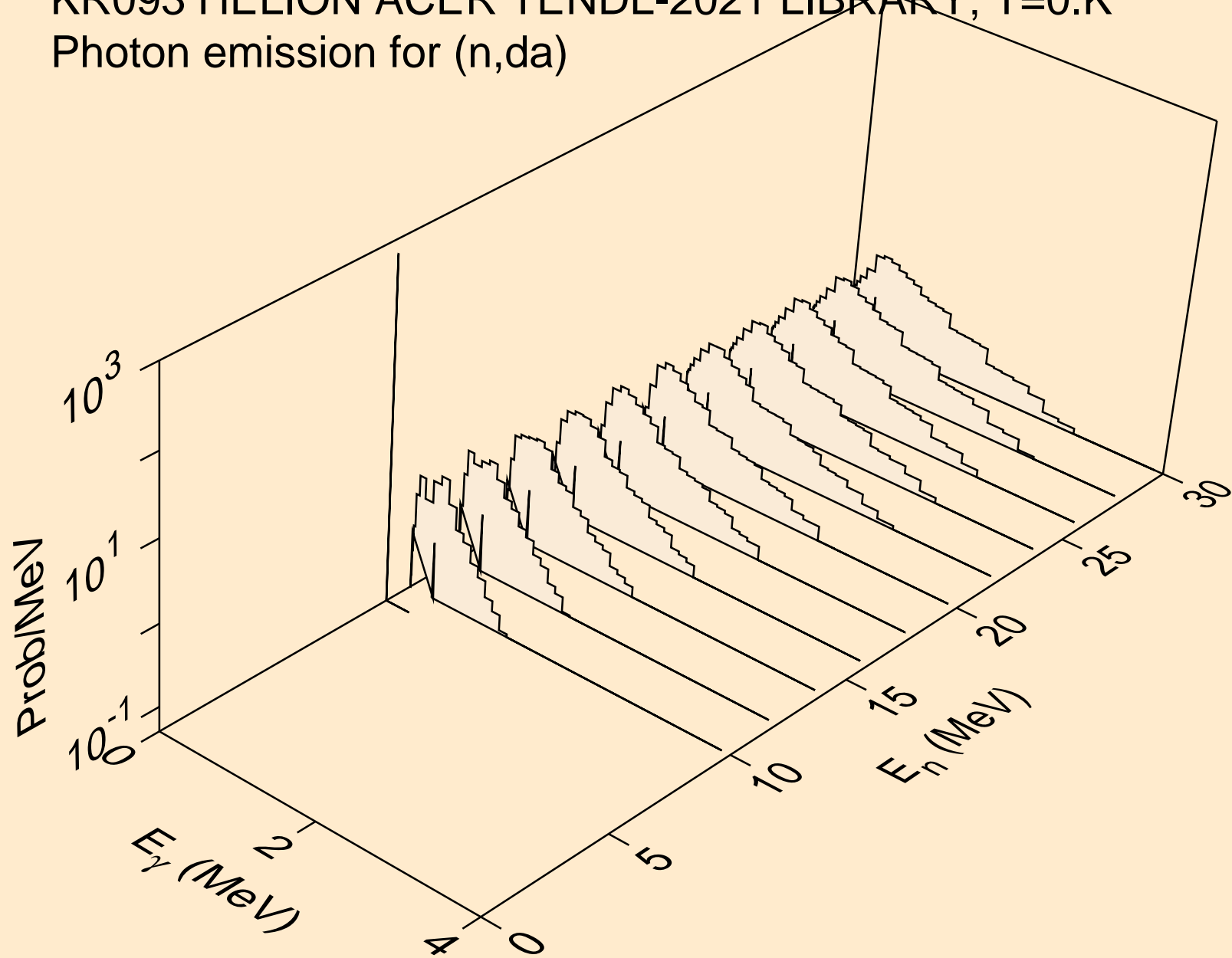

KR093 HELION ACER TENDL-2021 LIBRARY; T=0.K  
Particle heating contributions

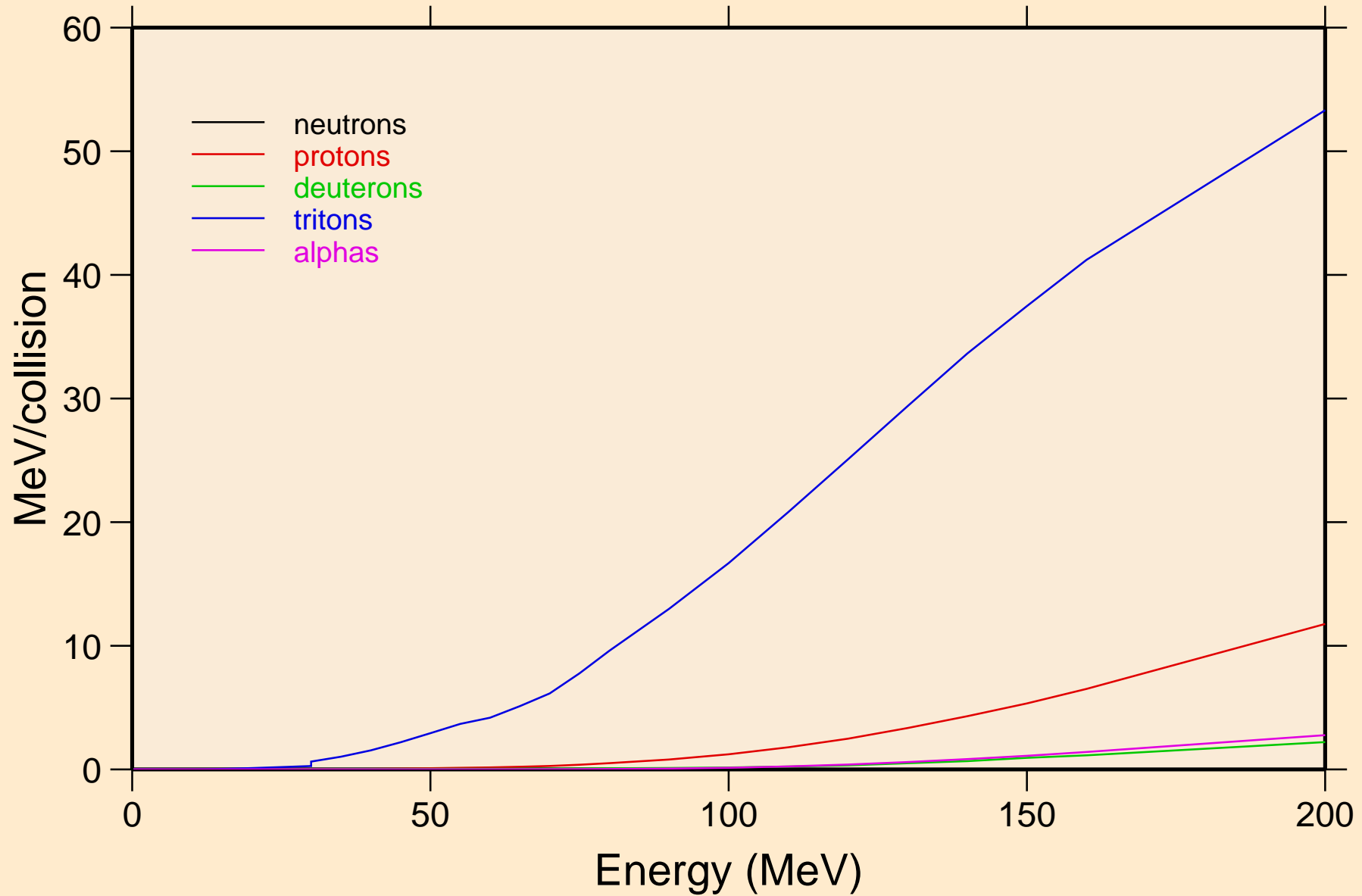

KR093 HELION ACER TENDL-2021 LIBRARY; T=0.K  
Recoil Heating

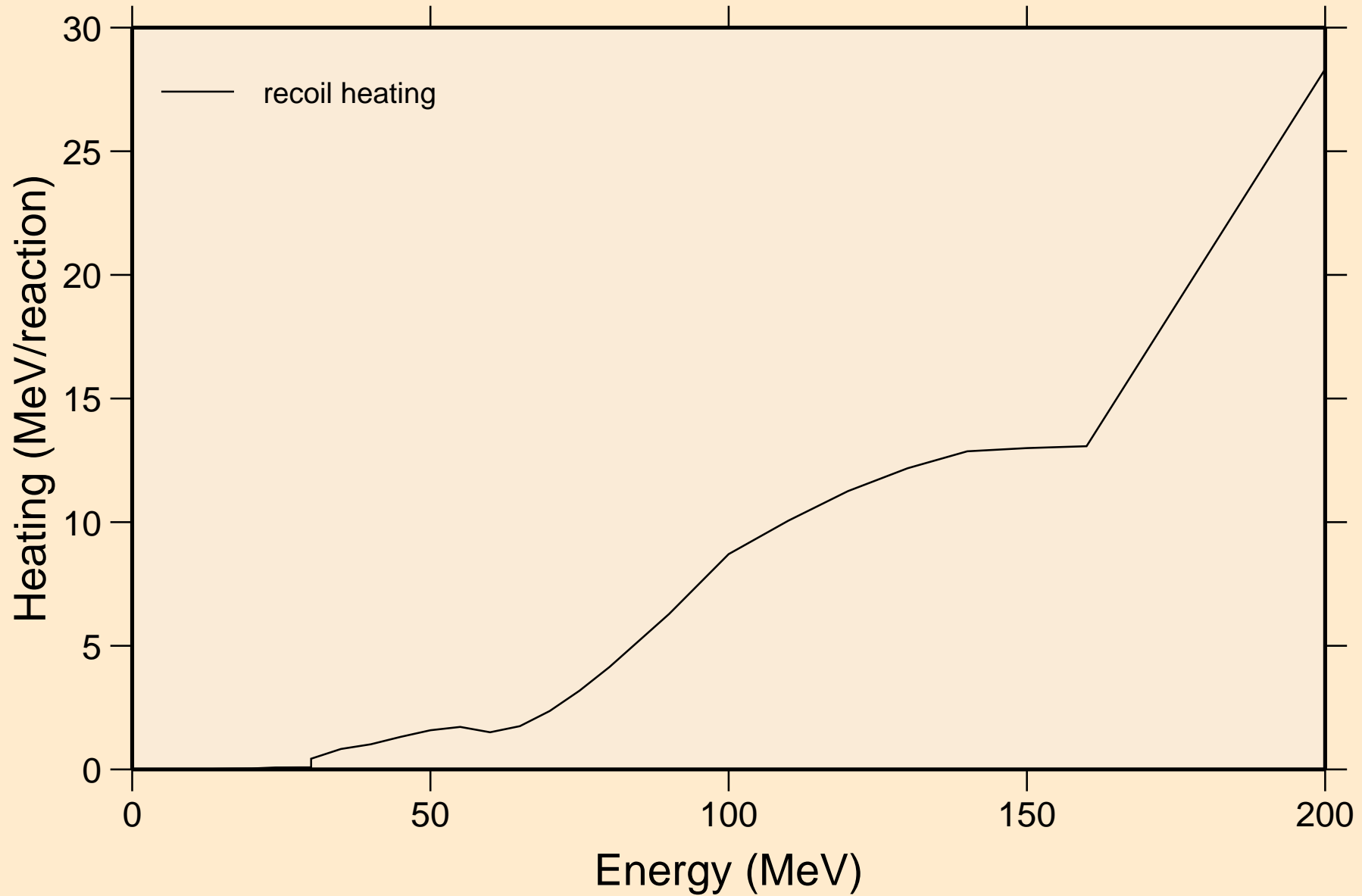



KR093 HELION ACER TENDL-2021 LIBRARY; T=0.K  
Particle production cross sections

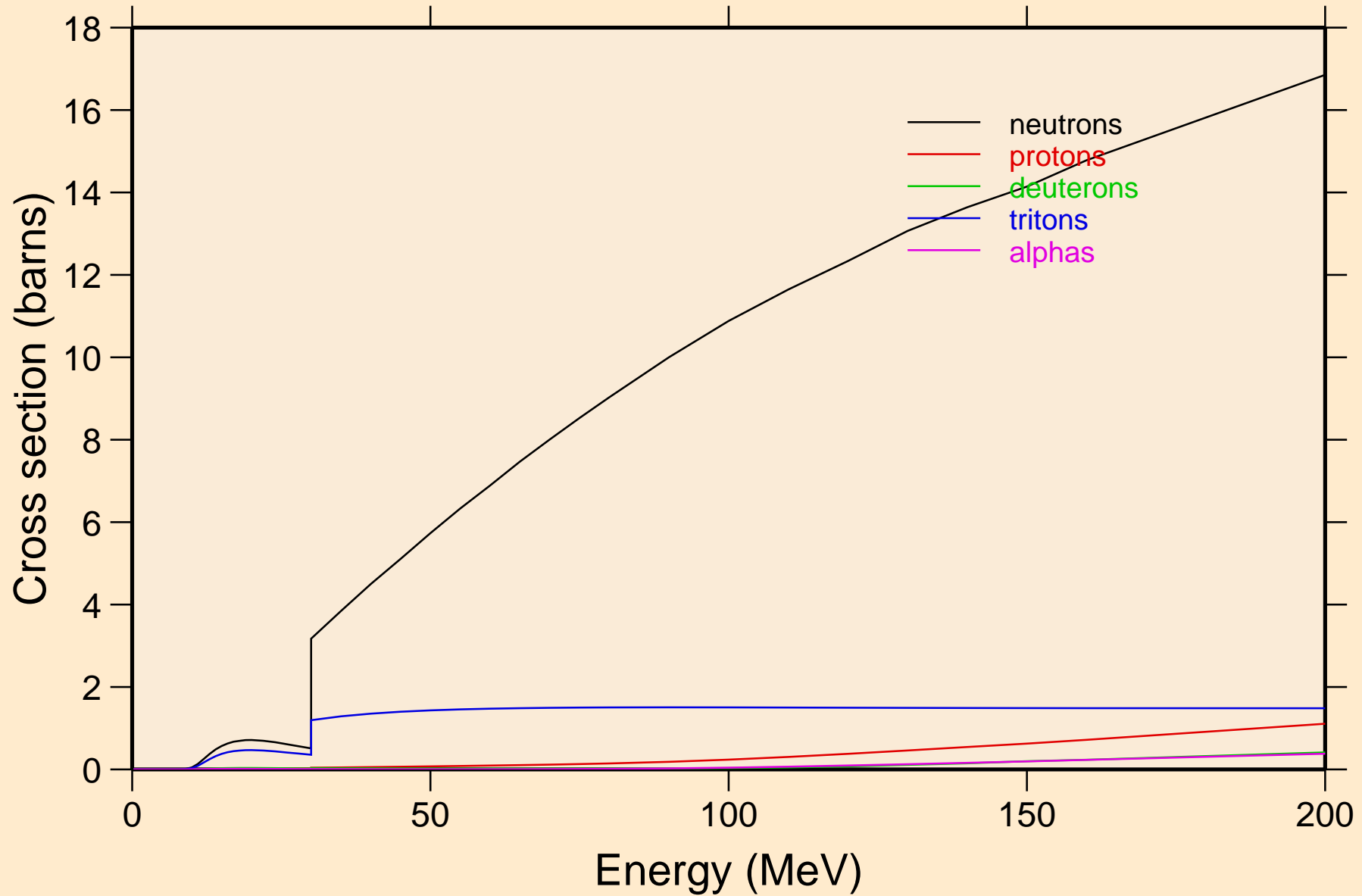

KR093 HELION ACER TENDL-2021 LIBRARY; T=0.K  
neutrons from (s,n)

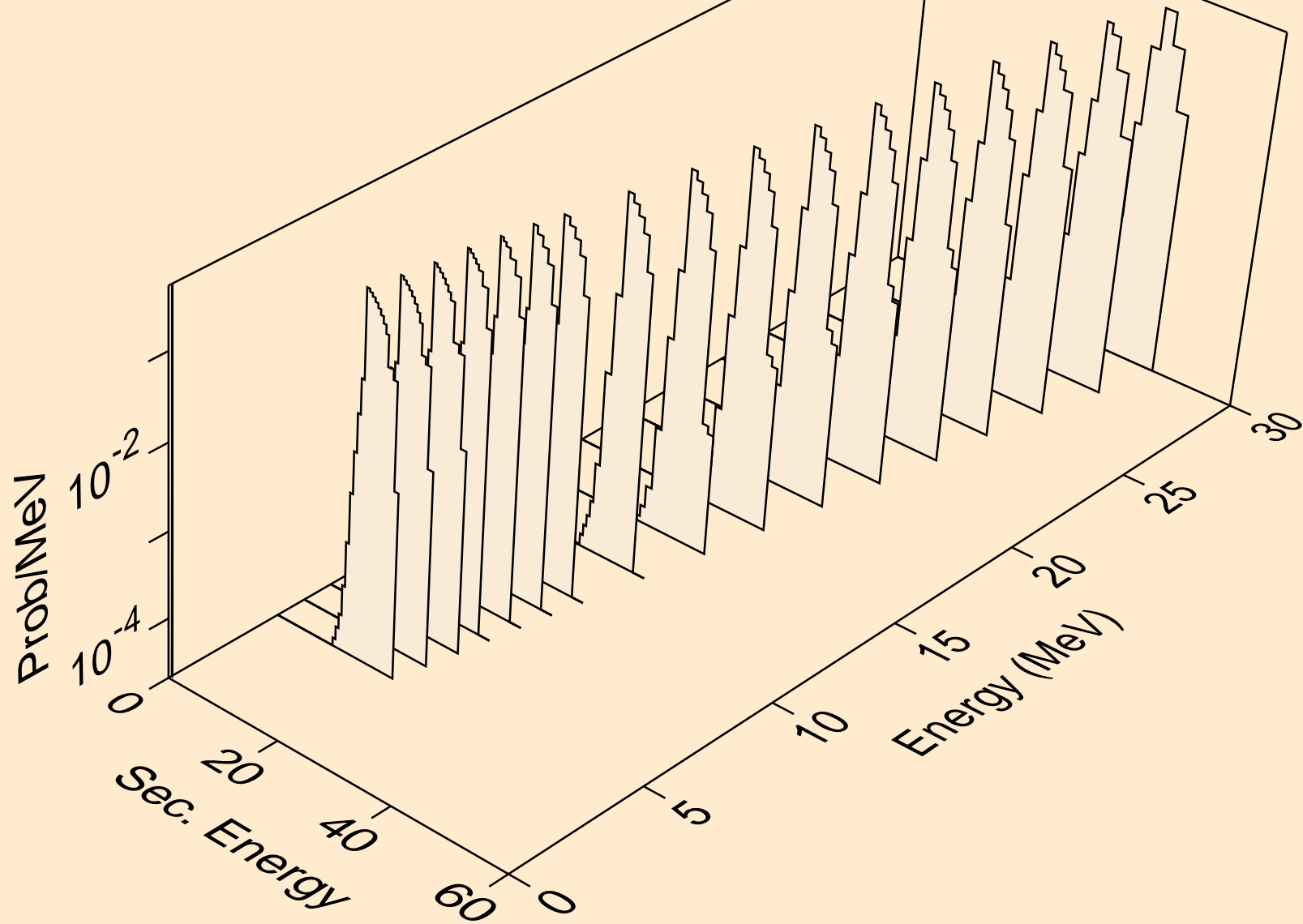

KR093 HELION ACER TENDL-2021 LIBRARY; T=0.K  
neutrons from (s,x)

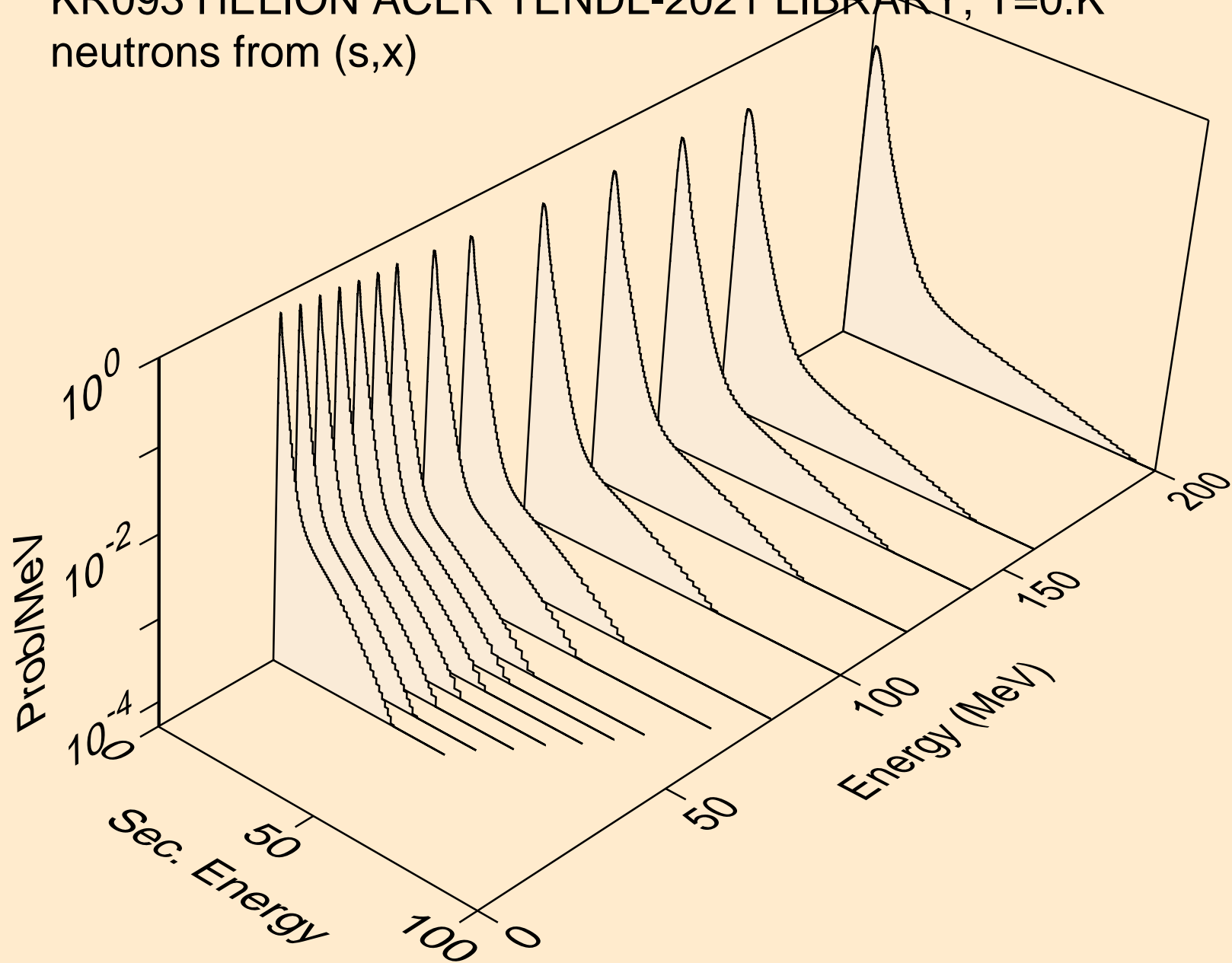

KR093 HELION ACER TENDL-2021 LIBRARY; T=0.K  
neutrons from (s,2nd)

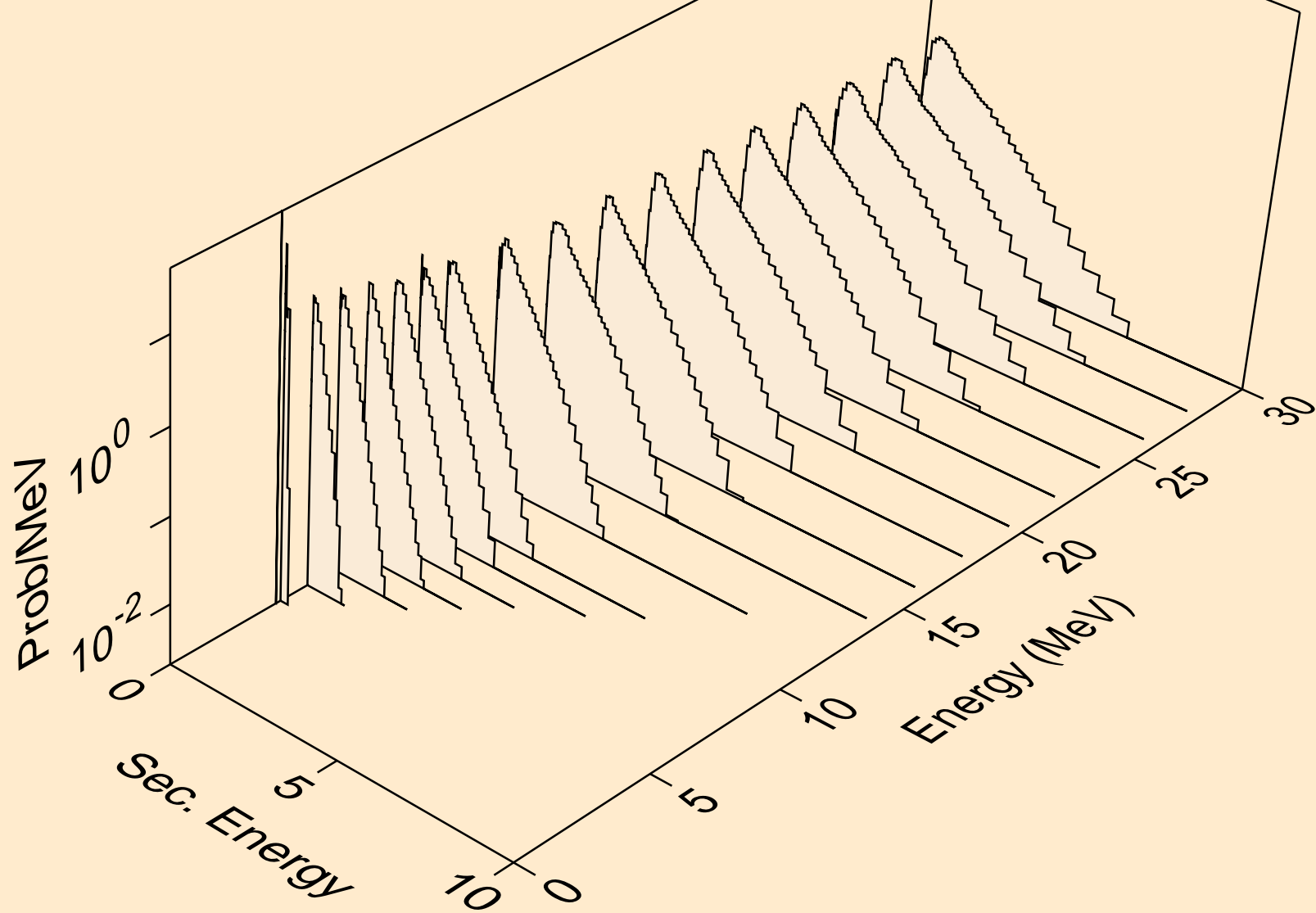

KR093 HELION ACER TENDL-2021 LIBRARY; T=0.K  
neutrons from (s,2n)

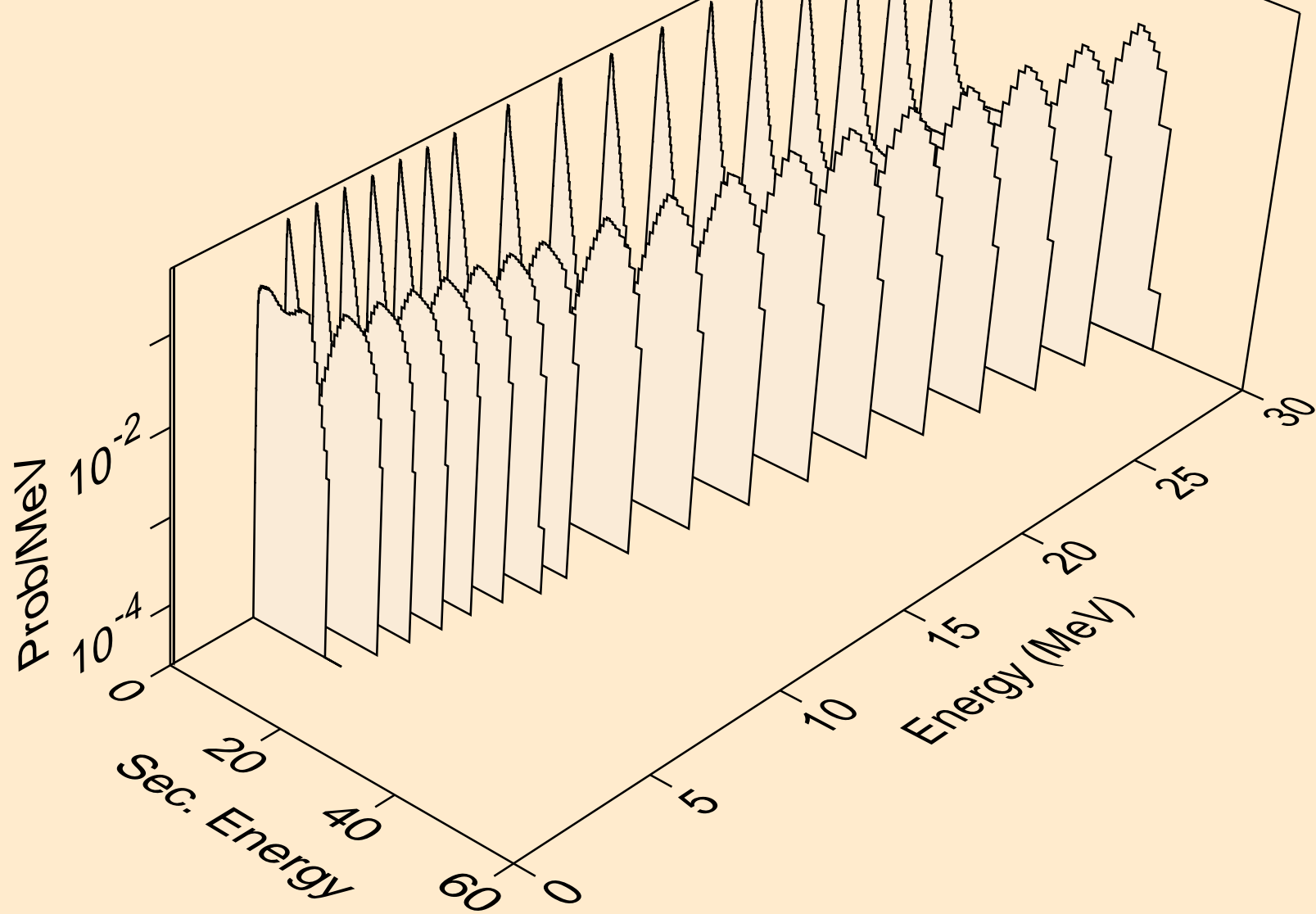

KR093 HELION ACER TENDL-2021 LIBRARY; T=0.K  
neutrons from (s,3n)

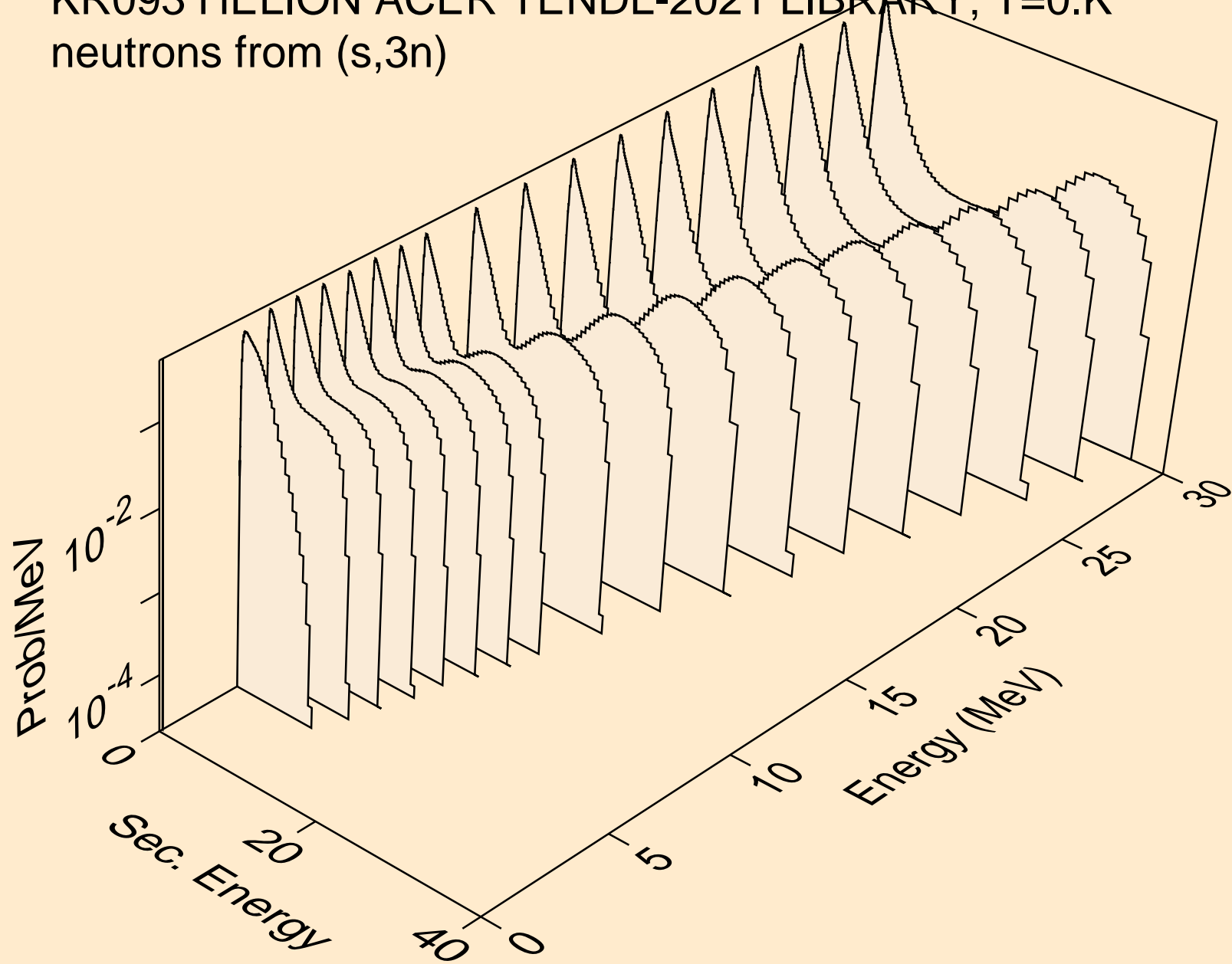

KR093 HELION ACER TENDL-2021 LIBRARY; T=0.K  
neutrons from (s,n\*)a

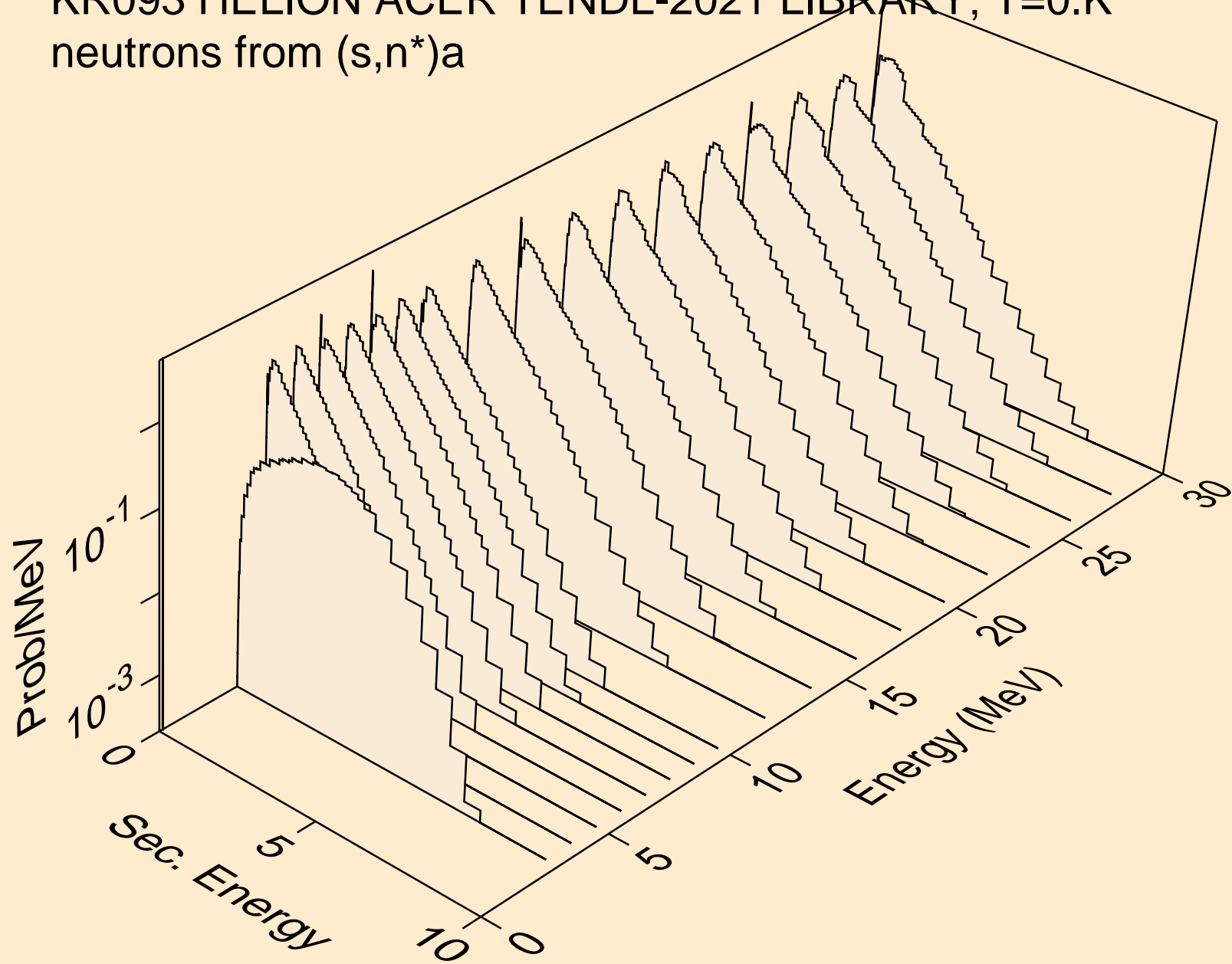

KR093 HELION ACER TENDL-2021 LIBRARY; T=0.K  
neutrons from (s,2n)a

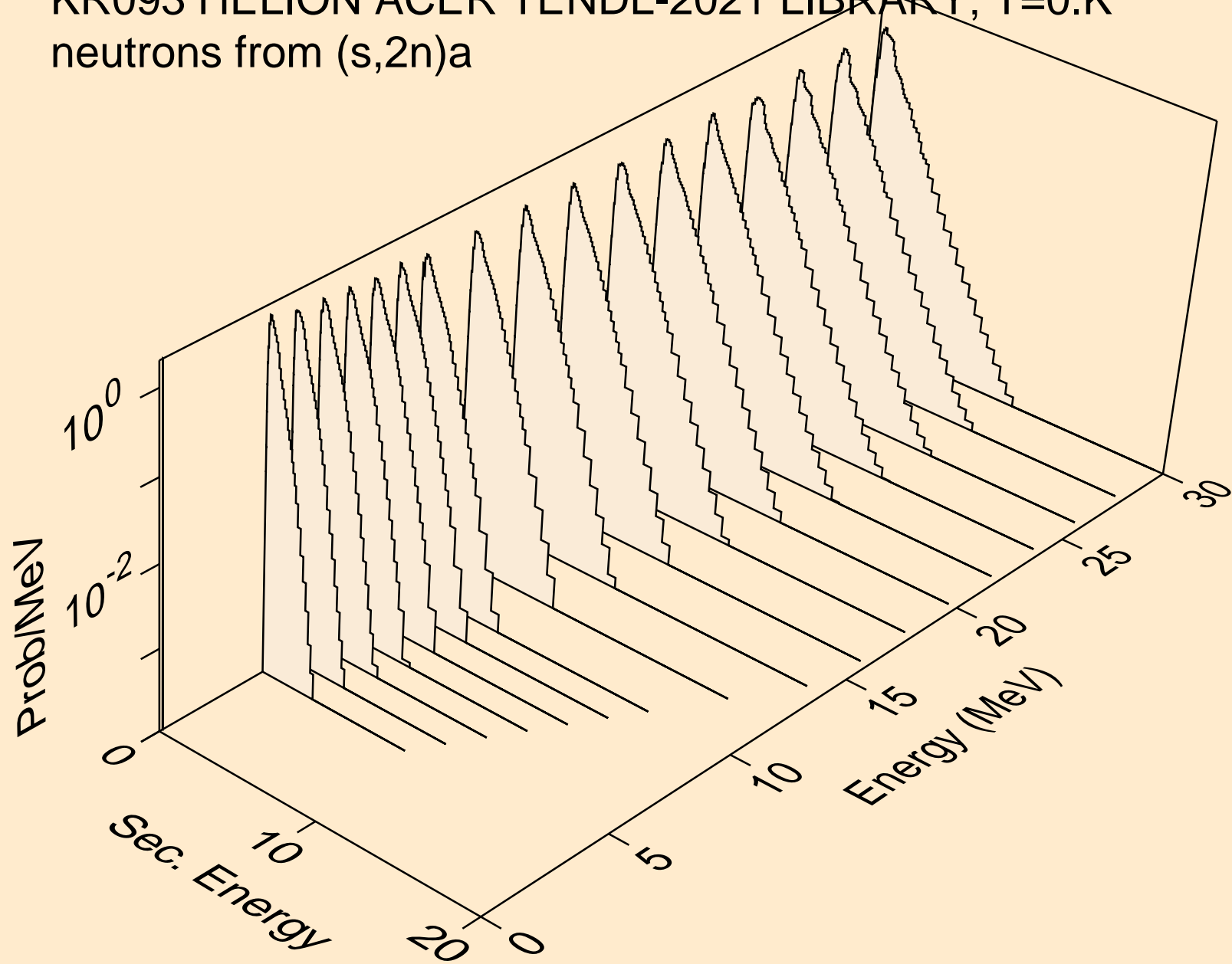



KR093 HELION ACER TENDL-2021 LIBRARY; T=0.K  
neutrons from (s,3n)a

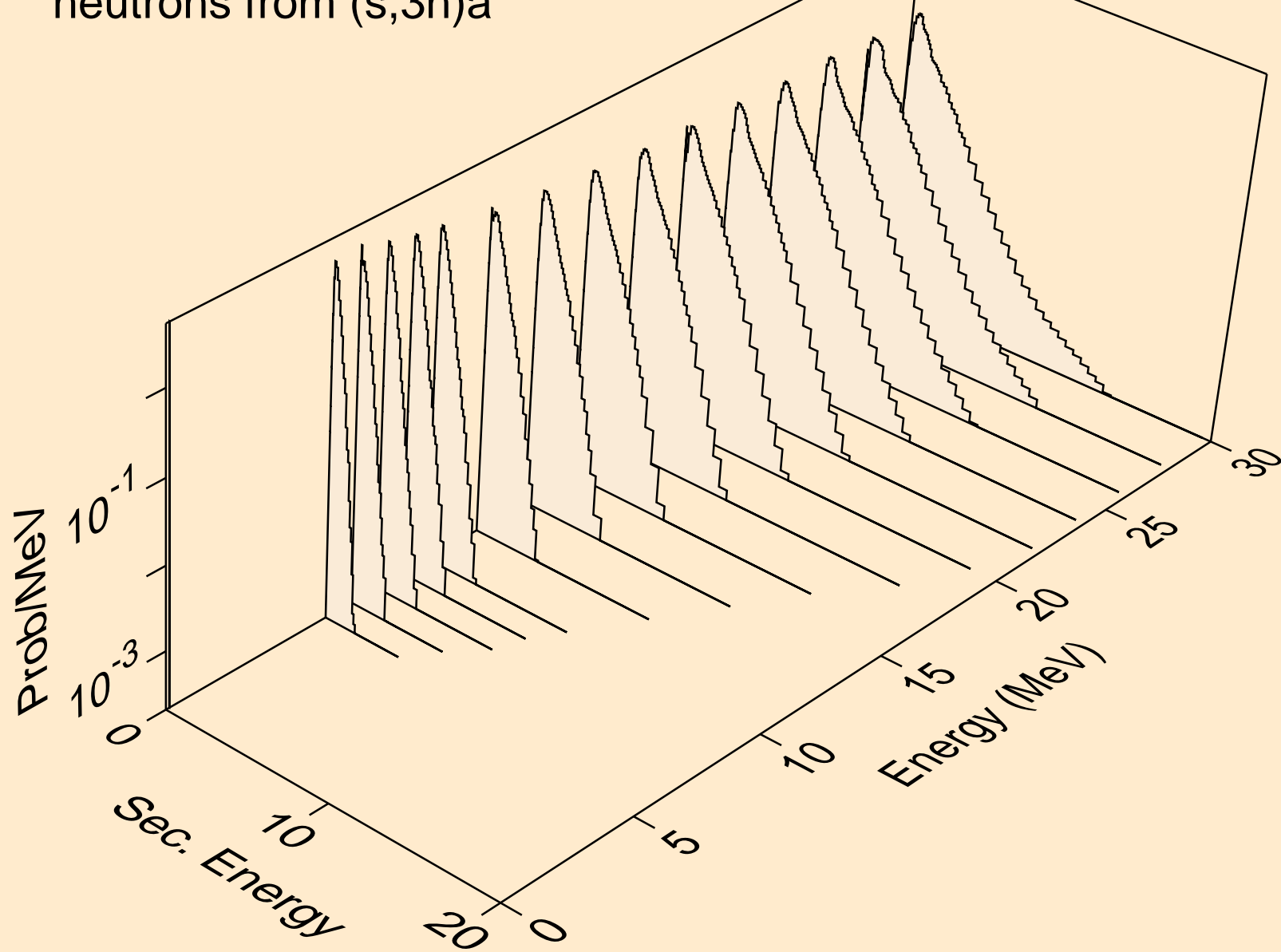

KR093 HELION ACER TENDL-2021 LIBRARY; T=0.K  
neutrons from (s,n\*)p

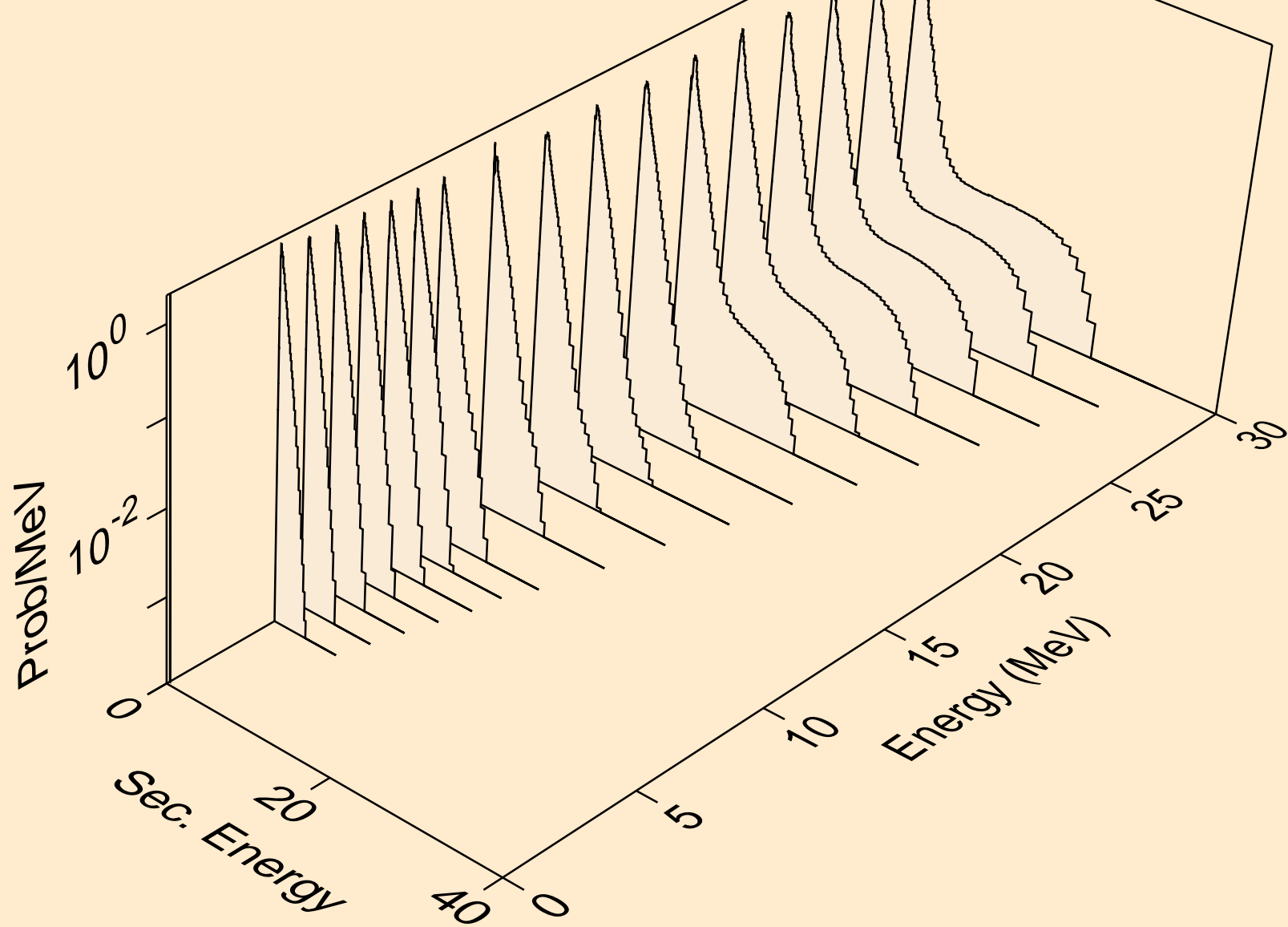

KR093 HELION ACER TENDL-2021 LIBRARY; T=0.K  
neutrons from (s,n\*)2a

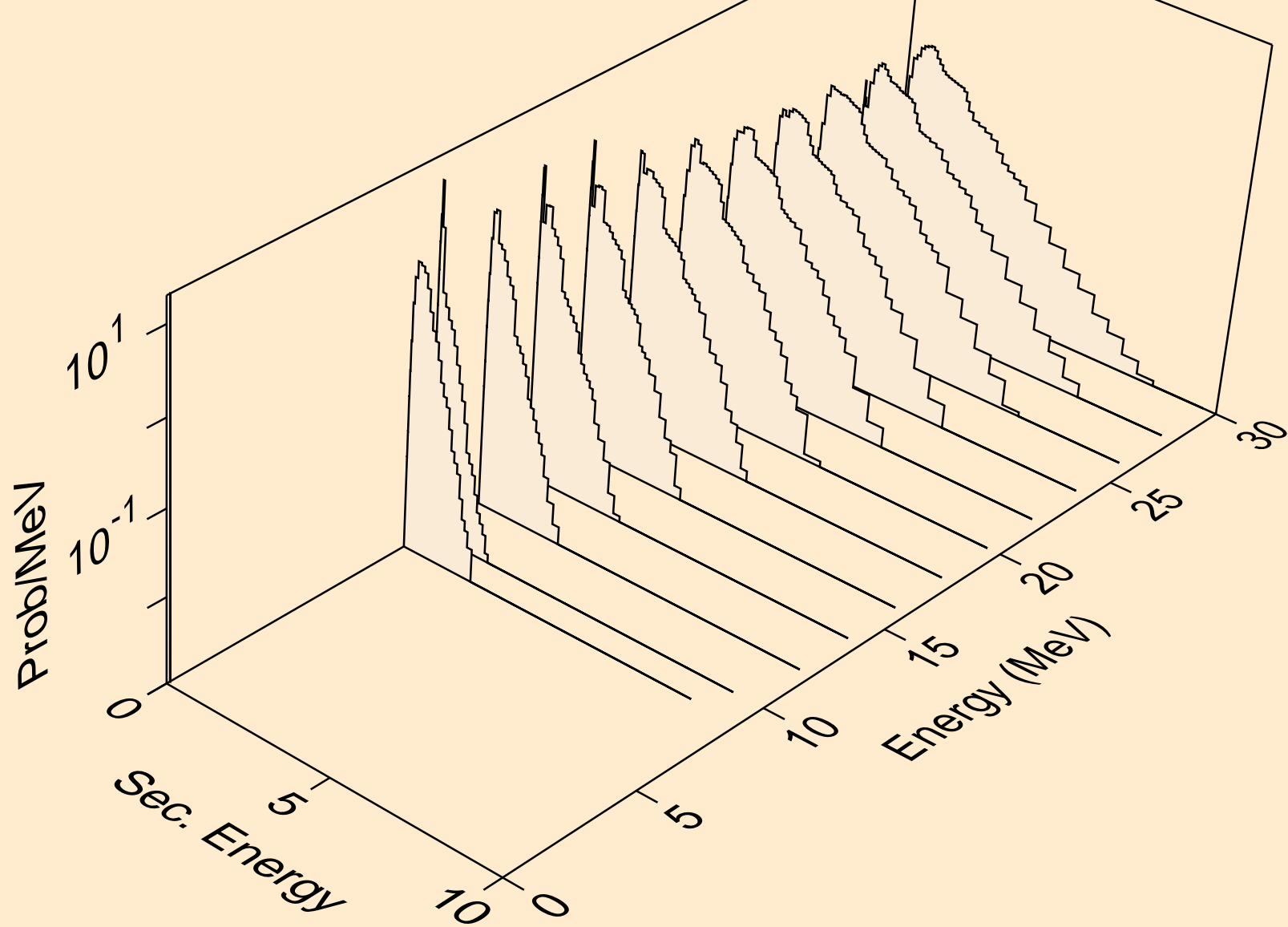

KR093 HELION ACER TENDL-2021 LIBRARY; T=0.K  
neutrons from (s,2n)2a

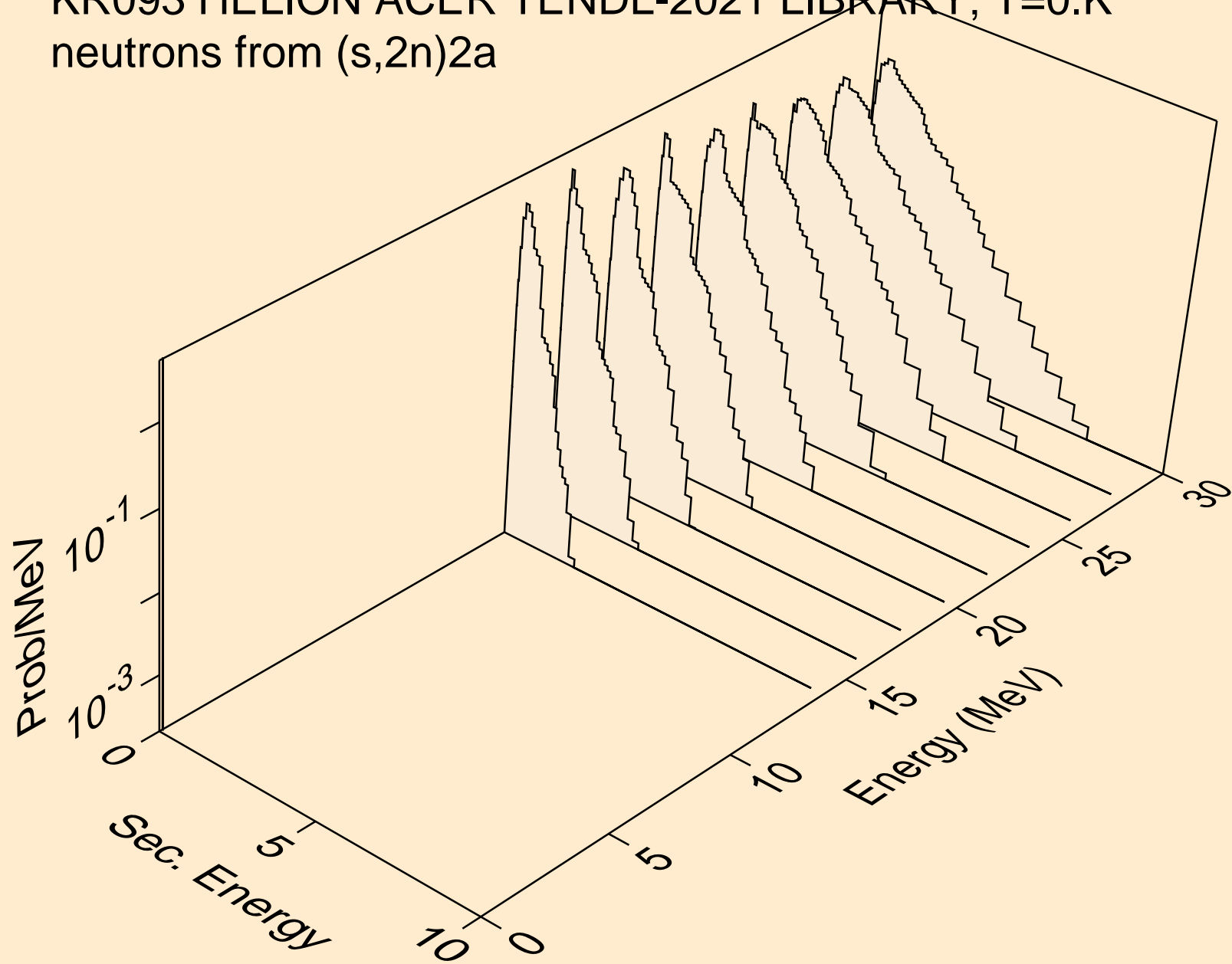

KR093 HELION ACER TENDL-2021 LIBRARY; T=0.K  
neutrons from (s,n\*)d

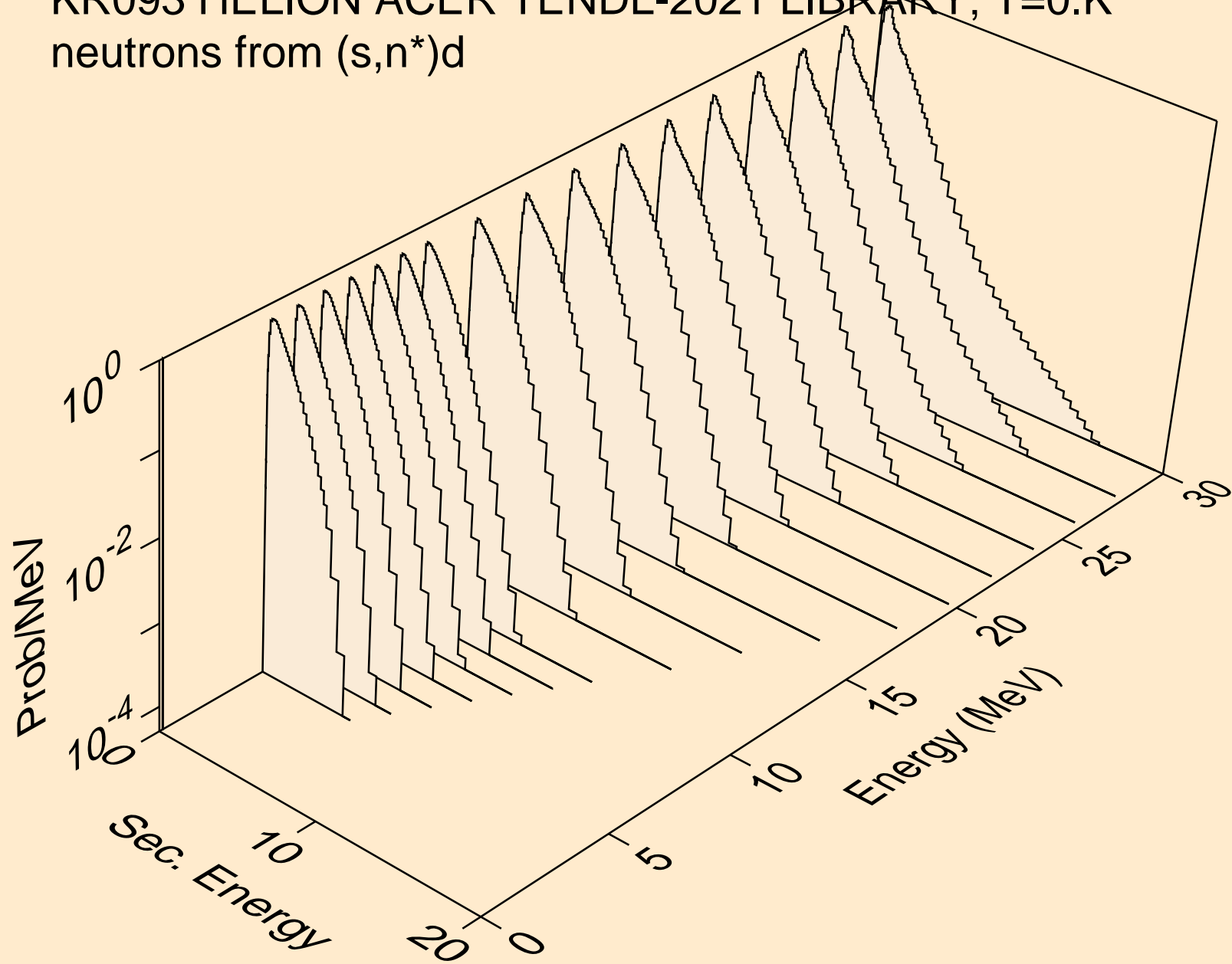

KR093 HELION ACER TENDL-2021 LIBRARY; T=0.K  
neutrons from (s,n\*)t

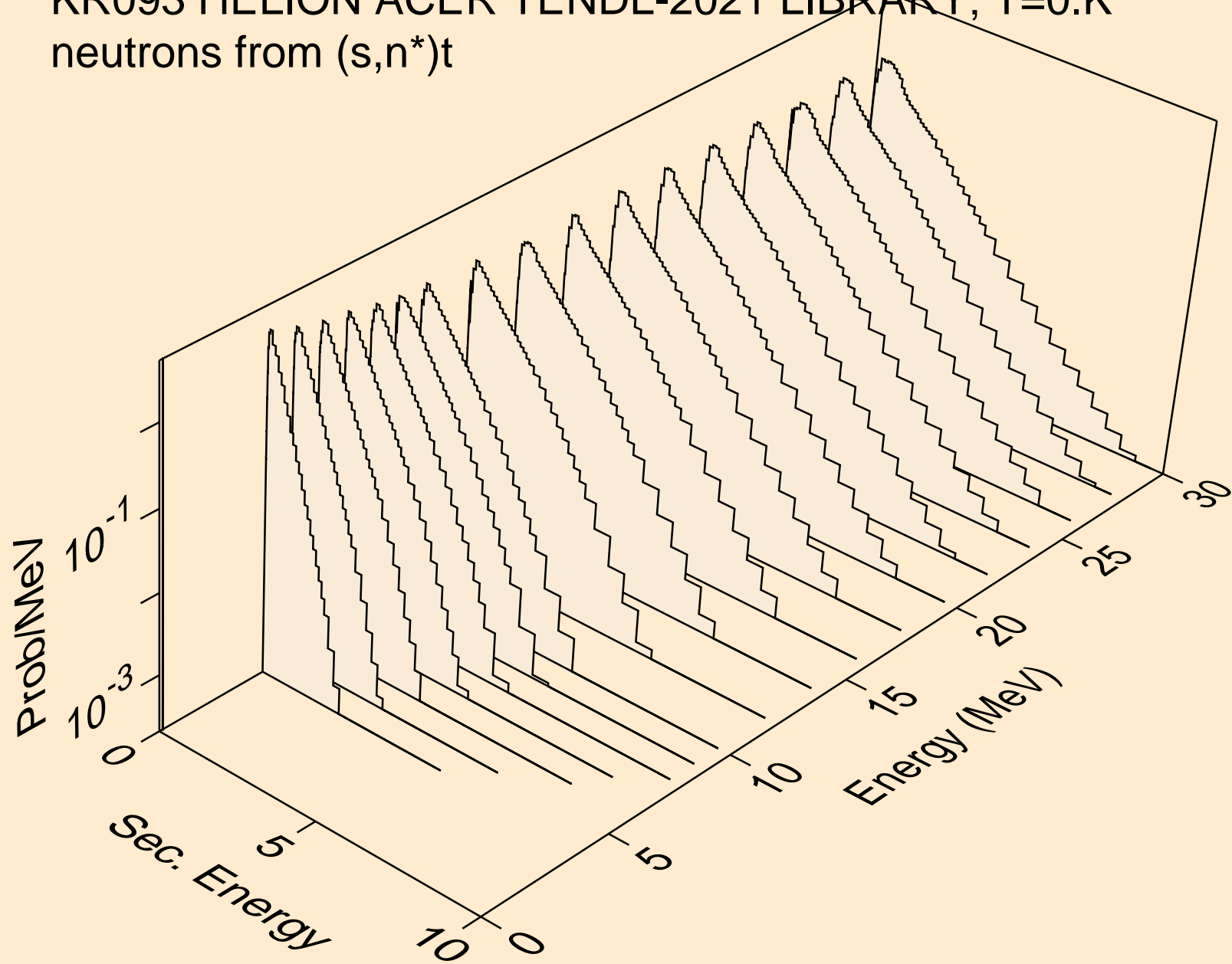

KR093 HELION ACER TENDL-2021 LIBRARY; T=0.K  
neutrons from (s,n\*)he3

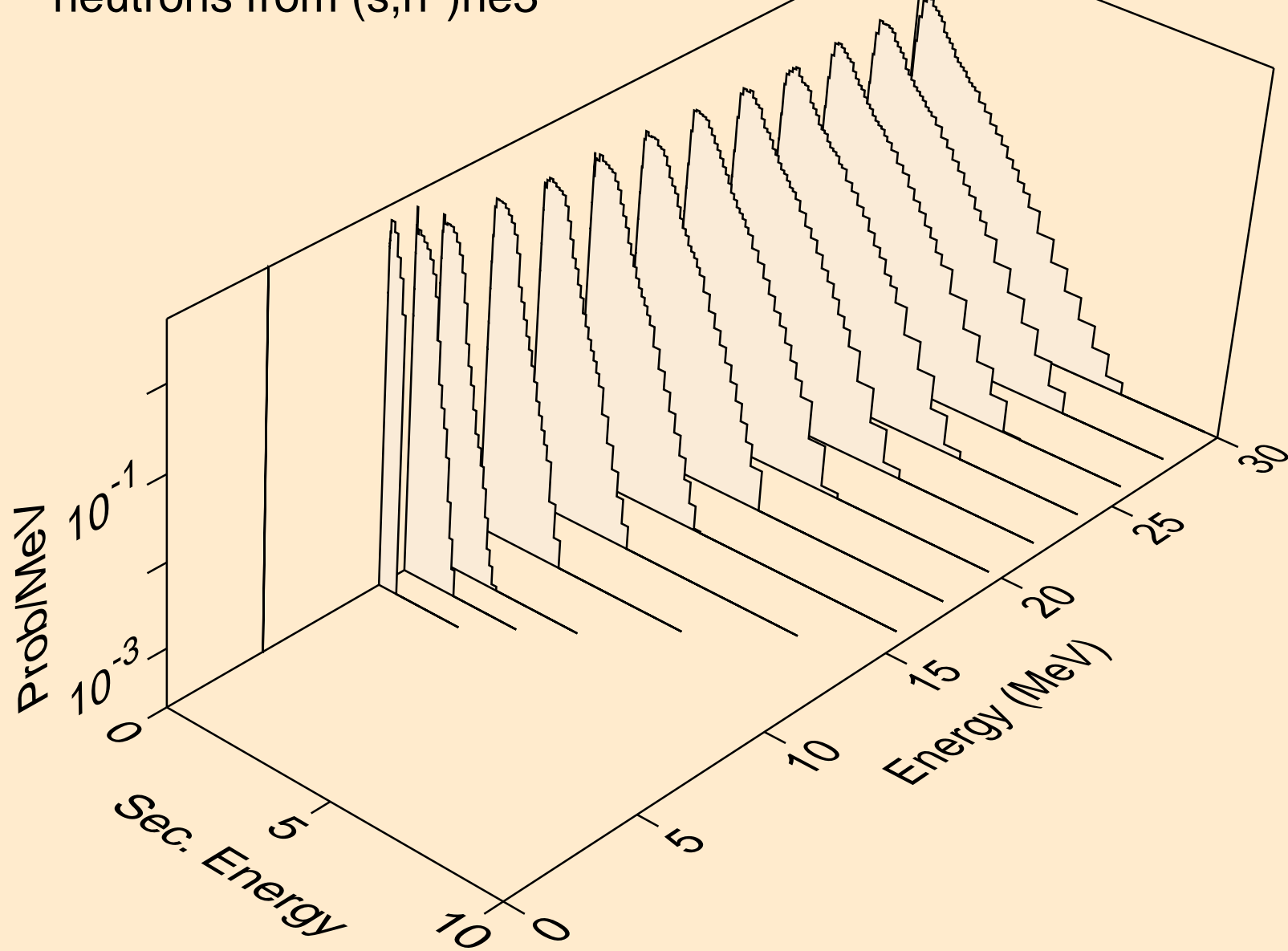

KR093 HELION ACER TENDL-2021 LIBRARY; T=0.K  
neutrons from (s,4n)

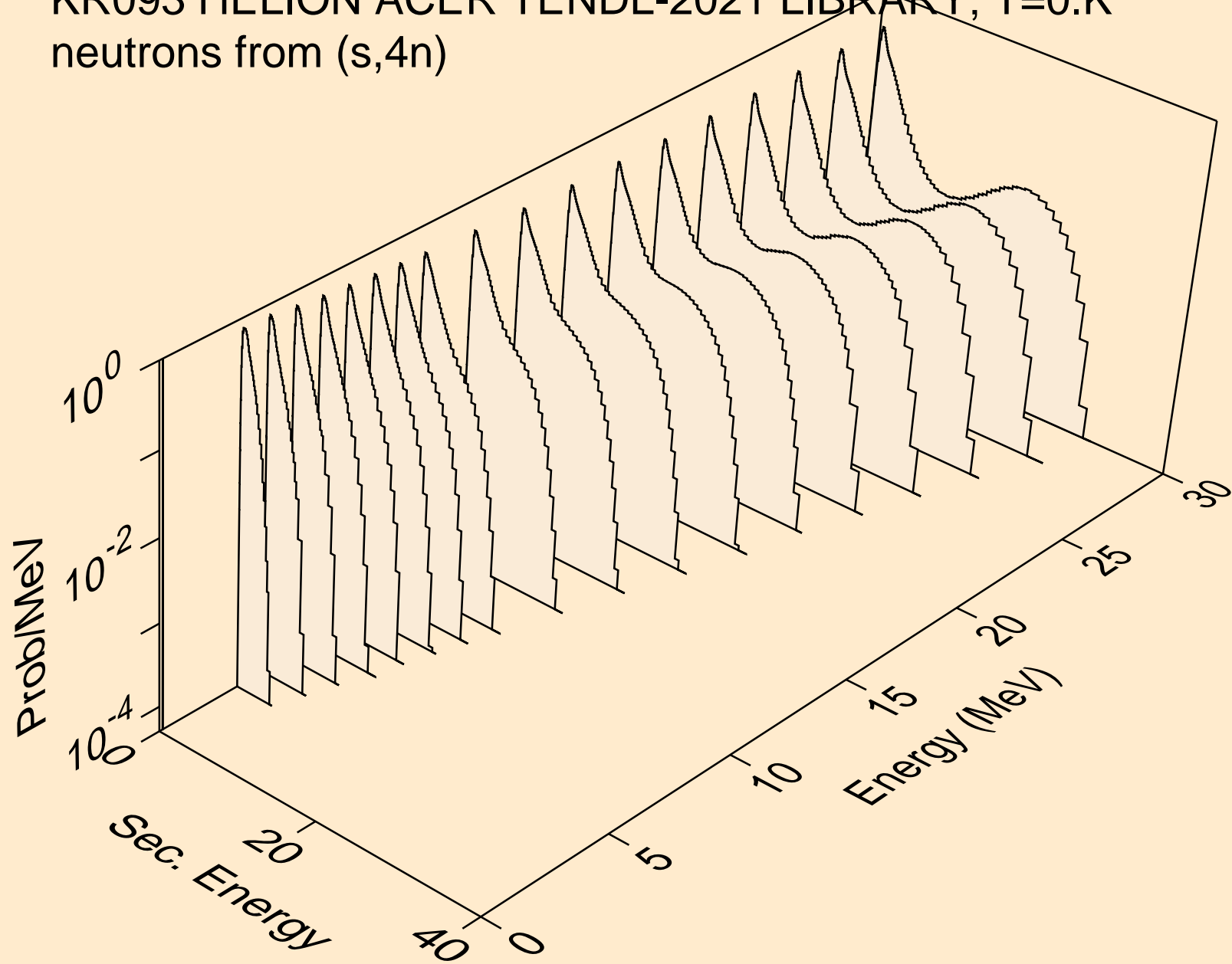



KR093 HELION ACER TENDL-2021 LIBRARY; T=0.K  
neutrons from (s,2np)

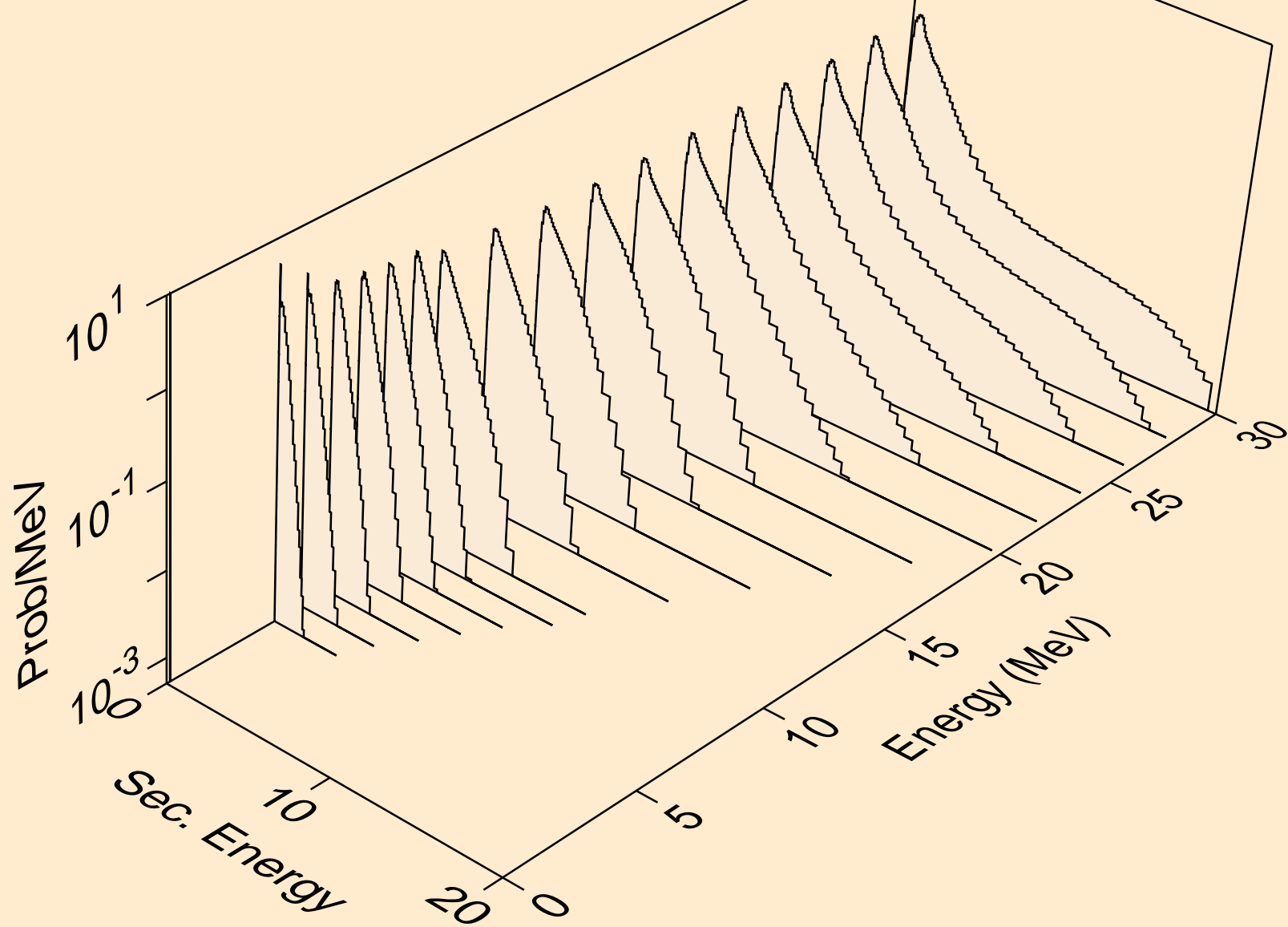

KR093 HELION ACER TENDL-2021 LIBRARY; T=0.K  
neutrons from (s,3np)

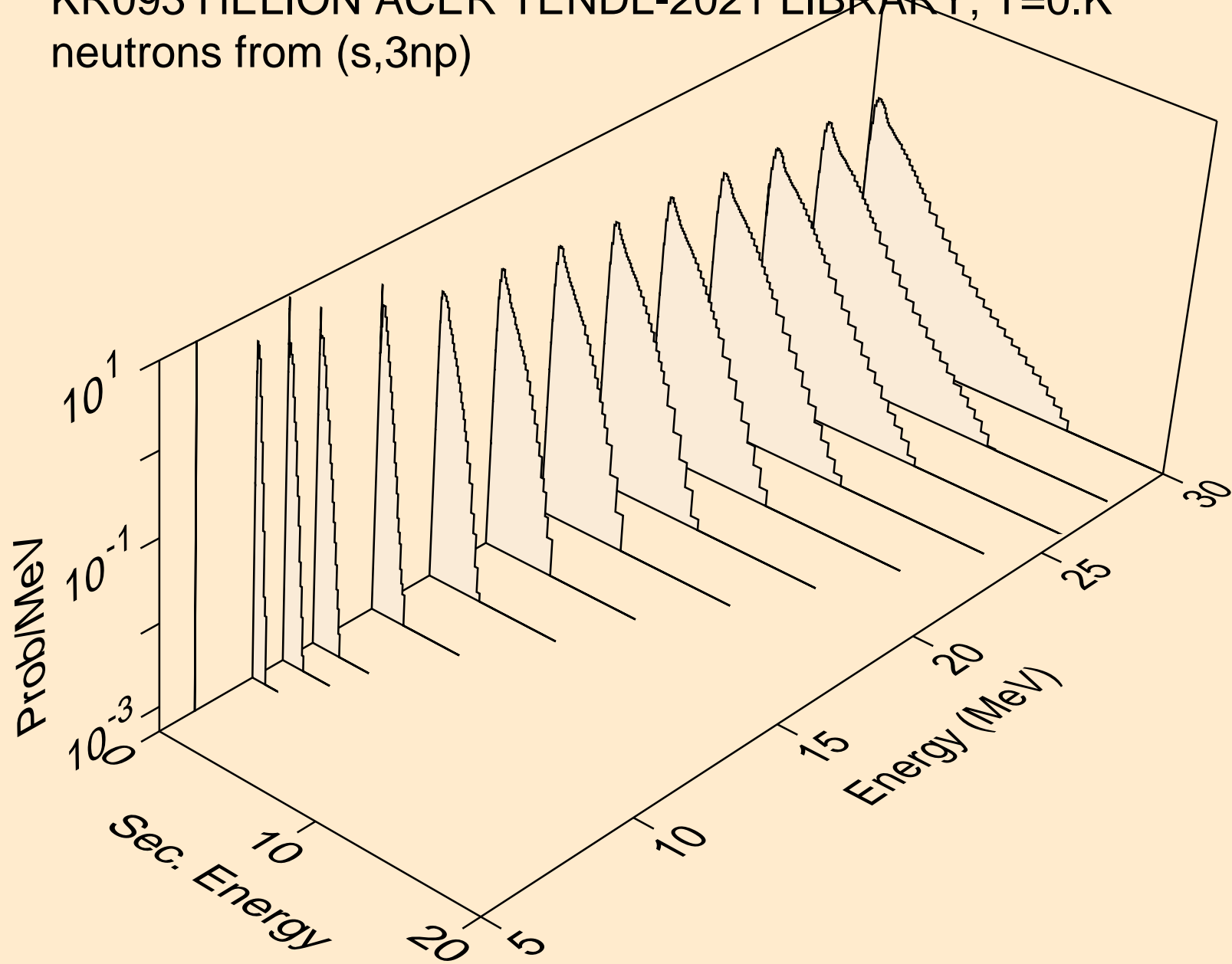

KR093 HELION ACER TENDL-2021 LIBRARY; T=0.K  
neutrons from (s,2np)

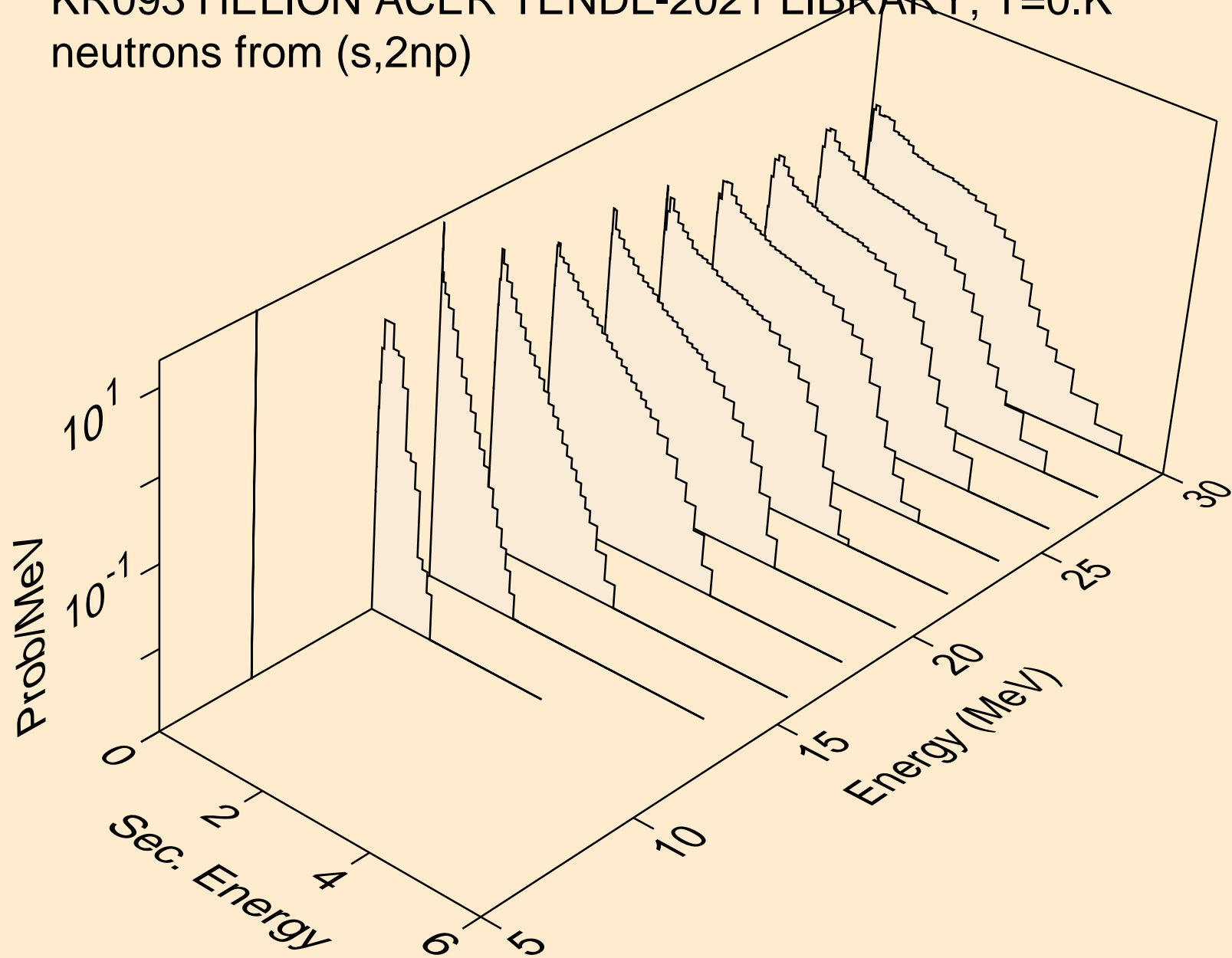

KR093 HELION ACER TENDL-2021 LIBRARY; T=0.K  
neutrons from (s,npa)

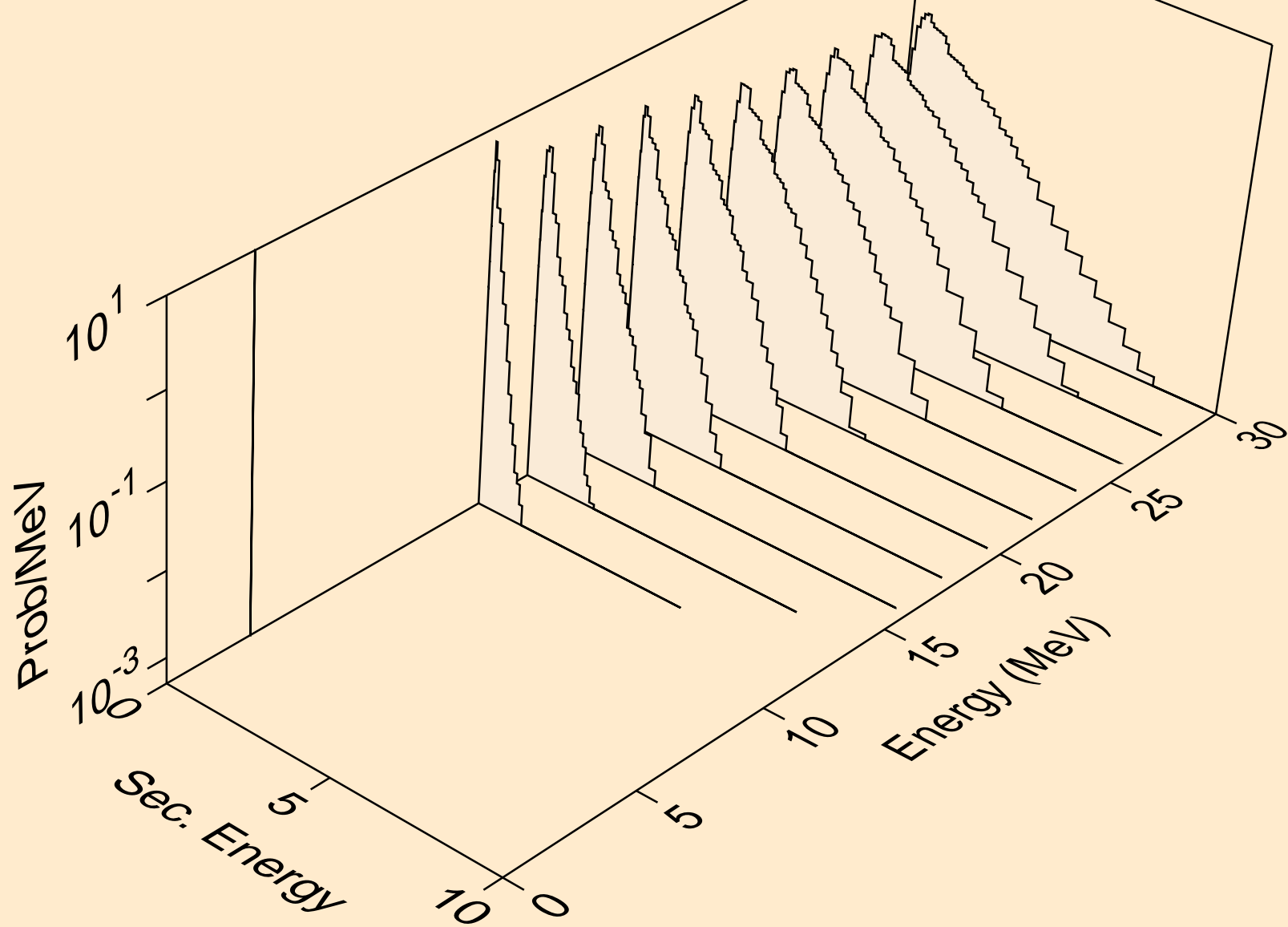

KR093 HELION ACER TENDL-2021 LIBRARY; T=0.K  
protons from (s,x)

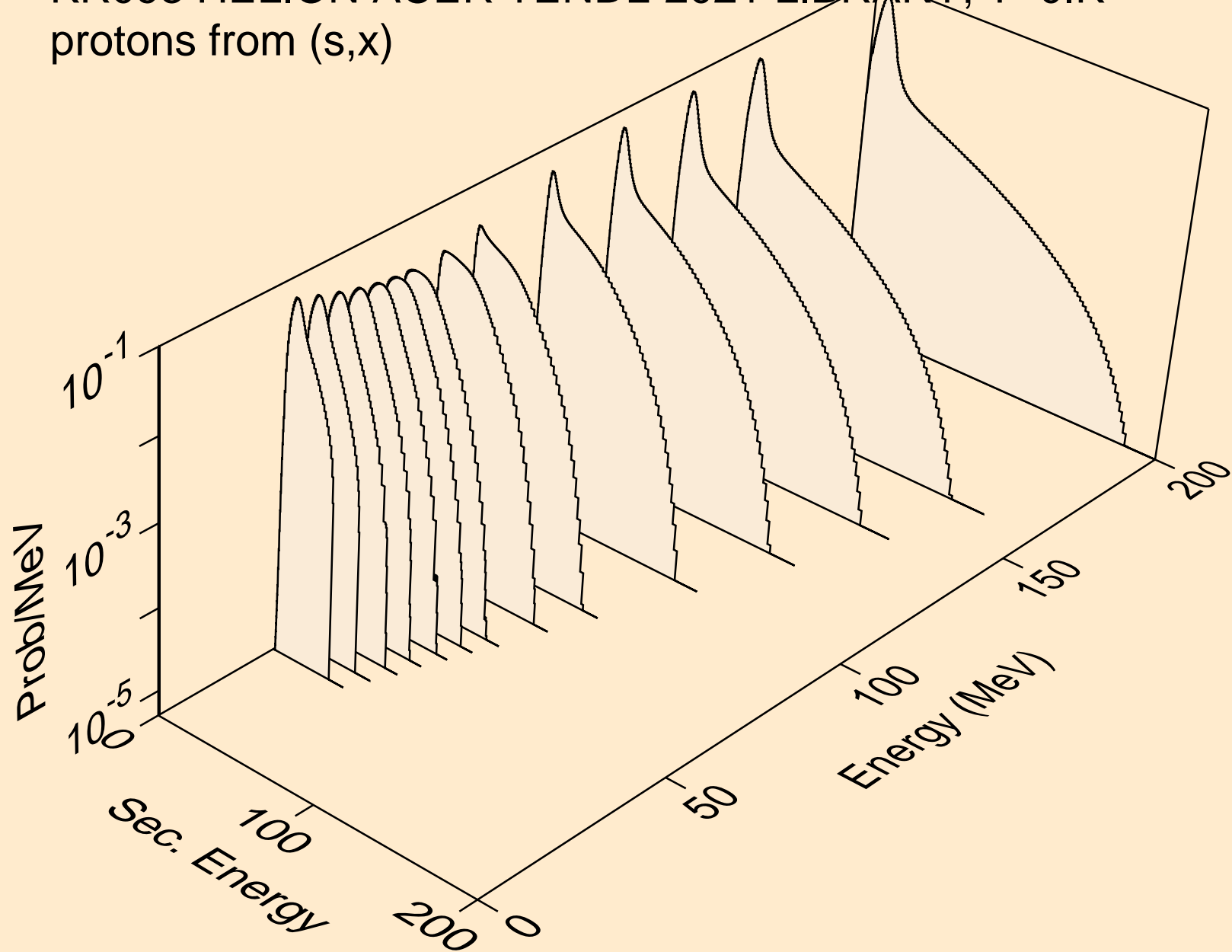

KR093 HELION ACER TENDL-2021 LIBRARY; T=0.K  
protons from (s,n\*)p

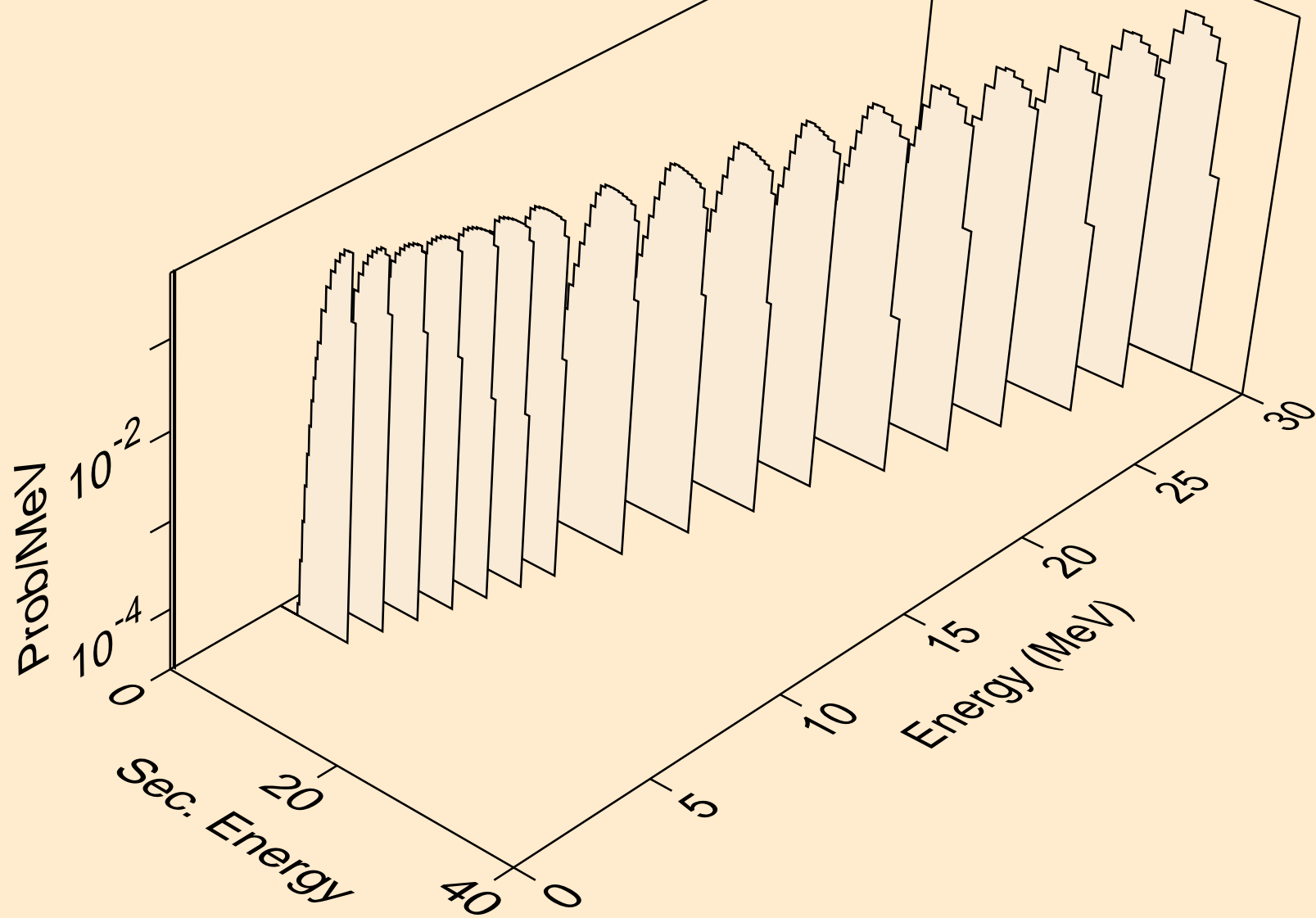

KR093 HELION ACER TENDL-2021 LIBRARY; T=0.K  
protons from (s,2np)

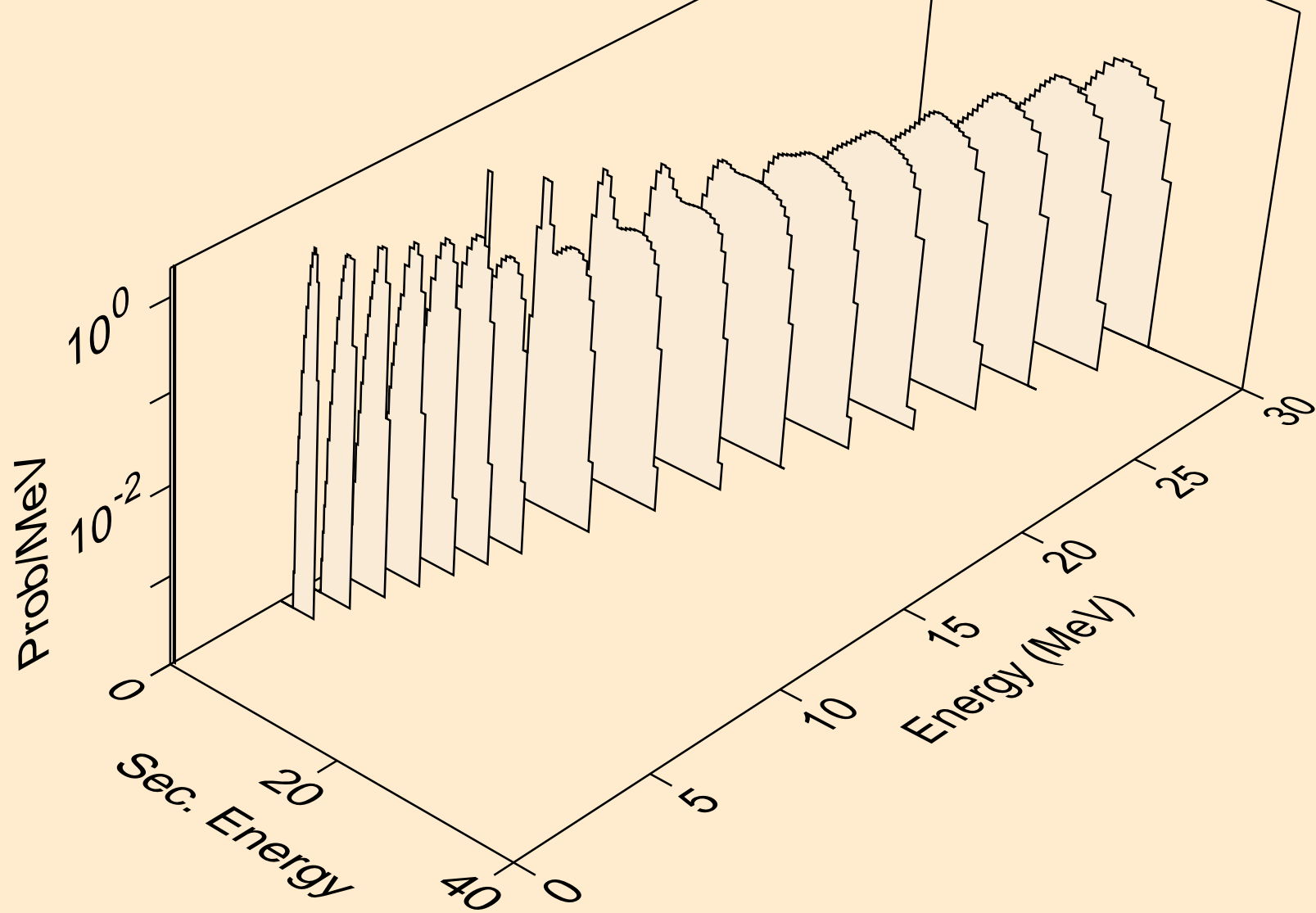

KR093 HELION ACER TENDL-2021 LIBRARY; T=0.K  
protons from (s,3np)

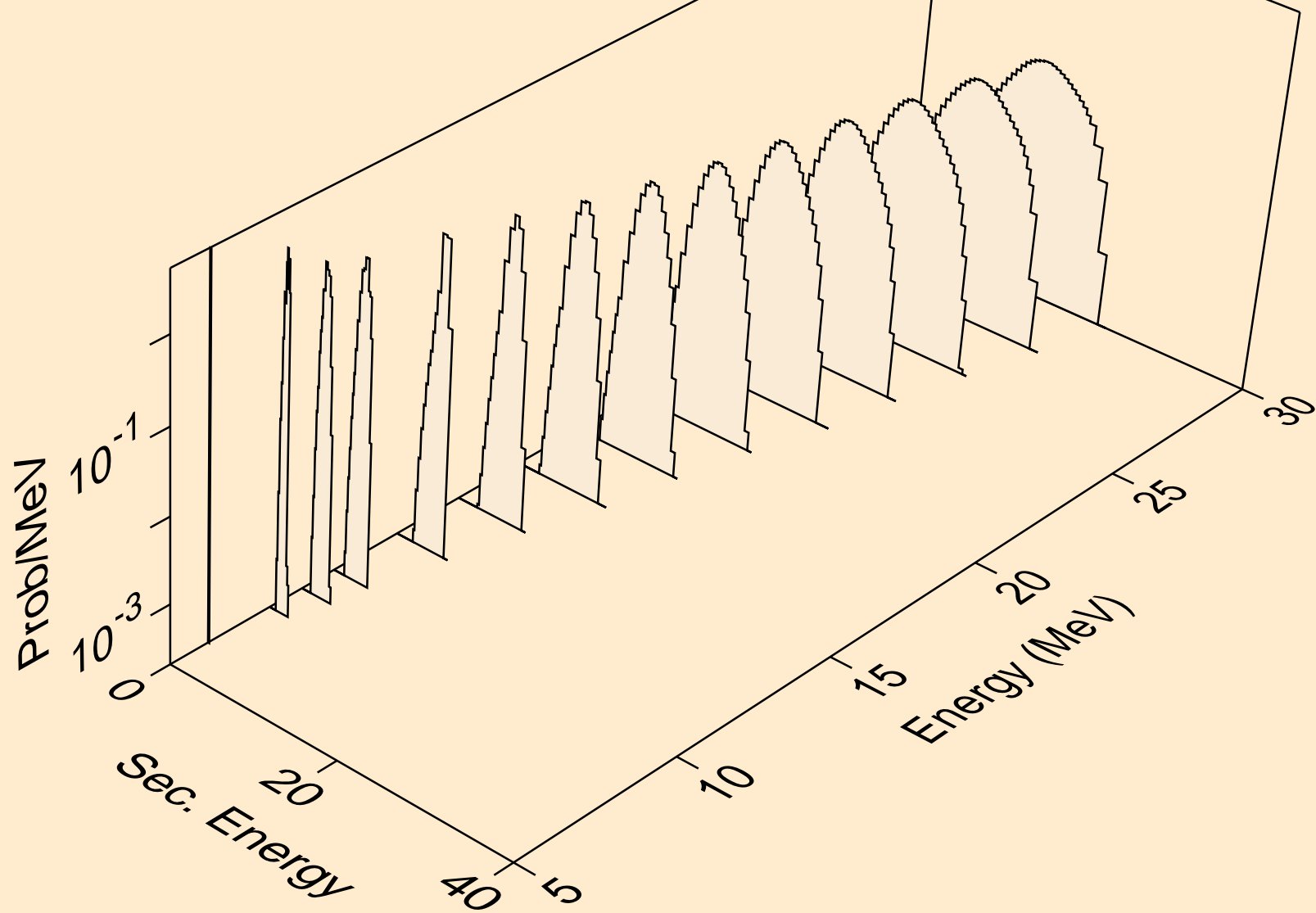



KR093 HELION ACER TENDL-2021 LIBRARY; T=0.K  
protons from (s,2np)

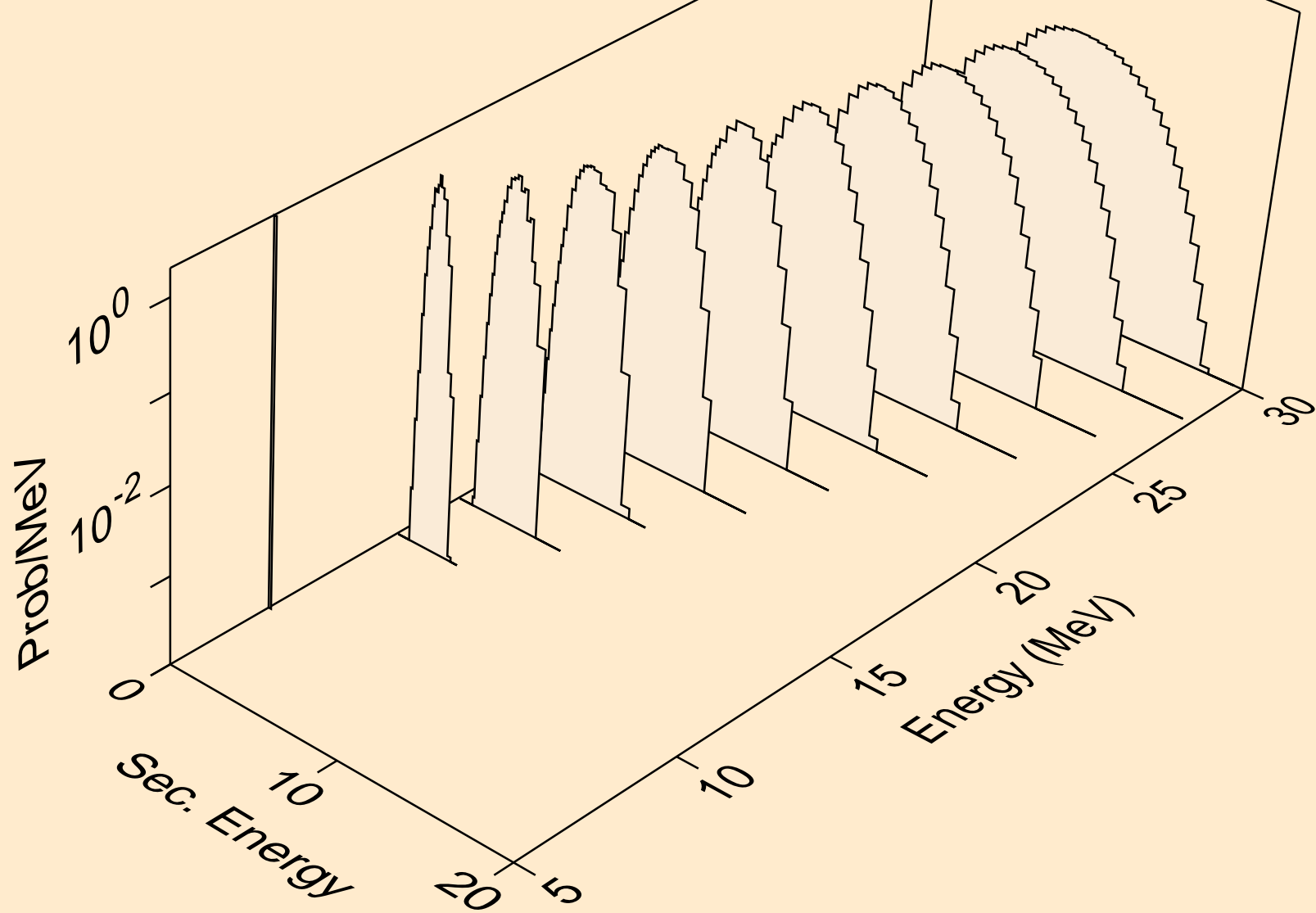

KR093 HELION ACER TENDL-2021 LIBRARY; T=0.K  
protons from (s,npa)

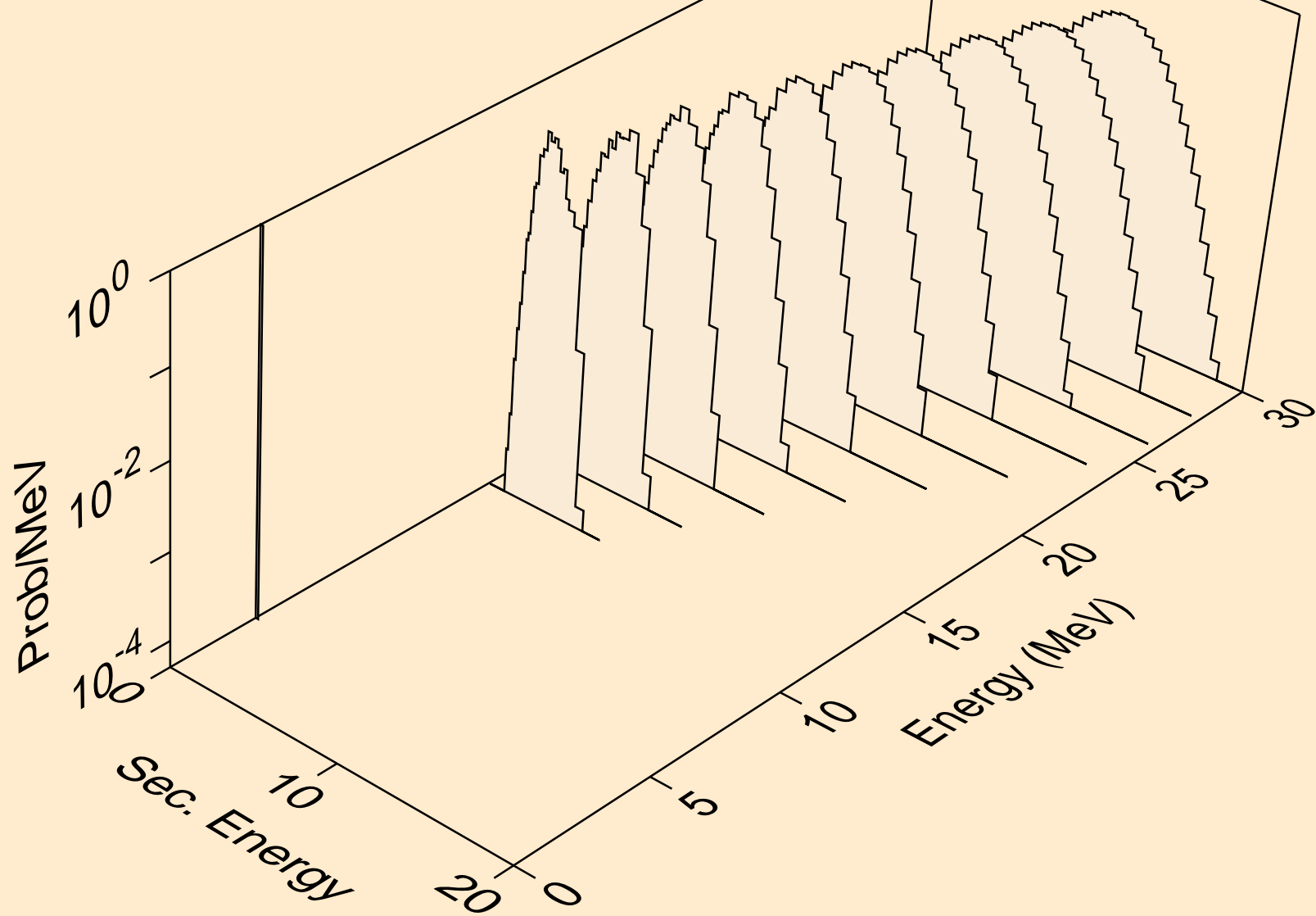

KR093 HELION ACER TENDL-2021 LIBRARY; T=0.K  
protons from (s,p)

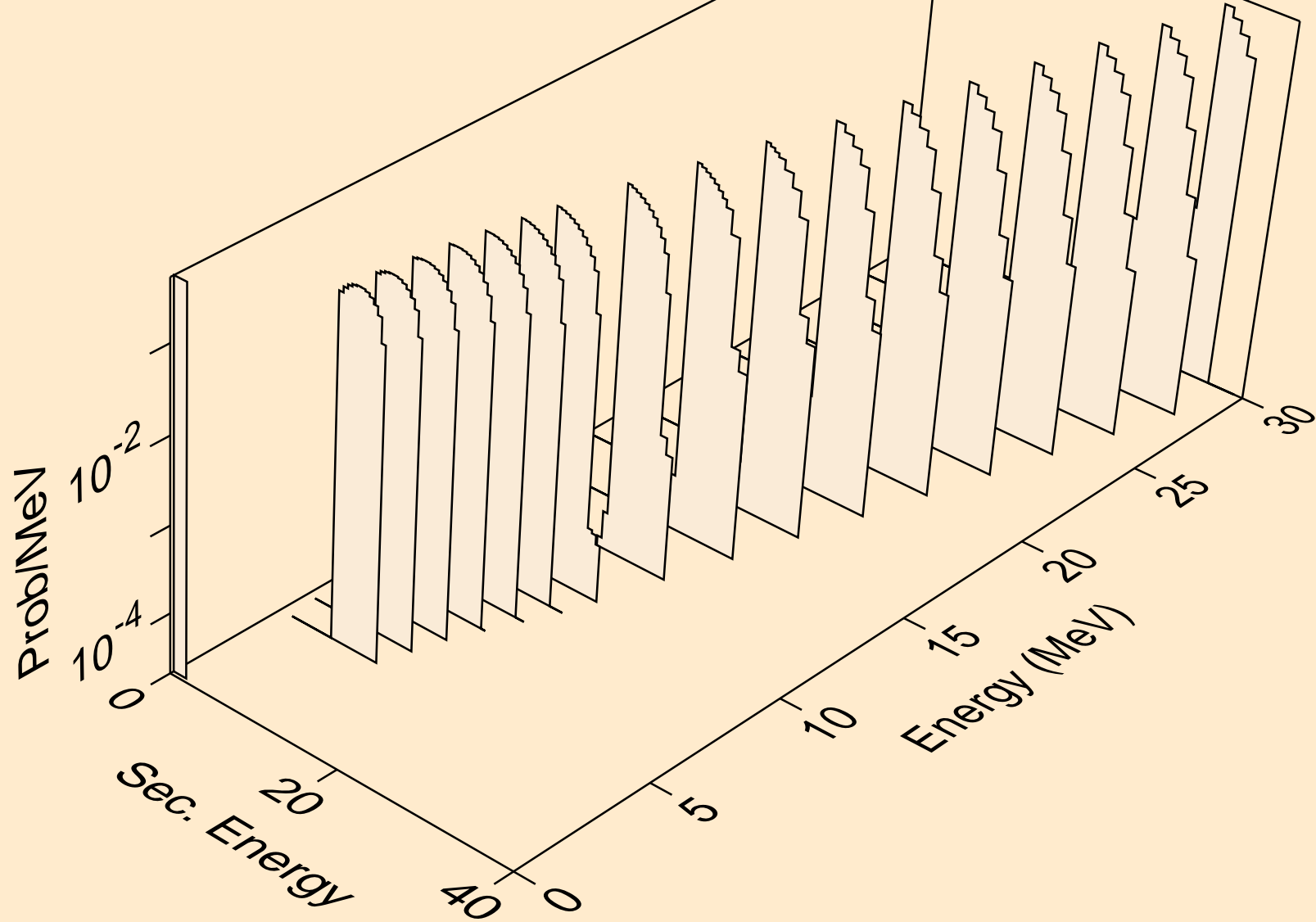

KR093 HELION ACER TENDL-2021 LIBRARY; T=0.K  
protons from (s,2p)

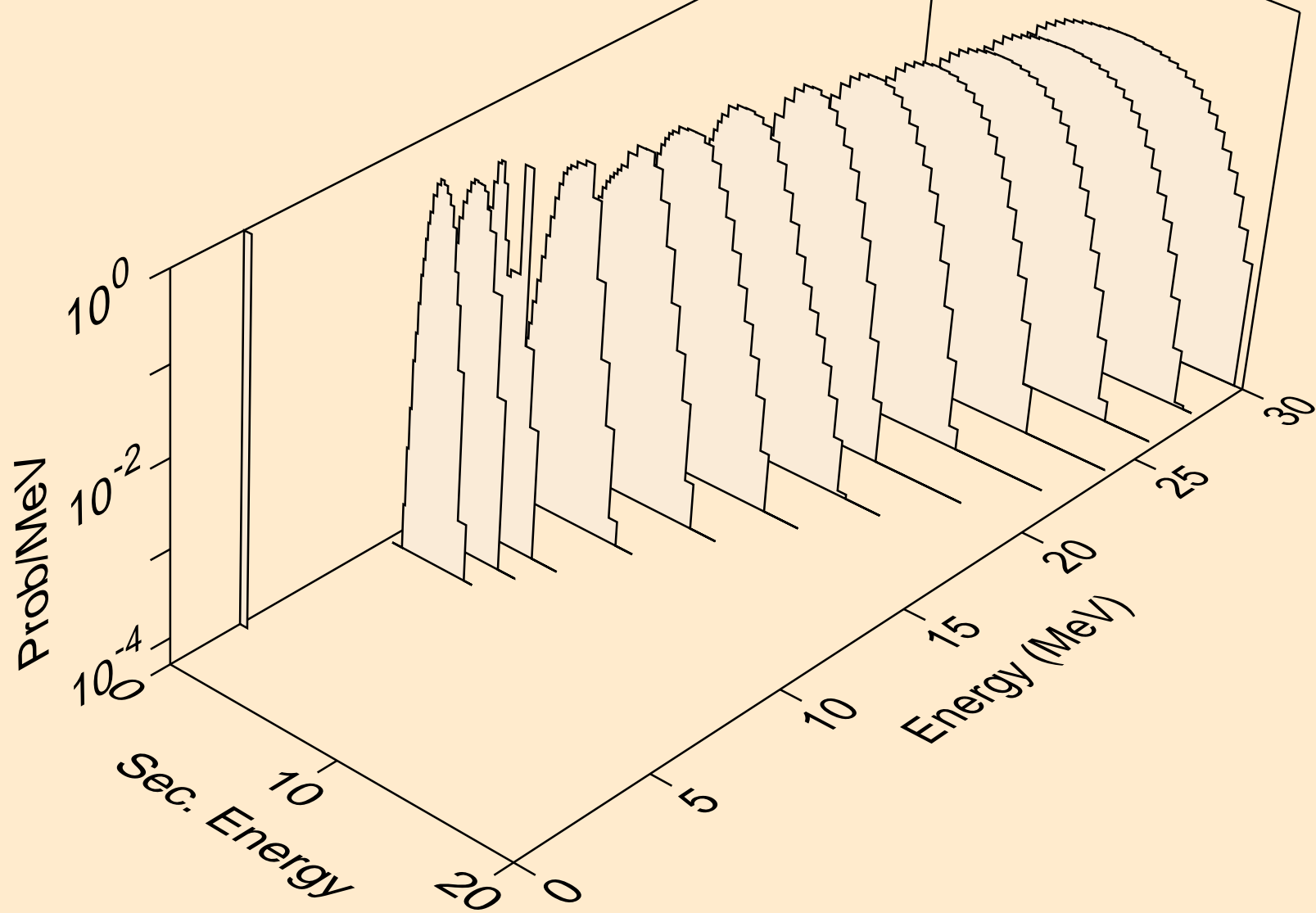

KR093 HELION ACER TENDL-2021 LIBRARY; T=0.K  
protons from (s,pa)

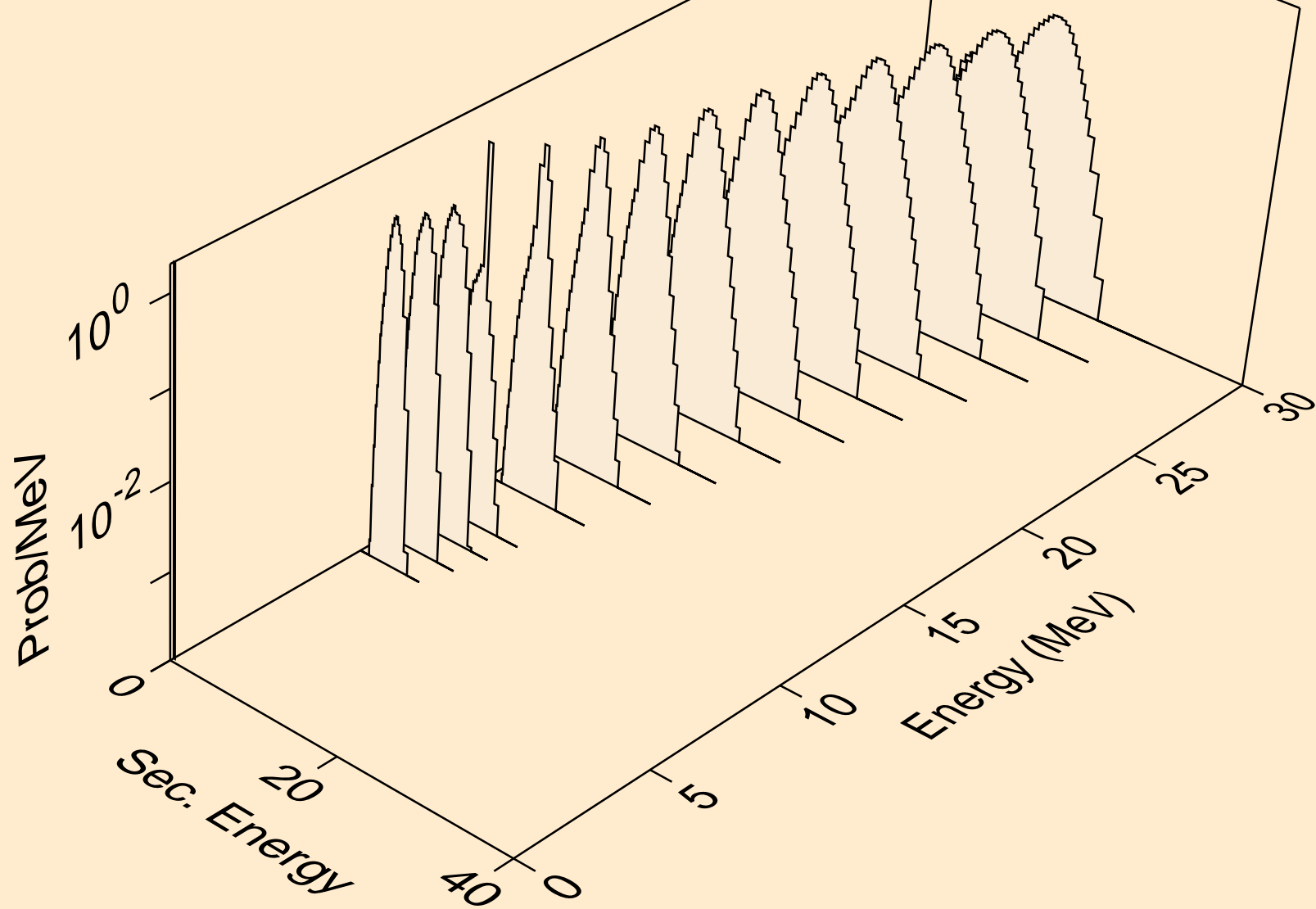

KR093 HELION ACER TENDL-2021 LIBRARY; T=0.K  
protons from (s,pd)

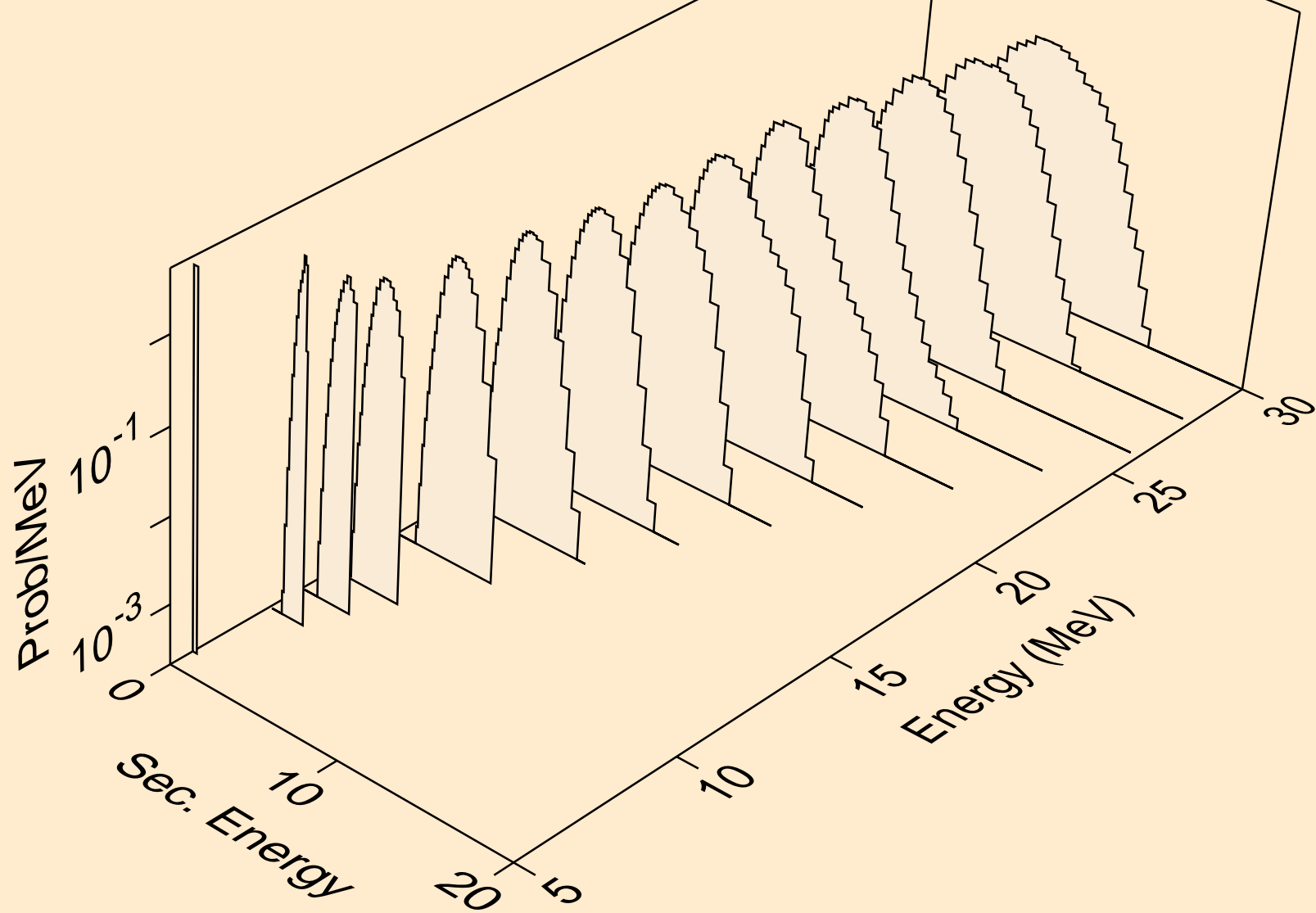

KR093 HELION ACER TENDL-2021 LIBRARY; T=0.K  
protons from (s,pt)

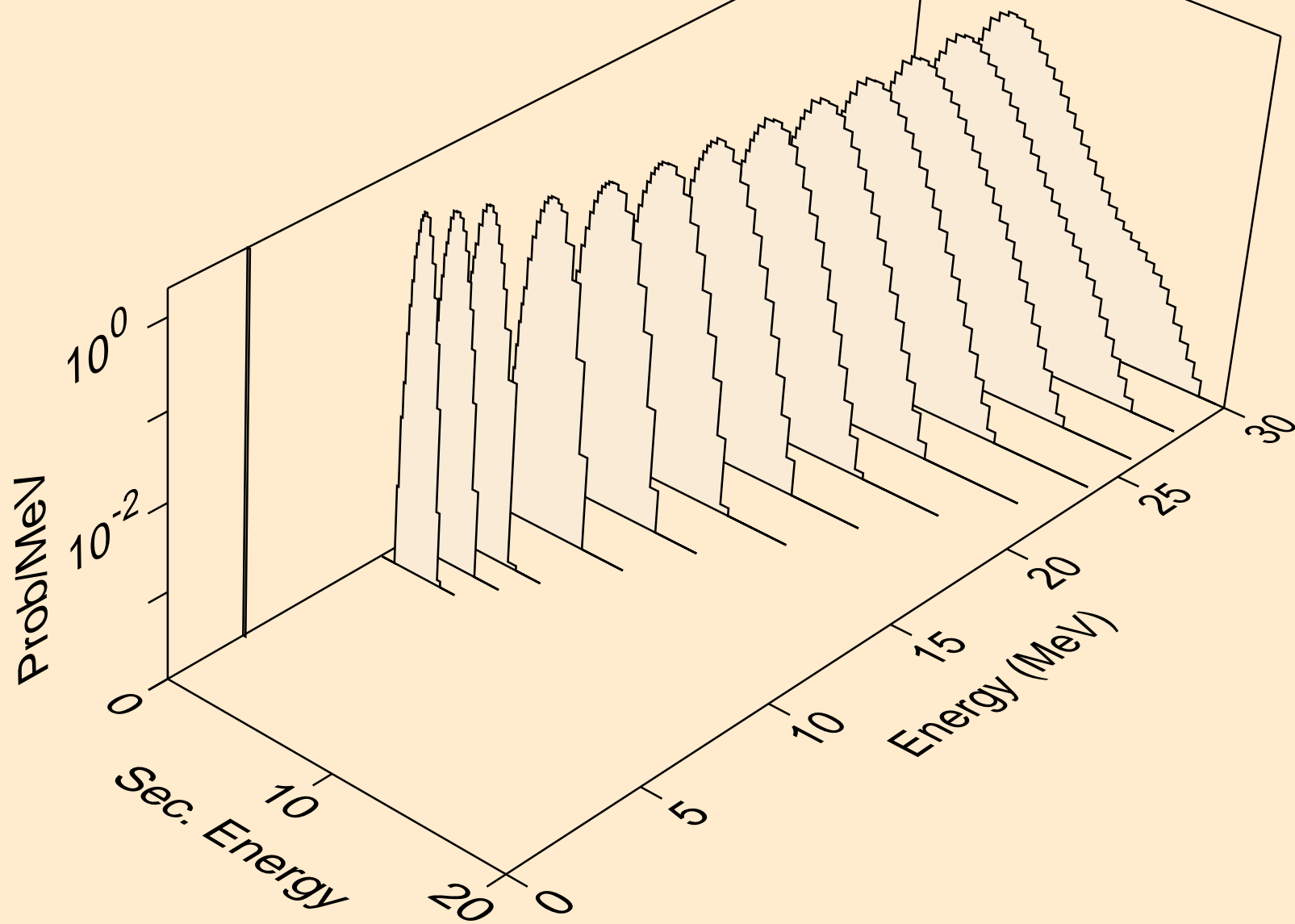

KR093 HELION ACER TENDL-2021 LIBRARY; T=0.K  
deuterons from (s,x)

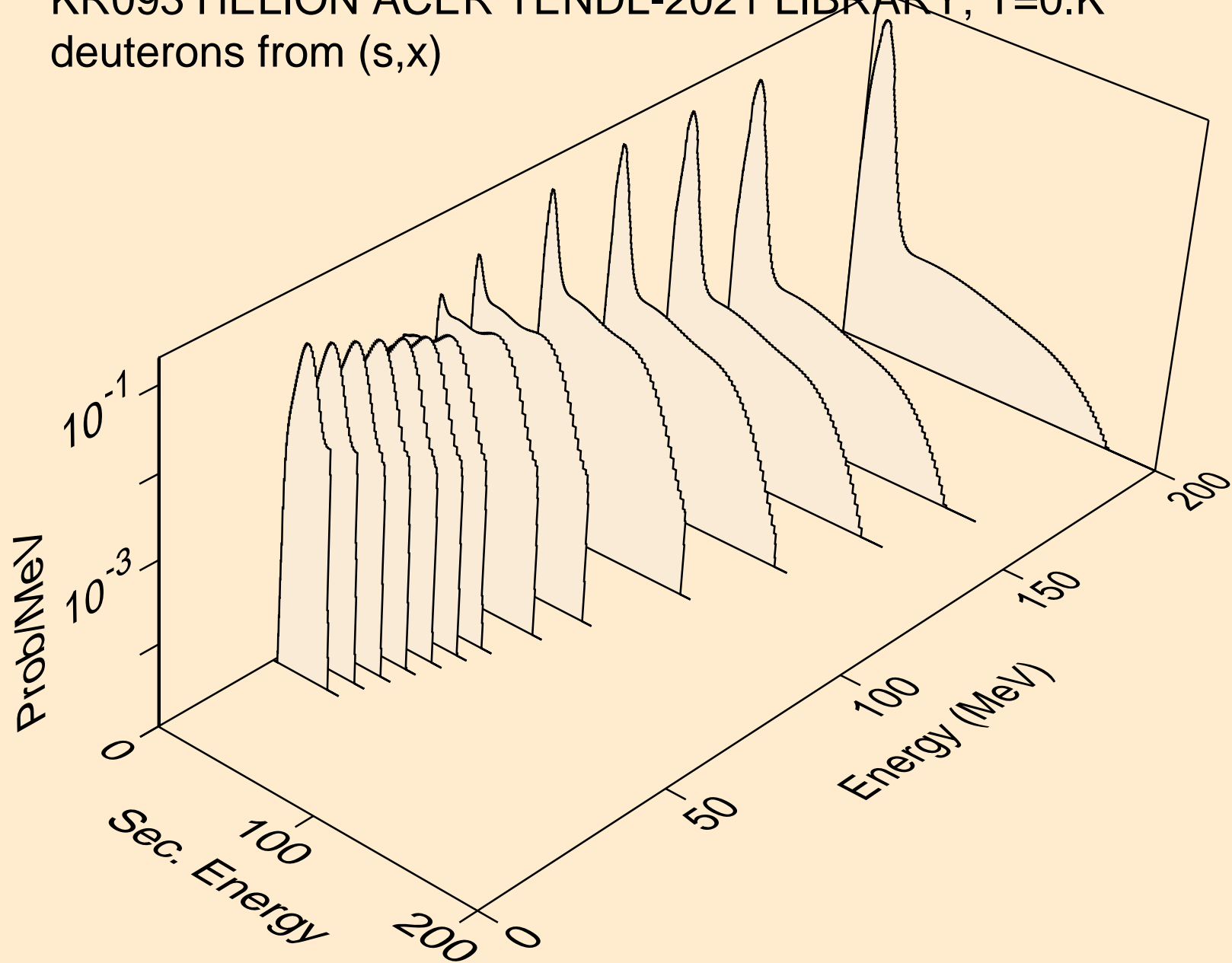



KR093 HELION ACER TENDL-2021 LIBRARY; T=0.K  
deuterons from (s,2nd)

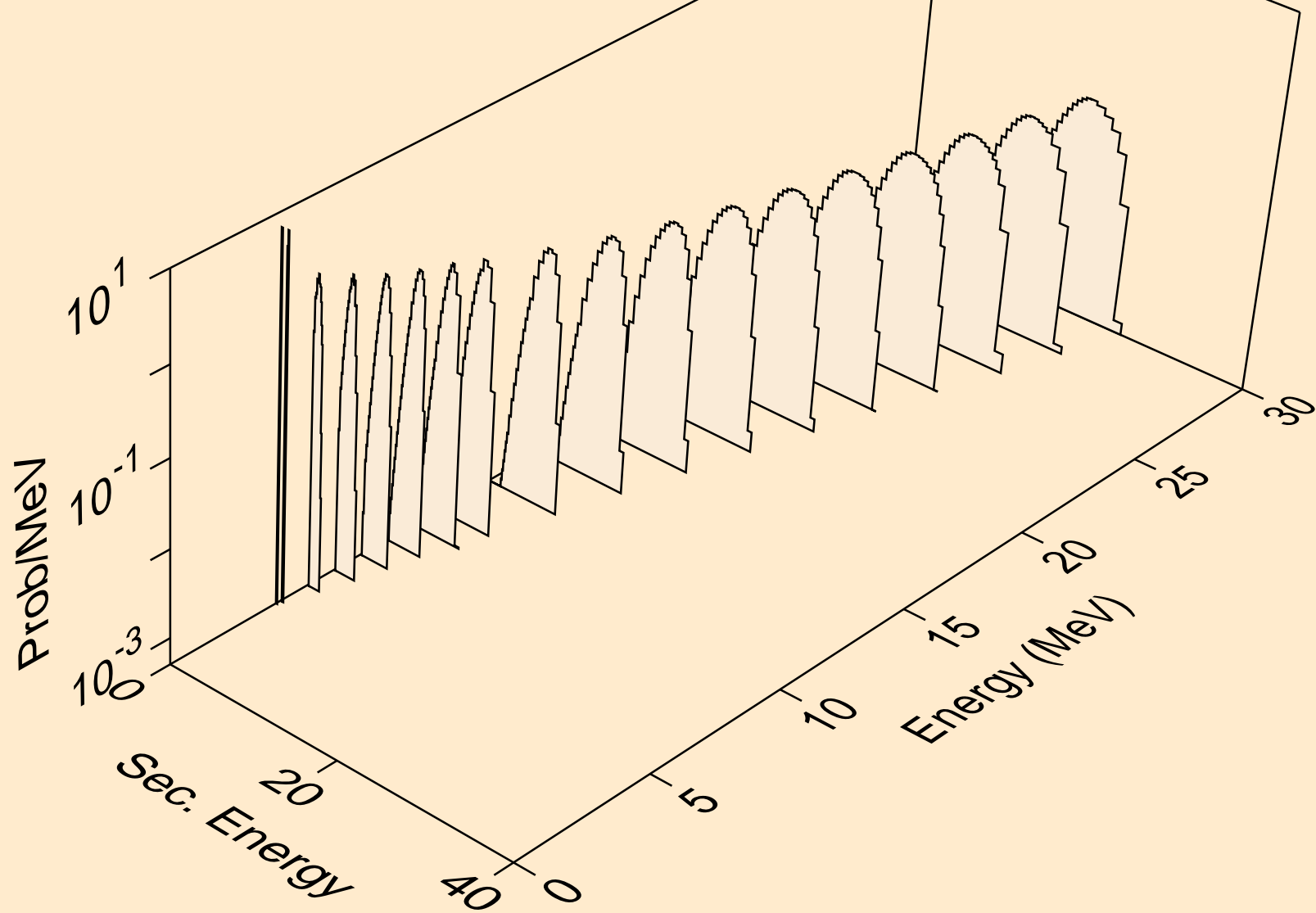

KR093 HELION ACER TENDL-2021 LIBRARY; T=0.K  
deuterons from (s,n\*)d

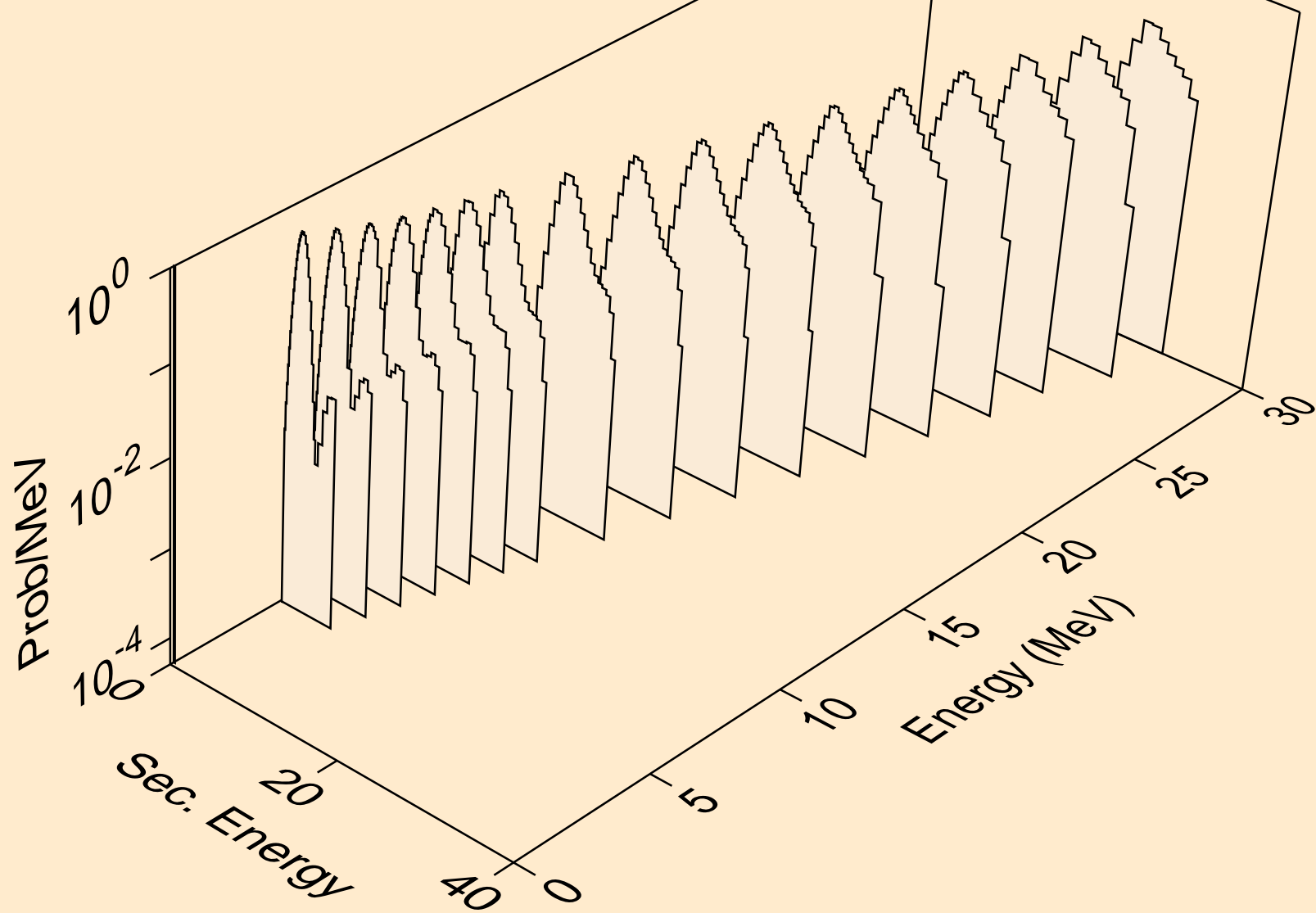

KR093 HELION ACER TENDL-2021 LIBRARY; T=0.K  
deuterons from (s,d)

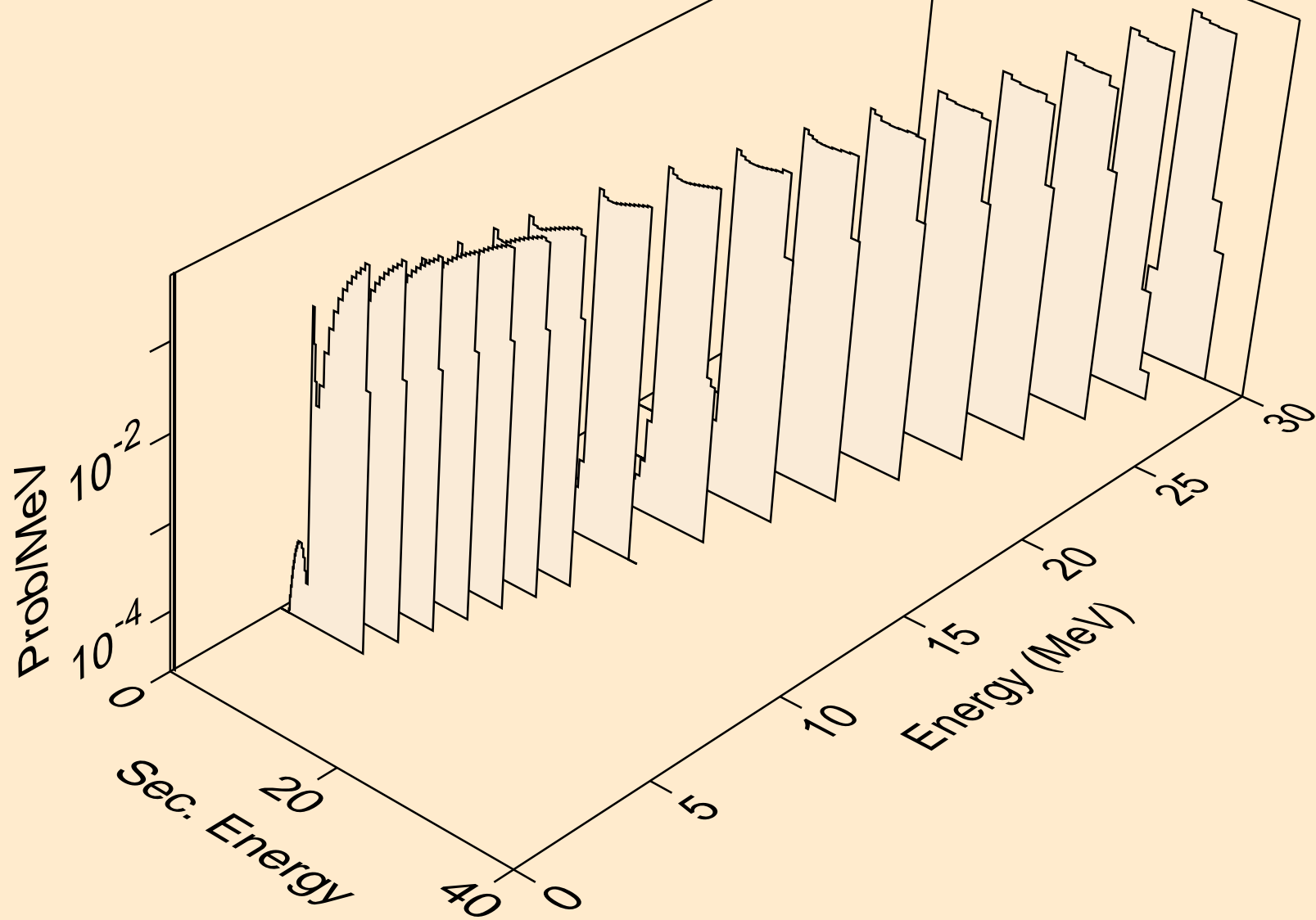

KR093 HELION ACER TENDL-2021 LIBRARY; T=0.K  
deuterons from (s,pd)

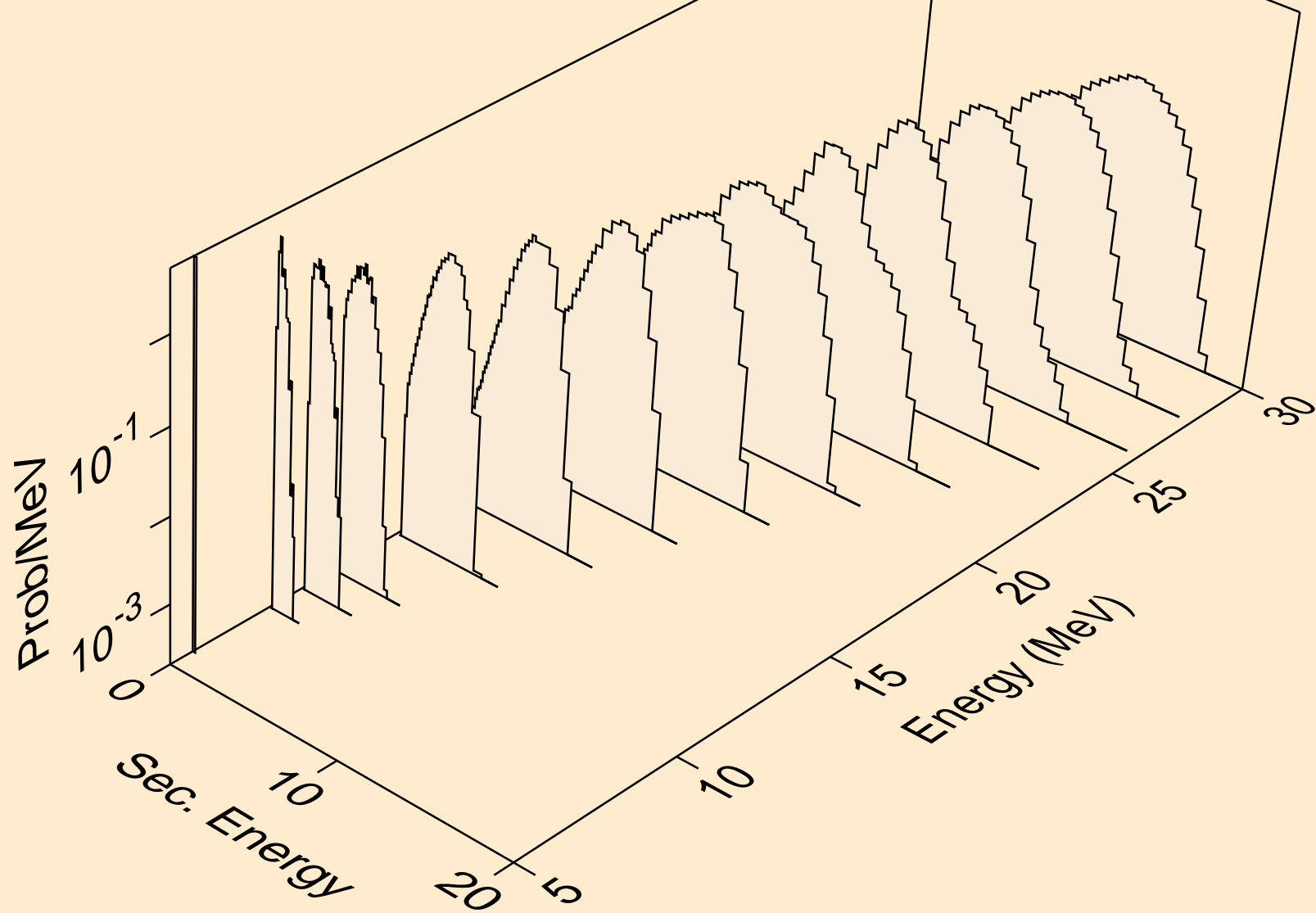

KR093 HELION ACER TENDL-2021 LIBRARY; T=0.K  
deuterons from (s,da)

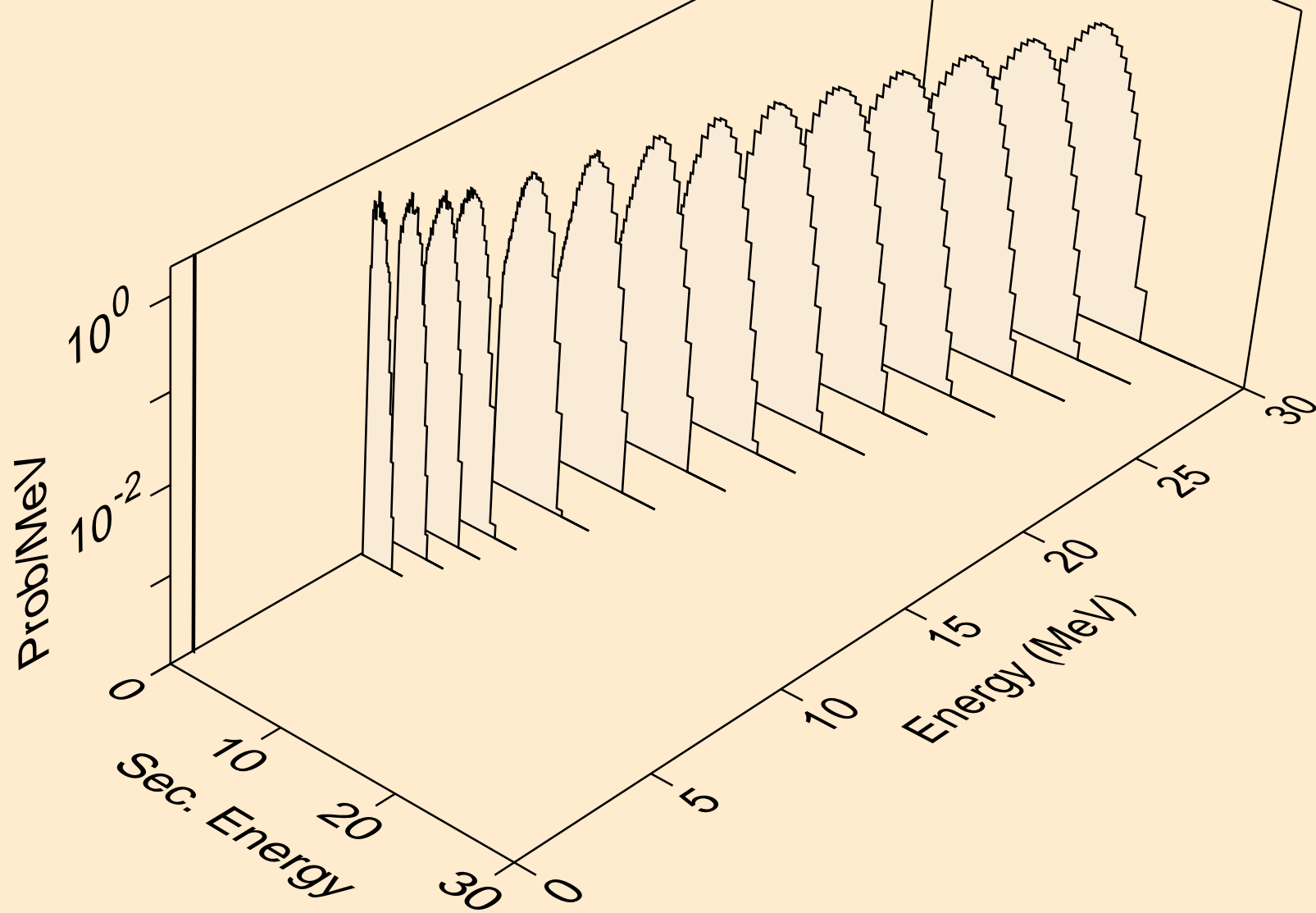

KR093 HELION ACER TENDL-2021 LIBRARY; T=0.K  
tritons from (s,x)

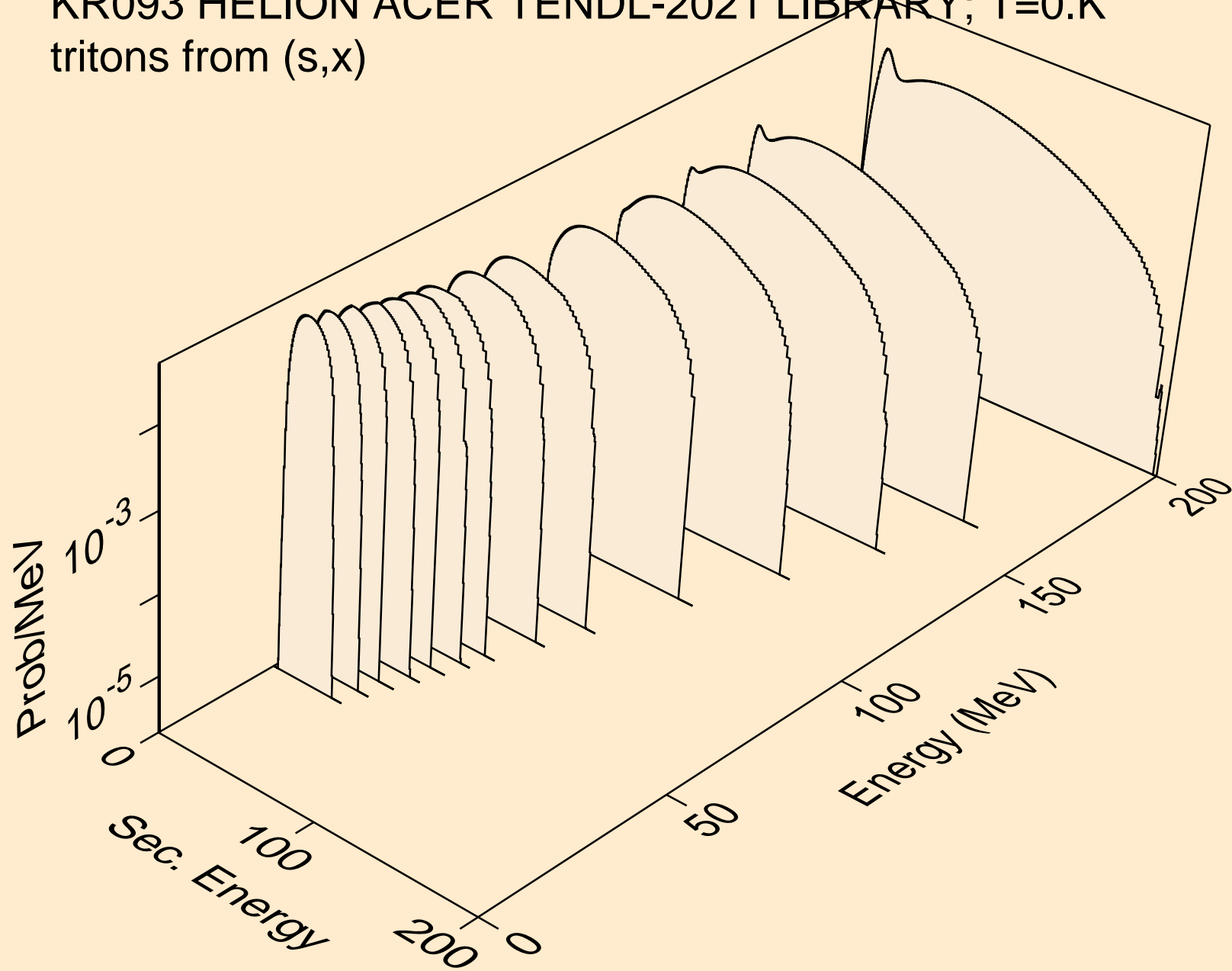

KR093 HELION ACER TENDL-2021 LIBRARY; T=0.K  
tritons from (s,n\*)t

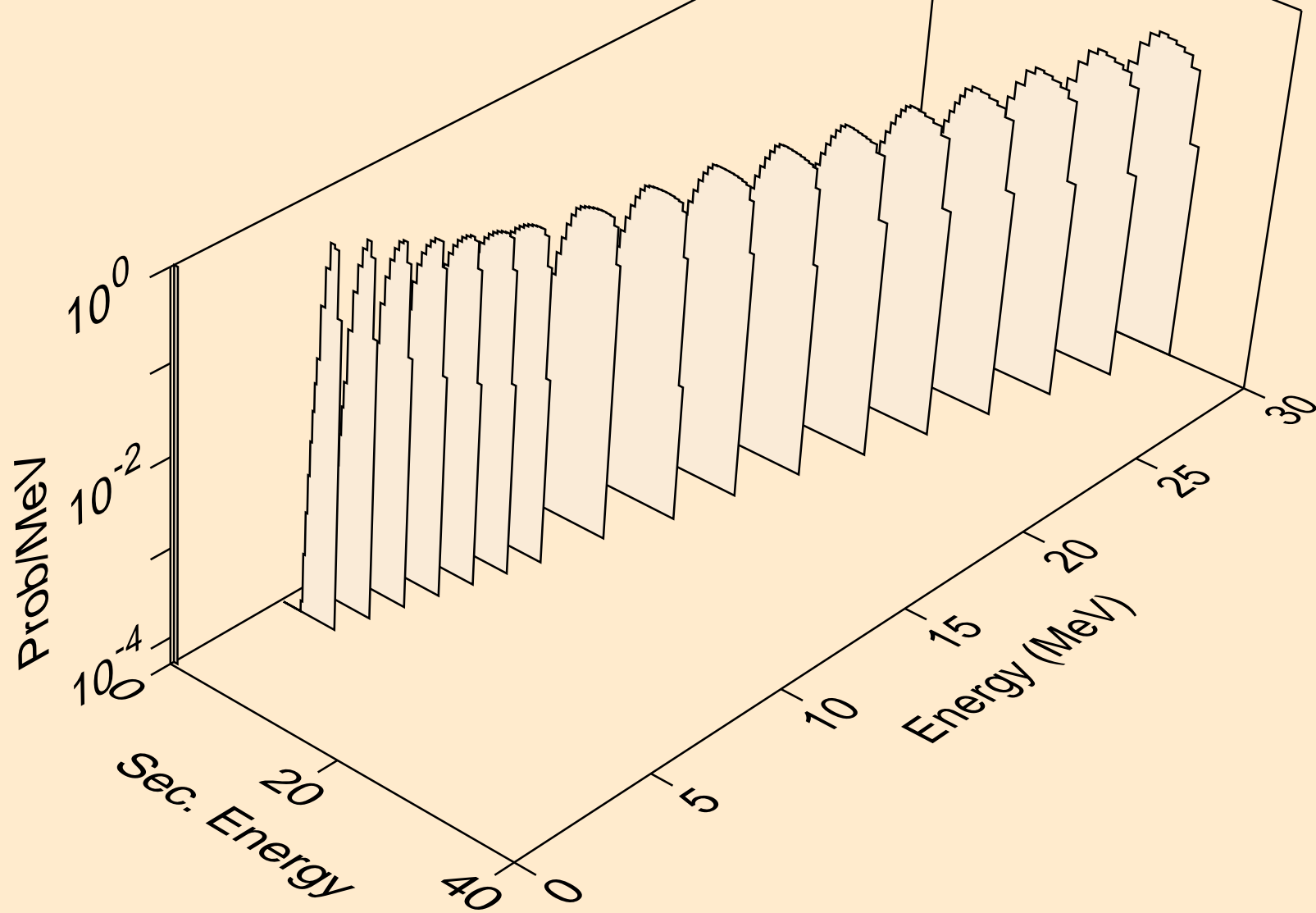

KR093 HELION ACER TENDL-2021 LIBRARY; T=0.K  
tritons from (s,t)

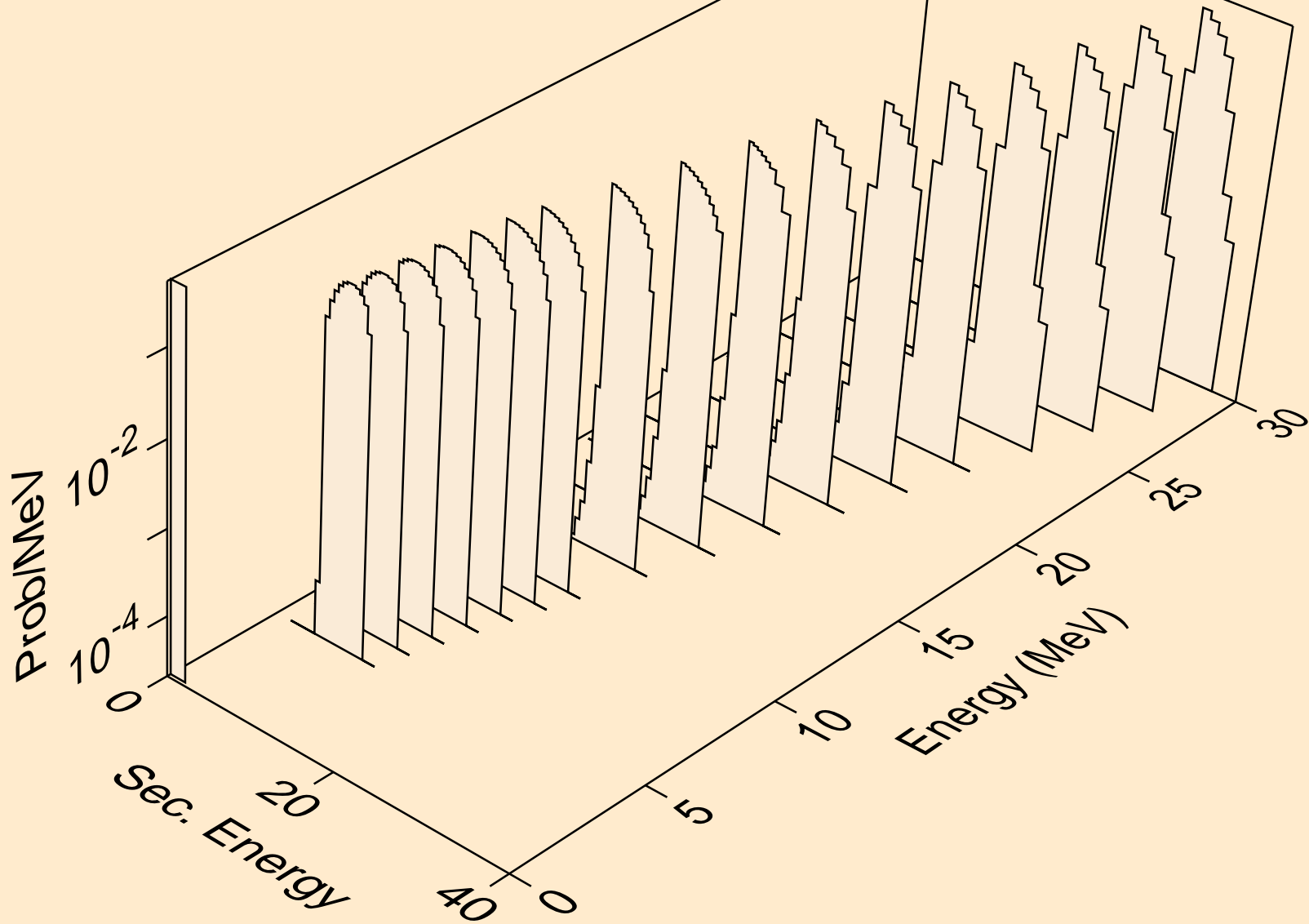



KR093 HELION ACER TENDL-2021 LIBRARY; T=0.K  
tritons from (s,pt)

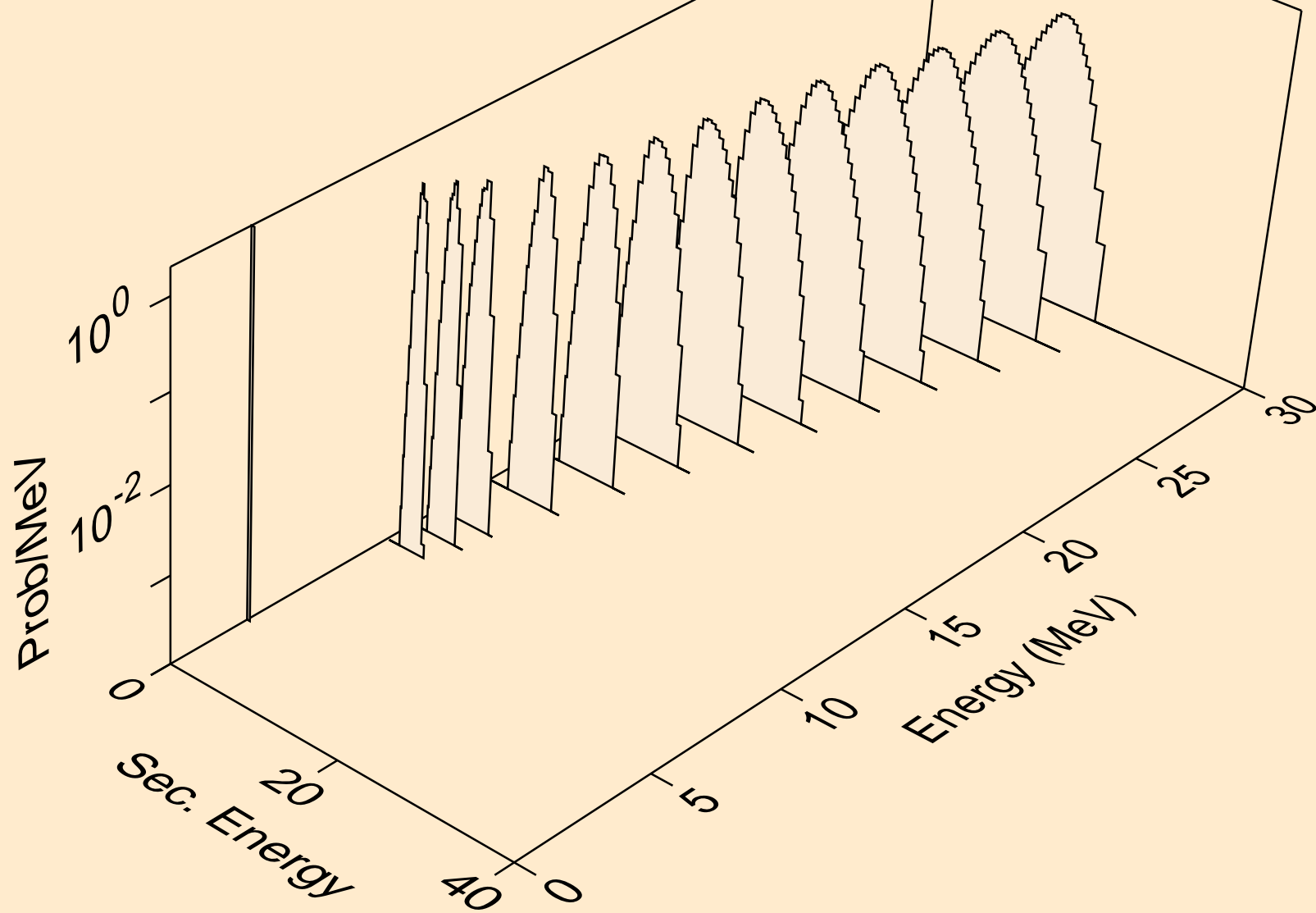

KR093 HELION ACER TENDL-2021 LIBRARY; T=0.K  
alphas from (s,x)

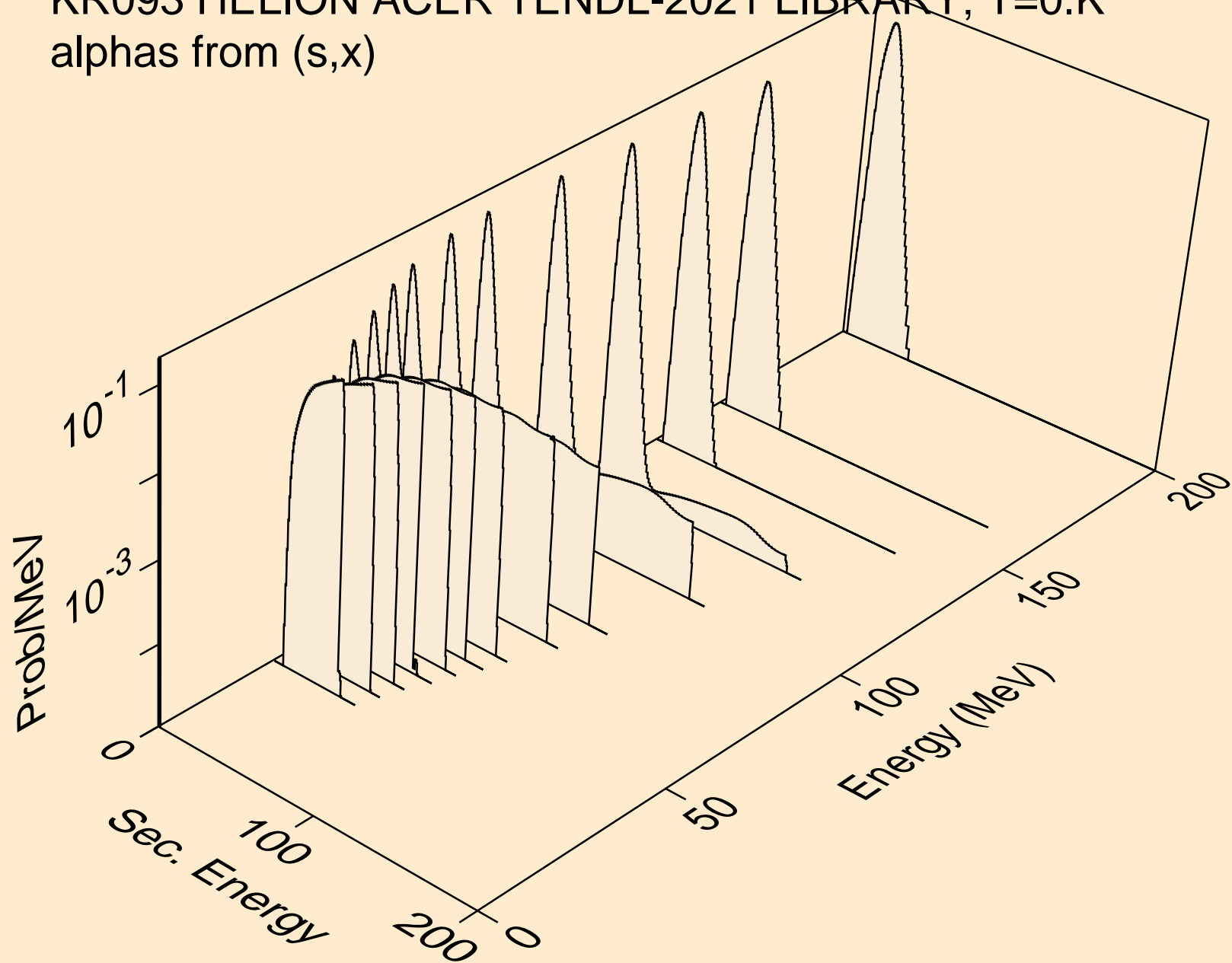

KR093 HELION ACER TENDL-2021 LIBRARY; T=0.K  
alphas from (s,n\*)a

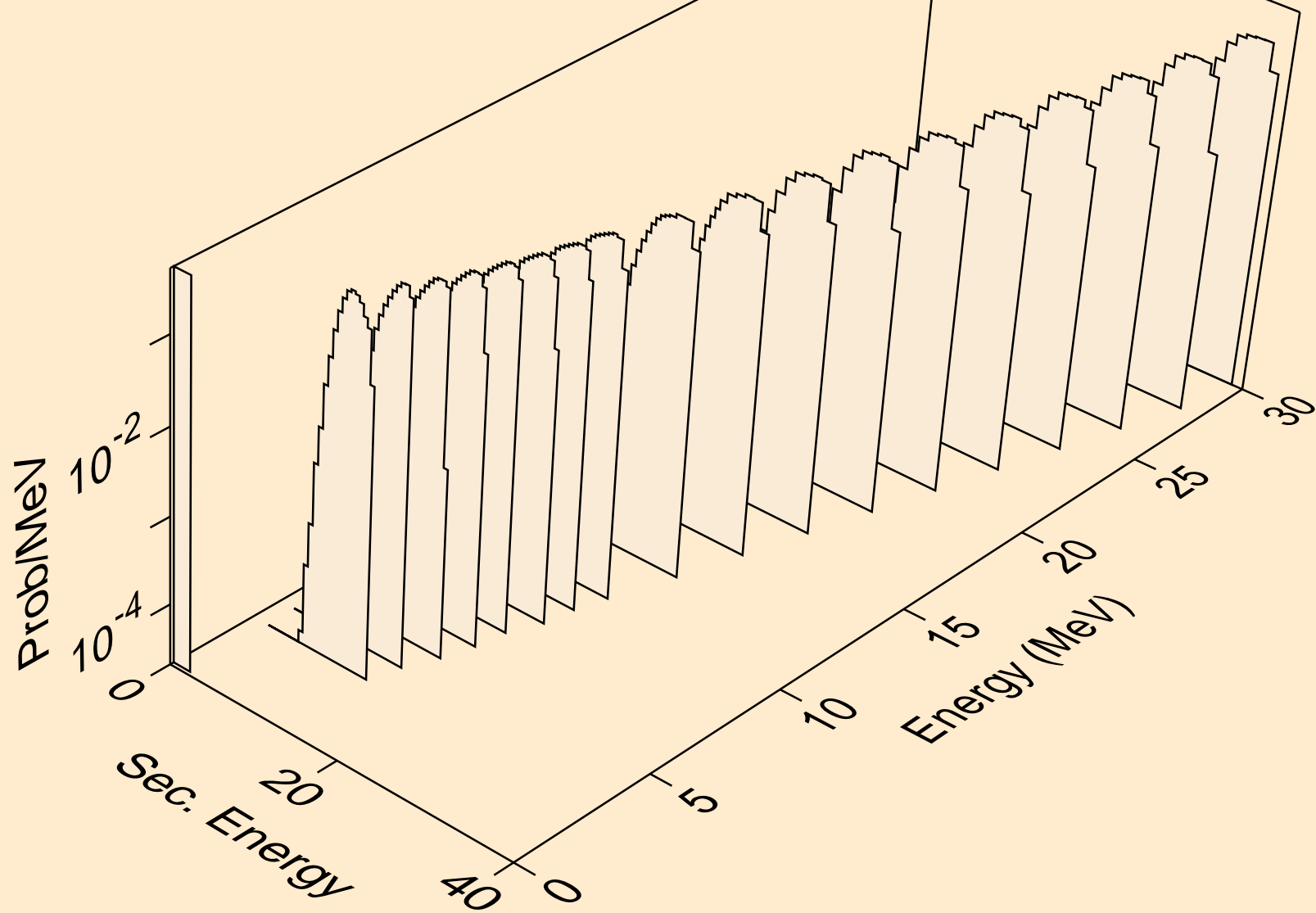

KR093 HELION ACER TENDL-2021 LIBRARY; T=0.K  
alphas from (s,2n)a

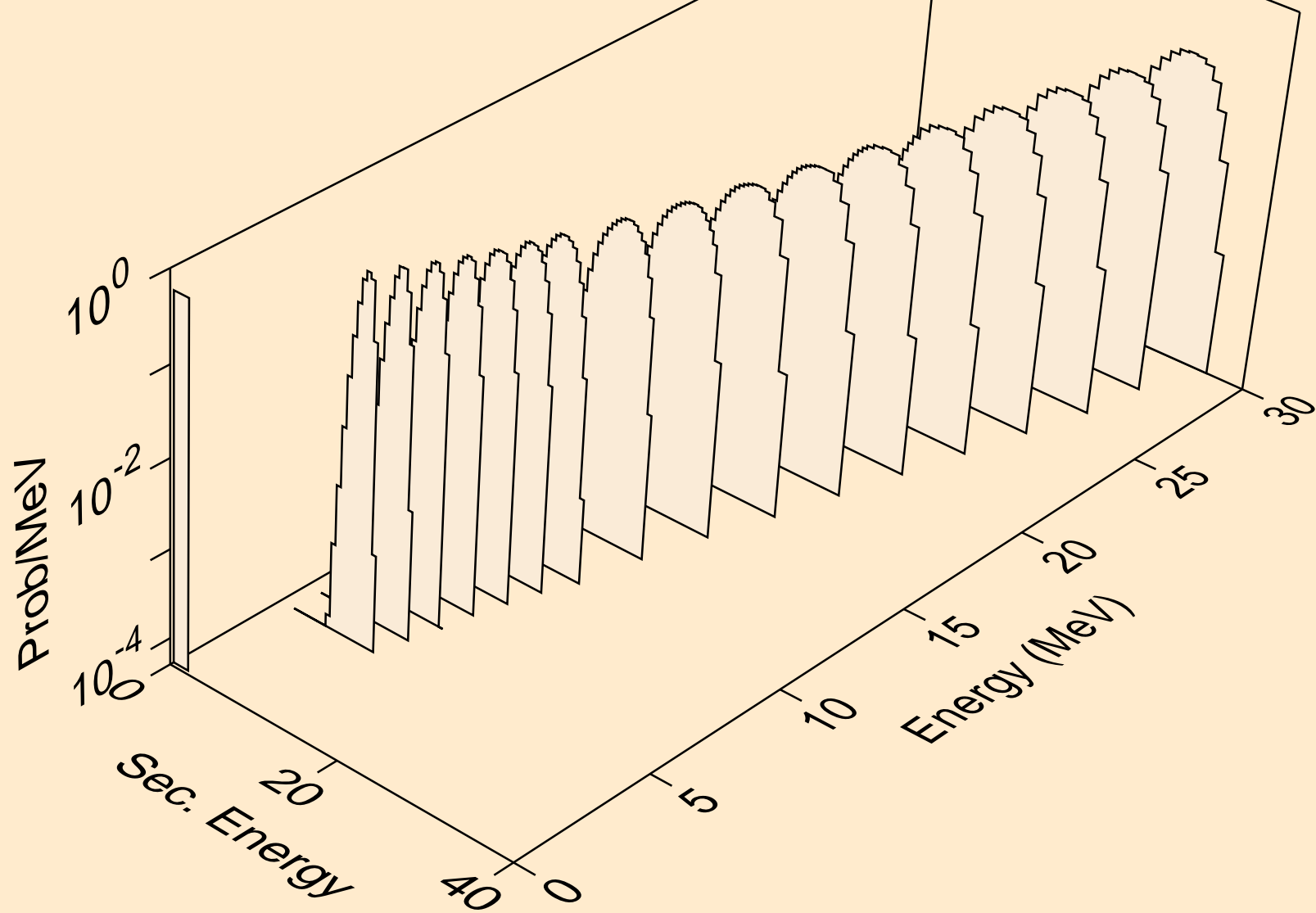

KR093 HELION ACER TENDL-2021 LIBRARY; T=0.K  
alphas from (s,3n)a

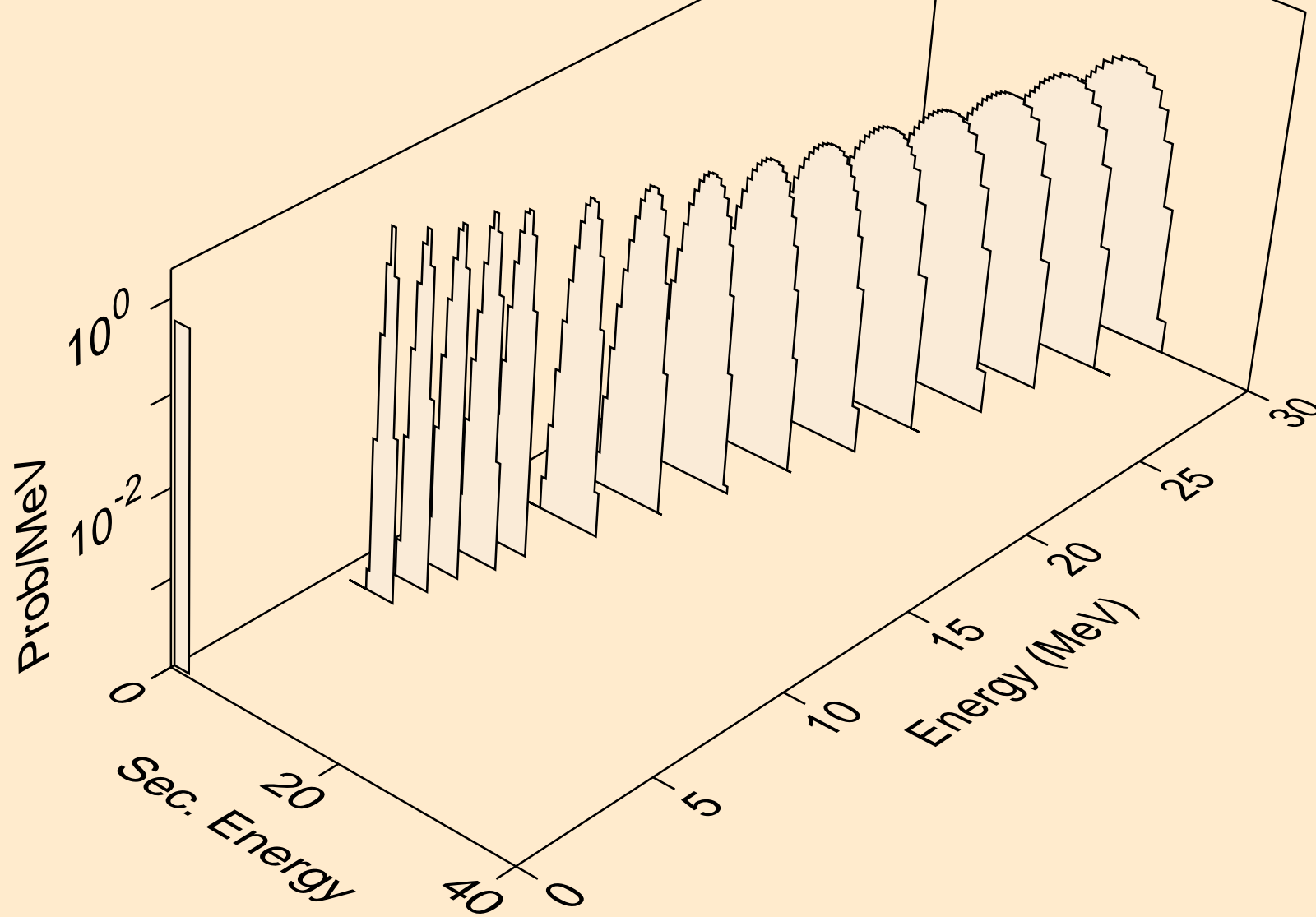

KR093 HELION ACER TENDL-2021 LIBRARY; T=0.K  
alphas from (s,n\*)2a

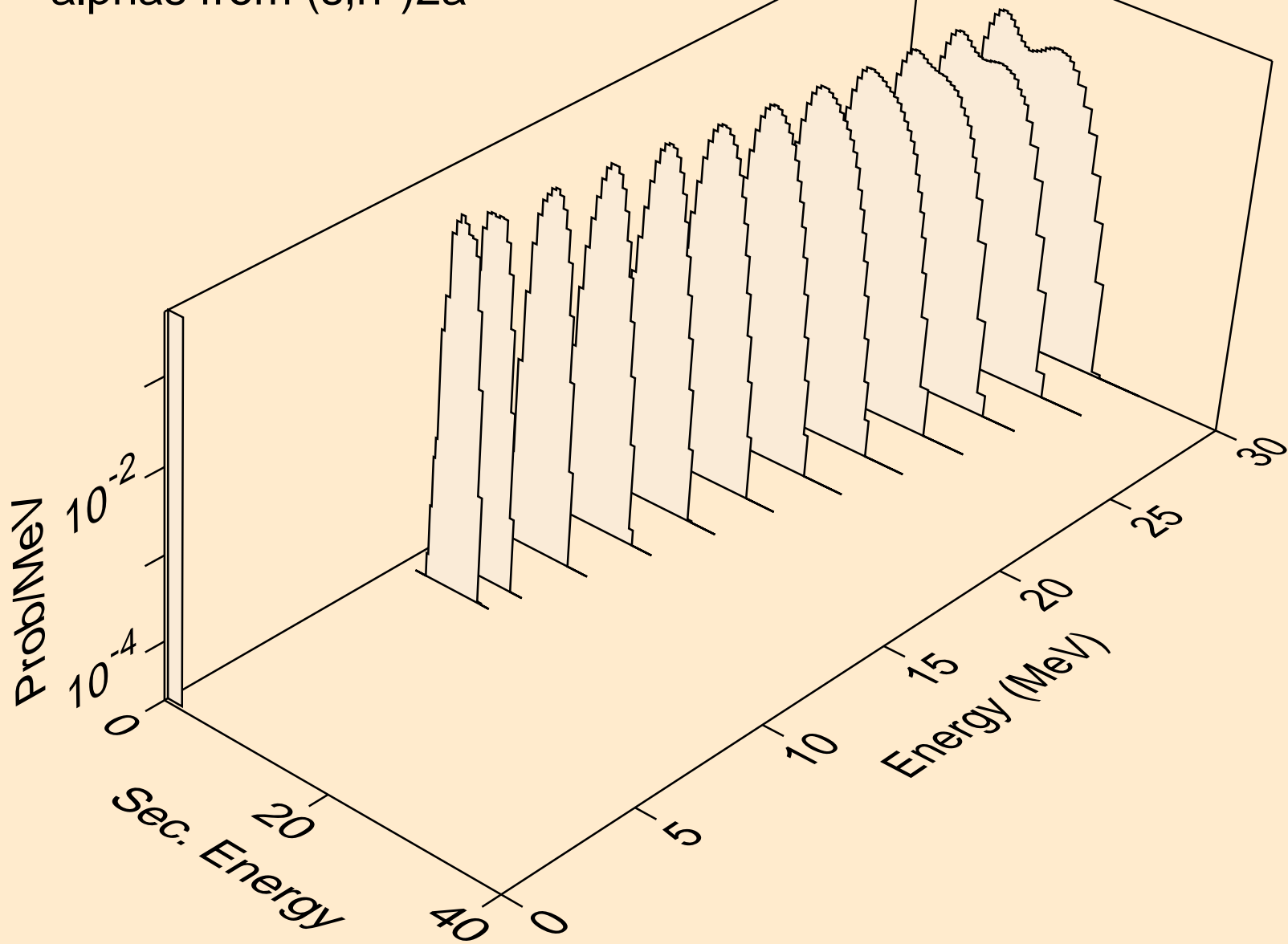

KR093 HELION ACER TENDL-2021 LIBRARY; T=0.K  
alphas from (s,2n)2a

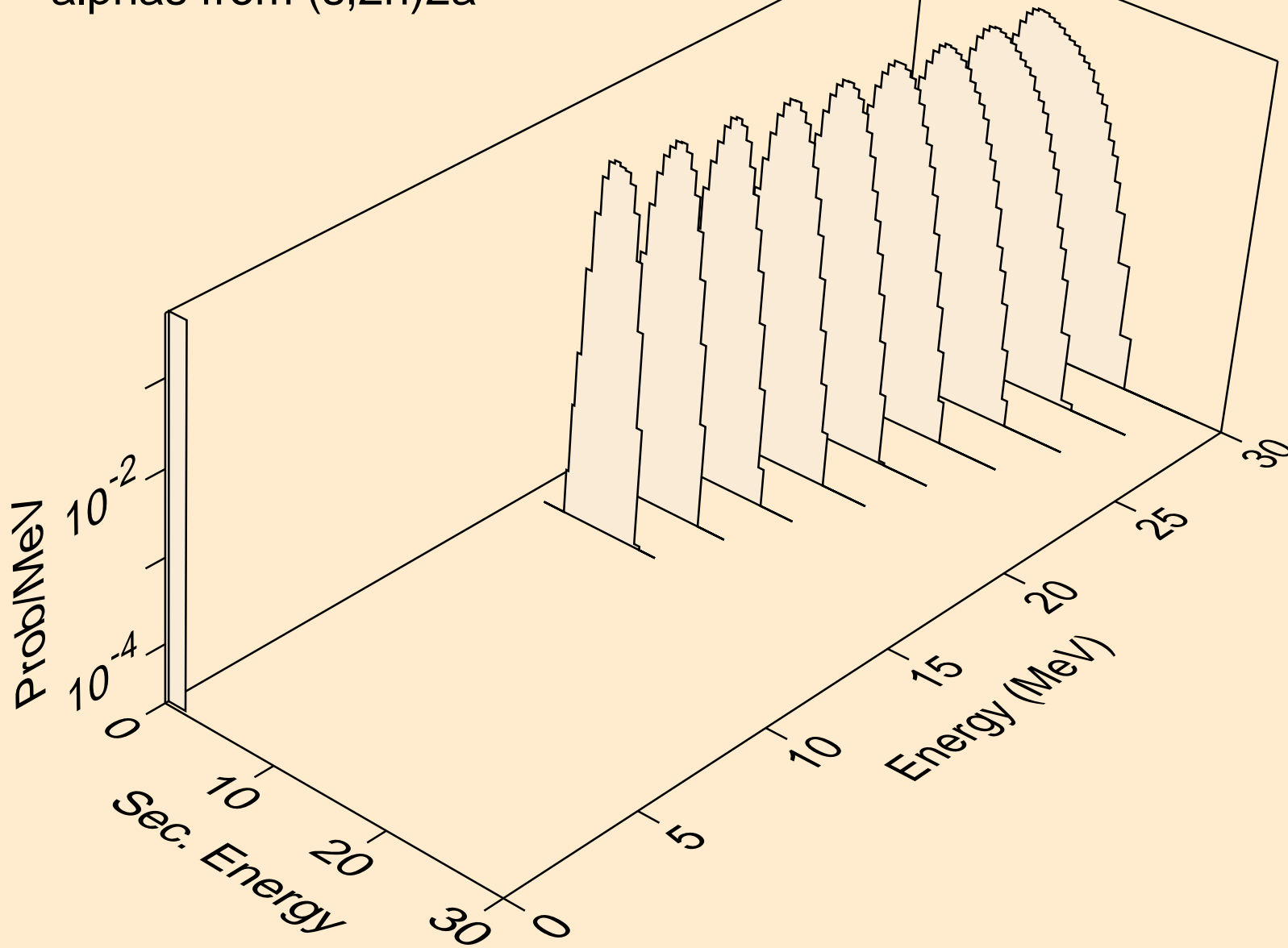

KR093 HELION ACER TENDL-2021 LIBRARY; T=0.K  
alphas from (s,npa)

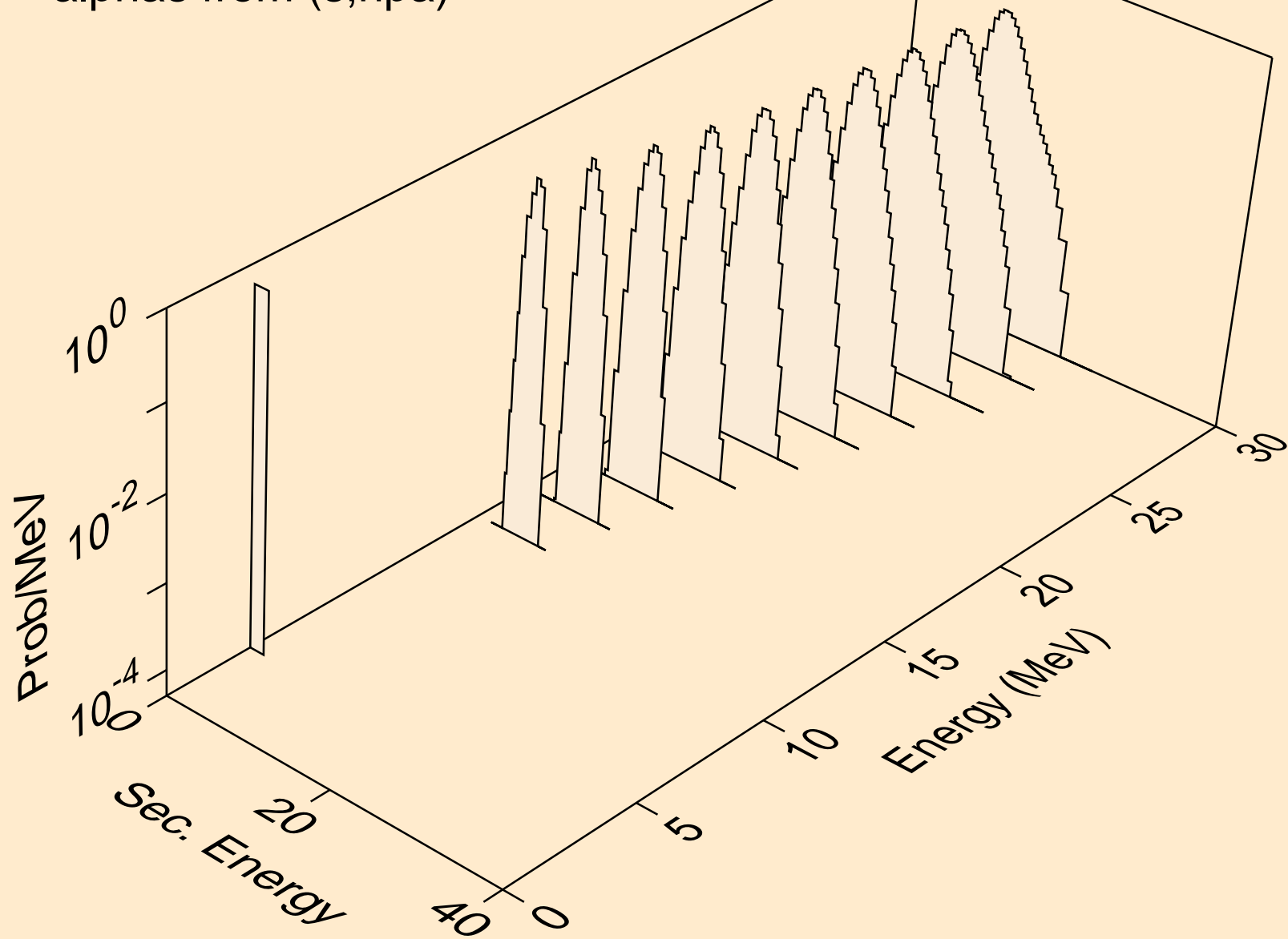



KR093 HELION ACER TENDL-2021 LIBRARY; T=0.K  
alphas from (s,a)

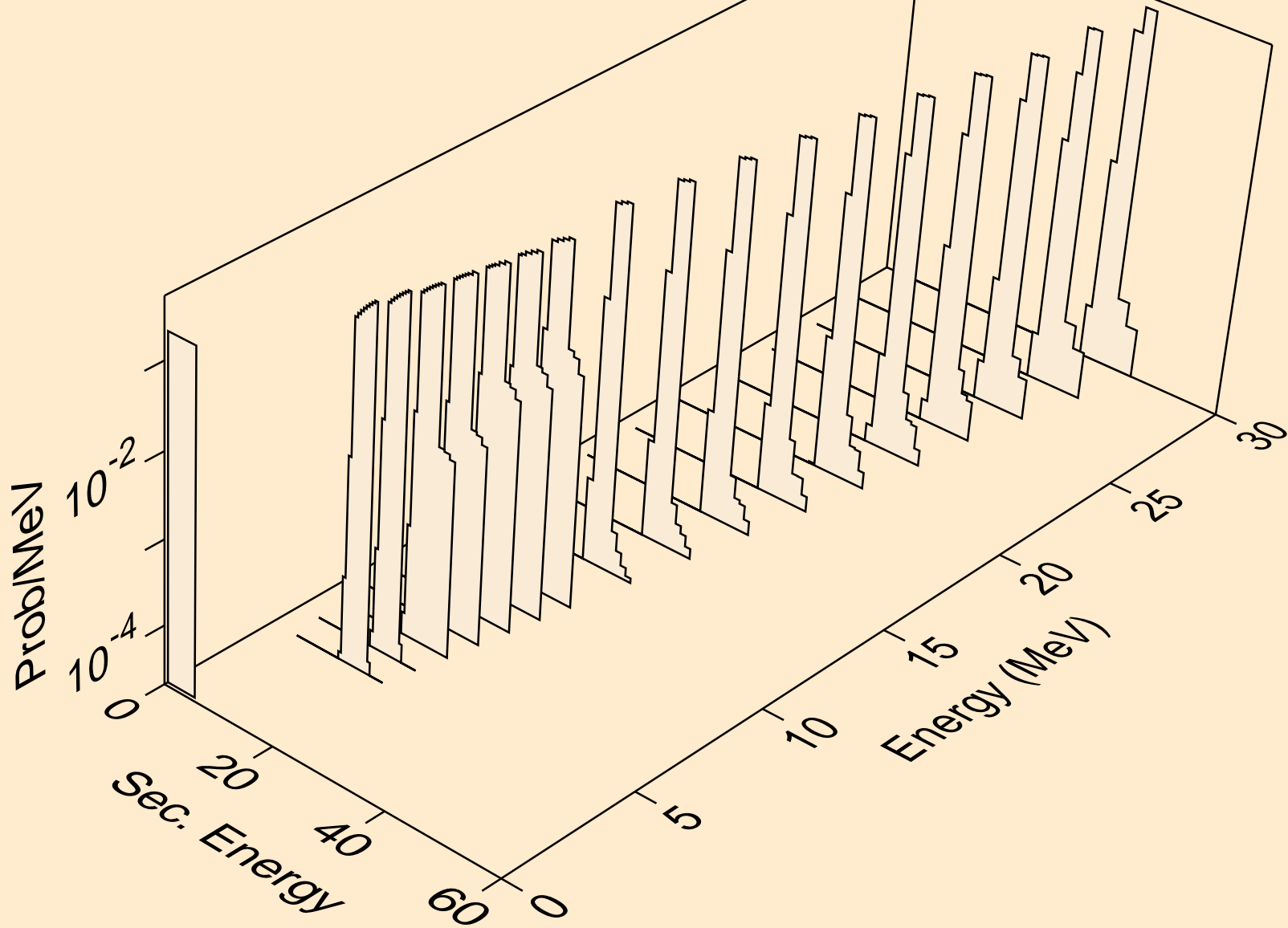

KR093 HELION ACER TENDL-2021 LIBRARY; T=0.K  
alphas from (s,pa)

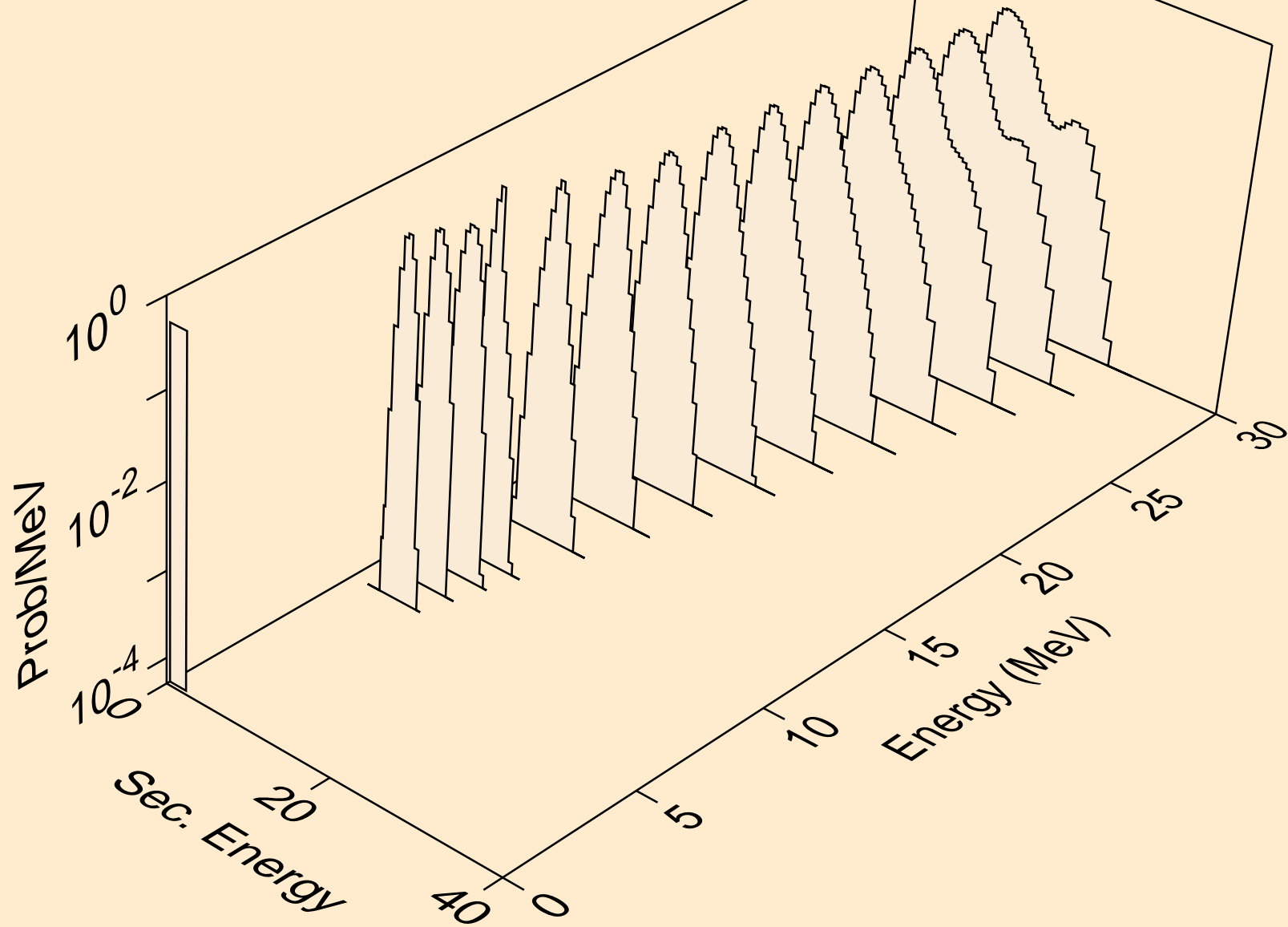

KR093 HELION ACER TENDL-2021 LIBRARY; T=0.K  
alphas from (s,da)

