

LA124M HELION ACER TENDL-2021 LIBRARY; T=0.K  
Principal cross sections

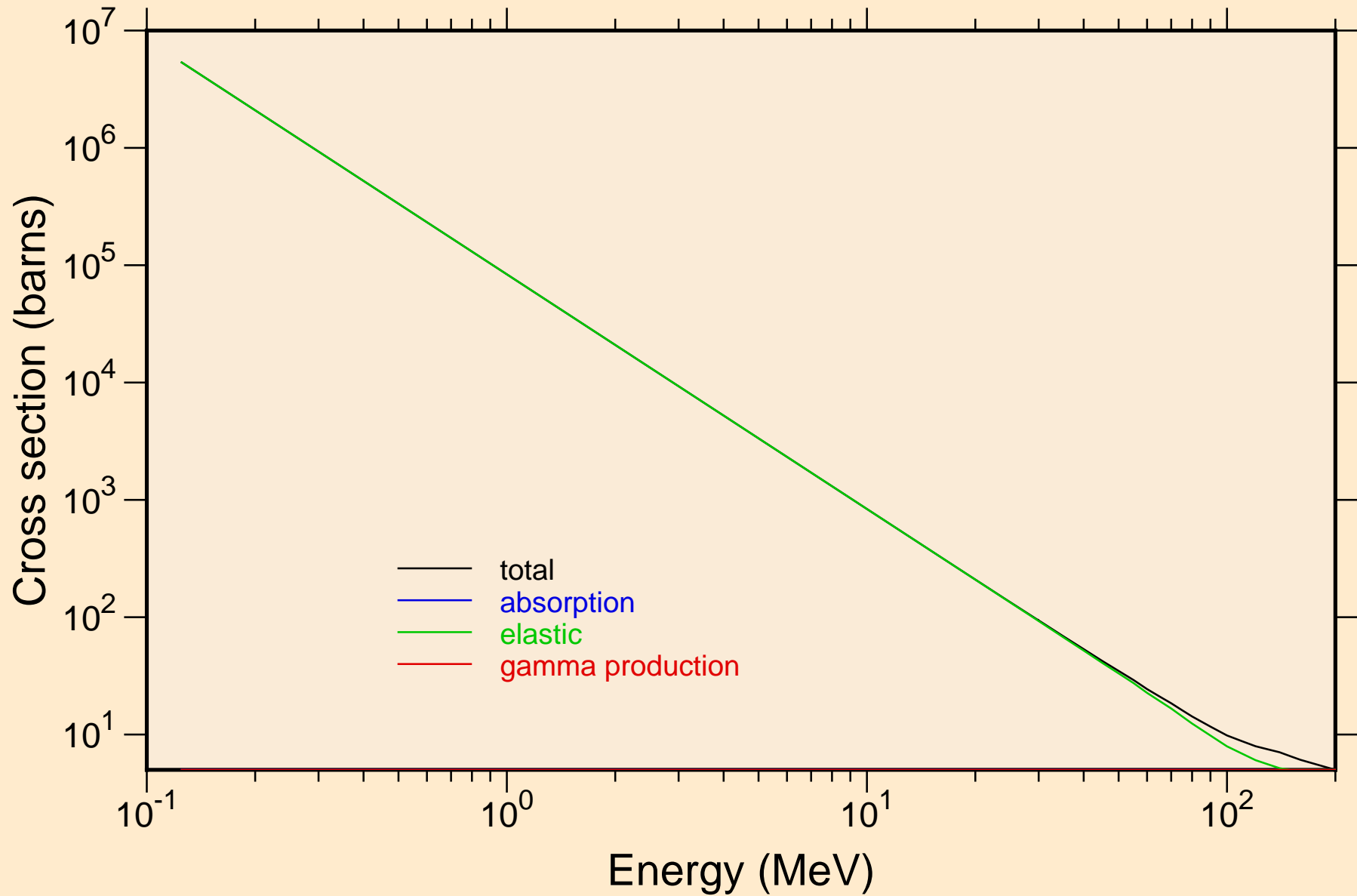

LA124M HELION ACER TENDL-2021 LIBRARY; T=0.K

Heating

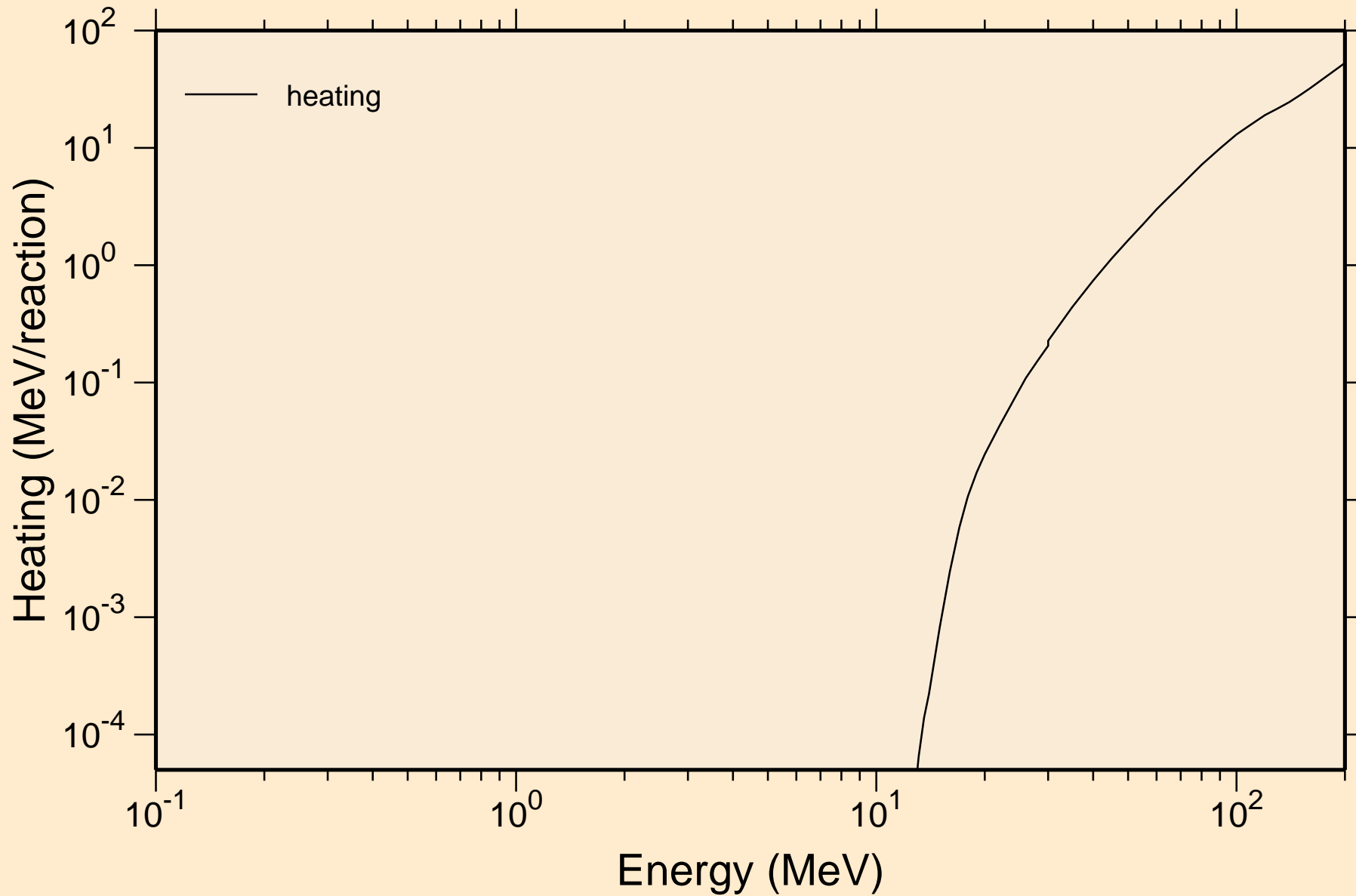

# LA124M HELION ACER TENDL-2021 LIBRARY; T=0.K

## Principal cross sections

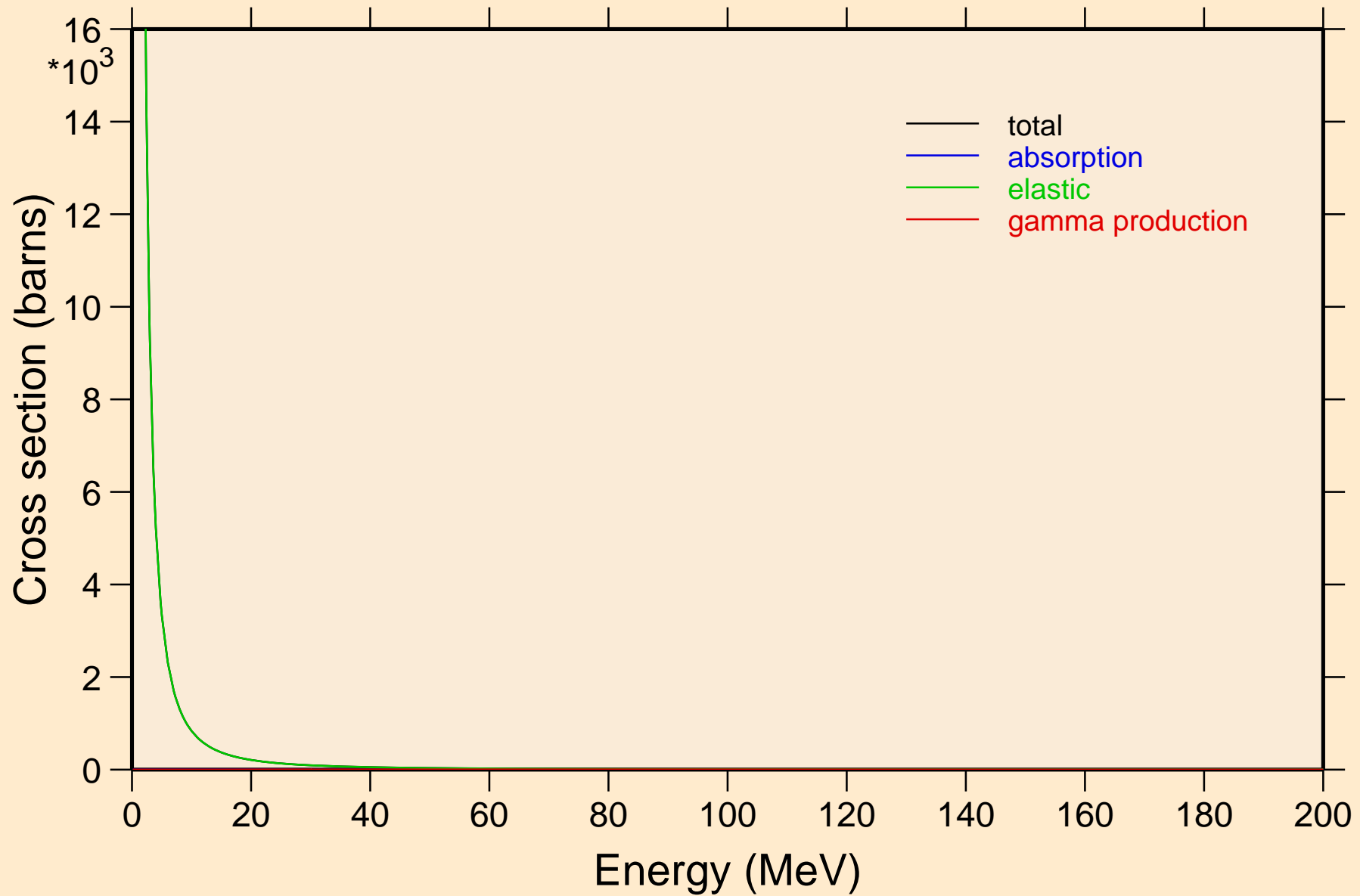

LA124M HELION ACER TENDL-2021 LIBRARY; T=0.K

Heating

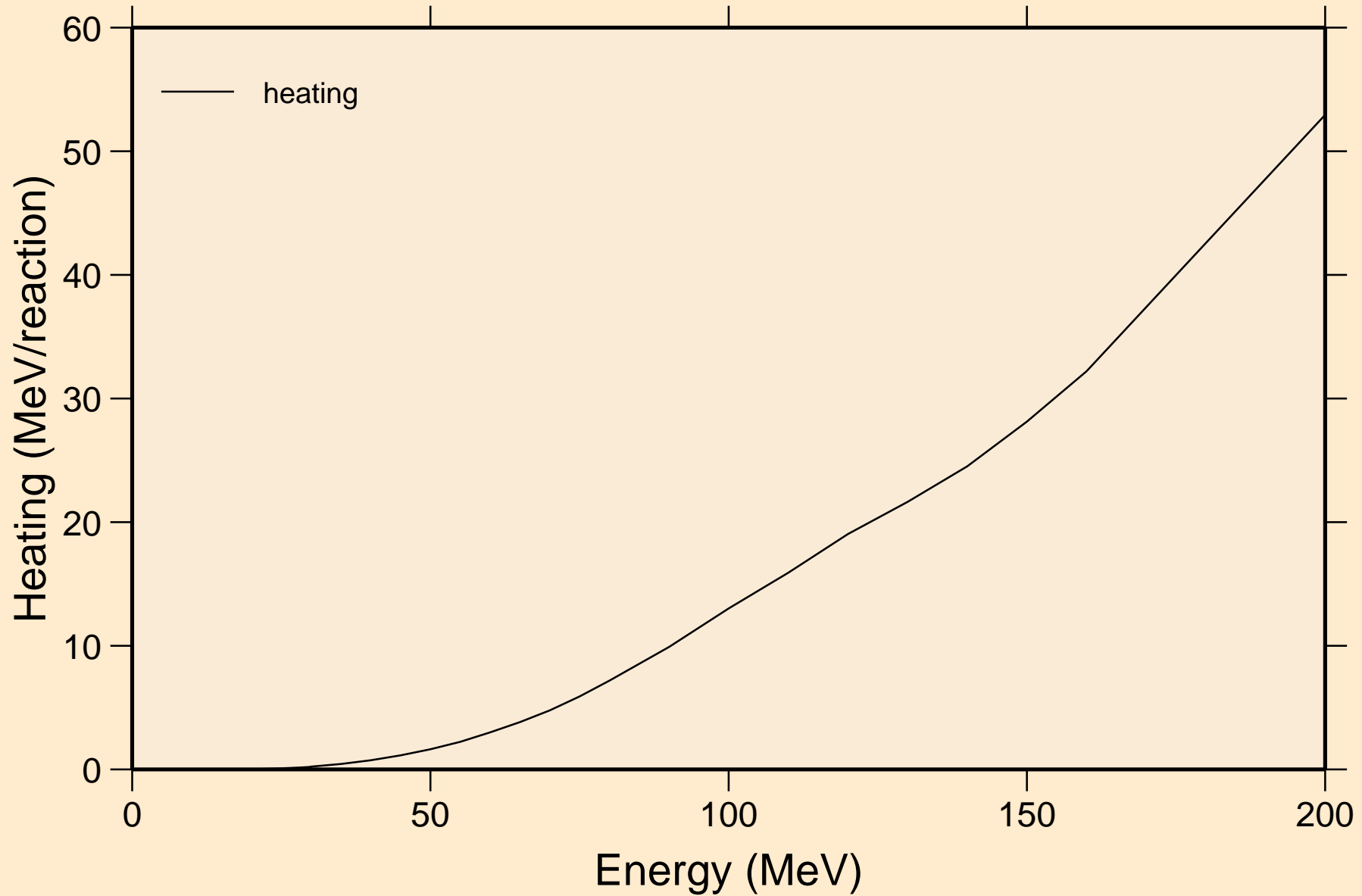

LA124M HELION ACER TENDL-2021 LIBRARY; T=0.K  
Threshold reactions

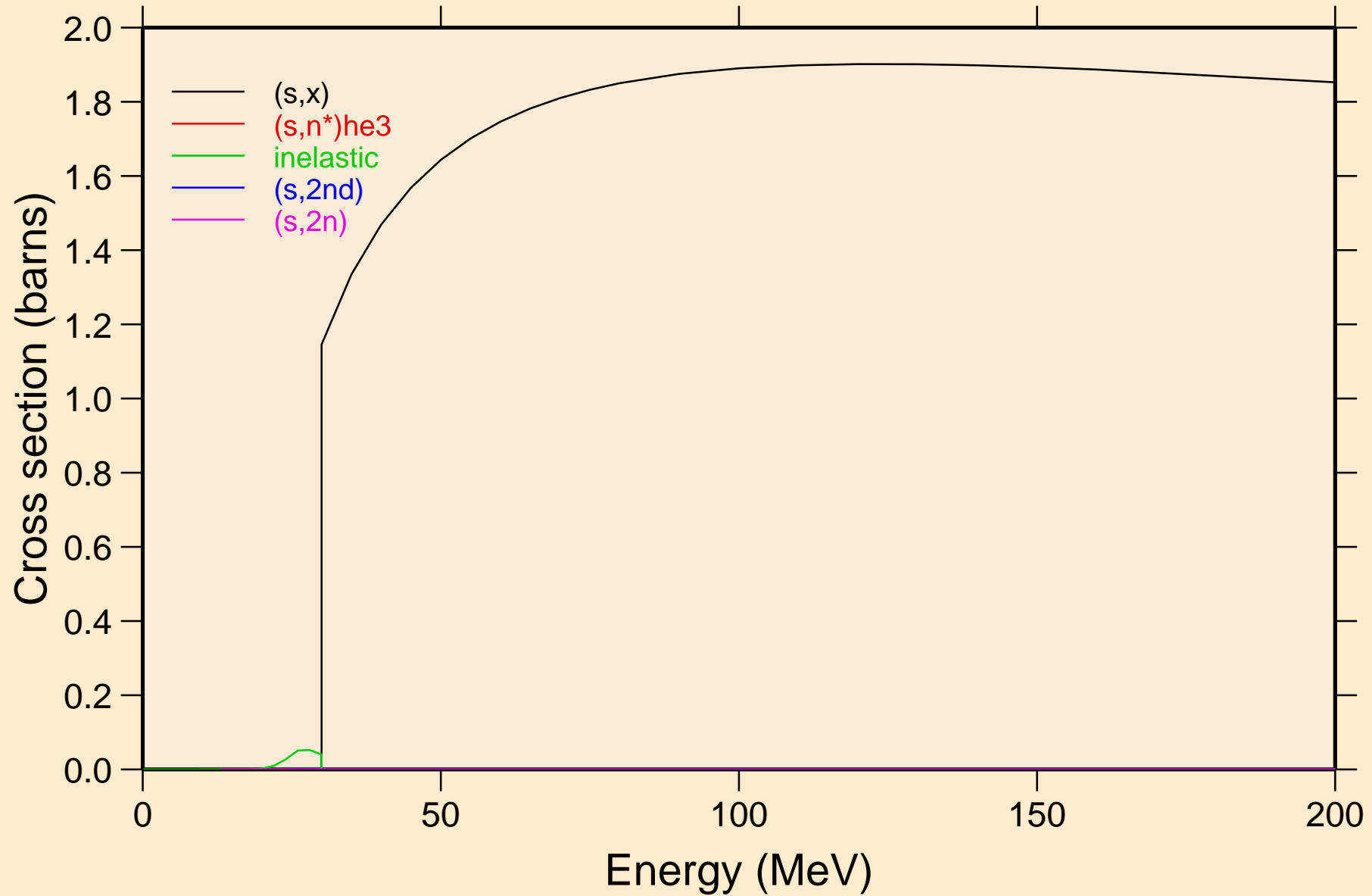

LA124M HELION ACER TENDL-2021 LIBRARY; T=0.K  
Threshold reactions

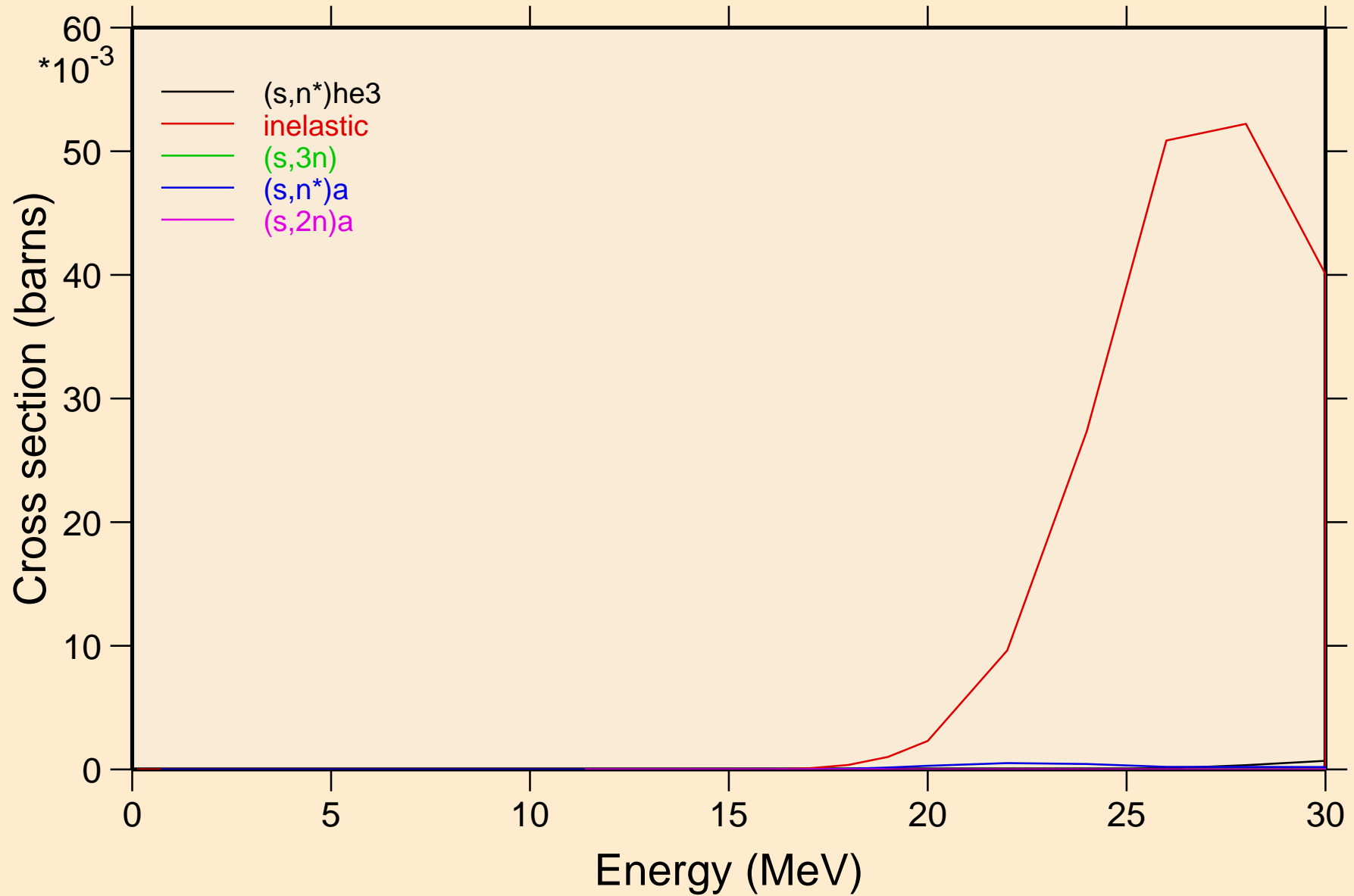

LA124M HELION ACER TENDL-2021 LIBRARY; T=0.K  
Threshold reactions

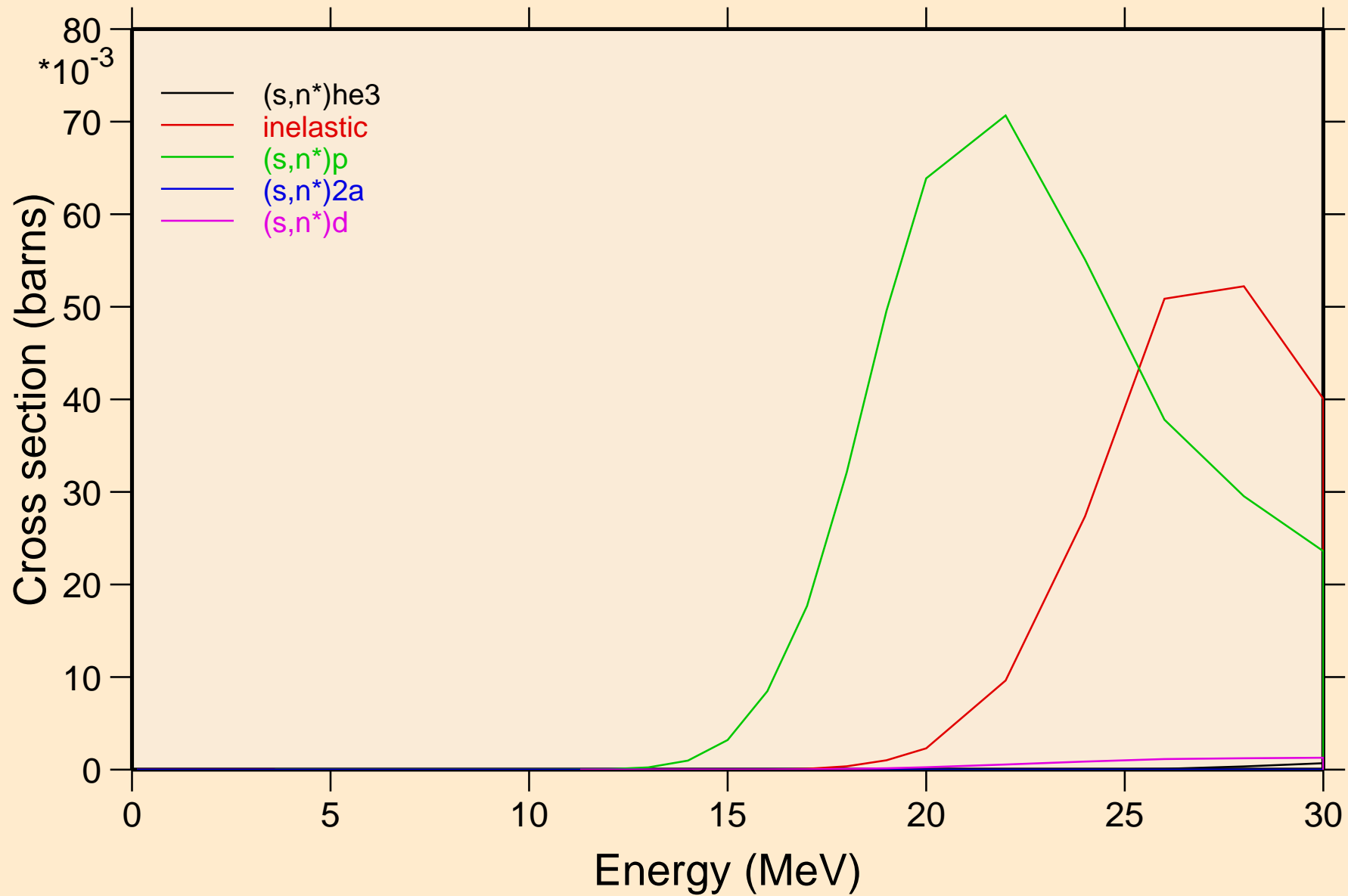

LA124M HELION ACER TENDL-2021 LIBRARY; T=0.K  
Threshold reactions

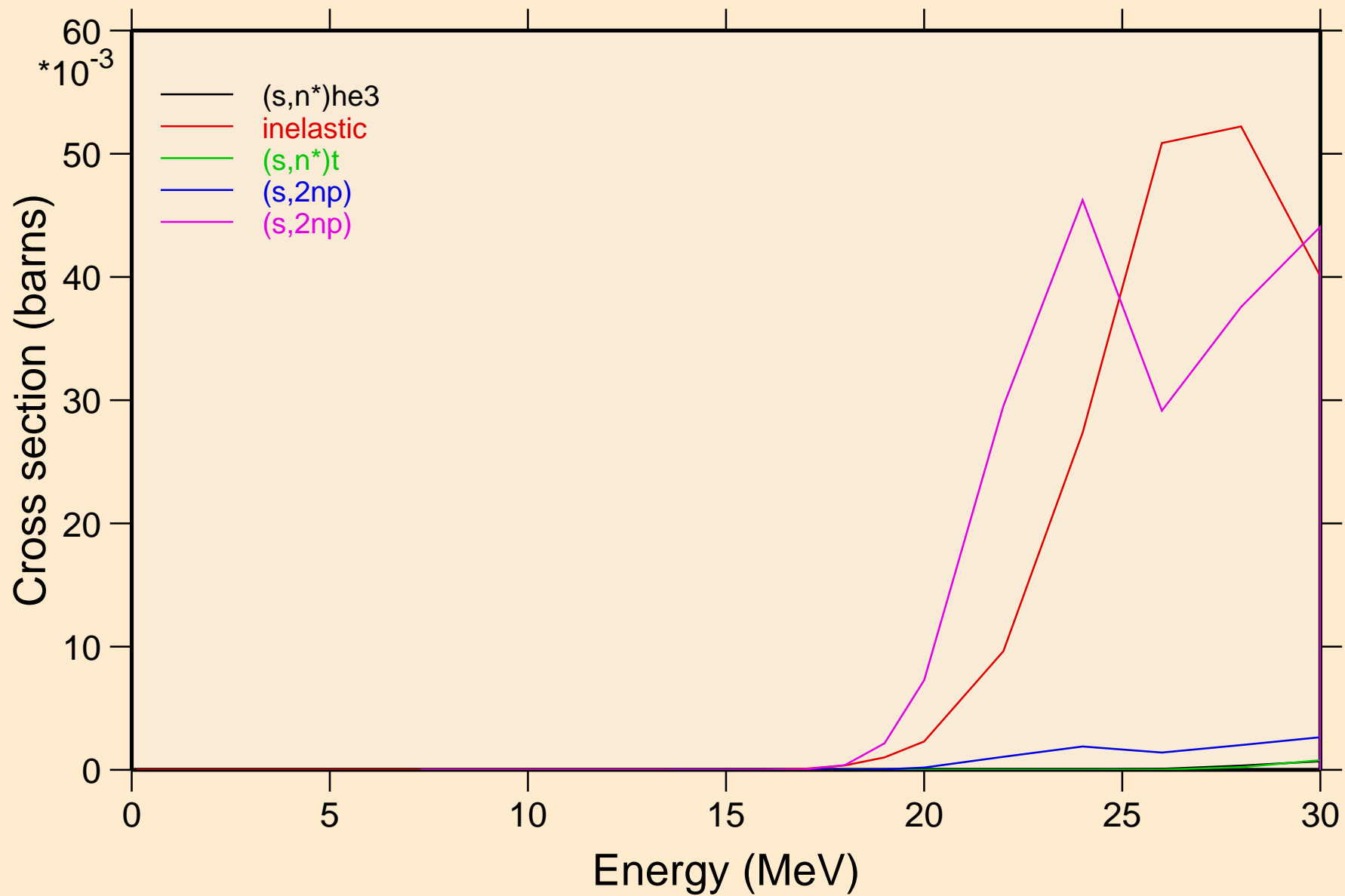



LA124M HELION ACER TENDL-2021 LIBRARY; T=0.K  
Threshold reactions

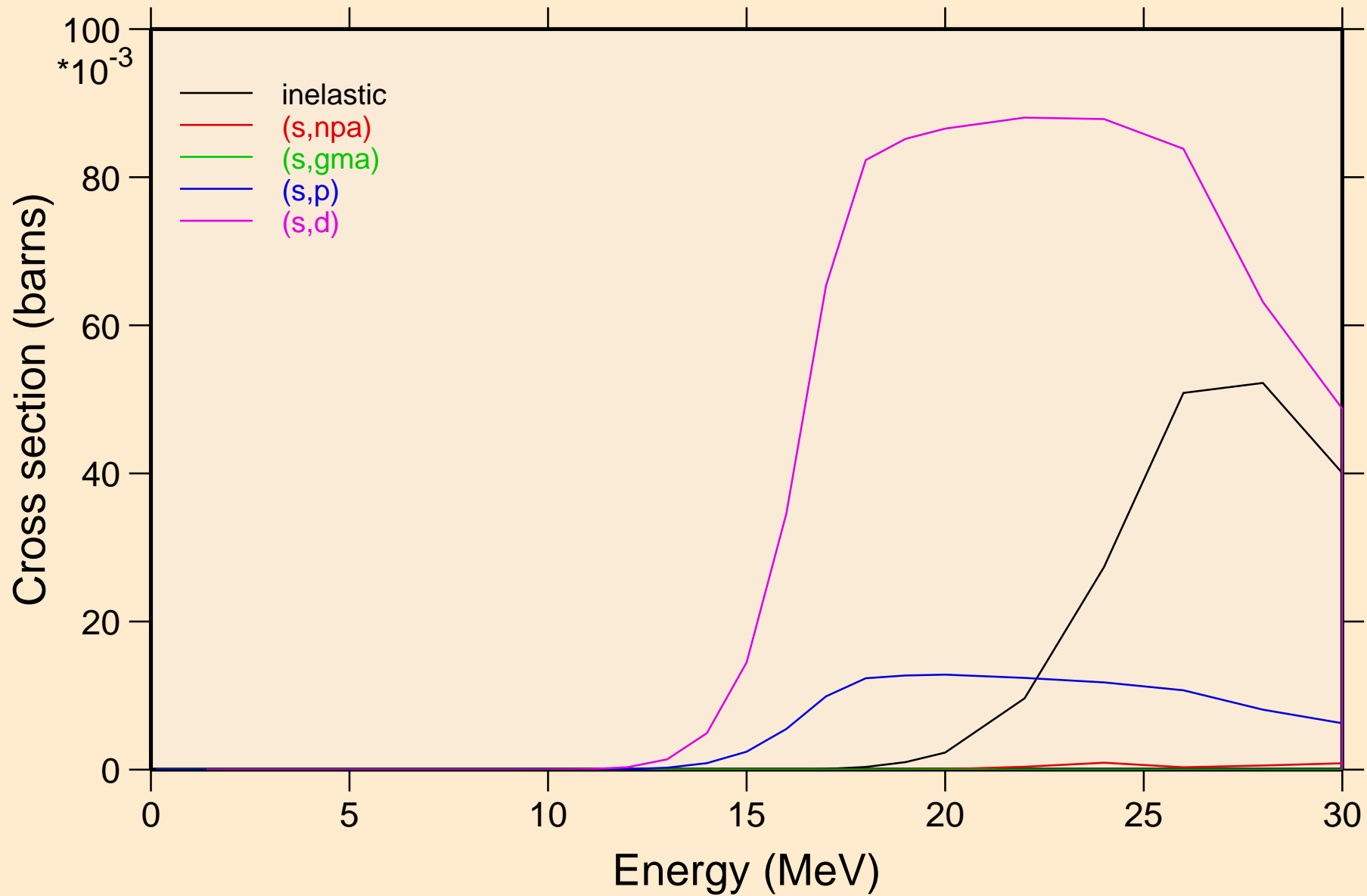

LA124M HELION ACER TENDL-2021 LIBRARY; T=0.K  
Threshold reactions

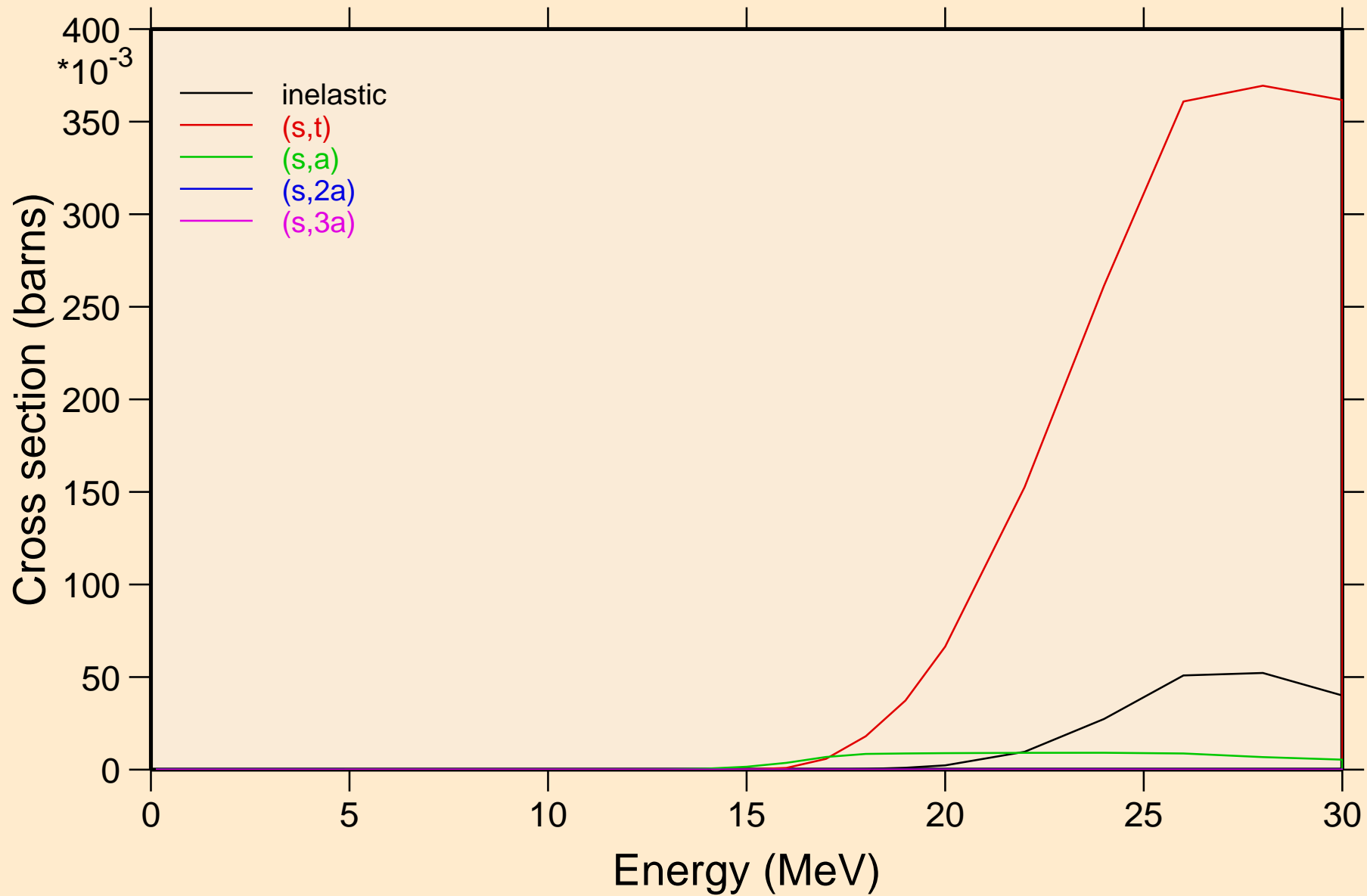

LA124M HELION ACER TENDL-2021 LIBRARY; T=0.K  
Threshold reactions

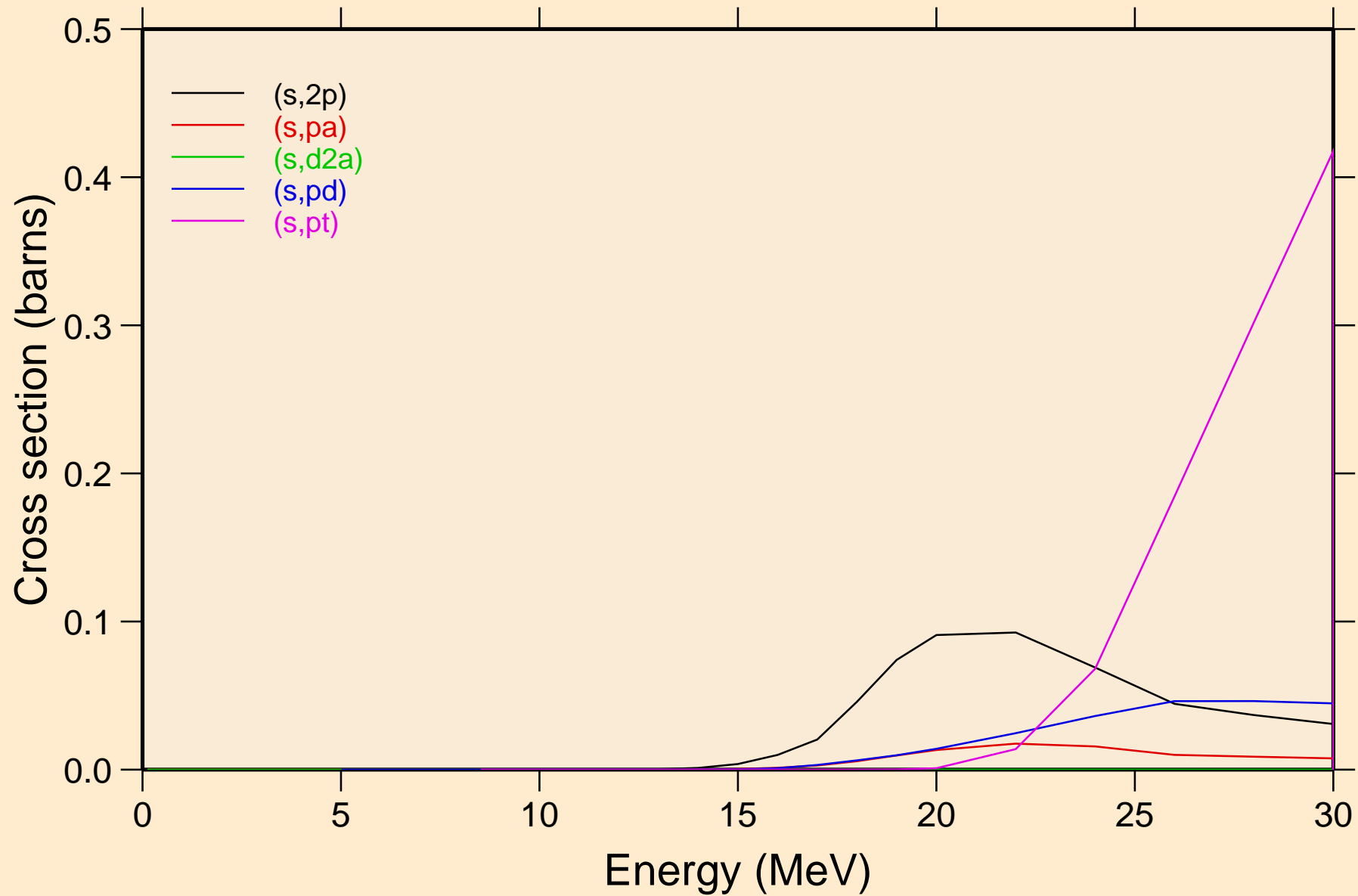

LA124M HELION ACER TENDL-2021 LIBRARY; T=0.K  
Threshold reactions

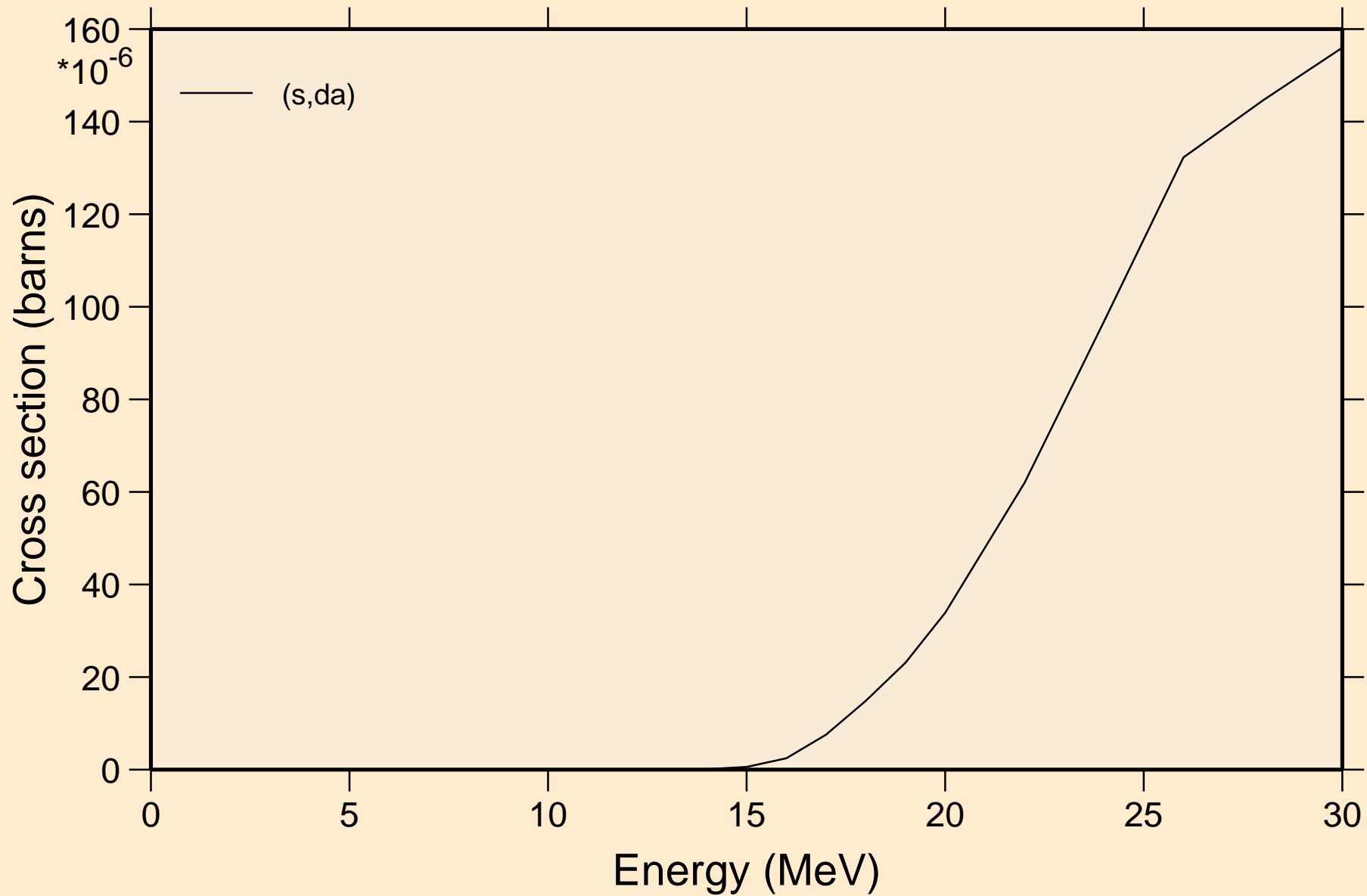

LA124M HELION ACER TENDL-2021 LIBRARY; T=0.K  
angular distribution for elastic

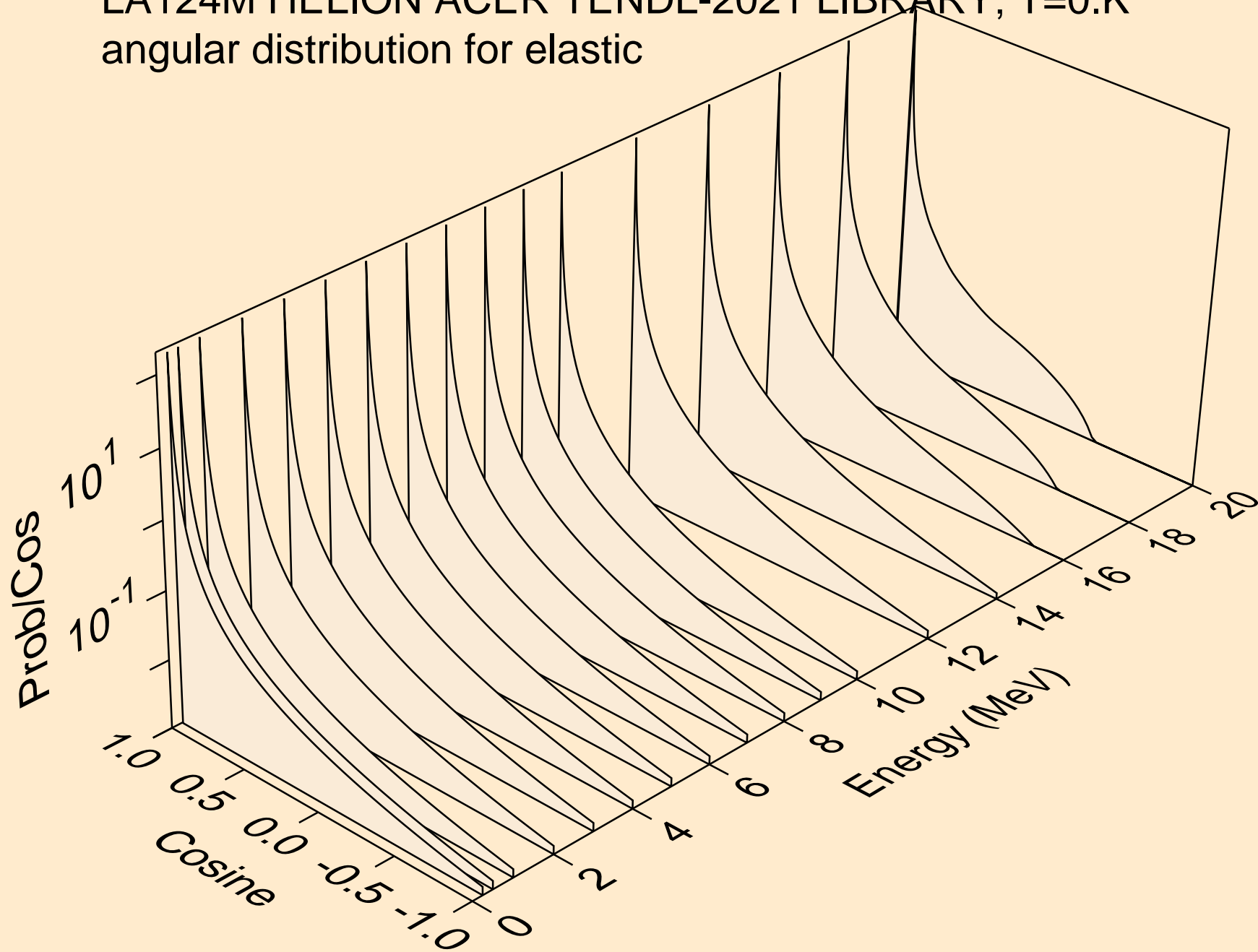

LA124M HELION ACER TENDL-2021 LIBRARY; T=0.K  
angular distribution for elastic

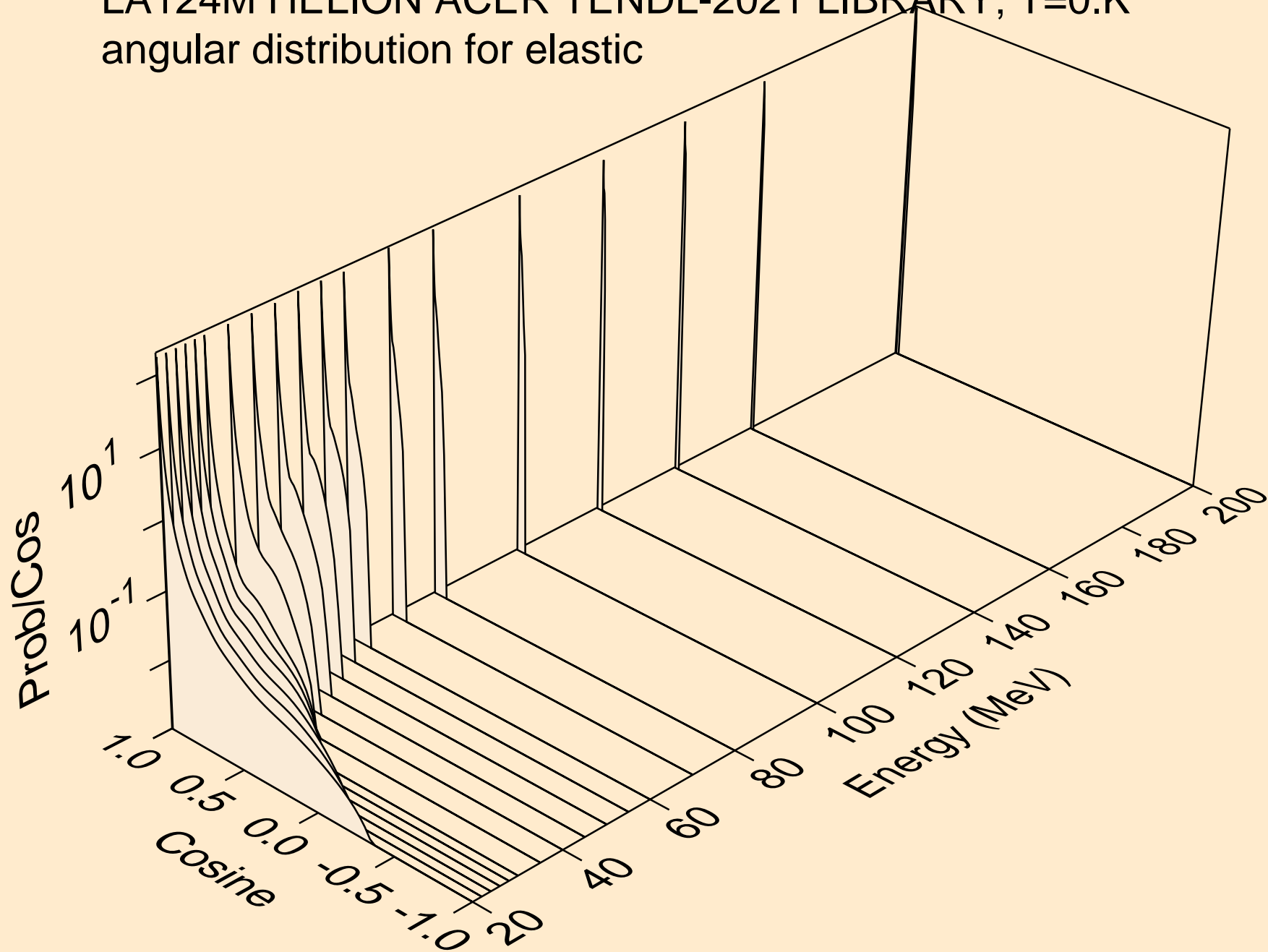

LA124M HELION ACER TENDL-2021 LIBRARY; T=0.K  
He-3 emission for (s,x)

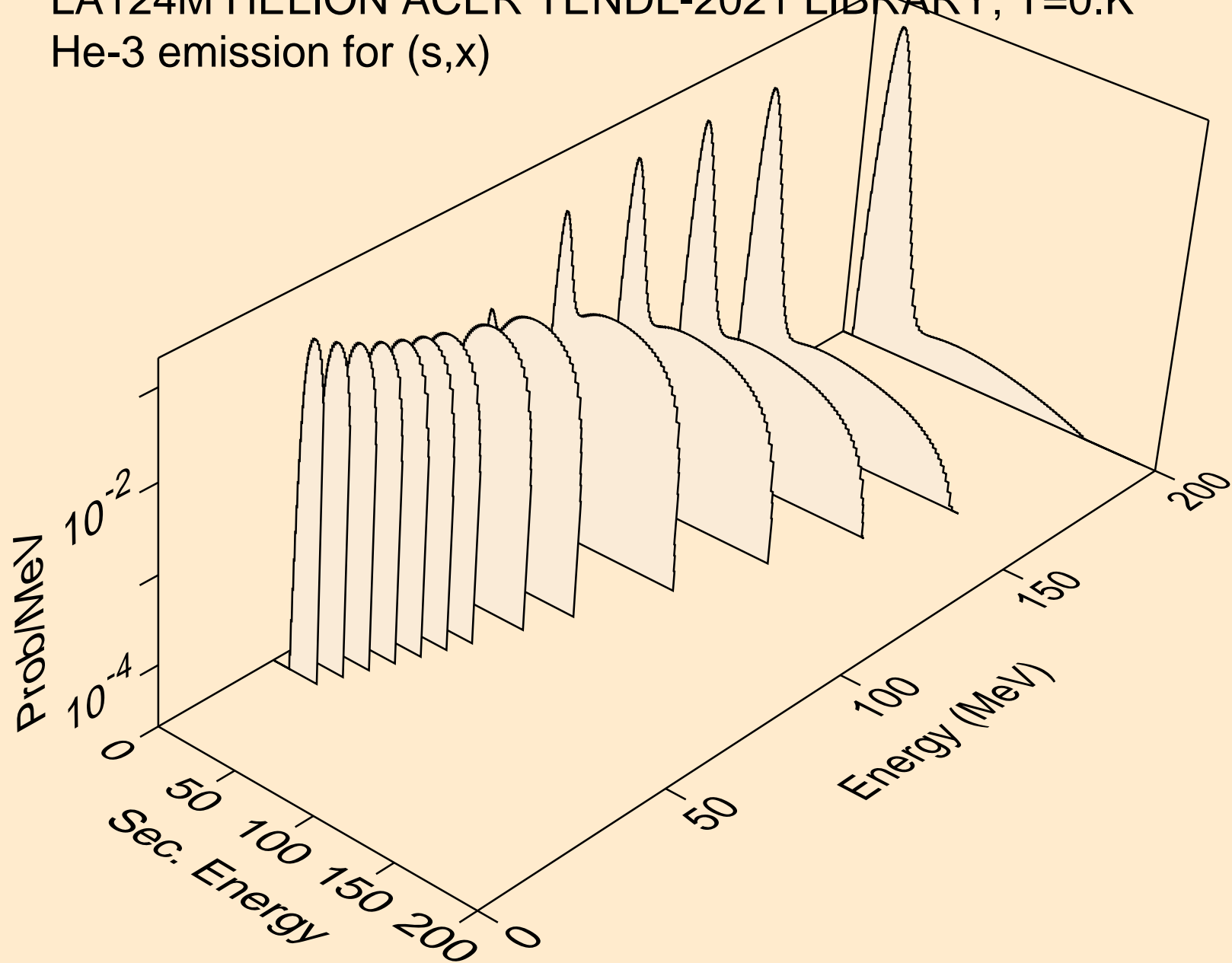

LA124M HELION ACER TENDL-2021 LIBRARY; T=0.K  
He-3 emission for (s,n\*)he3

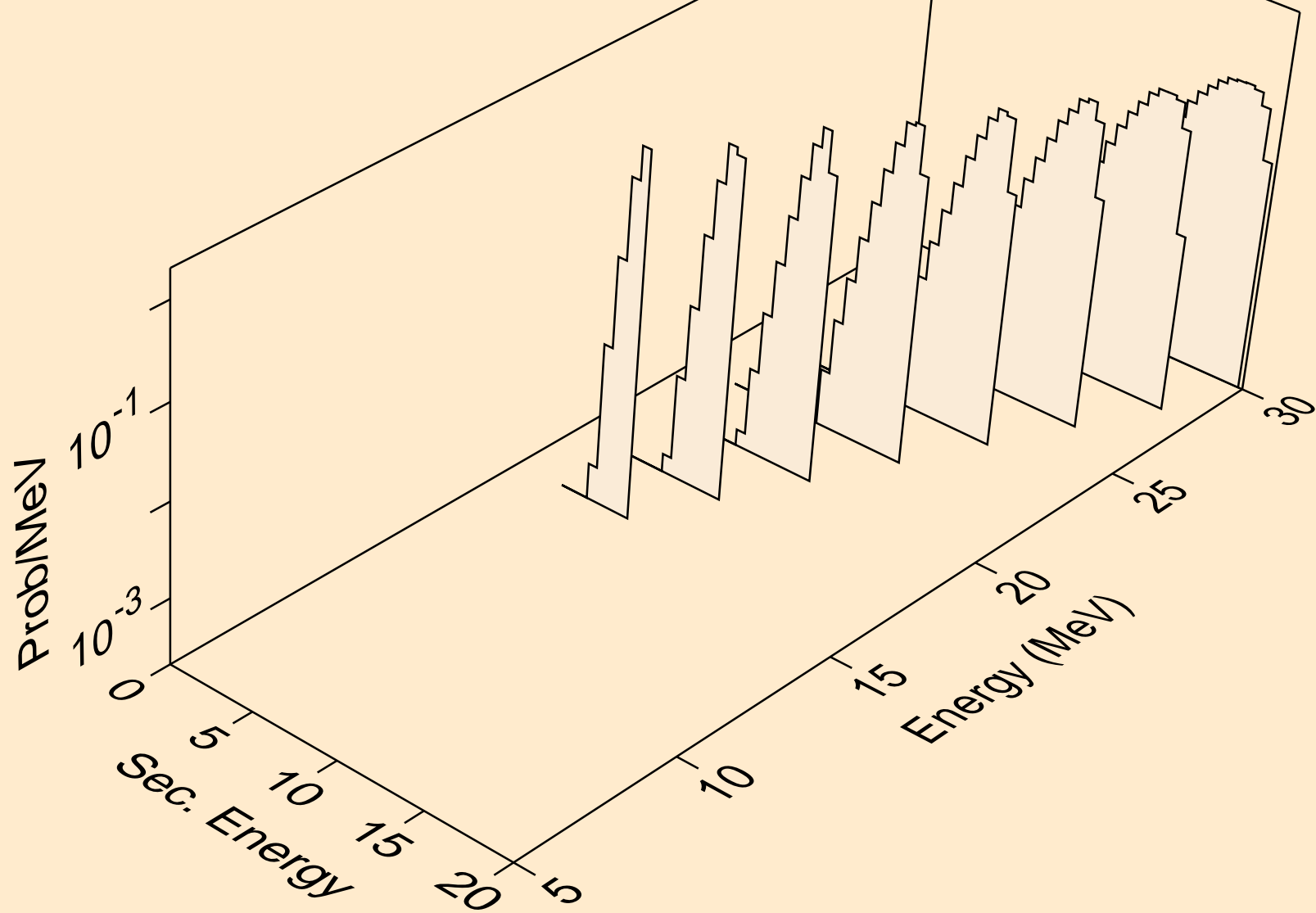



LA124M HELION ACER TENDL-2021 LIBRARY; T=0.K  
He-3 emission for inelastic

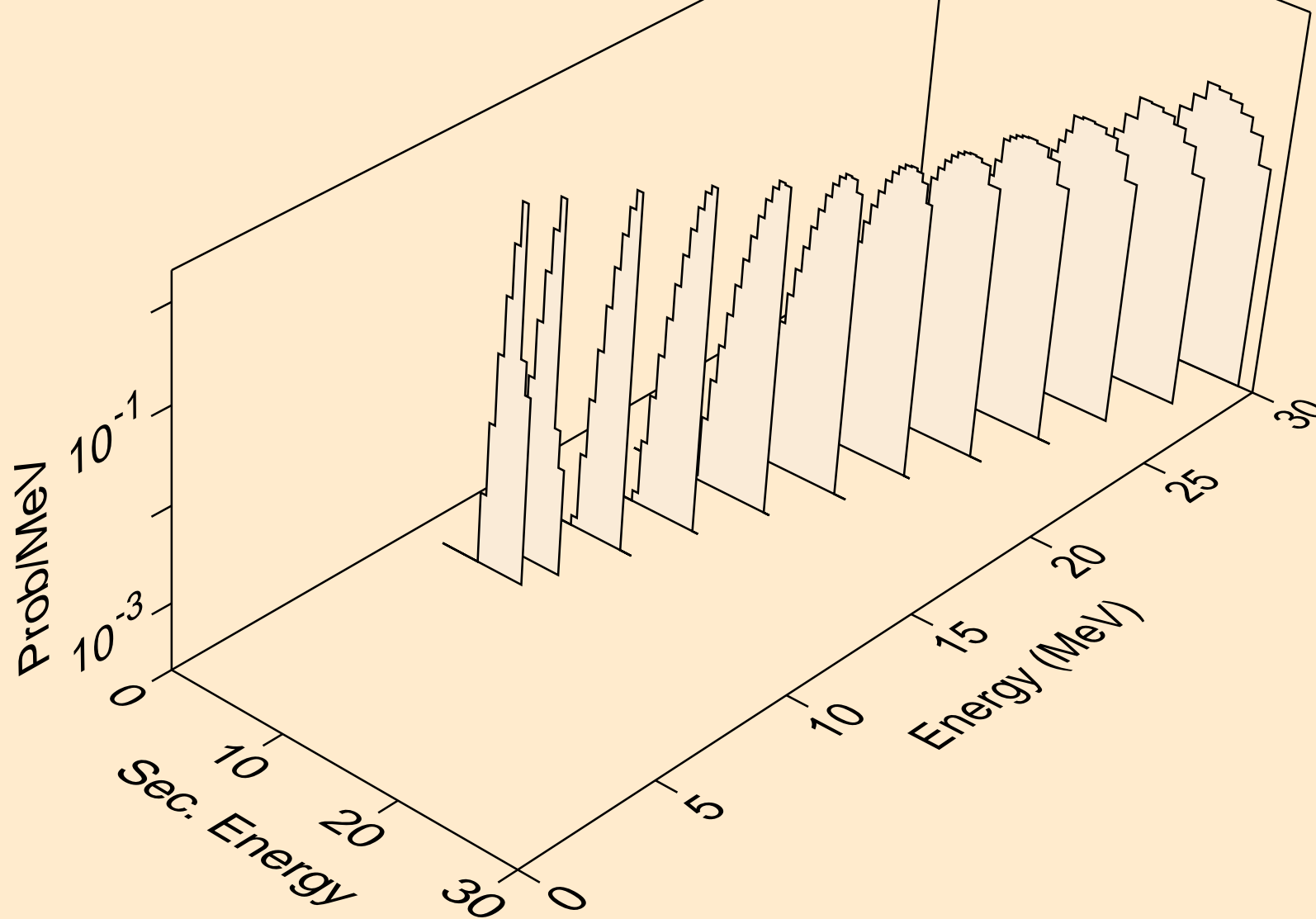

LA124M HELION ACER TENDL-2021 LIBRARY; T=0.K  
Photon emission for (z,n)

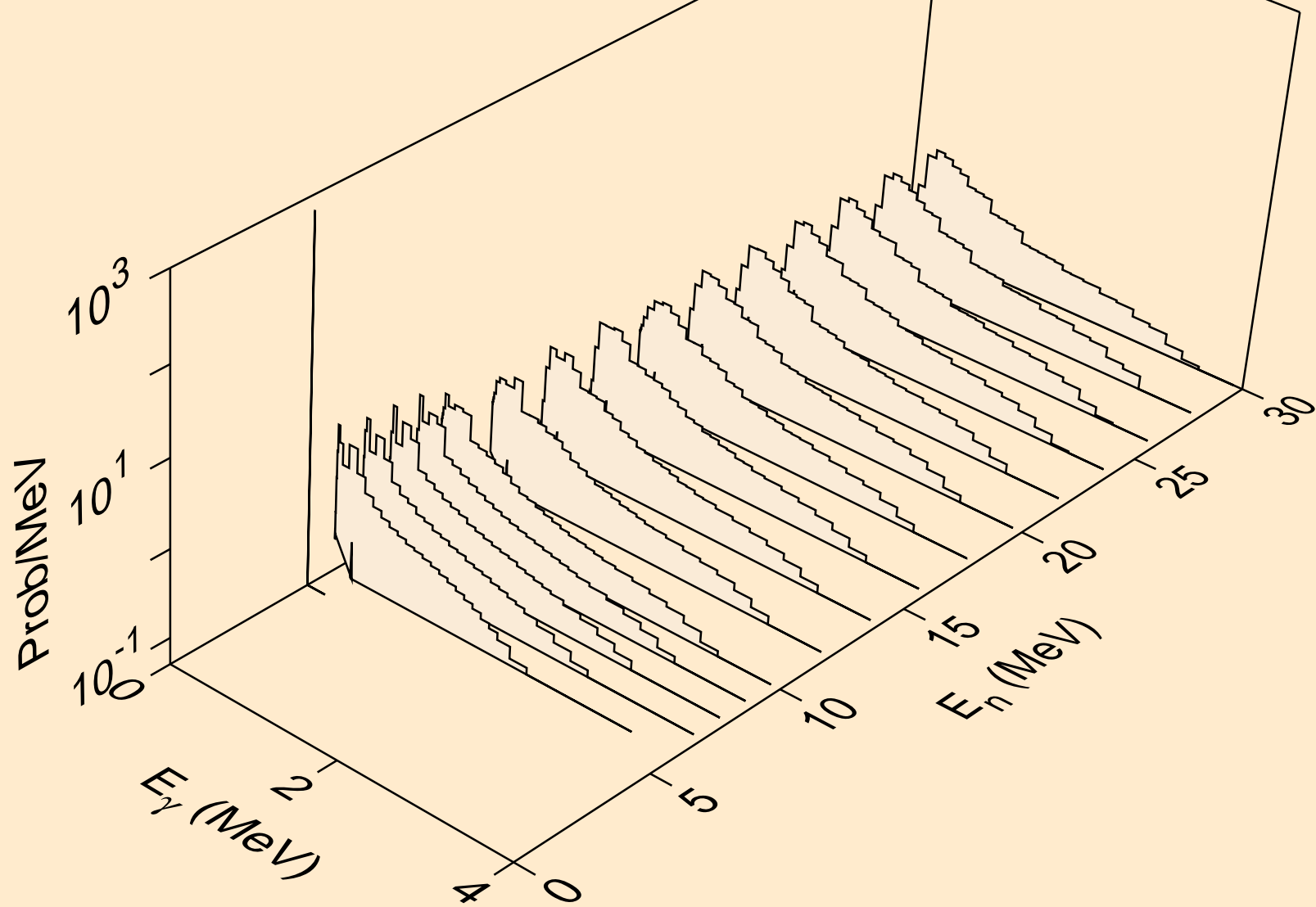

LA124M HELION ACER TENDL-2021 LIBRARY; T=0.K  
Photon emission for (n,x)

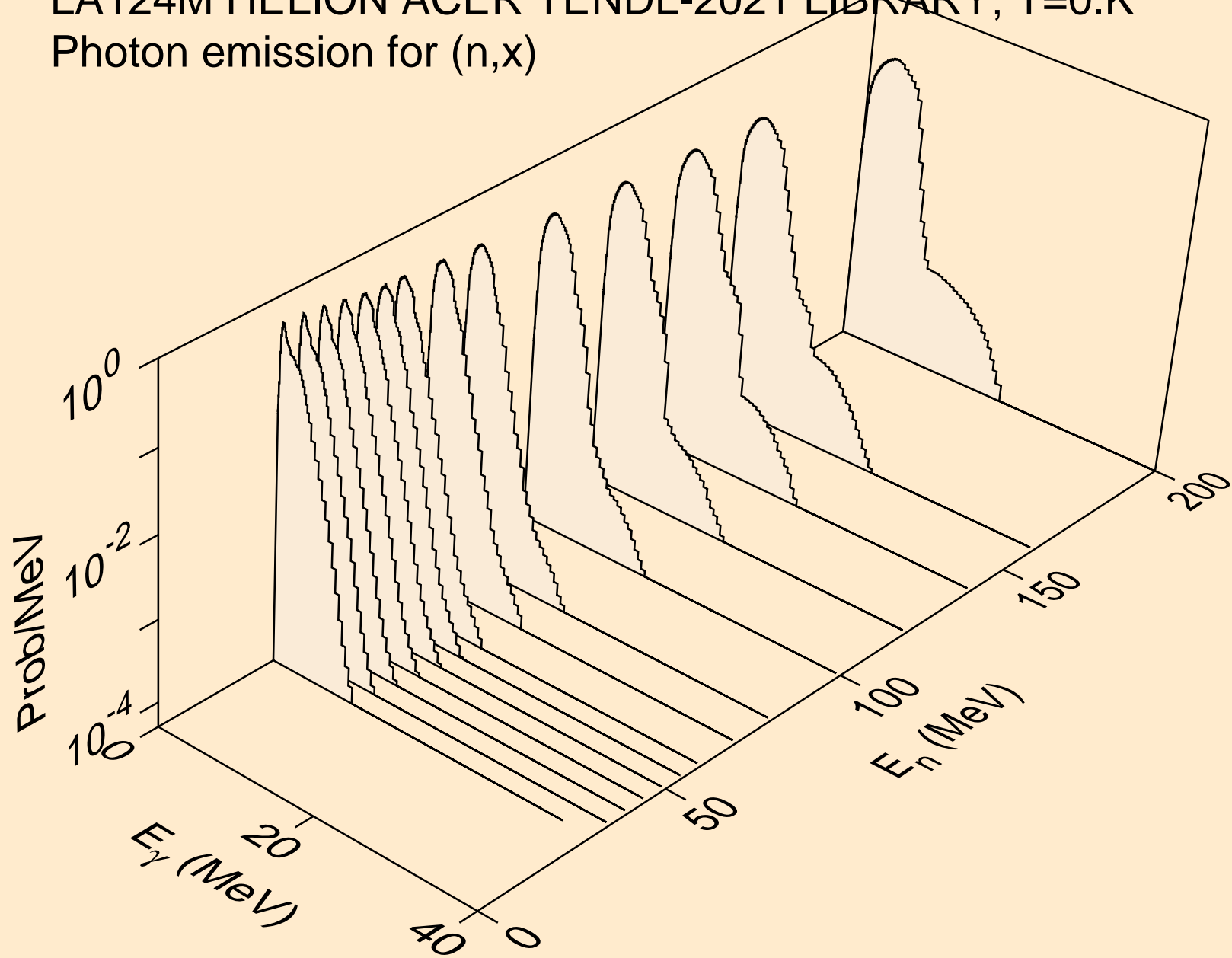

LA124M HELION ACER TENDL-2021 LIBRARY; T=0.K  
Photon emission for (n,2nd)

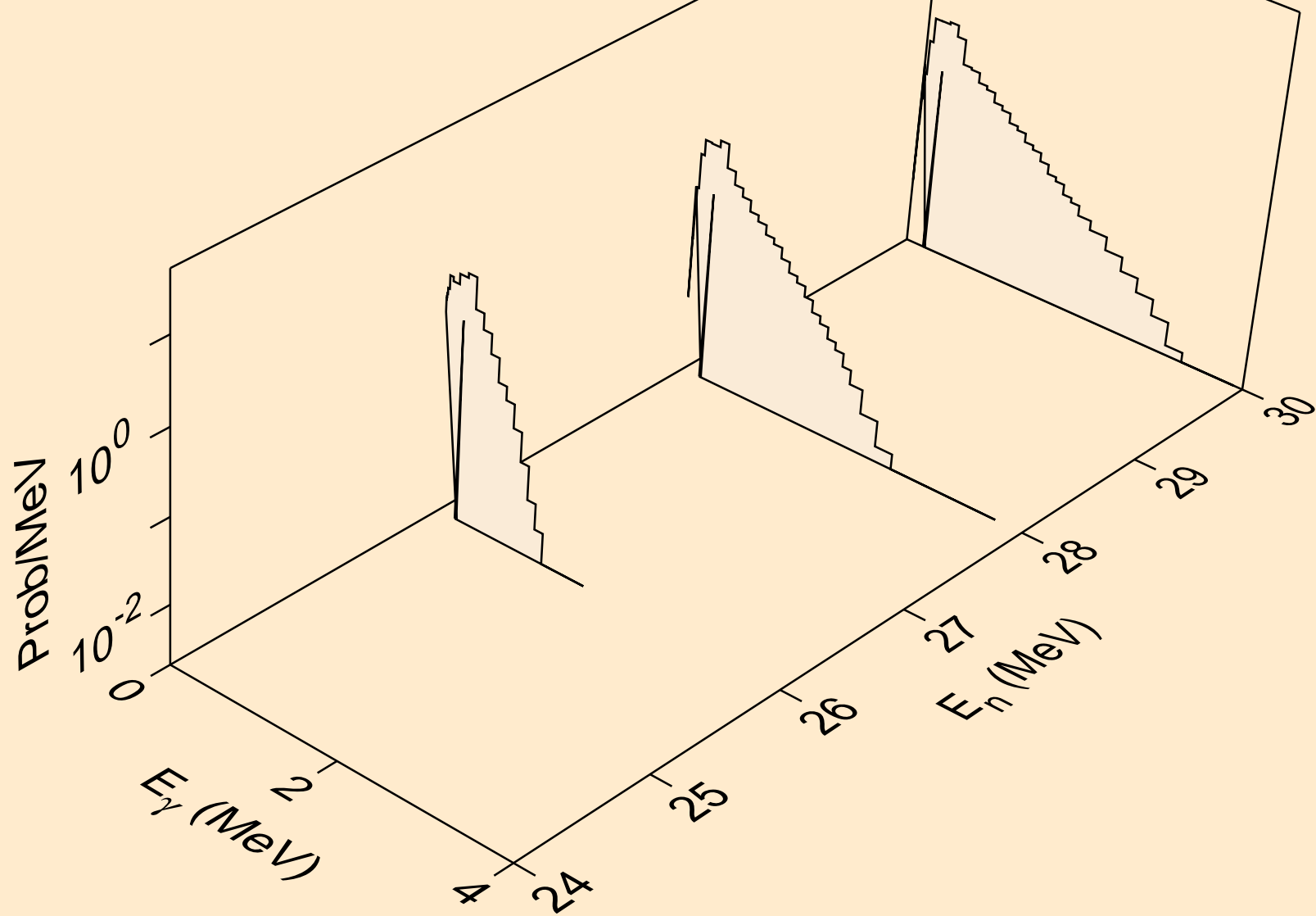

LA124M HELION ACER TENDL-2021 LIBRARY; T=0.K  
Photon emission for (n,2n)

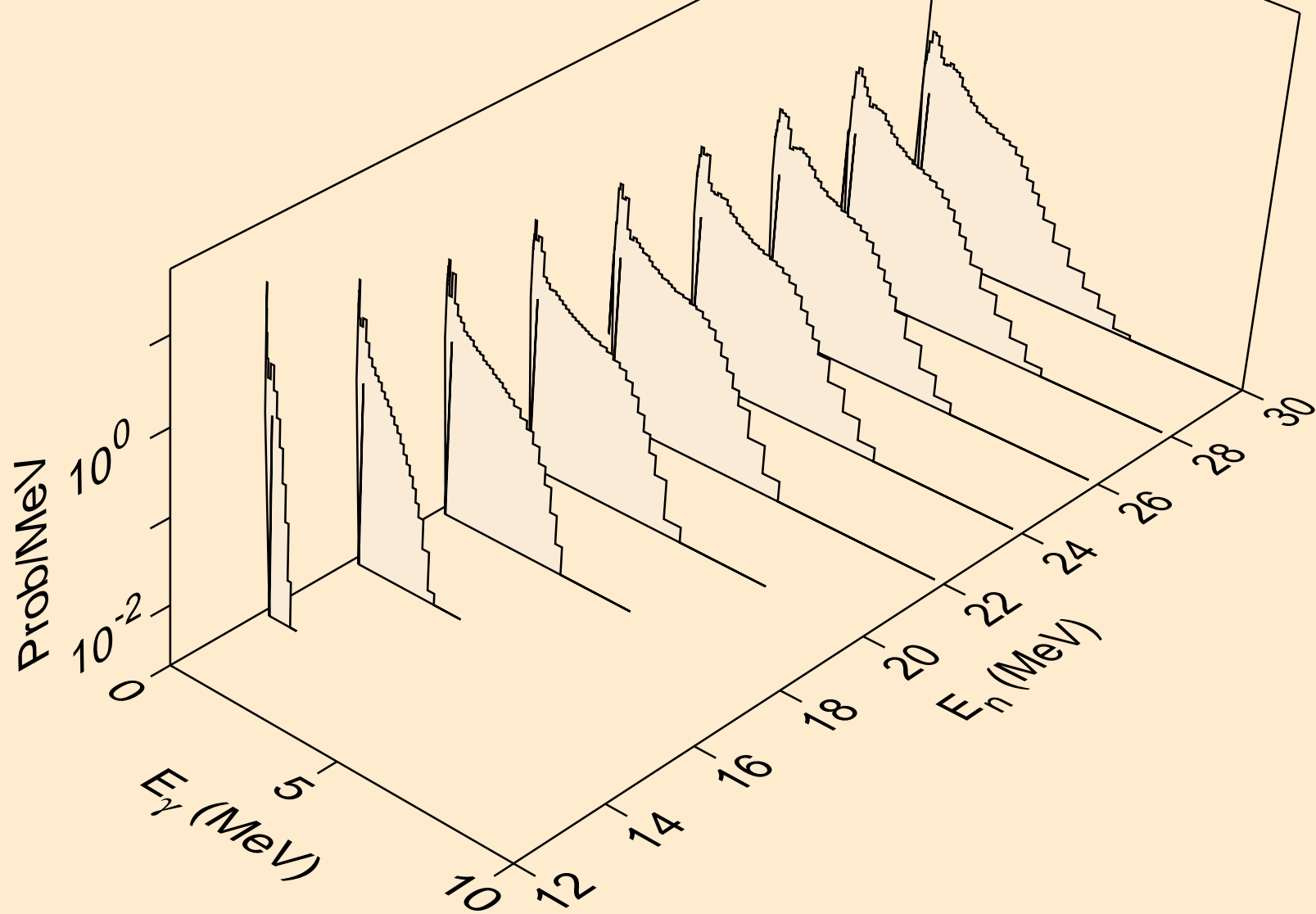

LA124M HELION ACER TENDL-2021 LIBRARY; T=0.K  
Photon emission for (n,3n)

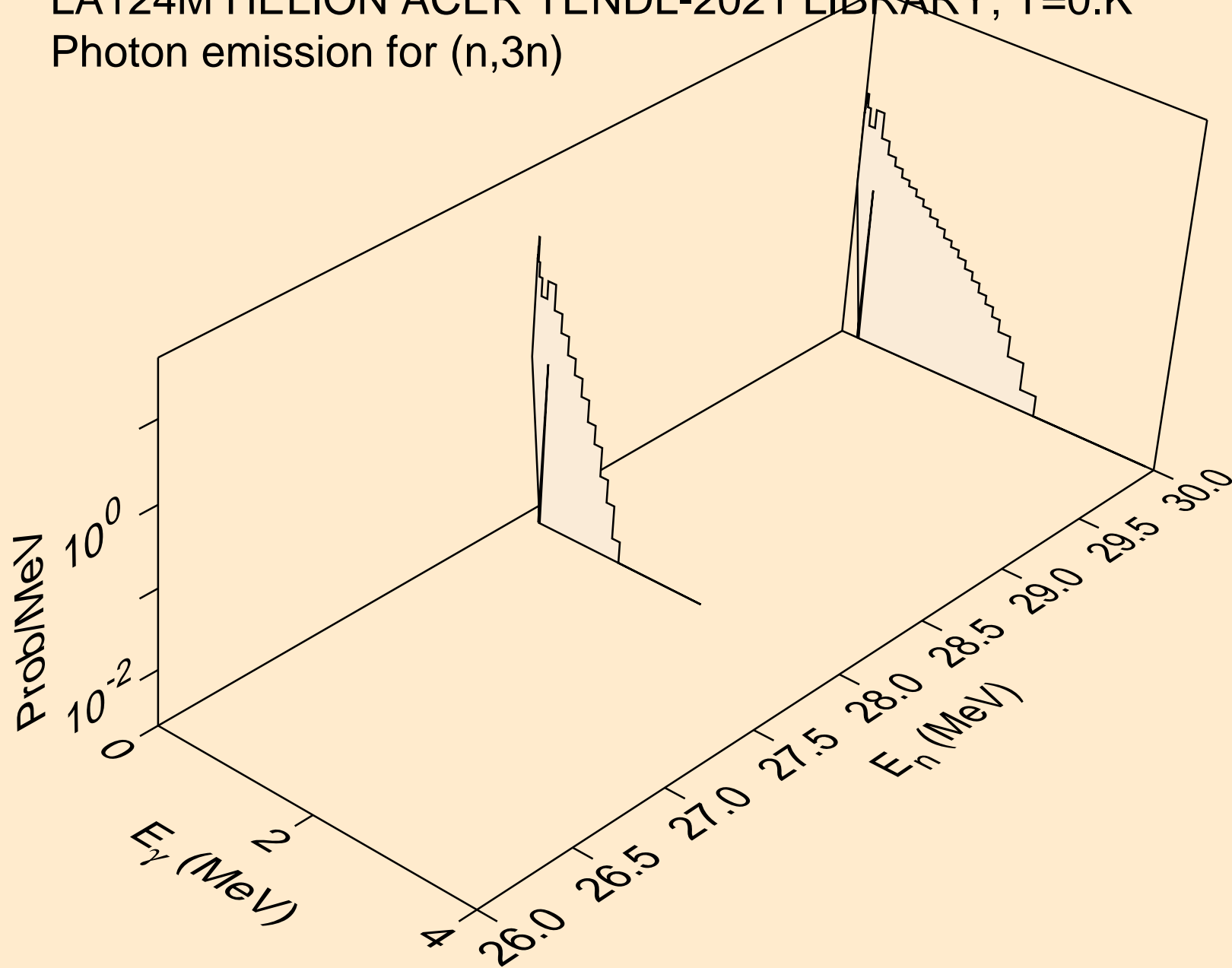

LA124M HELION ACER TENDL-2021 LIBRARY; T=0.K  
Photon emission for (n,n\*)a

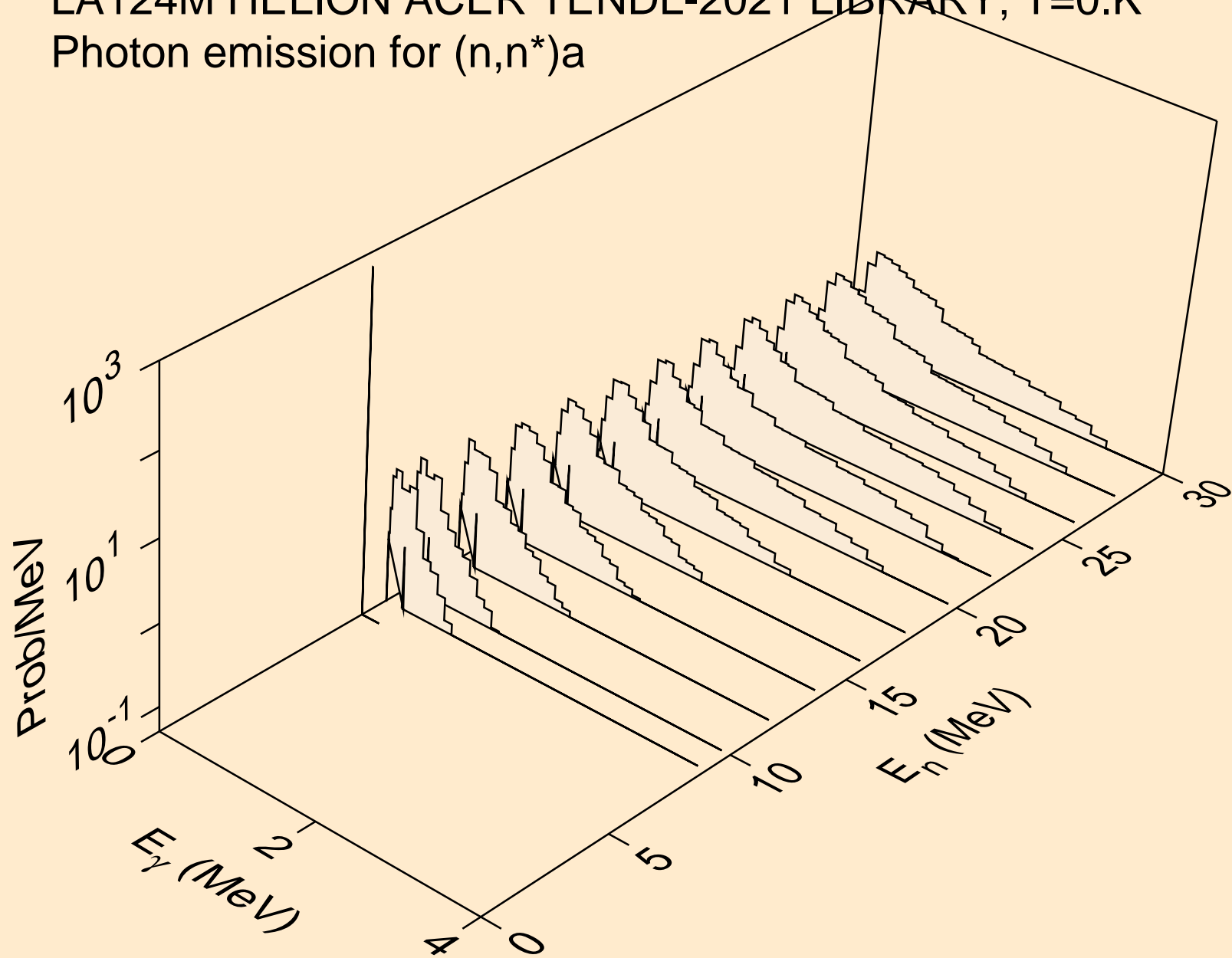

LA124M HELION ACER TENDL-2021 LIBRARY; T=0.K  
Photon emission for (n,2n)a

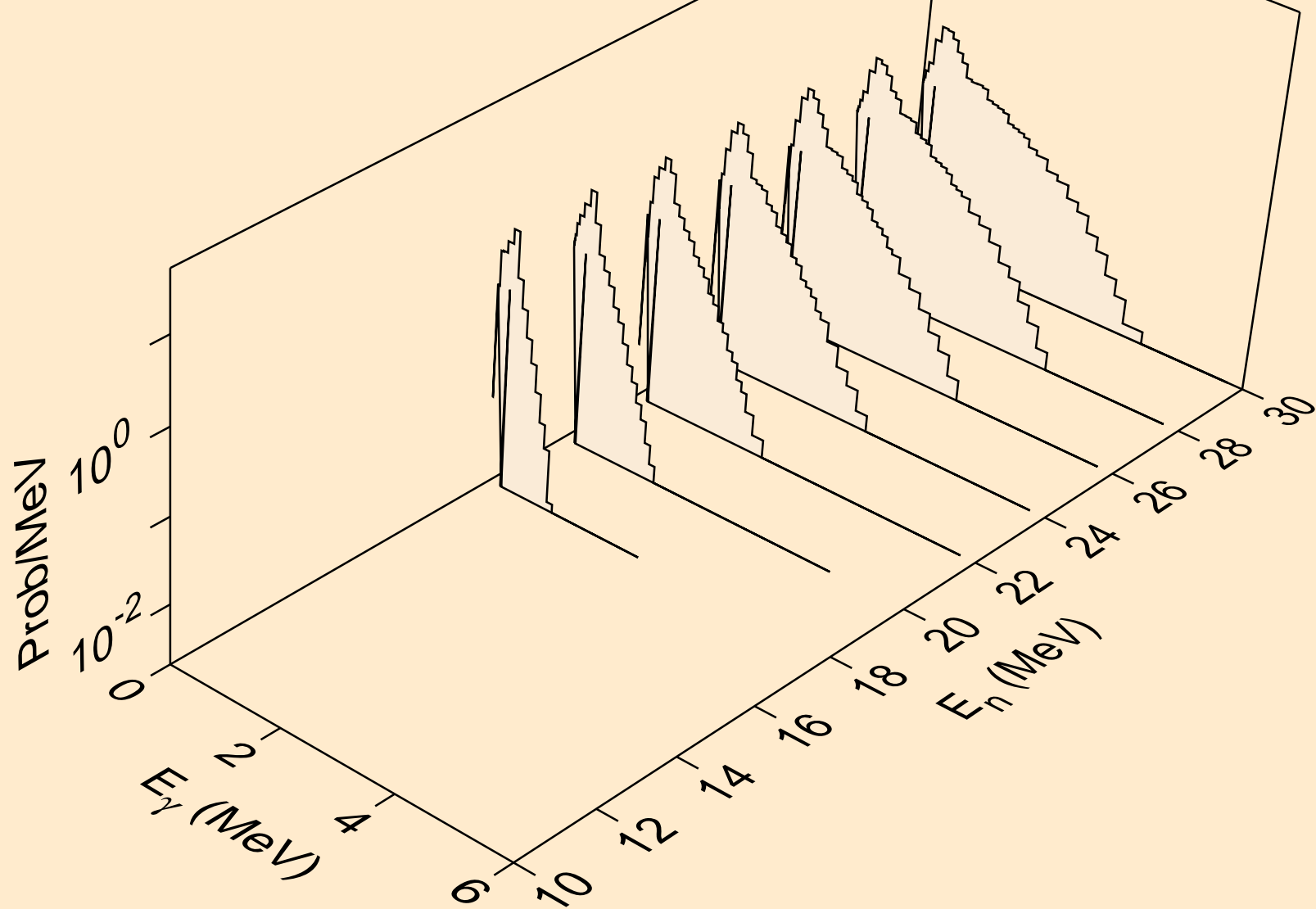



LA124M HELION ACER TENDL-2021 LIBRARY; T=0.K  
Photon emission for (n,n\*)p

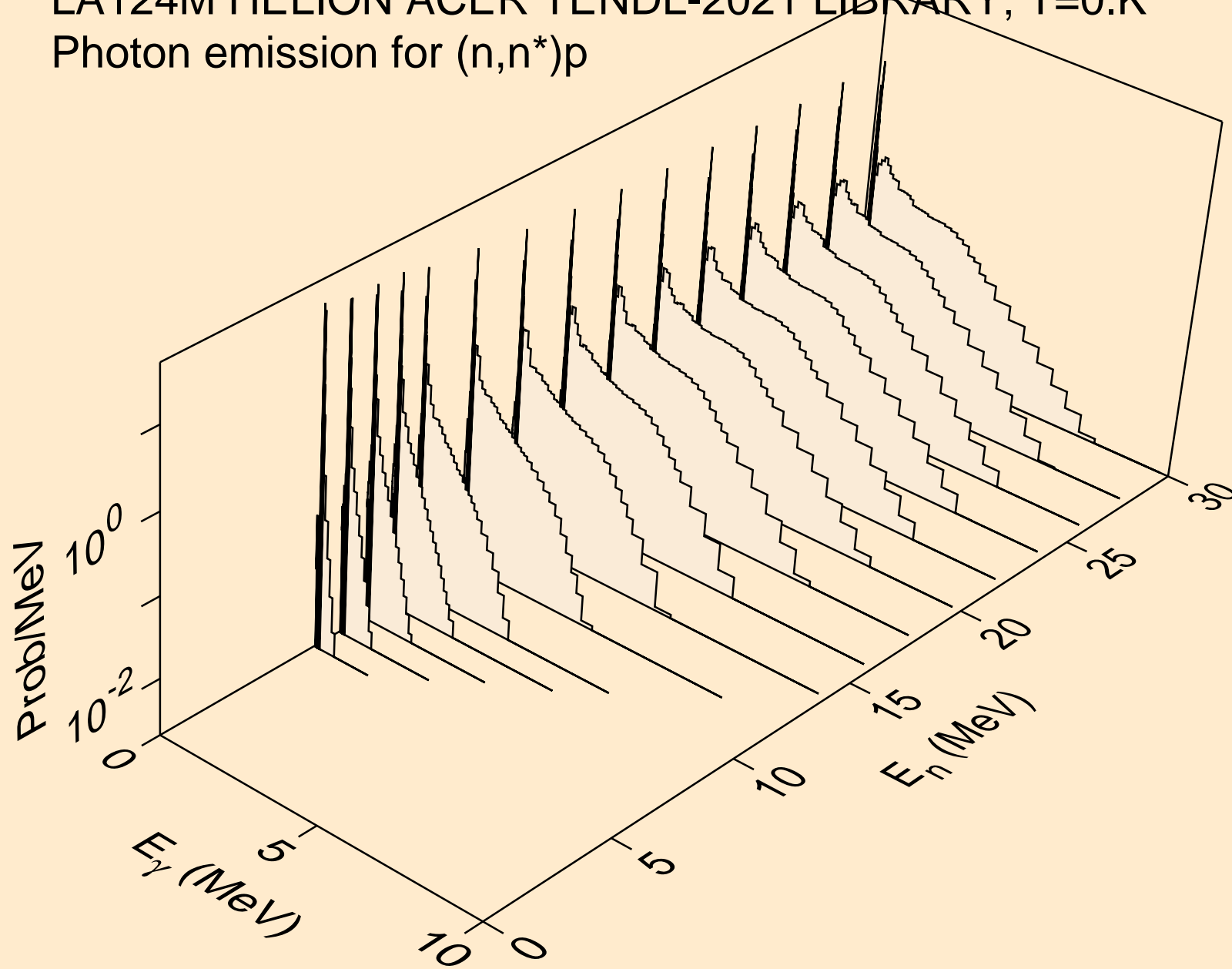

LA124M HELION ACER TENDL-2021 LIBRARY; T=0.K  
Photon emission for (n,n\*)2a

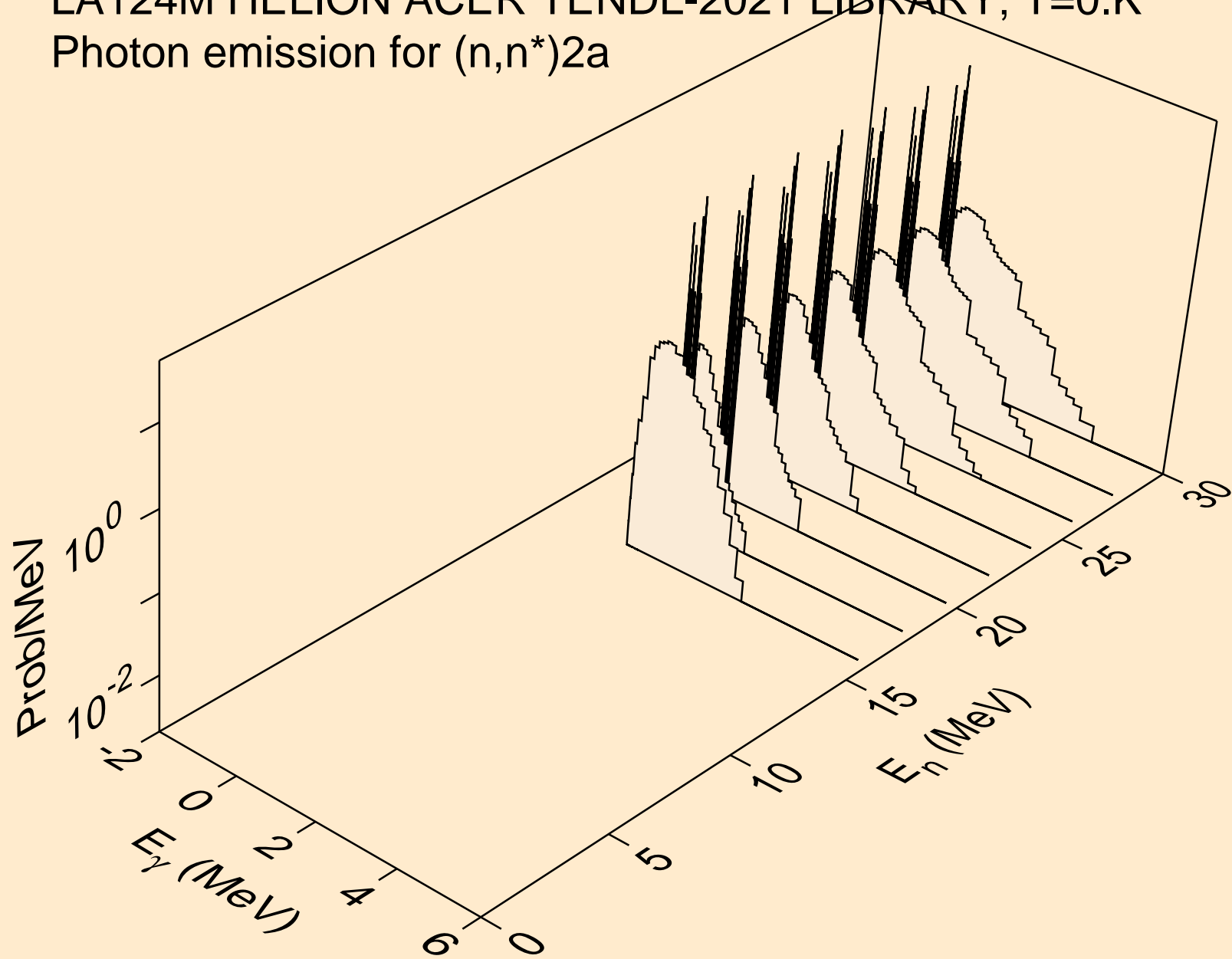

LA124M HELION ACER TENDL-2021 LIBRARY; T=0.K  
Photon emission for (n,n\*)d

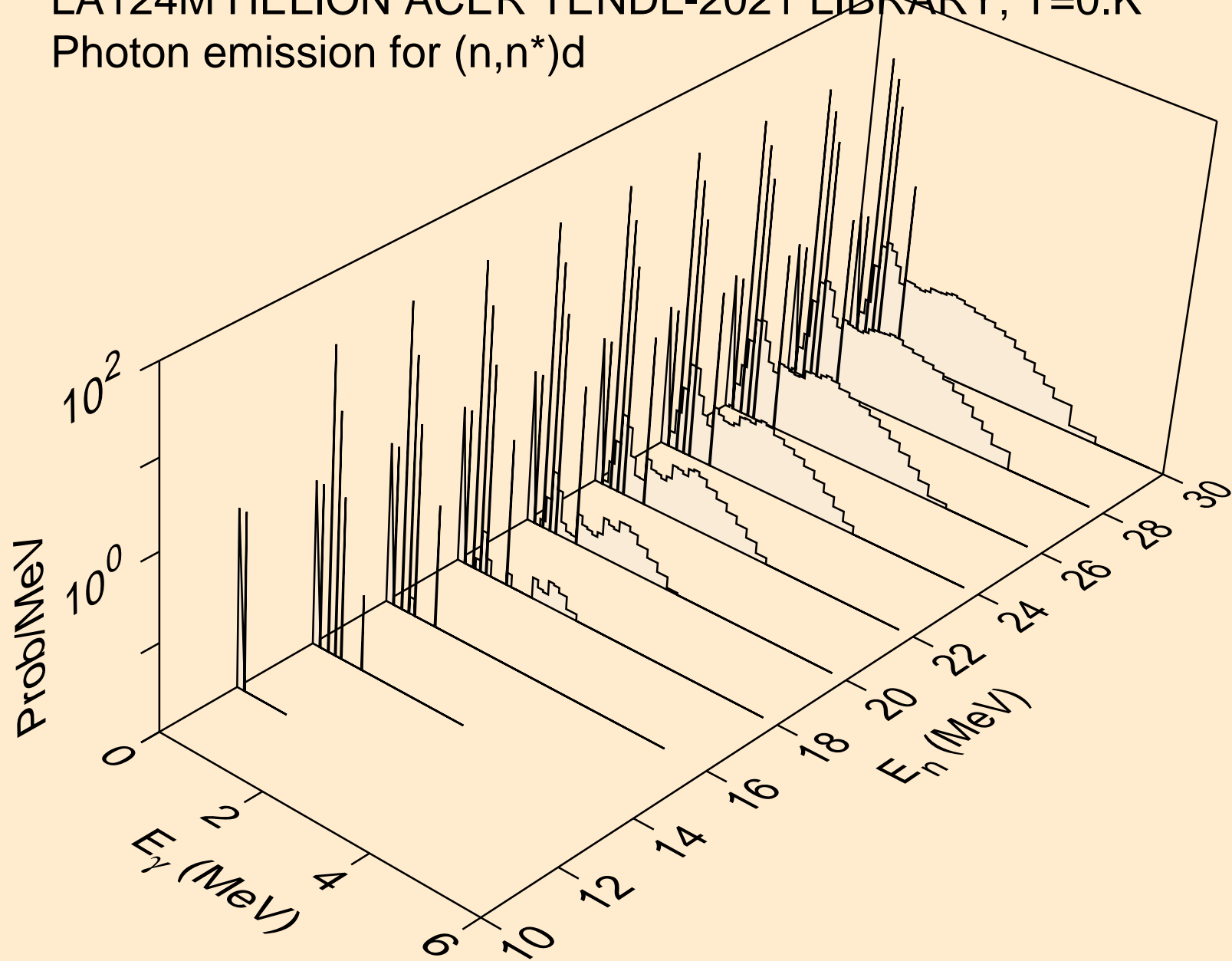

LA124M HELION ACER TENDL-2021 LIBRARY; T=0.K  
Photon emission for (n,n\*)t

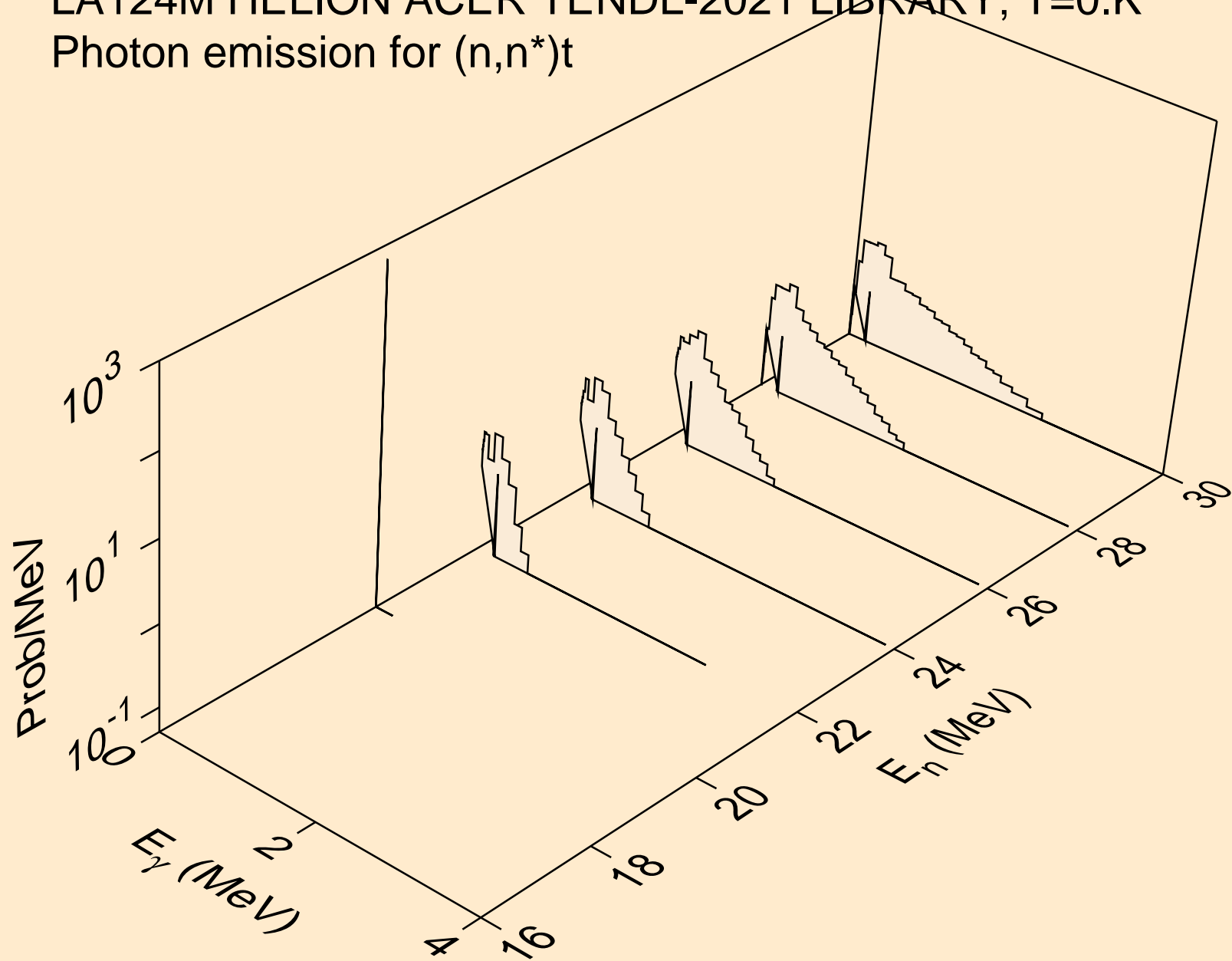

LA124M HELION ACER TENDL-2021 LIBRARY; T=0.K  
Photon emission for (n,n\*)he3

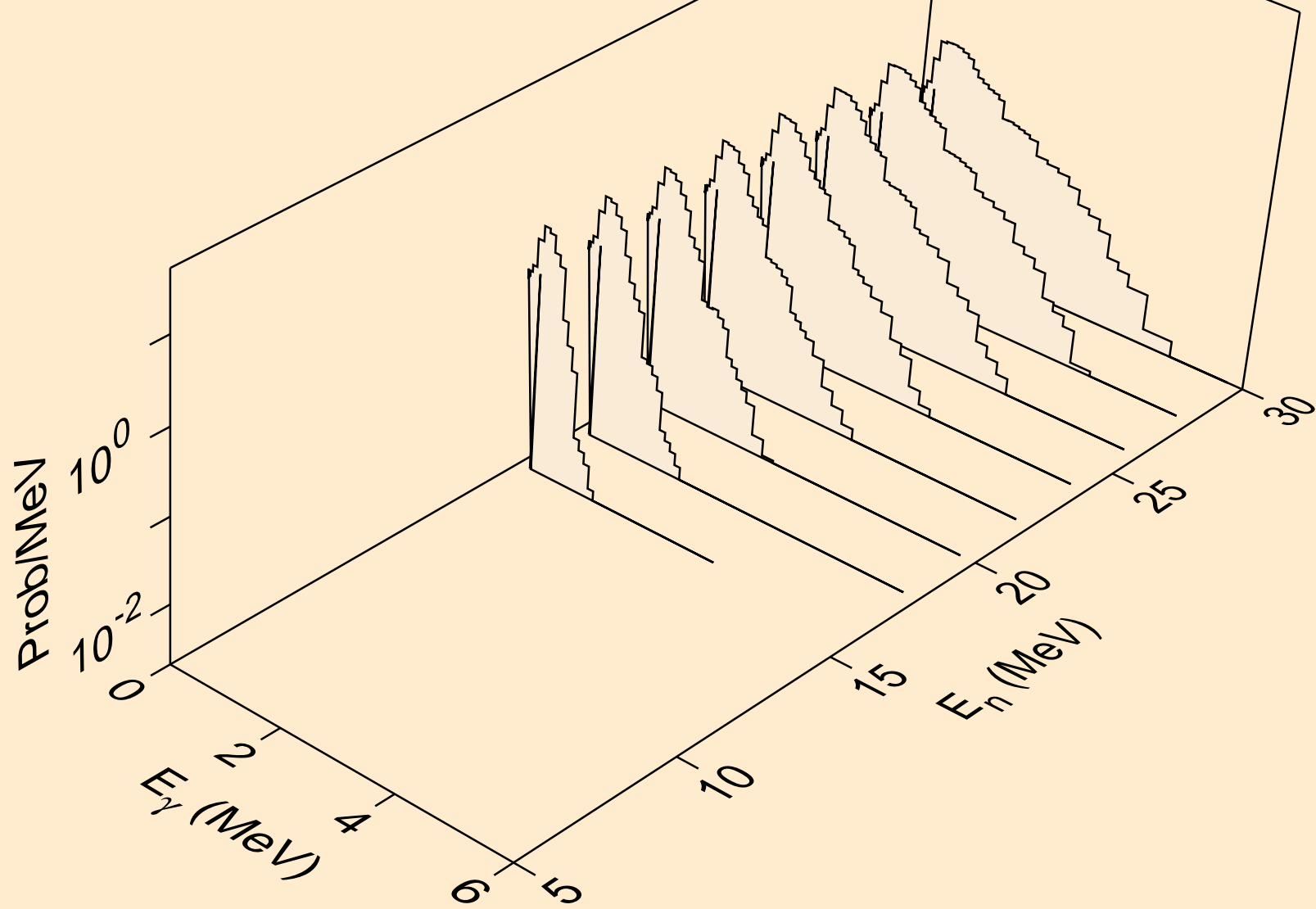

LA124M HELION ACER TENDL-2021 LIBRARY; T=0.K  
Photon emission for (n,2np)

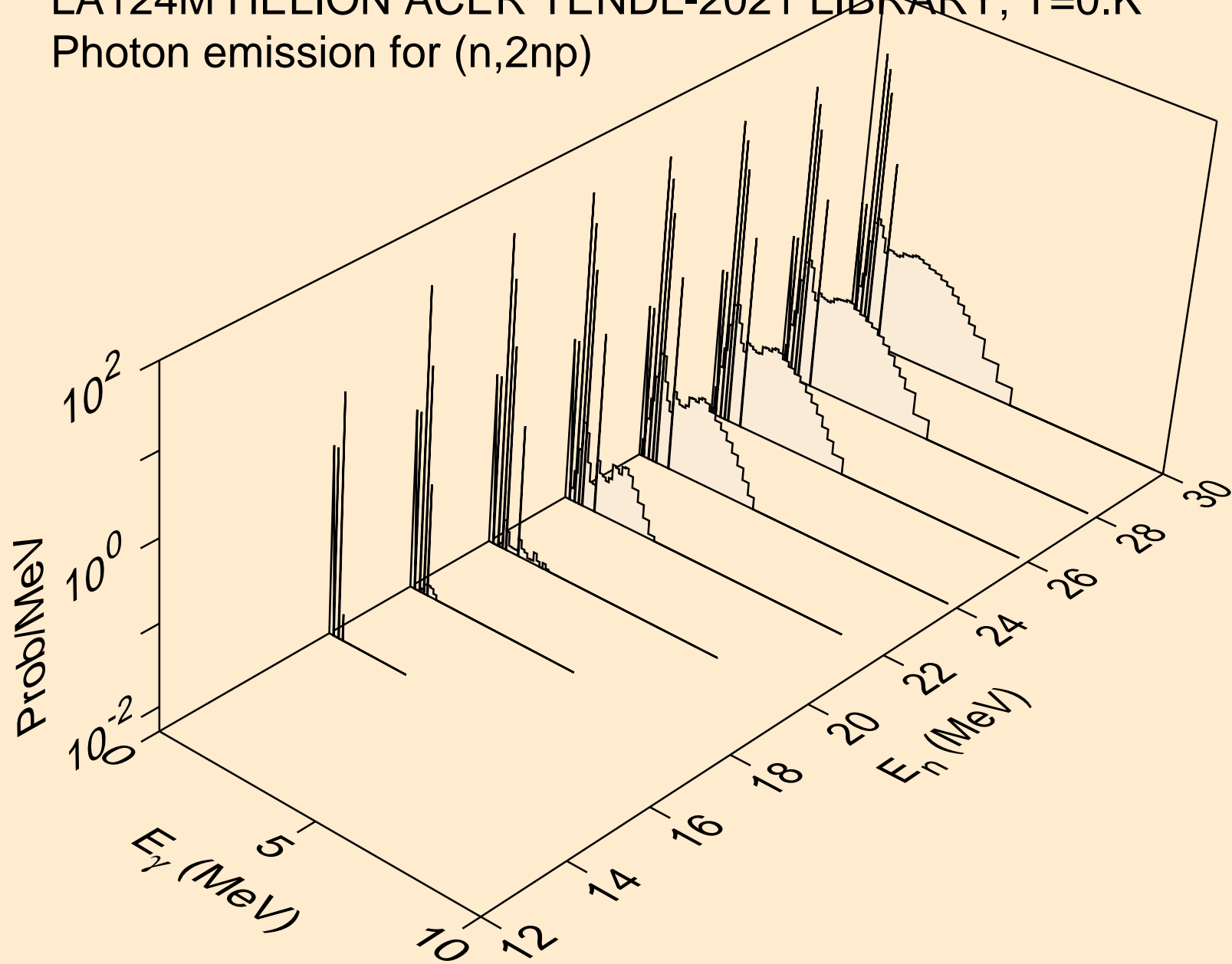

LA124M HELION ACER TENDL-2021 LIBRARY; T=0.K  
Photon emission for (n,2np)

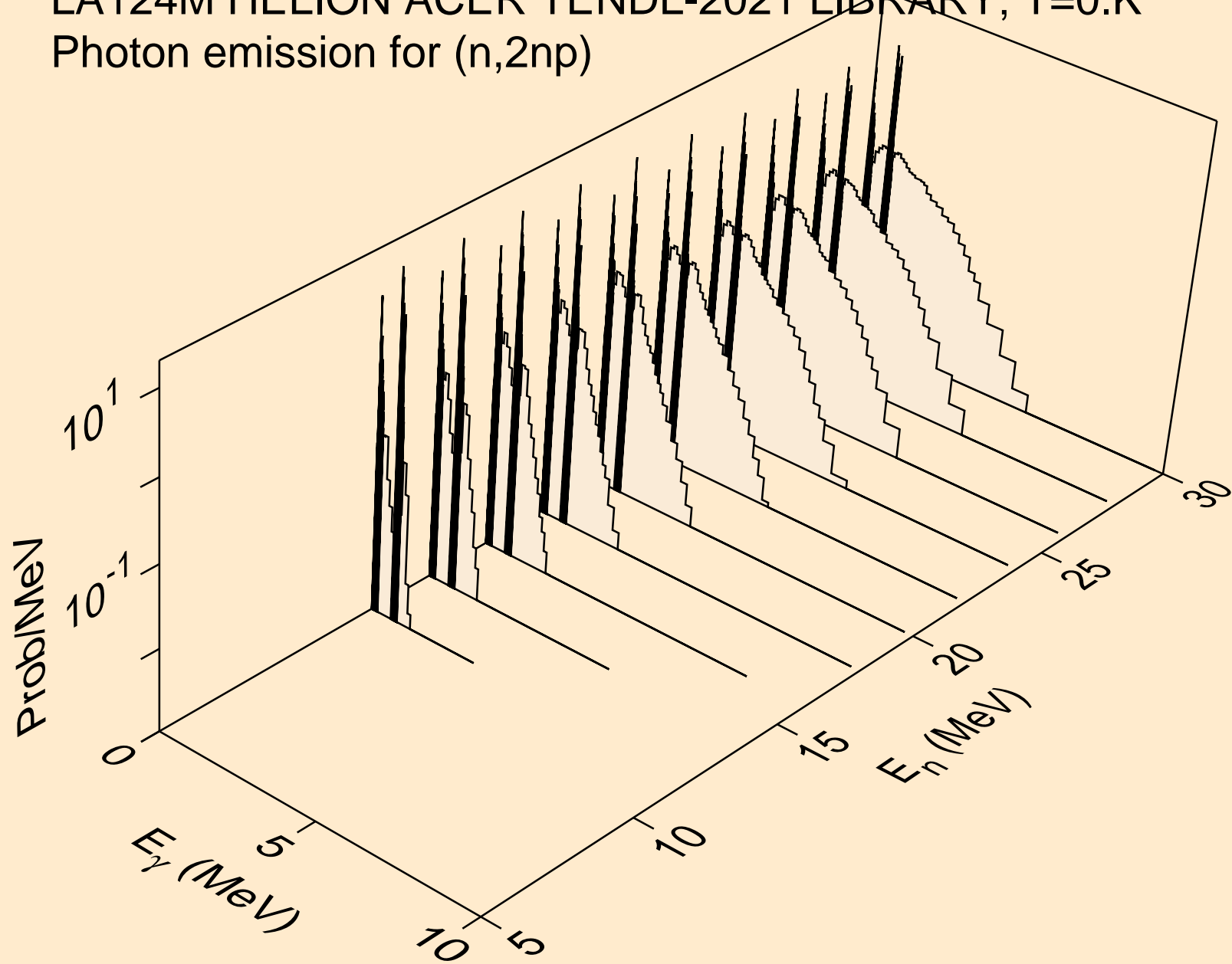

LA124M HELION ACER TENDL-2021 LIBRARY; T=0.K  
Photon emission for (n,npa)

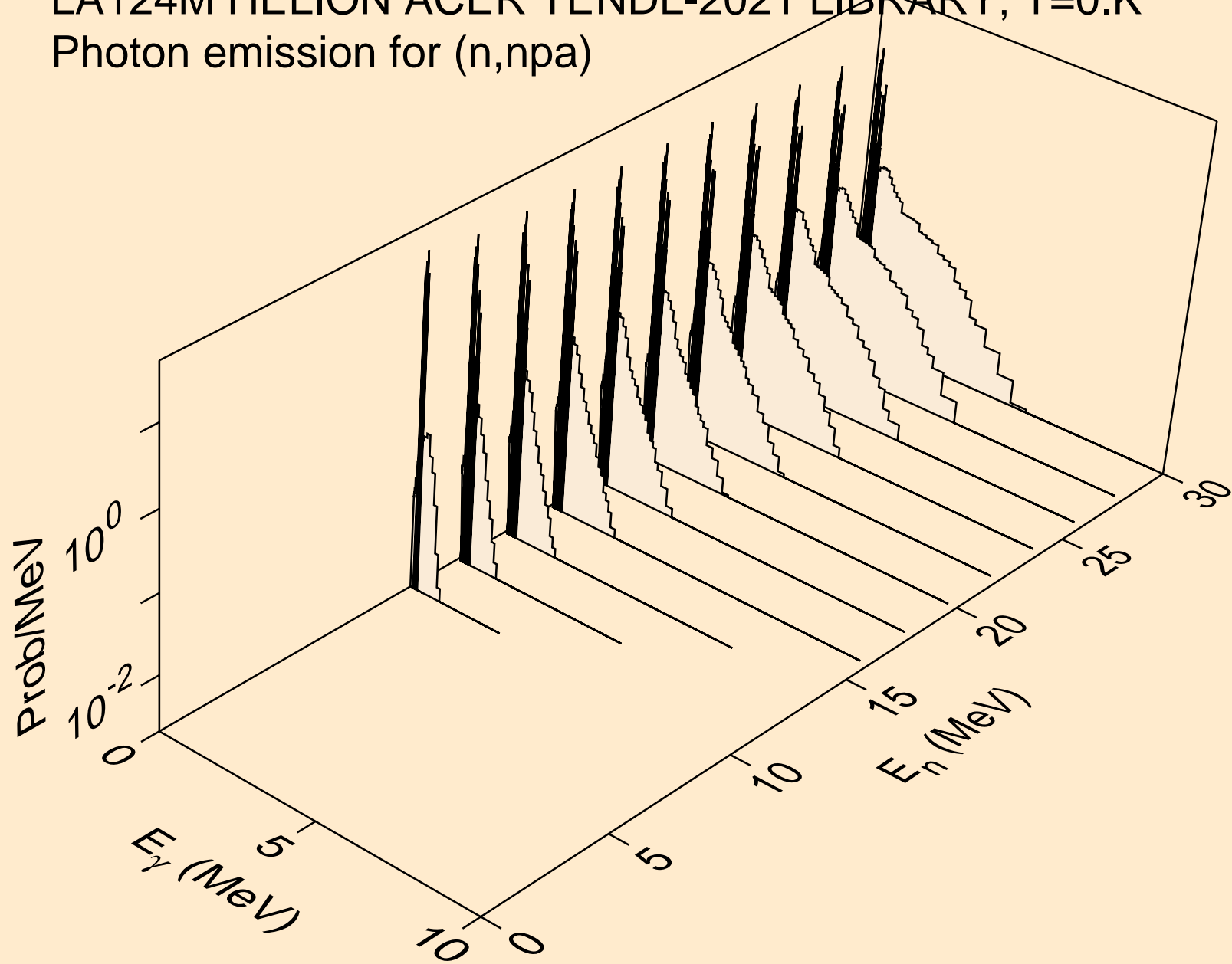



LA124M HELION ACER TENDL-2021 LIBRARY; T=0.K  
Photon emission for (n,gma)

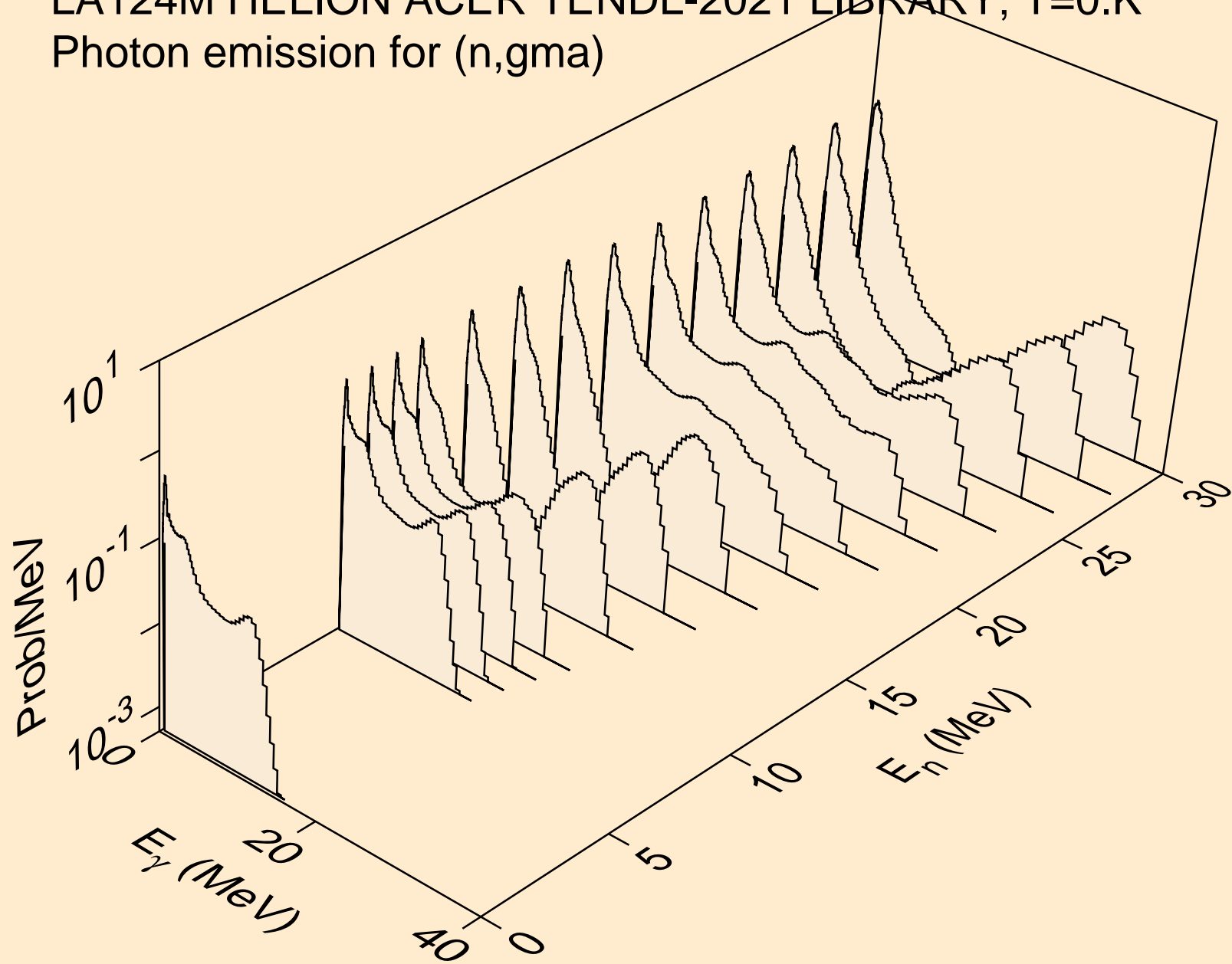

LA124M HELION ACER TENDL-2021 LIBRARY; T=0.K  
Photon emission for (n,p)

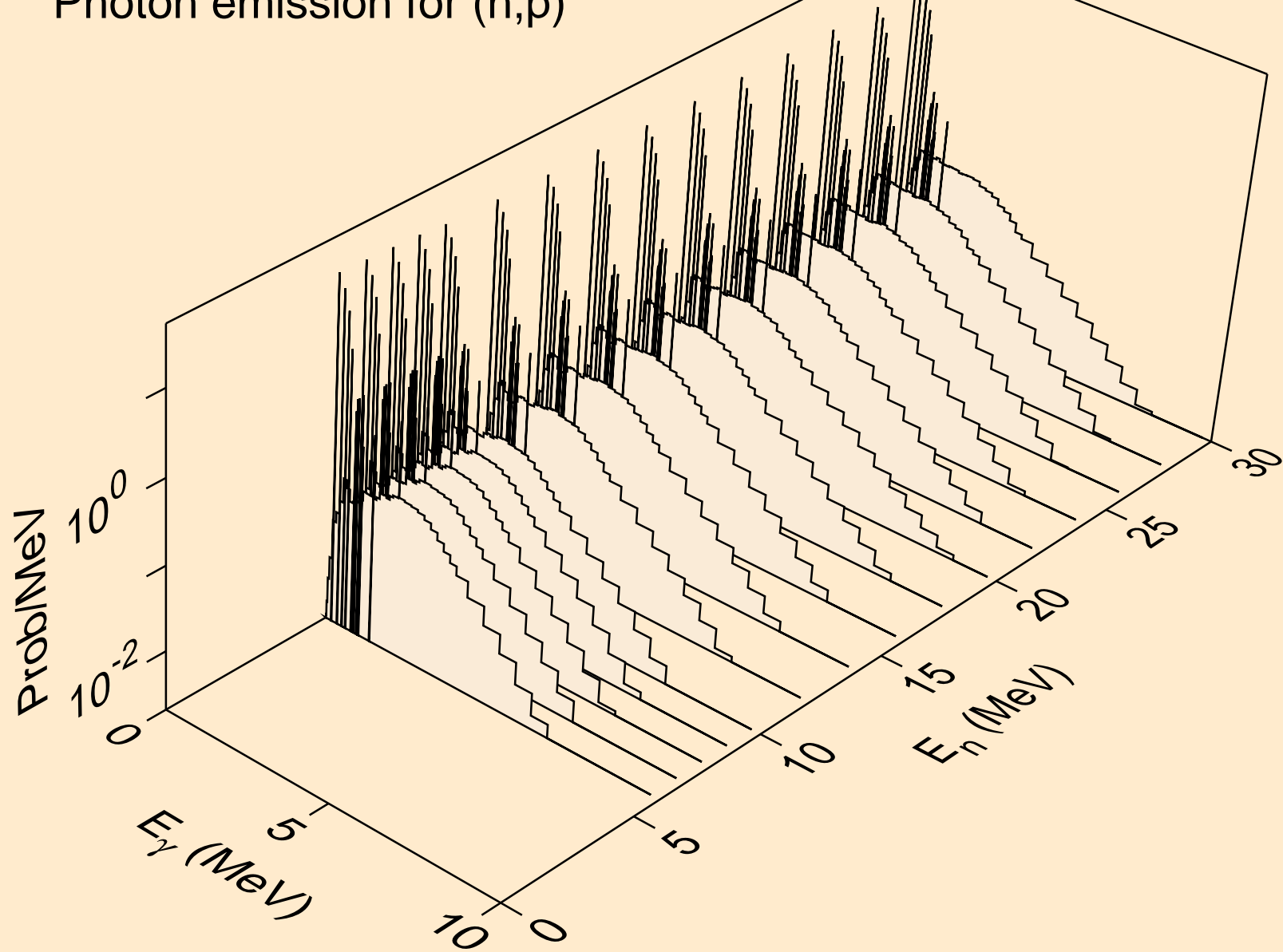

LA124M HELION ACER TENDL-2021 LIBRARY; T=0.K  
Photon emission for (n,d)

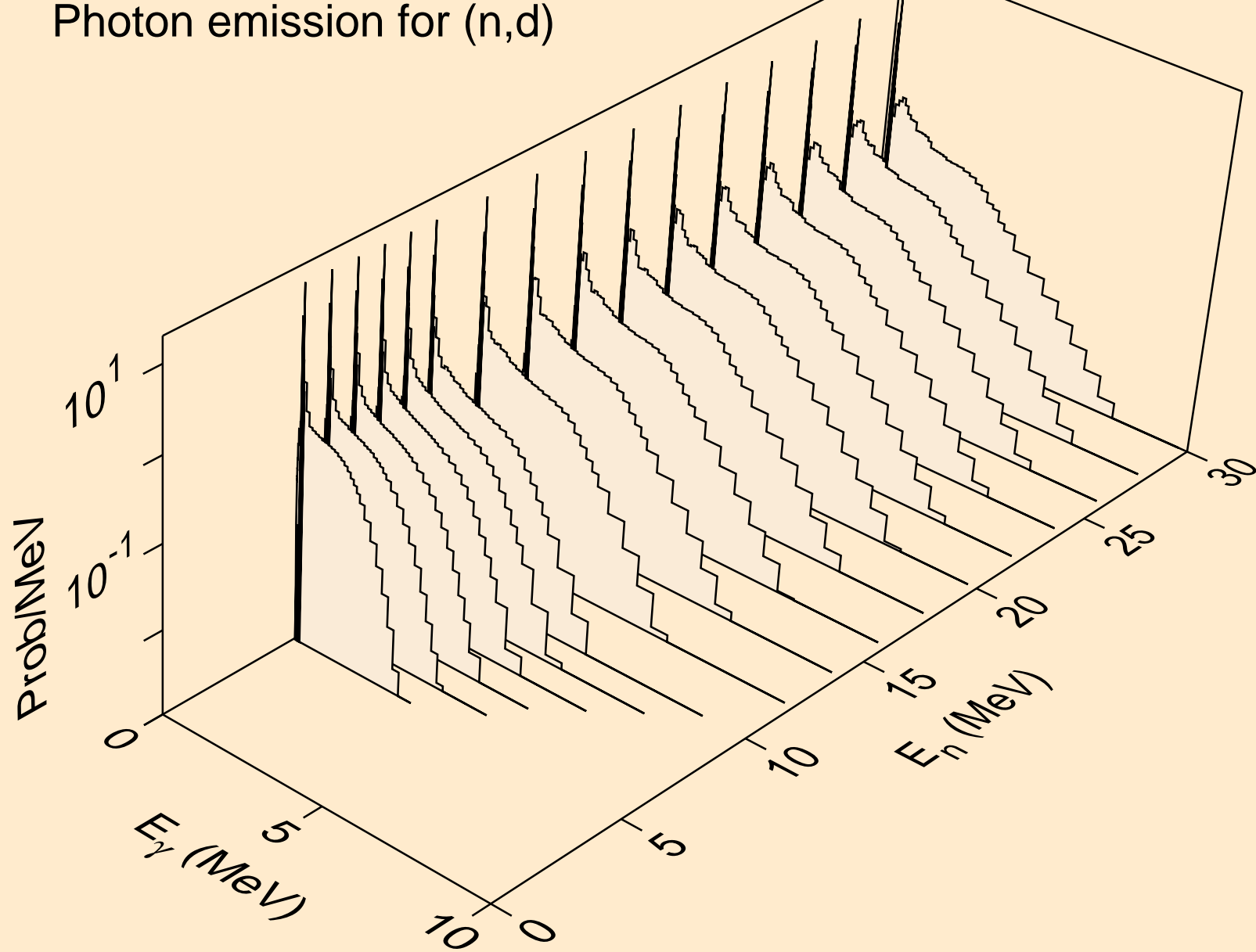

LA124M HELION ACER TENDL-2021 LIBRARY; T=0.K  
Photon emission for (n,t)

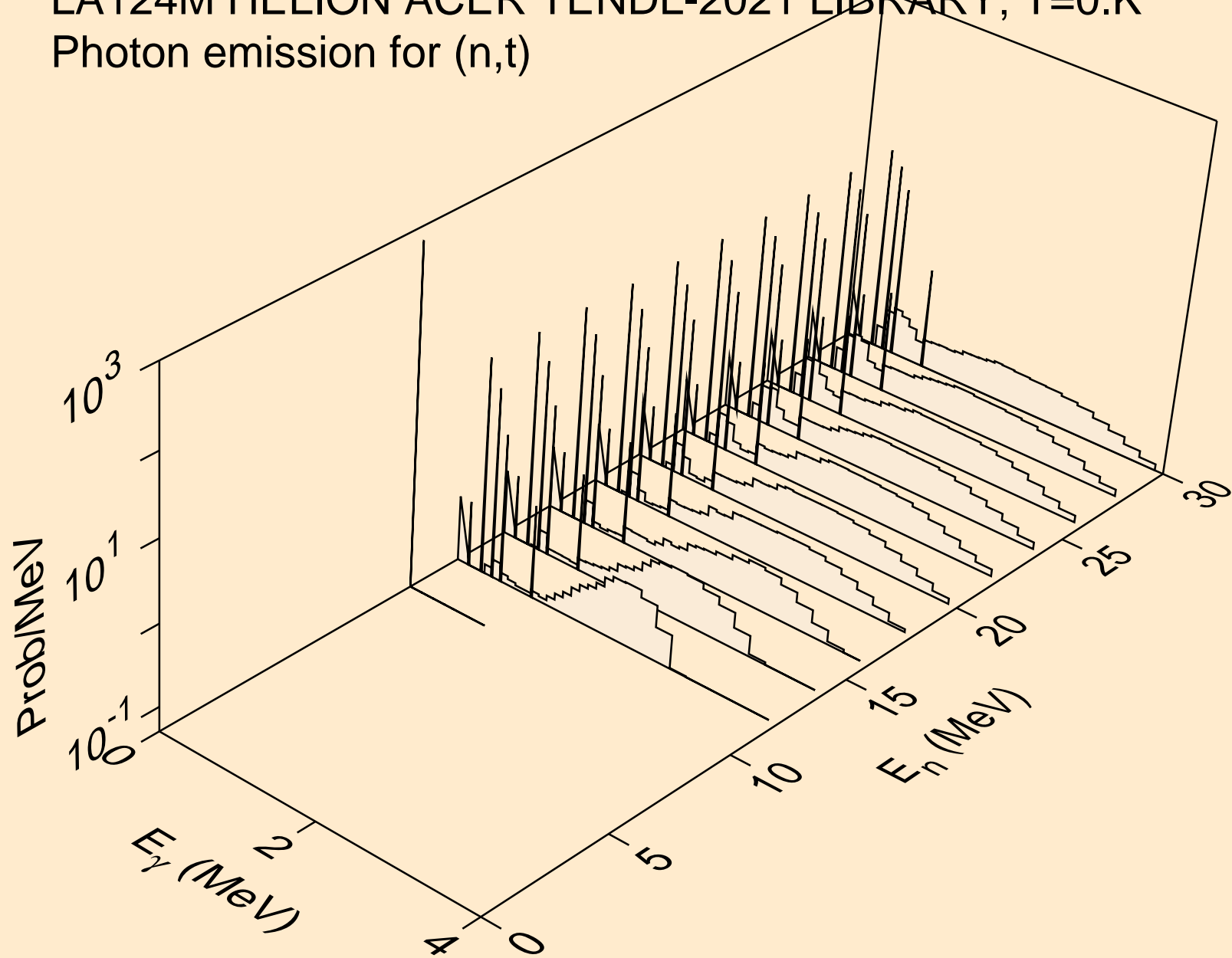

LA124M HELION ACER TENDL-2021 LIBRARY; T=0.K  
Photon emission for inelastic

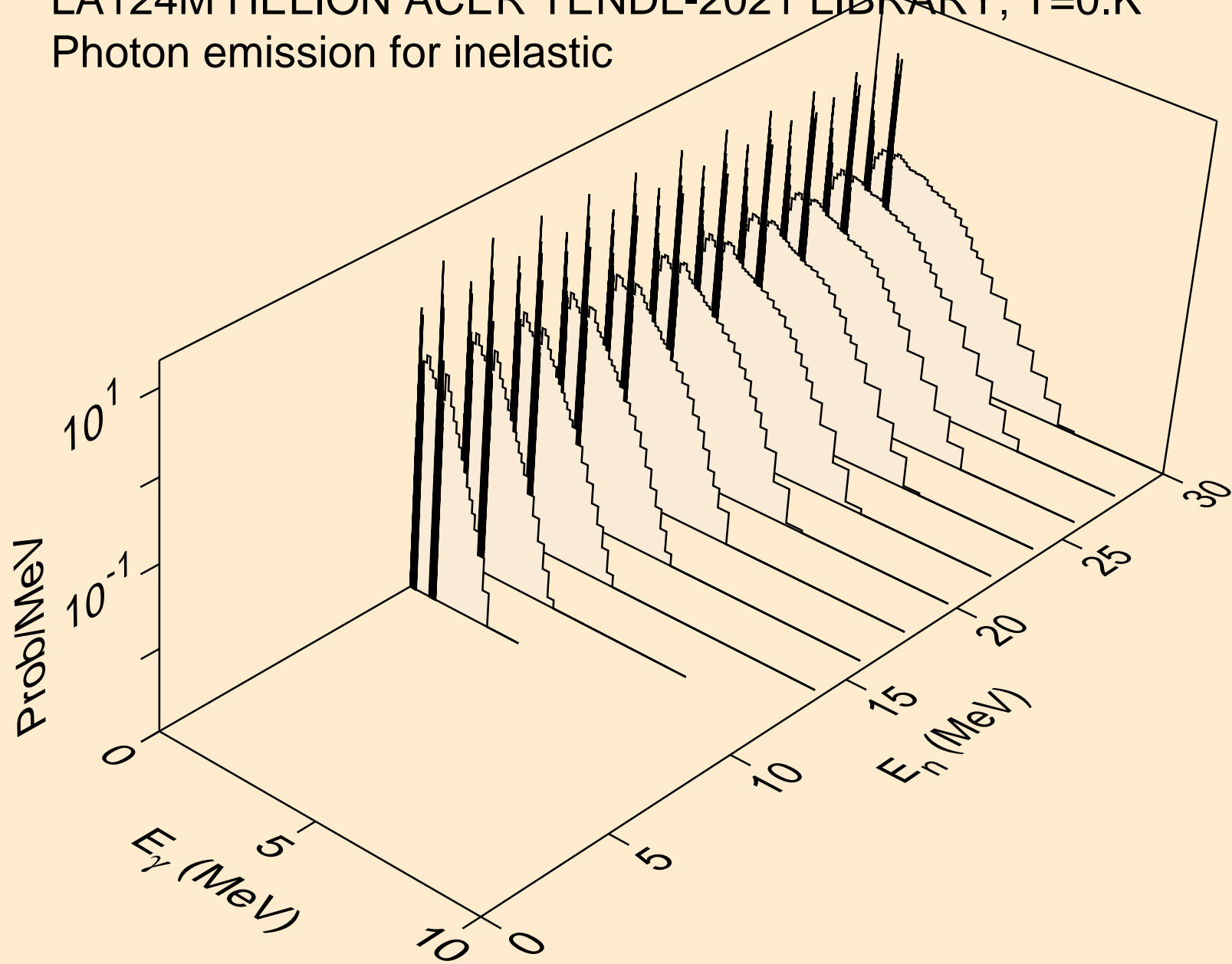

LA124M HELION ACER TENDL-2021 LIBRARY; T=0.K  
Photon emission for (n,a)

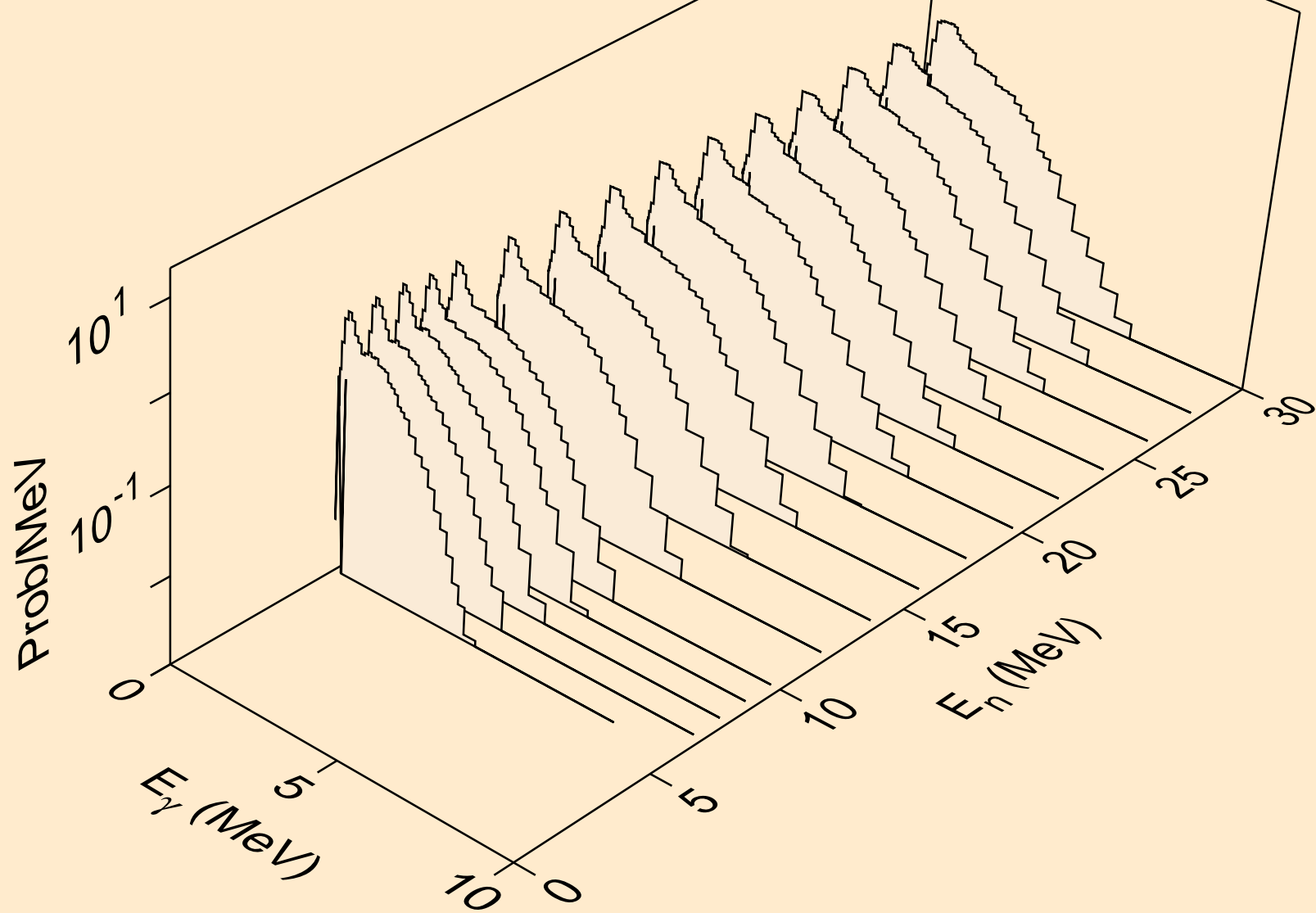

LA124M HELION ACER TENDL-2021 LIBRARY; T=0.K  
Photon emission for (n,2a)

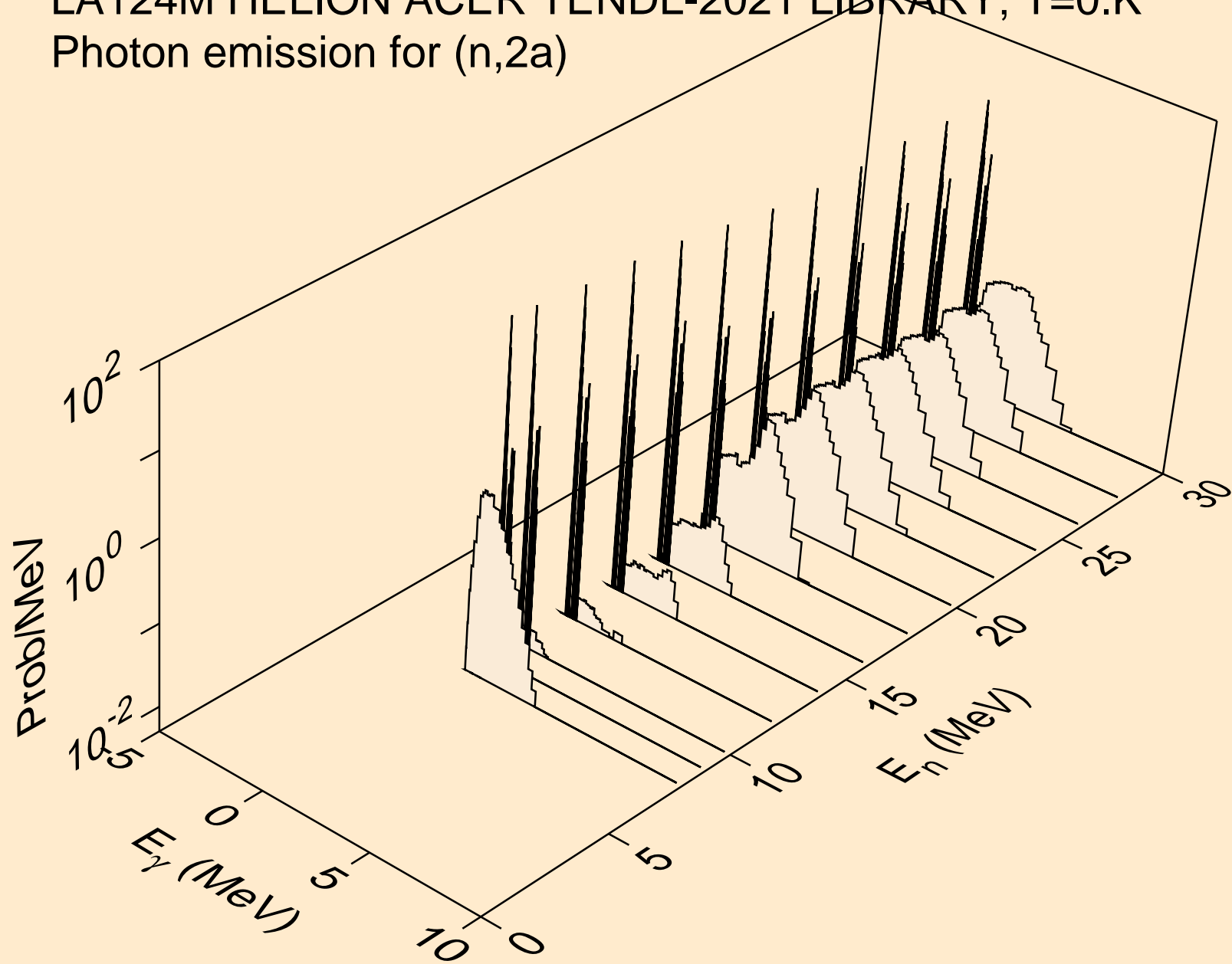

LA124M HELION ACER TENDL-2021 LIBRARY; T=0.K  
Photon emission for (n,3a)

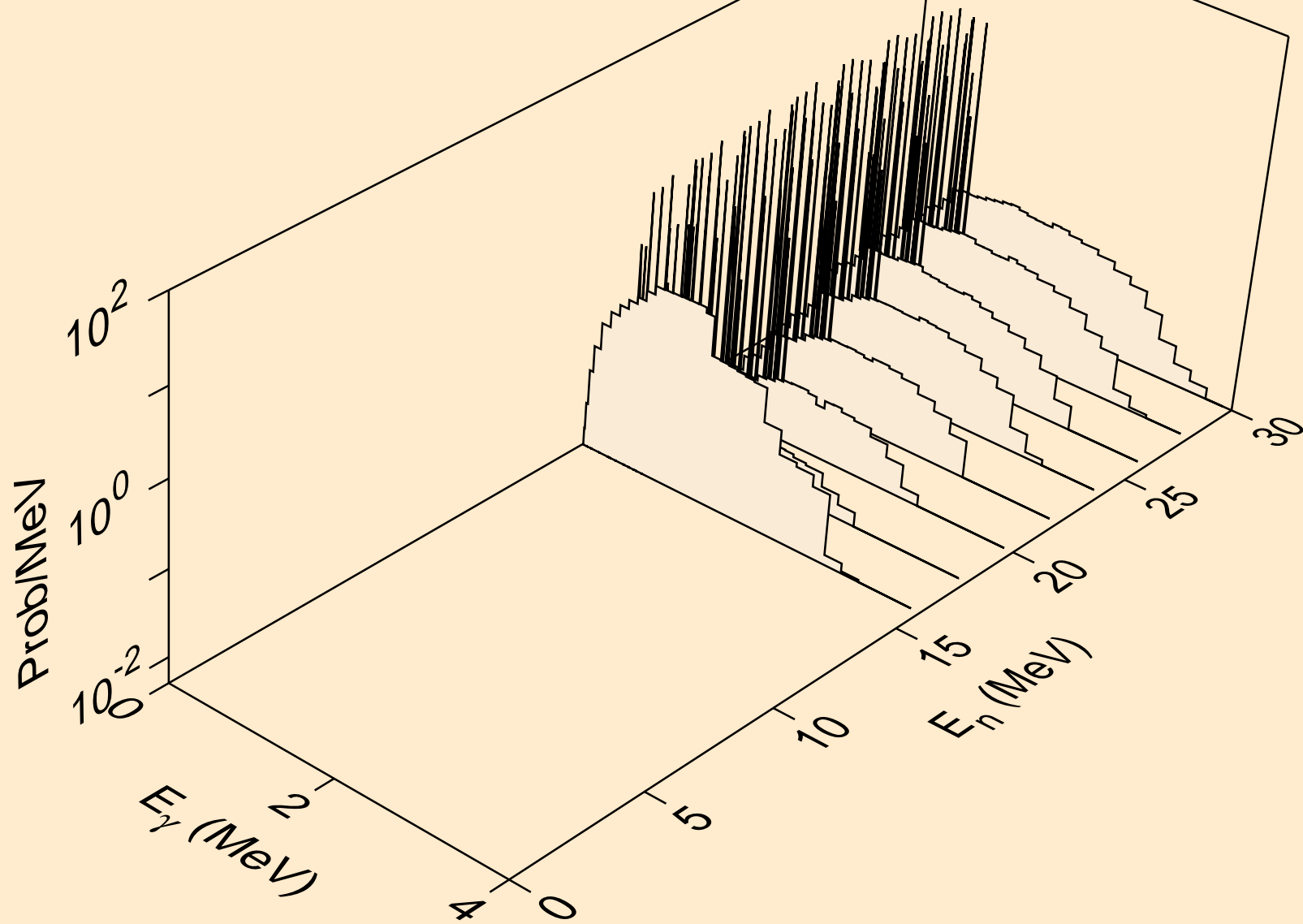



LA124M HELION ACER TENDL-2021 LIBRARY; T=0.K  
Photon emission for (n,2p)

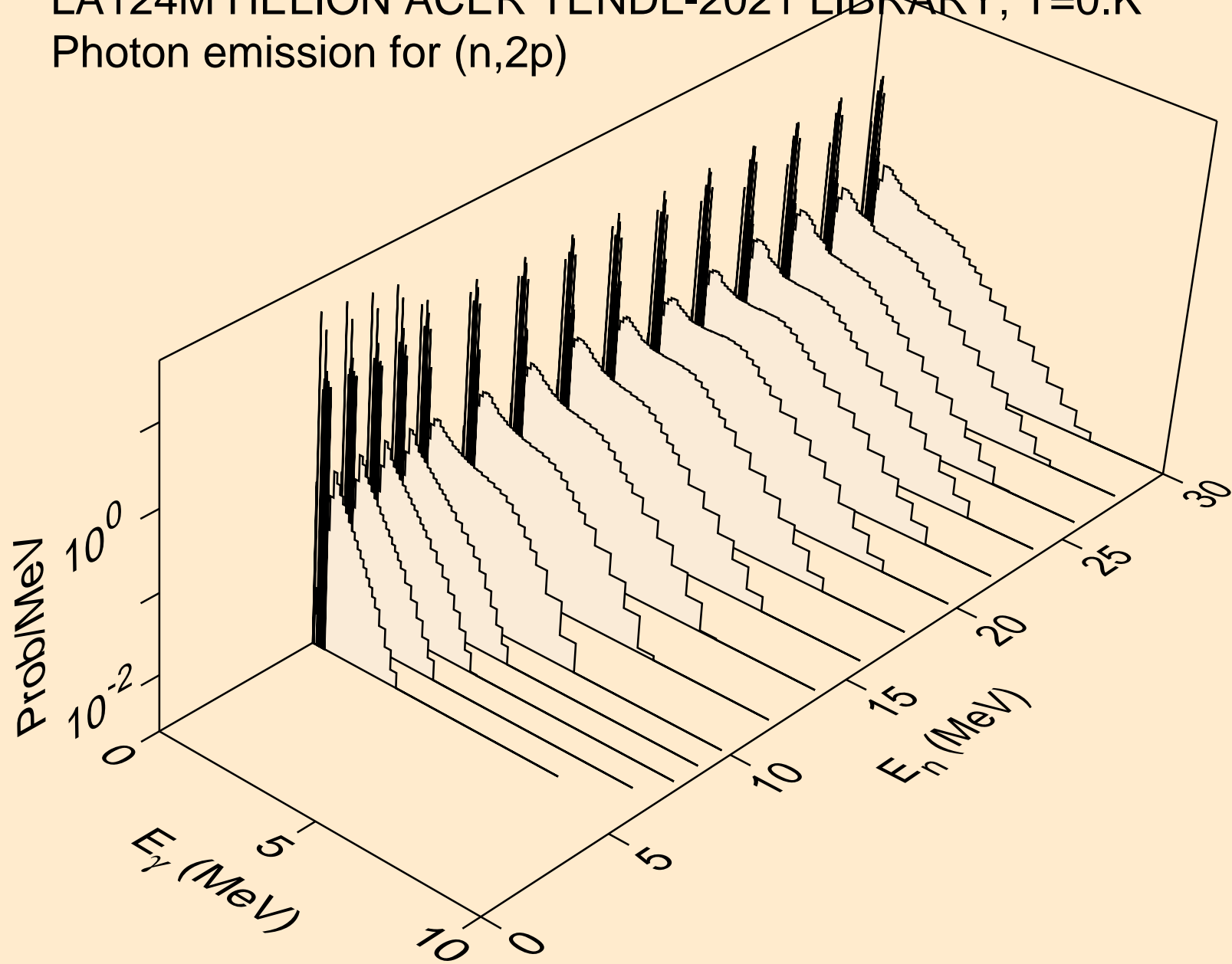

LA124M HELION ACER TENDL-2021 LIBRARY; T=0.K  
Photon emission for (n,pa)

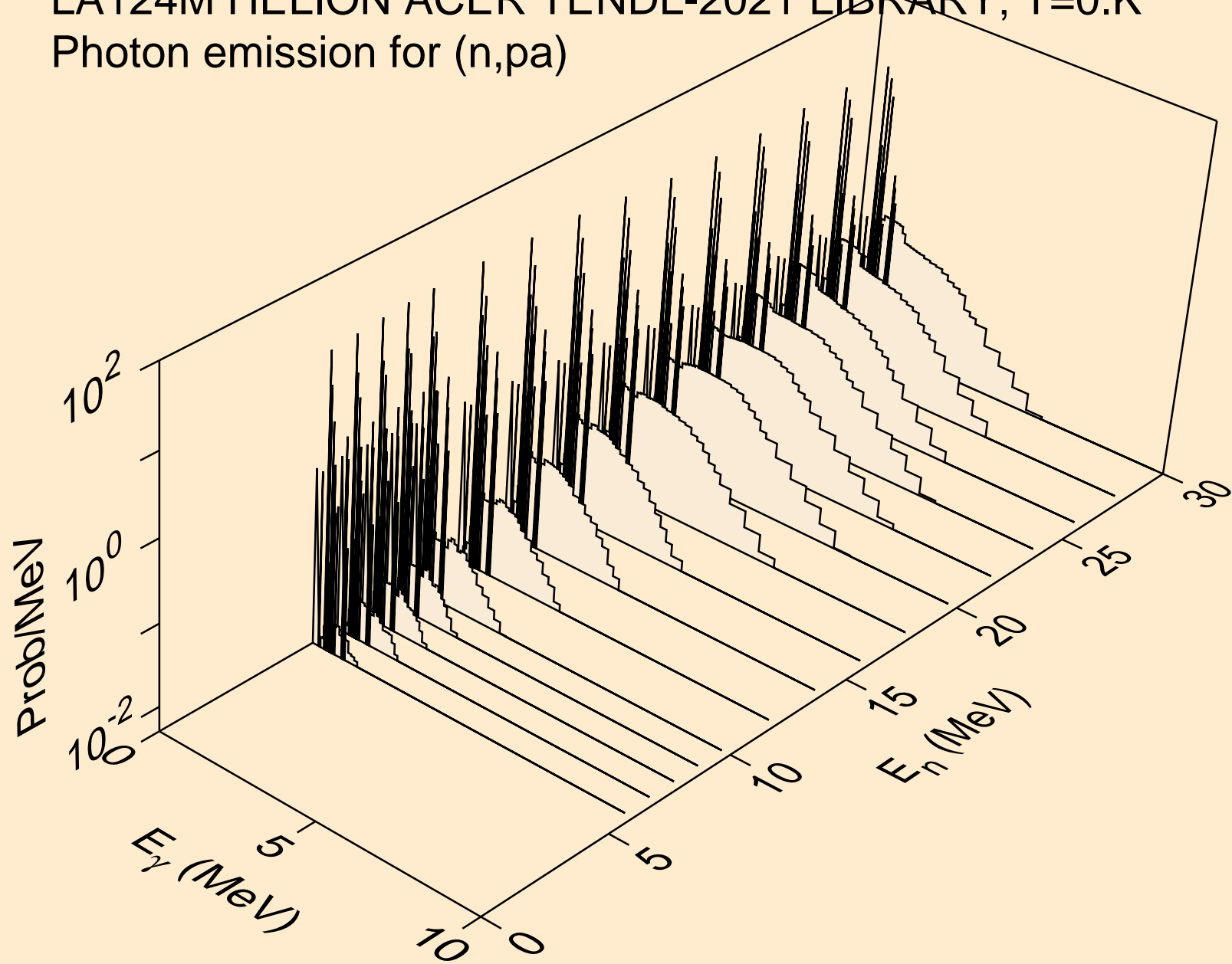

LA124M HELION ACER TENDL-2021 LIBRARY; T=0.K  
Photon emission for (n,d2a)

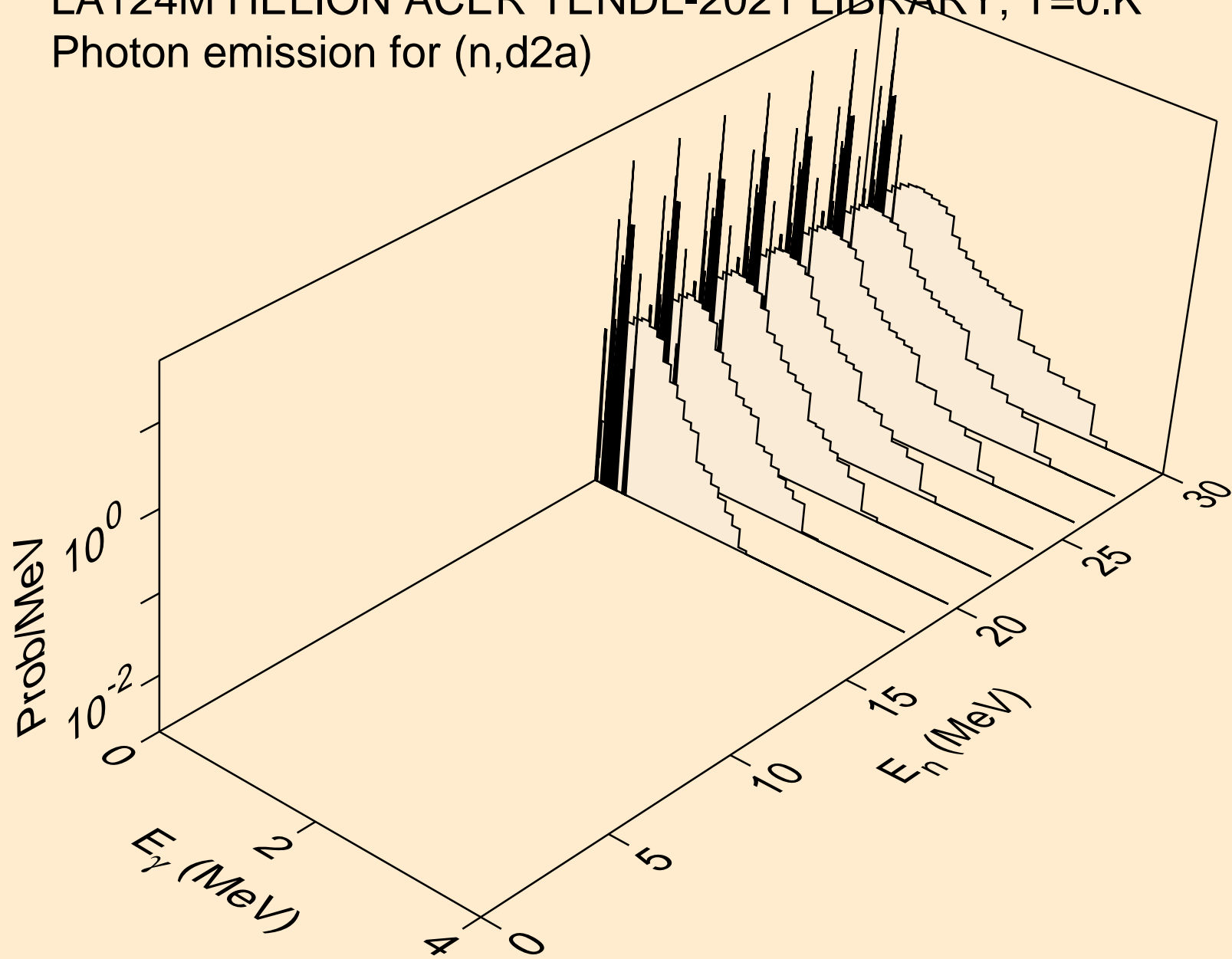

LA124M HELION ACER TENDL-2021 LIBRARY; T=0.K  
Photon emission for (n,pd)

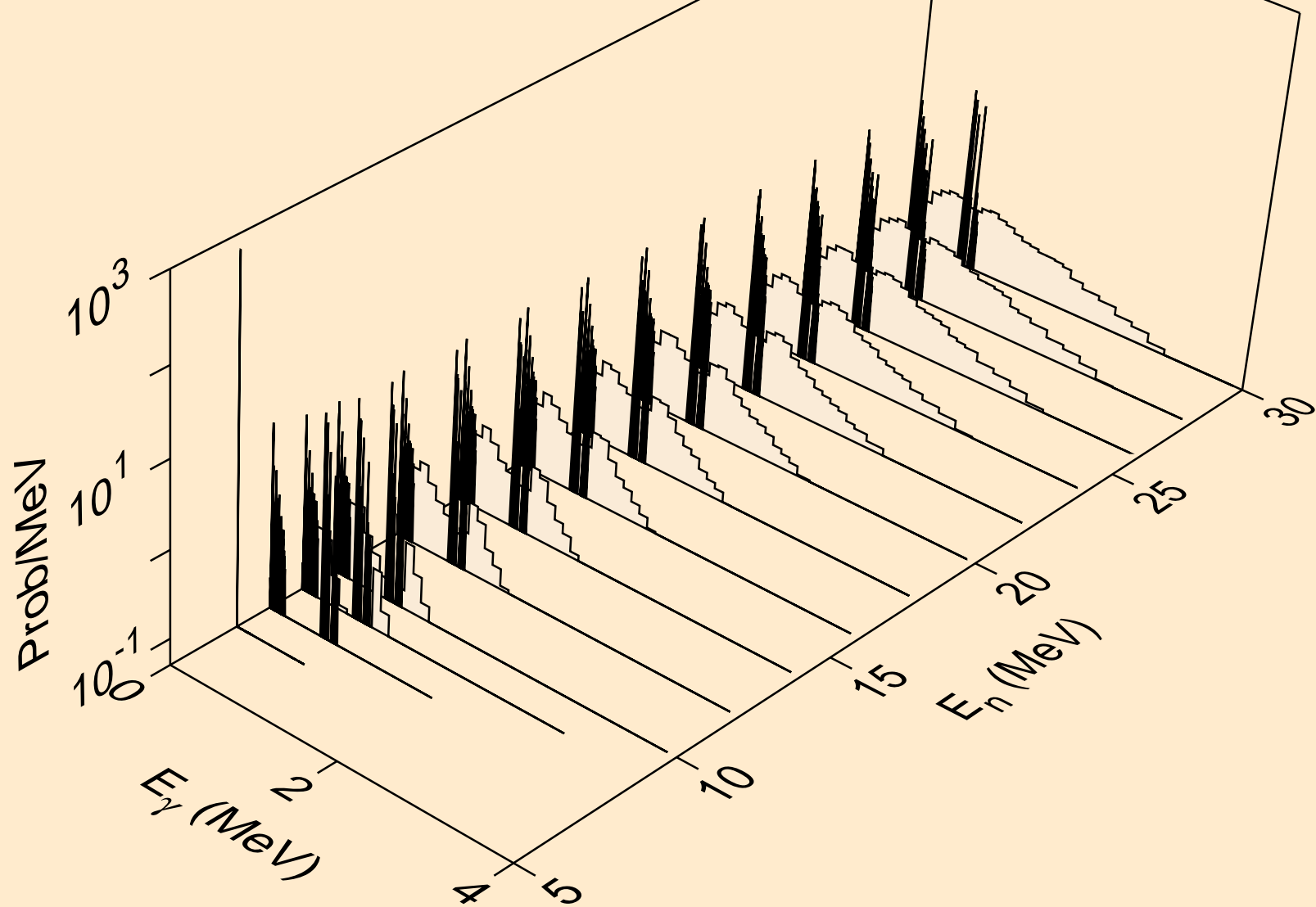

LA124M HELION ACER TENDL-2021 LIBRARY; T=0.K  
Photon emission for (n,pt)

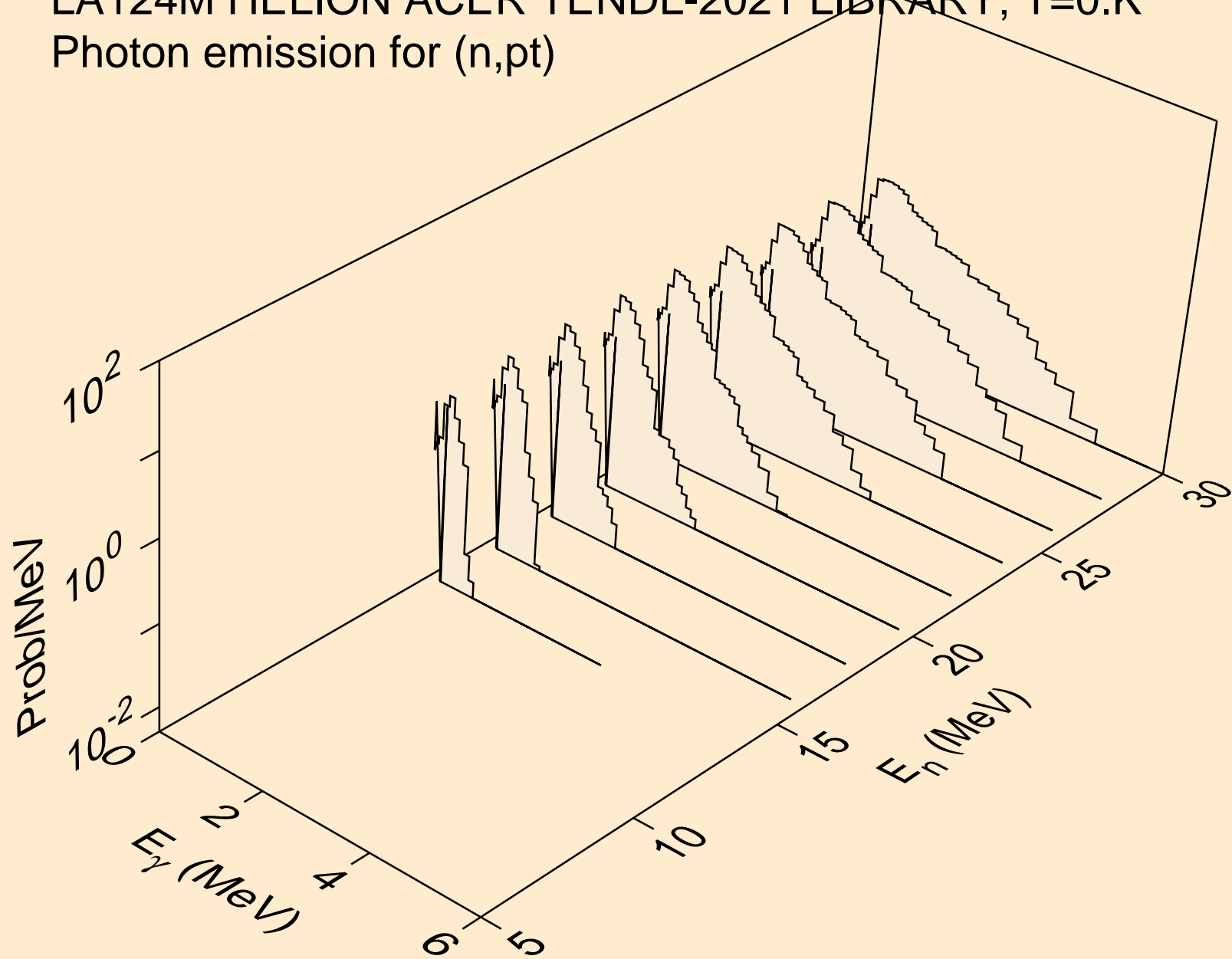

LA124M HELION ACER TENDL-2021 LIBRARY; T=0.K  
Photon emission for (n,da)

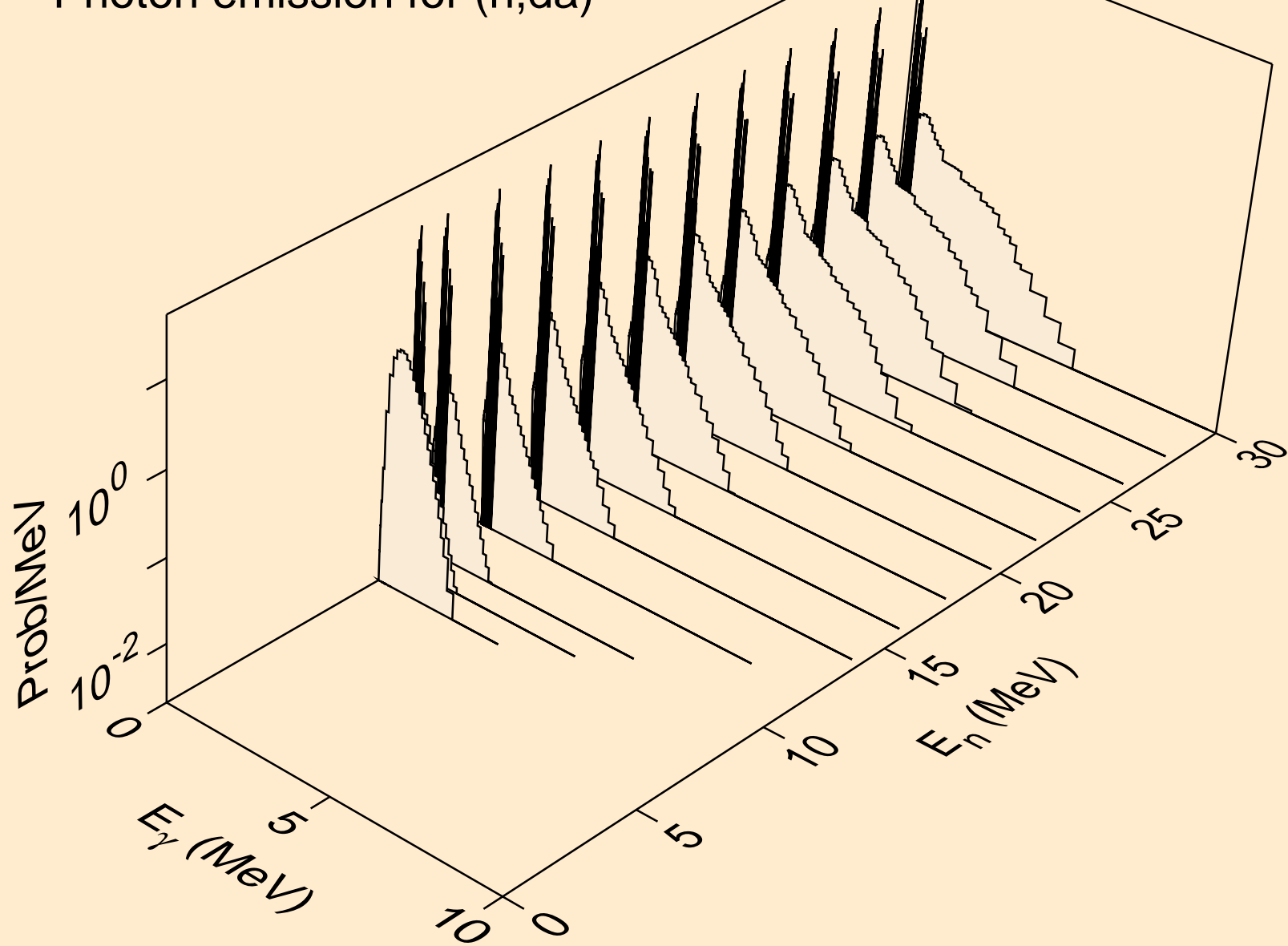

LA124M HELION ACER TENDL-2021 LIBRARY; T=0.K  
Particle heating contributions

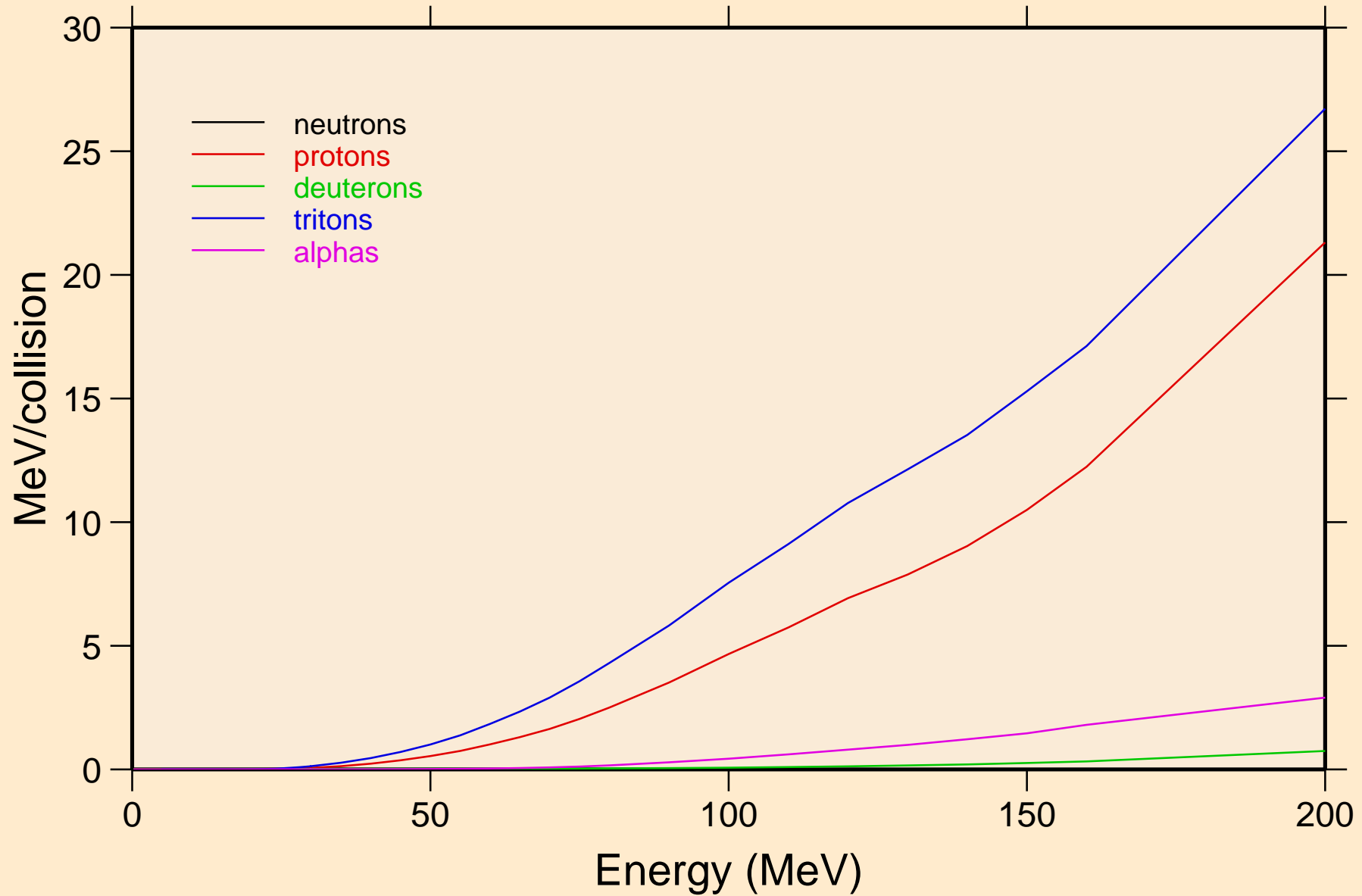

LA124M HELION ACER TENDL-2021 LIBRARY; T=0.K  
Recoil Heating

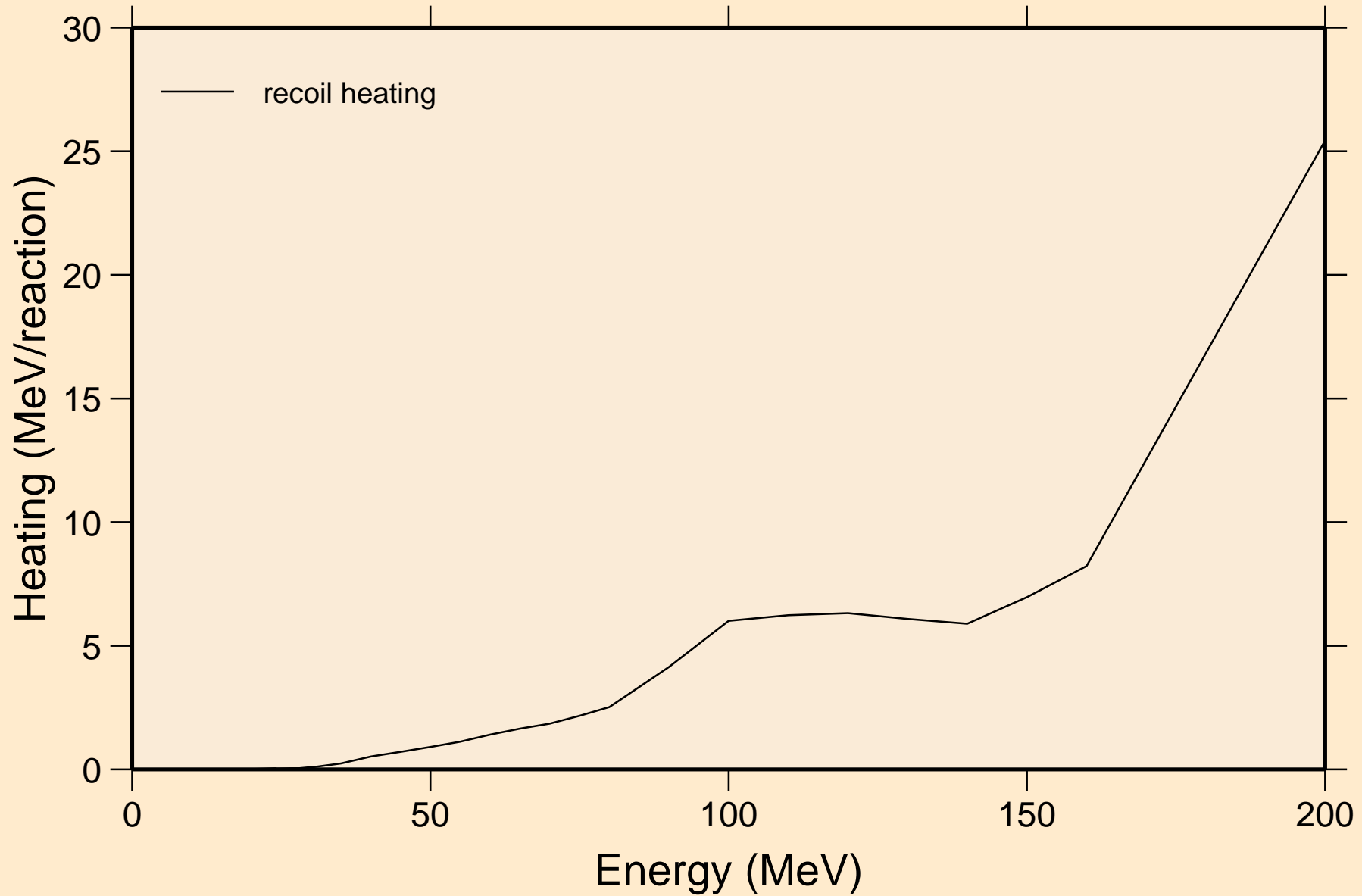



LA124M HELION ACER TENDL-2021 LIBRARY; T=0.K  
Particle production cross sections

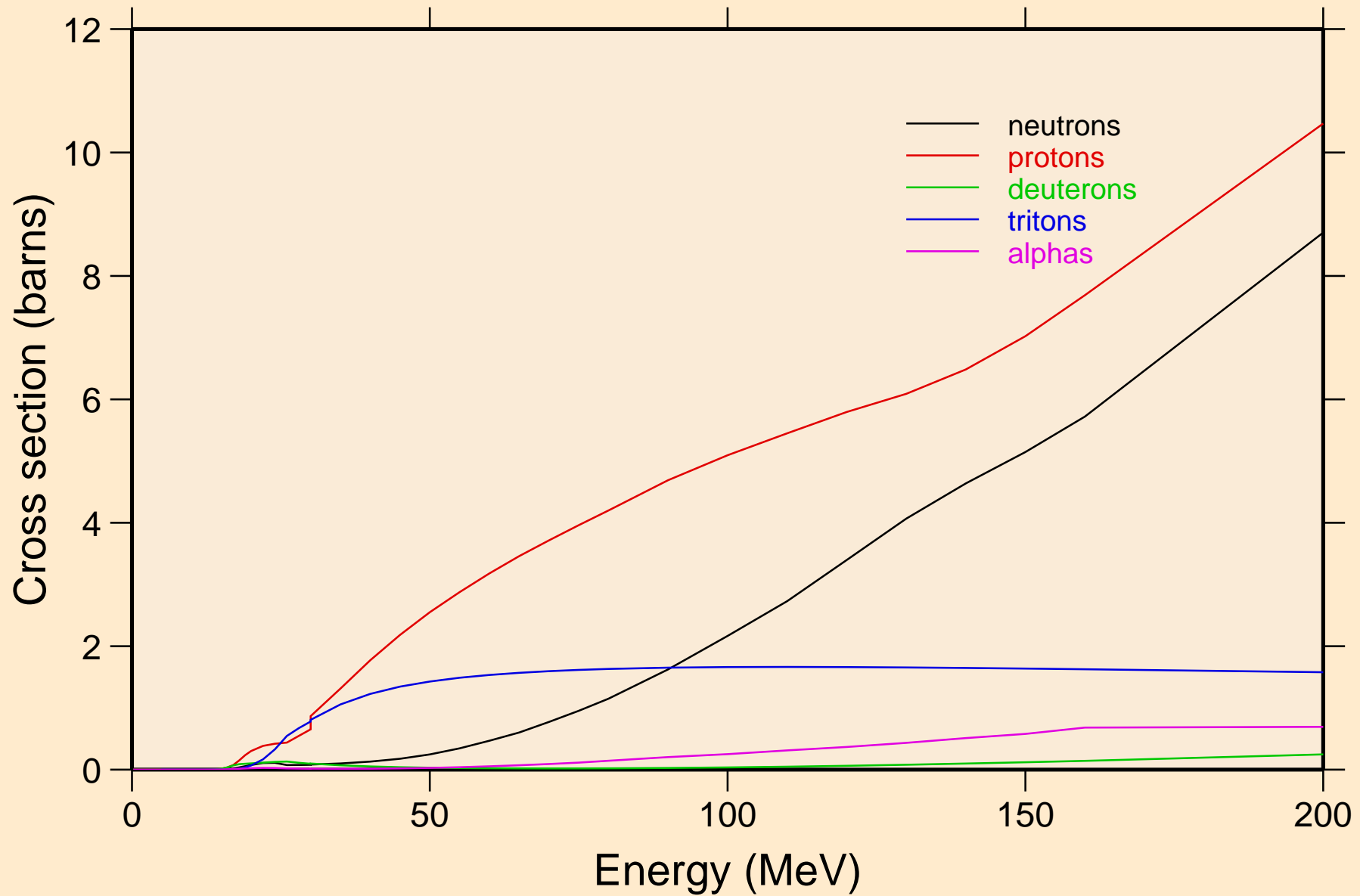

LA124M HELION ACER TENDL-2021 LIBRARY; T=0.K  
neutrons from (s,n)

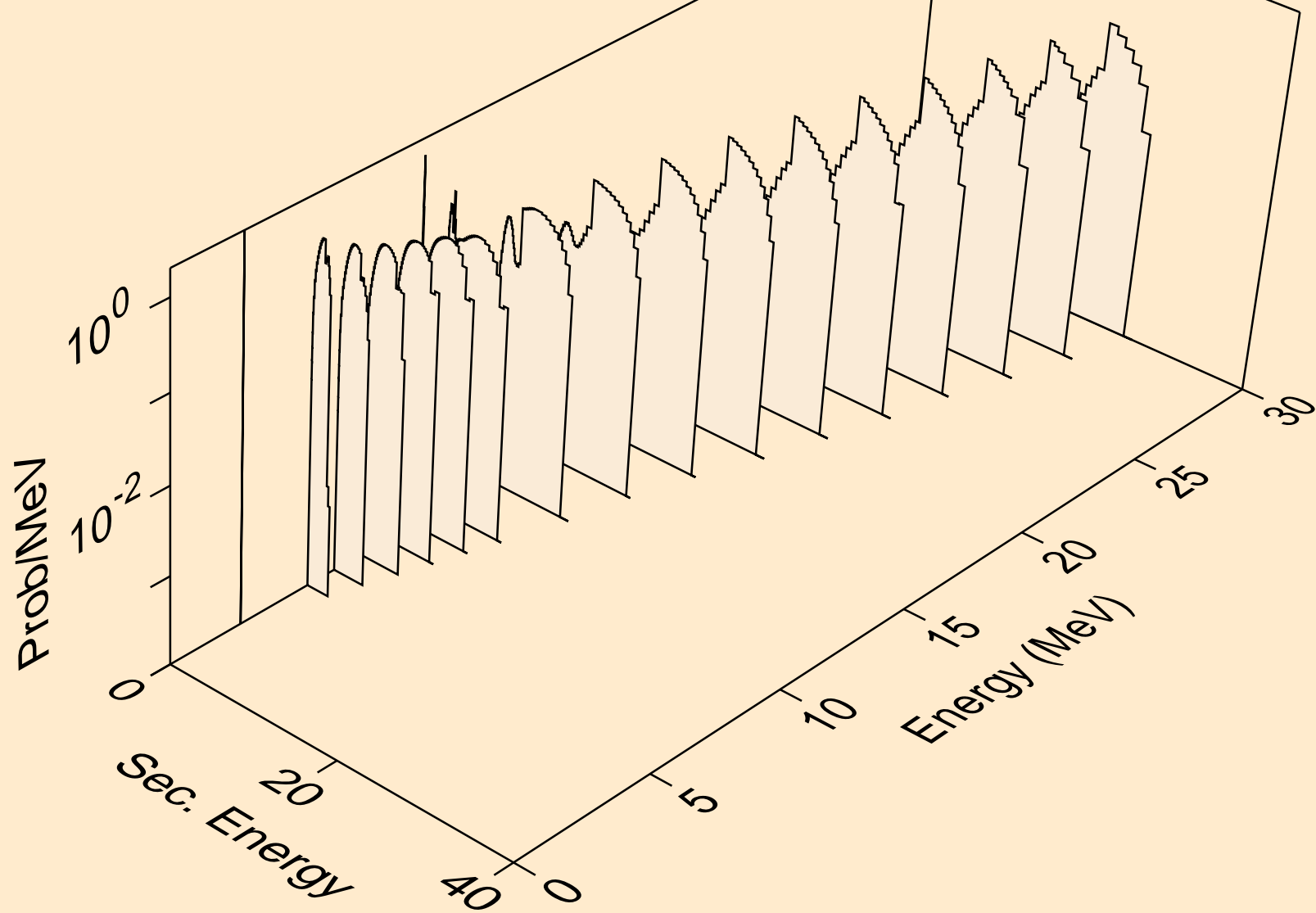

LA124M HELION ACER TENDL-2021 LIBRARY; T=0.K  
neutrons from (s,x)

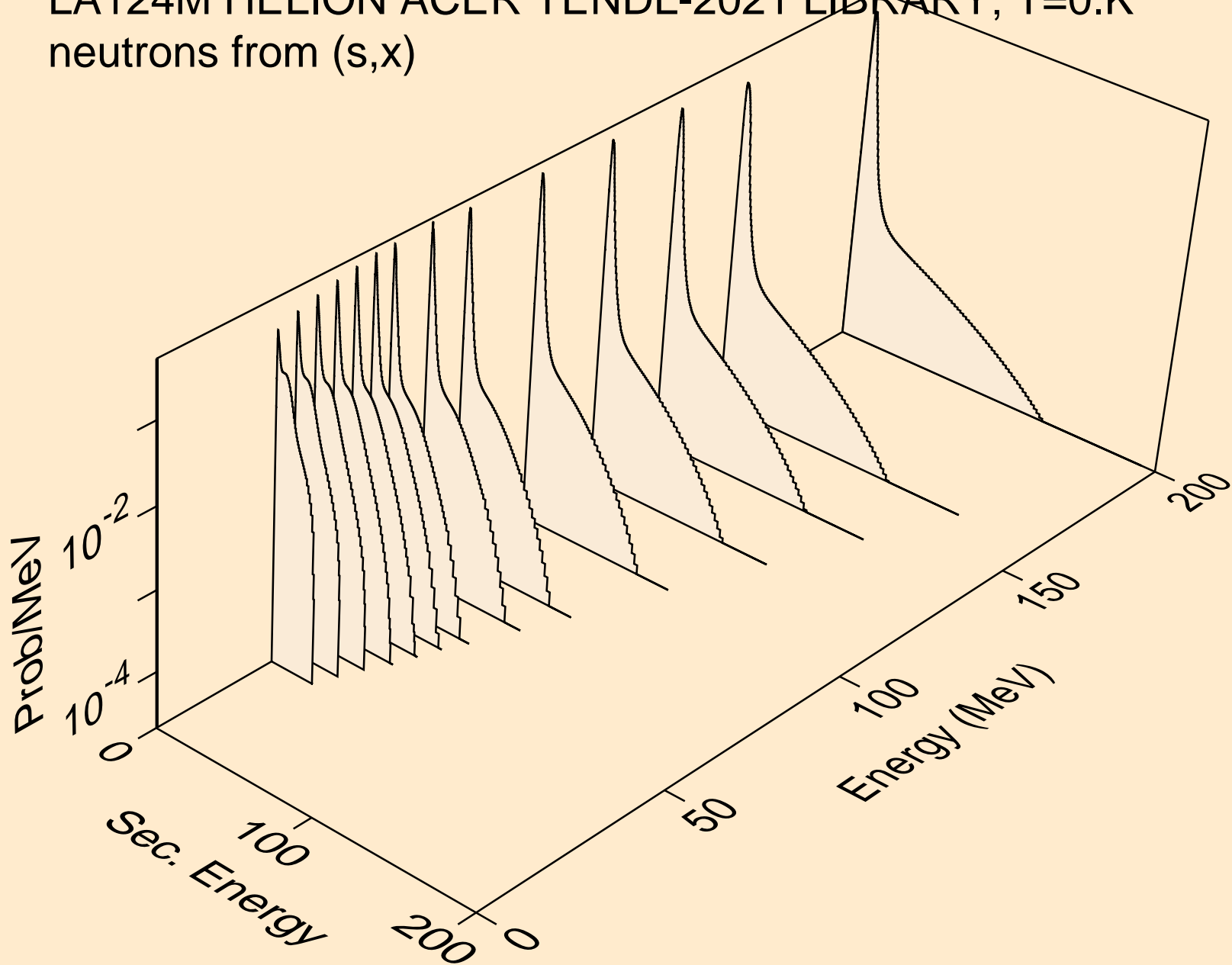

LA124M HELION ACER TENDL-2021 LIBRARY; T=0.K  
neutrons from (s,2nd)

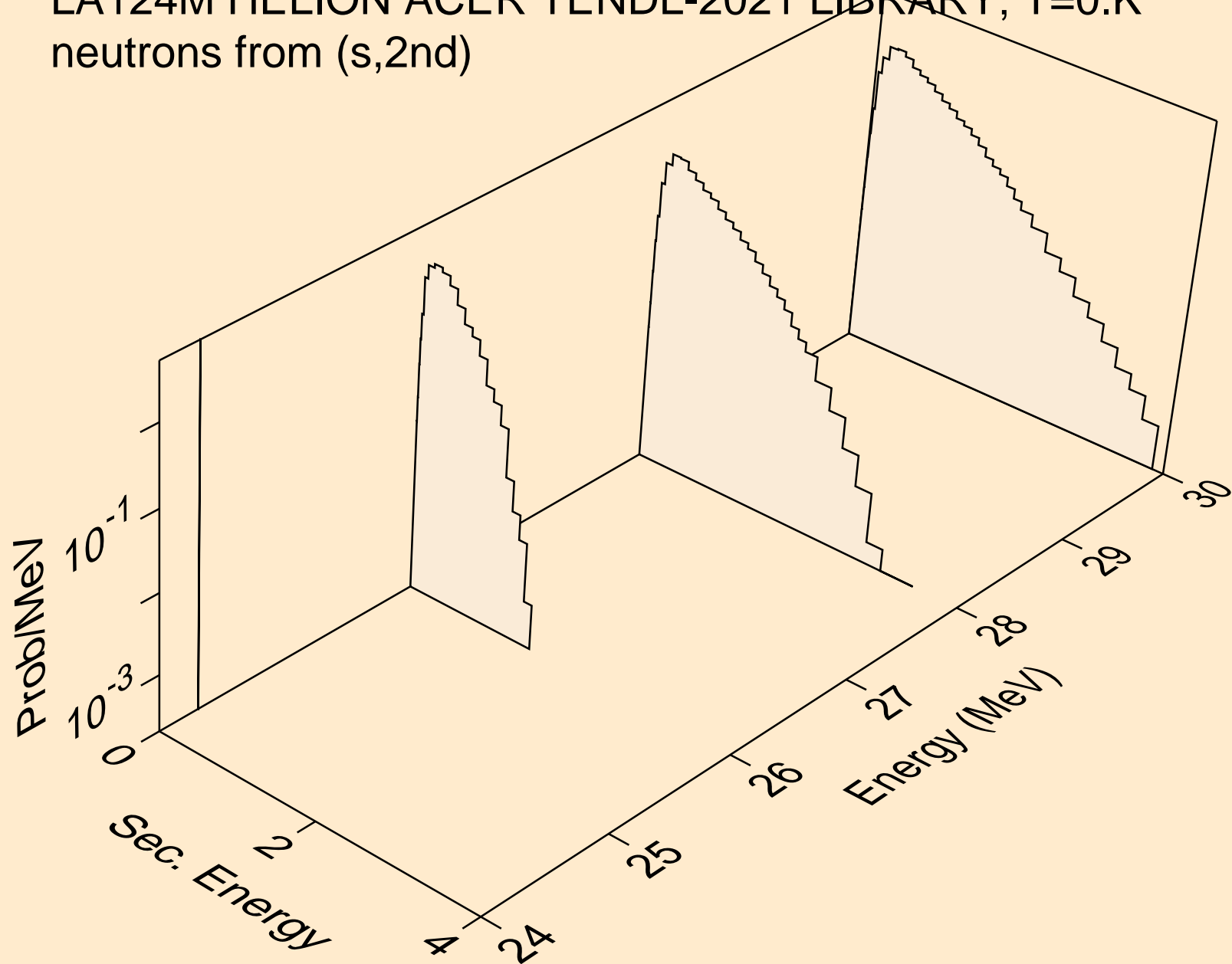

LA124M HELION ACER TENDL-2021 LIBRARY; T=0.K  
neutrons from (s,2n)

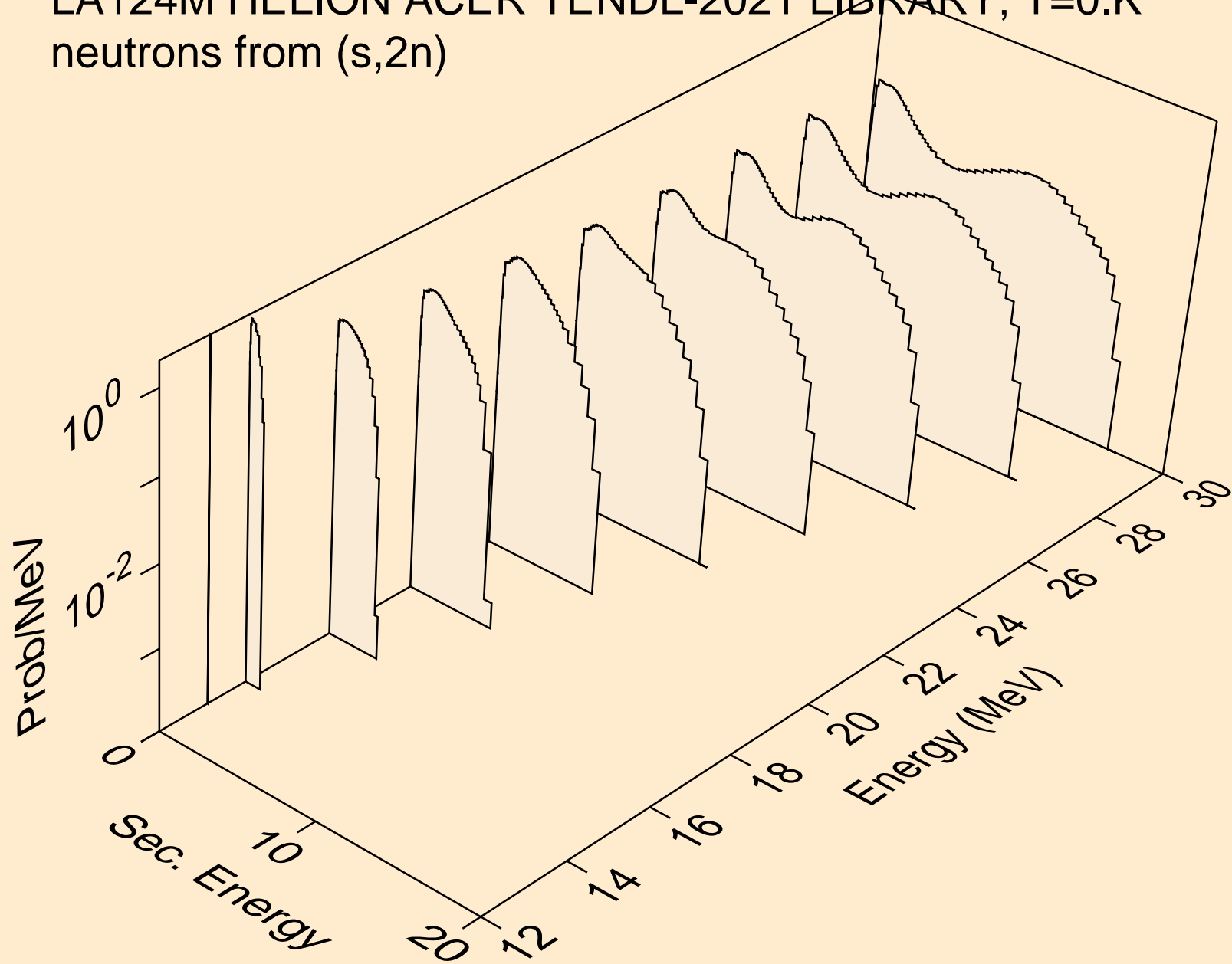

LA124M HELION ACER TENDL-2021 LIBRARY; T=0.K  
neutrons from (s,3n)

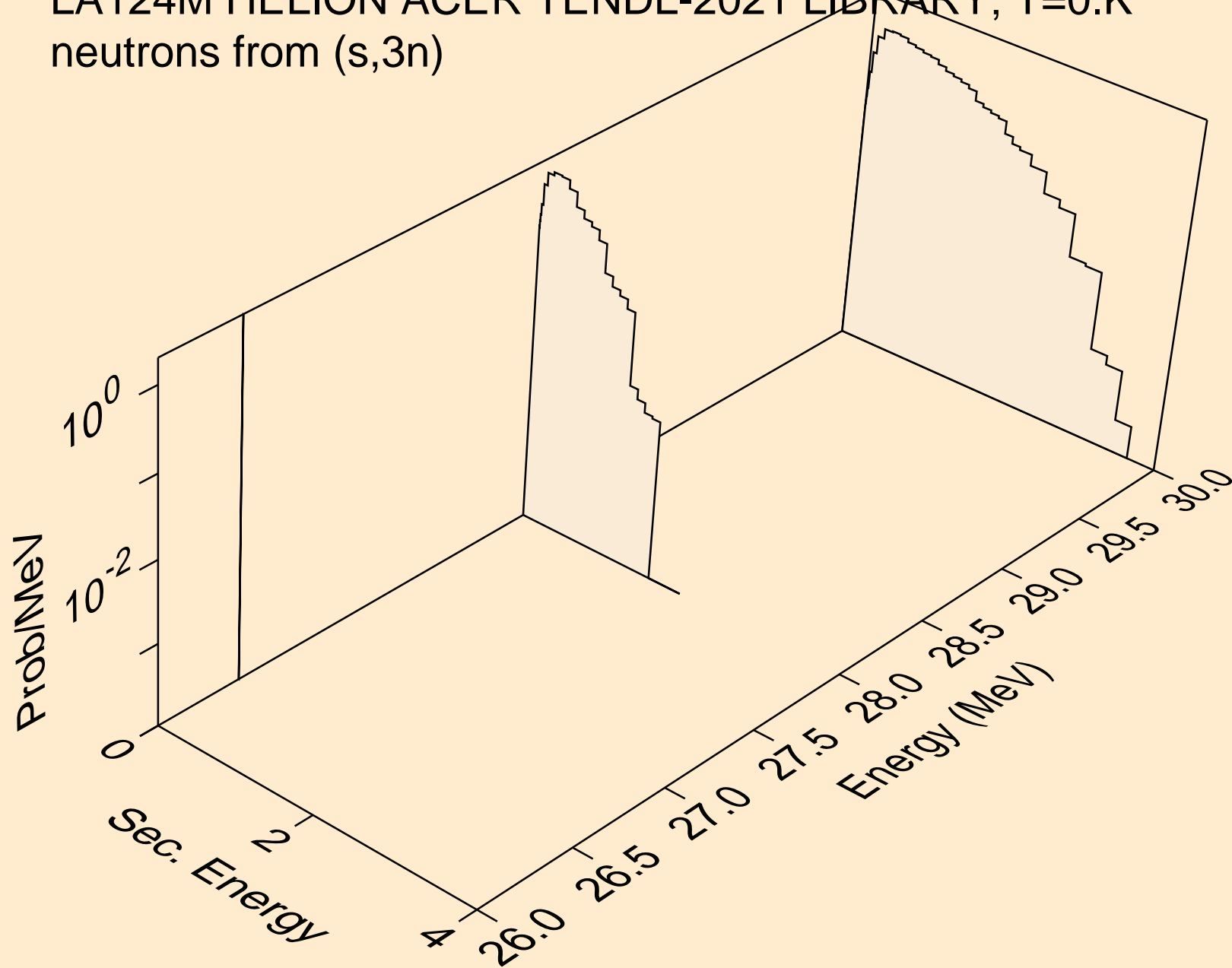

LA124M HELION ACER TENDL-2021 LIBRARY; T=0.K  
neutrons from (s,n\*)a

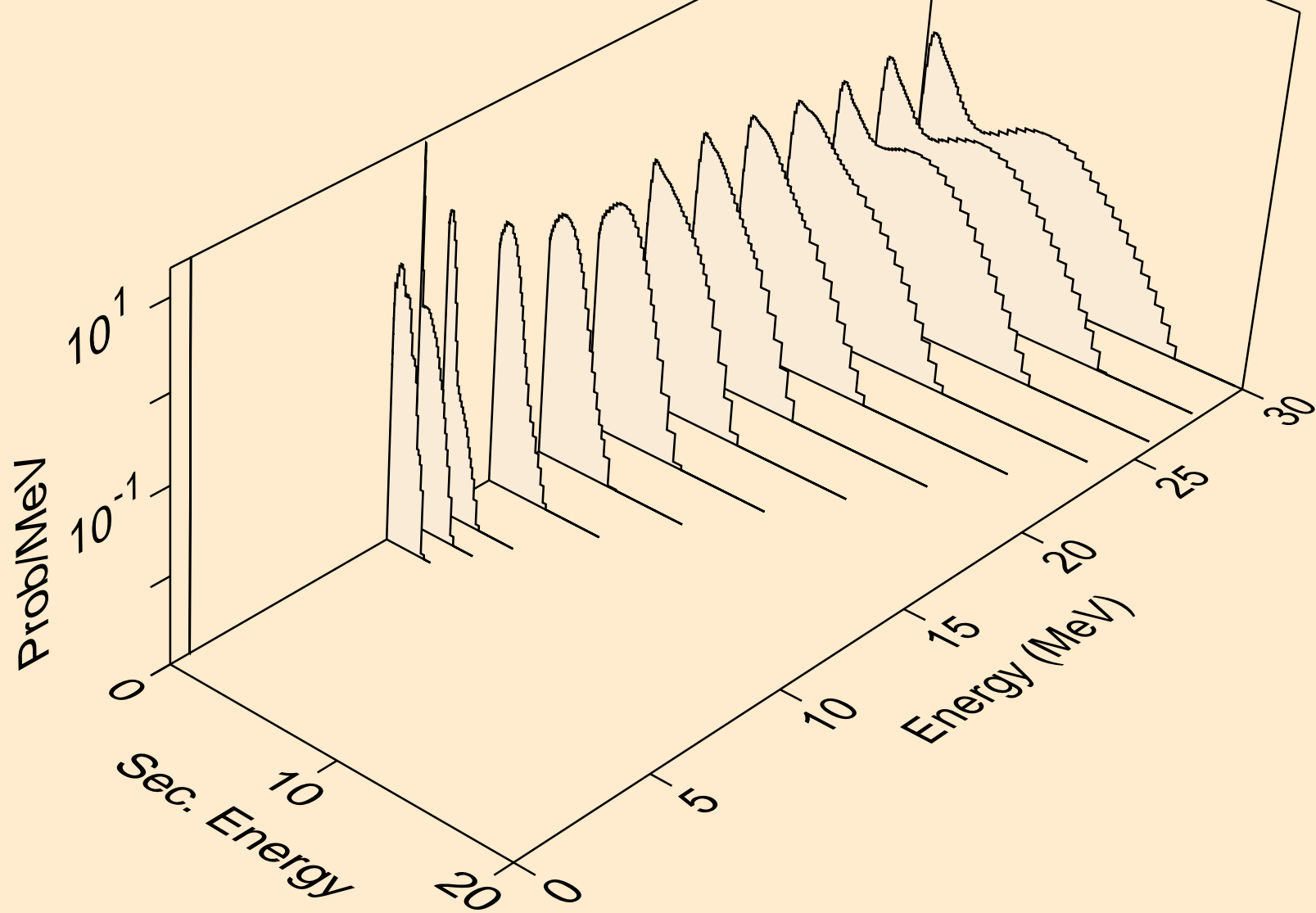

LA124M HELION ACER TENDL-2021 LIBRARY; T=0.K  
neutrons from (s,2n)a

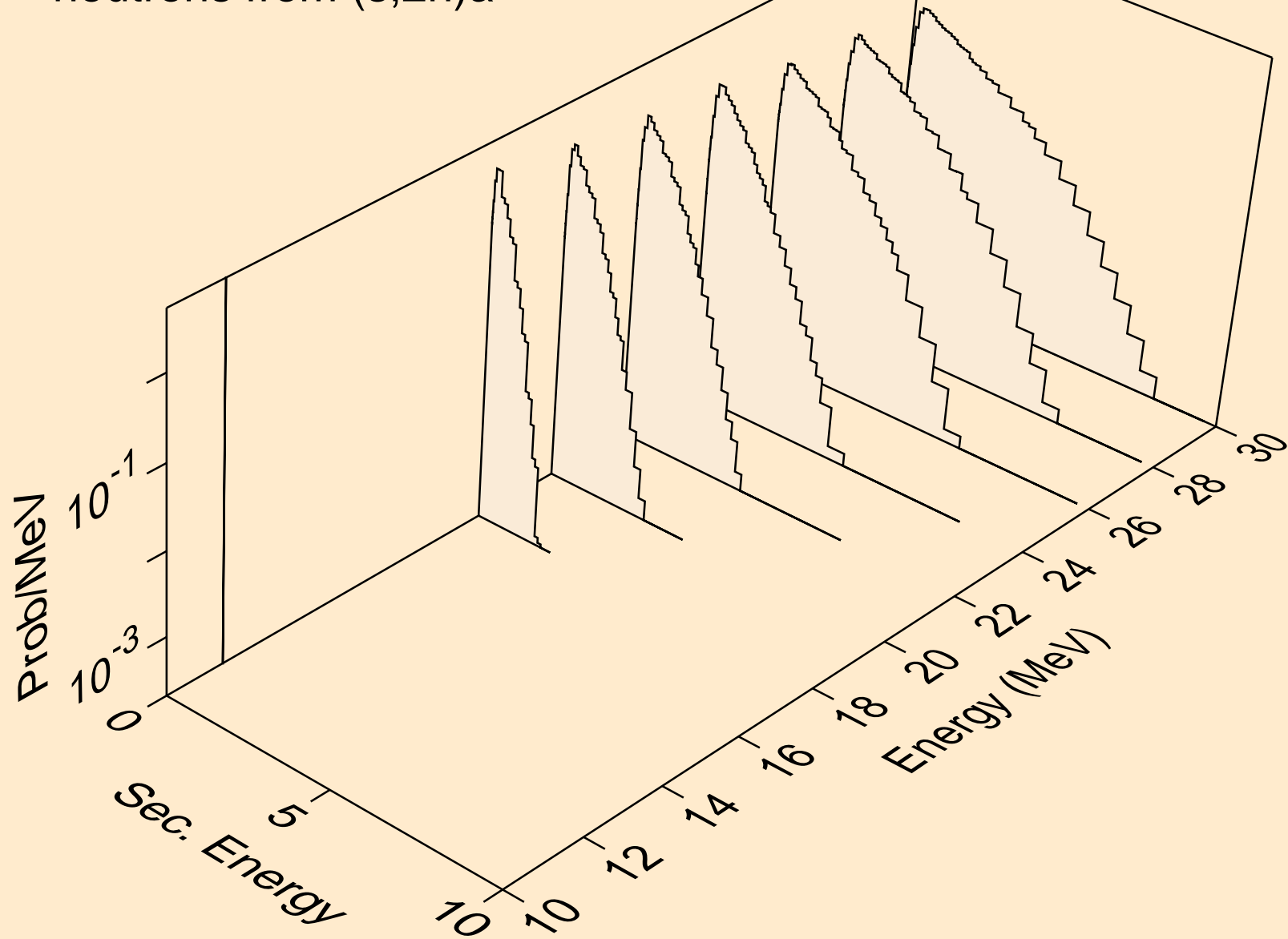



LA124M HELION ACER TENDL-2021 LIBRARY; T=0.K  
neutrons from (s,n\*)p

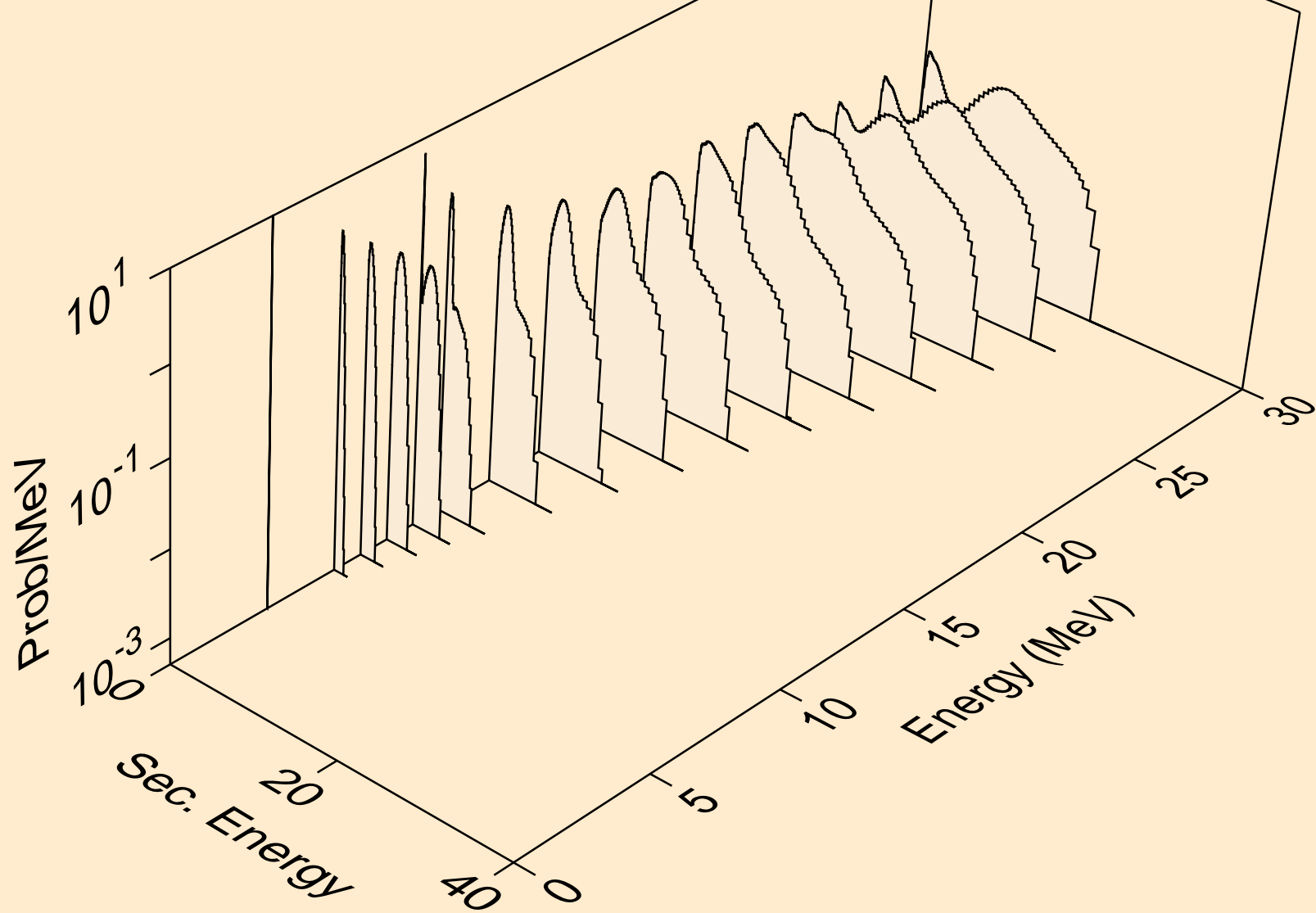

LA124M HELION ACER TENDL-2021 LIBRARY; T=0.K  
neutrons from (s,n\*)2a

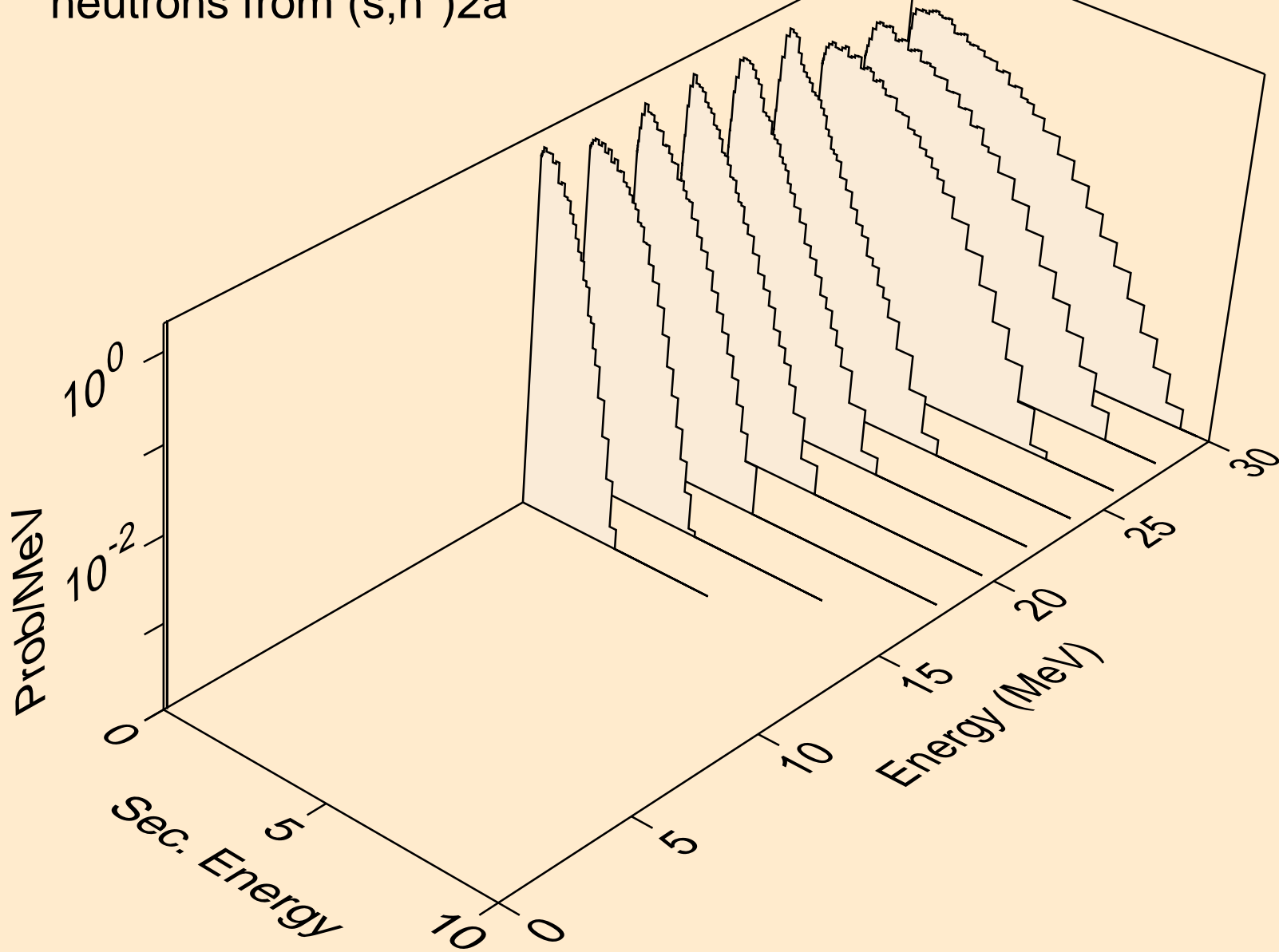

LA124M HELION ACER TENDL-2021 LIBRARY; T=0.K  
neutrons from (s,n\*)d

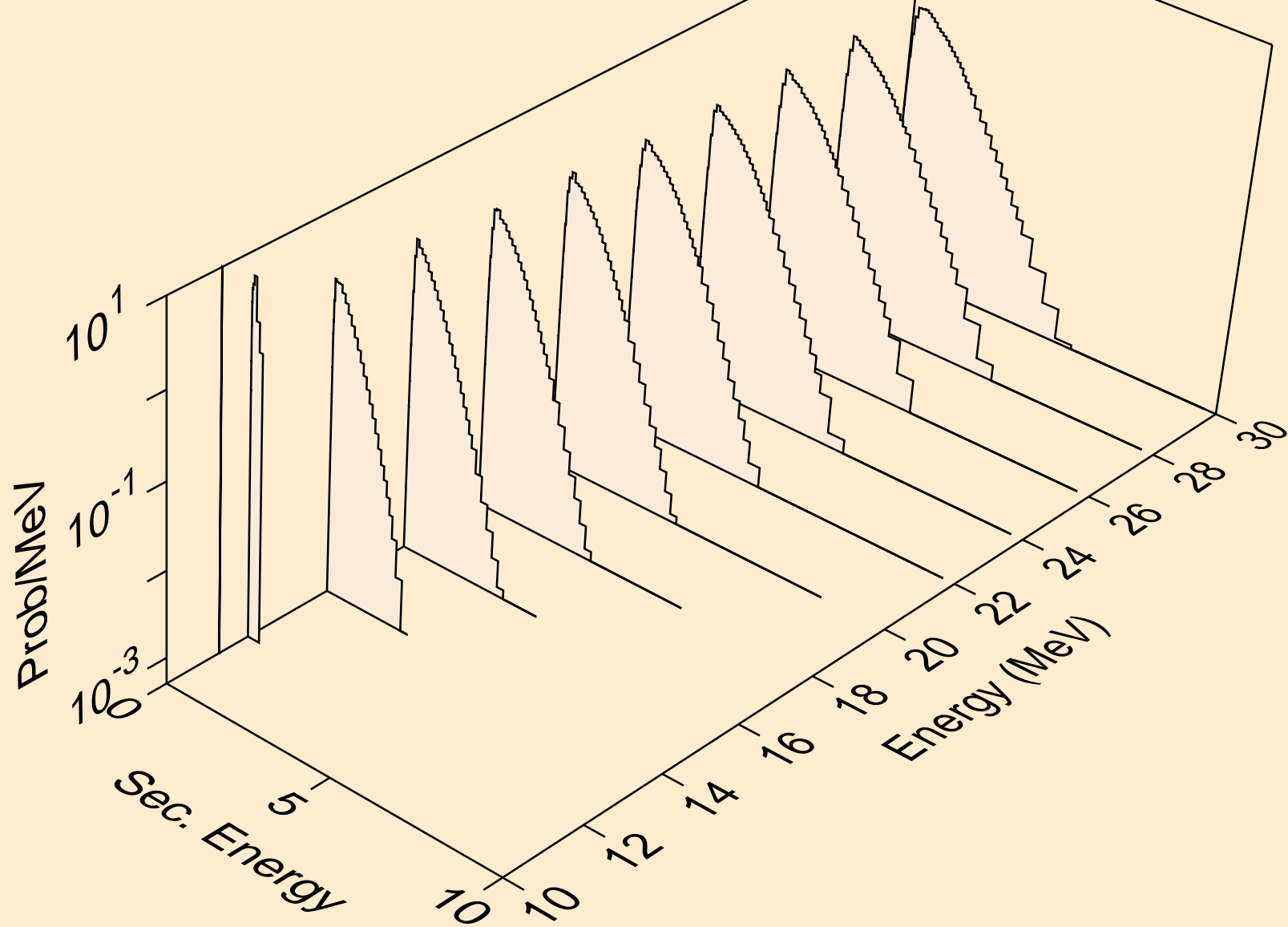

LA124M HELION ACER TENDL-2021 LIBRARY; T=0.K  
neutrons from (s,n\*)t

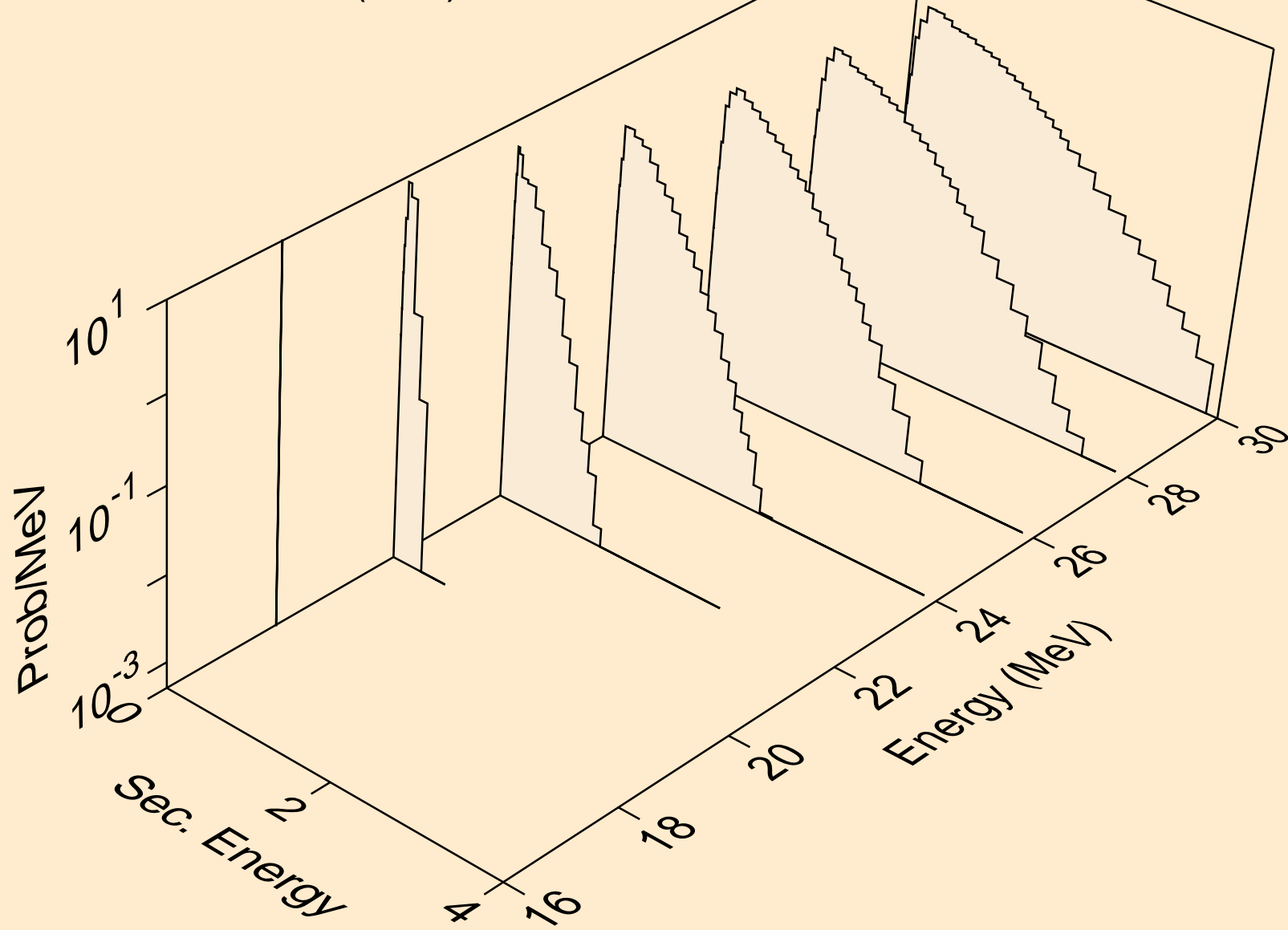

LA124M HELION ACER TENDL-2021 LIBRARY; T=0.K  
neutrons from (s,n\*)he3

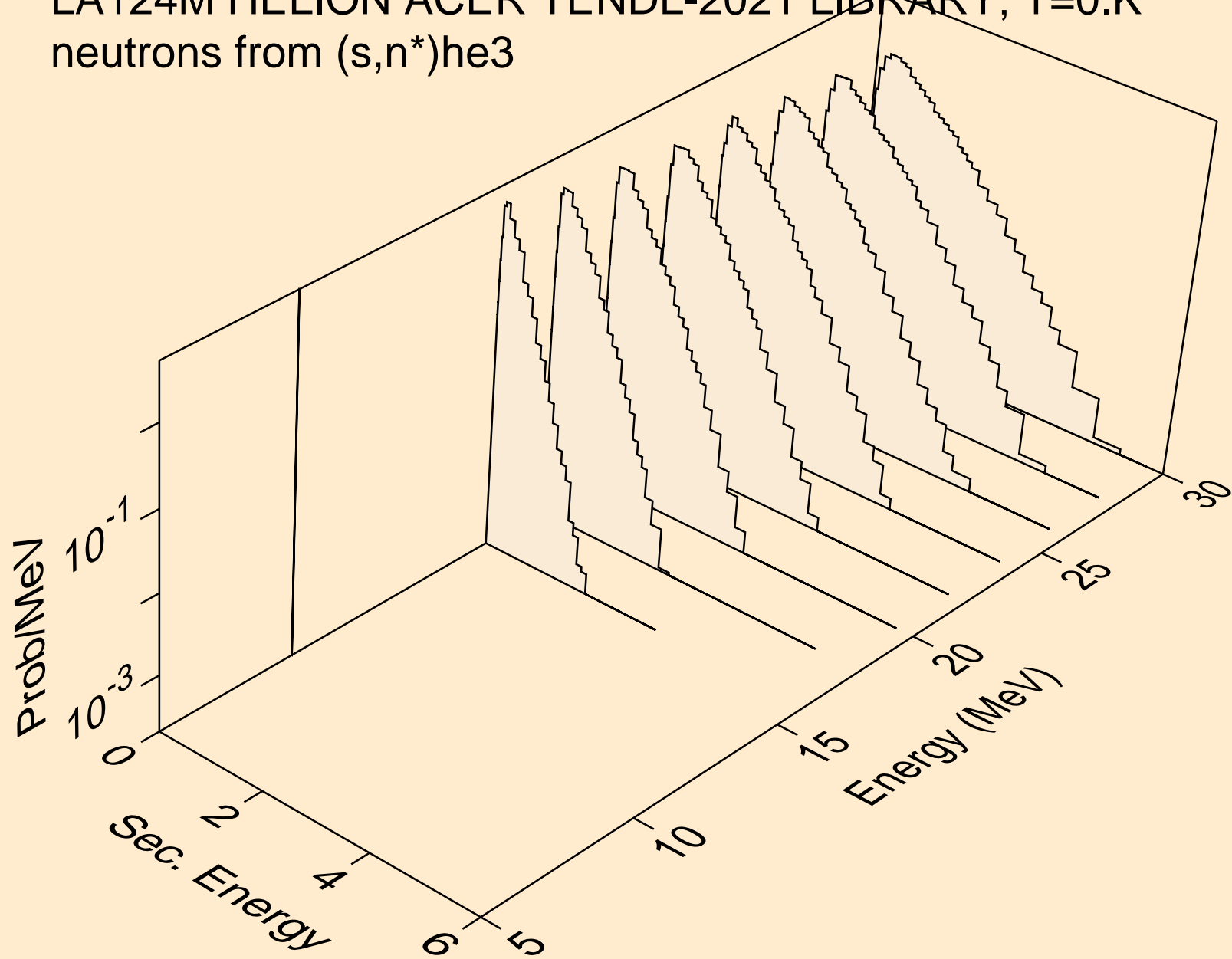

LA124M HELION ACER TENDL-2021 LIBRARY; T=0.K  
neutrons from (s,2np)

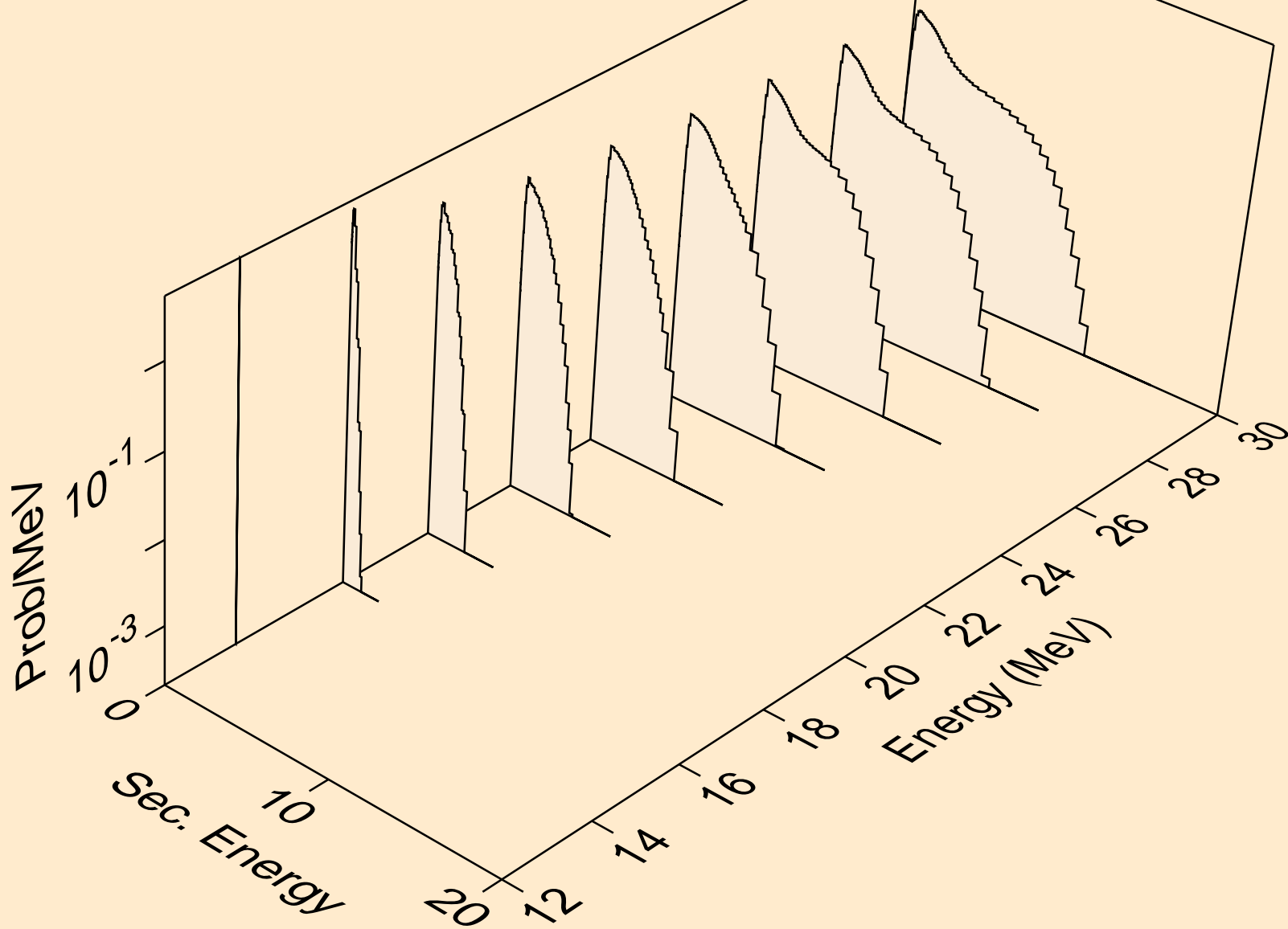

LA124M HELION ACER TENDL-2021 LIBRARY; T=0.K  
neutrons from (s,2np)

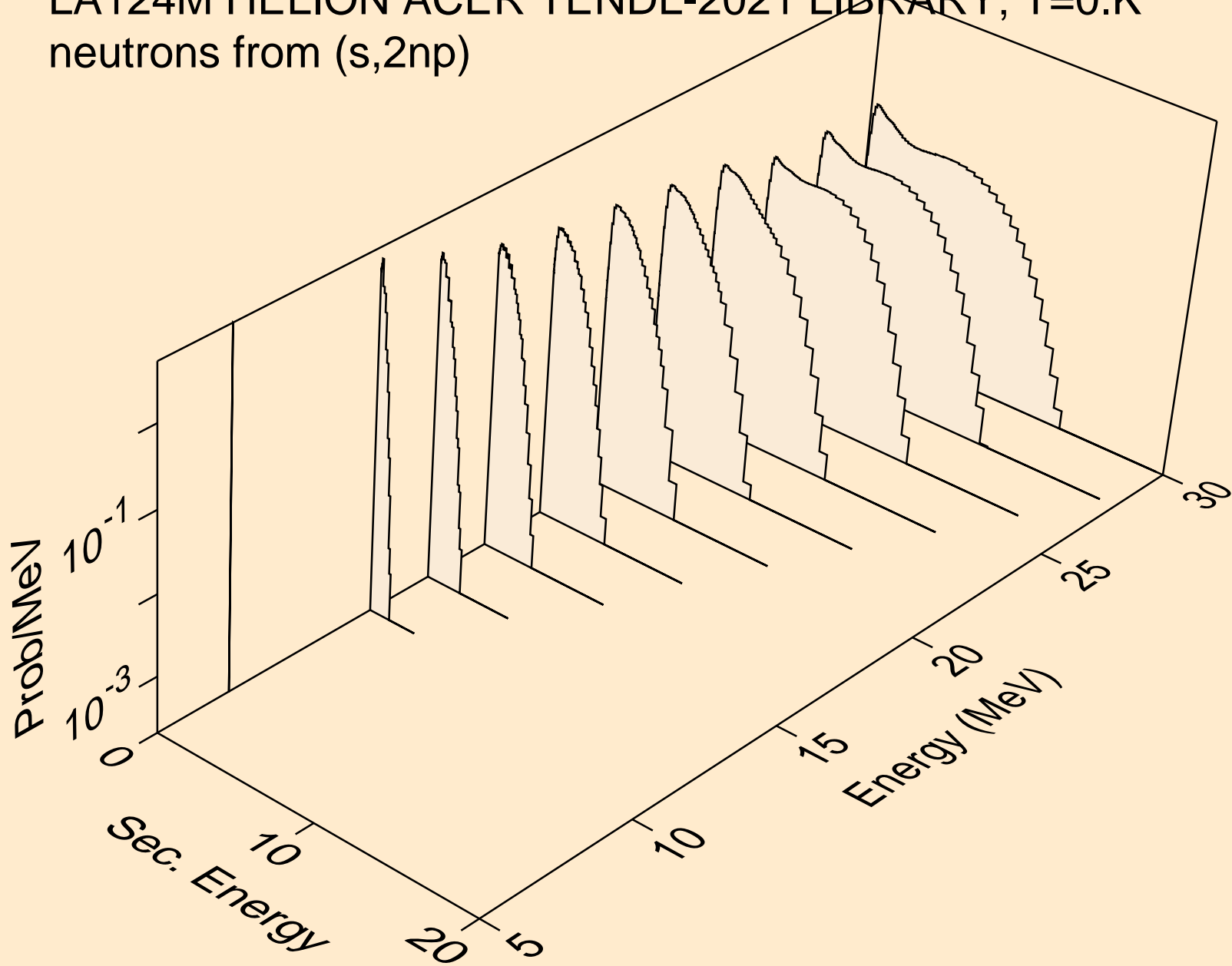

LA124M HELION ACER TENDL-2021 LIBRARY; T=0.K  
neutrons from (s,npa)

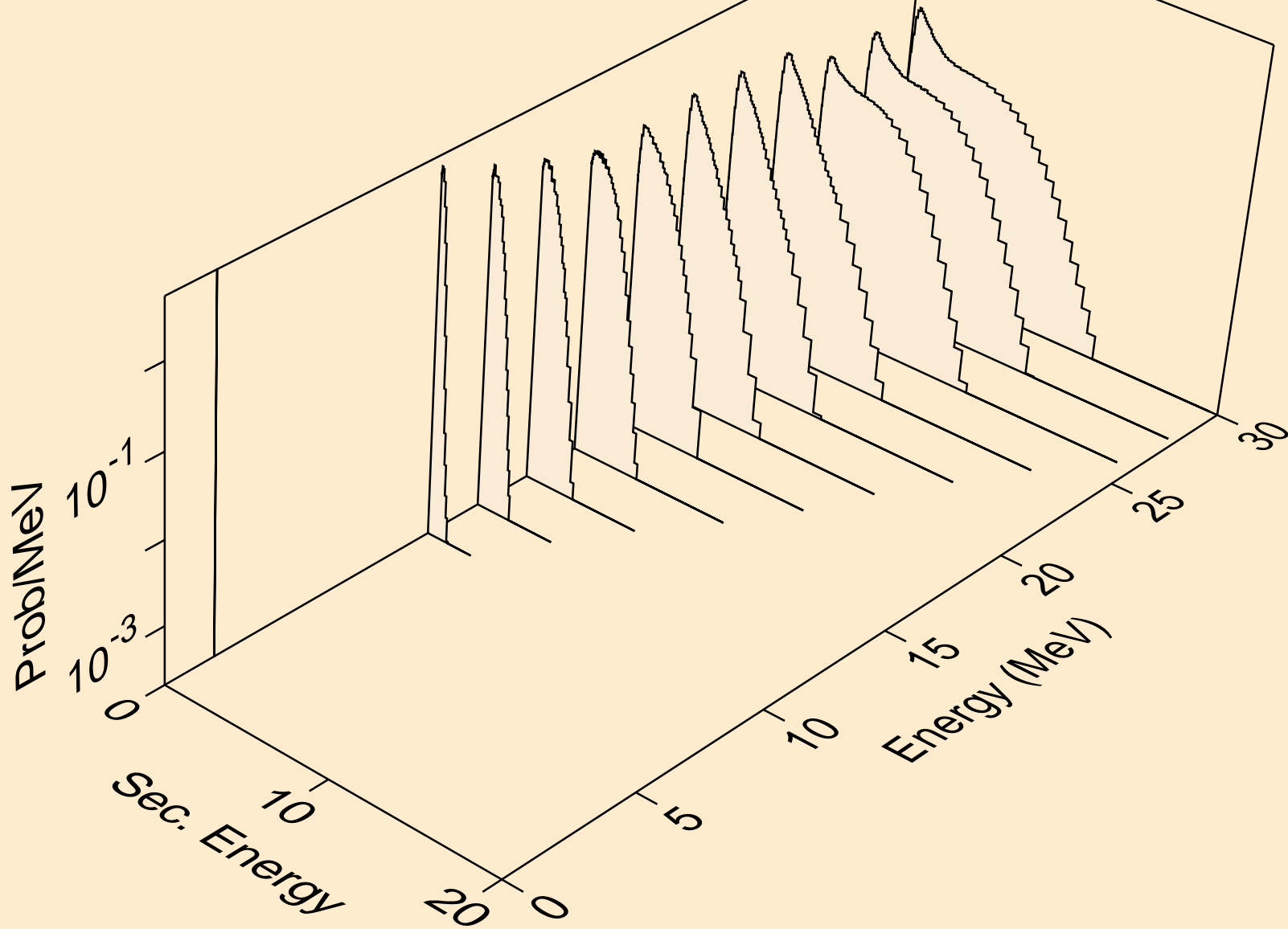



LA124M HELION ACER TENDL-2021 LIBRARY; T=0.K  
protons from (s,x)

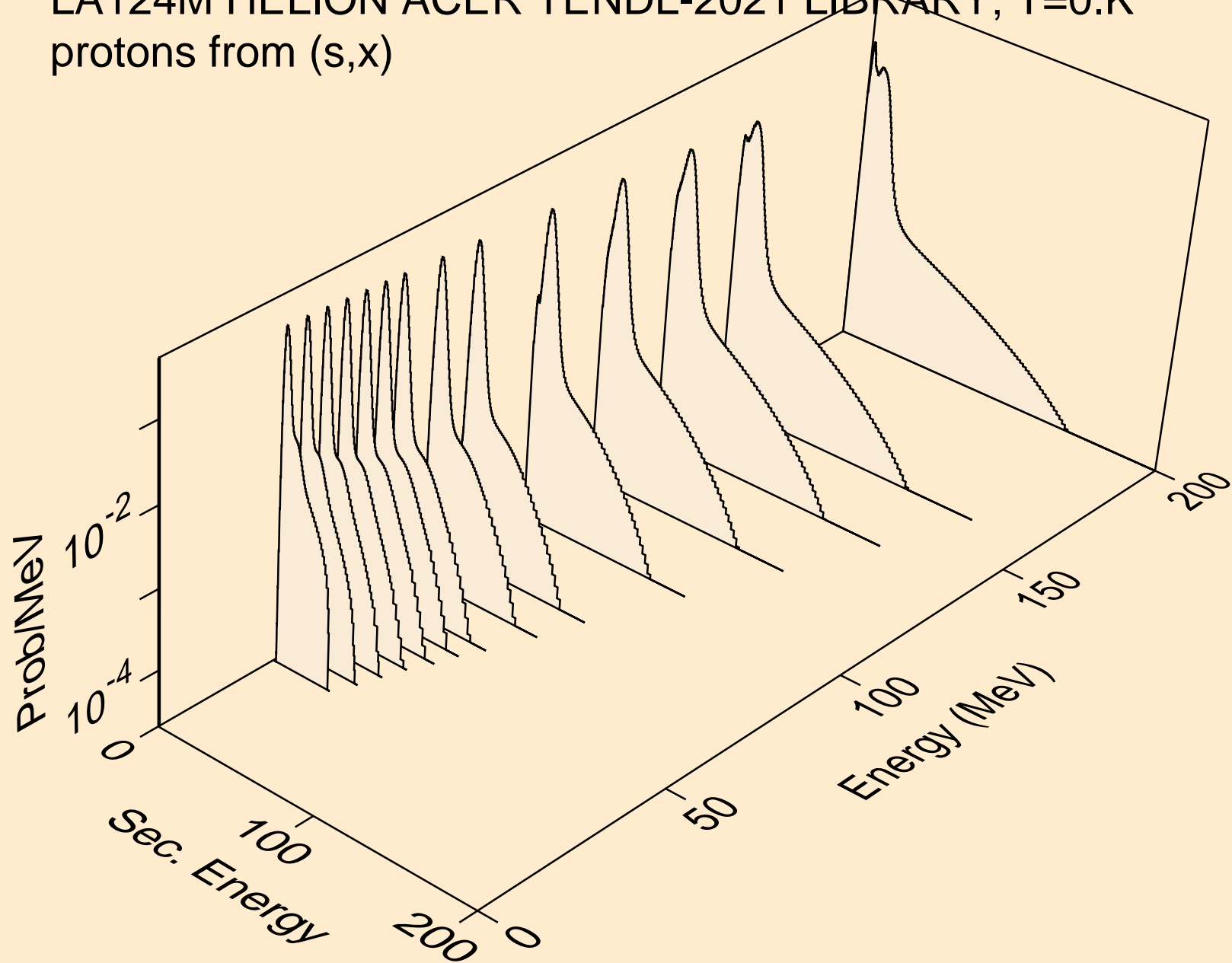

LA124M HELION ACER TENDL-2021 LIBRARY; T=0.K  
protons from (s,n\*)p

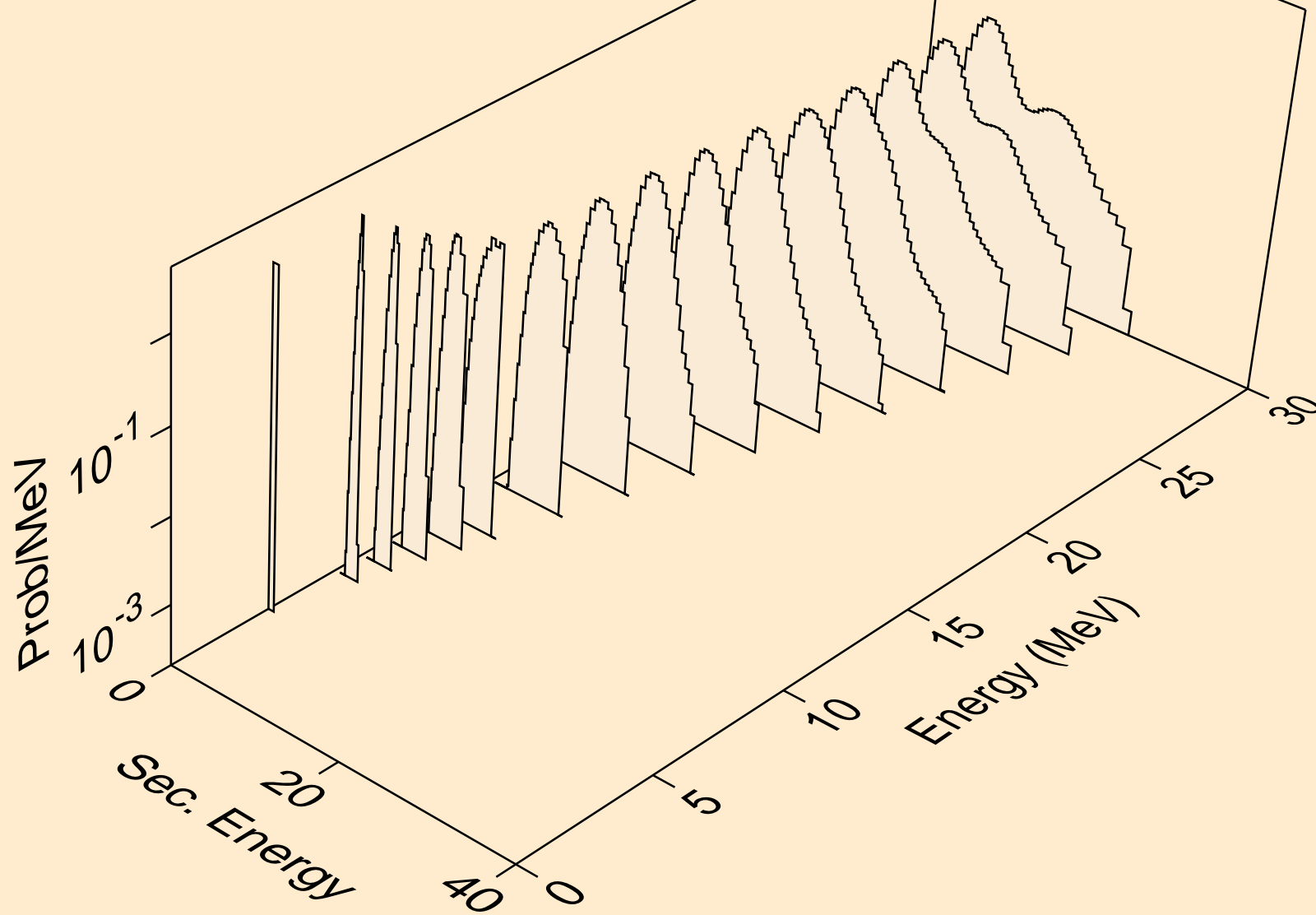

LA124M HELION ACER TENDL-2021 LIBRARY; T=0.K  
protons from (s,2np)

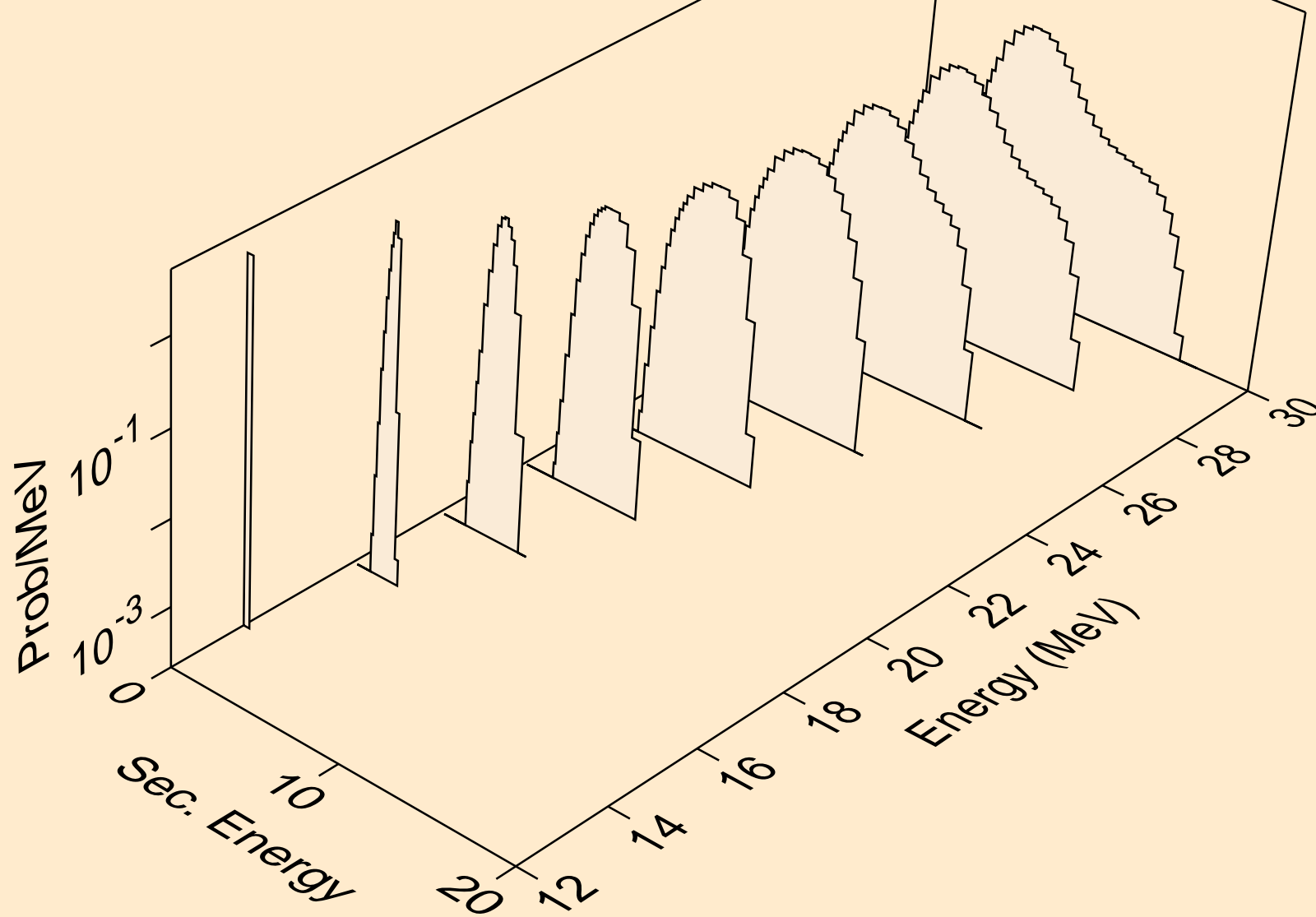

LA124M HELION ACER TENDL-2021 LIBRARY; T=0.K  
protons from (s,2np)

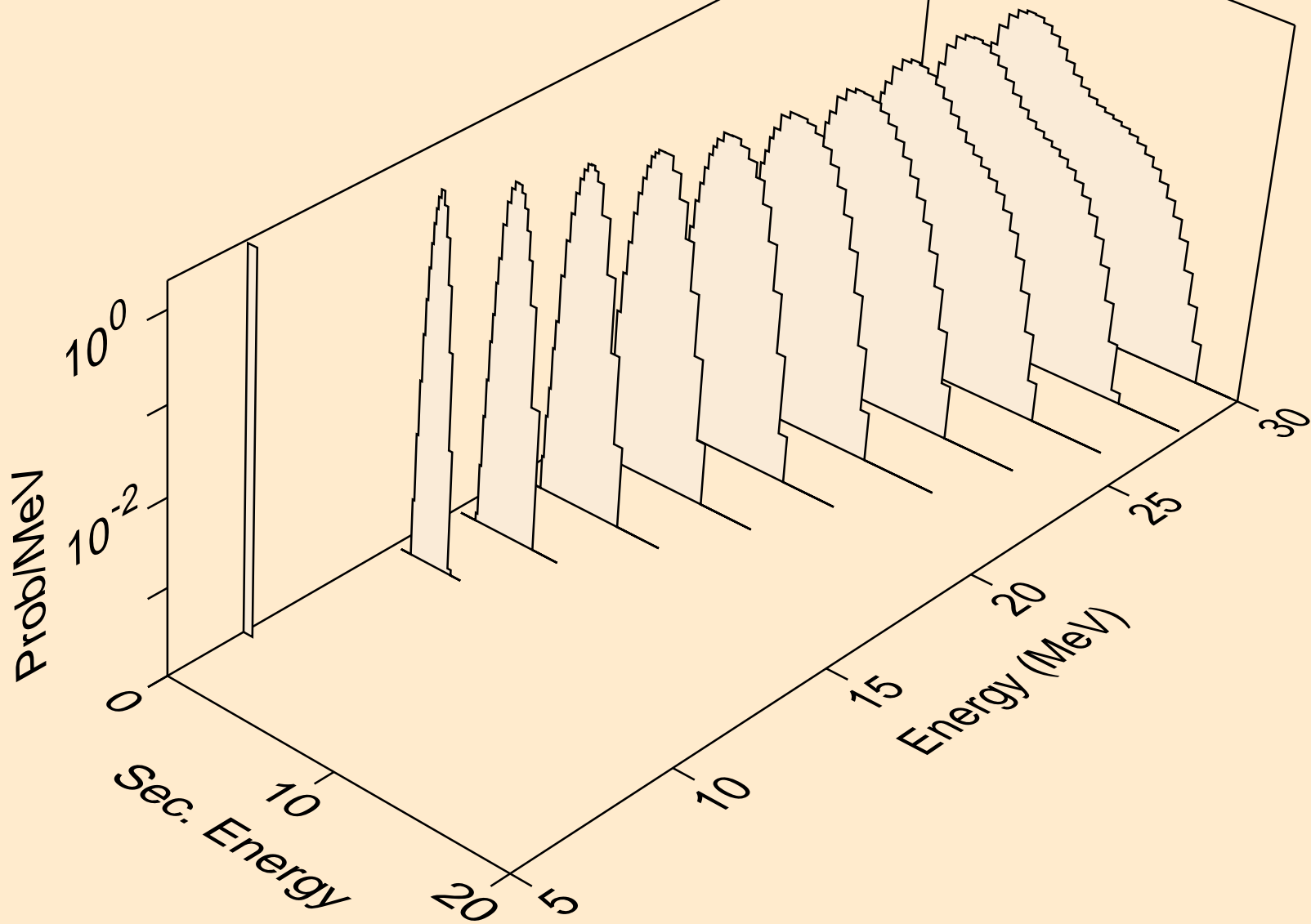

LA124M HELION ACER TENDL-2021 LIBRARY; T=0.K  
protons from (s,npa)

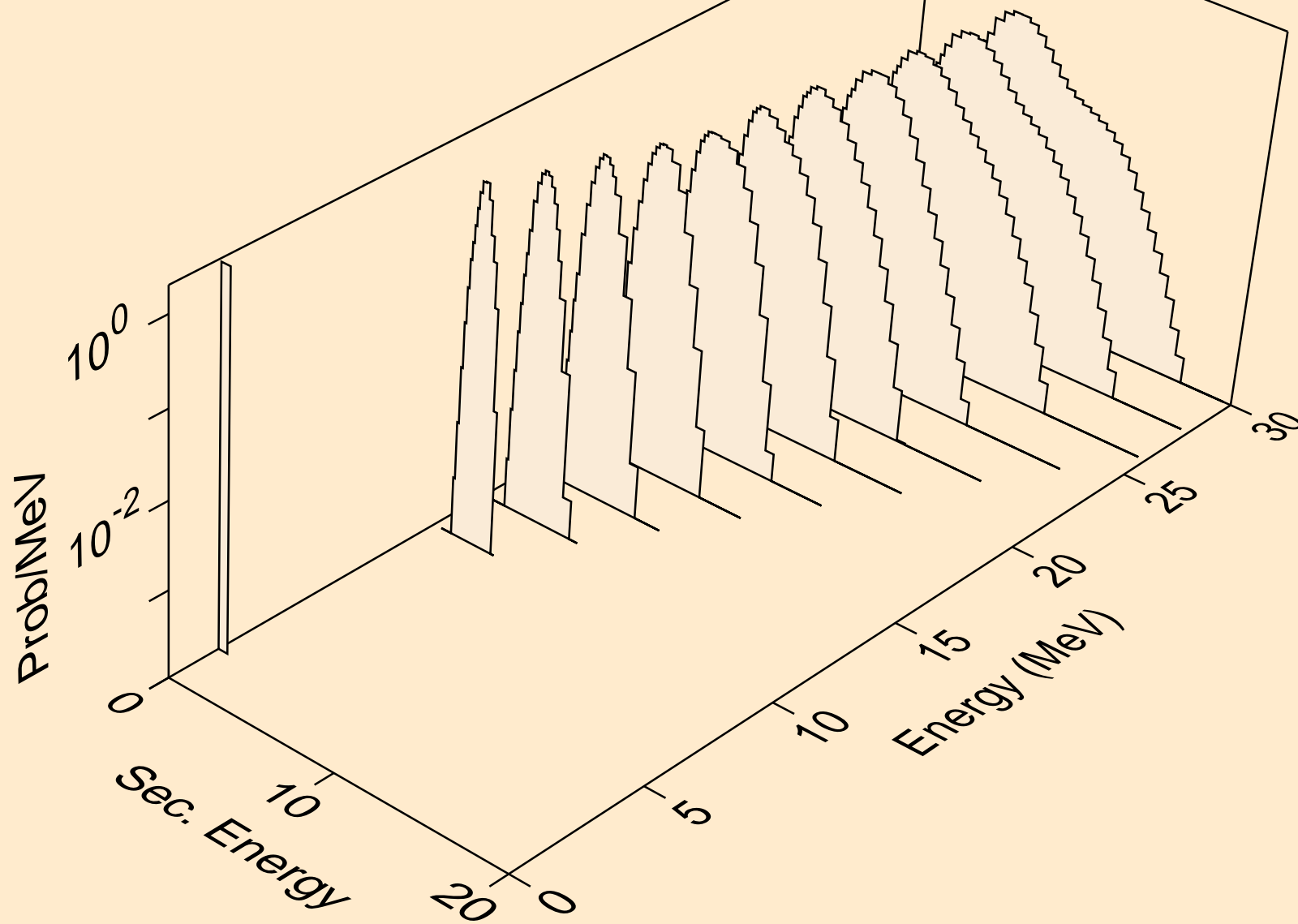

LA124M HELION ACER TENDL-2021 LIBRARY; T=0.K  
protons from (s,p)

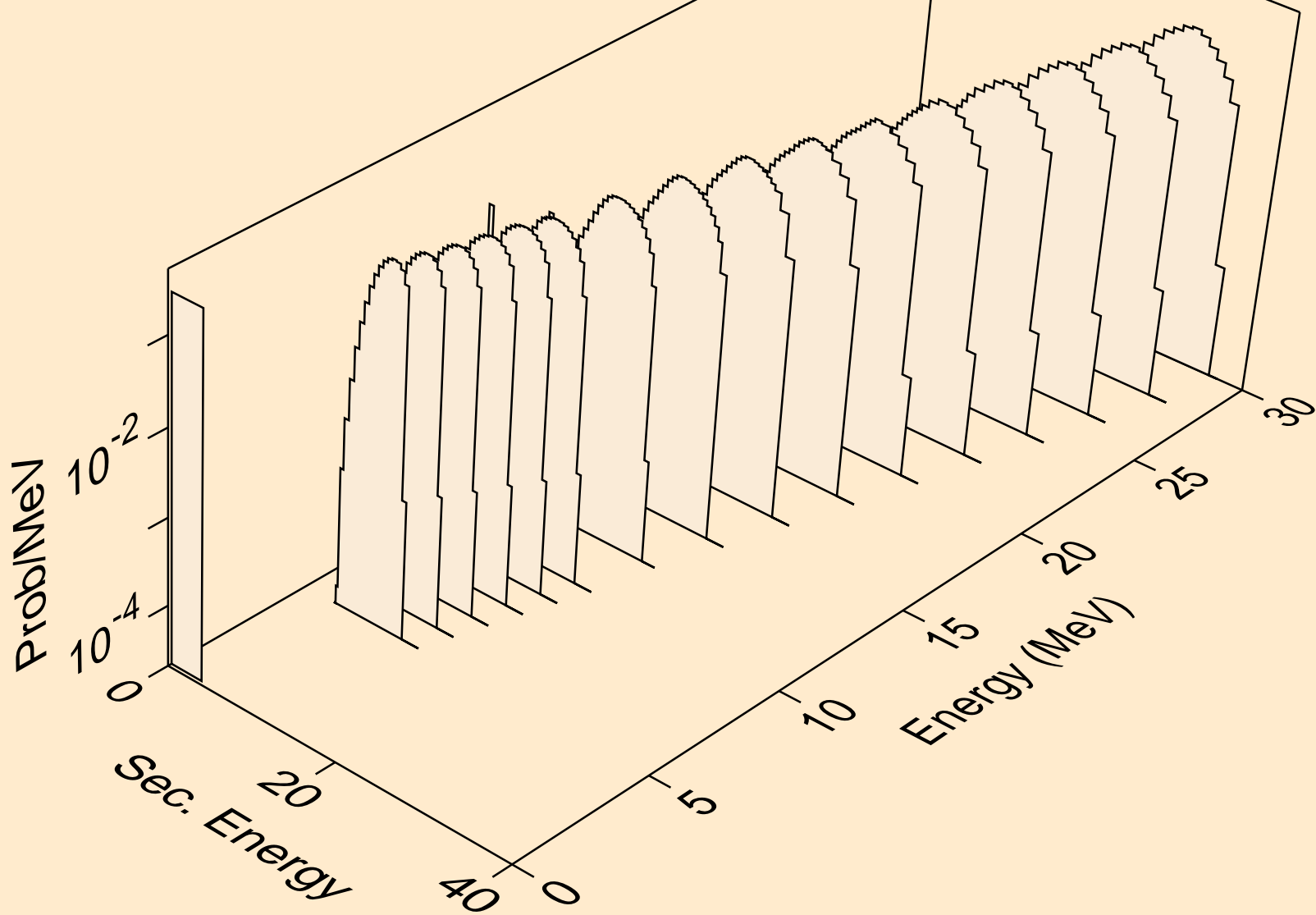

LA124M HELION ACER TENDL-2021 LIBRARY; T=0.K  
protons from (s,2p)

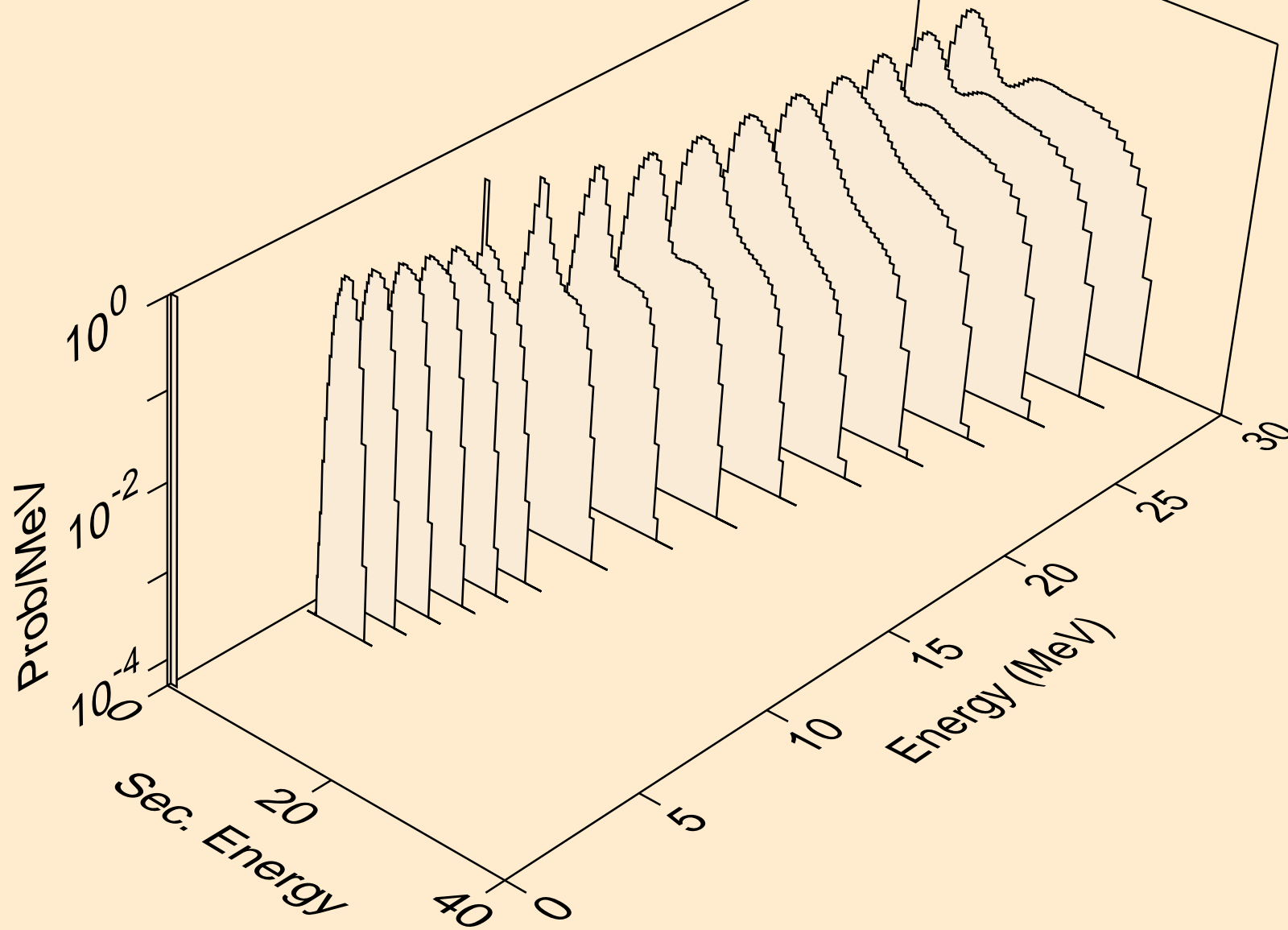

LA124M HELION ACER TENDL-2021 LIBRARY; T=0.K  
protons from (s,pa)

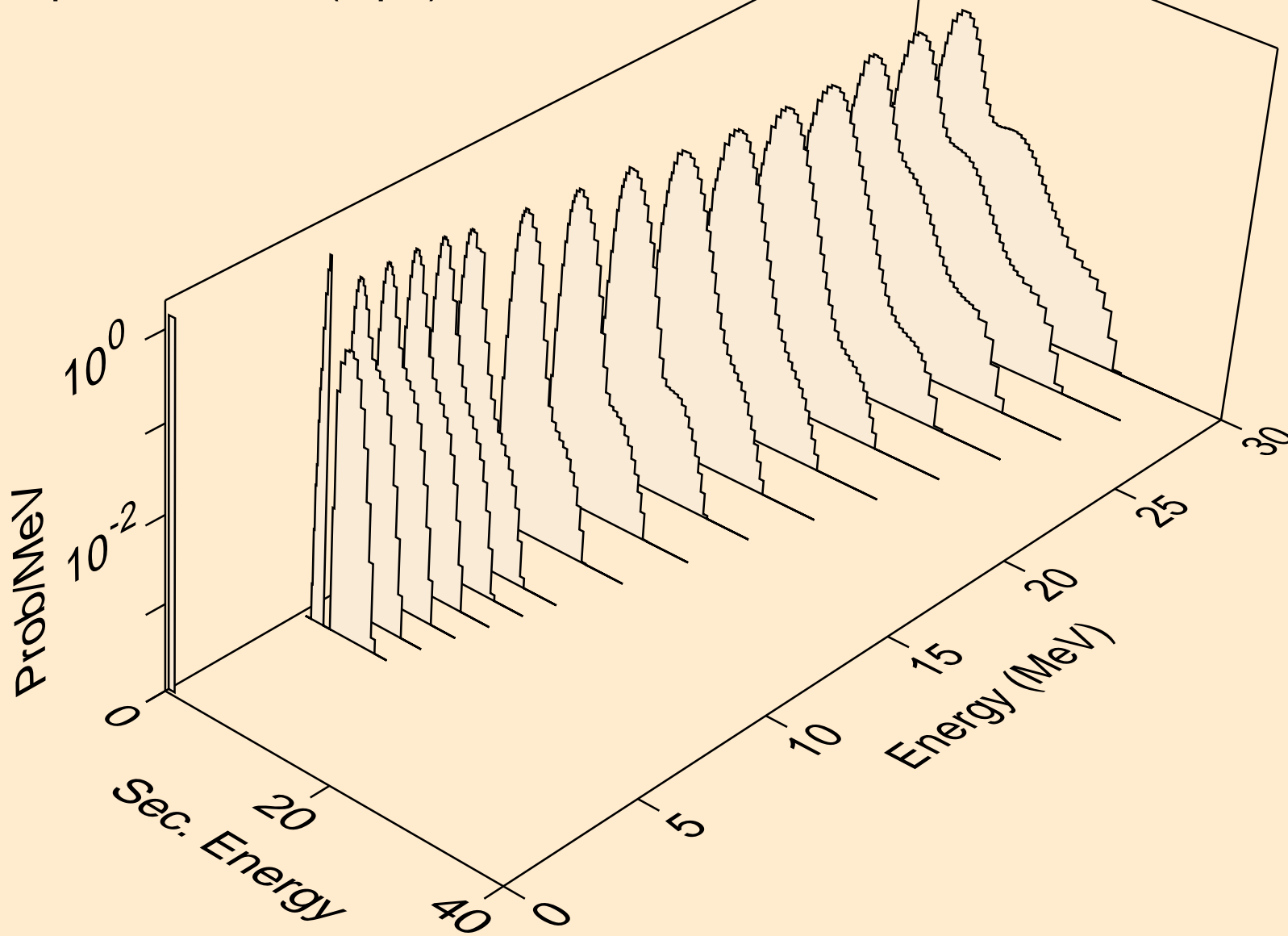



LA124M HELION ACER TENDL-2021 LIBRARY; T=0.K  
protons from (s,pd)

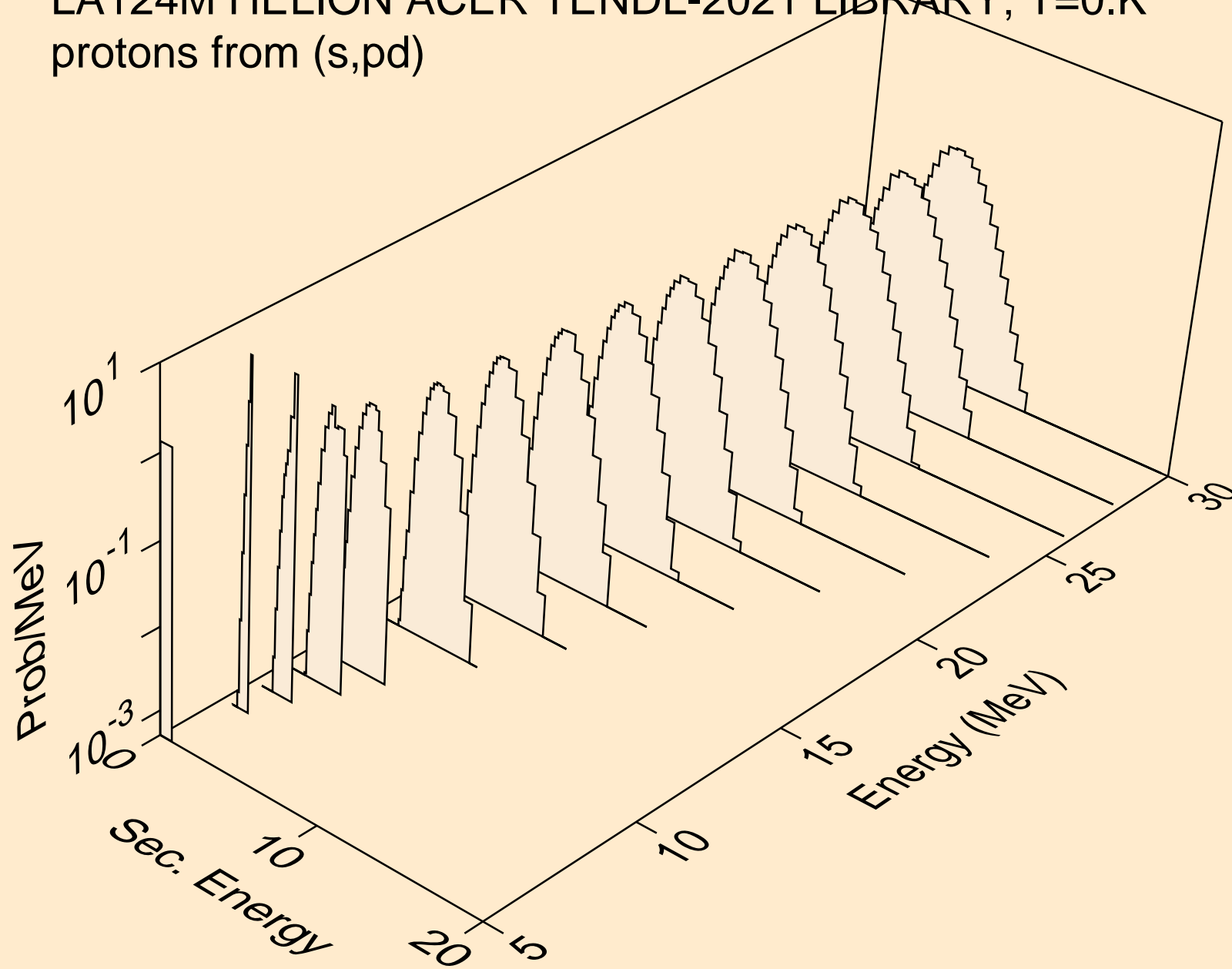

LA124M HELION ACER TENDL-2021 LIBRARY; T=0.K  
protons from (s,pt)

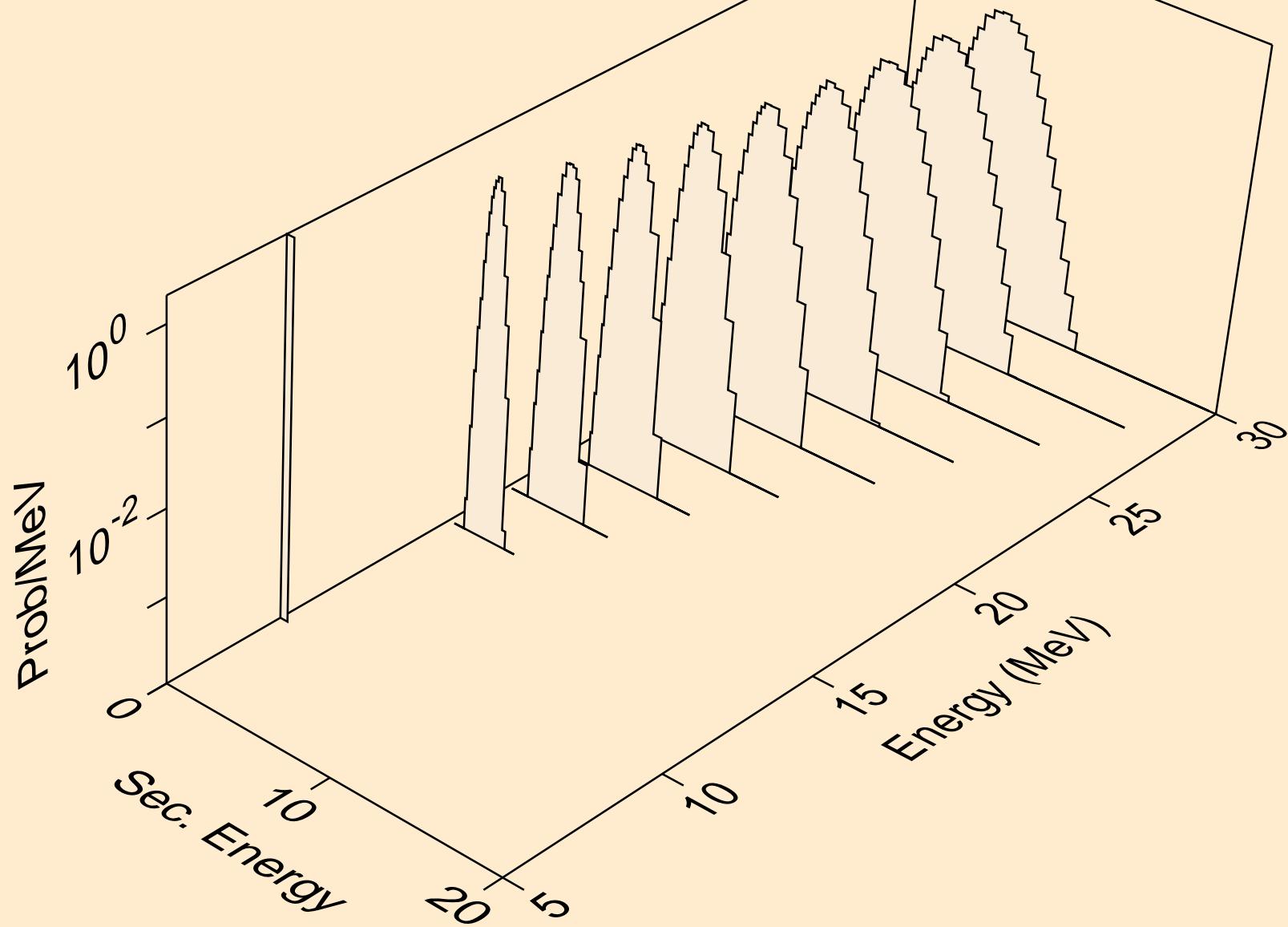

LA124M HELION ACER TENDL-2021 LIBRARY; T=0.K  
deuterons from (s,x)

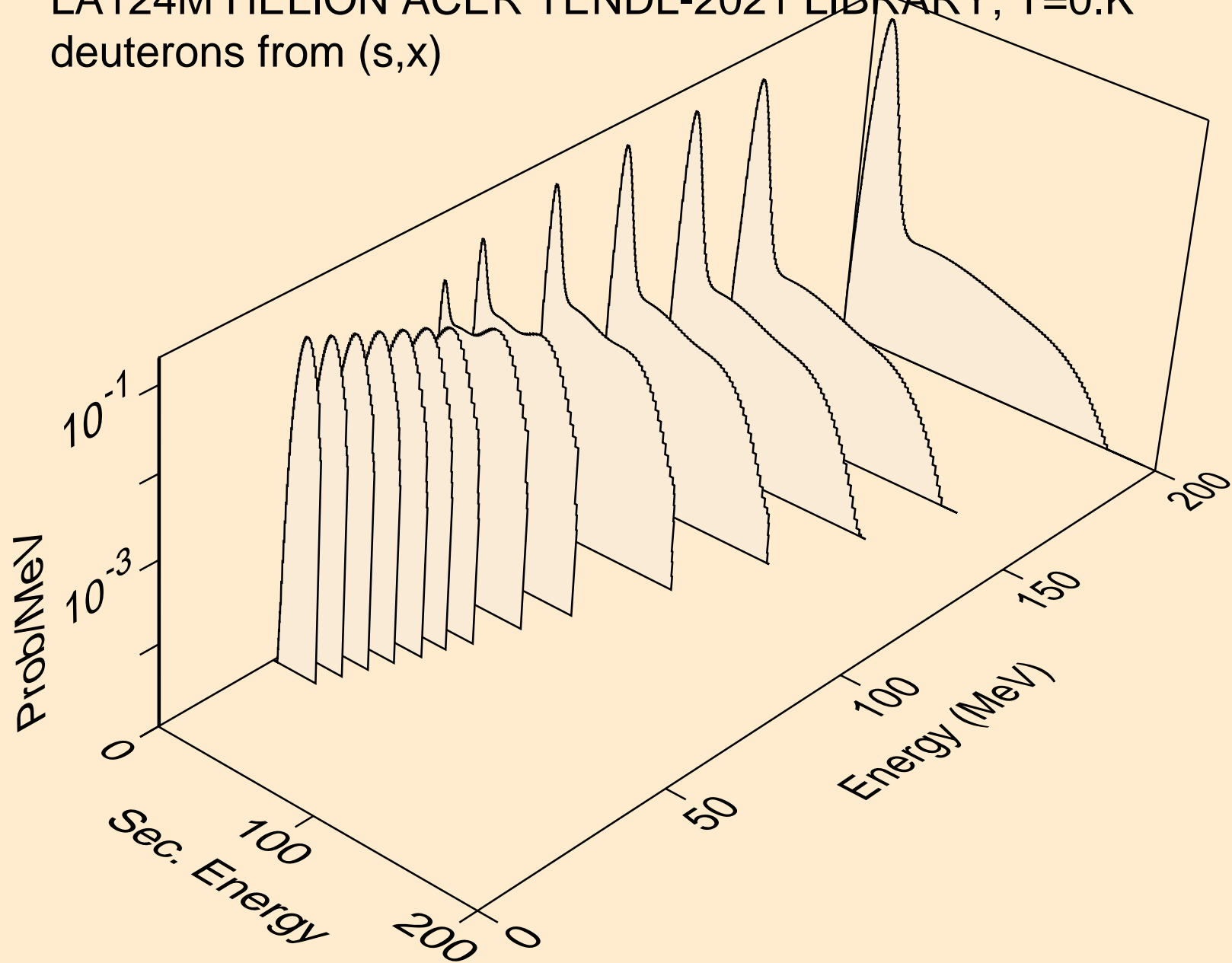

LA124M HELION ACER TENDL-2021 LIBRARY; T=0.K  
deuterons from (s,2nd)

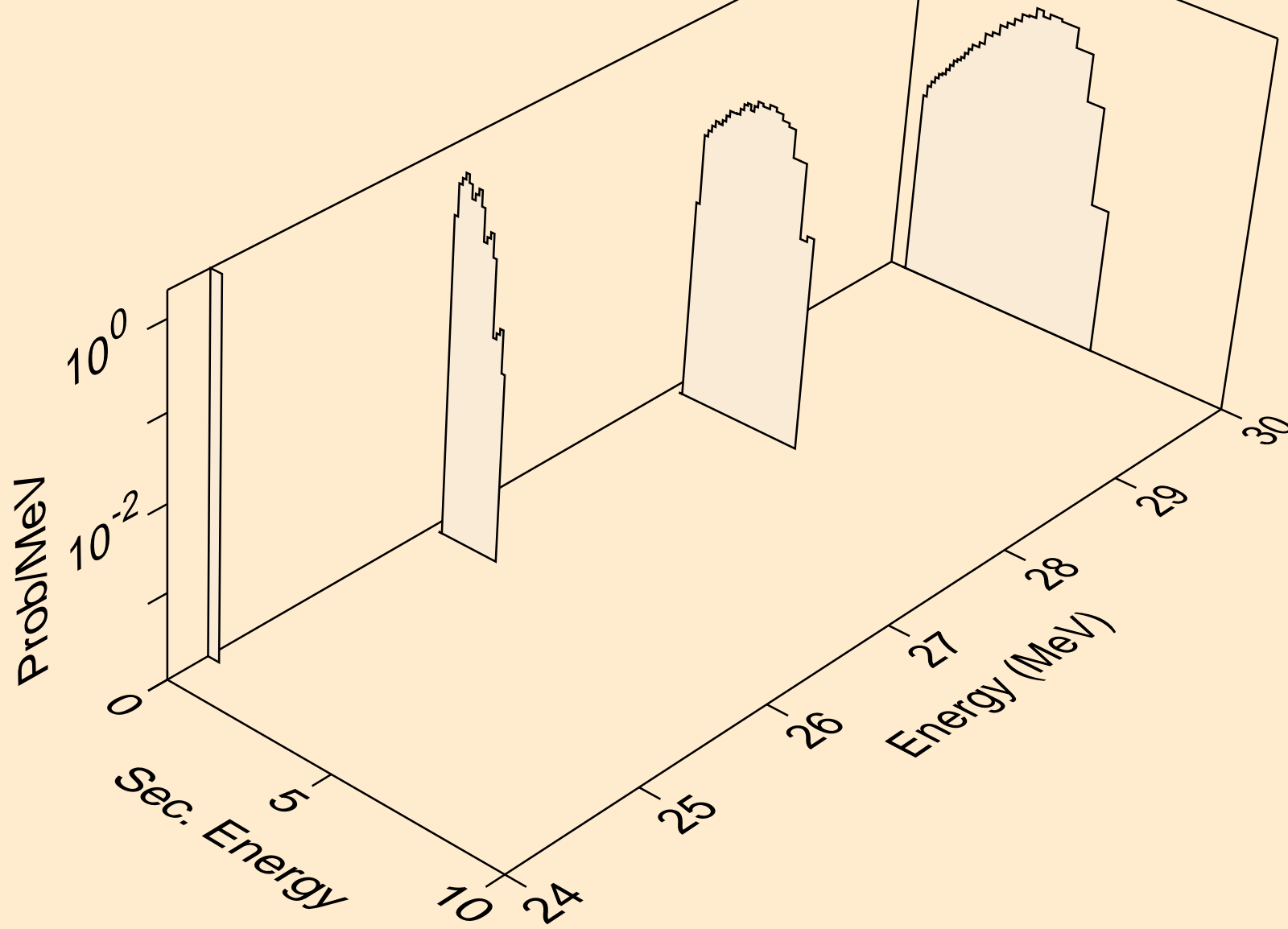

LA124M HELION ACER TENDL-2021 LIBRARY; T=0.K  
deuterons from (s,n\*)d

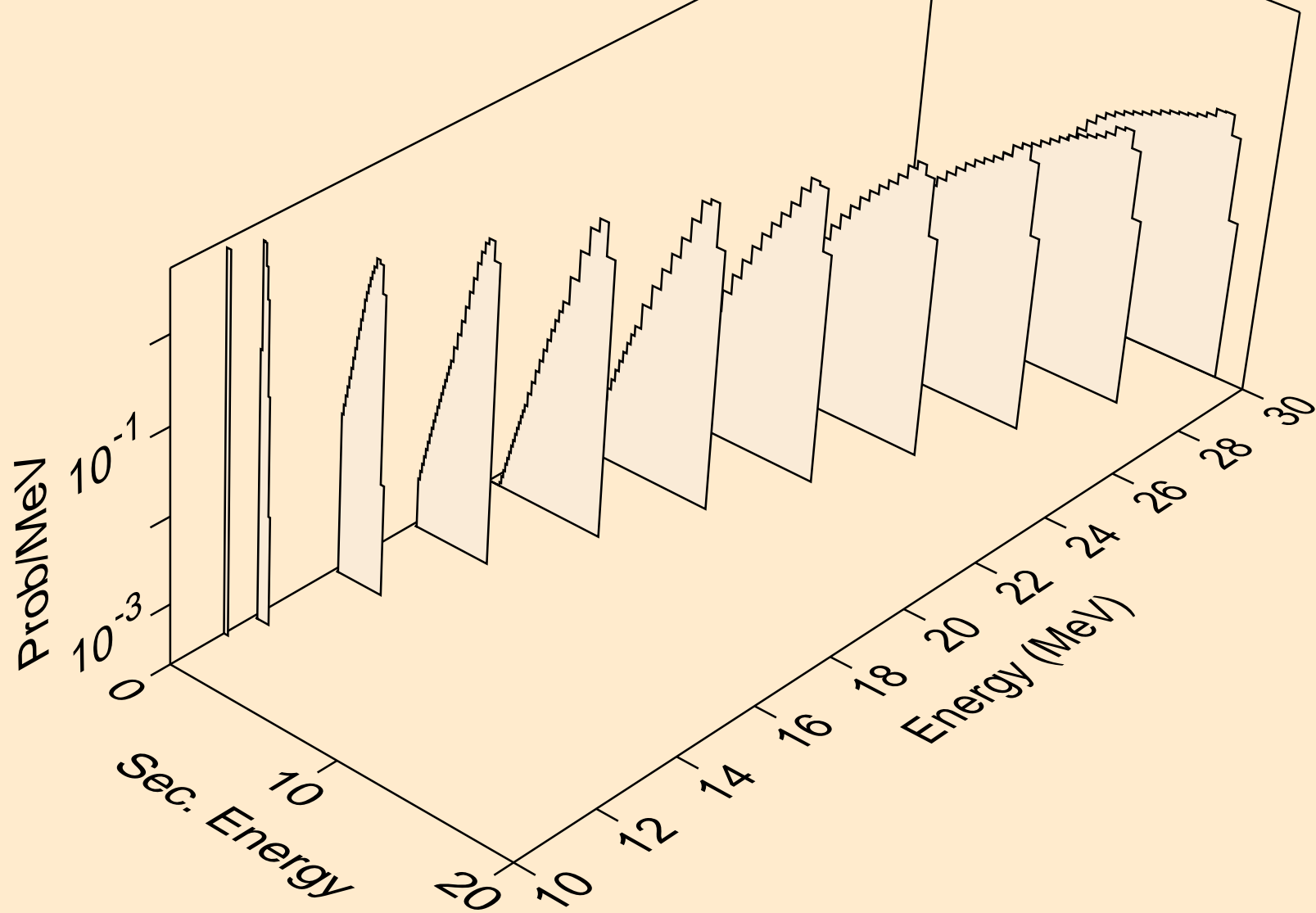

LA124M HELION ACER TENDL-2021 LIBRARY; T=0.K  
deuterons from (s,d)

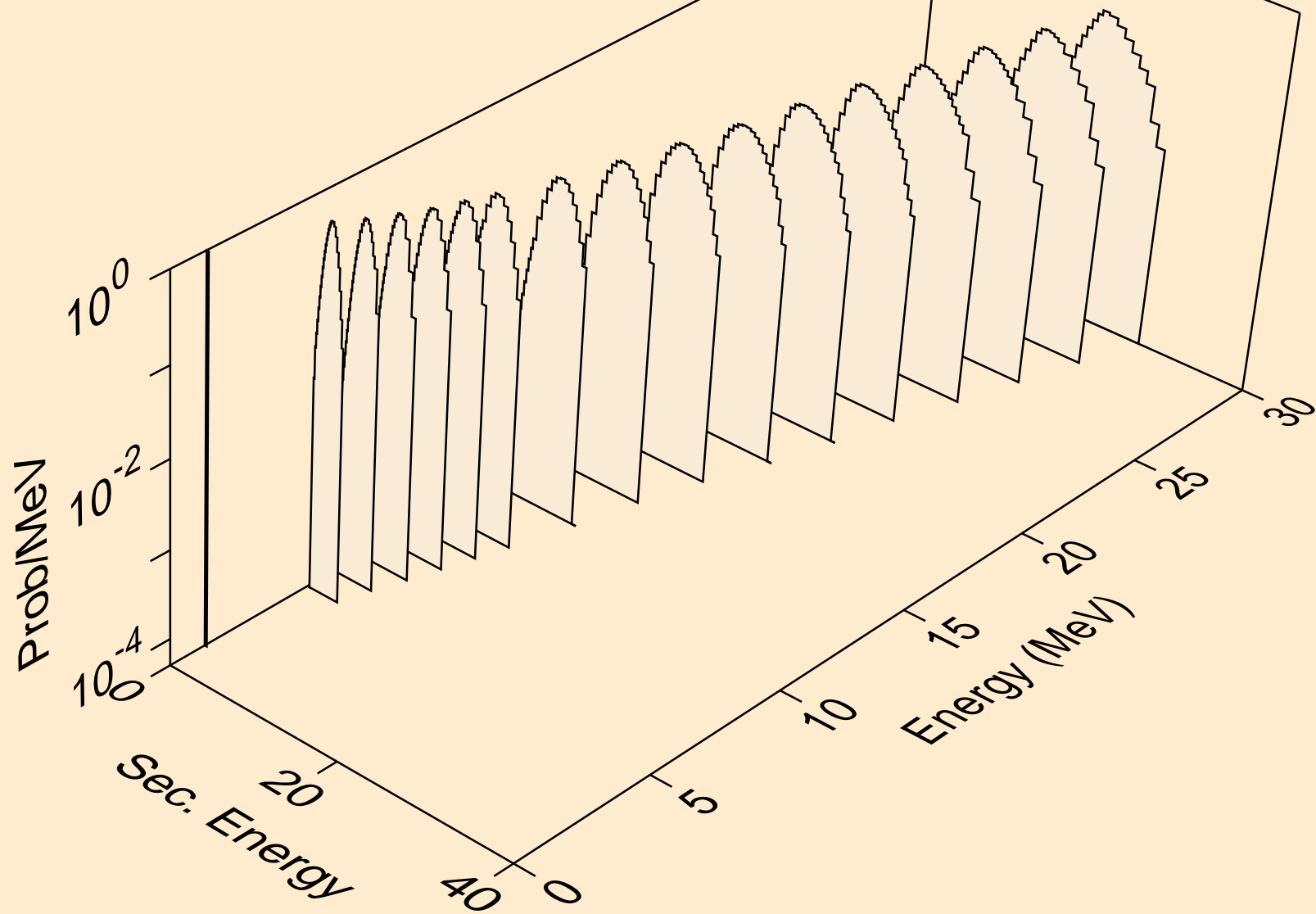

LA124M HELION ACER TENDL-2021 LIBRARY; T=0.K  
deuterons from (s,d2a)

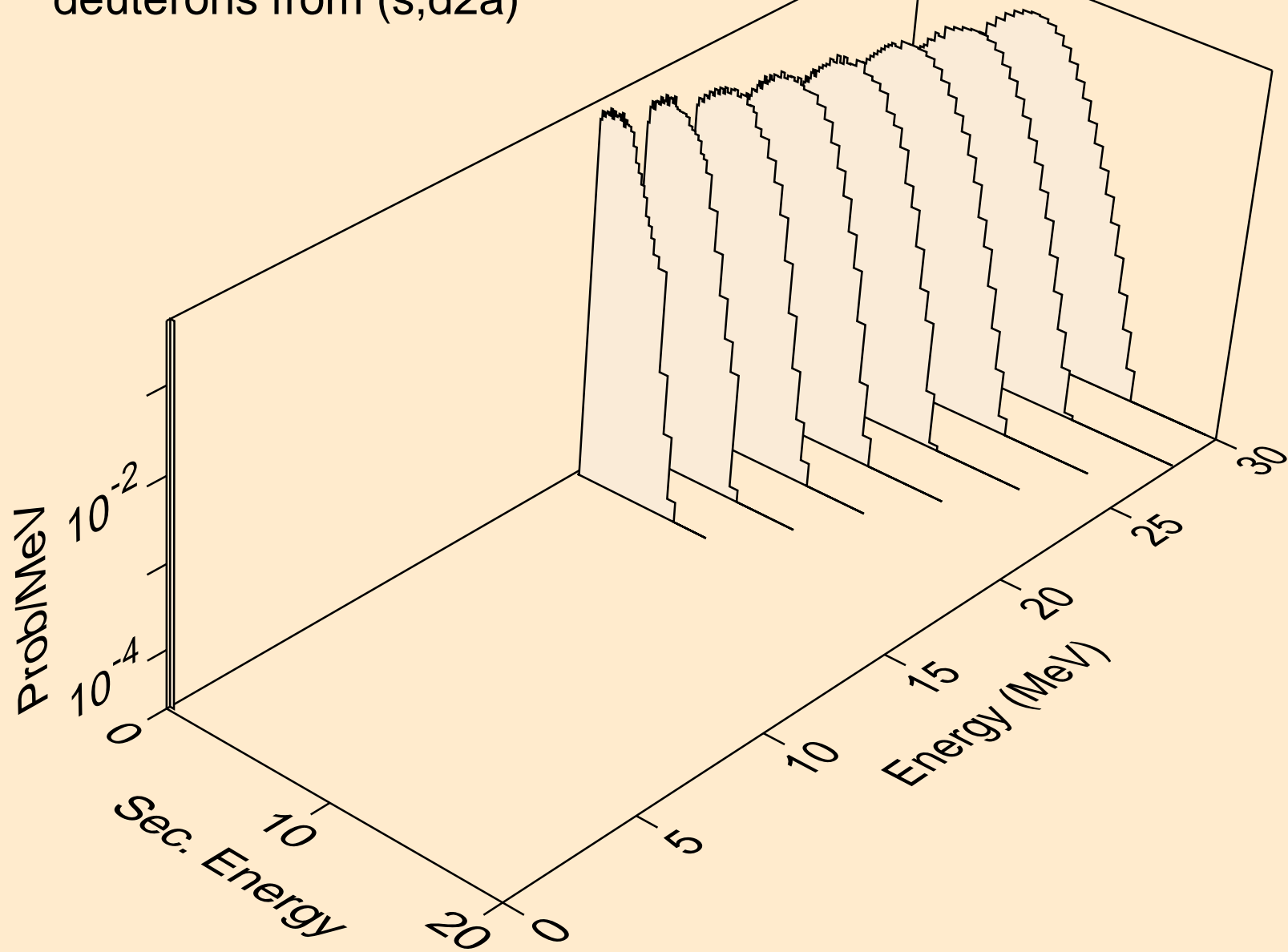

LA124M HELION ACER TENDL-2021 LIBRARY; T=0.K  
deuterons from (s,pd)

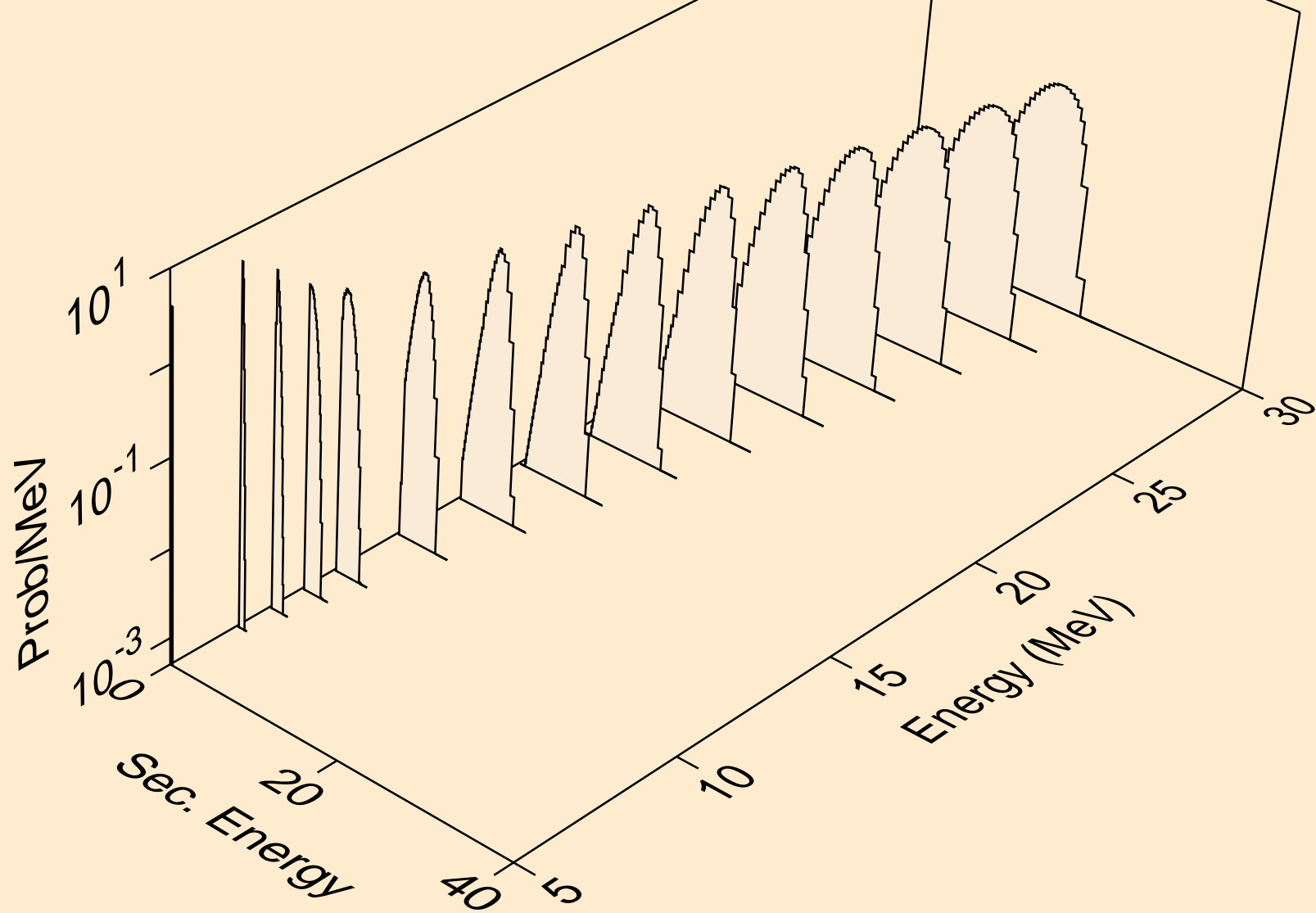



LA124M HELION ACER TENDL-2021 LIBRARY; T=0.K  
deuterons from (s,da)

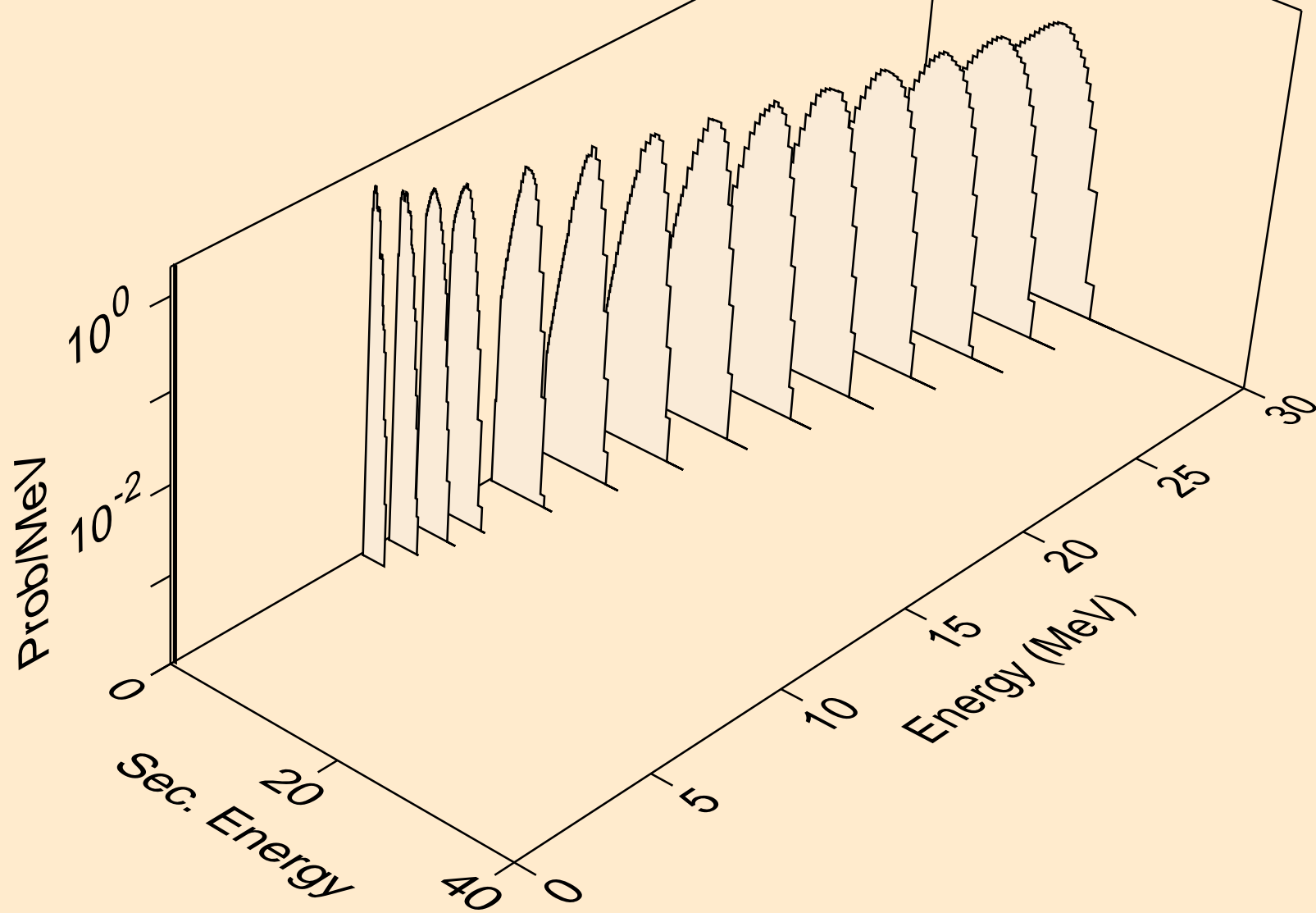

LA124M HELION ACER TENDL-2021 LIBRARY; T=0.K  
tritons from (s,x)

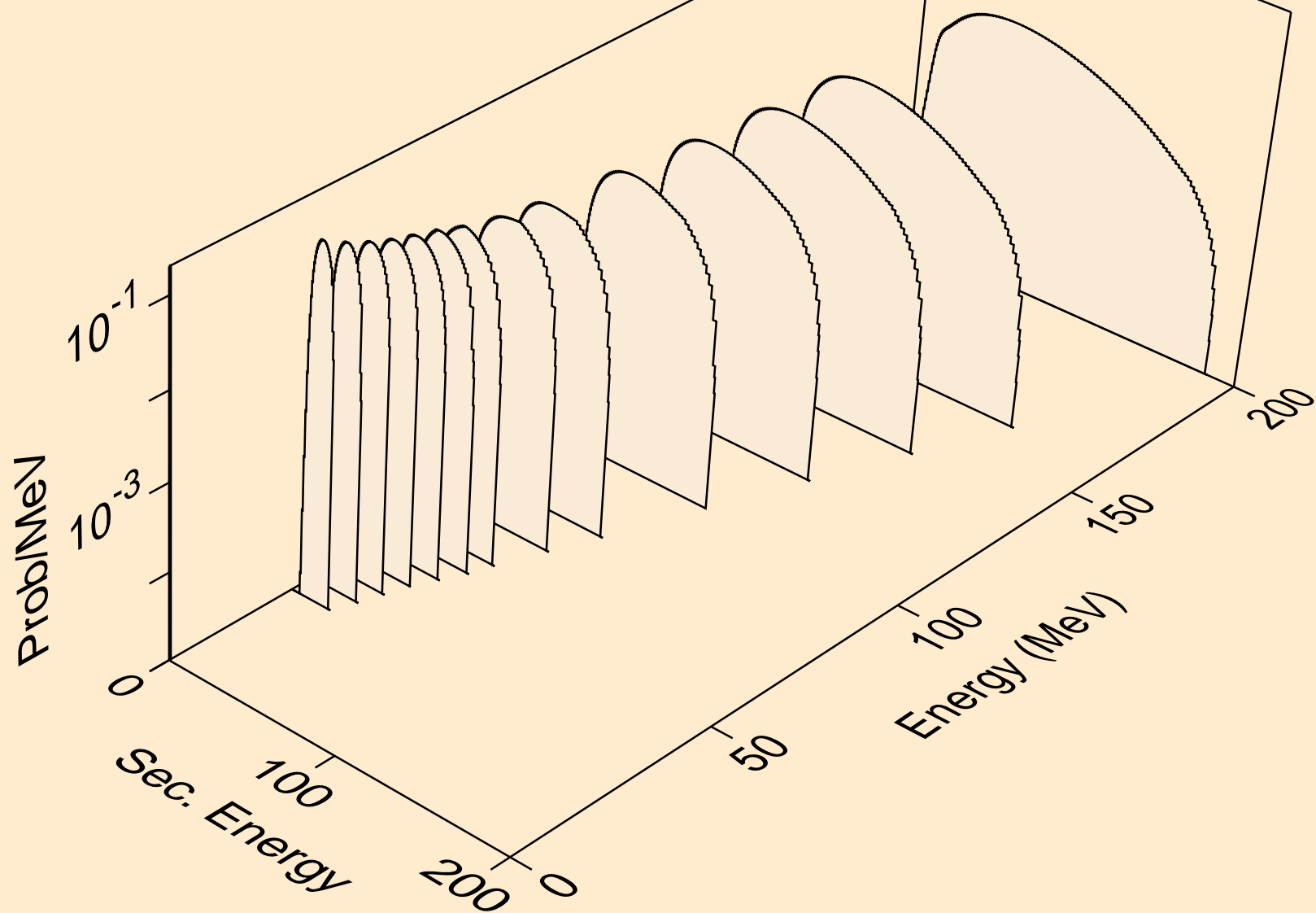

LA124M HELION ACER TENDL-2021 LIBRARY; T=0.K  
tritons from (s,n\*)t

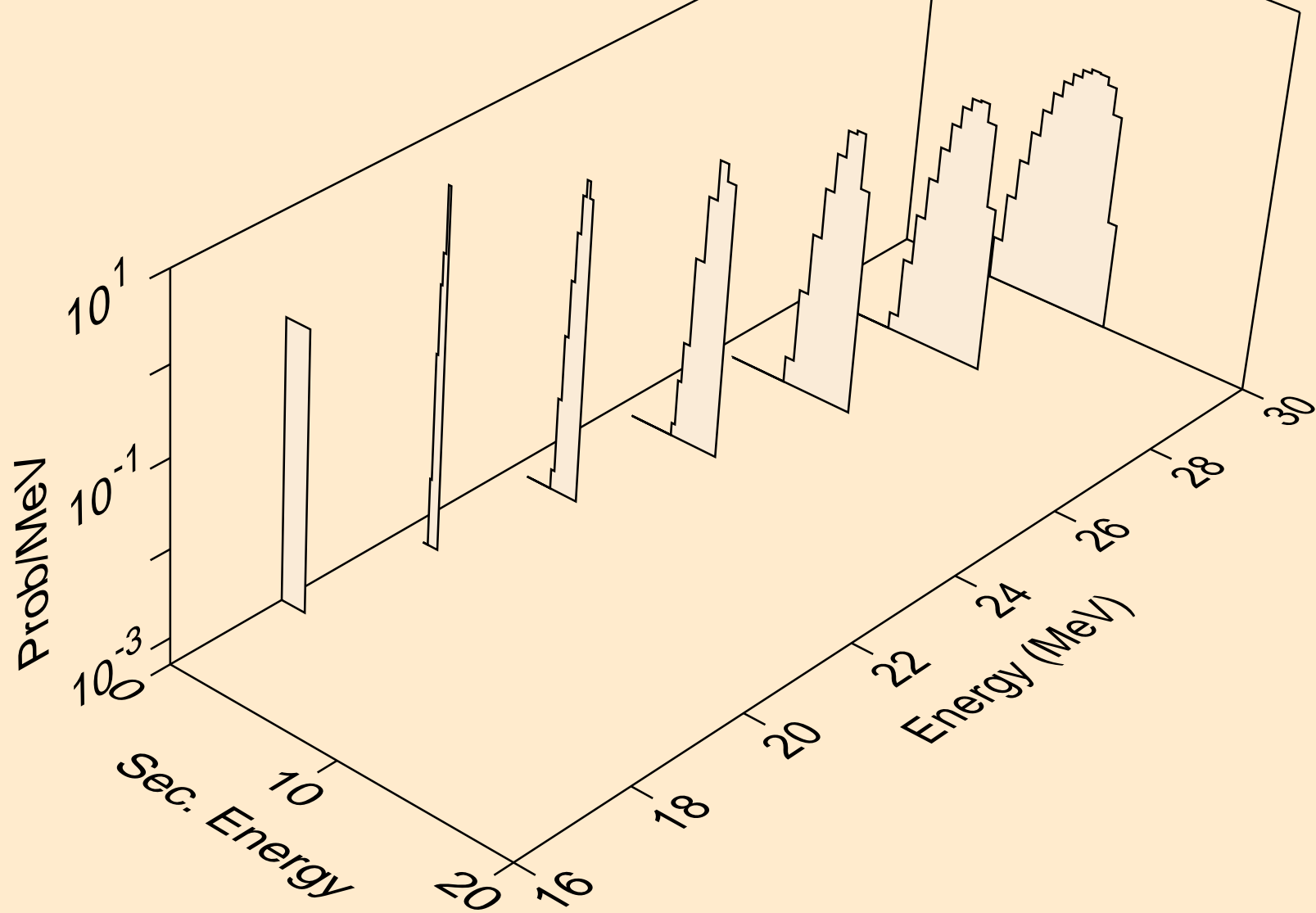

LA124M HELION ACER TENDL-2021 LIBRARY; T=0.K  
tritons from (s,t)

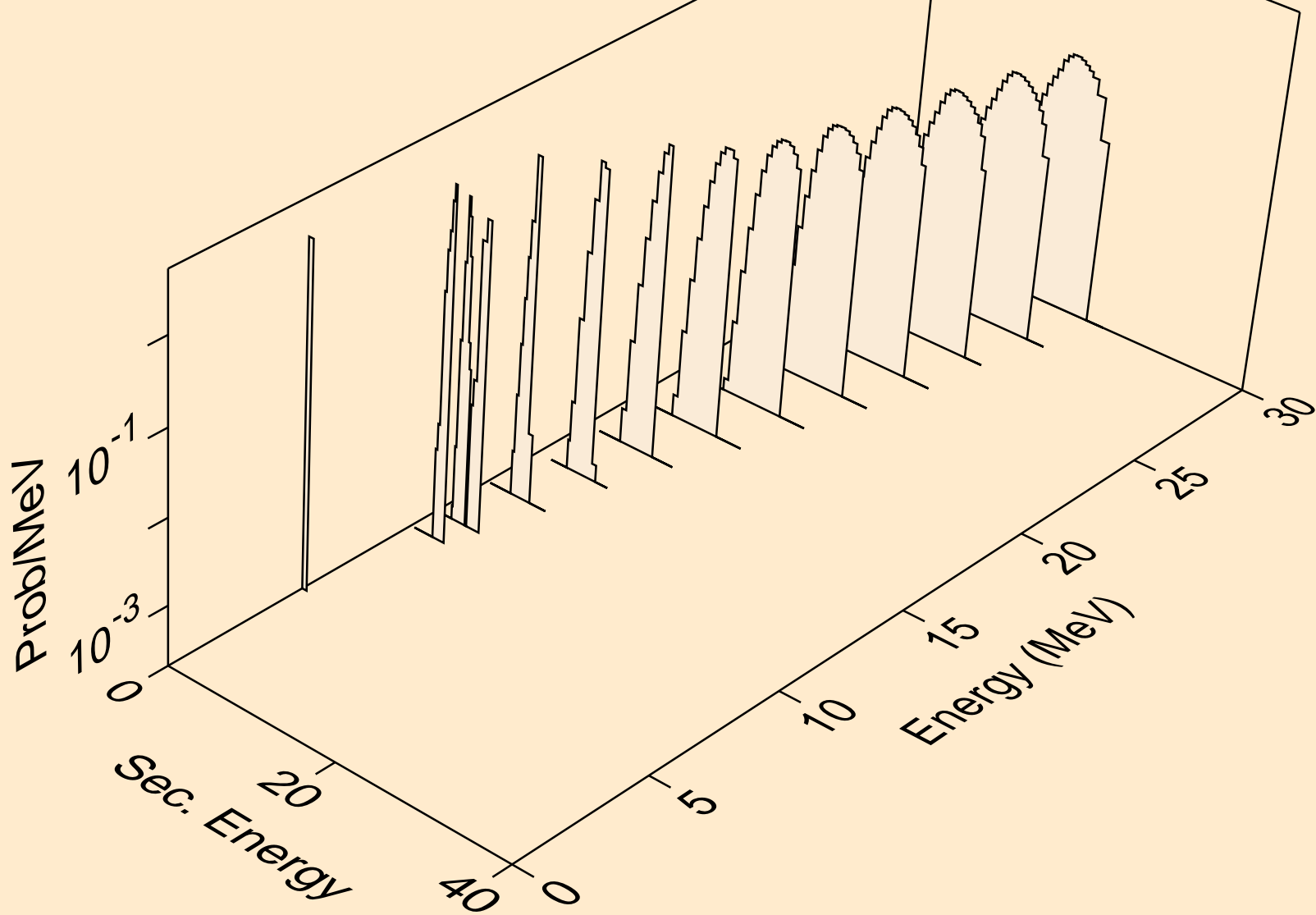

LA124M HELION ACER TENDL-2021 LIBRARY; T=0.K  
tritons from (s,pt)

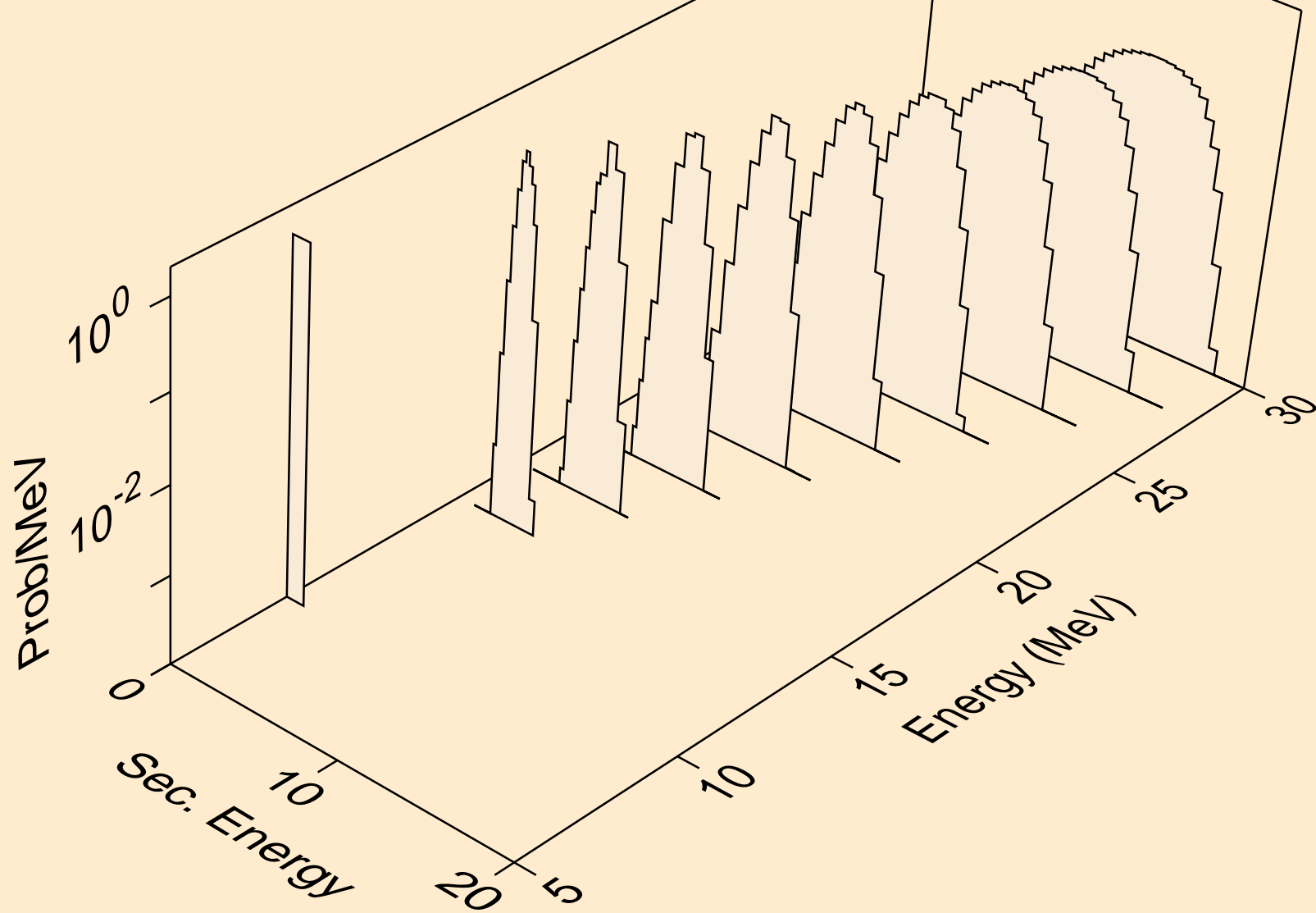

LA124M HELION ACER TENDL-2021 LIBRARY; T=0.K  
alphas from (s,x)

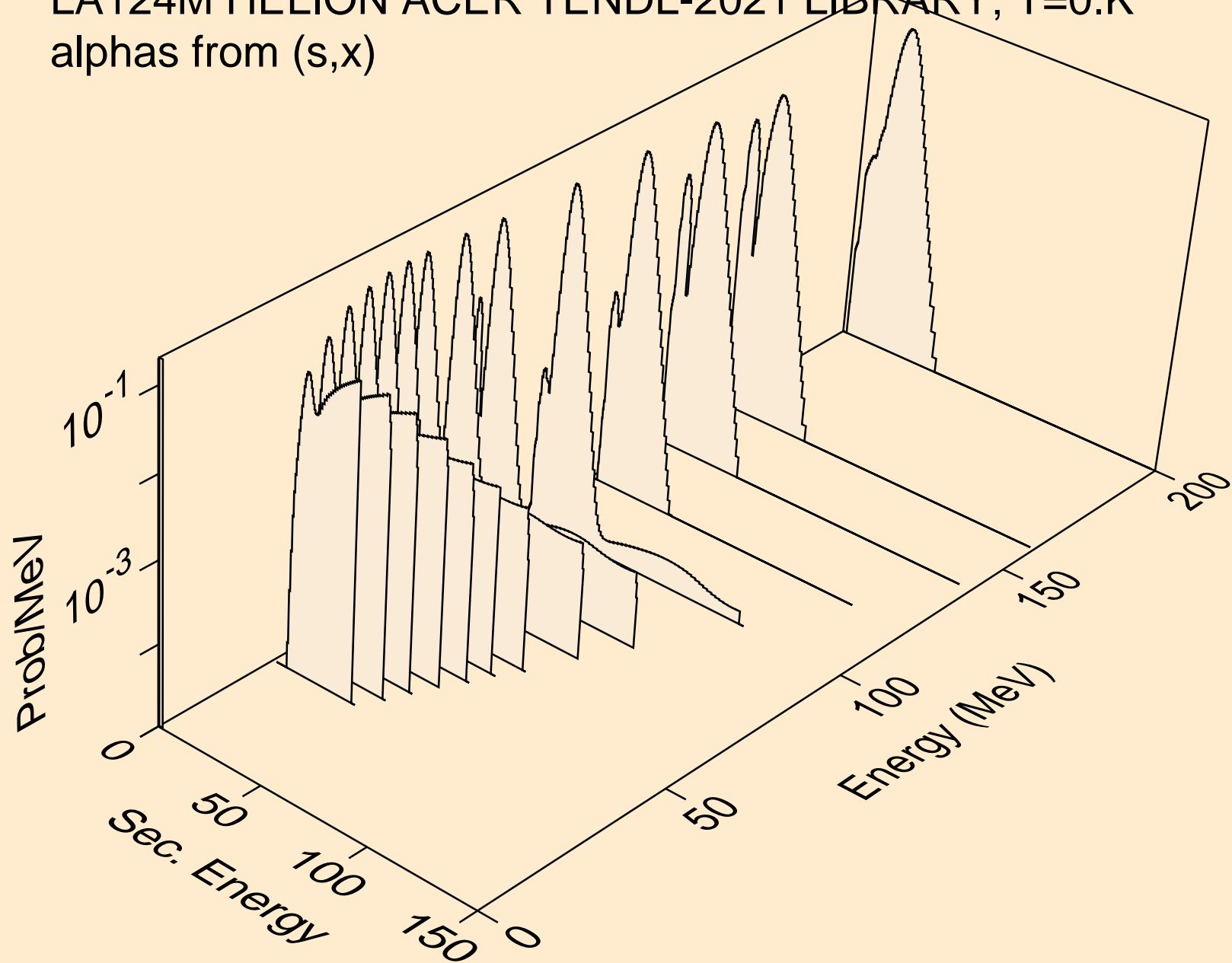

LA124M HELION ACER TENDL-2021 LIBRARY; T=0.K  
alphas from (s,n\*)a

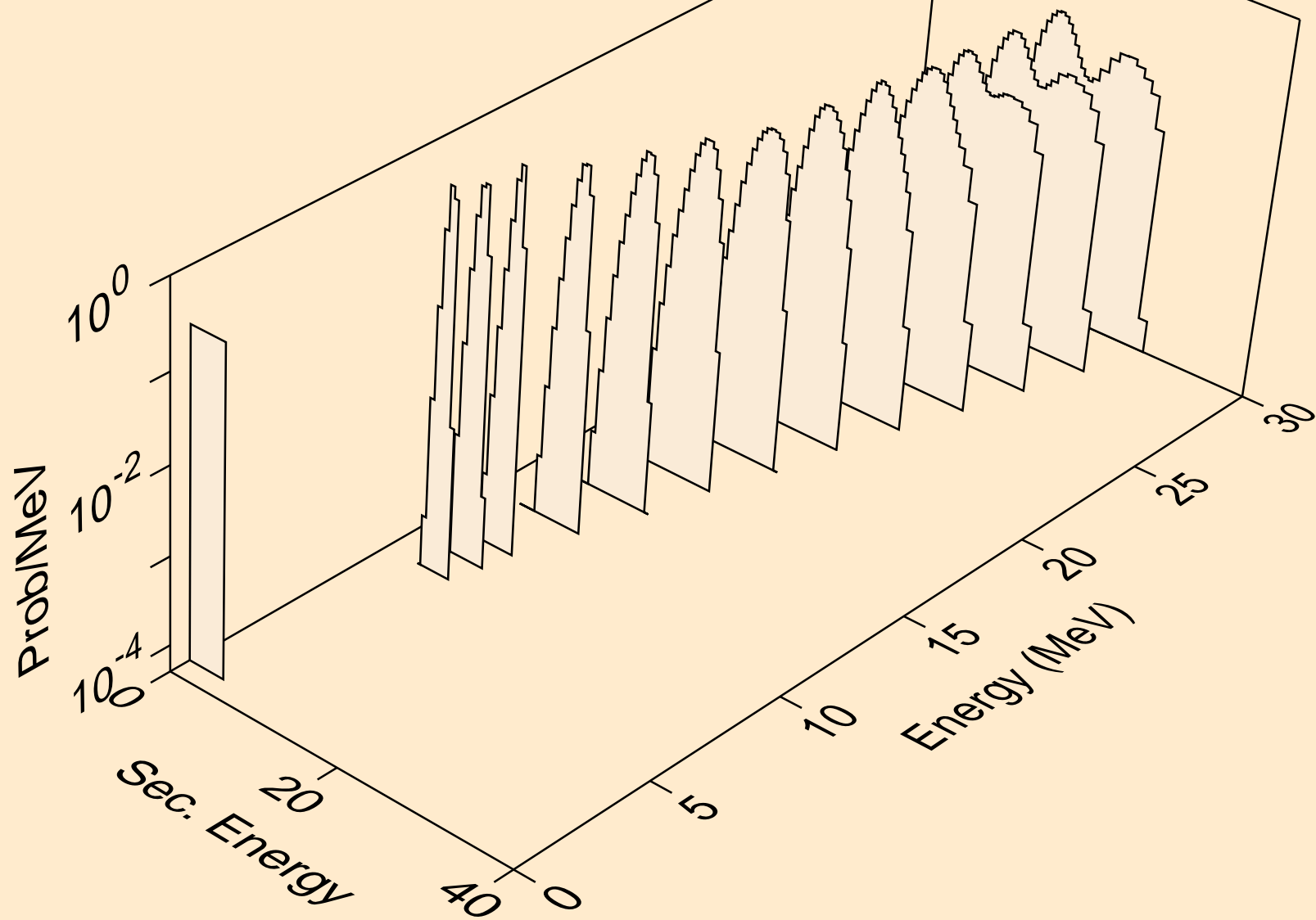

LA124M HELION ACER TENDL-2021 LIBRARY; T=0.K  
alphas from (s,2n)a

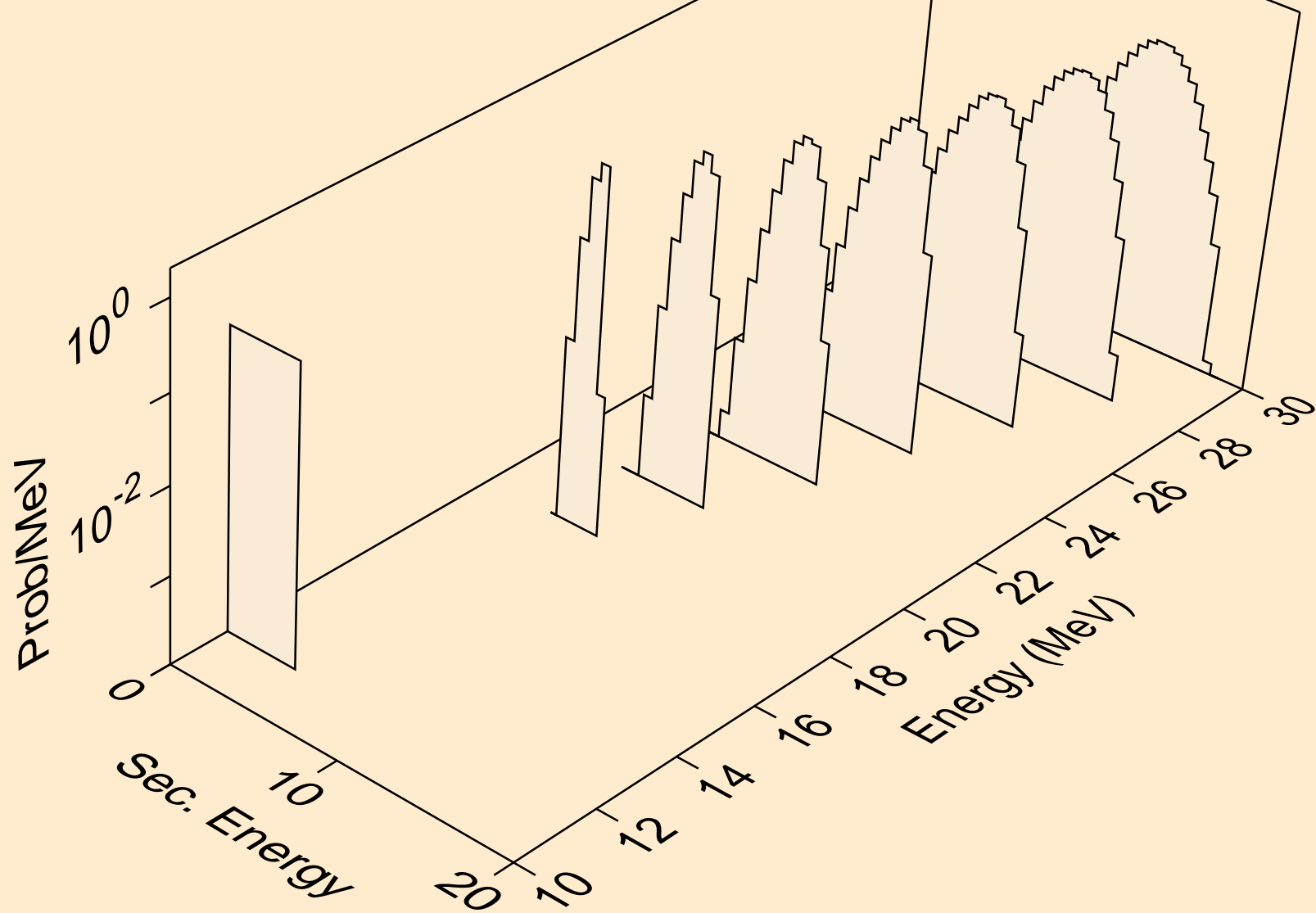



LA124M HELION ACER TENDL-2021 LIBRARY; T=0.K  
alphas from (s,n\*)2a

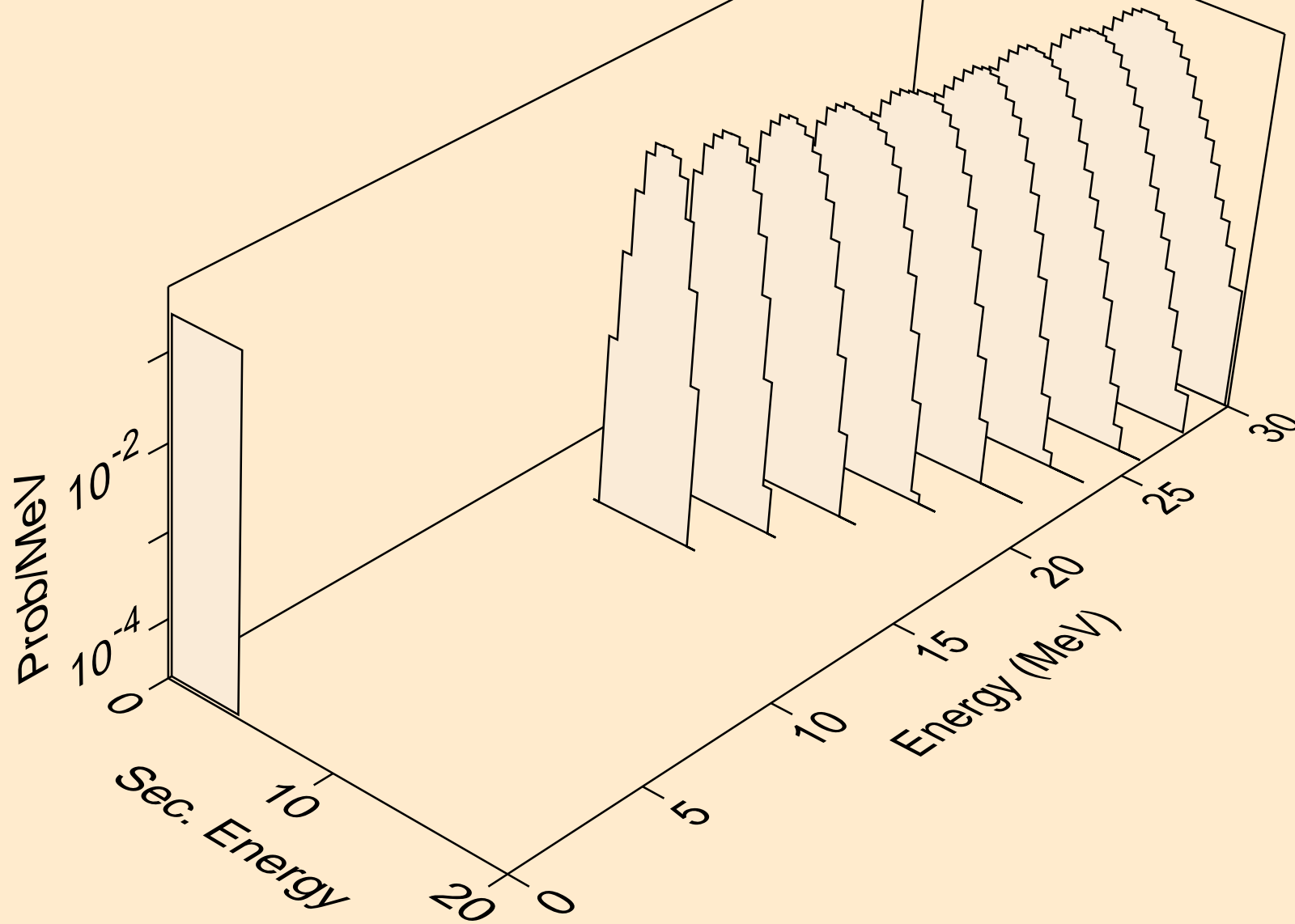

LA124M HELION ACER TENDL-2021 LIBRARY; T=0.K  
alphas from (s,npa)

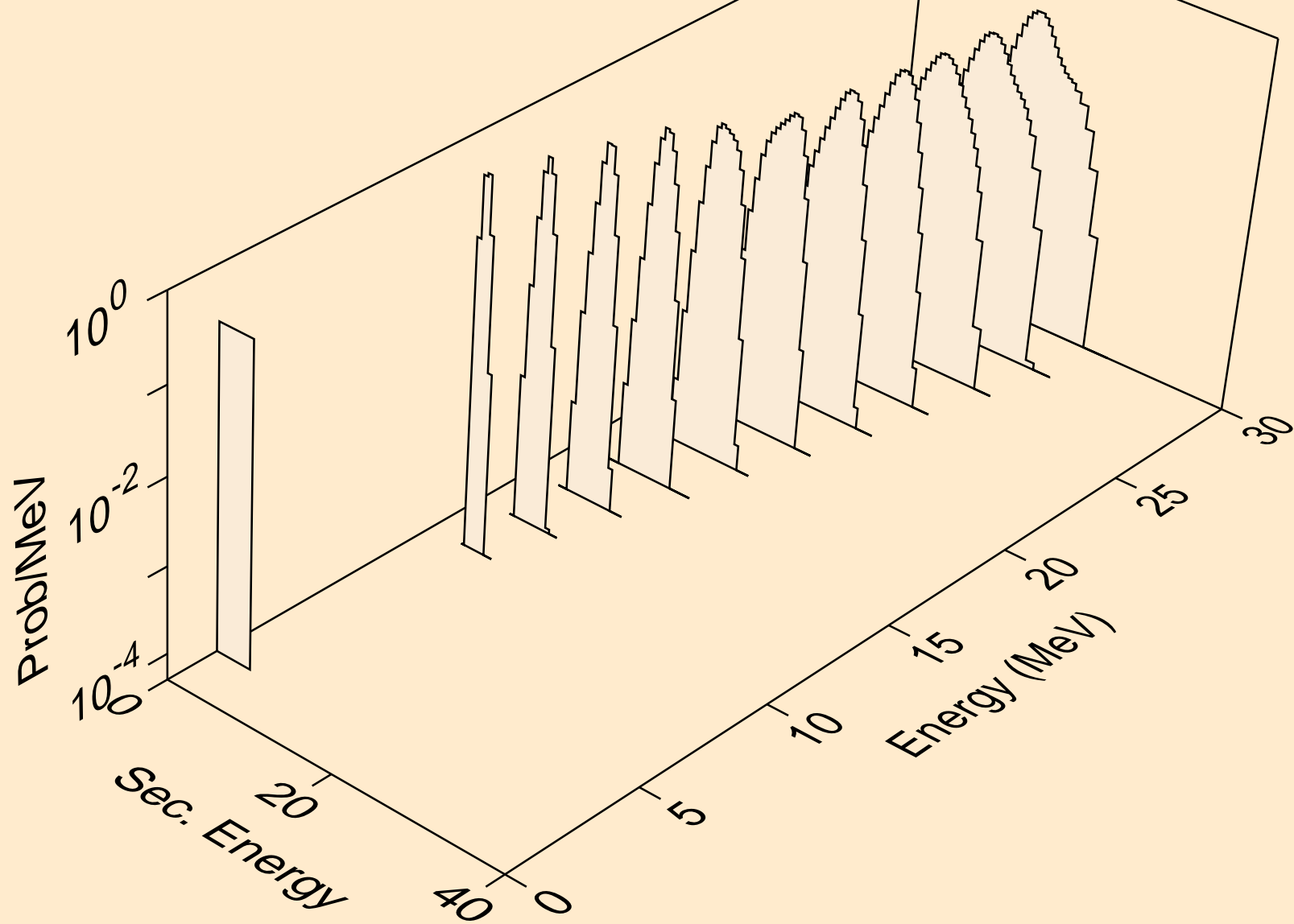

LA124M HELION ACER TENDL-2021 LIBRARY; T=0.K  
alphas from (s,a)

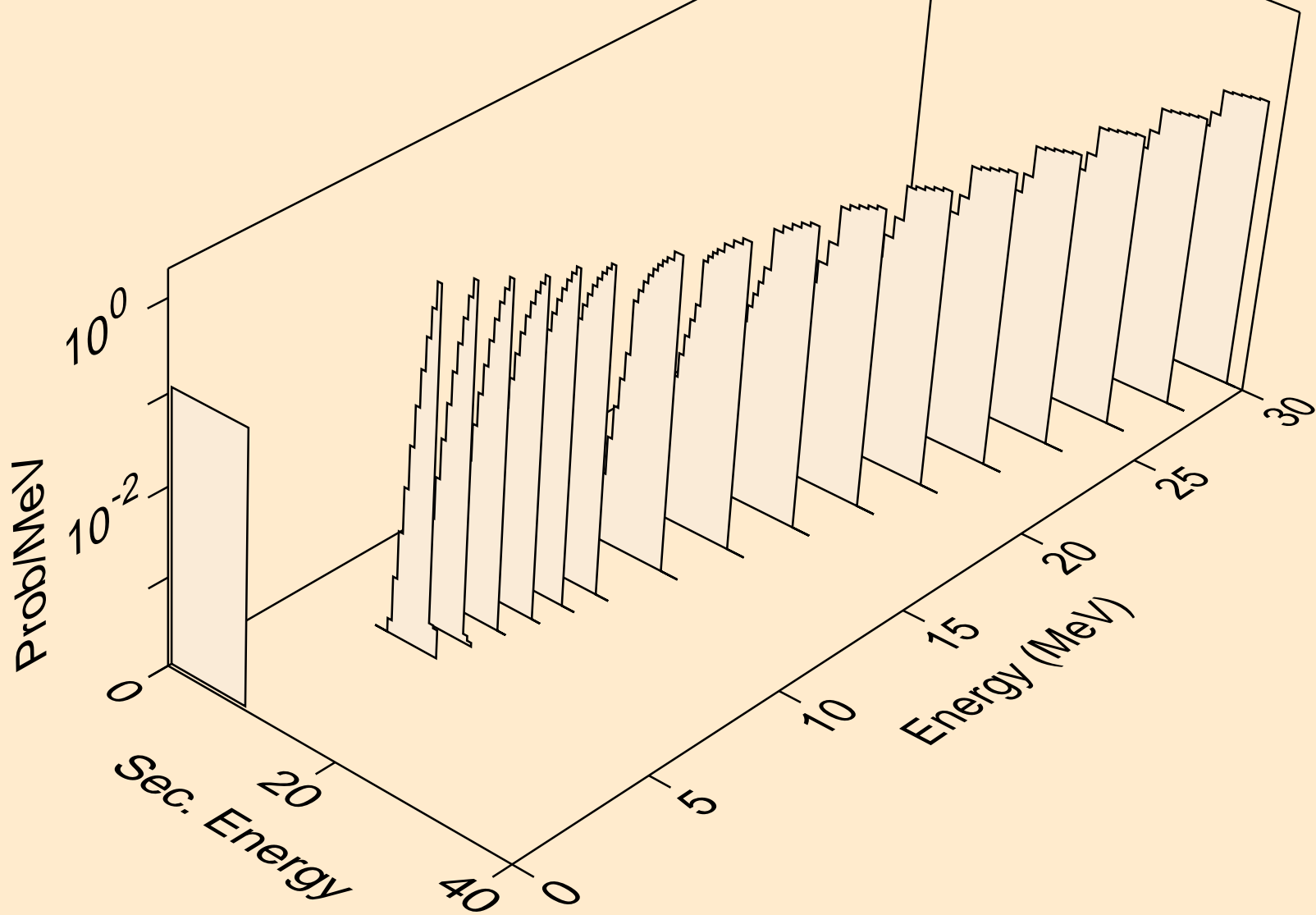

LA124M HELION ACER TENDL-2021 LIBRARY; T=0.K  
alphas from (s,2a)

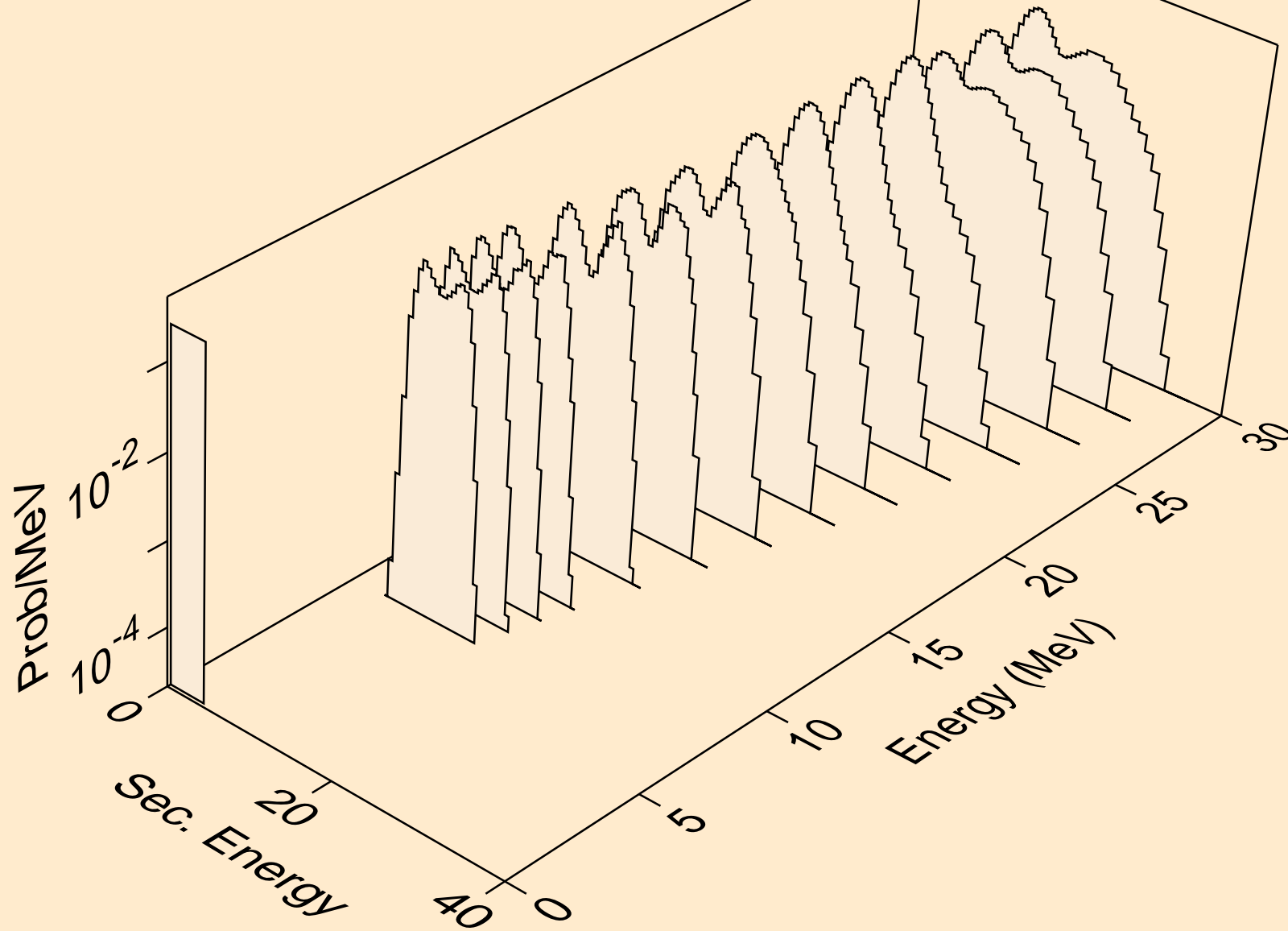

LA124M HELION ACER TENDL-2021 LIBRARY; T=0.K  
alphas from (s,3a)

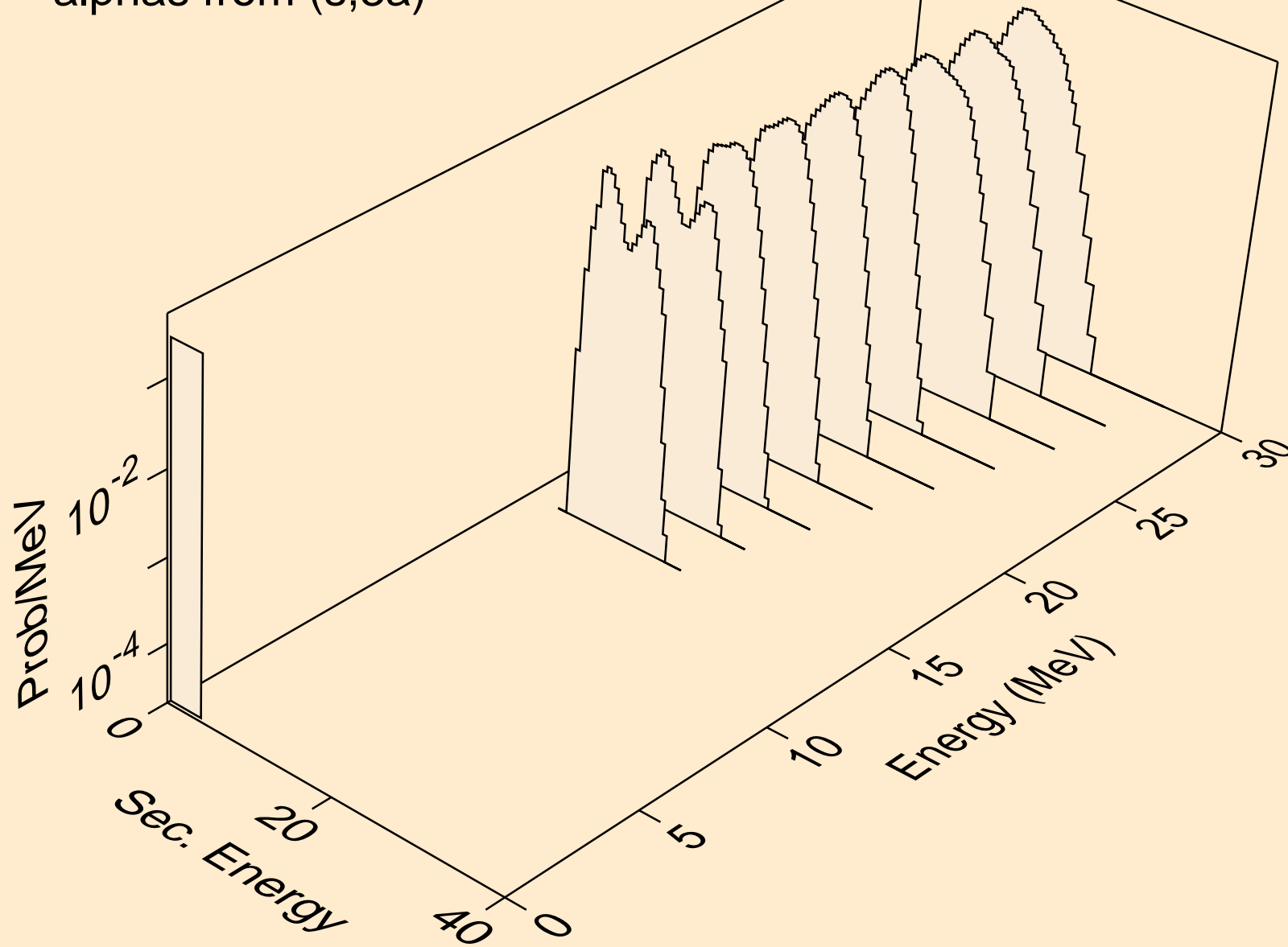

LA124M HELION ACER TENDL-2021 LIBRARY; T=0.K  
alphas from (s,pa)

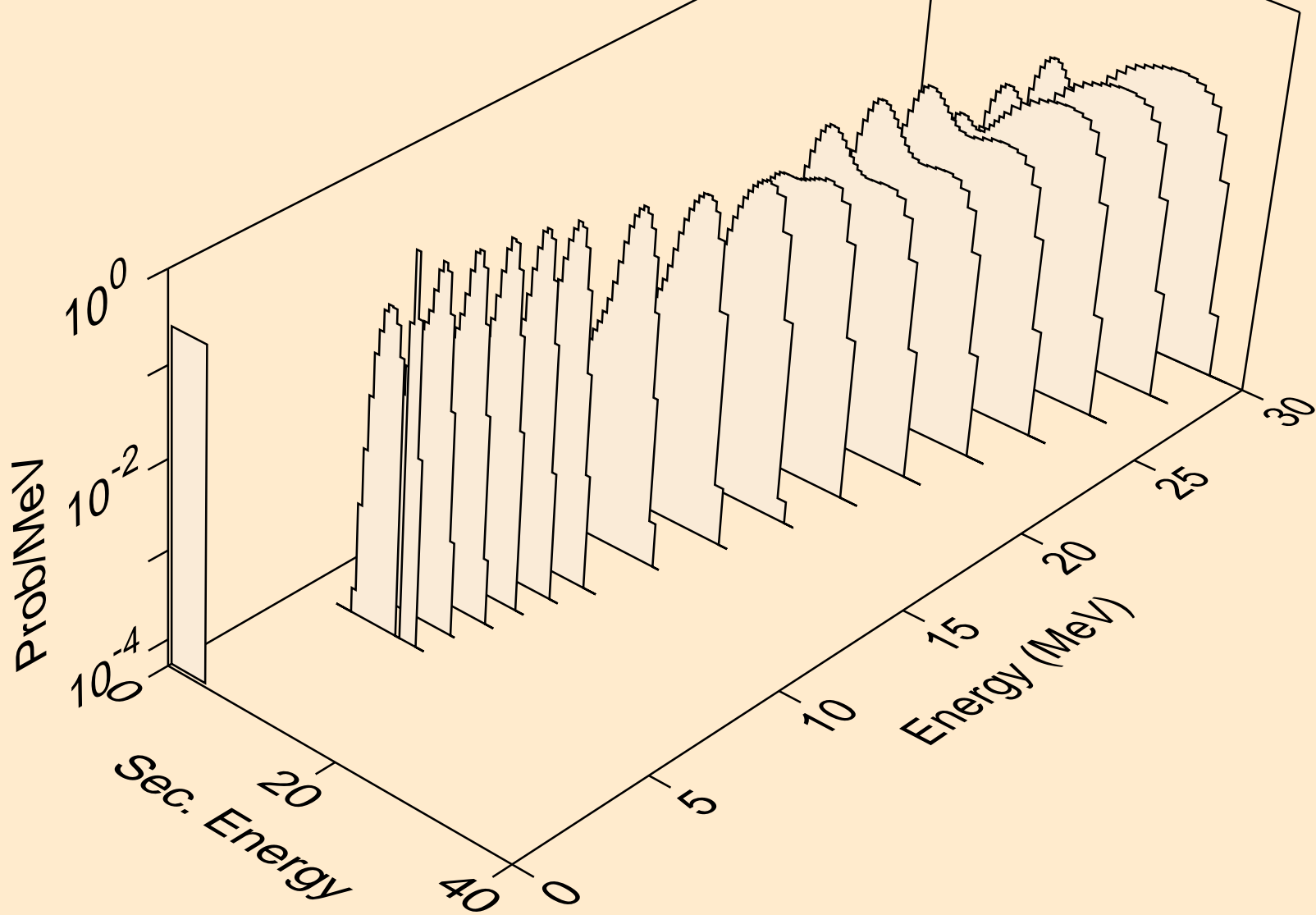

LA124M HELION ACER TENDL-2021 LIBRARY; T=0.K  
alphas from (s,d2a)

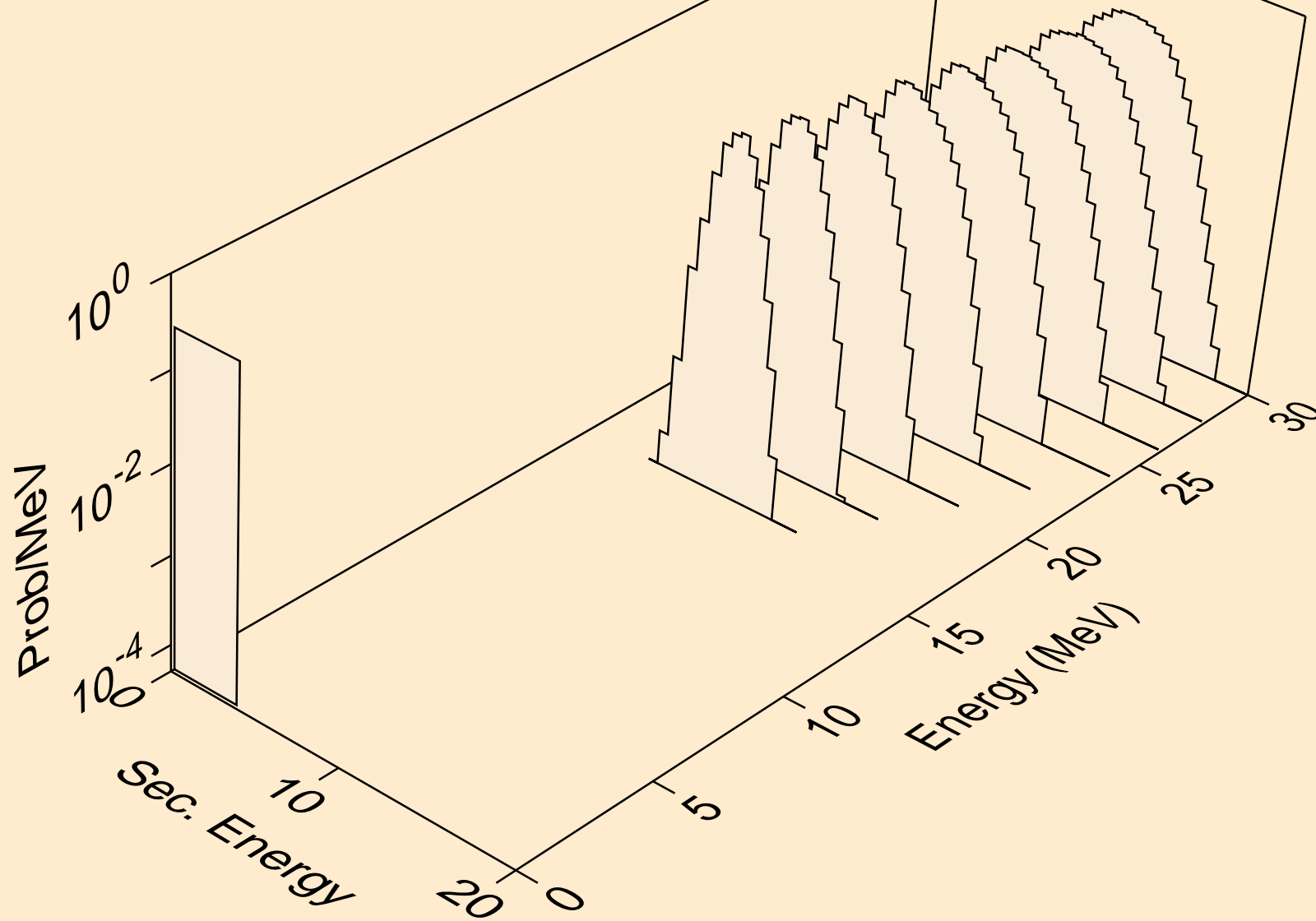

LA124M HELION ACER TENDL-2021 LIBRARY; T=0.K  
alphas from (s,da)

