

LR265 HELION ACER TENDL-2021 LIBRARY; T=0.K
Principal cross sections

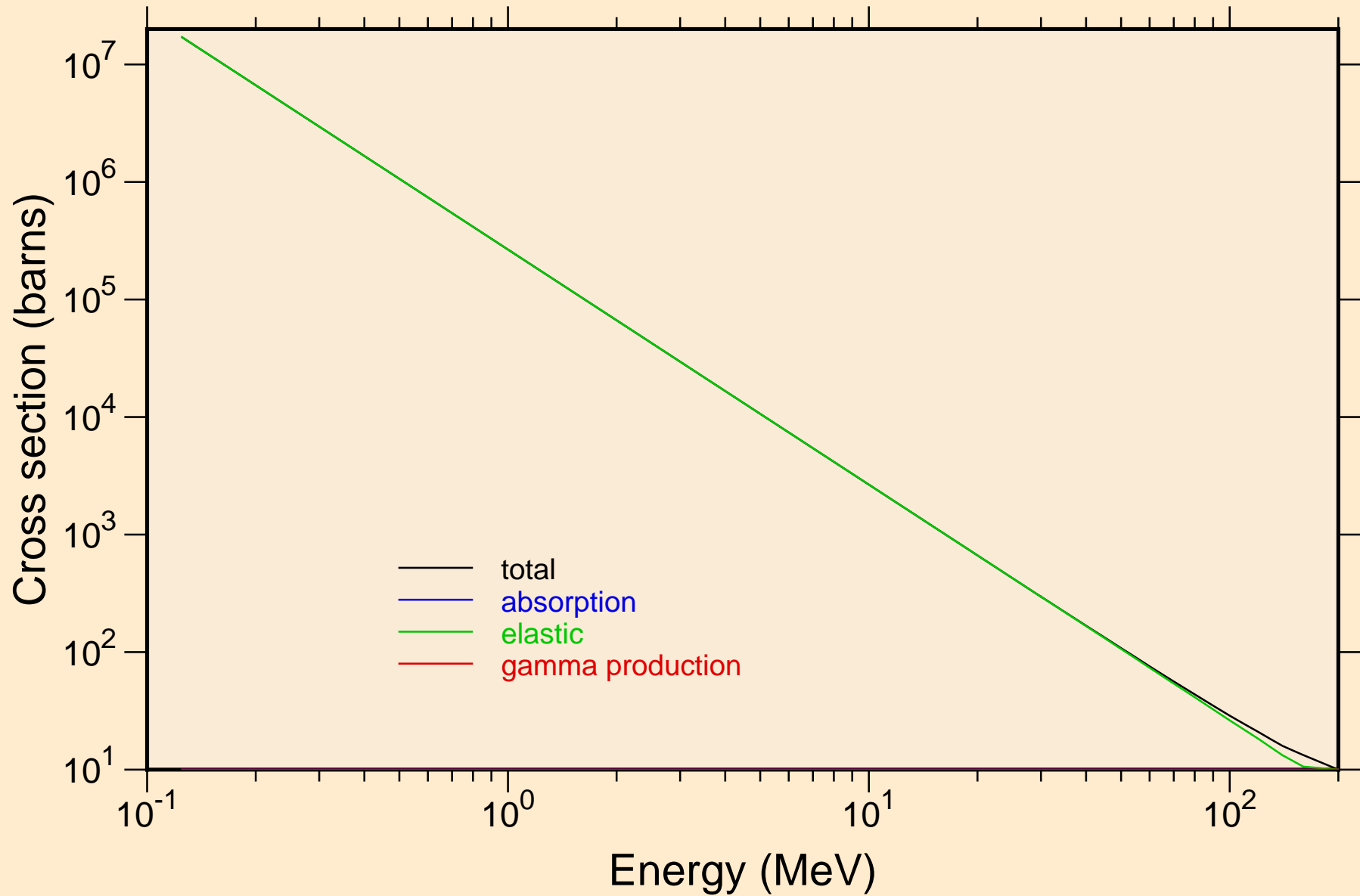

LR265 HELION ACER TENDL-2021 LIBRARY; T=0.K

Heating

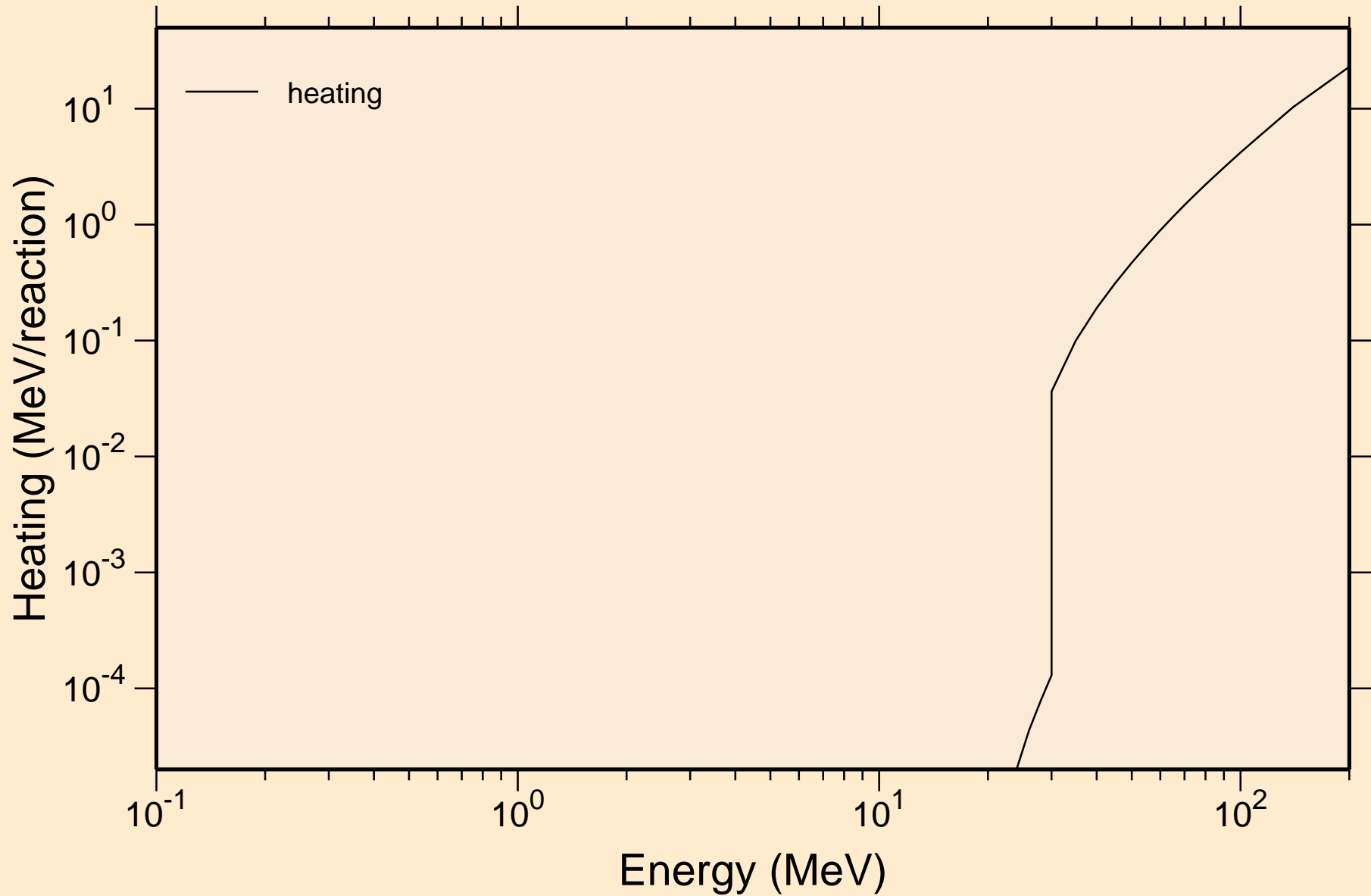

LR265 HELION ACER TENDL-2021 LIBRARY; T=0.K

Principal cross sections

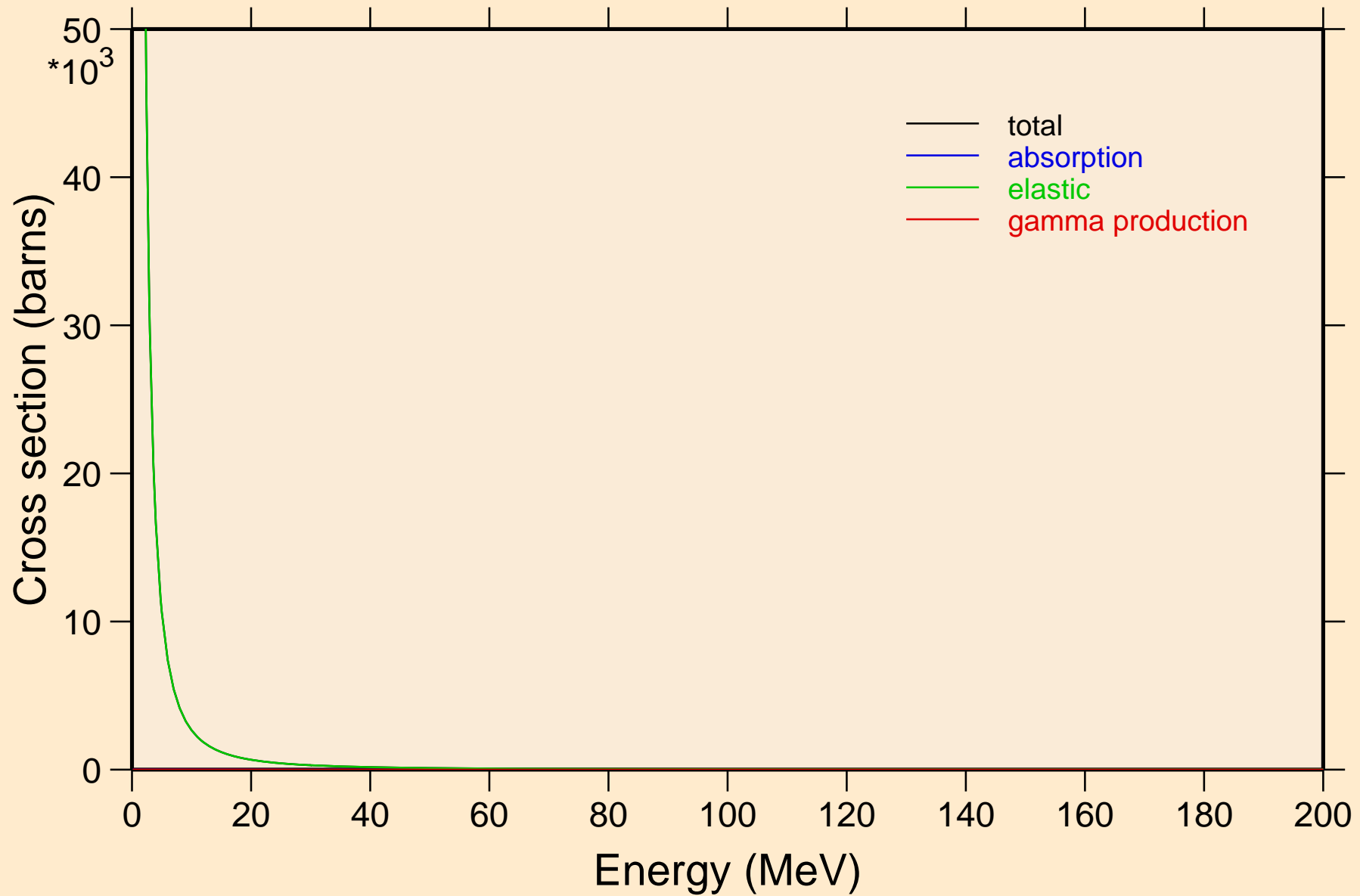

LR265 HELION ACER TENDL-2021 LIBRARY; T=0.K

Heating

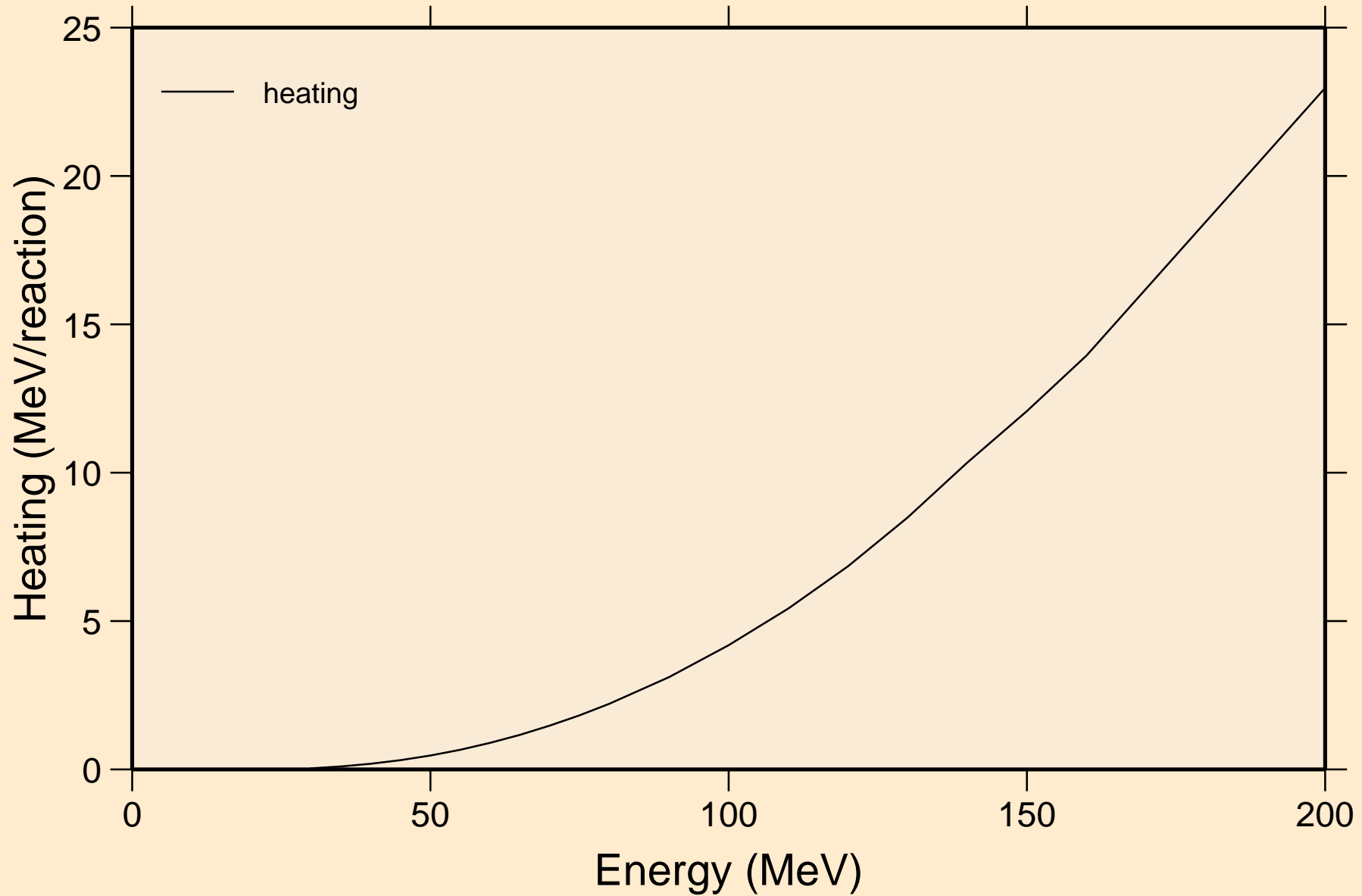

LR265 HELION ACER TENDL-2021 LIBRARY; T=0.K
Threshold reactions

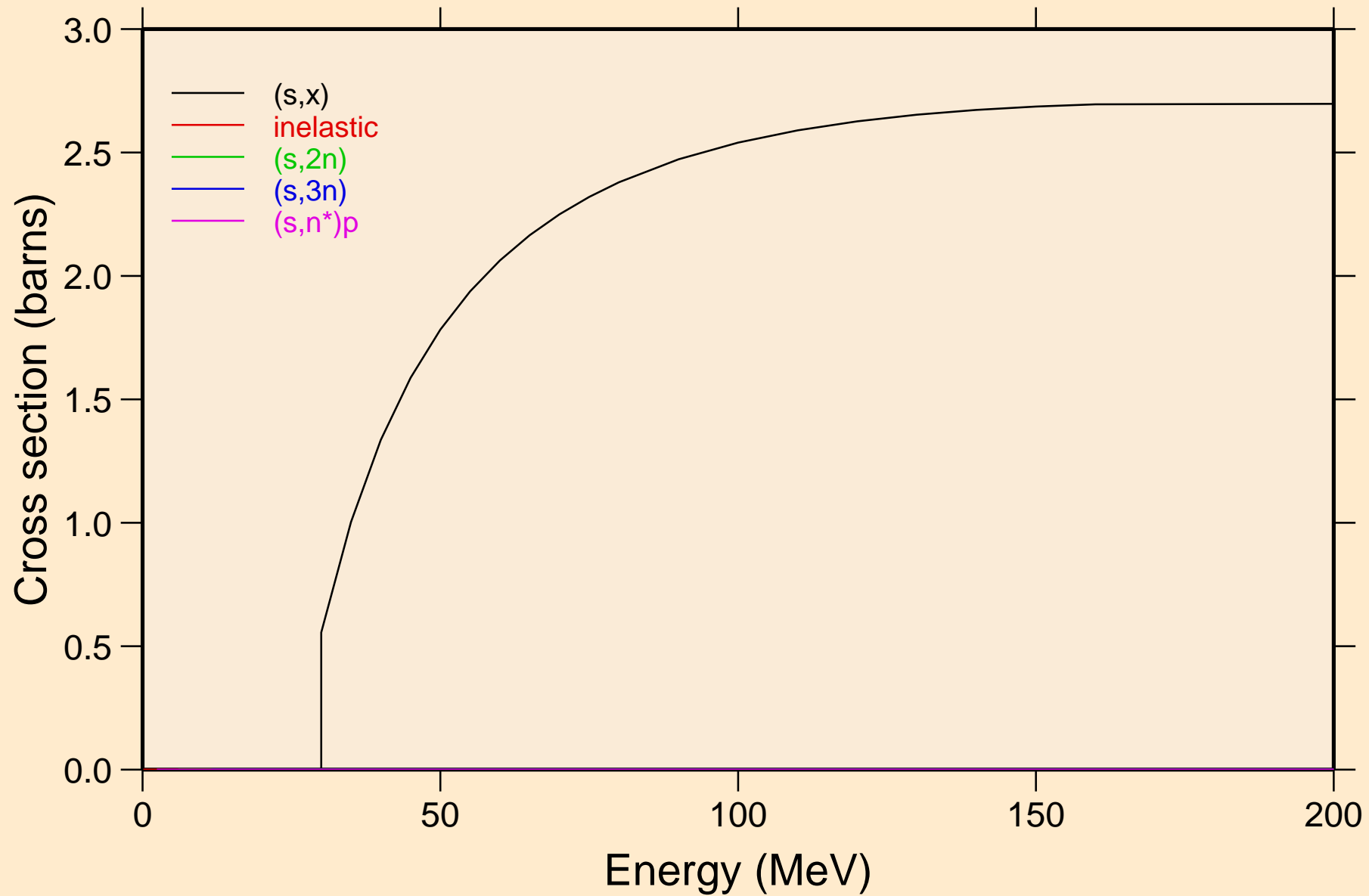

LR265 HELION ACER TENDL-2021 LIBRARY; T=0.K
Threshold reactions

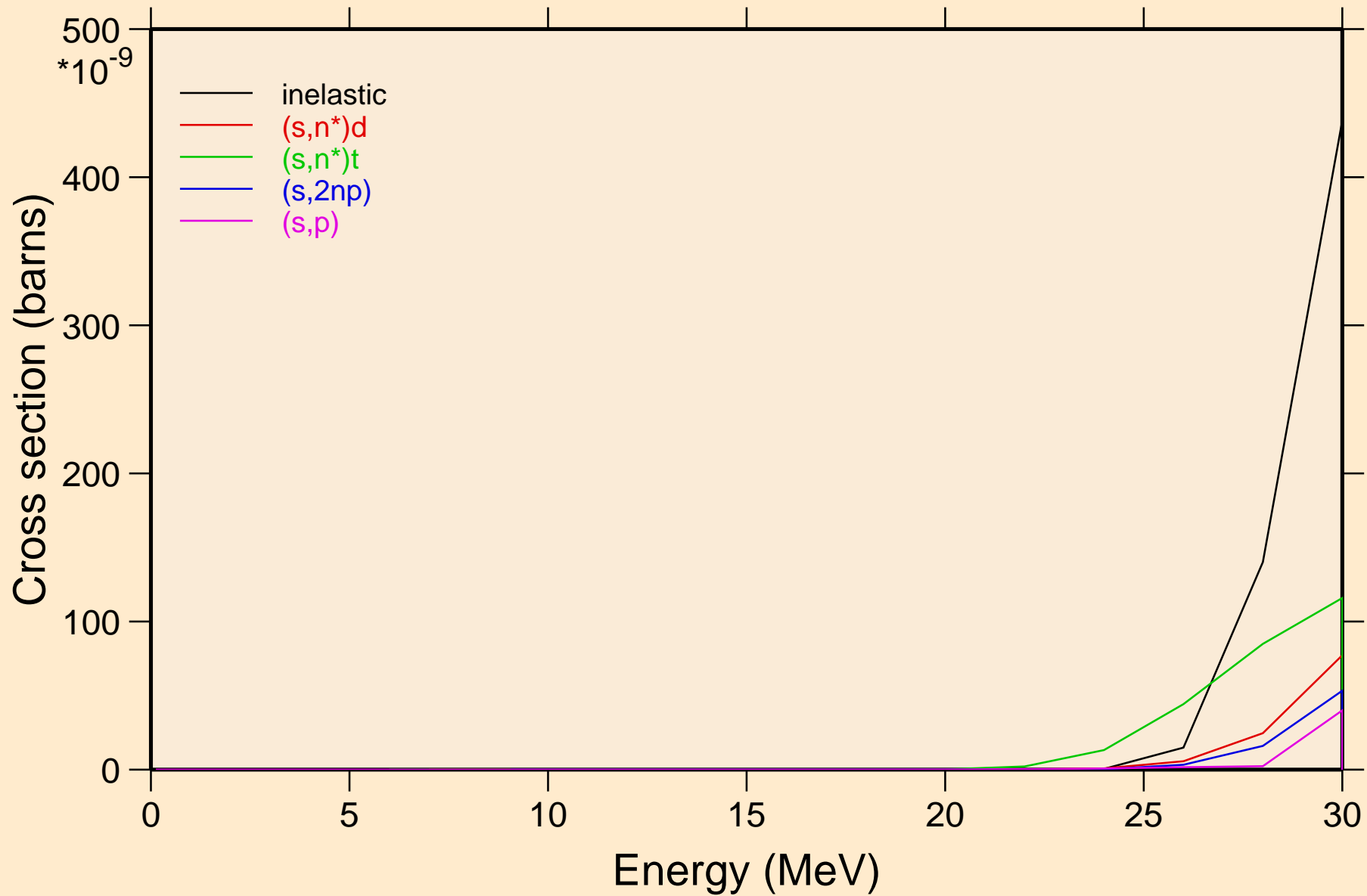

LR265 HELION ACER TENDL-2021 LIBRARY; T=0.K
Threshold reactions

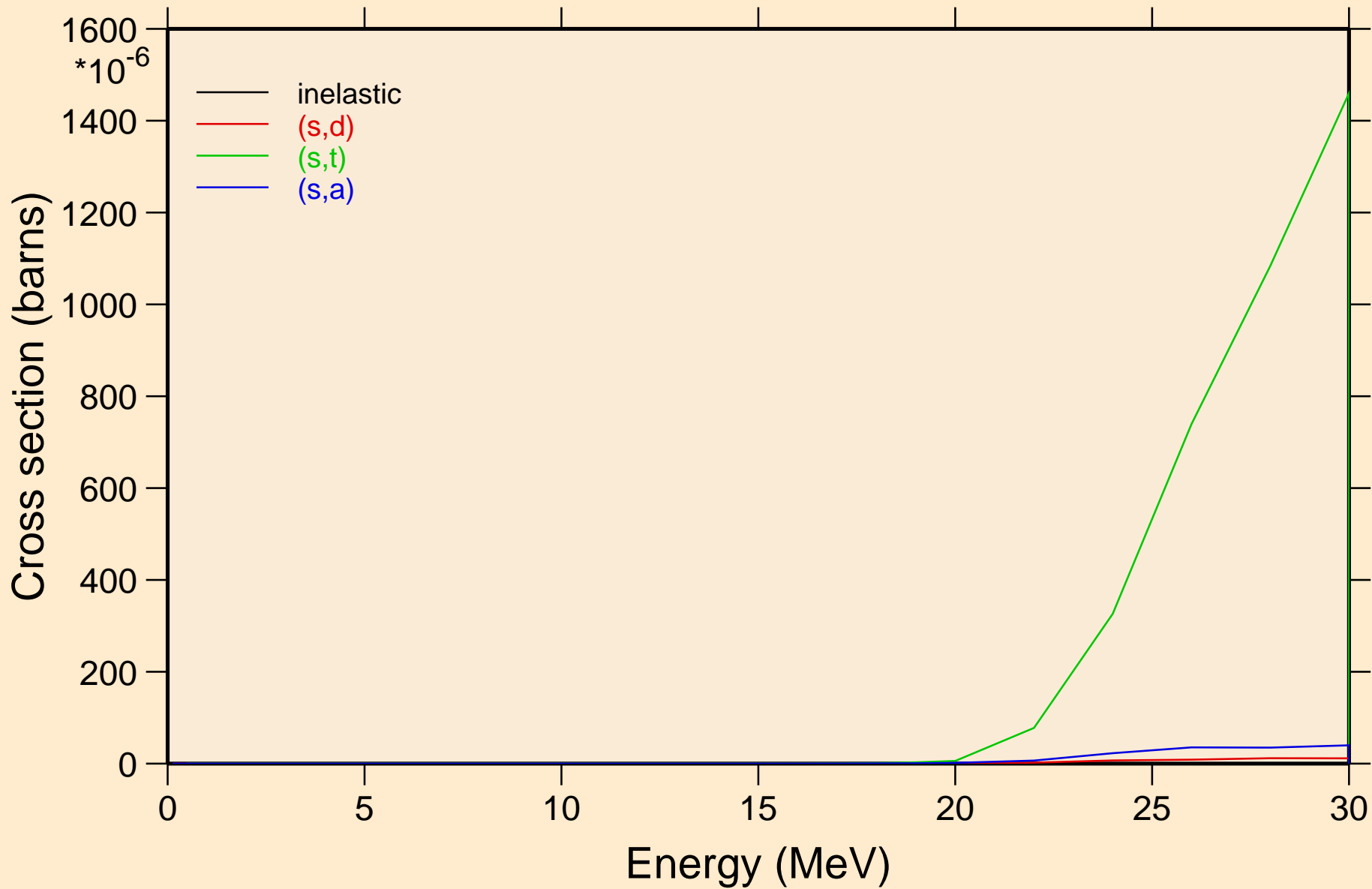

LR265 HELION ACER TENDL-2021 LIBRARY; T=0.K
angular distribution for elastic

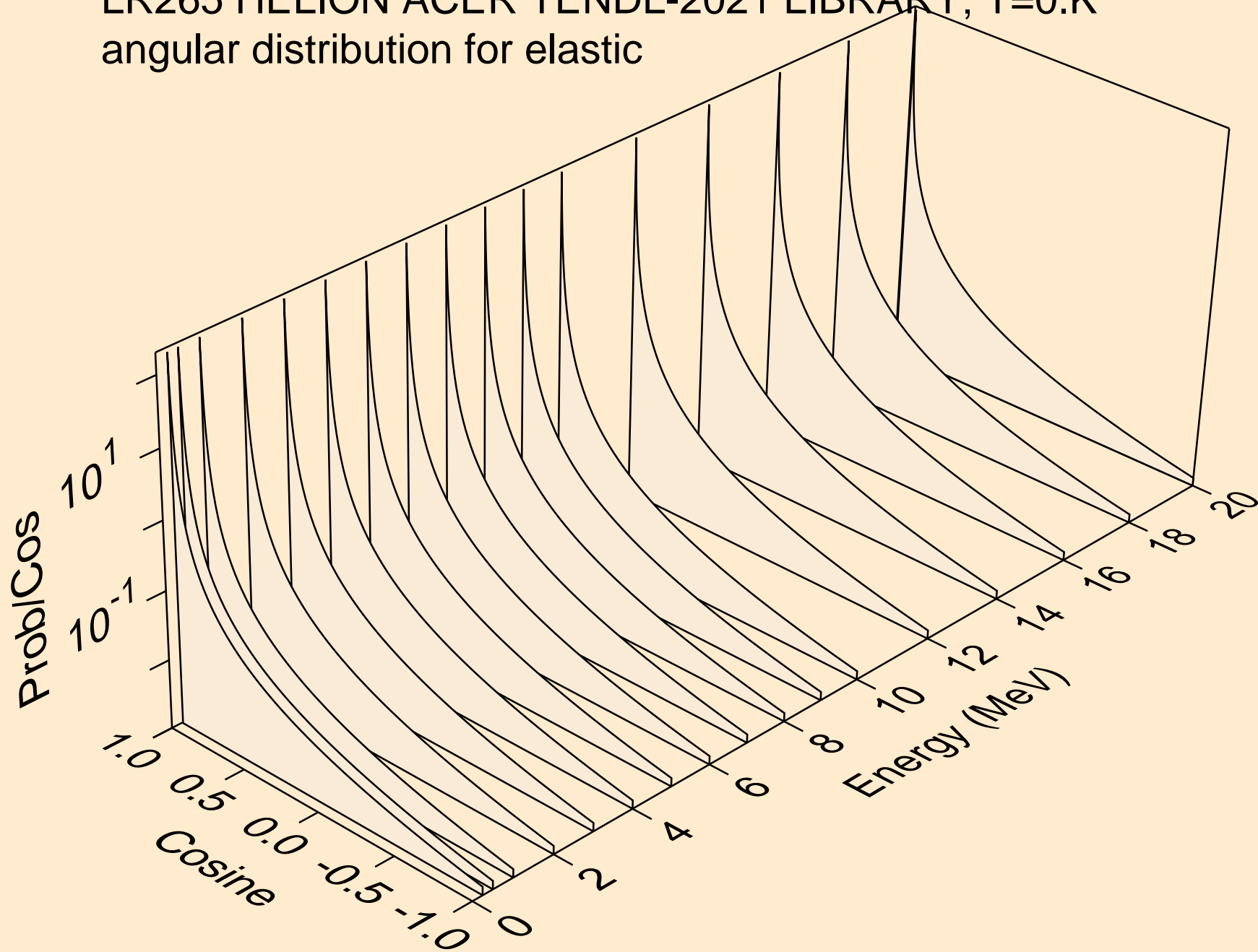

LR265 HELION ACER TENDL-2021 LIBRARY; T=0.K
angular distribution for elastic

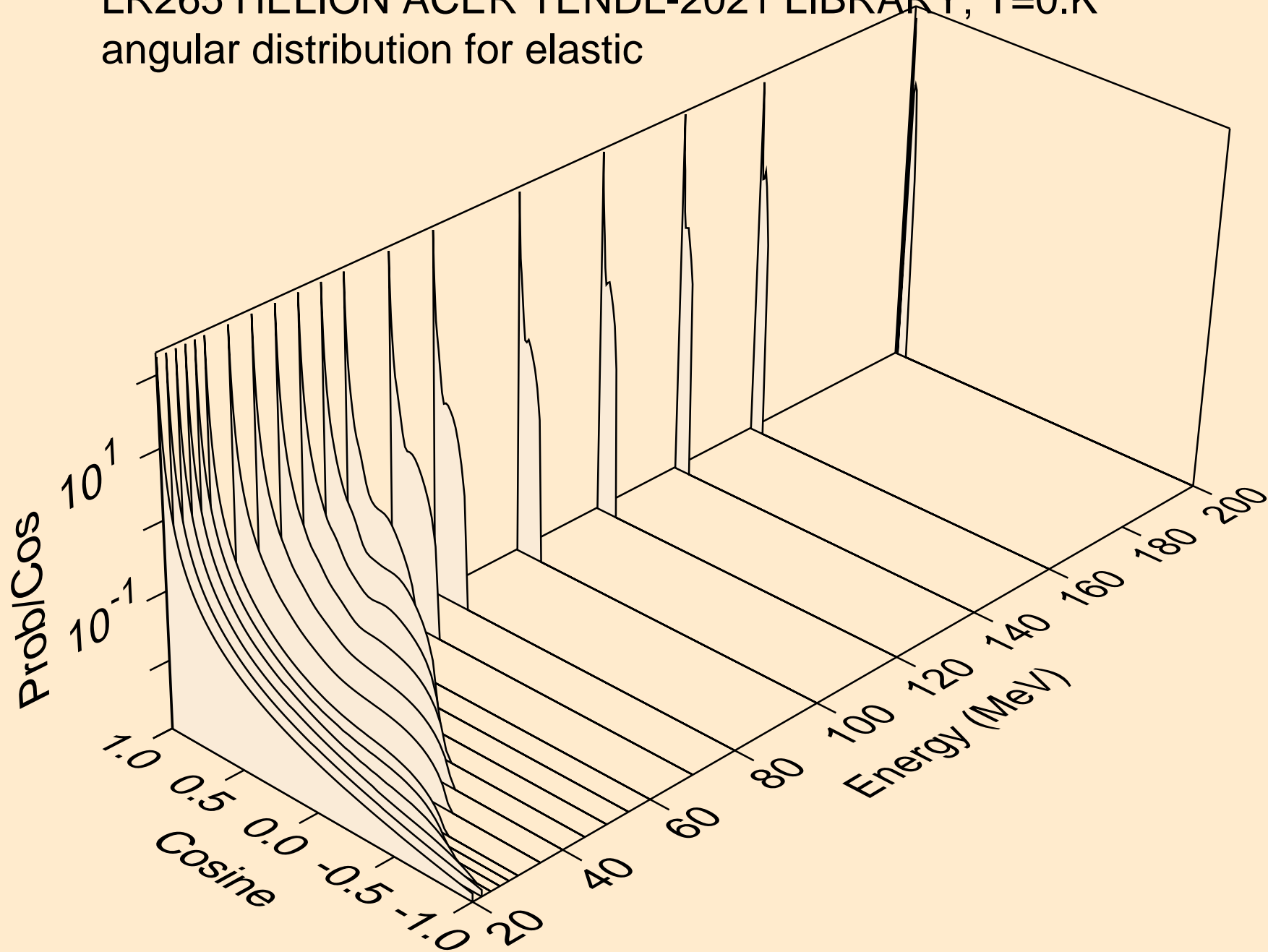

LR265 HELION ACER TENDL-2021 LIBRARY; T=0.K
He-3 emission for (s,x)

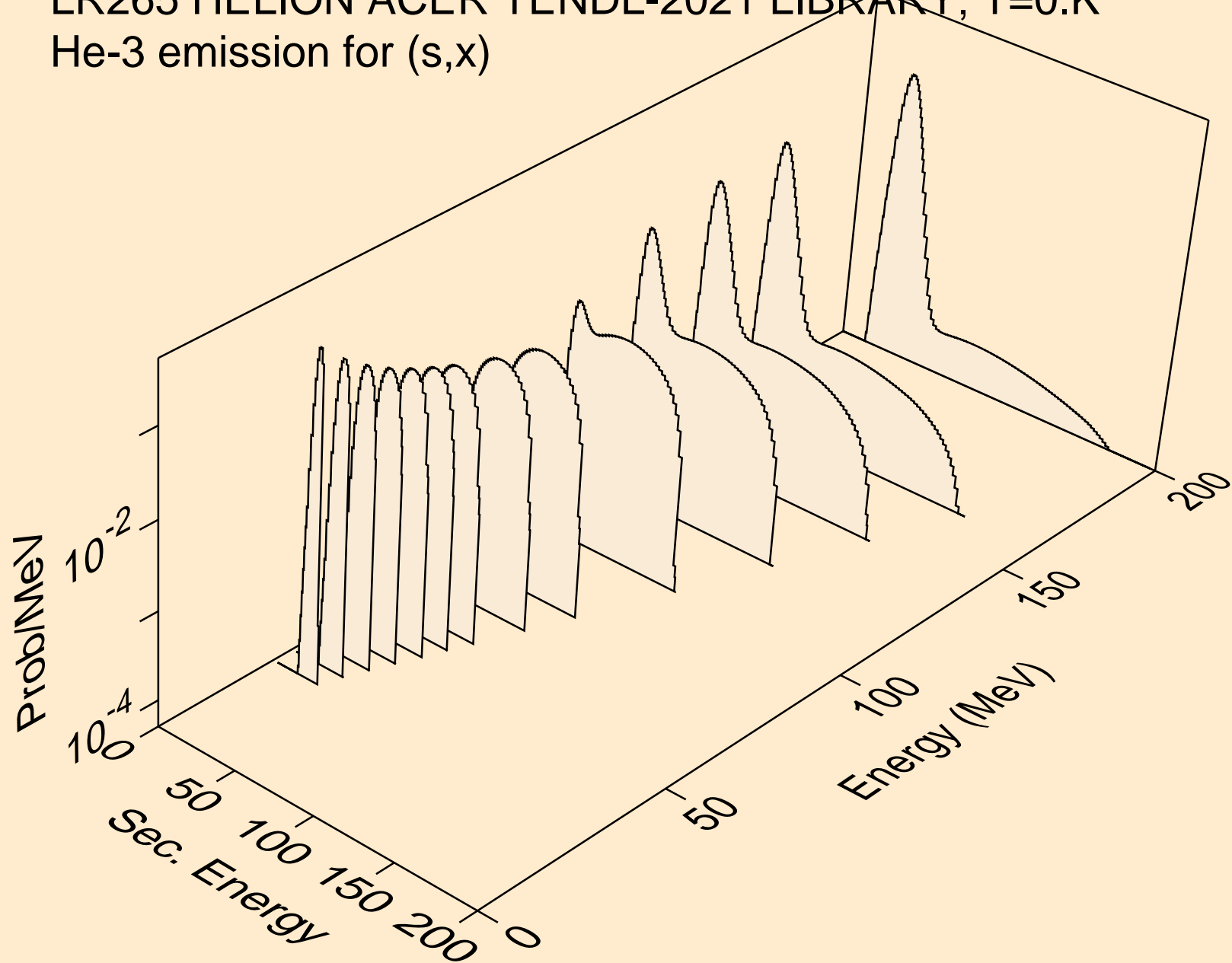

LR265 HELION ACER TENDL-2021 LIBRARY; T=0.K
He-3 emission for inelastic

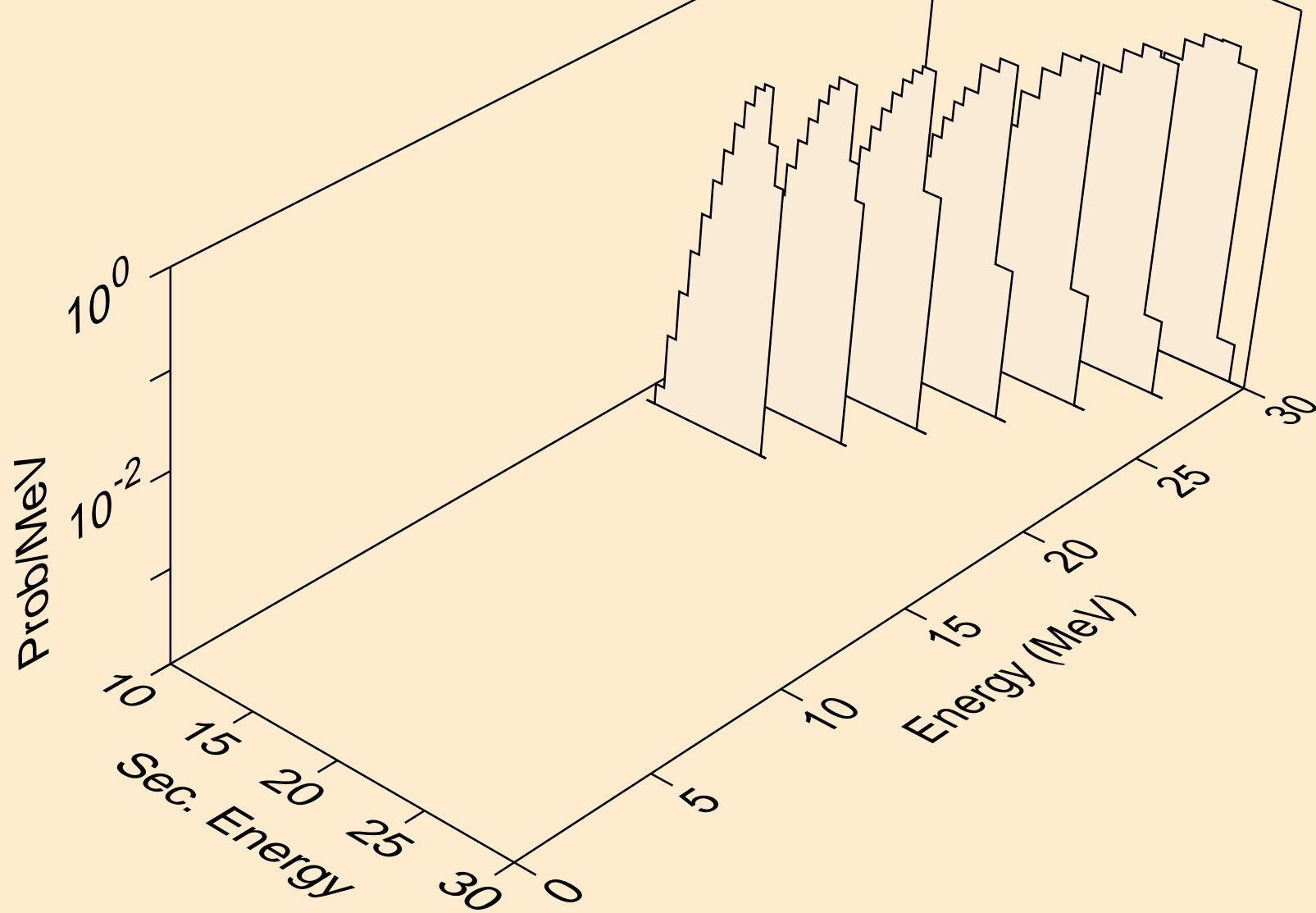

LR265 HELION ACER TENDL-2021 LIBRARY; T=0.K
Photon emission for (z,n)

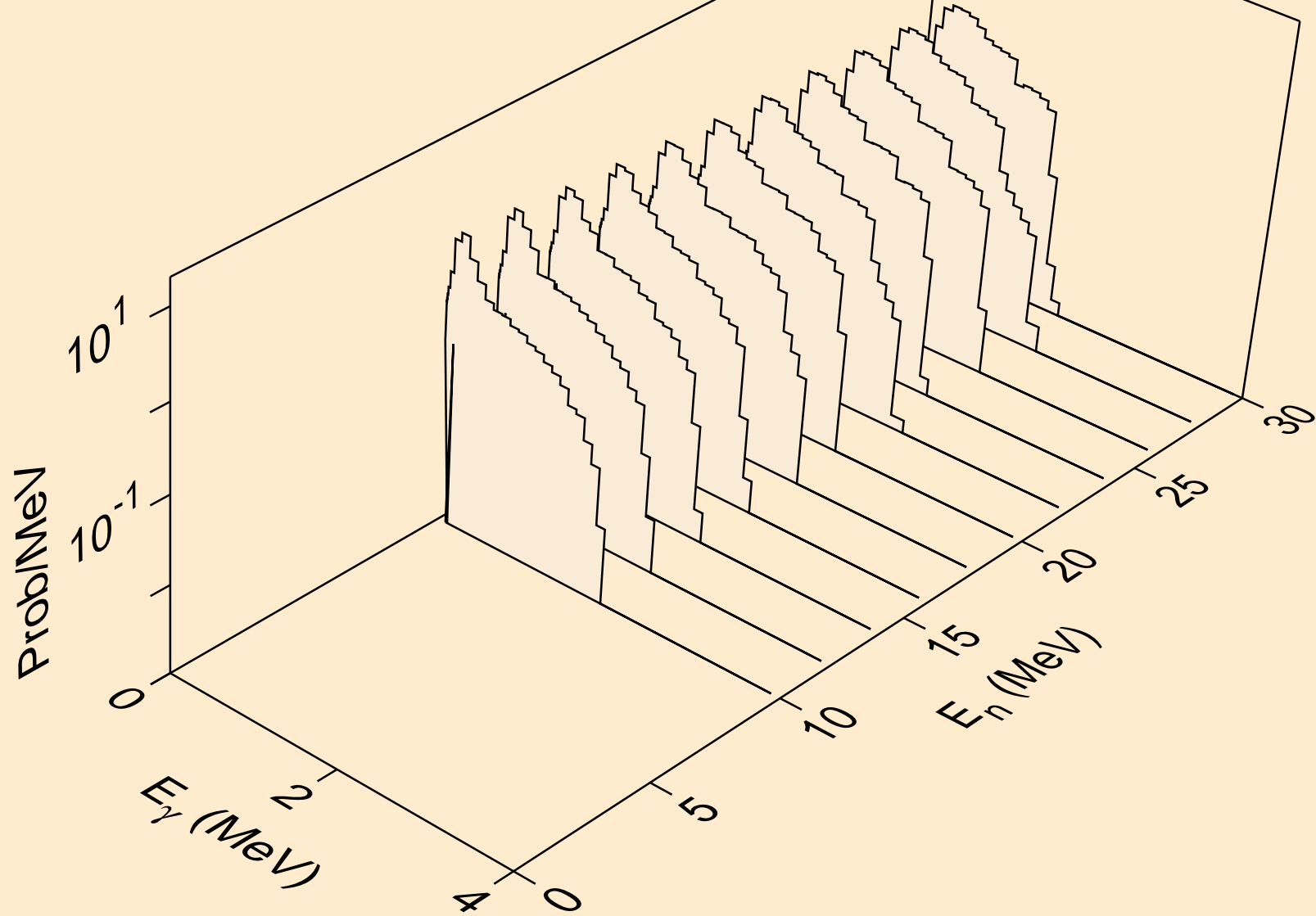

LR265 HELION ACER TENDL-2021 LIBRARY; T=0.K
Photon emission for (n,x)

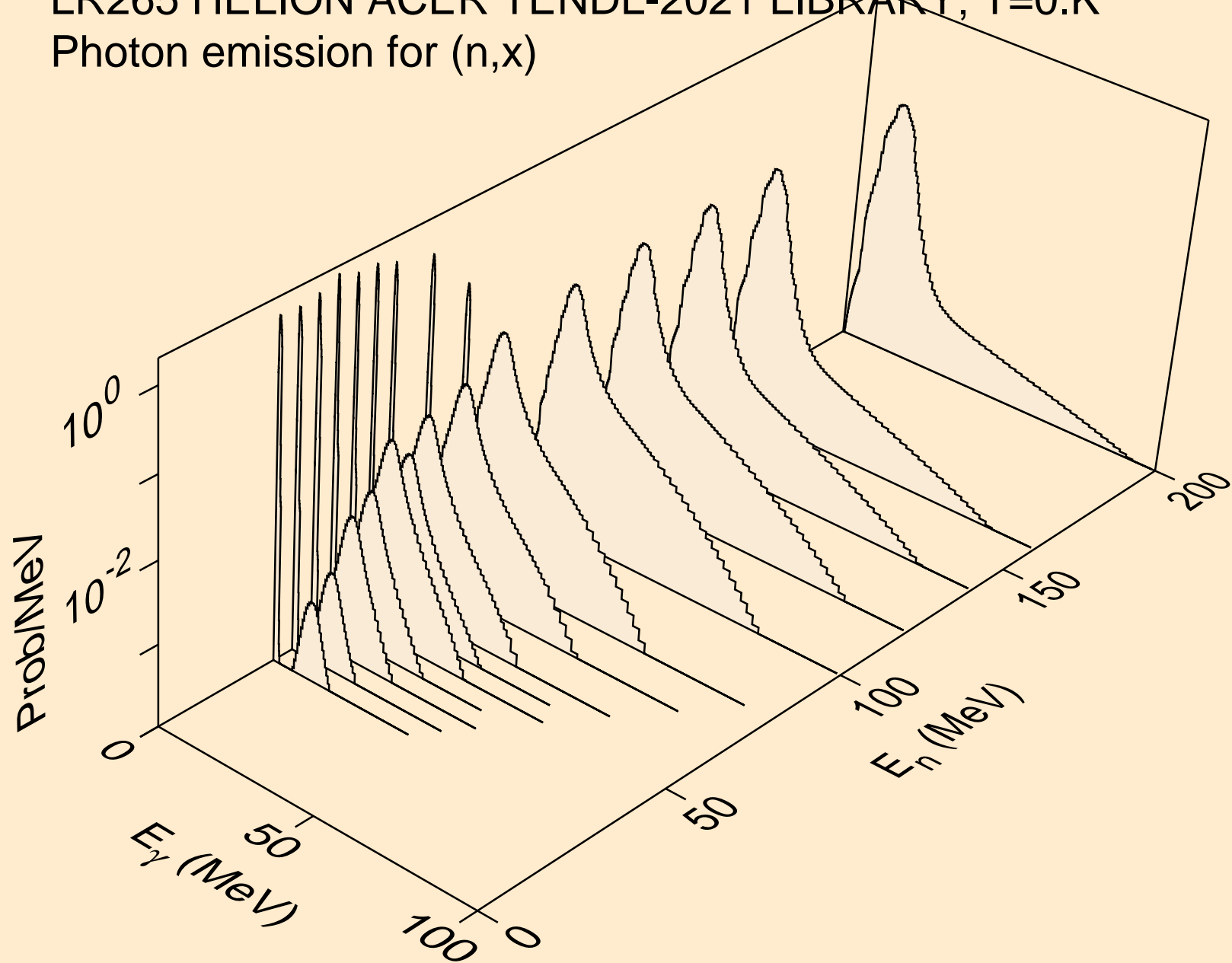

LR265 HELION ACER TENDL-2021 LIBRARY; T=0.K
Photon emission for (n,2n)

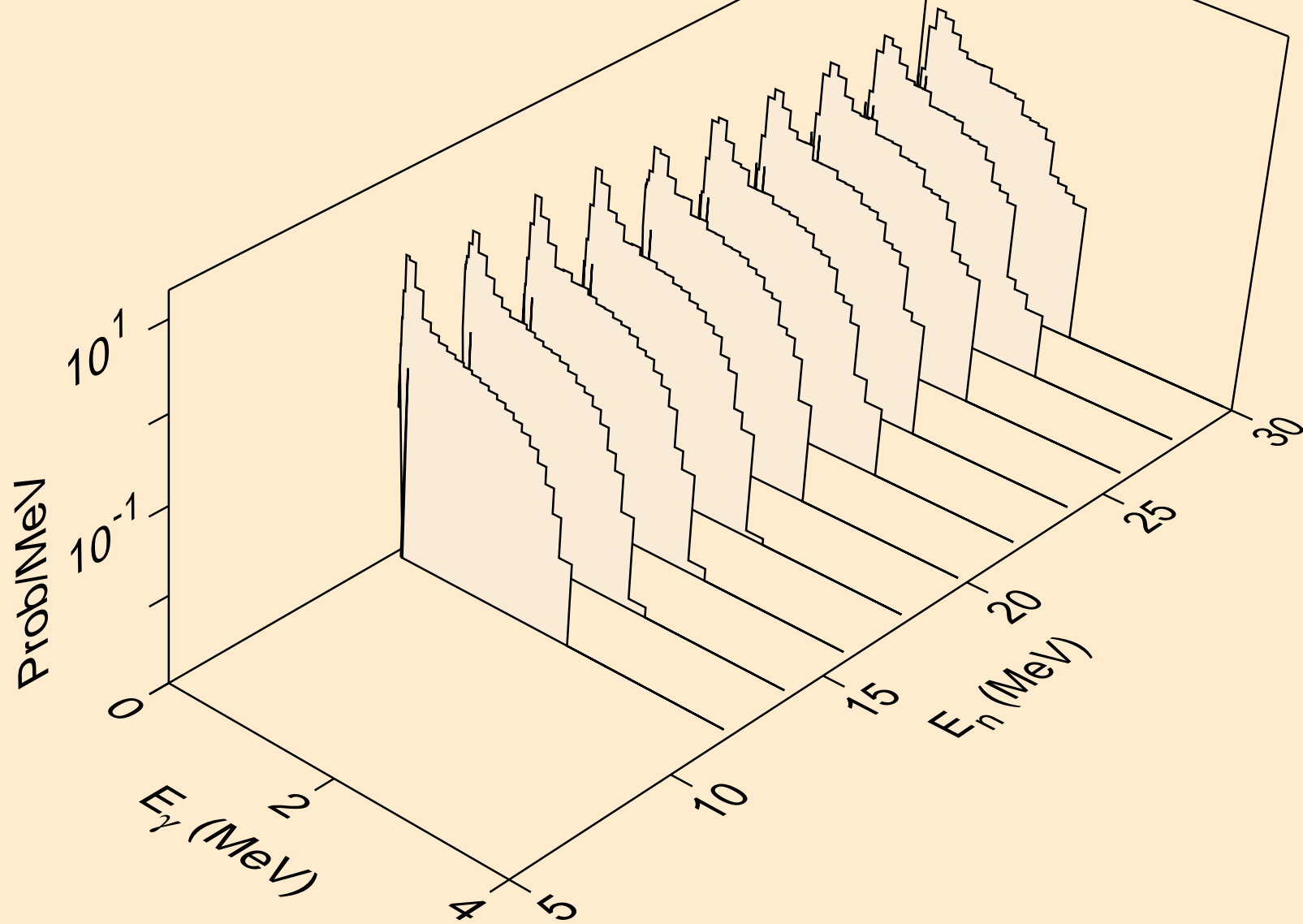

LR265 HELION ACER TENDL-2021 LIBRARY; T=0.K
Photon emission for (n,3n)

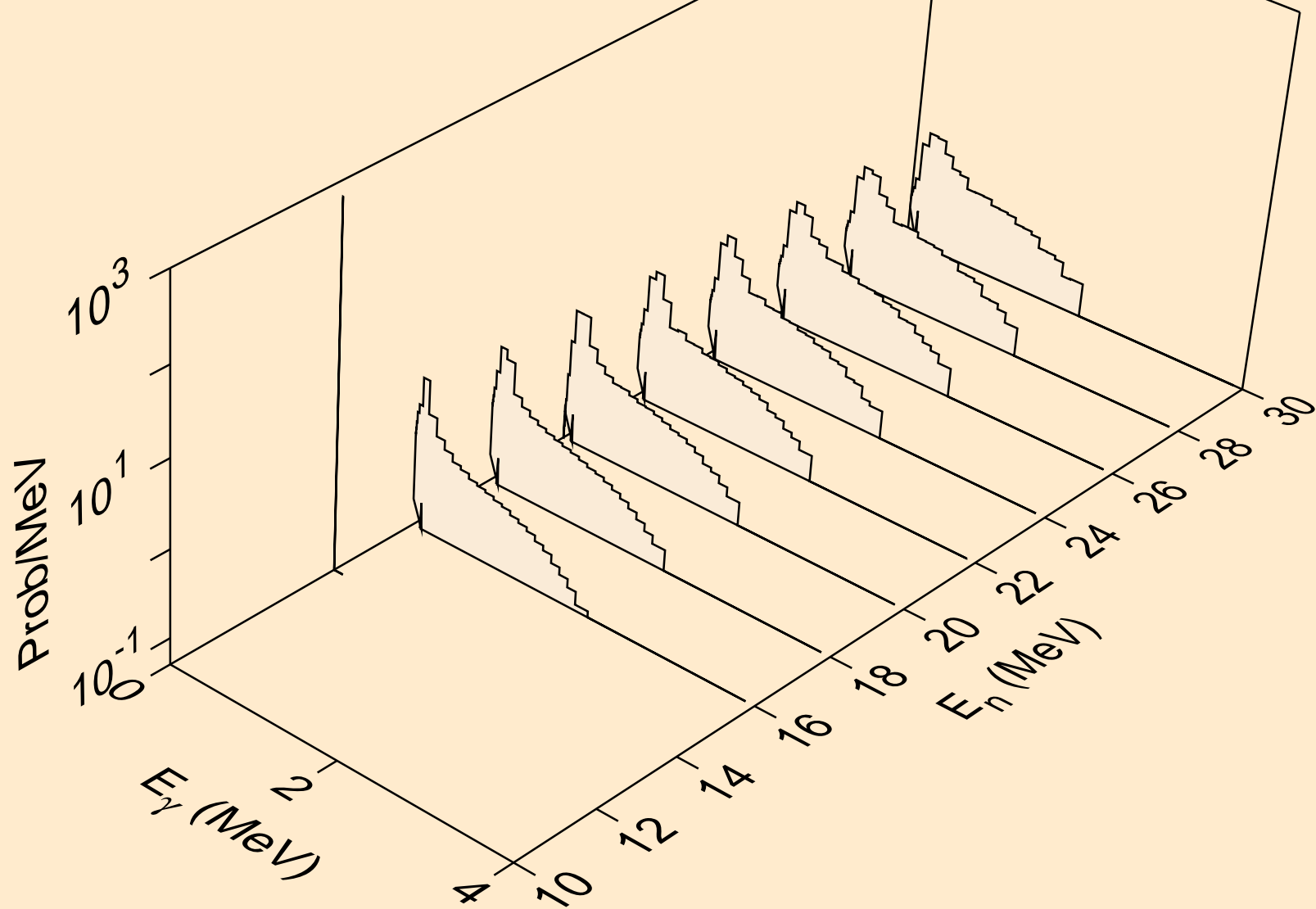

LR265 HELION ACER TENDL-2021 LIBRARY; T=0.K
Photon emission for (n,n*)p

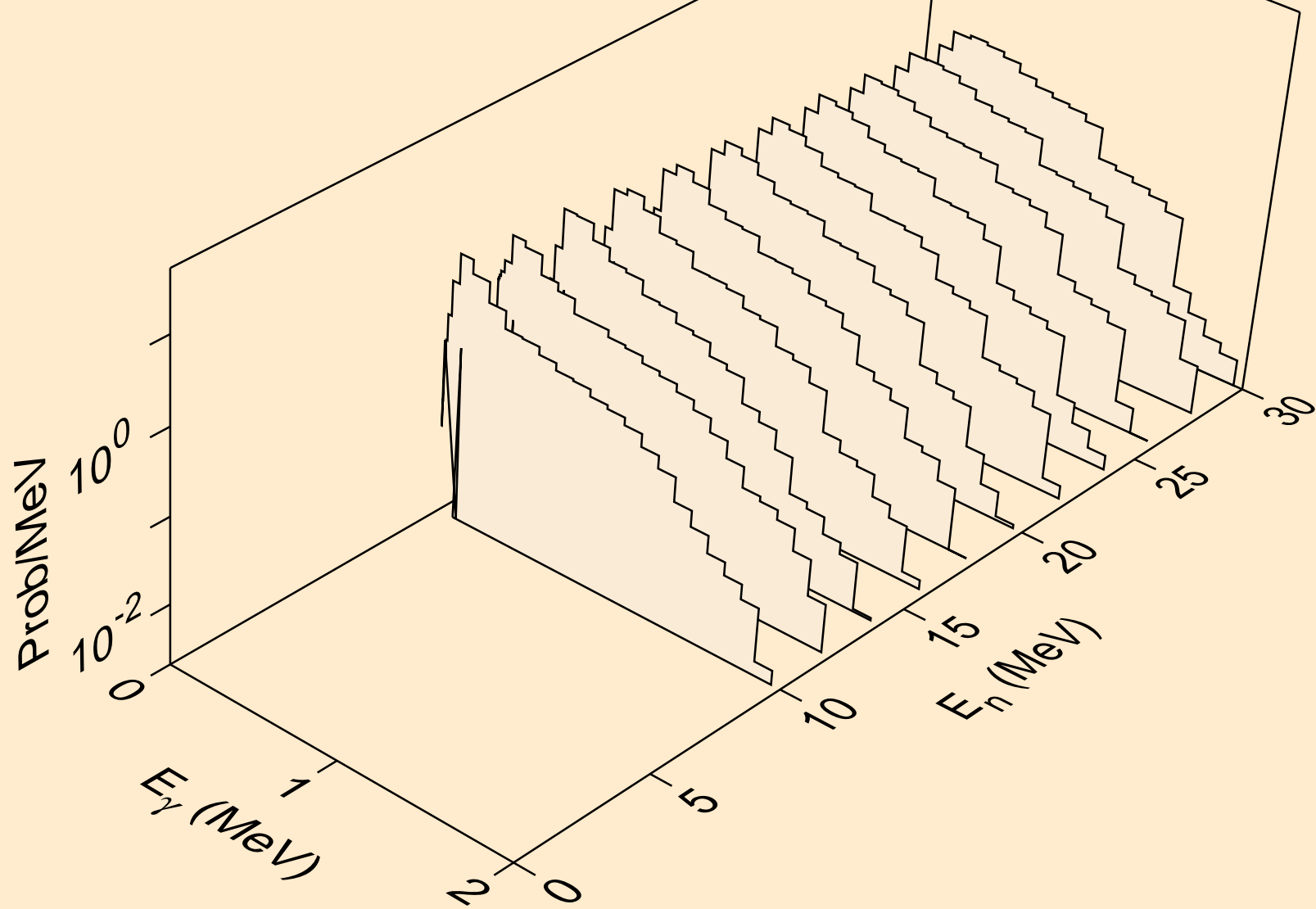

LR265 HELION ACER TENDL-2021 LIBRARY; T=0.K
Photon emission for (n,n*)d

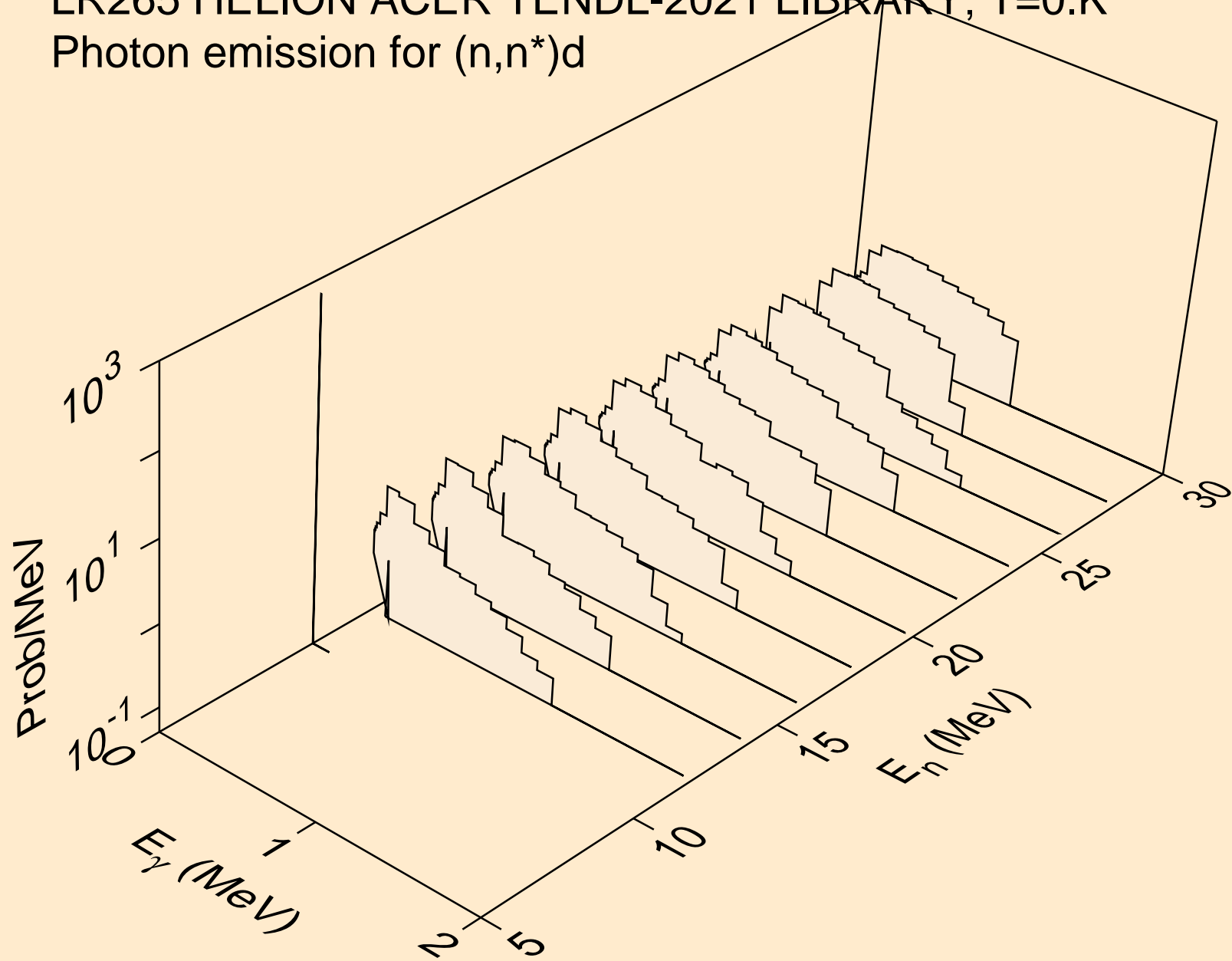

LR265 HELION ACER TENDL-2021 LIBRARY; T=0.K
Photon emission for (n,n*)t

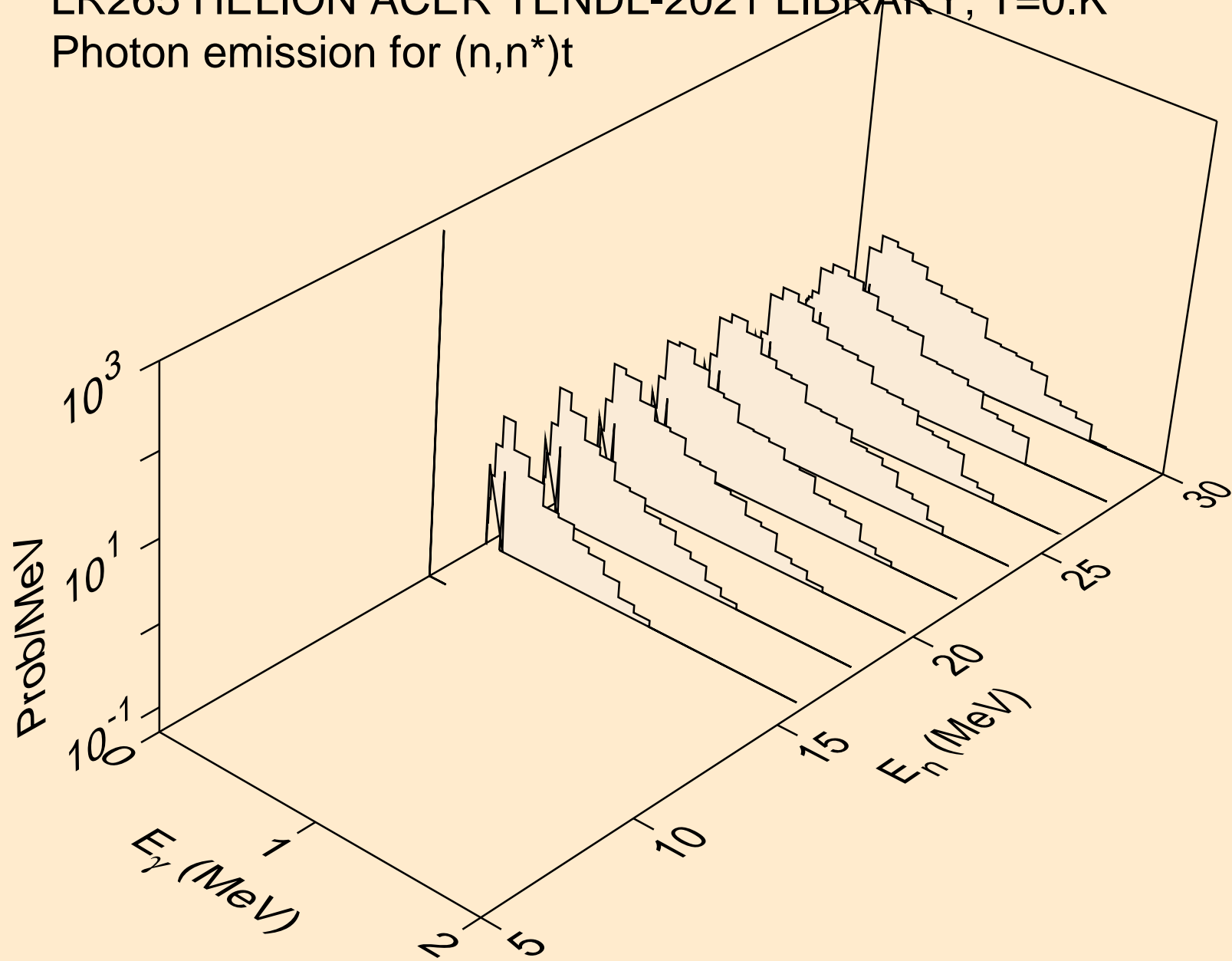

LR265 HELION ACER TENDL-2021 LIBRARY; T=0.K
Photon emission for (n,2np)

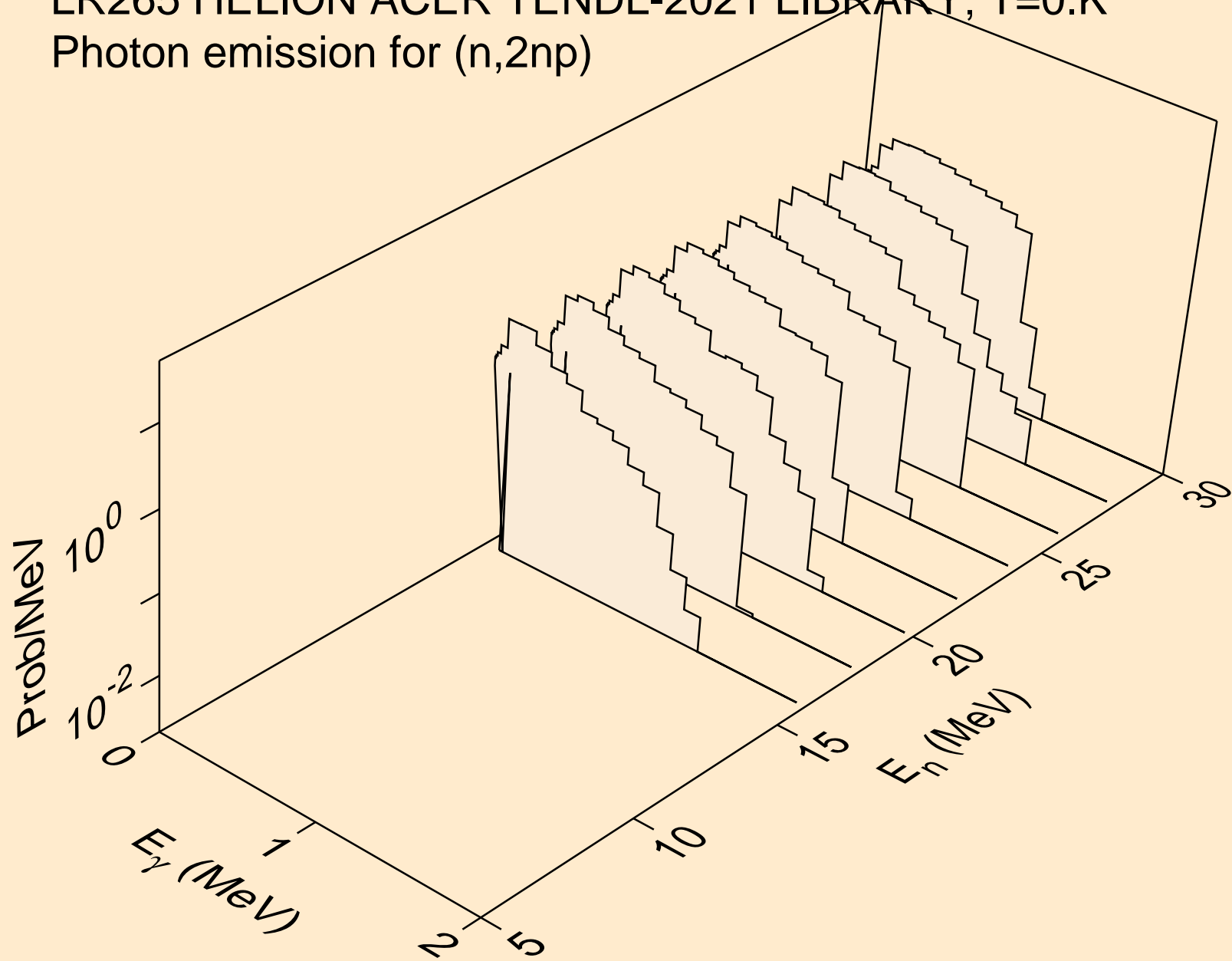

LR265 HELION ACER TENDL-2021 LIBRARY; T=0.K
Photon emission for (n,p)

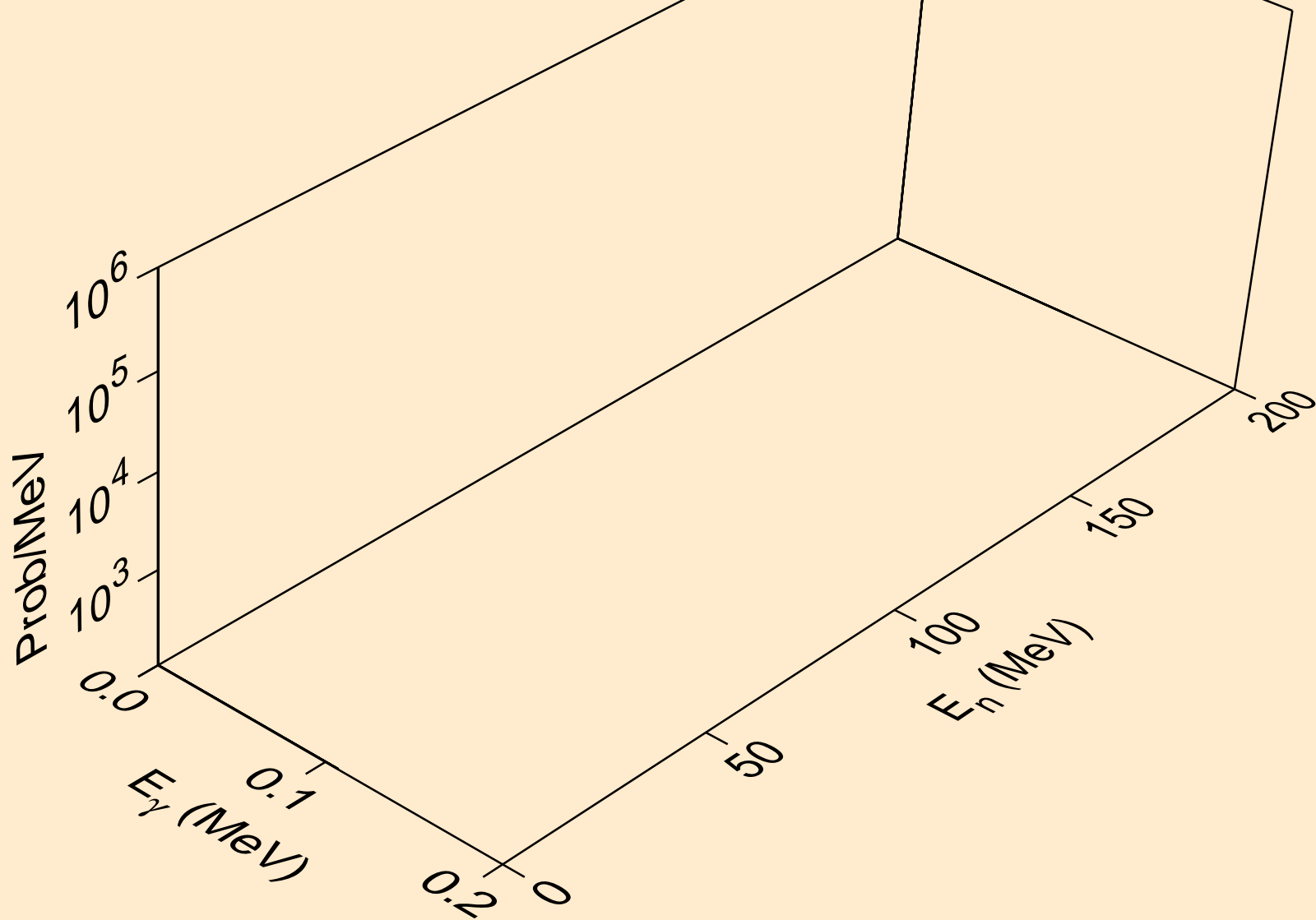

LR265 HELION ACER TENDL-2021 LIBRARY; T=0.K
Photon emission for (n,d)

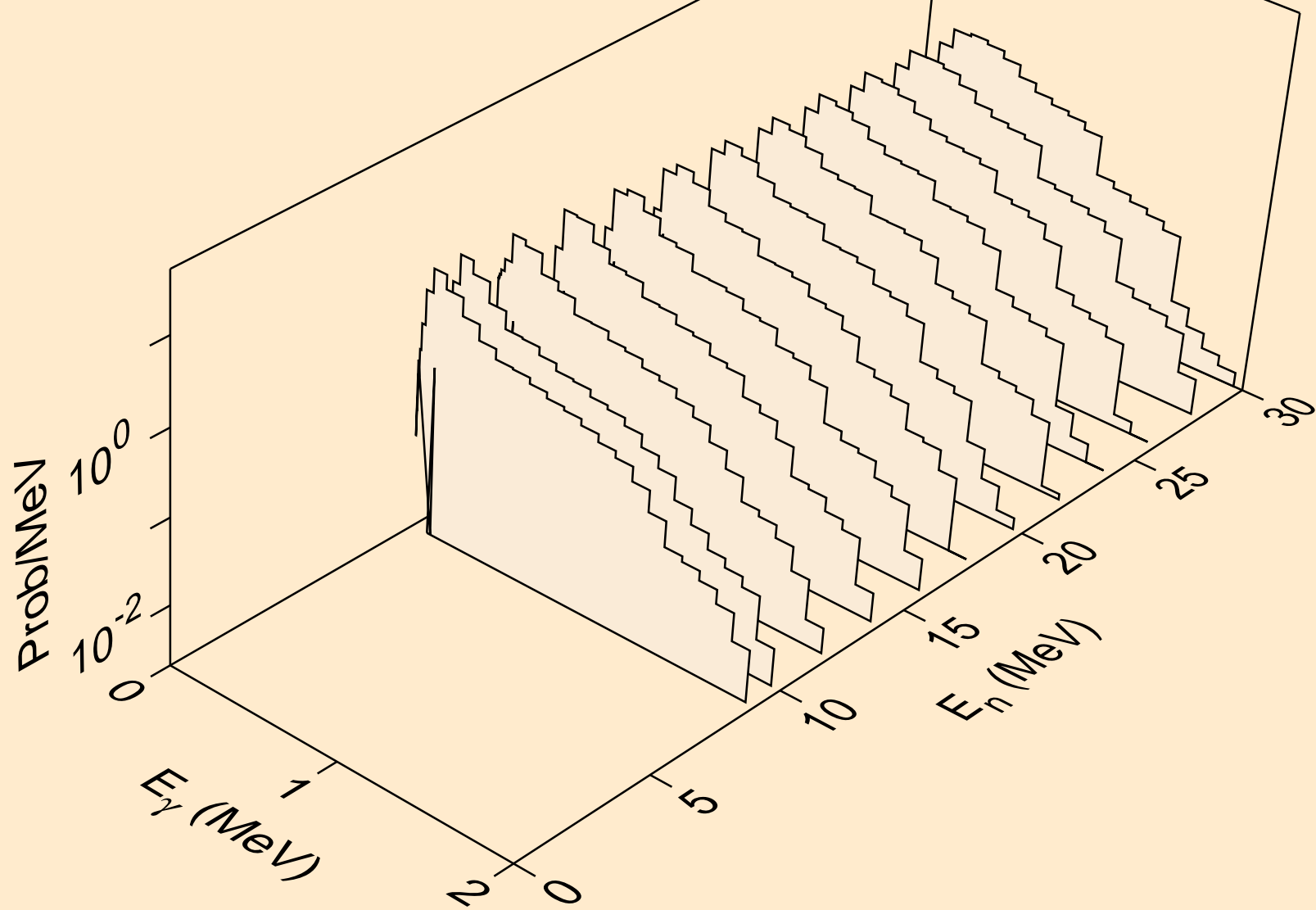

LR265 HELION ACER TENDL-2021 LIBRARY; T=0.K
Photon emission for (n,t)

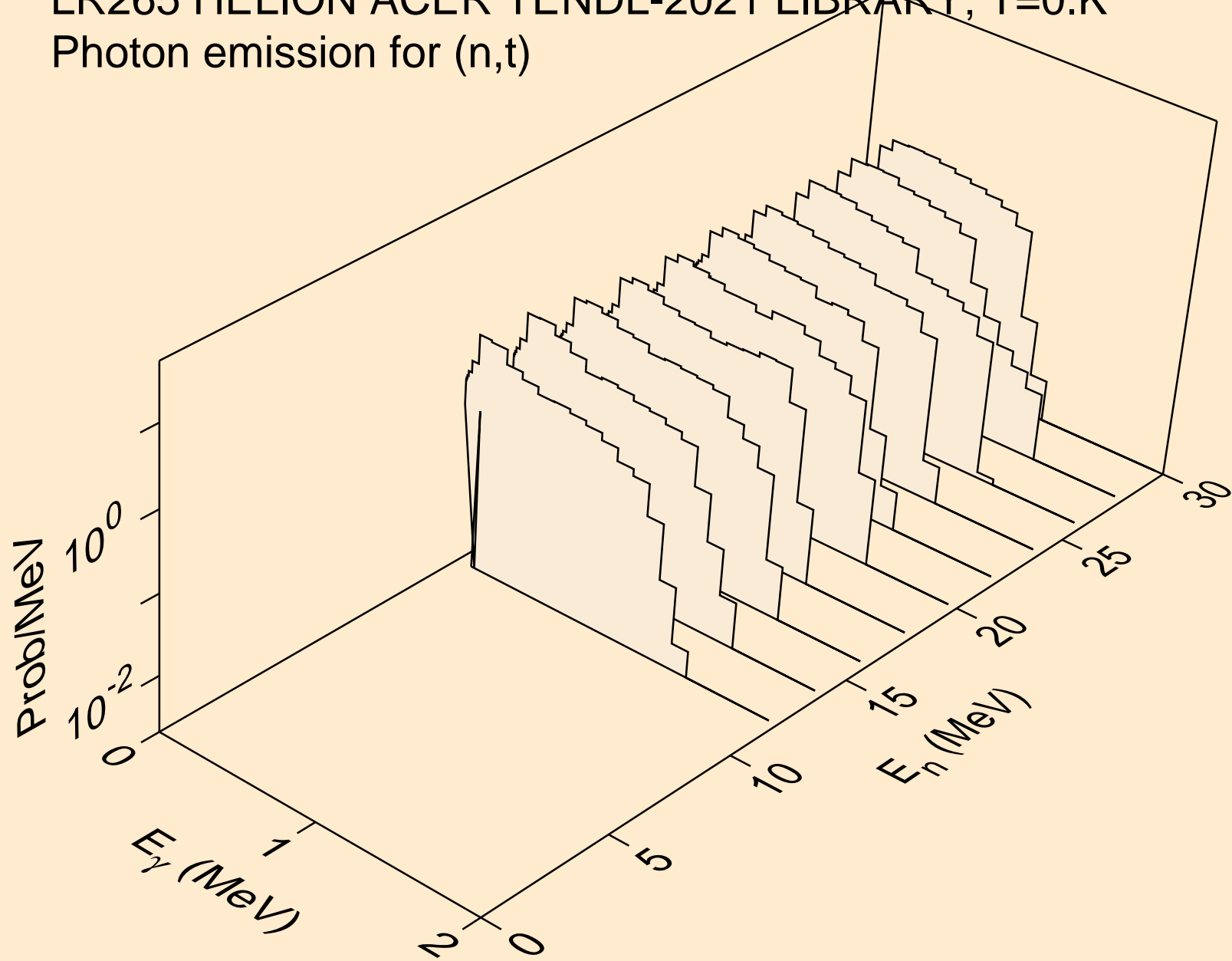

LR265 HELION ACER TENDL-2021 LIBRARY; T=0.K
Photon emission for inelastic

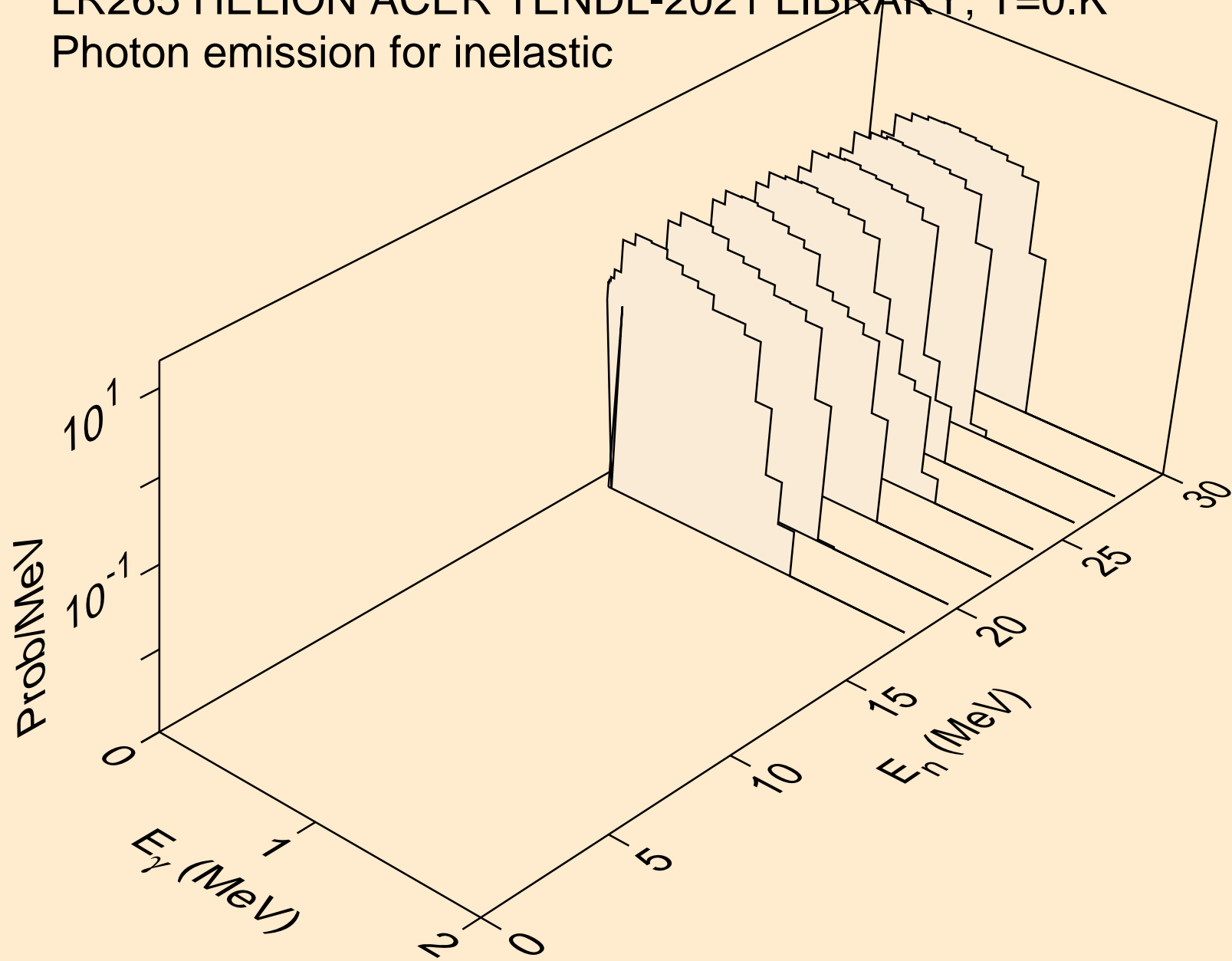

LR265 HELION ACER TENDL-2021 LIBRARY; T=0.K
Photon emission for (n,a)

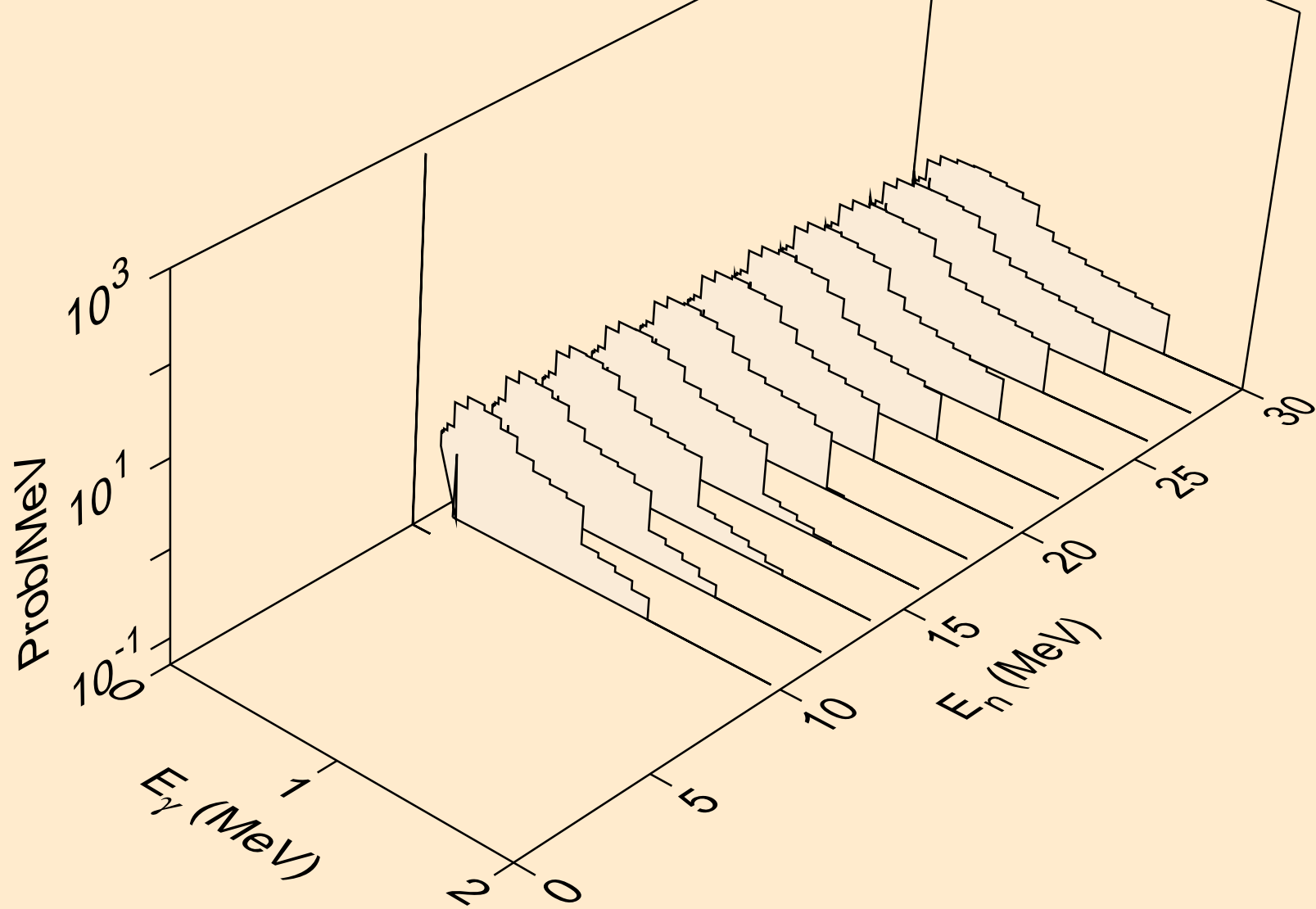

LR265 HELION ACER TENDL-2021 LIBRARY; T=0.K
Particle heating contributions

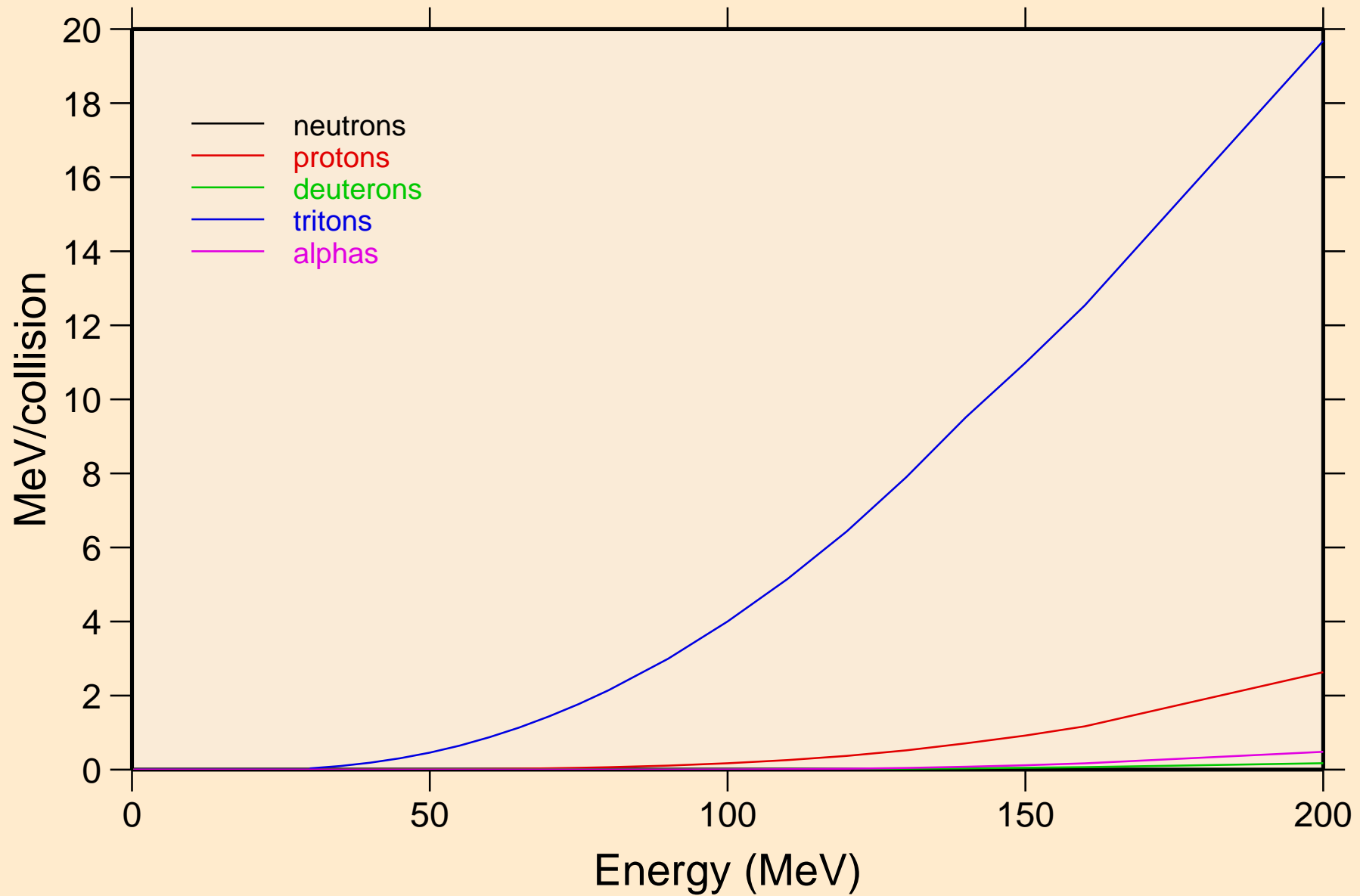

LR265 HELION ACER TENDL-2021 LIBRARY; T=0.K
Recoil Heating

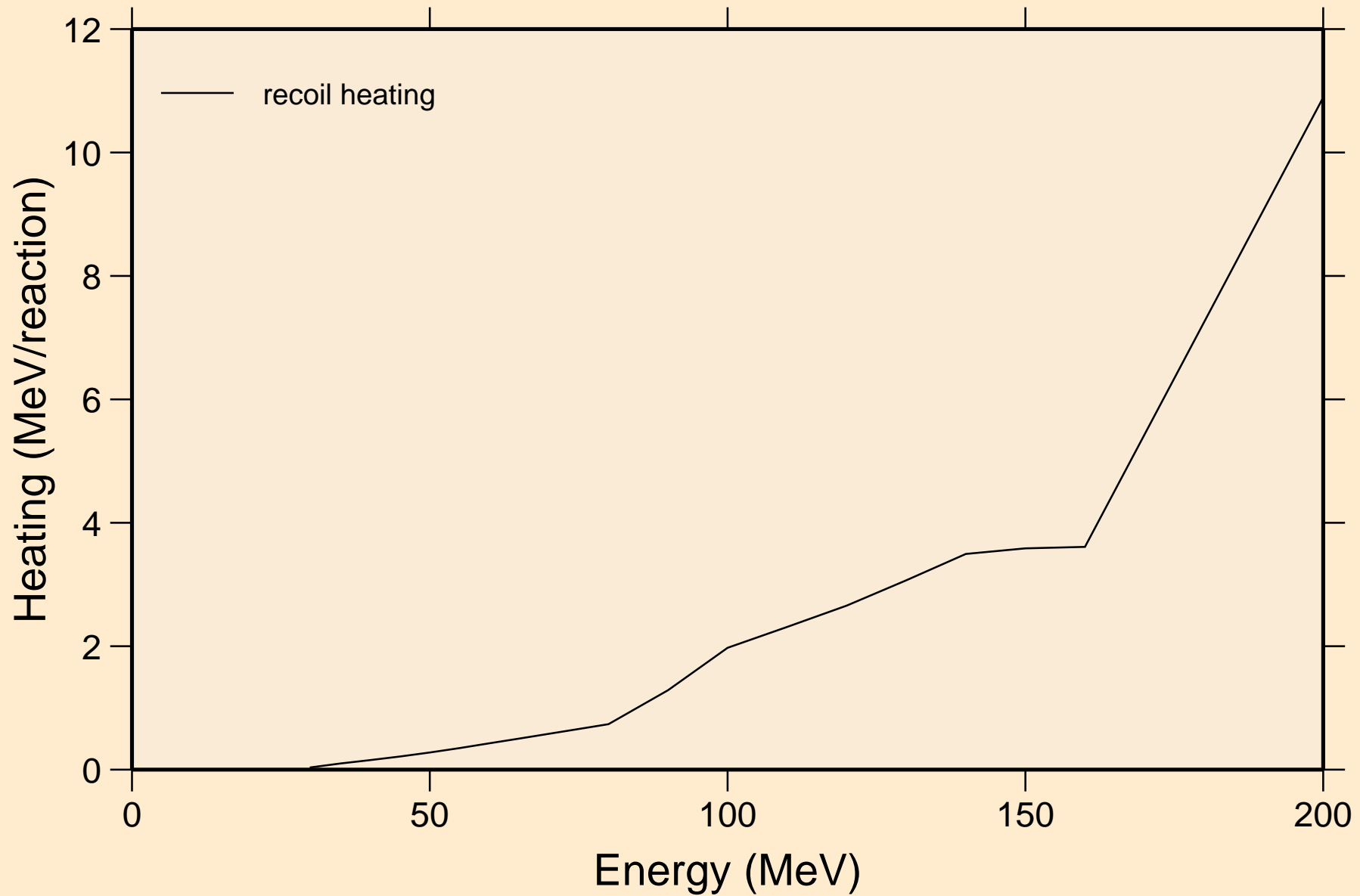

LR265 HELION ACER TENDL-2021 LIBRARY; T=0.K
Particle production cross sections

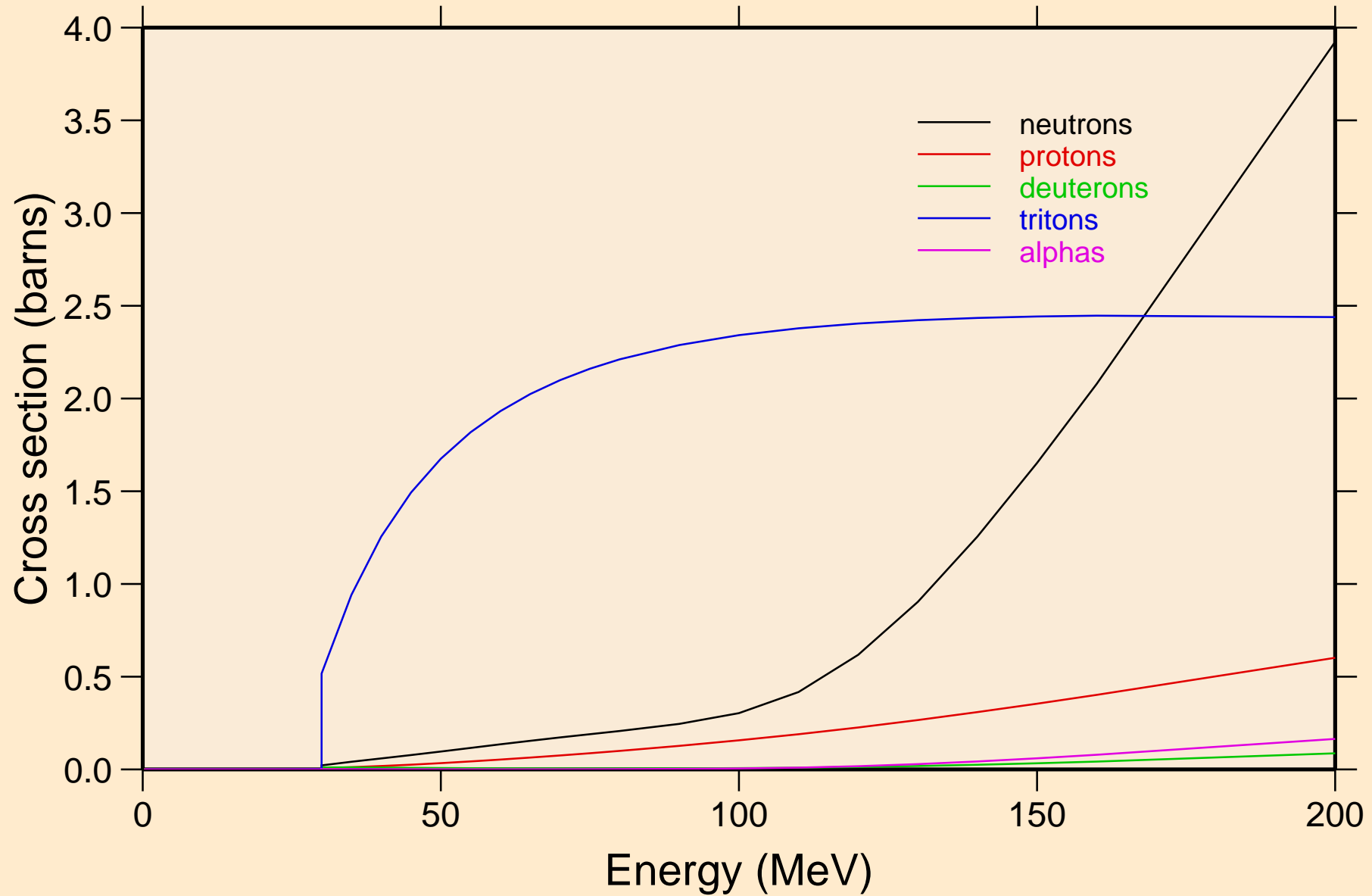

LR265 HELION ACER TENDL-2021 LIBRARY; T=0.K
neutrons from (s,n)

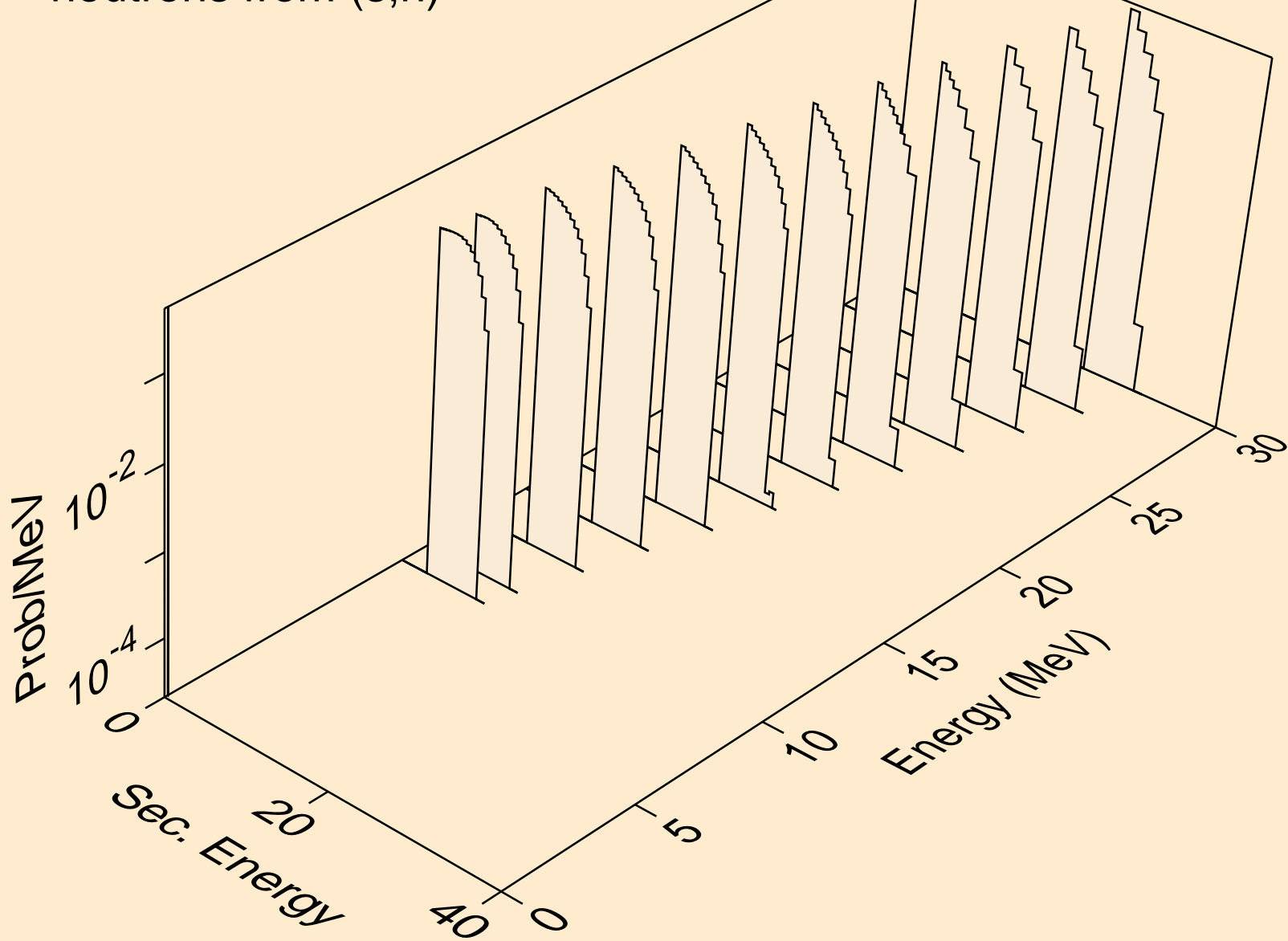

LR265 HELION ACER TENDL-2021 LIBRARY; T=0.K
neutrons from (s,x)

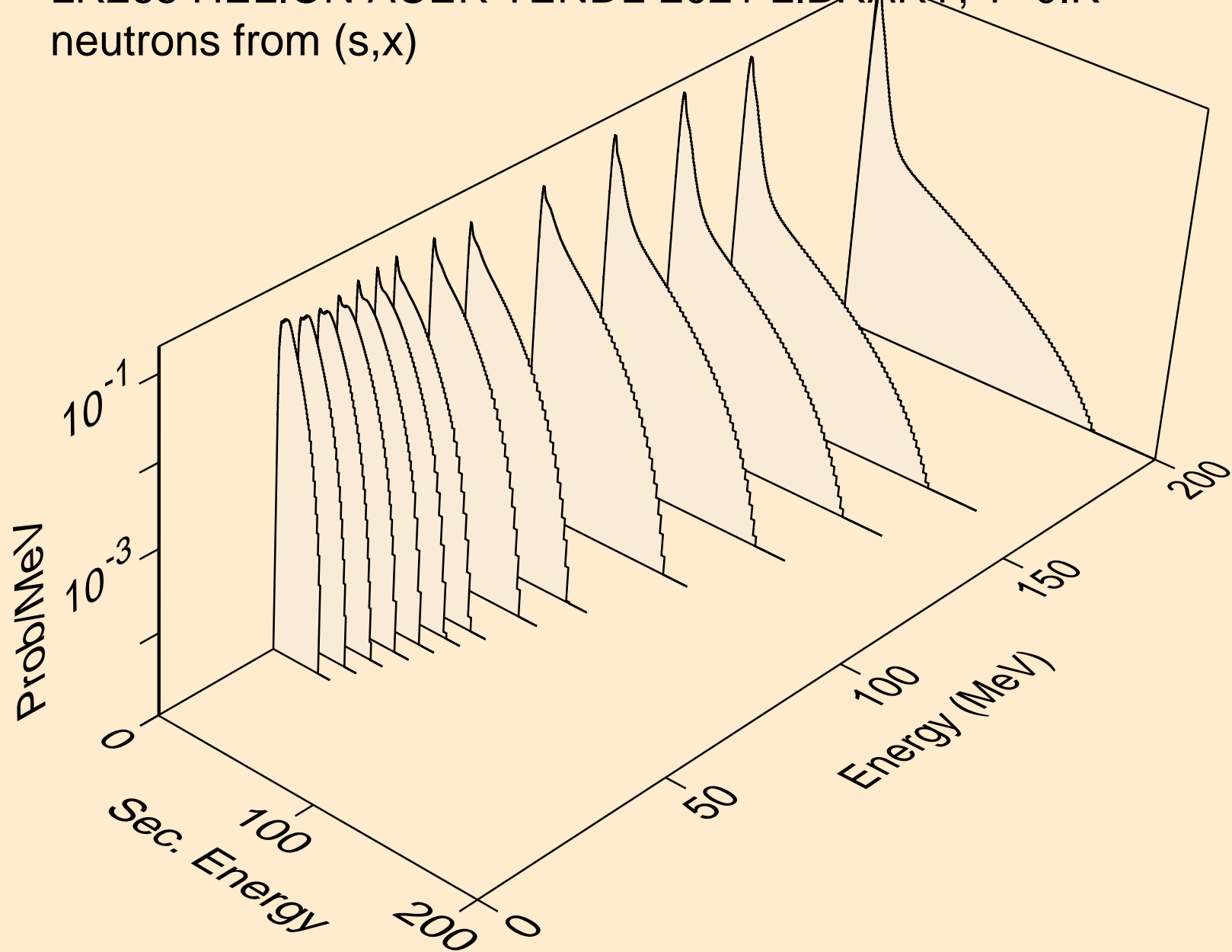

LR265 HELION ACER TENDL-2021 LIBRARY; T=0.K
neutrons from (s,2n)

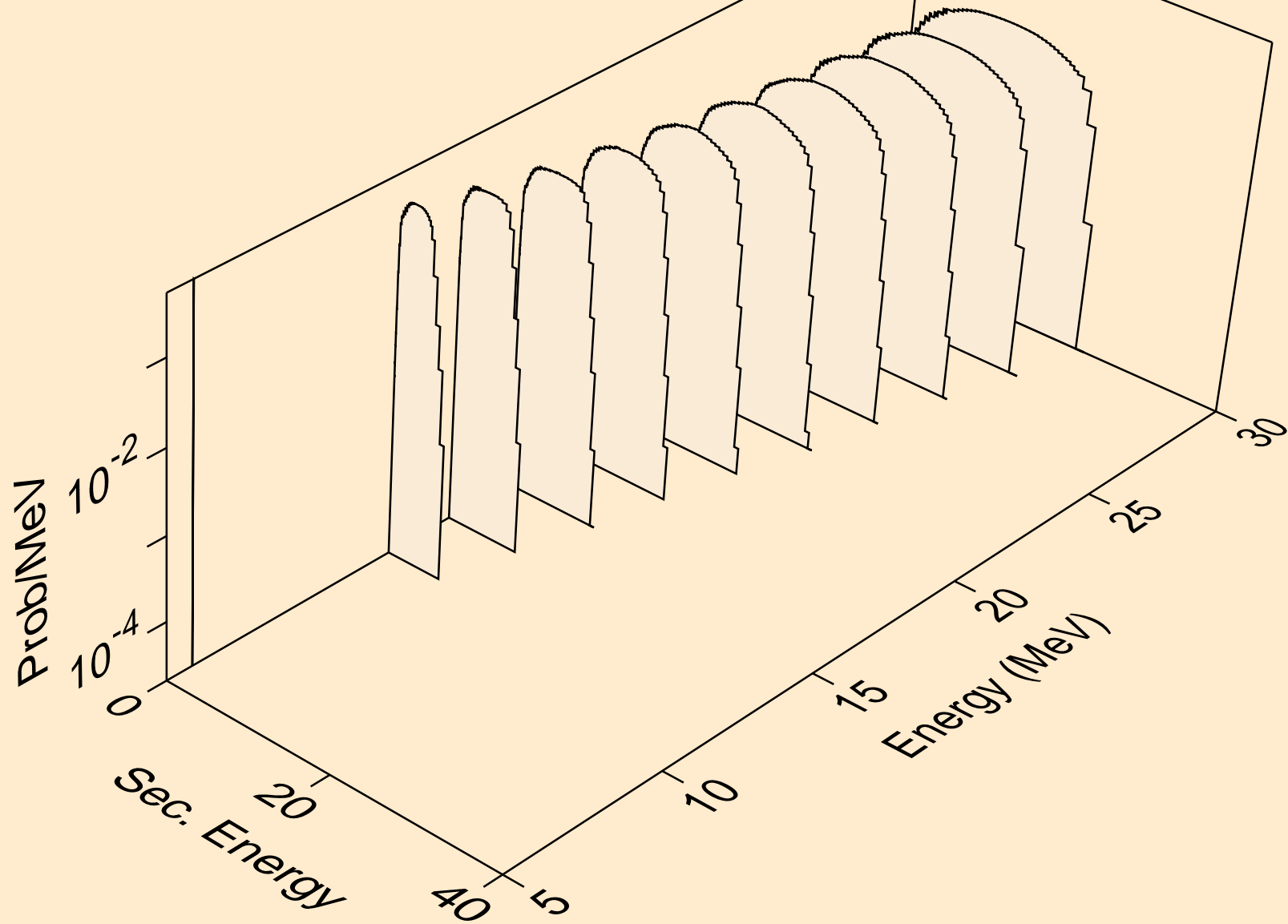

LR265 HELION ACER TENDL-2021 LIBRARY; T=0.K
neutrons from (s,3n)

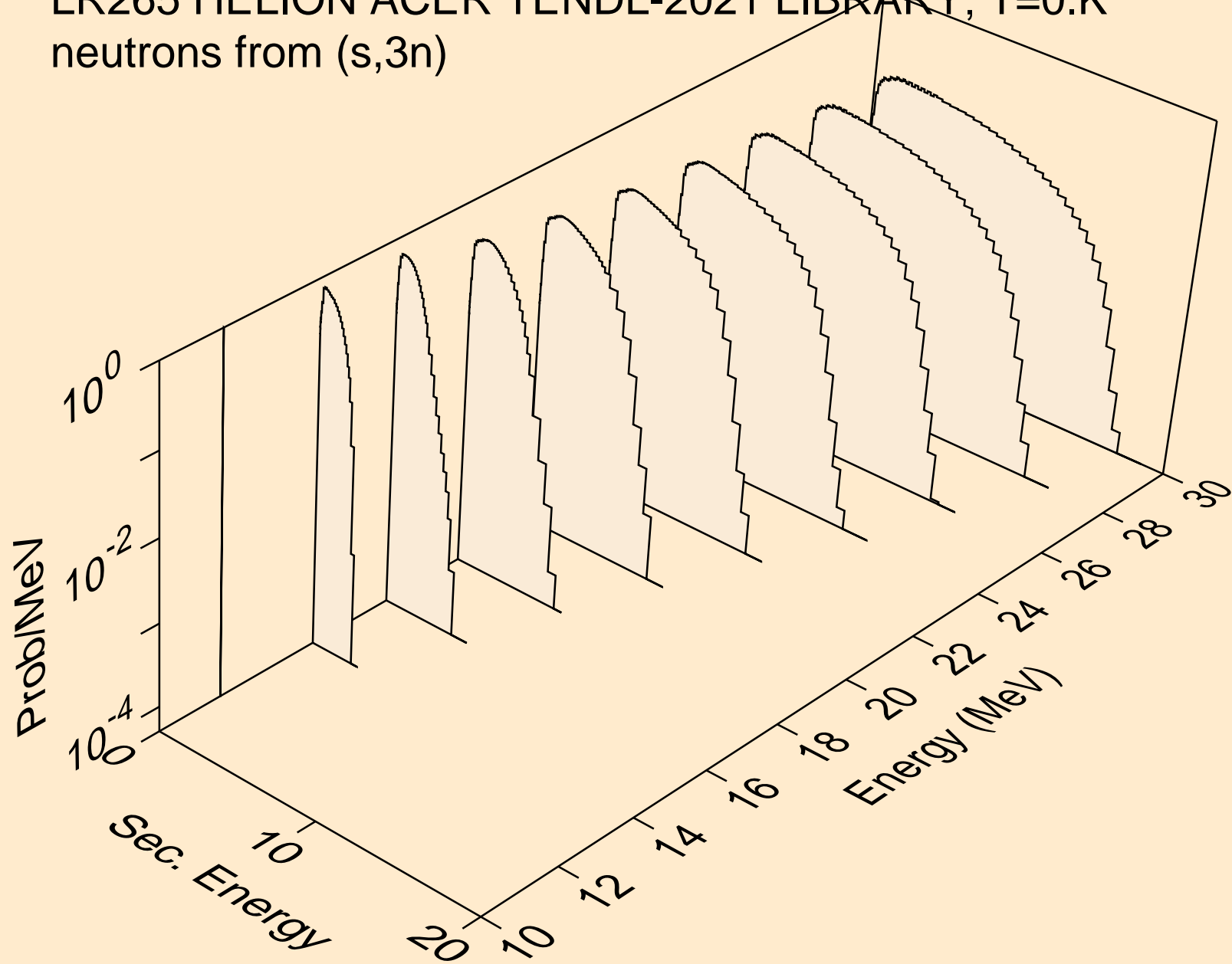

LR265 HELION ACER TENDL-2021 LIBRARY; T=0.K
neutrons from (s,n*)p

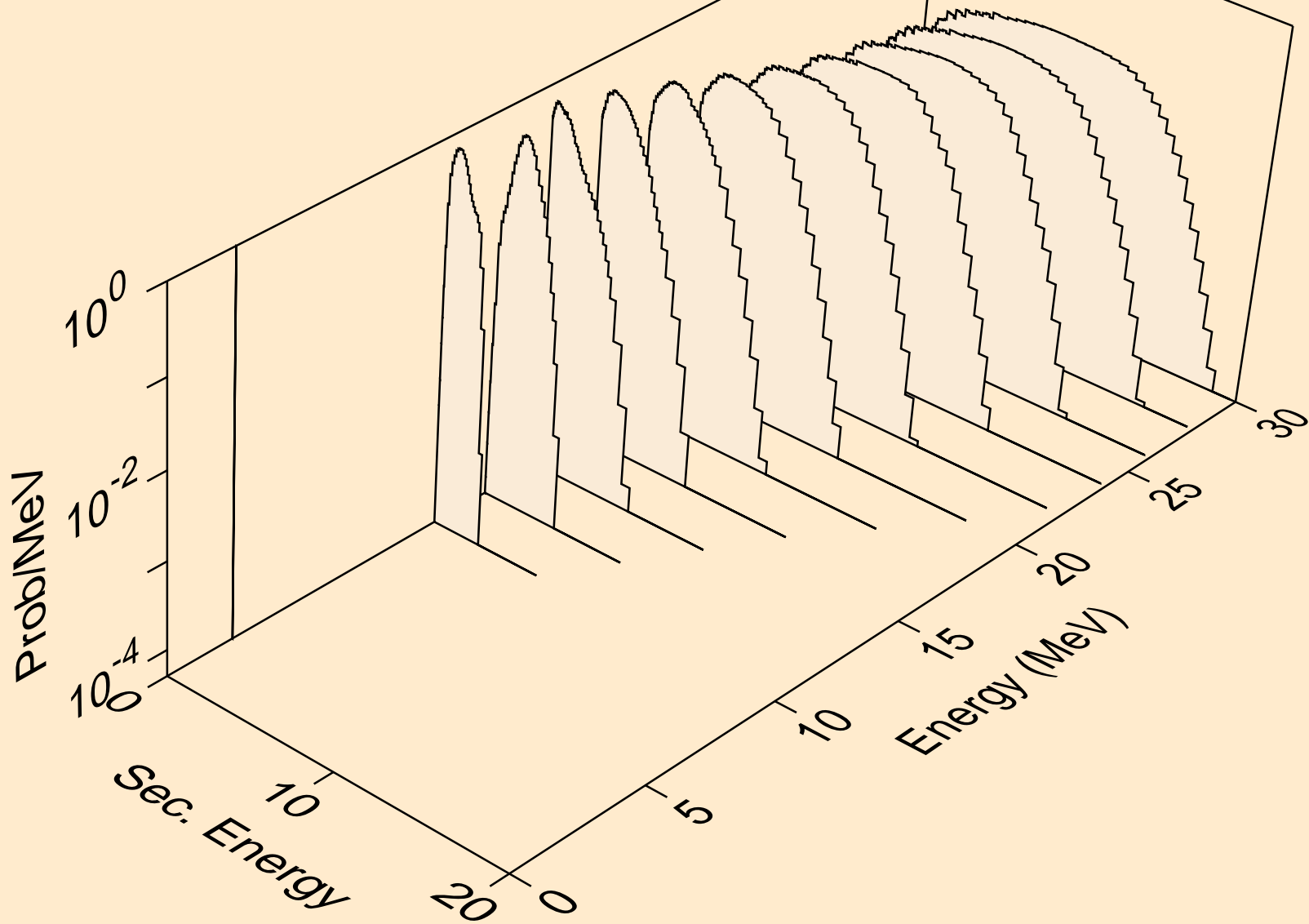

LR265 HELION ACER TENDL-2021 LIBRARY; T=0.K
neutrons from (s,n*)d

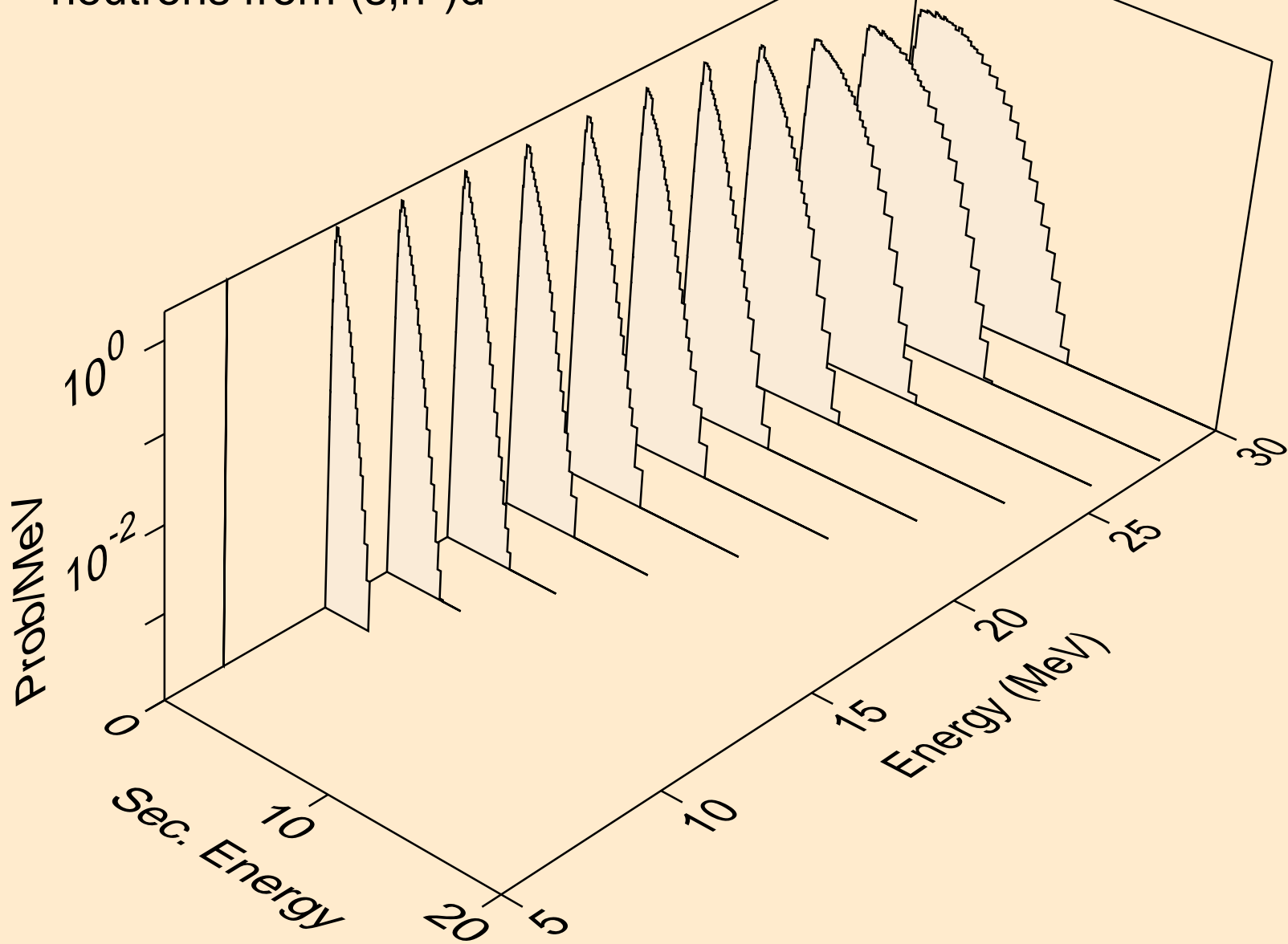

LR265 HELION ACER TENDL-2021 LIBRARY; T=0.K
neutrons from (s,n*)t

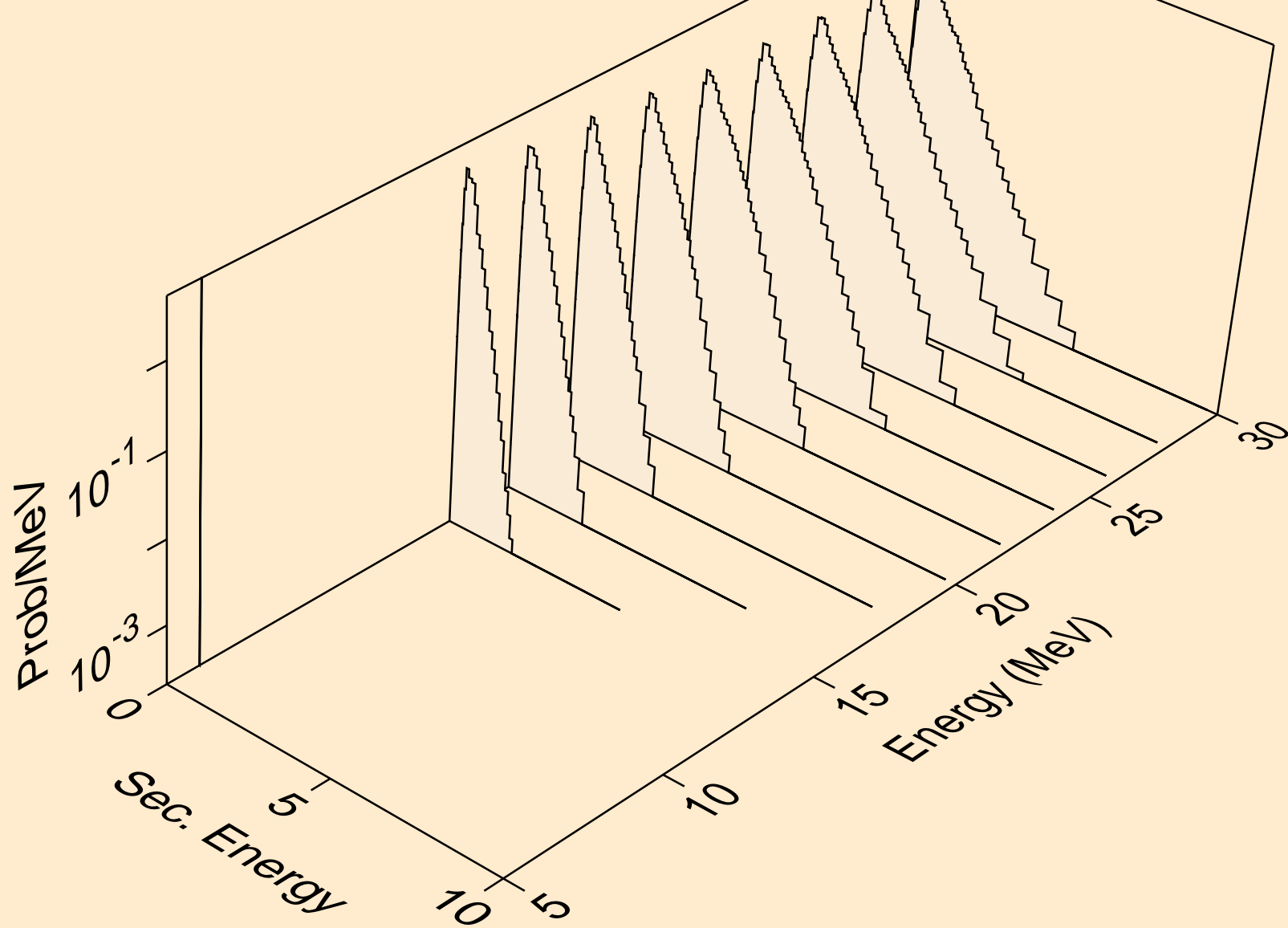

LR265 HELION ACER TENDL-2021 LIBRARY; T=0.K
neutrons from (s,2np)

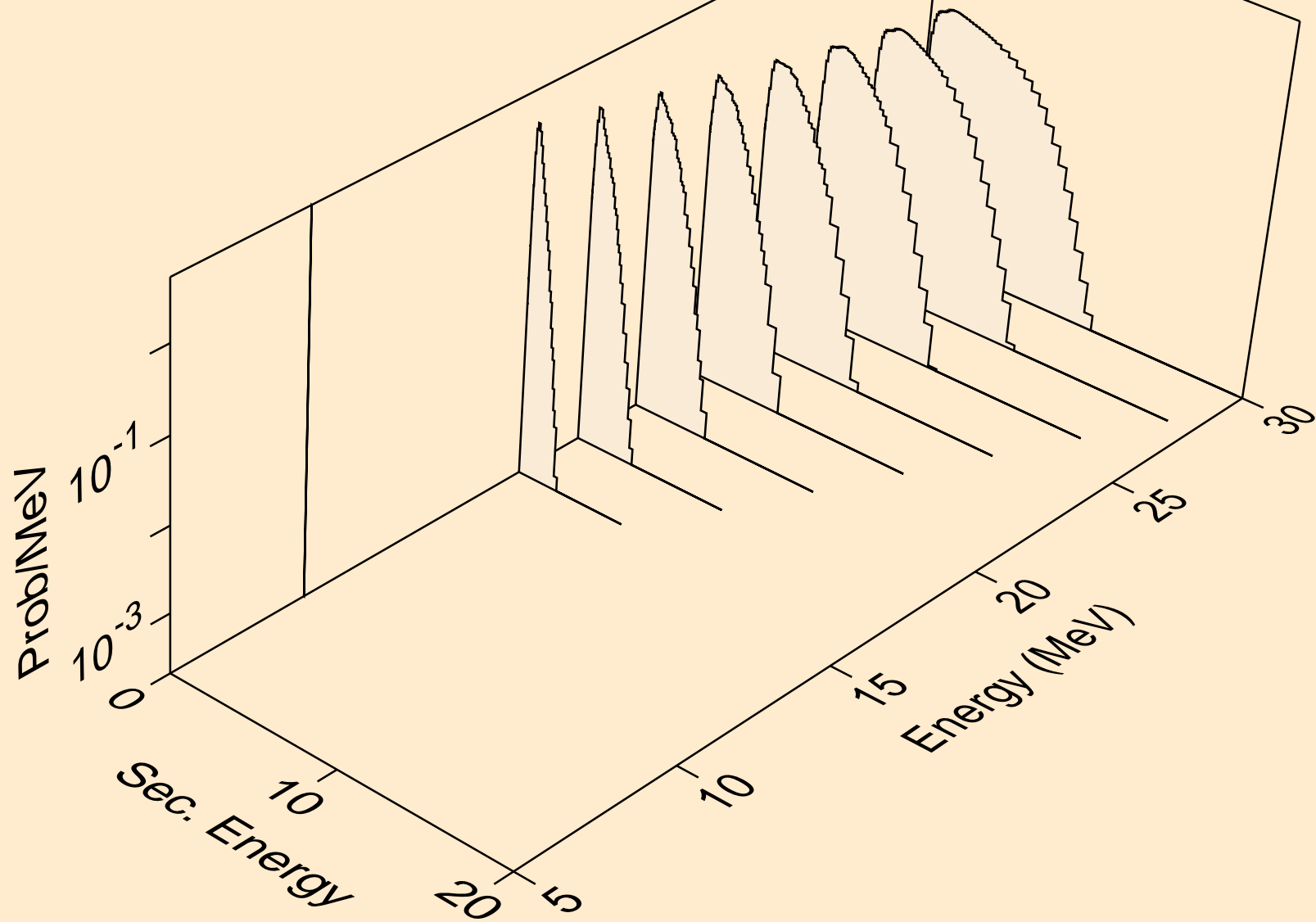

LR265 HELION ACER TENDL-2021 LIBRARY; T=0.K
protons from (s,x)

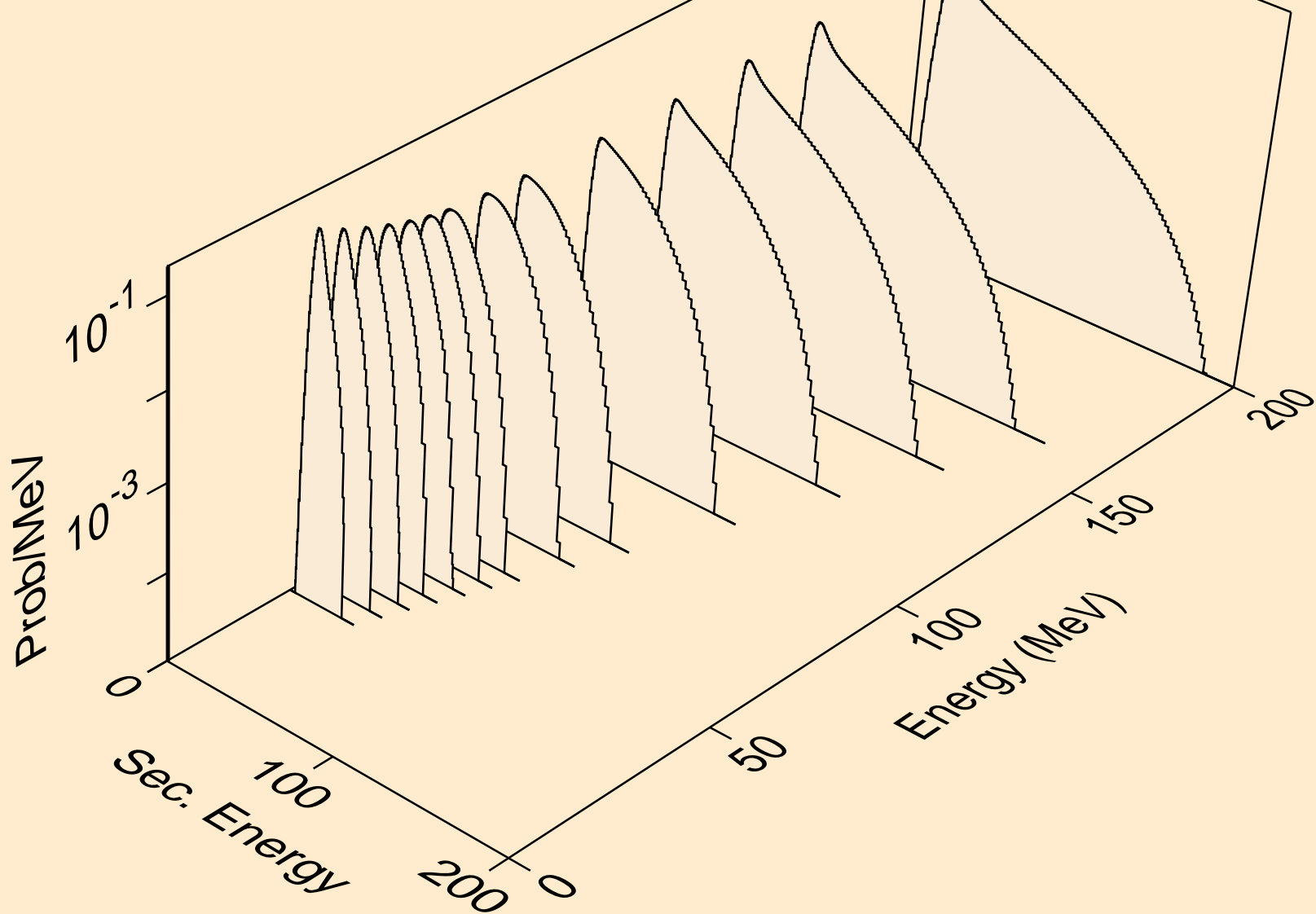

LR265 HELION ACER TENDL-2021 LIBRARY; T=0.K
protons from (s,n*)p

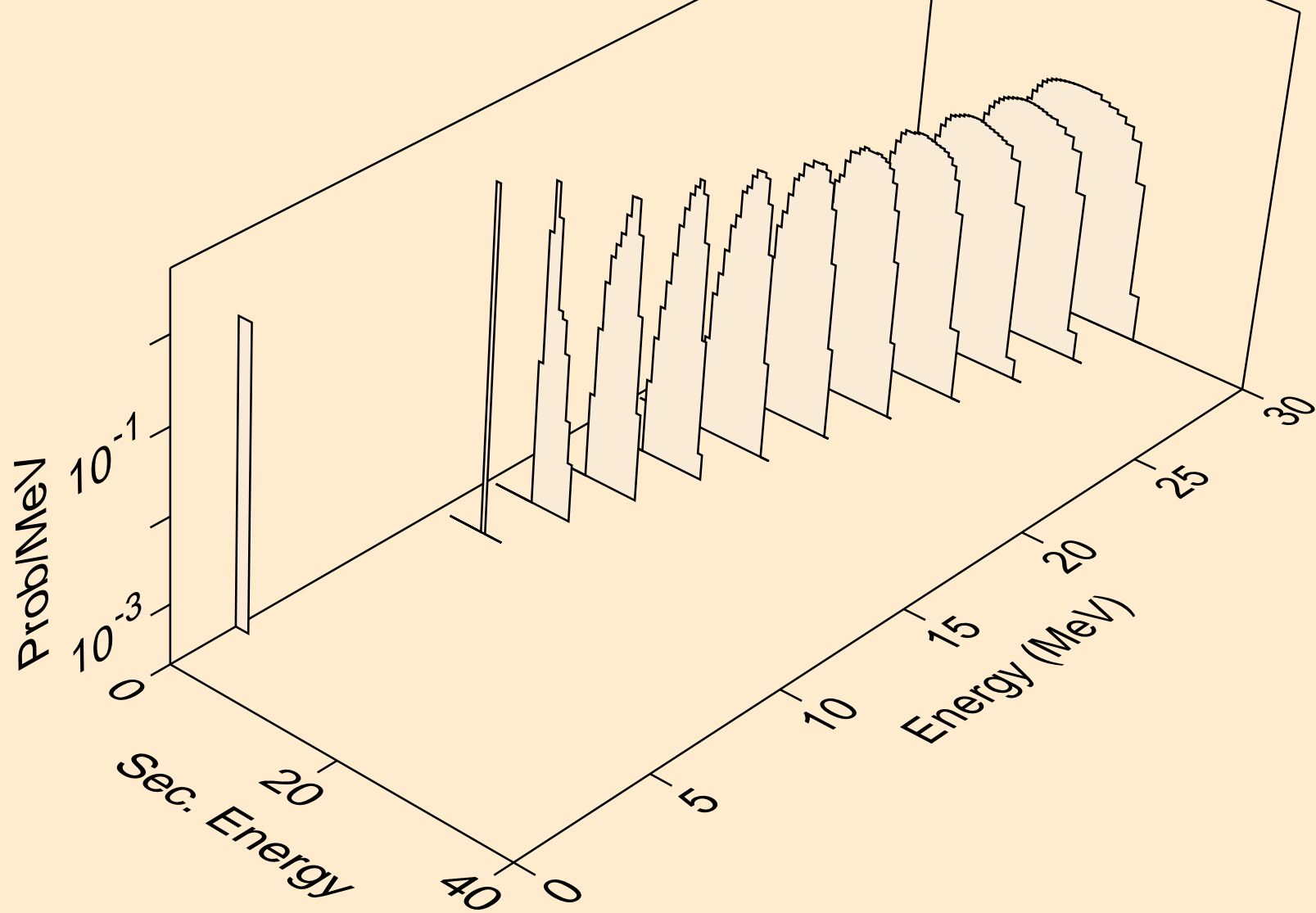

LR265 HELION ACER TENDL-2021 LIBRARY; T=0.K
protons from (s,2np)

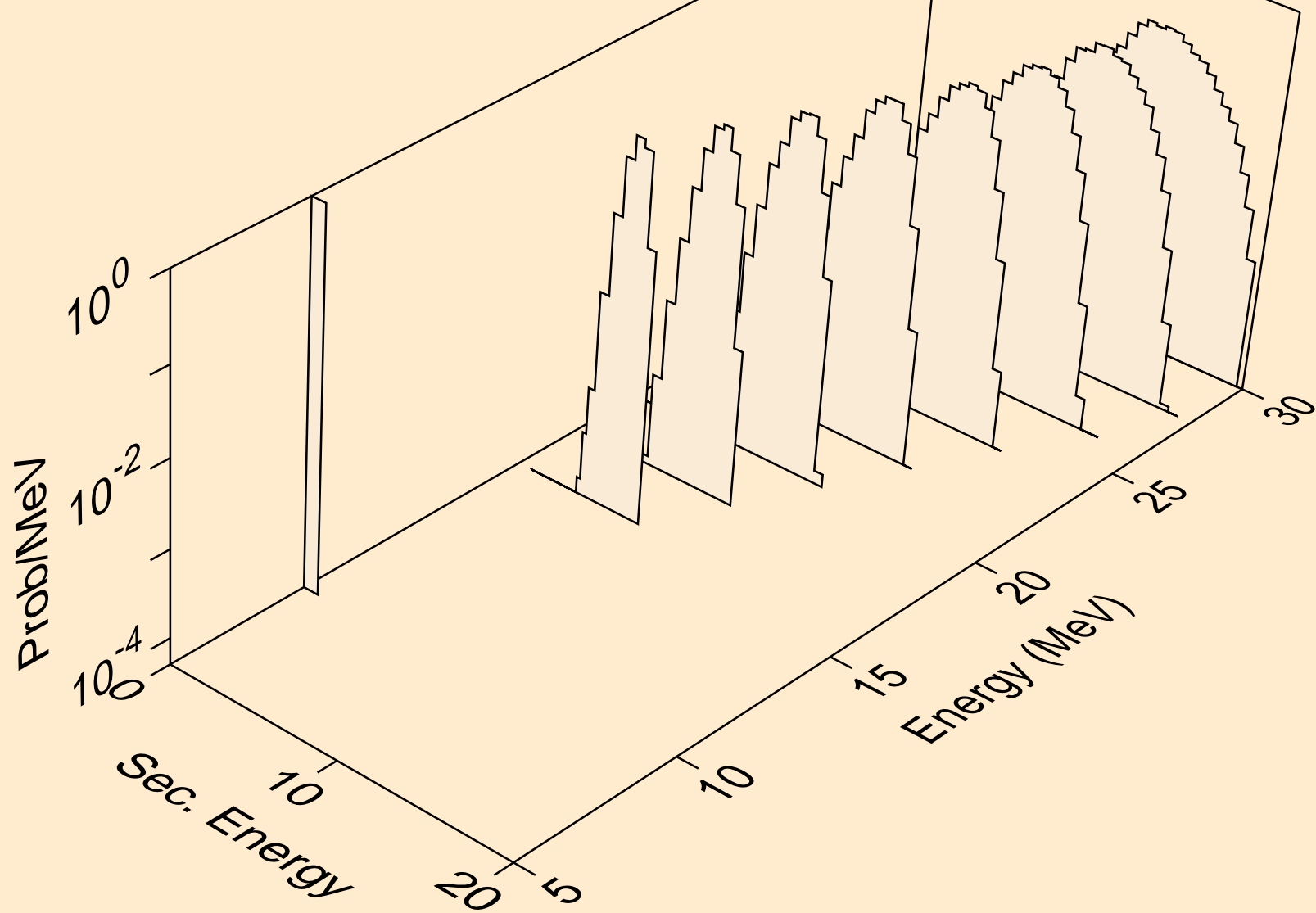

LR265 HELION ACER TENDL-2021 LIBRARY; T=0.K
protons from (s,p)

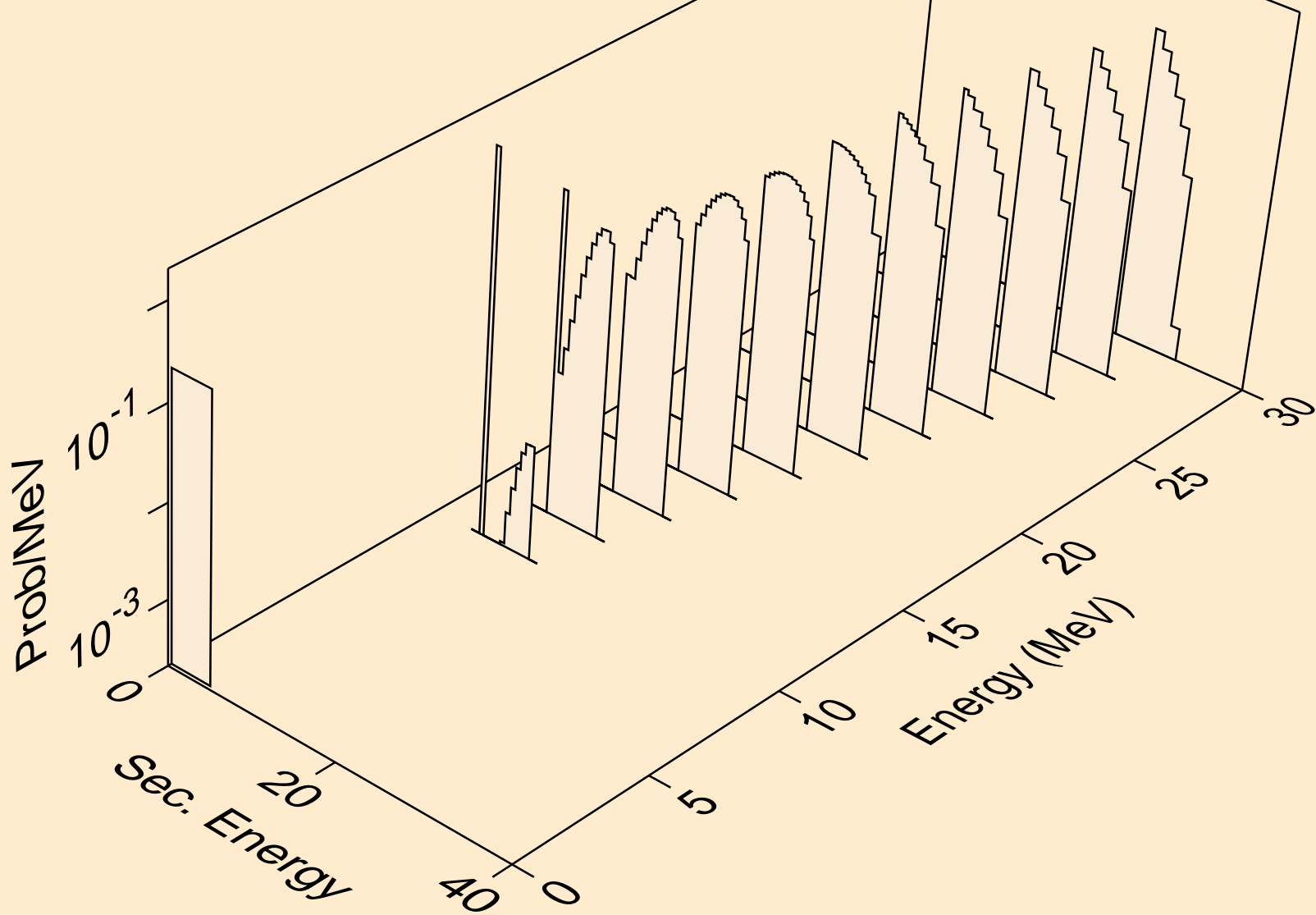

LR265 HELION ACER TENDL-2021 LIBRARY; T=0.K
deuterons from (s,x)

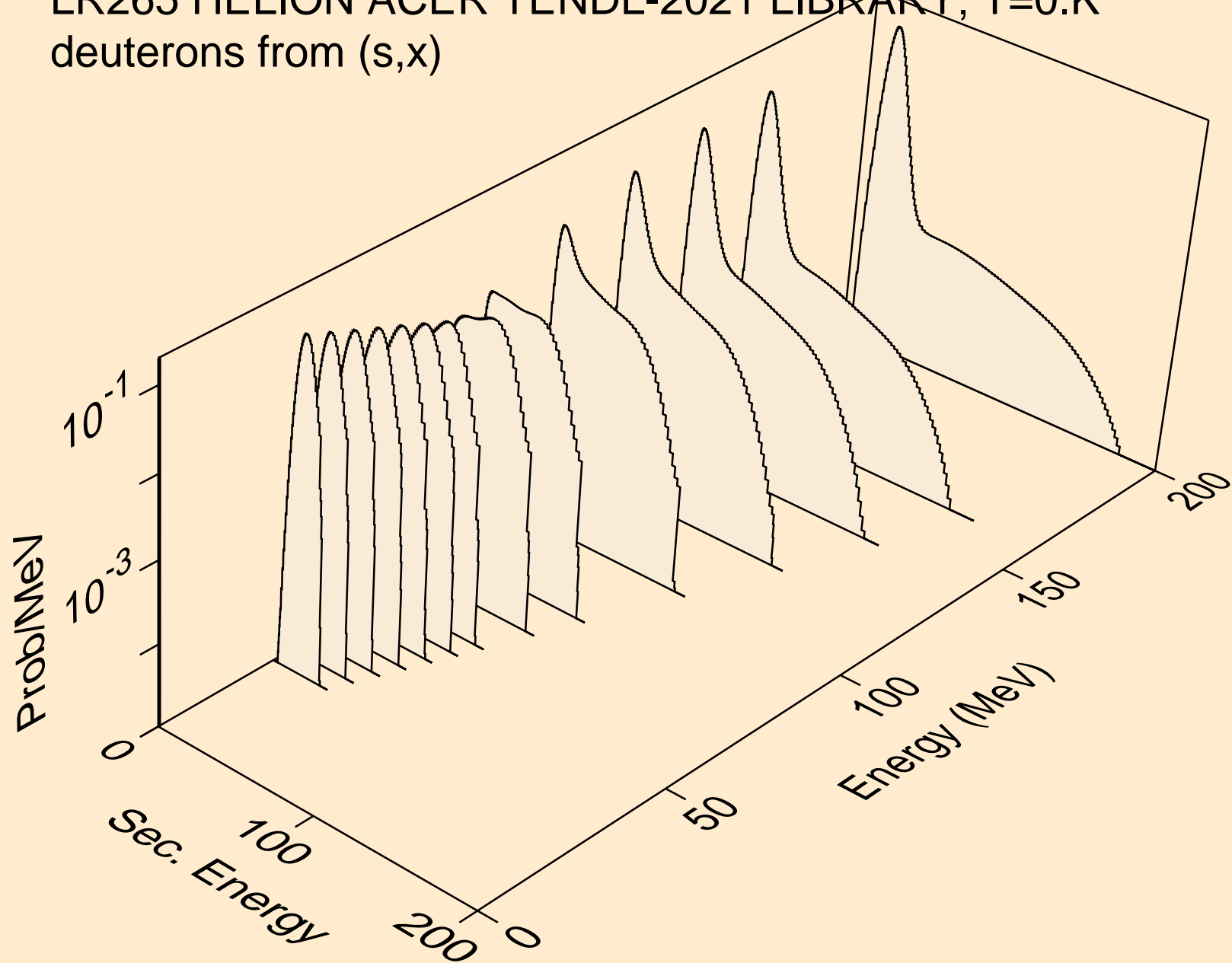

LR265 HELION ACER TENDL-2021 LIBRARY; T=0.K
deuterons from (s,n*)d

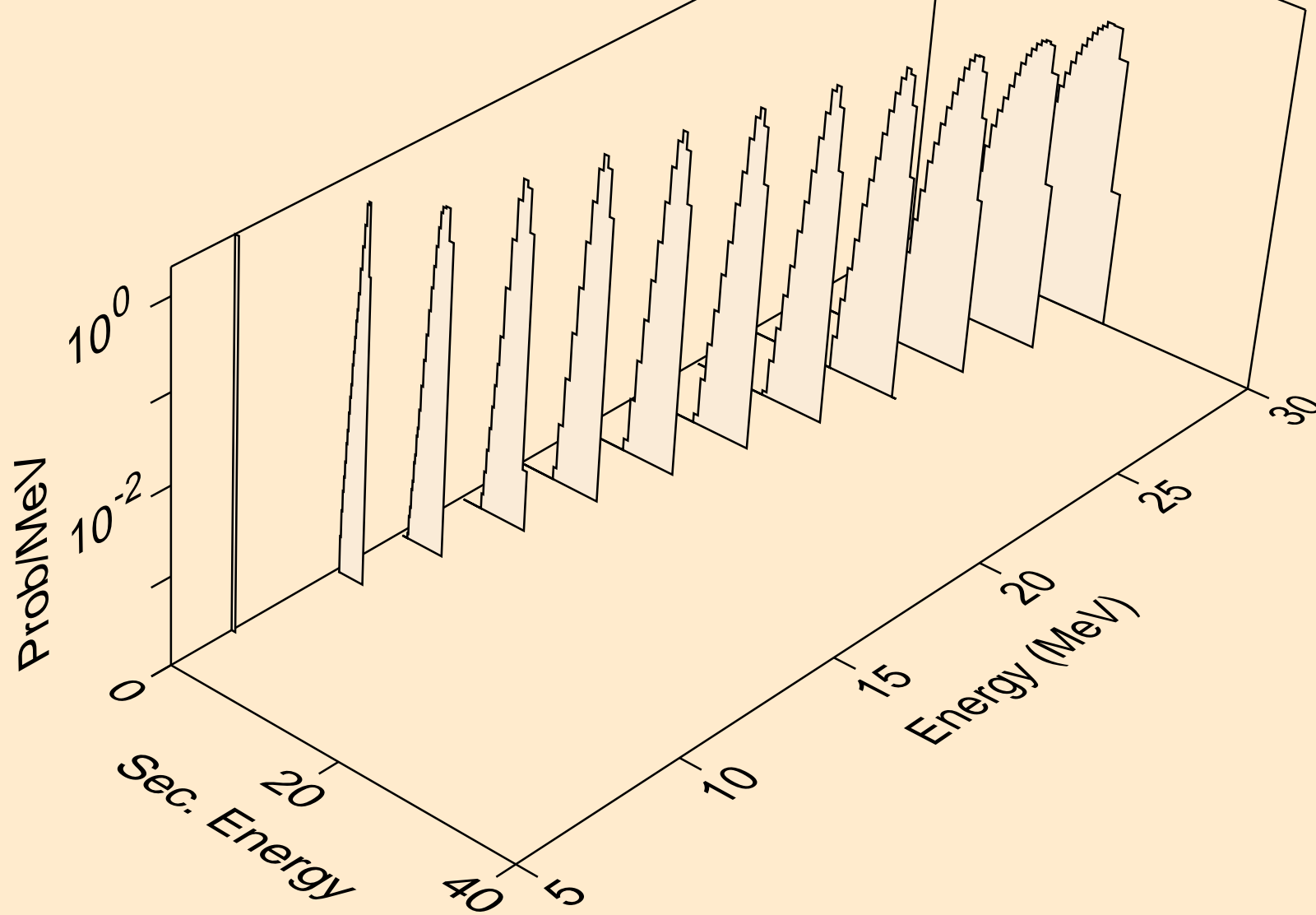

LR265 HELION ACER TENDL-2021 LIBRARY; T=0.K
deuterons from (s,d)

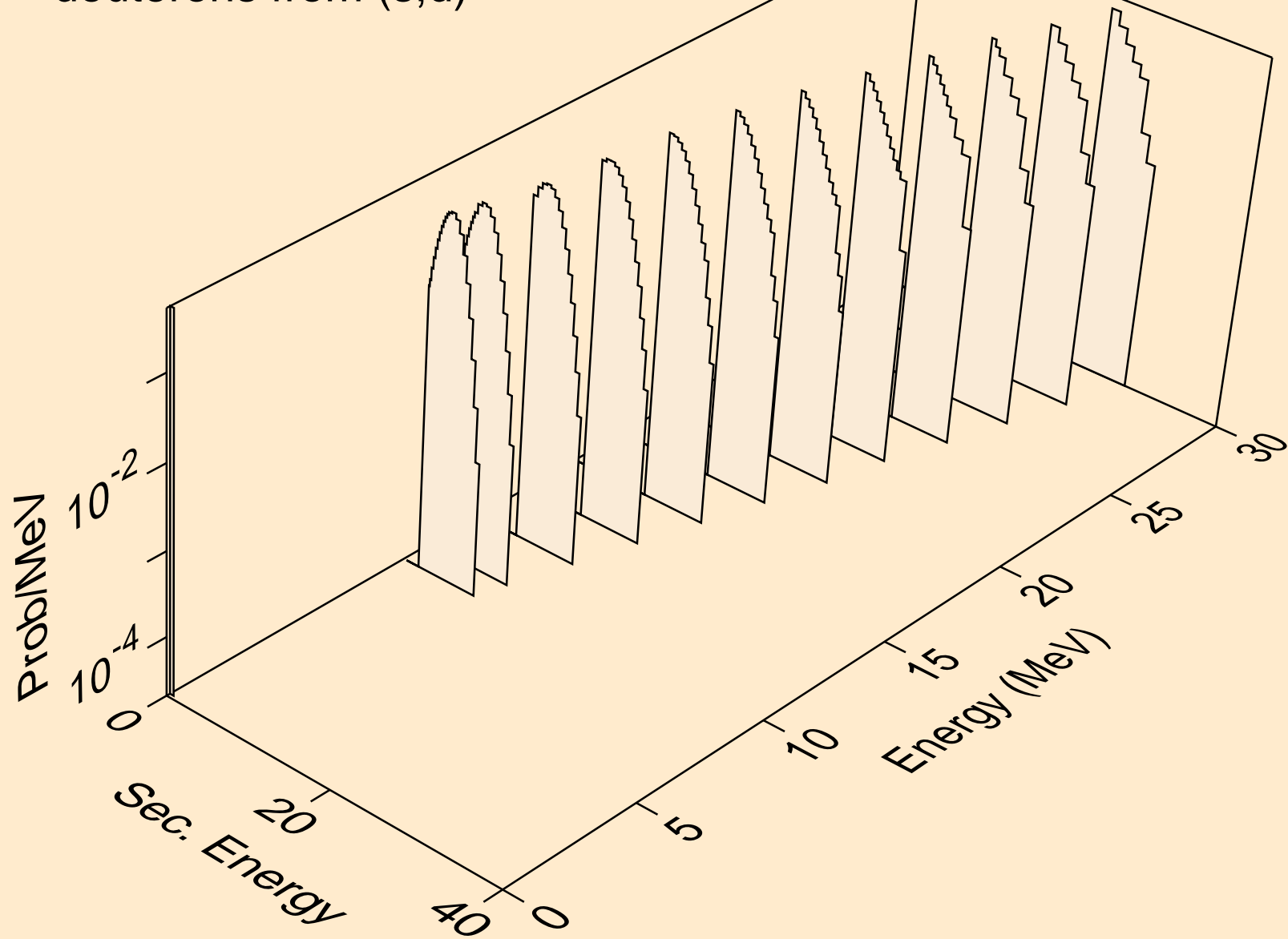

LR265 HELION ACER TENDL-2021 LIBRARY; T=0.K
tritons from (s,x)

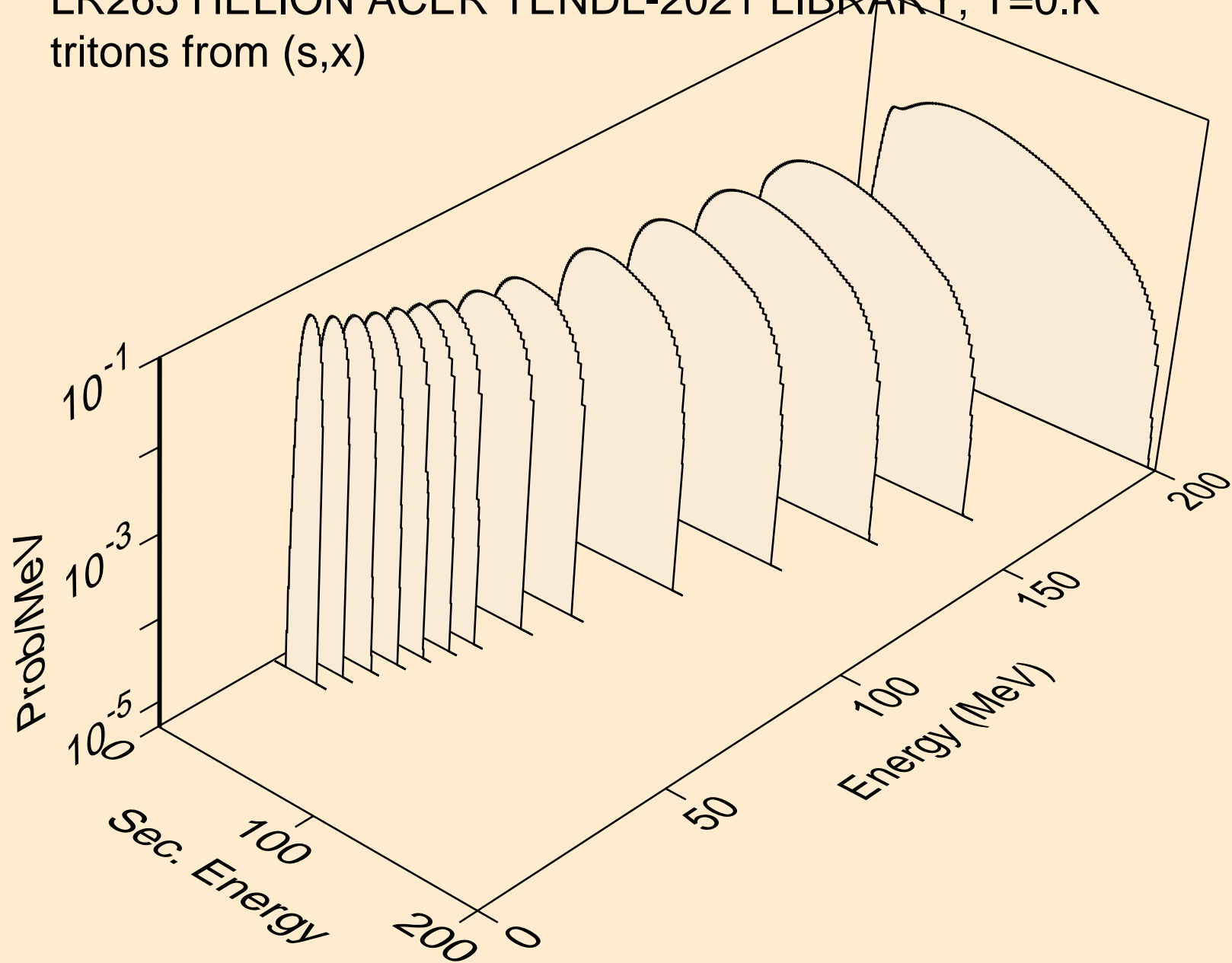

LR265 HELION ACER TENDL-2021 LIBRARY; T=0.K
tritons from (s,n*)t

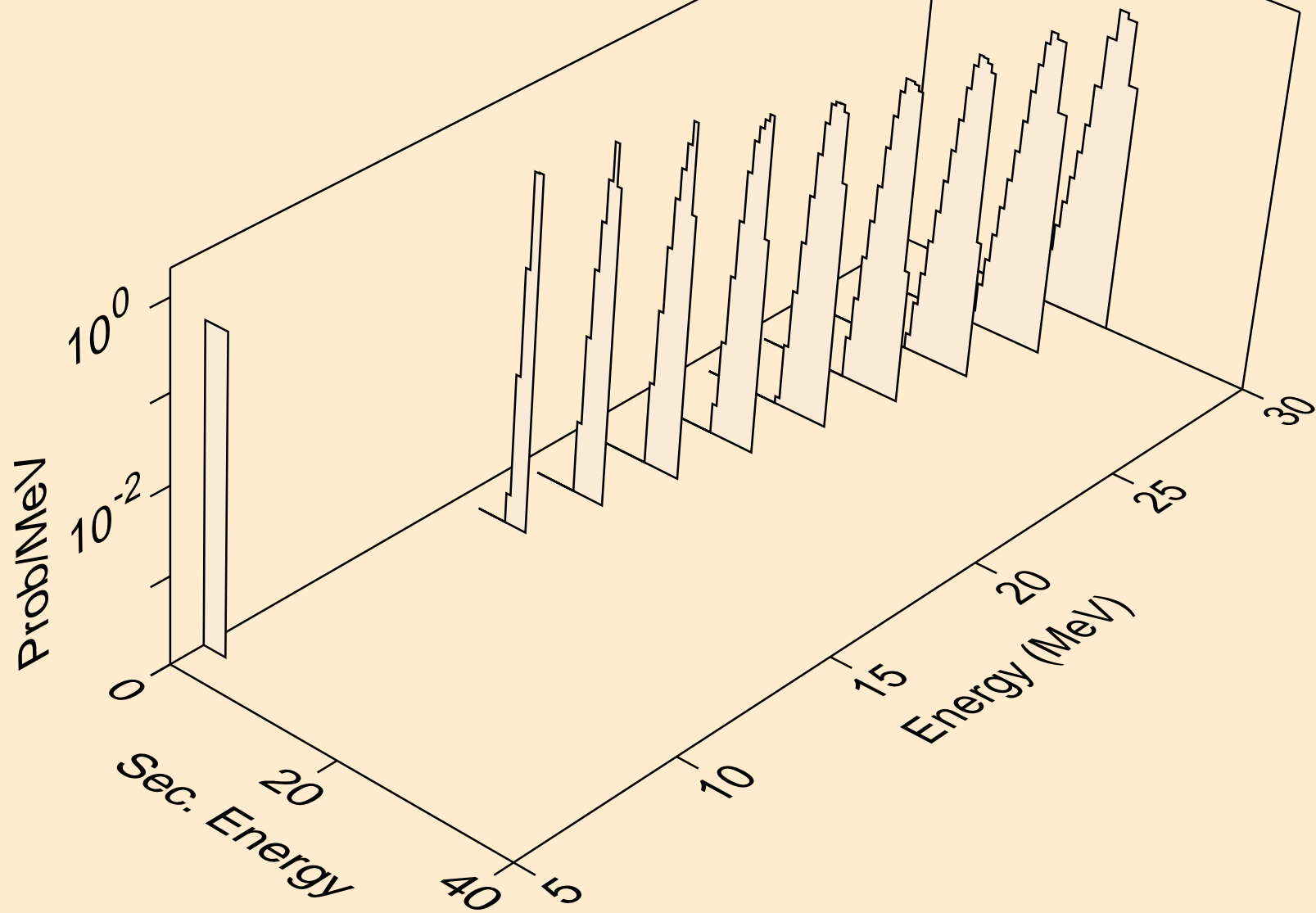

LR265 HELION ACER TENDL-2021 LIBRARY; T=0.K
tritons from (s,t)

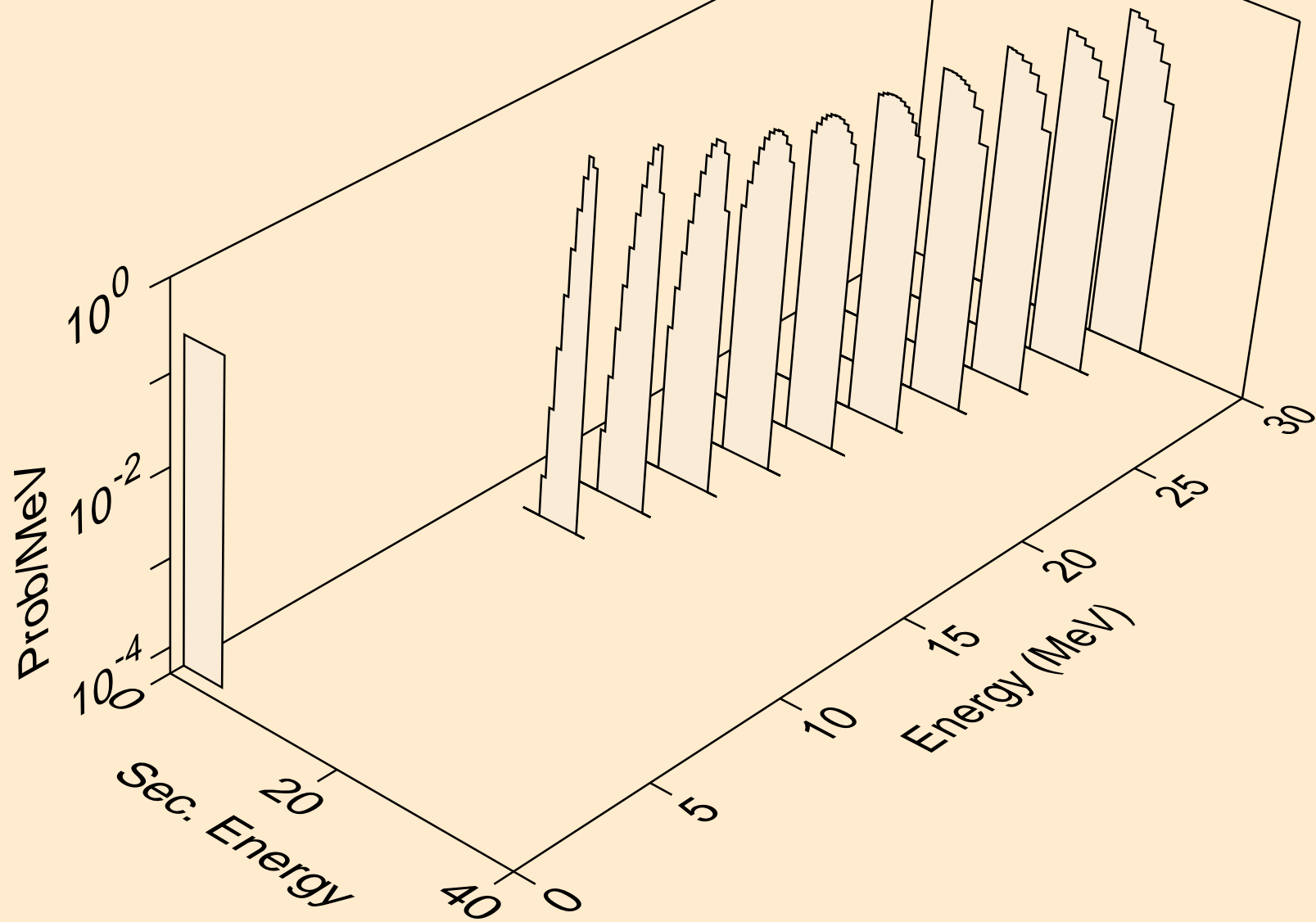

LR265 HELION ACER TENDL-2021 LIBRARY; T=0.K
alphas from (s,x)

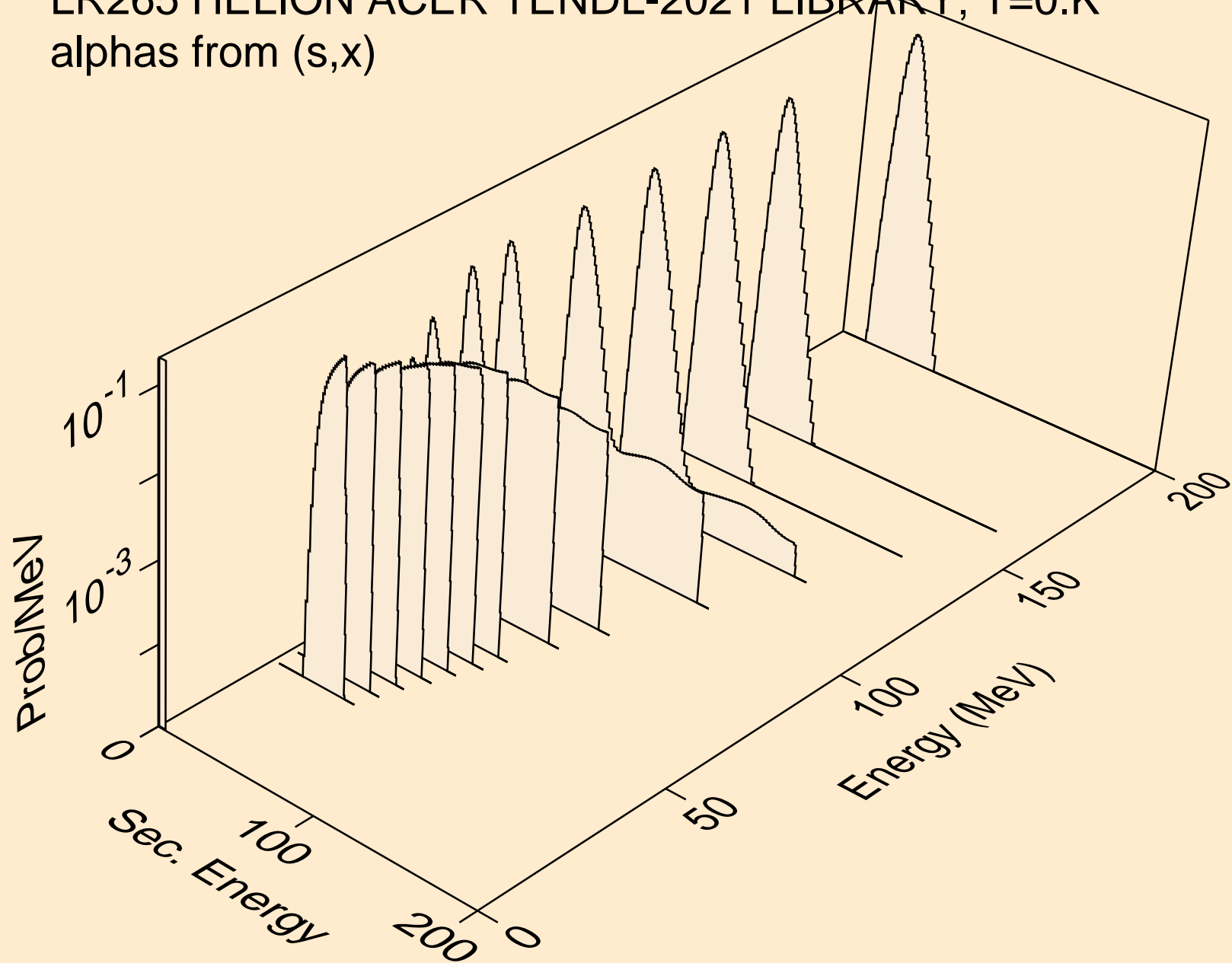

LR265 HELION ACER TENDL-2021 LIBRARY; T=0.K
alphas from (s,a)

