

LU154M HELION ACER TENDL-2021 LIBRARY; T=0.K  
Principal cross sections

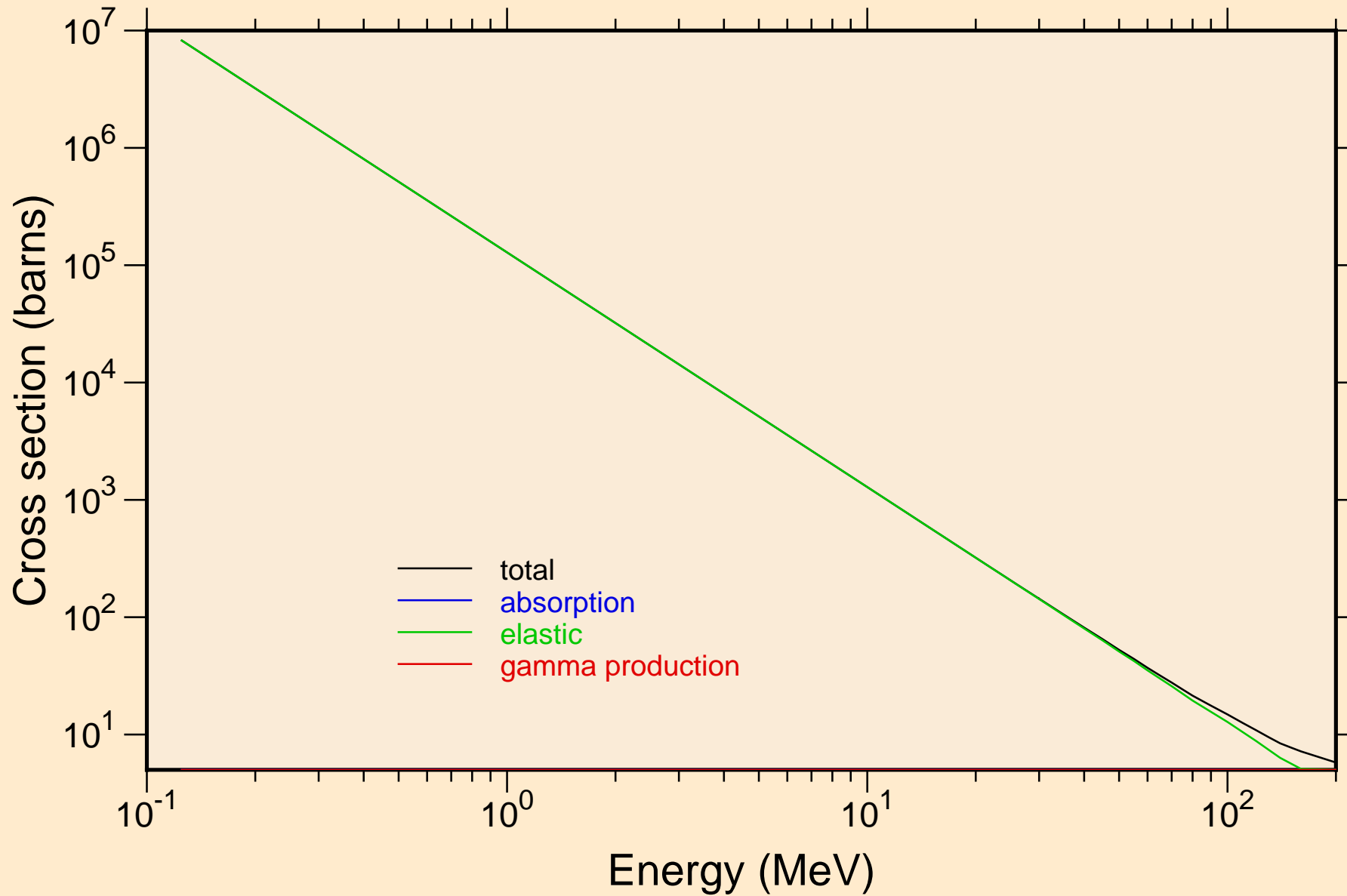

LU154M HELION ACER TENDL-2021 LIBRARY; T=0.K

Heating

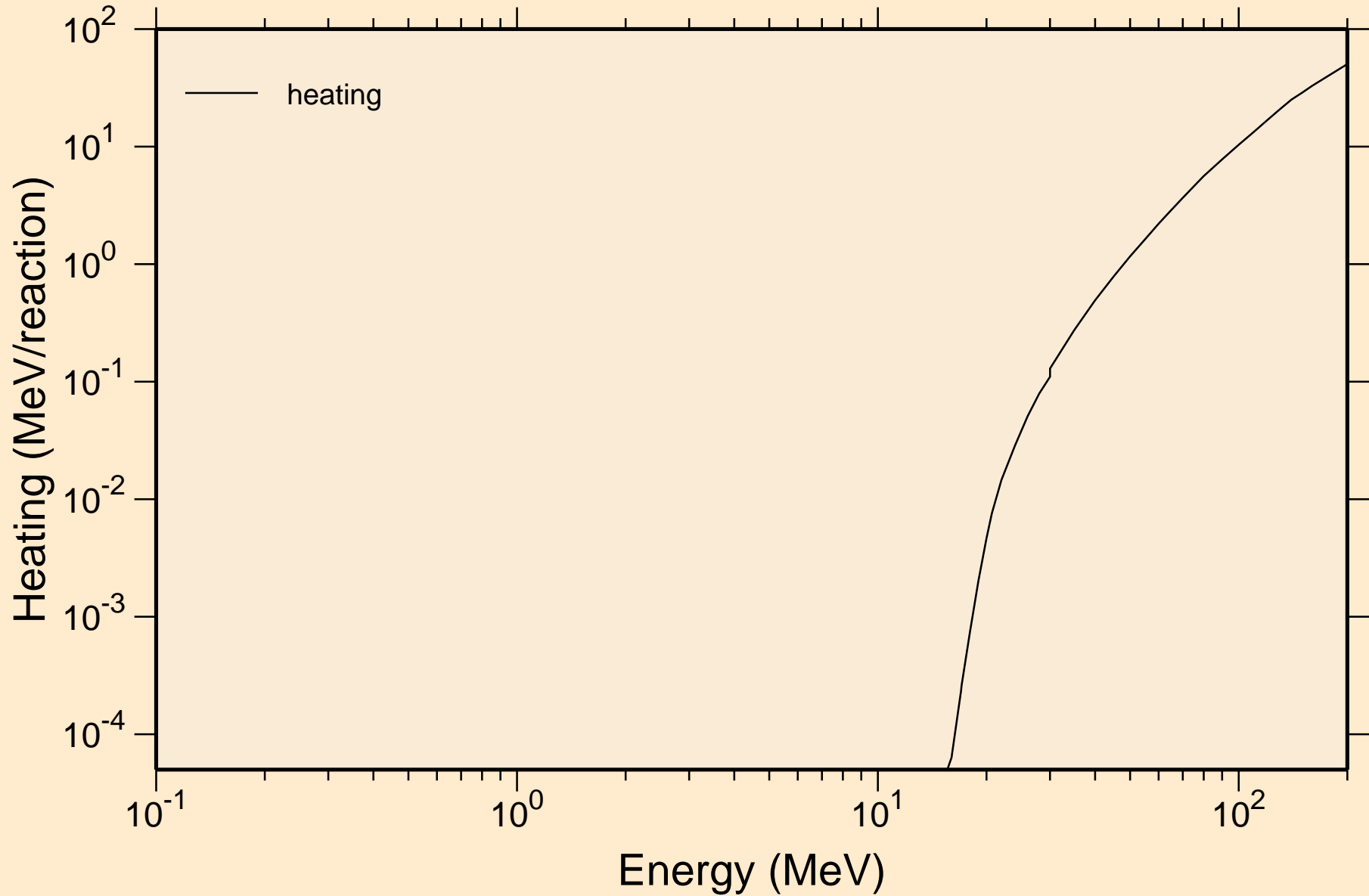

# LU154M HELION ACER TENDL-2021 LIBRARY; T=0.K

## Principal cross sections

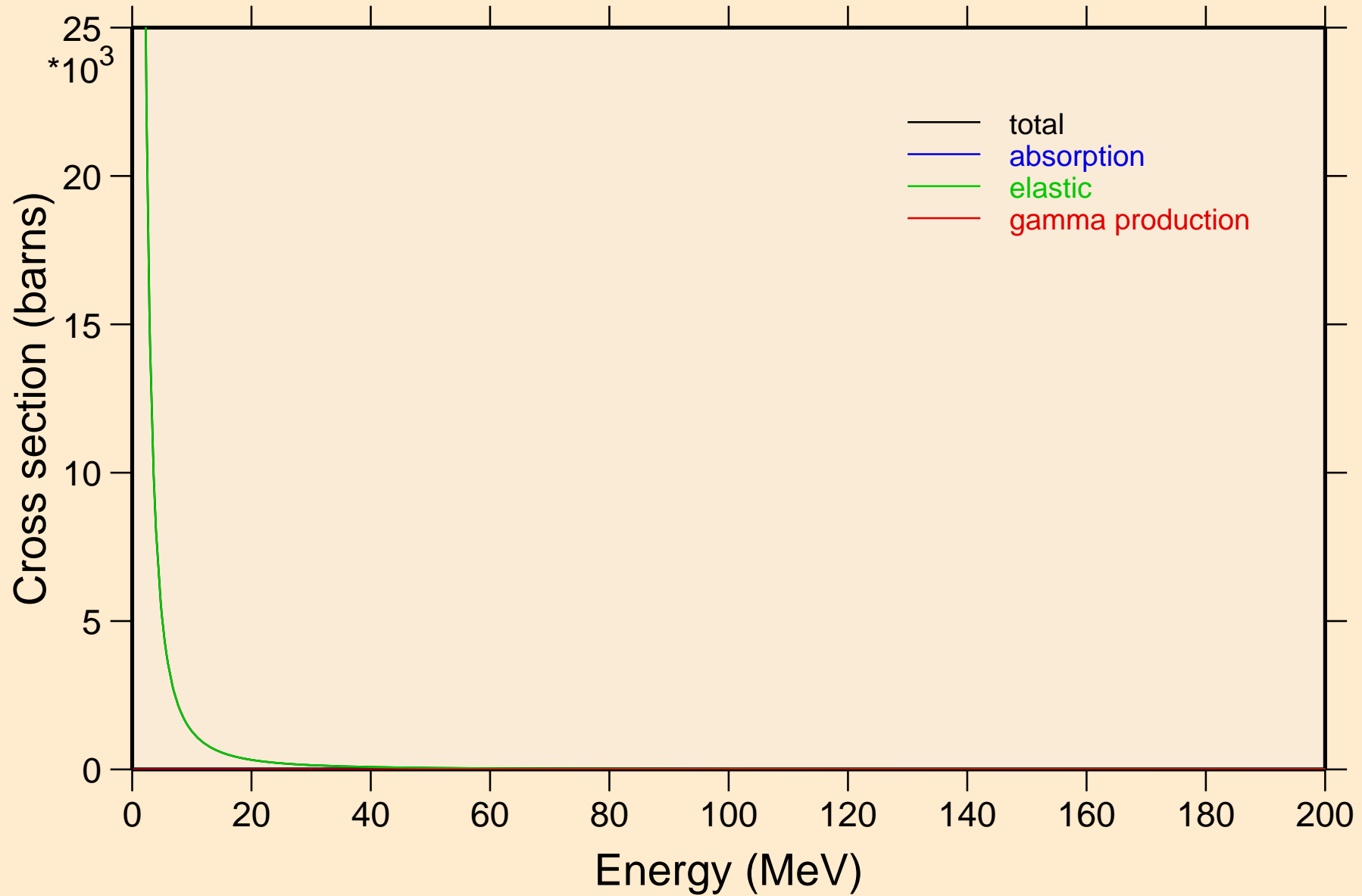

LU154M HELION ACER TENDL-2021 LIBRARY; T=0.K

Heating

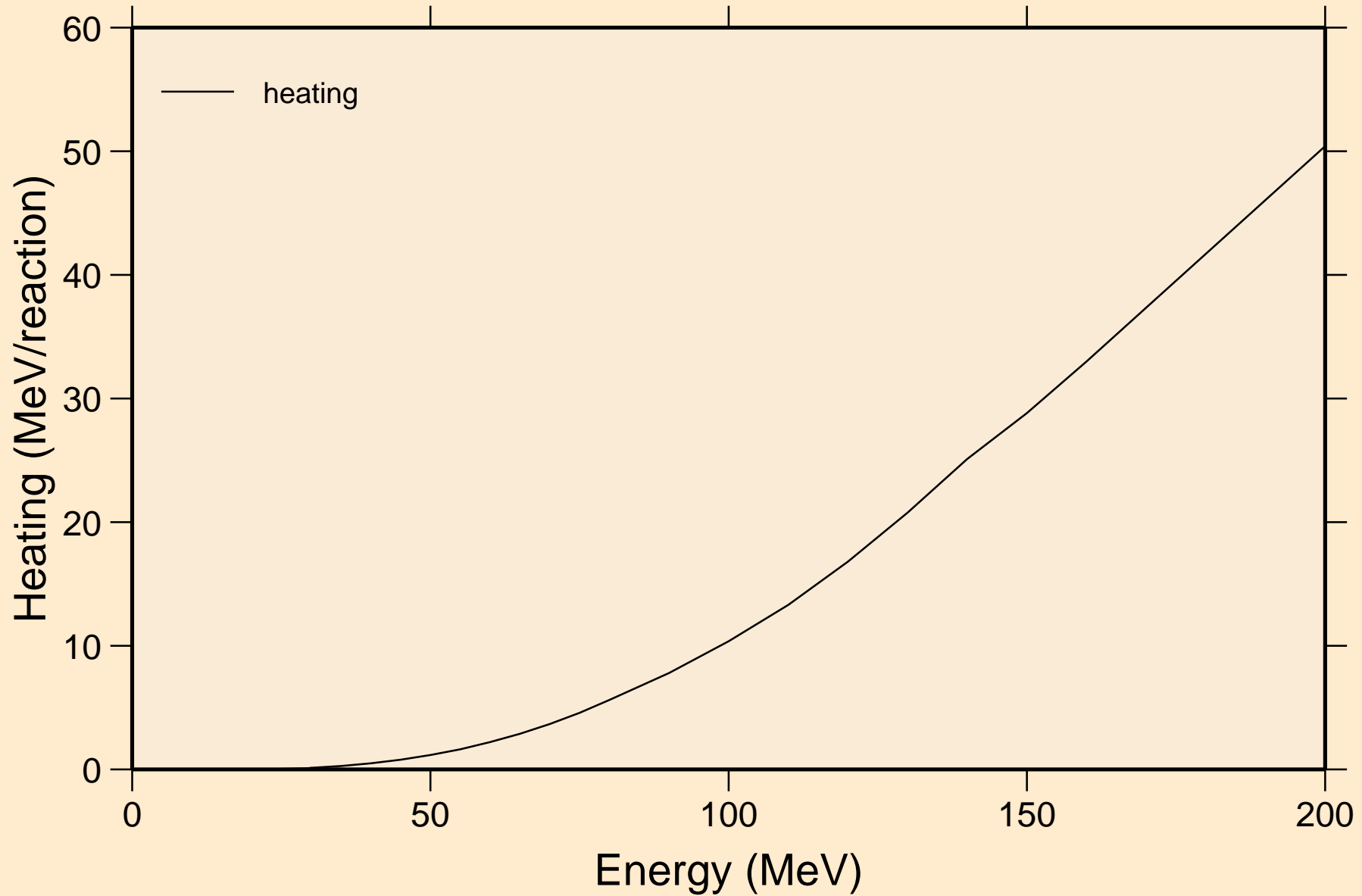

LU154M HELION ACER TENDL-2021 LIBRARY; T=0.K  
Threshold reactions

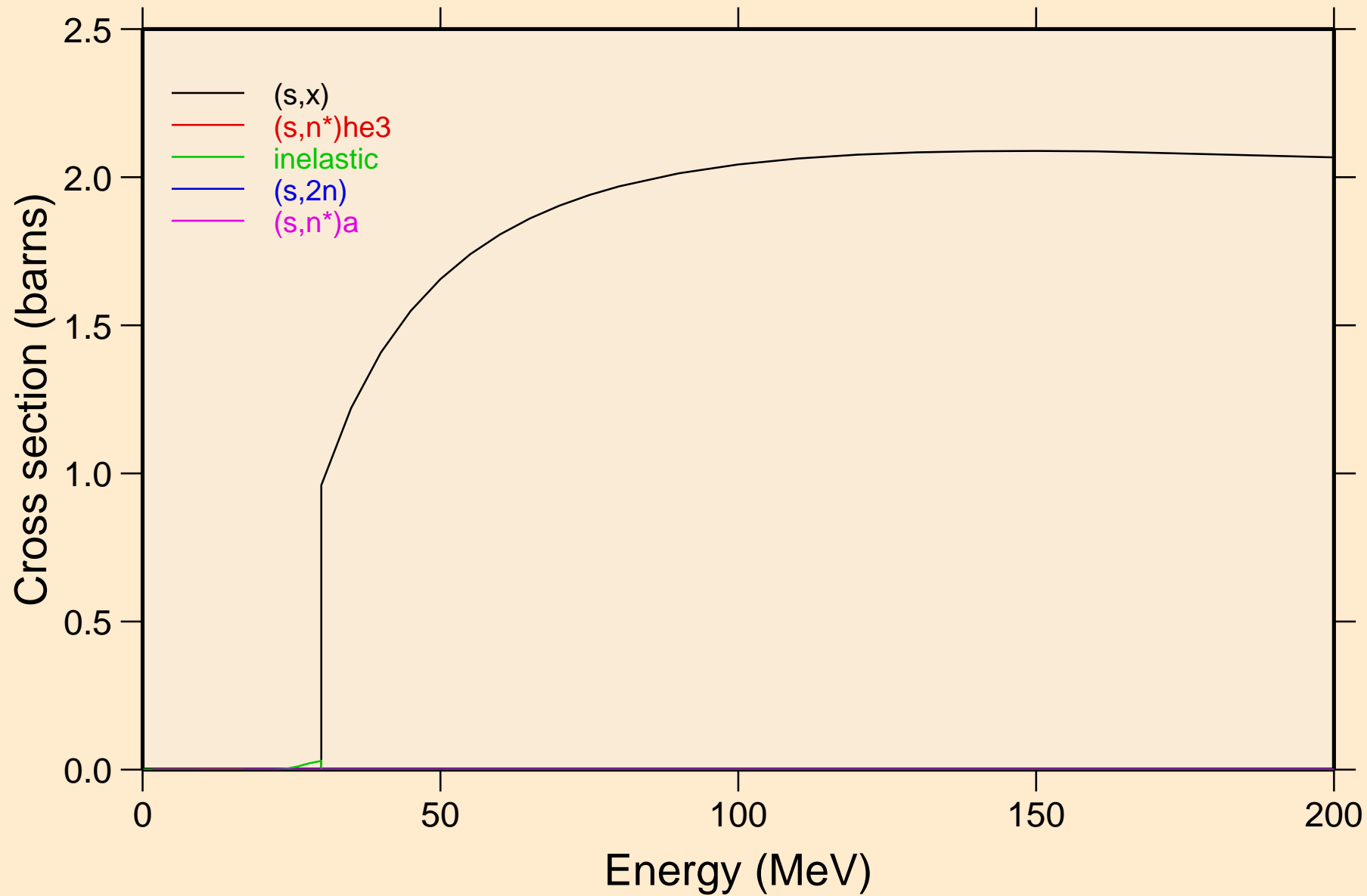

LU154M HELION ACER TENDL-2021 LIBRARY; T=0.K  
Threshold reactions

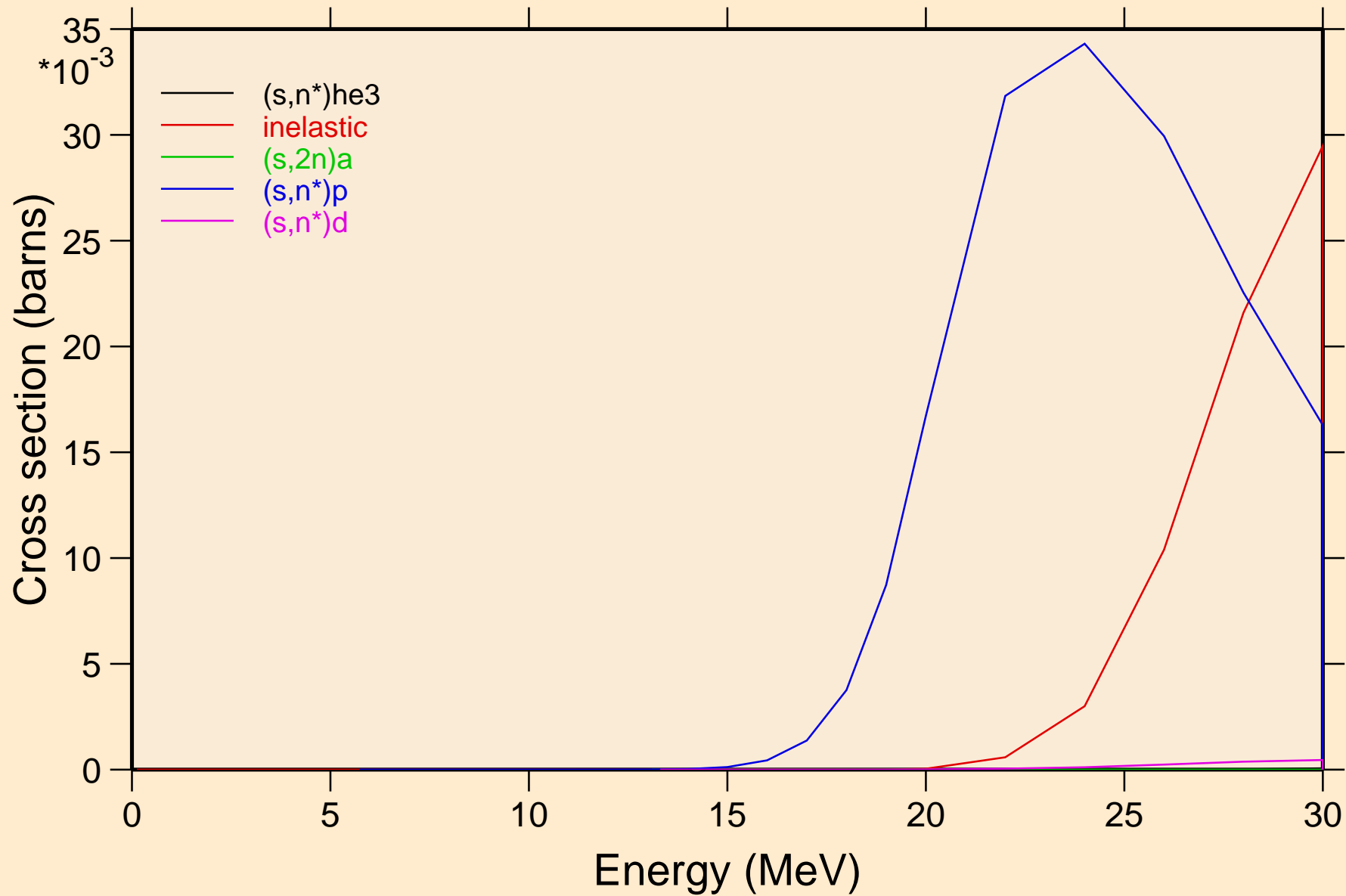

LU154M HELION ACER TENDL-2021 LIBRARY; T=0.K  
Threshold reactions

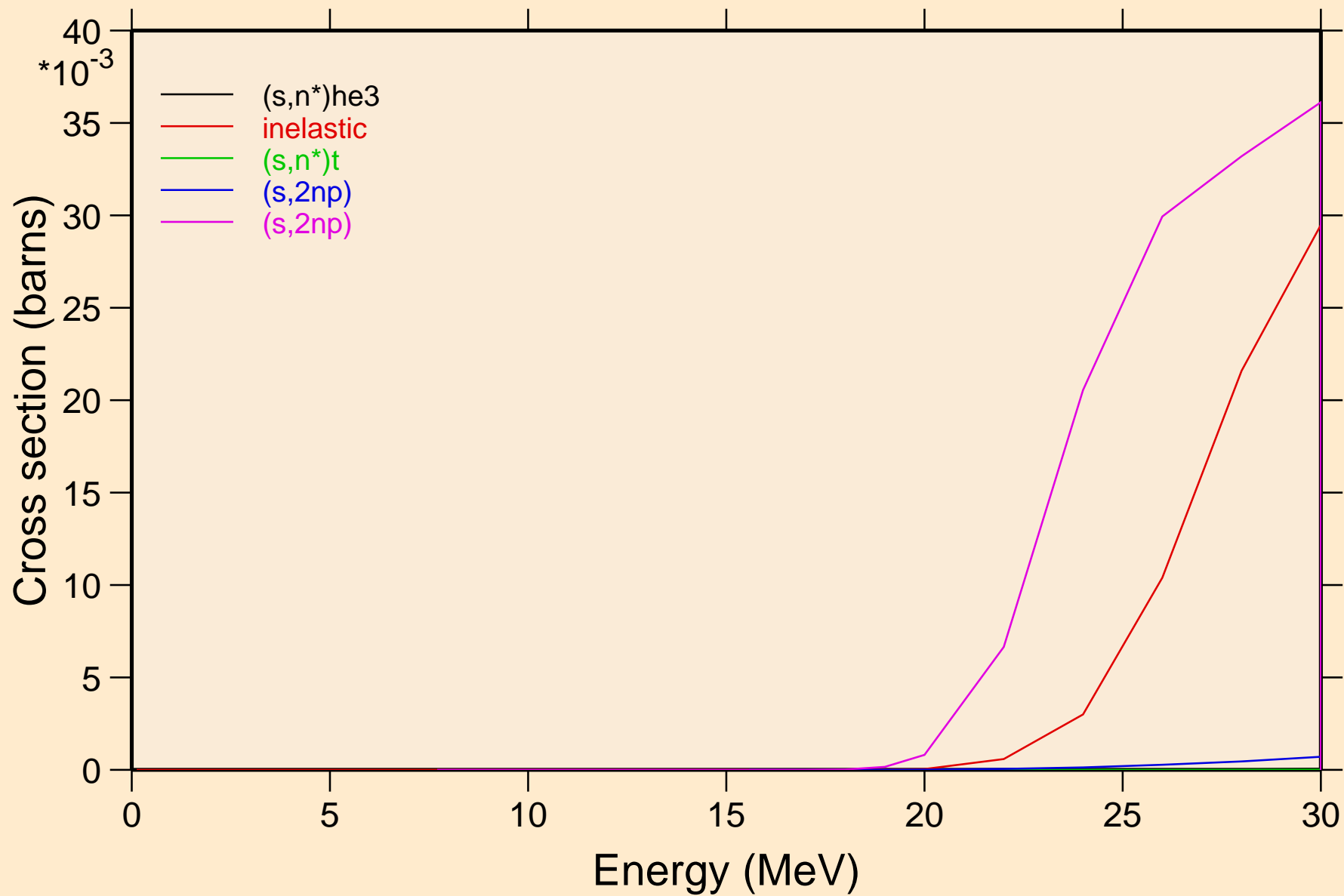

LU154M HELION ACER TENDL-2021 LIBRARY; T=0.K  
Threshold reactions

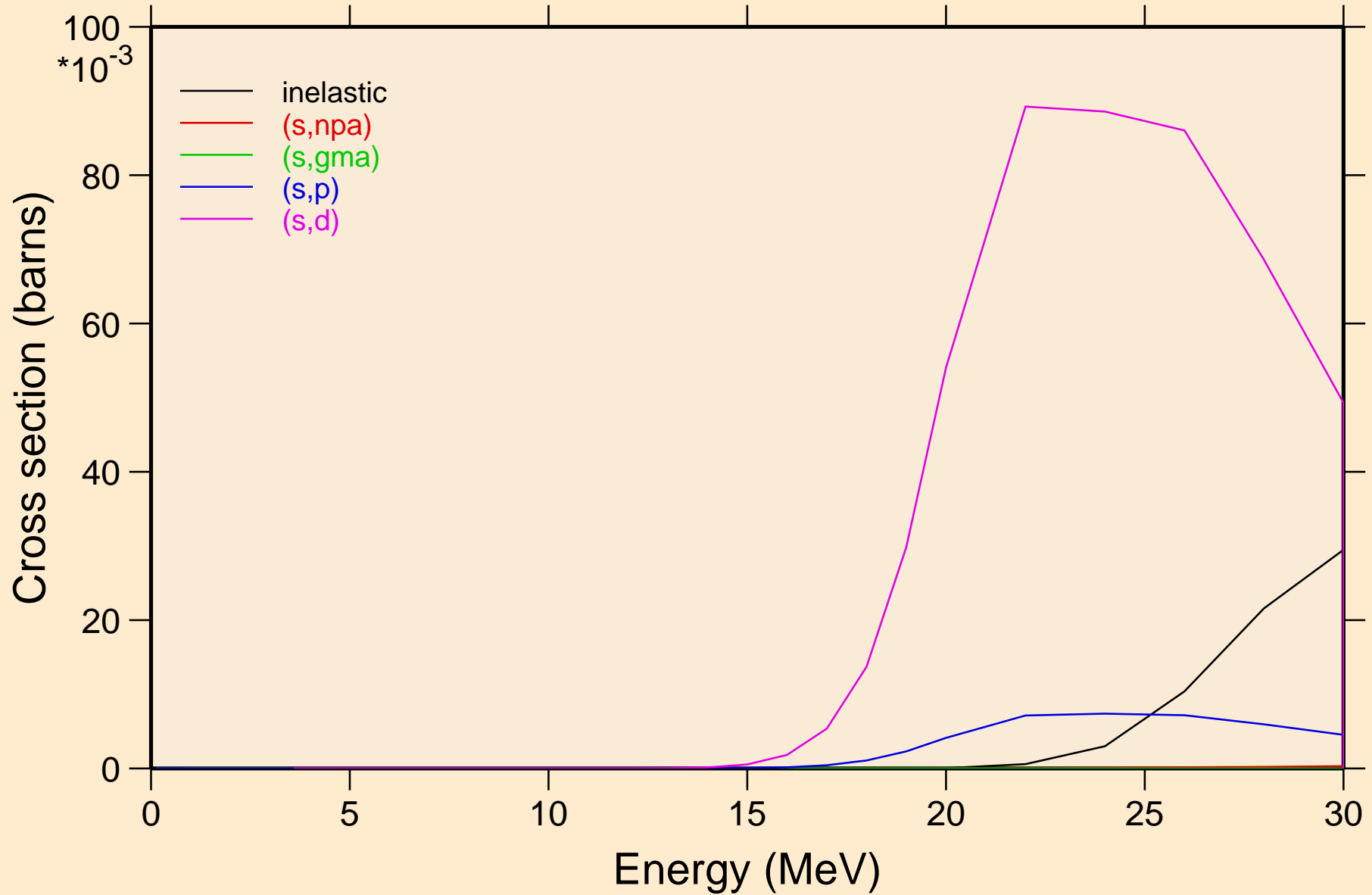



LU154M HELION ACER TENDL-2021 LIBRARY; T=0.K  
Threshold reactions

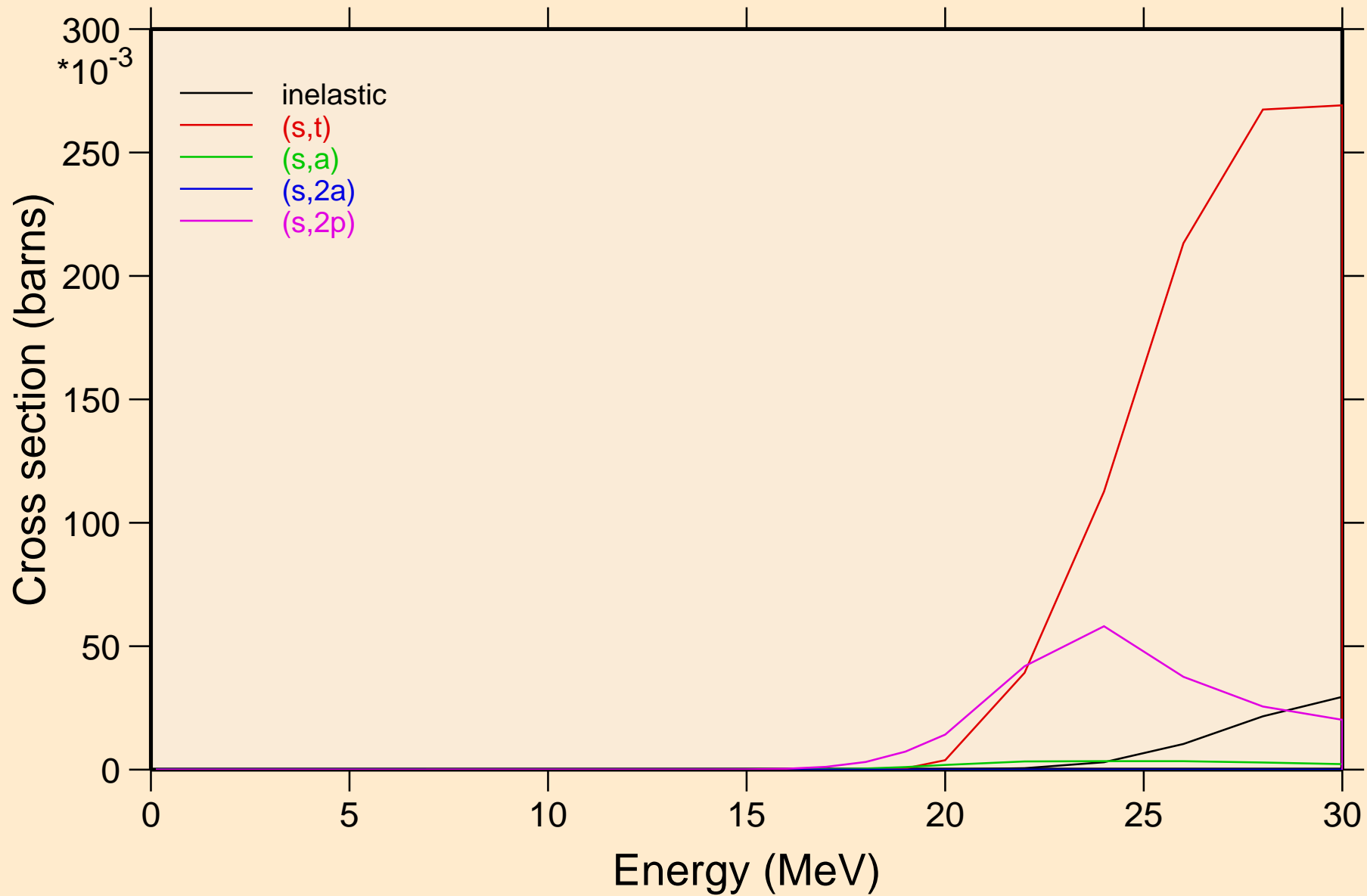

LU154M HELION ACER TENDL-2021 LIBRARY; T=0.K  
Threshold reactions

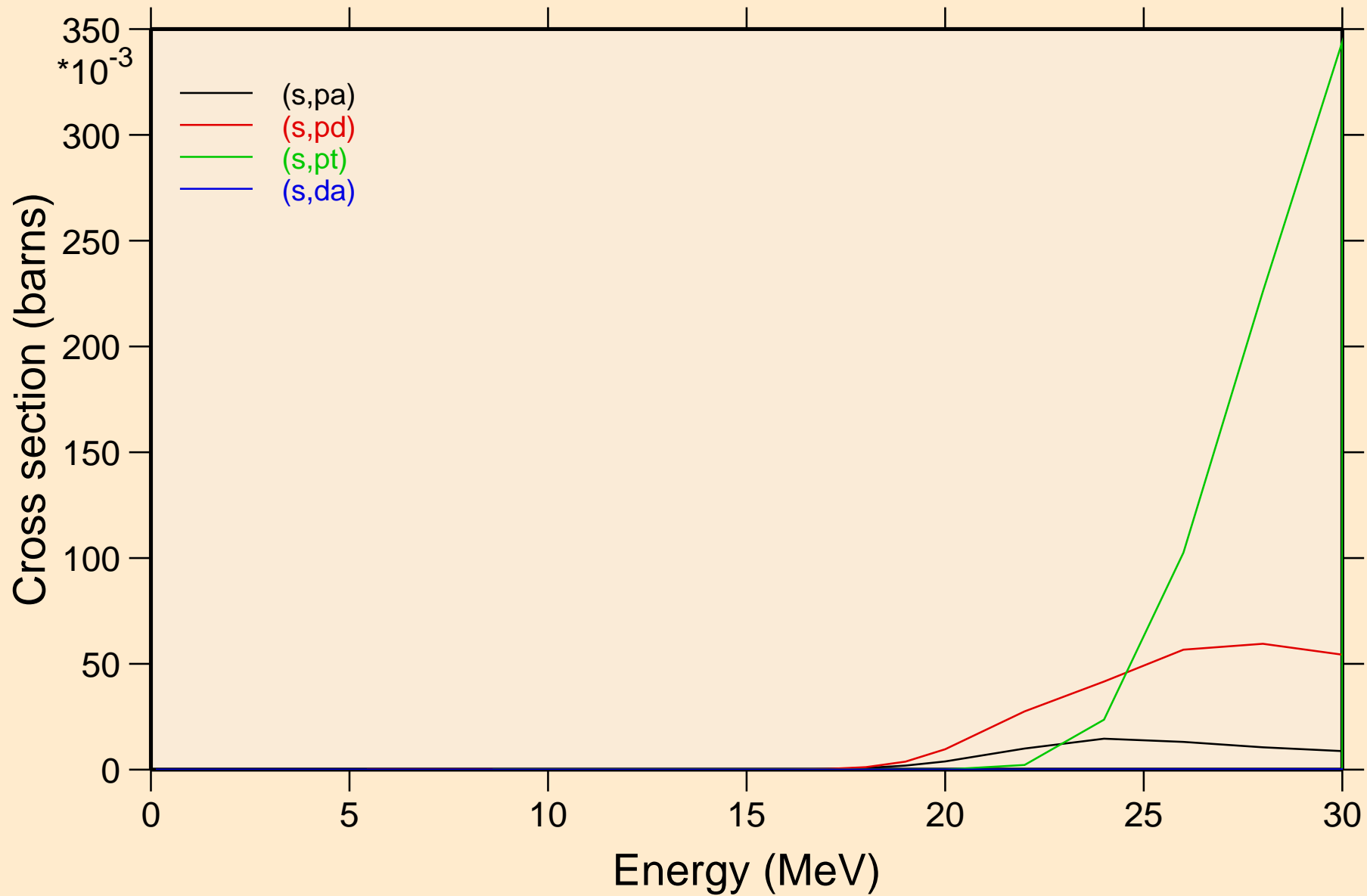

LU154M HELION ACER TENDL-2021 LIBRARY; T=0.K  
angular distribution for elastic

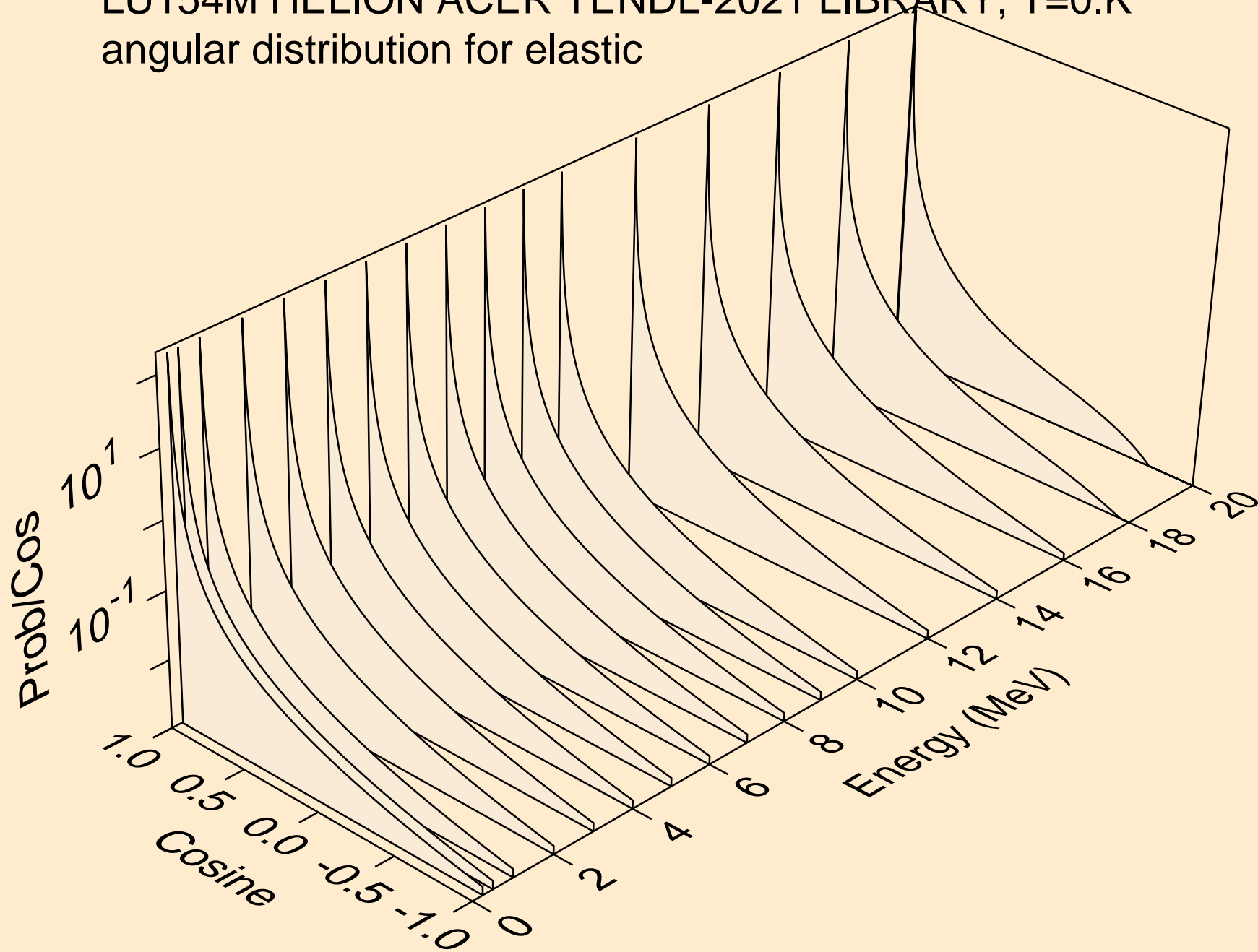

LU154M HELION ACER TENDL-2021 LIBRARY; T=0.K  
angular distribution for elastic

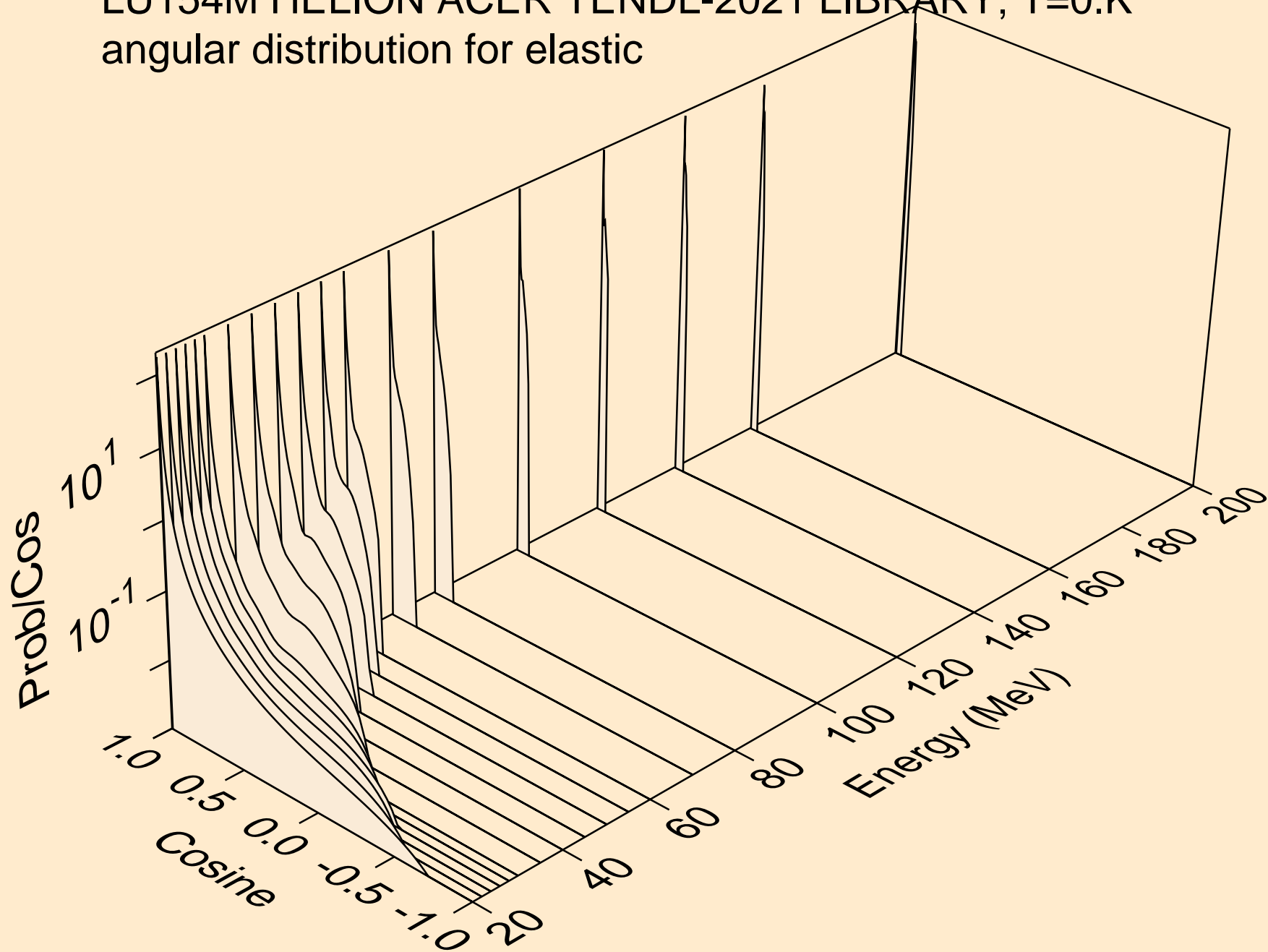

LU154M HELION ACER TENDL-2021 LIBRARY; T=0.K  
He-3 emission for (s,x)

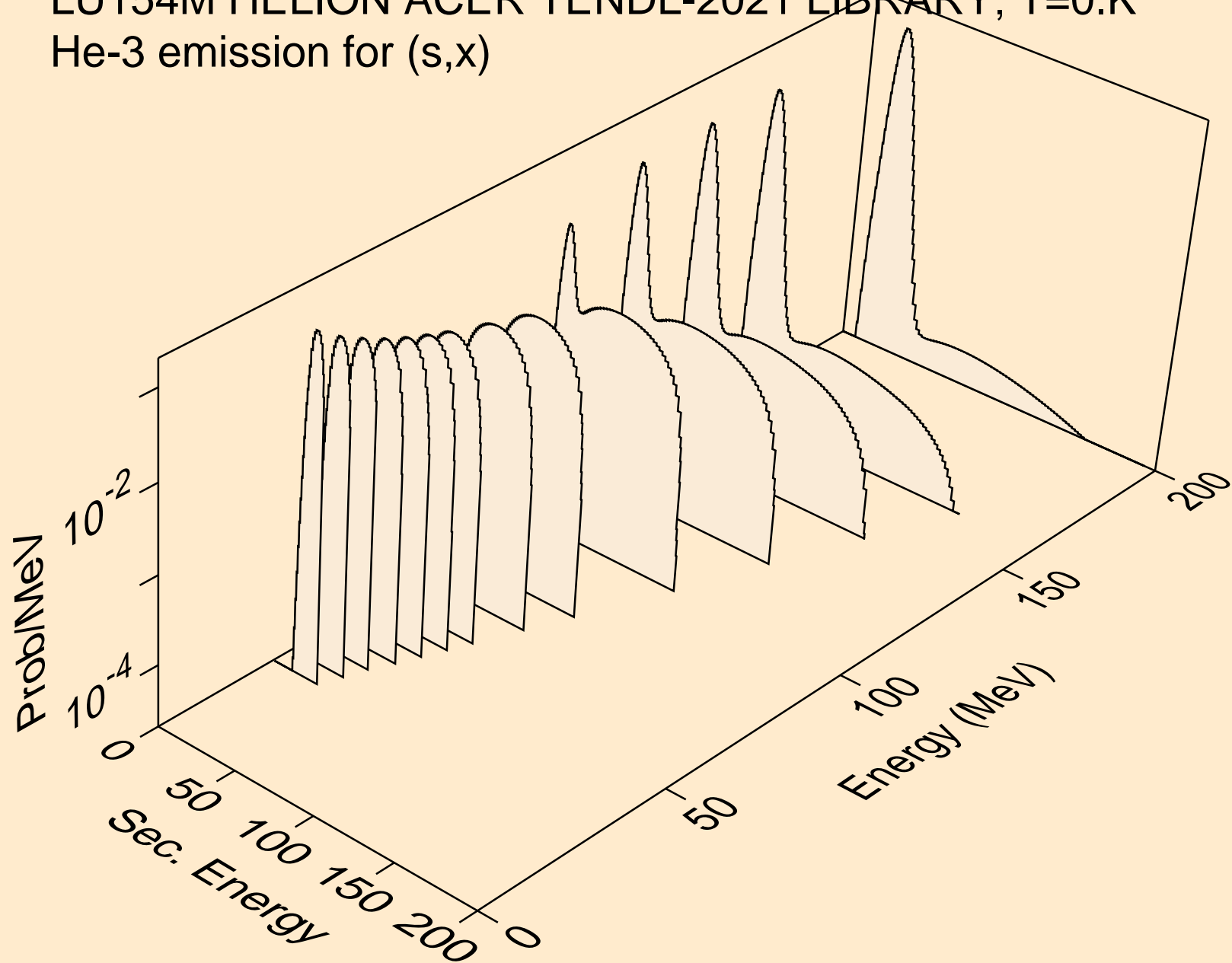

LU154M HELION ACER TENDL-2021 LIBRARY; T=0.K  
He-3 emission for (s,n\*)he3

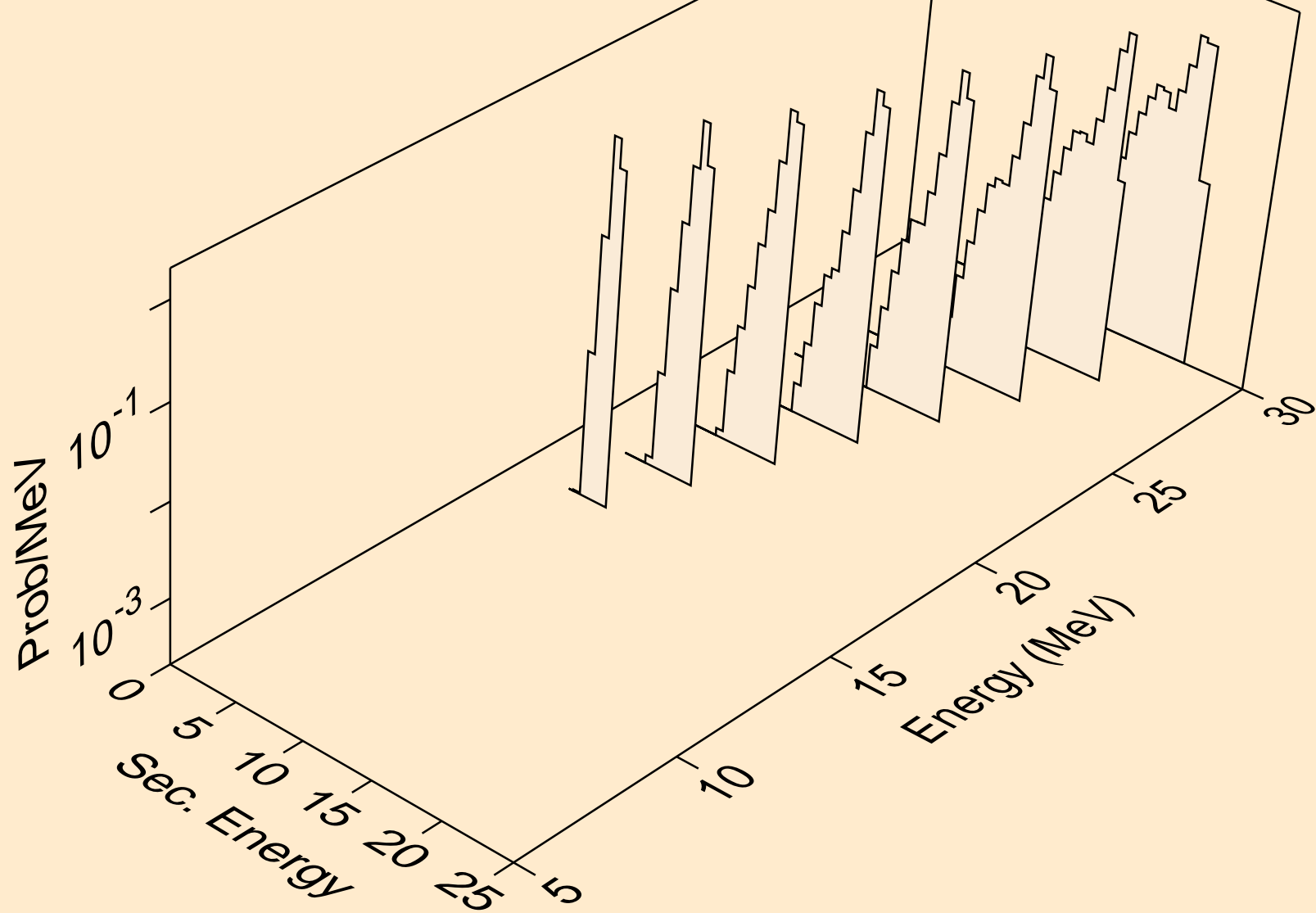

LU154M HELION ACER TENDL-2021 LIBRARY; T=0.K  
He-3 emission for inelastic

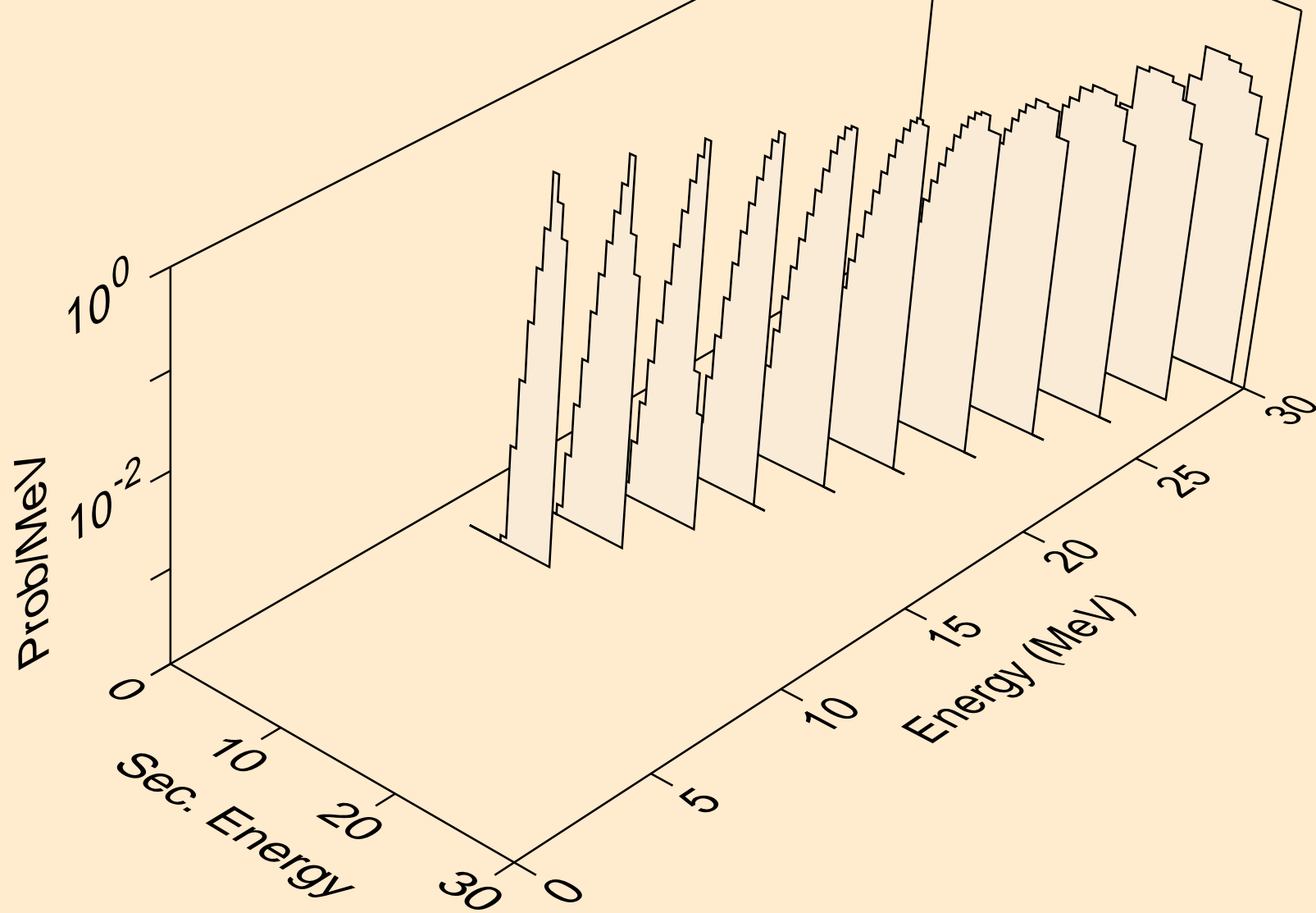

LU154M HELION ACER TENDL-2021 LIBRARY; T=0.K  
Photon emission for (z,n)

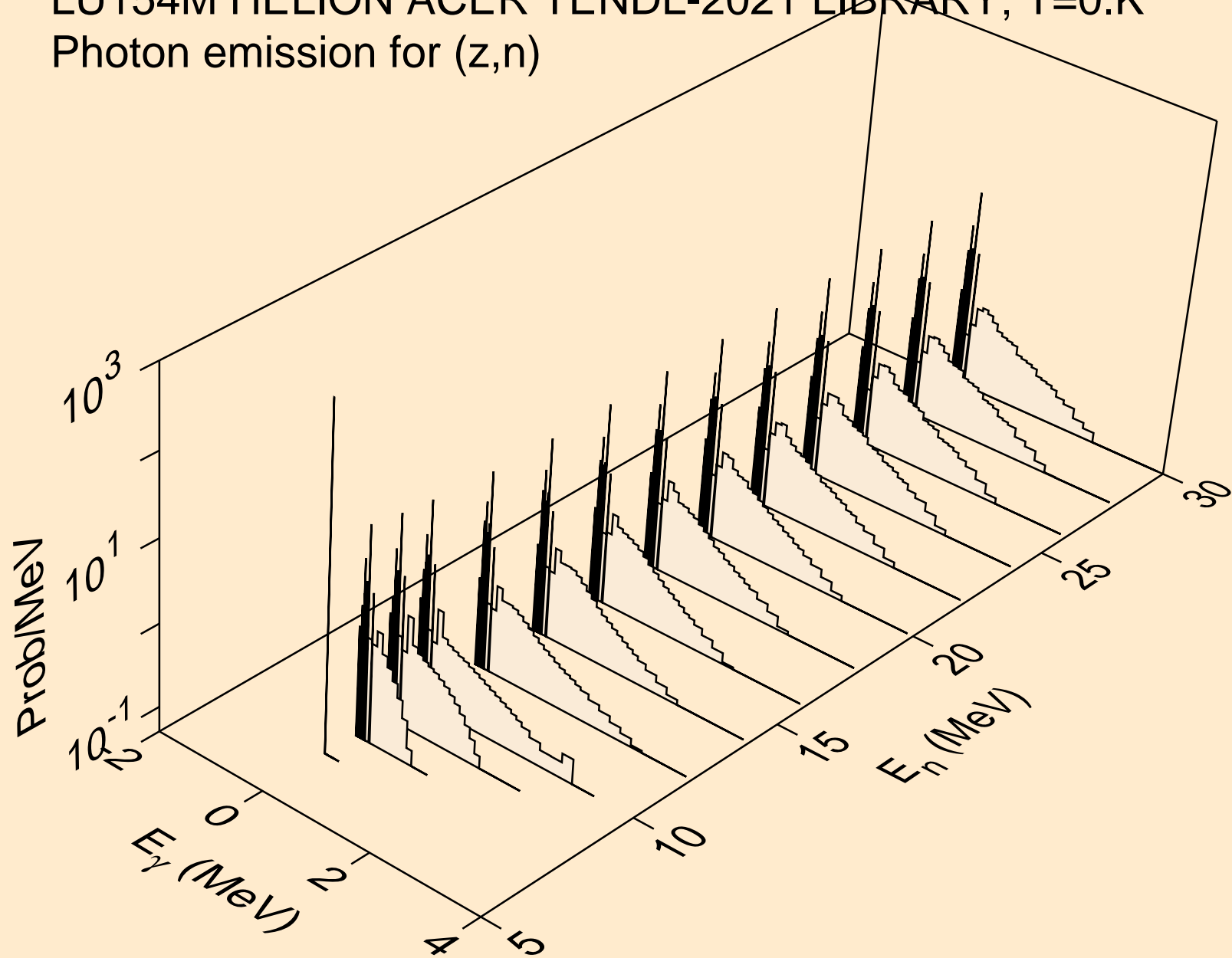



LU154M HELION ACER TENDL-2021 LIBRARY; T=0.K  
Photon emission for (n,x)

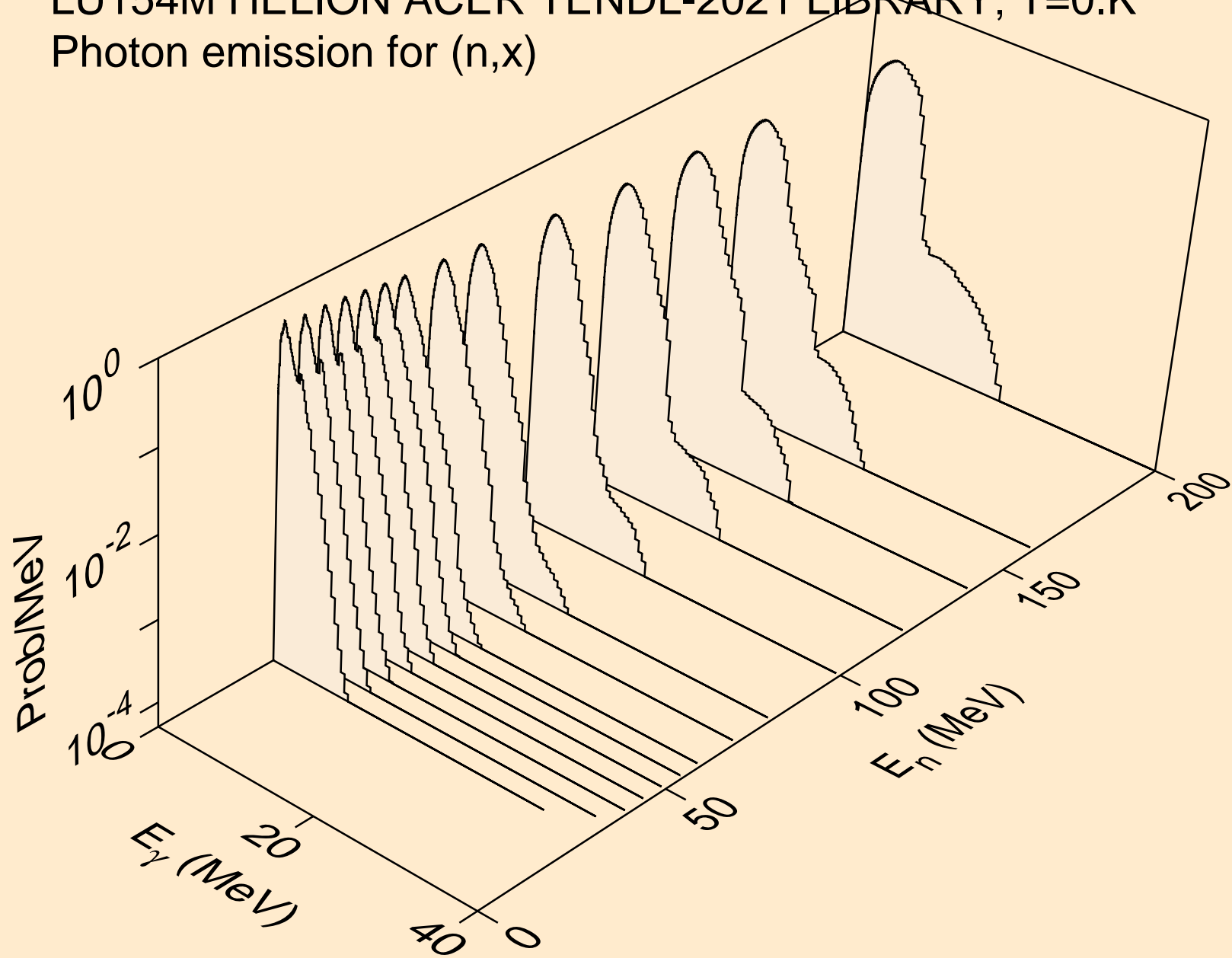

LU154M HELION ACER TENDL-2021 LIBRARY; T=0.K  
Photon emission for (n,2n)

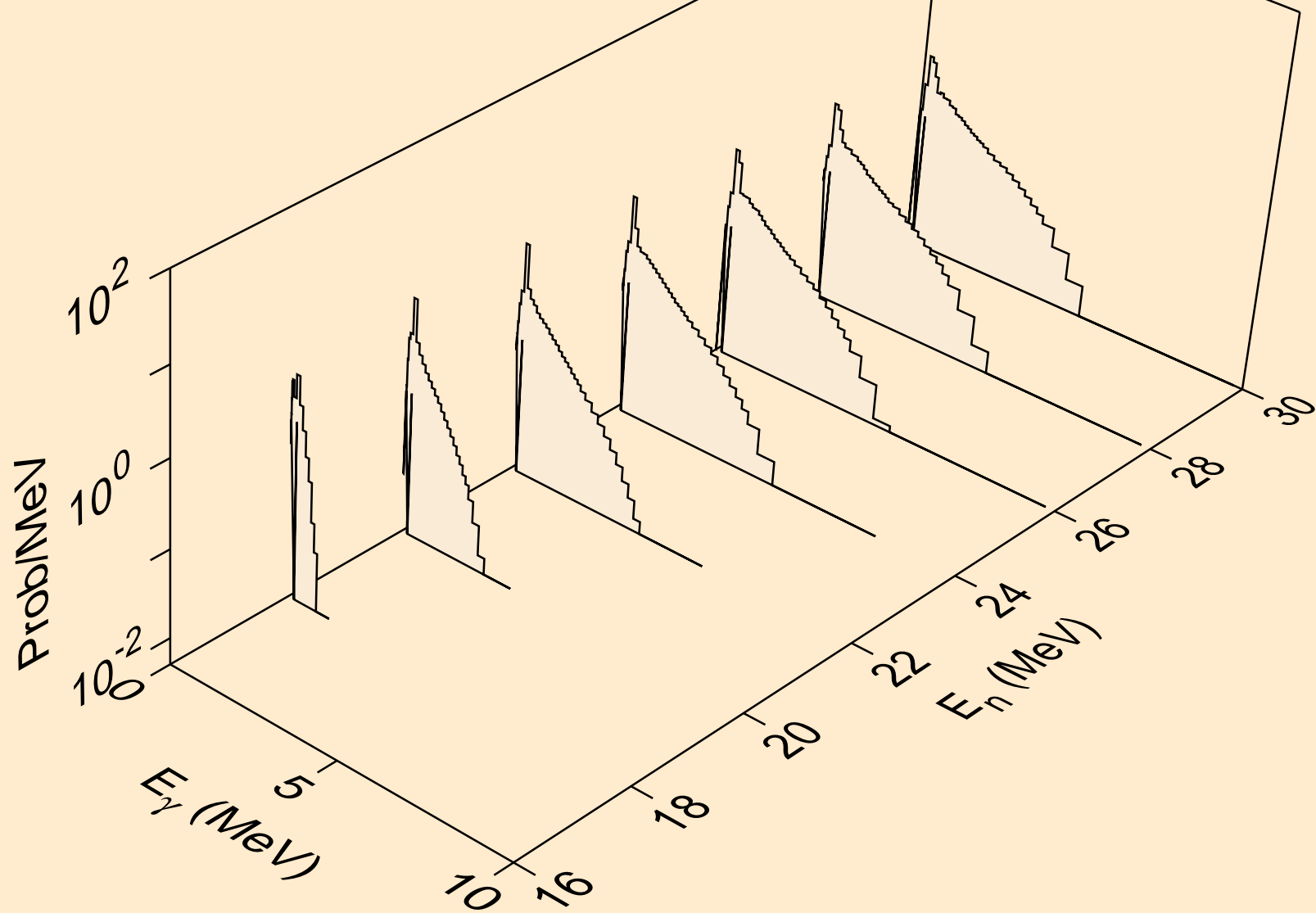

LU154M HELION ACER TENDL-2021 LIBRARY; T=0.K  
Photon emission for (n,n\*)a

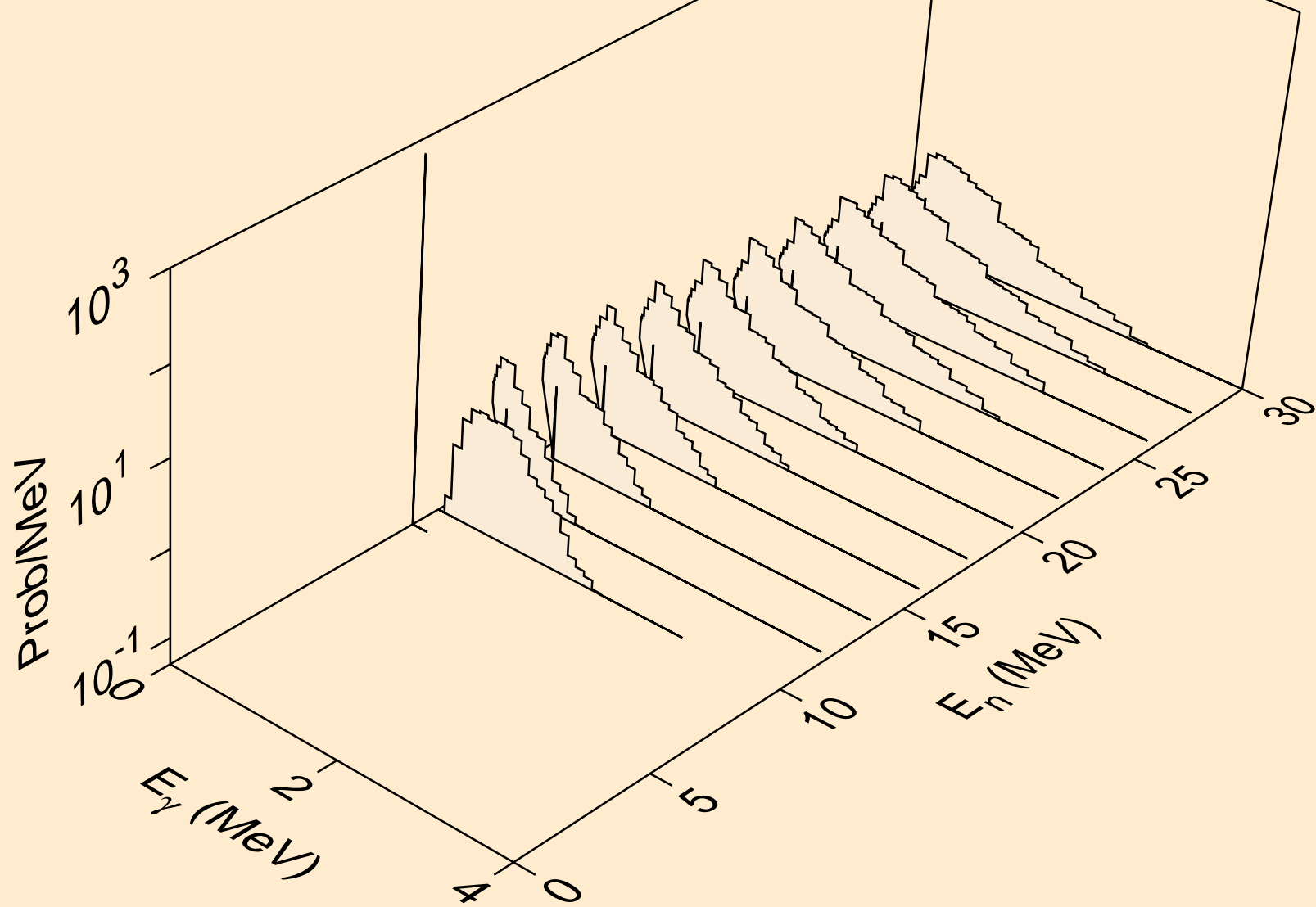

LU154M HELION ACER TENDL-2021 LIBRARY; T=0.K  
Photon emission for (n,2n)a

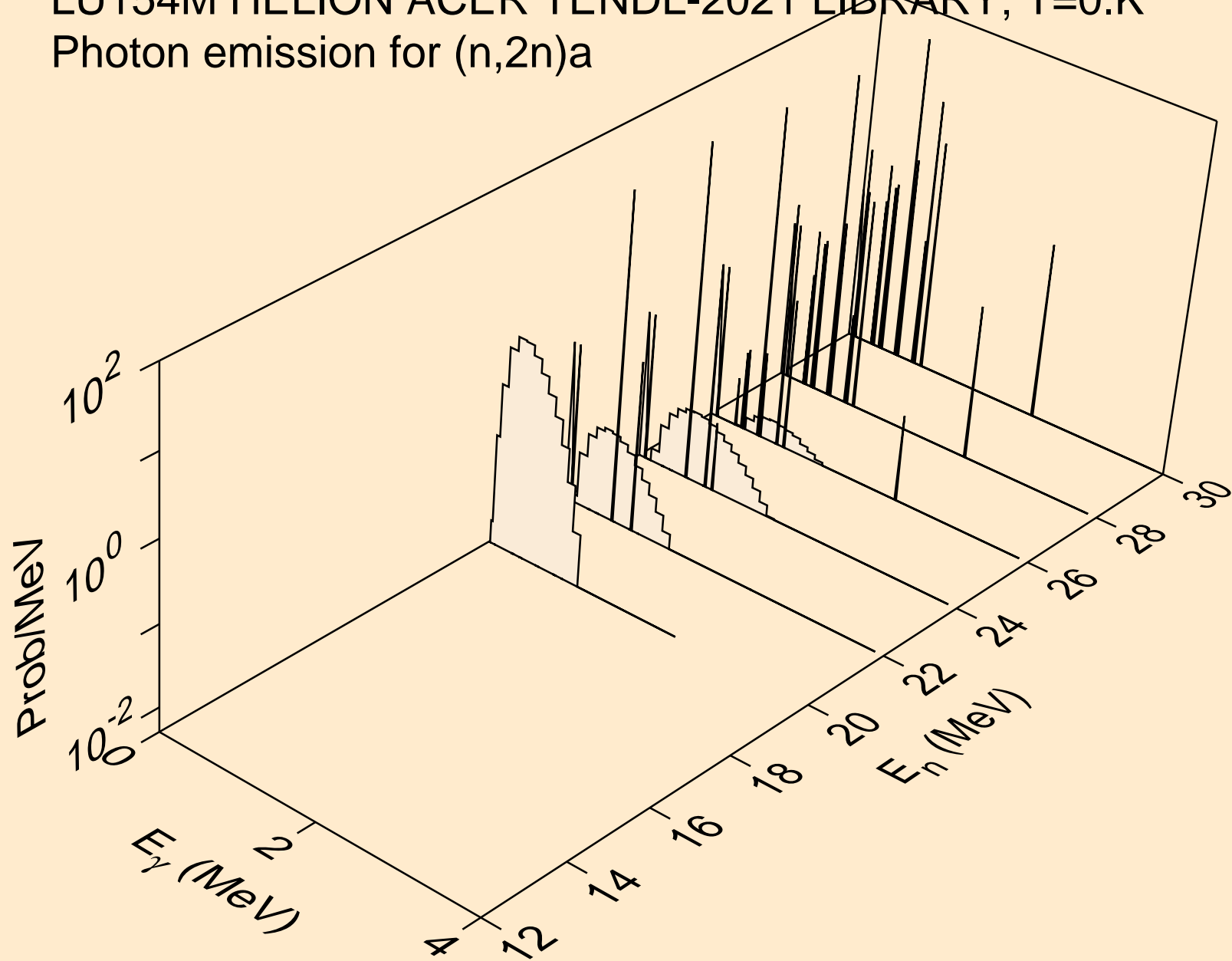

LU154M HELION ACER TENDL-2021 LIBRARY; T=0.K  
Photon emission for (n,n\*)p

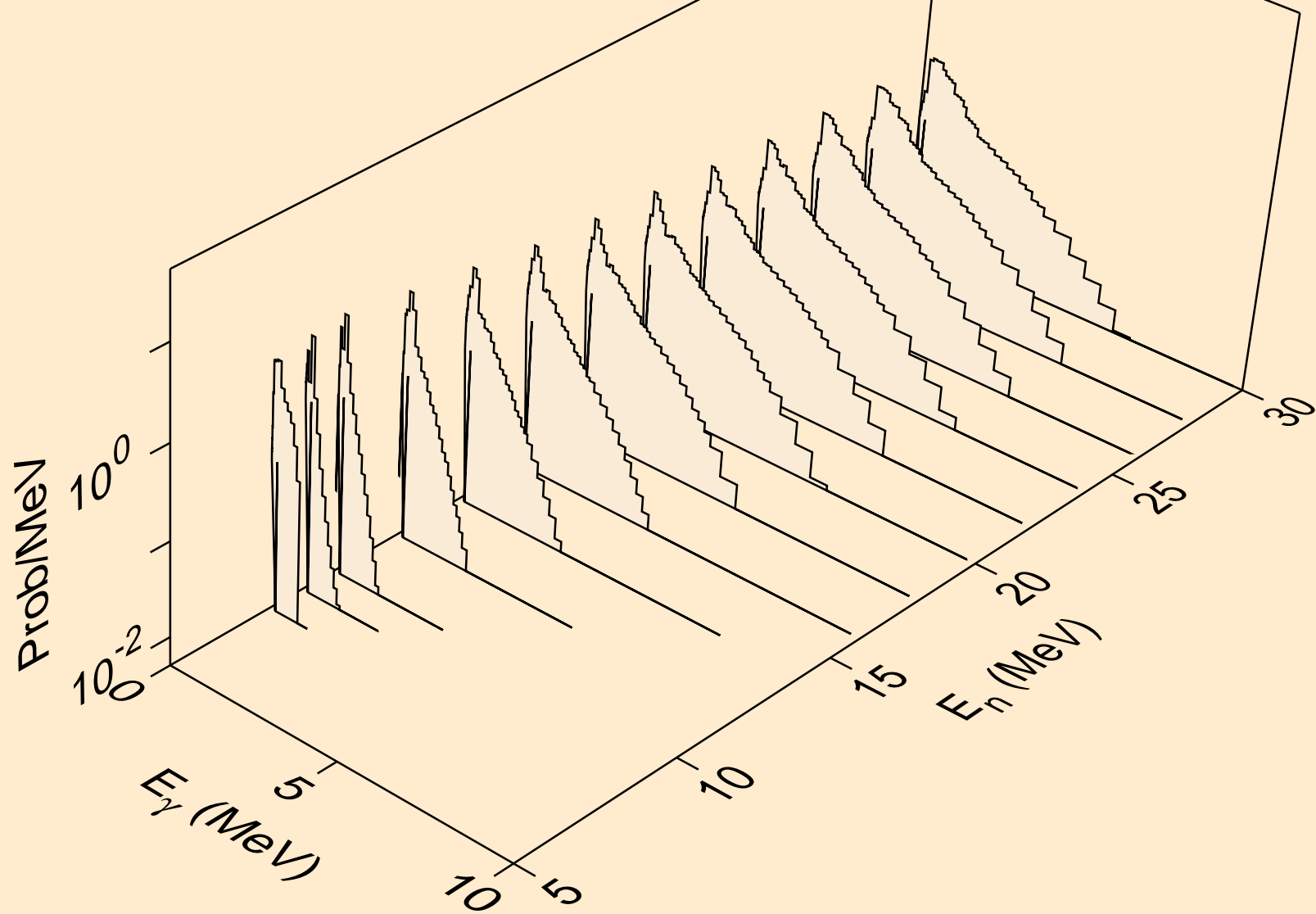

LU154M HELION ACER TENDL-2021 LIBRARY; T=0.K  
Photon emission for (n,n\*)d

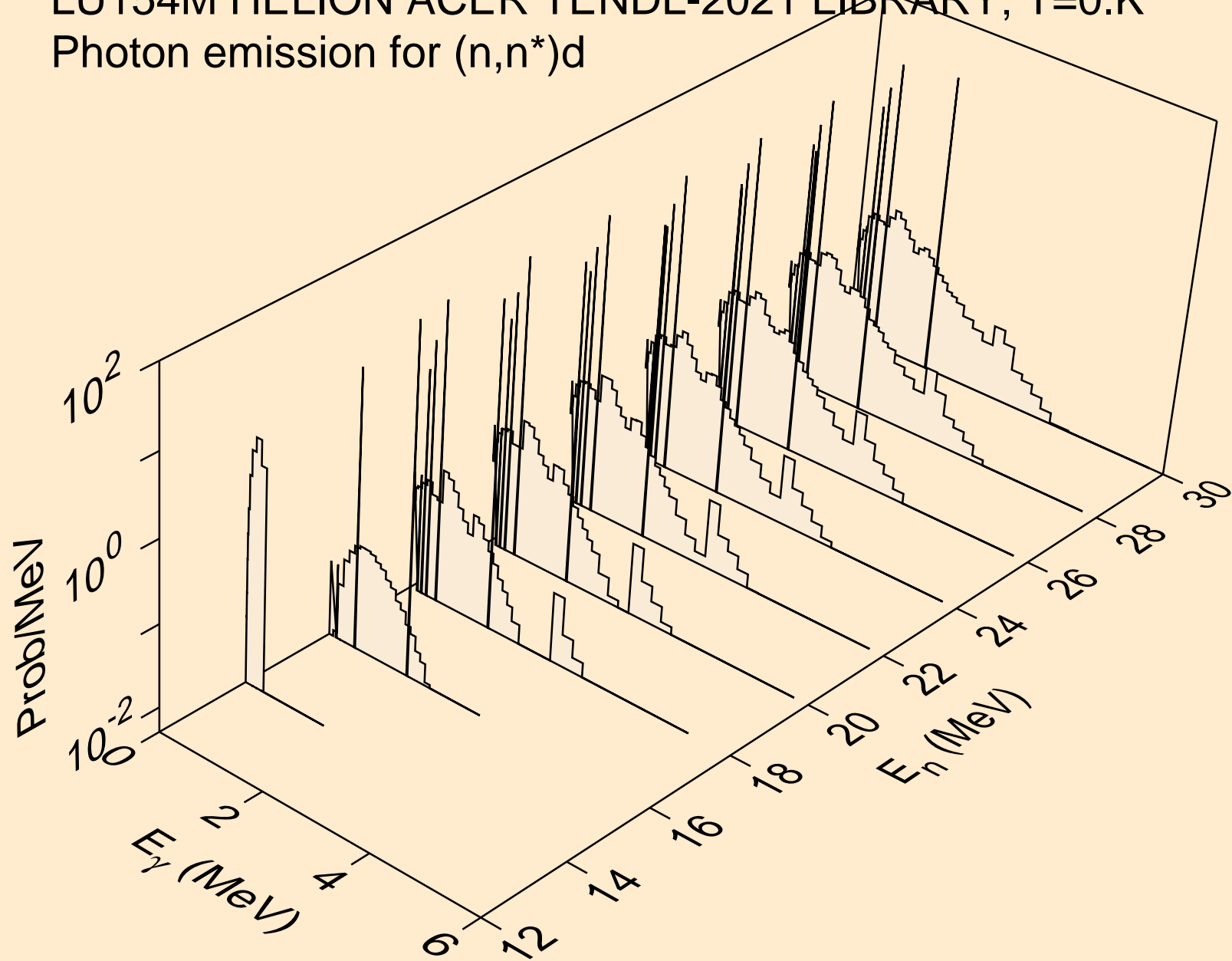

LU154M HELION ACER TENDL-2021 LIBRARY; T=0.K  
Photon emission for (n,n\*)t

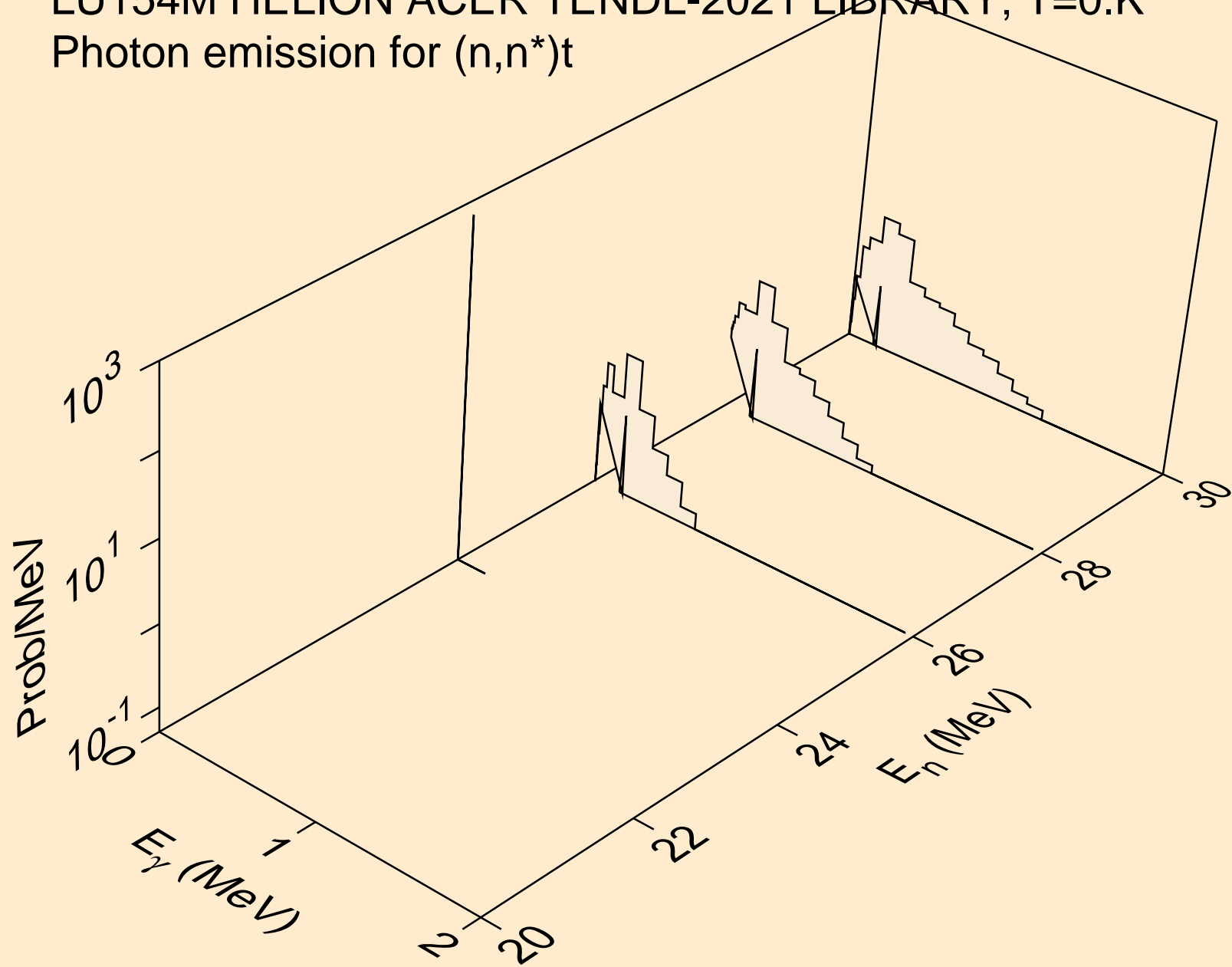

LU154M HELION ACER TENDL-2021 LIBRARY; T=0.K  
Photon emission for (n,n\*)he3

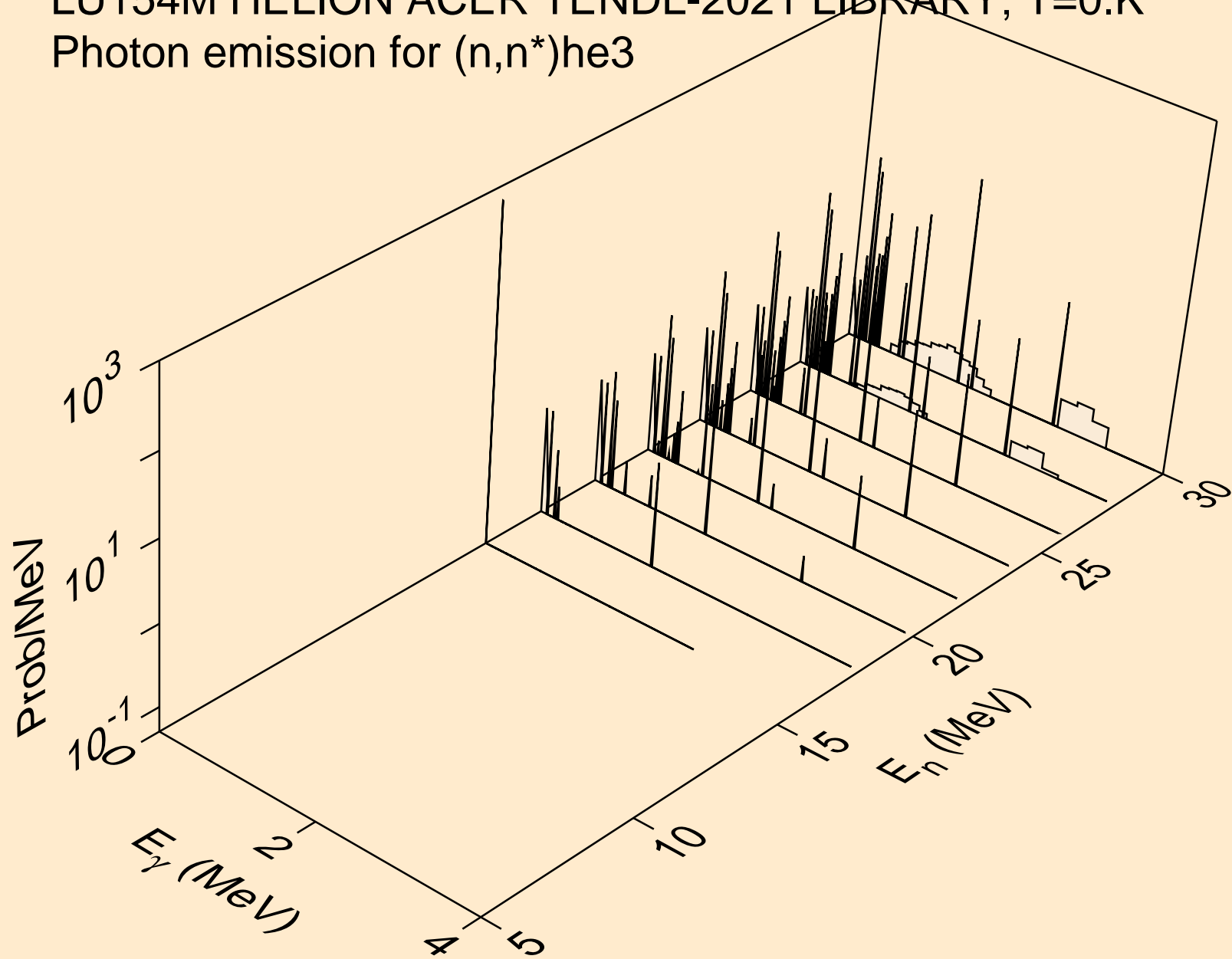



LU154M HELION ACER TENDL-2021 LIBRARY; T=0.K  
Photon emission for (n,2np)

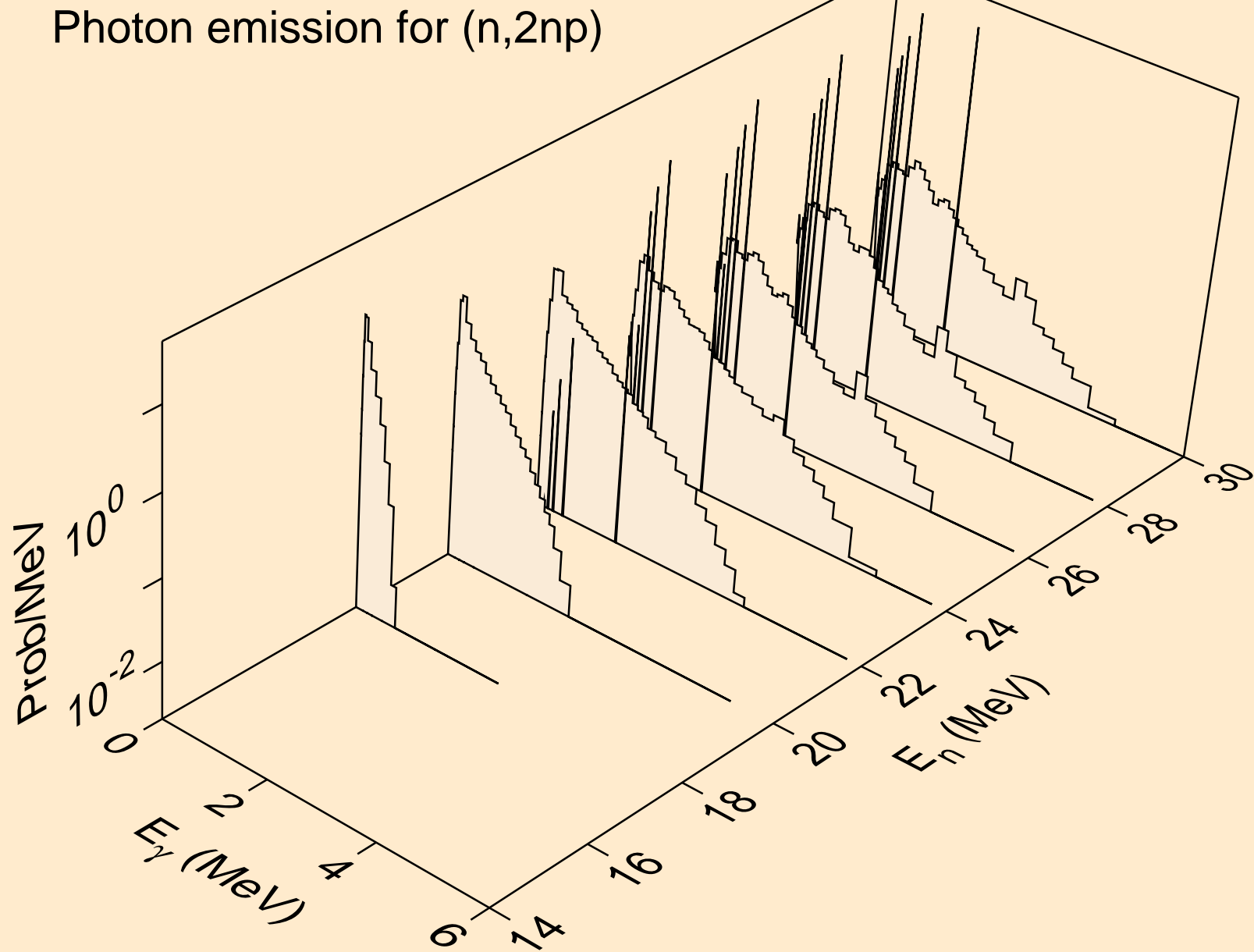

LU154M HELION ACER TENDL-2021 LIBRARY; T=0.K  
Photon emission for (n,2np)

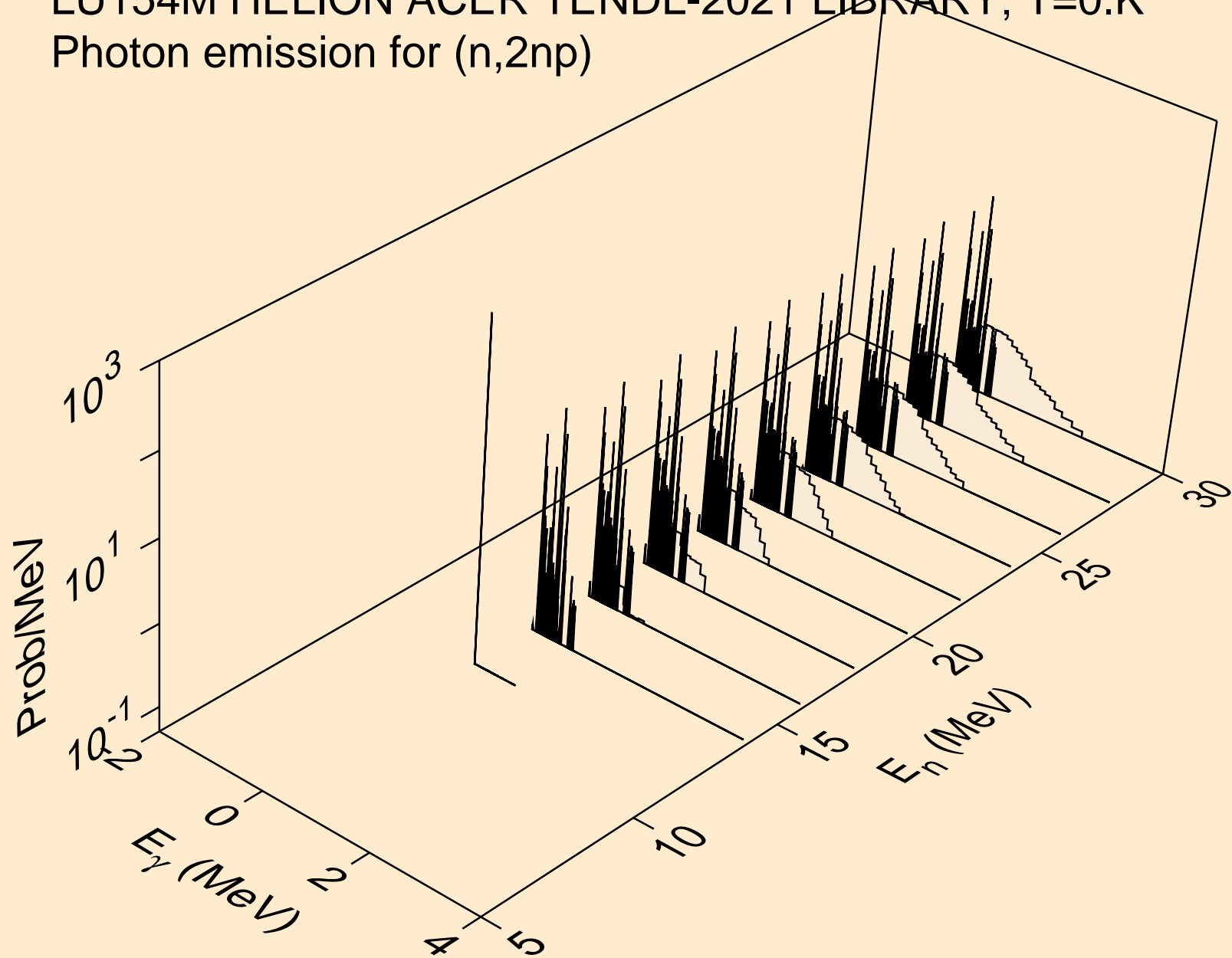

LU154M HELION ACER TENDL-2021 LIBRARY; T=0.K  
Photon emission for (n,npa)

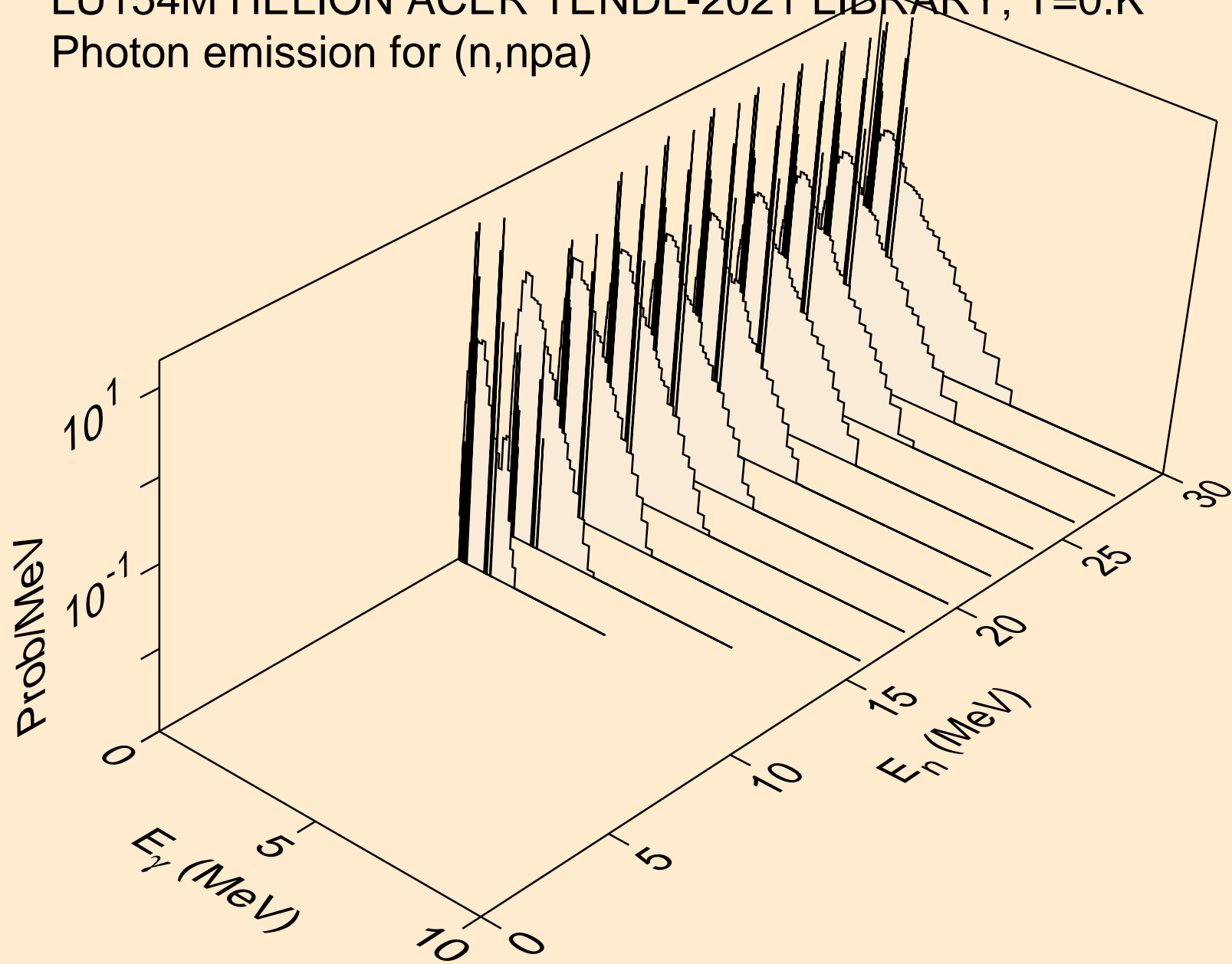

LU154M HELION ACER TENDL-2021 LIBRARY; T=0.K  
Photon emission for (n,gma)

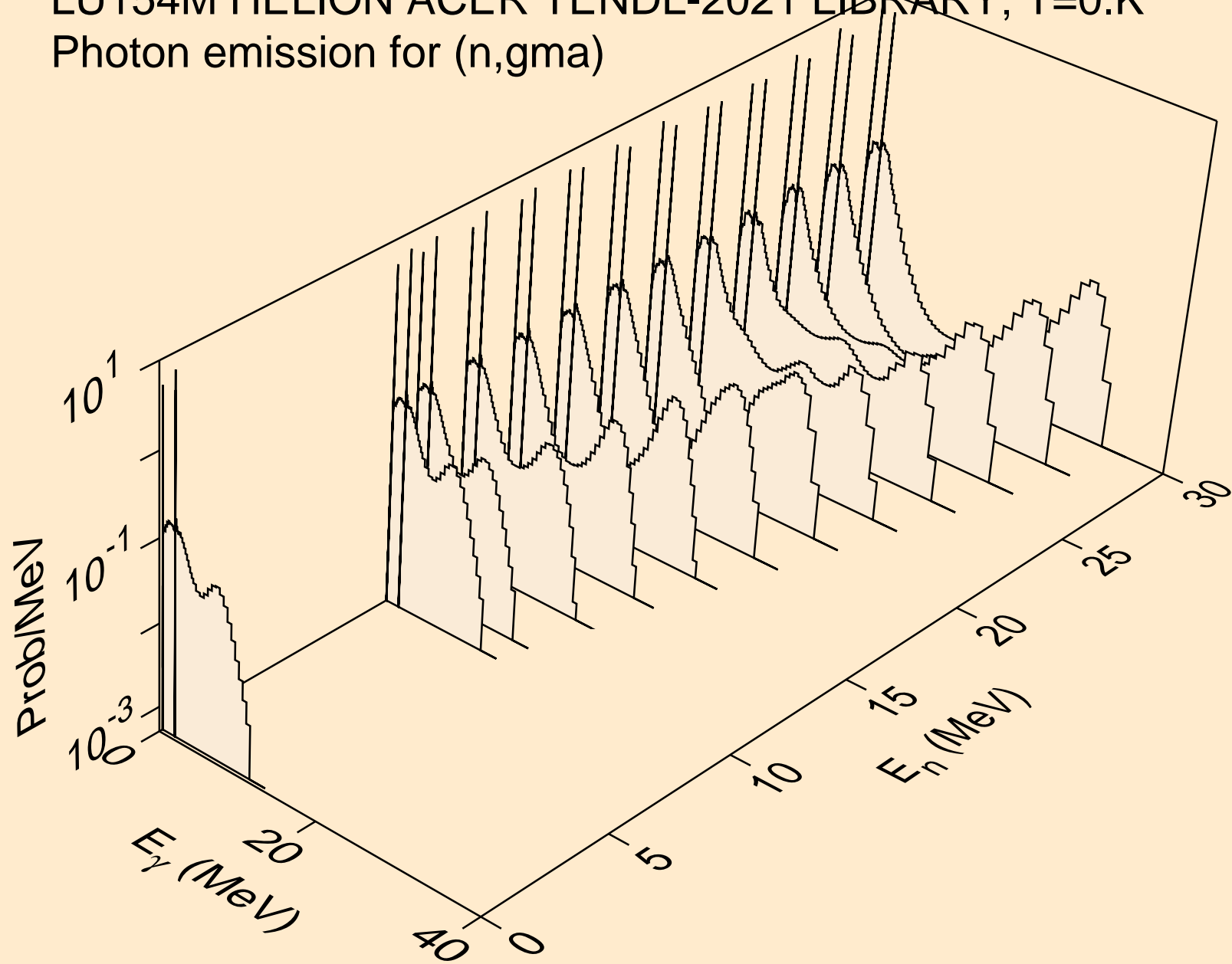

LU154M HELION ACER TENDL-2021 LIBRARY; T=0.K  
Photon emission for (n,p)

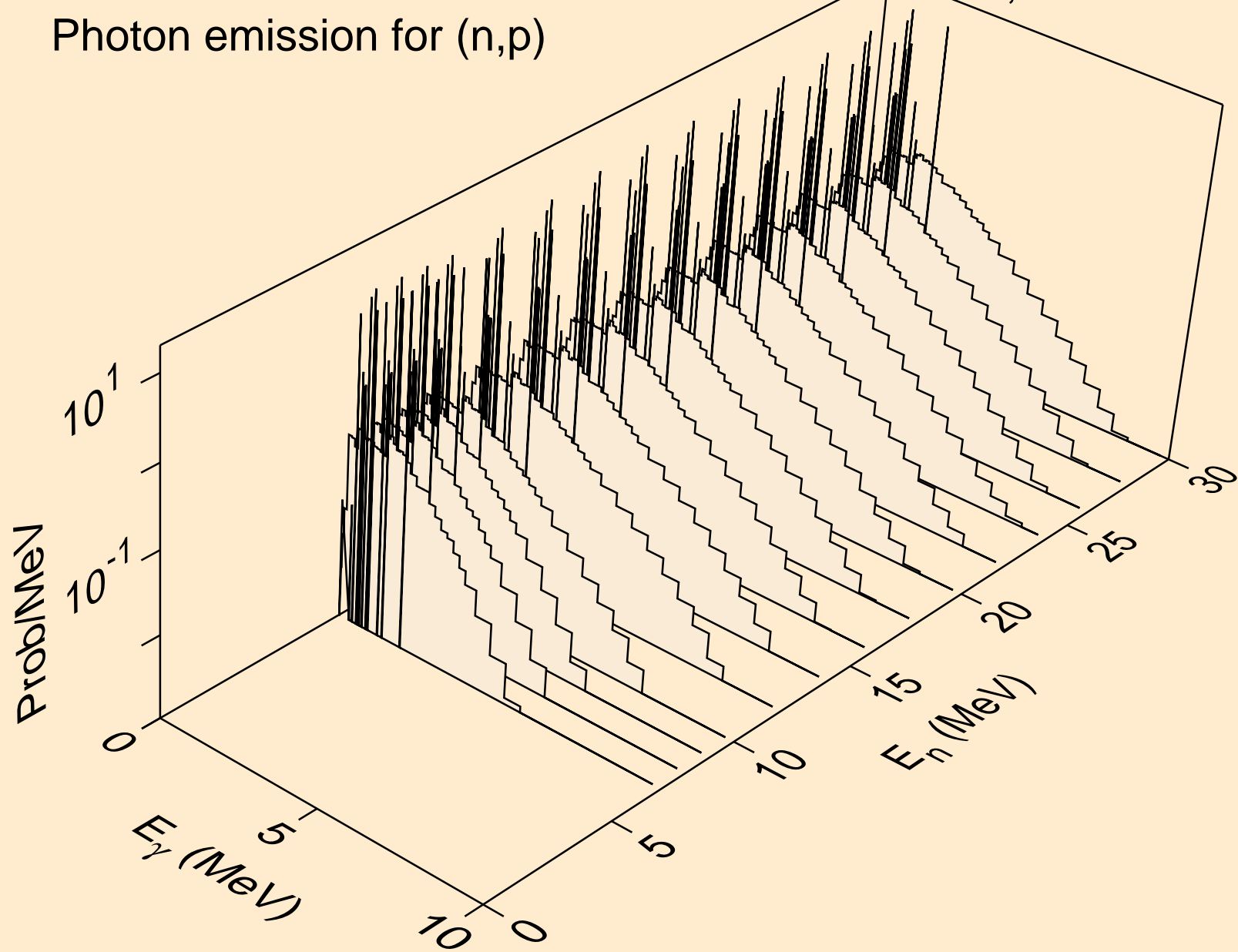

LU154M HELION ACER TENDL-2021 LIBRARY; T=0.K  
Photon emission for (n,d)

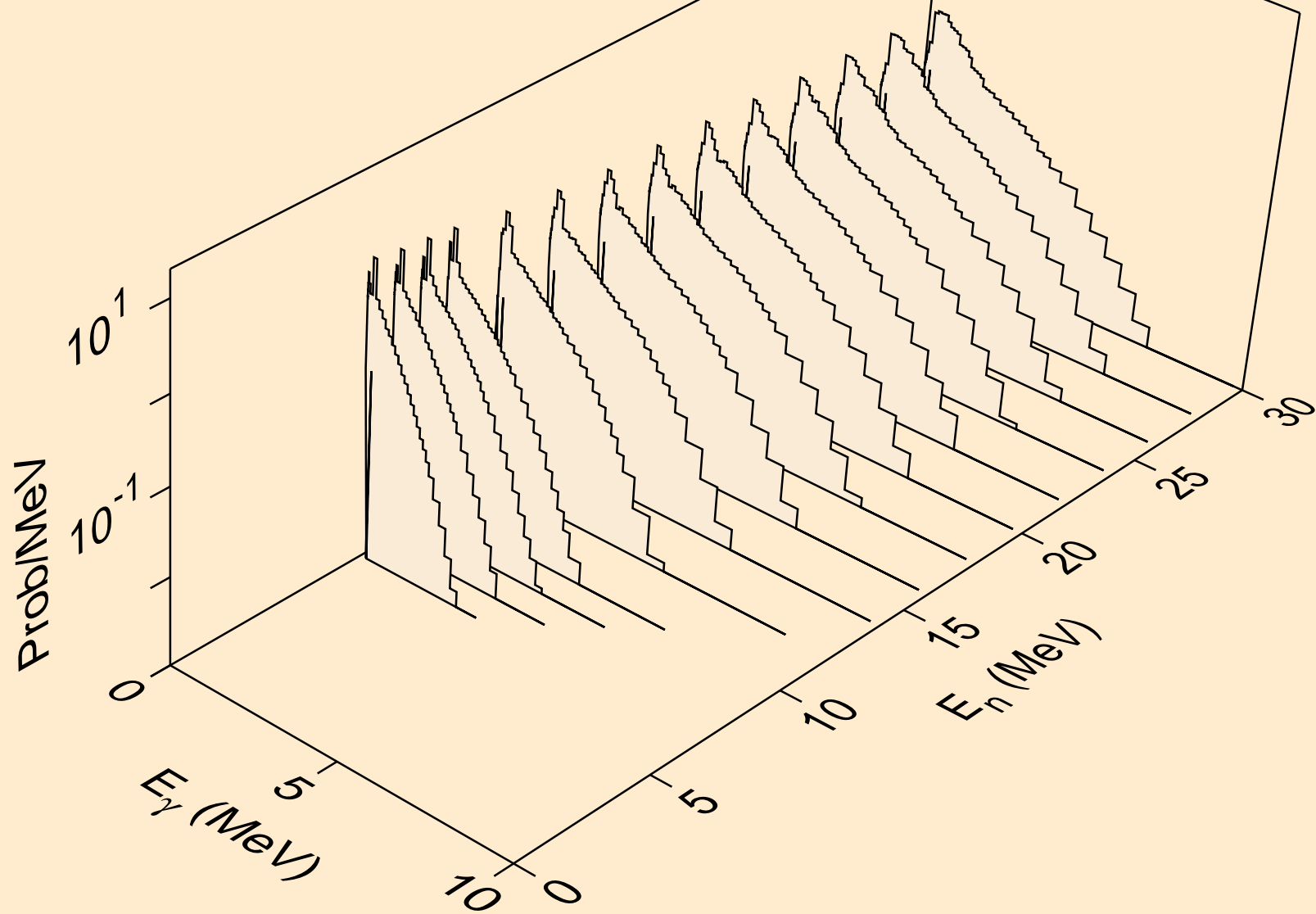

LU154M HELION ACER TENDL-2021 LIBRARY; T=0.K  
Photon emission for (n,t)

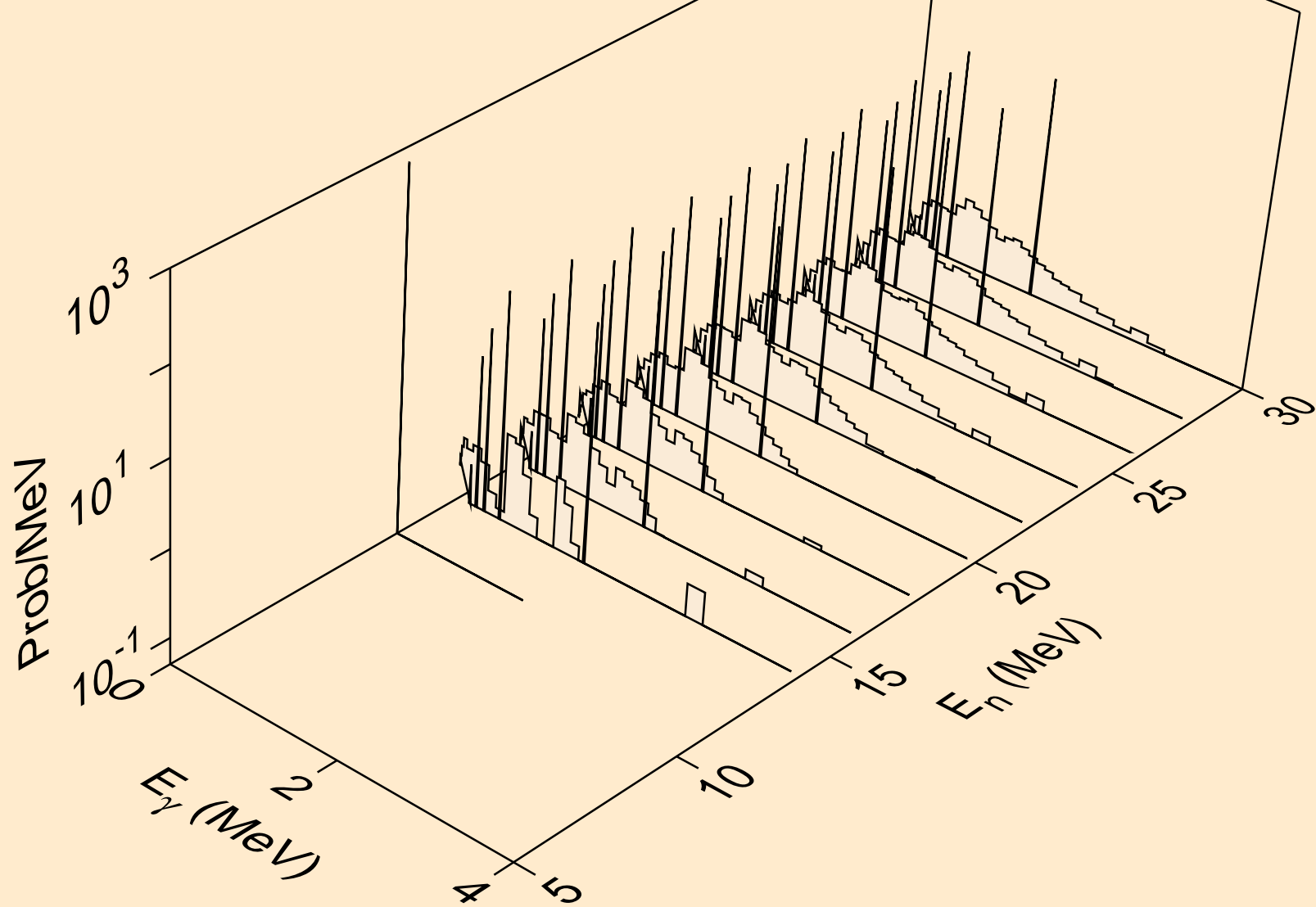

LU154M HELION ACER TENDL-2021 LIBRARY; T=0.K  
Photon emission for inelastic

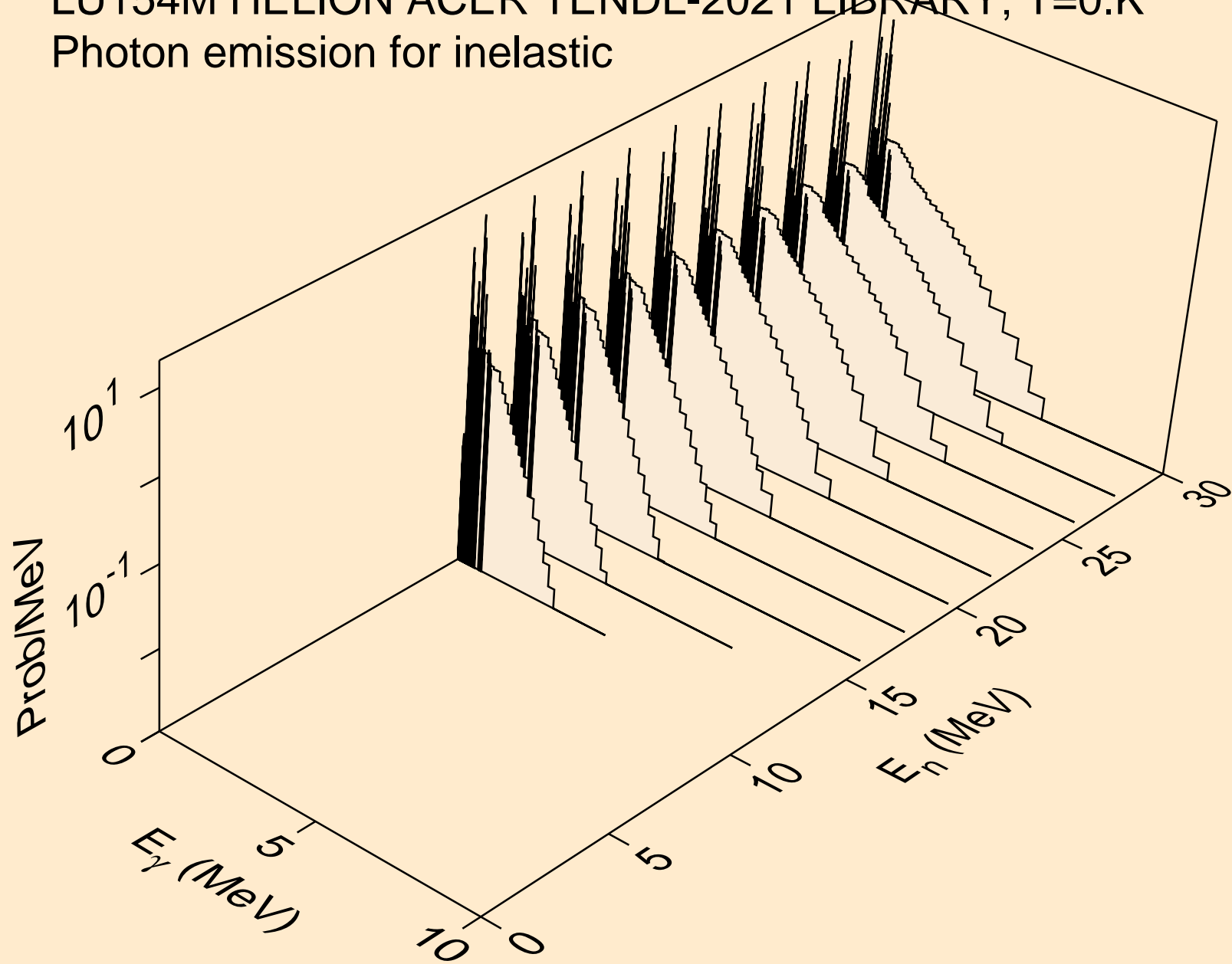



LU154M HELION ACER TENDL-2021 LIBRARY; T=0.K  
Photon emission for (n,a)

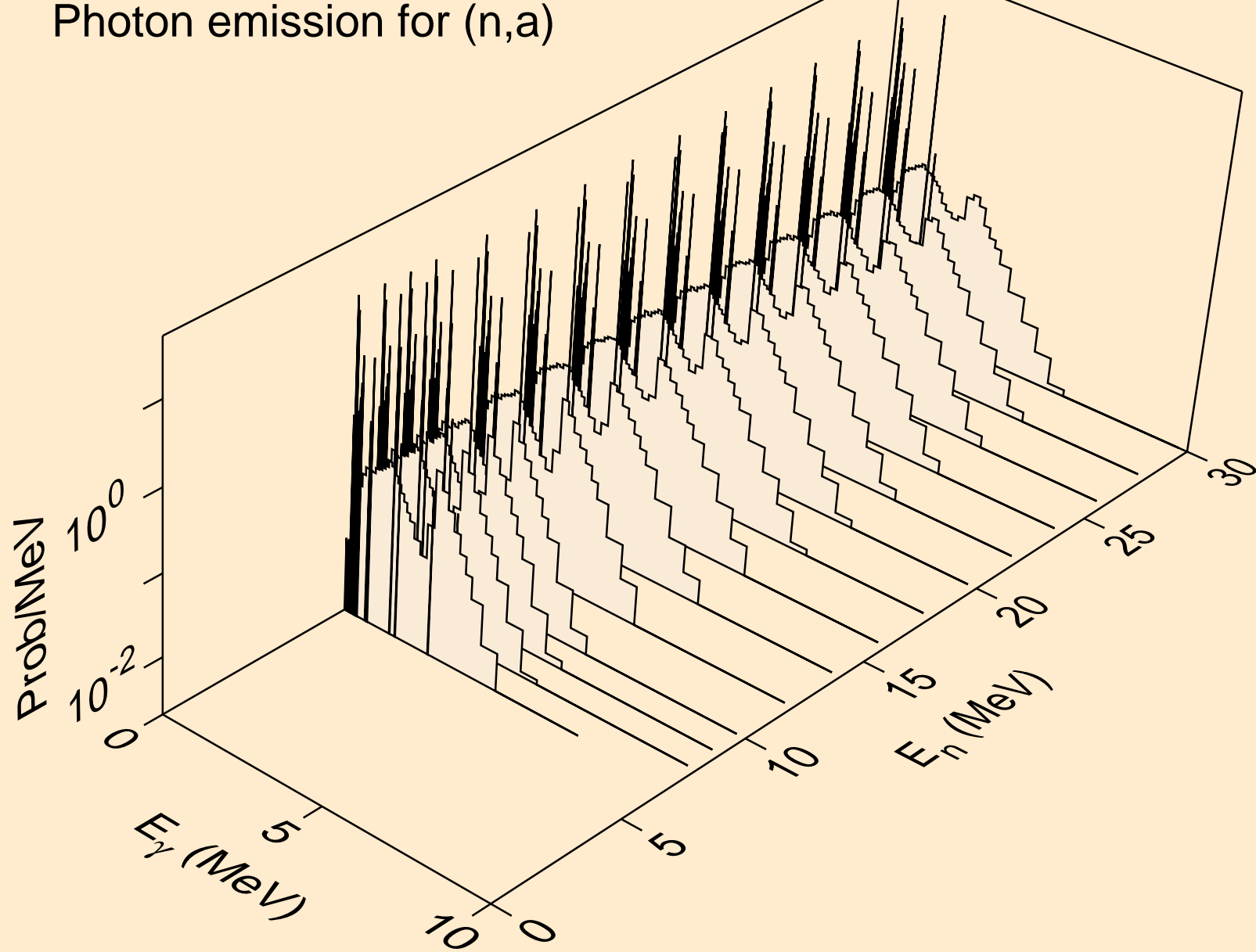

LU154M HELION ACER TENDL-2021 LIBRARY; T=0.K  
Photon emission for (n,2a)

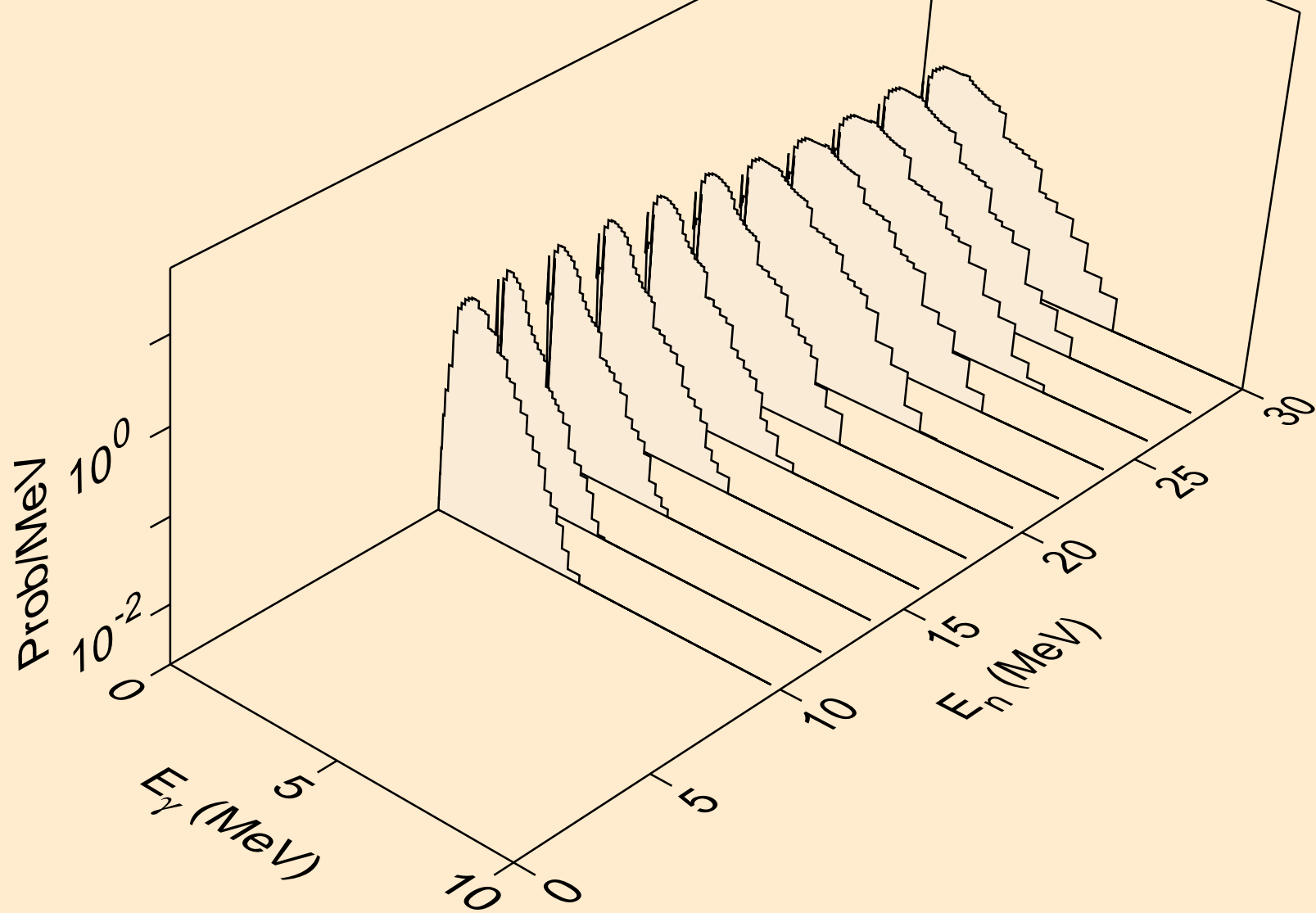

LU154M HELION ACER TENDL-2021 LIBRARY; T=0.K  
Photon emission for (n,2p)

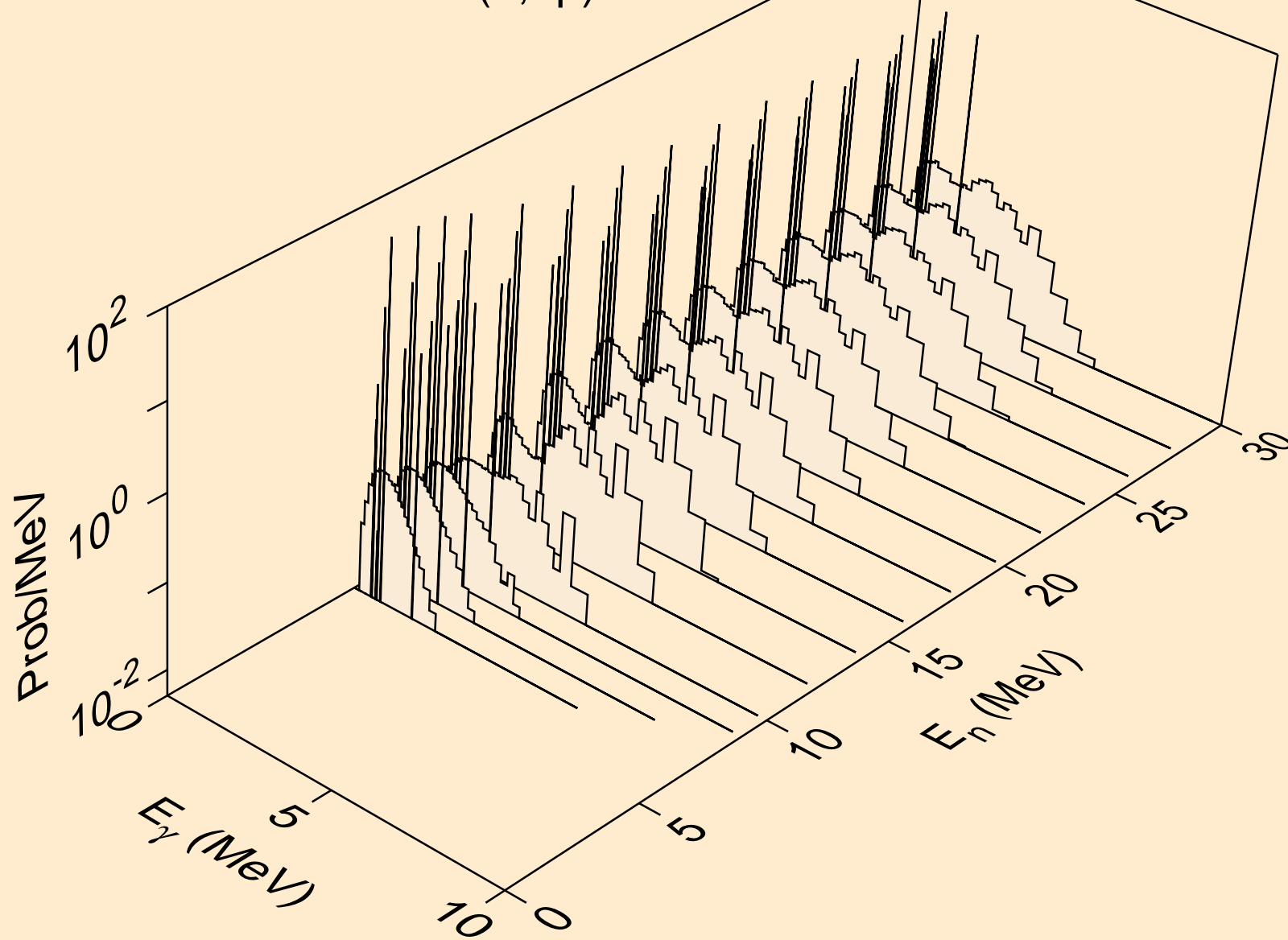

LU154M HELION ACER TENDL-2021 LIBRARY; T=0.K  
Photon emission for (n,pa)

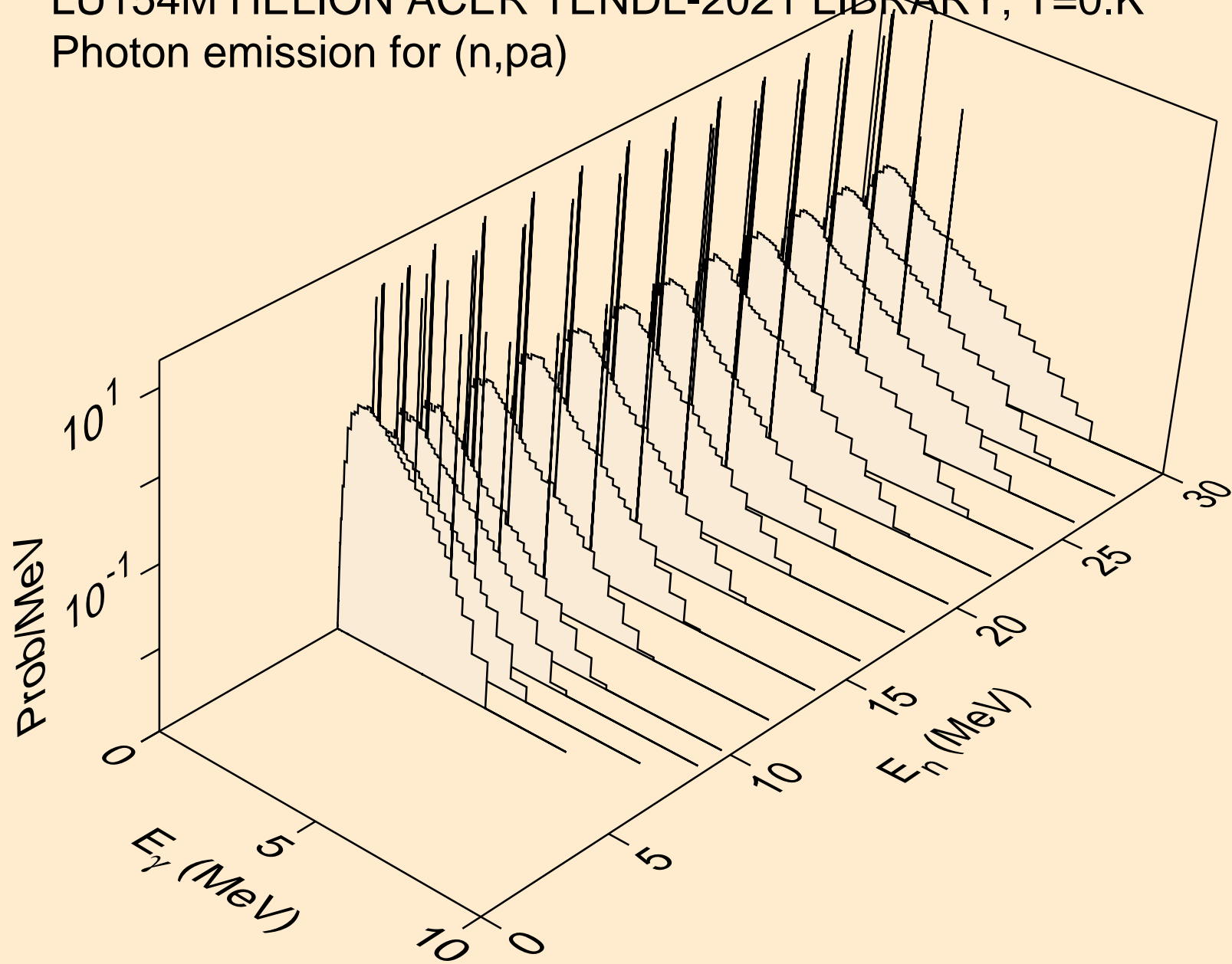

LU154M HELION ACER TENDL-2021 LIBRARY; T=0.K  
Photon emission for (n,pd)

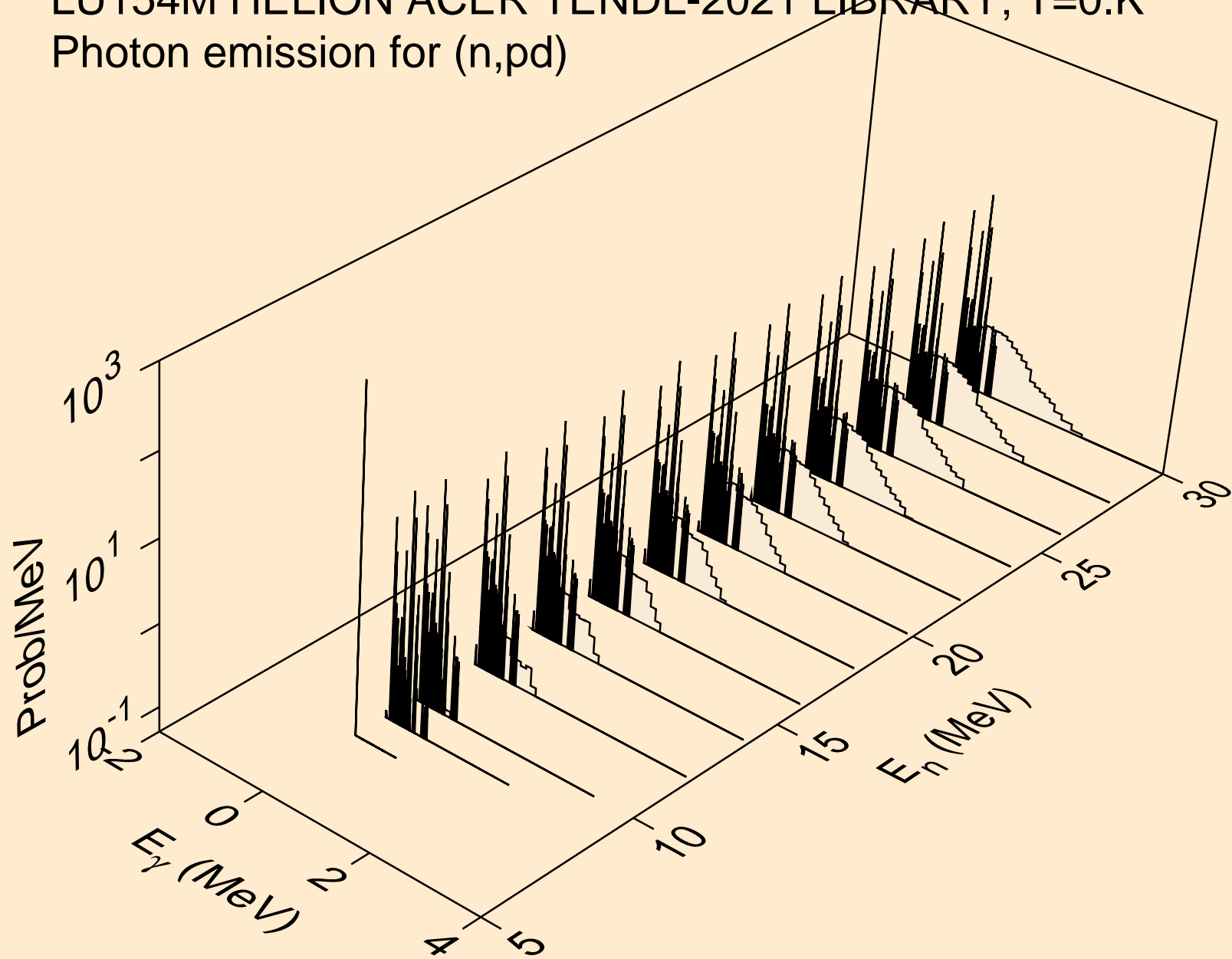

LU154M HELION ACER TENDL-2021 LIBRARY; T=0.K  
Photon emission for (n,pt)

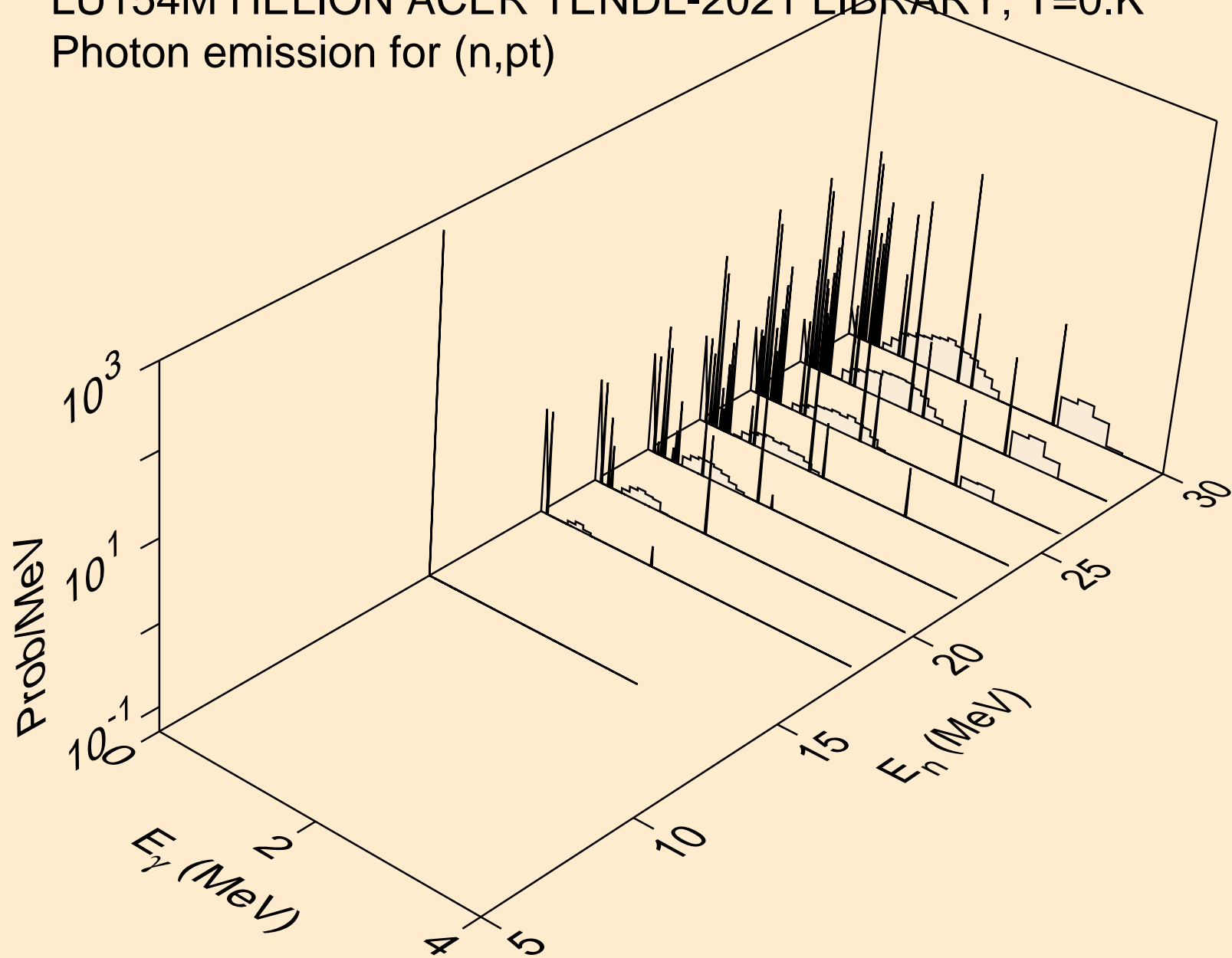

LU154M HELION ACER TENDL-2021 LIBRARY; T=0.K  
Photon emission for (n,da)

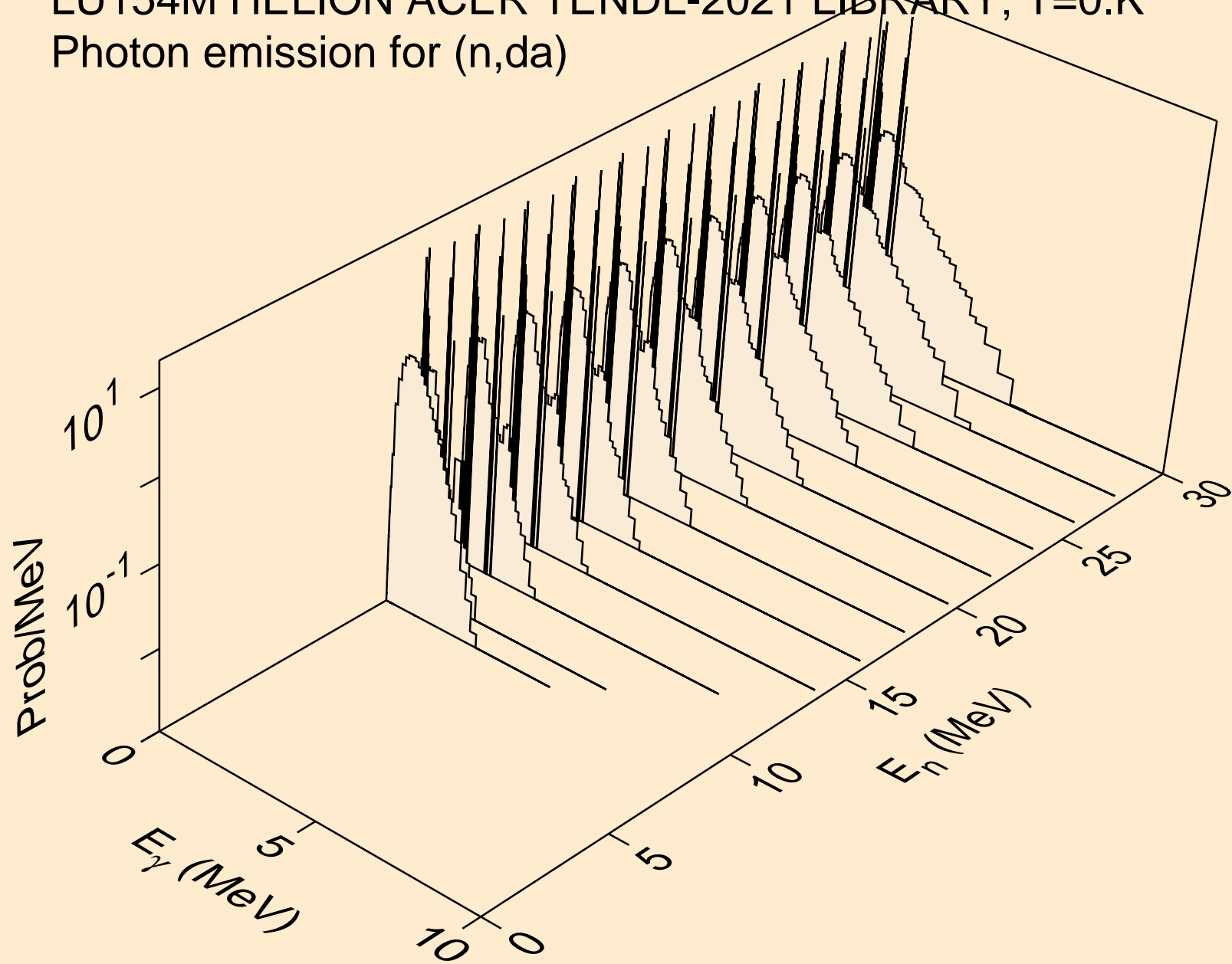

LU154M HELION ACER TENDL-2021 LIBRARY; T=0.K  
Particle heating contributions

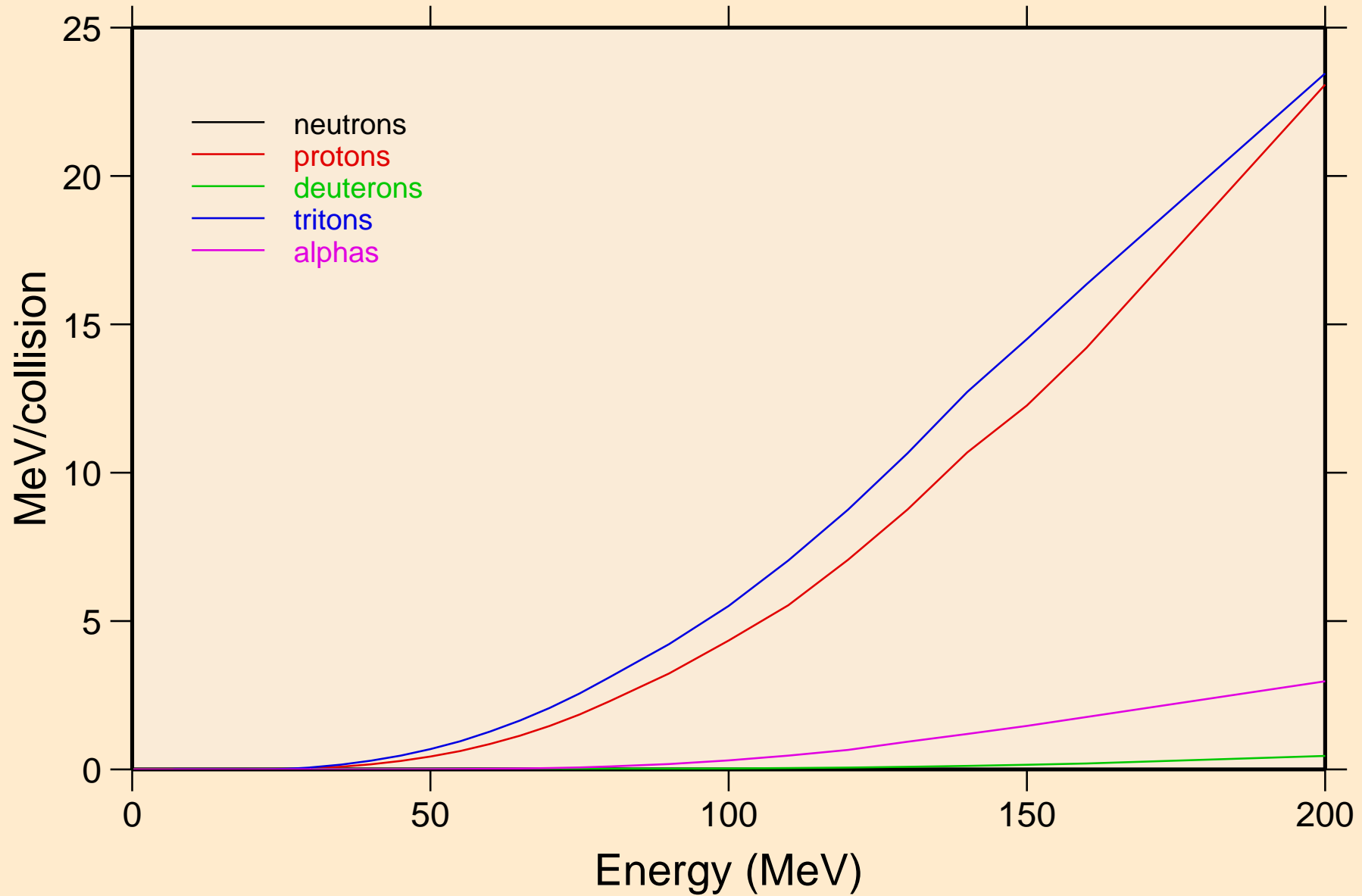



LU154M HELION ACER TENDL-2021 LIBRARY; T=0.K  
Recoil Heating

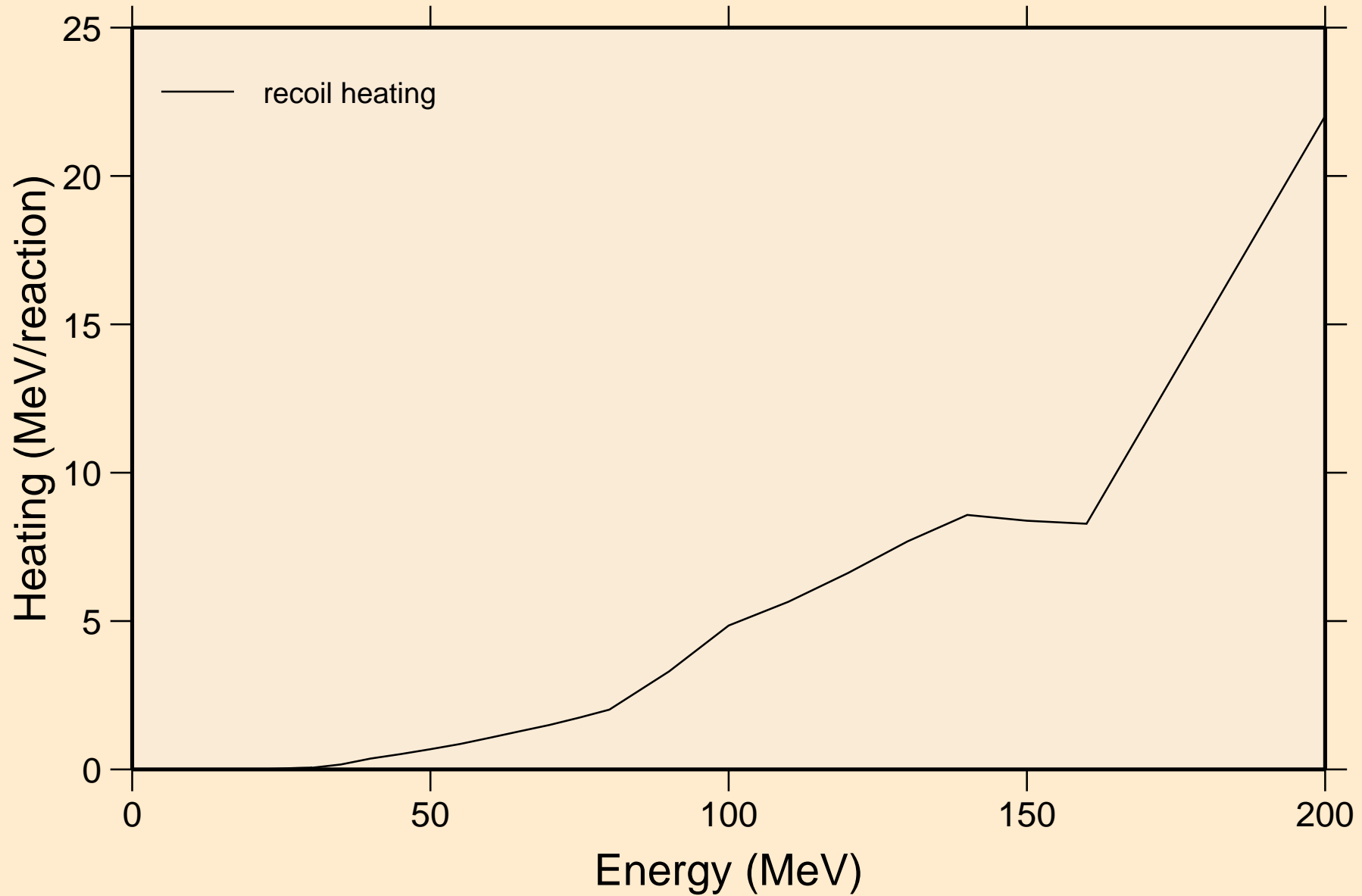

LU154M HELION ACER TENDL-2021 LIBRARY; T=0.K  
Particle production cross sections

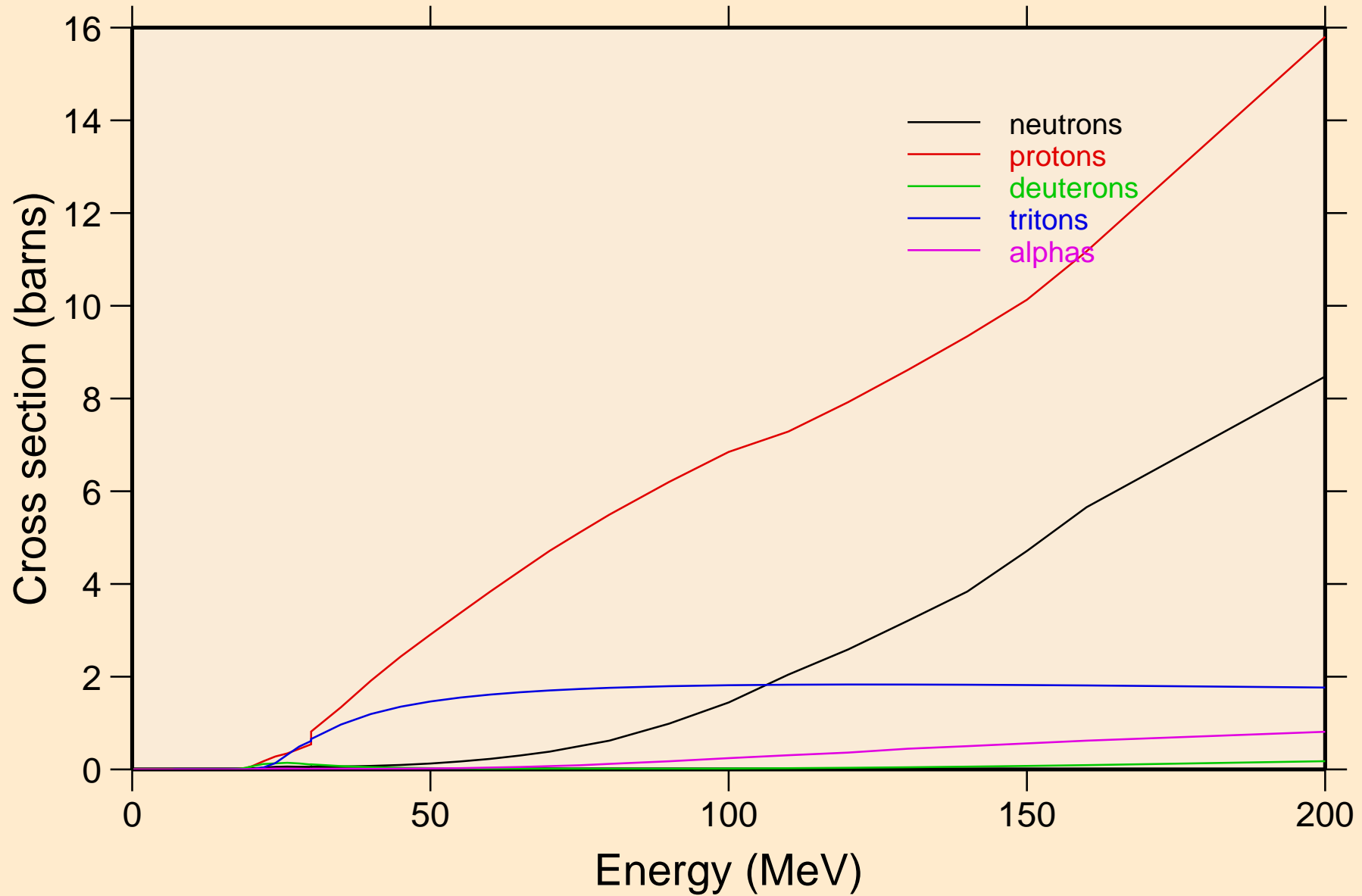

LU154M HELION ACER TENDL-2021 LIBRARY; T=0.K  
neutrons from (s,n)

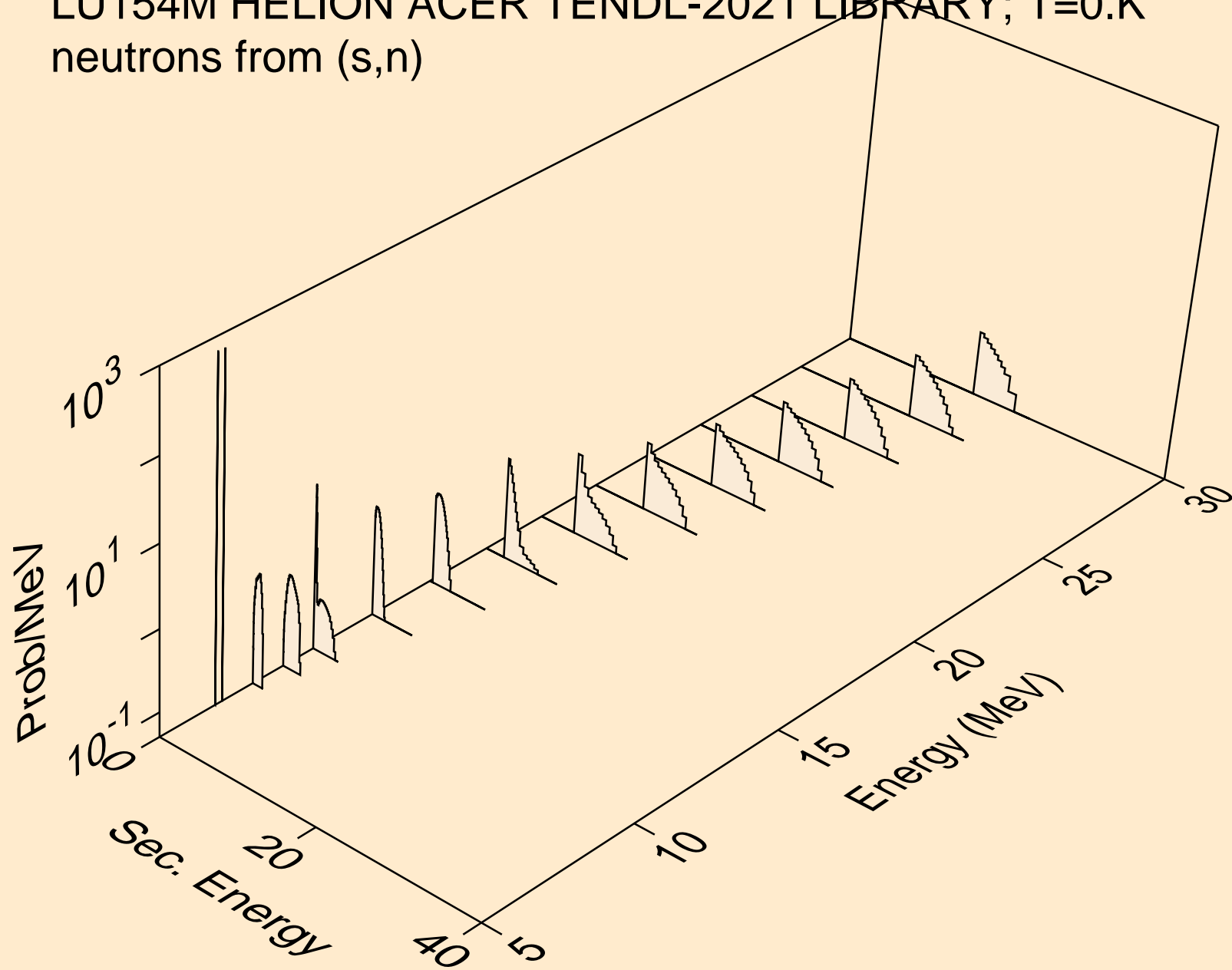

LU154M HELION ACER TENDL-2021 LIBRARY; T=0.K  
neutrons from (s,x)

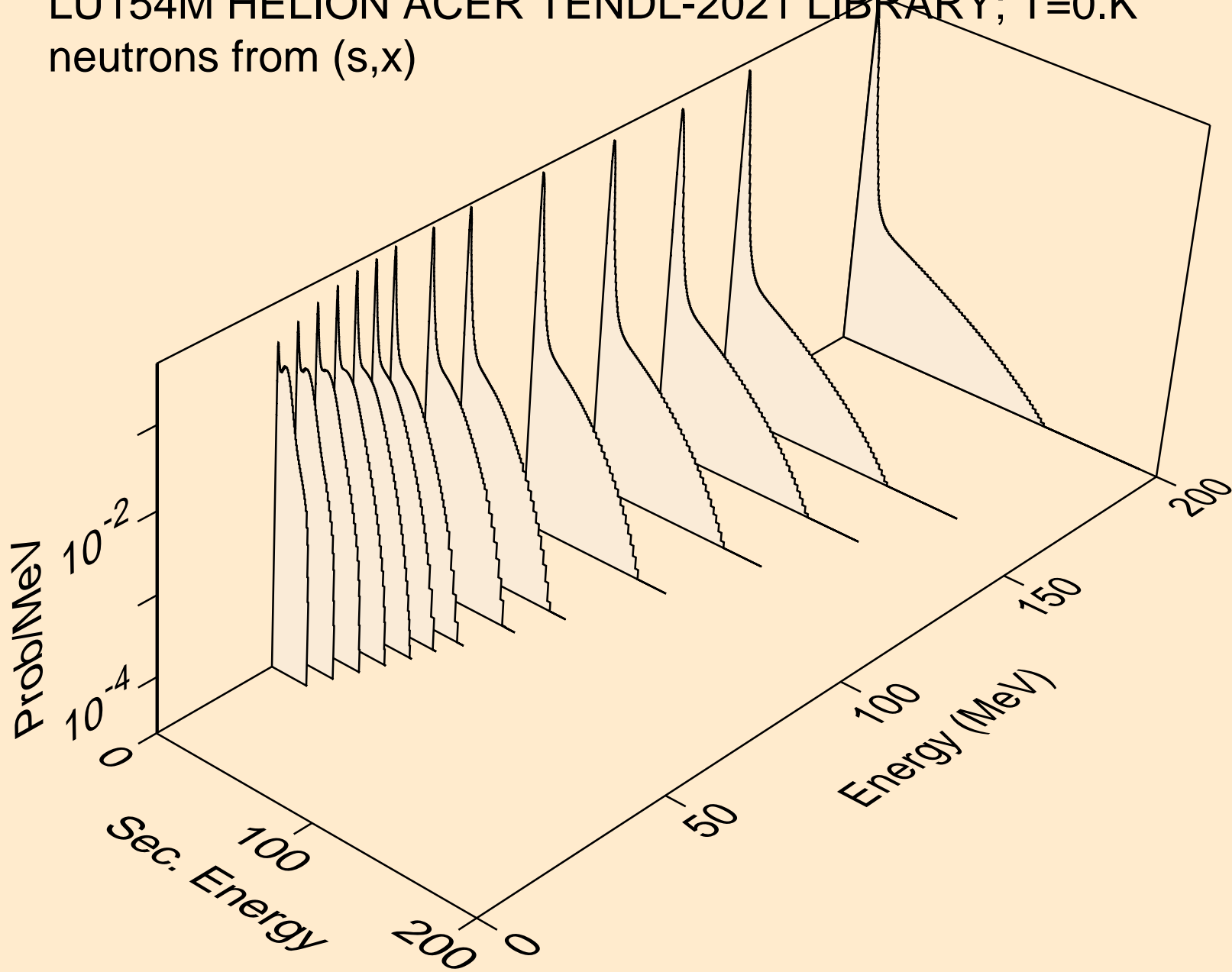

LU154M HELION ACER TENDL-2021 LIBRARY; T=0.K  
neutrons from (s,2n)

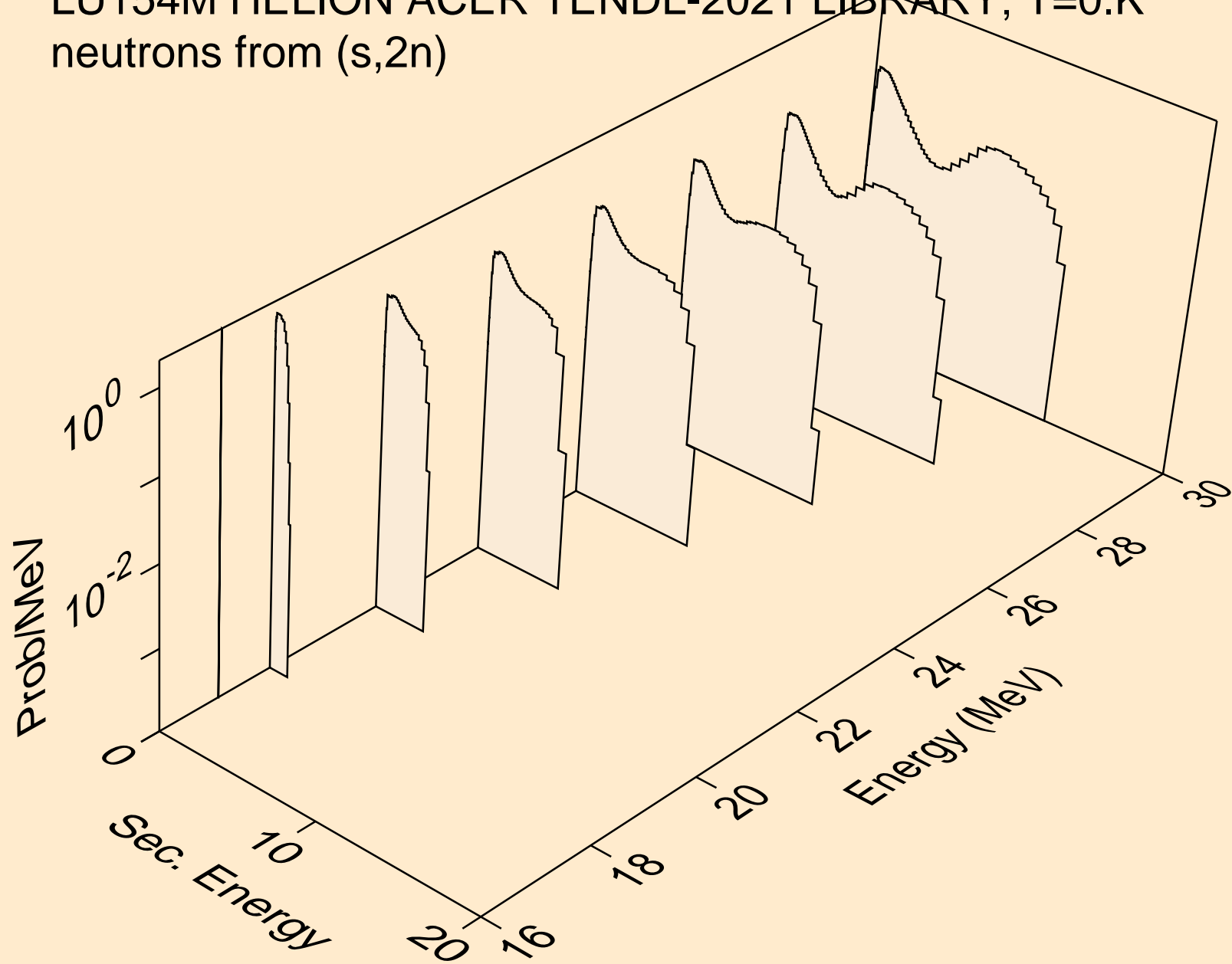

LU154M HELION ACER TENDL-2021 LIBRARY; T=0.K  
neutrons from (s,n\*)a

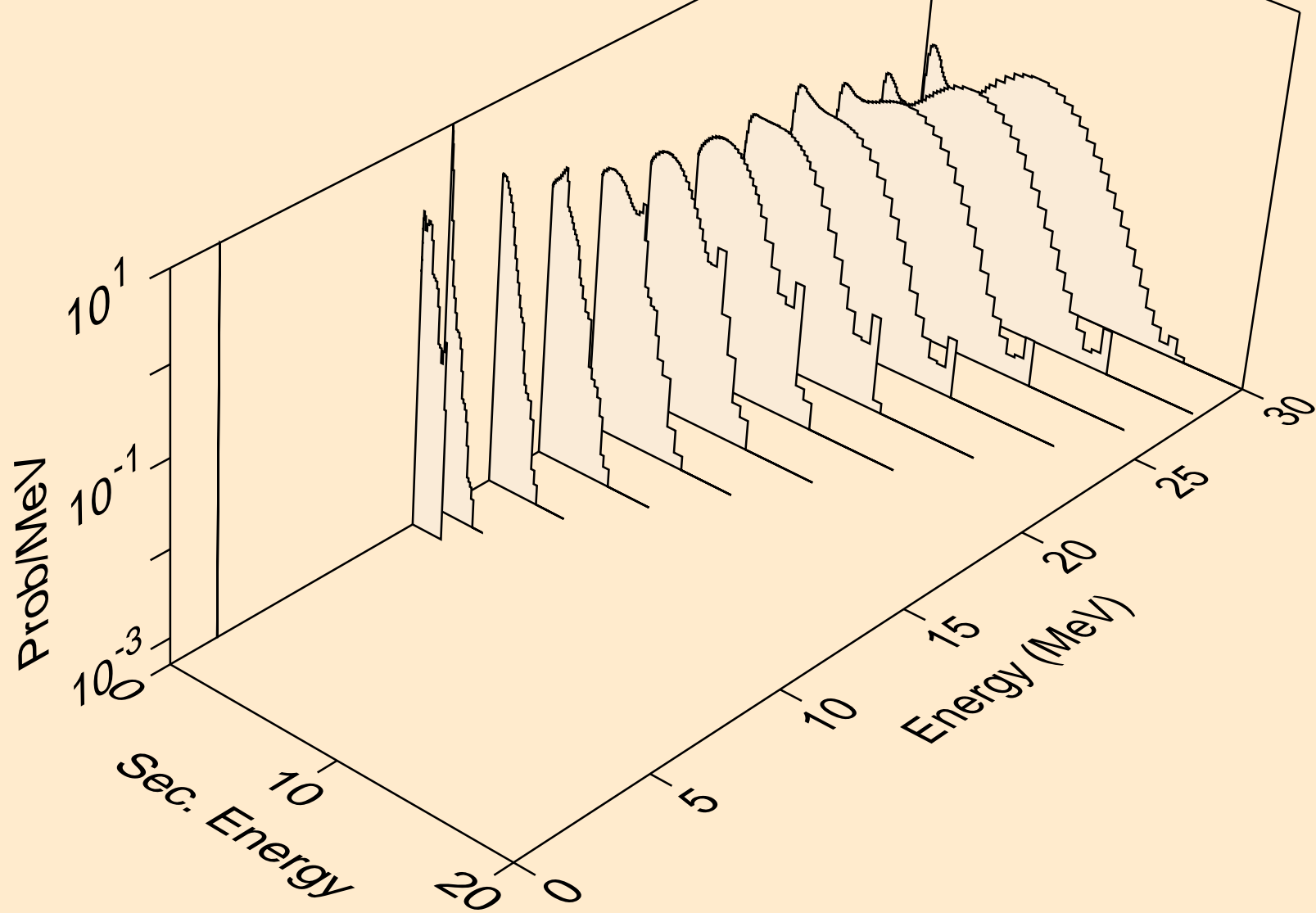

LU154M HELION ACER TENDL-2021 LIBRARY; T=0.K  
neutrons from (s,2n)a

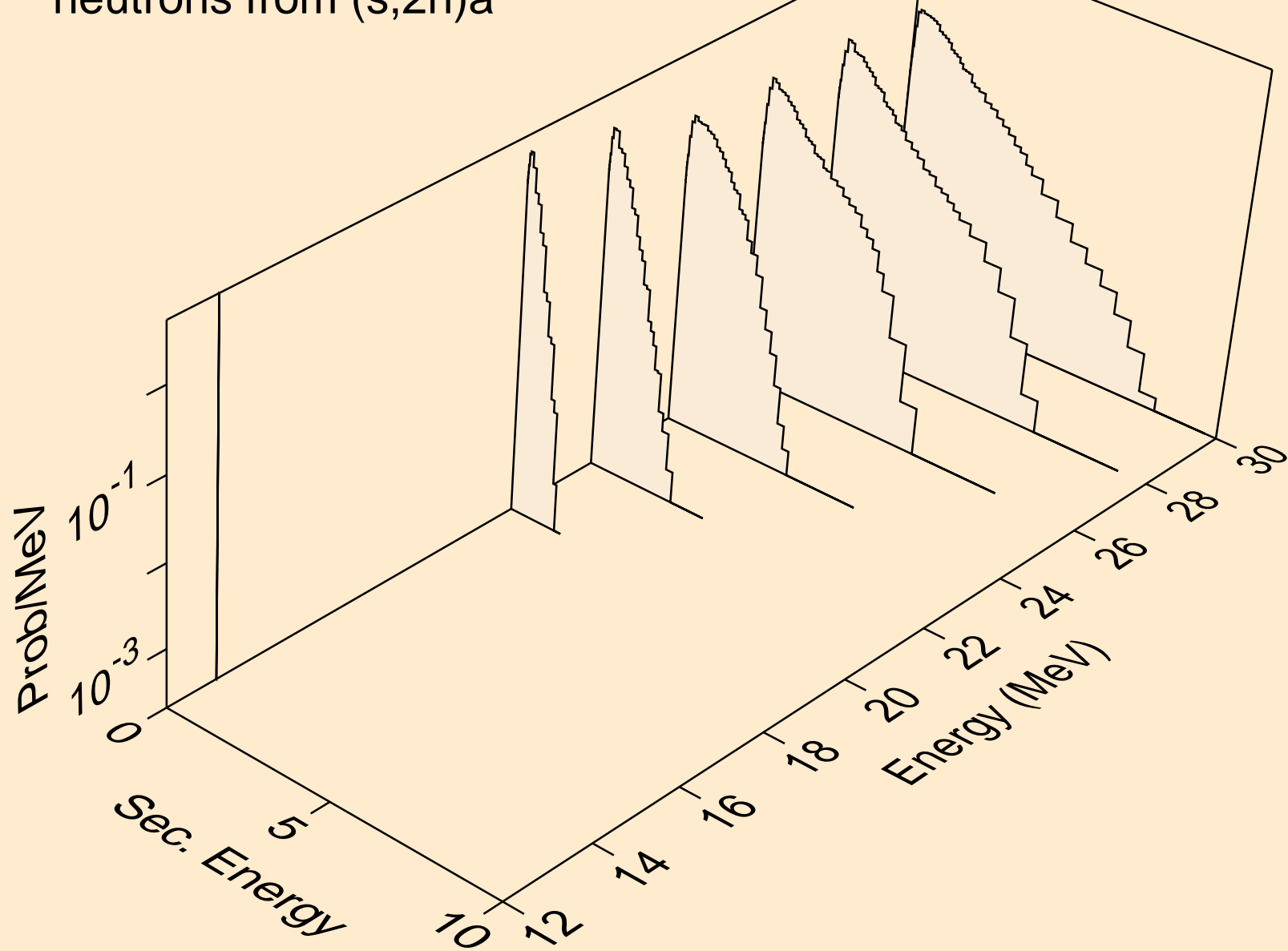

LU154M HELION ACER TENDL-2021 LIBRARY; T=0.K  
neutrons from (s,n\*)p

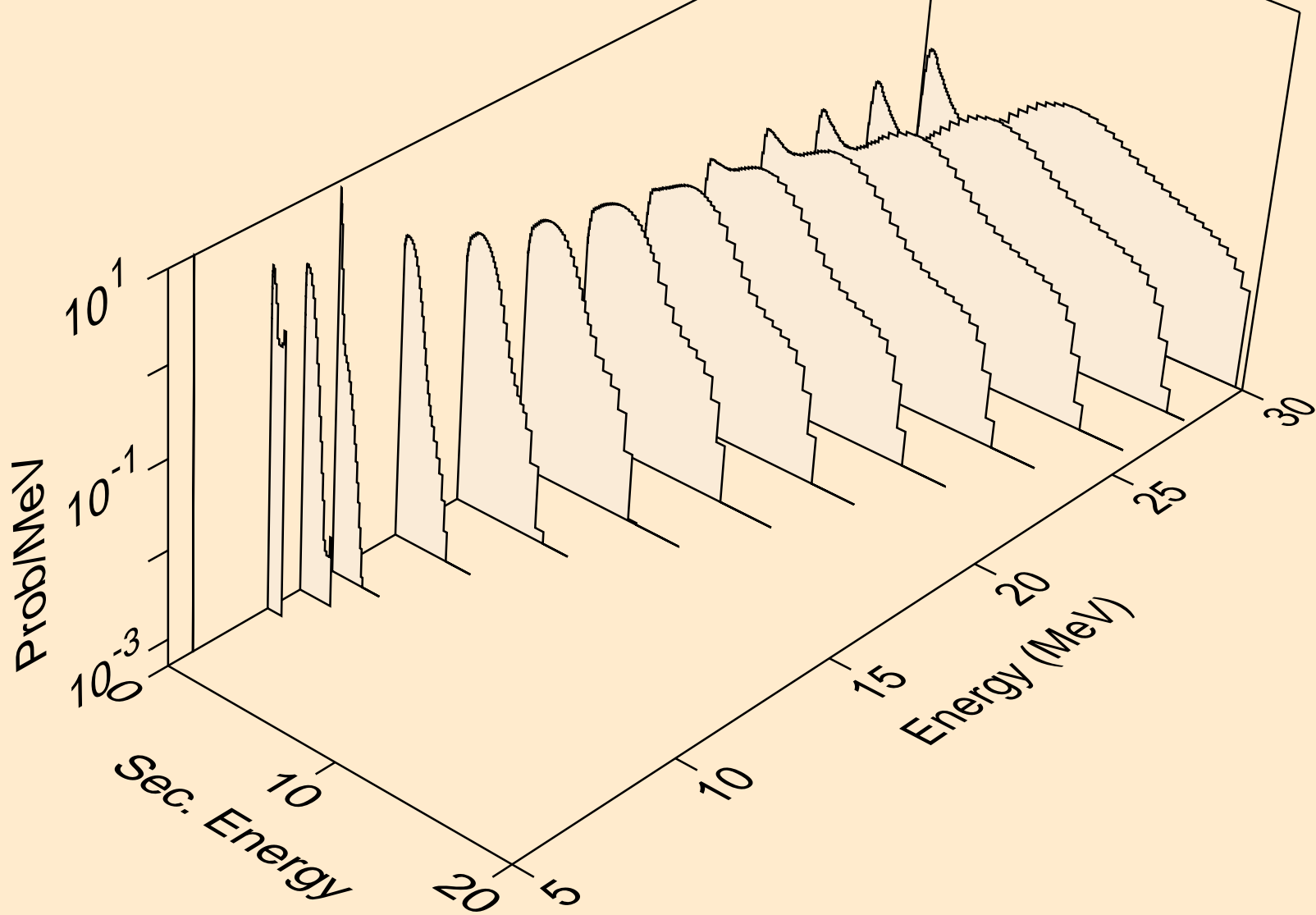



LU154M HELION ACER TENDL-2021 LIBRARY; T=0.K  
neutrons from (s,n\*)d

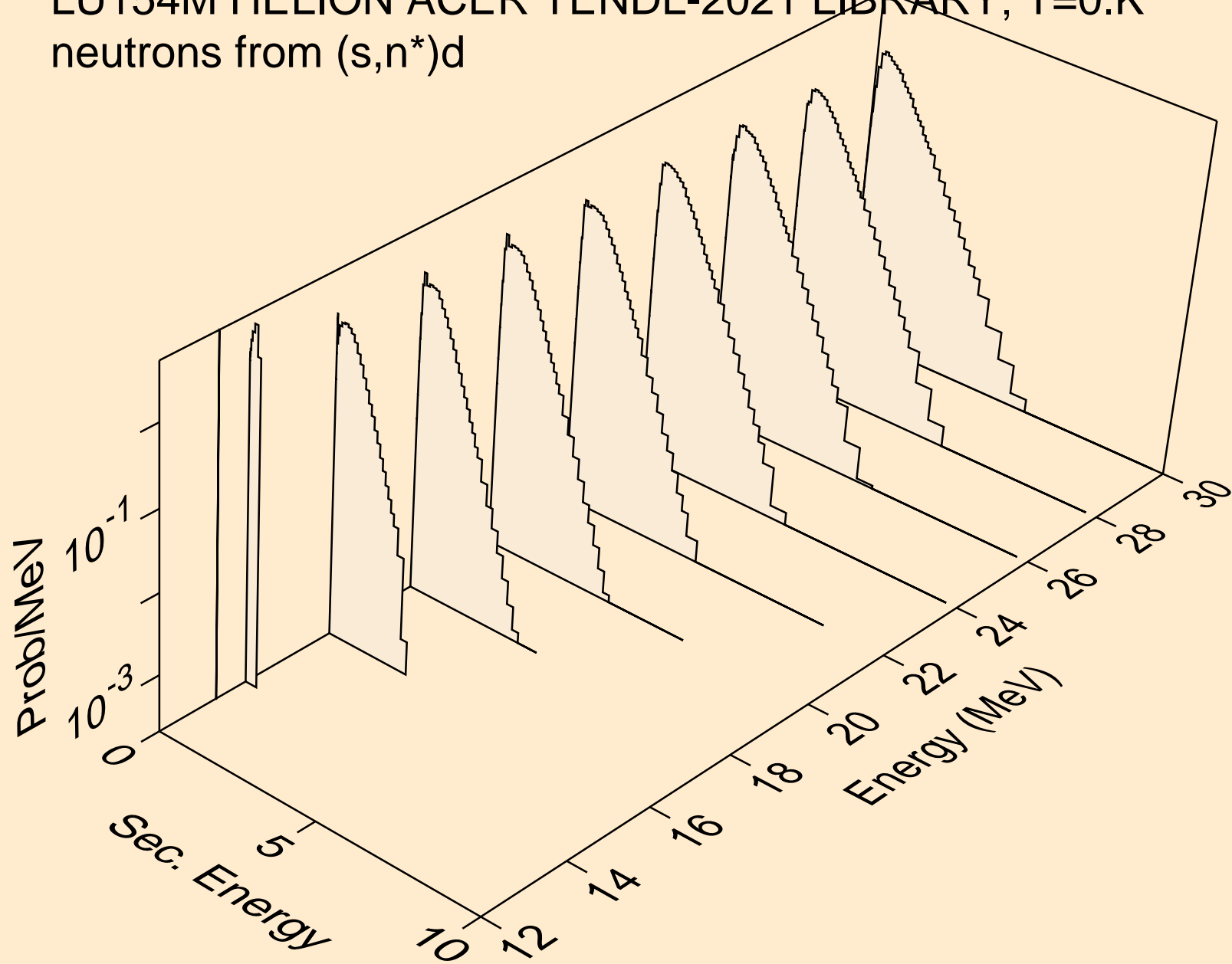

LU154M HELION ACER TENDL-2021 LIBRARY; T=0.K  
neutrons from (s,n\*)t

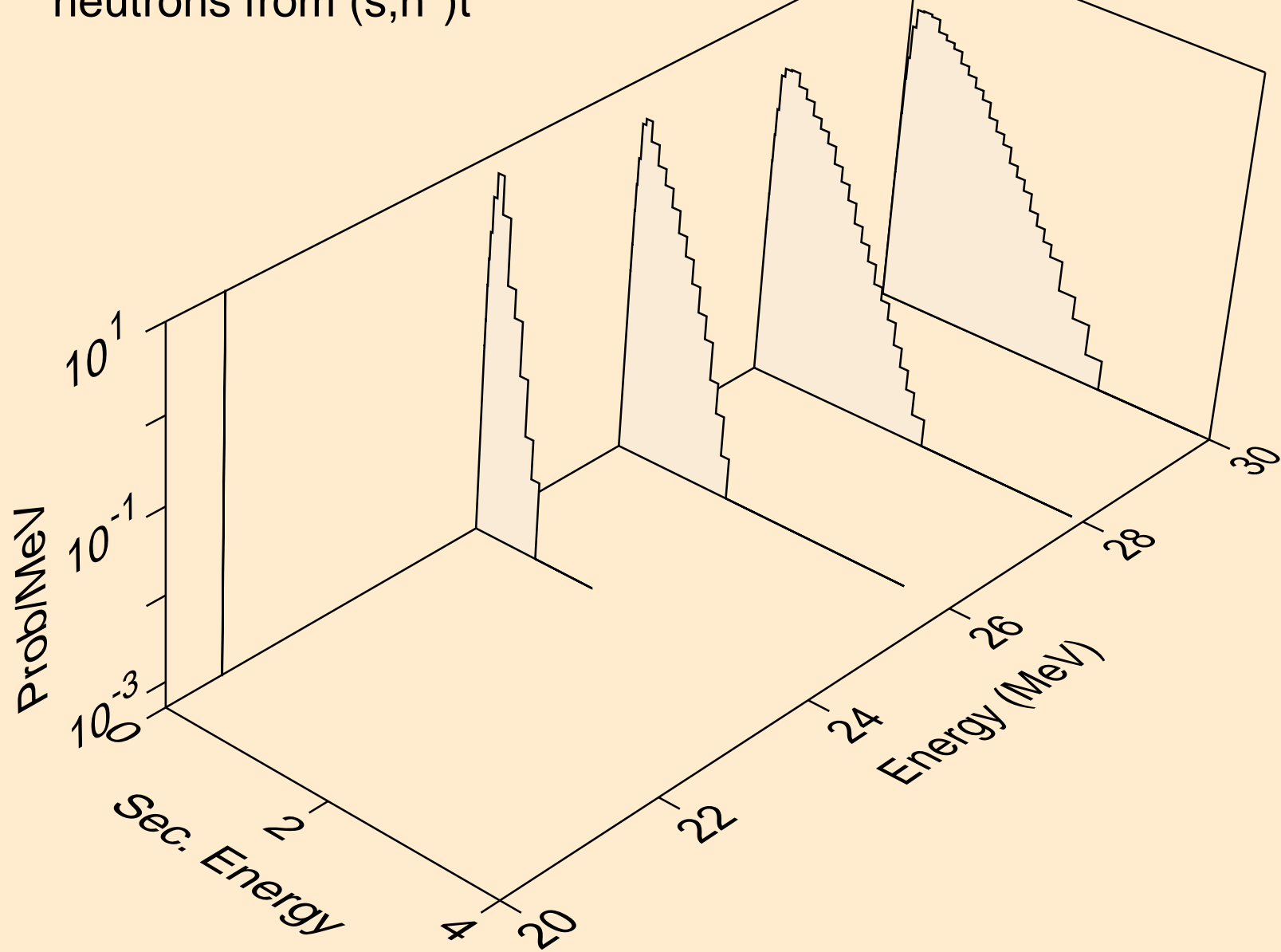

LU154M HELION ACER TENDL-2021 LIBRARY; T=0.K  
neutrons from (s,n\*)he3

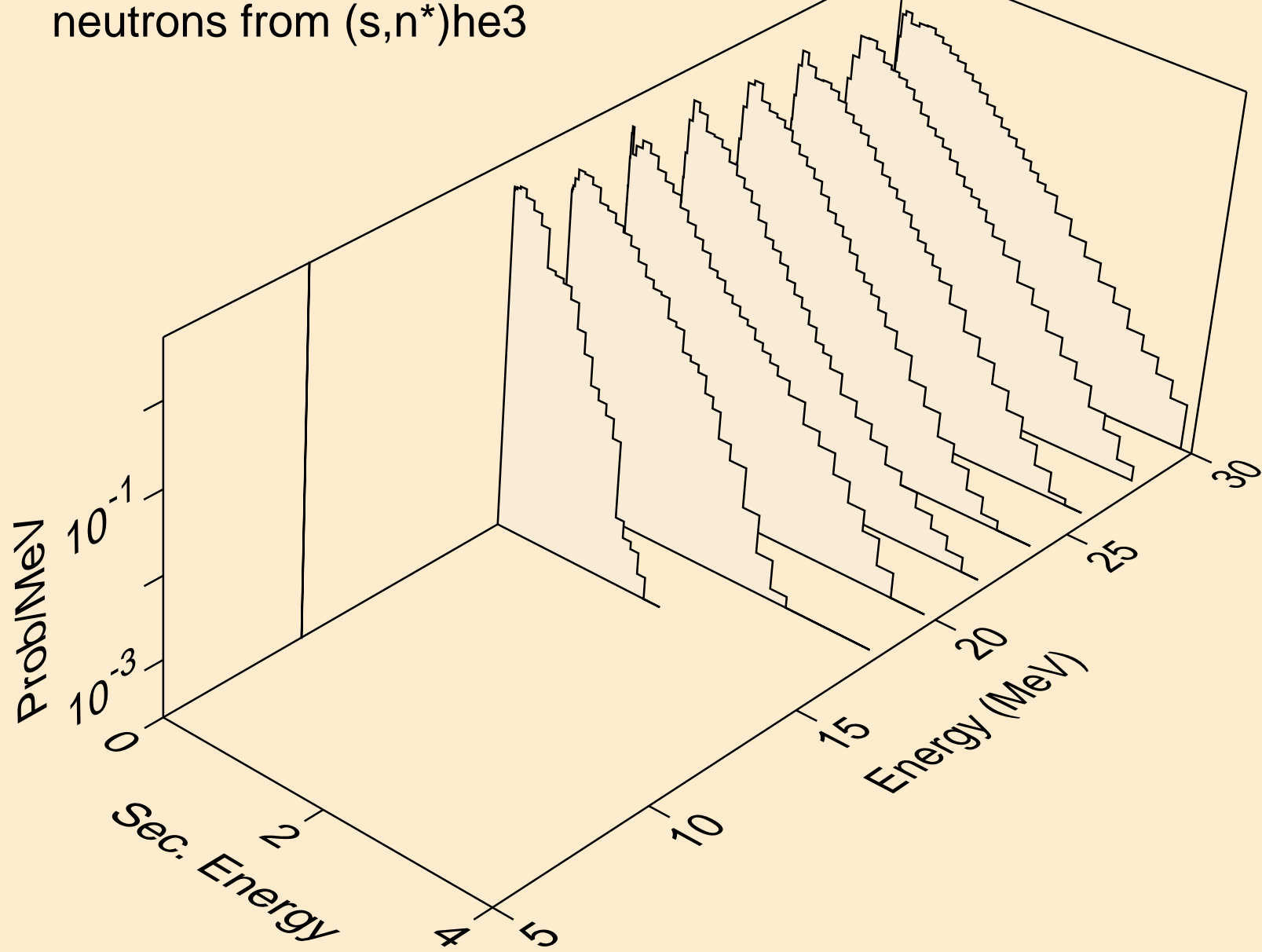

LU154M HELION ACER TENDL-2021 LIBRARY; T=0.K  
neutrons from (s,2np)

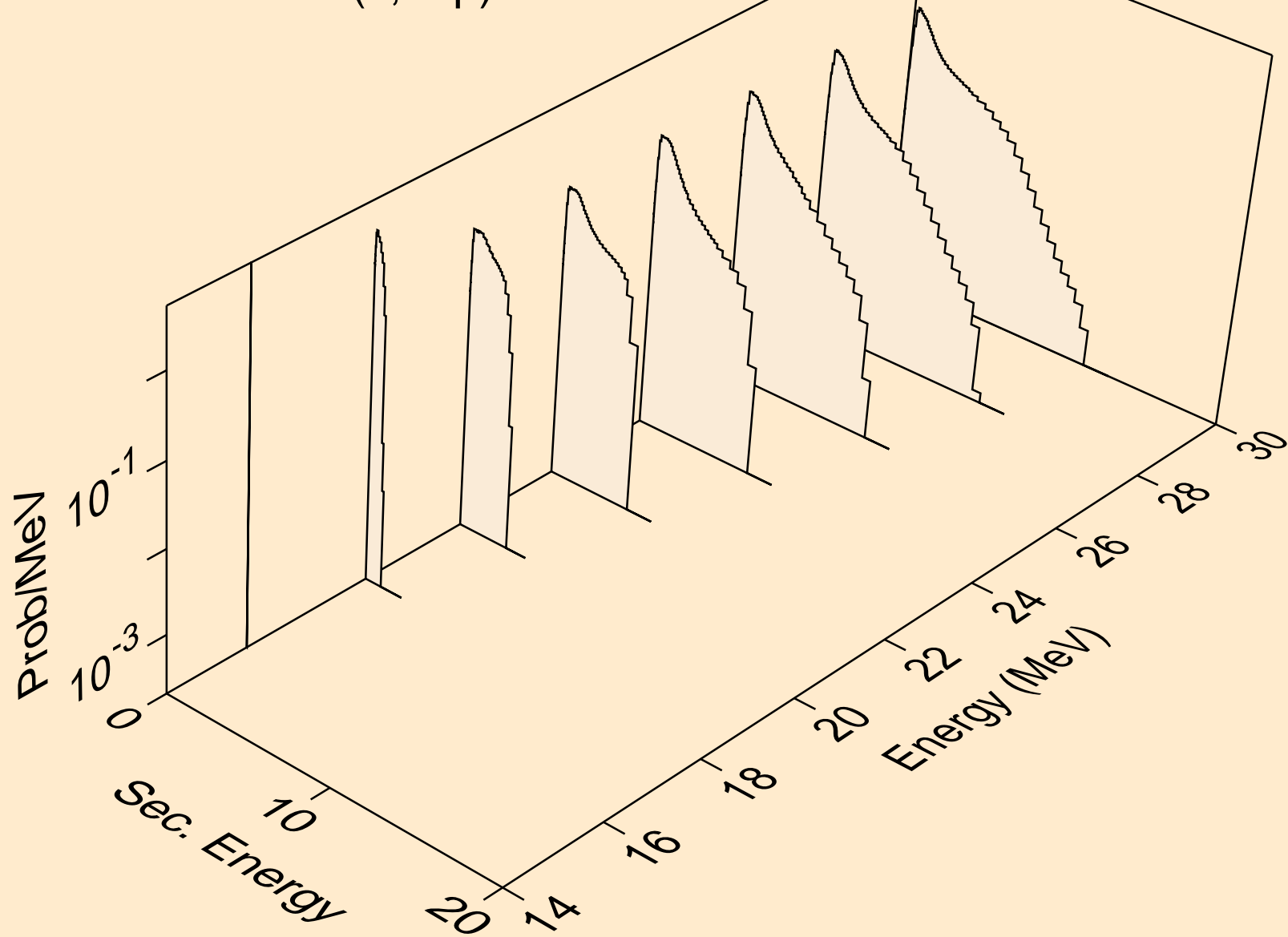

LU154M HELION ACER TENDL-2021 LIBRARY; T=0.K  
neutrons from (s,2np)

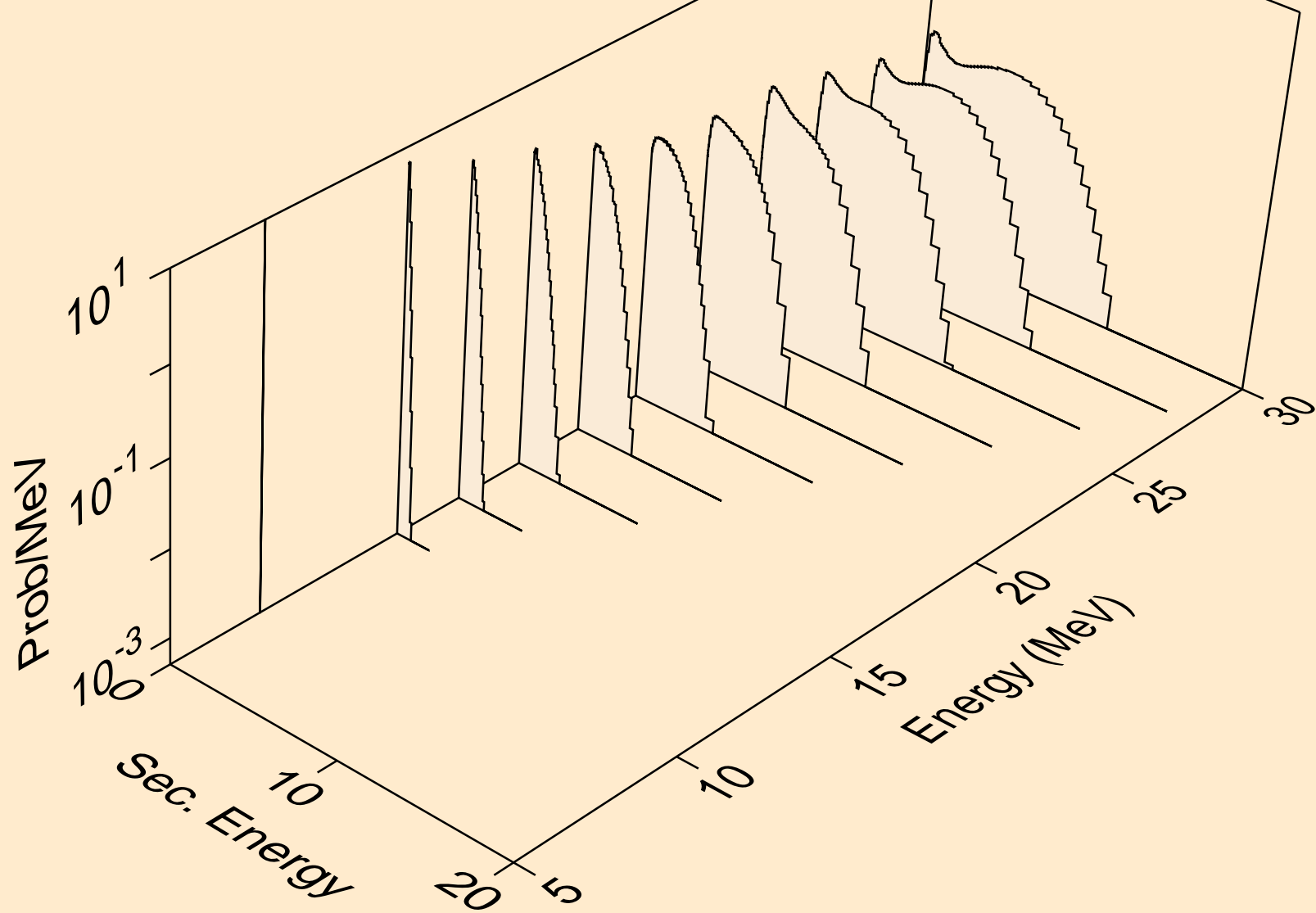

LU154M HELION ACER TENDL-2021 LIBRARY; T=0.K  
neutrons from (s,npa)

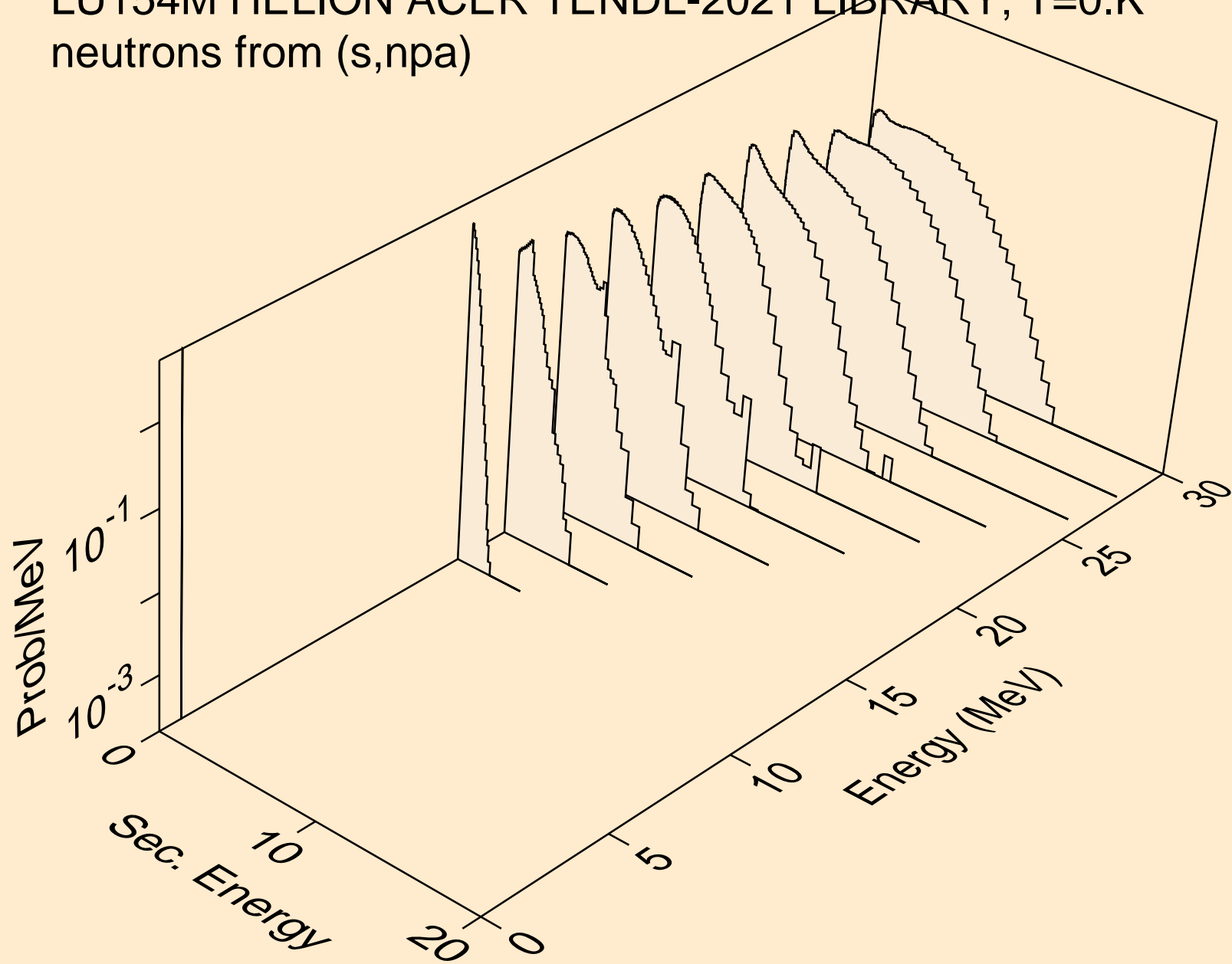

LU154M HELION ACER TENDL-2021 LIBRARY; T=0.K  
protons from (s,x)

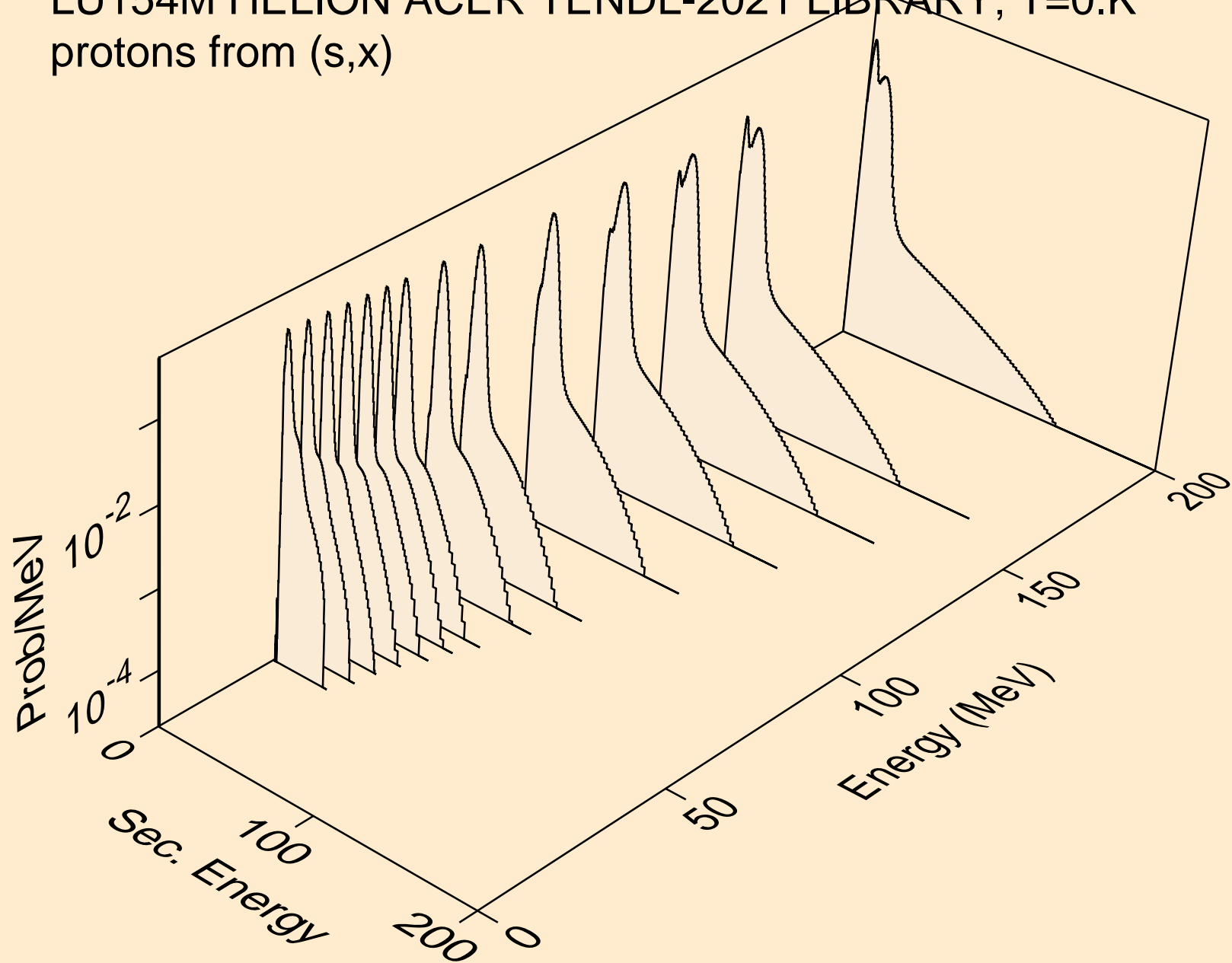

LU154M HELION ACER TENDL-2021 LIBRARY; T=0.K  
protons from (s,n\*)p

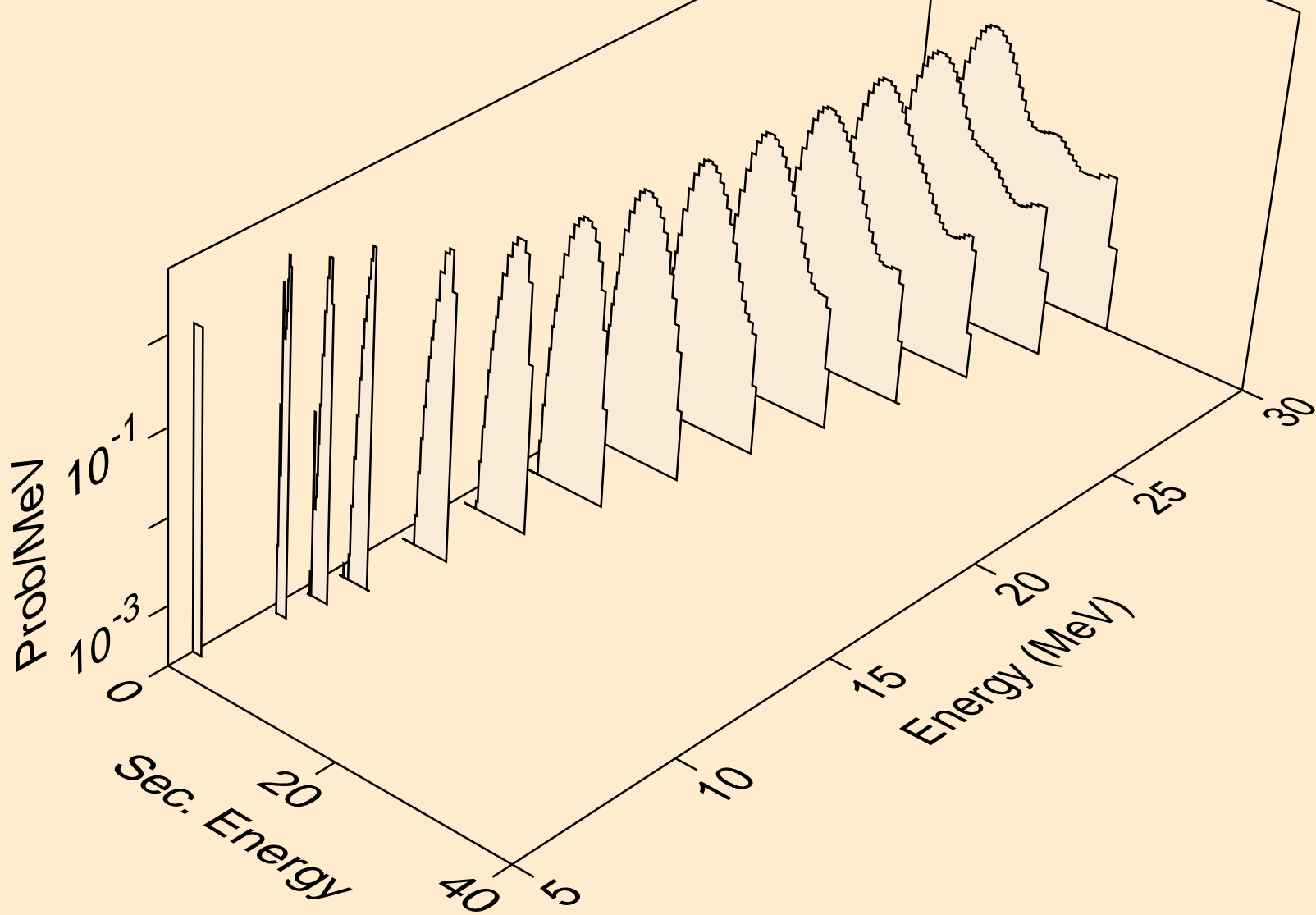



LU154M HELION ACER TENDL-2021 LIBRARY; T=0.K  
protons from (s,2np)

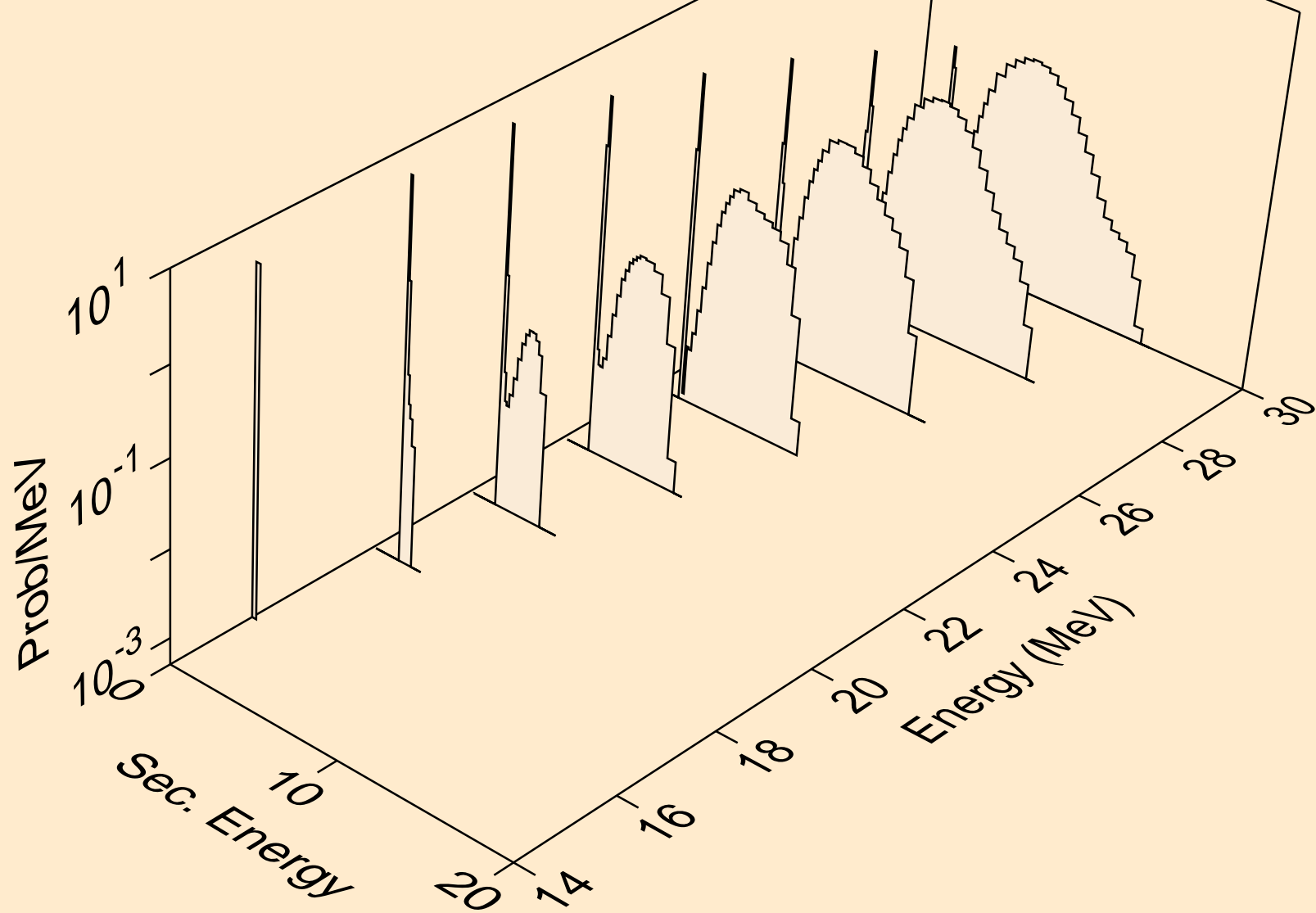

LU154M HELION ACER TENDL-2021 LIBRARY; T=0.K  
protons from (s,2np)

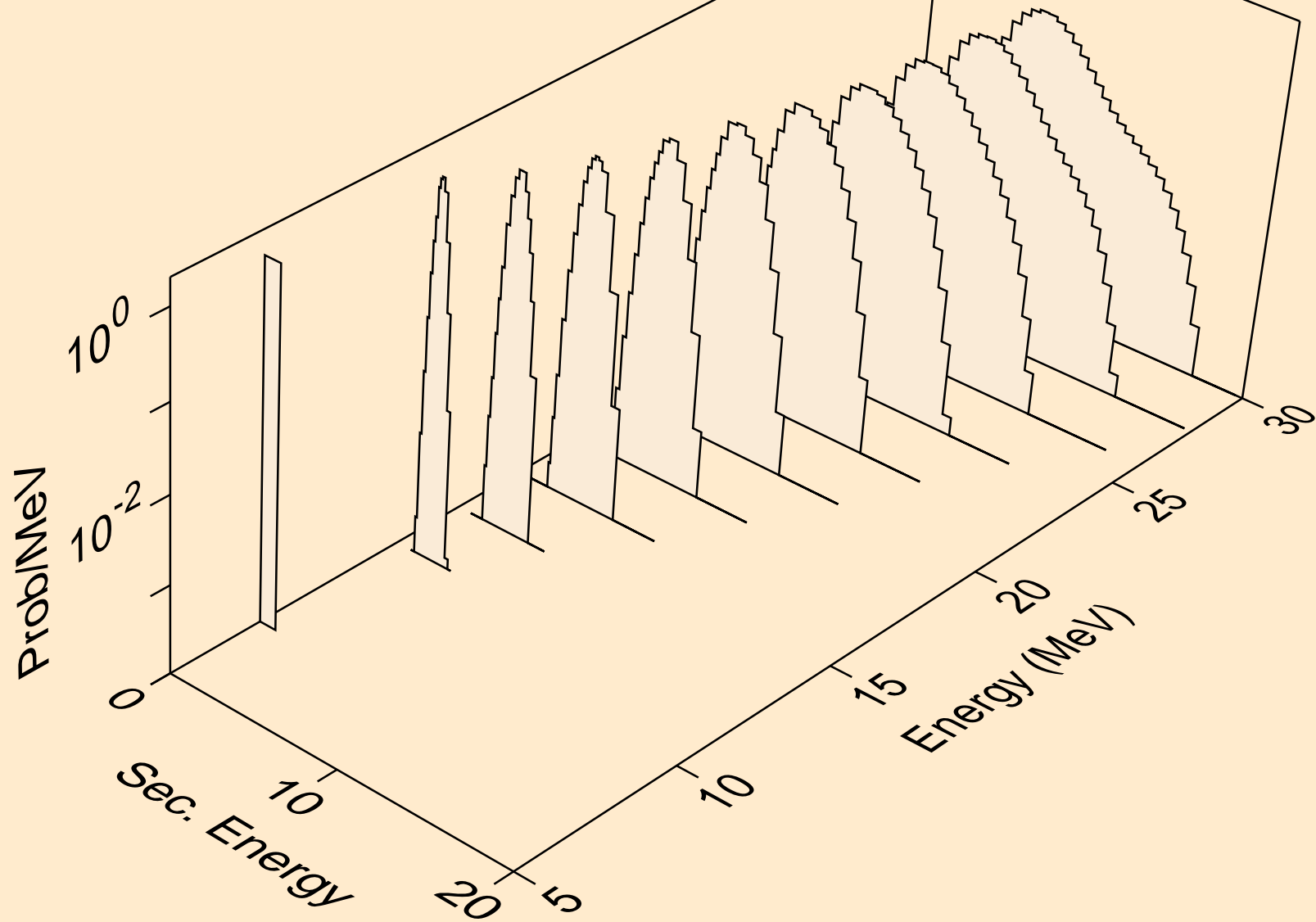

LU154M HELION ACER TENDL-2021 LIBRARY; T=0.K  
protons from (s,npa)

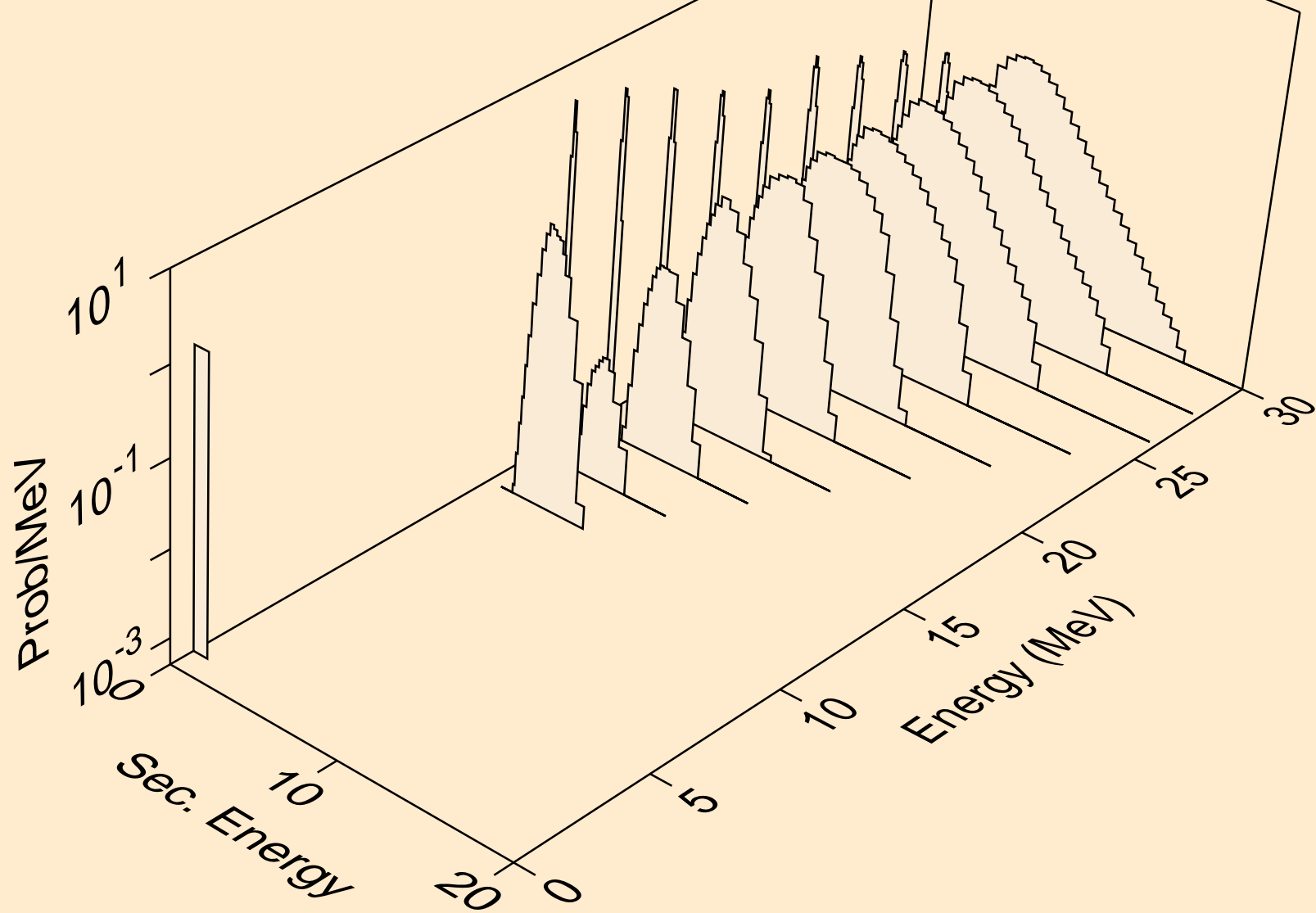

LU154M HELION ACER TENDL-2021 LIBRARY; T=0.K  
protons from (s,p)

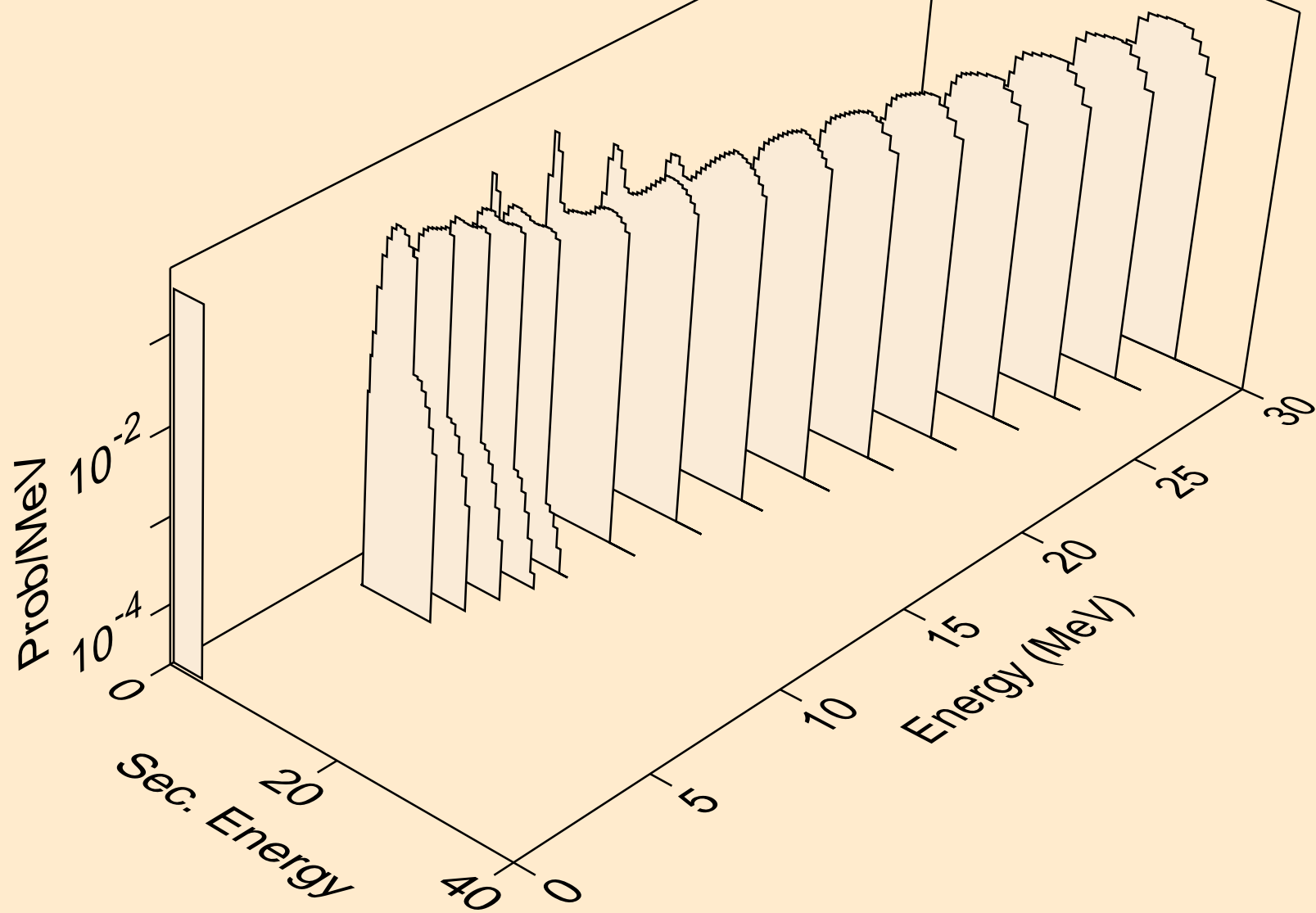

LU154M HELION ACER TENDL-2021 LIBRARY; T=0.K  
protons from (s,2p)

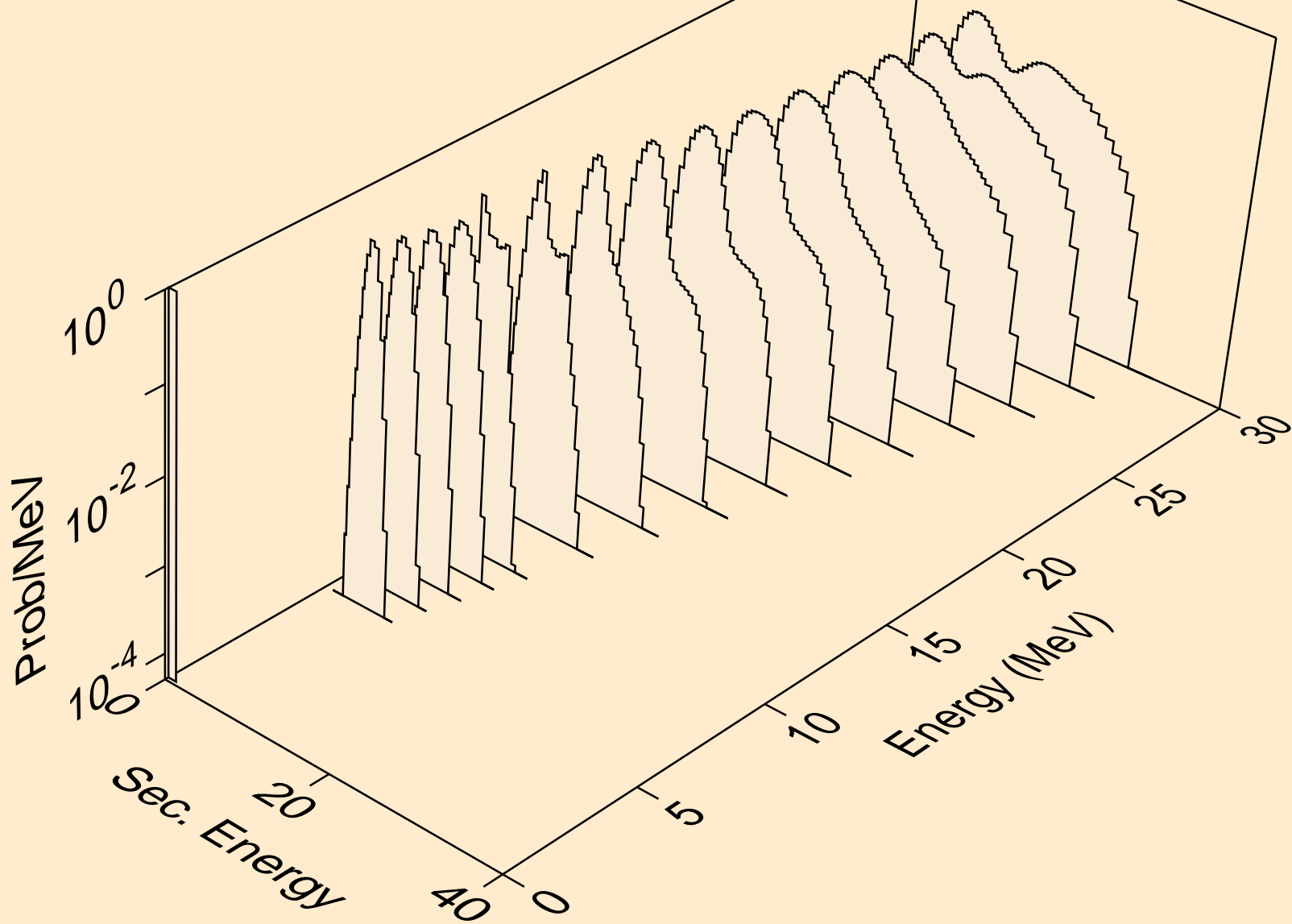

LU154M HELION ACER TENDL-2021 LIBRARY; T=0.K  
protons from (s,pa)

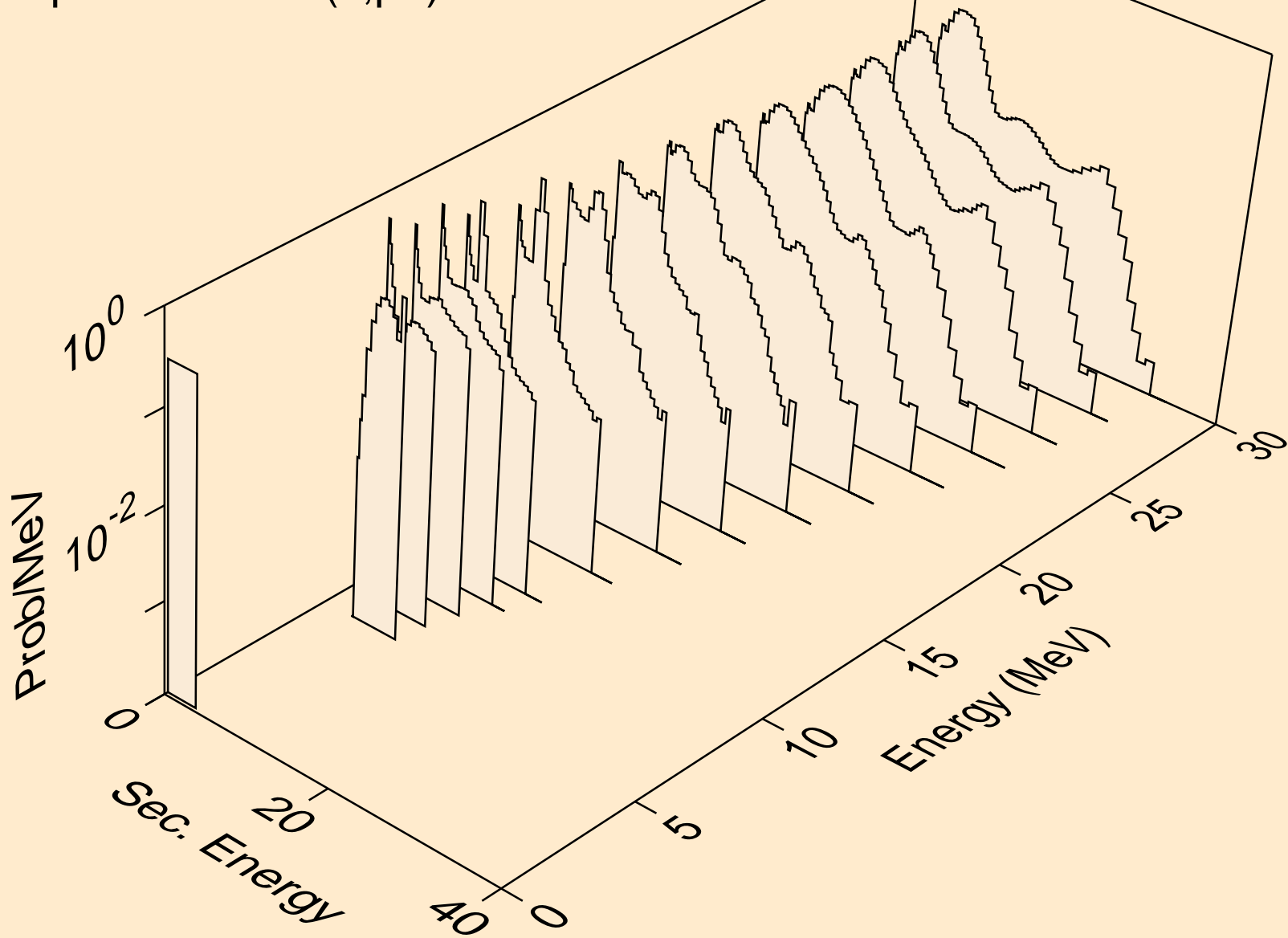

LU154M HELION ACER TENDL-2021 LIBRARY; T=0.K  
protons from (s,pd)

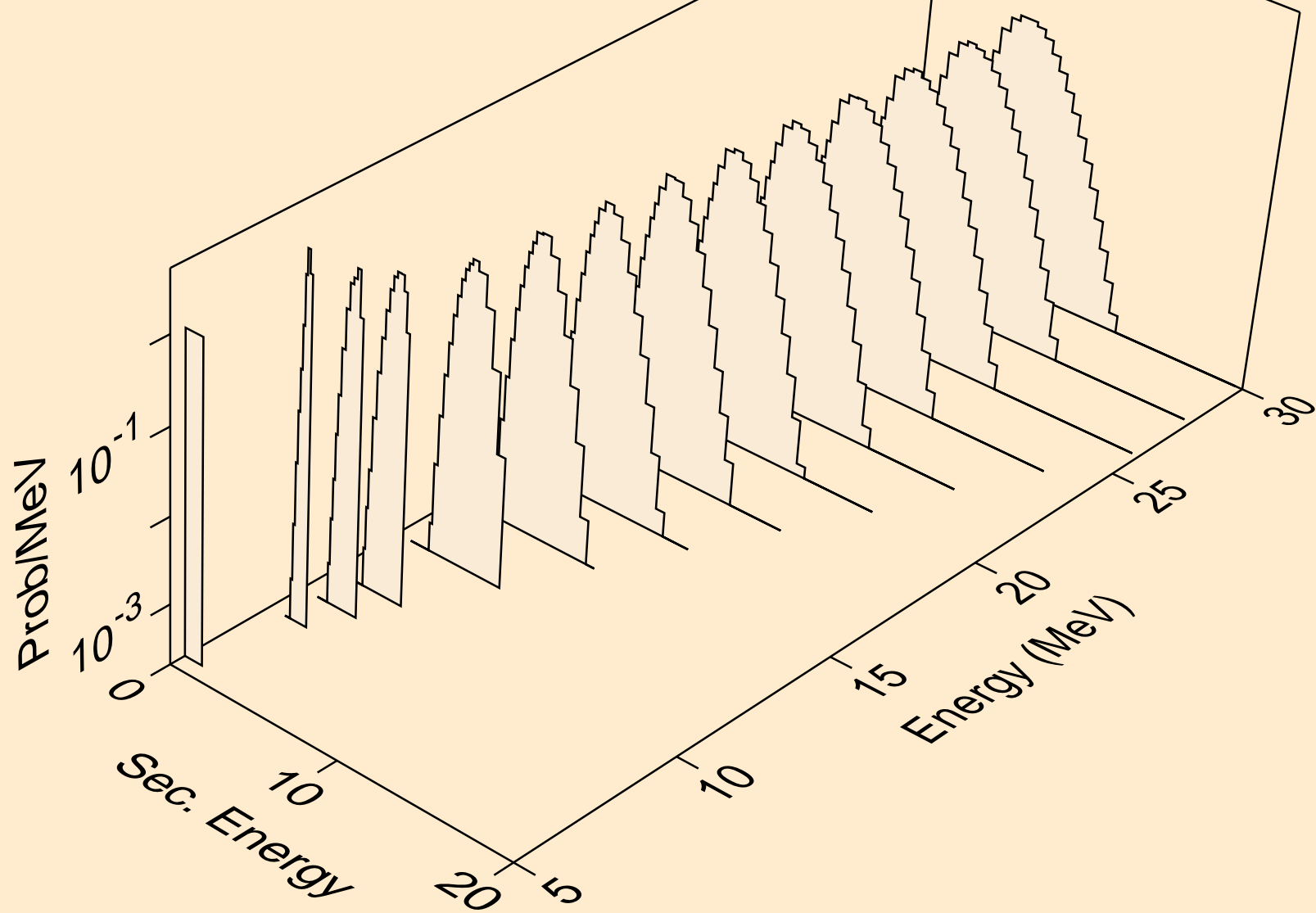

LU154M HELION ACER TENDL-2021 LIBRARY; T=0.K  
protons from (s,pt)

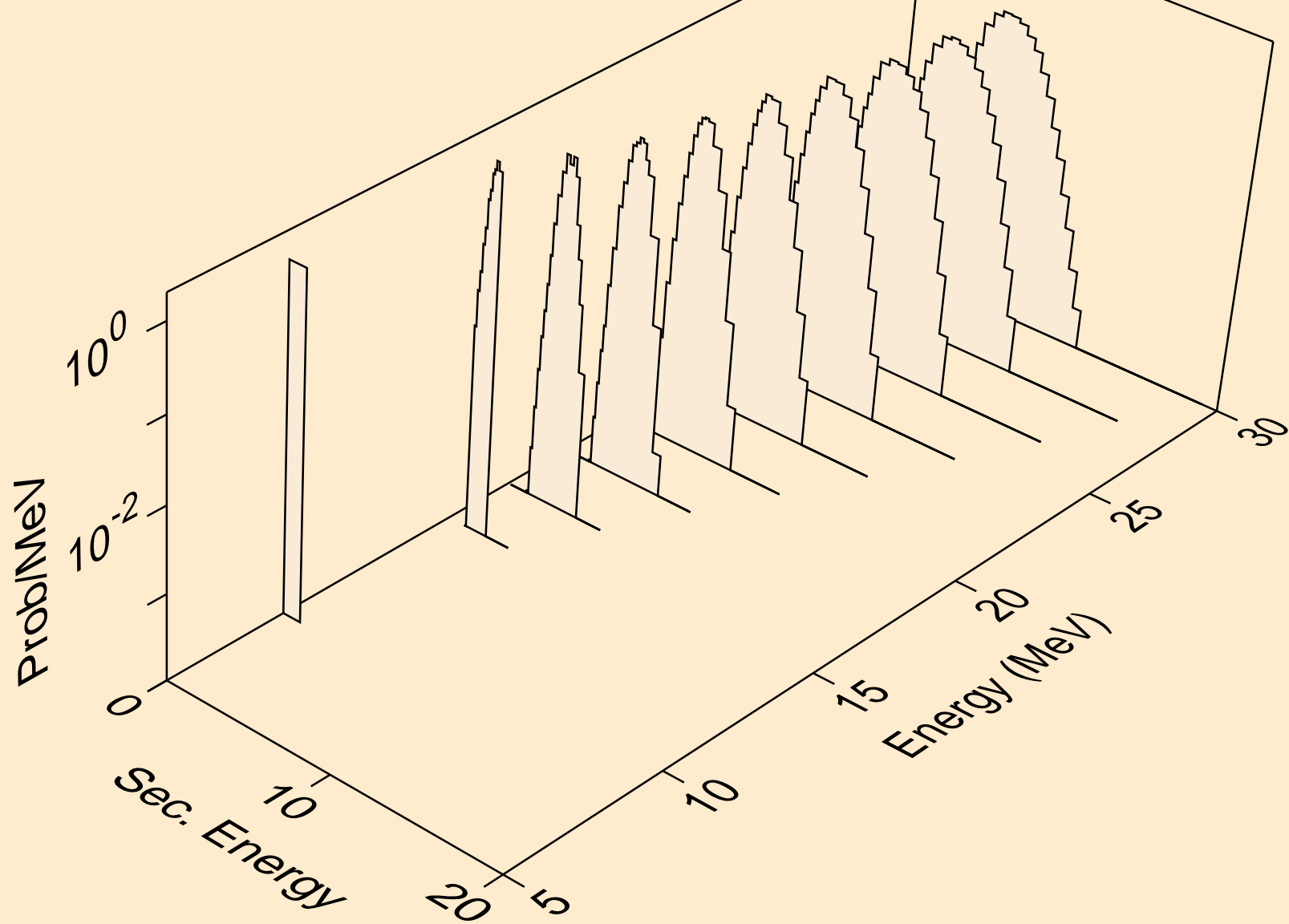



LU154M HELION ACER TENDL-2021 LIBRARY; T=0.K  
deuterons from (s,x)

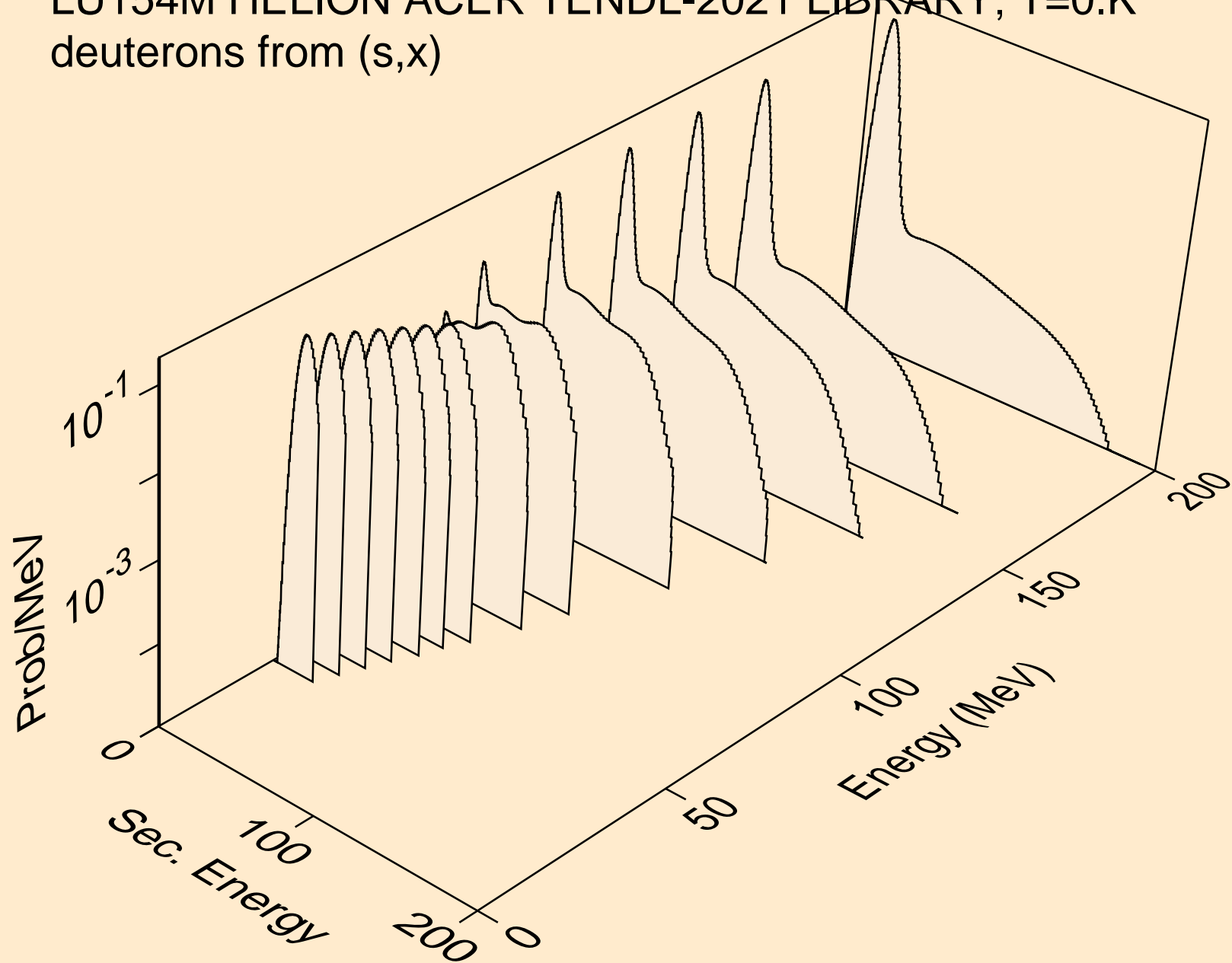

LU154M HELION ACER TENDL-2021 LIBRARY; T=0.K  
deuterons from (s,n\*)d

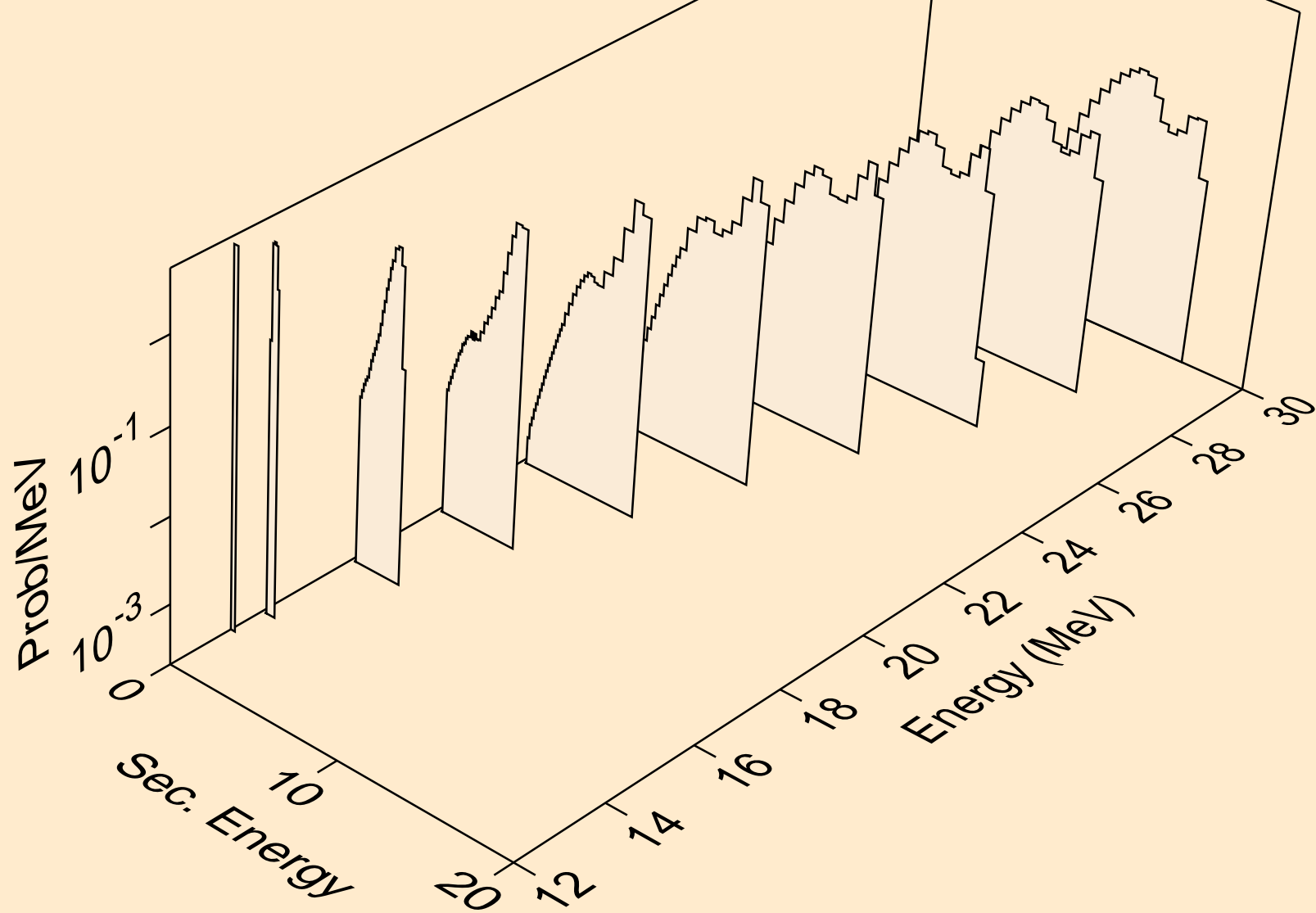

LU154M HELION ACER TENDL-2021 LIBRARY; T=0.K  
deuterons from (s,d)

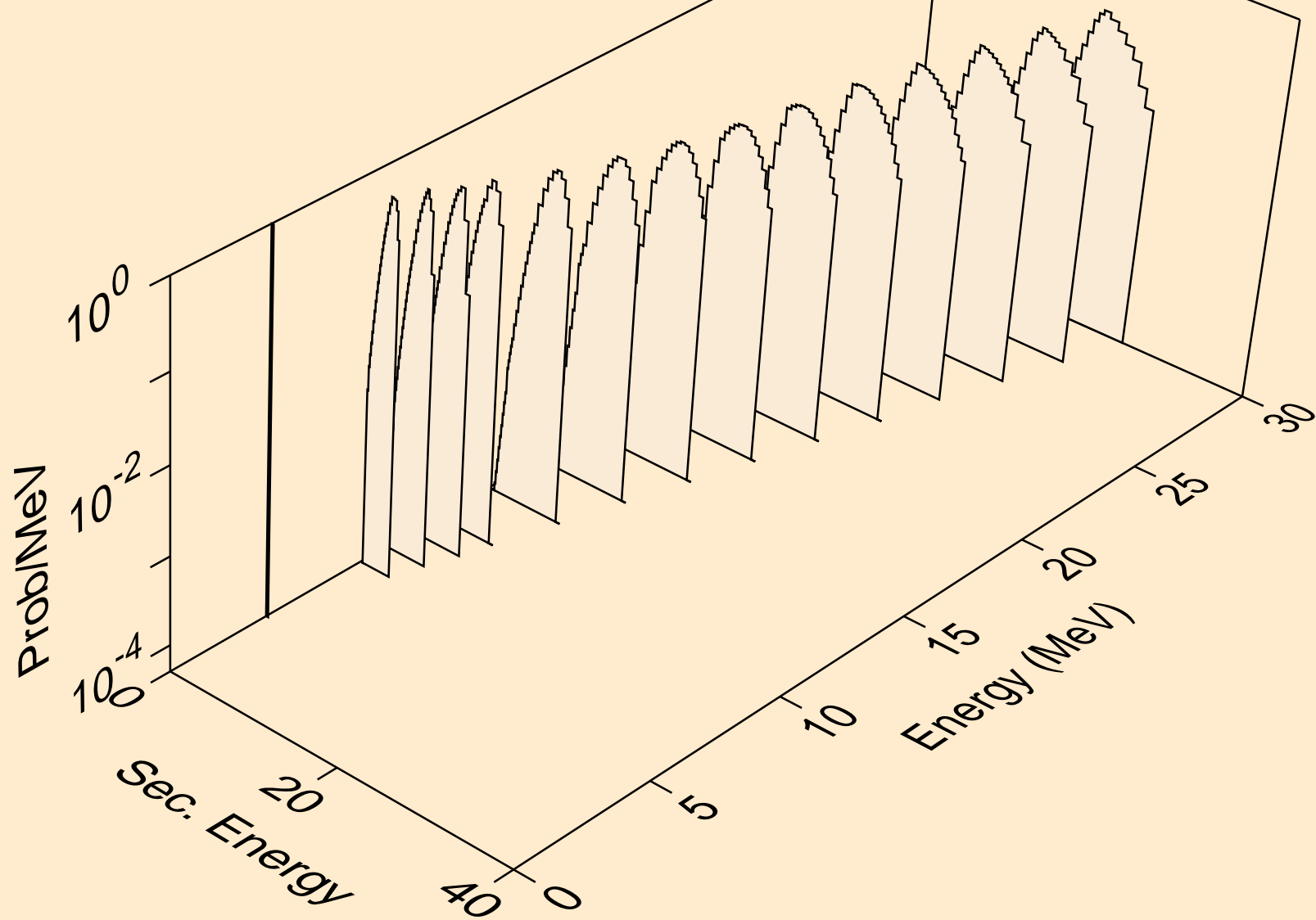

LU154M HELION ACER TENDL-2021 LIBRARY; T=0.K  
deuterons from (s,pd)

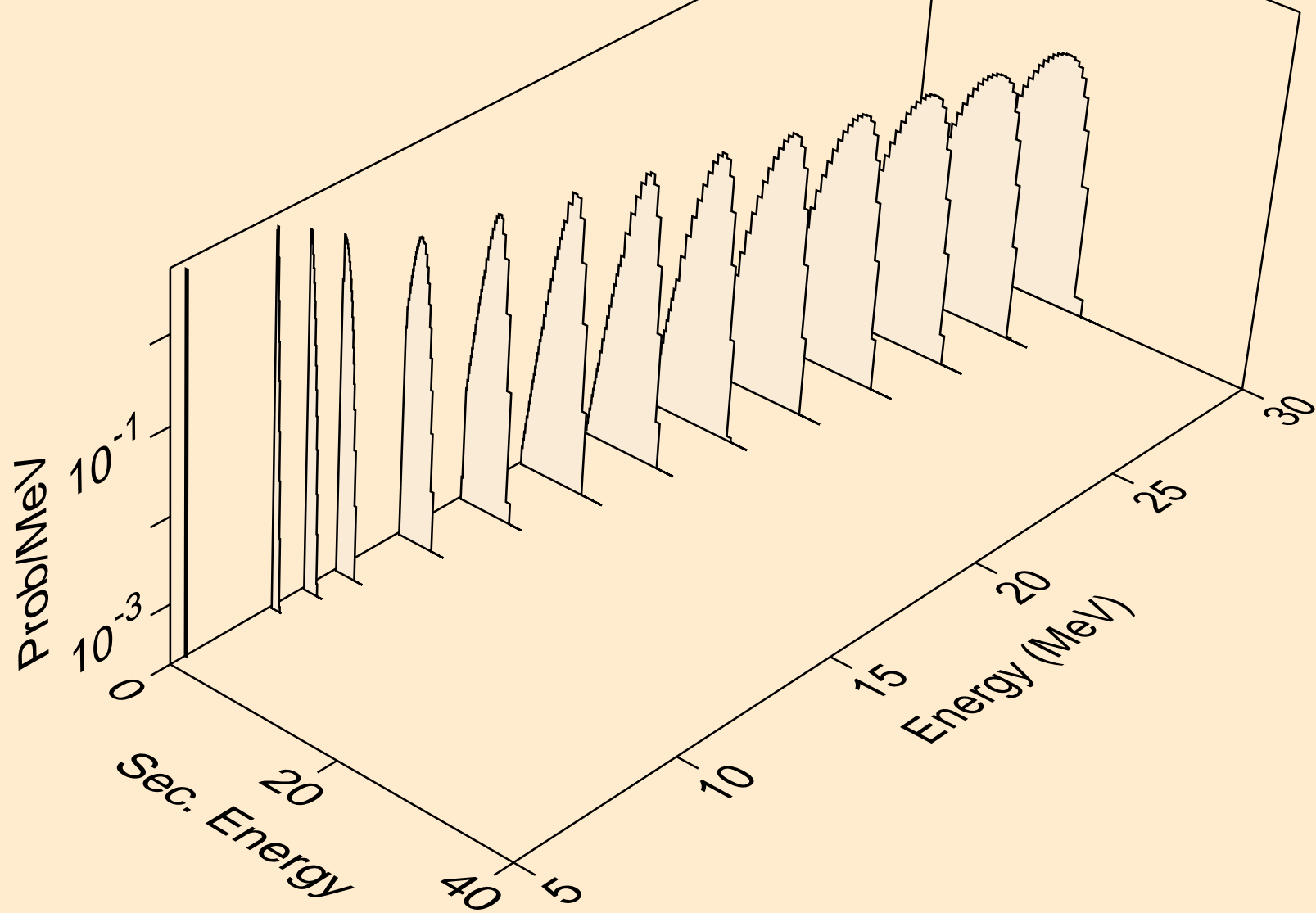

LU154M HELION ACER TENDL-2021 LIBRARY; T=0.K  
deuterons from (s,da)

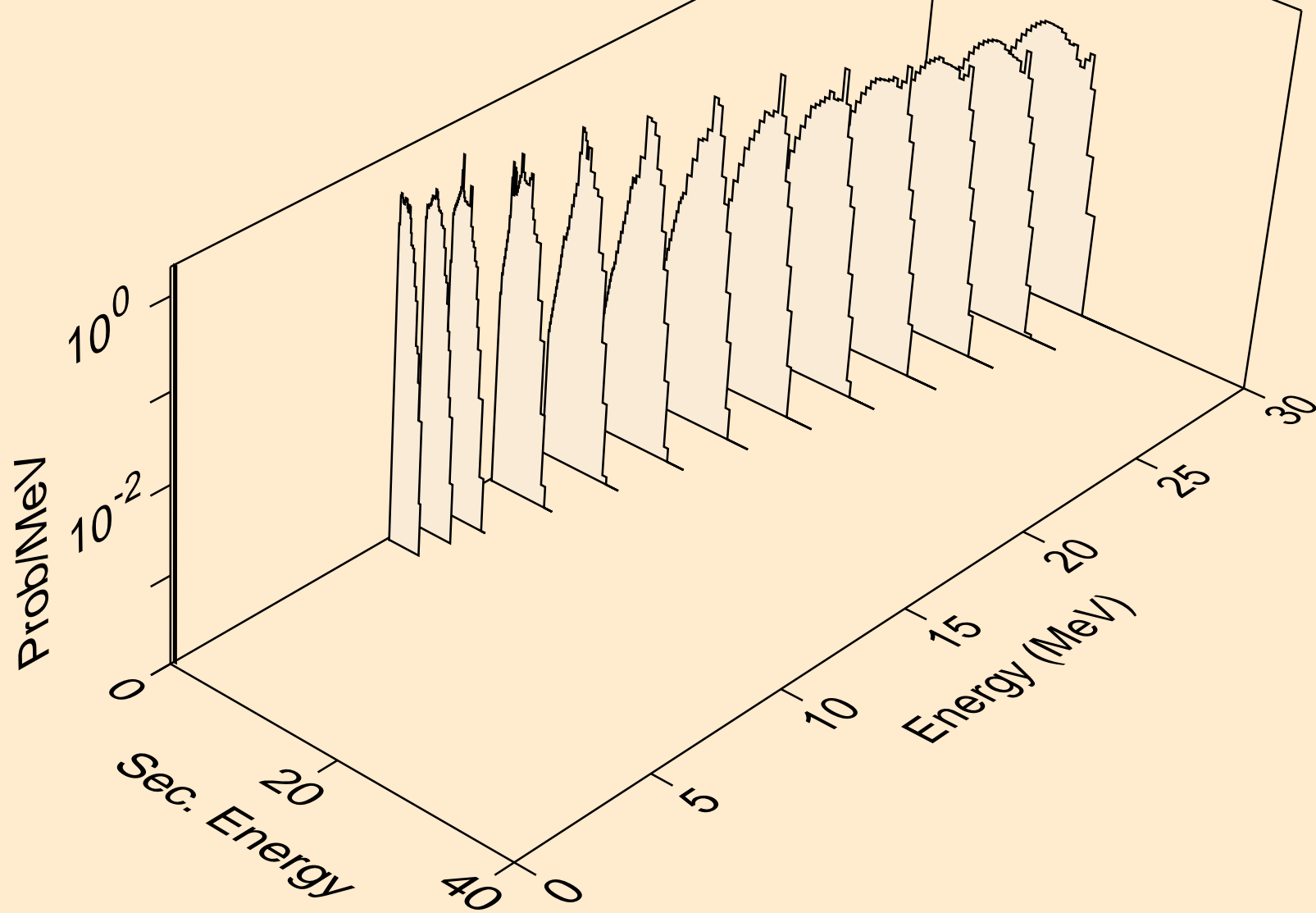

LU154M HELION ACER TENDL-2021 LIBRARY; T=0.K  
tritons from (s,x)

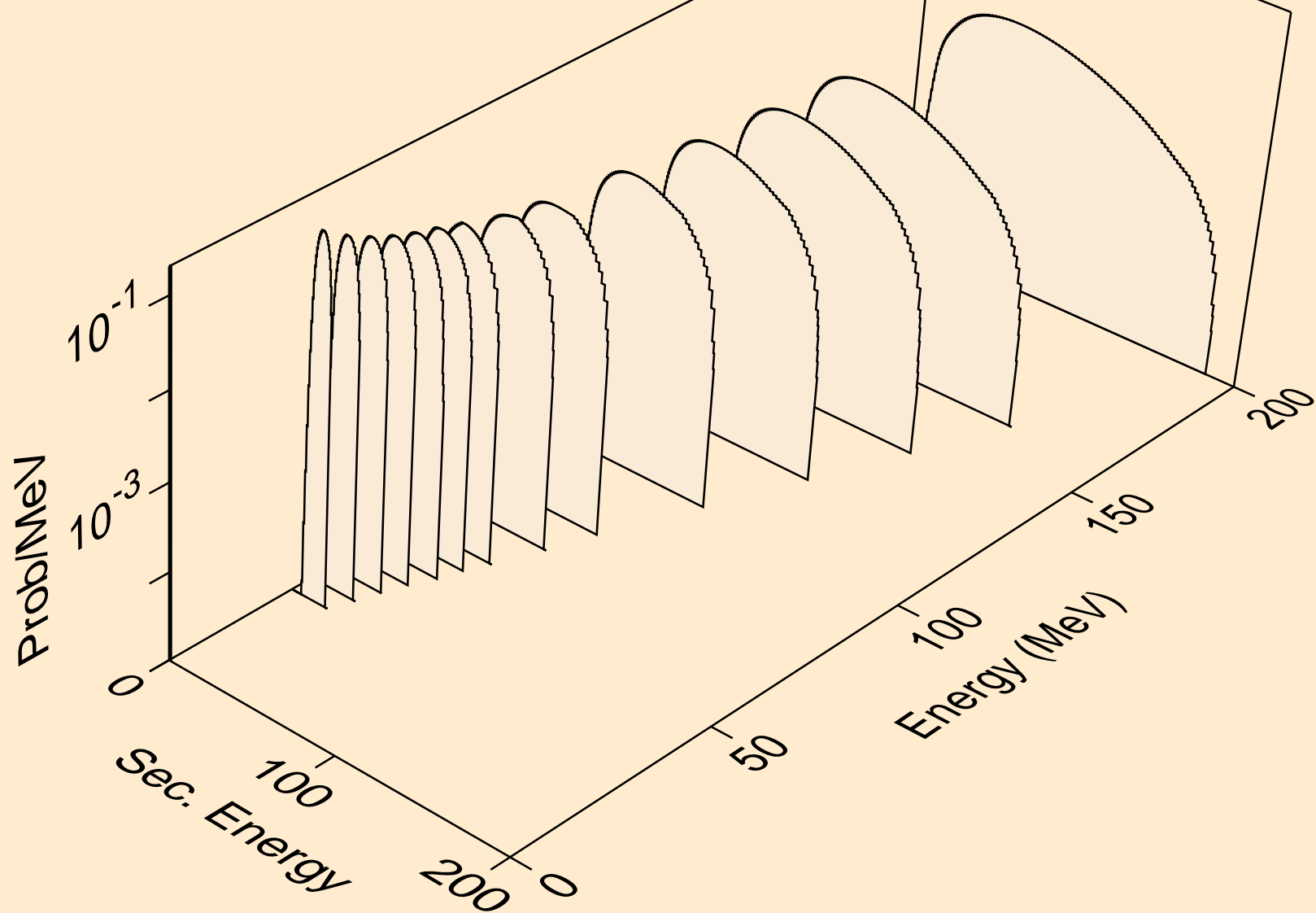

LU154M HELION ACER TENDL-2021 LIBRARY; T=0.K  
tritons from (s,n\*)t

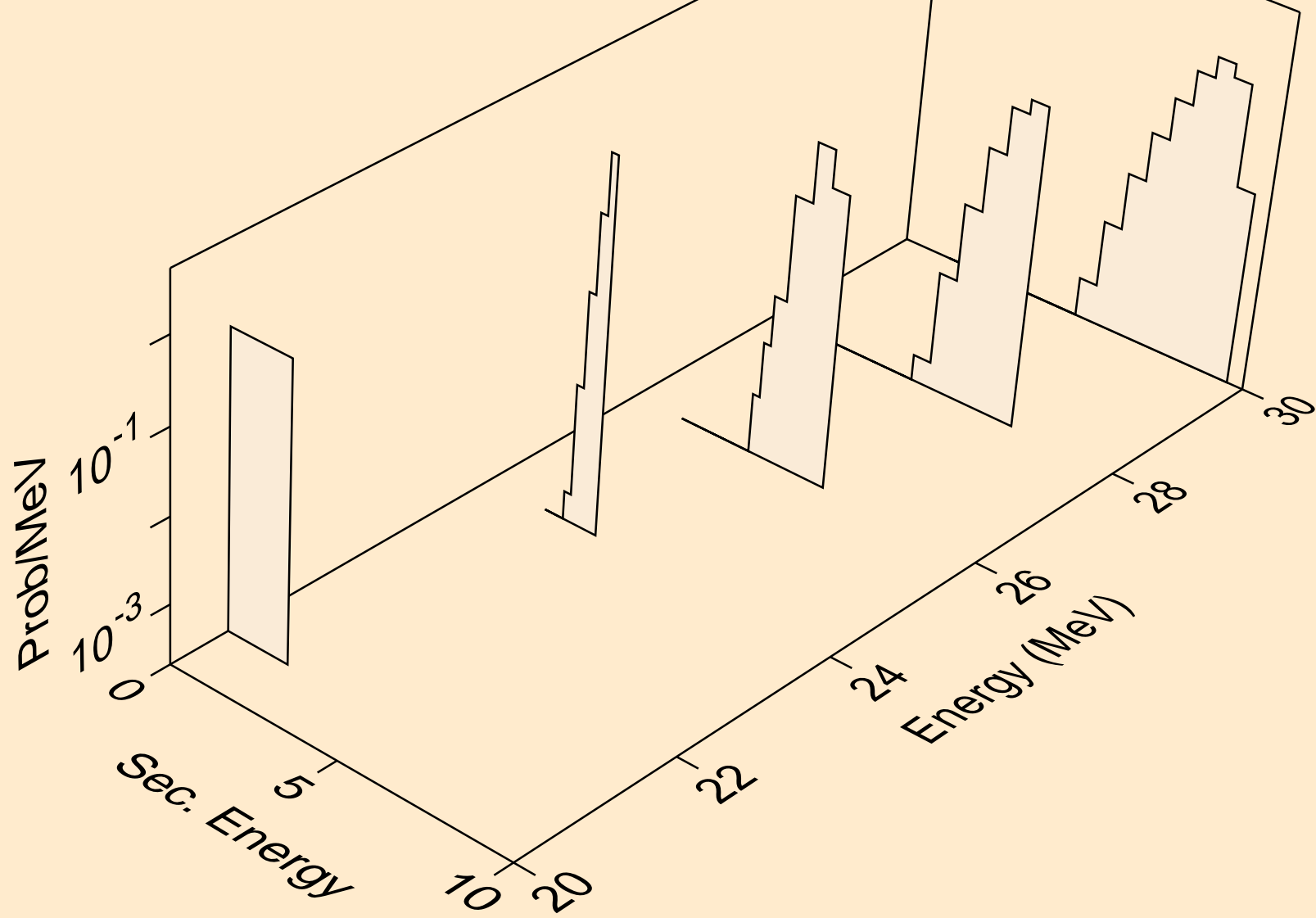

LU154M HELION ACER TENDL-2021 LIBRARY; T=0.K  
tritons from (s,t)

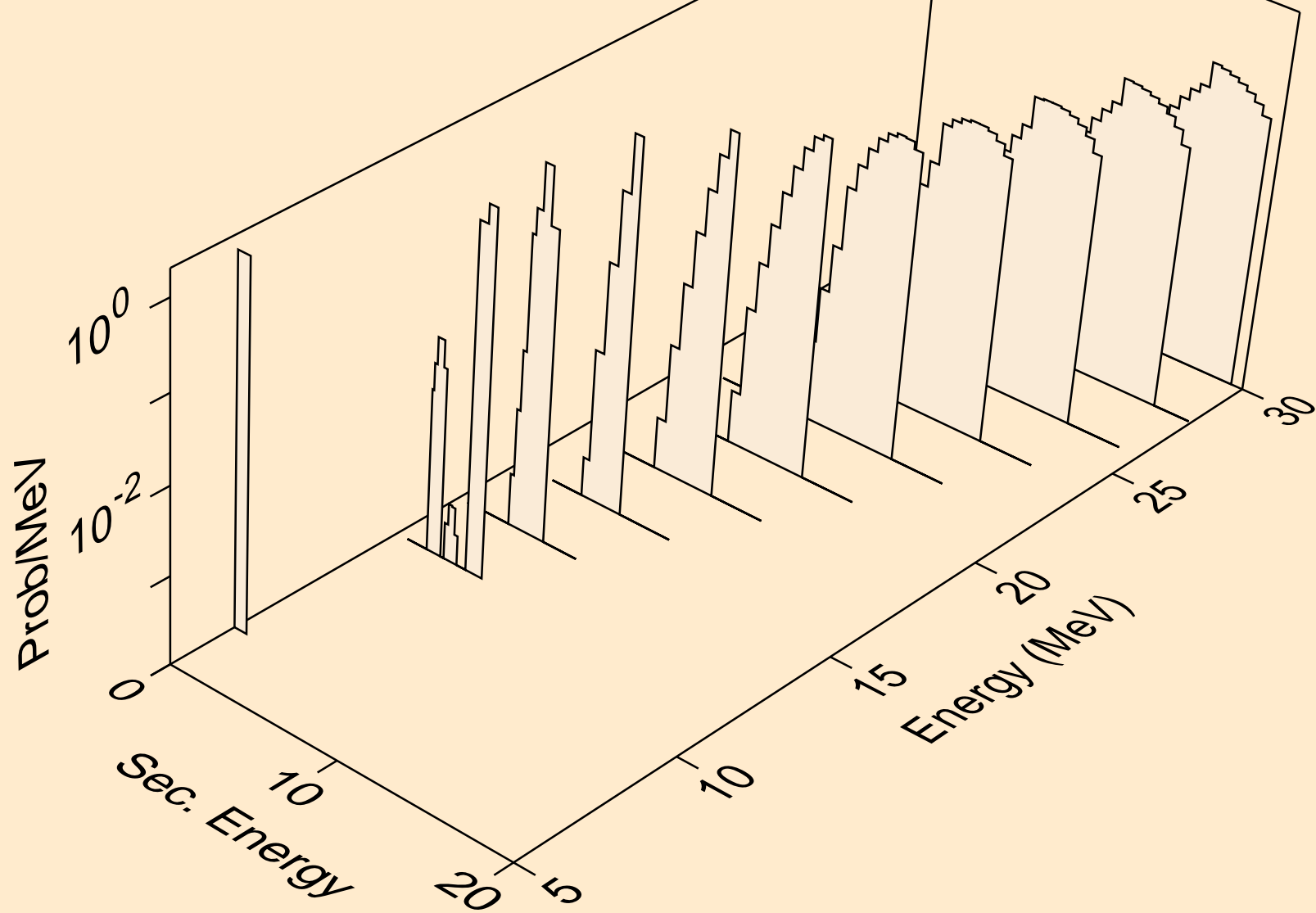



LU154M HELION ACER TENDL-2021 LIBRARY; T=0.K  
tritons from (s,pt)

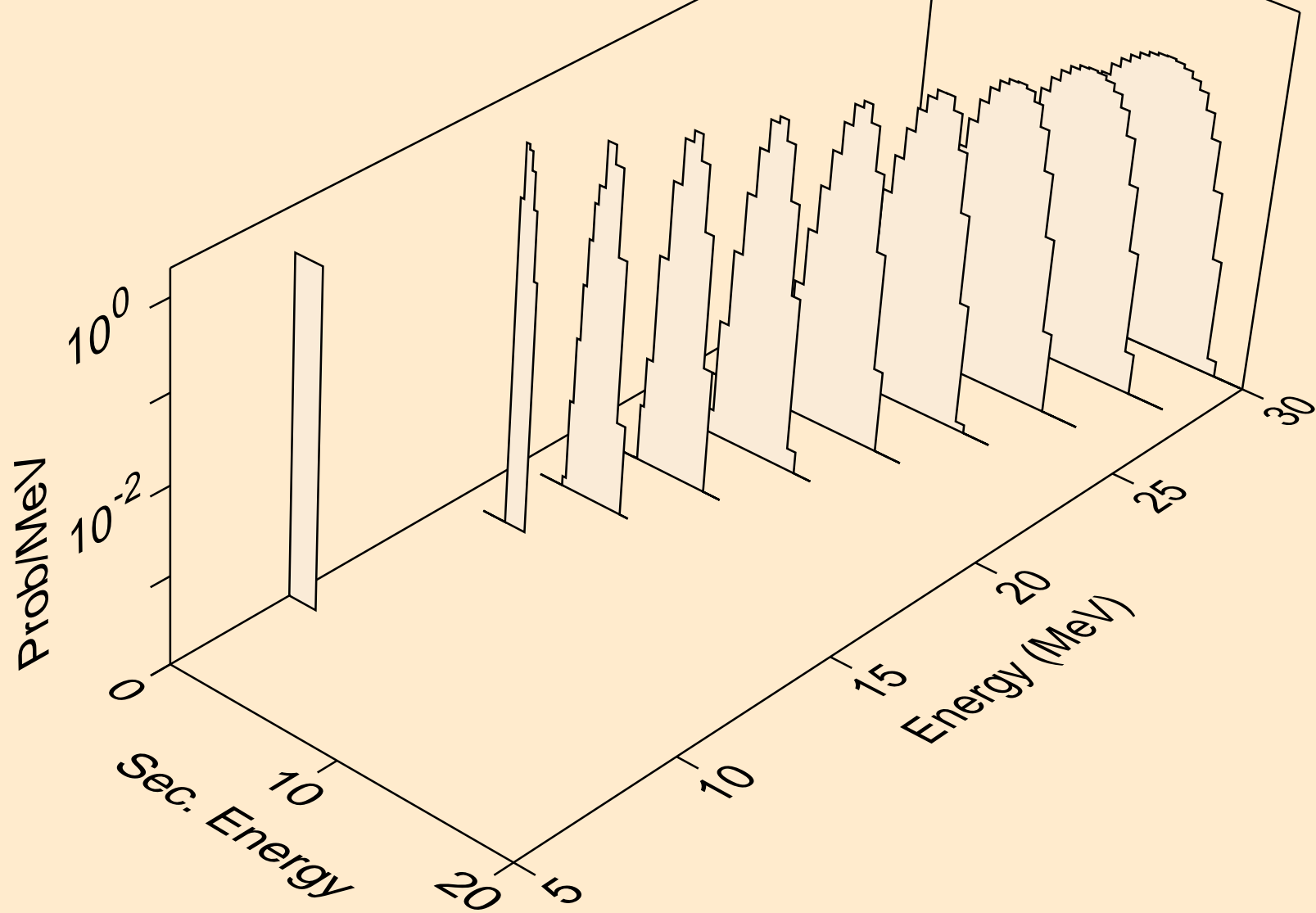

LU154M HELION ACER TENDL-2021 LIBRARY; T=0.K  
alphas from (s,x)

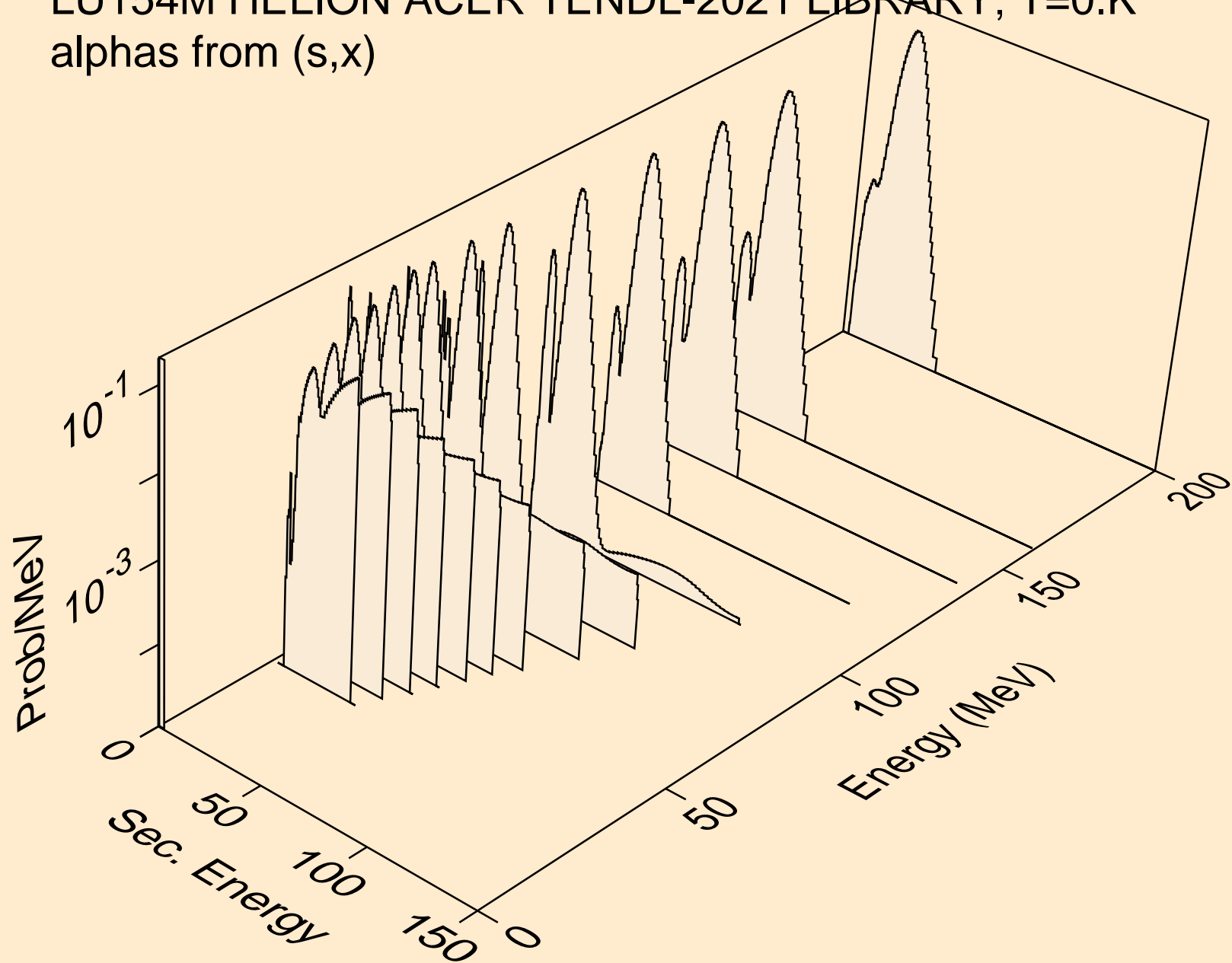

LU154M HELION ACER TENDL-2021 LIBRARY; T=0.K  
alphas from (s,n\*)a

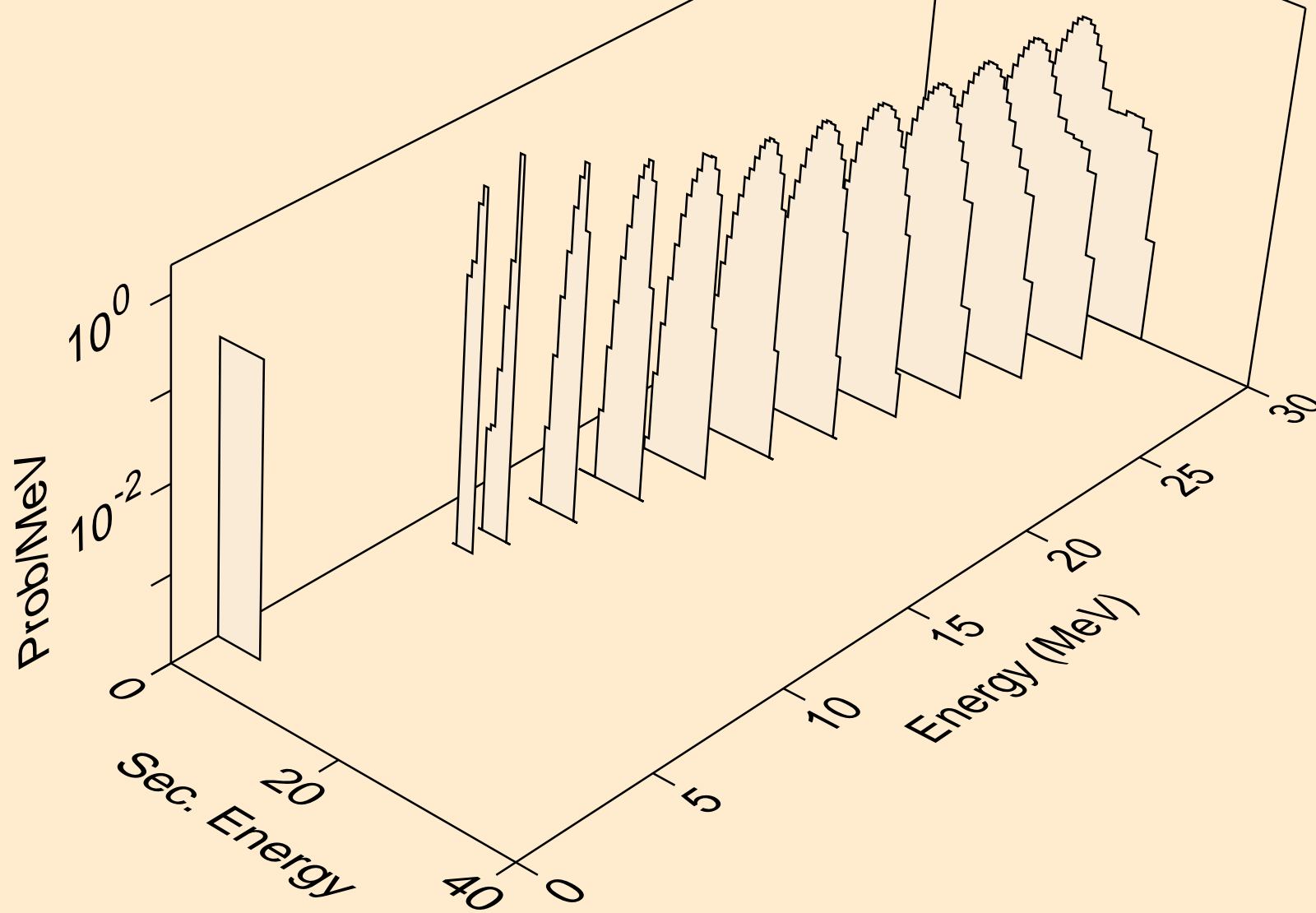

LU154M HELION ACER TENDL-2021 LIBRARY; T=0.K  
alphas from (s,2n)a

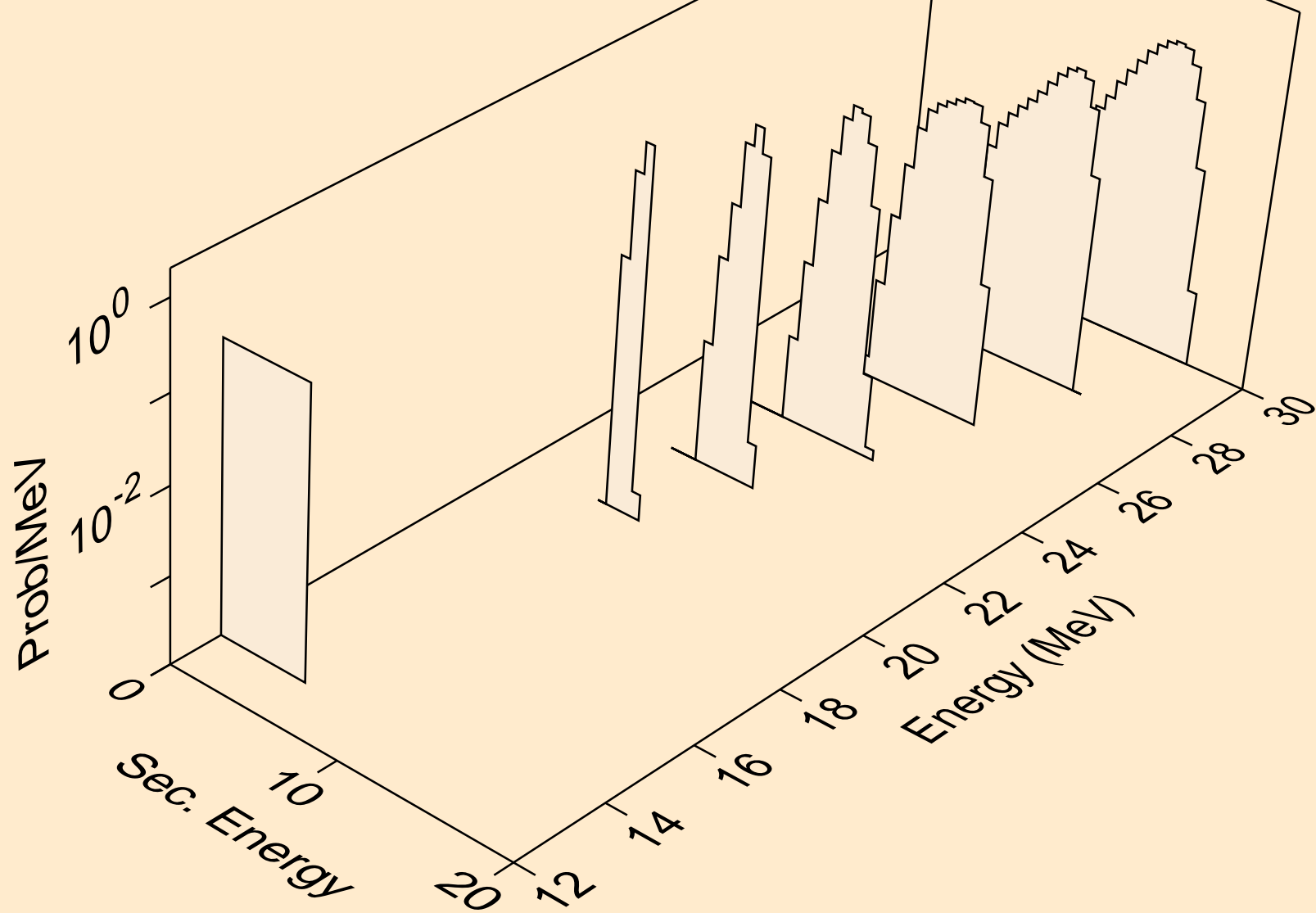

LU154M HELION ACER TENDL-2021 LIBRARY; T=0.K  
alphas from (s,npa)

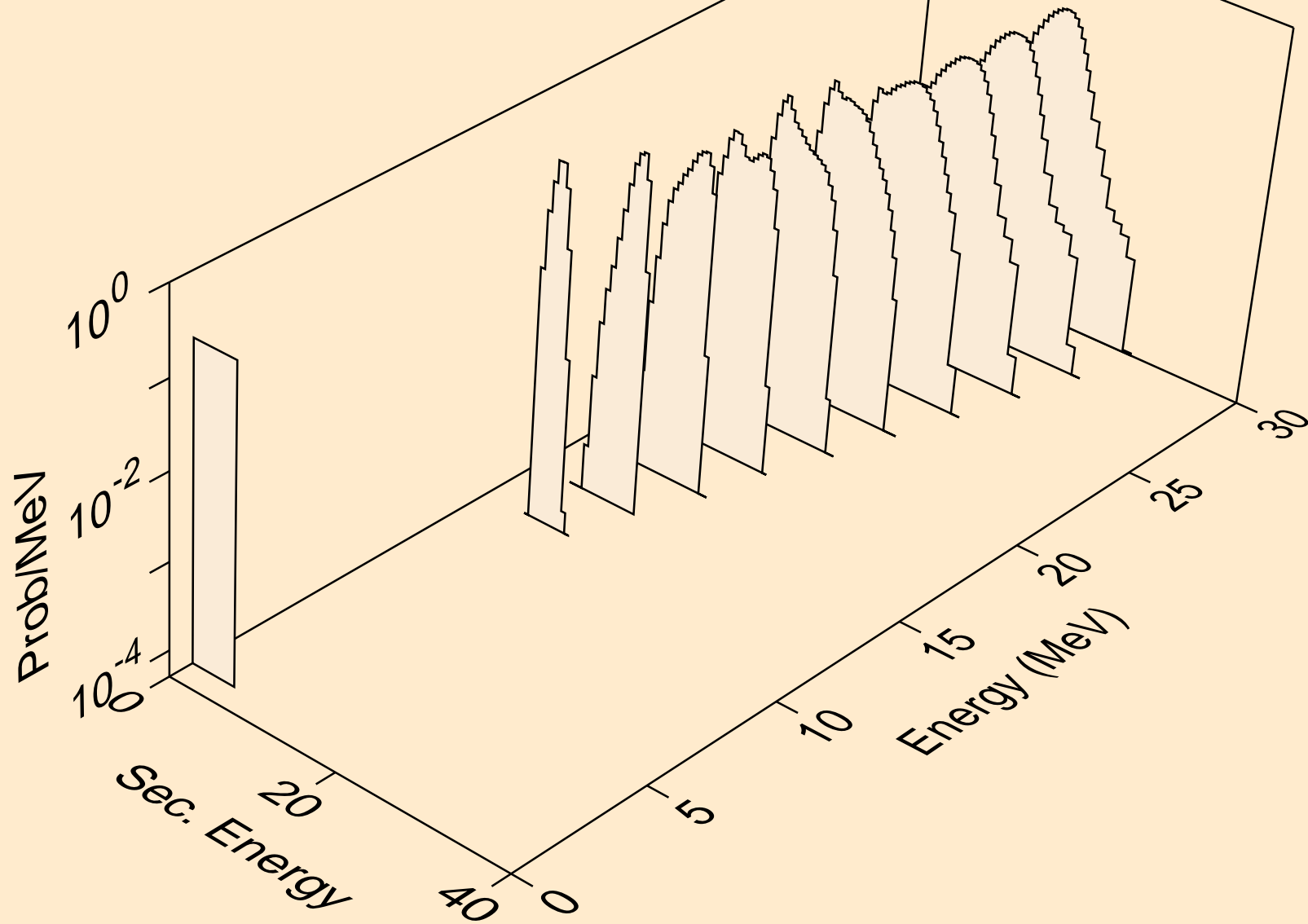

LU154M HELION ACER TENDL-2021 LIBRARY; T=0.K  
alphas from (s,a)

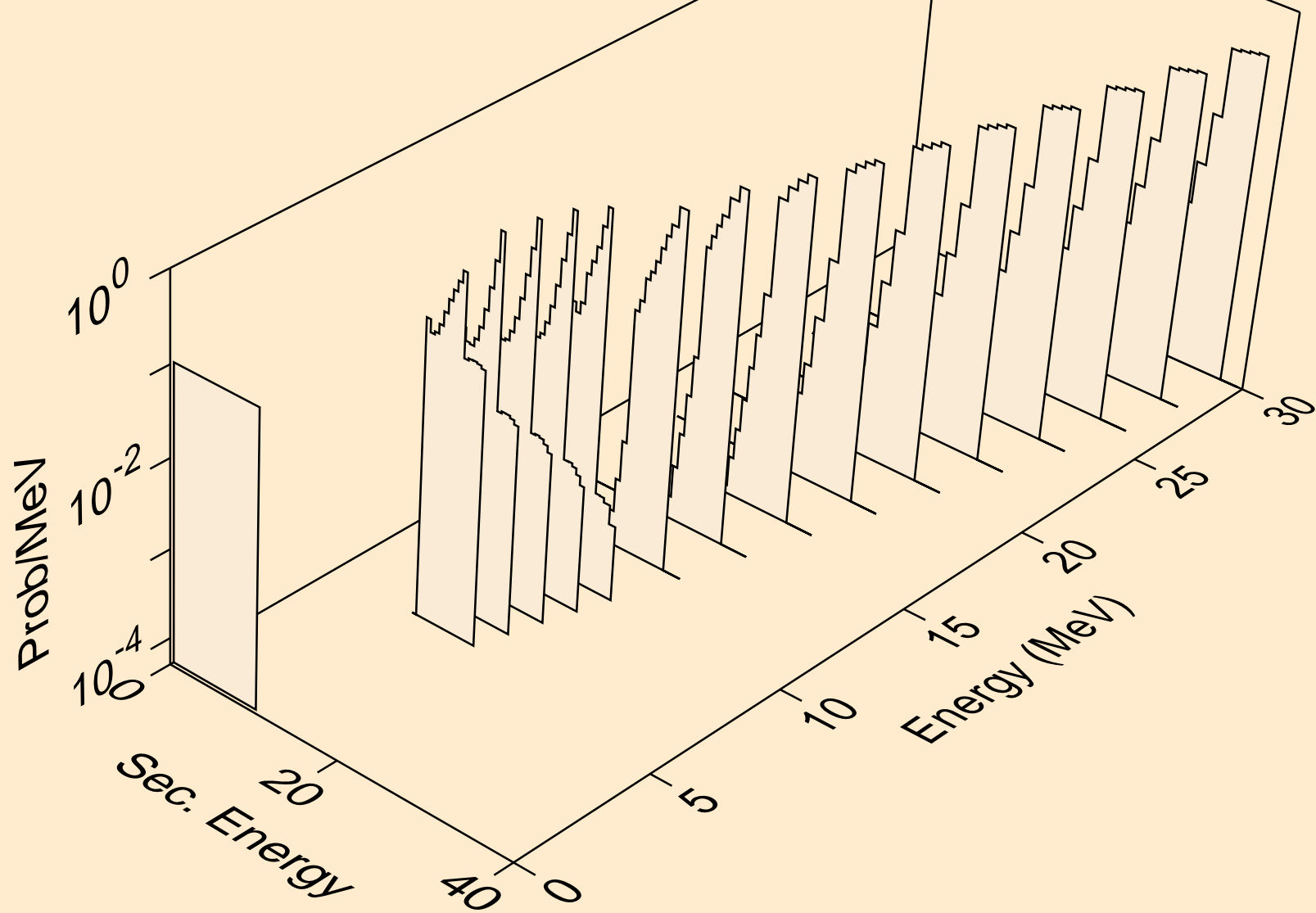

LU154M HELION ACER TENDL-2021 LIBRARY; T=0.K  
alphas from (s,2a)

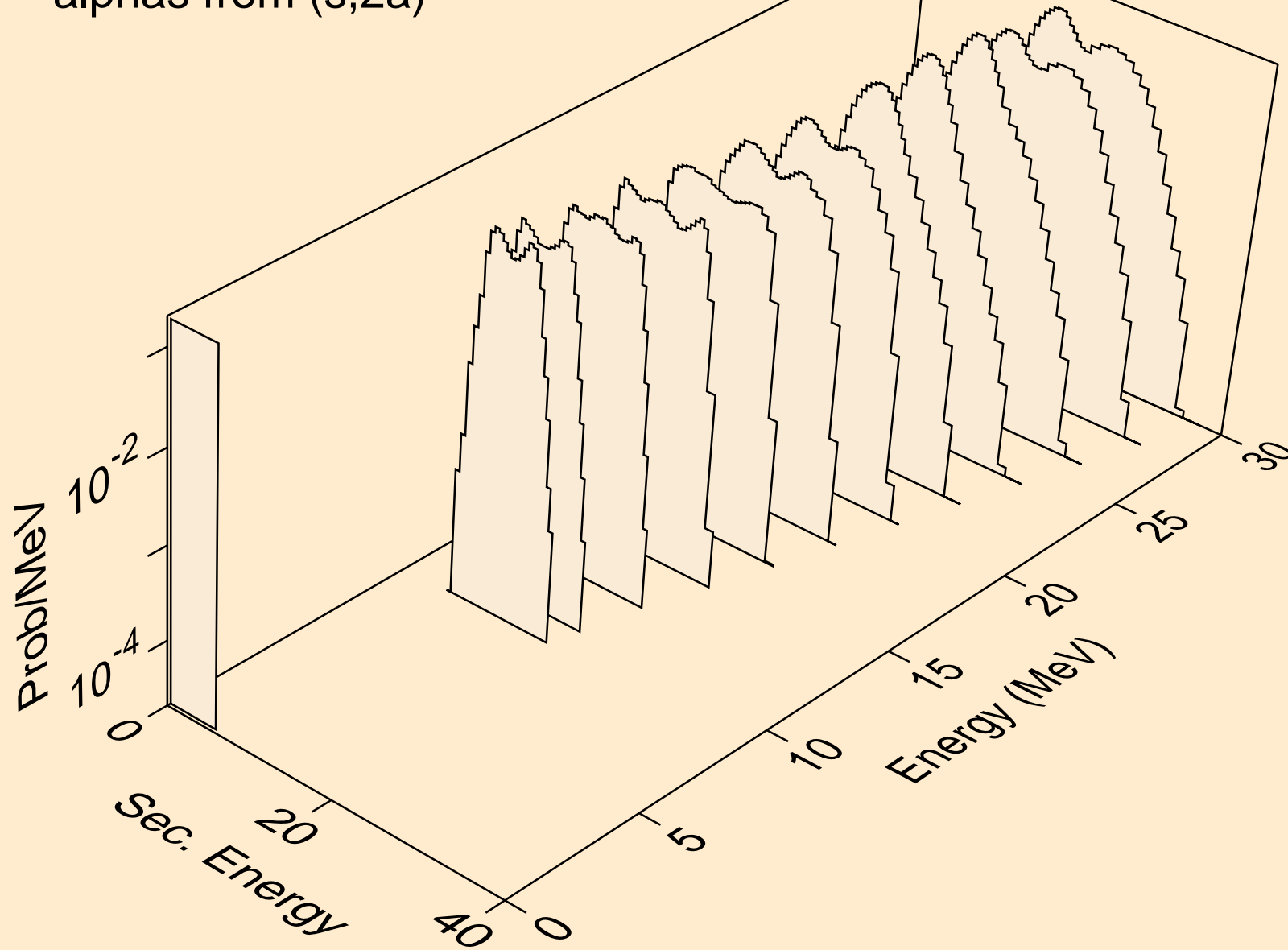

LU154M HELION ACER TENDL-2021 LIBRARY; T=0.K  
alphas from (s,pa)

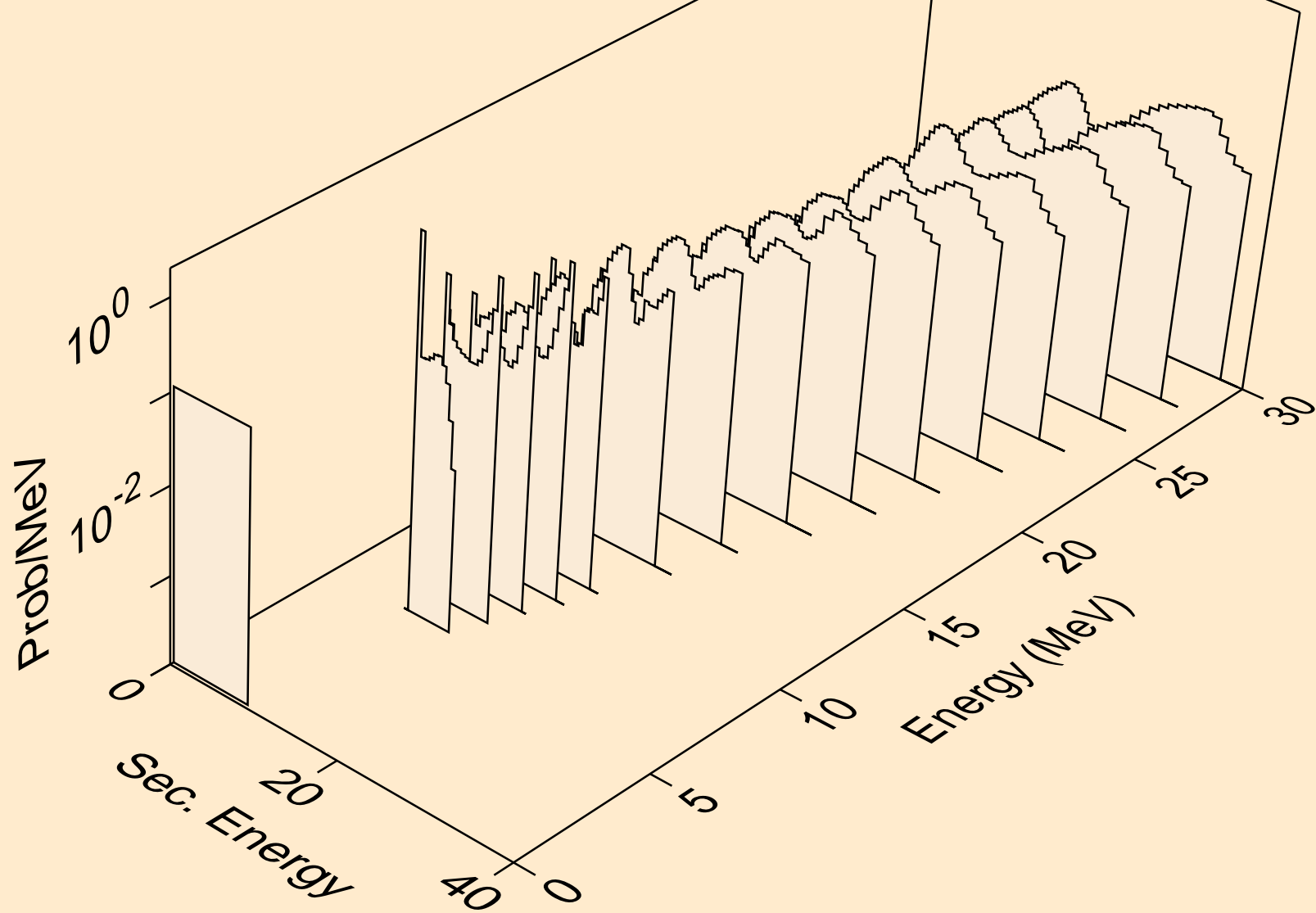



LU154M HELION ACER TENDL-2021 LIBRARY; T=0.K  
alphas from (s,da)

