

LU160 HELION ACER TENDL-2021 LIBRARY; T=0.K
Principal cross sections

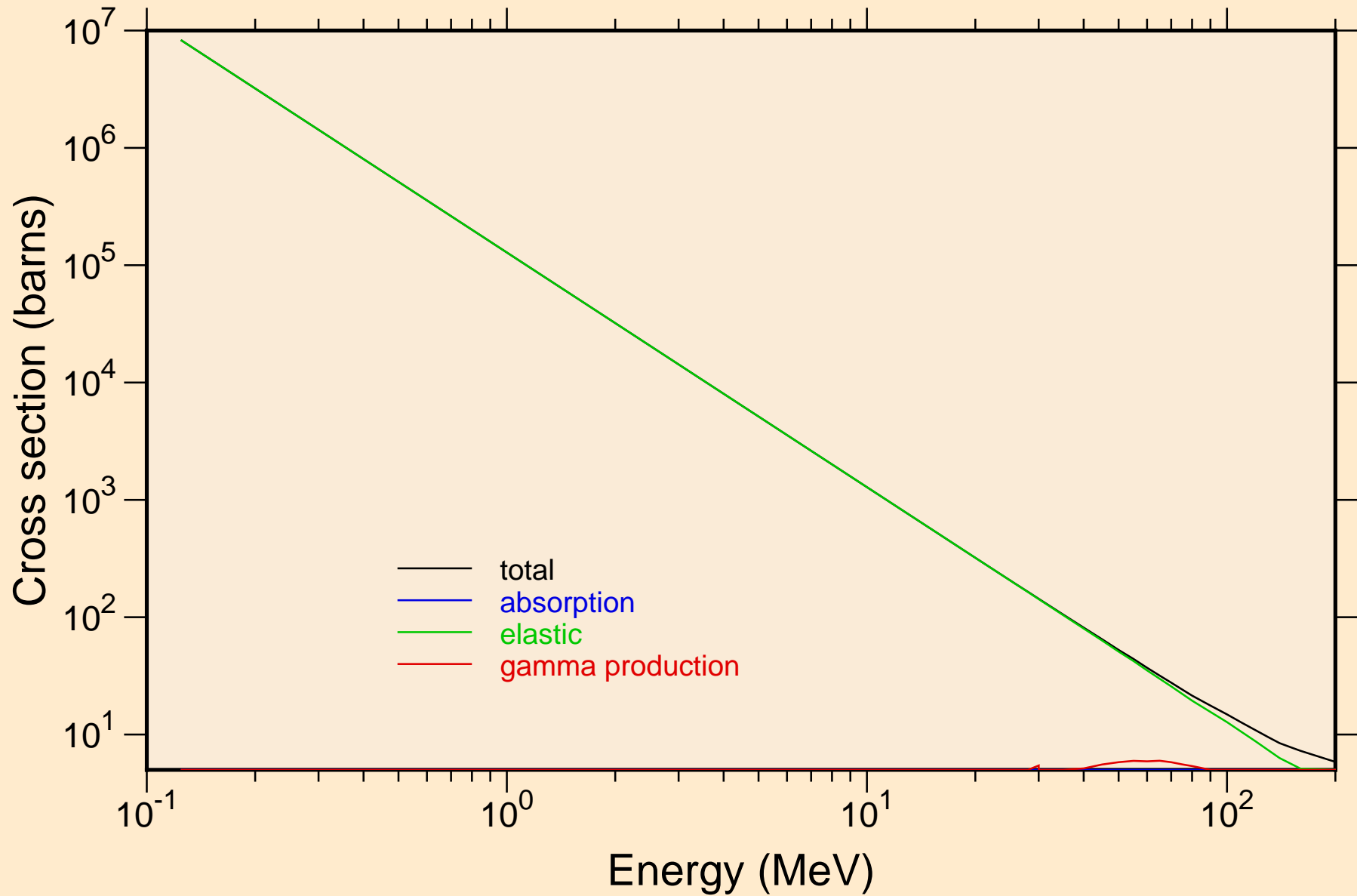

LU160 HELION ACER TENDL-2021 LIBRARY; T=0.K

Heating

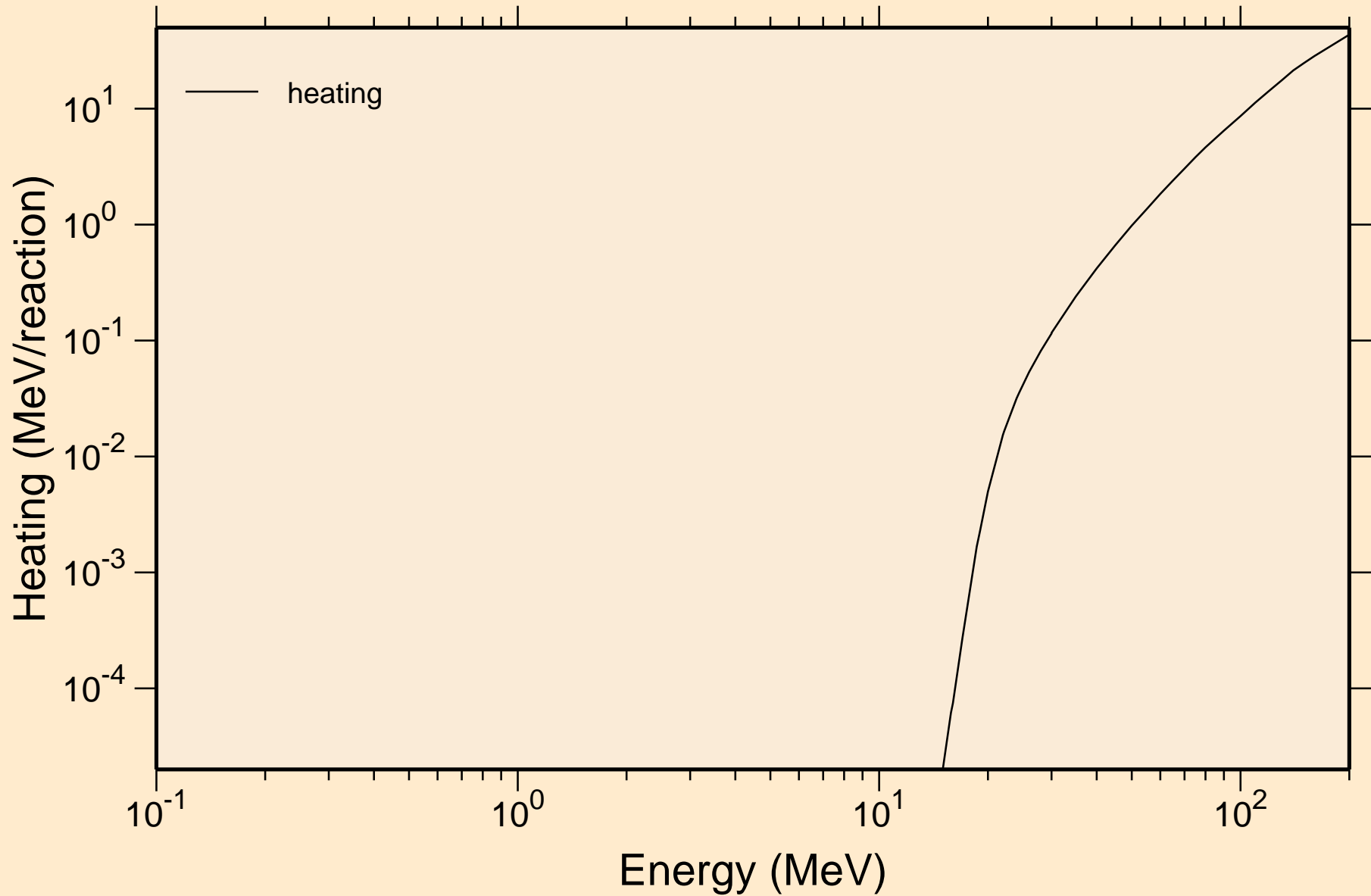

LU160 HELION ACER TENDL-2021 LIBRARY; T=0.K

Principal cross sections

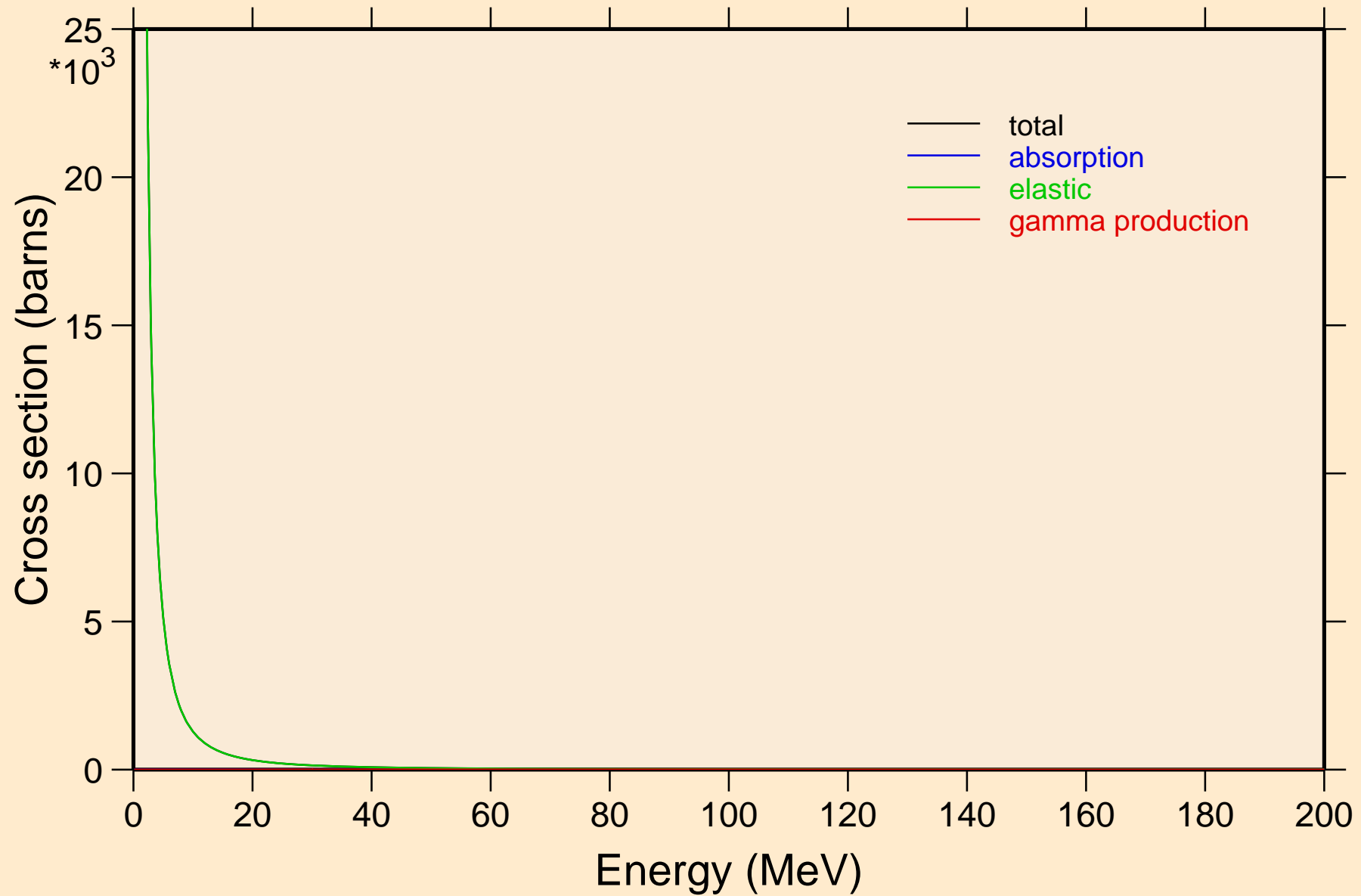

LU160 HELION ACER TENDL-2021 LIBRARY; T=0.K

Heating

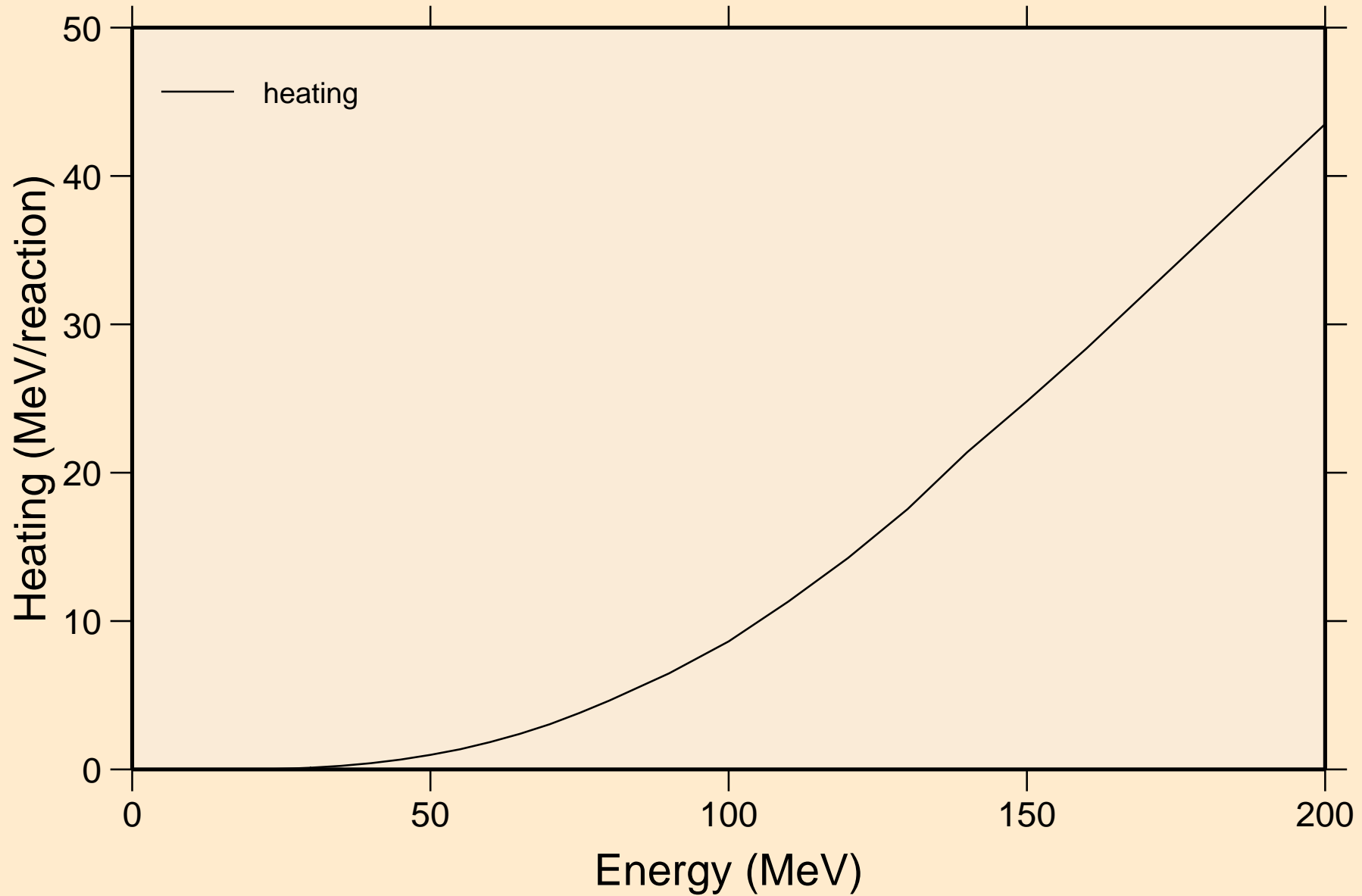

LU160 HELION ACER TENDL-2021 LIBRARY; T=0.K
Threshold reactions

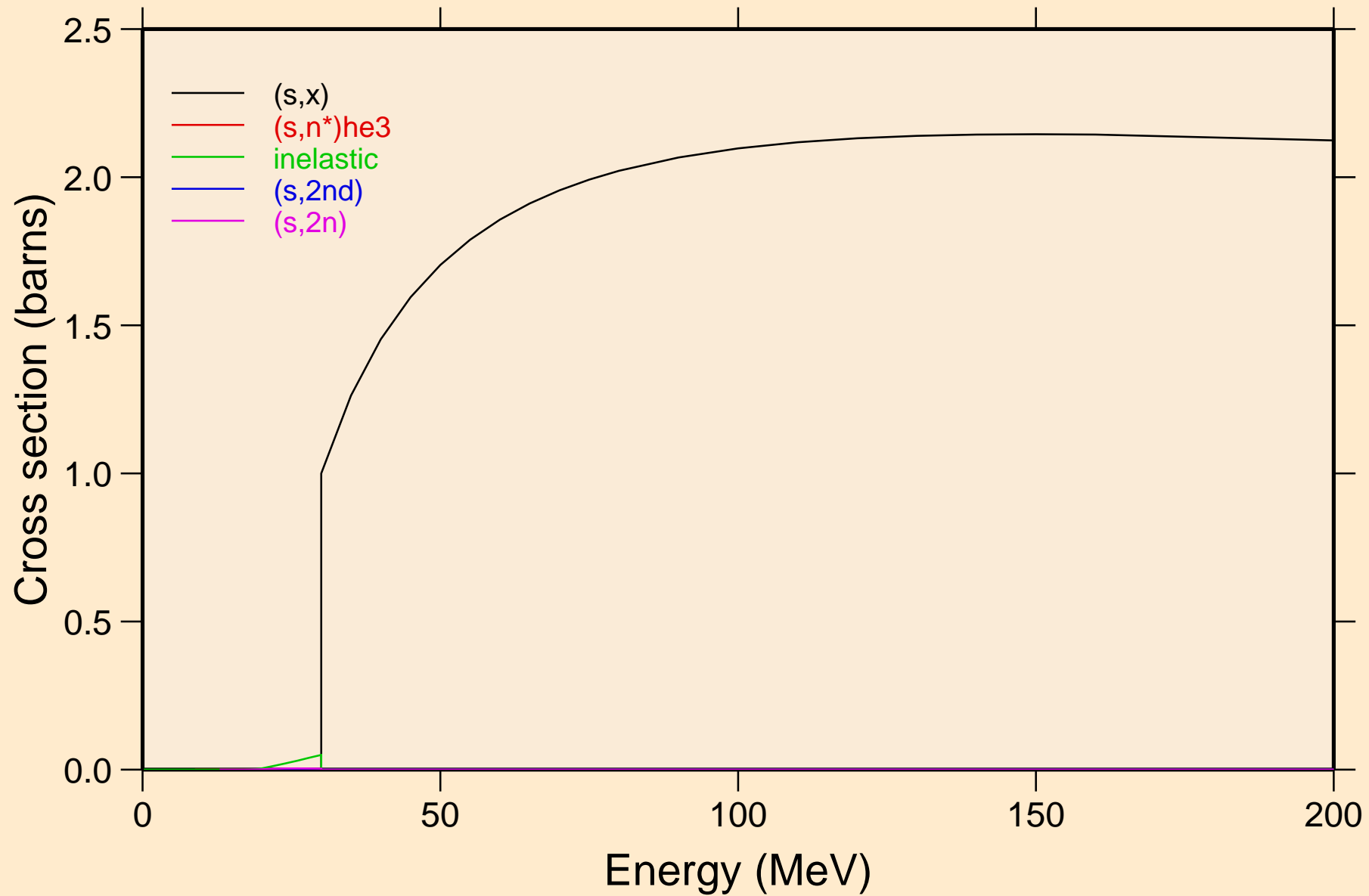

LU160 HELION ACER TENDL-2021 LIBRARY; T=0.K
Threshold reactions

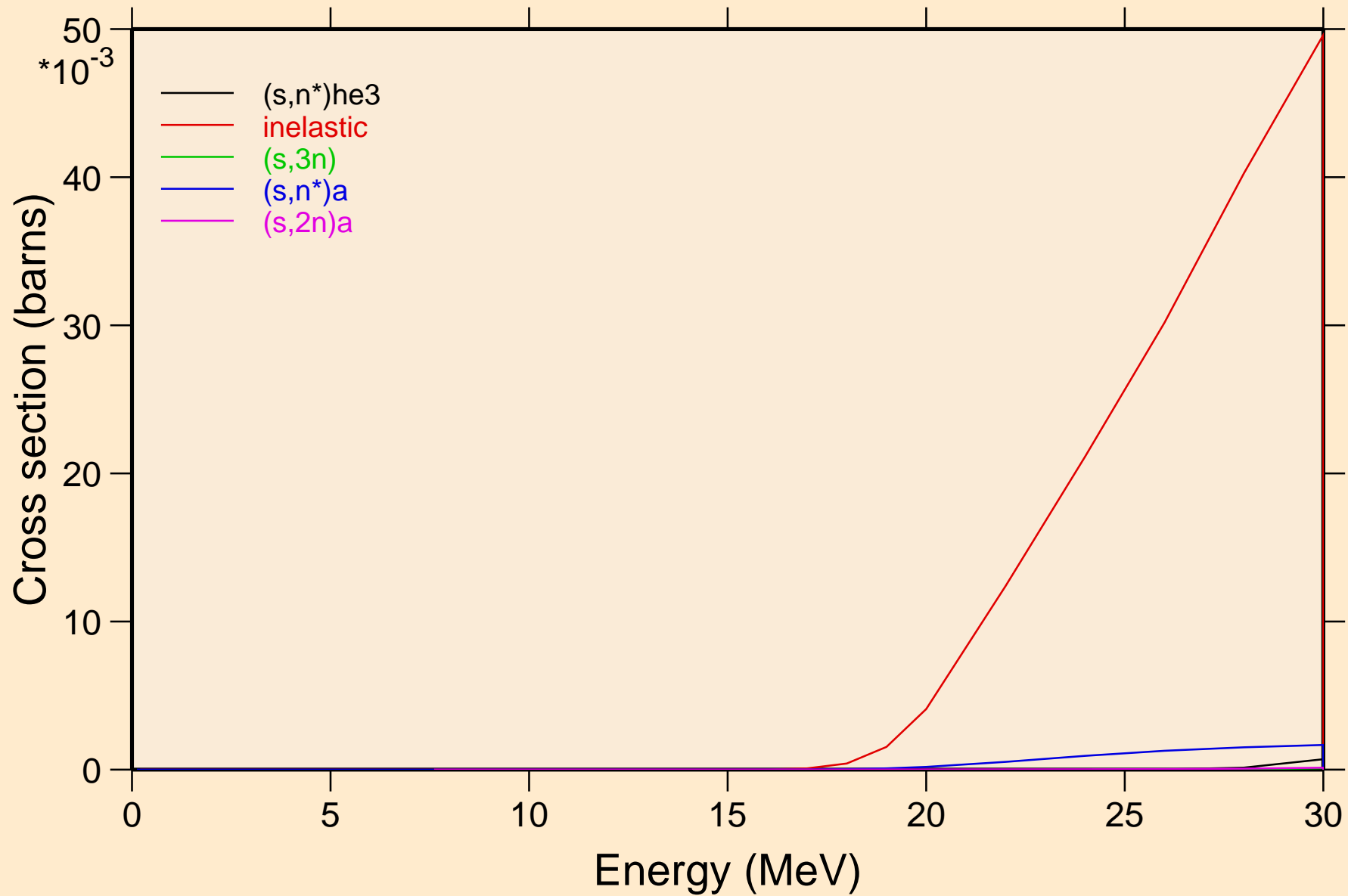

LU160 HELION ACER TENDL-2021 LIBRARY; T=0.K
Threshold reactions

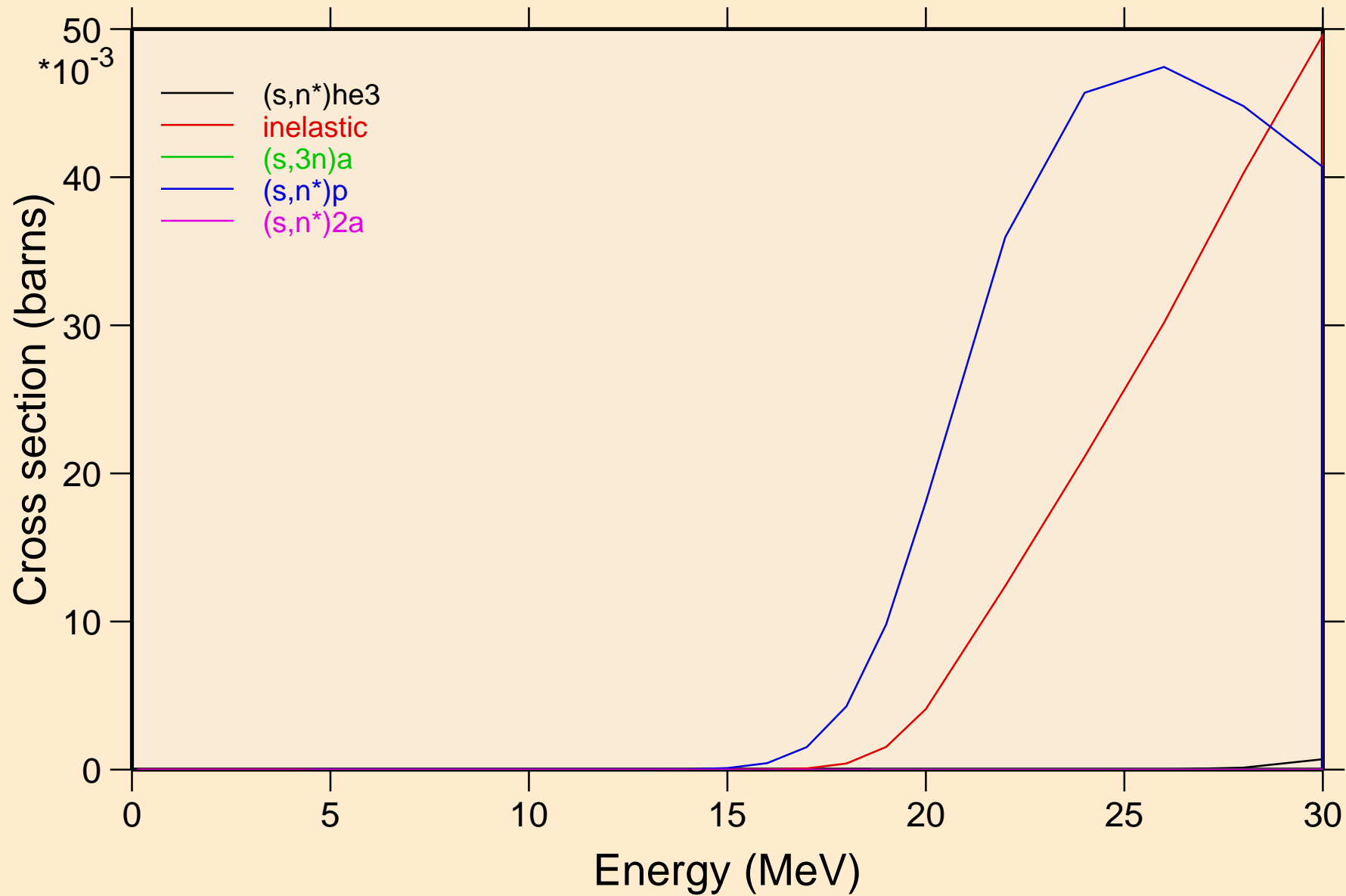

LU160 HELION ACER TENDL-2021 LIBRARY; T=0.K
Threshold reactions

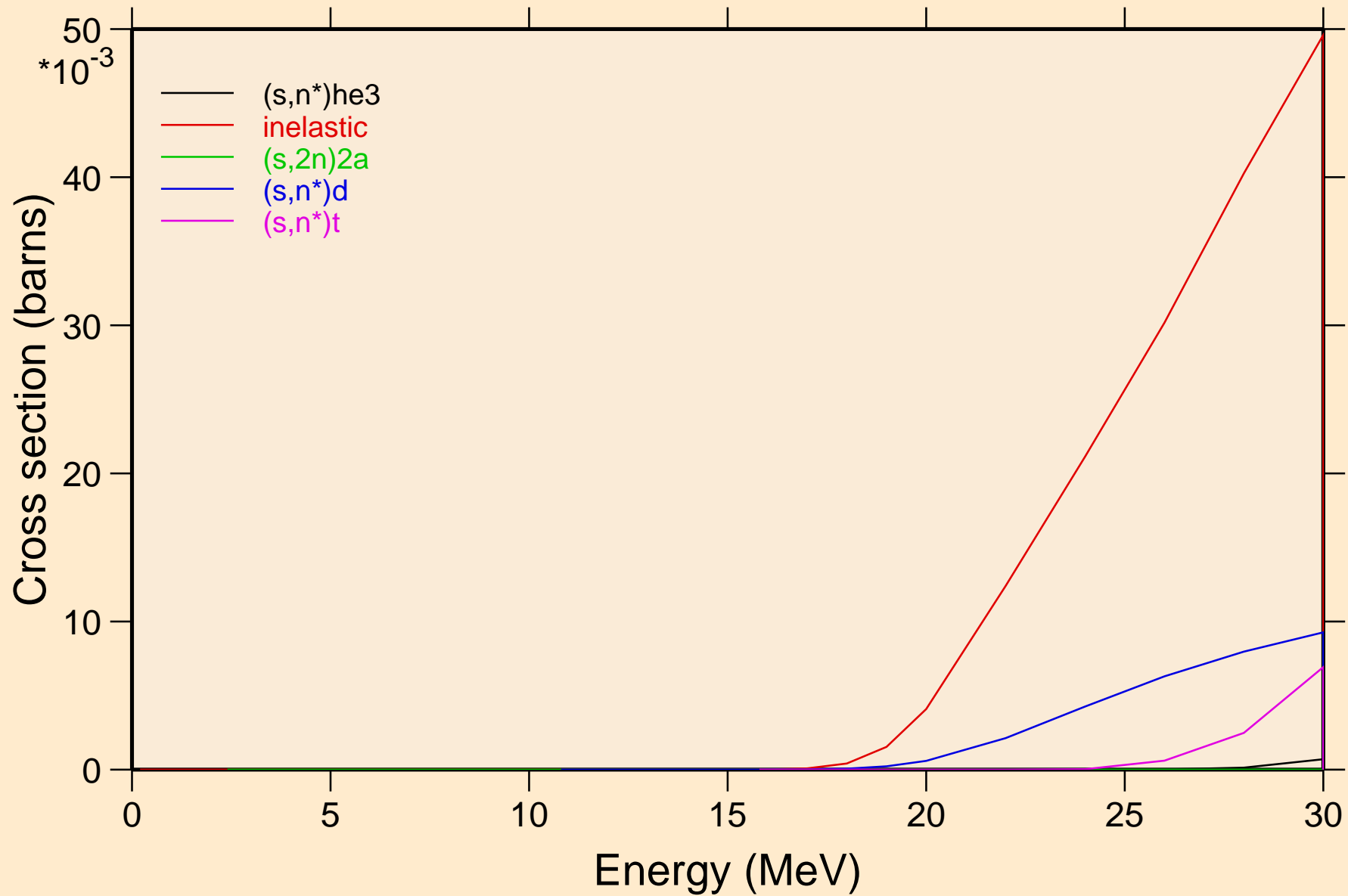

LU160 HELION ACER TENDL-2021 LIBRARY; T=0.K
Threshold reactions

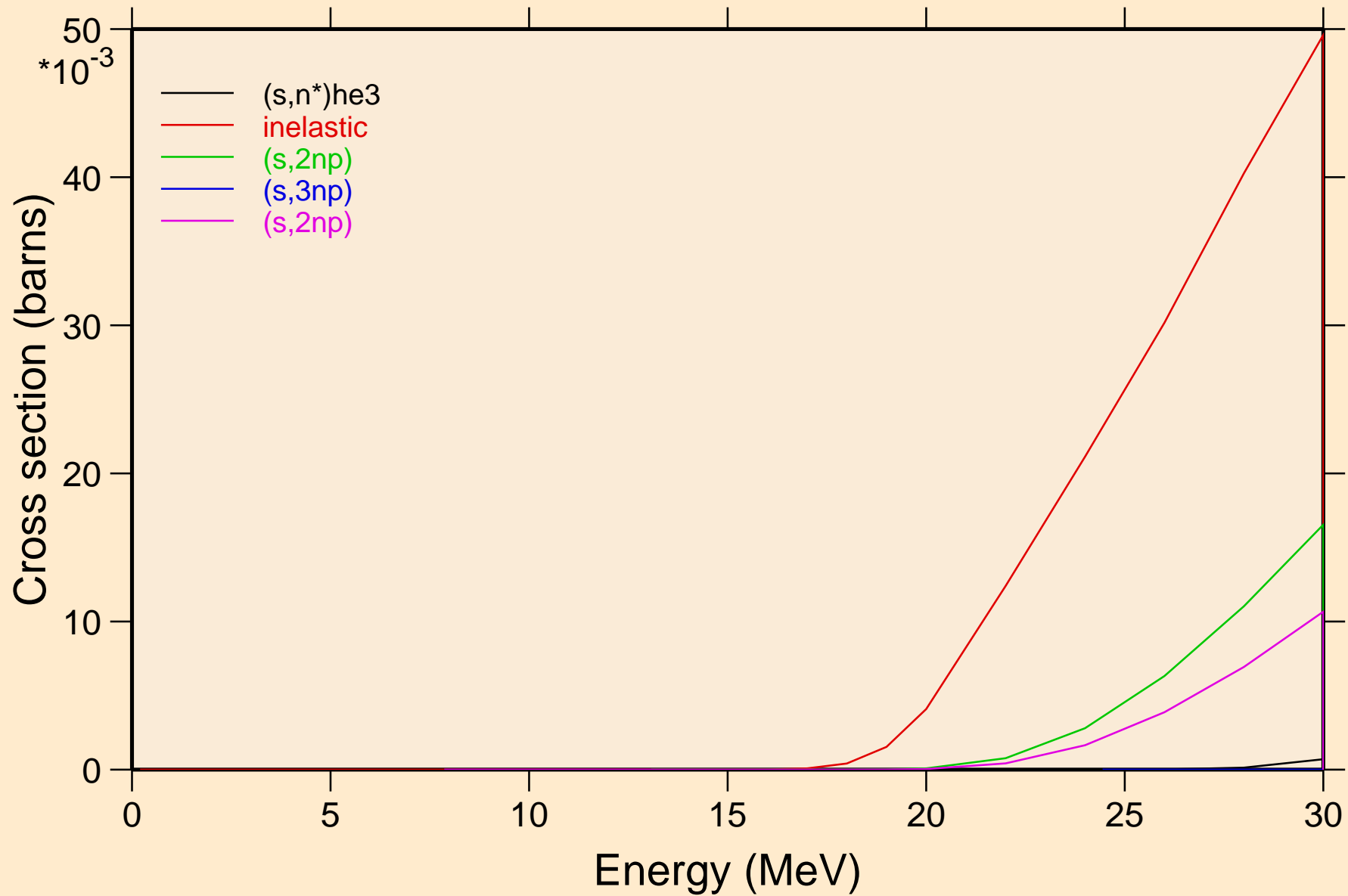

LU160 HELION ACER TENDL-2021 LIBRARY; T=0.K
Threshold reactions

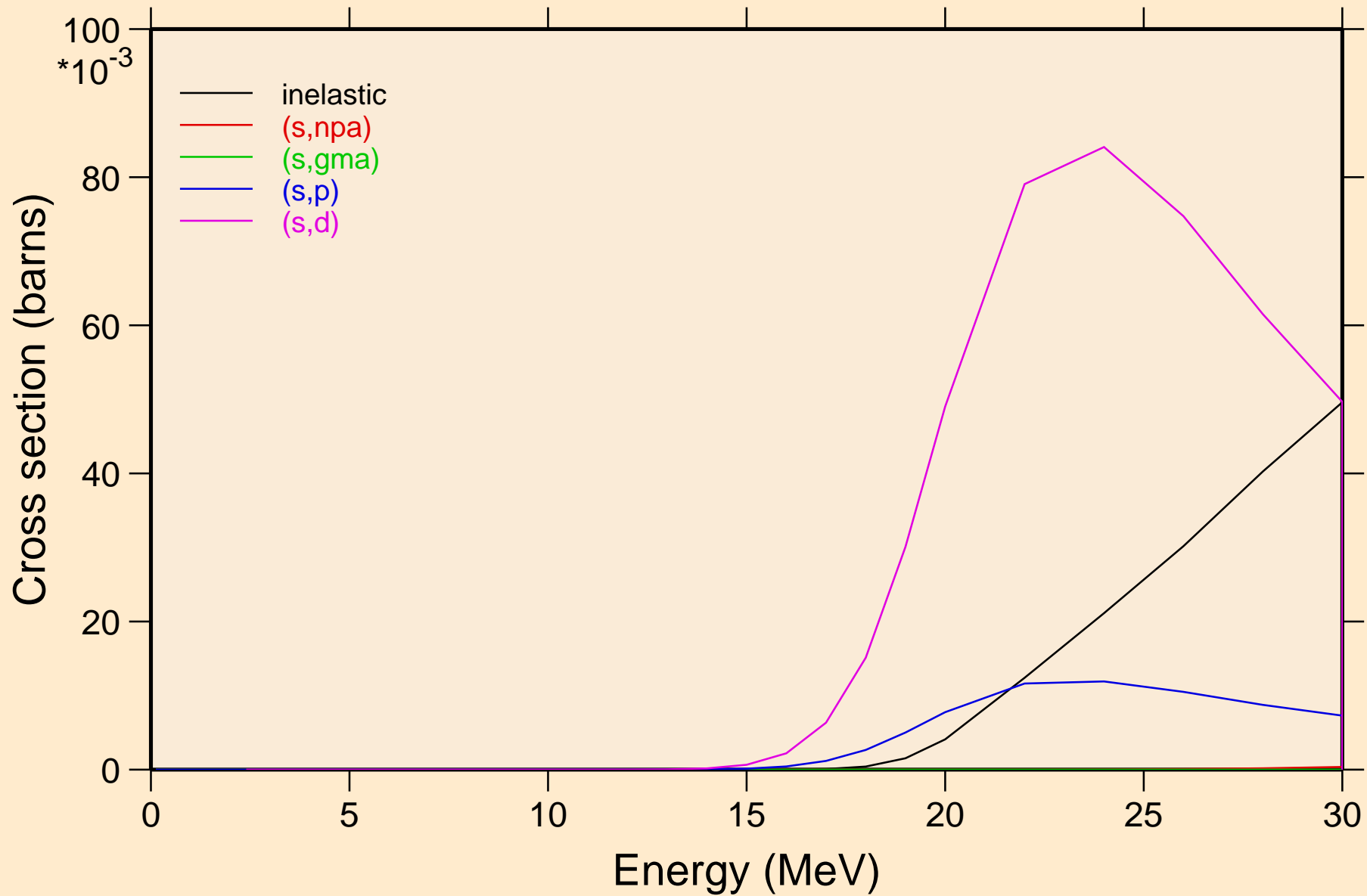

LU160 HELION ACER TENDL-2021 LIBRARY; T=0.K
Threshold reactions

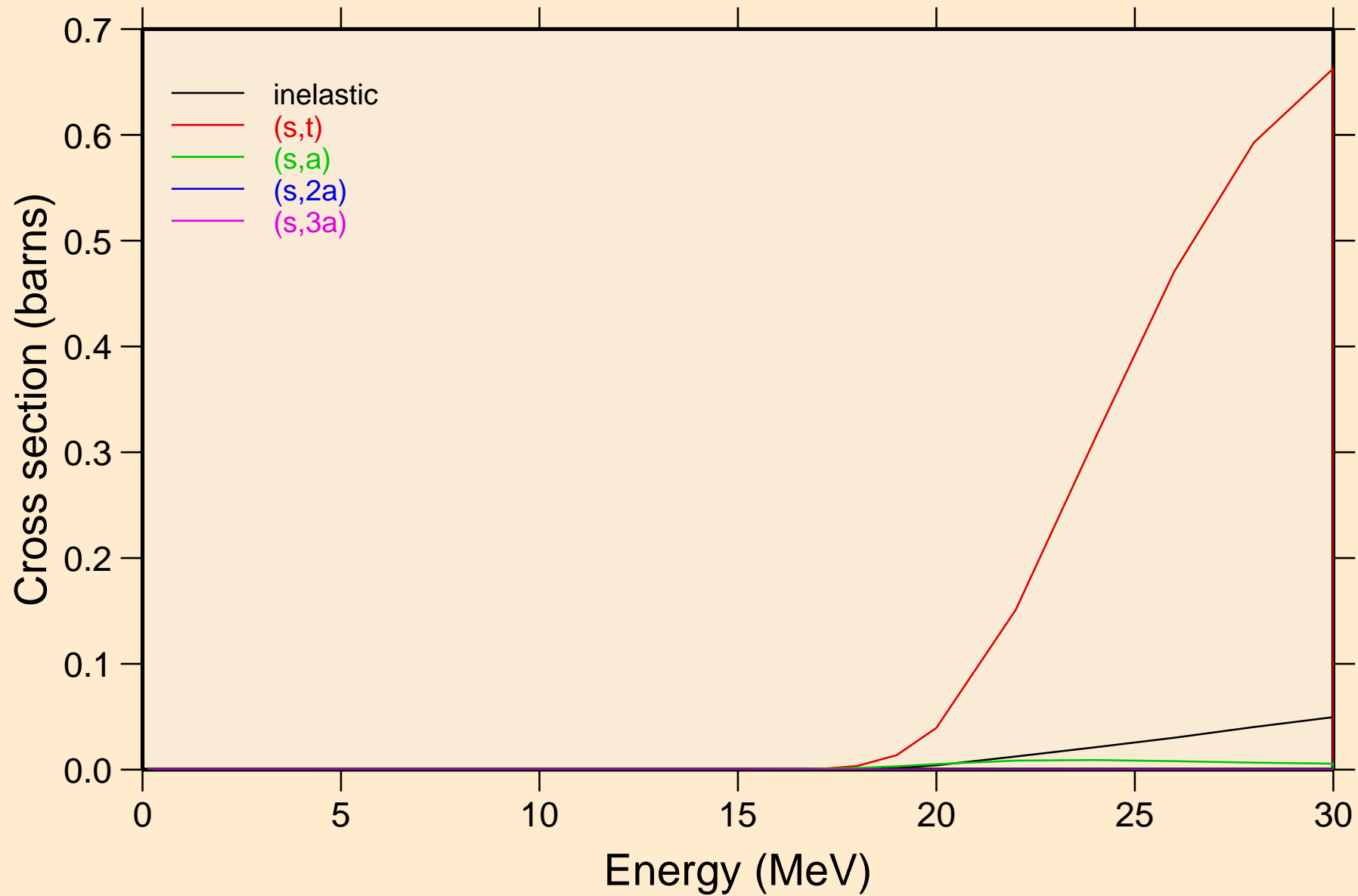

LU160 HELION ACER TENDL-2021 LIBRARY; T=0.K
Threshold reactions

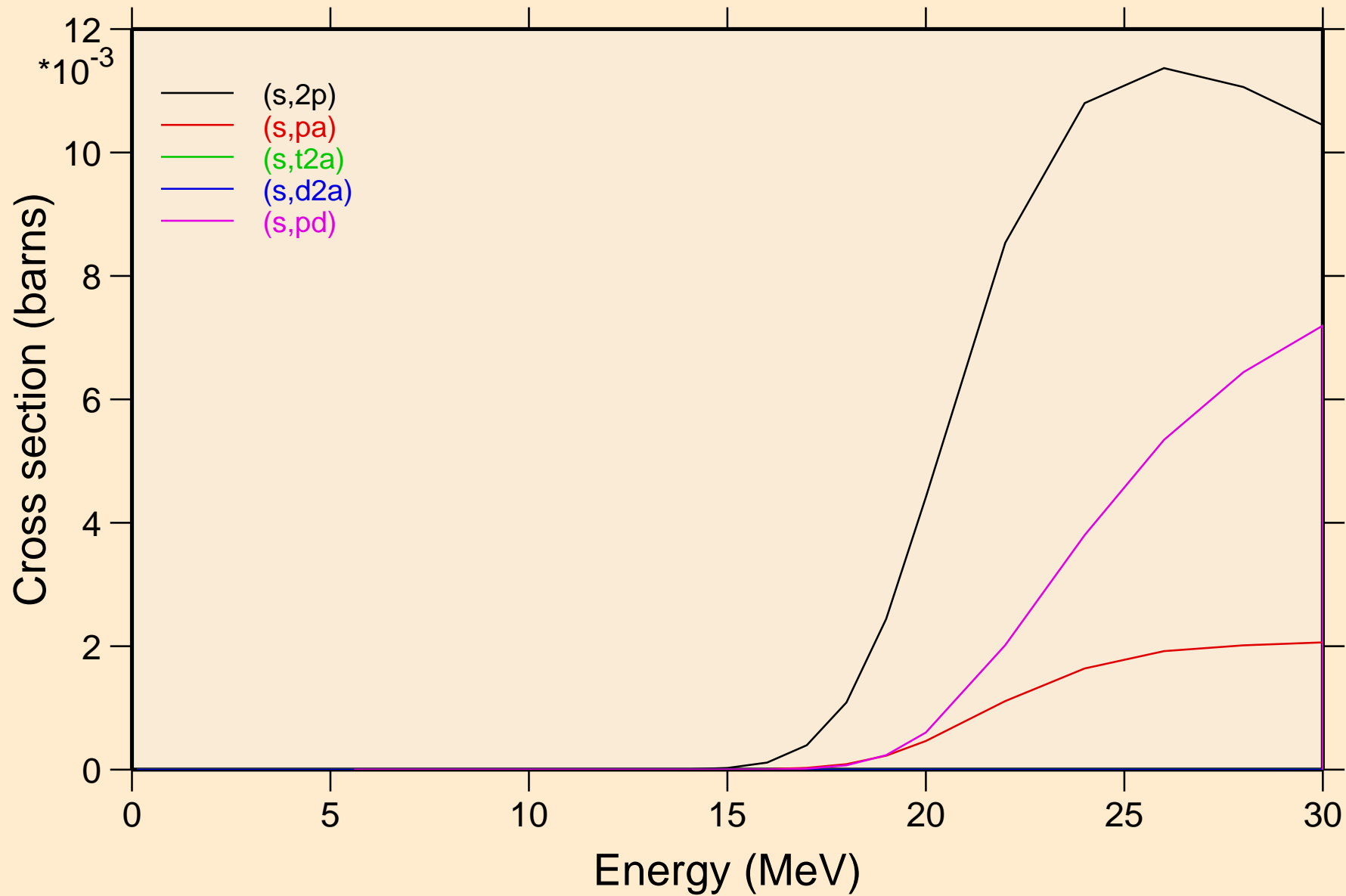

LU160 HELION ACER TENDL-2021 LIBRARY; T=0.K
Threshold reactions

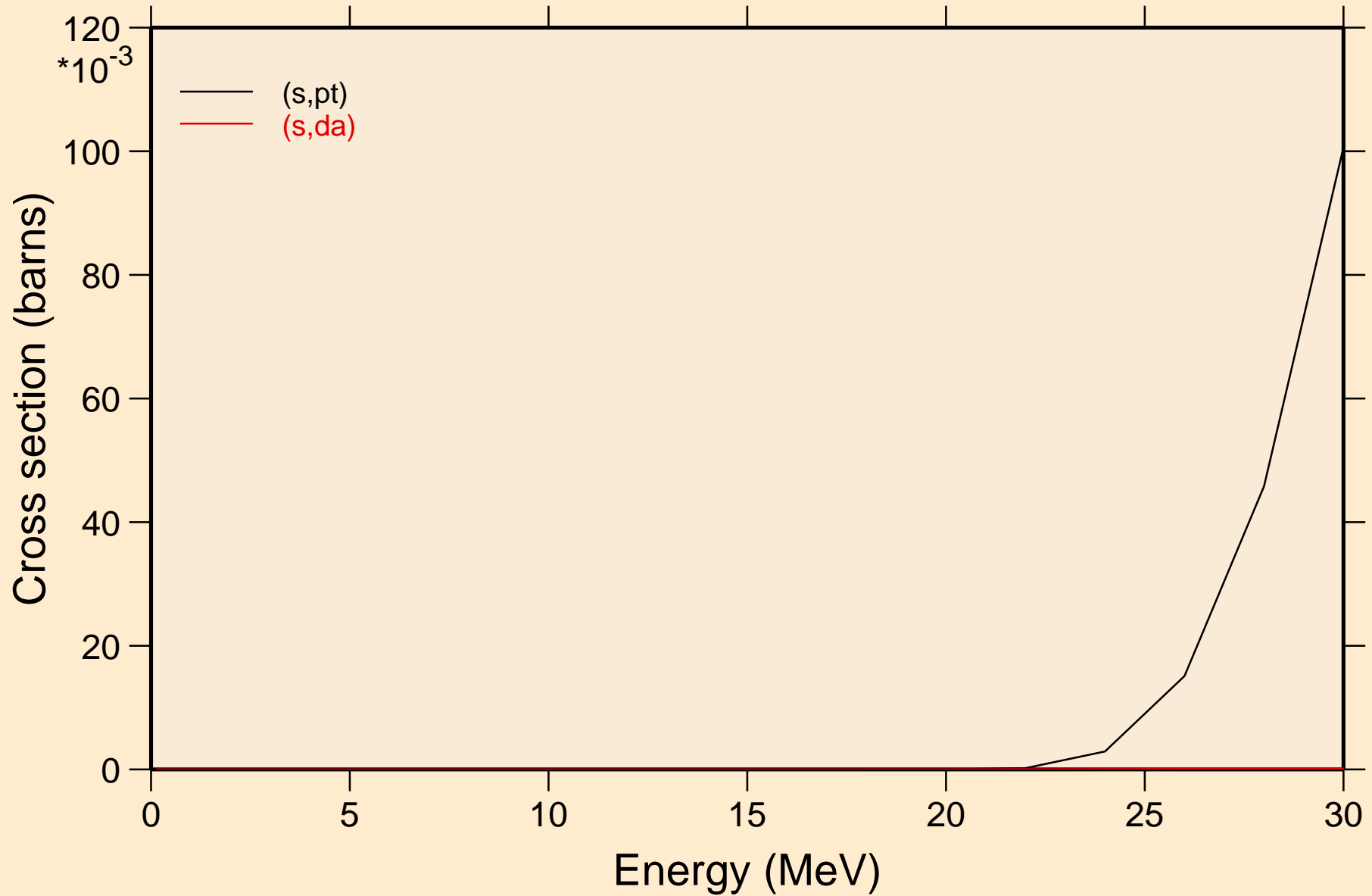

LU160 HELION ACER TENDL-2021 LIBRARY; T=0.K
angular distribution for elastic

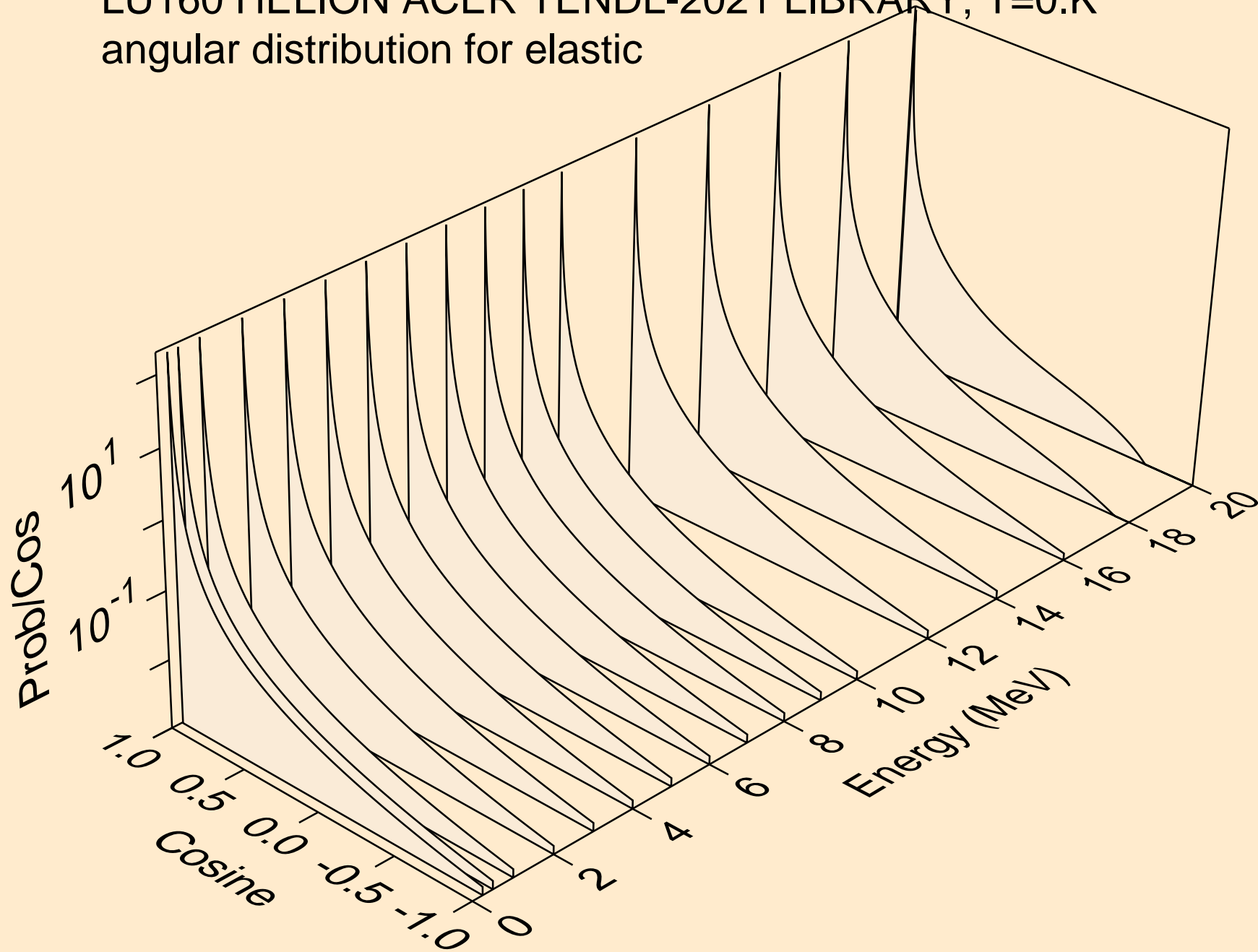

LU160 HELION ACER TENDL-2021 LIBRARY; T=0.K
angular distribution for elastic

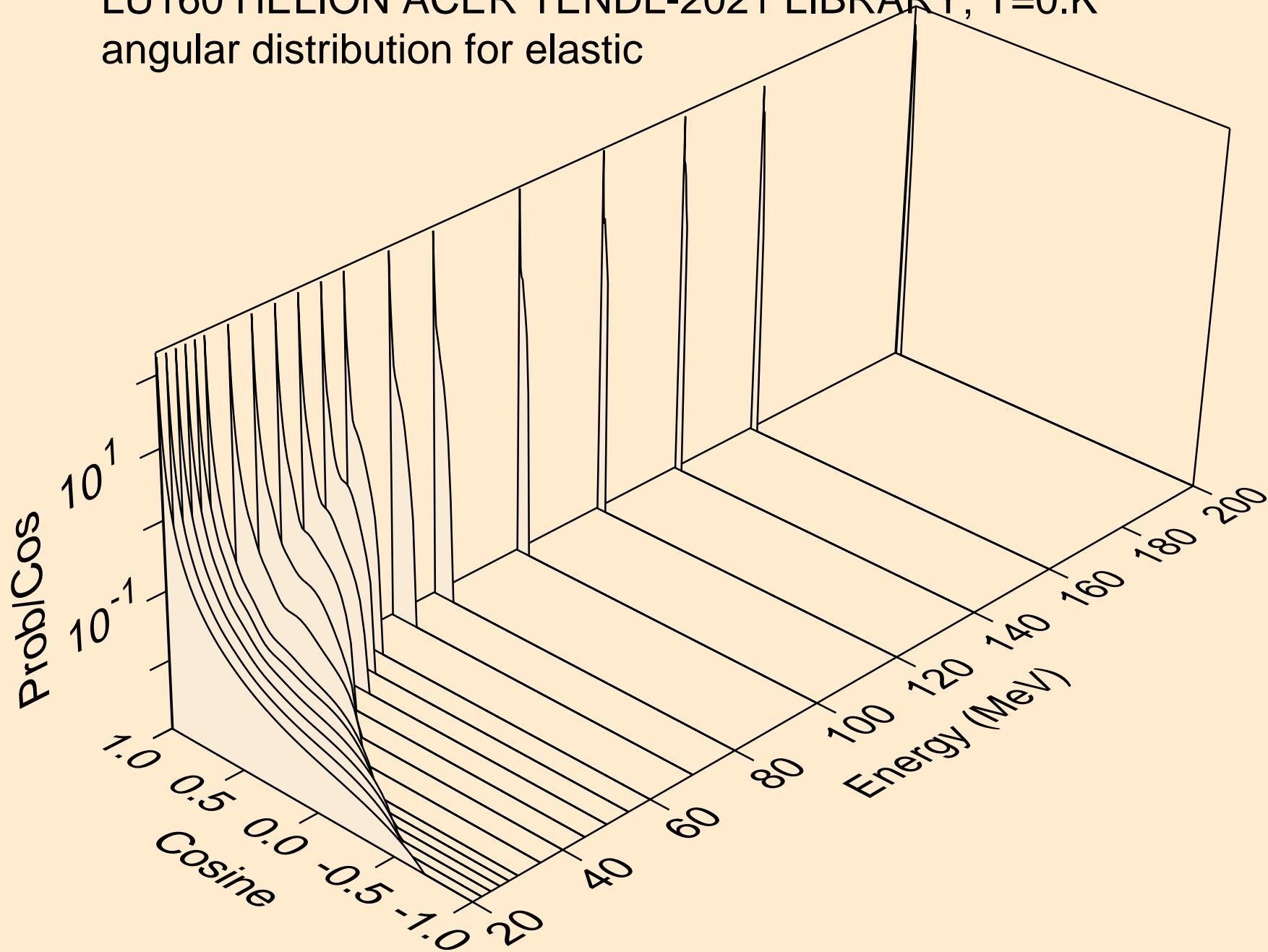

LU160 HELION ACER TENDL-2021 LIBRARY; T=0.K
He-3 emission for (s,x)

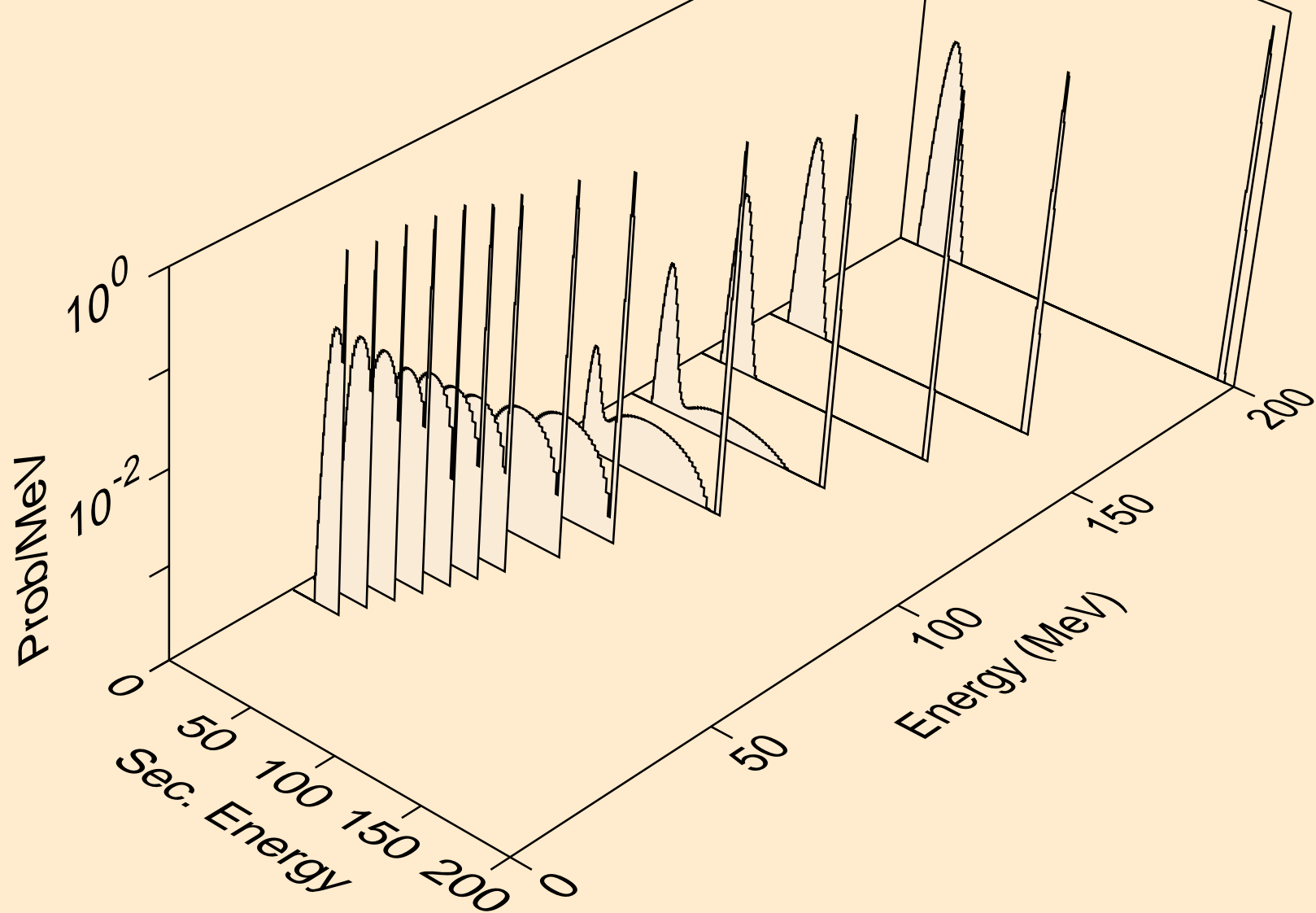

LU160 HELION ACER TENDL-2021 LIBRARY; T=0.K
He-3 emission for (s,n*)he3

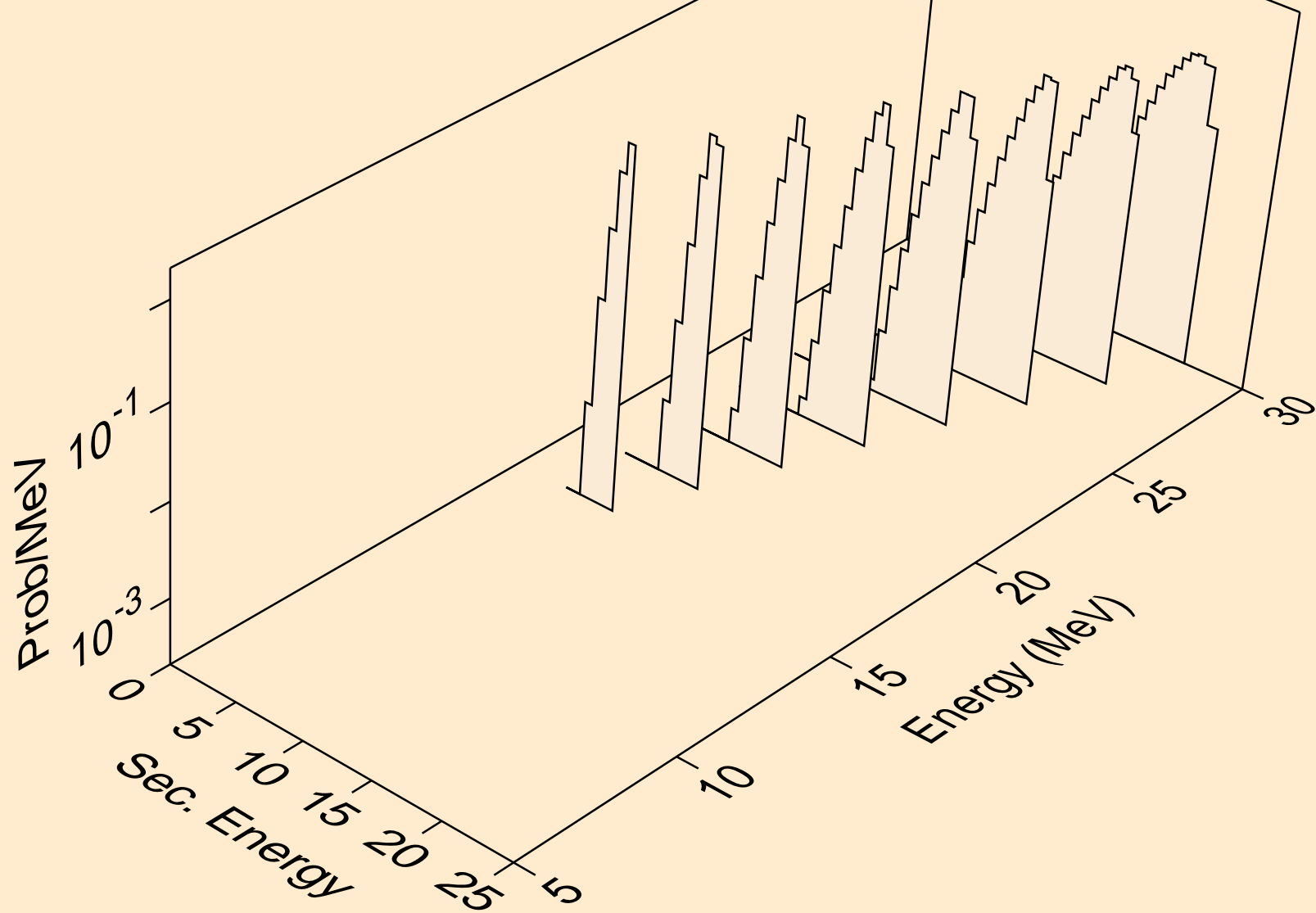

LU160 HELION ACER TENDL-2021 LIBRARY; T=0.K
He-3 emission for inelastic

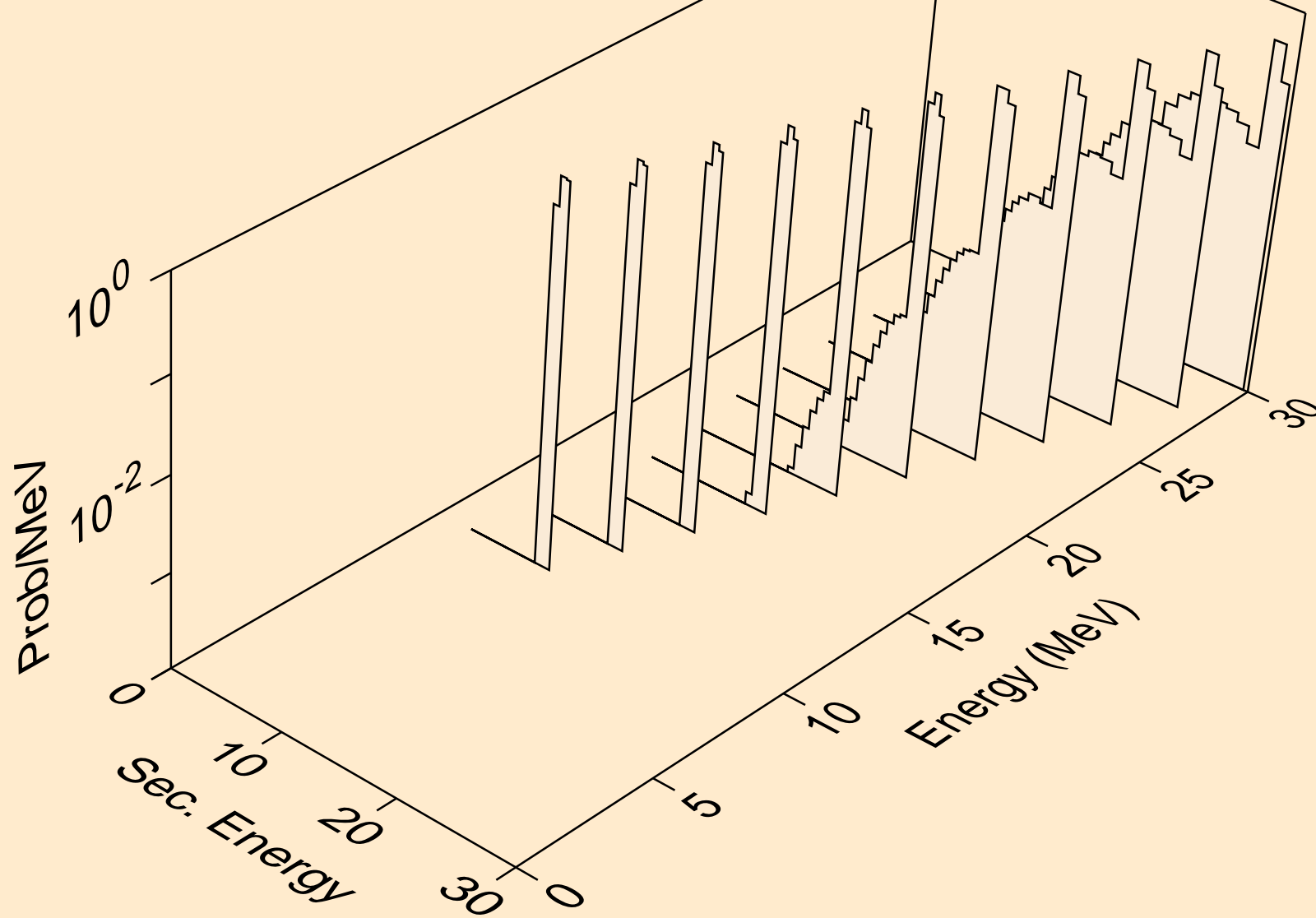

LU160 HELION ACER TENDL-2021 LIBRARY; T=0.K
Photon emission for (z,n)

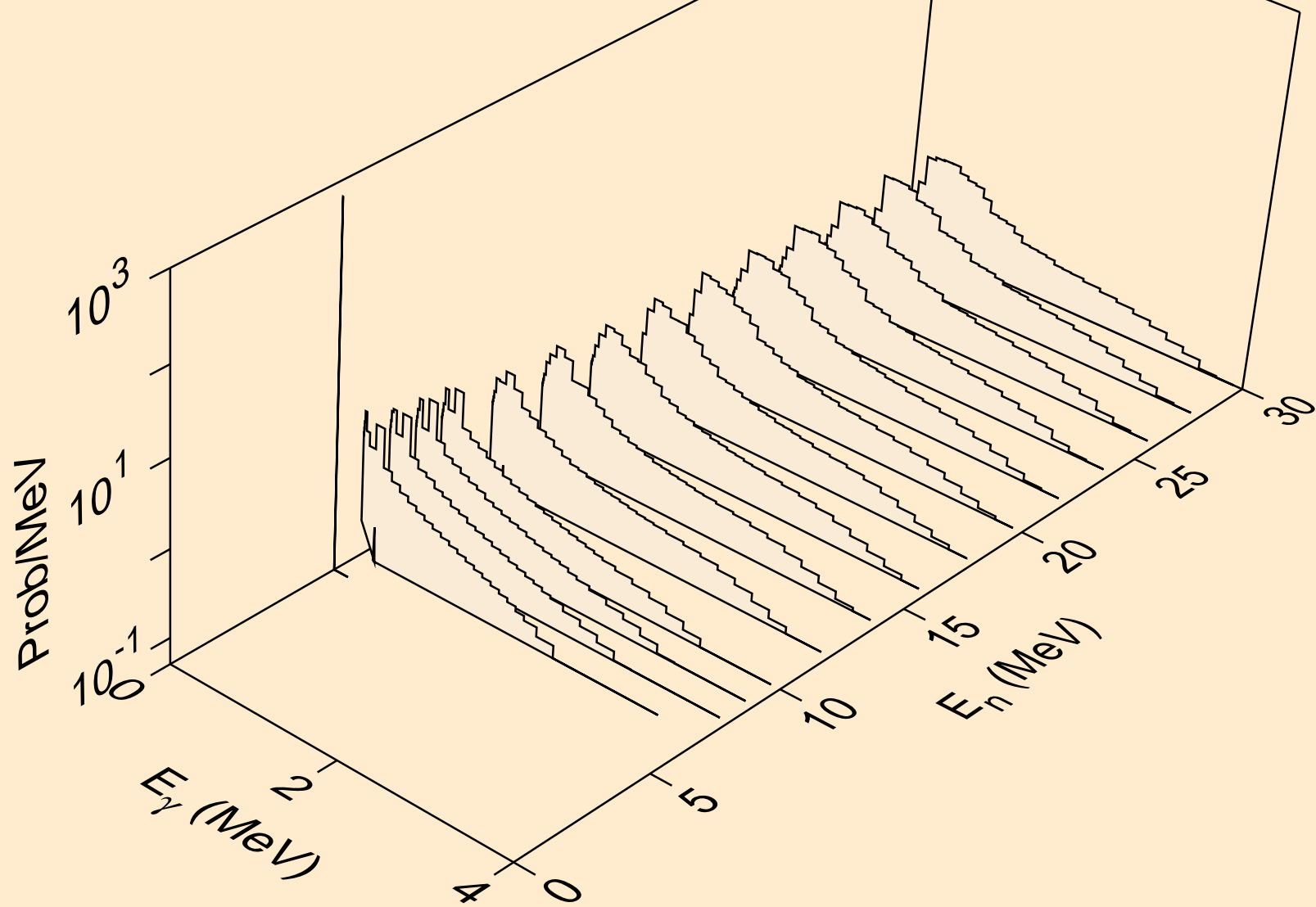

LU160 HELION ACER TENDL-2021 LIBRARY; T=0.K
Photon emission for (n,x)

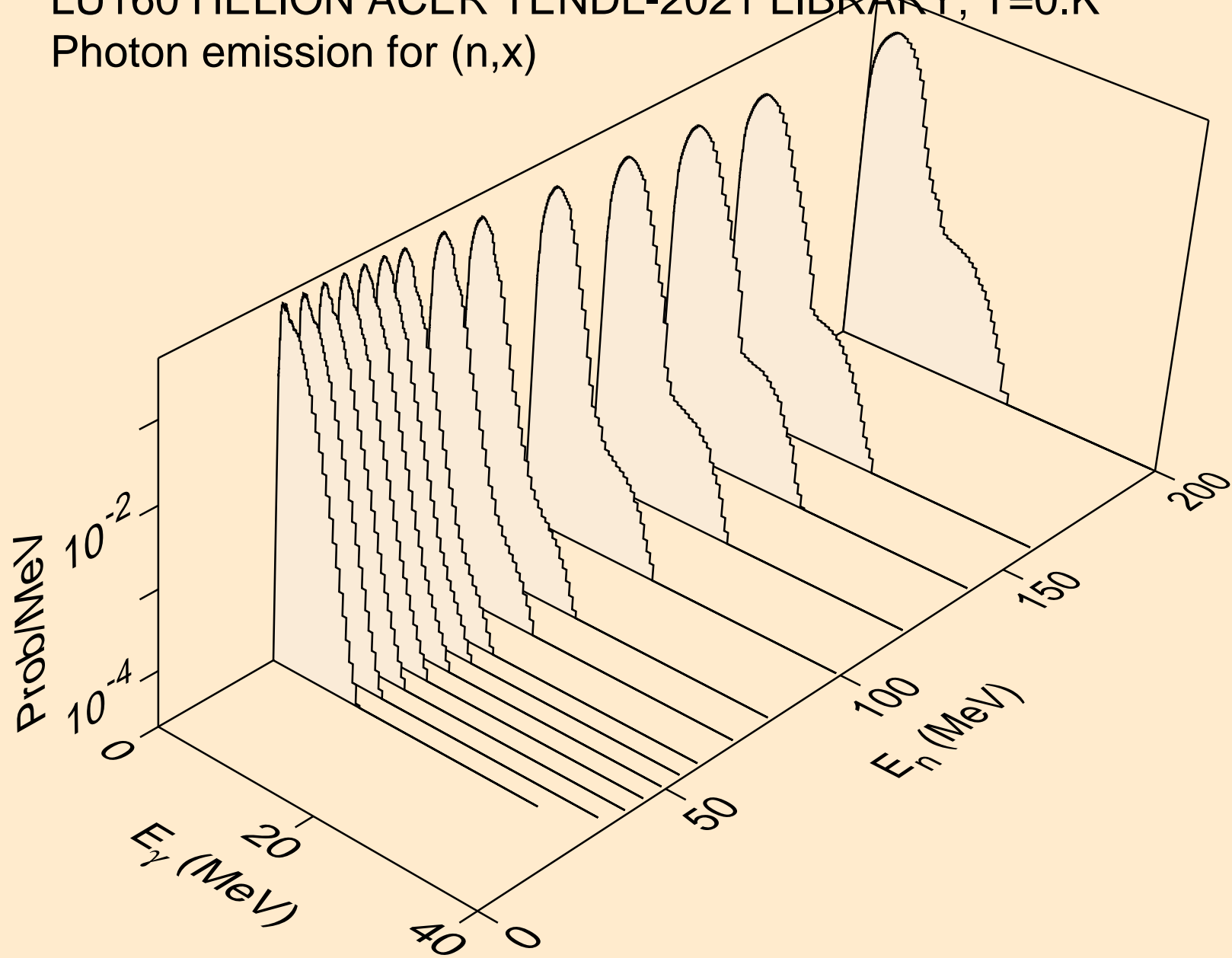

LU160 HELION ACER TENDL-2021 LIBRARY; T=0.K
Photon emission for (n,2nd)

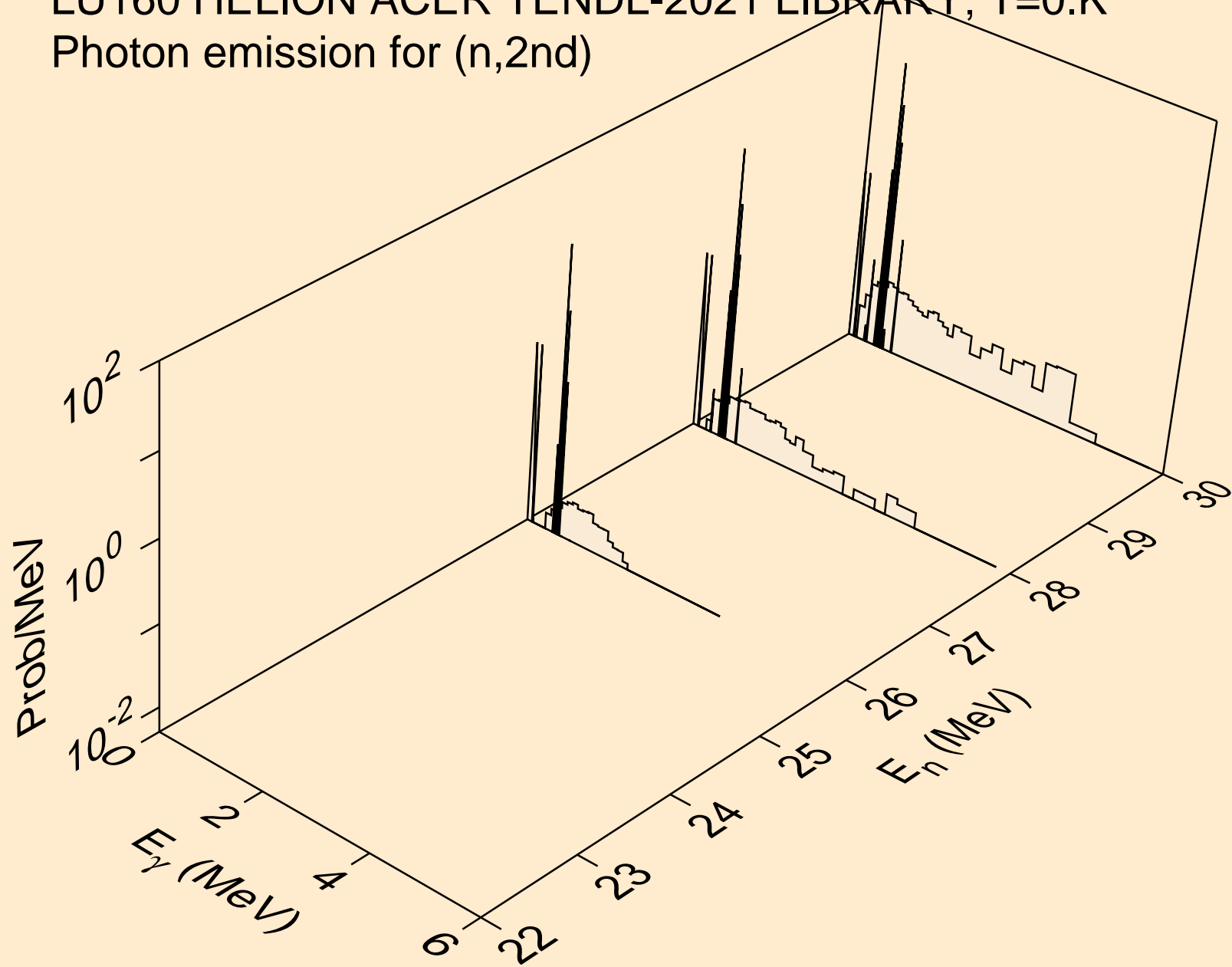

LU160 HELION ACER TENDL-2021 LIBRARY; T=0.K
Photon emission for (n,2n)

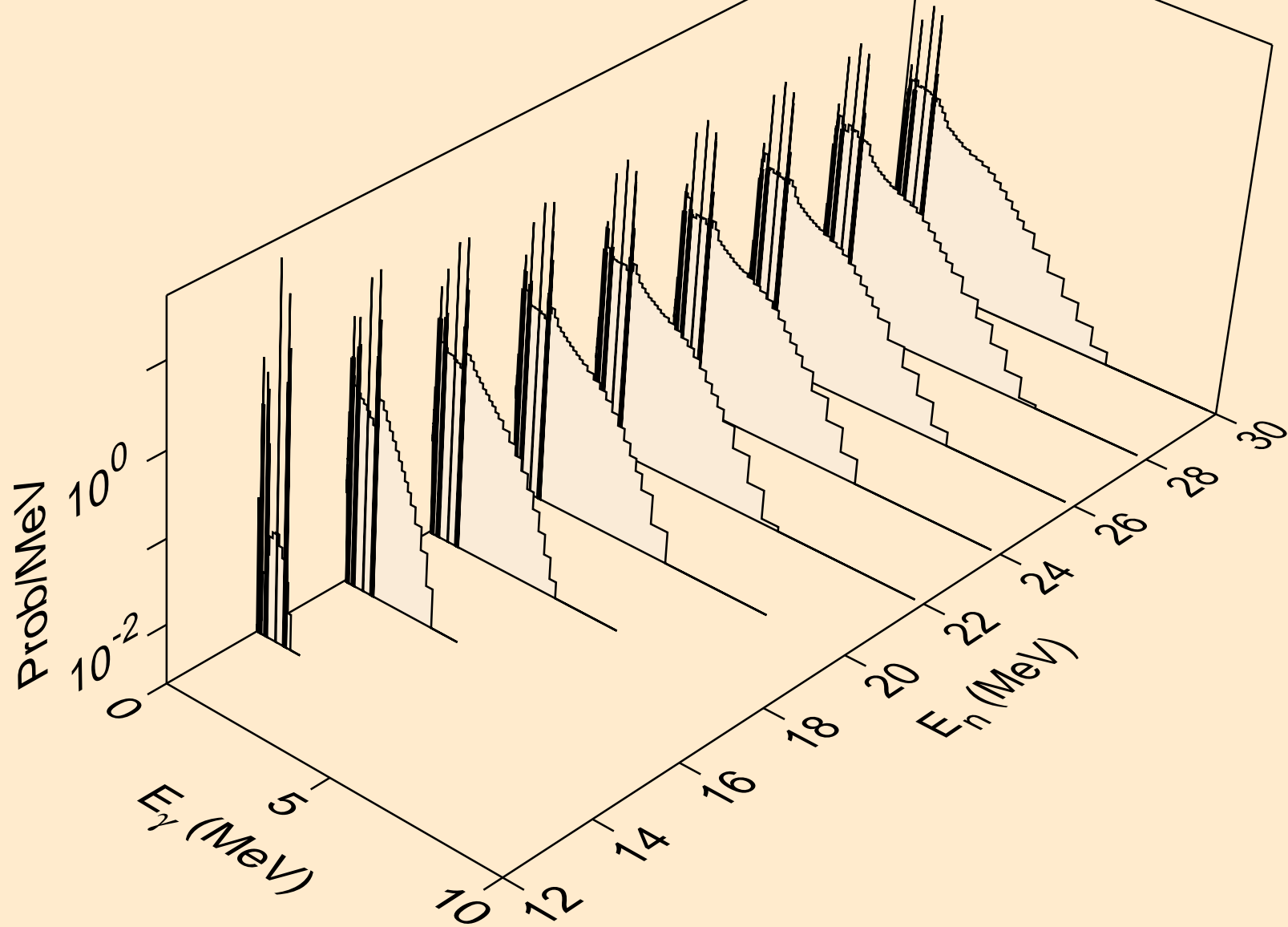

LU160 HELION ACER TENDL-2021 LIBRARY; T=0.K
Photon emission for (n,3n)

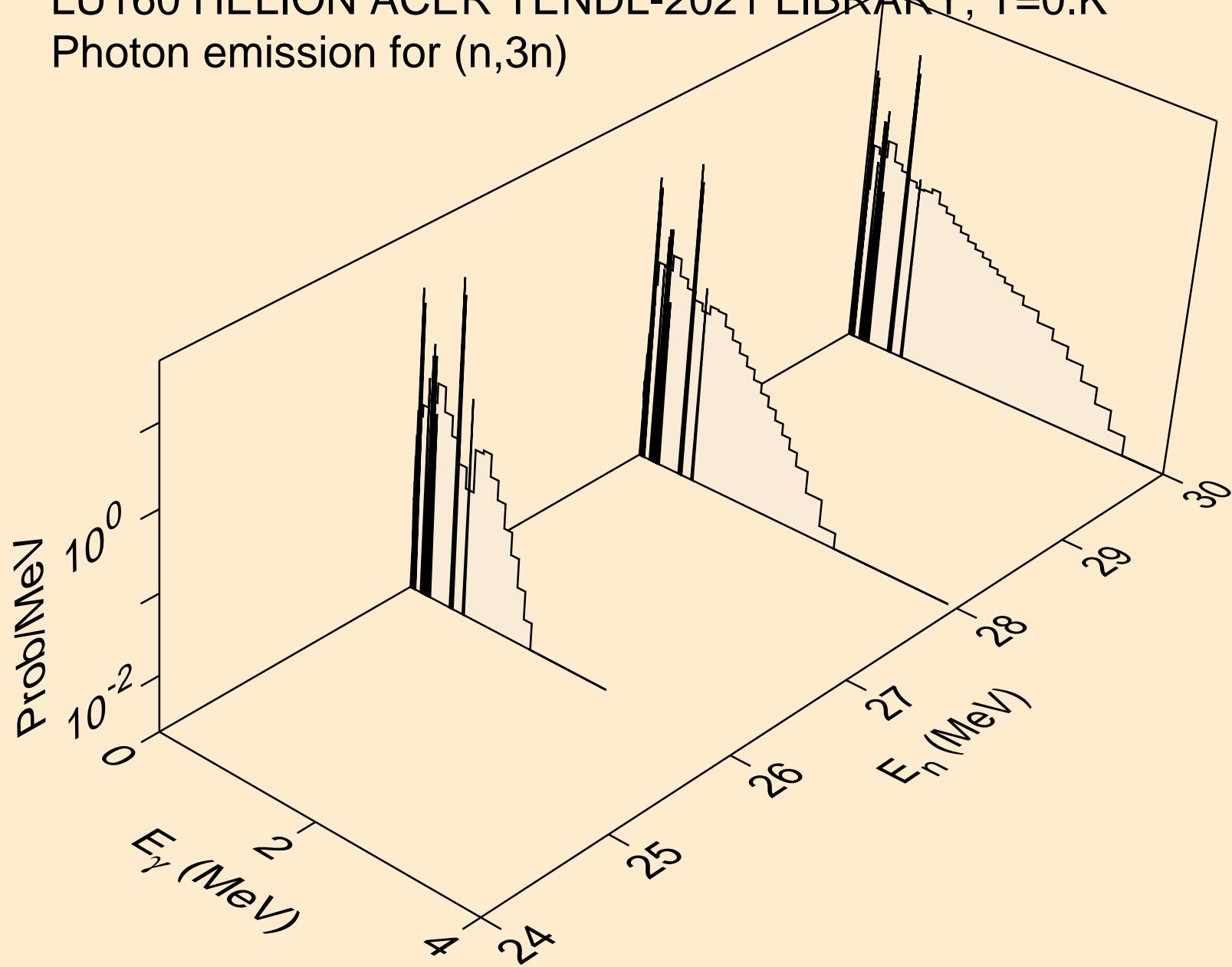

LU160 HELION ACER TENDL-2021 LIBRARY; T=0.K
Photon emission for (n,n*)a

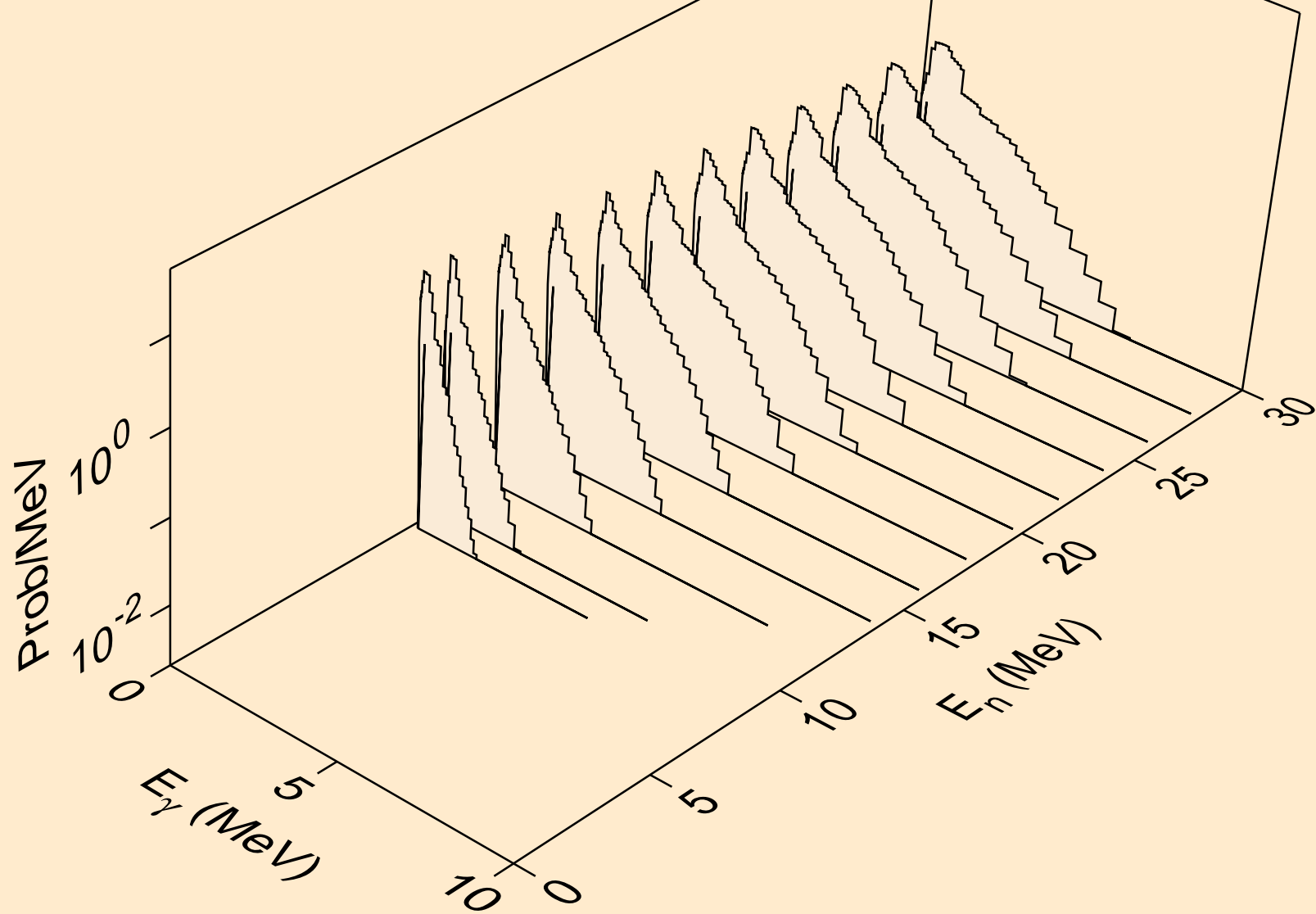

LU160 HELION ACER TENDL-2021 LIBRARY; T=0.K
Photon emission for (n,2n)a

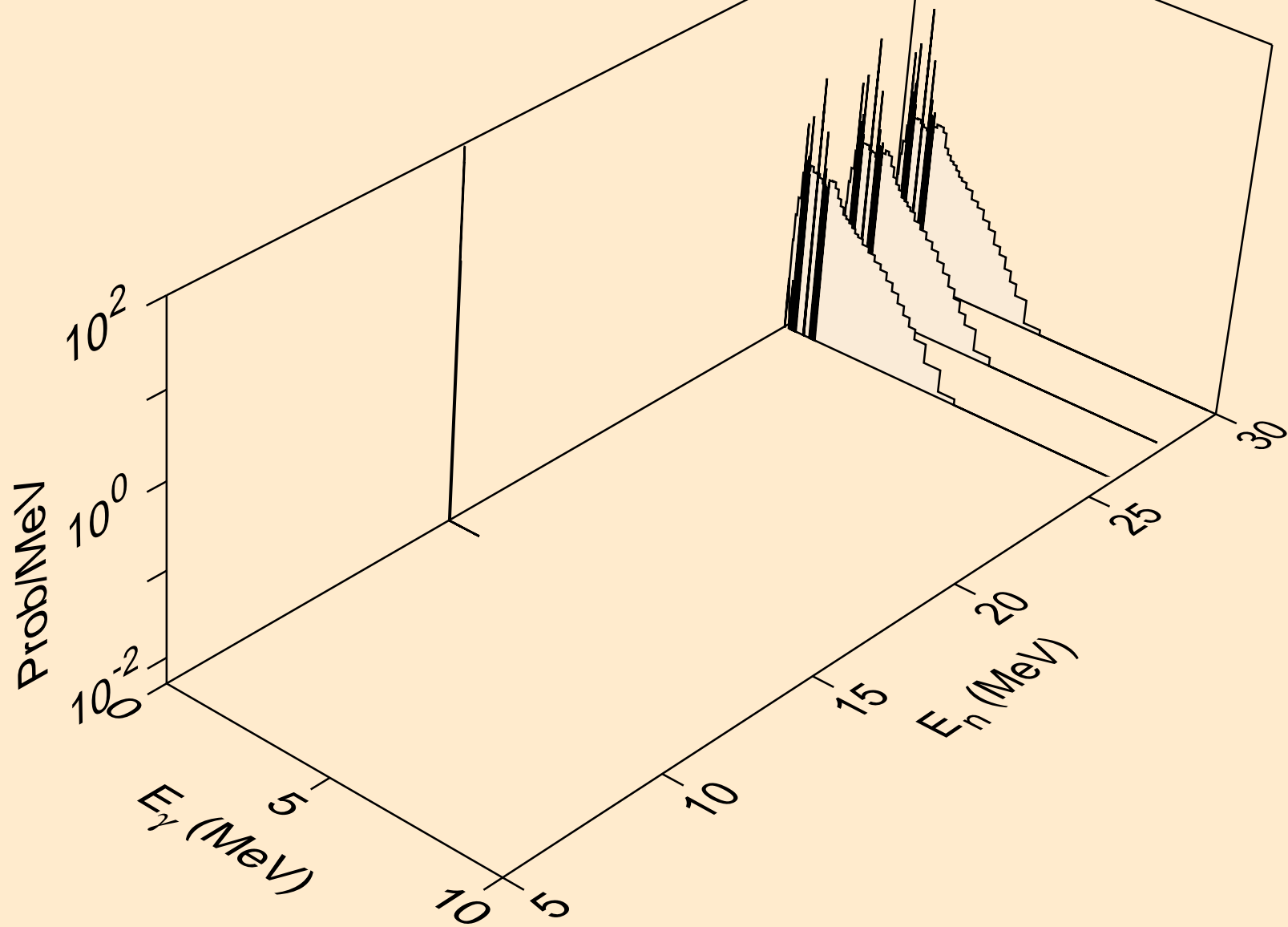

LU160 HELION ACER TENDL-2021 LIBRARY; T=0.K
Photon emission for (n,3n)a

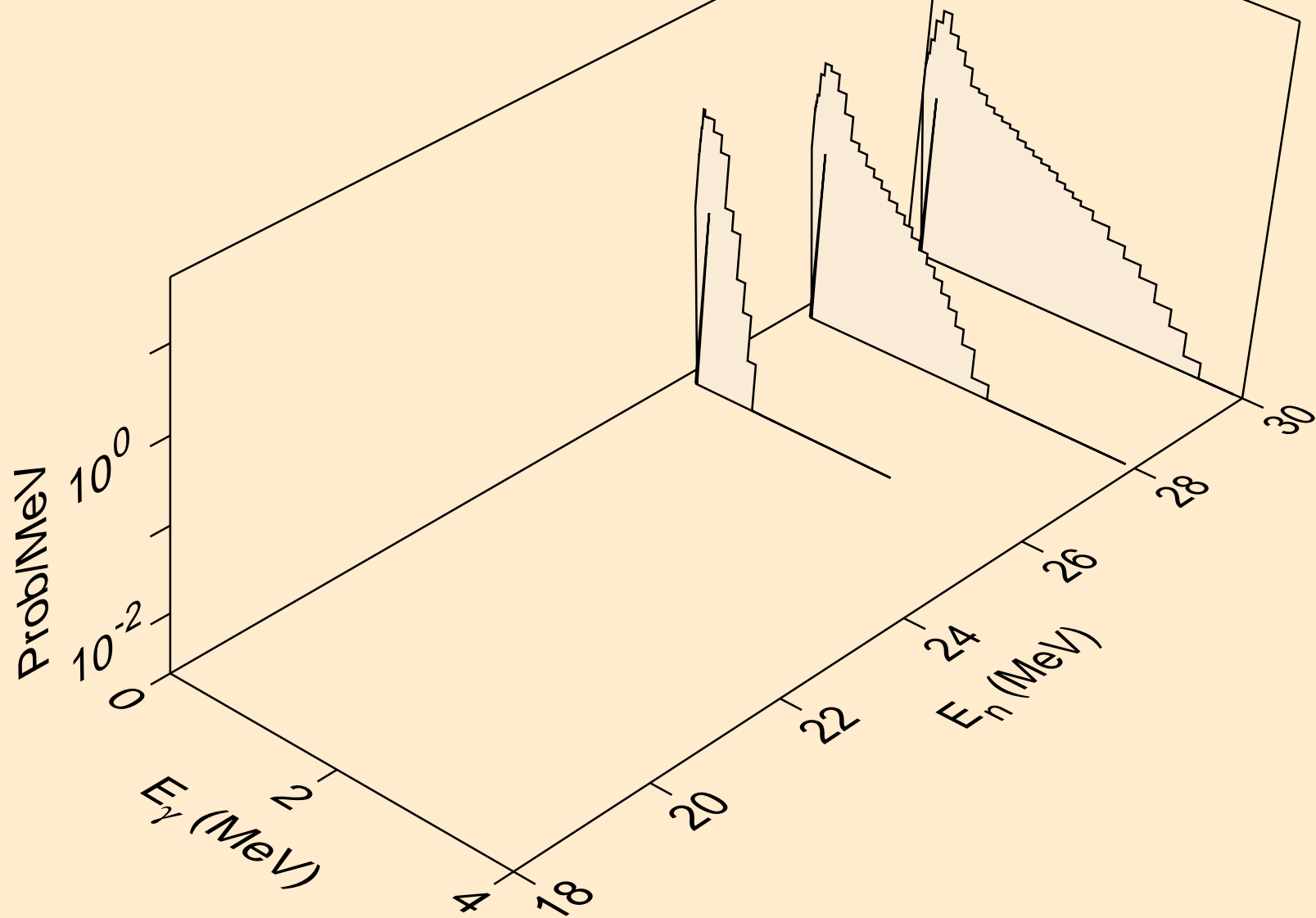

LU160 HELION ACER TENDL-2021 LIBRARY; T=0.K
Photon emission for (n,n*)p

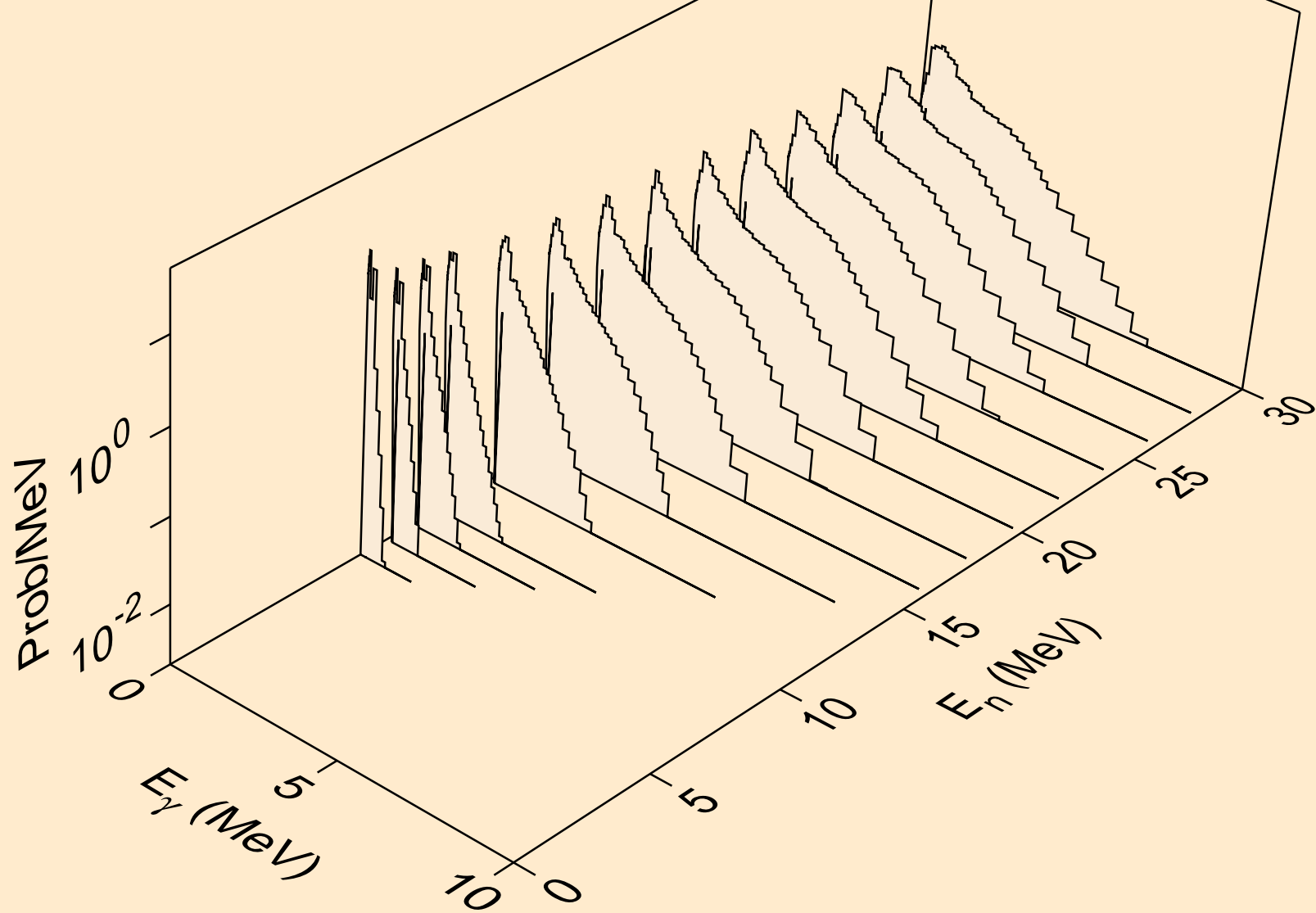

LU160 HELION ACER TENDL-2021 LIBRARY; T=0.K
Photon emission for (n,n*)2a

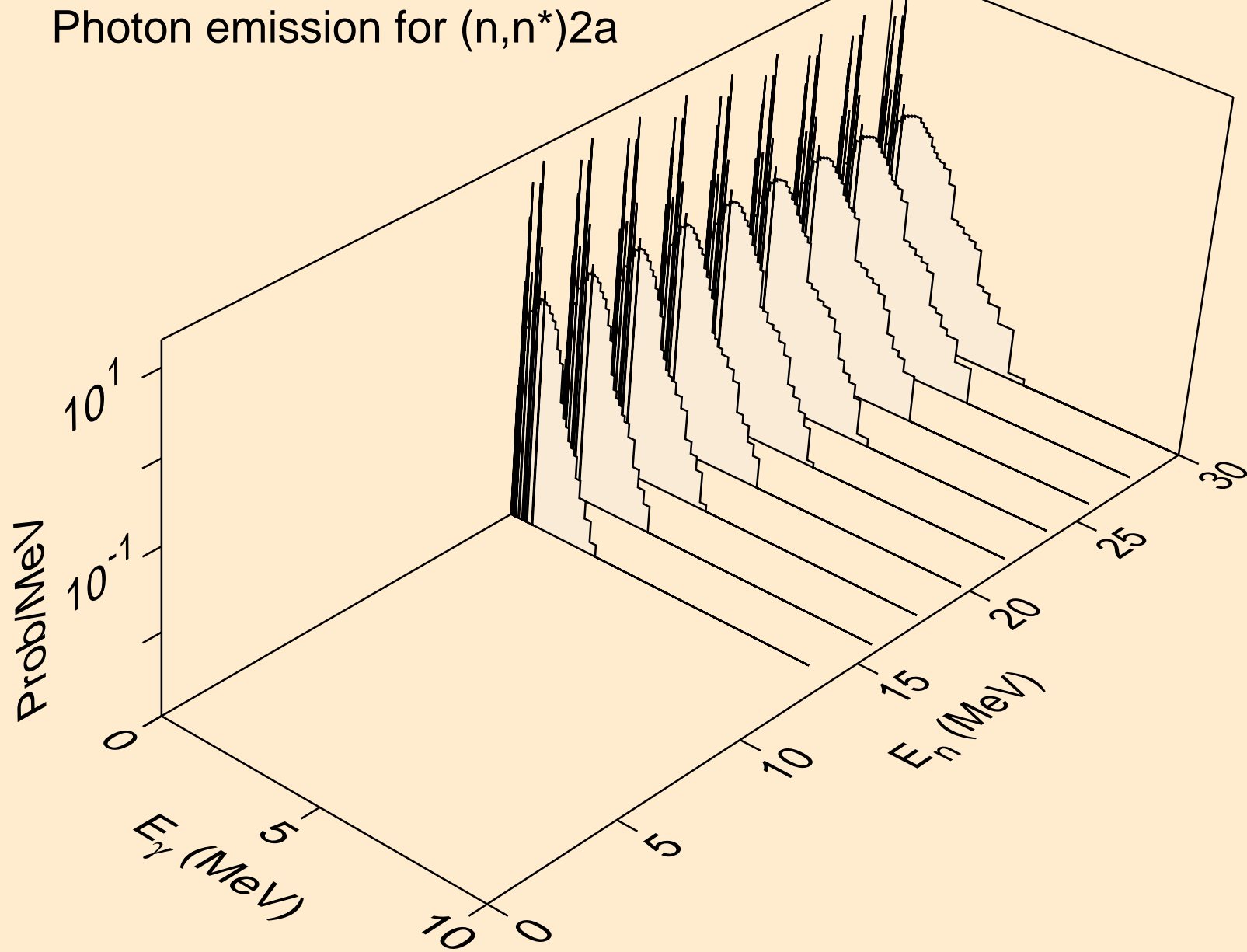

LU160 HELION ACER TENDL-2021 LIBRARY; T=0.K
Photon emission for (n,2n)2a

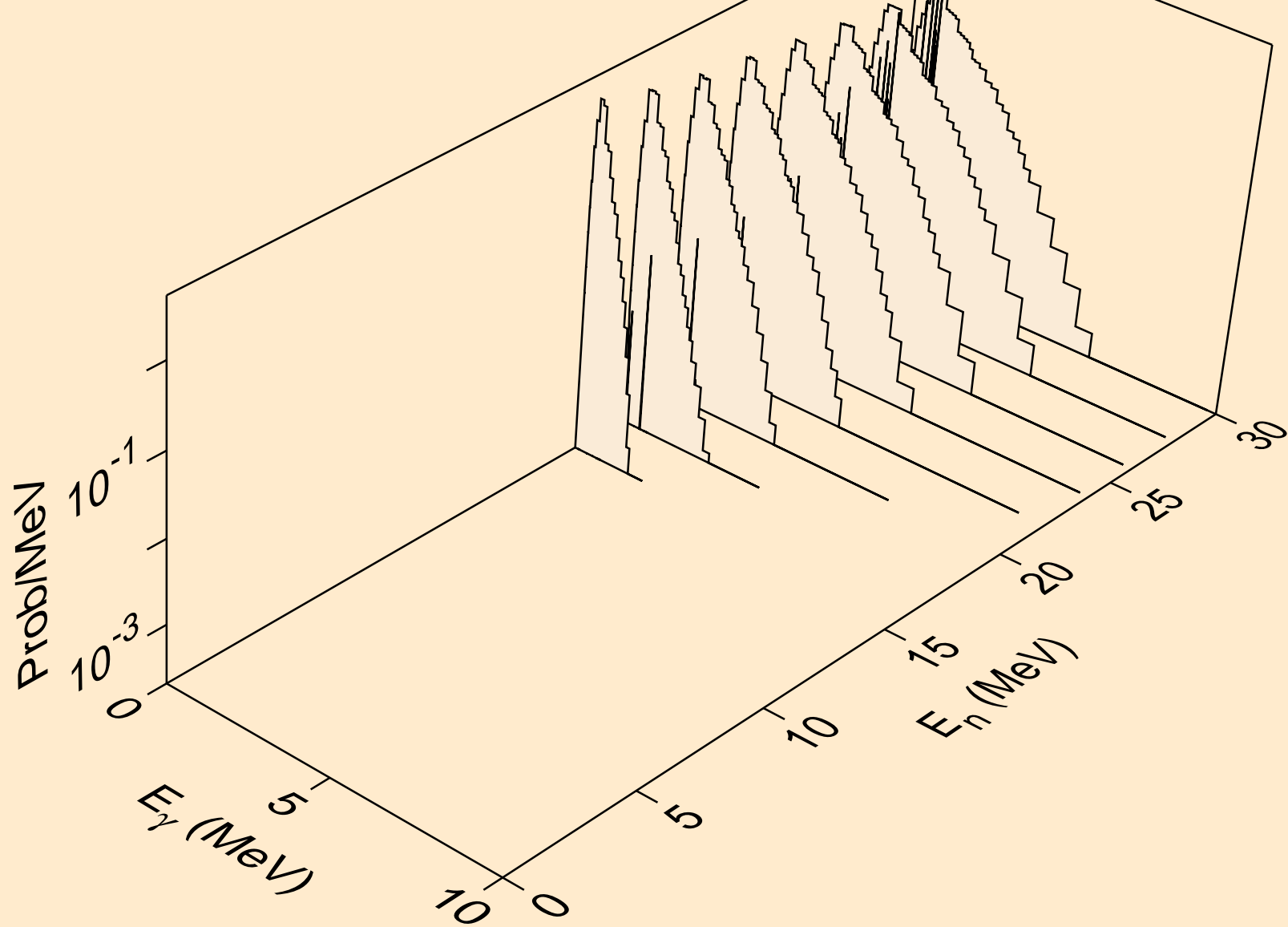

LU160 HELION ACER TENDL-2021 LIBRARY; T=0.K
Photon emission for (n,n*)d

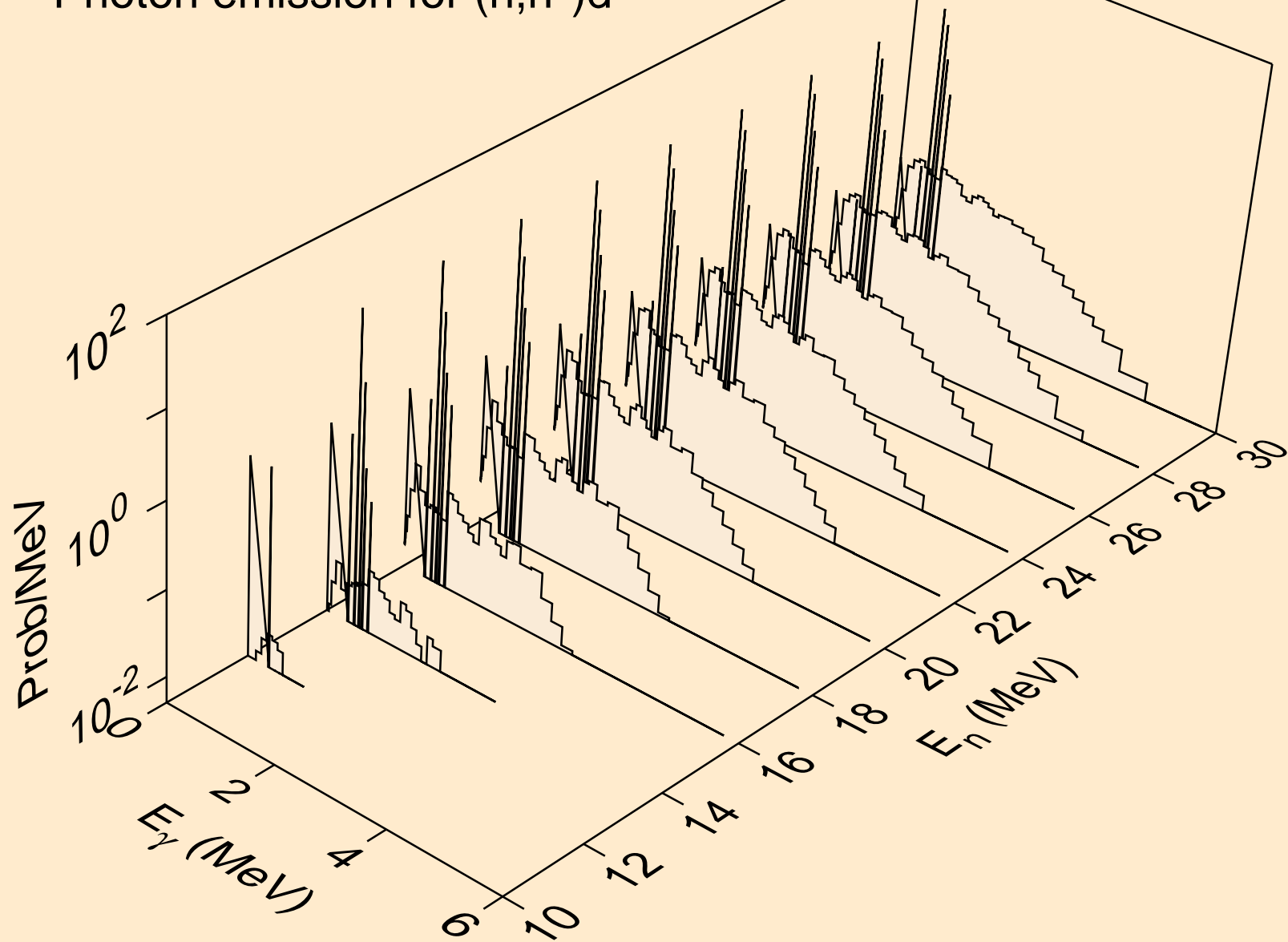

LU160 HELION ACER TENDL-2021 LIBRARY; T=0.K
Photon emission for (n,n*)t

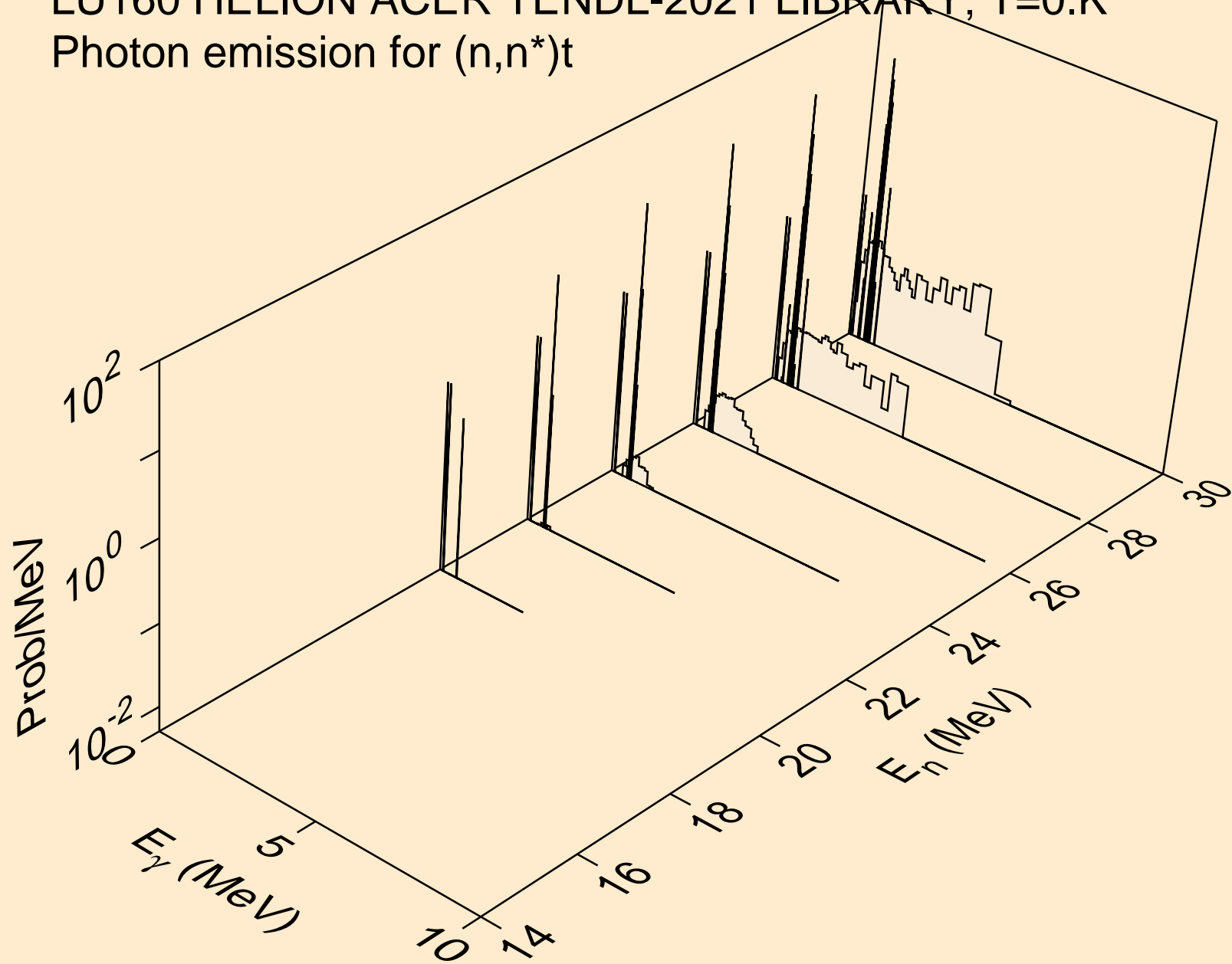

LU160 HELION ACER TENDL-2021 LIBRARY; T=0.K
Photon emission for (n,n*)he3

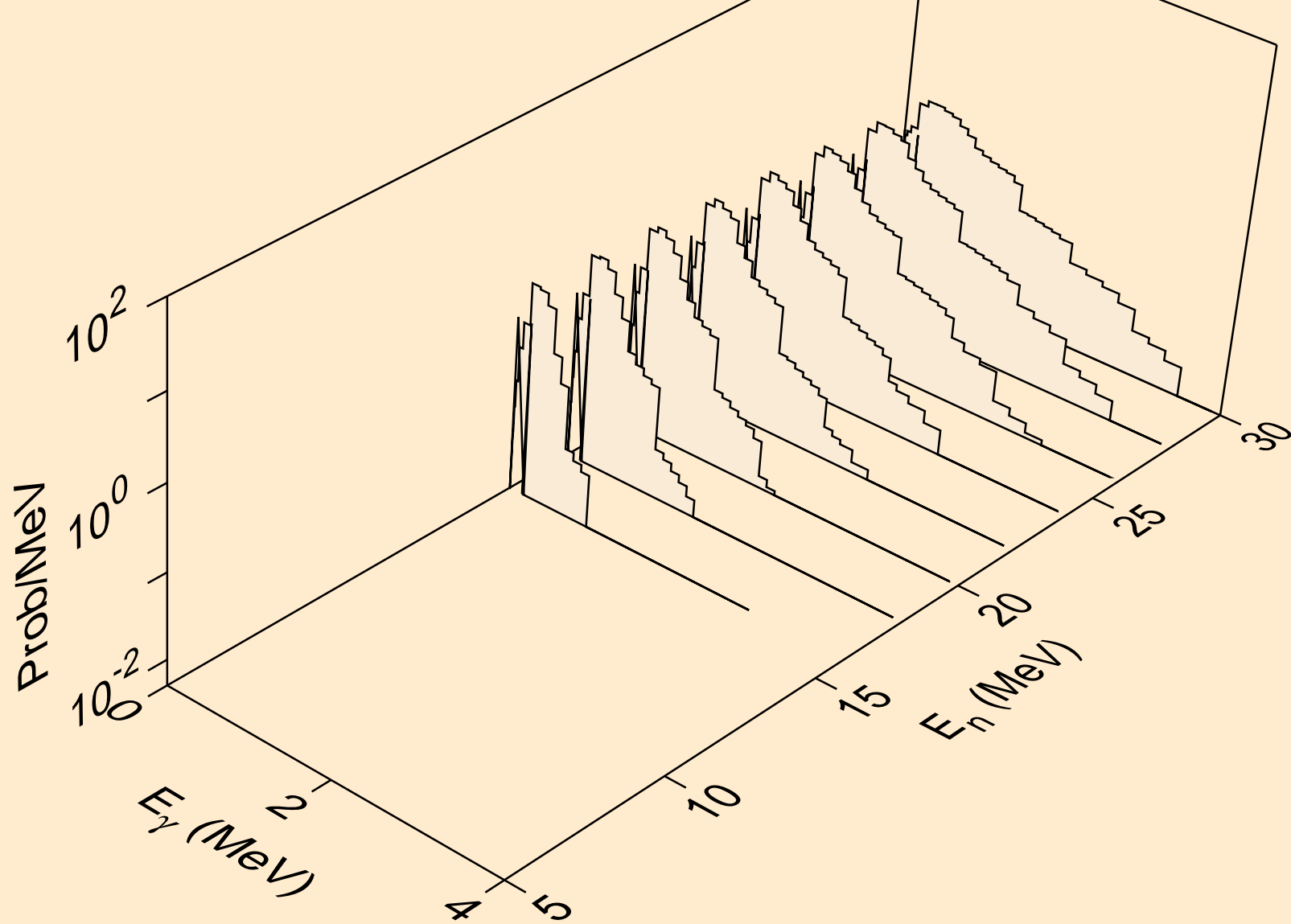

LU160 HELION ACER TENDL-2021 LIBRARY; T=0.K
Photon emission for (n,2np)

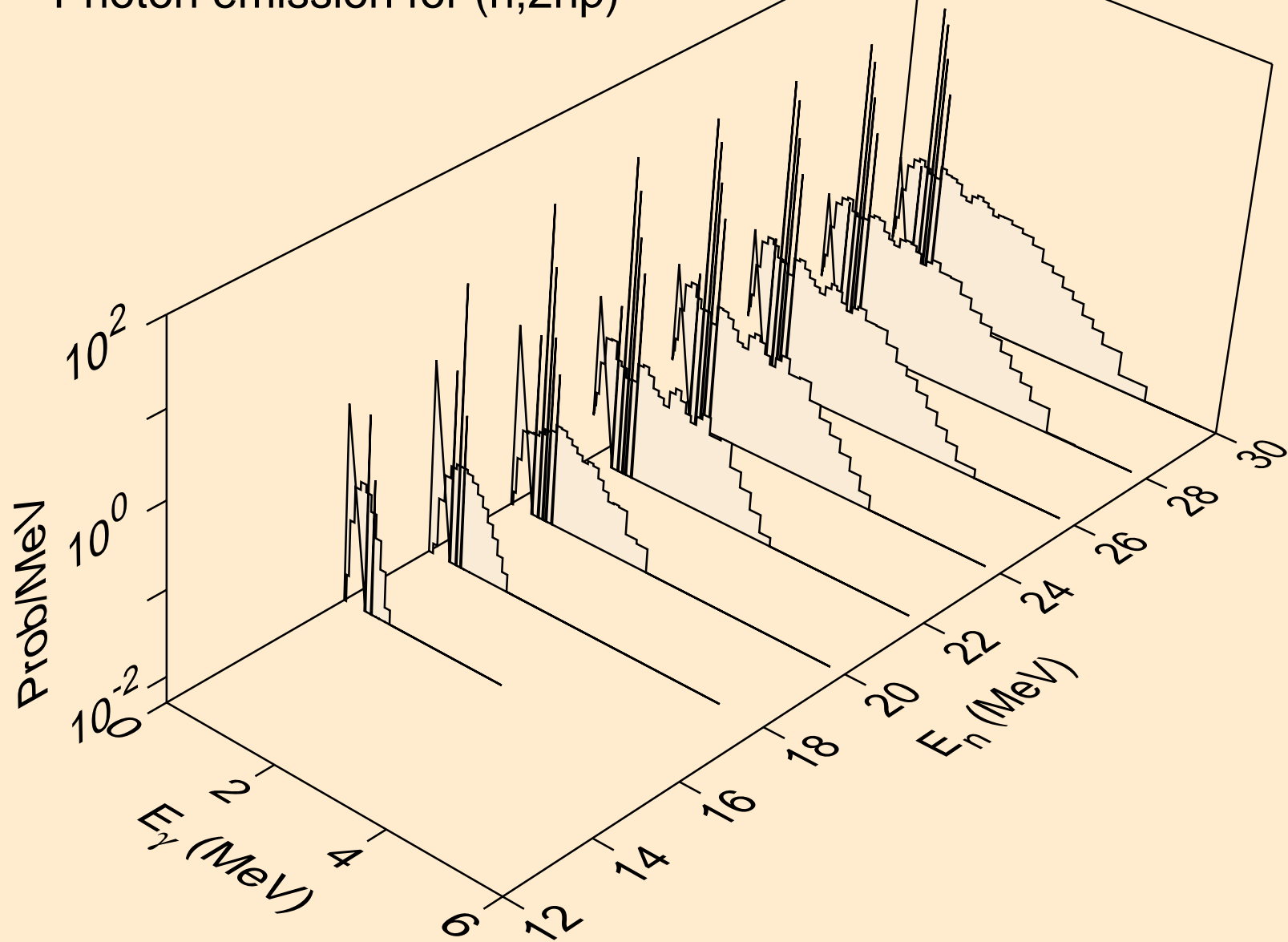

LU160 HELION ACER TENDL-2021 LIBRARY; T=0.K
Photon emission for (n,3np)

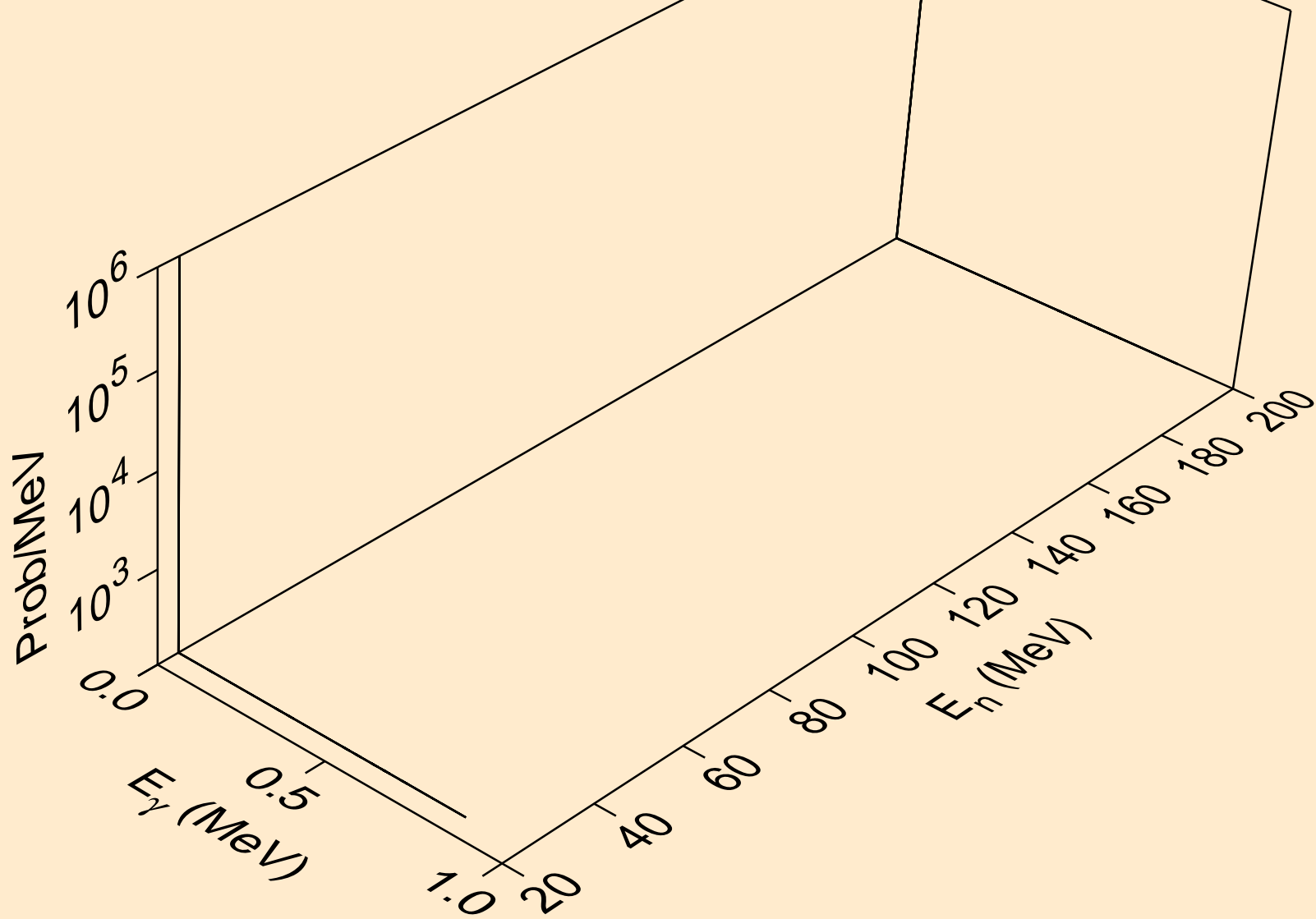

LU160 HELION ACER TENDL-2021 LIBRARY; T=0.K
Photon emission for (n,2np)

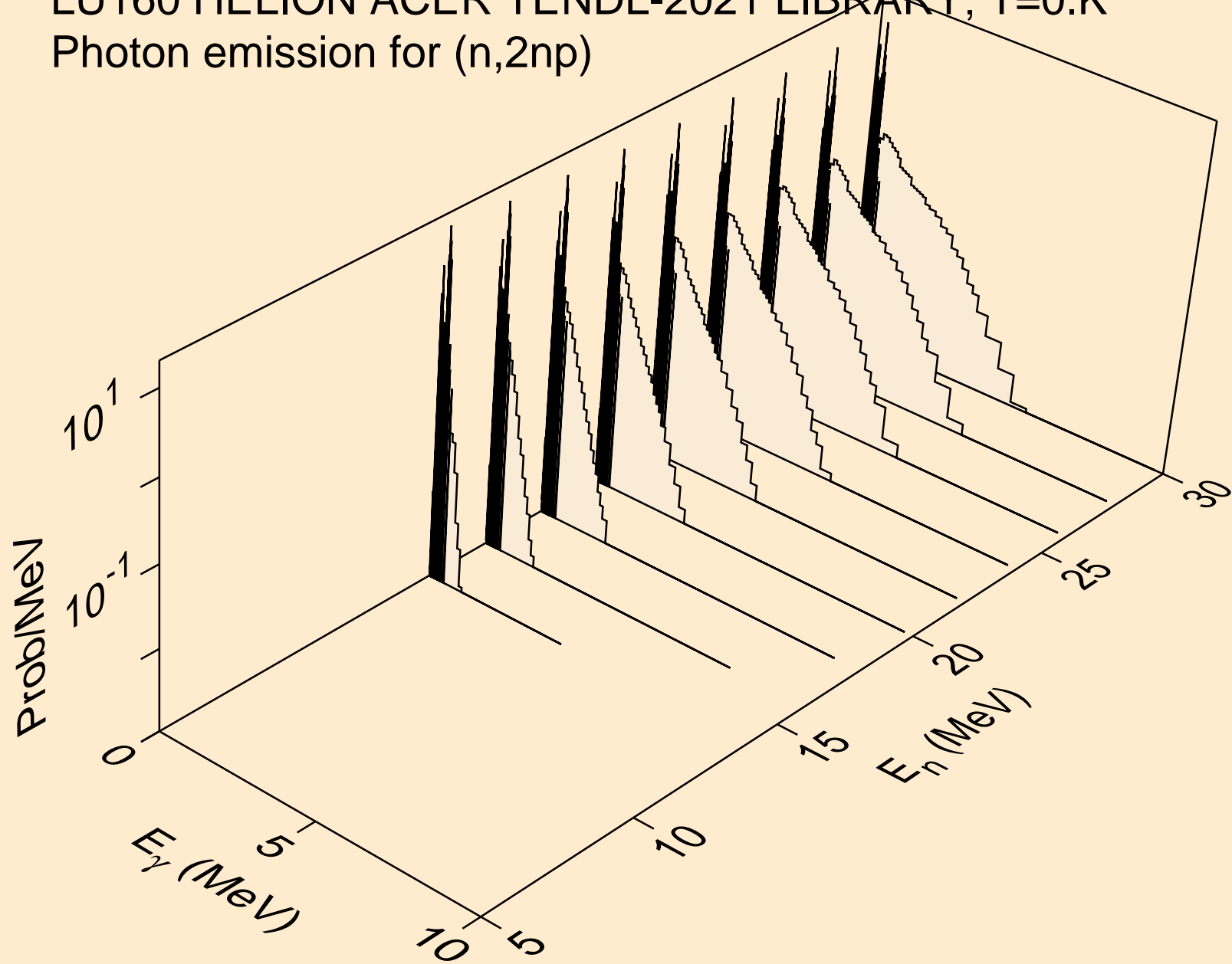

LU160 HELION ACER TENDL-2021 LIBRARY; T=0.K
Photon emission for (n,npa)

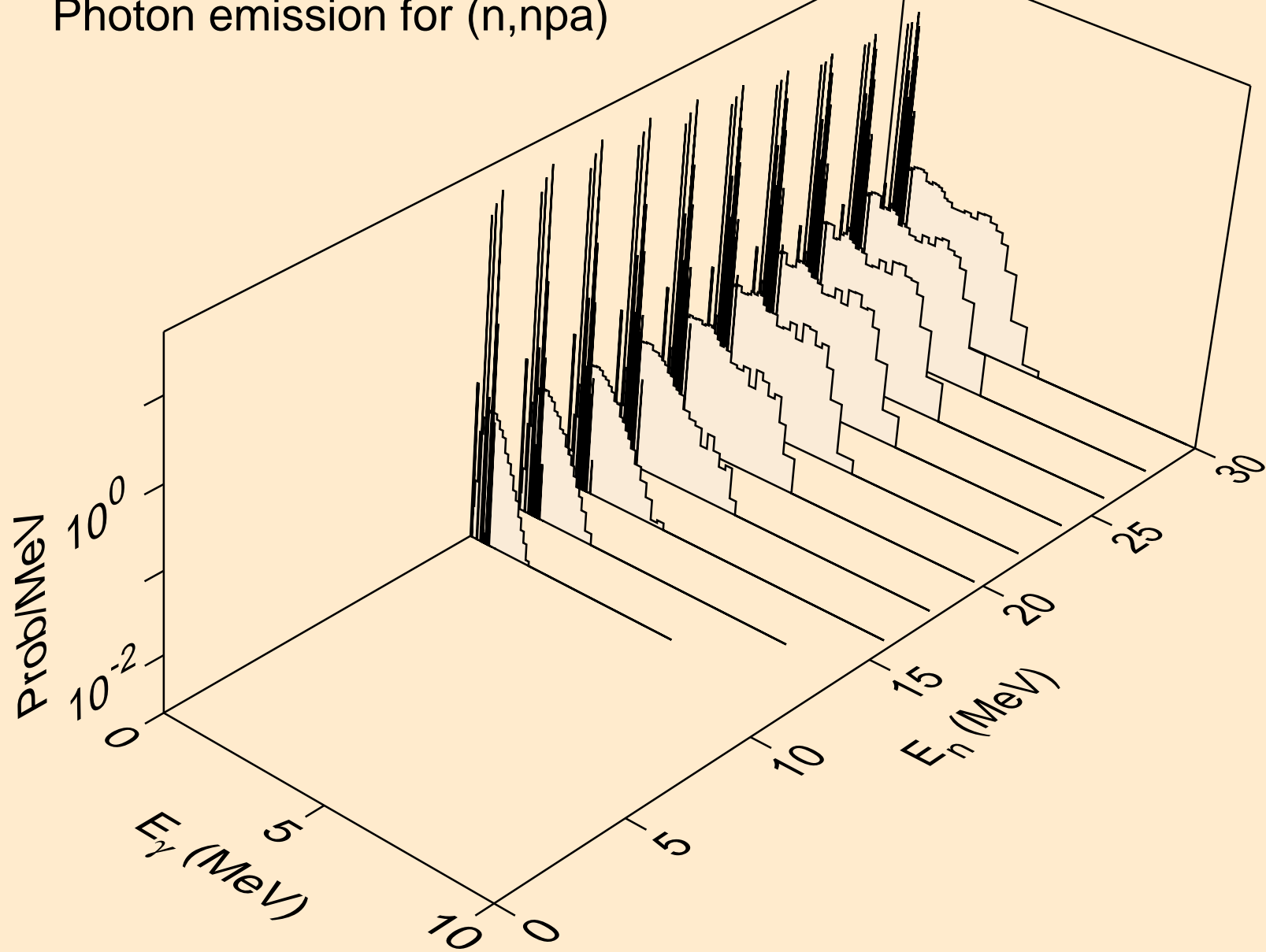

LU160 HELION ACER TENDL-2021 LIBRARY; T=0.K
Photon emission for (n,gma)

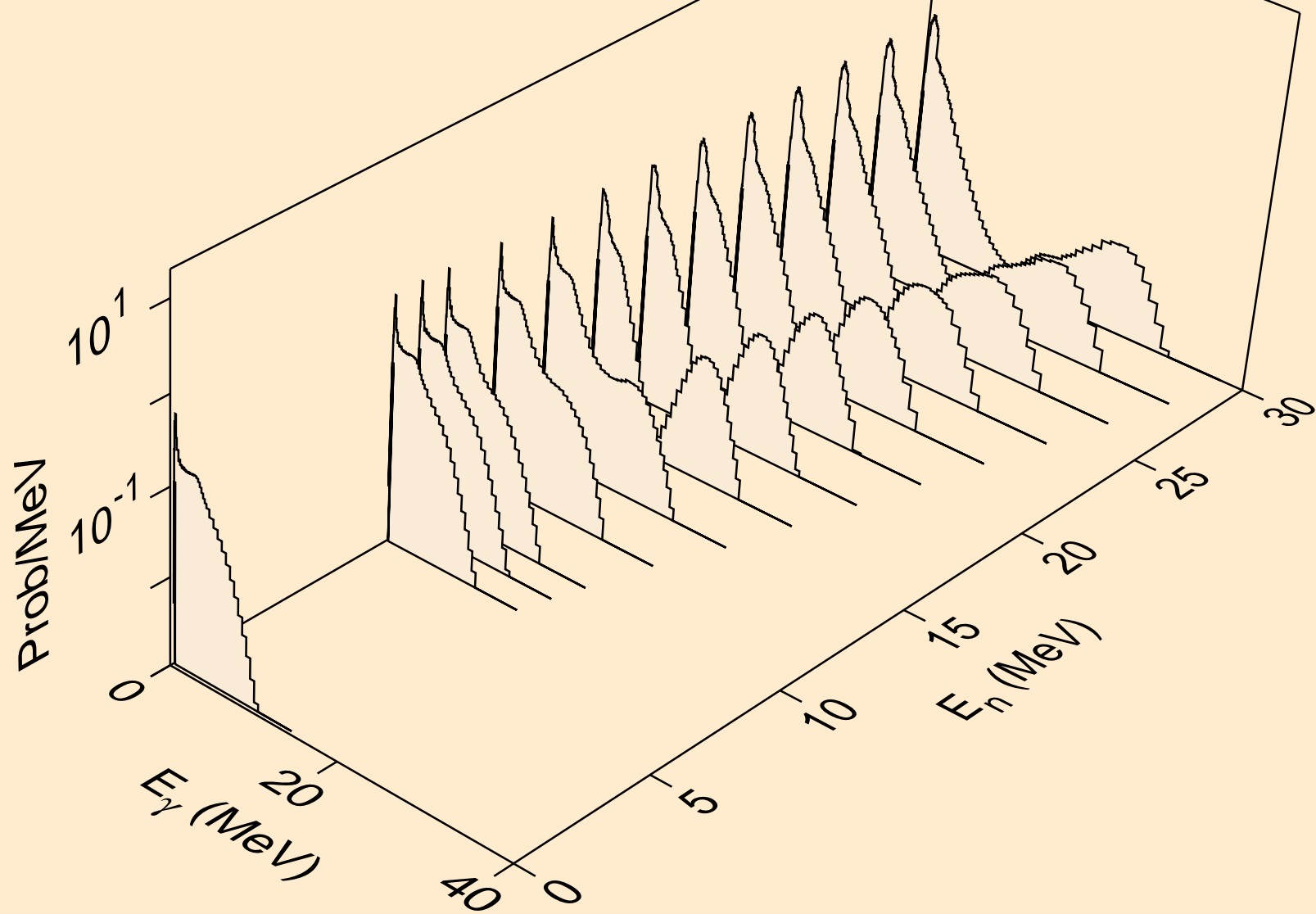

LU160 HELION ACER TENDL-2021 LIBRARY; T=0.K
Photon emission for (n,p)

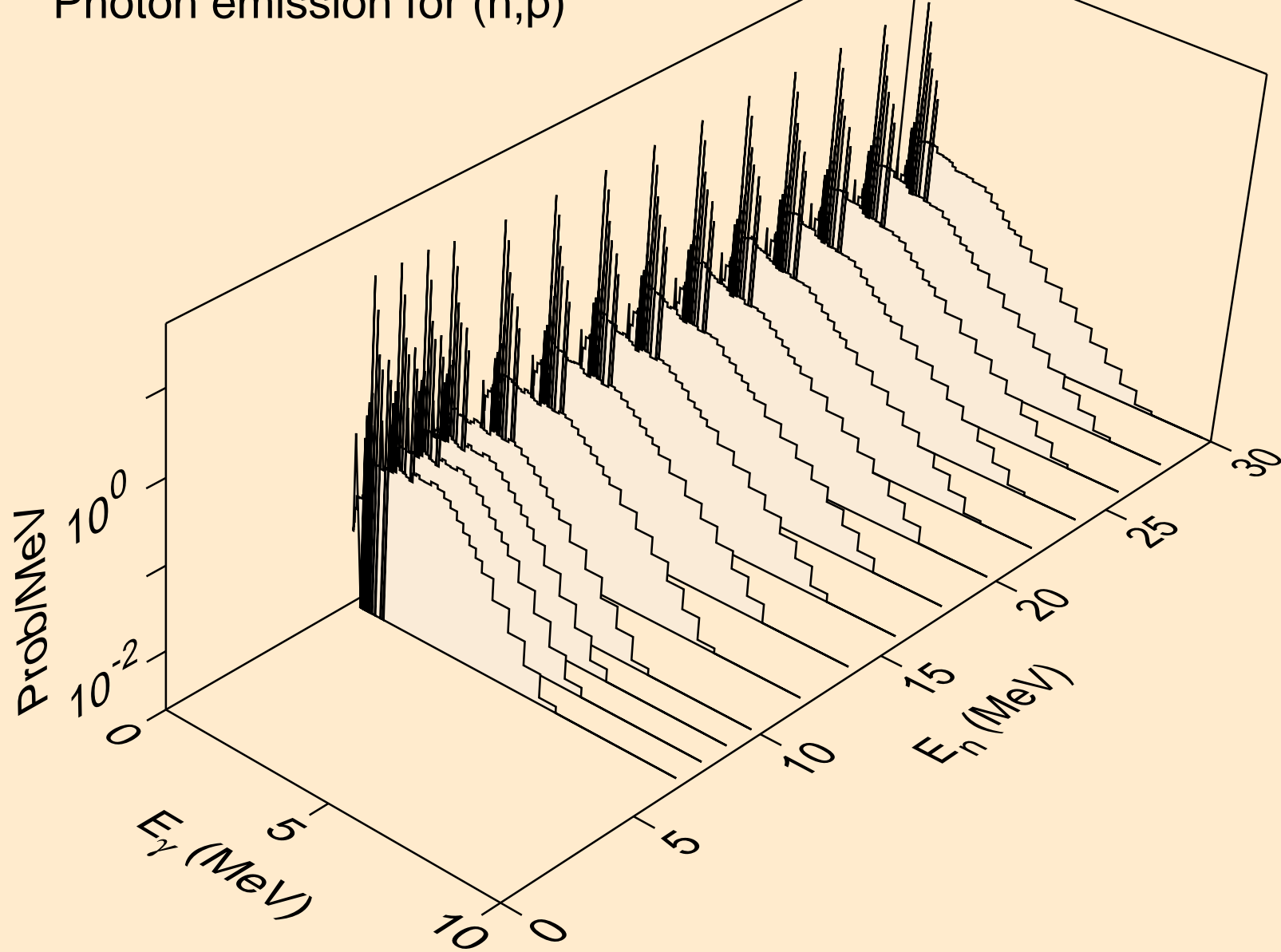

LU160 HELION ACER TENDL-2021 LIBRARY; T=0.K
Photon emission for (n,d)

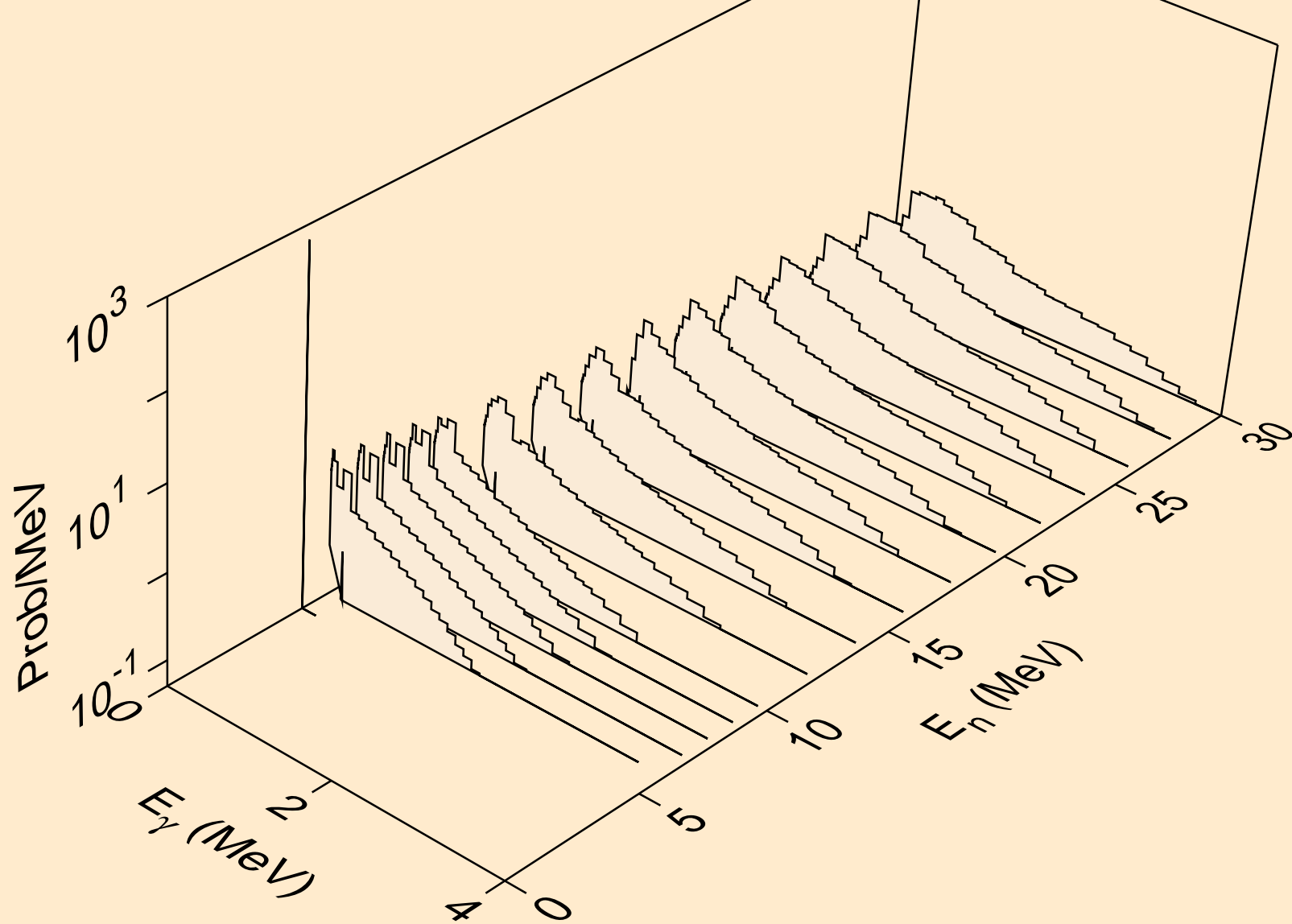

LU160 HELION ACER TENDL-2021 LIBRARY; T=0.K
Photon emission for (n,t)

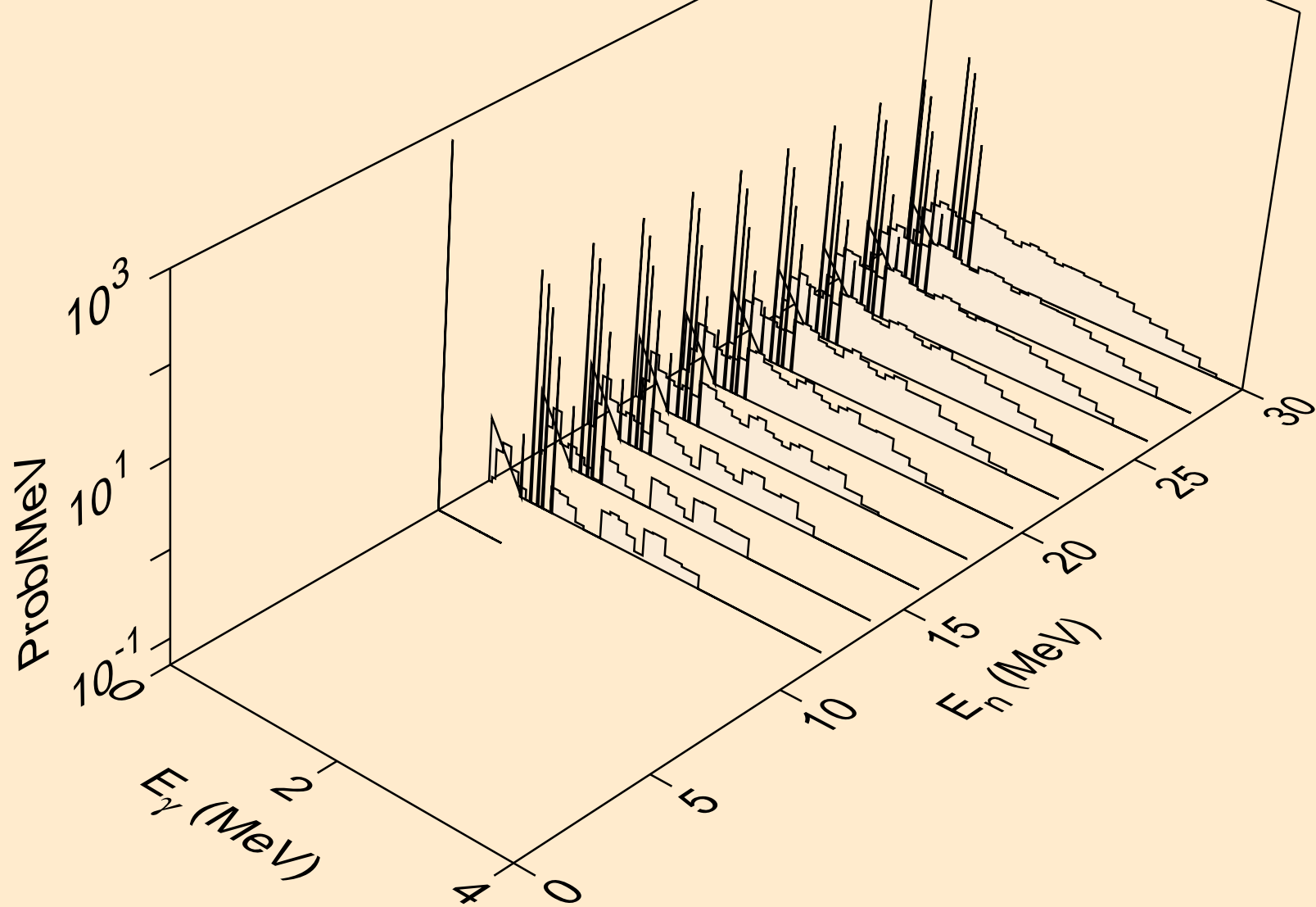

LU160 HELION ACER TENDL-2021 LIBRARY; T=0.K
Photon emission for inelastic

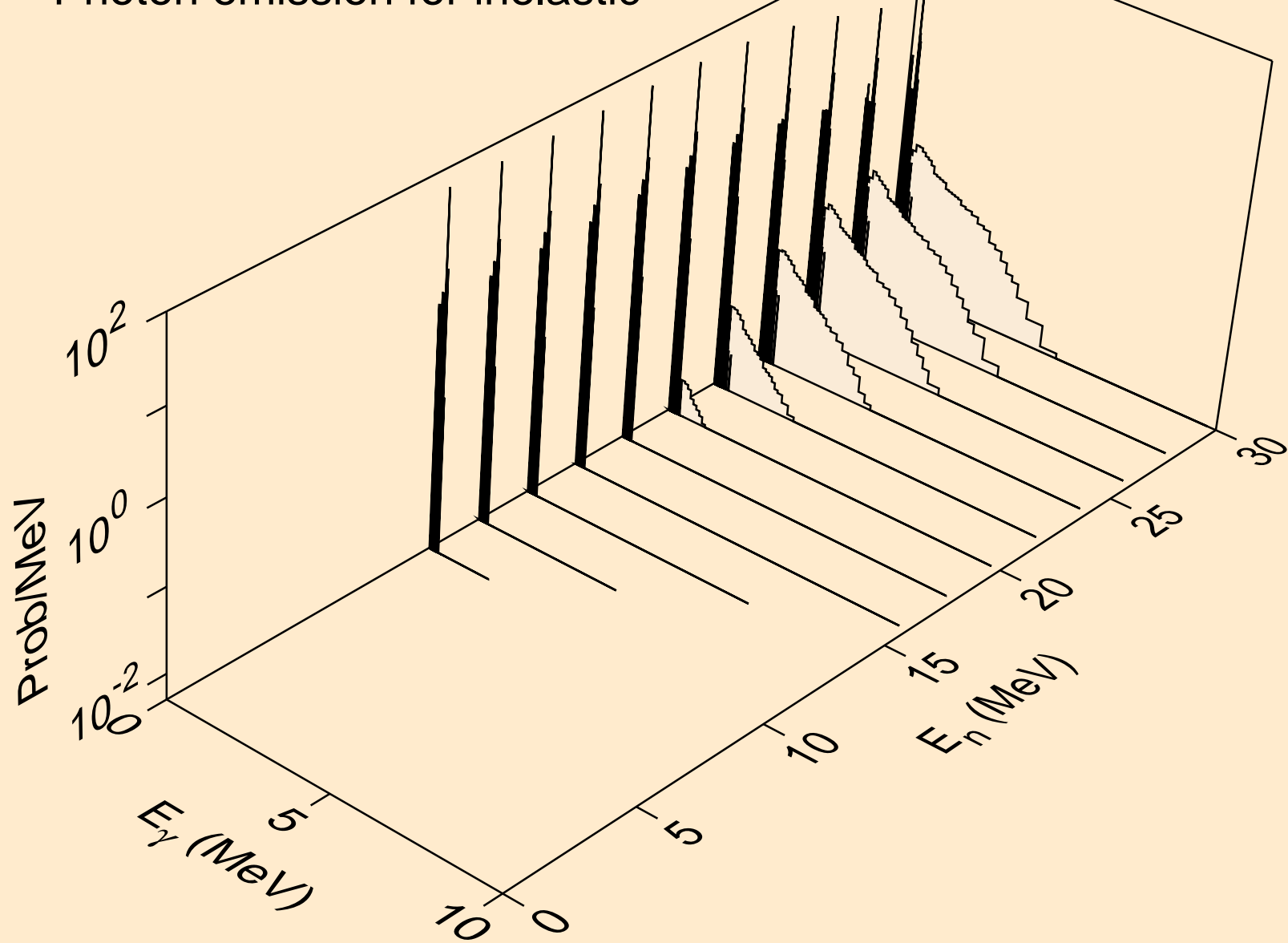

LU160 HELION ACER TENDL-2021 LIBRARY; T=0.K
Photon emission for (n,a)

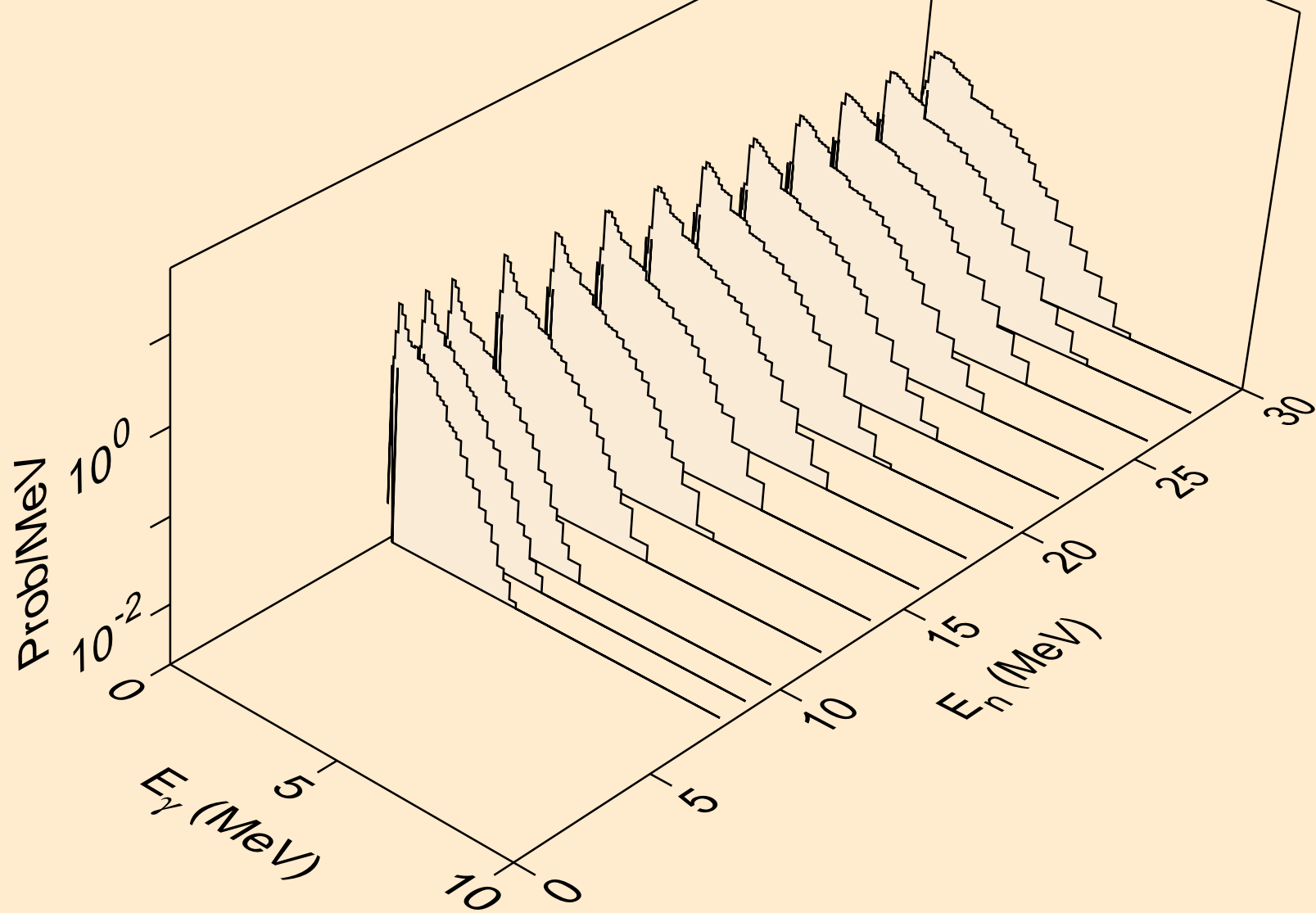

LU160 HELION ACER TENDL-2021 LIBRARY; T=0.K
Photon emission for (n,2a)

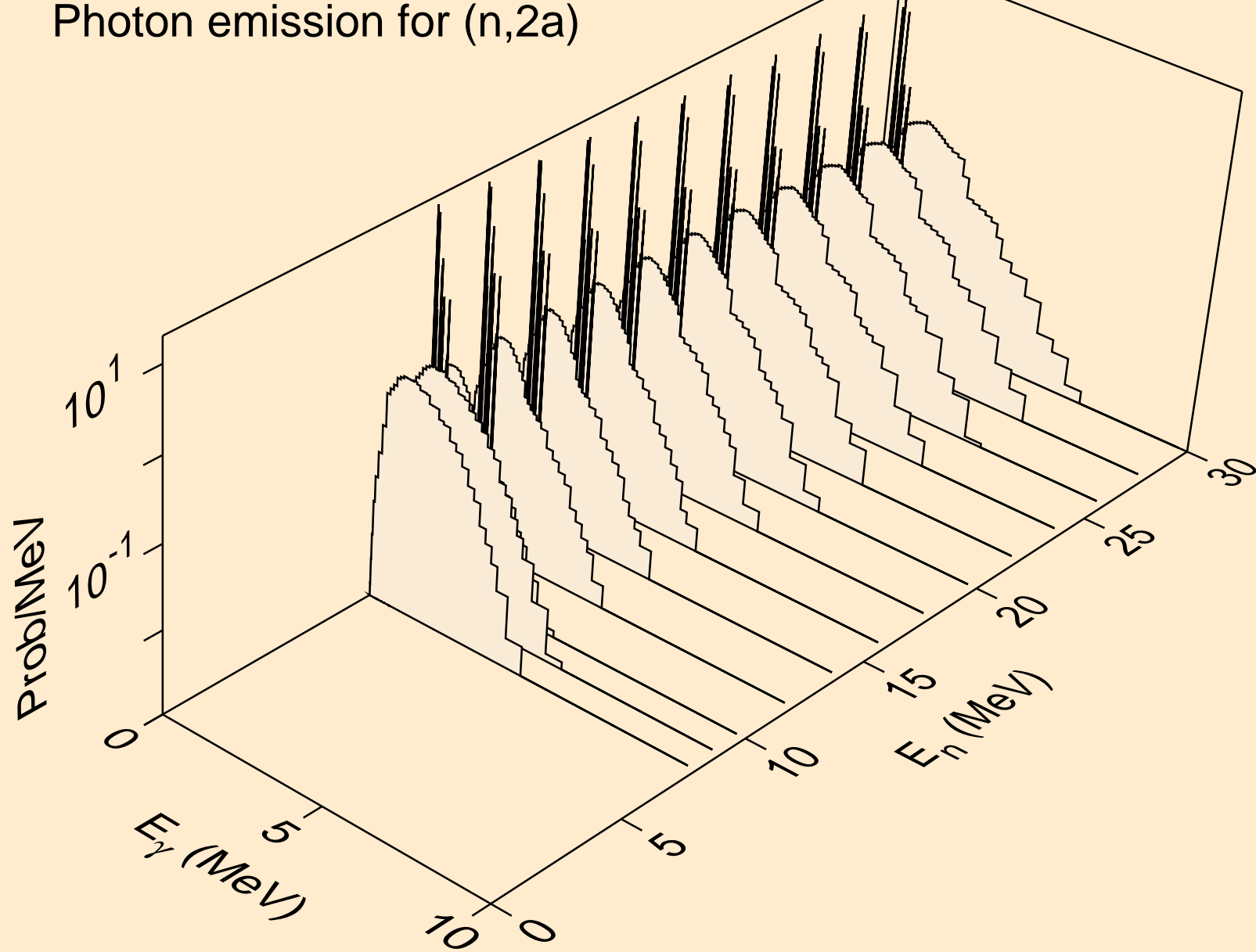

LU160 HELION ACER TENDL-2021 LIBRARY; T=0.K
Photon emission for (n,3a)

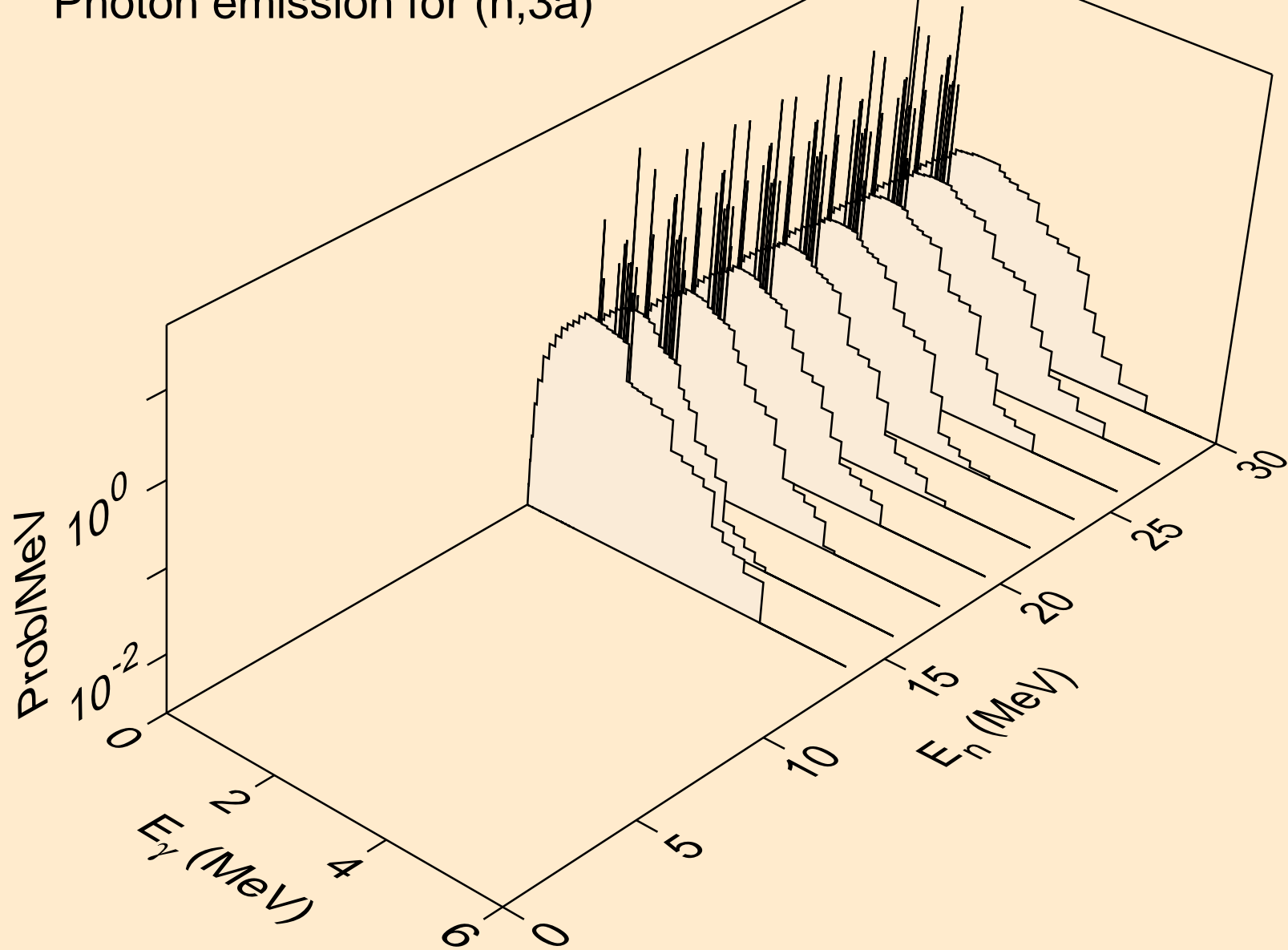

LU160 HELION ACER TENDL-2021 LIBRARY; T=0.K
Photon emission for (n,2p)

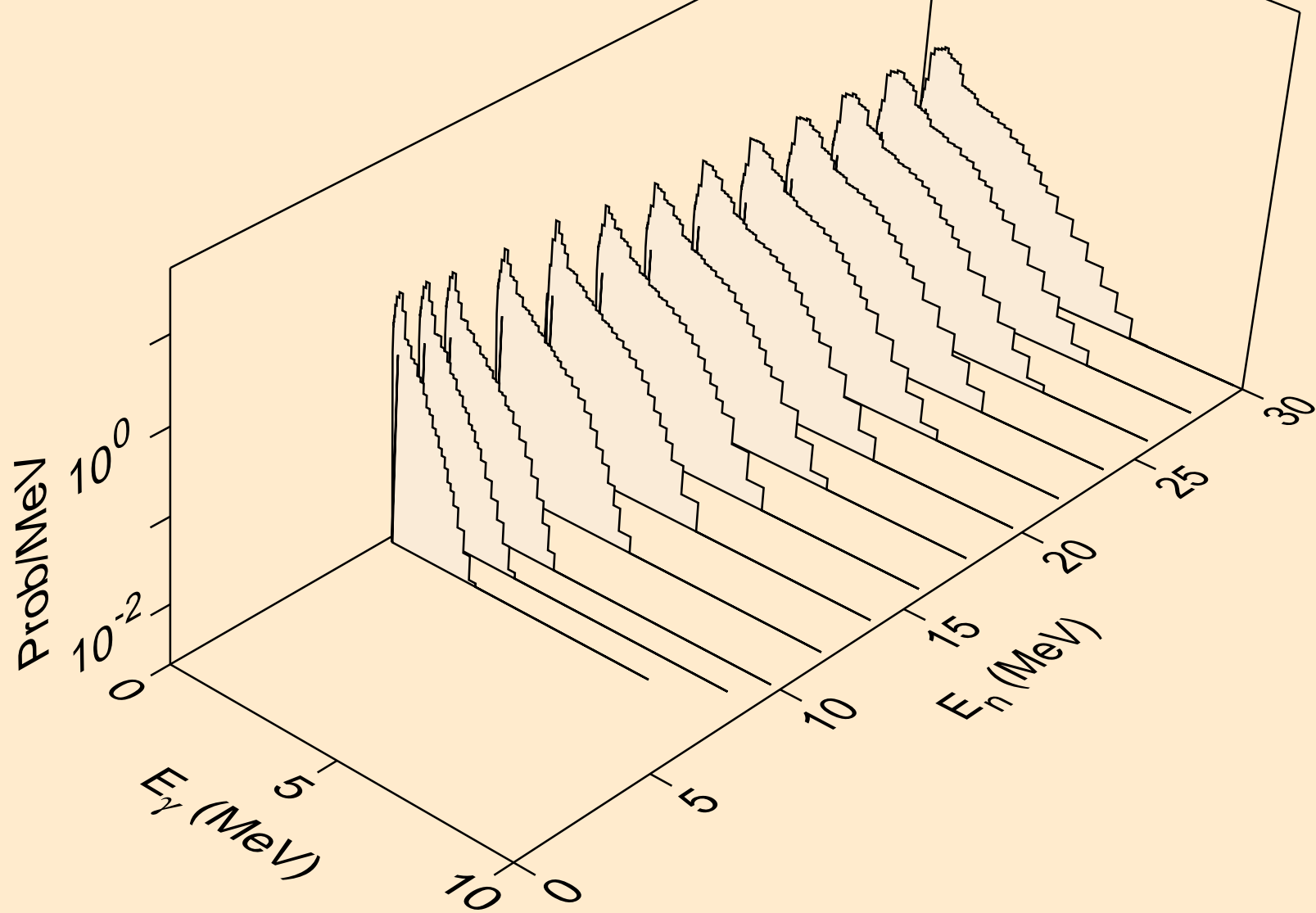

LU160 HELION ACER TENDL-2021 LIBRARY; T=0.K
Photon emission for (n,pa)

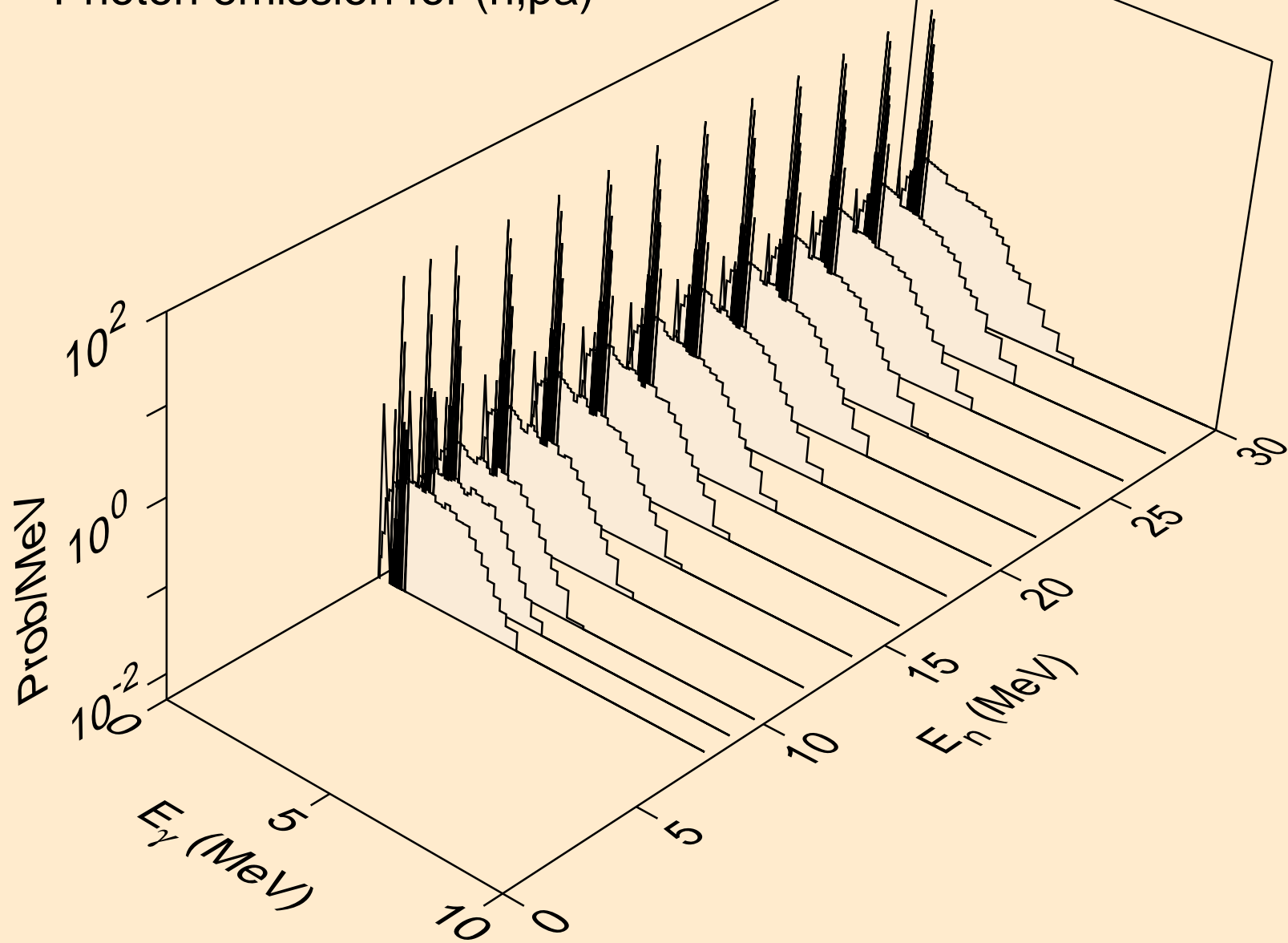

LU160 HELION ACER TENDL-2021 LIBRARY; T=0.K
Photon emission for (n,t2a)

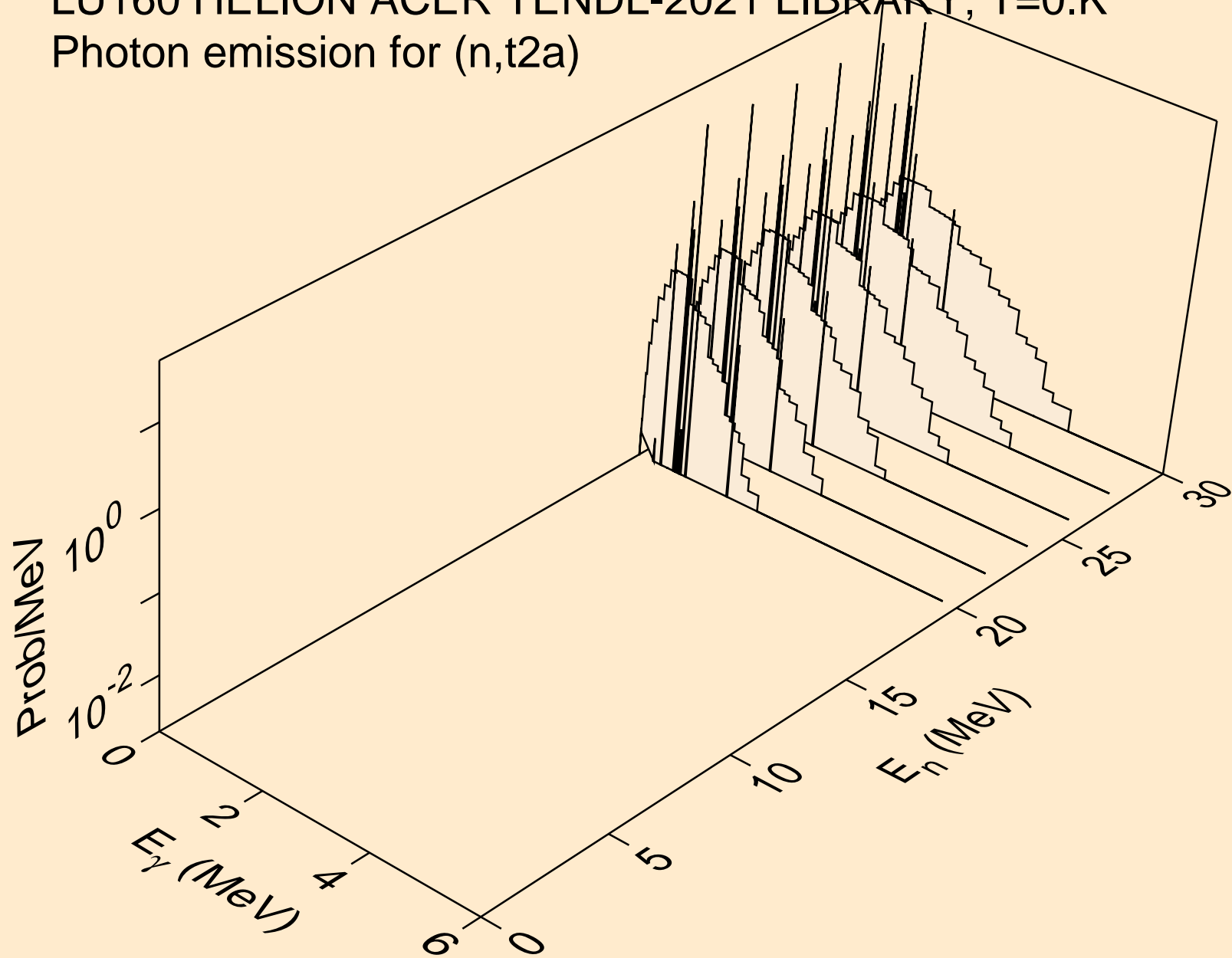

LU160 HELION ACER TENDL-2021 LIBRARY; T=0.K
Photon emission for (n,d2a)

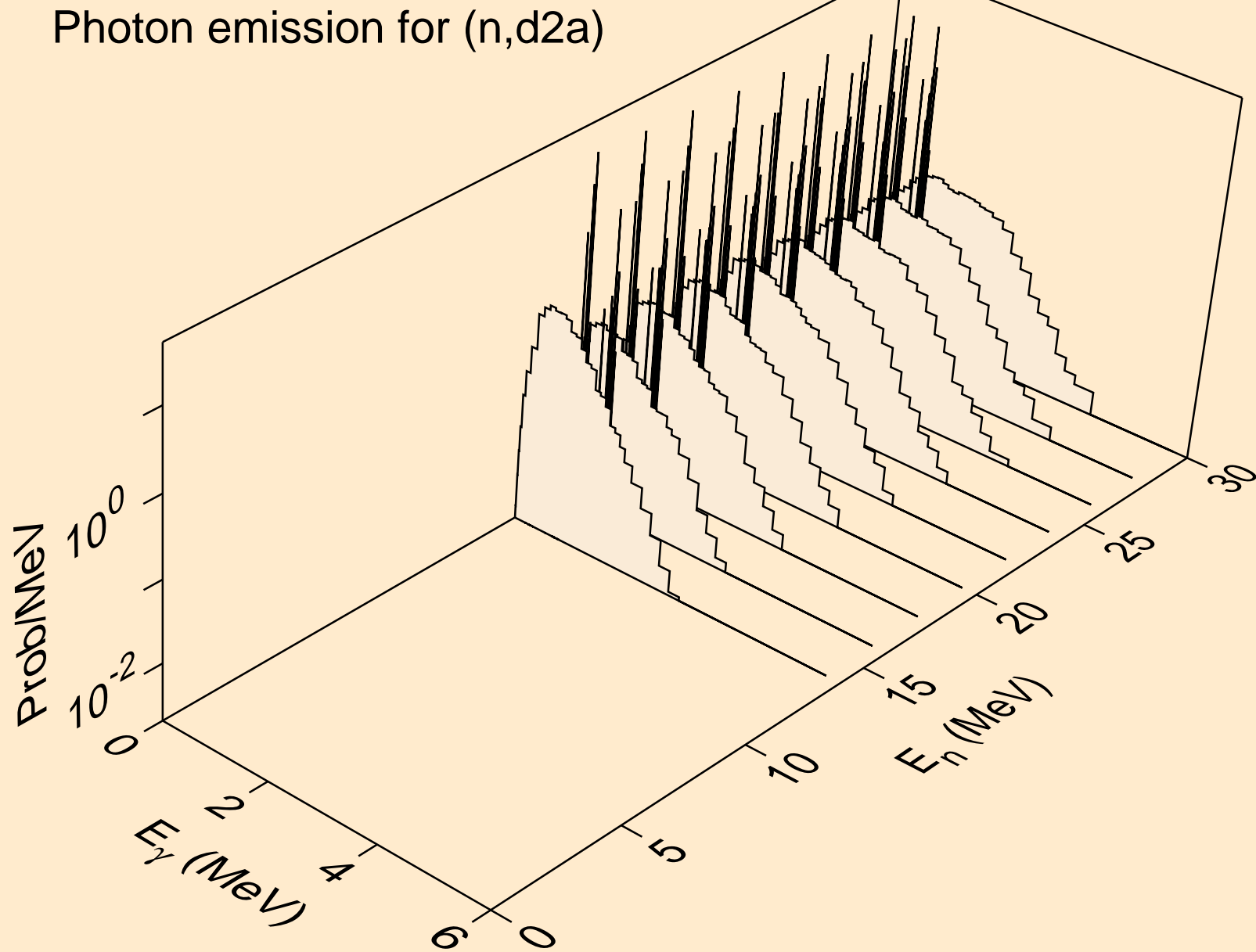

LU160 HELION ACER TENDL-2021 LIBRARY; T=0.K
Photon emission for (n,pd)

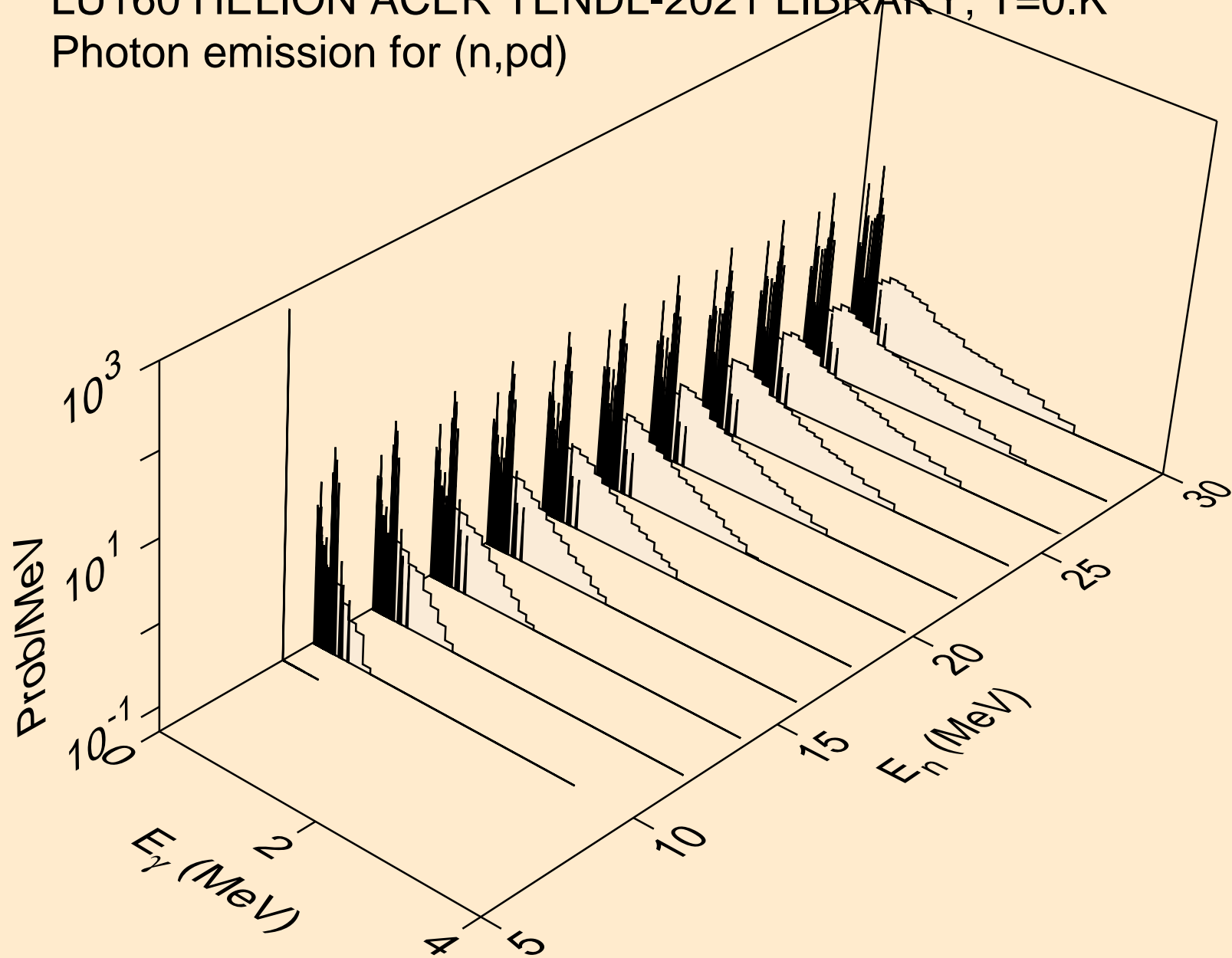

LU160 HELION ACER TENDL-2021 LIBRARY; T=0.K
Photon emission for (n,pt)

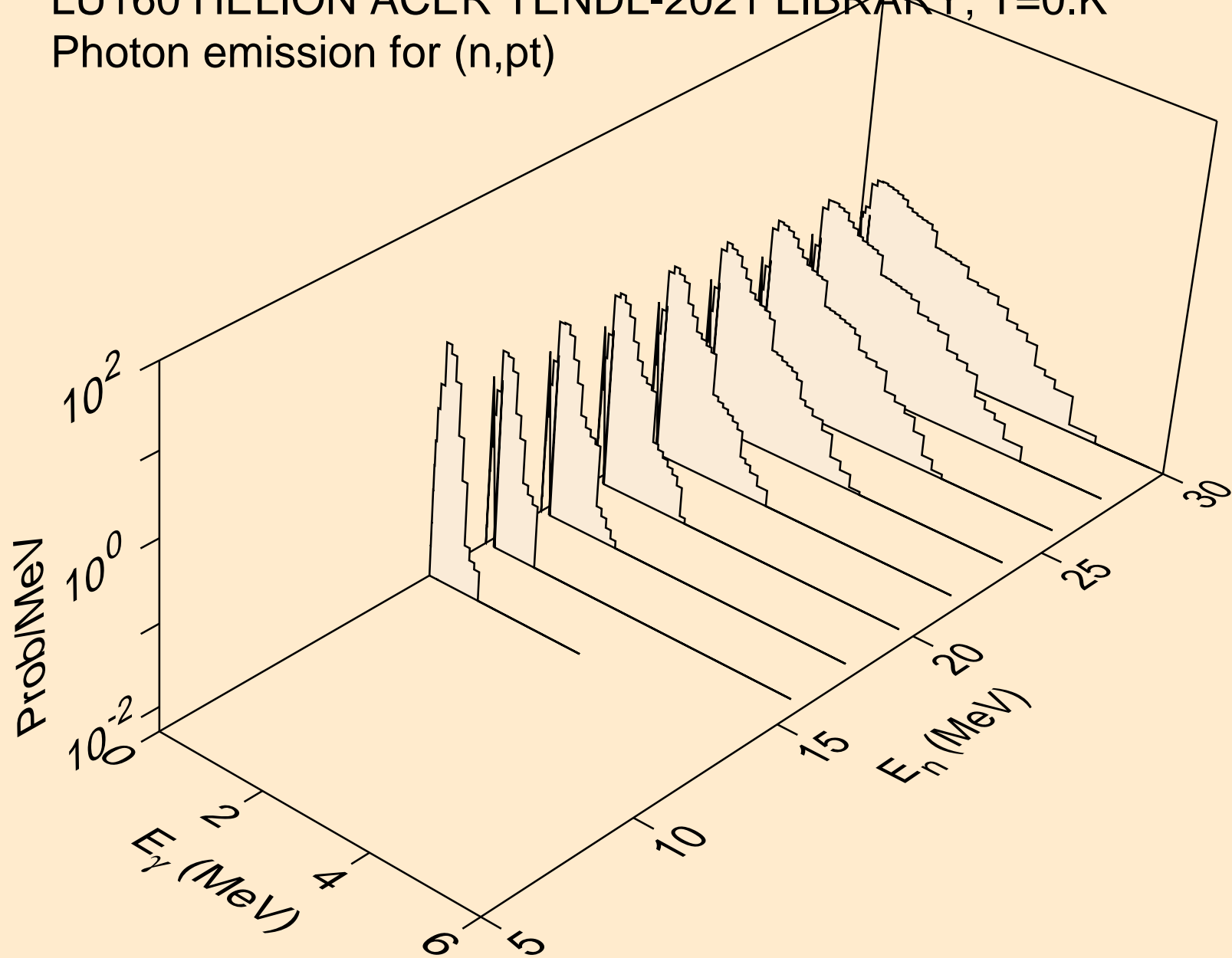

LU160 HELION ACER TENDL-2021 LIBRARY; T=0.K
Photon emission for (n,da)

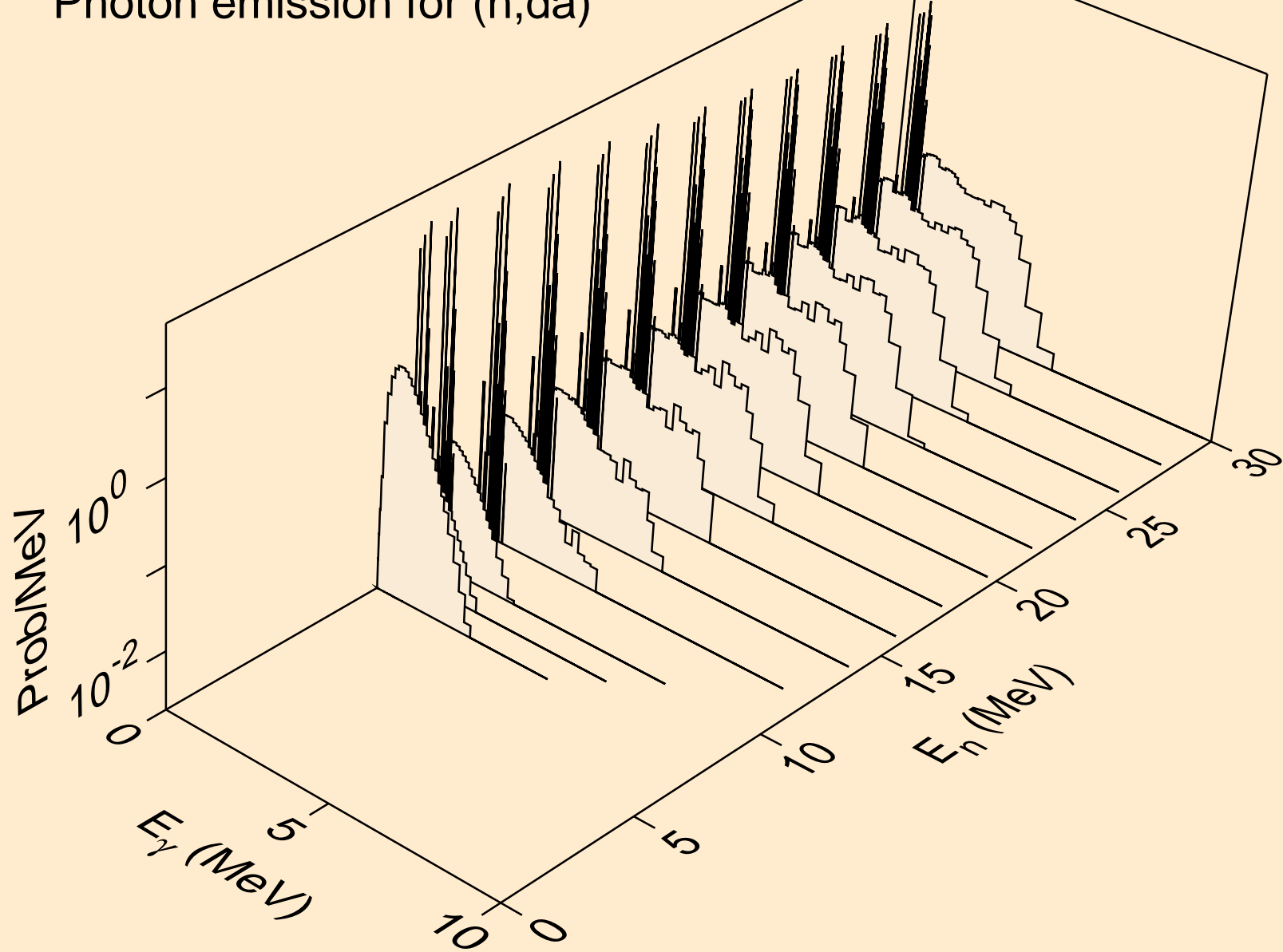

LU160 HELION ACER TENDL-2021 LIBRARY; T=0.K
Particle heating contributions

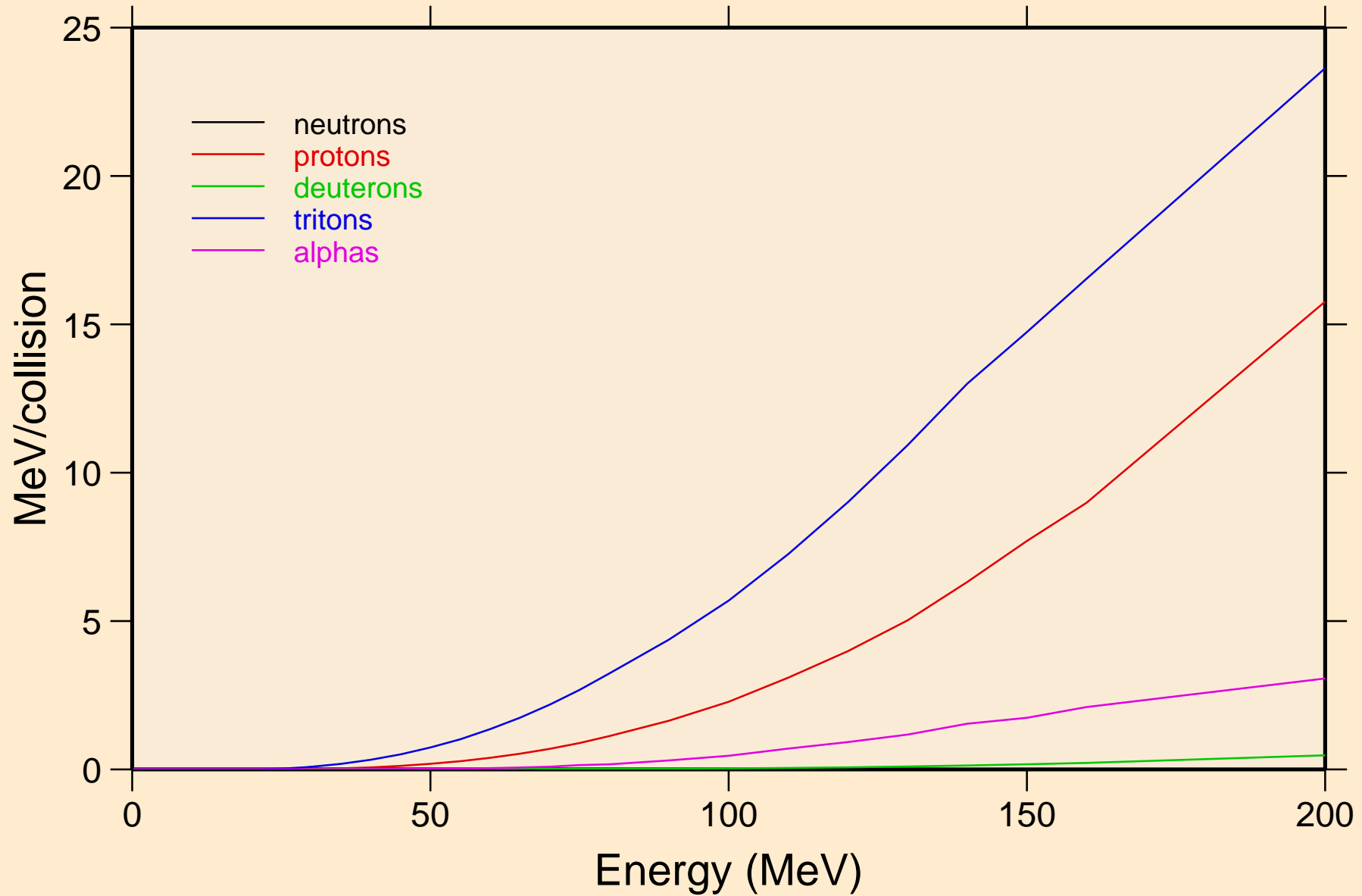

LU160 HELION ACER TENDL-2021 LIBRARY; T=0.K
Recoil Heating

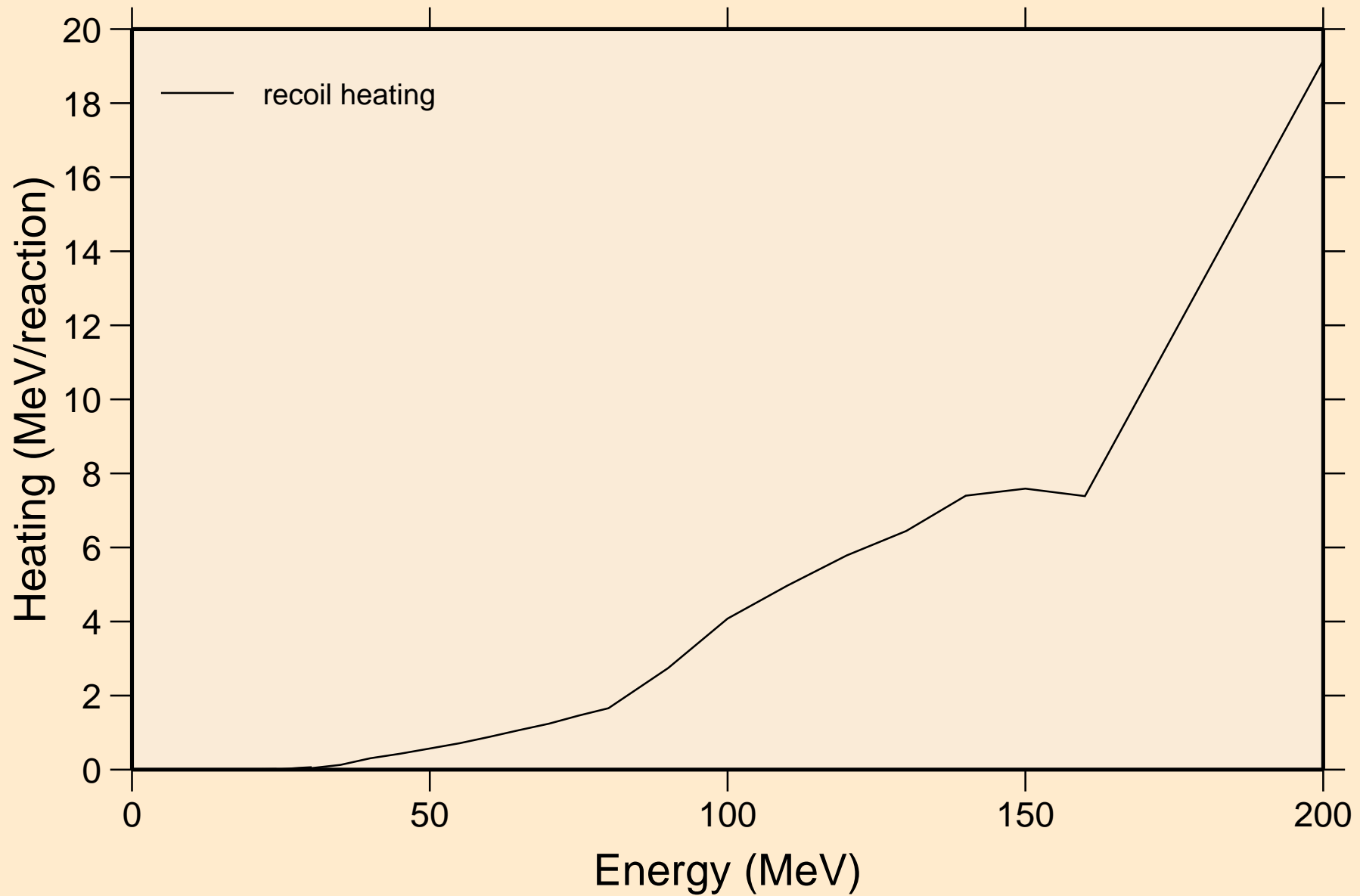

LU160 HELION ACER TENDL-2021 LIBRARY; T=0.K
Particle production cross sections

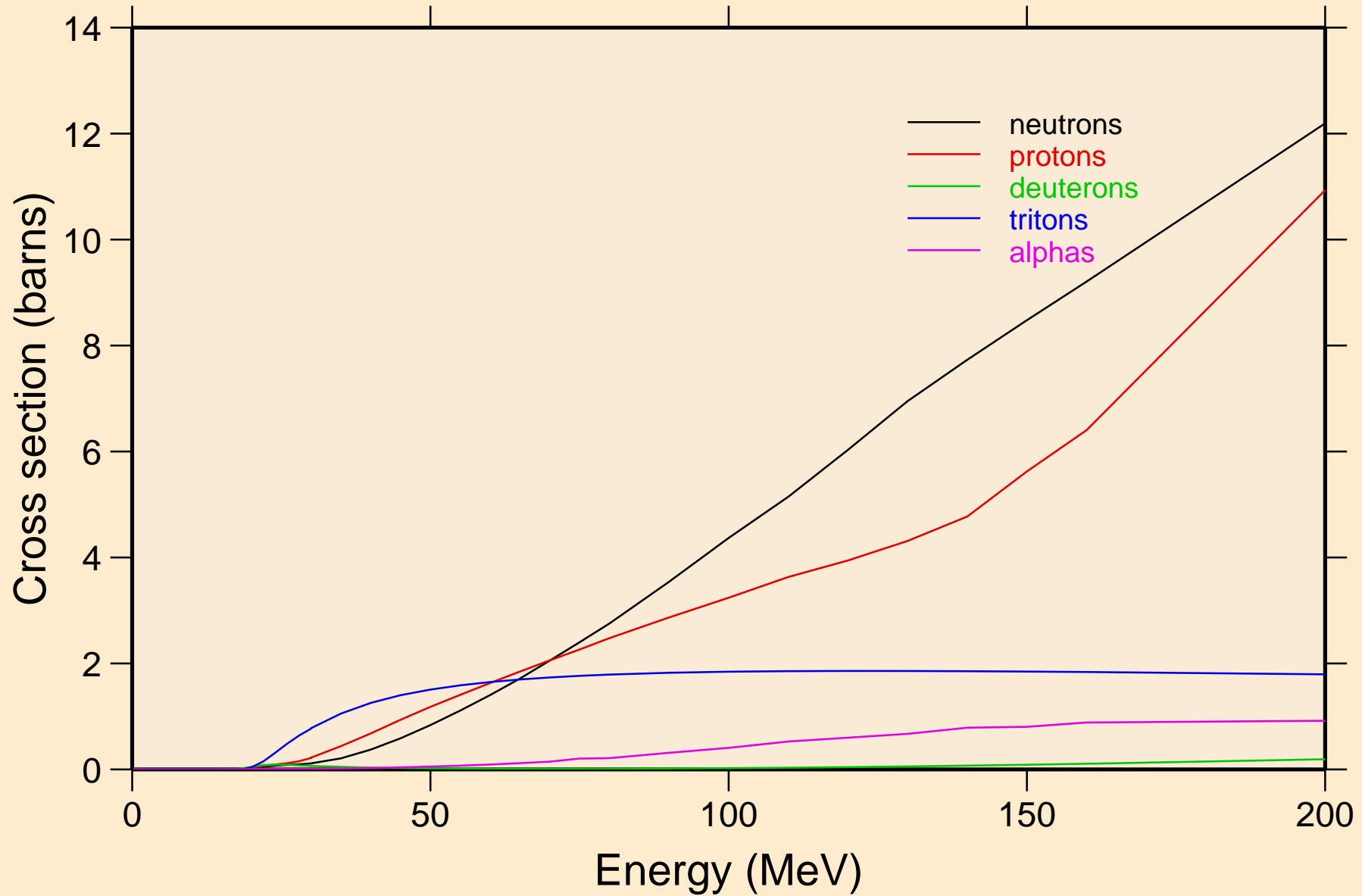

LU160 HELION ACER TENDL-2021 LIBRARY; T=0.K
neutrons from (s,n)

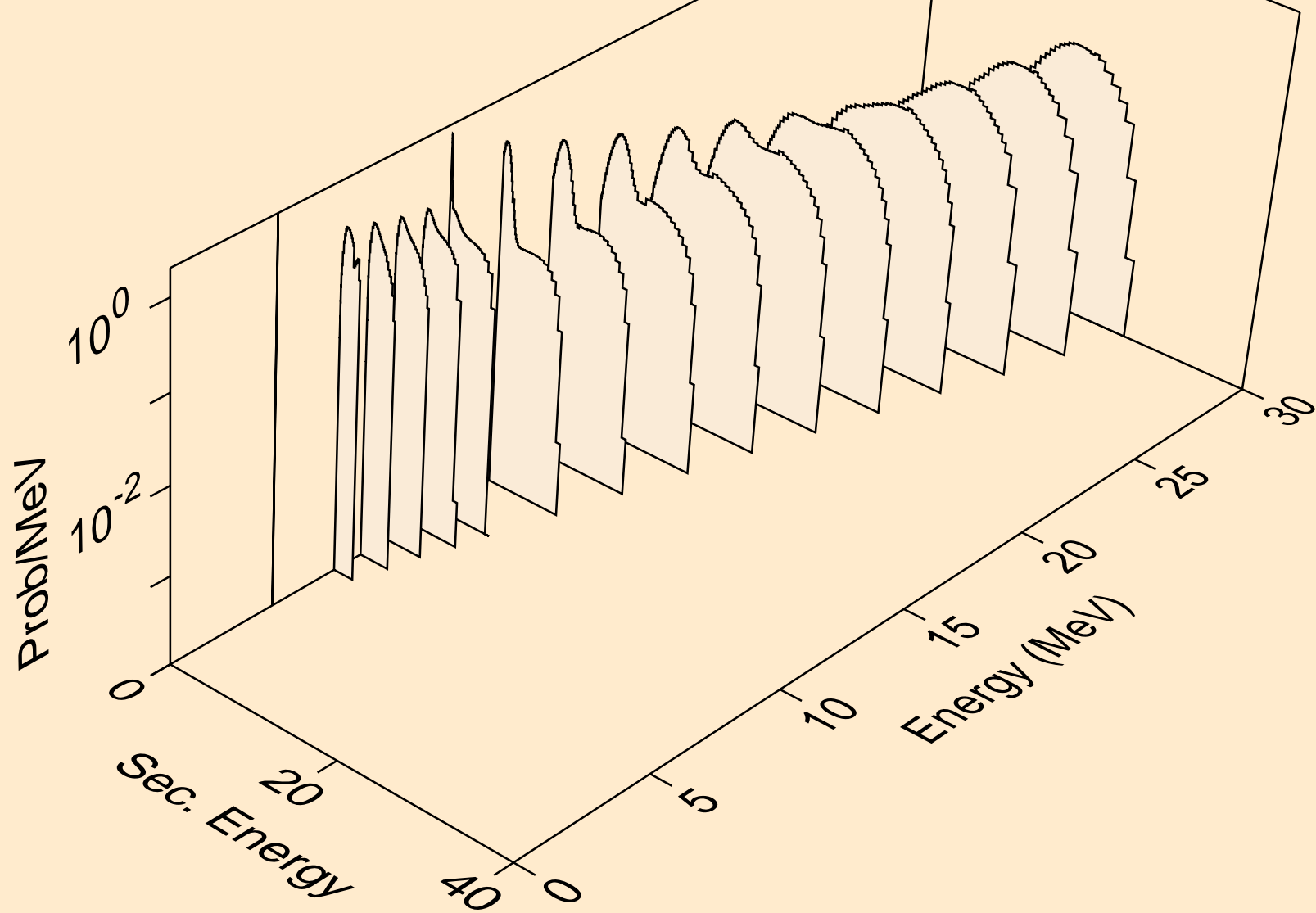

LU160 HELION ACER TENDL-2021 LIBRARY; T=0.K
neutrons from (s,x)

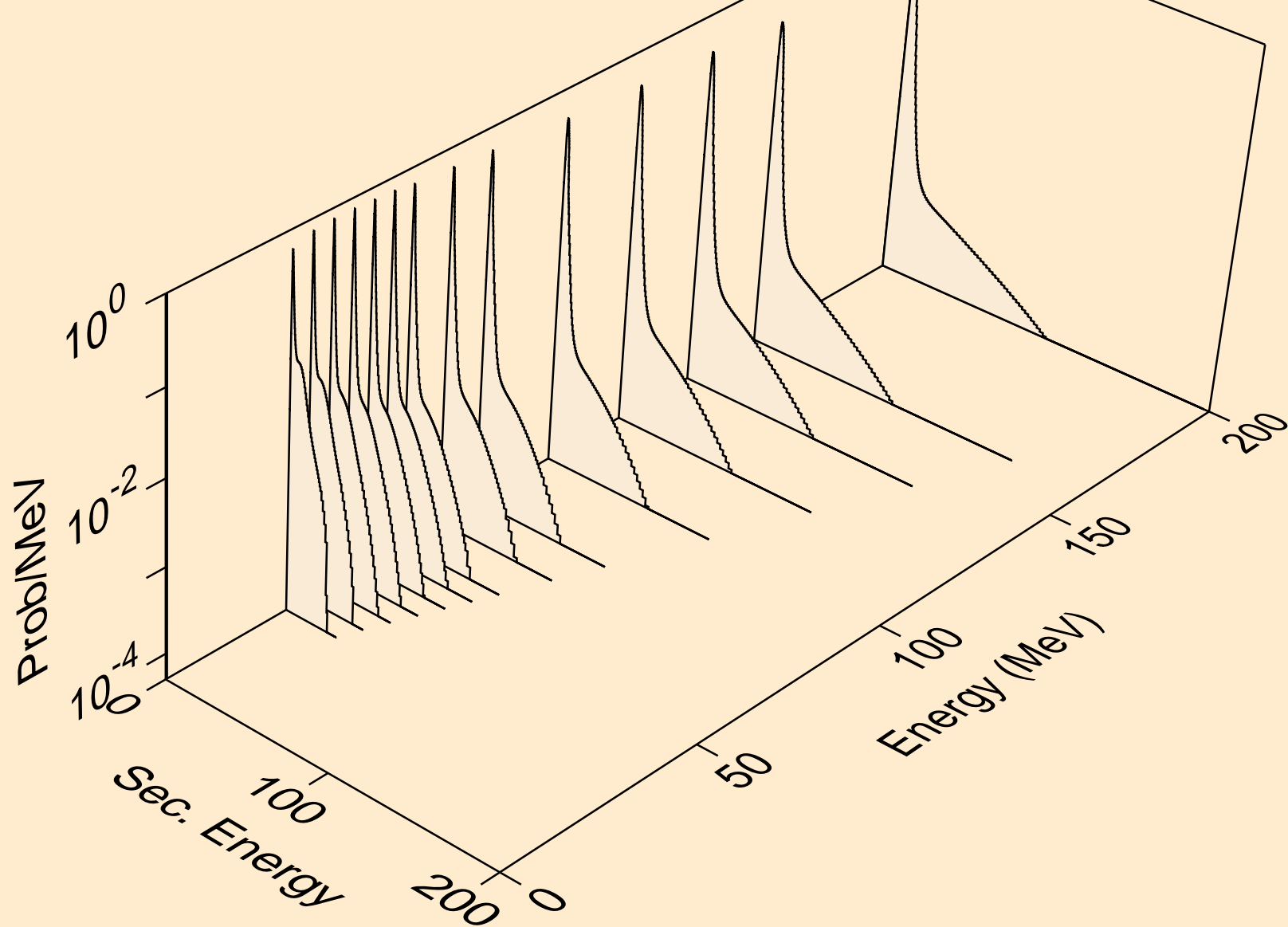

LU160 HELION ACER TENDL-2021 LIBRARY; T=0.K
neutrons from (s,2nd)

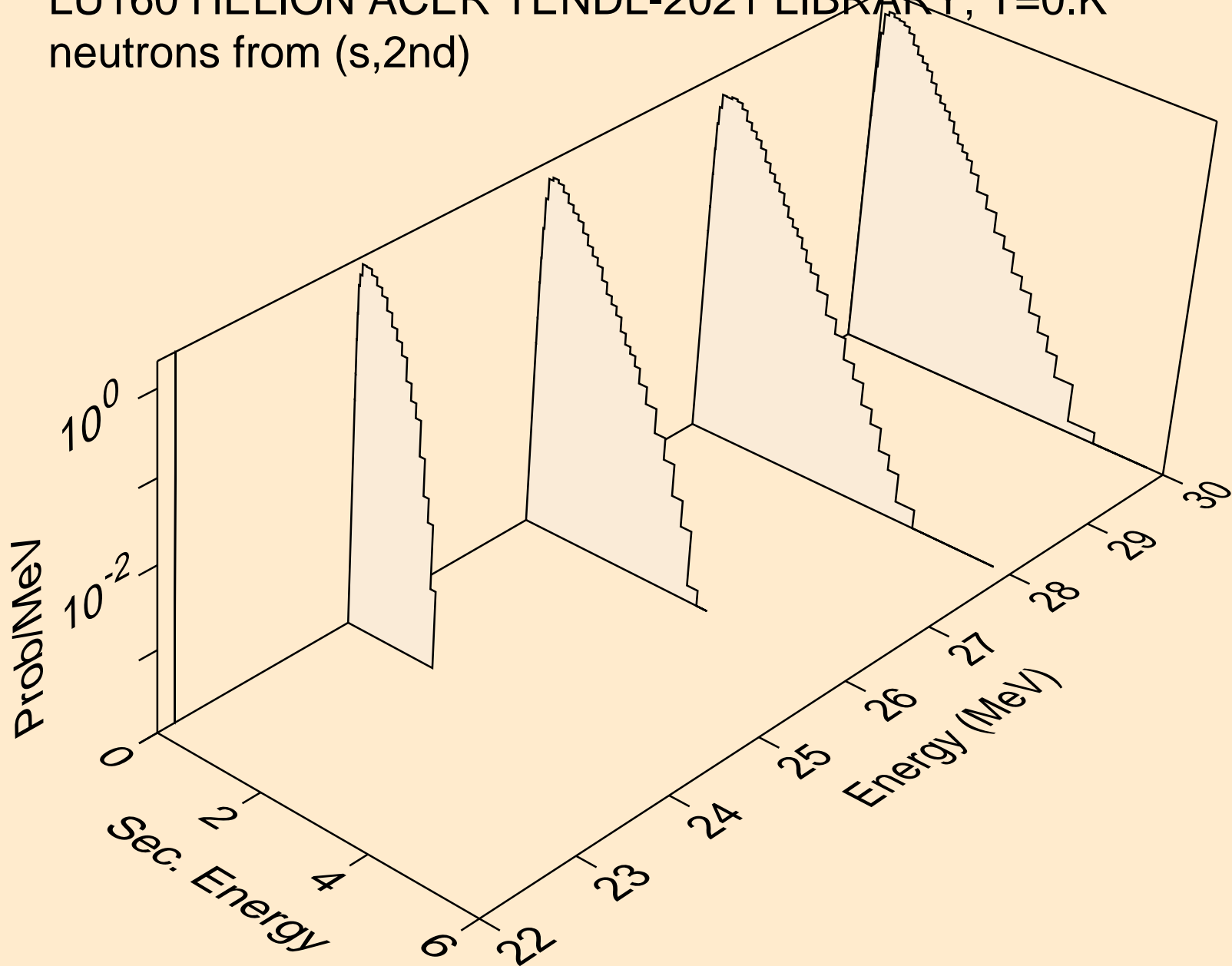

LU160 HELION ACER TENDL-2021 LIBRARY; T=0.K
neutrons from (s,2n)

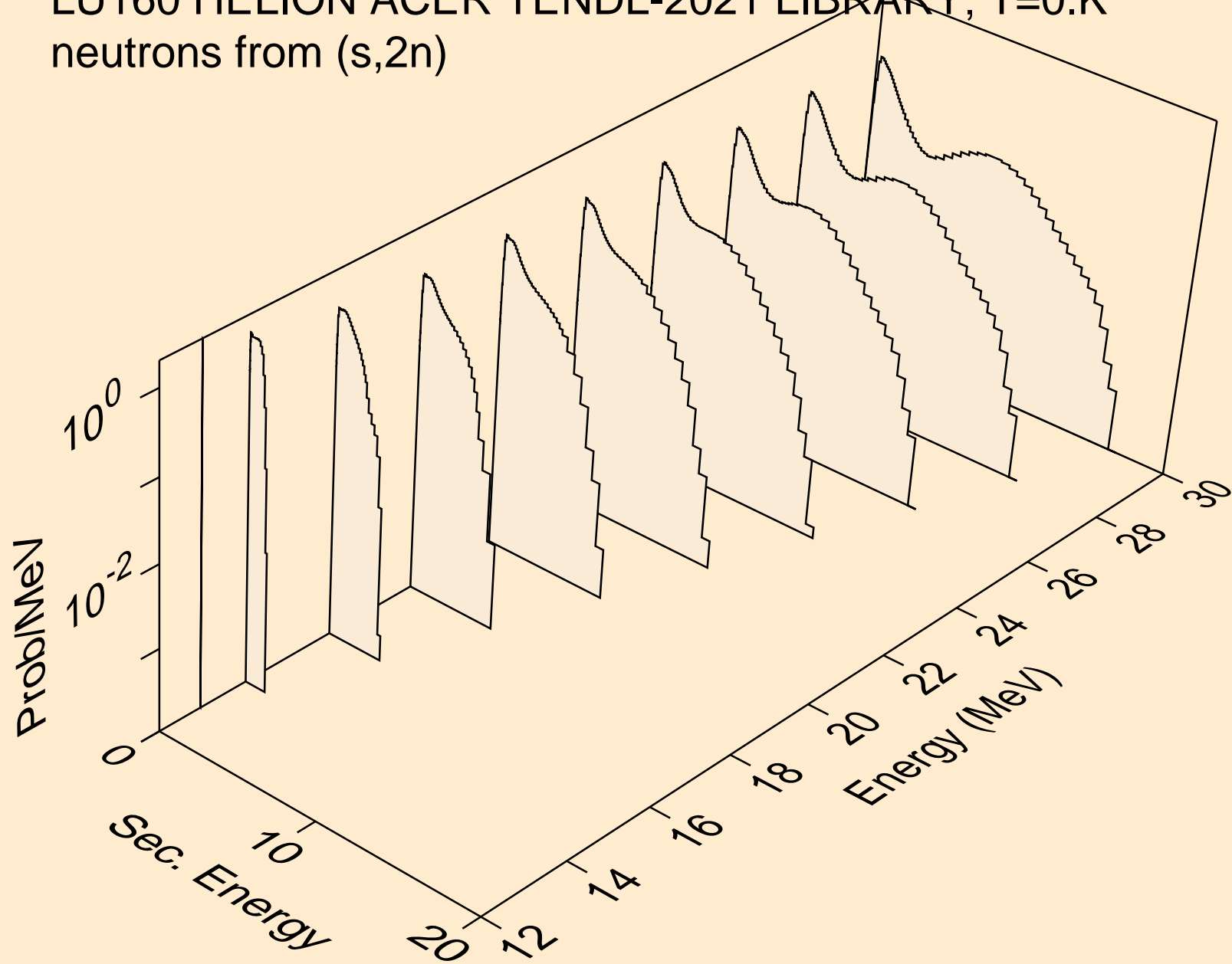

LU160 HELION ACER TENDL-2021 LIBRARY; T=0.K
neutrons from (s,3n)

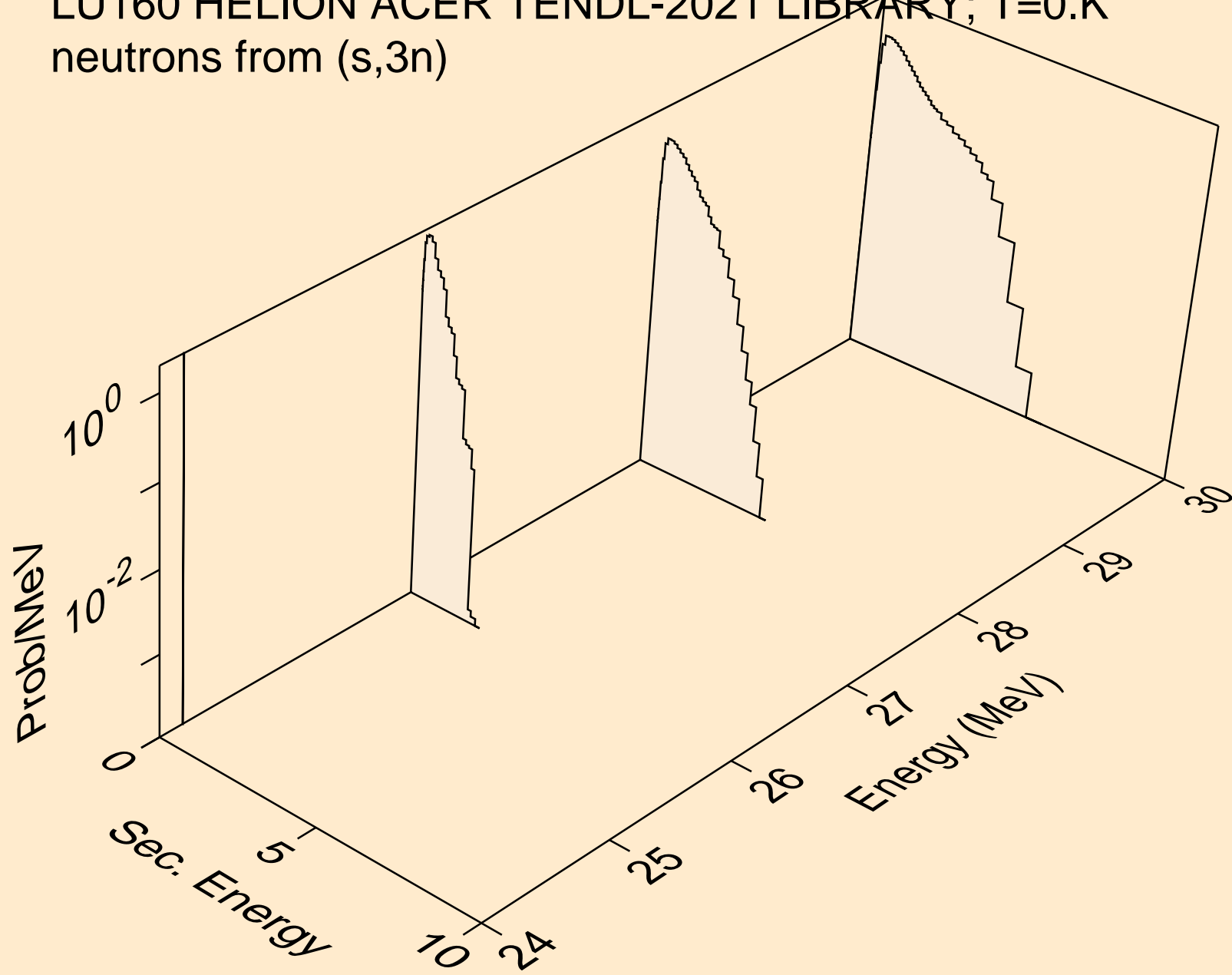

LU160 HELION ACER TENDL-2021 LIBRARY; T=0.K
neutrons from (s,n*)a

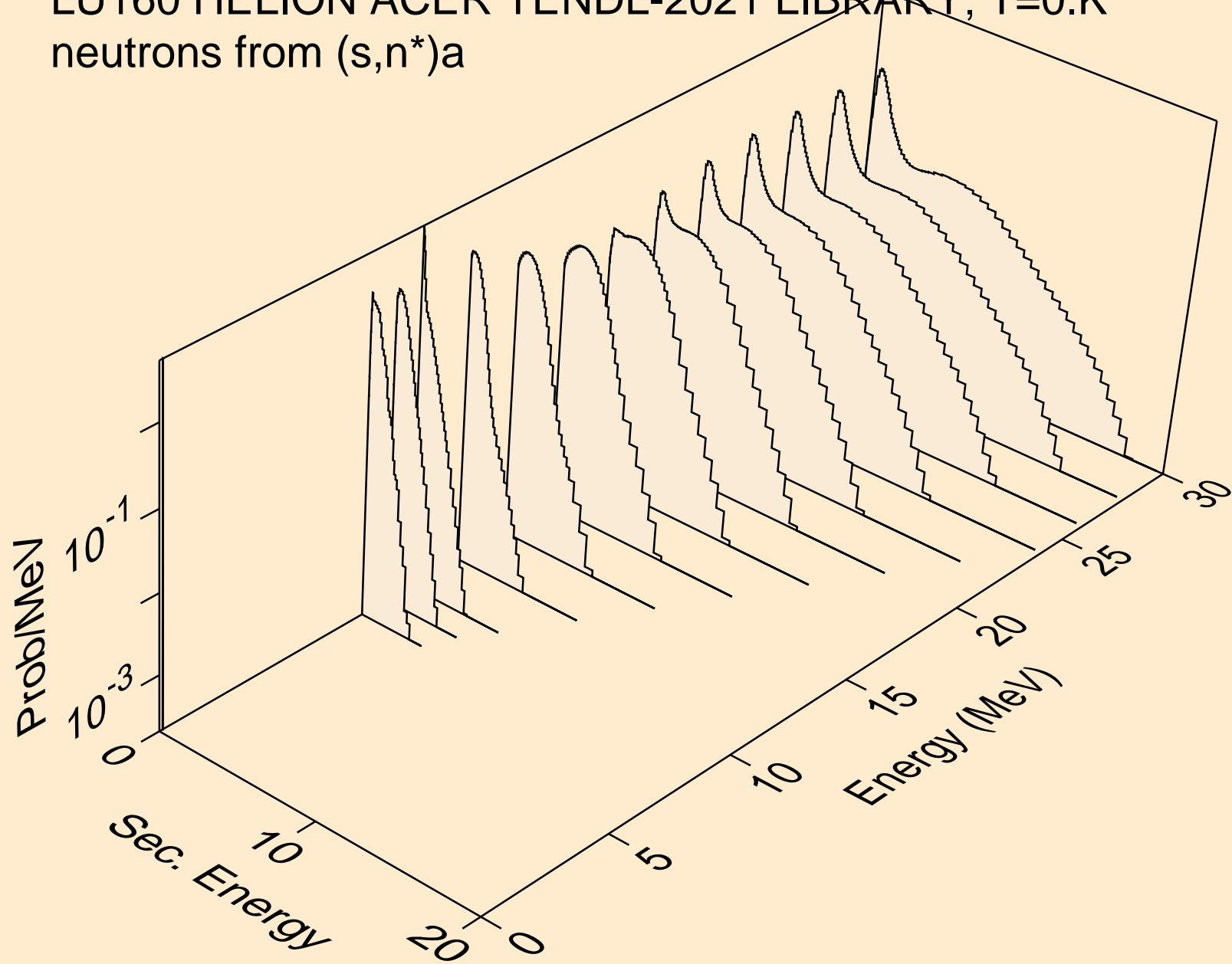

LU160 HELION ACER TENDL-2021 LIBRARY; T=0.K
neutrons from (s,2n)a

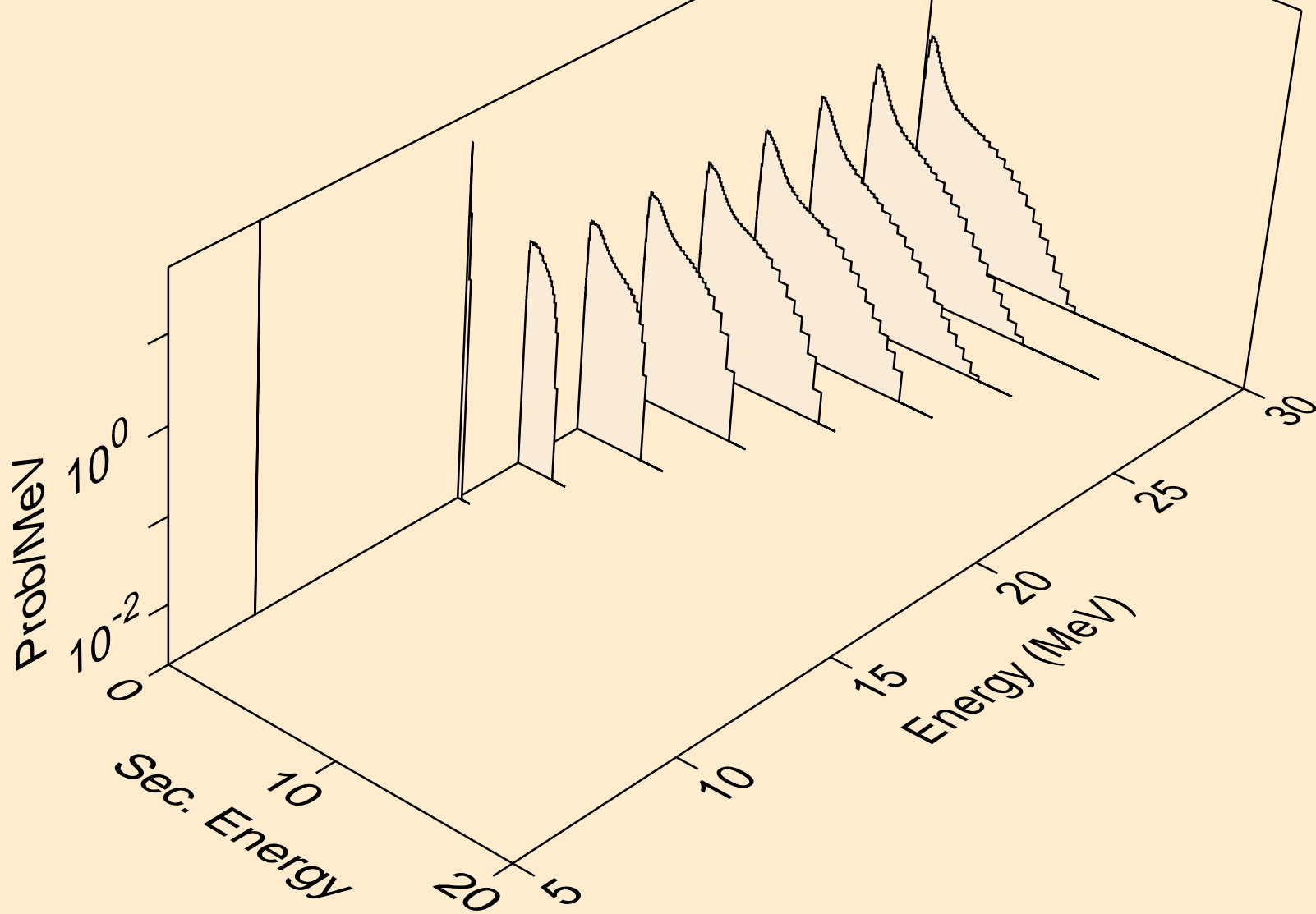

LU160 HELION ACER TENDL-2021 LIBRARY; T=0.K
neutrons from (s,3n)a

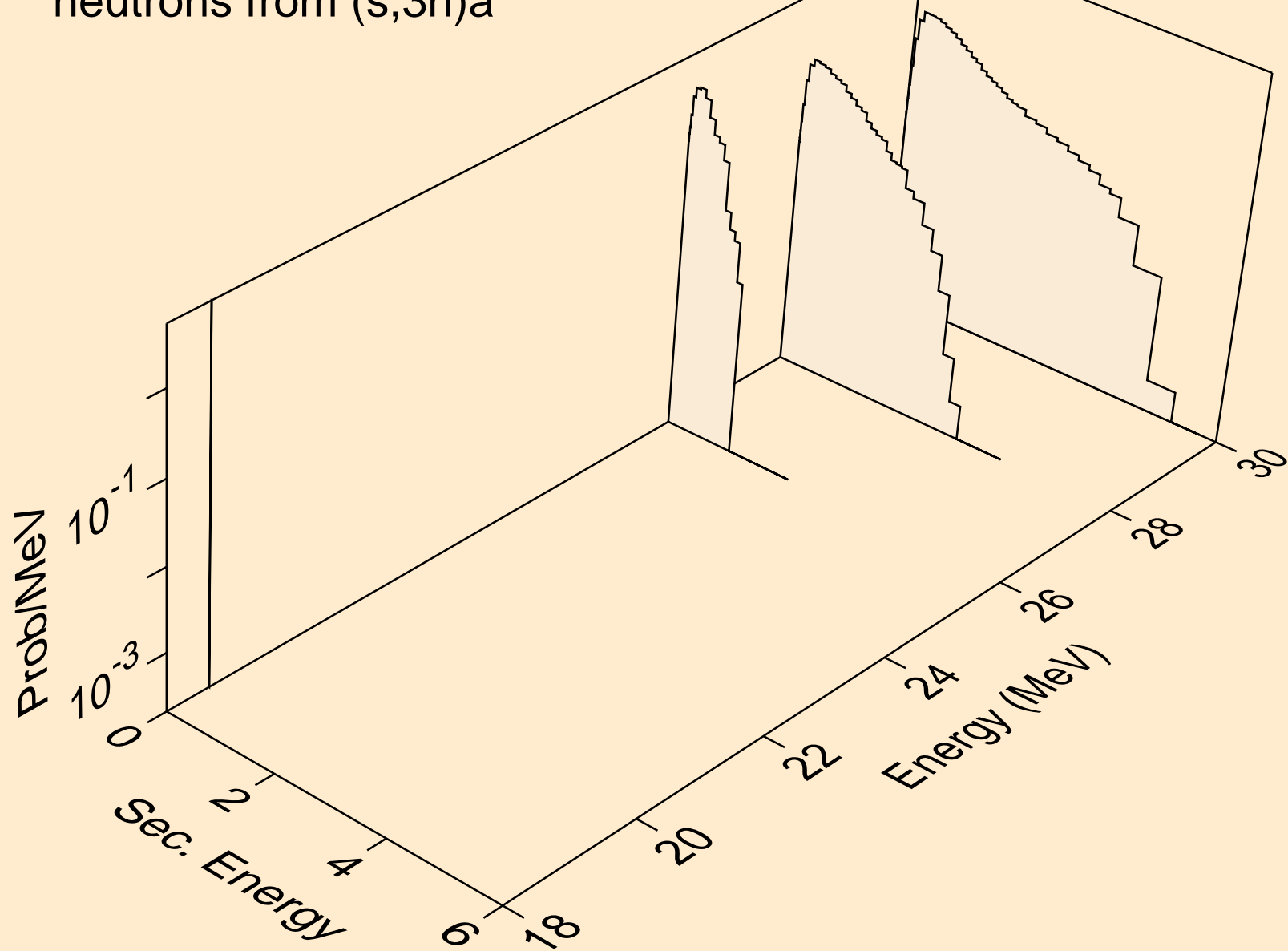

LU160 HELION ACER TENDL-2021 LIBRARY; T=0.K
neutrons from (s,n*)p

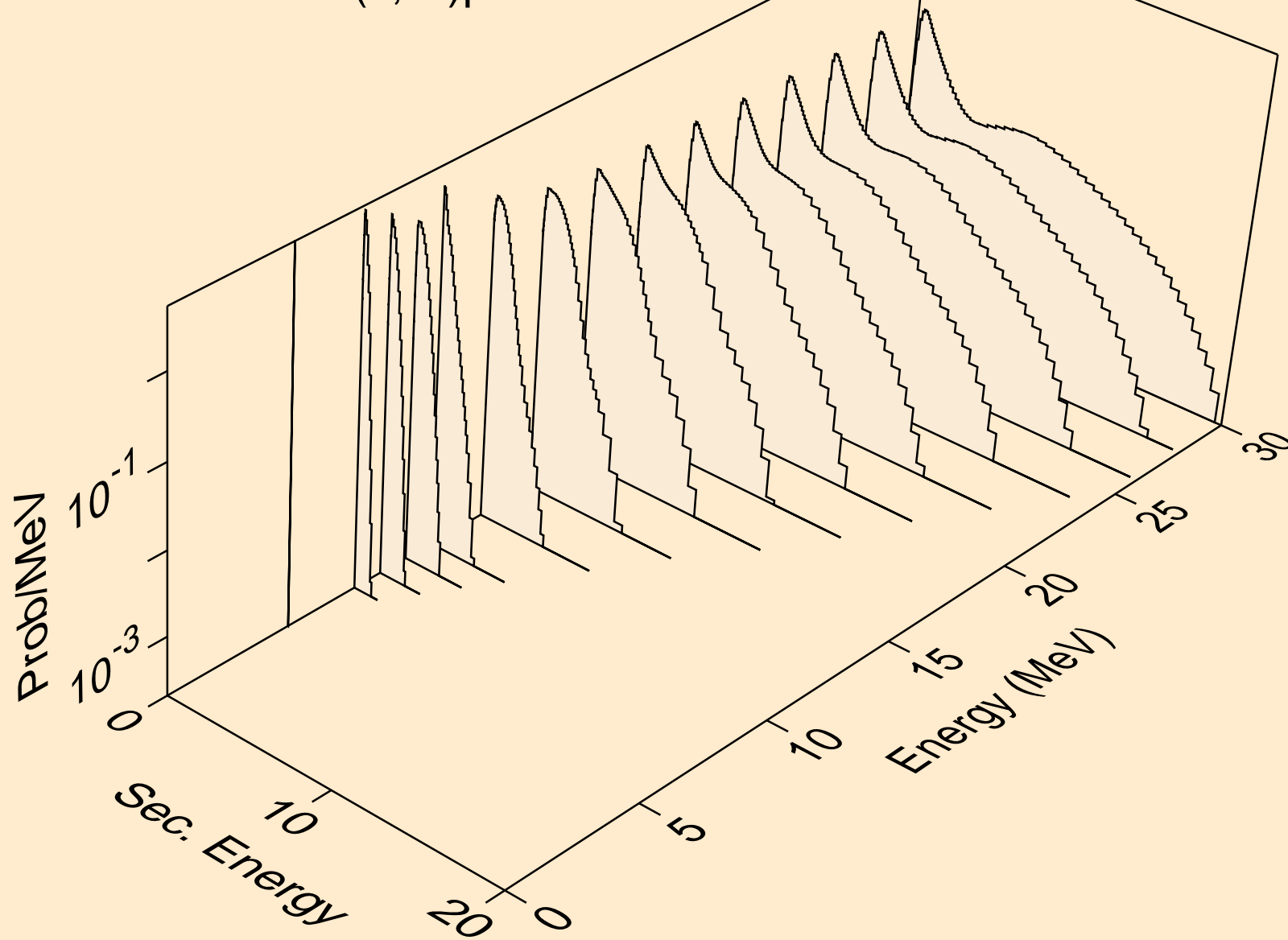

LU160 HELION ACER TENDL-2021 LIBRARY; T=0.K
neutrons from (s,n*)2a

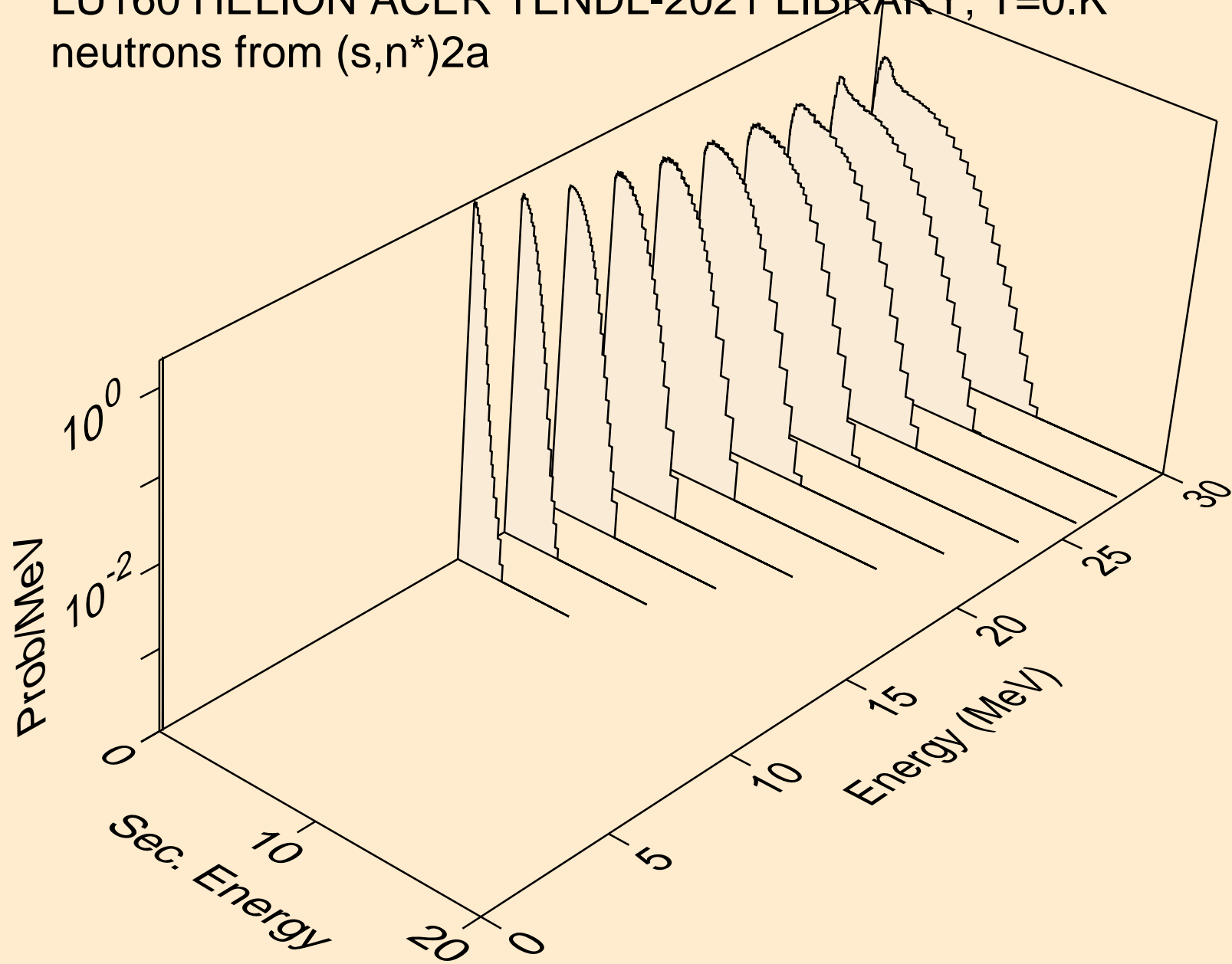

LU160 HELION ACER TENDL-2021 LIBRARY; T=0.K
neutrons from (s,2n)2a

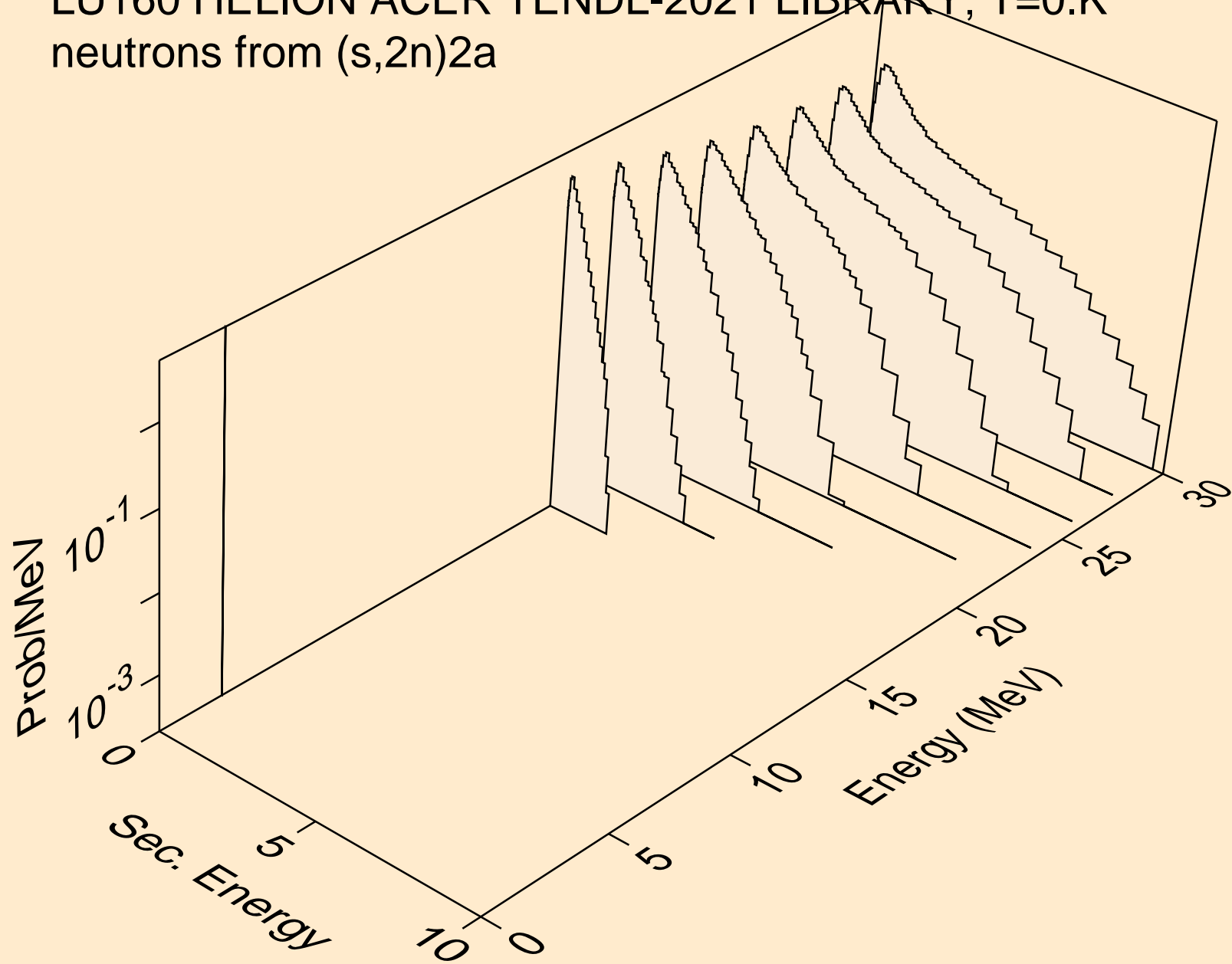

LU160 HELION ACER TENDL-2021 LIBRARY; T=0.K
neutrons from (s,n*)d

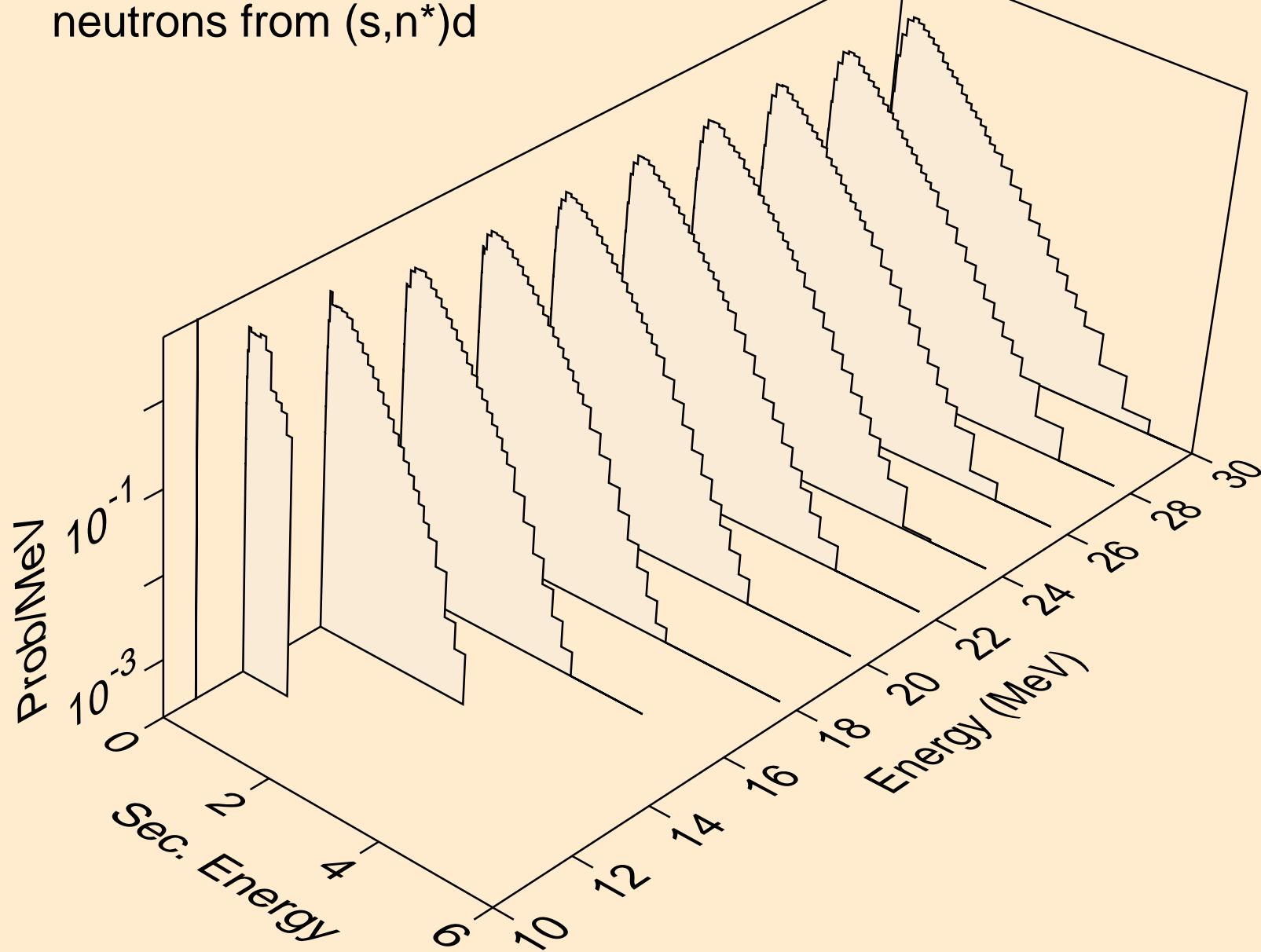

LU160 HELION ACER TENDL-2021 LIBRARY; T=0.K
neutrons from (s,n*)t

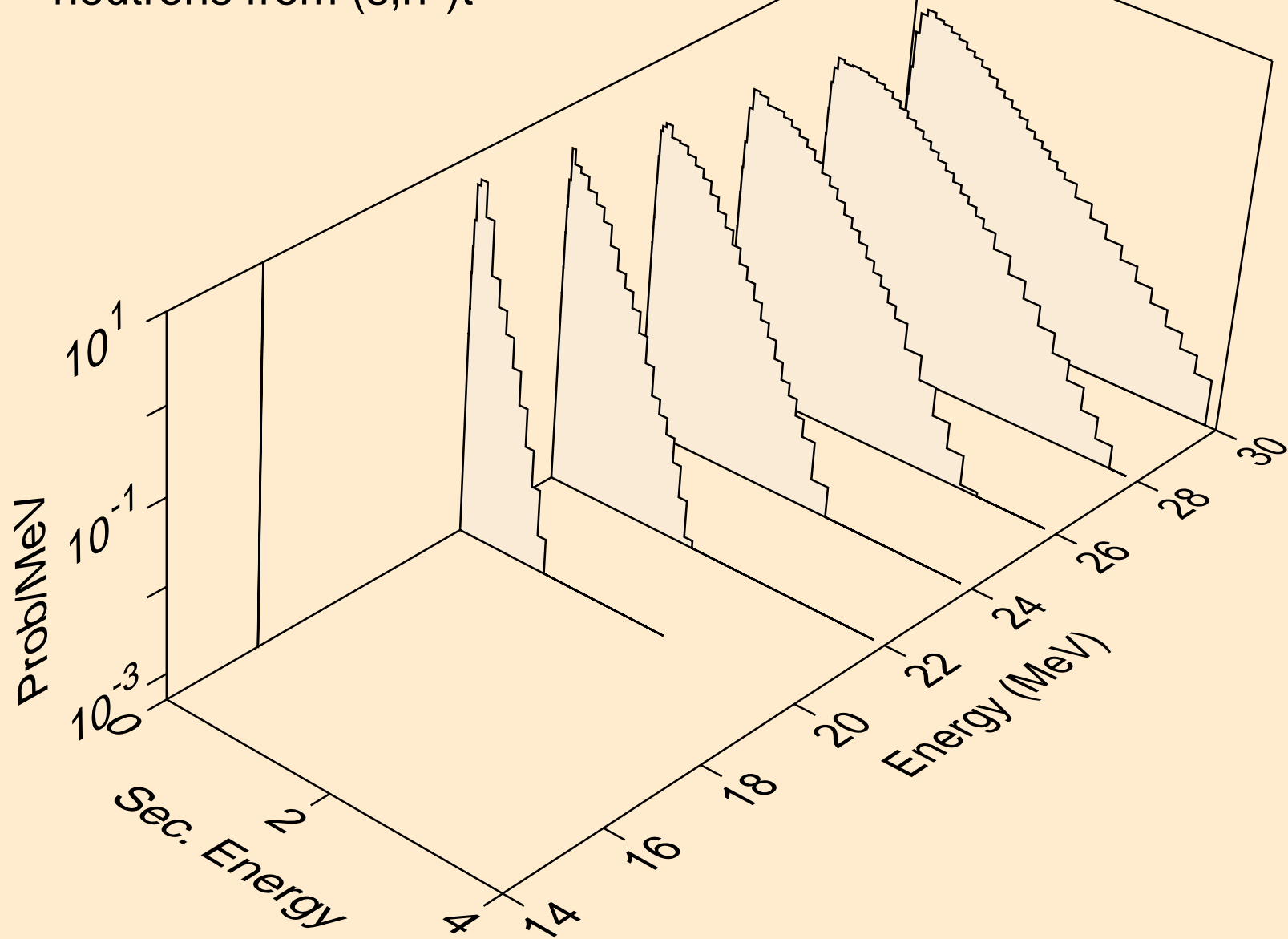

LU160 HELION ACER TENDL-2021 LIBRARY; T=0.K
neutrons from (s,n*)he3

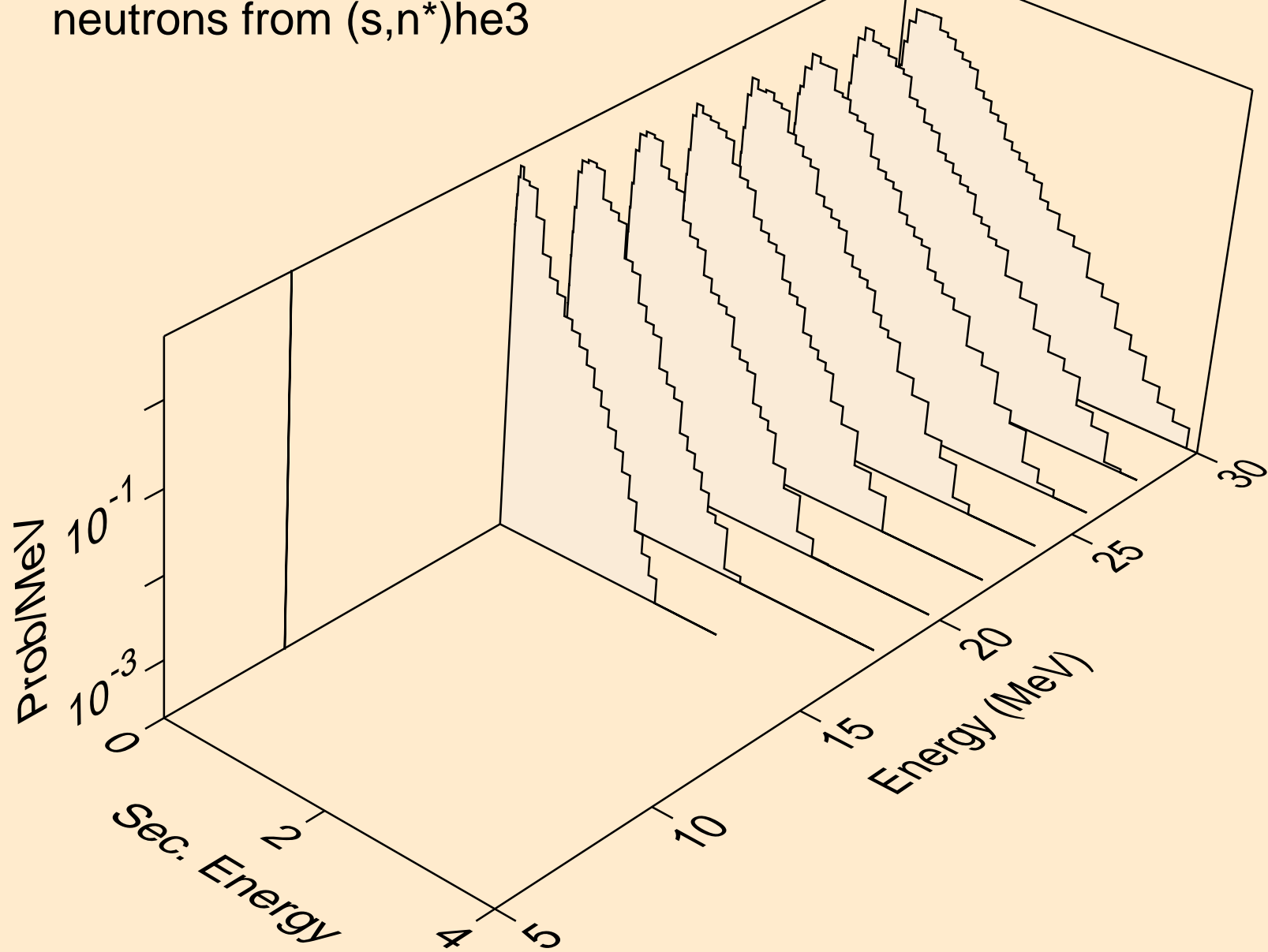

LU160 HELION ACER TENDL-2021 LIBRARY; T=0.K
neutrons from (s,2np)

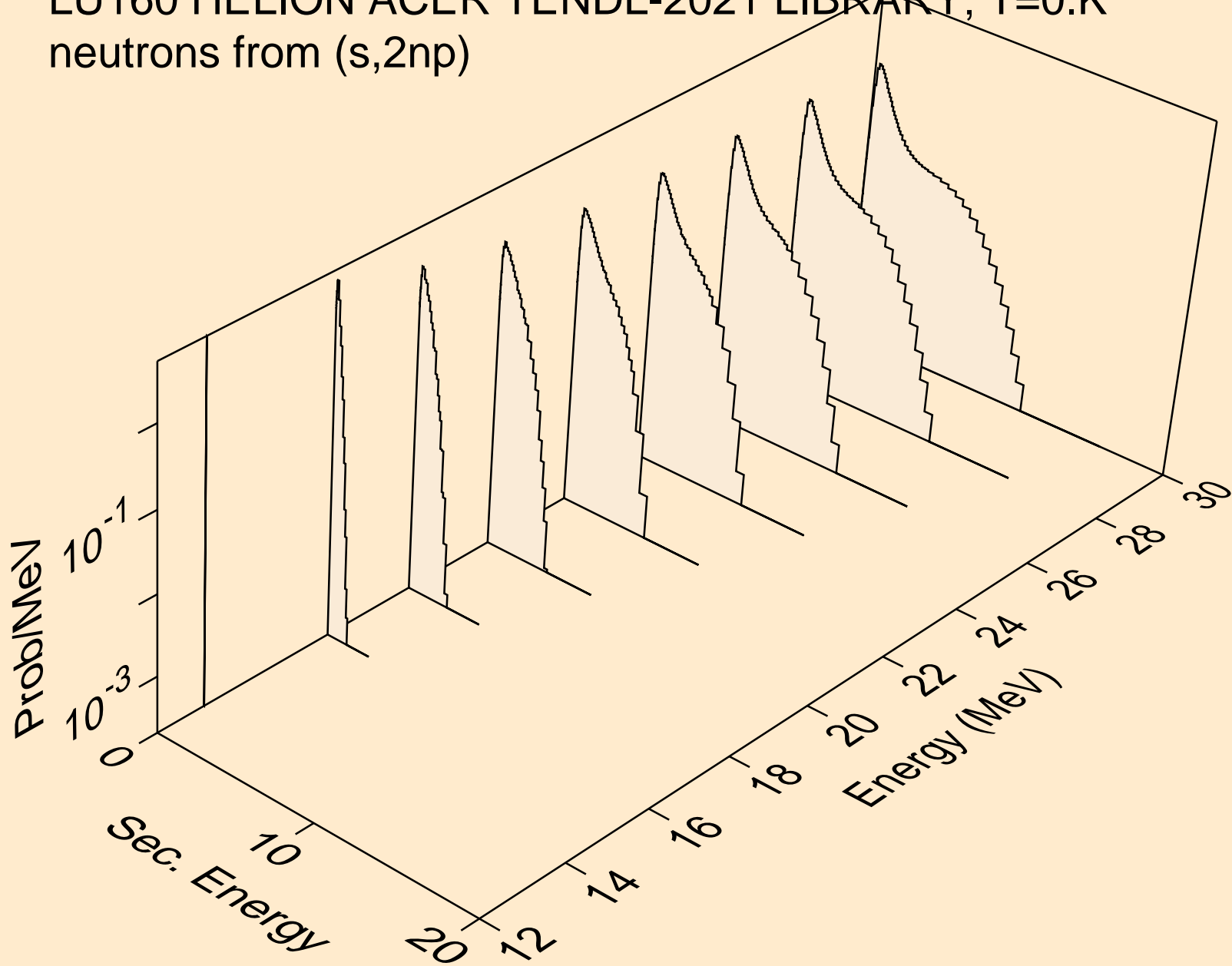

LU160 HELION ACER TENDL-2021 LIBRARY; T=0.K
neutrons from (s,3np)

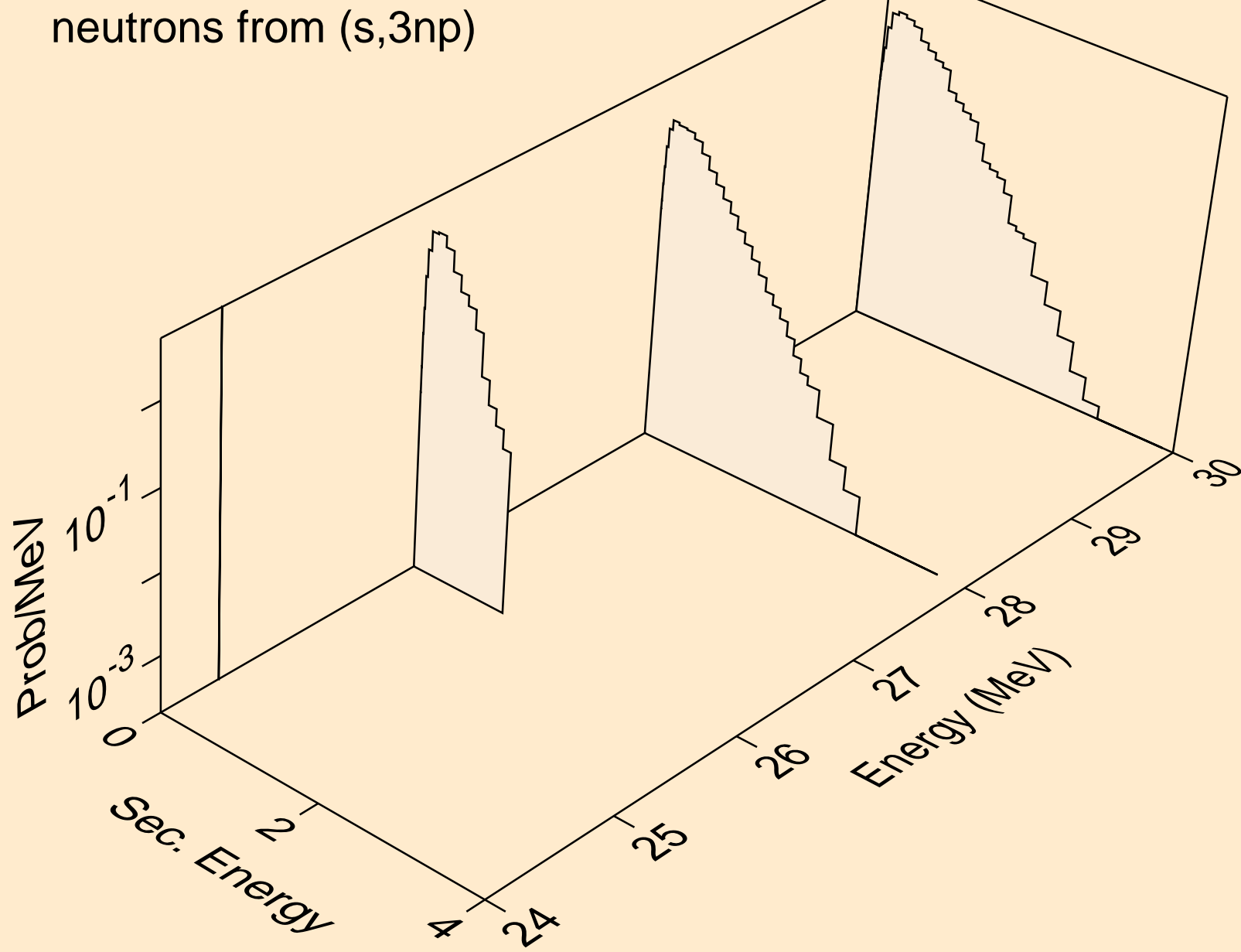

LU160 HELION ACER TENDL-2021 LIBRARY; T=0.K
neutrons from (s,2np)

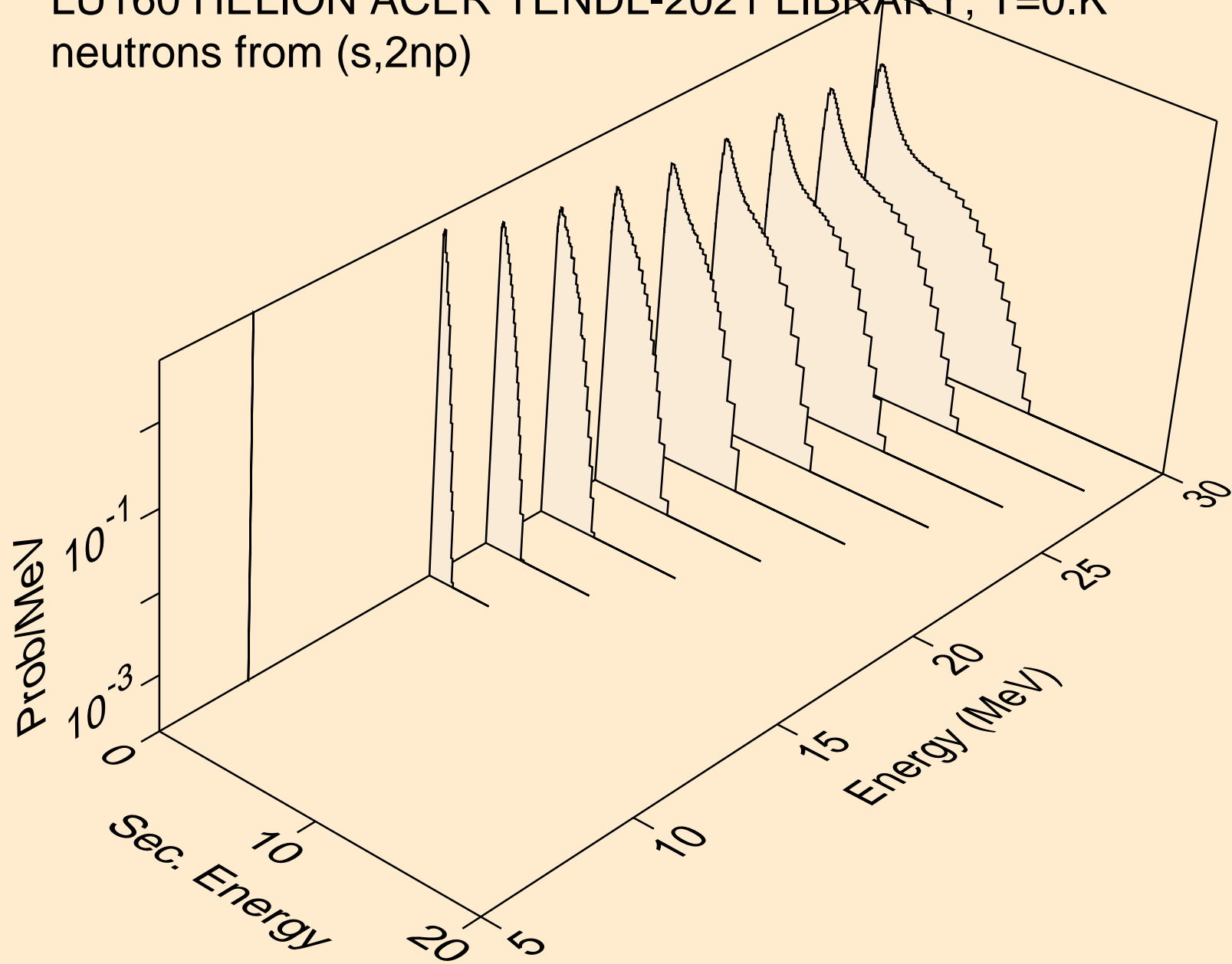

LU160 HELION ACER TENDL-2021 LIBRARY; T=0.K
neutrons from (s,npa)

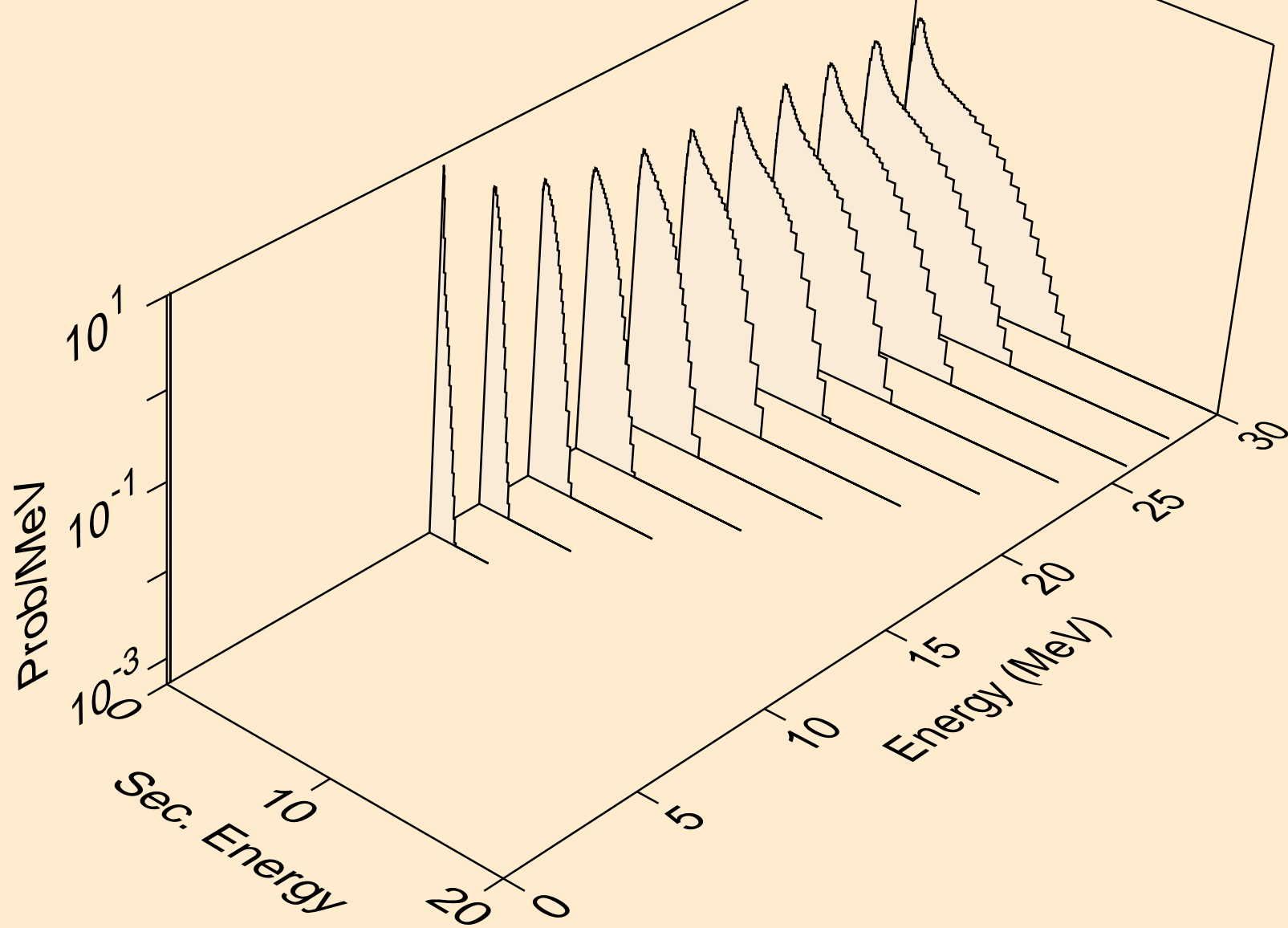

LU160 HELION ACER TENDL-2021 LIBRARY; T=0.K
protons from (s,x)

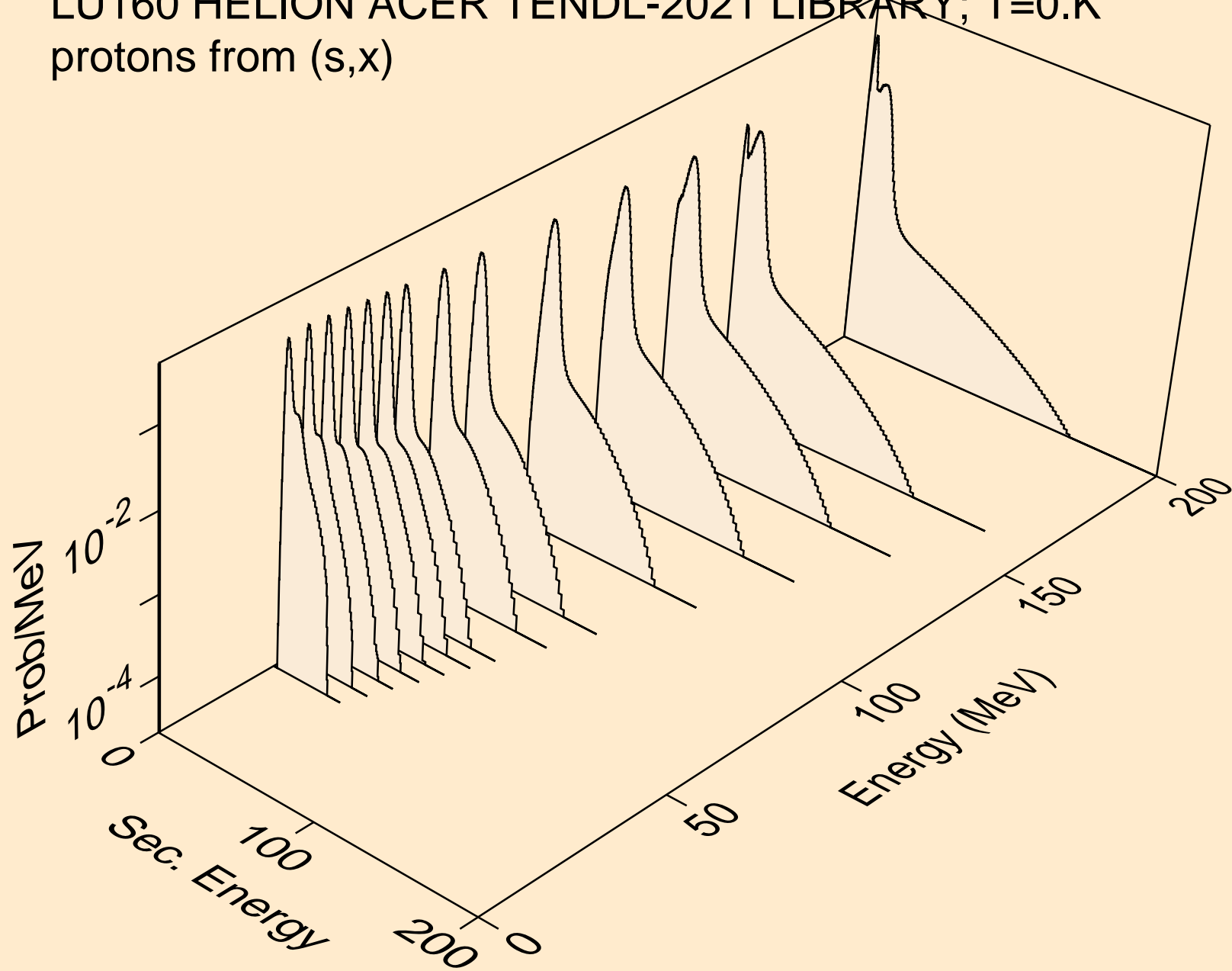

LU160 HELION ACER TENDL-2021 LIBRARY; T=0.K
protons from (s,n*)p

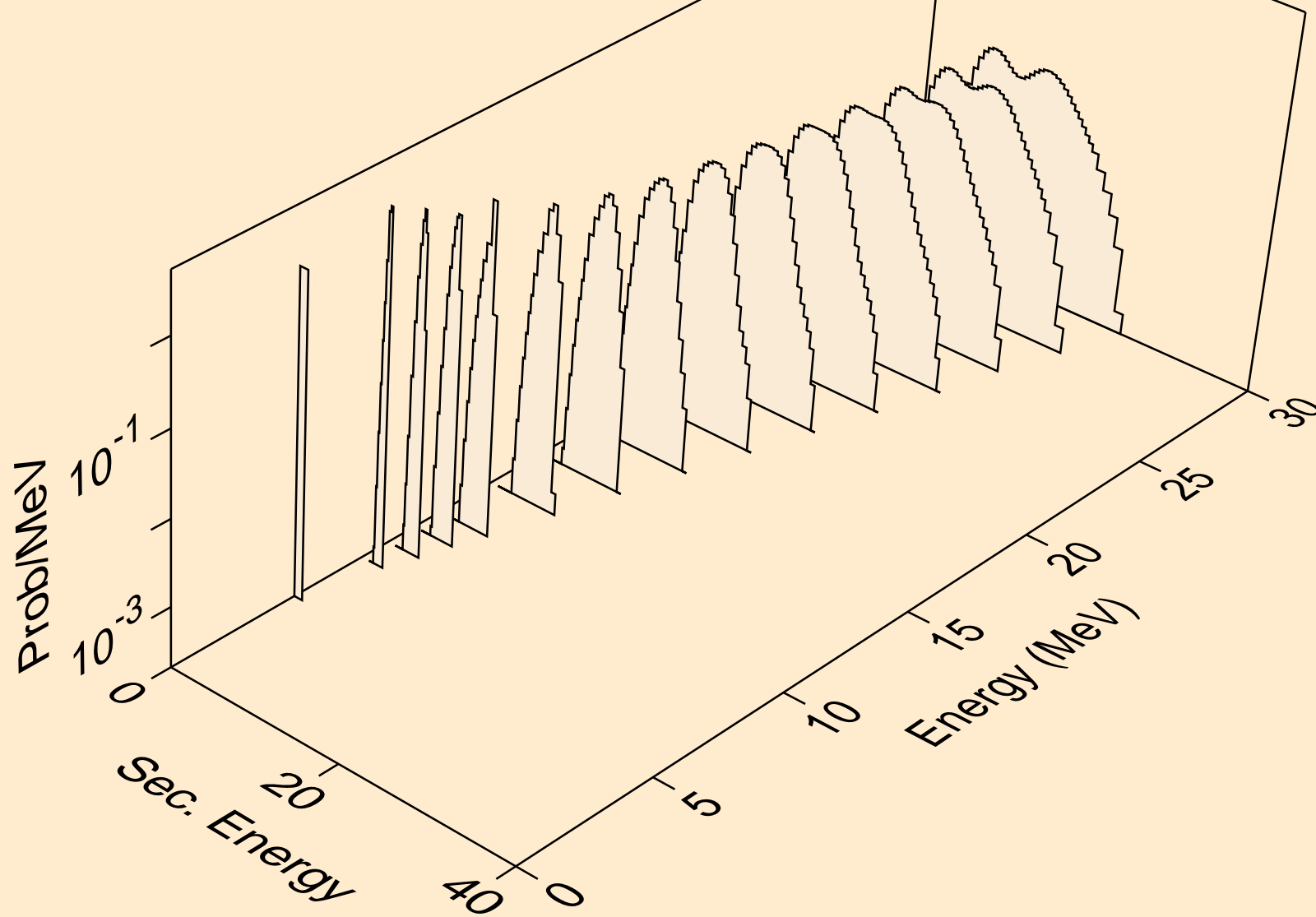

LU160 HELION ACER TENDL-2021 LIBRARY; T=0.K
protons from (s,2np)

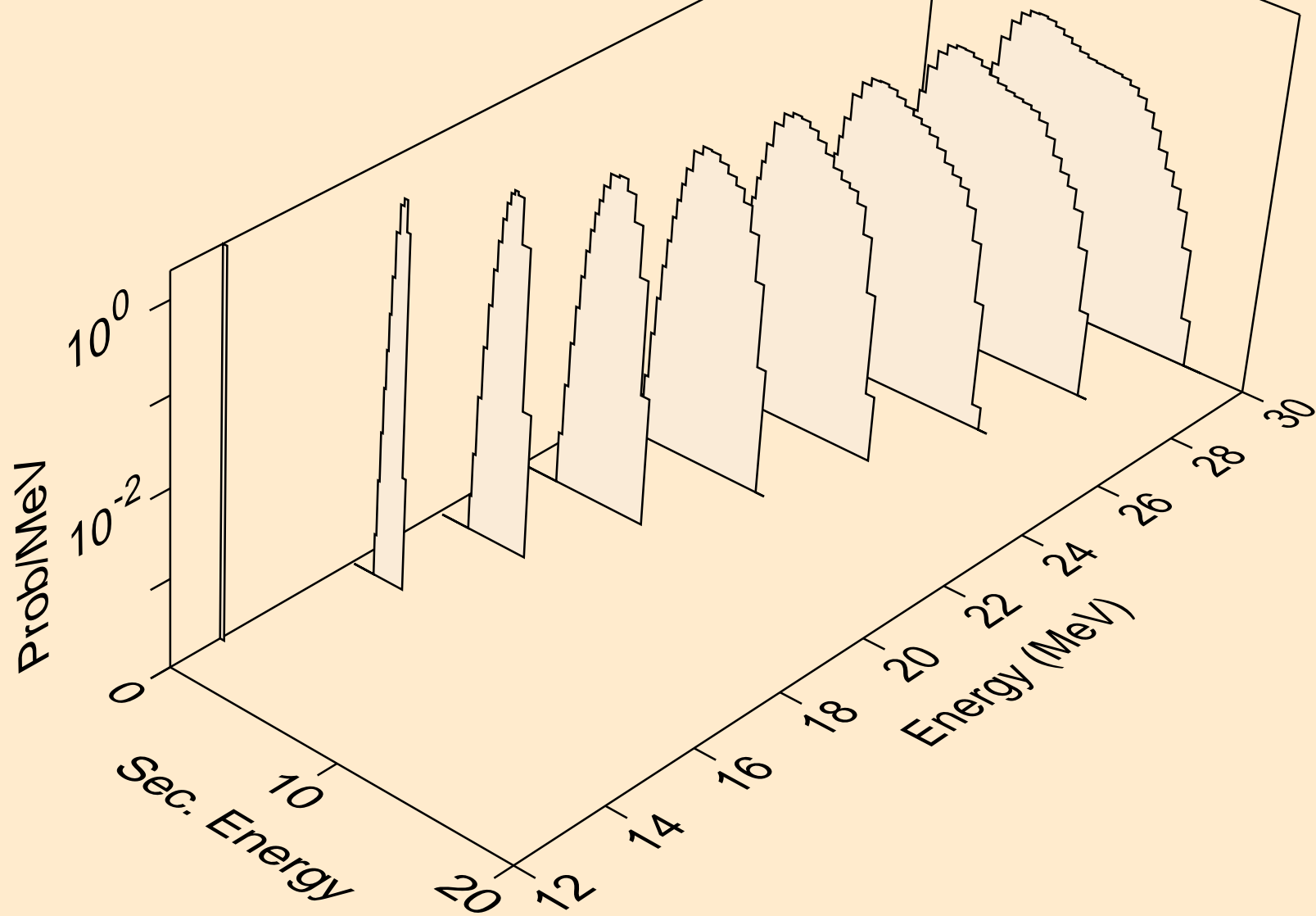

LU160 HELION ACER TENDL-2021 LIBRARY; T=0.K
protons from (s,3np)

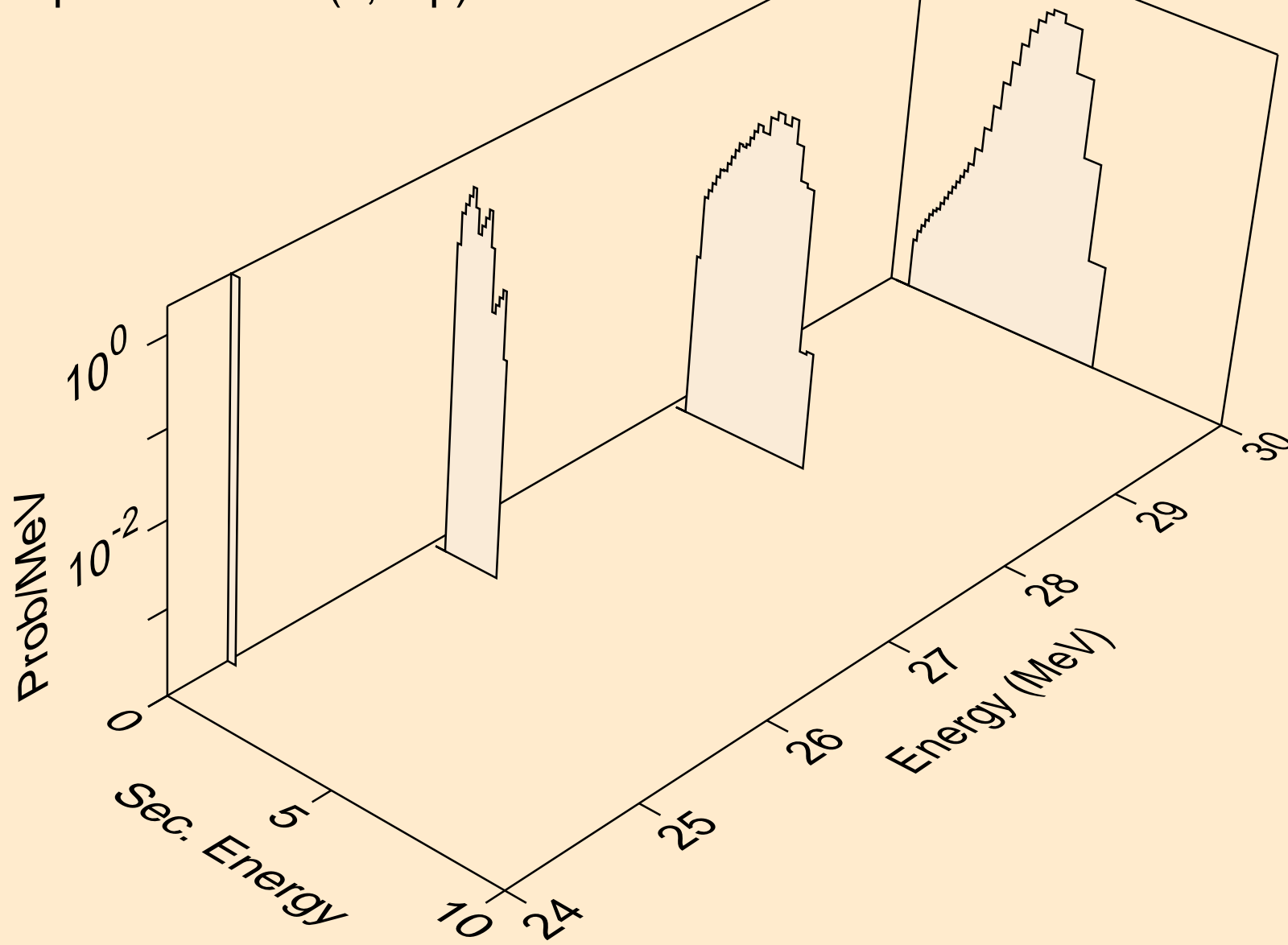

LU160 HELION ACER TENDL-2021 LIBRARY; T=0.K
protons from (s,2np)

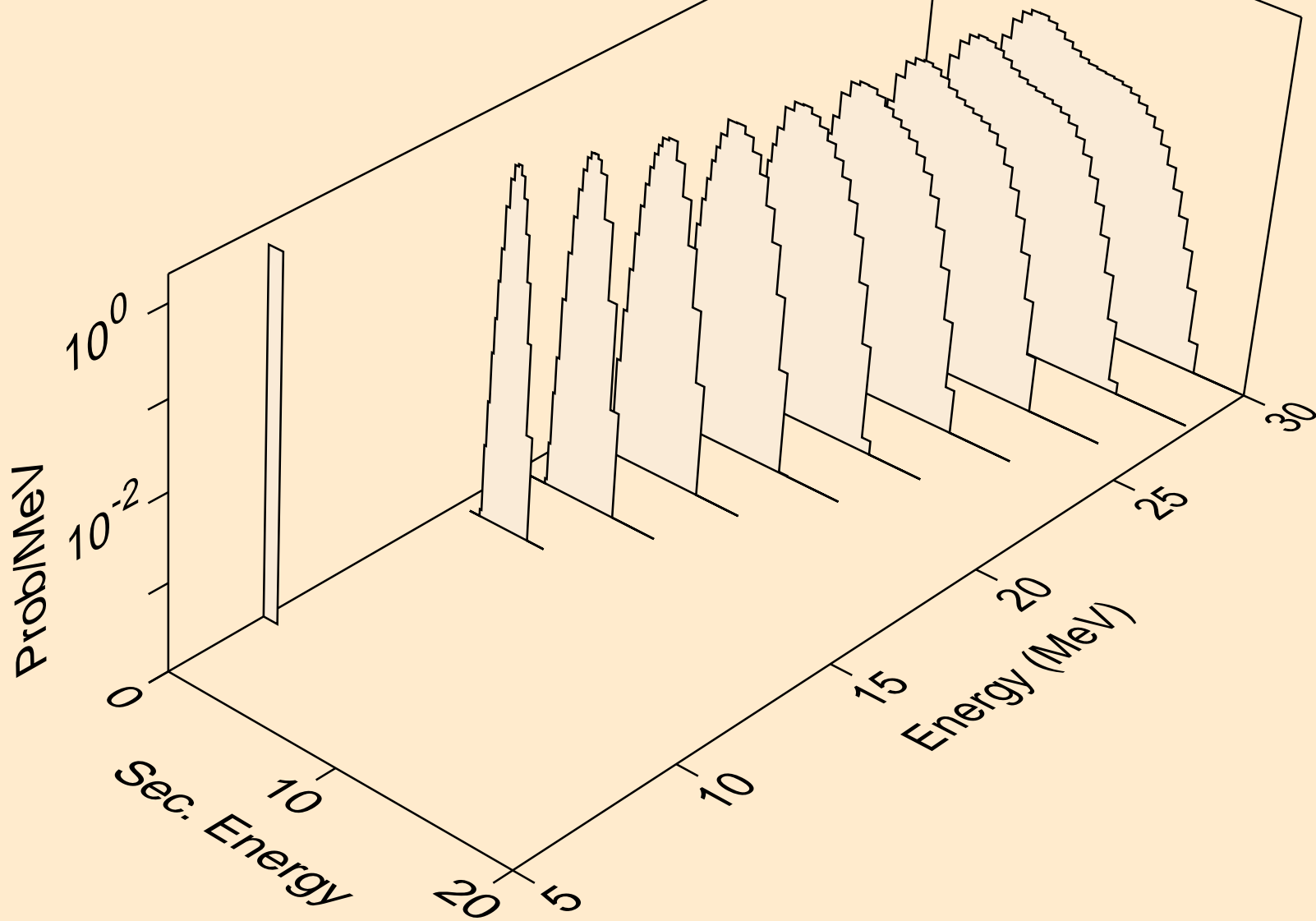

LU160 HELION ACER TENDL-2021 LIBRARY; T=0.K
protons from (s,npa)

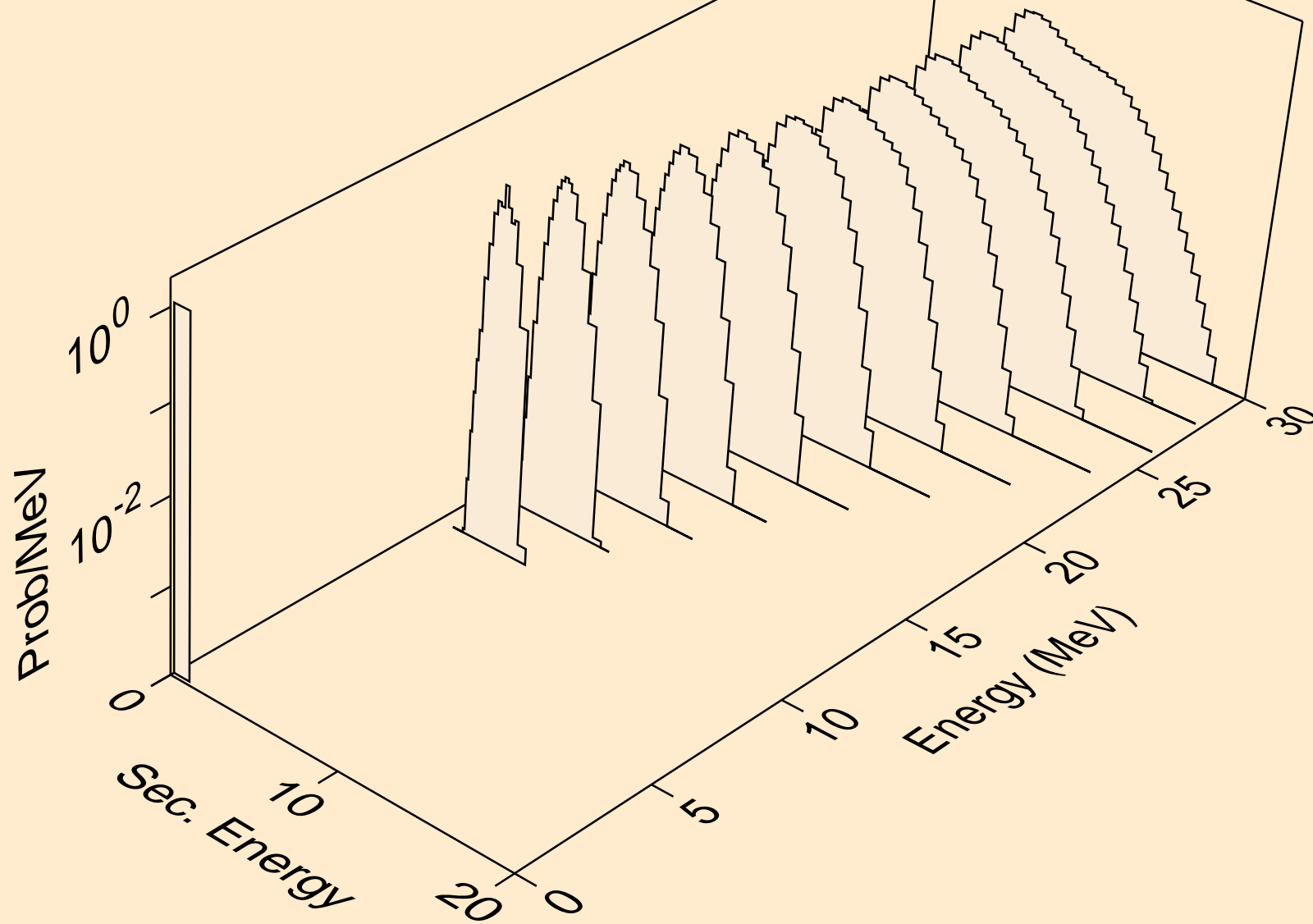

LU160 HELION ACER TENDL-2021 LIBRARY; T=0.K
protons from (s,p)

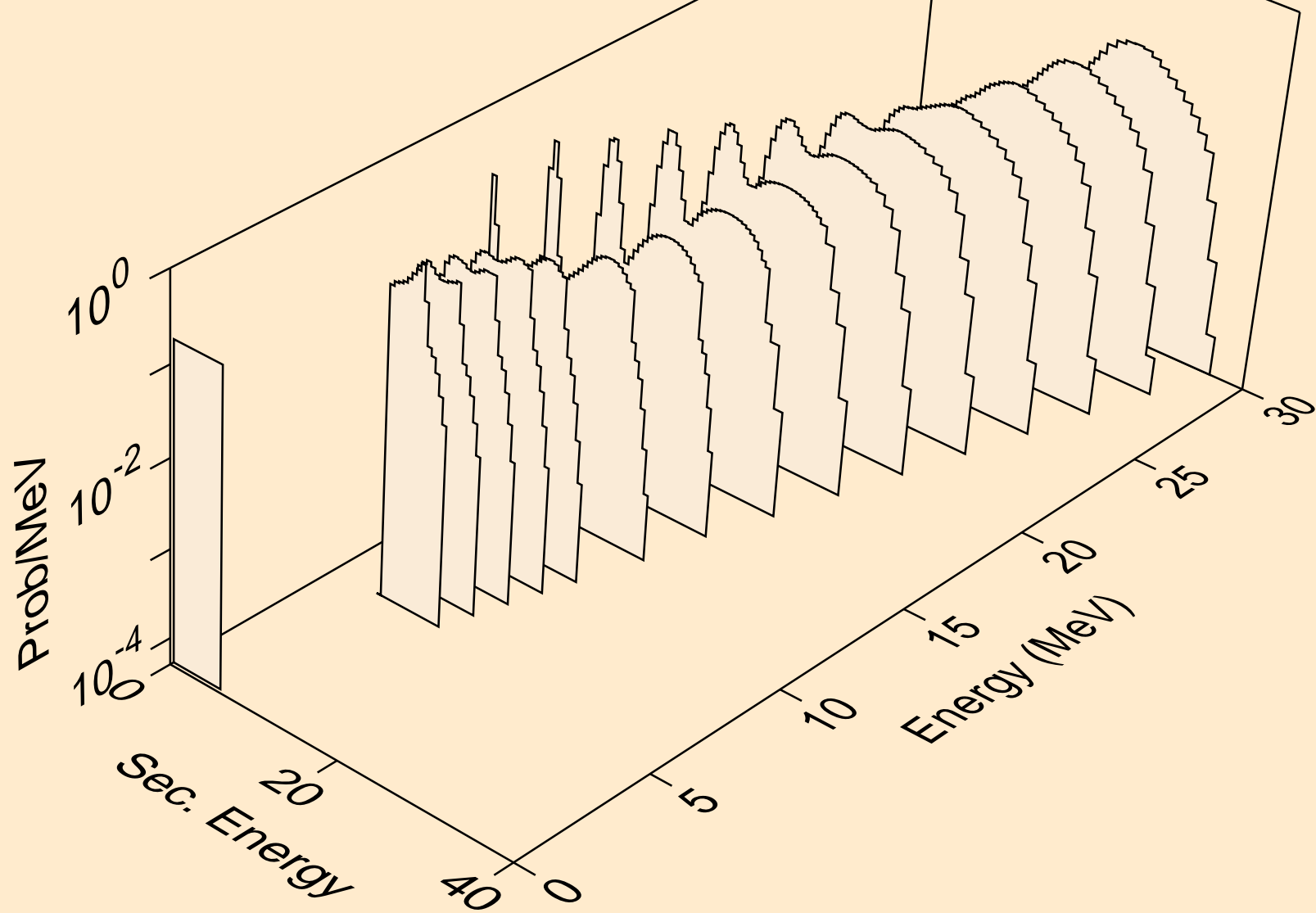

LU160 HELION ACER TENDL-2021 LIBRARY; T=0.K
protons from (s,2p)

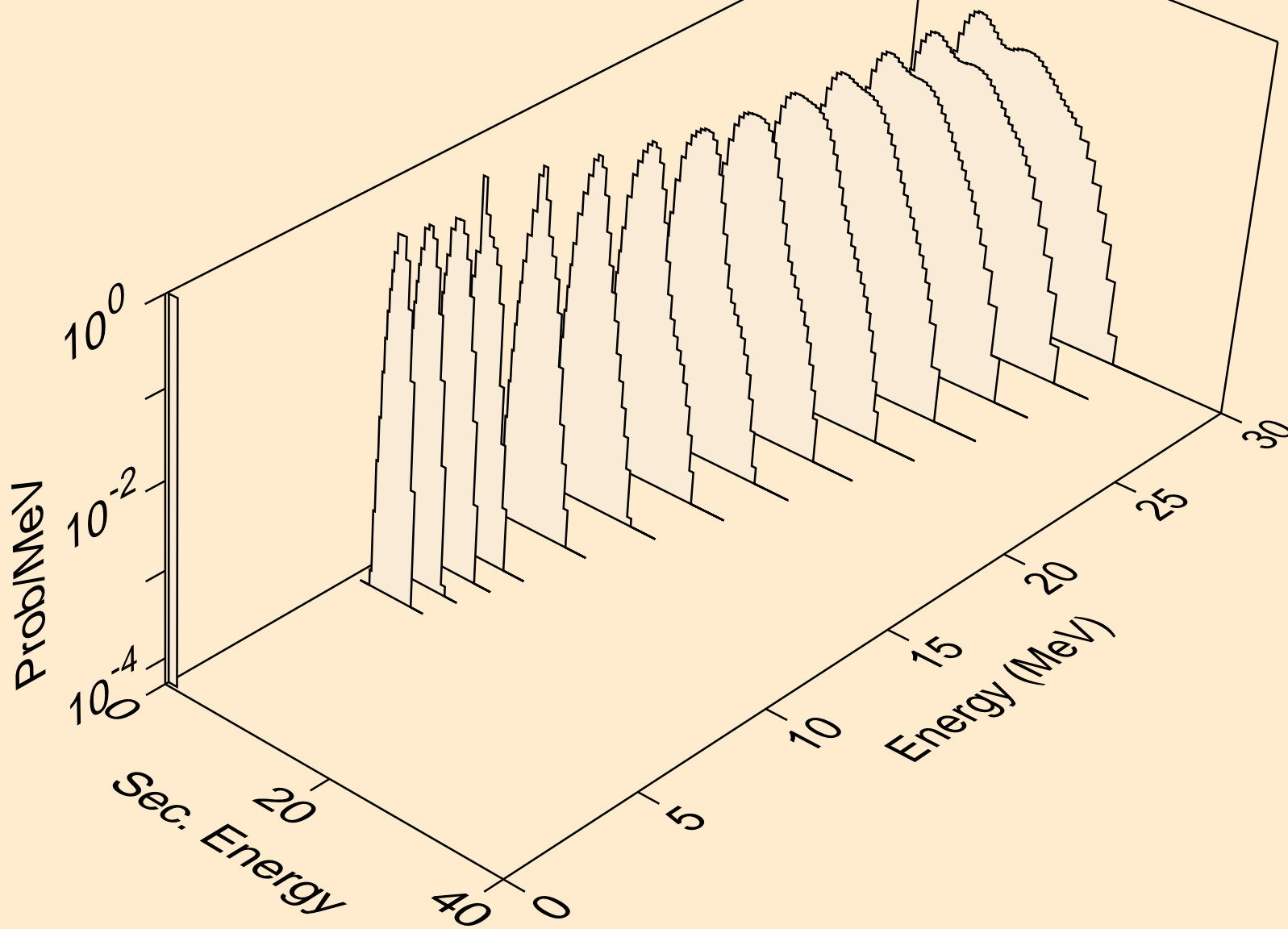

LU160 HELION ACER TENDL-2021 LIBRARY; T=0.K
protons from (s,pa)

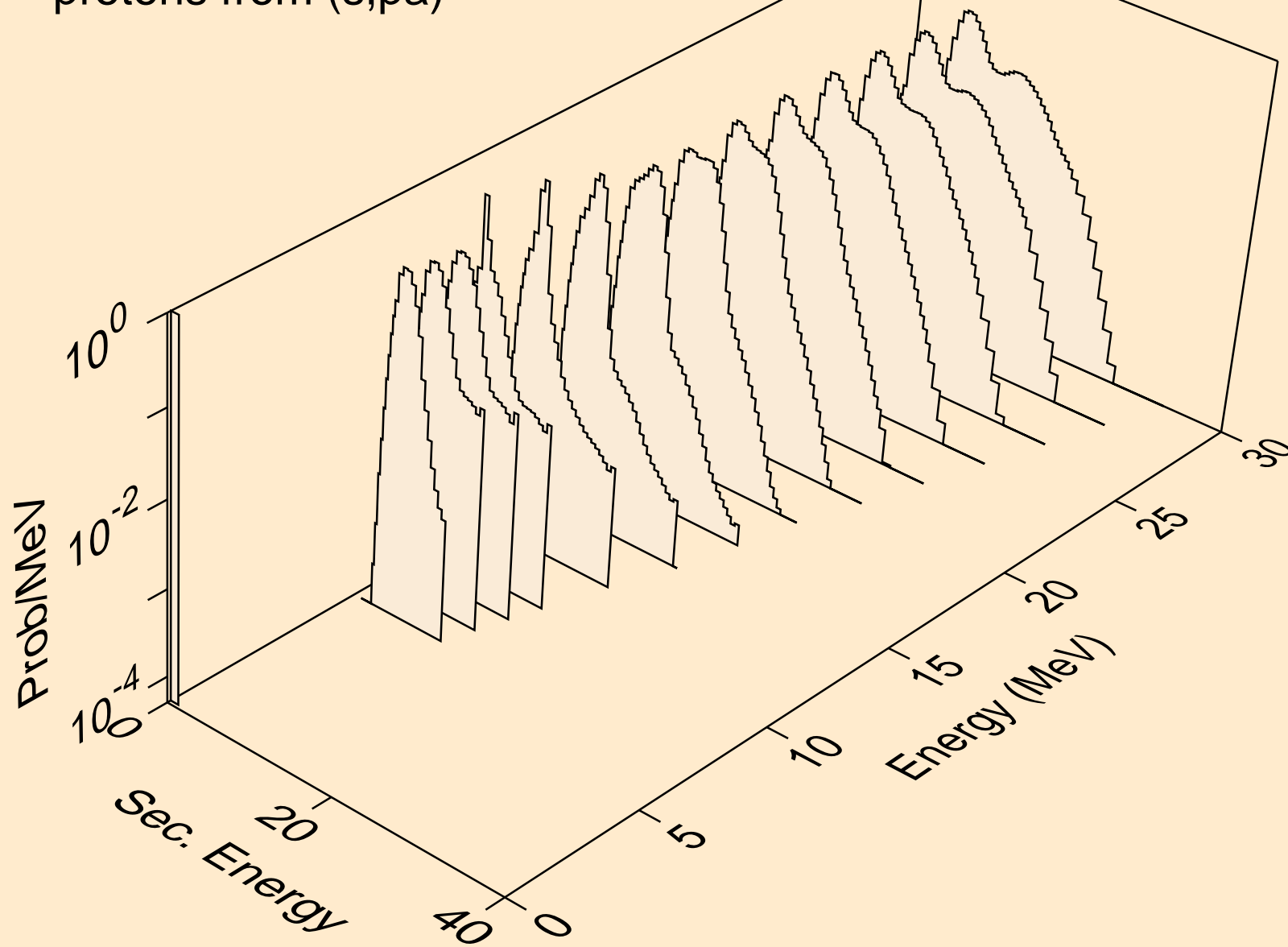

LU160 HELION ACER TENDL-2021 LIBRARY; T=0.K
protons from (s,pd)

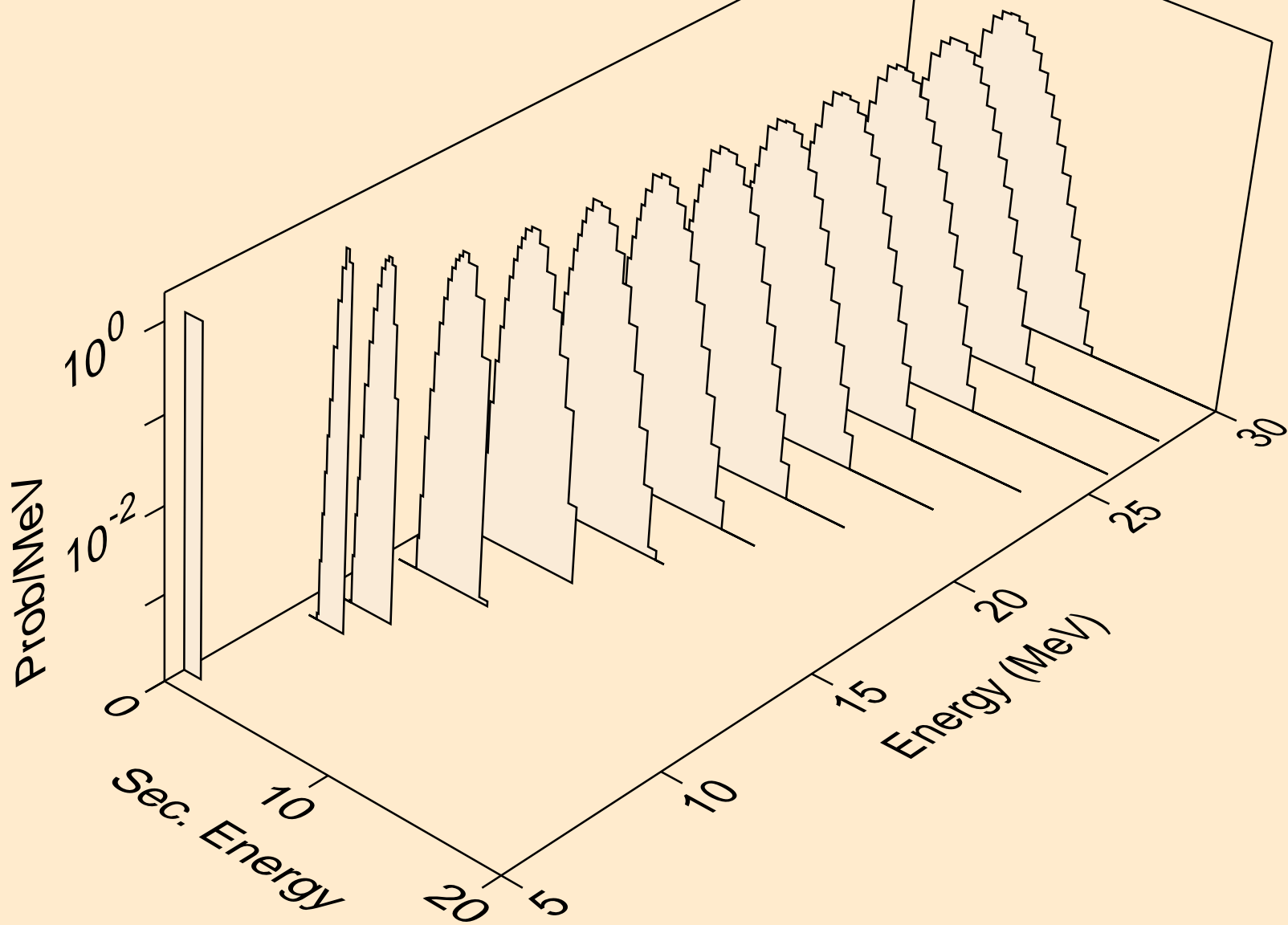

LU160 HELION ACER TENDL-2021 LIBRARY; T=0.K
protons from (s,pt)

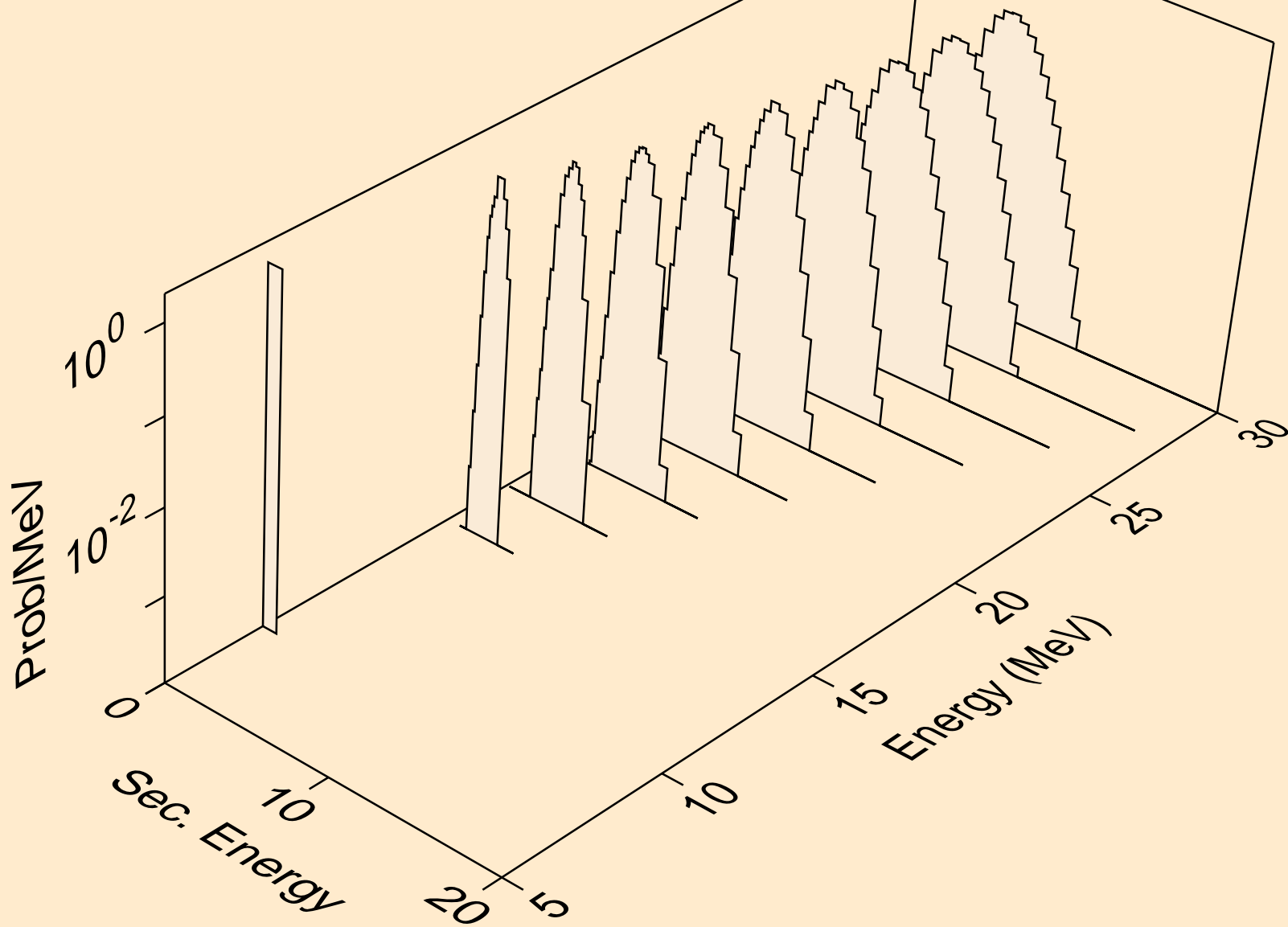

LU160 HELION ACER TENDL-2021 LIBRARY; T=0.K
deuterons from (s,x)

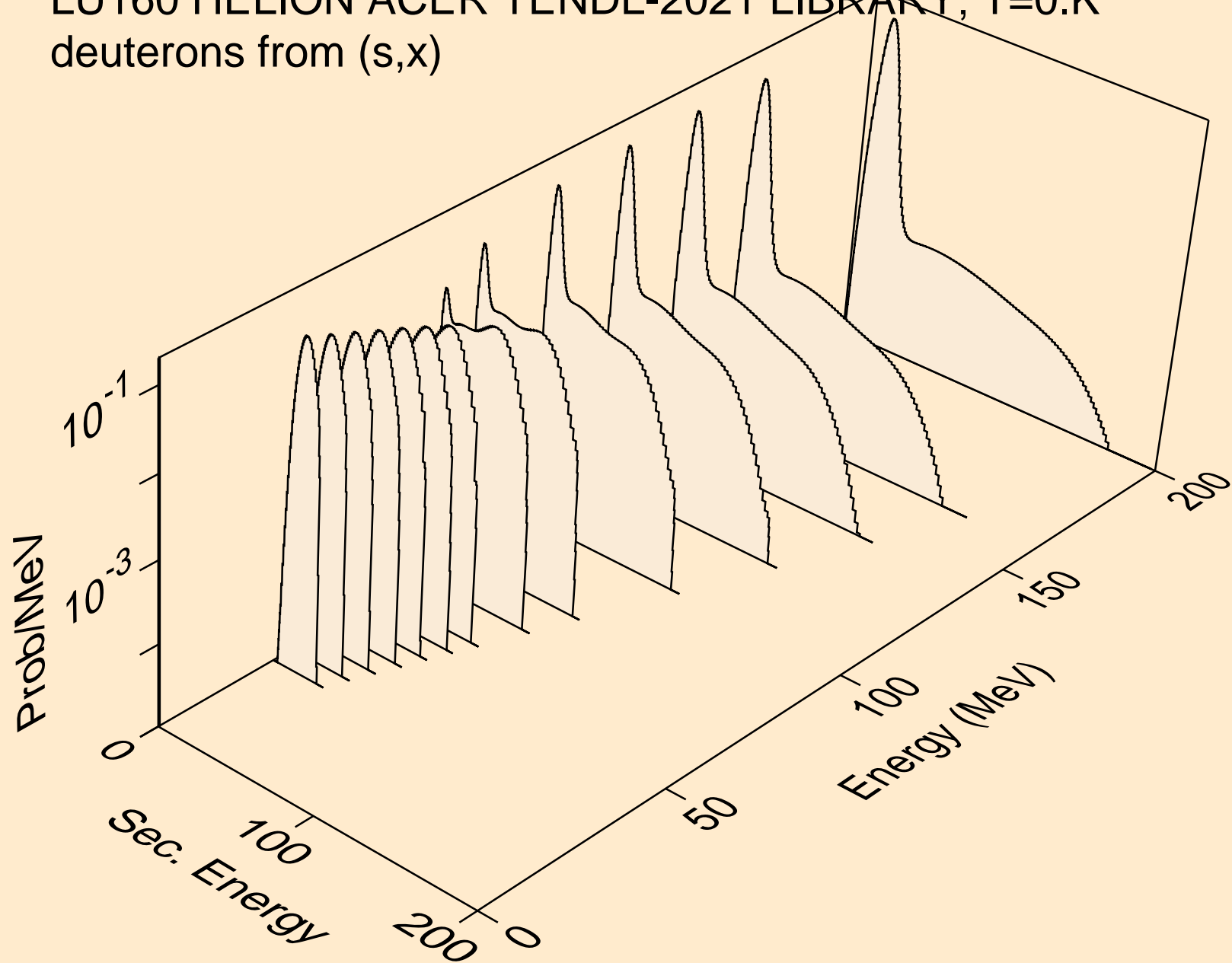

LU160 HELION ACER TENDL-2021 LIBRARY; T=0.K
deuterons from (s,2nd)

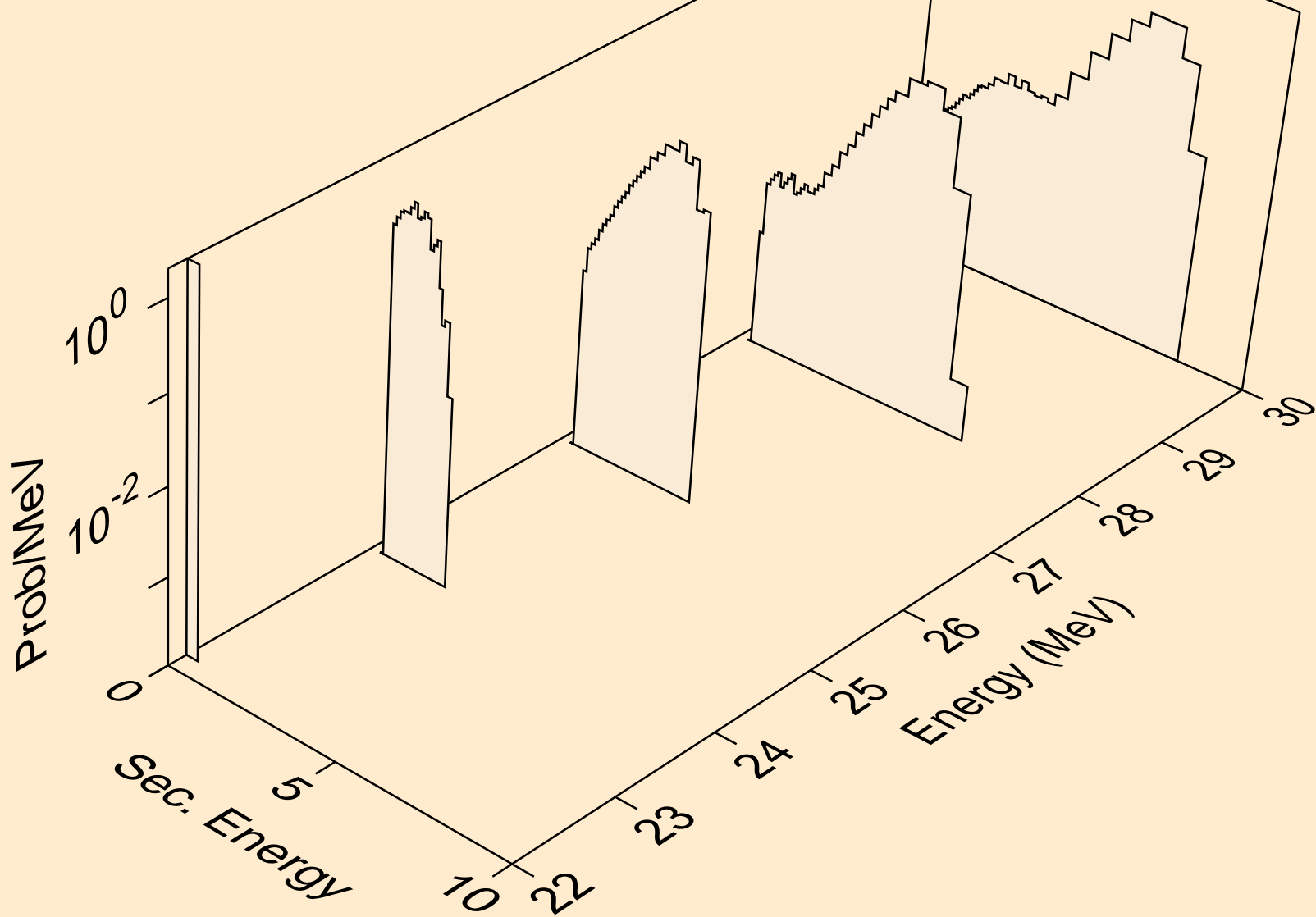

LU160 HELION ACER TENDL-2021 LIBRARY; T=0.K
deuterons from (s,n*)d

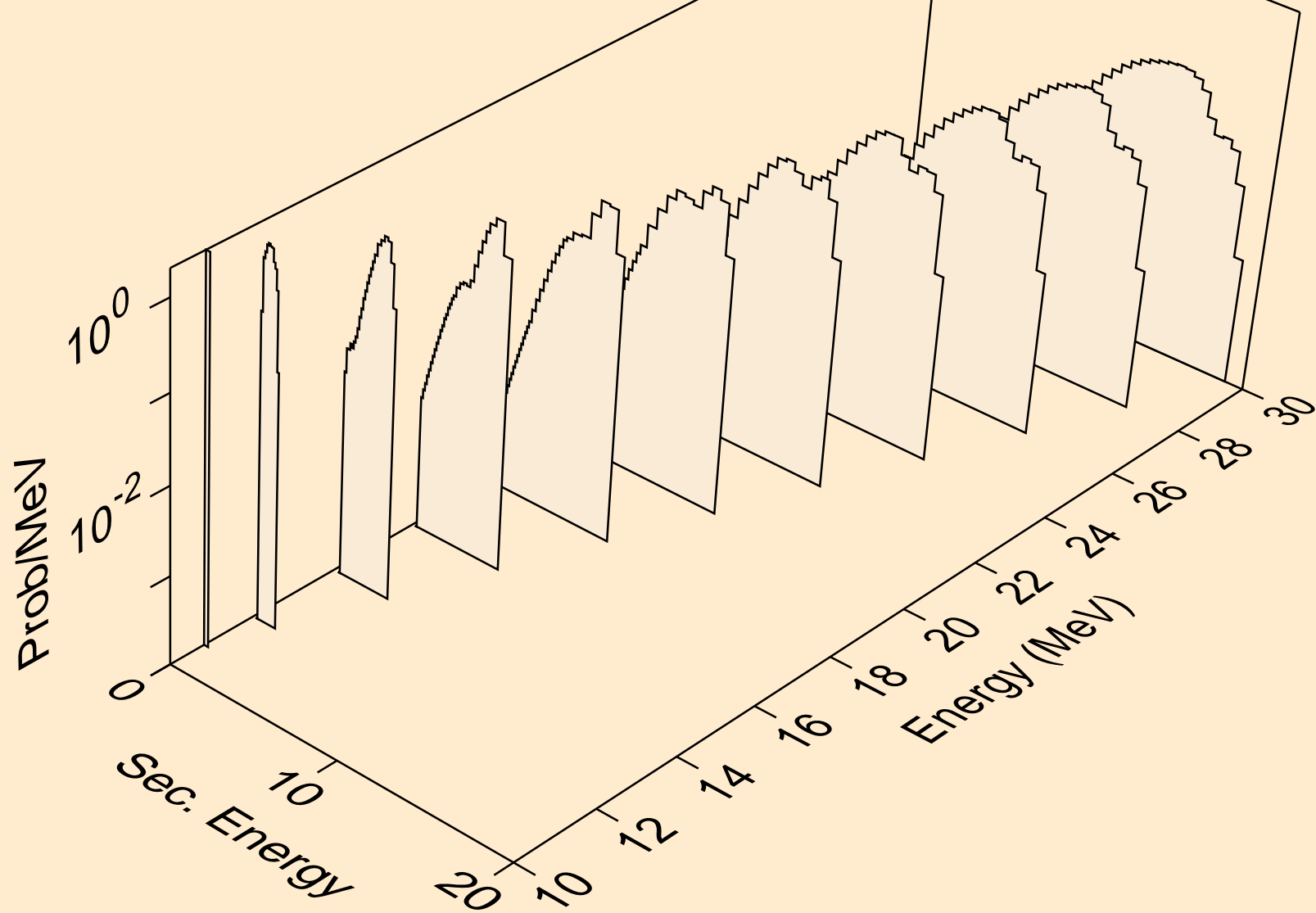

LU160 HELION ACER TENDL-2021 LIBRARY; T=0.K
deuterons from (s,d)

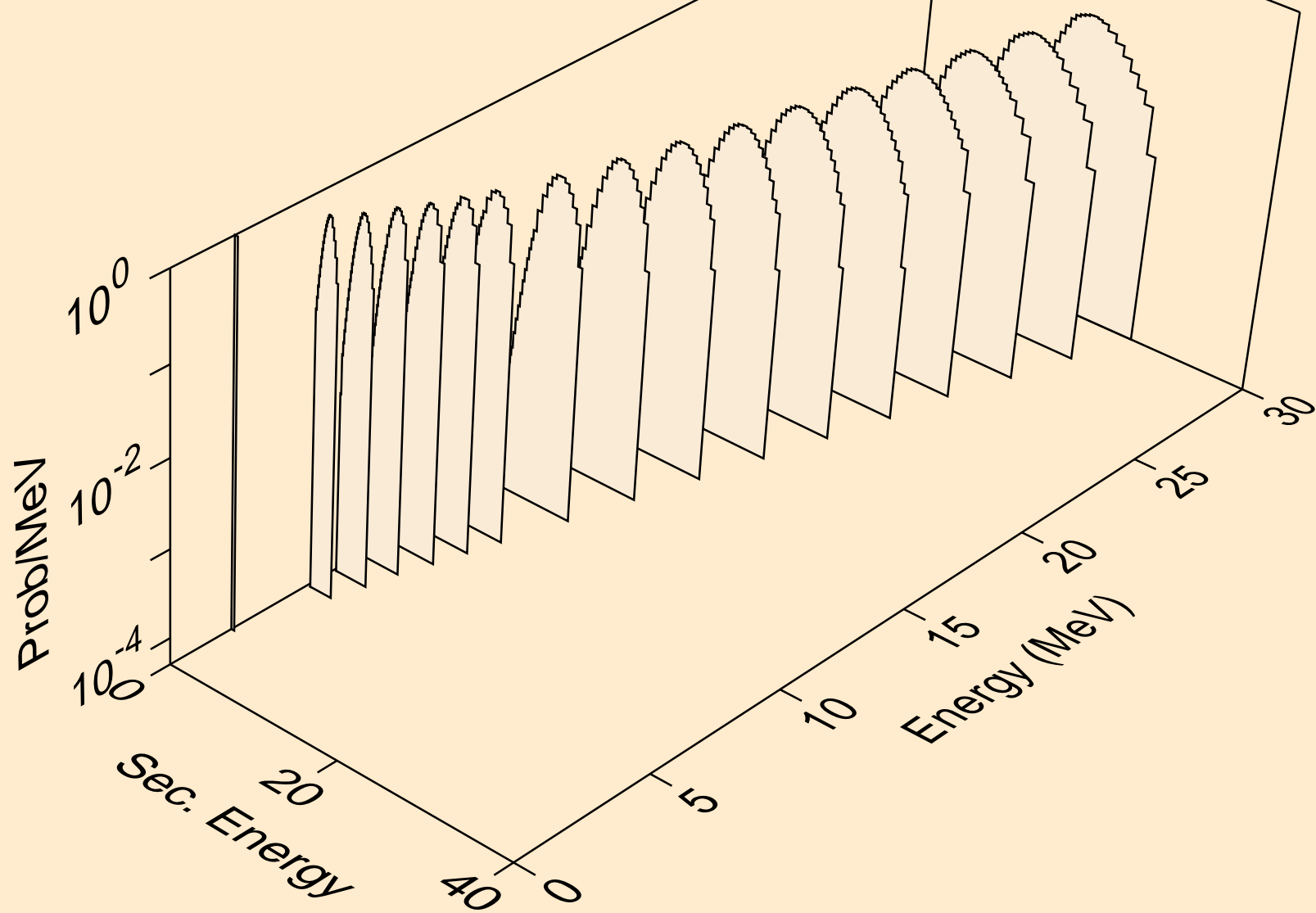

LU160 HELION ACER TENDL-2021 LIBRARY; T=0.K
deuterons from (s,d2a)

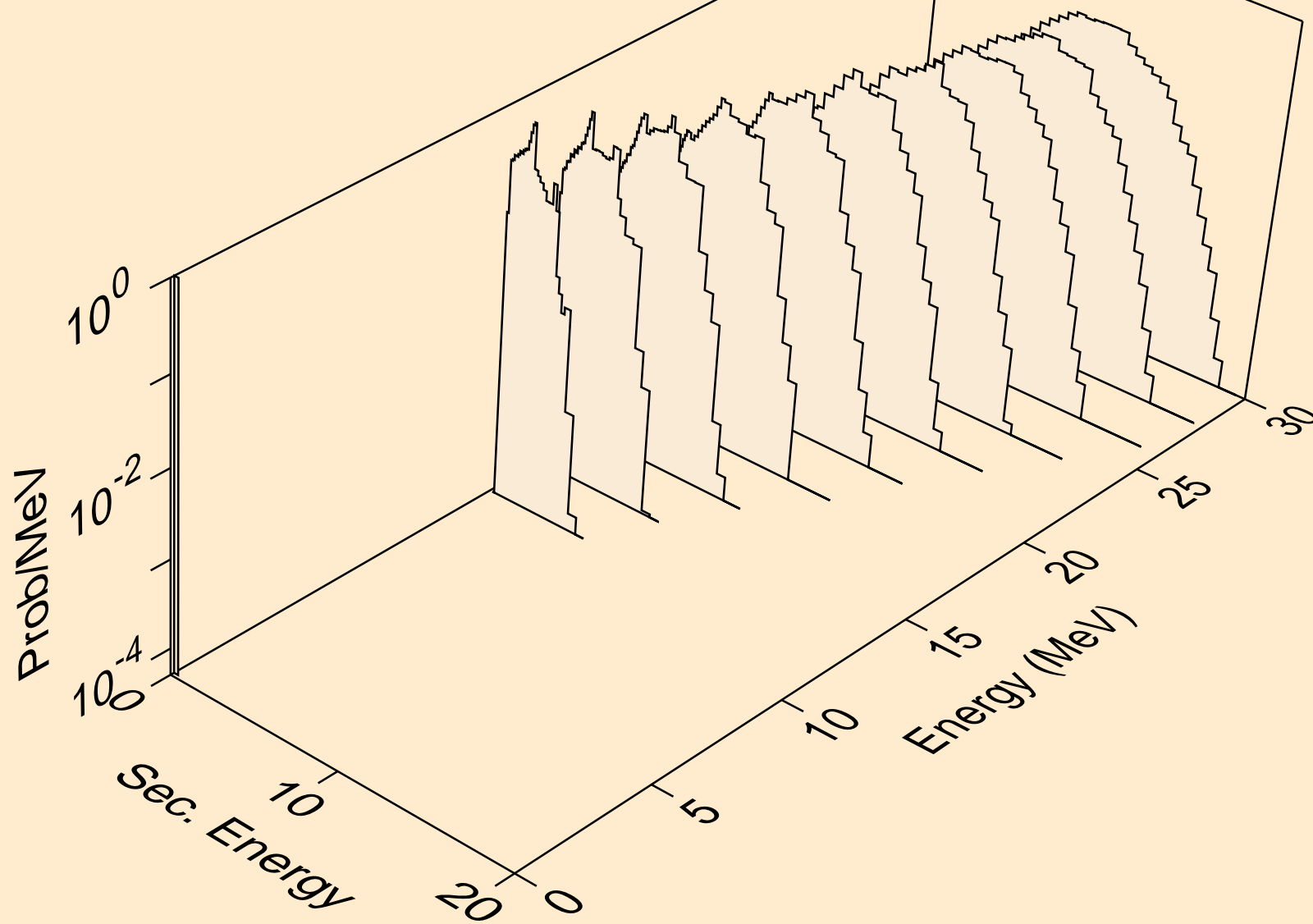

LU160 HELION ACER TENDL-2021 LIBRARY; T=0.K
deuterons from (s,pd)

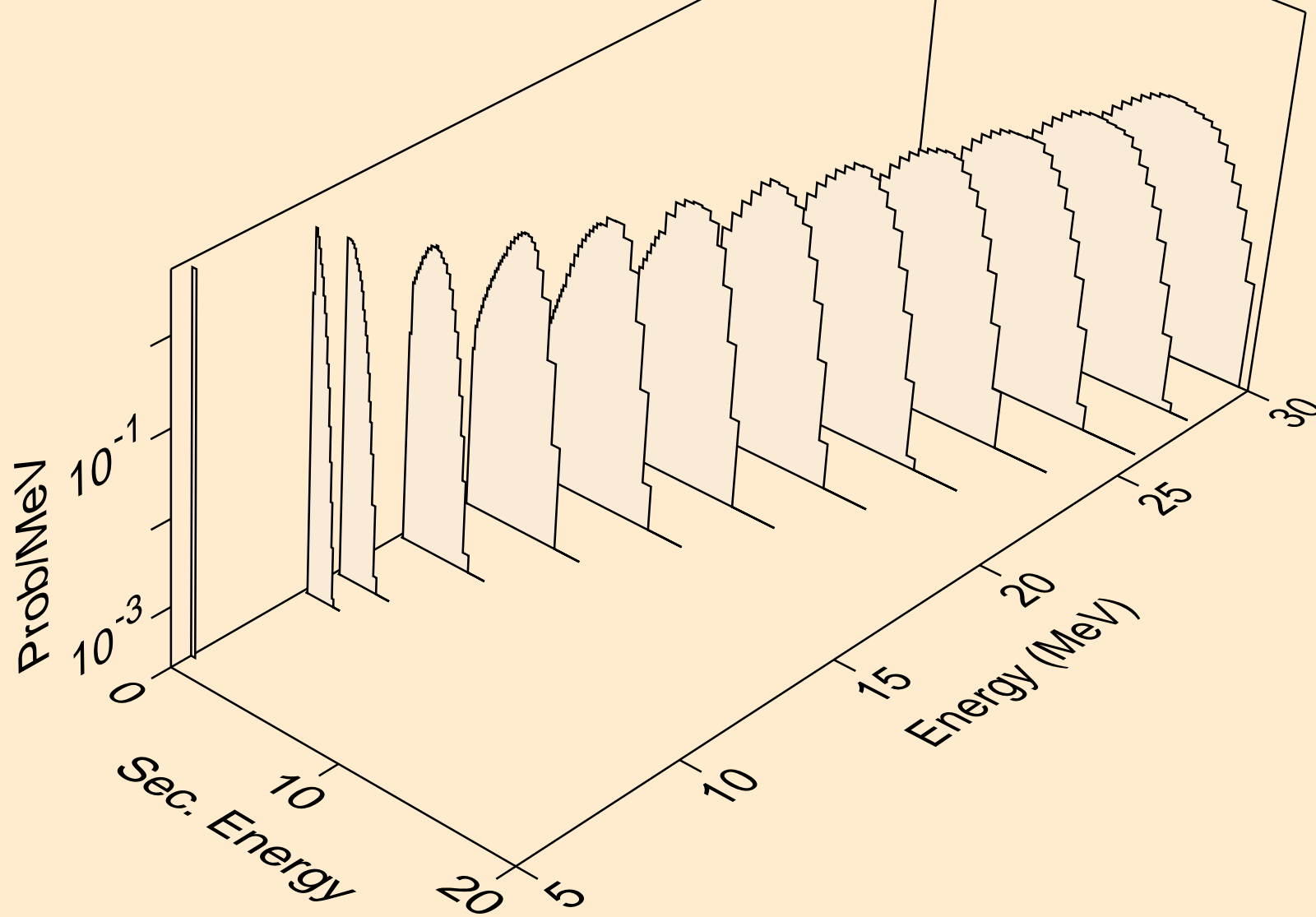

LU160 HELION ACER TENDL-2021 LIBRARY; T=0.K
deuterons from (s,da)

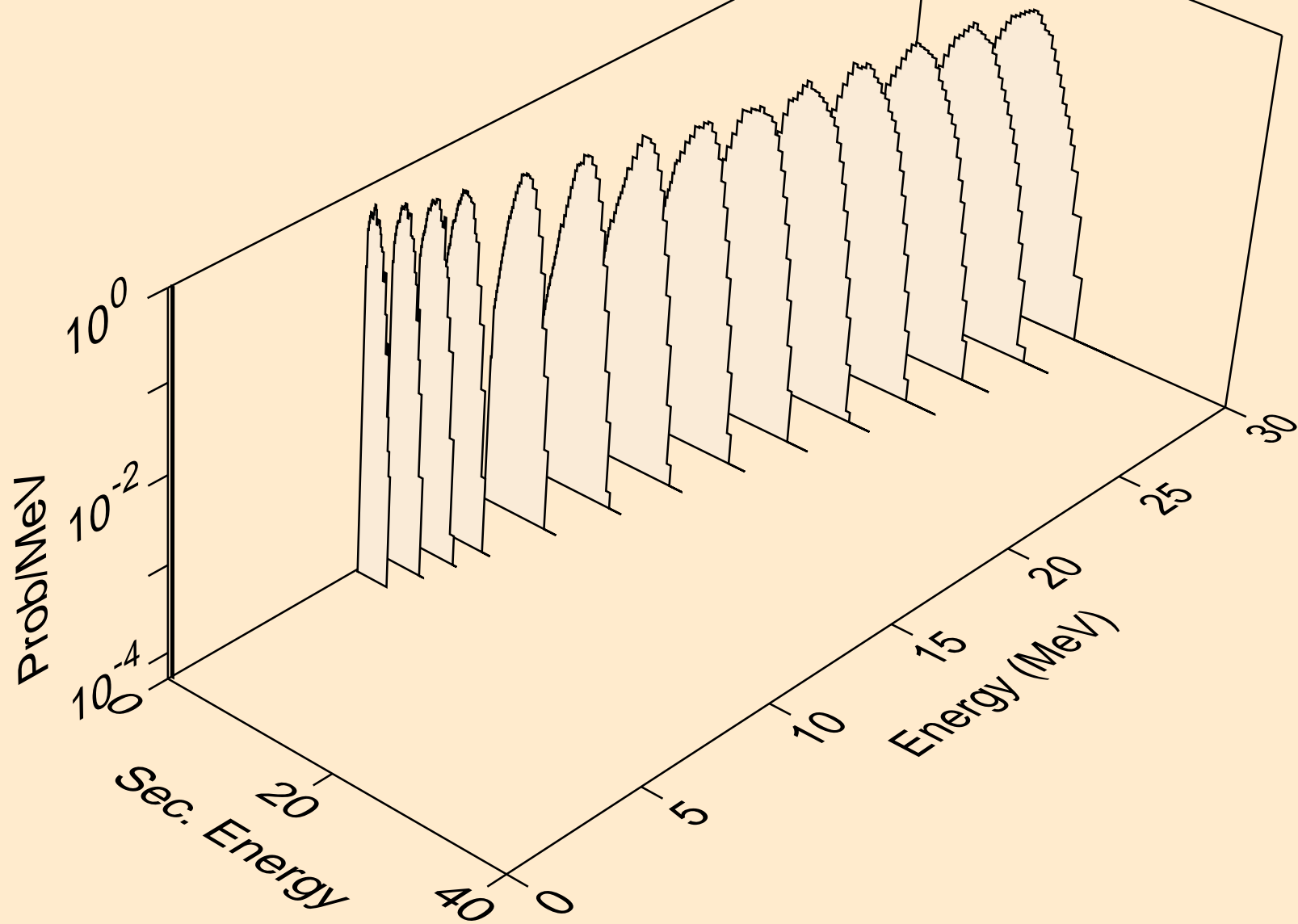

LU160 HELION ACER TENDL-2021 LIBRARY; T=0.K
tritons from (s,x)

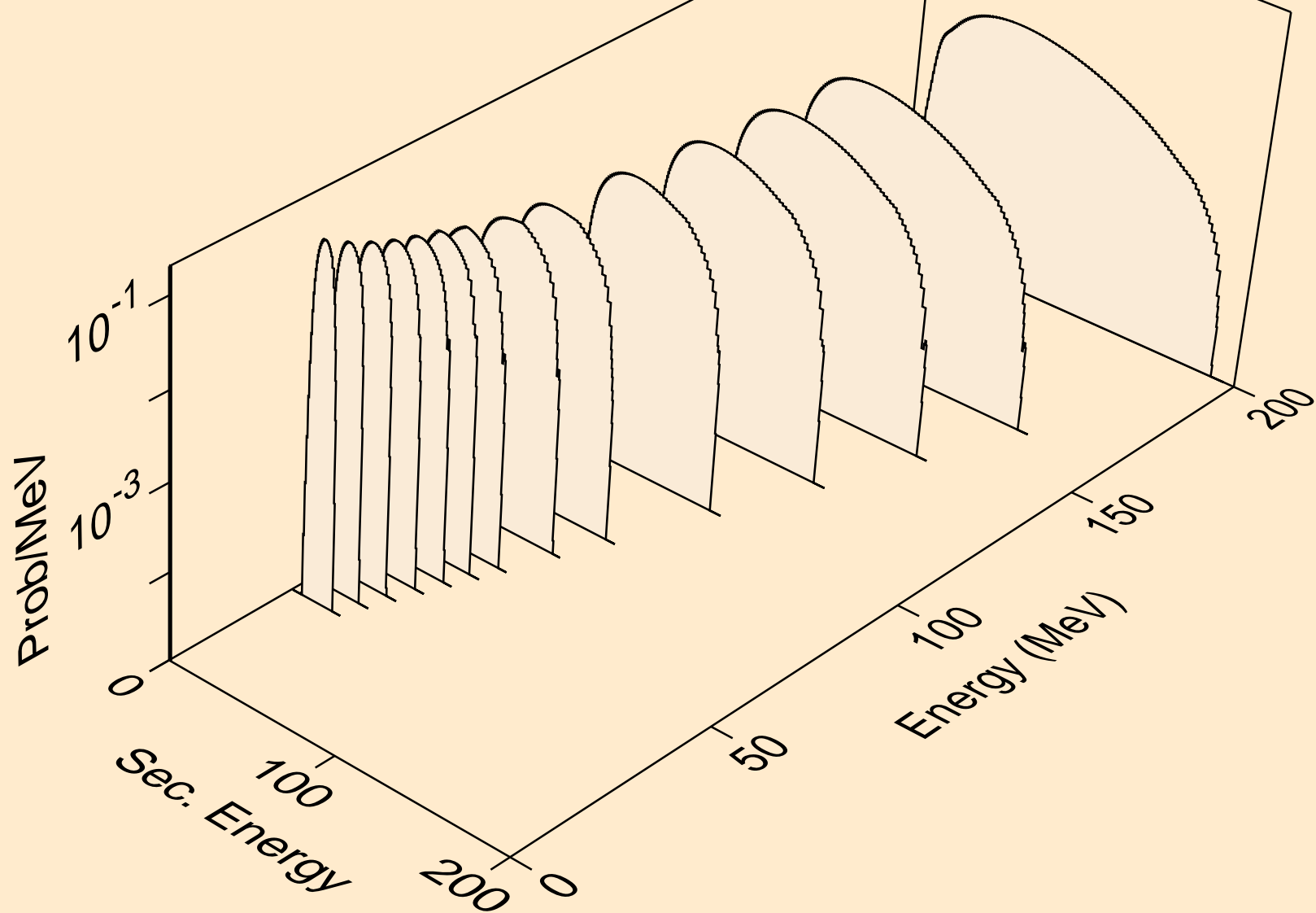

LU160 HELION ACER TENDL-2021 LIBRARY; T=0.K
tritons from (s,n*)t

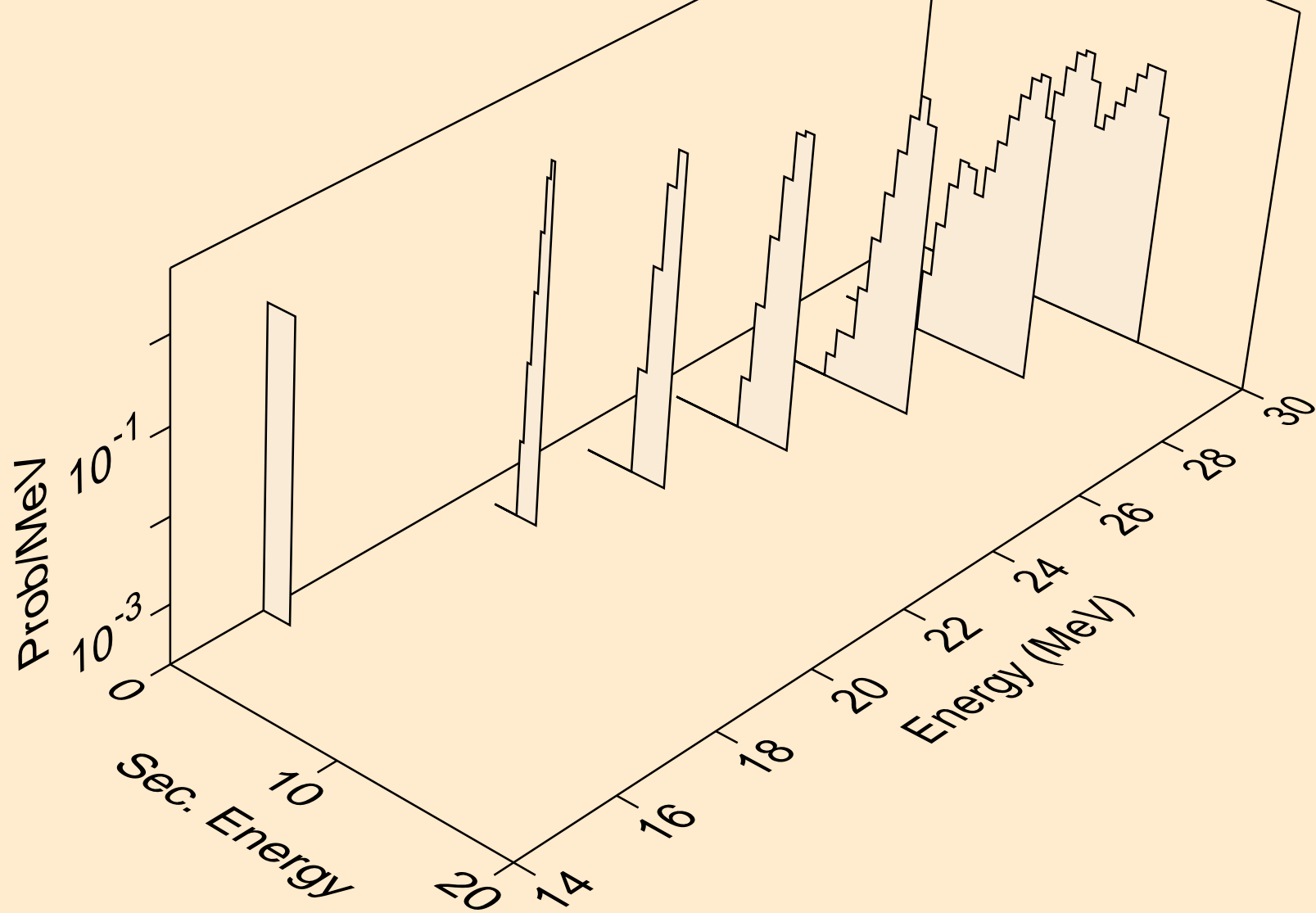

LU160 HELION ACER TENDL-2021 LIBRARY; T=0.K
tritons from (s,t)

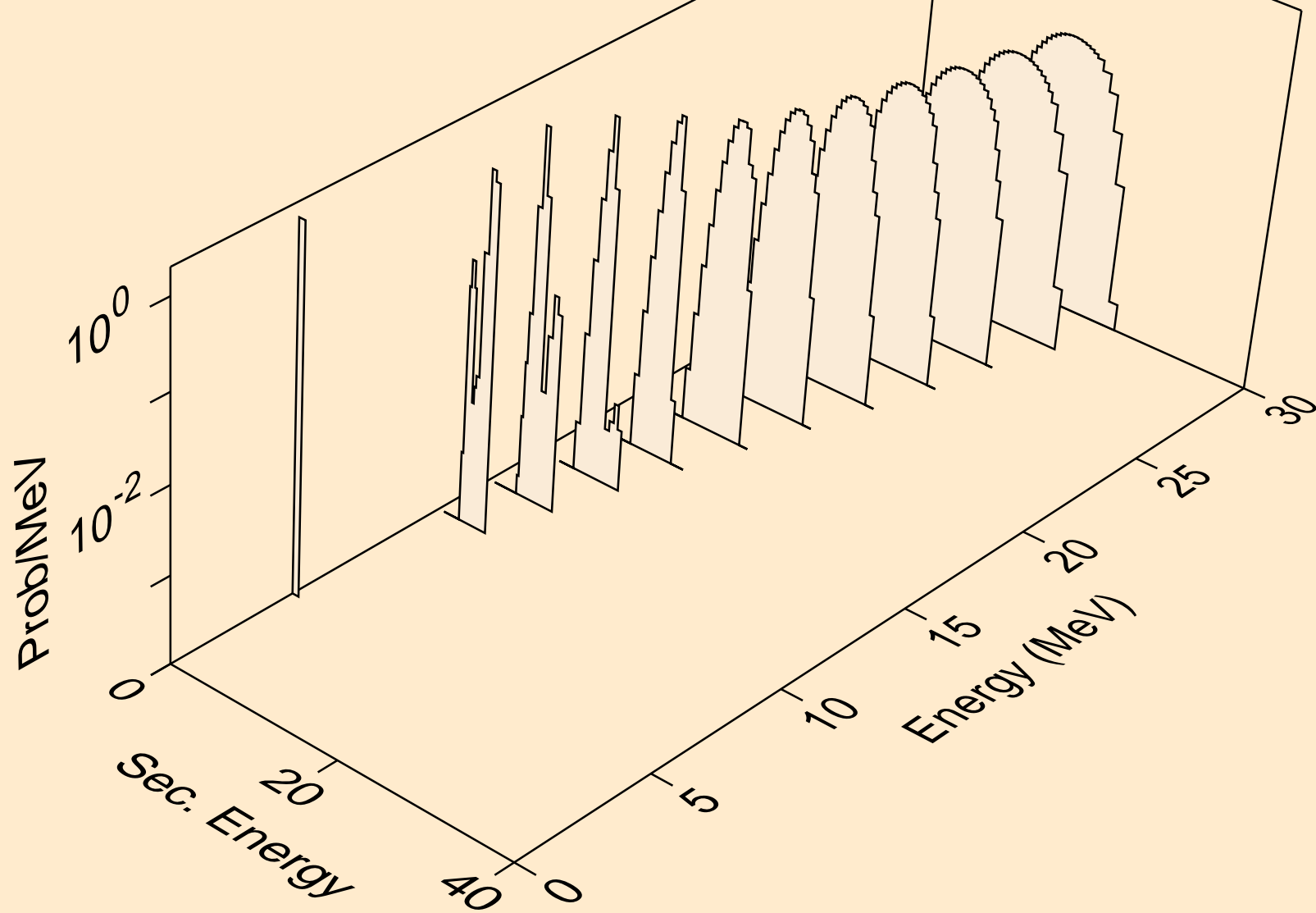

LU160 HELION ACER TENDL-2021 LIBRARY; T=0.K
tritons from (s,t2a)

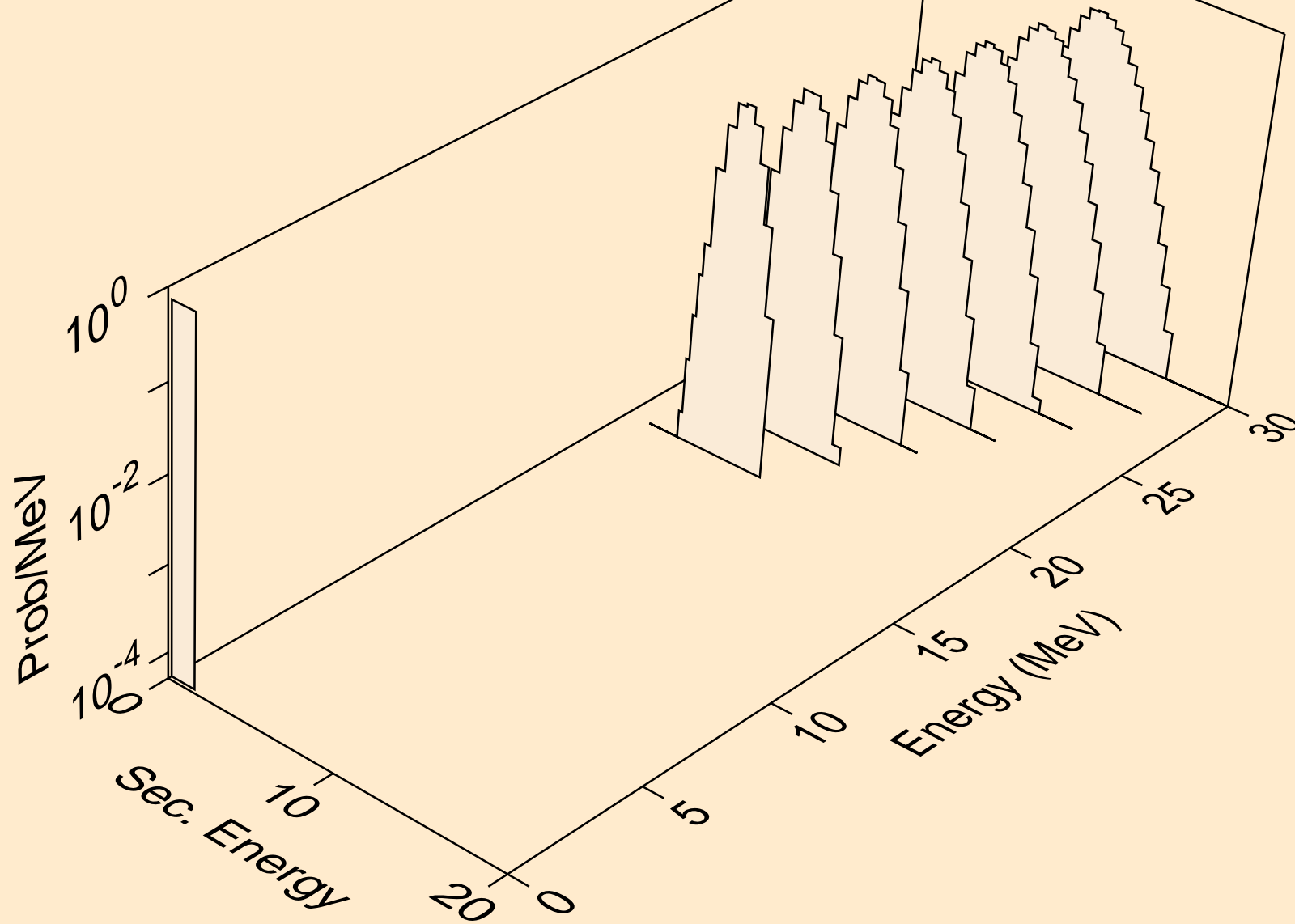

LU160 HELION ACER TENDL-2021 LIBRARY; T=0.K
tritons from (s,pt)

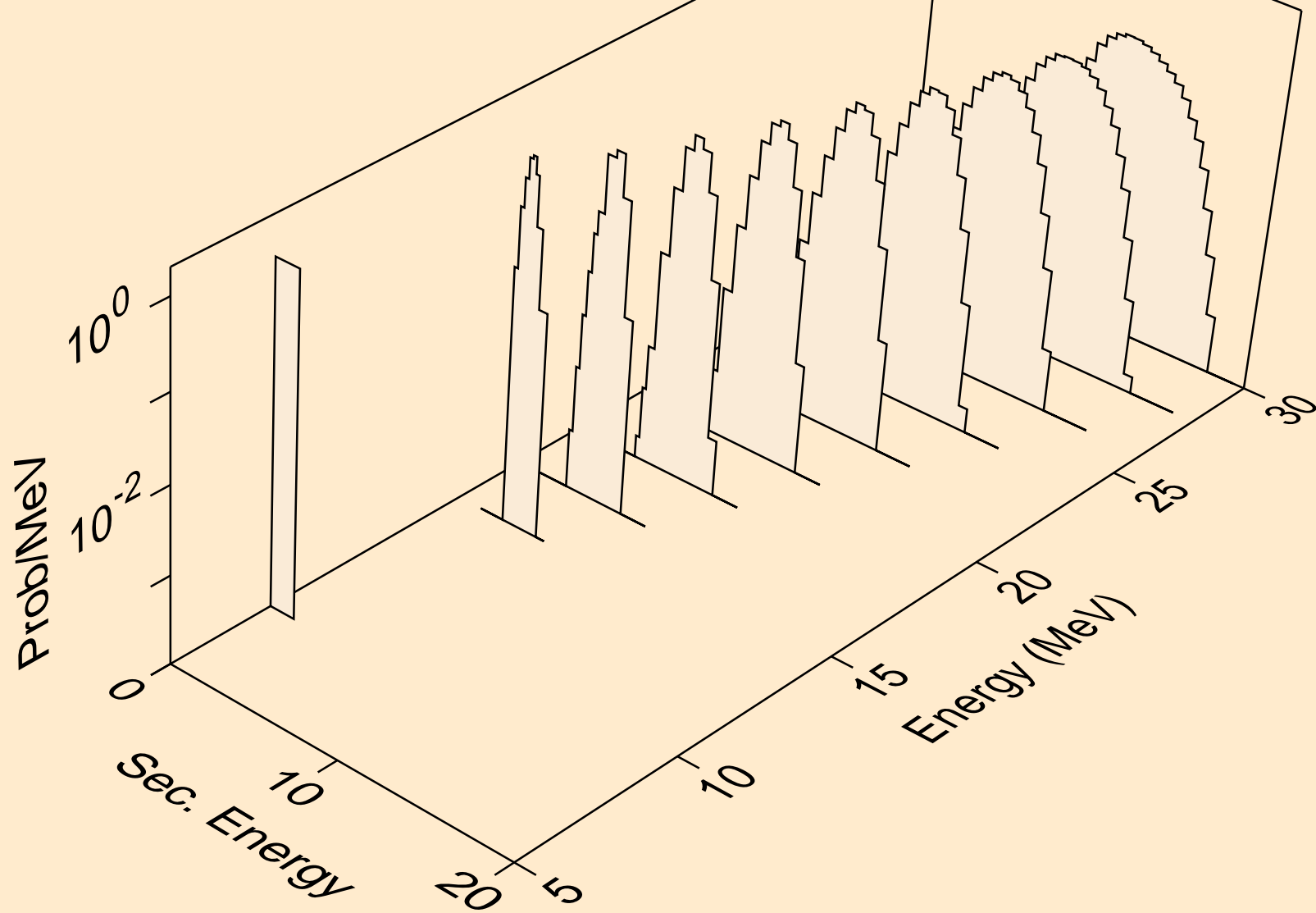

LU160 HELION ACER TENDL-2021 LIBRARY; T=0.K
alphas from (s,x)

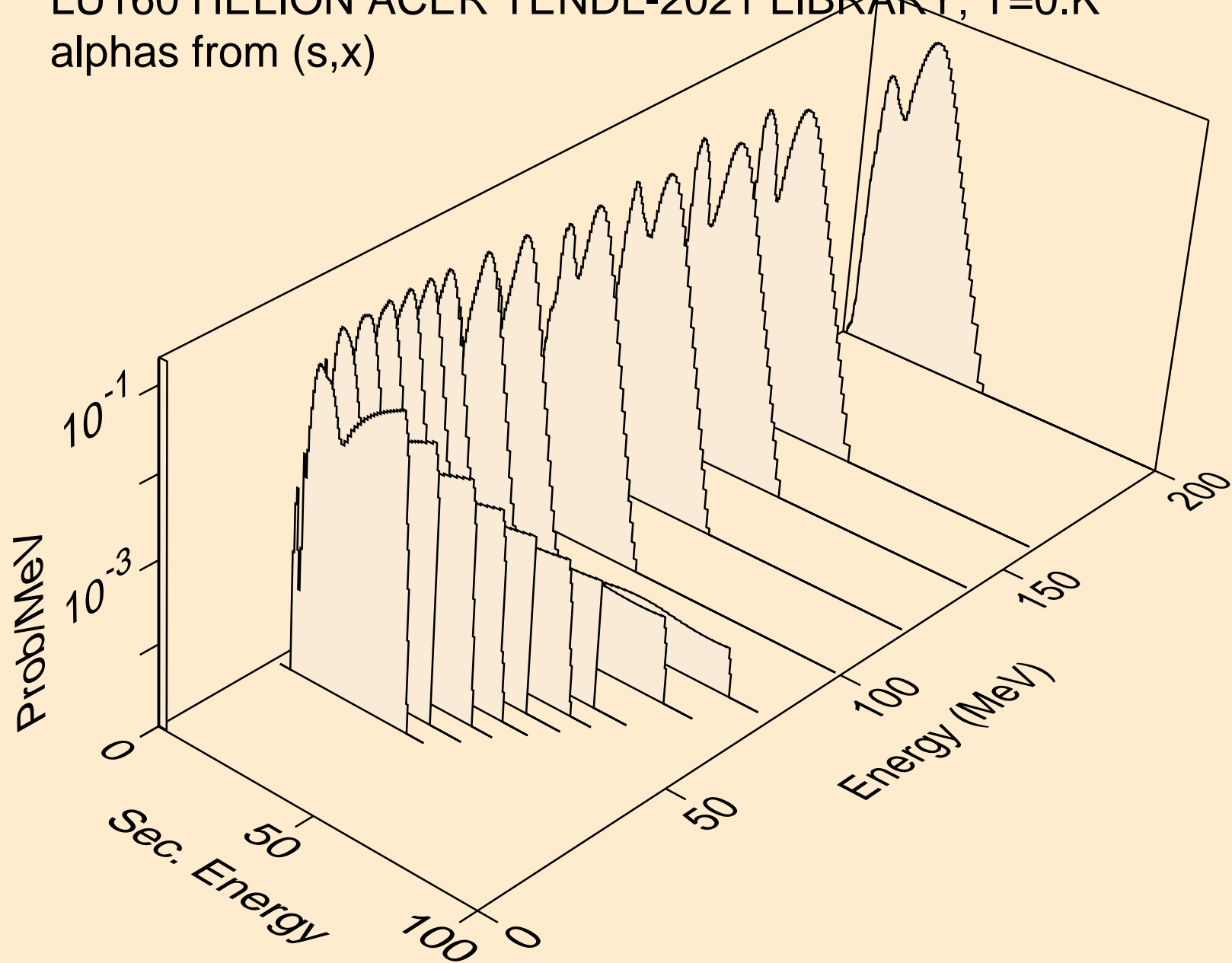

LU160 HELION ACER TENDL-2021 LIBRARY; T=0.K
alphas from (s,n*)a

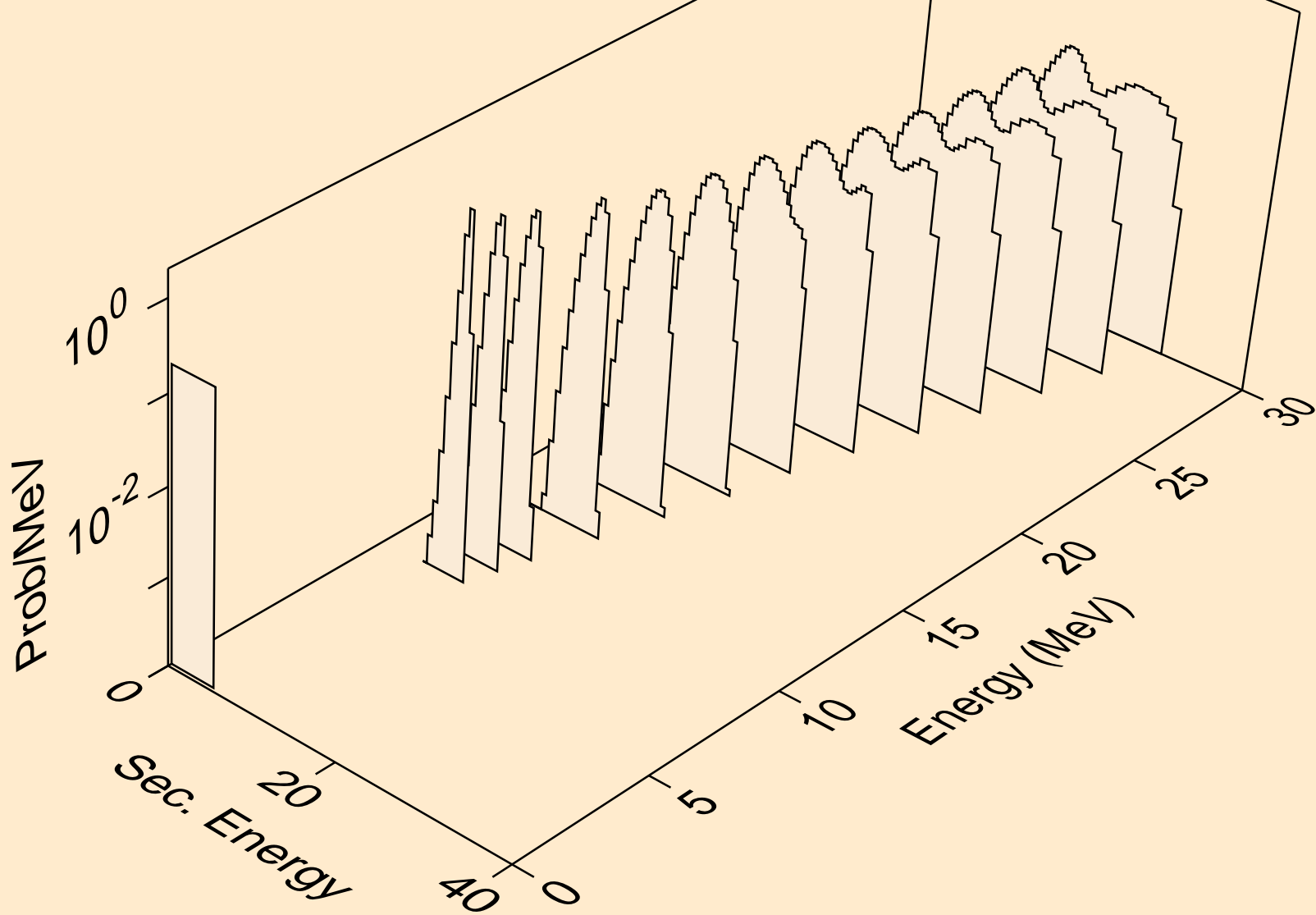

LU160 HELION ACER TENDL-2021 LIBRARY; T=0.K
alphas from (s,2n)a

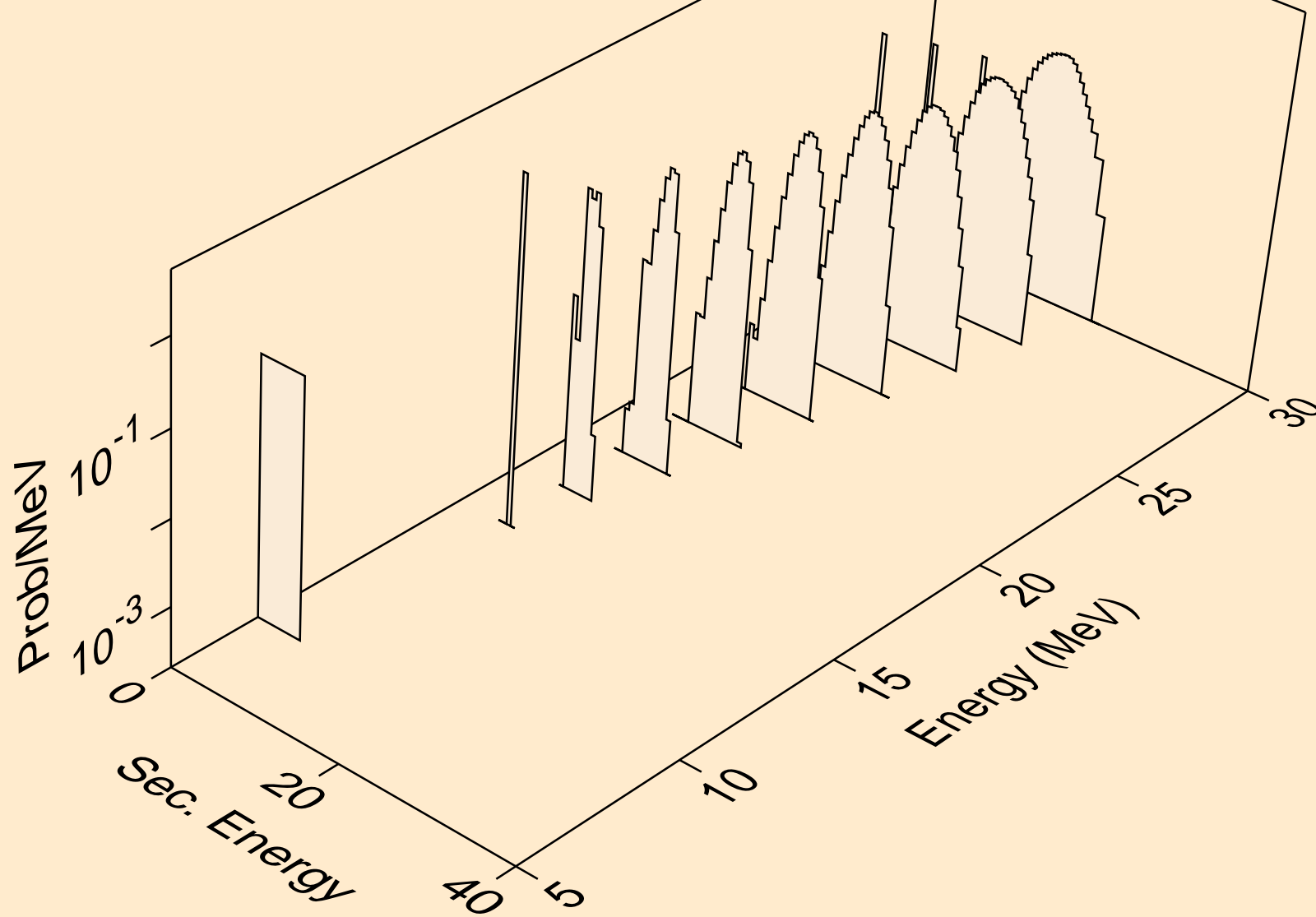

LU160 HELION ACER TENDL-2021 LIBRARY; T=0.K
alphas from (s,3n)a

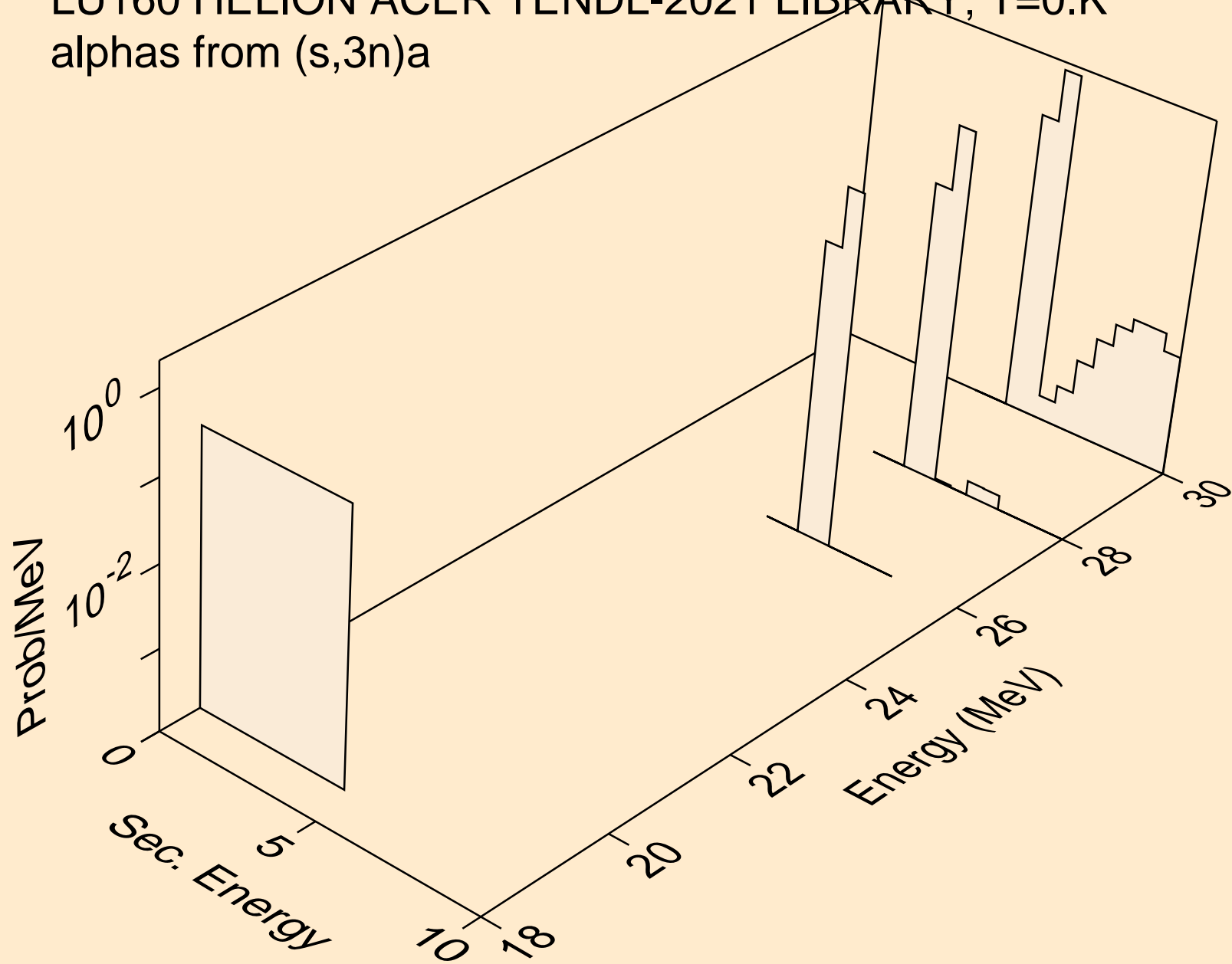

LU160 HELION ACER TENDL-2021 LIBRARY; T=0.K
alphas from (s,n*)2a

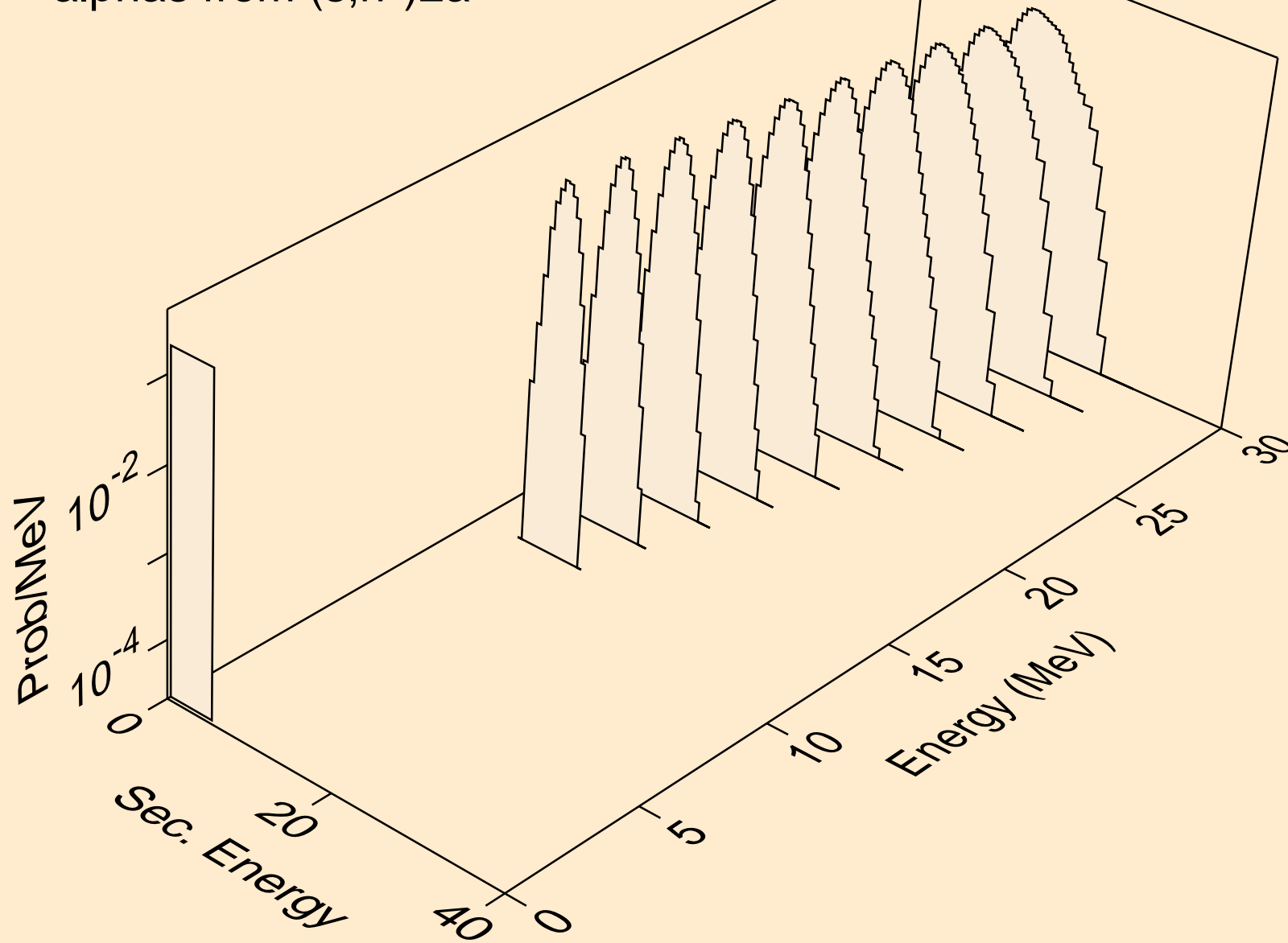

LU160 HELION ACER TENDL-2021 LIBRARY; T=0.K
alphas from (s,2n)2a

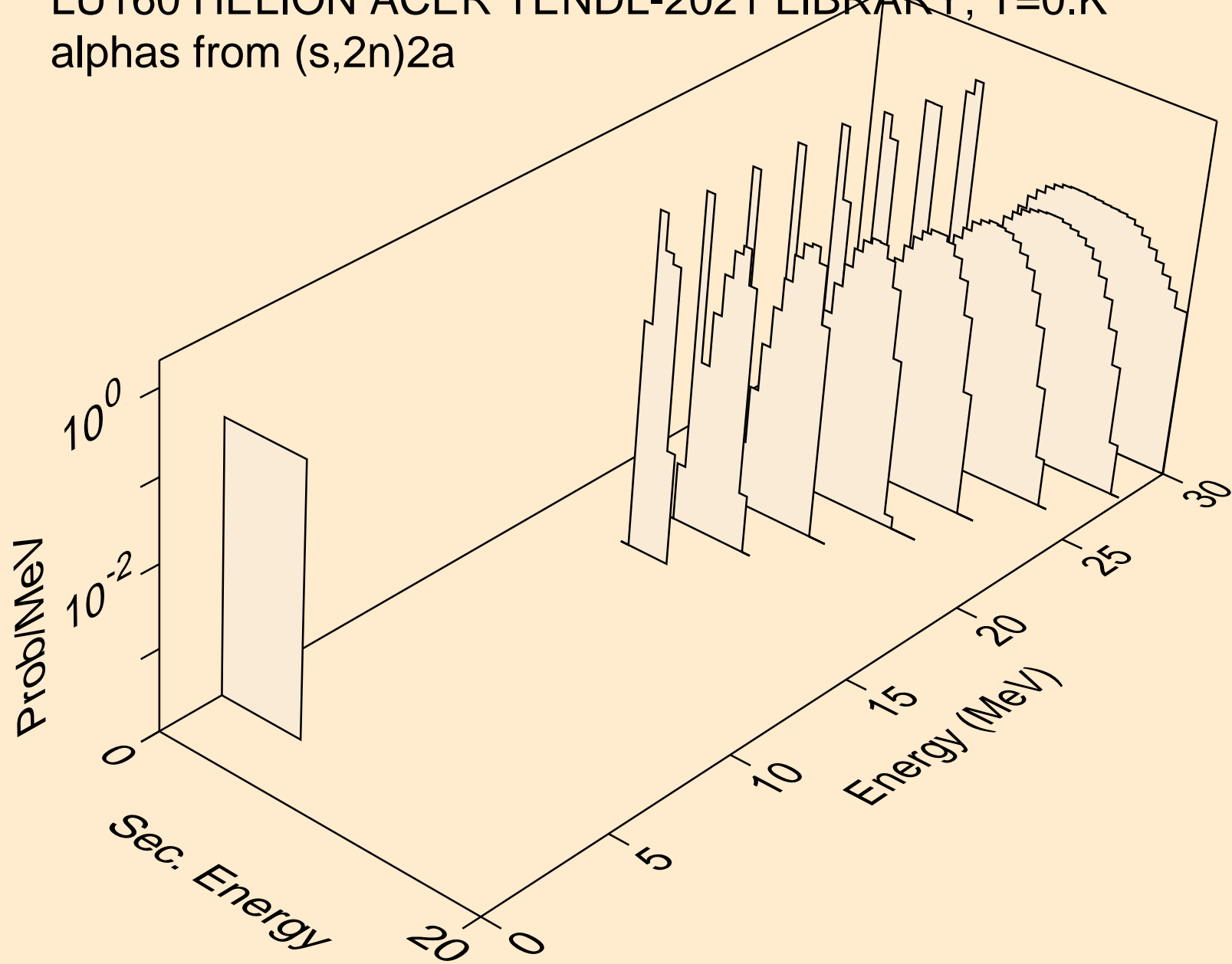

LU160 HELION ACER TENDL-2021 LIBRARY; T=0.K
alphas from (s,npa)

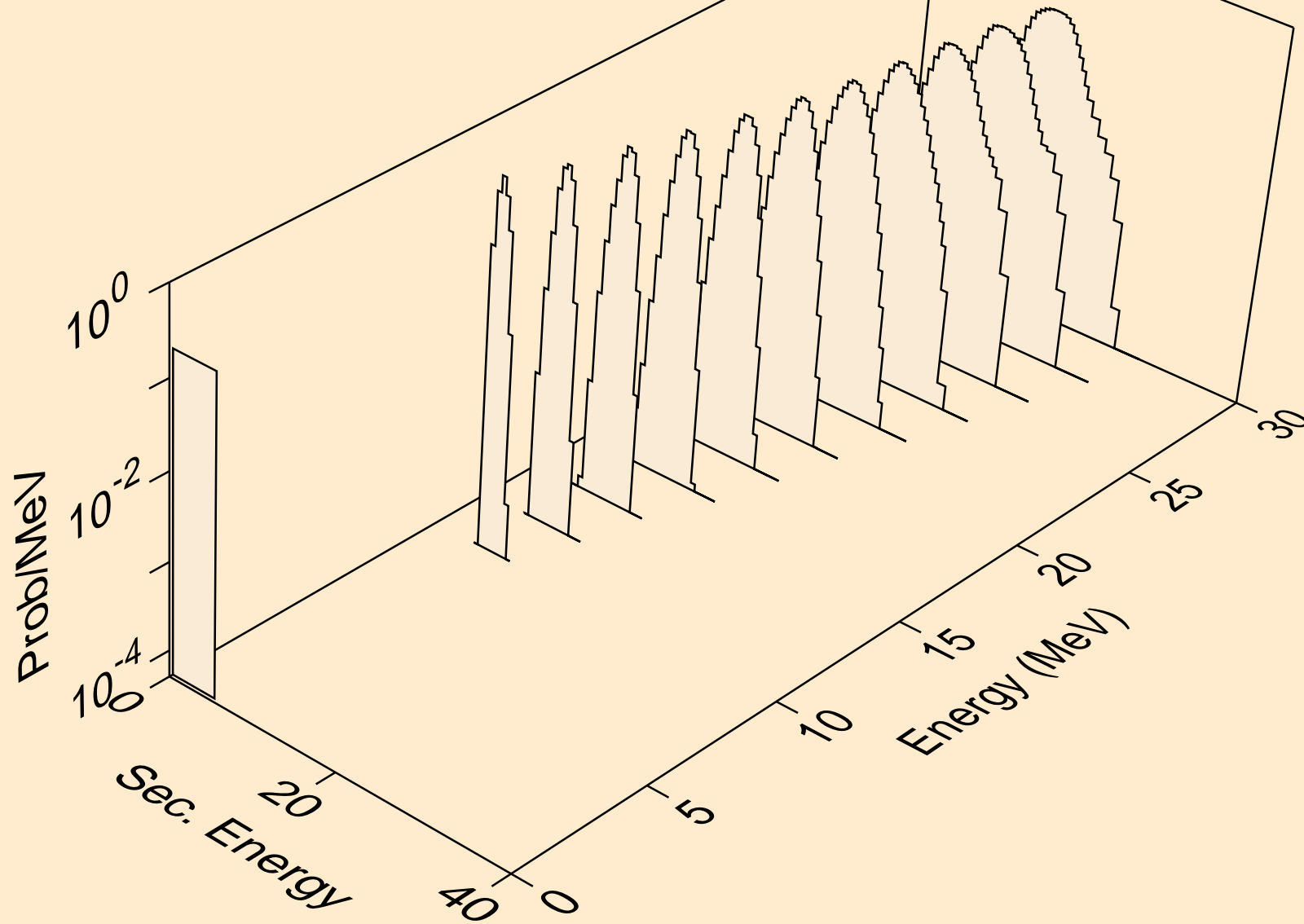

LU160 HELION ACER TENDL-2021 LIBRARY; T=0.K
alphas from (s,a)

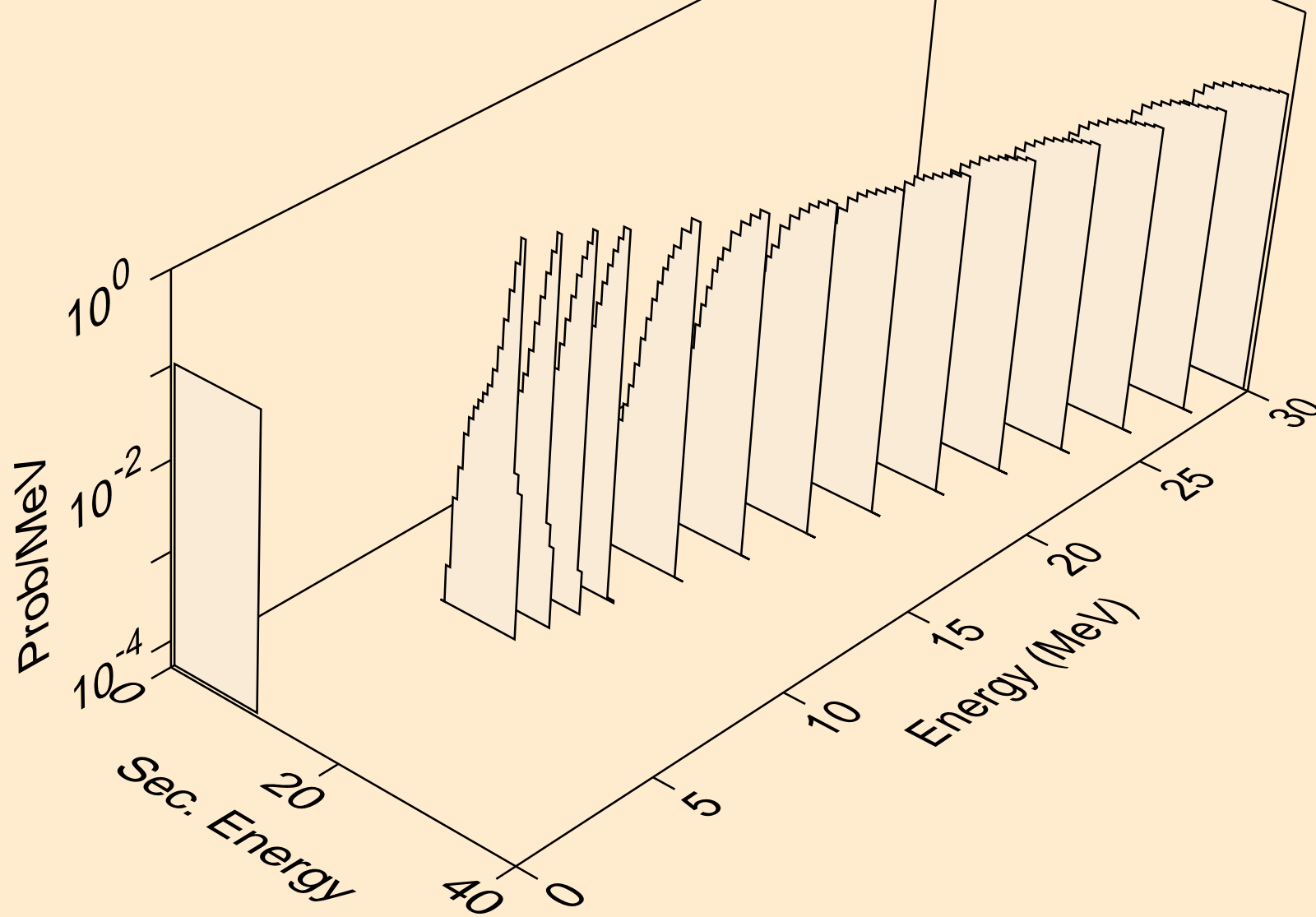

LU160 HELION ACER TENDL-2021 LIBRARY; T=0.K
alphas from (s,2a)

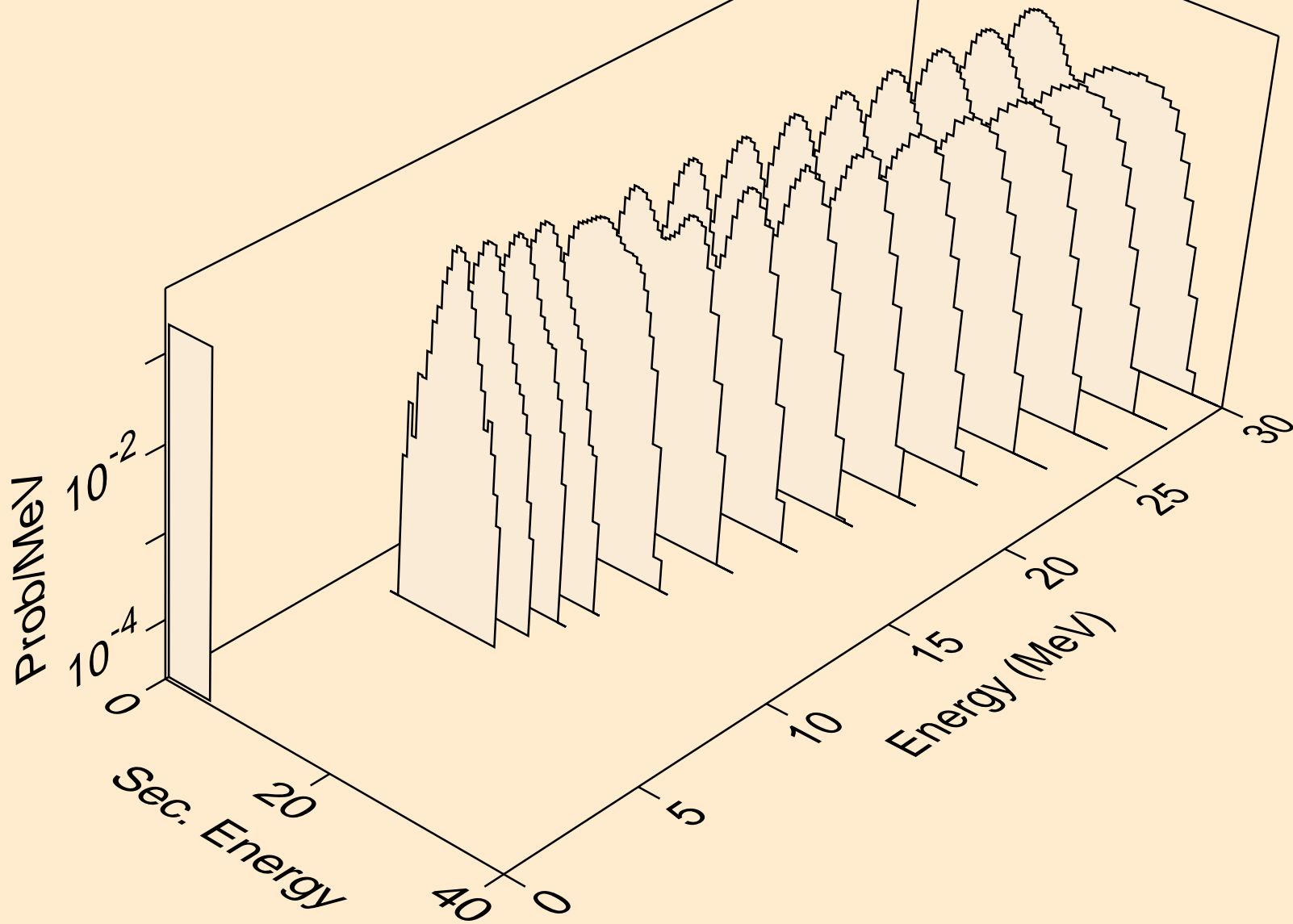

LU160 HELION ACER TENDL-2021 LIBRARY; T=0.K
alphas from (s,3a)

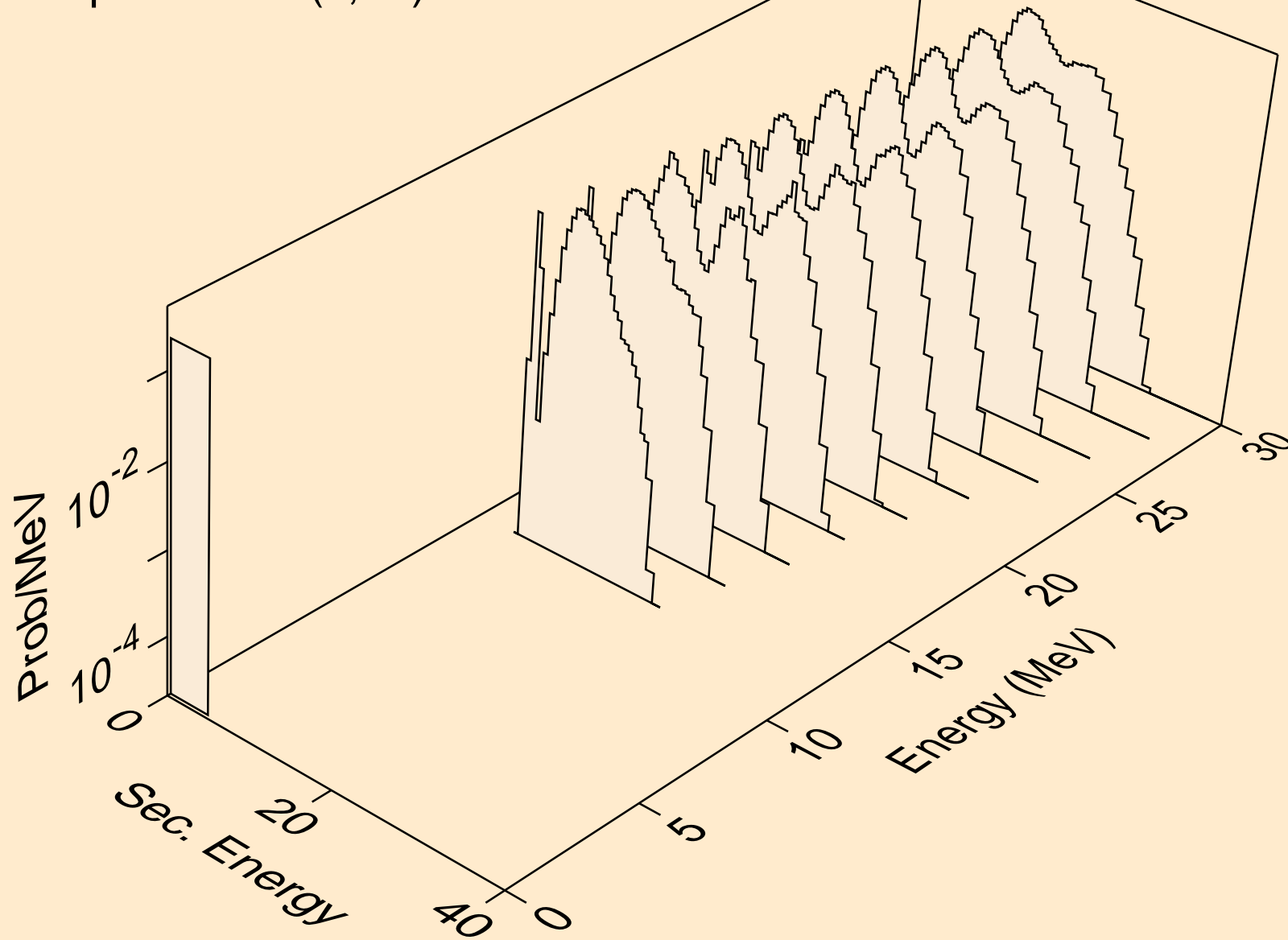

LU160 HELION ACER TENDL-2021 LIBRARY; T=0.K
alphas from (s,pa)

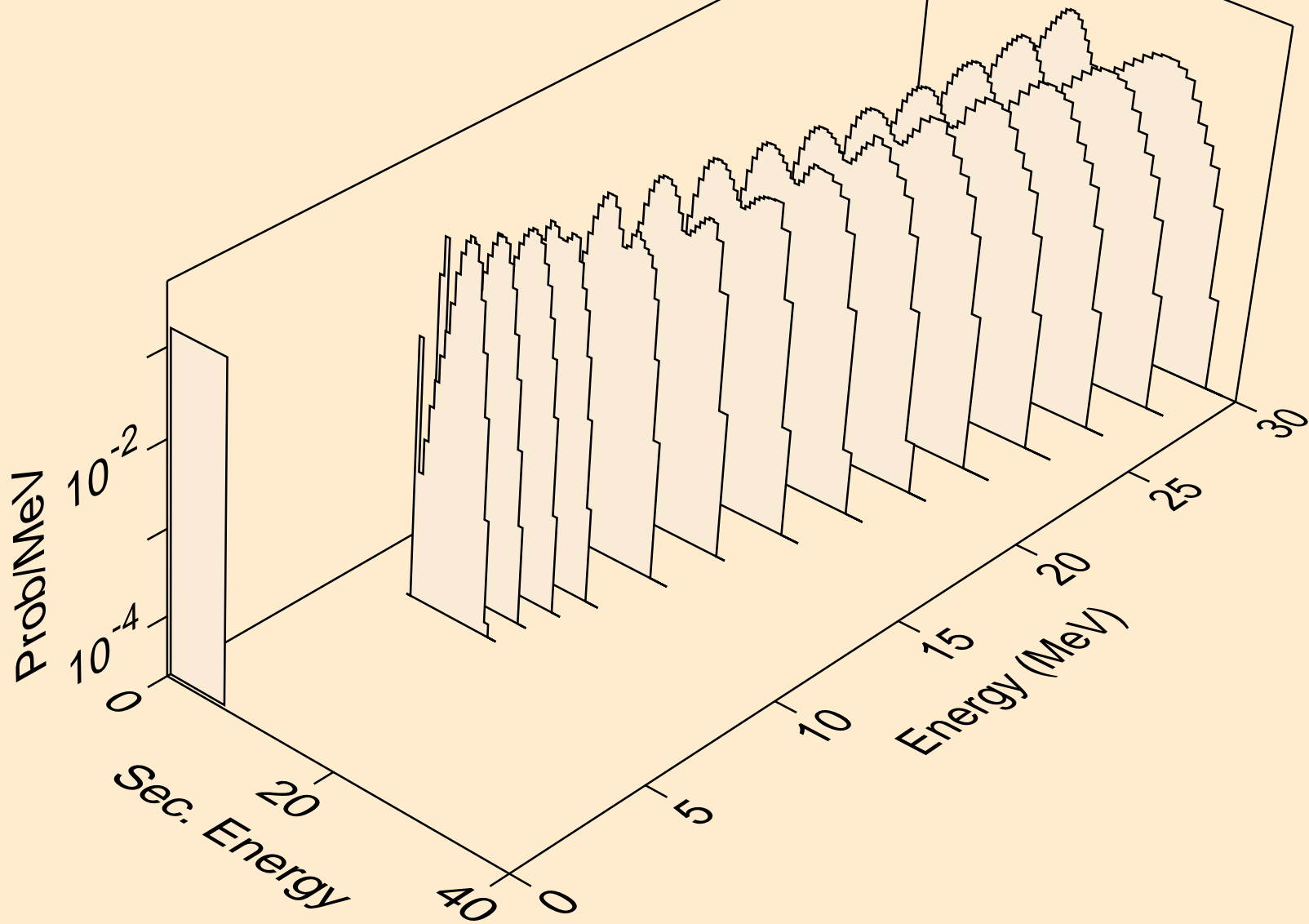

LU160 HELION ACER TENDL-2021 LIBRARY; T=0.K
alphas from (s,t2a)

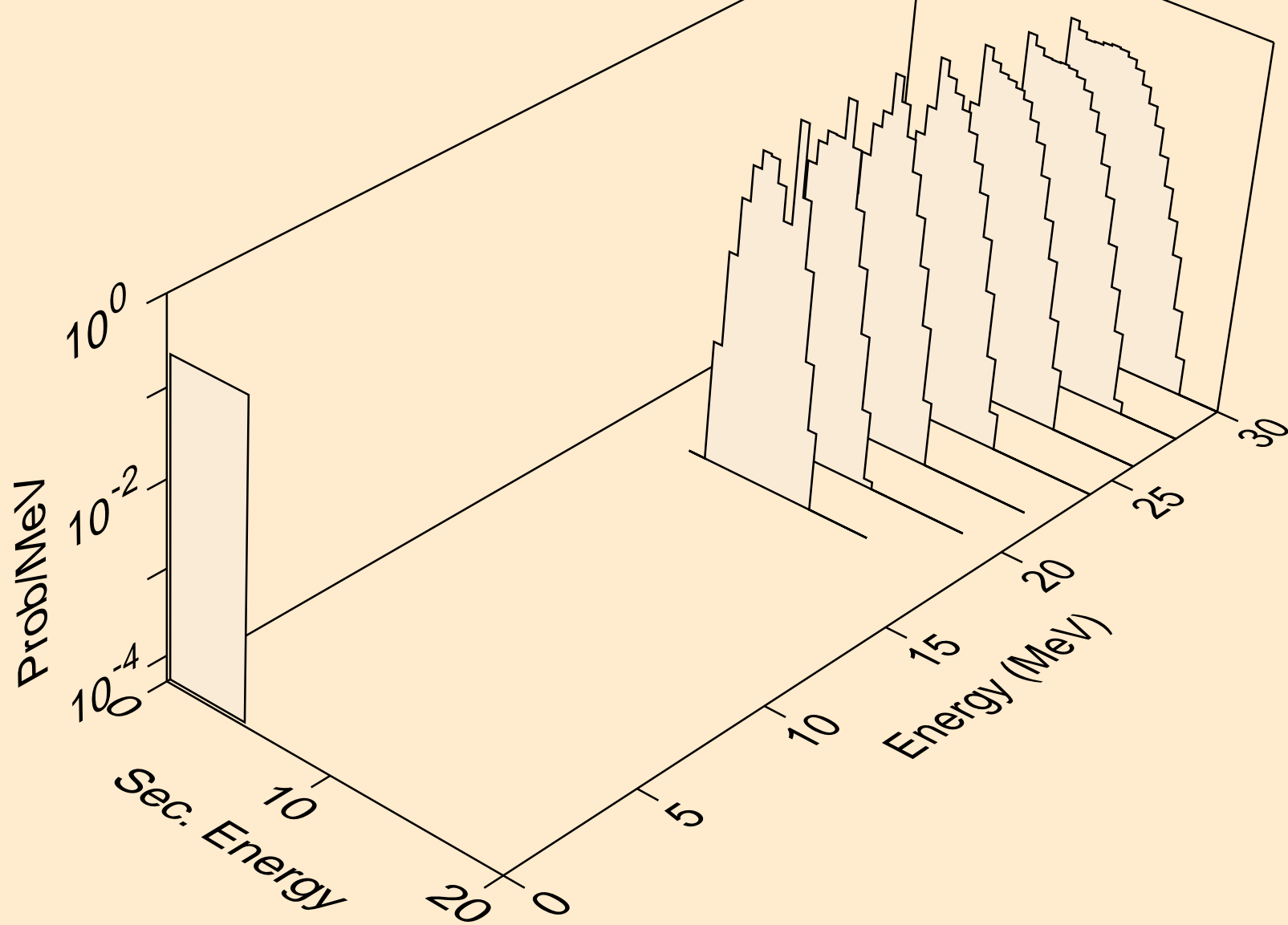

LU160 HELION ACER TENDL-2021 LIBRARY; T=0.K
alphas from (s,d2a)

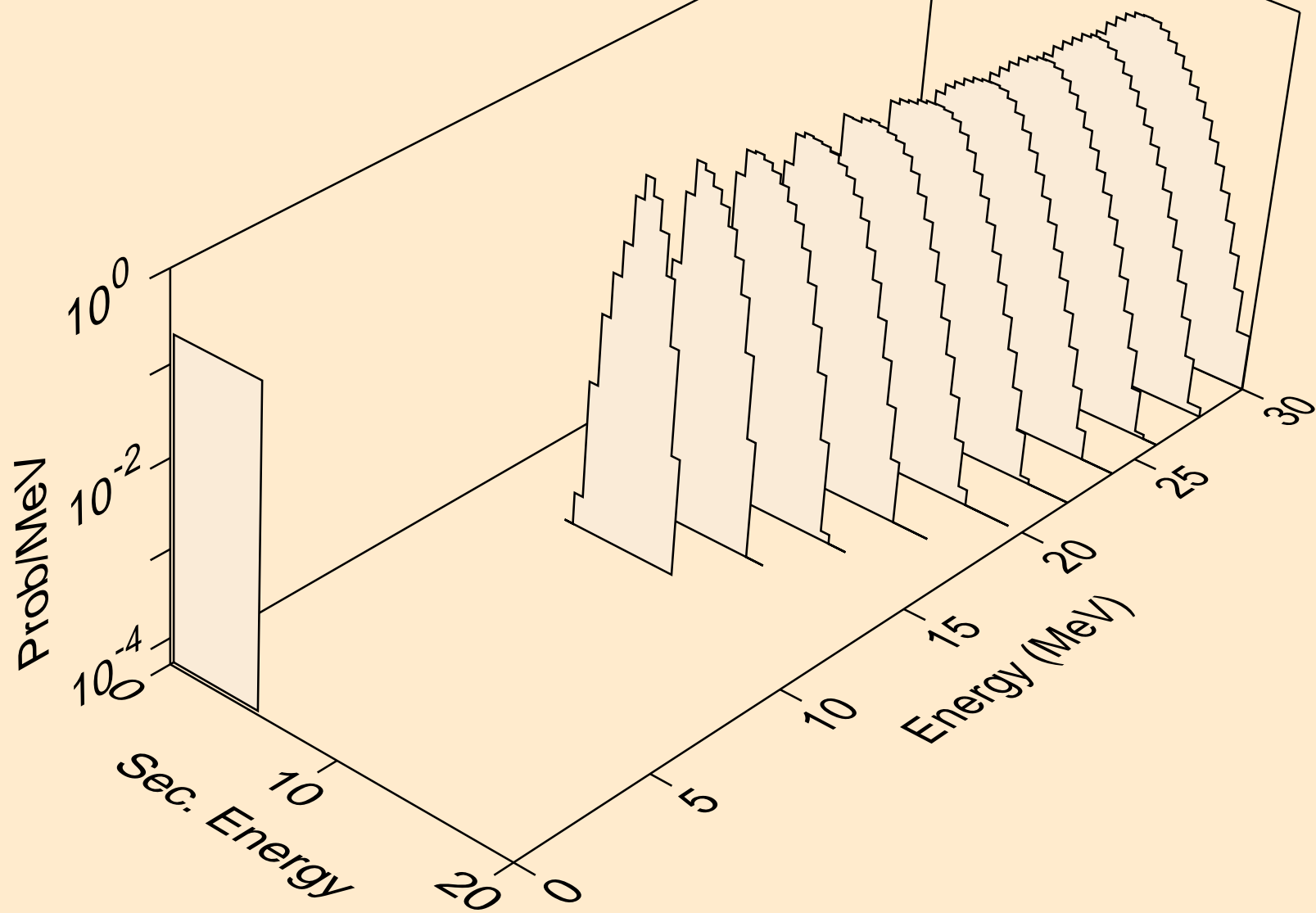

LU160 HELION ACER TENDL-2021 LIBRARY; T=0.K
alphas from (s,da)

