

LU164 HELION ACER TENDL-2021 LIBRARY; T=0.K  
Principal cross sections

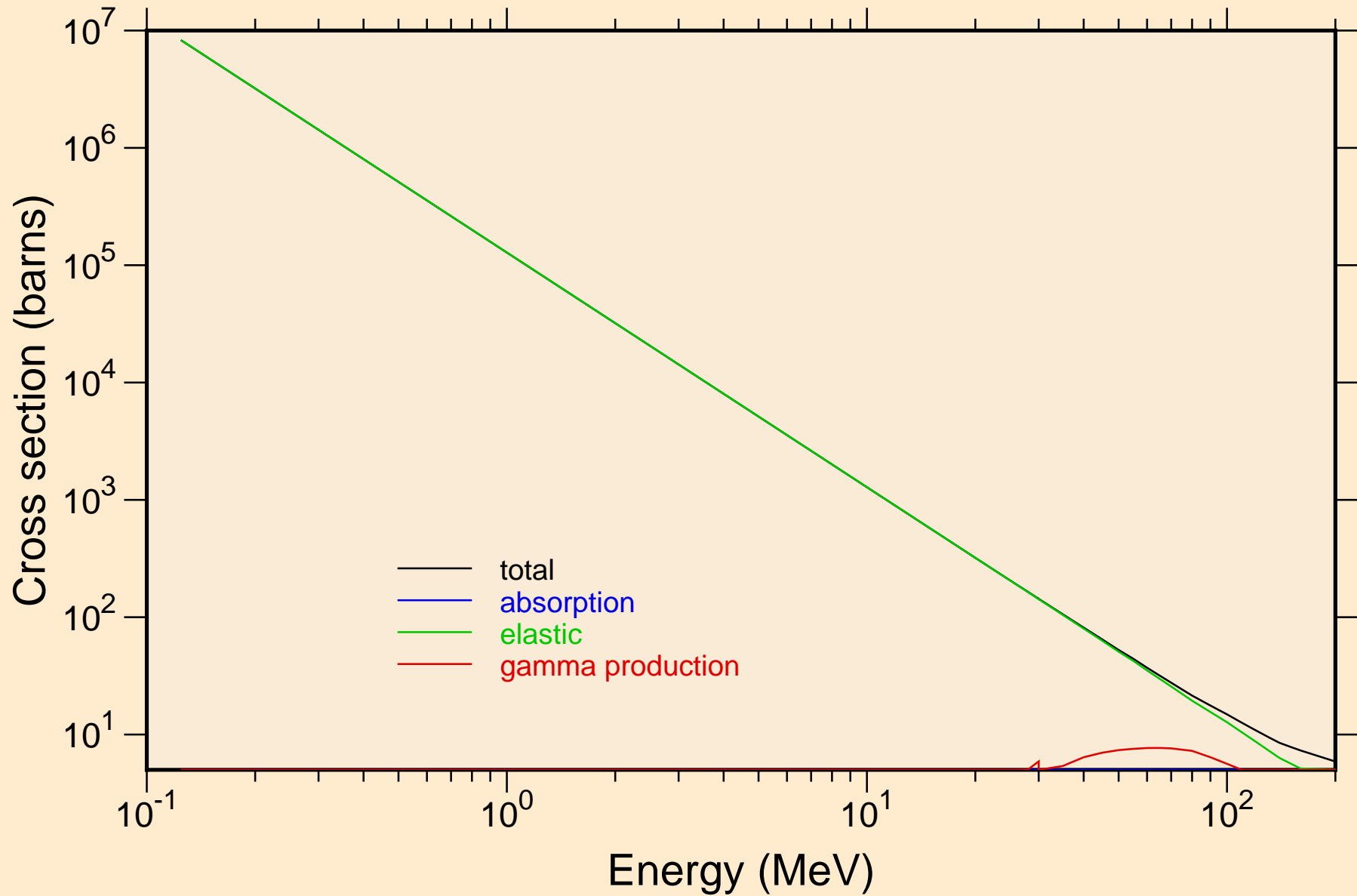

LU164 HELION ACER TENDL-2021 LIBRARY; T=0.K

Heating

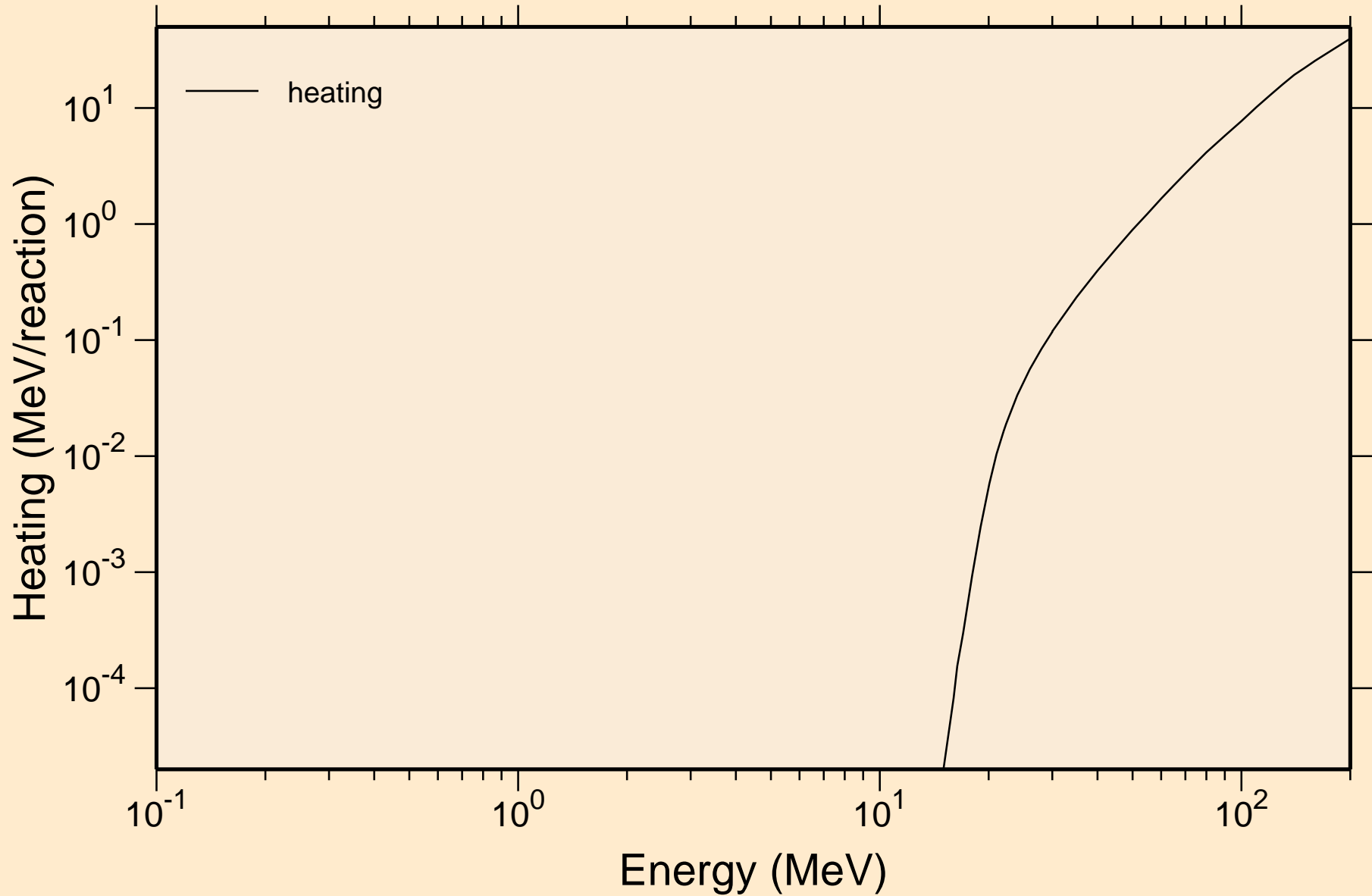

# LU164 HELION ACER TENDL-2021 LIBRARY; T=0.K

## Principal cross sections

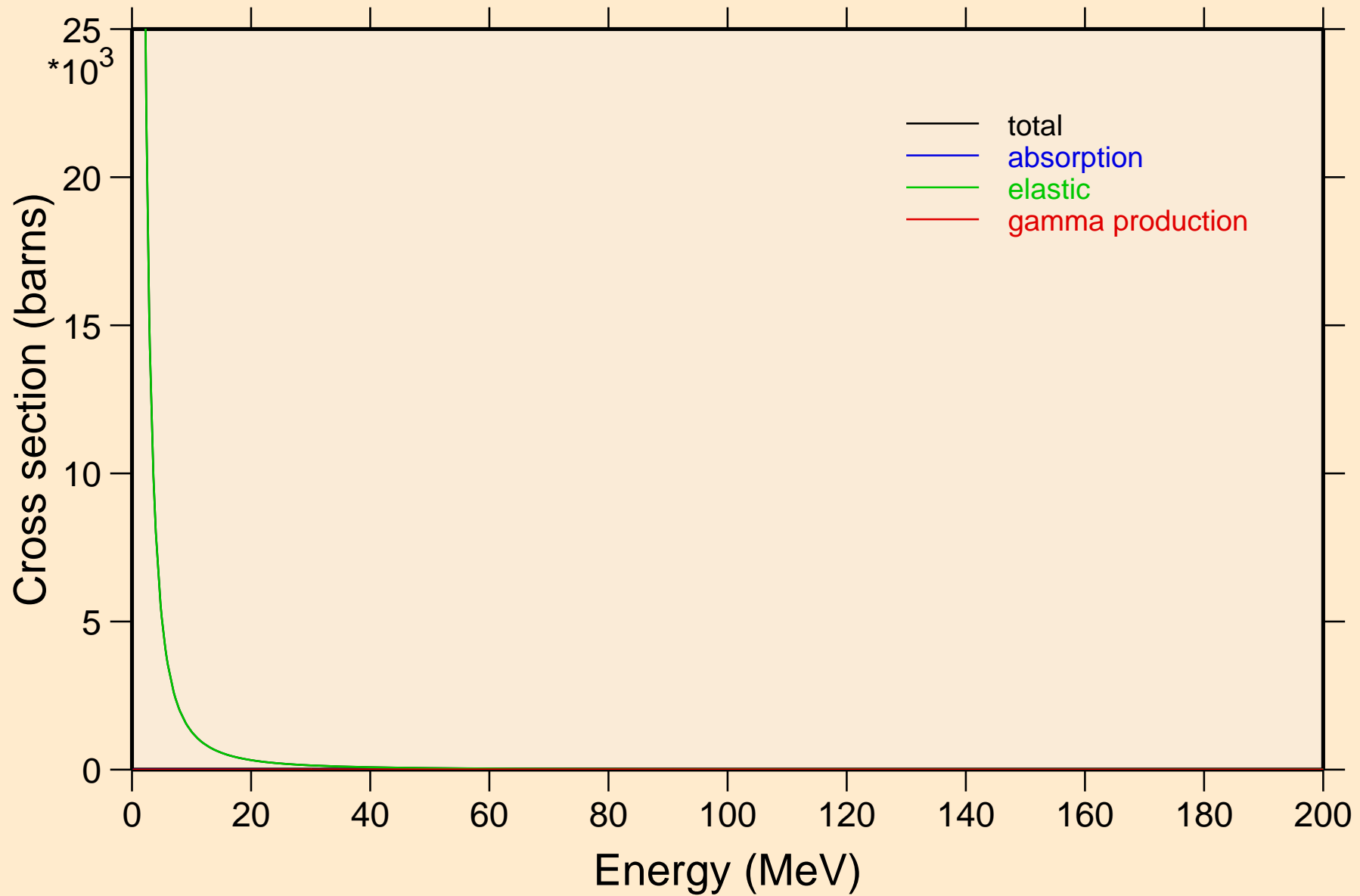

LU164 HELION ACER TENDL-2021 LIBRARY; T=0.K

Heating

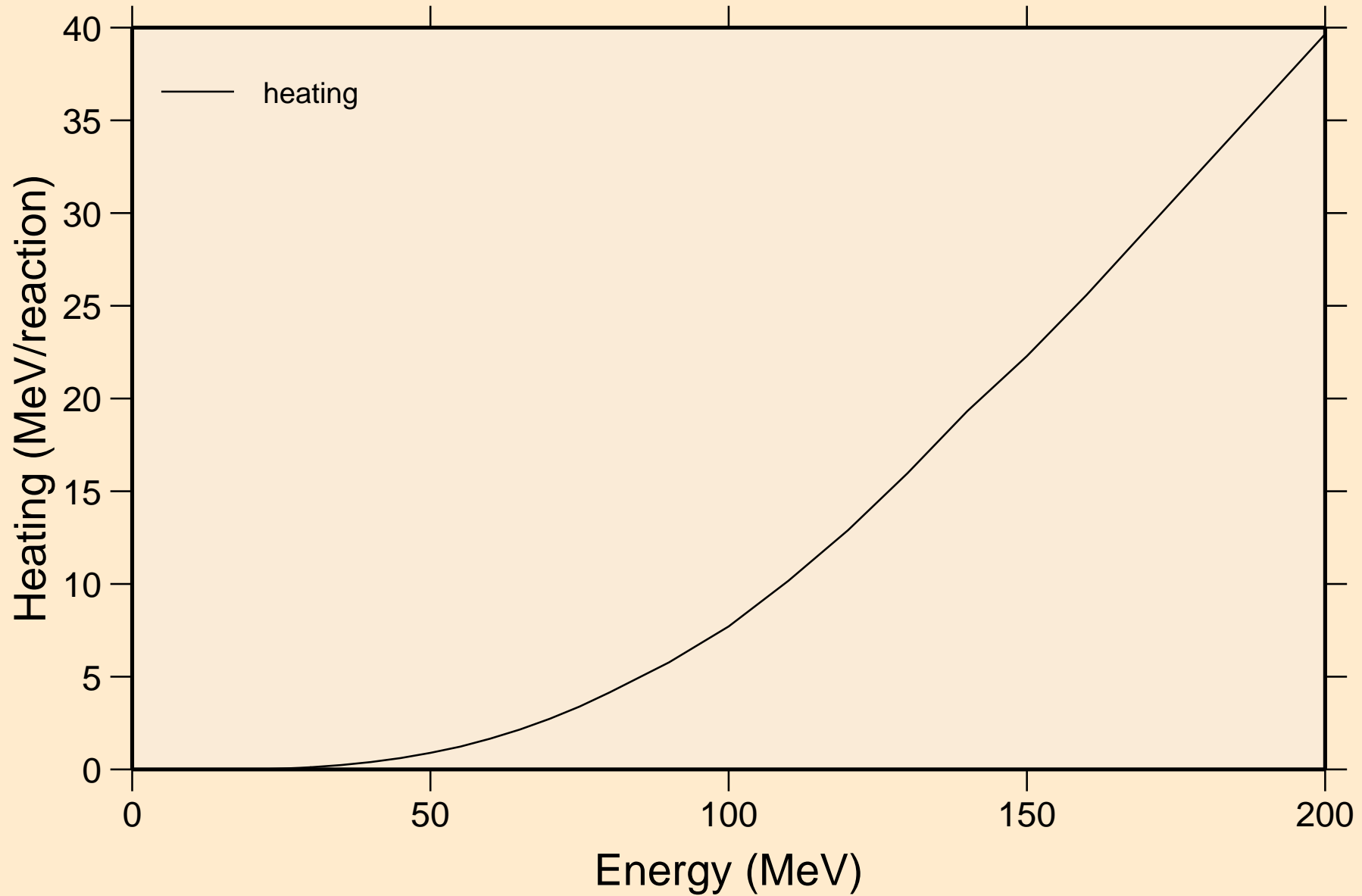

LU164 HELION ACER TENDL-2021 LIBRARY; T=0.K  
Threshold reactions

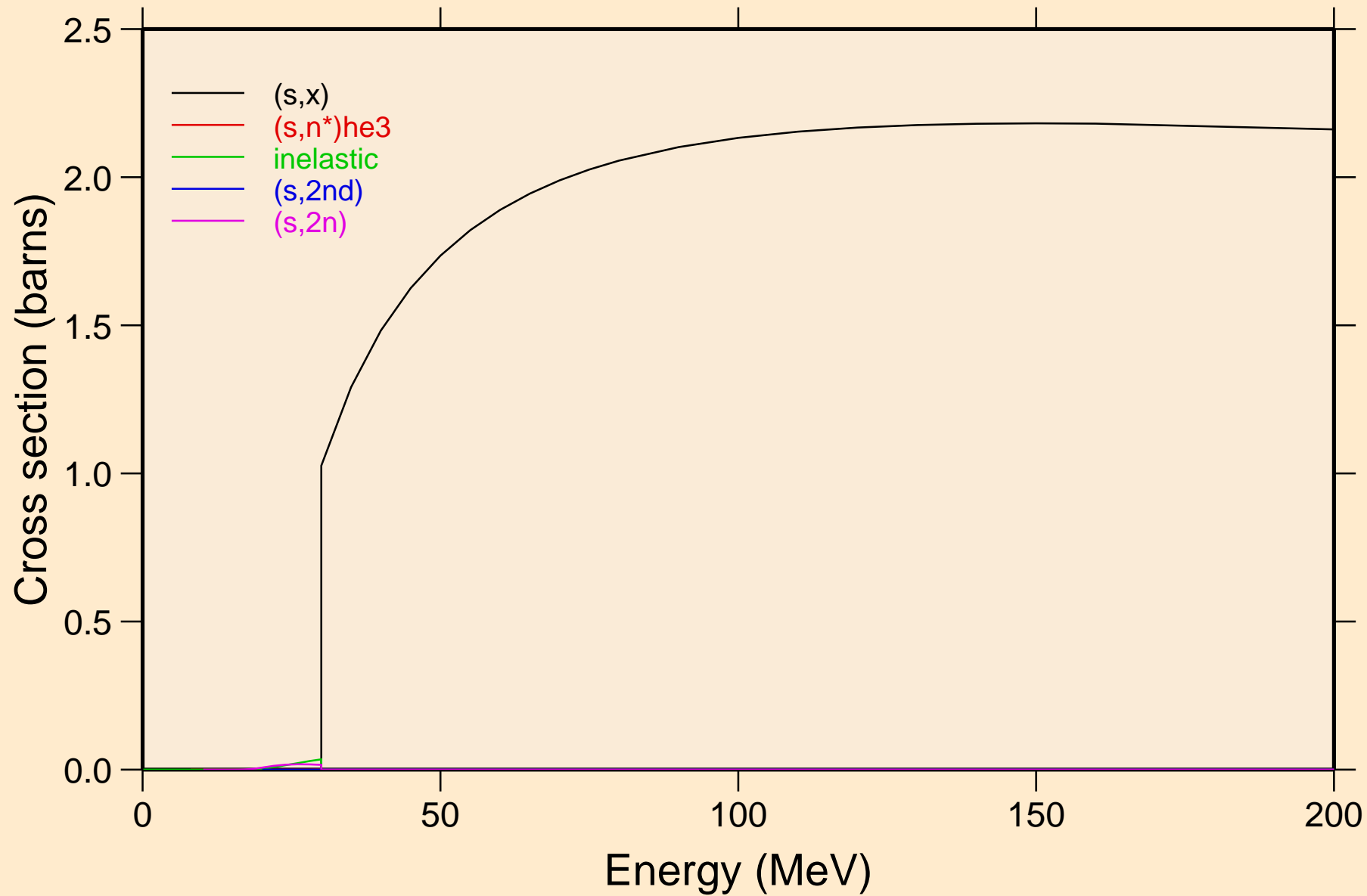

LU164 HELION ACER TENDL-2021 LIBRARY; T=0.K  
Threshold reactions

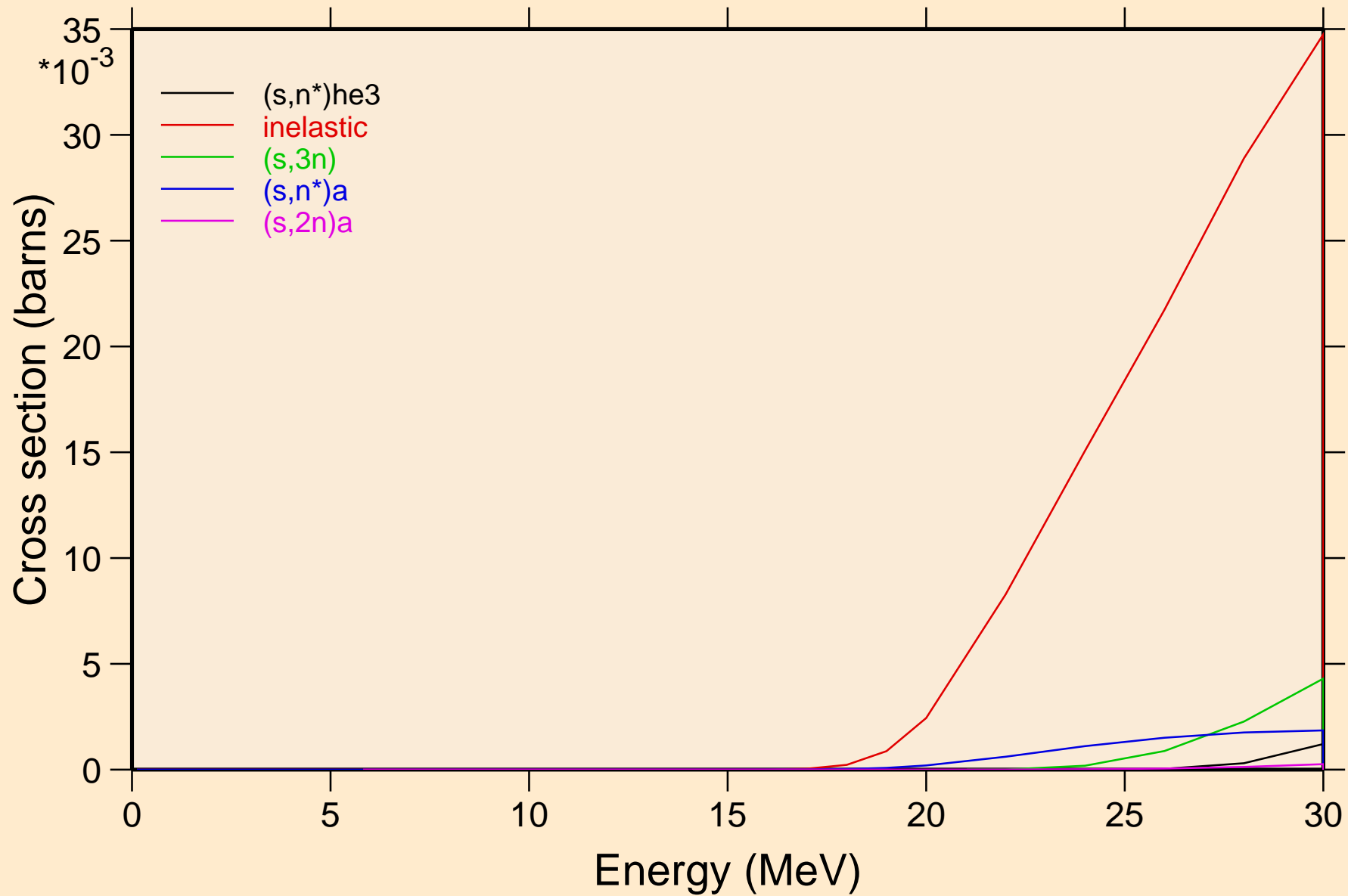

LU164 HELION ACER TENDL-2021 LIBRARY; T=0.K  
Threshold reactions

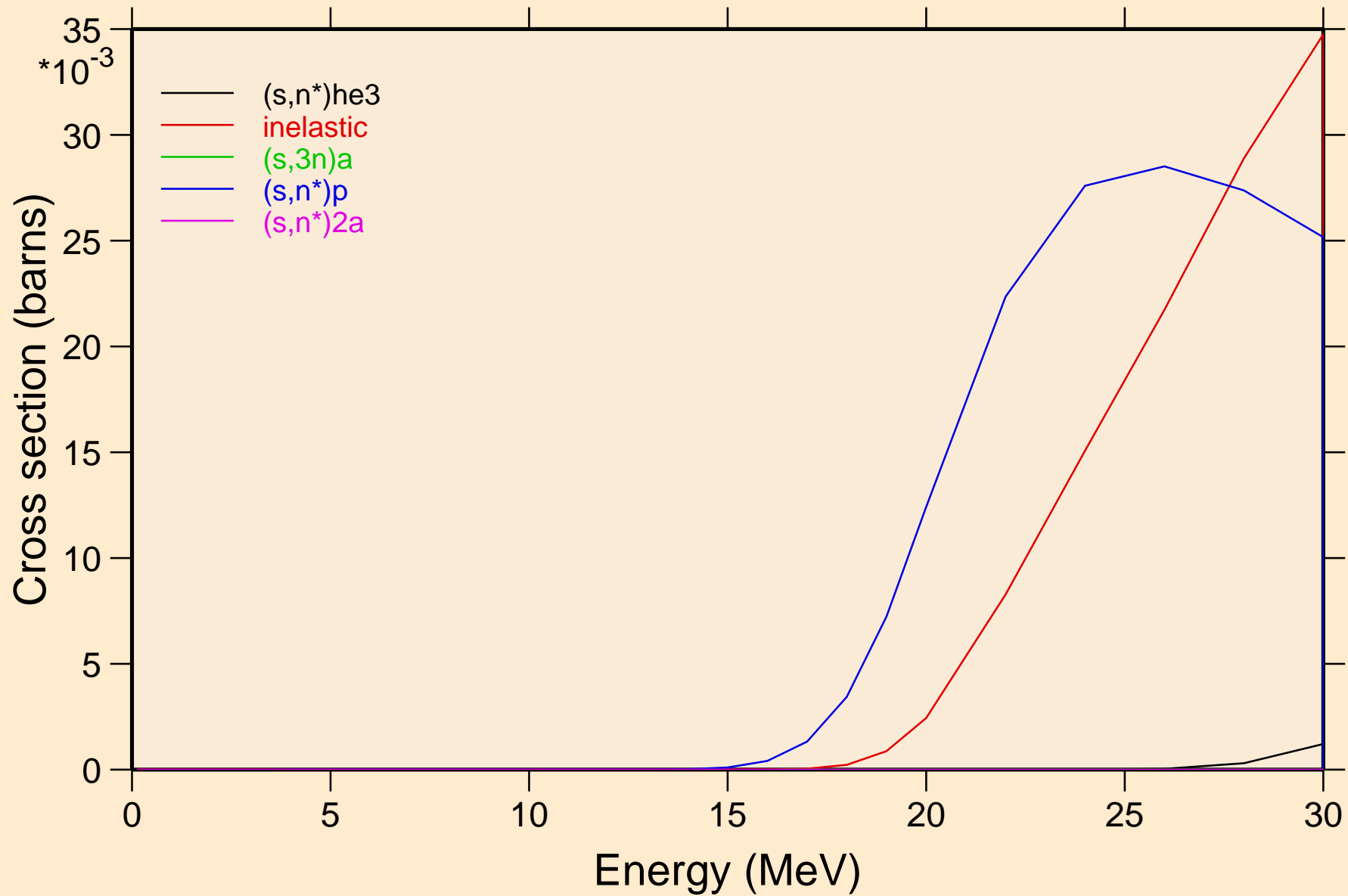

LU164 HELION ACER TENDL-2021 LIBRARY; T=0.K  
Threshold reactions

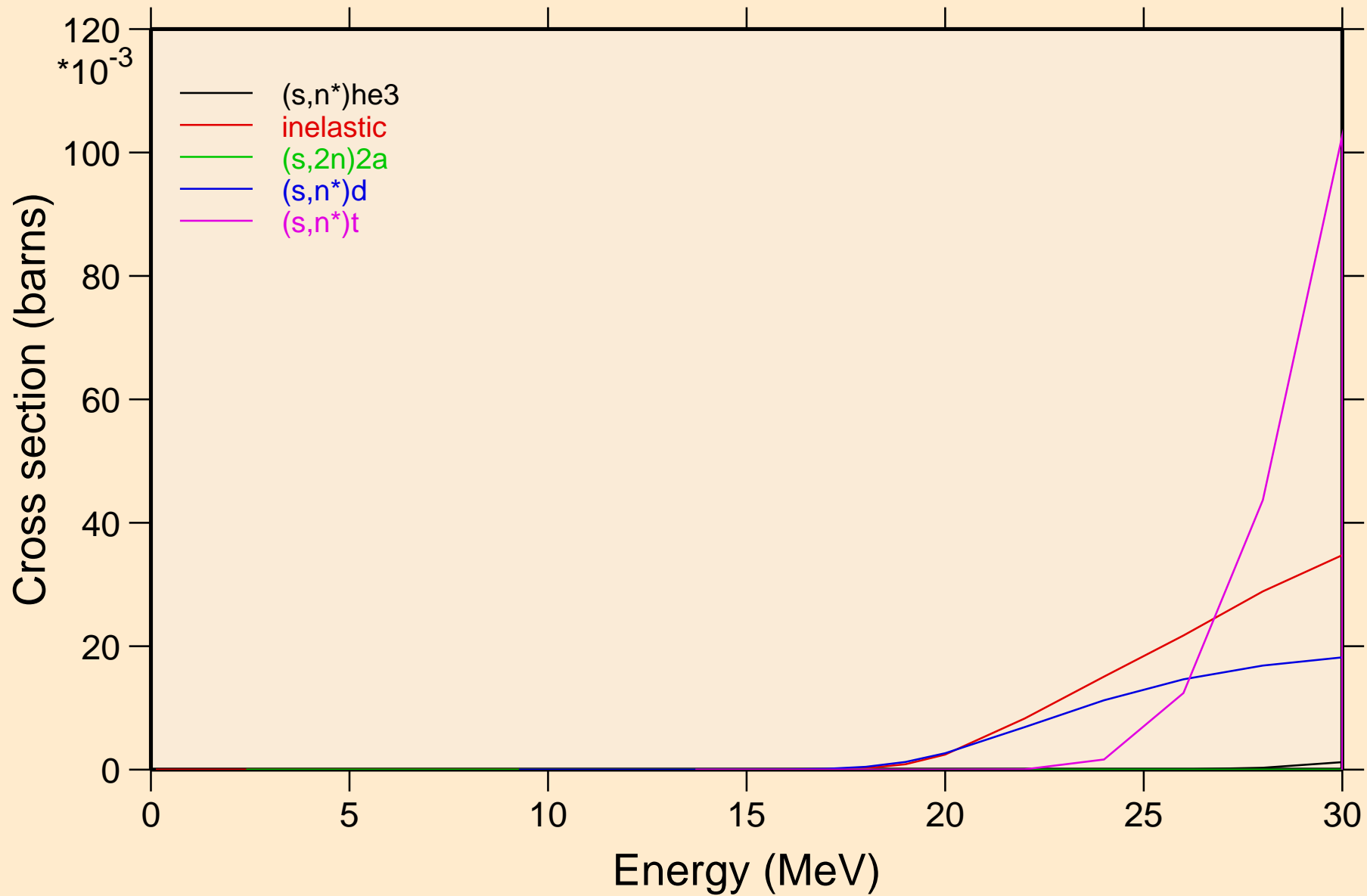



LU164 HELION ACER TENDL-2021 LIBRARY; T=0.K  
Threshold reactions

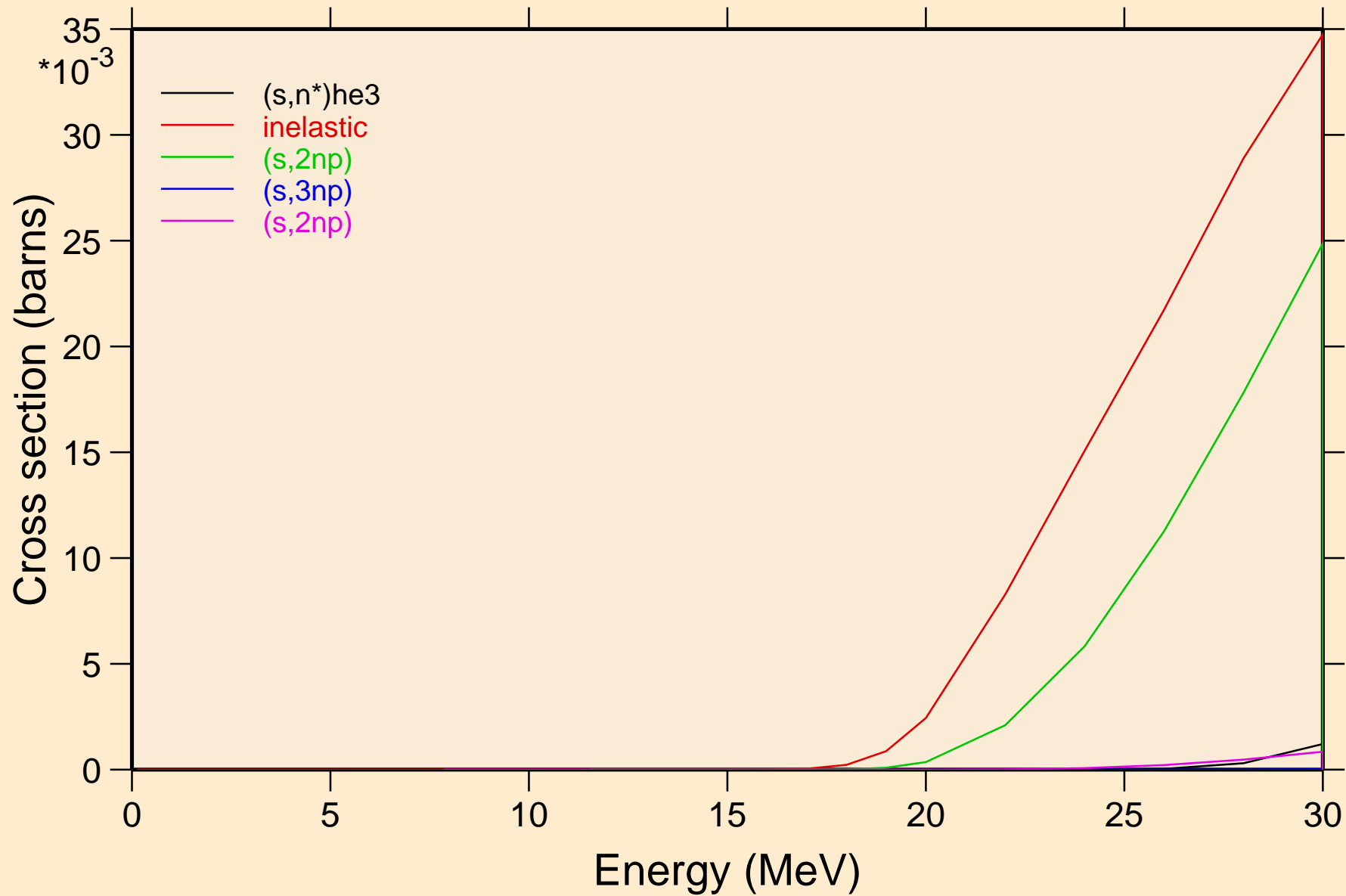

LU164 HELION ACER TENDL-2021 LIBRARY; T=0.K  
Threshold reactions

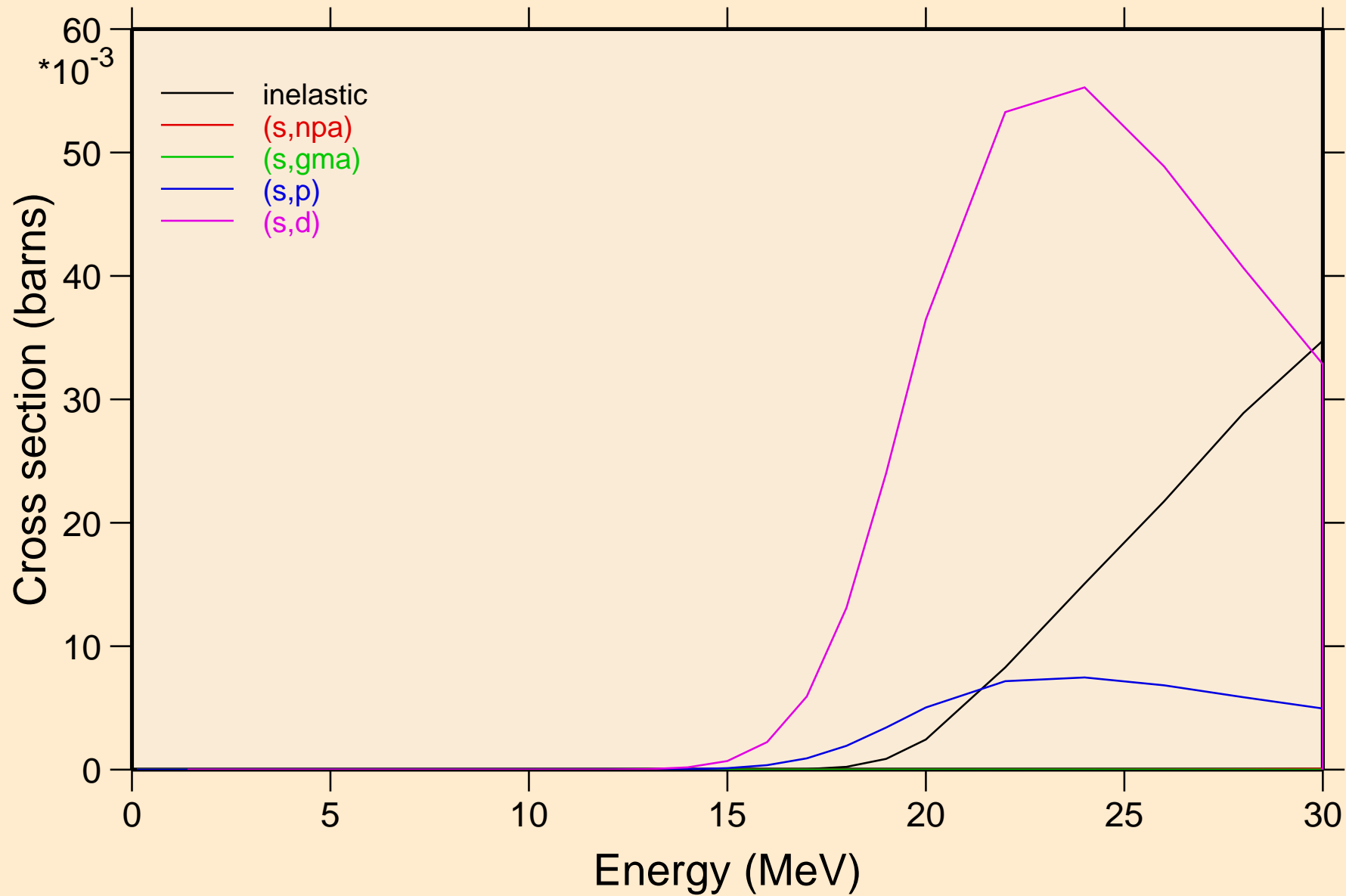

LU164 HELION ACER TENDL-2021 LIBRARY; T=0.K  
Threshold reactions

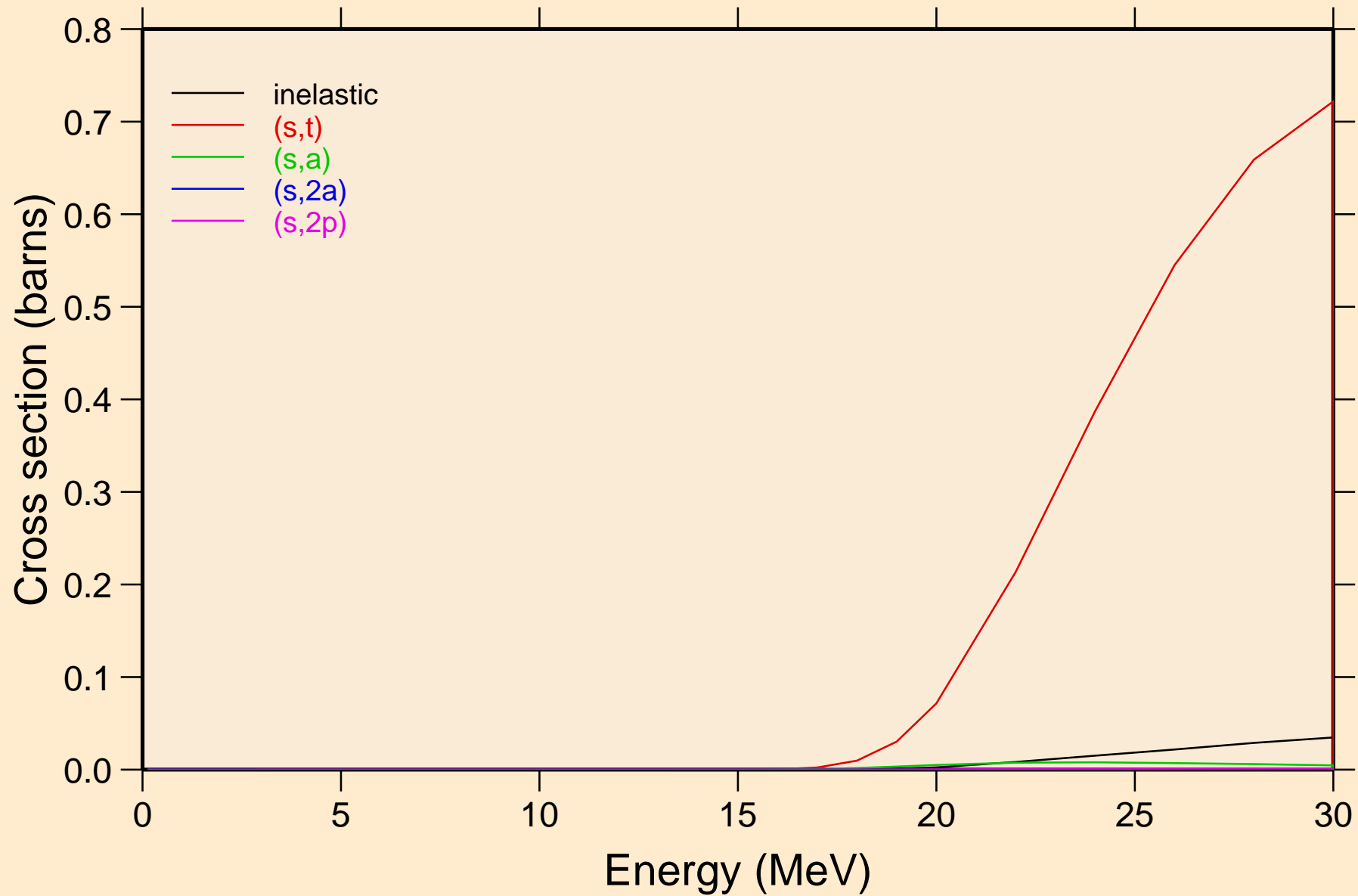

LU164 HELION ACER TENDL-2021 LIBRARY; T=0.K  
Threshold reactions

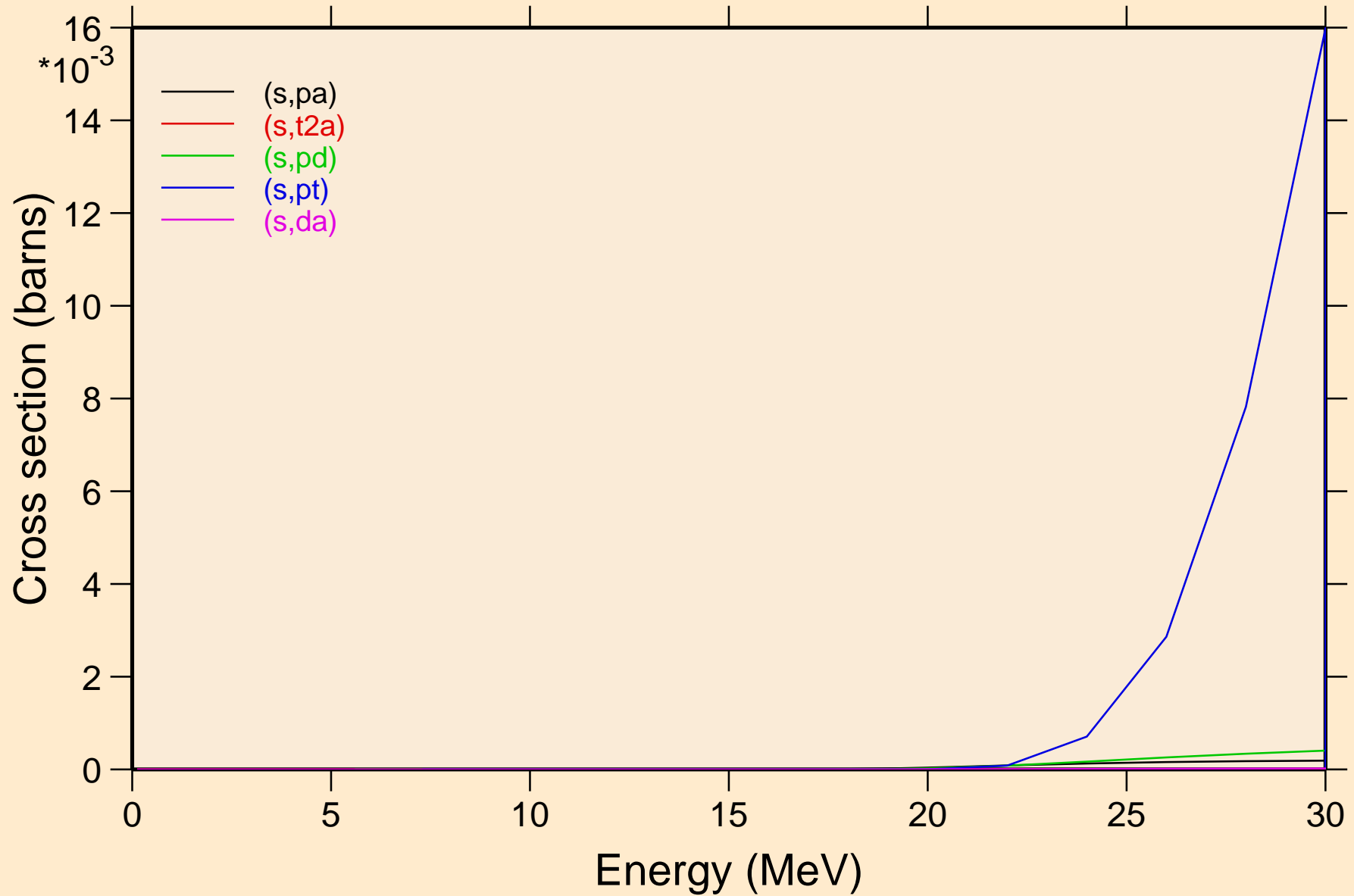

LU164 HELION ACER TENDL-2021 LIBRARY; T=0.K  
angular distribution for elastic

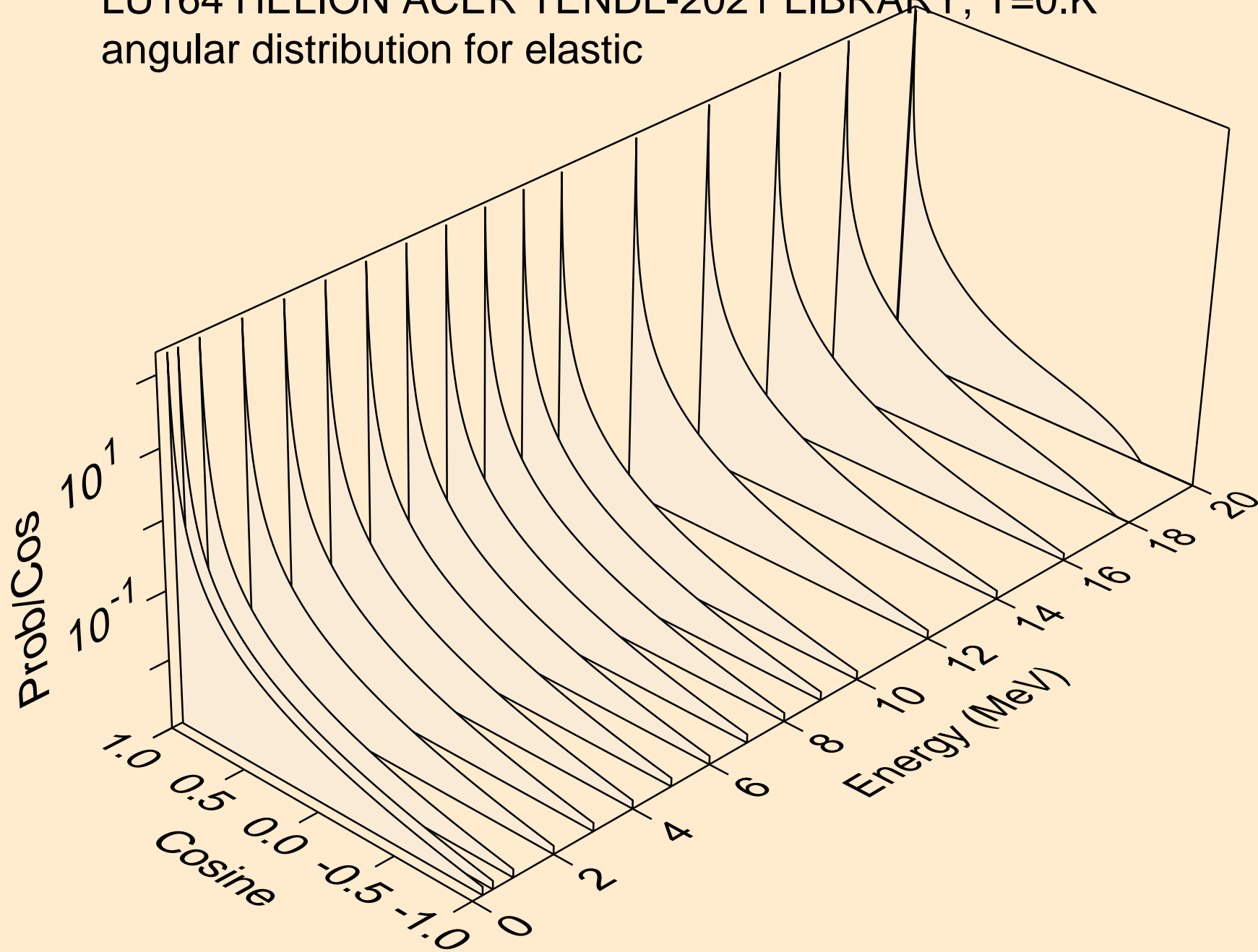

LU164 HELION ACER TENDL-2021 LIBRARY; T=0.K  
angular distribution for elastic

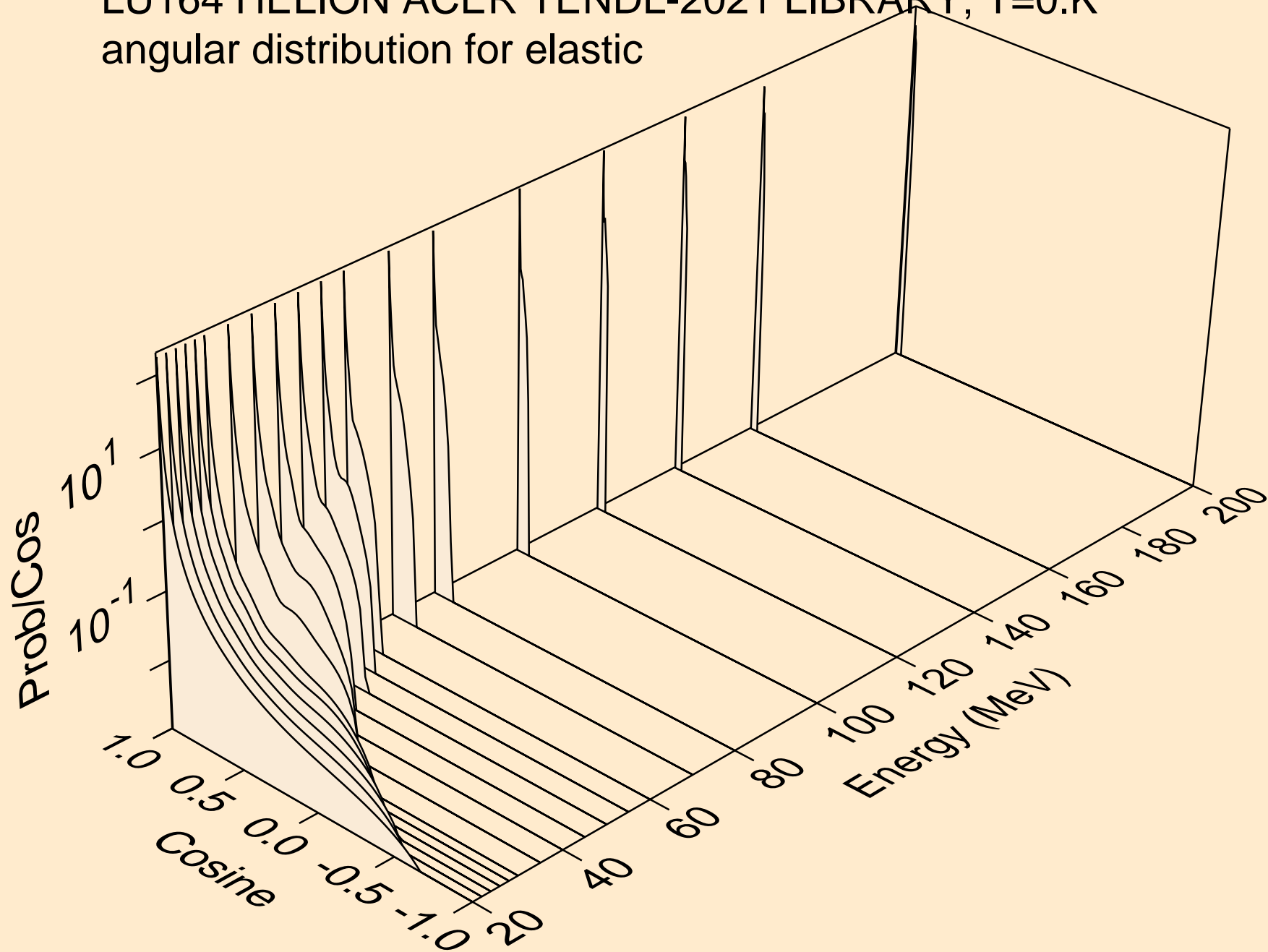

LU164 HELION ACER TENDL-2021 LIBRARY; T=0.K  
He-3 emission for (s,x)

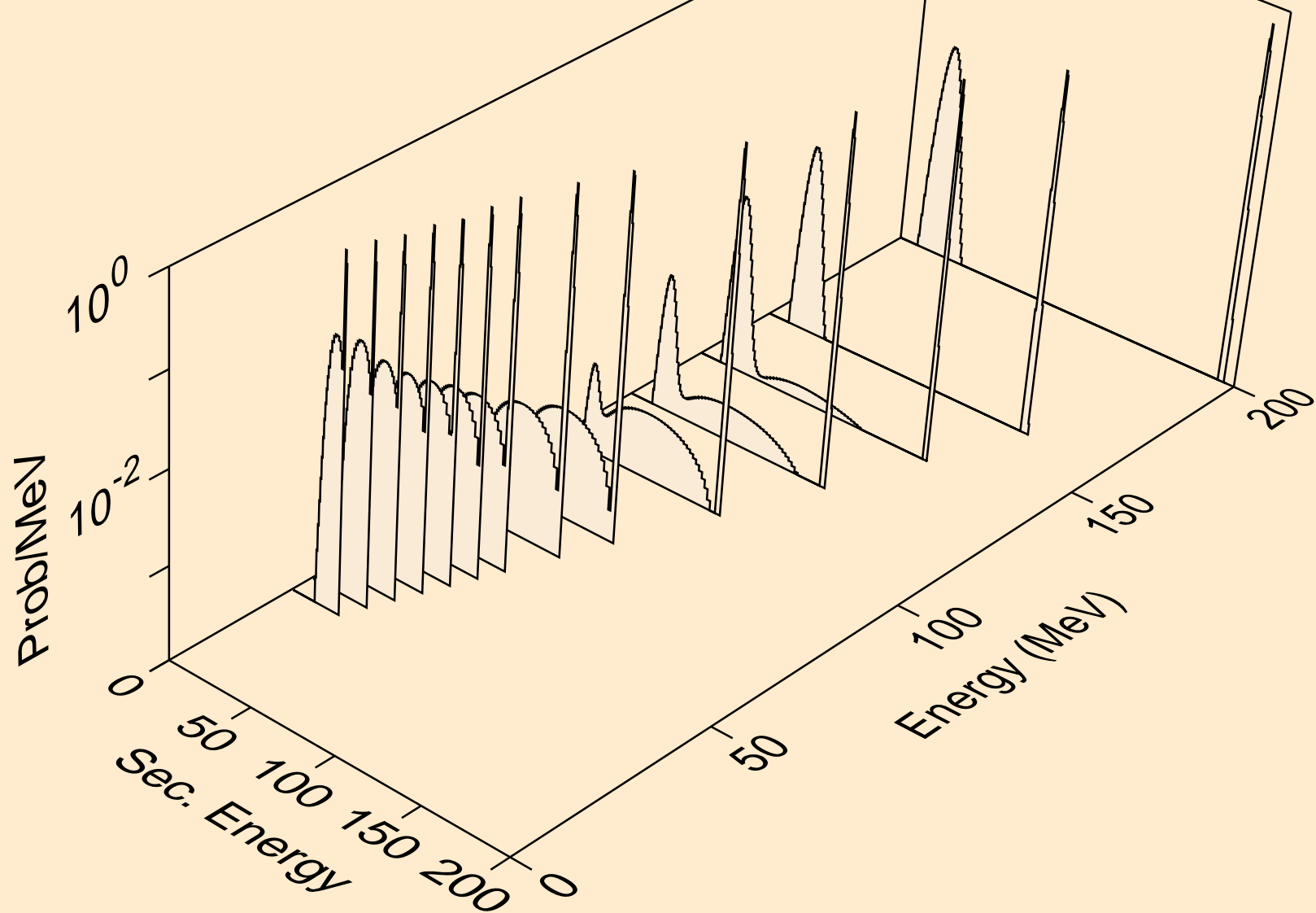

LU164 HELION ACER TENDL-2021 LIBRARY; T=0.K  
He-3 emission for (s,n\*)he3

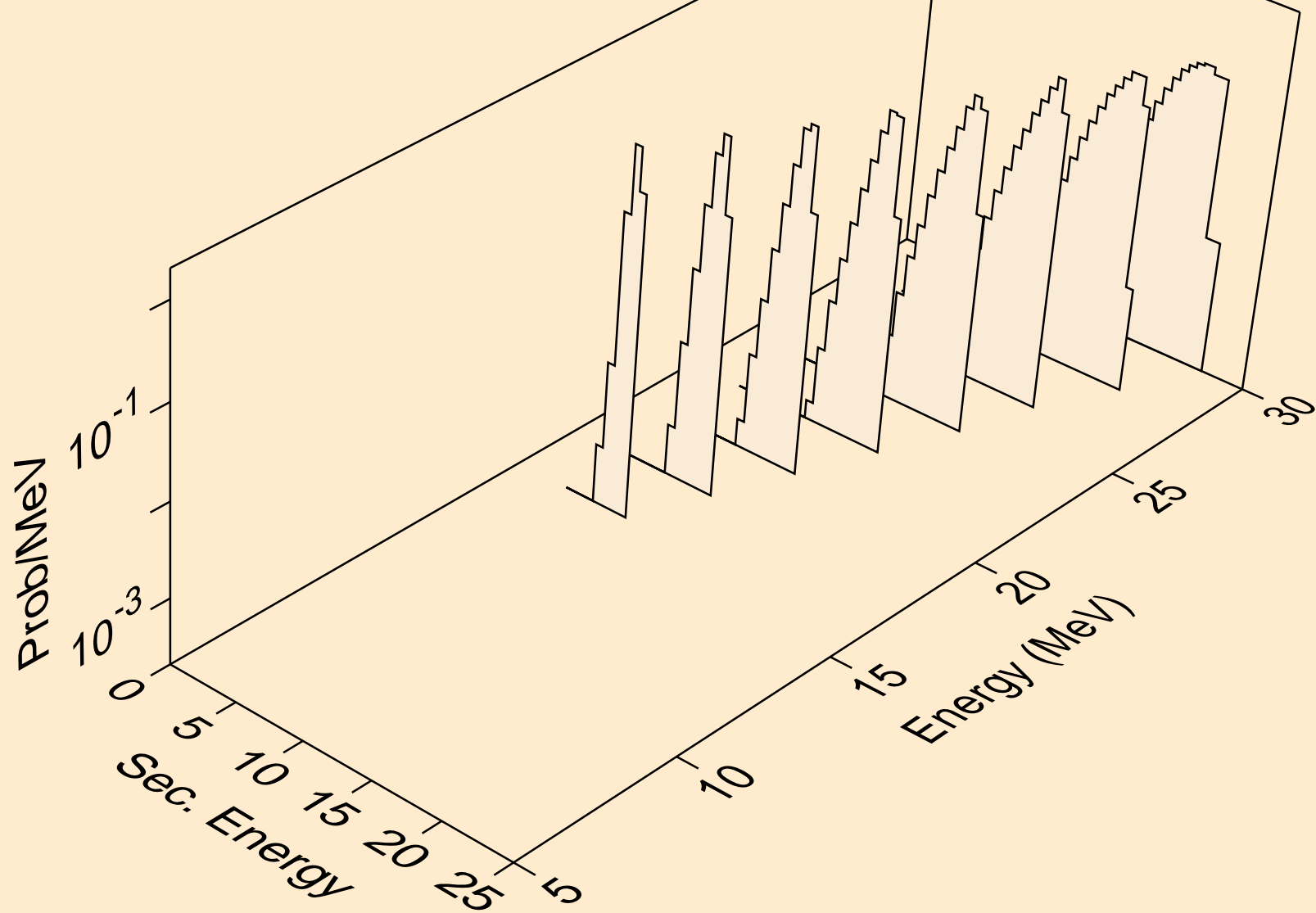



LU164 HELION ACER TENDL-2021 LIBRARY; T=0.K  
He-3 emission for inelastic

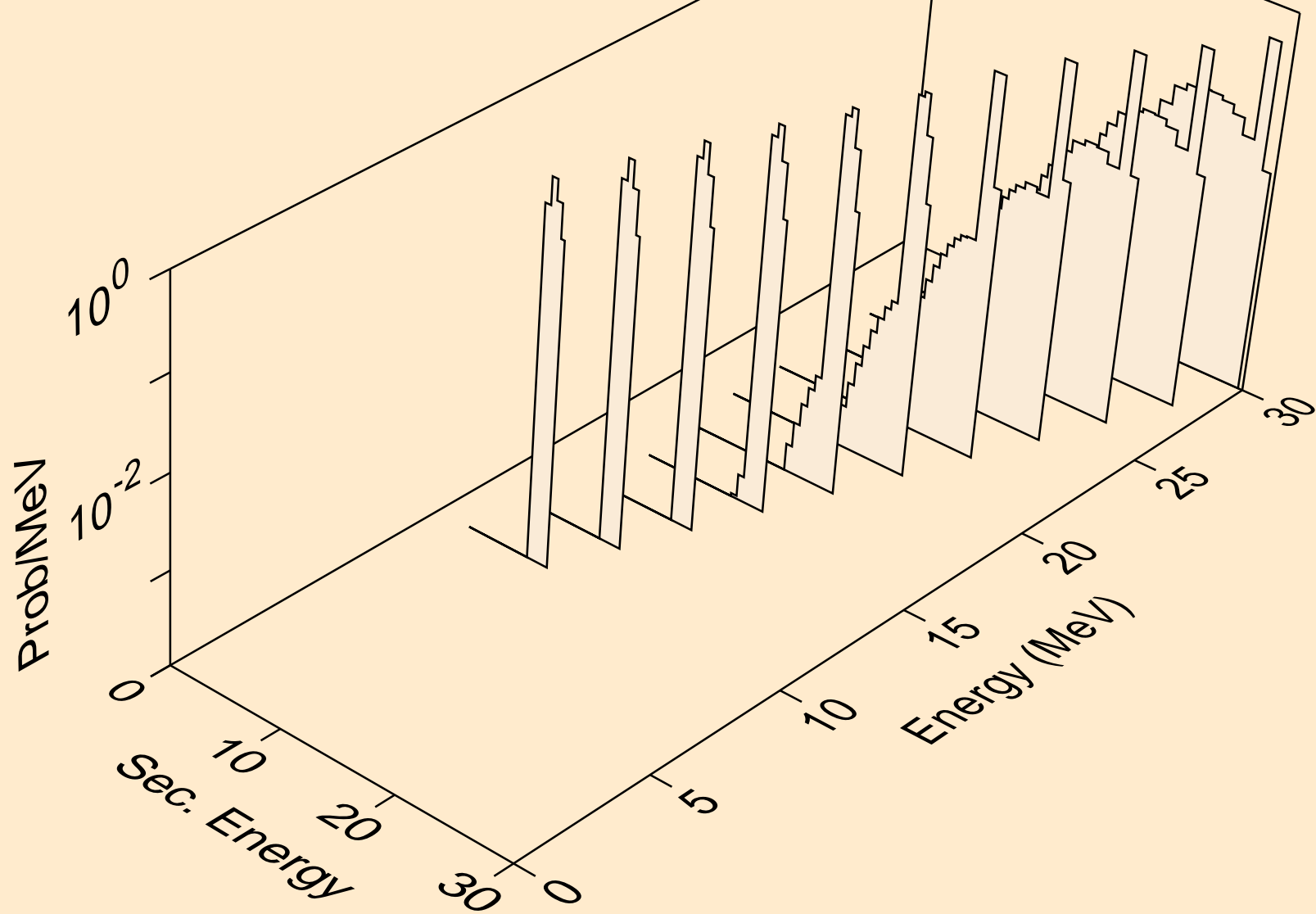

LU164 HELION ACER TENDL-2021 LIBRARY; T=0.K  
Photon emission for (z,n)

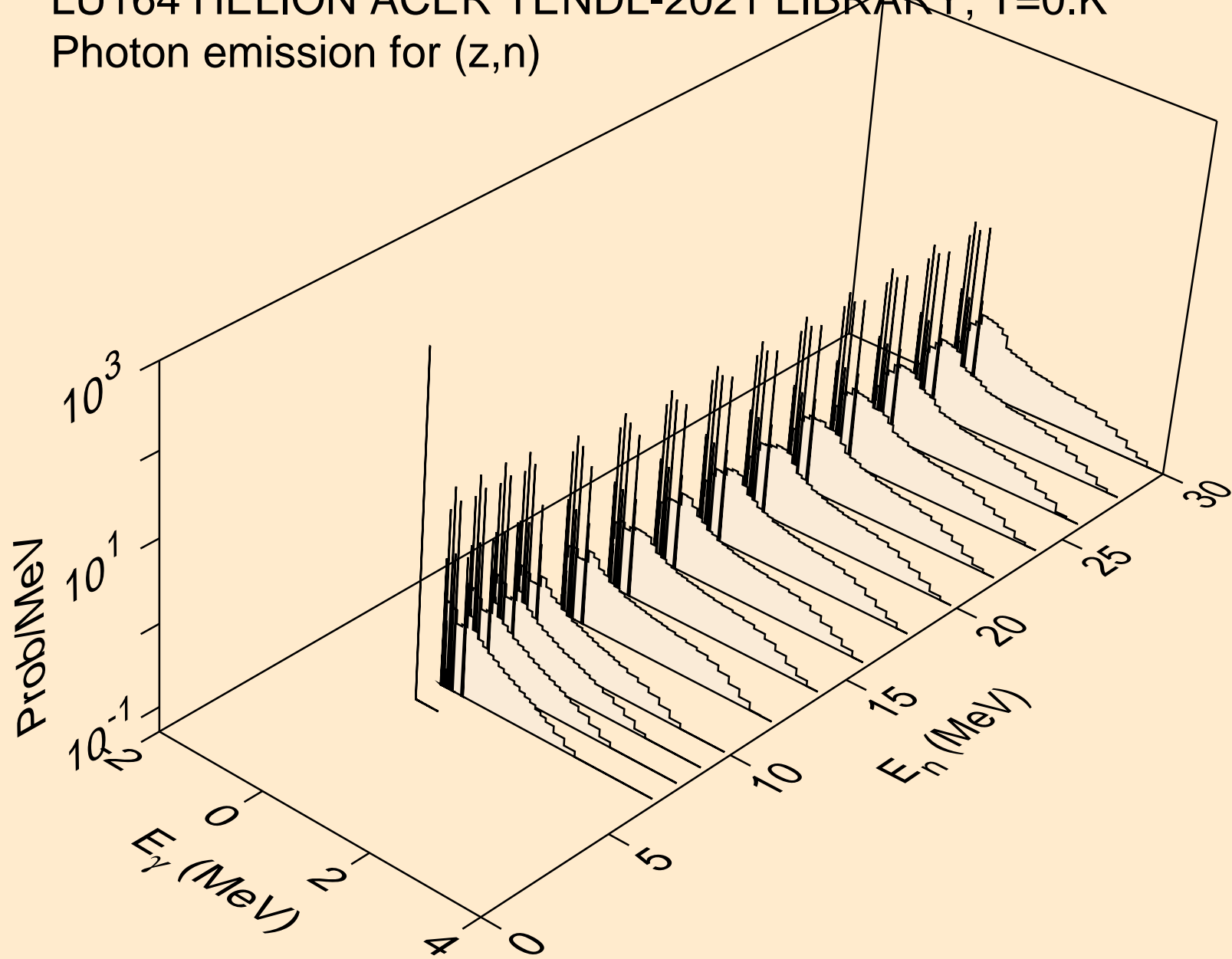

LU164 HELION ACER TENDL-2021 LIBRARY; T=0.K  
Photon emission for (n,x)

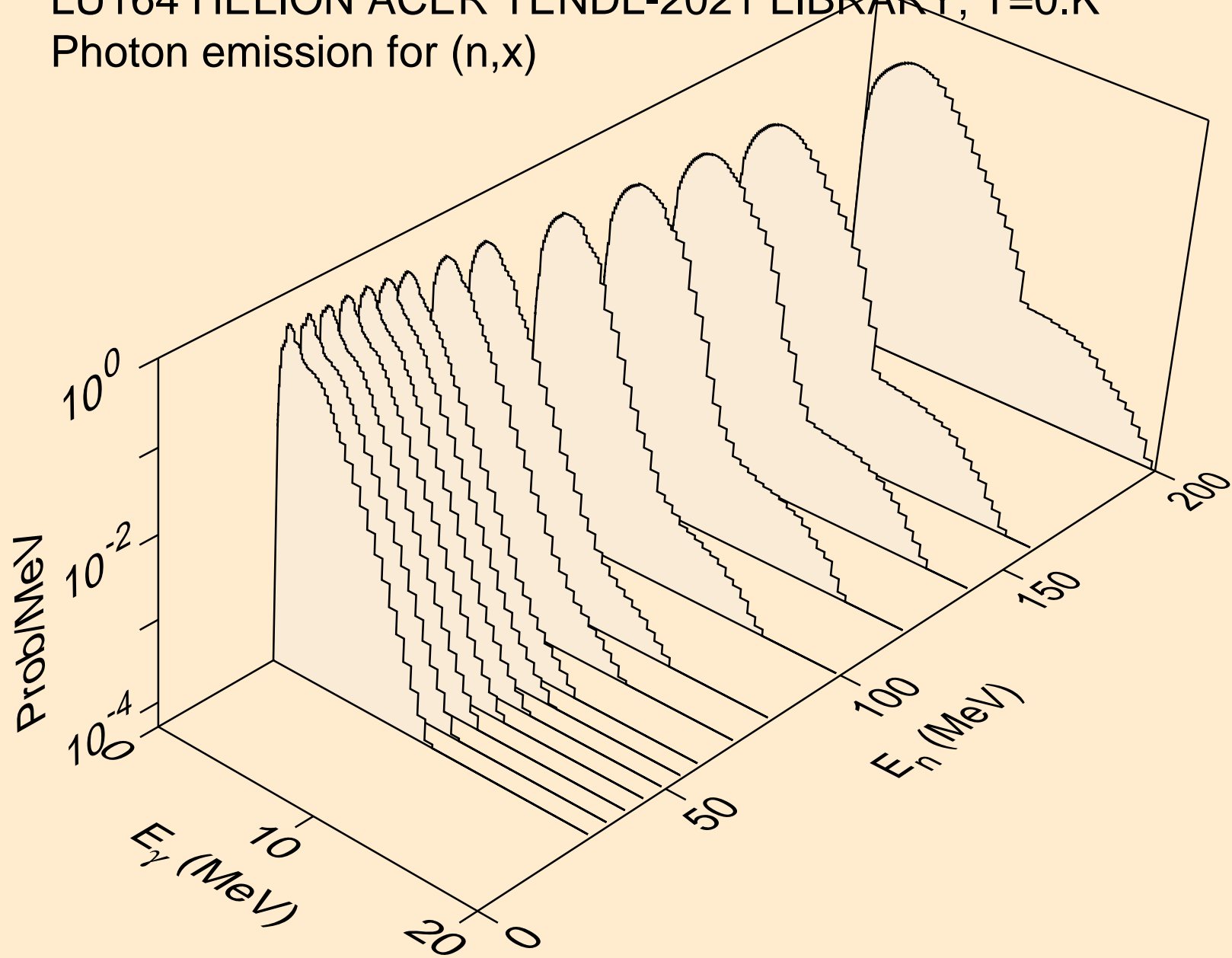

LU164 HELION ACER TENDL-2021 LIBRARY; T=0.K  
Photon emission for (n,2nd)

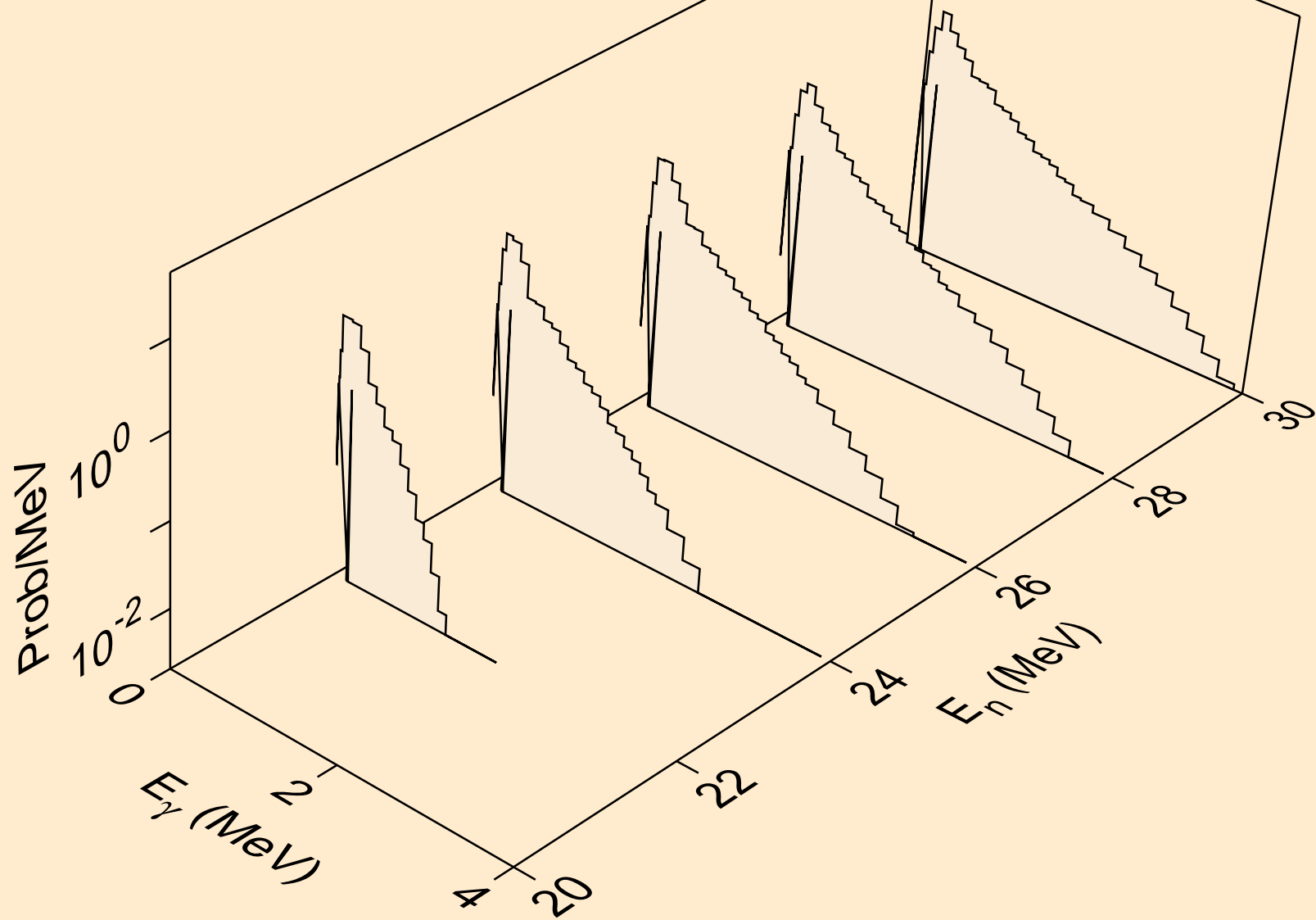

LU164 HELION ACER TENDL-2021 LIBRARY; T=0.K  
Photon emission for (n,2n)

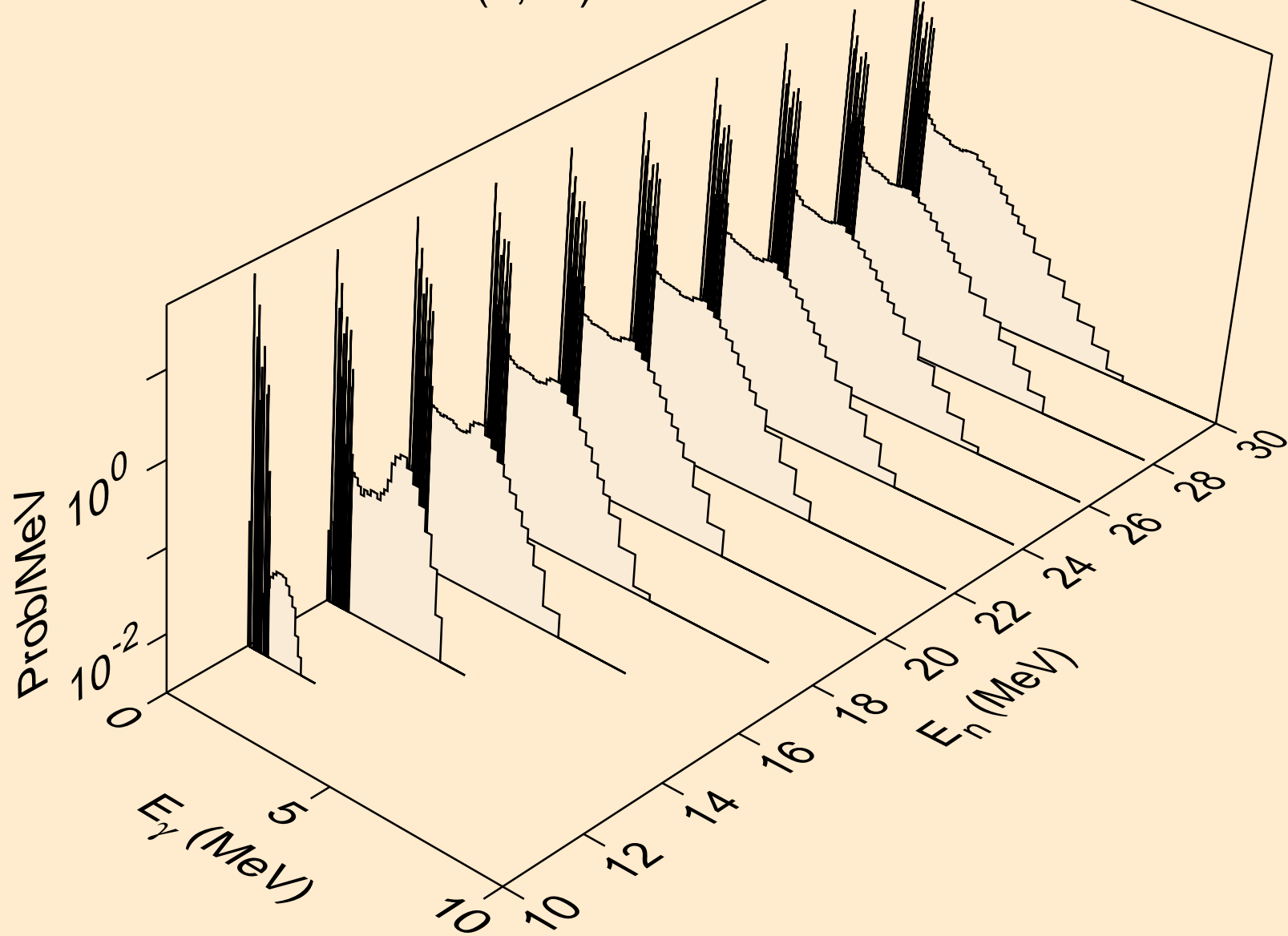

LU164 HELION ACER TENDL-2021 LIBRARY; T=0.K  
Photon emission for (n,3n)

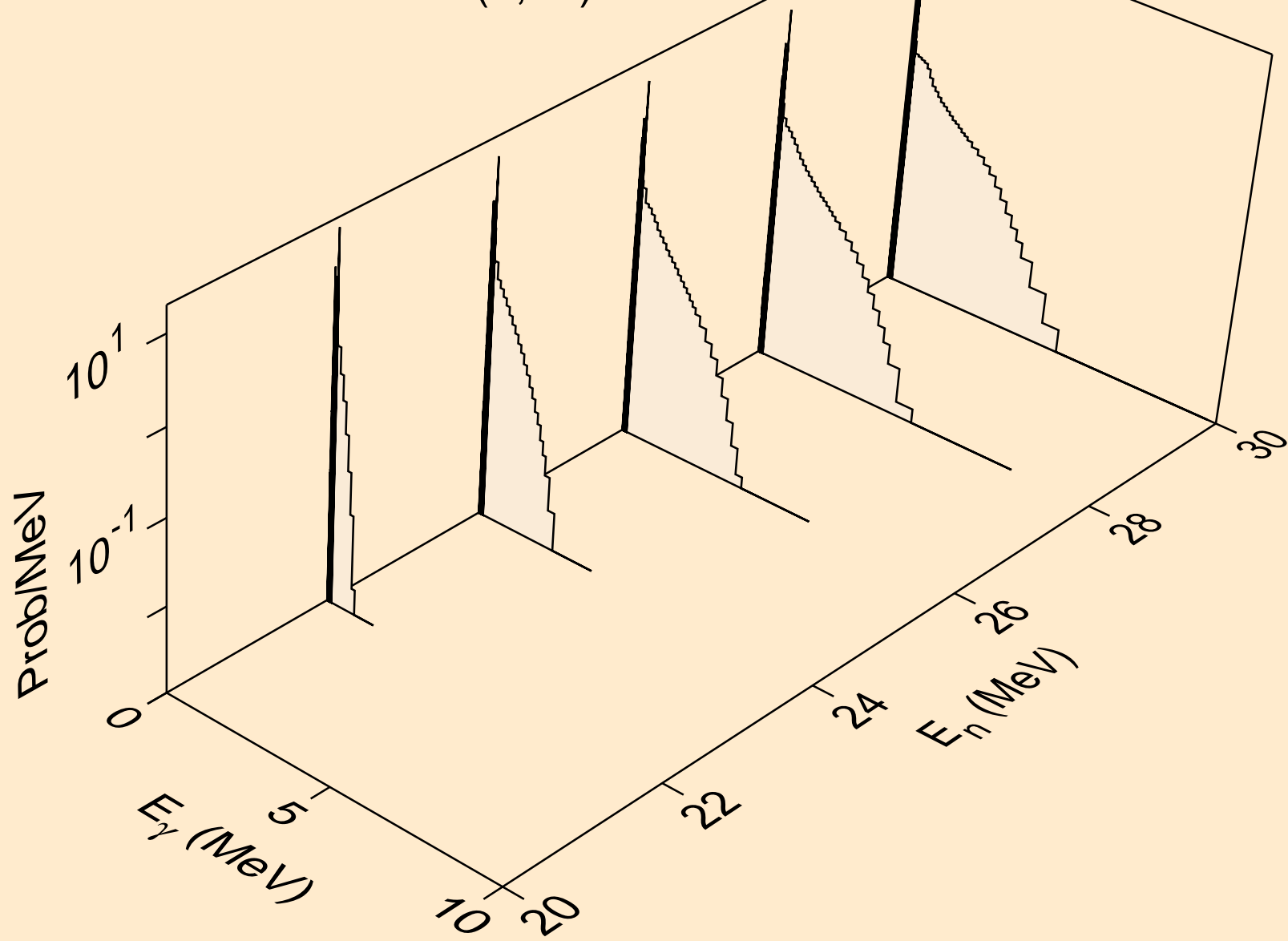

LU164 HELION ACER TENDL-2021 LIBRARY; T=0.K  
Photon emission for (n,n\*)a

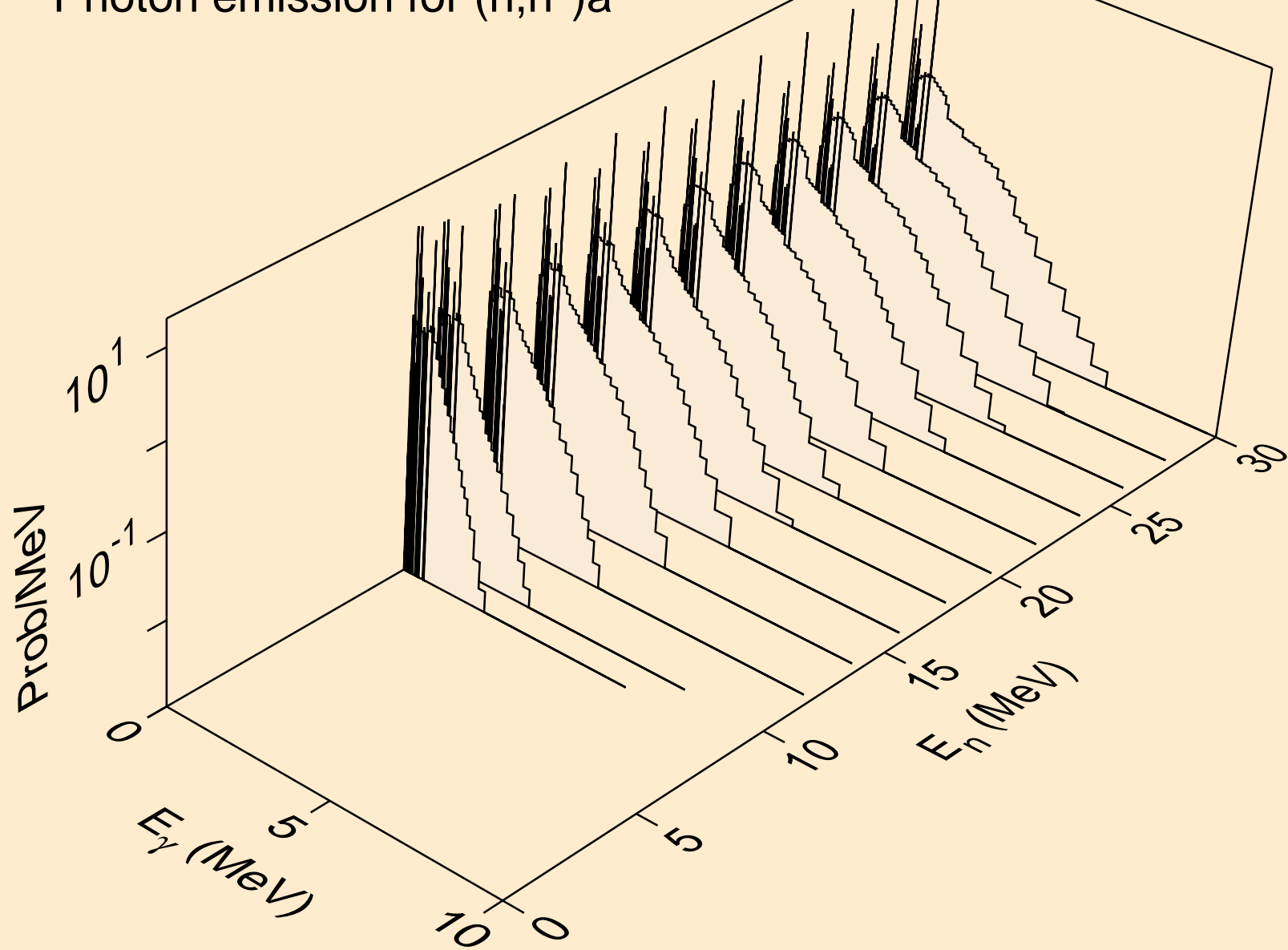

LU164 HELION ACER TENDL-2021 LIBRARY; T=0.K  
Photon emission for (n,2n)a

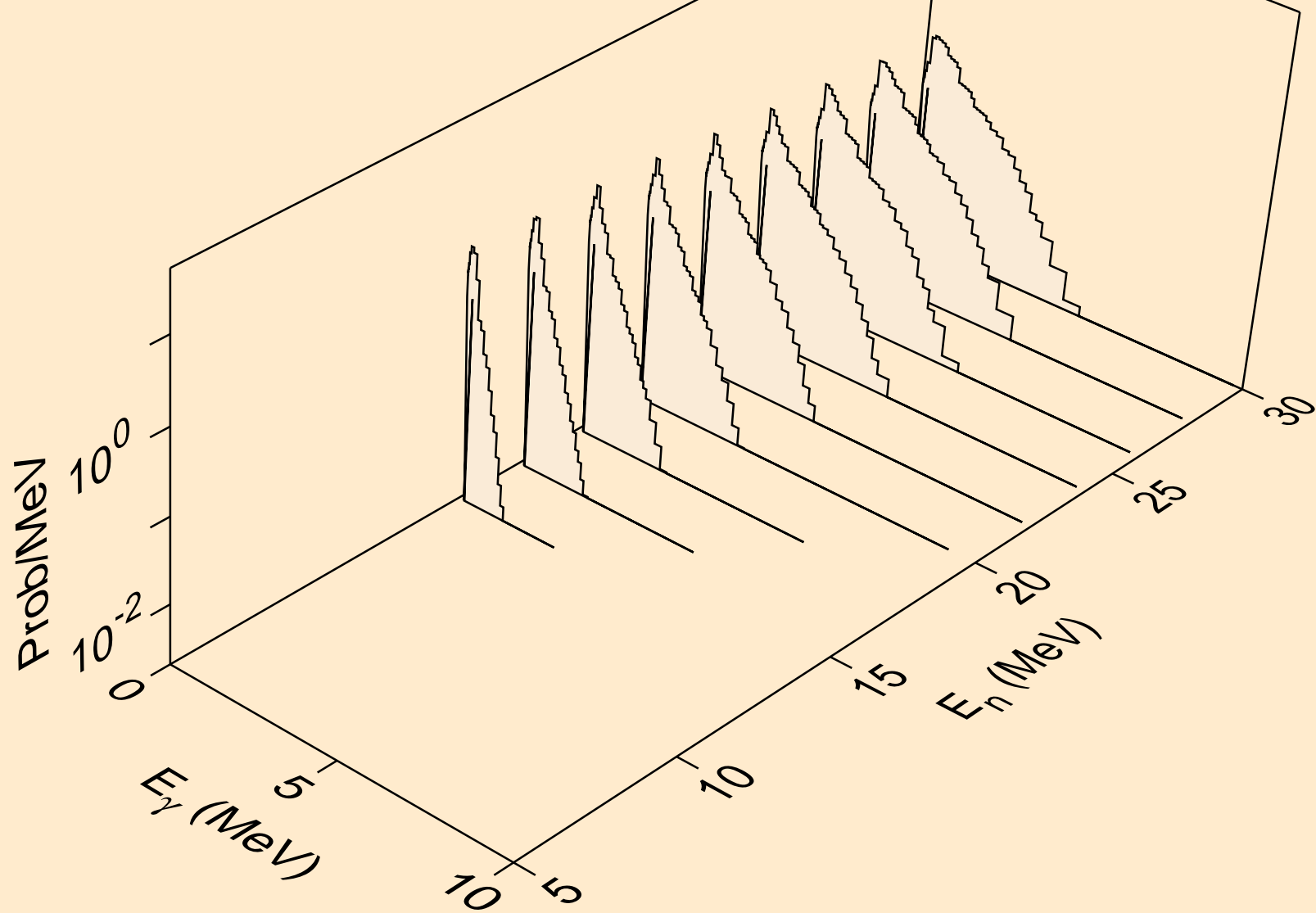



LU164 HELION ACER TENDL-2021 LIBRARY; T=0.K  
Photon emission for (n,3n)a

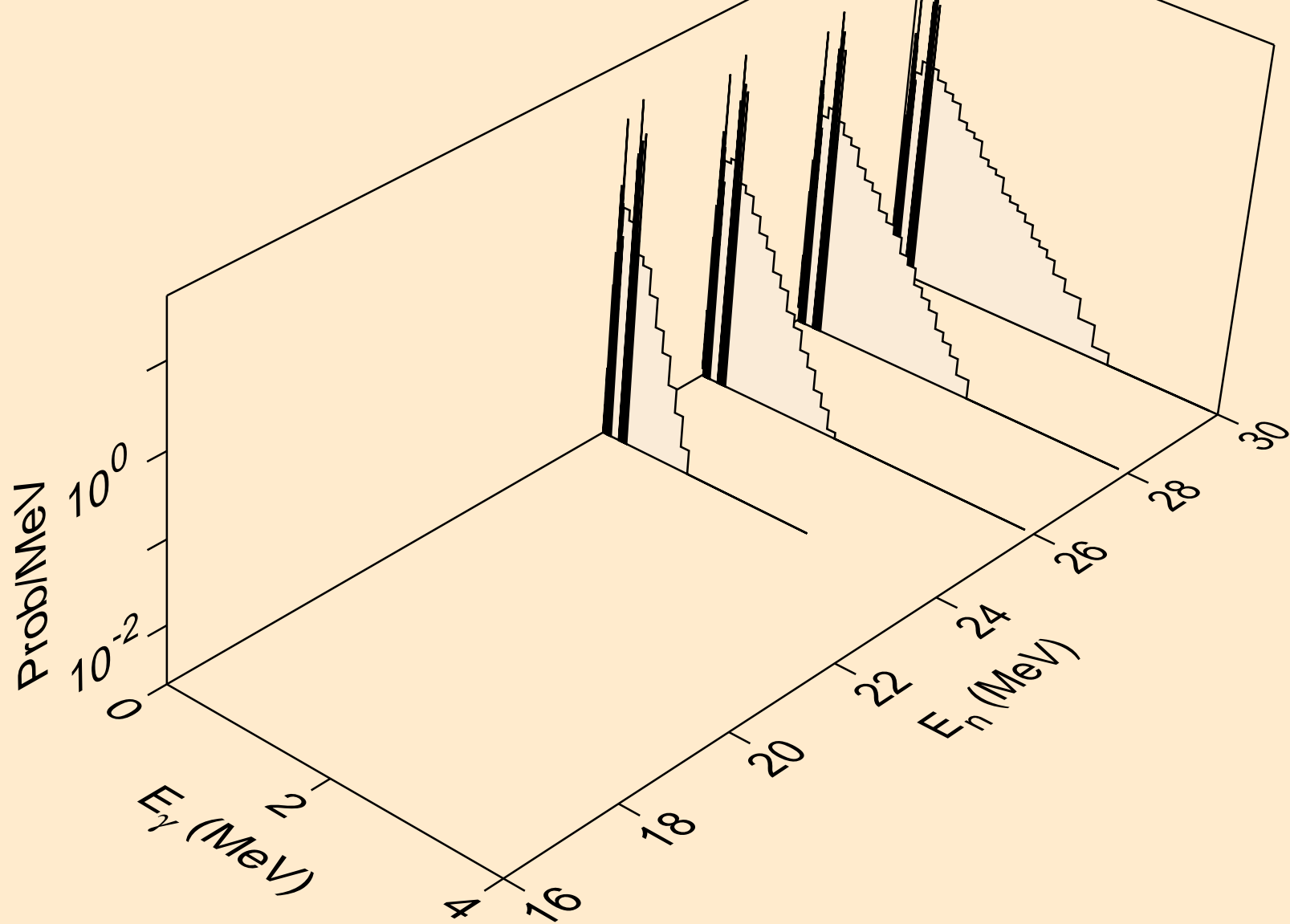

LU164 HELION ACER TENDL-2021 LIBRARY; T=0.K  
Photon emission for (n,n\*)p

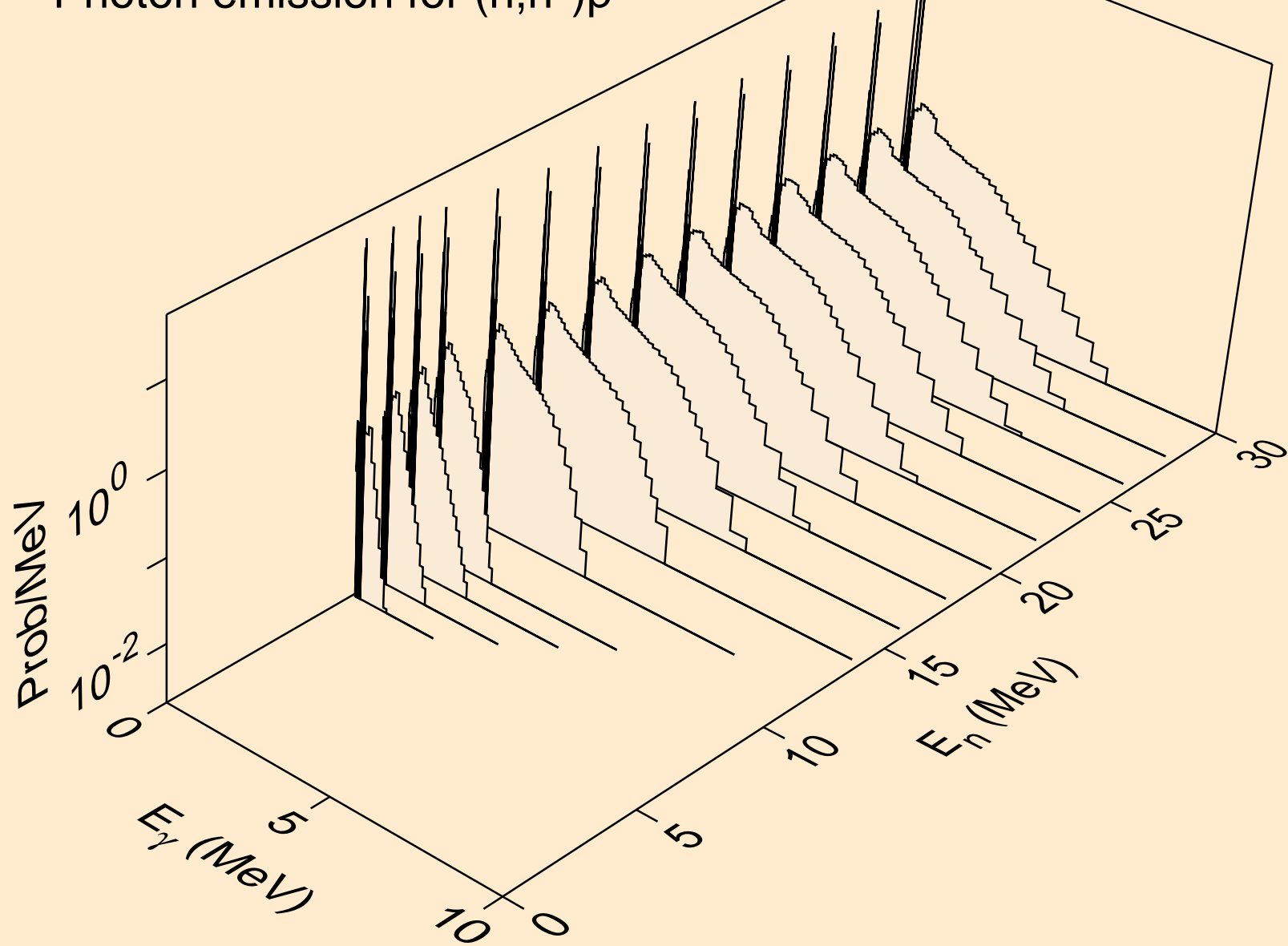

LU164 HELION ACER TENDL-2021 LIBRARY; T=0.K  
Photon emission for (n,n\*)2a

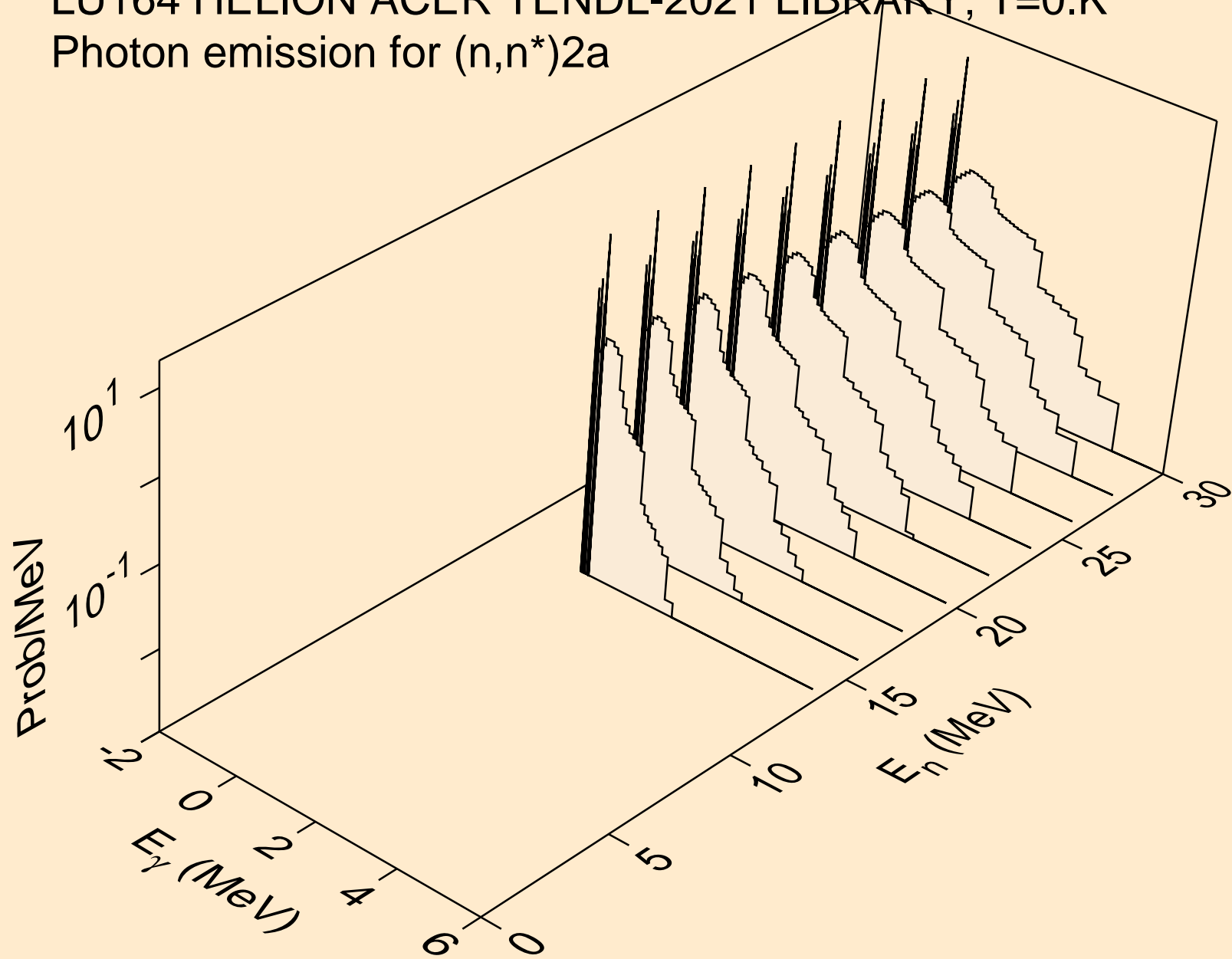

LU164 HELION ACER TENDL-2021 LIBRARY; T=0.K  
Photon emission for (n,2n)2a

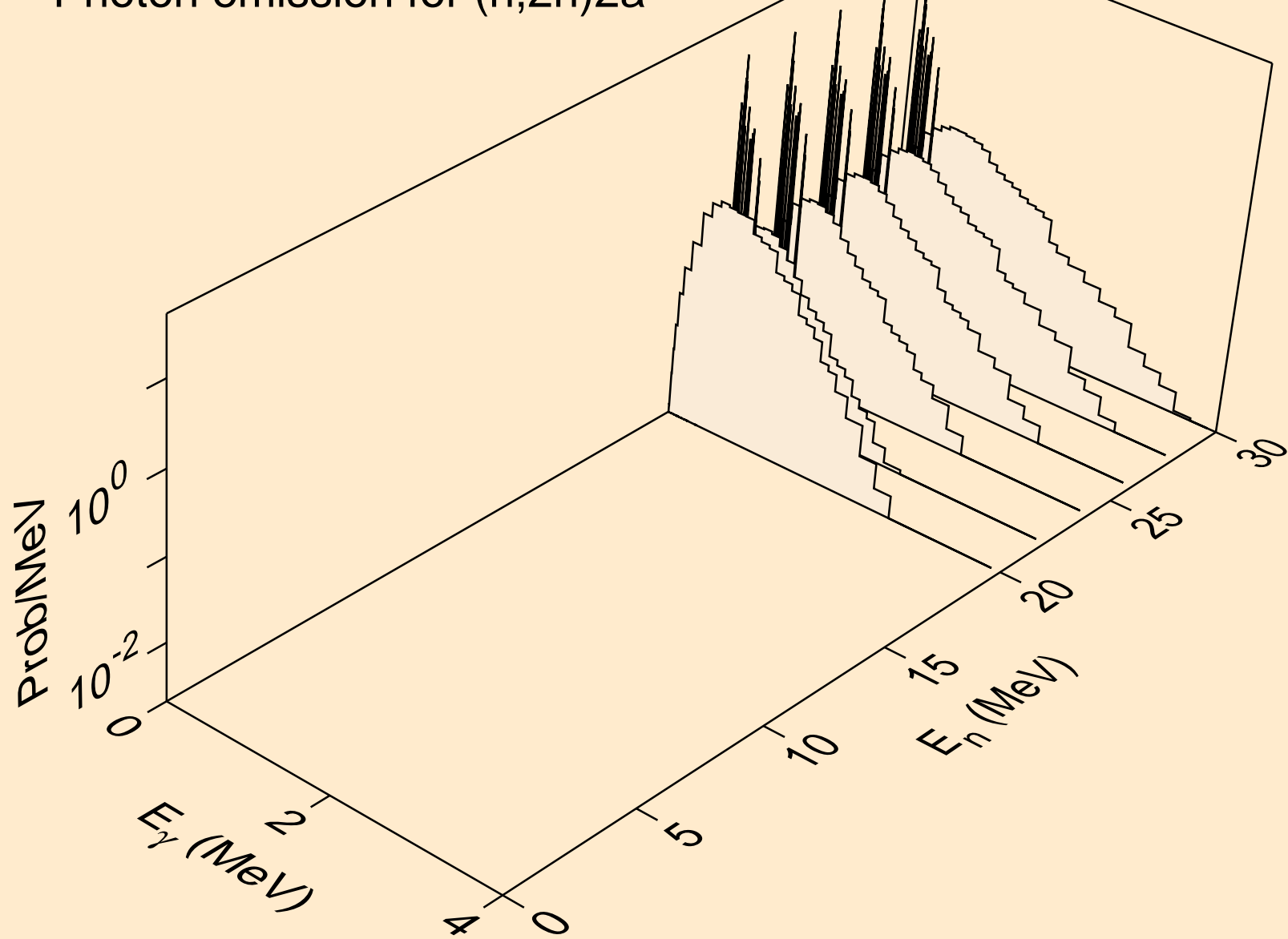

LU164 HELION ACER TENDL-2021 LIBRARY; T=0.K  
Photon emission for (n,n\*)d

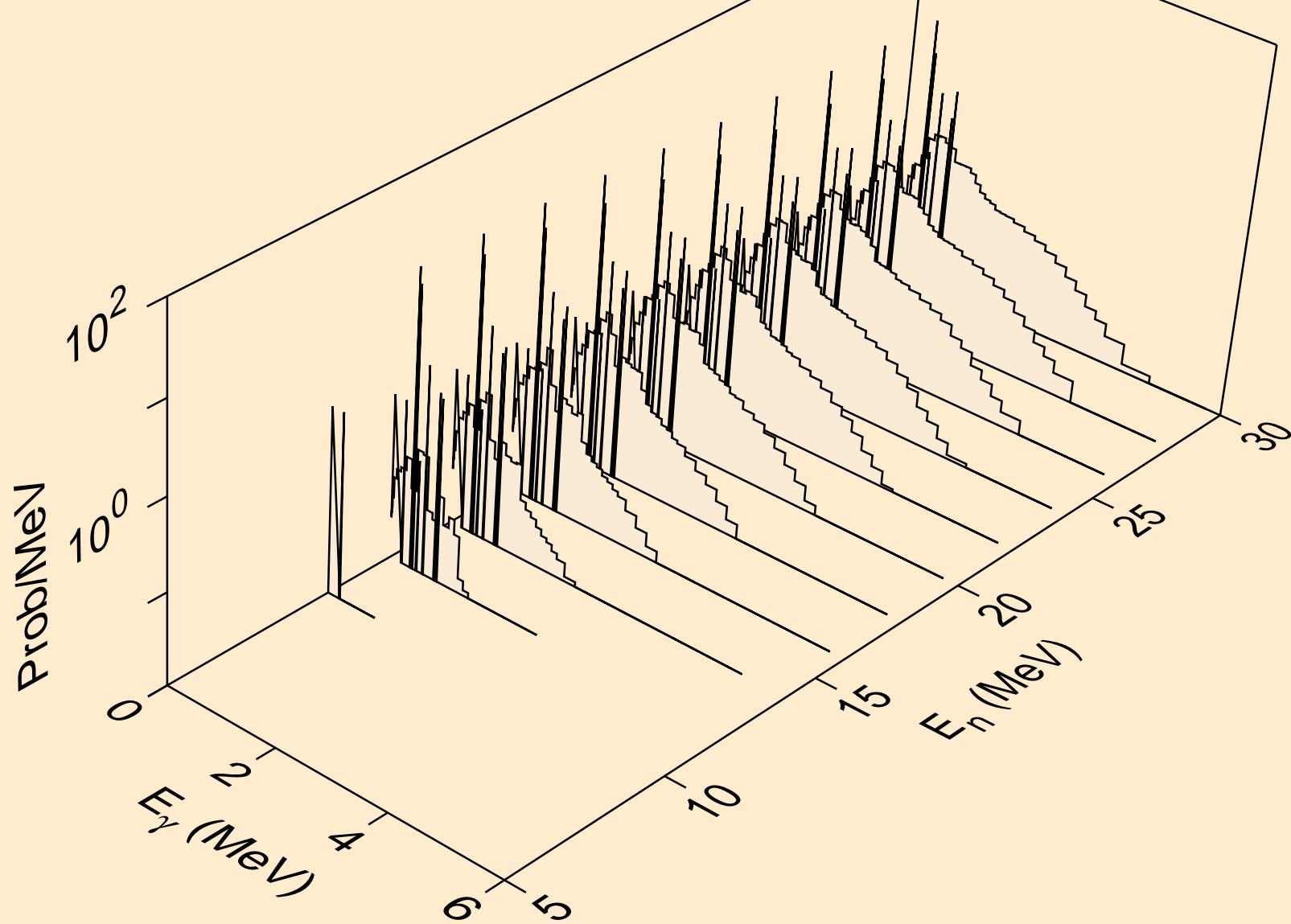

LU164 HELION ACER TENDL-2021 LIBRARY; T=0.K  
Photon emission for (n,n\*)t

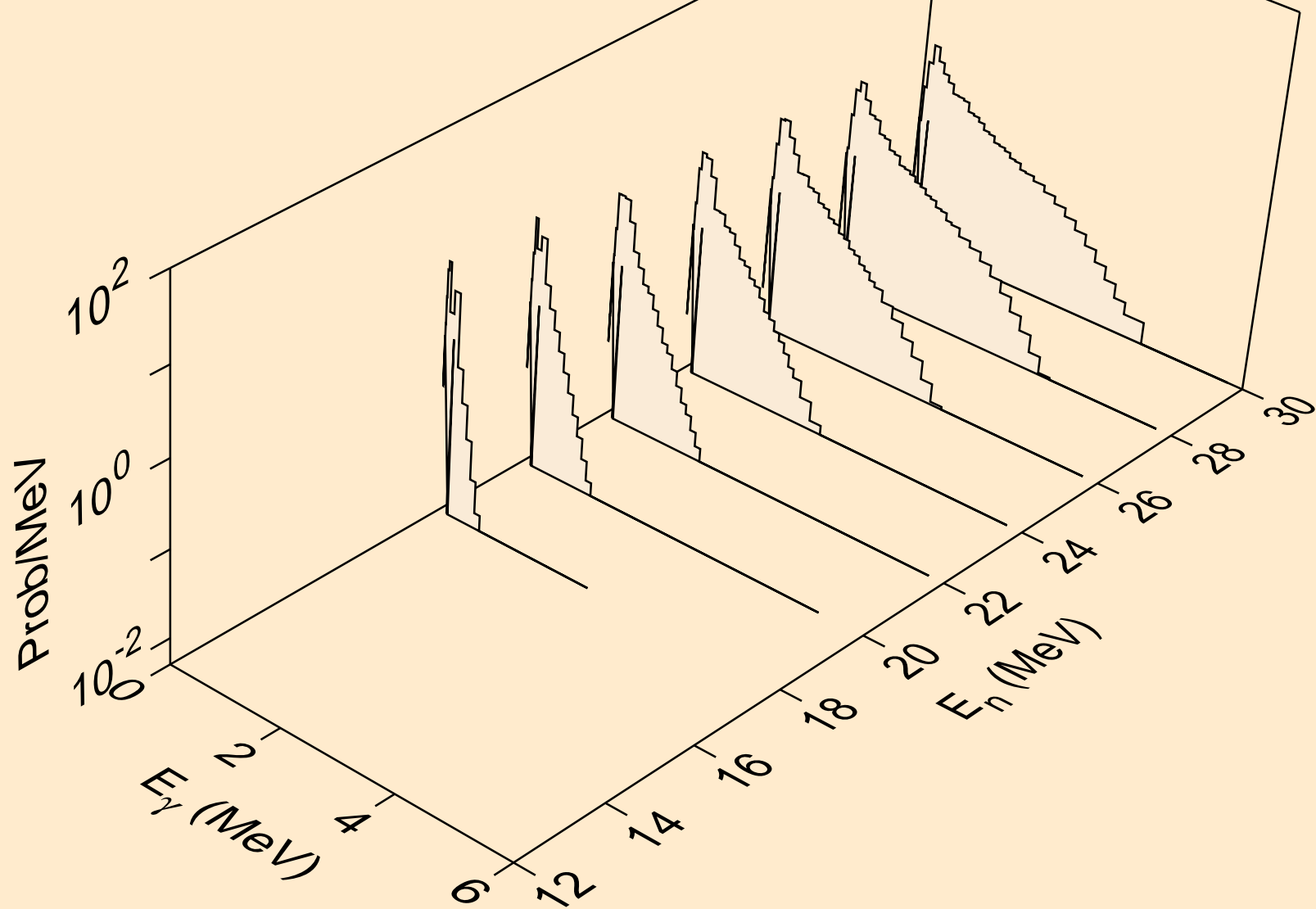

LU164 HELION ACER TENDL-2021 LIBRARY; T=0.K  
Photon emission for (n,n\*)he3

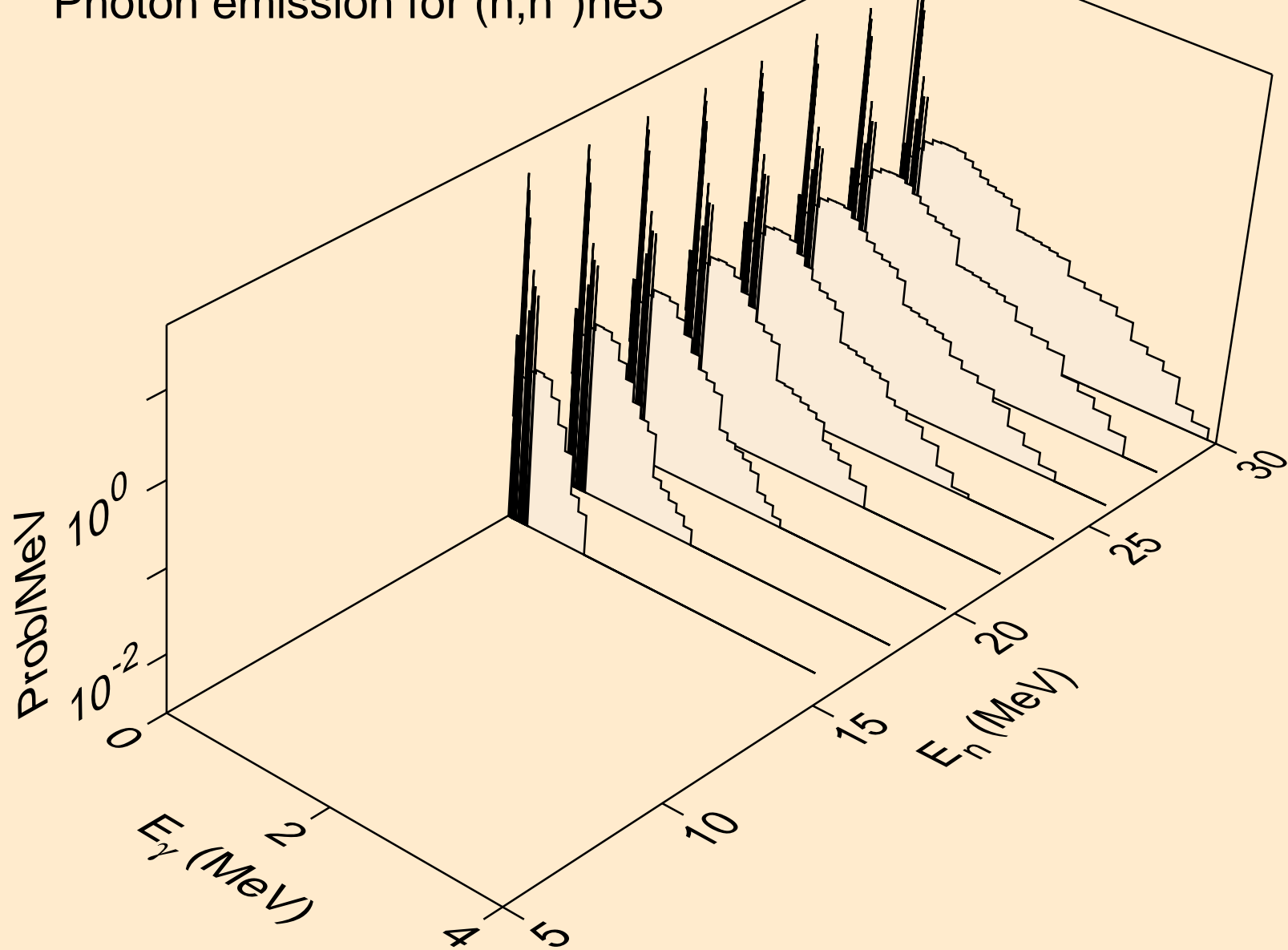

LU164 HELION ACER TENDL-2021 LIBRARY; T=0.K  
Photon emission for (n,2np)

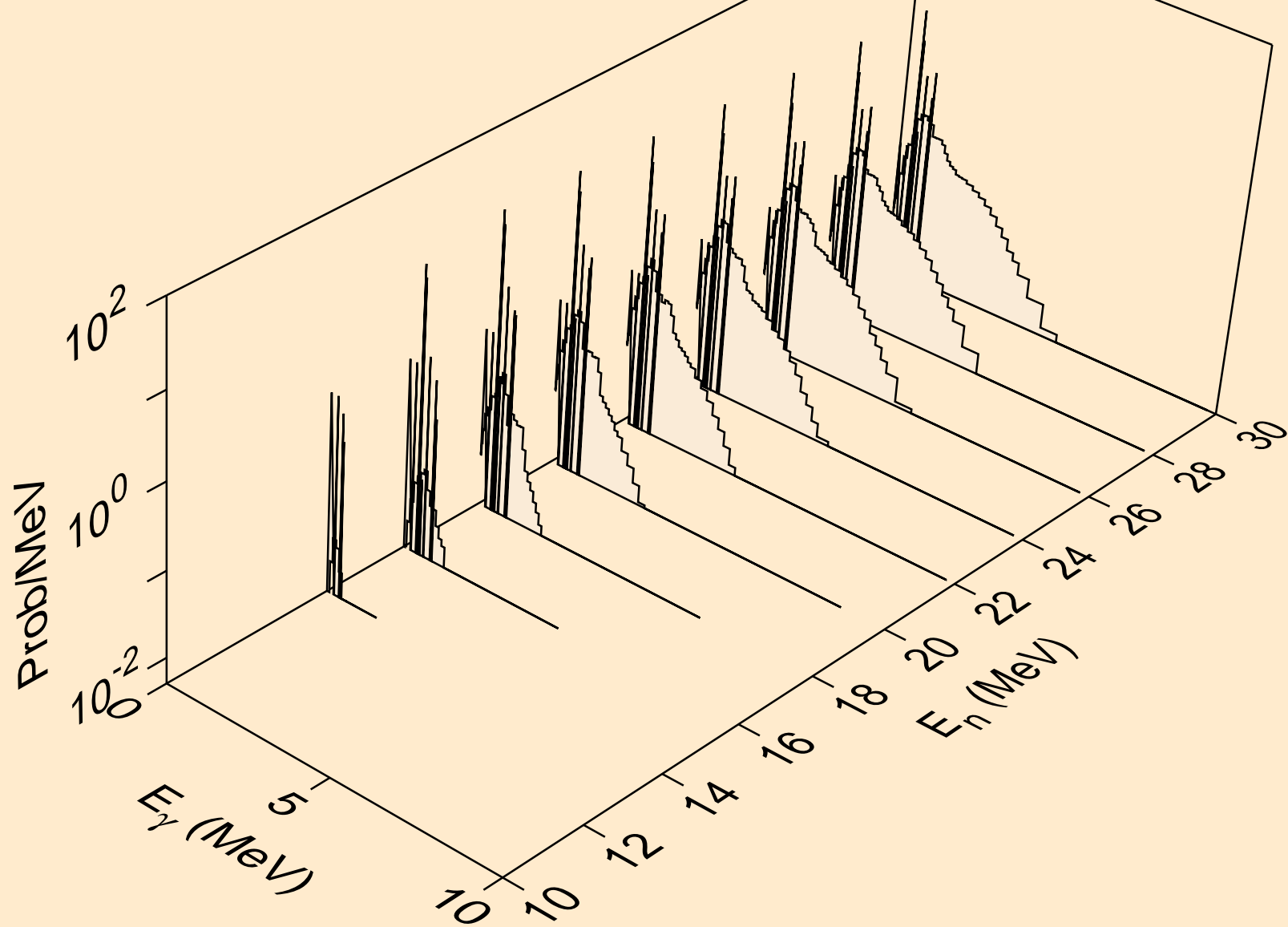



LU164 HELION ACER TENDL-2021 LIBRARY; T=0.K  
Photon emission for (n,3np)

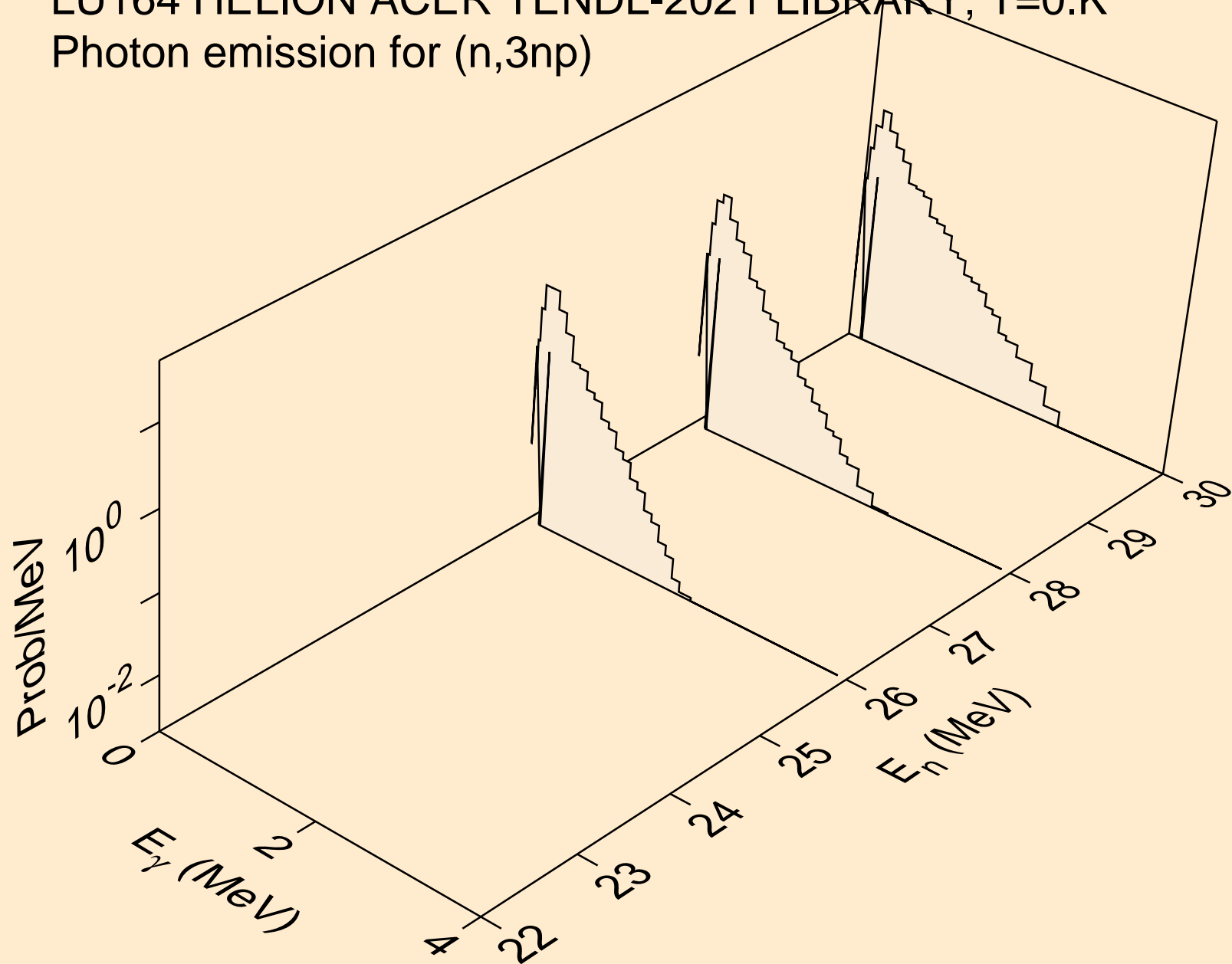

LU164 HELION ACER TENDL-2021 LIBRARY; T=0.K  
Photon emission for (n,2np)

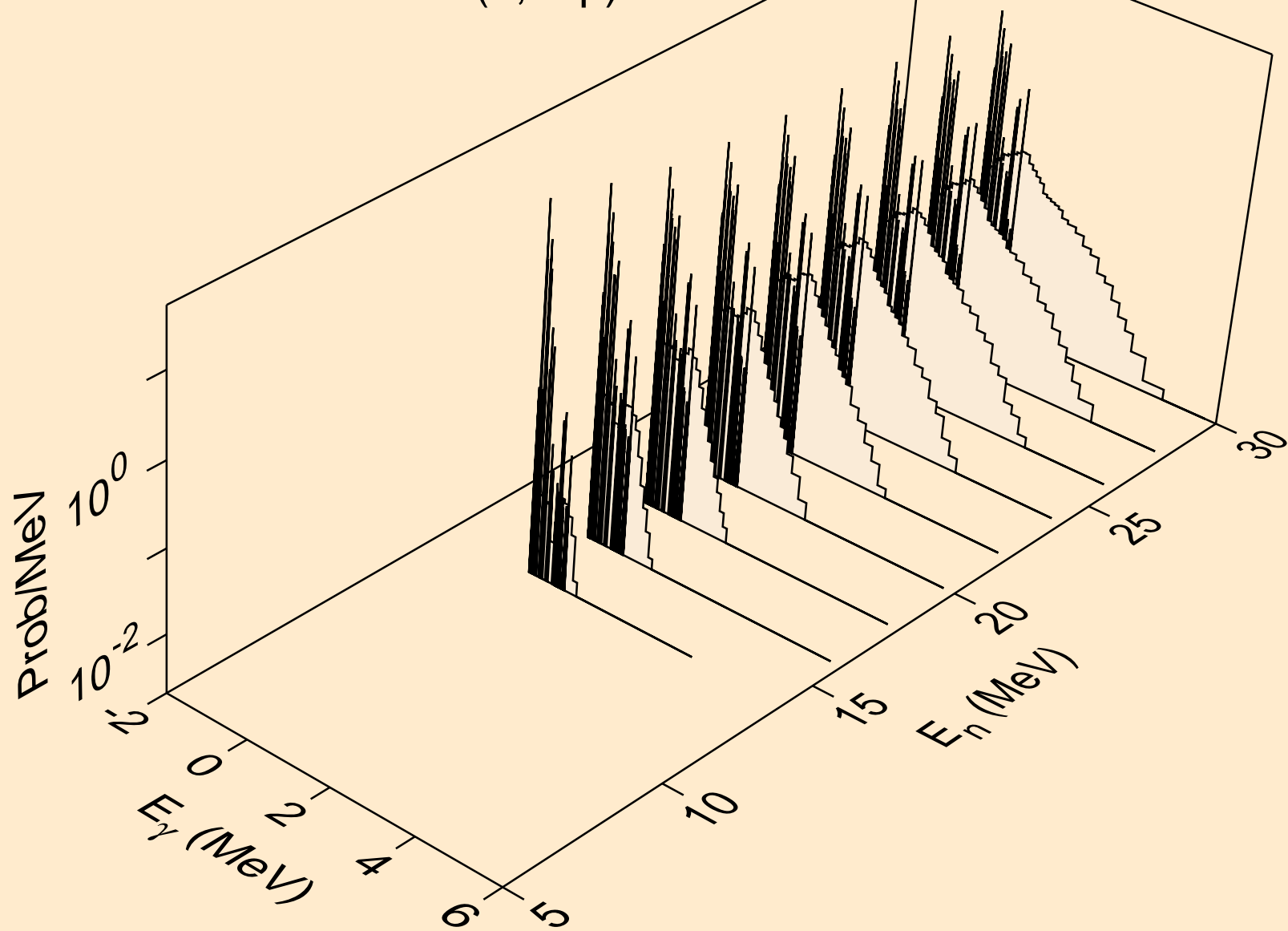

LU164 HELION ACER TENDL-2021 LIBRARY; T=0.K  
Photon emission for (n,npa)

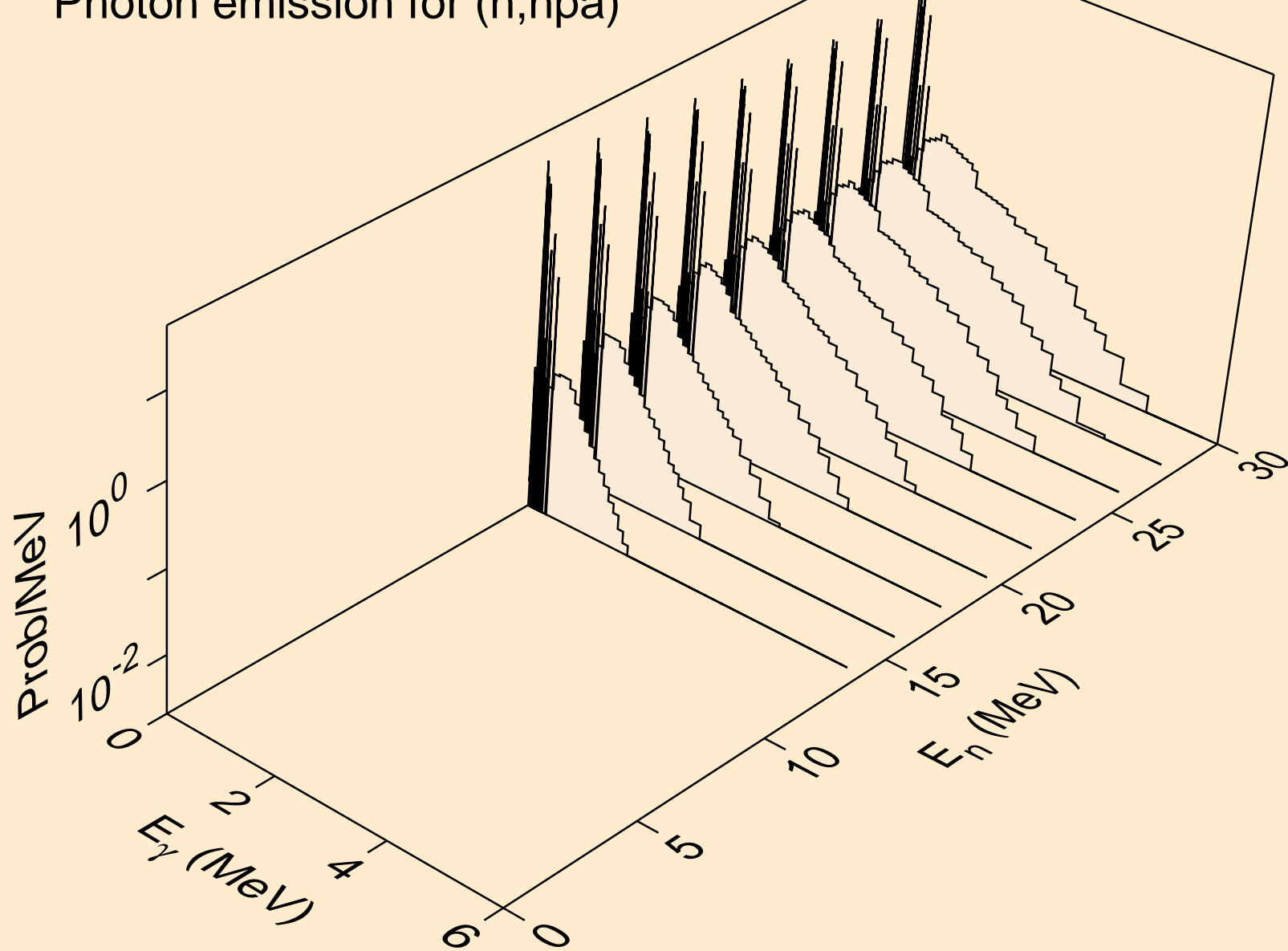

LU164 HELION ACER TENDL-2021 LIBRARY; T=0.K  
Photon emission for (n,gma)

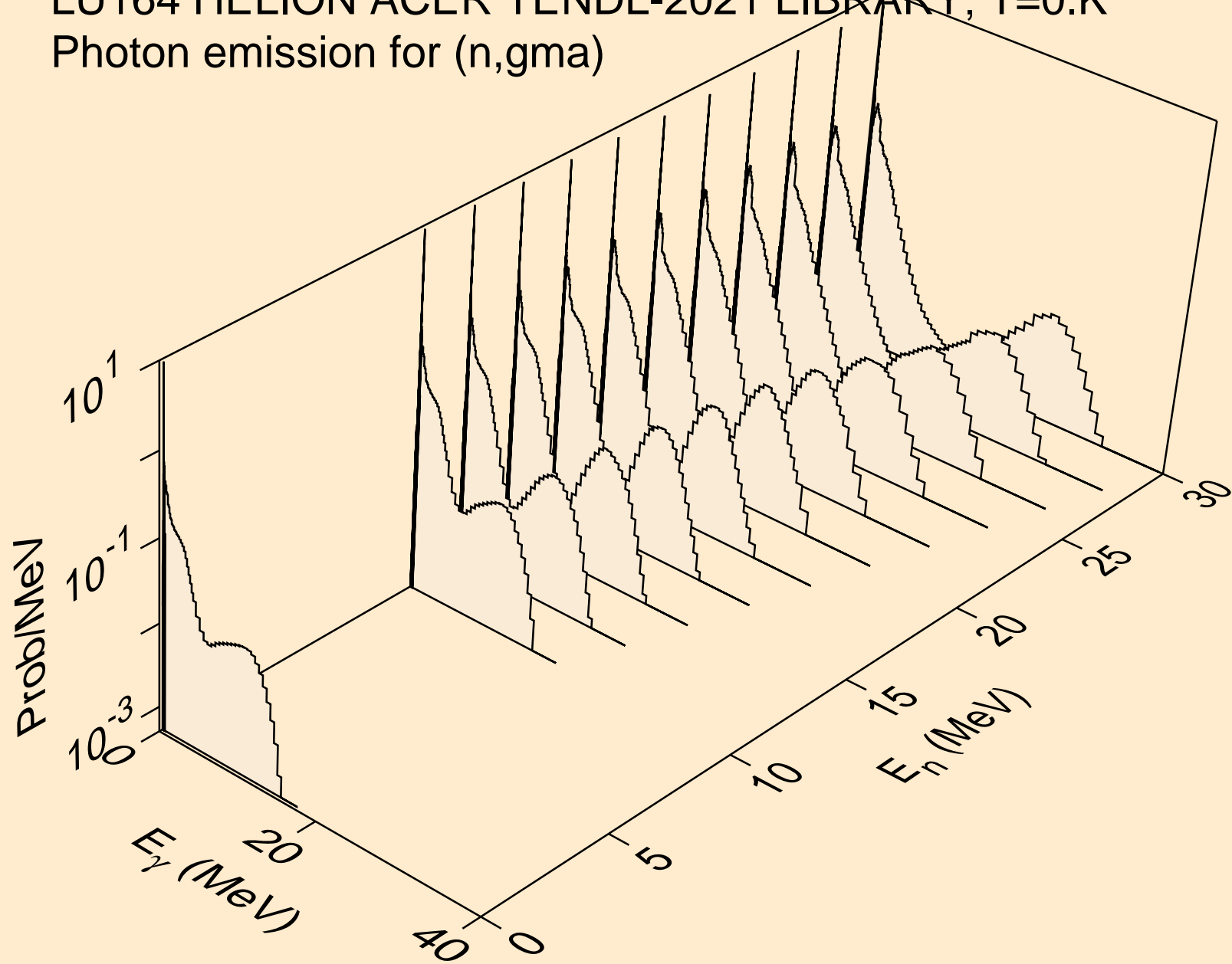

LU164 HELION ACER TENDL-2021 LIBRARY; T=0.K  
Photon emission for (n,p)

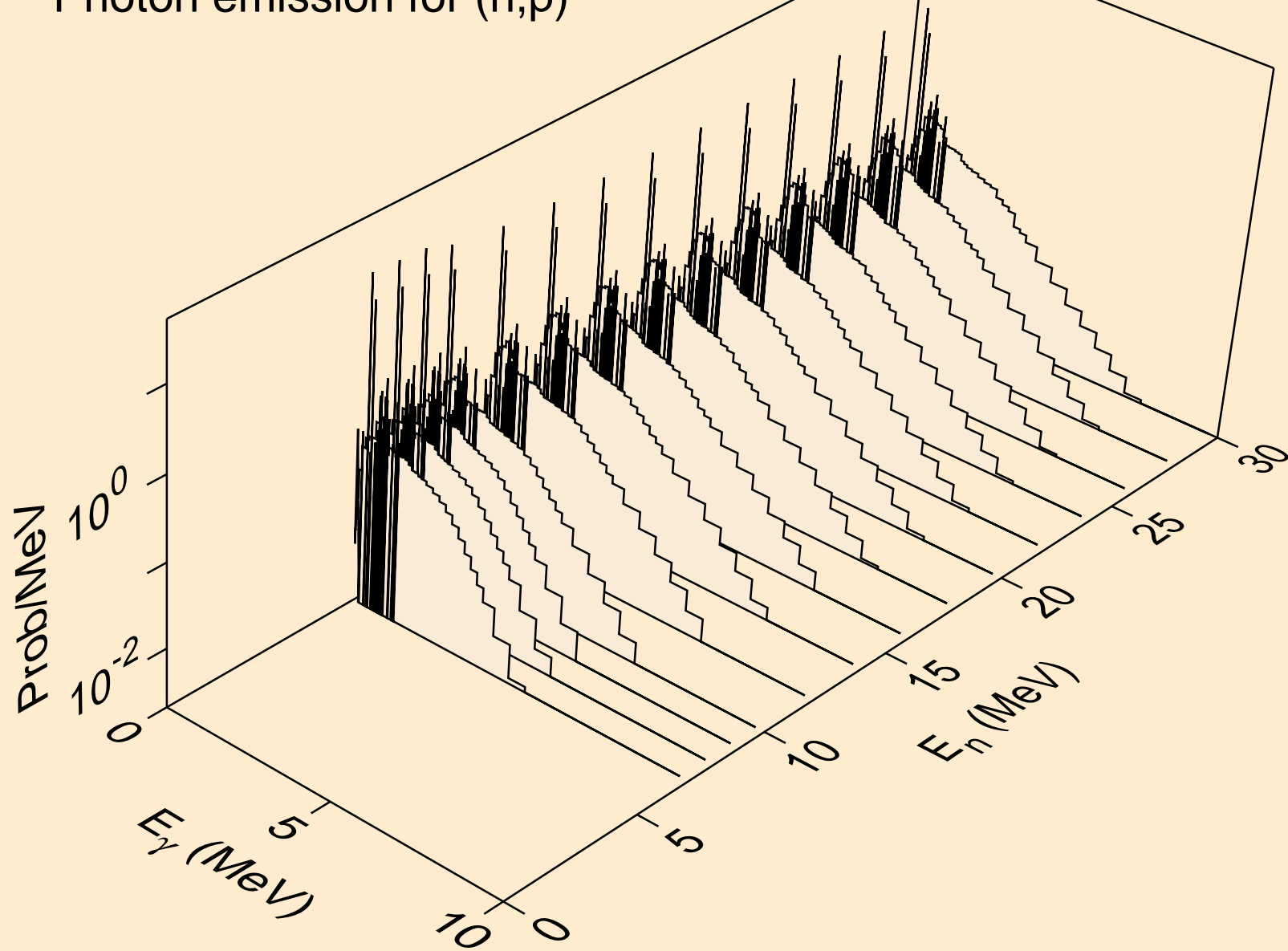

LU164 HELION ACER TENDL-2021 LIBRARY; T=0.K  
Photon emission for (n,d)

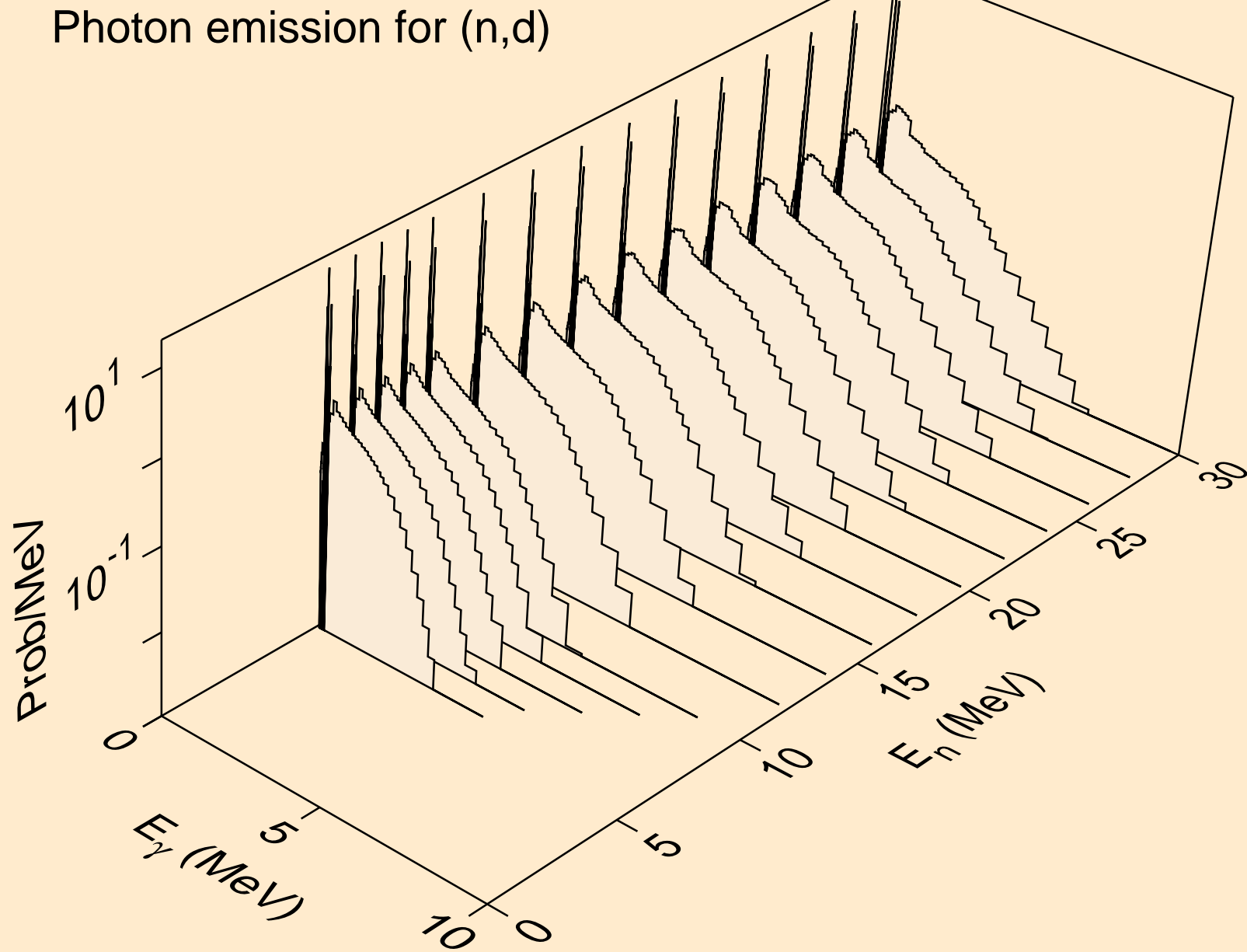

LU164 HELION ACER TENDL-2021 LIBRARY; T=0.K  
Photon emission for (n,t)

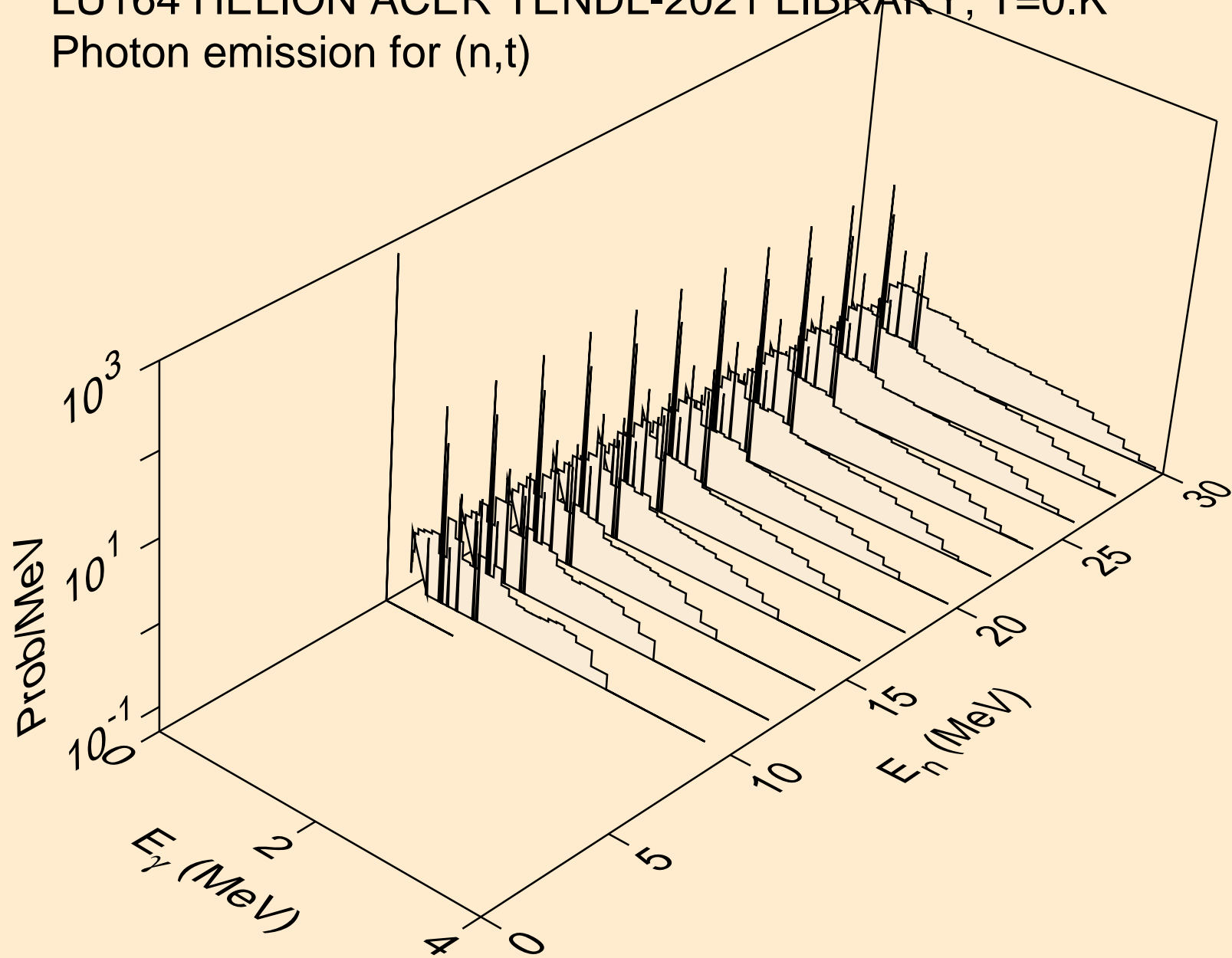

LU164 HELION ACER TENDL-2021 LIBRARY; T=0.K  
Photon emission for inelastic

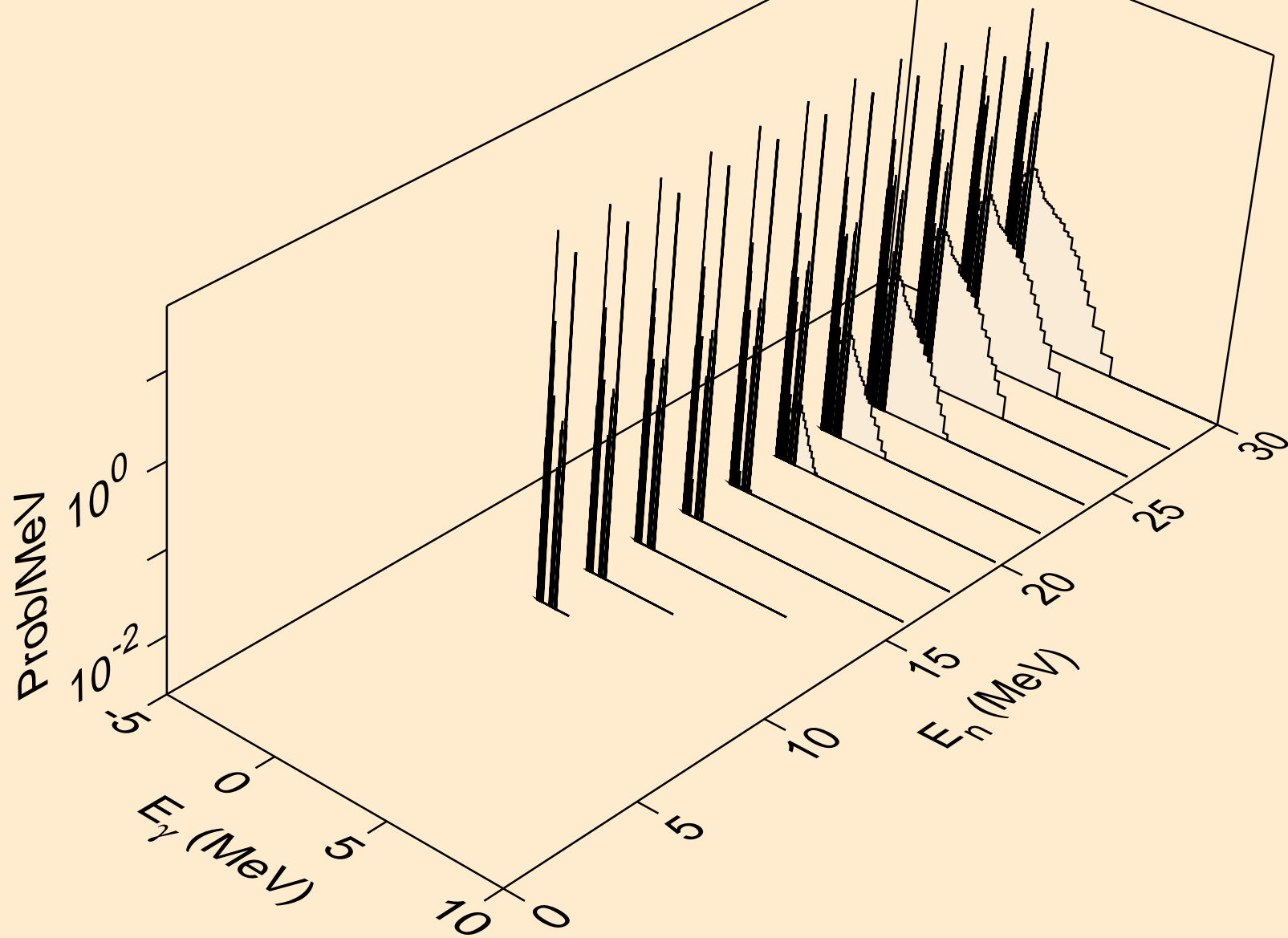



LU164 HELION ACER TENDL-2021 LIBRARY; T=0.K  
Photon emission for (n,a)

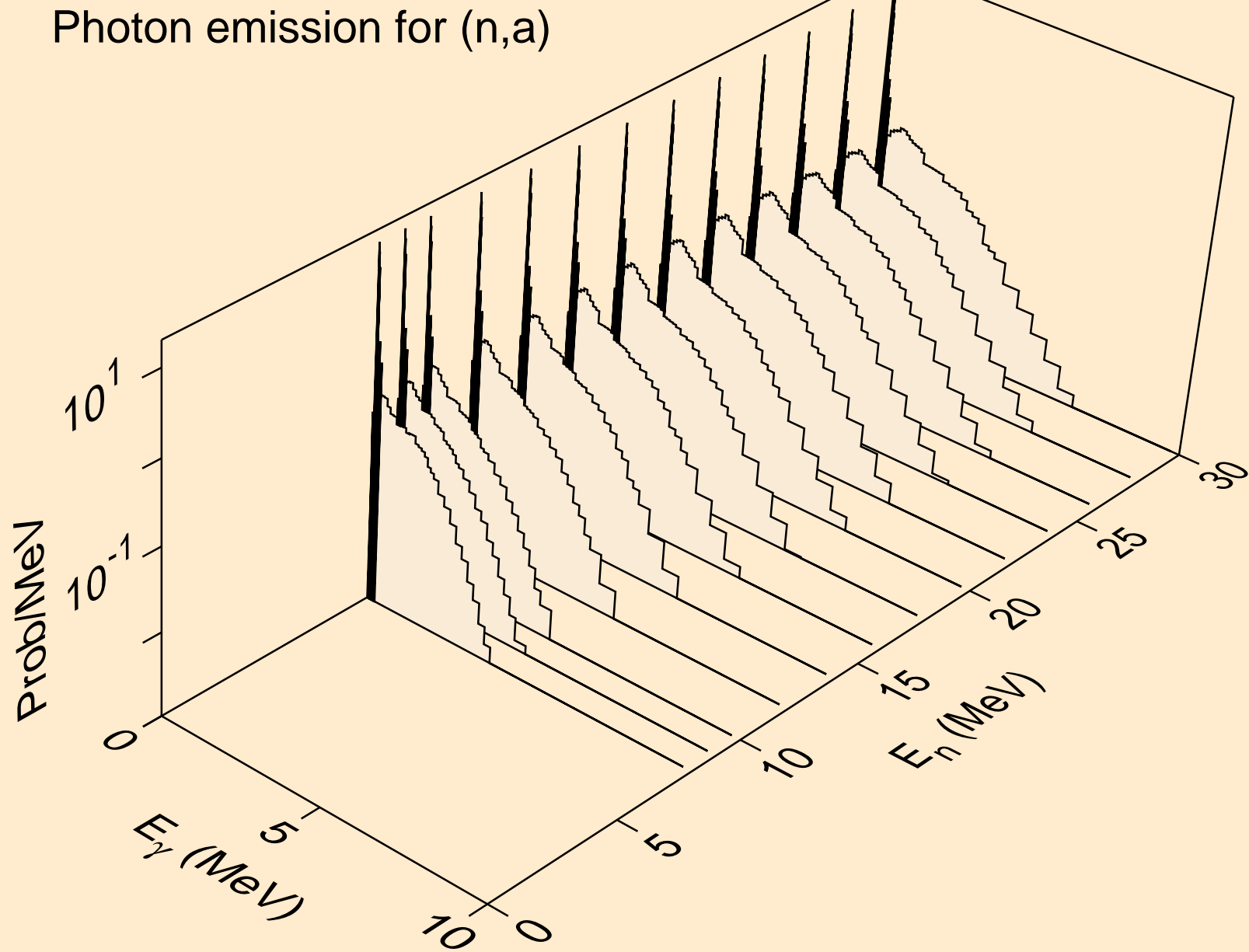

LU164 HELION ACER TENDL-2021 LIBRARY; T=0.K  
Photon emission for (n,2a)

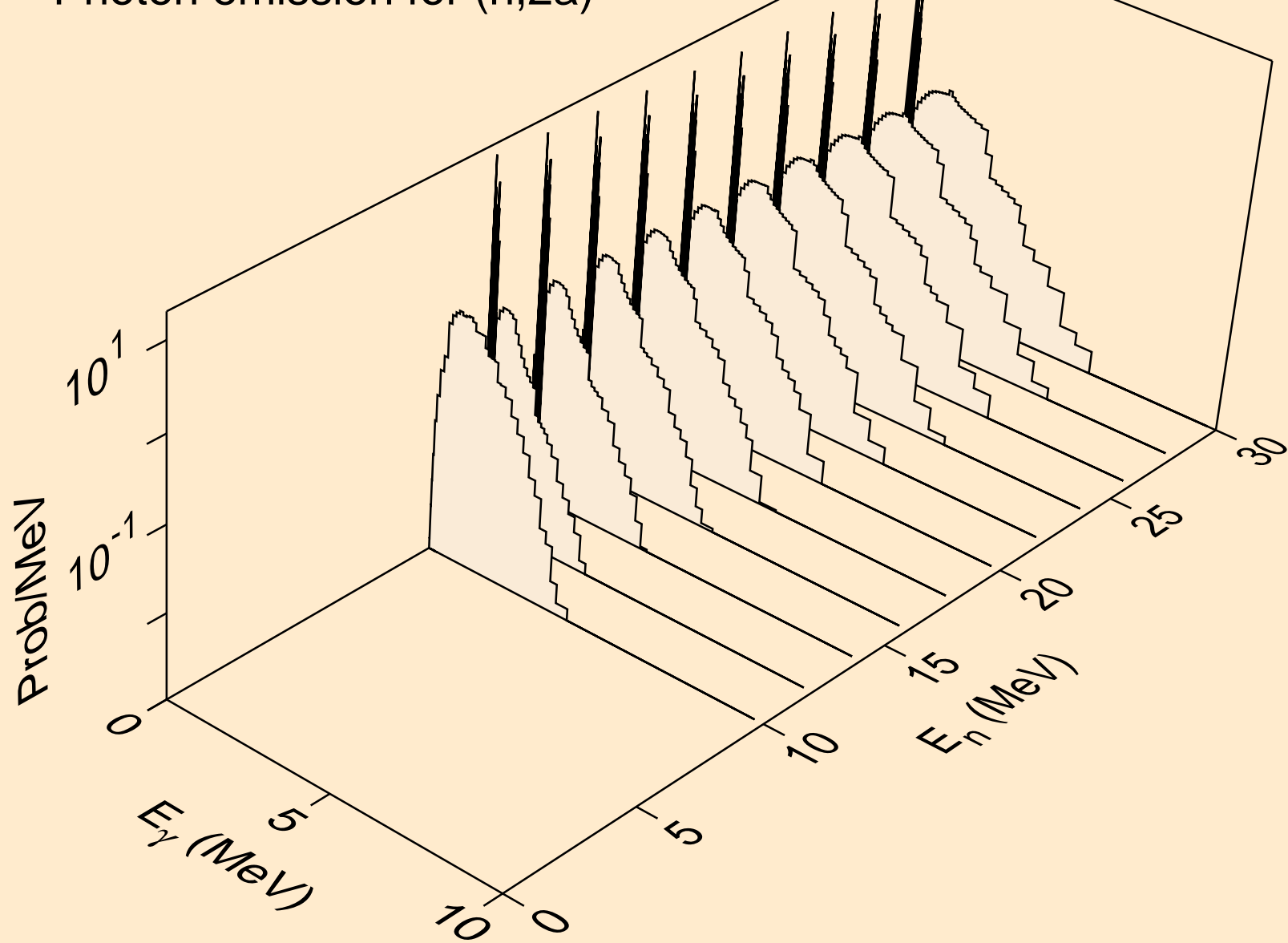

LU164 HELION ACER TENDL-2021 LIBRARY; T=0.K  
Photon emission for (n,2p)

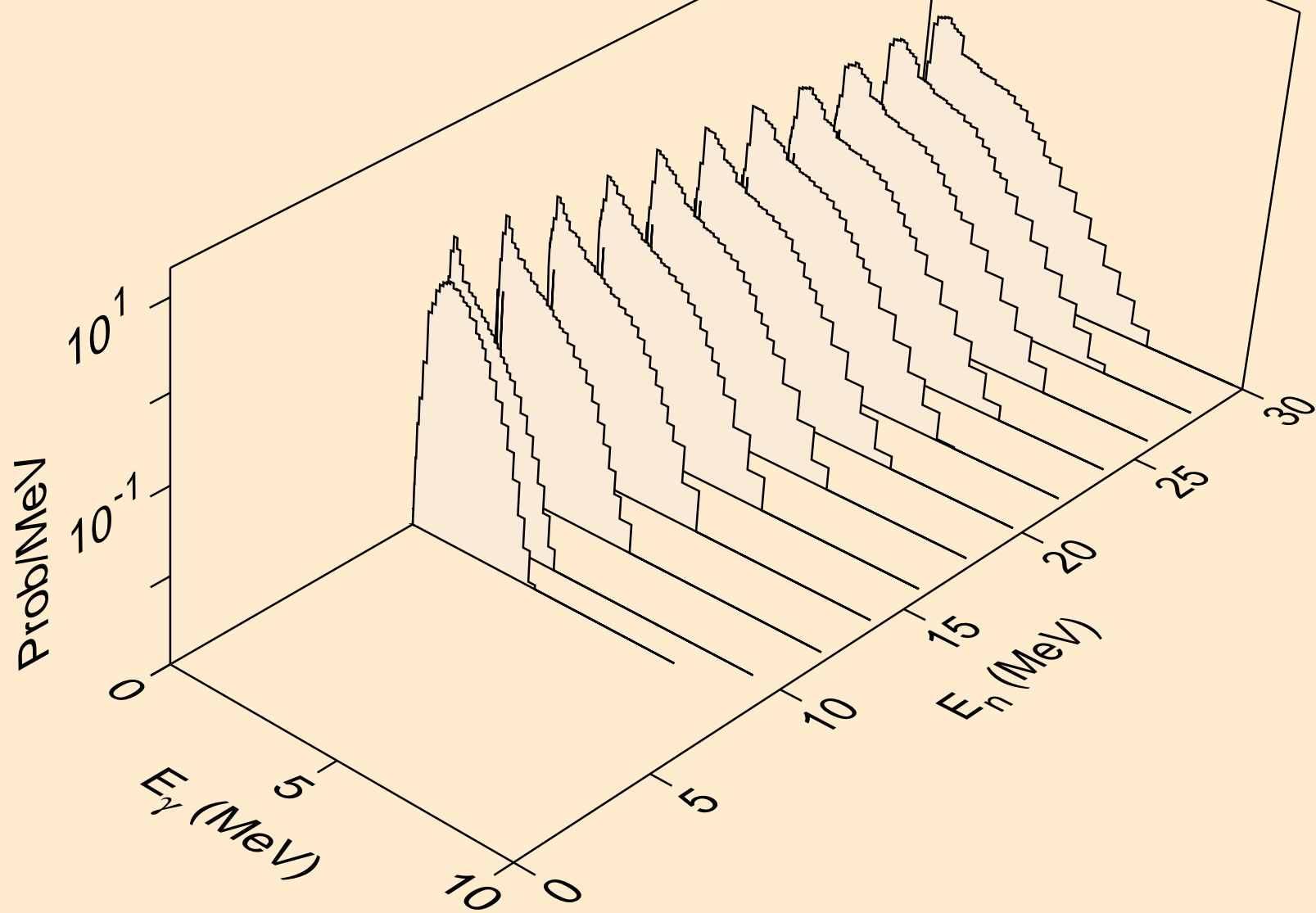

LU164 HELION ACER TENDL-2021 LIBRARY; T=0.K  
Photon emission for (n,pa)

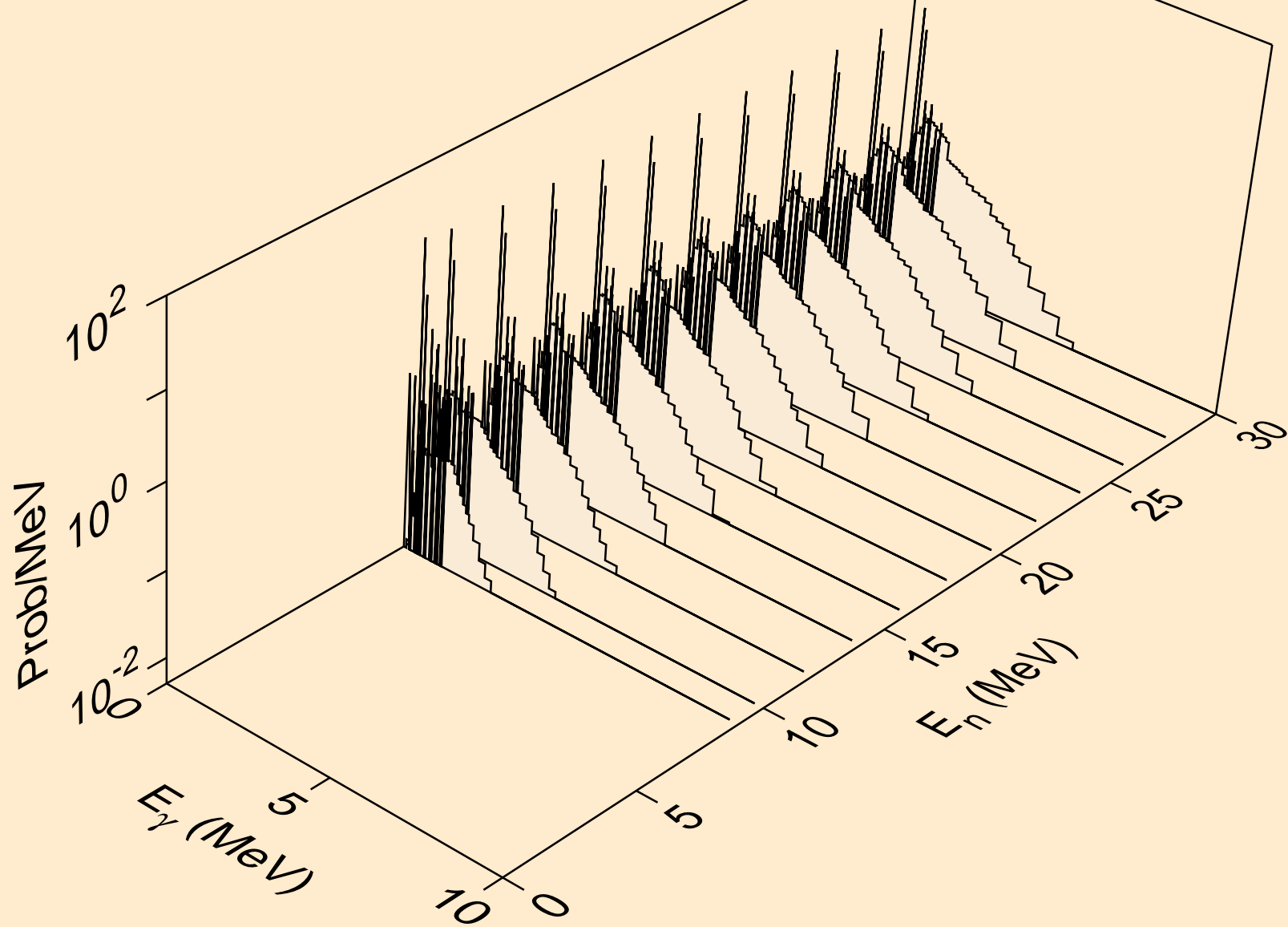

LU164 HELION ACER TENDL-2021 LIBRARY; T=0.K  
Photon emission for (n,t2a)

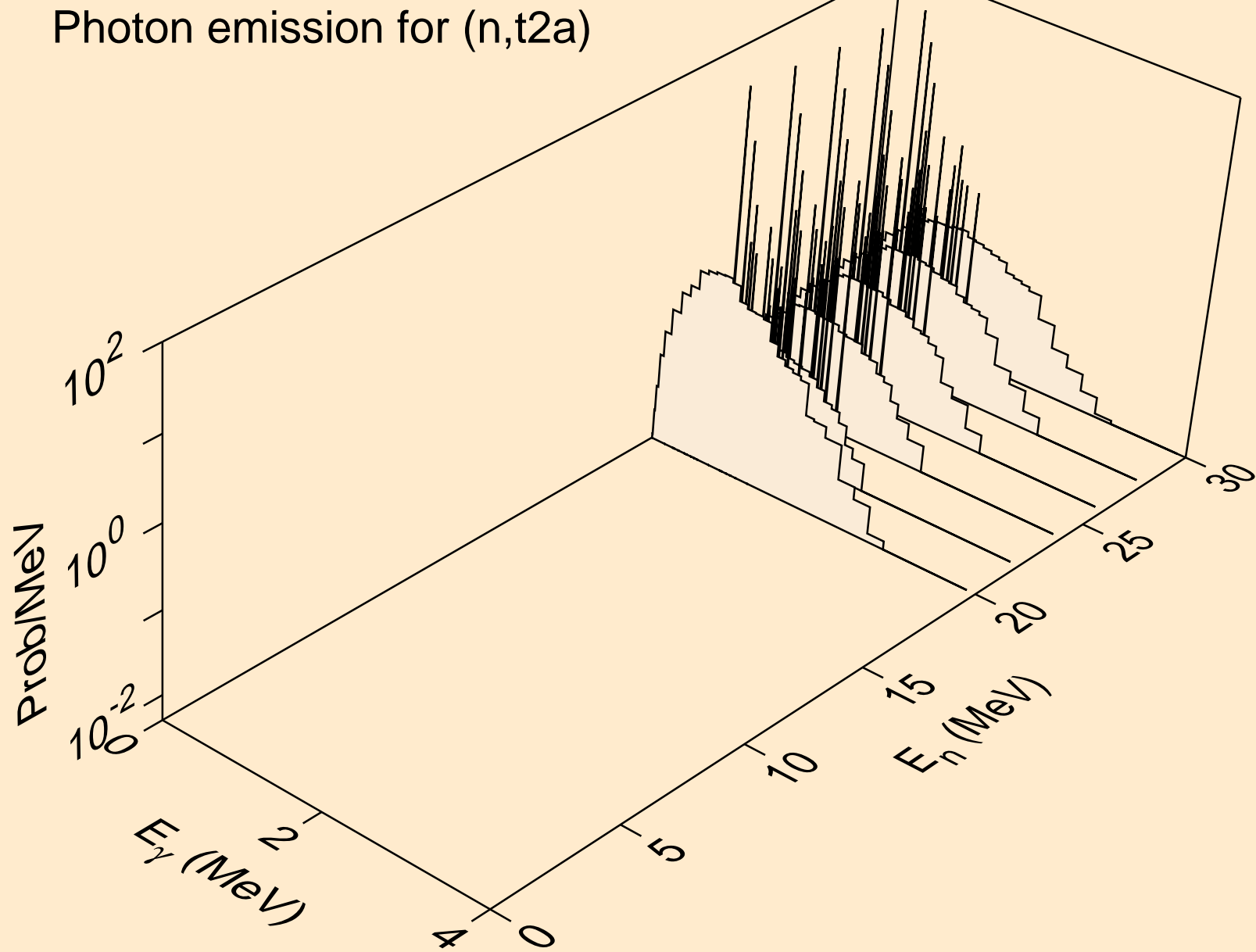

LU164 HELION ACER TENDL-2021 LIBRARY; T=0.K  
Photon emission for (n,pd)

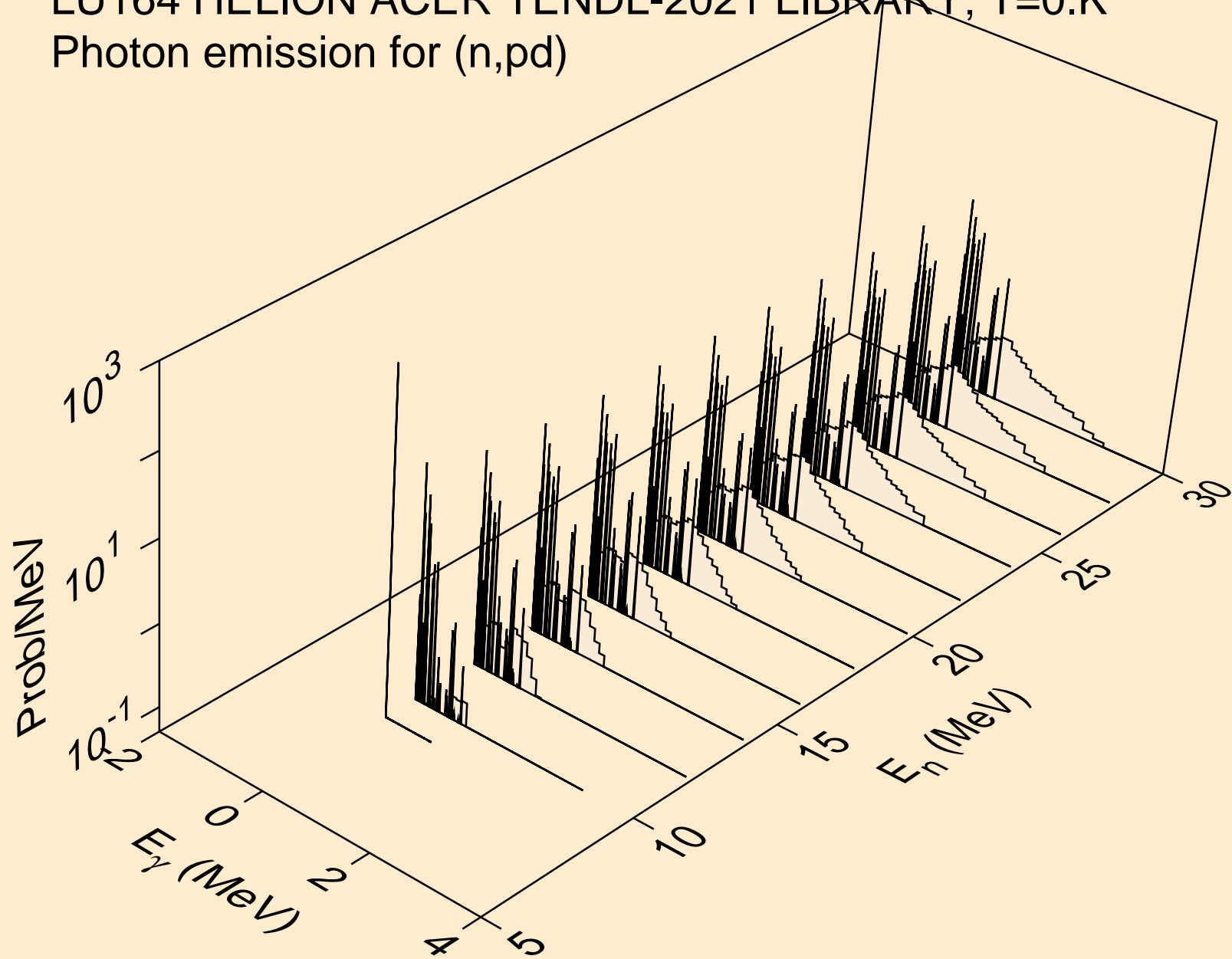

LU164 HELION ACER TENDL-2021 LIBRARY; T=0.K  
Photon emission for (n,pt)

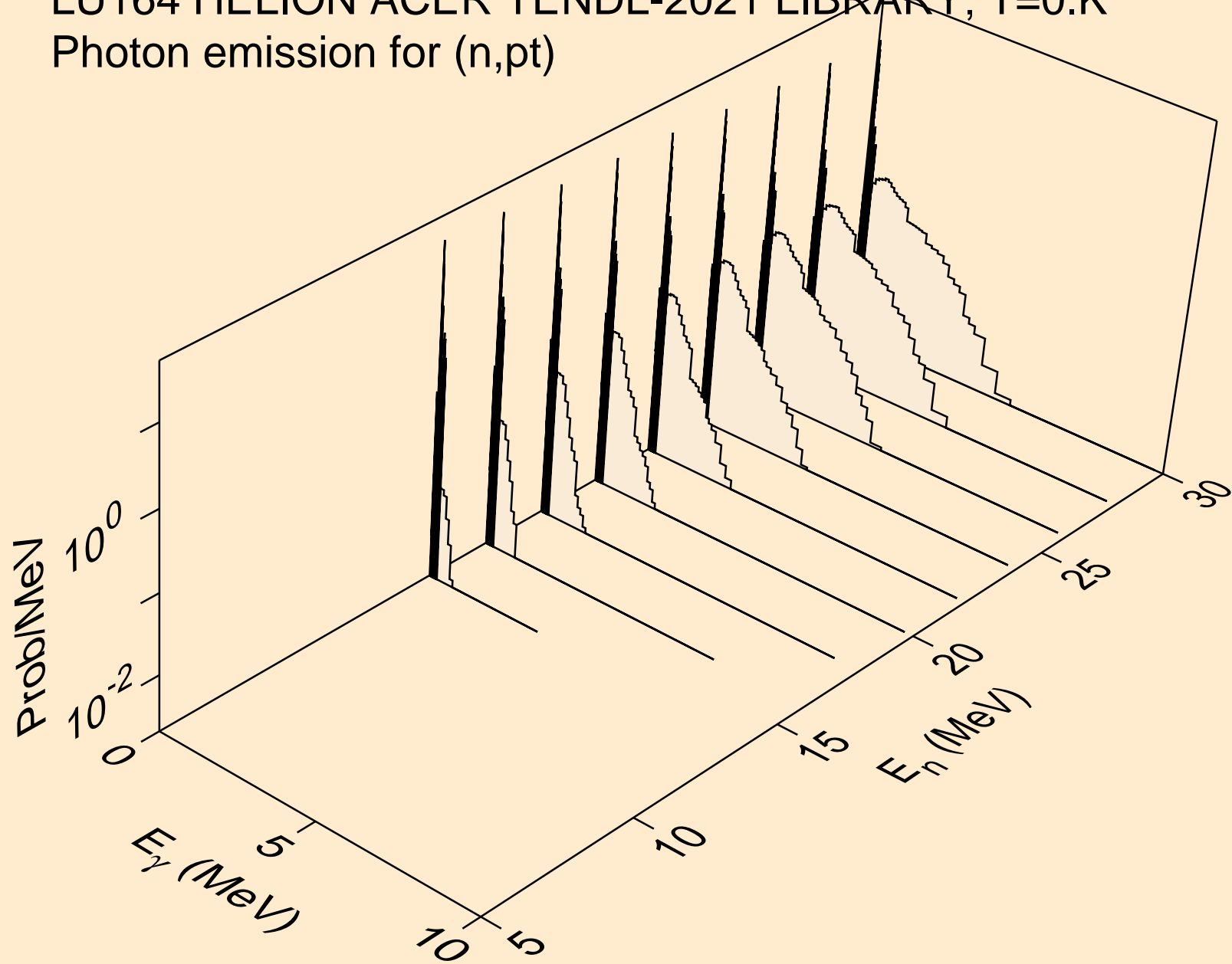

LU164 HELION ACER TENDL-2021 LIBRARY; T=0.K  
Photon emission for (n,da)

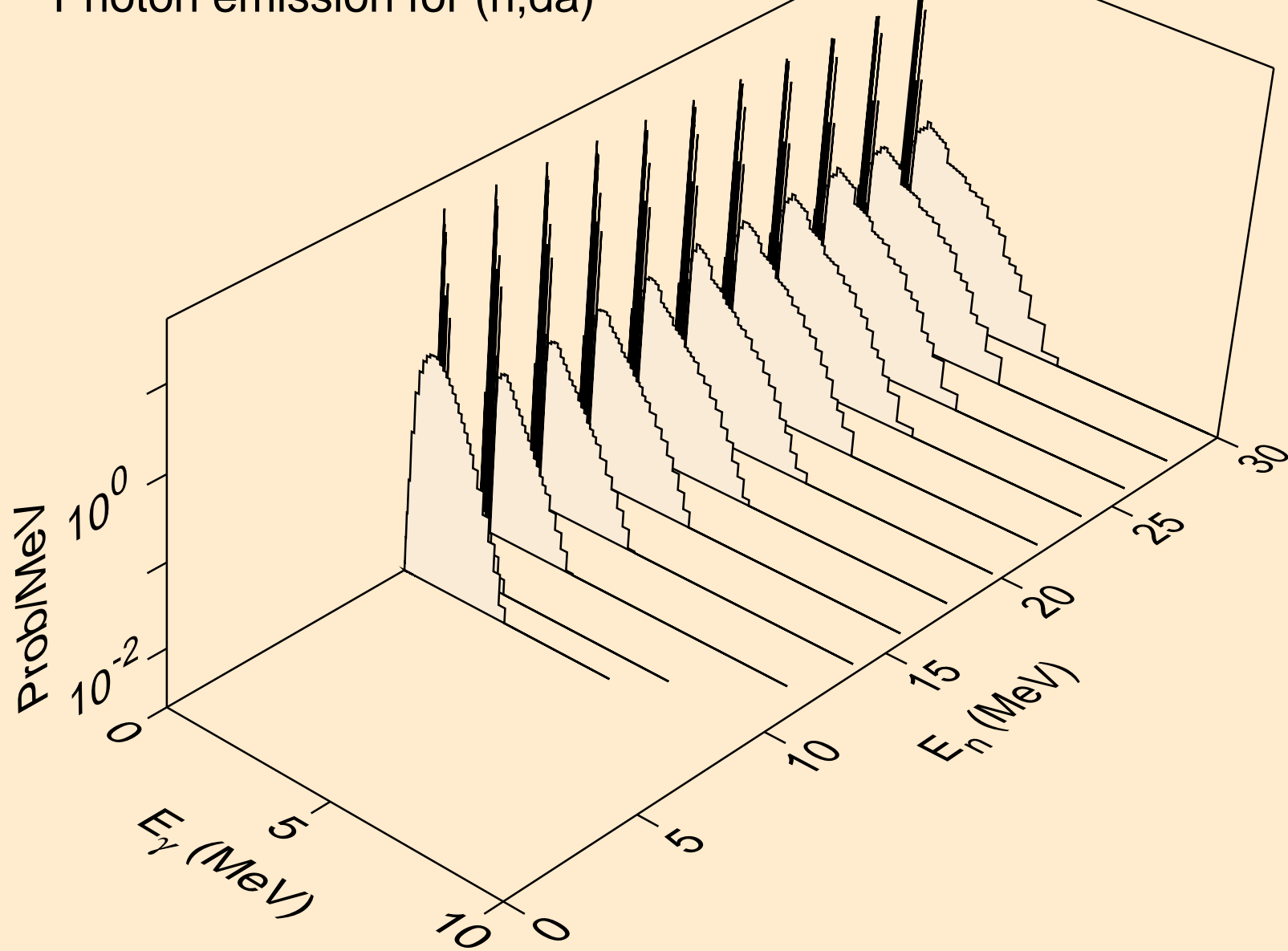



LU164 HELION ACER TENDL-2021 LIBRARY; T=0.K  
Particle heating contributions

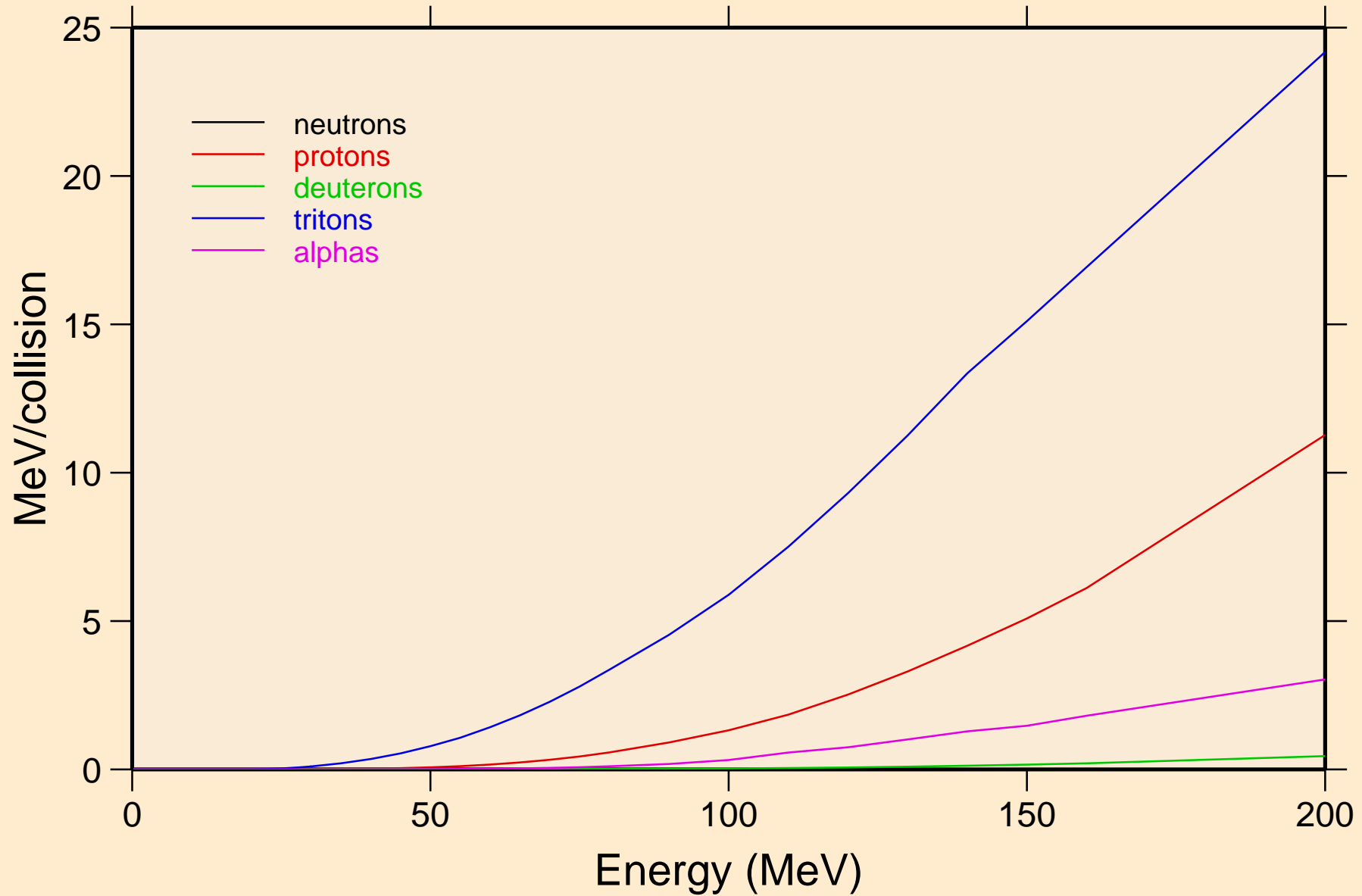

LU164 HELION ACER TENDL-2021 LIBRARY; T=0.K  
Recoil Heating

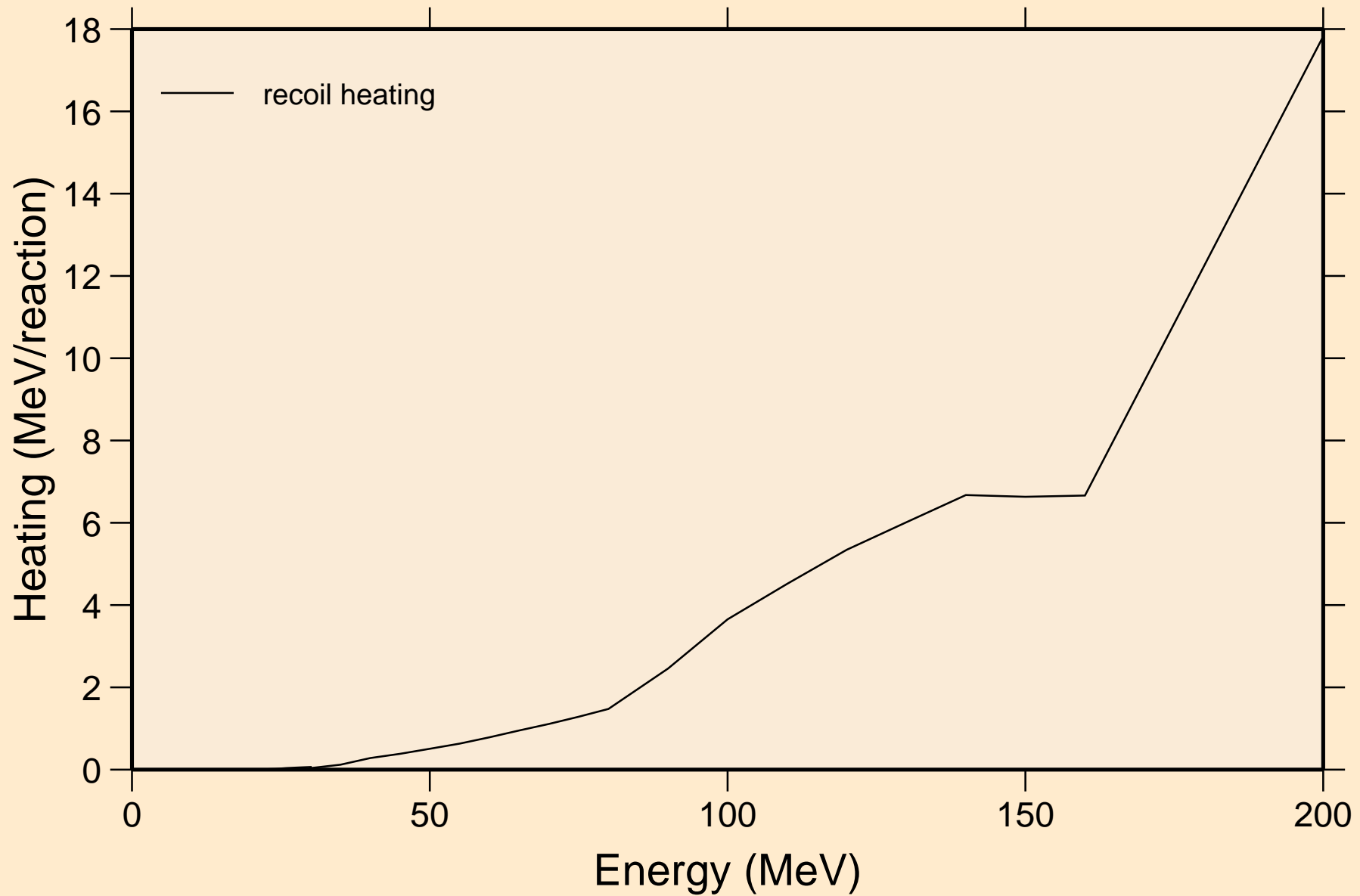

LU164 HELION ACER TENDL-2021 LIBRARY; T=0.K  
Particle production cross sections

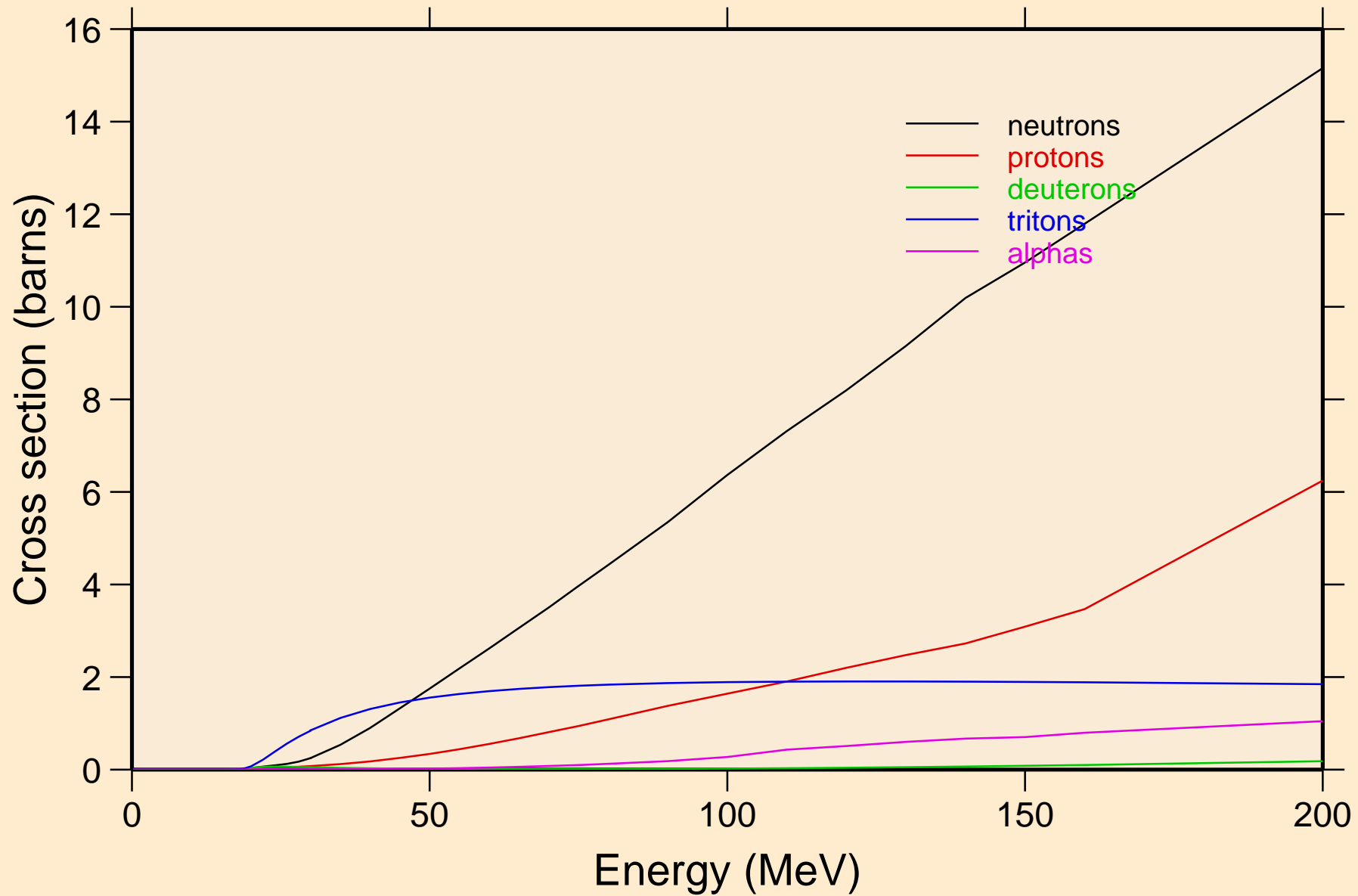

LU164 HELION ACER TENDL-2021 LIBRARY; T=0.K  
neutrons from (s,n)

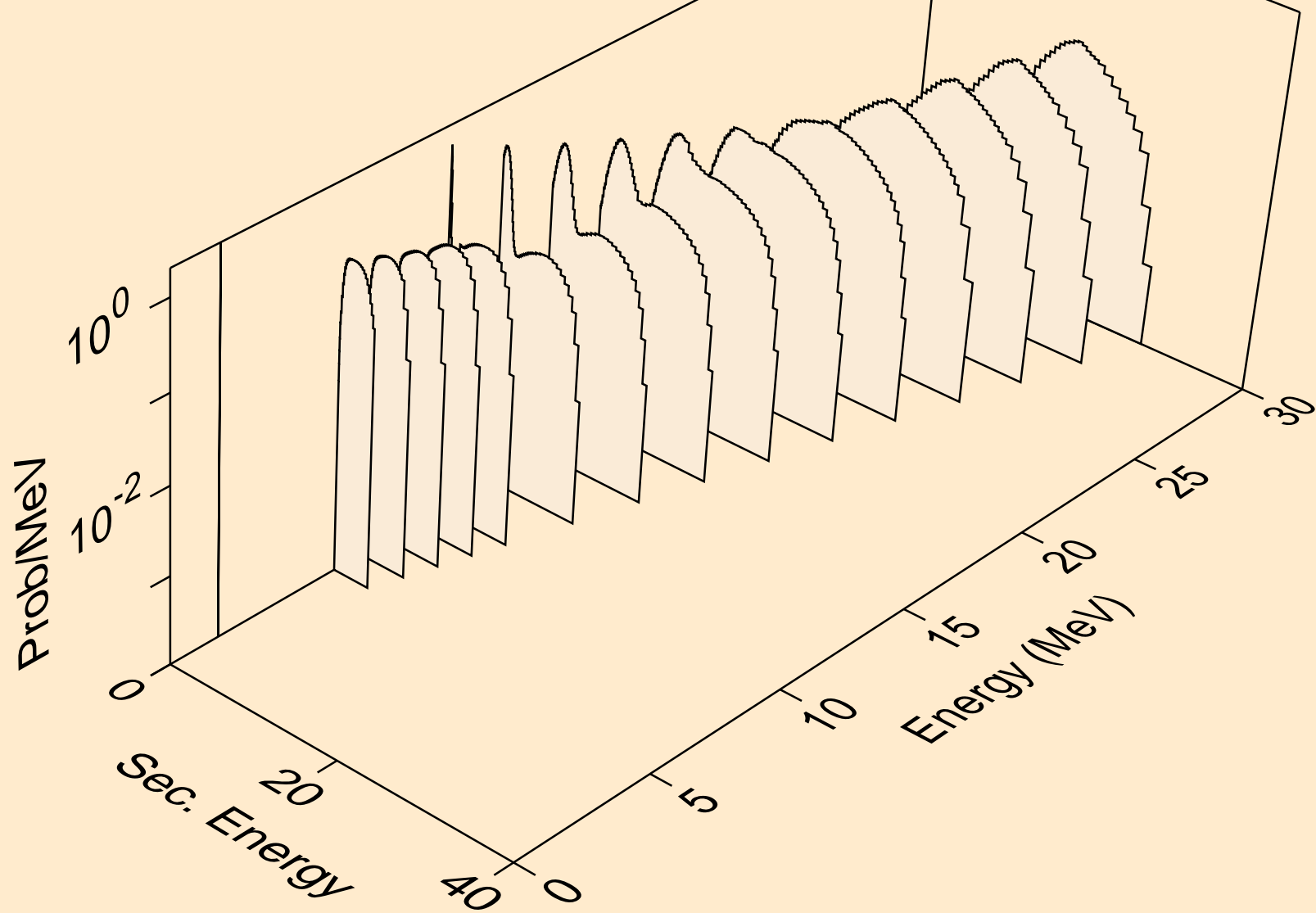

LU164 HELION ACER TENDL-2021 LIBRARY; T=0.K  
neutrons from (s,x)

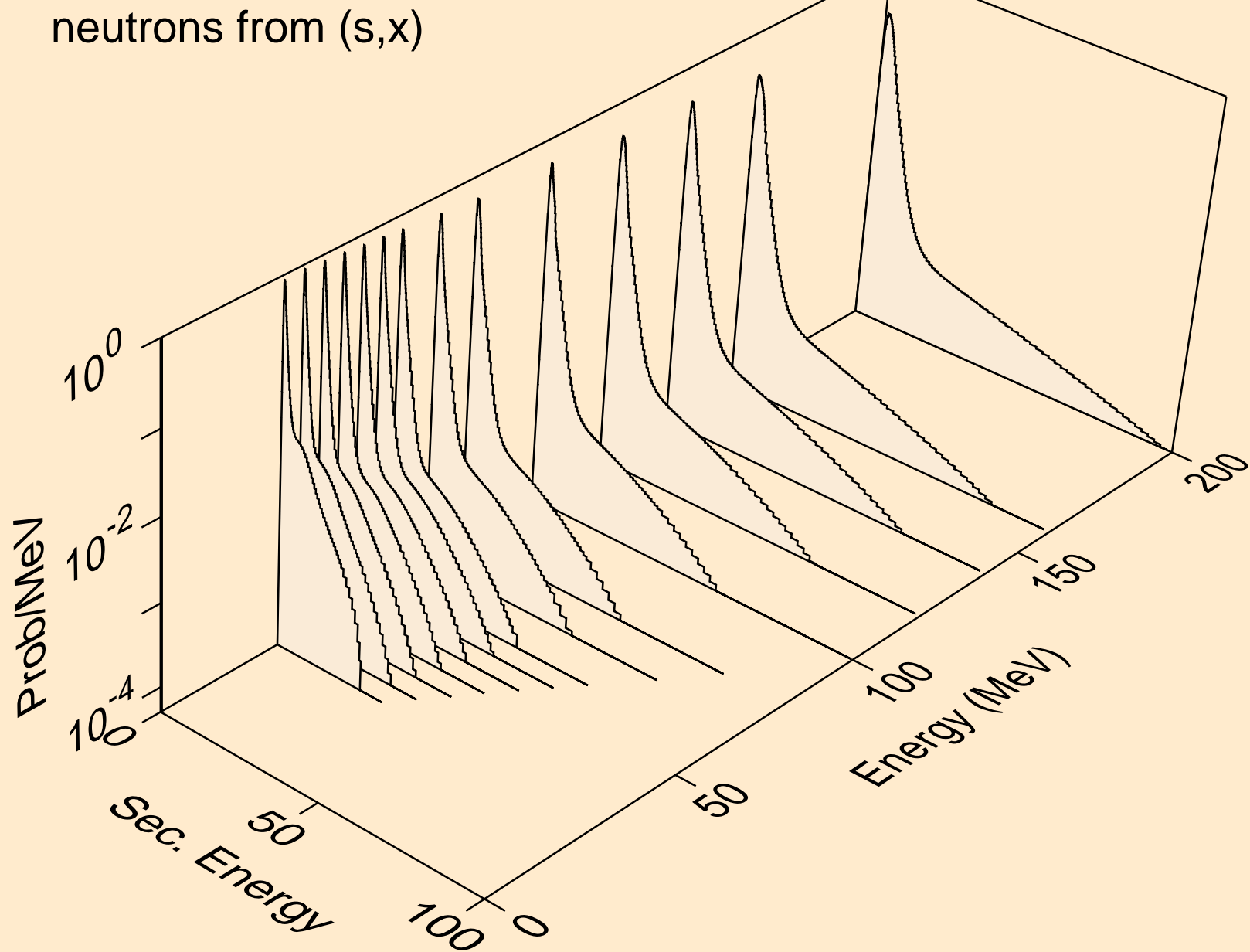

LU164 HELION ACER TENDL-2021 LIBRARY; T=0.K  
neutrons from (s,2nd)

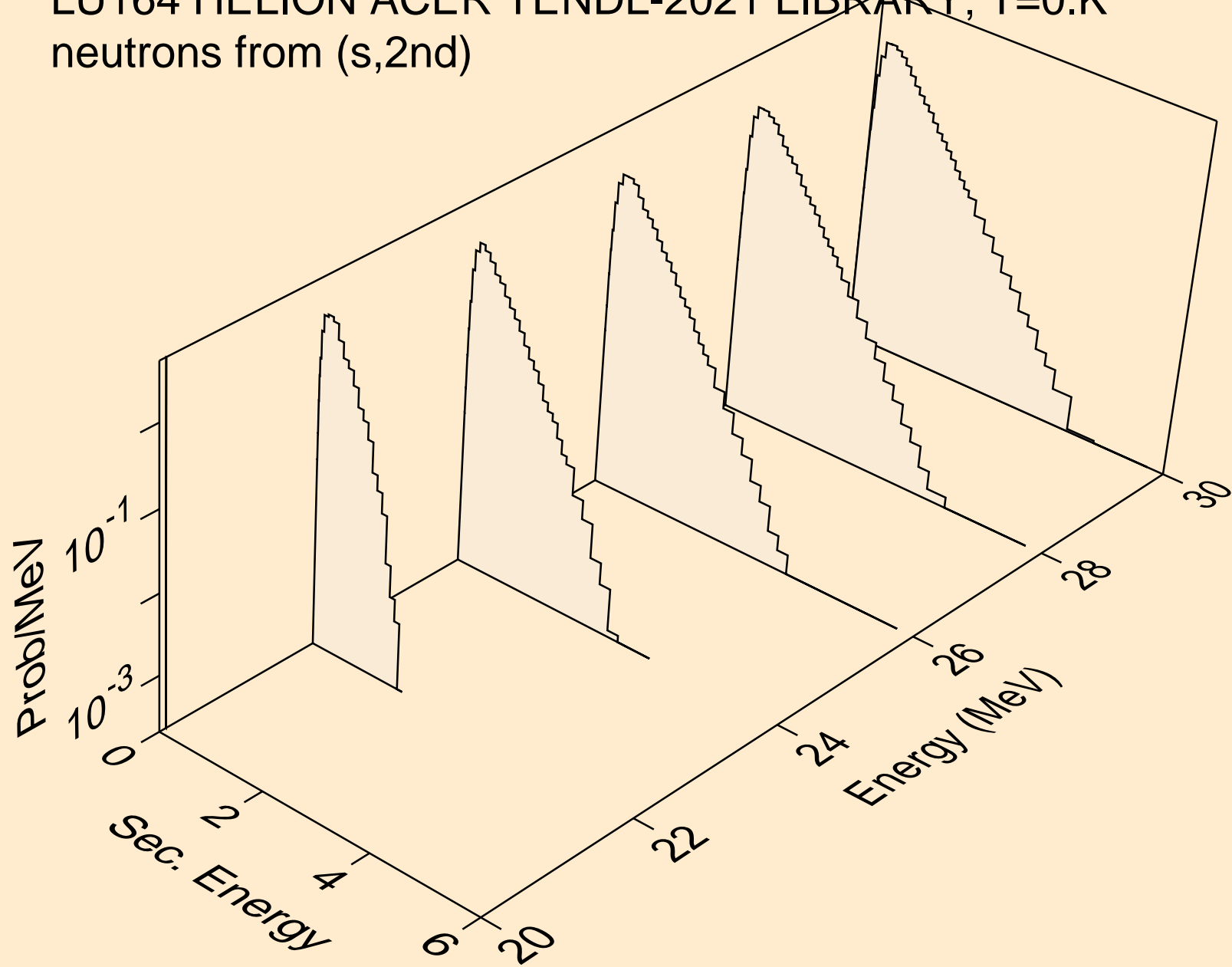

LU164 HELION ACER TENDL-2021 LIBRARY; T=0.K  
neutrons from (s,2n)

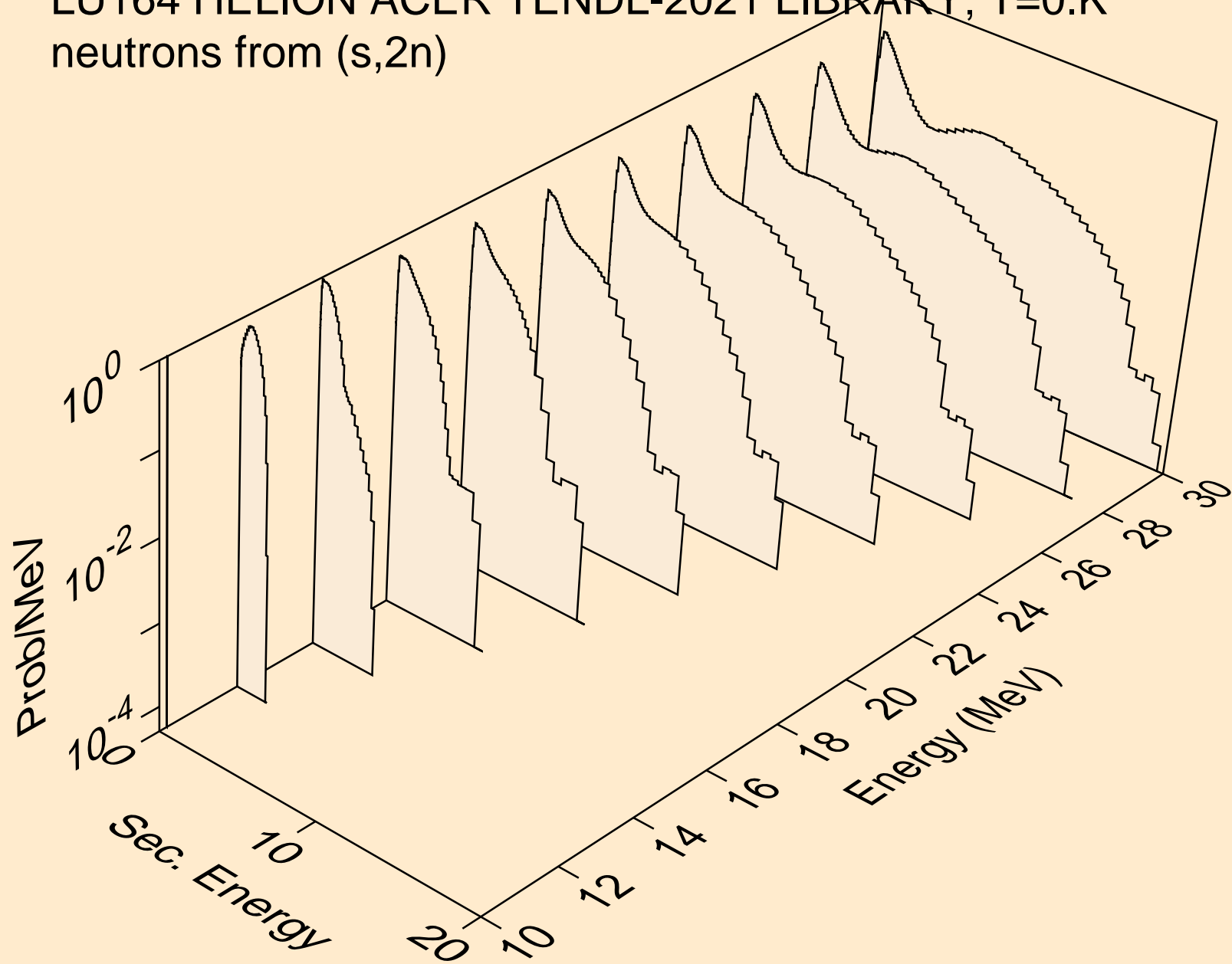

LU164 HELION ACER TENDL-2021 LIBRARY; T=0.K  
neutrons from (s,3n)

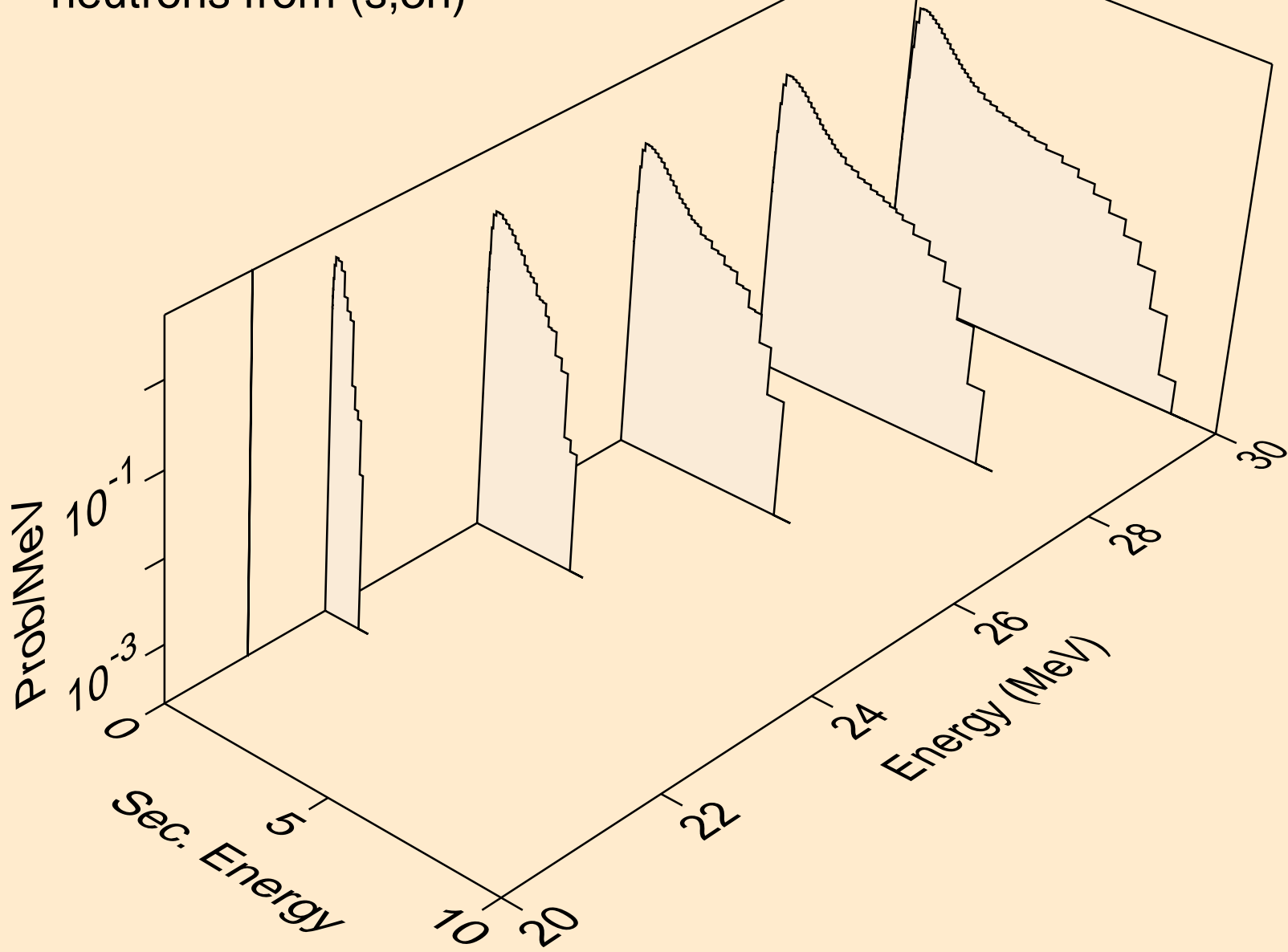



LU164 HELION ACER TENDL-2021 LIBRARY; T=0.K  
neutrons from (s,n\*)a

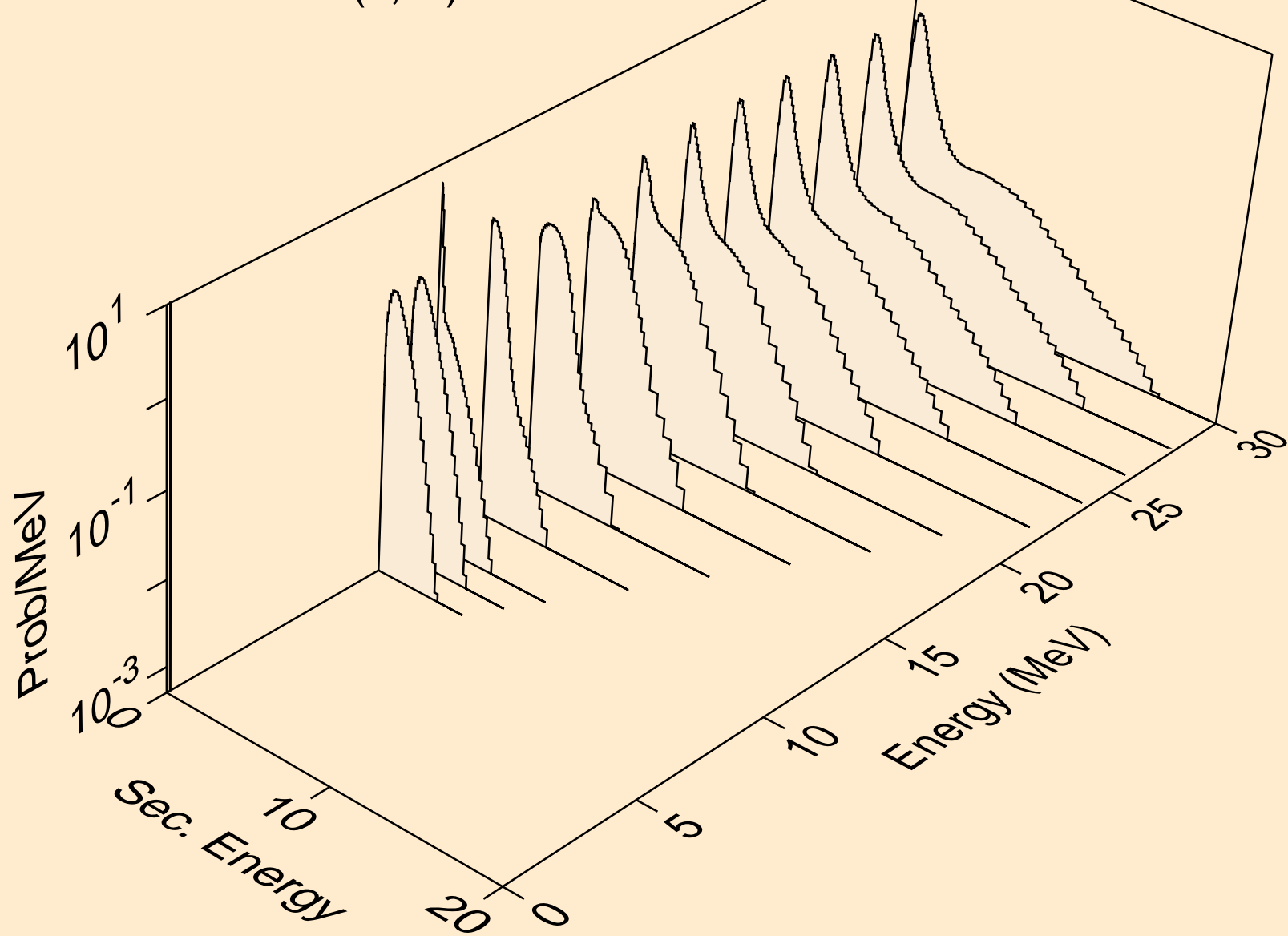

LU164 HELION ACER TENDL-2021 LIBRARY; T=0.K  
neutrons from (s,2n)a

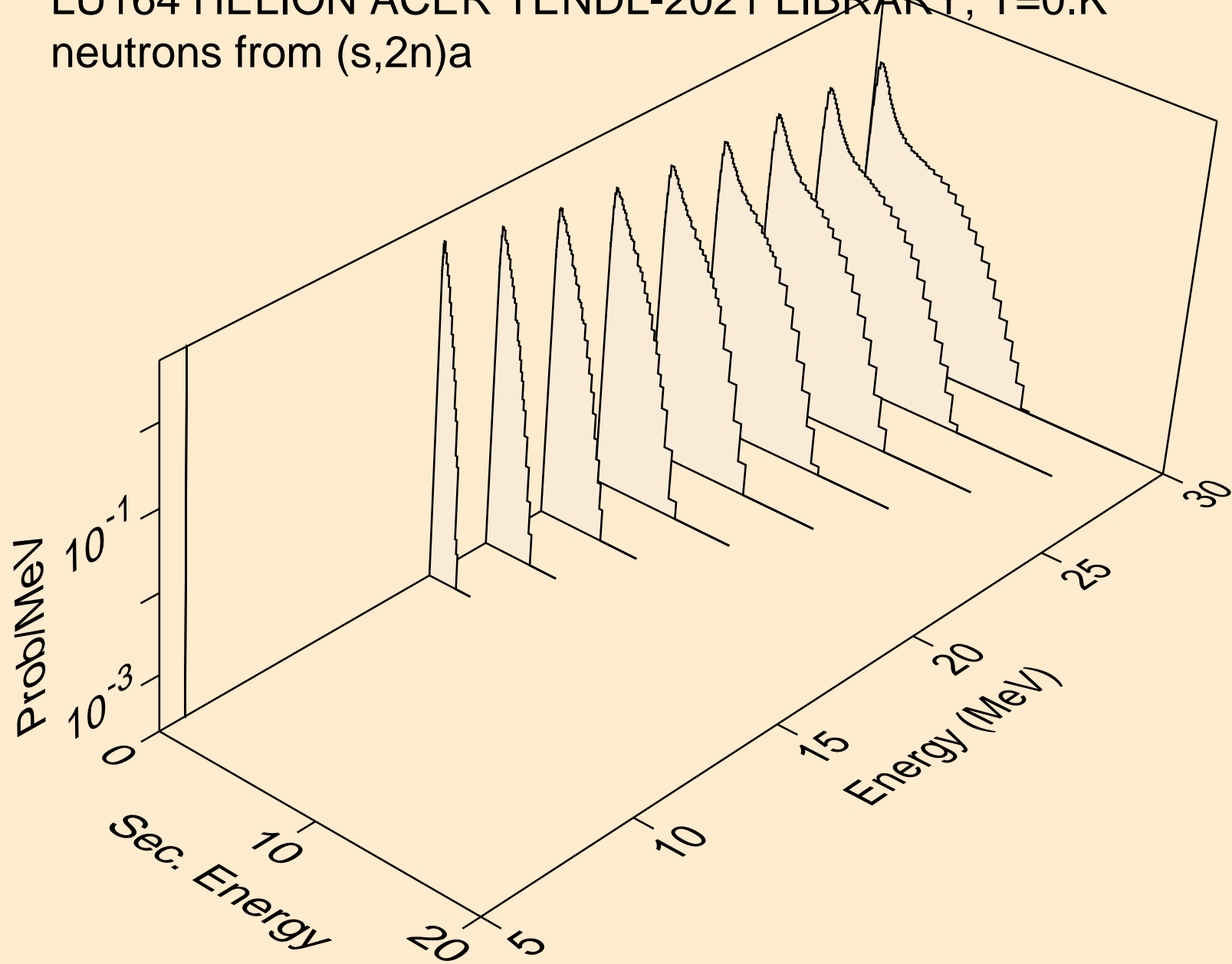

LU164 HELION ACER TENDL-2021 LIBRARY; T=0.K  
neutrons from (s,3n)a

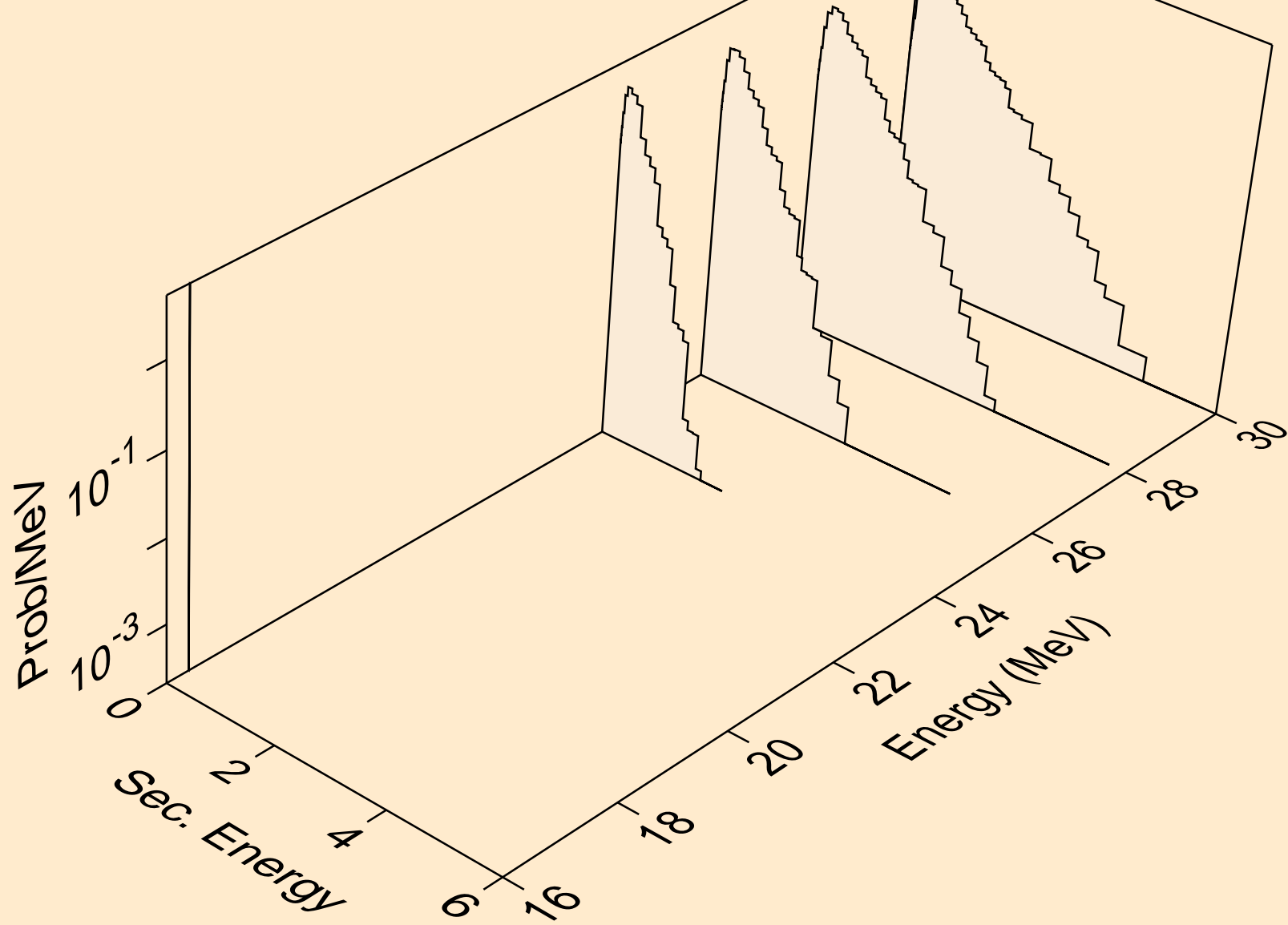

LU164 HELION ACER TENDL-2021 LIBRARY; T=0.K  
neutrons from (s,n\*)p

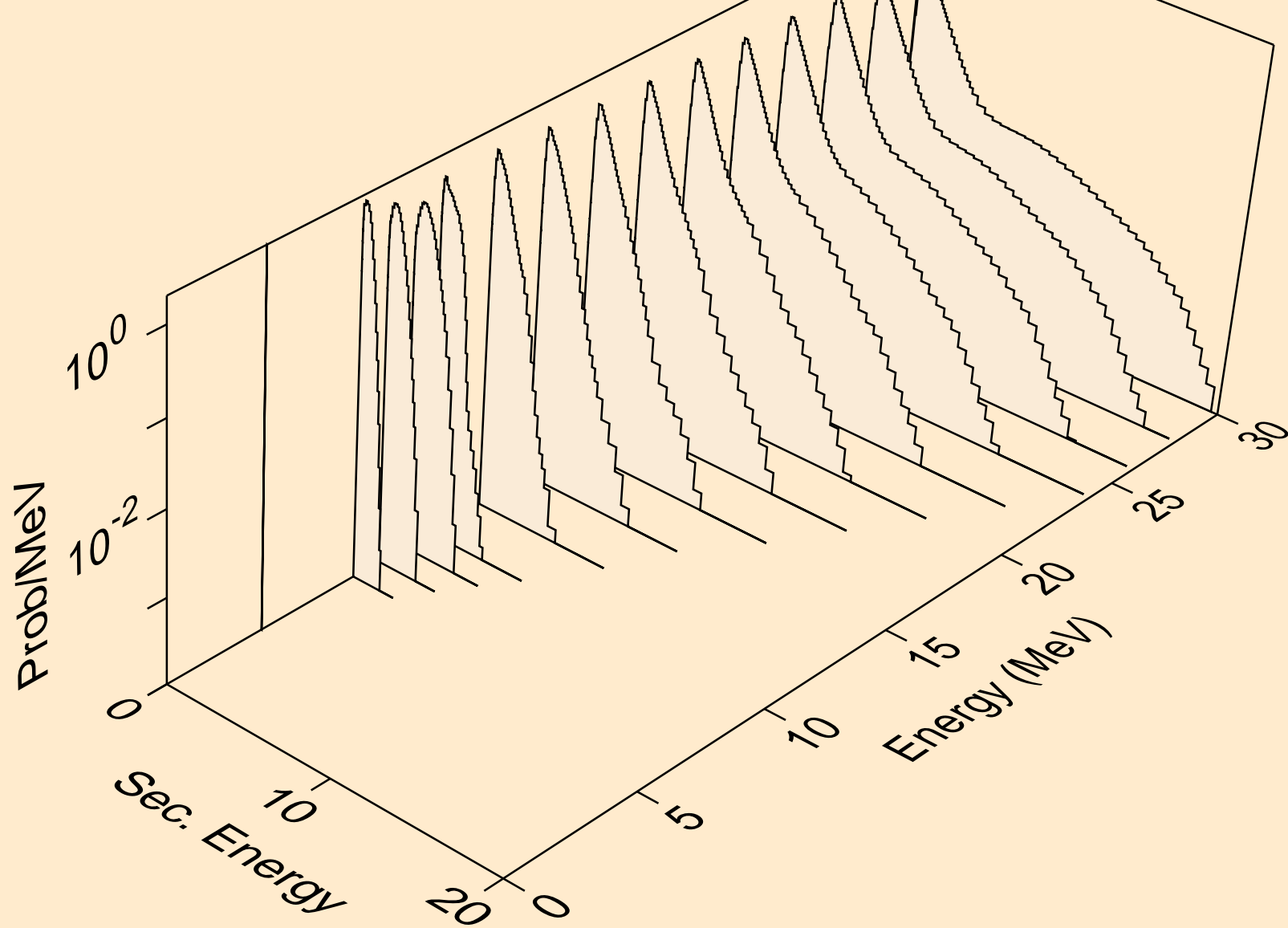

LU164 HELION ACER TENDL-2021 LIBRARY; T=0.K  
neutrons from (s,n\*)2a

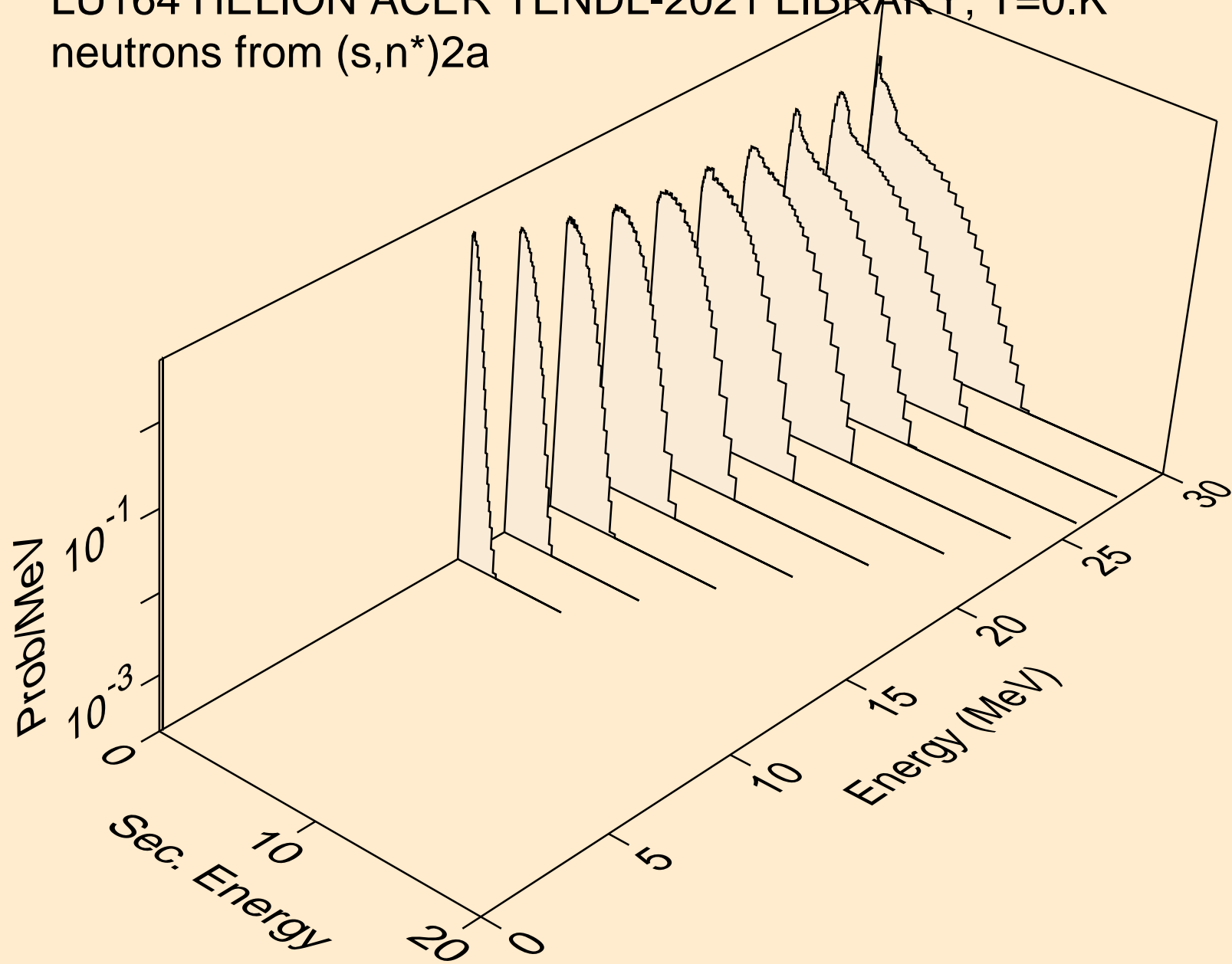

LU164 HELION ACER TENDL-2021 LIBRARY; T=0.K  
neutrons from (s,2n)2a

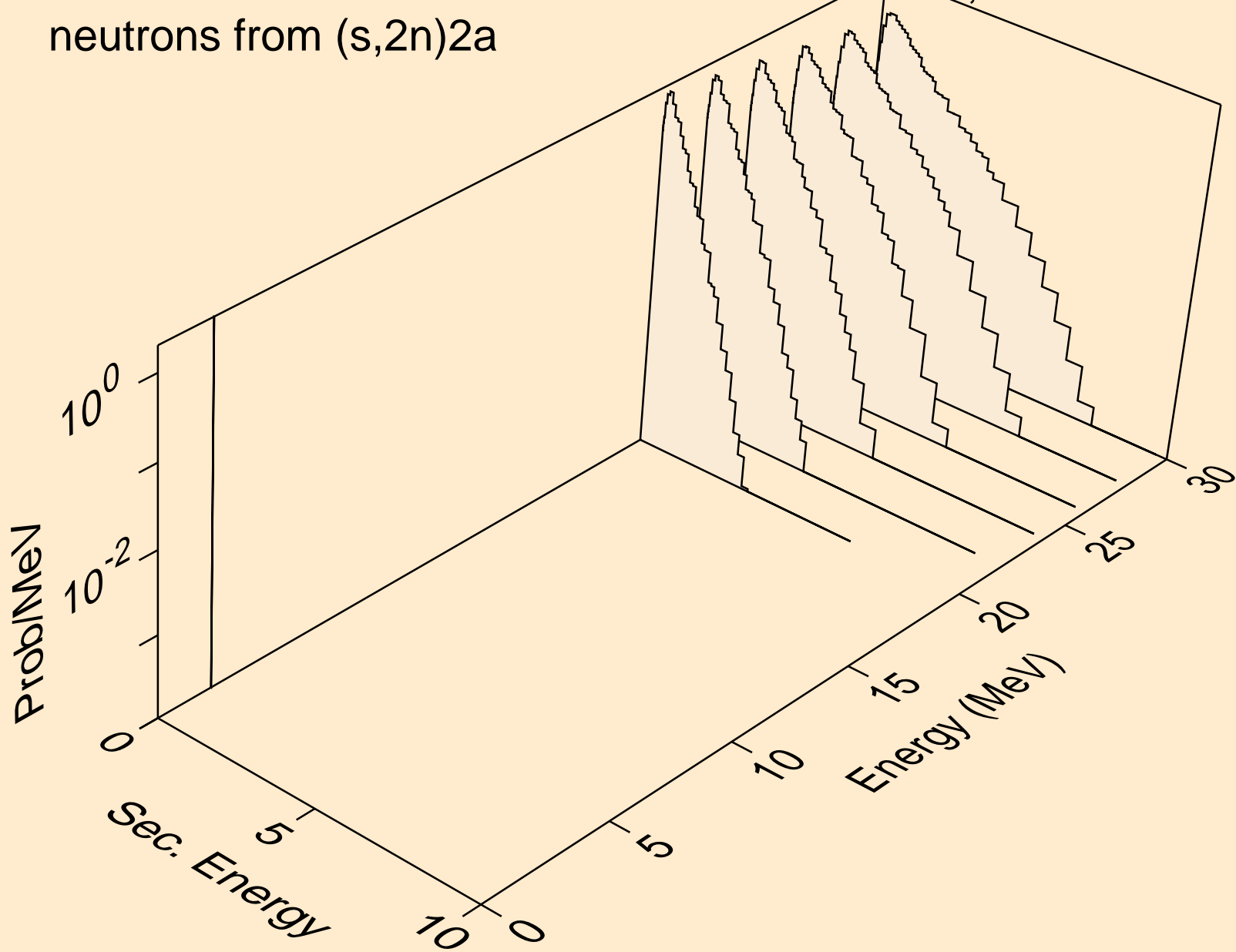

LU164 HELION ACER TENDL-2021 LIBRARY; T=0.K  
neutrons from (s,n\*)d

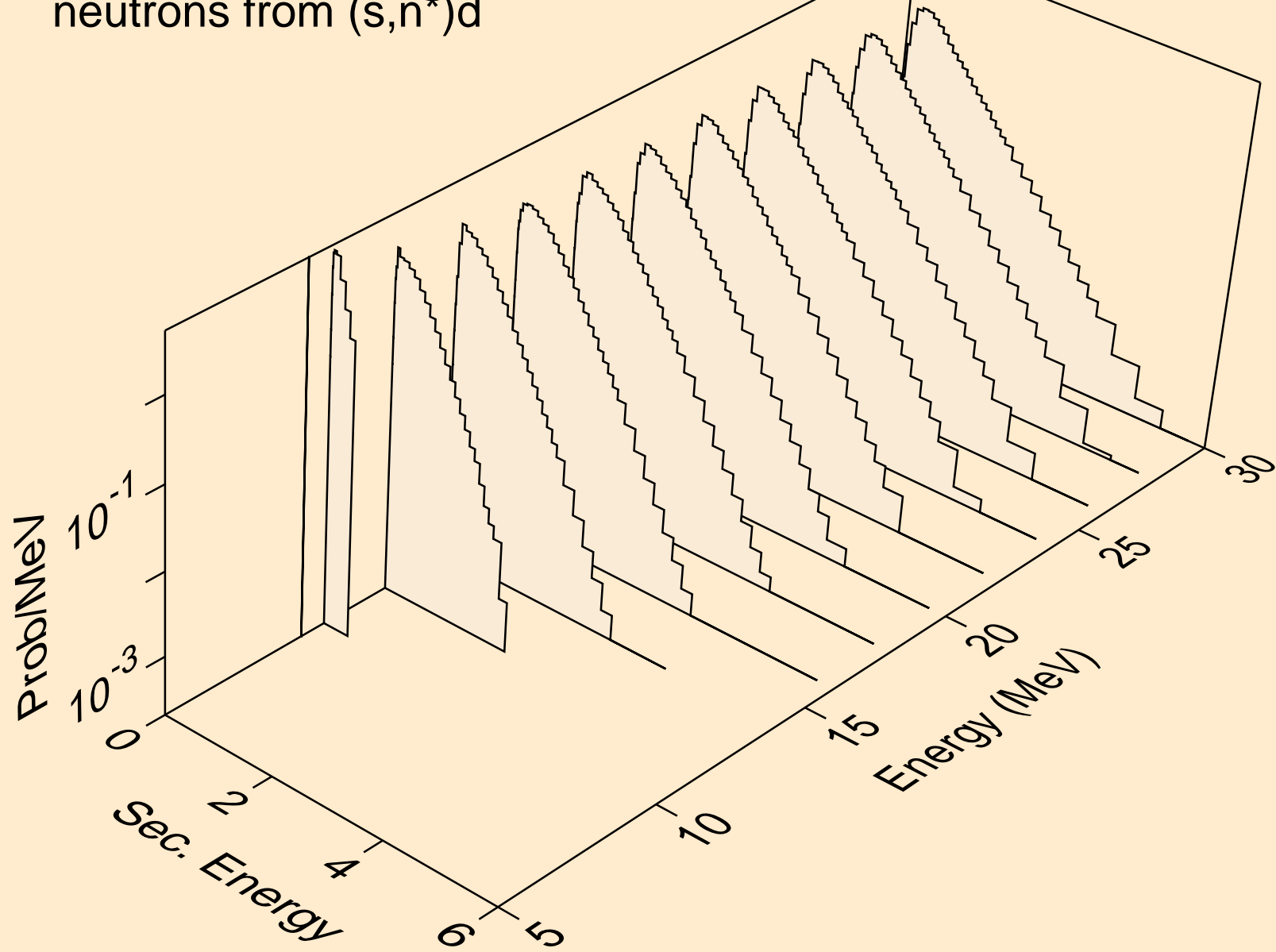

LU164 HELION ACER TENDL-2021 LIBRARY; T=0.K  
neutrons from (s,n\*)t

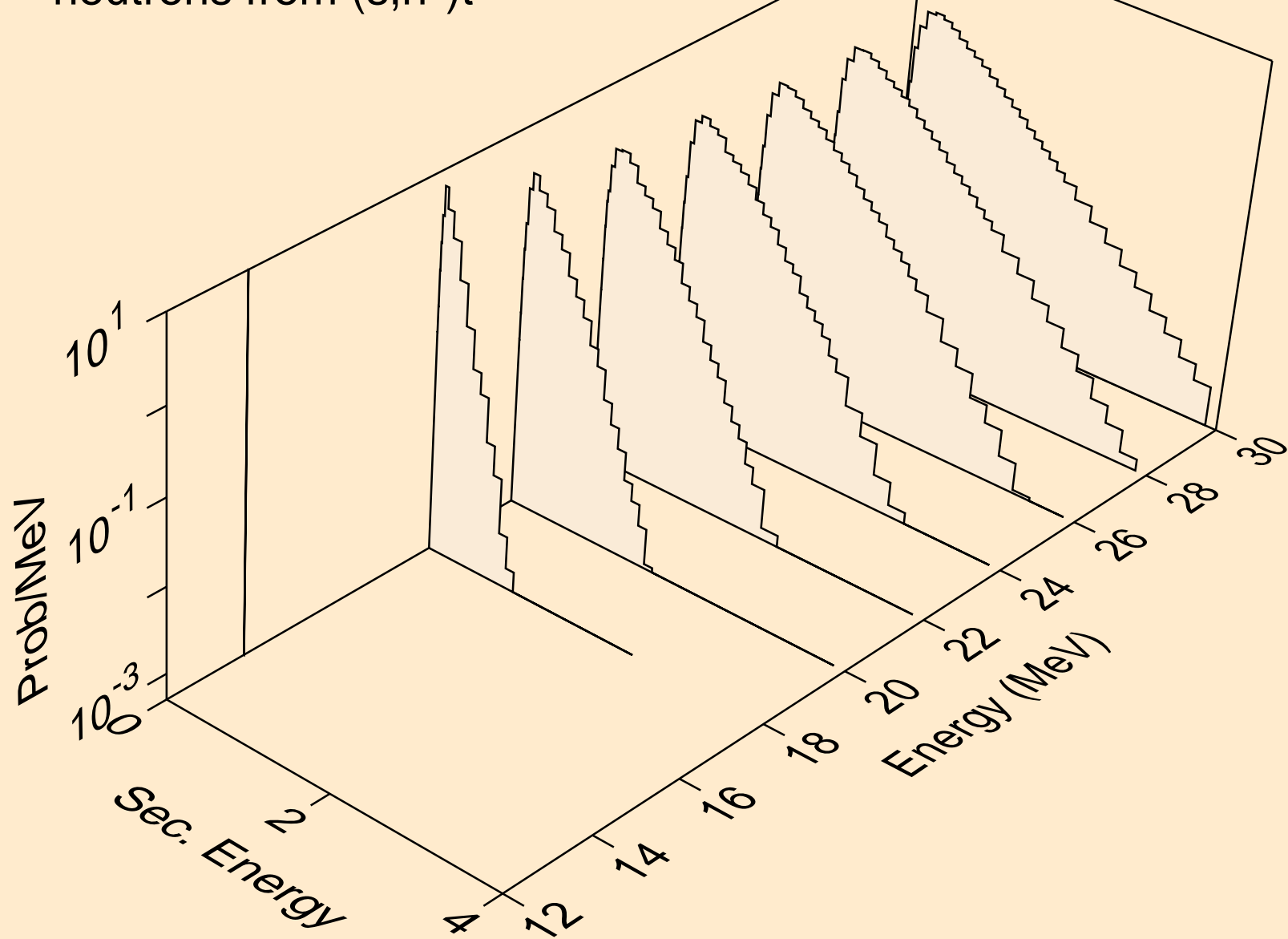



LU164 HELION ACER TENDL-2021 LIBRARY; T=0.K  
neutrons from (s,n\*)he3

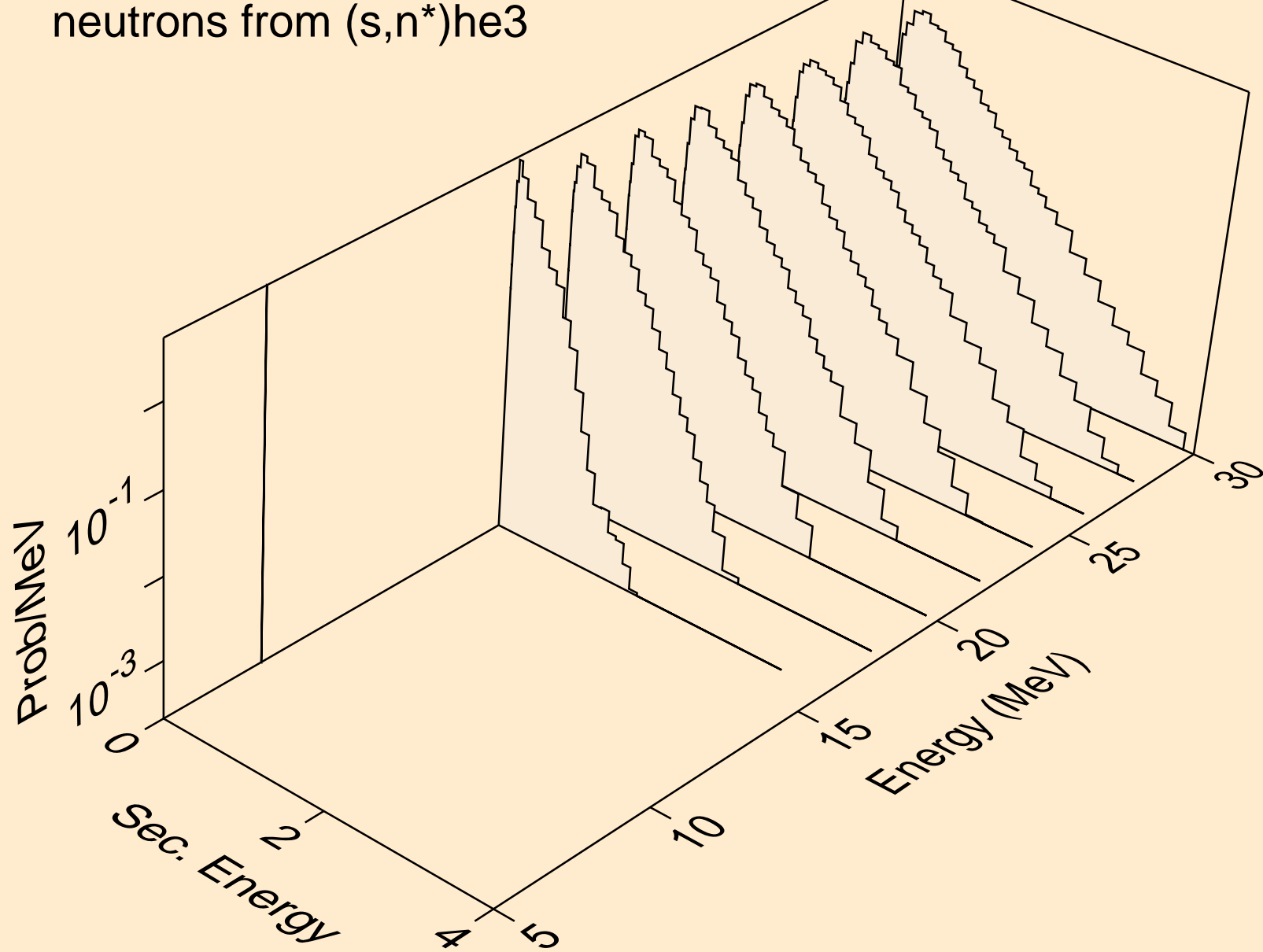

LU164 HELION ACER TENDL-2021 LIBRARY; T=0.K  
neutrons from (s,2np)

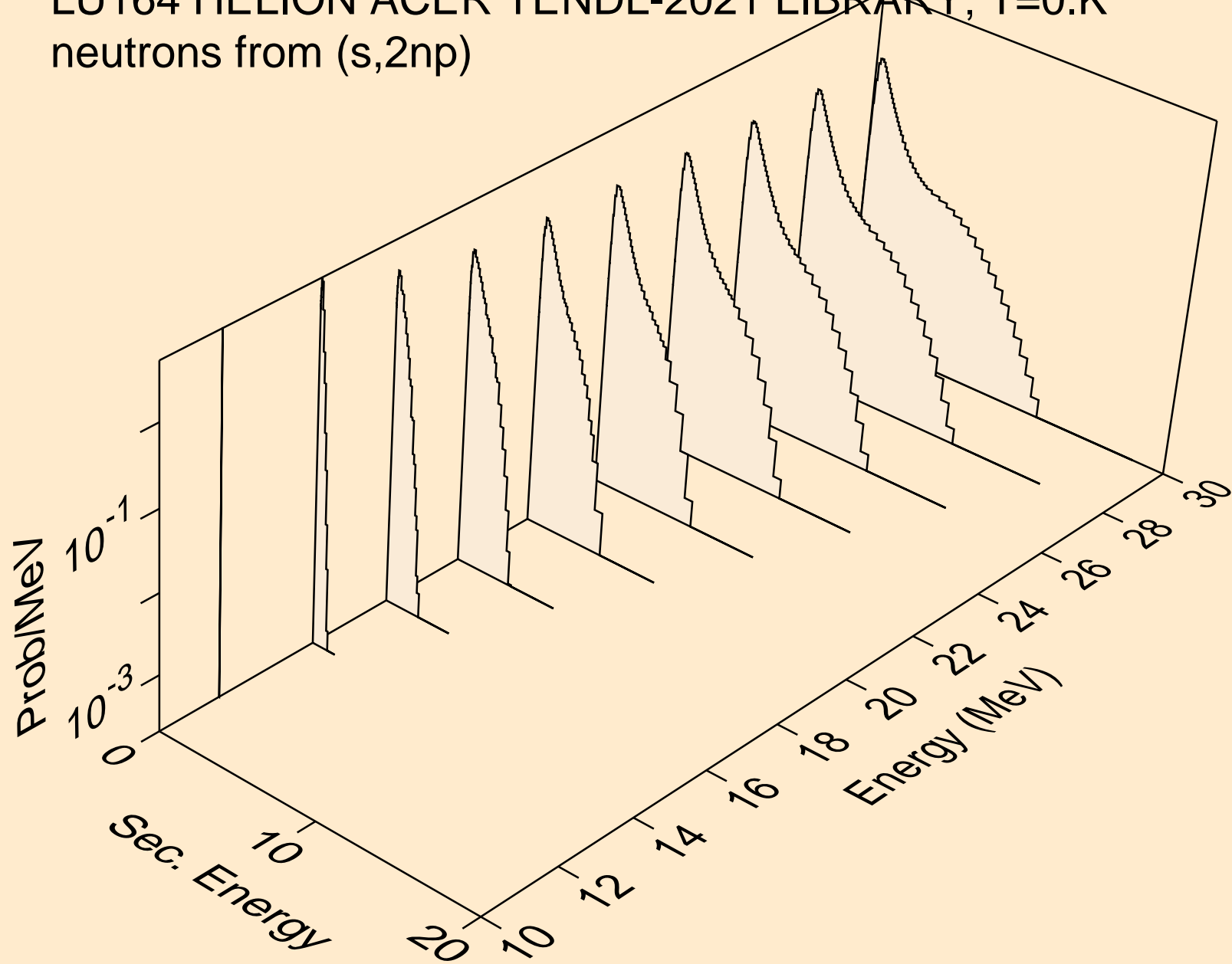

LU164 HELION ACER TENDL-2021 LIBRARY; T=0.K  
neutrons from (s,3np)

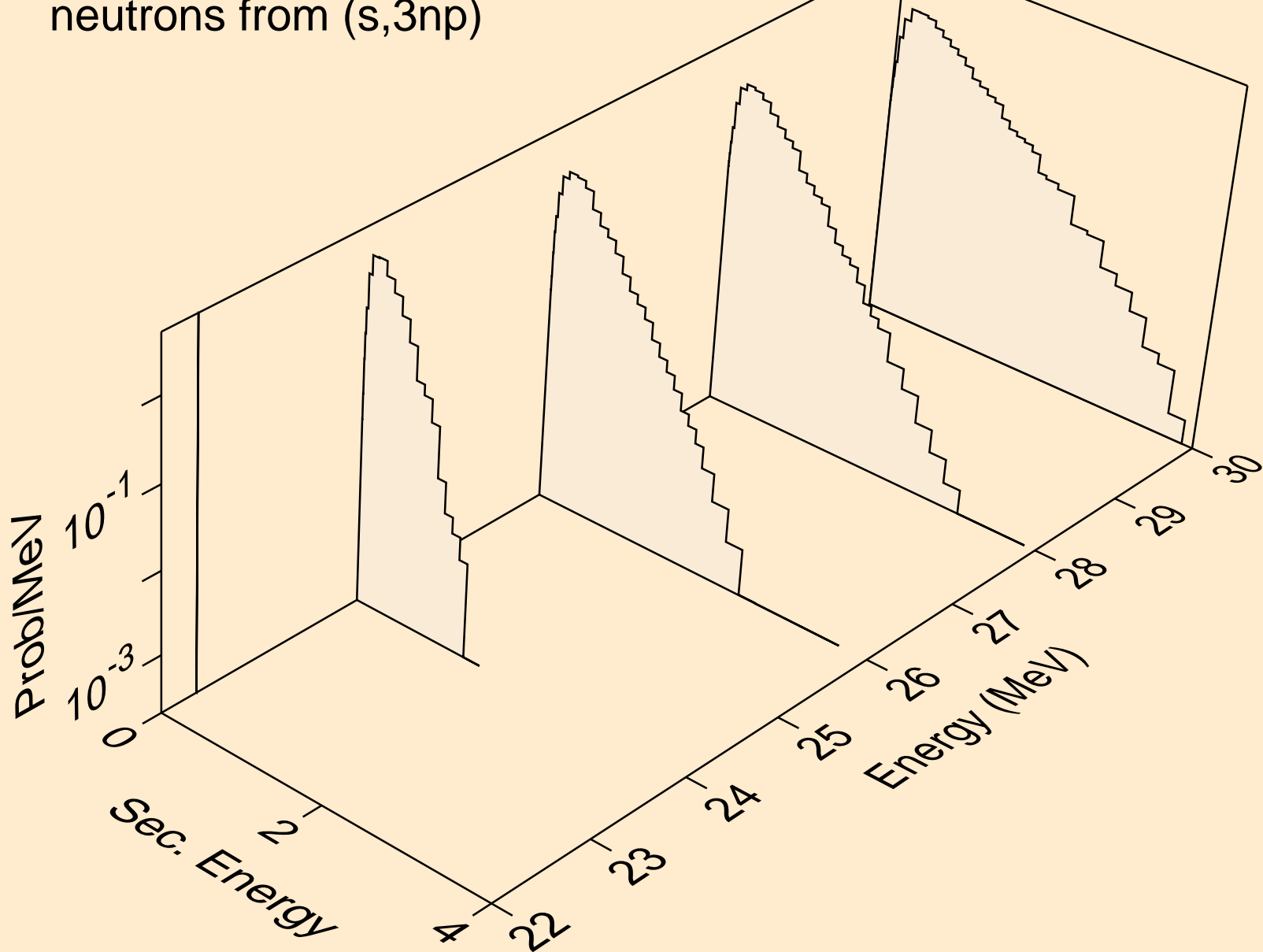

LU164 HELION ACER TENDL-2021 LIBRARY; T=0.K  
neutrons from (s,2np)

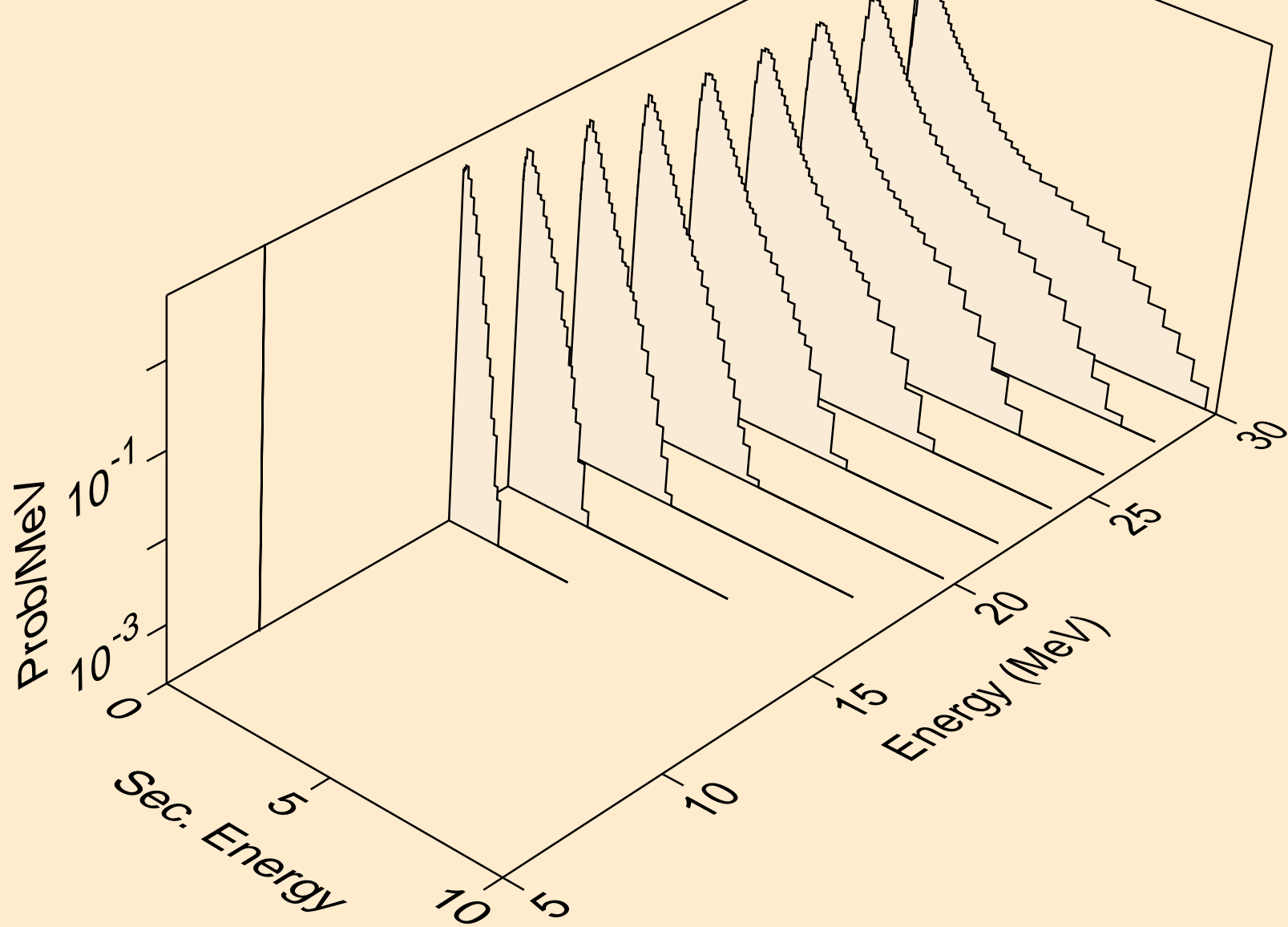

LU164 HELION ACER TENDL-2021 LIBRARY; T=0.K  
neutrons from (s,npa)

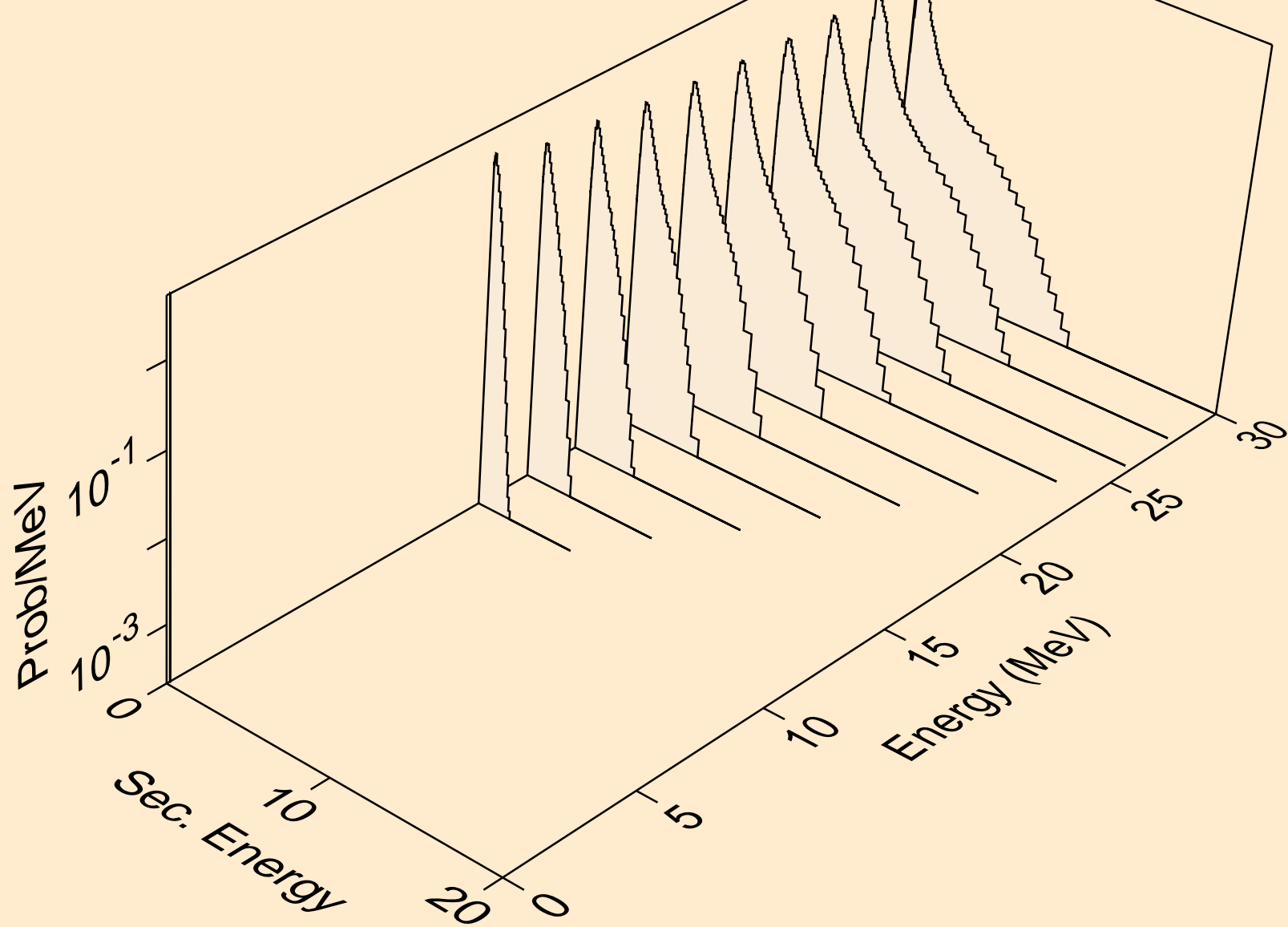

LU164 HELION ACER TENDL-2021 LIBRARY; T=0.K  
protons from (s,x)

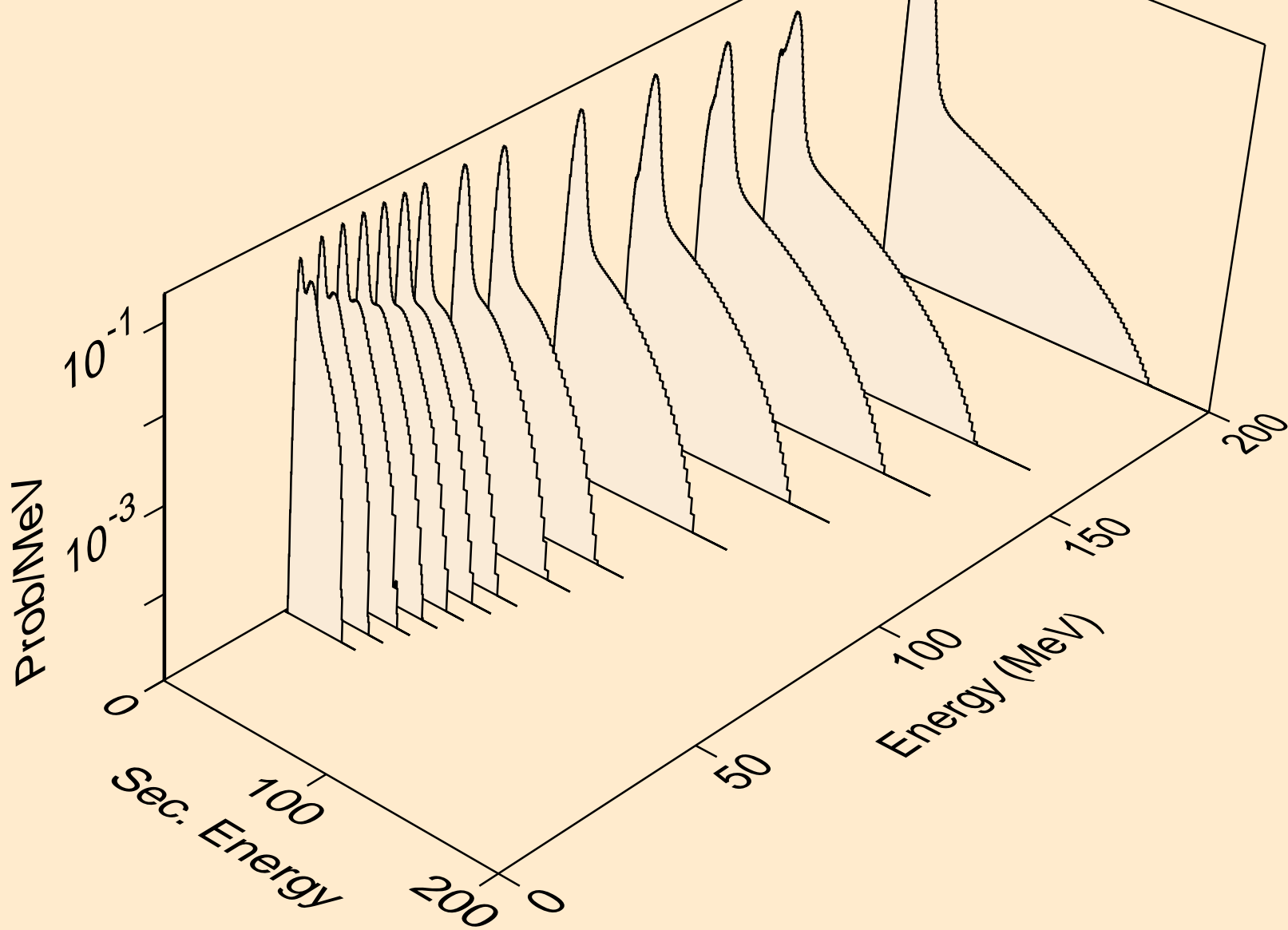

LU164 HELION ACER TENDL-2021 LIBRARY; T=0.K  
protons from (s,n\*)p

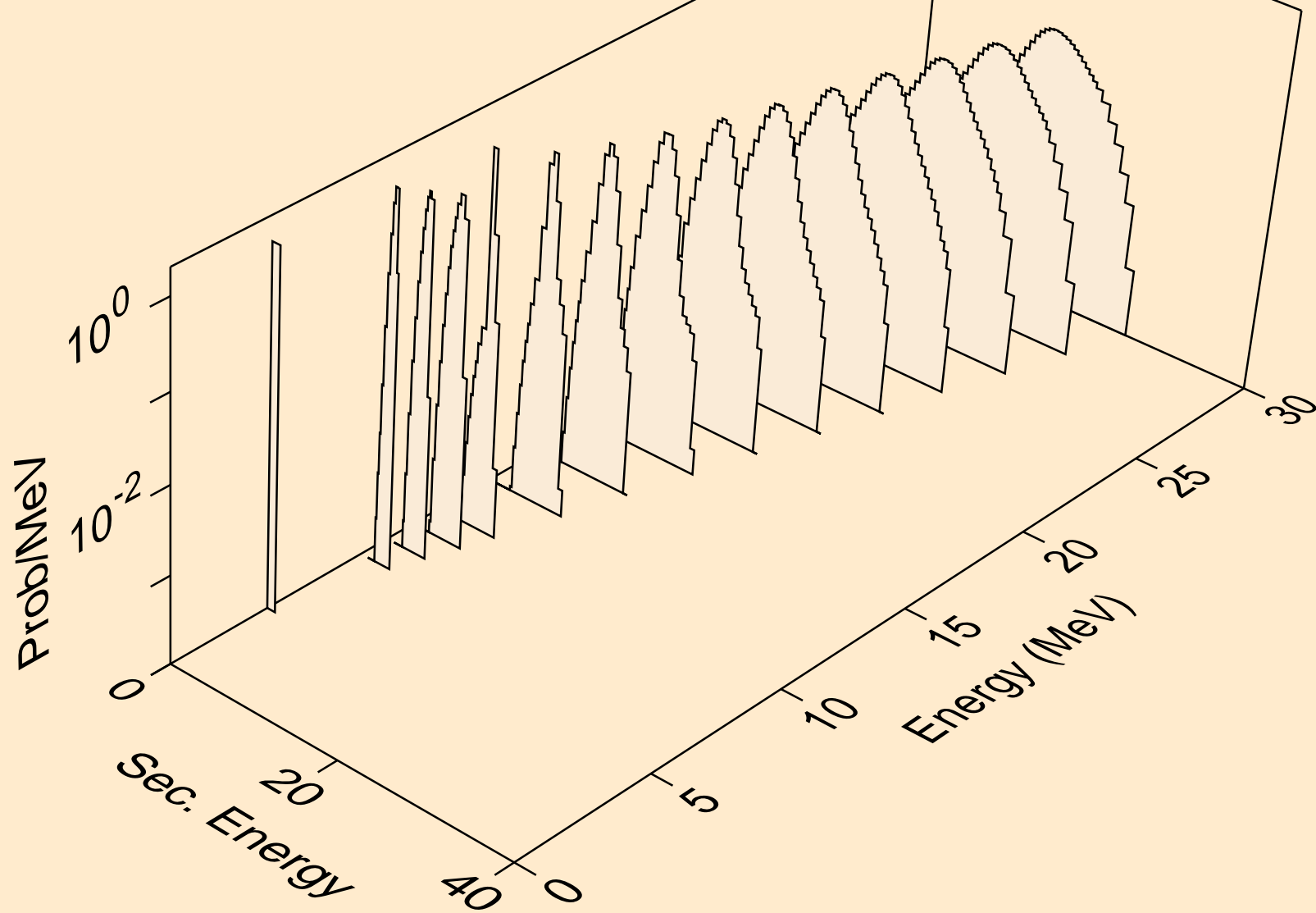

LU164 HELION ACER TENDL-2021 LIBRARY; T=0.K  
protons from (s,2np)

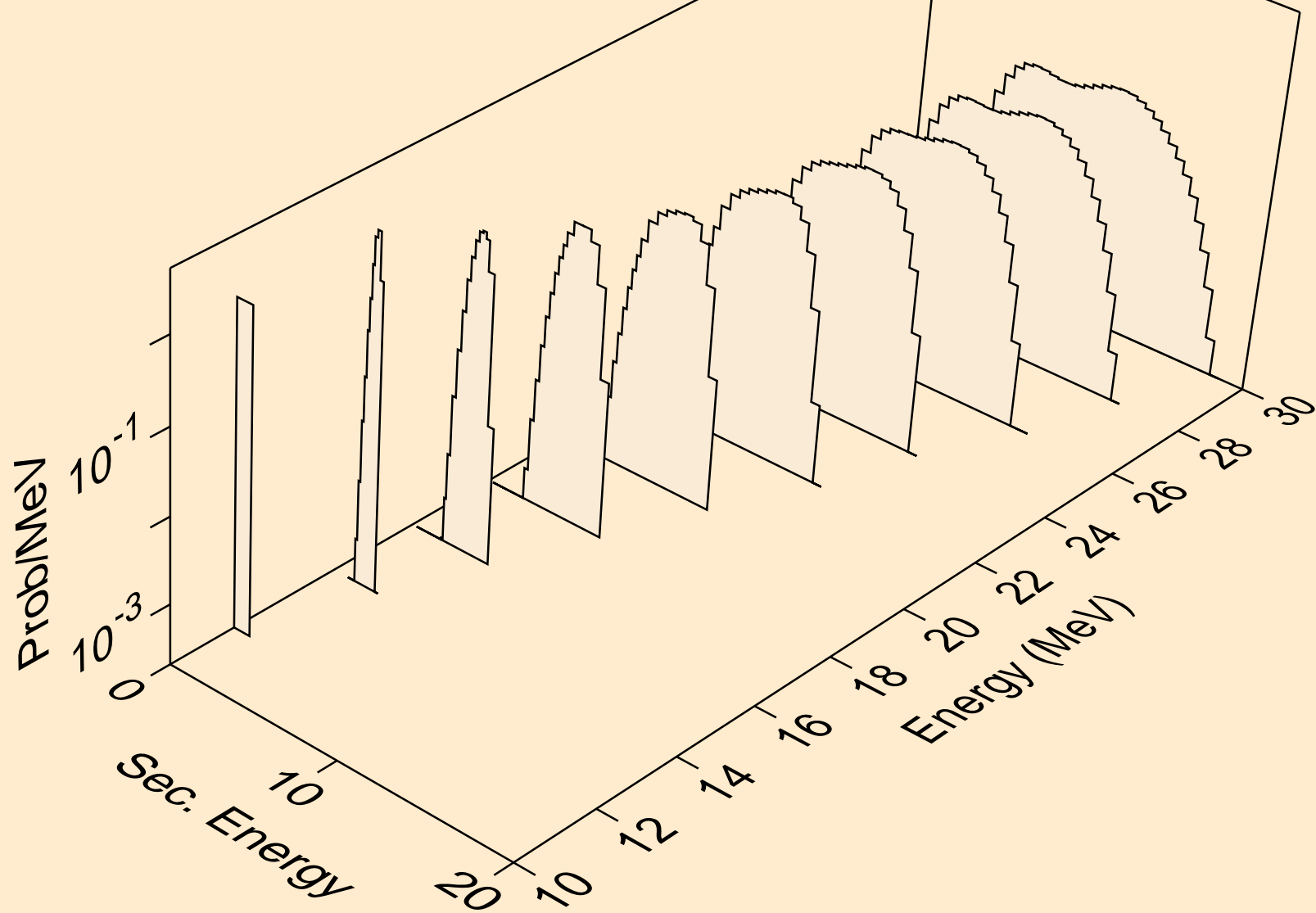



LU164 HELION ACER TENDL-2021 LIBRARY; T=0.K  
protons from (s,3np)

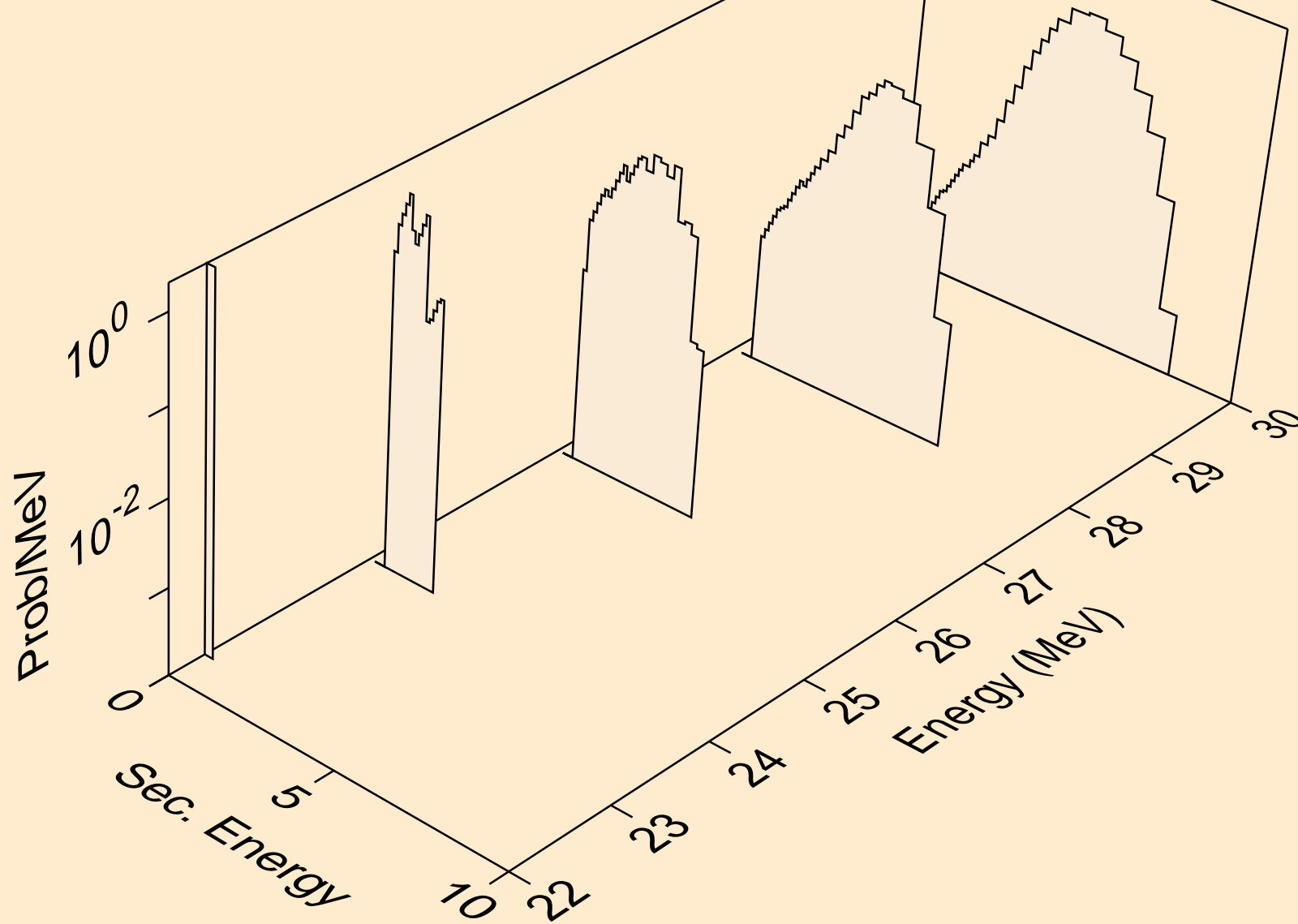

LU164 HELION ACER TENDL-2021 LIBRARY; T=0.K  
protons from (s,2np)

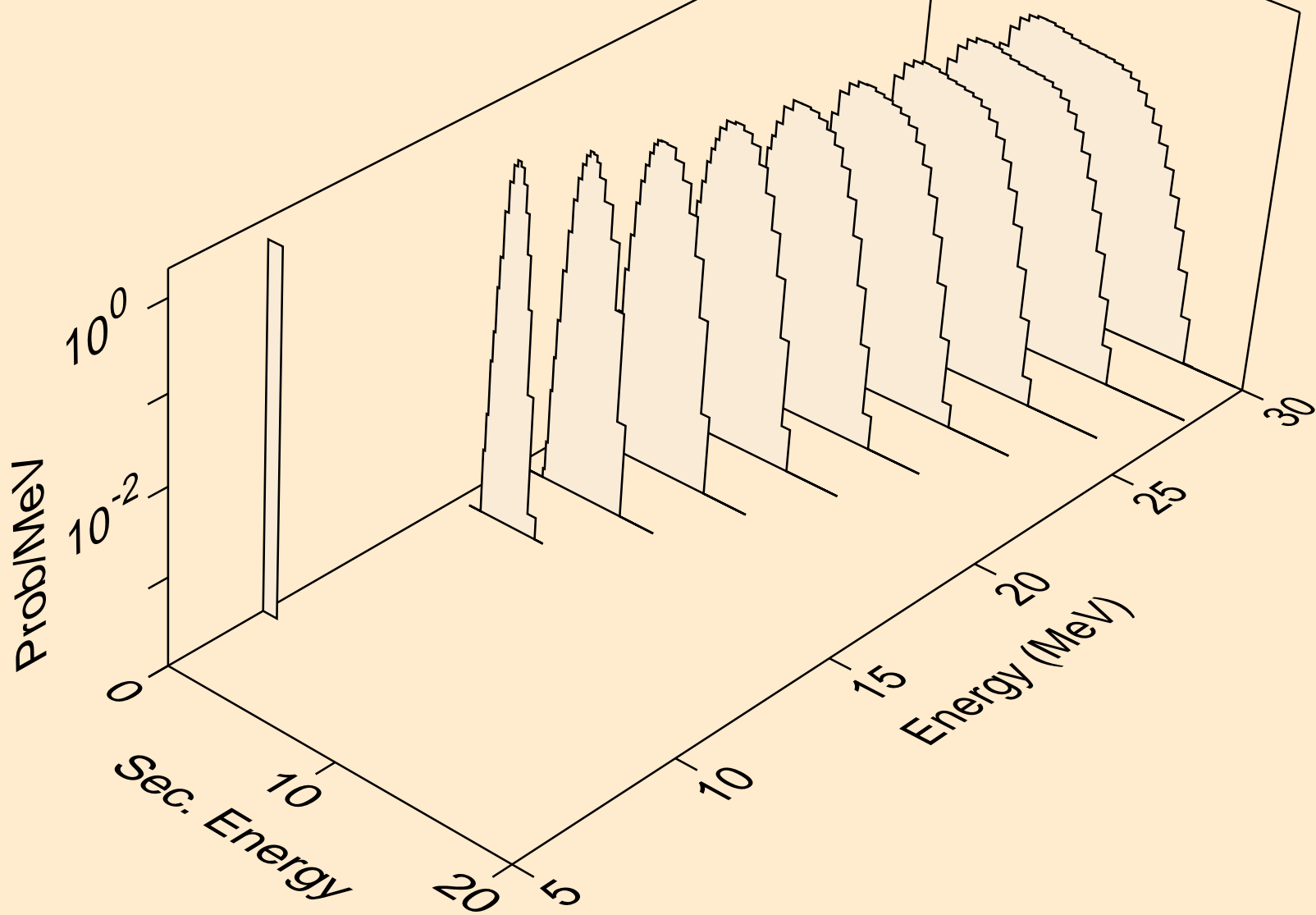

LU164 HELION ACER TENDL-2021 LIBRARY; T=0.K  
protons from (s,npa)

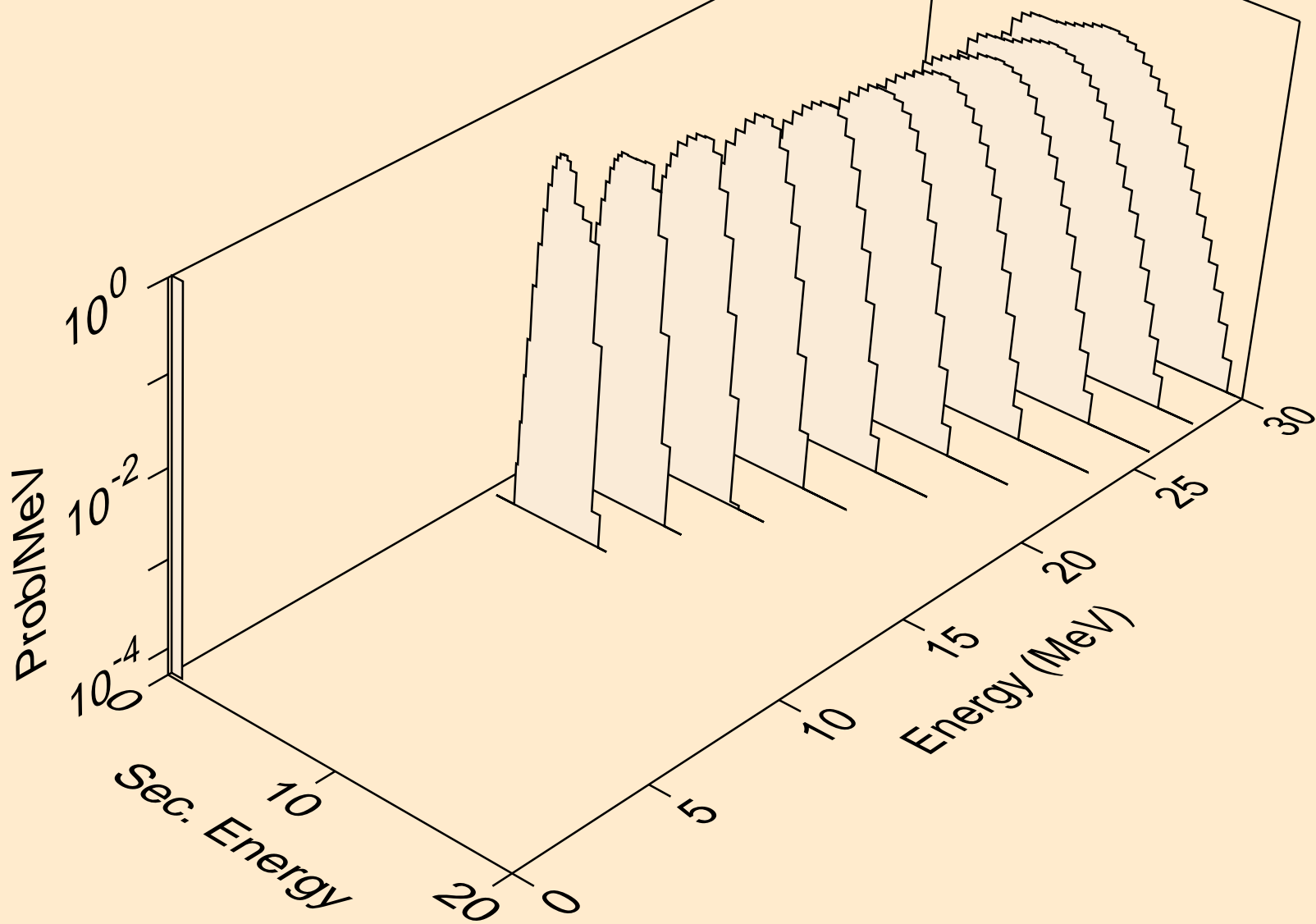

LU164 HELION ACER TENDL-2021 LIBRARY; T=0.K  
protons from (s,p)

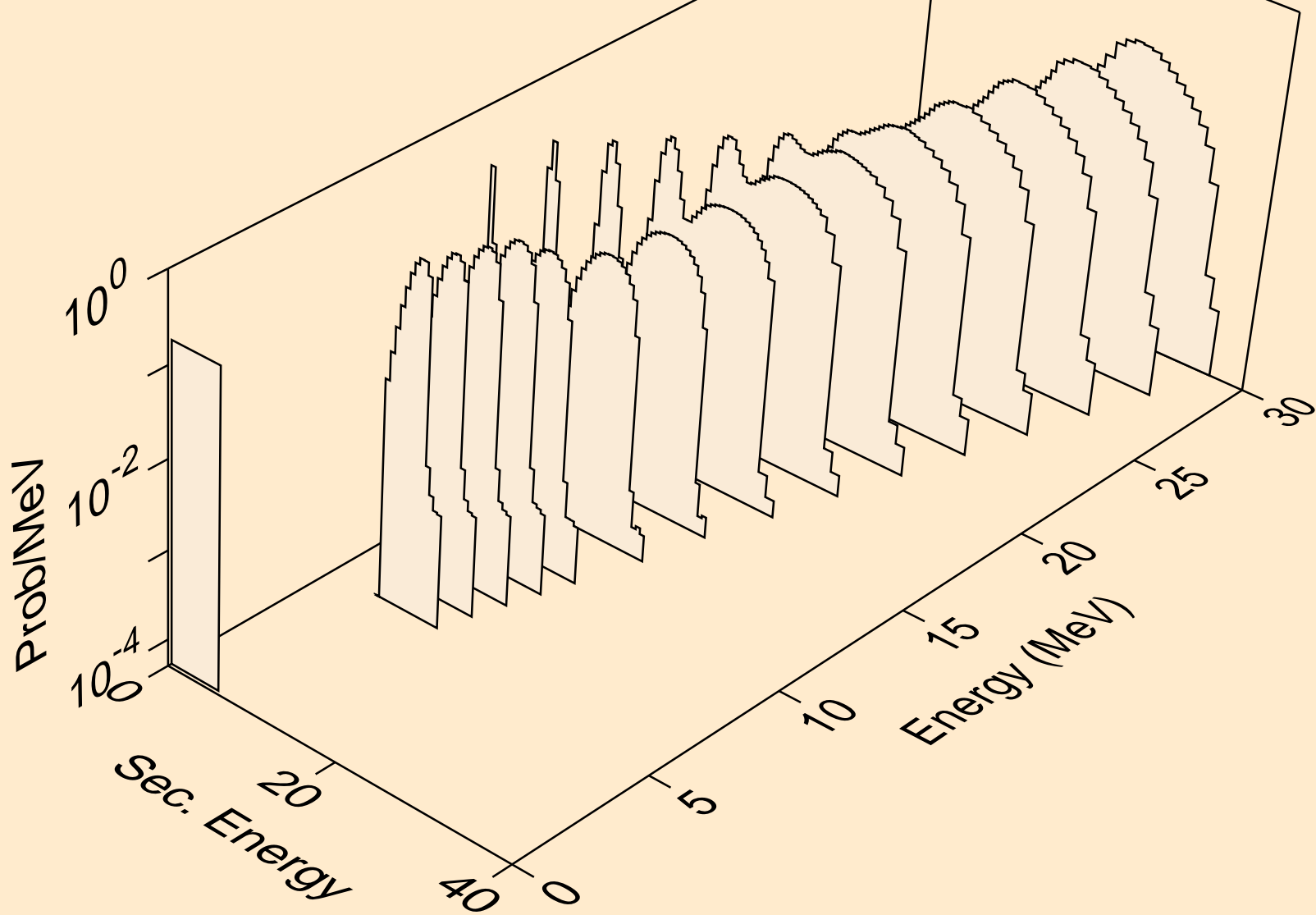

LU164 HELION ACER TENDL-2021 LIBRARY; T=0.K  
protons from (s,2p)

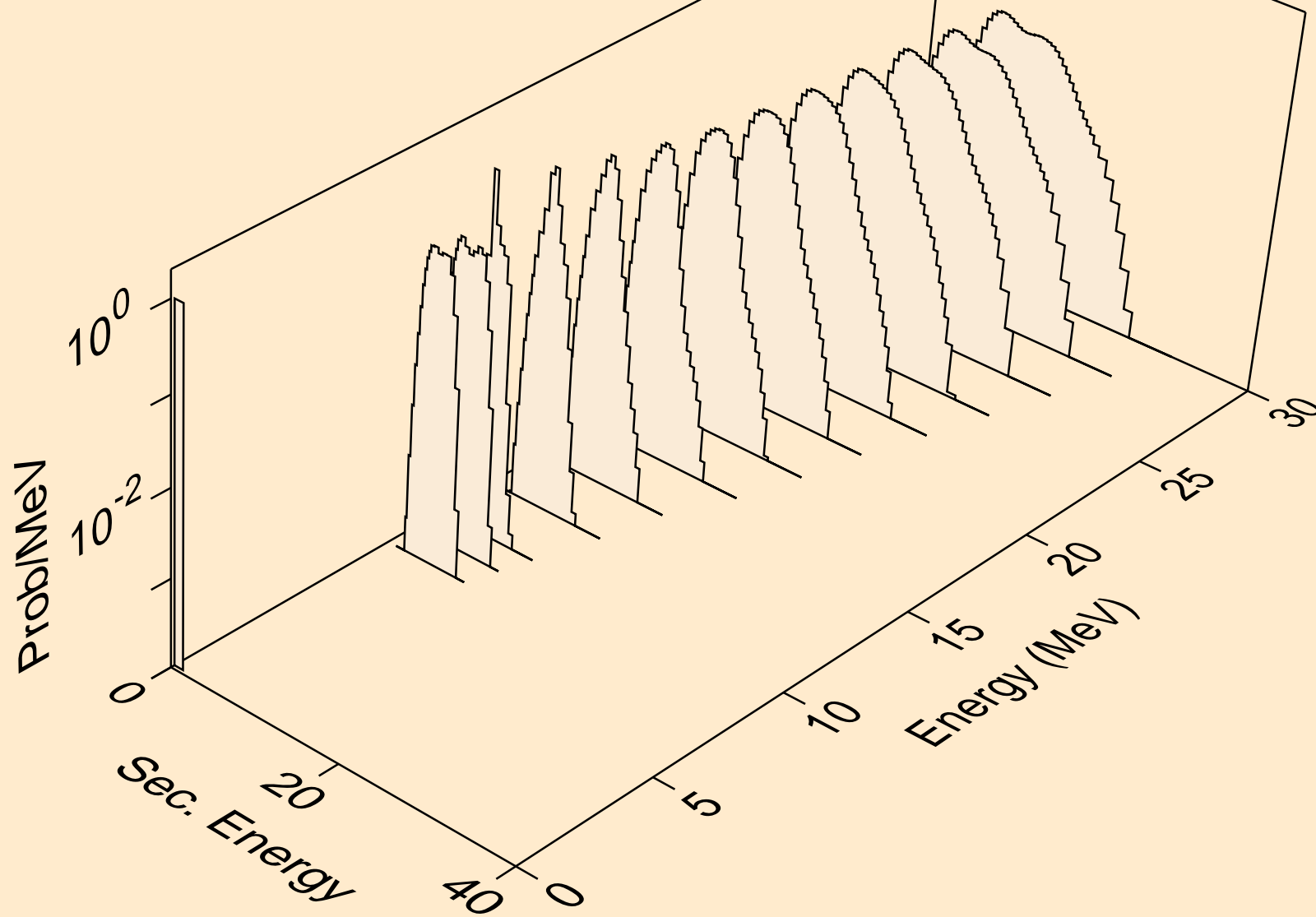

LU164 HELION ACER TENDL-2021 LIBRARY; T=0.K  
protons from (s,pa)

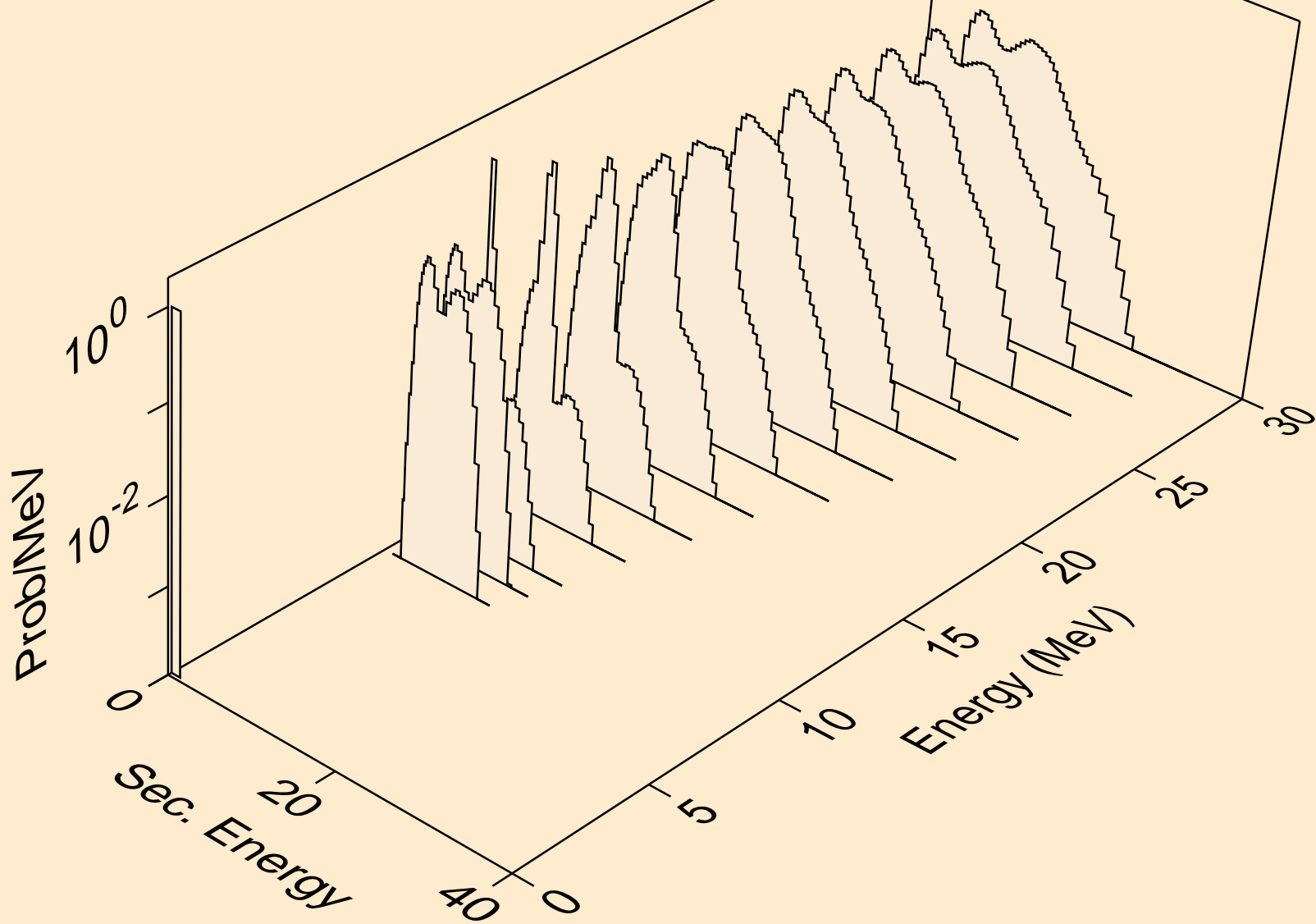

LU164 HELION ACER TENDL-2021 LIBRARY; T=0.K  
protons from (s,pd)

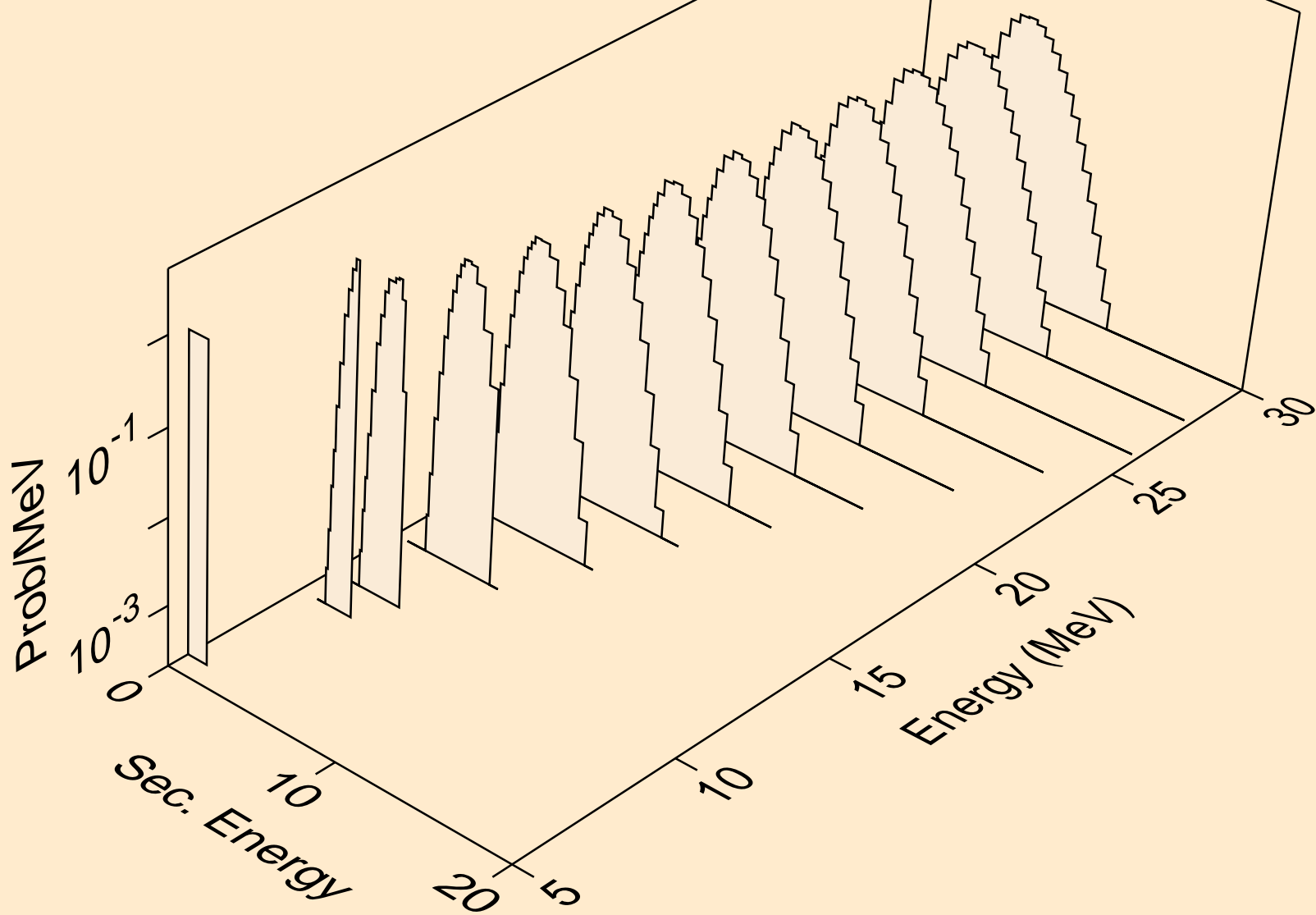

LU164 HELION ACER TENDL-2021 LIBRARY; T=0.K  
protons from (s,pt)

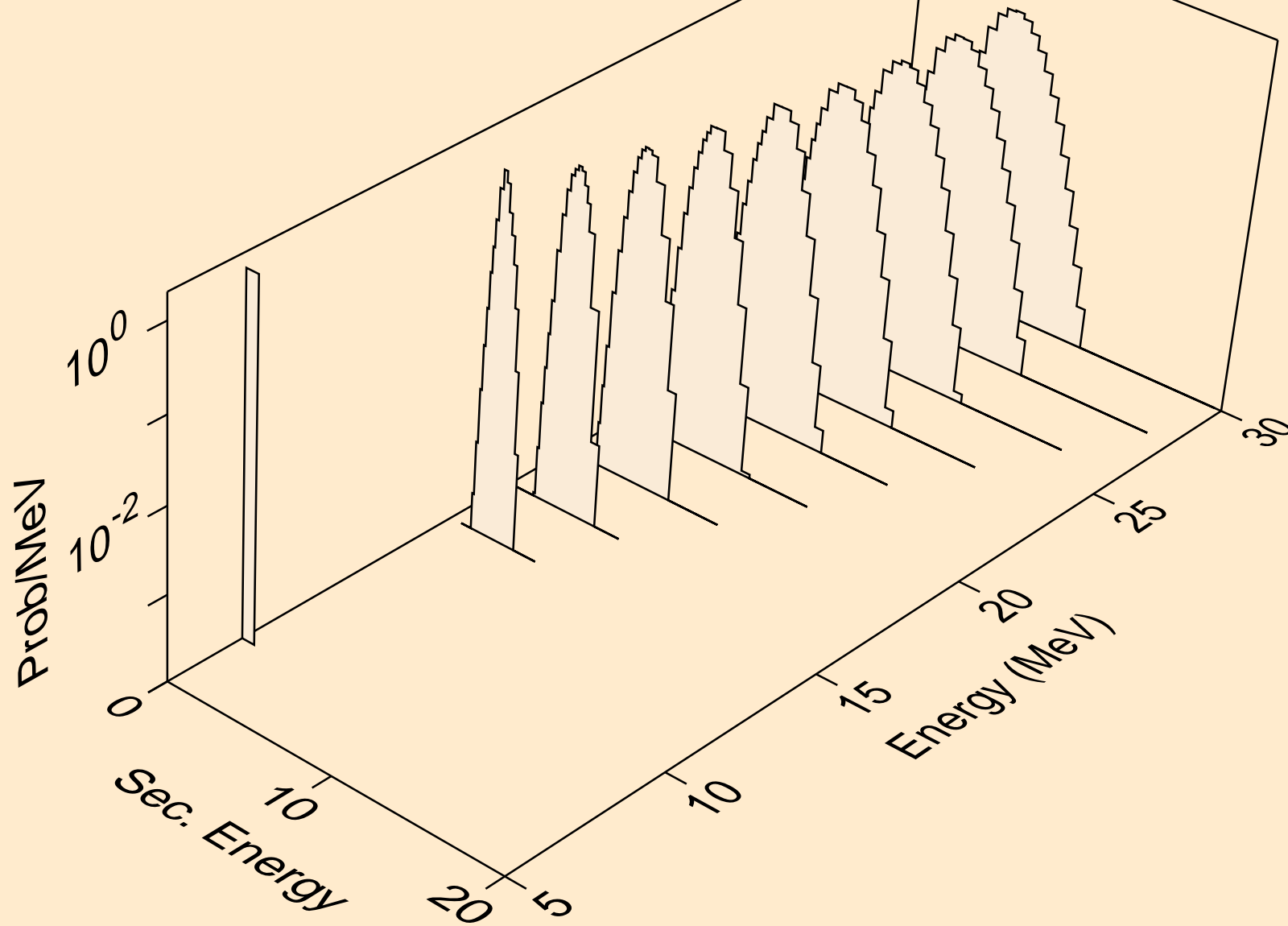



LU164 HELION ACER TENDL-2021 LIBRARY; T=0.K  
deuterons from (s,x)

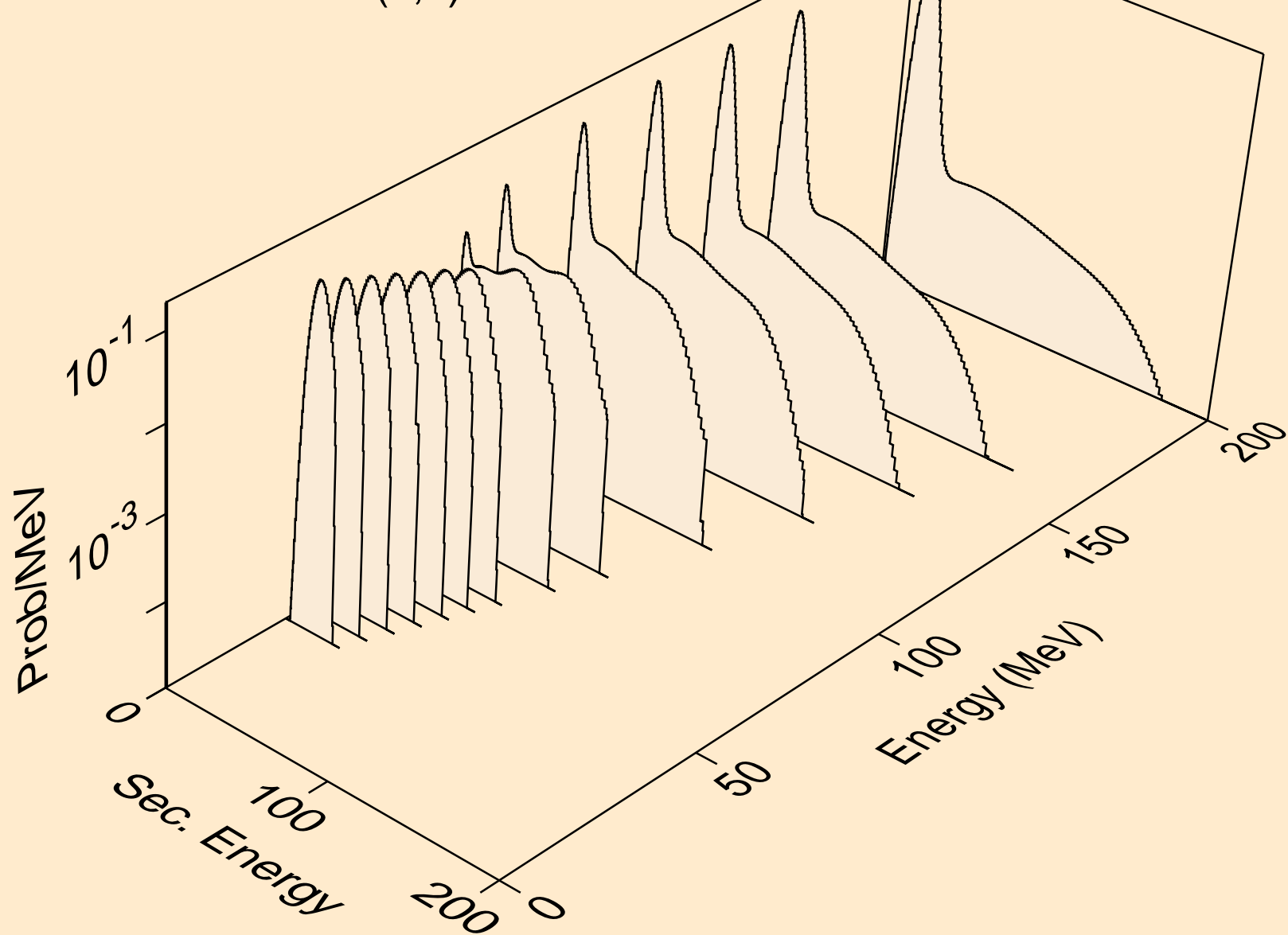

LU164 HELION ACER TENDL-2021 LIBRARY; T=0.K  
deuterons from (s,2nd)

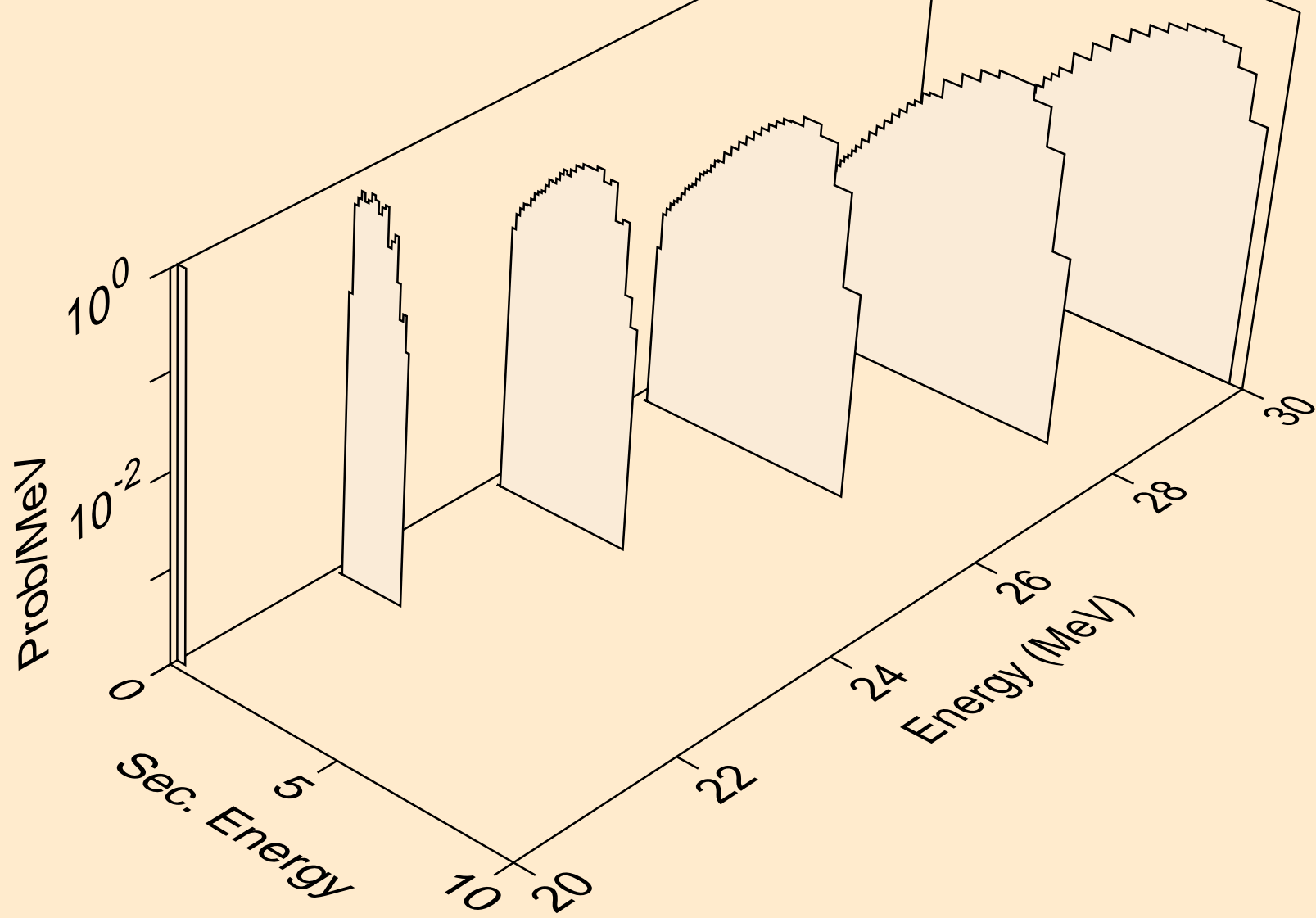

LU164 HELION ACER TENDL-2021 LIBRARY; T=0.K  
deuterons from (s,n\*)d

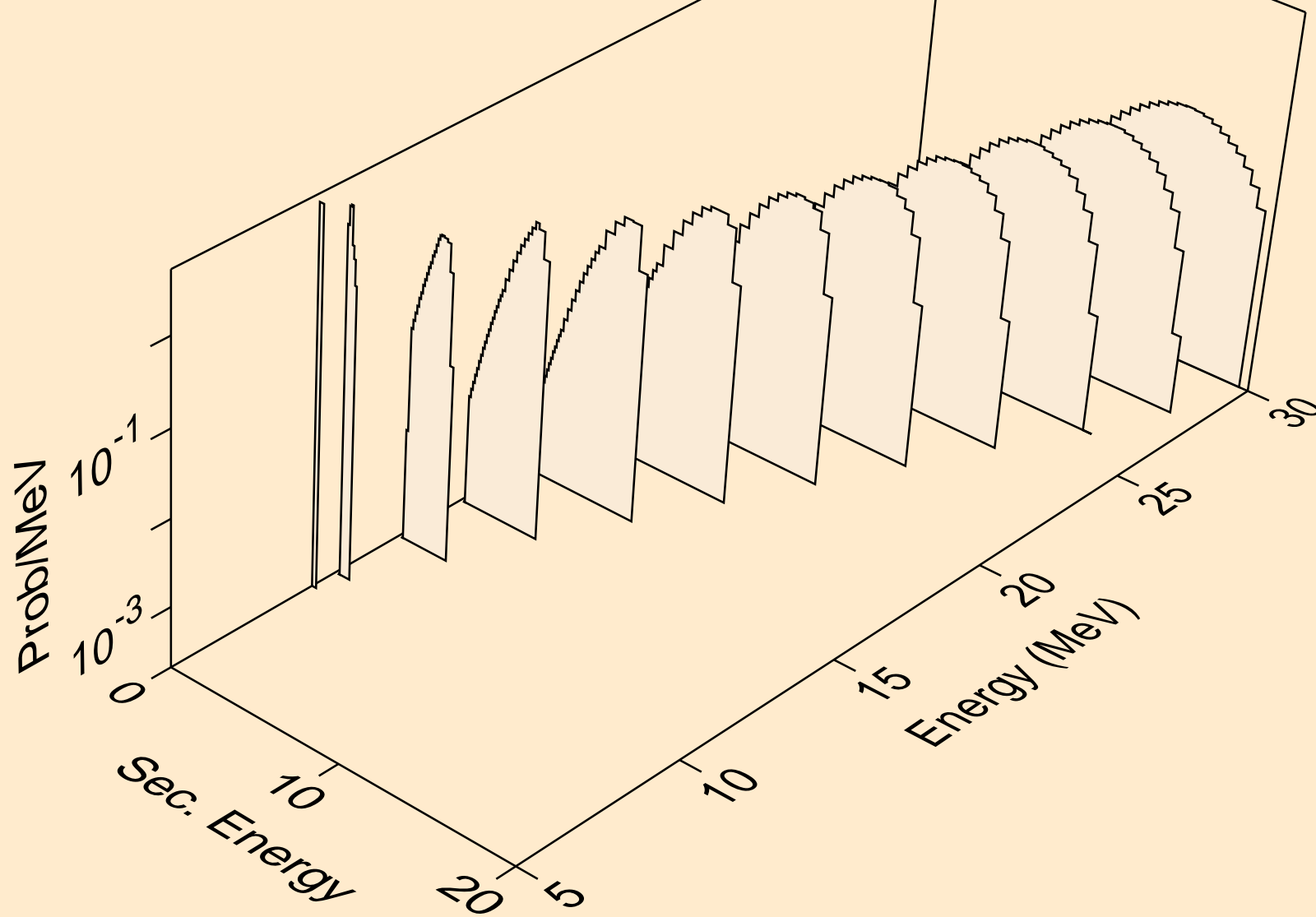

LU164 HELION ACER TENDL-2021 LIBRARY; T=0.K  
deuterons from (s,d)

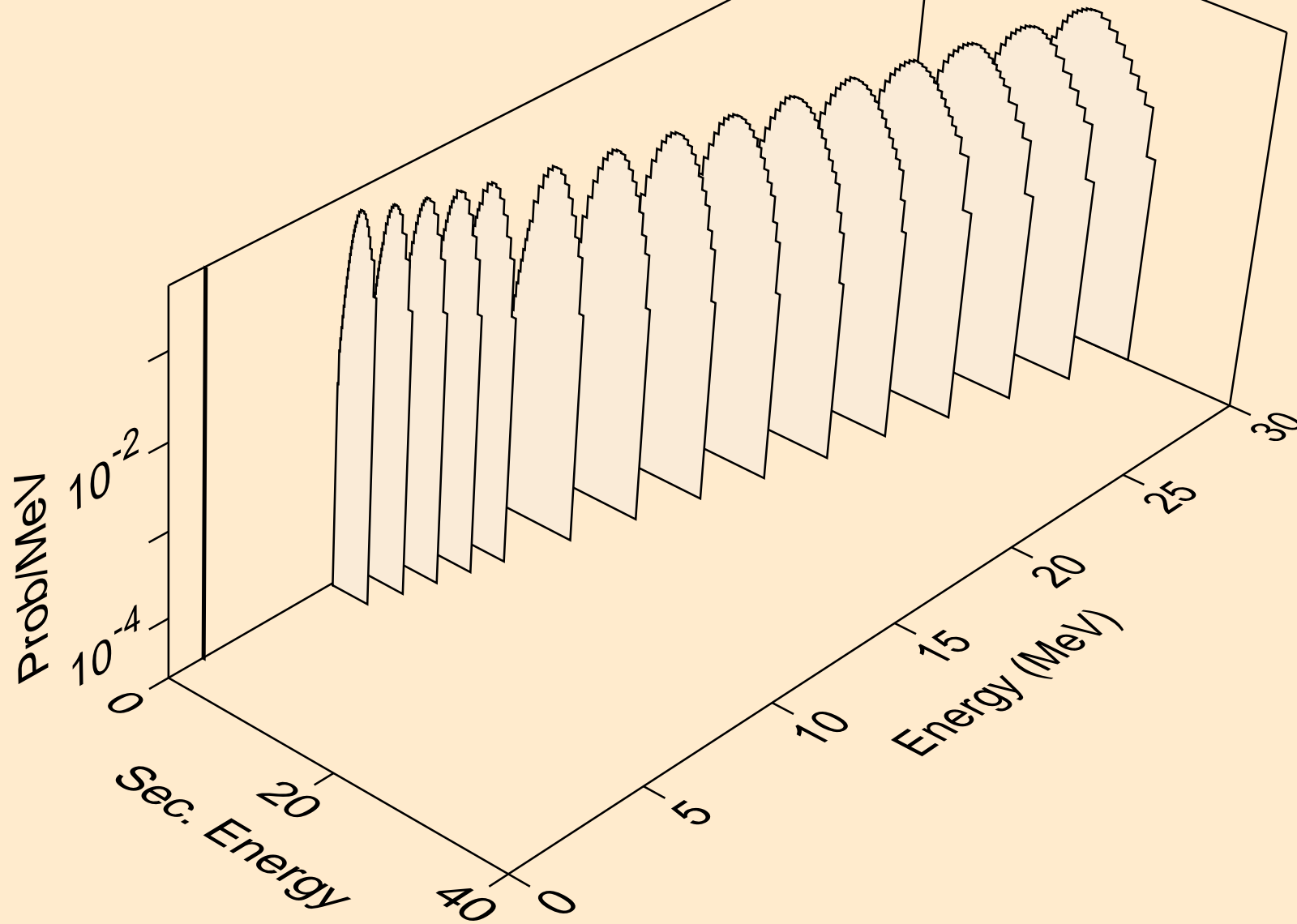

LU164 HELION ACER TENDL-2021 LIBRARY; T=0.K  
deuterons from (s,pd)

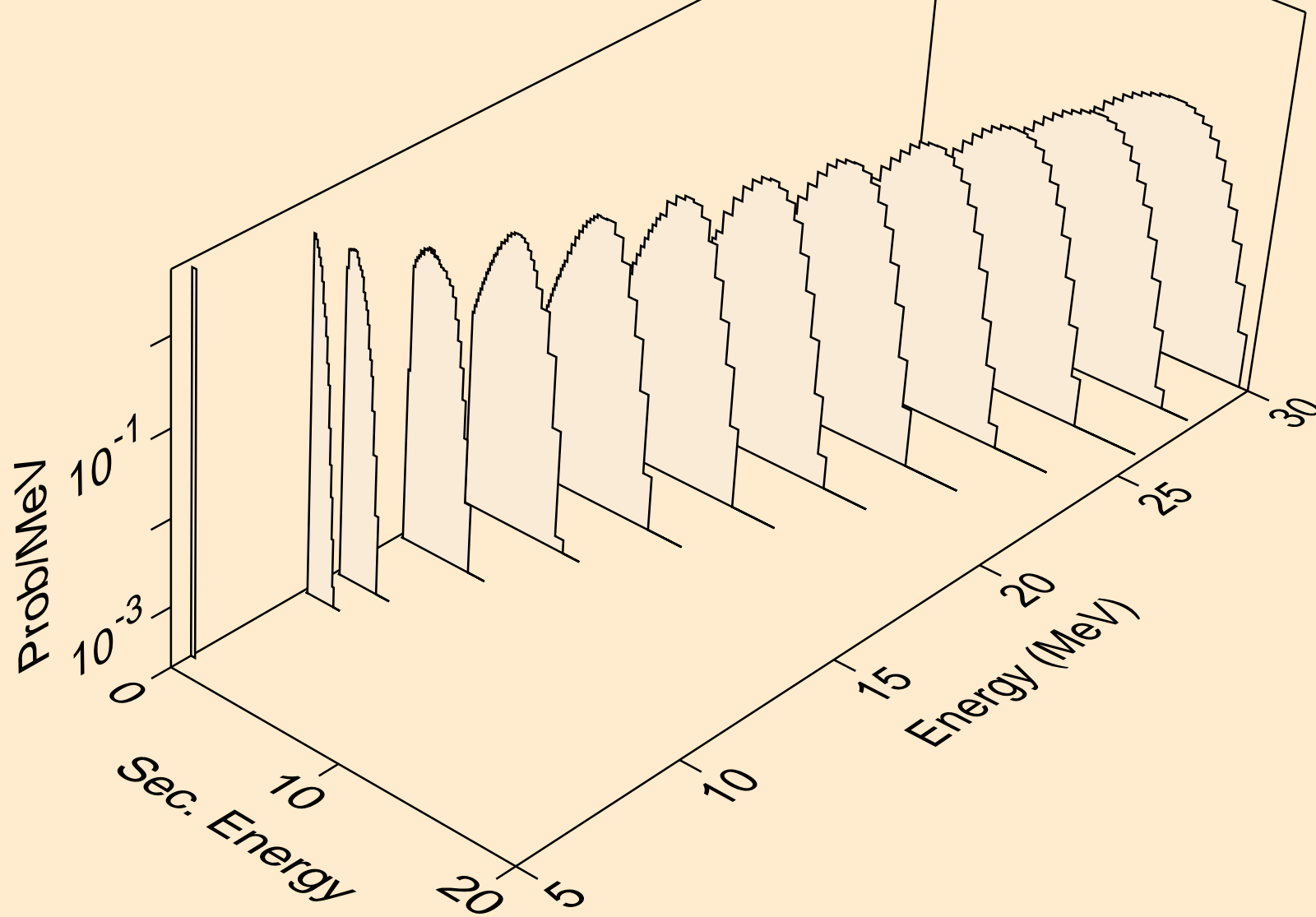

LU164 HELION ACER TENDL-2021 LIBRARY; T=0.K  
deuterons from (s,da)

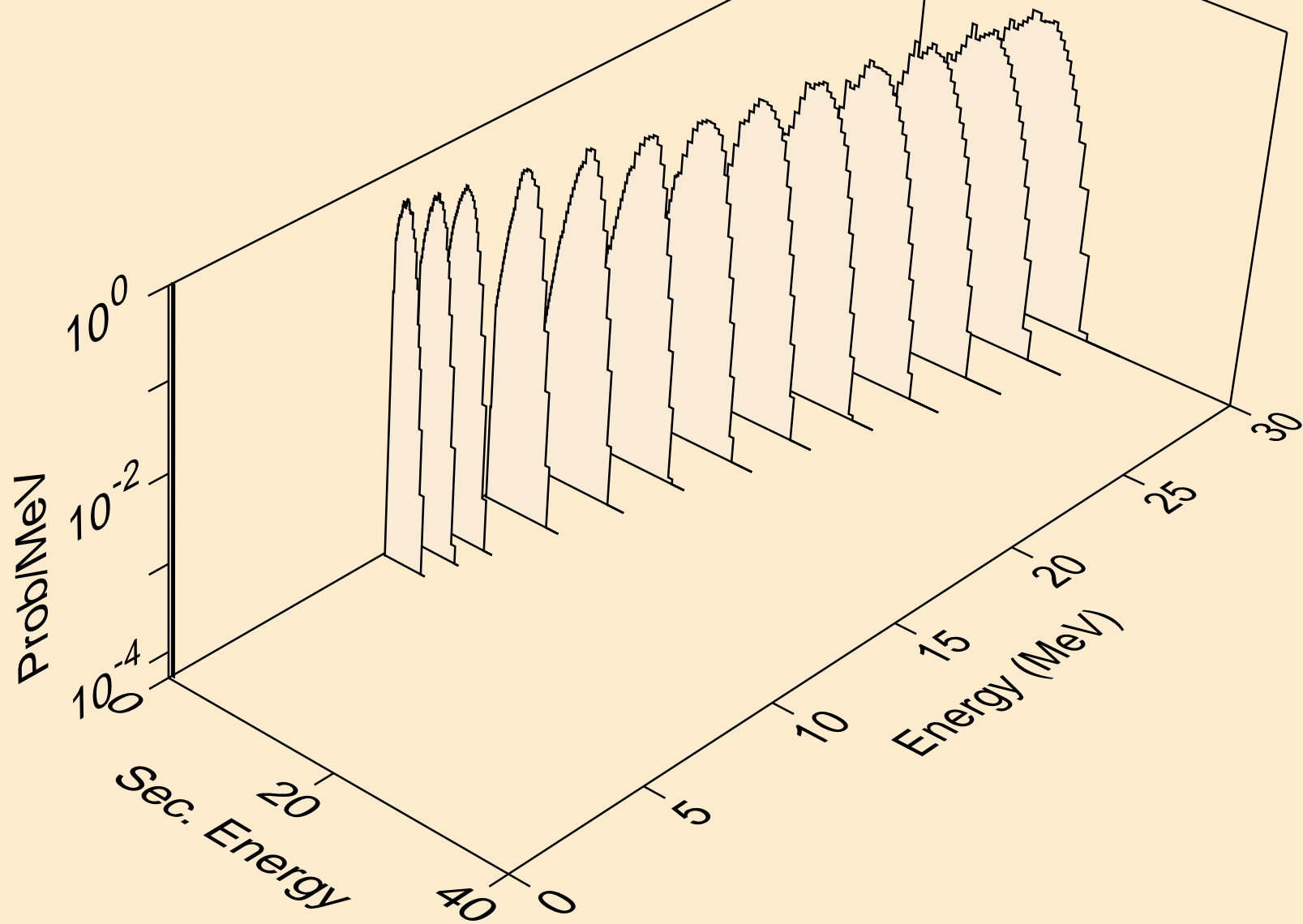

LU164 HELION ACER TENDL-2021 LIBRARY; T=0.K  
tritons from (s,x)

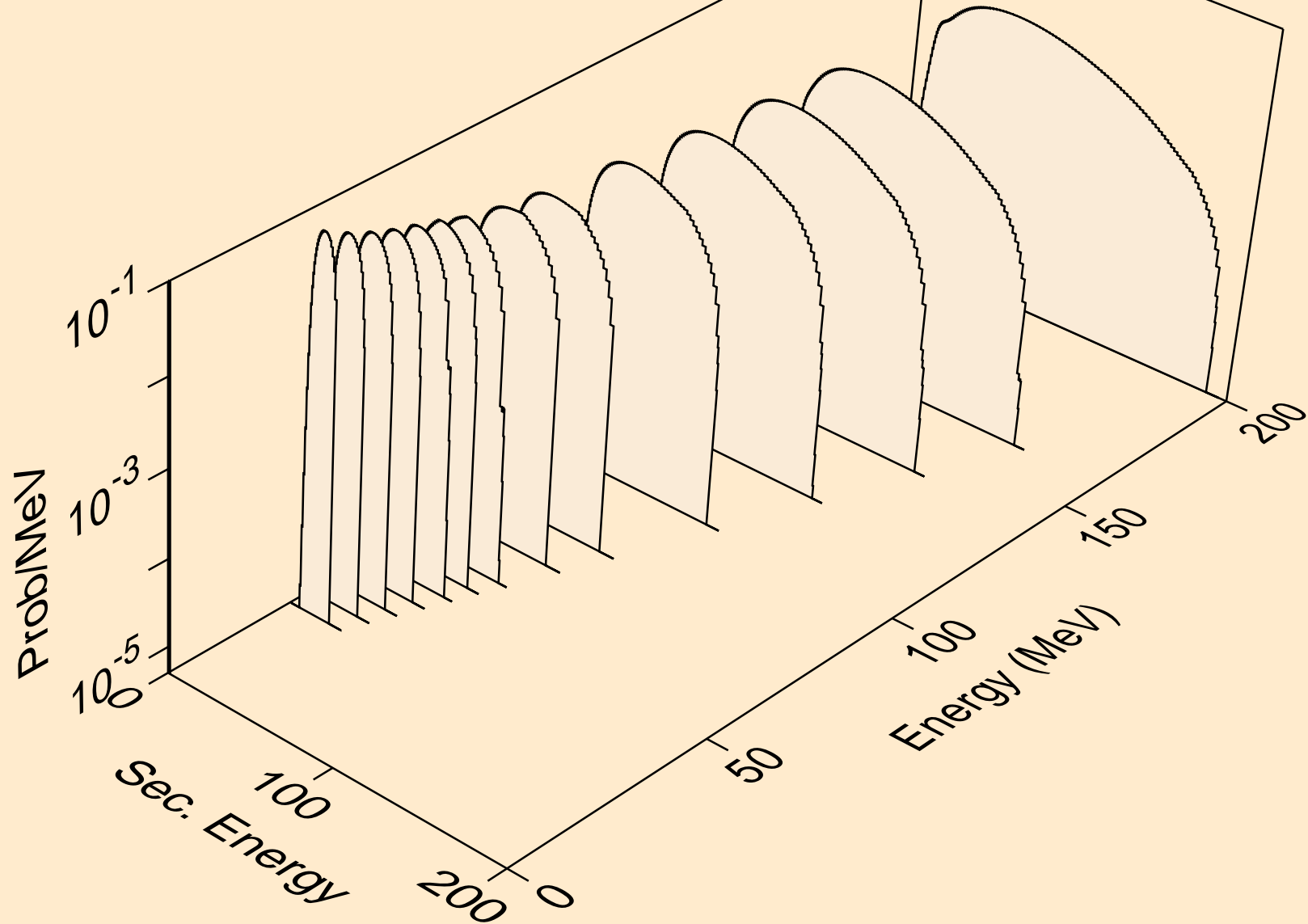

LU164 HELION ACER TENDL-2021 LIBRARY; T=0.K  
tritons from (s,n\*)t

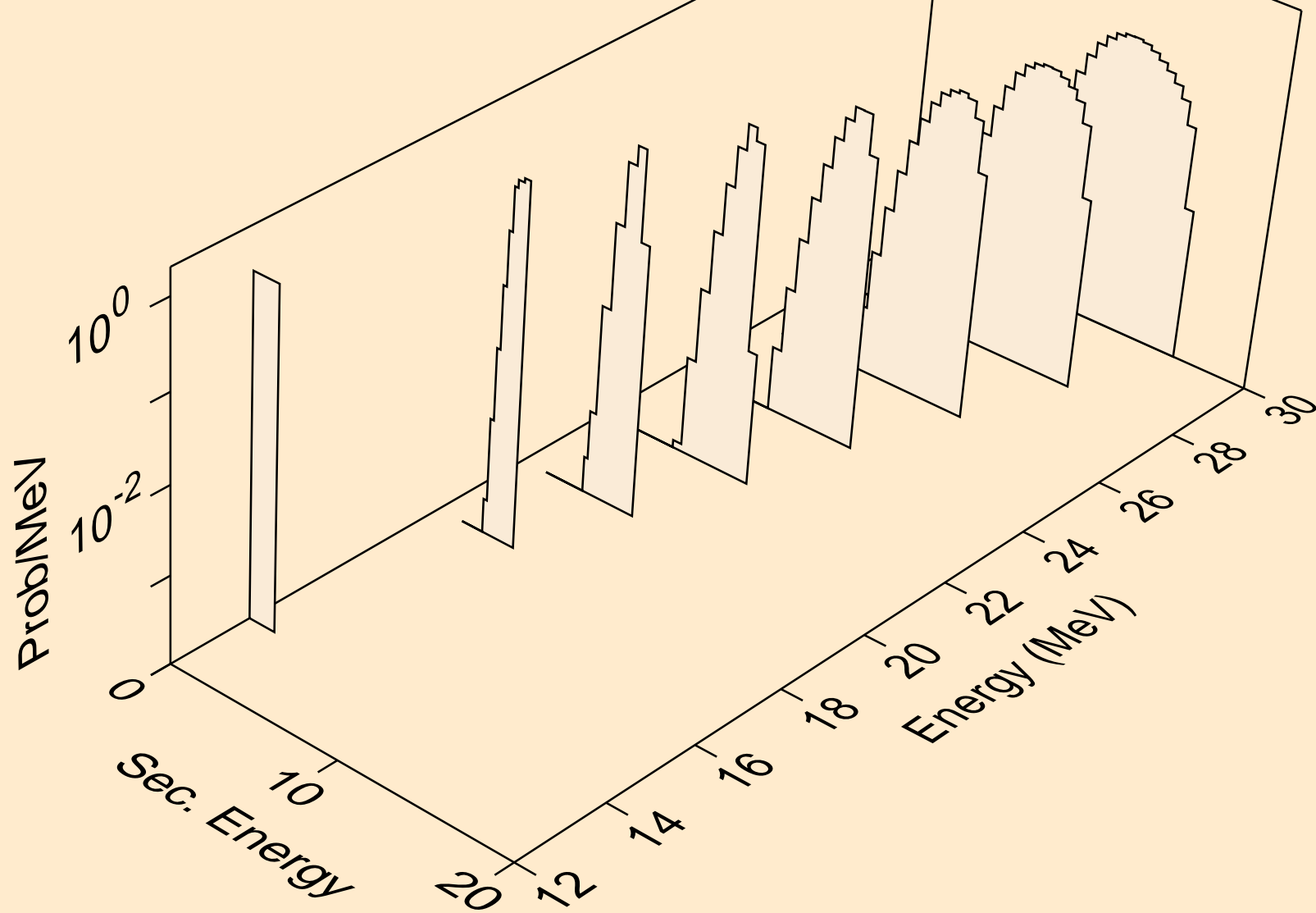



LU164 HELION ACER TENDL-2021 LIBRARY; T=0.K  
tritons from (s,t)

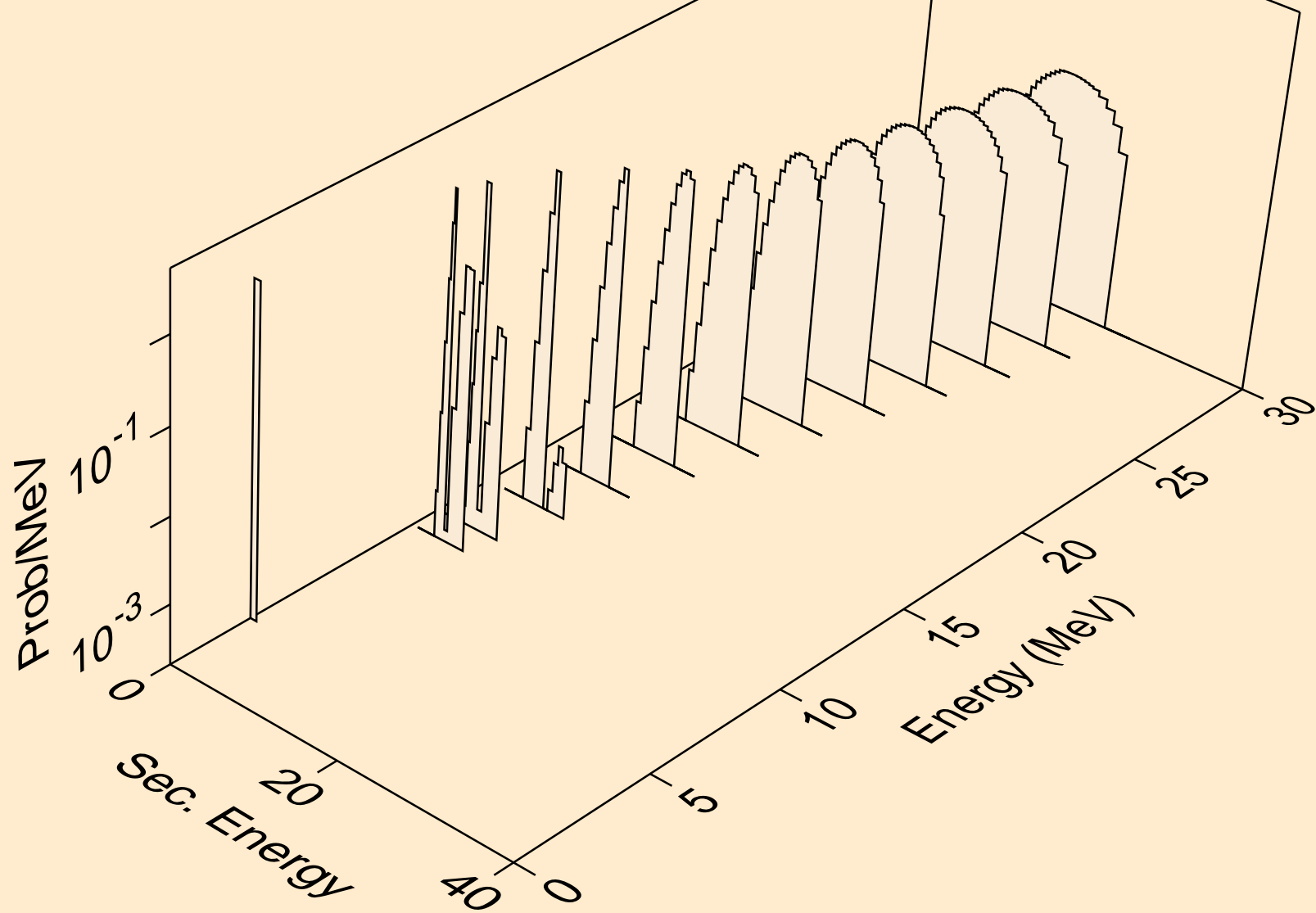

LU164 HELION ACER TENDL-2021 LIBRARY; T=0.K  
tritons from (s,t2a)

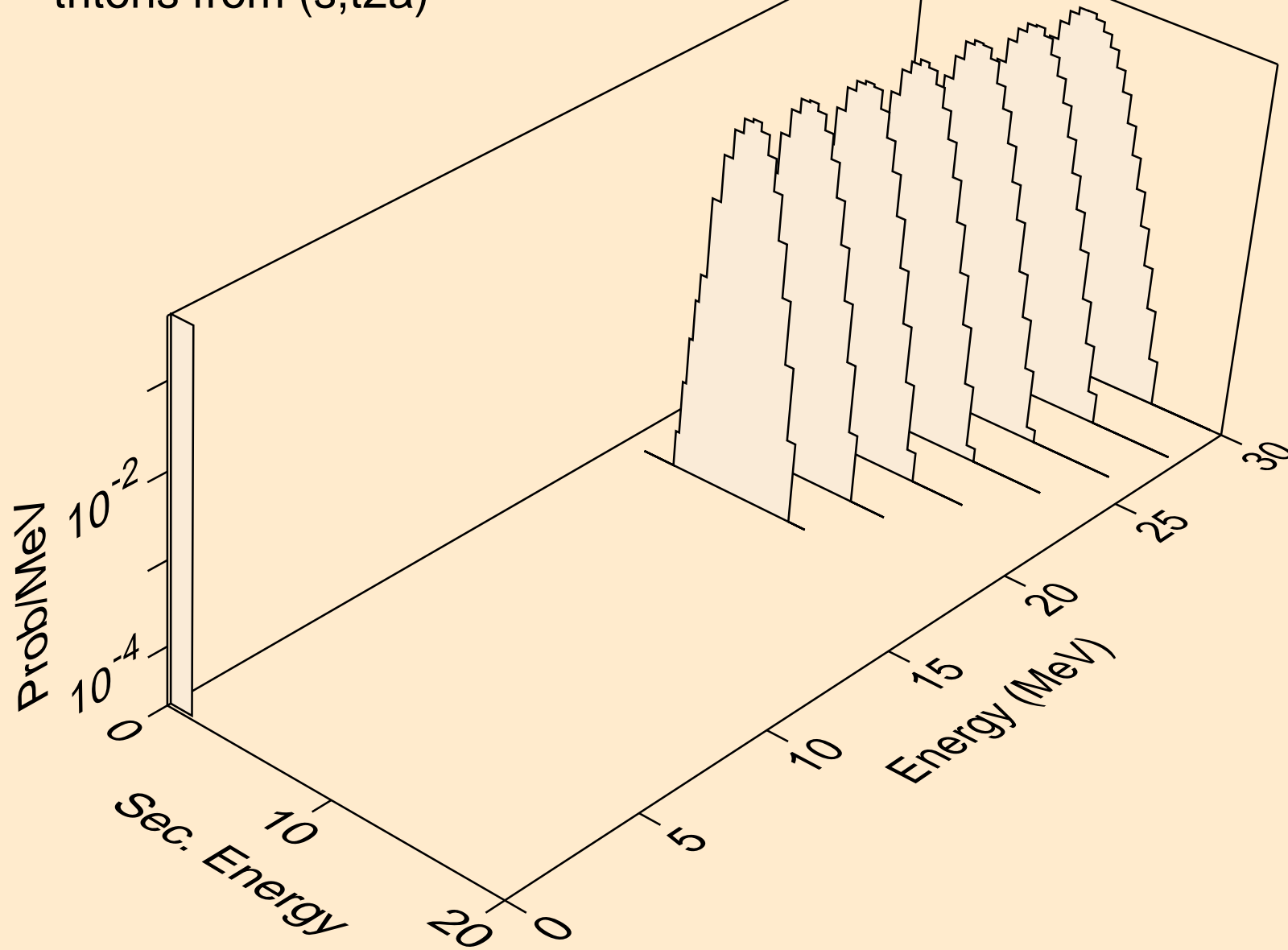

LU164 HELION ACER TENDL-2021 LIBRARY; T=0.K  
tritons from (s,pt)

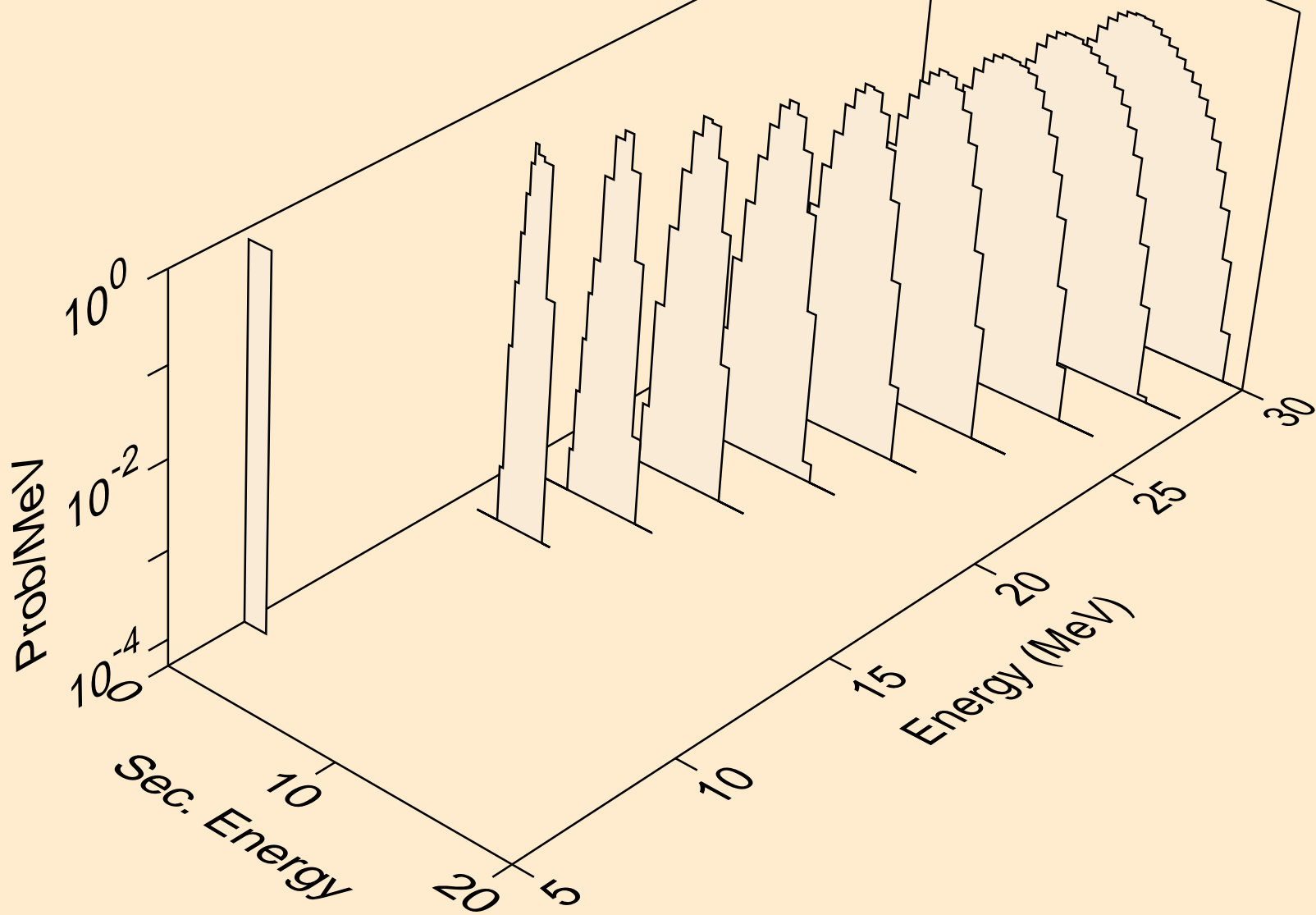

LU164 HELION ACER TENDL-2021 LIBRARY; T=0.K  
alphas from (s,x)

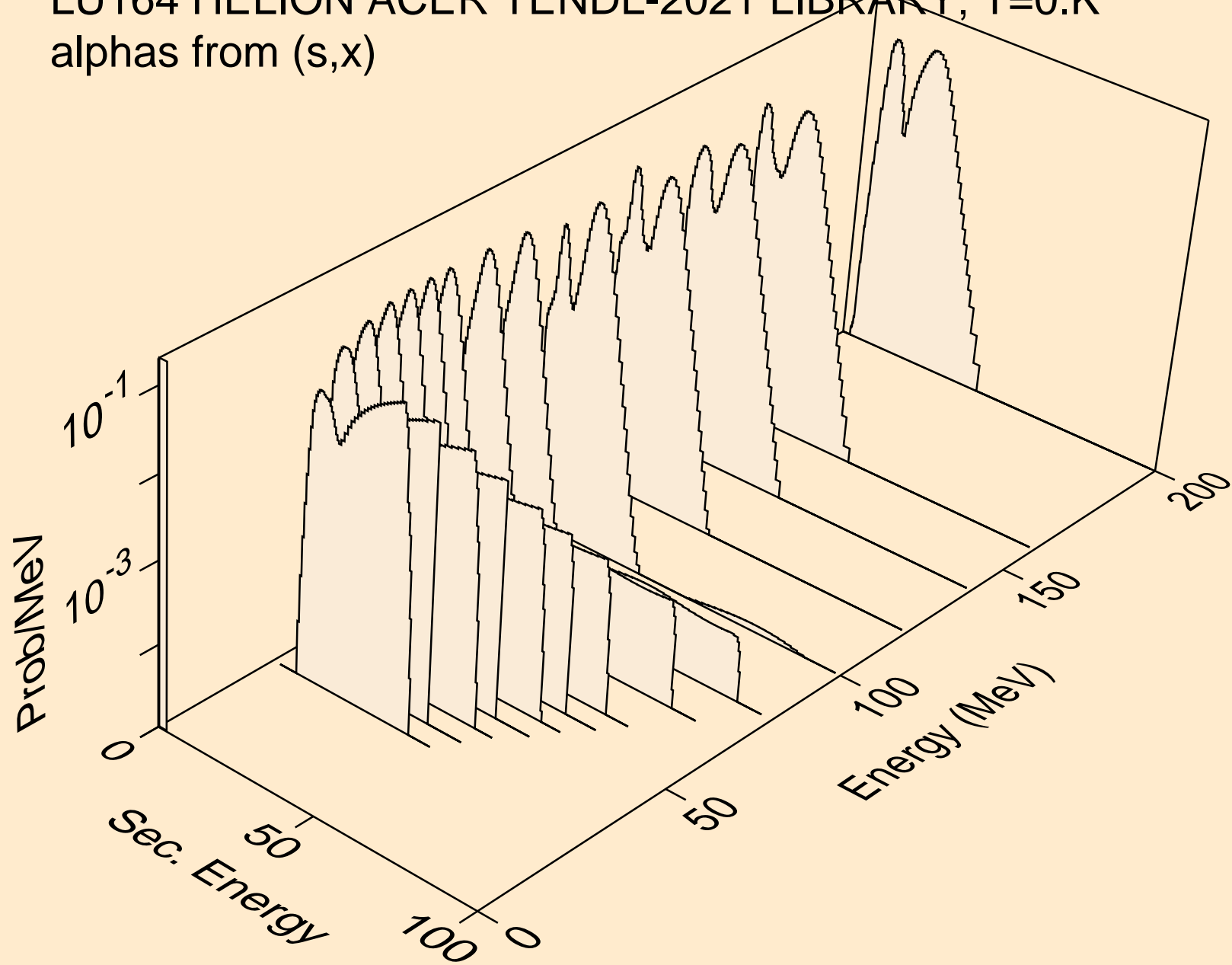

LU164 HELION ACER TENDL-2021 LIBRARY; T=0.K  
alphas from (s,n\*)a

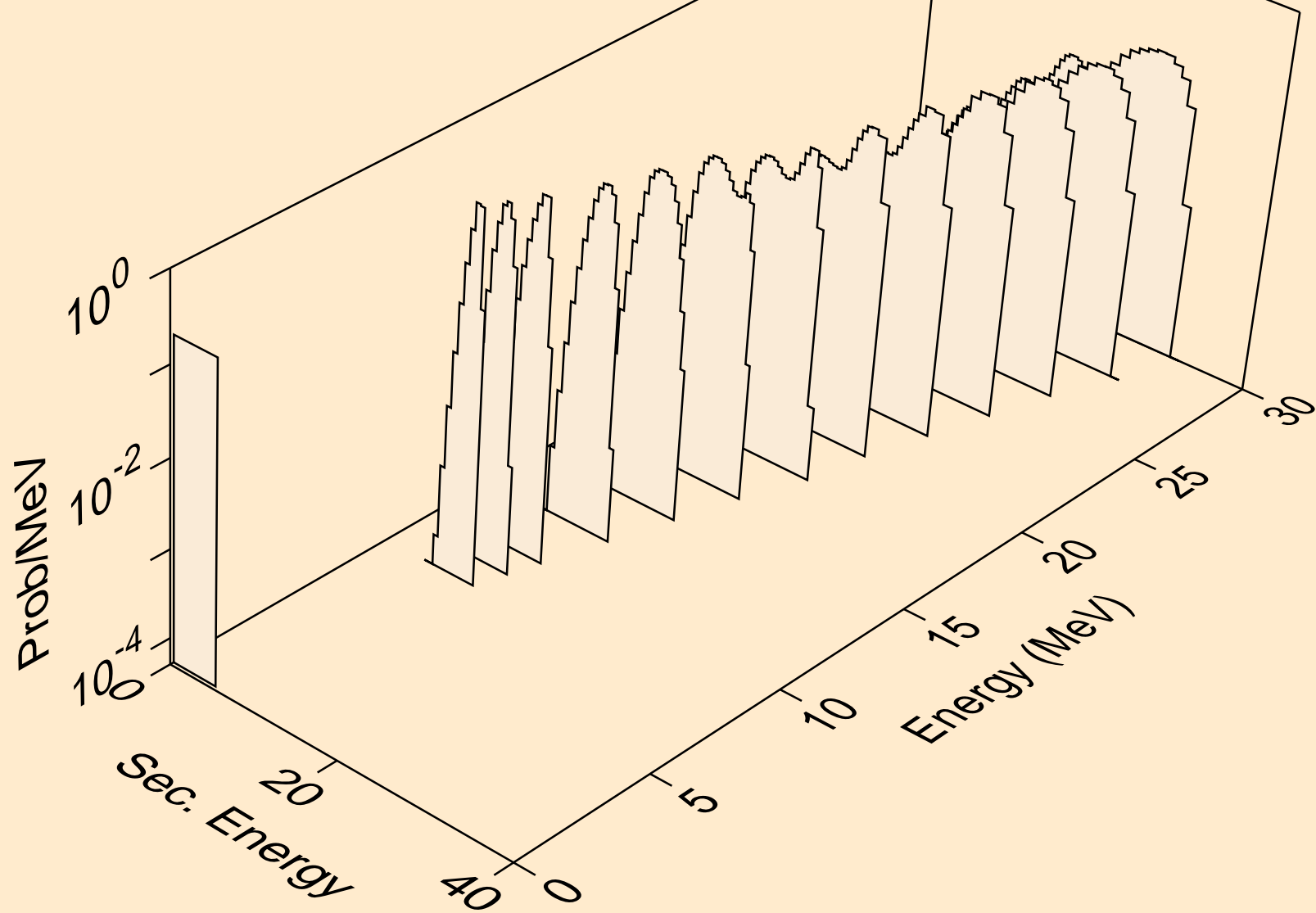

LU164 HELION ACER TENDL-2021 LIBRARY; T=0.K  
alphas from (s,2n)a

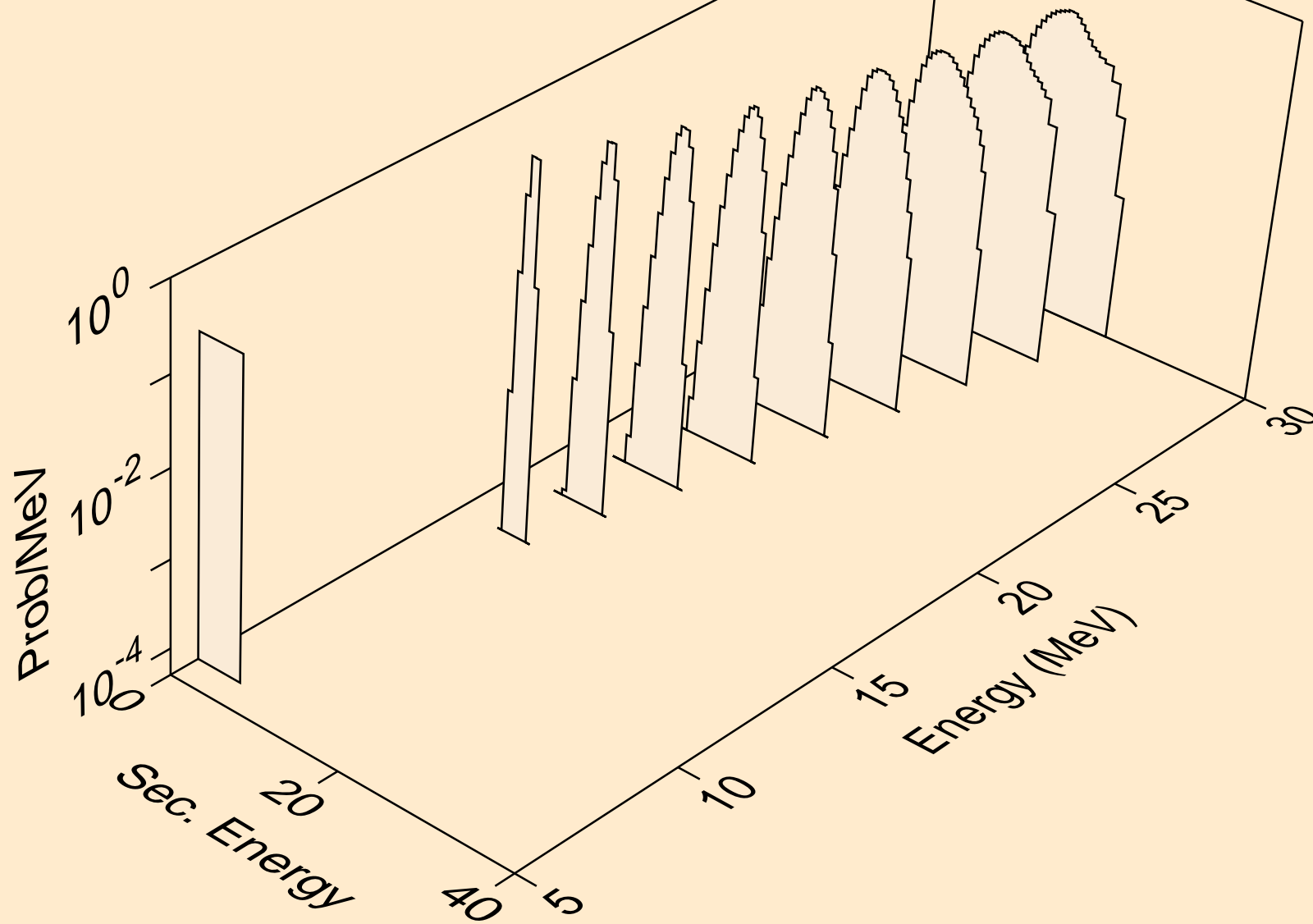

LU164 HELION ACER TENDL-2021 LIBRARY; T=0.K  
alphas from (s,3n)a

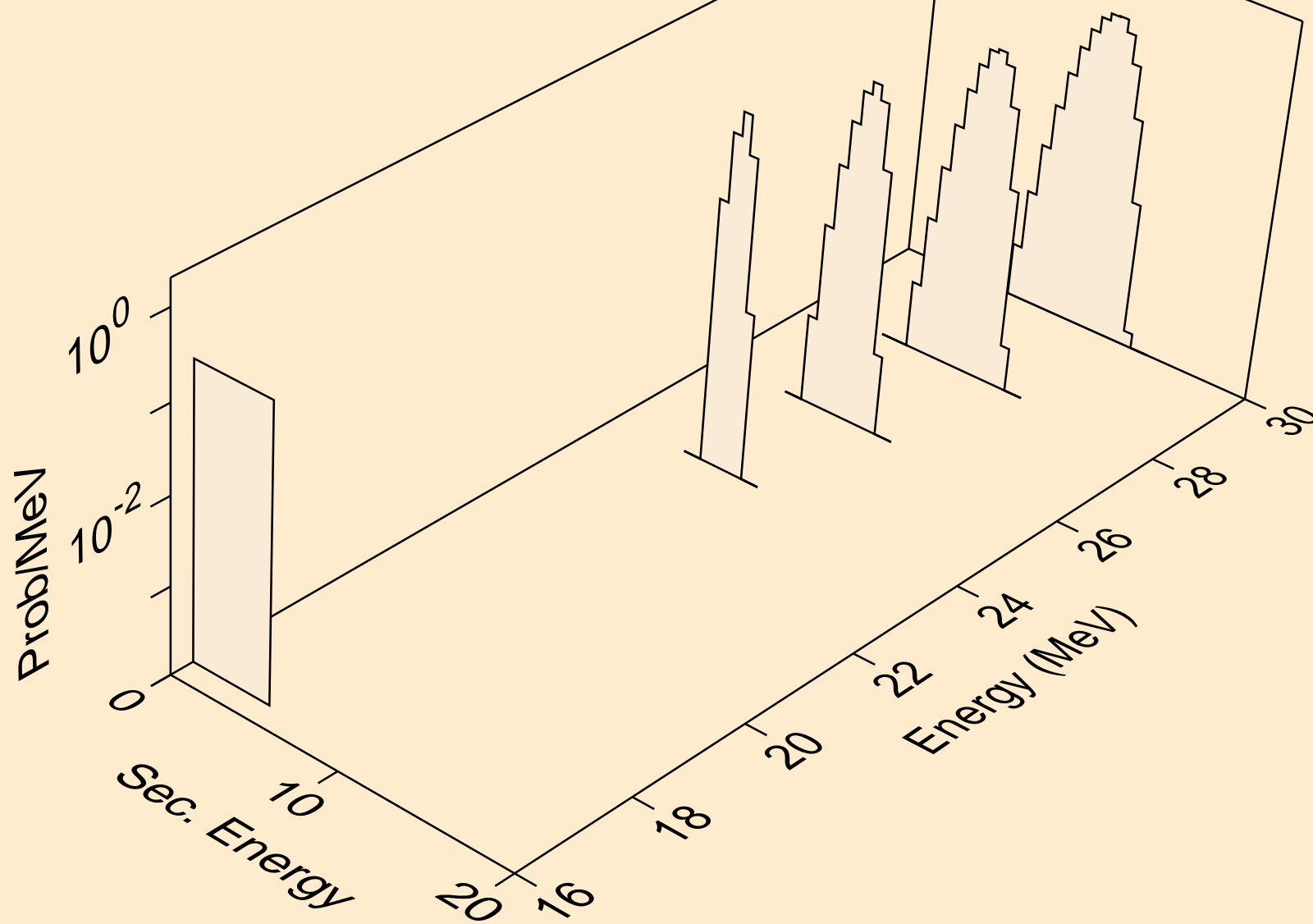

LU164 HELION ACER TENDL-2021 LIBRARY; T=0.K  
alphas from (s,n\*)2a

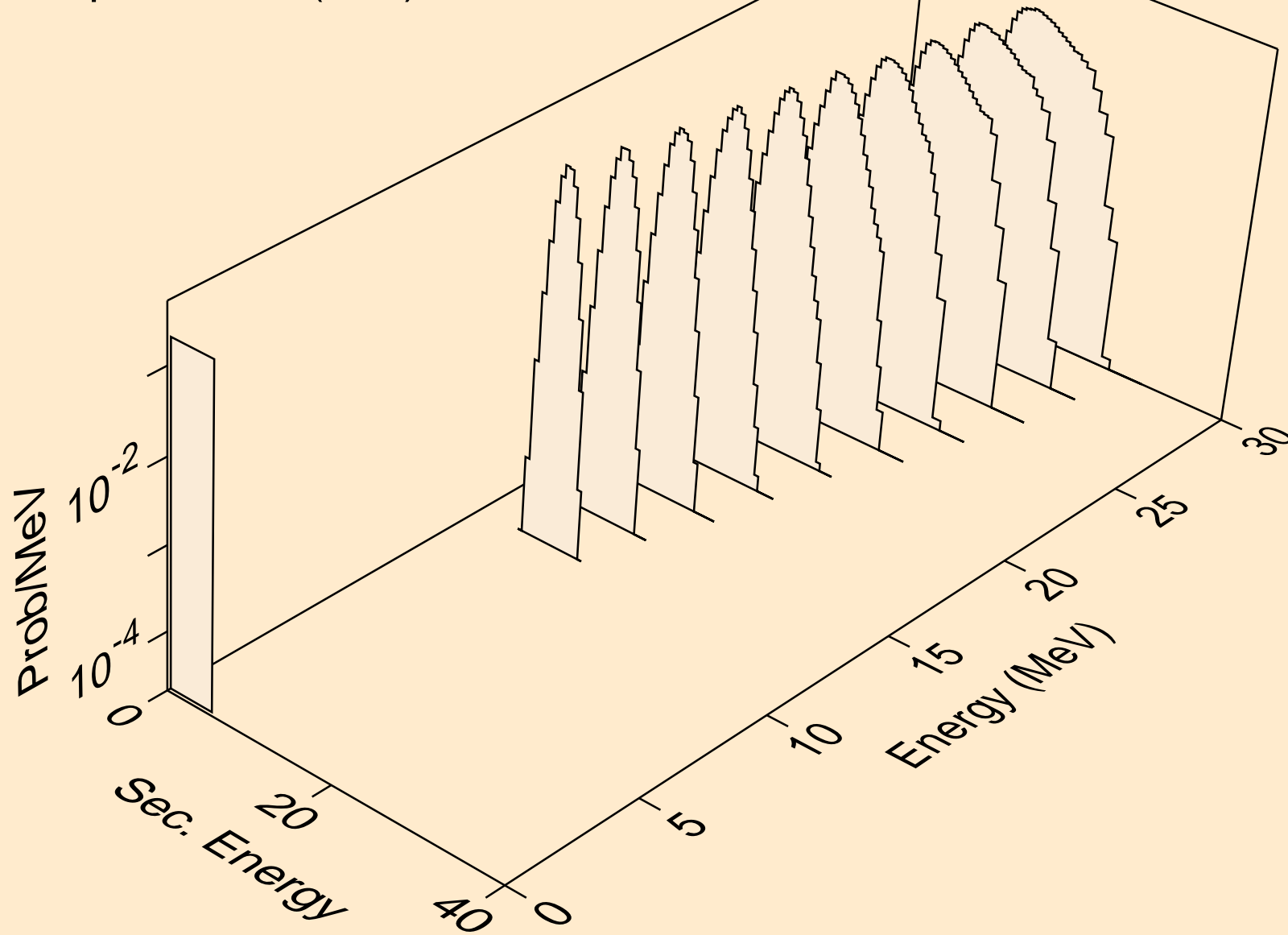



LU164 HELION ACER TENDL-2021 LIBRARY; T=0.K  
alphas from (s,2n)2a

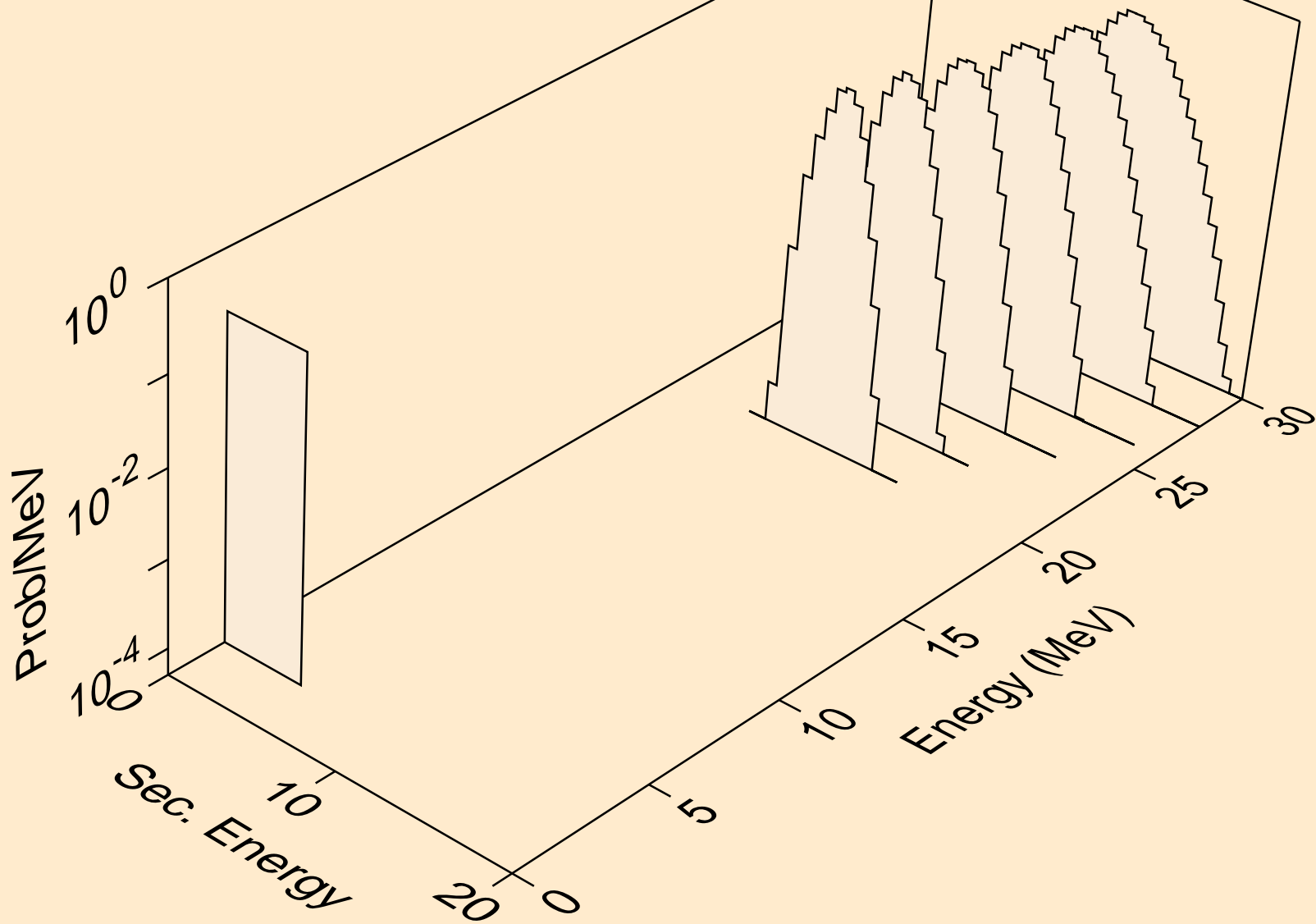

LU164 HELION ACER TENDL-2021 LIBRARY; T=0.K  
alphas from (s,npa)

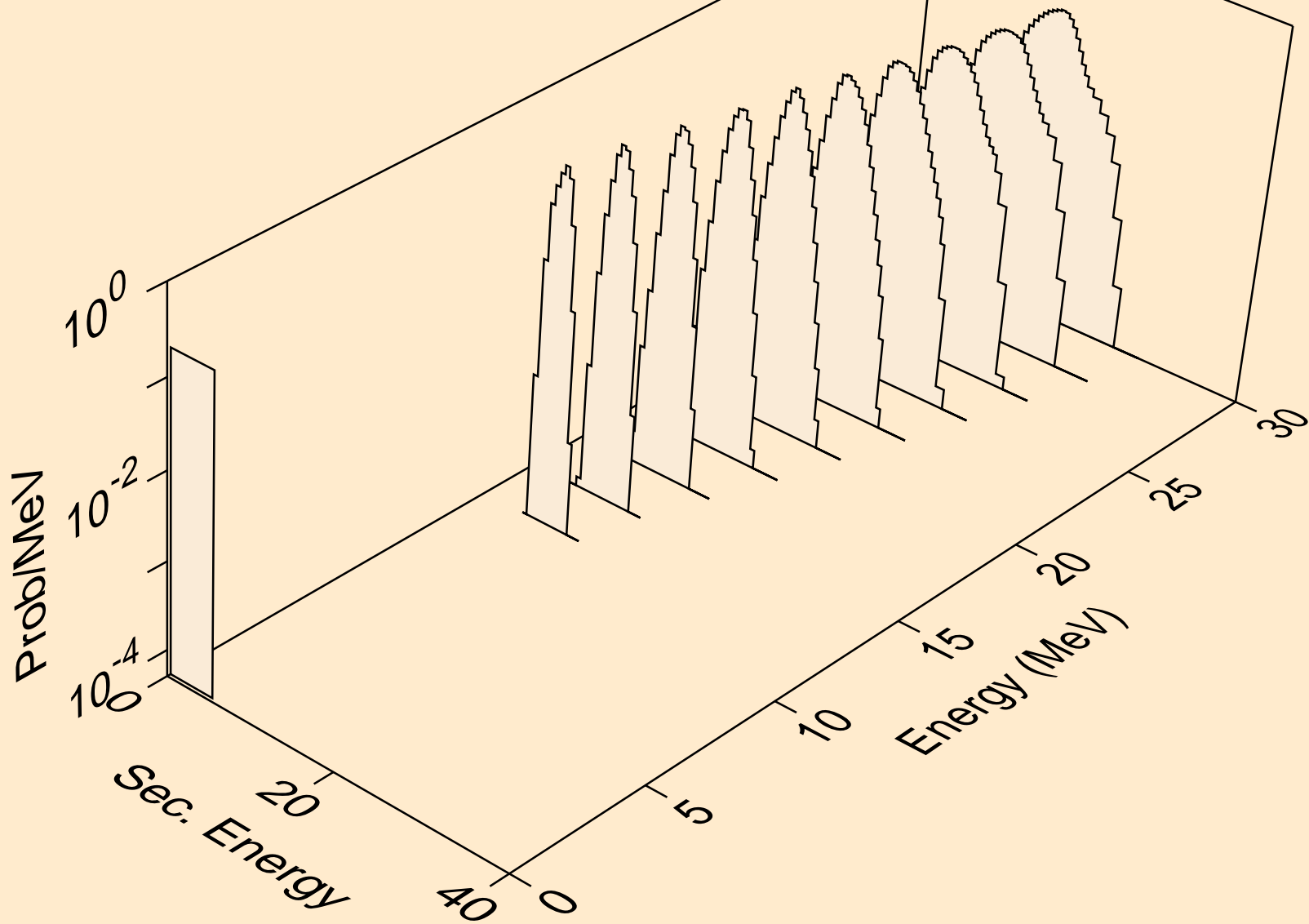

LU164 HELION ACER TENDL-2021 LIBRARY; T=0.K  
alphas from (s,a)

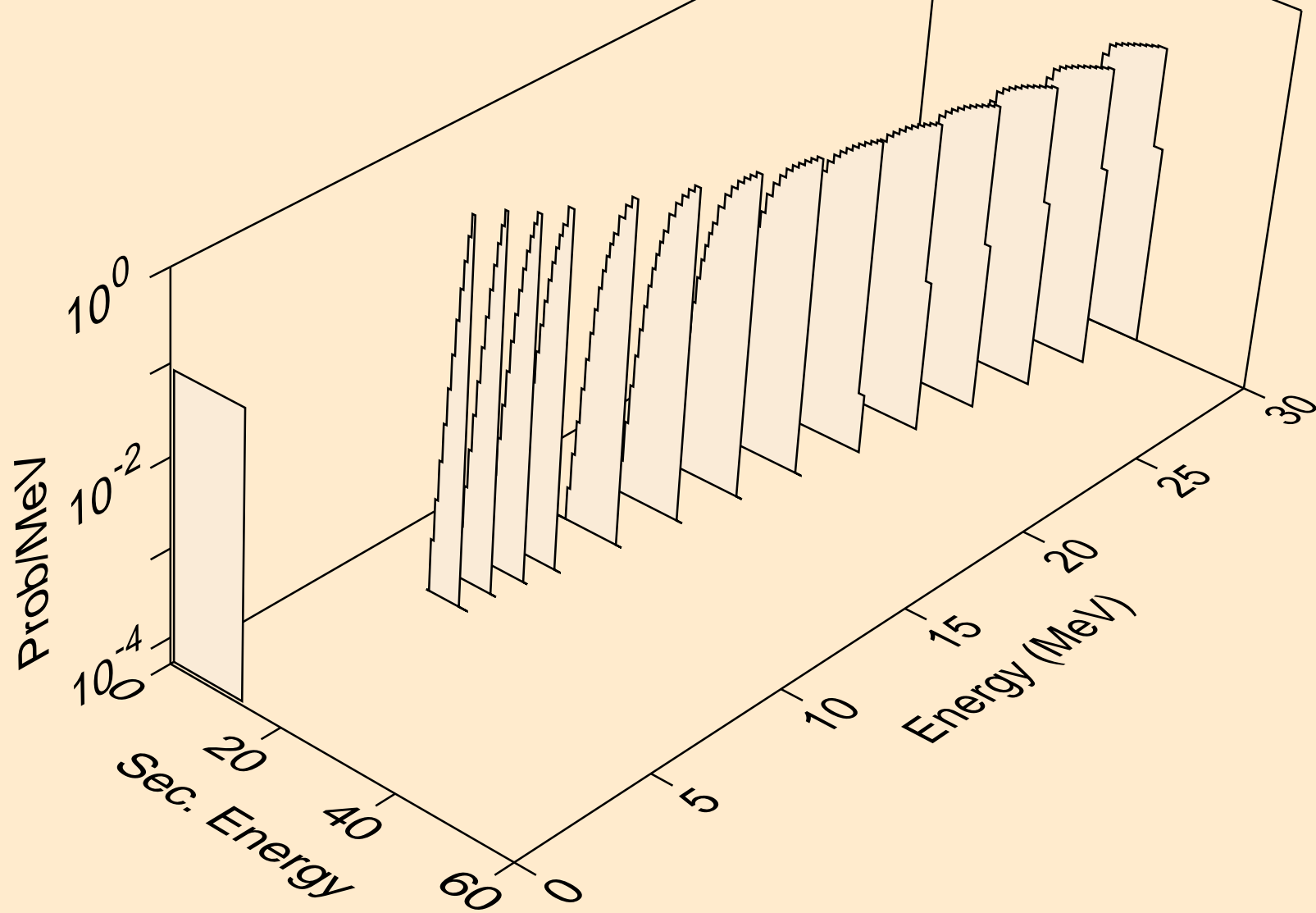

LU164 HELION ACER TENDL-2021 LIBRARY; T=0.K  
alphas from (s,2a)

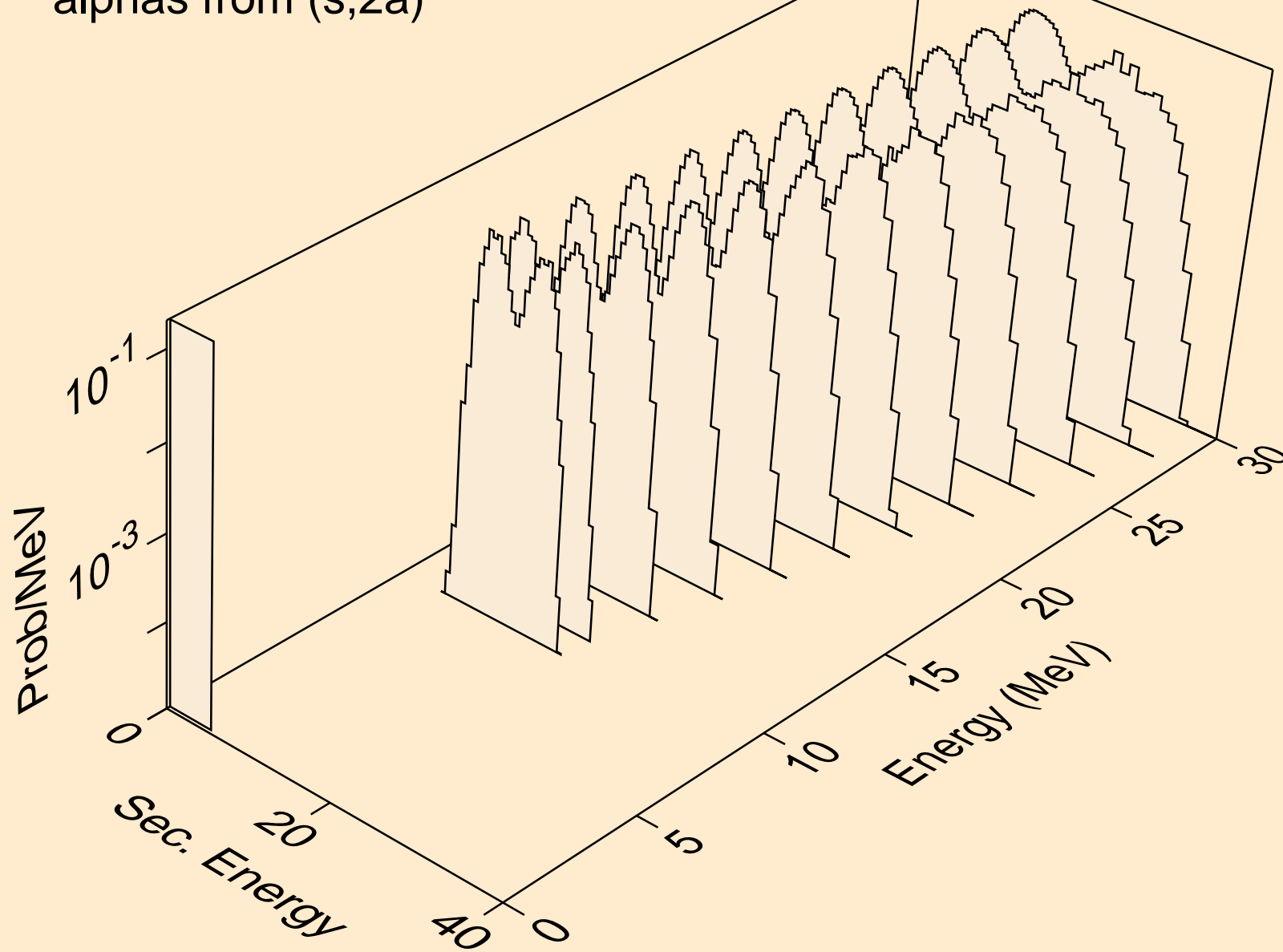

LU164 HELION ACER TENDL-2021 LIBRARY; T=0.K  
alphas from (s,pa)

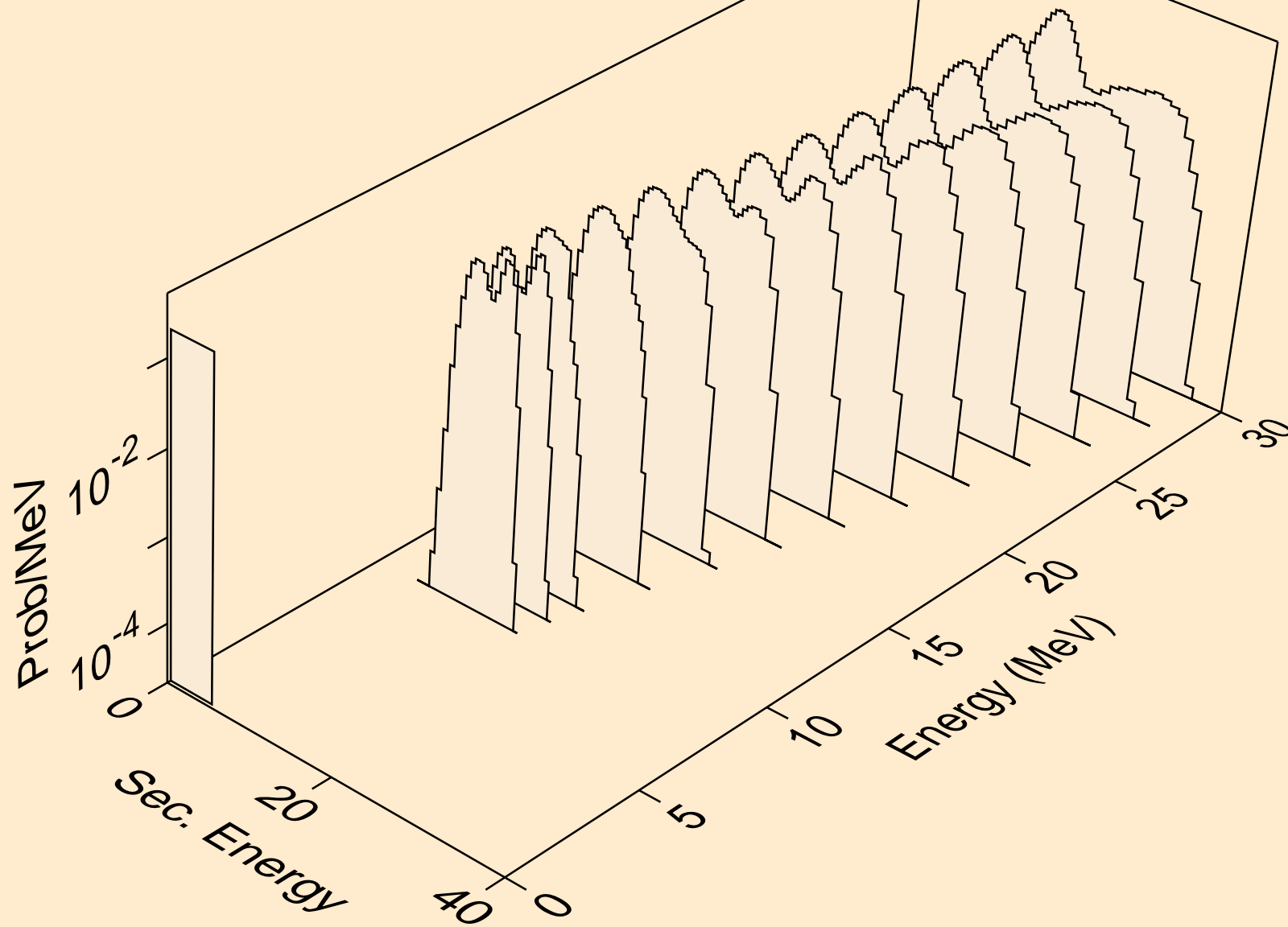

LU164 HELION ACER TENDL-2021 LIBRARY; T=0.K  
alphas from (s,t2a)

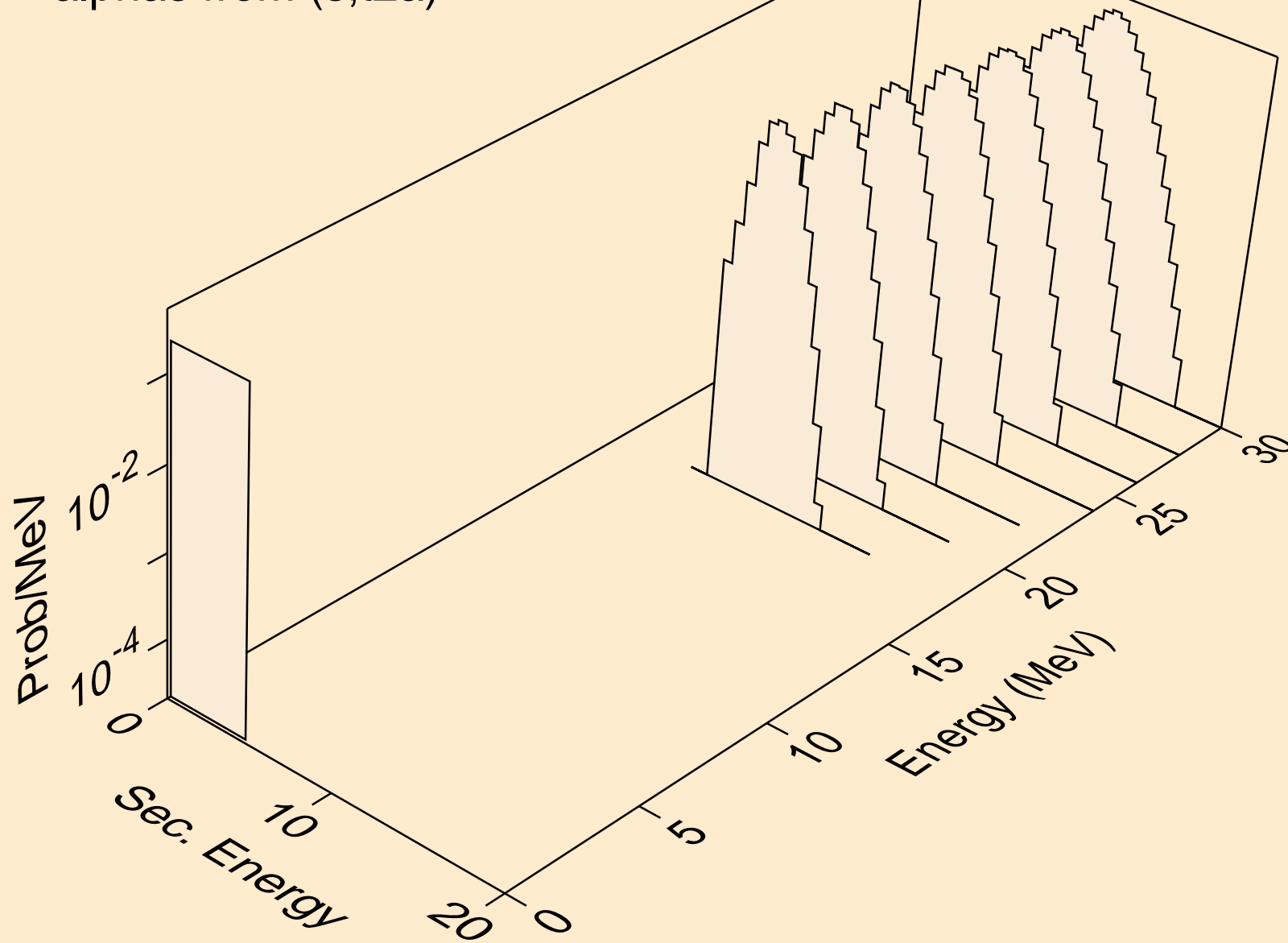

LU164 HELION ACER TENDL-2021 LIBRARY; T=0.K  
alphas from (s,da)

