

N013 HELION ACER TENDL-2021 LIBRARY; T=0.K  
Principal cross sections

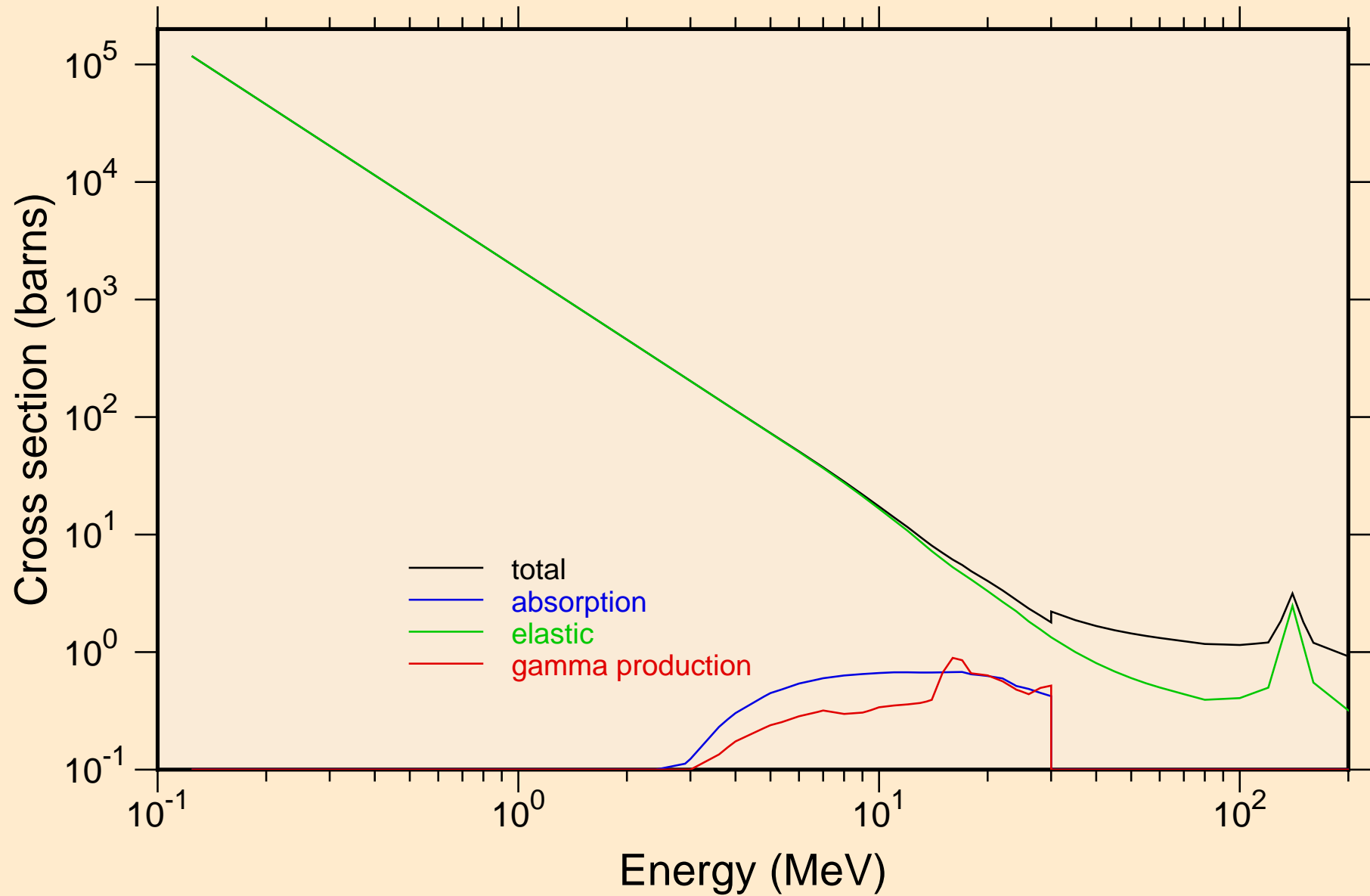

# N013 HELION ACER TENDL-2021 LIBRARY; T=0.K

## Heating

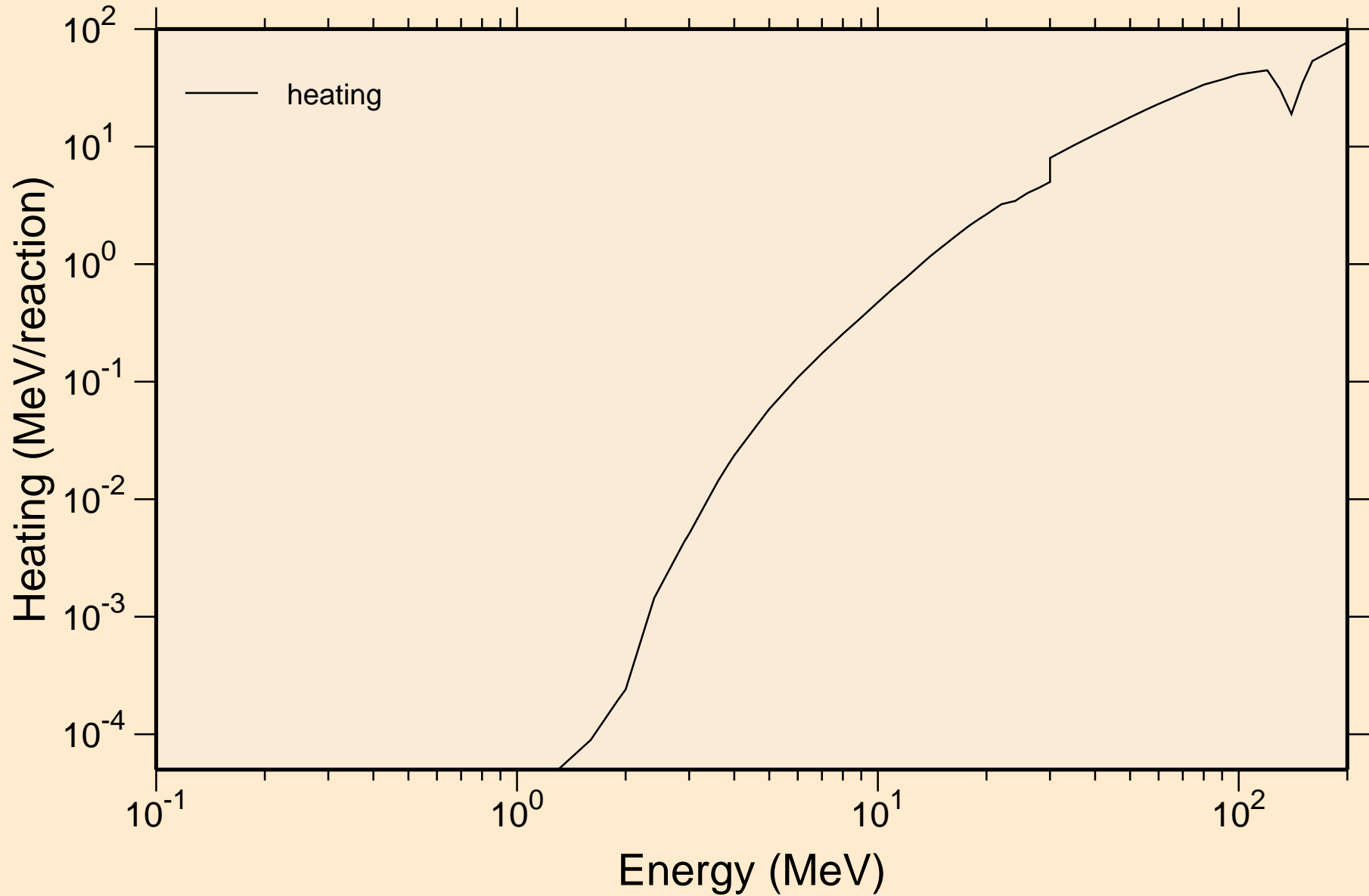

# N013 HELION ACER TENDL-2021 LIBRARY; T=0.K

## Principal cross sections

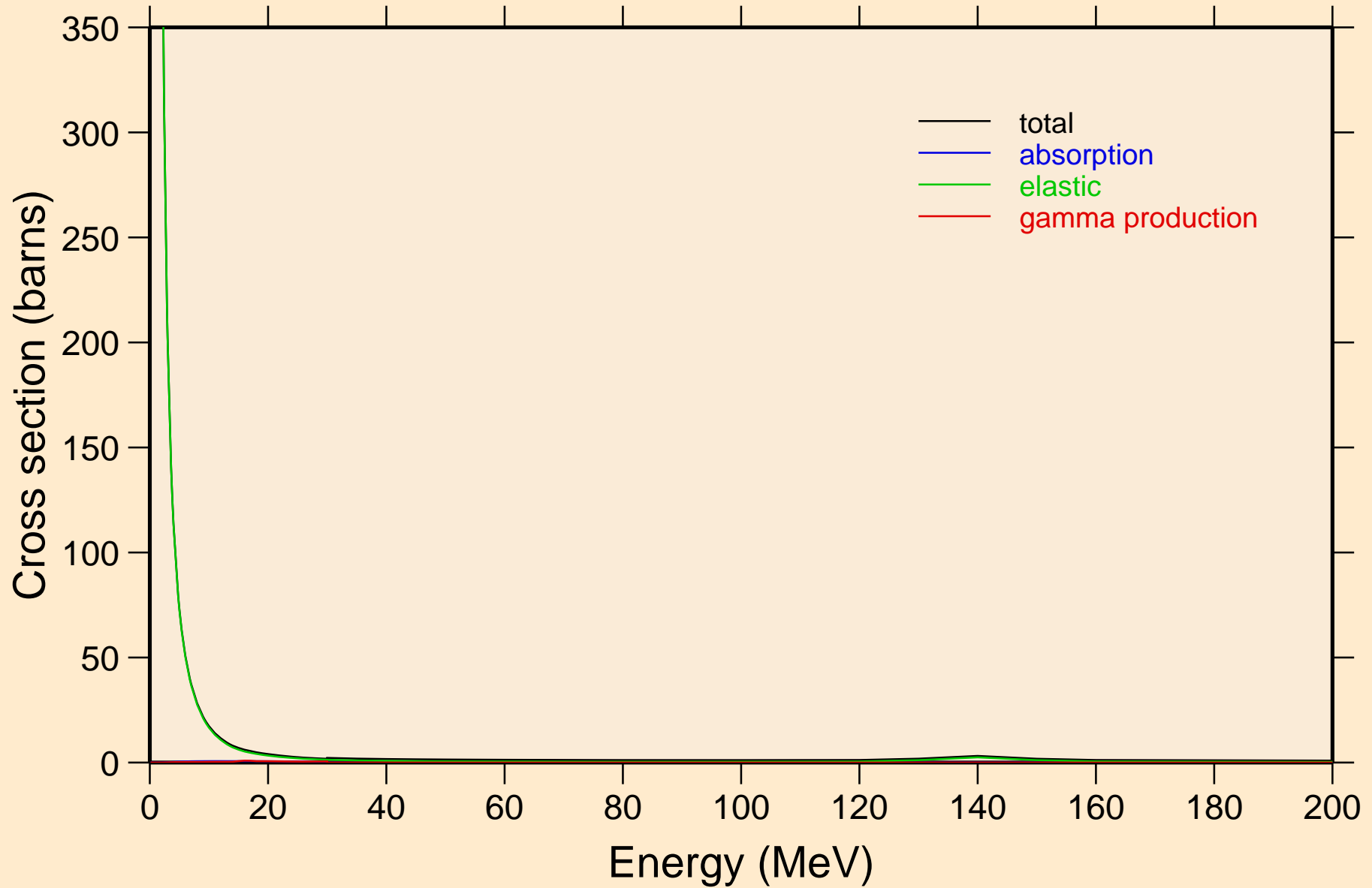

# N013 HELION ACER TENDL-2021 LIBRARY; T=0.K

## Heating

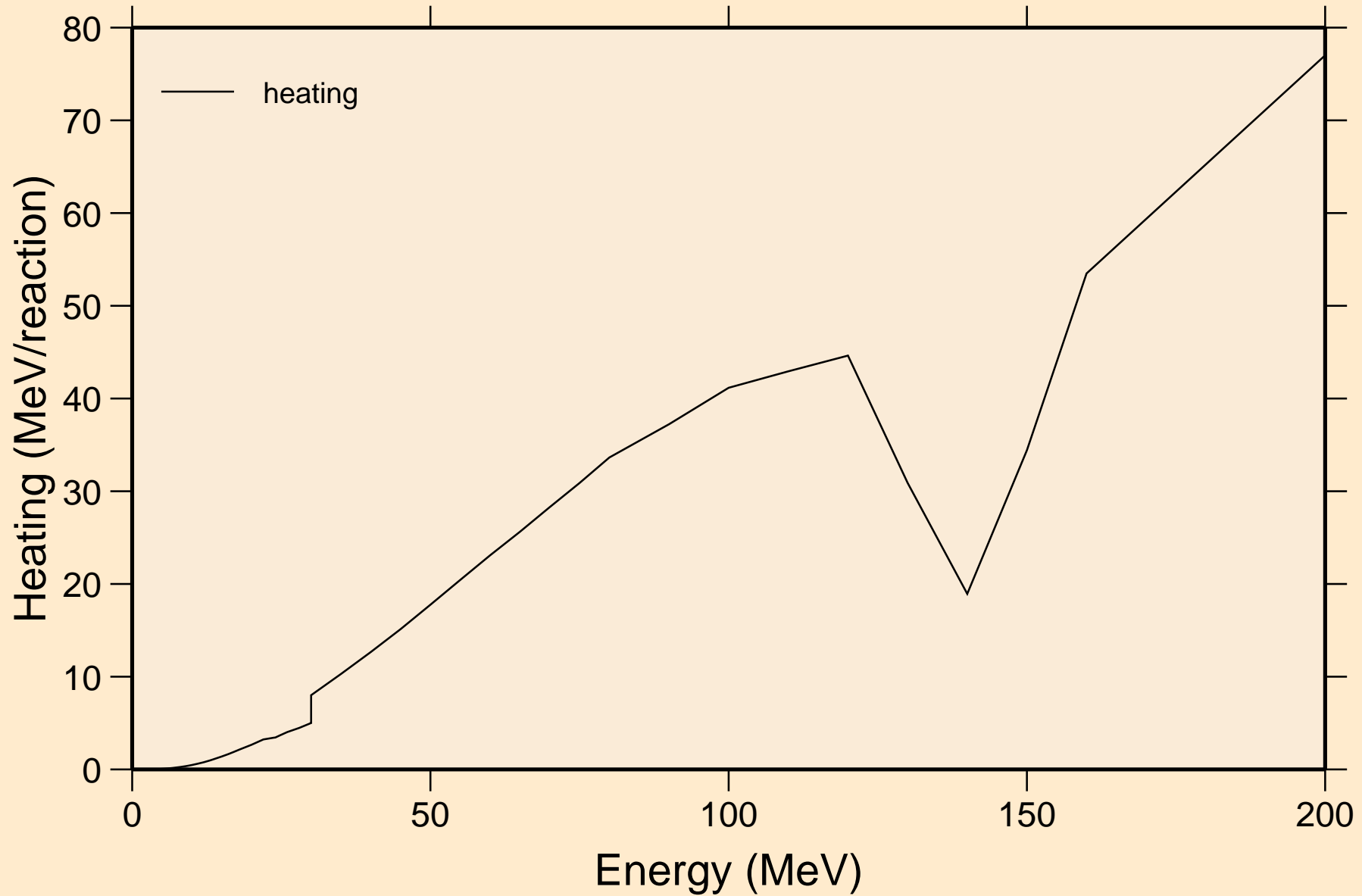

N013 HELION ACER TENDL-2021 LIBRARY; T=0.K  
Threshold reactions

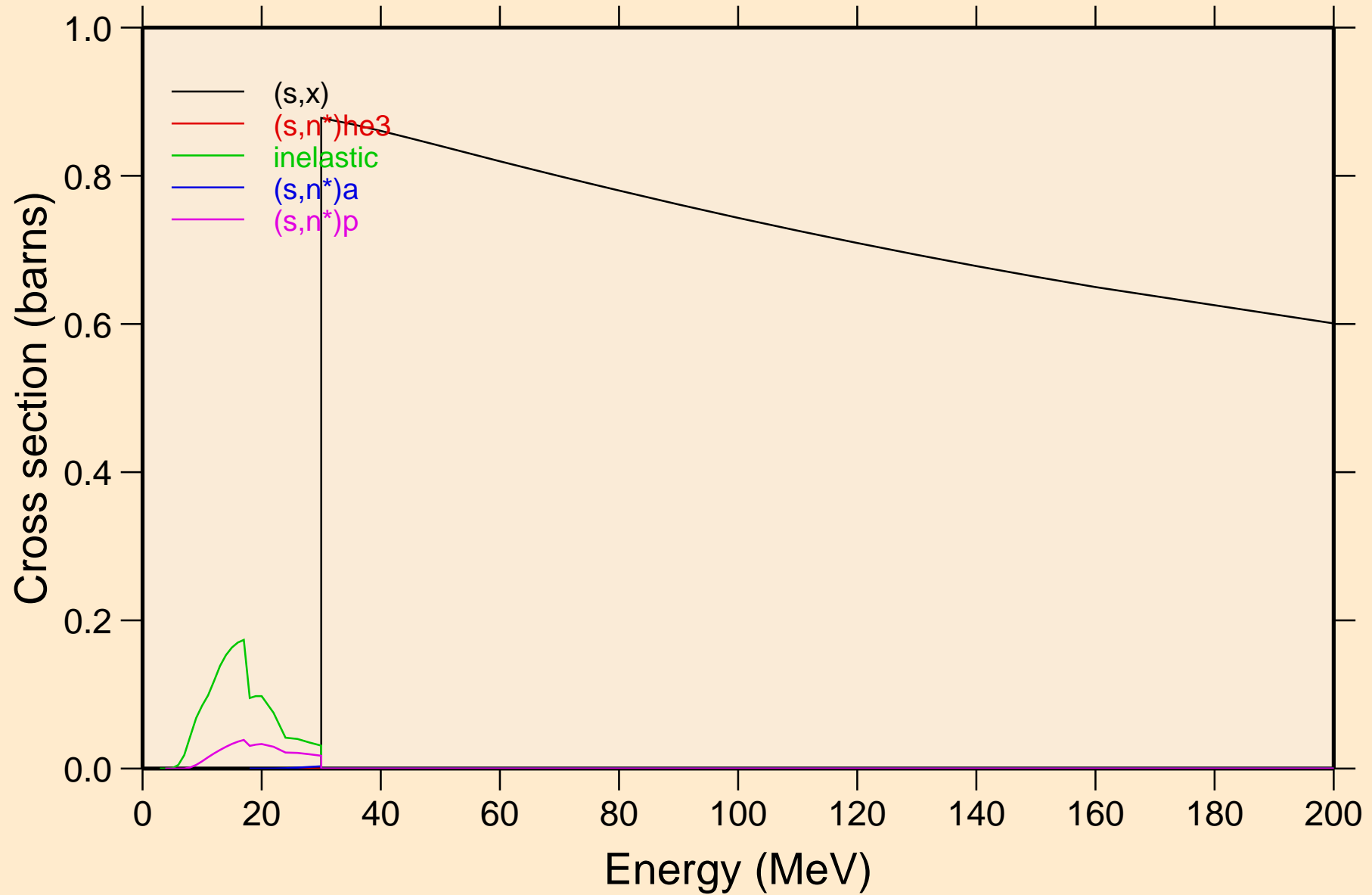

# N013 HELION ACER TENDL-2021 LIBRARY; T=0.K

## Threshold reactions

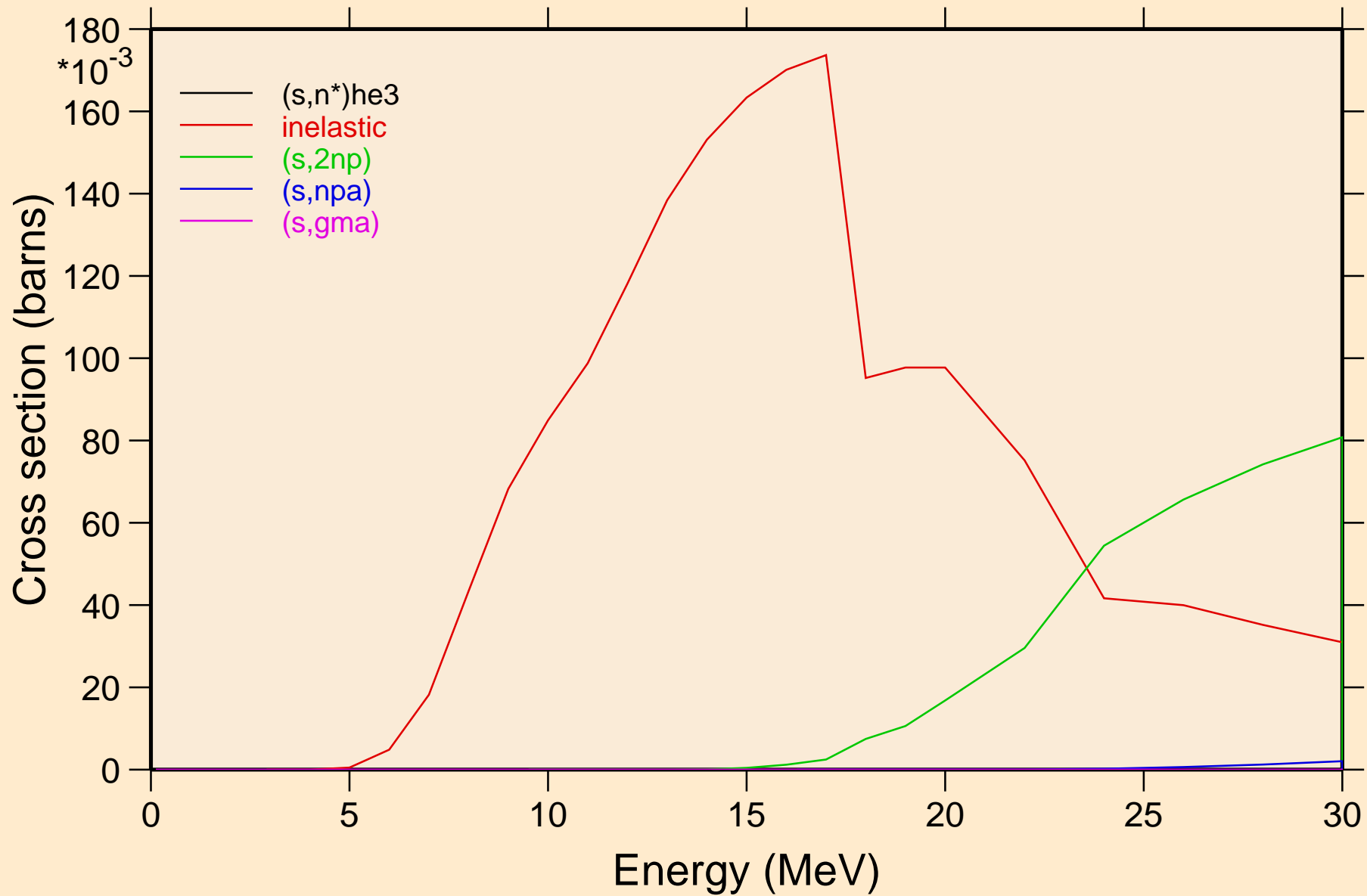

N013 HELION ACER TENDL-2021 LIBRARY; T=0.K  
Threshold reactions

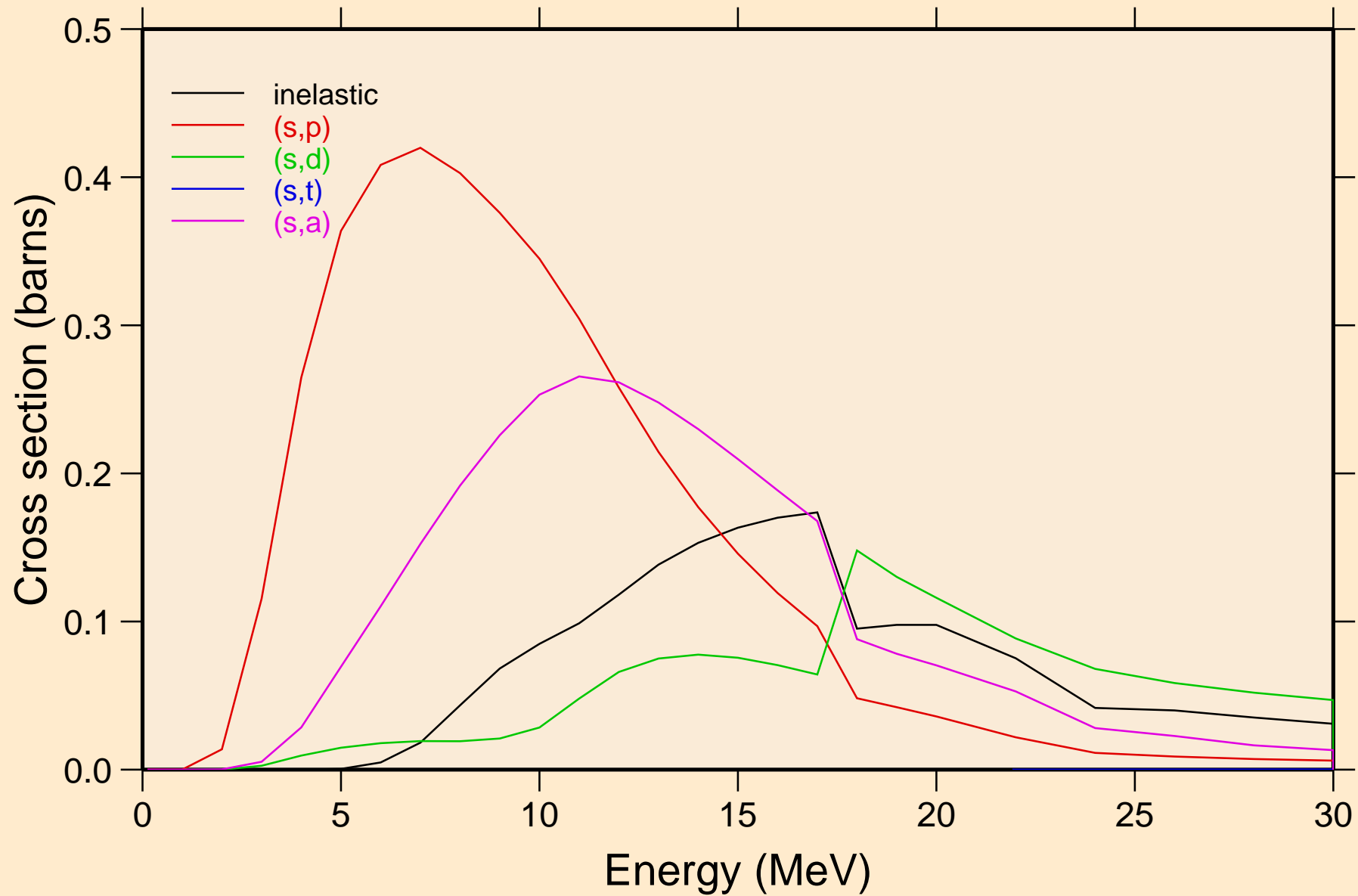

# N013 HELION ACER TENDL-2021 LIBRARY; T=0.K

## Threshold reactions

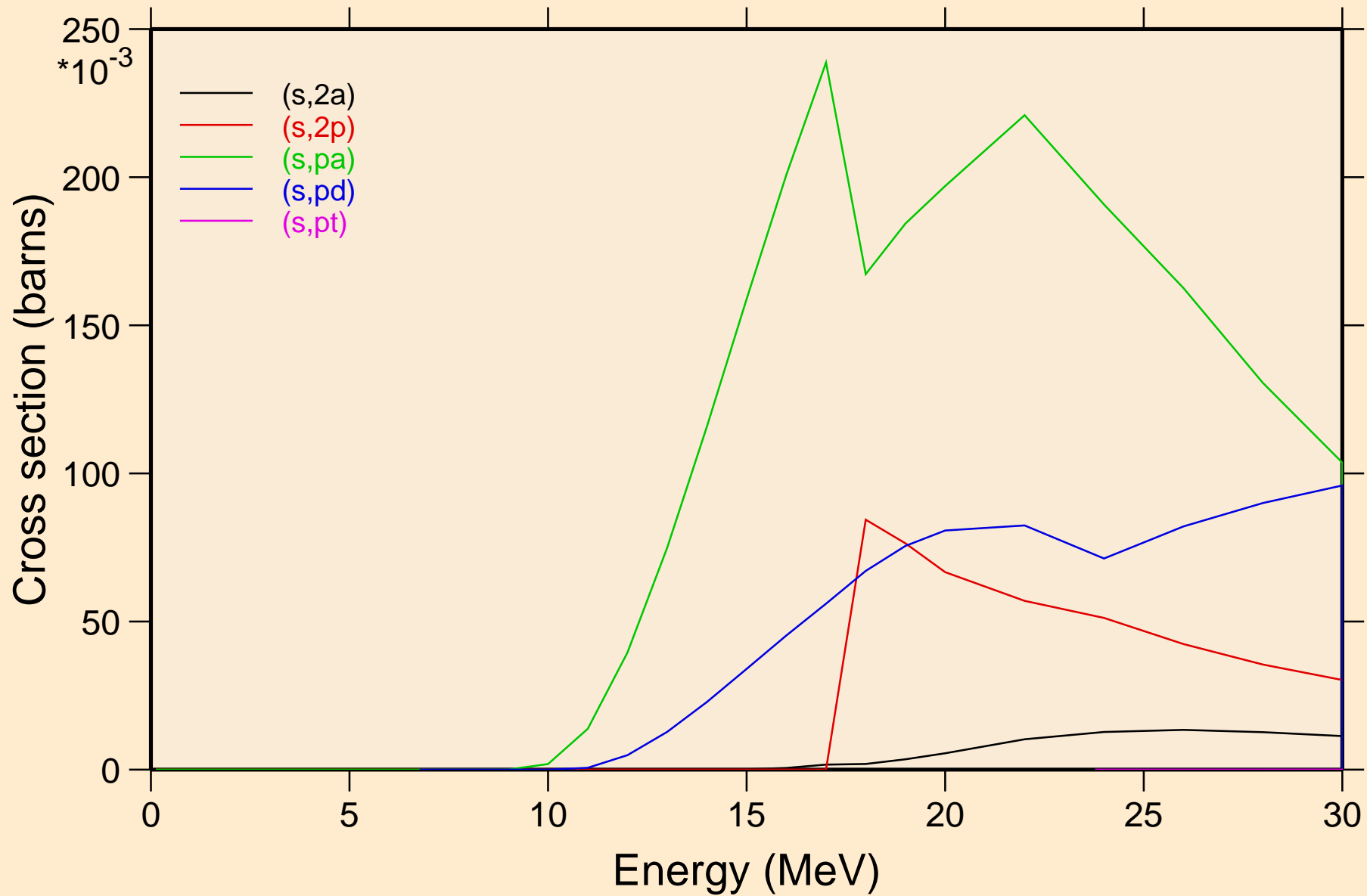



N013 HELION ACER TENDL-2021 LIBRARY; T=0.K  
Threshold reactions

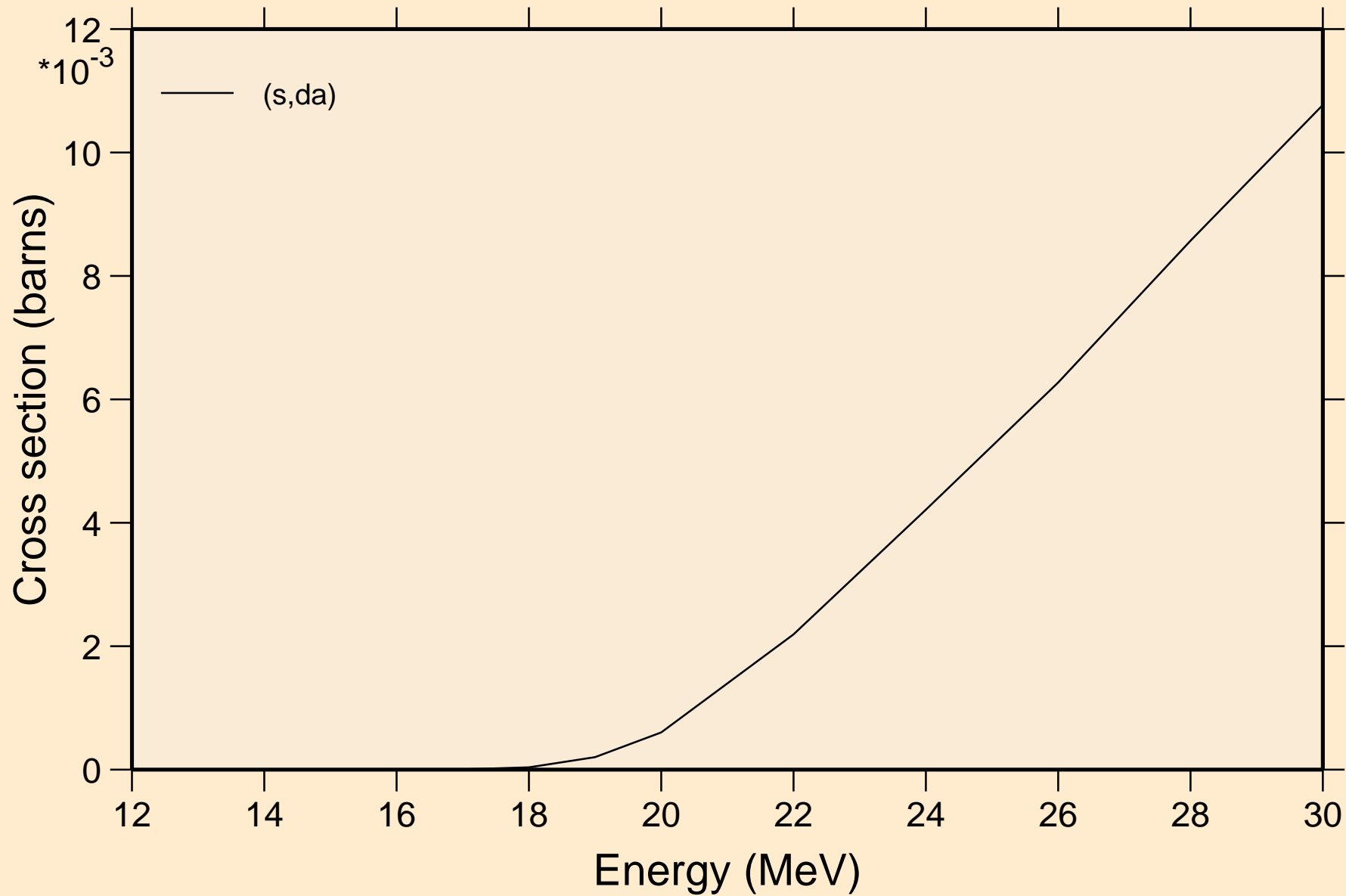

N013 HELION ACER TENDL-2021 LIBRARY; T=0.K  
angular distribution for elastic

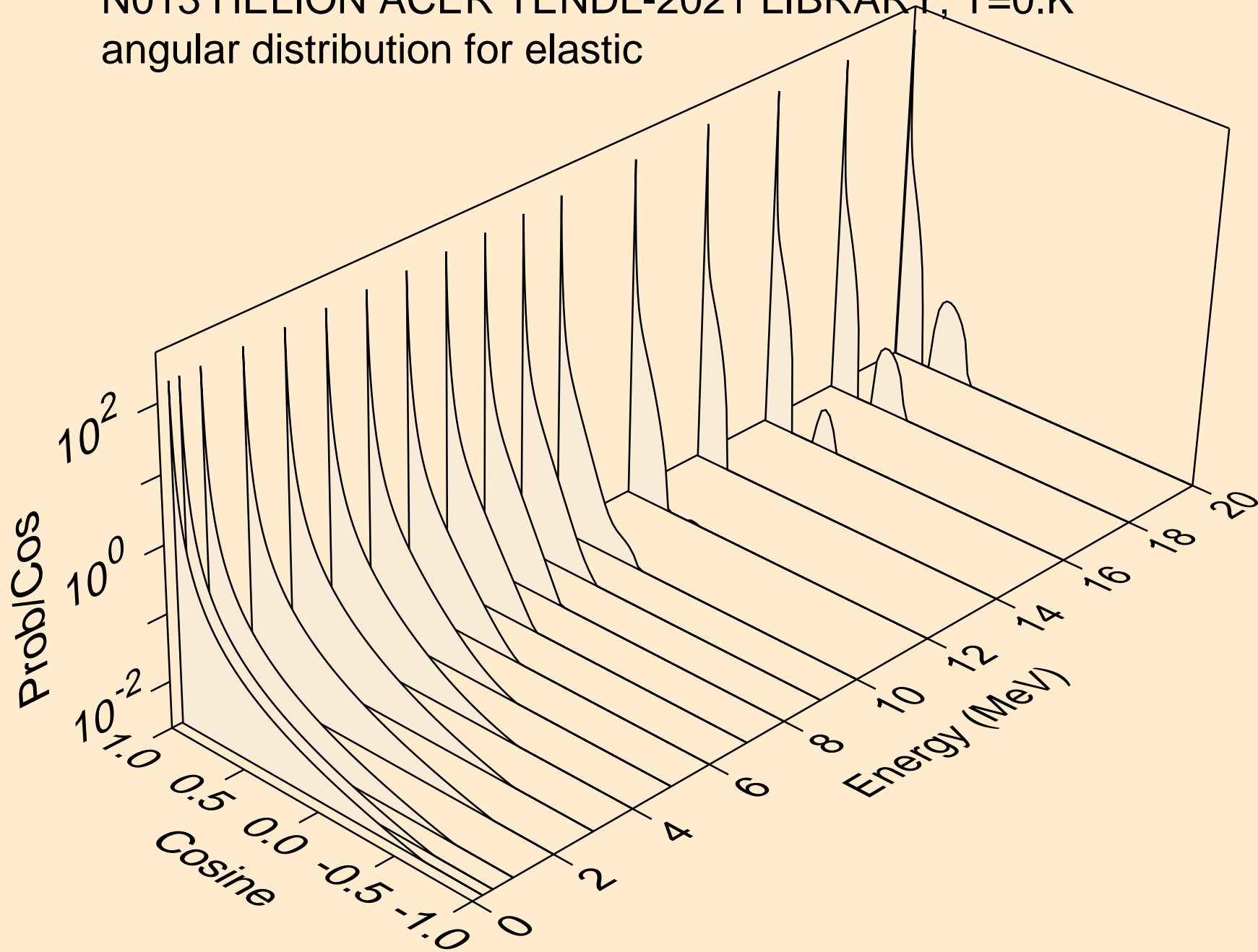

N013 HELION ACER TENDL-2021 LIBRARY; T=0.K  
angular distribution for elastic

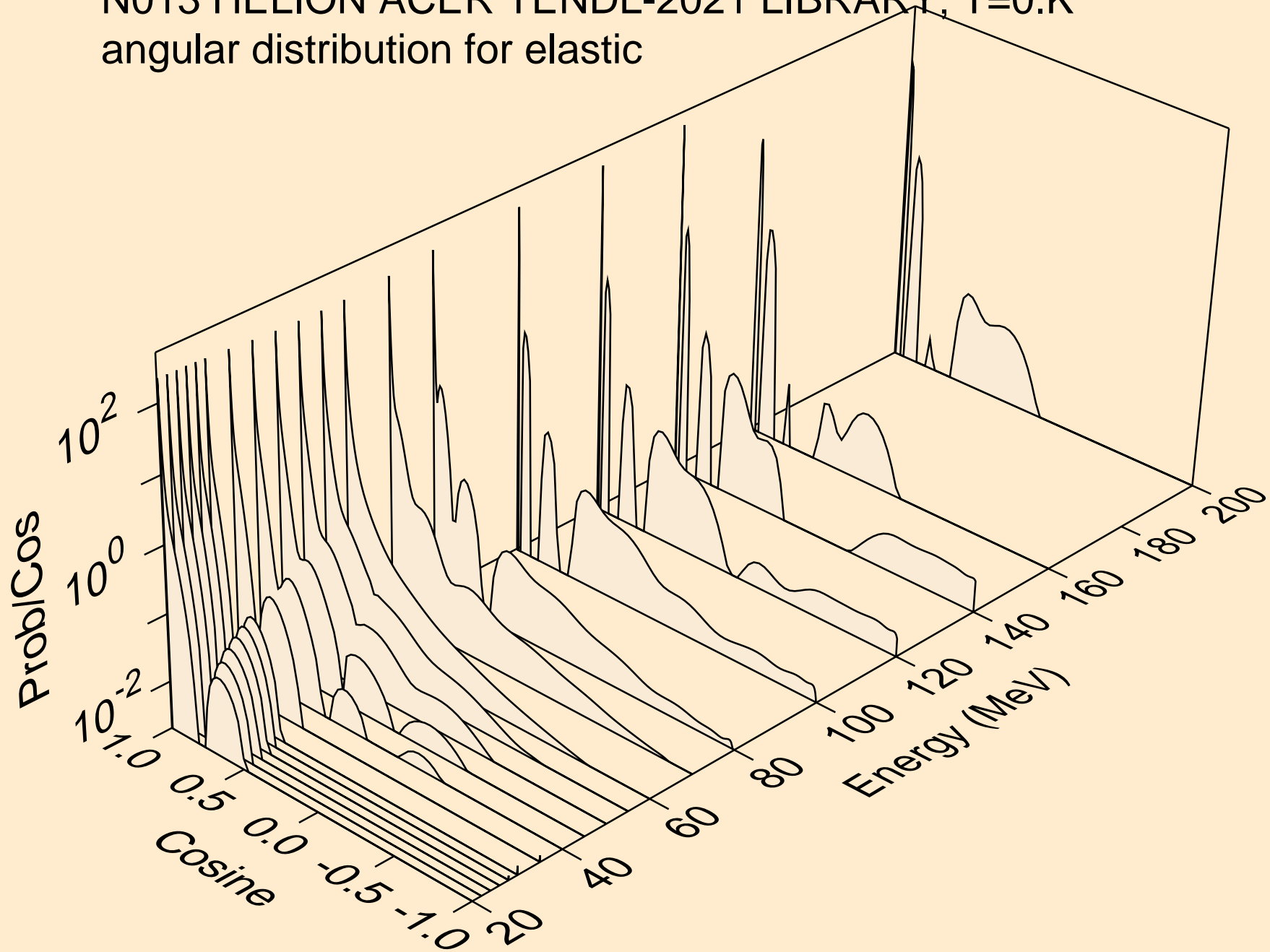

N013 HELION ACER TENDL-2021 LIBRARY; T=0.K  
He-3 emission for (s,x)

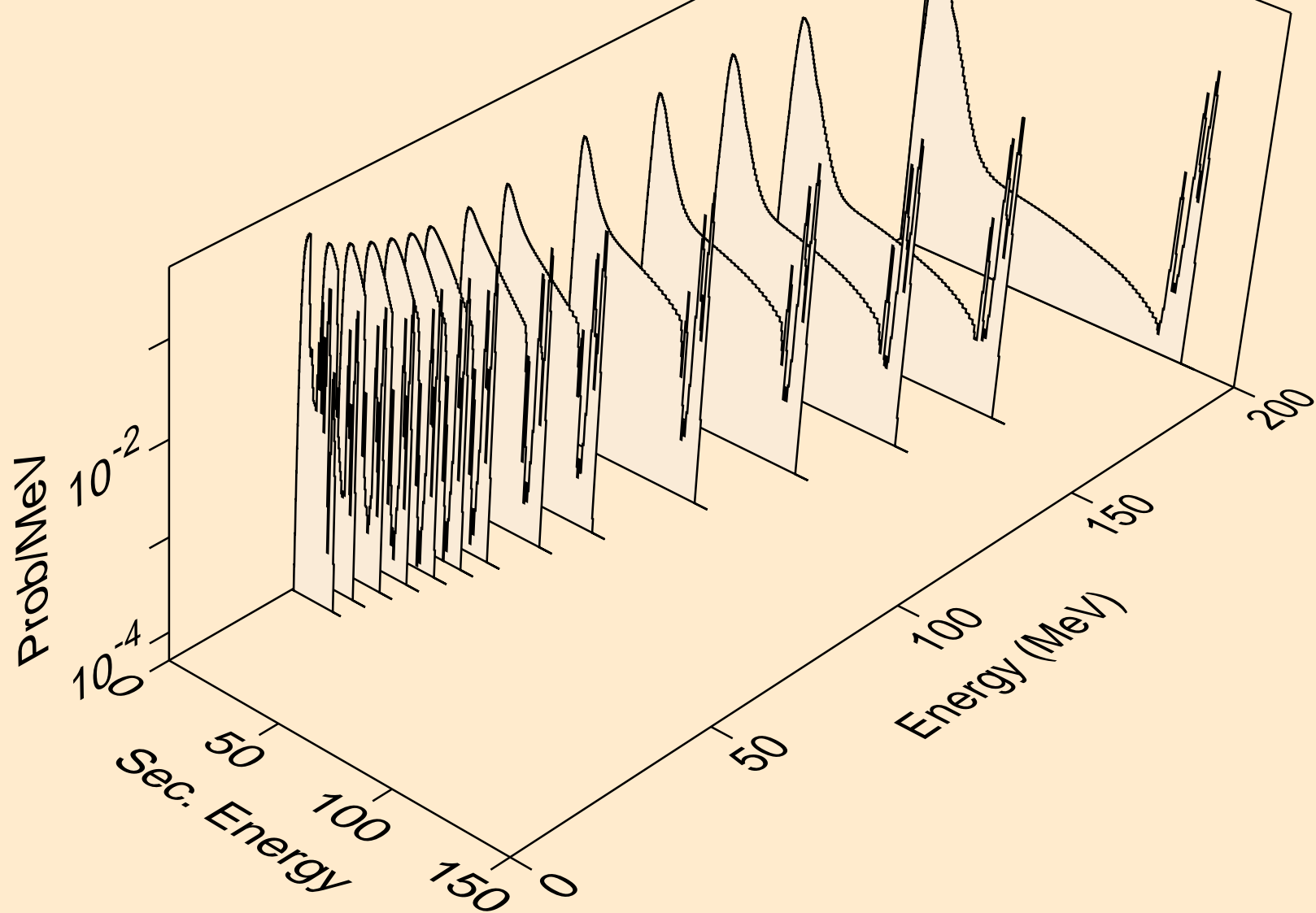

N013 HELION ACER TENDL-2021 LIBRARY; T=0.K  
He-3 emission for (s,n\*)he3

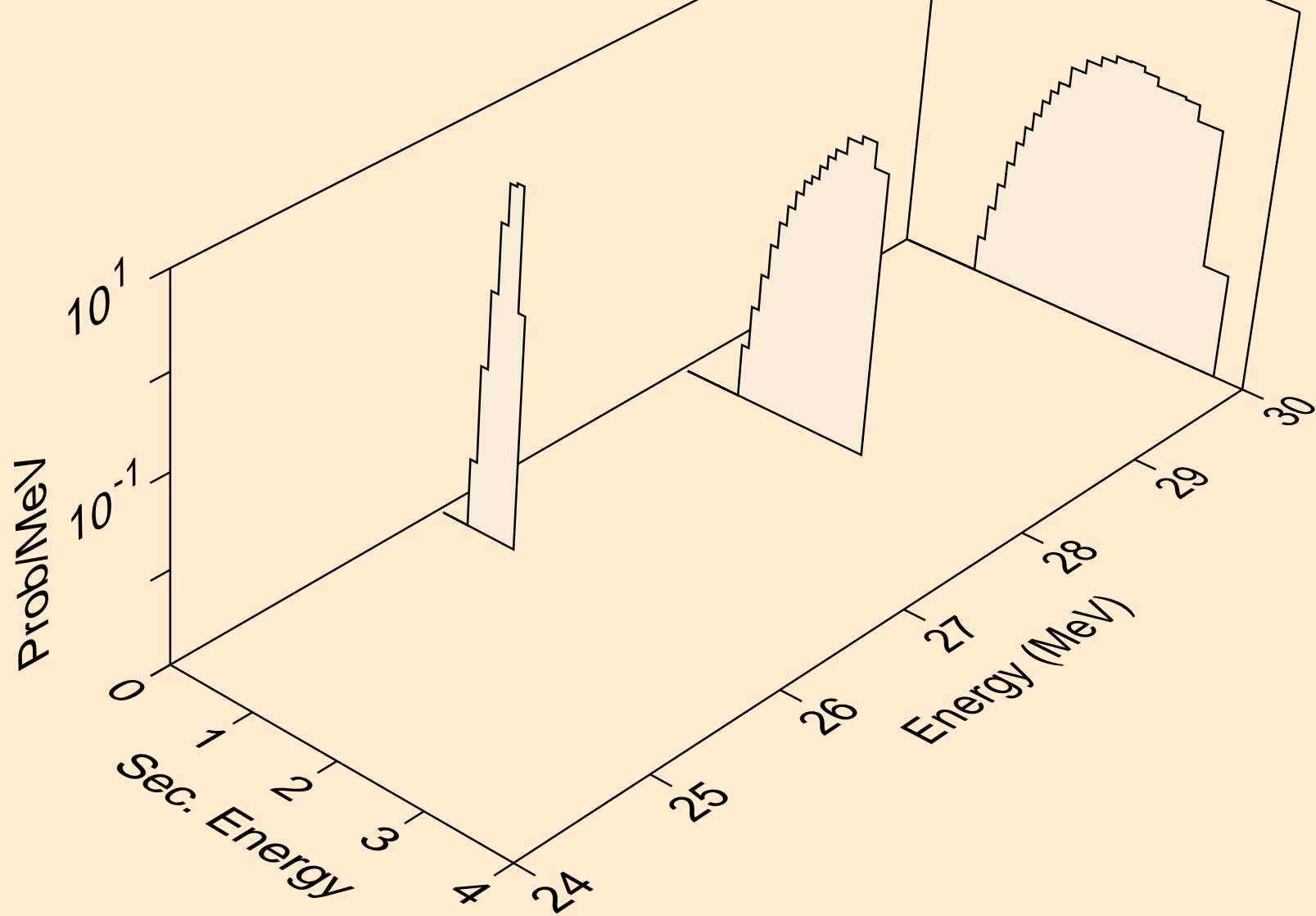

N013 HELION ACER TENDL-2021 LIBRARY; T=0.K  
He-3 emission for inelastic

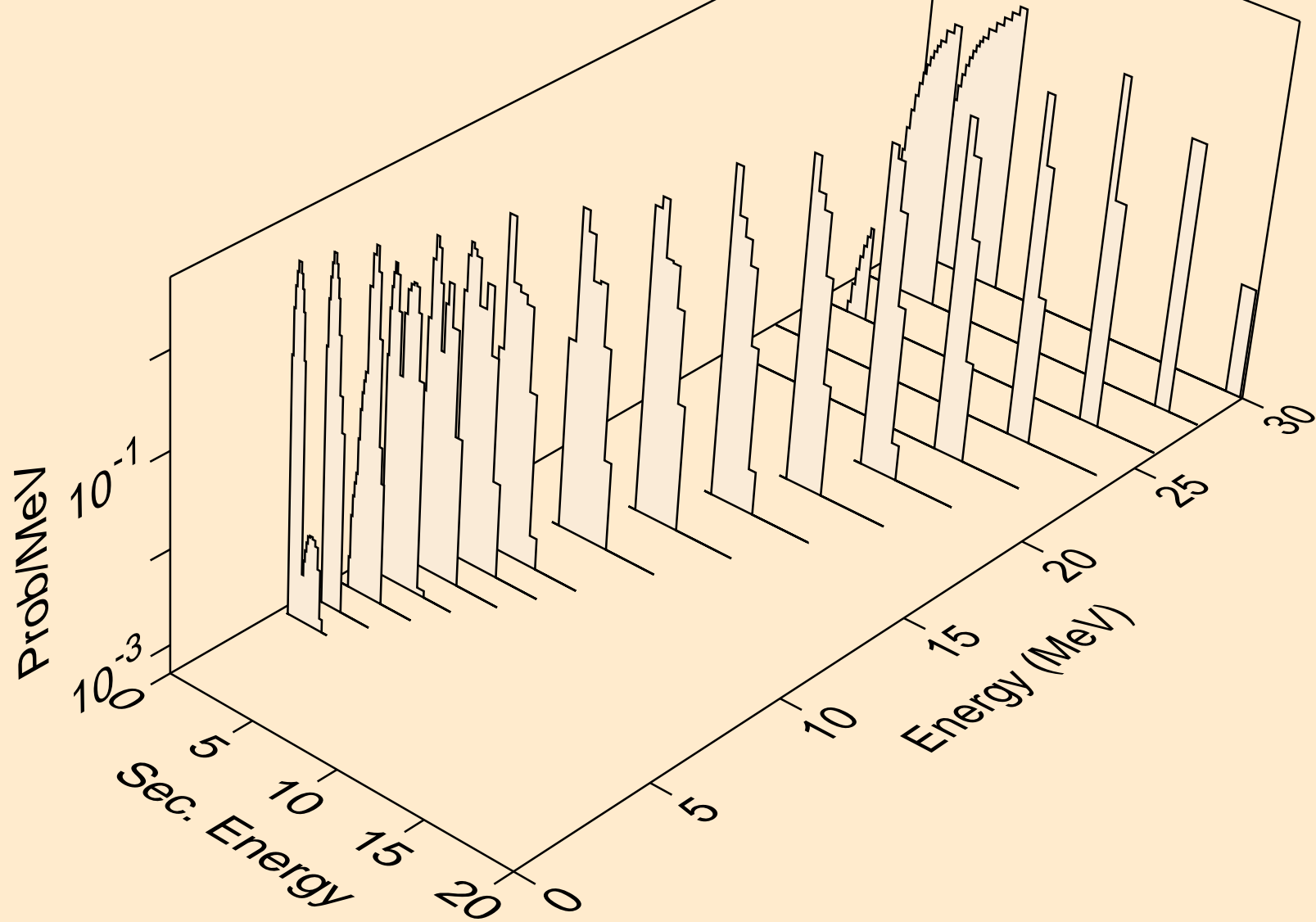

N013 HELION ACER TENDL-2021 LIBRARY; T=0.K  
Photon emission for (z,n)

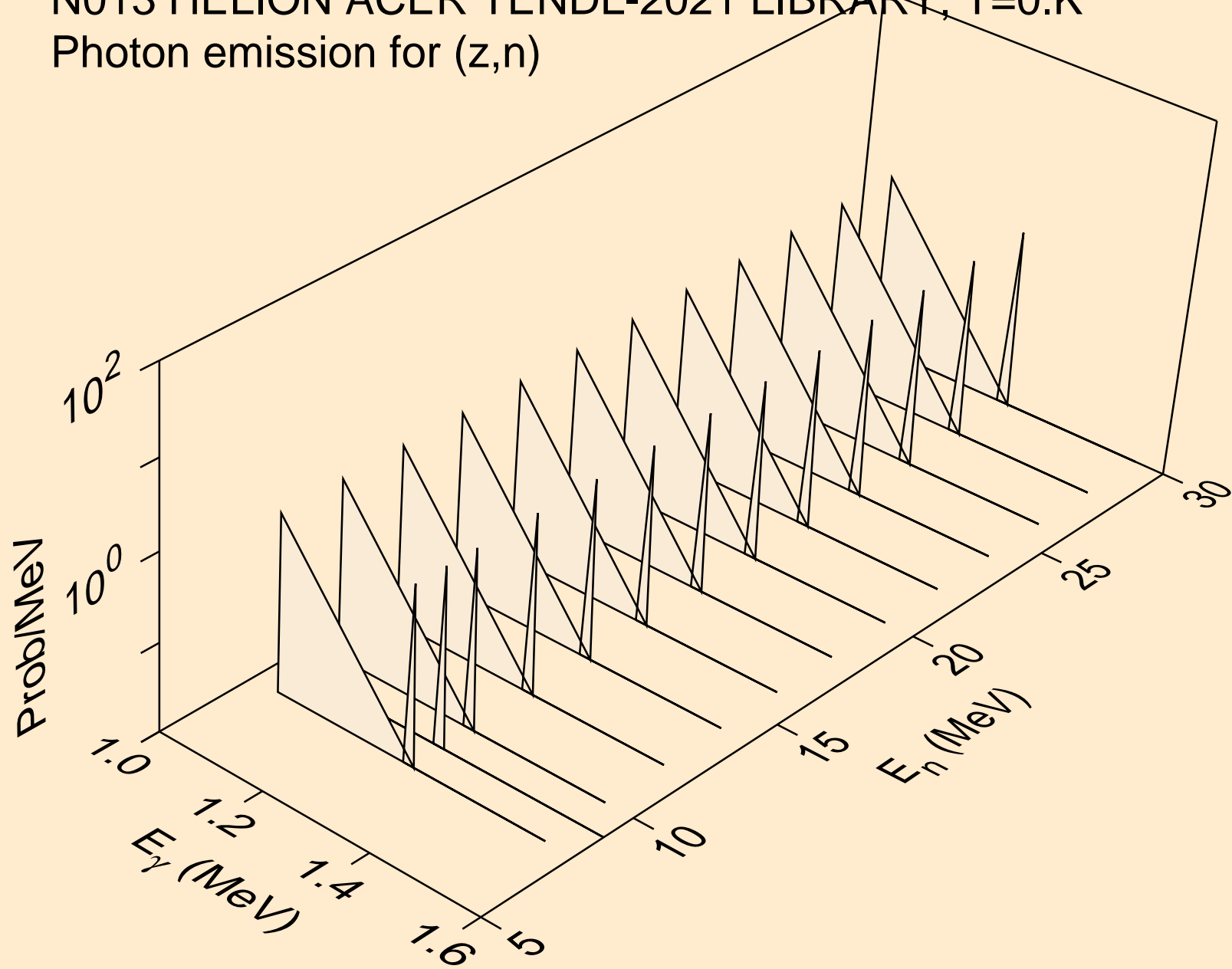

N013 HELION ACER TENDL-2021 LIBRARY; T=0.K  
Photon emission for (n,x)

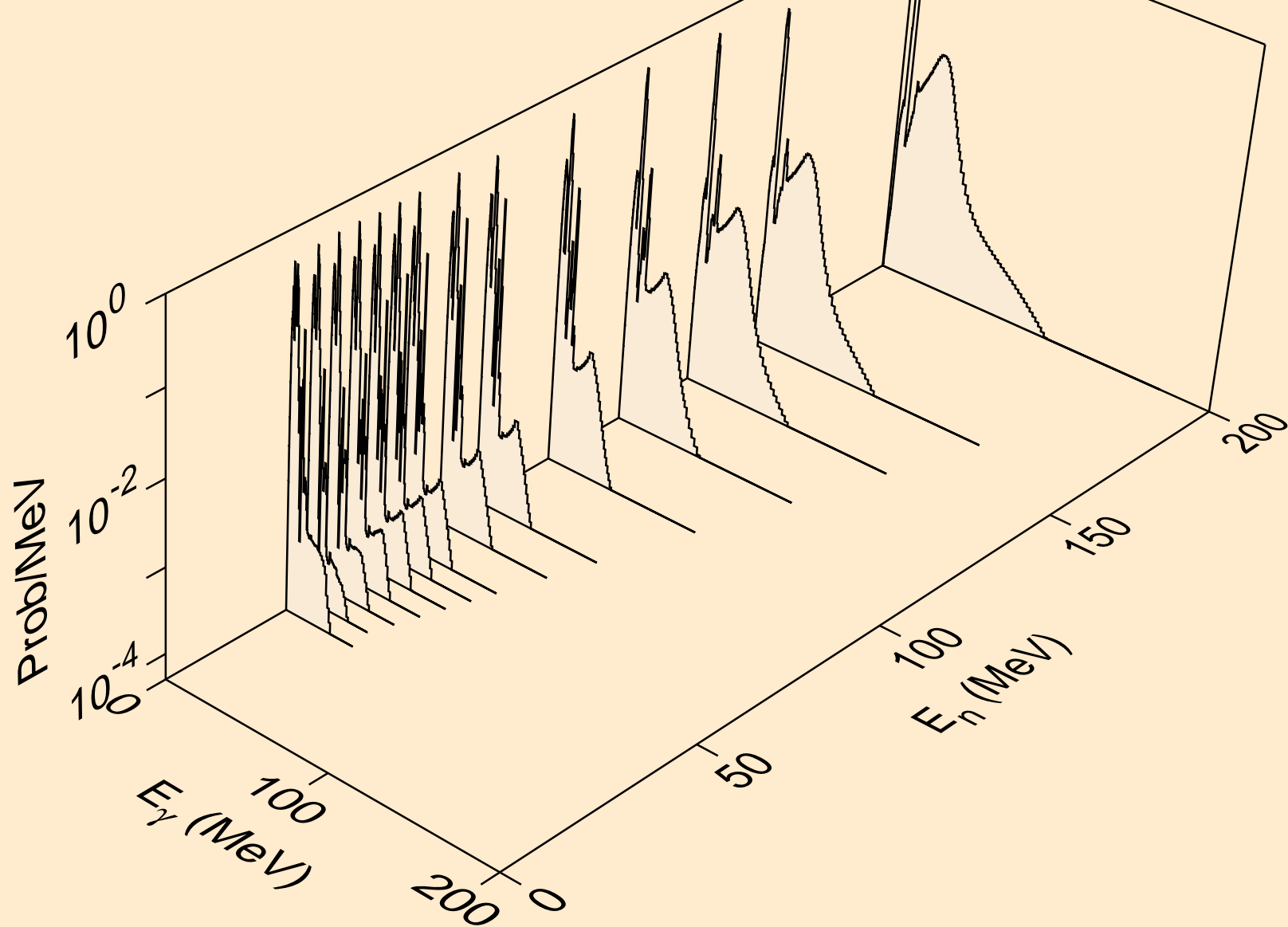



N013 HELION ACER TENDL-2021 LIBRARY; T=0.K  
Photon emission for (n,n\*)a

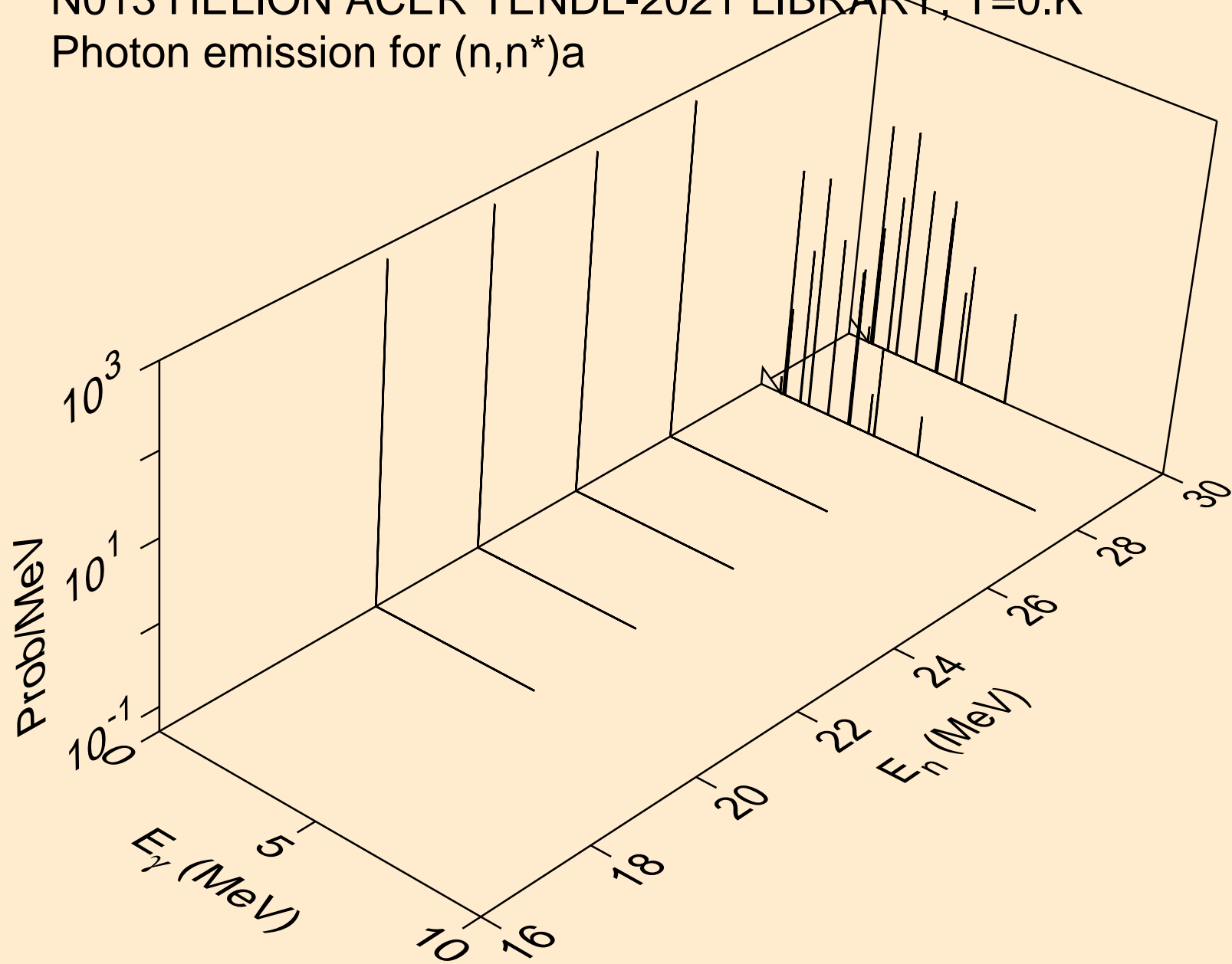

N013 HELION ACER TENDL-2021 LIBRARY; T=0.K  
Photon emission for (n,n\*)p

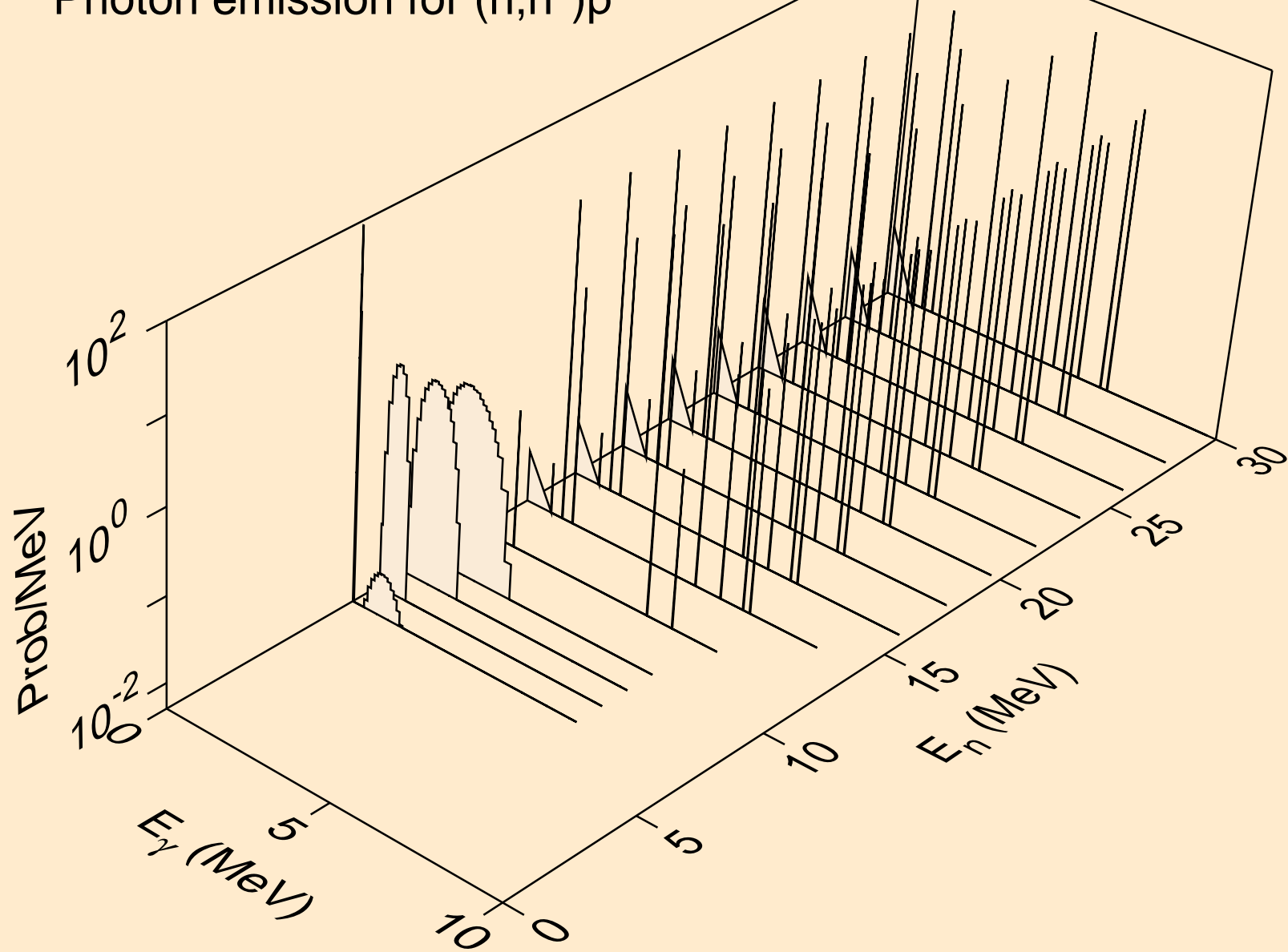

N013 HELION ACER TENDL-2021 LIBRARY; T=0.K  
Photon emission for (n,n\*)he3

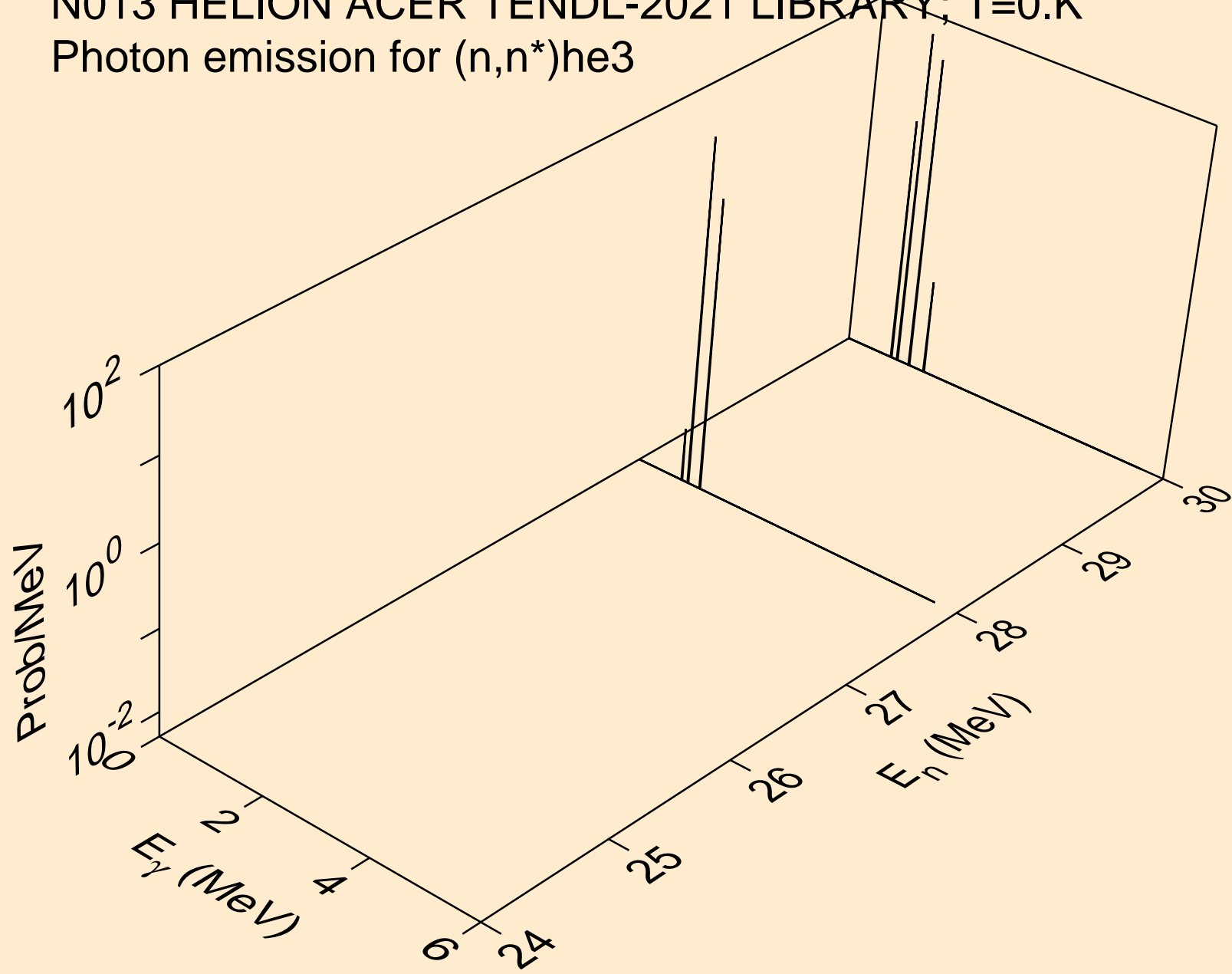

N013 HELION ACER TENDL-2021 LIBRARY; T=0.K  
Photon emission for (n,2np)

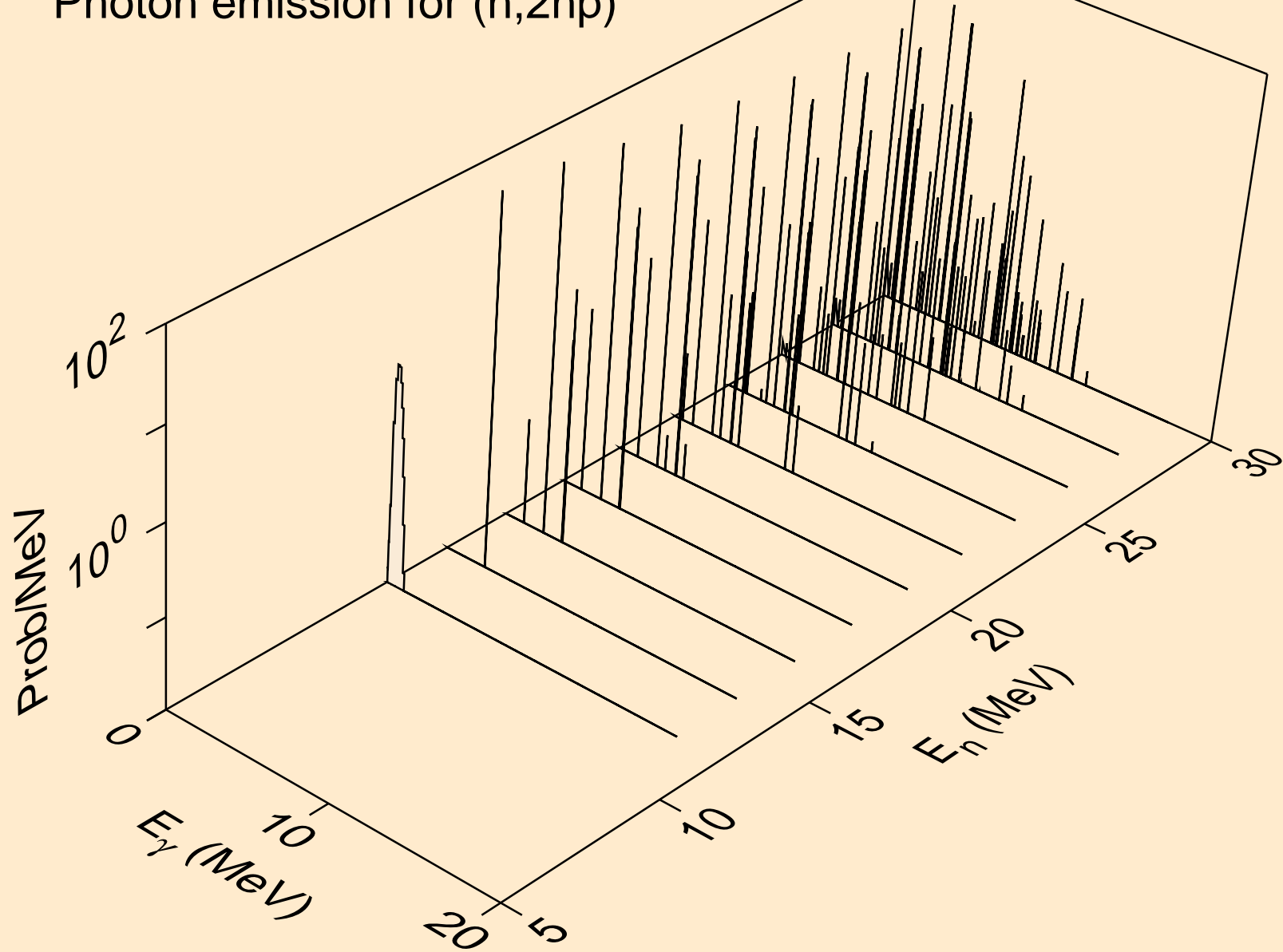

N013 HELION ACER TENDL-2021 LIBRARY; T=0.K  
Photon emission for (n,npa)

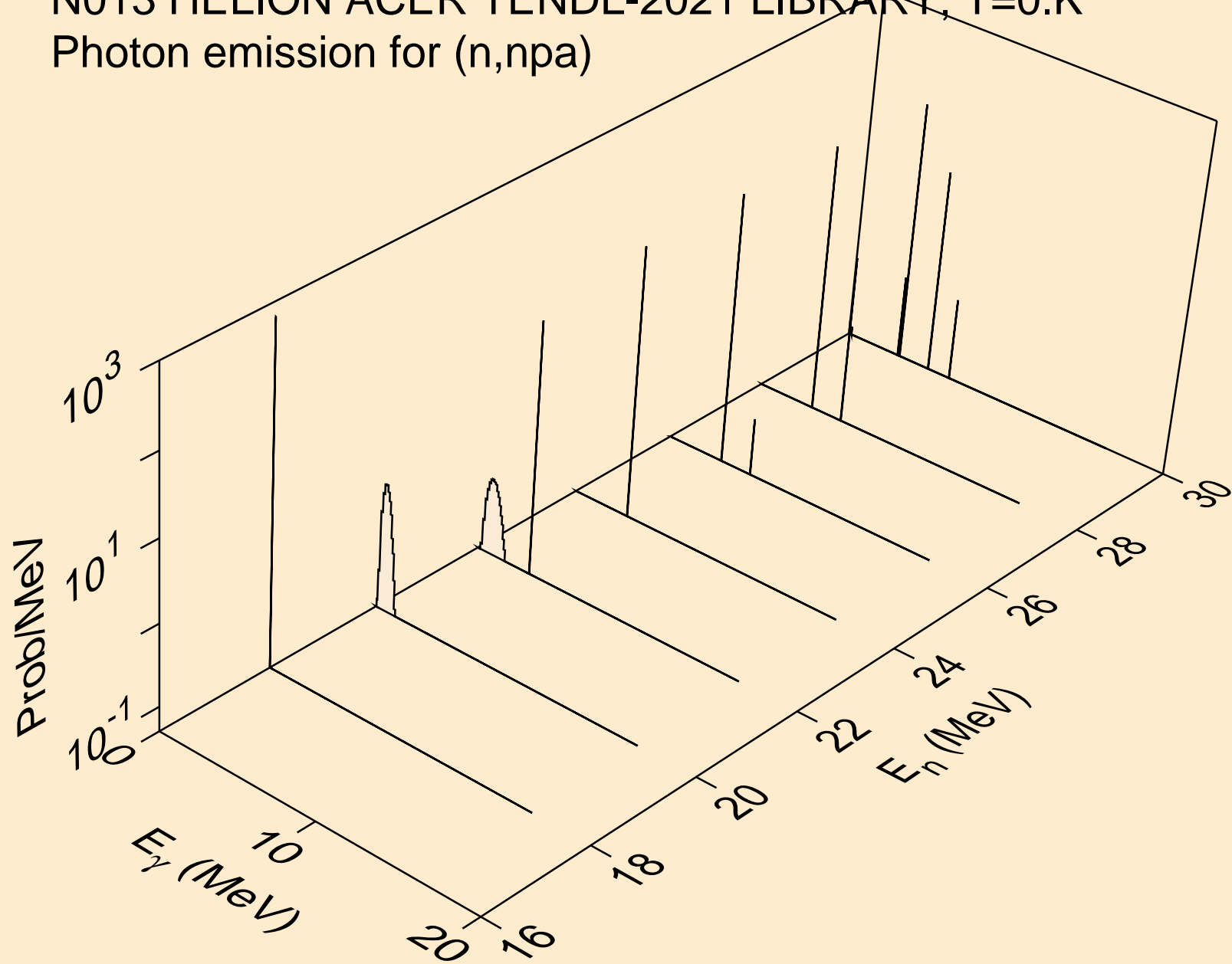

N013 HELION ACER TENDL-2021 LIBRARY; T=0.K  
Photon emission for (n,gma)

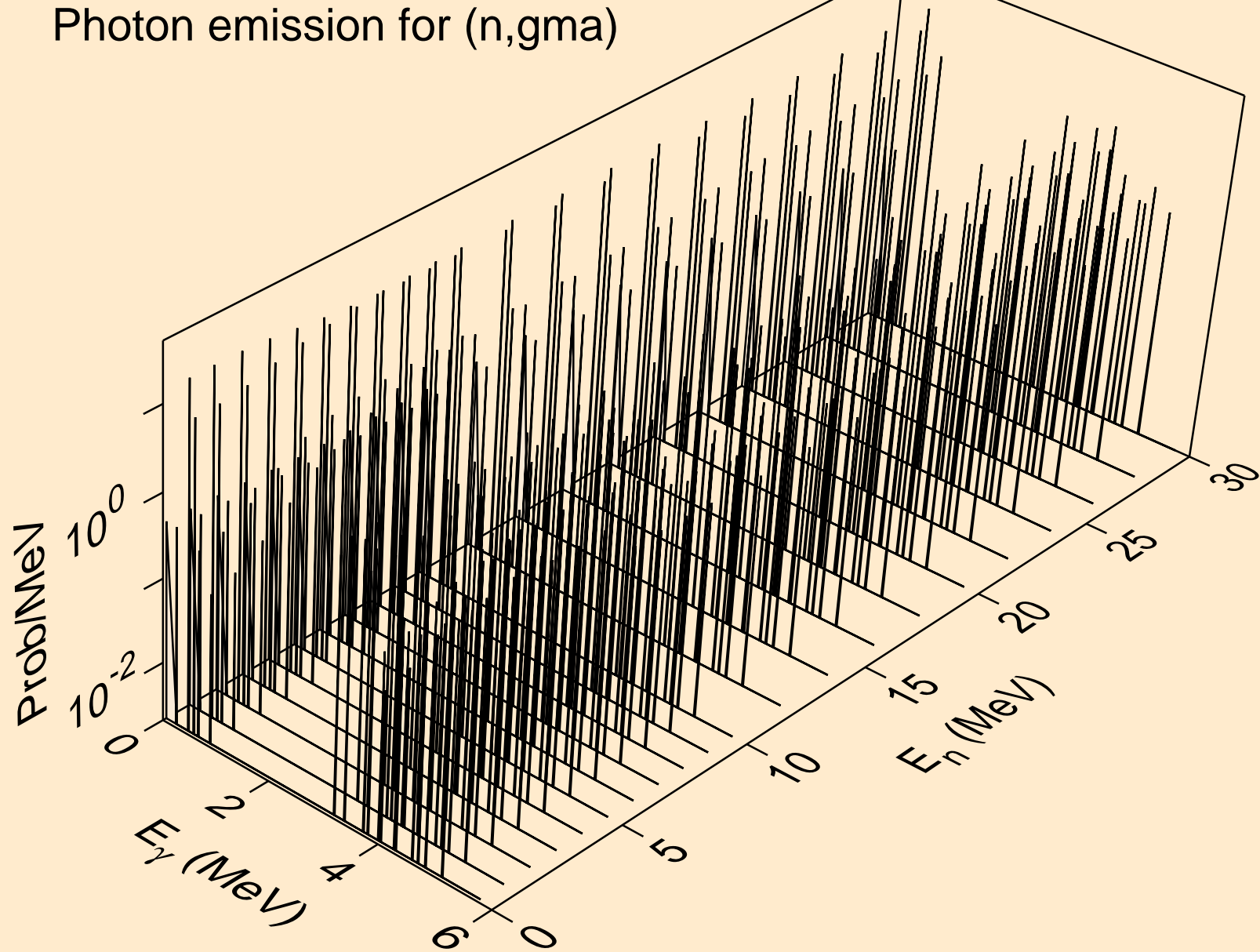

N013 HELION ACER TENDL-2021 LIBRARY; T=0.K  
Photon emission for (n,p)

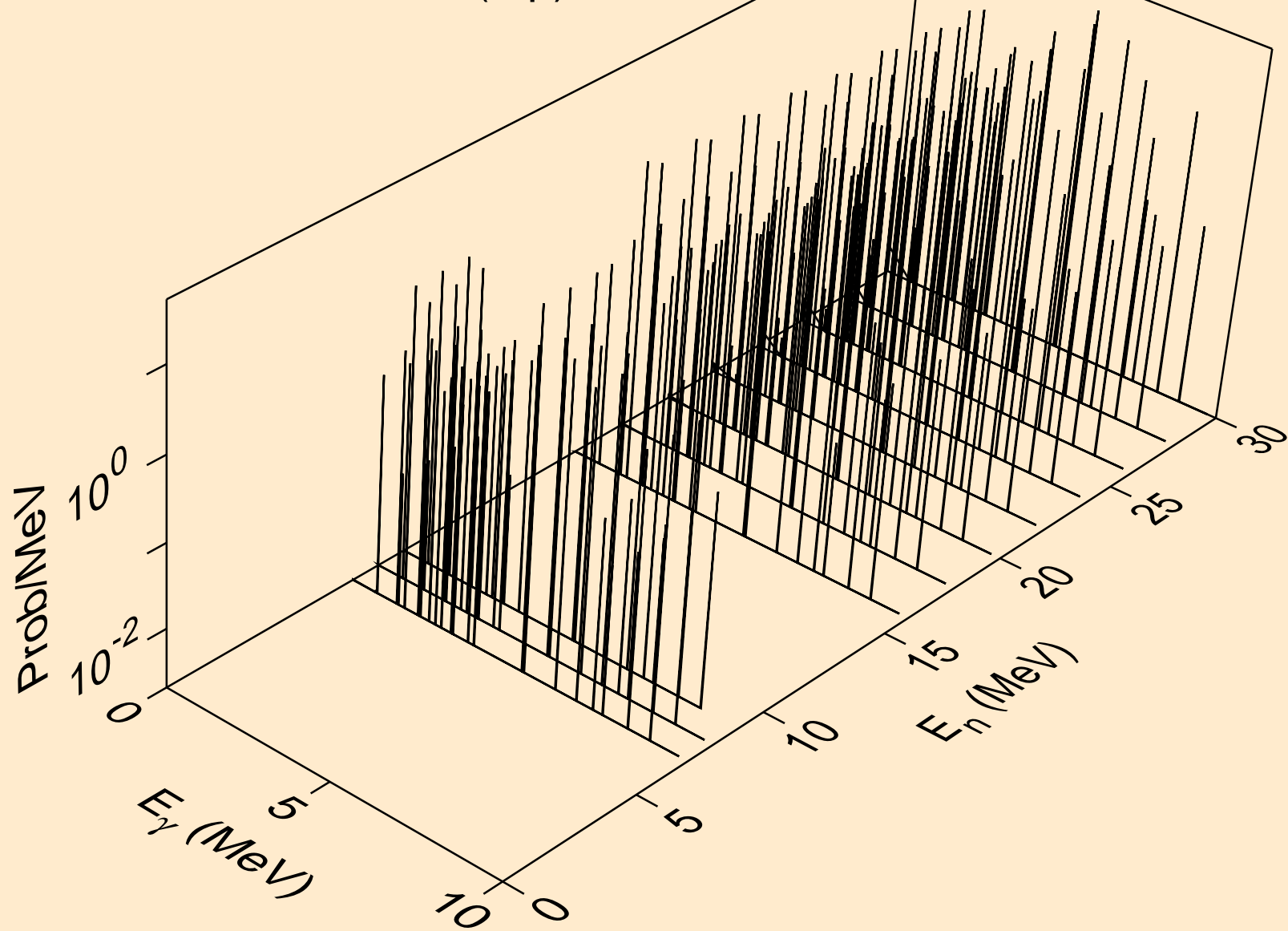

N013 HELION ACER TENDL-2021 LIBRARY; T=0.K  
Photon emission for (n,d)

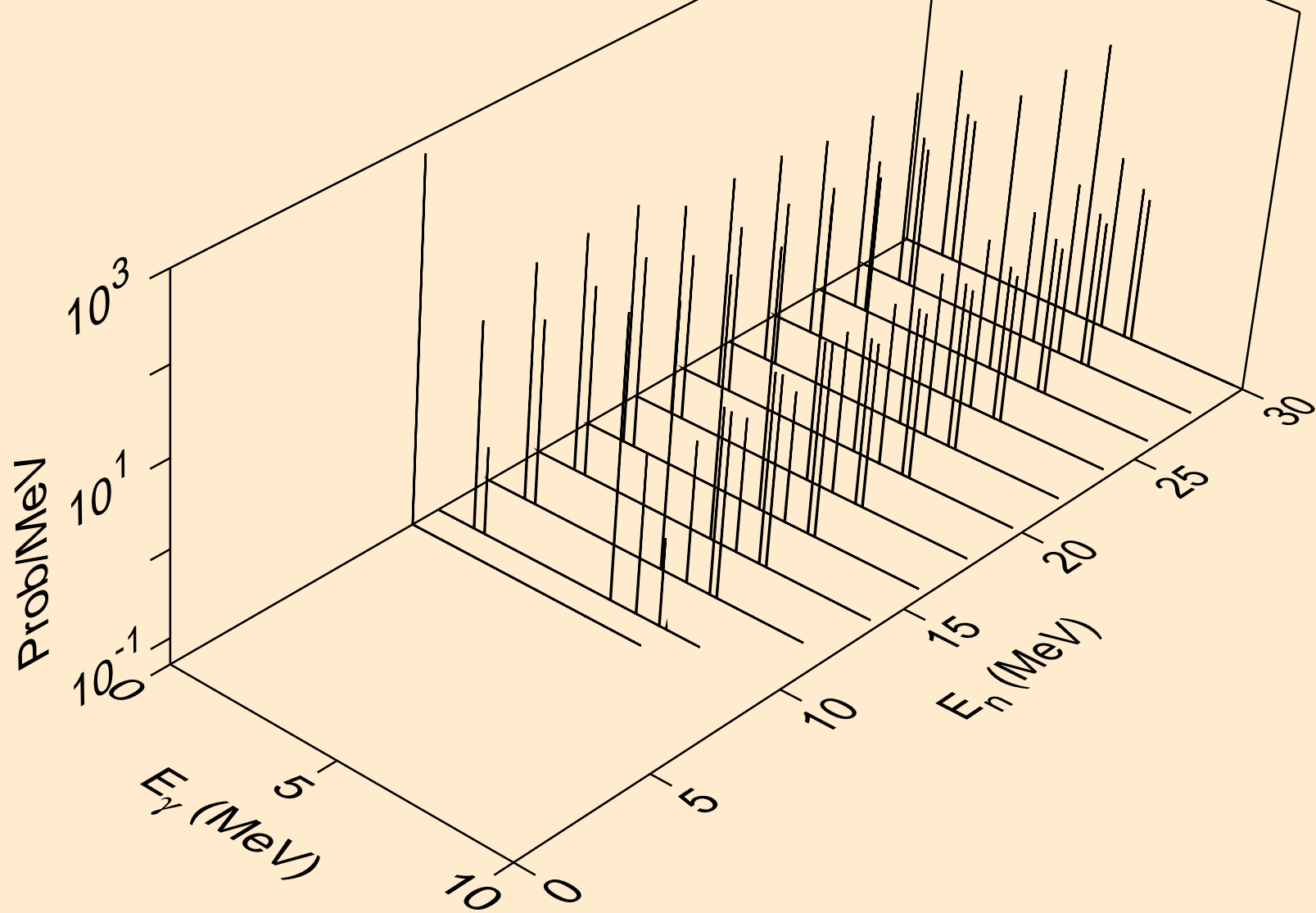



N013 HELION ACER TENDL-2021 LIBRARY; T=0.K  
Photon emission for (n,t)

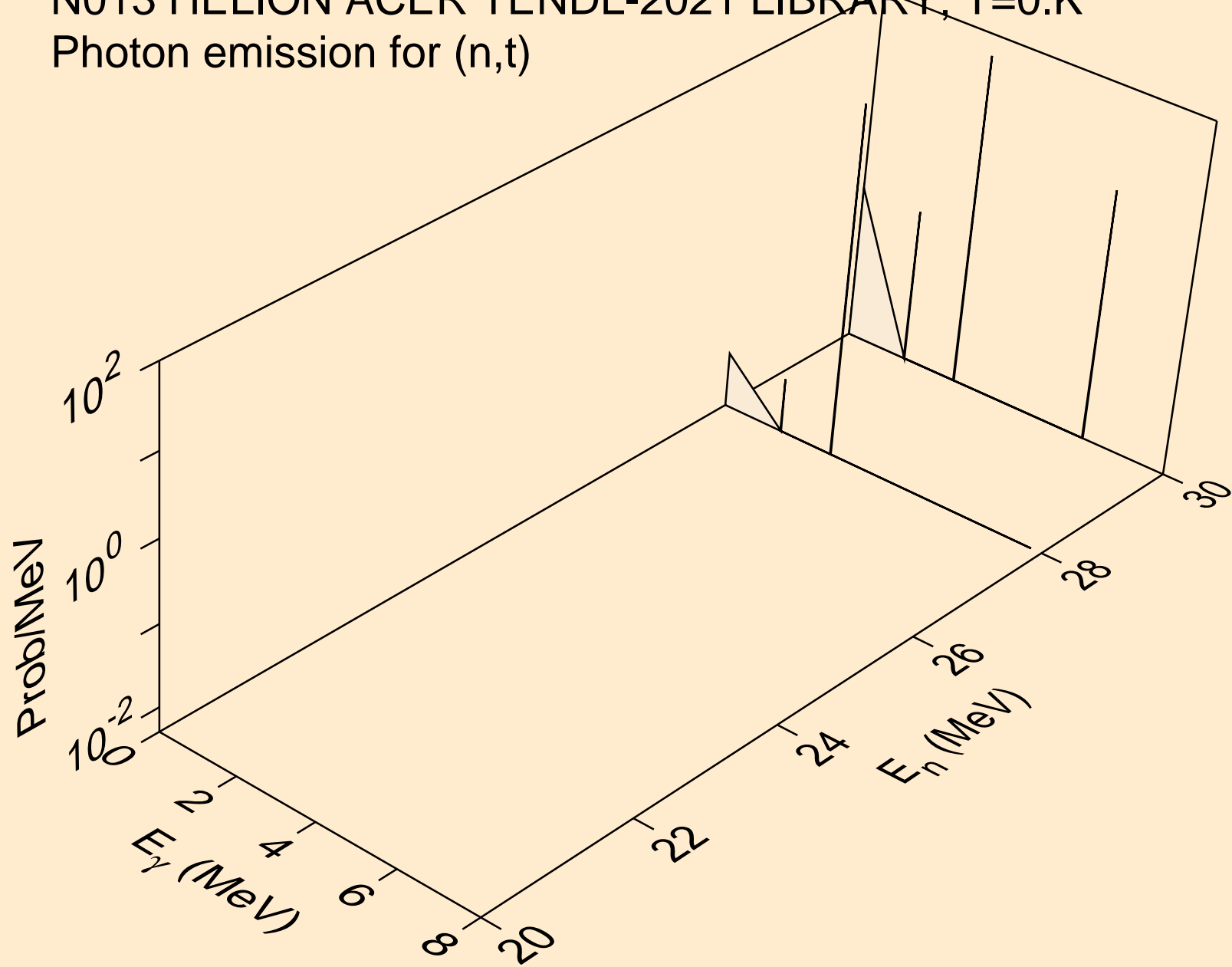

N013 HELION ACER TENDL-2021 LIBRARY; T=0.K  
Photon emission for inelastic

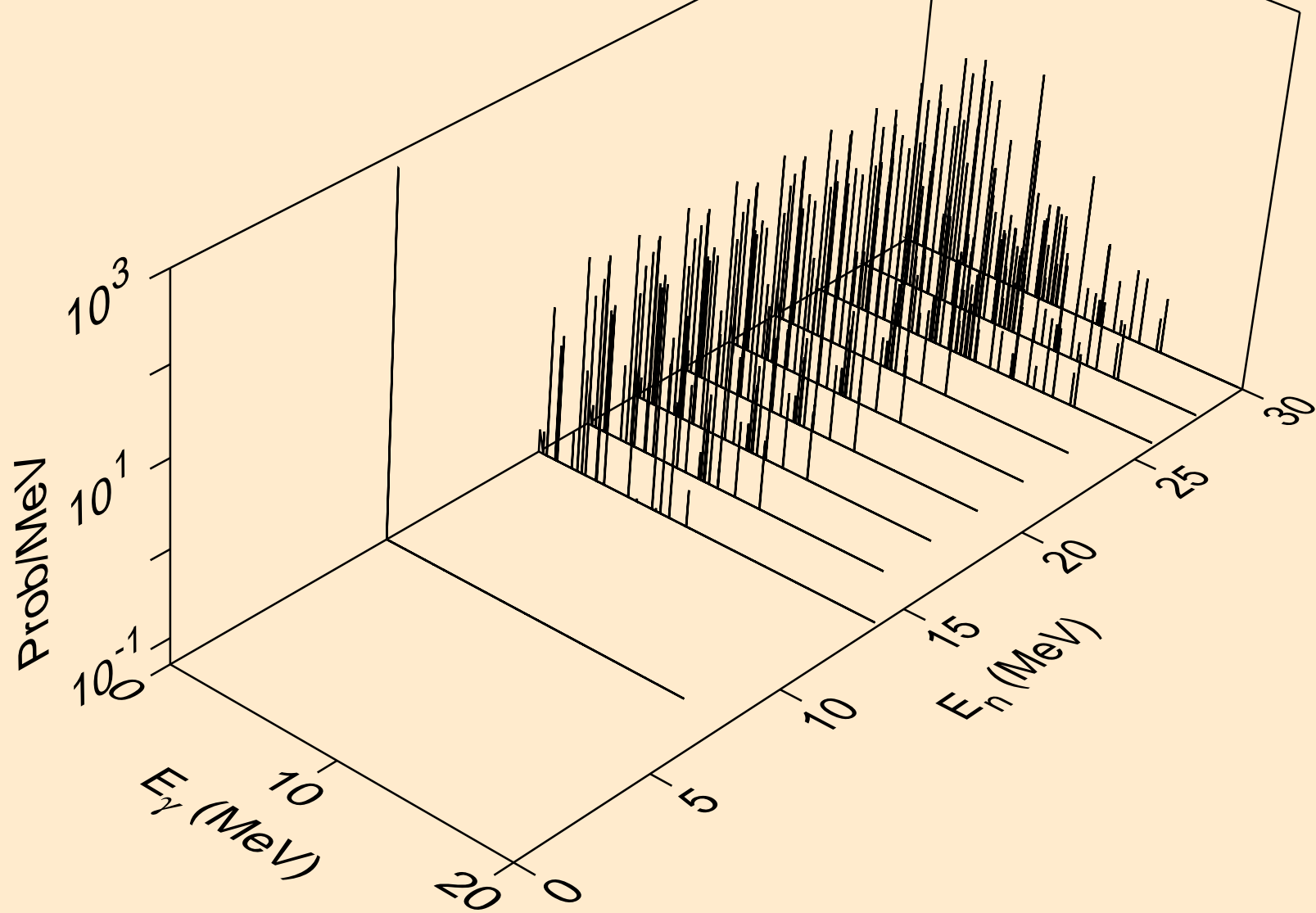

N013 HELION ACER TENDL-2021 LIBRARY; T=0.K  
Photon emission for (n,a)

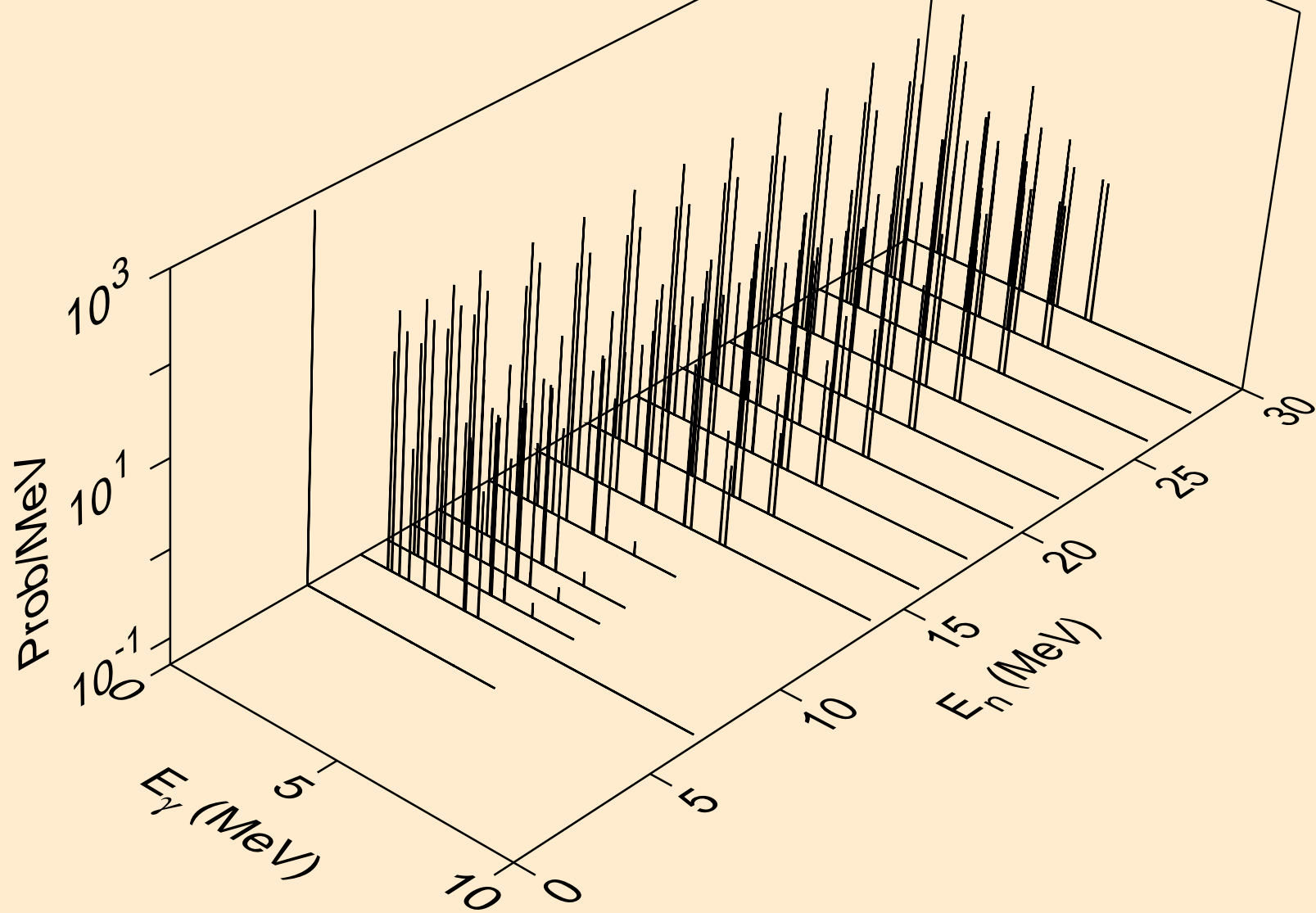

N013 HELION ACER TENDL-2021 LIBRARY; T=0.K  
Photon emission for (n,2a)

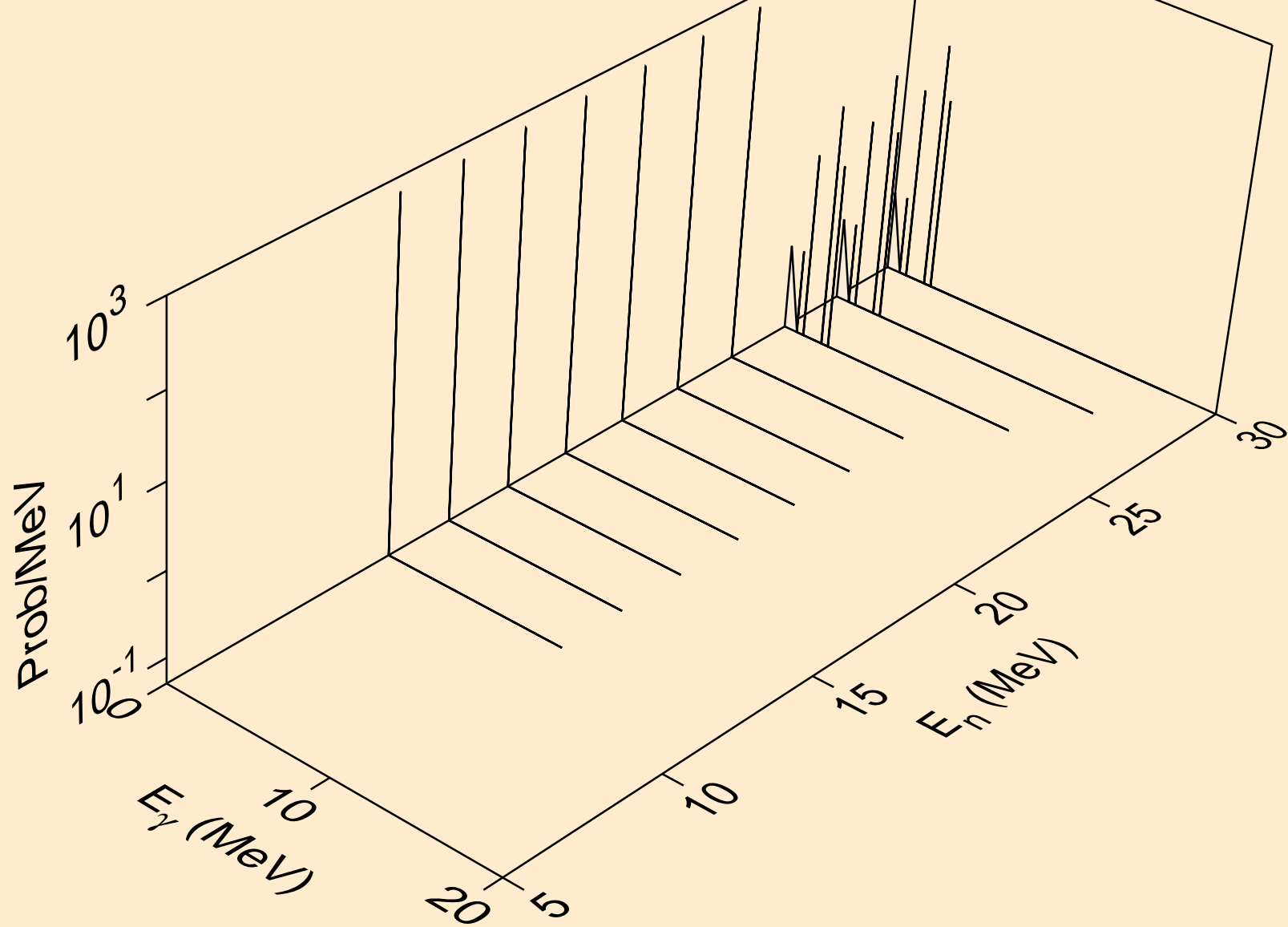

N013 HELION ACER TENDL-2021 LIBRARY; T=0.K  
Photon emission for (n,2p)

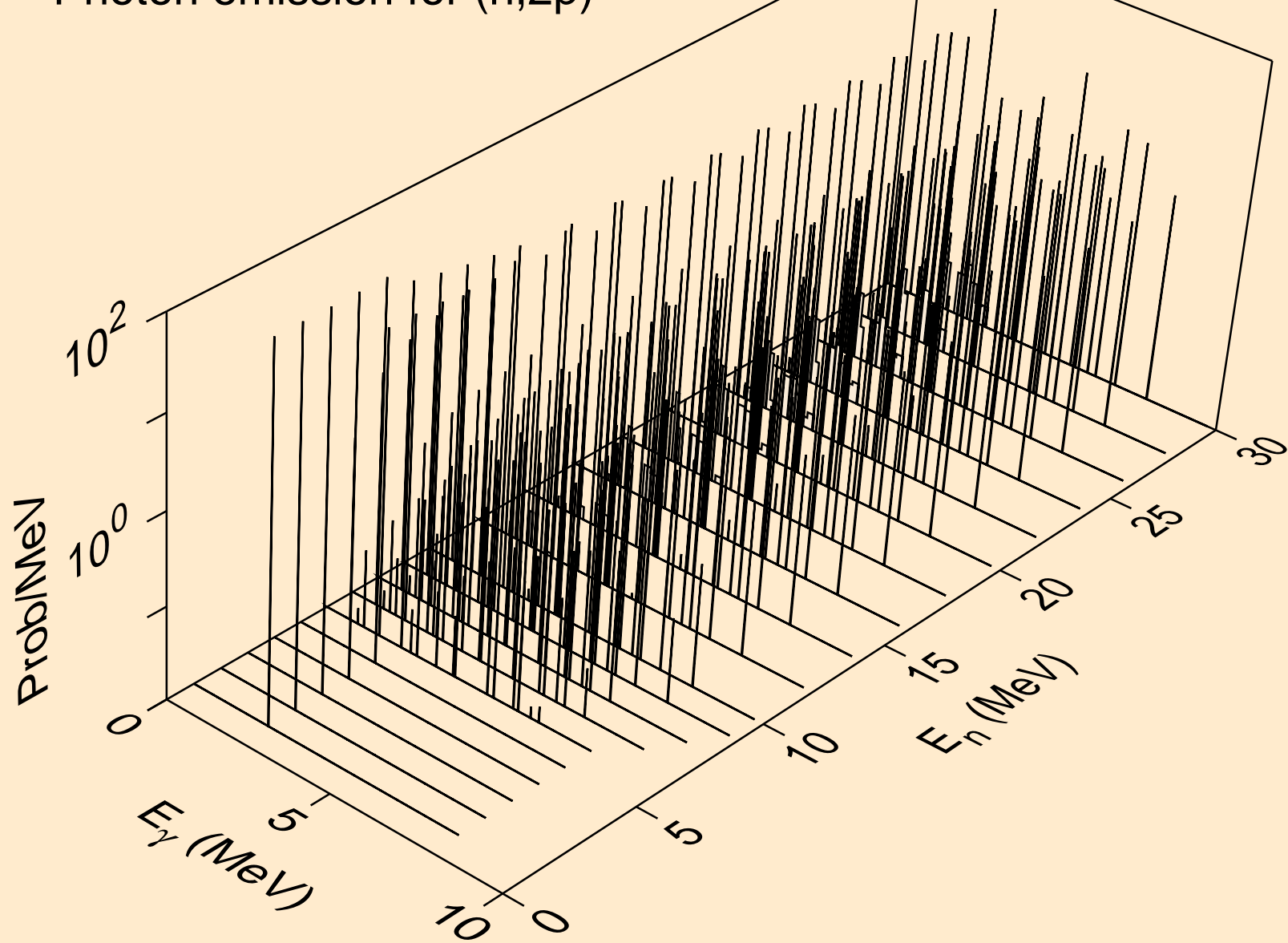

N013 HELION ACER TENDL-2021 LIBRARY; T=0.K  
Photon emission for (n,pa)

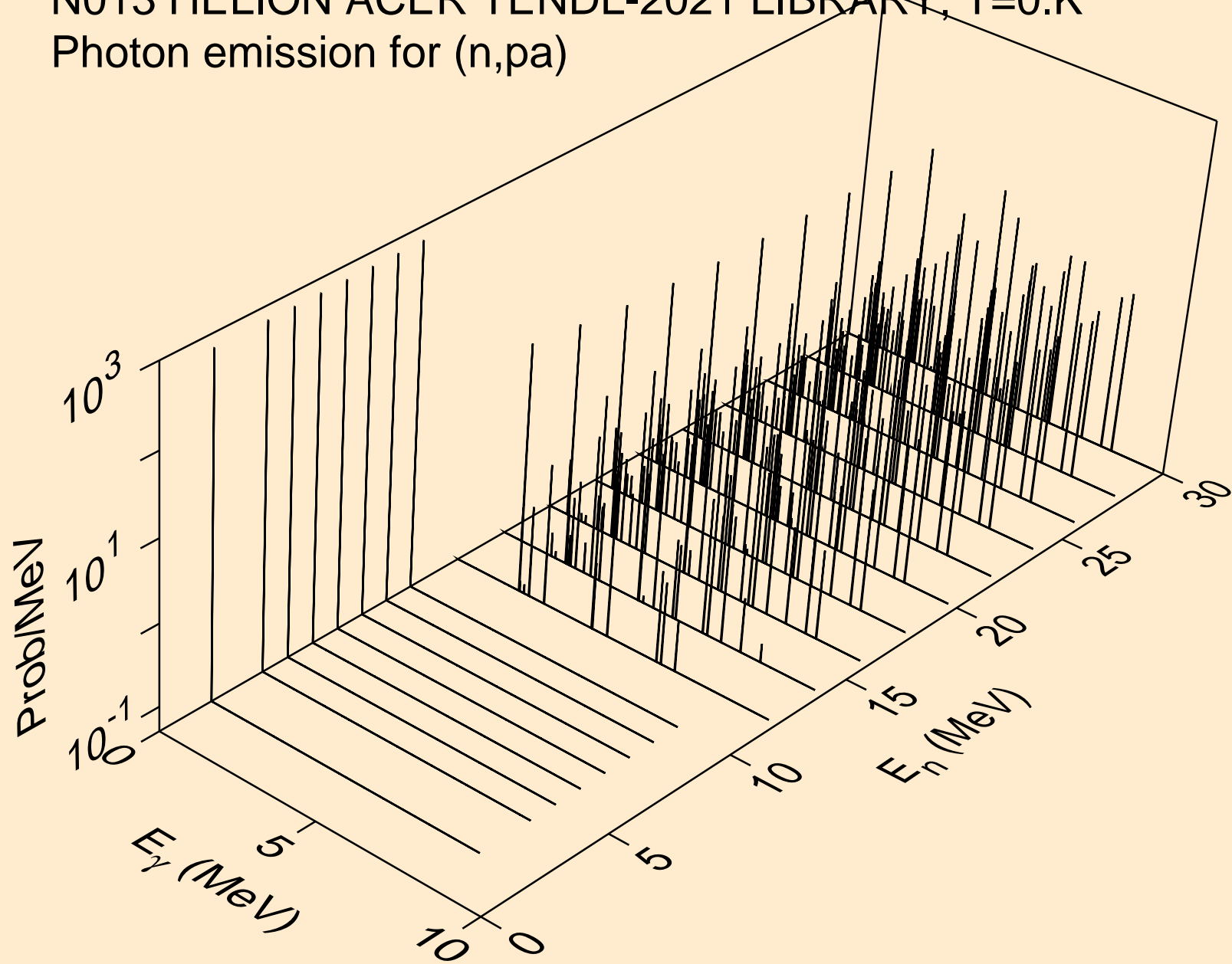

N013 HELION ACER TENDL-2021 LIBRARY; T=0.K  
Photon emission for (n,pd)

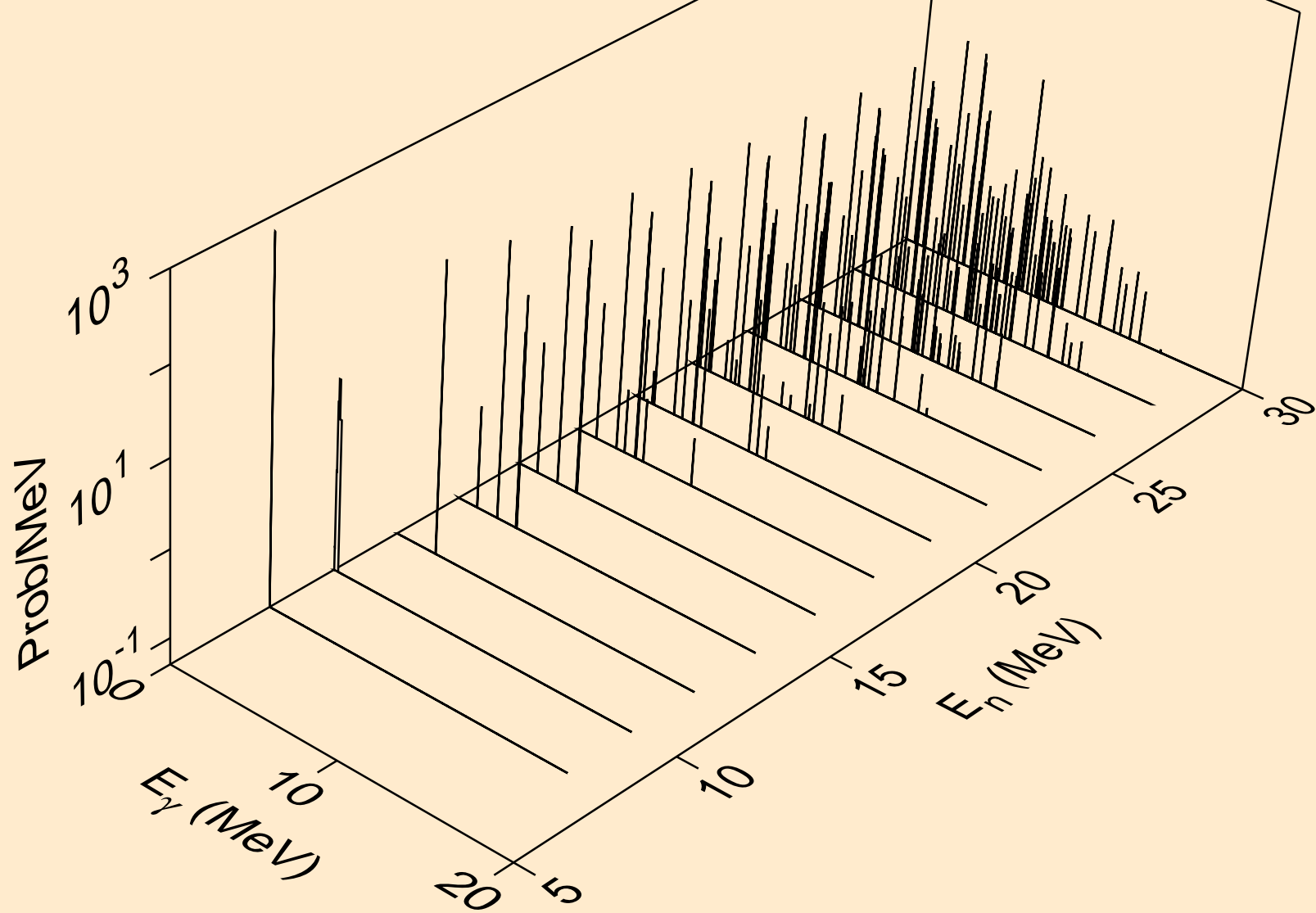

N013 HELION ACER TENDL-2021 LIBRARY; T=0.K  
Photon emission for (n,pt)

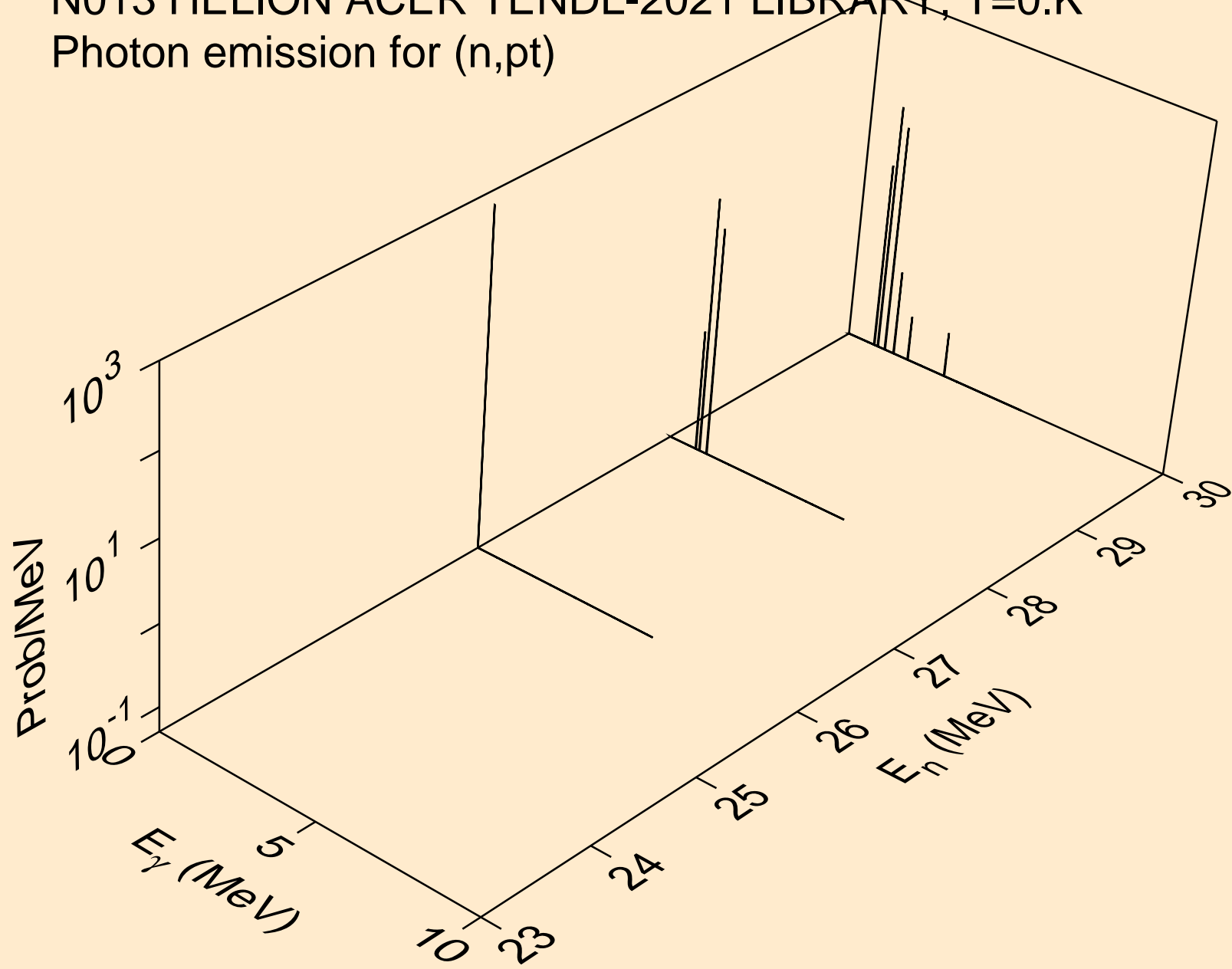



N013 HELION ACER TENDL-2021 LIBRARY; T=0.K  
Photon emission for (n,da)

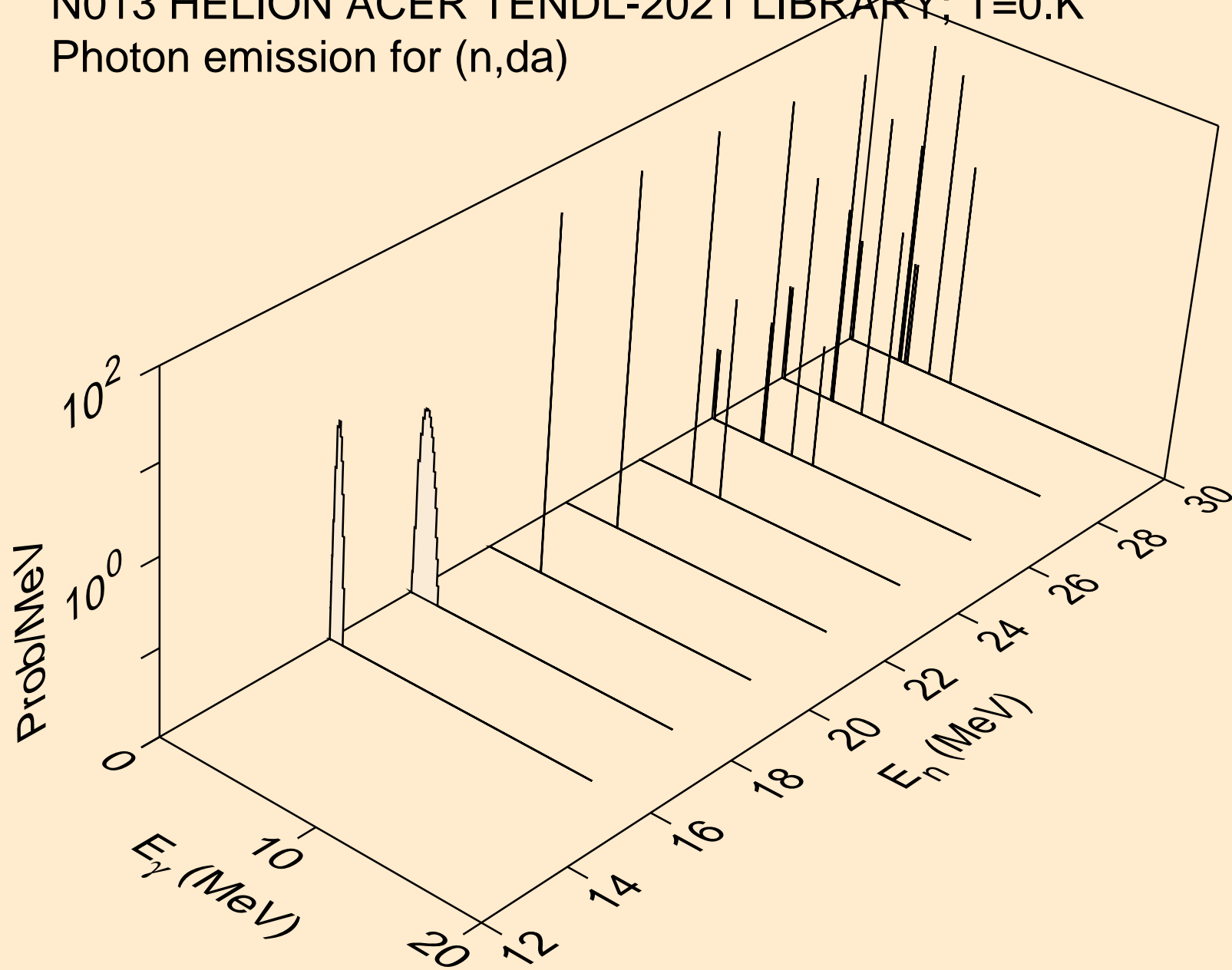

# N013 HELION ACER TENDL-2021 LIBRARY; T=0.K

## Particle heating contributions

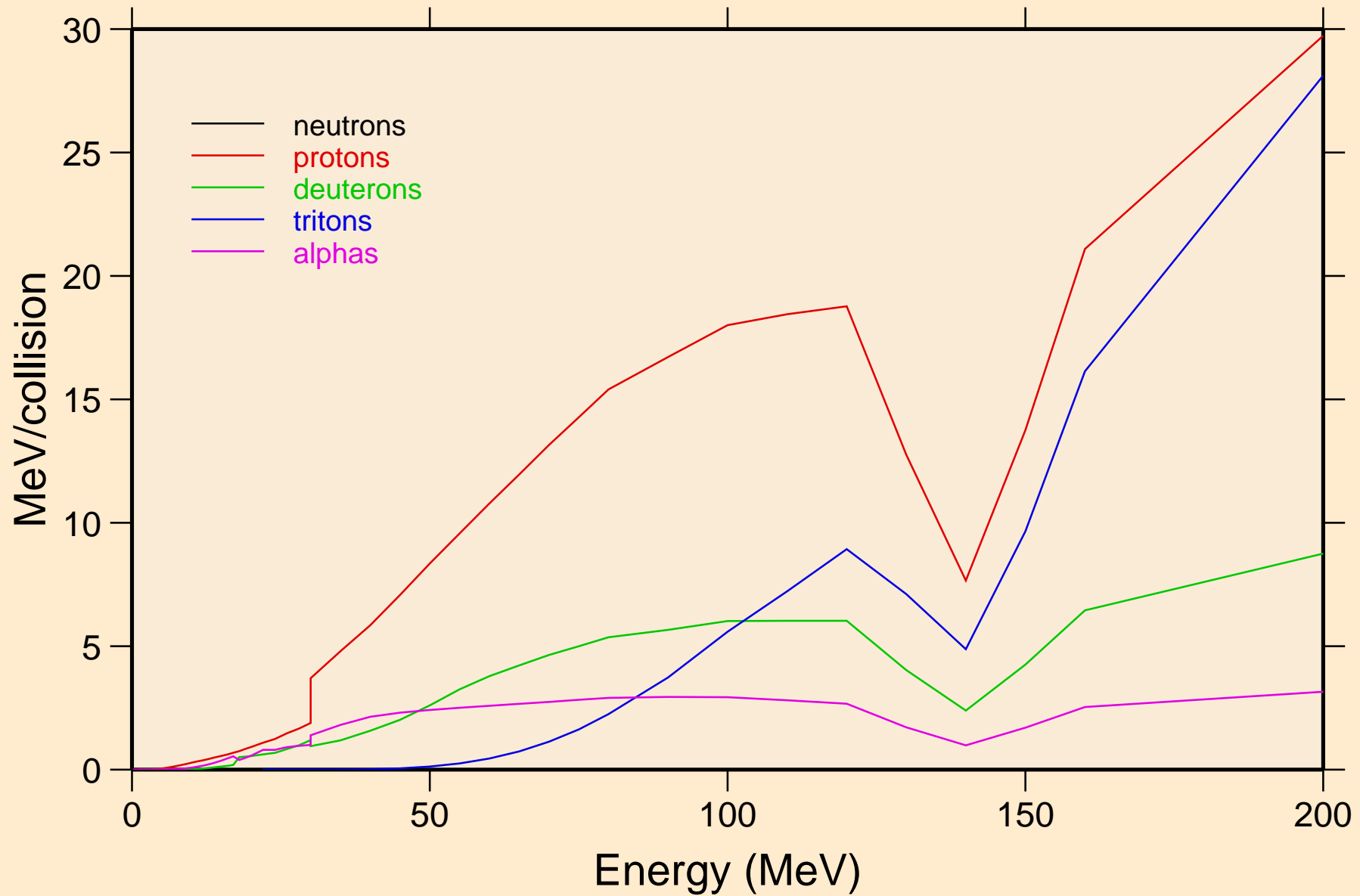

N013 HELION ACER TENDL-2021 LIBRARY; T=0.K  
Recoil Heating

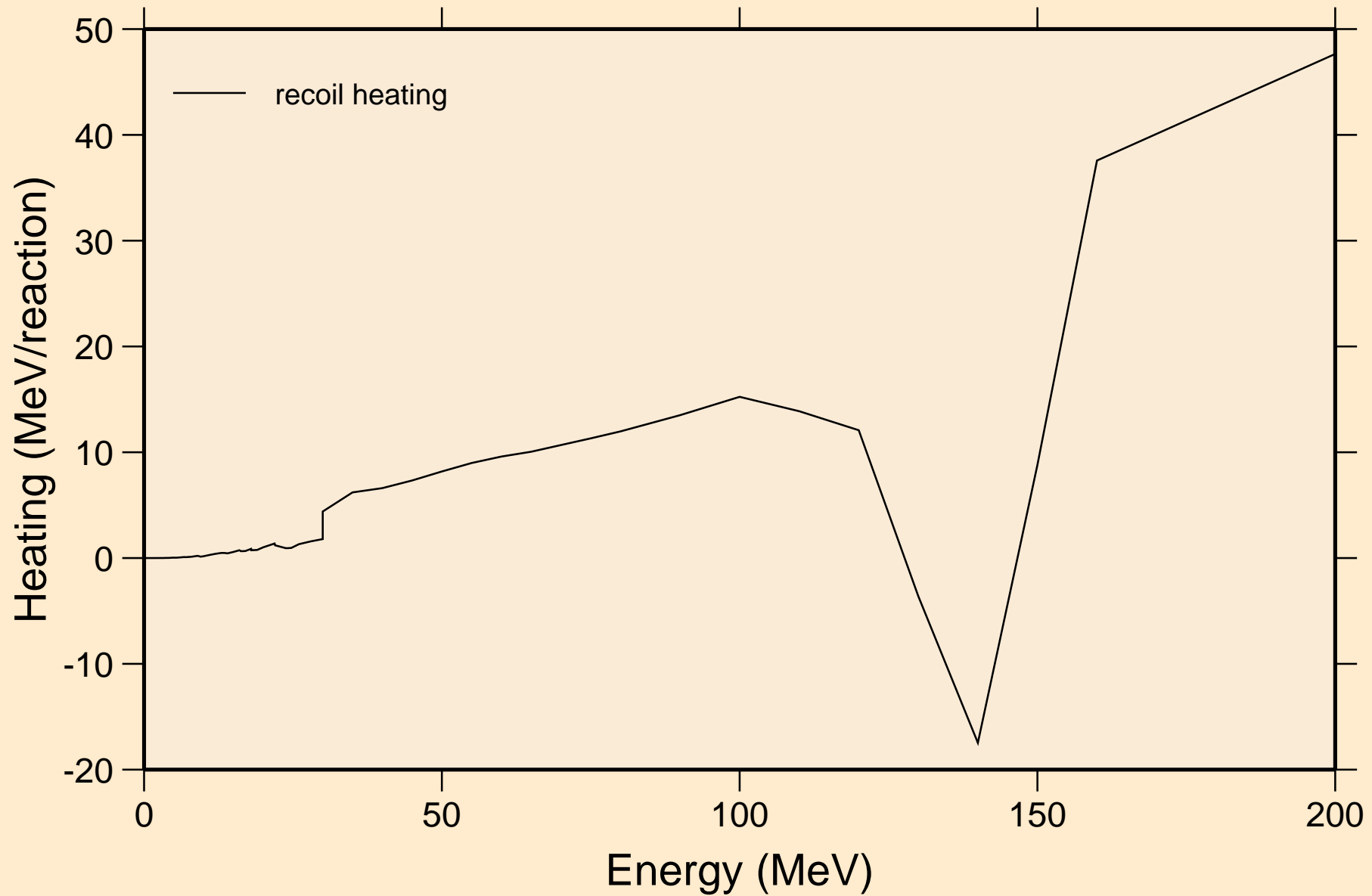

# N013 HELION ACER TENDL-2021 LIBRARY; T=0.K

## Particle production cross sections

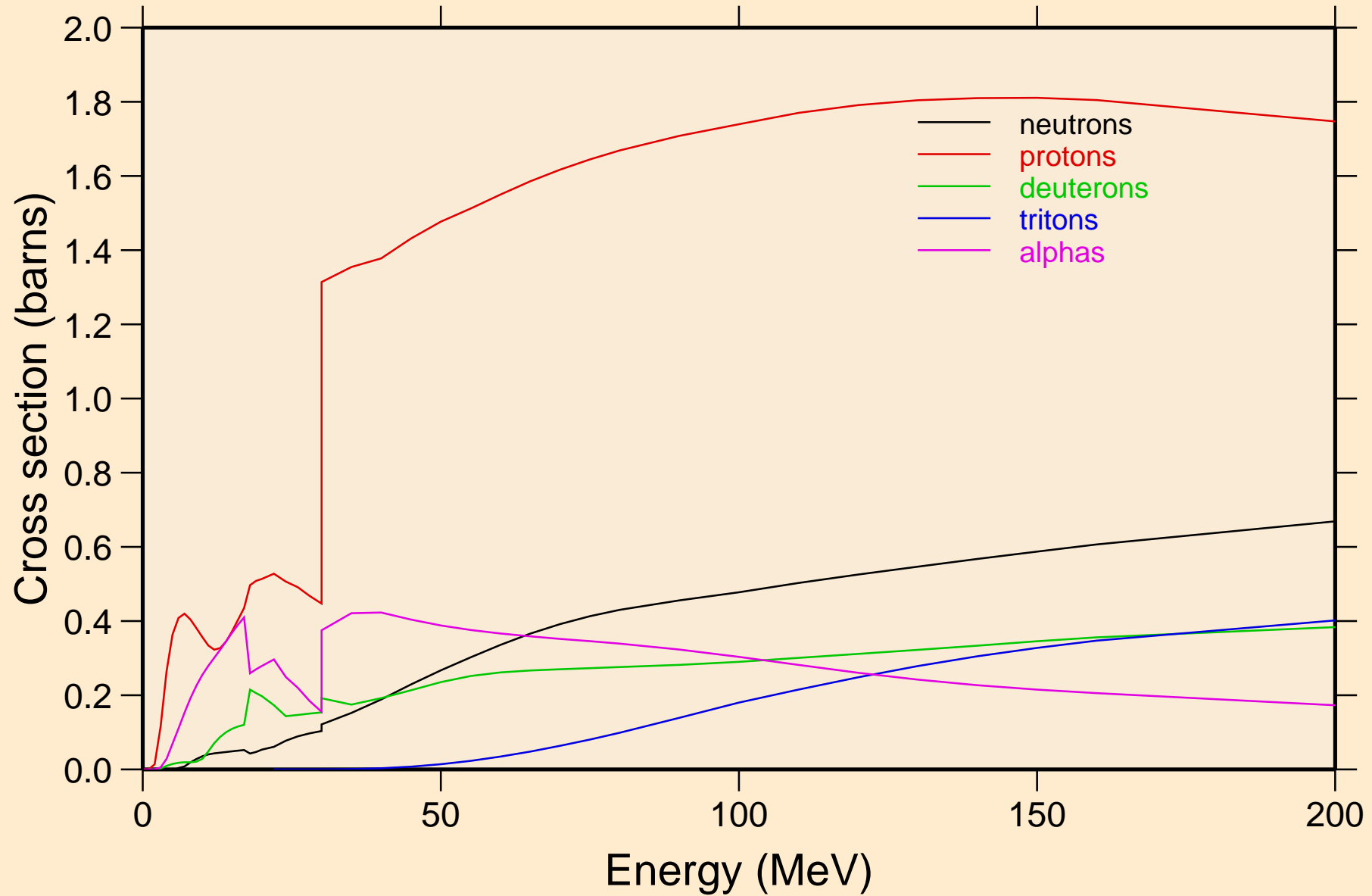

N013 HELION ACER TENDL-2021 LIBRARY; T=0.K  
neutrons from (s,n)

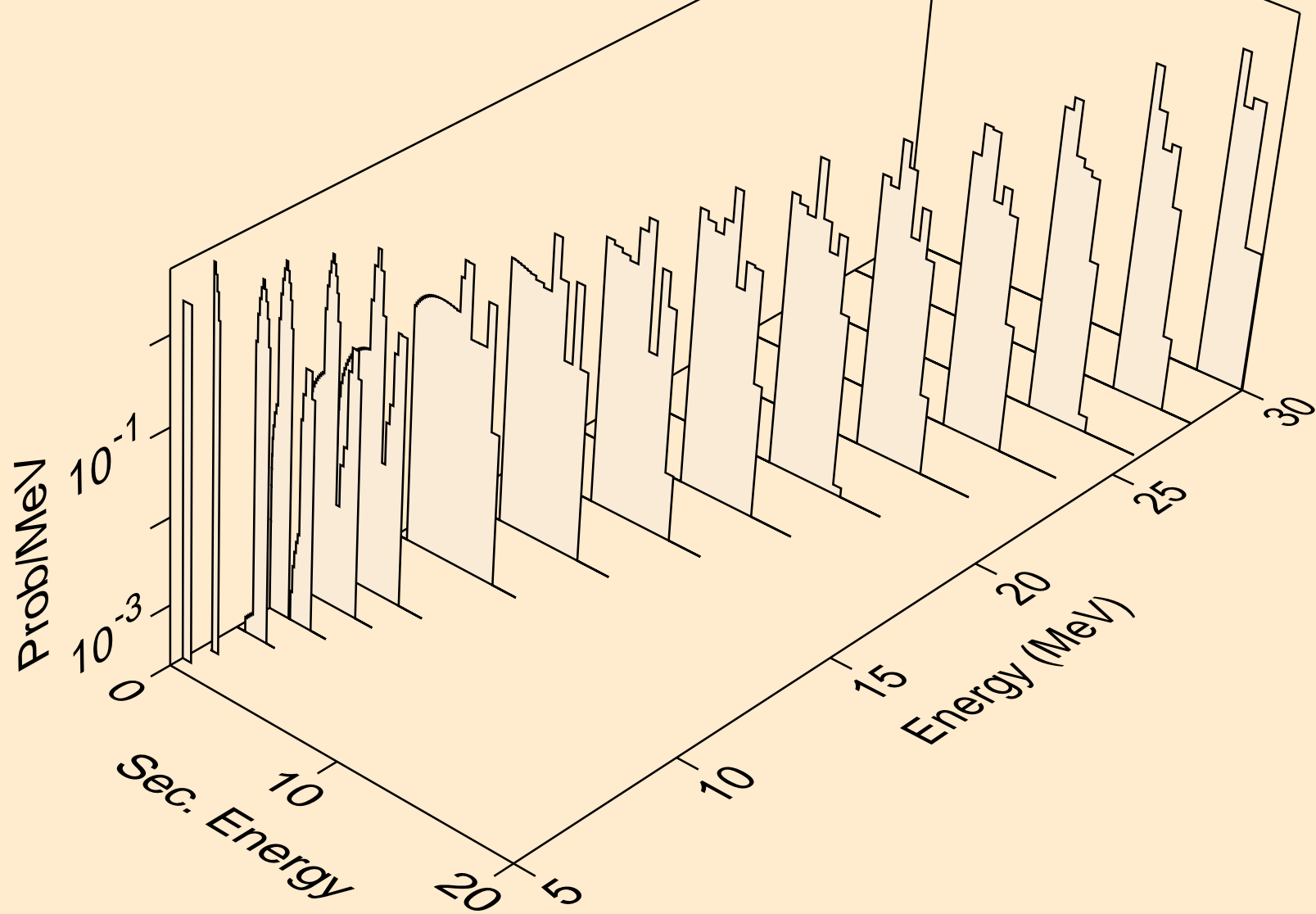

N013 HELION ACER TENDL-2021 LIBRARY; T=0.K  
neutrons from (s,x)

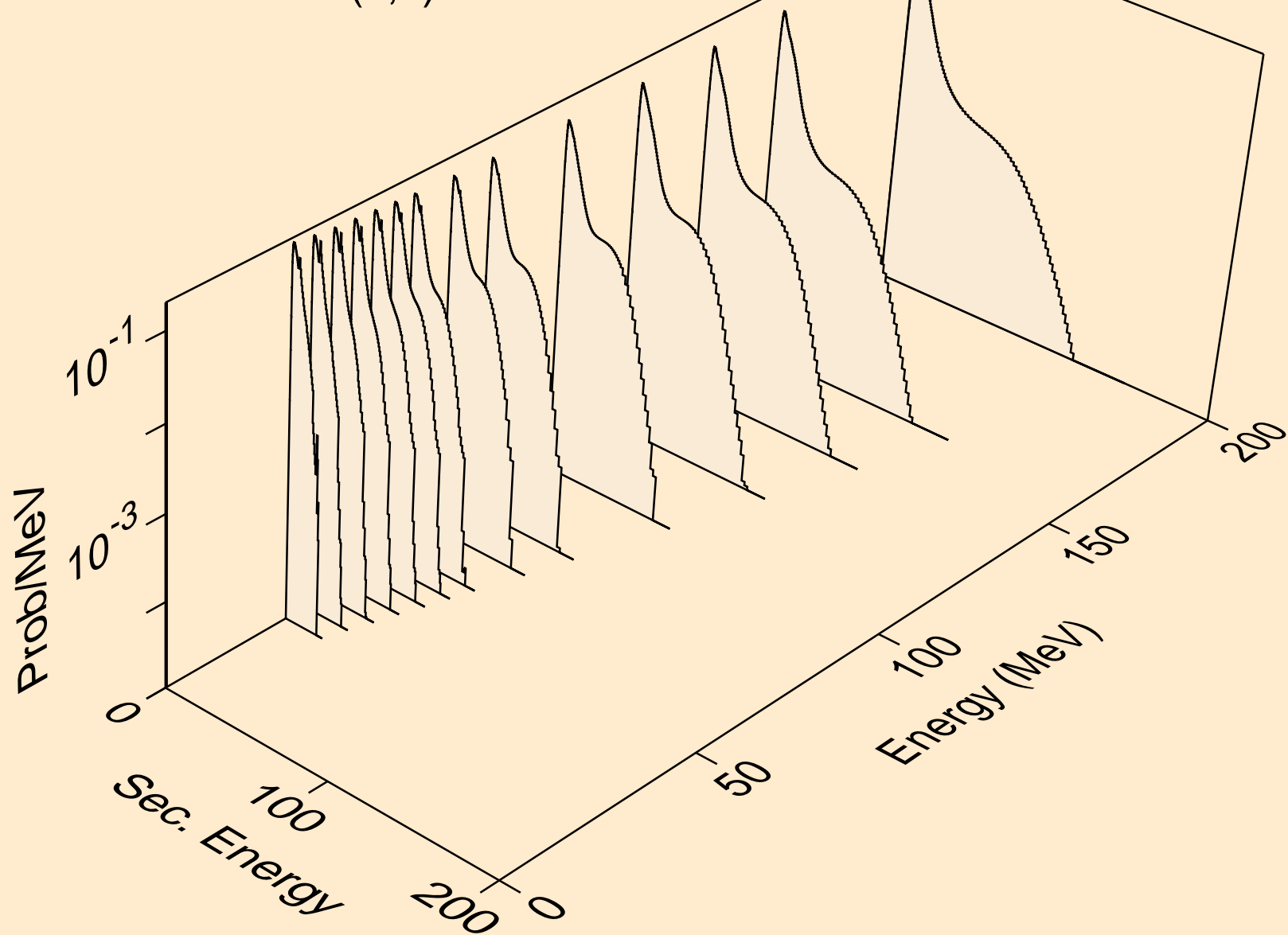

N013 HELION ACER TENDL-2021 LIBRARY; T=0.K  
neutrons from (s,n\*)a

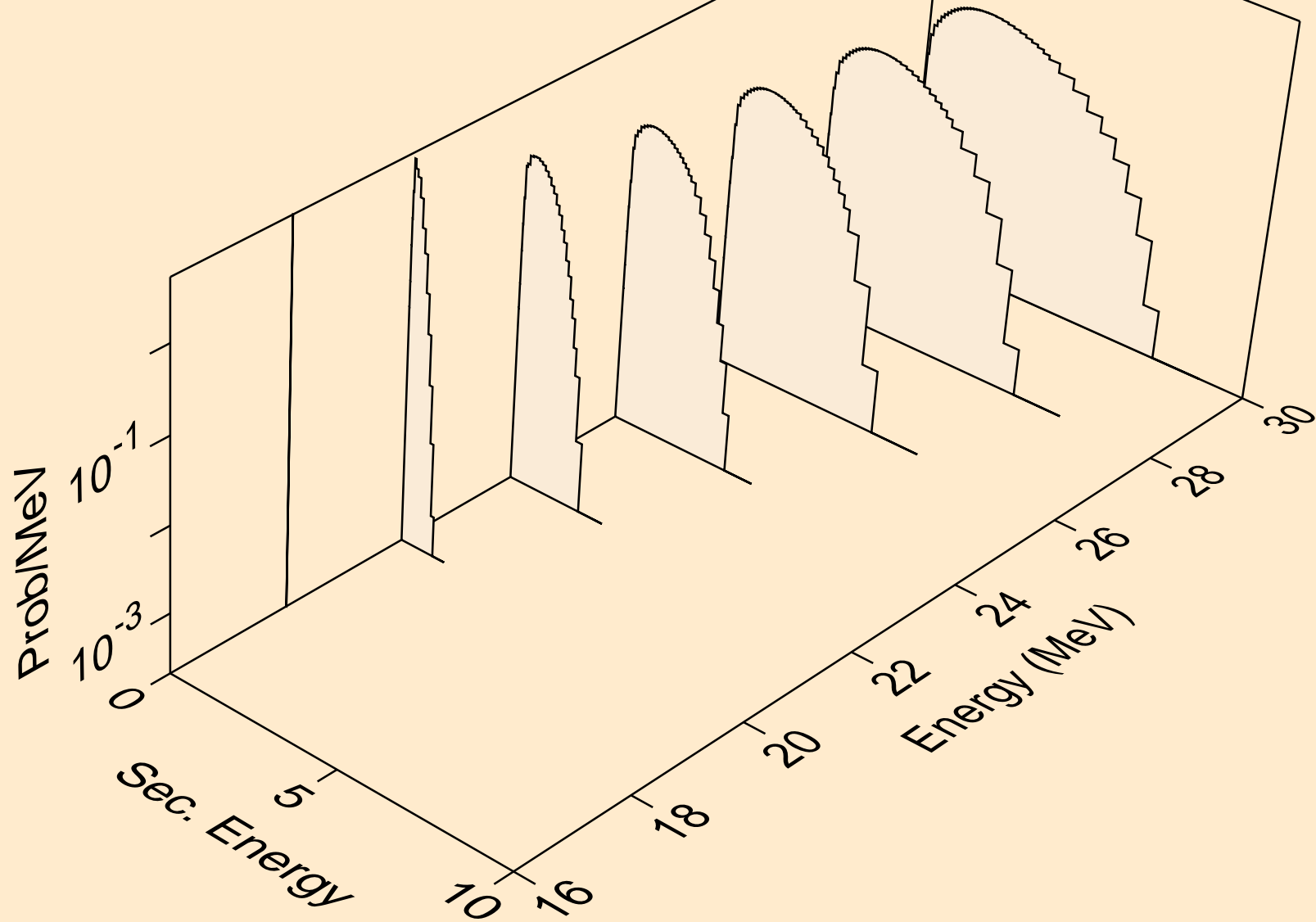

N013 HELION ACER TENDL-2021 LIBRARY; T=0.K  
neutrons from (s,n\*)p

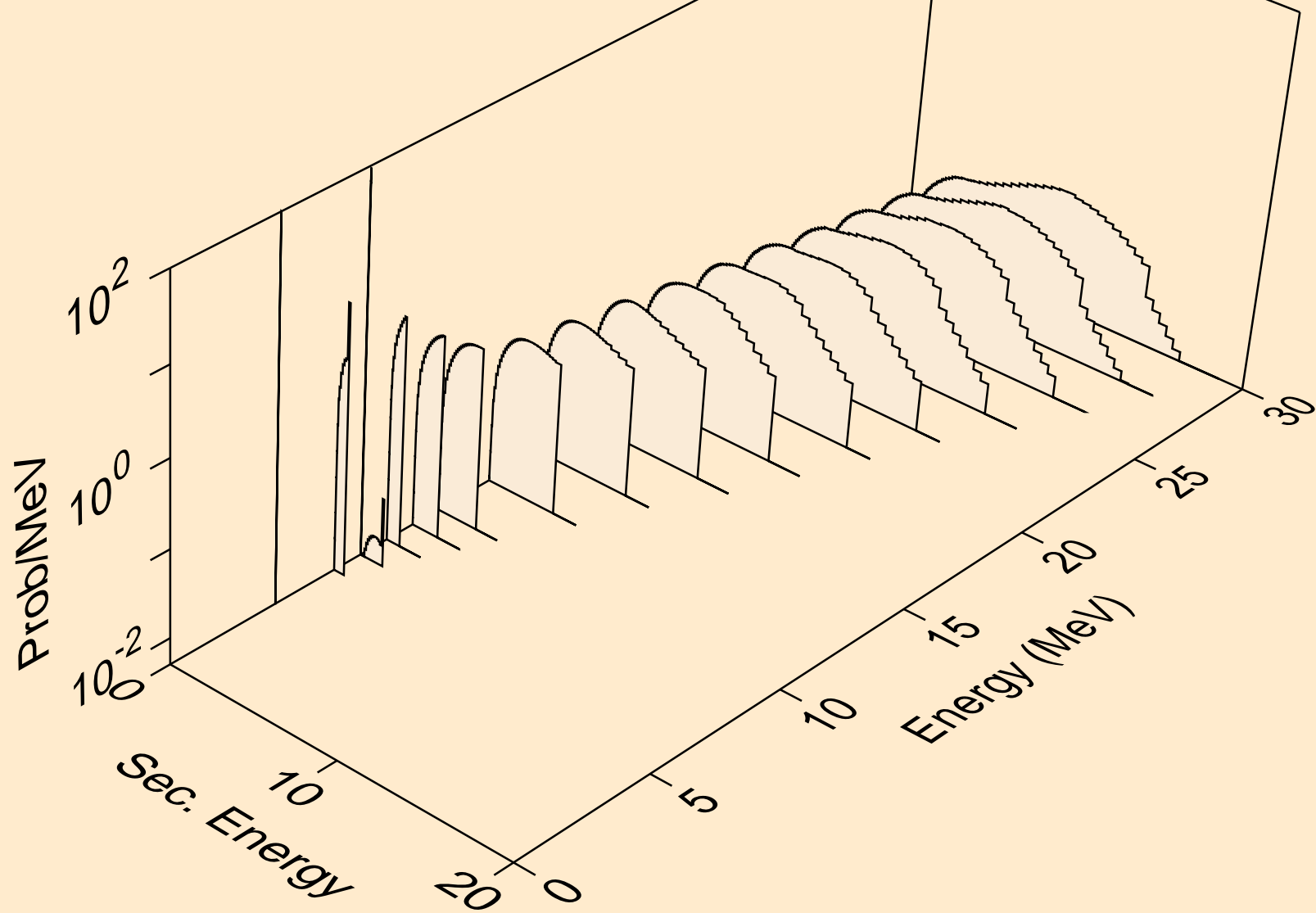



N013 HELION ACER TENDL-2021 LIBRARY; T=0.K  
neutrons from (s,n\*)he3

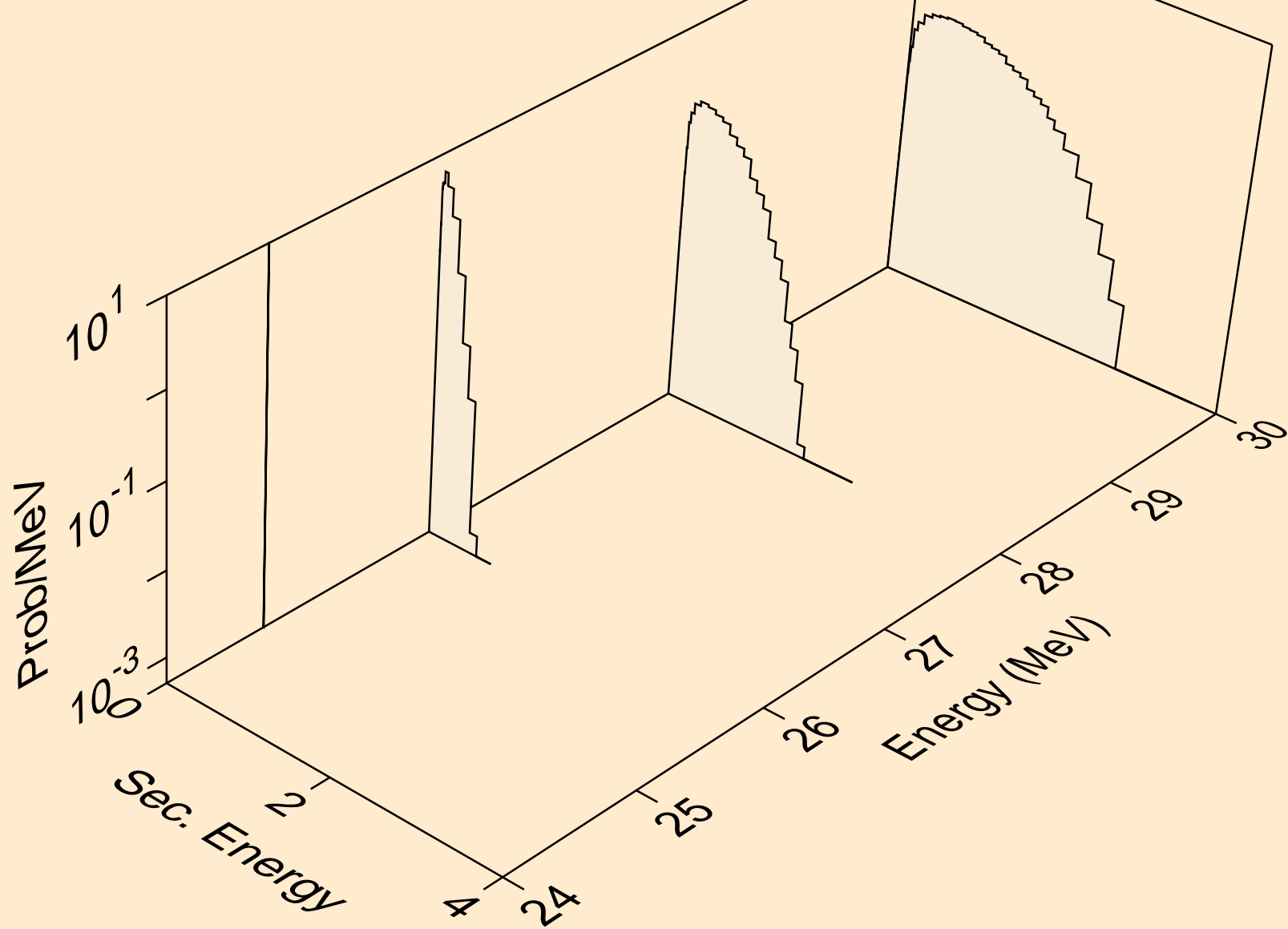

N013 HELION ACER TENDL-2021 LIBRARY; T=0.K  
neutrons from (s,2np)

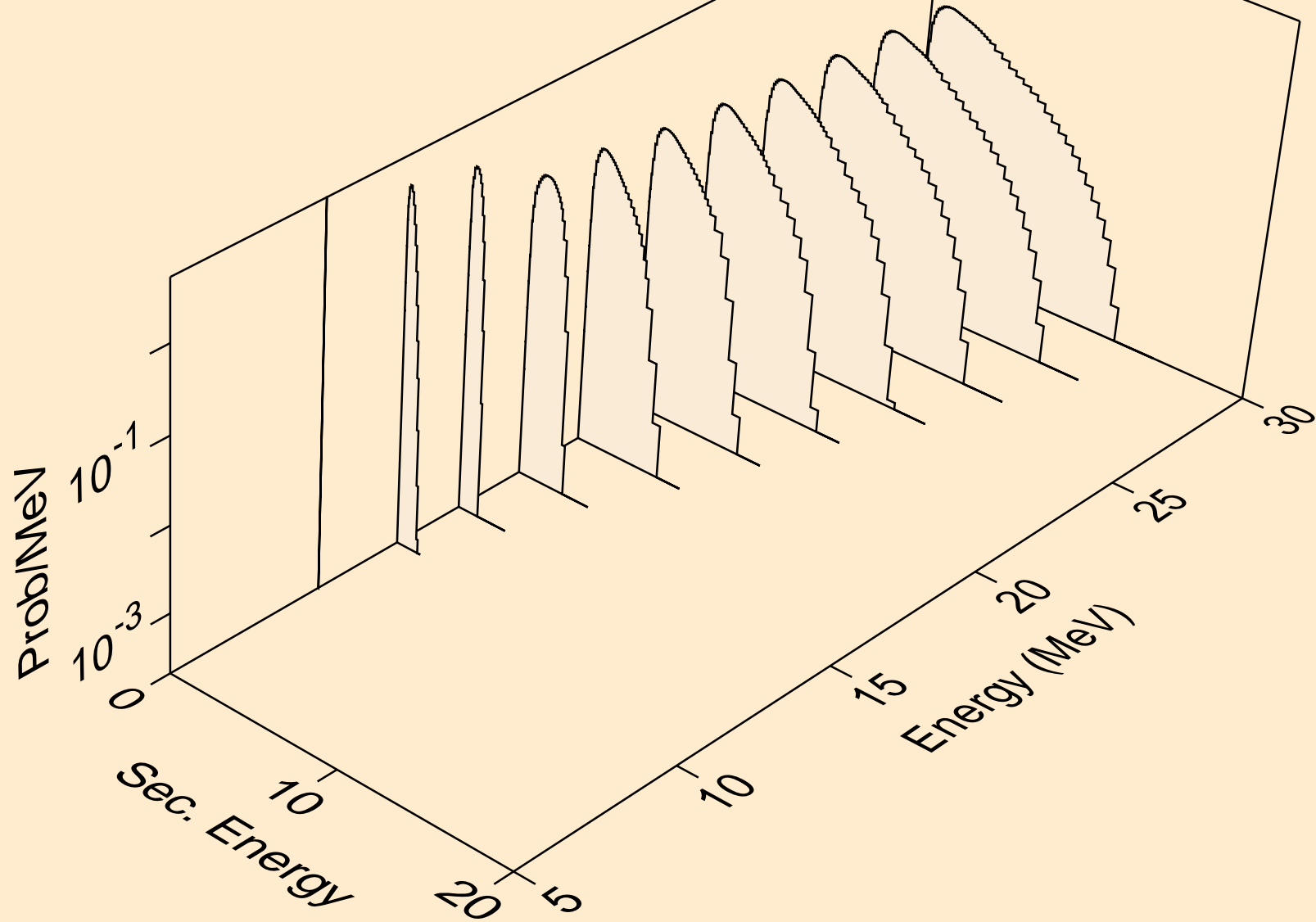

N013 HELION ACER TENDL-2021 LIBRARY; T=0.K  
neutrons from (s,npa)

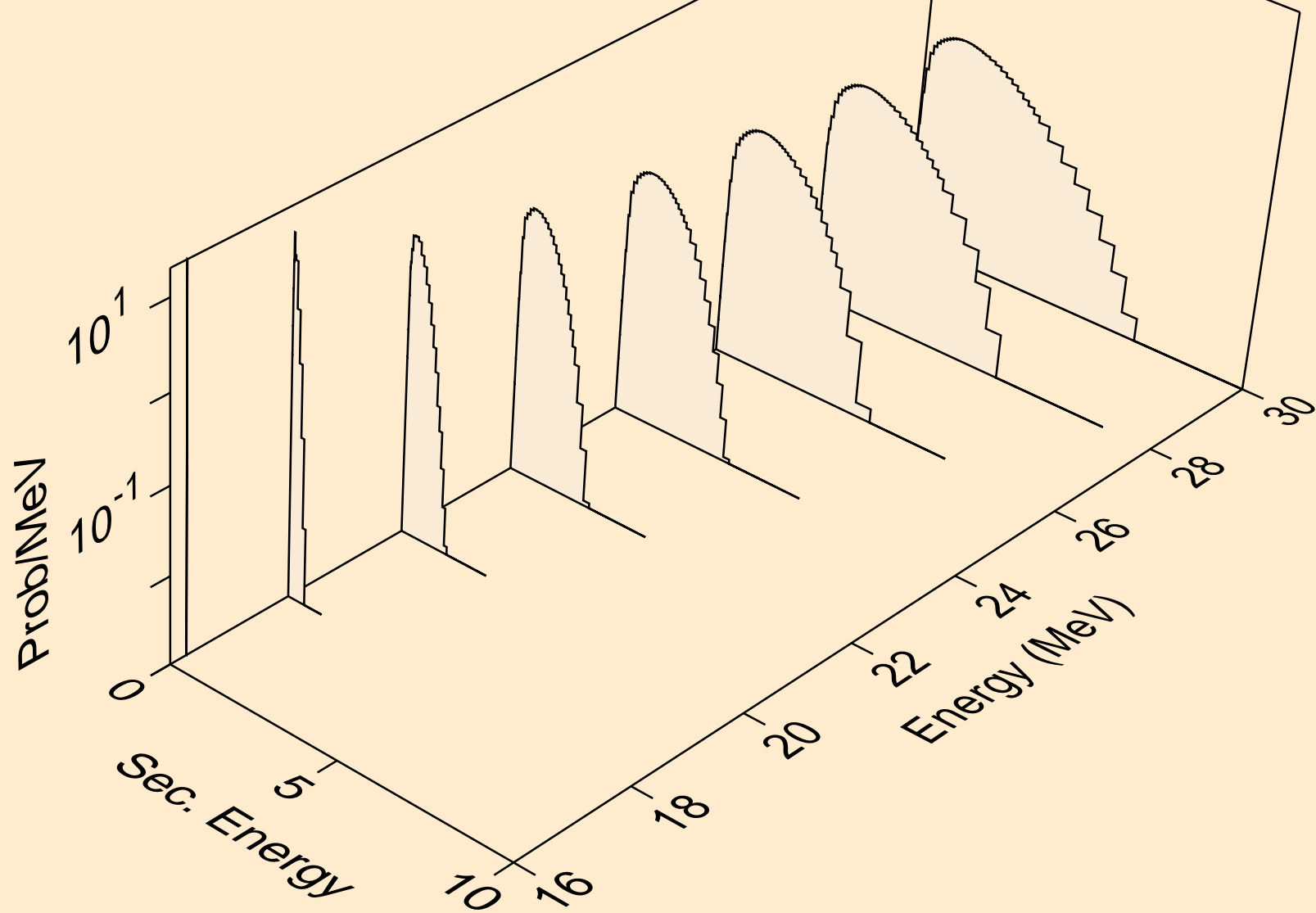

N013 HELION ACER TENDL-2021 LIBRARY; T=0.K  
protons from (s,x)

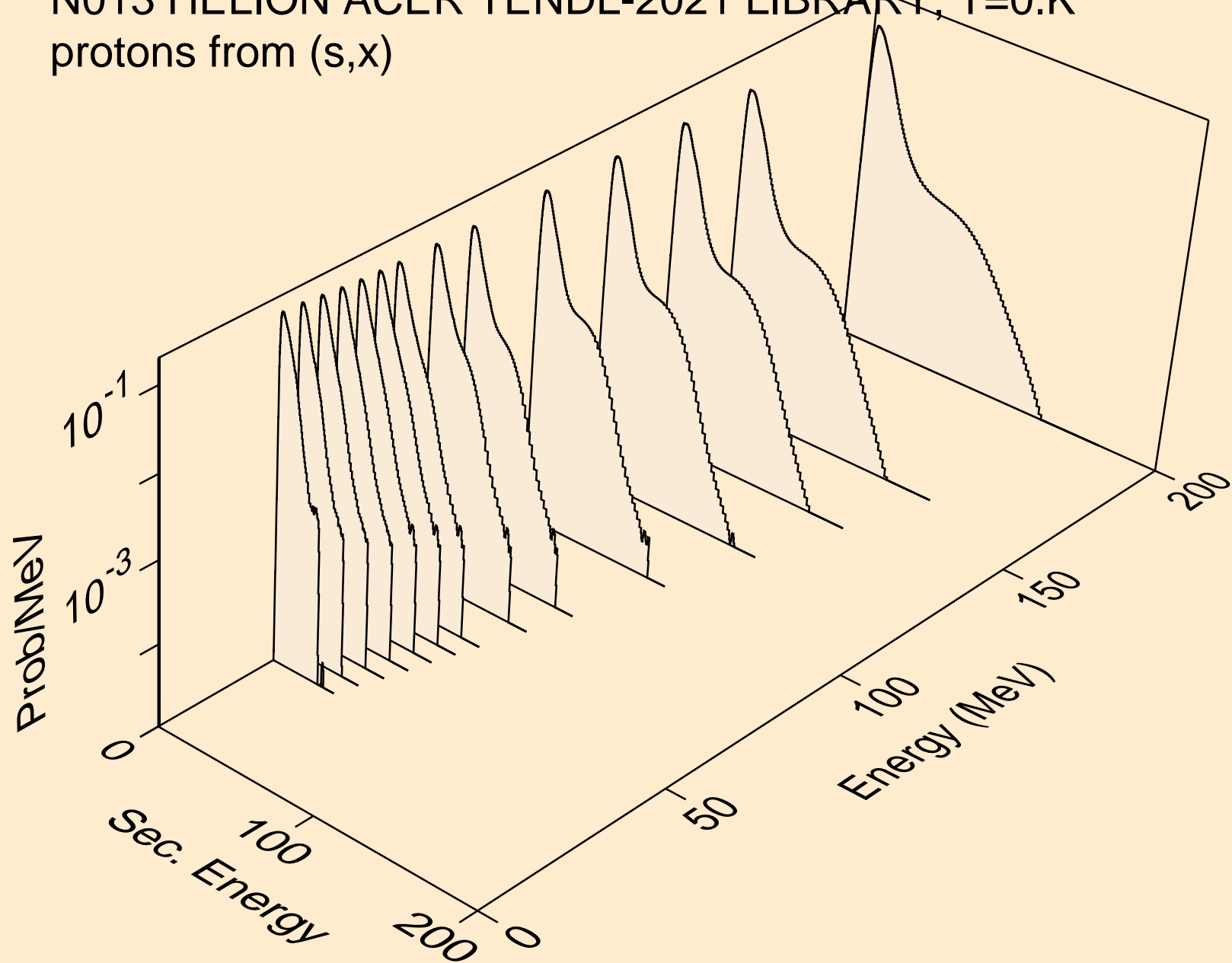

N013 HELION ACER TENDL-2021 LIBRARY; T=0.K  
protons from (s,n\*)p

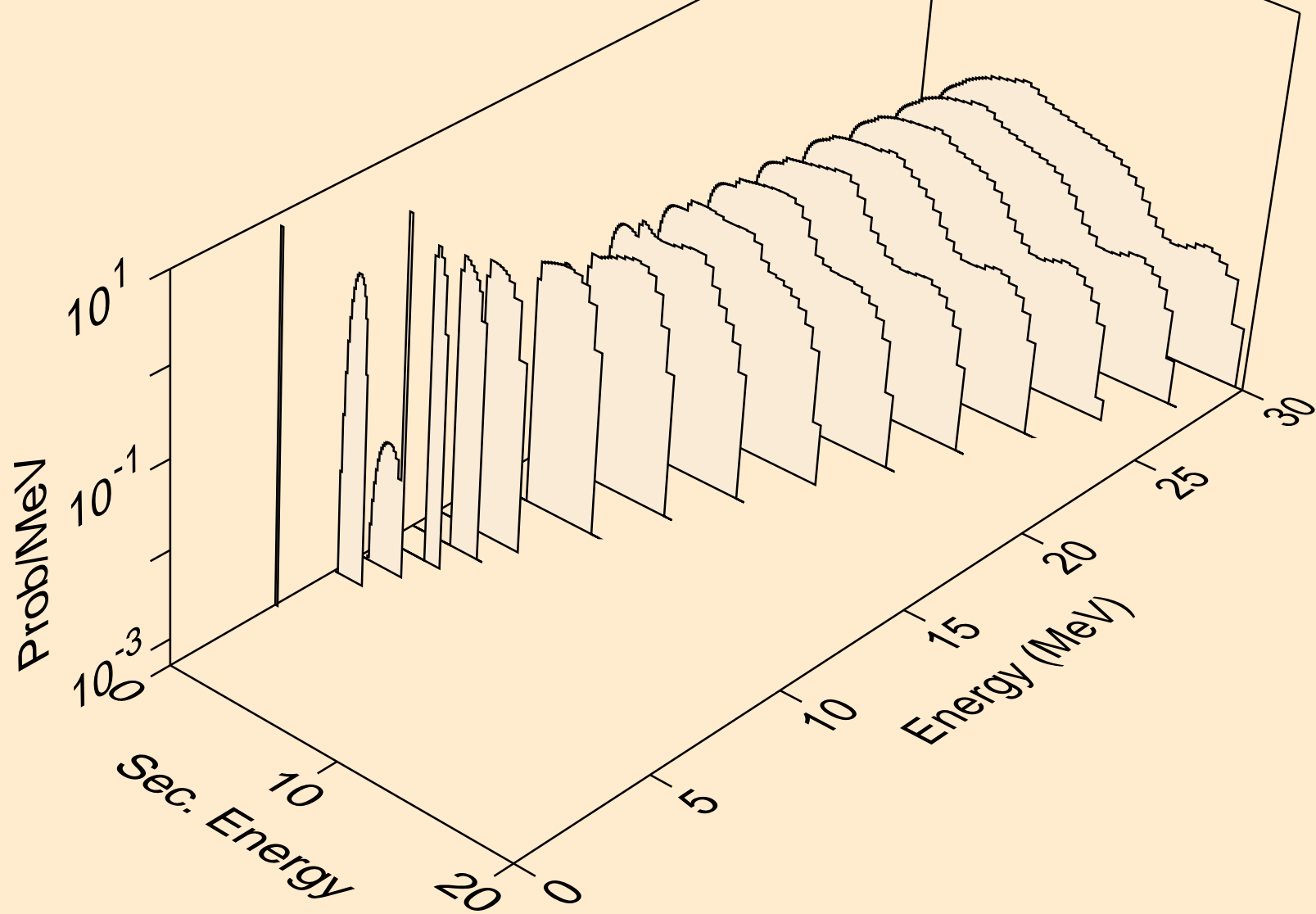

N013 HELION ACER TENDL-2021 LIBRARY; T=0.K  
protons from (s,2np)

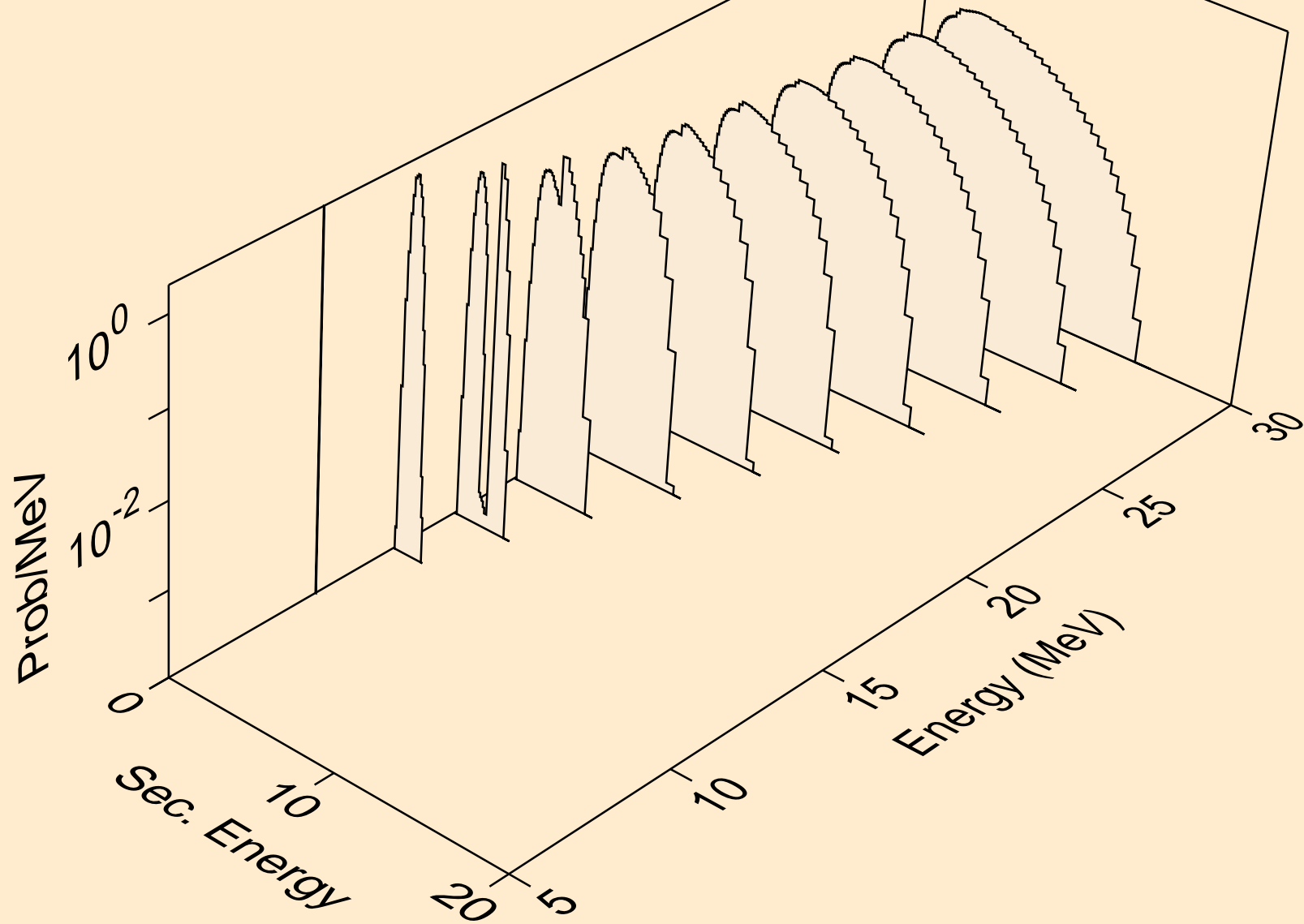

N013 HELION ACER TENDL-2021 LIBRARY; T=0.K  
protons from (s,npa)

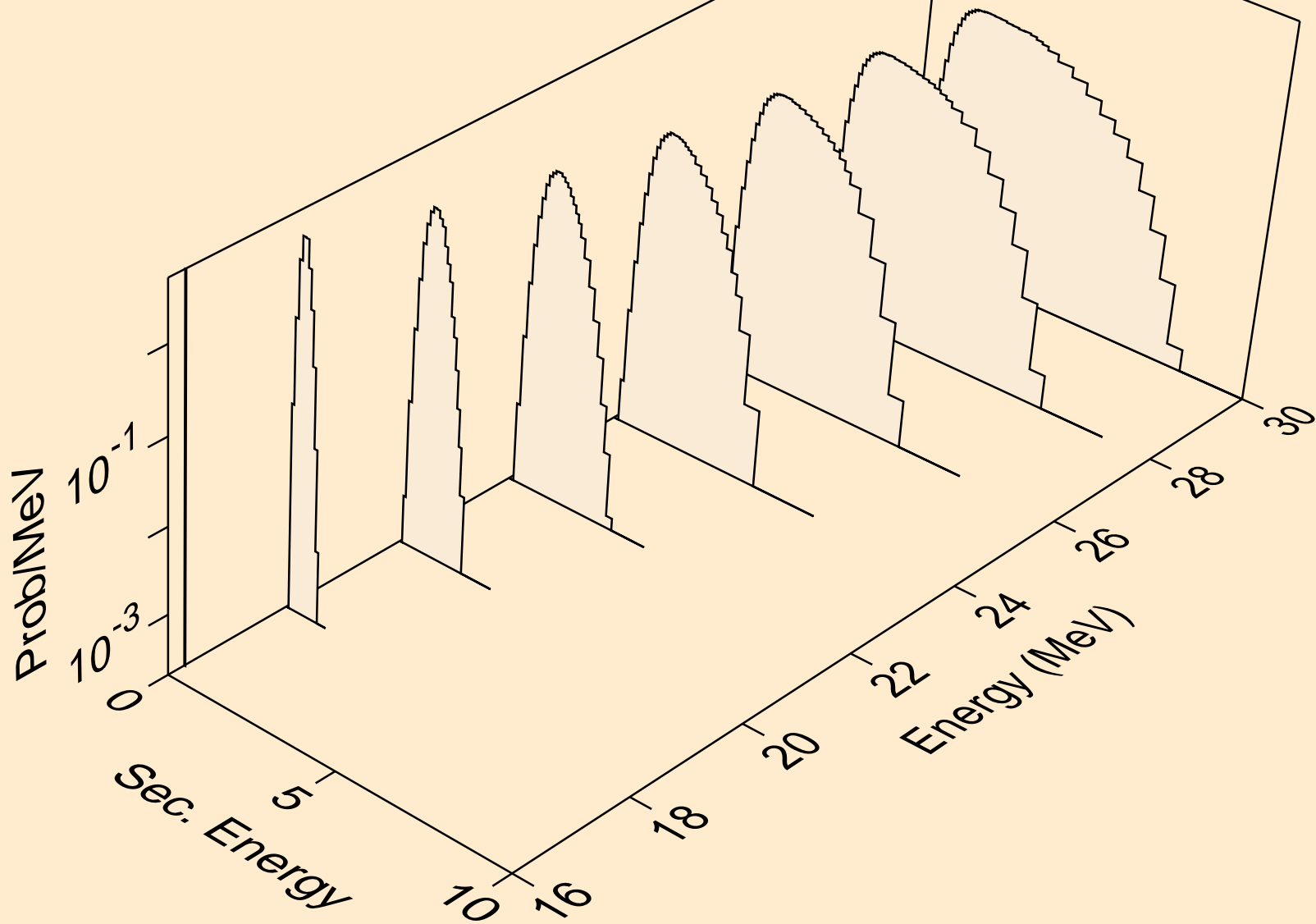

N013 HELION ACER TENDL-2021 LIBRARY; T=0.K  
protons from (s,p)

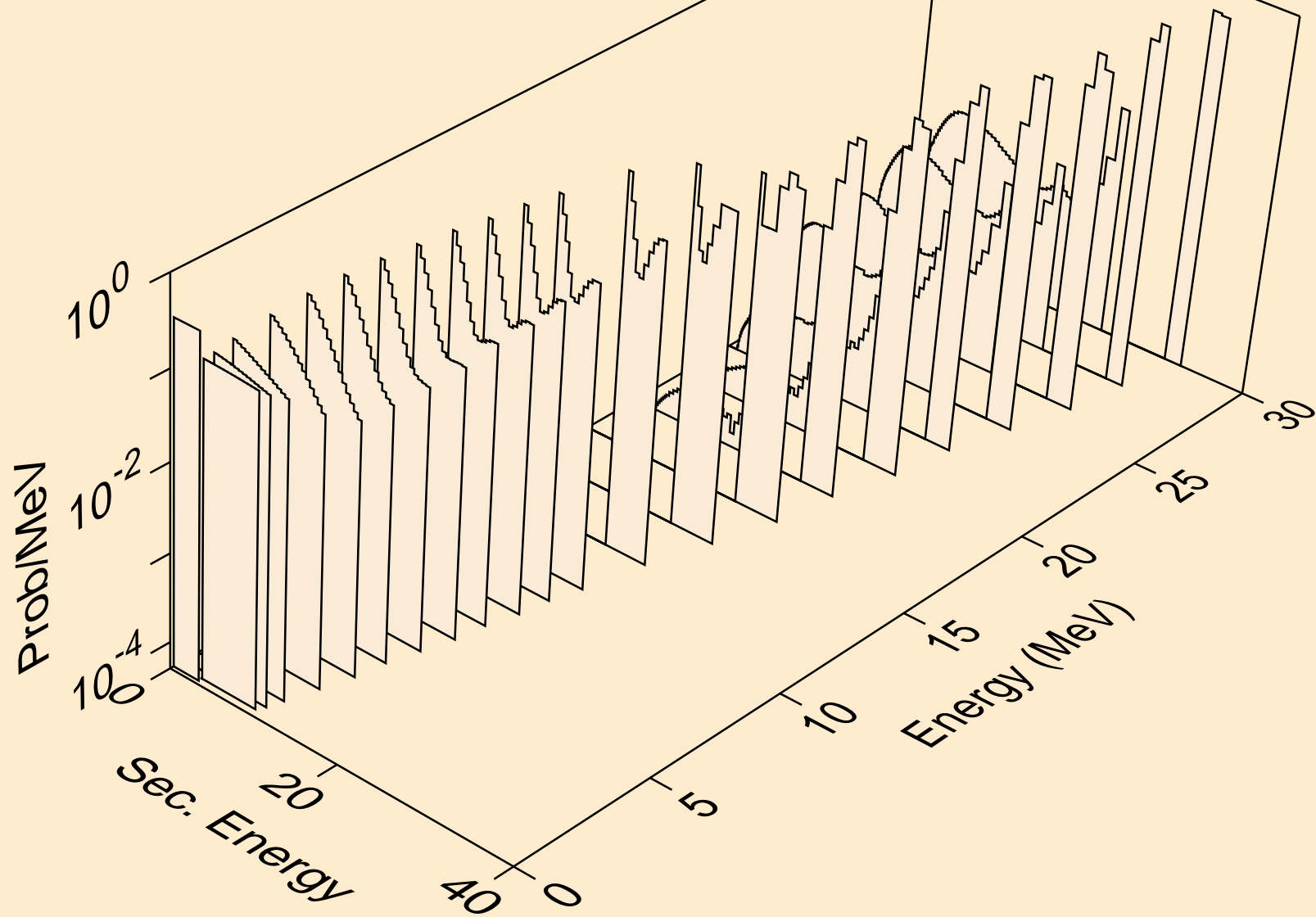



N013 HELION ACER TENDL-2021 LIBRARY; T=0.K  
protons from (s,2p)

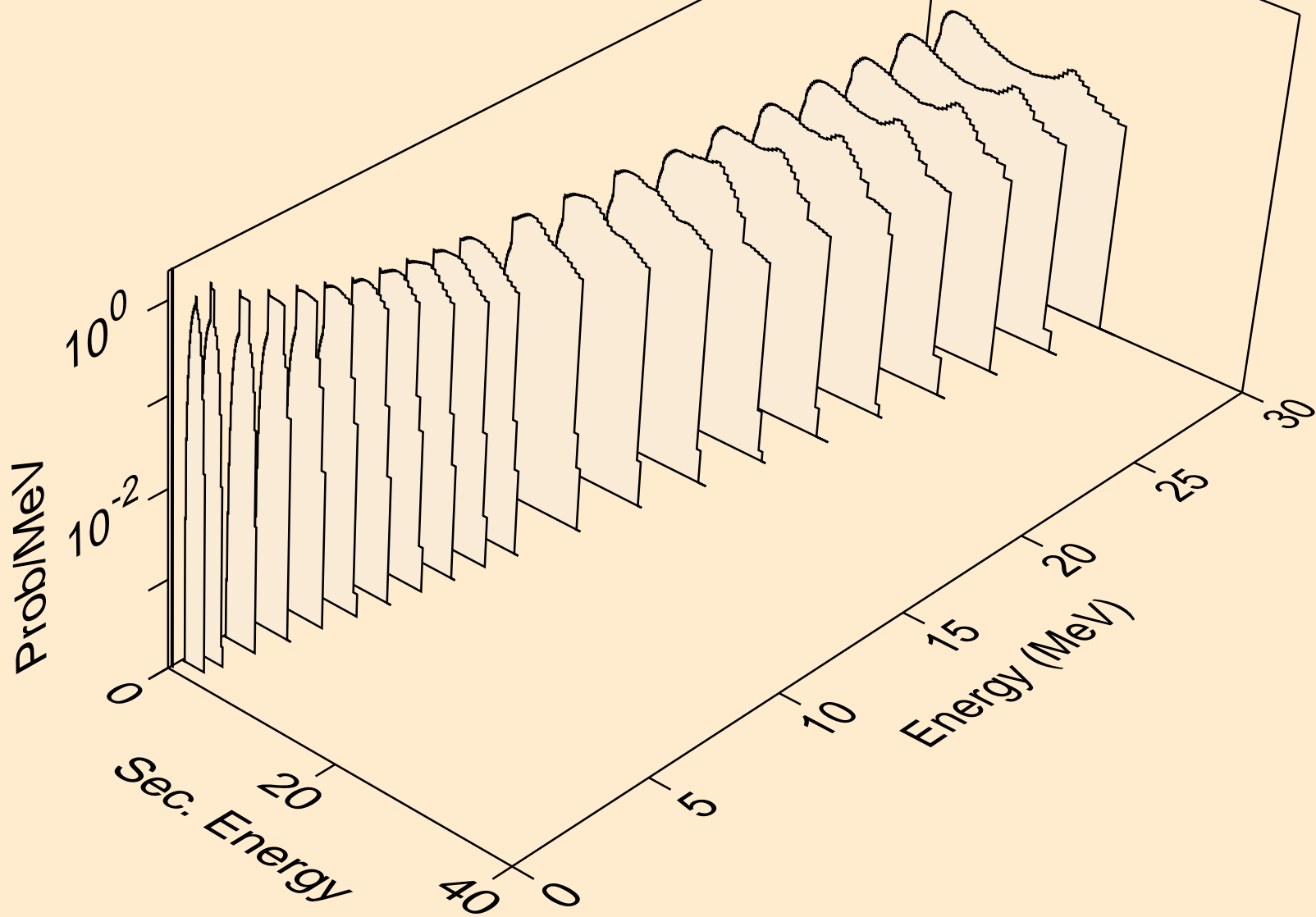

N013 HELION ACER TENDL-2021 LIBRARY; T=0.K  
protons from (s,pa)

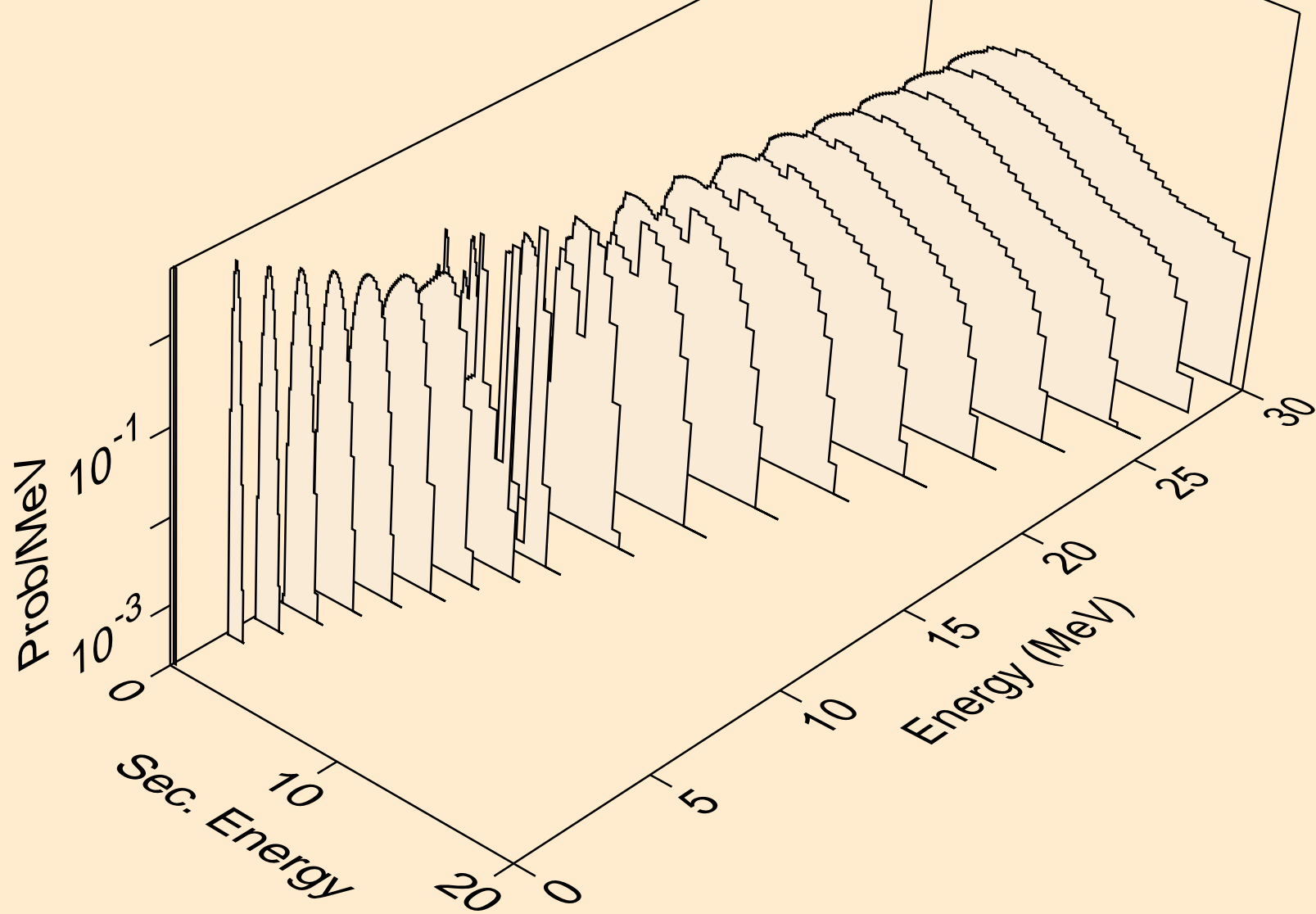

N013 HELION ACER TENDL-2021 LIBRARY; T=0.K  
protons from (s,pd)

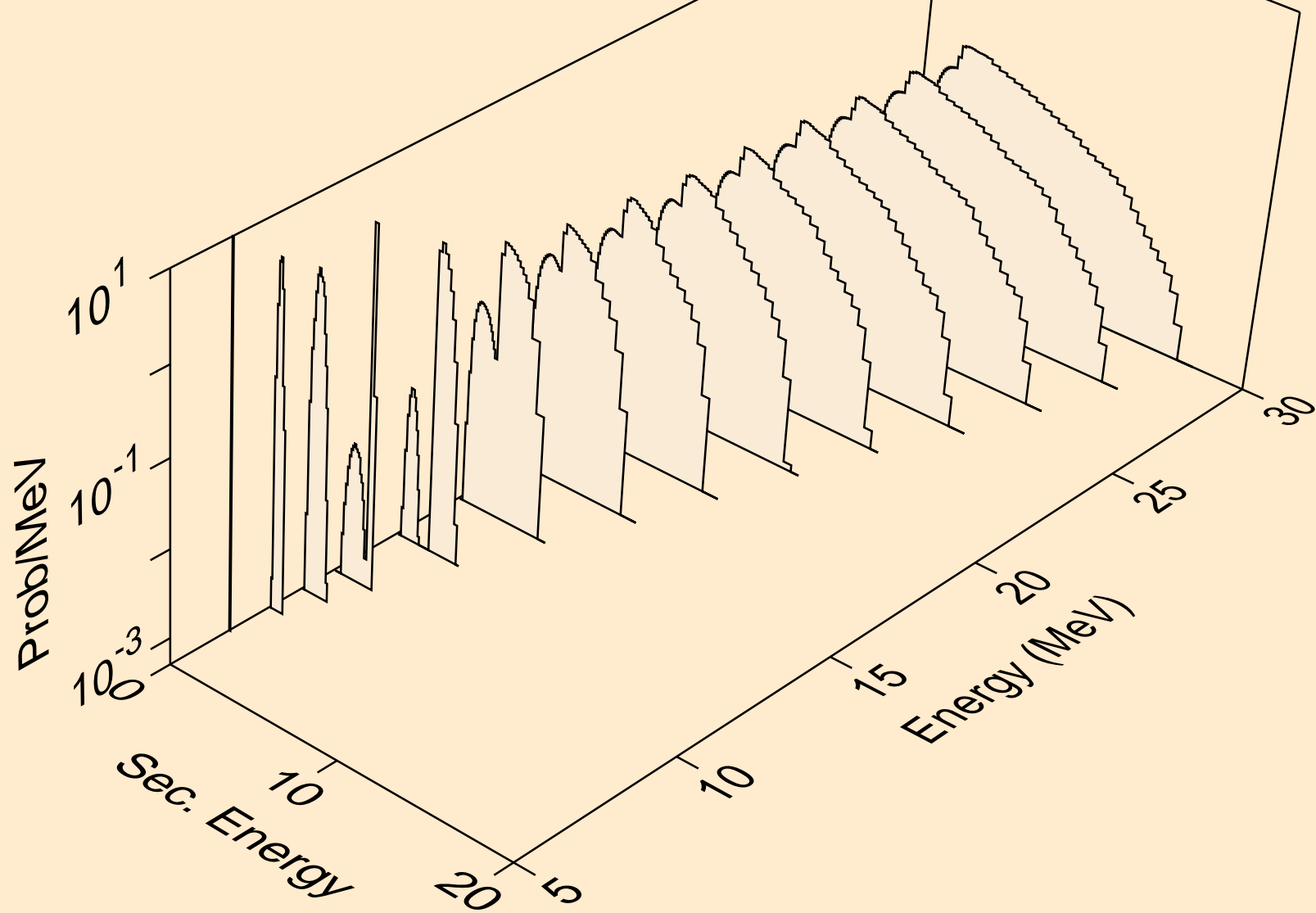

N013 HELION ACER TENDL-2021 LIBRARY; T=0.K  
protons from (s,pt)

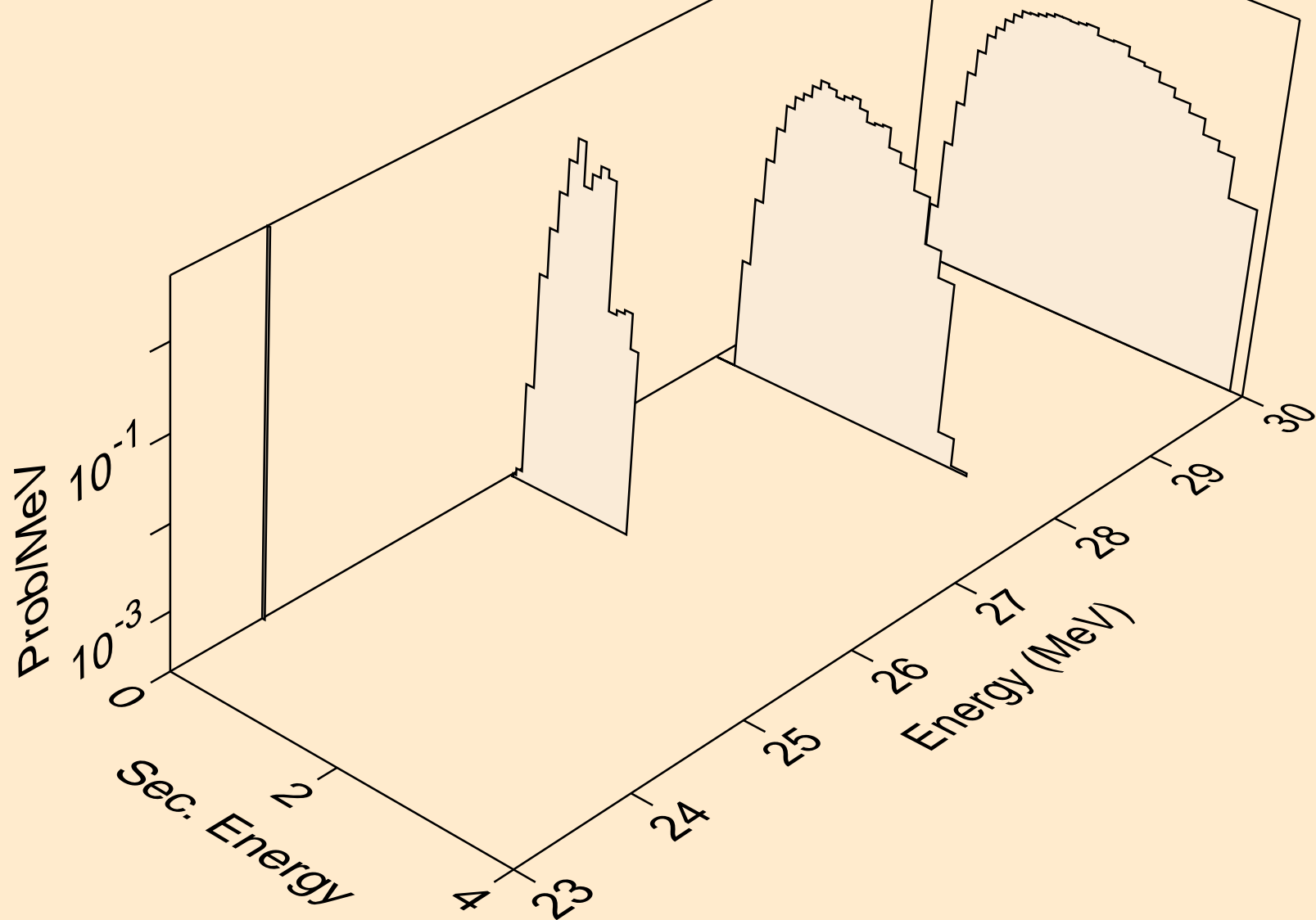

N013 HELION ACER TENDL-2021 LIBRARY; T=0.K  
deuterons from (s,x)

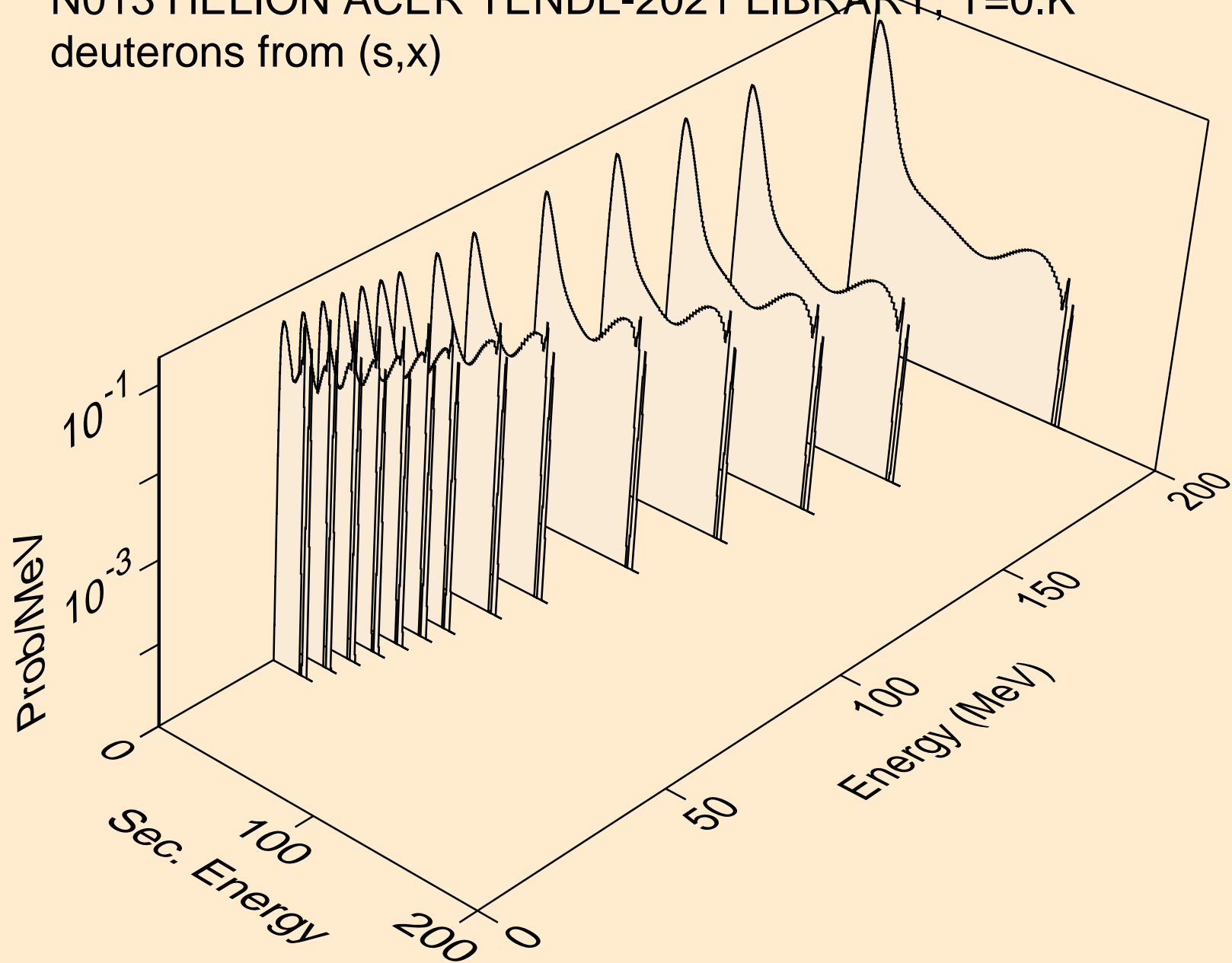

N013 HELION ACER TENDL-2021 LIBRARY; T=0.K  
deuterons from (s,d)

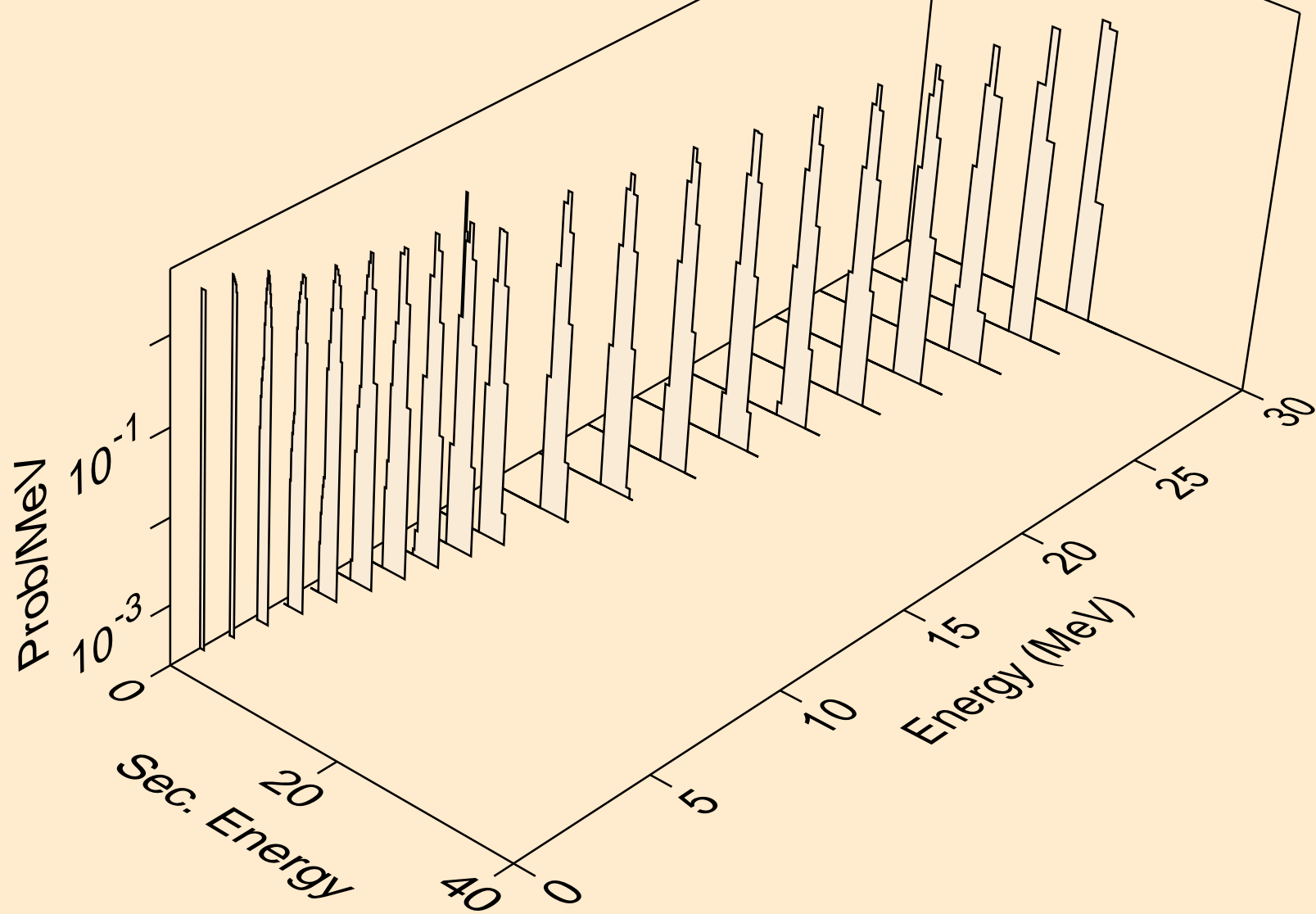

N013 HELION ACER TENDL-2021 LIBRARY; T=0.K  
deuterons from (s,pd)

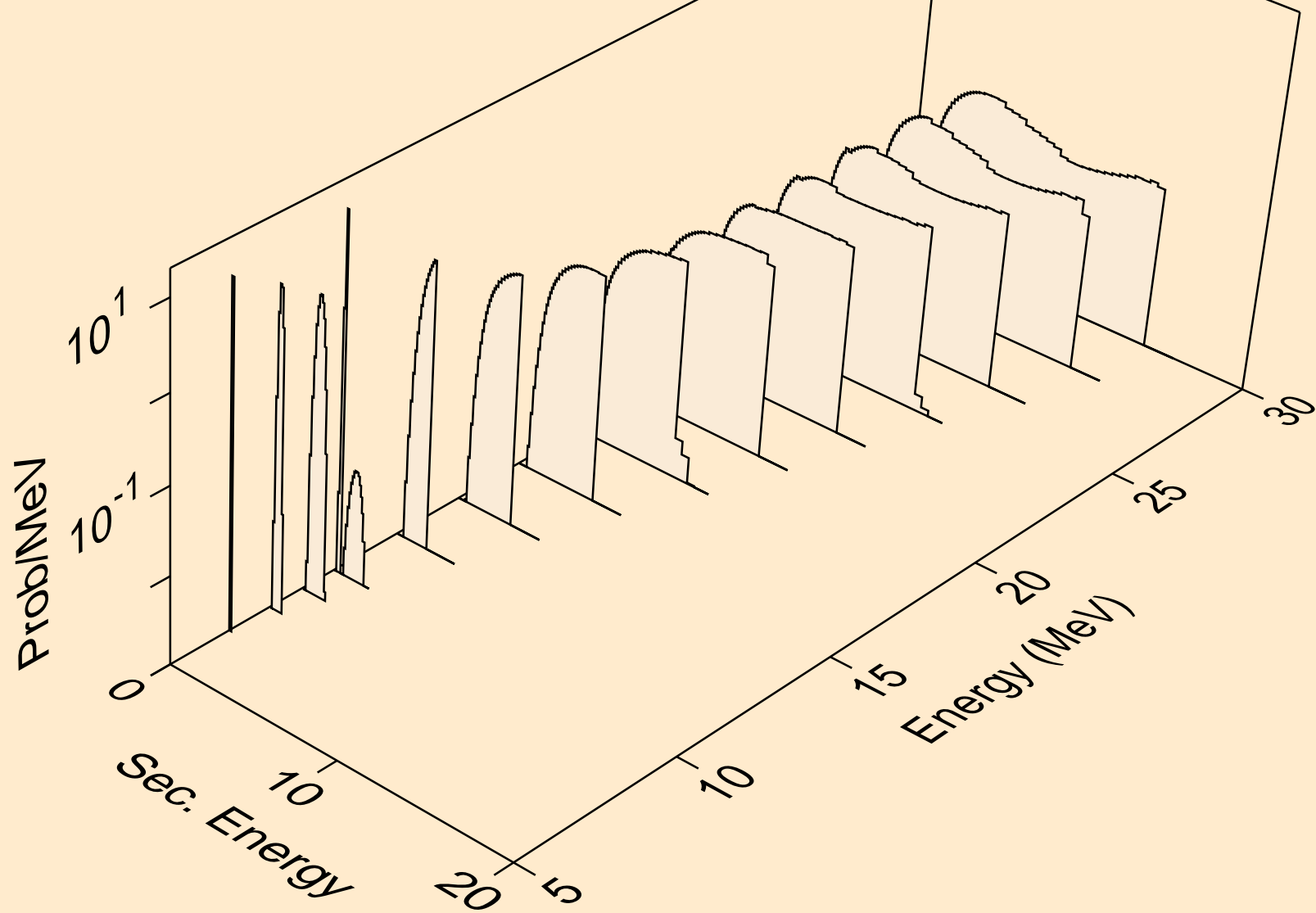

N013 HELION ACER TENDL-2021 LIBRARY; T=0.K  
deuterons from (s,da)

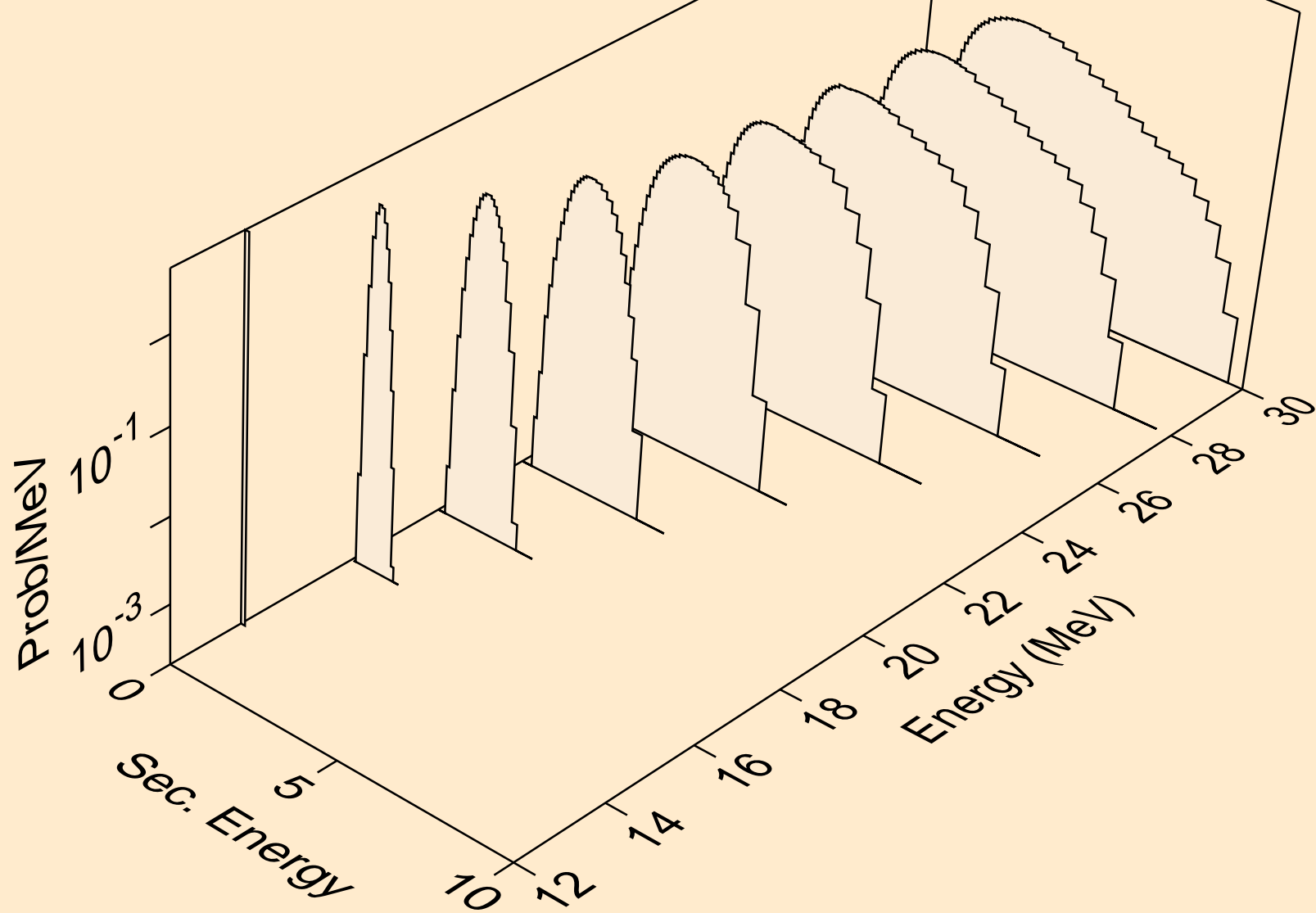



N013 HELION ACER TENDL-2021 LIBRARY; T=0.K  
tritons from (s,x)

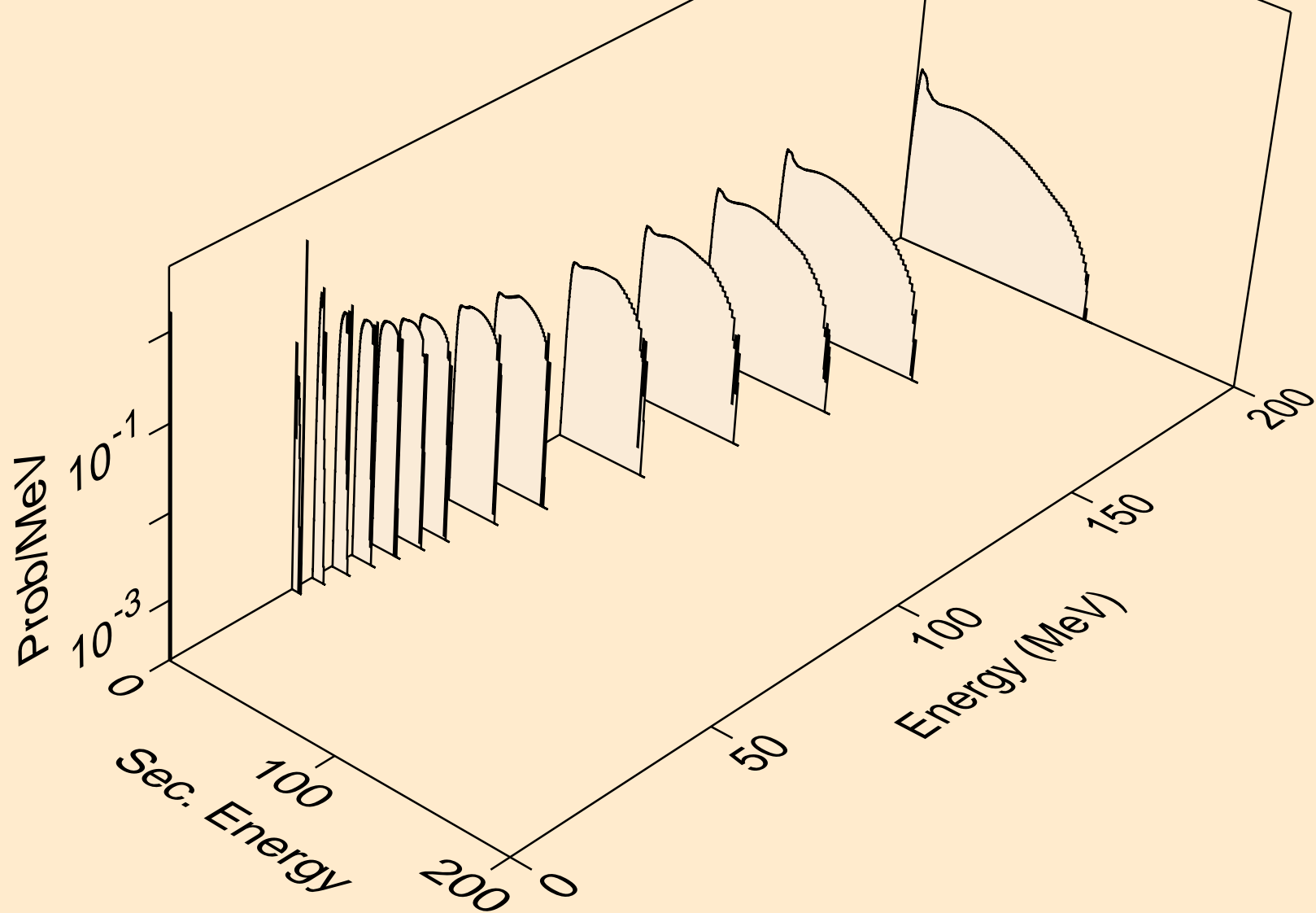

N013 HELION ACER TENDL-2021 LIBRARY; T=0.K  
tritons from (s,t)

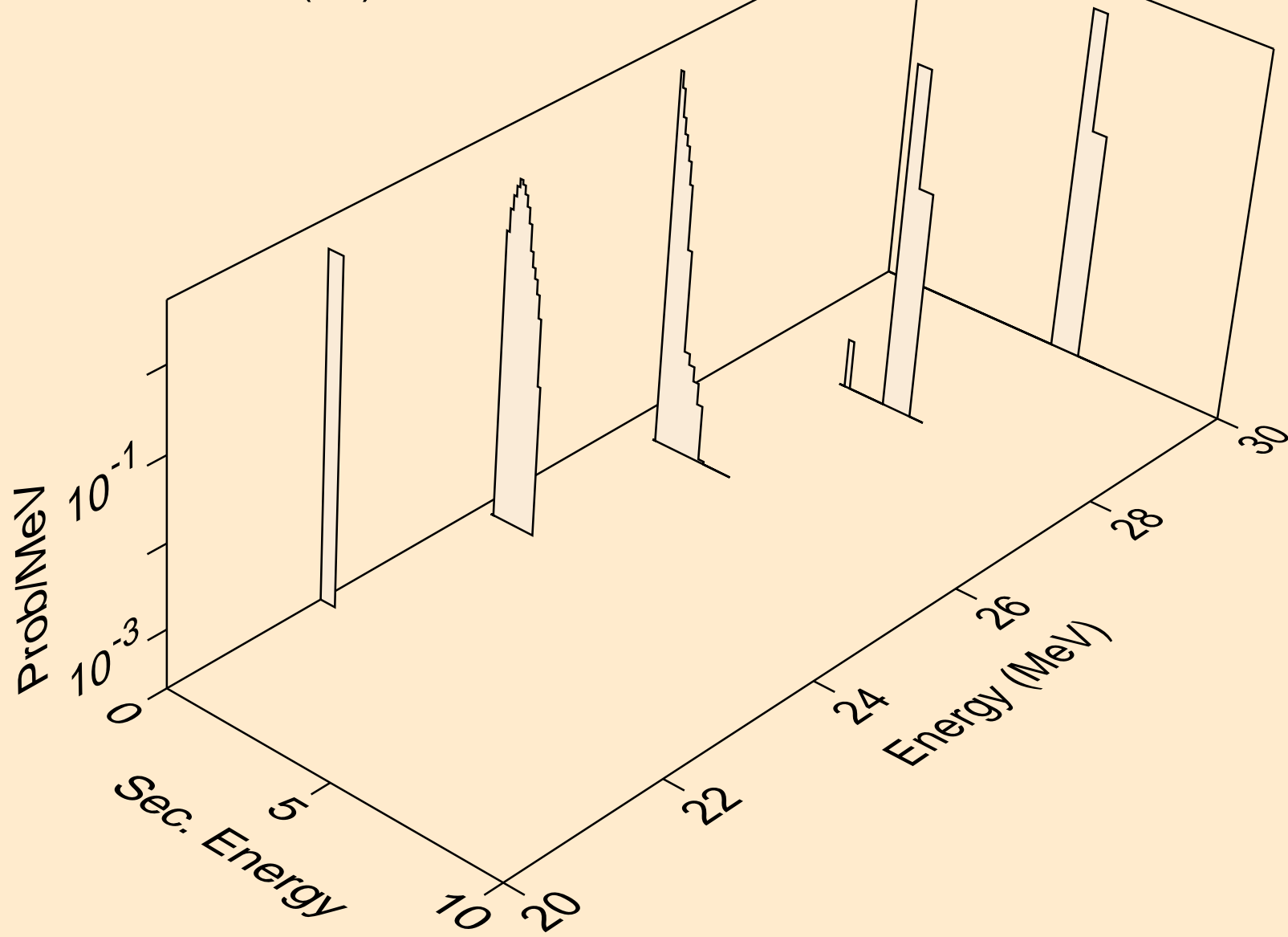

N013 HELION ACER TENDL-2021 LIBRARY; T=0.K  
tritons from (s,pt)

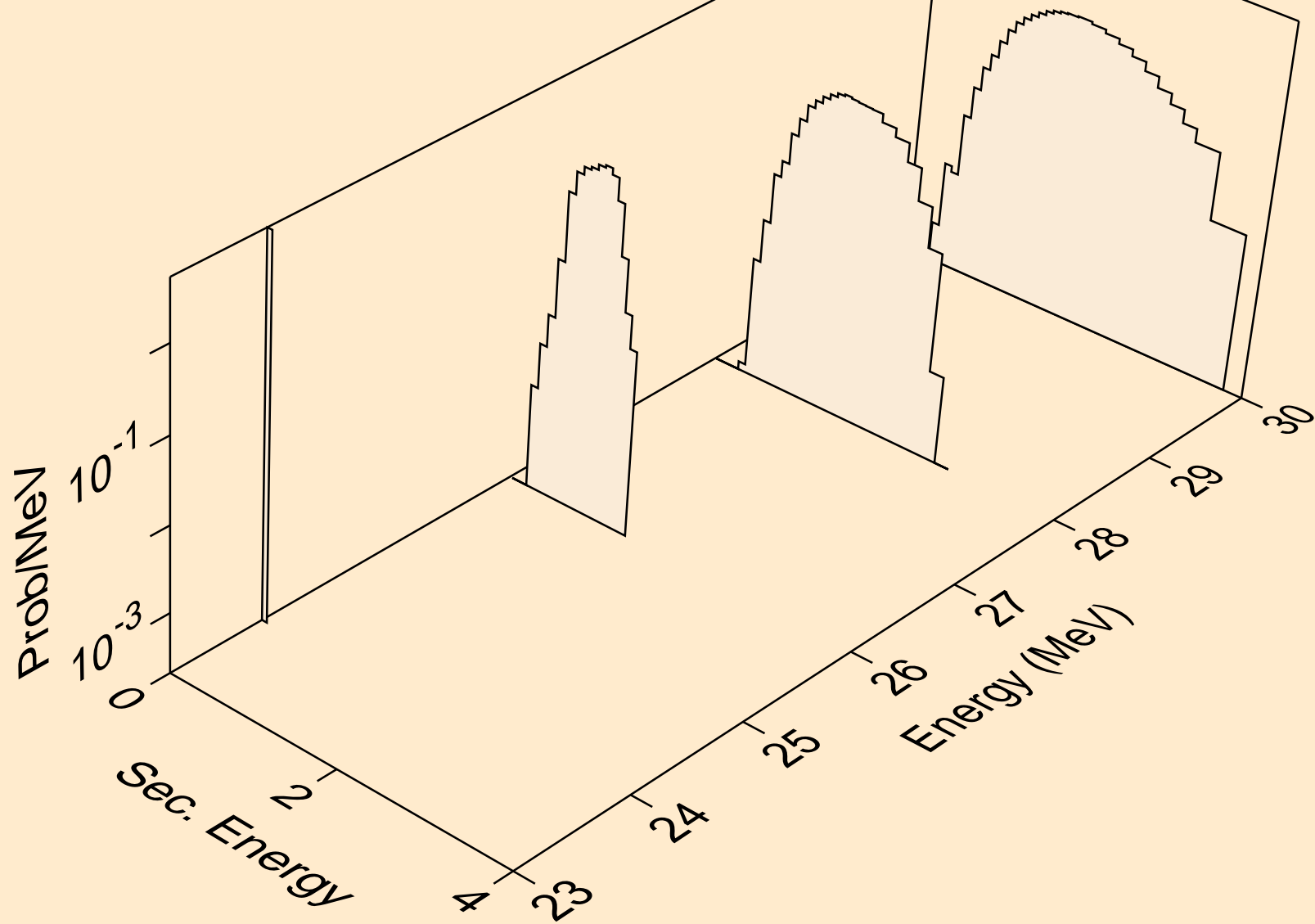

N013 HELION ACER TENDL-2021 LIBRARY; T=0.K  
alphas from (s,x)

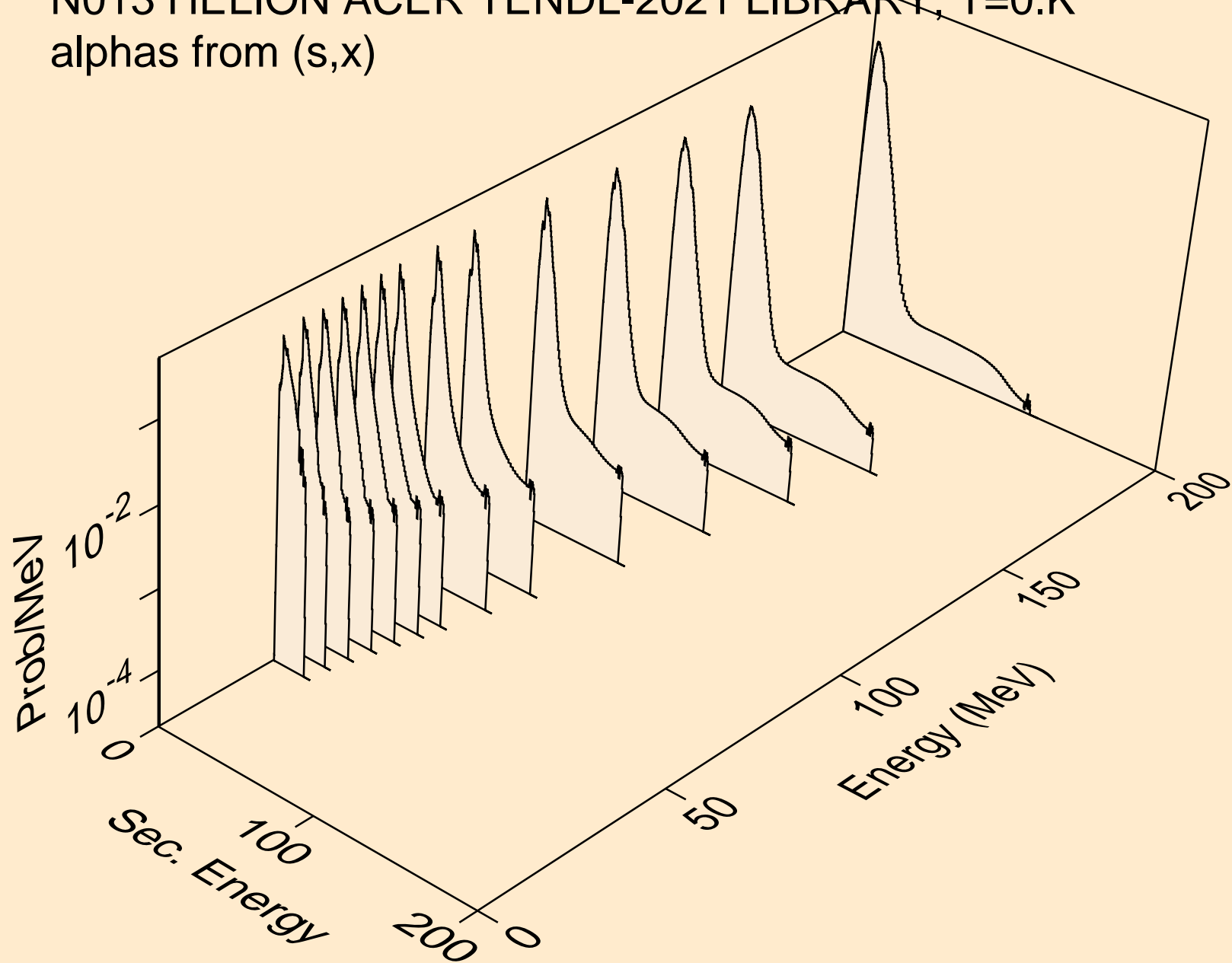

N013 HELION ACER TENDL-2021 LIBRARY; T=0.K  
alphas from (s,n\*)a

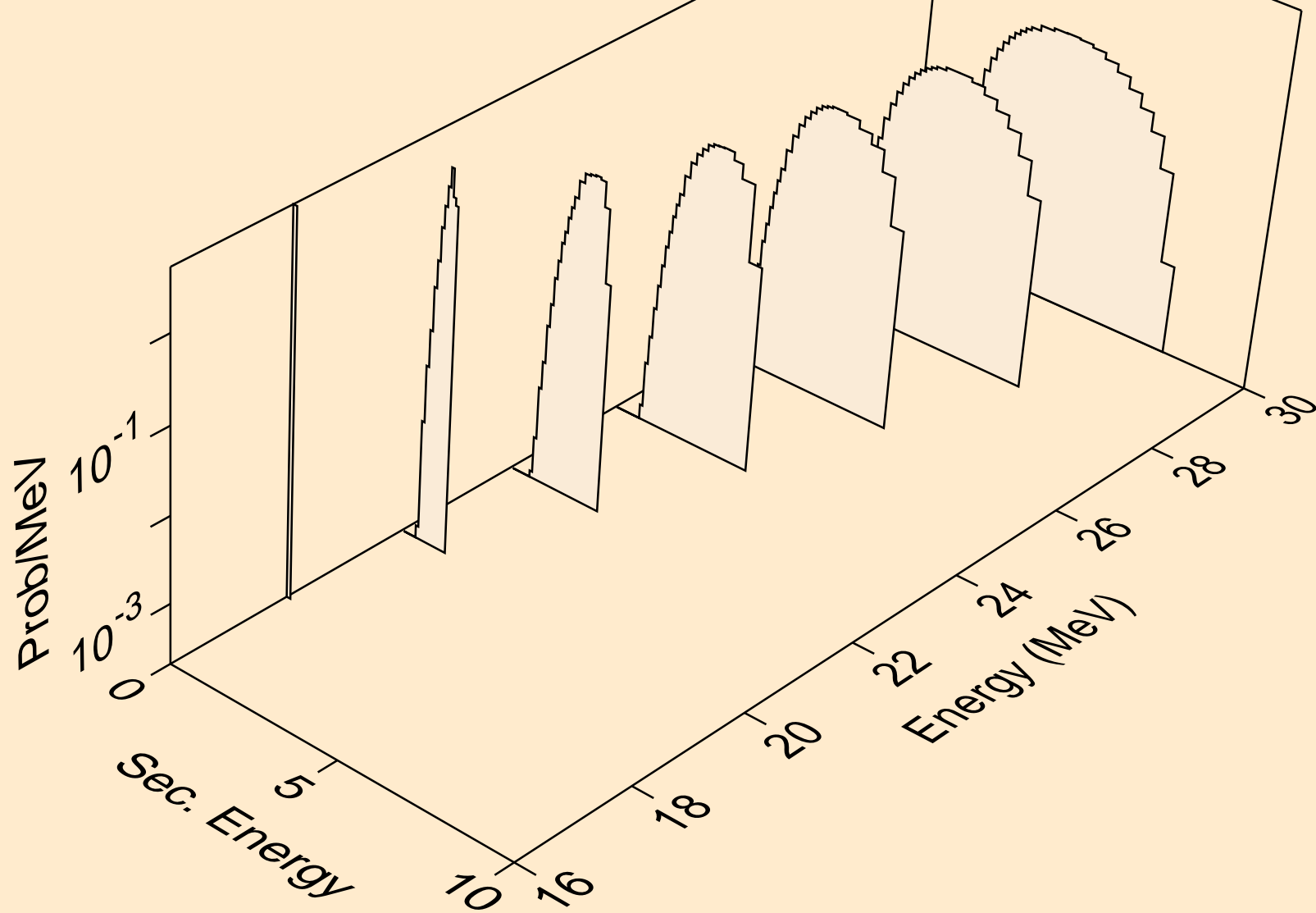

N013 HELION ACER TENDL-2021 LIBRARY; T=0.K  
alphas from (s,npa)

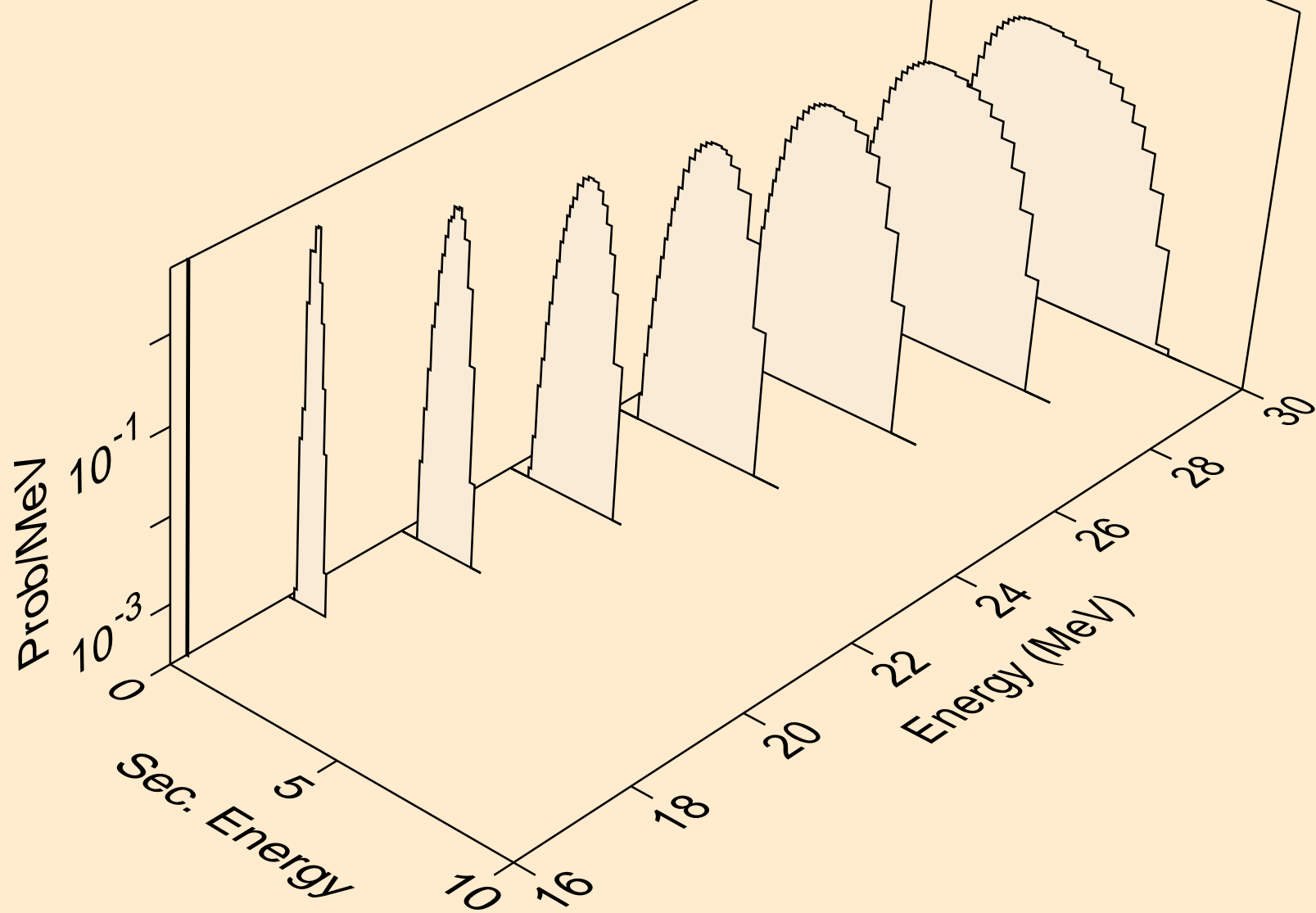

N013 HELION ACER TENDL-2021 LIBRARY; T=0.K  
alphas from (s,a)

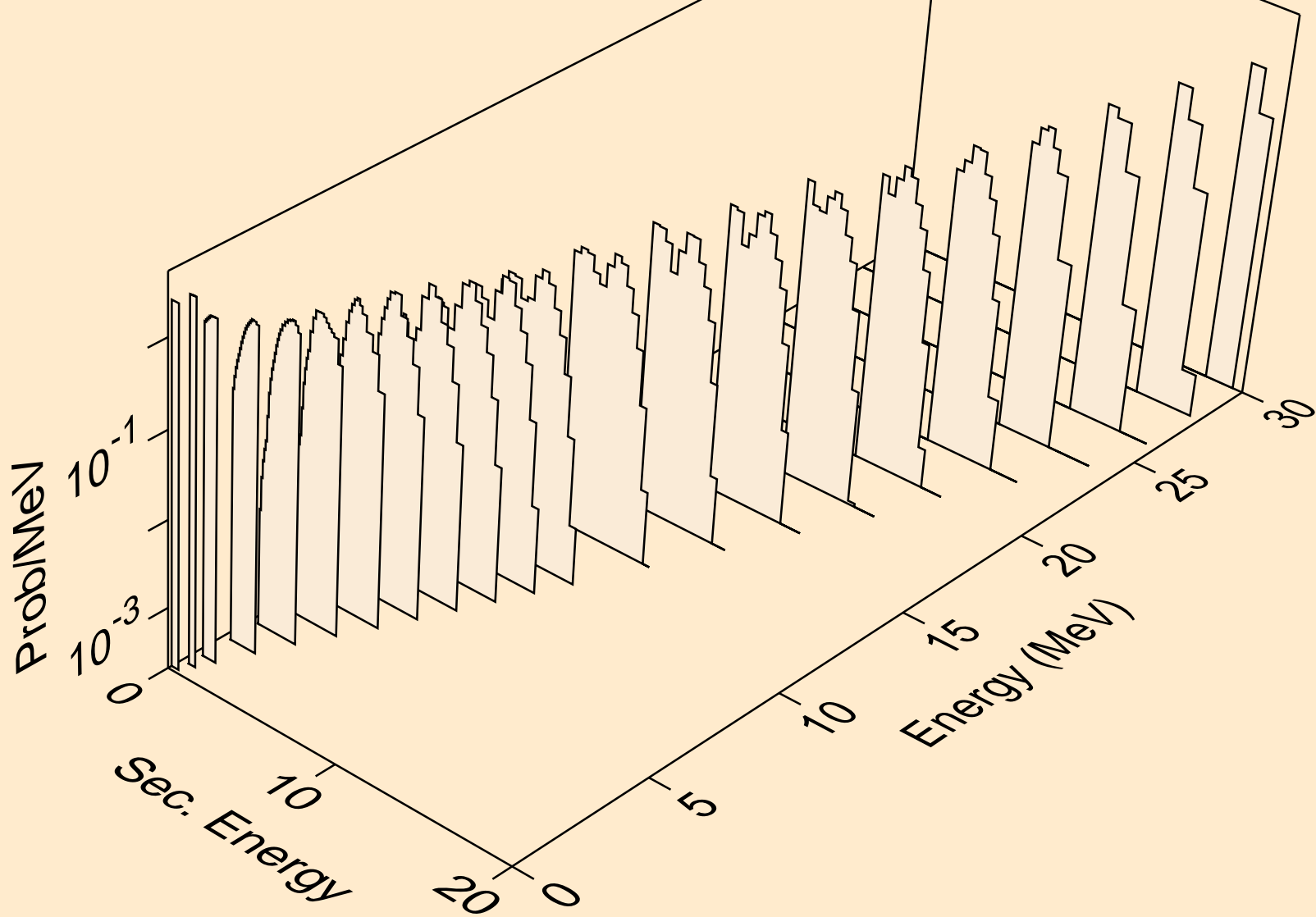

N013 HELION ACER TENDL-2021 LIBRARY; T=0.K  
alphas from (s,2a)

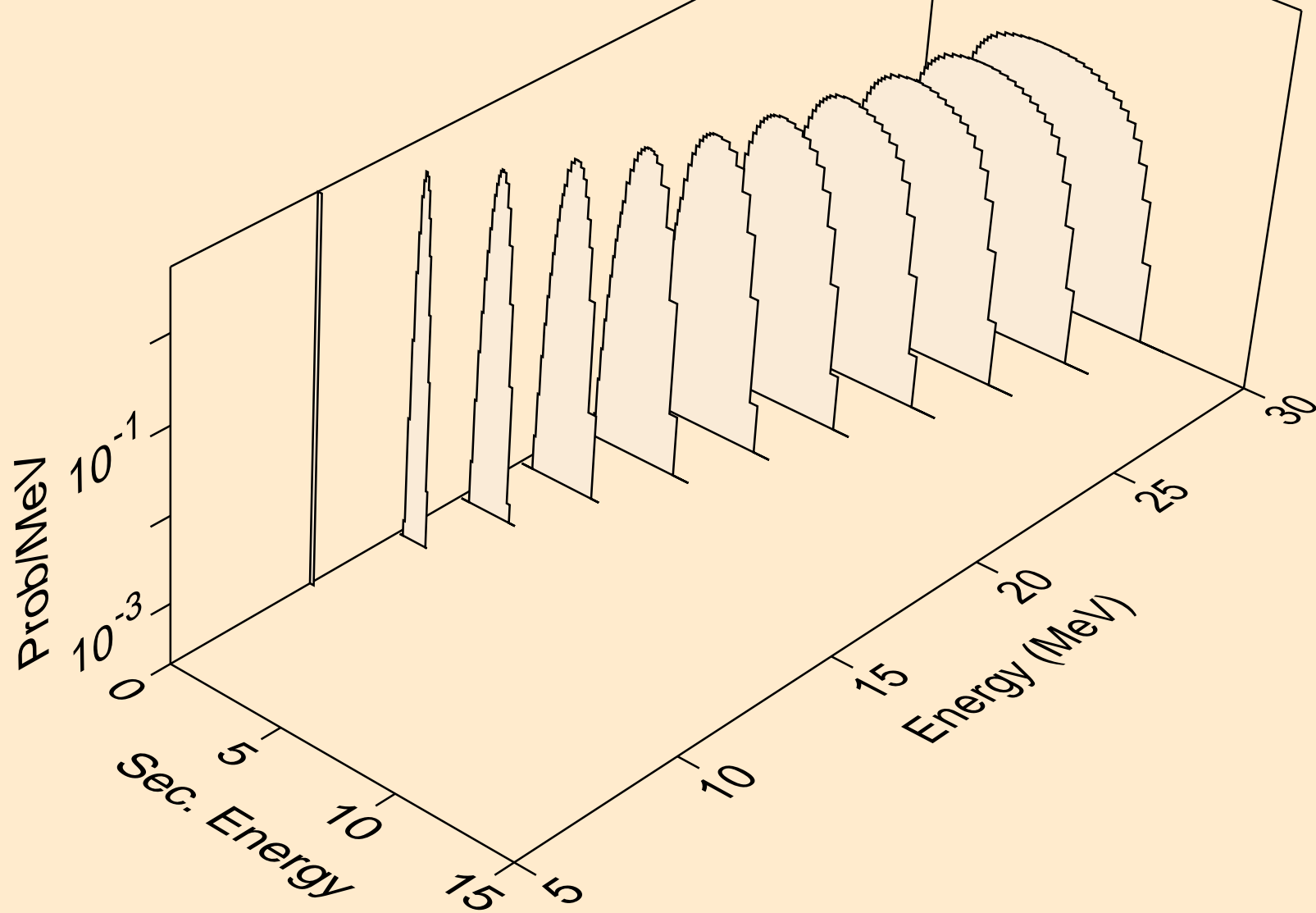



N013 HELION ACER TENDL-2021 LIBRARY; T=0.K  
alphas from (s,pa)

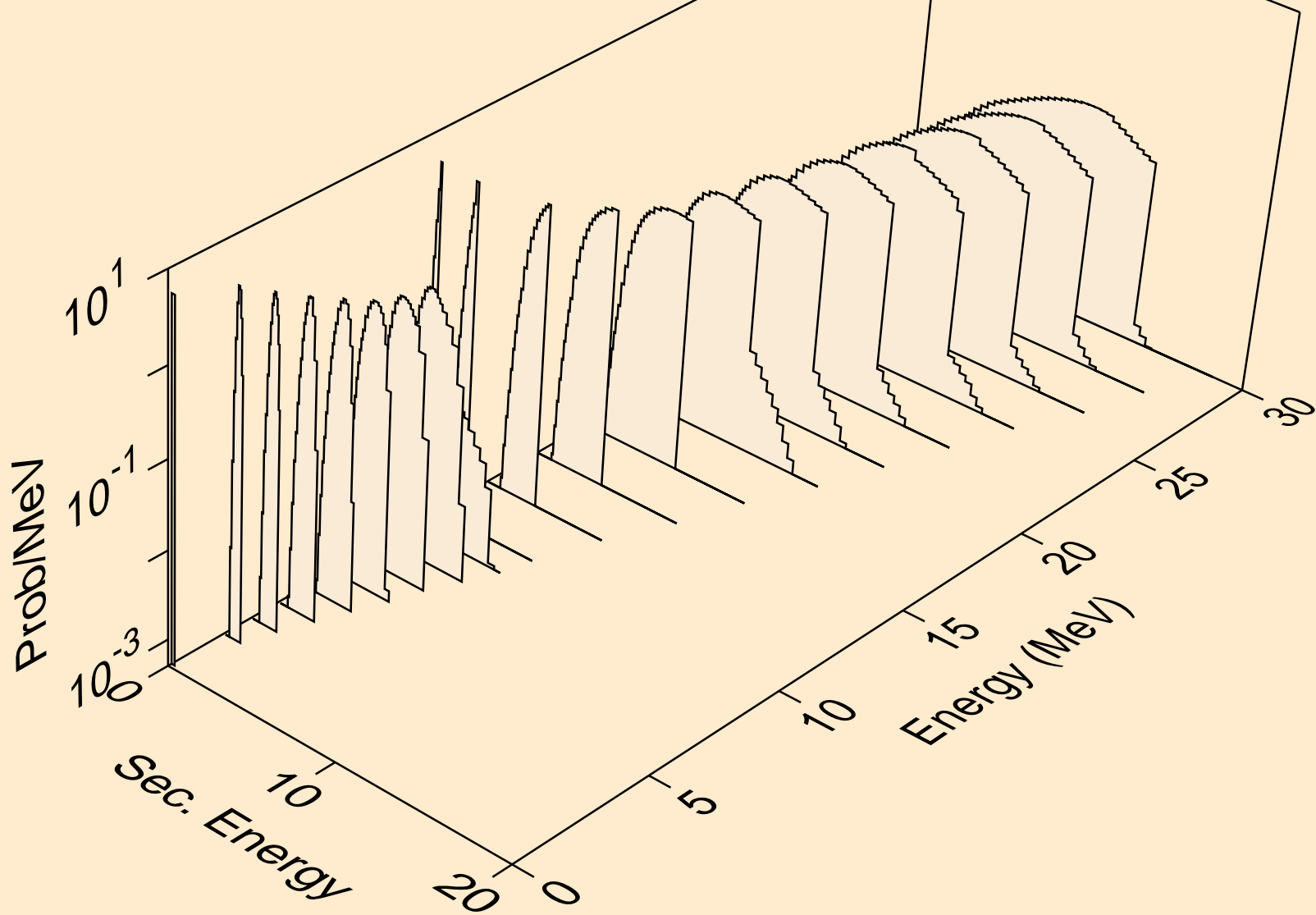

N013 HELION ACER TENDL-2021 LIBRARY; T=0.K  
alphas from (s,da)

