

NB106 HELION ACER TENDL-2021 LIBRARY; T=0.K  
Principal cross sections

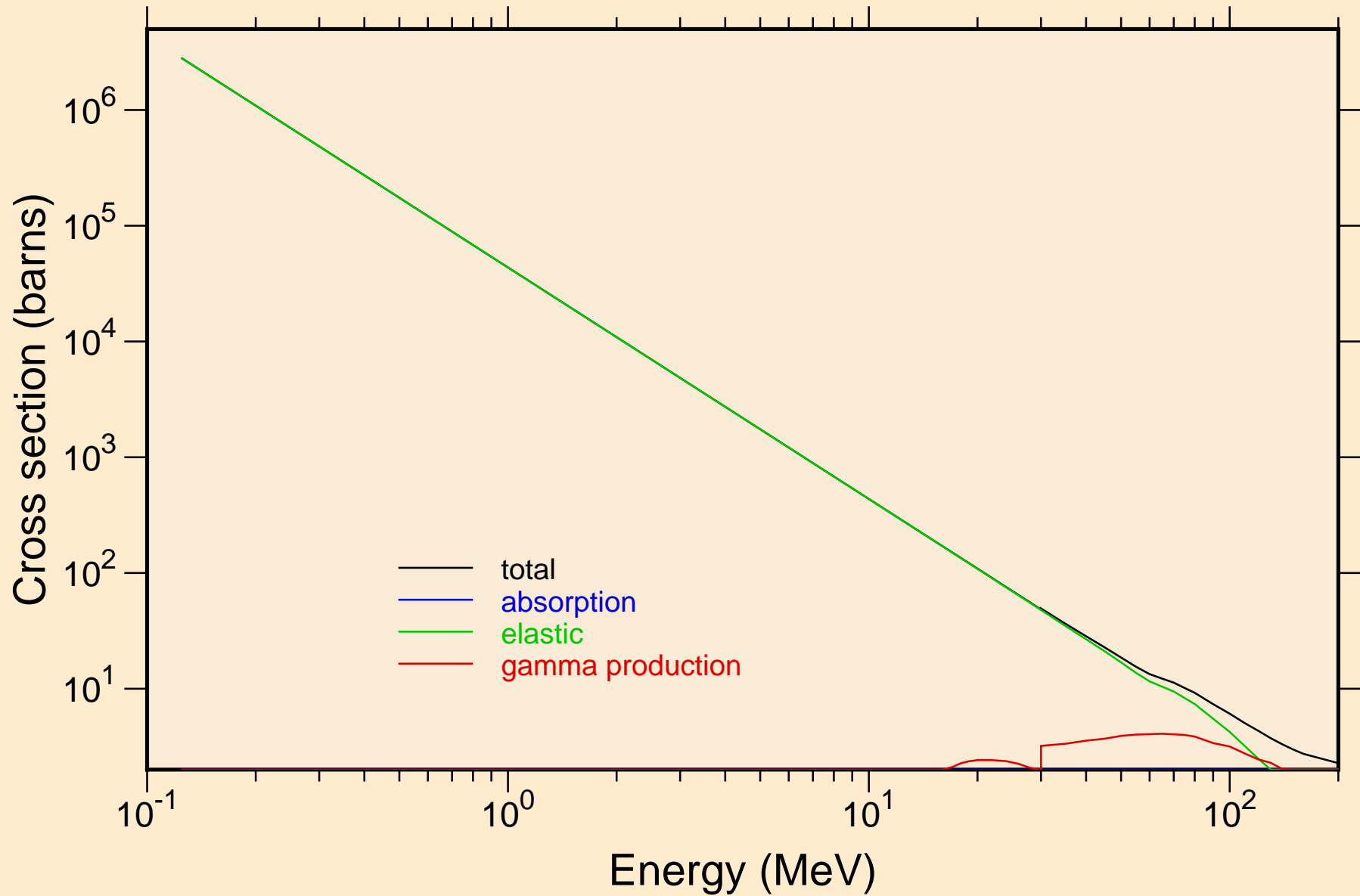

# NB106 HELION ACER TENDL-2021 LIBRARY; T=0.K

## Heating

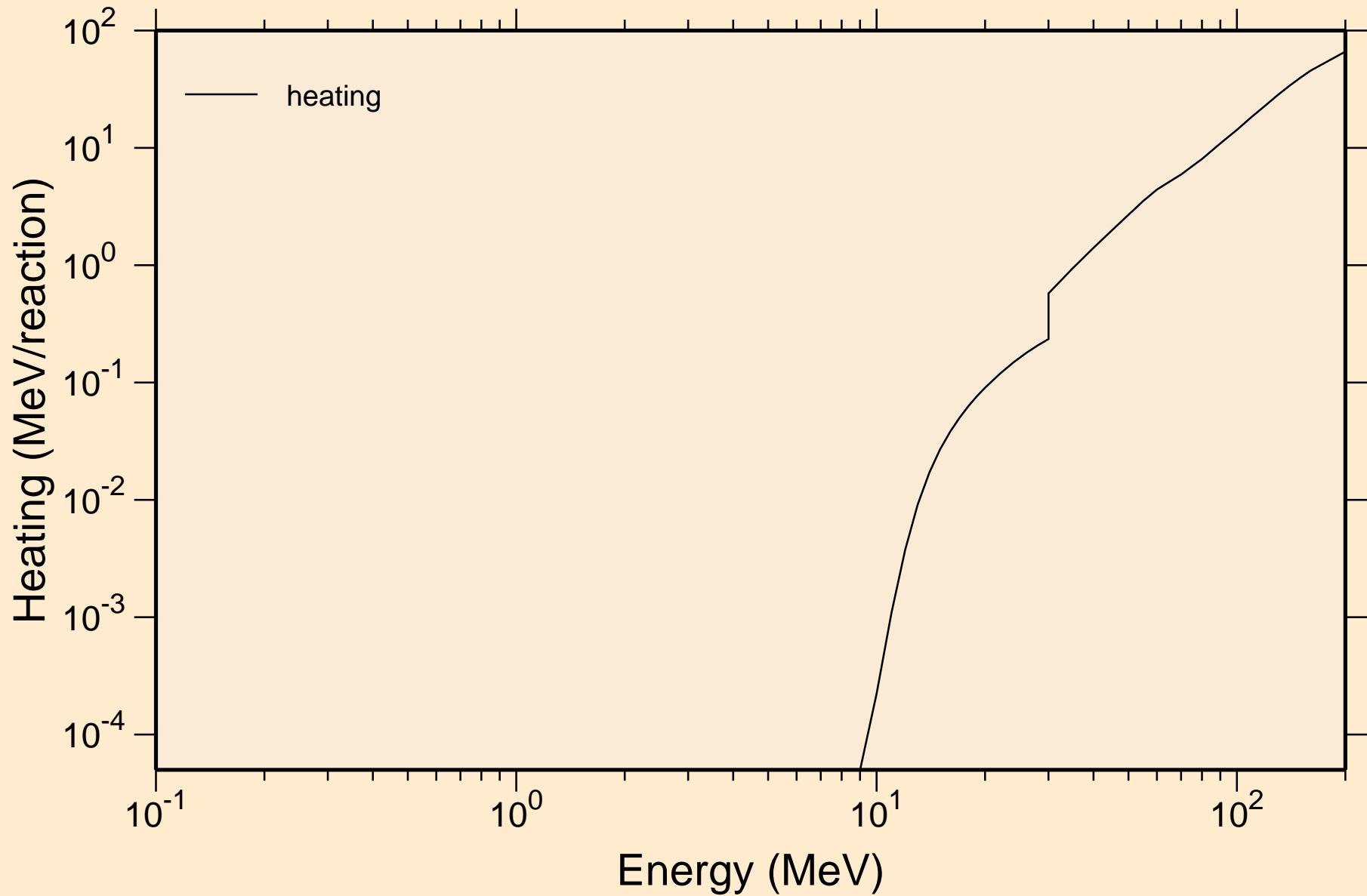

# NB106 HELION ACER TENDL-2021 LIBRARY; T=0.K

## Principal cross sections

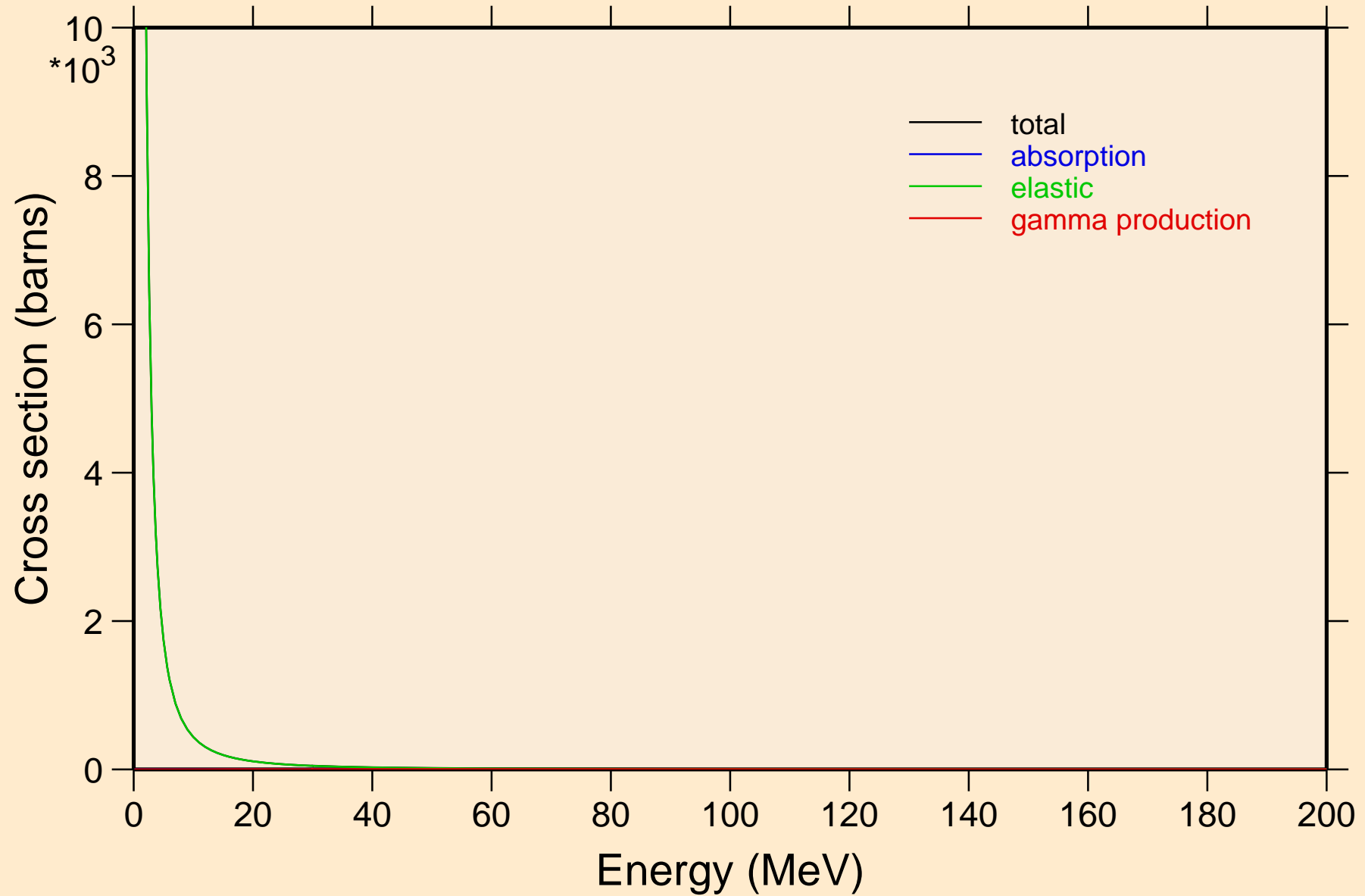

NB106 HELION ACER TENDL-2021 LIBRARY; T=0.K

Heating

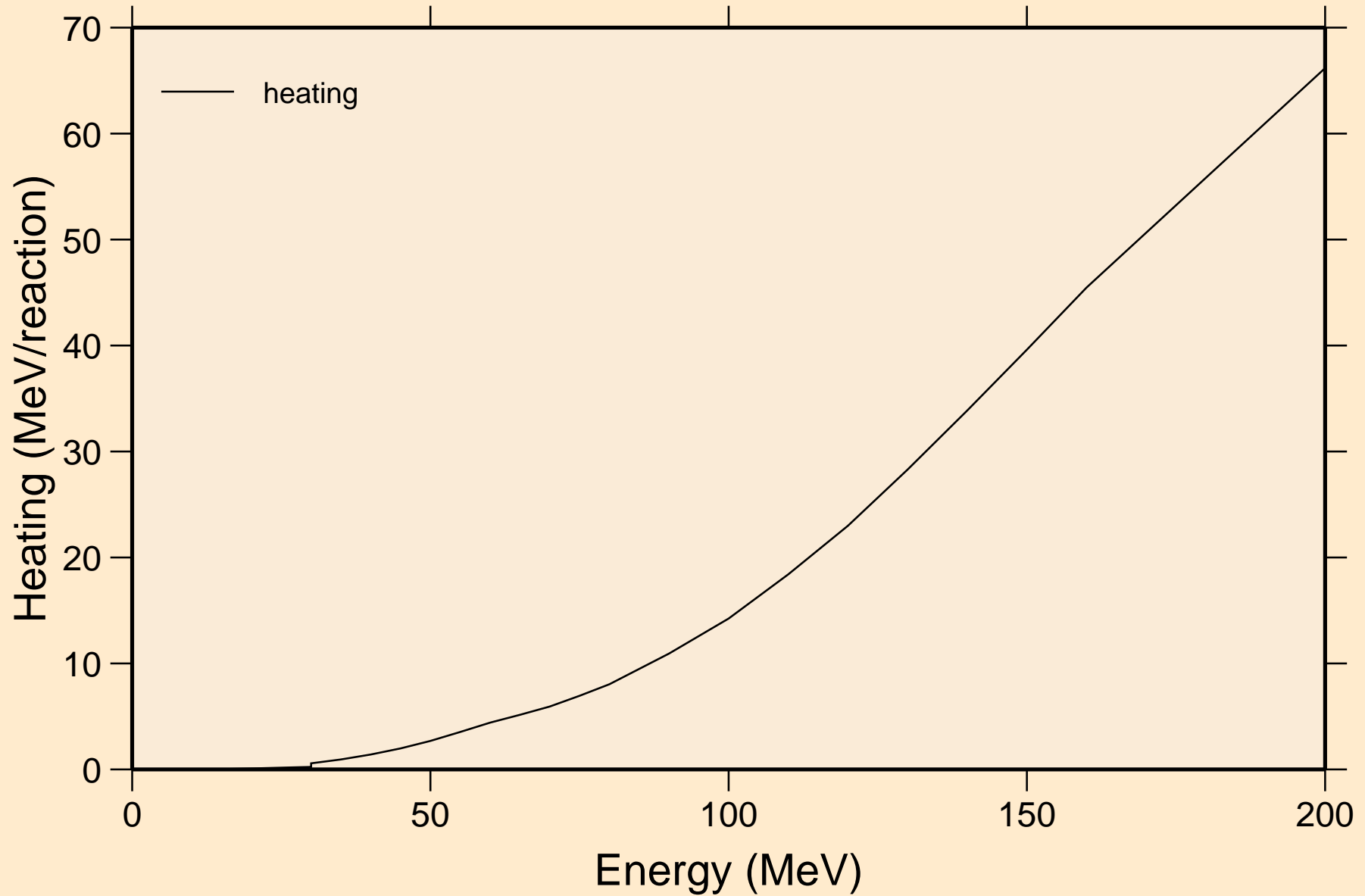

NB106 HELION ACER TENDL-2021 LIBRARY; T=0.K  
Threshold reactions

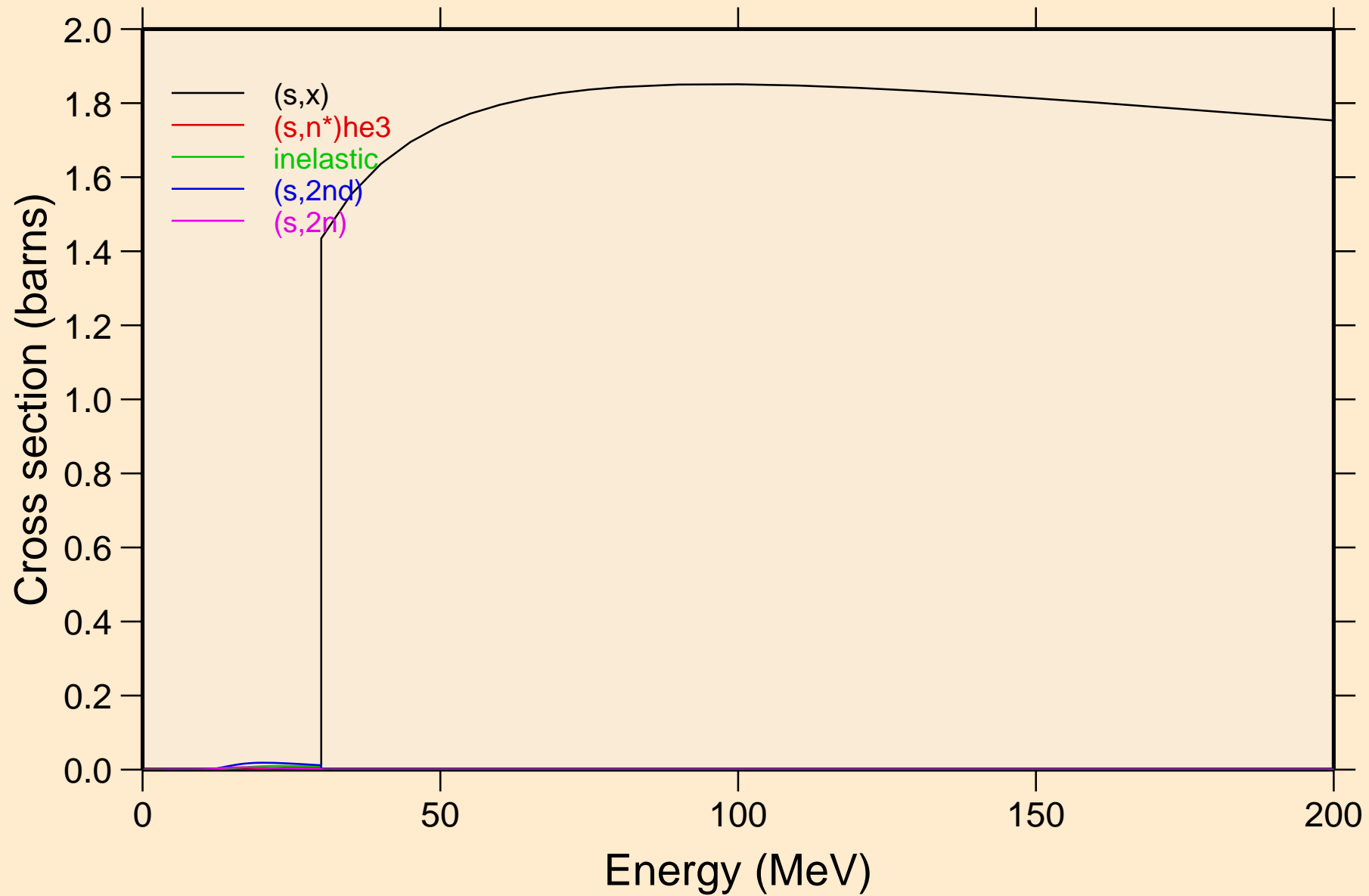

NB106 HELION ACER TENDL-2021 LIBRARY; T=0.K  
Threshold reactions

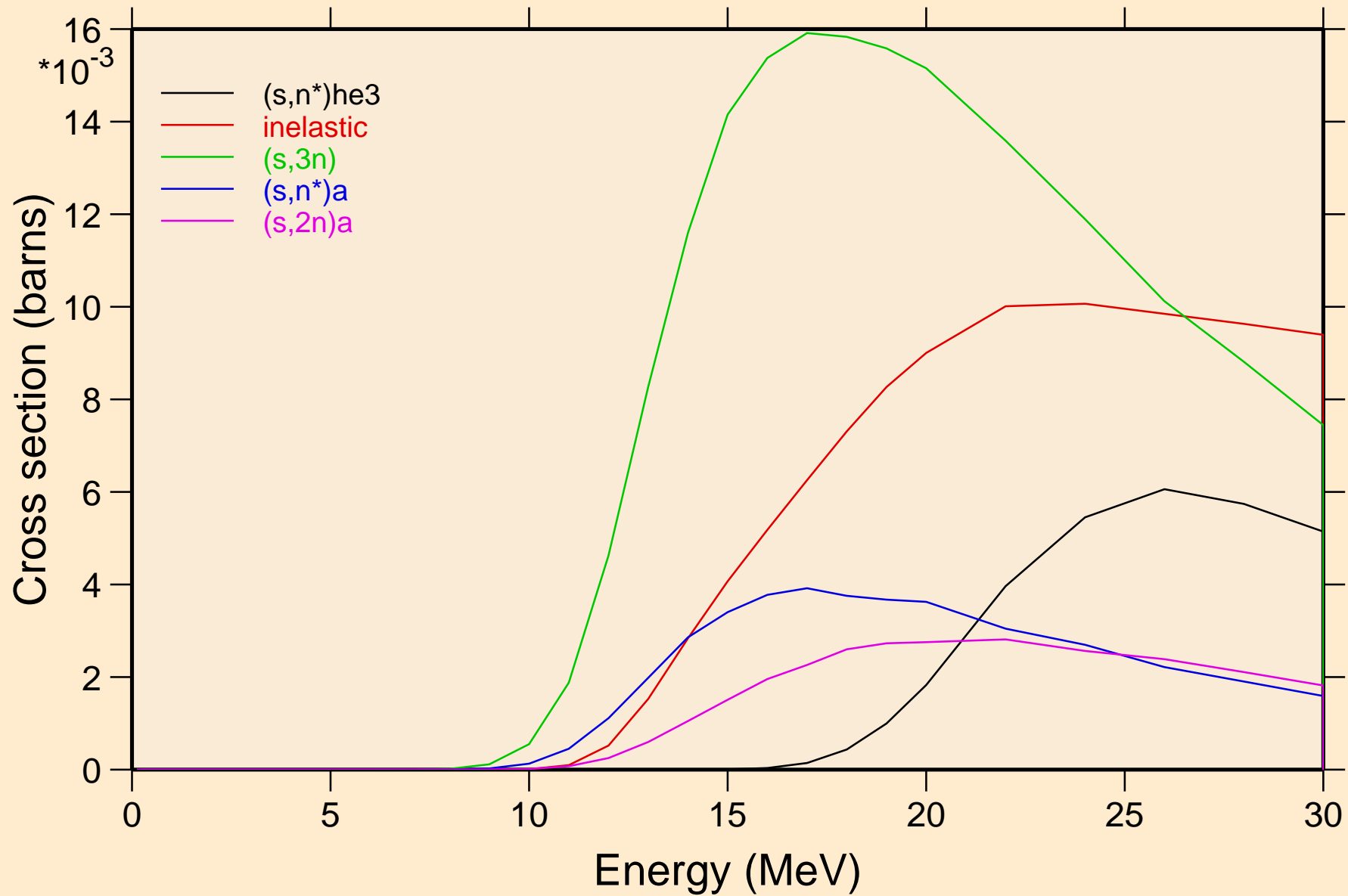

NB106 HELION ACER TENDL-2021 LIBRARY; T=0.K  
Threshold reactions

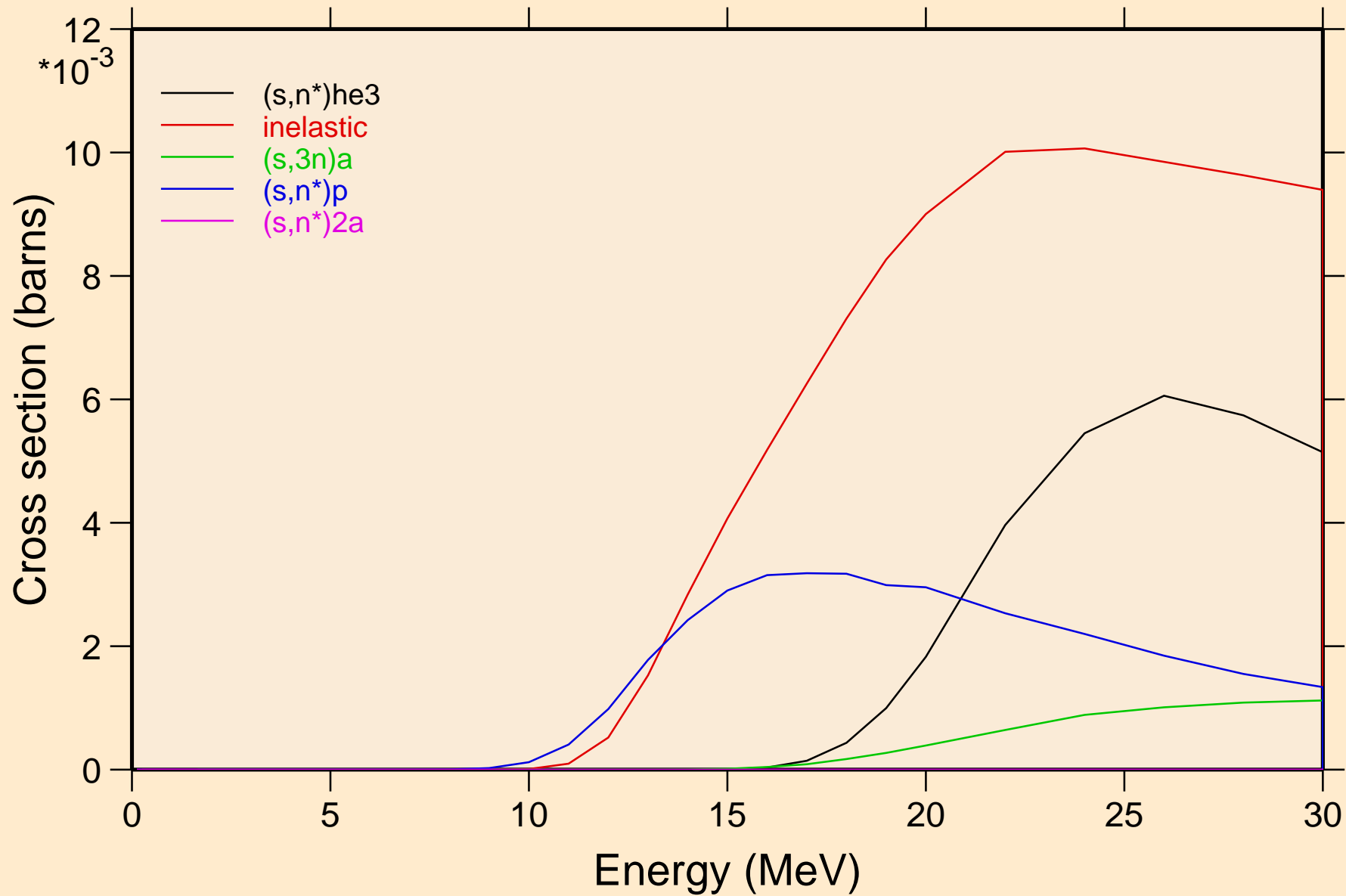

# NB106 HELION ACER TENDL-2021 LIBRARY; T=0.K

## Threshold reactions

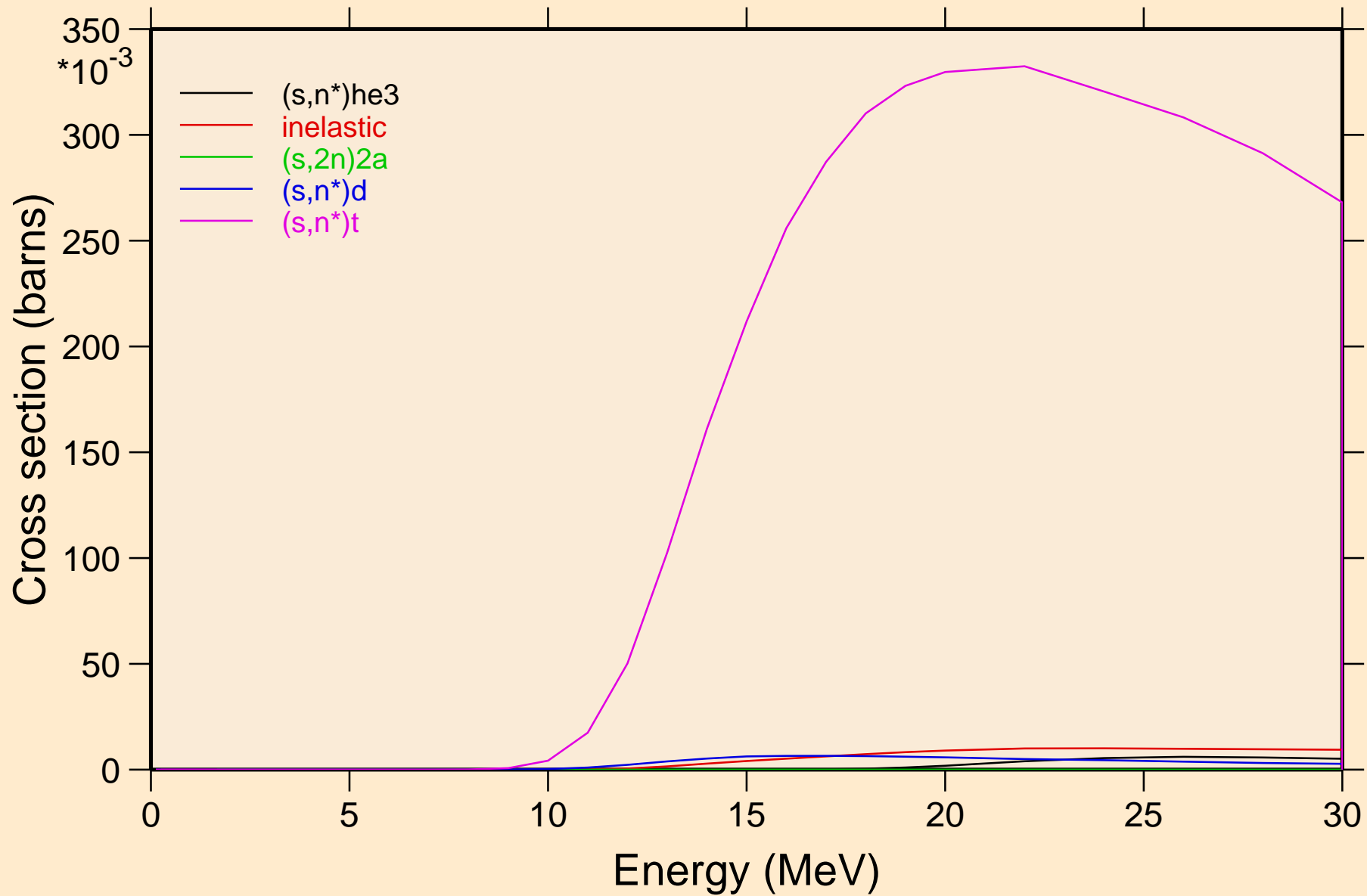



NB106 HELION ACER TENDL-2021 LIBRARY; T=0.K  
Threshold reactions

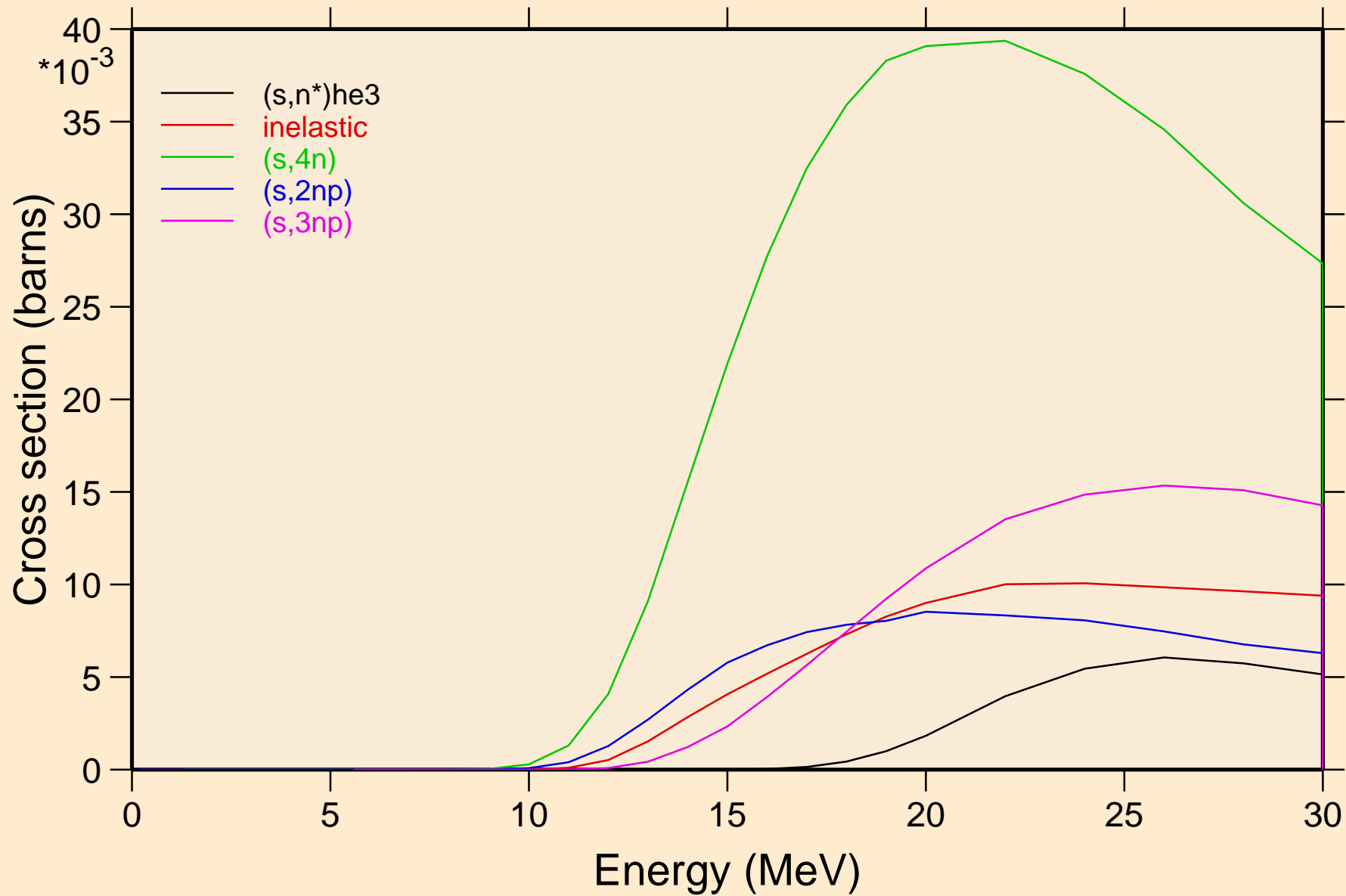

NB106 HELION ACER TENDL-2021 LIBRARY; T=0.K  
Threshold reactions

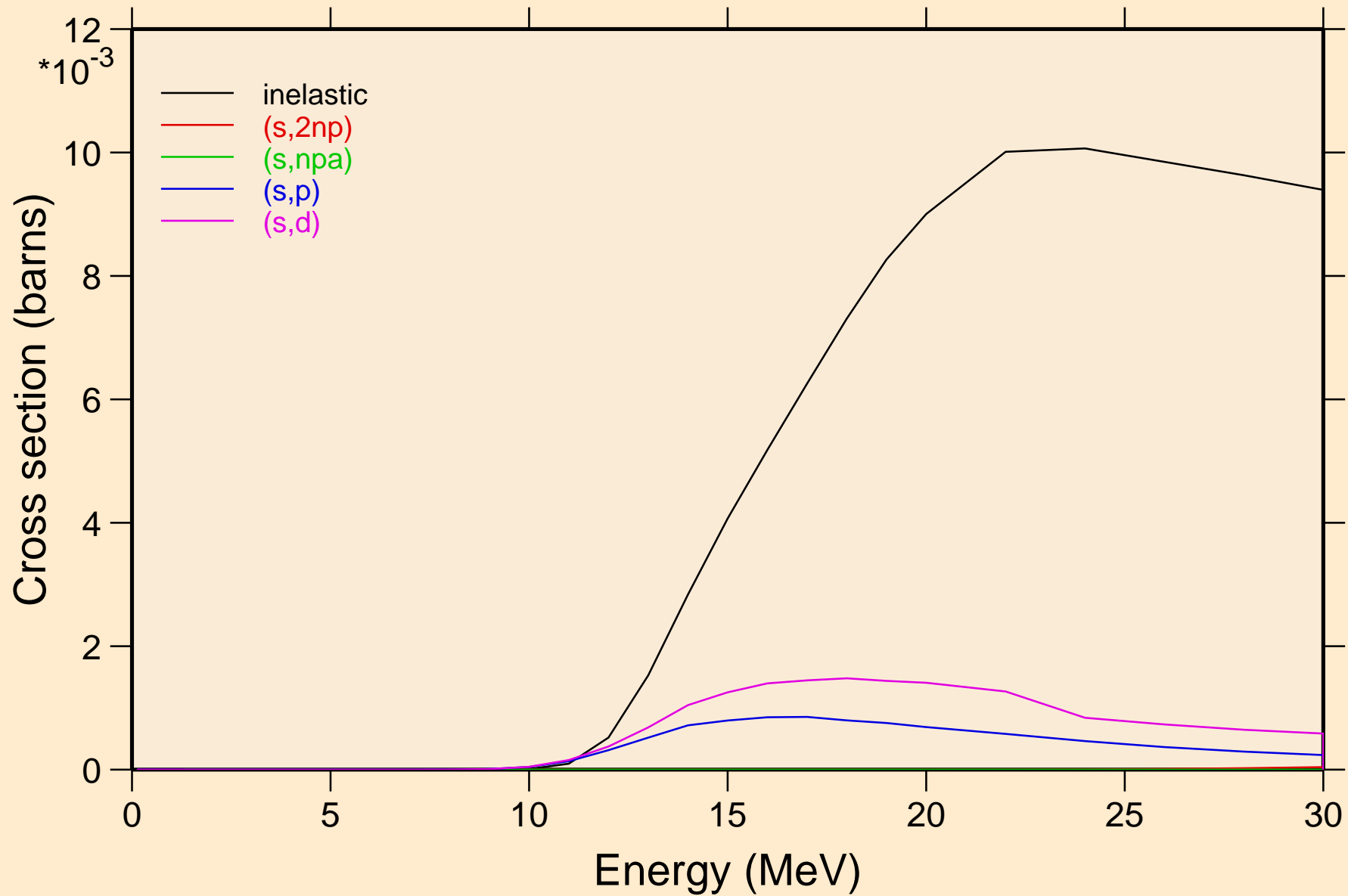

NB106 HELION ACER TENDL-2021 LIBRARY; T=0.K  
Threshold reactions

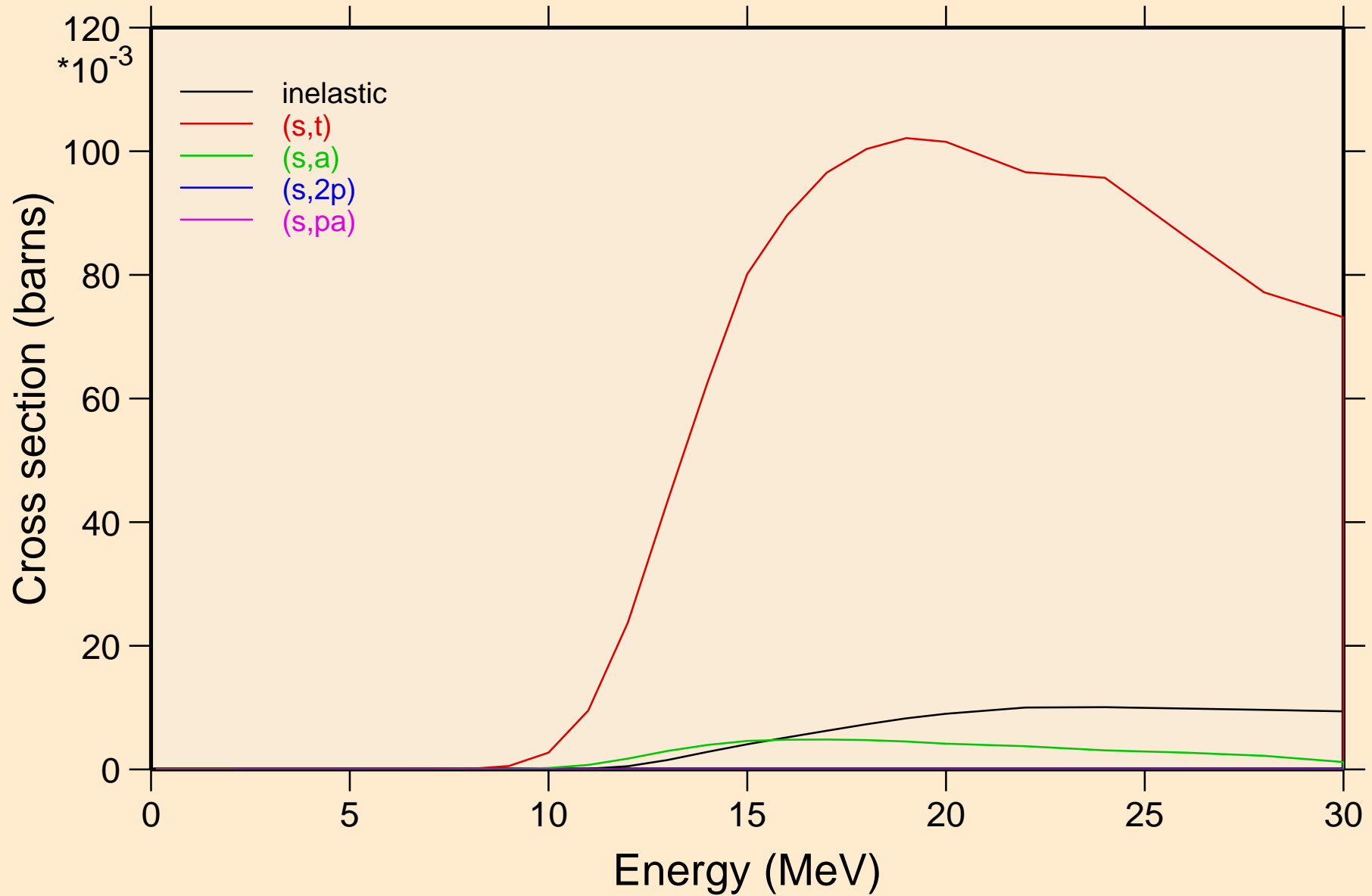

NB106 HELION ACER TENDL-2021 LIBRARY; T=0.K  
Threshold reactions

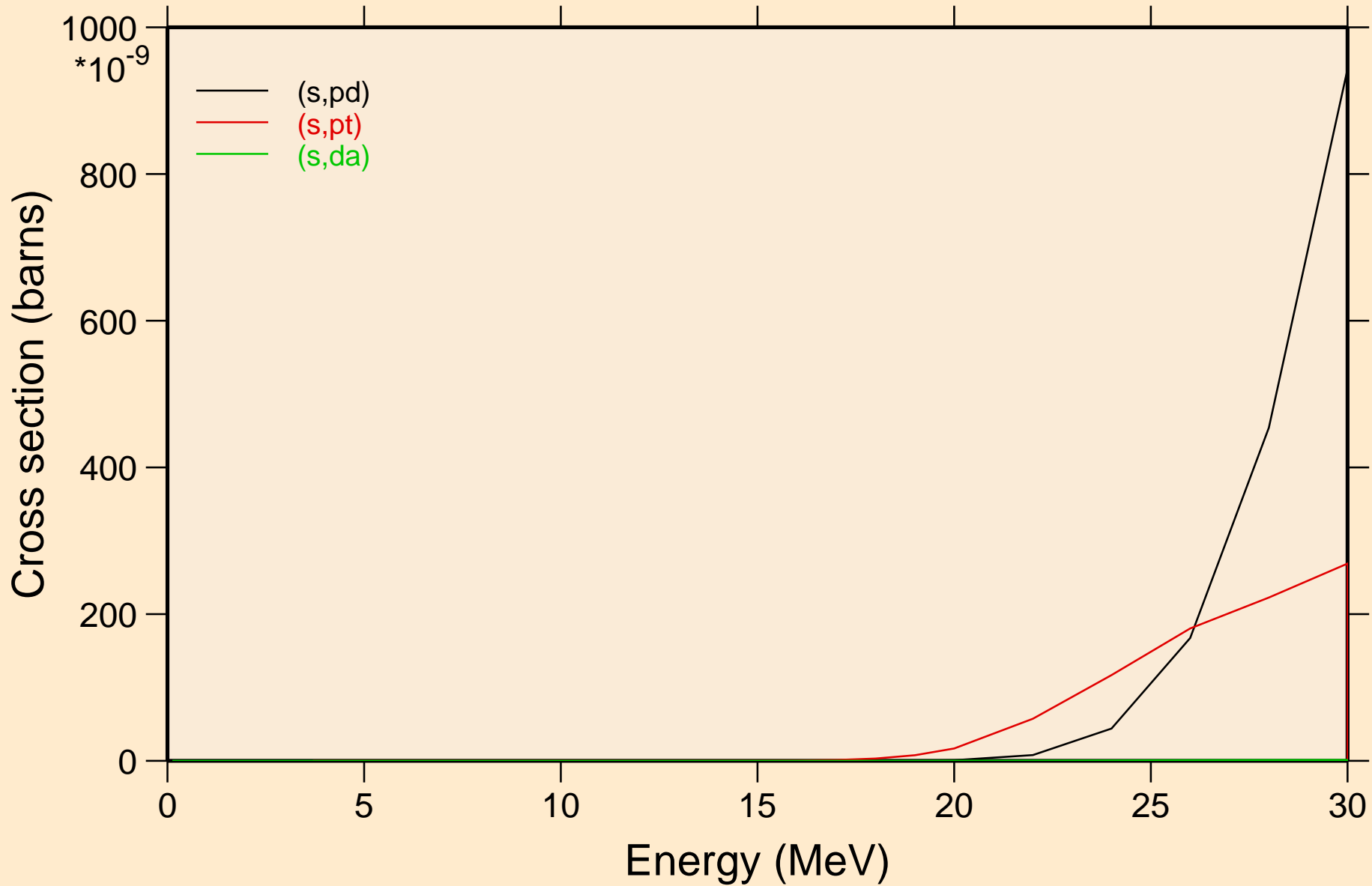

NB106 HELION ACER TENDL-2021 LIBRARY; T=0.K  
angular distribution for elastic

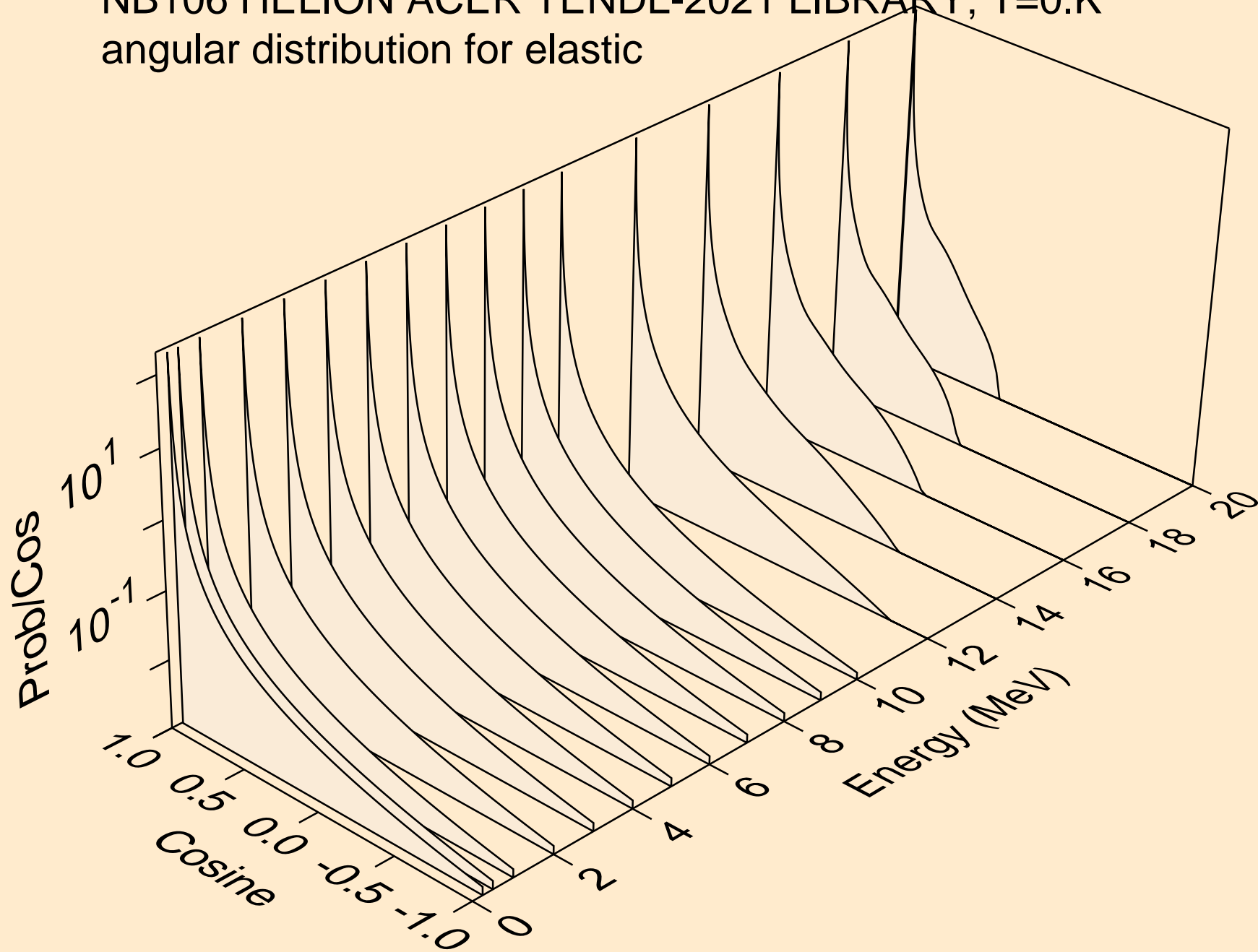

NB106 HELION ACER TENDL-2021 LIBRARY; T=0.K  
angular distribution for elastic

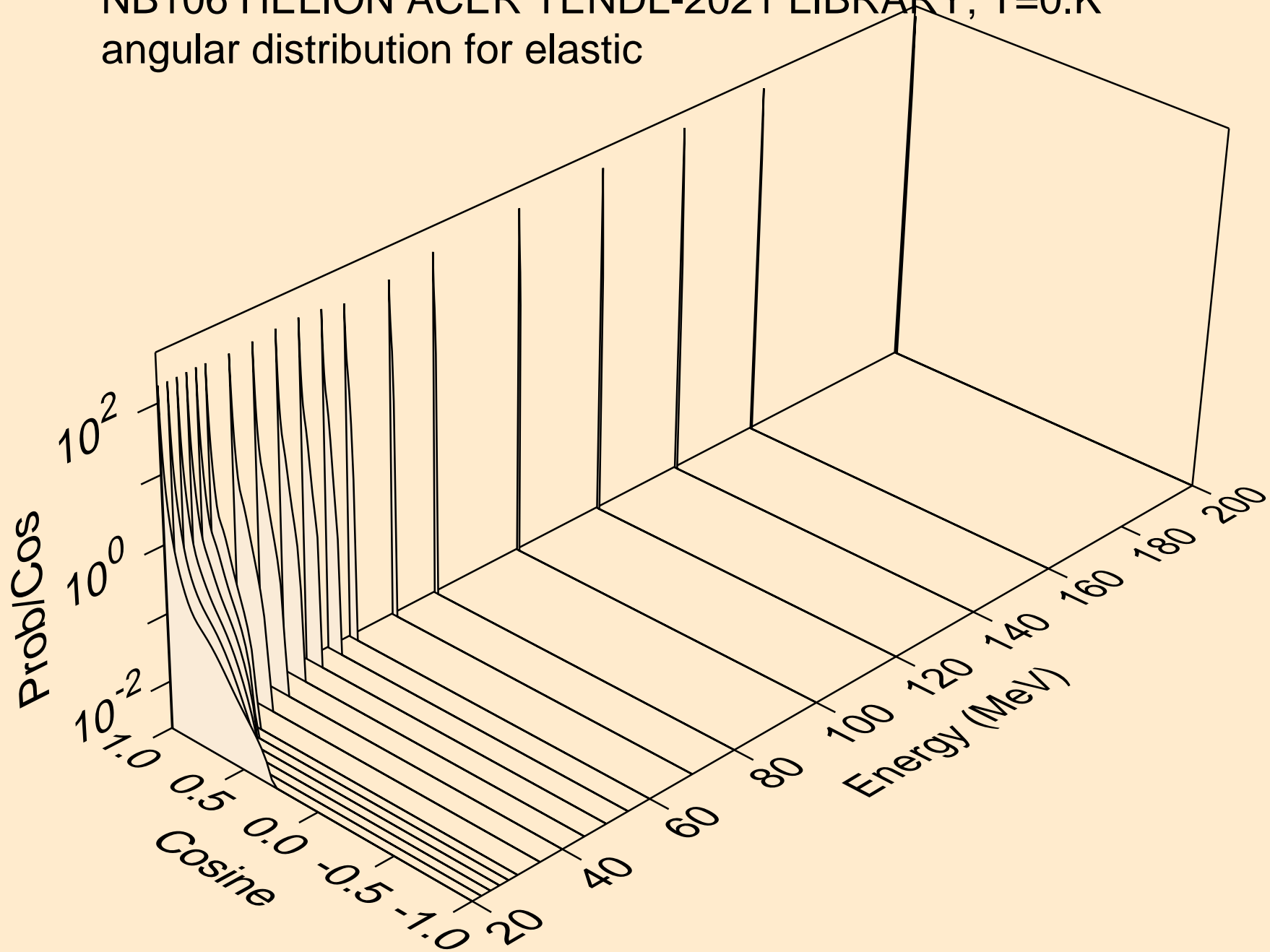

NB106 HELION ACER TENDL-2021 LIBRARY; T=0.K  
He-3 emission for (s,x)

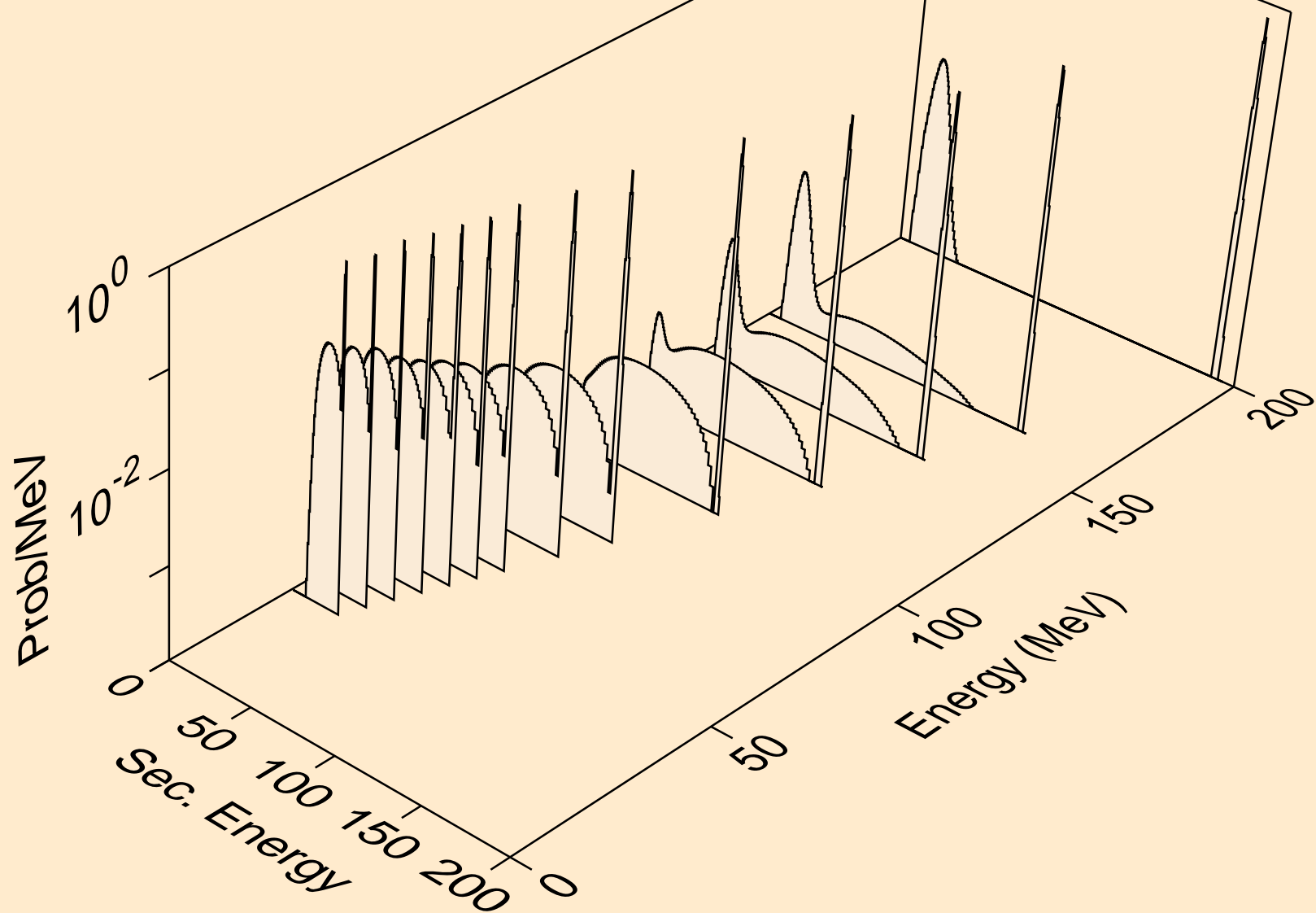

NB106 HELION ACER TENDL-2021 LIBRARY; T=0.K  
He-3 emission for (s,n\*)he3

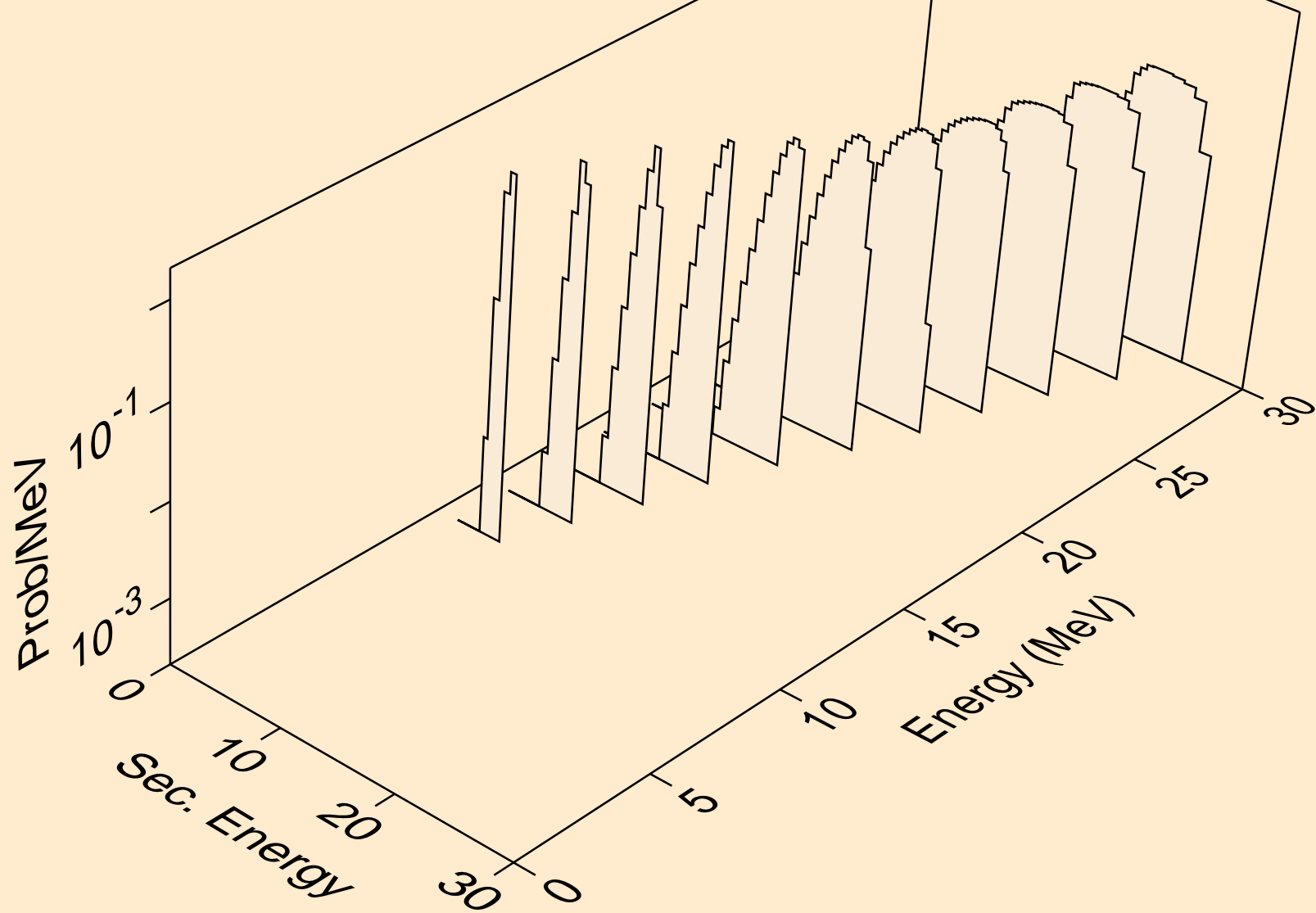



NB106 HELION ACER TENDL-2021 LIBRARY; T=0.K  
He-3 emission for inelastic

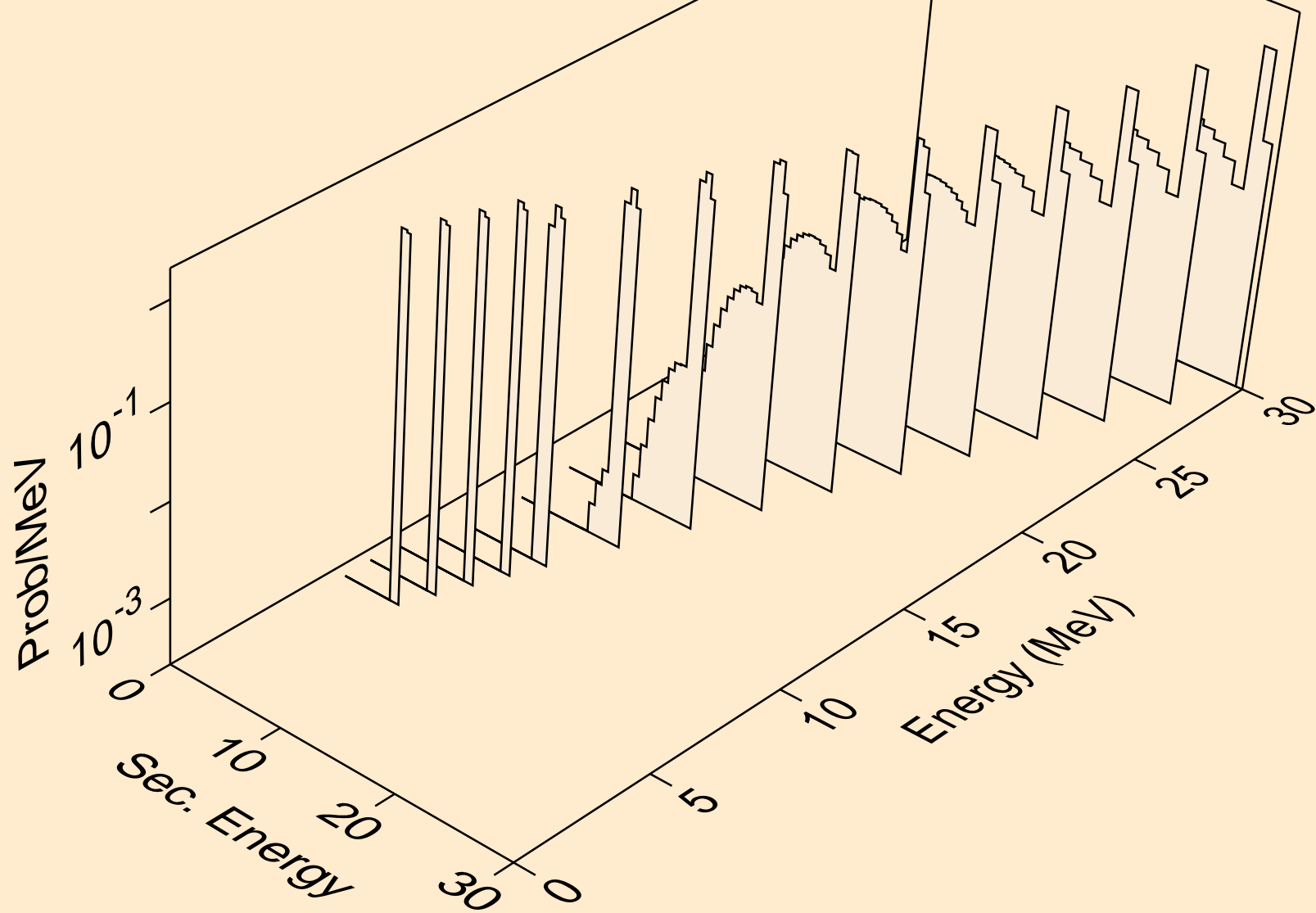

NB106 HELION ACER TENDL-2021 LIBRARY; T=0.K  
Photon emission for (z,n)

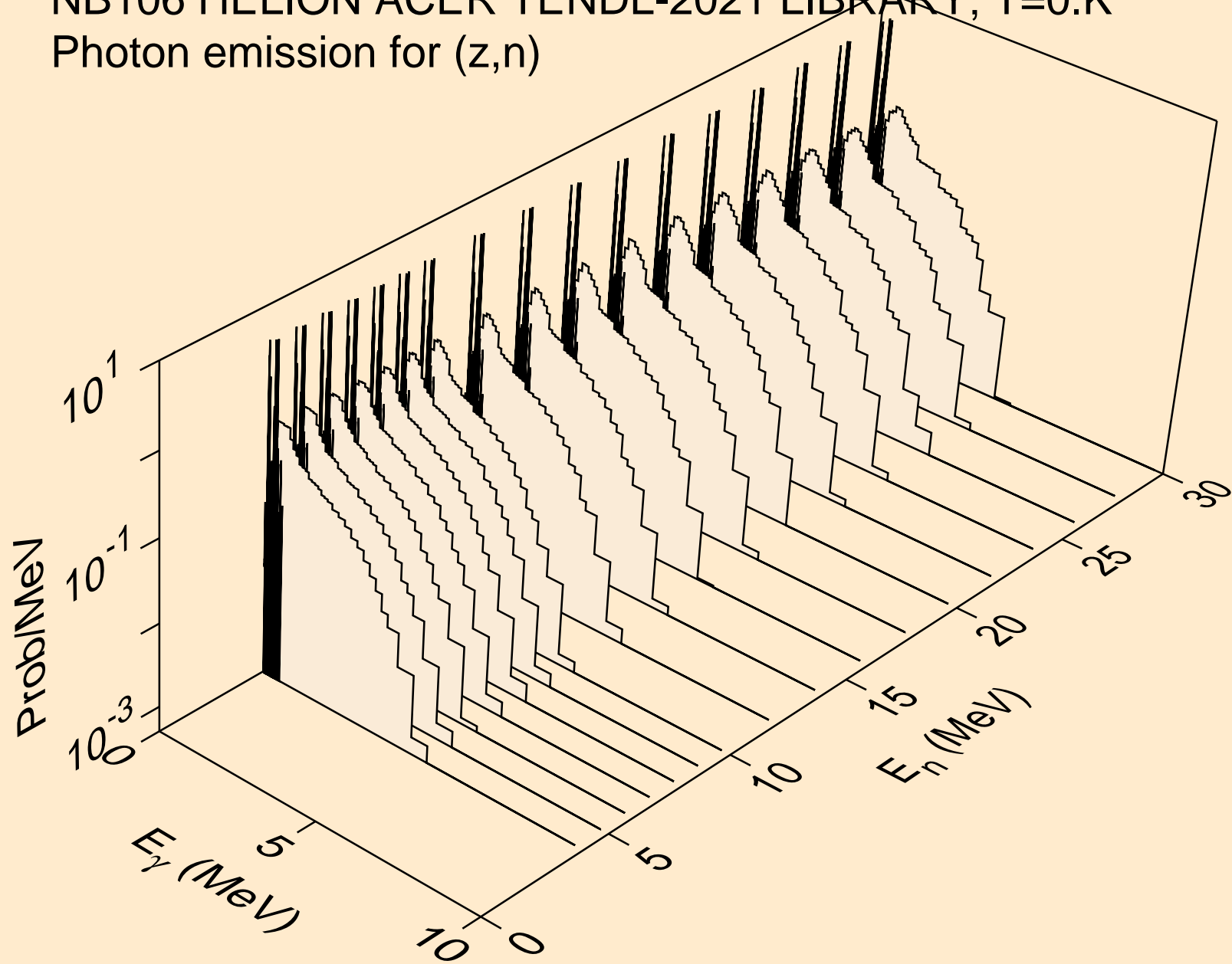

NB106 HELION ACER TENDL-2021 LIBRARY; T=0.K  
Photon emission for (n,x)

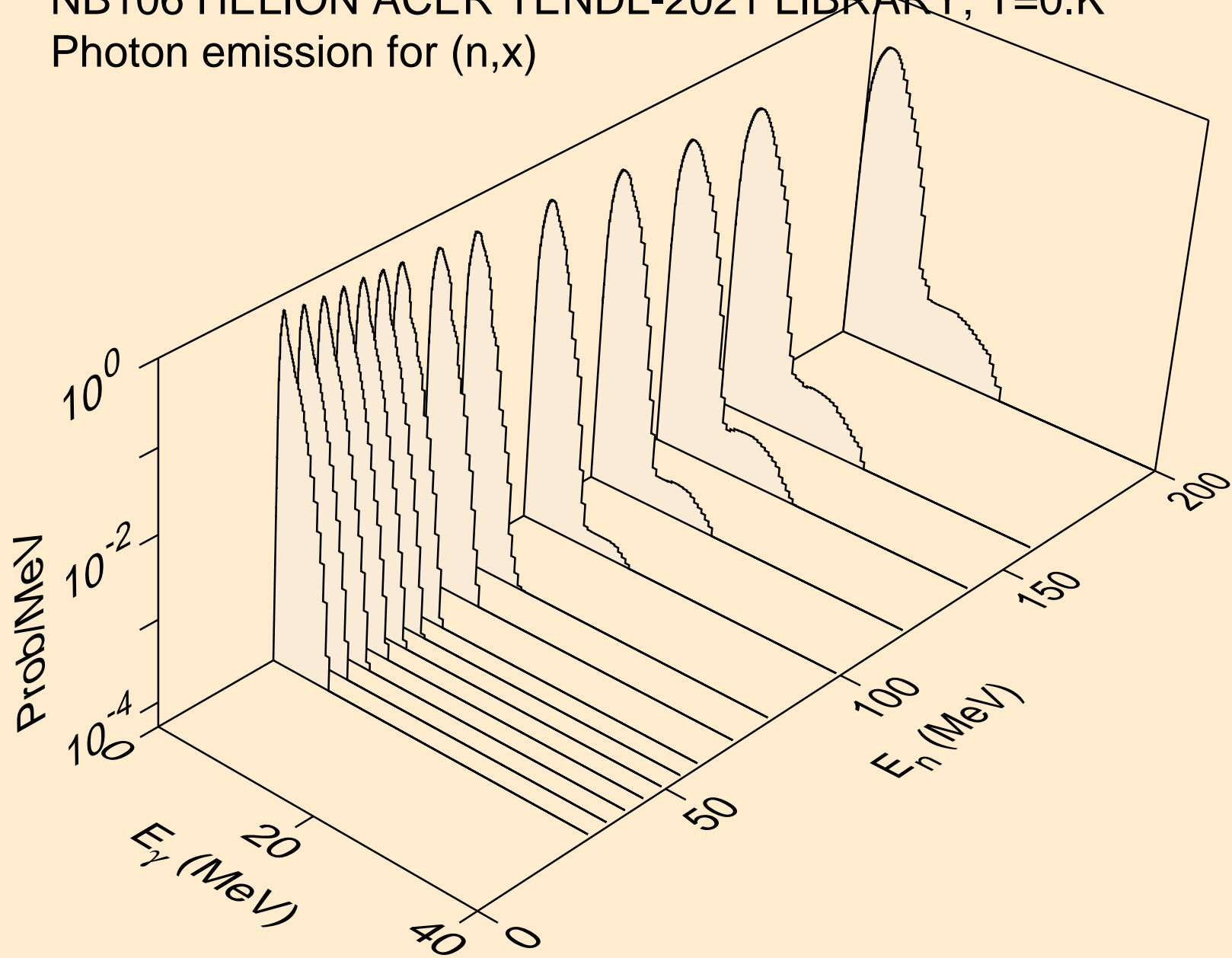

NB106 HELION ACER TENDL-2021 LIBRARY; T=0.K  
Photon emission for (n,2nd)

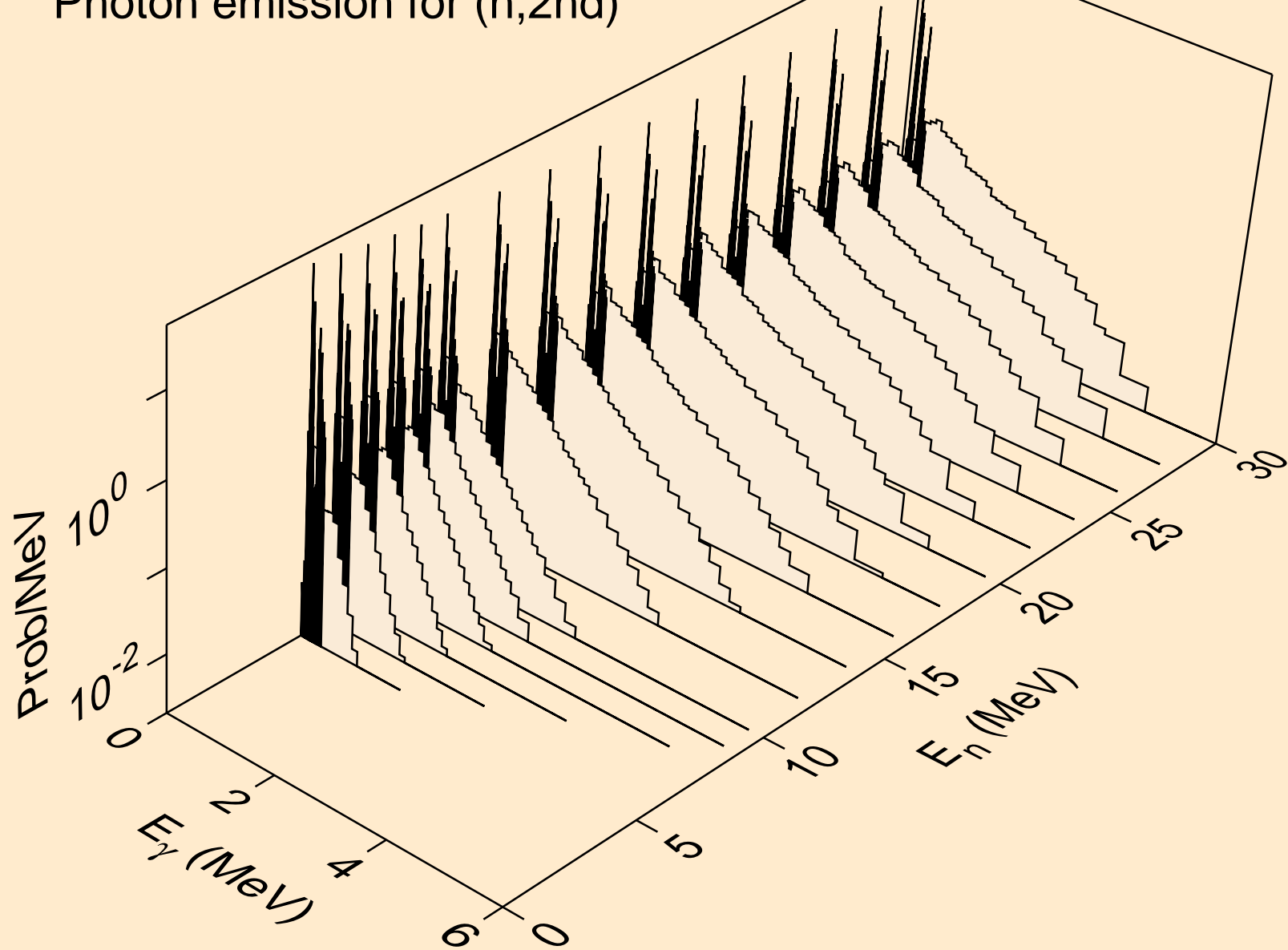

NB106 HELION ACER TENDL-2021 LIBRARY; T=0.K  
Photon emission for (n,2n)

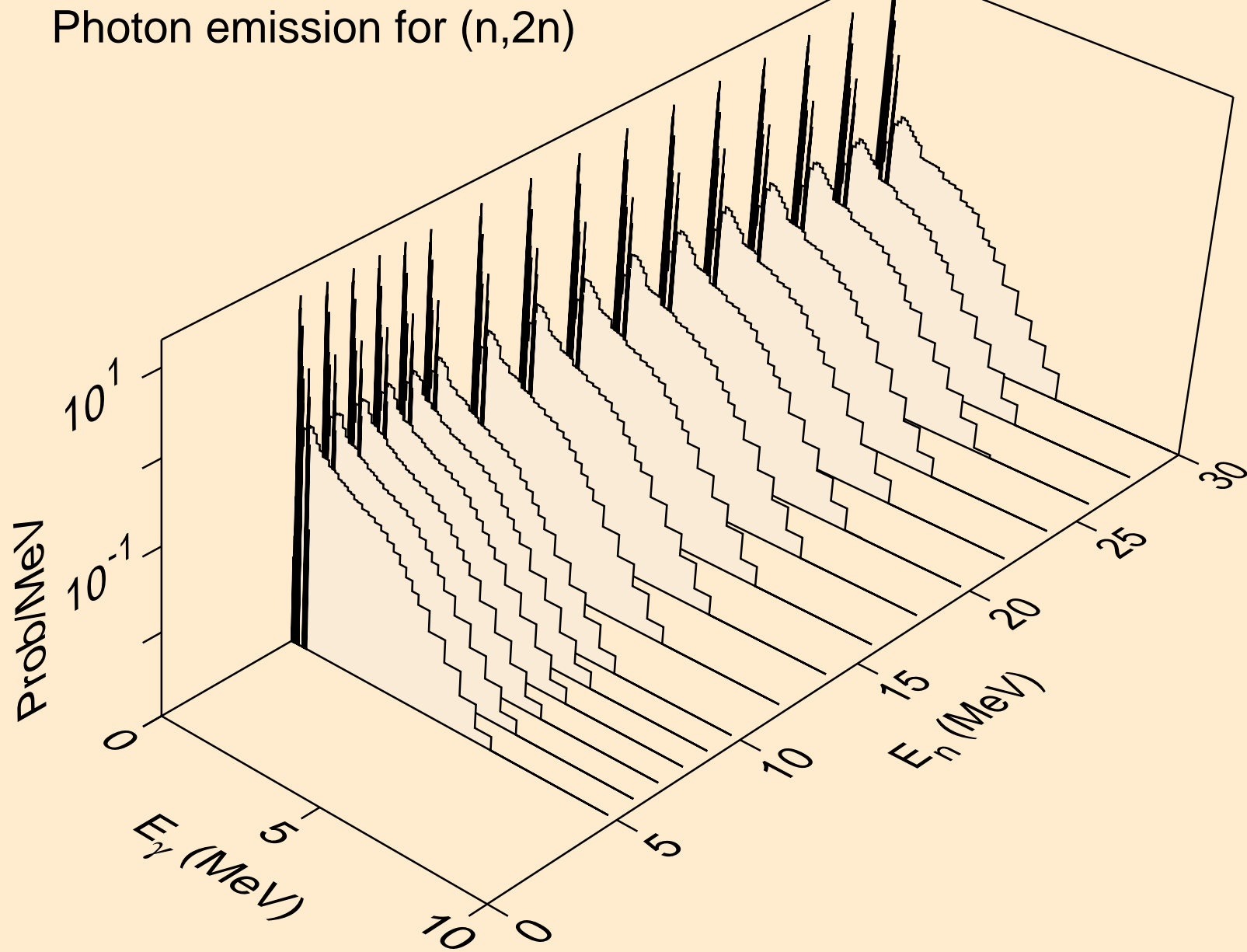

NB106 HELION ACER TENDL-2021 LIBRARY; T=0.K  
Photon emission for (n,3n)

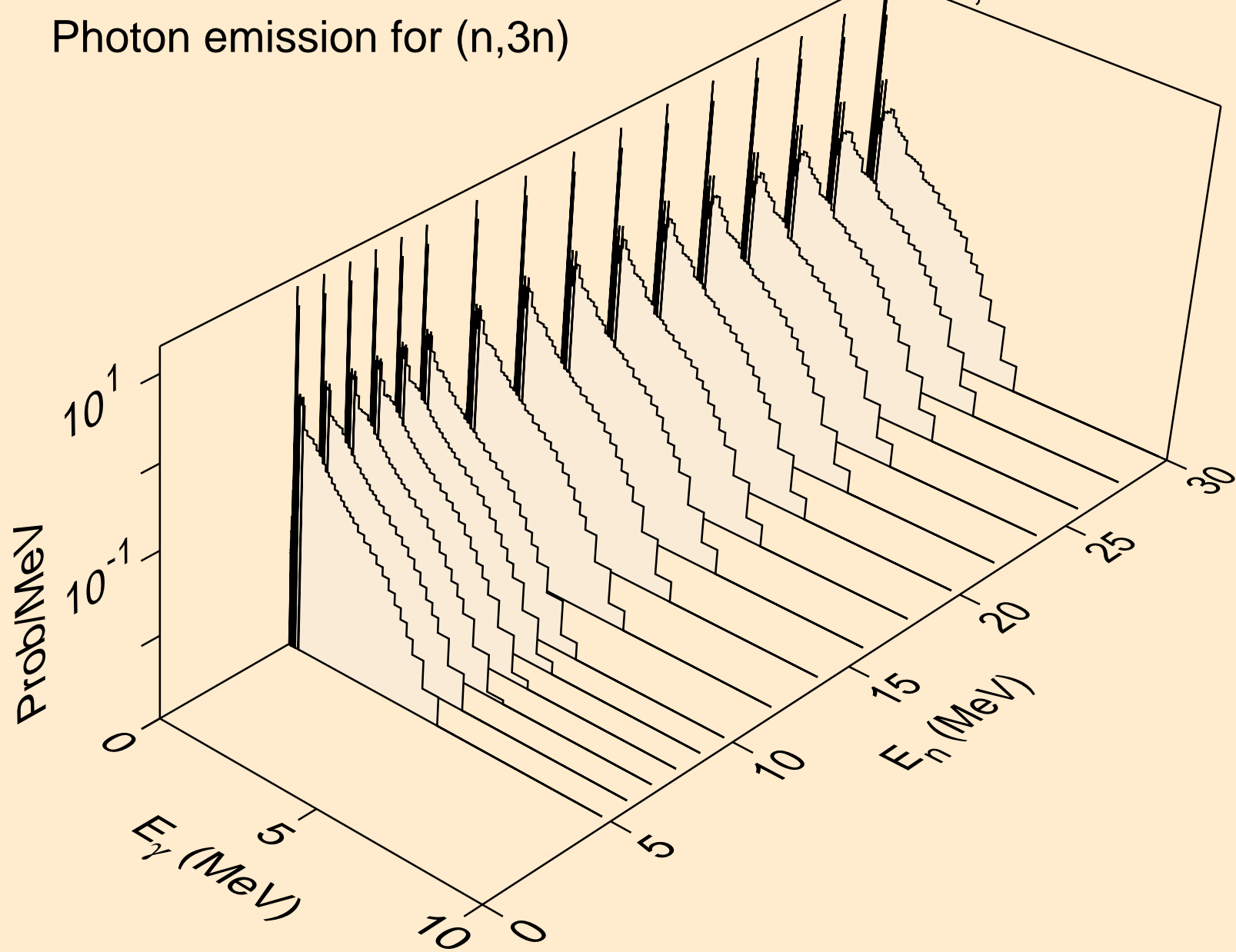

NB106 HELION ACER TENDL-2021 LIBRARY; T=0.K  
Photon emission for (n,n\*)a

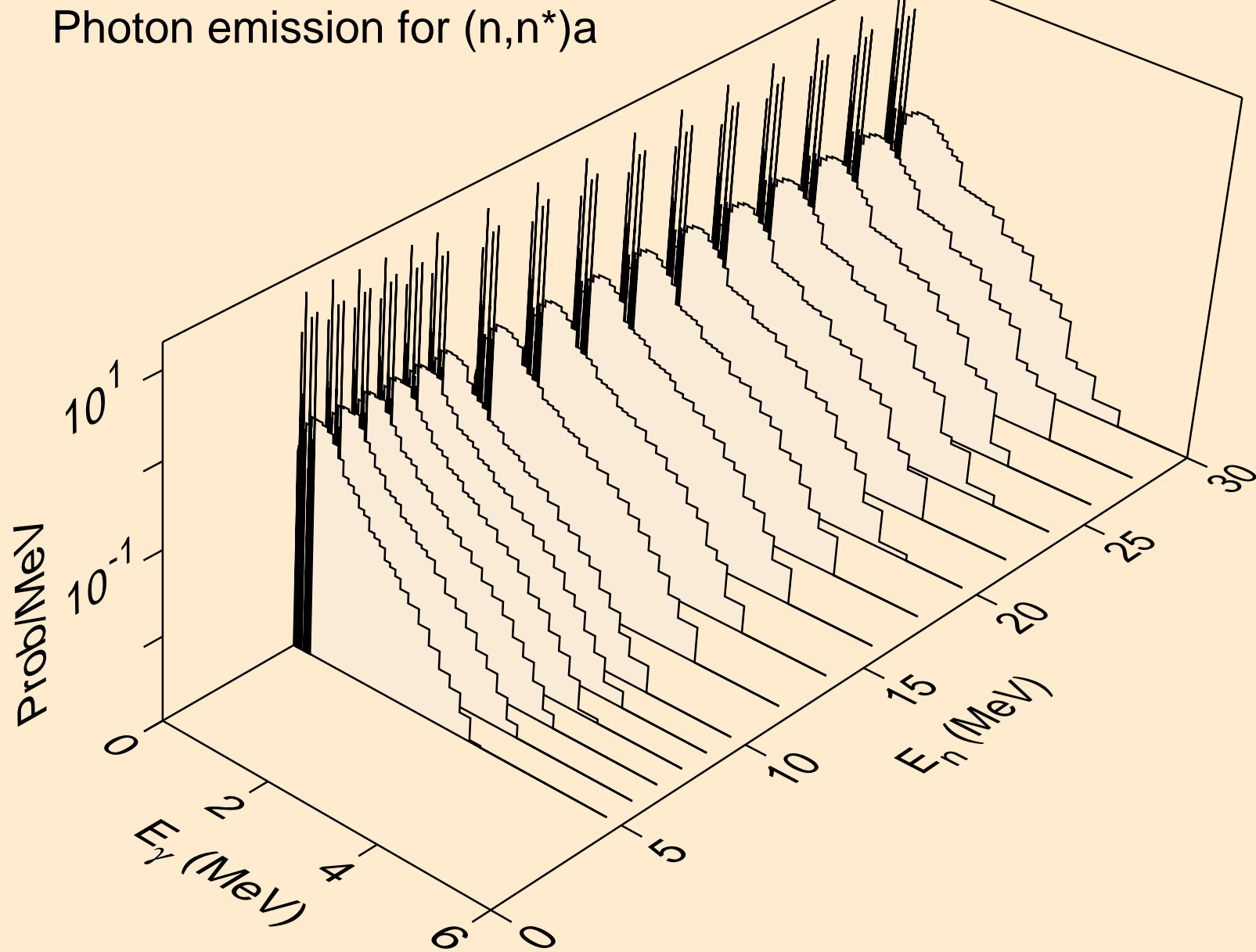

NB106 HELION ACER TENDL-2021 LIBRARY; T=0.K  
Photon emission for (n,2n)a

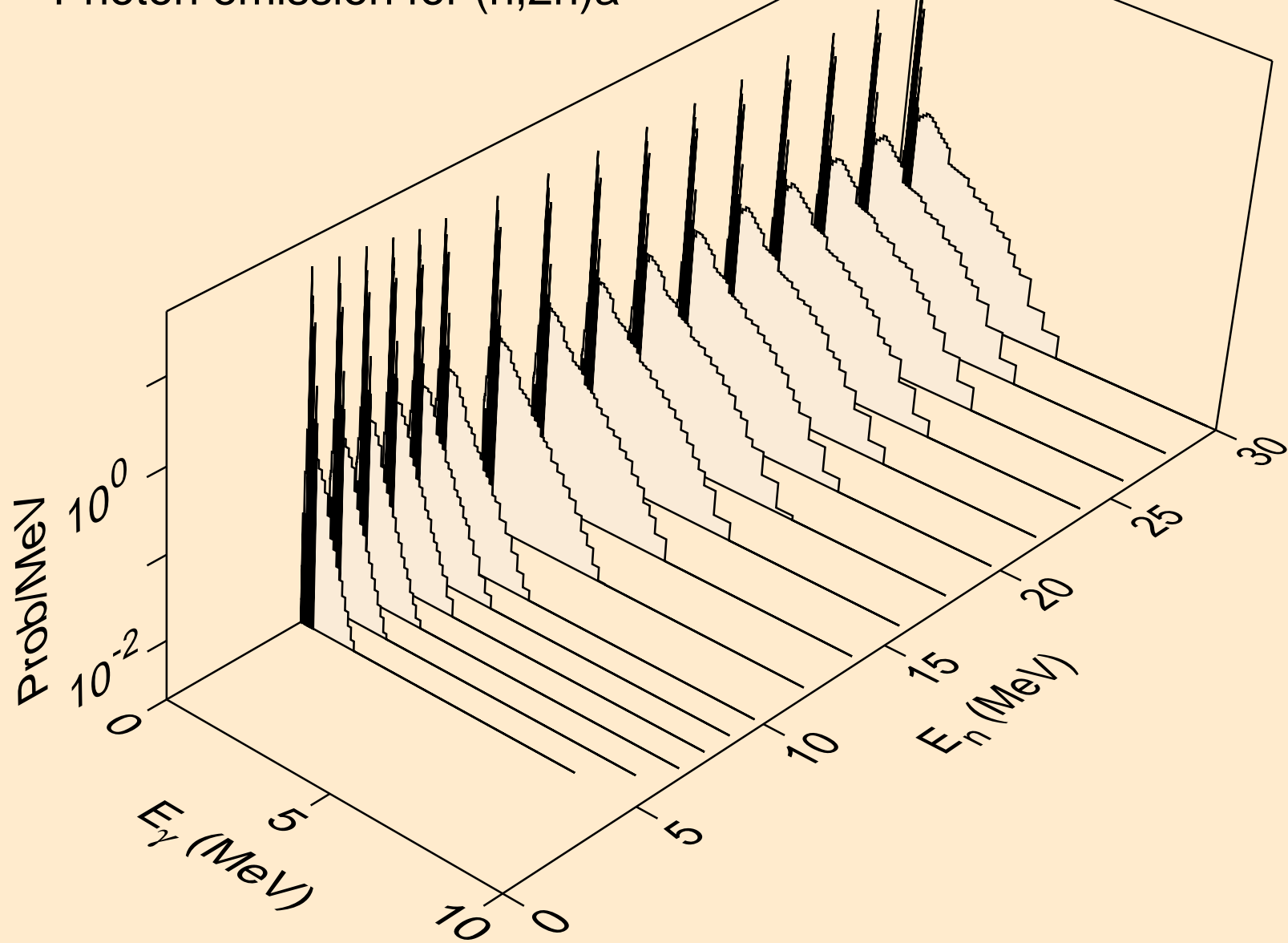



NB106 HELION ACER TENDL-2021 LIBRARY; T=0.K  
Photon emission for (n,3n)a

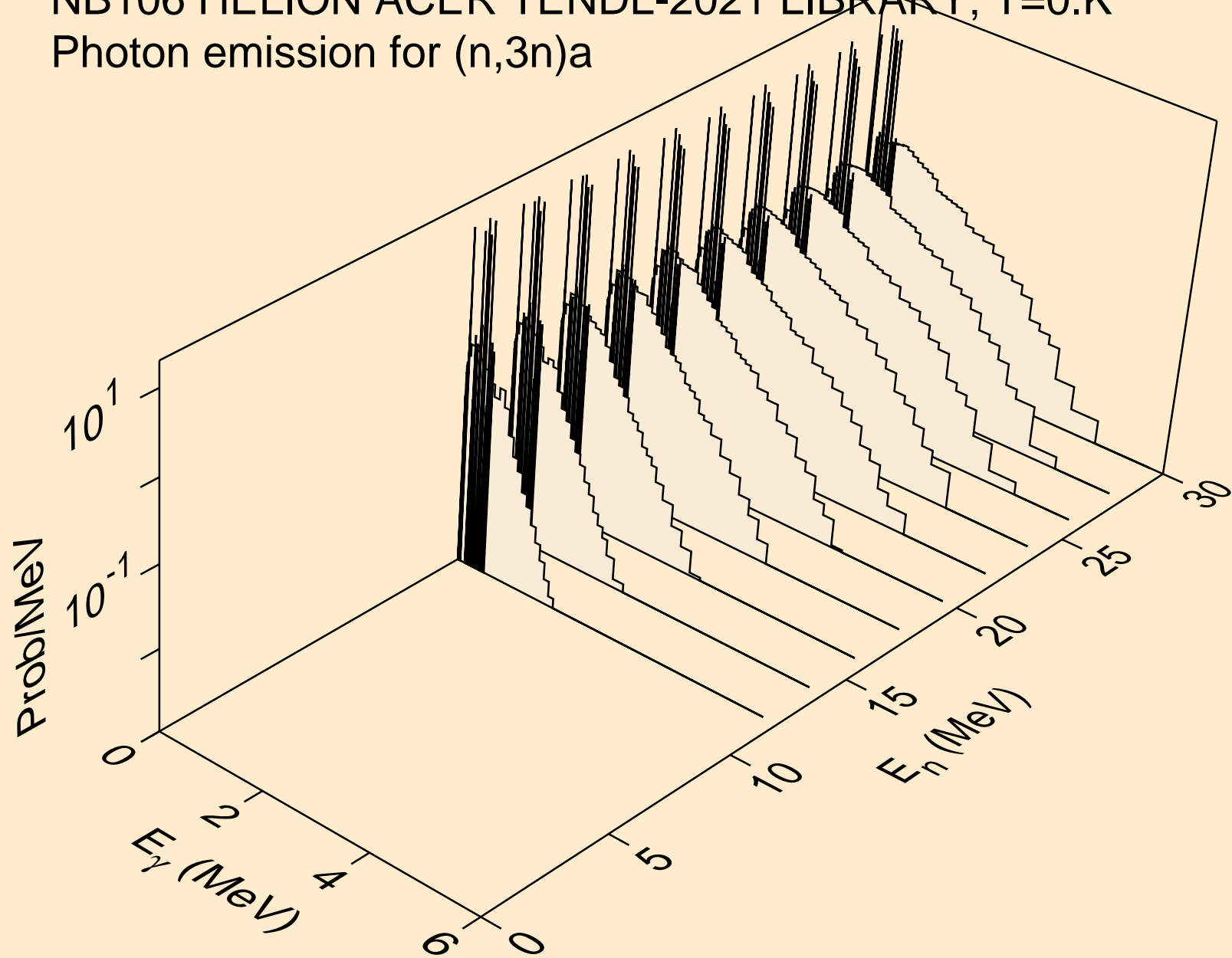

NB106 HELION ACER TENDL-2021 LIBRARY; T=0.K  
Photon emission for (n,n\*)p

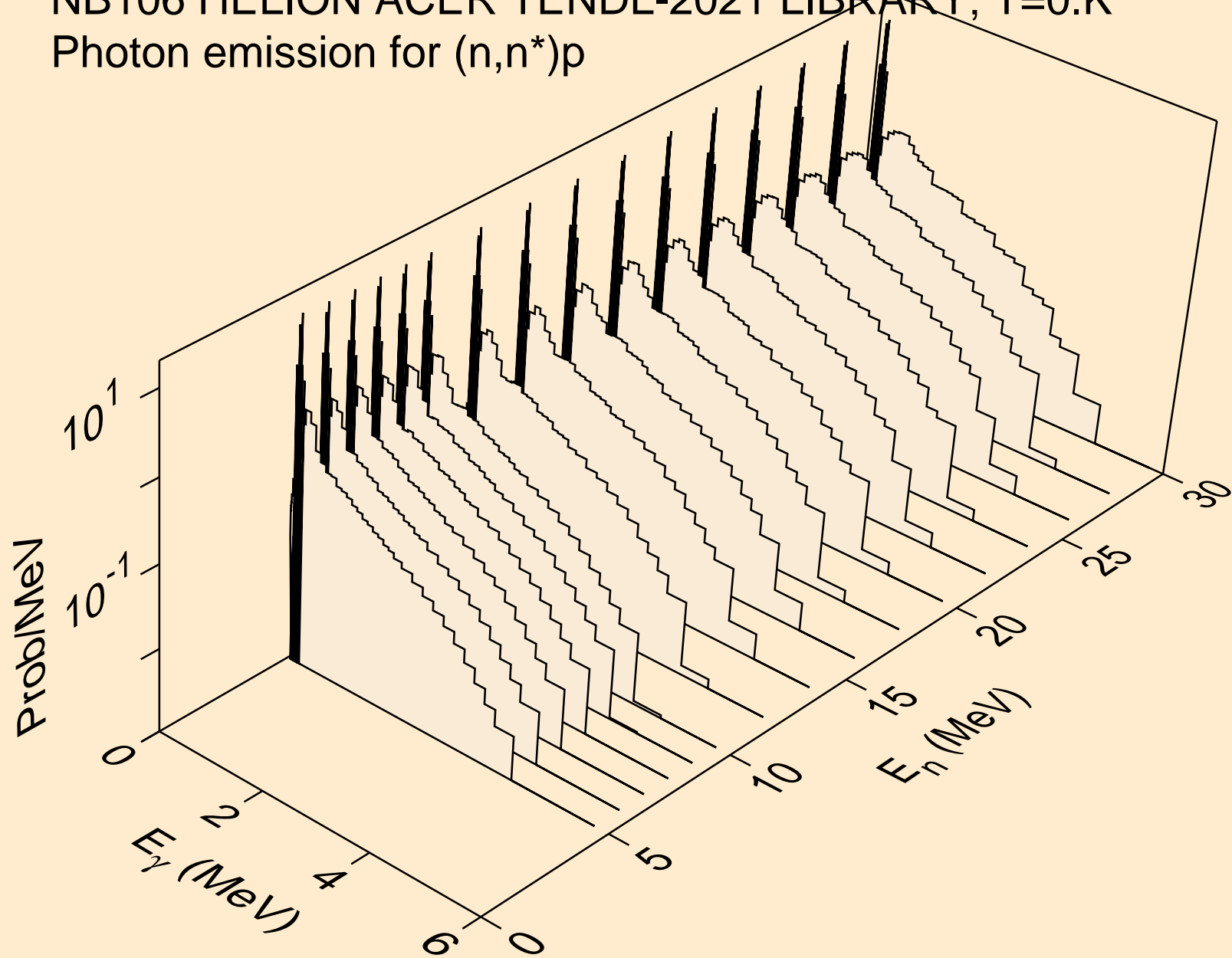

NB106 HELION ACER TENDL-2021 LIBRARY; T=0.K  
Photon emission for (n,n\*)2a

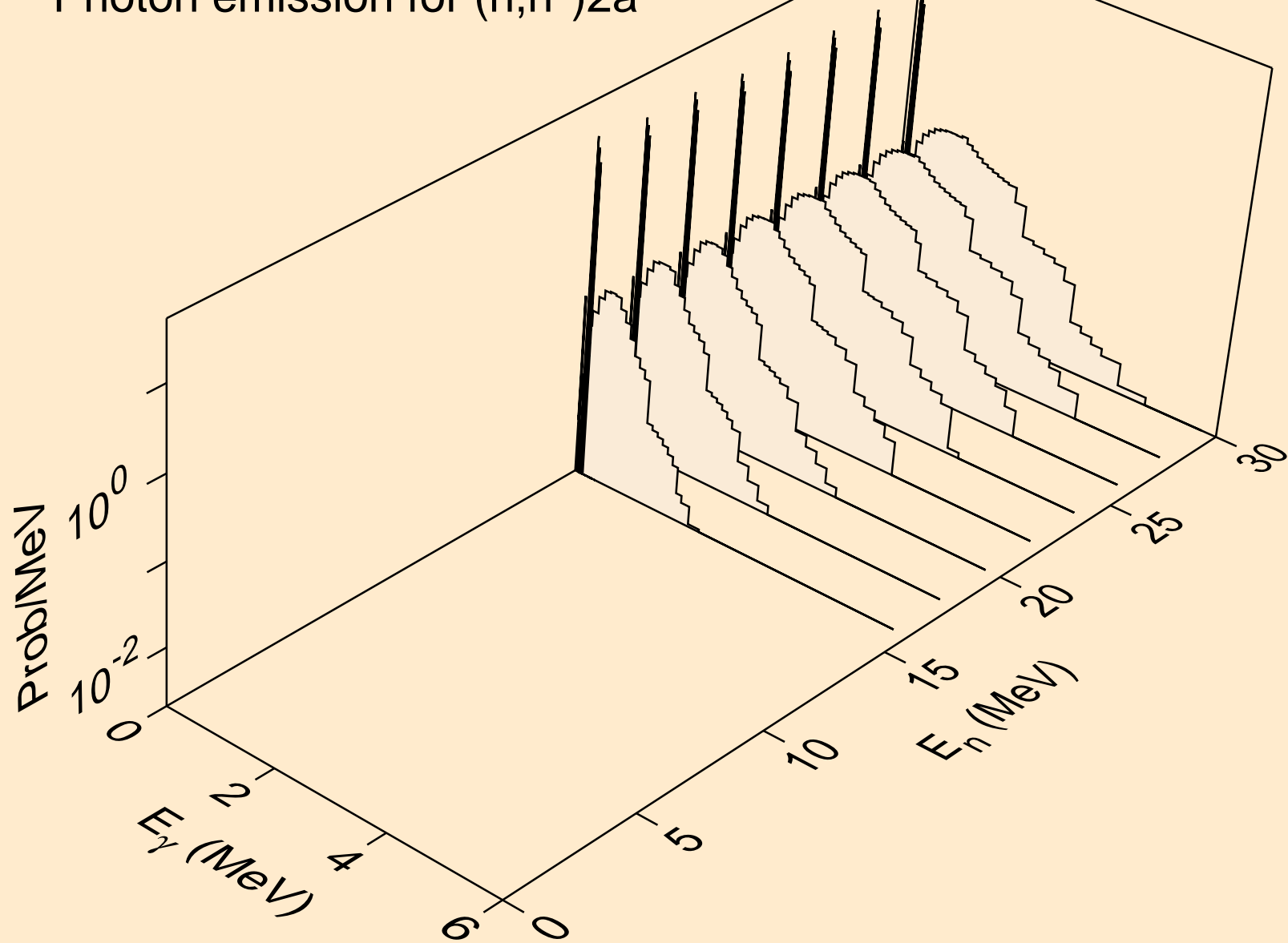

NB106 HELION ACER TENDL-2021 LIBRARY; T=0.K  
Photon emission for (n,2n)2a

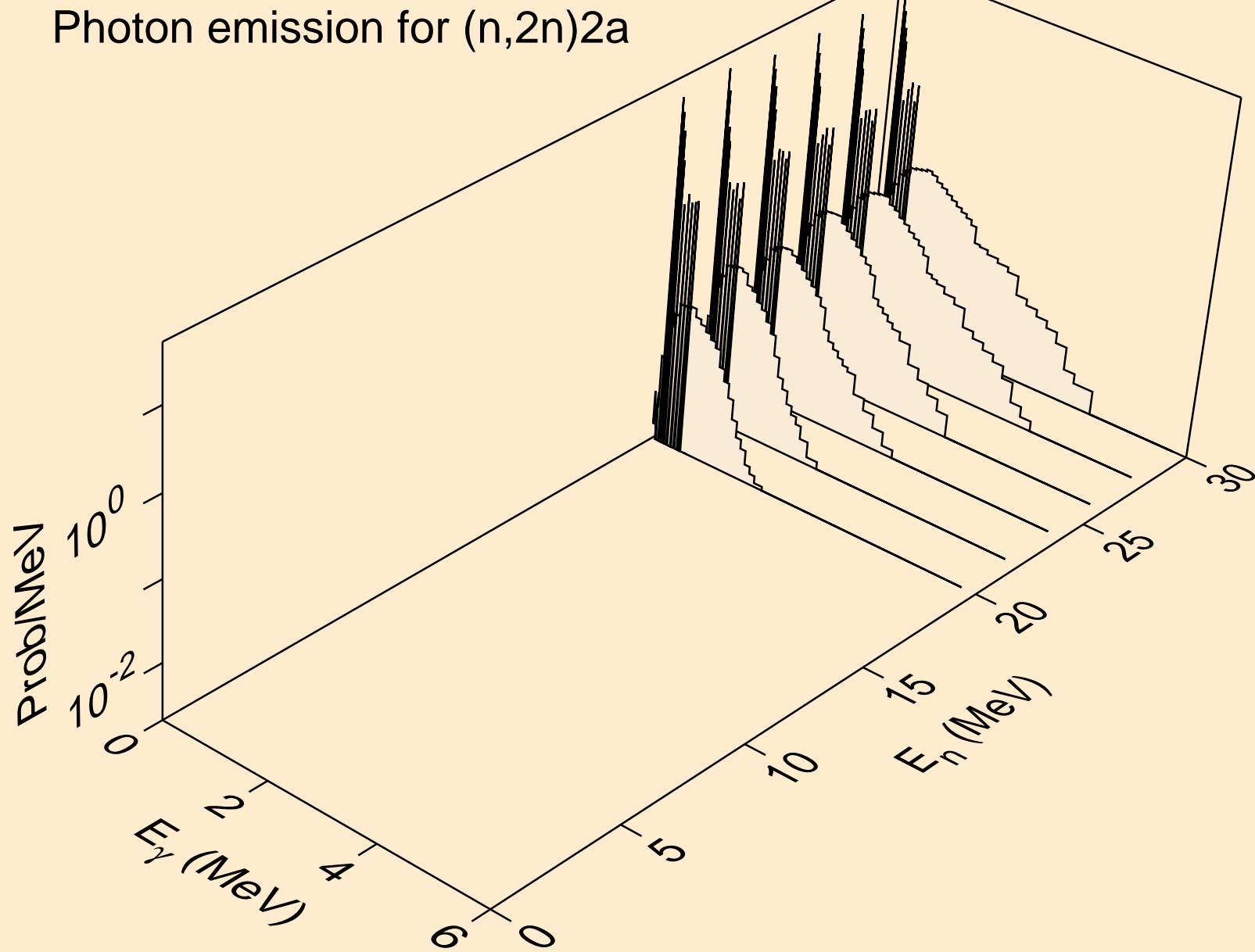

NB106 HELION ACER TENDL-2021 LIBRARY; T=0.K  
Photon emission for (n,n\*)d

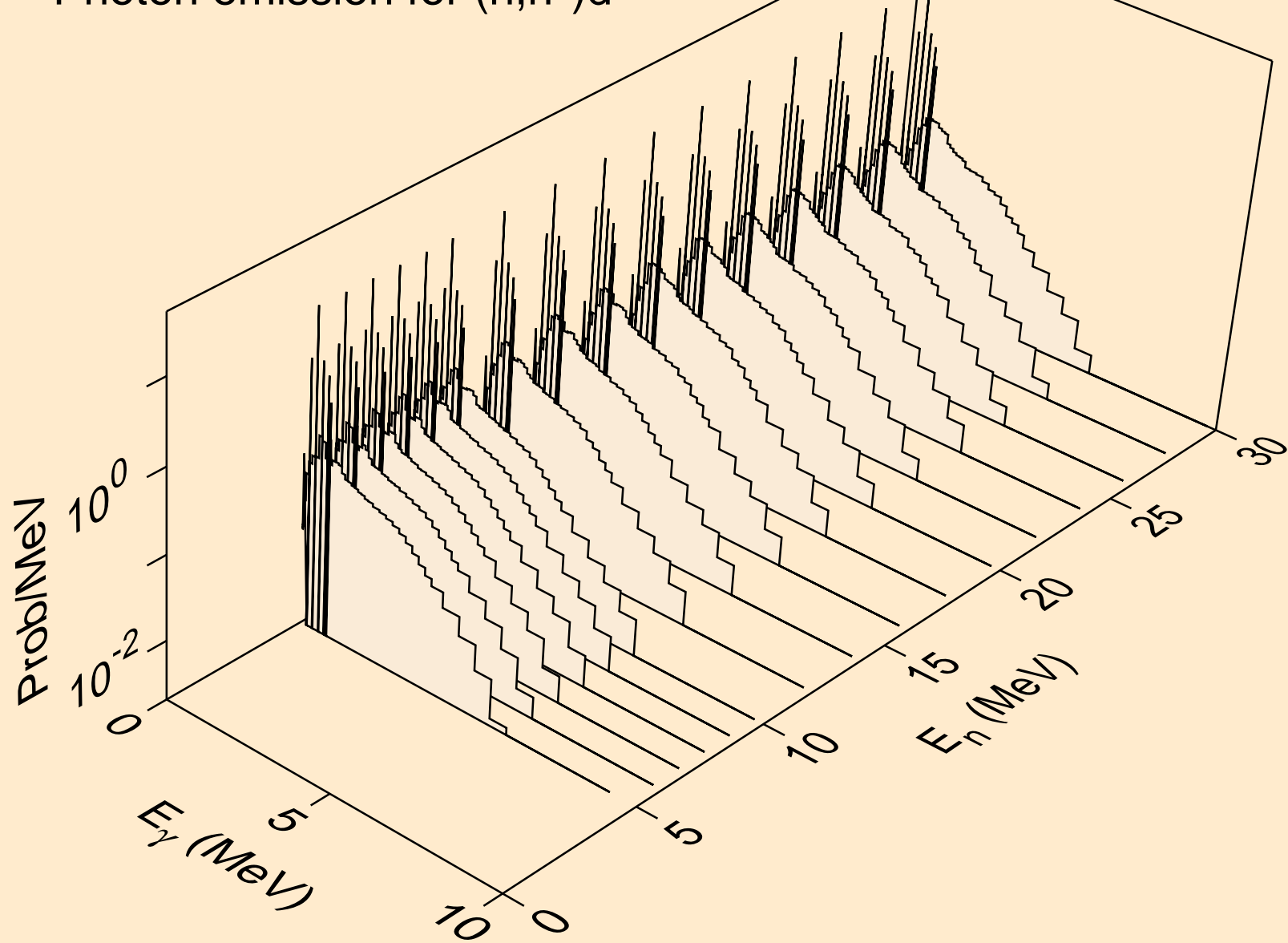

NB106 HELION ACER TENDL-2021 LIBRARY; T=0.K  
Photon emission for (n,n\*)t

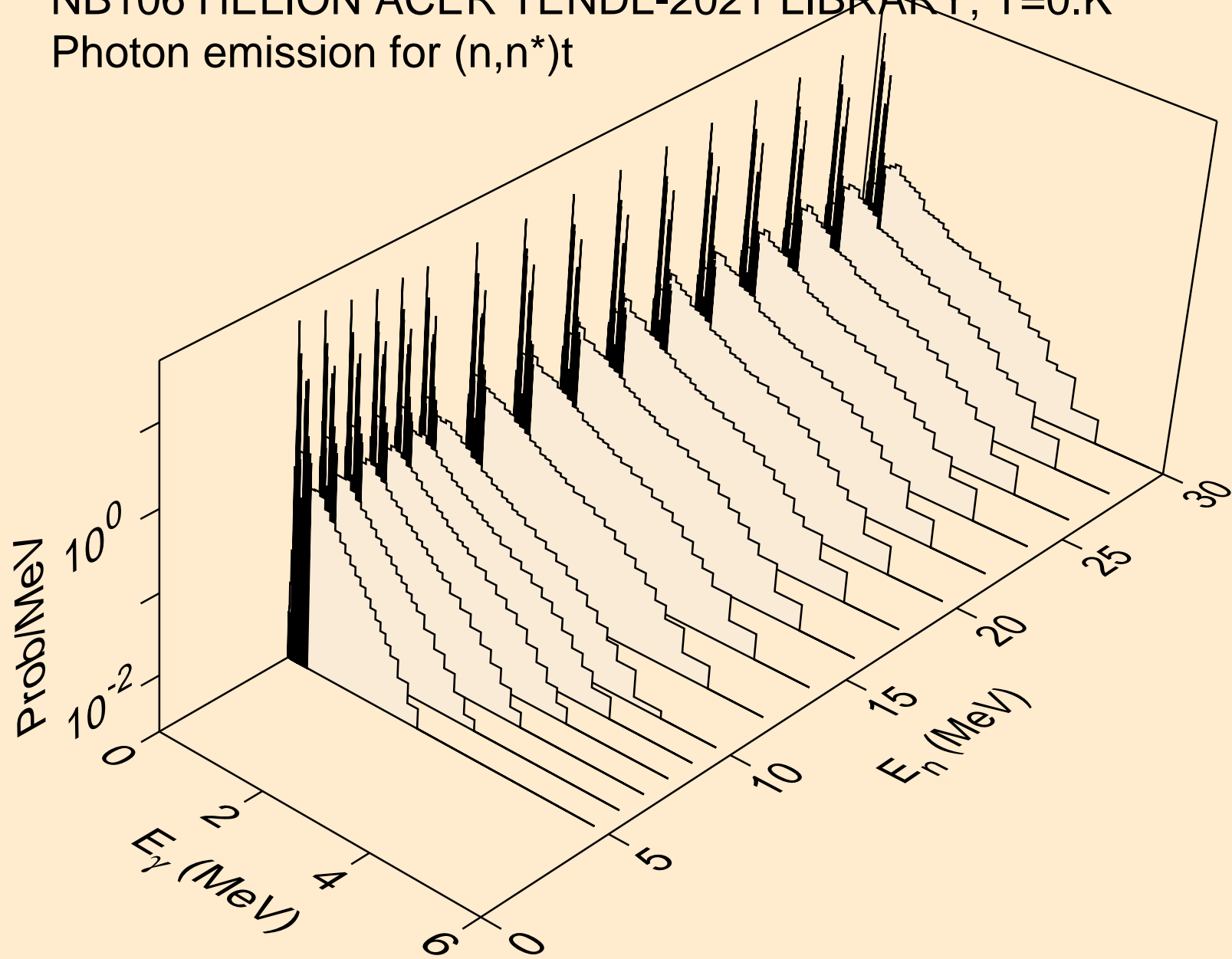

NB106 HELION ACER TENDL-2021 LIBRARY; T=0.K  
Photon emission for (n,n\*)he3

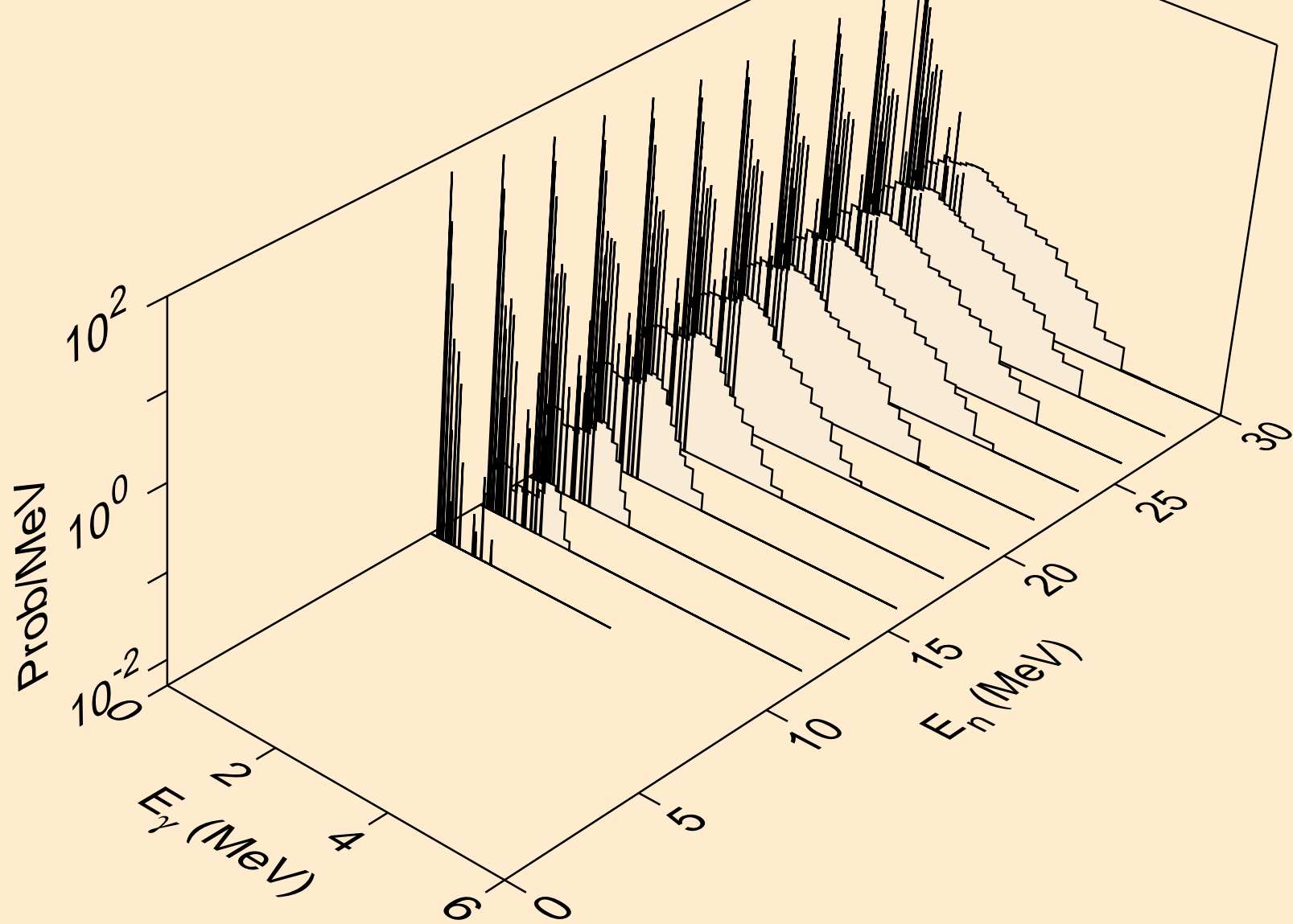

NB106 HELION ACER TENDL-2021 LIBRARY; T=0.K  
Photon emission for (n,4n)

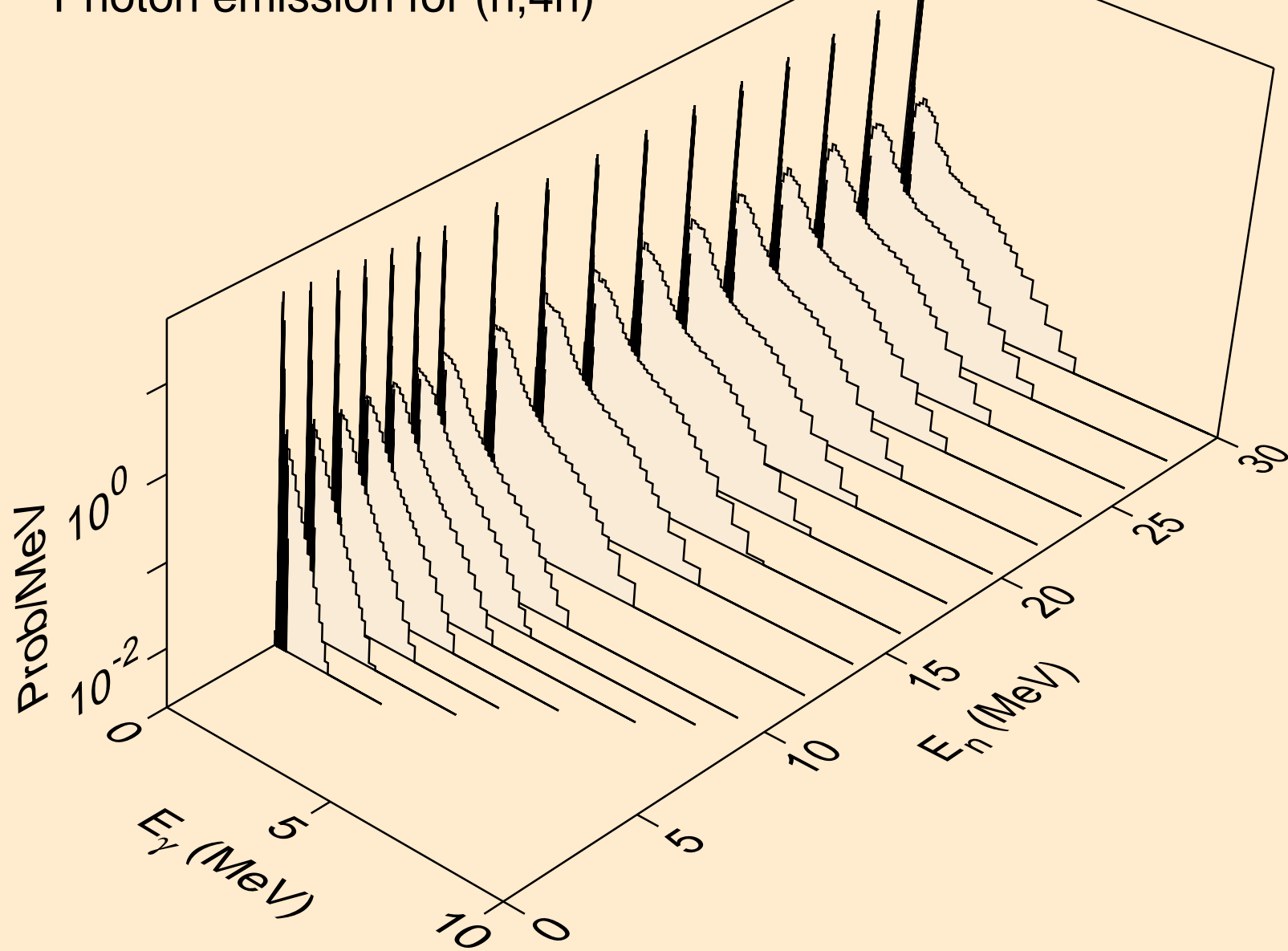



NB106 HELION ACER TENDL-2021 LIBRARY; T=0.K  
Photon emission for (n,2np)

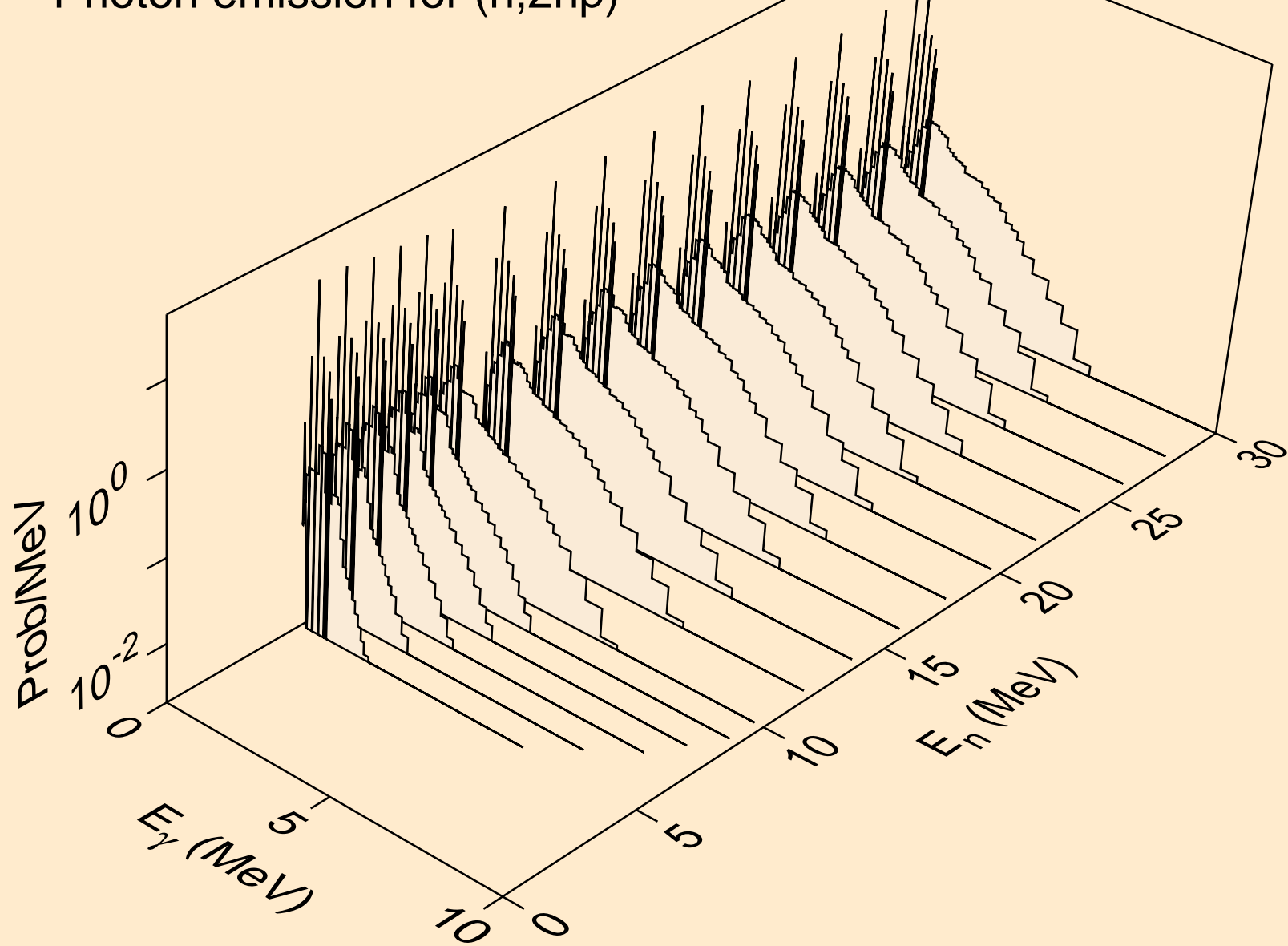

NB106 HELION ACER TENDL-2021 LIBRARY; T=0.K  
Photon emission for (n,3np)

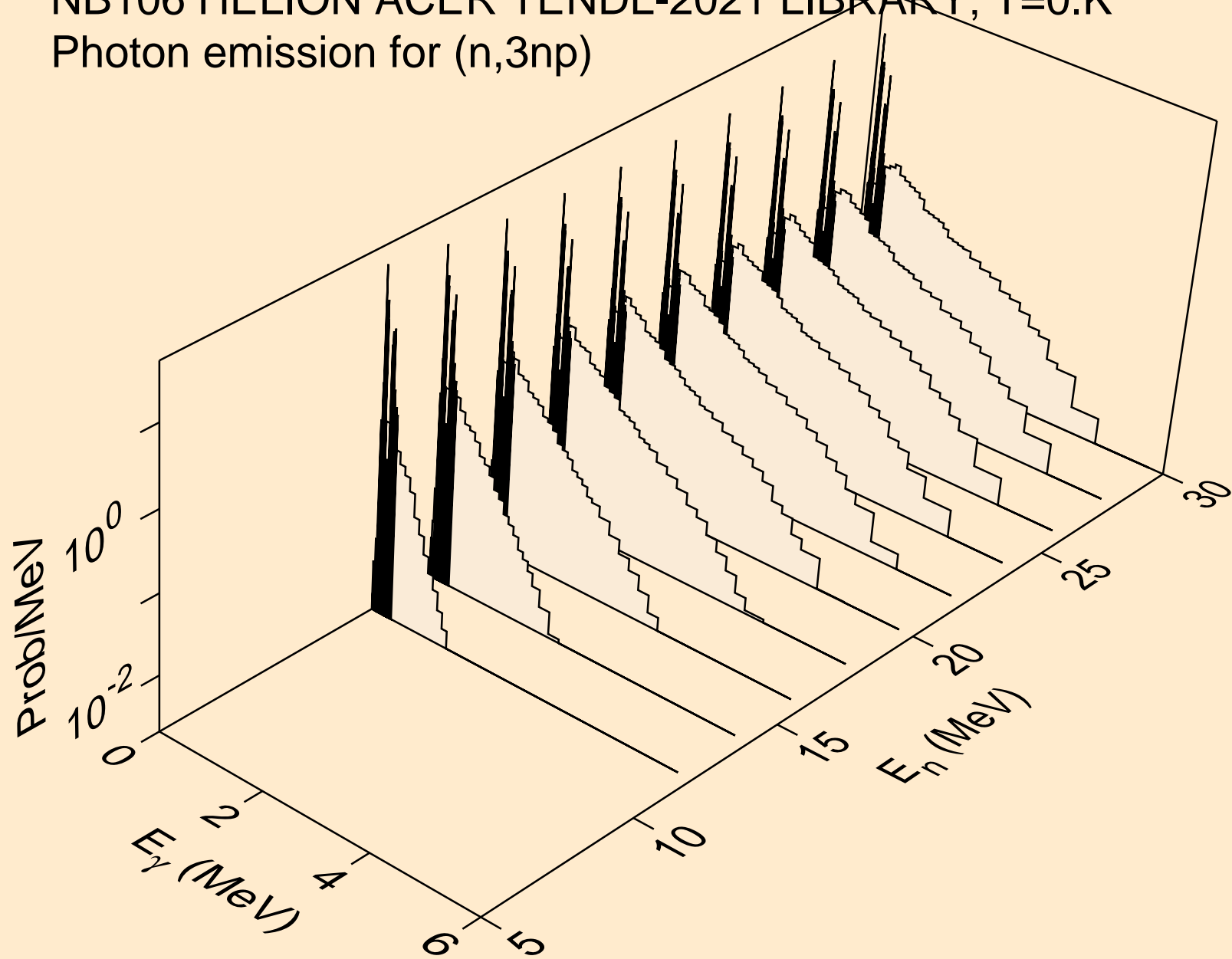

NB106 HELION ACER TENDL-2021 LIBRARY; T=0.K  
Photon emission for (n,2np)

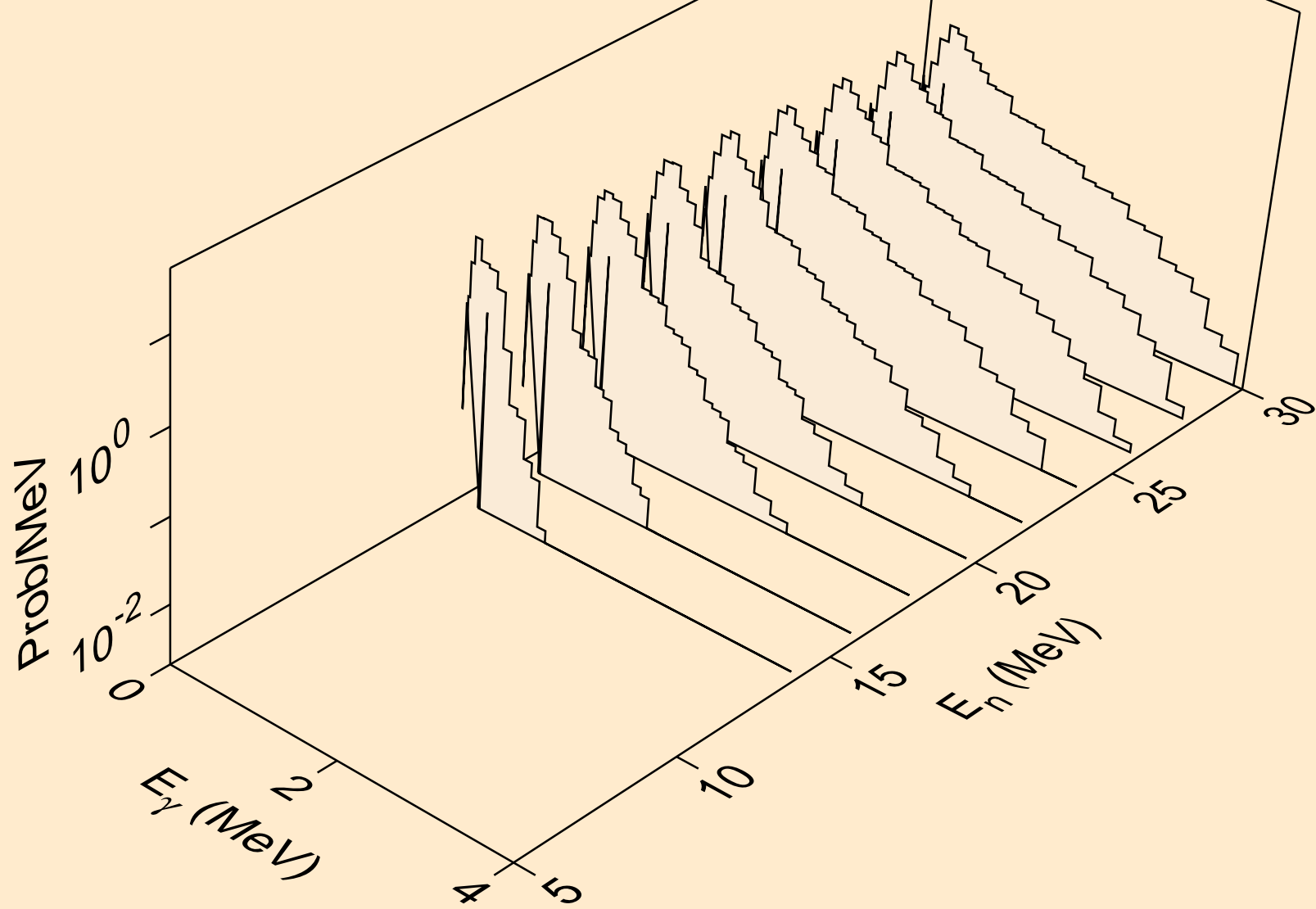

NB106 HELION ACER TENDL-2021 LIBRARY; T=0.K  
Photon emission for (n,npa)

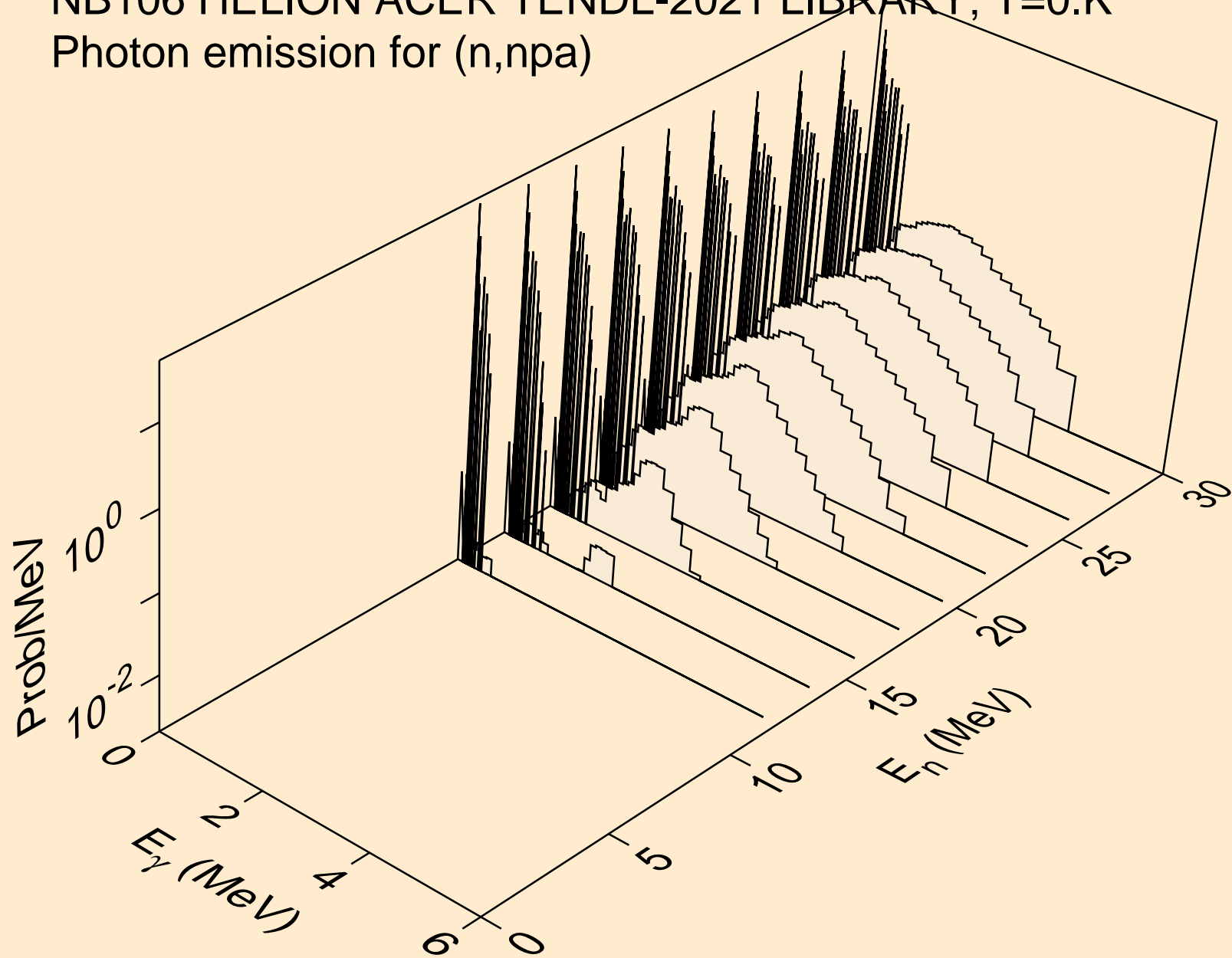

NB106 HELION ACER TENDL-2021 LIBRARY; T=0.K  
Photon emission for (n,p)

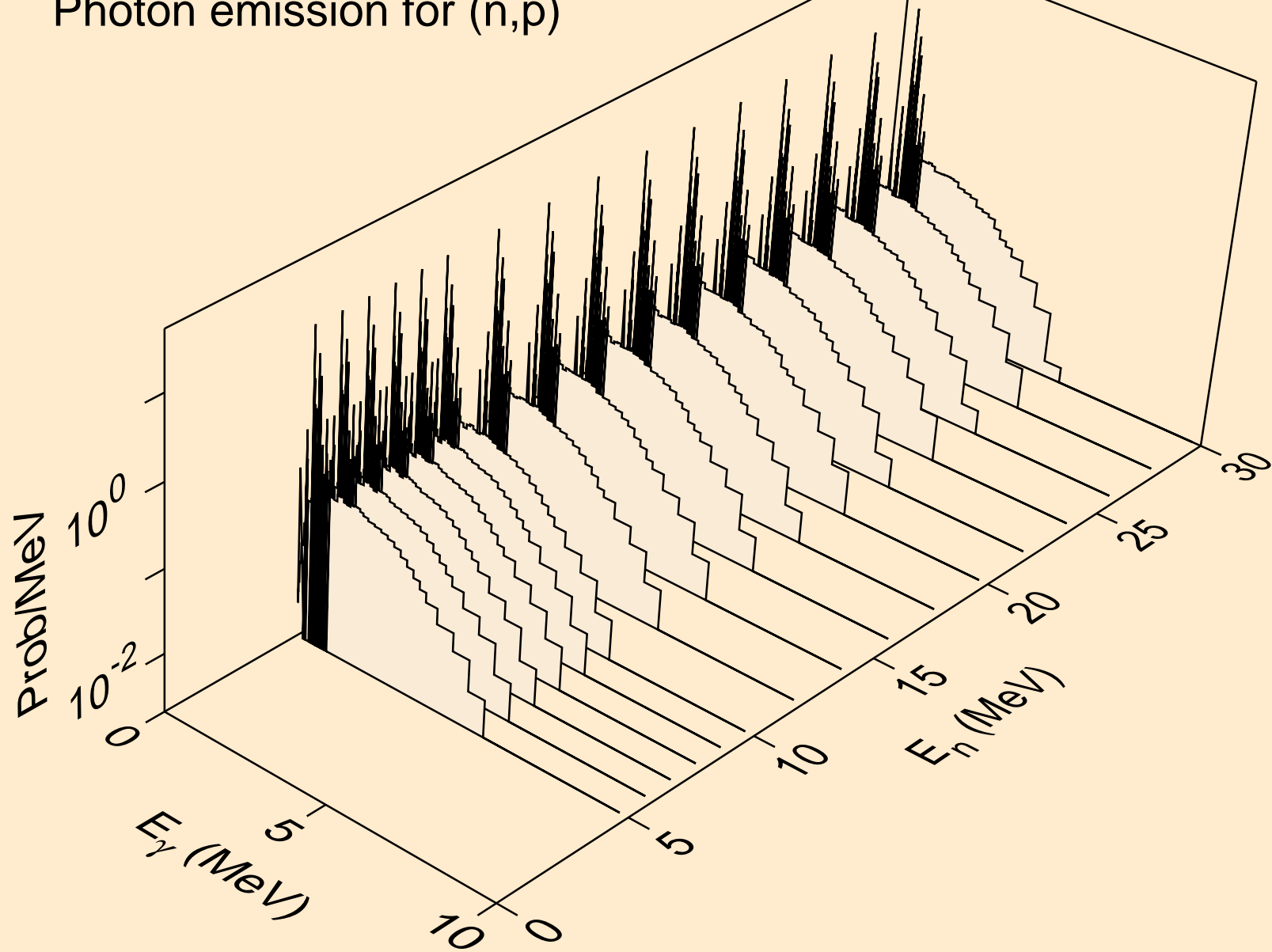

NB106 HELION ACER TENDL-2021 LIBRARY; T=0.K  
Photon emission for (n,d)

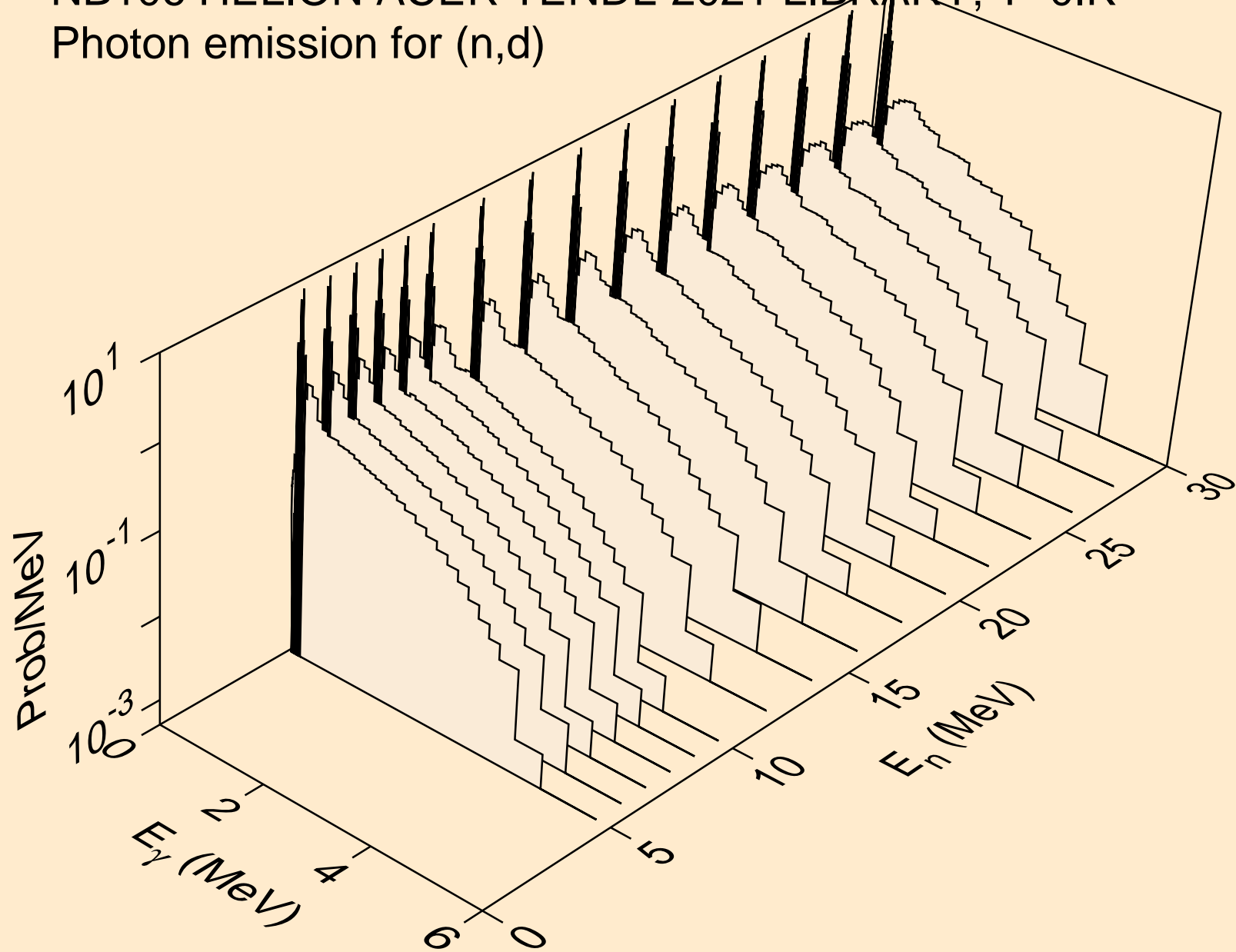

NB106 HELION ACER TENDL-2021 LIBRARY; T=0.K  
Photon emission for (n,t)

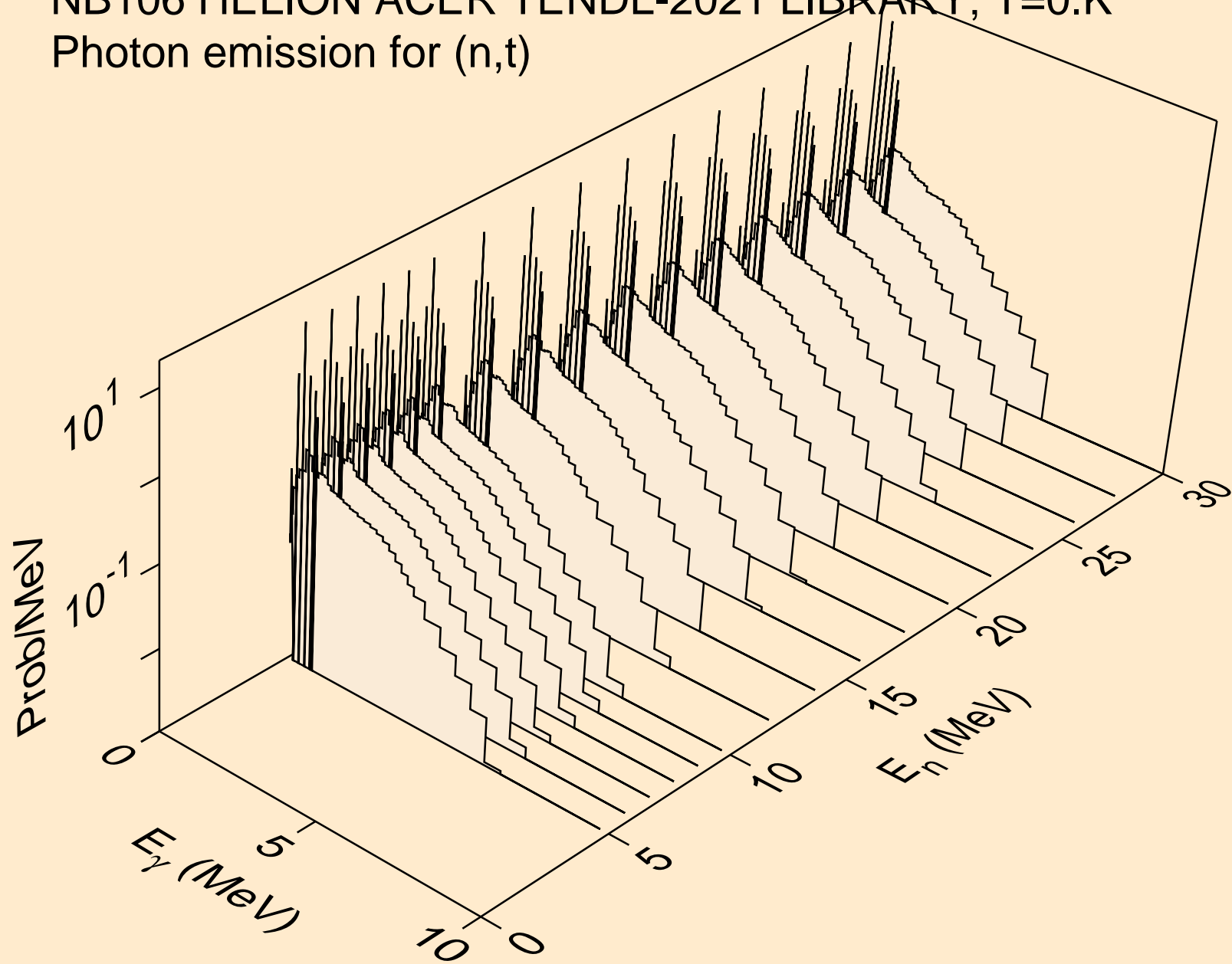

NB106 HELION ACER TENDL-2021 LIBRARY; T=0.K  
Photon emission for inelastic

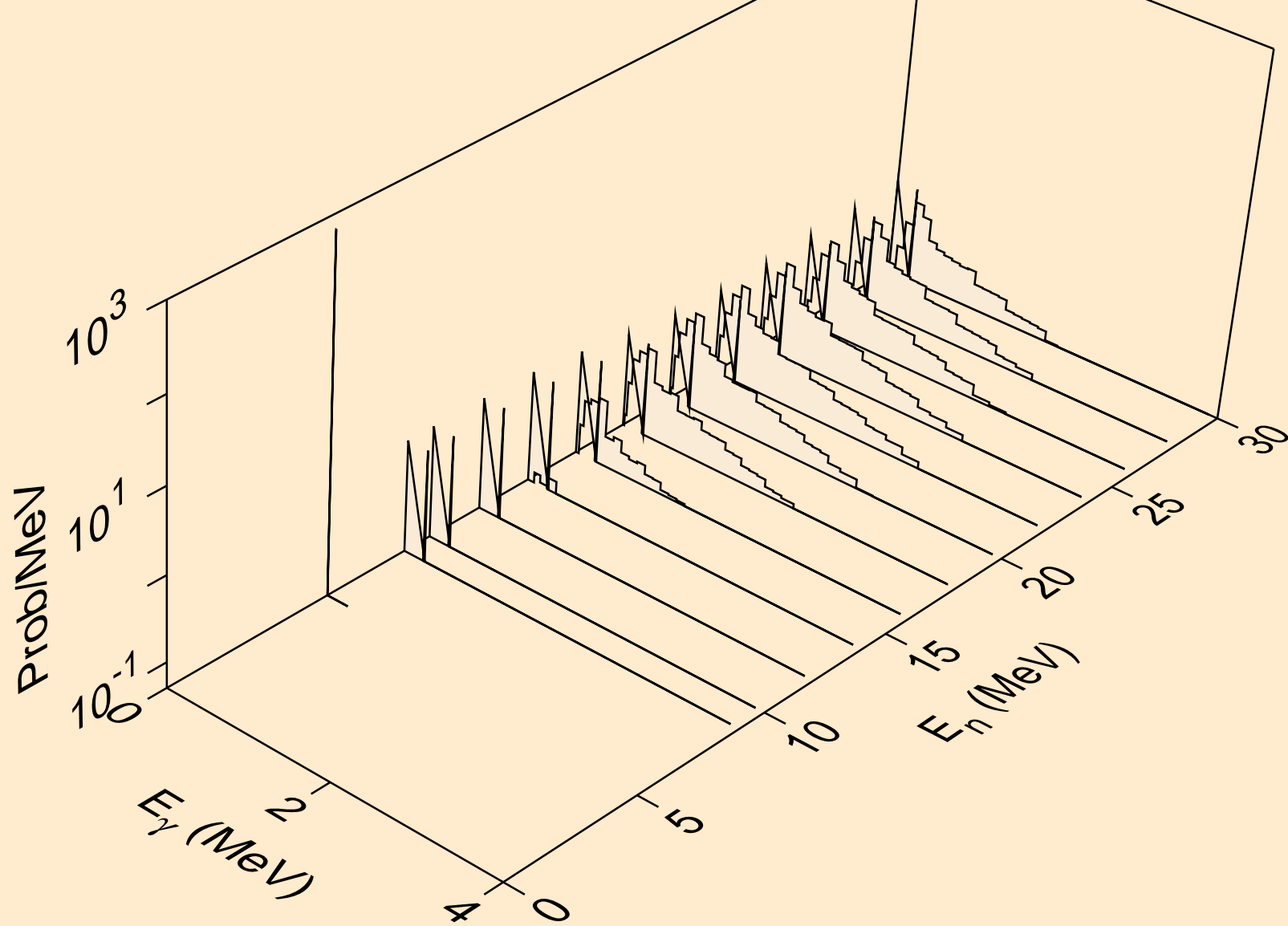



NB106 HELION ACER TENDL-2021 LIBRARY; T=0.K  
Photon emission for (n,a)

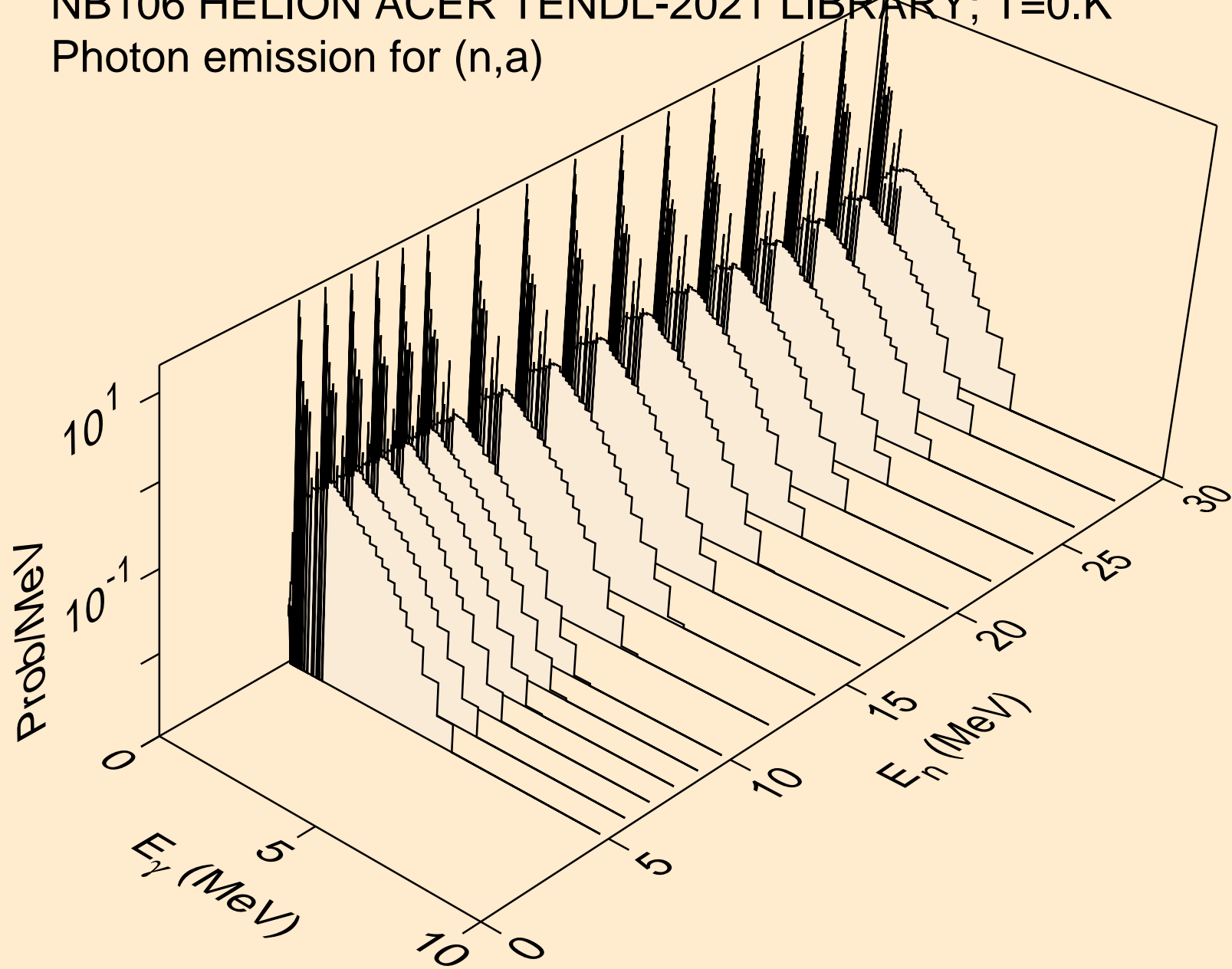

NB106 HELION ACER TENDL-2021 LIBRARY; T=0.K  
Photon emission for (n,2p)

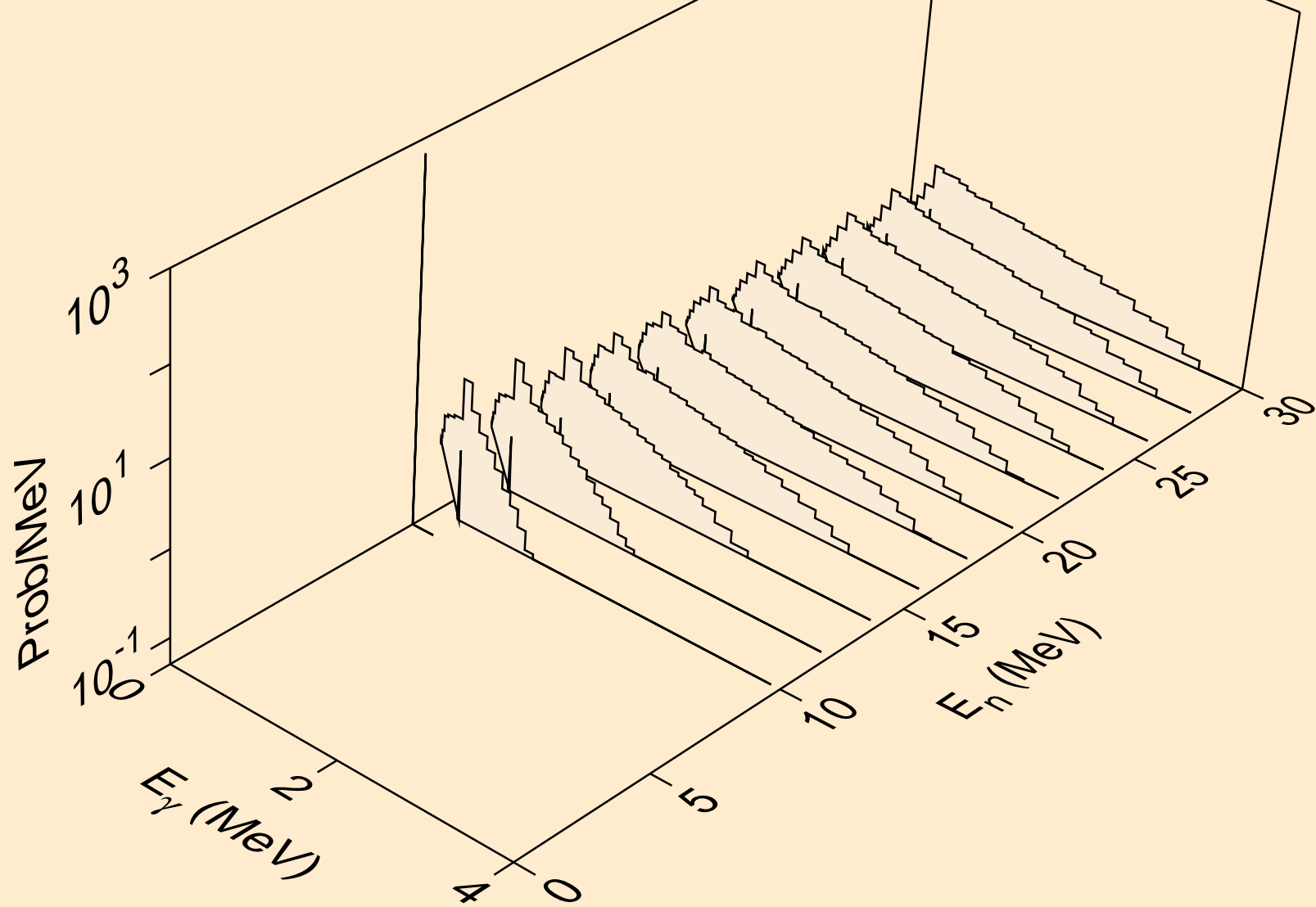

NB106 HELION ACER TENDL-2021 LIBRARY; T=0.K  
Photon emission for (n,pa)

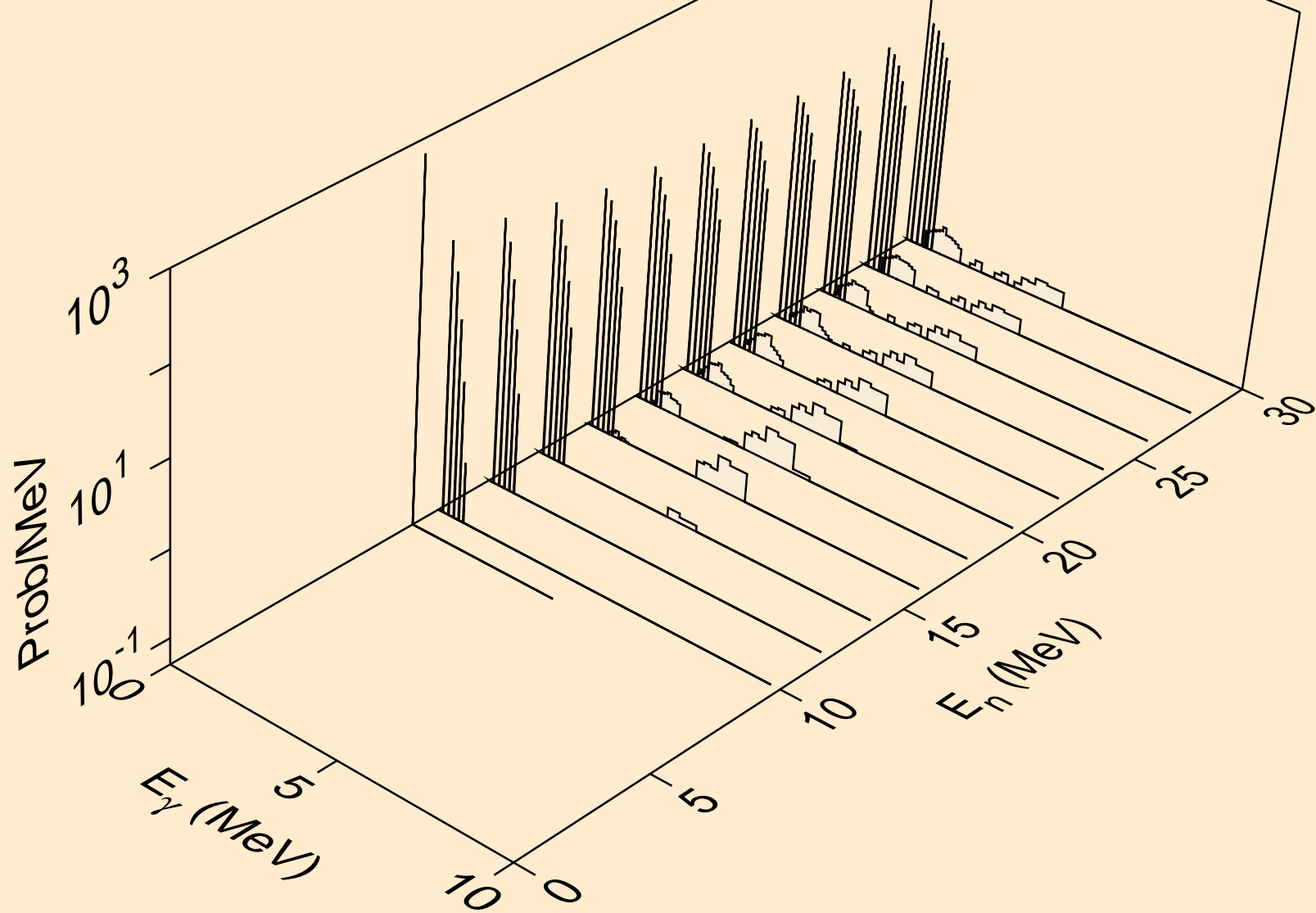

NB106 HELION ACER TENDL-2021 LIBRARY; T=0.K  
Photon emission for (n,pd)

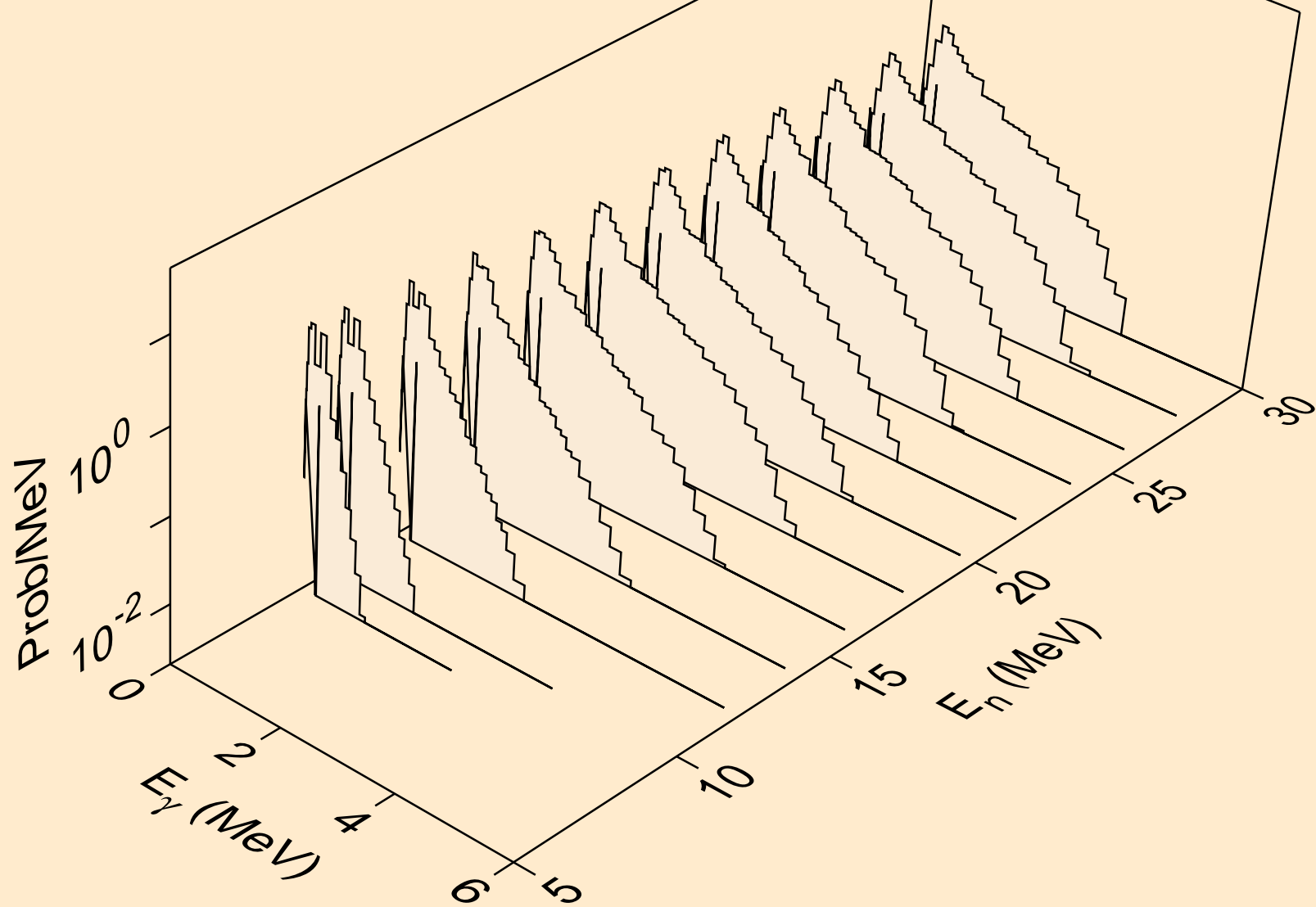

NB106 HELION ACER TENDL-2021 LIBRARY; T=0.K  
Photon emission for (n,pt)

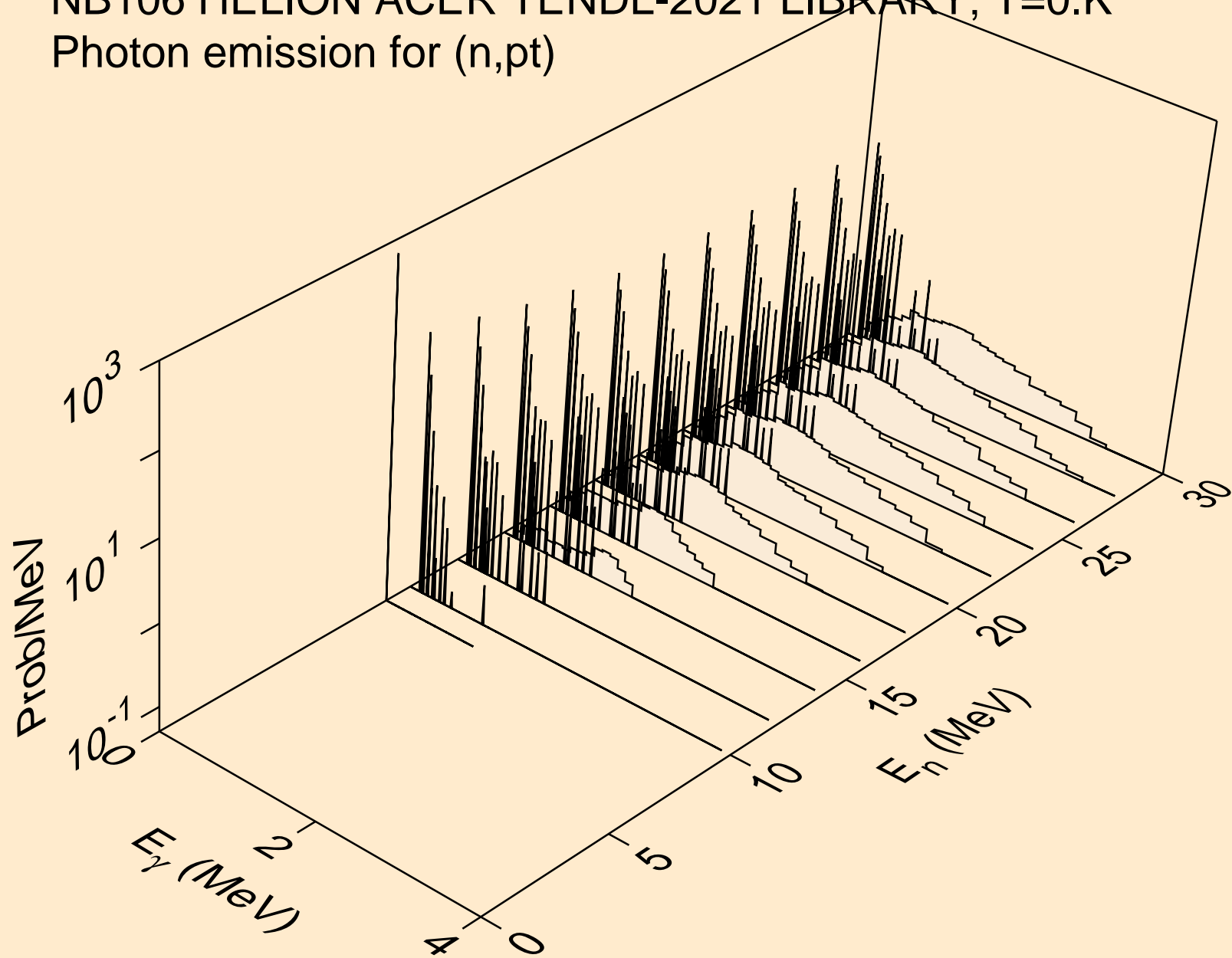

NB106 HELION ACER TENDL-2021 LIBRARY; T=0.K  
Photon emission for (n,da)

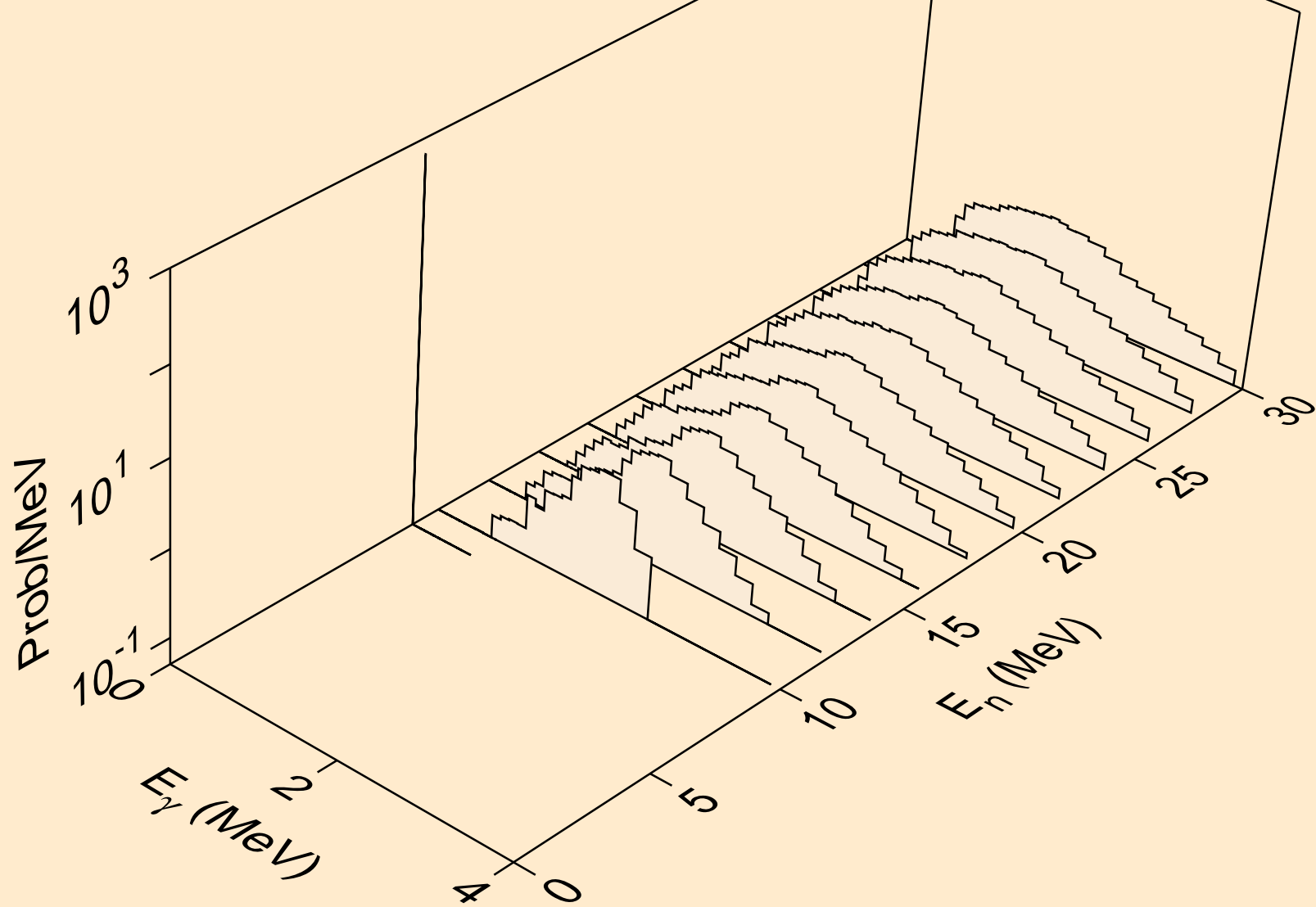

# NB106 HELION ACER TENDL-2021 LIBRARY; T=0.K

## Particle heating contributions

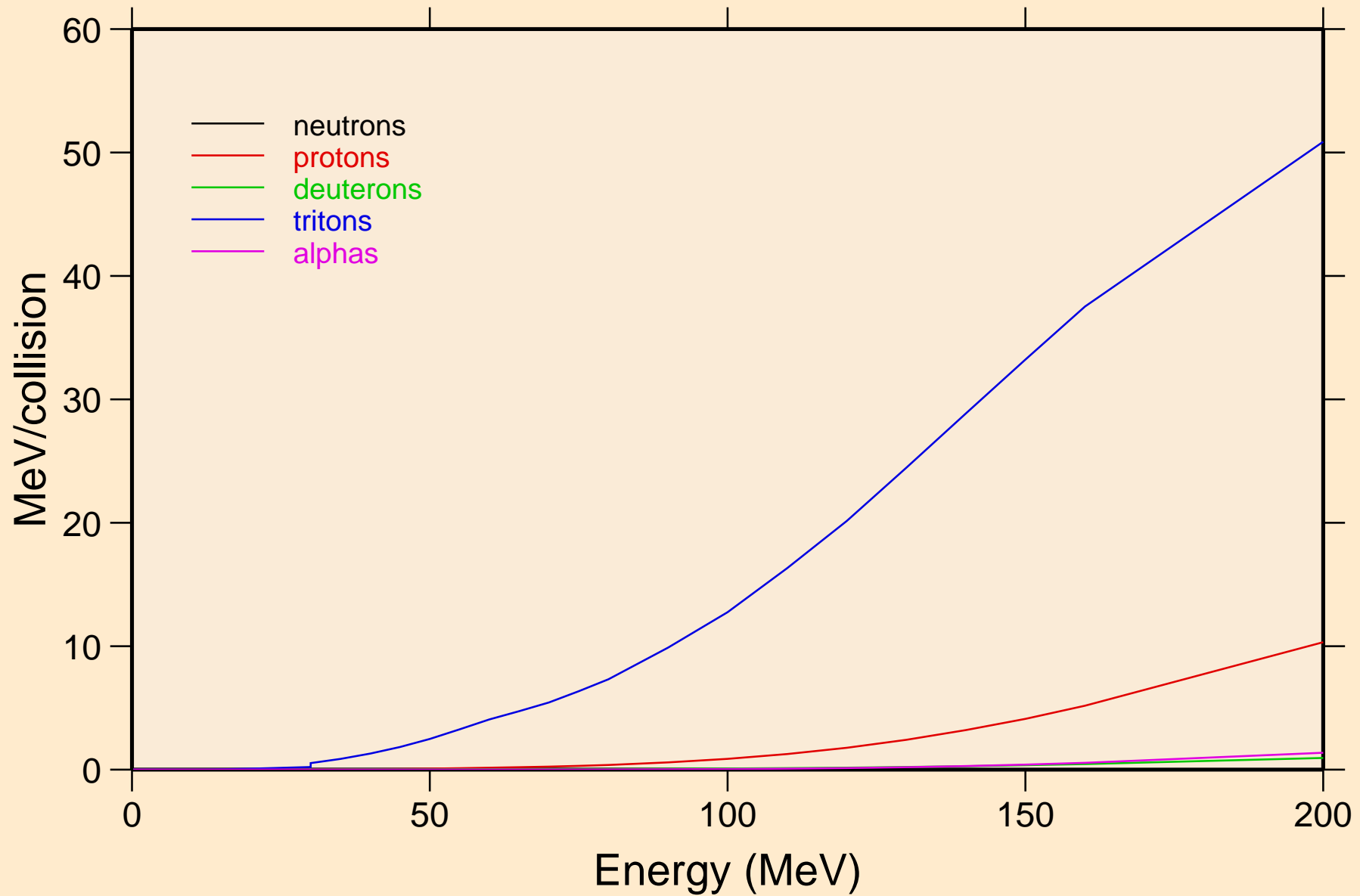

NB106 HELION ACER TENDL-2021 LIBRARY; T=0.K  
Recoil Heating

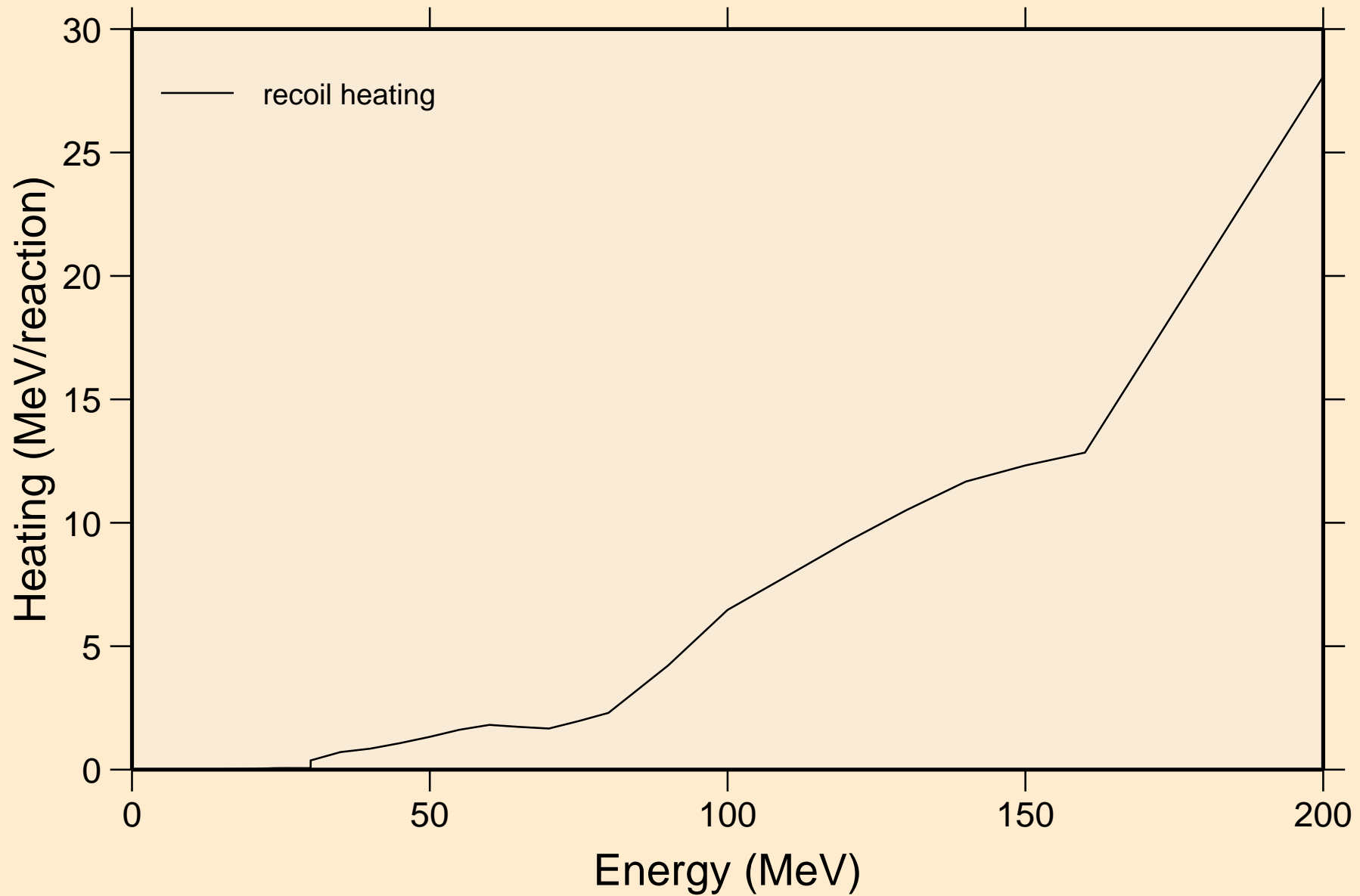



NB106 HELION ACER TENDL-2021 LIBRARY; T=0.K  
Particle production cross sections

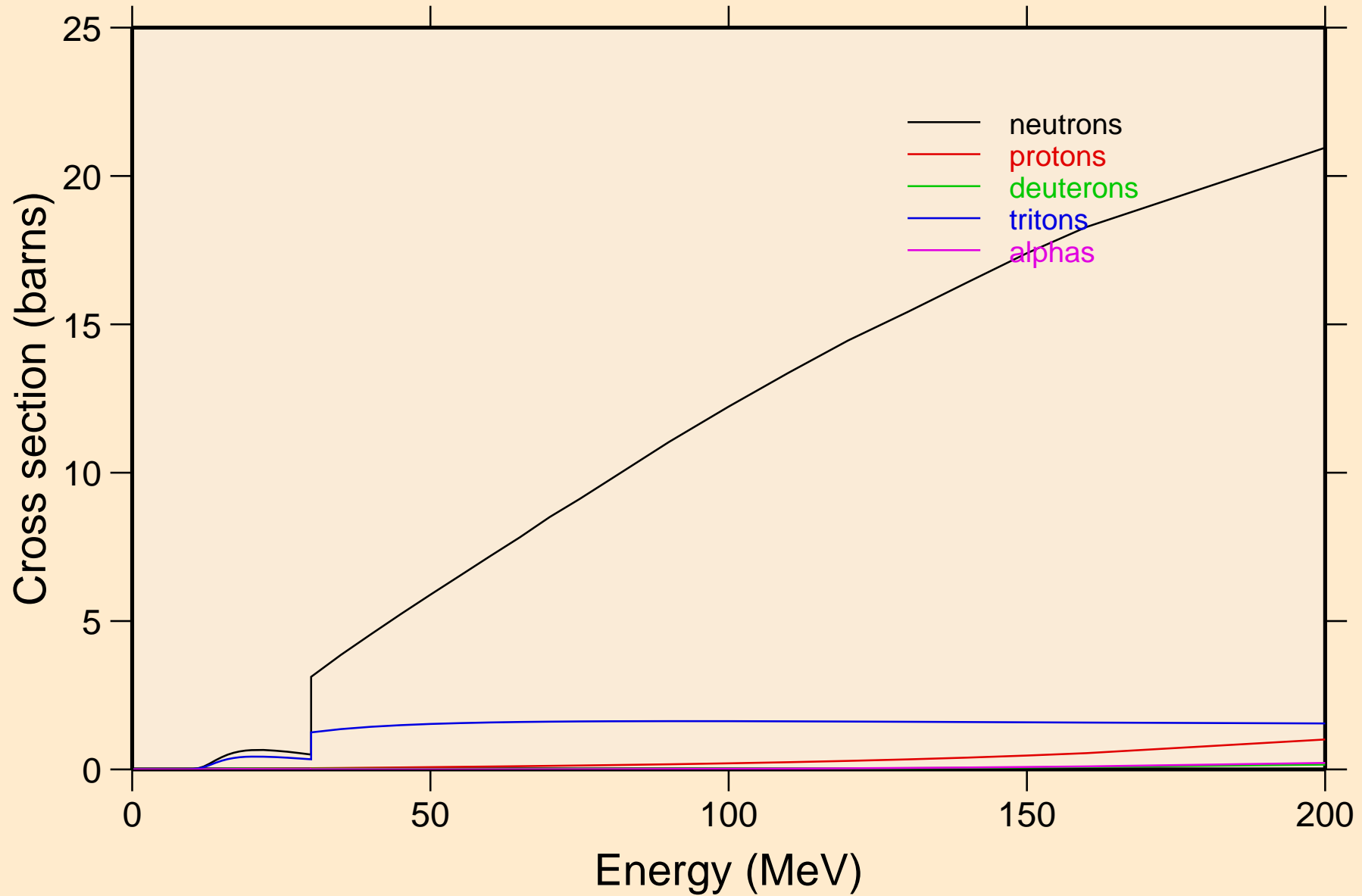

NB106 HELION ACER TENDL-2021 LIBRARY; T=0.K  
neutrons from (s,n)

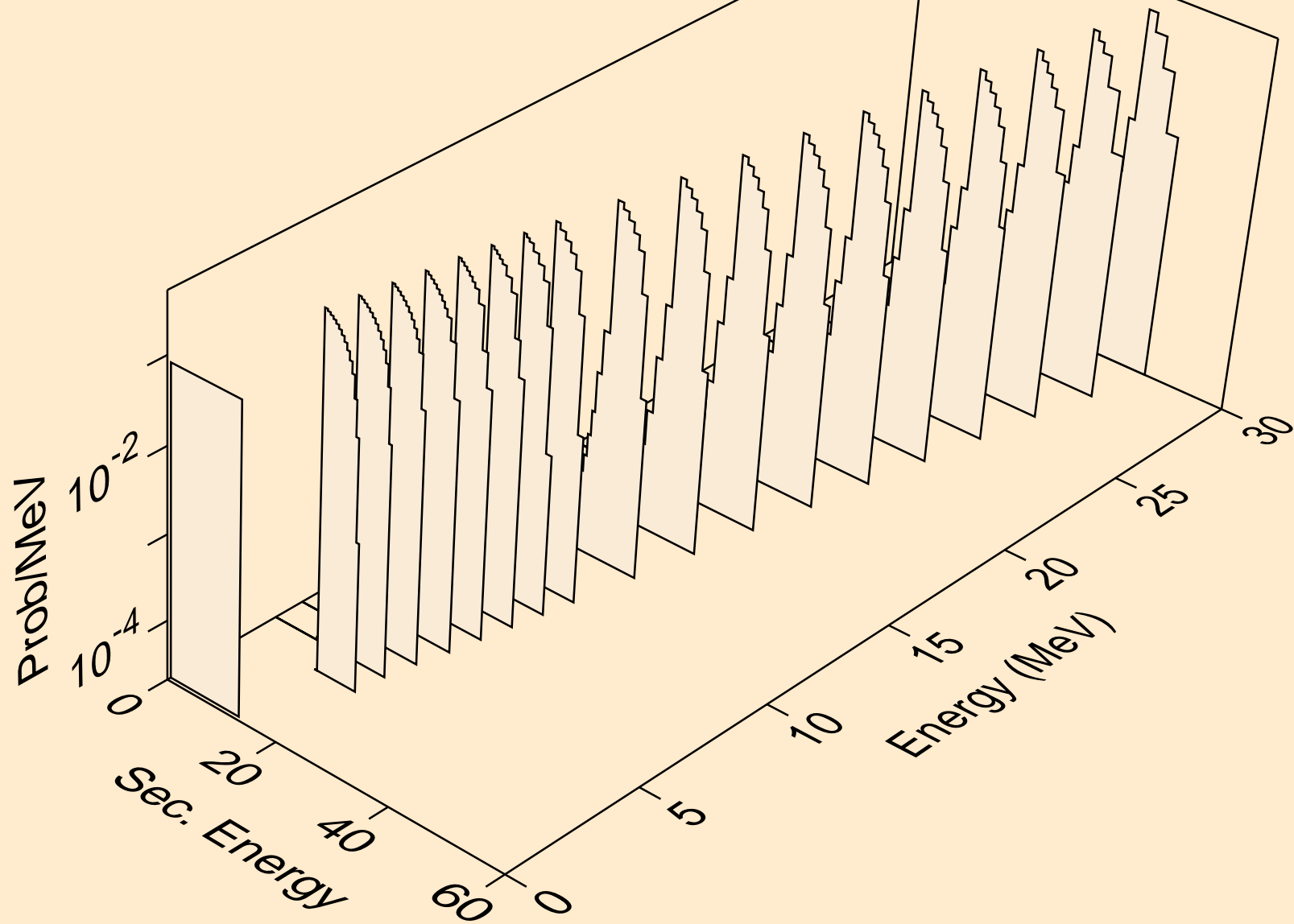

NB106 HELION ACER TENDL-2021 LIBRARY; T=0.K  
neutrons from (s,x)

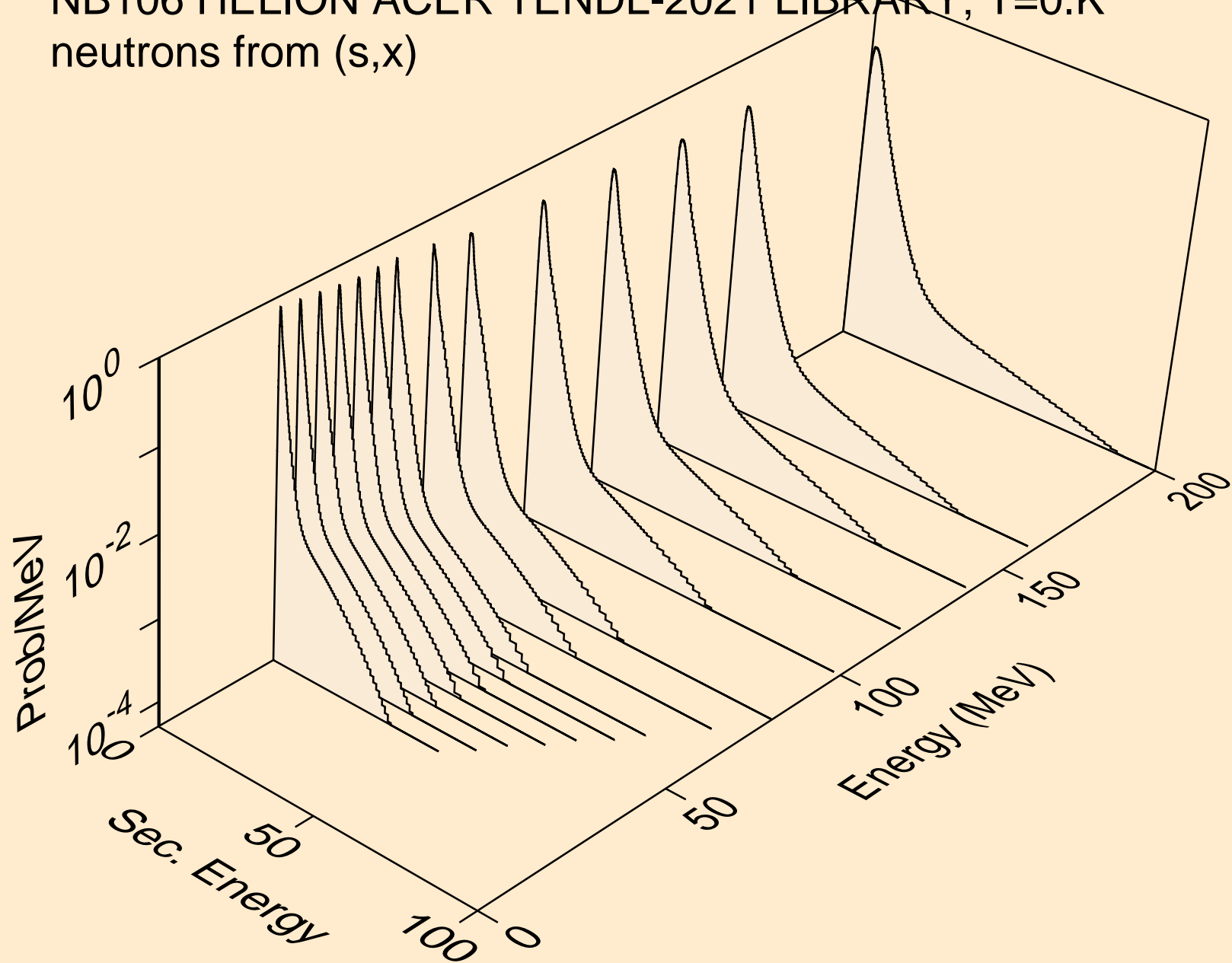

NB106 HELION ACER TENDL-2021 LIBRARY; T=0.K  
neutrons from (s,2nd)

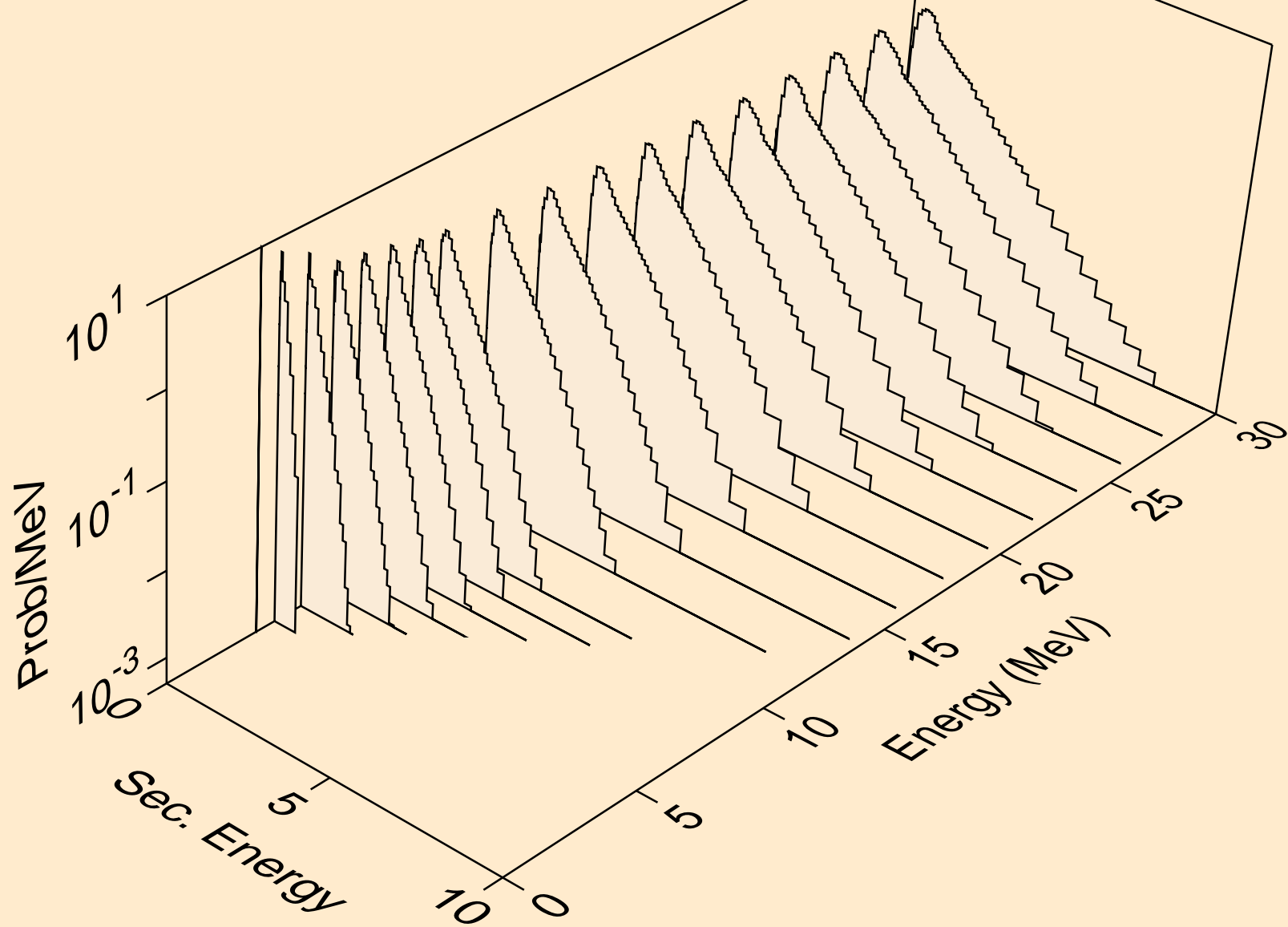

NB106 HELION ACER TENDL-2021 LIBRARY; T=0.K  
neutrons from (s,2n)

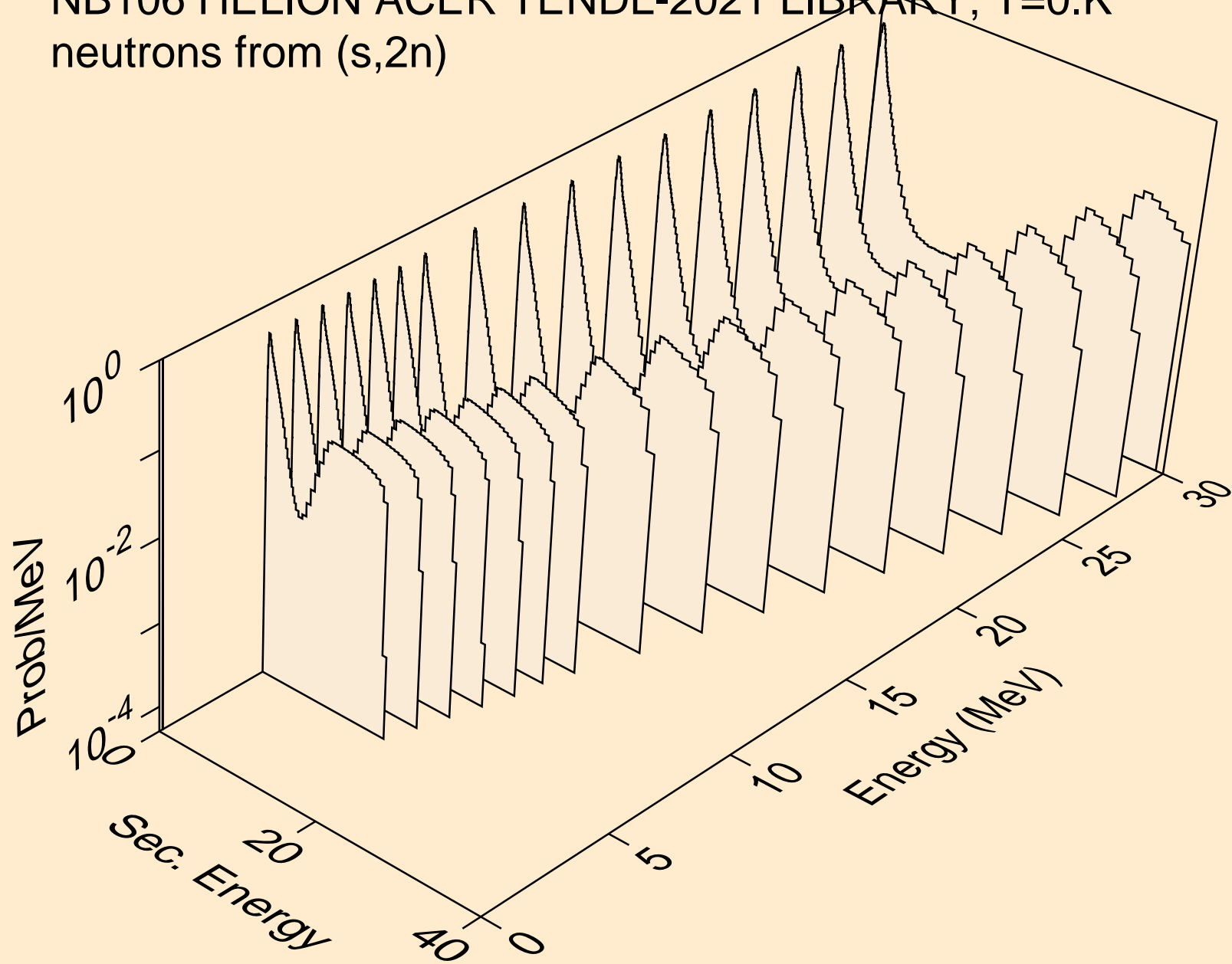

NB106 HELION ACER TENDL-2021 LIBRARY; T=0.K  
neutrons from (s,3n)

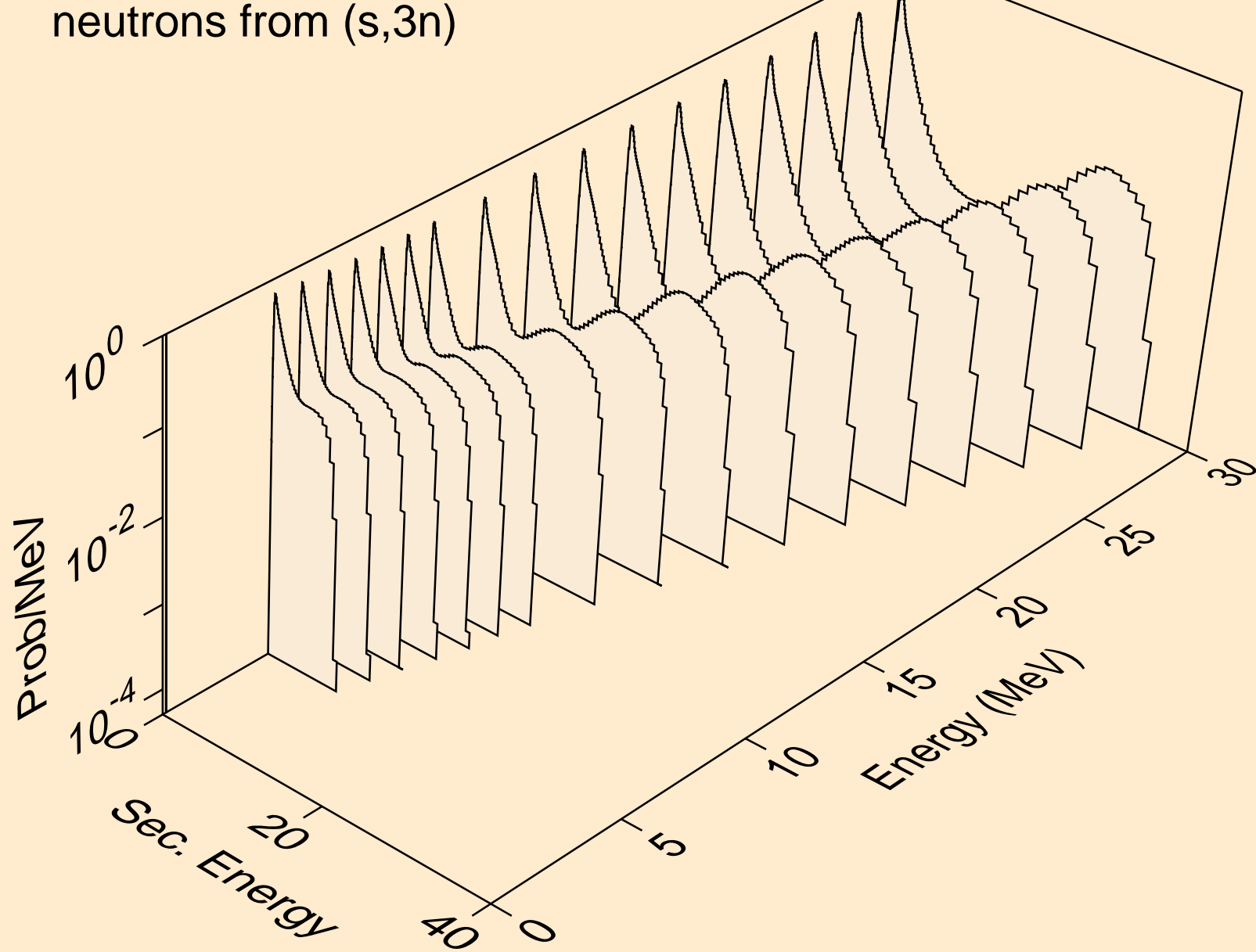

NB106 HELION ACER TENDL-2021 LIBRARY; T=0.K  
neutrons from (s,n\*)a

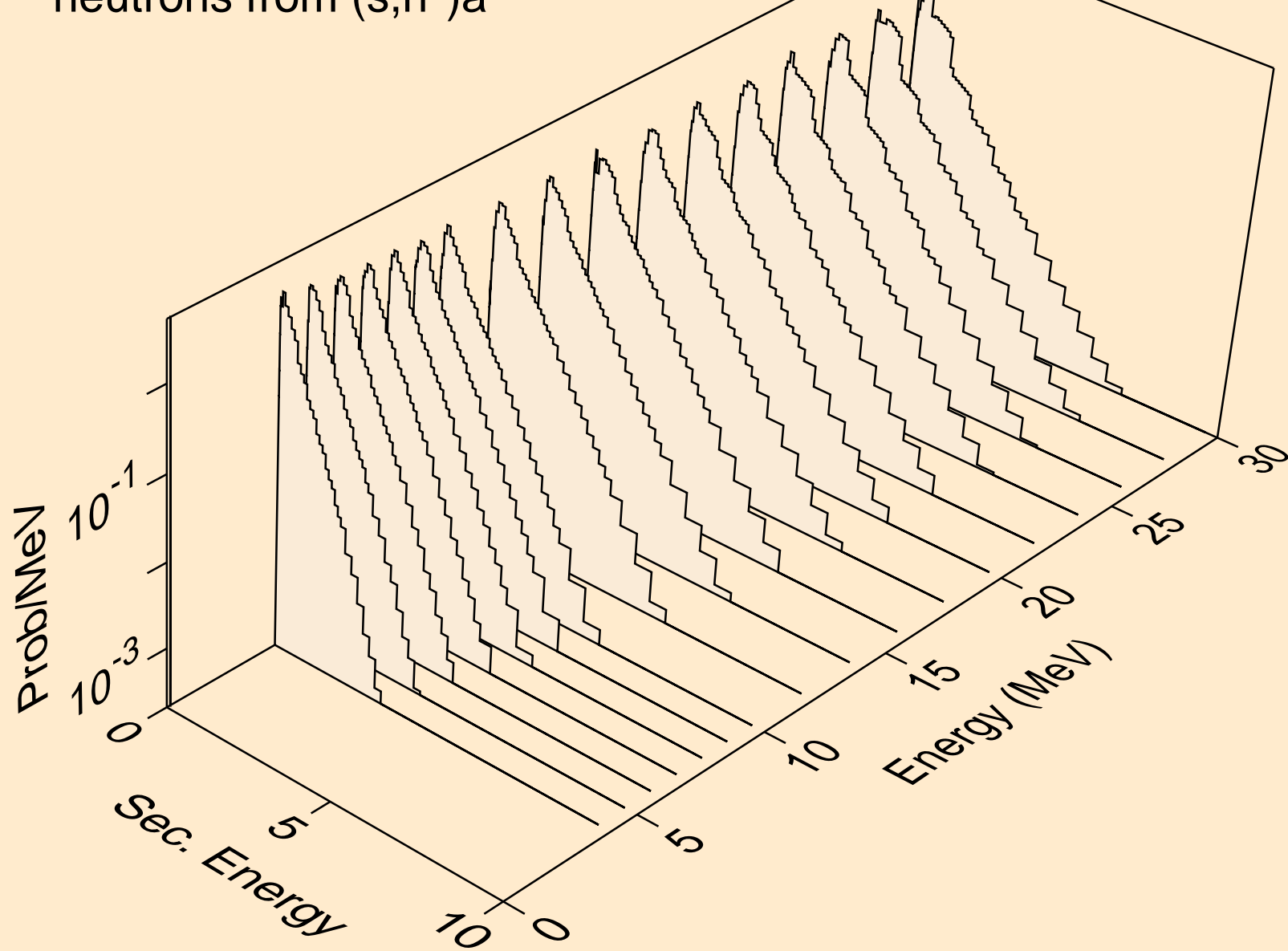

NB106 HELION ACER TENDL-2021 LIBRARY; T=0.K  
neutrons from (s,2n)a

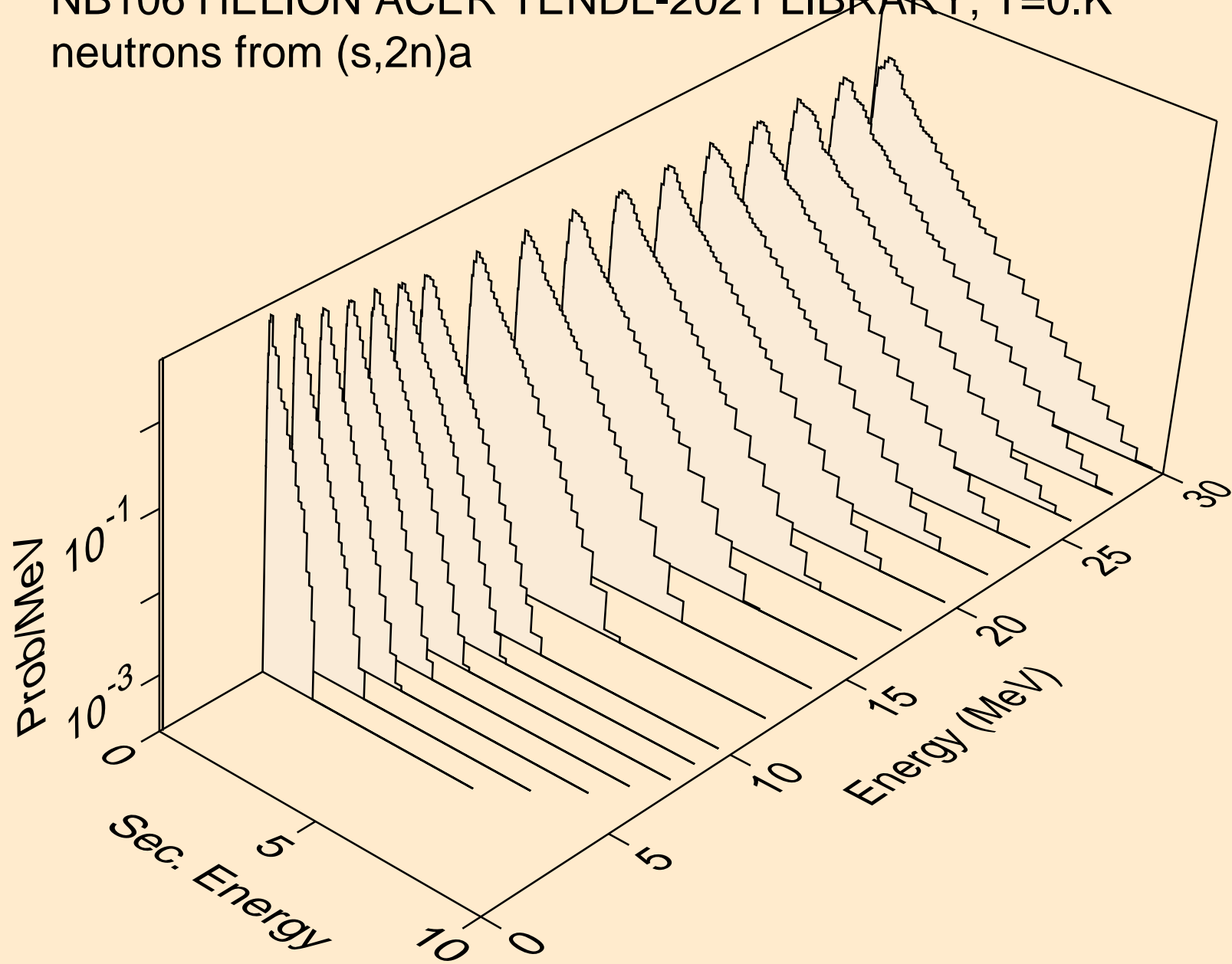



NB106 HELION ACER TENDL-2021 LIBRARY; T=0.K  
neutrons from (s,3n)a

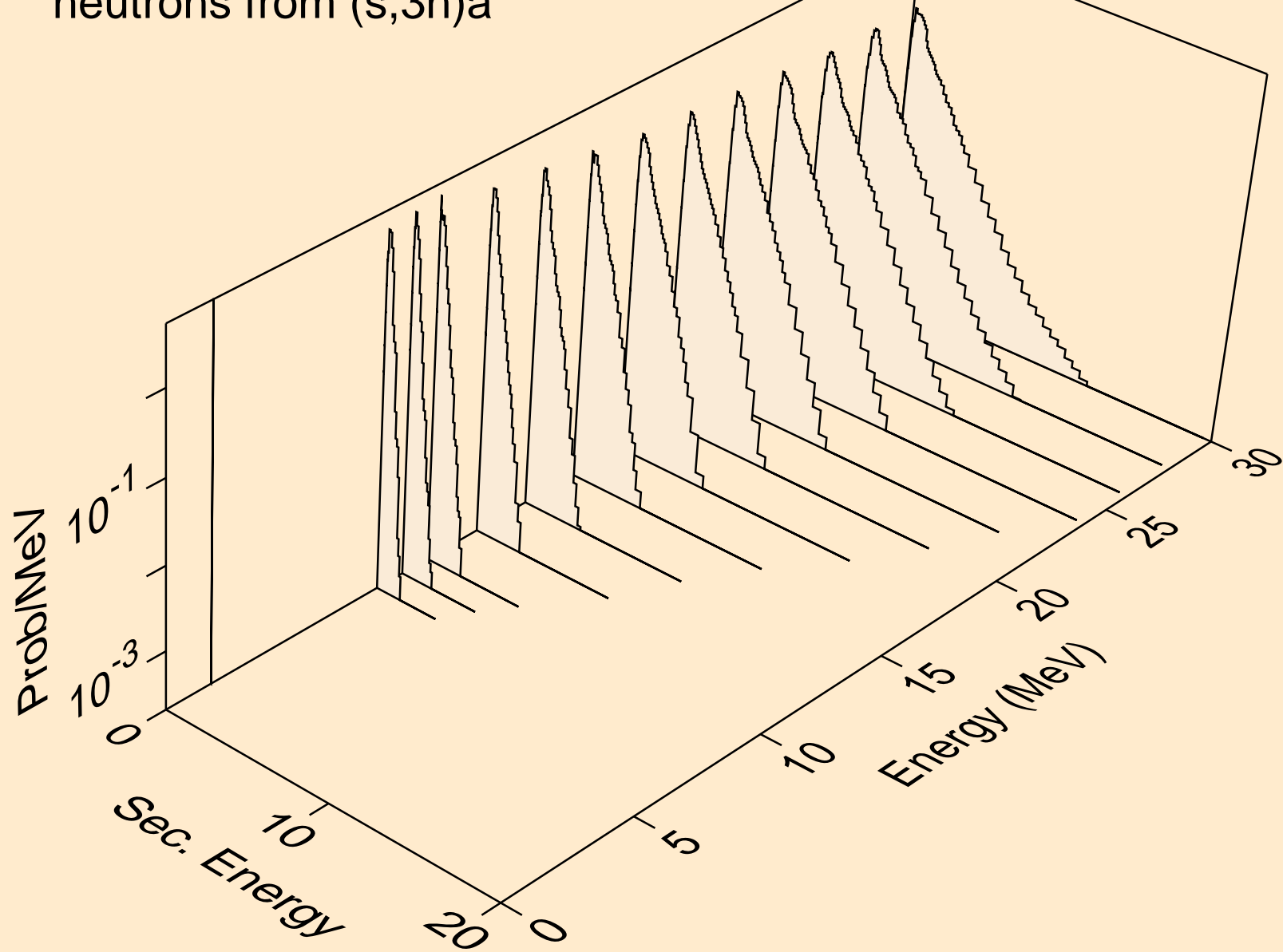

NB106 HELION ACER TENDL-2021 LIBRARY; T=0.K  
neutrons from (s,n\*)p

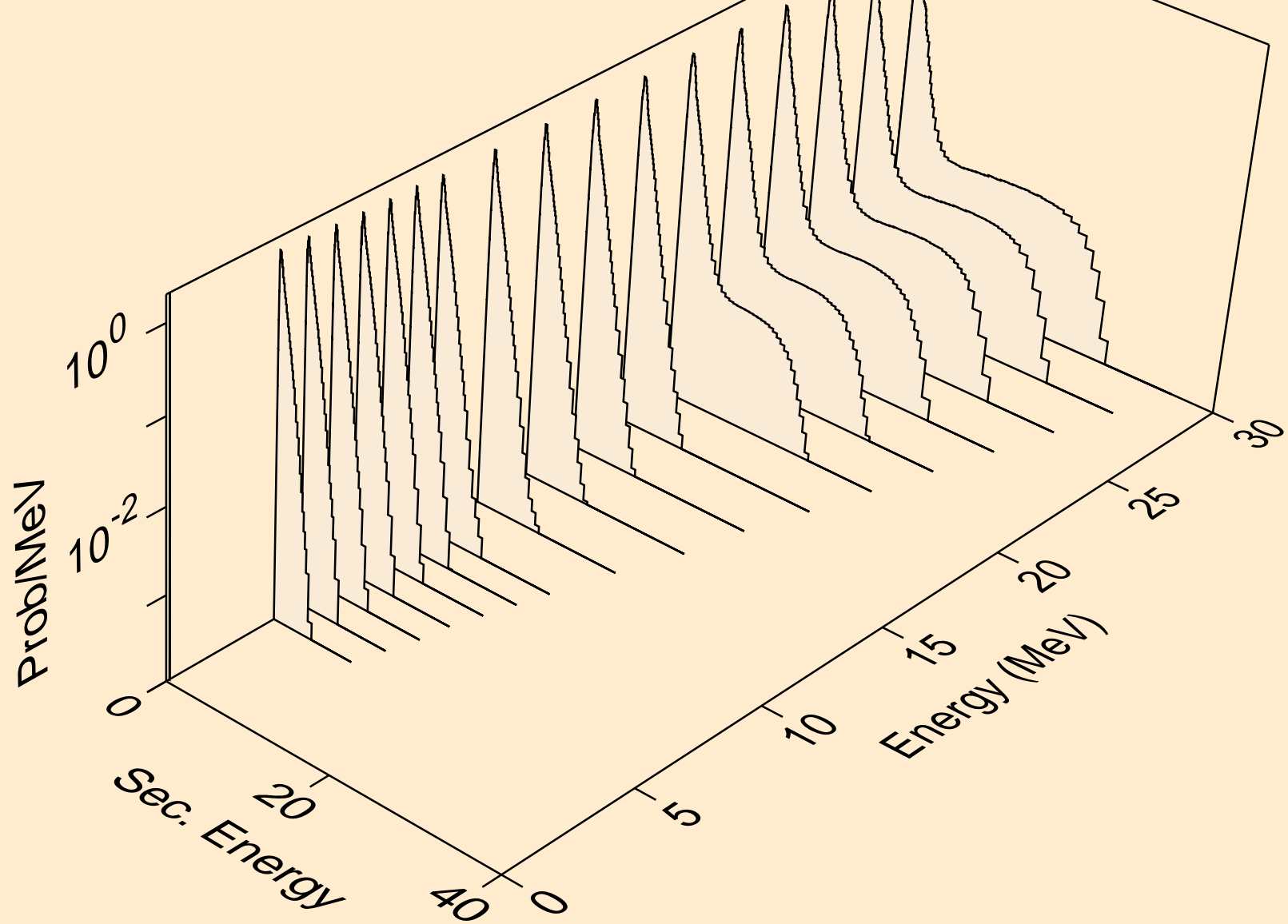

NB106 HELION ACER TENDL-2021 LIBRARY; T=0.K  
neutrons from (s,n\*)2a

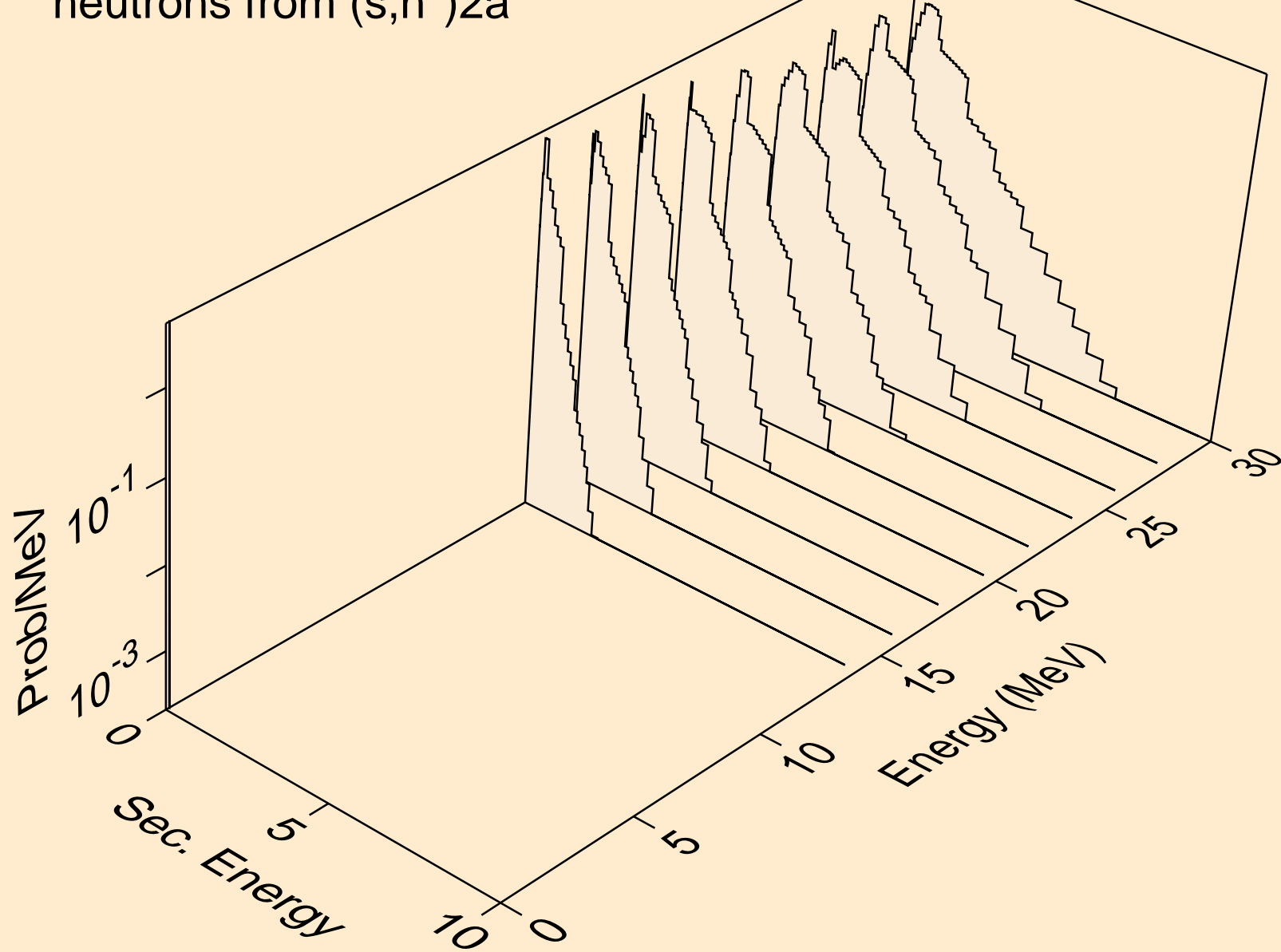

NB106 HELION ACER TENDL-2021 LIBRARY; T=0.K  
neutrons from (s,2n)2a

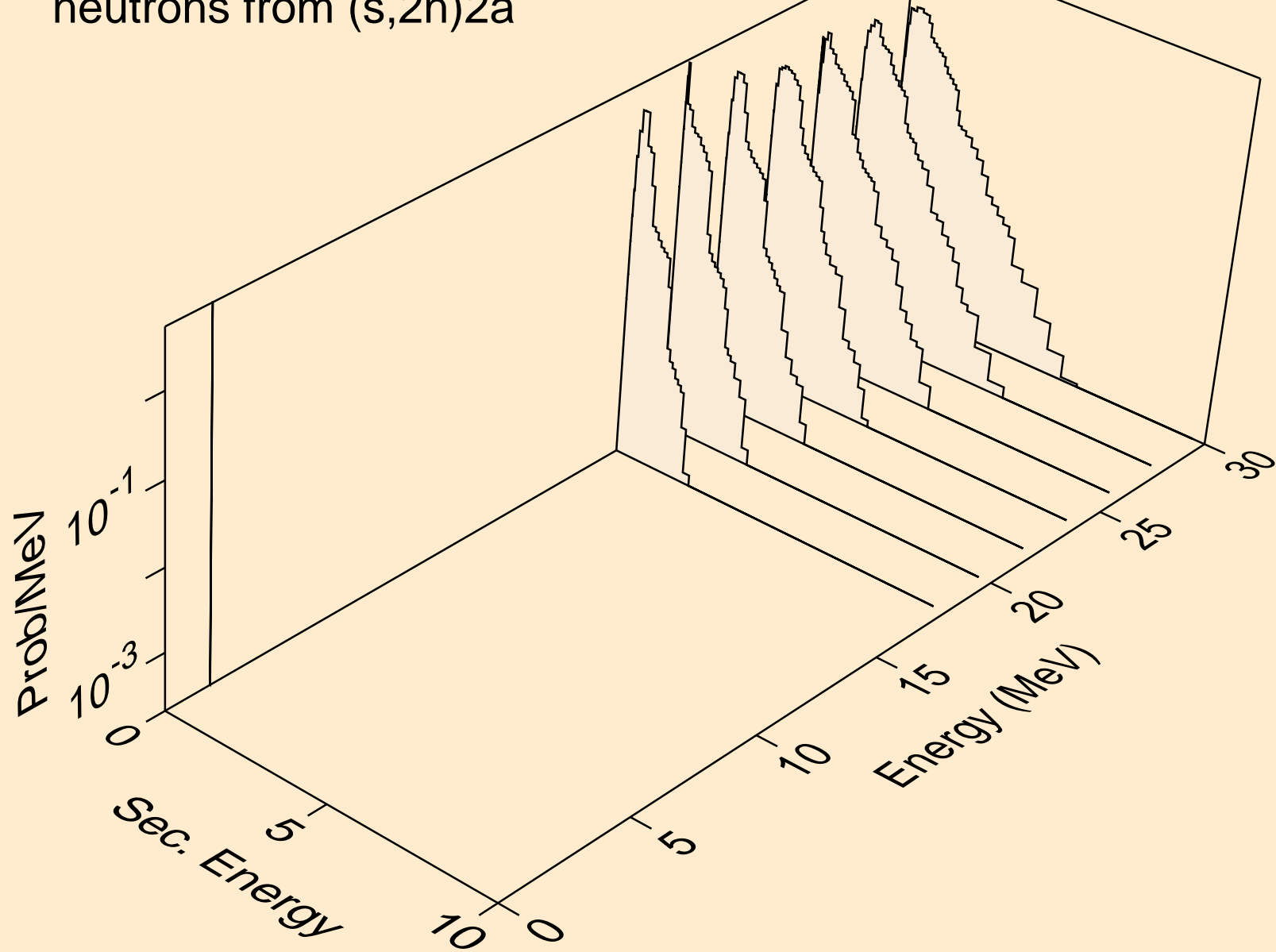

NB106 HELION ACER TENDL-2021 LIBRARY; T=0.K  
neutrons from (s,n\*)d

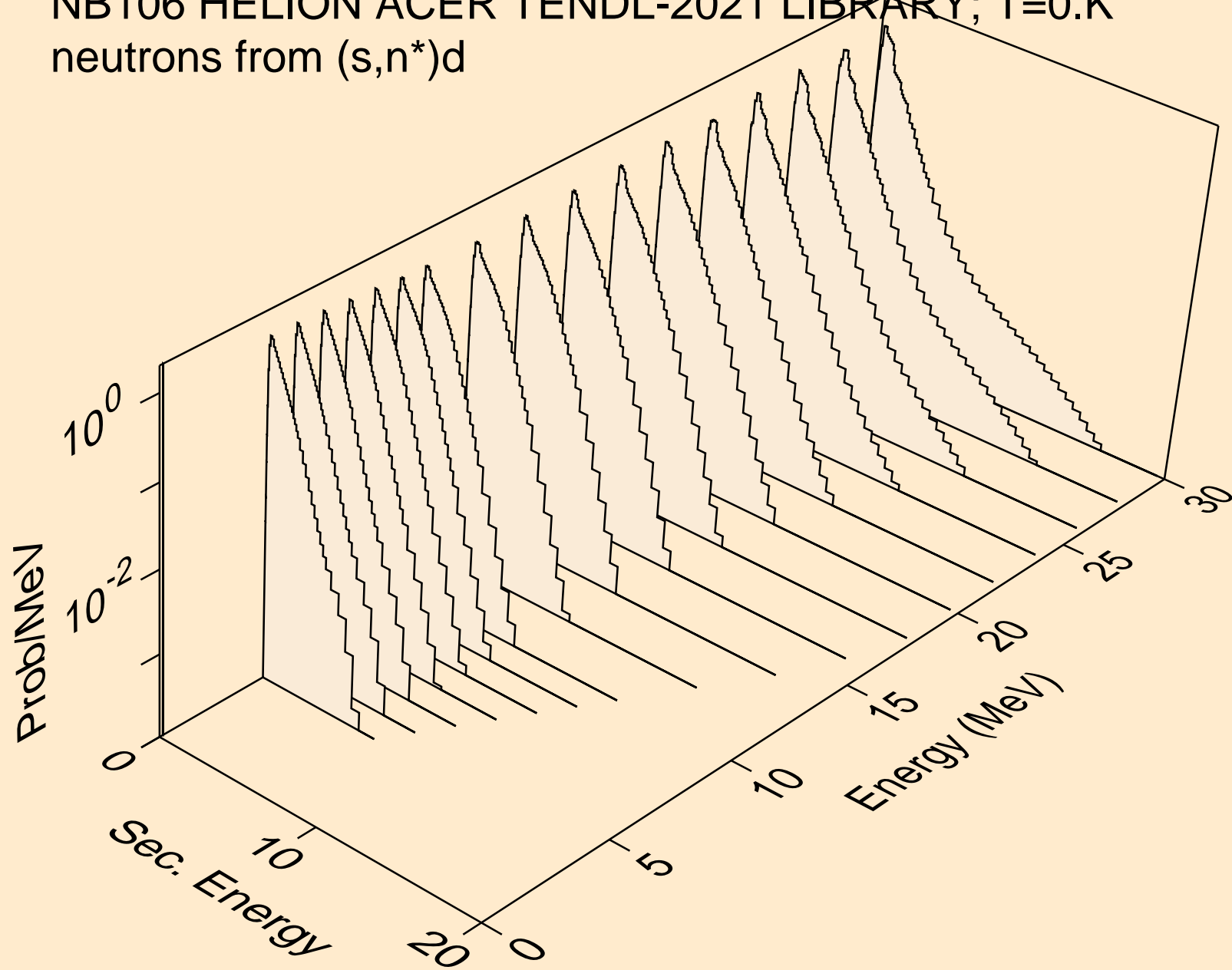

NB106 HELION ACER TENDL-2021 LIBRARY; T=0.K  
neutrons from (s,n\*)t

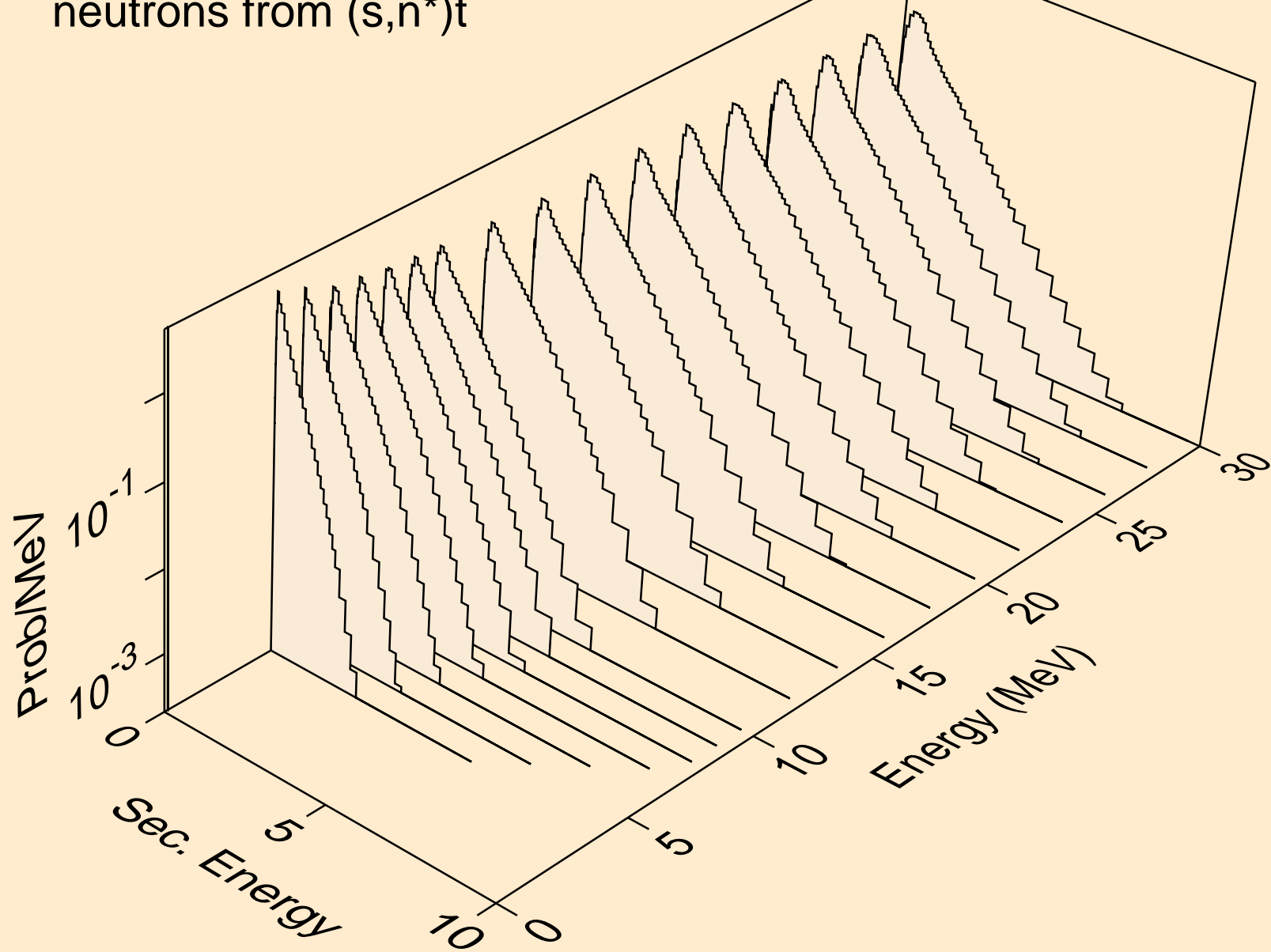

NB106 HELION ACER TENDL-2021 LIBRARY; T=0.K  
neutrons from (s,n\*)he3

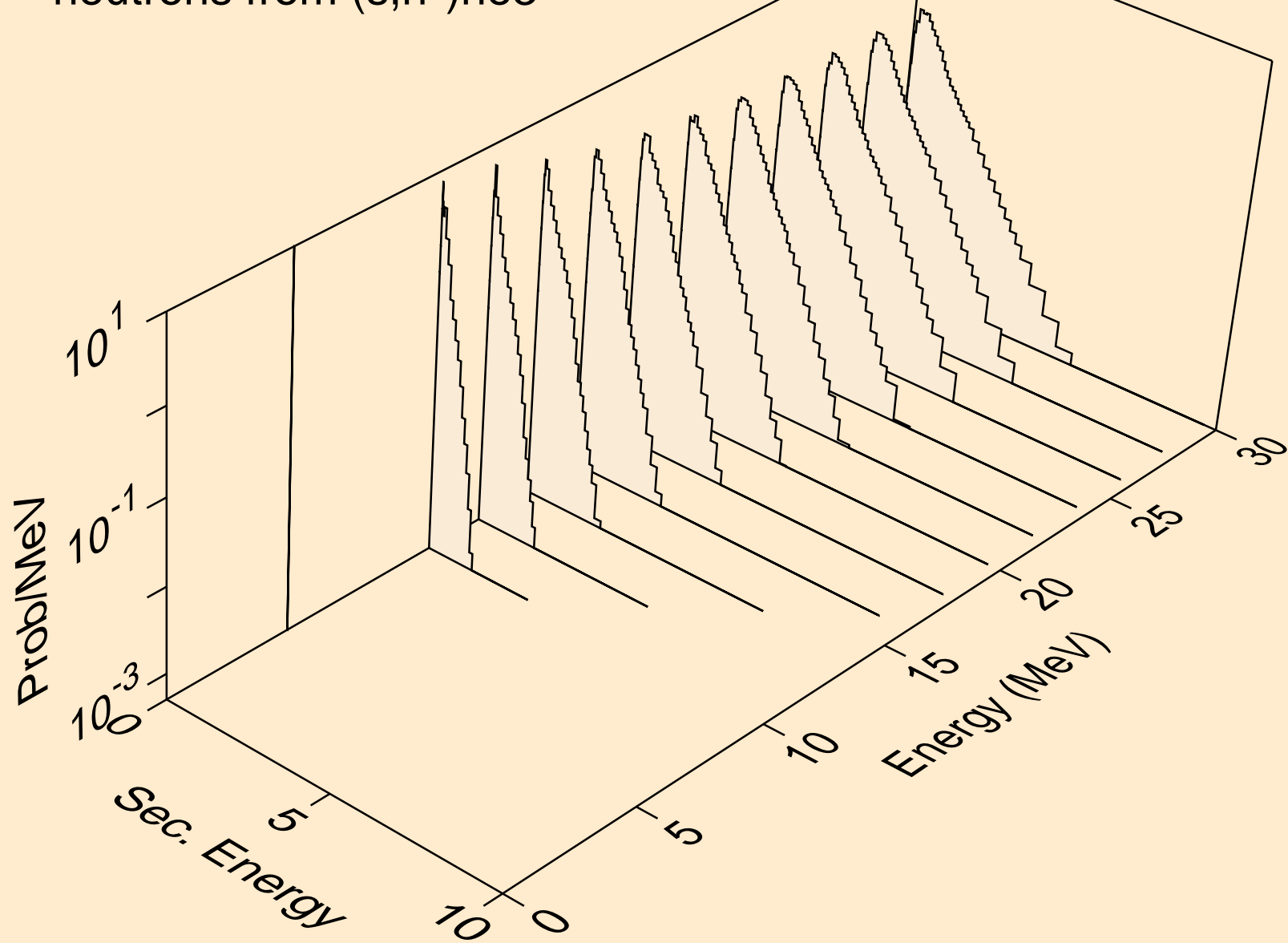

NB106 HELION ACER TENDL-2021 LIBRARY; T=0.K  
neutrons from (s,4n)

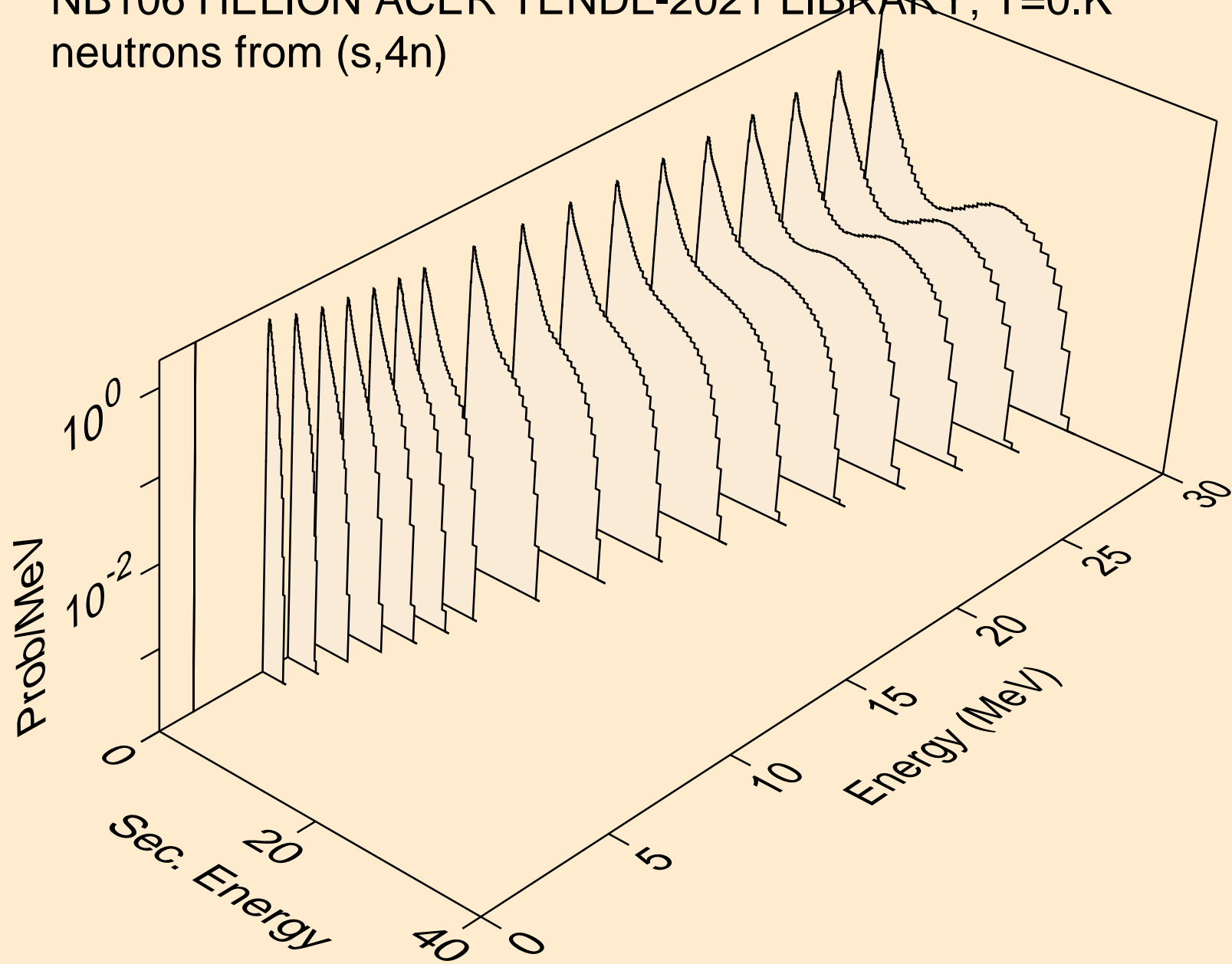



NB106 HELION ACER TENDL-2021 LIBRARY; T=0.K  
neutrons from (s,2np)

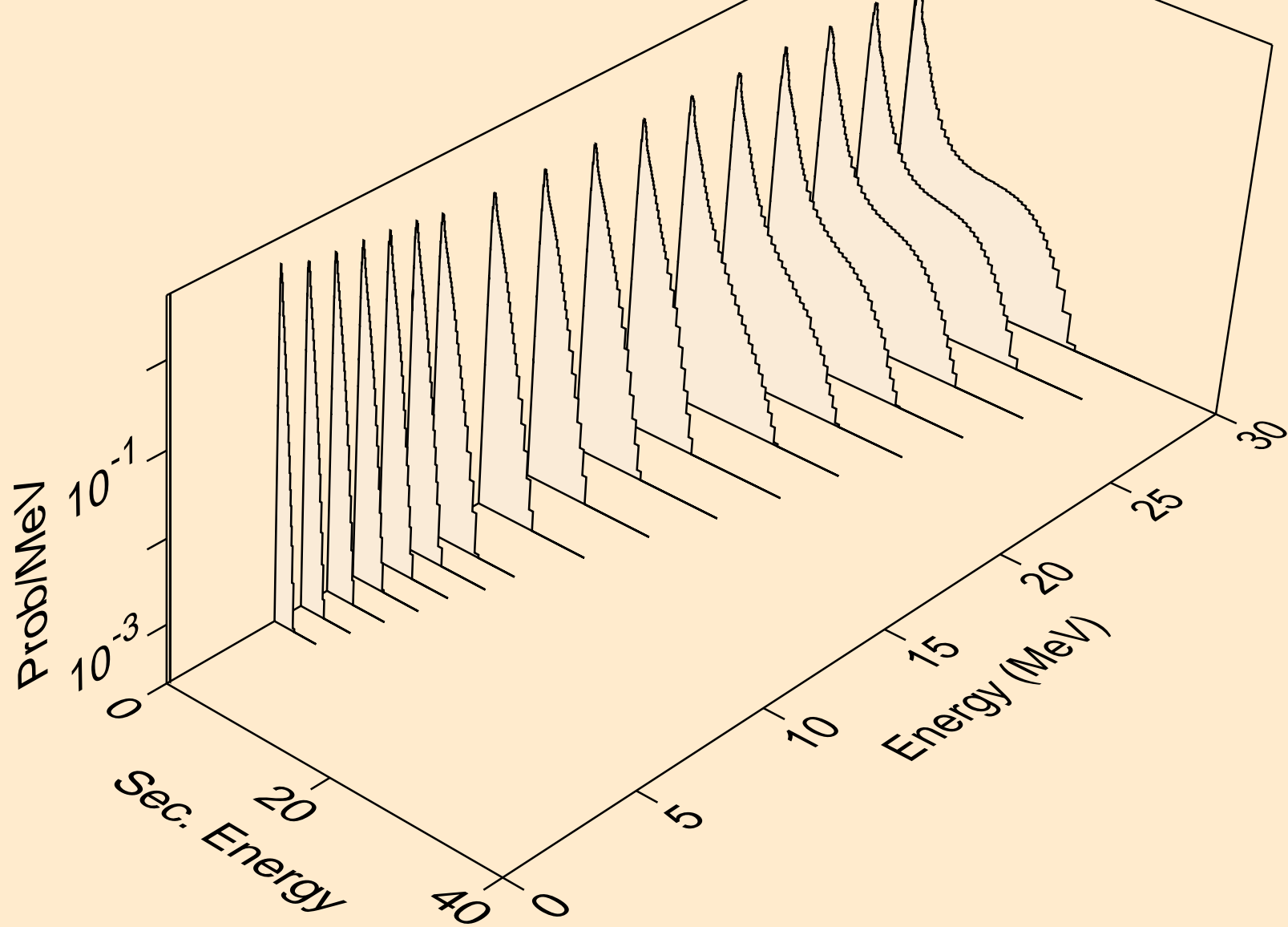

NB106 HELION ACER TENDL-2021 LIBRARY; T=0.K  
neutrons from (s,3np)

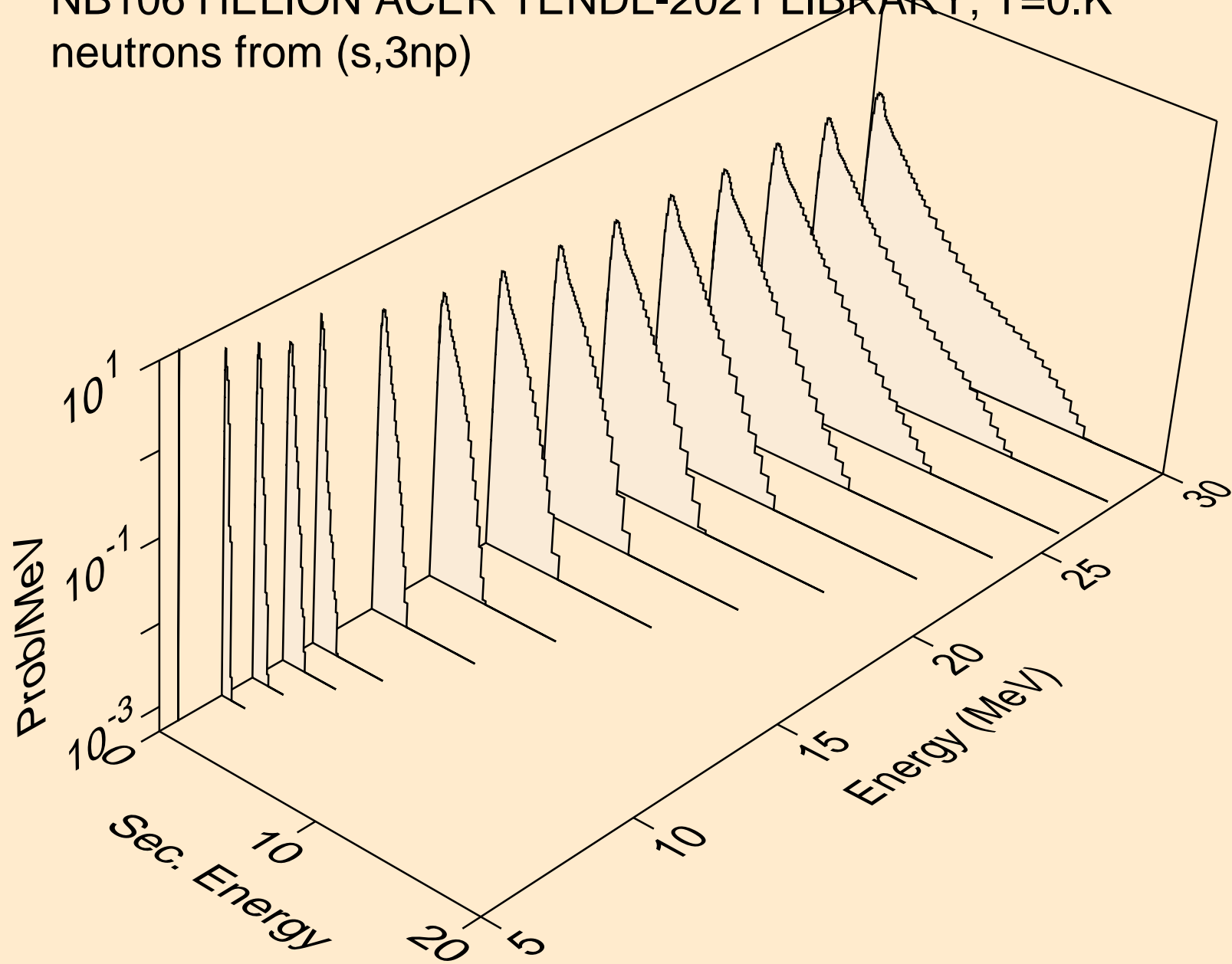

NB106 HELION ACER TENDL-2021 LIBRARY; T=0.K  
neutrons from (s,2np)

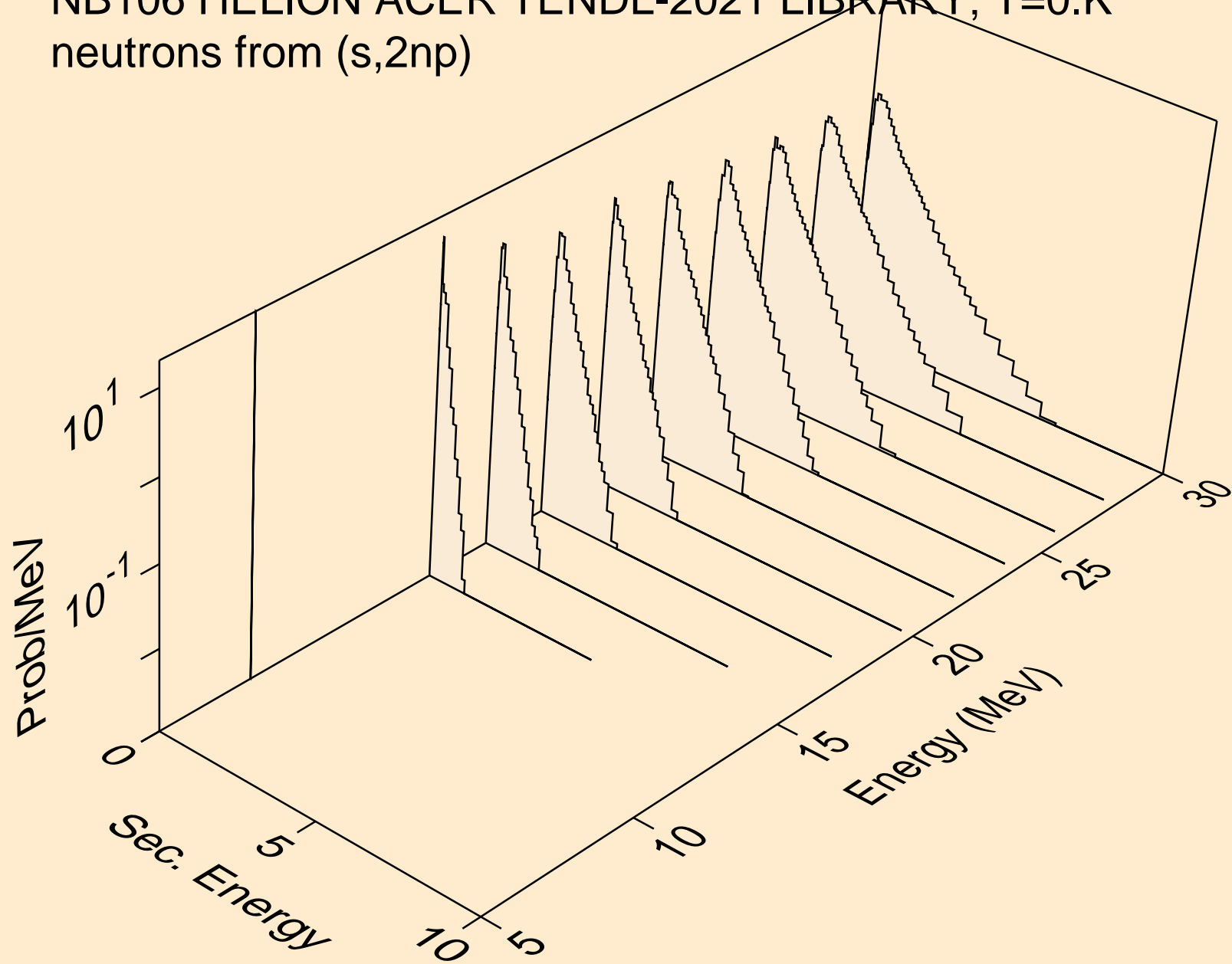

NB106 HELION ACER TENDL-2021 LIBRARY; T=0.K  
neutrons from (s,npa)

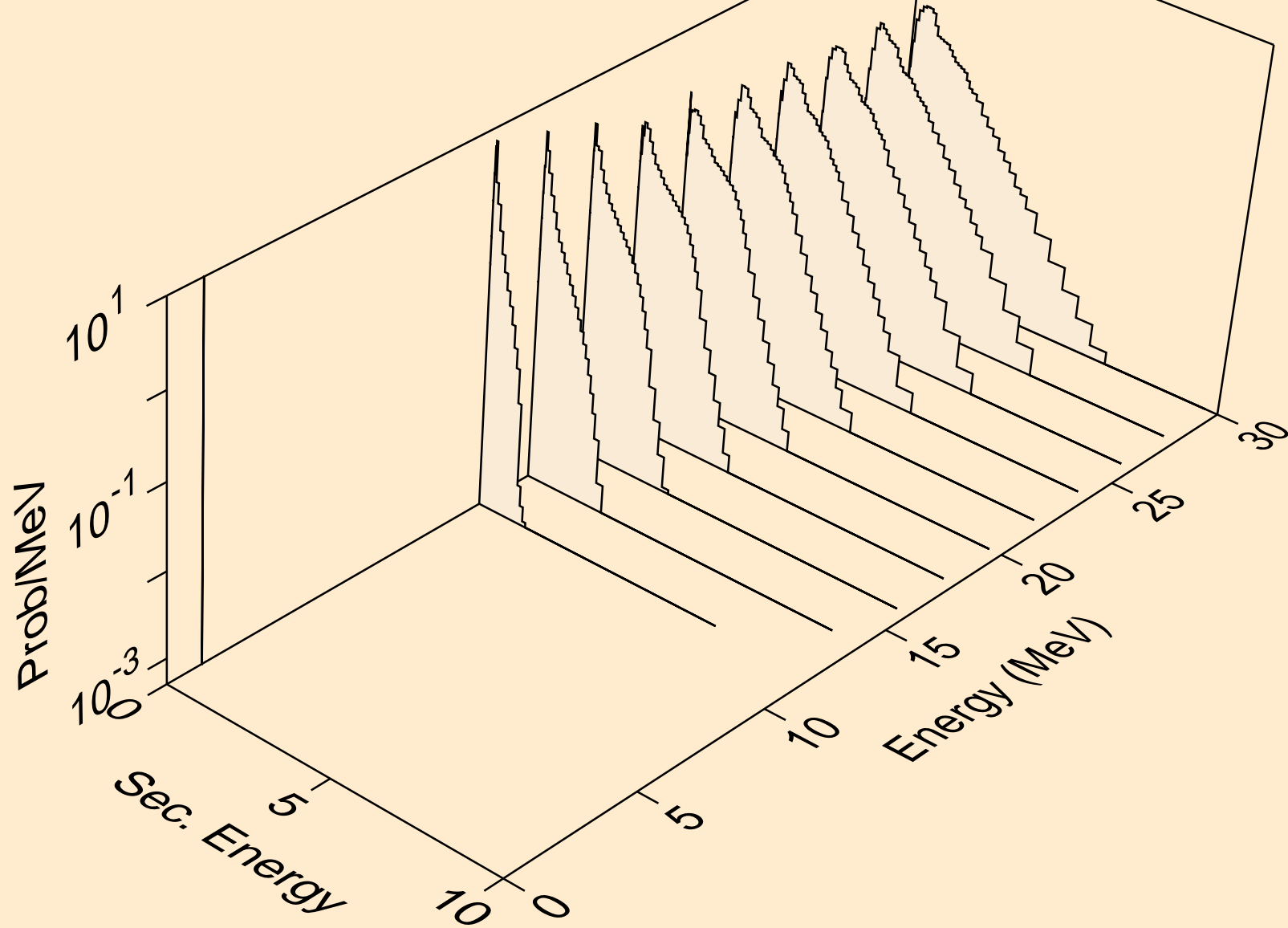

NB106 HELION ACER TENDL-2021 LIBRARY; T=0.K  
protons from (s,x)

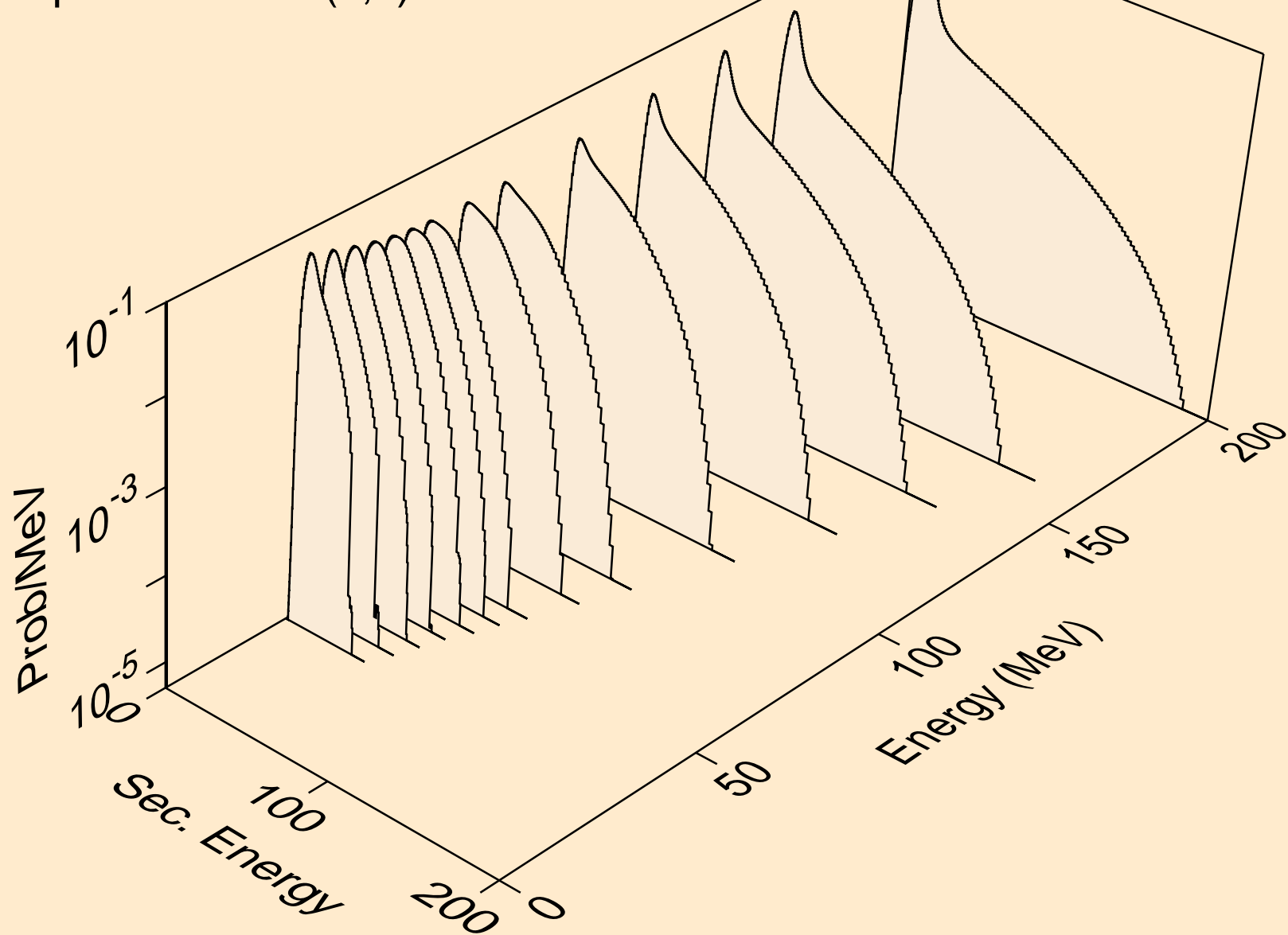

NB106 HELION ACER TENDL-2021 LIBRARY; T=0.K  
protons from (s,n\*)p

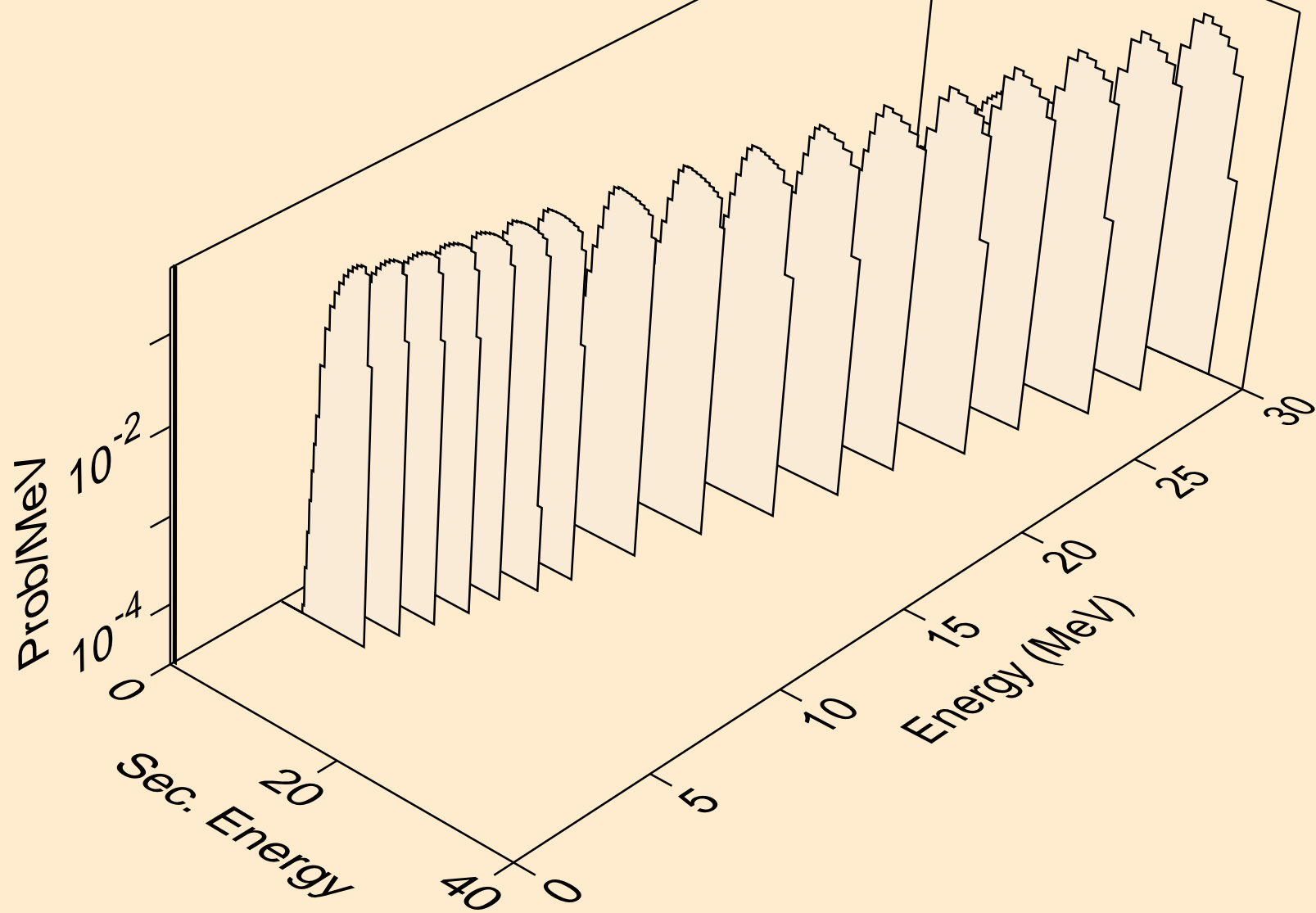

NB106 HELION ACER TENDL-2021 LIBRARY; T=0.K  
protons from (s,2np)

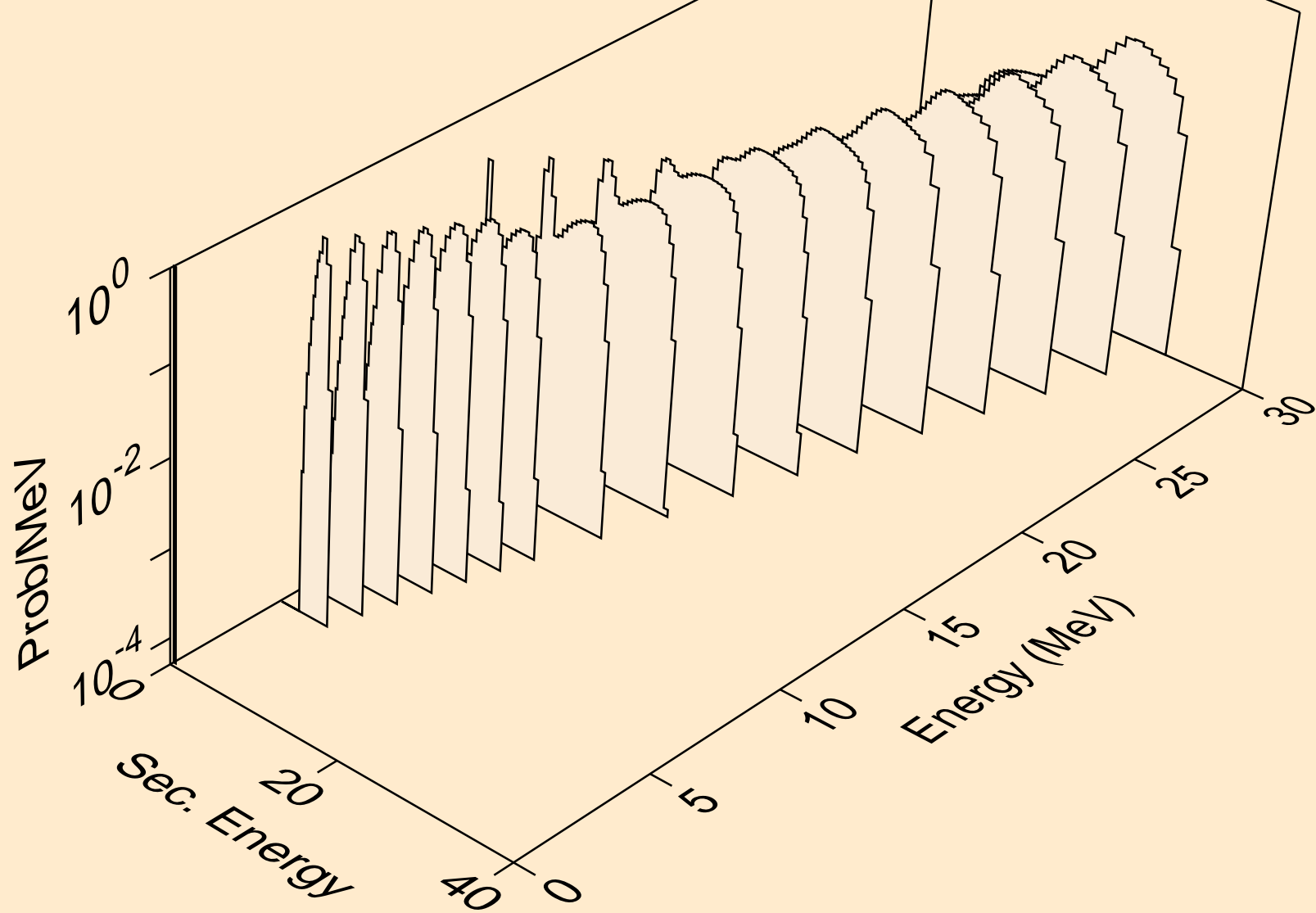

NB106 HELION ACER TENDL-2021 LIBRARY; T=0.K  
protons from (s,3np)

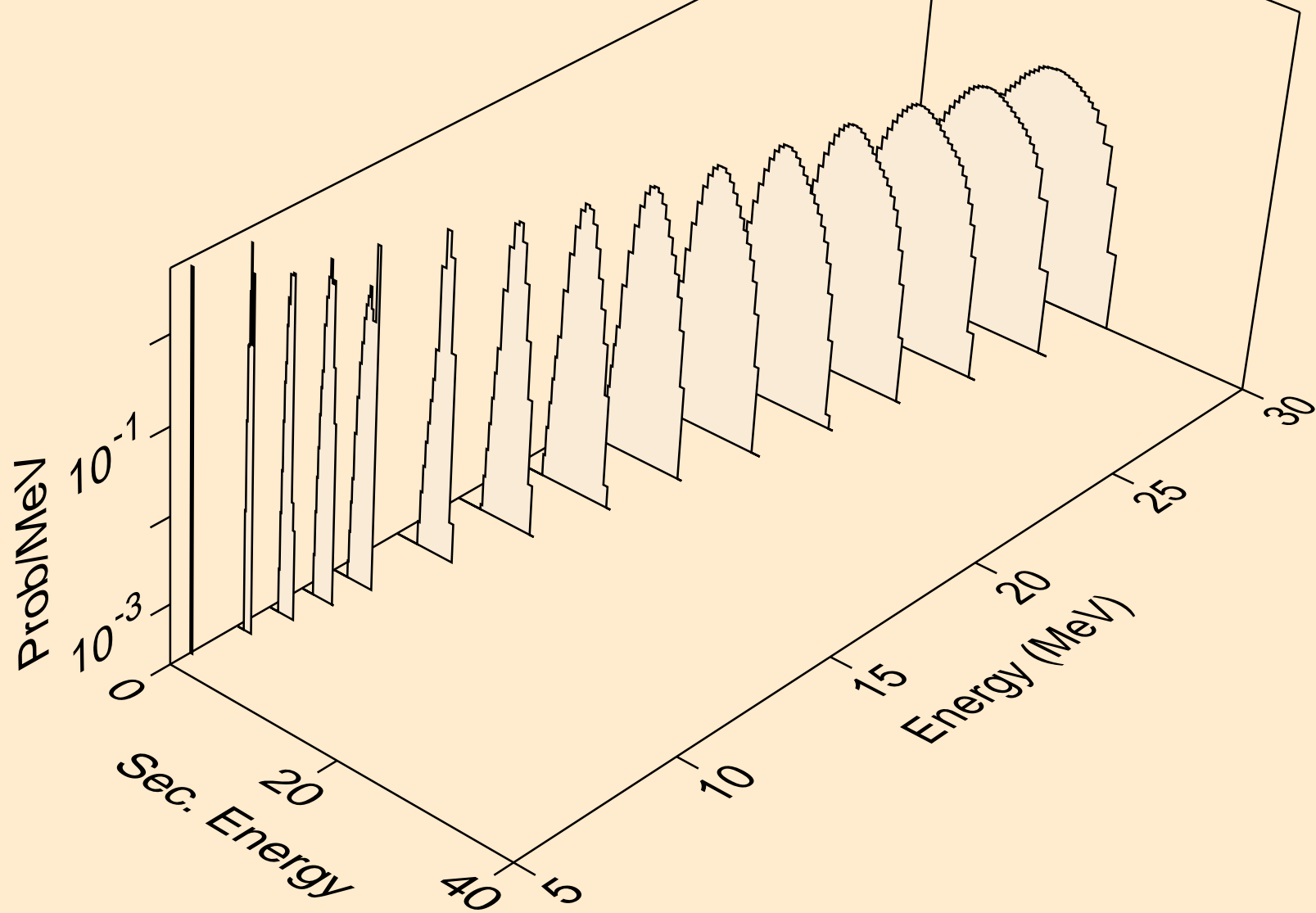



NB106 HELION ACER TENDL-2021 LIBRARY; T=0.K  
protons from (s,2np)

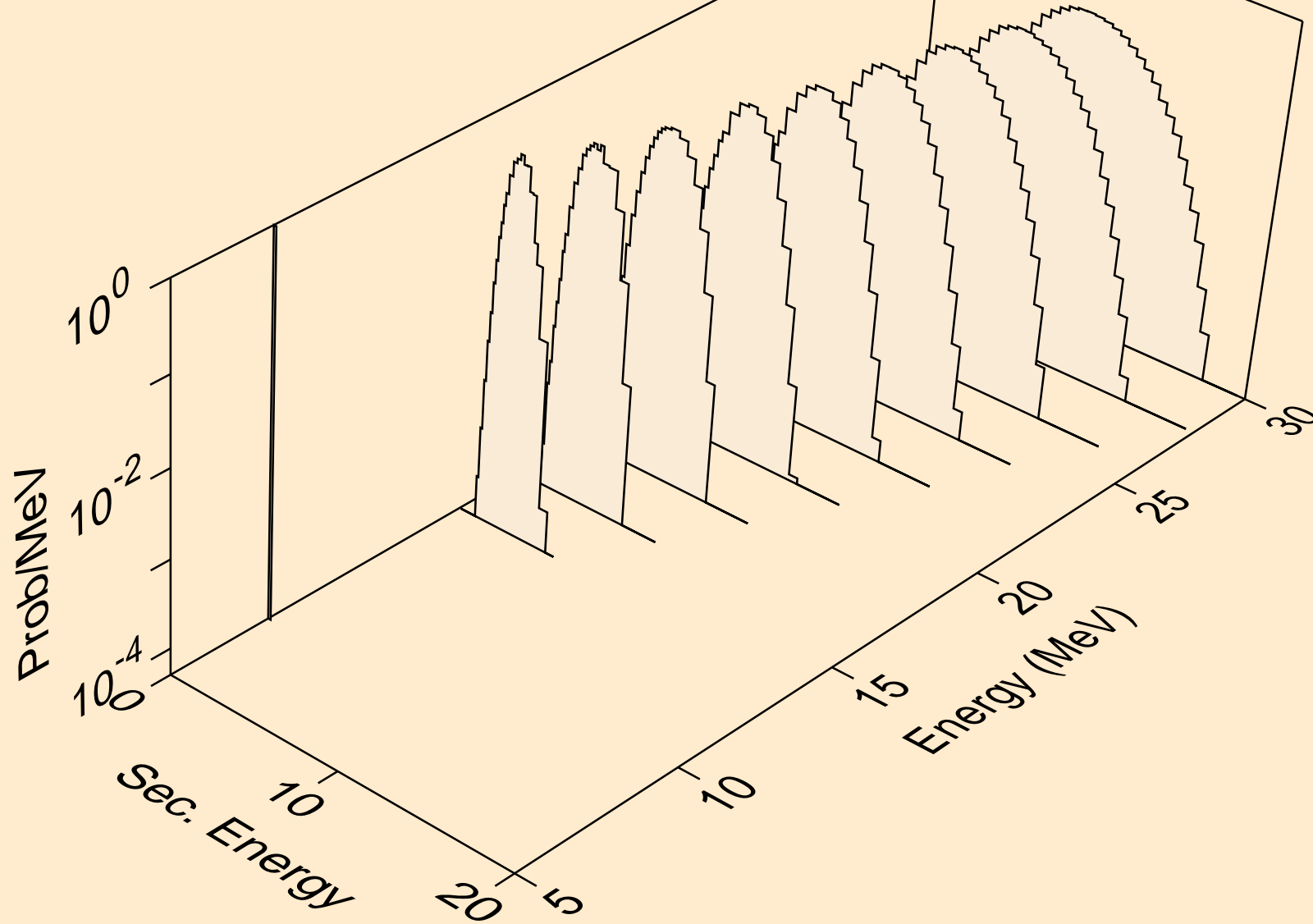

NB106 HELION ACER TENDL-2021 LIBRARY; T=0.K  
protons from (s,npa)

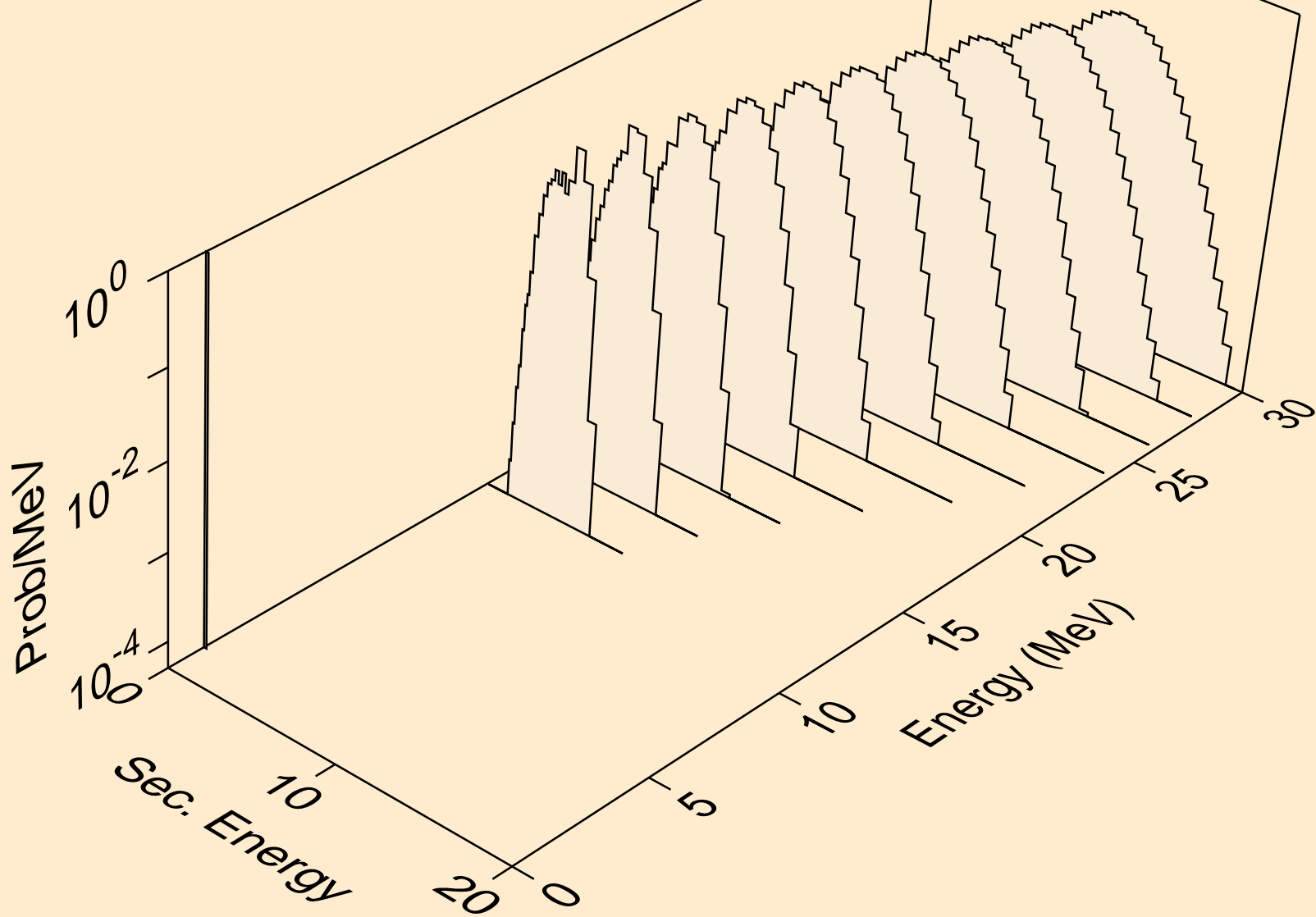

NB106 HELION ACER TENDL-2021 LIBRARY; T=0.K  
protons from (s,p)

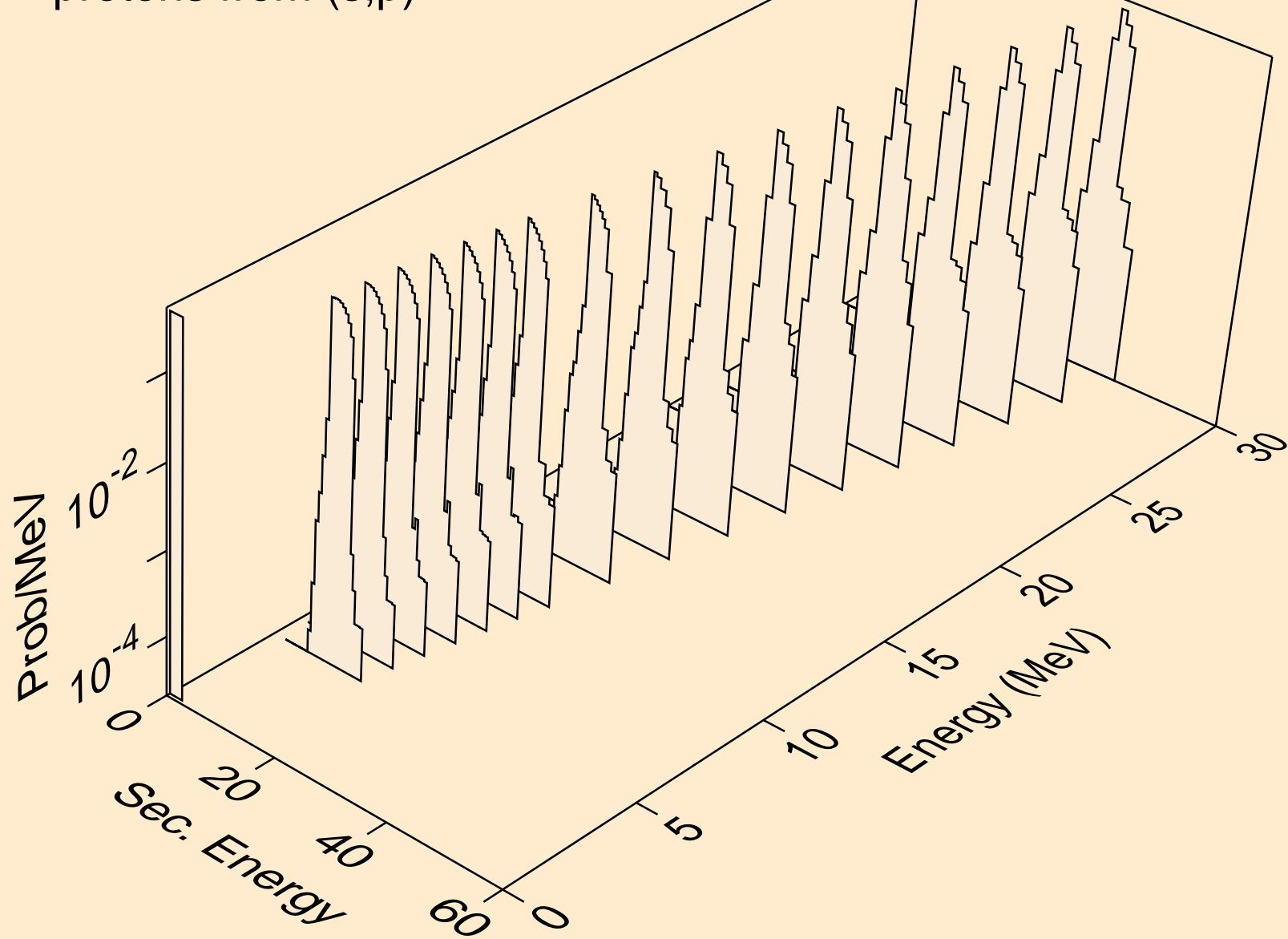

NB106 HELION ACER TENDL-2021 LIBRARY; T=0.K  
protons from (s,2p)

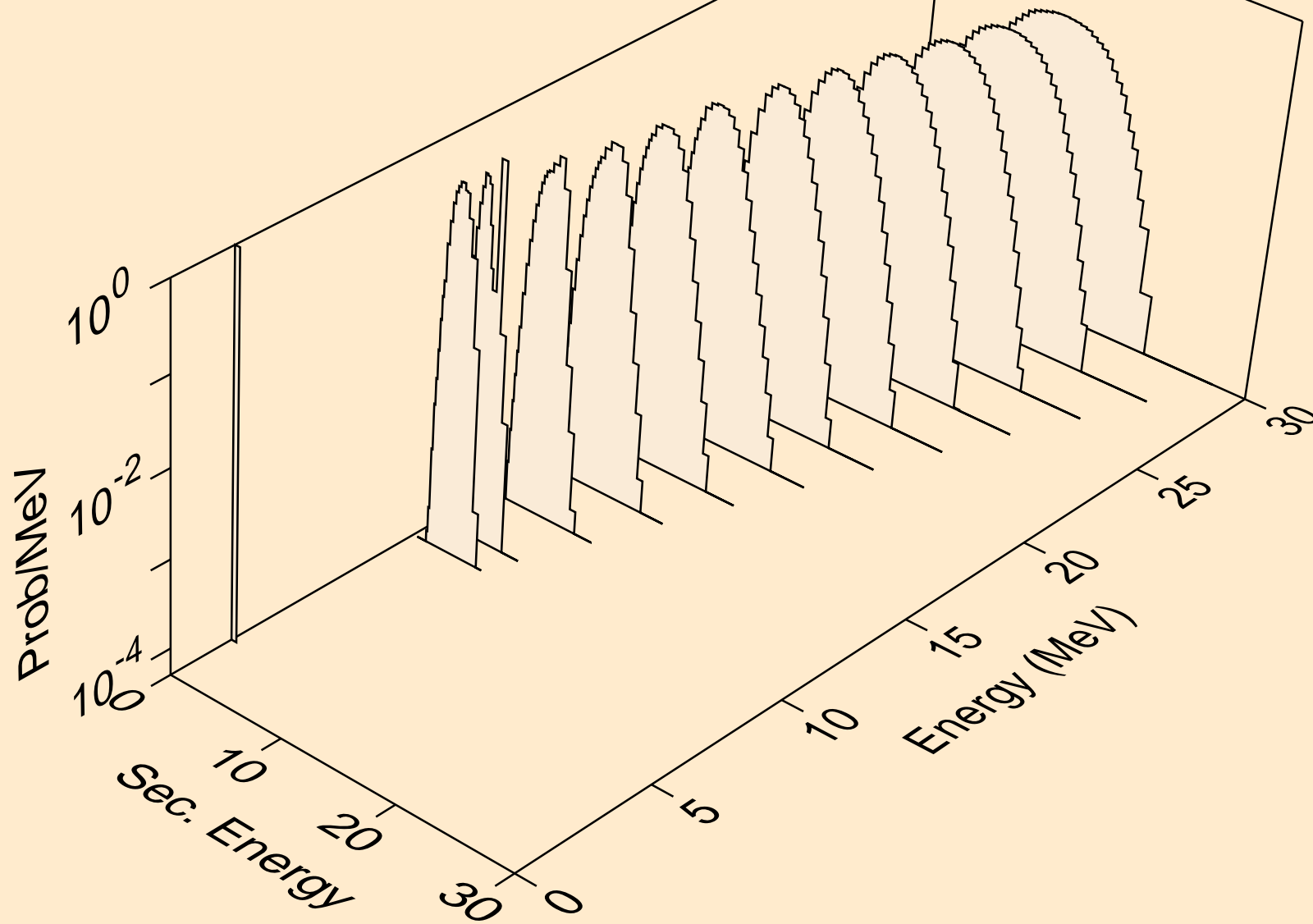

NB106 HELION ACER TENDL-2021 LIBRARY; T=0.K  
protons from (s,pa)

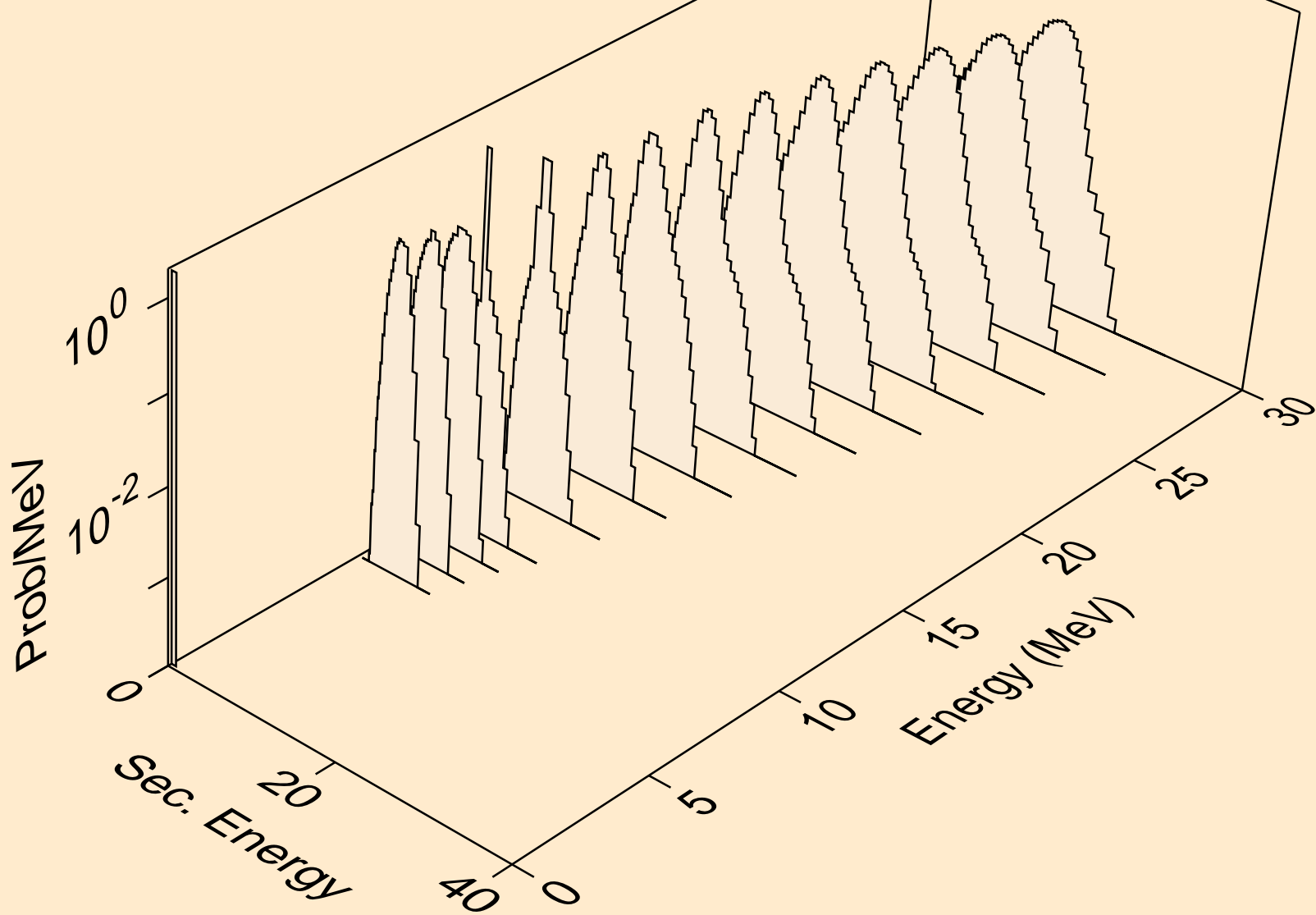

NB106 HELION ACER TENDL-2021 LIBRARY; T=0.K  
protons from (s,pd)

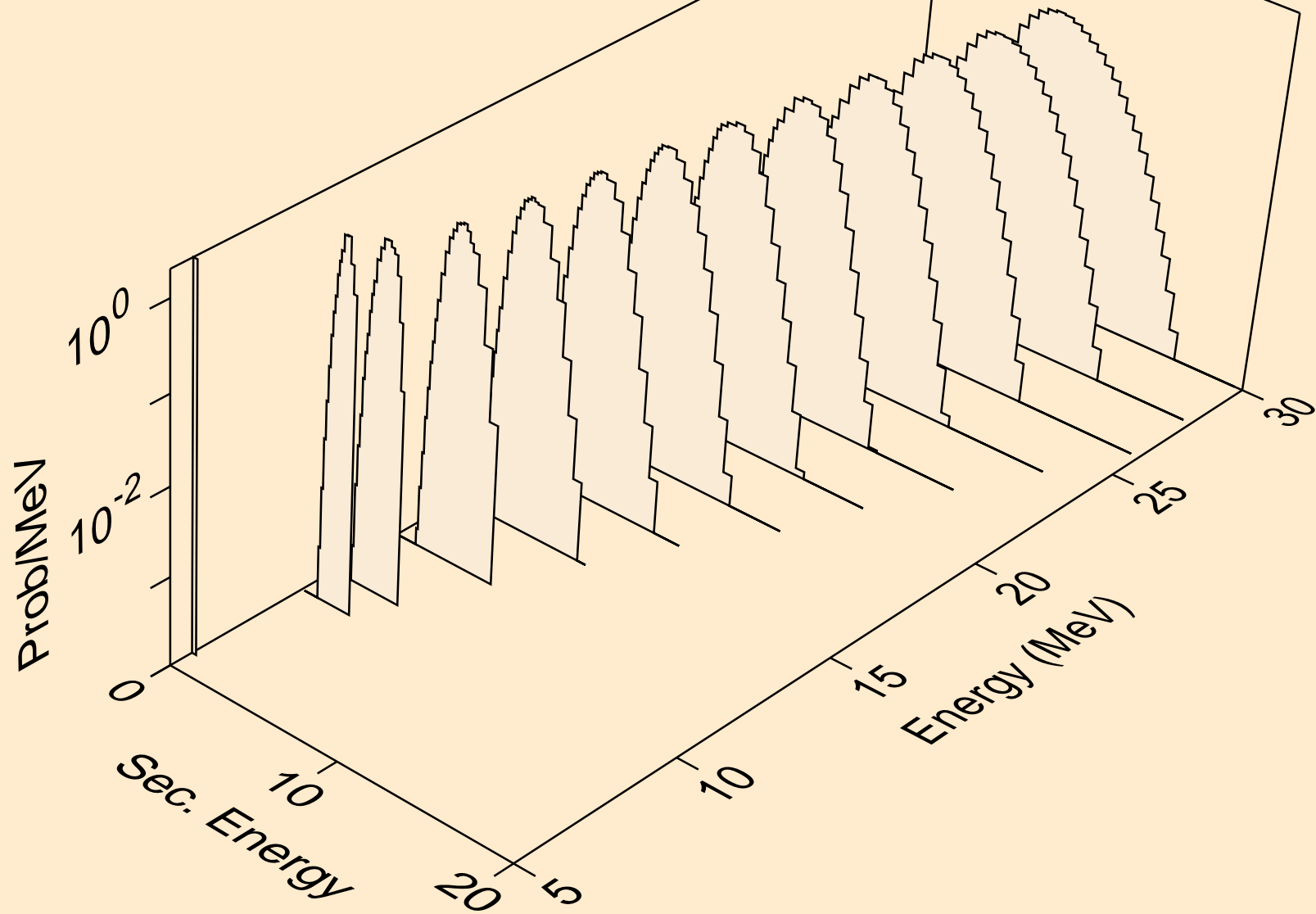

NB106 HELION ACER TENDL-2021 LIBRARY; T=0.K  
protons from (s,pt)

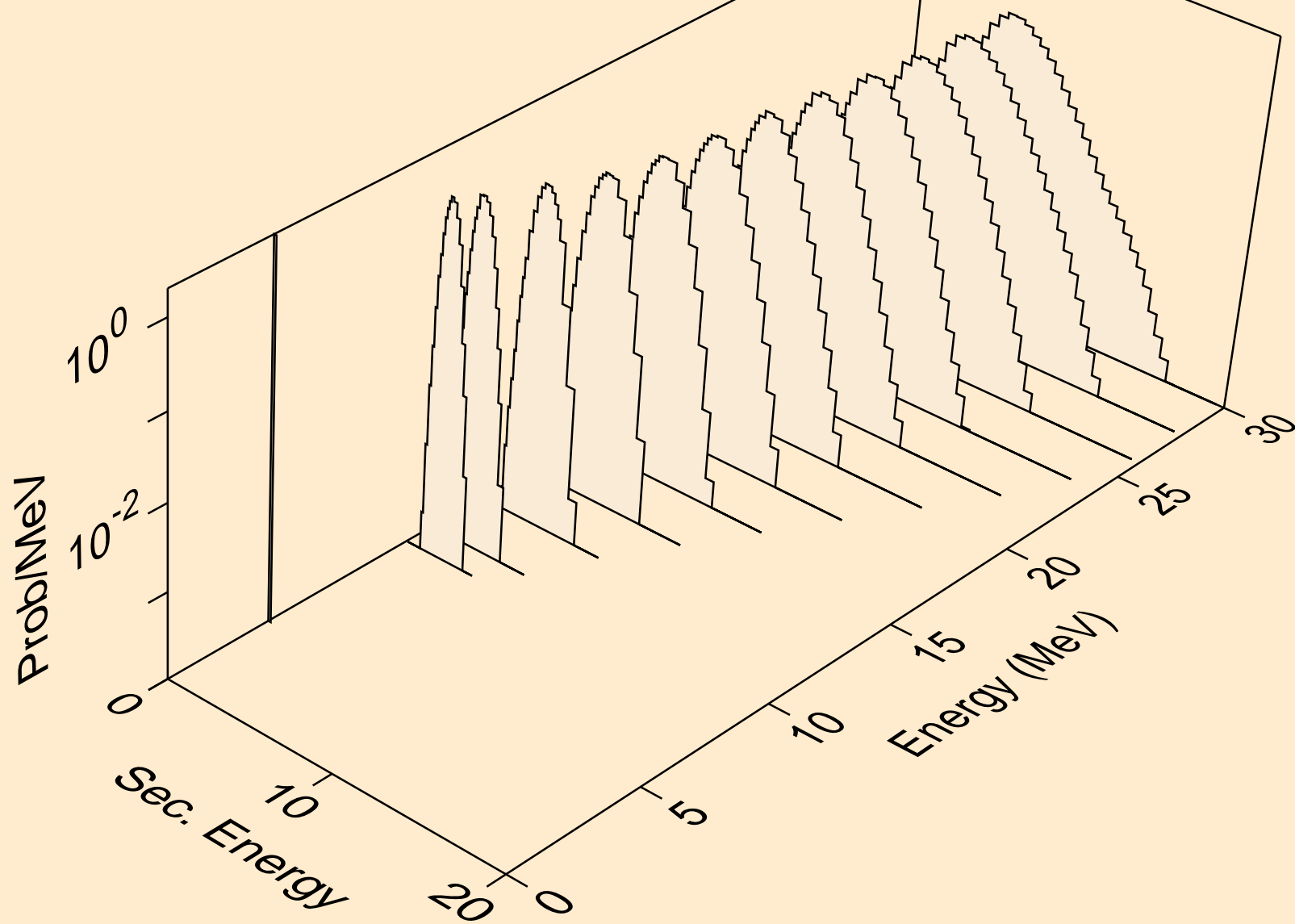

NB106 HELION ACER TENDL-2021 LIBRARY; T=0.K  
deuterons from (s,x)

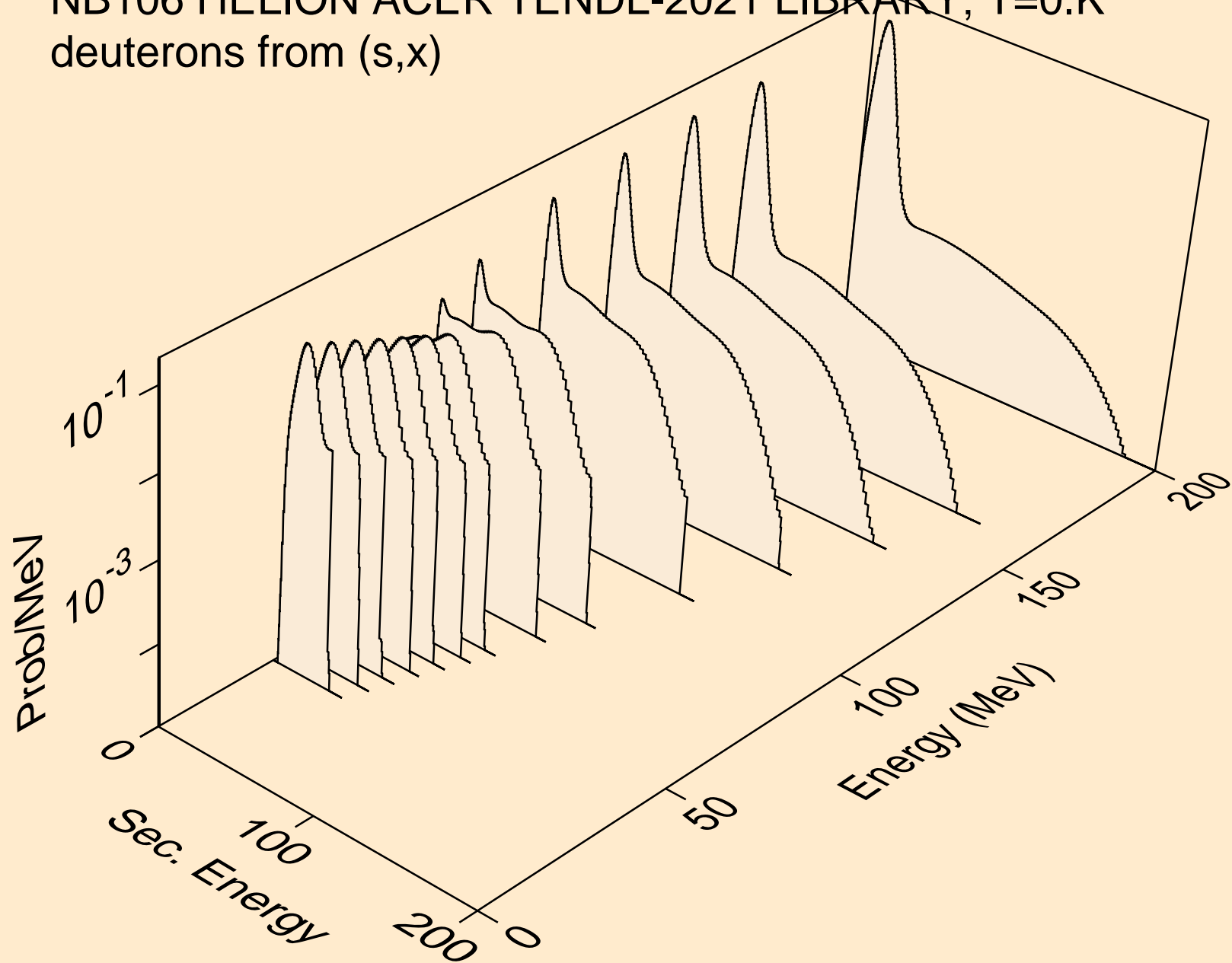



NB106 HELION ACER TENDL-2021 LIBRARY; T=0.K  
deuterons from (s,2nd)

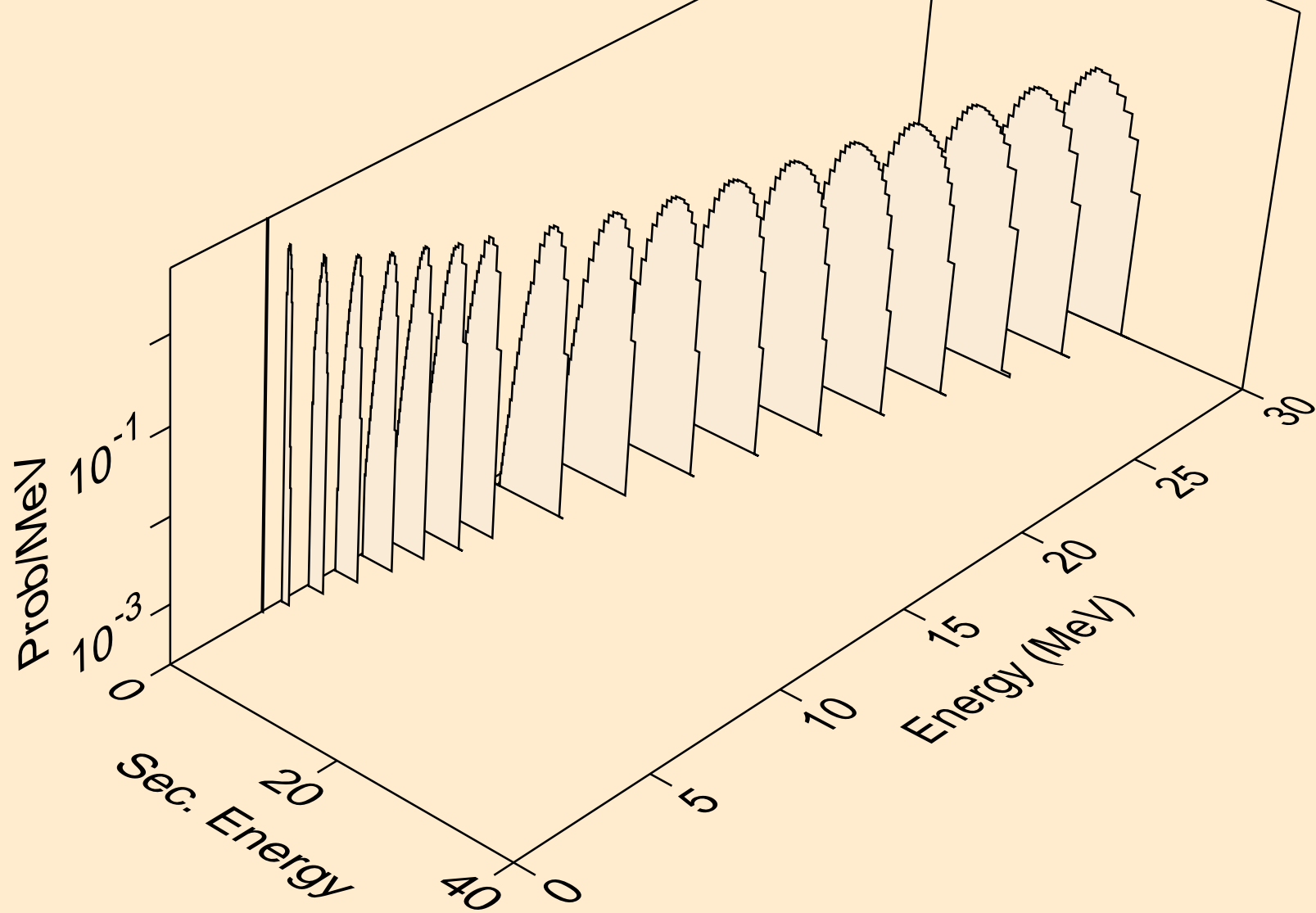

NB106 HELION ACER TENDL-2021 LIBRARY; T=0.K  
deuterons from (s,n\*)d

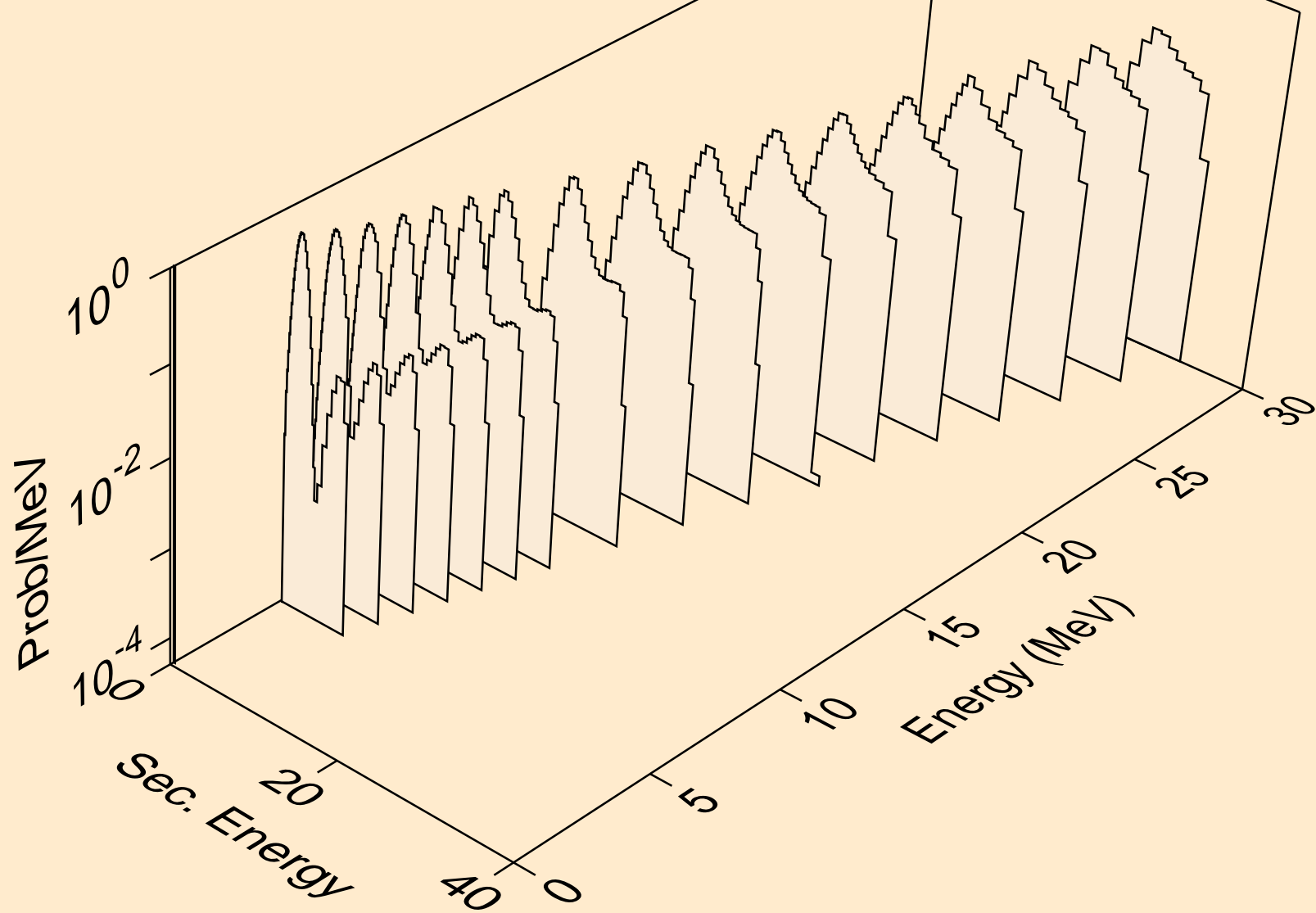

NB106 HELION ACER TENDL-2021 LIBRARY; T=0.K  
deuterons from (s,d)

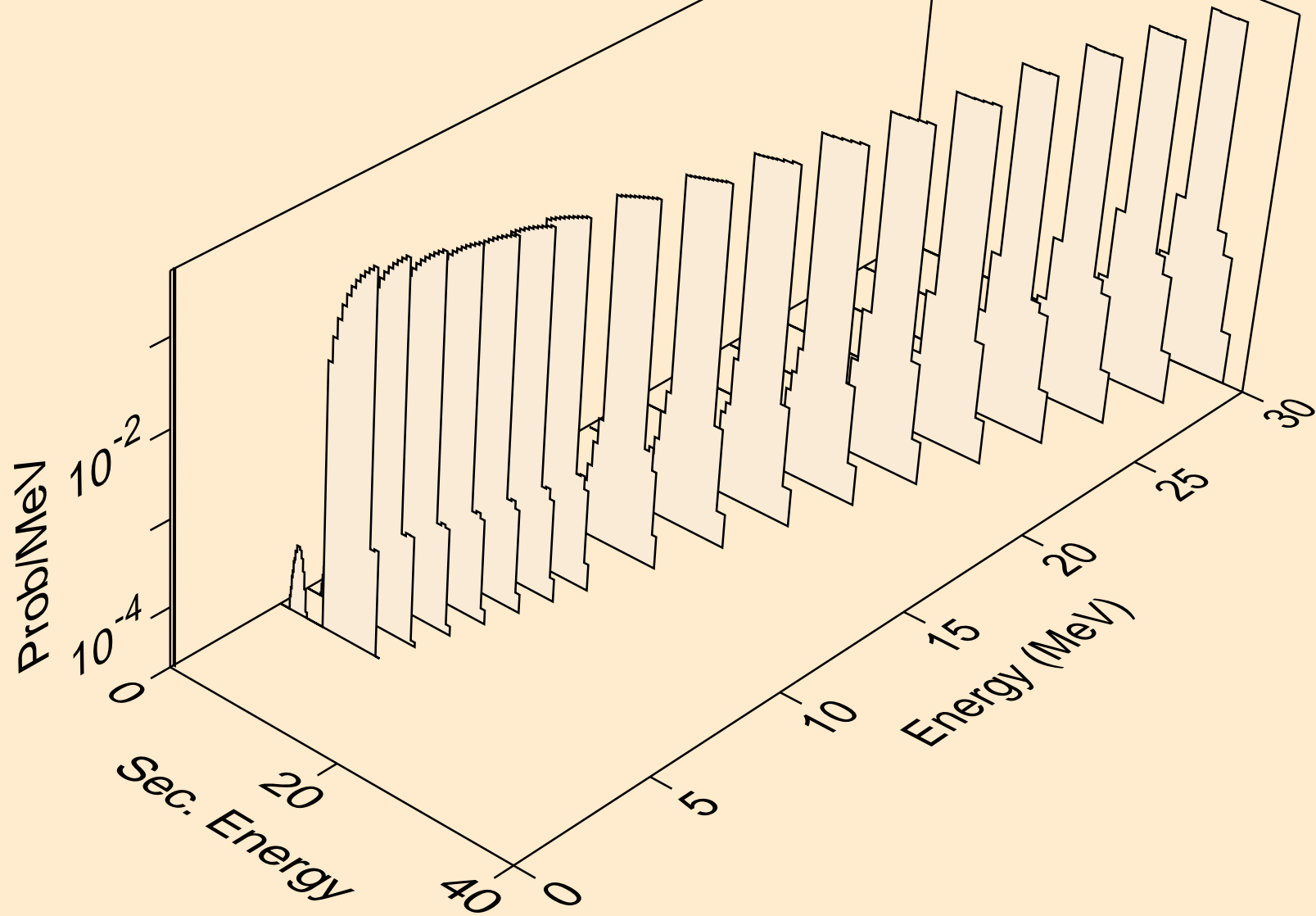

NB106 HELION ACER TENDL-2021 LIBRARY; T=0.K  
deuterons from (s,pd)

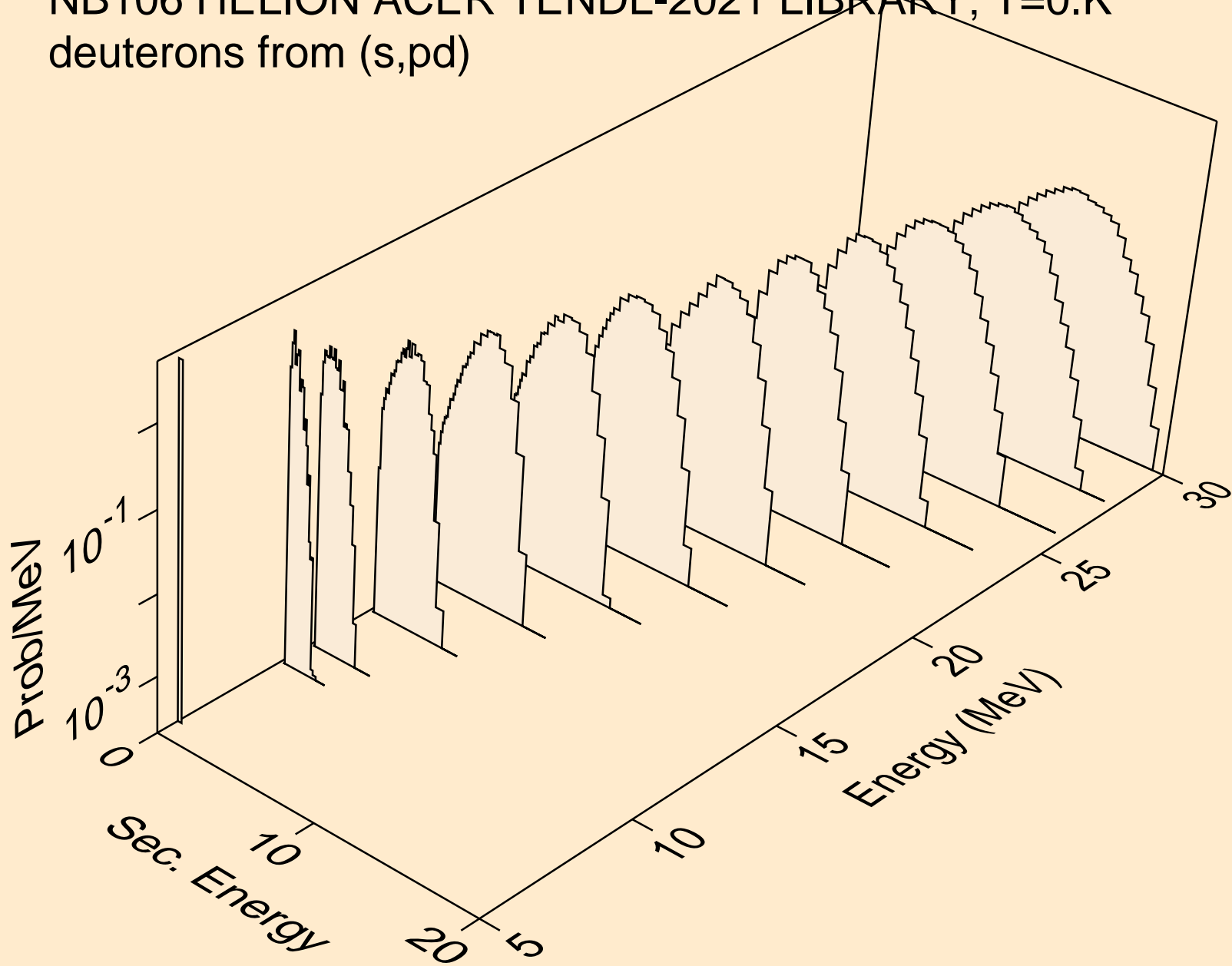

NB106 HELION ACER TENDL-2021 LIBRARY; T=0.K  
deuterons from (s,da)

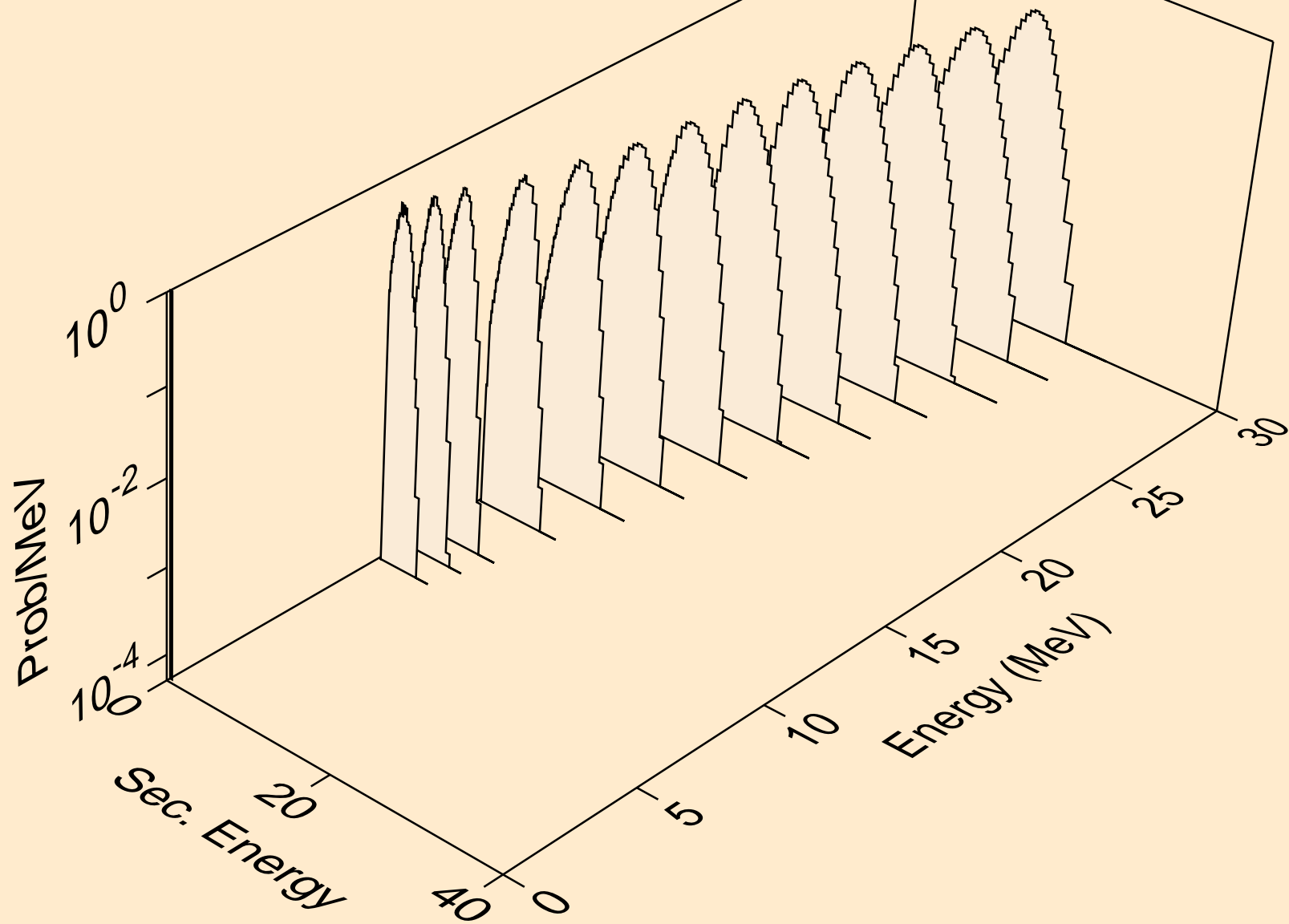

NB106 HELION ACER TENDL-2021 LIBRARY; T=0.K  
tritons from (s,x)

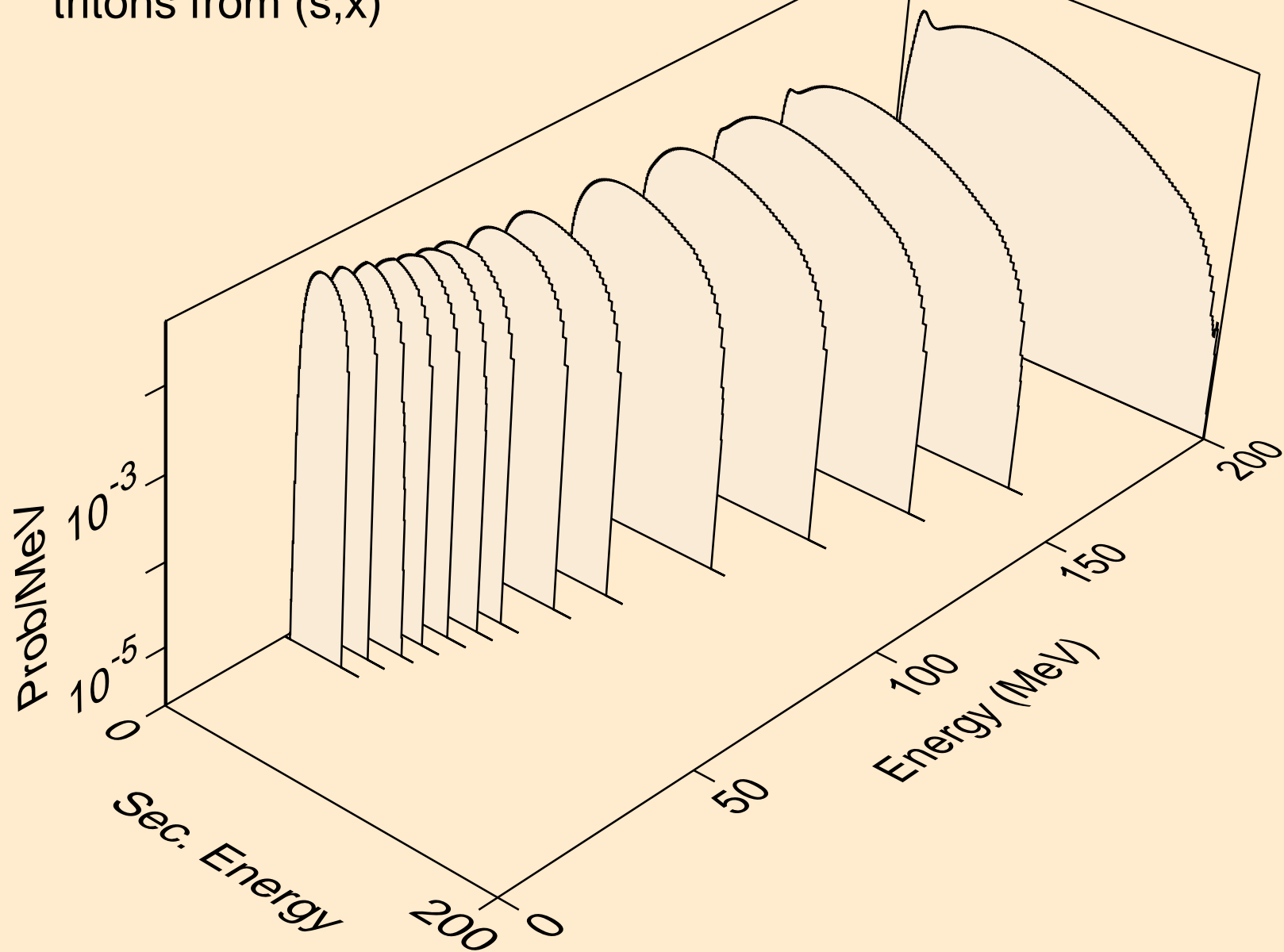

NB106 HELION ACER TENDL-2021 LIBRARY; T=0.K  
tritons from (s,n\*)t

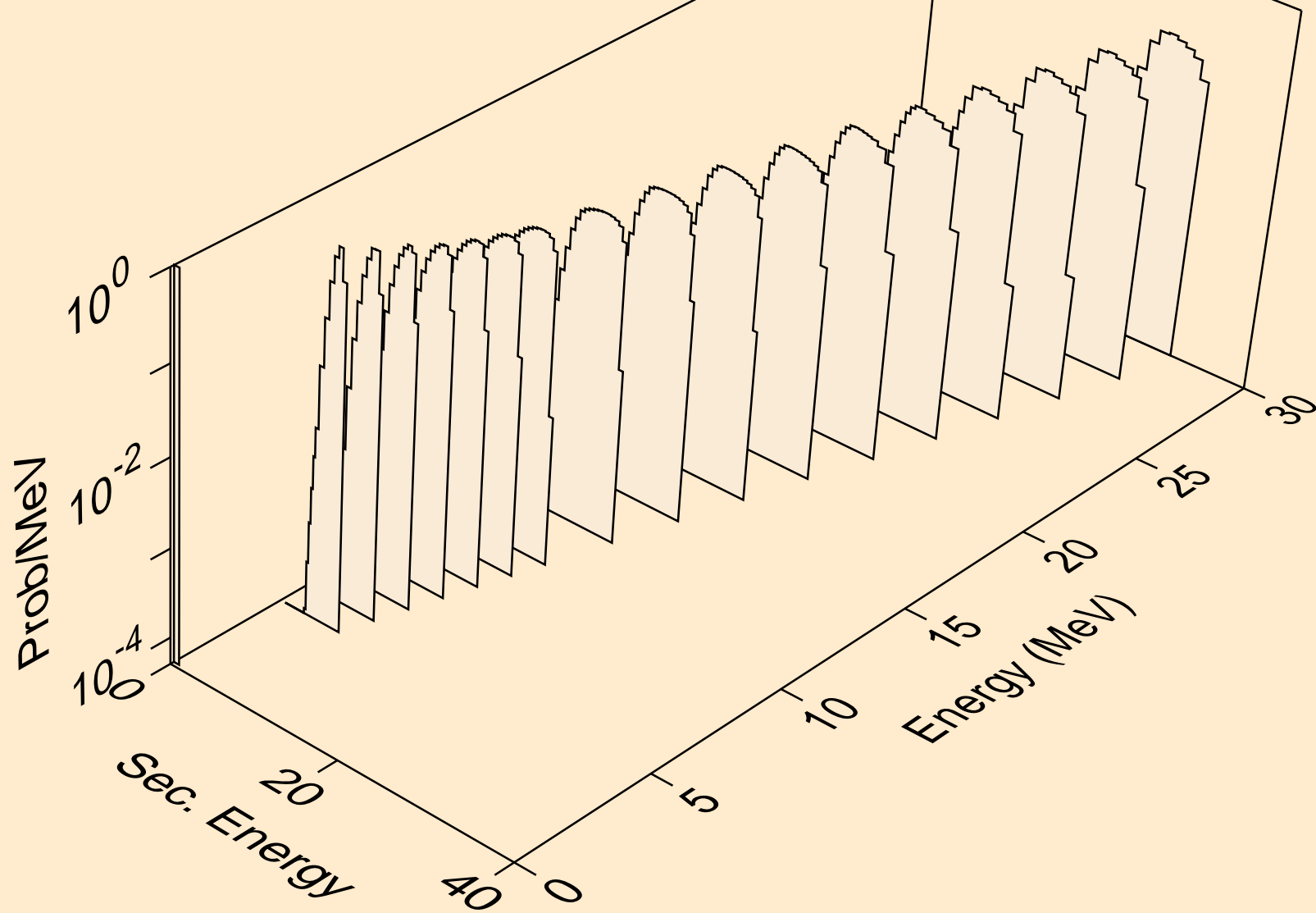

NB106 HELION ACER TENDL-2021 LIBRARY; T=0.K  
tritons from (s,t)

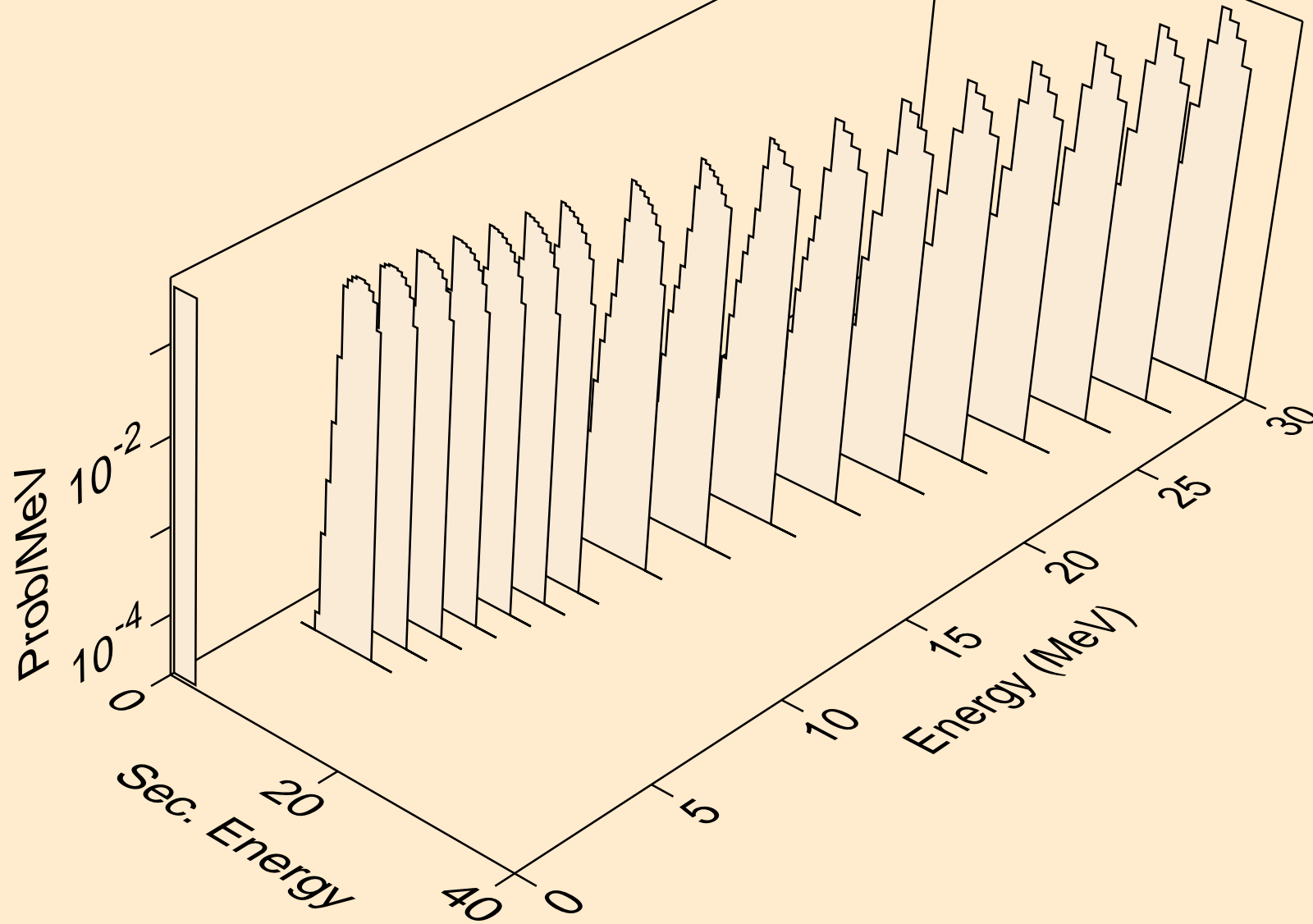



NB106 HELION ACER TENDL-2021 LIBRARY; T=0.K  
tritons from (s,pt)

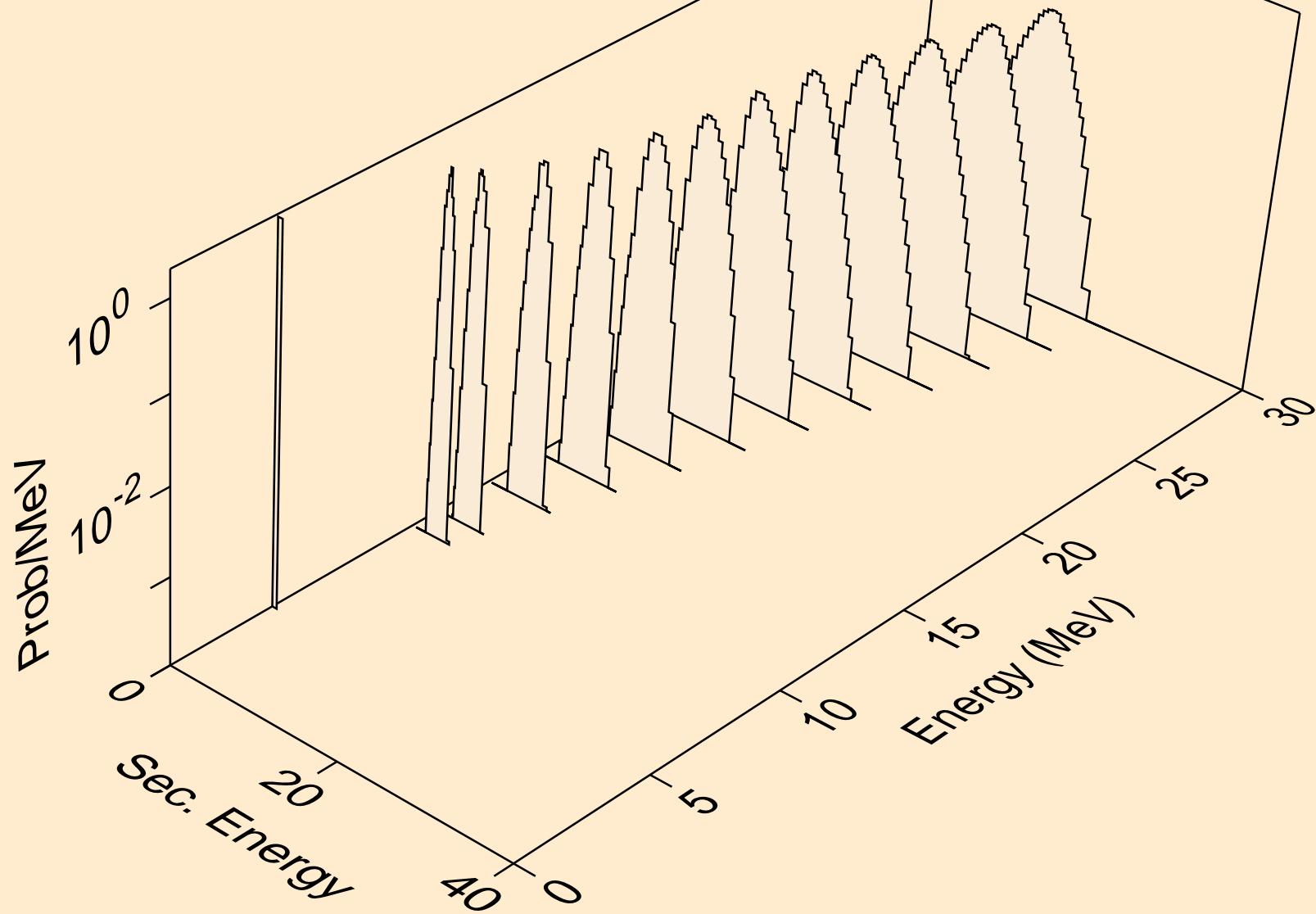

NB106 HELION ACER TENDL-2021 LIBRARY; T=0.K  
alphas from (s,x)

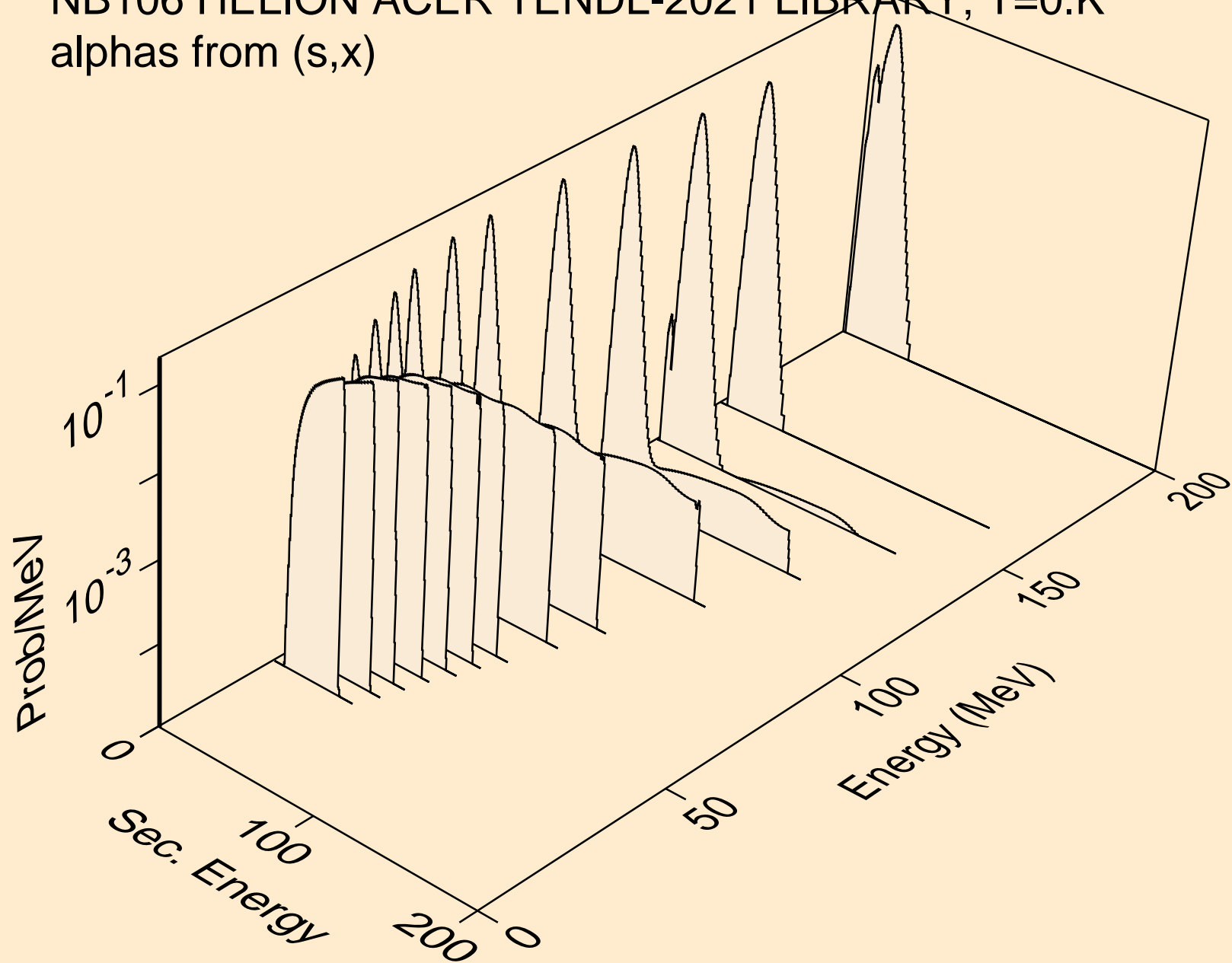

NB106 HELION ACER TENDL-2021 LIBRARY; T=0.K  
alphas from (s,n\*)a

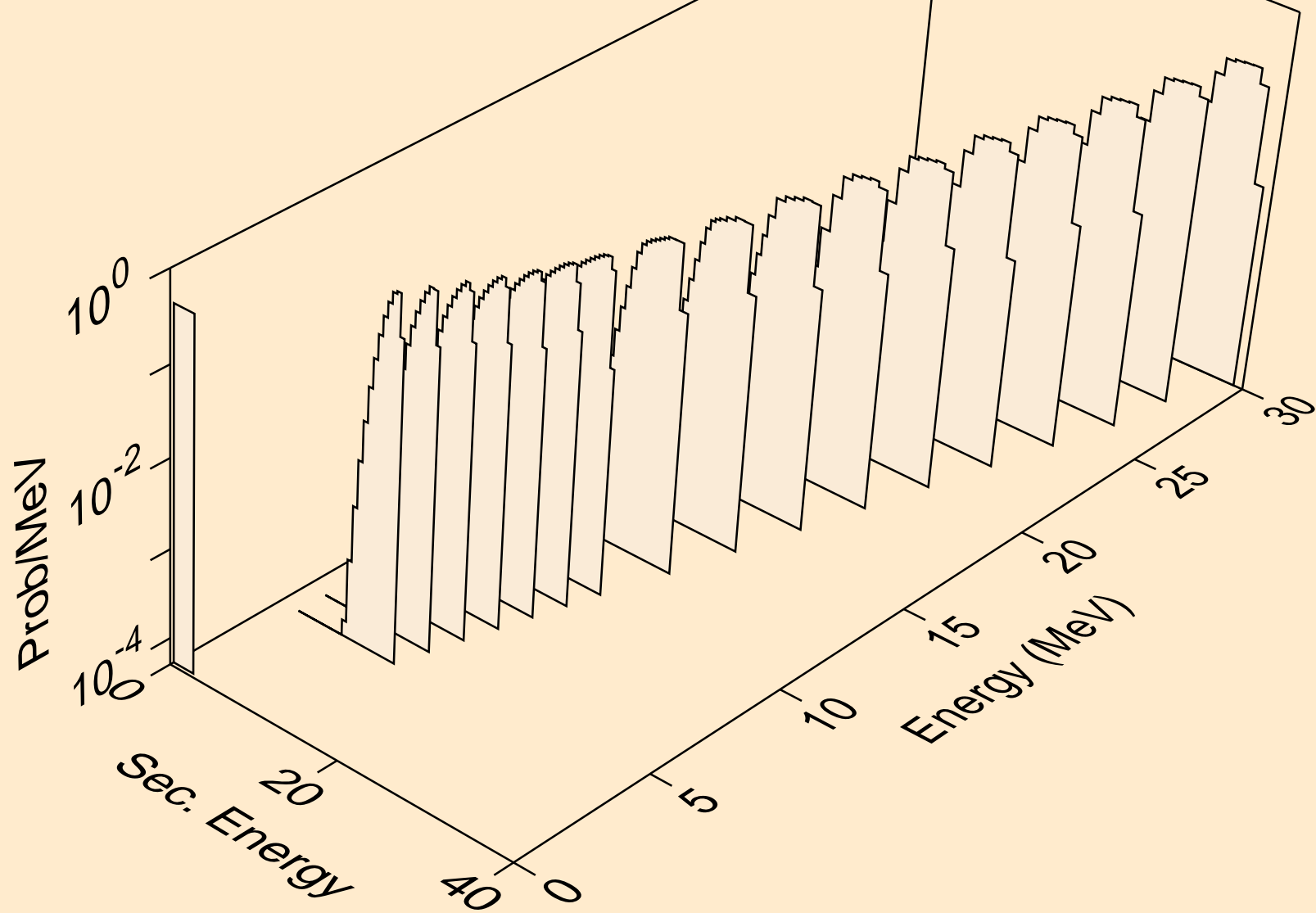

NB106 HELION ACER TENDL-2021 LIBRARY; T=0.K  
alphas from (s,2n)a

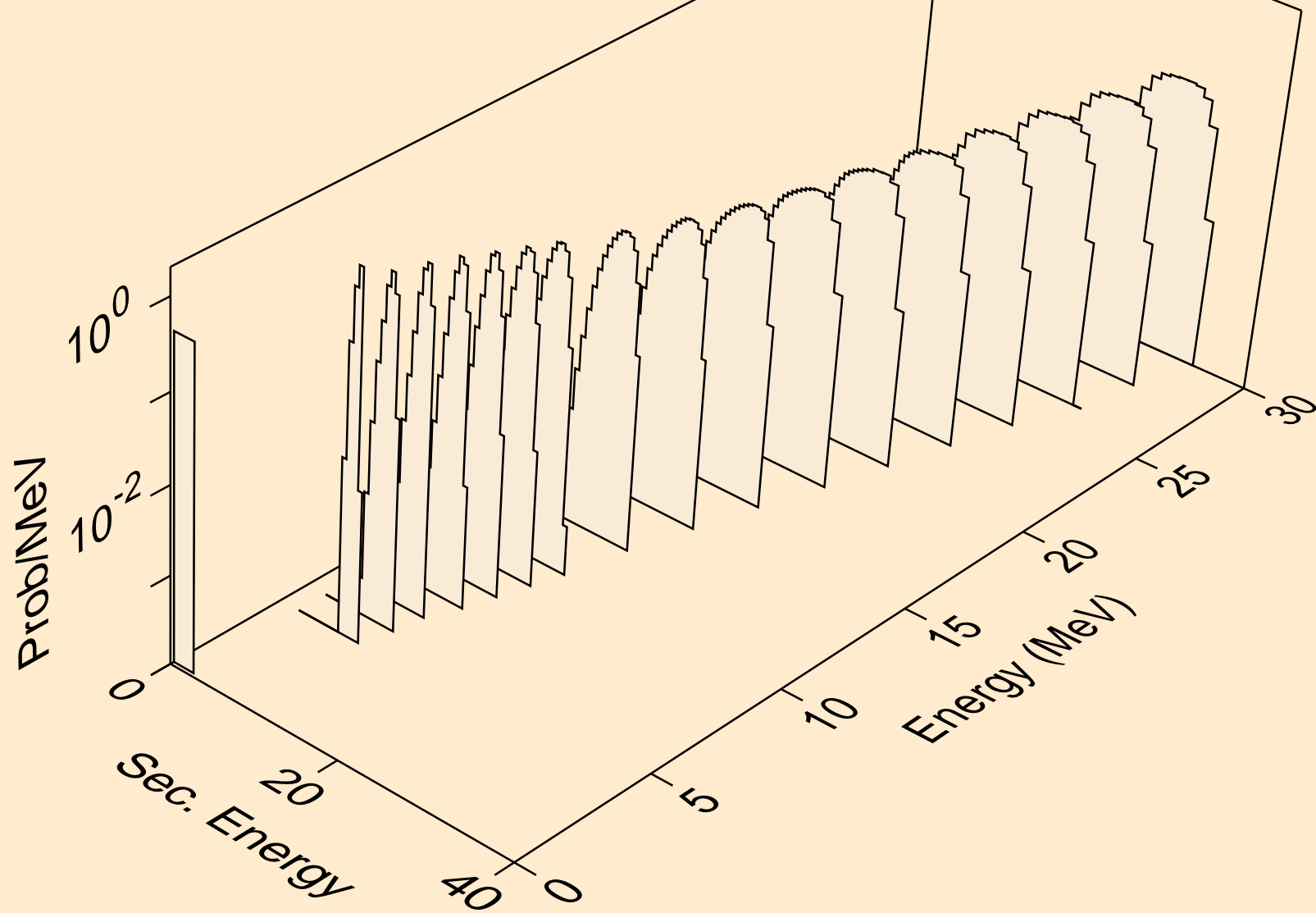

NB106 HELION ACER TENDL-2021 LIBRARY; T=0.K  
alphas from (s,3n)a

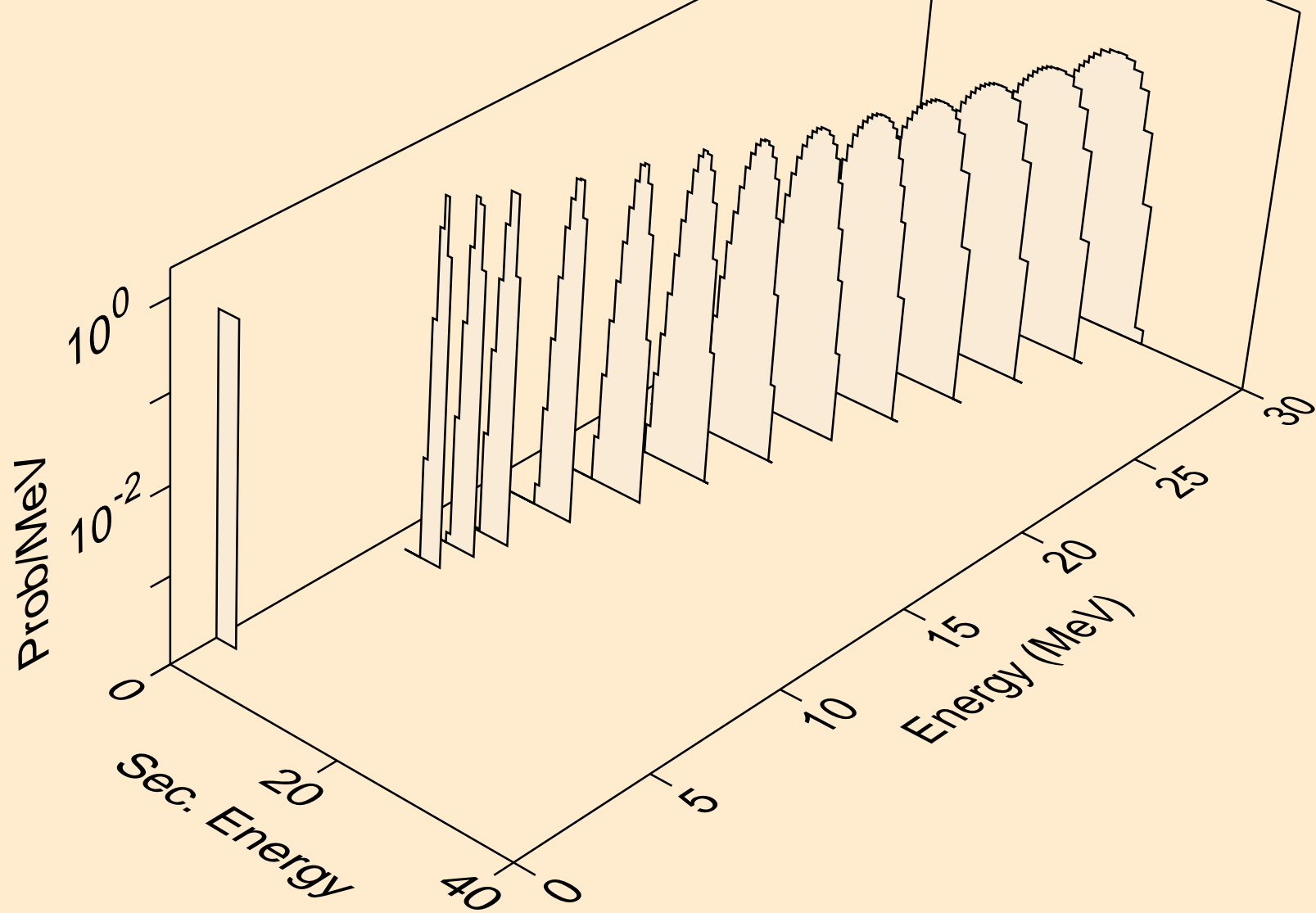

NB106 HELION ACER TENDL-2021 LIBRARY; T=0.K  
alphas from (s,n\*)2a

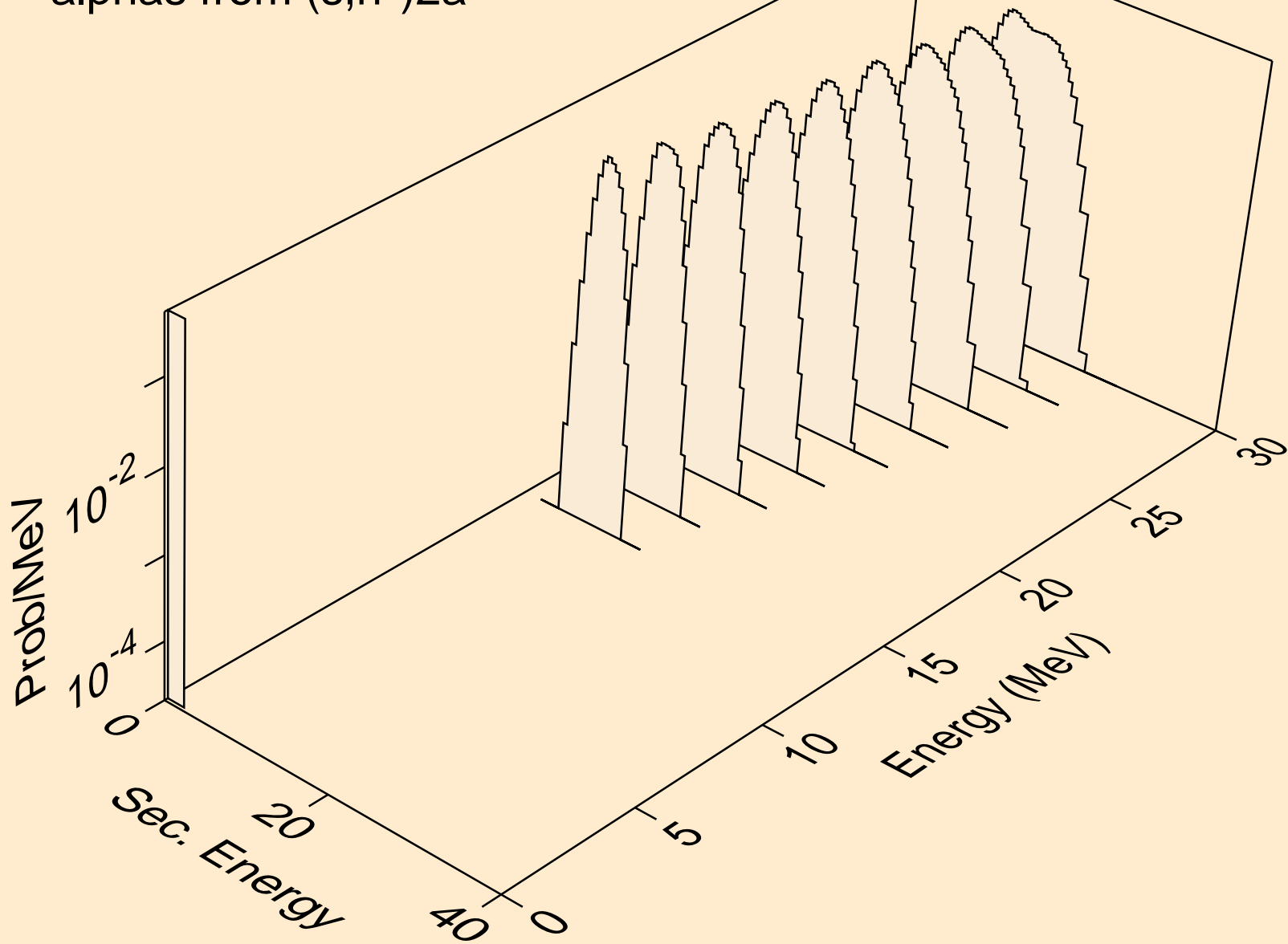

NB106 HELION ACER TENDL-2021 LIBRARY; T=0.K  
alphas from (s,2n)2a

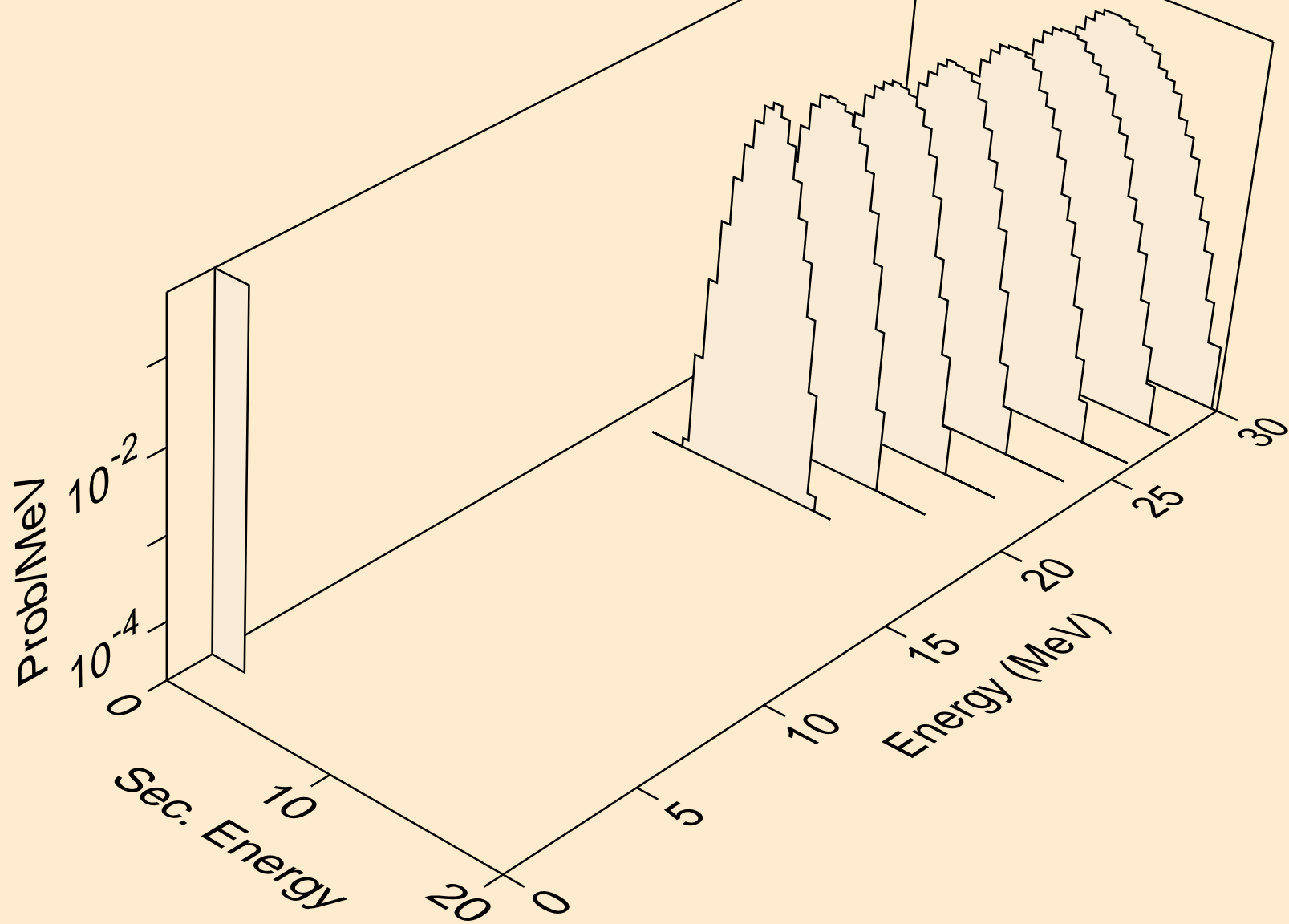

NB106 HELION ACER TENDL-2021 LIBRARY; T=0.K  
alphas from (s,npa)

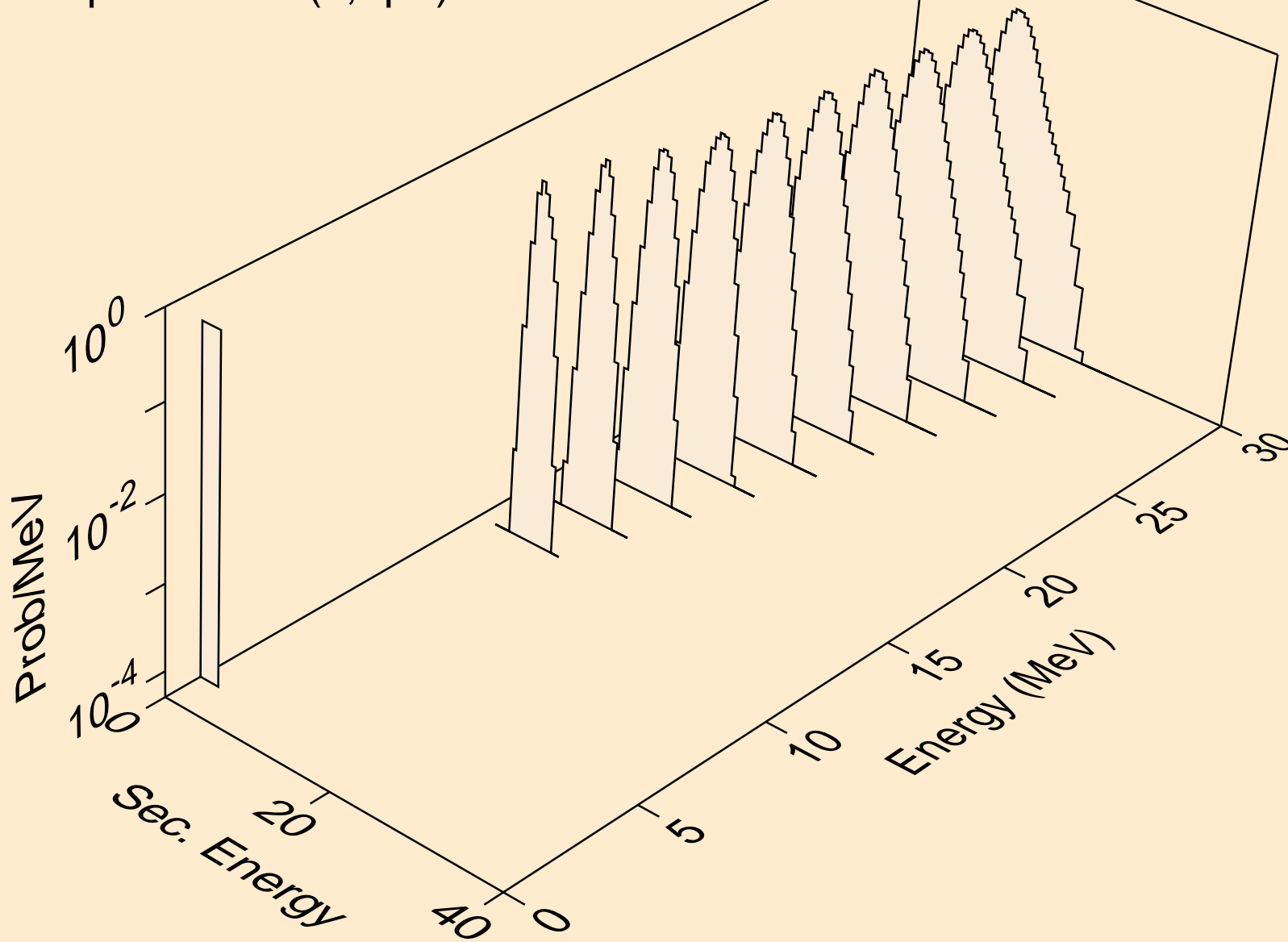



NB106 HELION ACER TENDL-2021 LIBRARY; T=0.K  
alphas from (s,a)

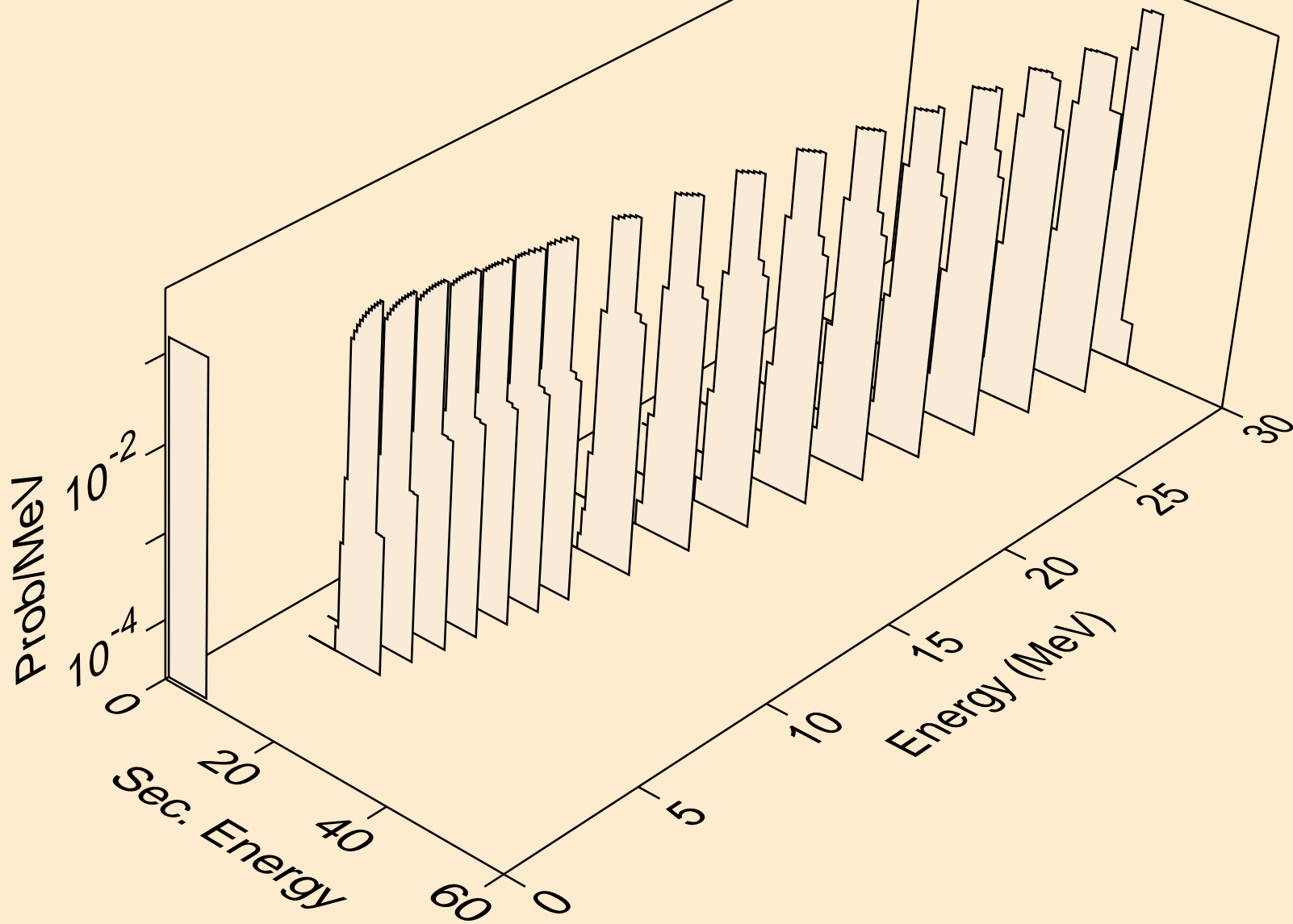

NB106 HELION ACER TENDL-2021 LIBRARY; T=0.K  
alphas from (s,pa)

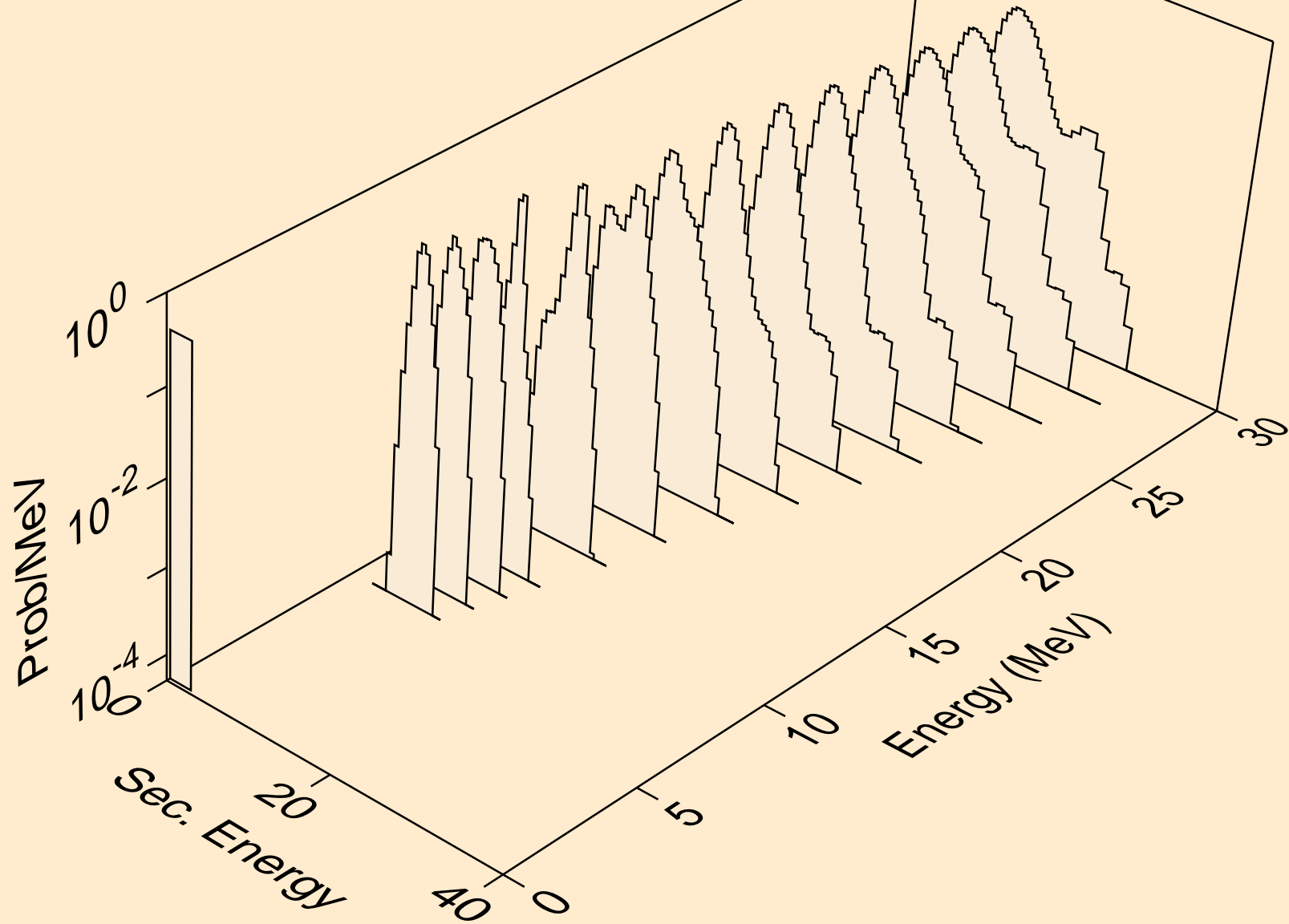

NB106 HELION ACER TENDL-2021 LIBRARY; T=0.K  
alphas from (s,da)

