

# ND146 HELION ACER TENDL-2021 LIBRARY; T=0.K

## Principal cross sections

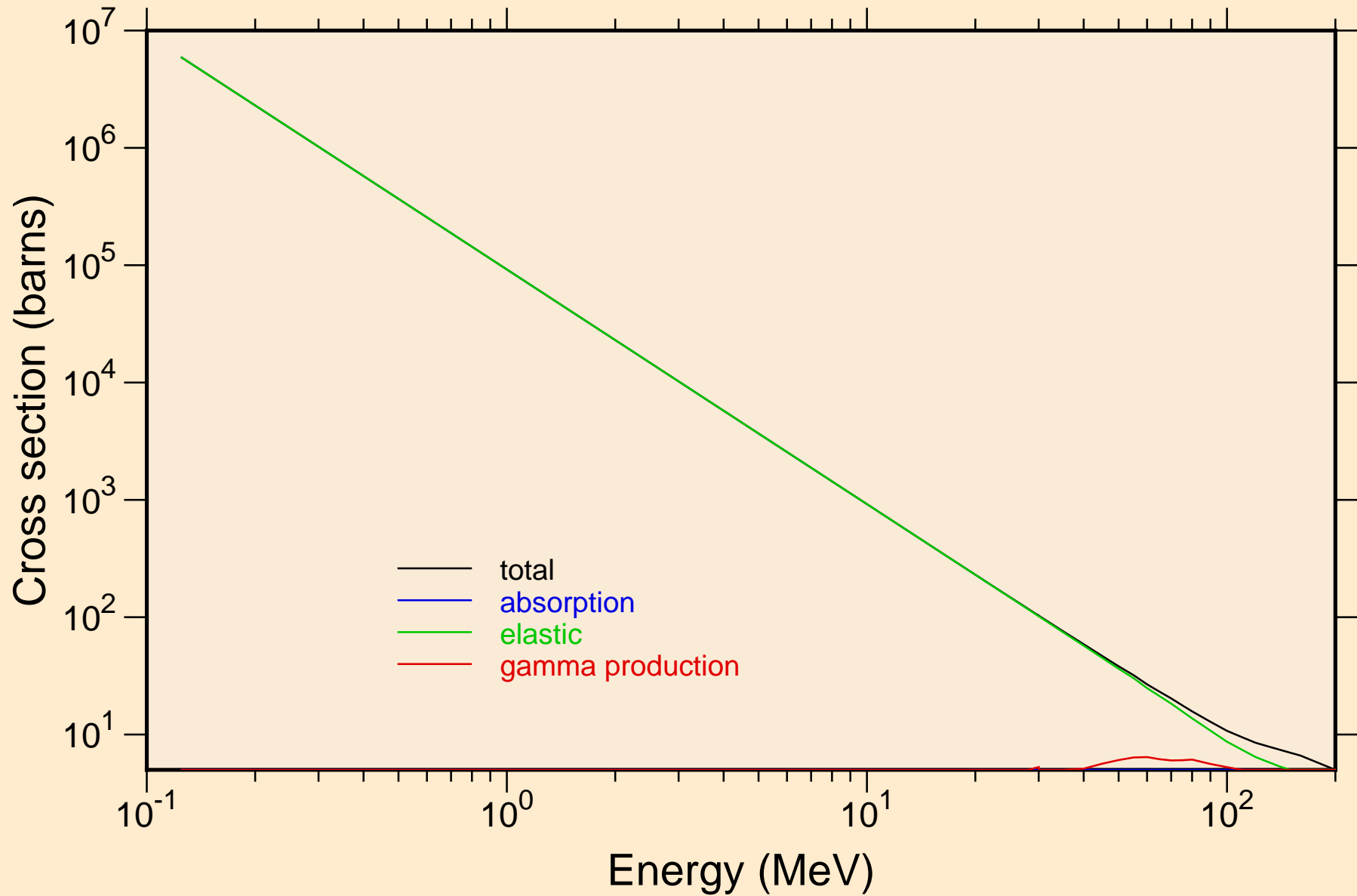

ND146 HELION ACER TENDL-2021 LIBRARY; T=0.K  
Heating

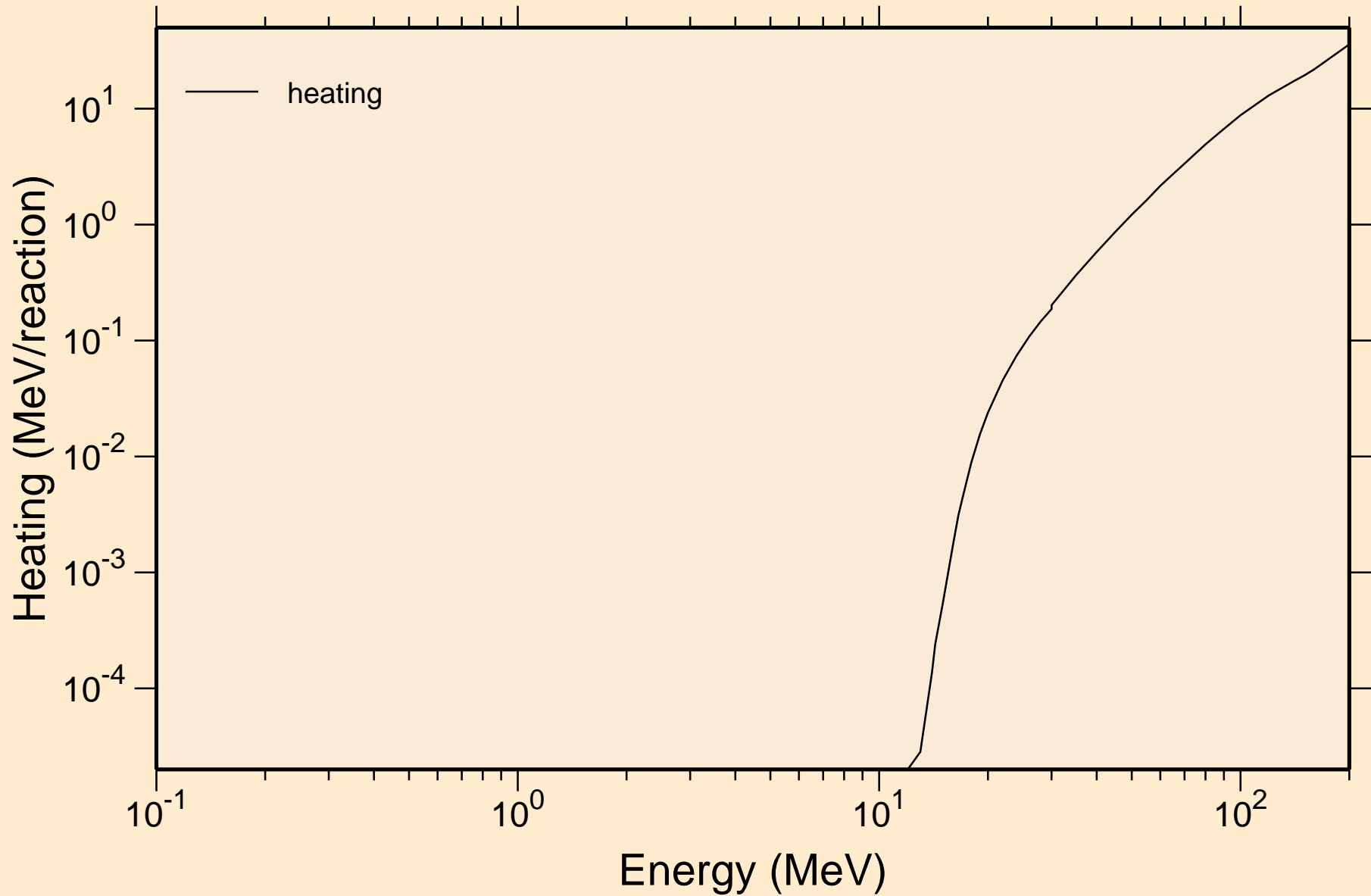

# ND146 HELION ACER TENDL-2021 LIBRARY; T=0.K

## Principal cross sections

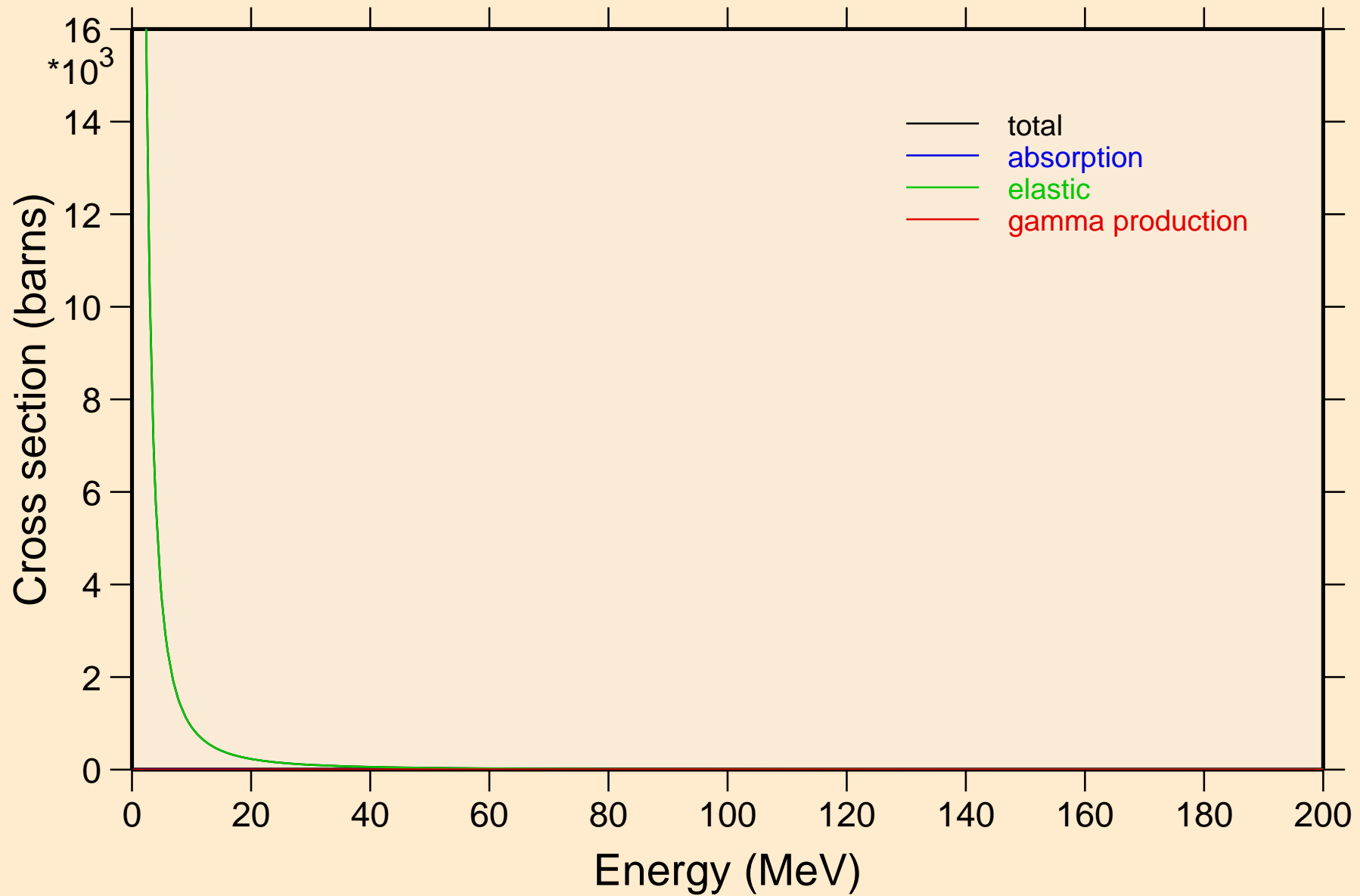

ND146 HELION ACER TENDL-2021 LIBRARY; T=0.K

Heating

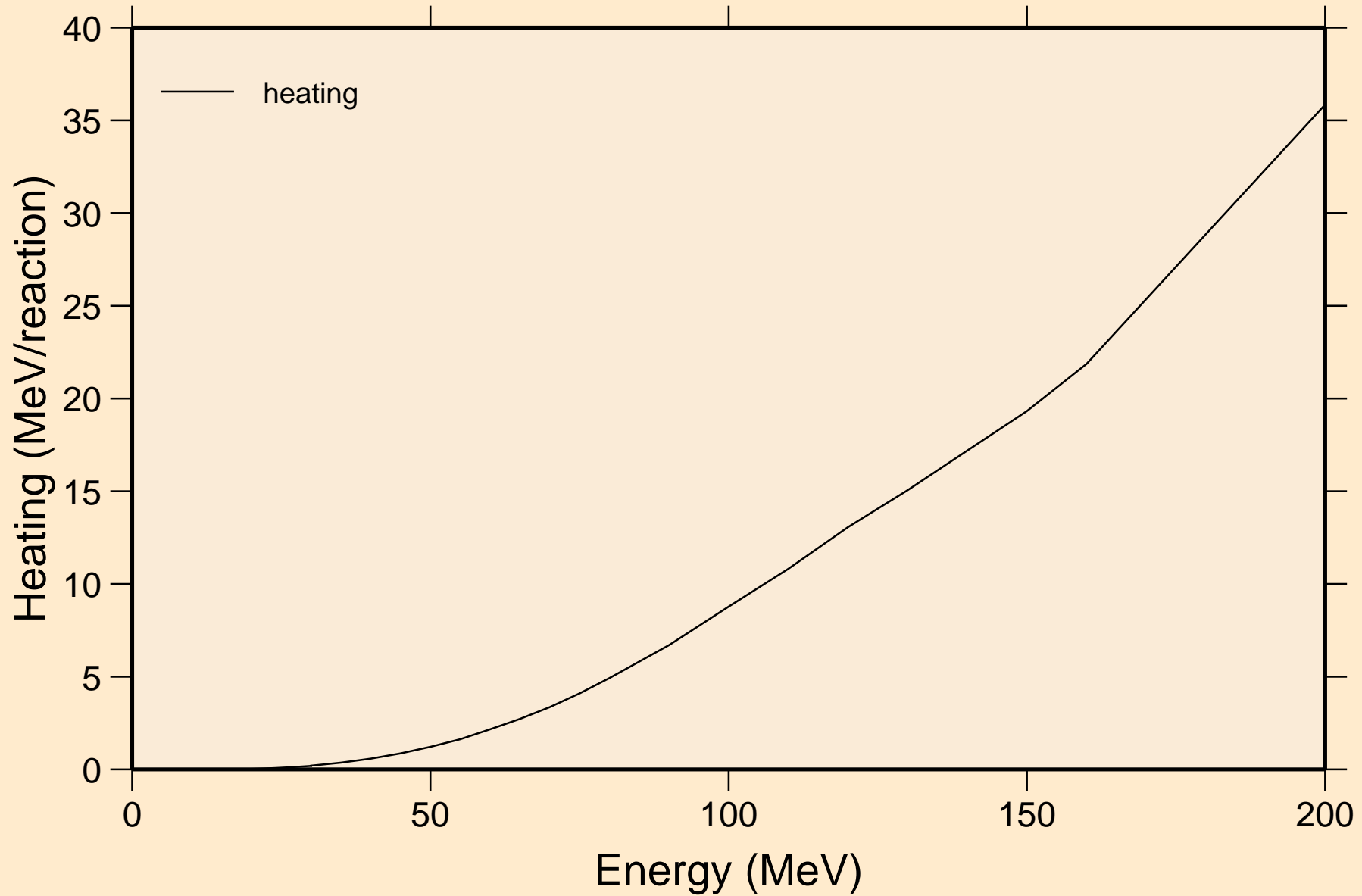

ND146 HELION ACER TENDL-2021 LIBRARY; T=0.K  
Threshold reactions

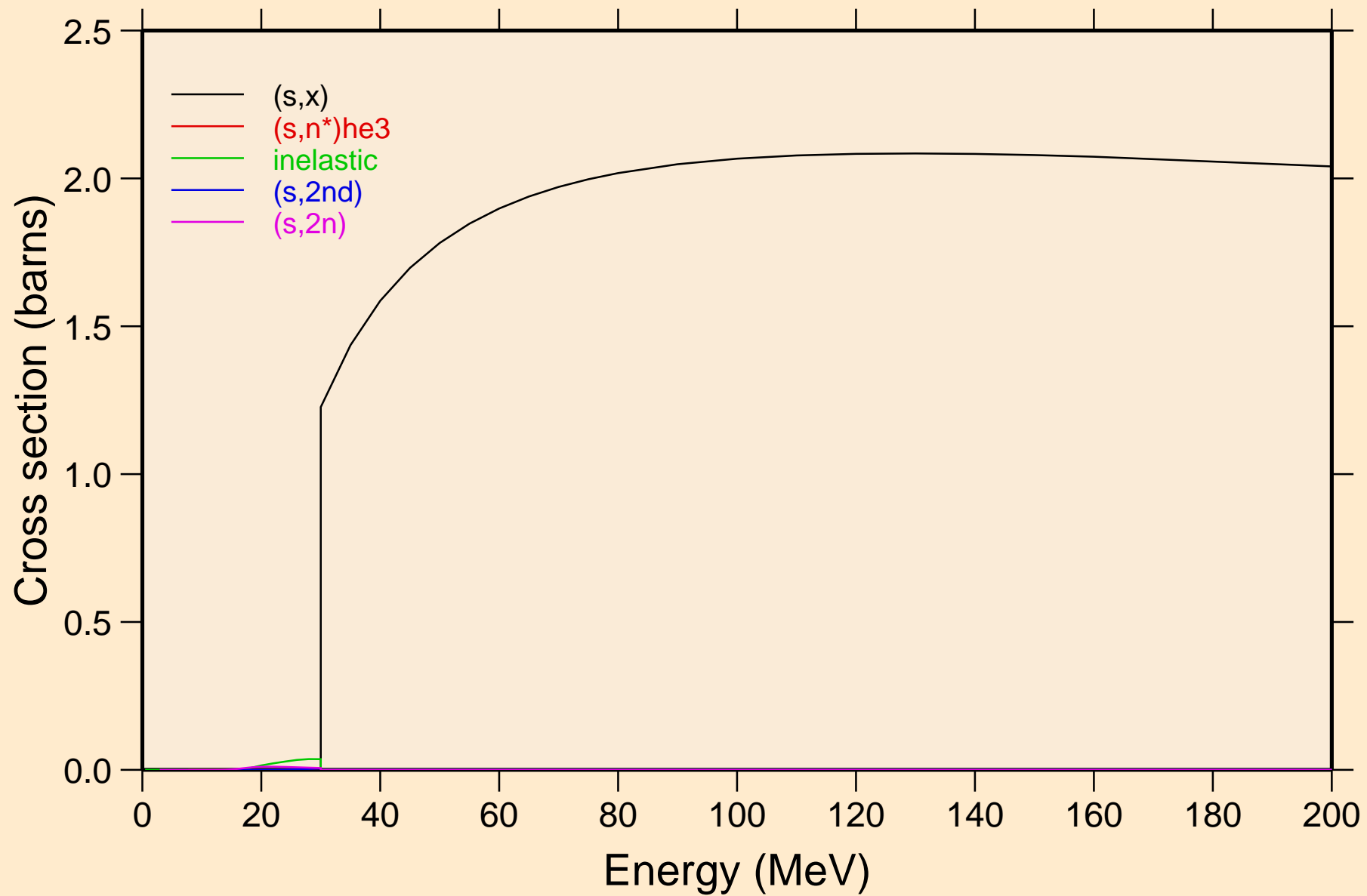

ND146 HELION ACER TENDL-2021 LIBRARY; T=0.K  
Threshold reactions

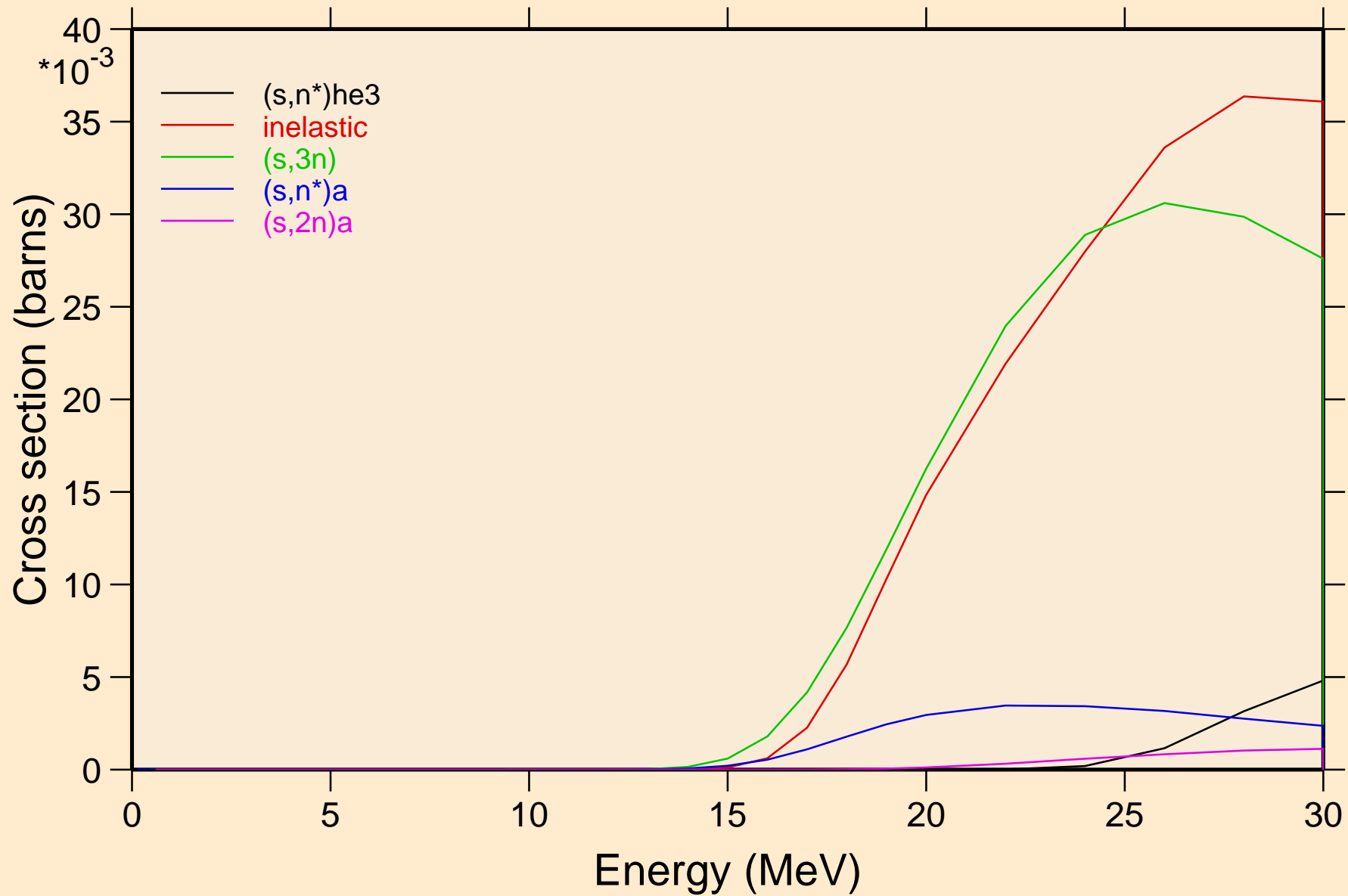

ND146 HELION ACER TENDL-2021 LIBRARY; T=0.K  
Threshold reactions

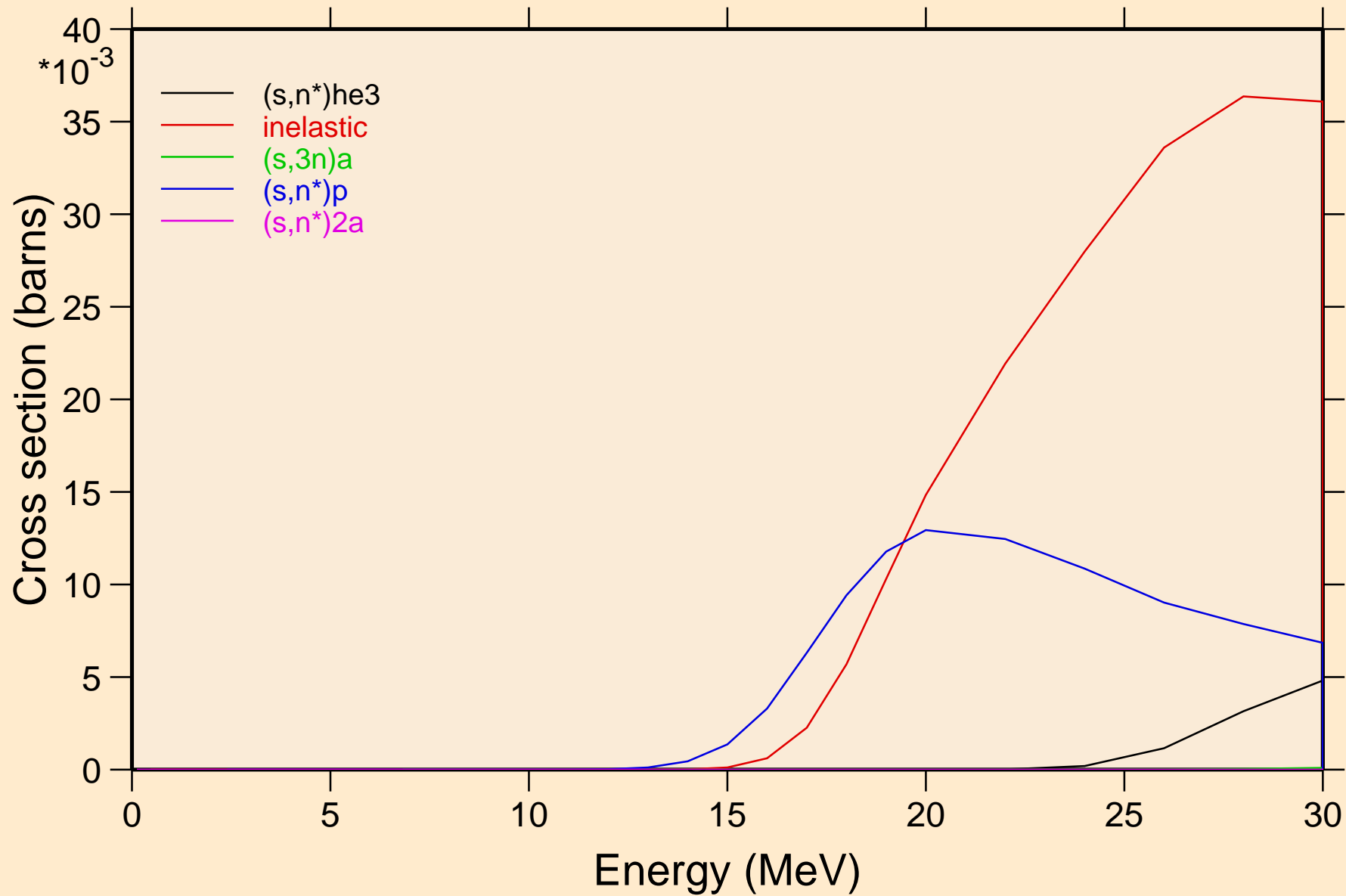

ND146 HELION ACER TENDL-2021 LIBRARY; T=0.K  
Threshold reactions

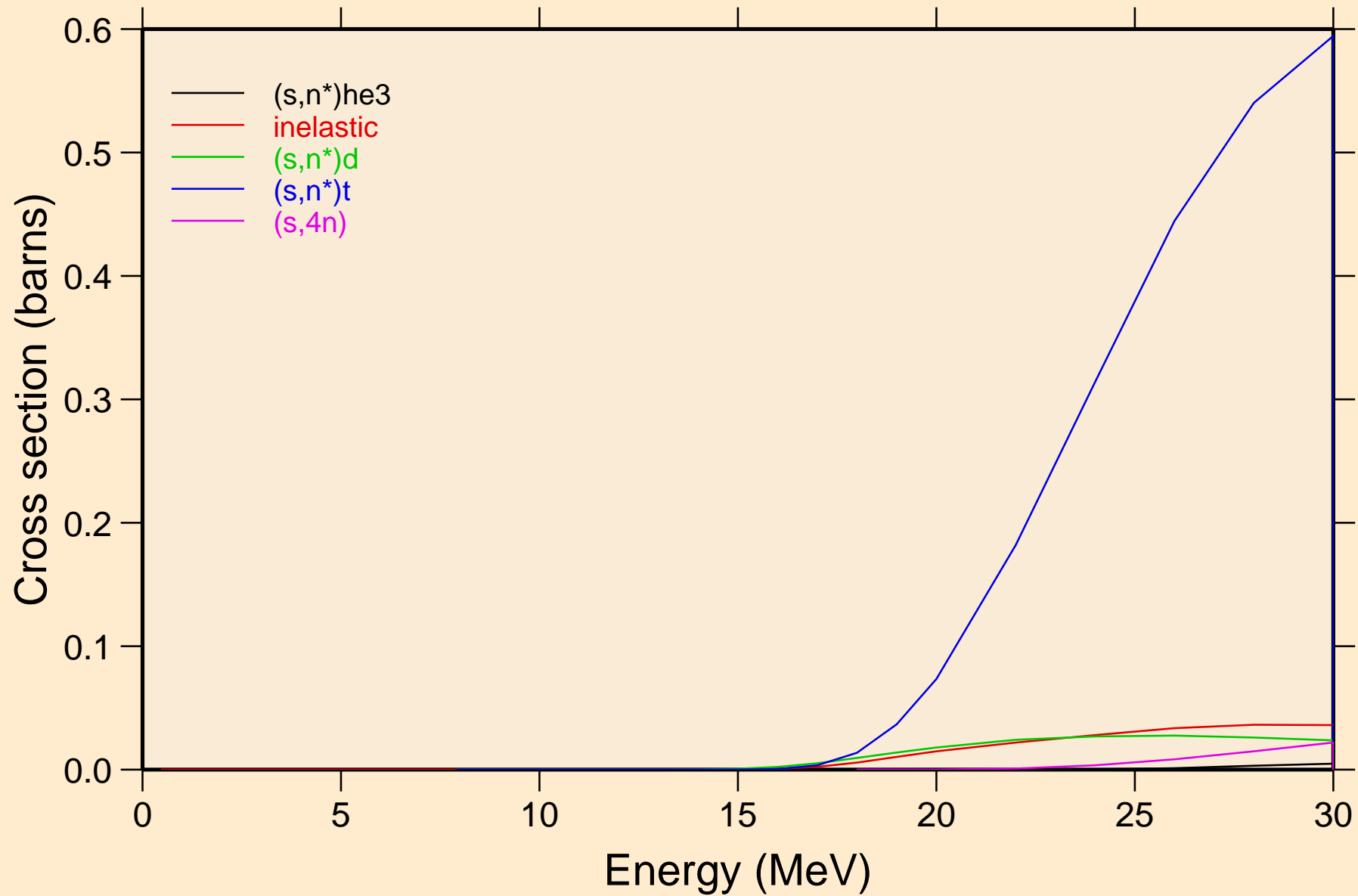



# ND146 HELION ACER TENDL-2021 LIBRARY; T=0.K

## Threshold reactions

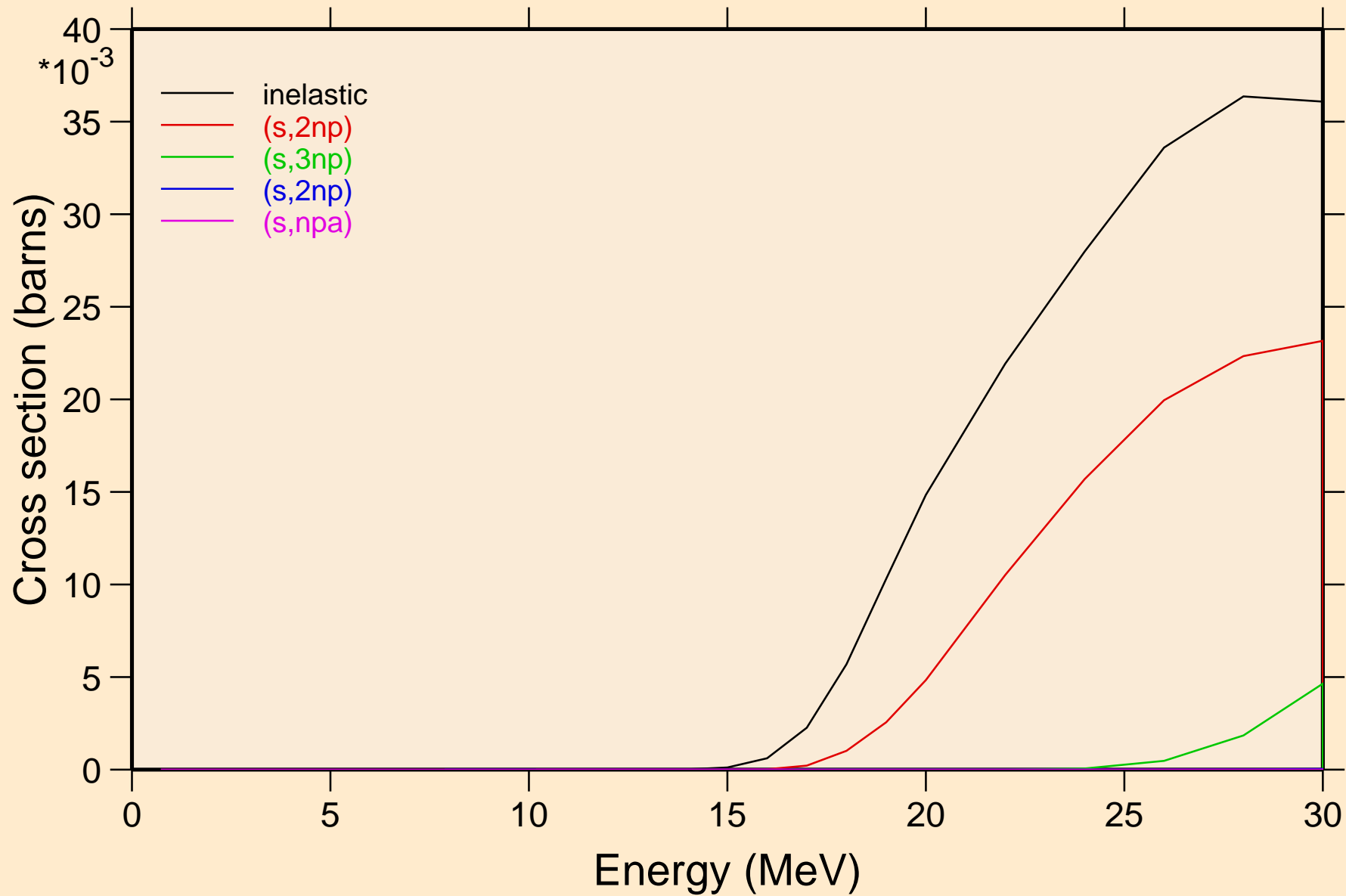

# ND146 HELION ACER TENDL-2021 LIBRARY; T=0.K

## Threshold reactions

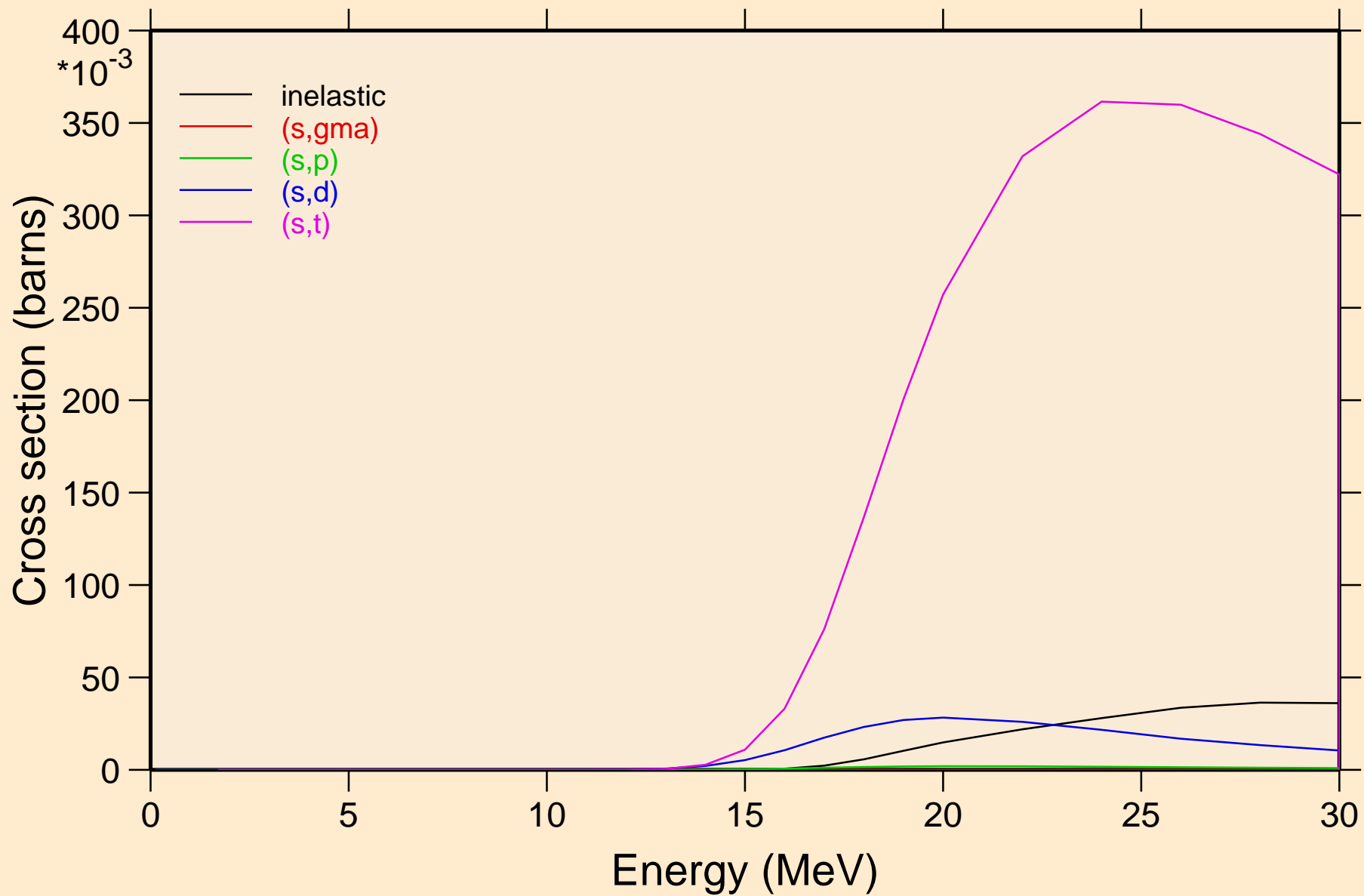

ND146 HELION ACER TENDL-2021 LIBRARY; T=0.K  
Threshold reactions

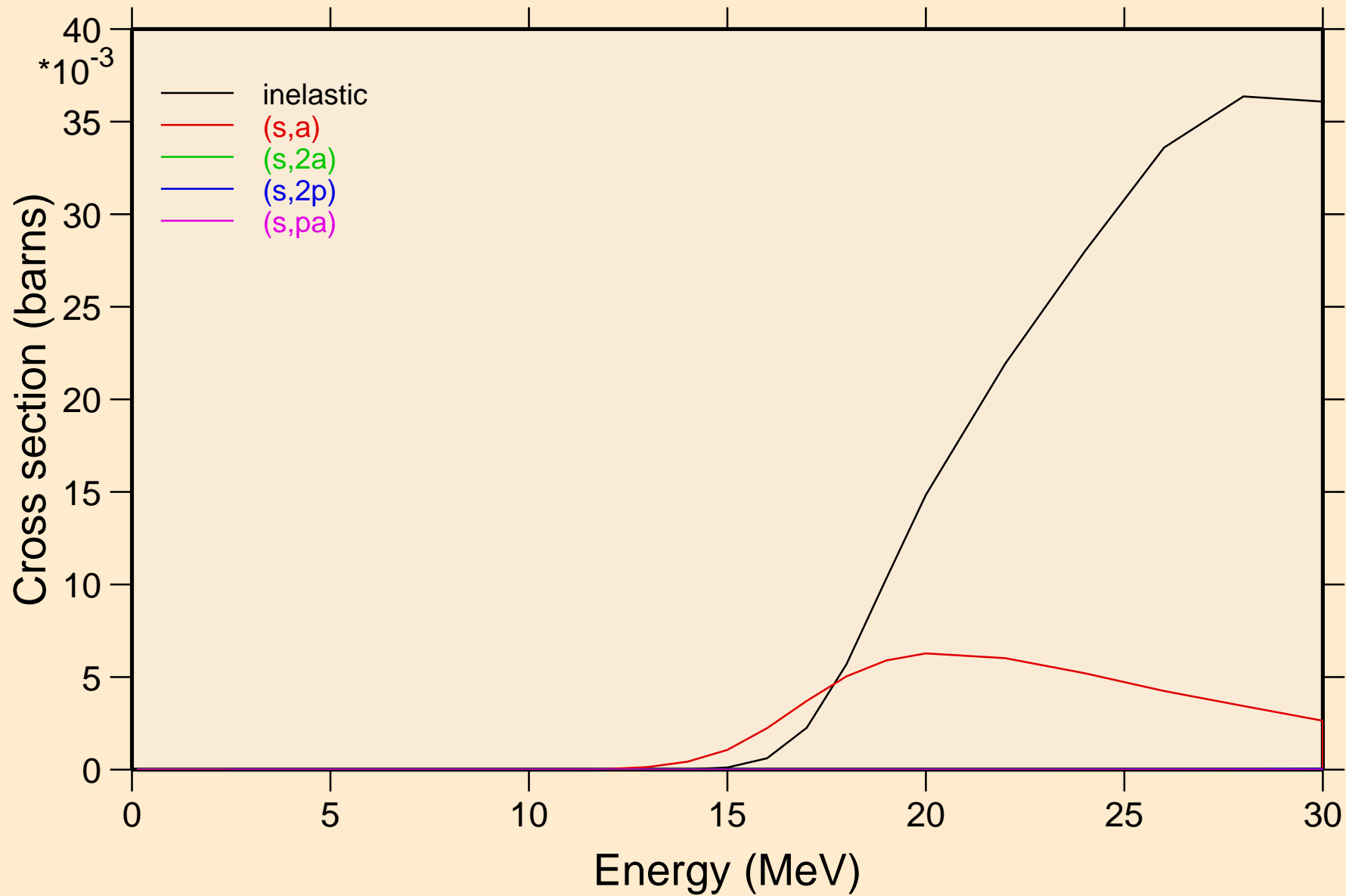

ND146 HELION ACER TENDL-2021 LIBRARY; T=0.K  
Threshold reactions

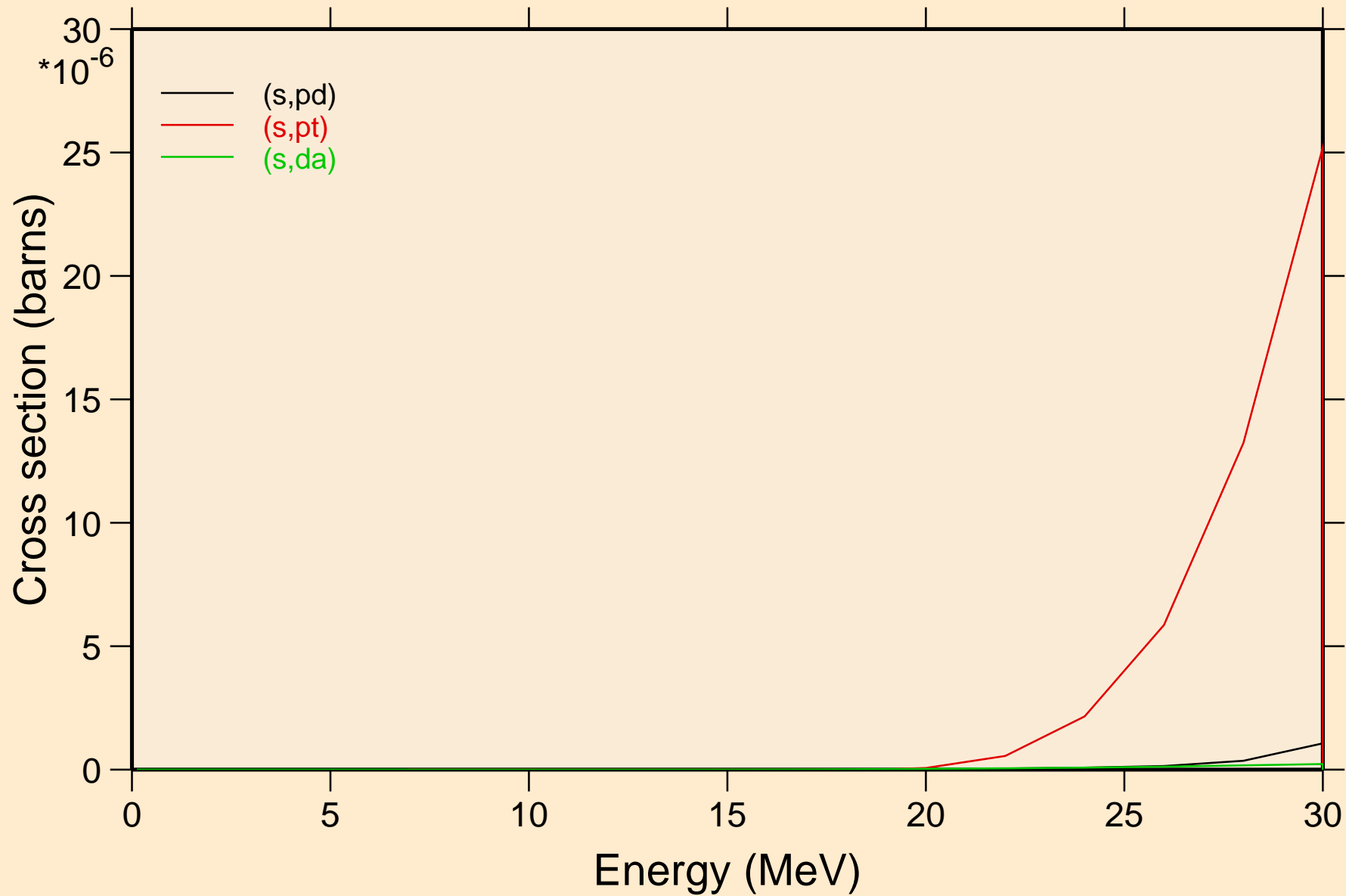

ND146 HELION ACER TENDL-2021 LIBRARY; T=0.K  
angular distribution for elastic

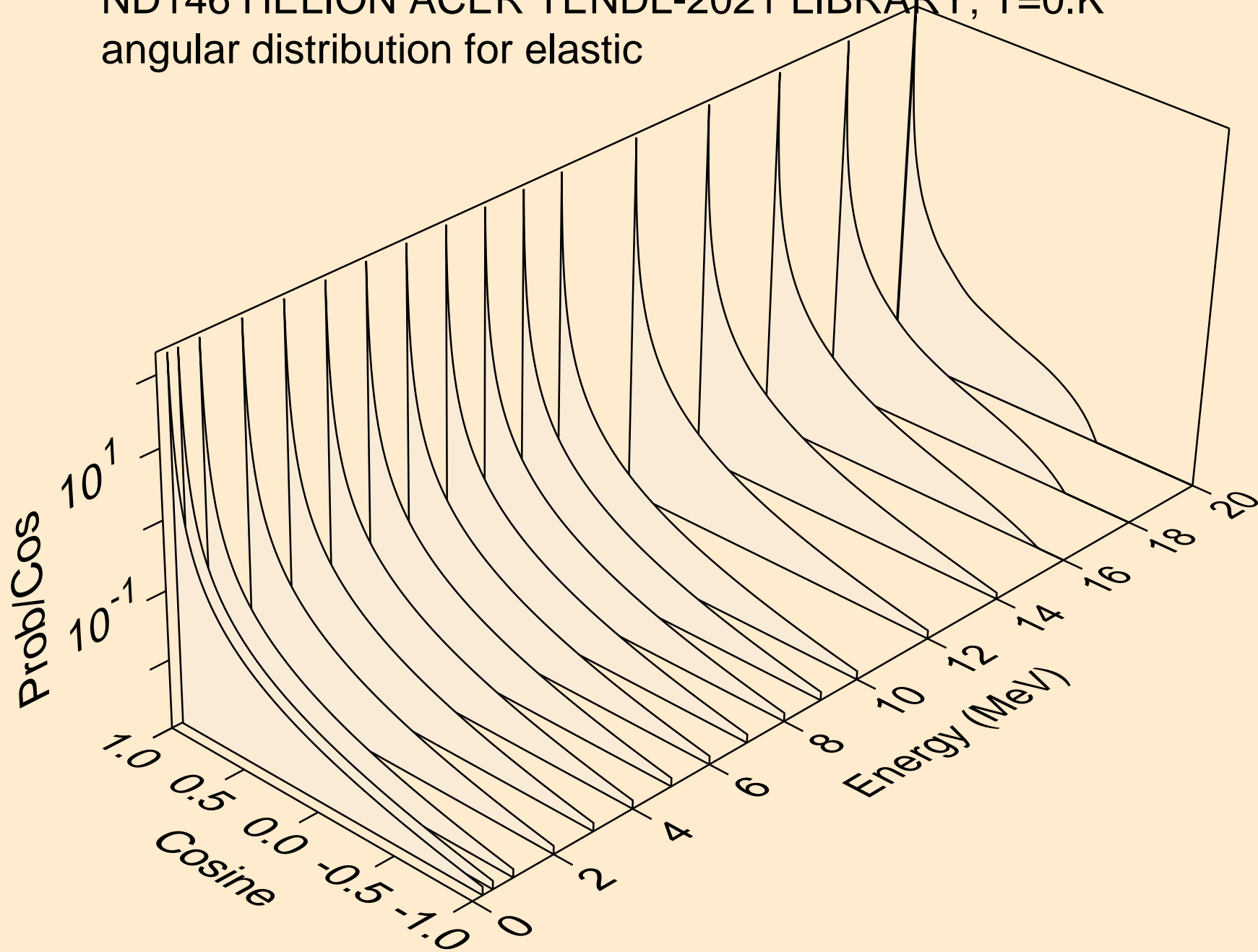

ND146 HELION ACER TENDL-2021 LIBRARY; T=0.K  
angular distribution for elastic

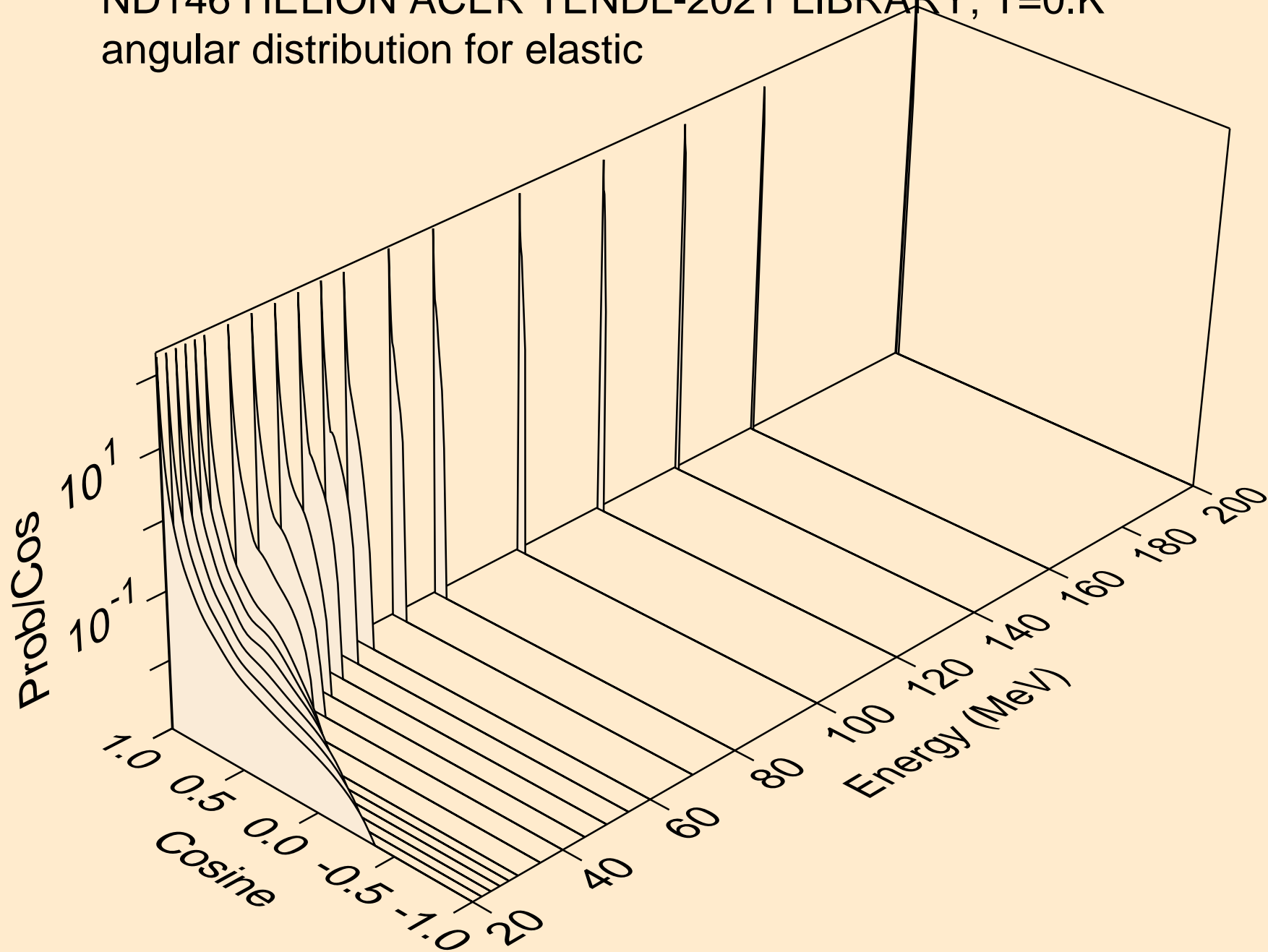

ND146 HELION ACER TENDL-2021 LIBRARY; T=0.K  
He-3 emission for (s,x)

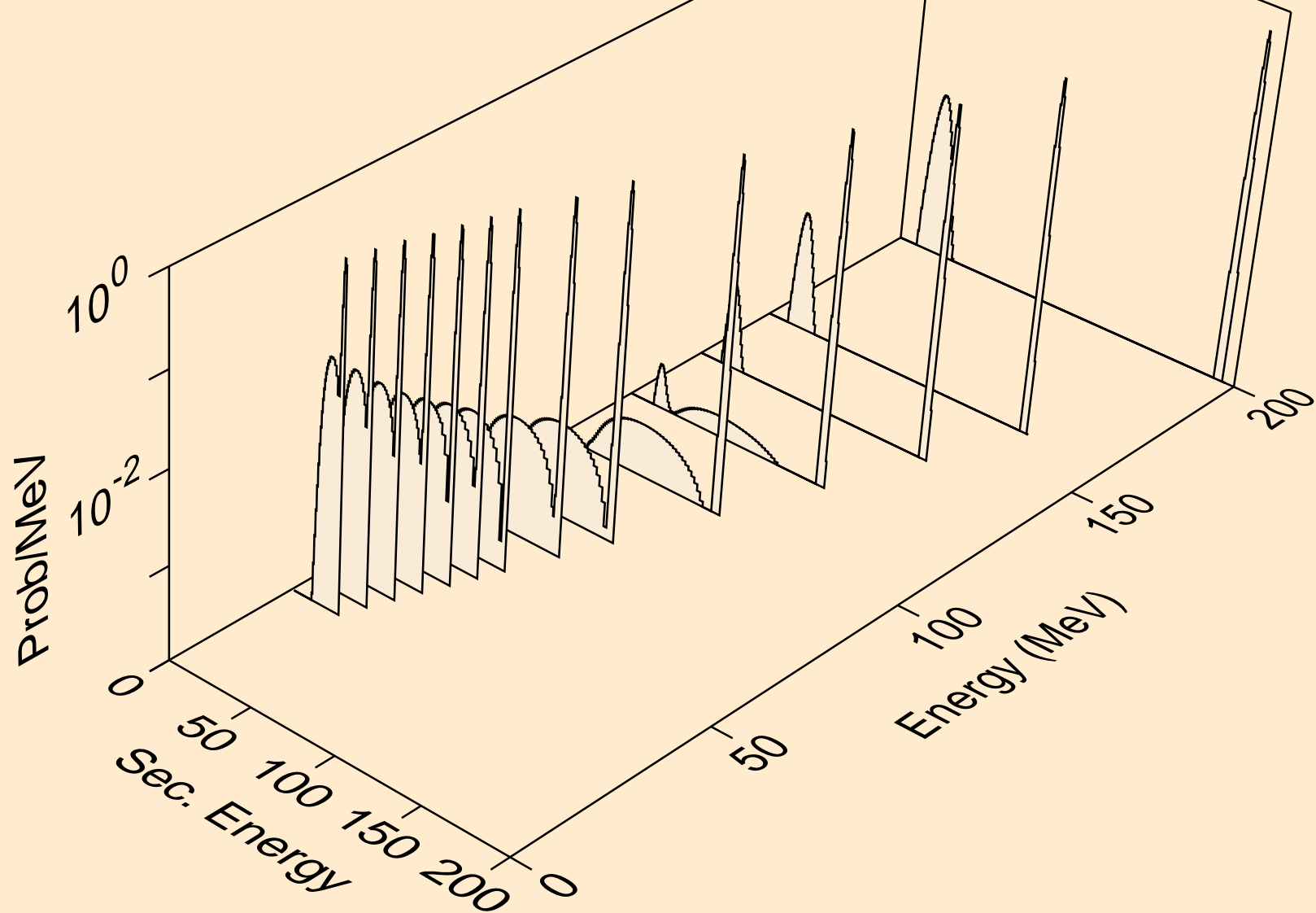

ND146 HELION ACER TENDL-2021 LIBRARY; T=0.K  
He-3 emission for (s,n\*)he3

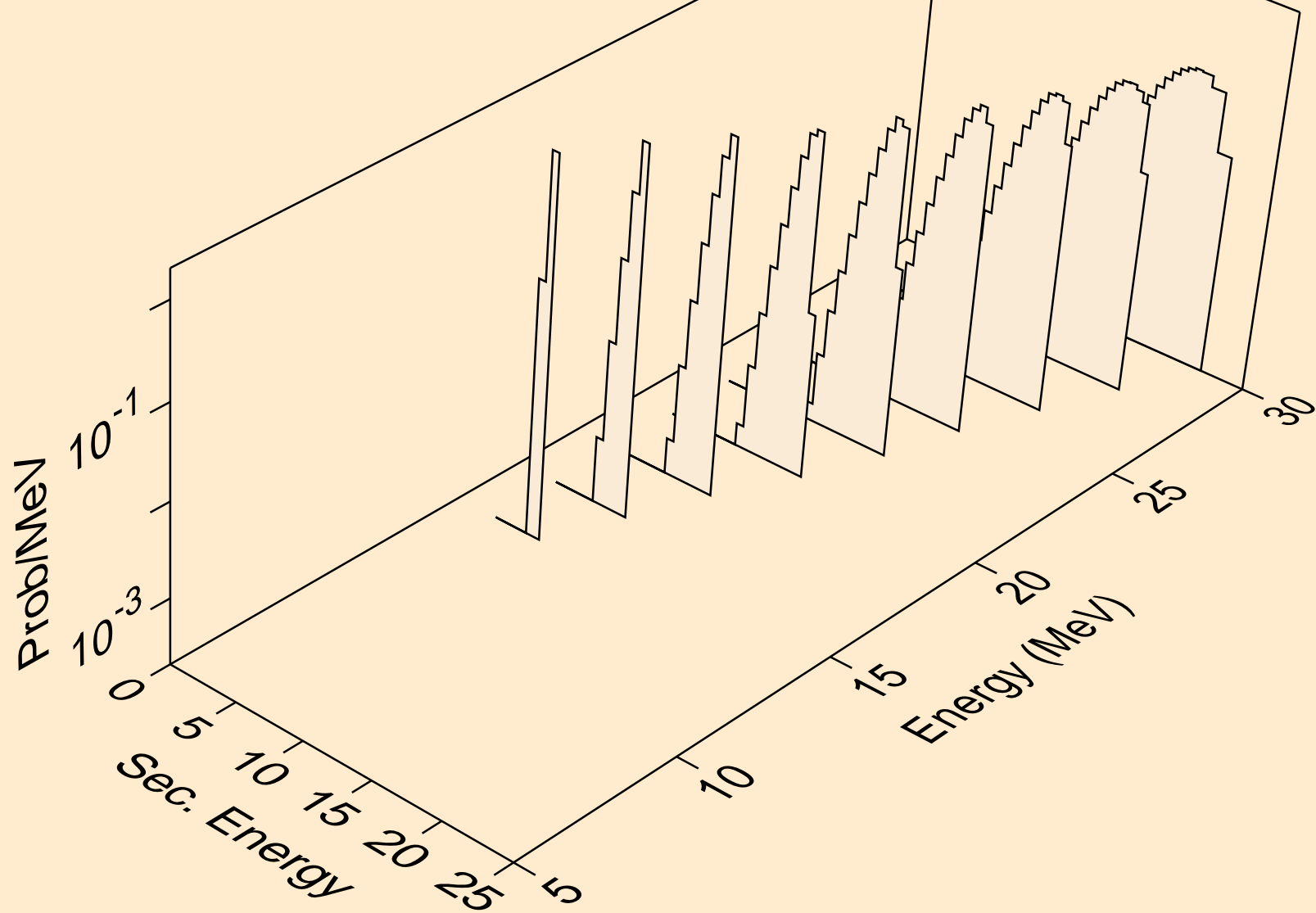



ND146 HELION ACER TENDL-2021 LIBRARY; T=0.K  
He-3 emission for inelastic

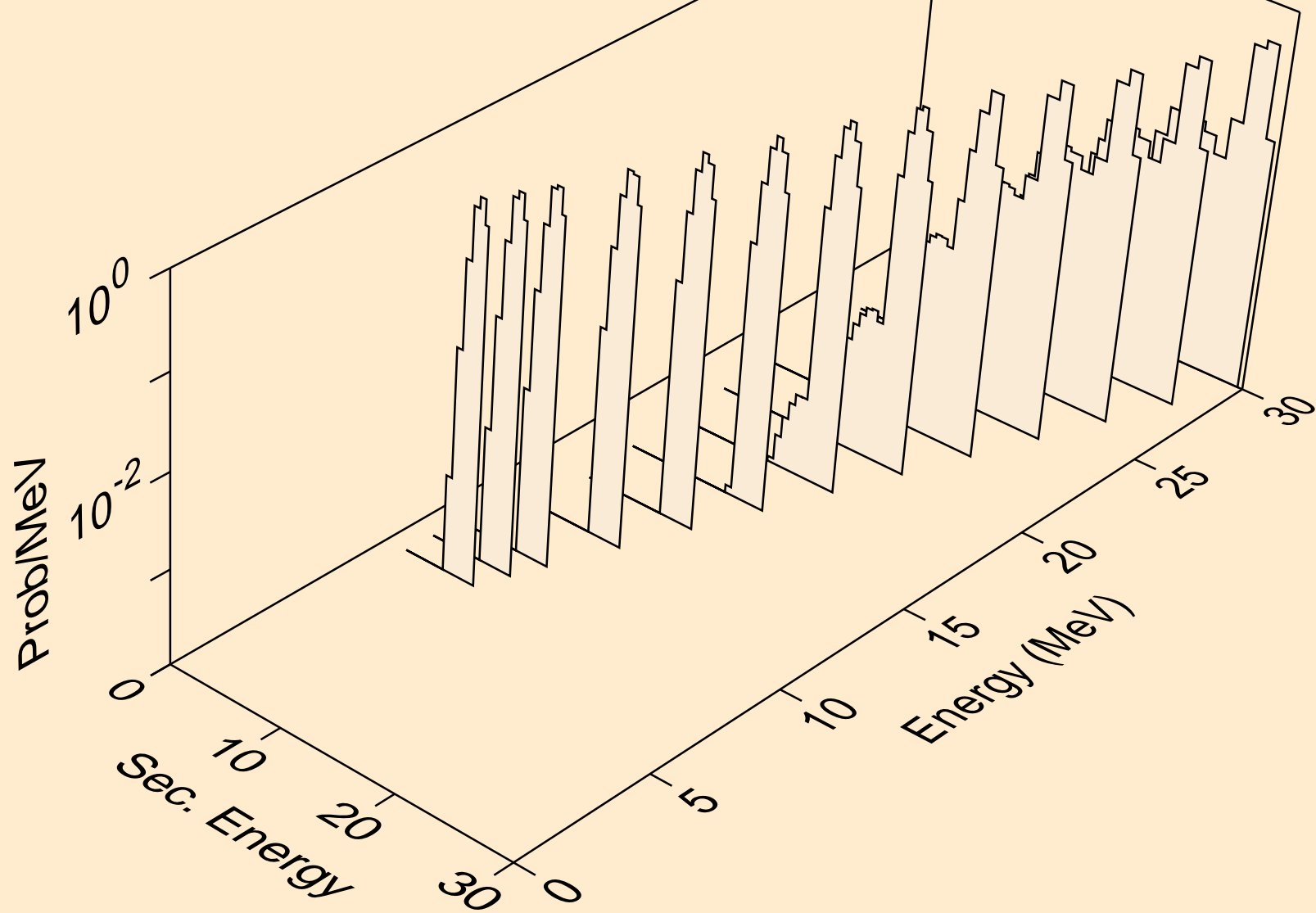

ND146 HELION ACER TENDL-2021 LIBRARY; T=0.K  
Photon emission for (z,n)

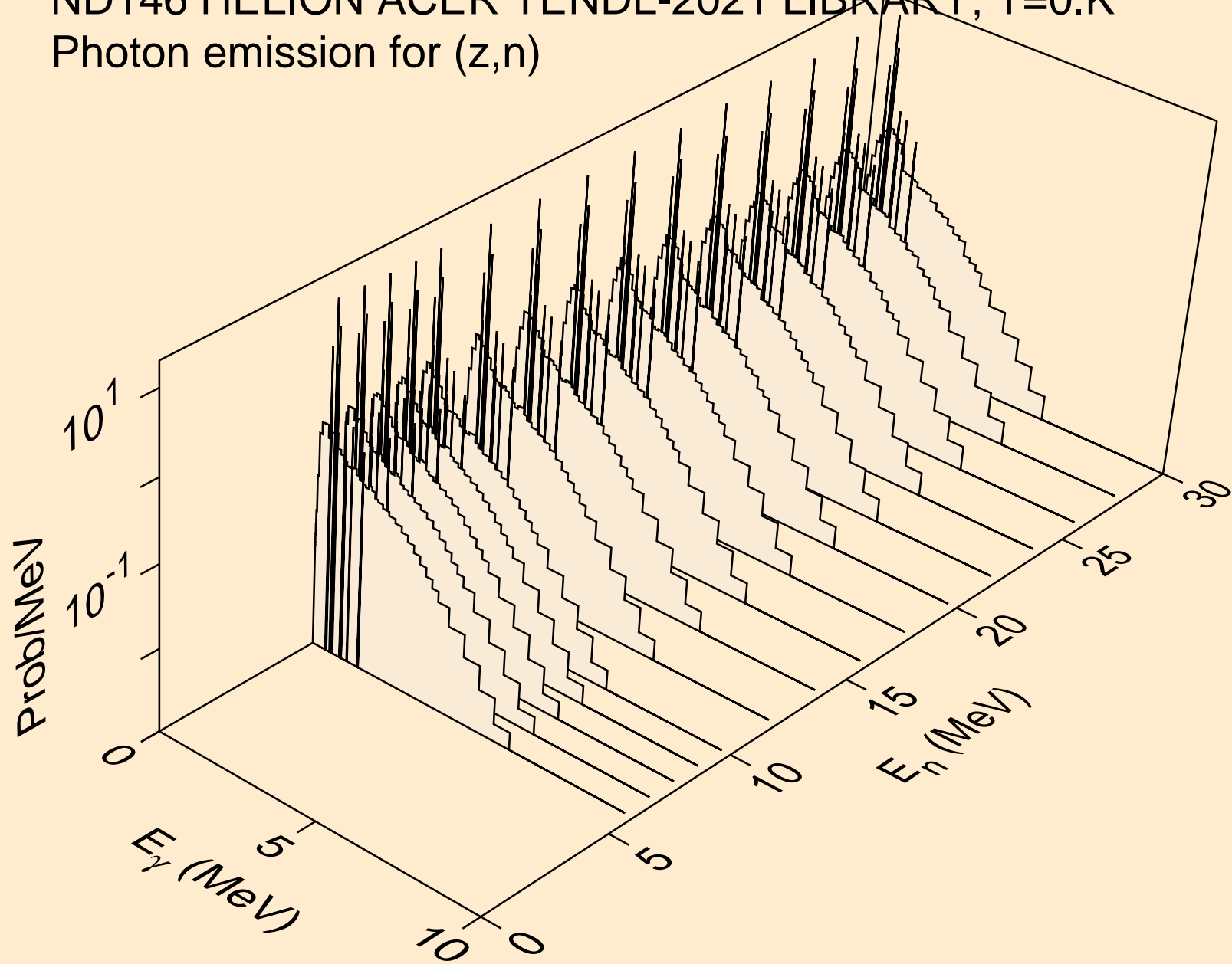

ND146 HELION ACER TENDL-2021 LIBRARY; T=0.K  
Photon emission for (n,x)

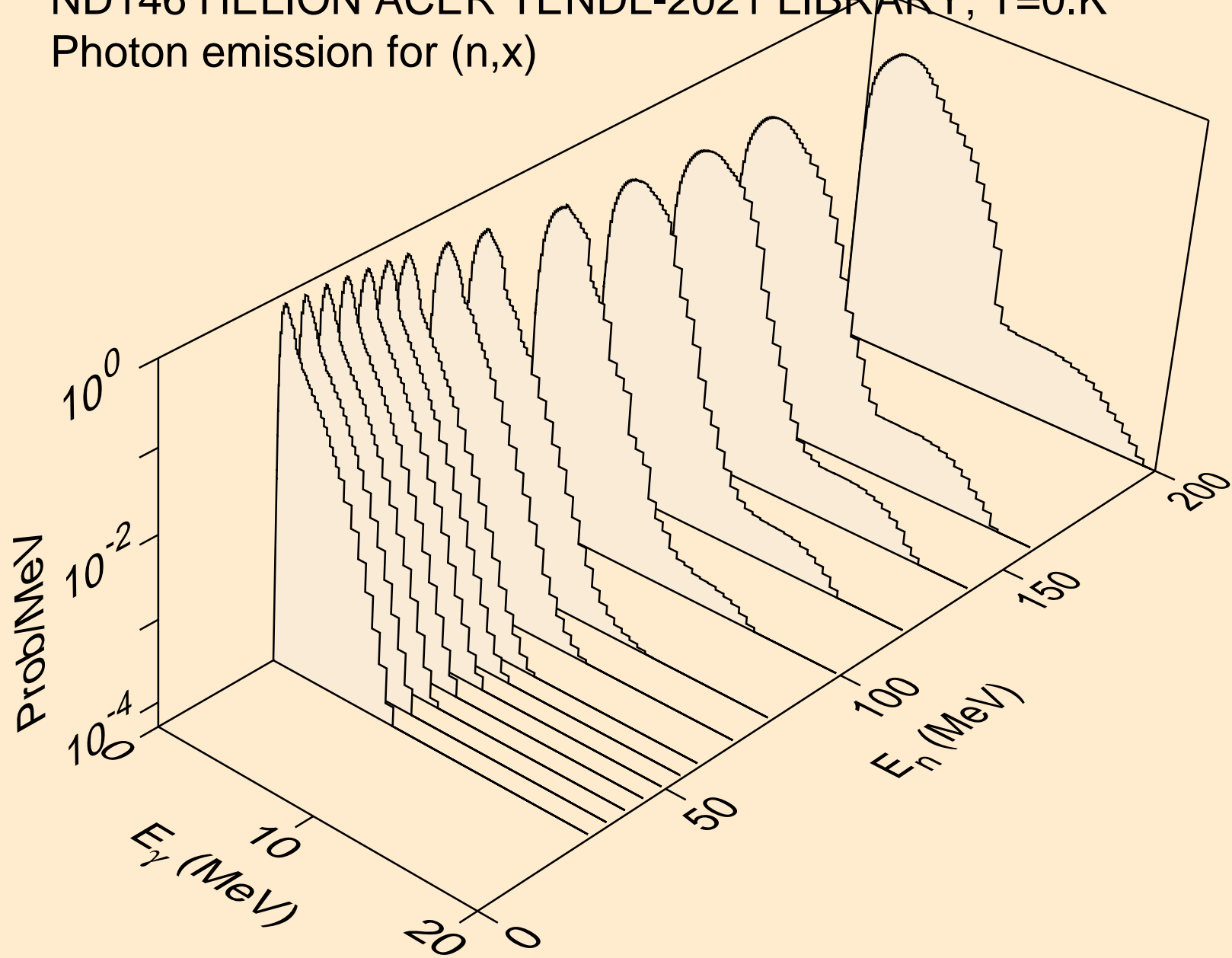

ND146 HELION ACER TENDL-2021 LIBRARY; T=0.K  
Photon emission for (n,2nd)

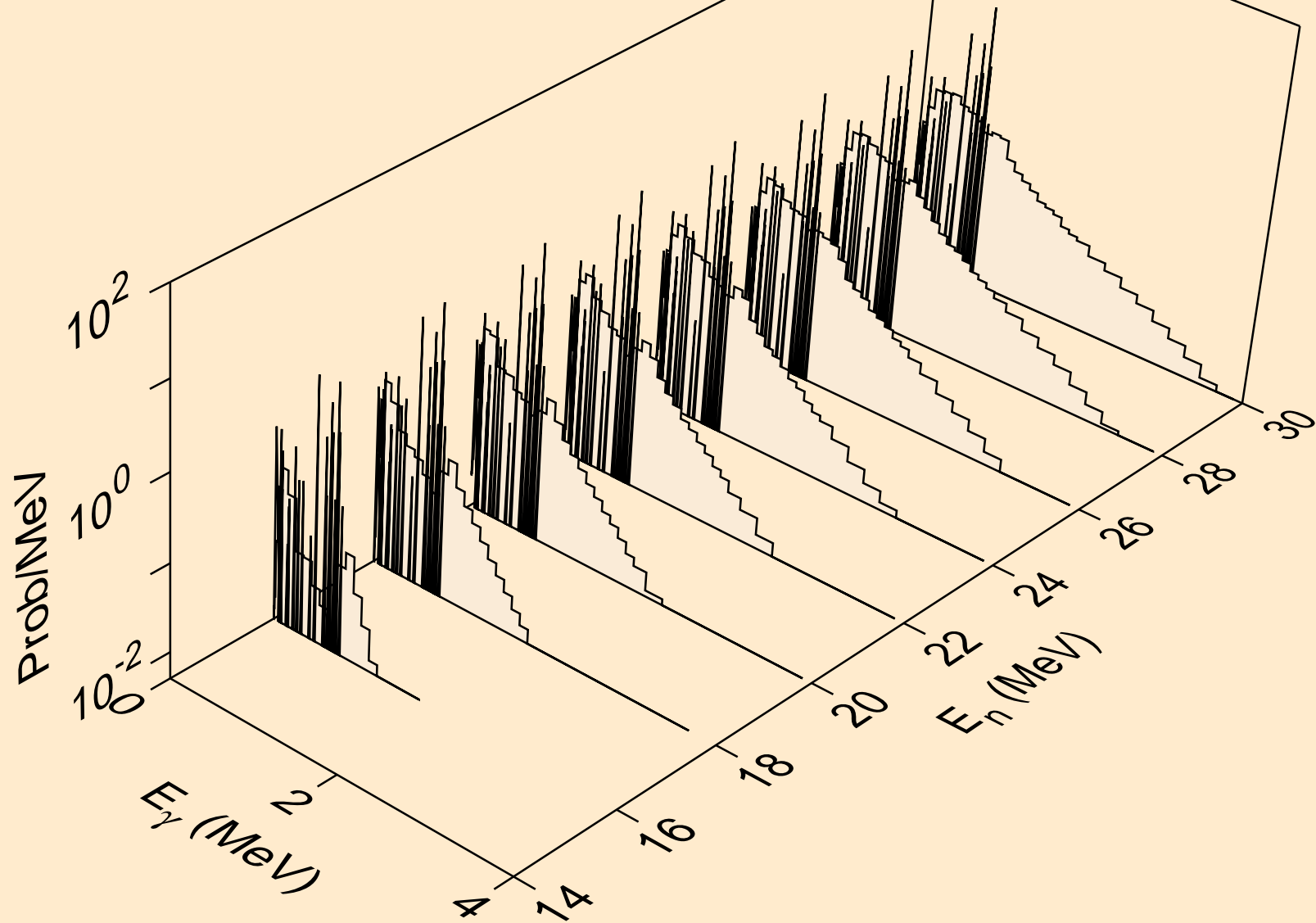

ND146 HELION ACER TENDL-2021 LIBRARY; T=0.K  
Photon emission for (n,2n)

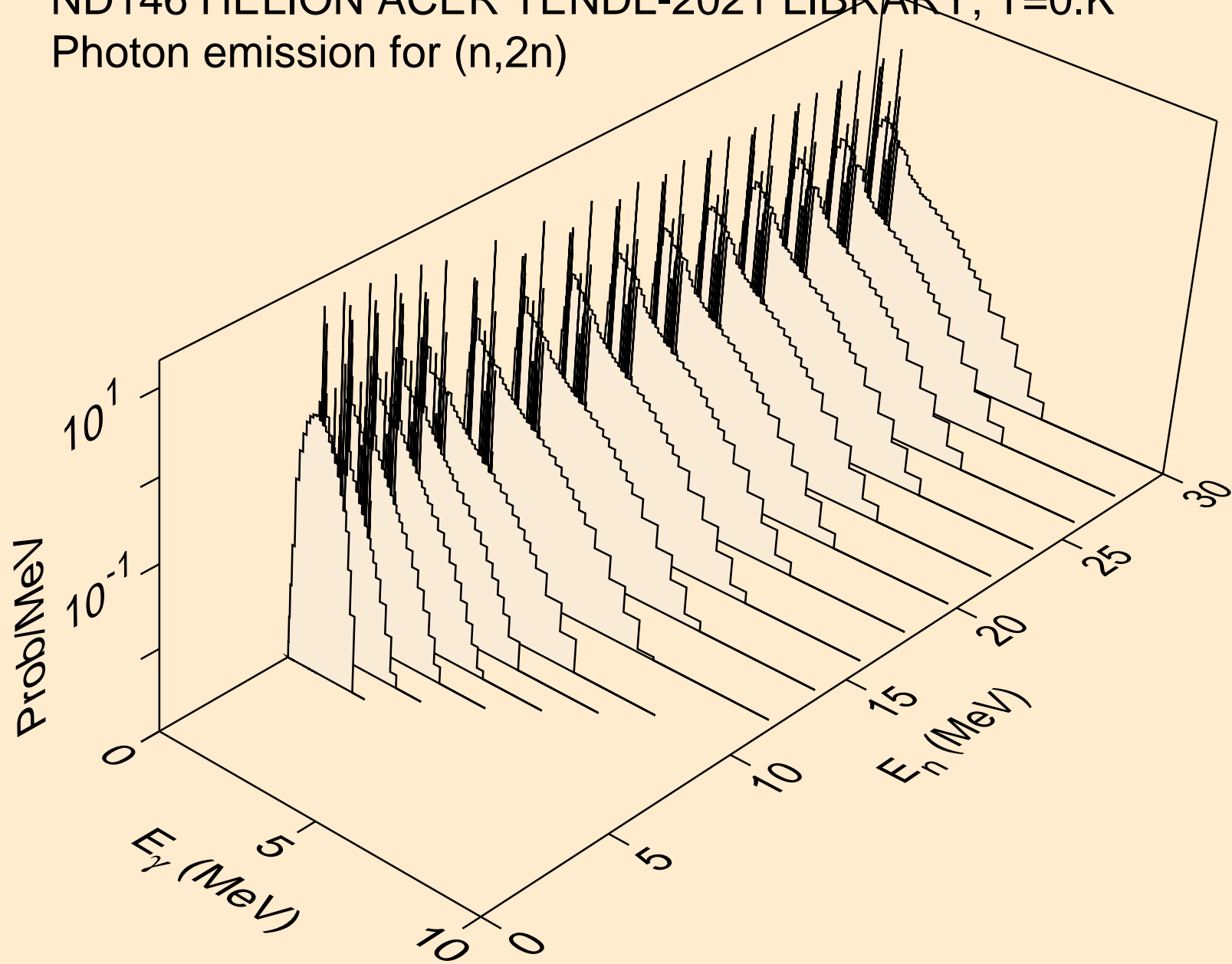

ND146 HELION ACER TENDL-2021 LIBRARY; T=0.K  
Photon emission for (n,3n)

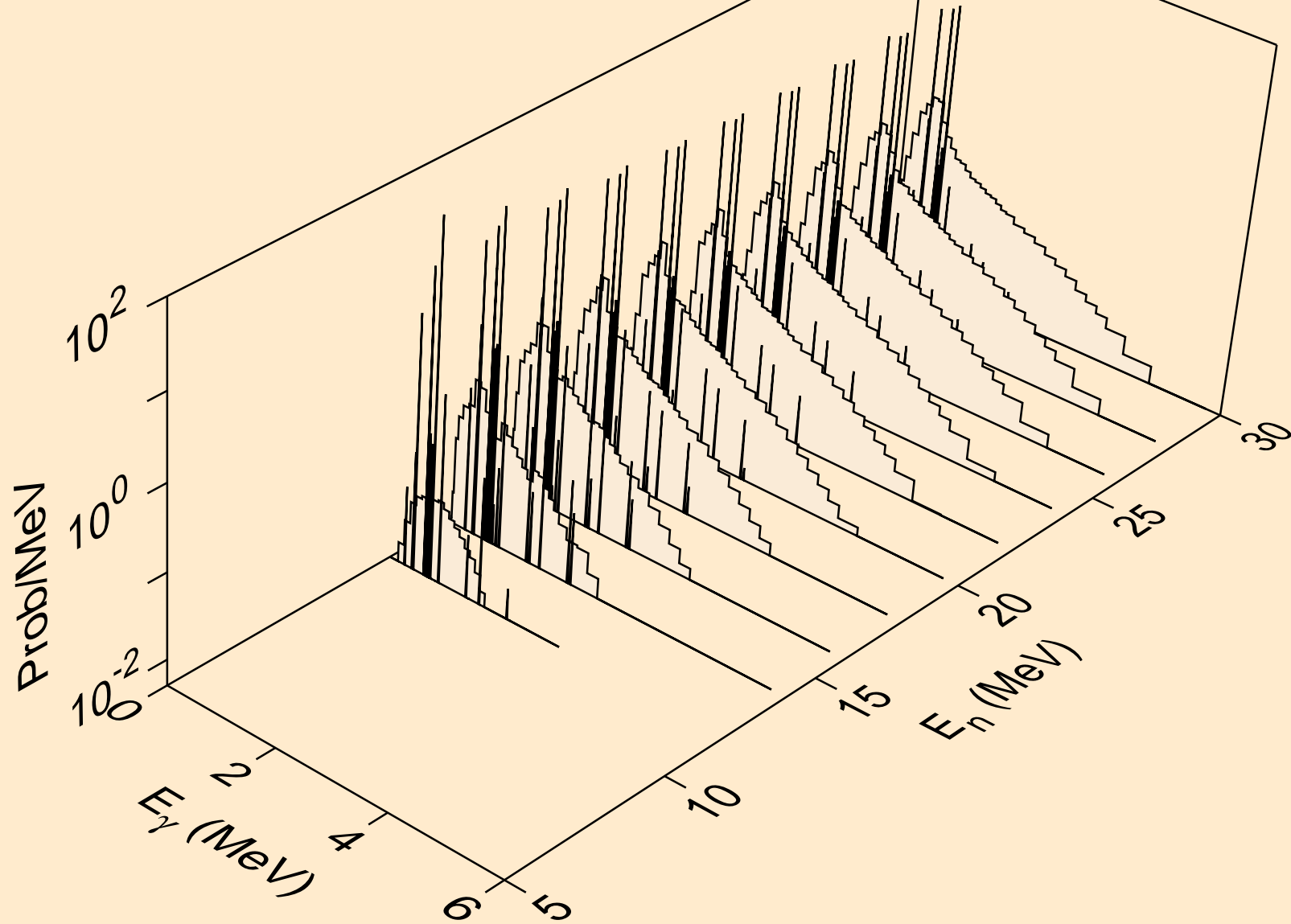

ND146 HELION ACER TENDL-2021 LIBRARY; T=0.K  
Photon emission for (n,n\*)a

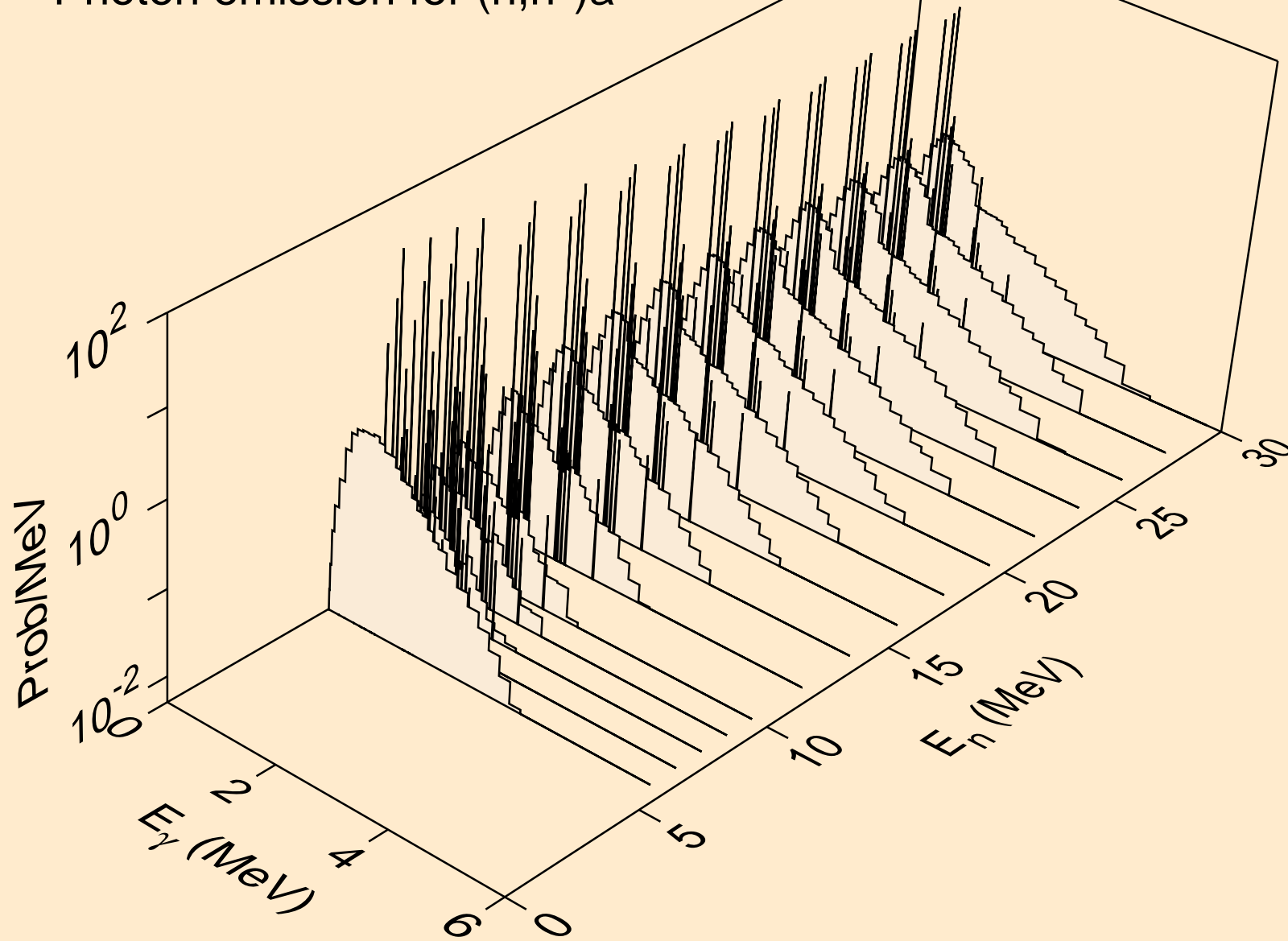

ND146 HELION ACER TENDL-2021 LIBRARY; T=0.K  
Photon emission for (n,2n)a

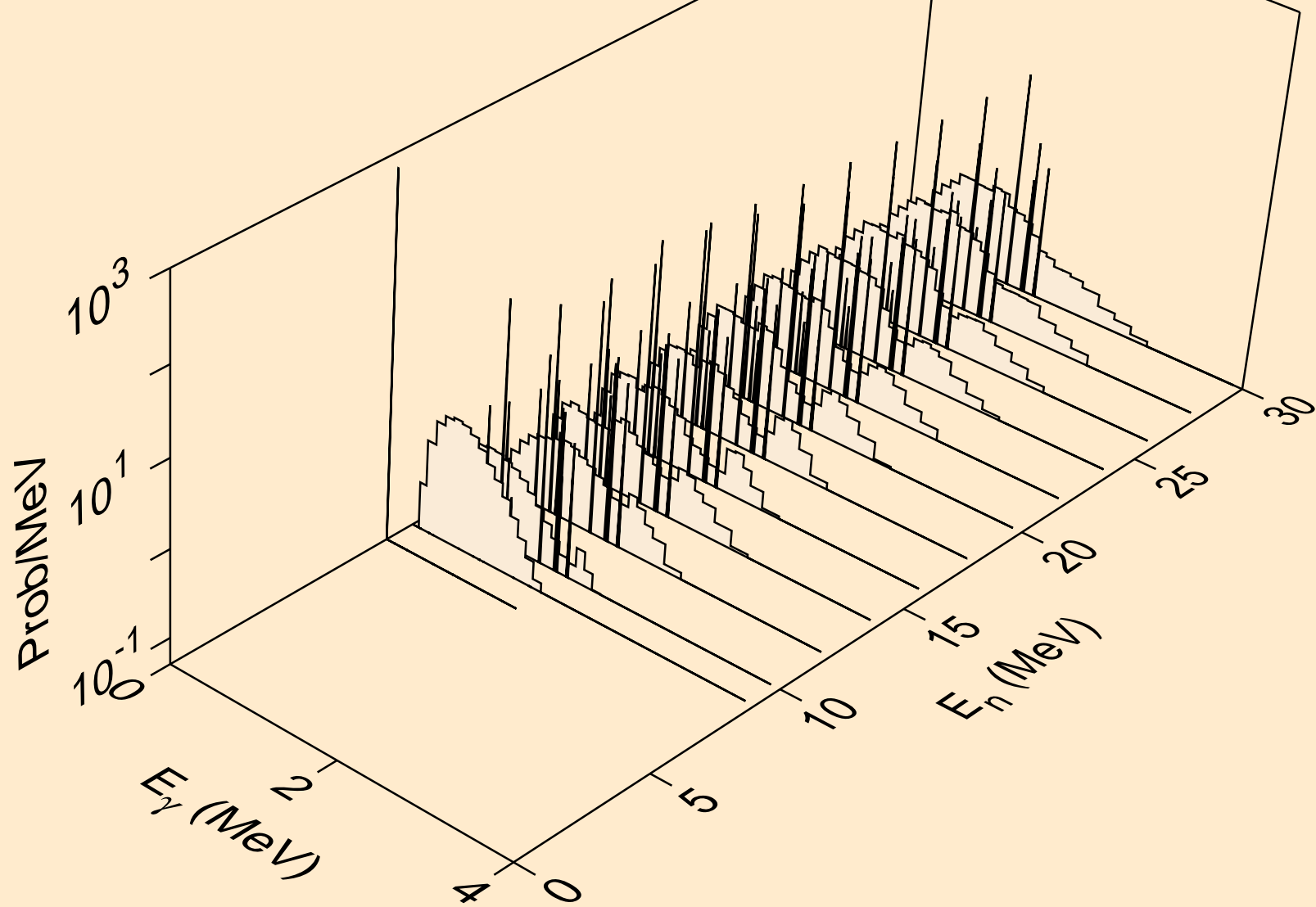



ND146 HELION ACER TENDL-2021 LIBRARY; T=0.K  
Photon emission for (n,3n)a

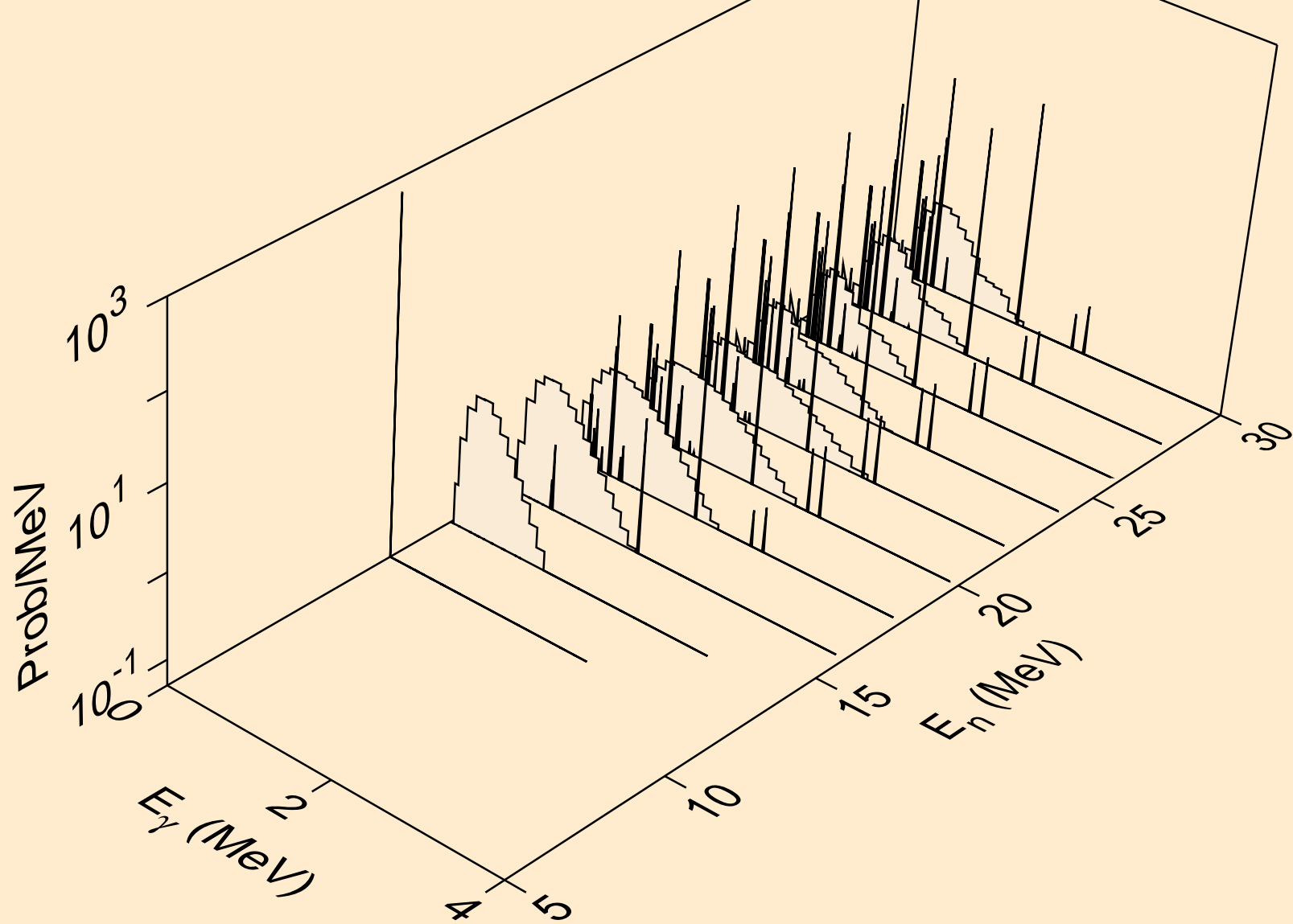

ND146 HELION ACER TENDL-2021 LIBRARY; T=0.K  
Photon emission for (n,n\*)p

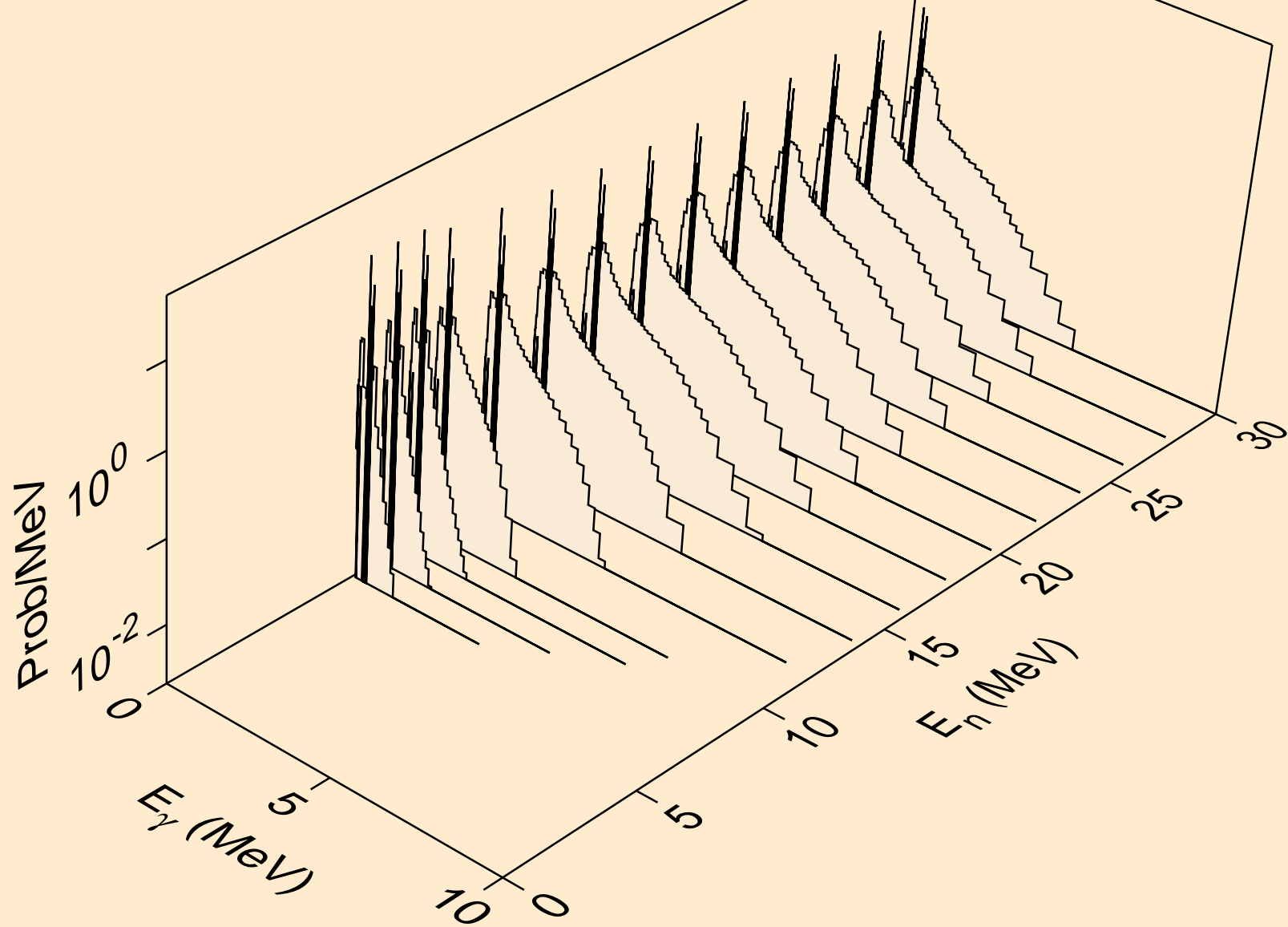

ND146 HELION ACER TENDL-2021 LIBRARY; T=0.K  
Photon emission for (n,n\*)2a

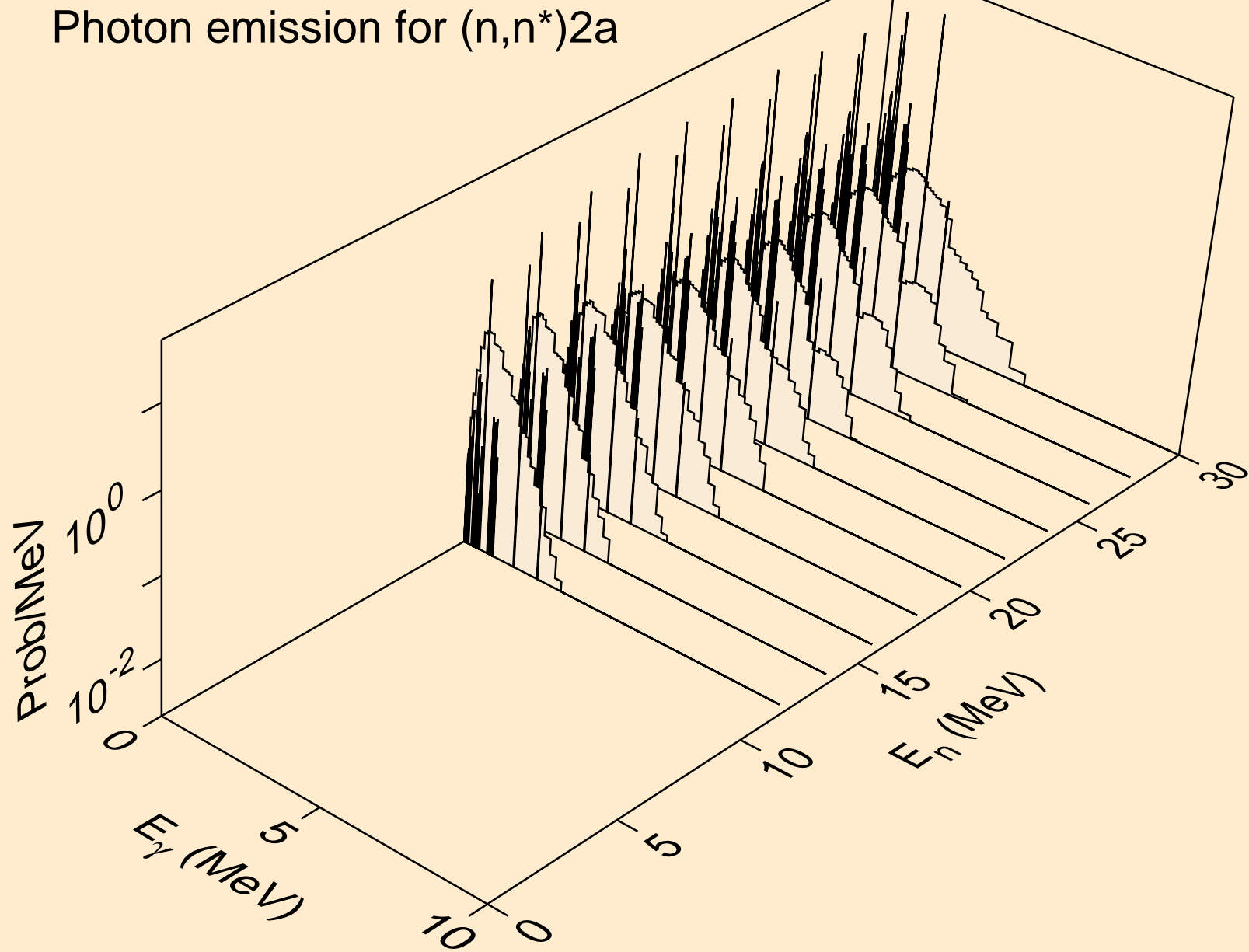

ND146 HELION ACER TENDL-2021 LIBRARY; T=0.K  
Photon emission for (n,n\*)d

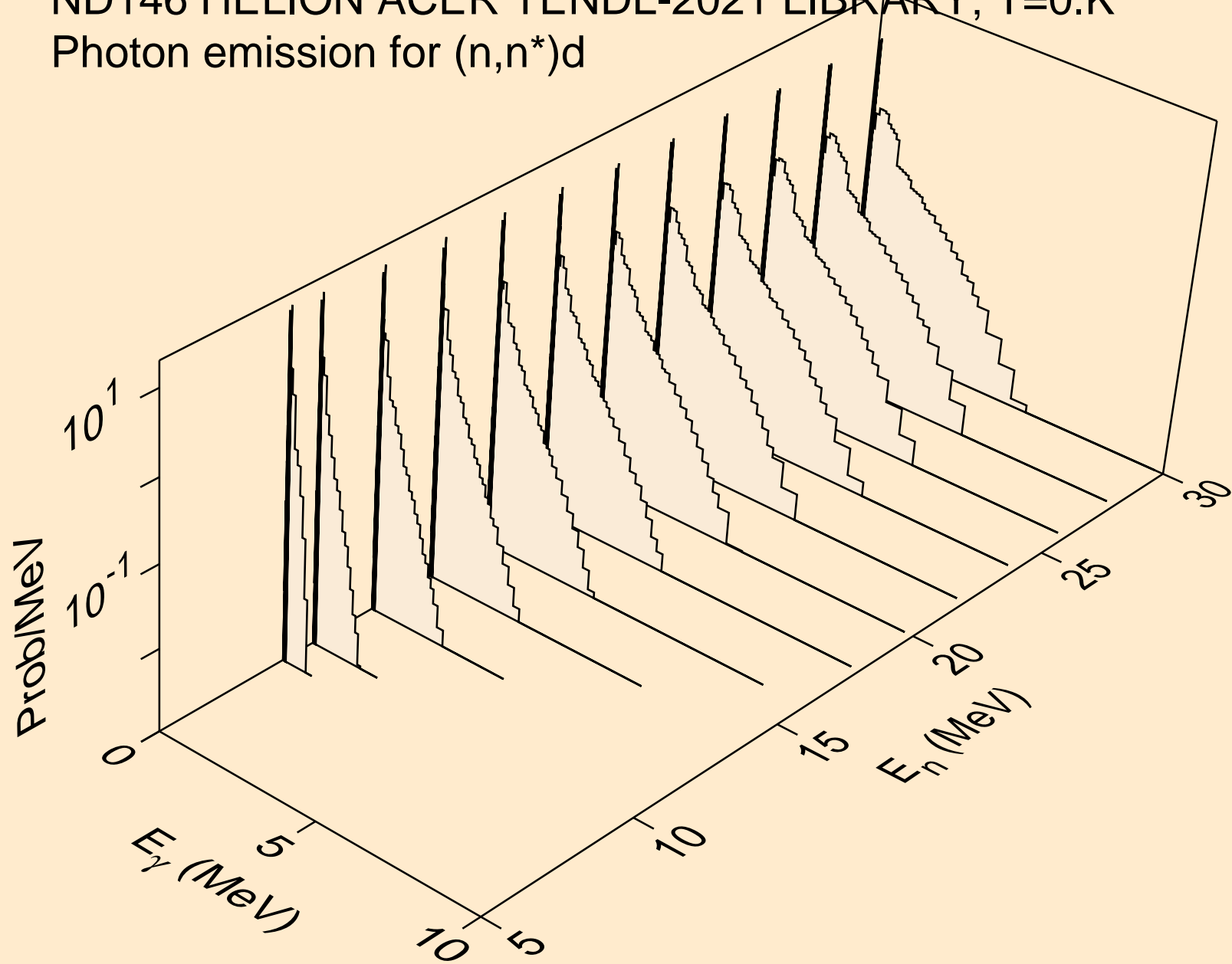

ND146 HELION ACER TENDL-2021 LIBRARY; T=0.K  
Photon emission for (n,n\*)t

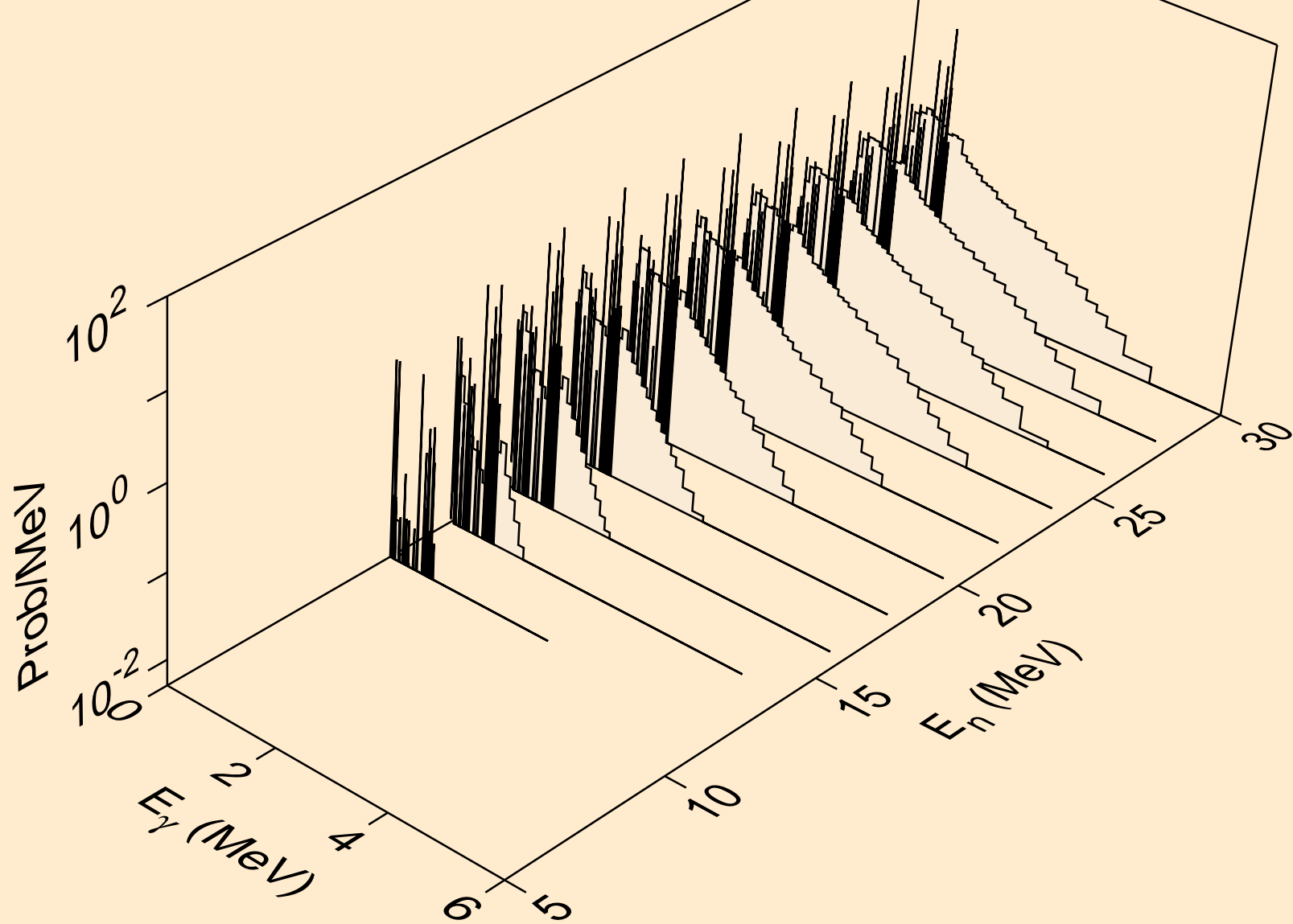

ND146 HELION ACER TENDL-2021 LIBRARY; T=0.K  
Photon emission for (n,n\*)he3

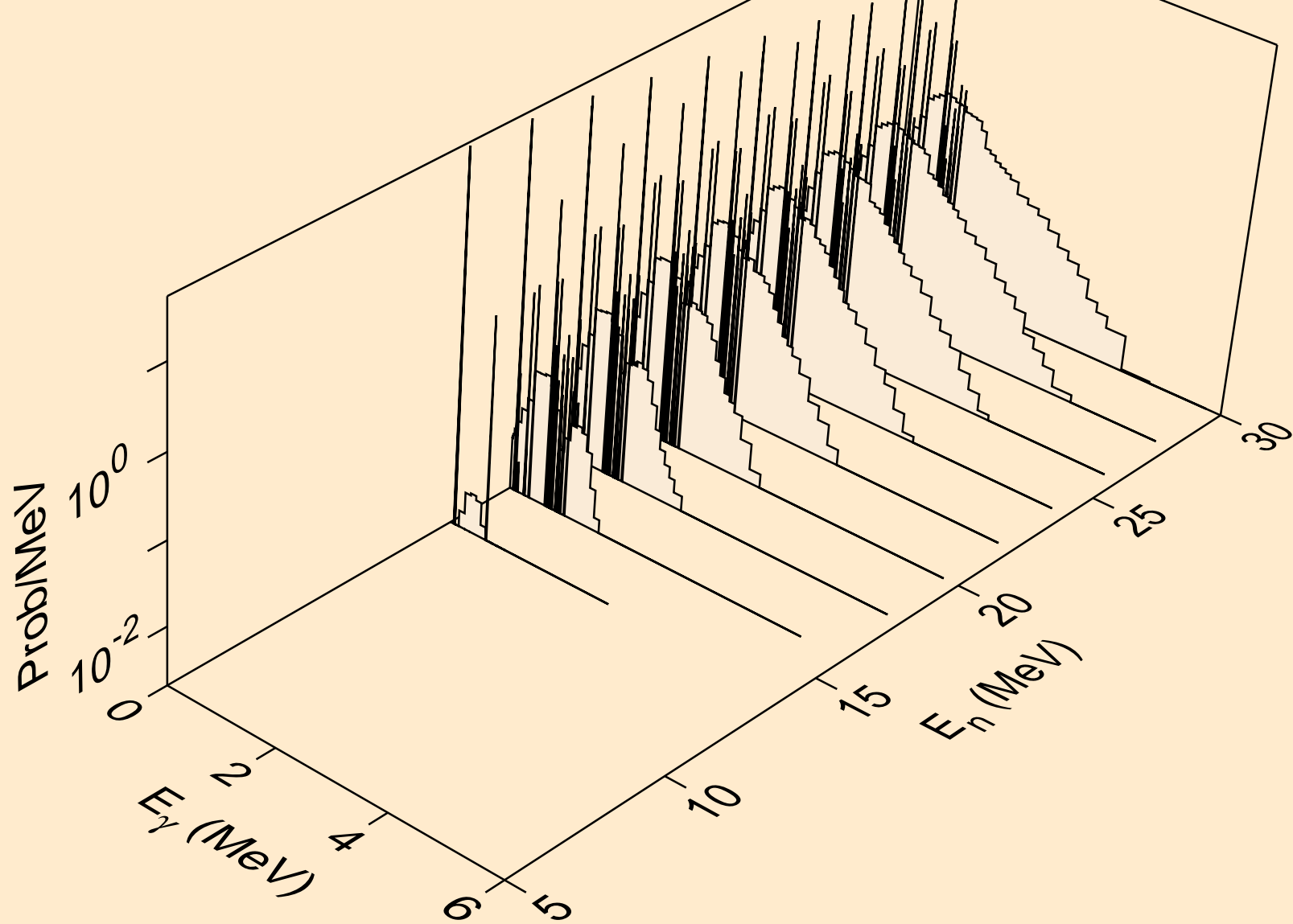

ND146 HELION ACER TENDL-2021 LIBRARY; T=0.K  
Photon emission for (n,4n)

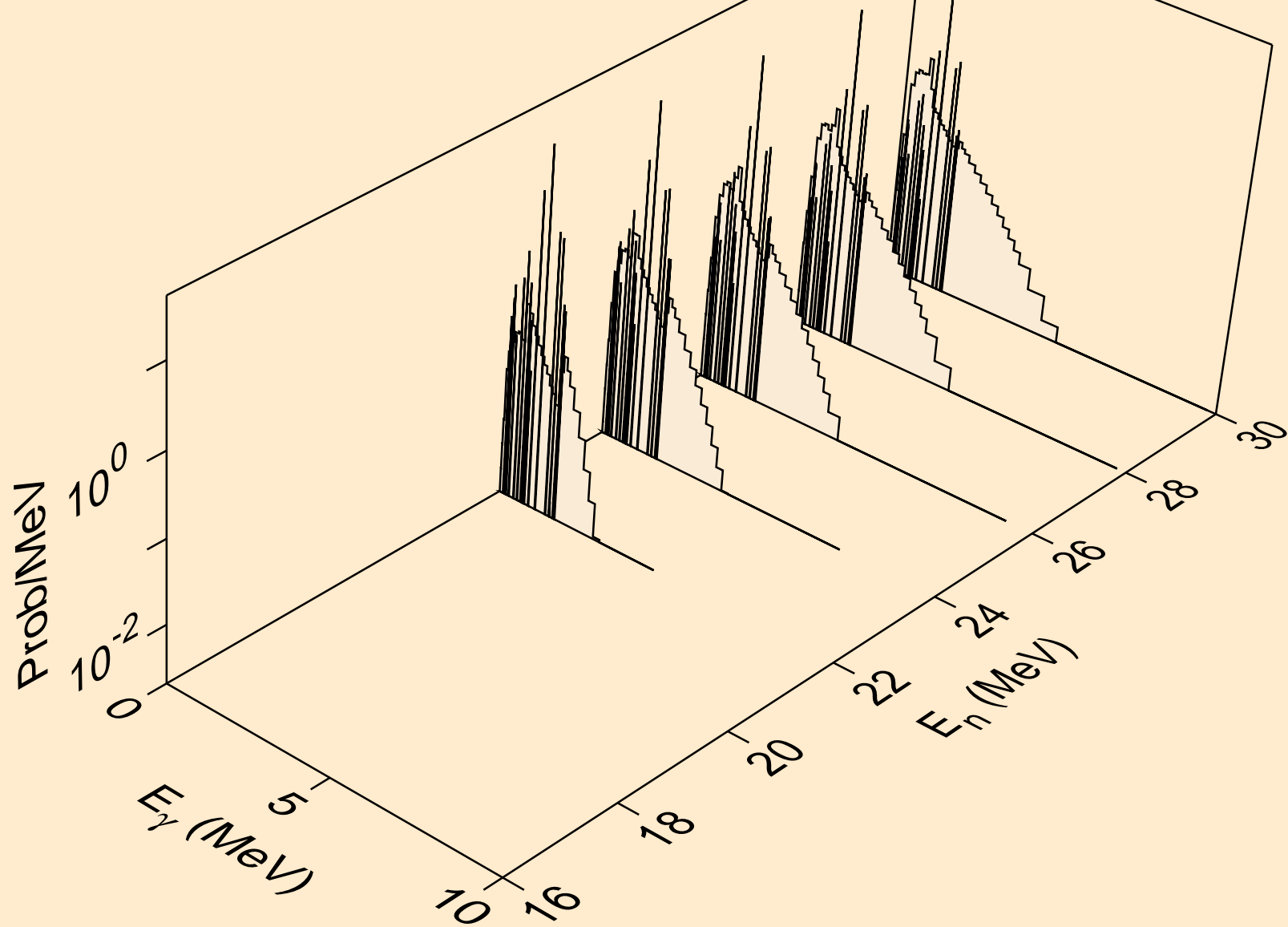

ND146 HELION ACER TENDL-2021 LIBRARY; T=0.K  
Photon emission for (n,2np)

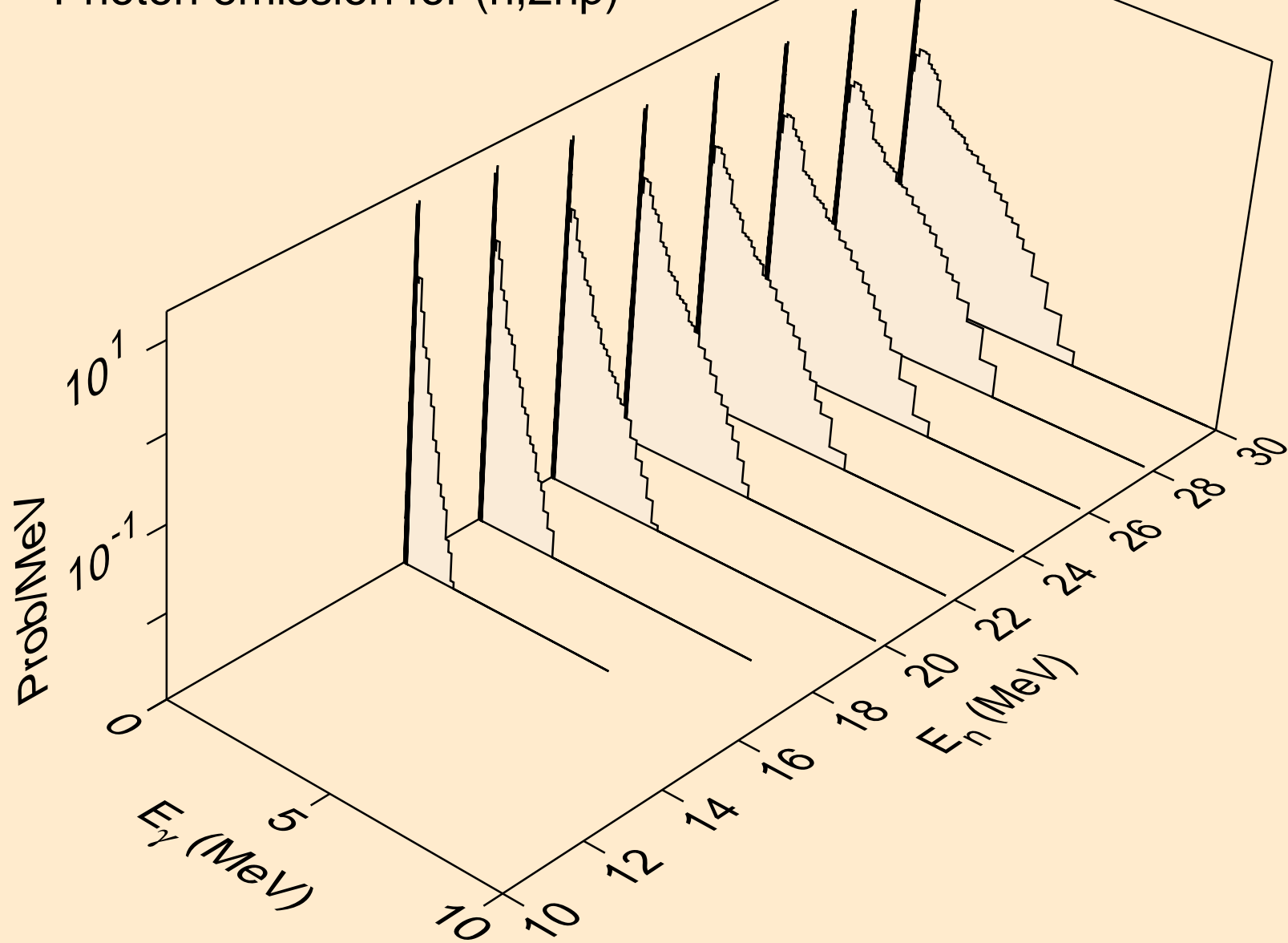



ND146 HELION ACER TENDL-2021 LIBRARY; T=0.K  
Photon emission for (n,3np)

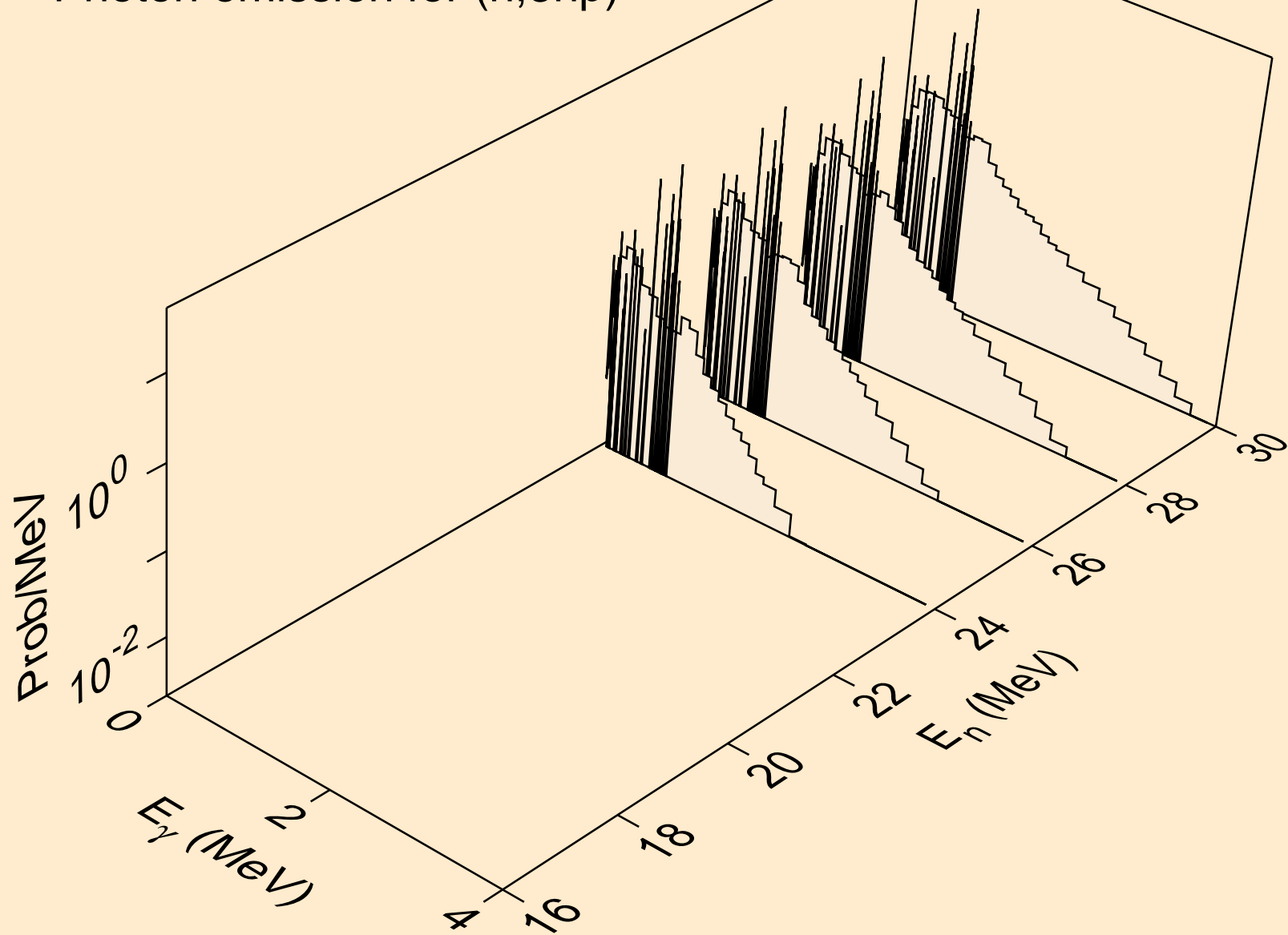

ND146 HELION ACER TENDL-2021 LIBRARY; T=0.K  
Photon emission for (n,2np)

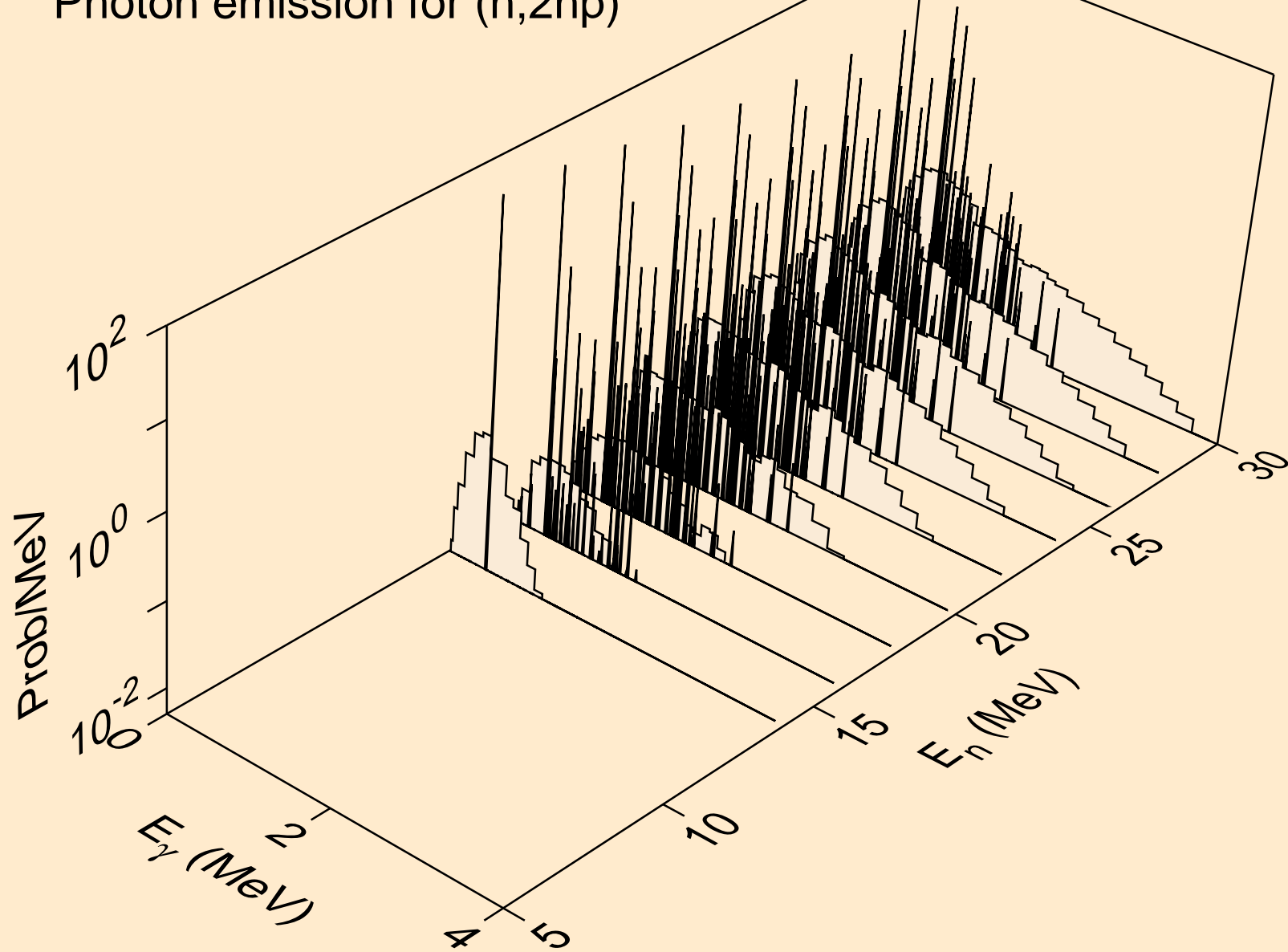

ND146 HELION ACER TENDL-2021 LIBRARY; T=0.K  
Photon emission for (n,npa)

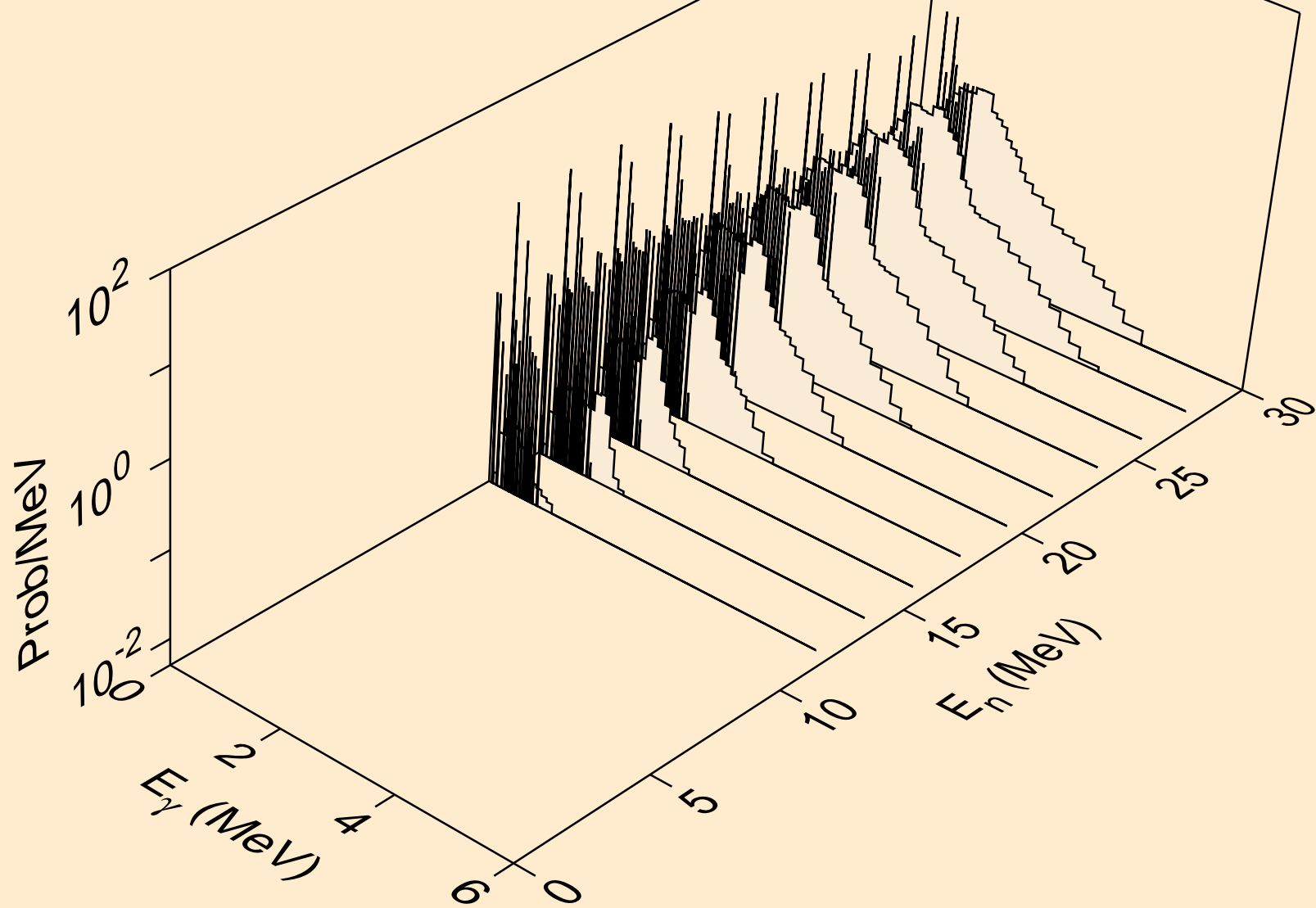

ND146 HELION ACER TENDL-2021 LIBRARY; T=0.K  
Photon emission for (n,gma)

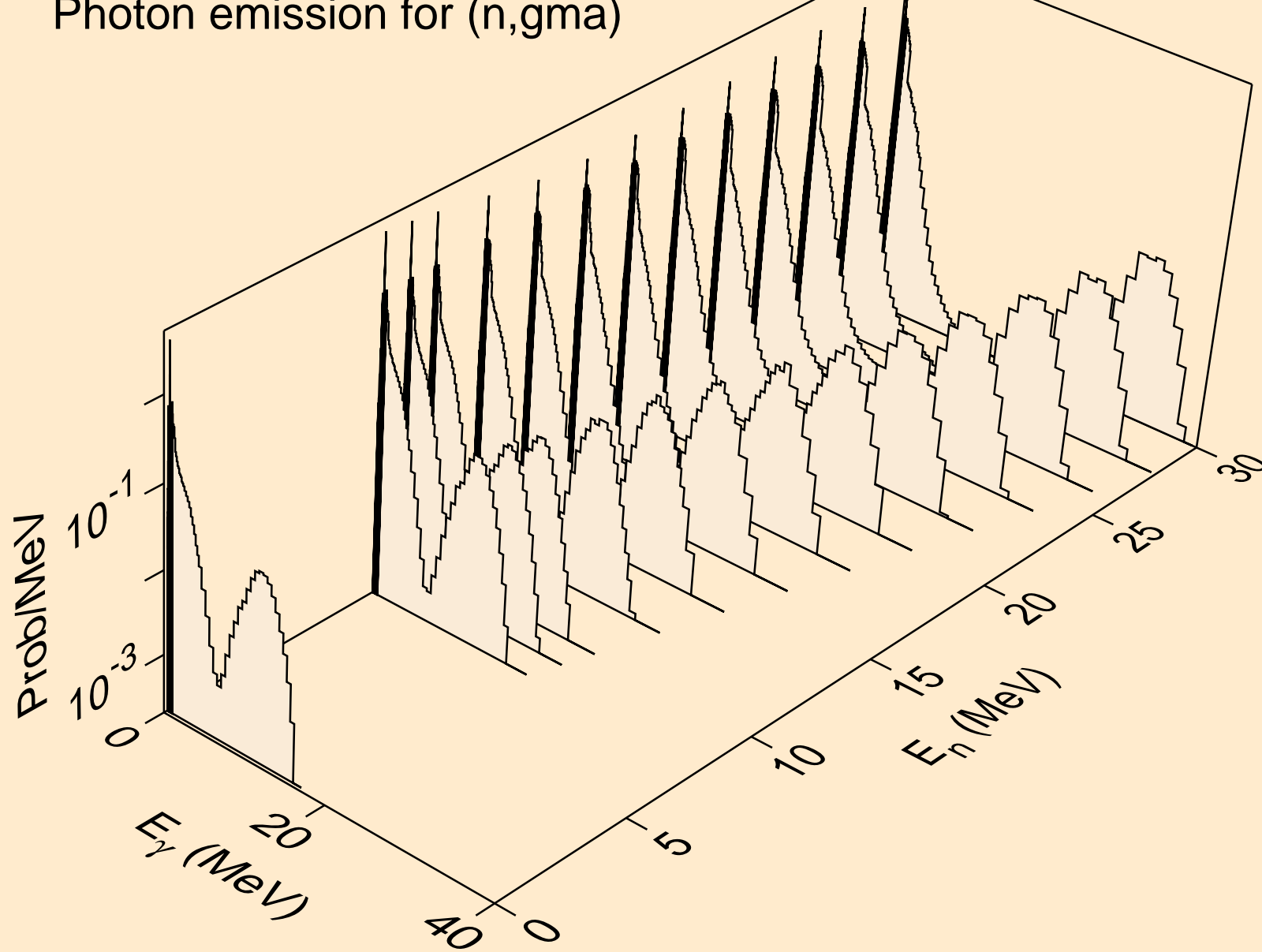

ND146 HELION ACER TENDL-2021 LIBRARY; T=0.K  
Photon emission for (n,p)

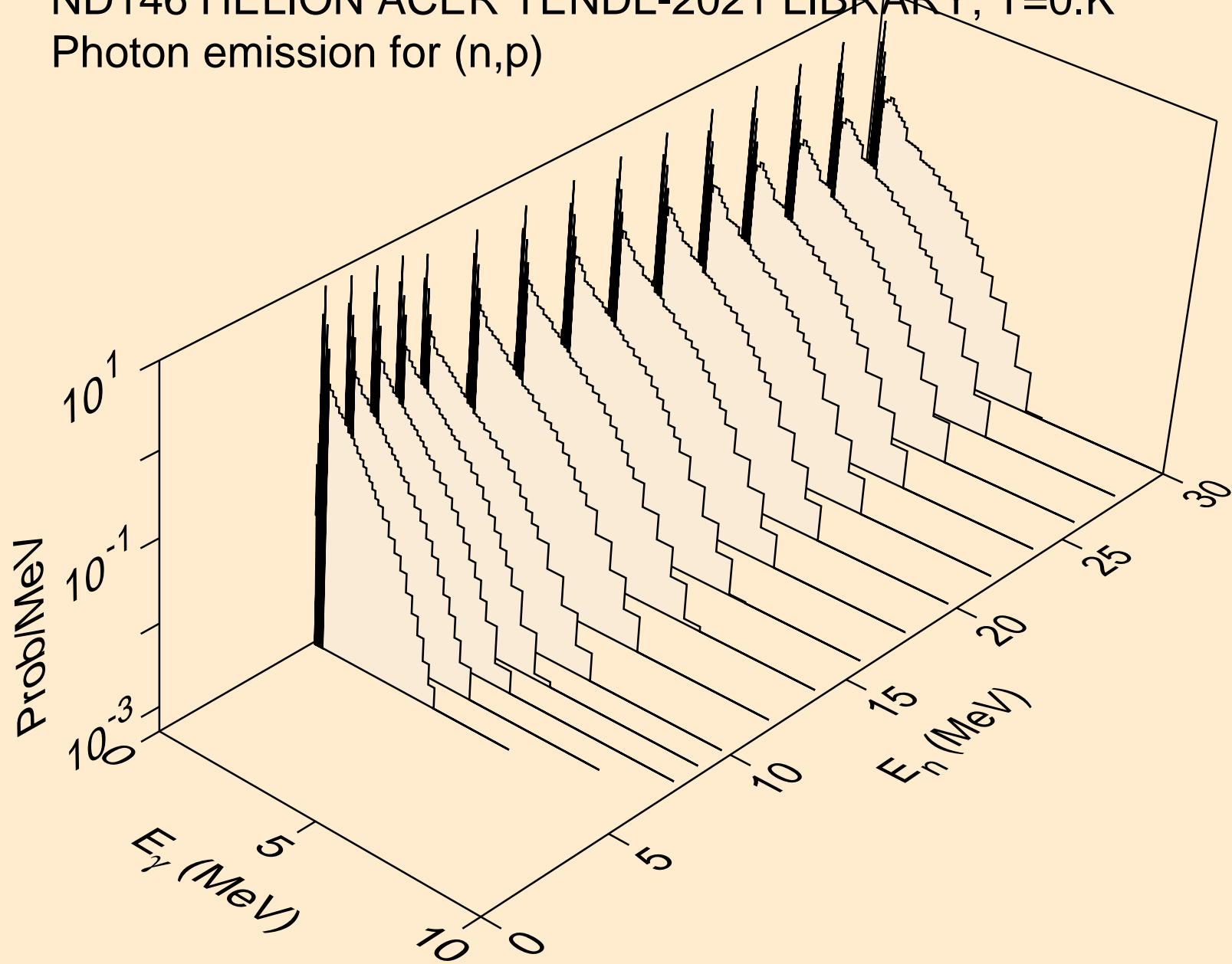

ND146 HELION ACER TENDL-2021 LIBRARY; T=0.K  
Photon emission for (n,d)

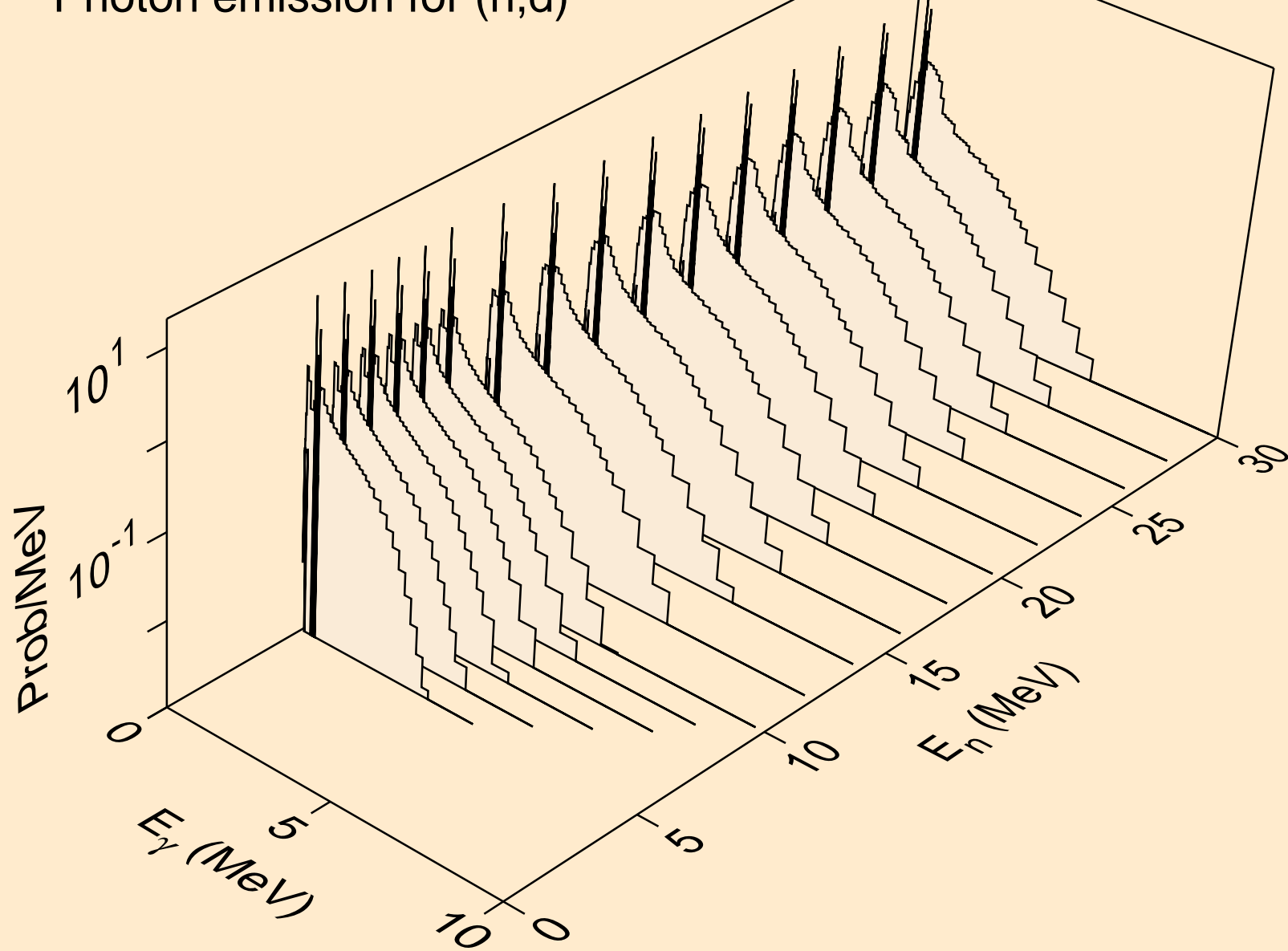

ND146 HELION ACER TENDL-2021 LIBRARY; T=0.K  
Photon emission for (n,t)

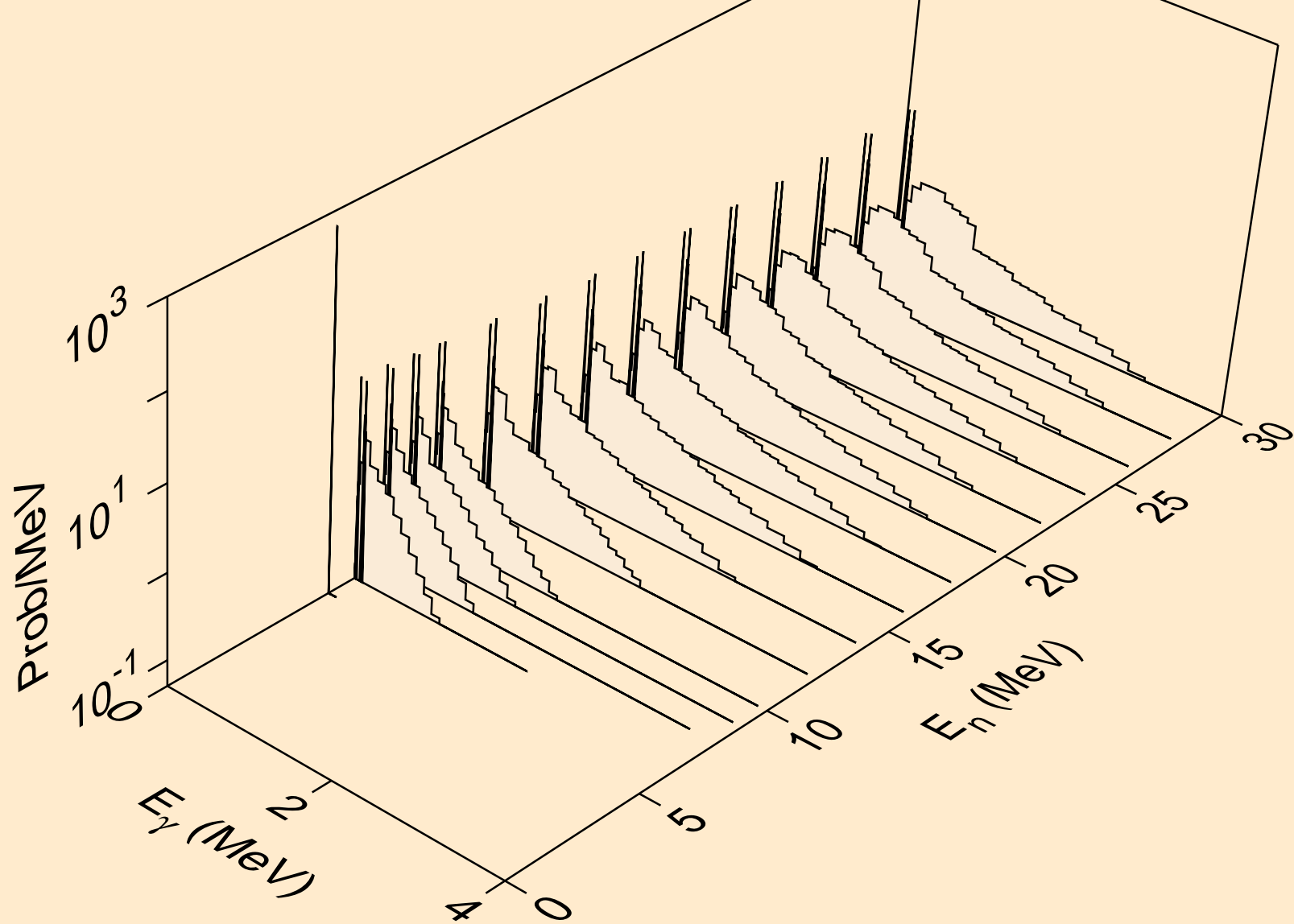

ND146 HELION ACER TENDL-2021 LIBRARY; T=0.K  
Photon emission for inelastic

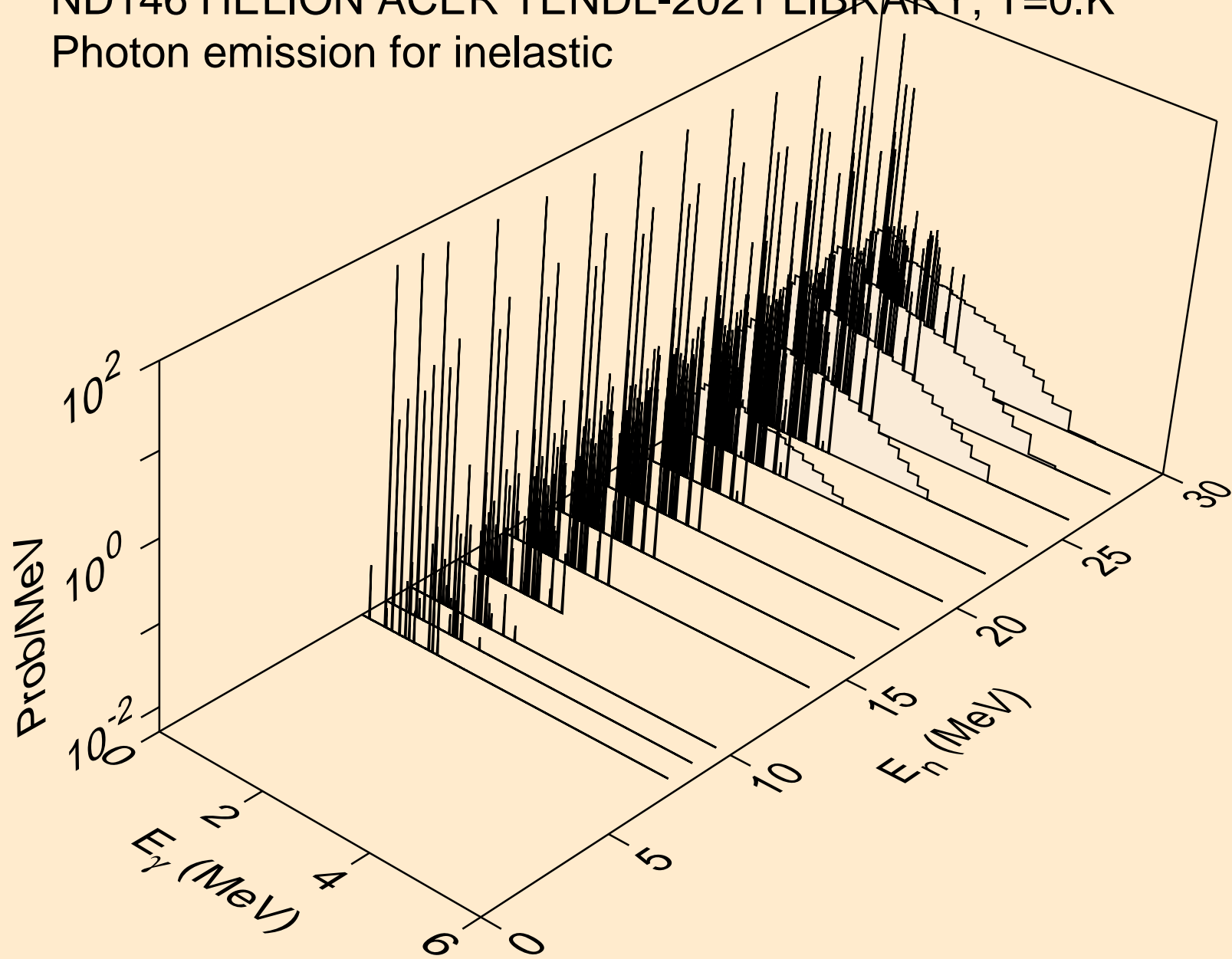



ND146 HELION ACER TENDL-2021 LIBRARY; T=0.K  
Photon emission for (n,a)

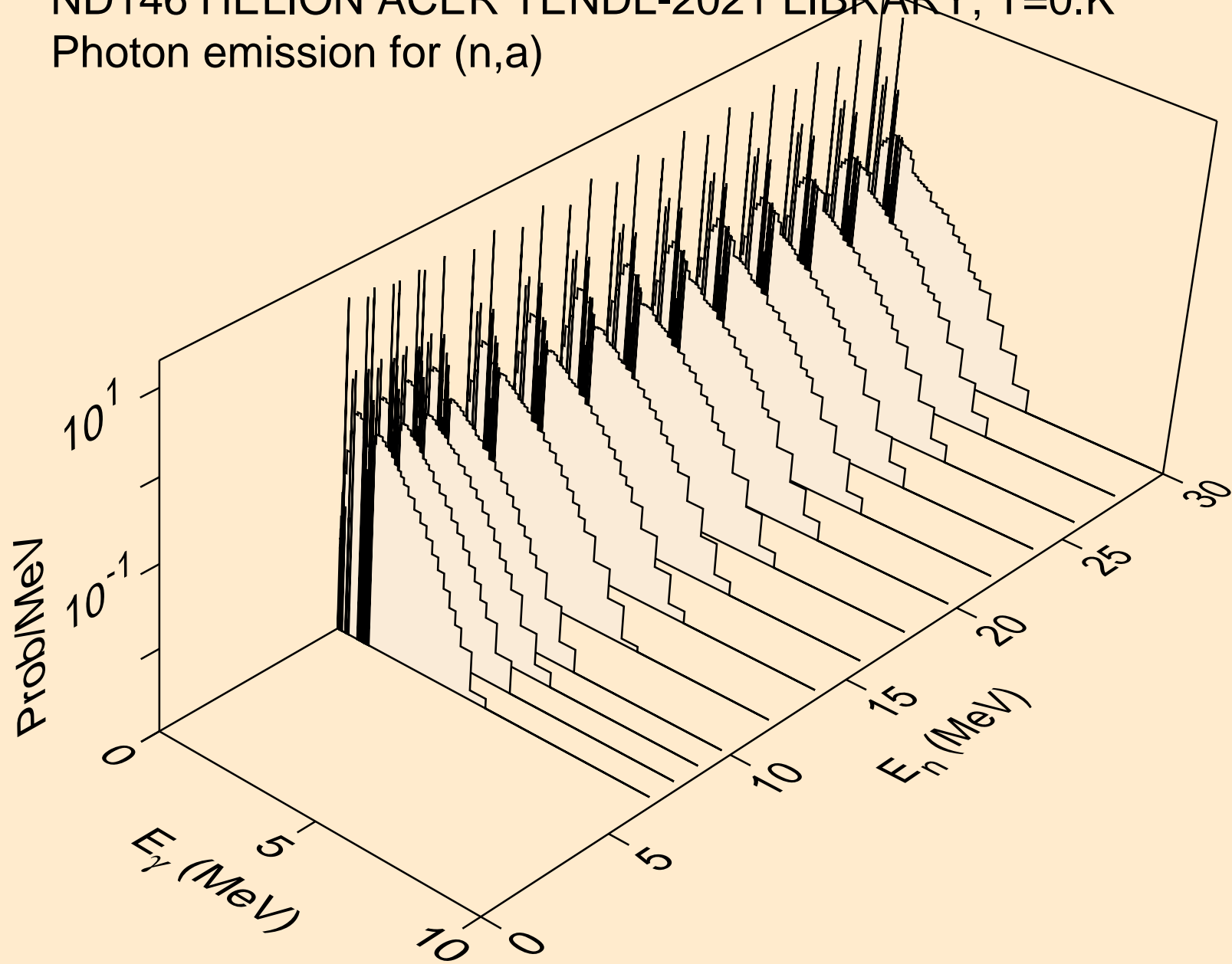

ND146 HELION ACER TENDL-2021 LIBRARY; T=0.K  
Photon emission for (n,2a)

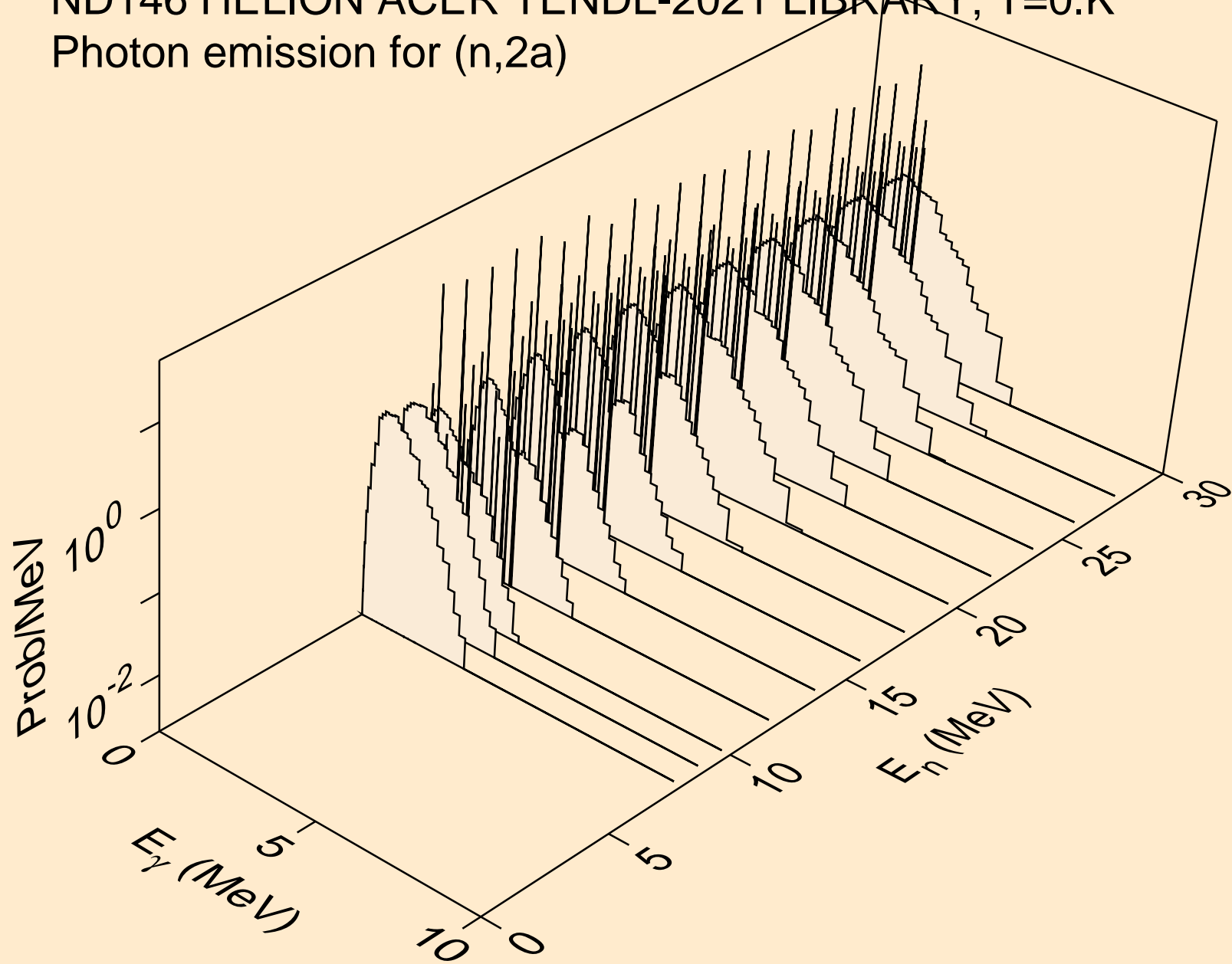

ND146 HELION ACER TENDL-2021 LIBRARY; T=0.K  
Photon emission for (n,2p)

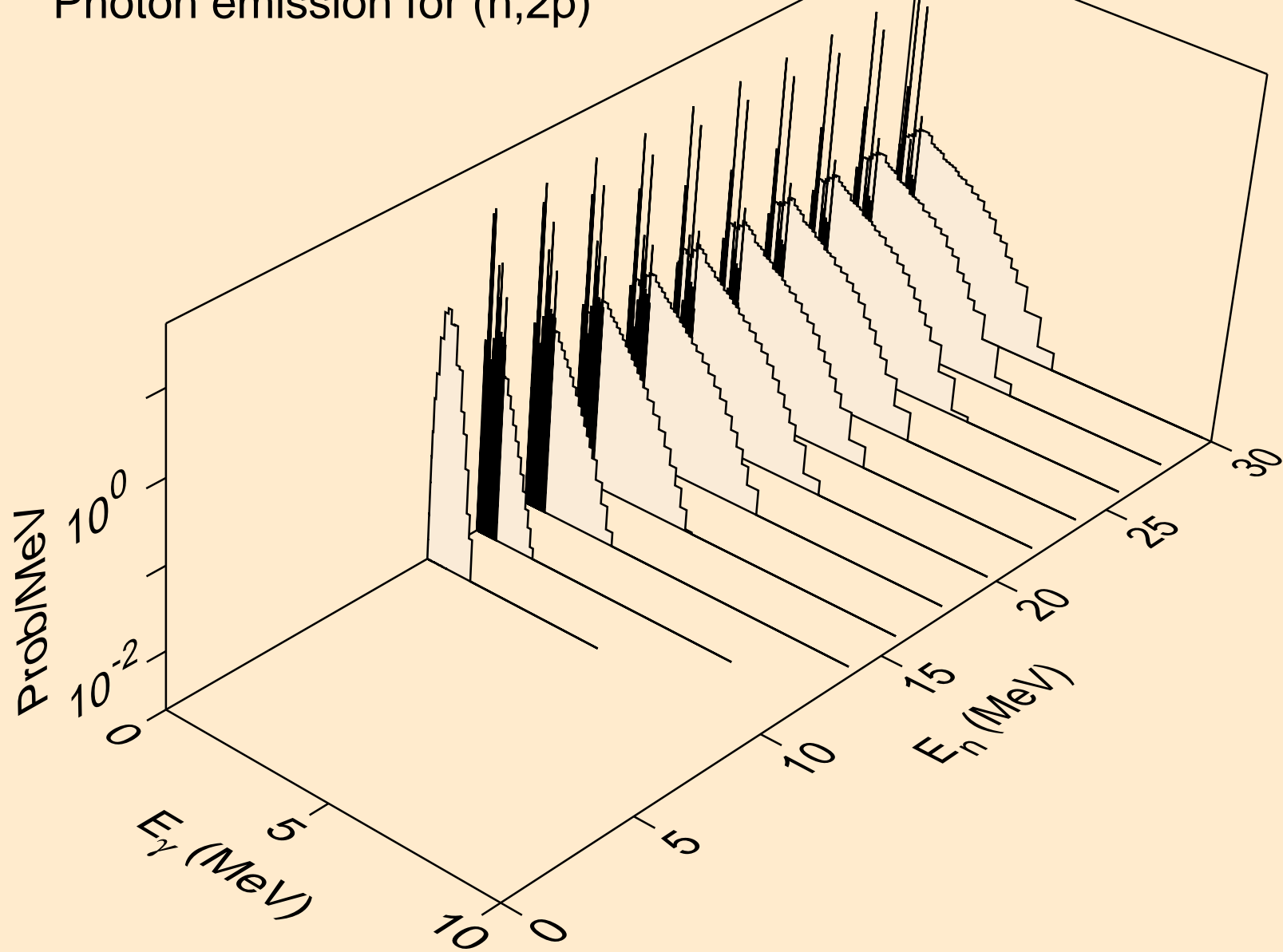

ND146 HELION ACER TENDL-2021 LIBRARY; T=0.K  
Photon emission for (n,pa)

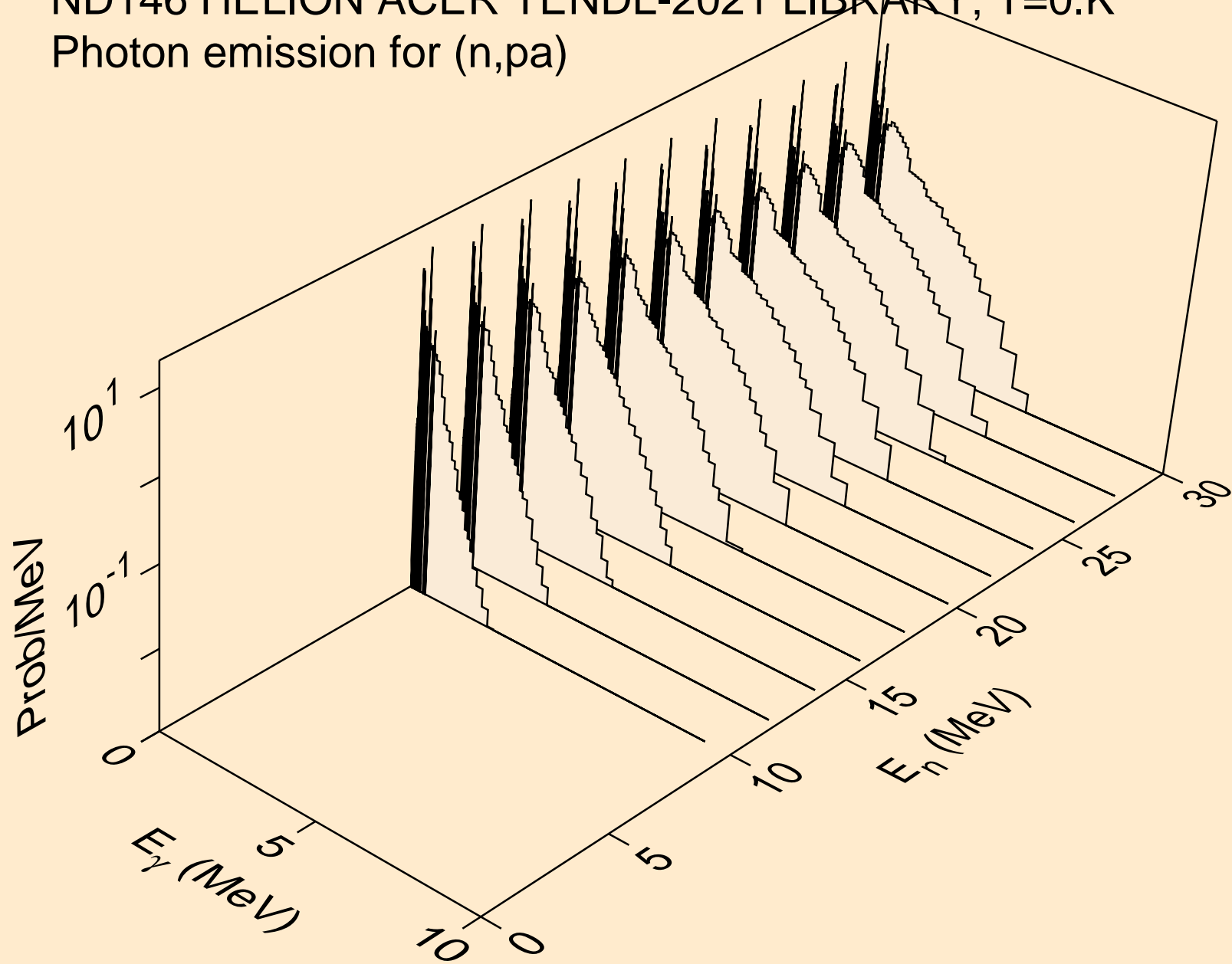

ND146 HELION ACER TENDL-2021 LIBRARY; T=0.K  
Photon emission for (n,pd)

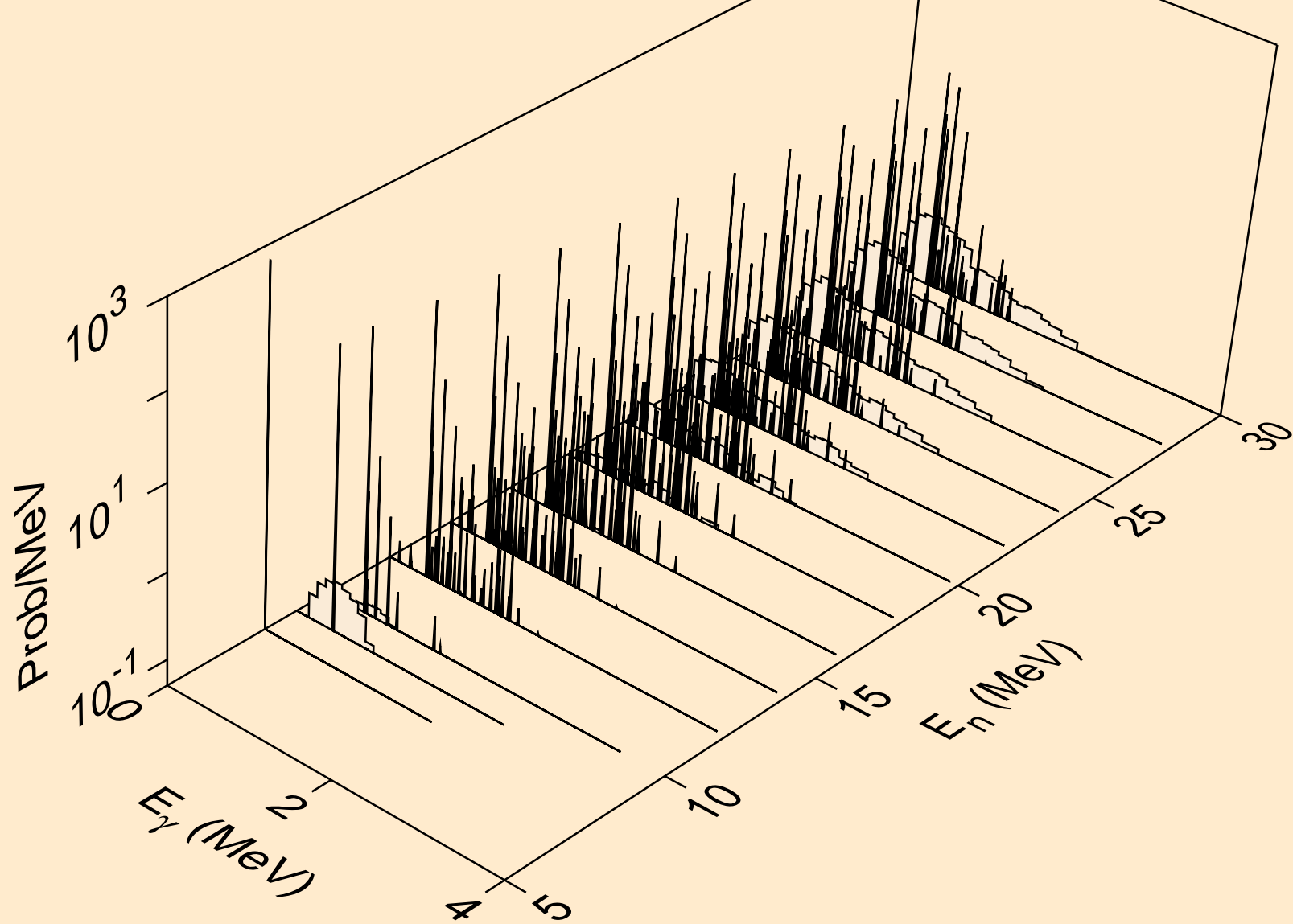

ND146 HELION ACER TENDL-2021 LIBRARY; T=0.K  
Photon emission for (n,pt)

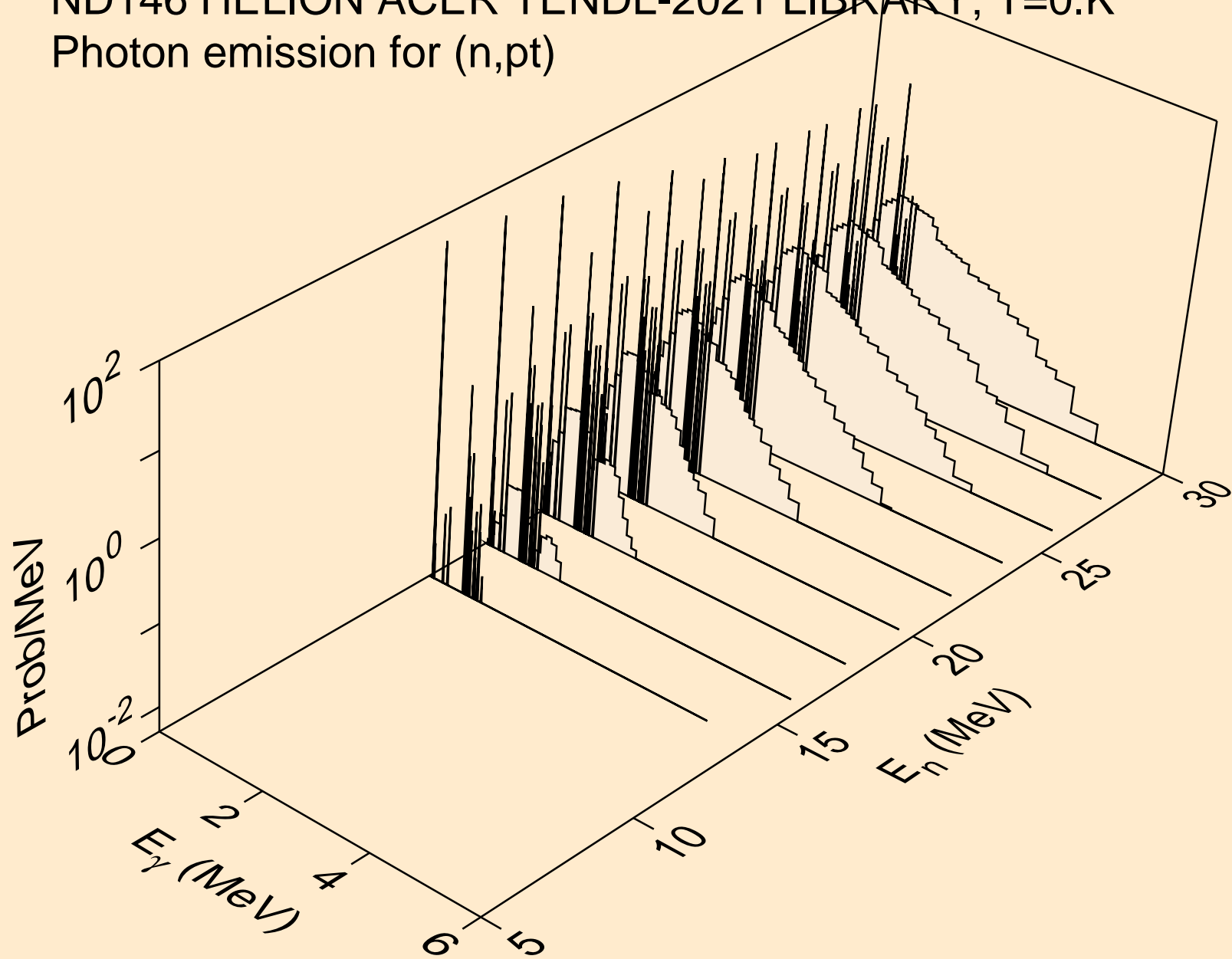

ND146 HELION ACER TENDL-2021 LIBRARY; T=0.K  
Photon emission for (n,da)

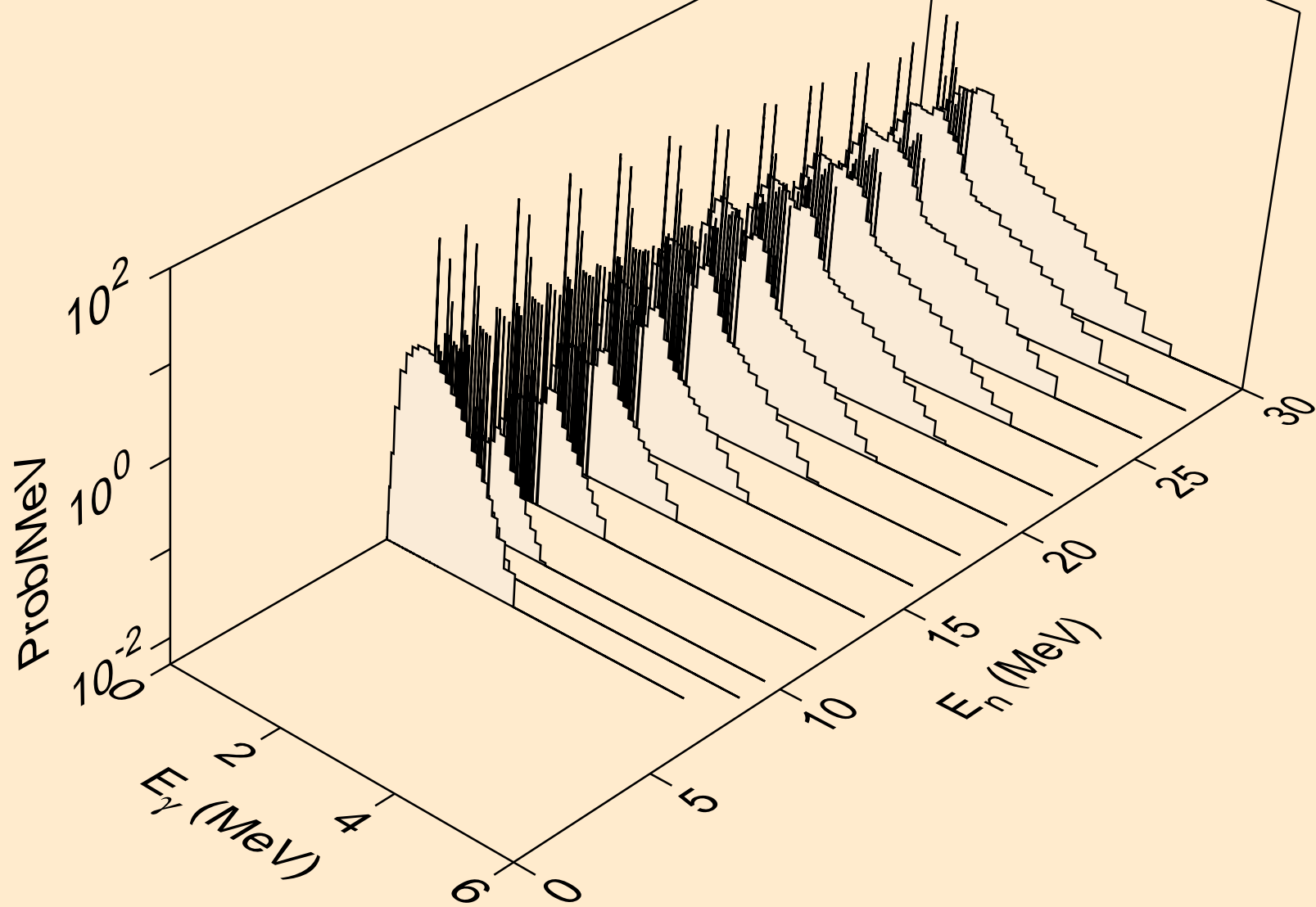

# ND146 HELION ACER TENDL-2021 LIBRARY; T=0.K

## Particle heating contributions

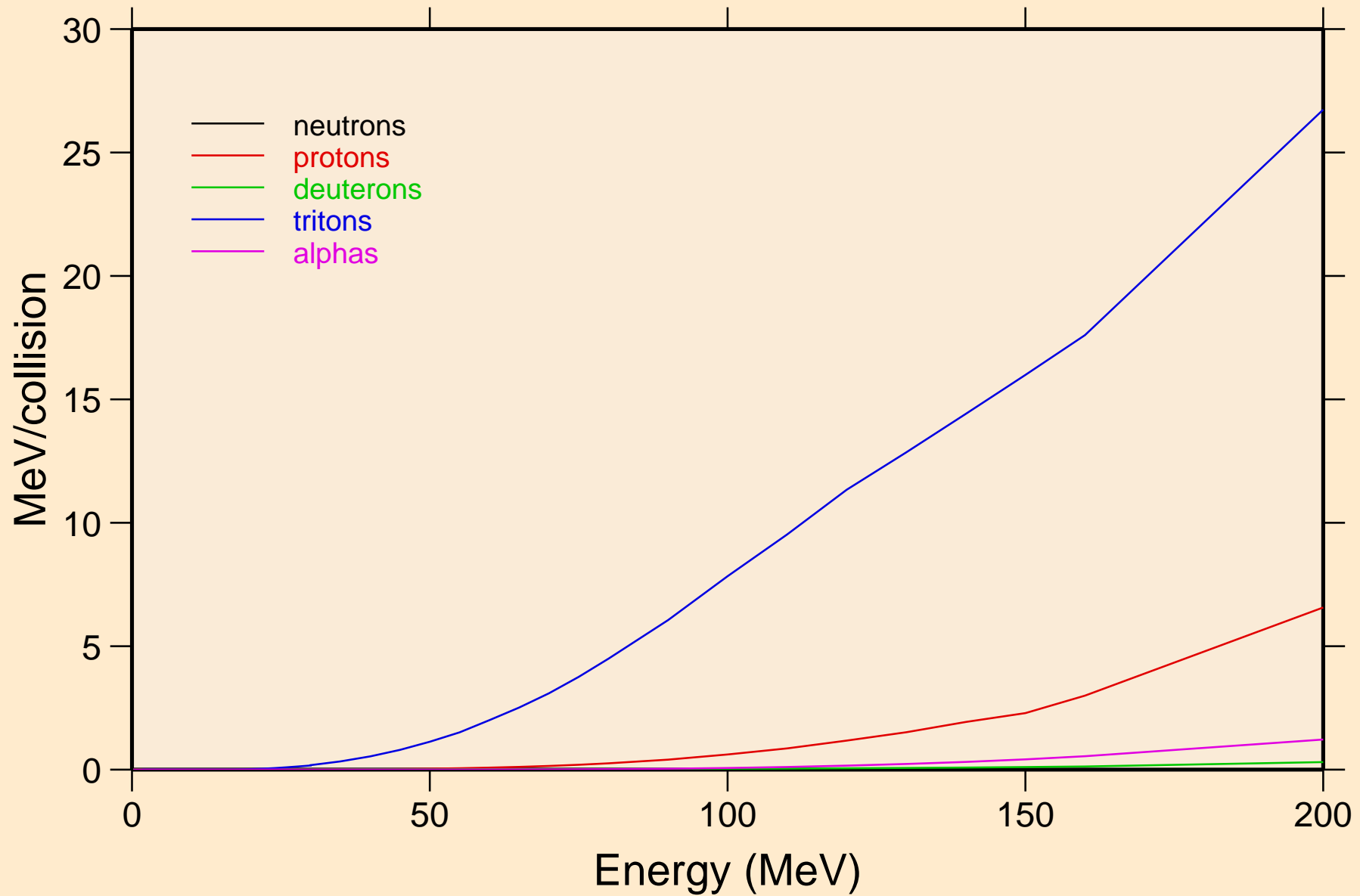



ND146 HELION ACER TENDL-2021 LIBRARY; T=0.K  
Recoil Heating

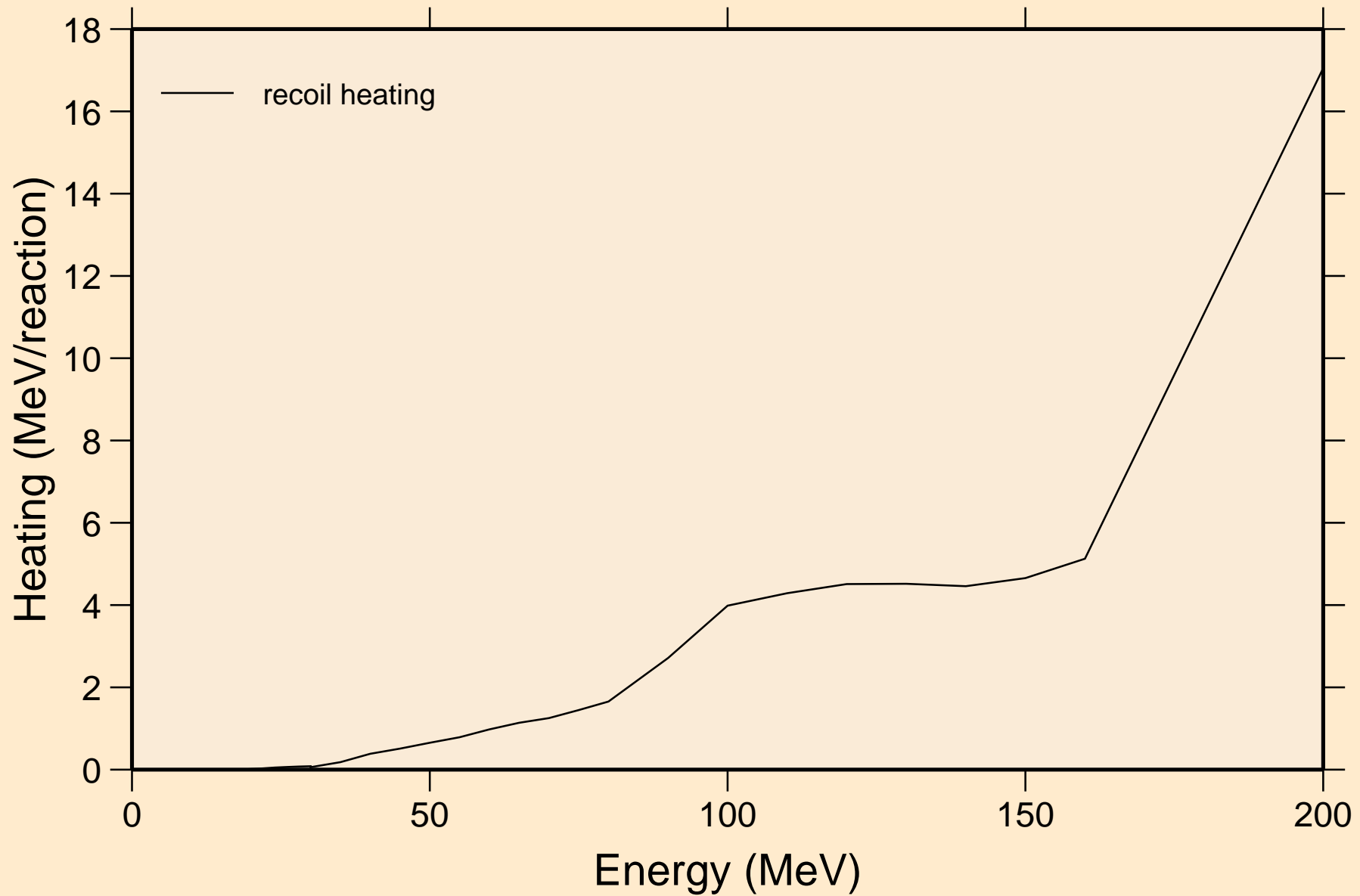

ND146 HELION ACER TENDL-2021 LIBRARY; T=0.K  
Particle production cross sections

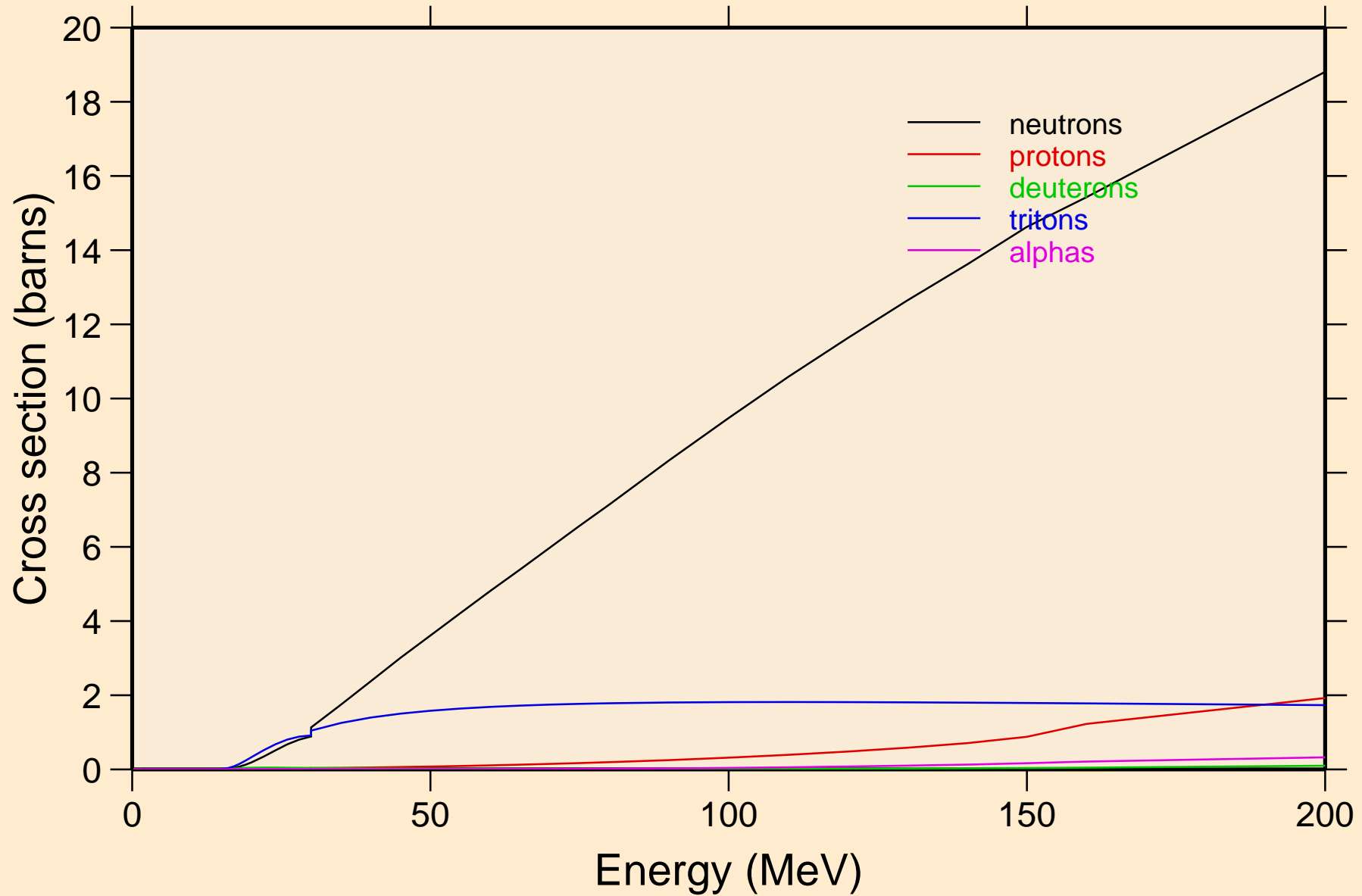

ND146 HELION ACER TENDL-2021 LIBRARY; T=0.K  
neutrons from (s,n)

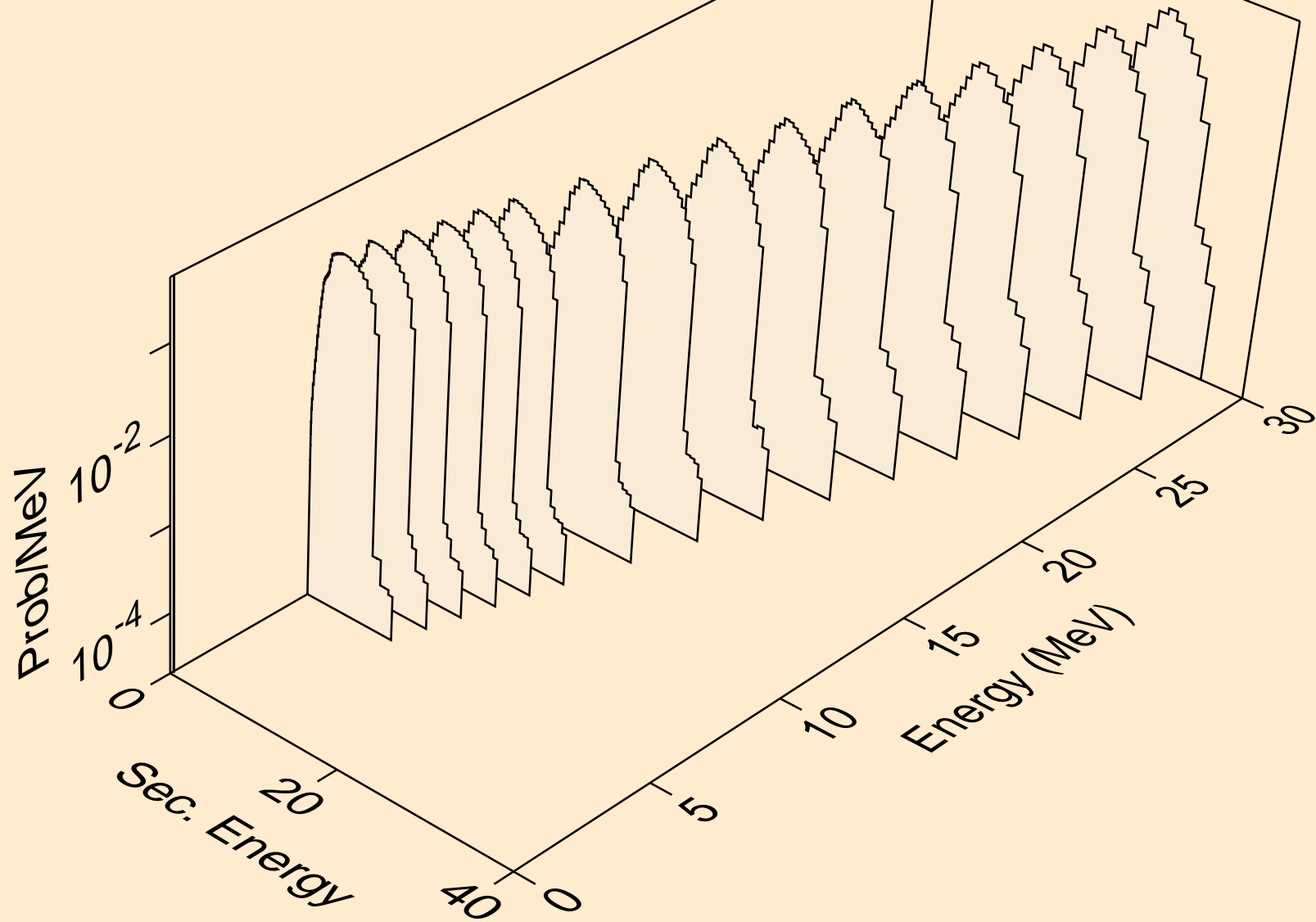

ND146 HELION ACER TENDL-2021 LIBRARY; T=0.K  
neutrons from (s,x)

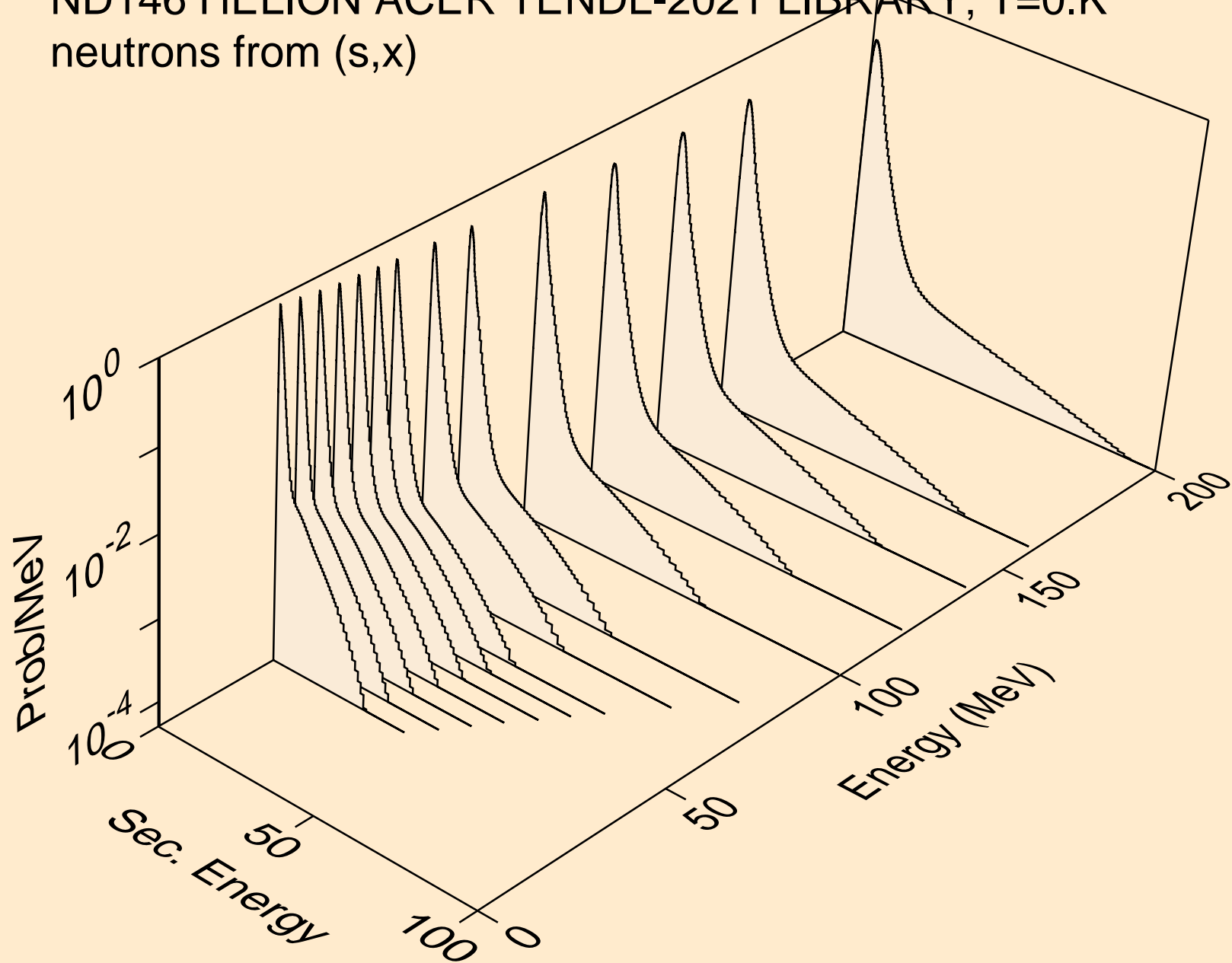

ND146 HELION ACER TENDL-2021 LIBRARY; T=0.K  
neutrons from (s,2nd)

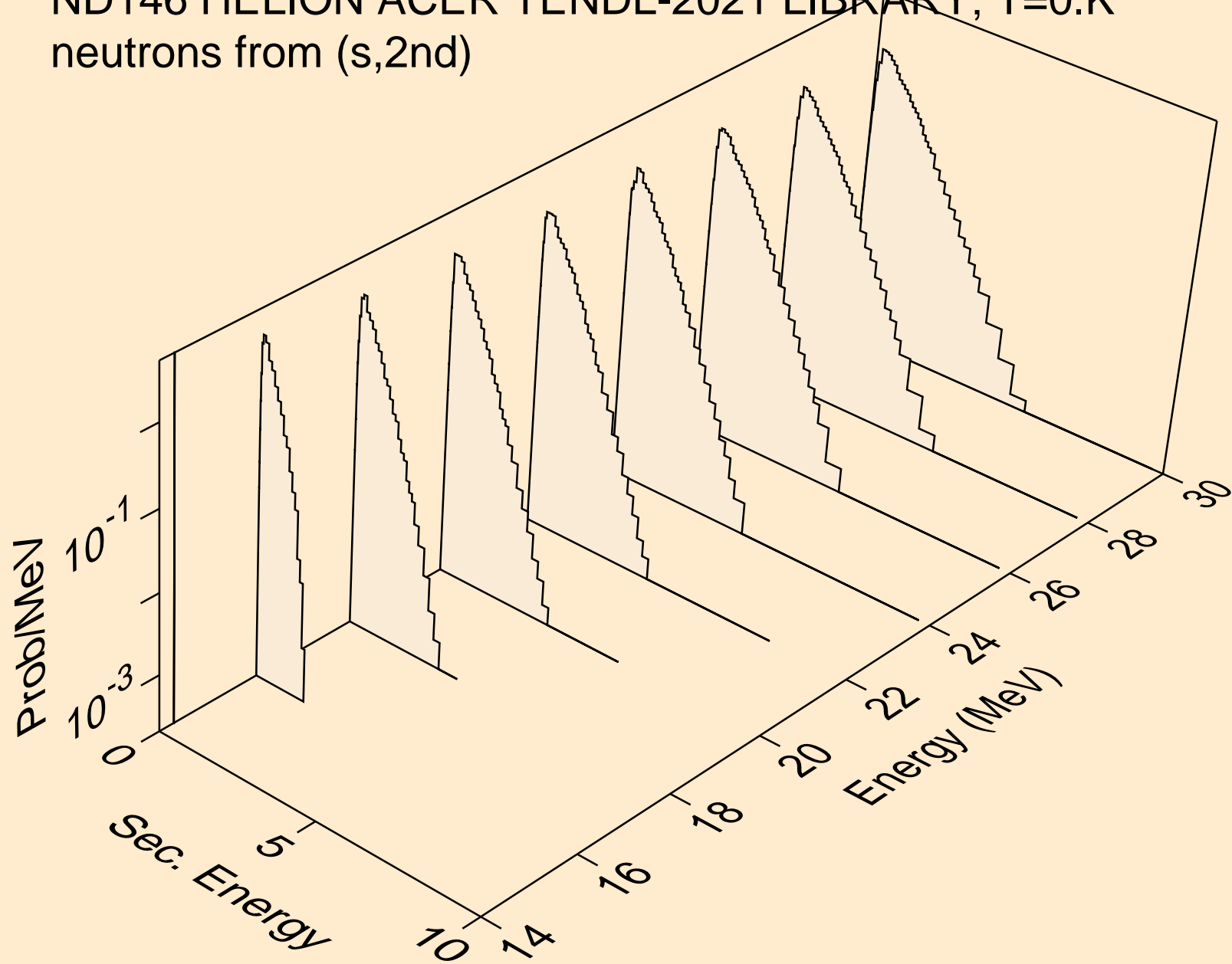

ND146 HELION ACER TENDL-2021 LIBRARY; T=0.K  
neutrons from (s,2n)

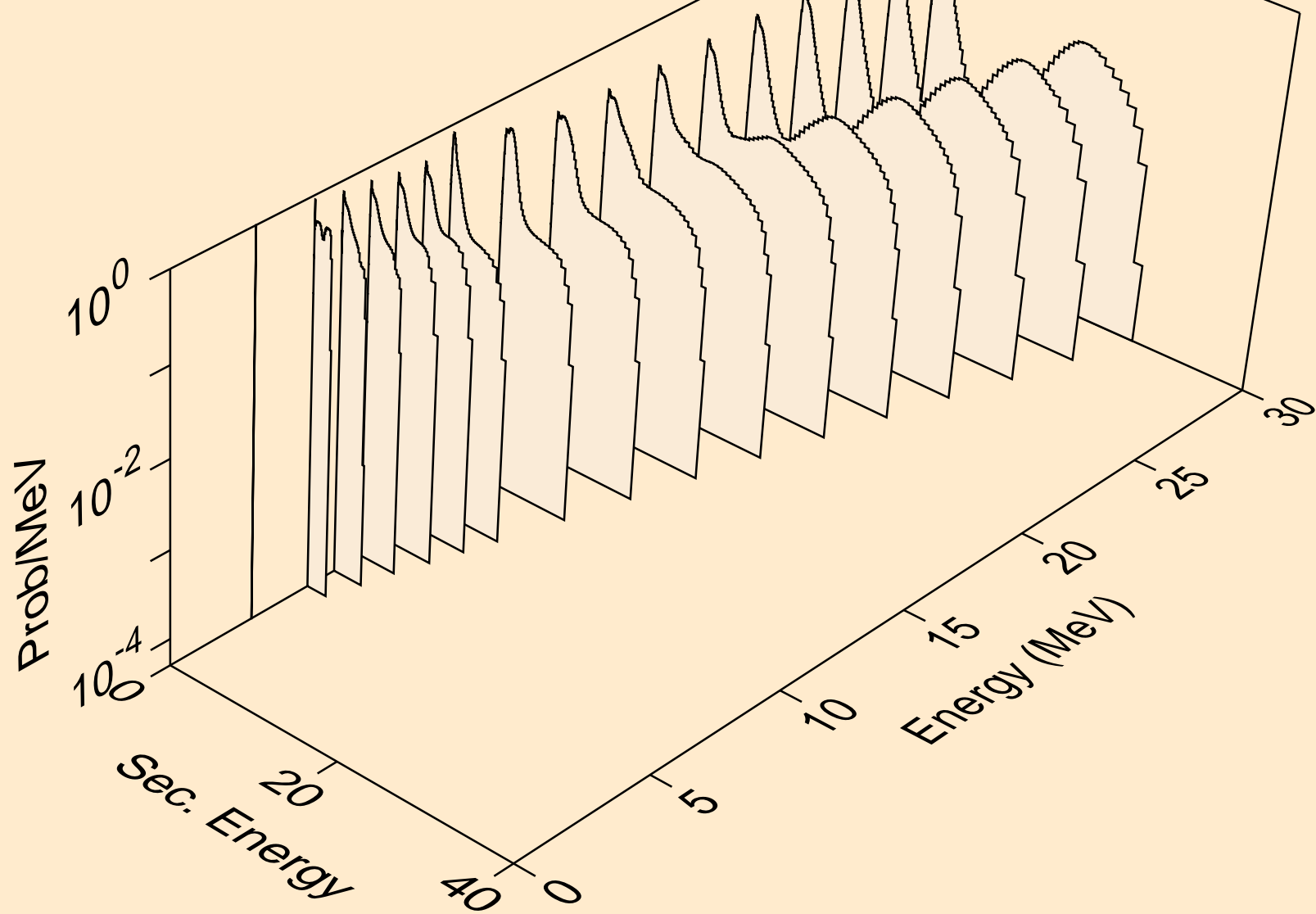

ND146 HELION ACER TENDL-2021 LIBRARY; T=0.K  
neutrons from (s,3n)

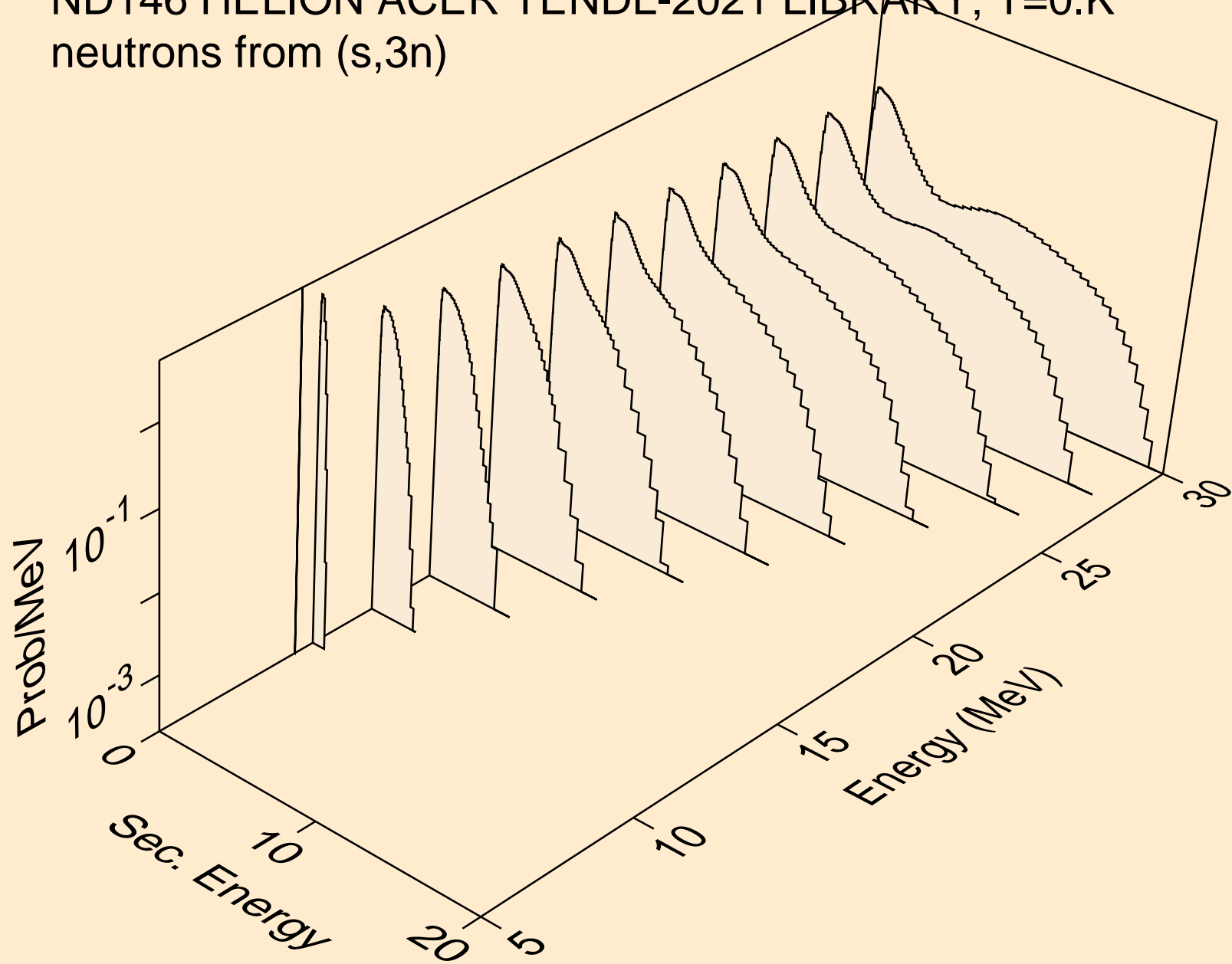

ND146 HELION ACER TENDL-2021 LIBRARY; T=0.K  
neutrons from (s,n\*)a

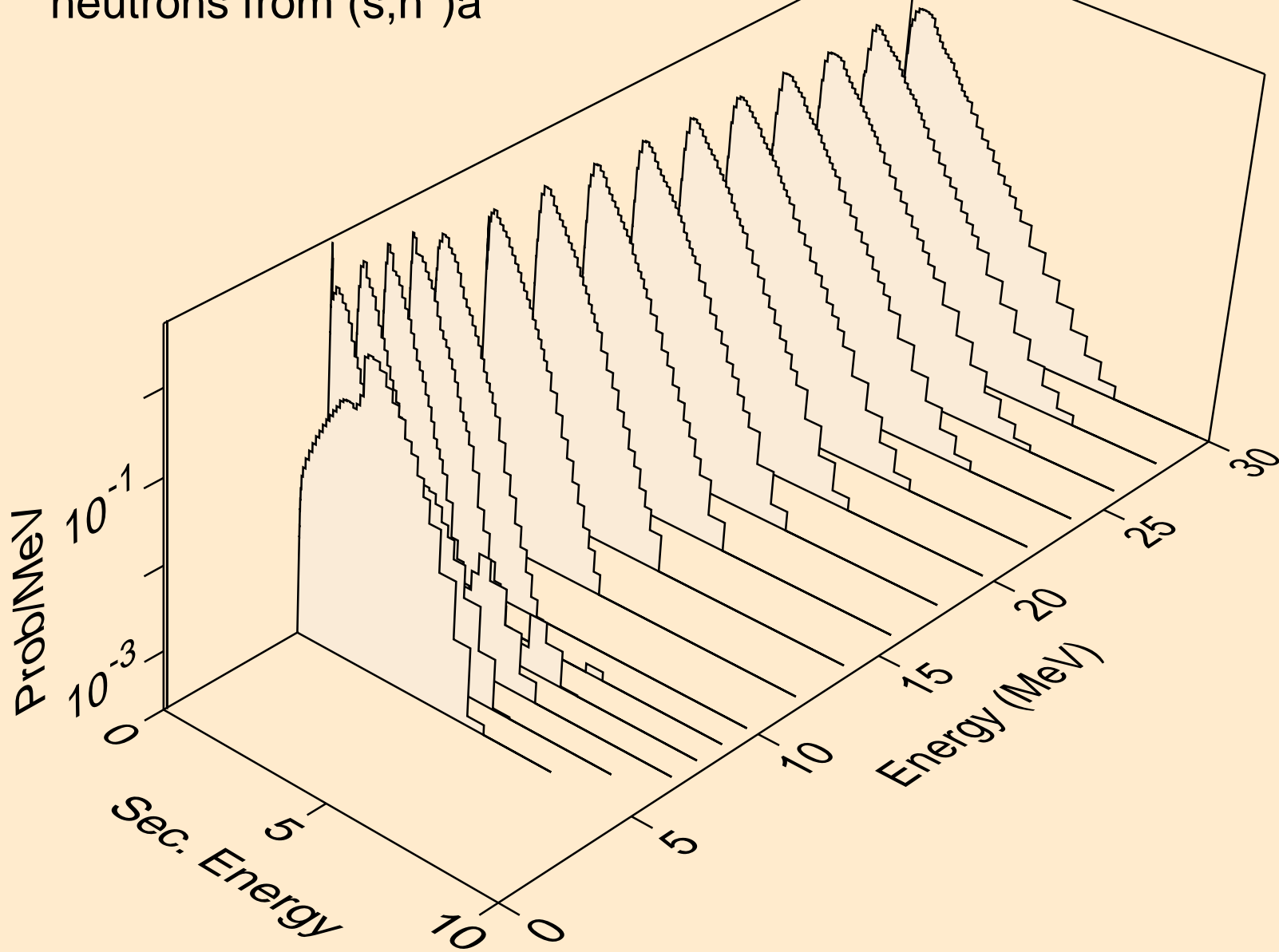



ND146 HELION ACER TENDL-2021 LIBRARY; T=0.K  
neutrons from (s,2n)a

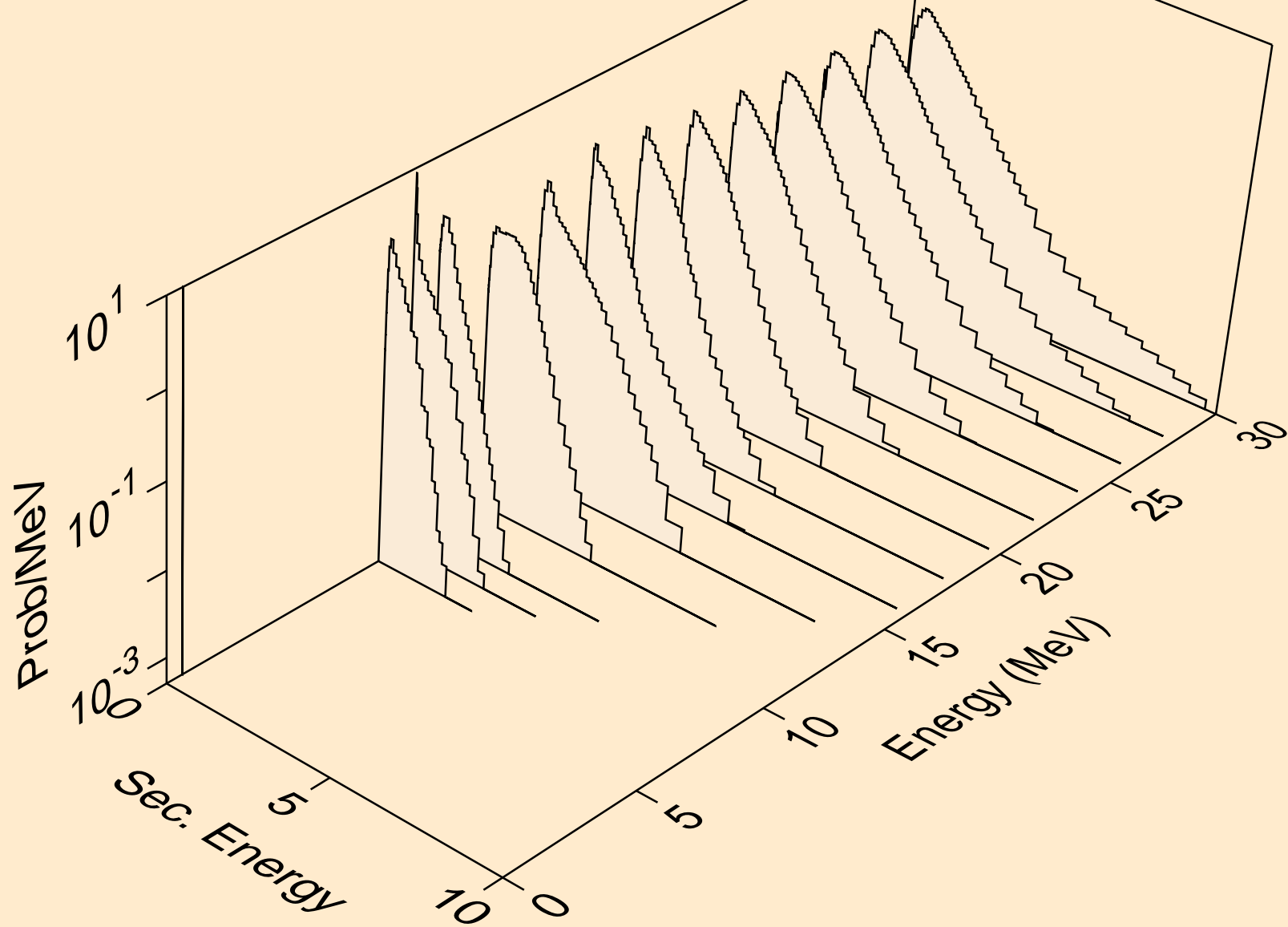

ND146 HELION ACER TENDL-2021 LIBRARY; T=0.K  
neutrons from (s,3n)a

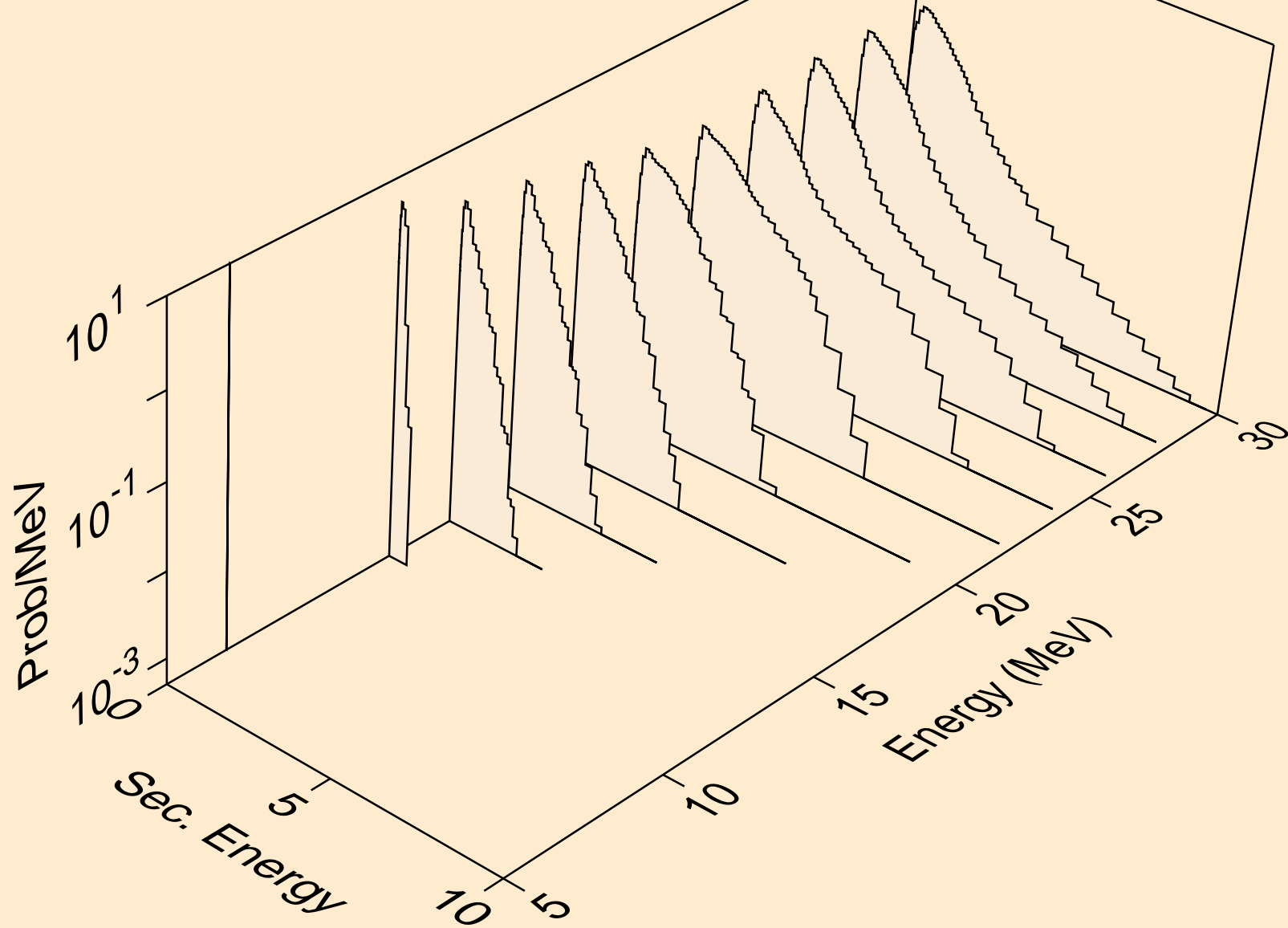

ND146 HELION ACER TENDL-2021 LIBRARY; T=0.K  
neutrons from (s,n\*)p

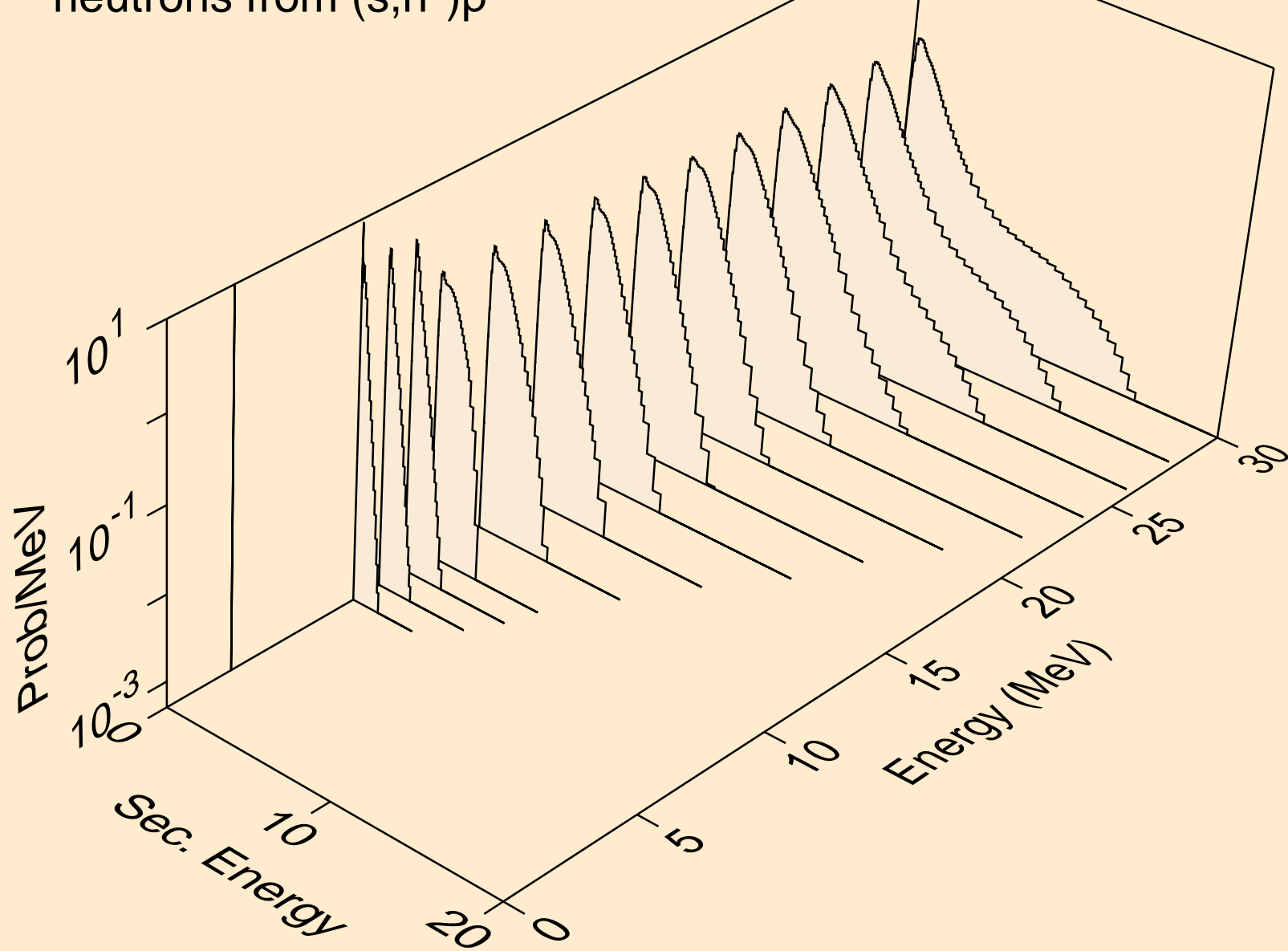

ND146 HELION ACER TENDL-2021 LIBRARY; T=0.K  
neutrons from (s,n\*)2a

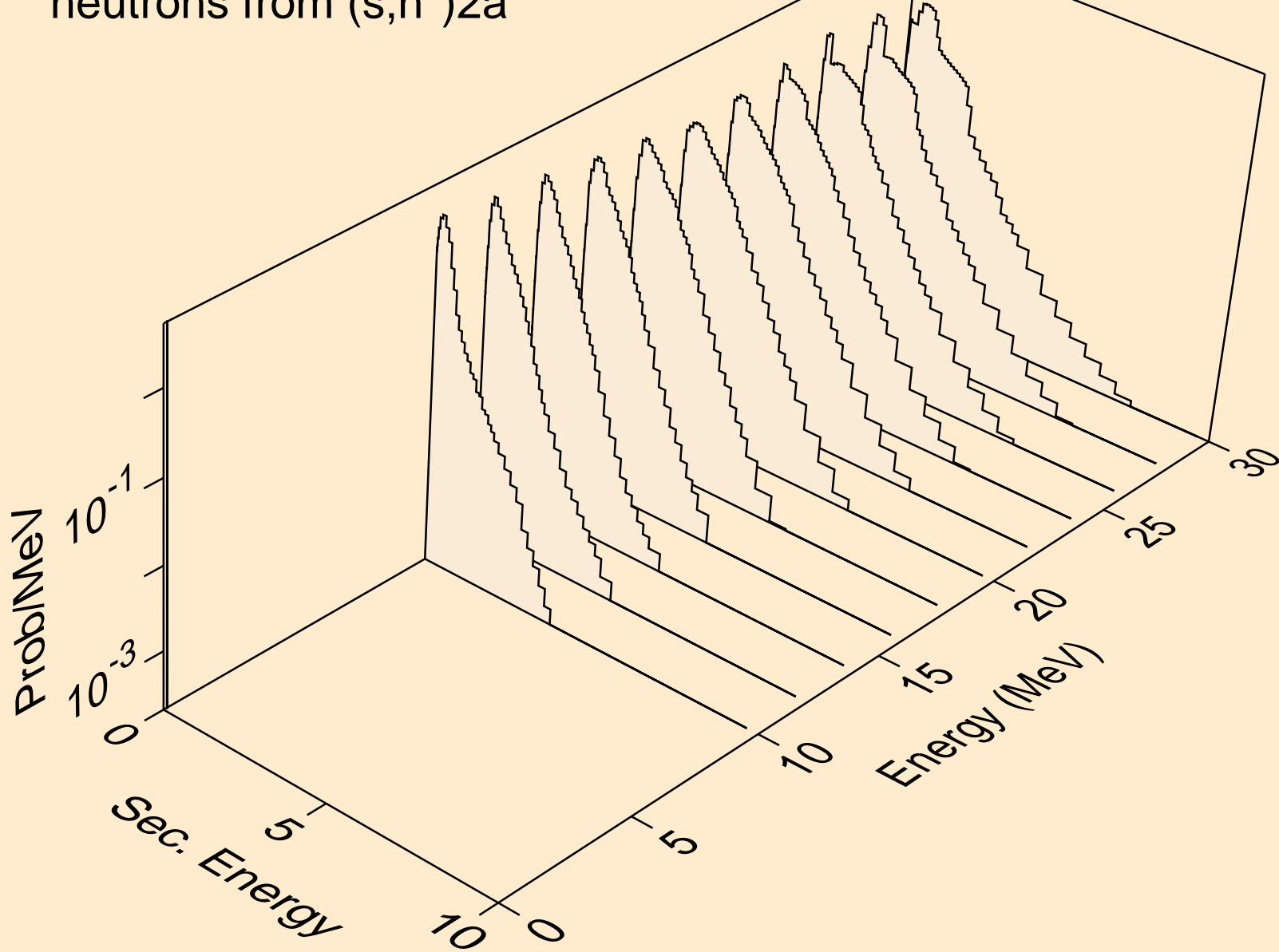

ND146 HELION ACER TENDL-2021 LIBRARY; T=0.K  
neutrons from (s,n\*)d

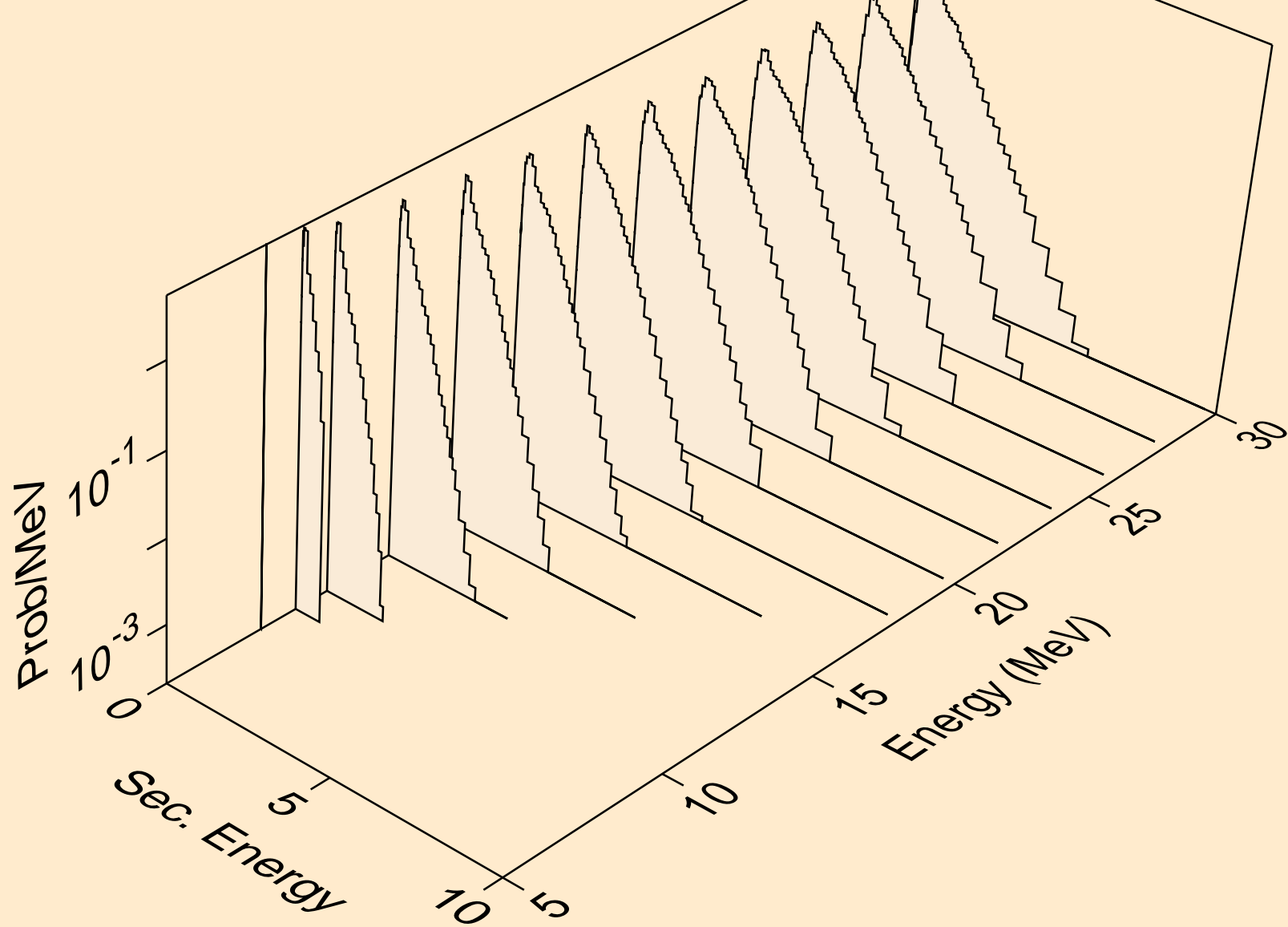

ND146 HELION ACER TENDL-2021 LIBRARY; T=0.K  
neutrons from (s,n\*)t

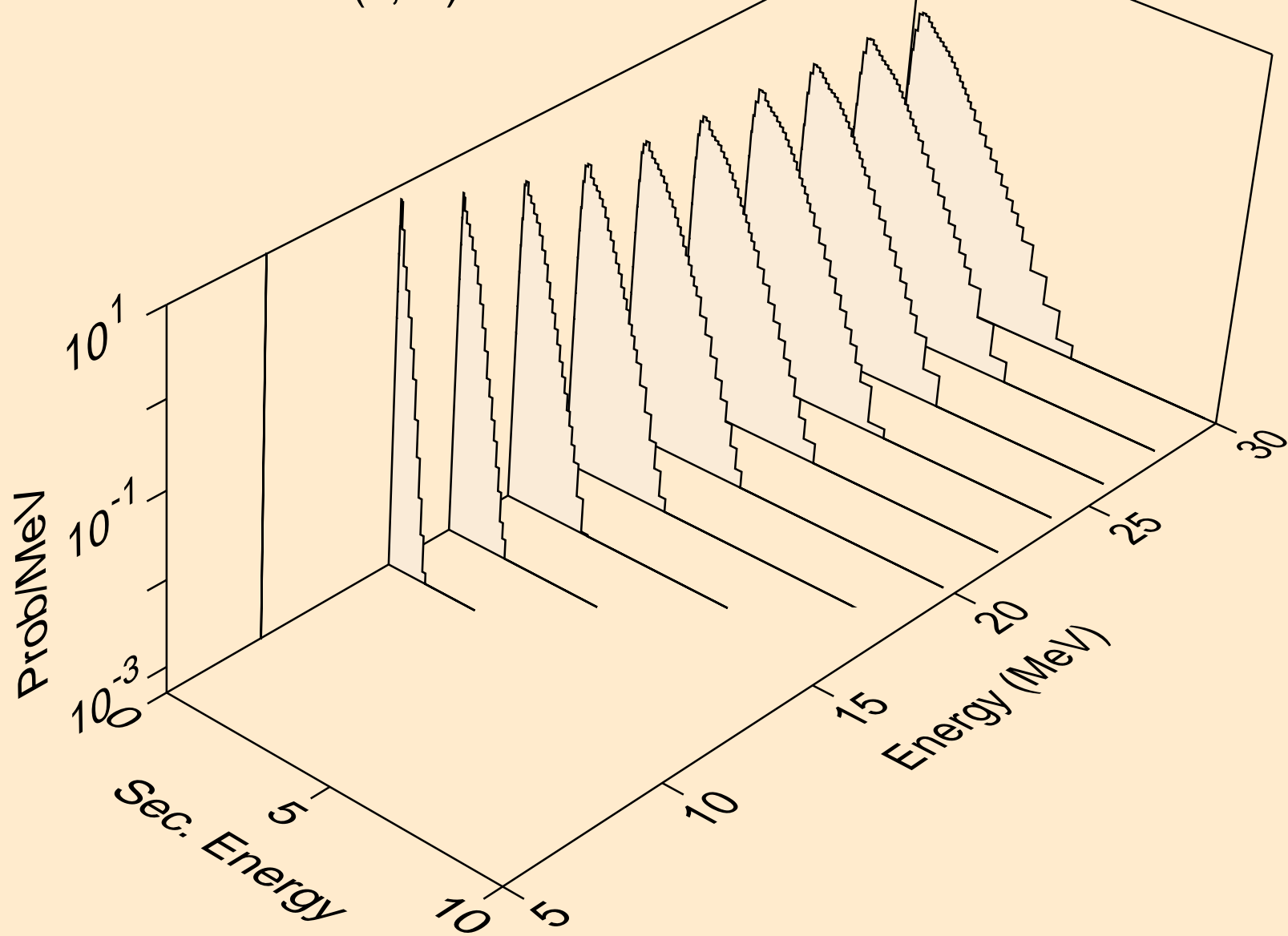

ND146 HELION ACER TENDL-2021 LIBRARY; T=0.K  
neutrons from (s,n\*)he3

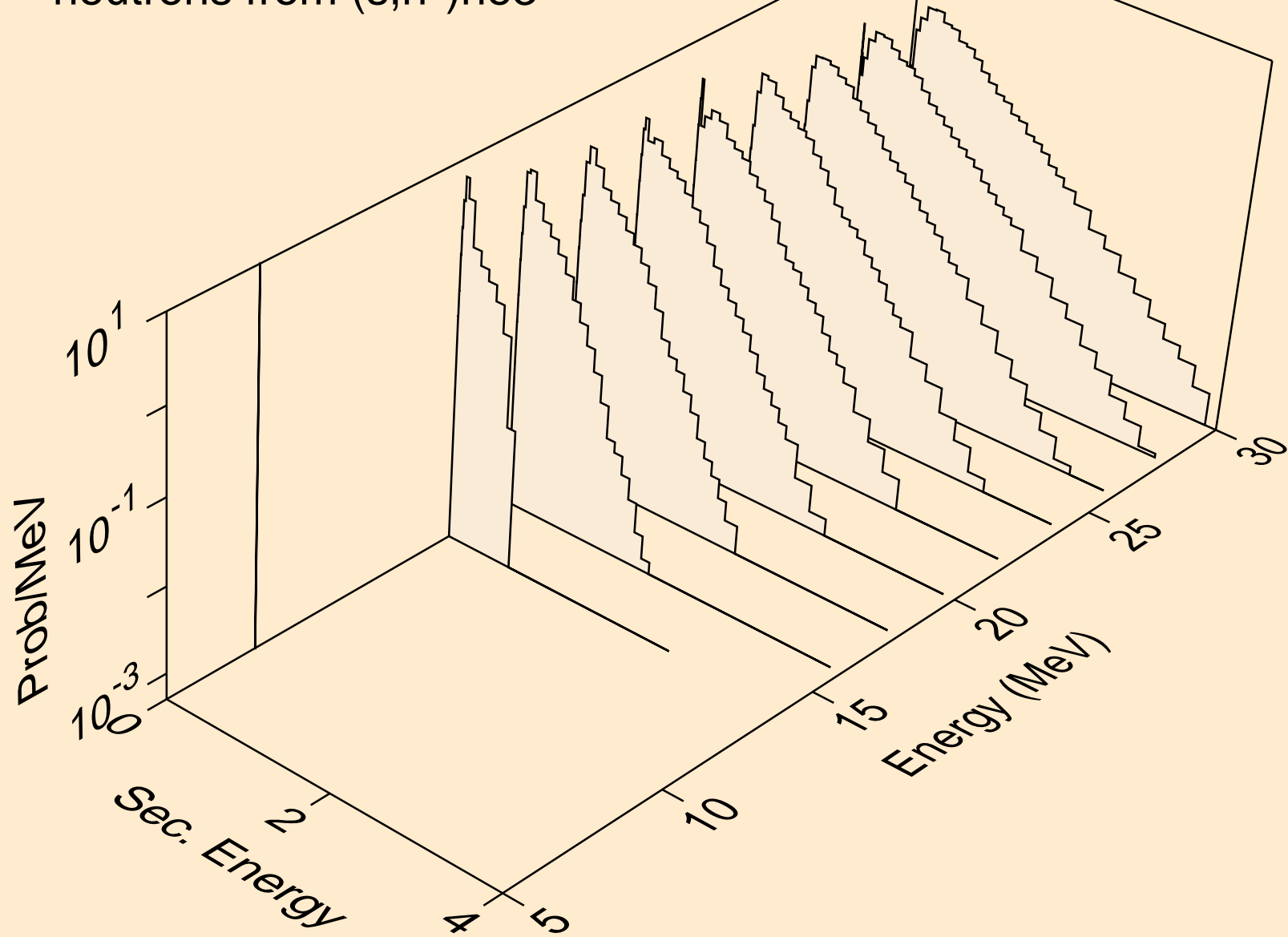

ND146 HELION ACER TENDL-2021 LIBRARY; T=0.K  
neutrons from (s,4n)

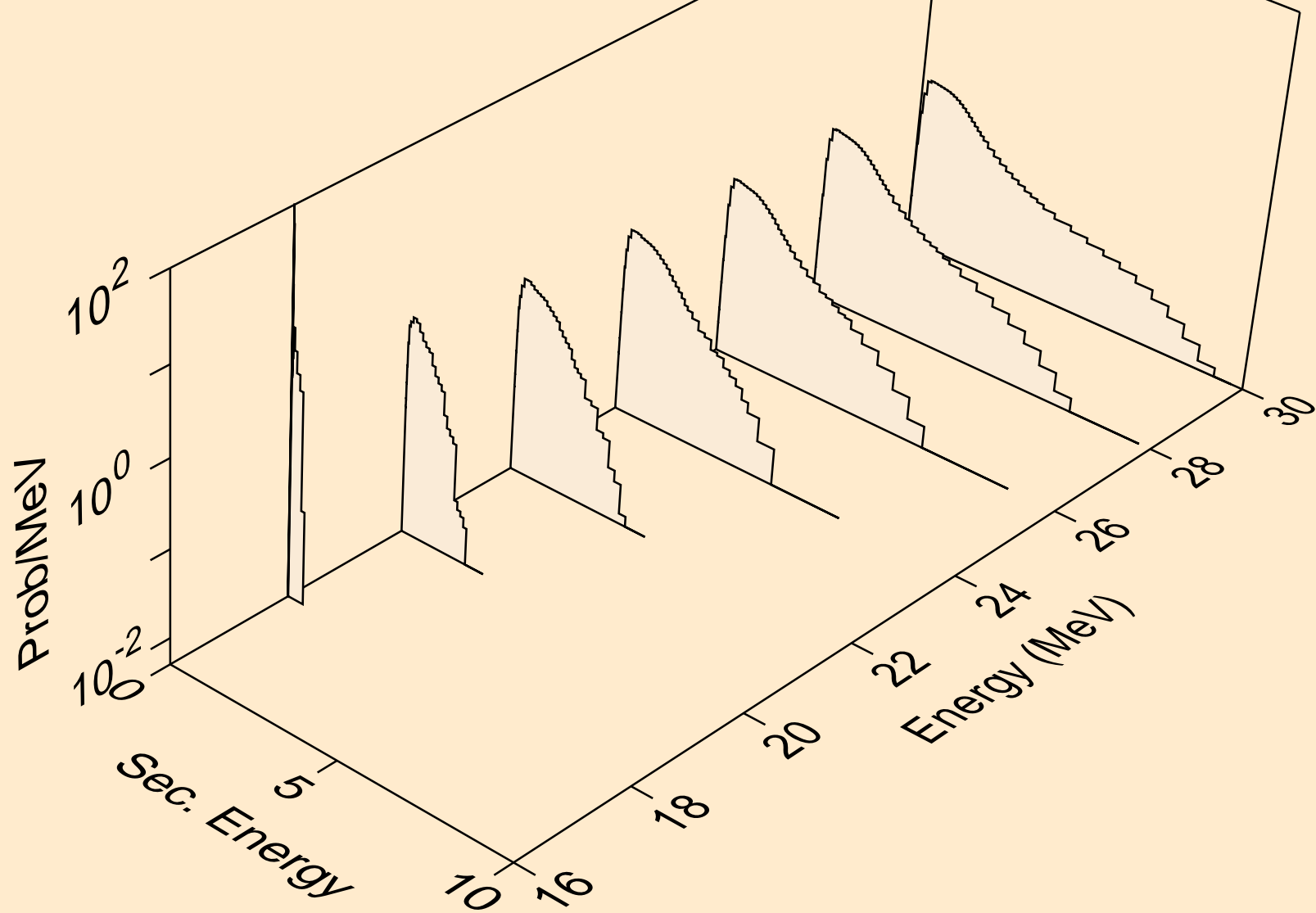



ND146 HELION ACER TENDL-2021 LIBRARY; T=0.K  
neutrons from (s,2np)

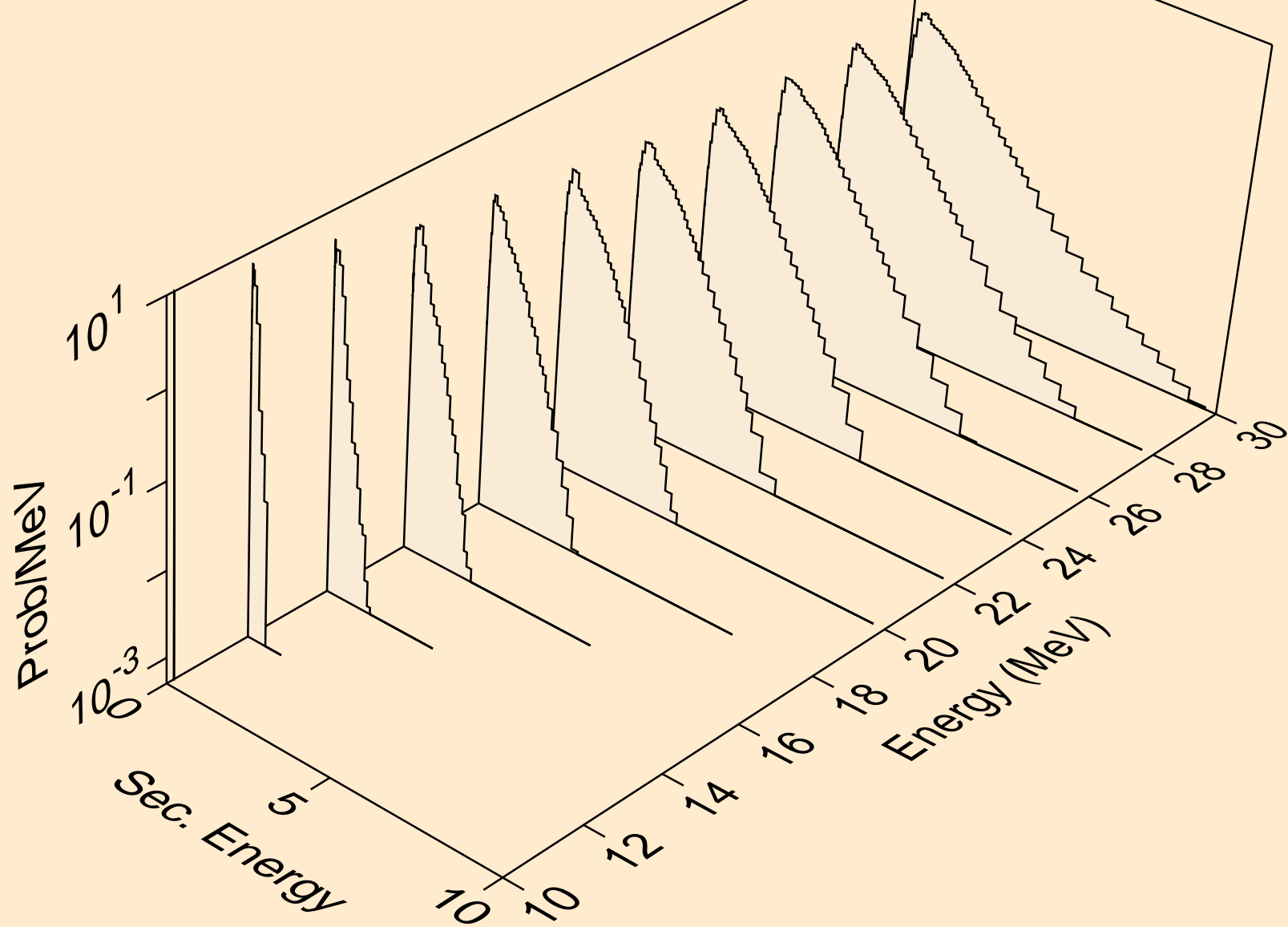

ND146 HELION ACER TENDL-2021 LIBRARY; T=0.K  
neutrons from (s,3np)

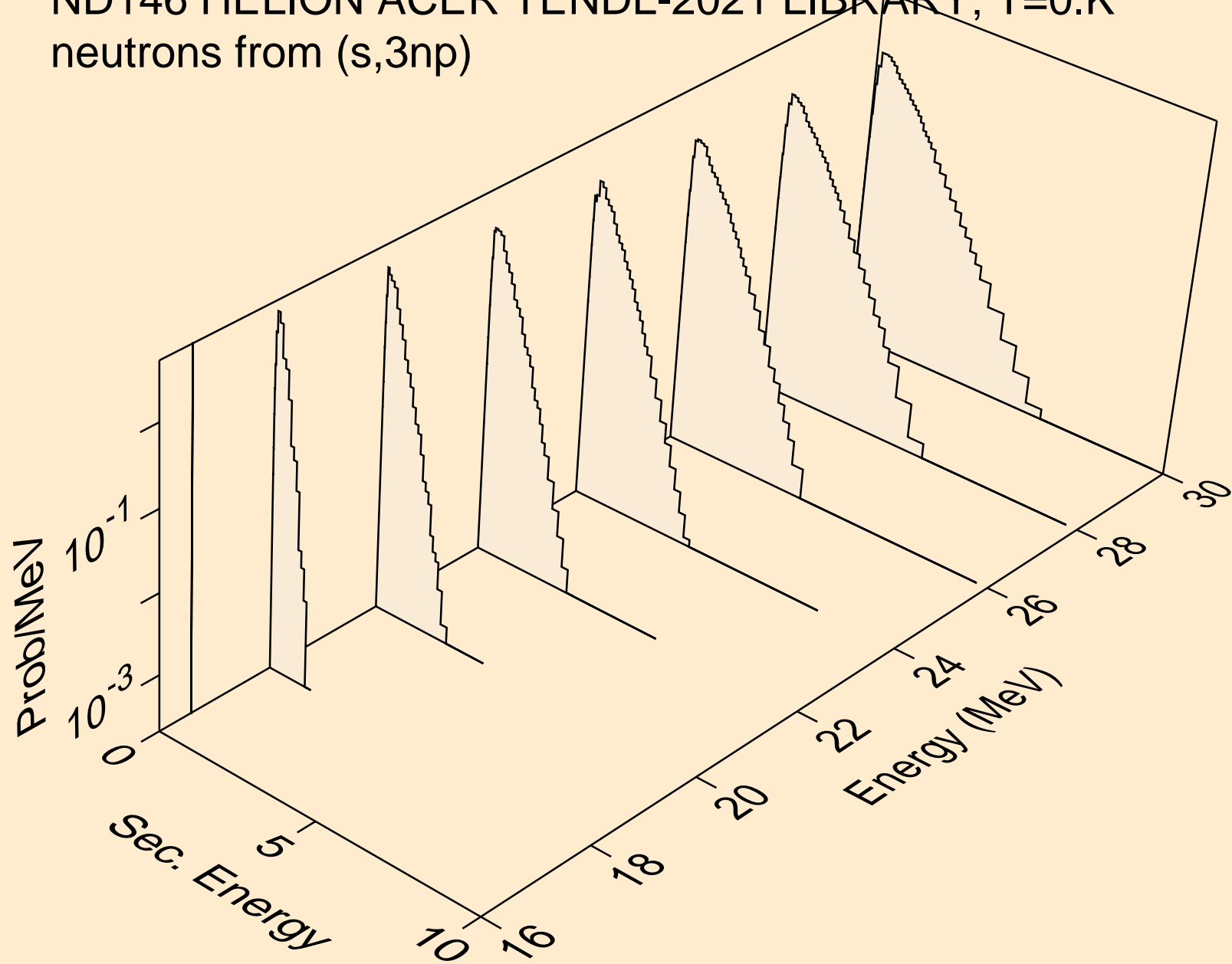

ND146 HELION ACER TENDL-2021 LIBRARY; T=0.K  
neutrons from (s,2np)

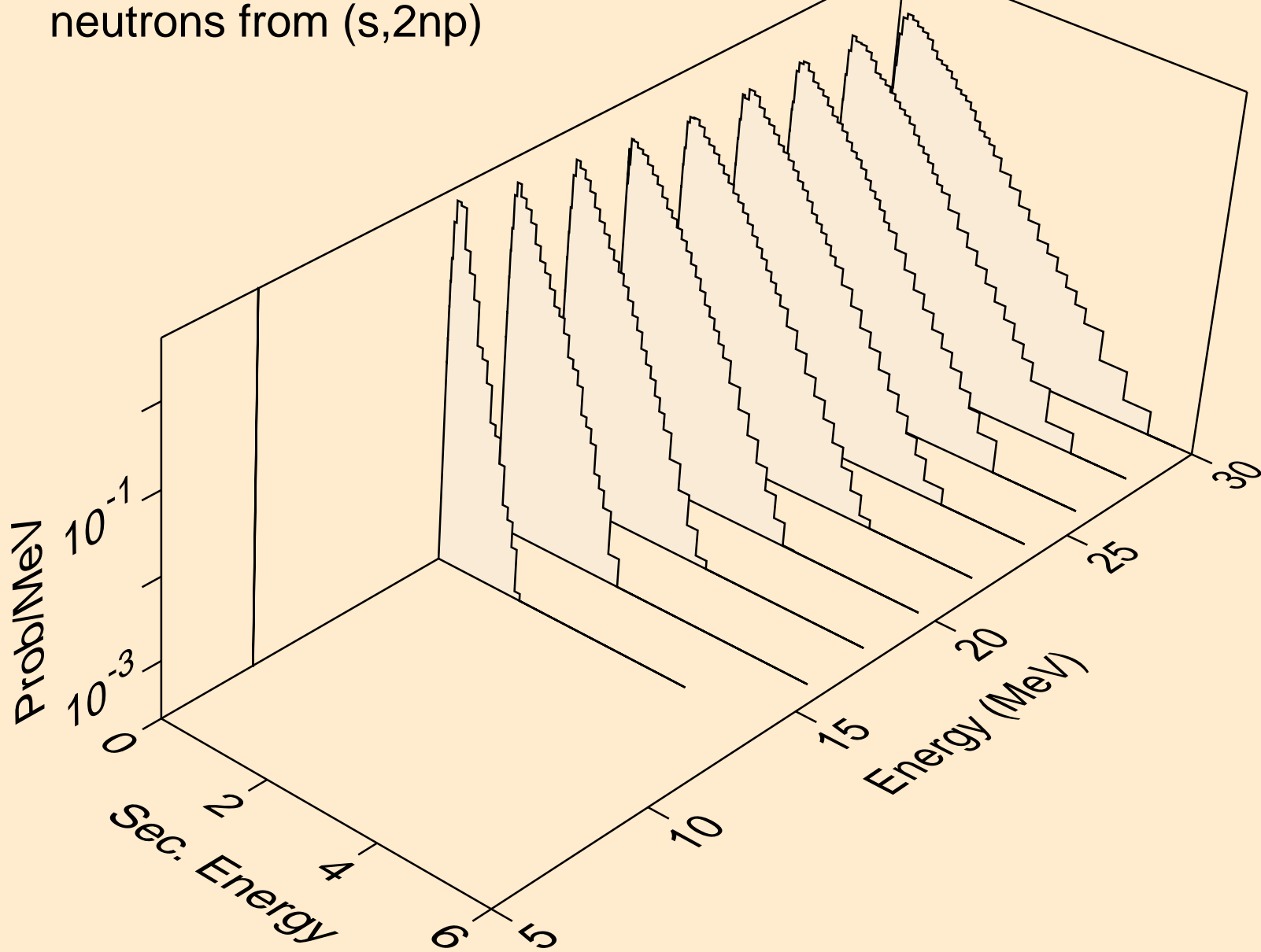

ND146 HELION ACER TENDL-2021 LIBRARY; T=0.K  
neutrons from (s,npa)

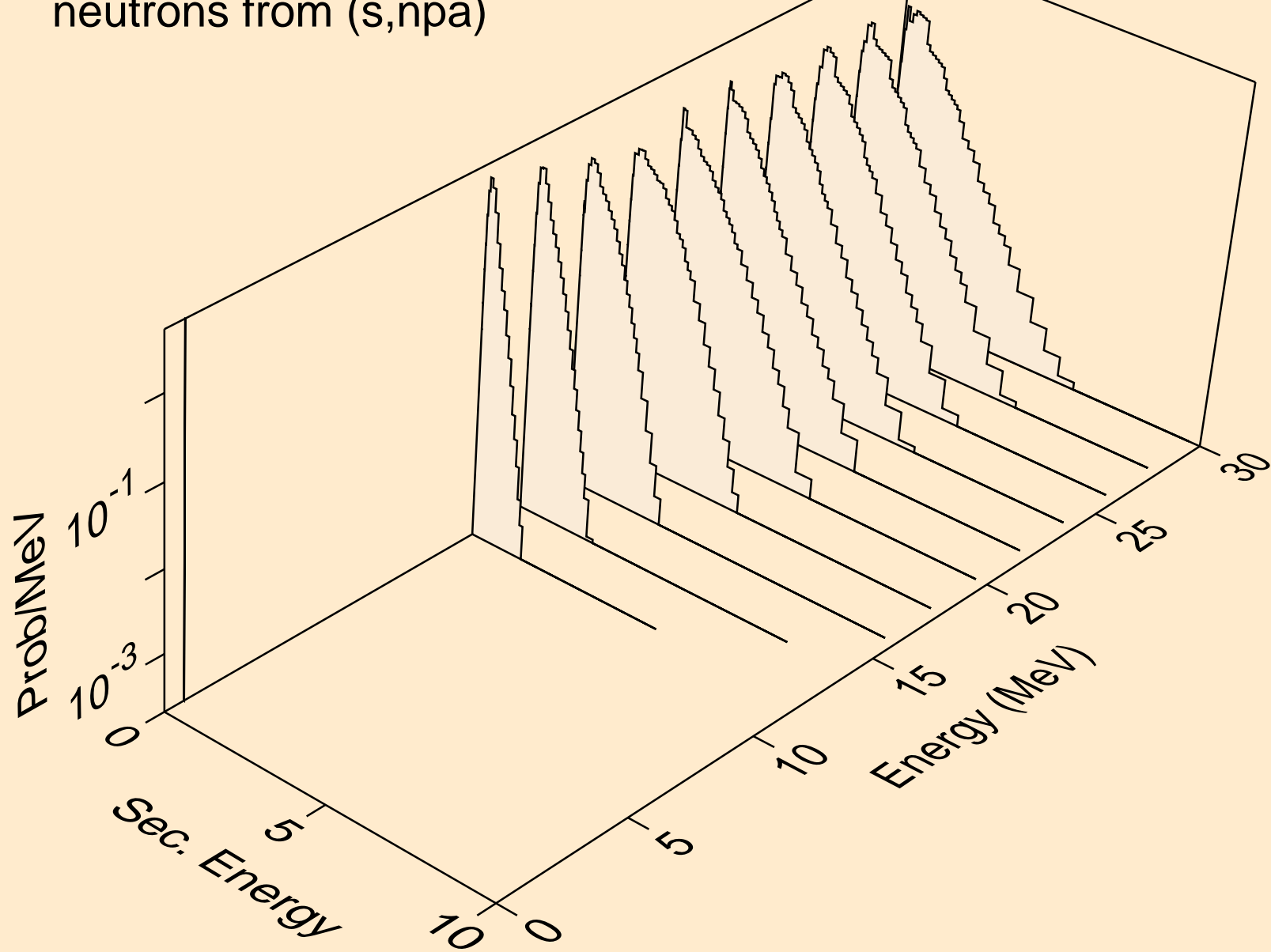

ND146 HELION ACER TENDL-2021 LIBRARY; T=0.K  
protons from (s,x)

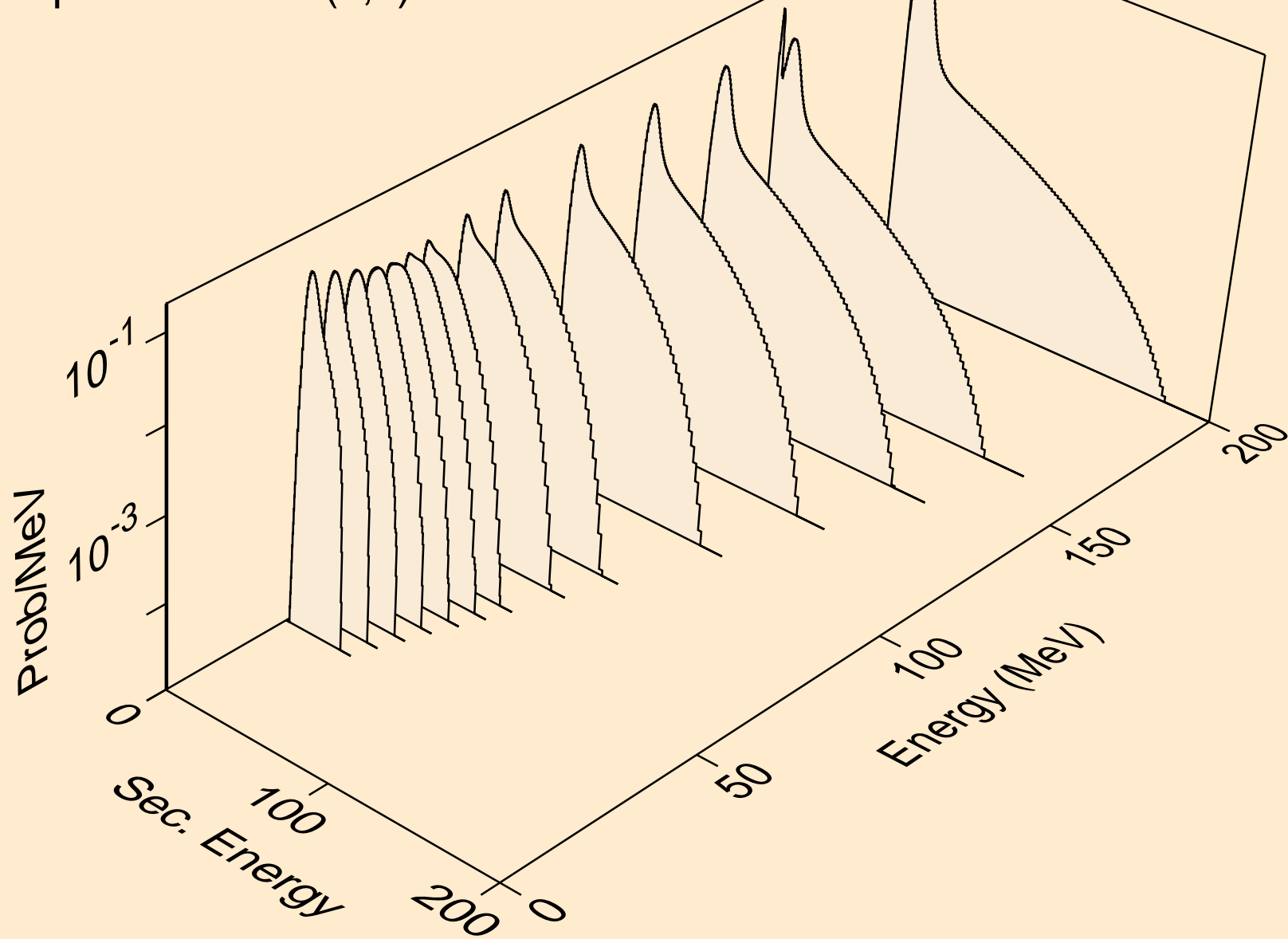

ND146 HELION ACER TENDL-2021 LIBRARY; T=0.K  
protons from (s,n\*)p

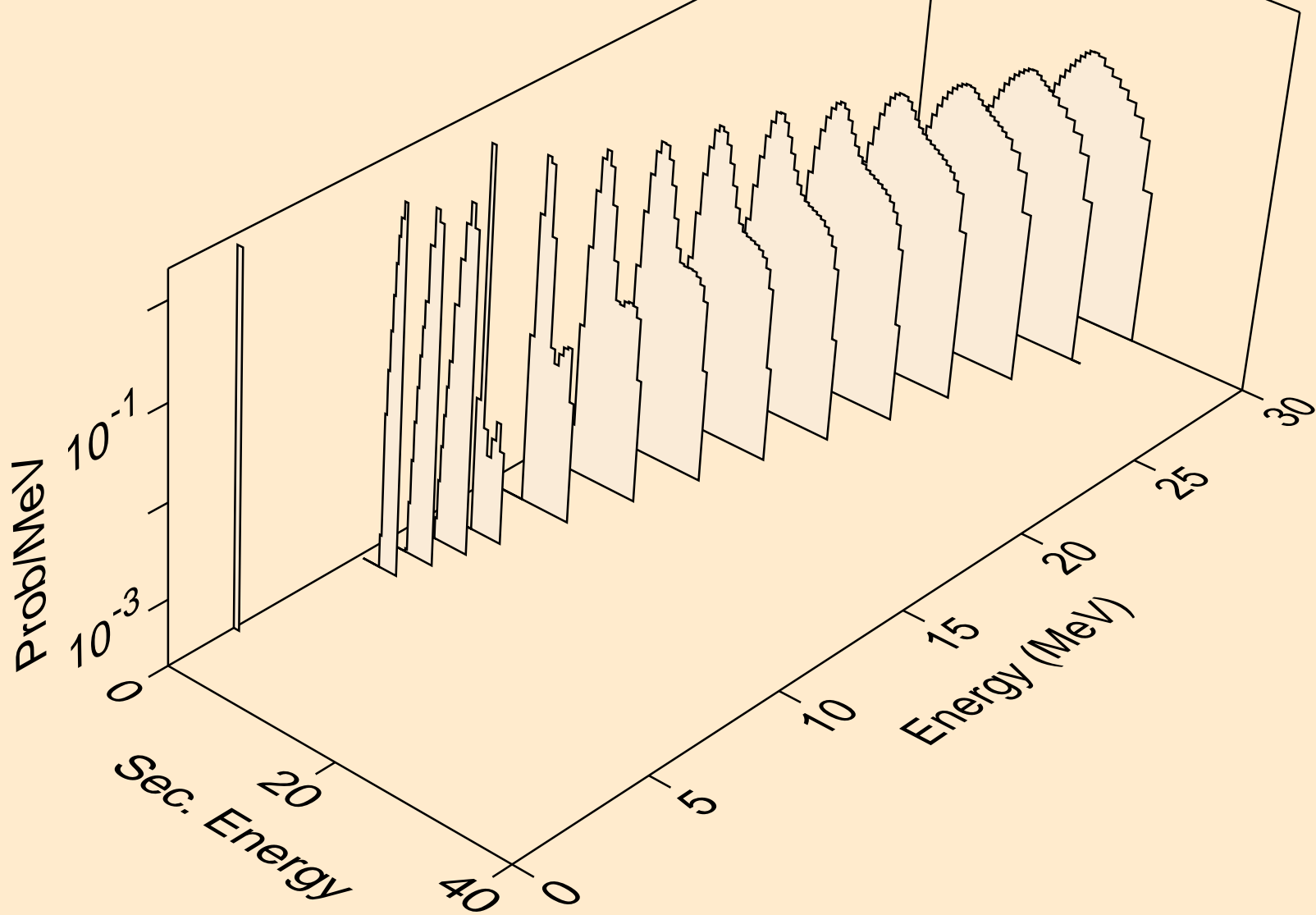

ND146 HELION ACER TENDL-2021 LIBRARY; T=0.K  
protons from (s,2np)

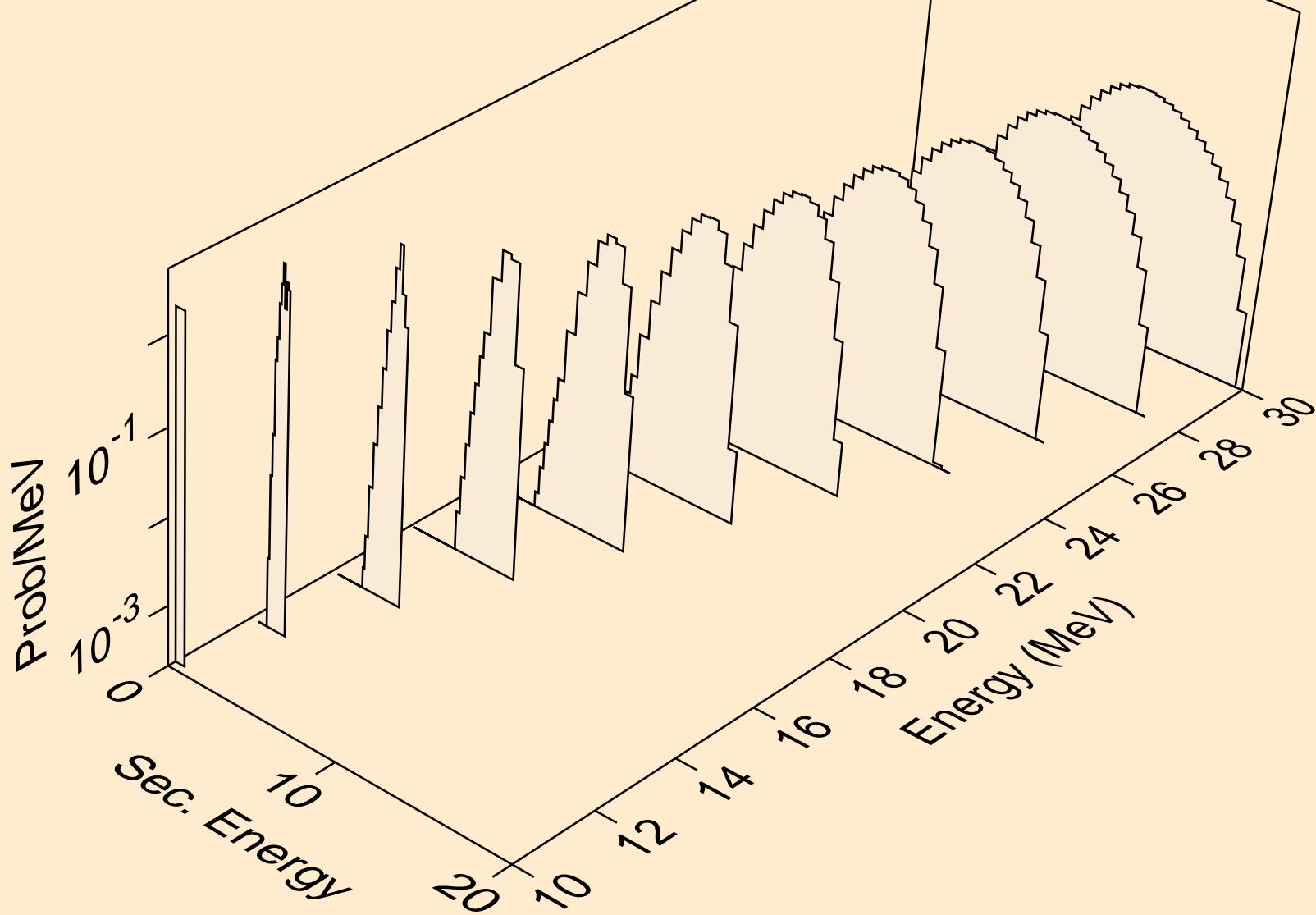

ND146 HELION ACER TENDL-2021 LIBRARY; T=0.K  
protons from (s,3np)

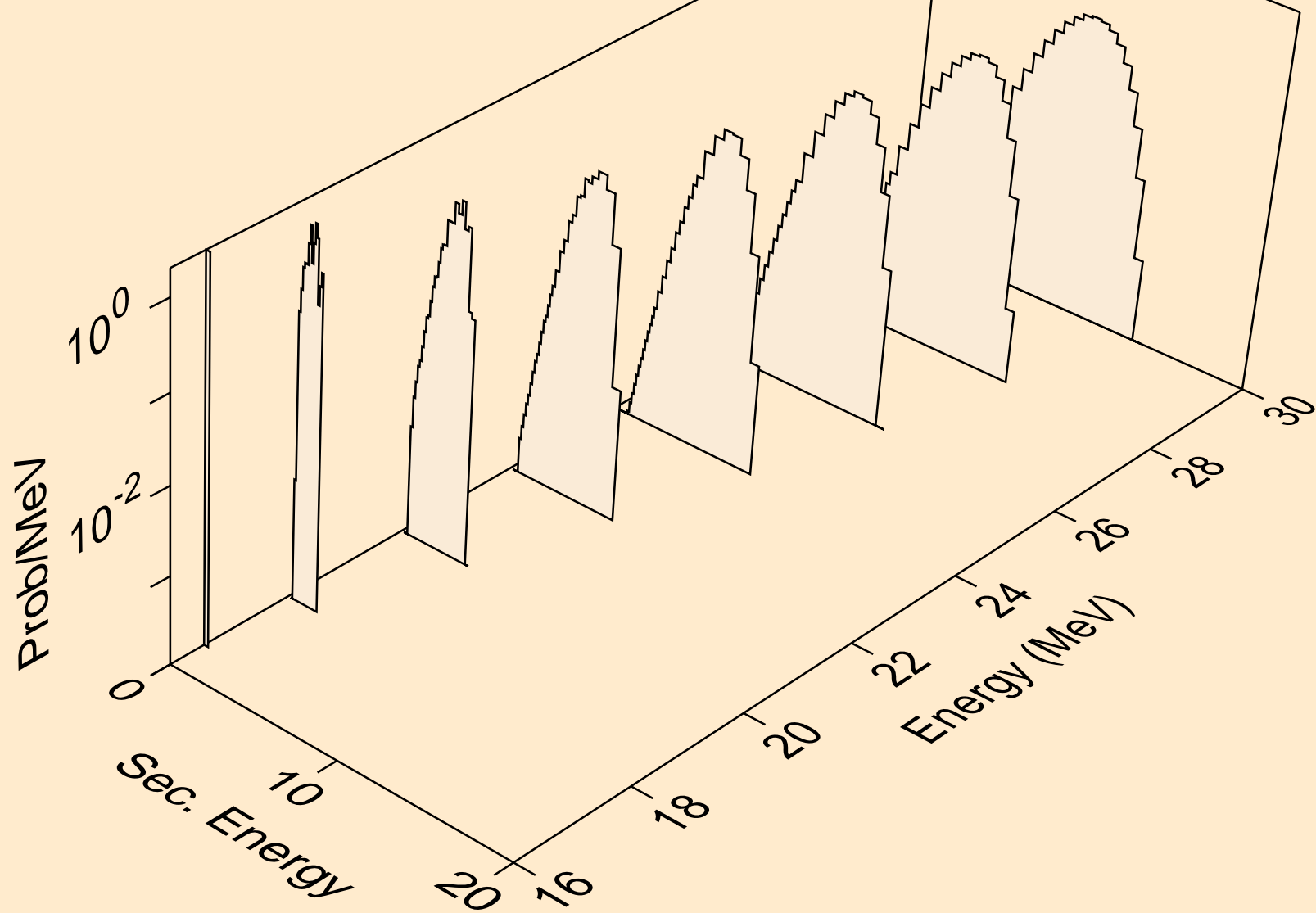



ND146 HELION ACER TENDL-2021 LIBRARY; T=0.K  
protons from (s,2np)

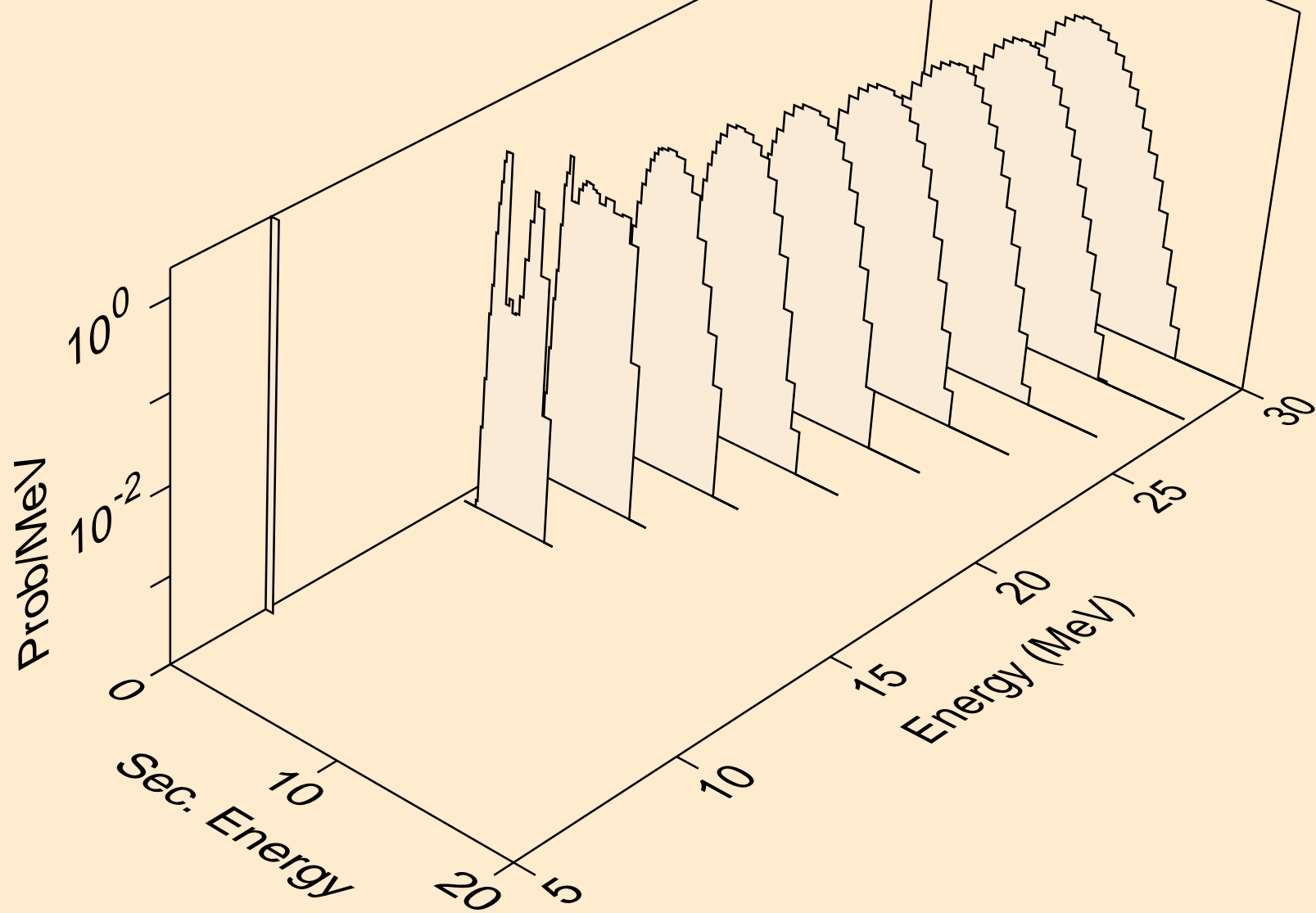

ND146 HELION ACER TENDL-2021 LIBRARY; T=0.K  
protons from (s,npa)

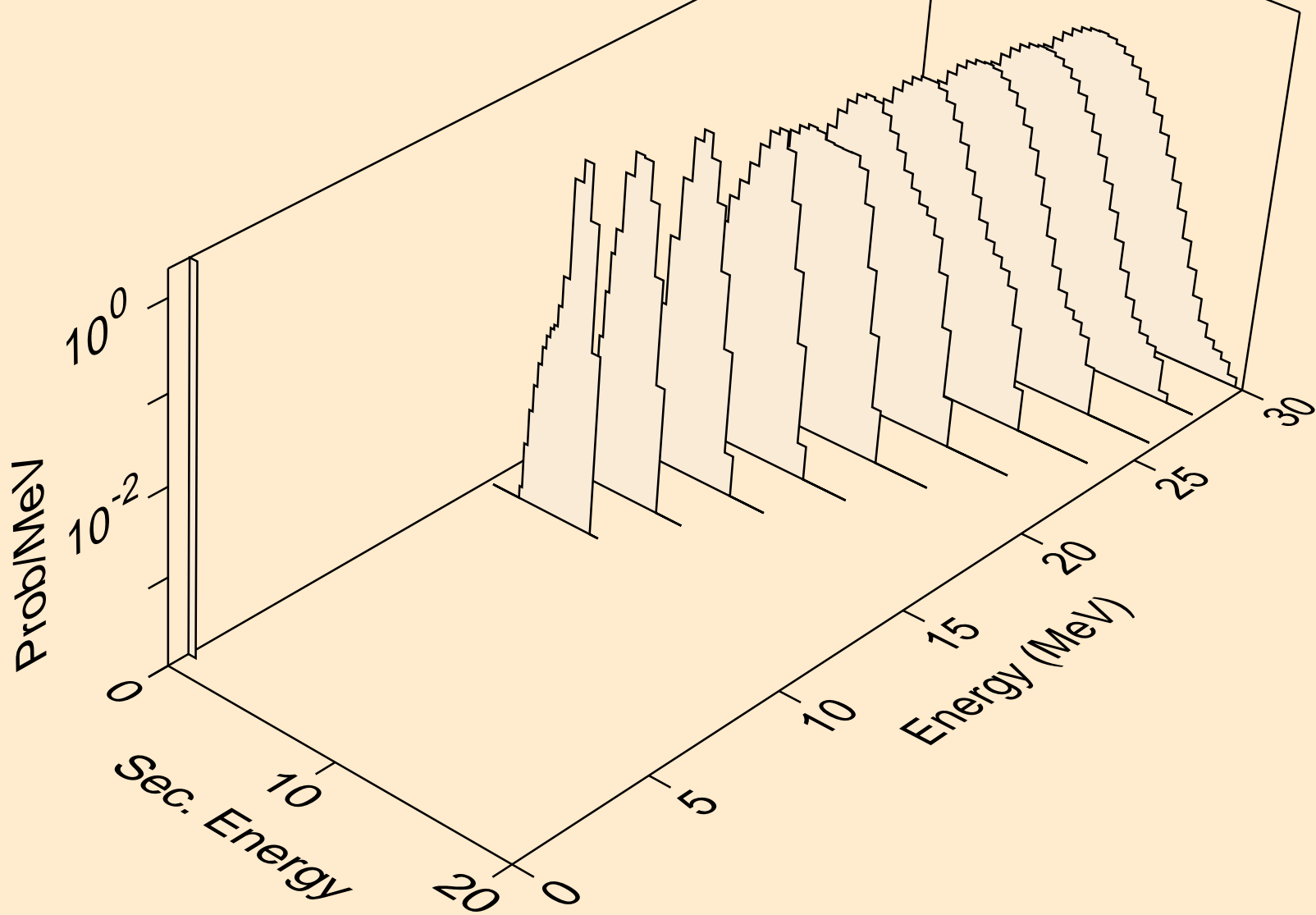

ND146 HELION ACER TENDL-2021 LIBRARY; T=0.K  
protons from (s,p)

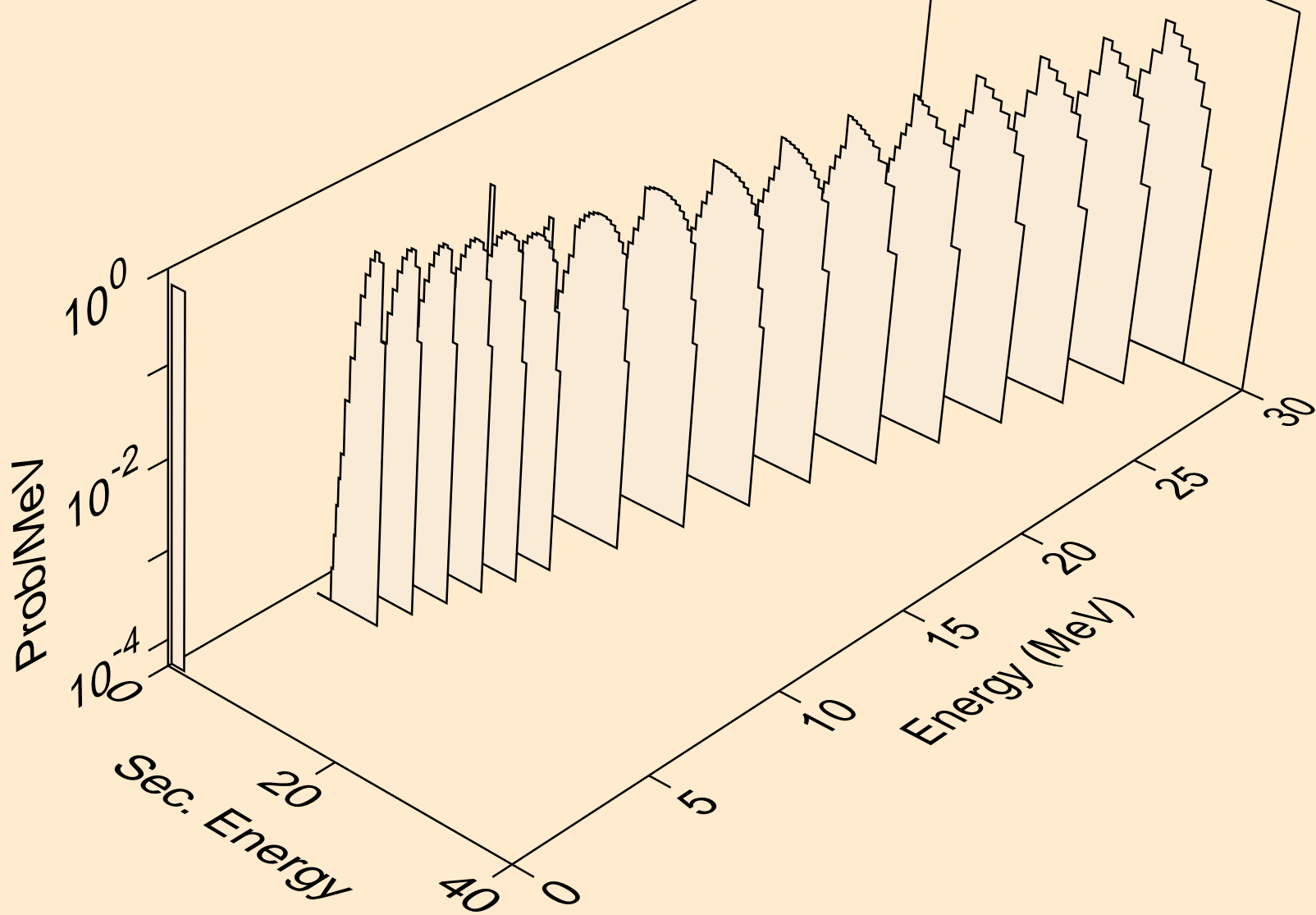

ND146 HELION ACER TENDL-2021 LIBRARY; T=0.K  
protons from (s,2p)

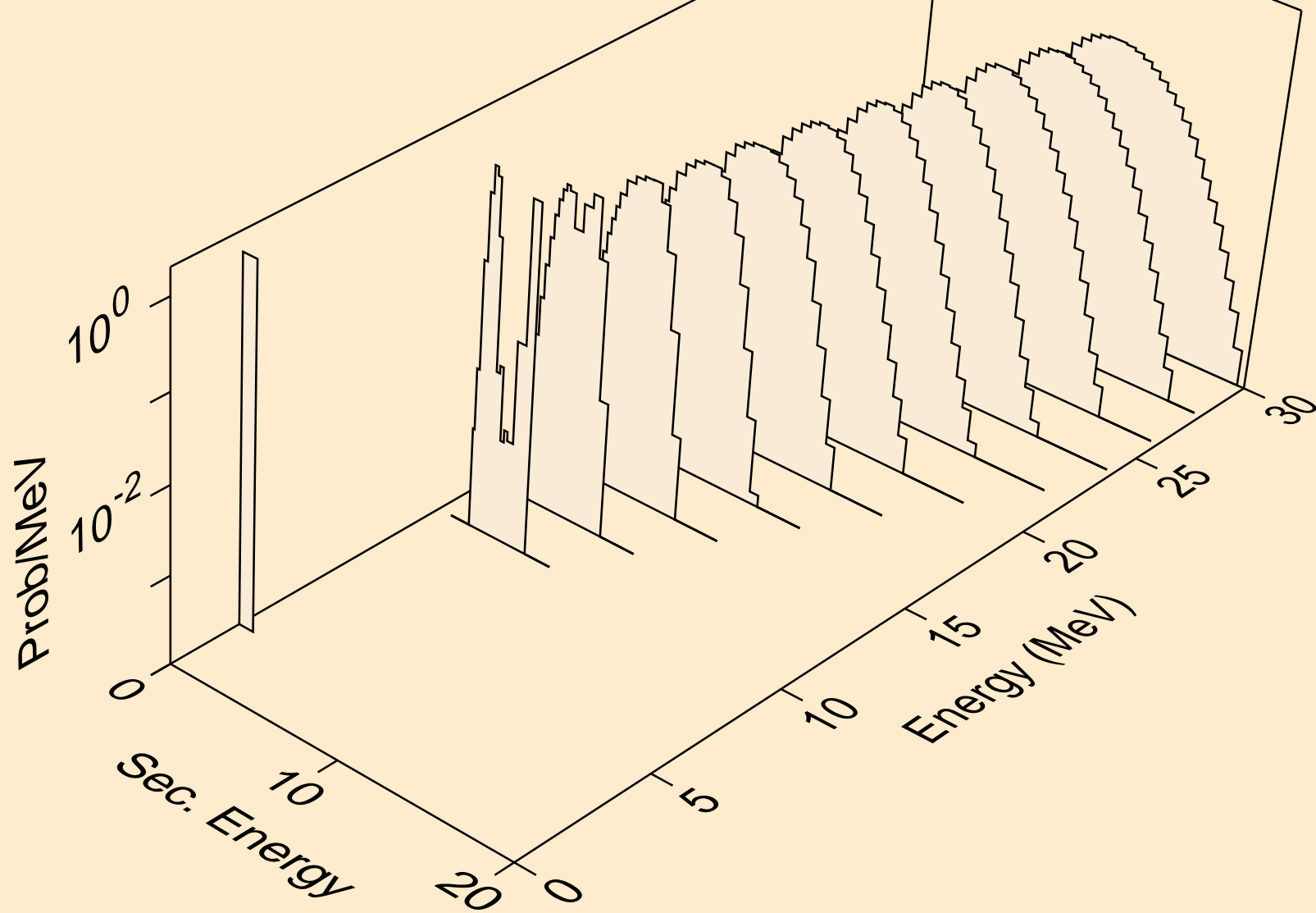

ND146 HELION ACER TENDL-2021 LIBRARY; T=0.K  
protons from (s,pa)

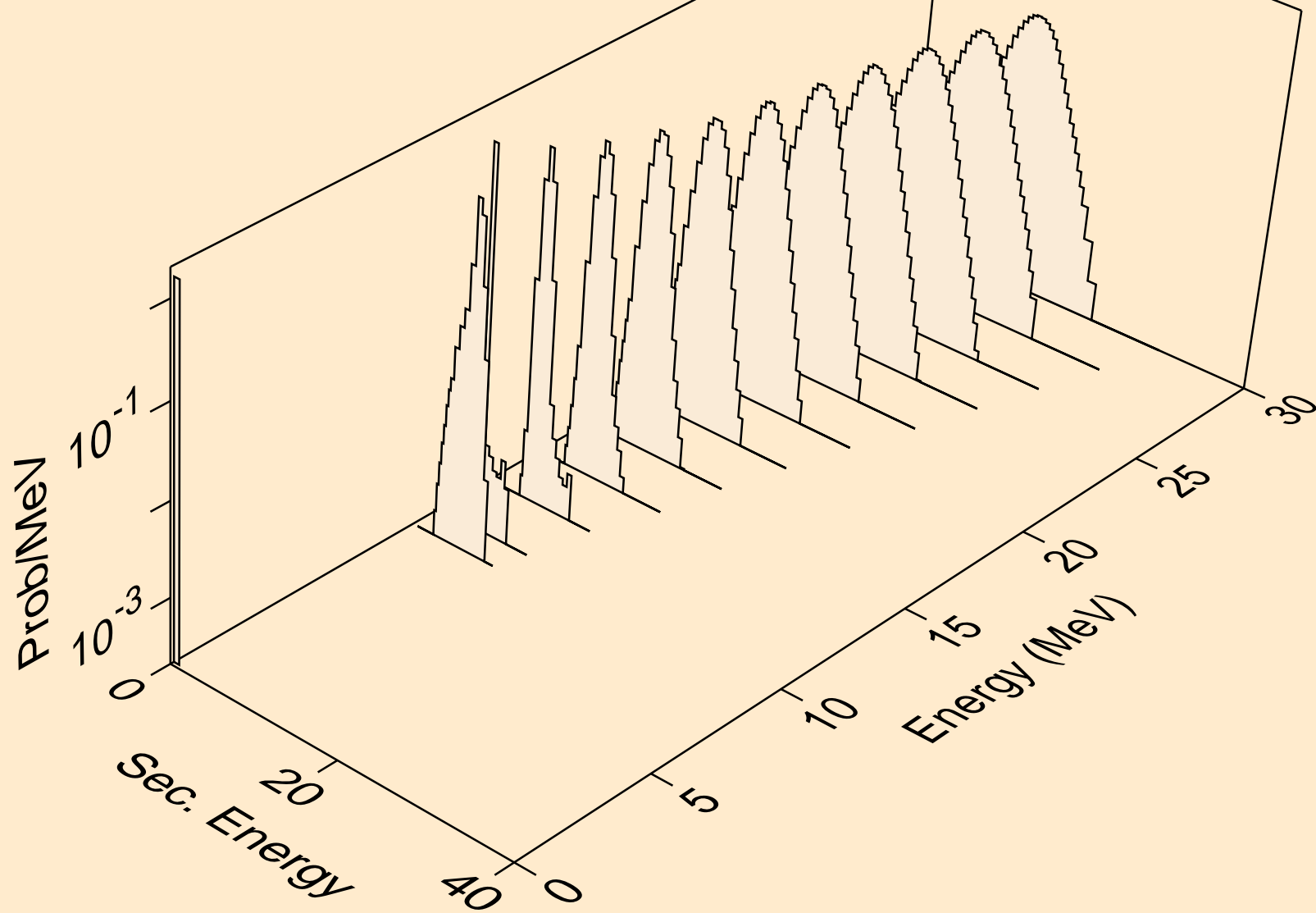

ND146 HELION ACER TENDL-2021 LIBRARY; T=0.K  
protons from (s,pd)

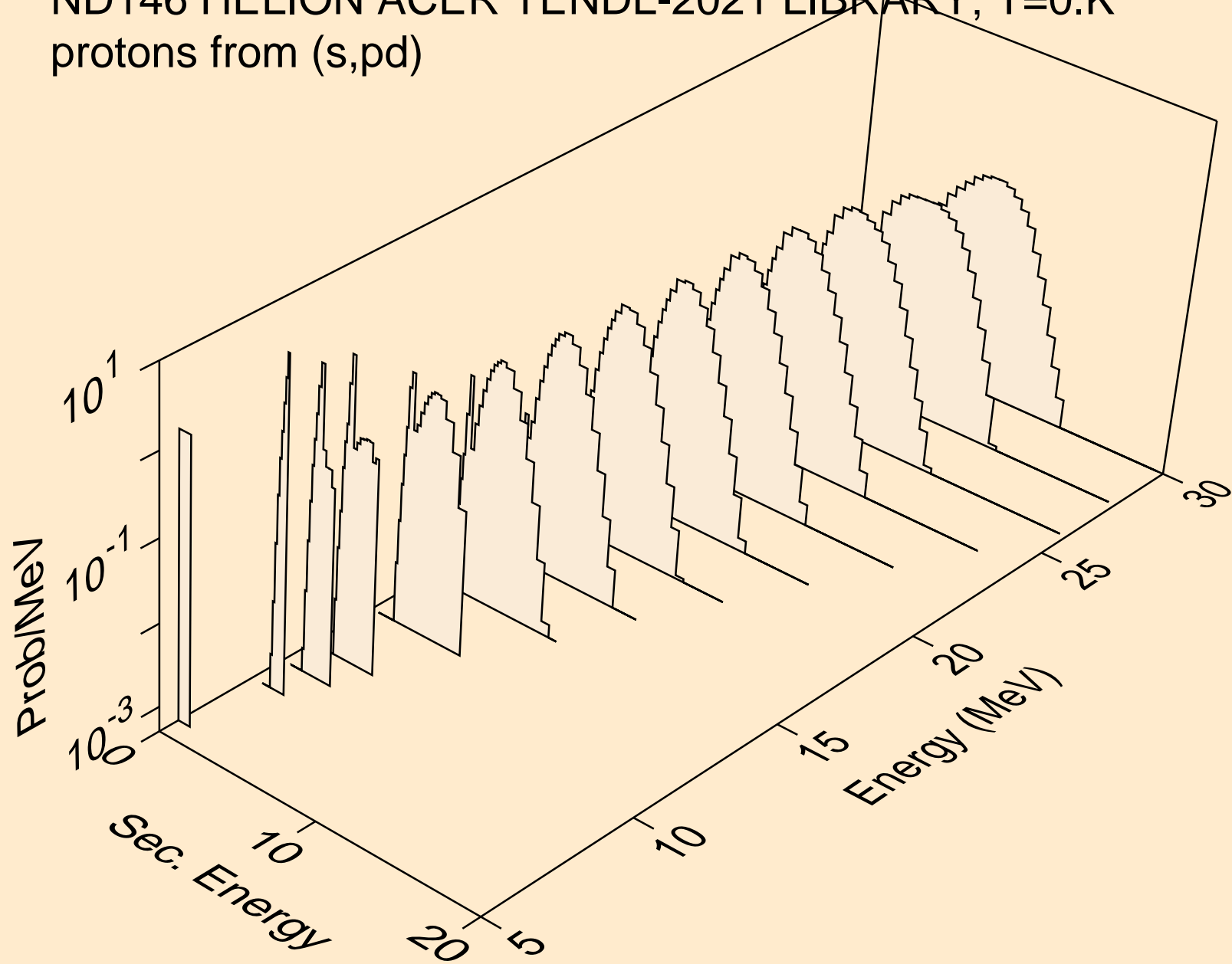

ND146 HELION ACER TENDL-2021 LIBRARY; T=0.K  
protons from (s,pt)

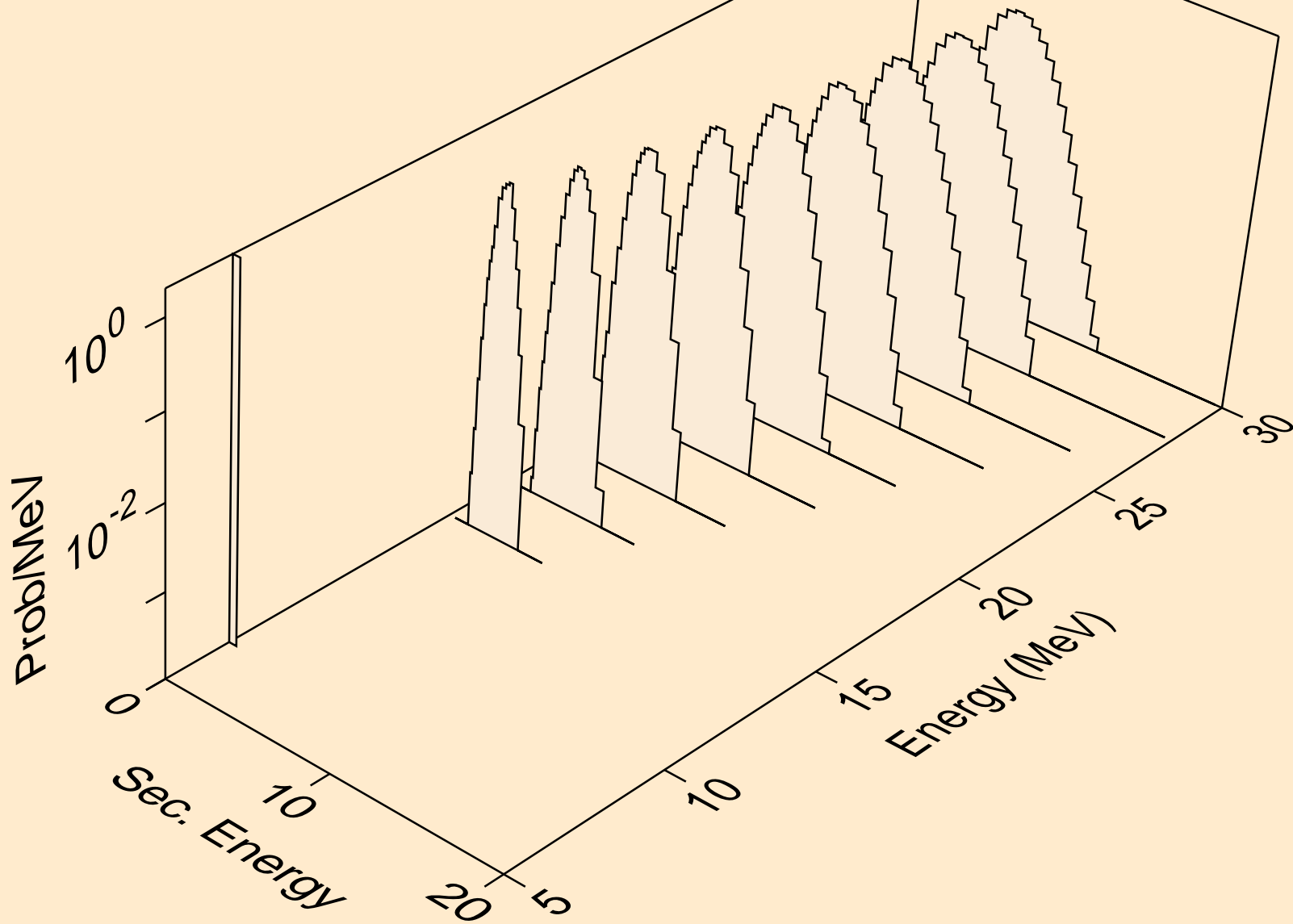

ND146 HELION ACER TENDL-2021 LIBRARY; T=0.K  
deuterons from (s,x)

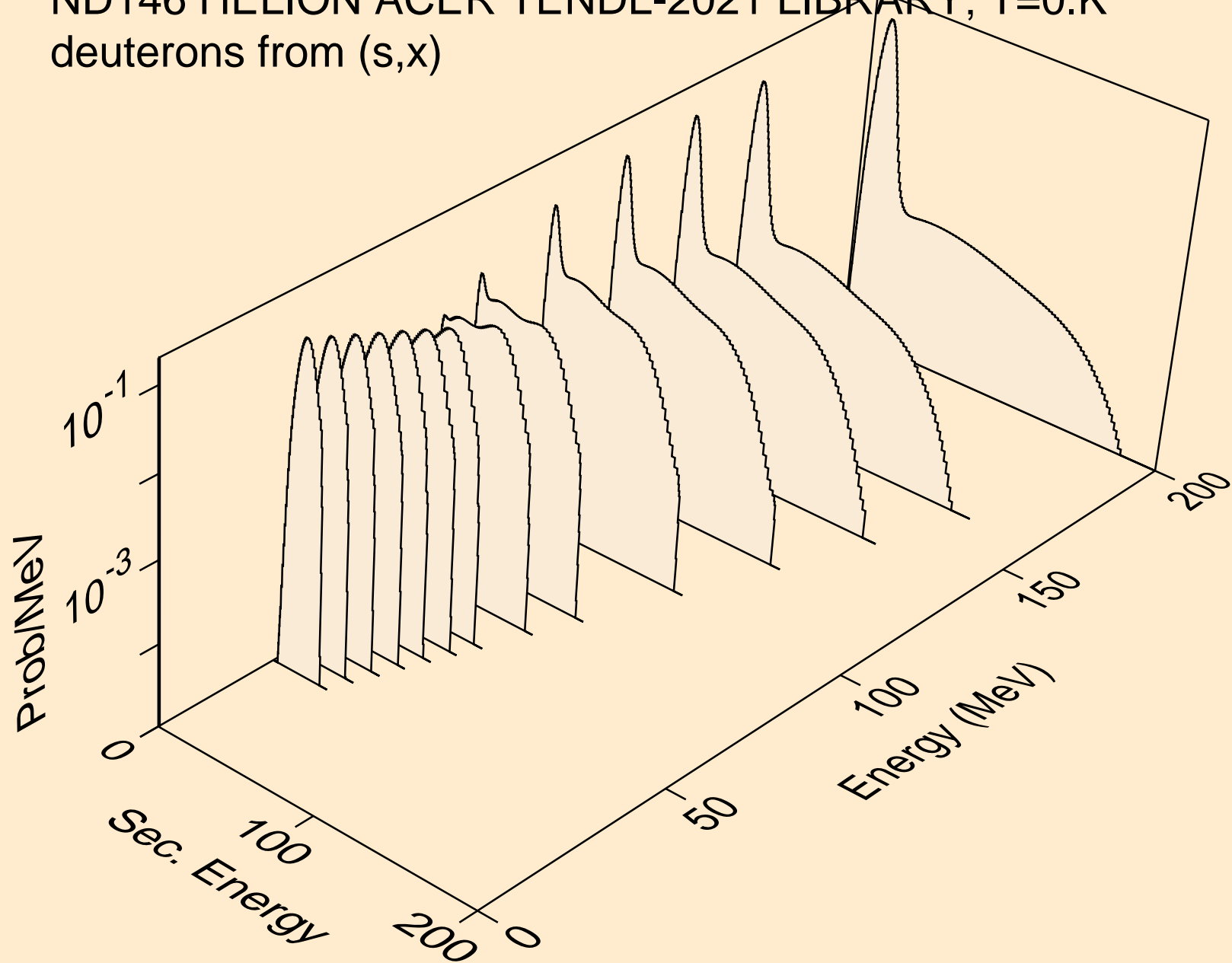



ND146 HELION ACER TENDL-2021 LIBRARY; T=0.K  
deuterons from (s,2nd)

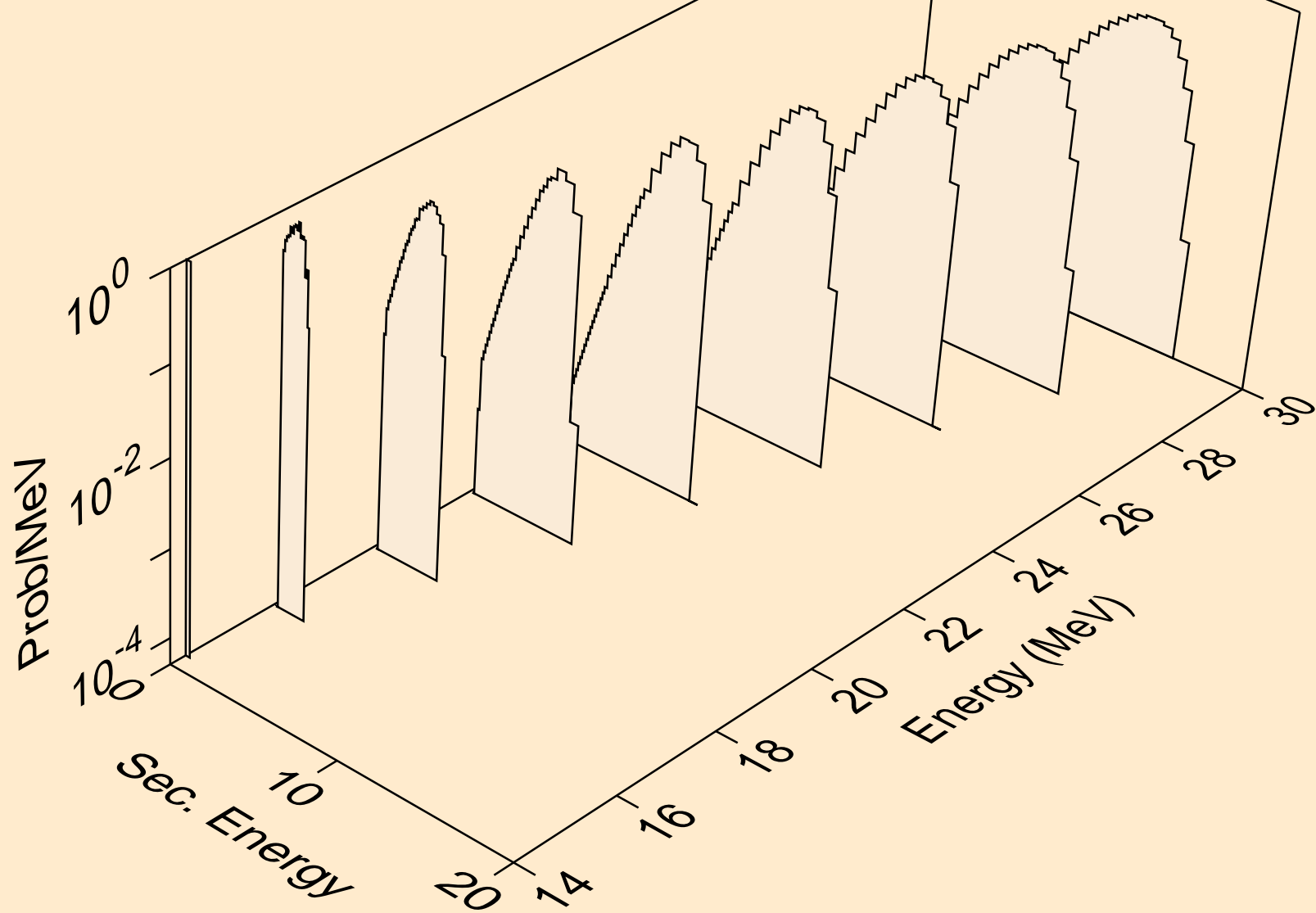

ND146 HELION ACER TENDL-2021 LIBRARY; T=0.K  
deuterons from (s,n\*)d

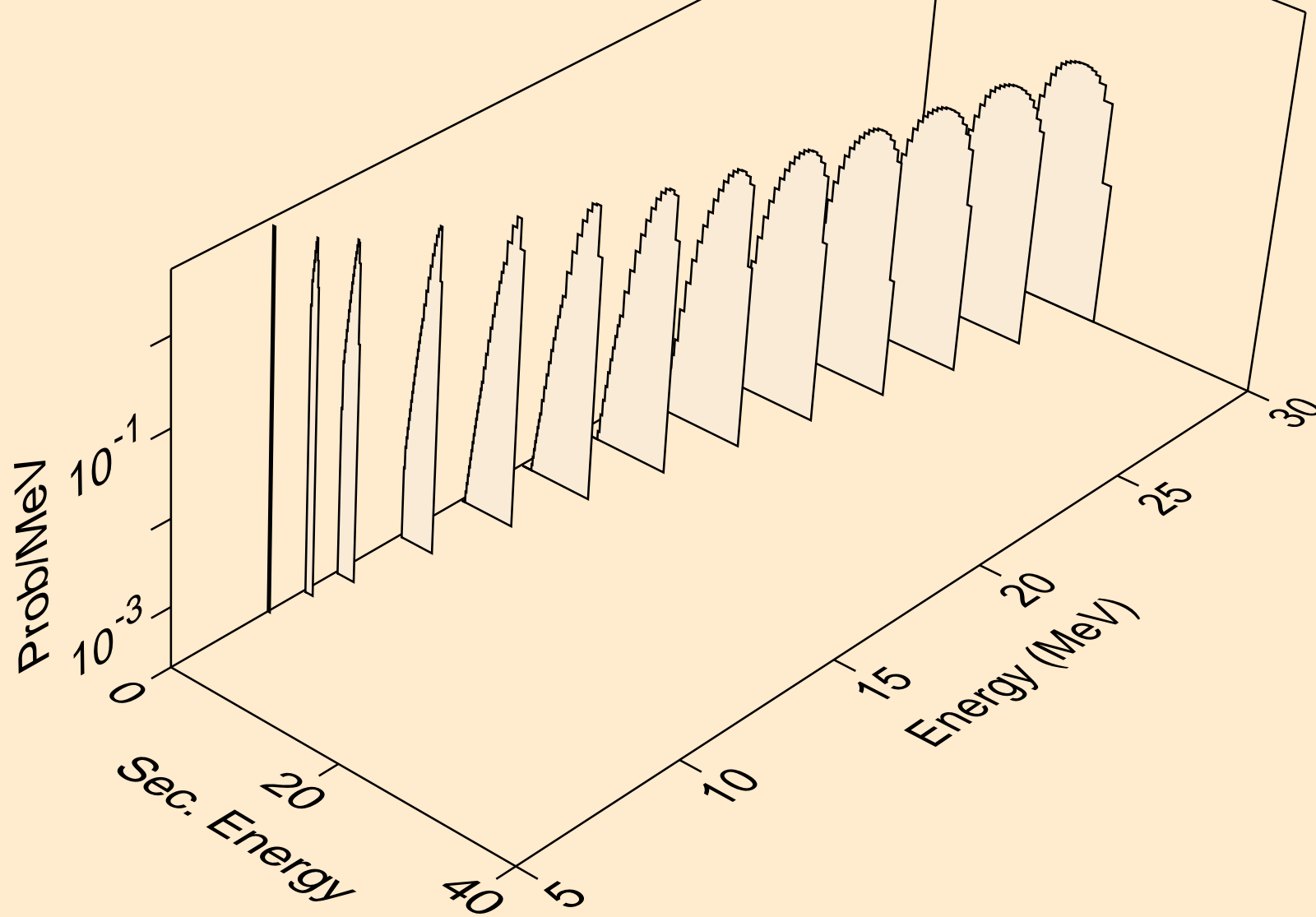

ND146 HELION ACER TENDL-2021 LIBRARY; T=0.K  
deuterons from (s,d)

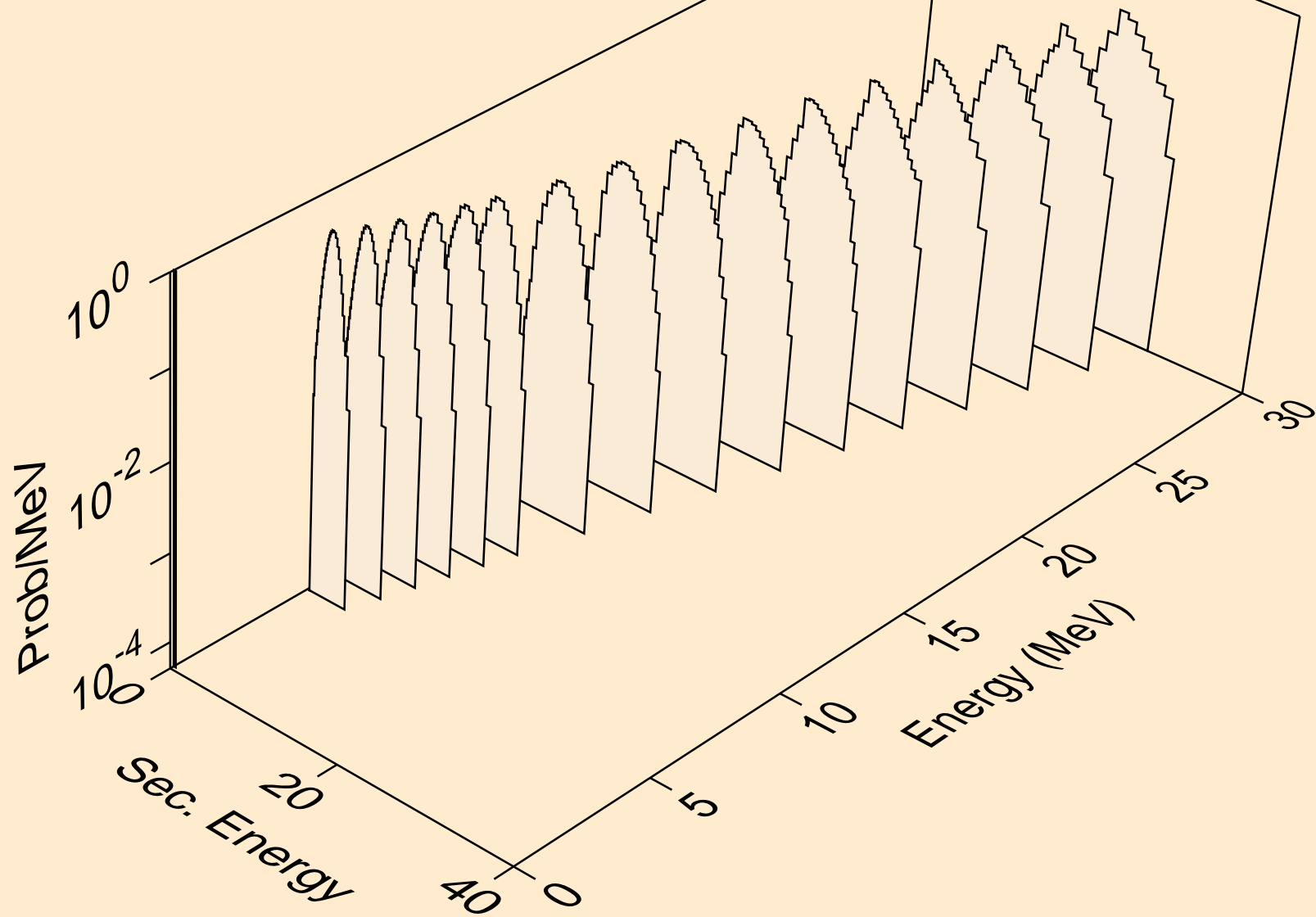

ND146 HELION ACER TENDL-2021 LIBRARY; T=0.K  
deuterons from (s,pd)

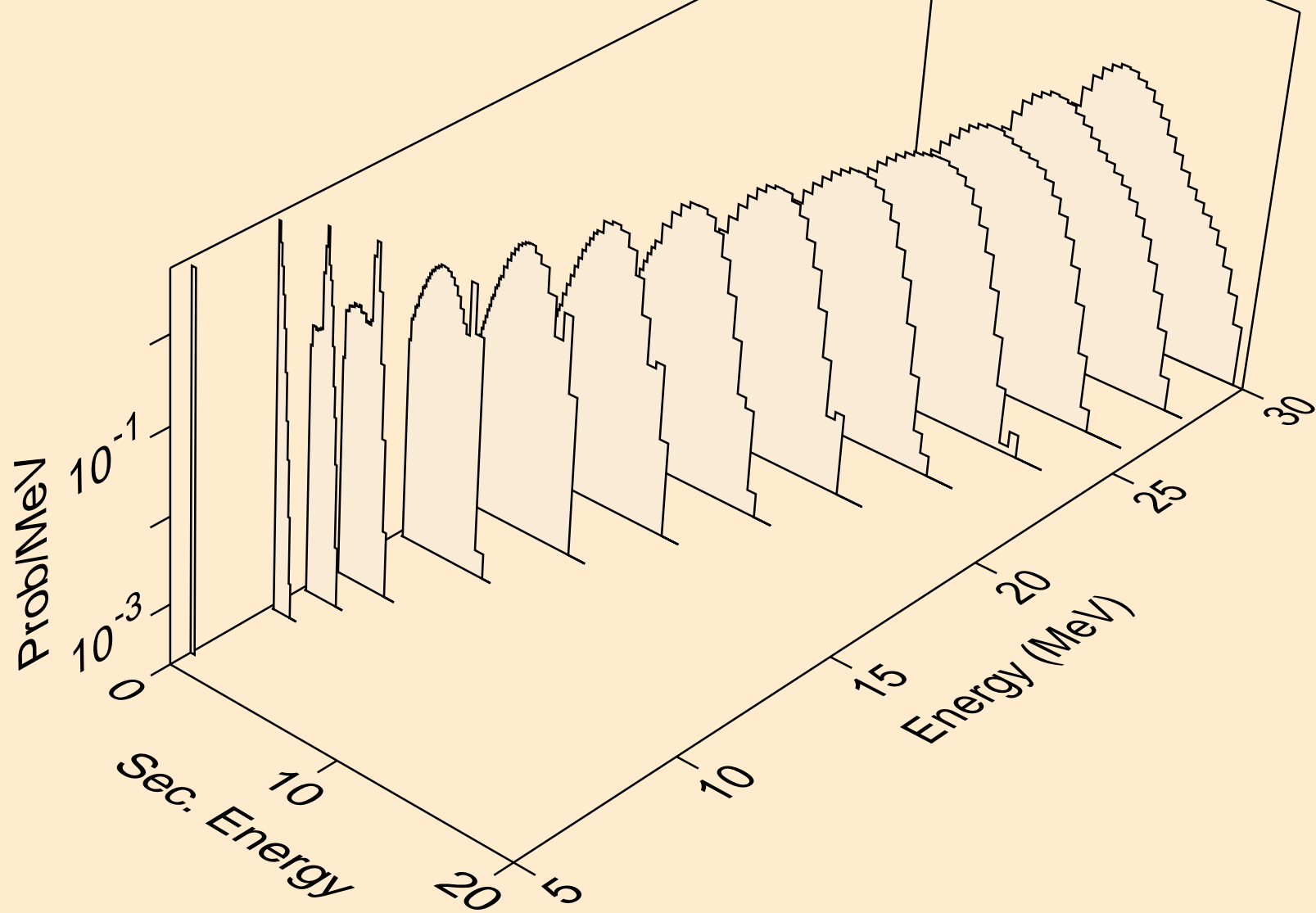

ND146 HELION ACER TENDL-2021 LIBRARY; T=0.K  
deuterons from (s,da)

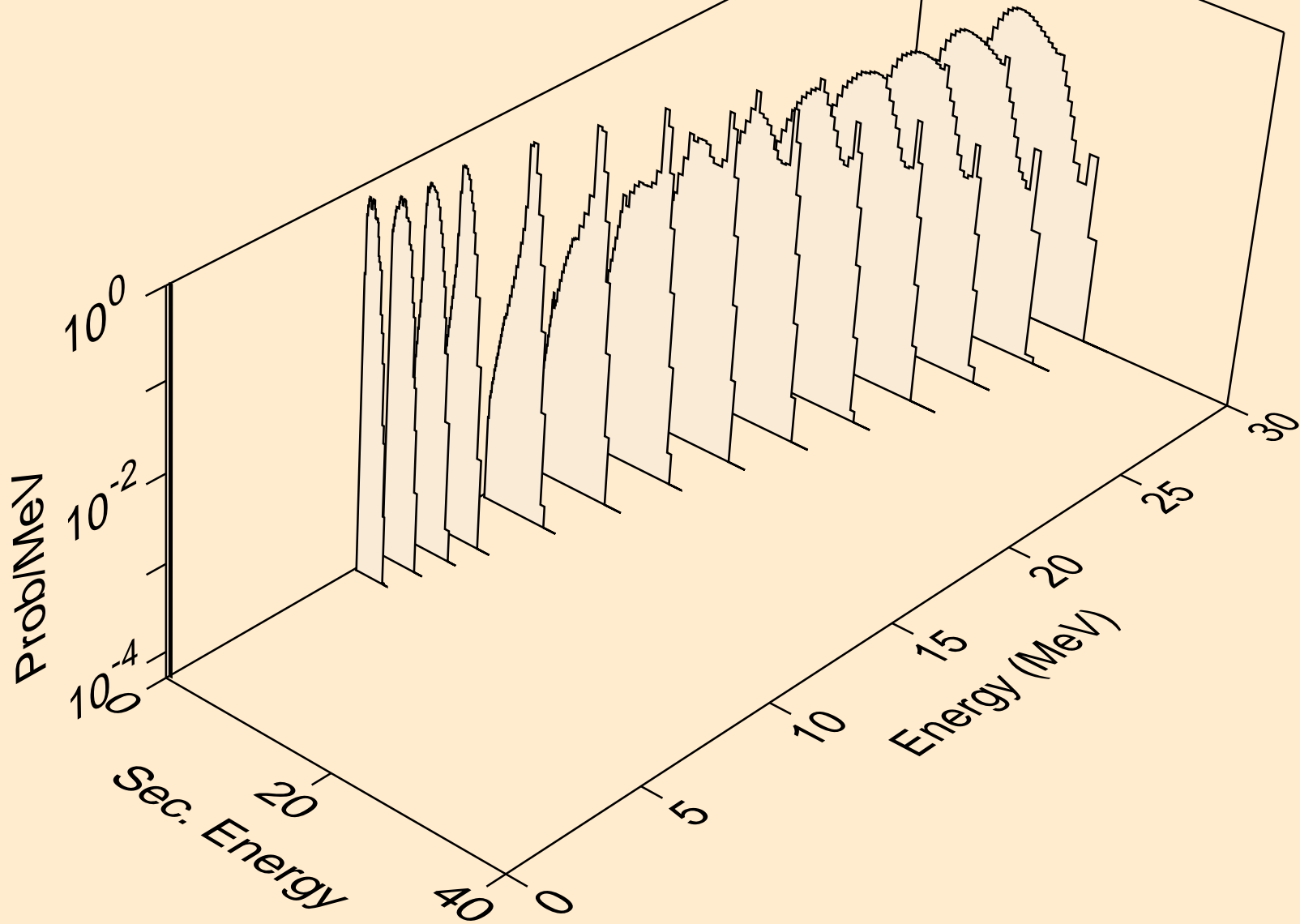

ND146 HELION ACER TENDL-2021 LIBRARY; T=0.K  
tritons from (s,x)

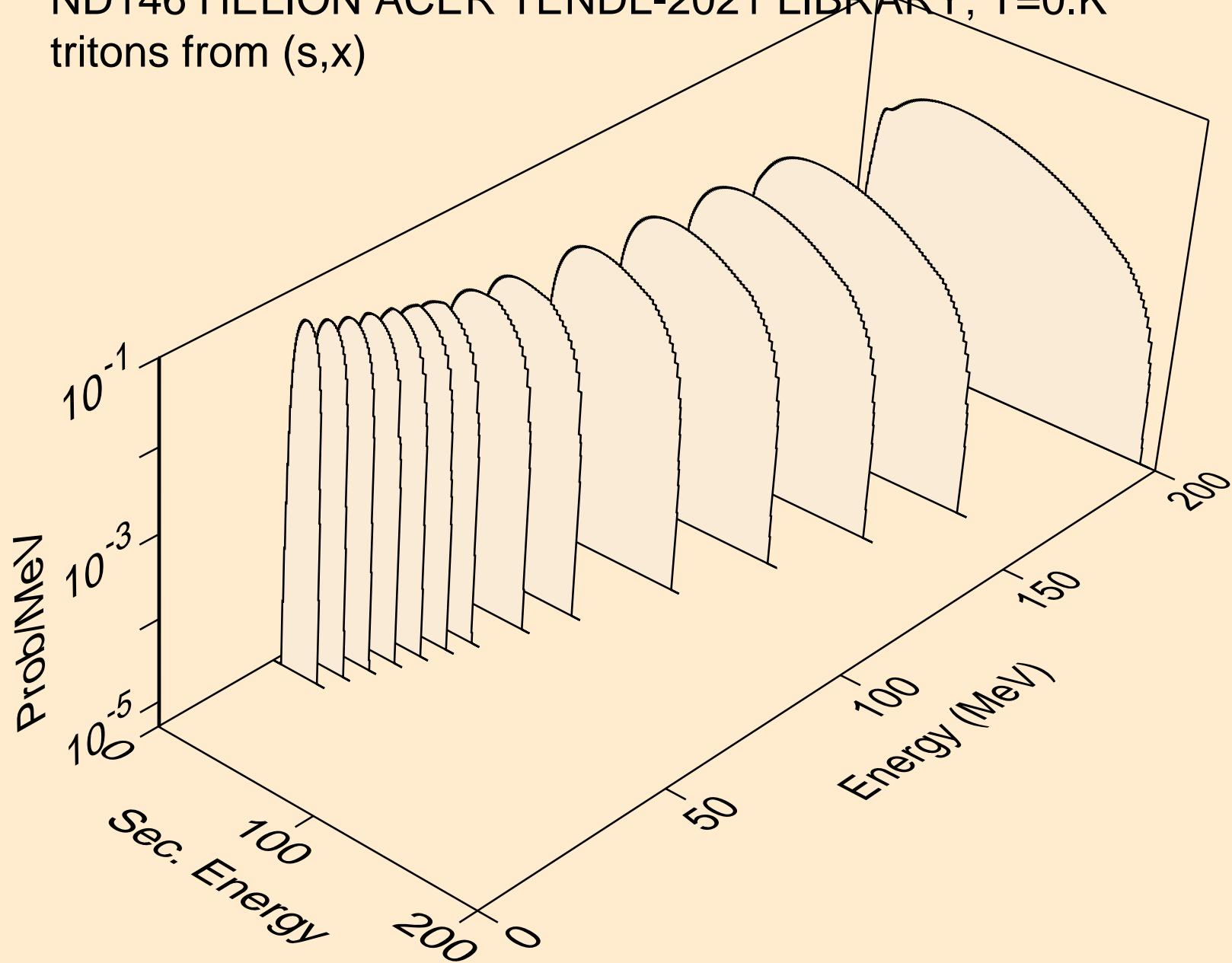

ND146 HELION ACER TENDL-2021 LIBRARY; T=0.K  
tritons from (s,n\*)t

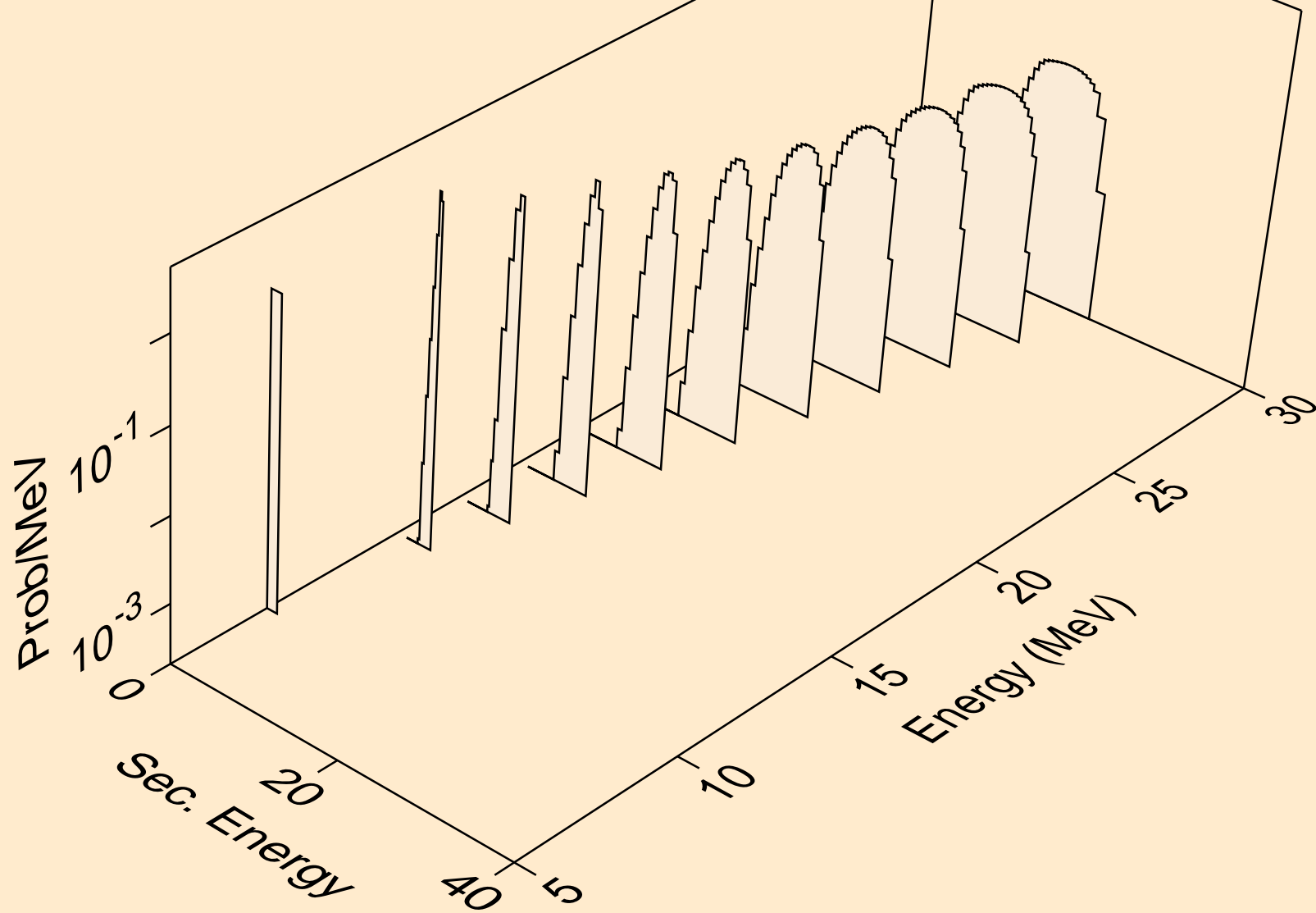

ND146 HELION ACER TENDL-2021 LIBRARY; T=0.K  
tritons from (s,t)

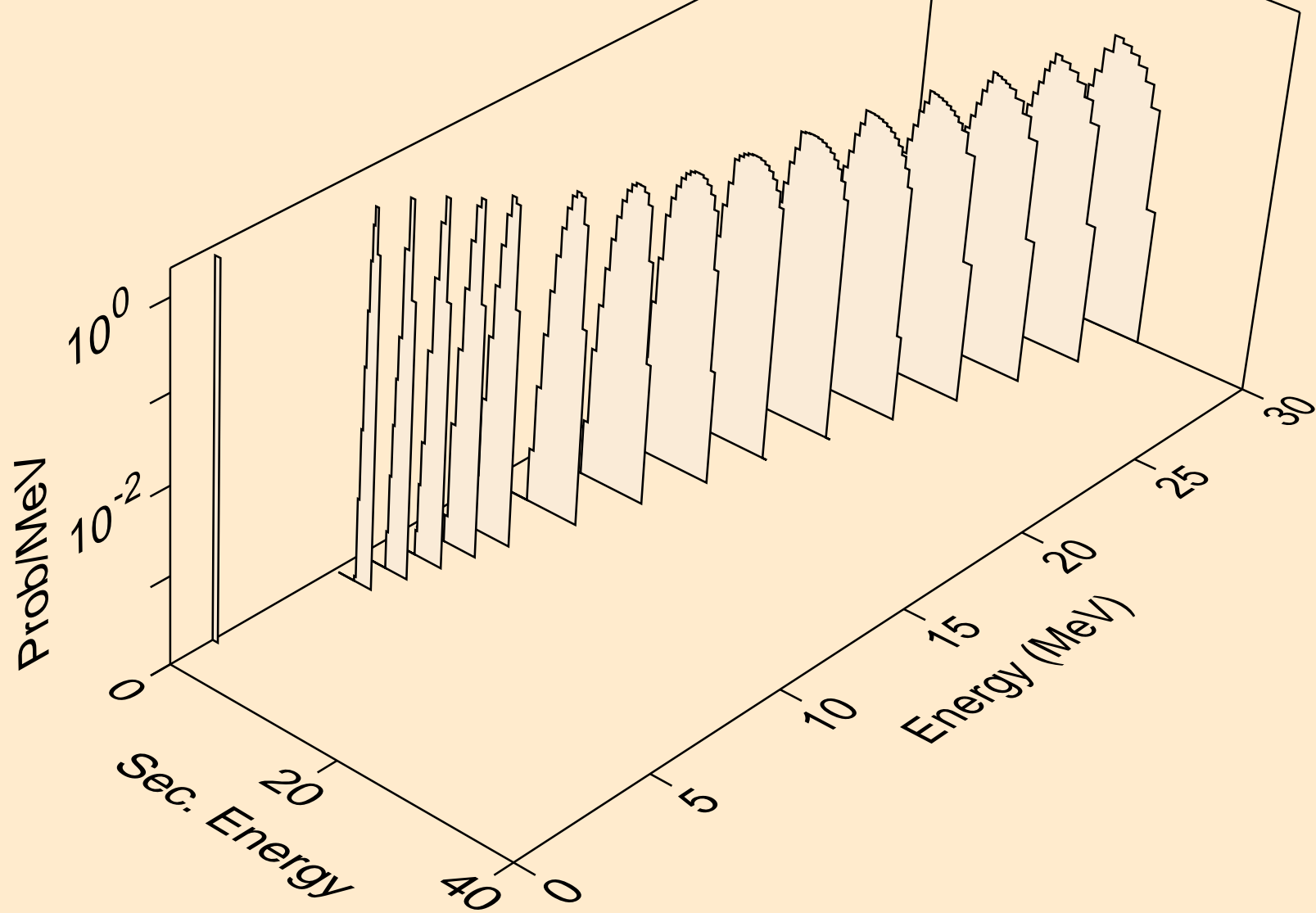



ND146 HELION ACER TENDL-2021 LIBRARY; T=0.K  
tritons from (s,pt)

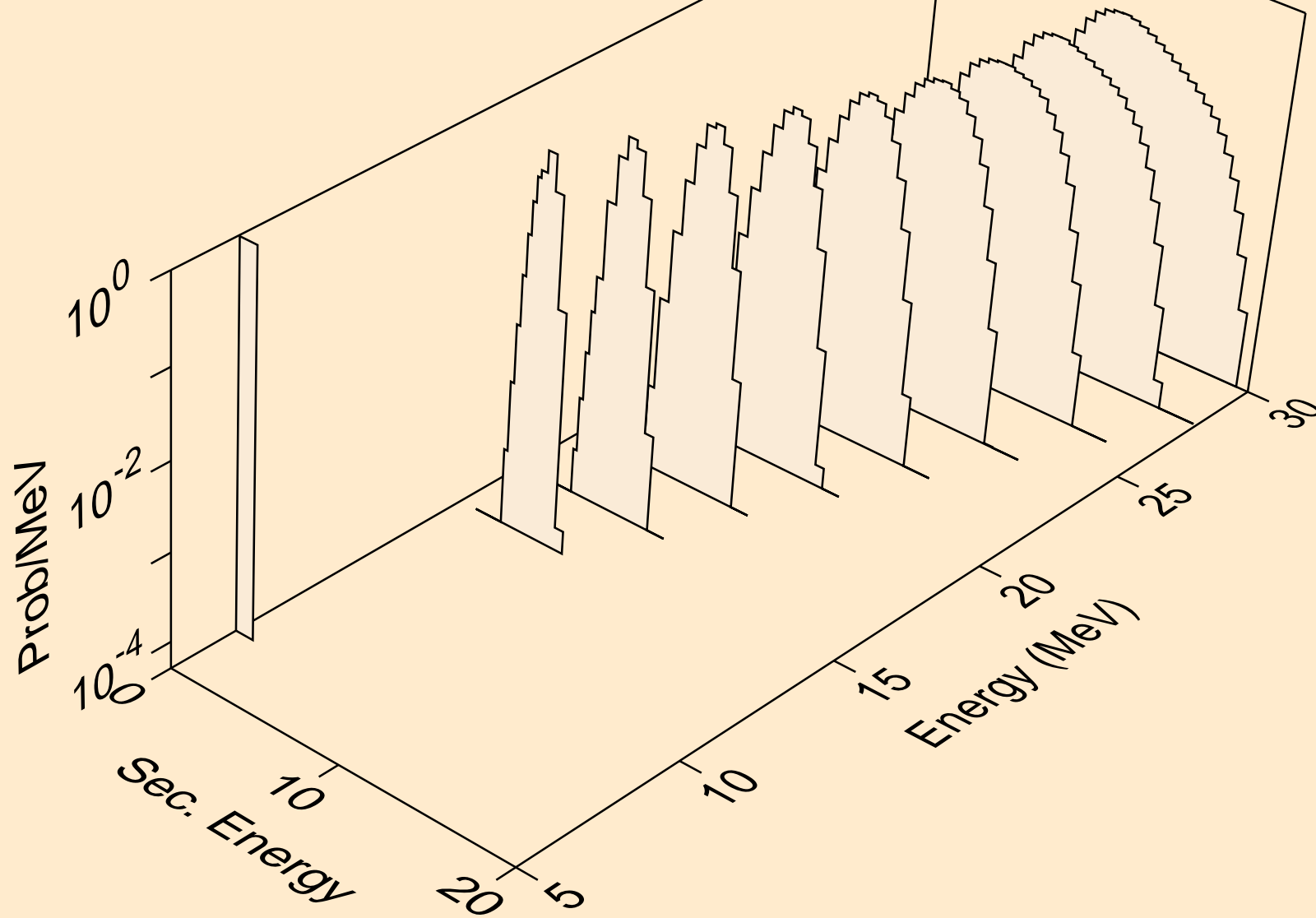

ND146 HELION ACER TENDL-2021 LIBRARY; T=0.K  
alphas from (s,x)

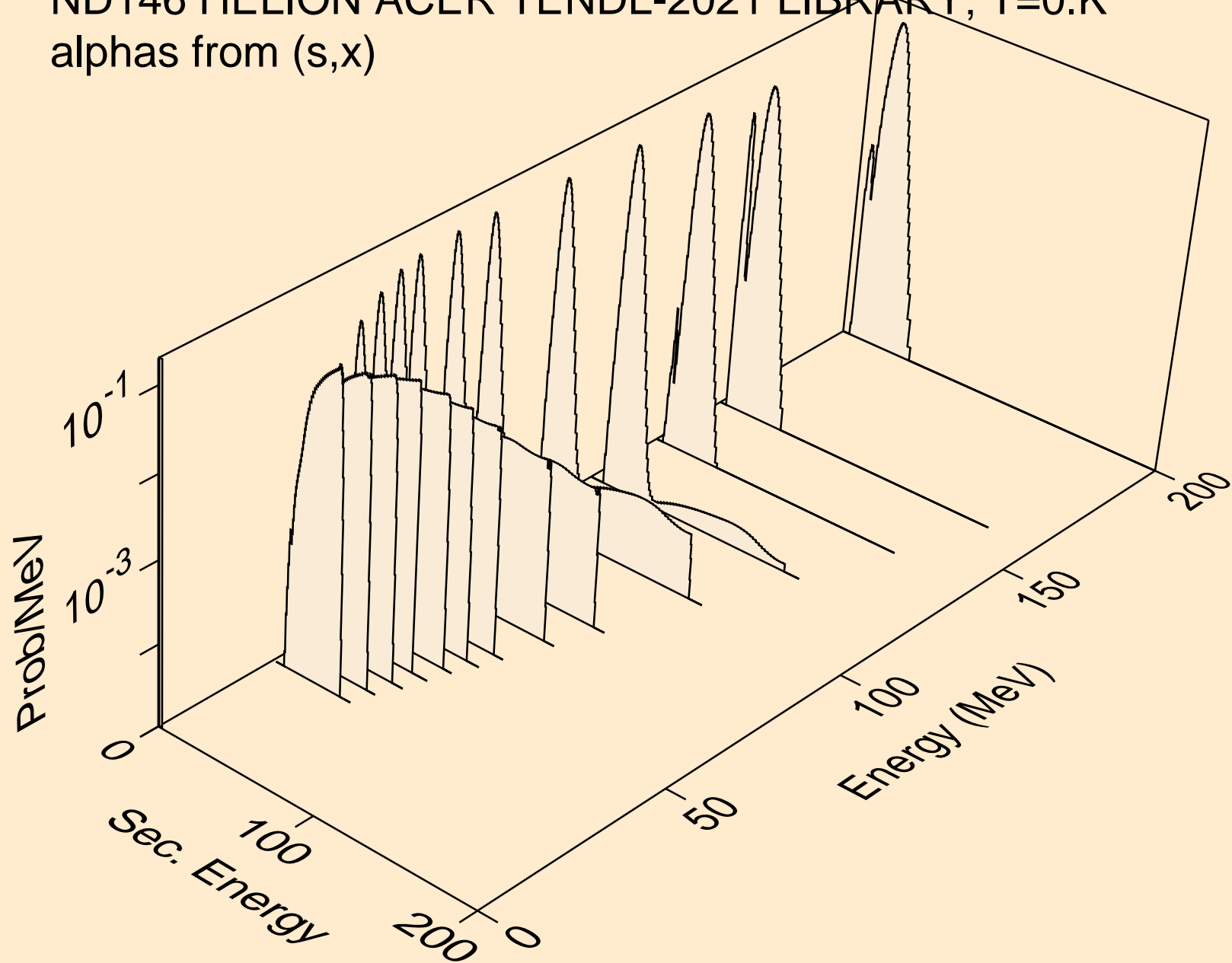

ND146 HELION ACER TENDL-2021 LIBRARY; T=0.K  
alphas from (s,n\*)a

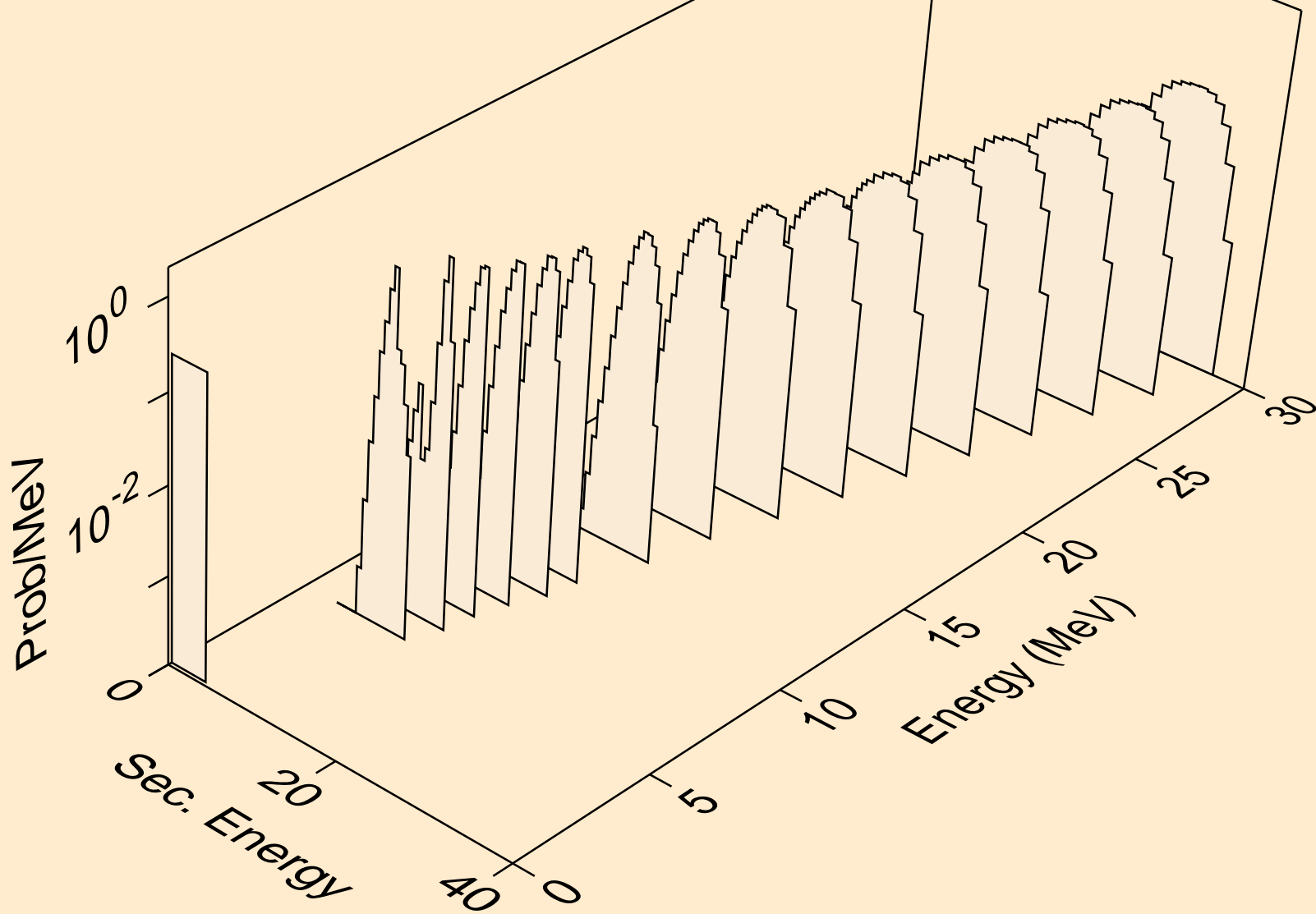

ND146 HELION ACER TENDL-2021 LIBRARY; T=0.K  
alphas from (s,2n)a

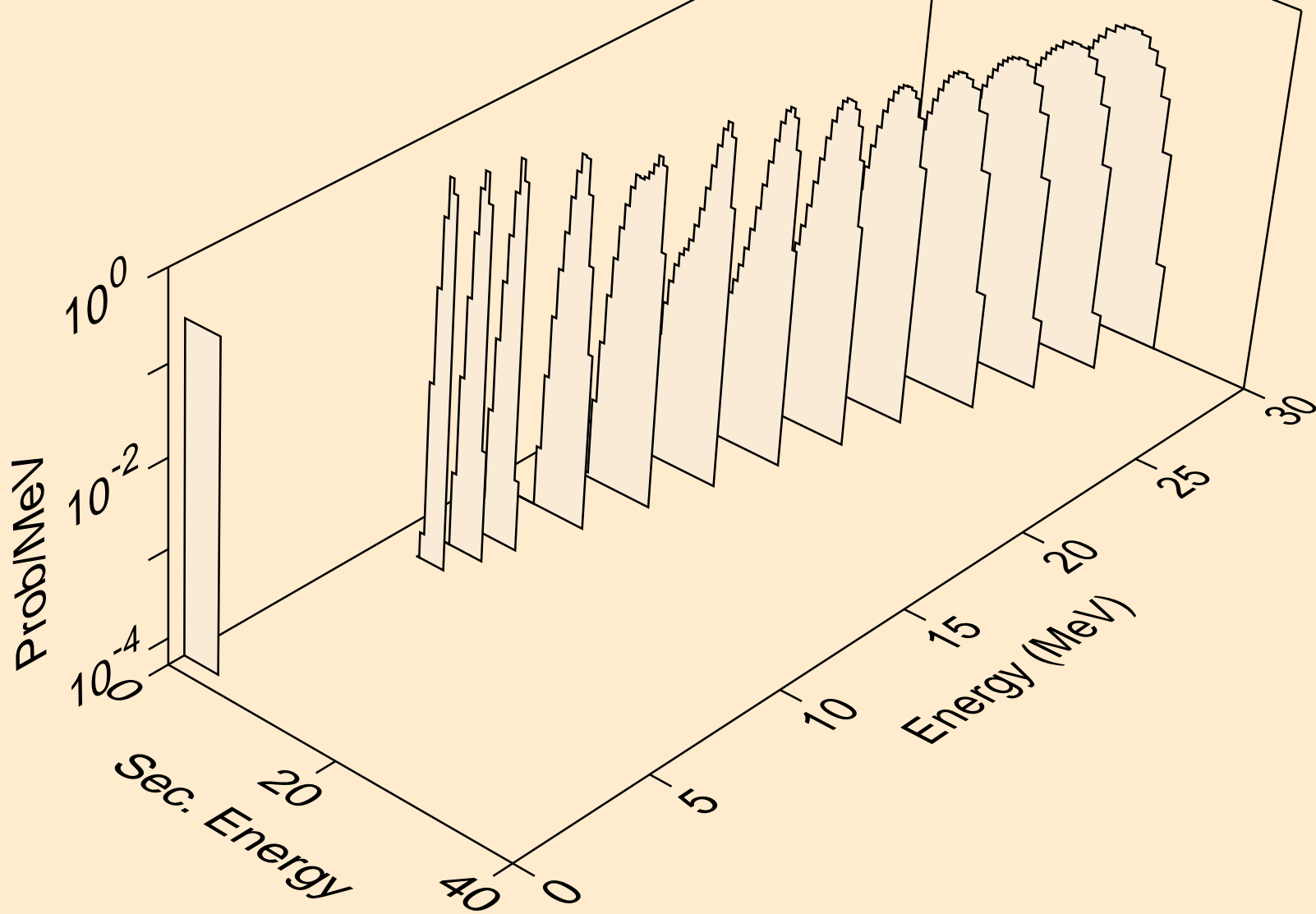

ND146 HELION ACER TENDL-2021 LIBRARY; T=0.K  
alphas from (s,3n)a

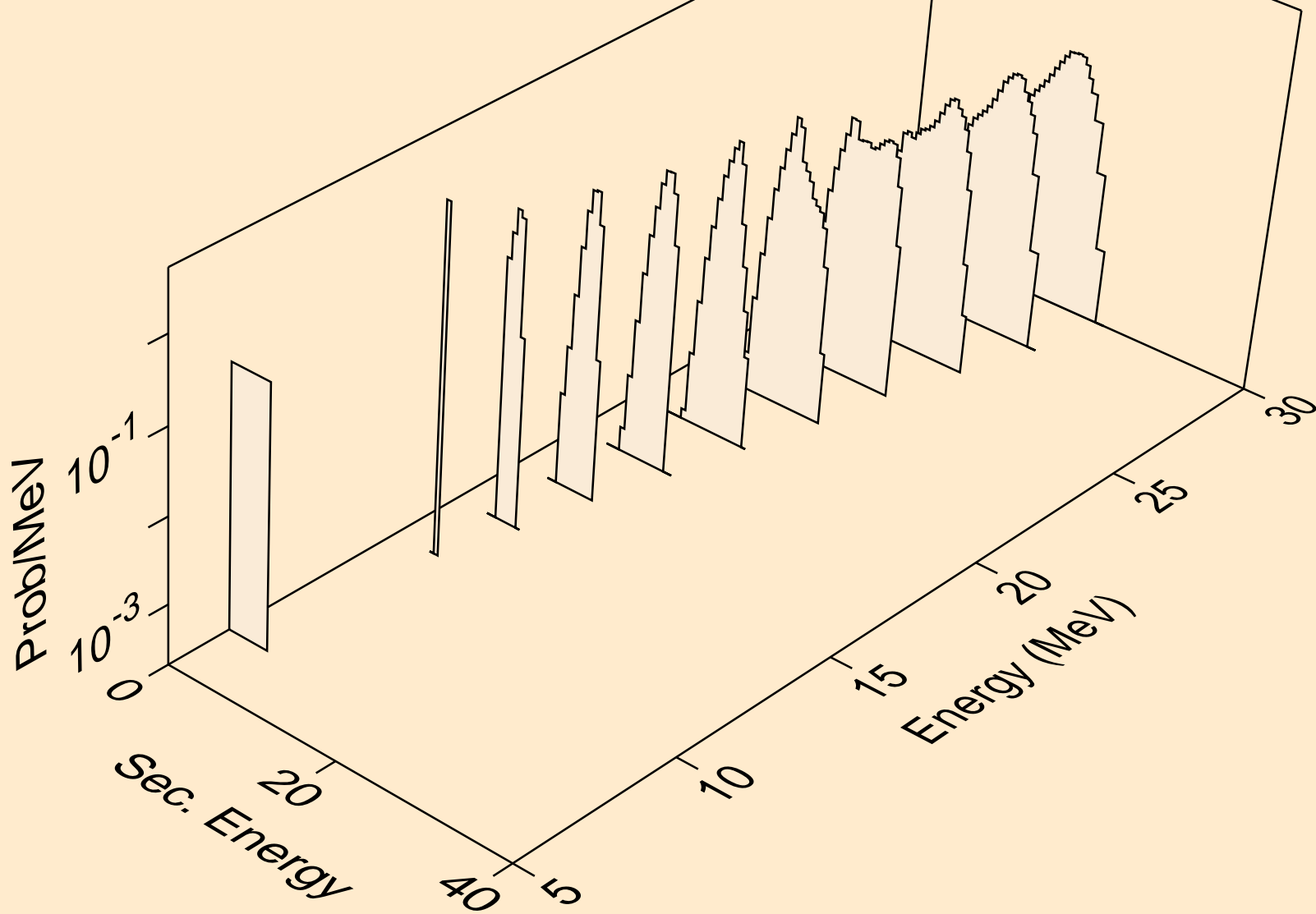

ND146 HELION ACER TENDL-2021 LIBRARY; T=0.K  
alphas from (s,n\*)2a

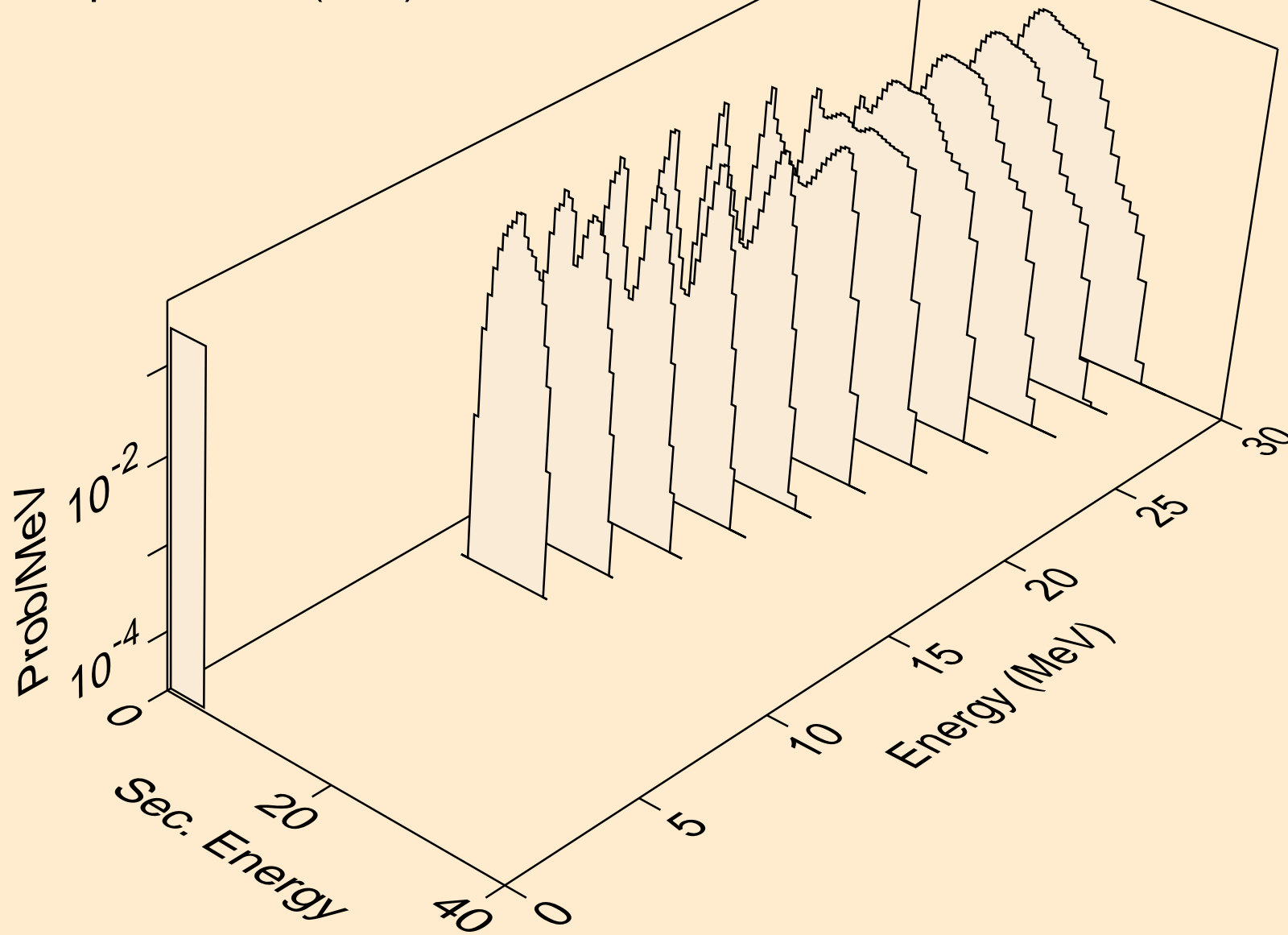

ND146 HELION ACER TENDL-2021 LIBRARY; T=0.K  
alphas from (s,npa)

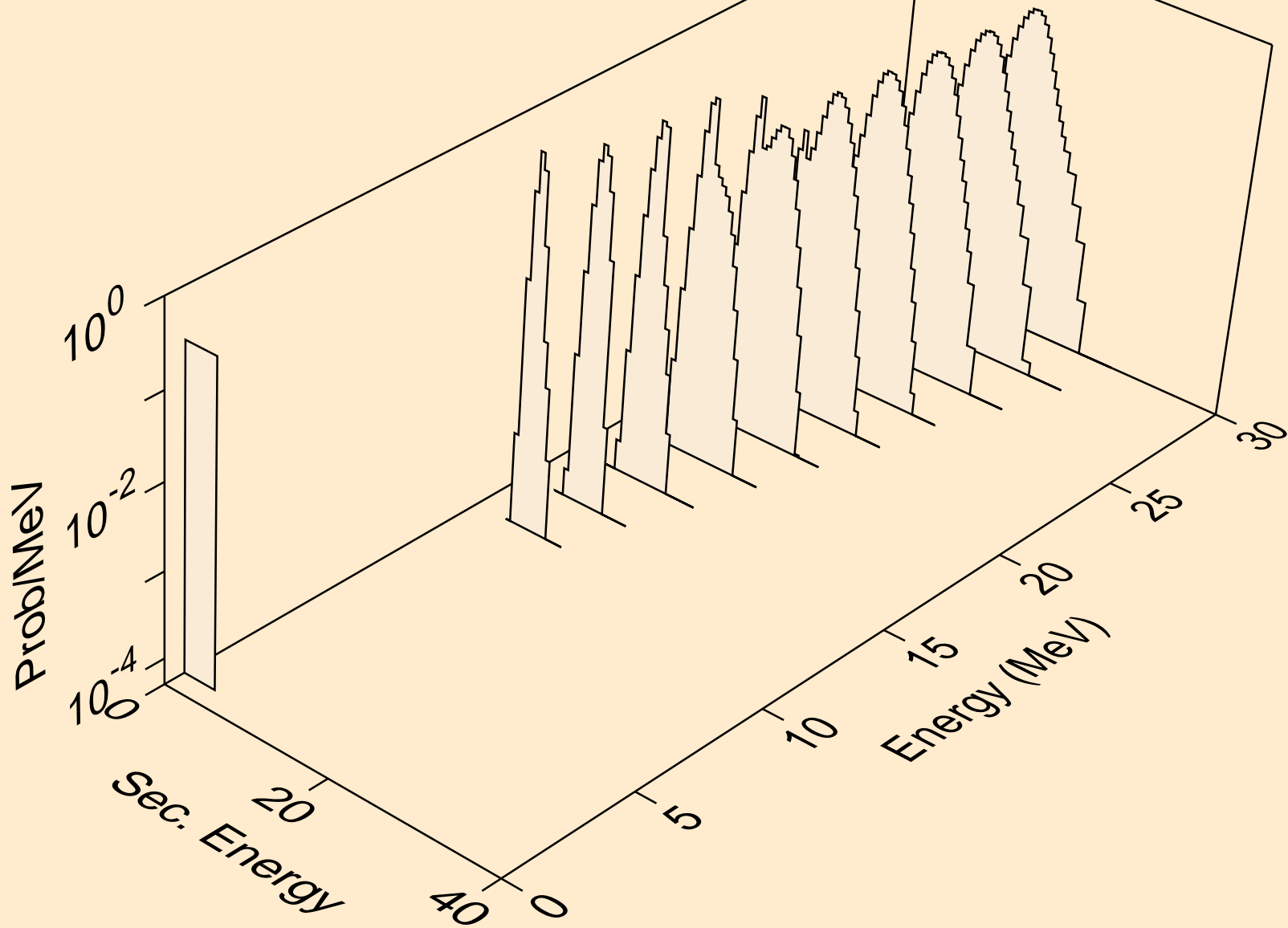

ND146 HELION ACER TENDL-2021 LIBRARY; T=0.K  
alphas from (s,a)

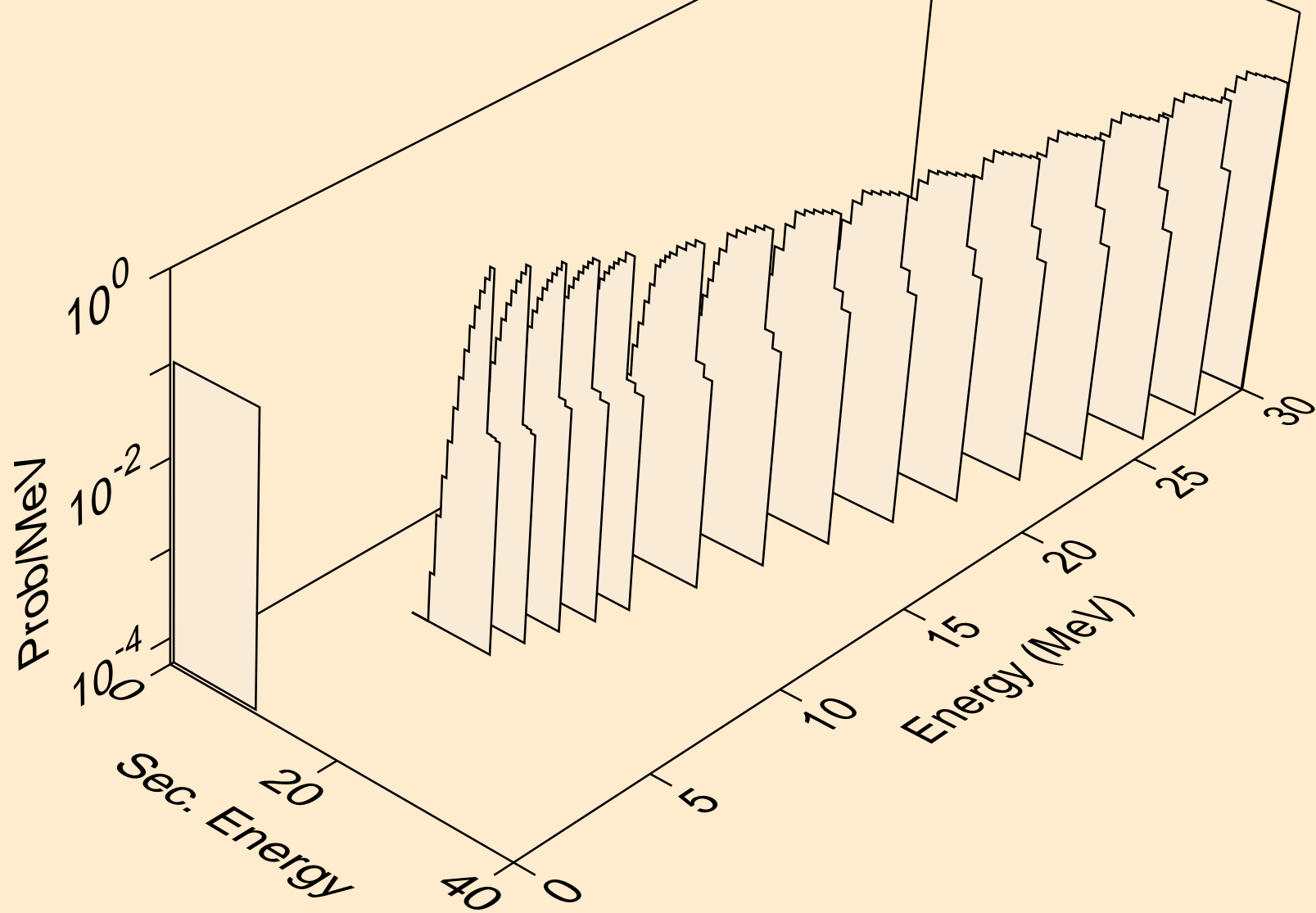



ND146 HELION ACER TENDL-2021 LIBRARY; T=0.K  
alphas from (s,2a)

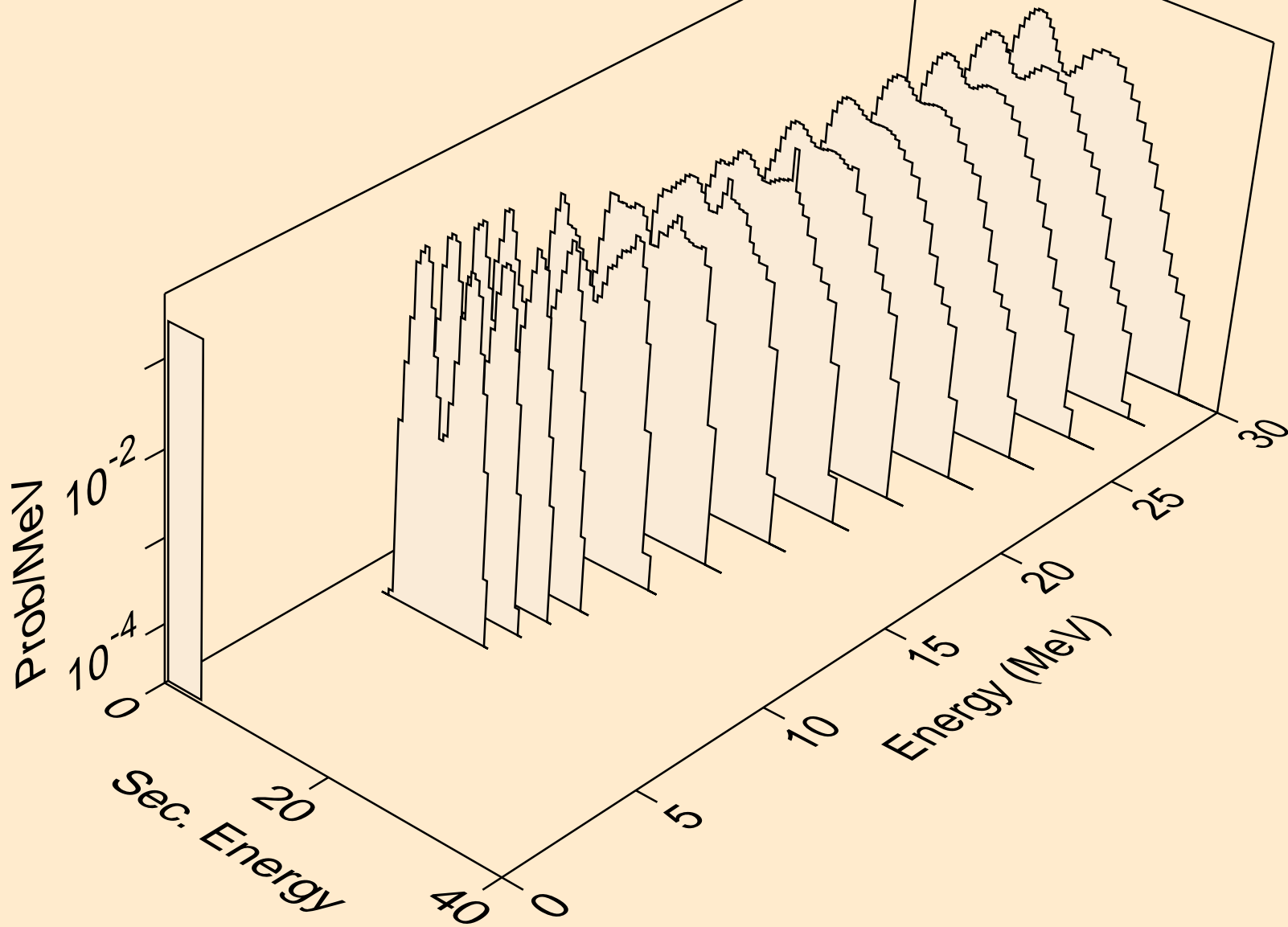

ND146 HELION ACER TENDL-2021 LIBRARY; T=0.K  
alphas from (s,pa)

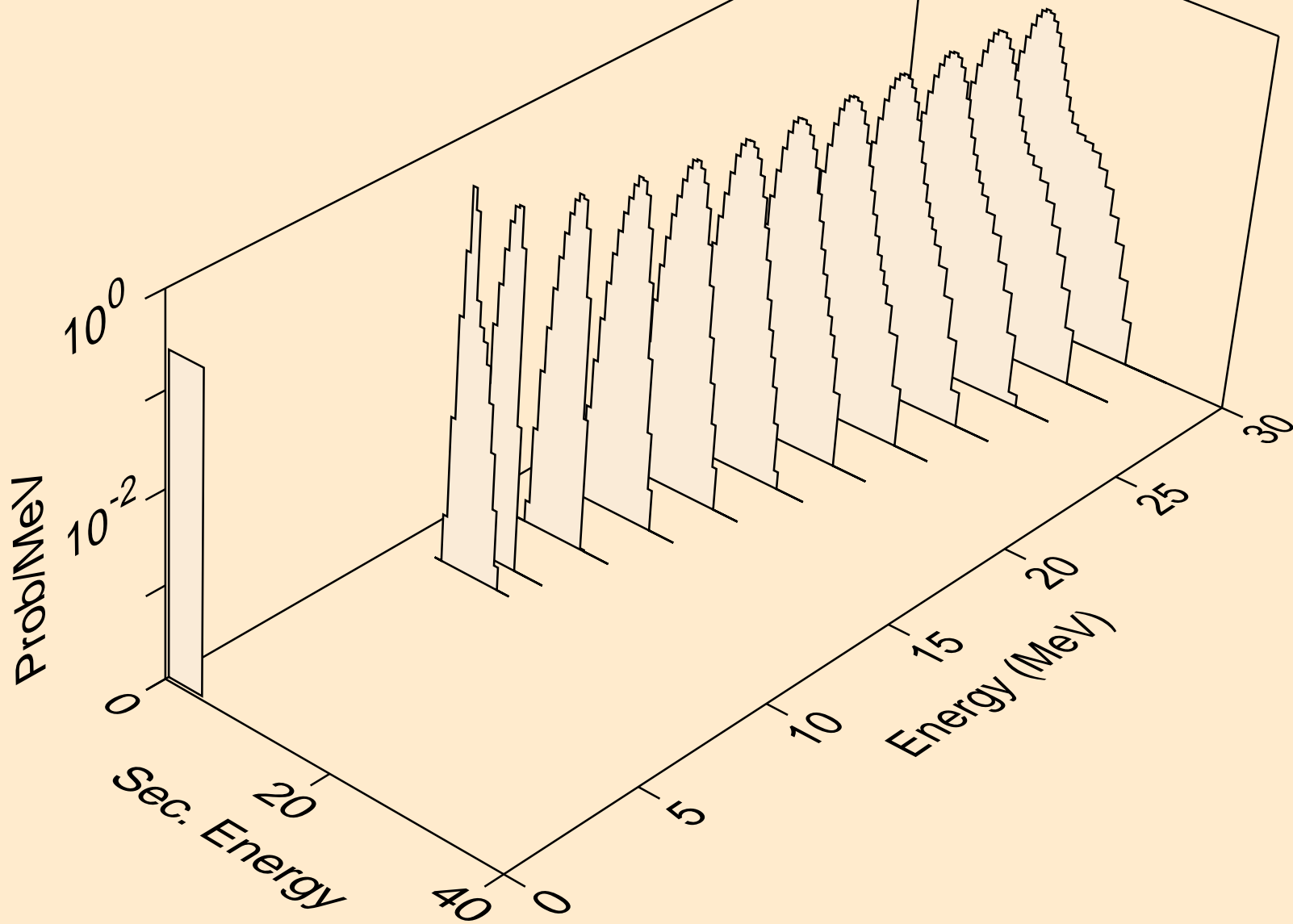

ND146 HELION ACER TENDL-2021 LIBRARY; T=0.K  
alphas from (s,da)

