

NO253 HELION ACER TENDL-2021 LIBRARY; T=0.K
Principal cross sections

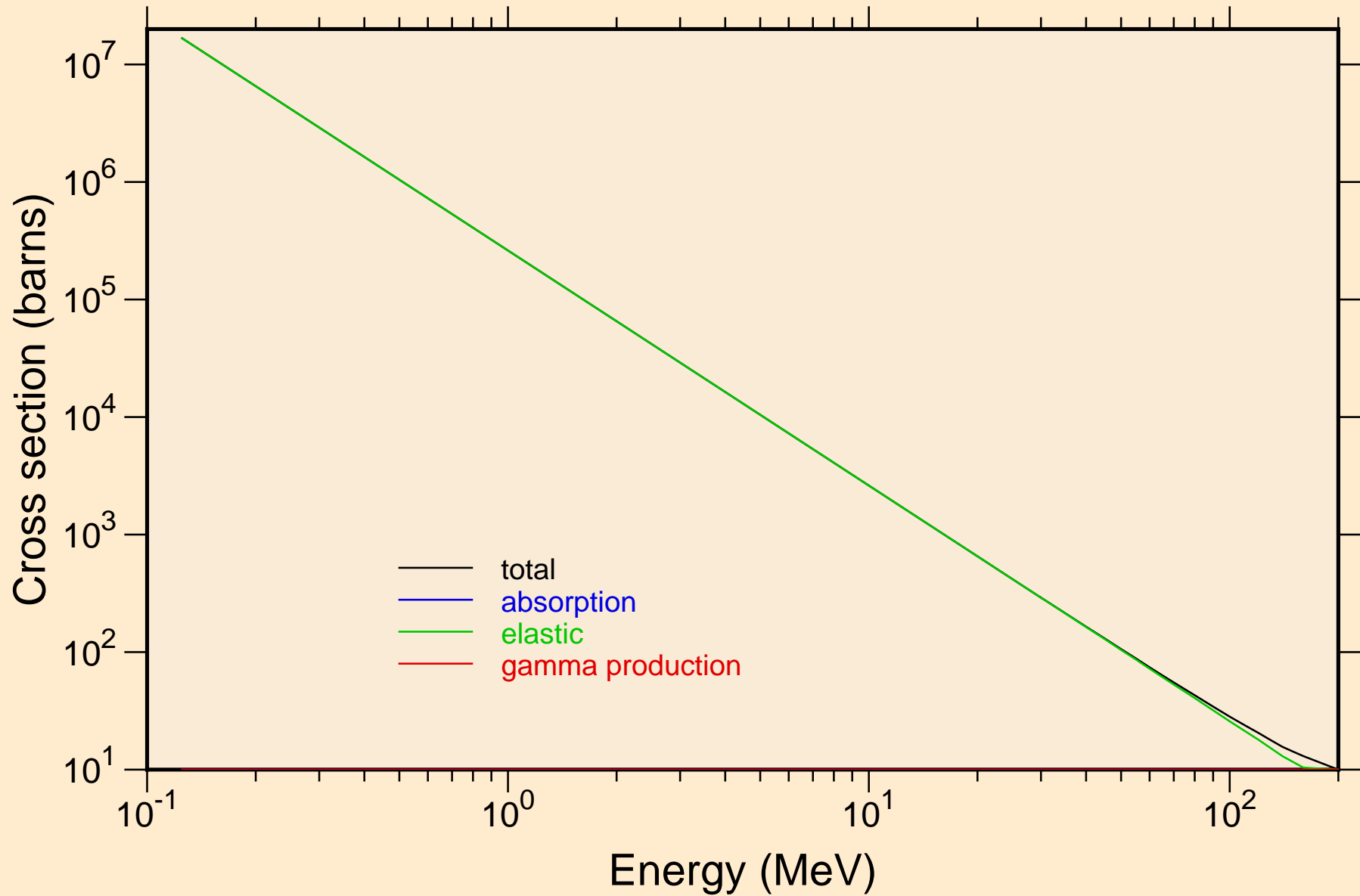

NO253 HELION ACER TENDL-2021 LIBRARY; T=0.K
Heating

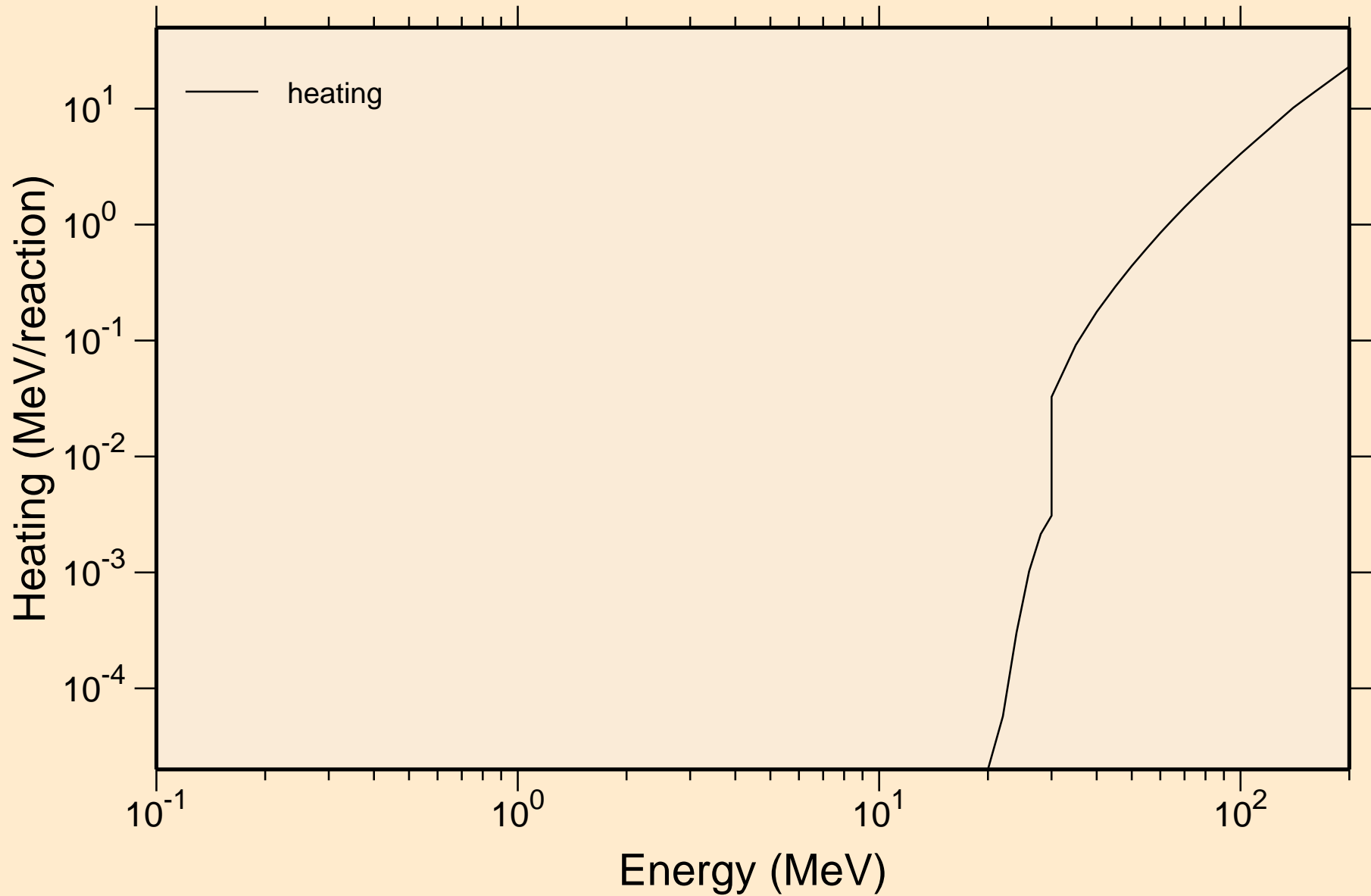

NO253 HELION ACER TENDL-2021 LIBRARY; T=0.K

Principal cross sections

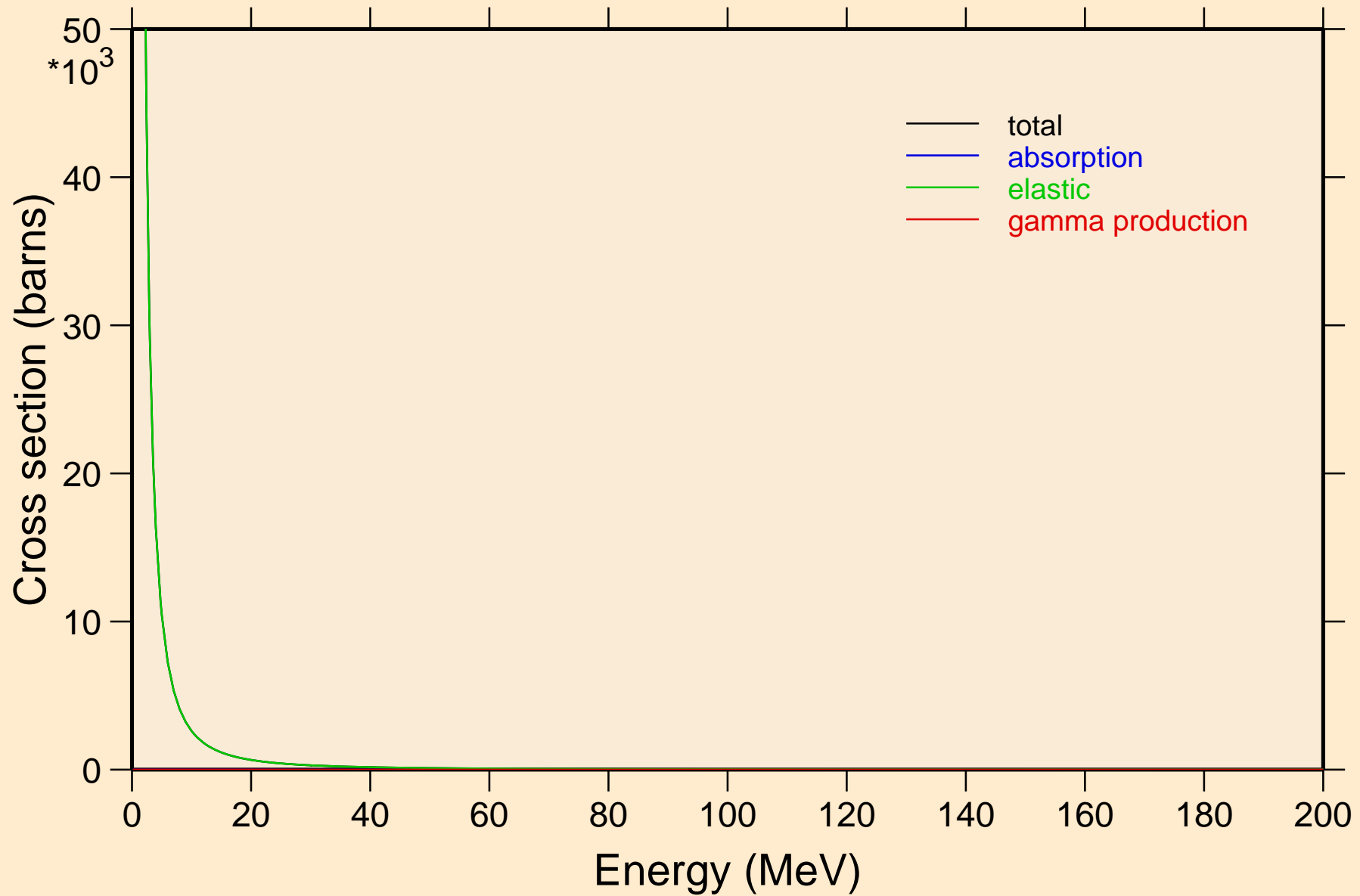

NO253 HELION ACER TENDL-2021 LIBRARY; T=0.K

Heating

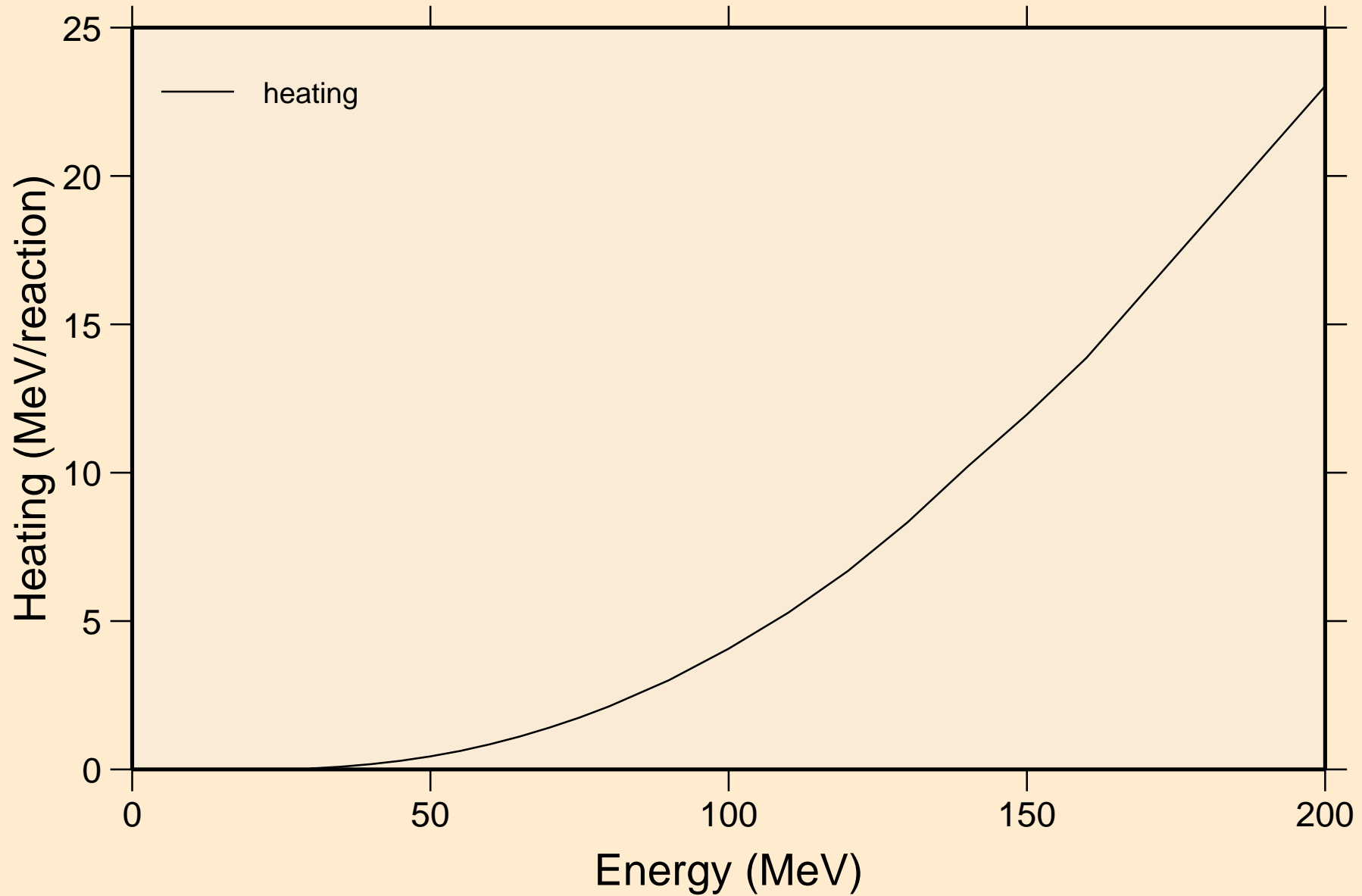

NO253 HELION ACER TENDL-2021 LIBRARY; T=0.K
Threshold reactions

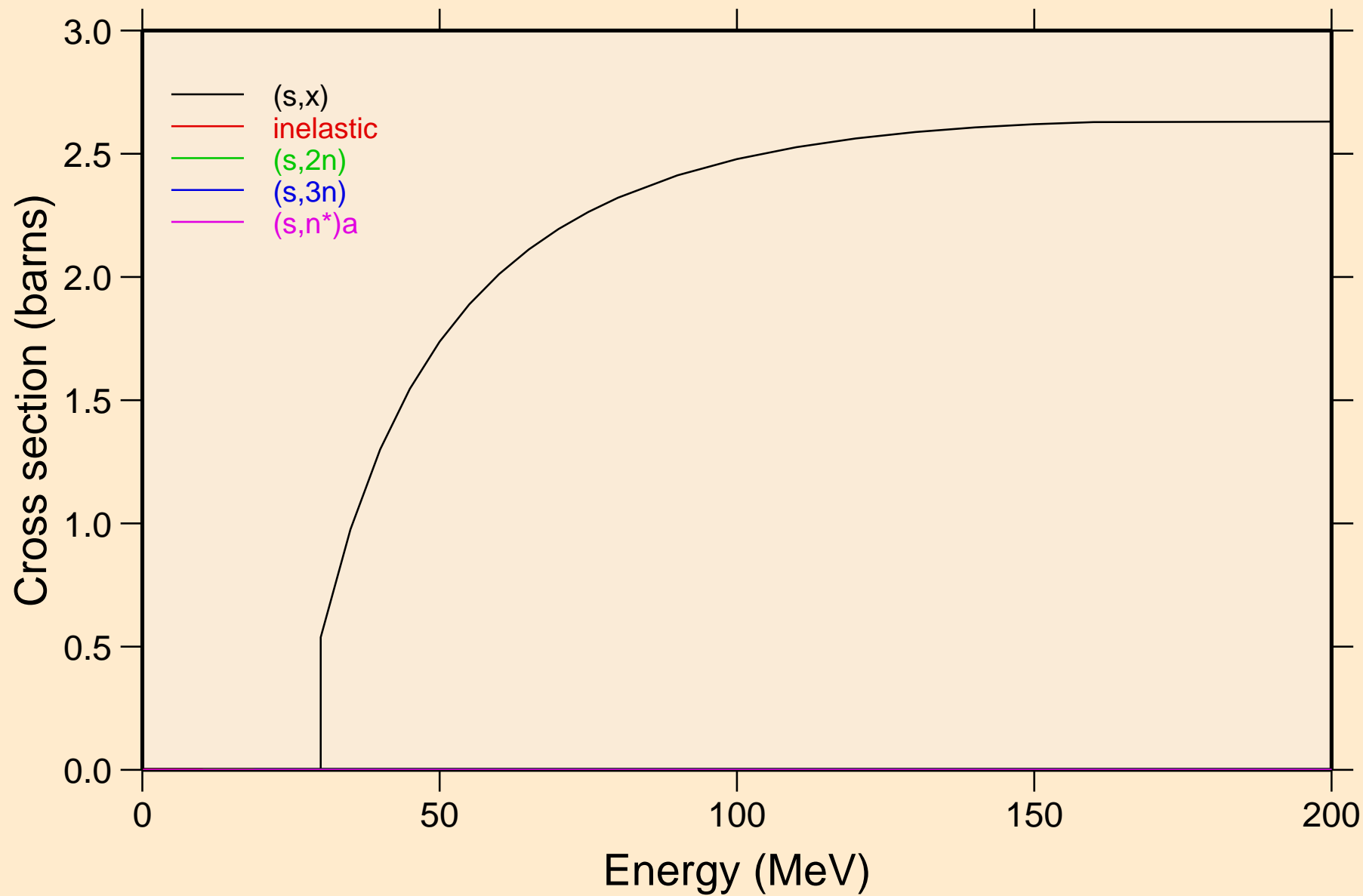

NO253 HELION ACER TENDL-2021 LIBRARY; T=0.K
Threshold reactions

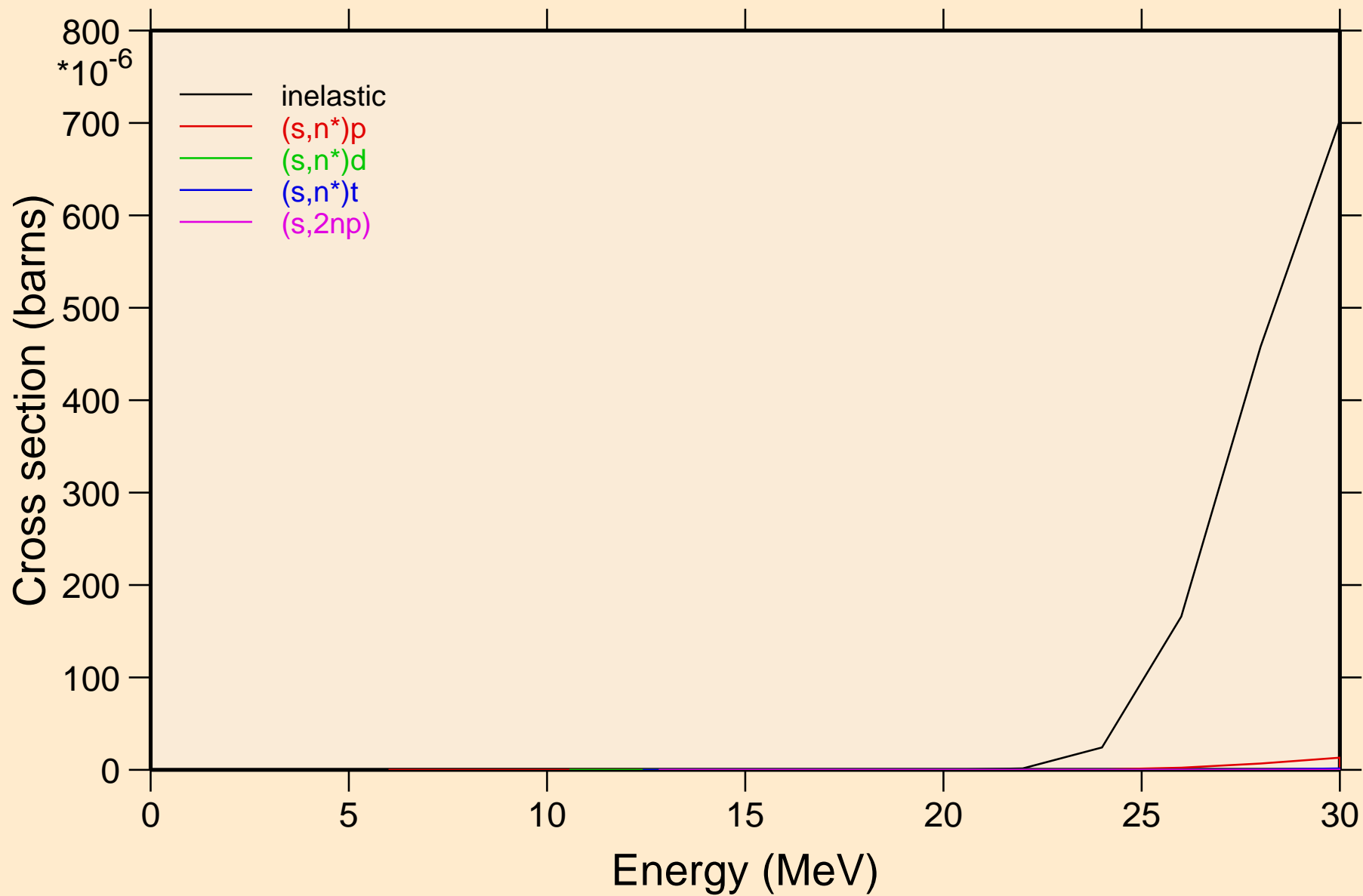

NO253 HELION ACER TENDL-2021 LIBRARY; T=0.K

Threshold reactions

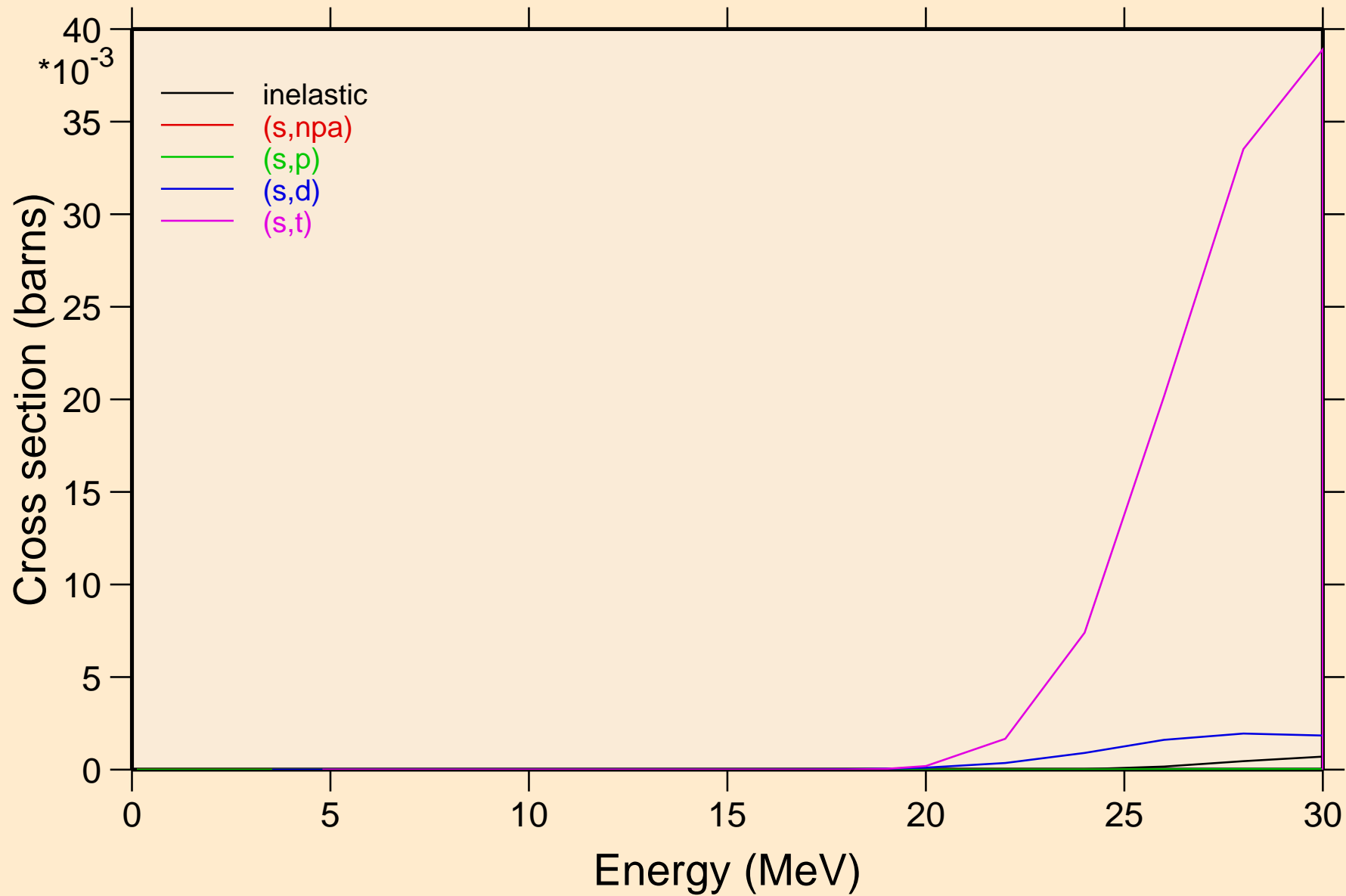

NO253 HELION ACER TENDL-2021 LIBRARY; T=0.K

Threshold reactions

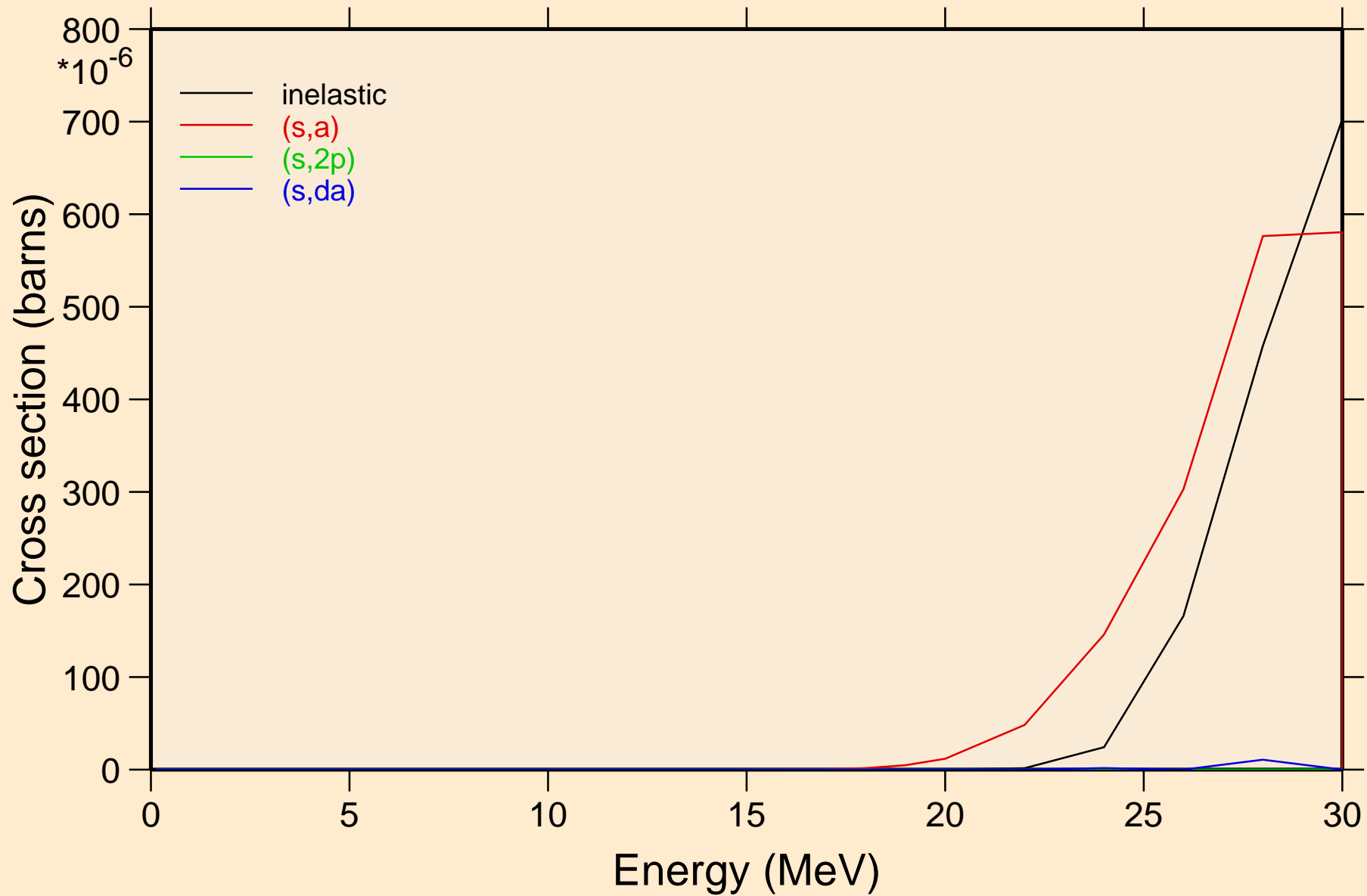

NO253 HELION ACER TENDL-2021 LIBRARY; T=0.K
angular distribution for elastic

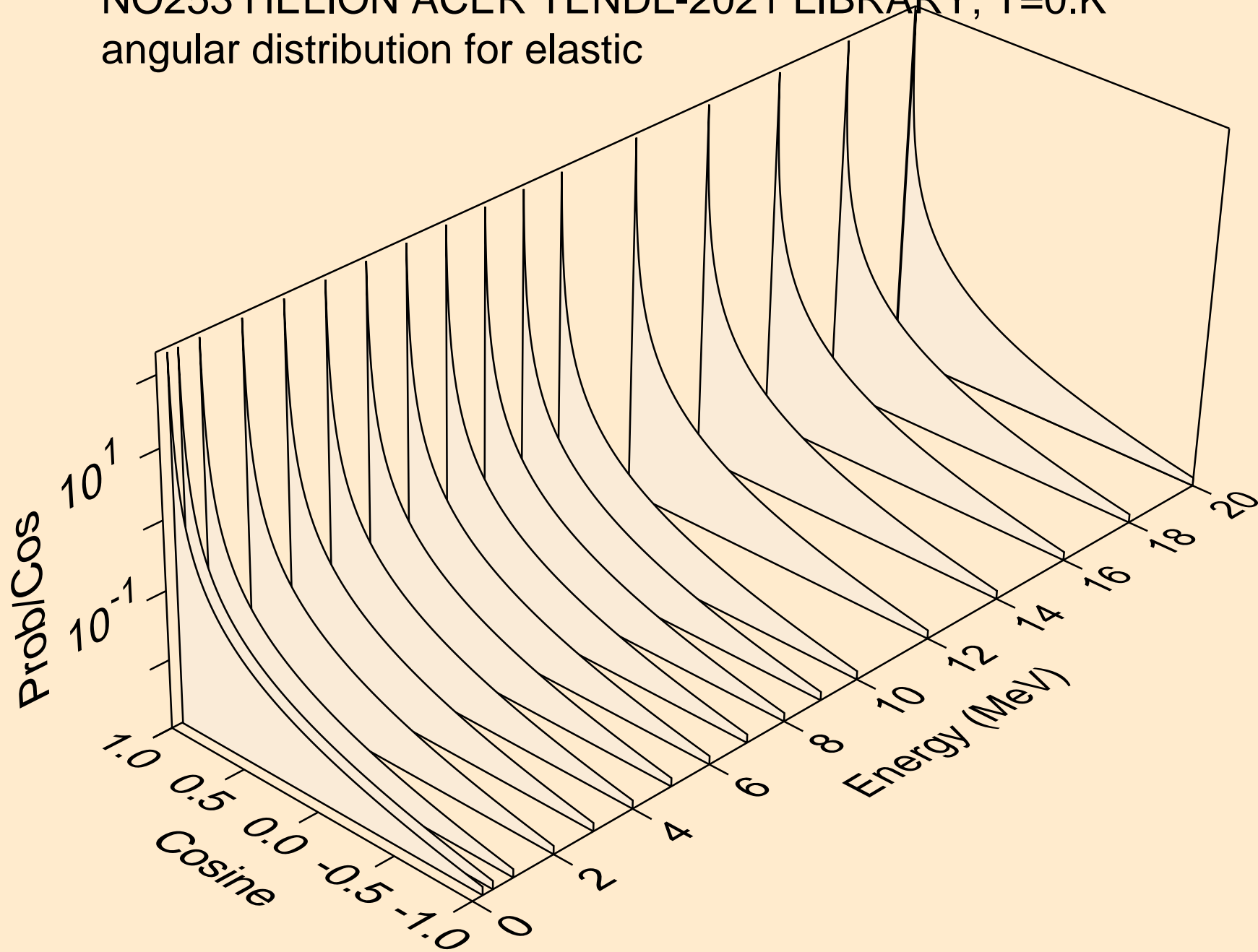

NO253 HELION ACER TENDL-2021 LIBRARY; T=0.K
angular distribution for elastic

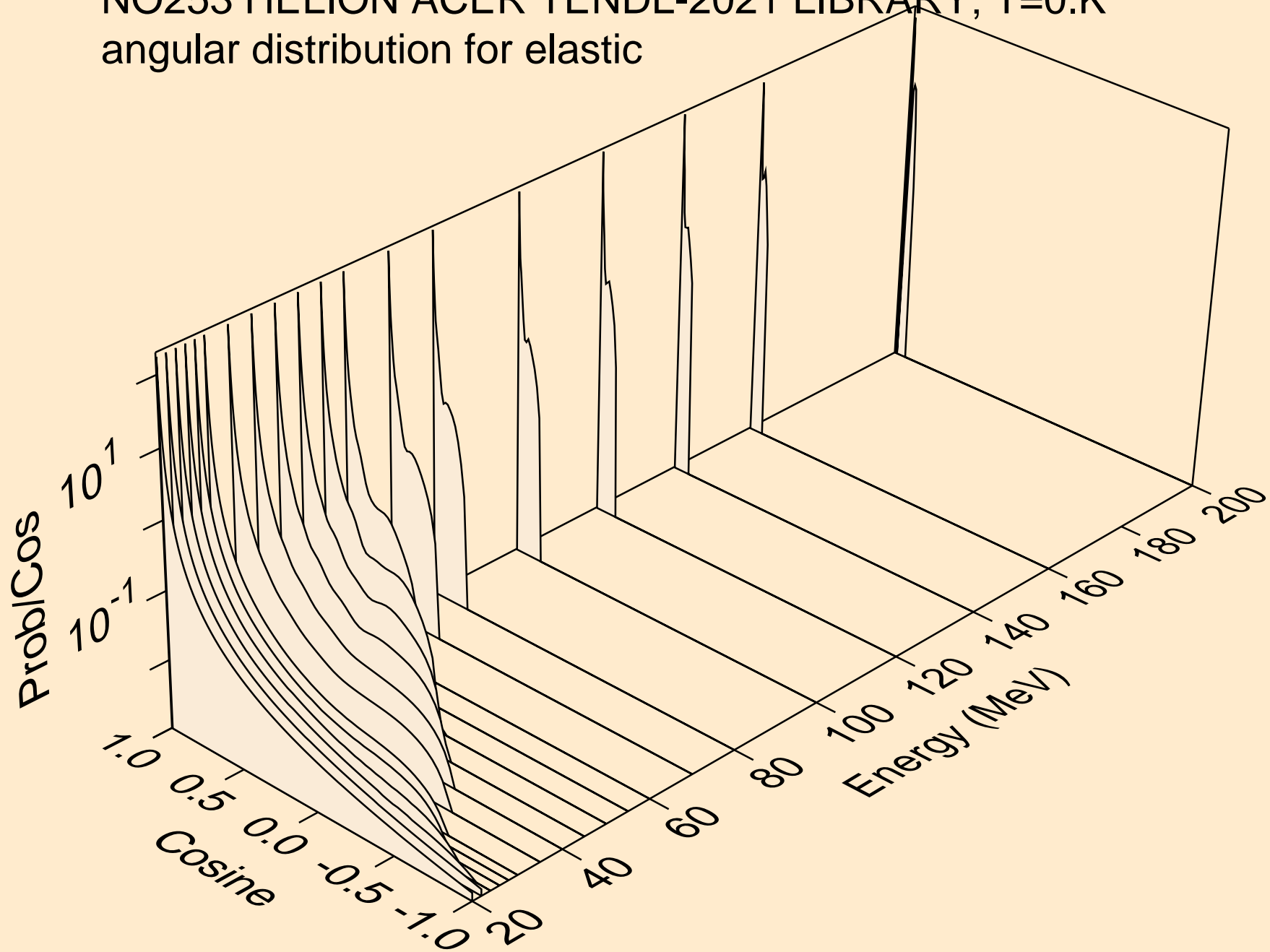

NO253 HELION ACER TENDL-2021 LIBRARY; T=0.K
He-3 emission for (s,x)

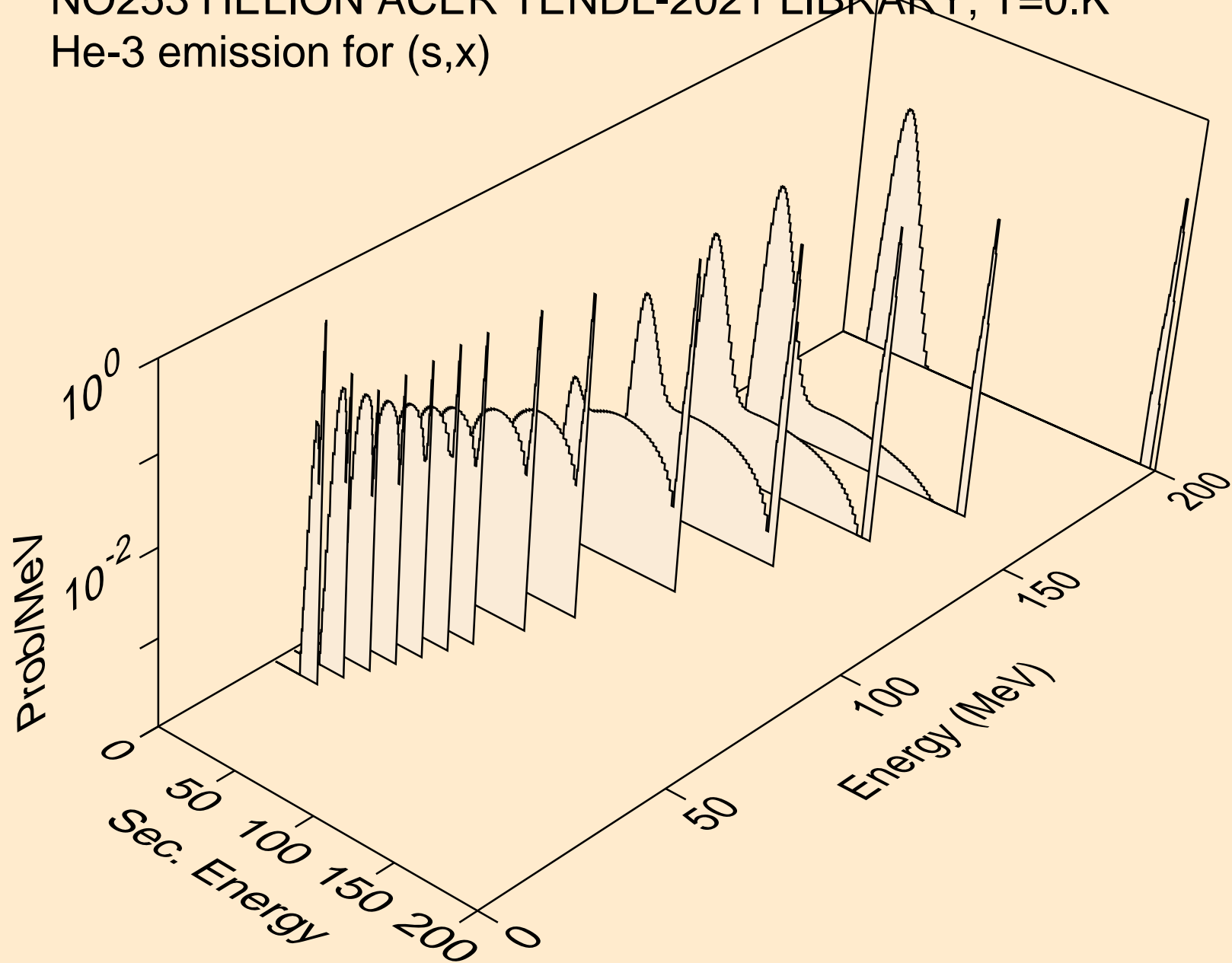

NO253 HELION ACER TENDL-2021 LIBRARY; T=0.K
He-3 emission for inelastic

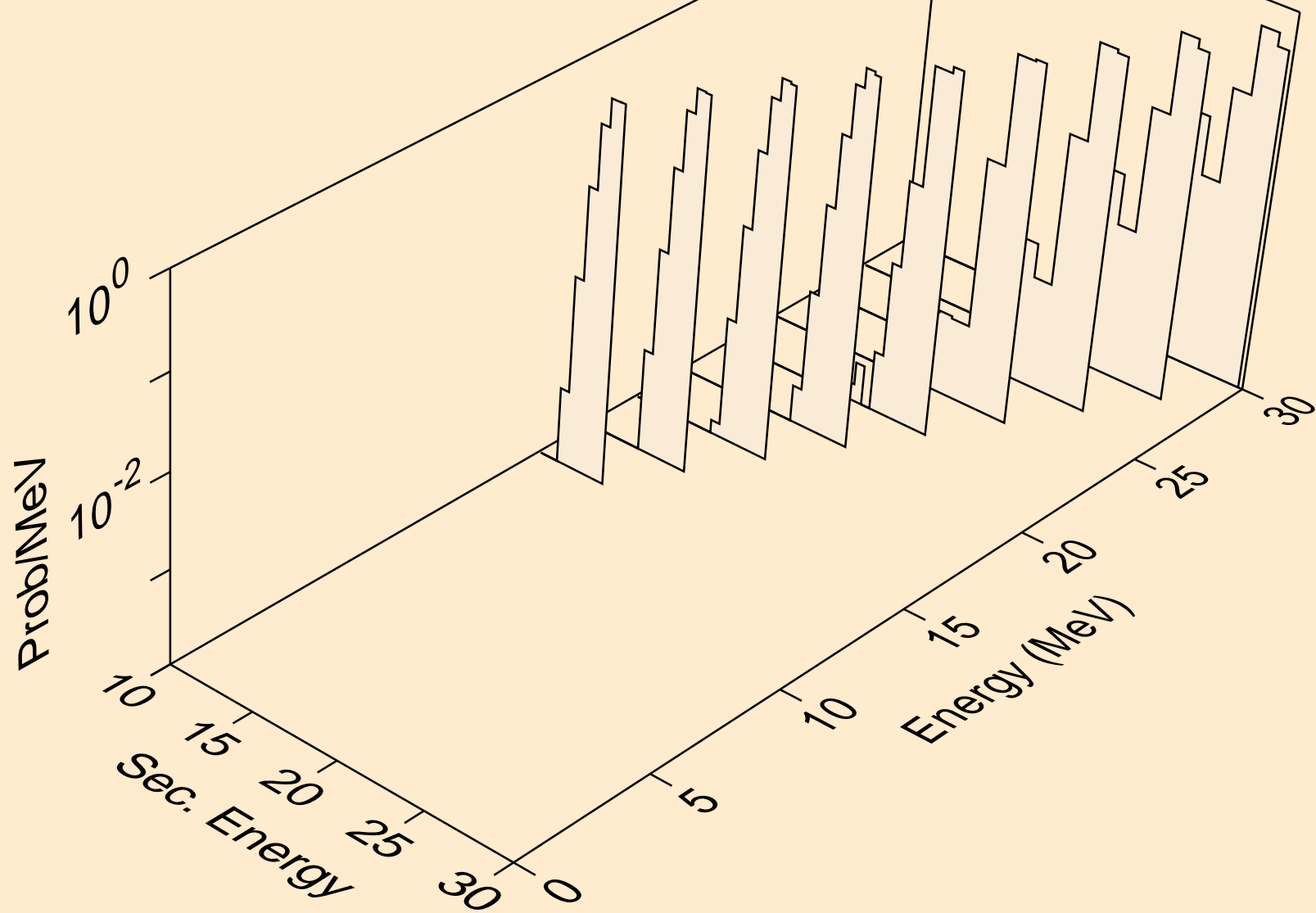

NO253 HELION ACER TENDL-2021 LIBRARY; T=0.K
Photon emission for (z,n)

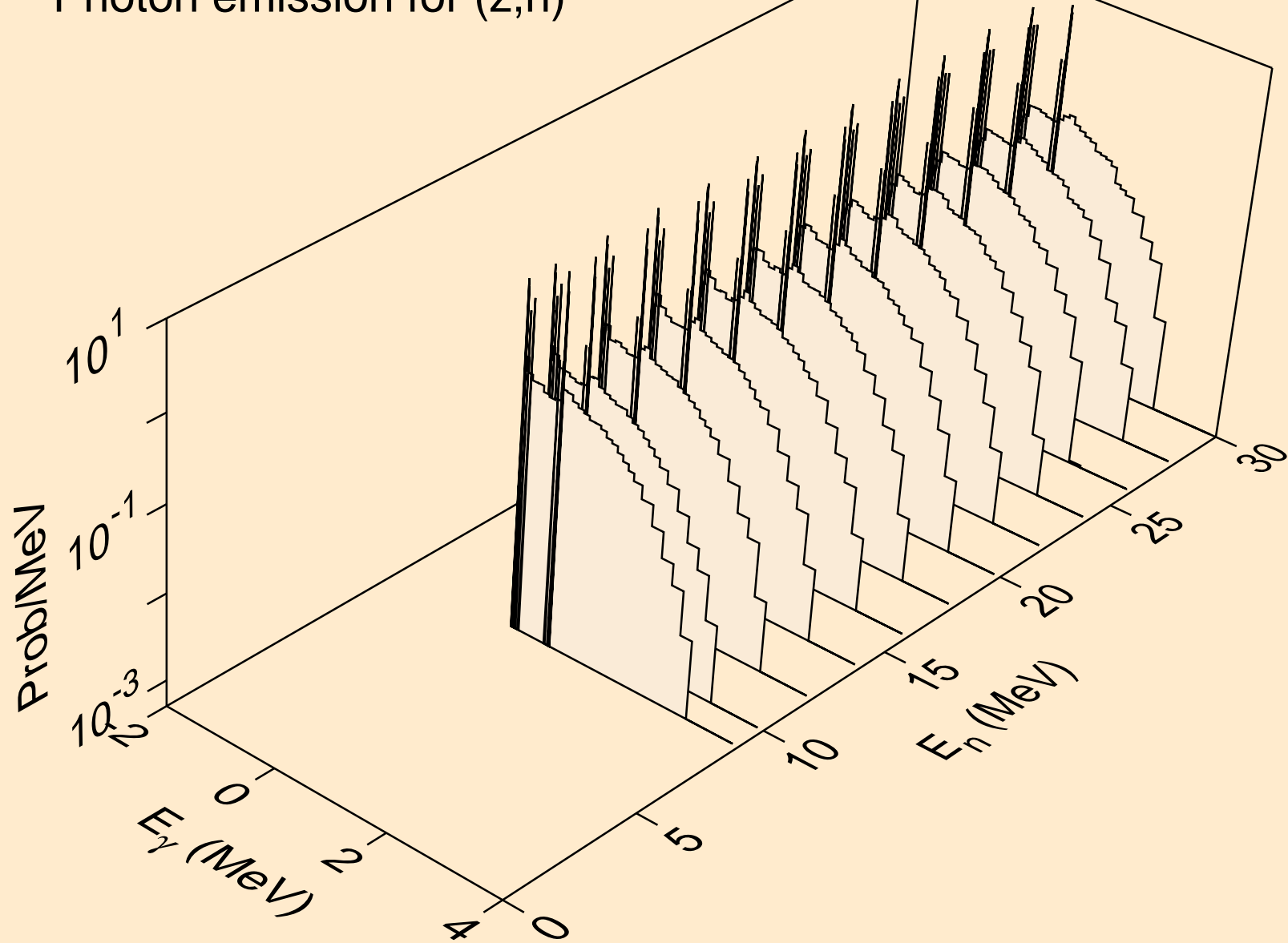

NO253 HELION ACER TENDL-2021 LIBRARY; T=0.K
Photon emission for (n,x)

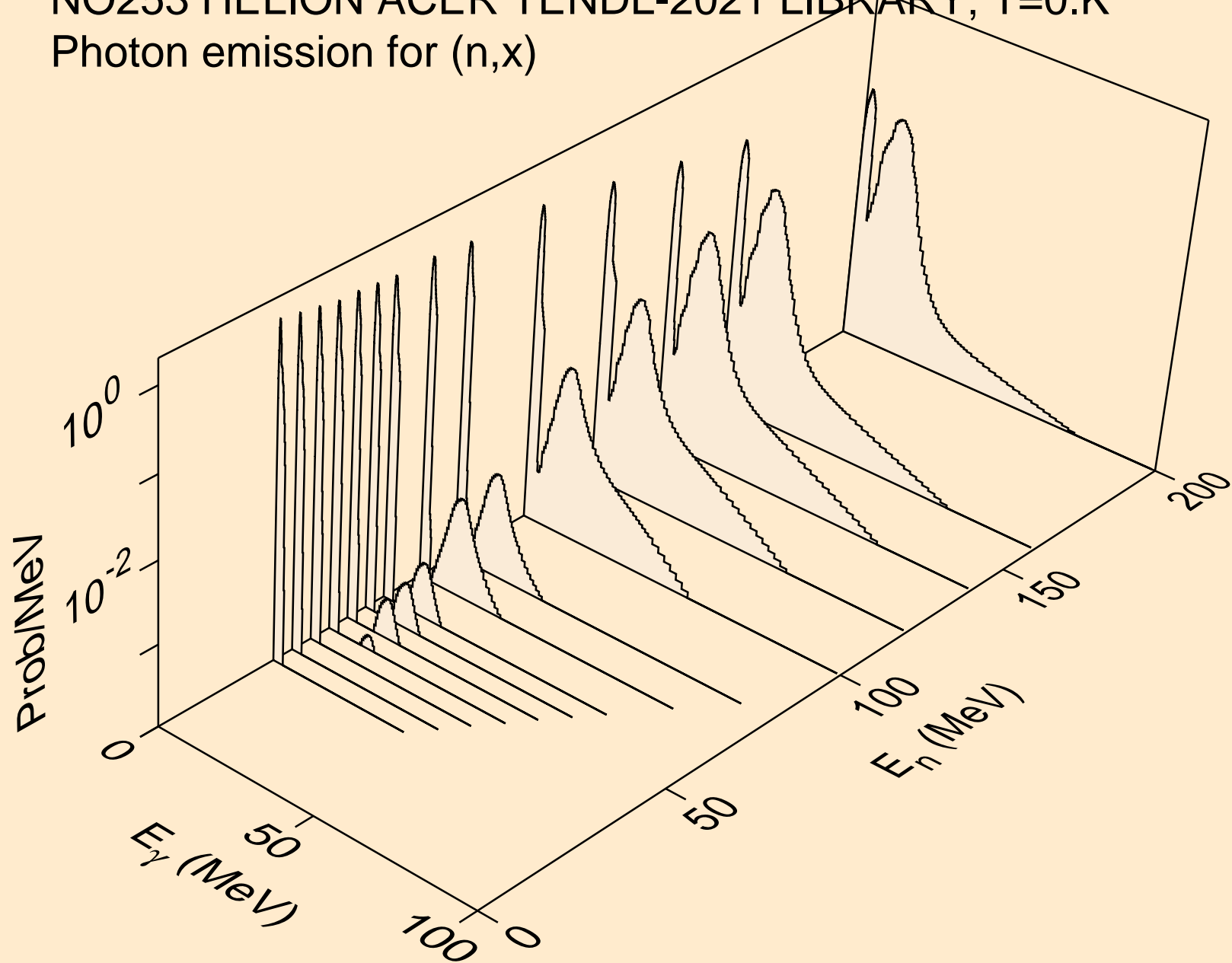

NO253 HELION ACER TENDL-2021 LIBRARY; T=0.K
Photon emission for (n,2n)

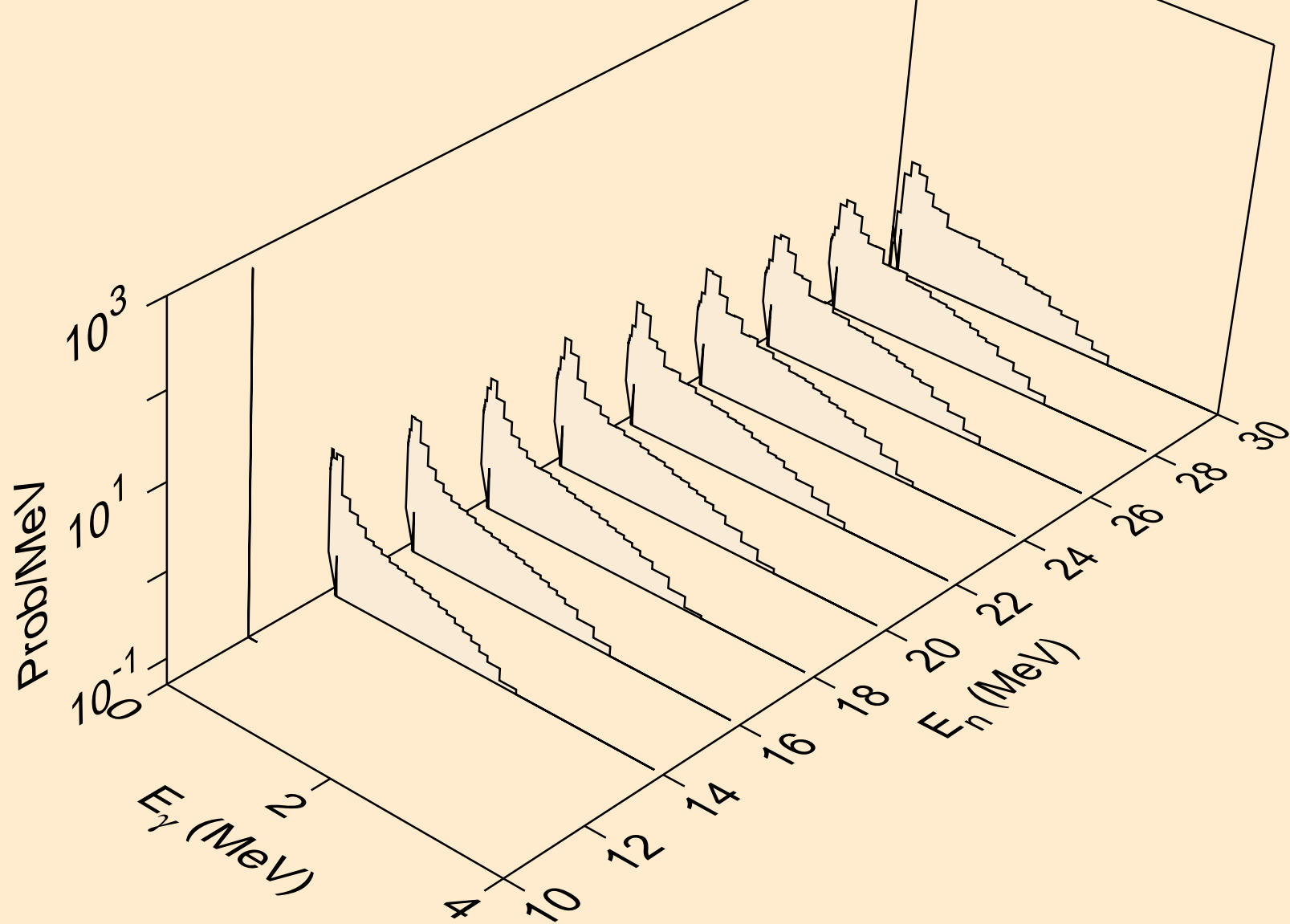

NO253 HELION ACER TENDL-2021 LIBRARY; T=0.K
Photon emission for (n,3n)

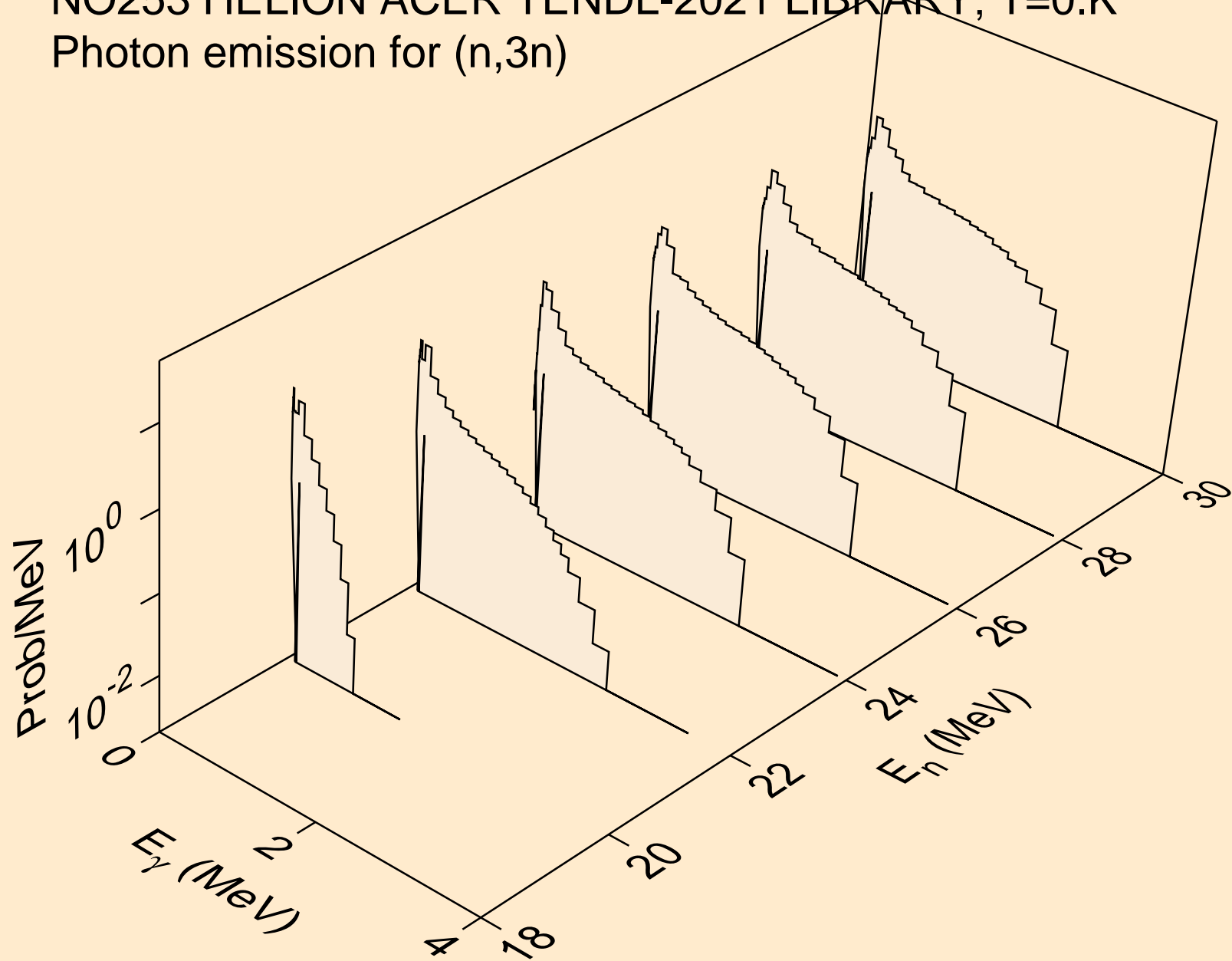

NO253 HELION ACER TENDL-2021 LIBRARY; T=0.K
Photon emission for (n,n*)a

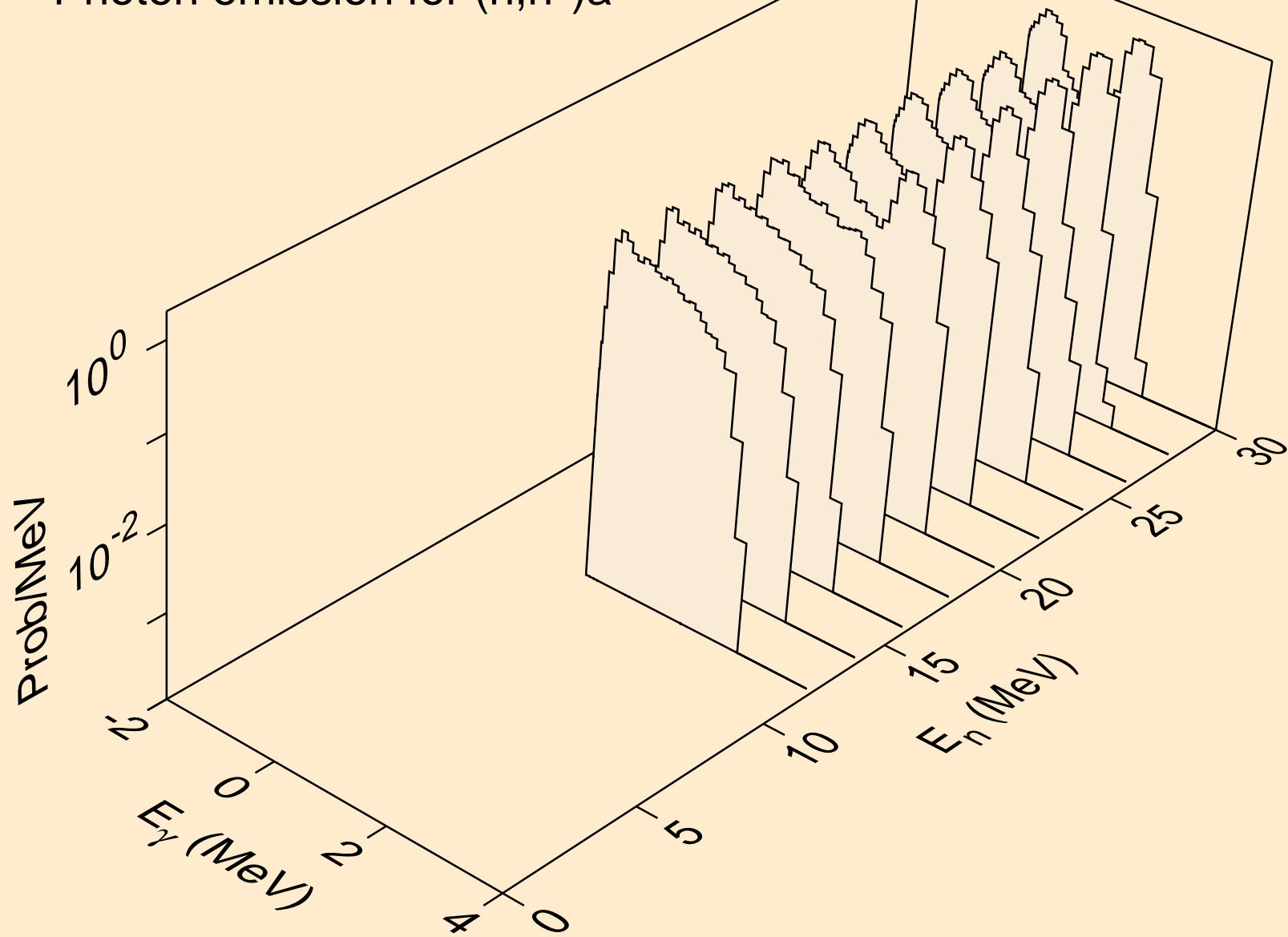

NO253 HELION ACER TENDL-2021 LIBRARY; T=0.K
Photon emission for (n,n*)p

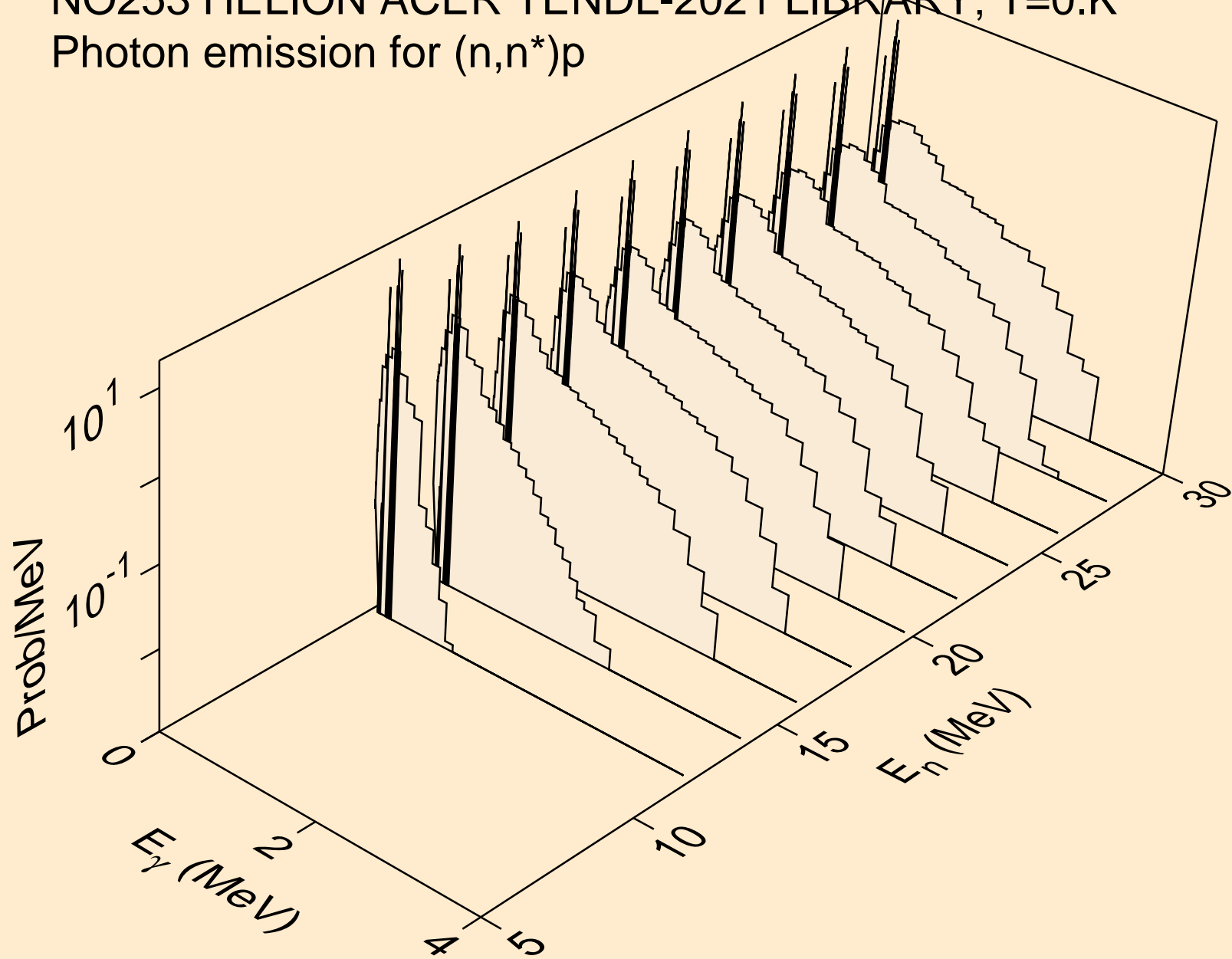

NO253 HELION ACER TENDL-2021 LIBRARY; T=0.K
Photon emission for (n,n*)d

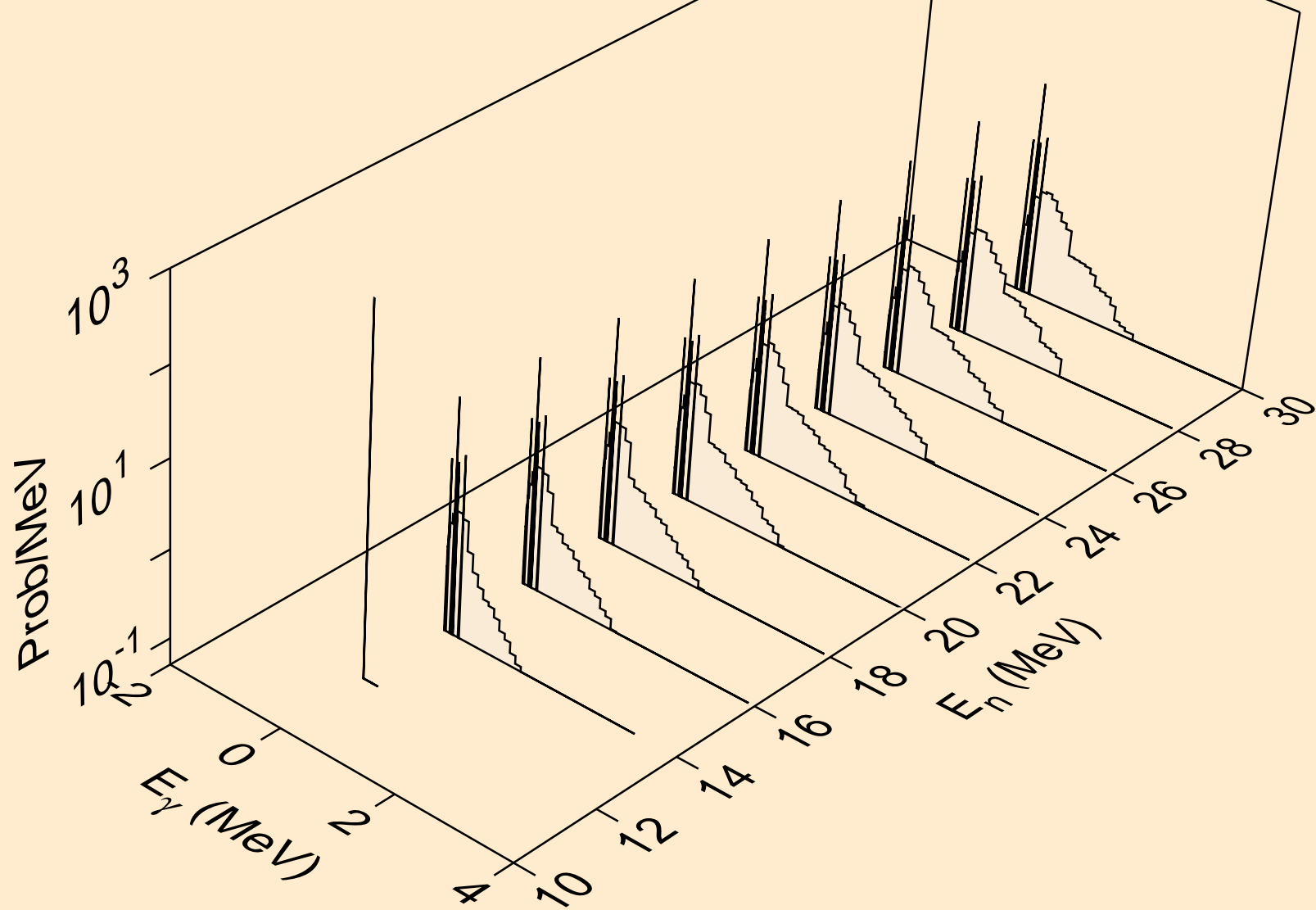

NO253 HELION ACER TENDL-2021 LIBRARY; T=0.K
Photon emission for (n,n*)t

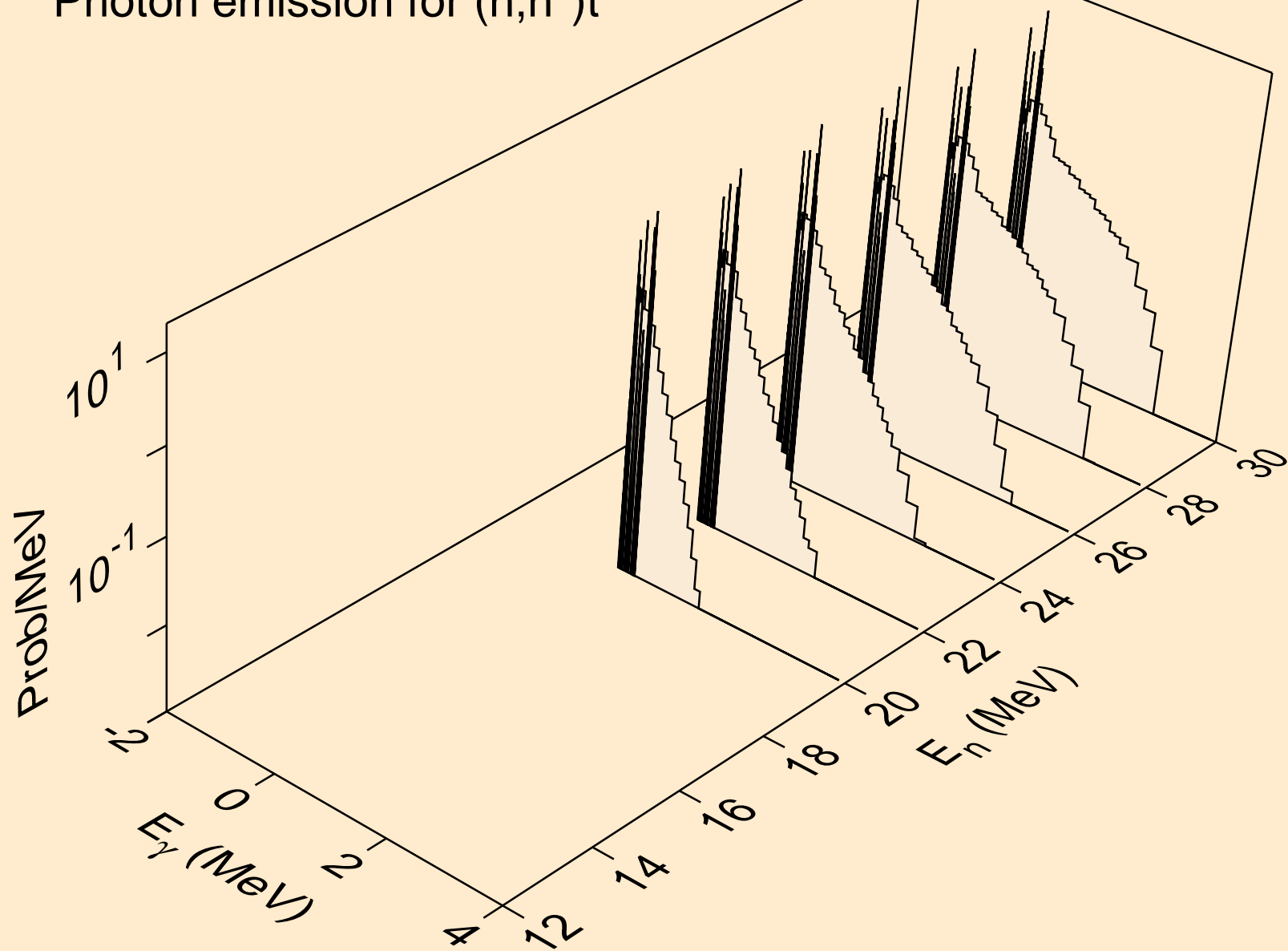

NO253 HELION ACER TENDL-2021 LIBRARY; T=0.K
Photon emission for (n,2np)

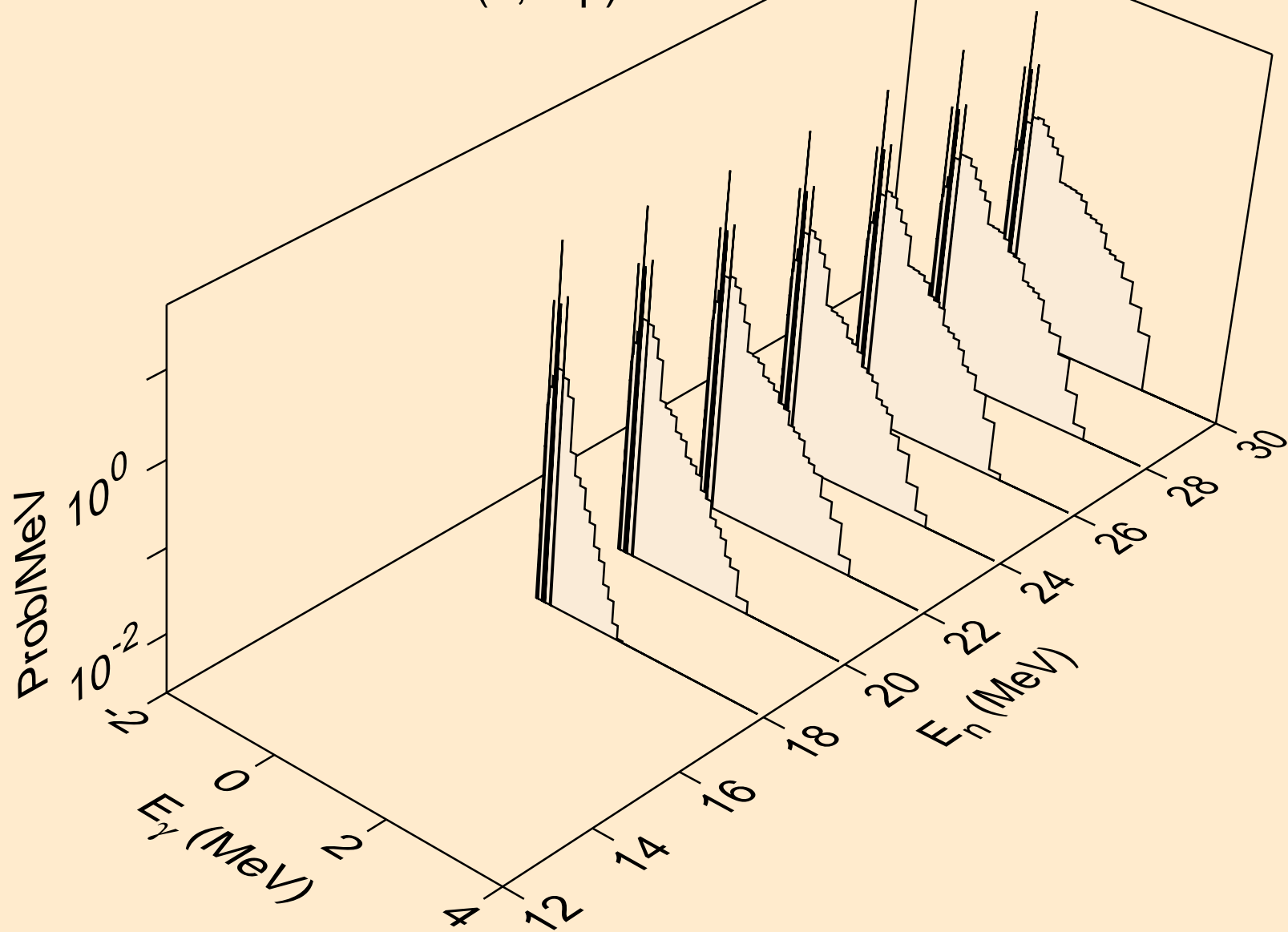

NO253 HELION ACER TENDL-2021 LIBRARY; T=0.K
Photon emission for (n,npa)

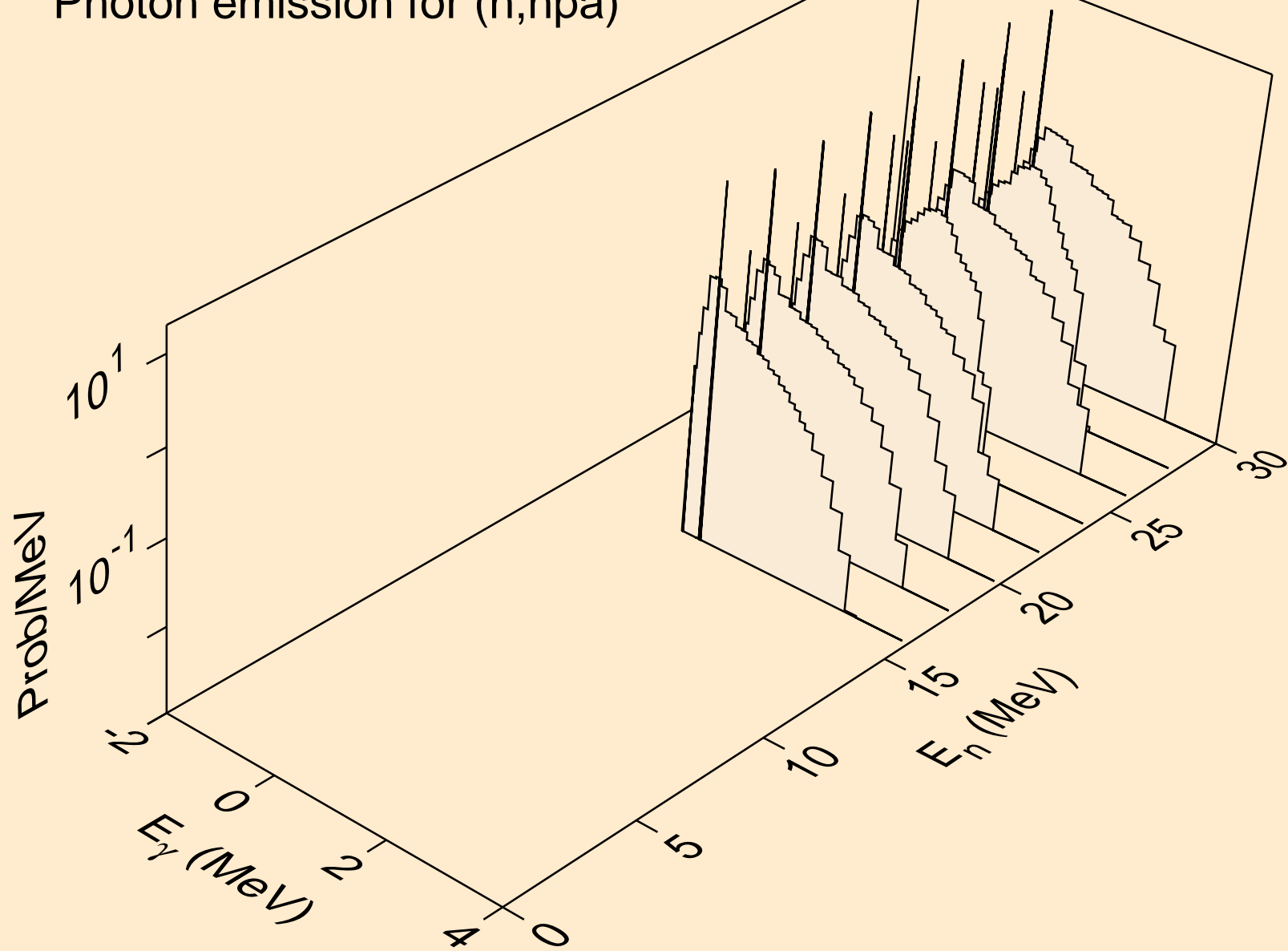

NO253 HELION ACER TENDL-2021 LIBRARY; T=0.K
Photon emission for (n,p)

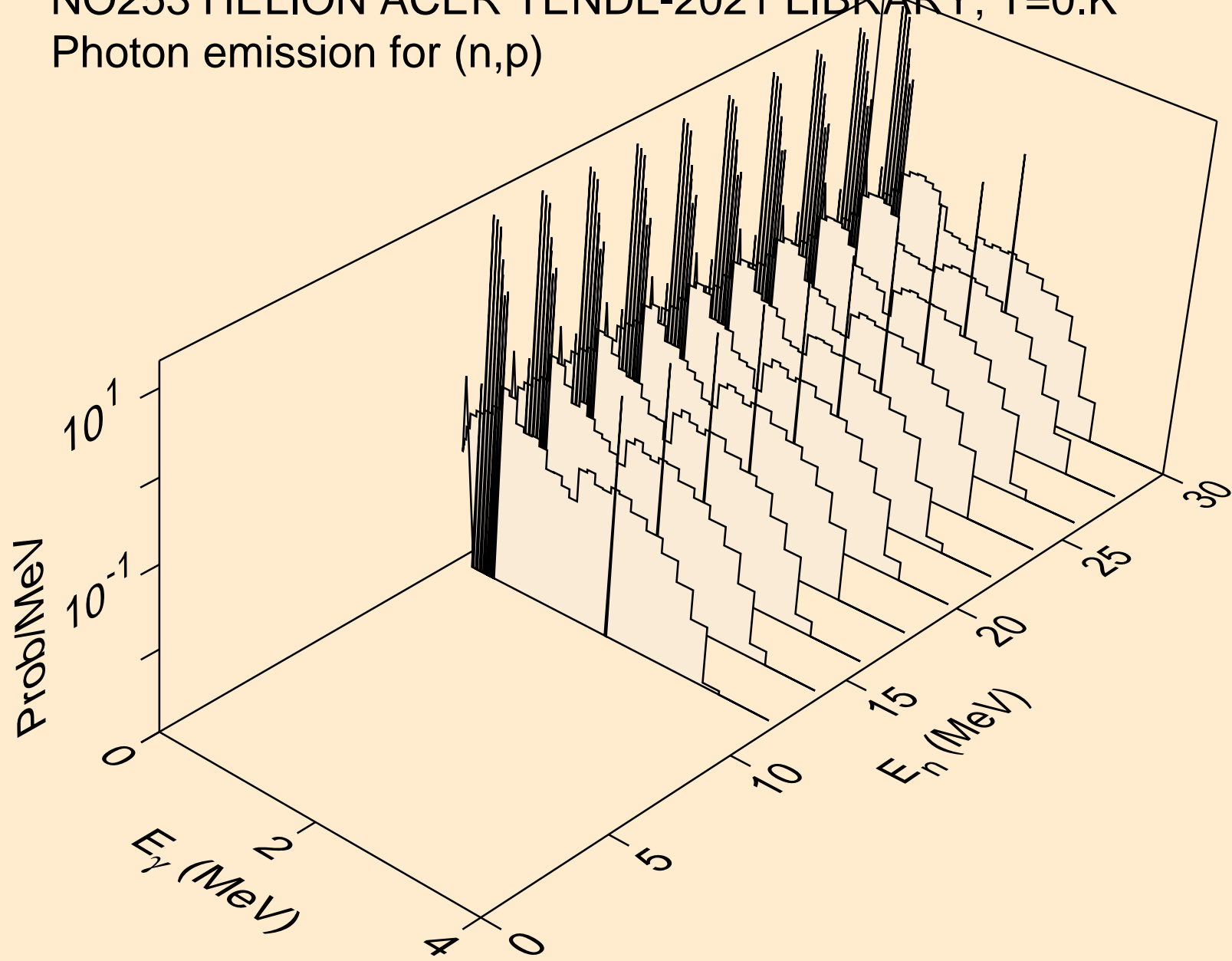

NO253 HELION ACER TENDL-2021 LIBRARY; T=0.K
Photon emission for (n,d)

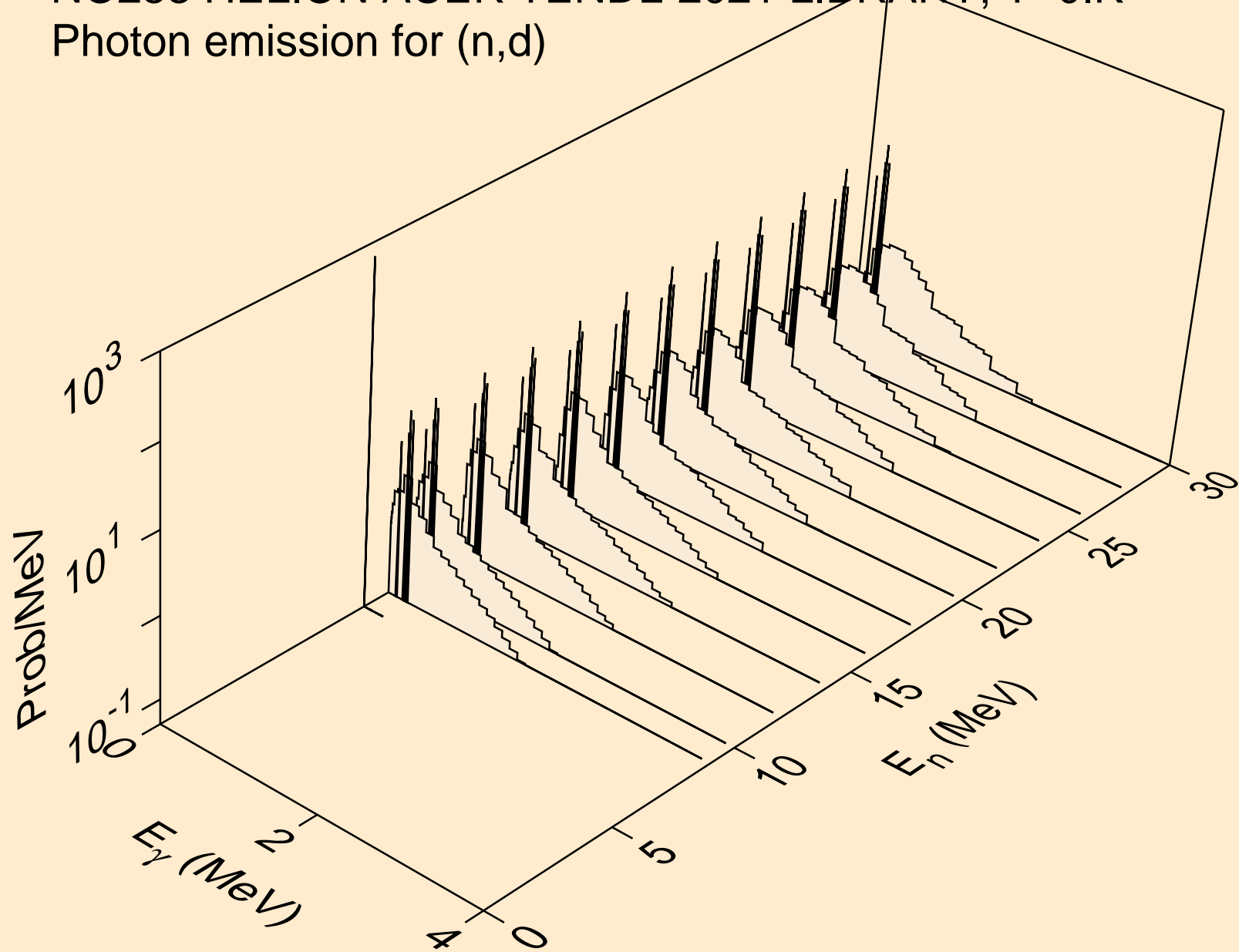

NO253 HELION ACER TENDL-2021 LIBRARY; T=0.K
Photon emission for (n,t)

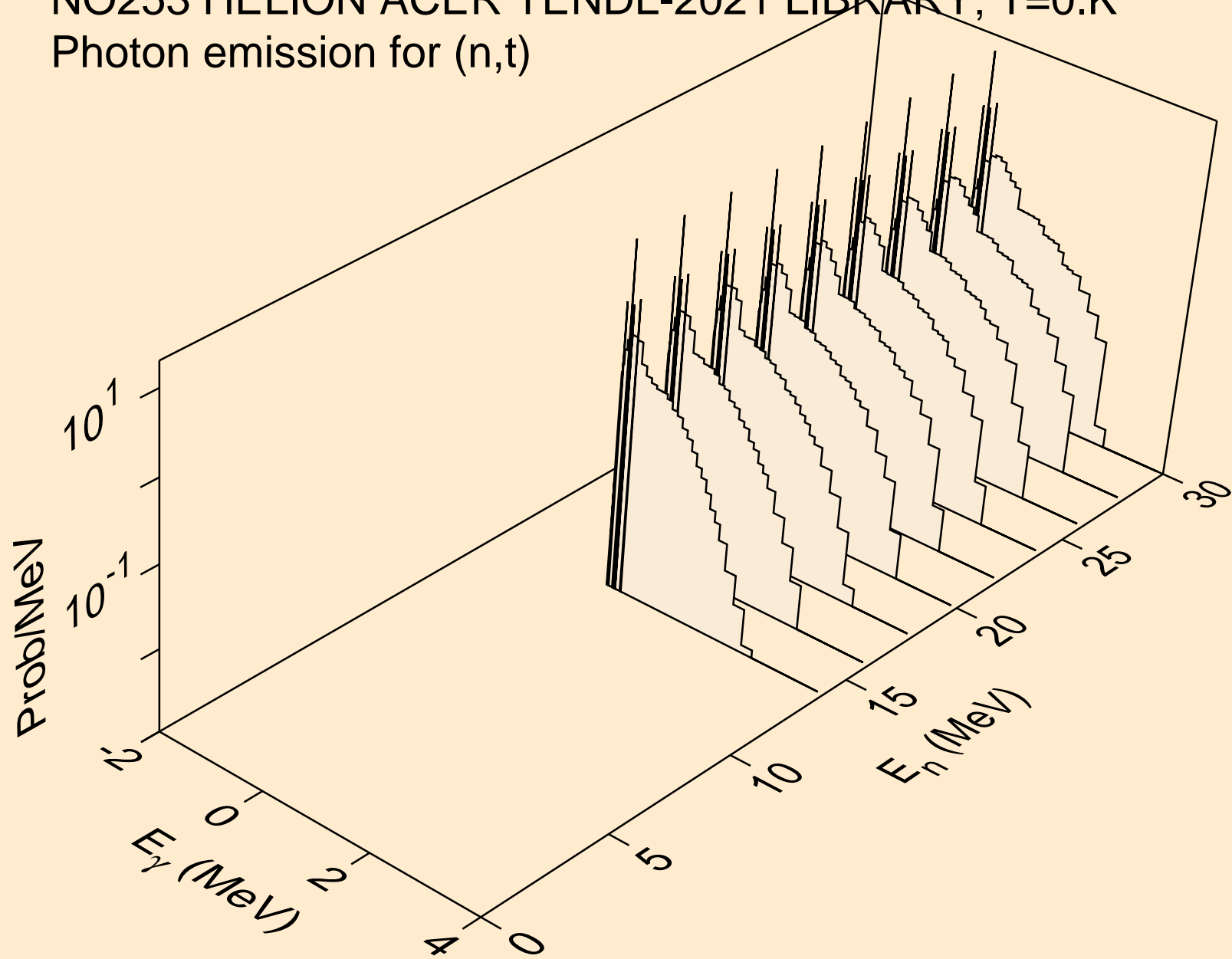

NO253 HELION ACER TENDL-2021 LIBRARY; T=0.K
Photon emission for inelastic

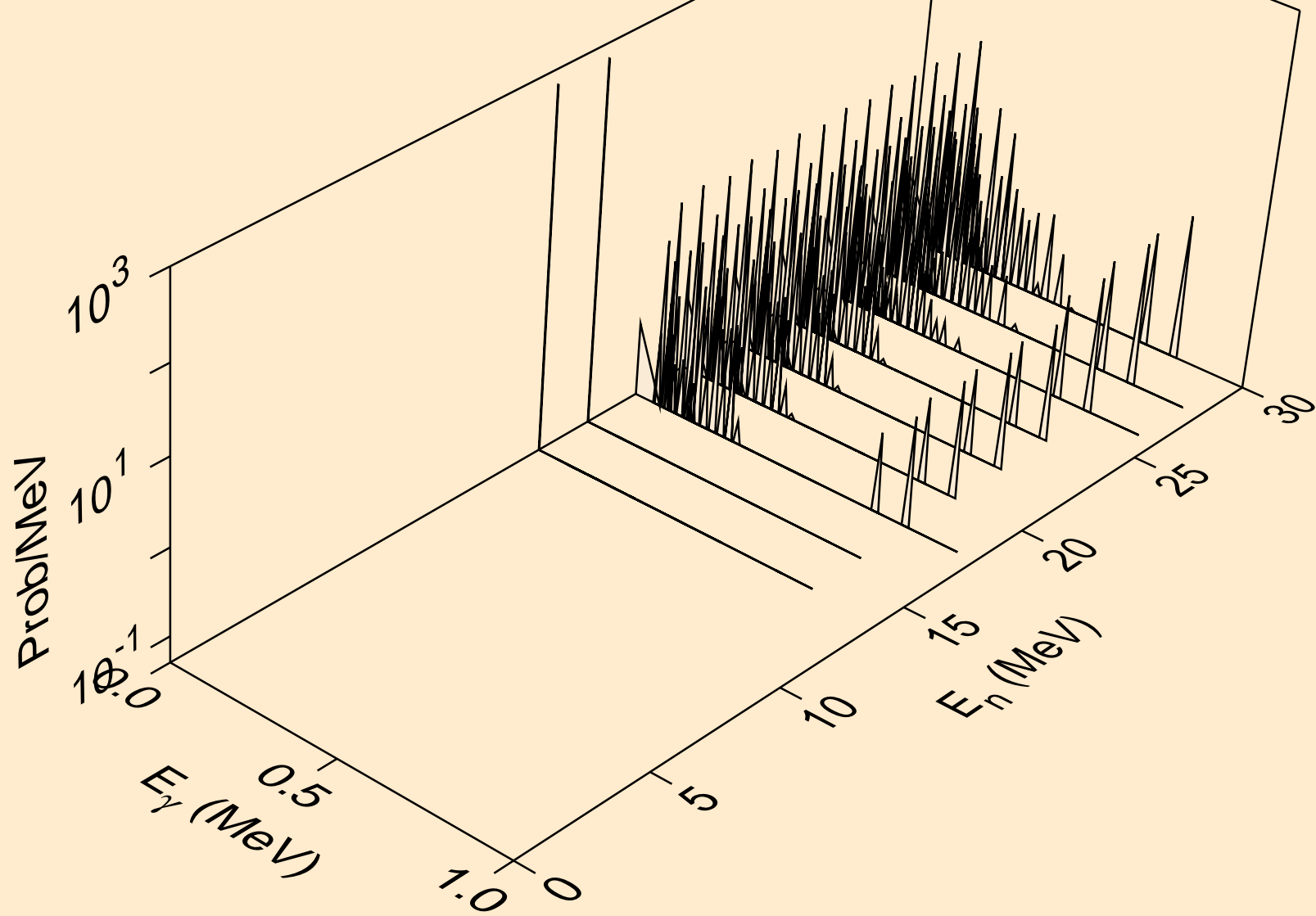

NO253 HELION ACER TENDL-2021 LIBRARY; T=0.K
Photon emission for (n,a)

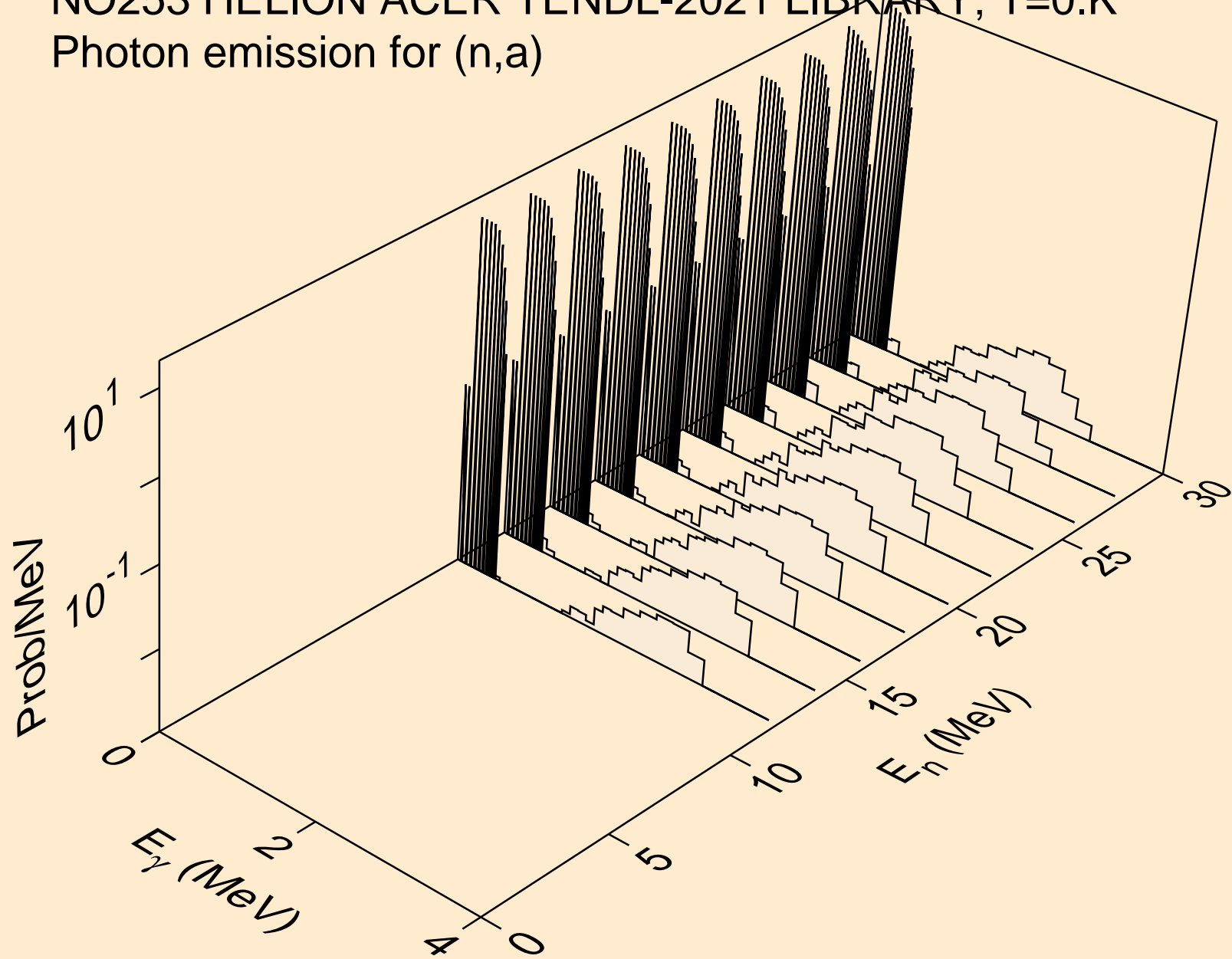

NO253 HELION ACER TENDL-2021 LIBRARY; T=0.K
Photon emission for (n,2p)

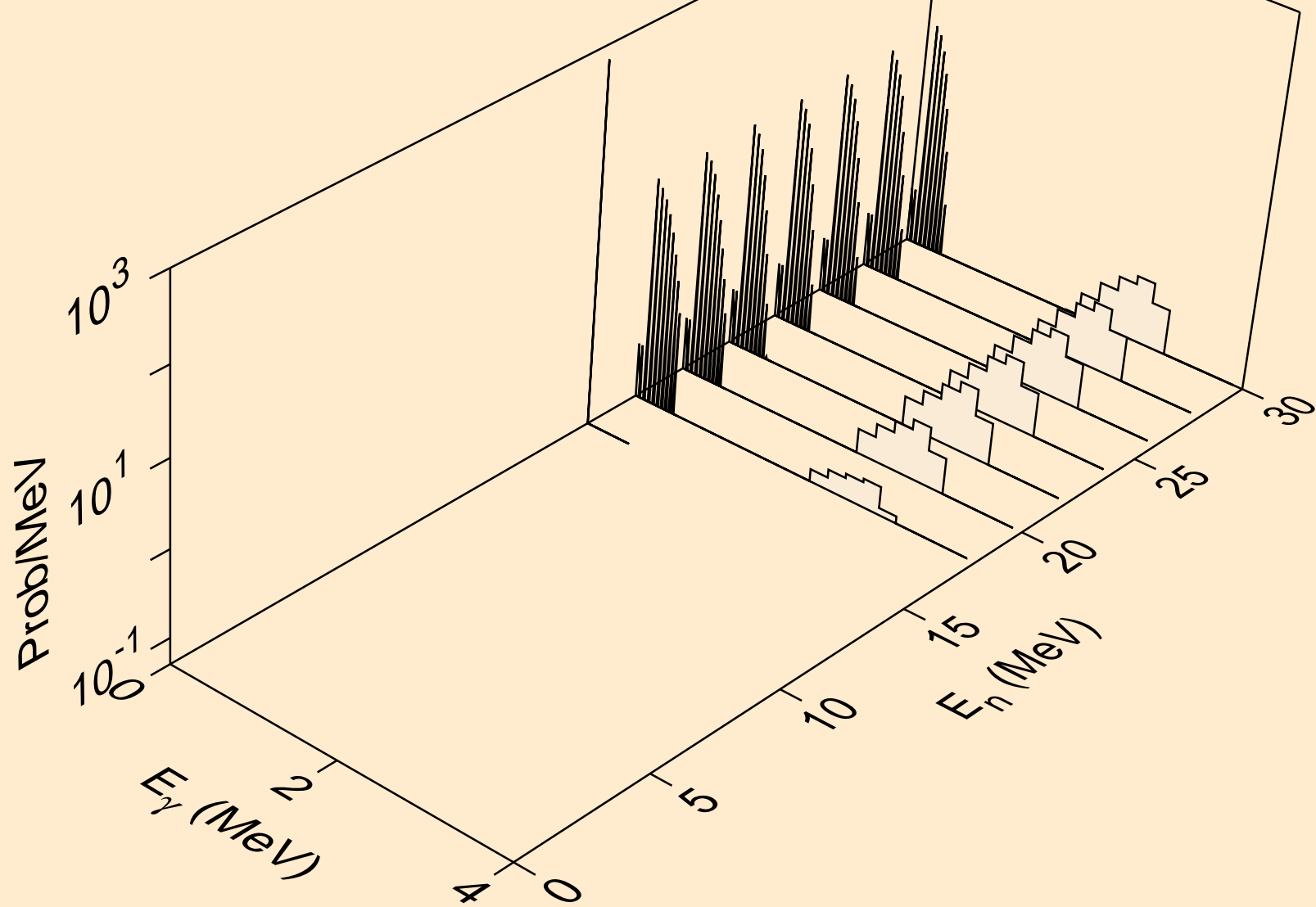

NO253 HELION ACER TENDL-2021 LIBRARY; T=0.K
Photon emission for (n,da)

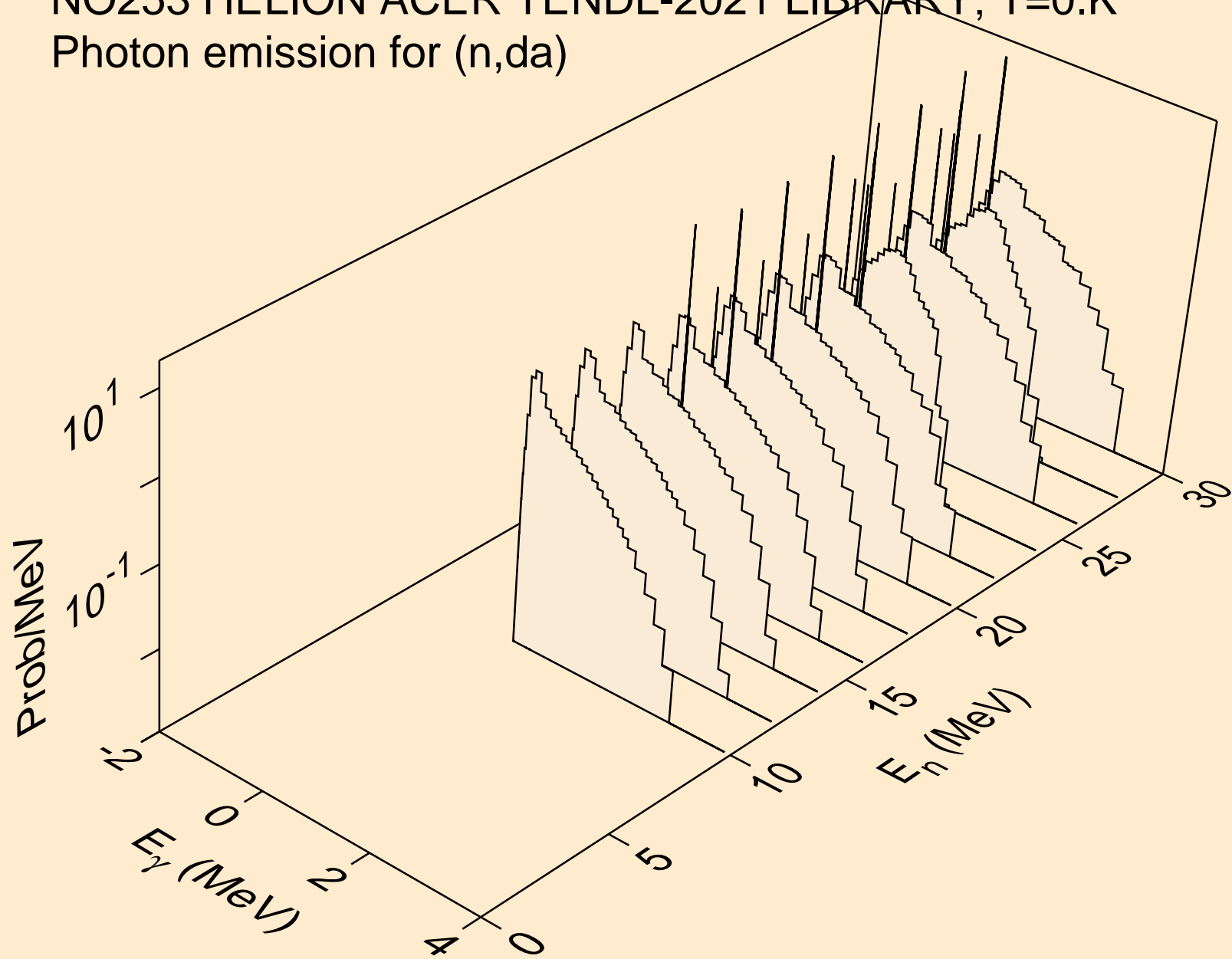

NO253 HELION ACER TENDL-2021 LIBRARY; T=0.K
Particle heating contributions

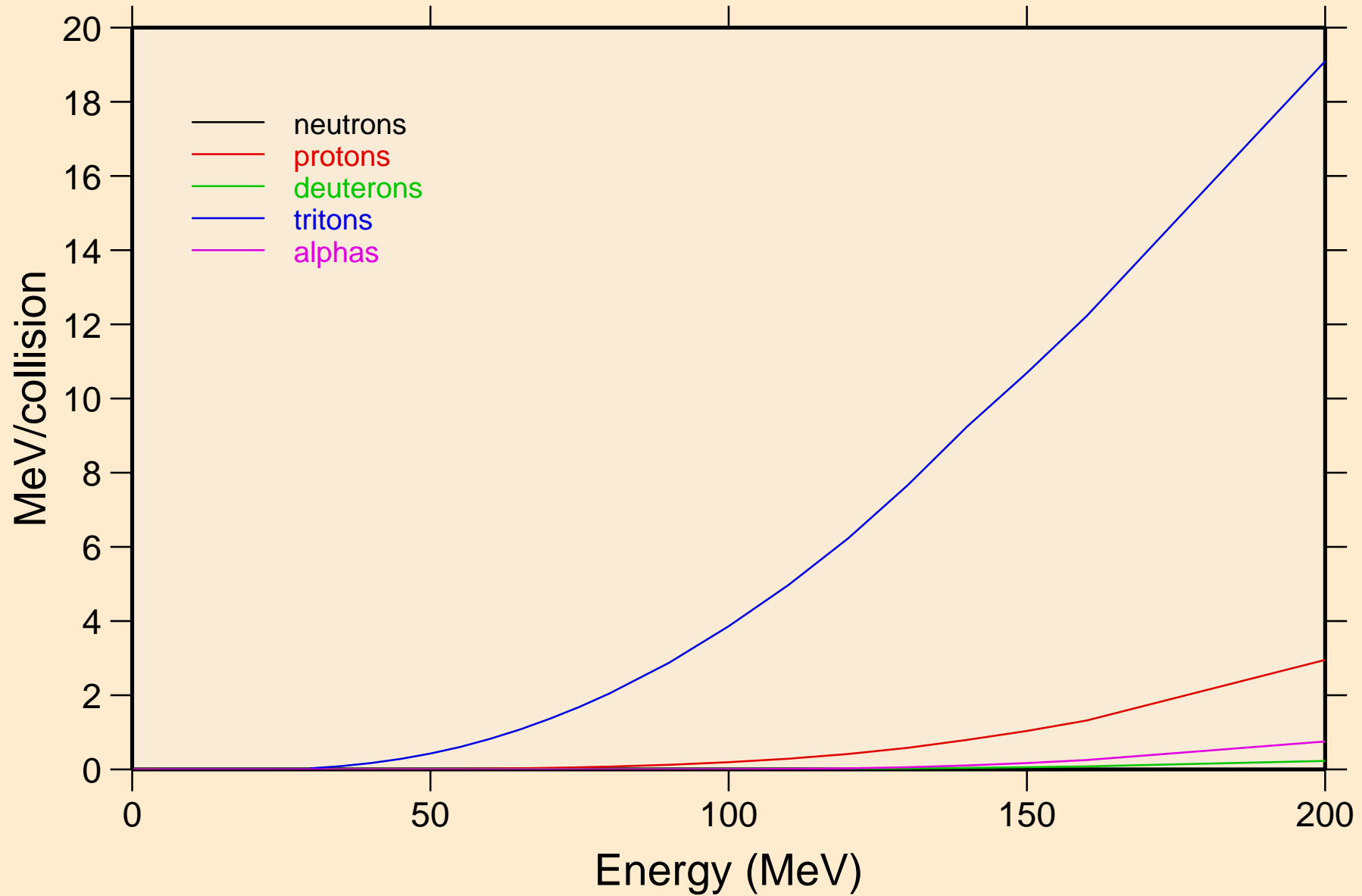

NO253 HELION ACER TENDL-2021 LIBRARY; T=0.K
Recoil Heating

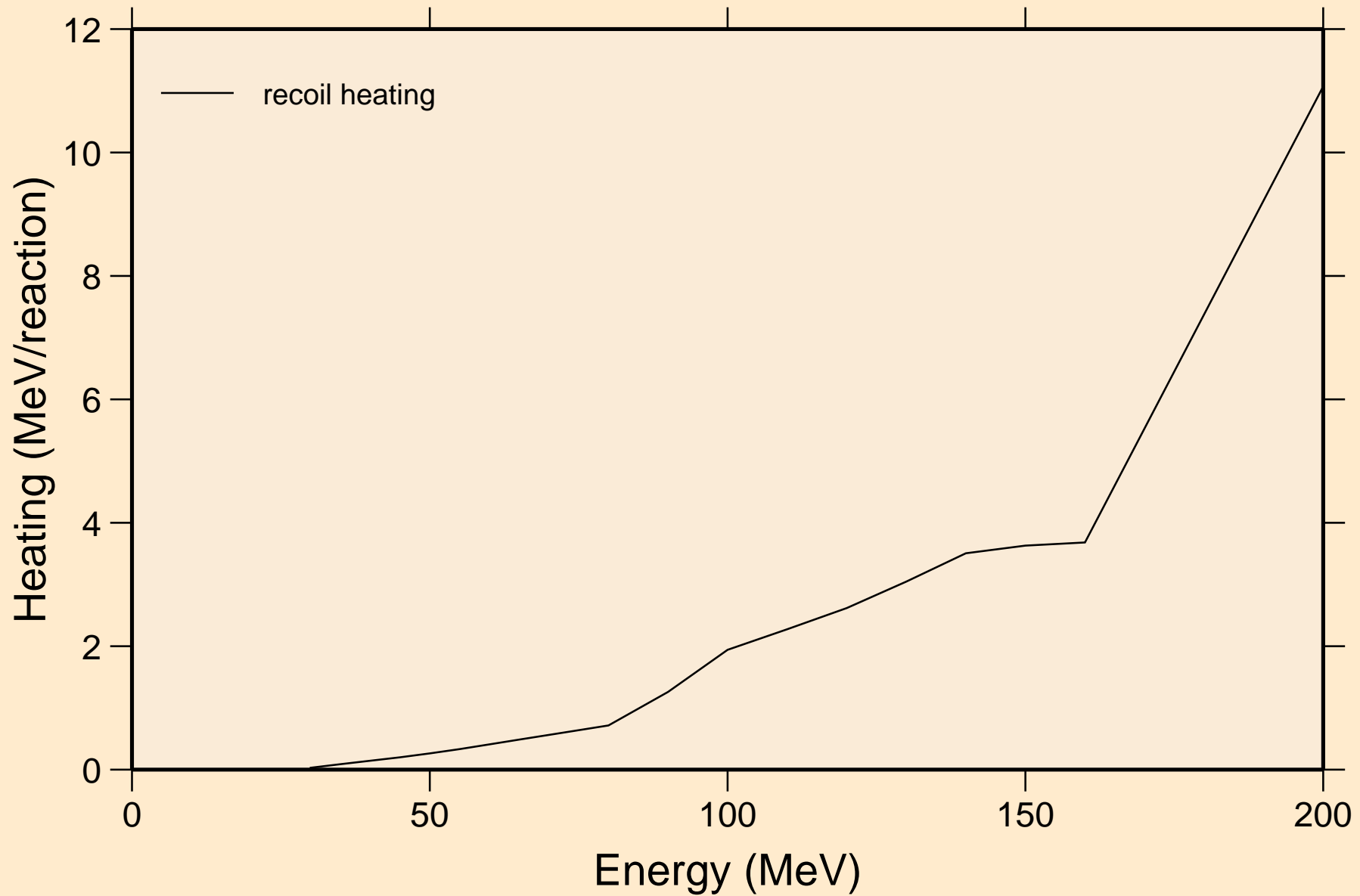

NO253 HELION ACER TENDL-2021 LIBRARY; T=0.K
Particle production cross sections

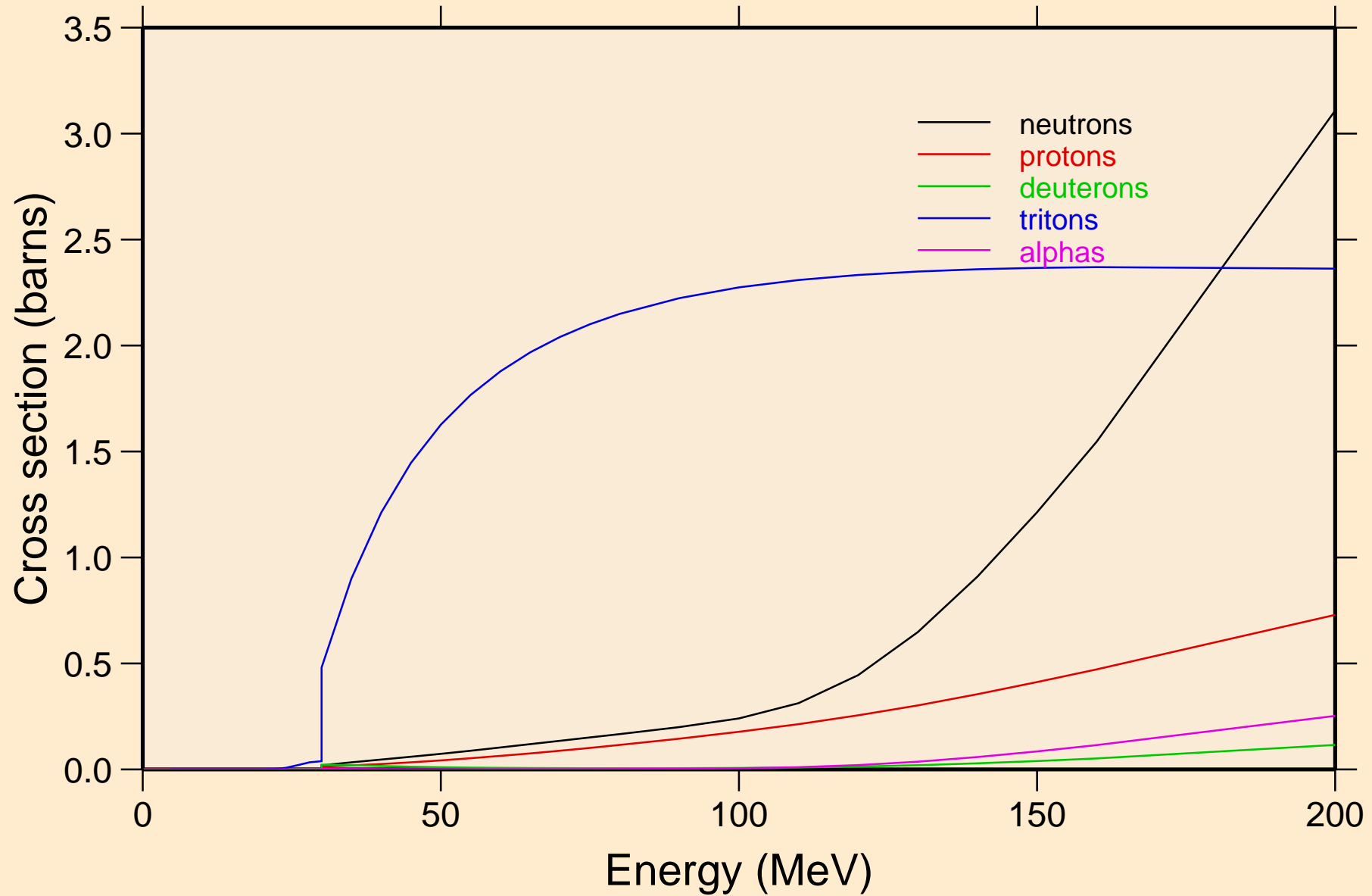

NO253 HELION ACER TENDL-2021 LIBRARY; T=0.K
neutrons from (s,n)

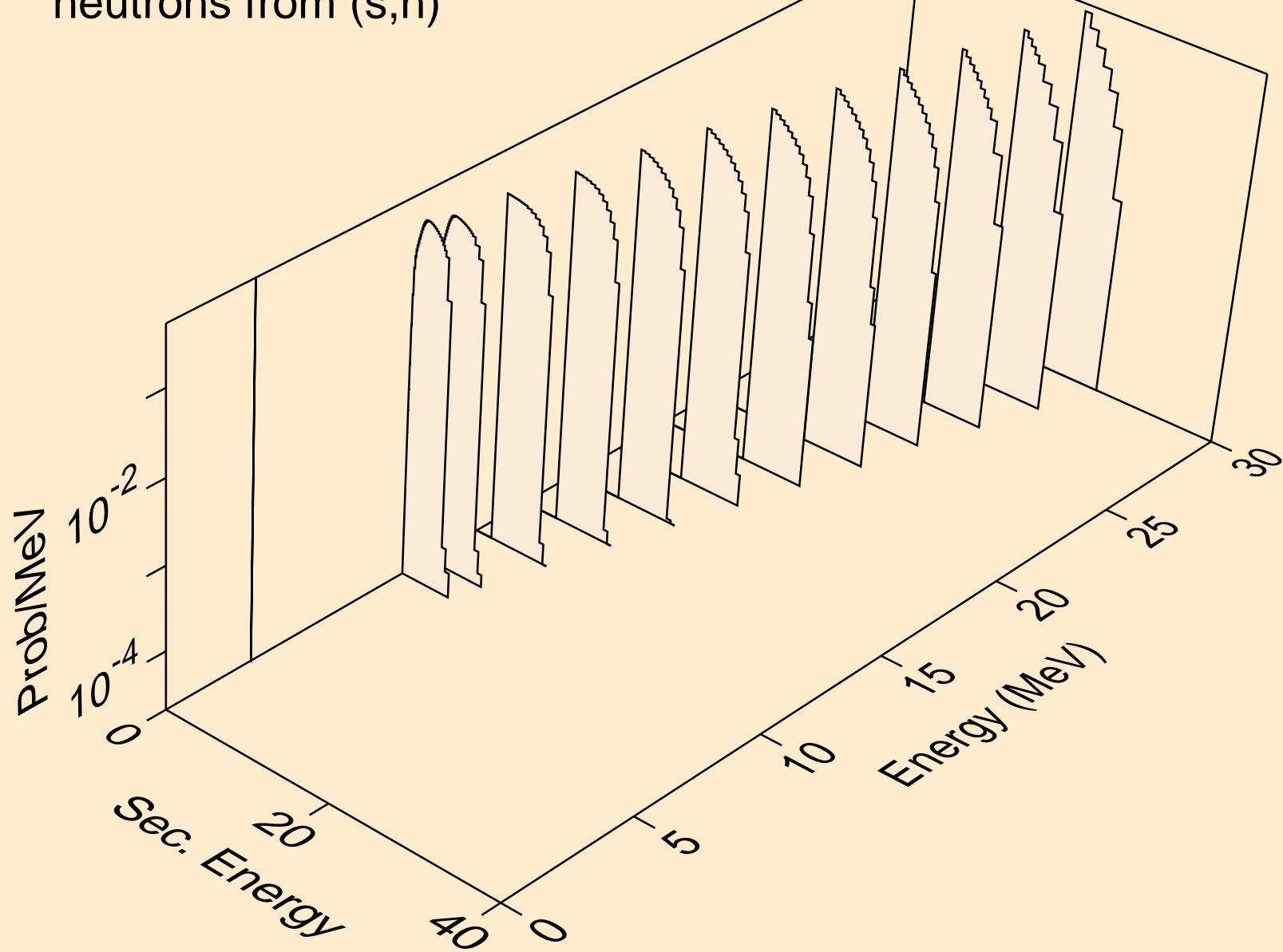

NO253 HELION ACER TENDL-2021 LIBRARY; T=0.K
neutrons from (s,x)

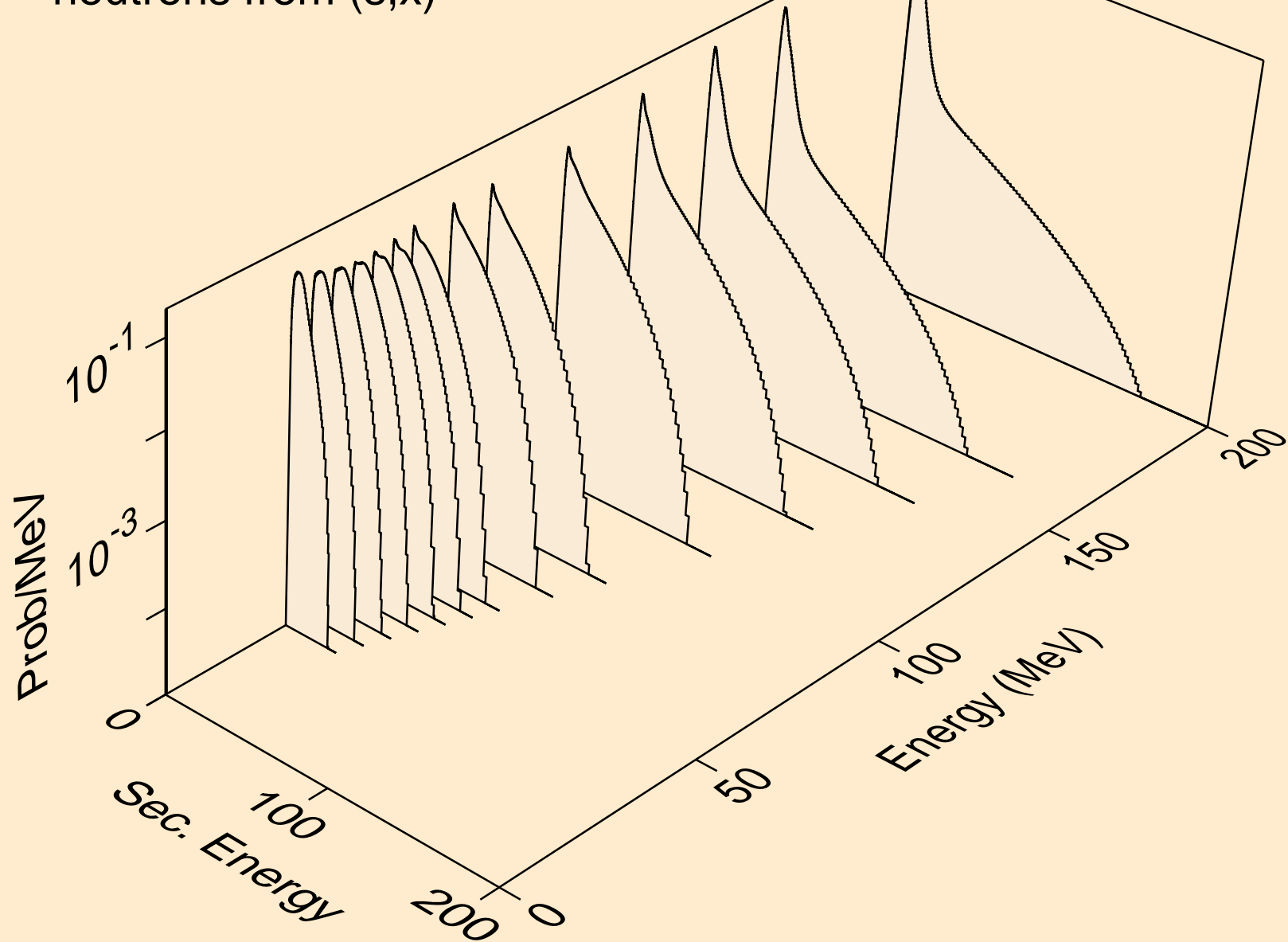

NO253 HELION ACER TENDL-2021 LIBRARY; T=0.K
neutrons from (s,2n)

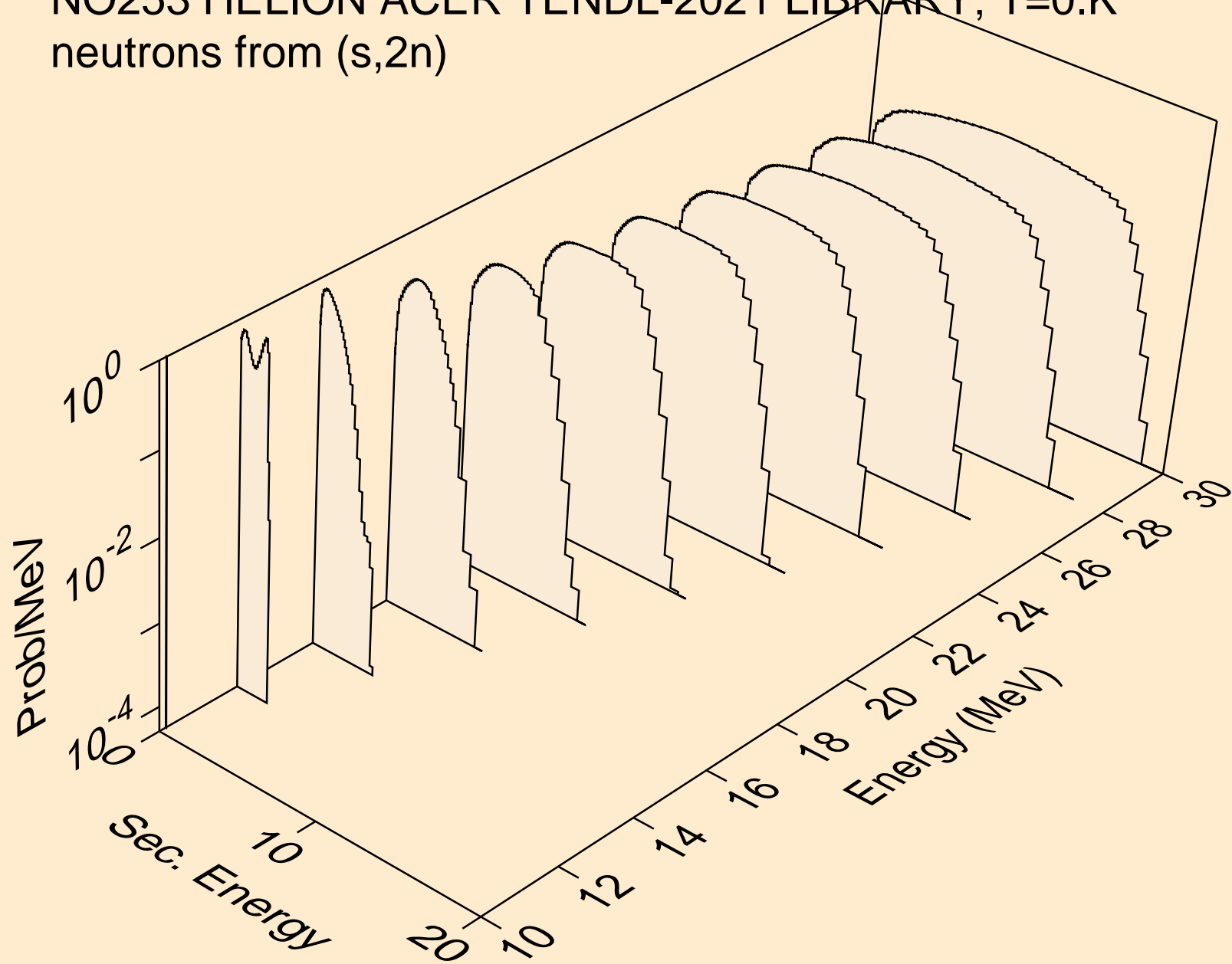

NO253 HELION ACER TENDL-2021 LIBRARY; T=0.K
neutrons from (s,3n)

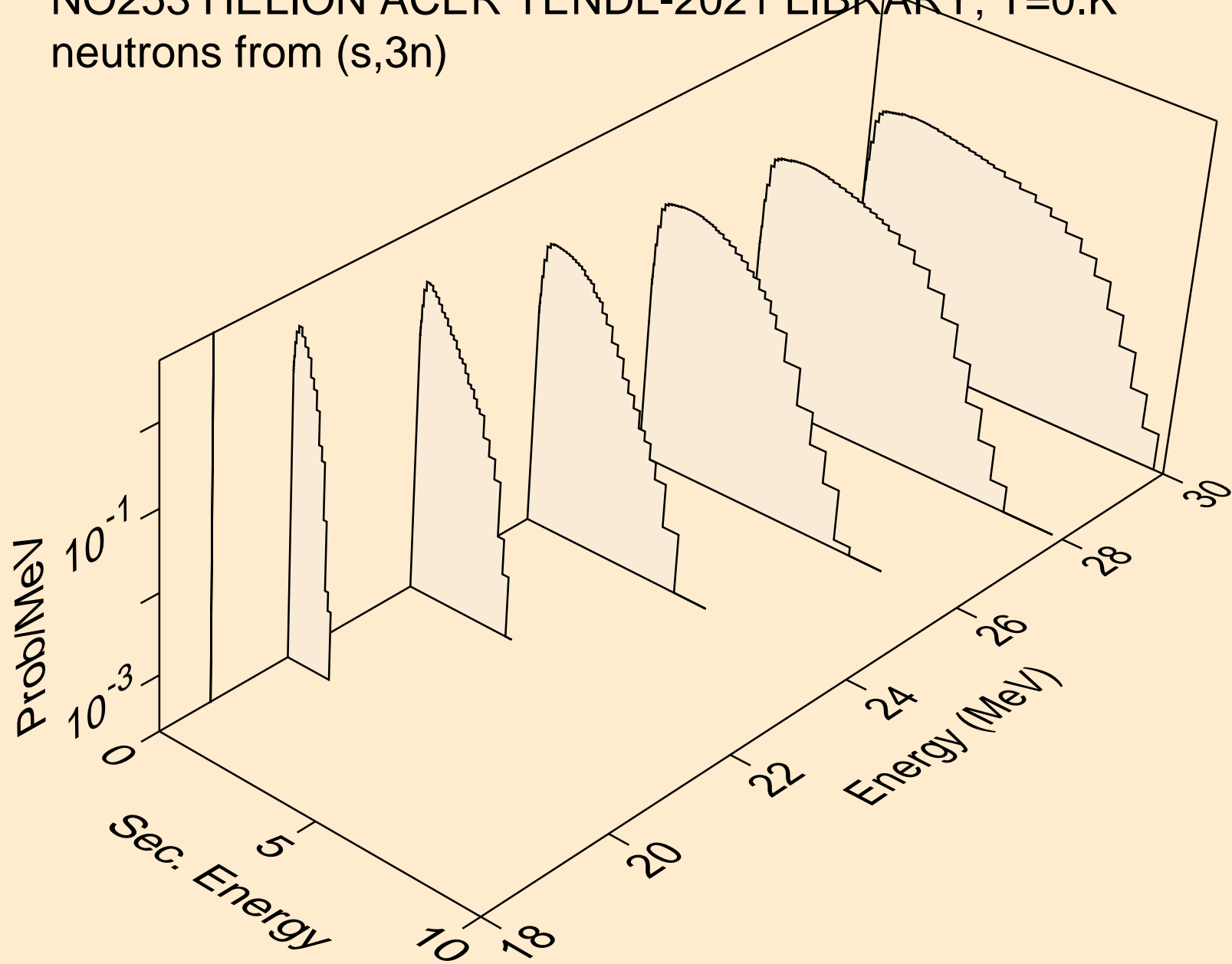

NO253 HELION ACER TENDL-2021 LIBRARY; T=0.K
neutrons from (s,n*)a

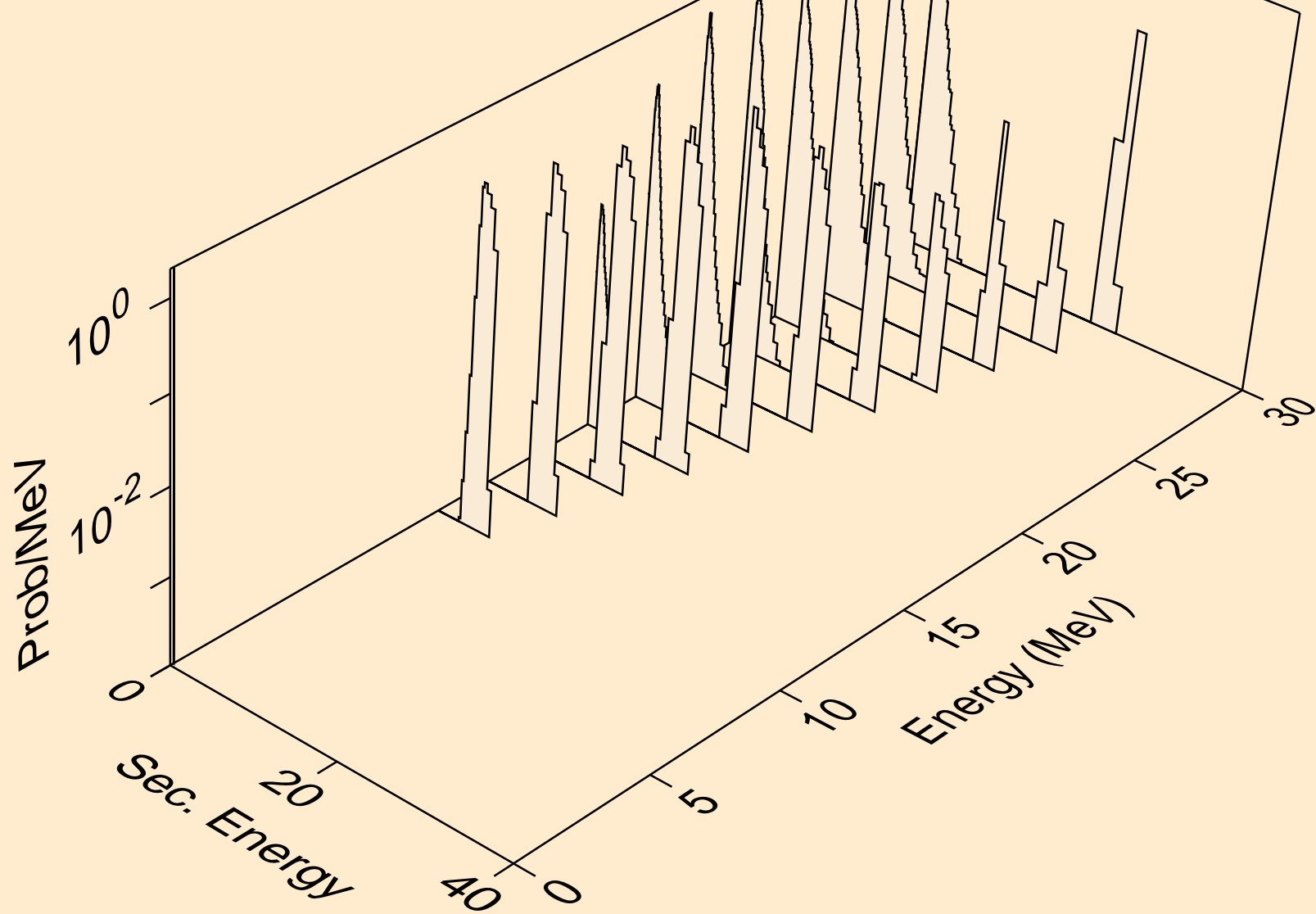

NO253 HELION ACER TENDL-2021 LIBRARY; T=0.K
neutrons from (s,n*)p

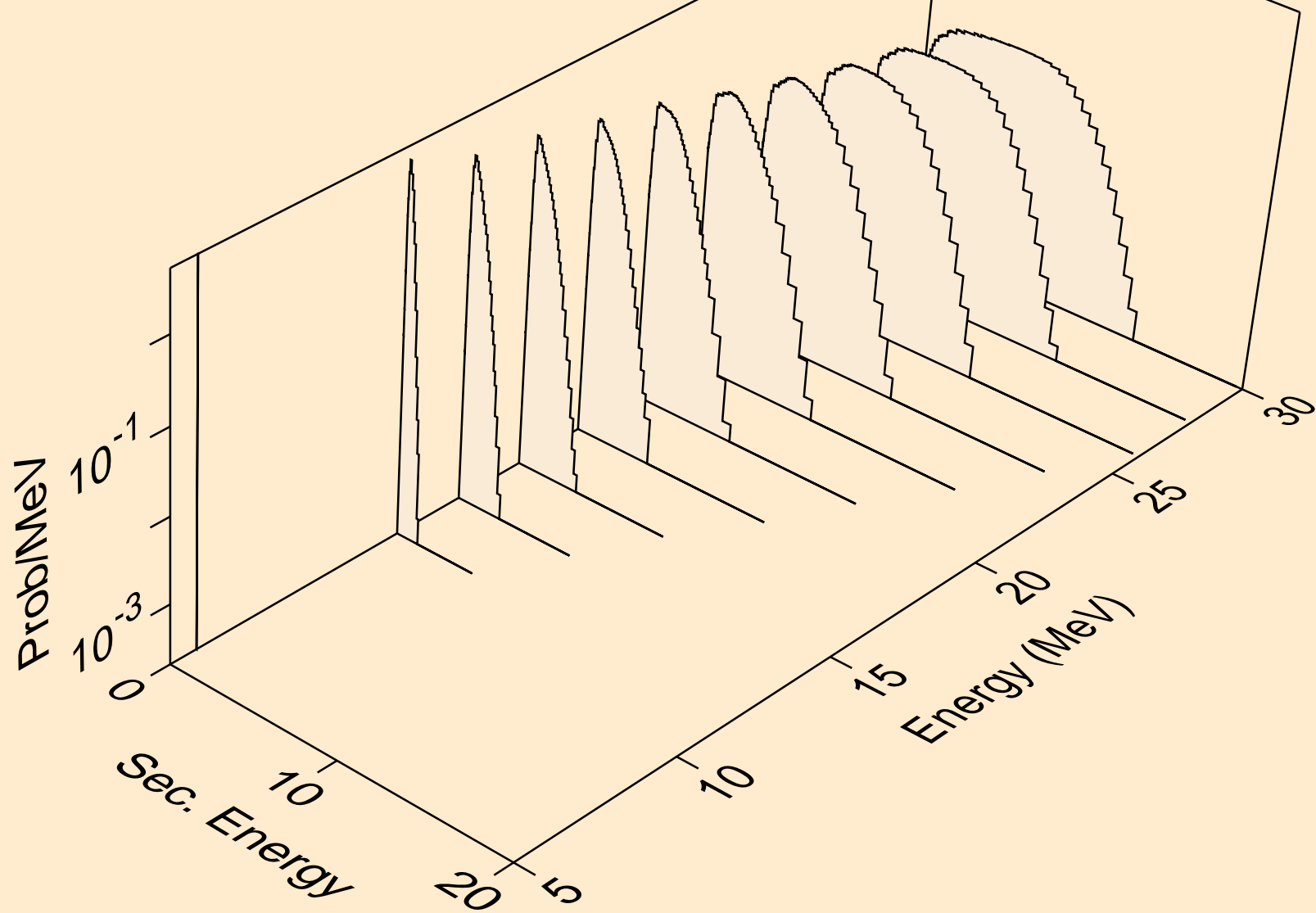

NO253 HELION ACER TENDL-2021 LIBRARY; T=0.K
neutrons from (s,n*)d

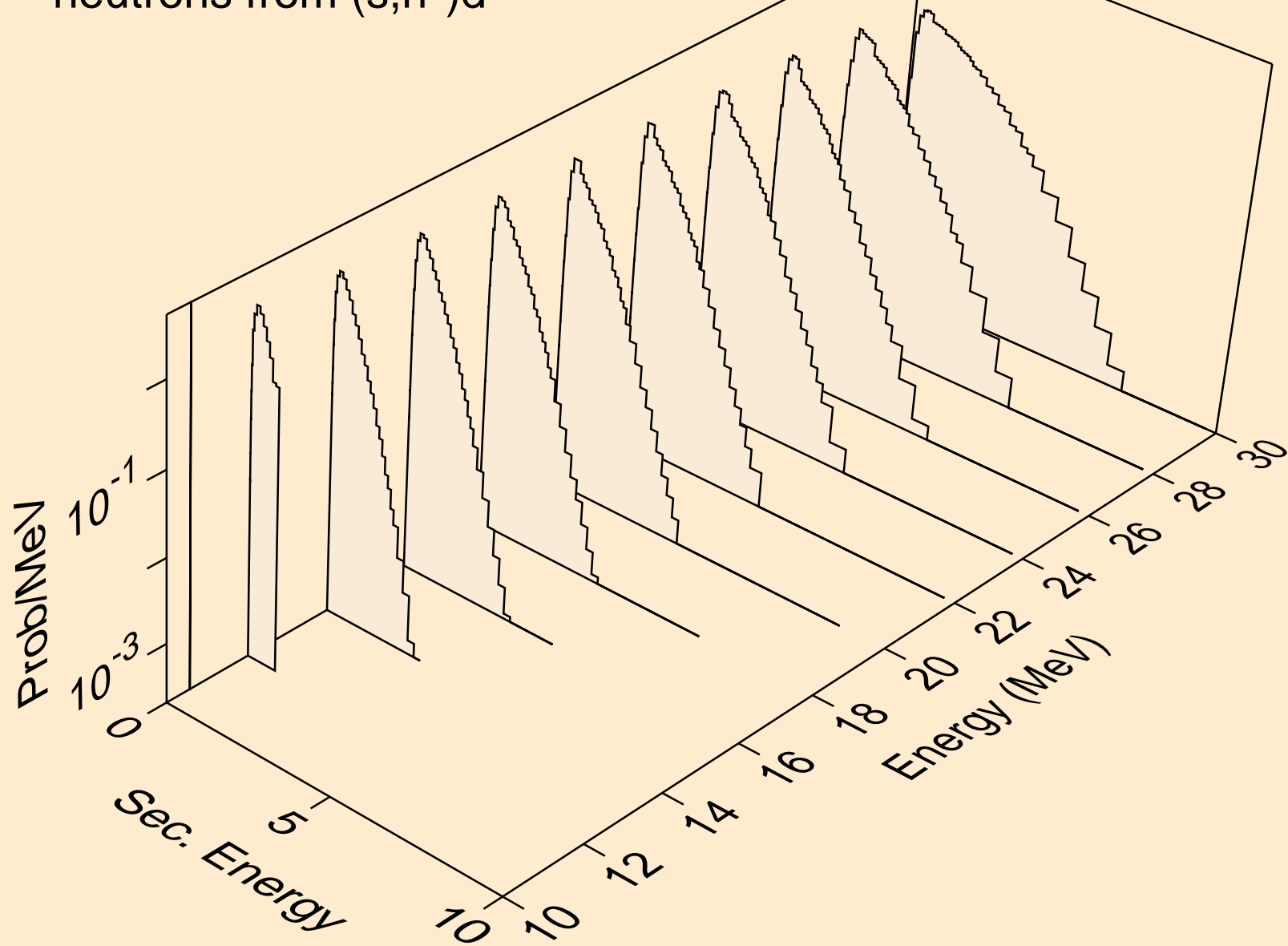

NO253 HELION ACER TENDL-2021 LIBRARY; T=0.K
neutrons from (s,n*)t

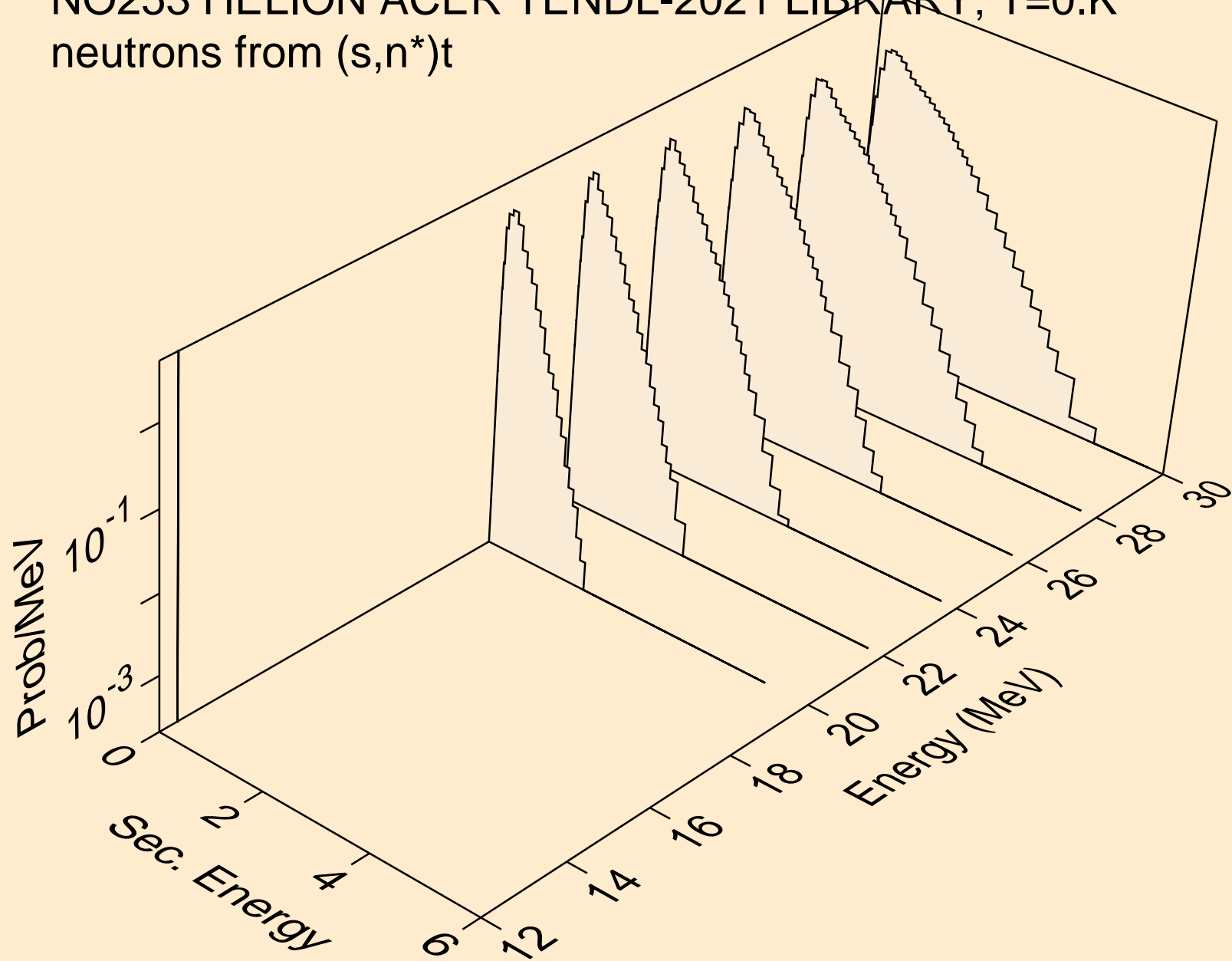

NO253 HELION ACER TENDL-2021 LIBRARY; T=0.K
neutrons from (s,2np)

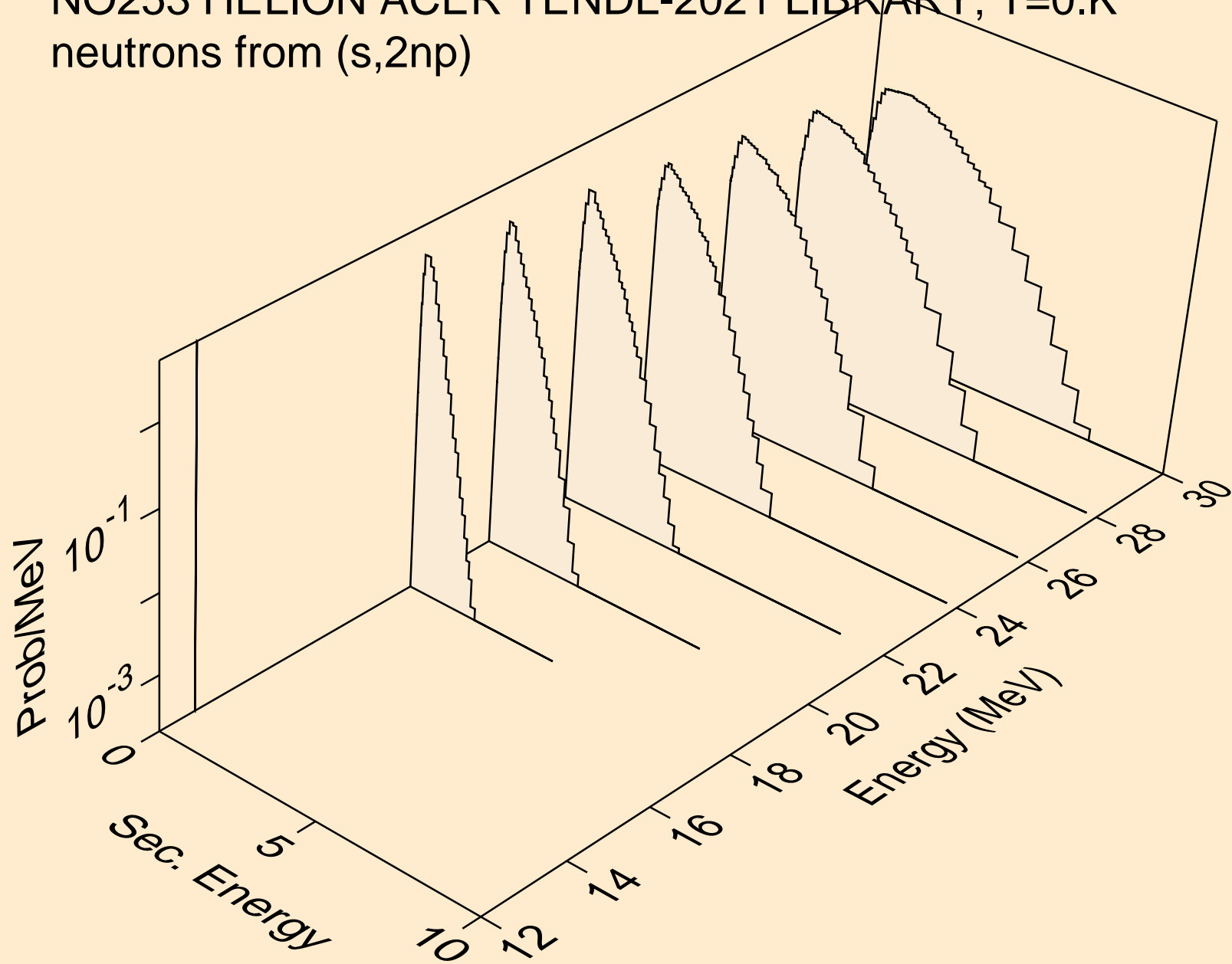

NO253 HELION ACER TENDL-2021 LIBRARY; T=0.K
neutrons from (s,npa)

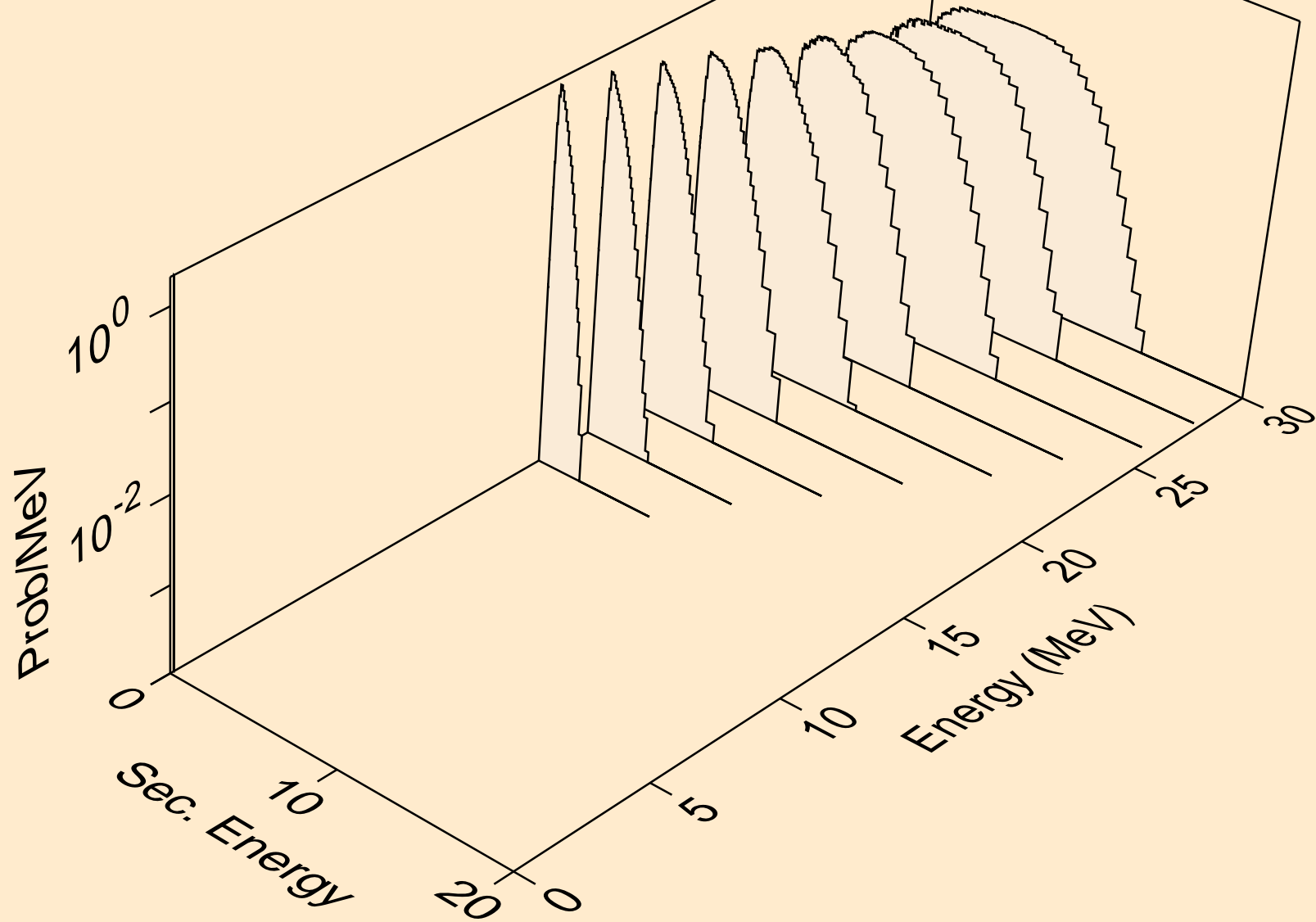

NO253 HELION ACER TENDL-2021 LIBRARY; T=0.K
protons from (s,x)

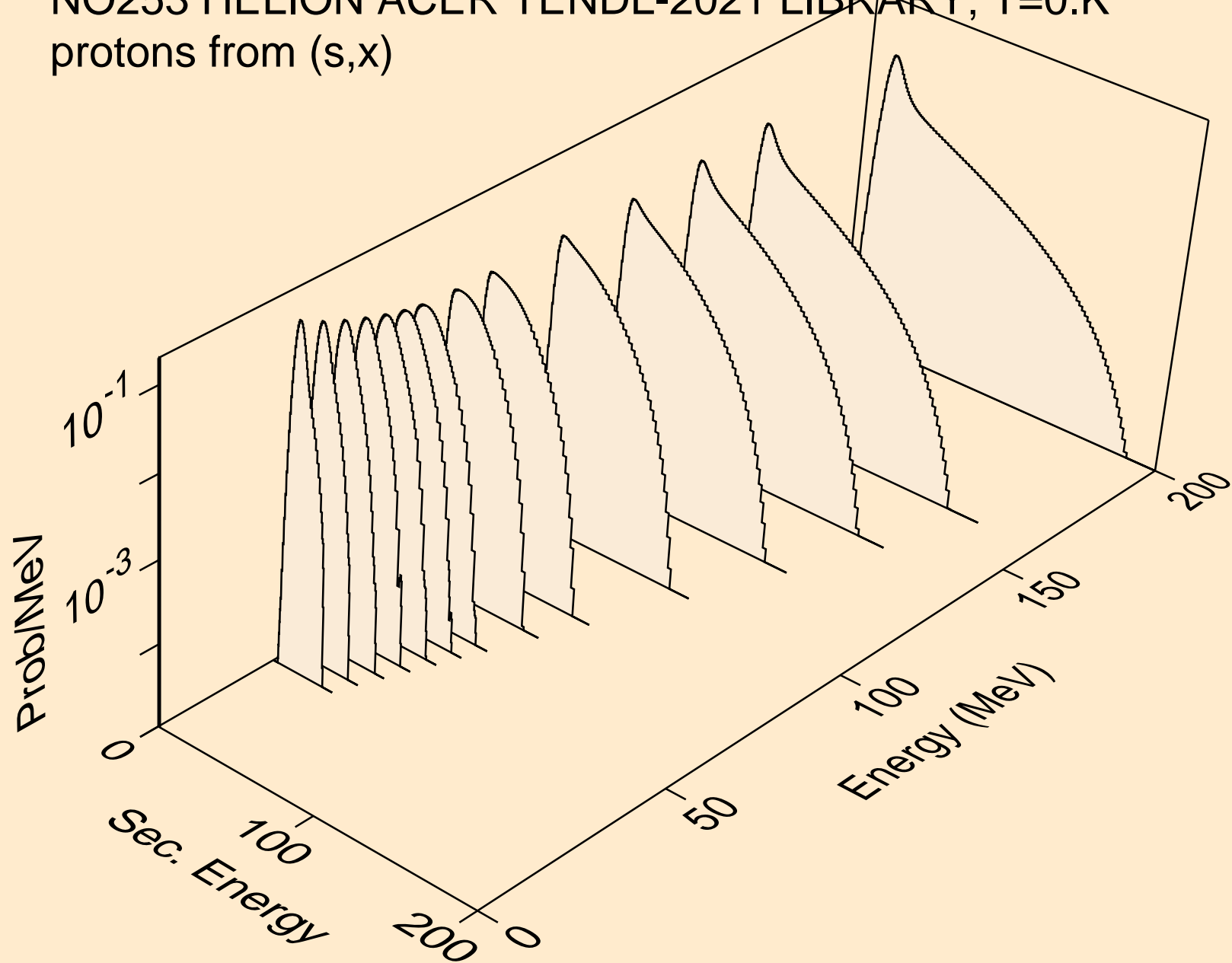

NO253 HELION ACER TENDL-2021 LIBRARY; T=0.K
protons from (s,n*)p

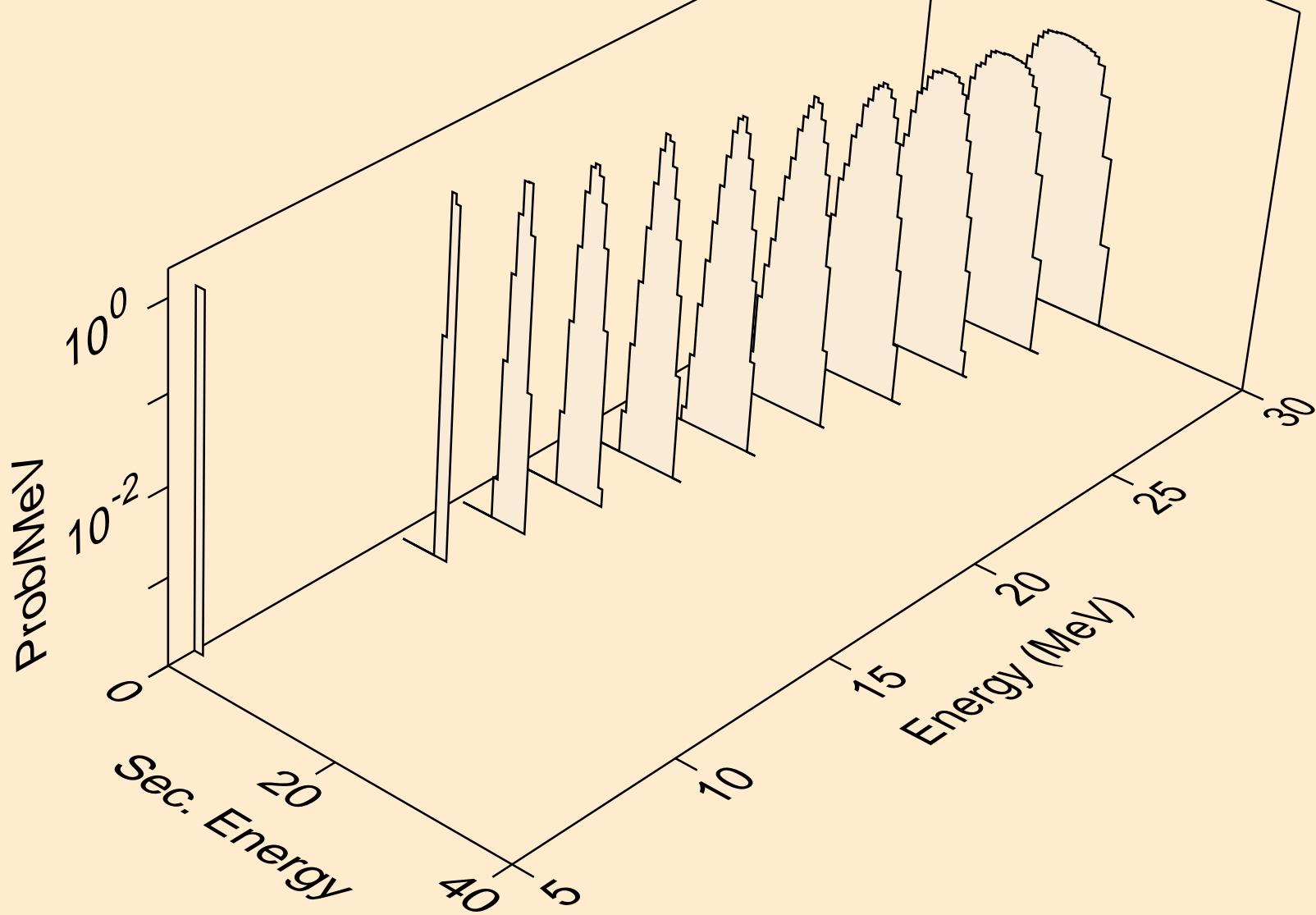

NO253 HELION ACER TENDL-2021 LIBRARY; T=0.K
protons from (s,2np)

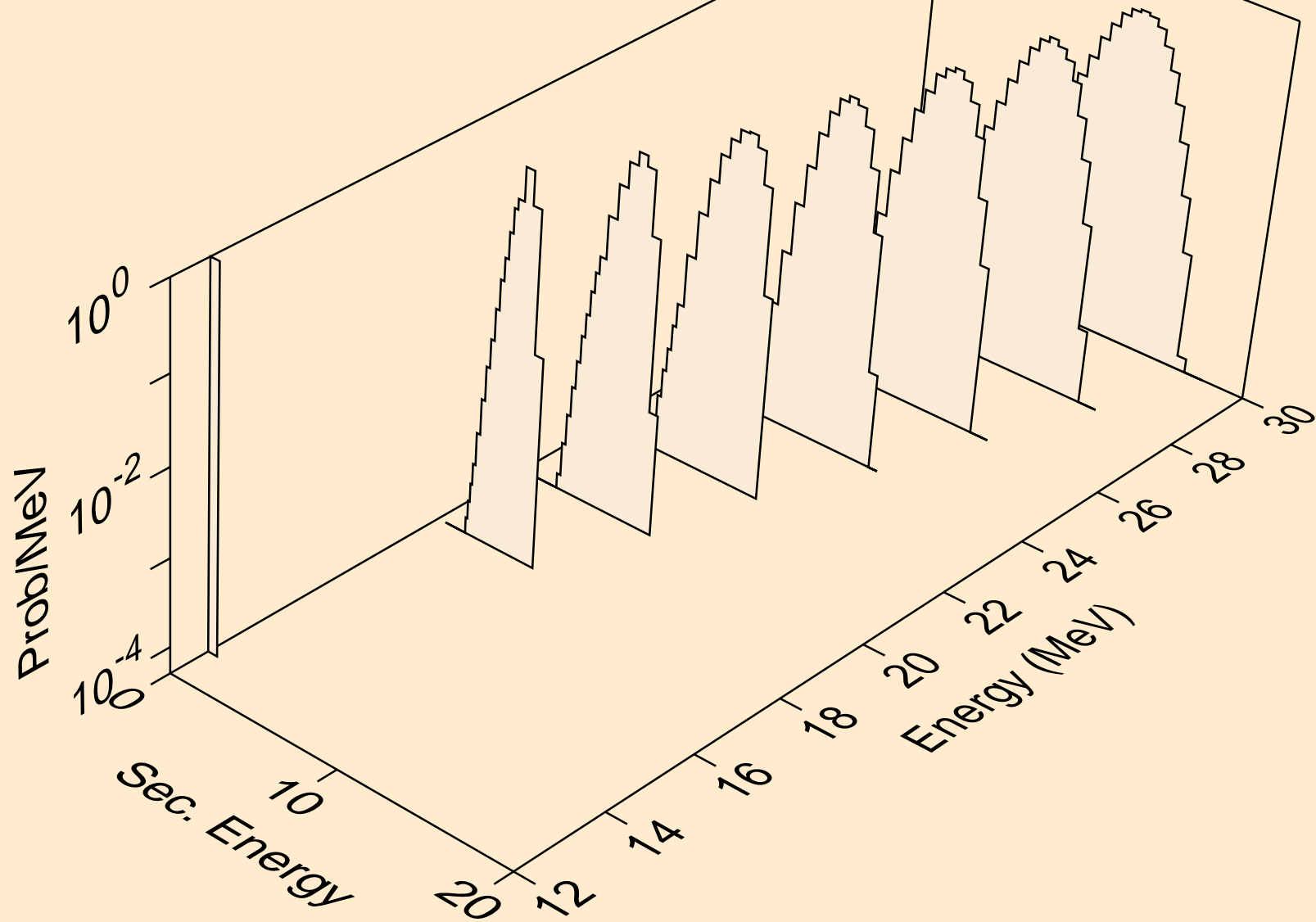

NO253 HELION ACER TENDL-2021 LIBRARY; T=0.K
protons from (s,npa)

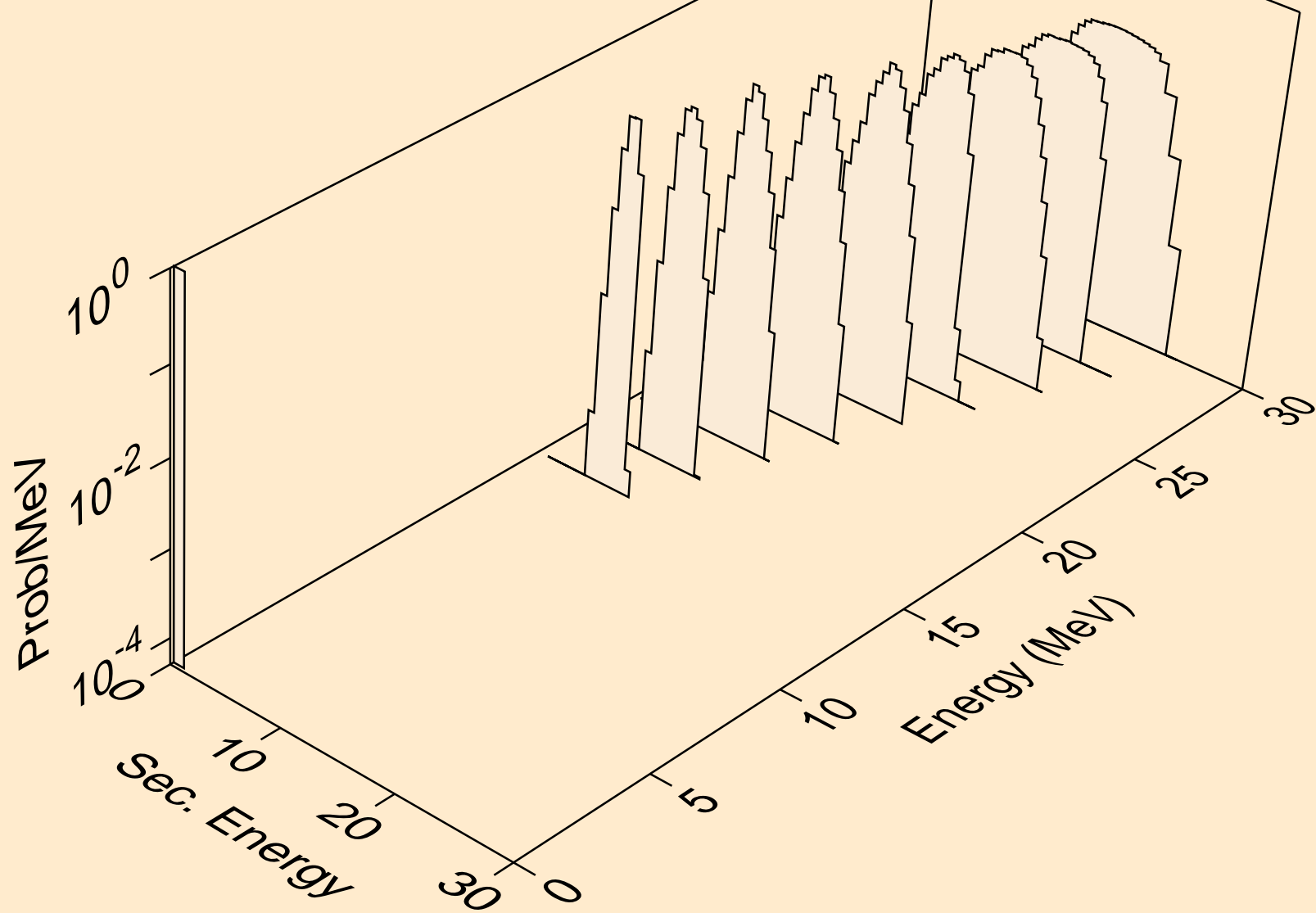

NO253 HELION ACER TENDL-2021 LIBRARY; T=0.K
protons from (s,p)

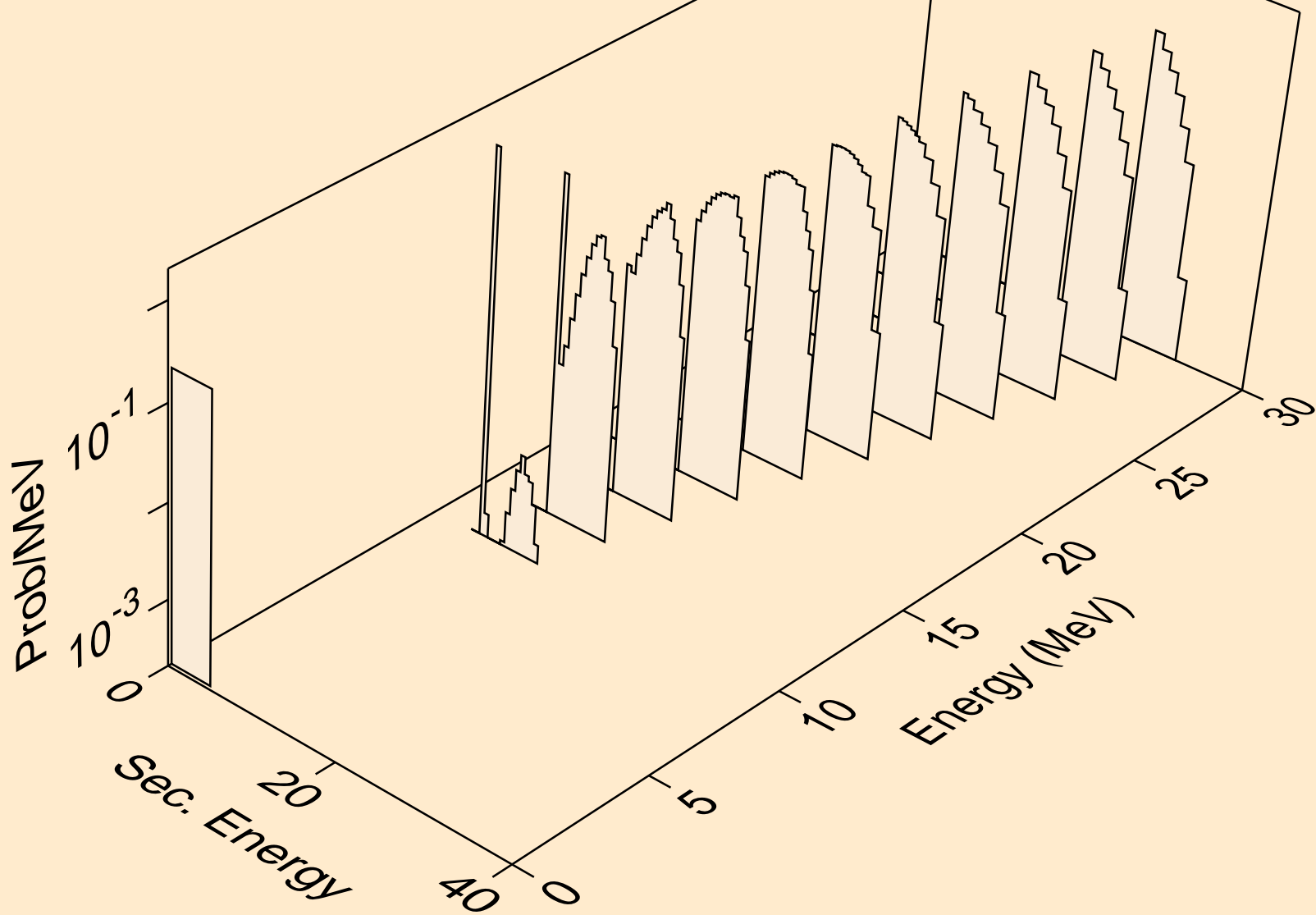

NO253 HELION ACER TENDL-2021 LIBRARY; T=0.K
protons from (s,2p)

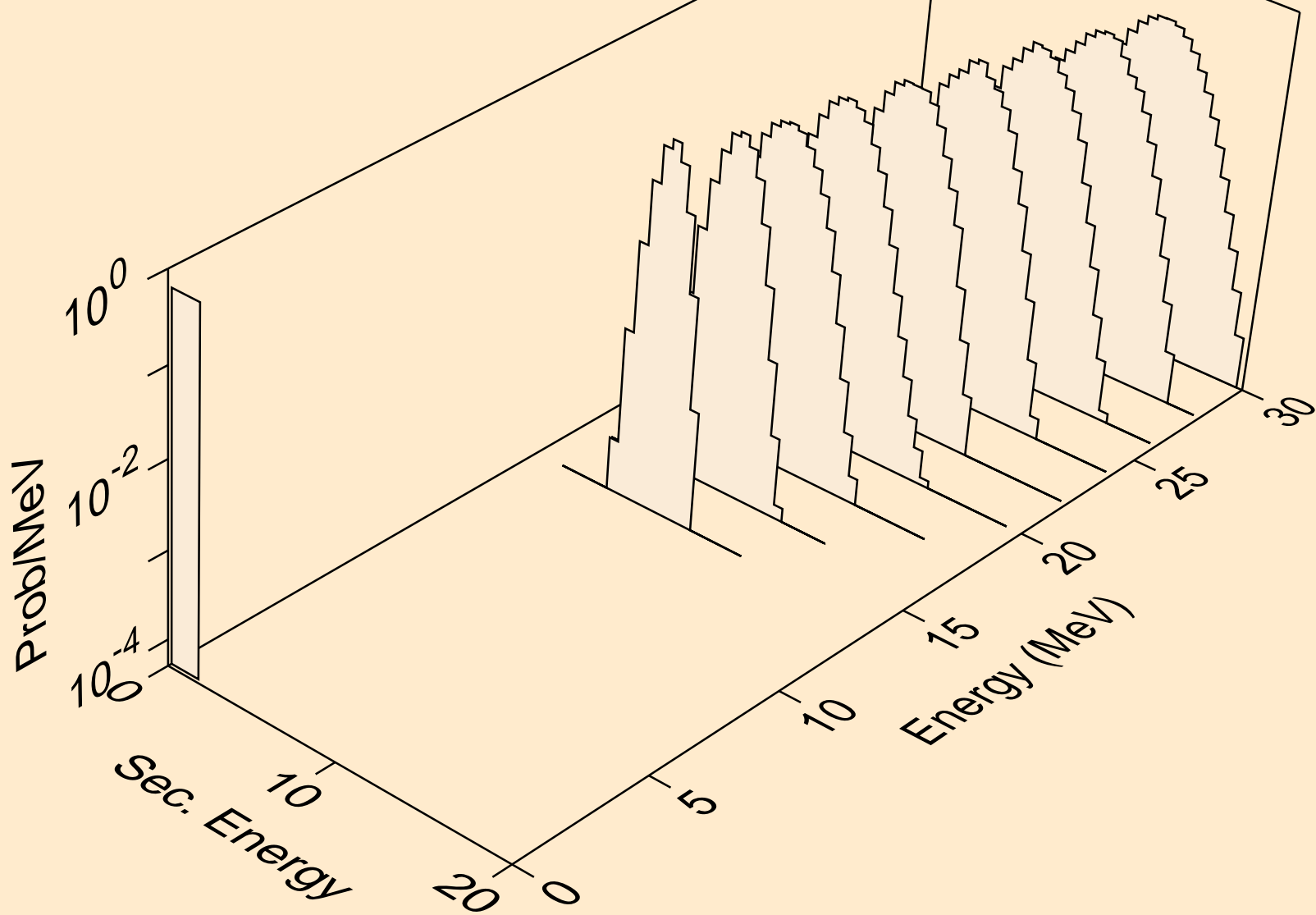

NO253 HELION ACER TENDL-2021 LIBRARY; T=0.K
deuterons from (s,x)

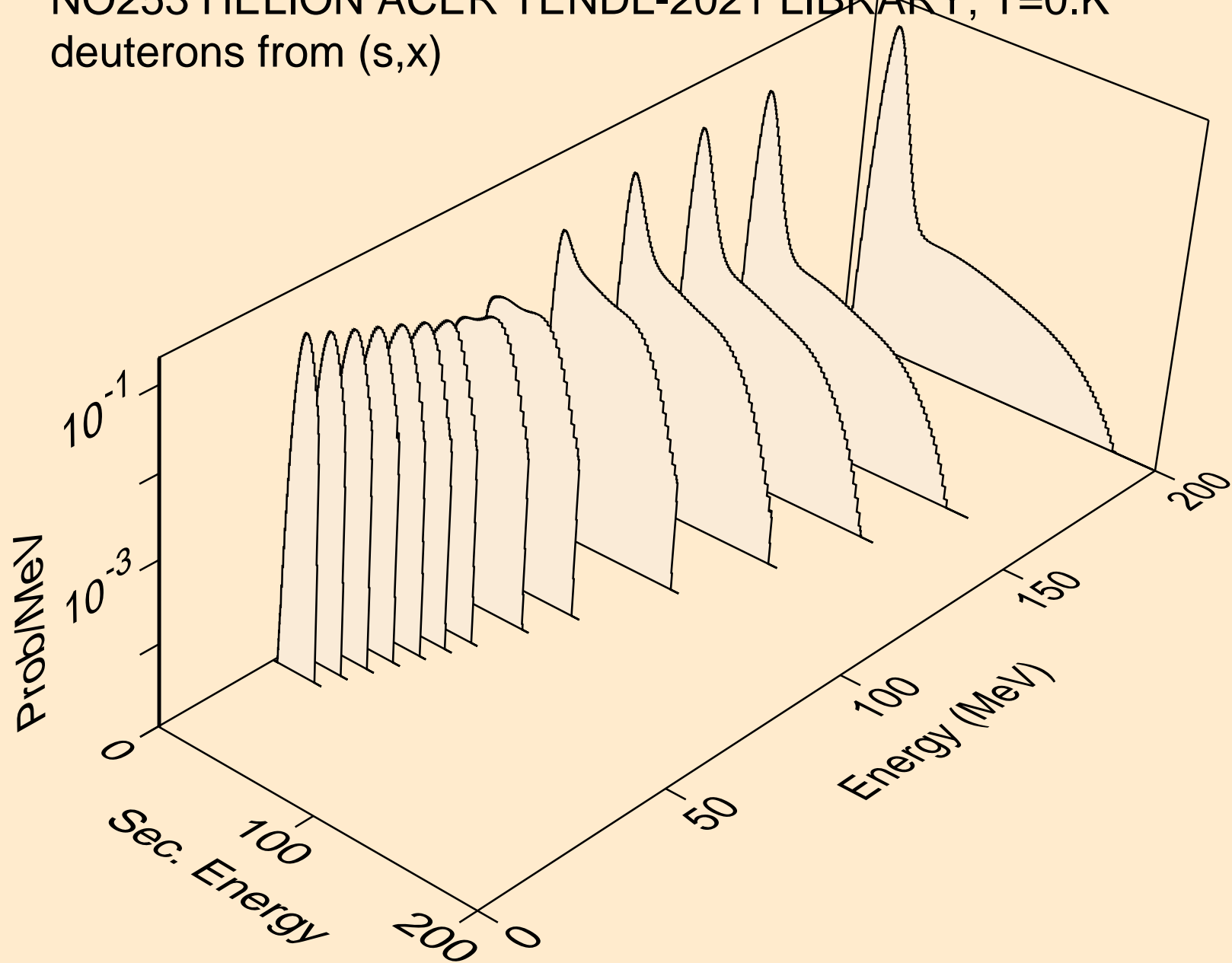

NO253 HELION ACER TENDL-2021 LIBRARY; T=0.K
deuterons from (s,n*)d

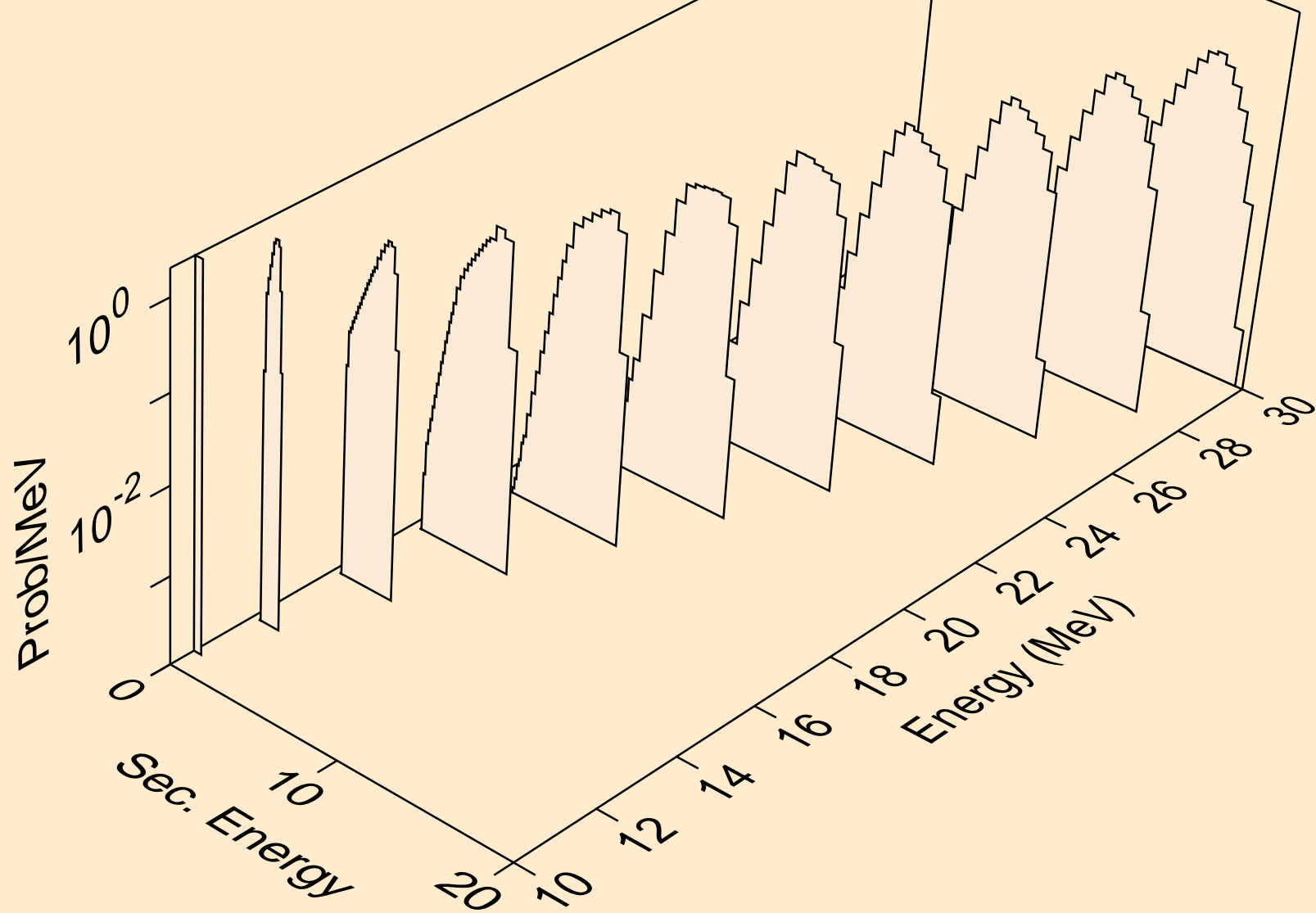

NO253 HELION ACER TENDL-2021 LIBRARY; T=0.K
deuterons from (s,d)

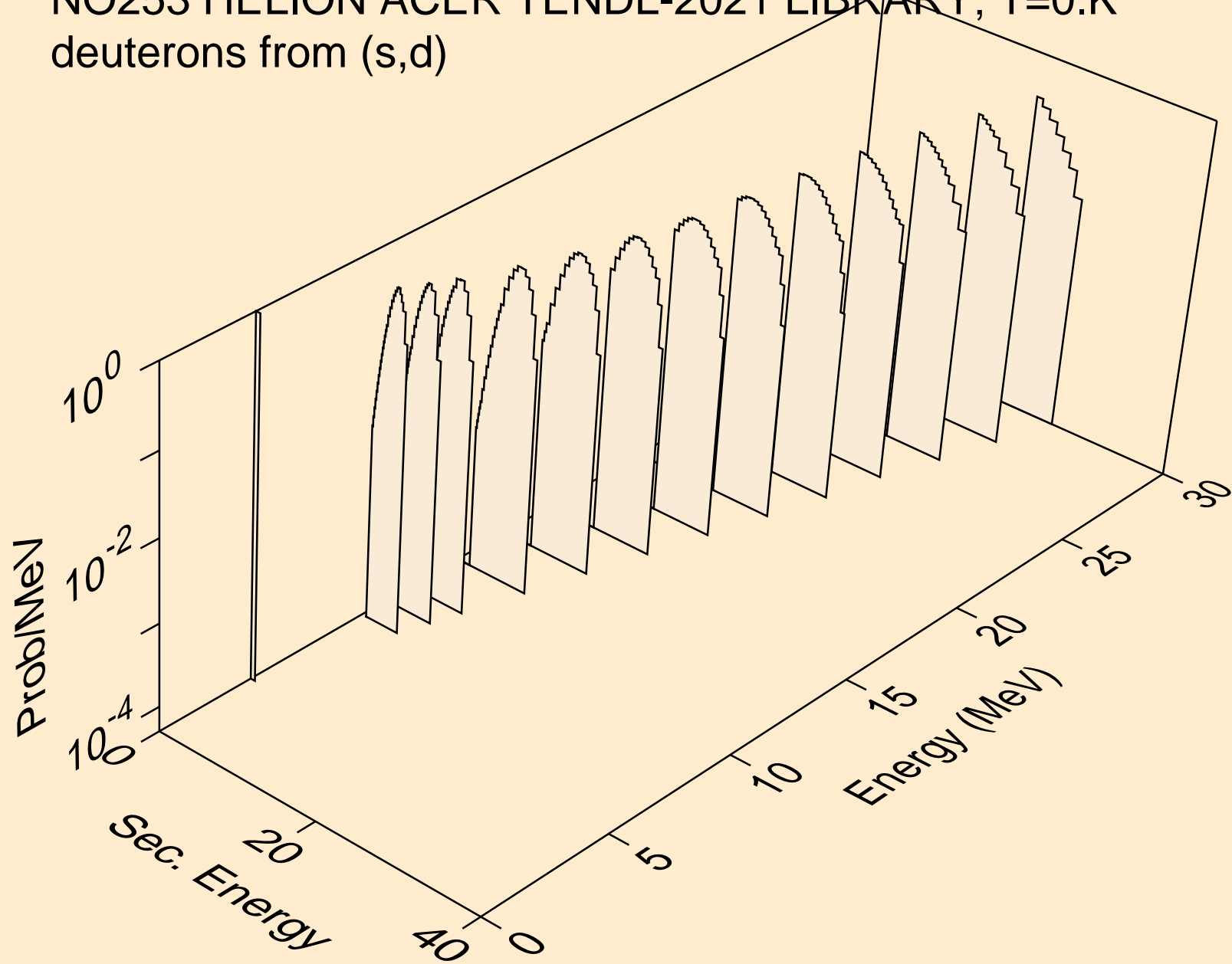

NO253 HELION ACER TENDL-2021 LIBRARY; T=0.K
deuterons from (s,da)

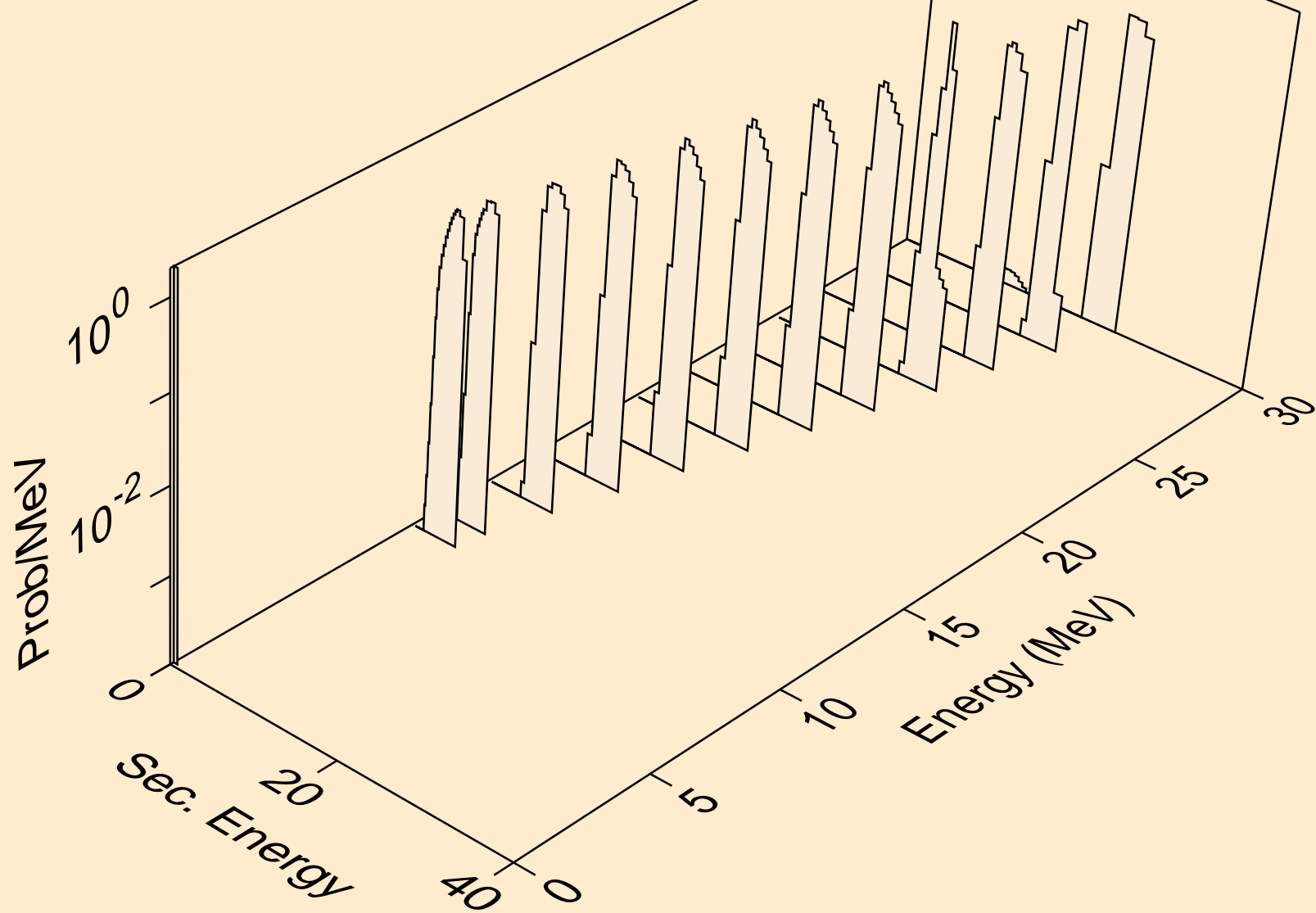

NO253 HELION ACER TENDL-2021 LIBRARY; T=0.K
tritons from (s,x)

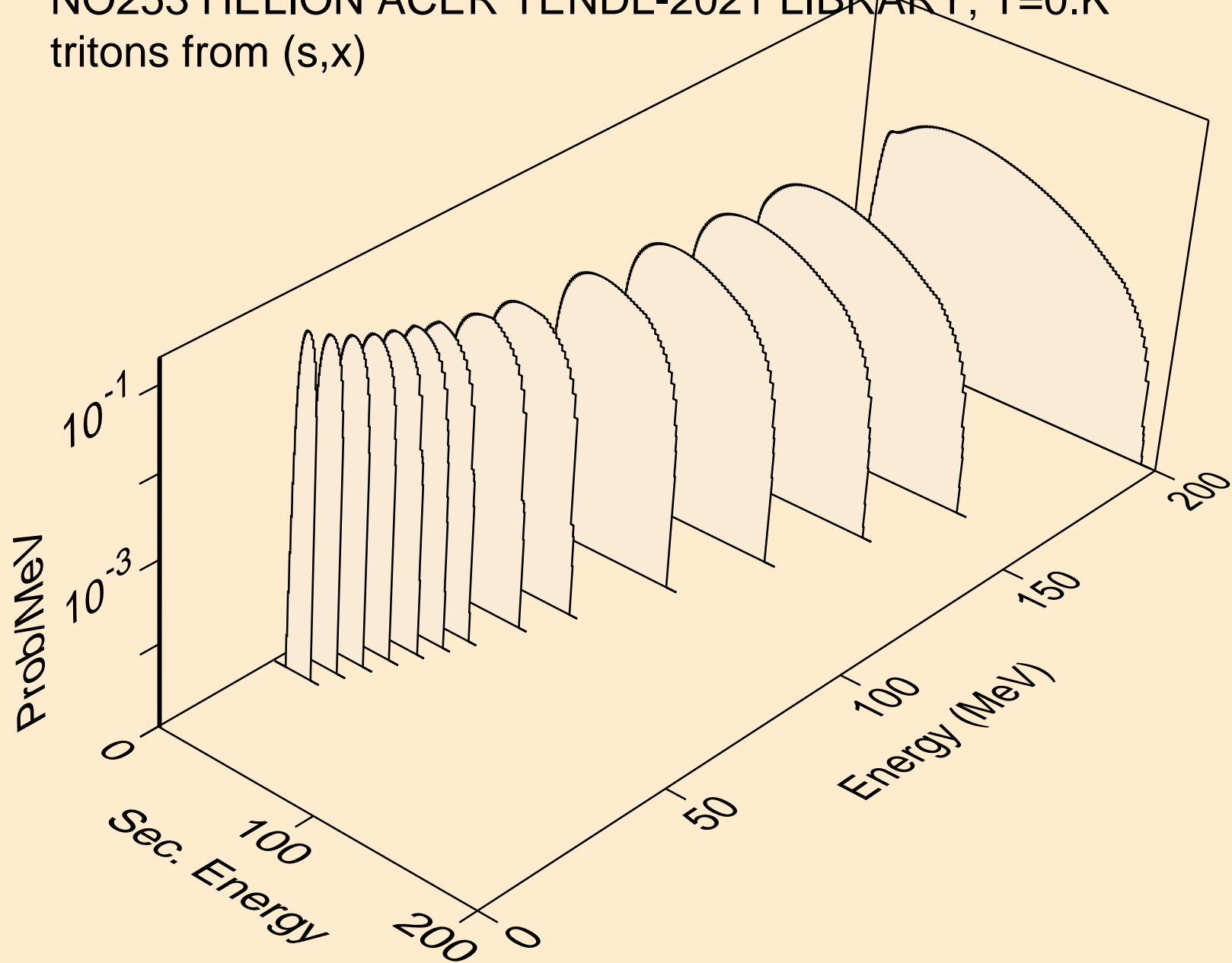

NO253 HELION ACER TENDL-2021 LIBRARY; T=0.K
tritons from (s,n*)t

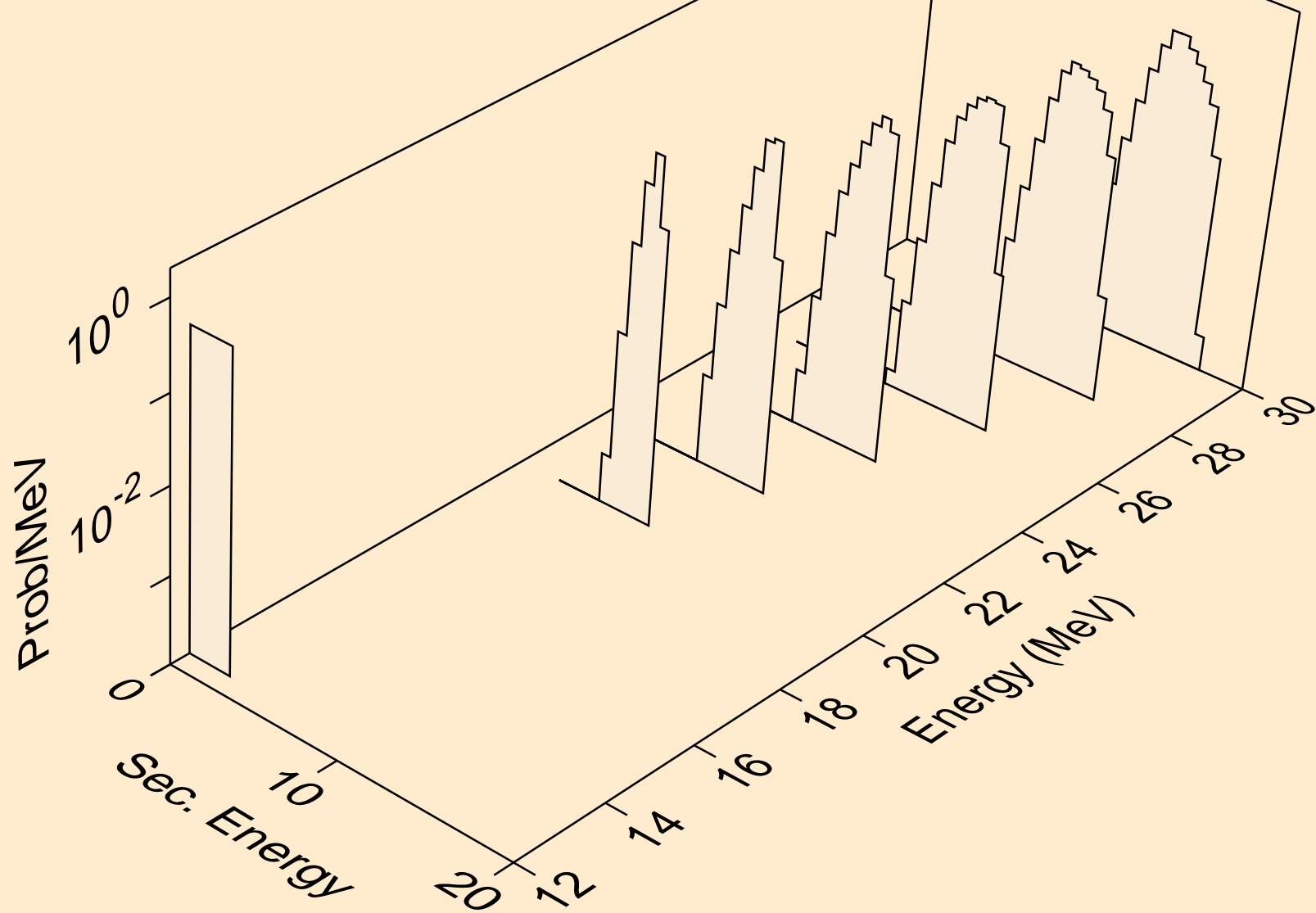

NO253 HELION ACER TENDL-2021 LIBRARY; T=0.K
tritons from (s,t)

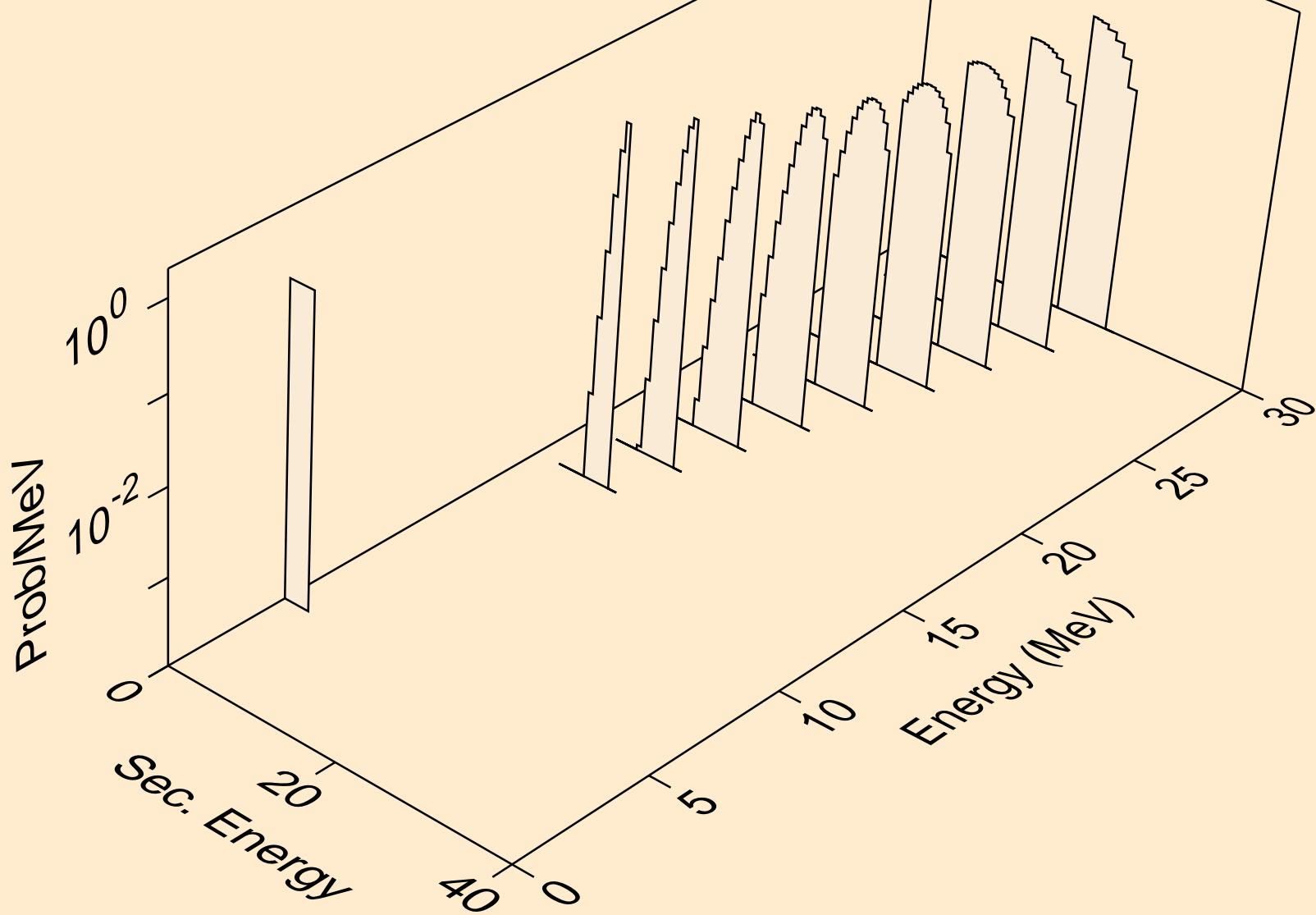

NO253 HELION ACER TENDL-2021 LIBRARY; T=0.K
alphas from (s,x)

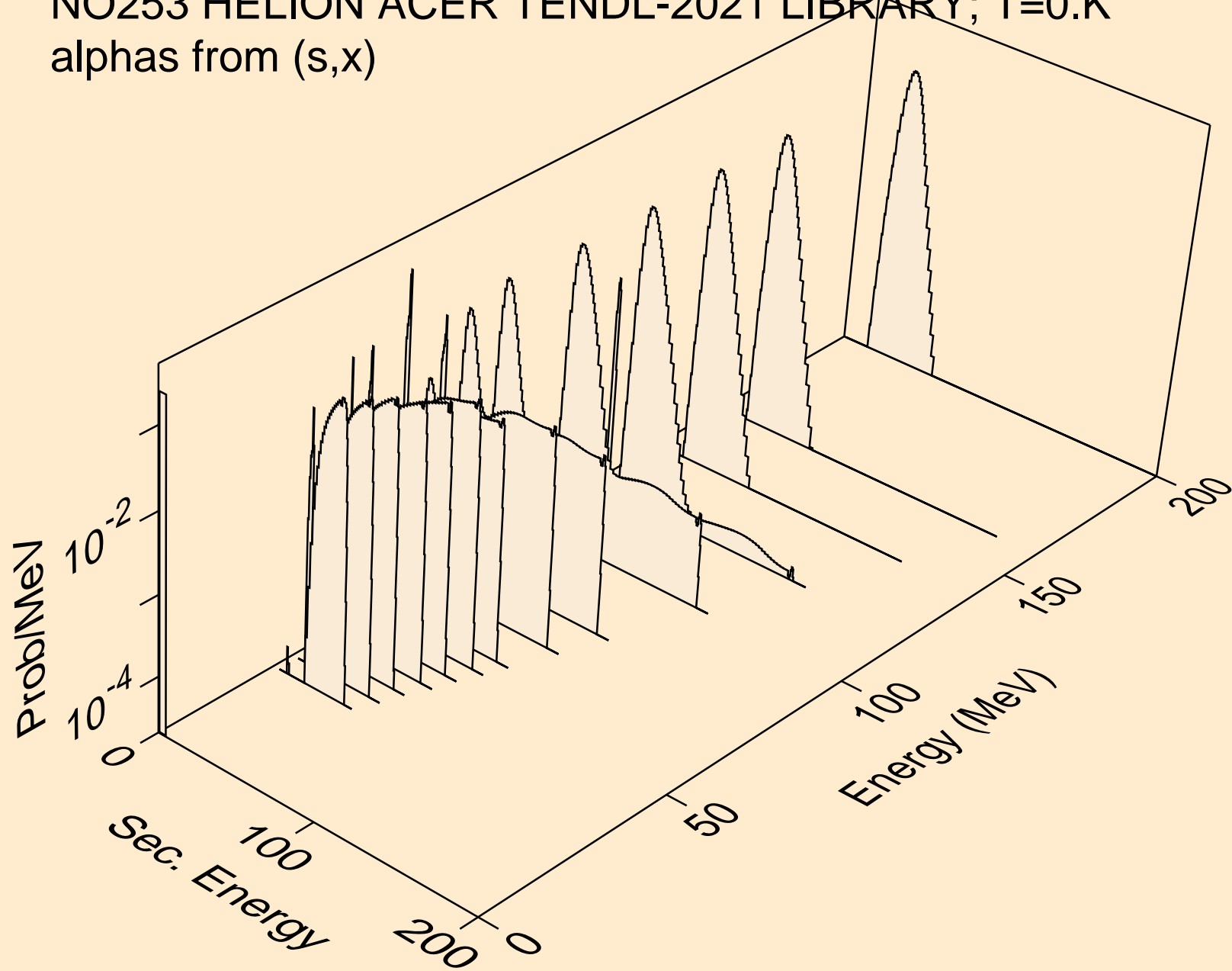

NO253 HELION ACER TENDL-2021 LIBRARY; T=0.K
alphas from (s,n*)a

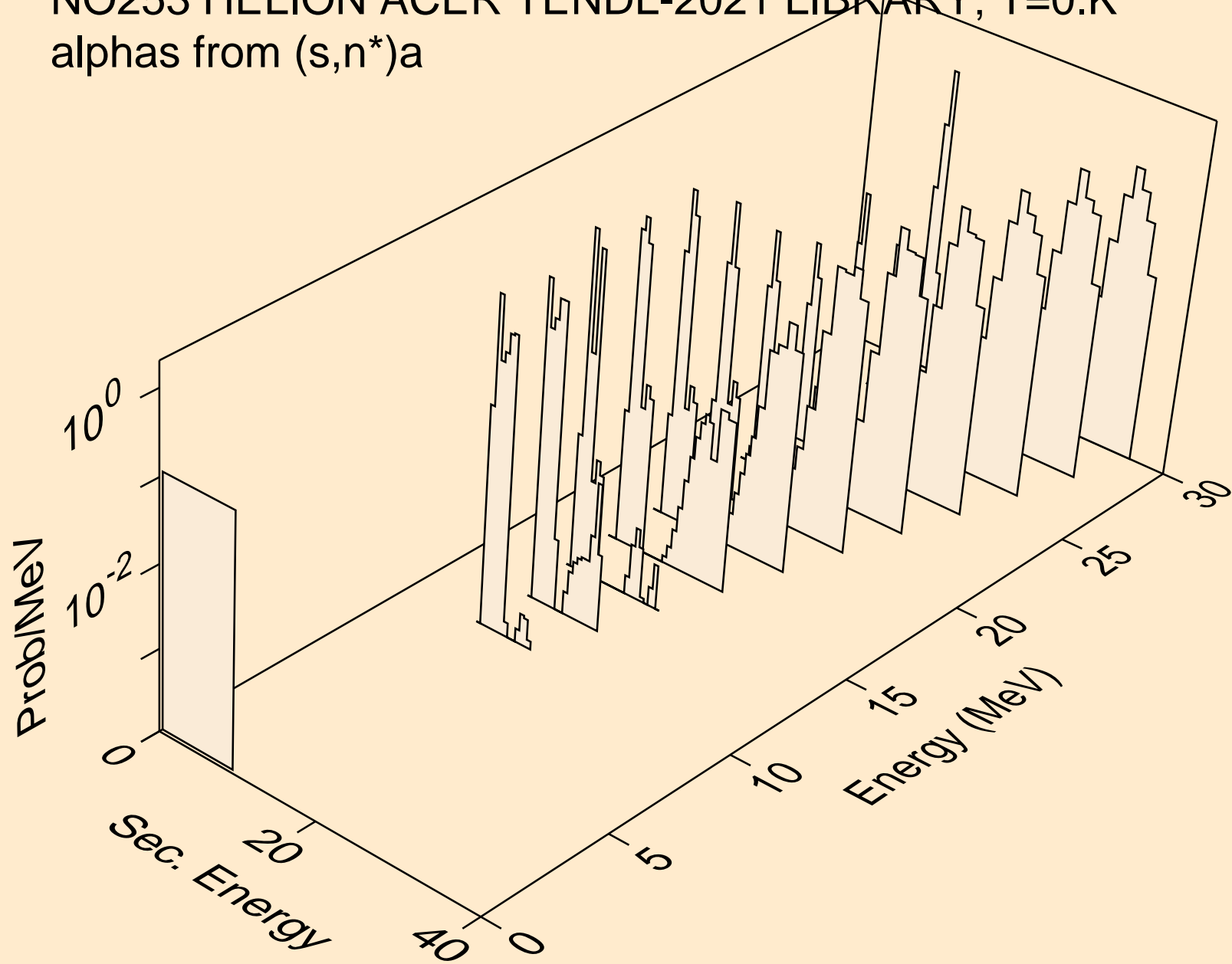

NO253 HELION ACER TENDL-2021 LIBRARY; T=0.K
alphas from (s,npa)

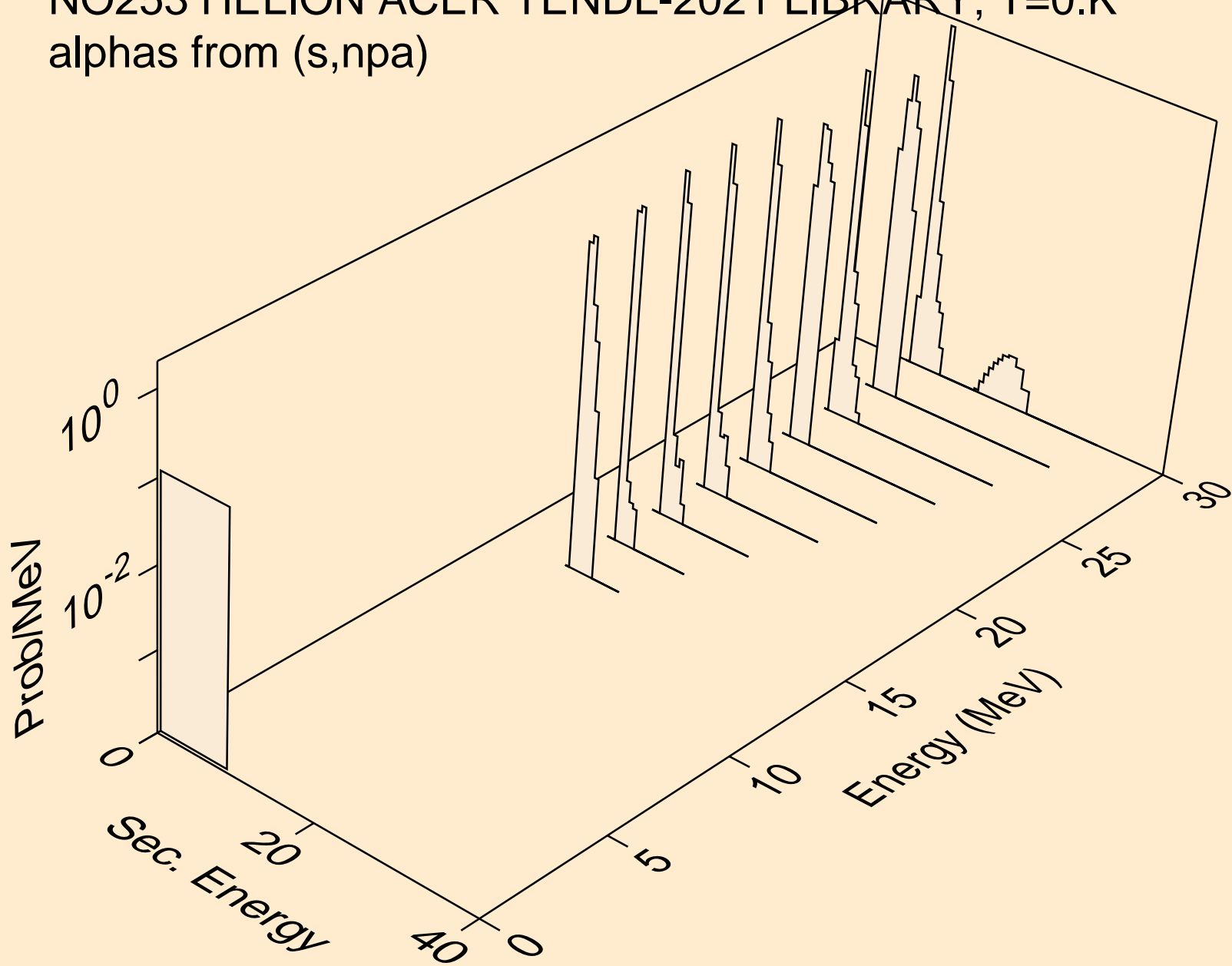

NO253 HELION ACER TENDL-2021 LIBRARY; T=0.K
alphas from (s,a)

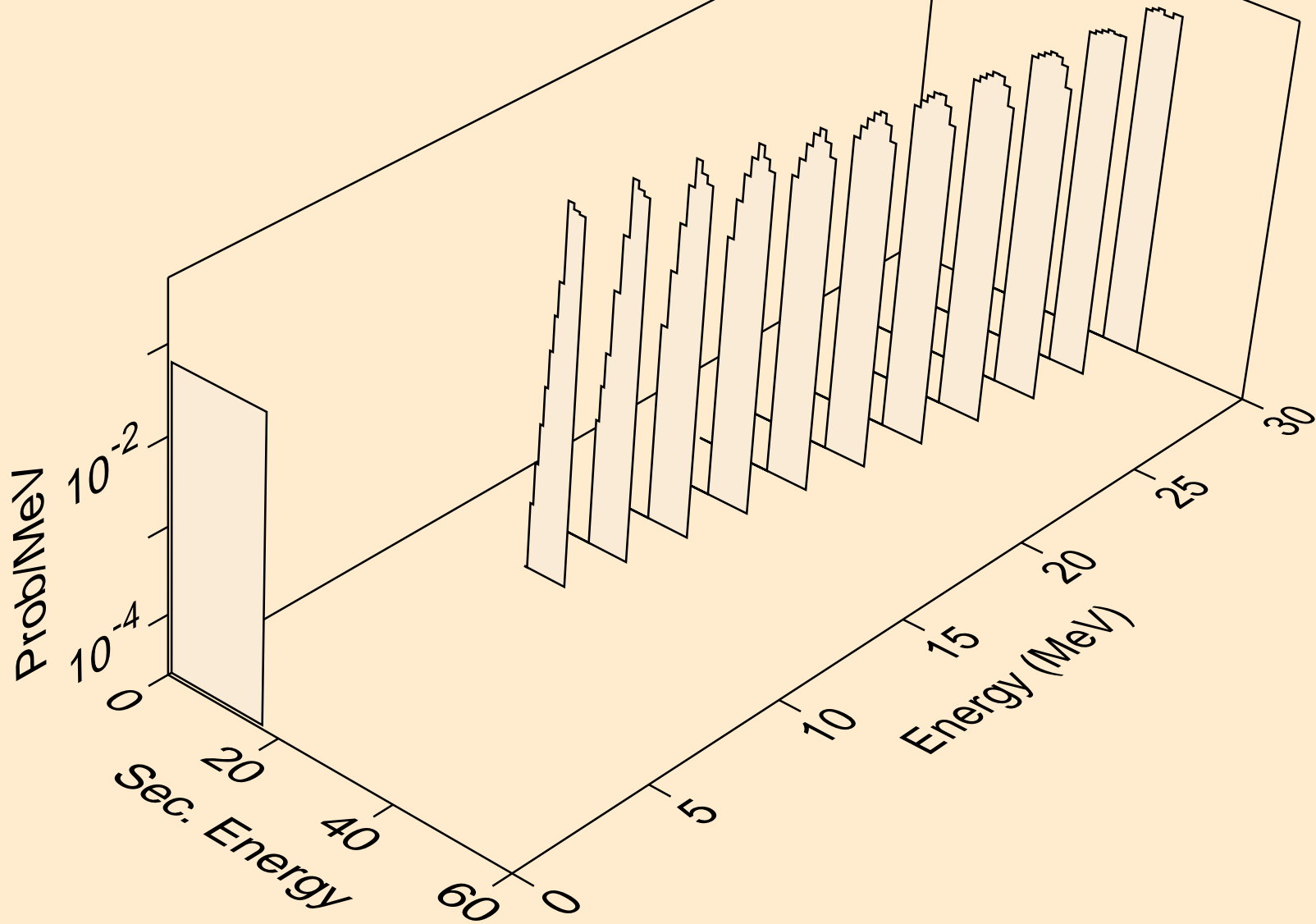

NO253 HELION ACER TENDL-2021 LIBRARY; T=0.K
alphas from (s,da)

