

NP243 HELION ACER TENDL-2021 LIBRARY; T=0.K  
Principal cross sections

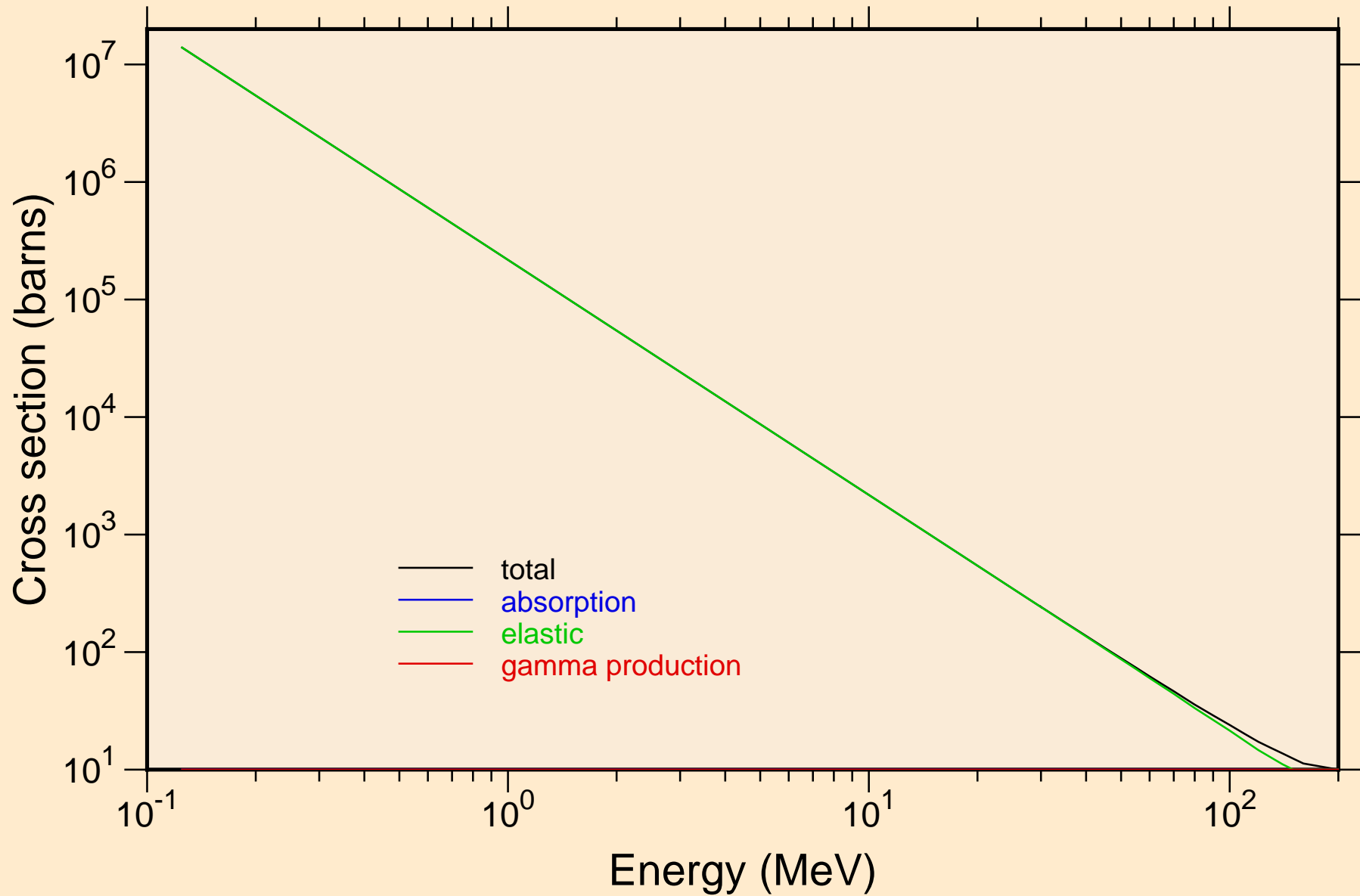

NP243 HELION ACER TENDL-2021 LIBRARY; T=0.K  
Heating

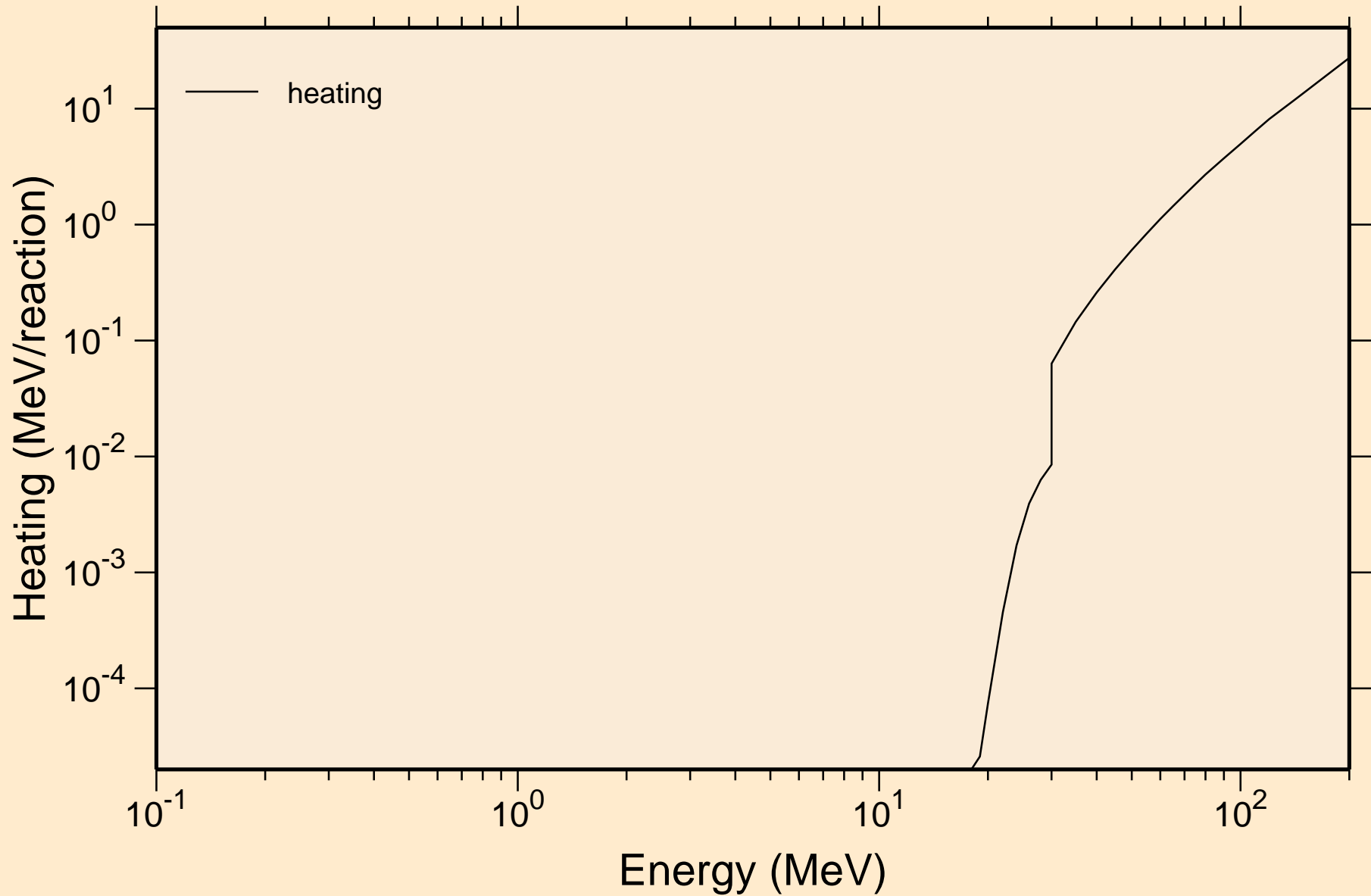

# NP243 HELION ACER TENDL-2021 LIBRARY; T=0.K

## Principal cross sections

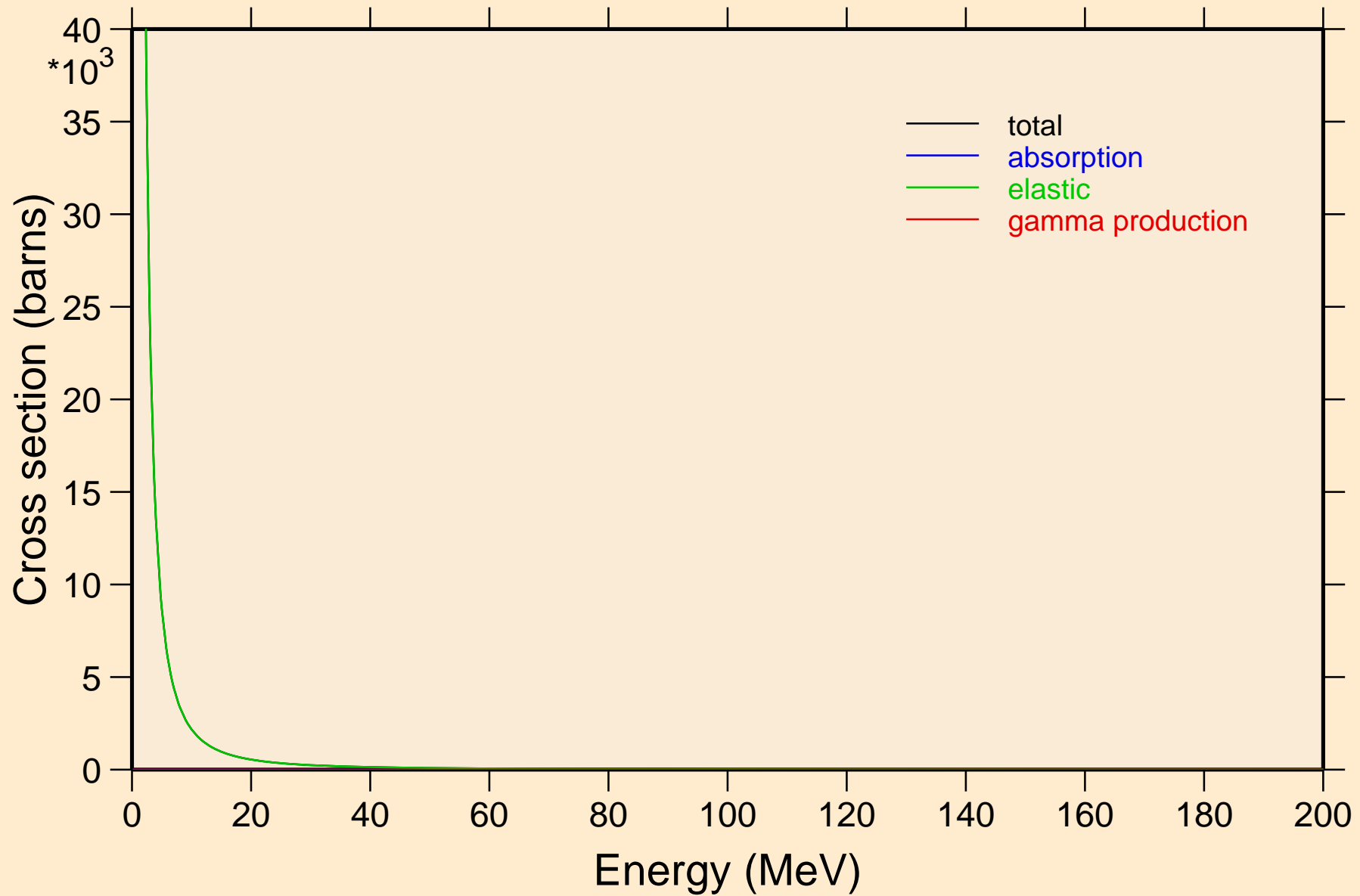

NP243 HELION ACER TENDL-2021 LIBRARY; T=0.K

Heating

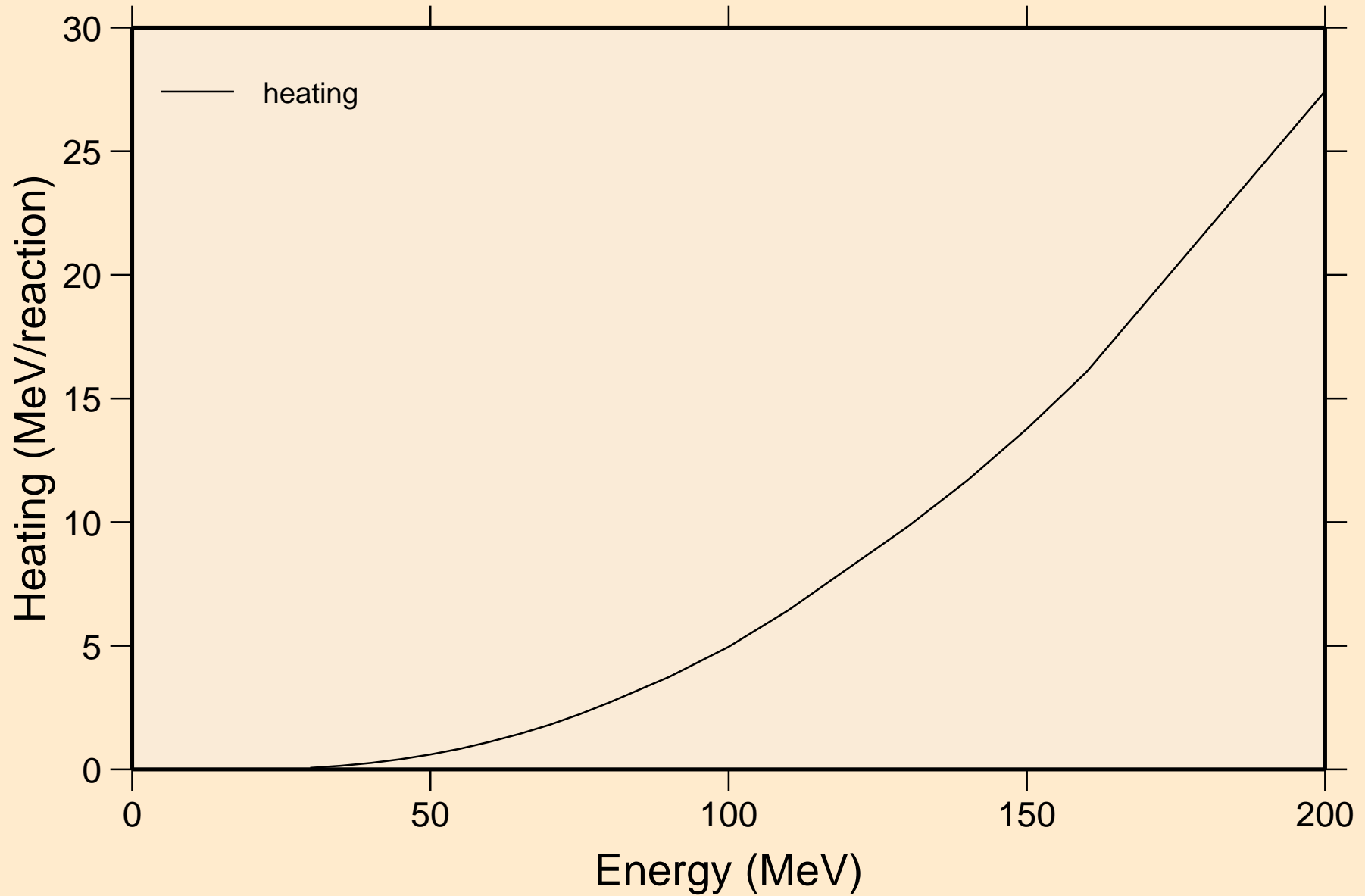

NP243 HELION ACER TENDL-2021 LIBRARY; T=0.K  
Threshold reactions

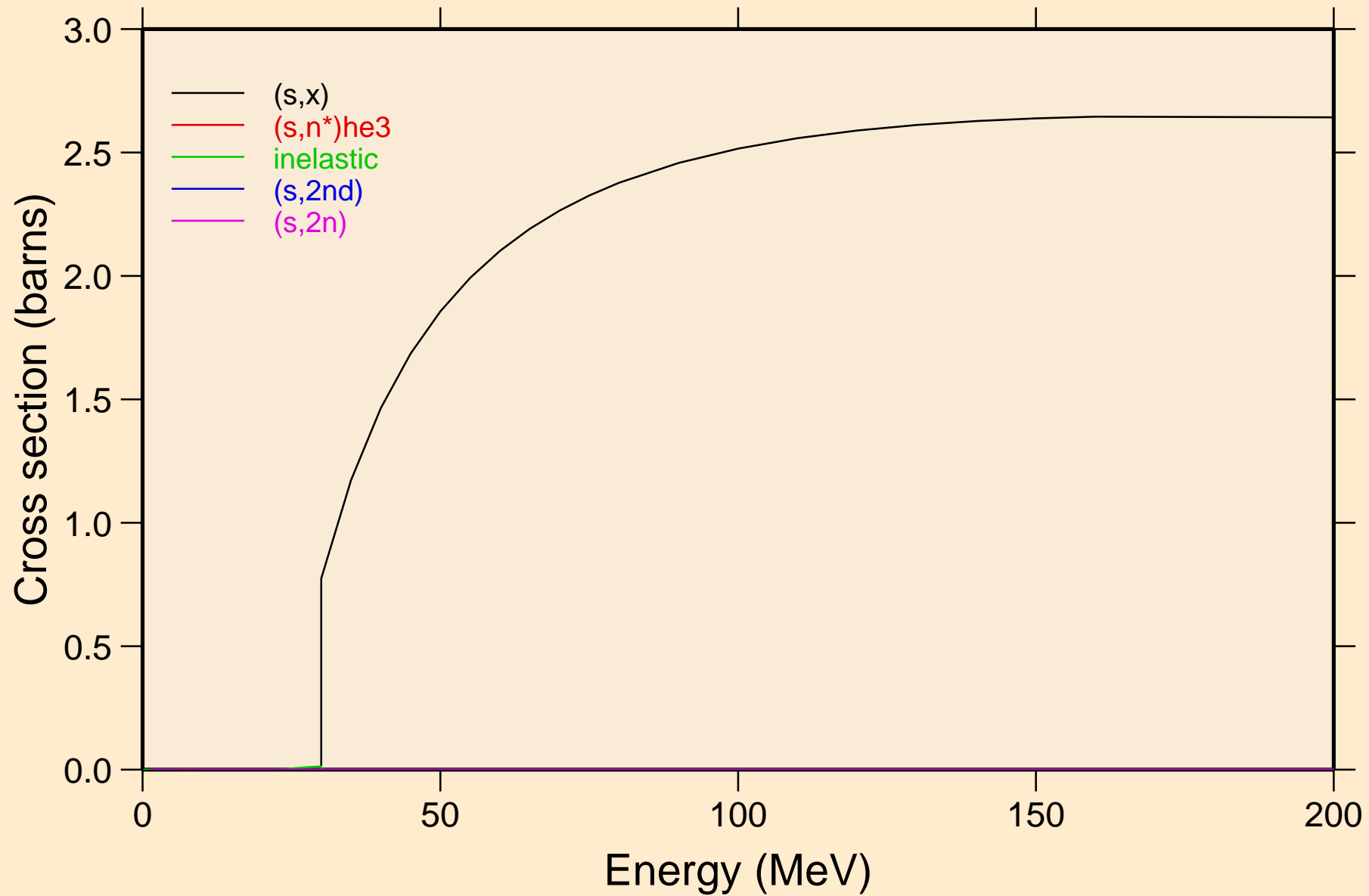

NP243 HELION ACER TENDL-2021 LIBRARY; T=0.K  
Threshold reactions

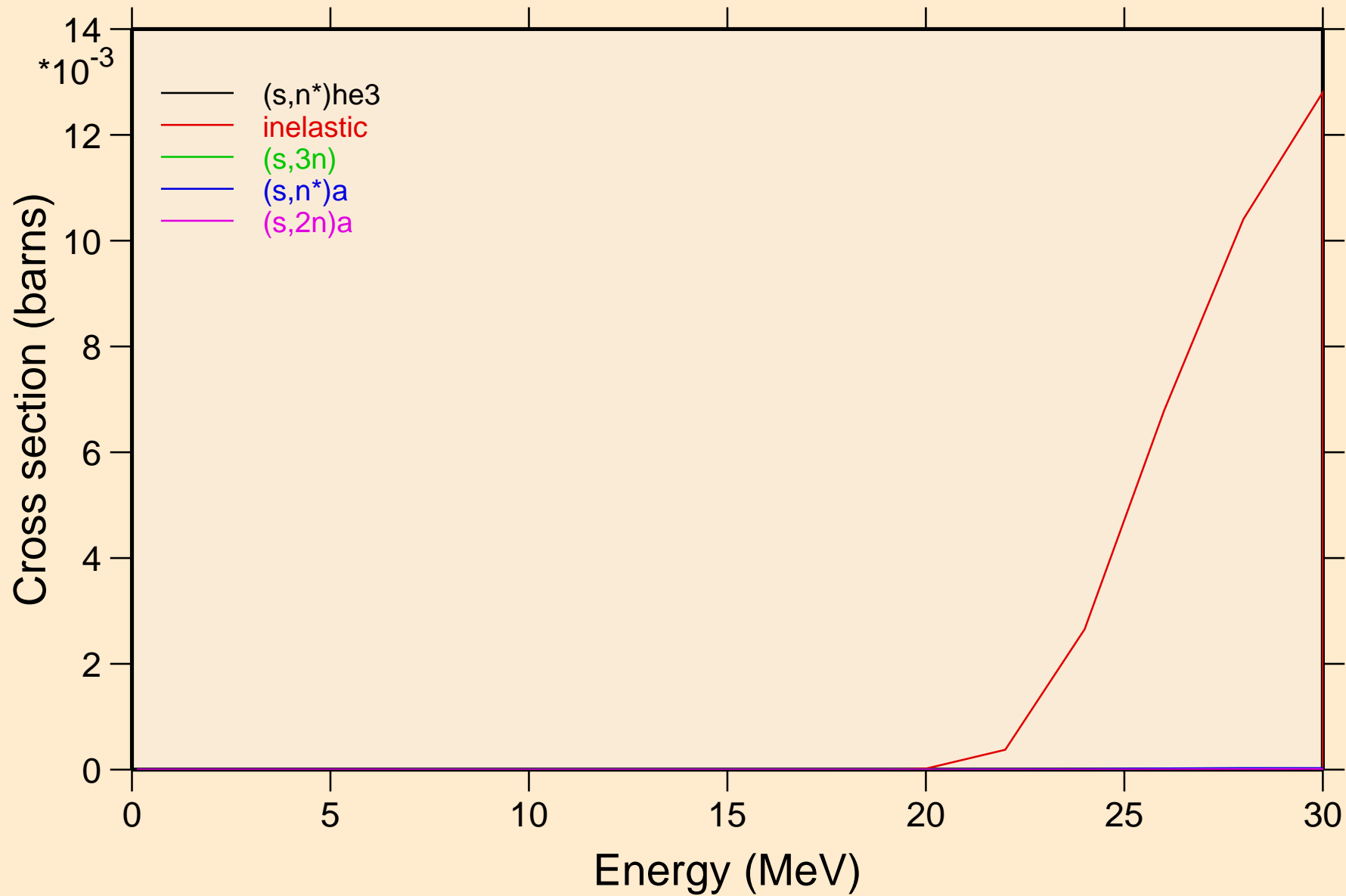

# NP243 HELION ACER TENDL-2021 LIBRARY; T=0.K

## Threshold reactions

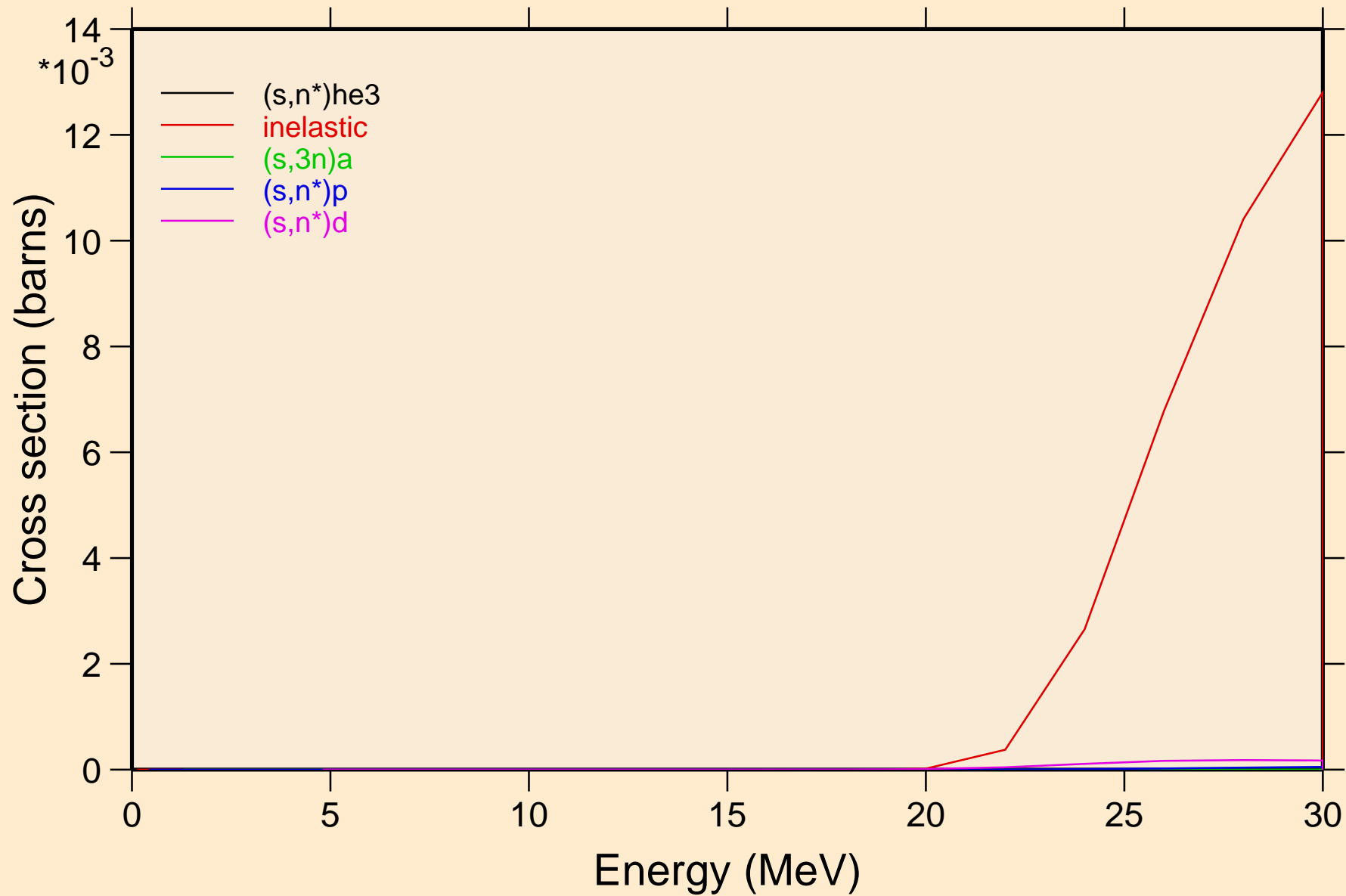

NP243 HELION ACER TENDL-2021 LIBRARY; T=0.K  
Threshold reactions

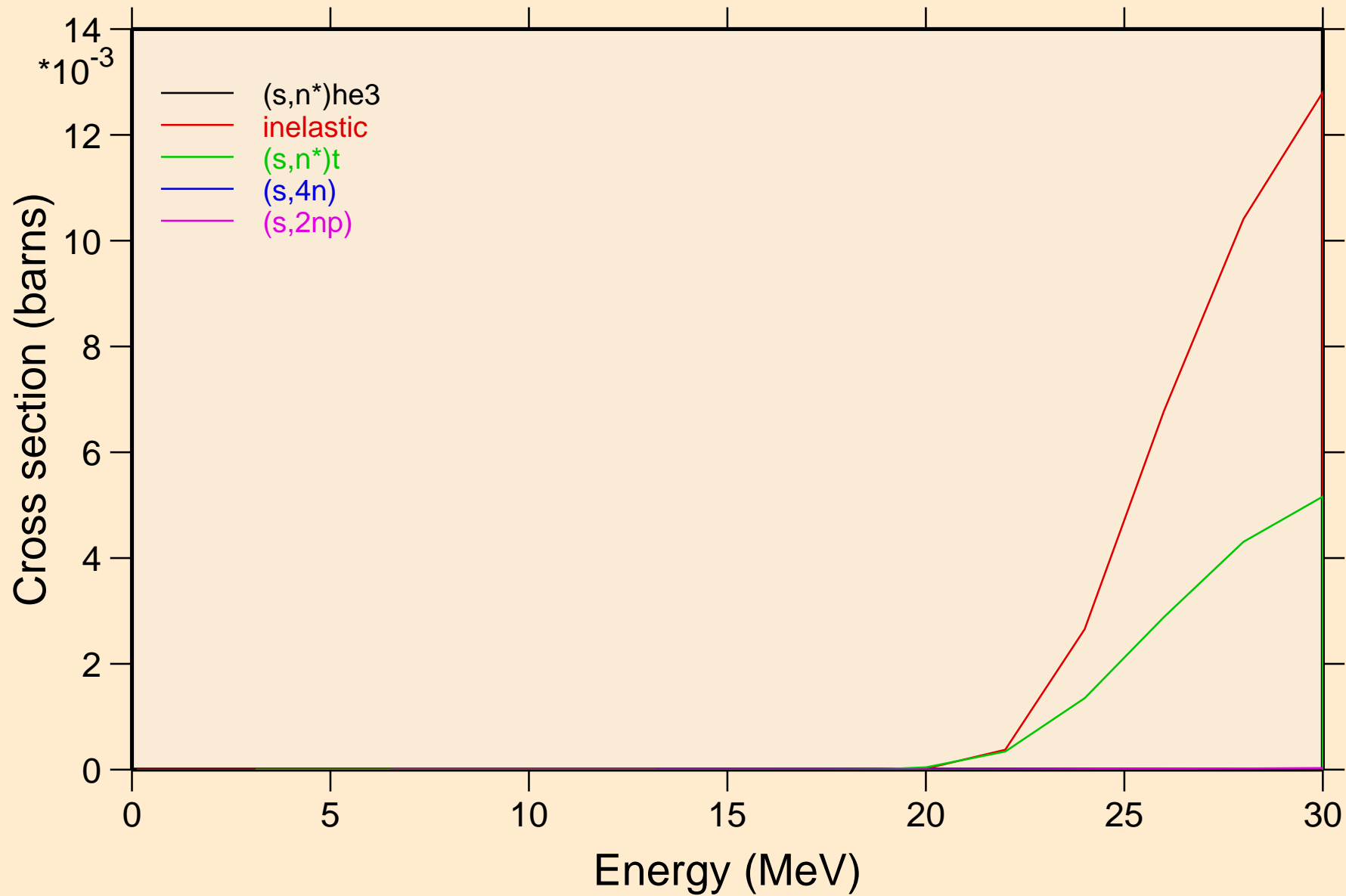



NP243 HELION ACER TENDL-2021 LIBRARY; T=0.K  
Threshold reactions

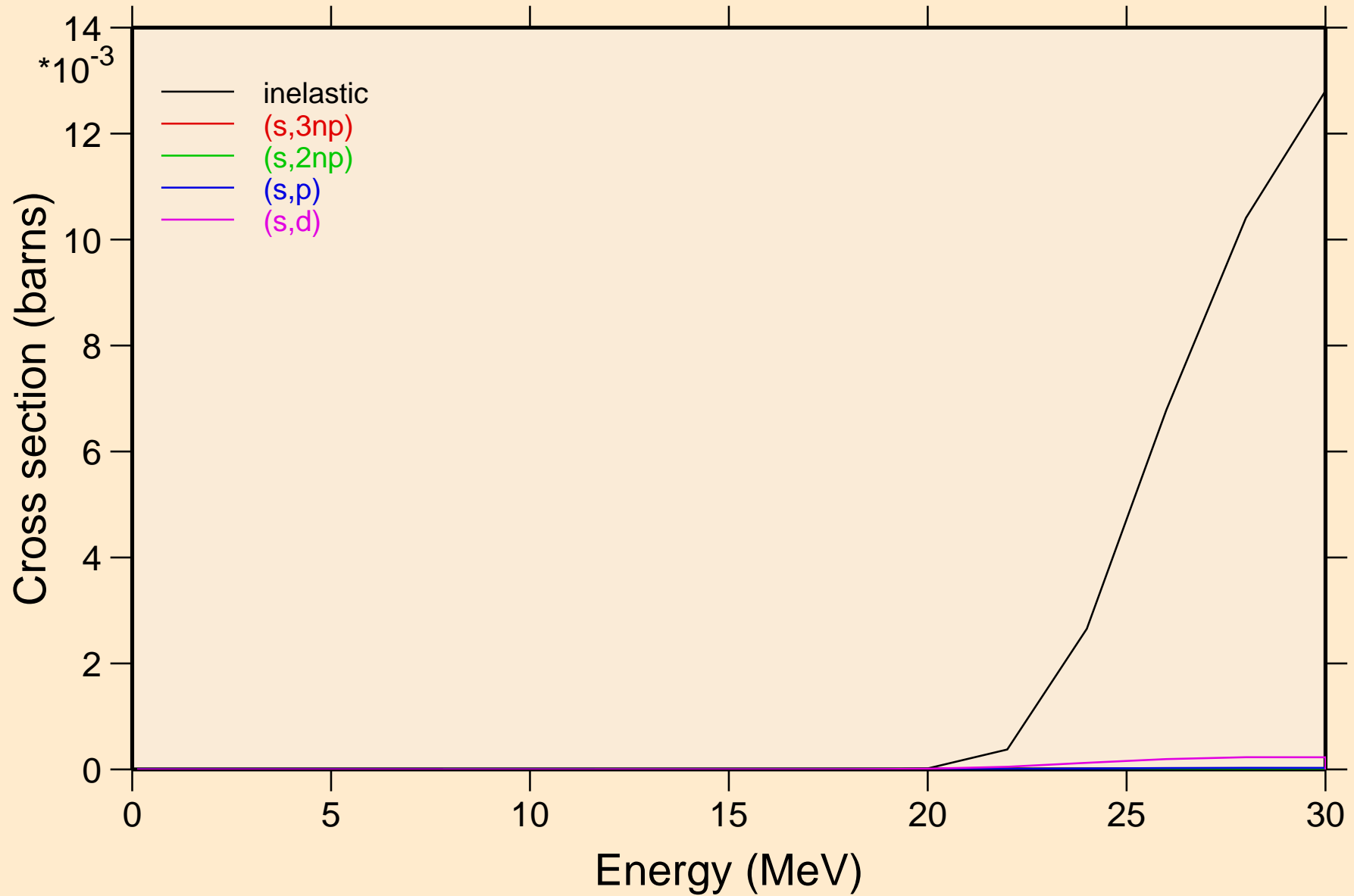

NP243 HELION ACER TENDL-2021 LIBRARY; T=0.K  
Threshold reactions

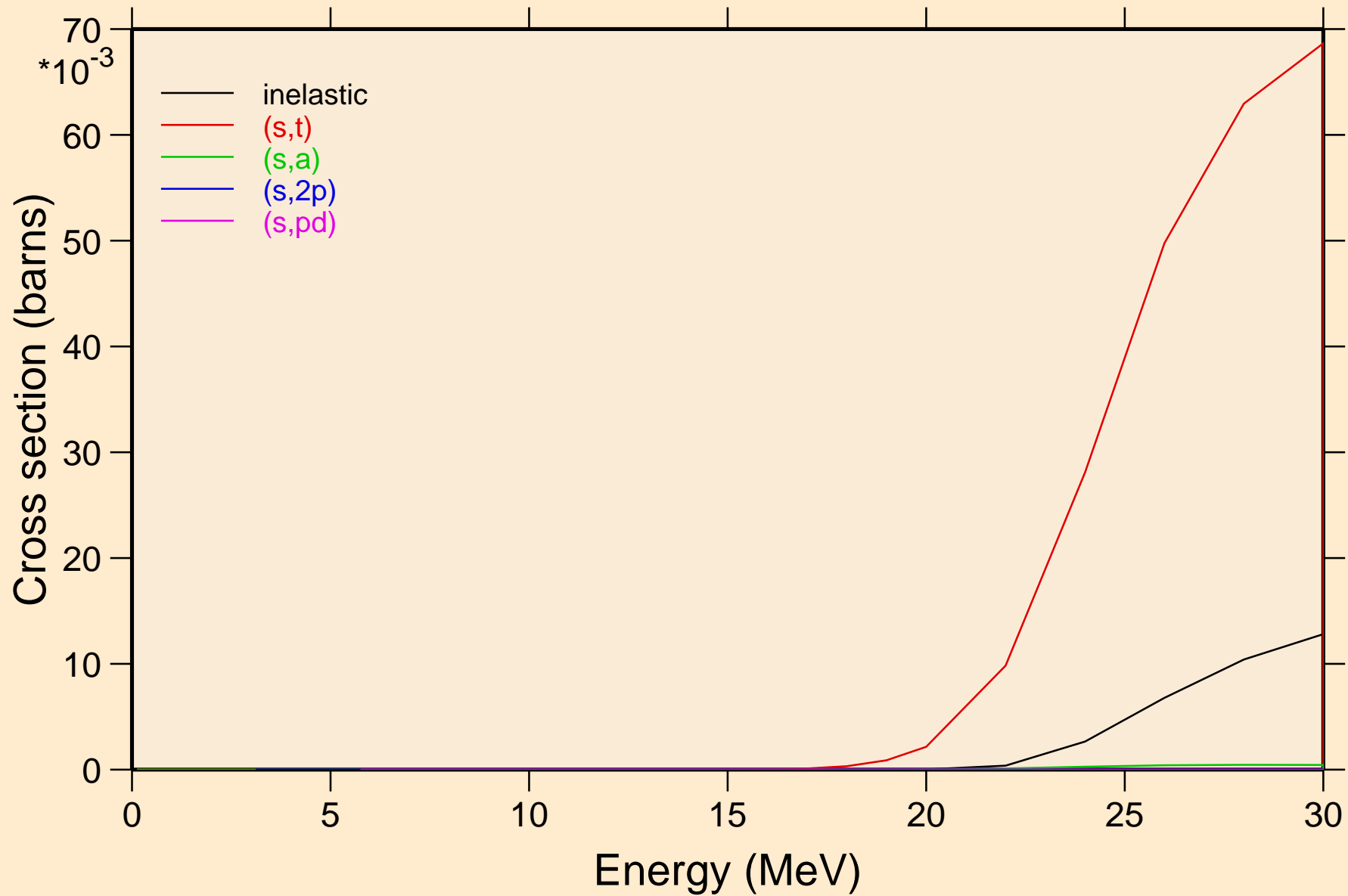

NP243 HELION ACER TENDL-2021 LIBRARY; T=0.K  
angular distribution for elastic

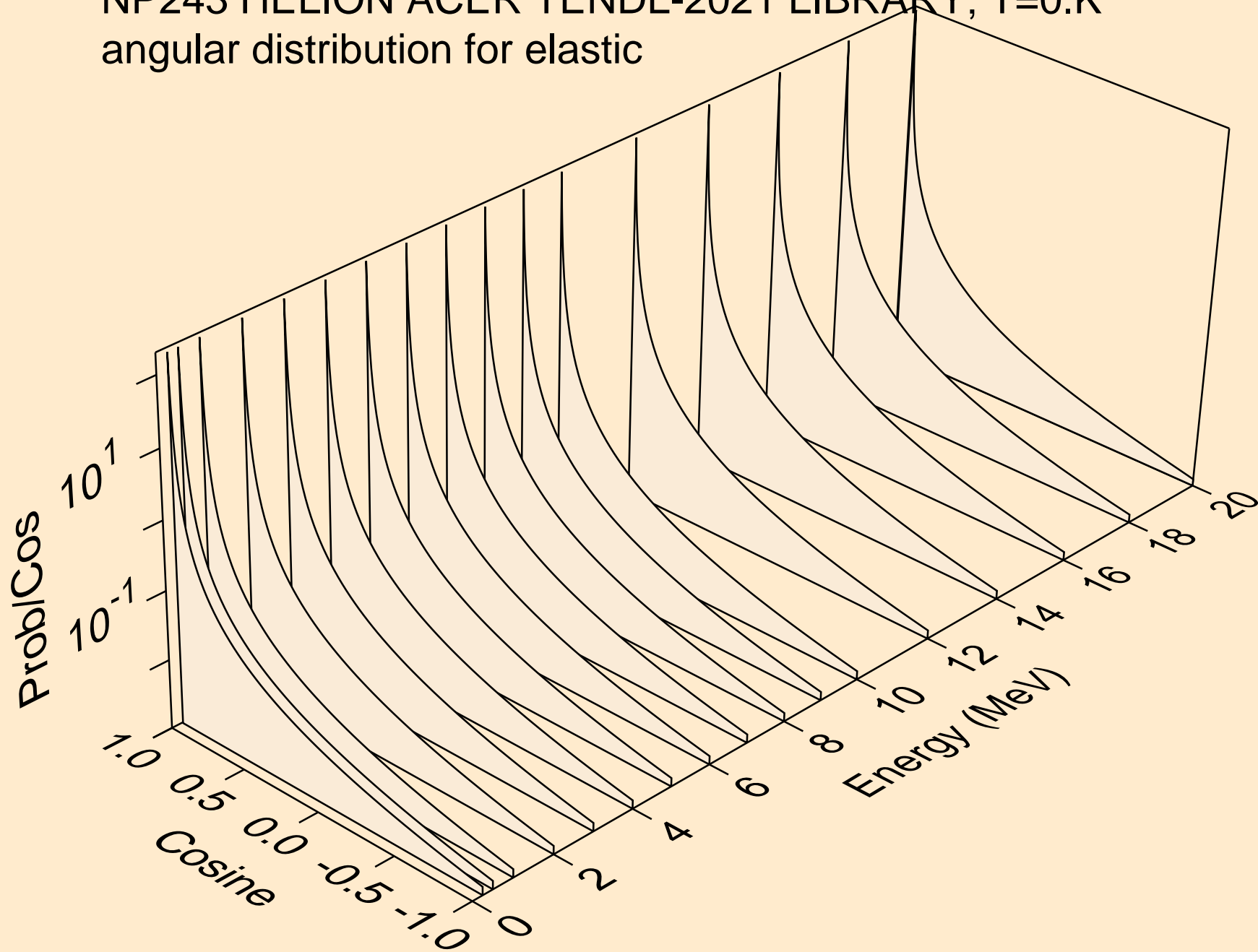

NP243 HELION ACER TENDL-2021 LIBRARY; T=0.K  
angular distribution for elastic

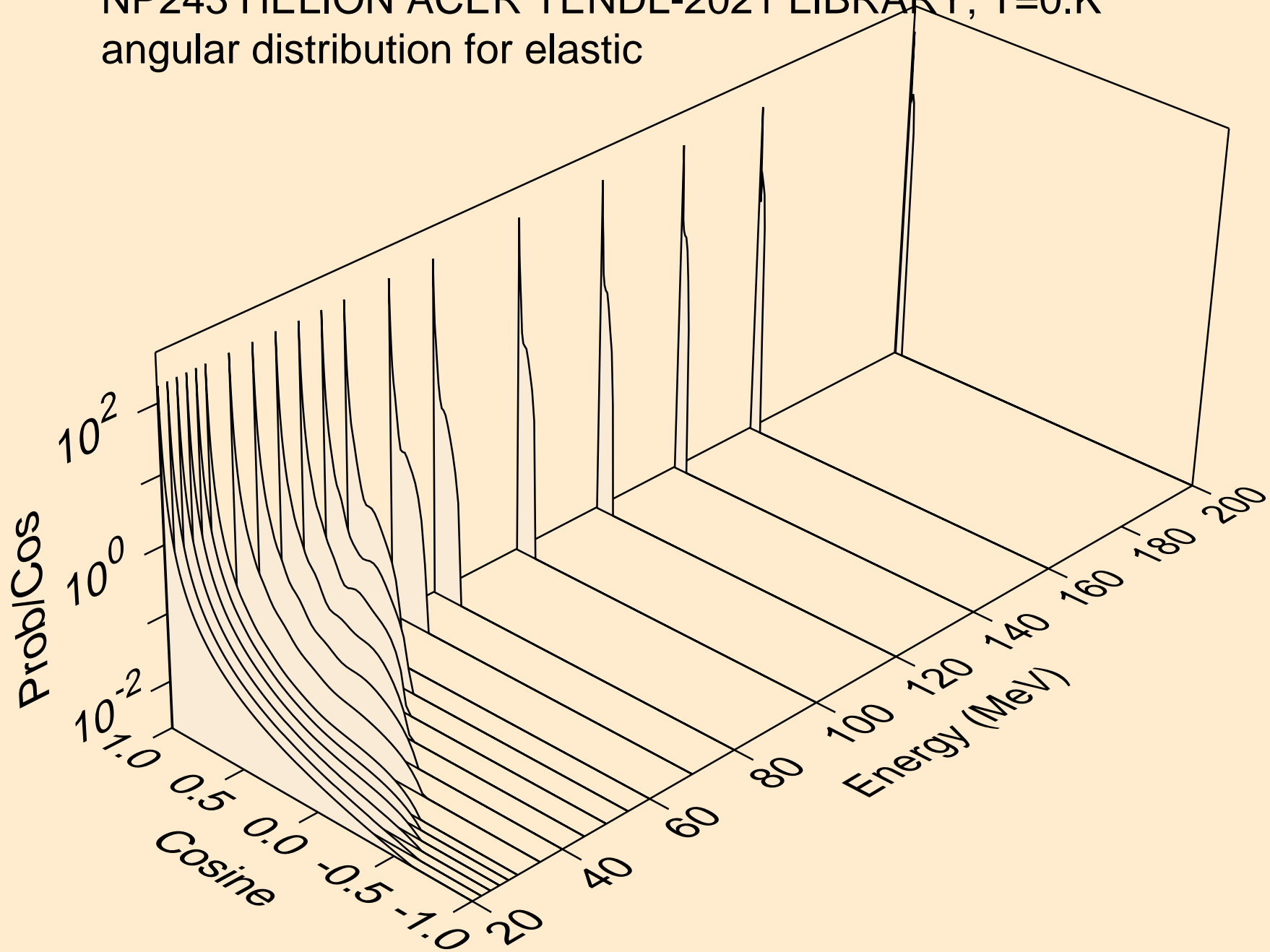

NP243 HELION ACER TENDL-2021 LIBRARY; T=0.K  
He-3 emission for (s,x)

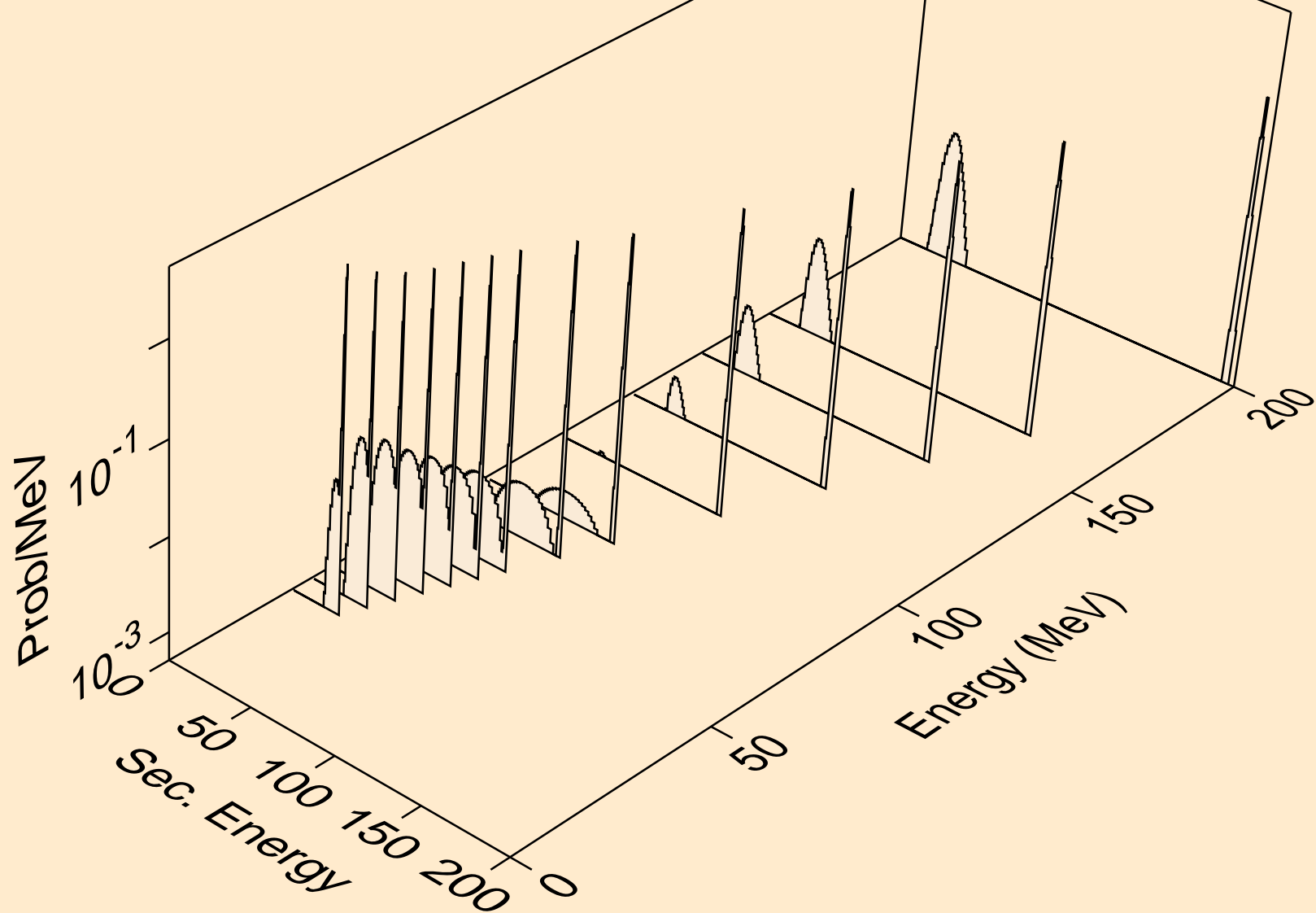

NP243 HELION ACER TENDL-2021 LIBRARY; T=0.K  
He-3 emission for (s,n\*)he3

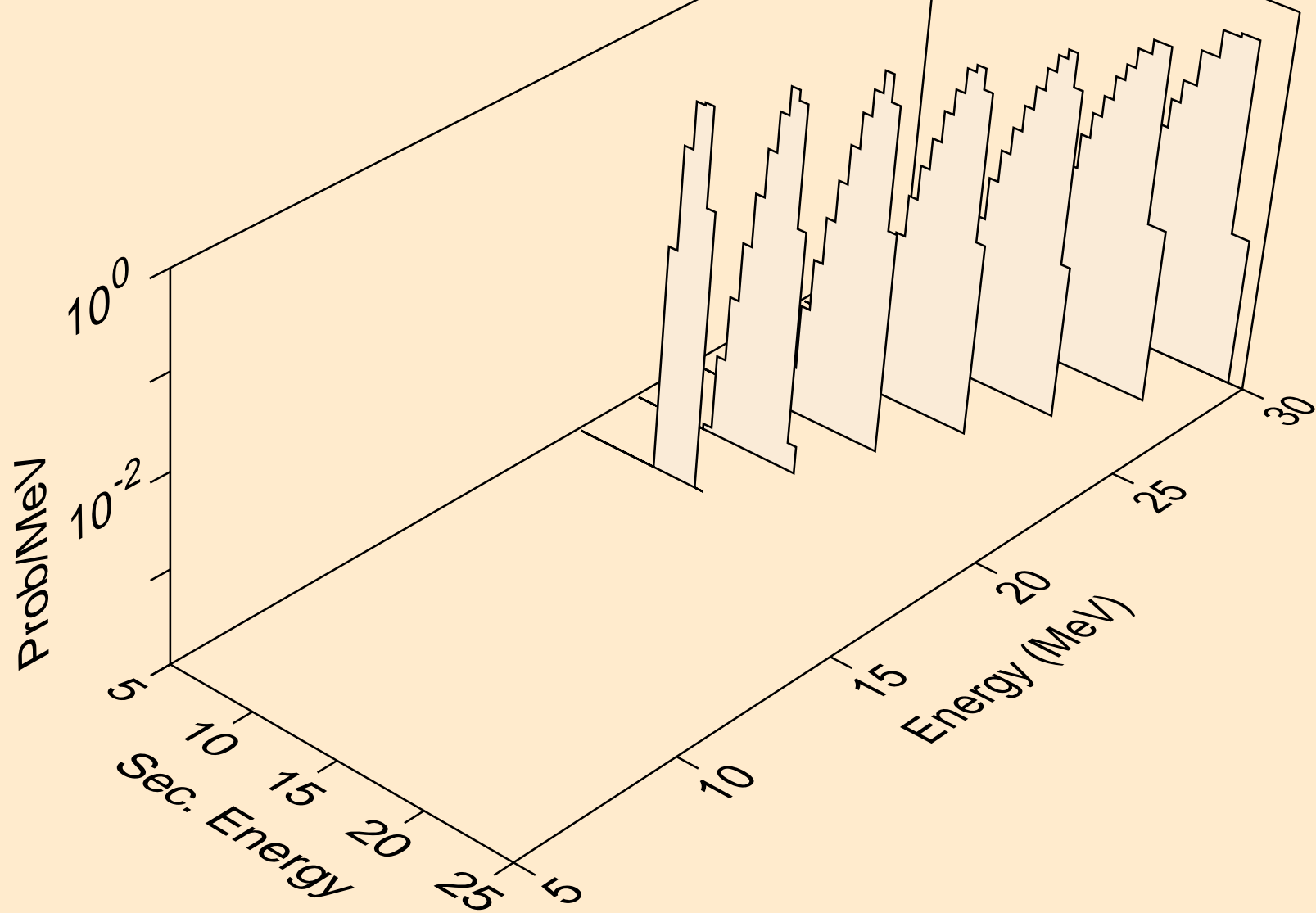

NP243 HELION ACER TENDL-2021 LIBRARY; T=0.K  
He-3 emission for inelastic

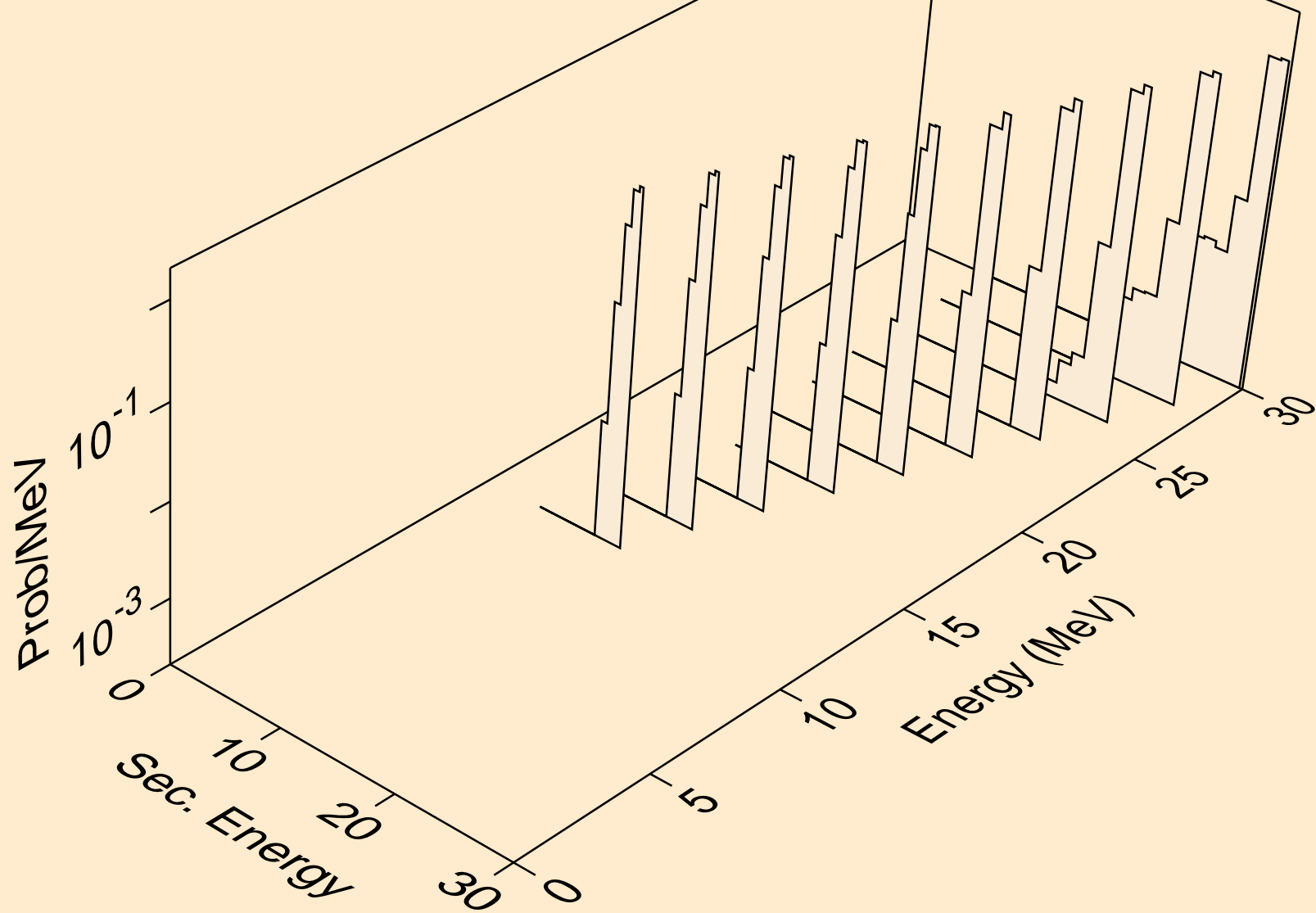

NP243 HELION ACER TENDL-2021 LIBRARY; T=0.K  
Photon emission for (z,n)

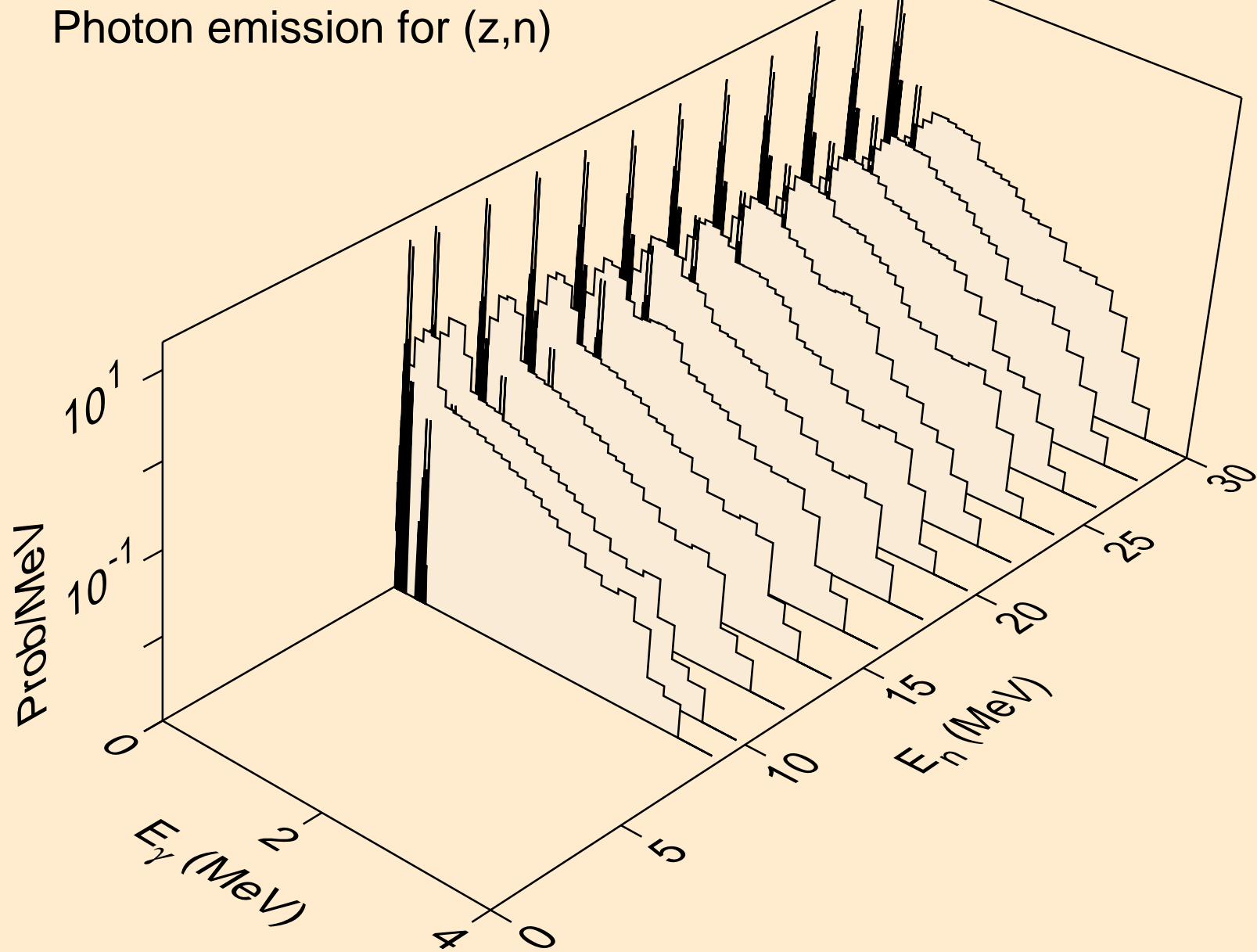



NP243 HELION ACER TENDL-2021 LIBRARY; T=0.K  
Photon emission for (n,x)

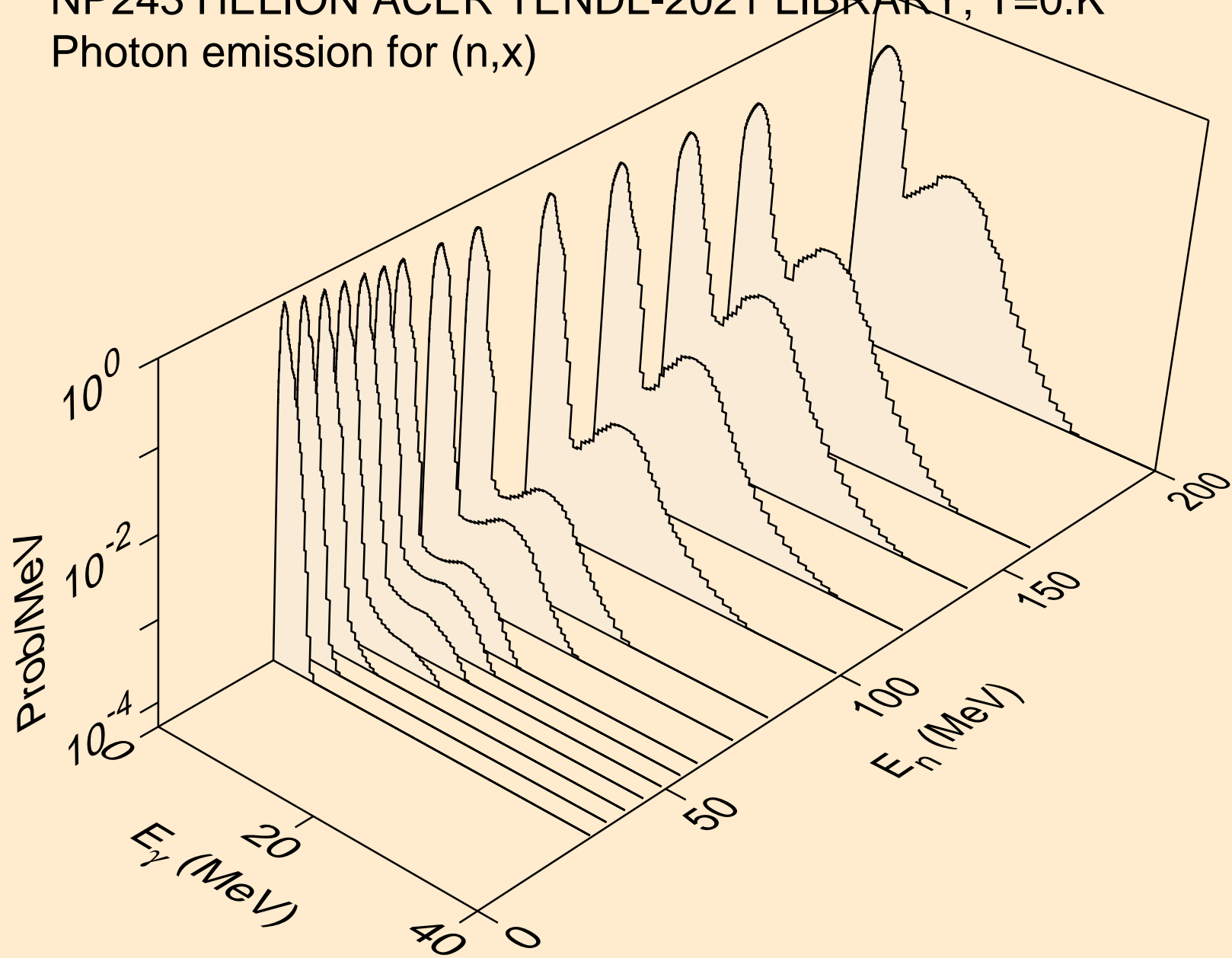

NP243 HELION ACER TENDL-2021 LIBRARY; T=0.K  
Photon emission for (n,2nd)

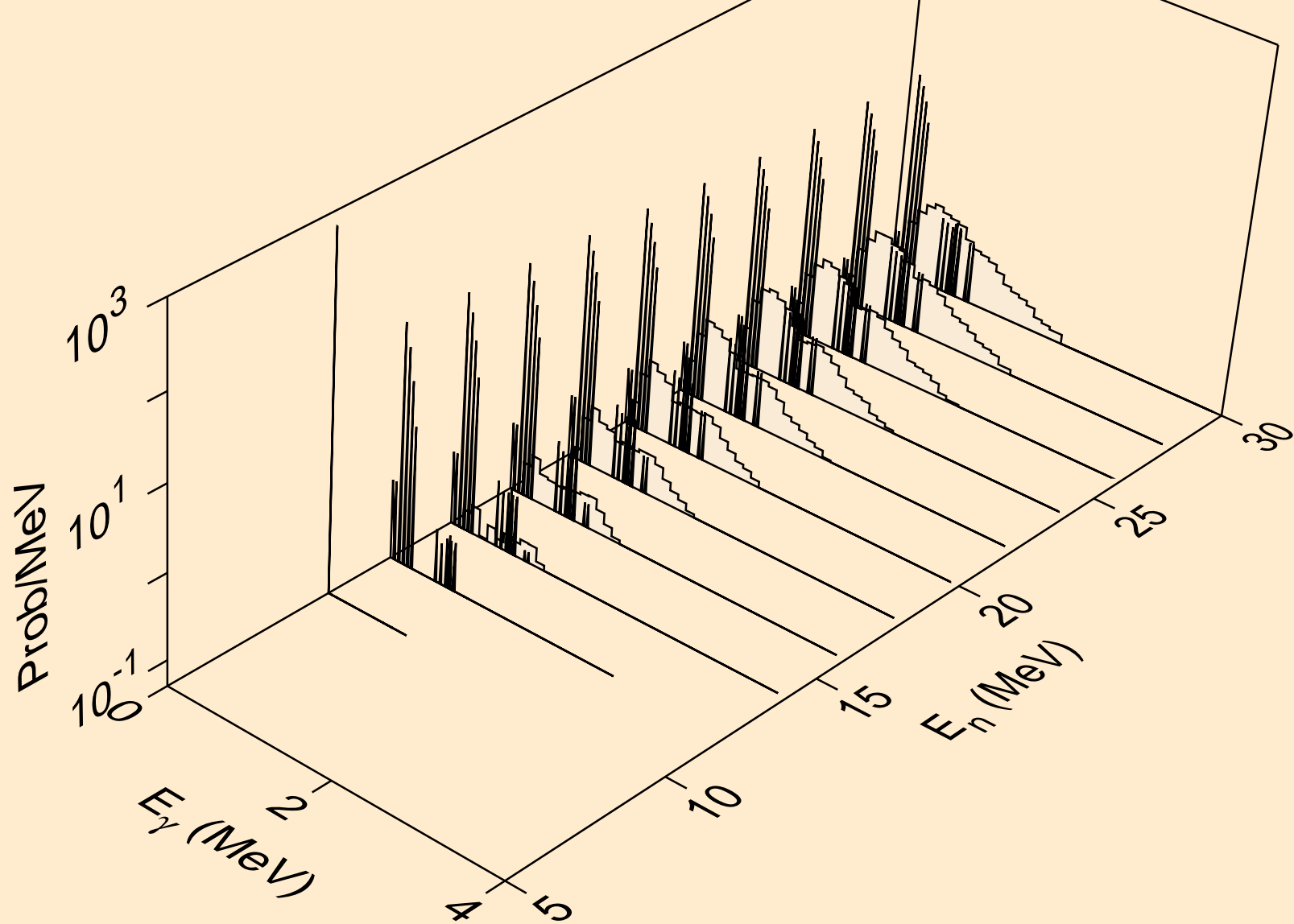

NP243 HELION ACER TENDL-2021 LIBRARY; T=0.K  
Photon emission for (n,2n)

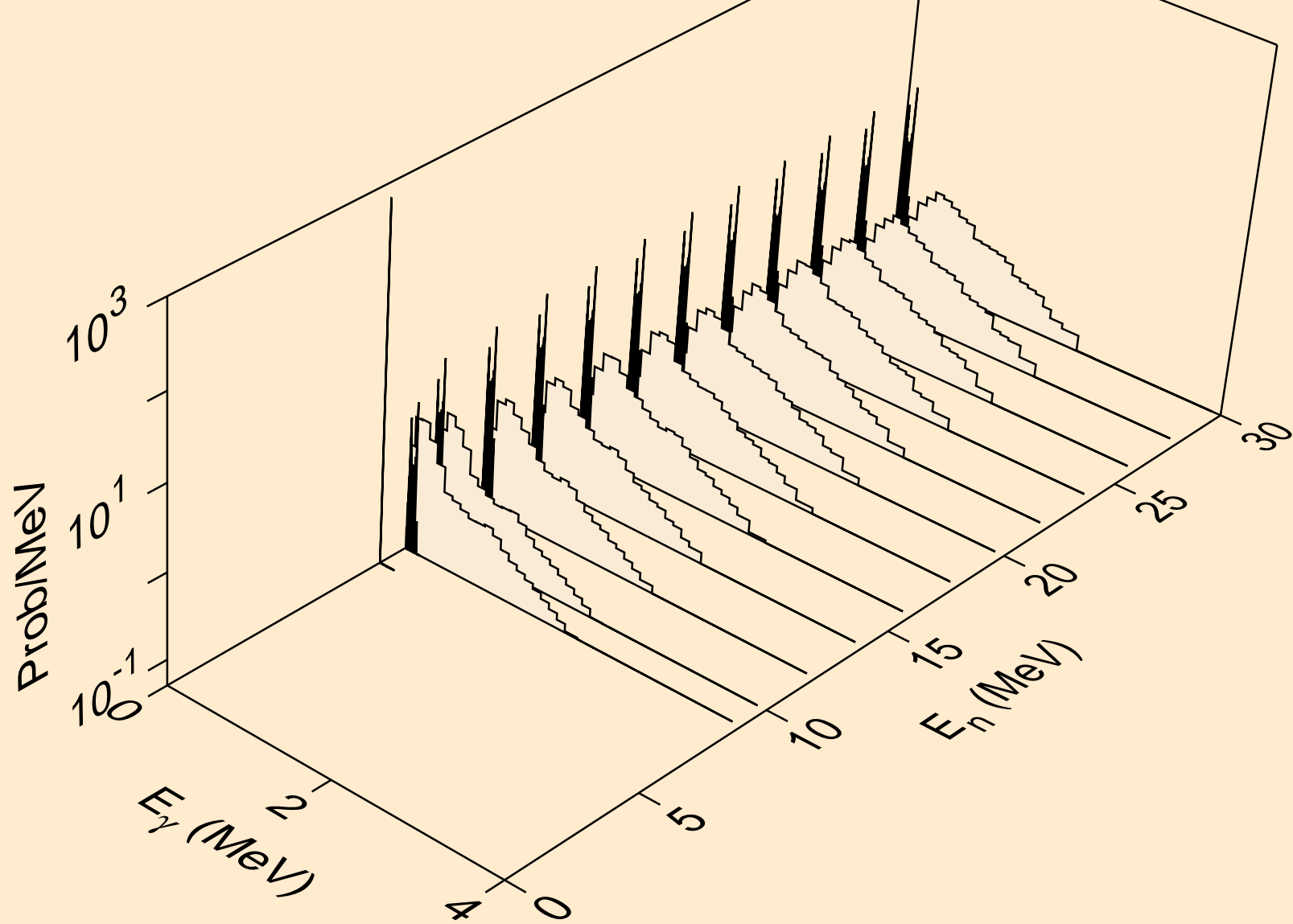

NP243 HELION ACER TENDL-2021 LIBRARY; T=0.K  
Photon emission for (n,3n)

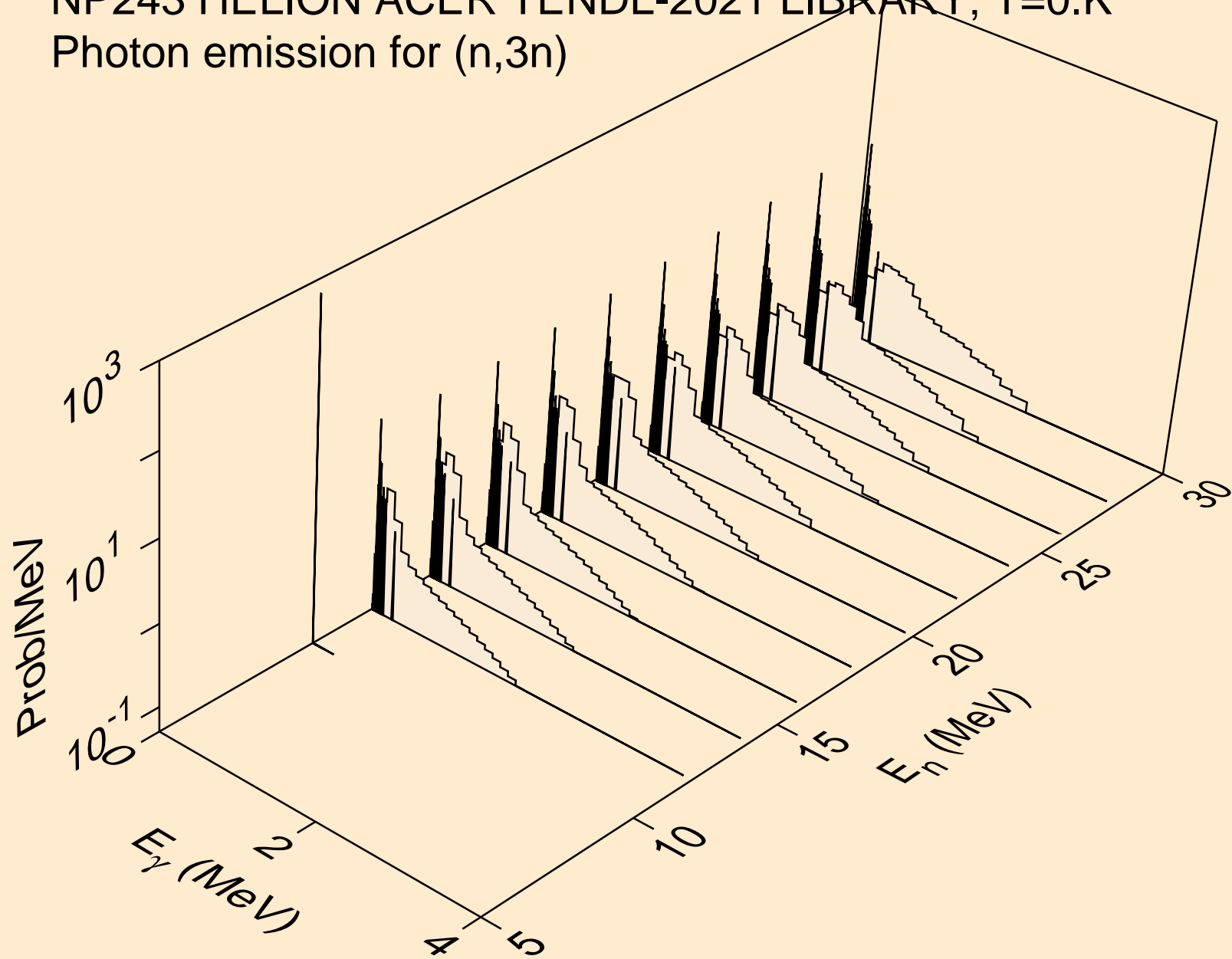

NP243 HELION ACER TENDL-2021 LIBRARY; T=0.K  
Photon emission for (n,n\*)a

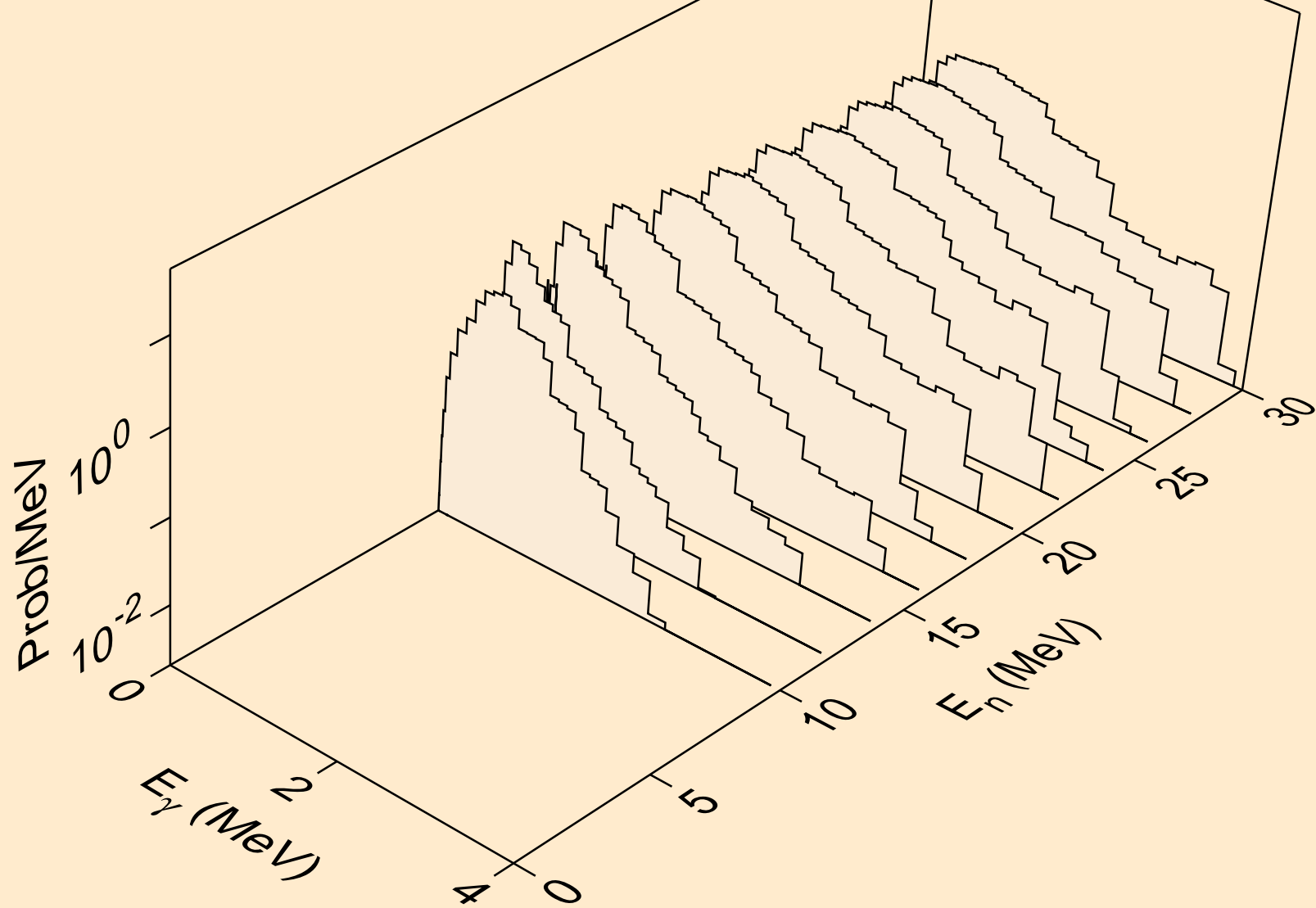

NP243 HELION ACER TENDL-2021 LIBRARY; T=0.K  
Photon emission for (n,2n)a

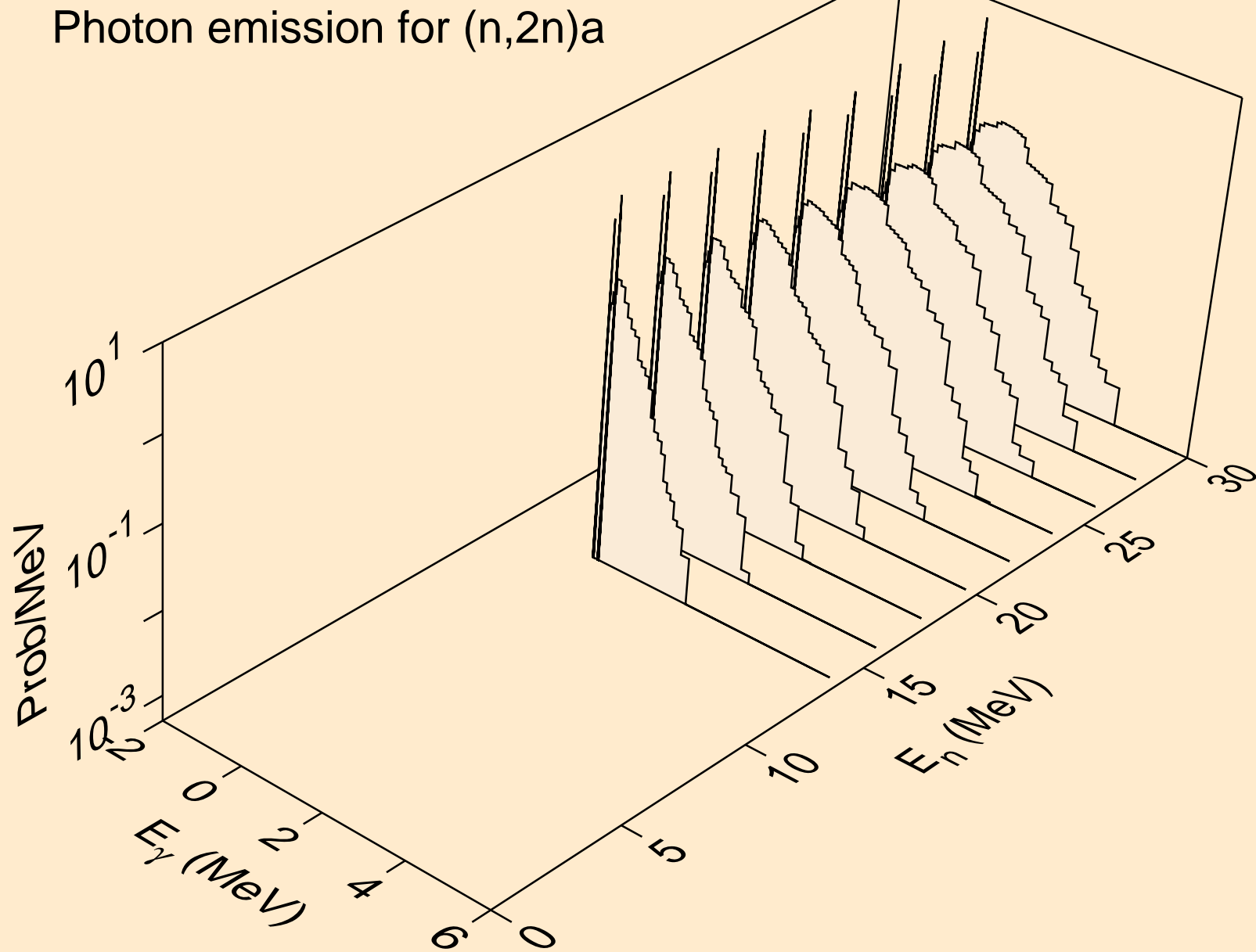

NP243 HELION ACER TENDL-2021 LIBRARY; T=0.K  
Photon emission for (n,3n)a

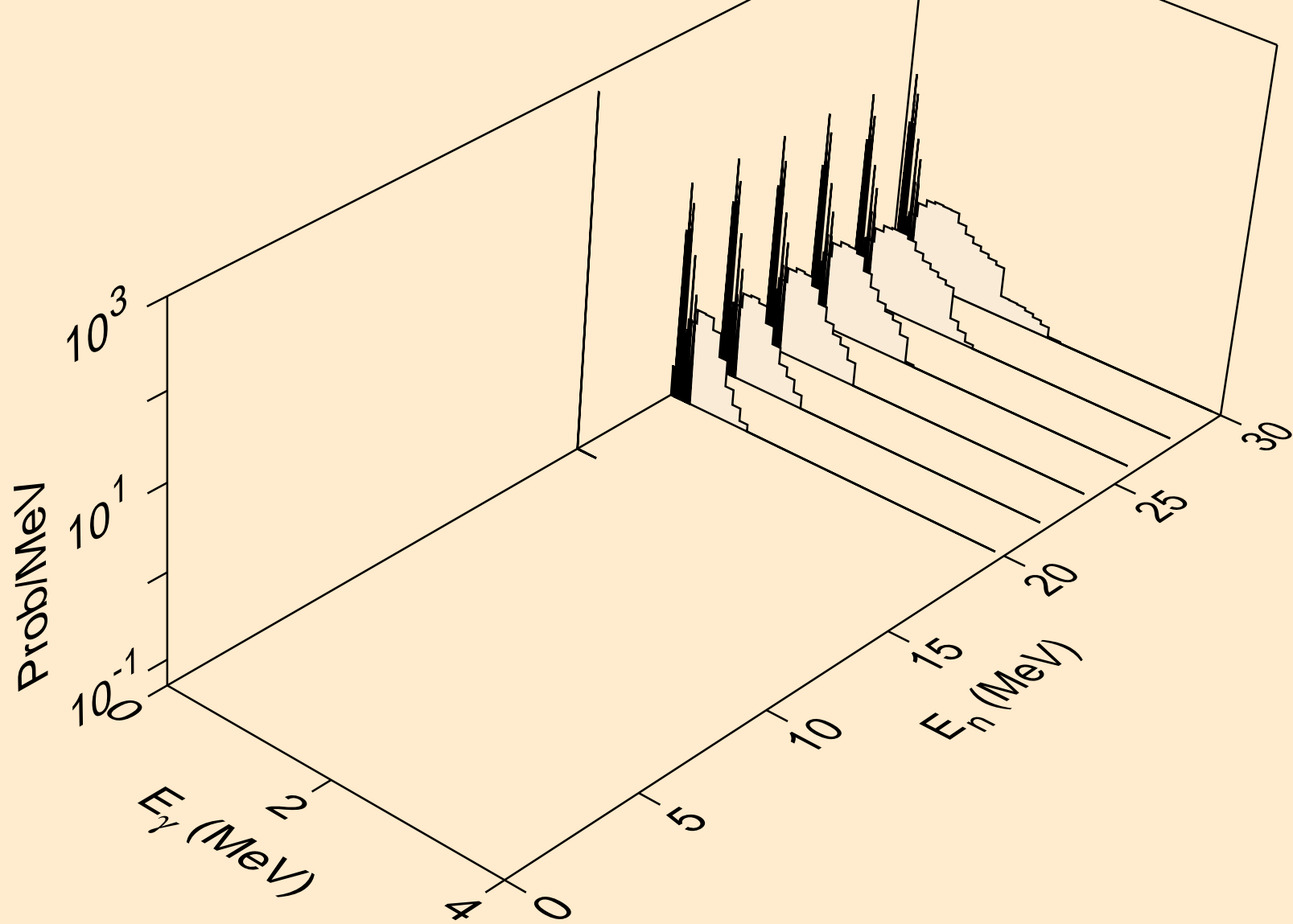

NP243 HELION ACER TENDL-2021 LIBRARY; T=0.K  
Photon emission for (n,n\*)p

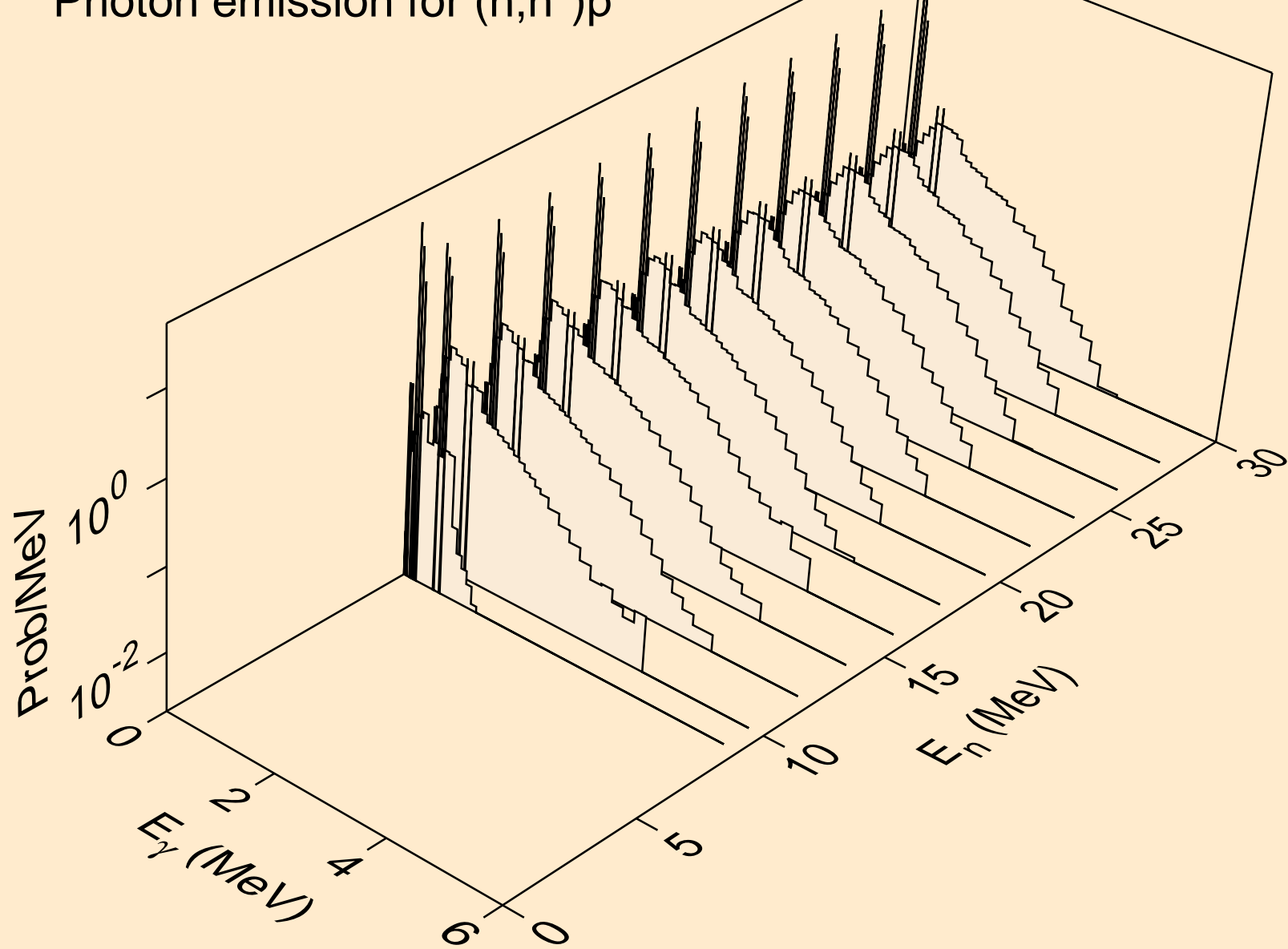



NP243 HELION ACER TENDL-2021 LIBRARY; T=0.K  
Photon emission for (n,n\*)d

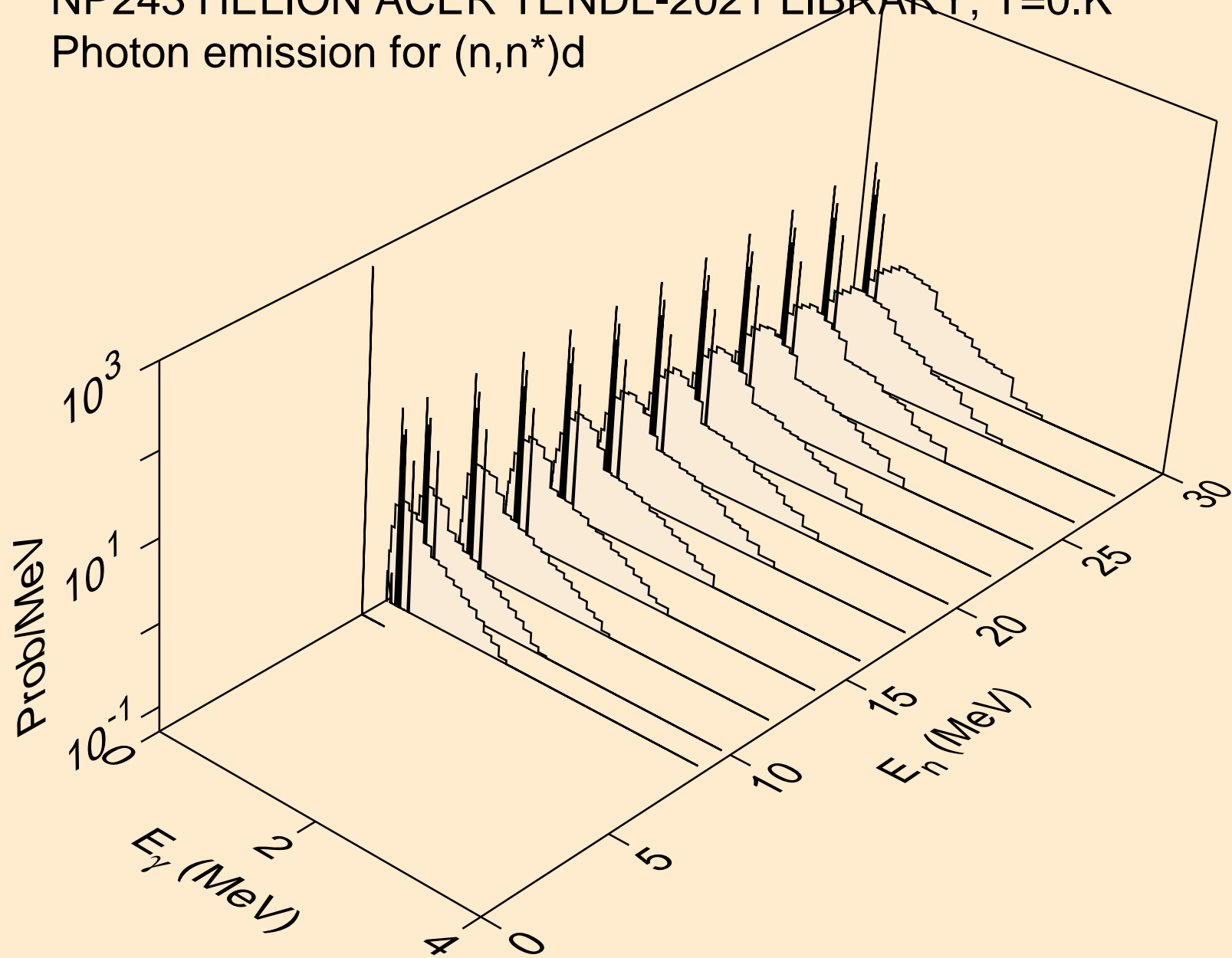

NP243 HELION ACER TENDL-2021 LIBRARY; T=0.K  
Photon emission for (n,n\*)t

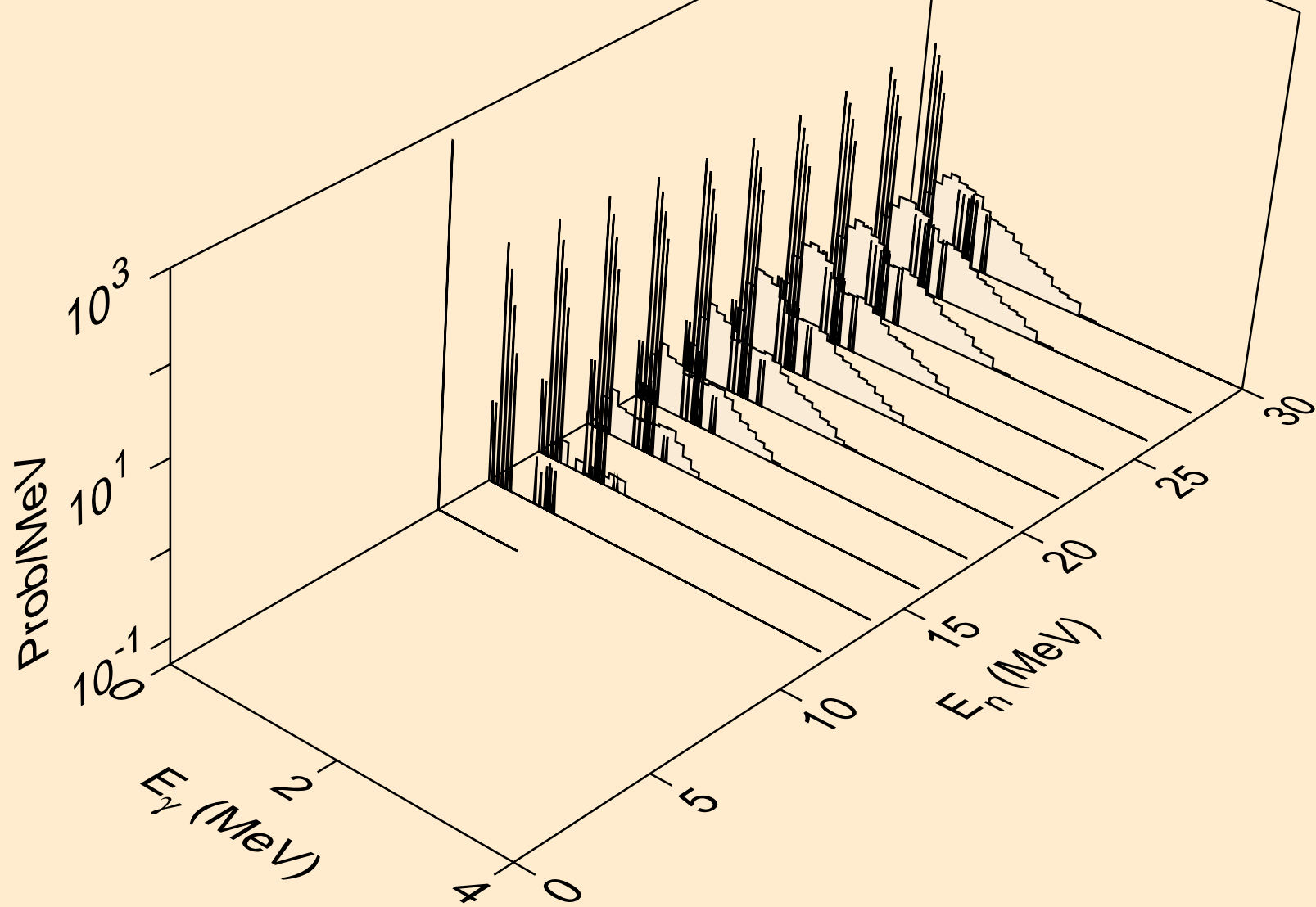

NP243 HELION ACER TENDL-2021 LIBRARY; T=0.K  
Photon emission for (n,n\*)he3

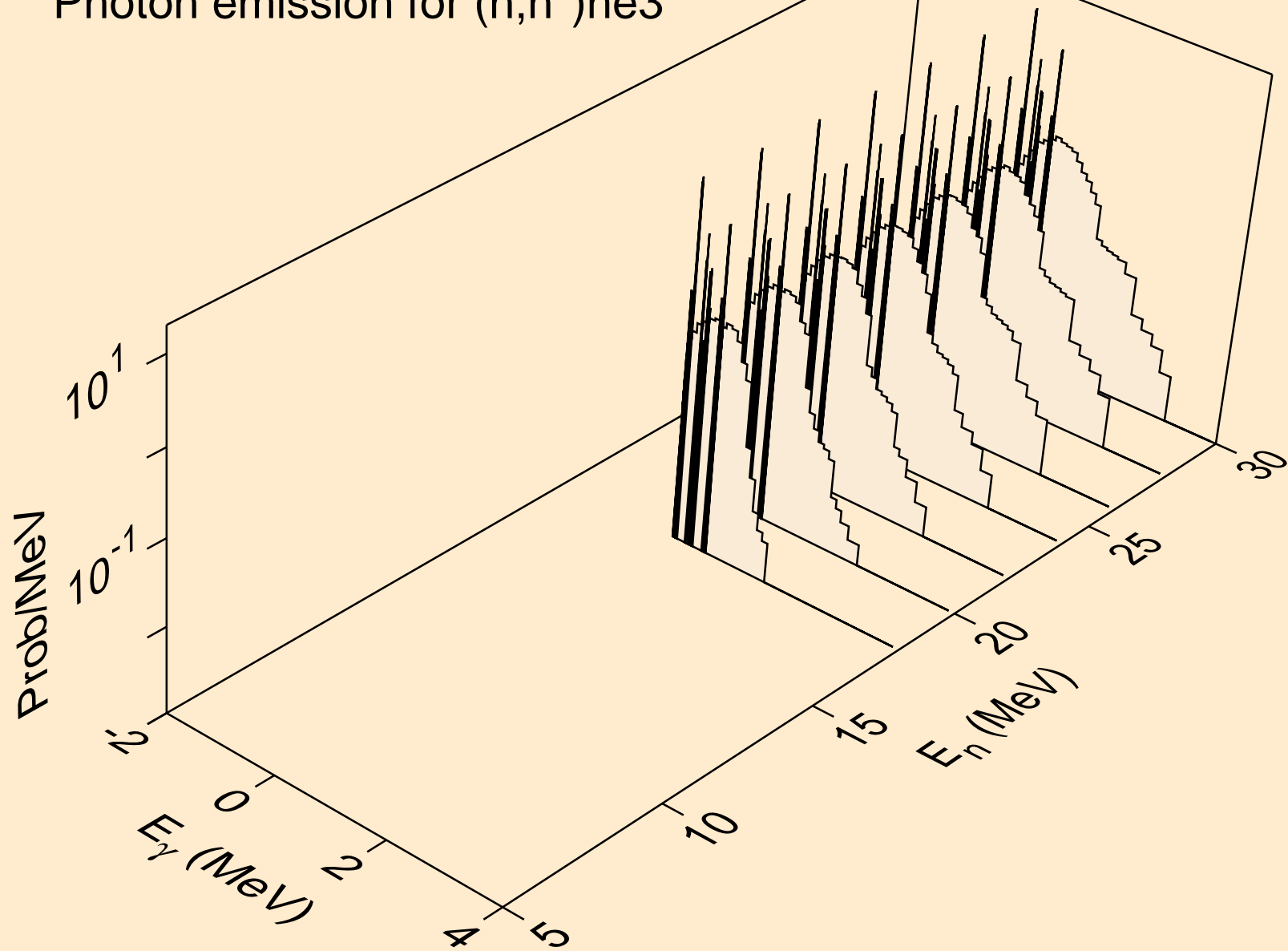

NP243 HELION ACER TENDL-2021 LIBRARY; T=0.K  
Photon emission for (n,4n)

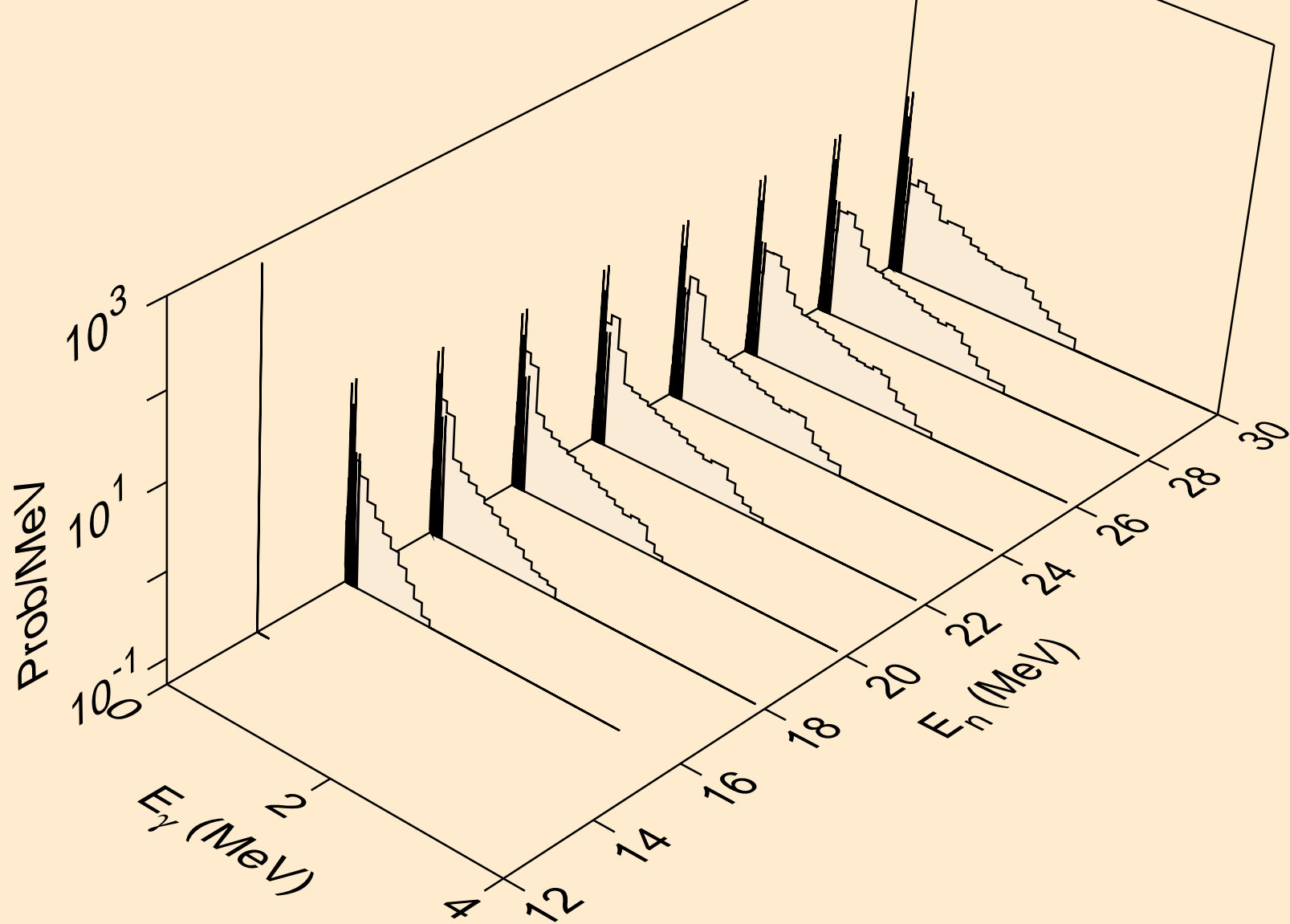

NP243 HELION ACER TENDL-2021 LIBRARY; T=0.K  
Photon emission for (n,2np)

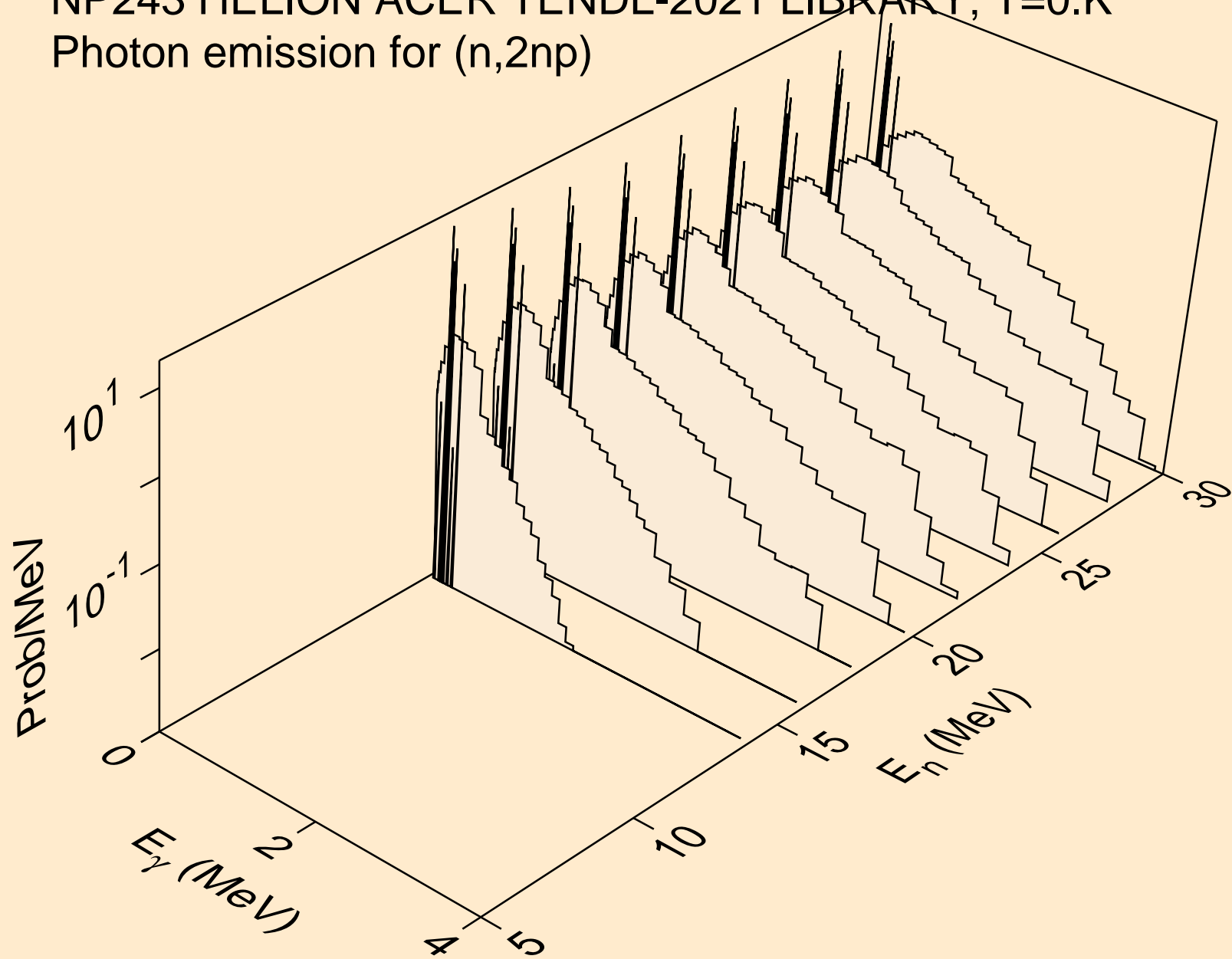

NP243 HELION ACER TENDL-2021 LIBRARY; T=0.K  
Photon emission for (n,3np)

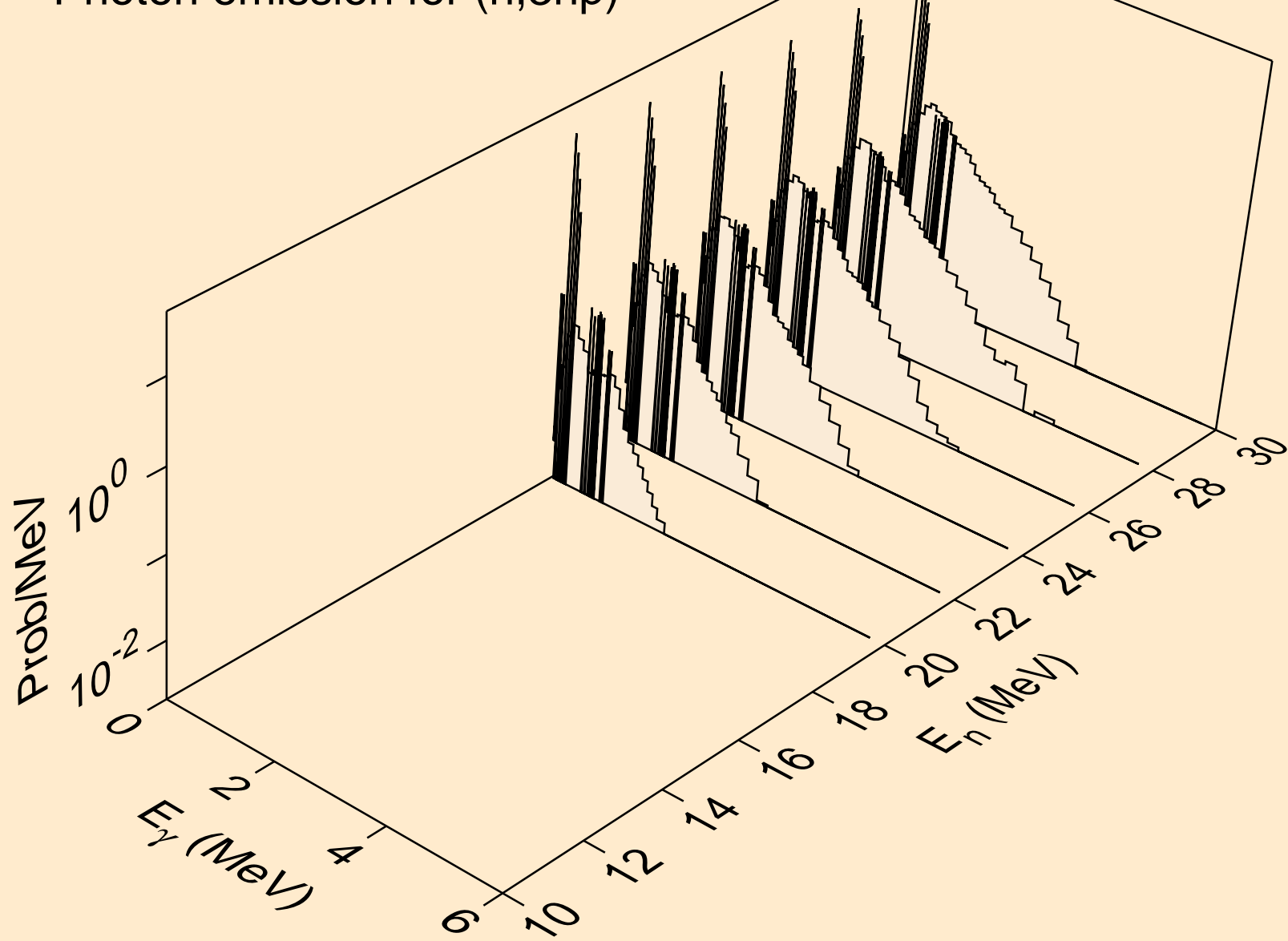

NP243 HELION ACER TENDL-2021 LIBRARY; T=0.K  
Photon emission for (n,2np)

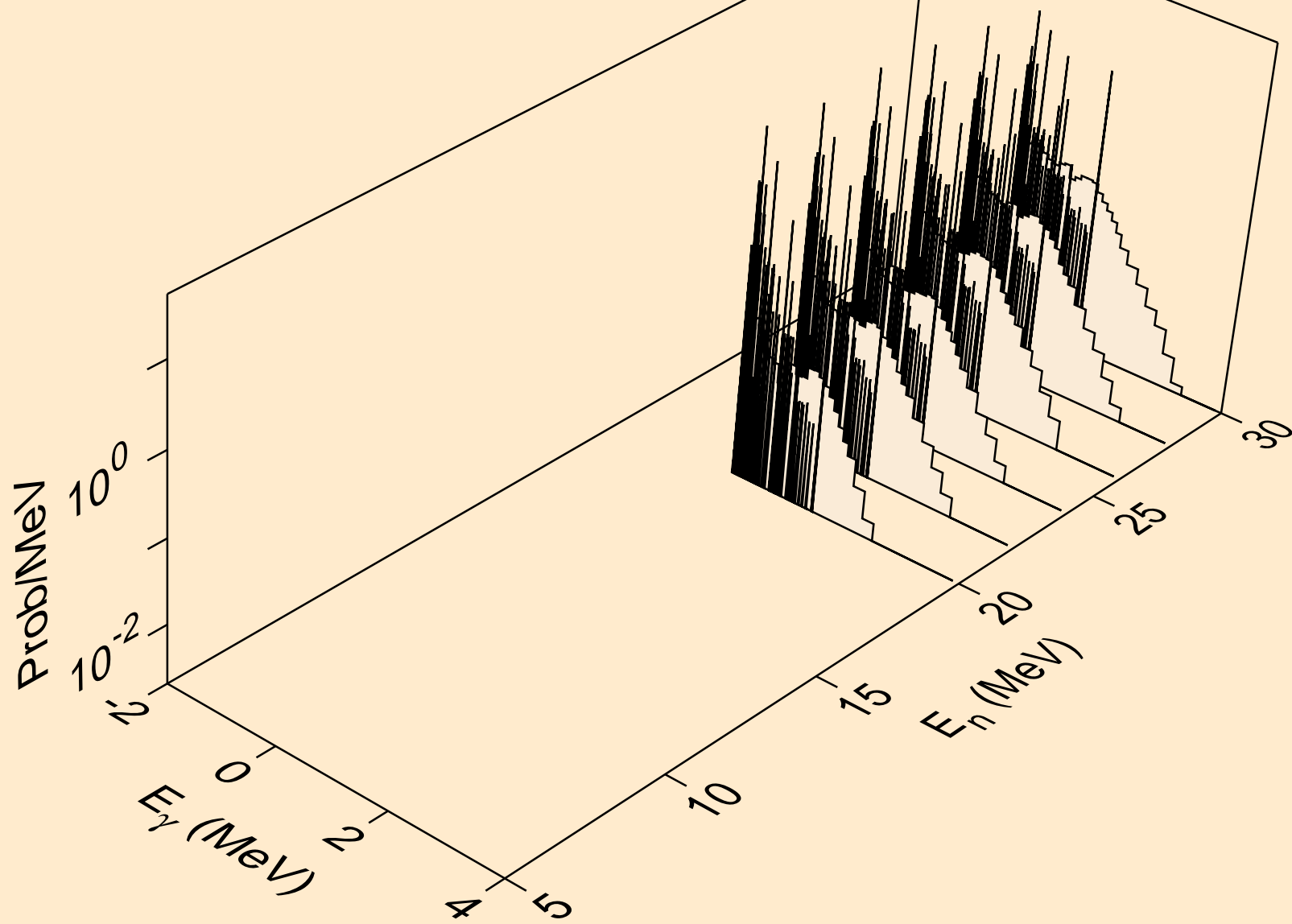

NP243 HELION ACER TENDL-2021 LIBRARY; T=0.K  
Photon emission for (n,p)

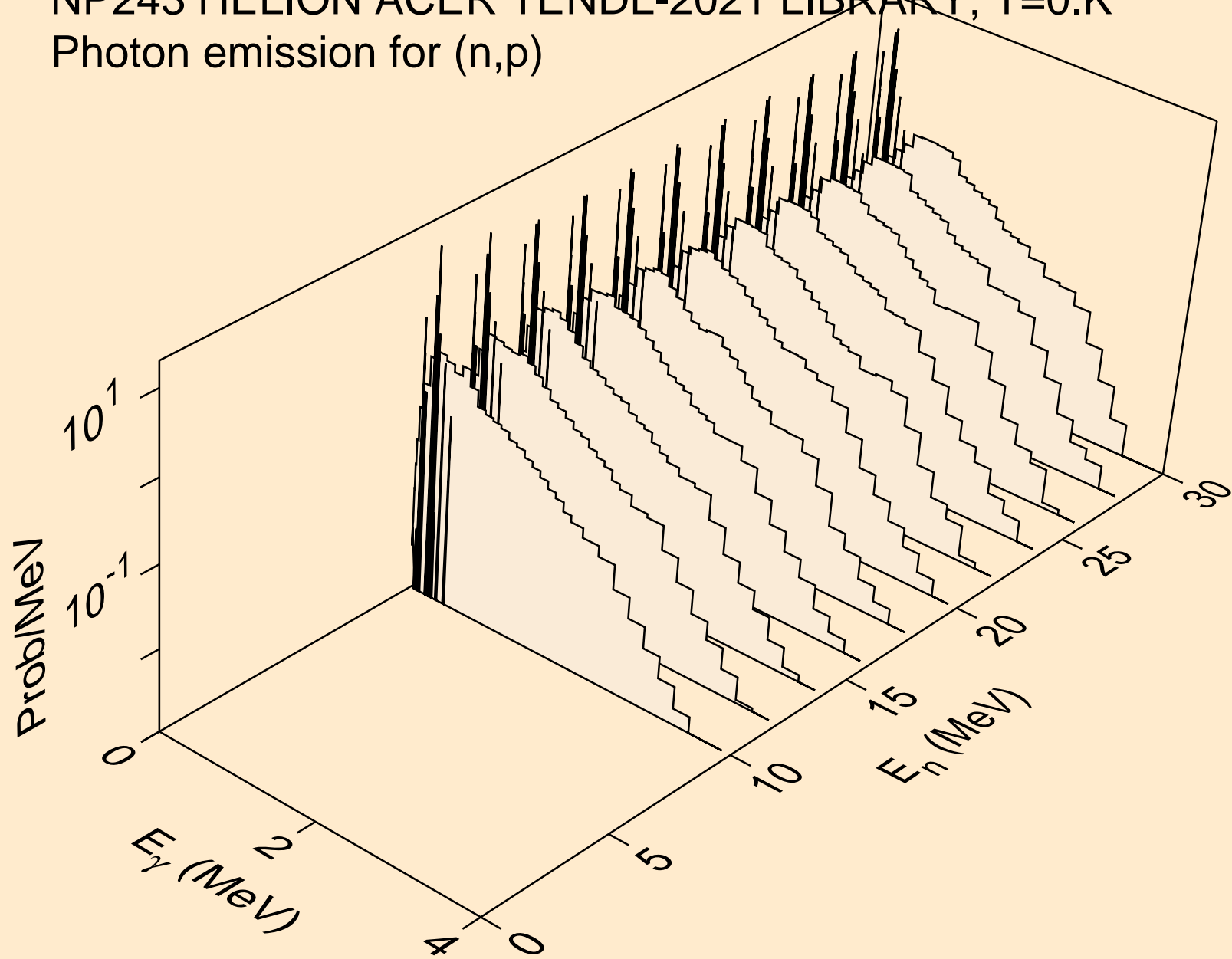



NP243 HELION ACER TENDL-2021 LIBRARY; T=0.K  
Photon emission for (n,d)

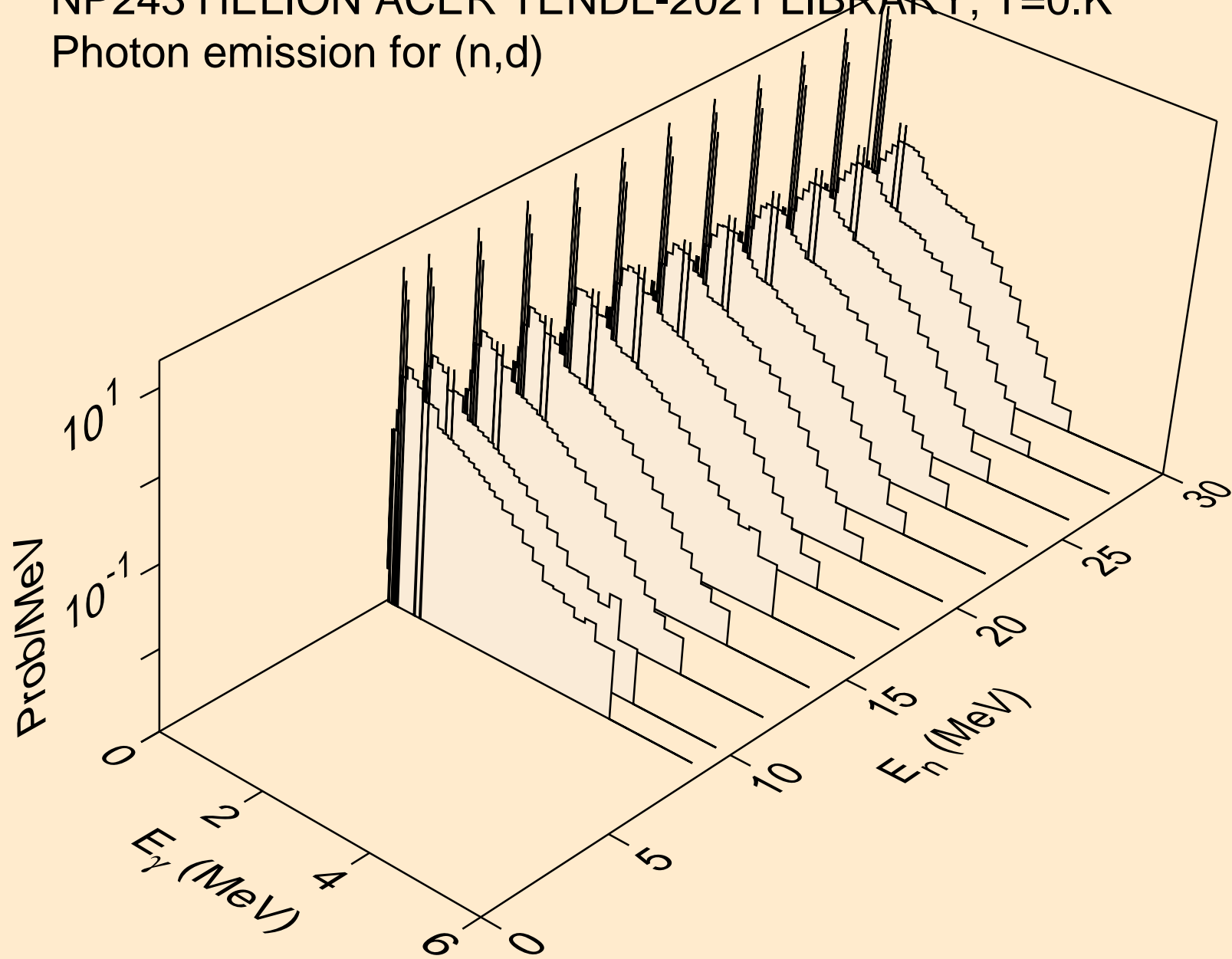

NP243 HELION ACER TENDL-2021 LIBRARY; T=0.K  
Photon emission for (n,t)

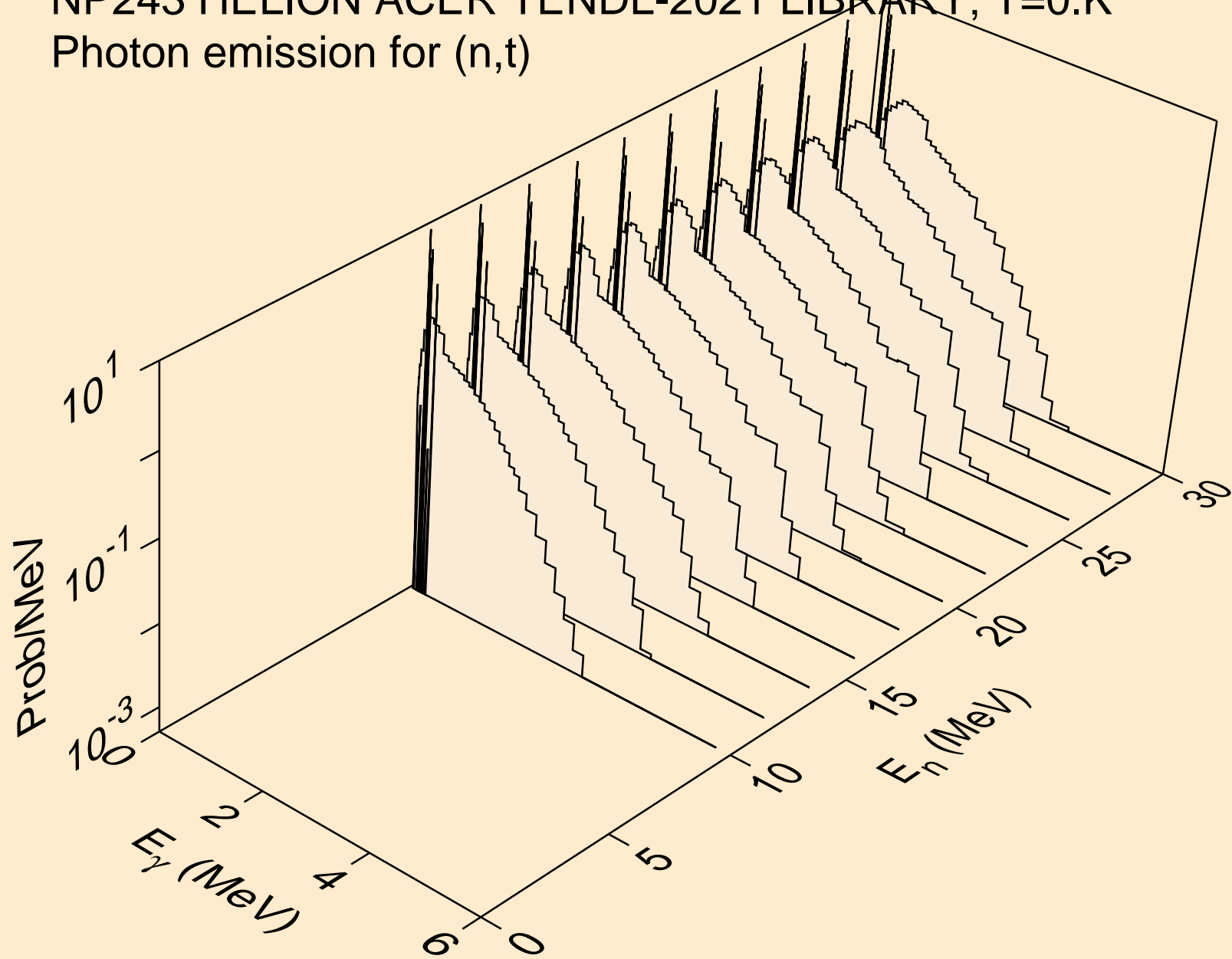

NP243 HELION ACER TENDL-2021 LIBRARY; T=0.K  
Photon emission for inelastic

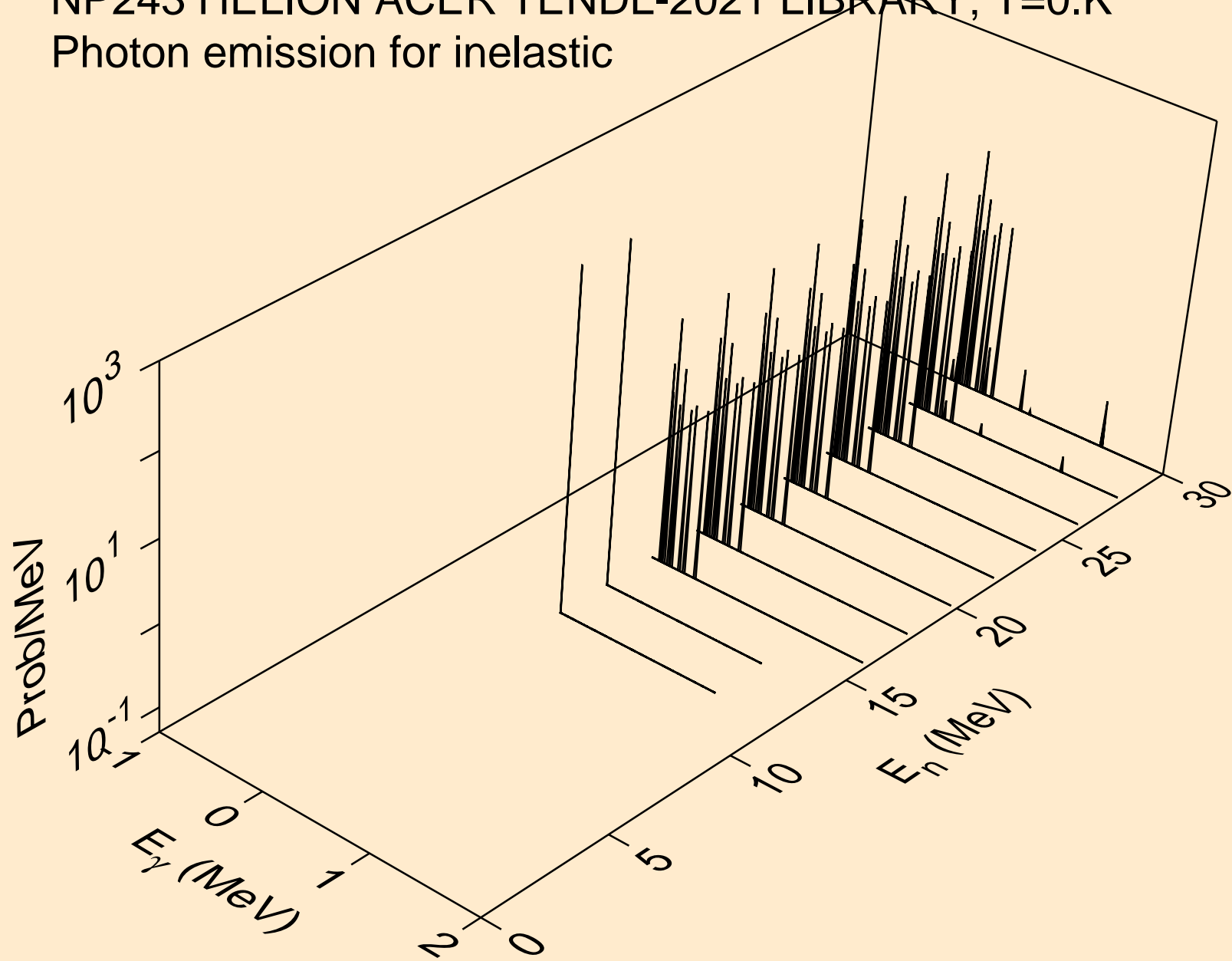

NP243 HELION ACER TENDL-2021 LIBRARY; T=0.K  
Photon emission for (n,a)

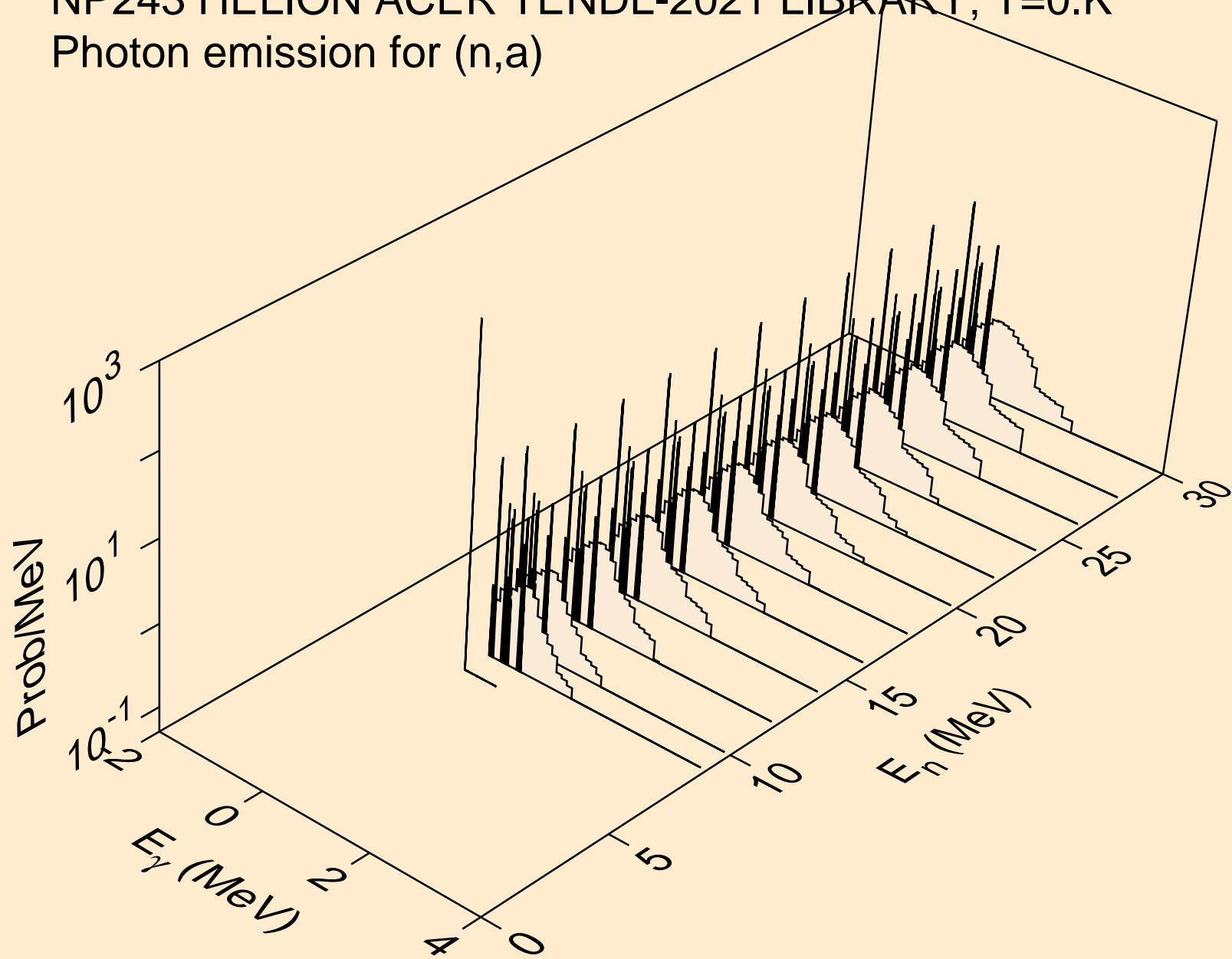

NP243 HELION ACER TENDL-2021 LIBRARY; T=0.K  
Photon emission for (n,2p)

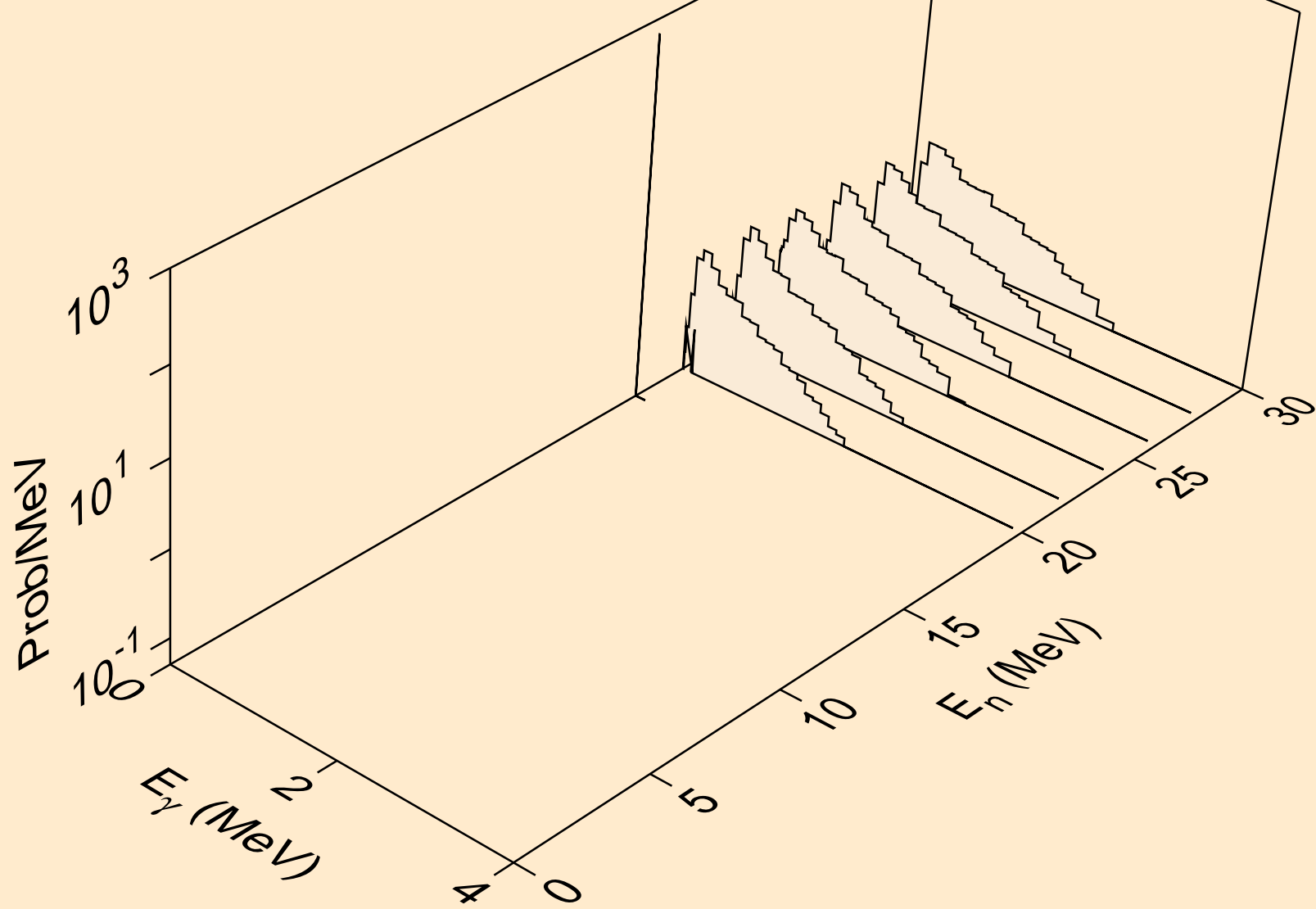

NP243 HELION ACER TENDL-2021 LIBRARY; T=0.K  
Photon emission for (n,pd)

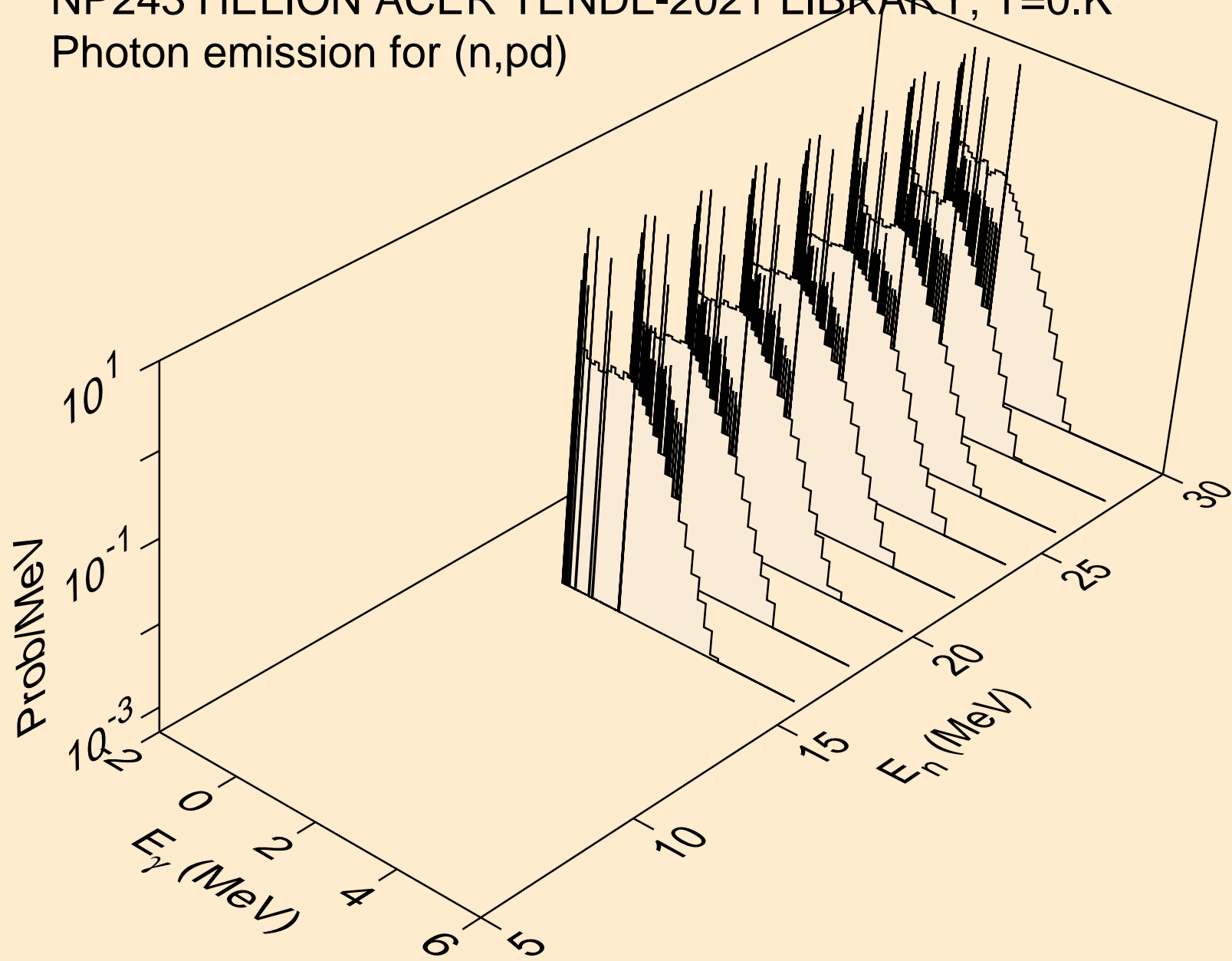

NP243 HELION ACER TENDL-2021 LIBRARY; T=0.K  
Particle heating contributions

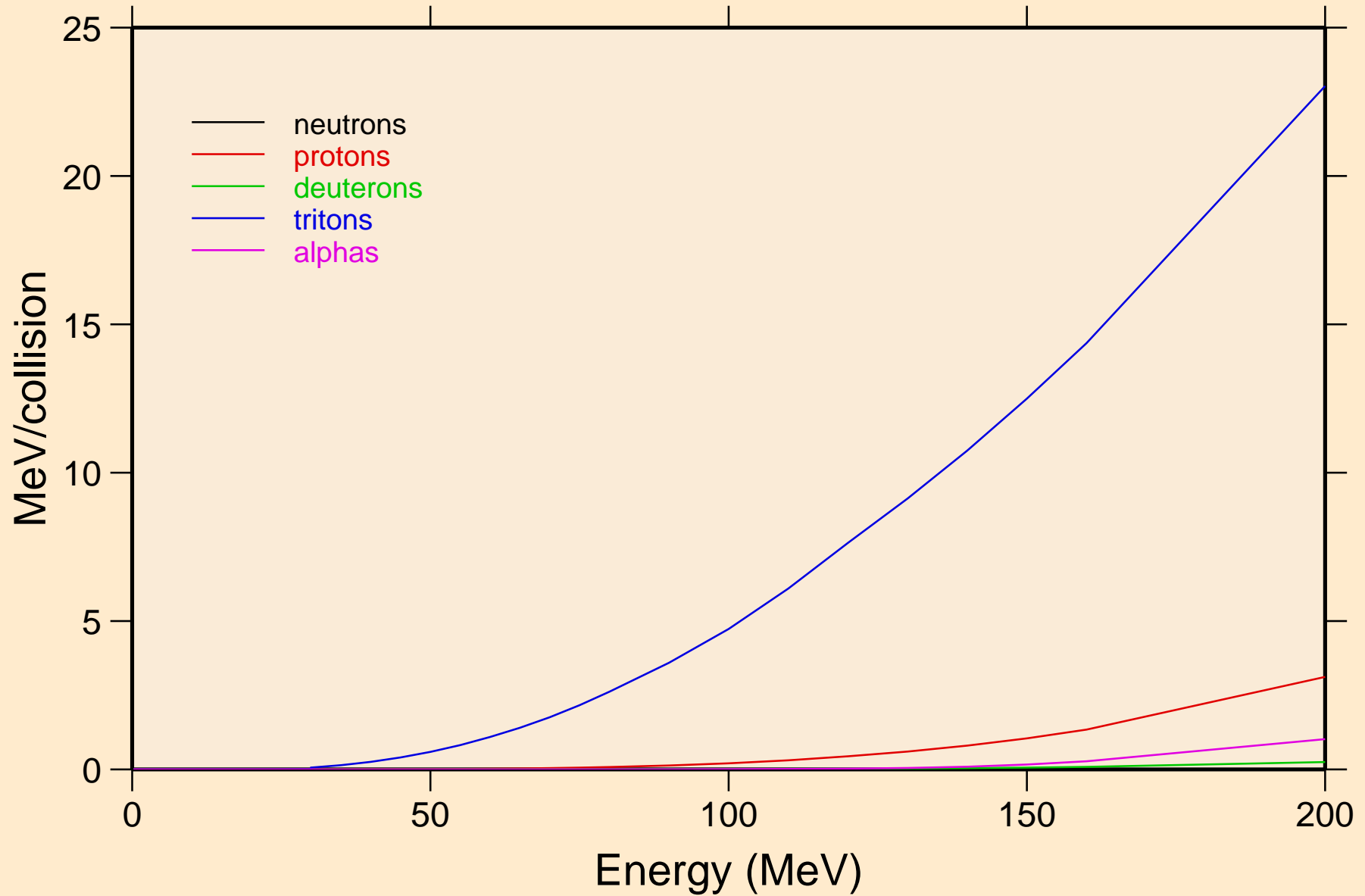

NP243 HELION ACER TENDL-2021 LIBRARY; T=0.K  
Recoil Heating

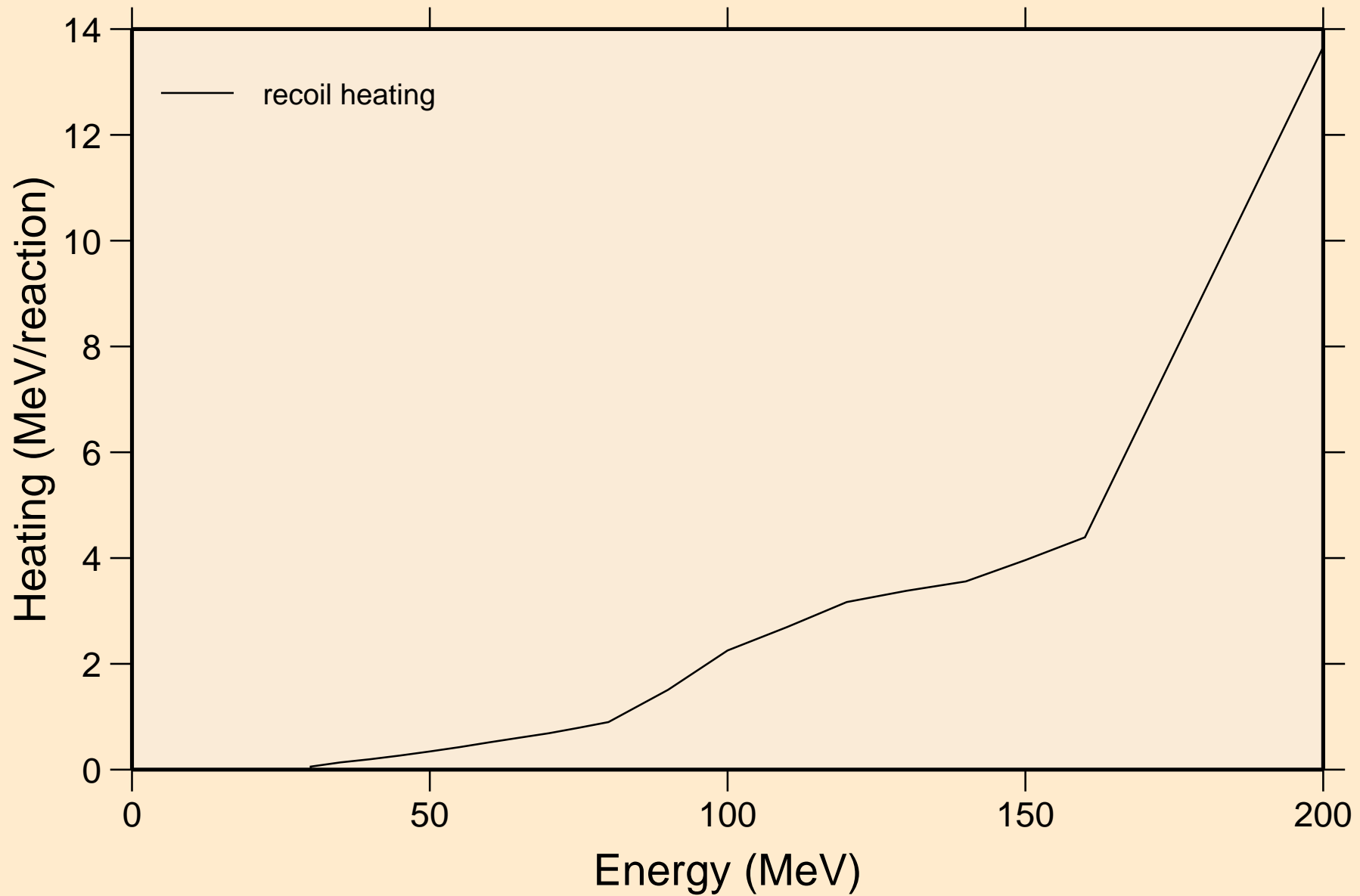



NP243 HELION ACER TENDL-2021 LIBRARY; T=0.K  
Particle production cross sections

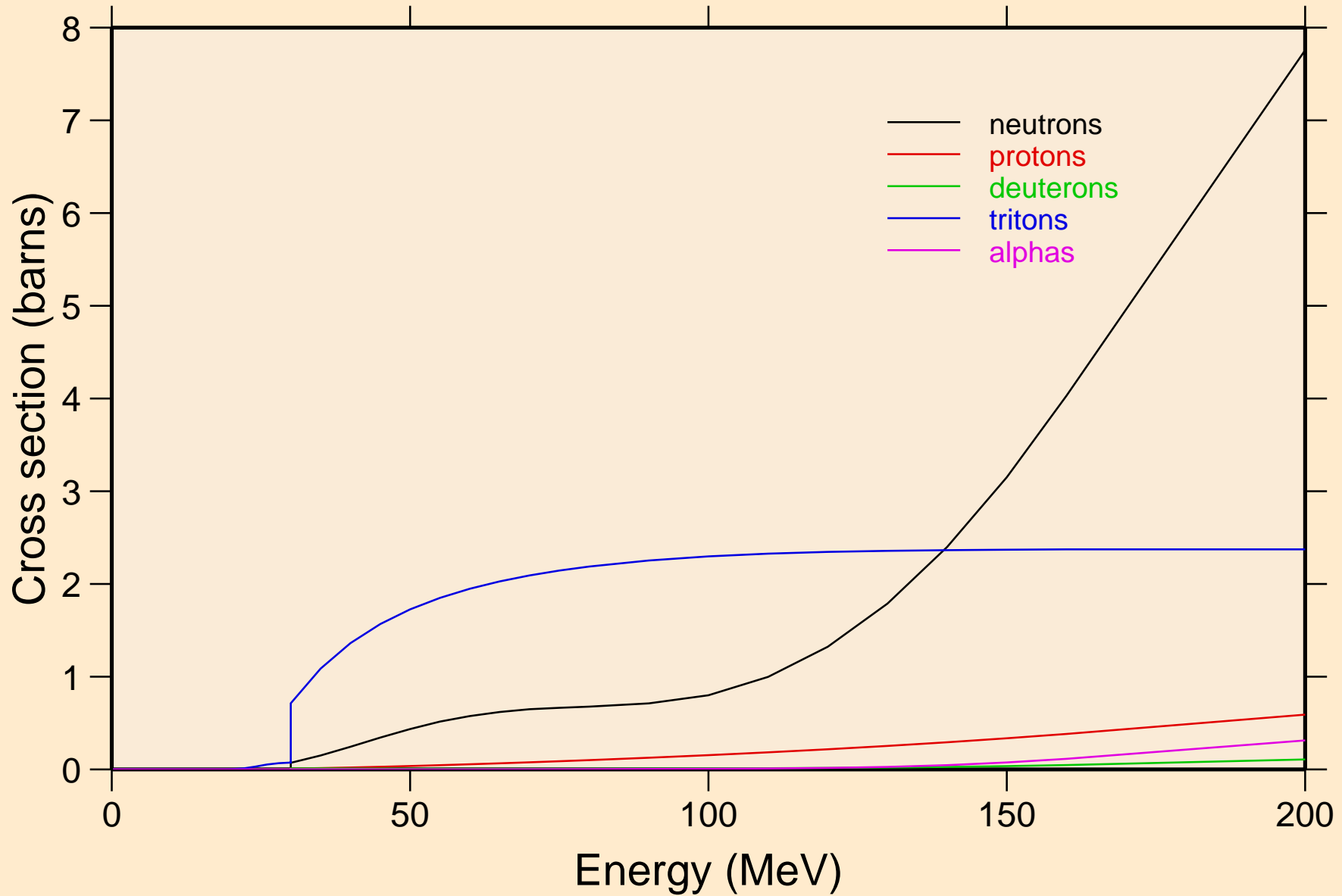

NP243 HELION ACER TENDL-2021 LIBRARY; T=0.K  
neutrons from (s,n)

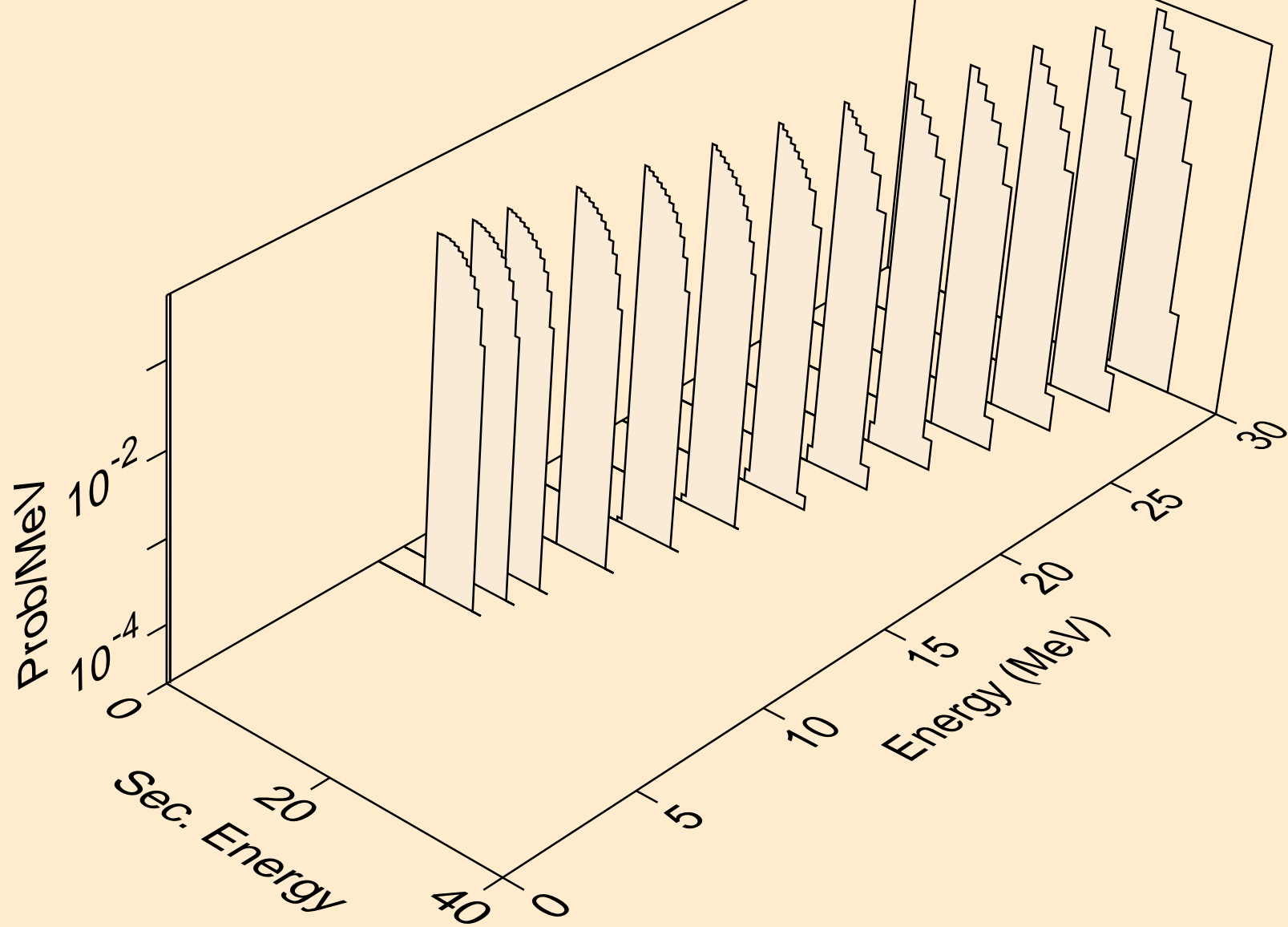

NP243 HELION ACER TENDL-2021 LIBRARY; T=0.K  
neutrons from (s,x)

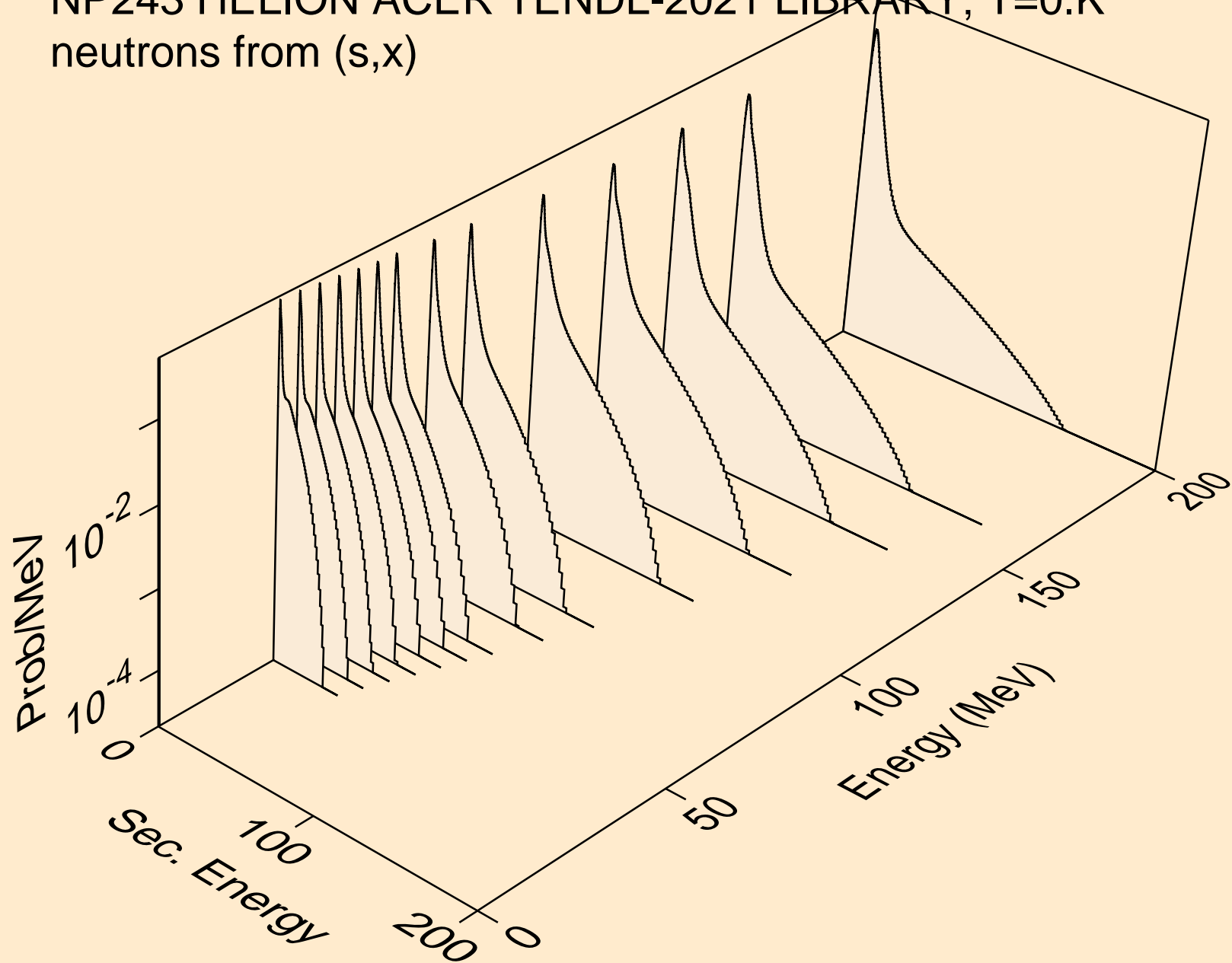

NP243 HELION ACER TENDL-2021 LIBRARY; T=0.K  
neutrons from (s,2nd)

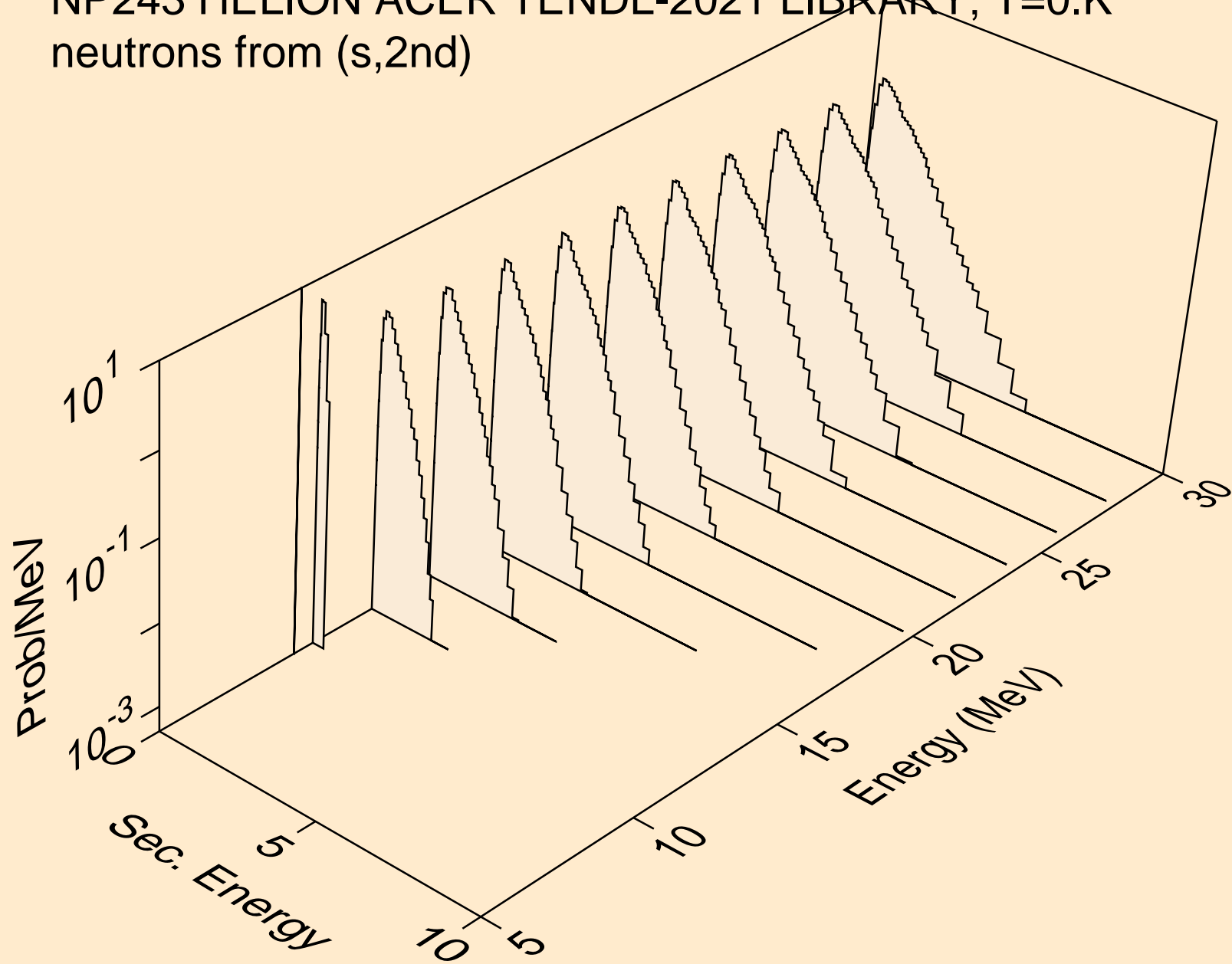

NP243 HELION ACER TENDL-2021 LIBRARY; T=0.K  
neutrons from (s,2n)

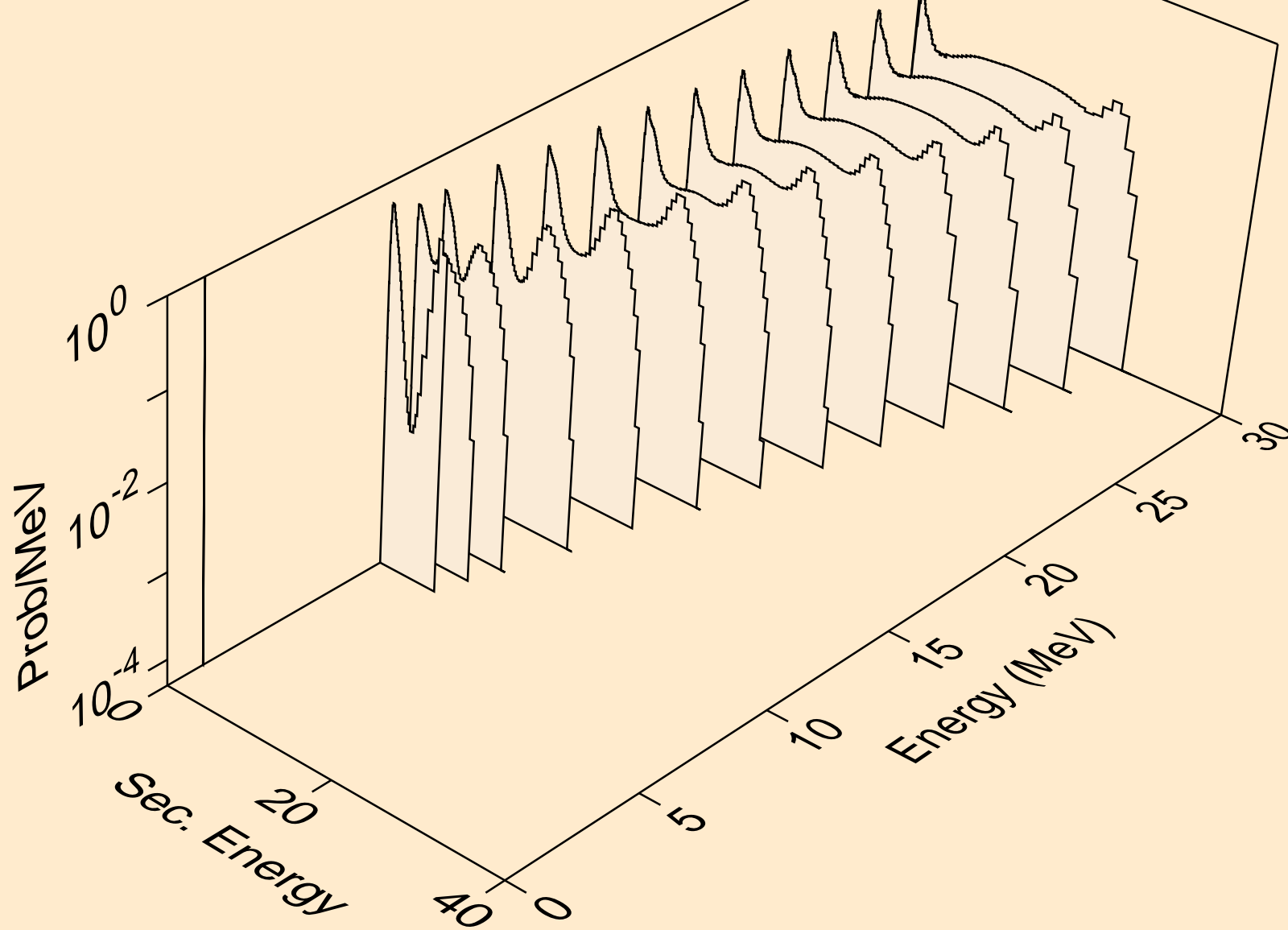

NP243 HELION ACER TENDL-2021 LIBRARY; T=0.K  
neutrons from (s,3n)

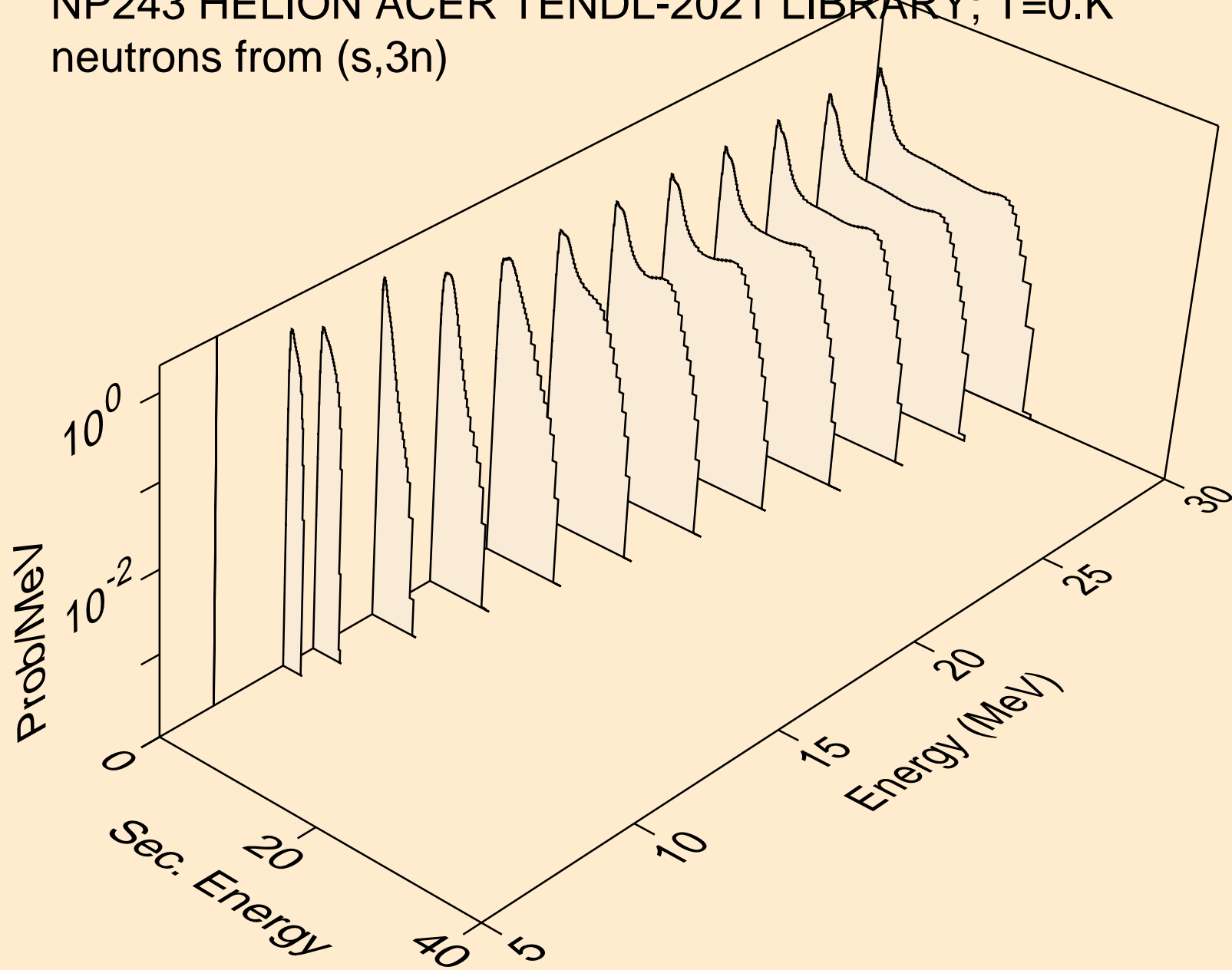

NP243 HELION ACER TENDL-2021 LIBRARY; T=0.K  
neutrons from (s,n\*)a

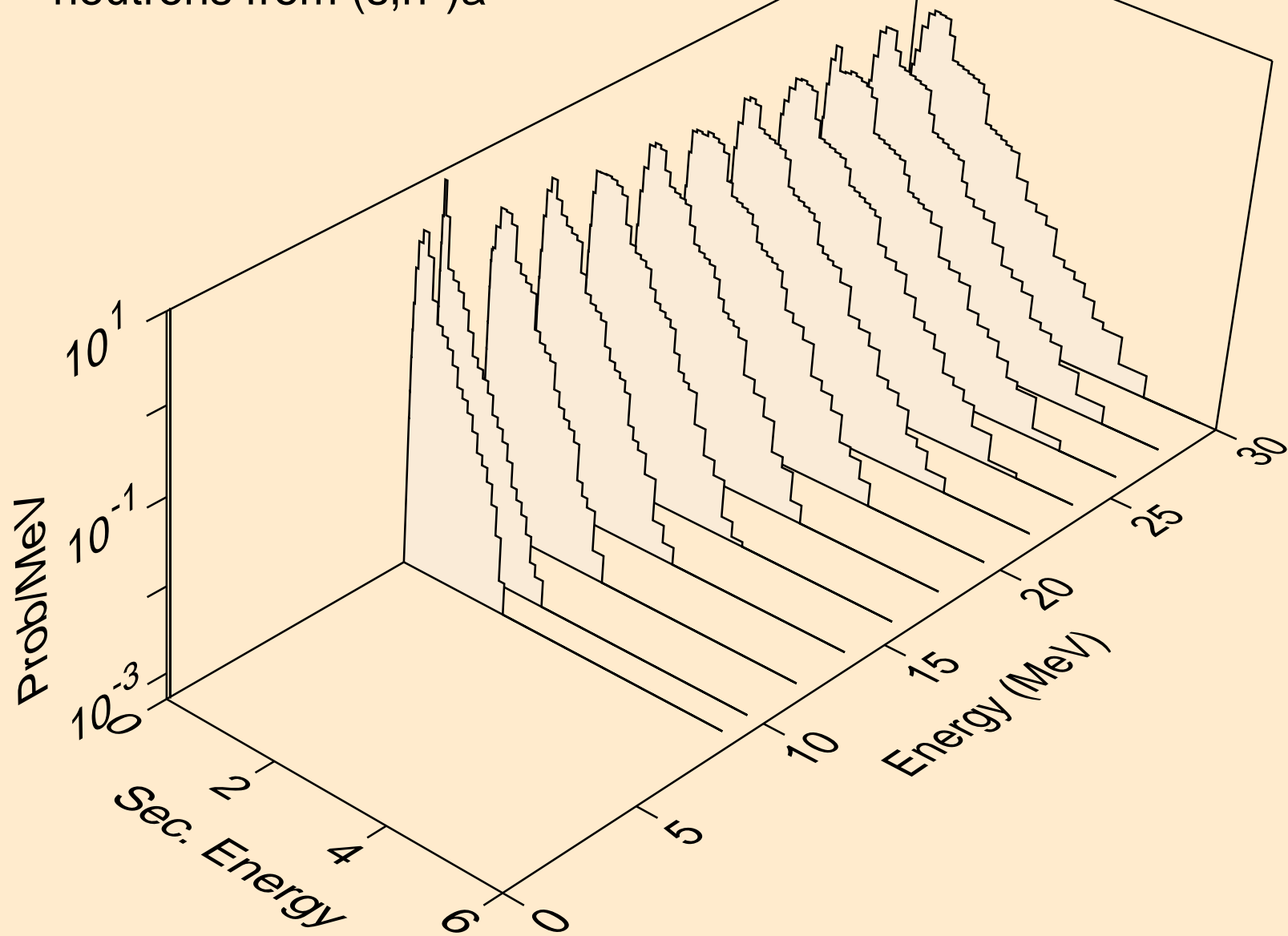

NP243 HELION ACER TENDL-2021 LIBRARY; T=0.K  
neutrons from (s,2n)a

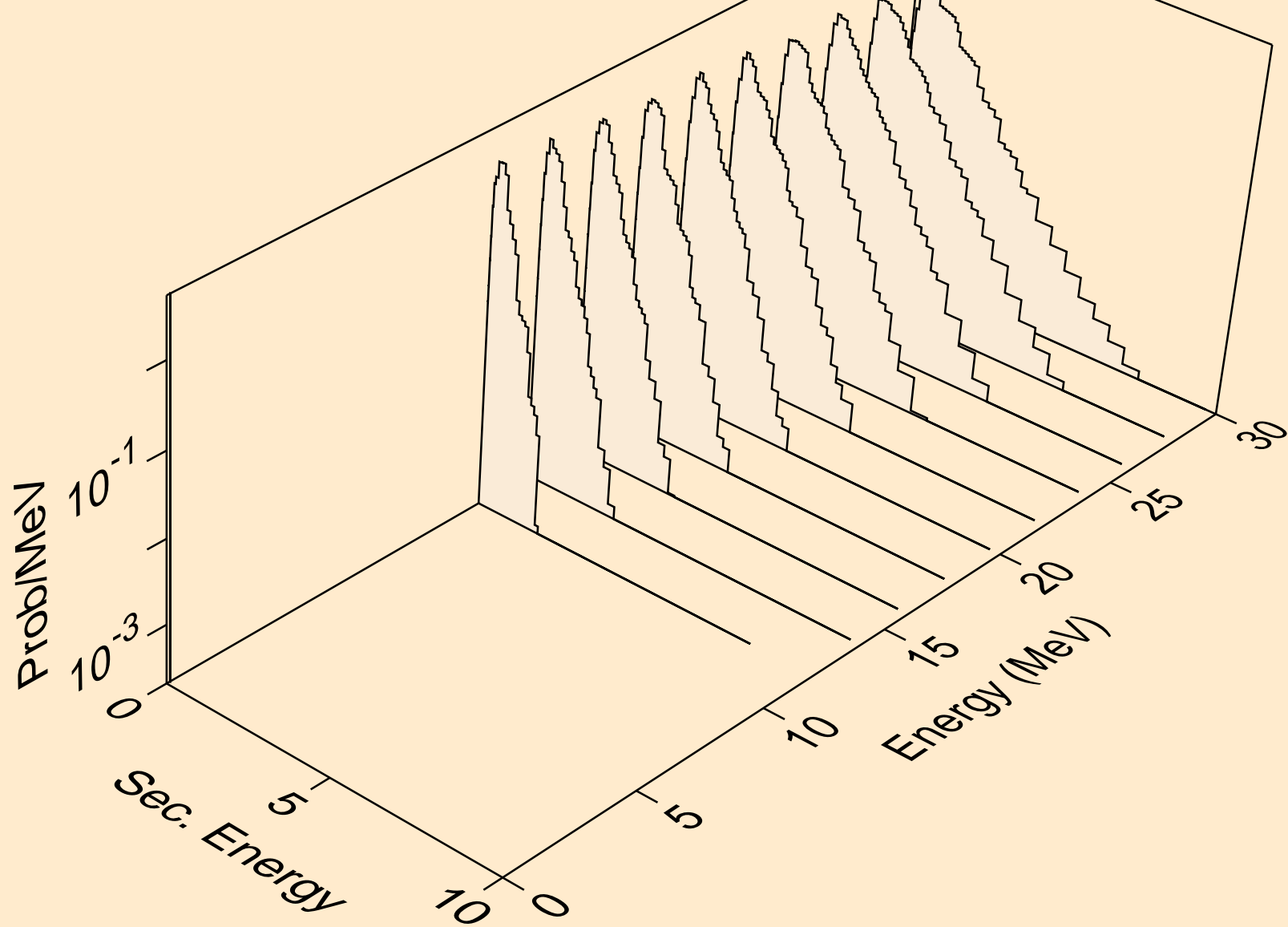



NP243 HELION ACER TENDL-2021 LIBRARY; T=0.K  
neutrons from (s,3n)a

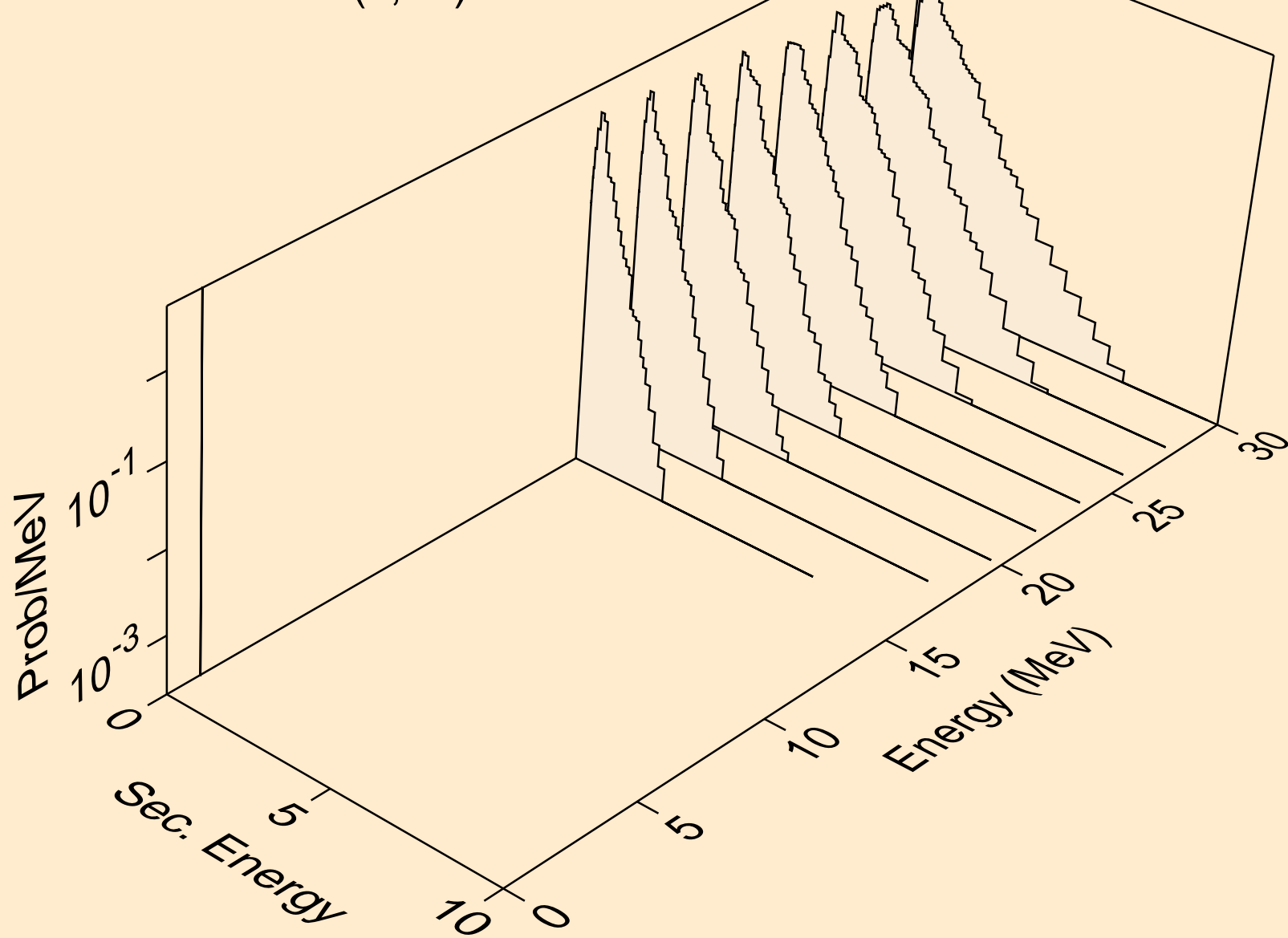

NP243 HELION ACER TENDL-2021 LIBRARY; T=0.K  
neutrons from (s,n\*)p

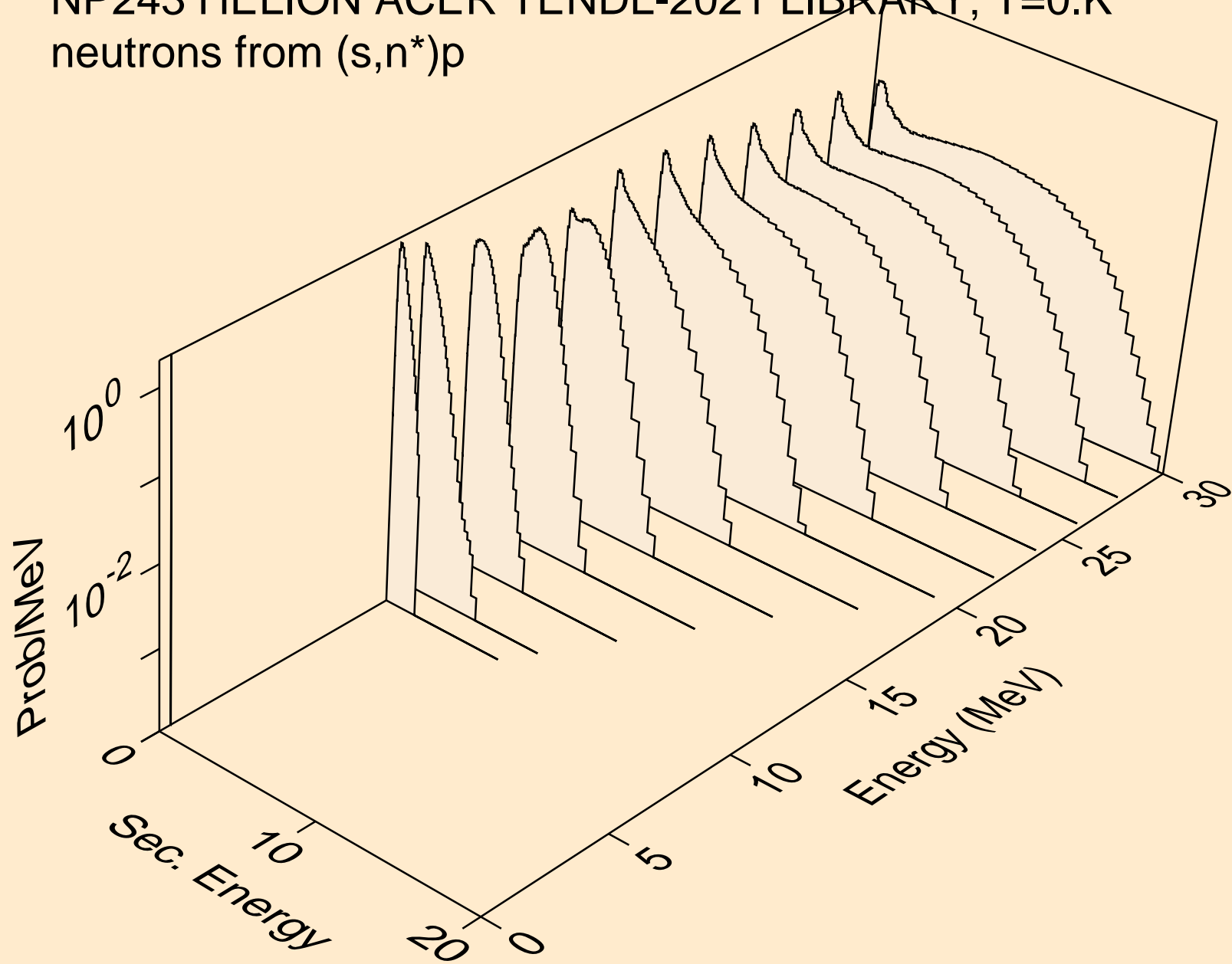

NP243 HELION ACER TENDL-2021 LIBRARY; T=0.K  
neutrons from (s,n\*)d

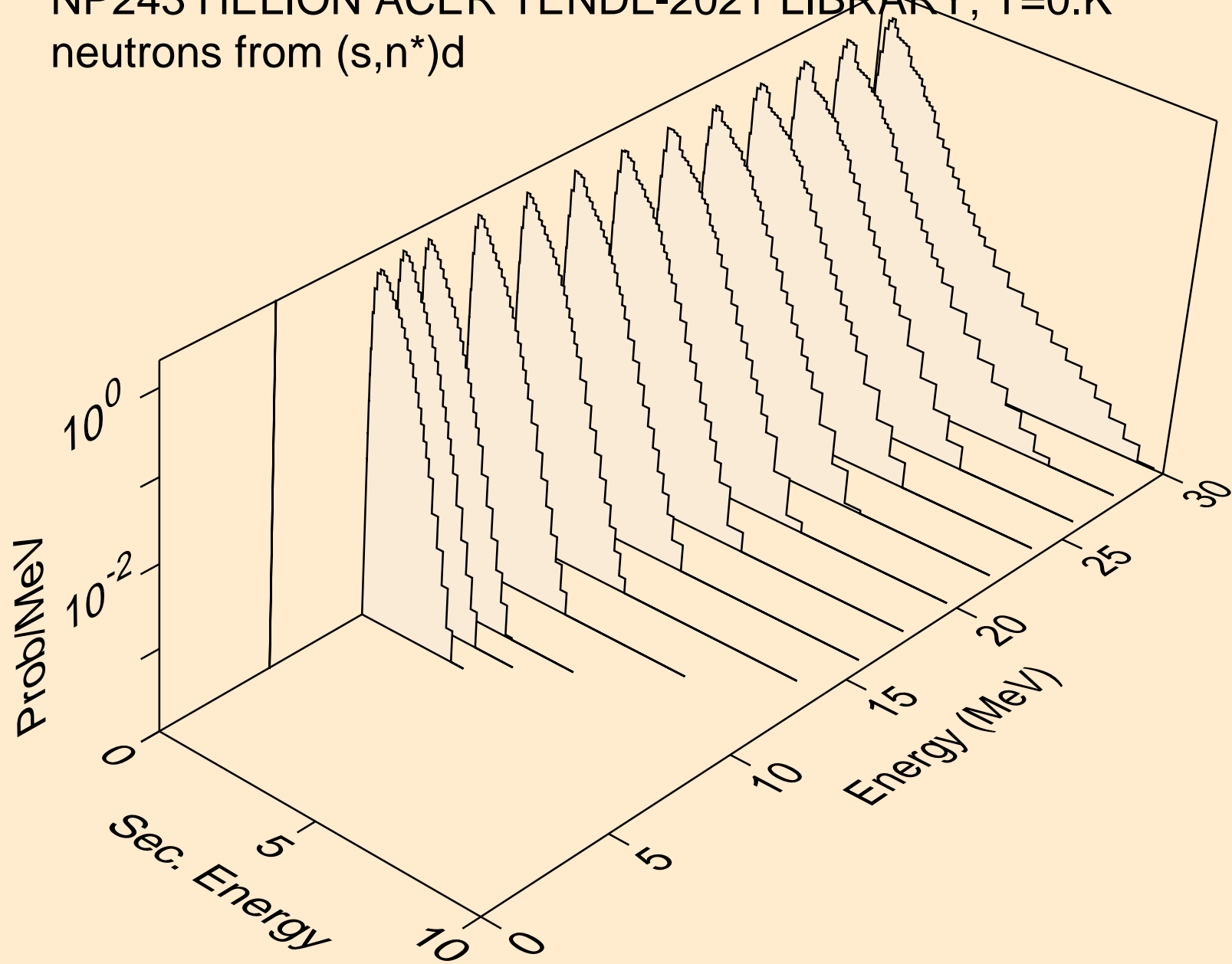

NP243 HELION ACER TENDL-2021 LIBRARY; T=0.K  
neutrons from (s,n\*)t

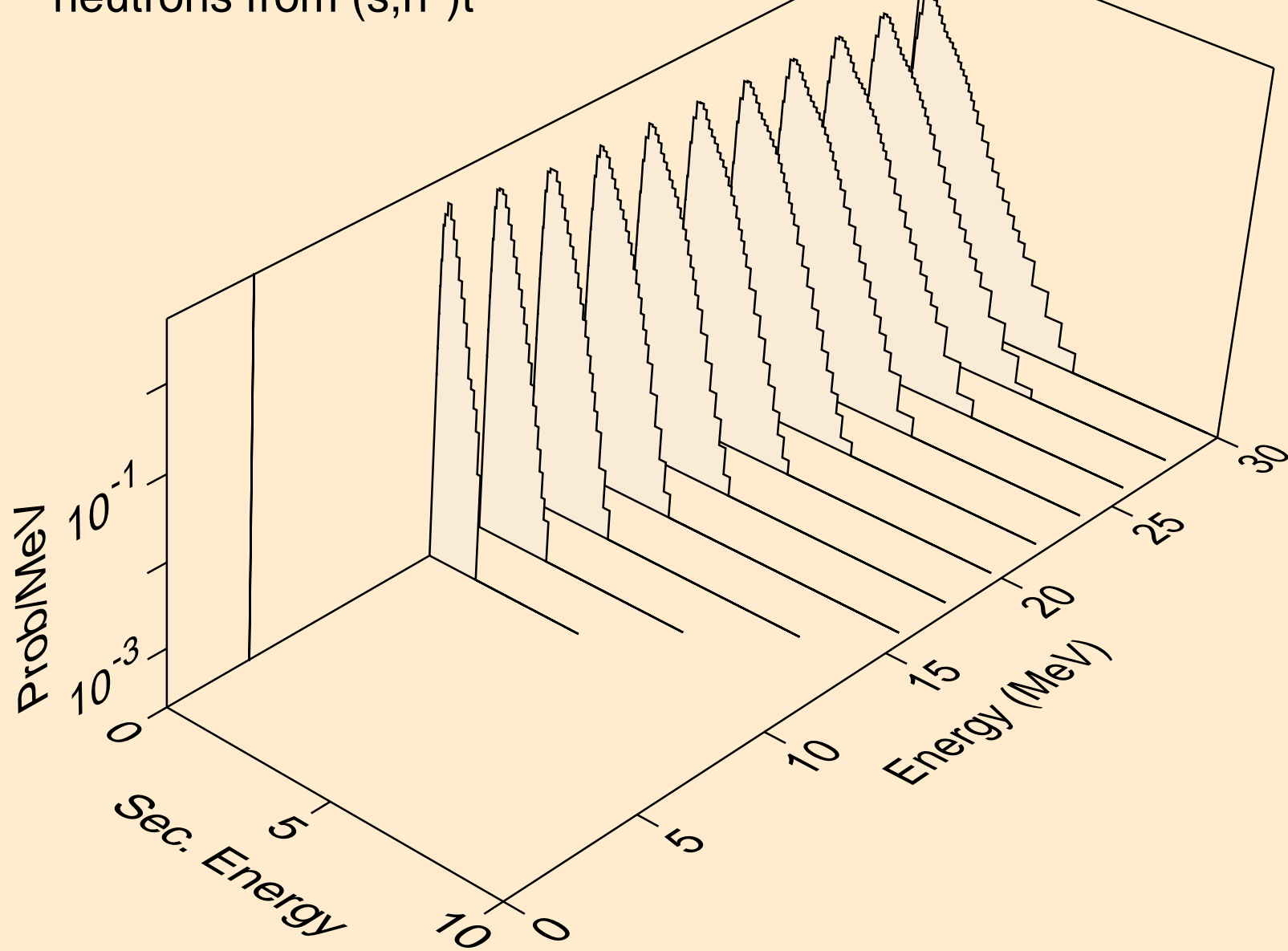

NP243 HELION ACER TENDL-2021 LIBRARY; T=0.K  
neutrons from (s,n\*)he3

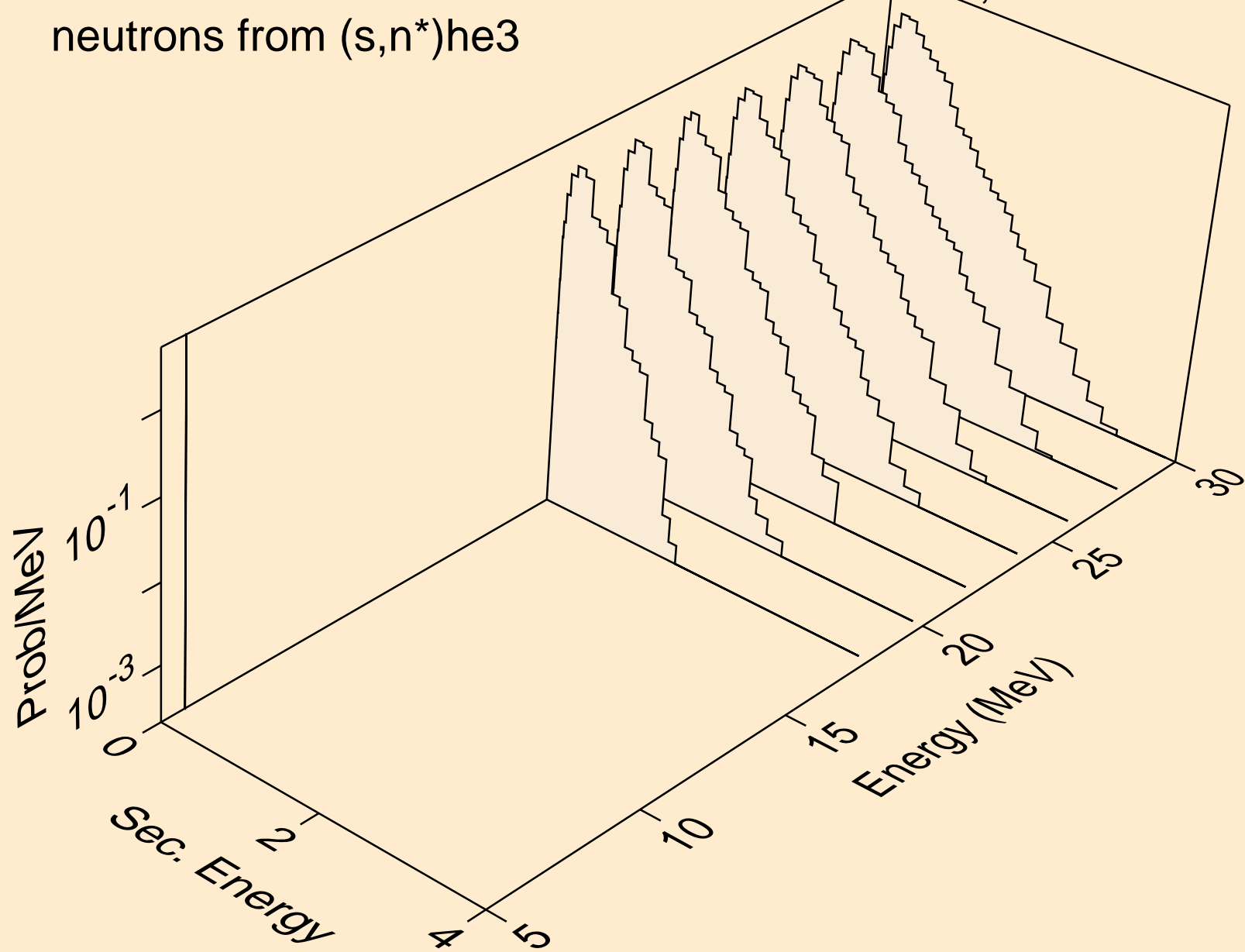

NP243 HELION ACER TENDL-2021 LIBRARY; T=0.K  
neutrons from (s,4n)

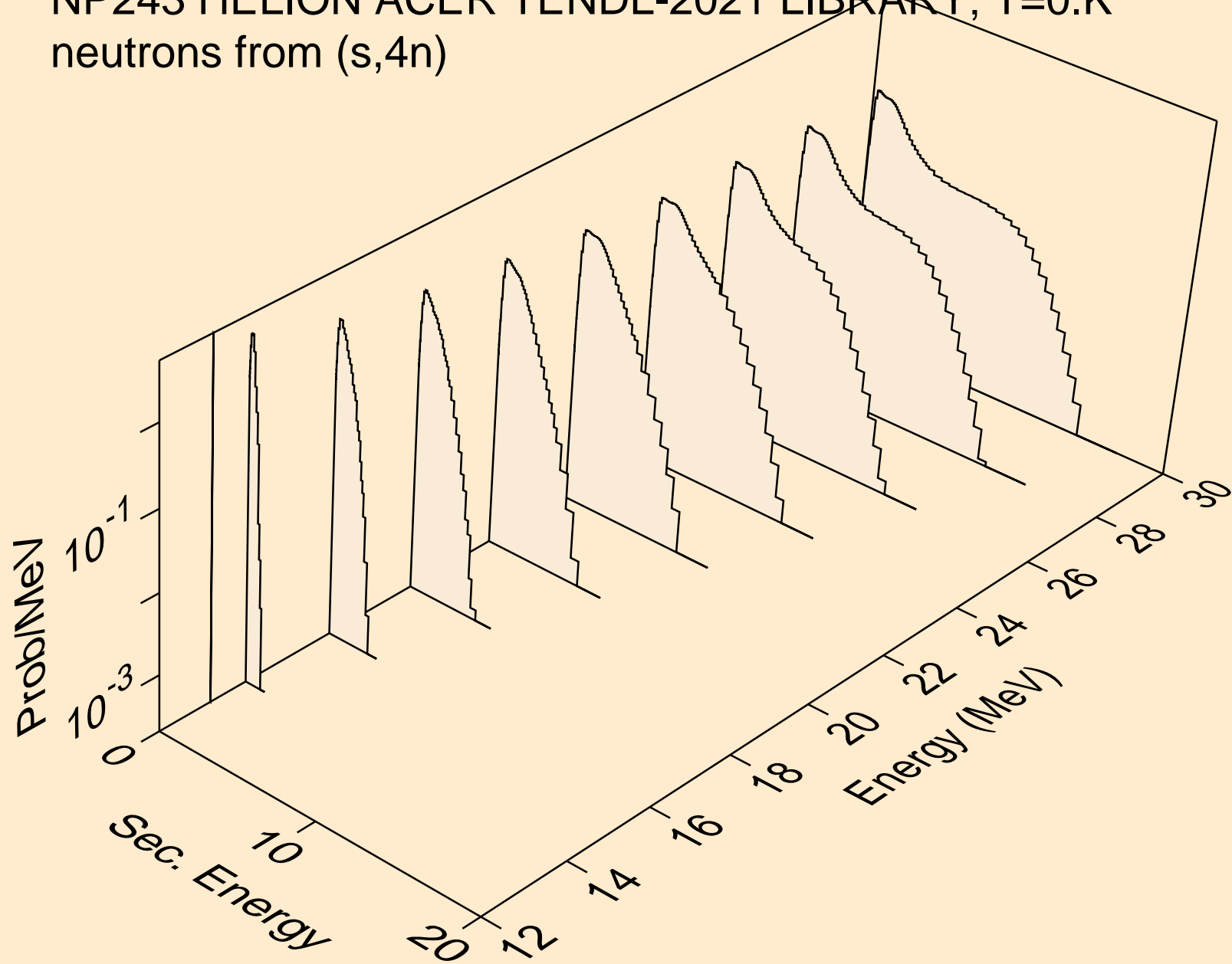

NP243 HELION ACER TENDL-2021 LIBRARY; T=0.K  
neutrons from (s,2np)

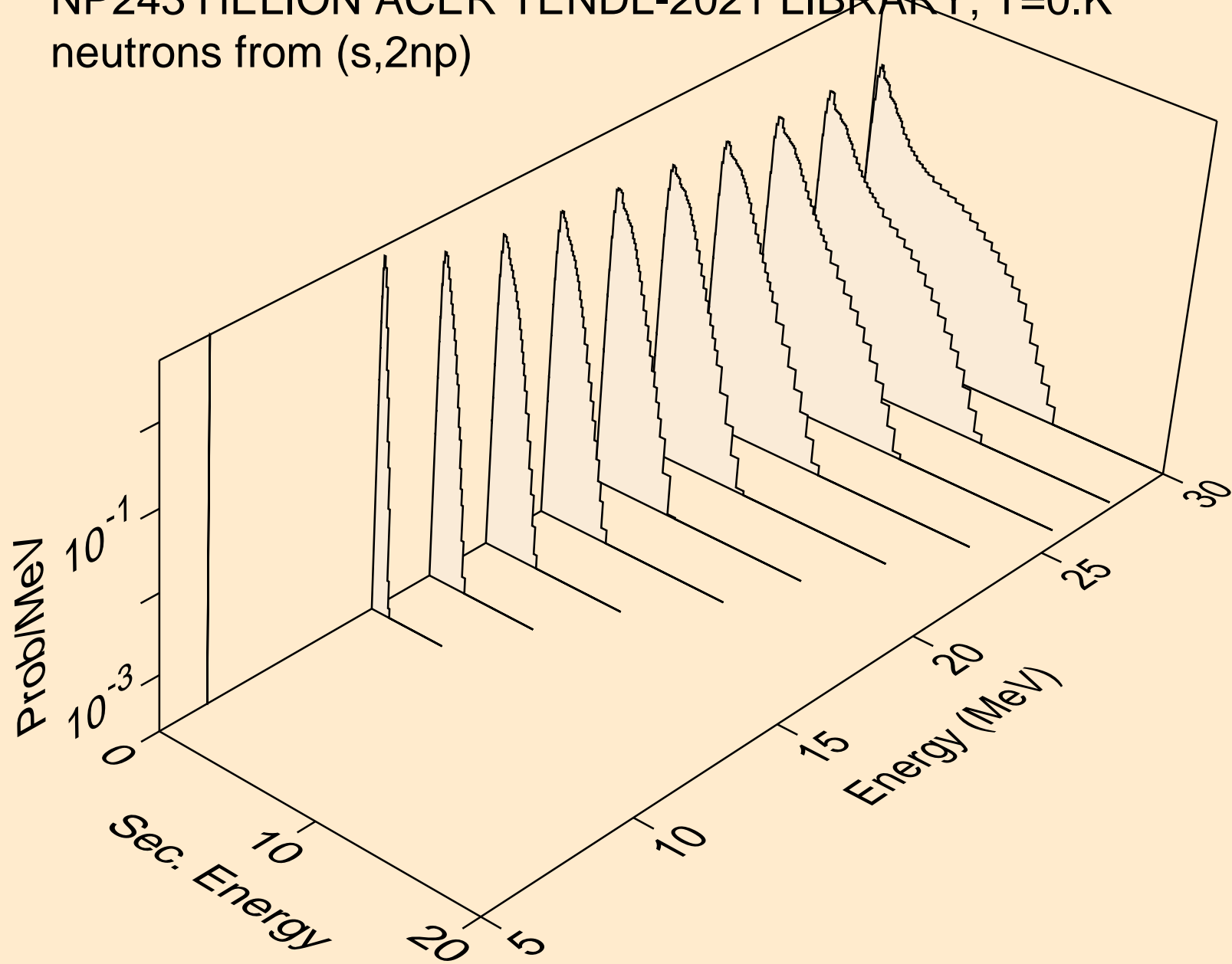

NP243 HELION ACER TENDL-2021 LIBRARY; T=0.K  
neutrons from (s,3np)

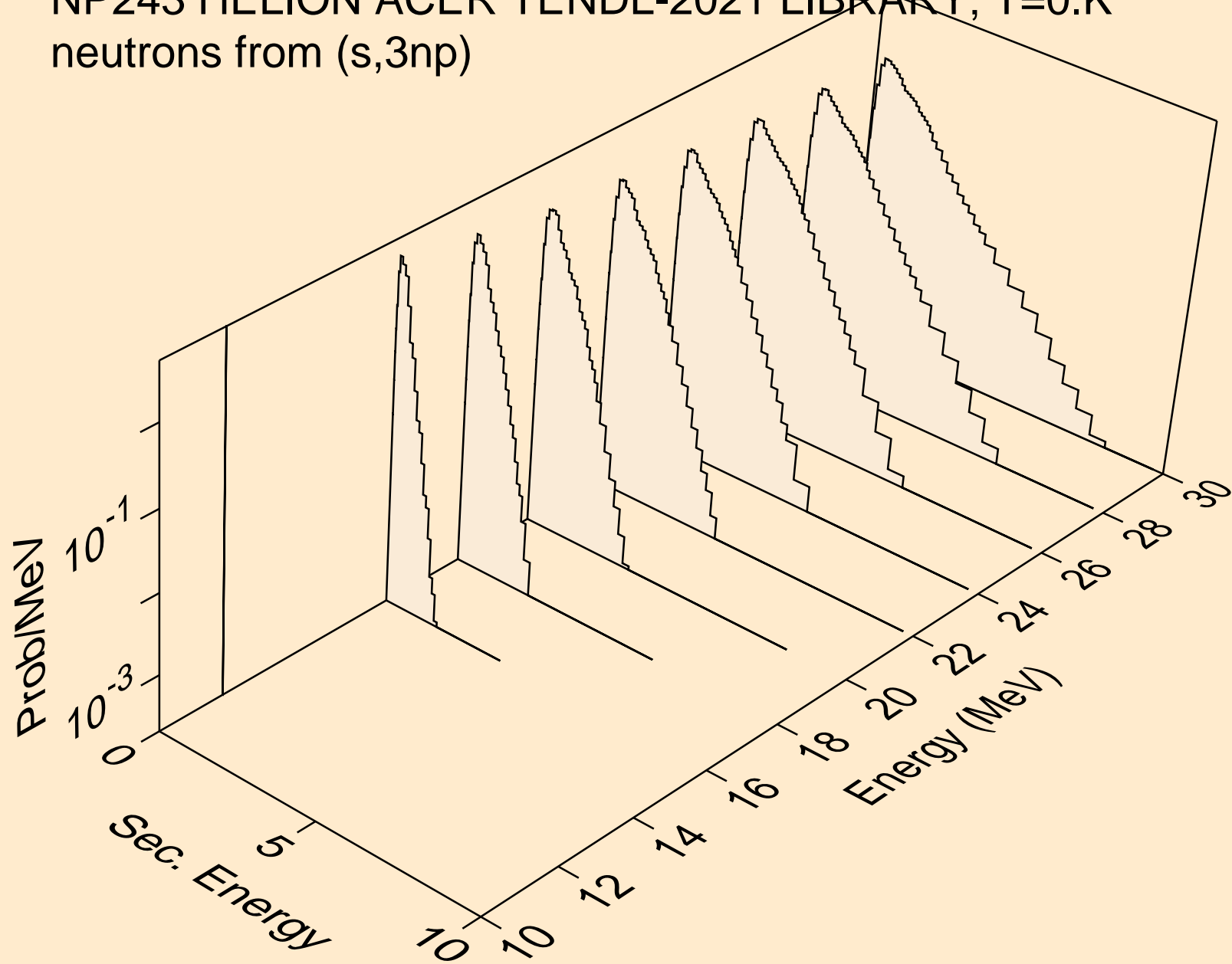



NP243 HELION ACER TENDL-2021 LIBRARY; T=0.K  
neutrons from (s,2np)

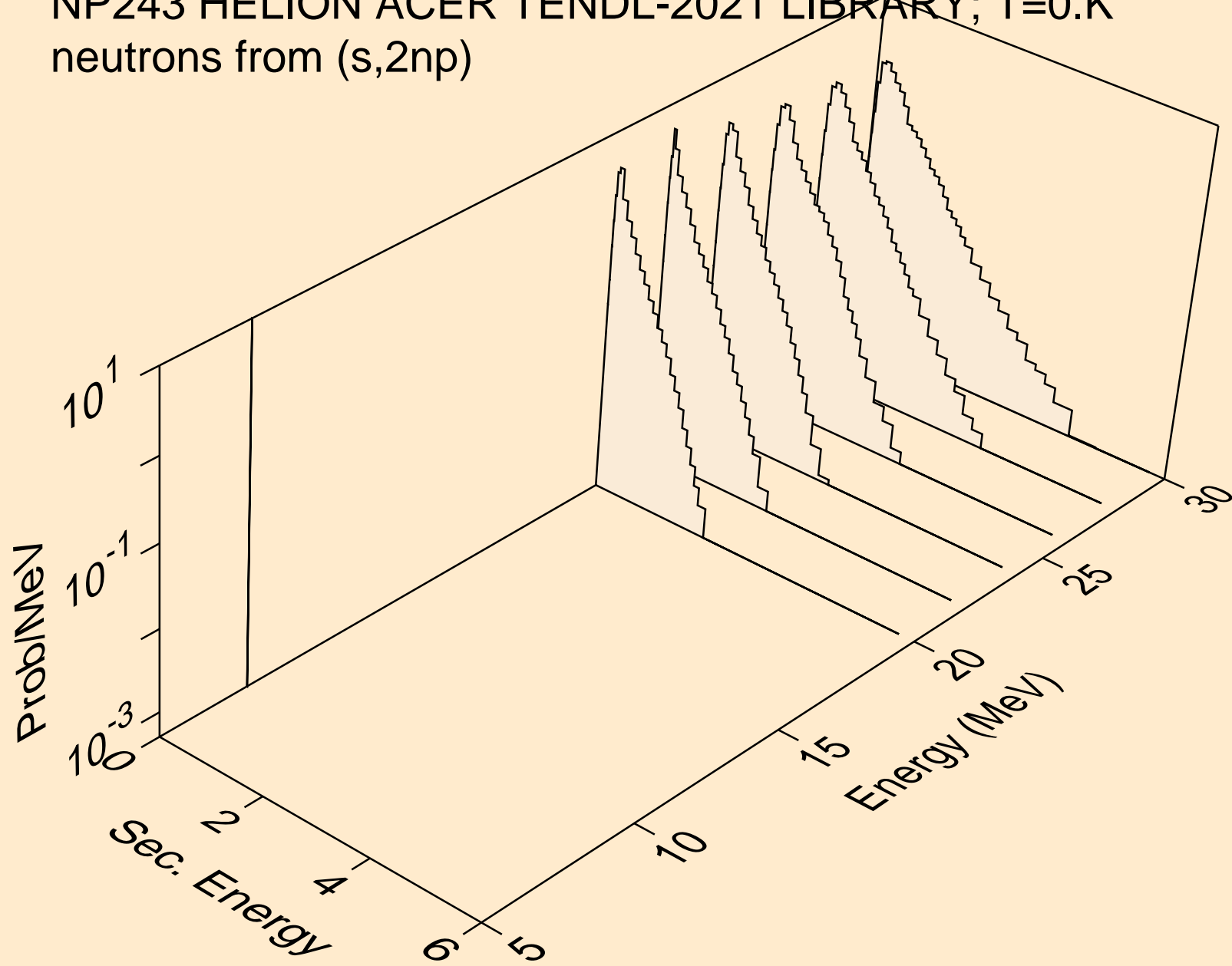

NP243 HELION ACER TENDL-2021 LIBRARY; T=0.K  
protons from (s,x)

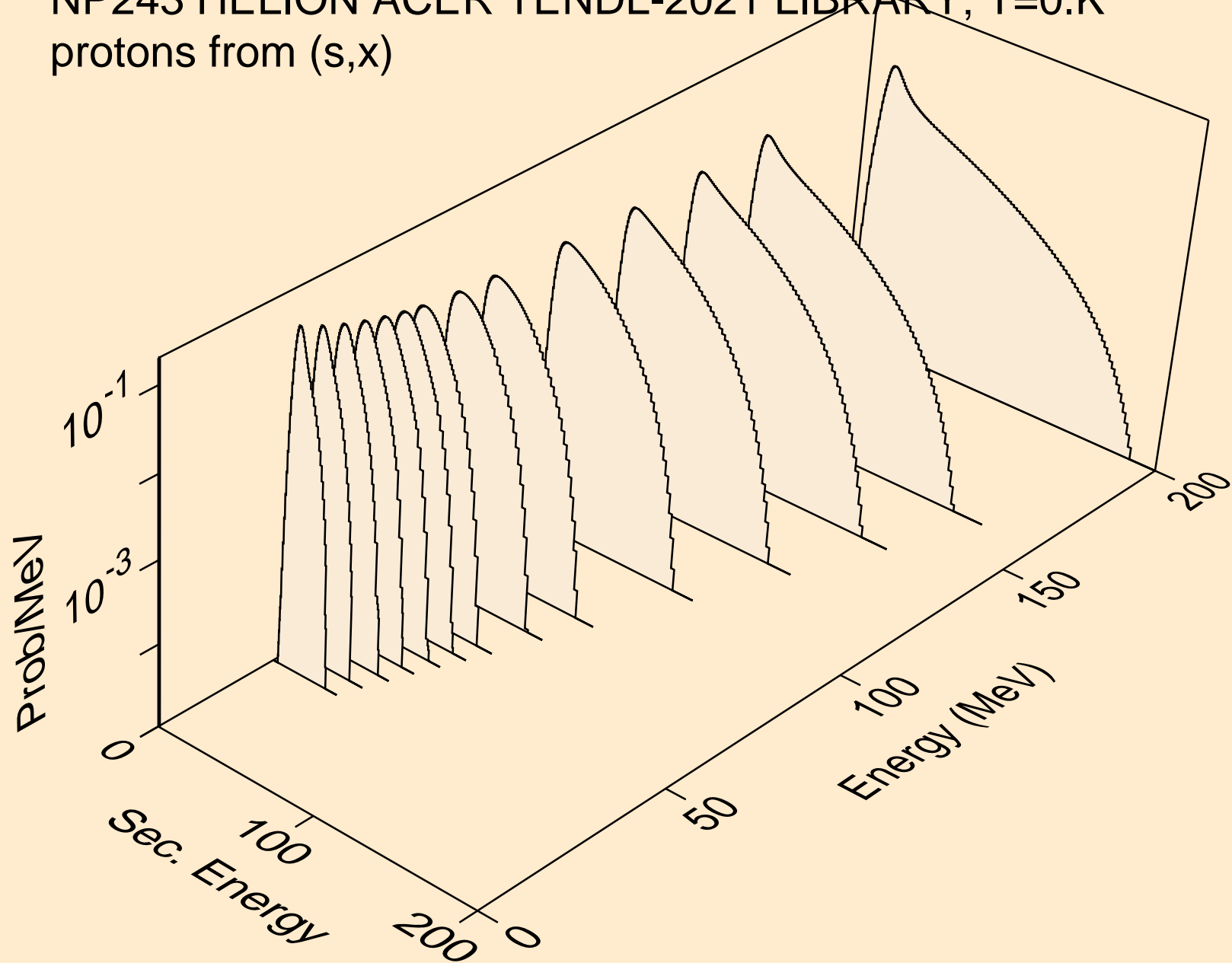

NP243 HELION ACER TENDL-2021 LIBRARY; T=0.K  
protons from (s,n\*)p

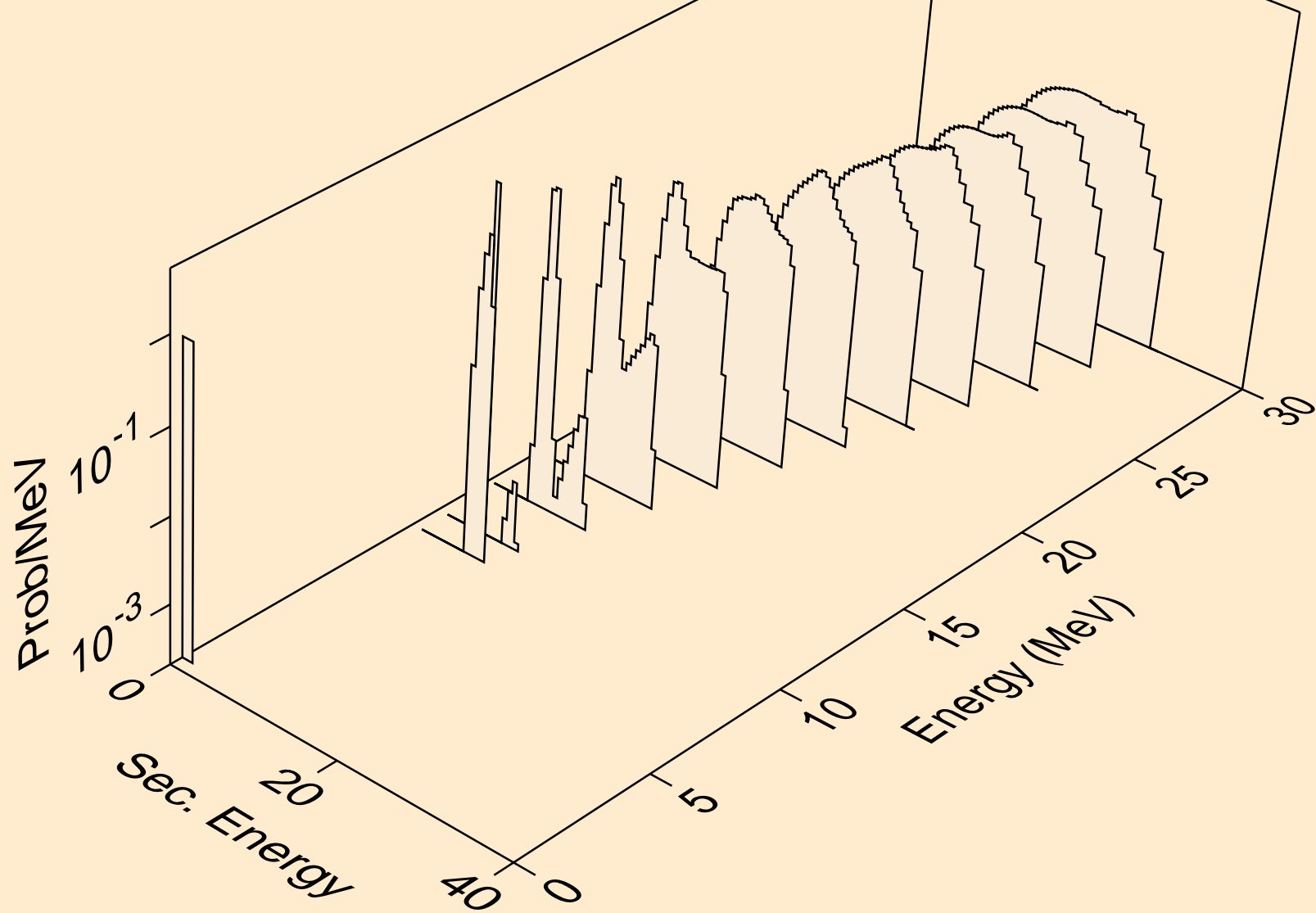

NP243 HELION ACER TENDL-2021 LIBRARY; T=0.K  
protons from (s,2np)

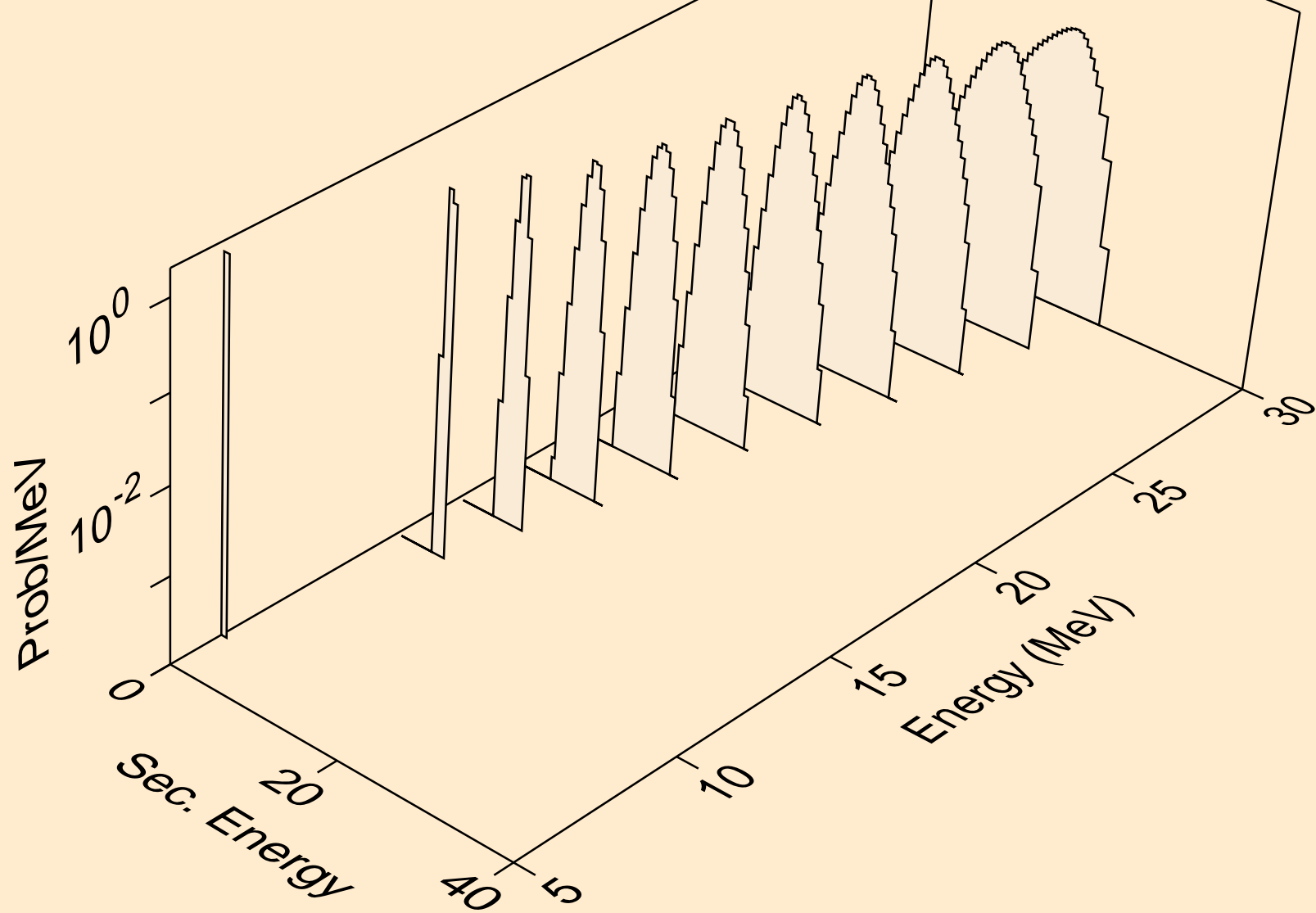

NP243 HELION ACER TENDL-2021 LIBRARY; T=0.K  
protons from (s,3np)

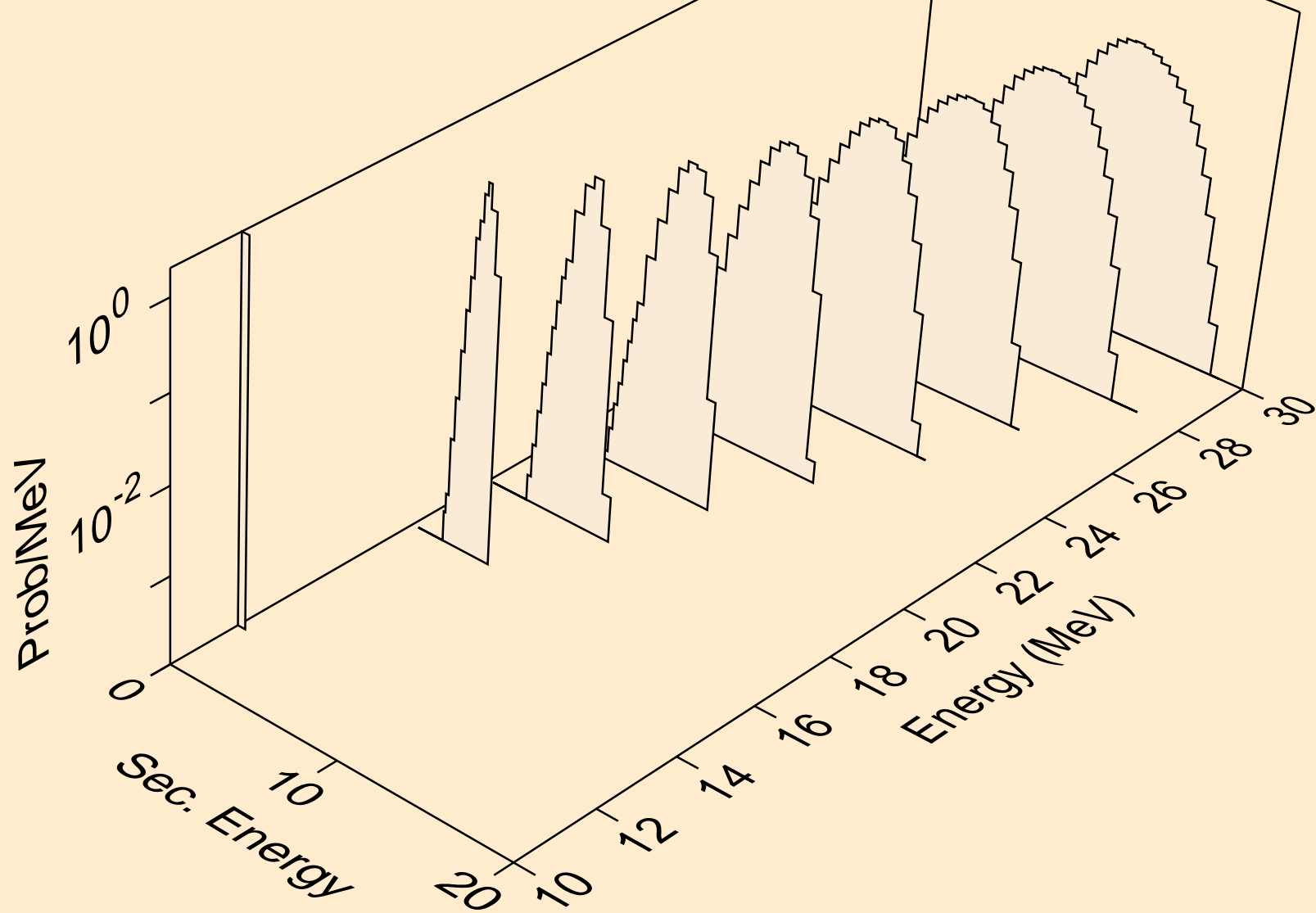

NP243 HELION ACER TENDL-2021 LIBRARY; T=0.K  
protons from (s,2np)

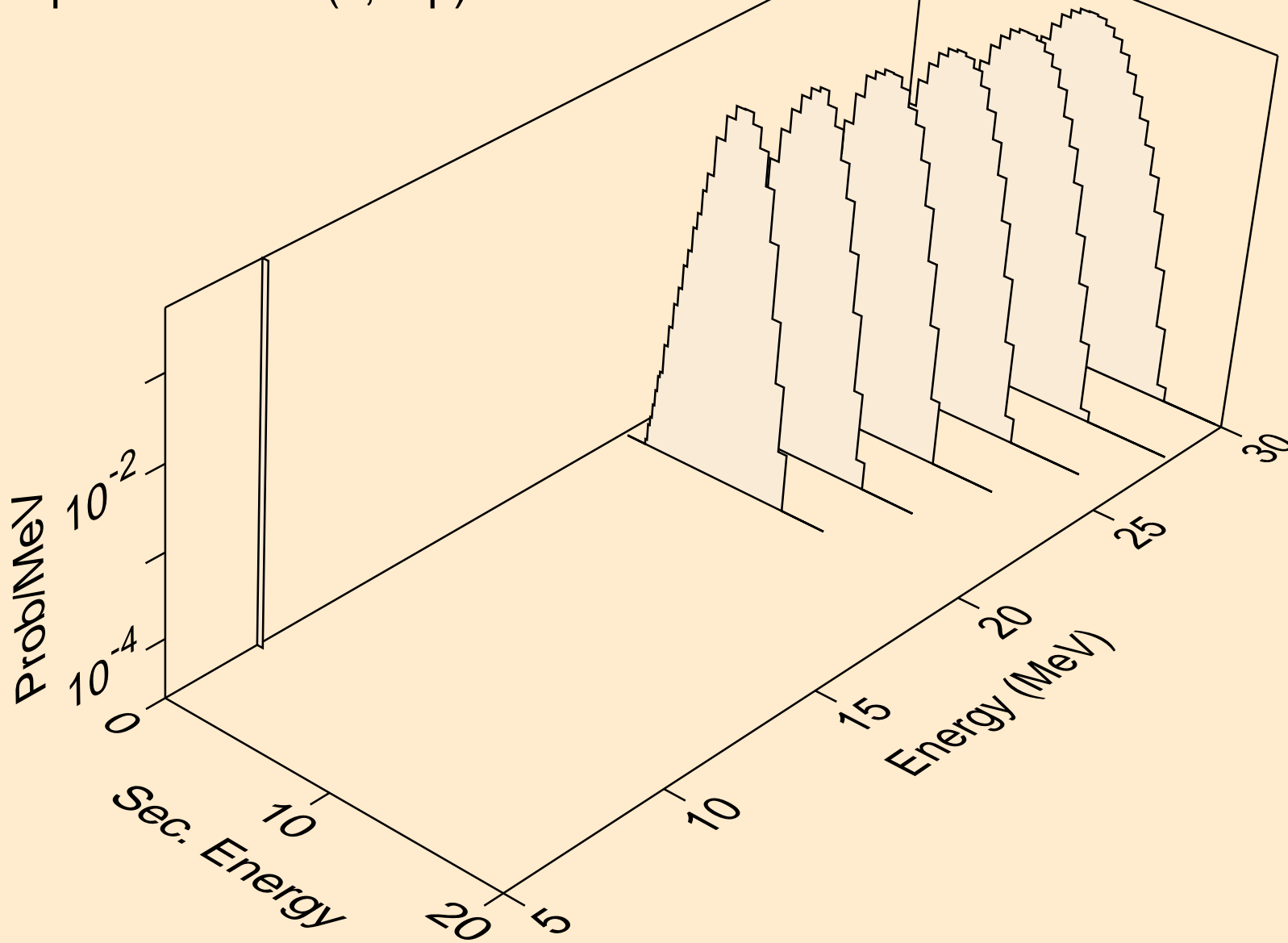

NP243 HELION ACER TENDL-2021 LIBRARY; T=0.K  
protons from (s,p)

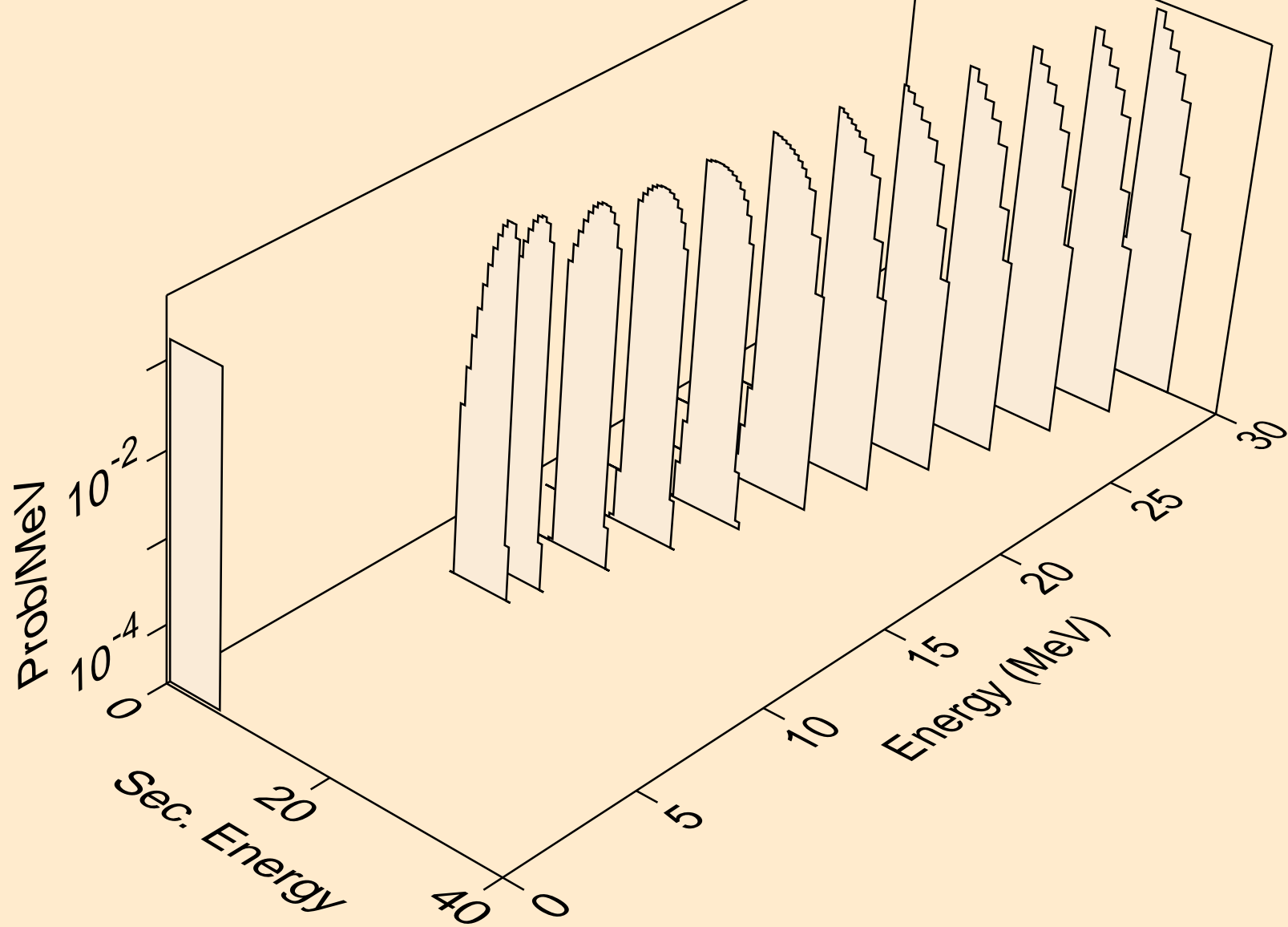

NP243 HELION ACER TENDL-2021 LIBRARY; T=0.K  
protons from (s,2p)

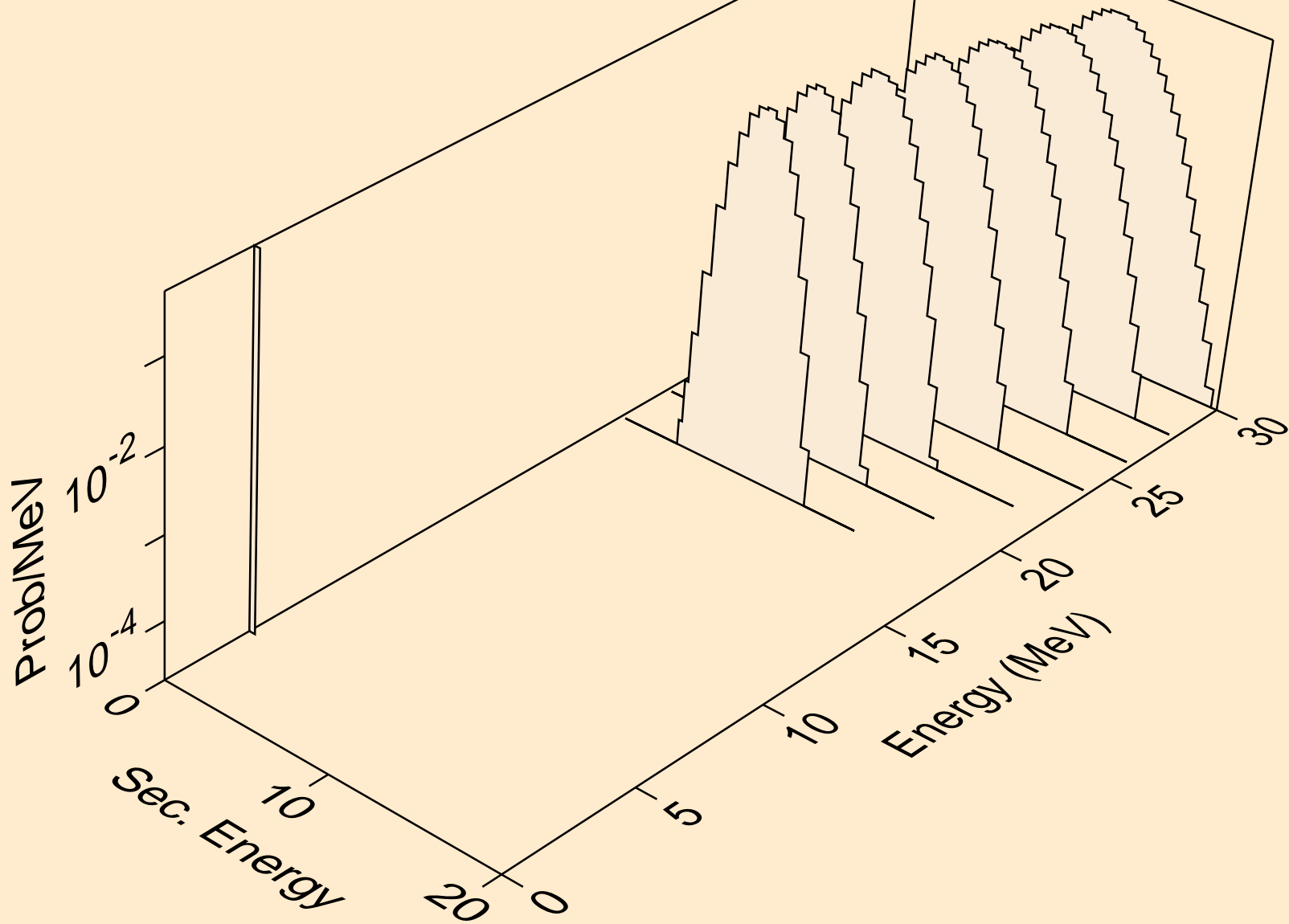



NP243 HELION ACER TENDL-2021 LIBRARY; T=0.K  
protons from (s,pd)

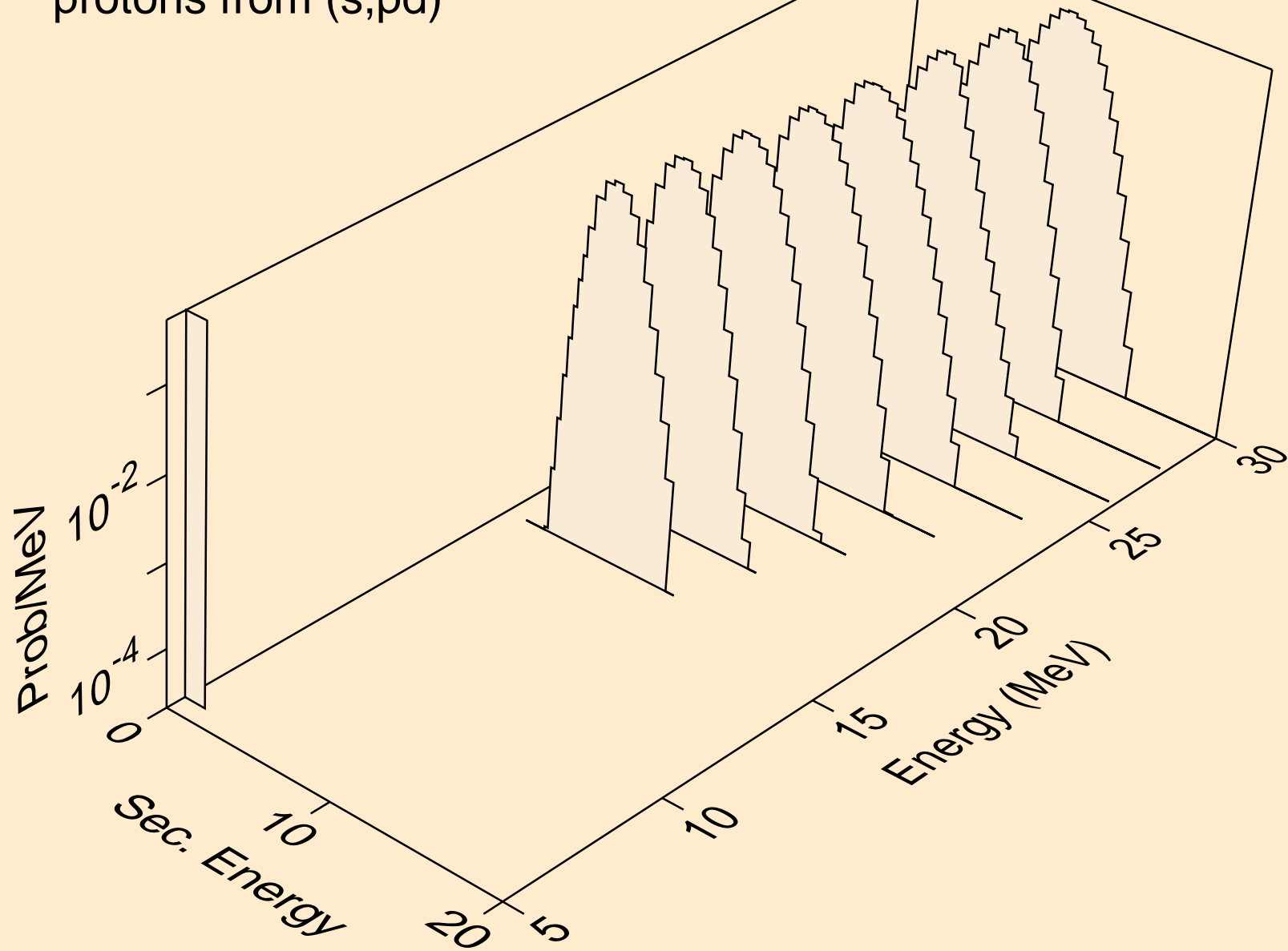

NP243 HELION ACER TENDL-2021 LIBRARY; T=0.K  
deuterons from (s,x)

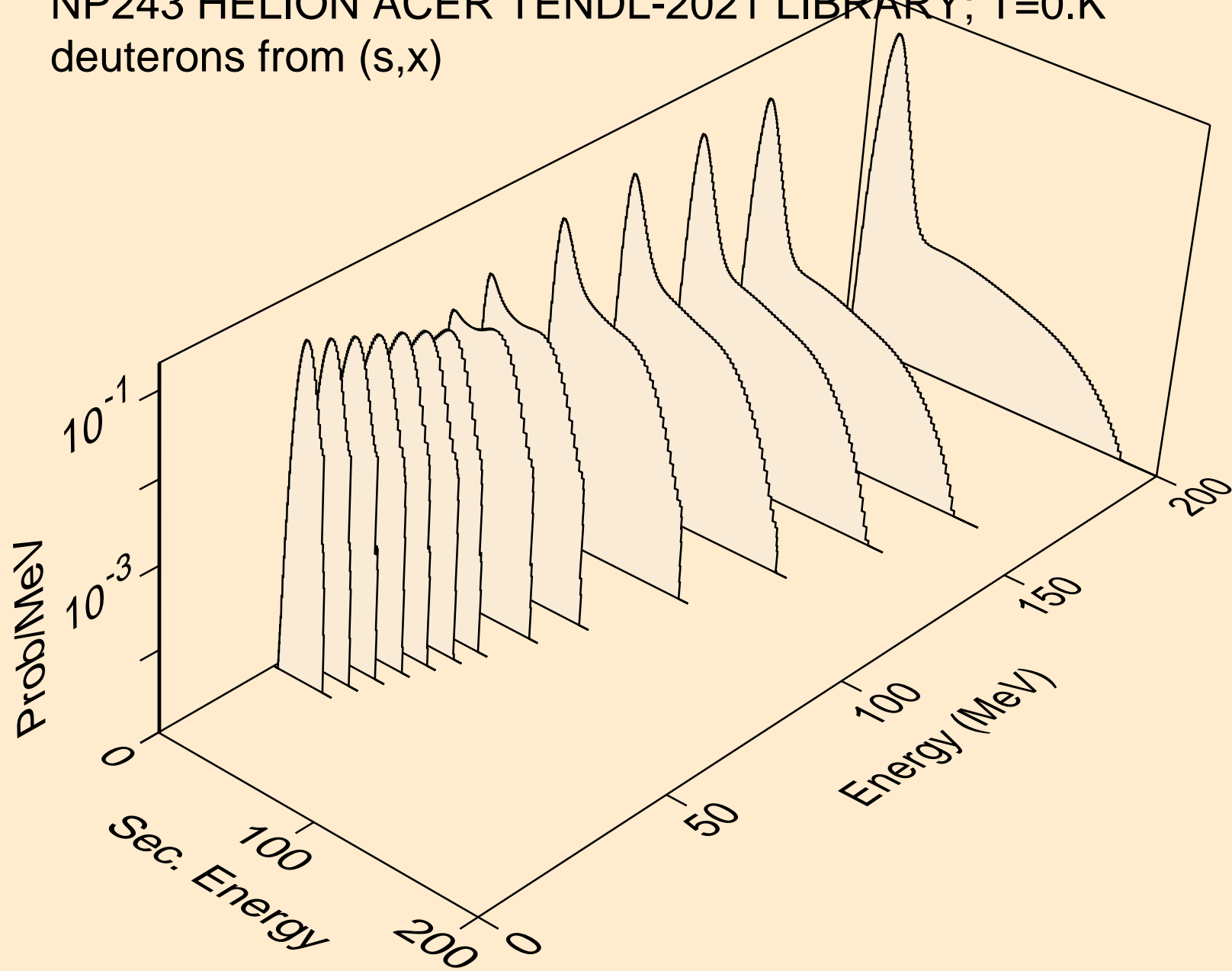

NP243 HELION ACER TENDL-2021 LIBRARY; T=0.K  
deuterons from (s,2nd)

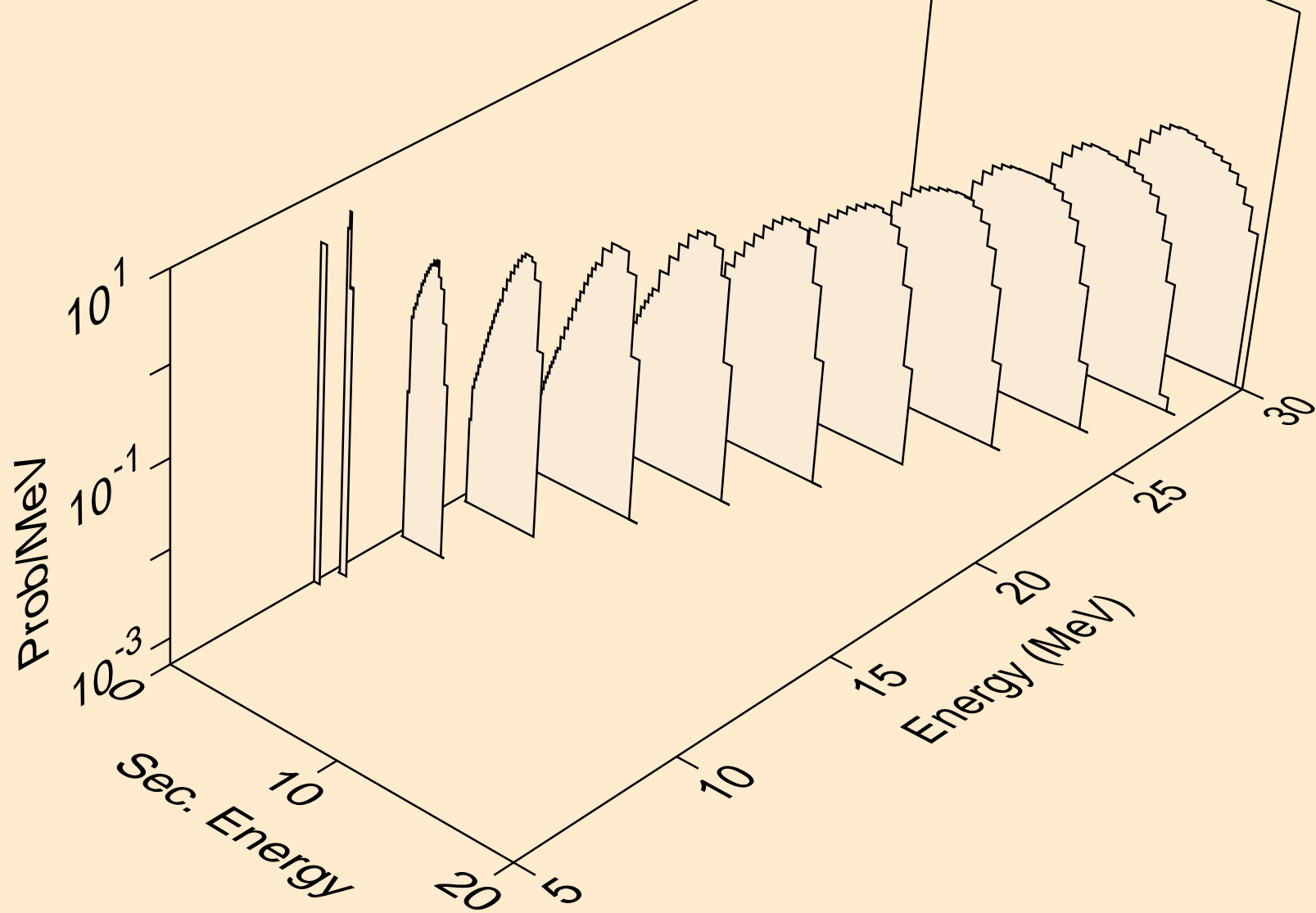

NP243 HELION ACER TENDL-2021 LIBRARY; T=0.K  
deuterons from (s,n\*)d

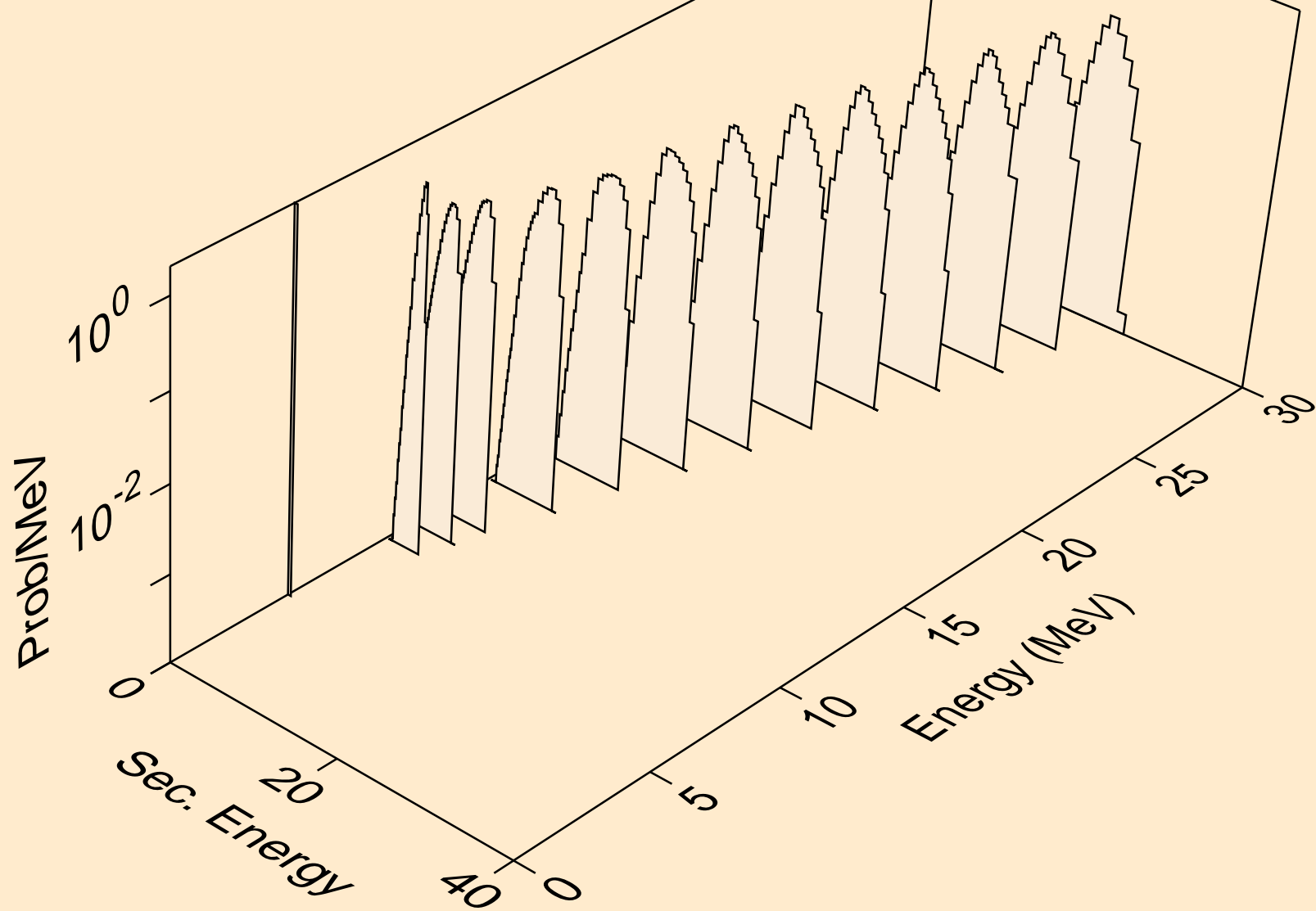

NP243 HELION ACER TENDL-2021 LIBRARY; T=0.K  
deuterons from (s,d)

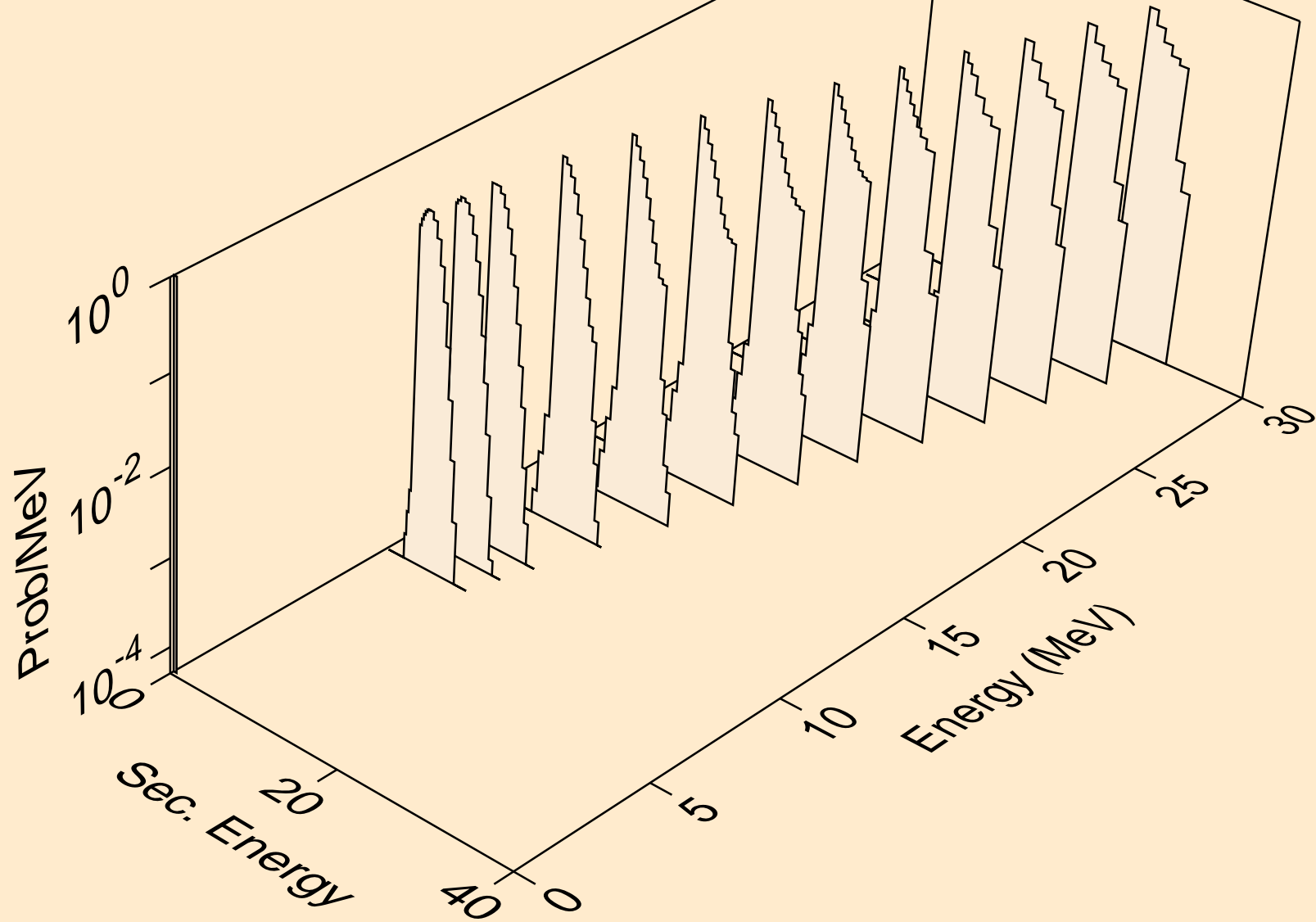

NP243 HELION ACER TENDL-2021 LIBRARY; T=0.K  
deuterons from (s,pd)

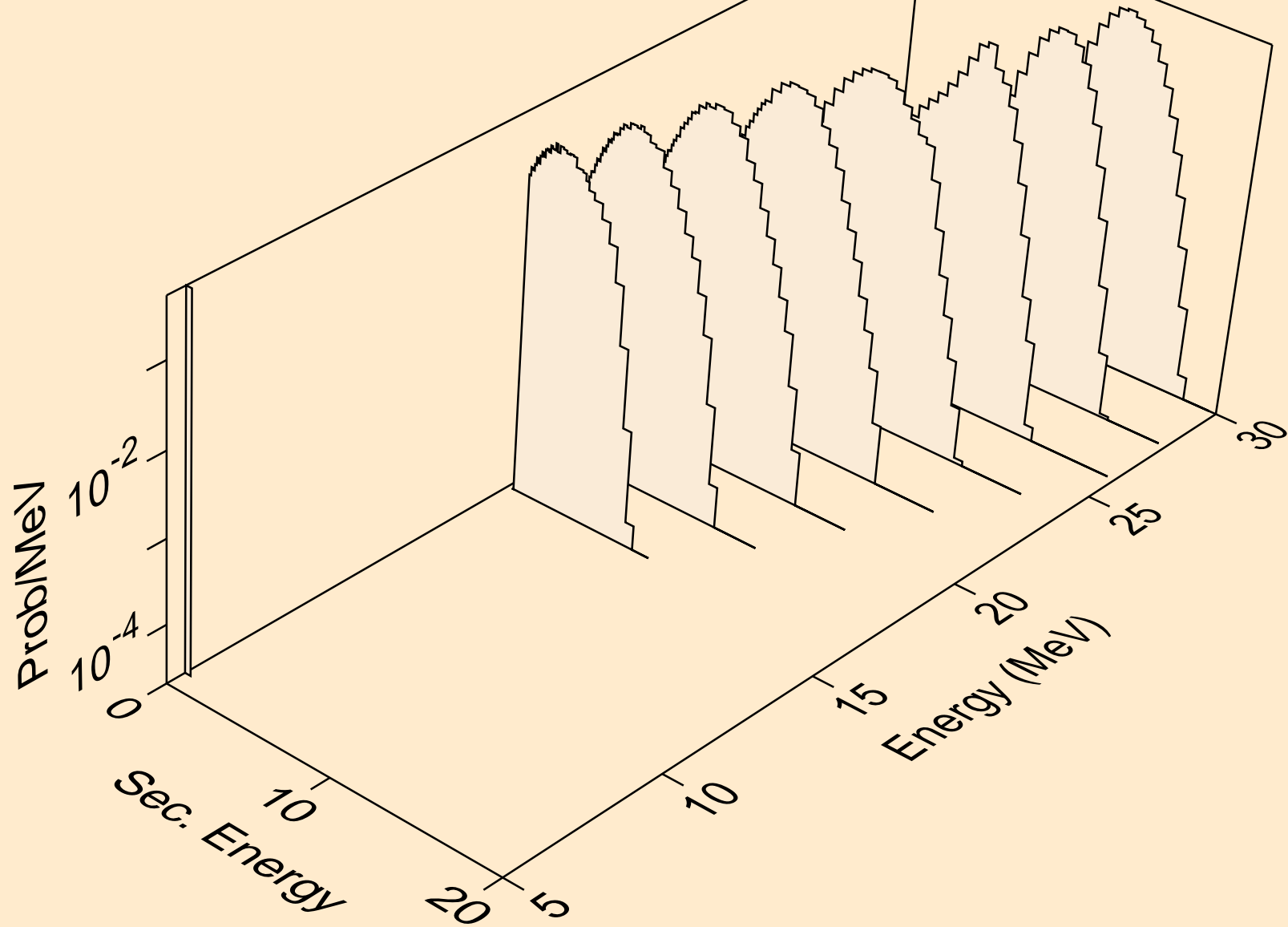

NP243 HELION ACER TENDL-2021 LIBRARY; T=0.K  
tritons from (s,x)

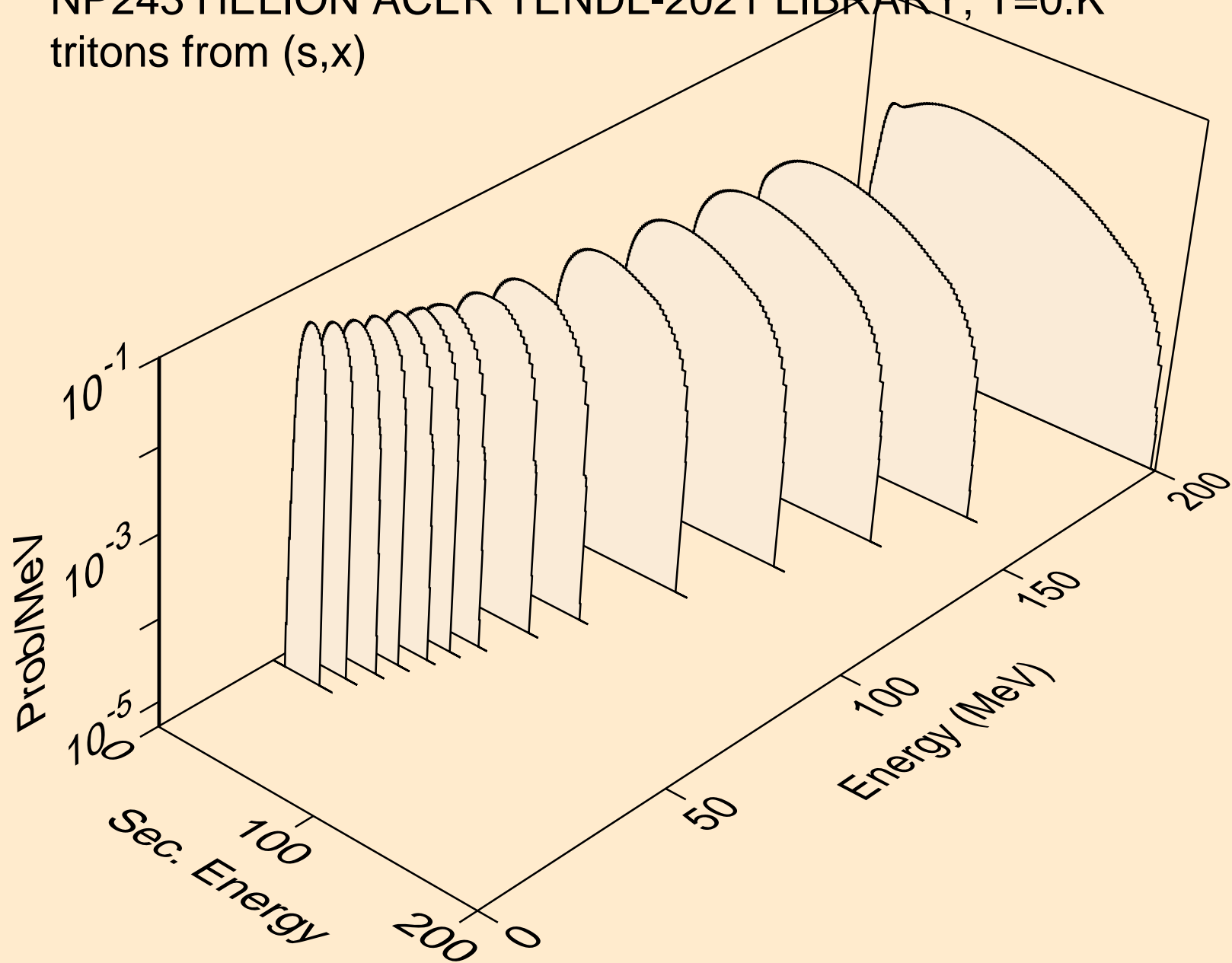

NP243 HELION ACER TENDL-2021 LIBRARY; T=0.K  
tritons from (s,n\*)t

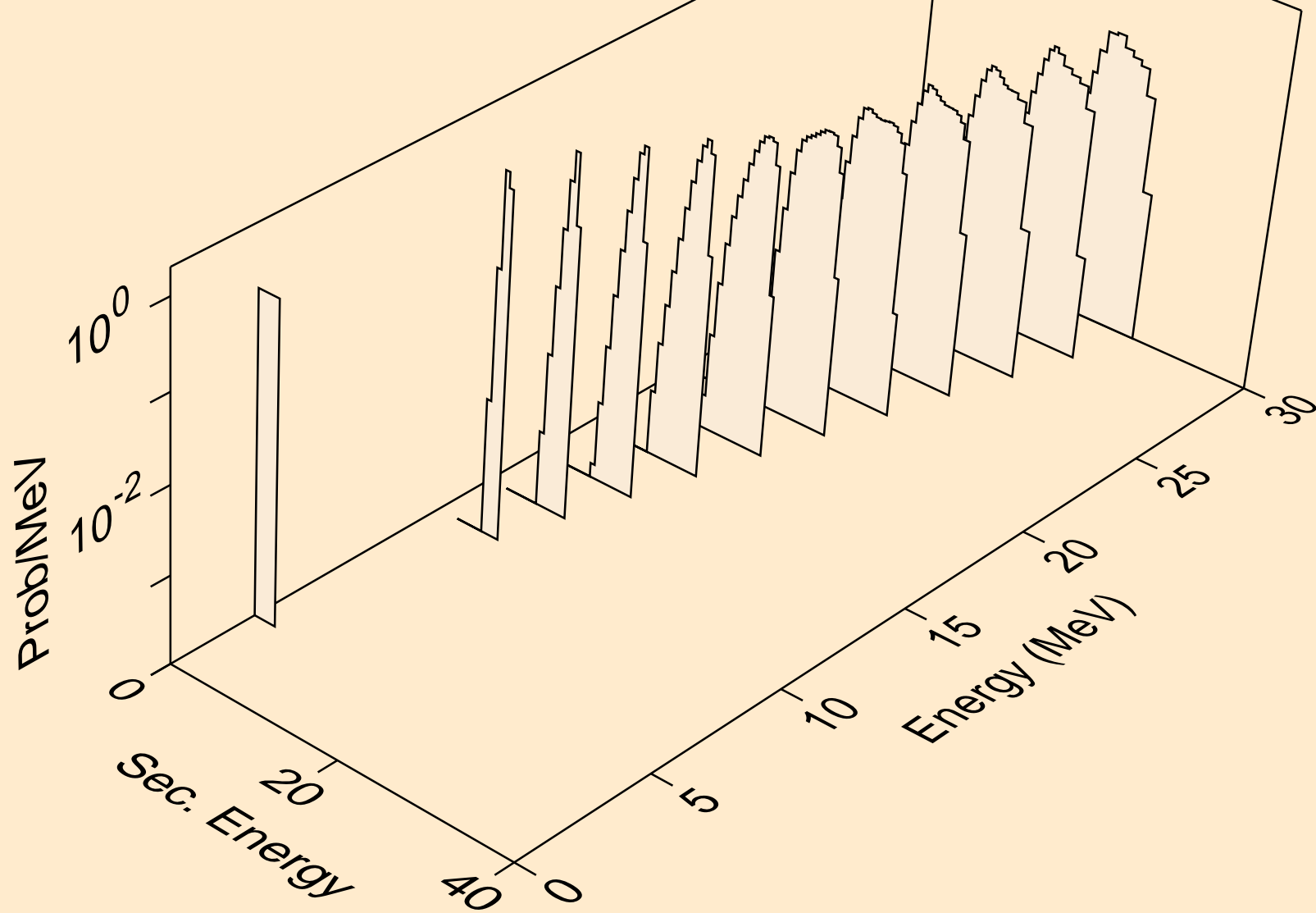



NP243 HELION ACER TENDL-2021 LIBRARY; T=0.K  
tritons from (s,t)

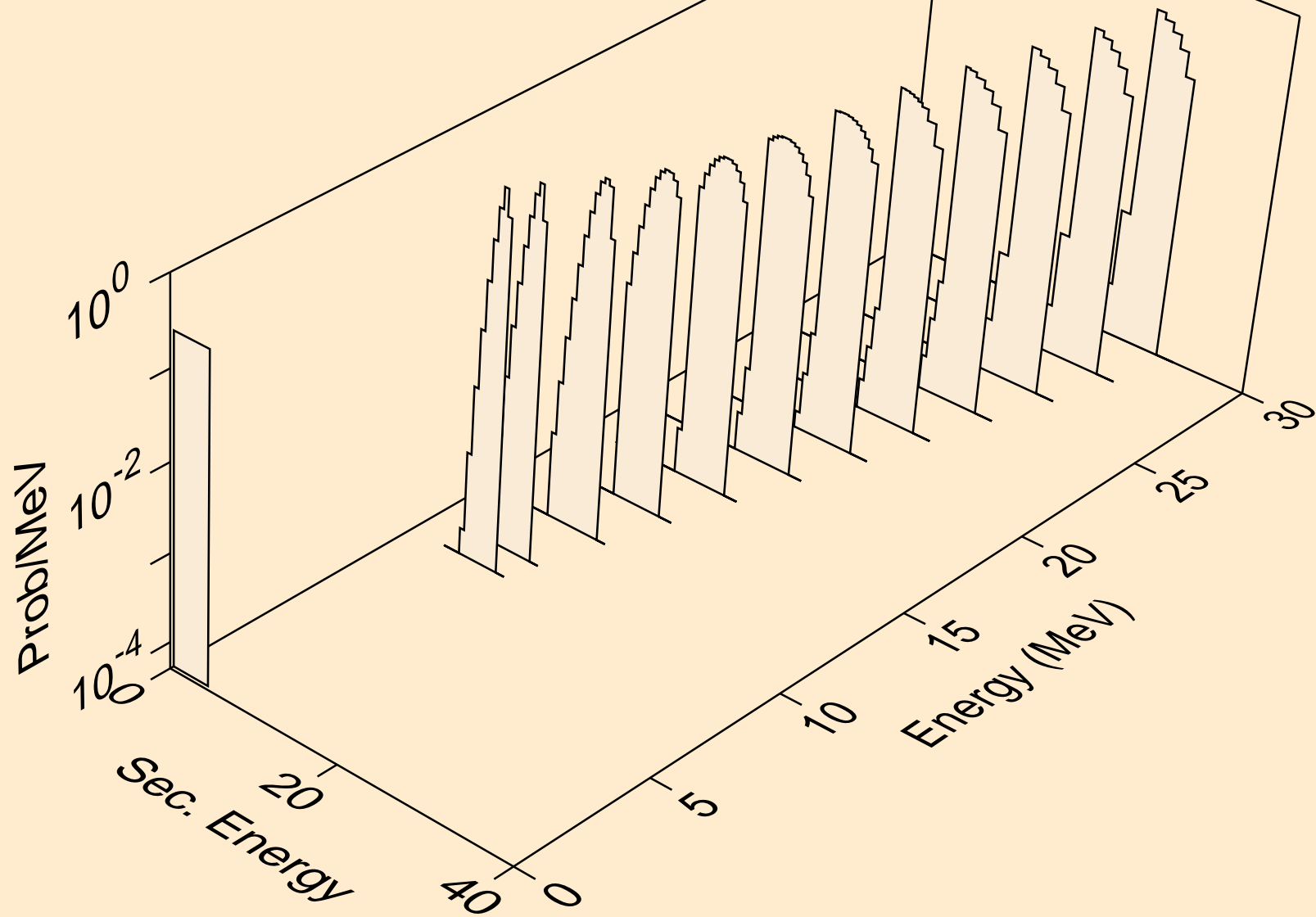

NP243 HELION ACER TENDL-2021 LIBRARY; T=0.K  
alphas from (s,x)

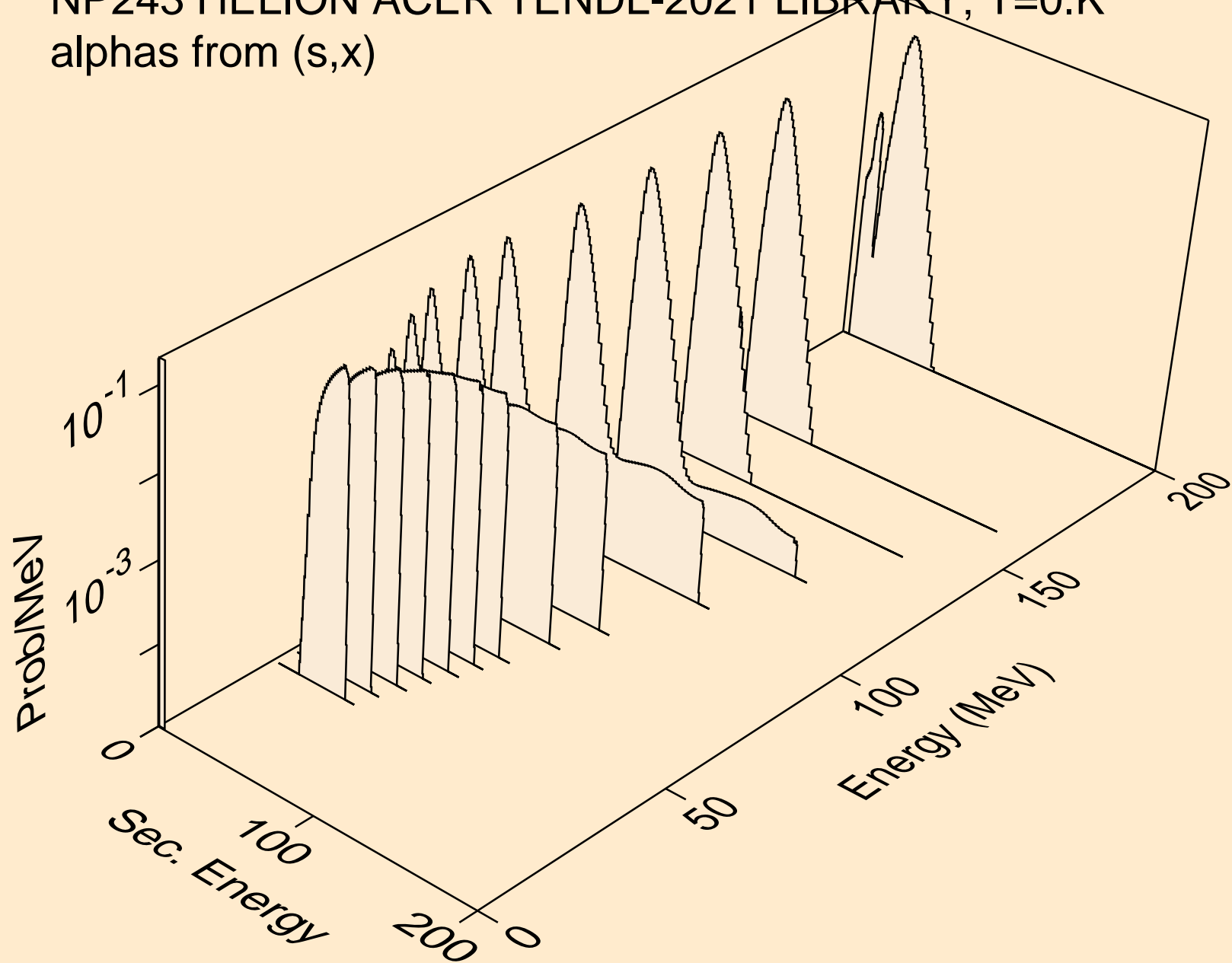

NP243 HELION ACER TENDL-2021 LIBRARY; T=0.K  
alphas from (s,n\*)a

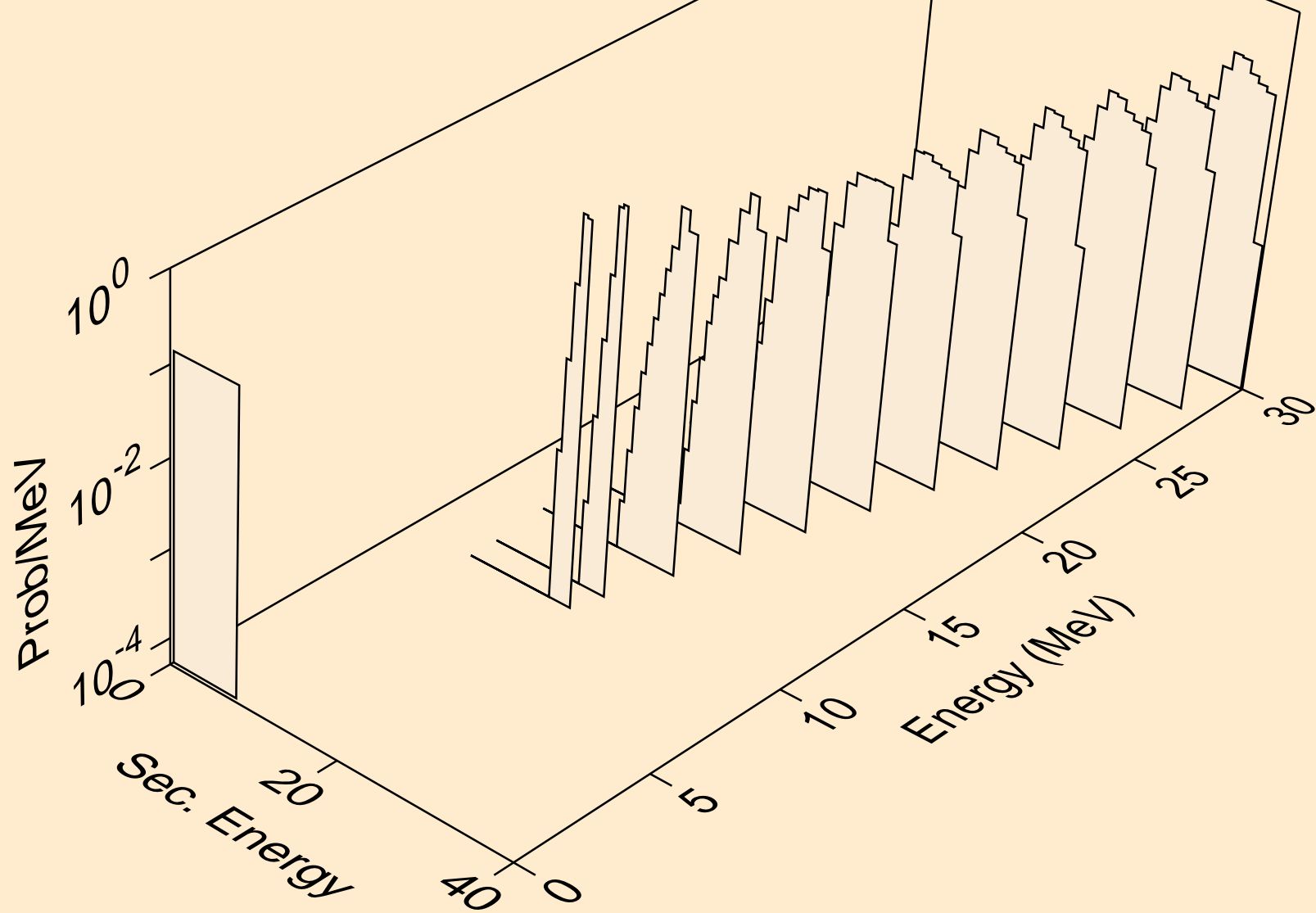

NP243 HELION ACER TENDL-2021 LIBRARY; T=0.K  
alphas from (s,2n)a

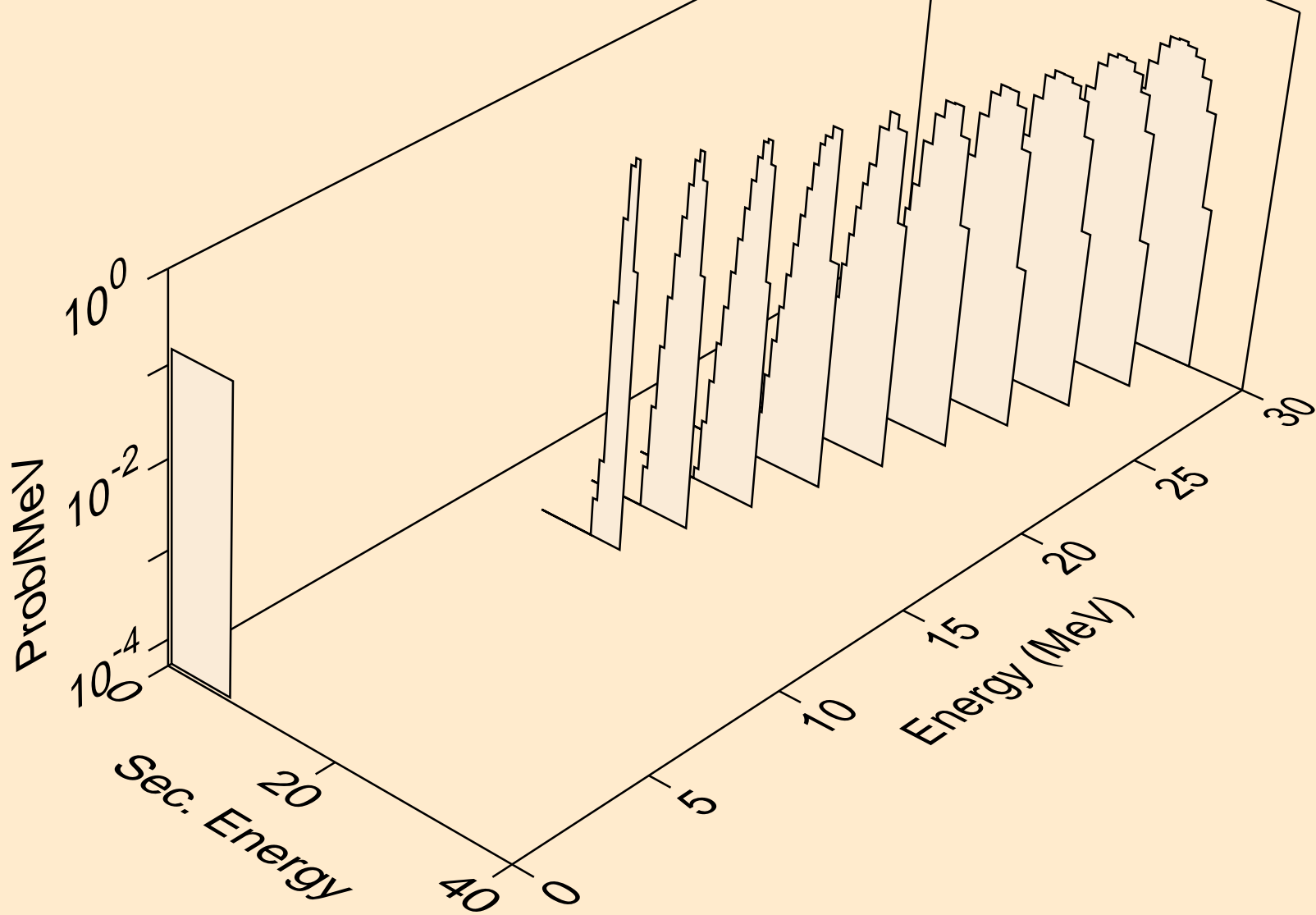

NP243 HELION ACER TENDL-2021 LIBRARY; T=0.K  
alphas from (s,3n)a

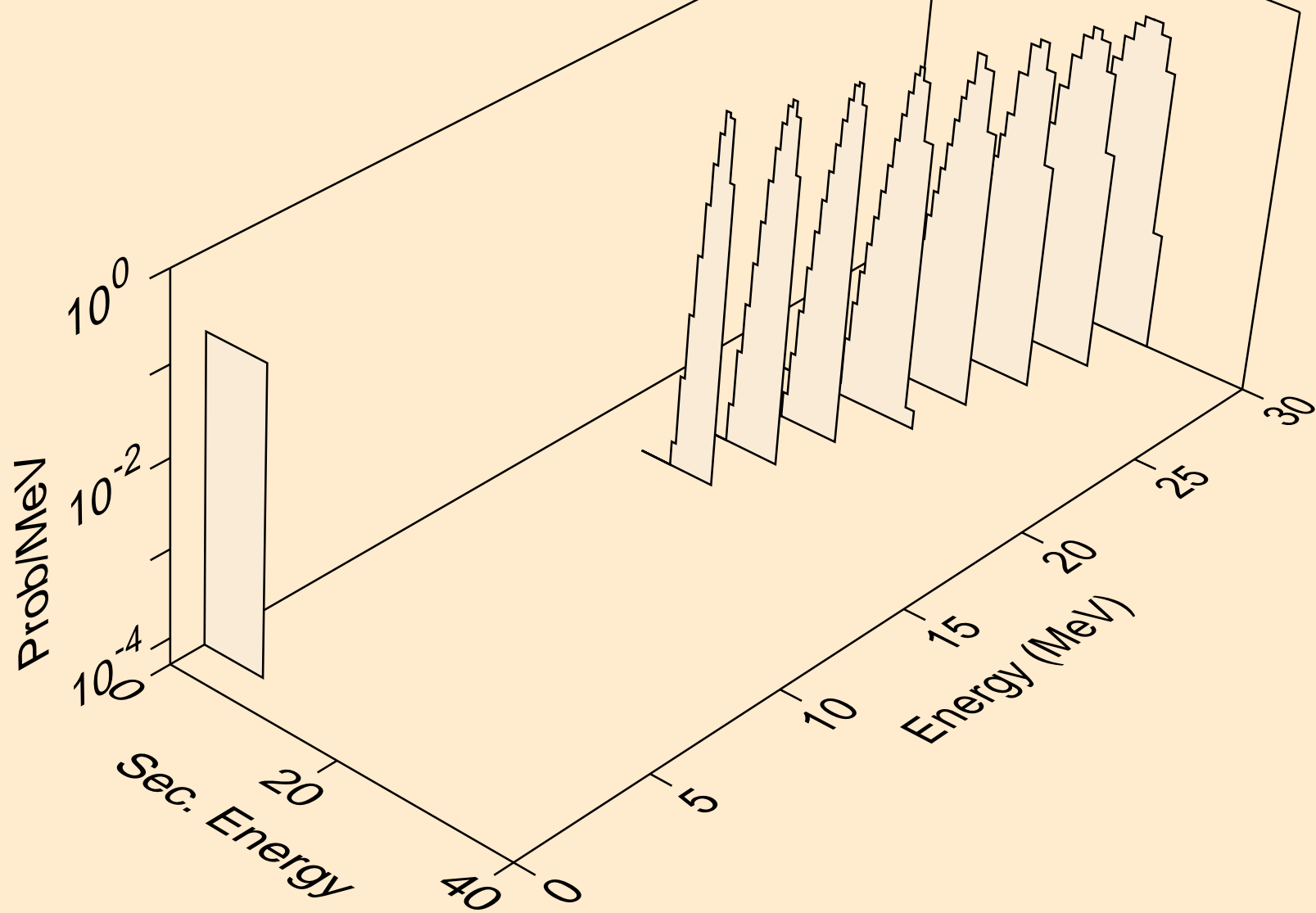

NP243 HELION ACER TENDL-2021 LIBRARY; T=0.K  
alphas from (s,a)

