

# OS178 HELION ACER TENDL-2021 LIBRARY; T=0.K

## Principal cross sections

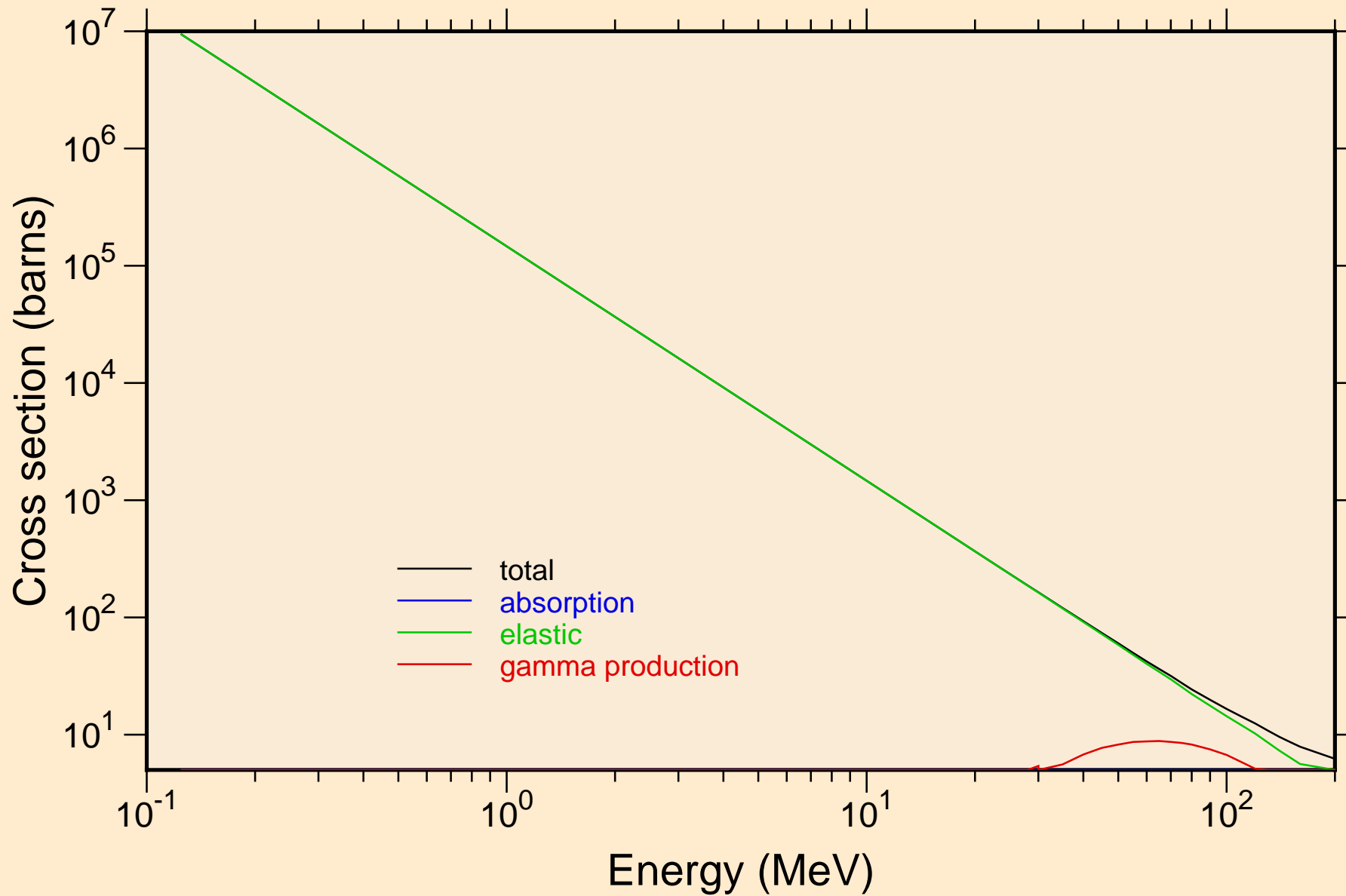

OS178 HELION ACER TENDL-2021 LIBRARY; T=0.K

Heating

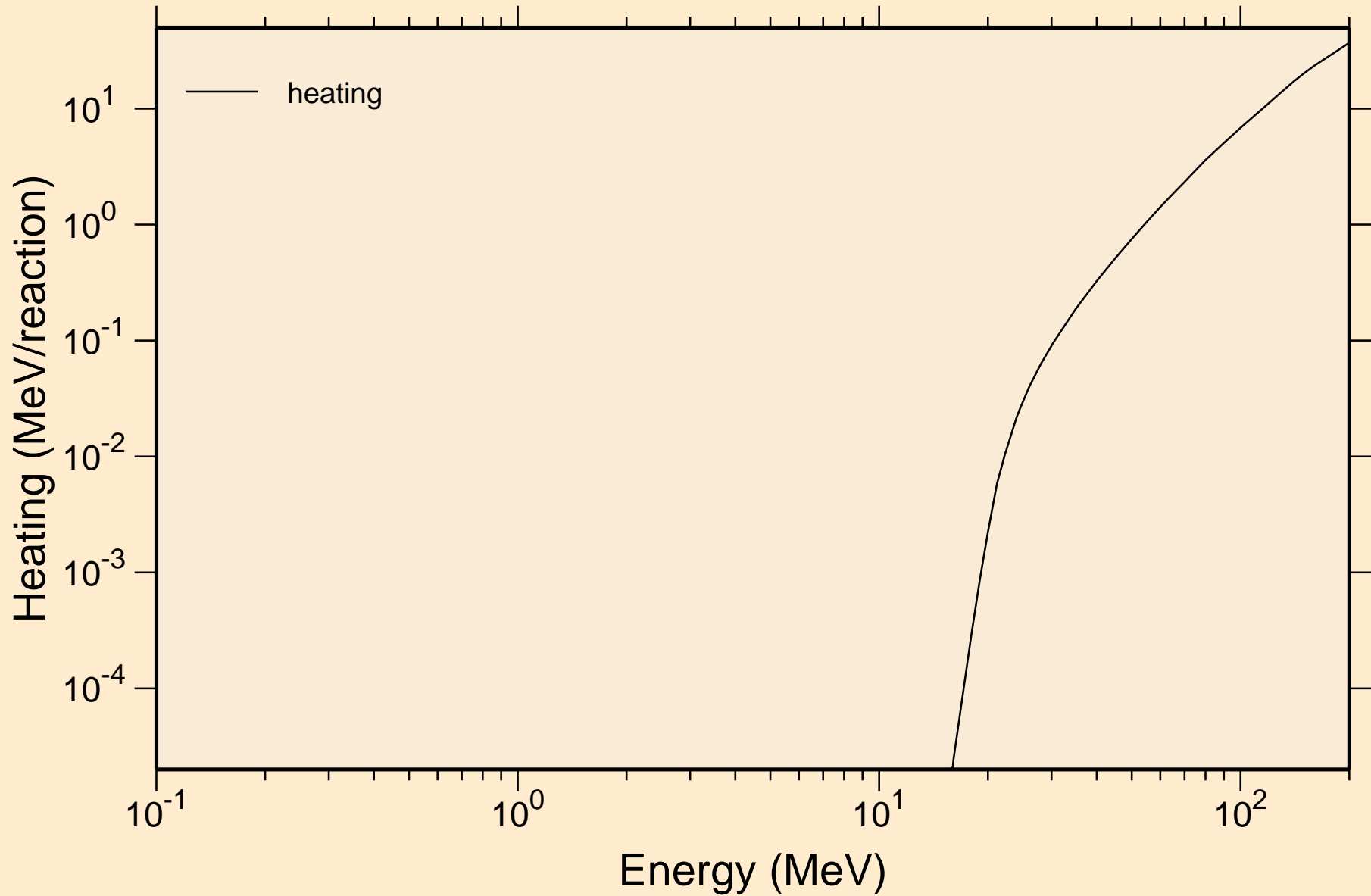

# OS178 HELION ACER TENDL-2021 LIBRARY; T=0.K

## Principal cross sections

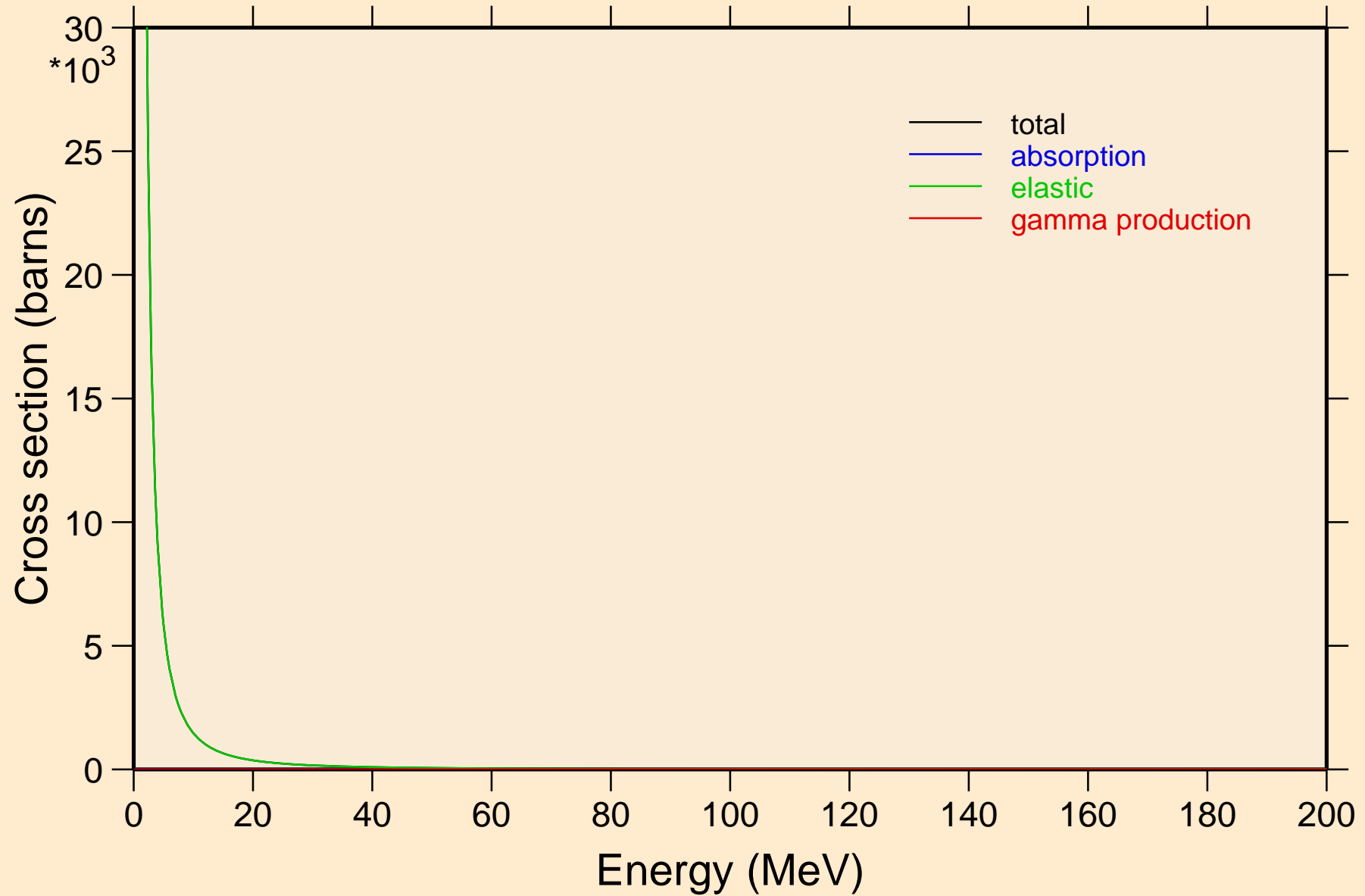

OS178 HELION ACER TENDL-2021 LIBRARY; T=0.K

Heating

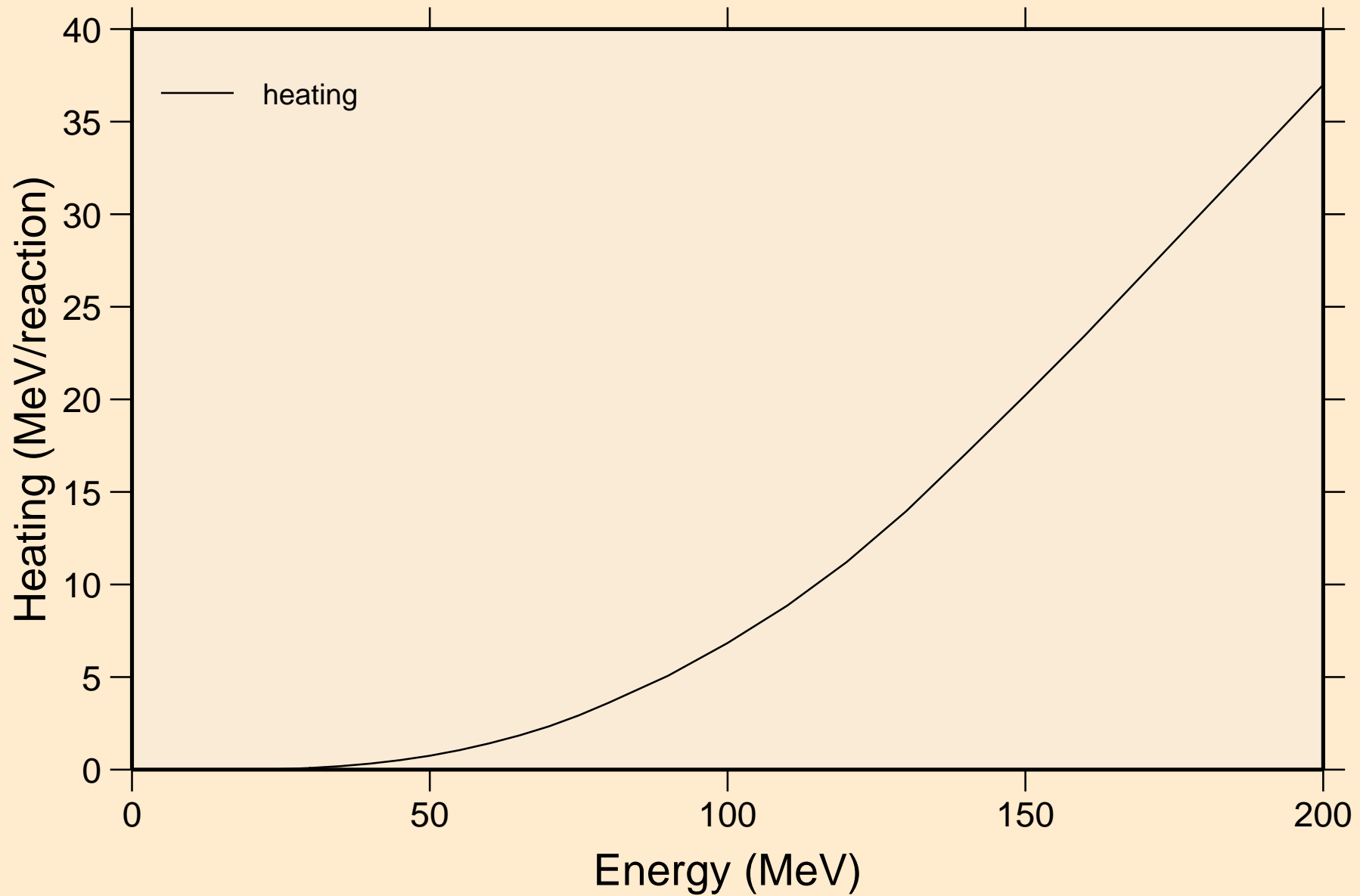

OS178 HELION ACER TENDL-2021 LIBRARY; T=0.K  
Threshold reactions

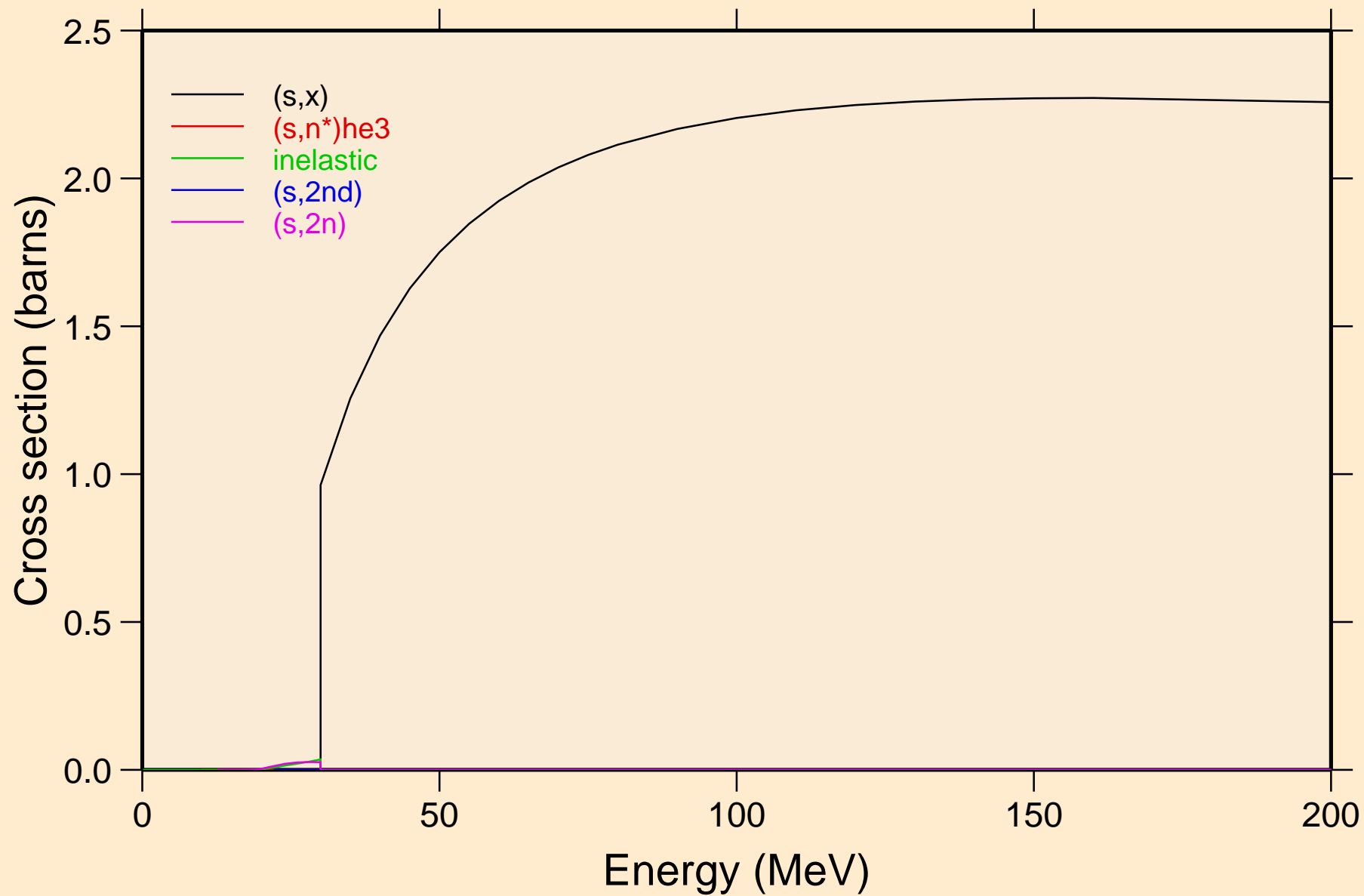

OS178 HELION ACER TENDL-2021 LIBRARY; T=0.K  
Threshold reactions

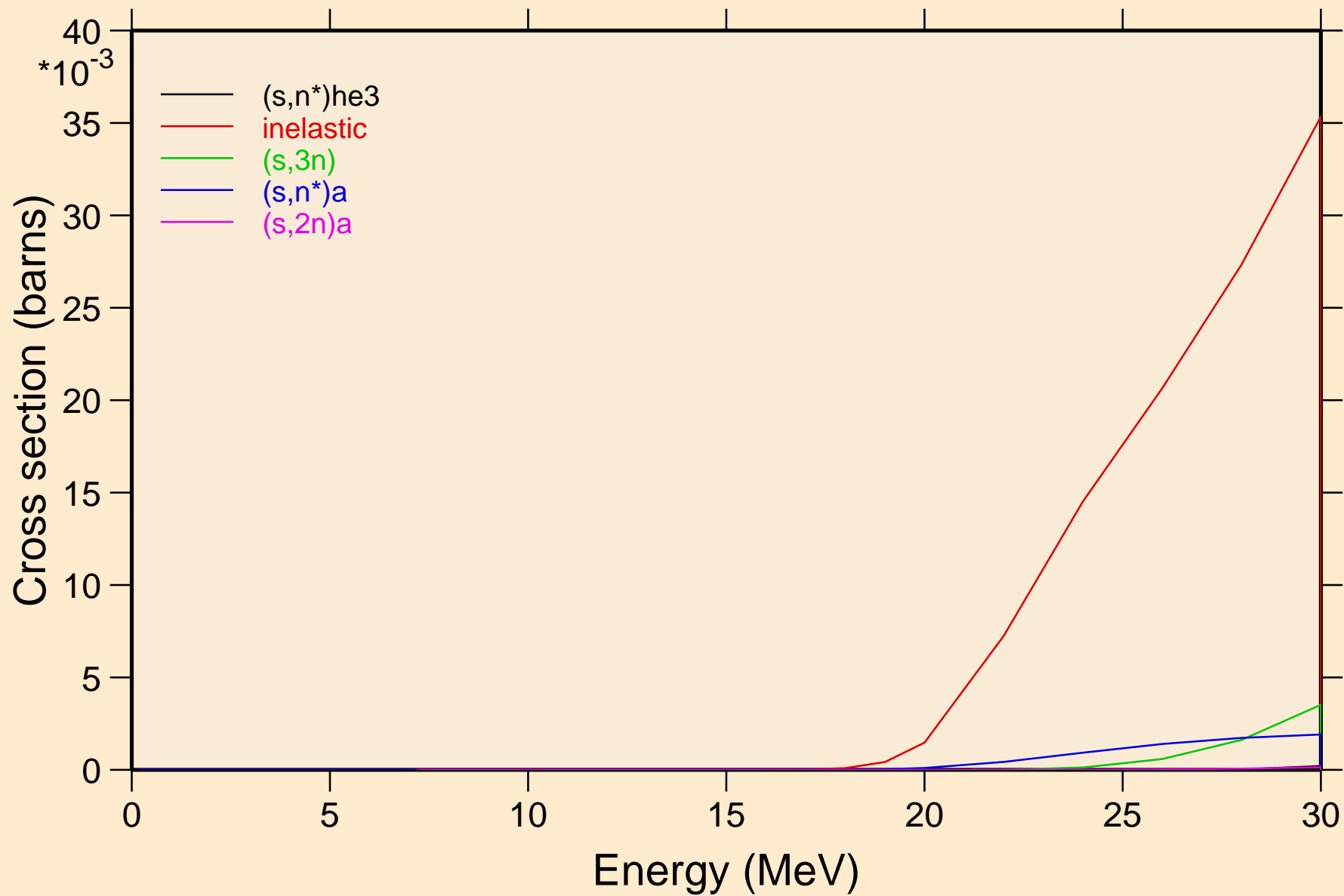

OS178 HELION ACER TENDL-2021 LIBRARY; T=0.K  
Threshold reactions

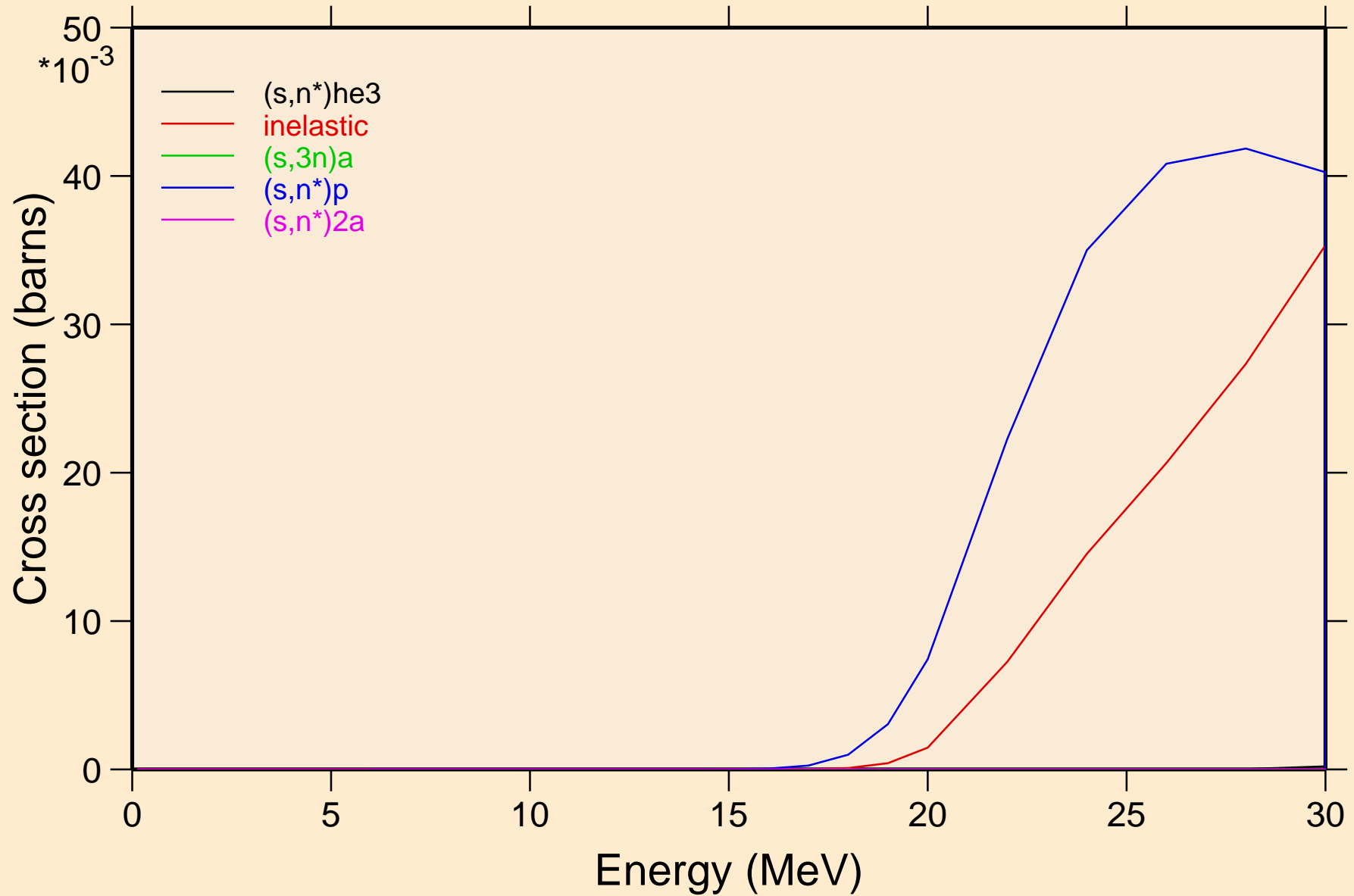

OS178 HELION ACER TENDL-2021 LIBRARY; T=0.K  
Threshold reactions

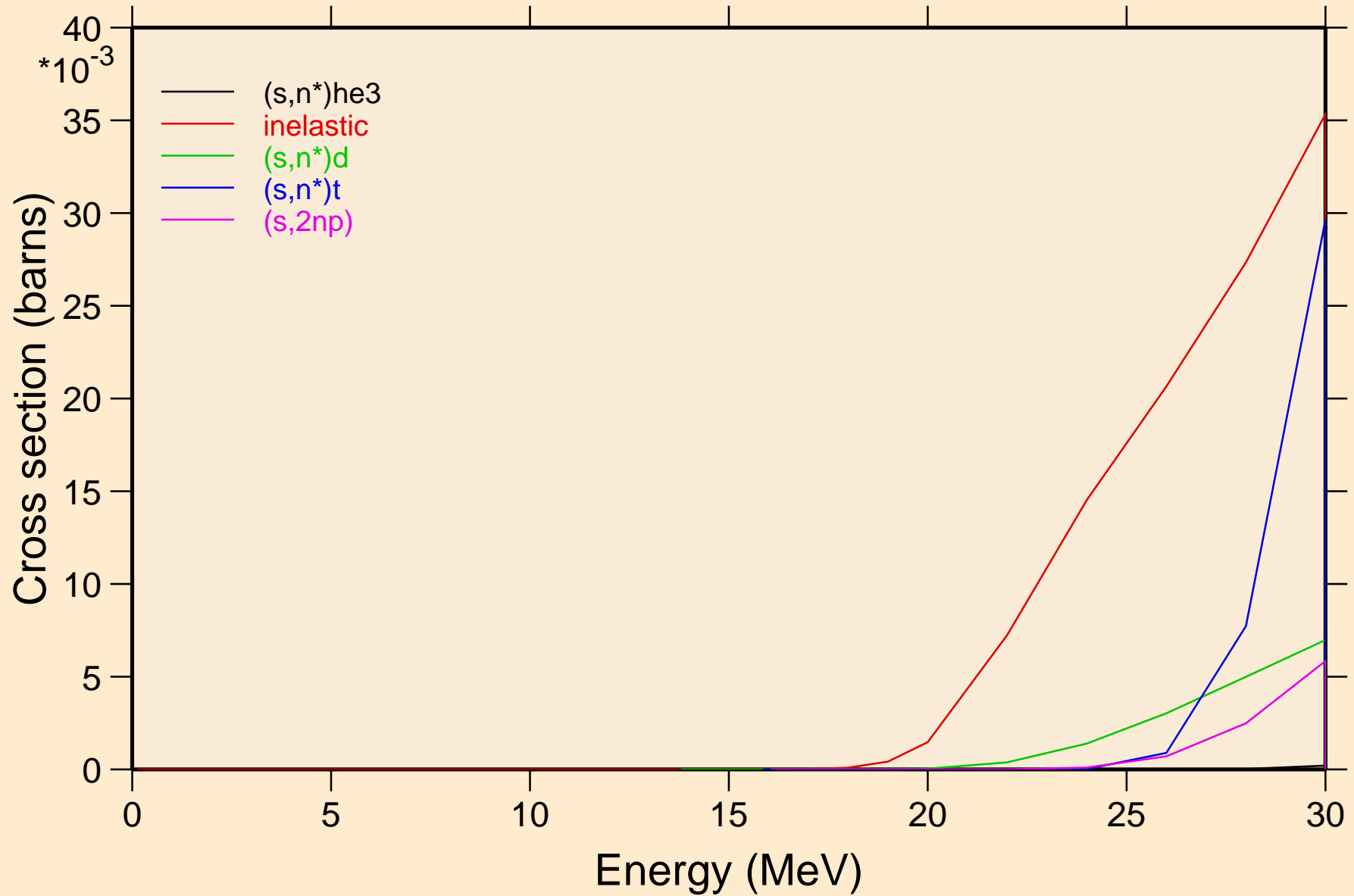



OS178 HELION ACER TENDL-2021 LIBRARY; T=0.K  
Threshold reactions

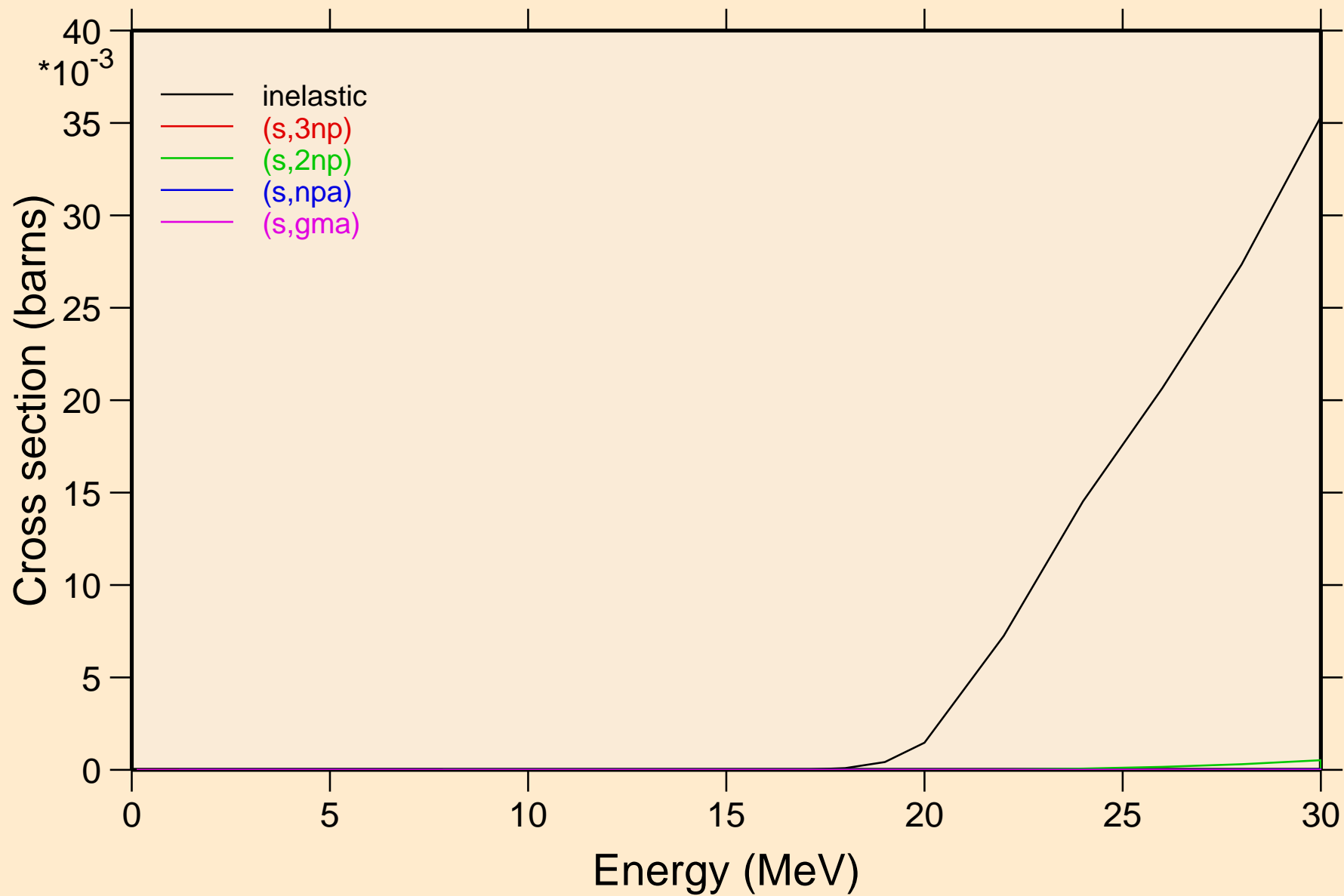

OS178 HELION ACER TENDL-2021 LIBRARY; T=0.K  
Threshold reactions

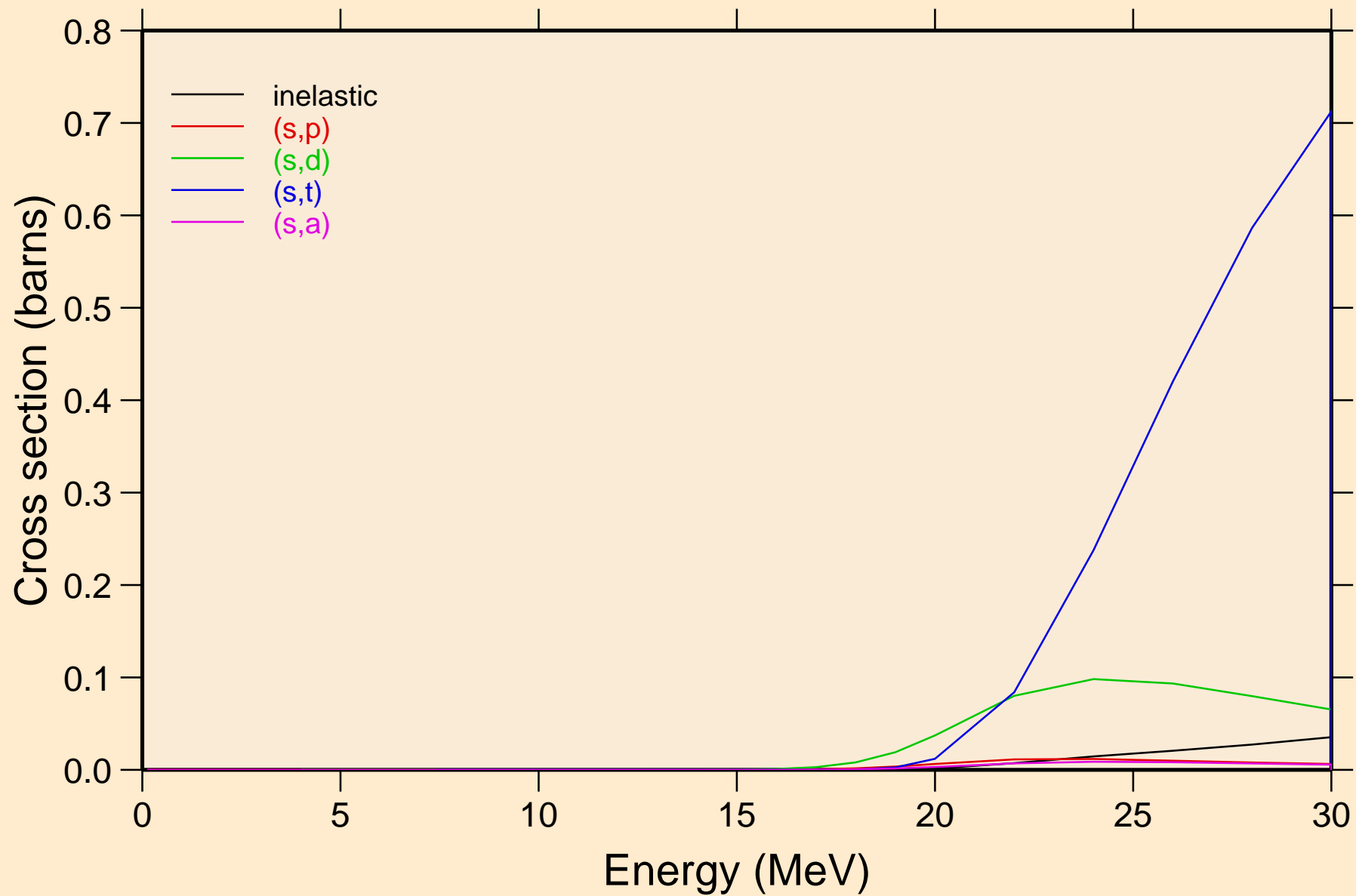

# OS178 HELION ACER TENDL-2021 LIBRARY; T=0.K

## Threshold reactions

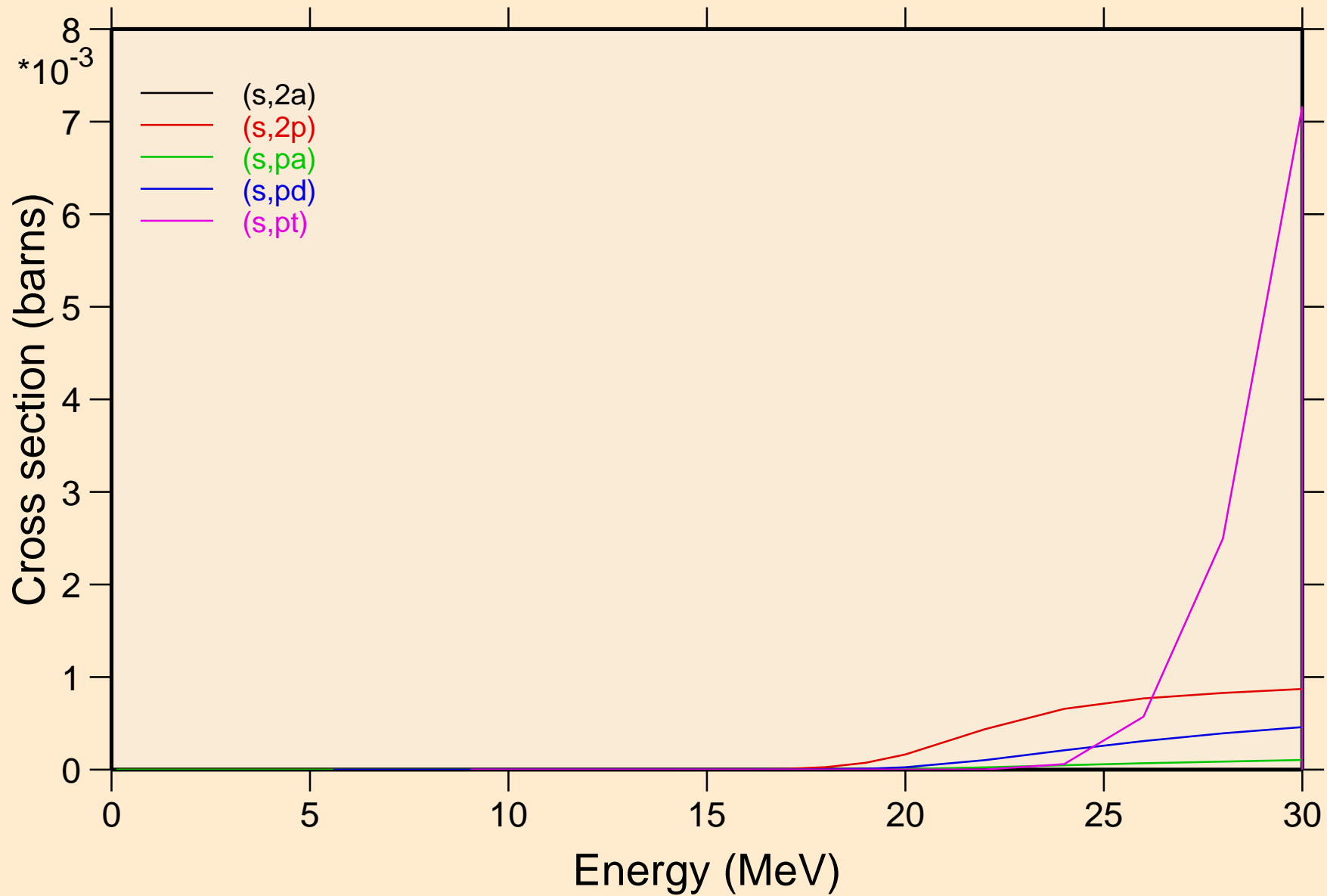

OS178 HELION ACER TENDL-2021 LIBRARY; T=0.K  
Threshold reactions

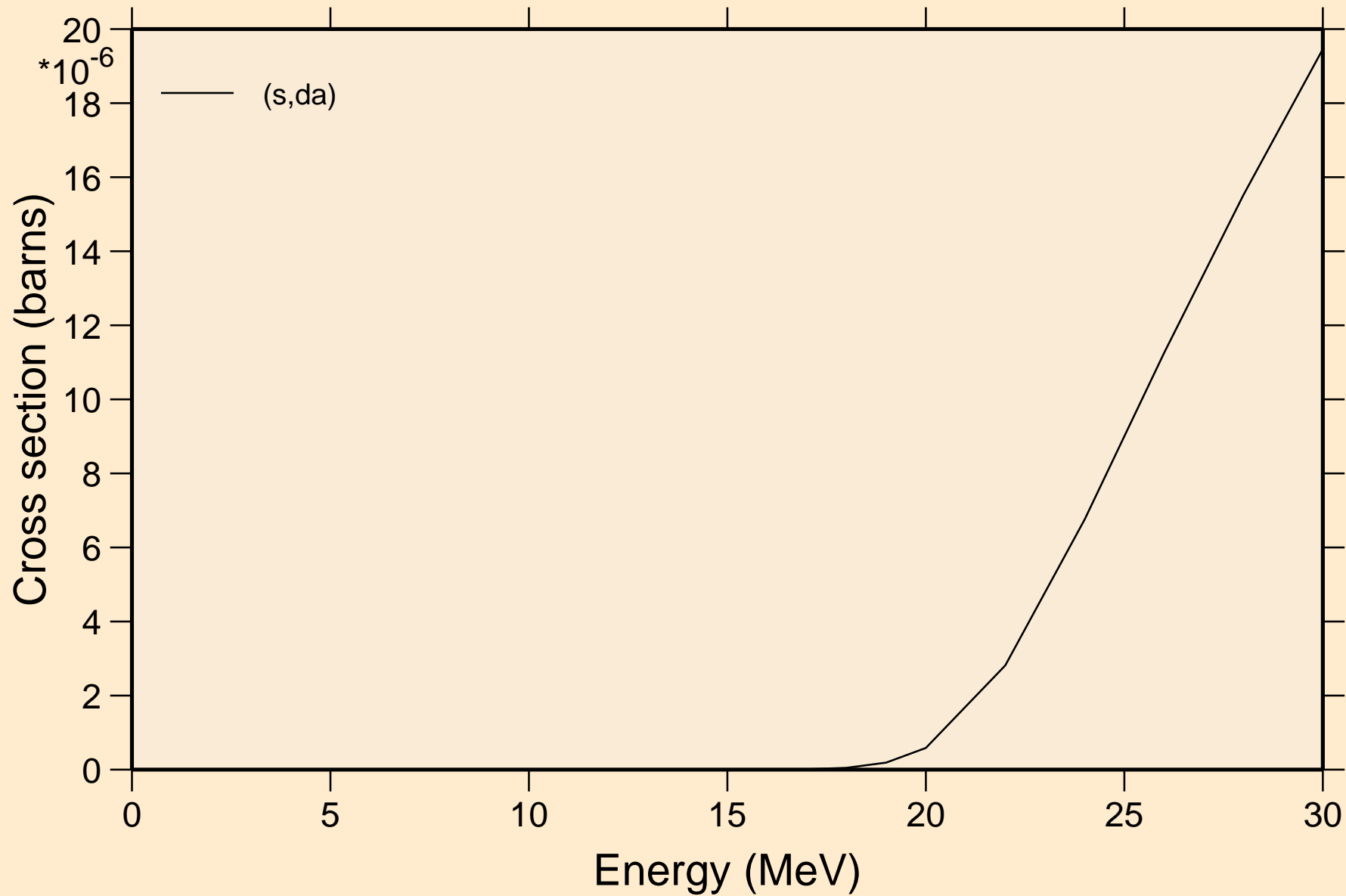

OS178 HELION ACER TENDL-2021 LIBRARY; T=0.K  
angular distribution for elastic

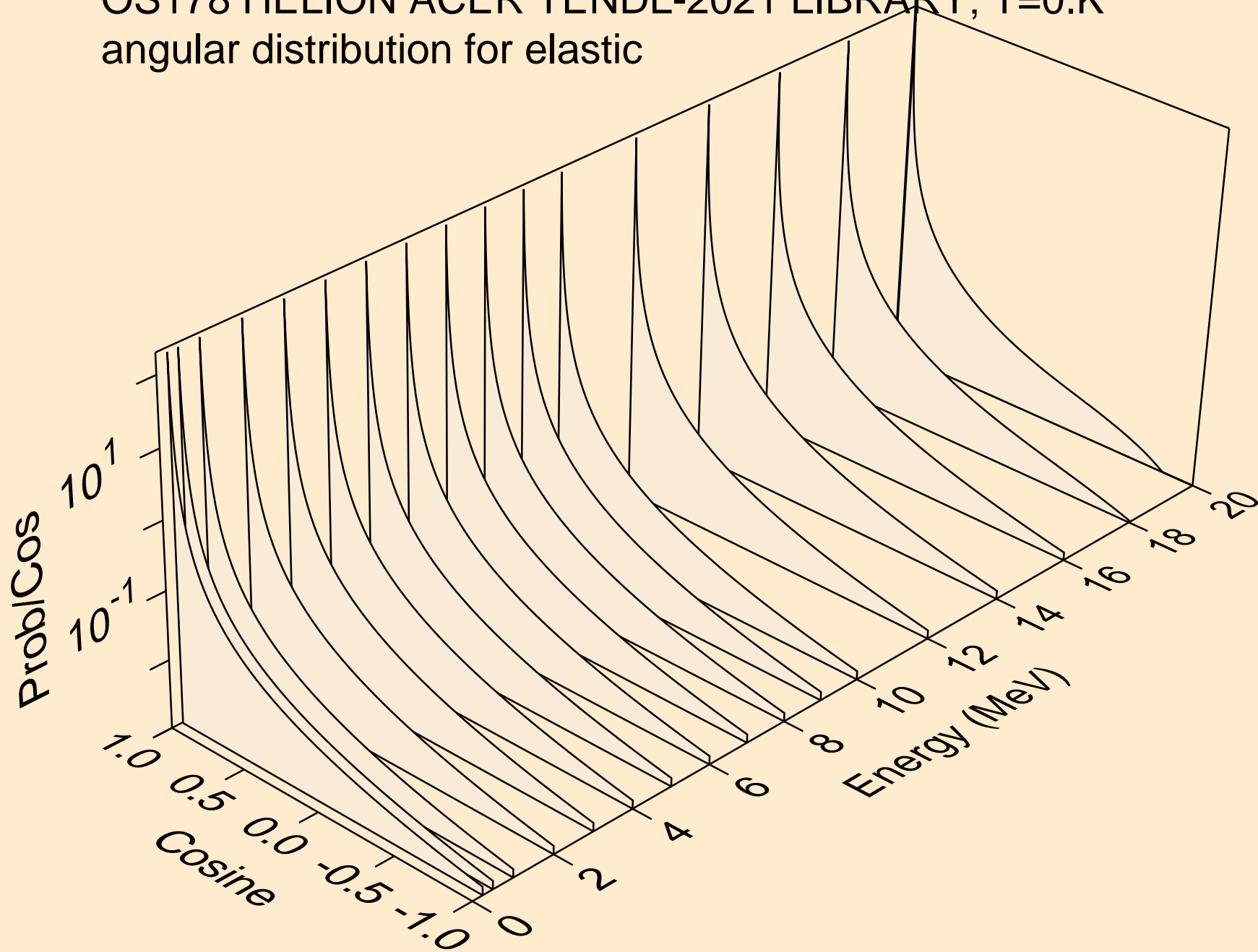

OS178 HELION ACER TENDL-2021 LIBRARY; T=0.K  
angular distribution for elastic

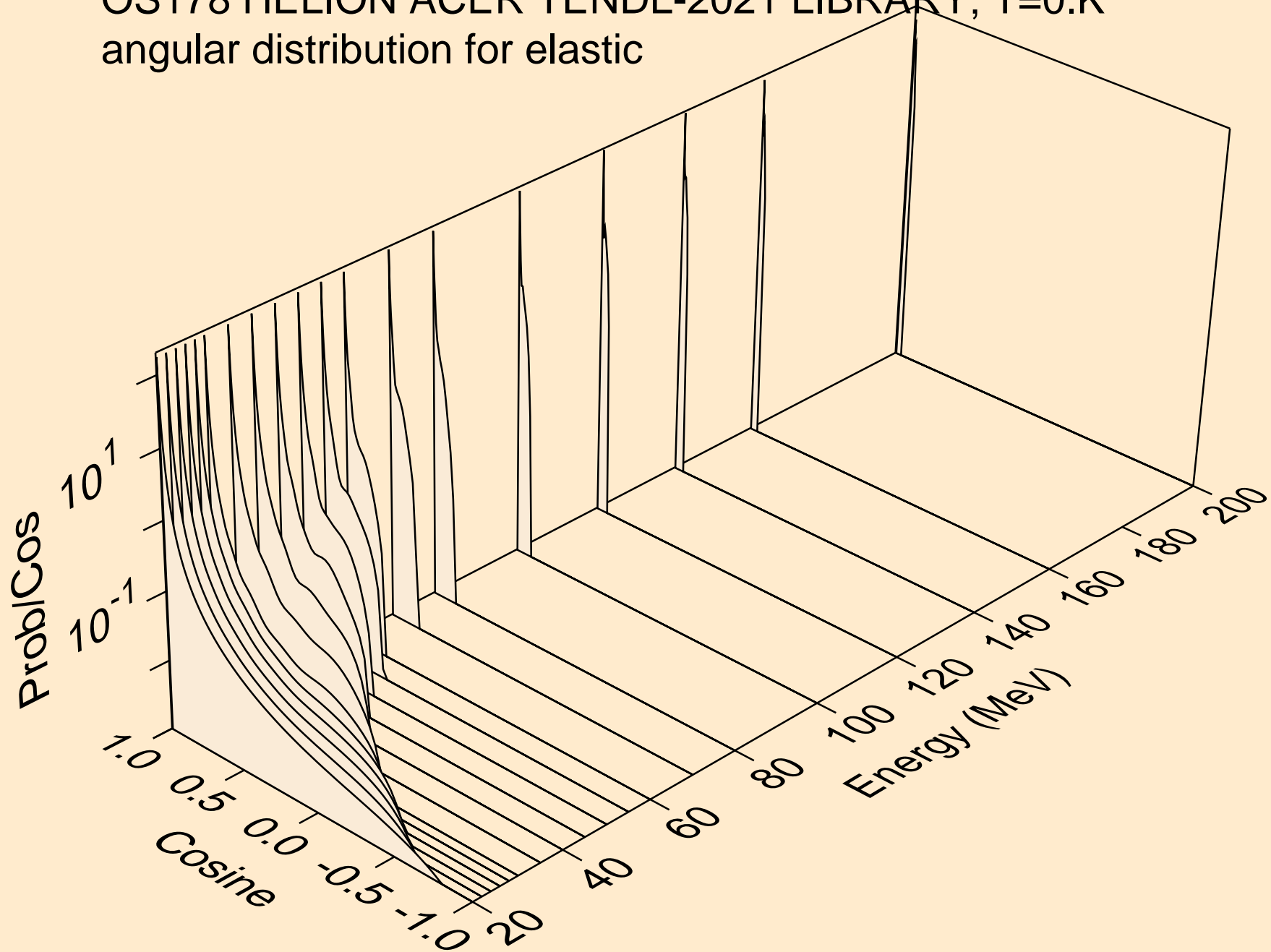

OS178 HELION ACER TENDL-2021 LIBRARY; T=0.K  
He-3 emission for (s,x)

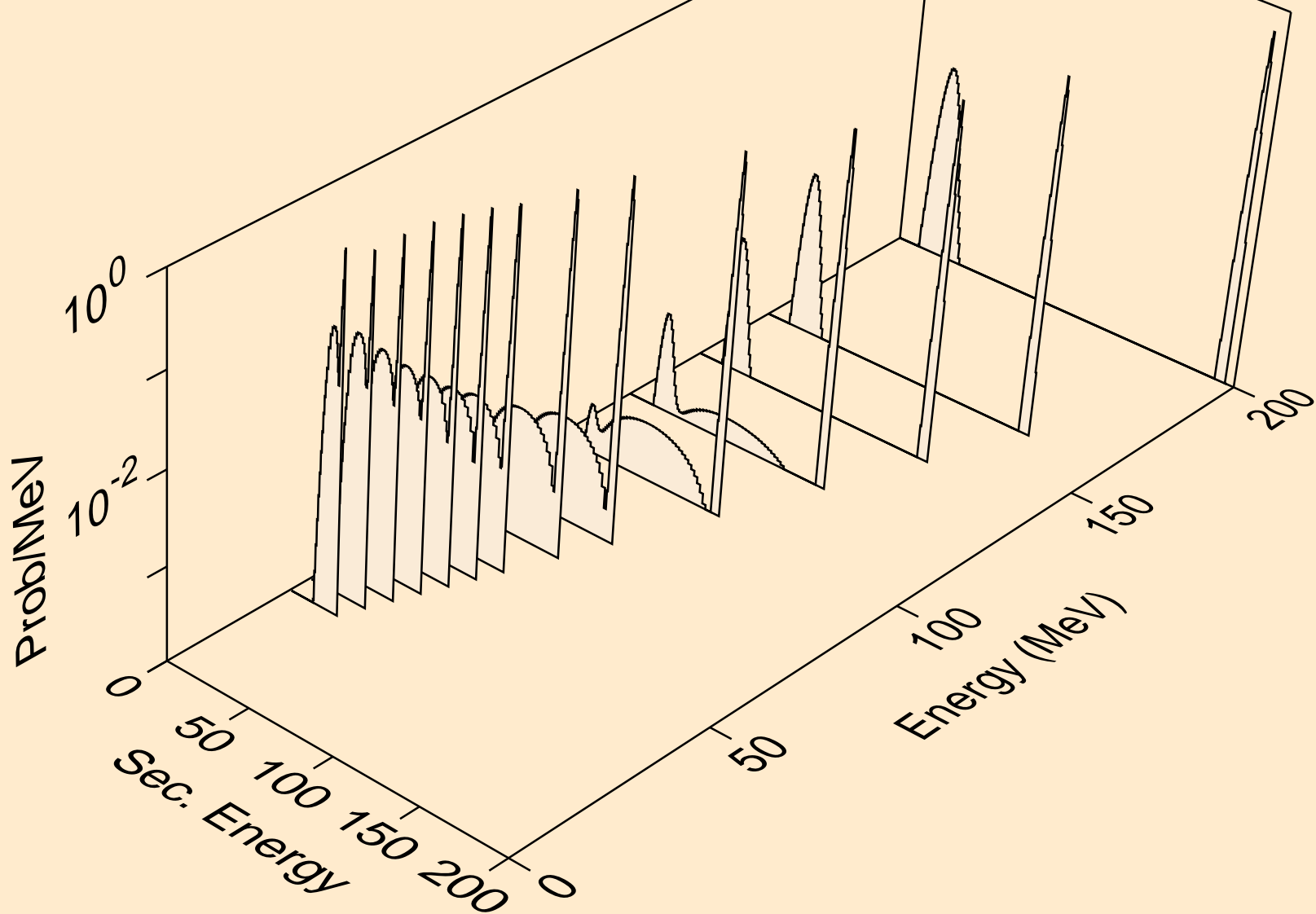

OS178 HELION ACER TENDL-2021 LIBRARY; T=0.K  
He-3 emission for (s,n\*)he3

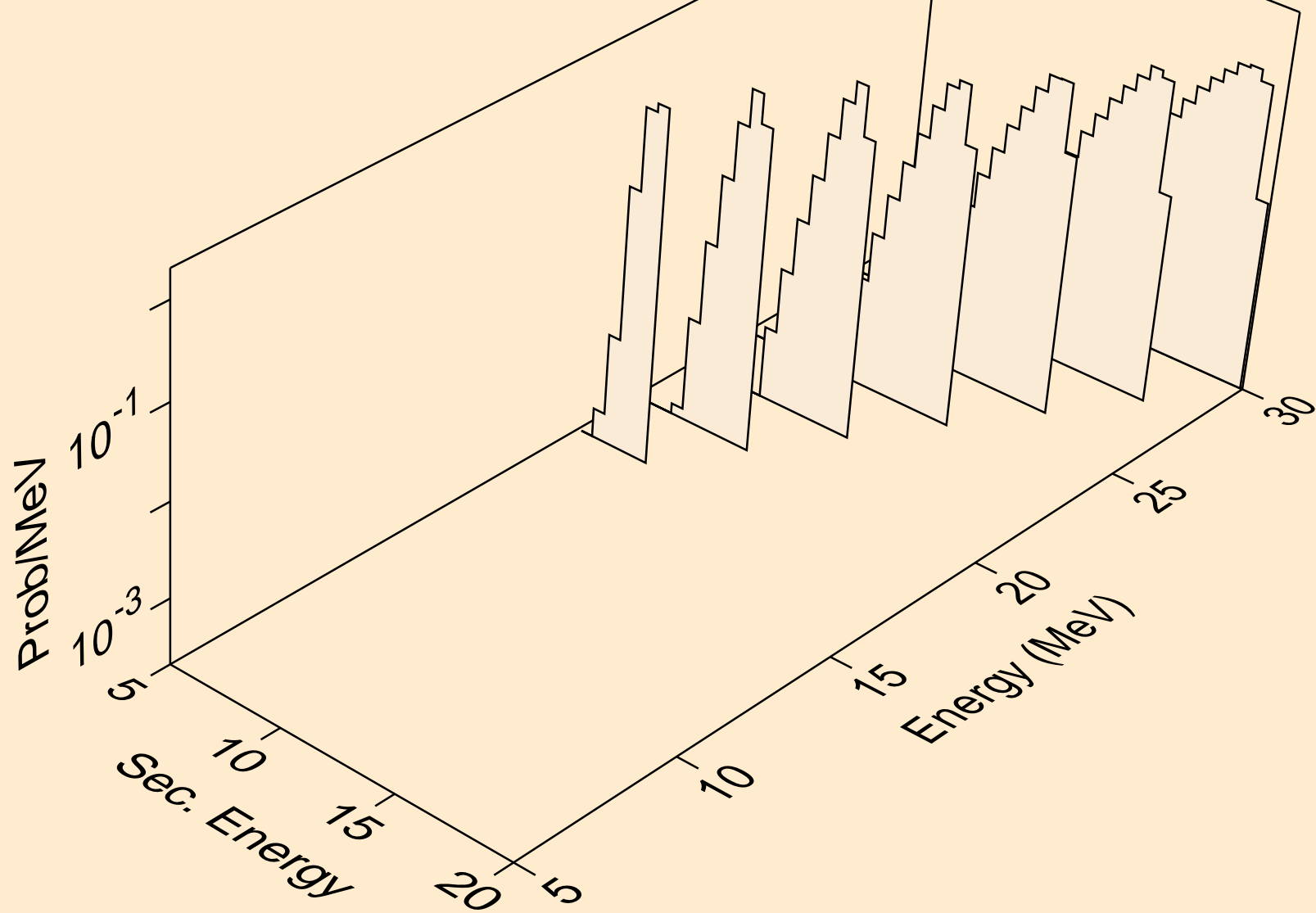



OS178 HELION ACER TENDL-2021 LIBRARY; T=0.K  
He-3 emission for inelastic

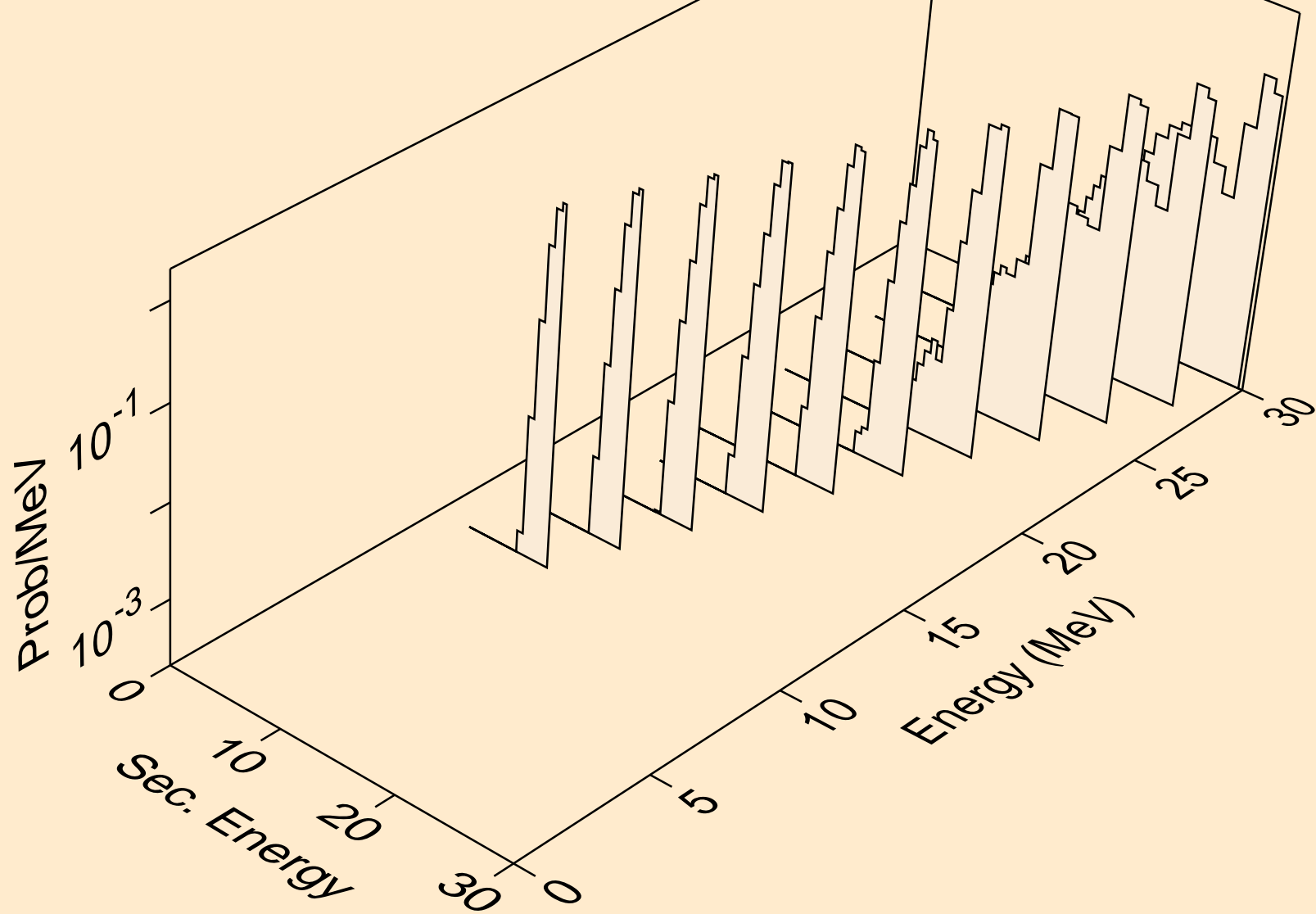

OS178 HELION ACER TENDL-2021 LIBRARY; T=0.K  
Photon emission for (z,n)

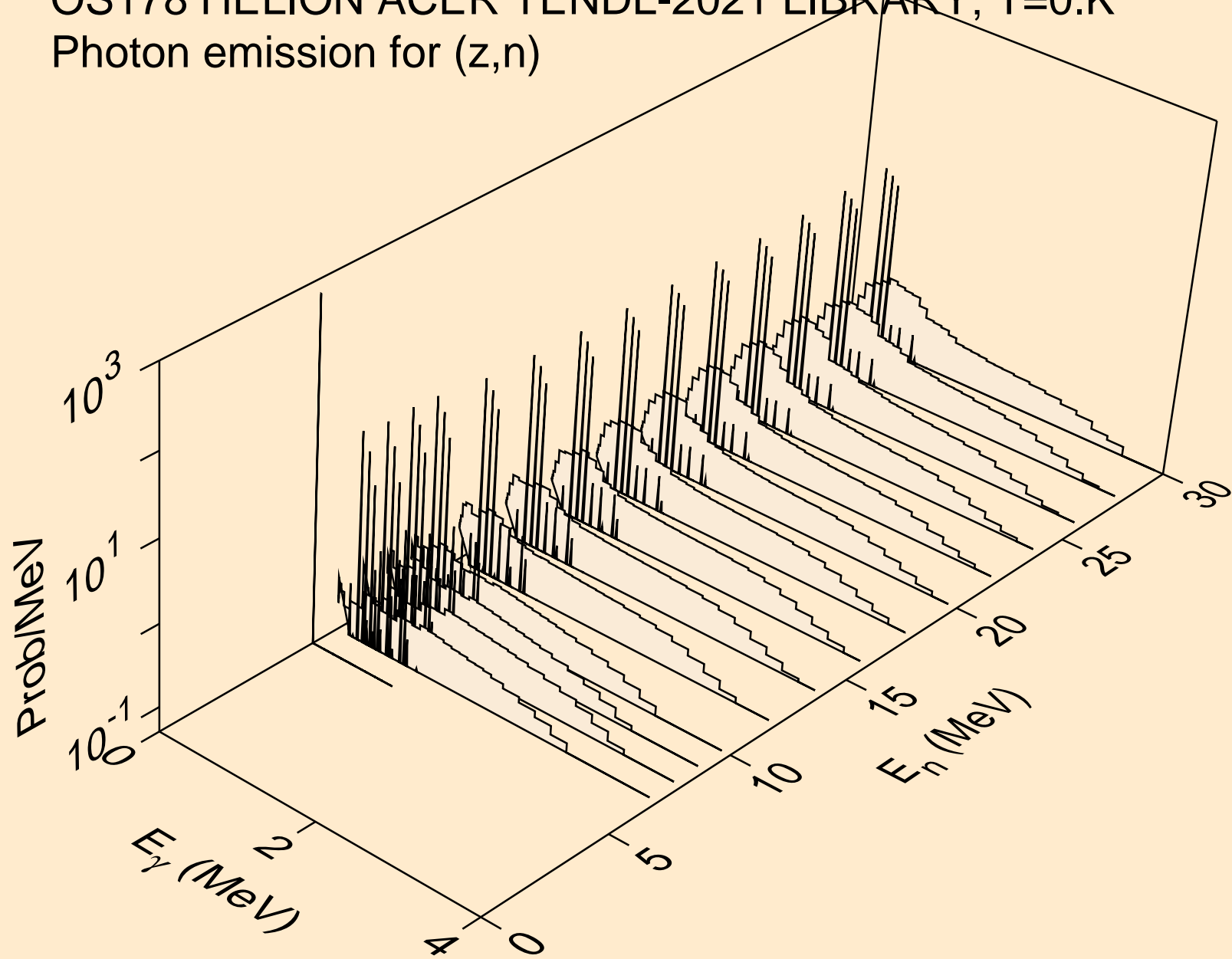

OS178 HELION ACER TENDL-2021 LIBRARY; T=0.K  
Photon emission for (n,x)

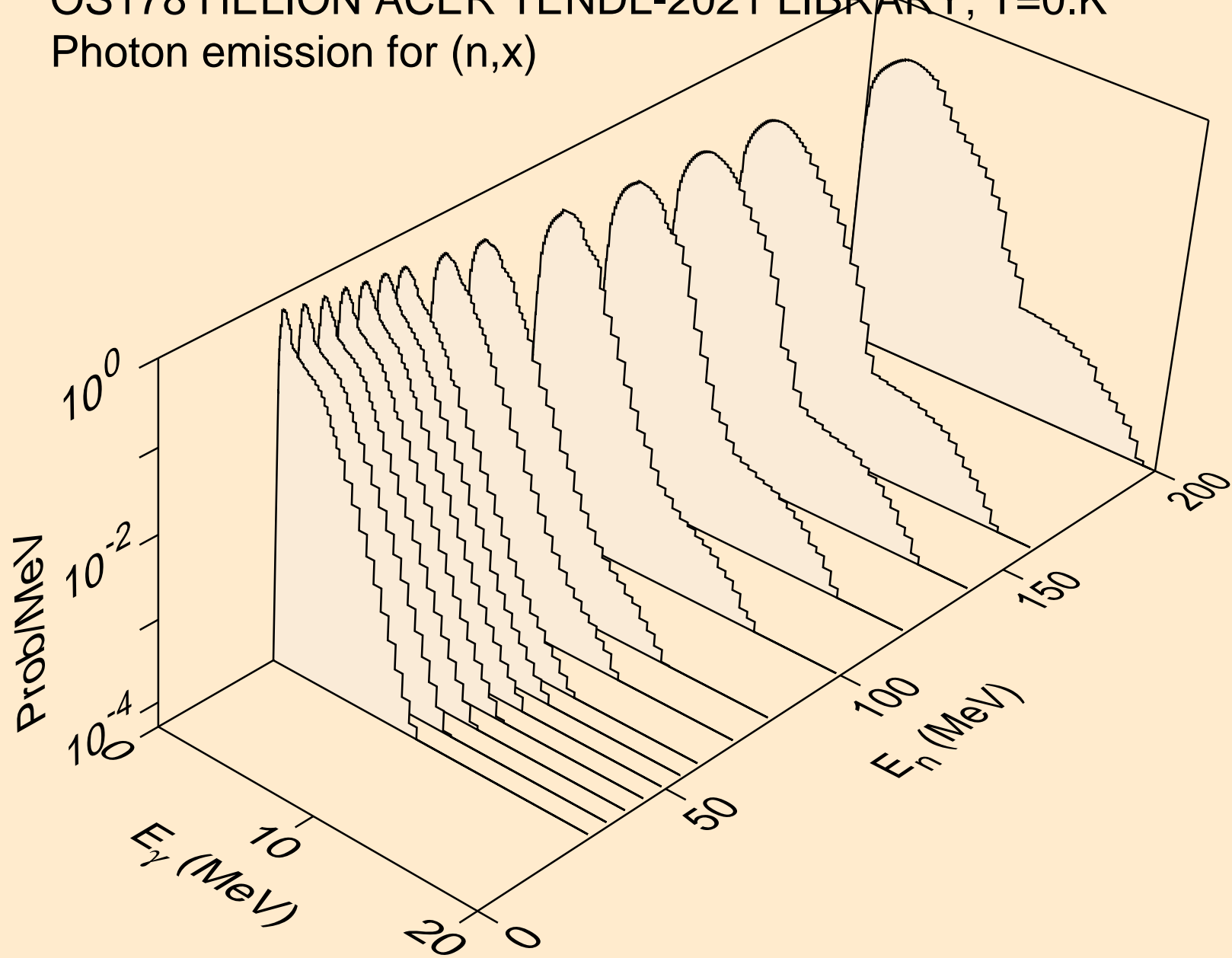

OS178 HELION ACER TENDL-2021 LIBRARY; T=0.K  
Photon emission for (n,2nd)

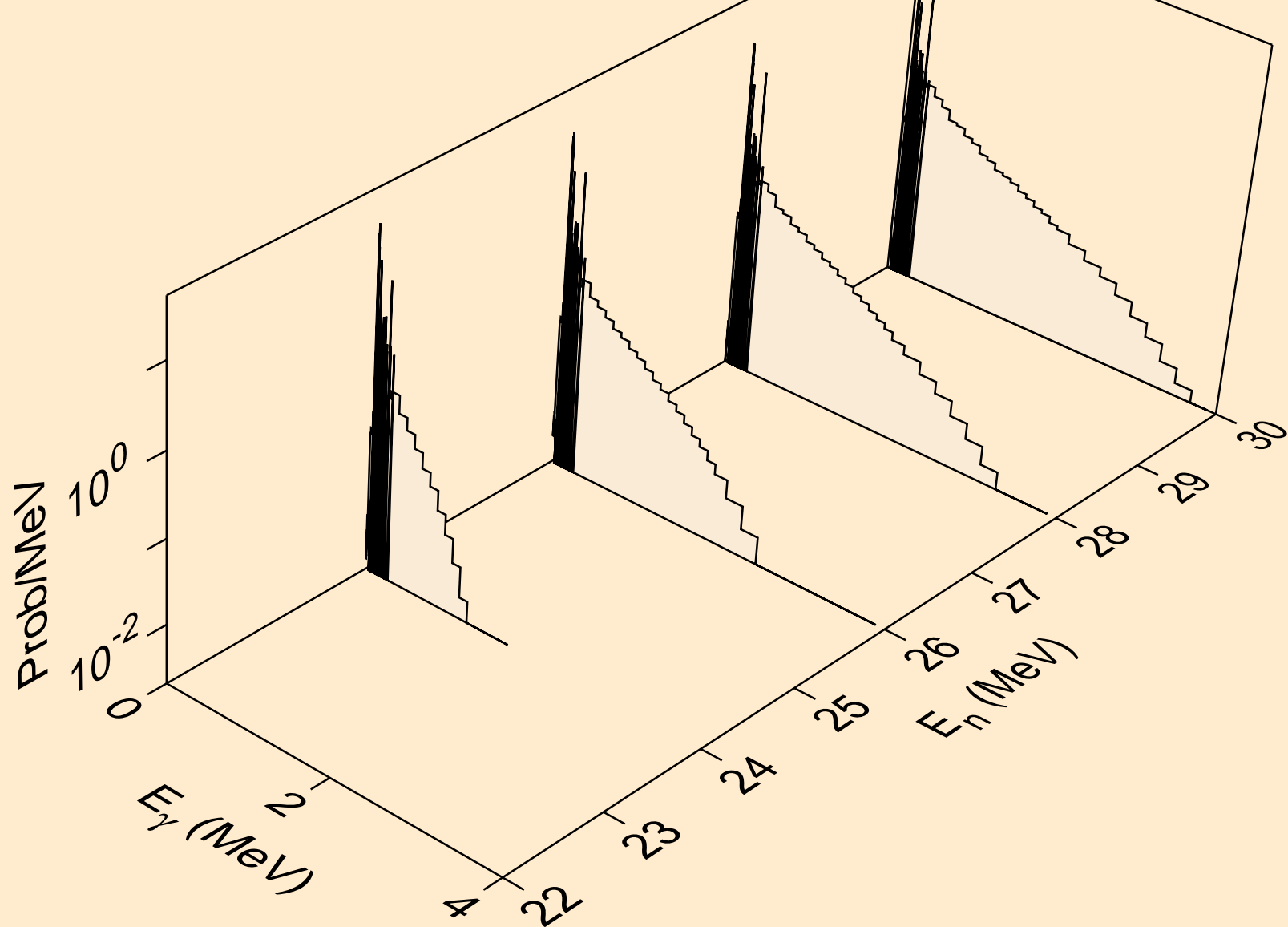

OS178 HELION ACER TENDL-2021 LIBRARY; T=0.K  
Photon emission for (n,2n)

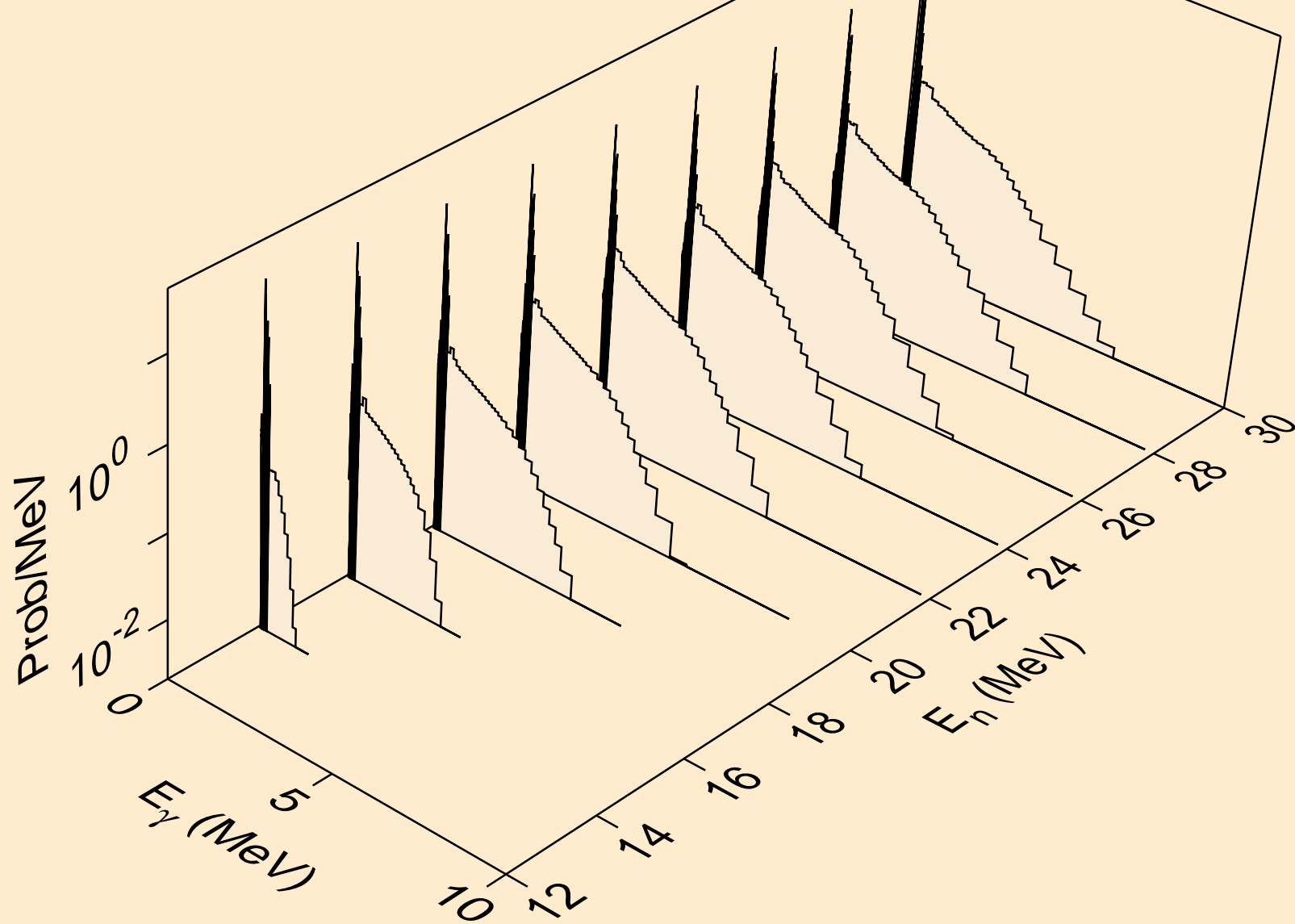

OS178 HELION ACER TENDL-2021 LIBRARY; T=0.K  
Photon emission for (n,3n)

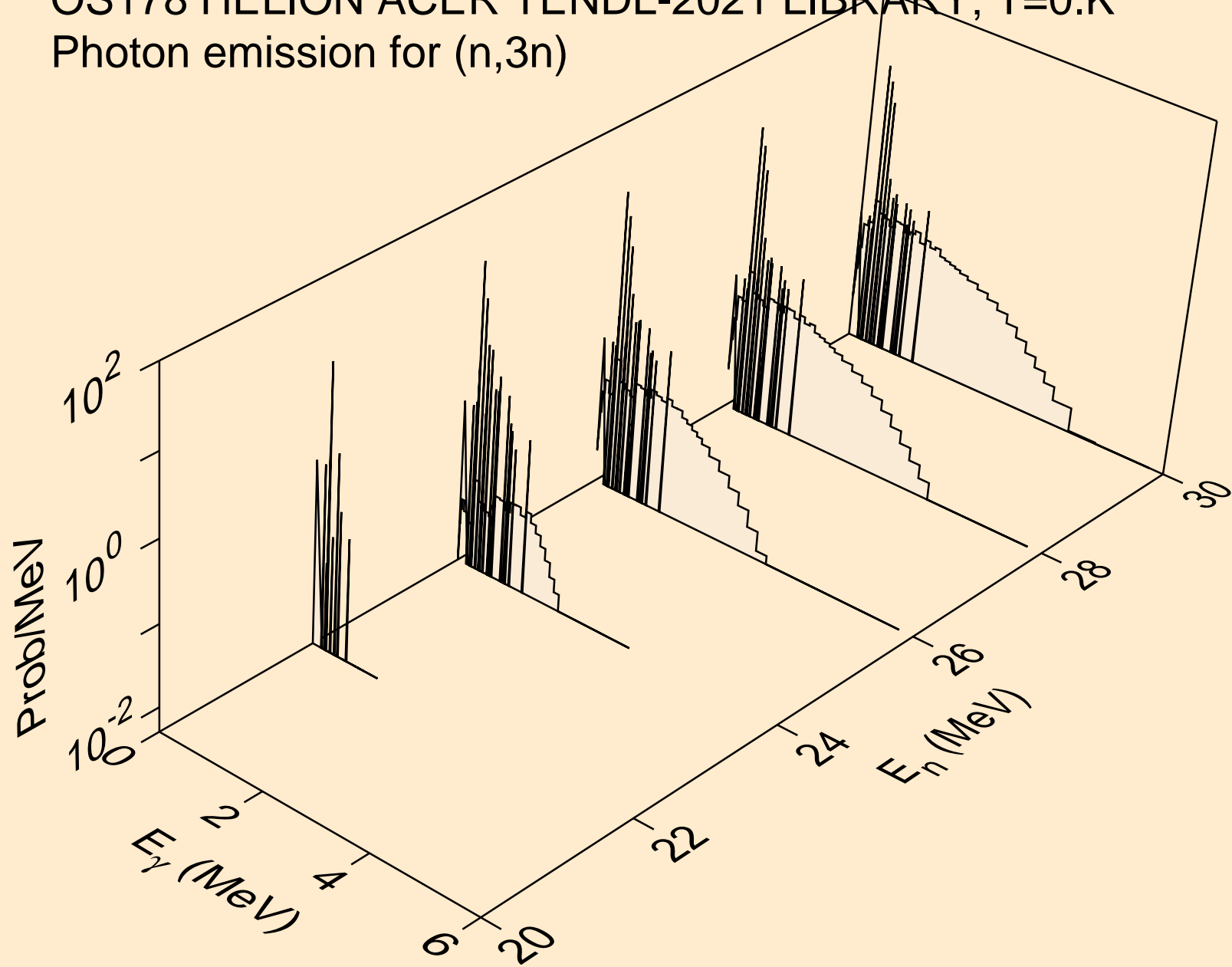

OS178 HELION ACER TENDL-2021 LIBRARY; T=0.K  
Photon emission for (n,n\*)a

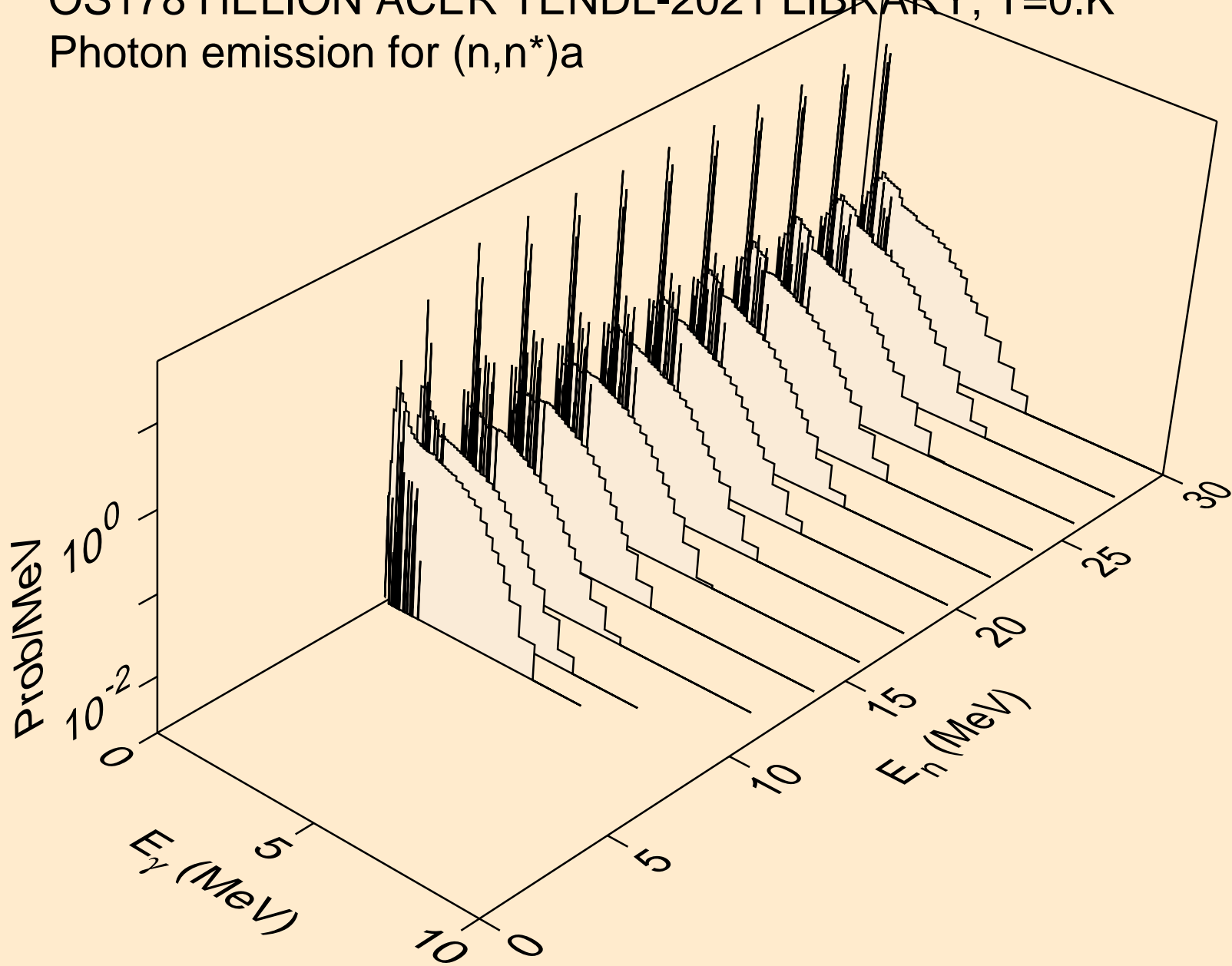

OS178 HELION ACER TENDL-2021 LIBRARY; T=0.K  
Photon emission for (n,2n)a

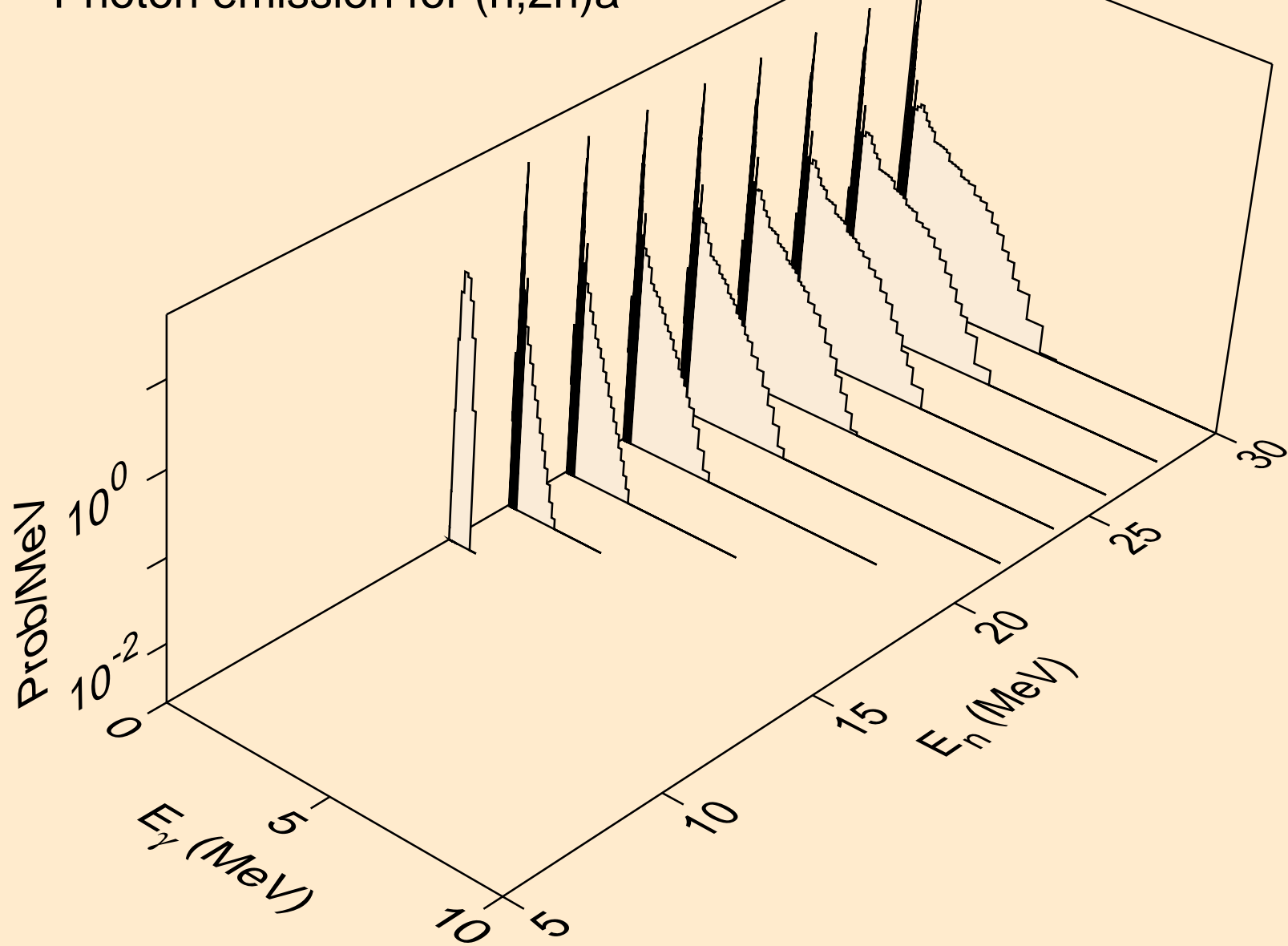



OS178 HELION ACER TENDL-2021 LIBRARY; T=0.K  
Photon emission for (n,3n)a

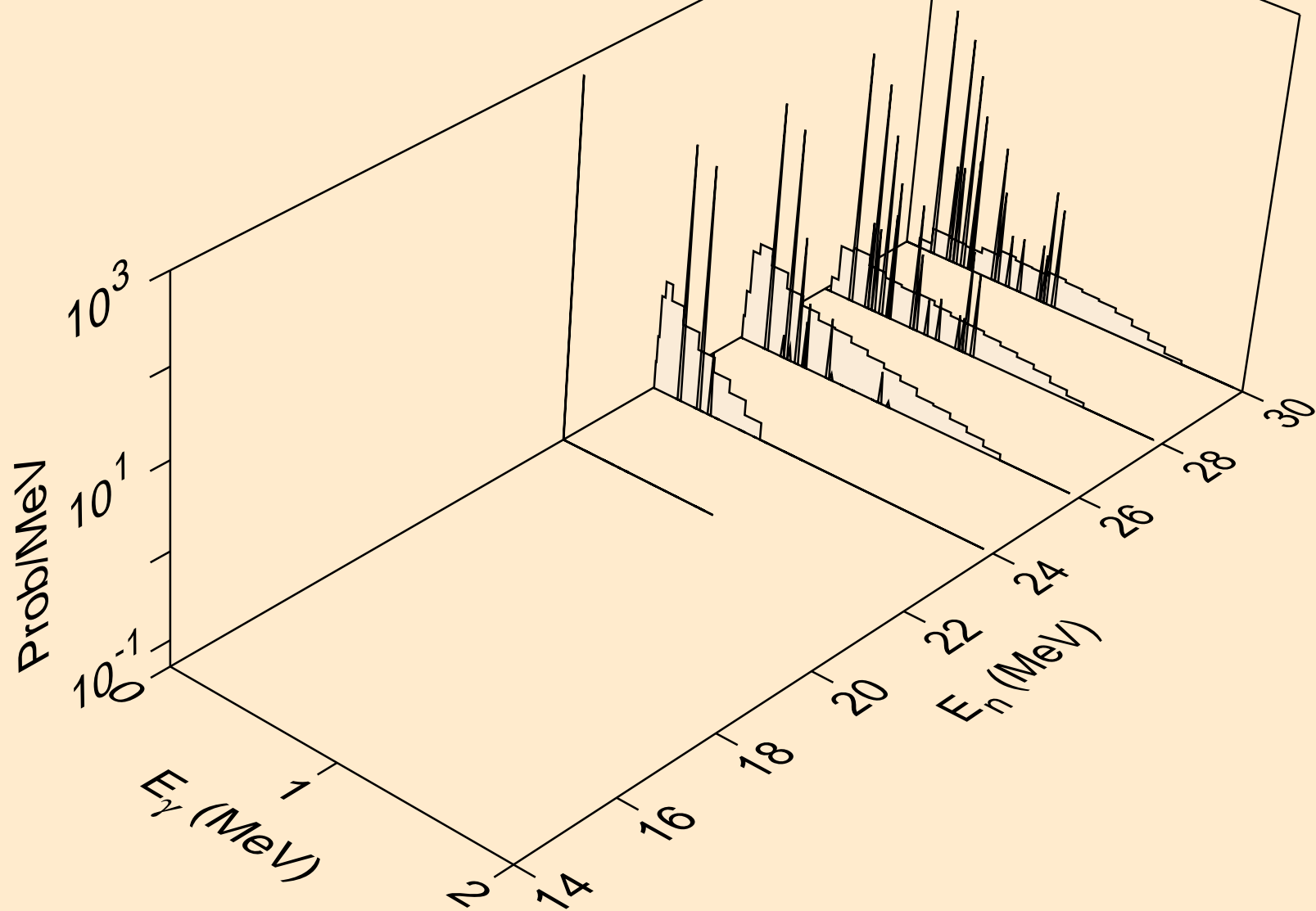

OS178 HELION ACER TENDL-2021 LIBRARY; T=0.K  
Photon emission for (n,n\*)p

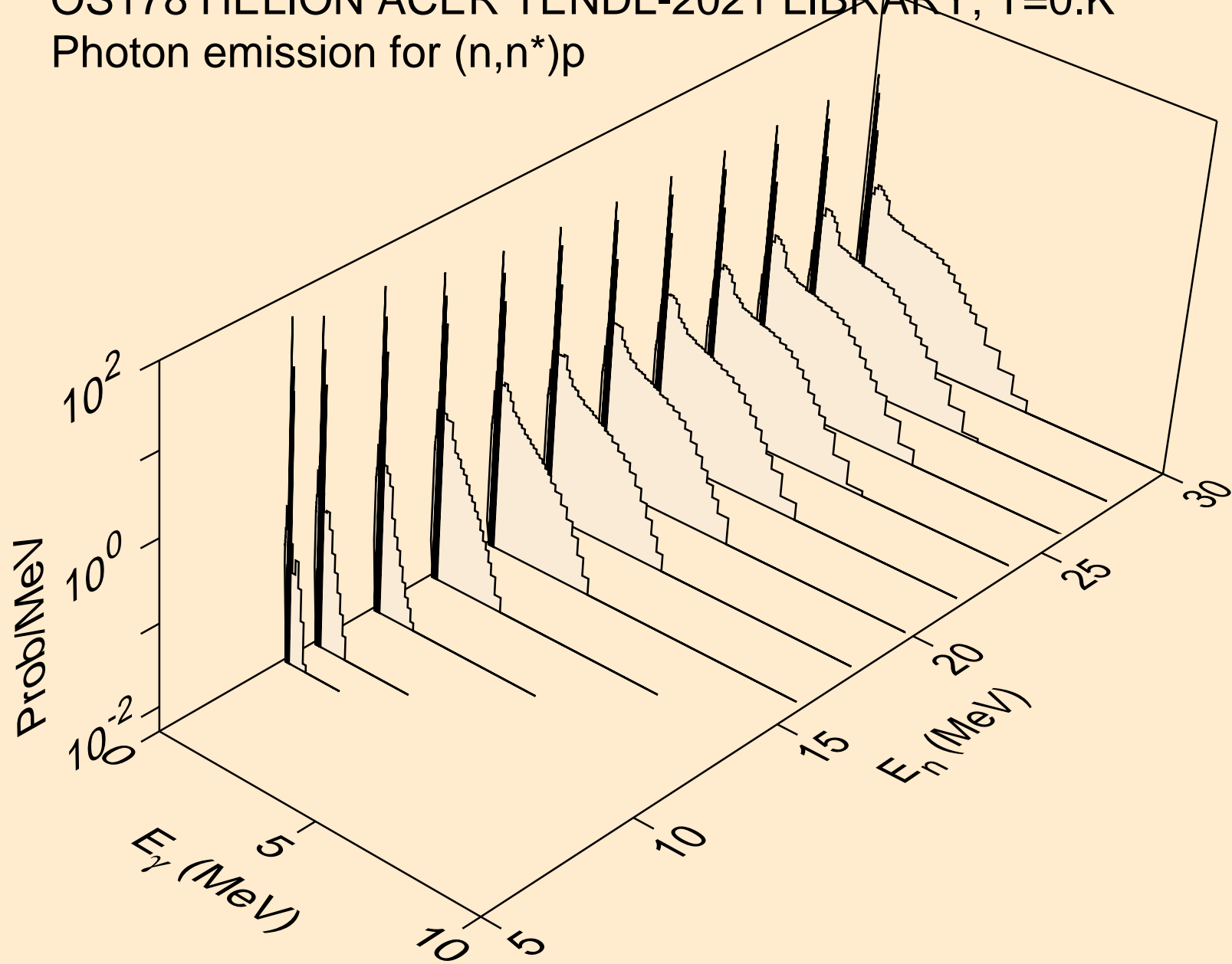

OS178 HELION ACER TENDL-2021 LIBRARY; T=0.K  
Photon emission for (n,n\*)2a

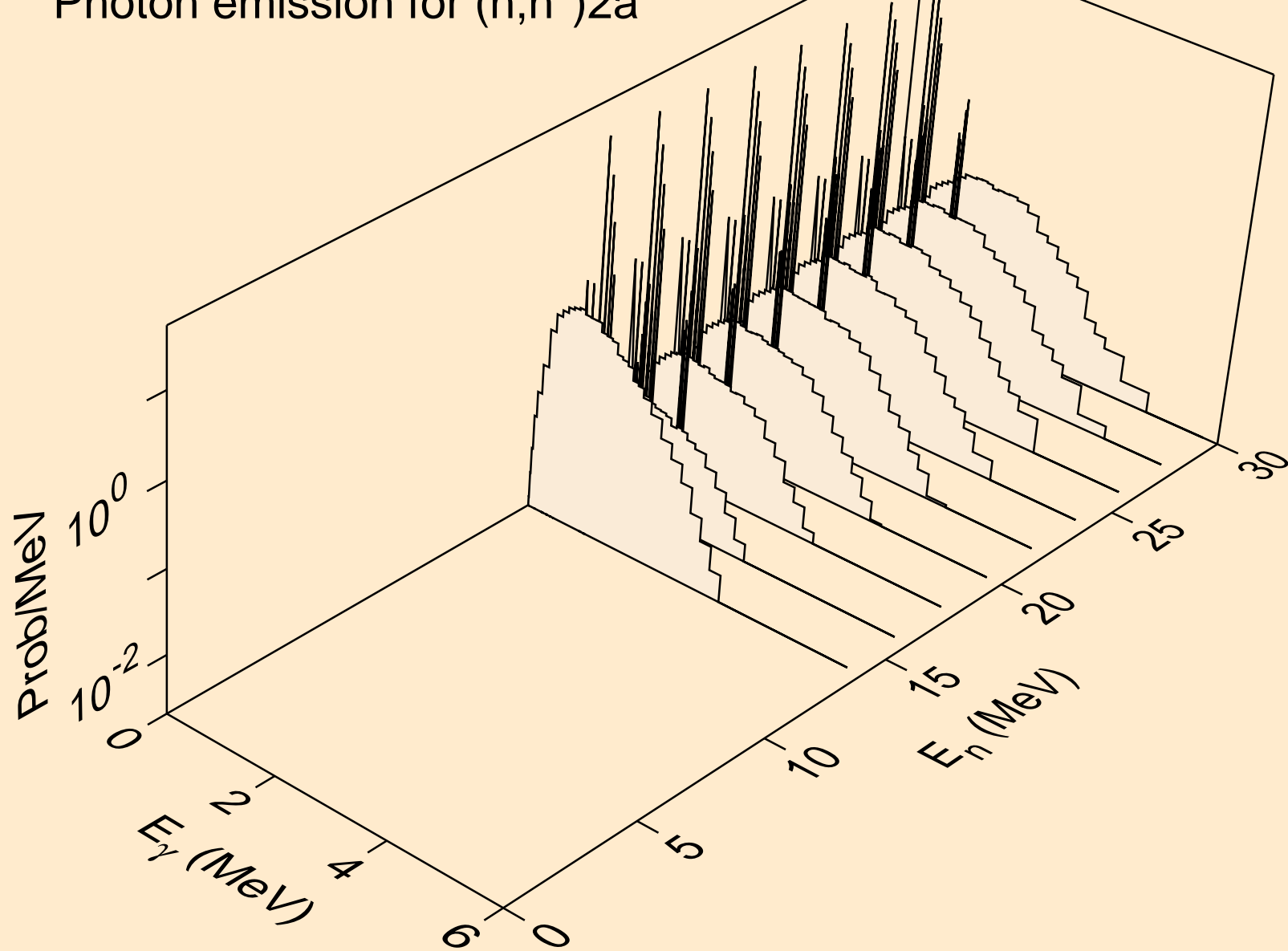

OS178 HELION ACER TENDL-2021 LIBRARY; T=0.K  
Photon emission for (n,n\*)d

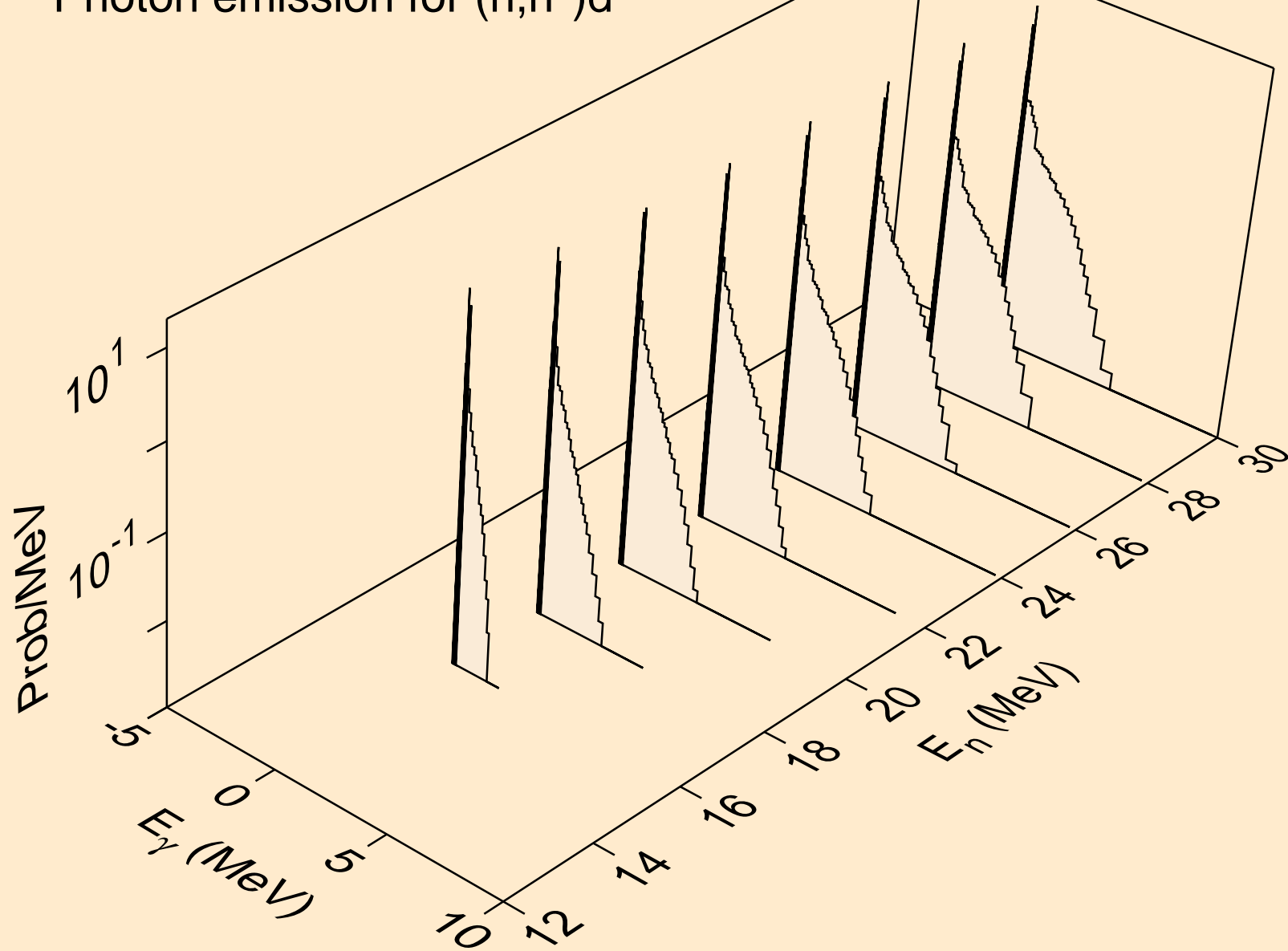

OS178 HELION ACER TENDL-2021 LIBRARY; T=0.K  
Photon emission for (n,n\*)t

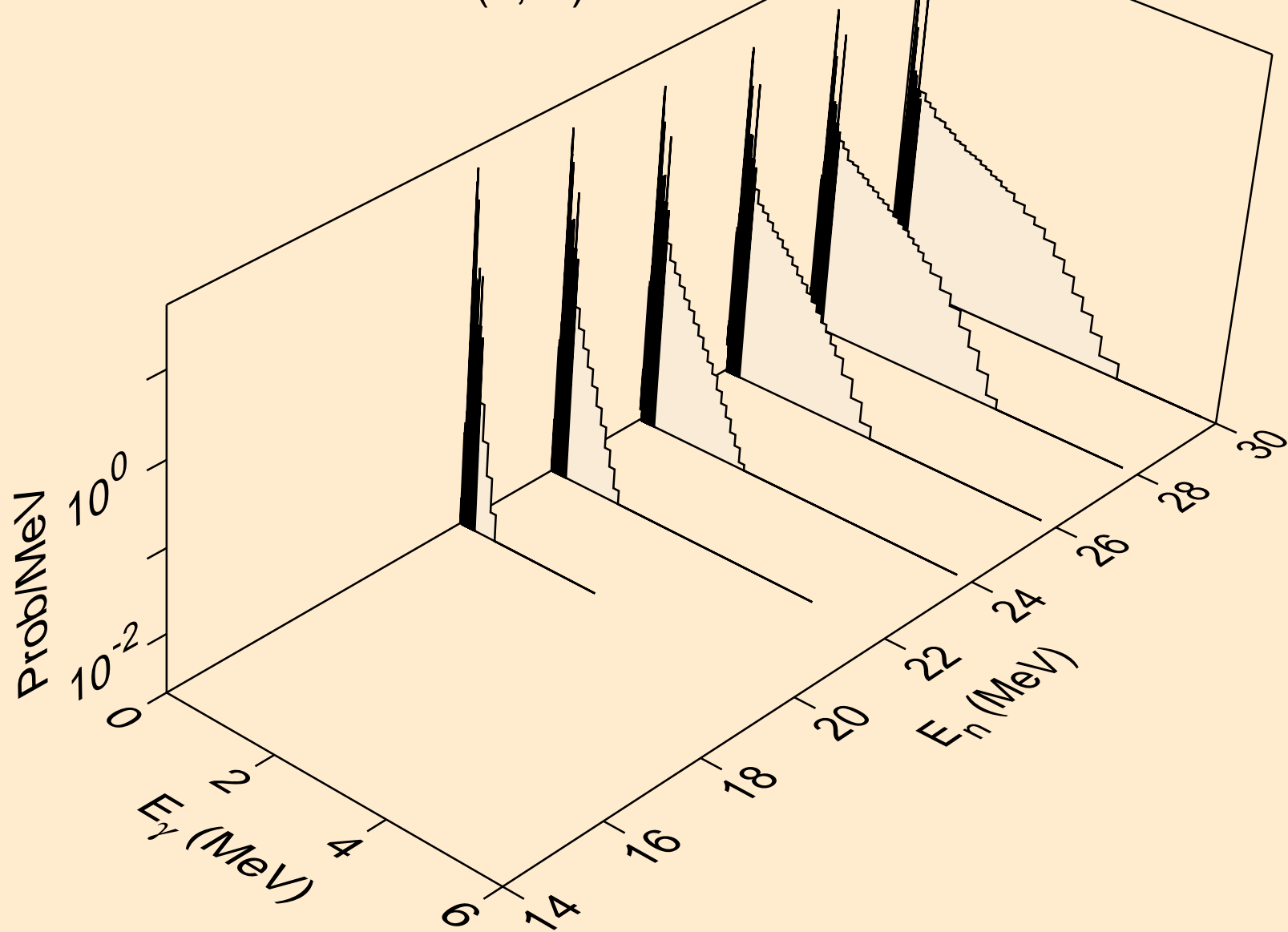

OS178 HELION ACER TENDL-2021 LIBRARY; T=0.K  
Photon emission for (n,n\*)he3

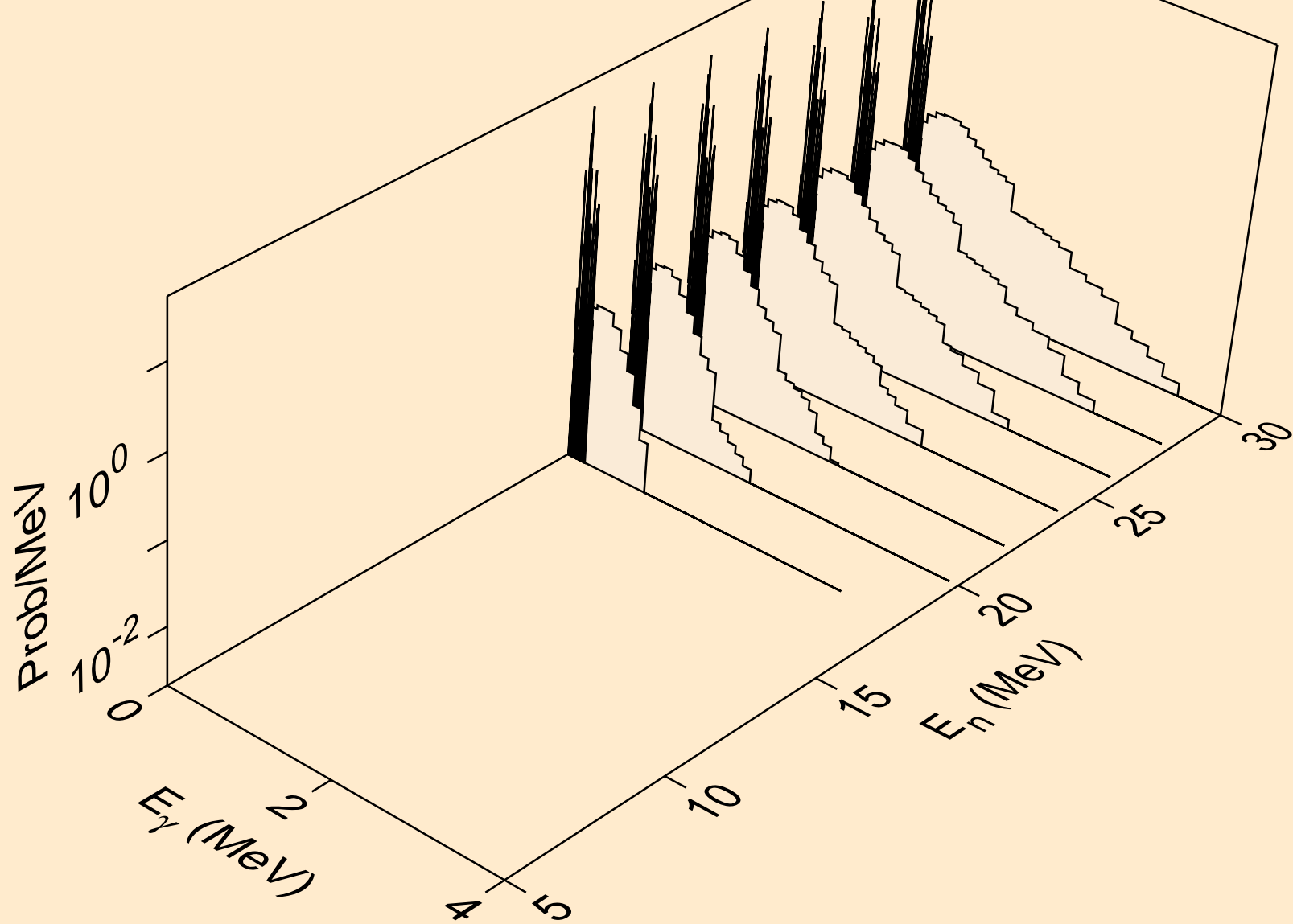

OS178 HELION ACER TENDL-2021 LIBRARY; T=0.K  
Photon emission for (n,2np)

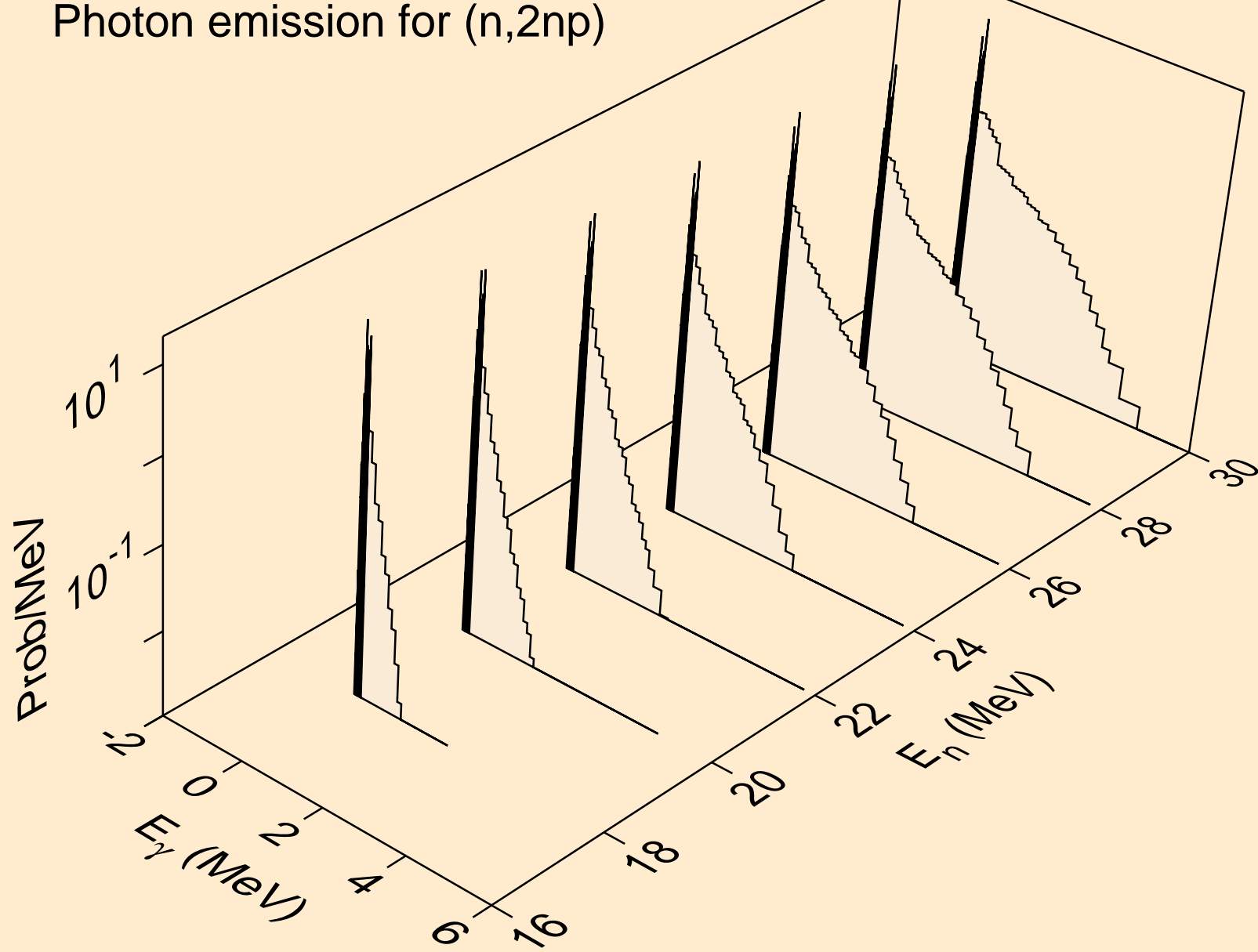

OS178 HELION ACER TENDL-2021 LIBRARY; T=0.K  
Photon emission for (n,3np)

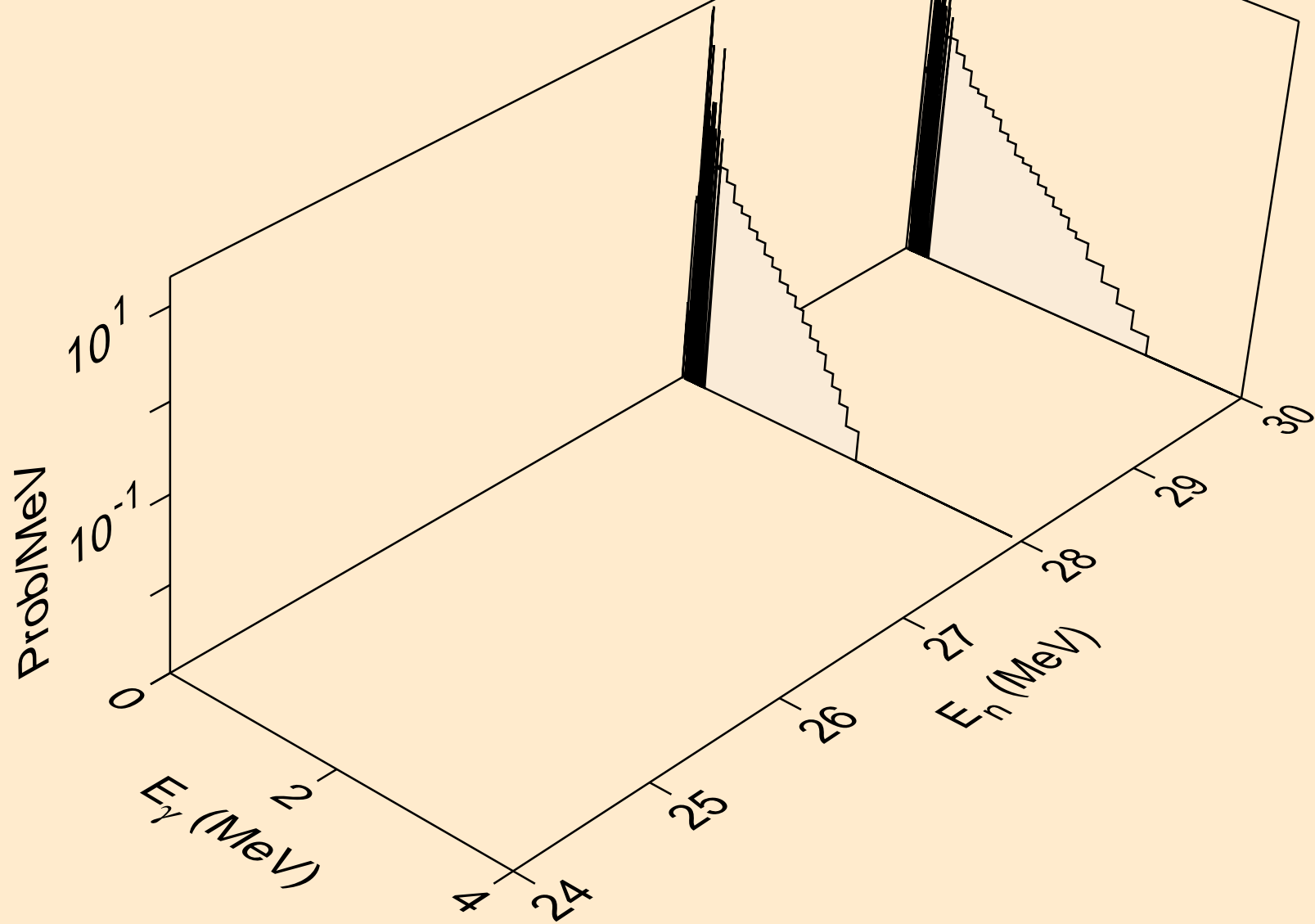



OS178 HELION ACER TENDL-2021 LIBRARY; T=0.K  
Photon emission for (n,2np)

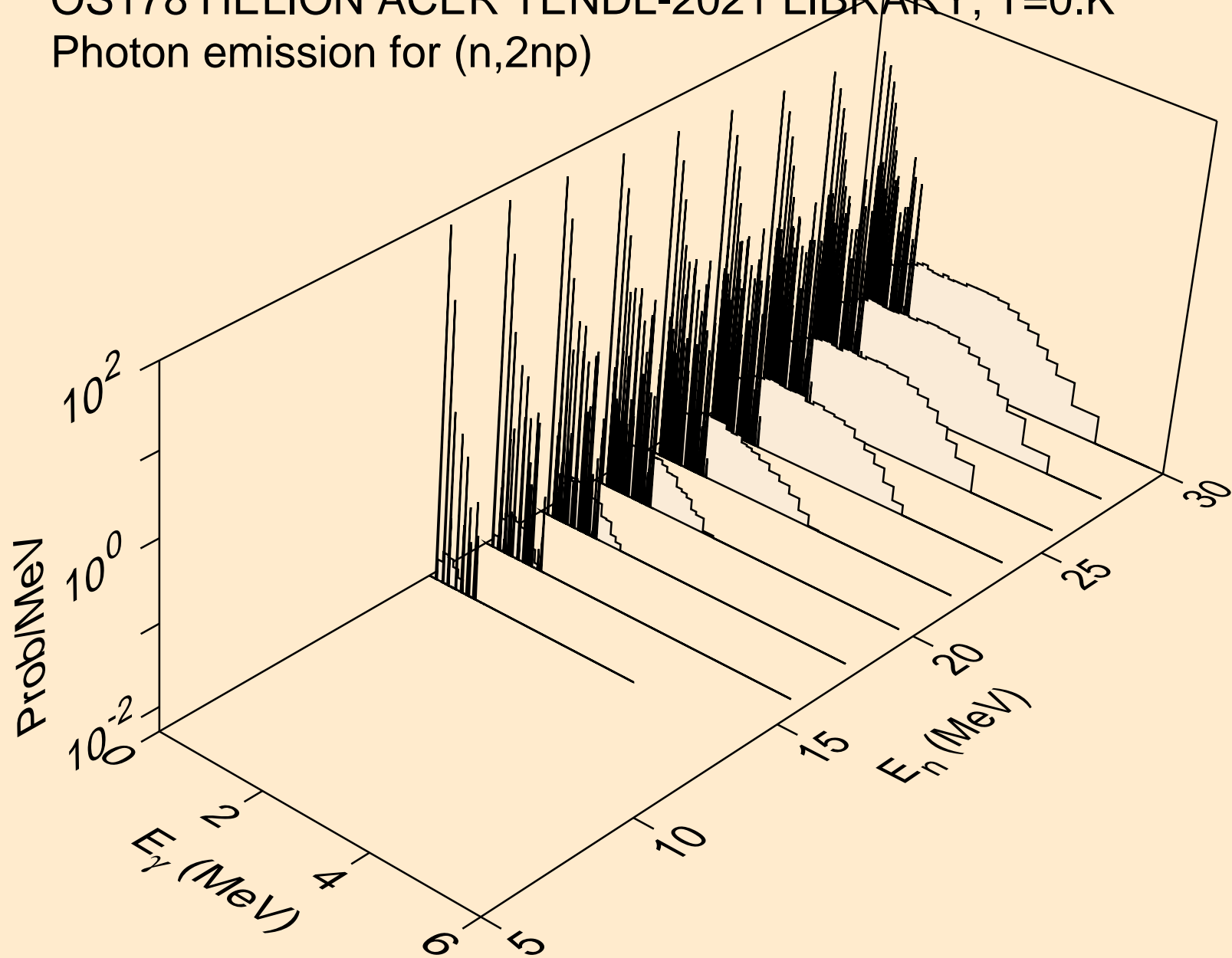

OS178 HELION ACER TENDL-2021 LIBRARY; T=0.K  
Photon emission for (n,npa)

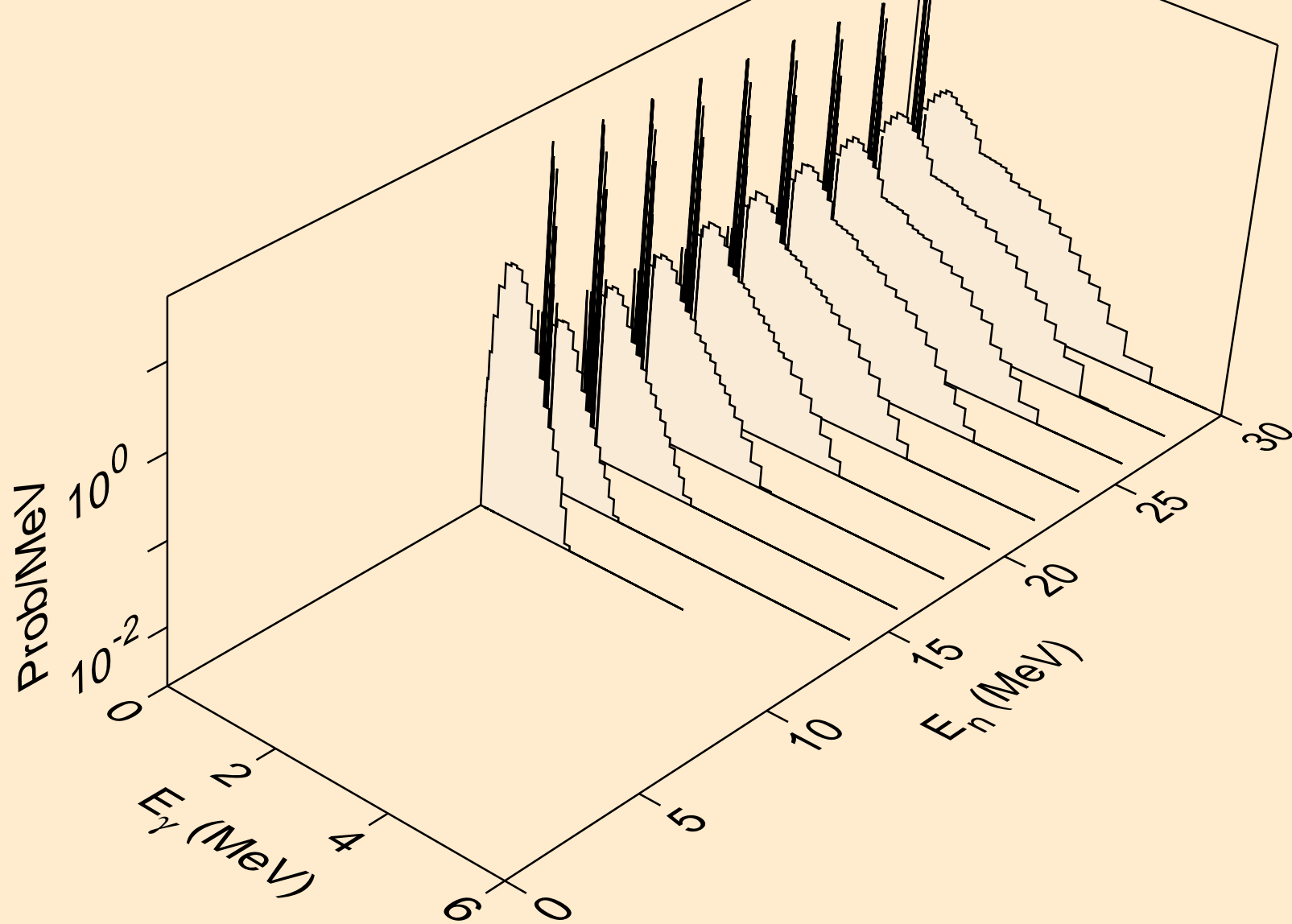

OS178 HELION ACER TENDL-2021 LIBRARY; T=0.K  
Photon emission for (n,gma)

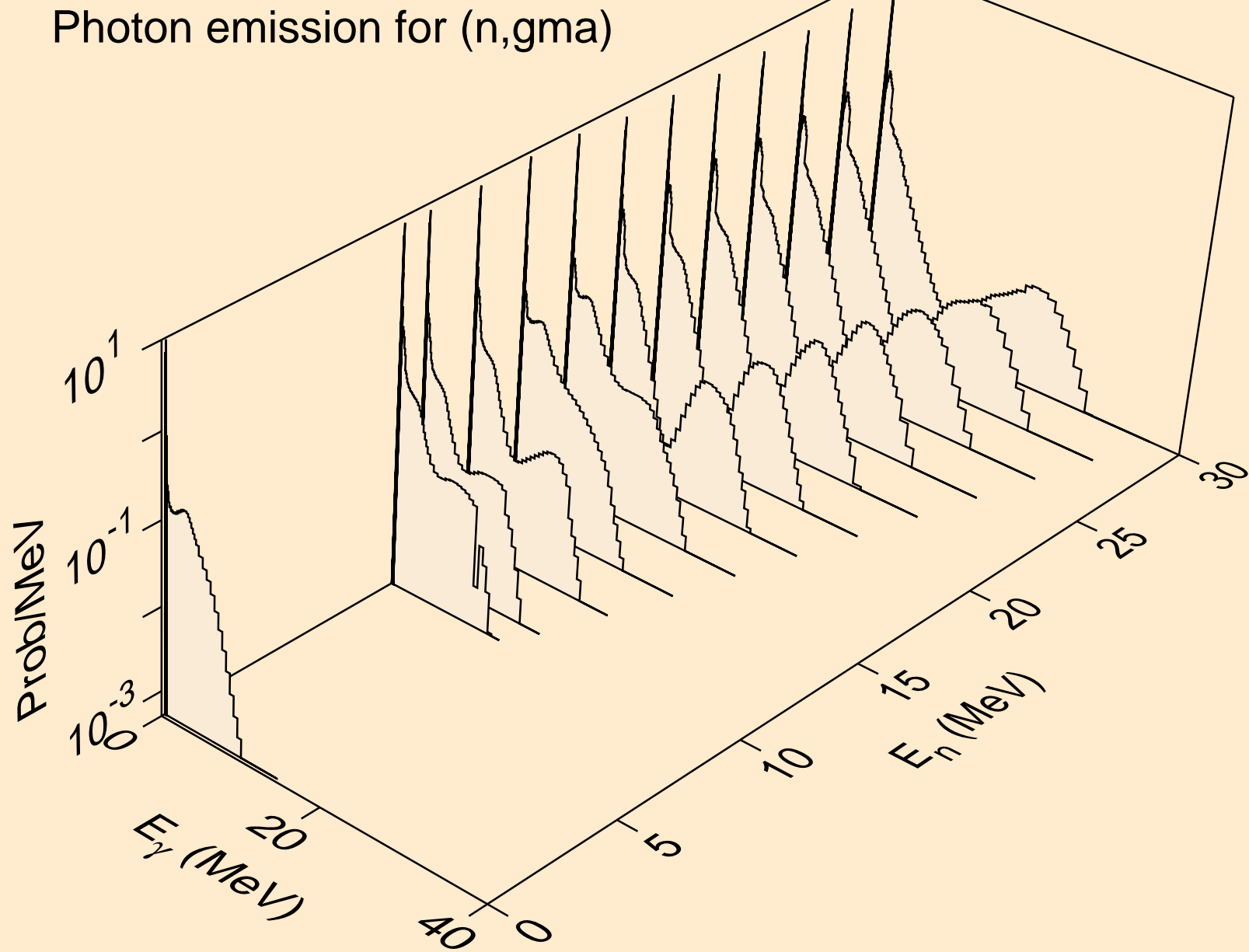

OS178 HELION ACER TENDL-2021 LIBRARY; T=0.K  
Photon emission for (n,p)

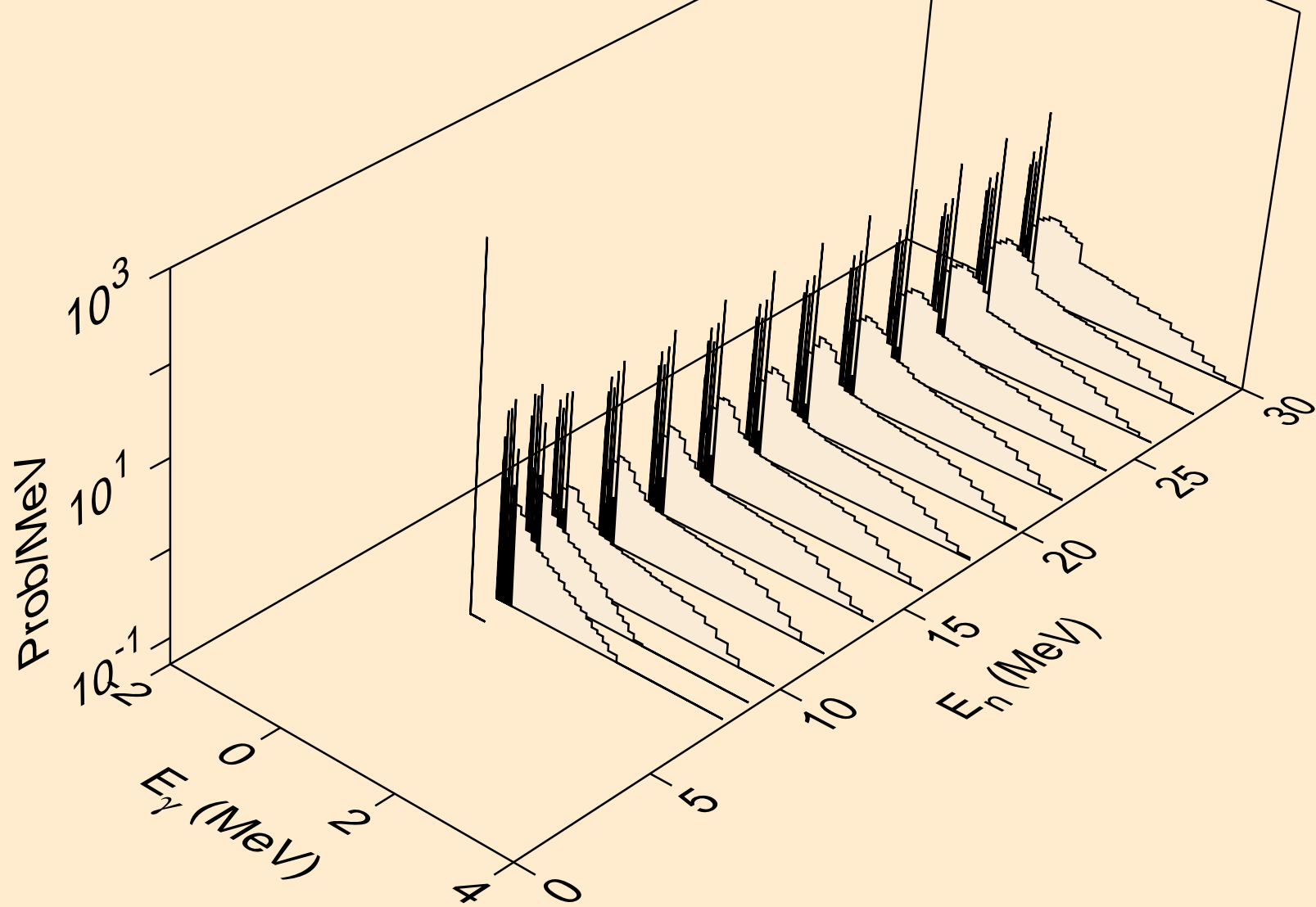

OS178 HELION ACER TENDL-2021 LIBRARY; T=0.K  
Photon emission for (n,d)

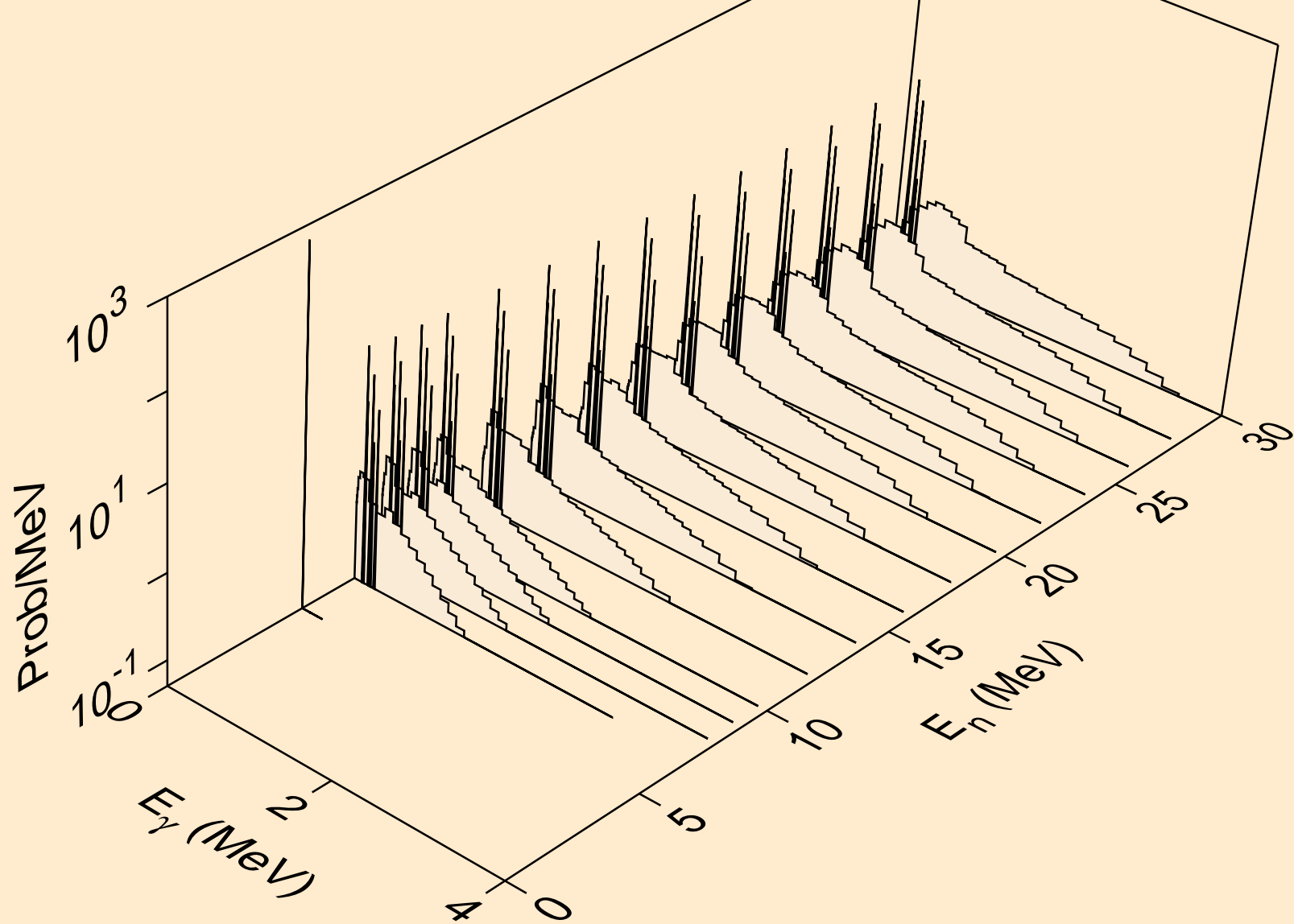

OS178 HELION ACER TENDL-2021 LIBRARY; T=0.K  
Photon emission for (n,t)

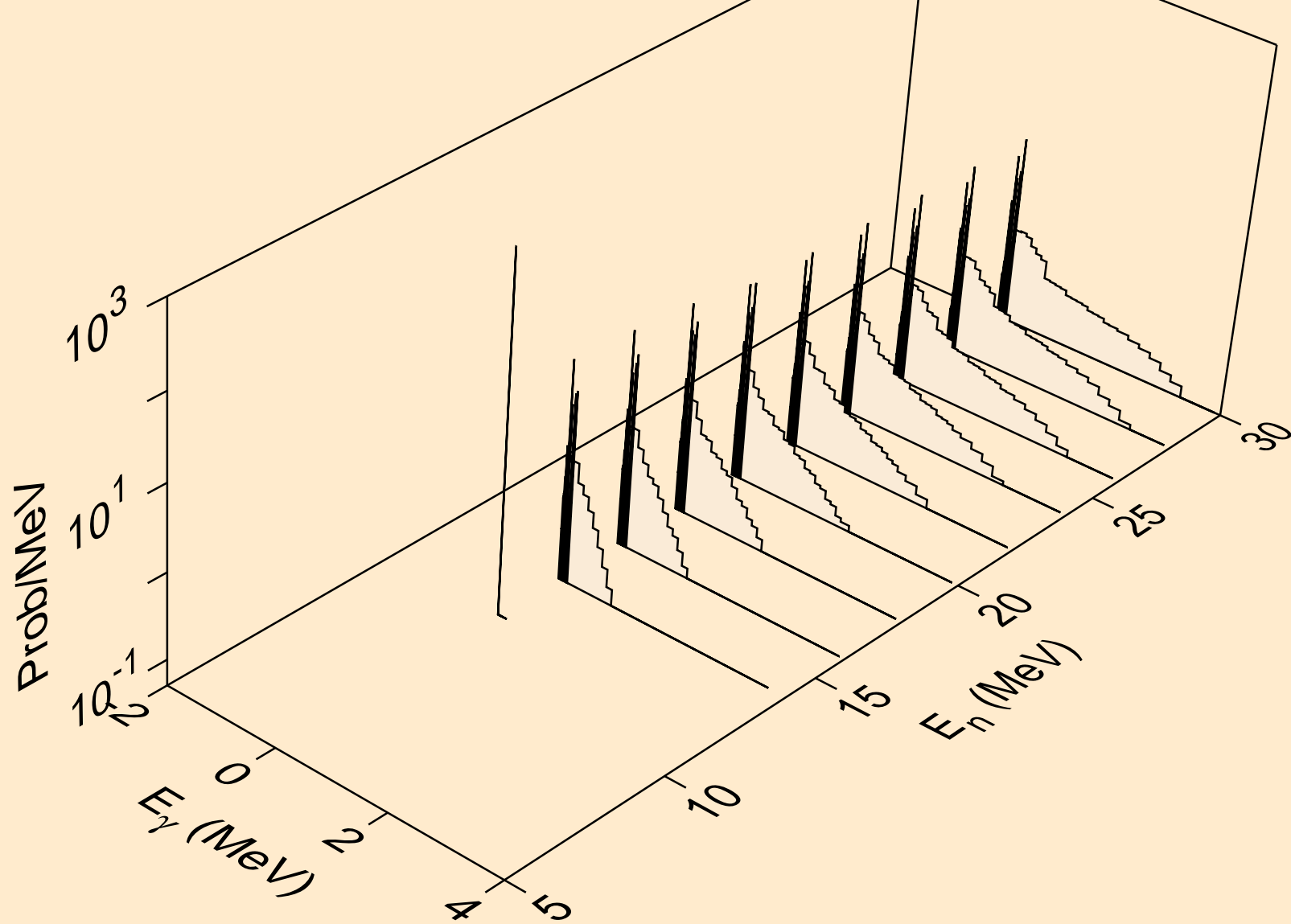

OS178 HELION ACER TENDL-2021 LIBRARY; T=0.K  
Photon emission for inelastic

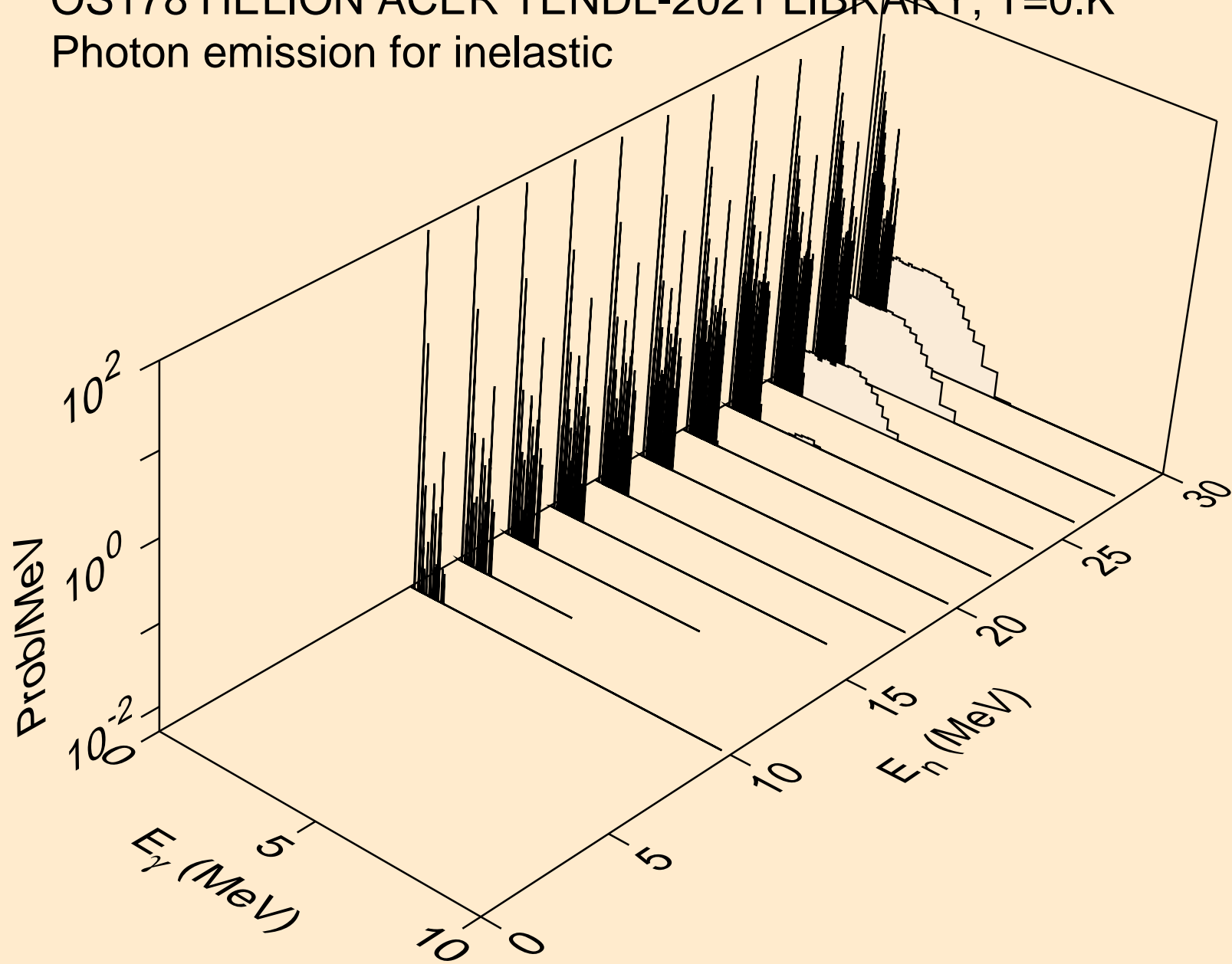

OS178 HELION ACER TENDL-2021 LIBRARY; T=0.K  
Photon emission for (n,a)

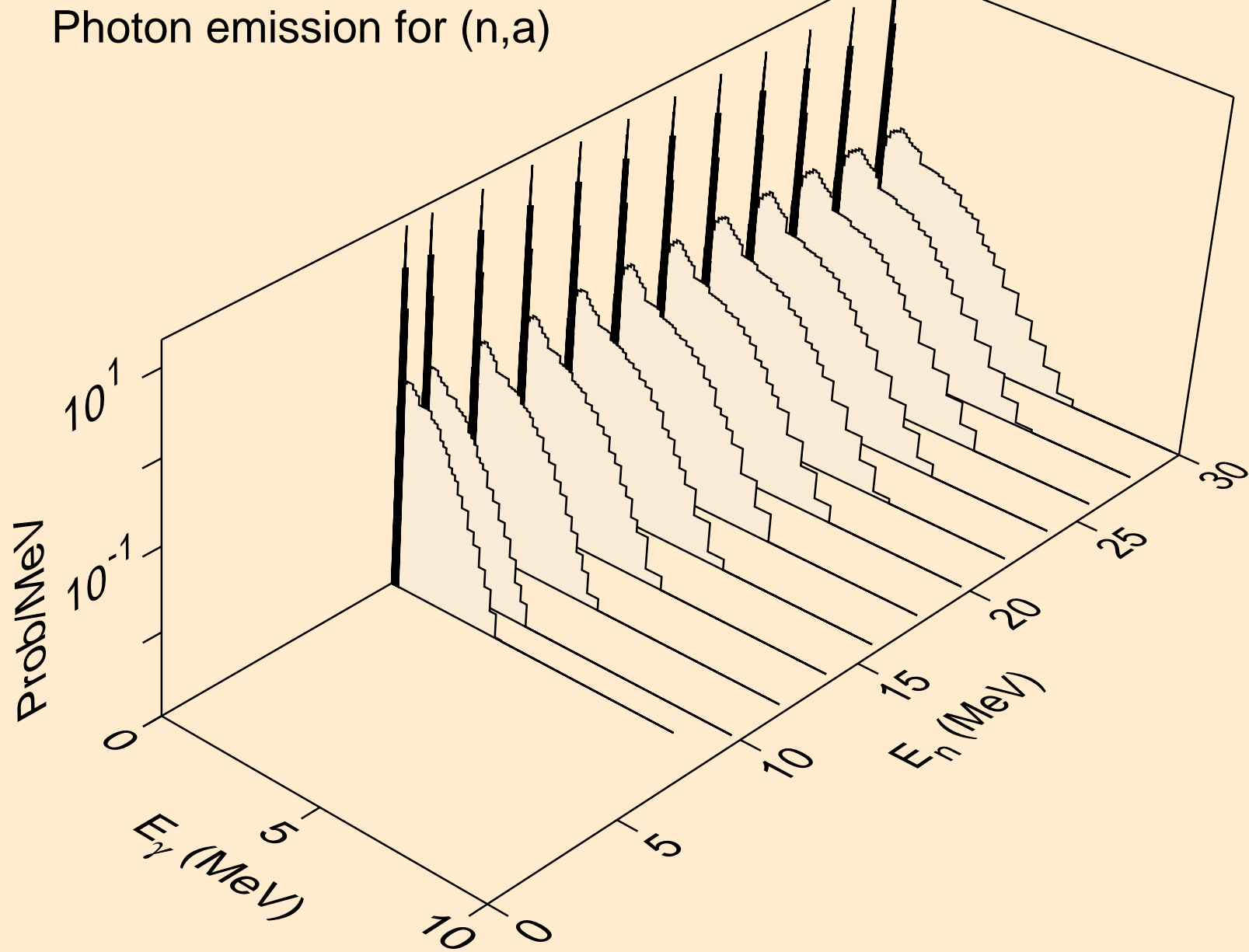



OS178 HELION ACER TENDL-2021 LIBRARY; T=0.K  
Photon emission for (n,2a)

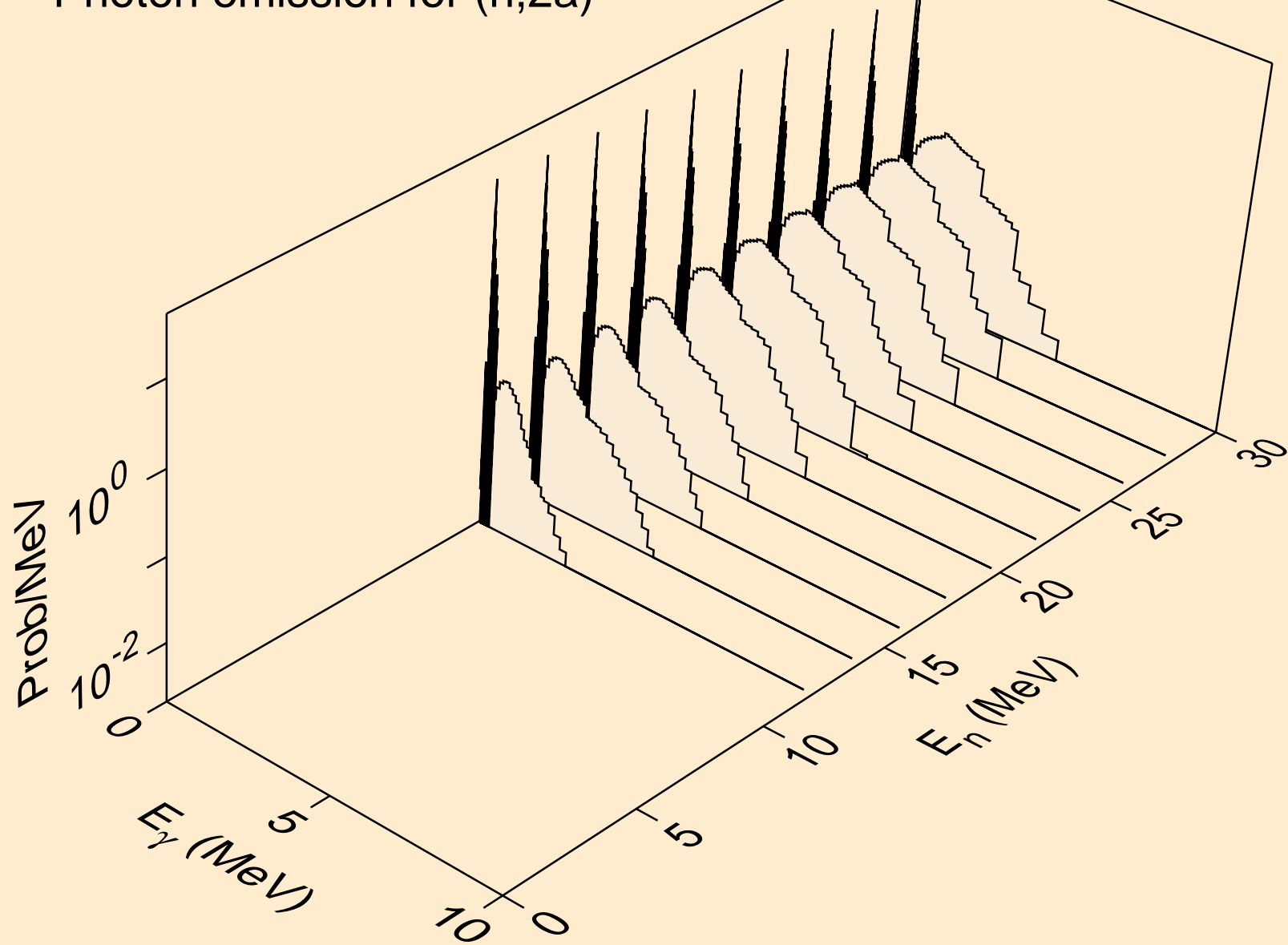

OS178 HELION ACER TENDL-2021 LIBRARY; T=0.K  
Photon emission for (n,2p)

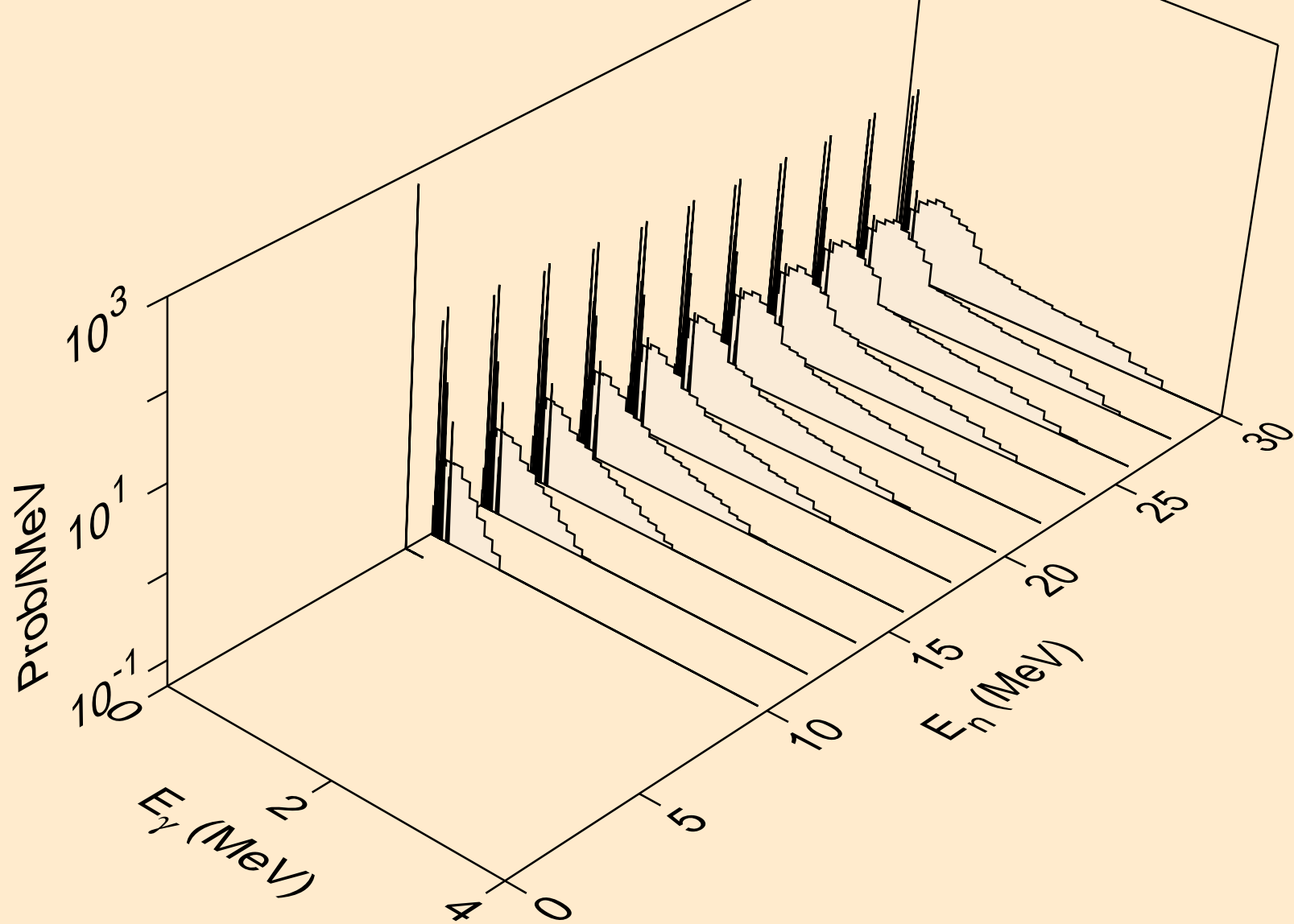

OS178 HELION ACER TENDL-2021 LIBRARY; T=0.K  
Photon emission for (n,pa)

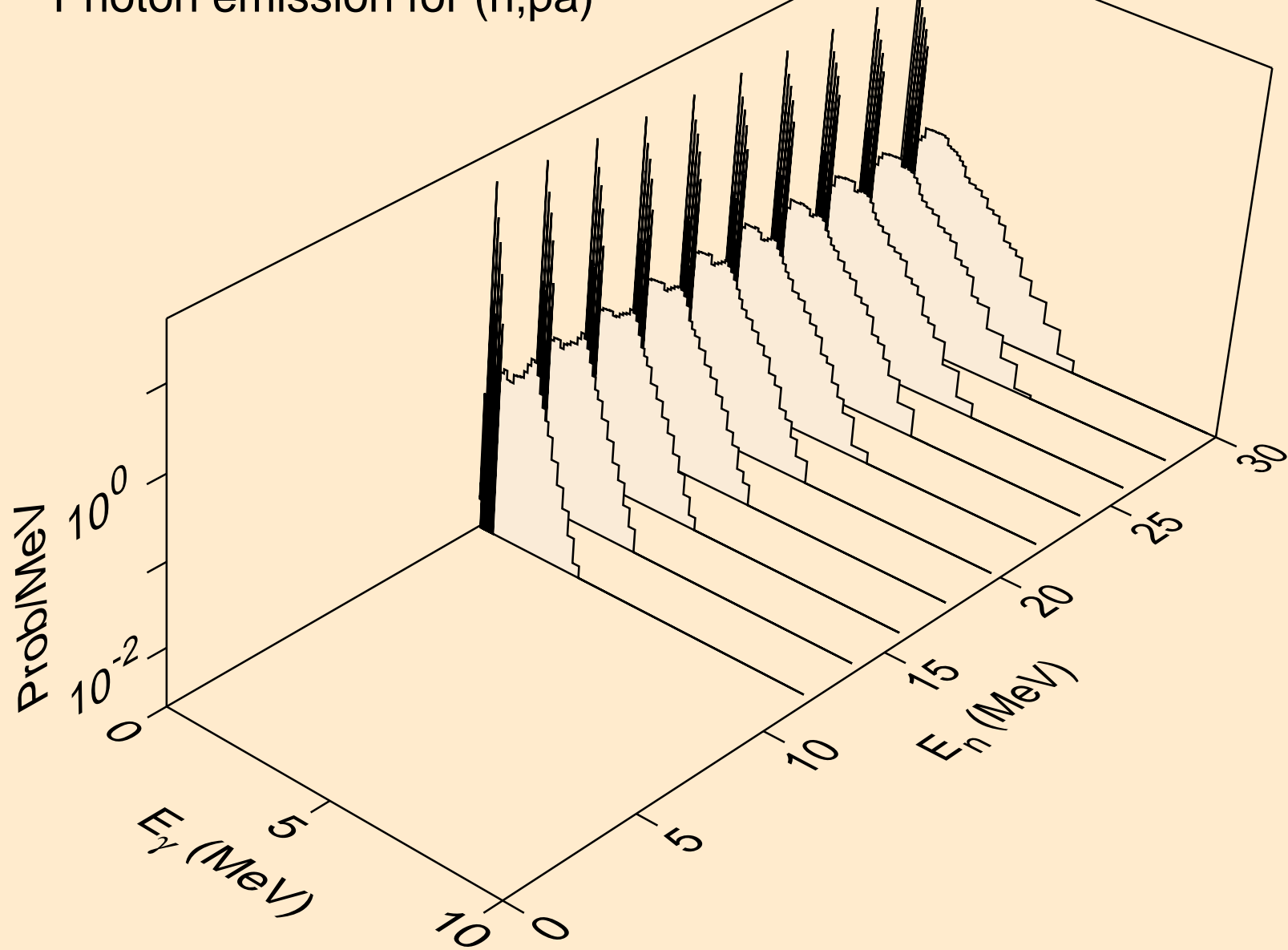

OS178 HELION ACER TENDL-2021 LIBRARY; T=0.K  
Photon emission for (n,pd)

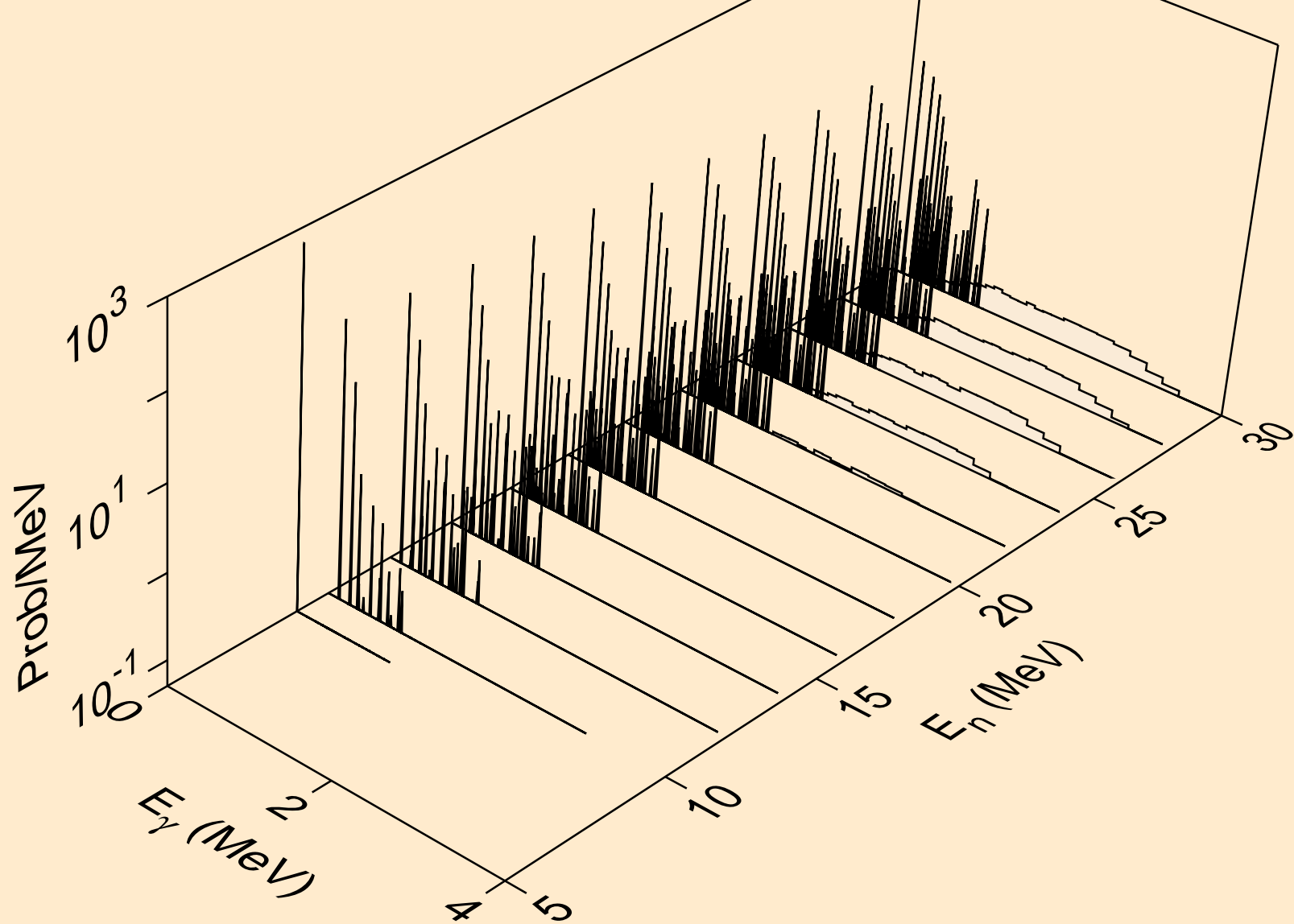

OS178 HELION ACER TENDL-2021 LIBRARY; T=0.K  
Photon emission for (n,pt)

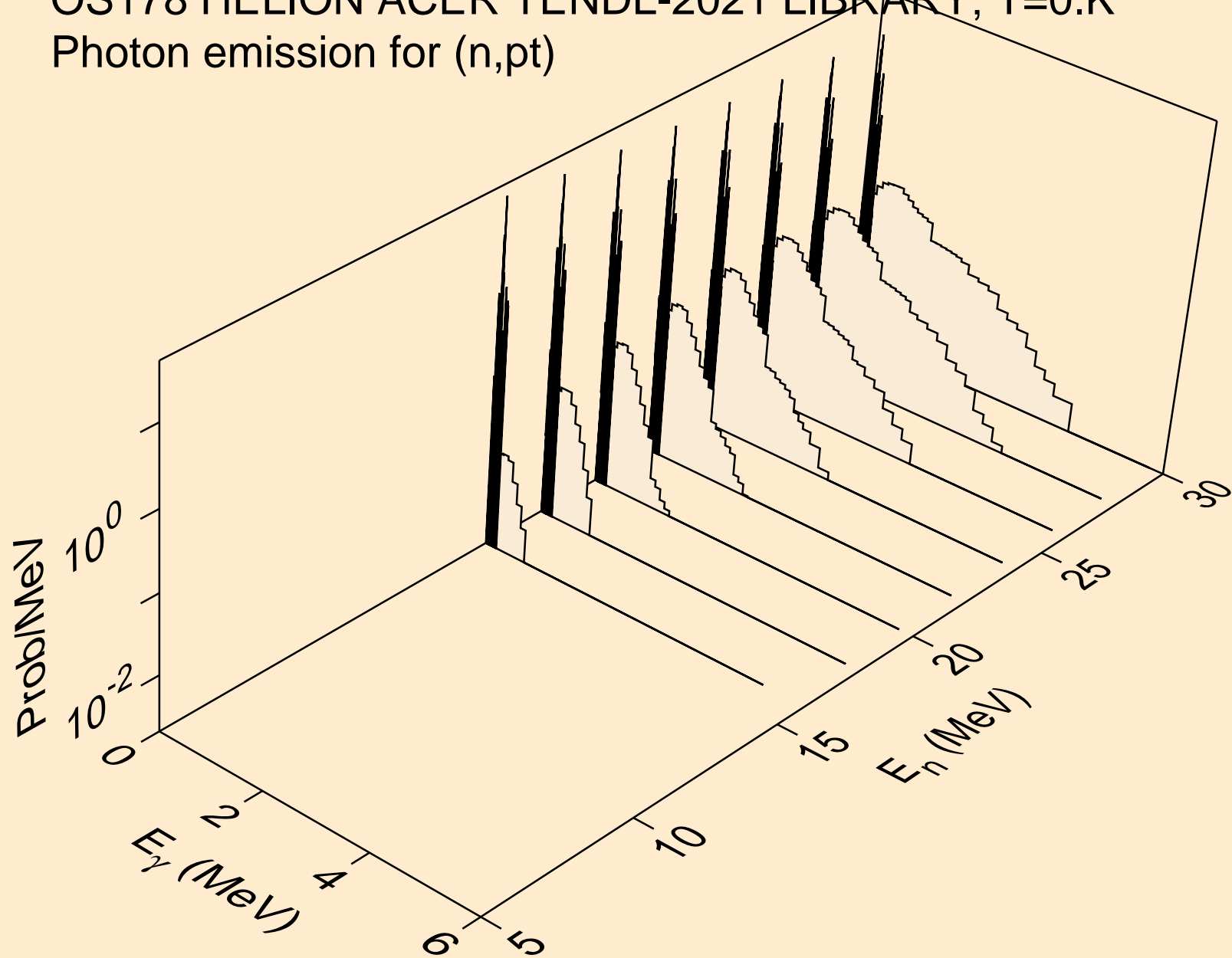

OS178 HELION ACER TENDL-2021 LIBRARY; T=0.K  
Photon emission for (n,da)

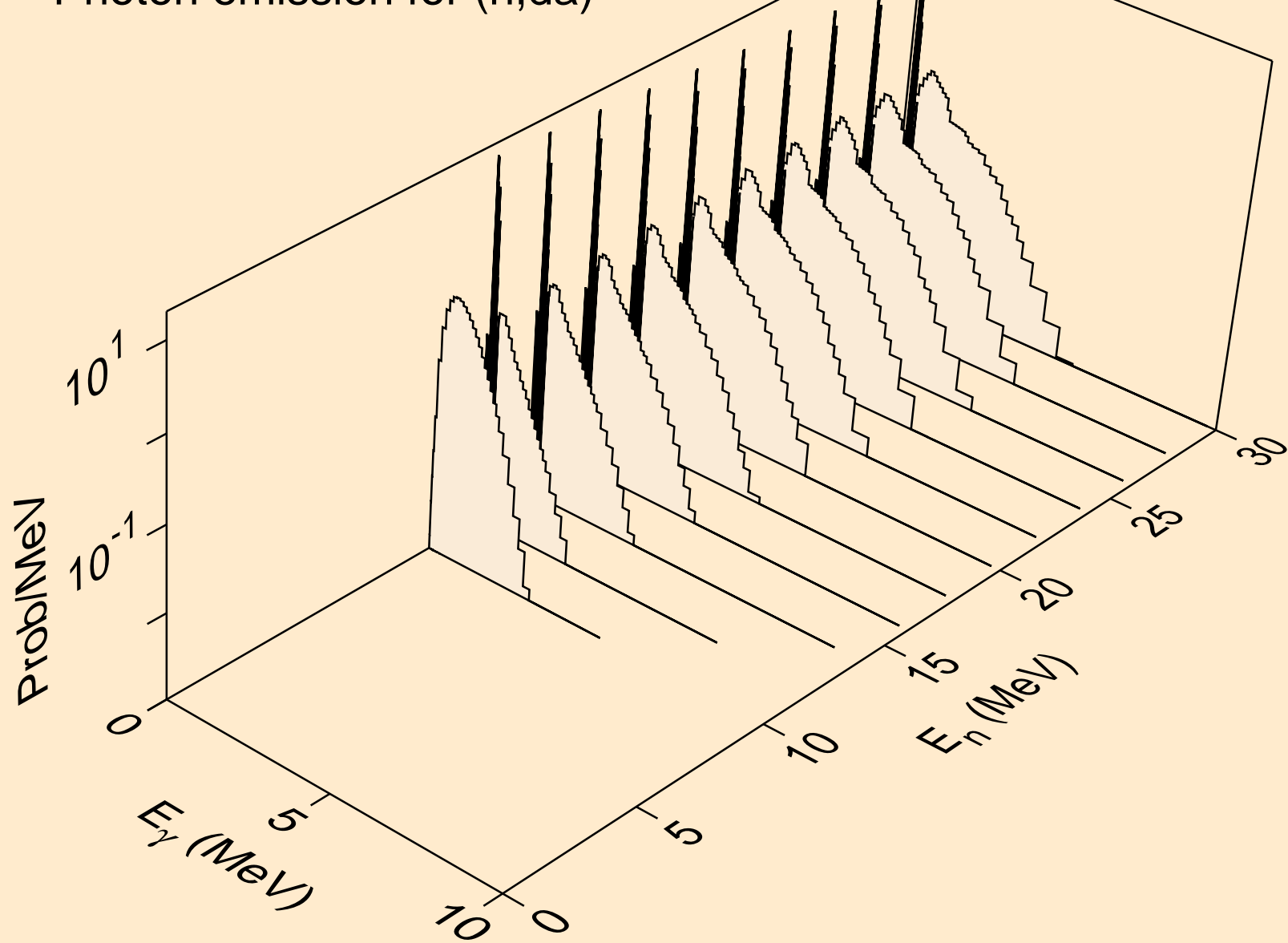

OS178 HELION ACER TENDL-2021 LIBRARY; T=0.K  
Particle heating contributions

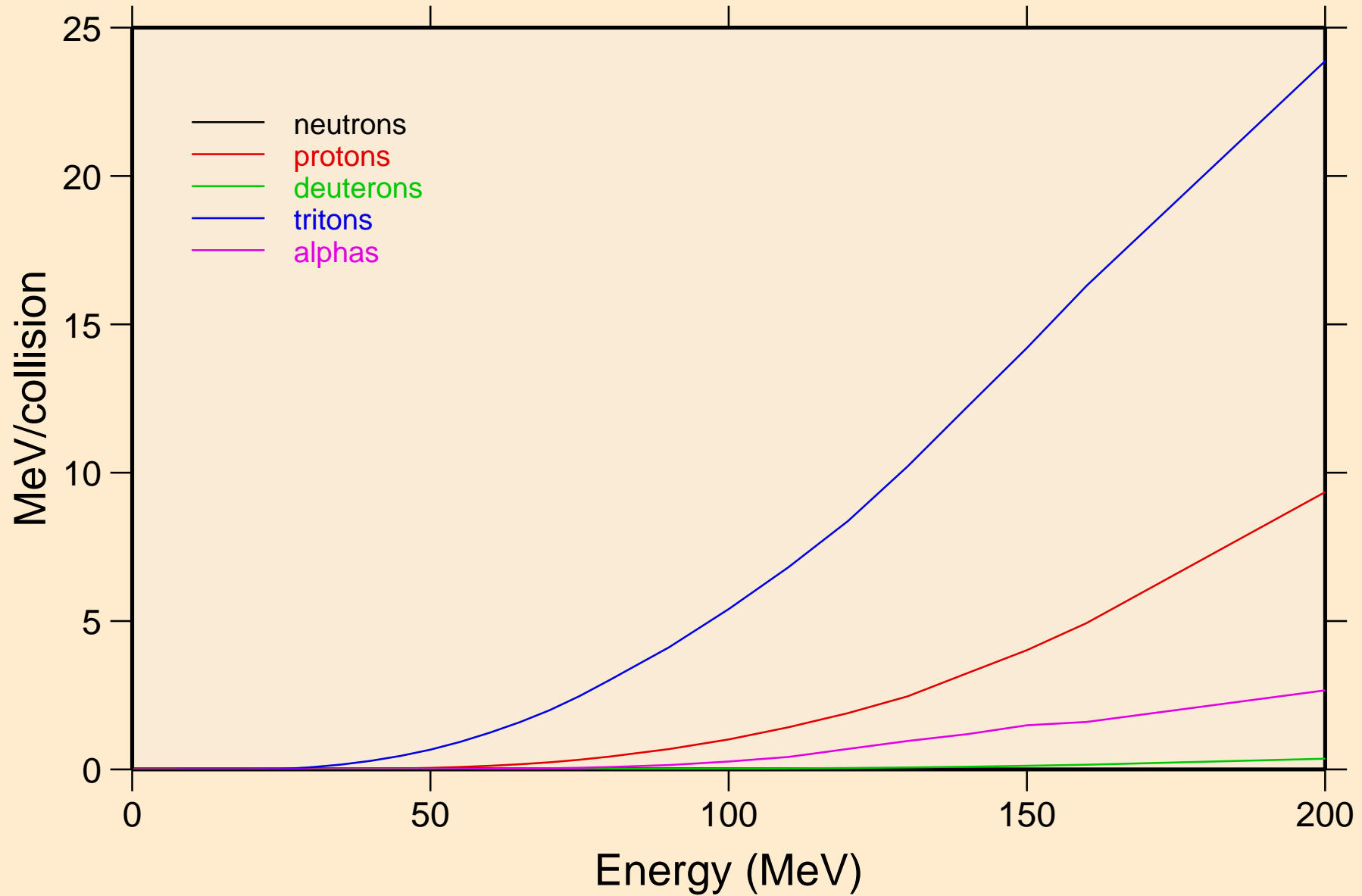

OS178 HELION ACER TENDL-2021 LIBRARY; T=0.K

Recoil Heating

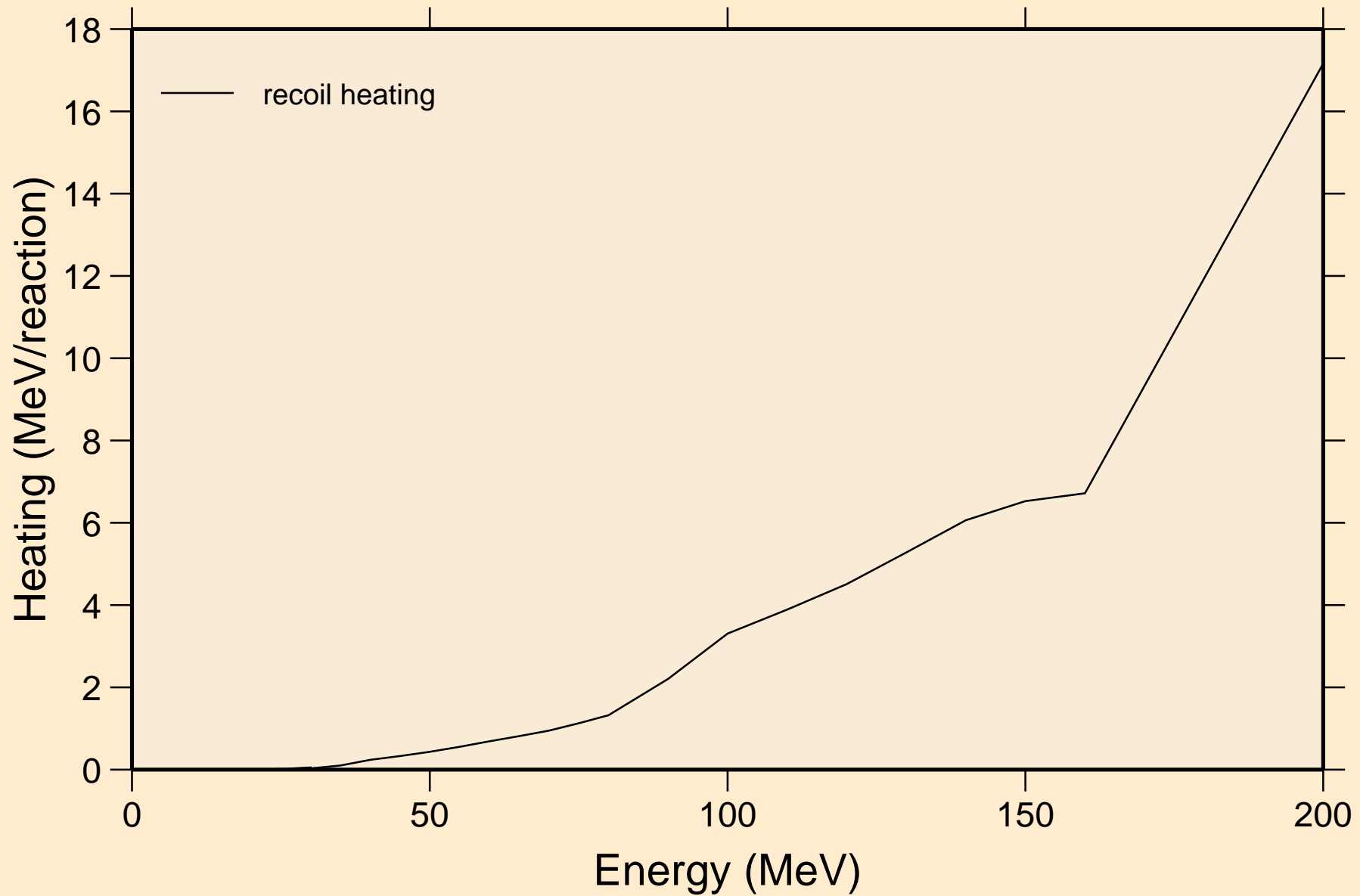



OS178 HELION ACER TENDL-2021 LIBRARY; T=0.K  
Particle production cross sections

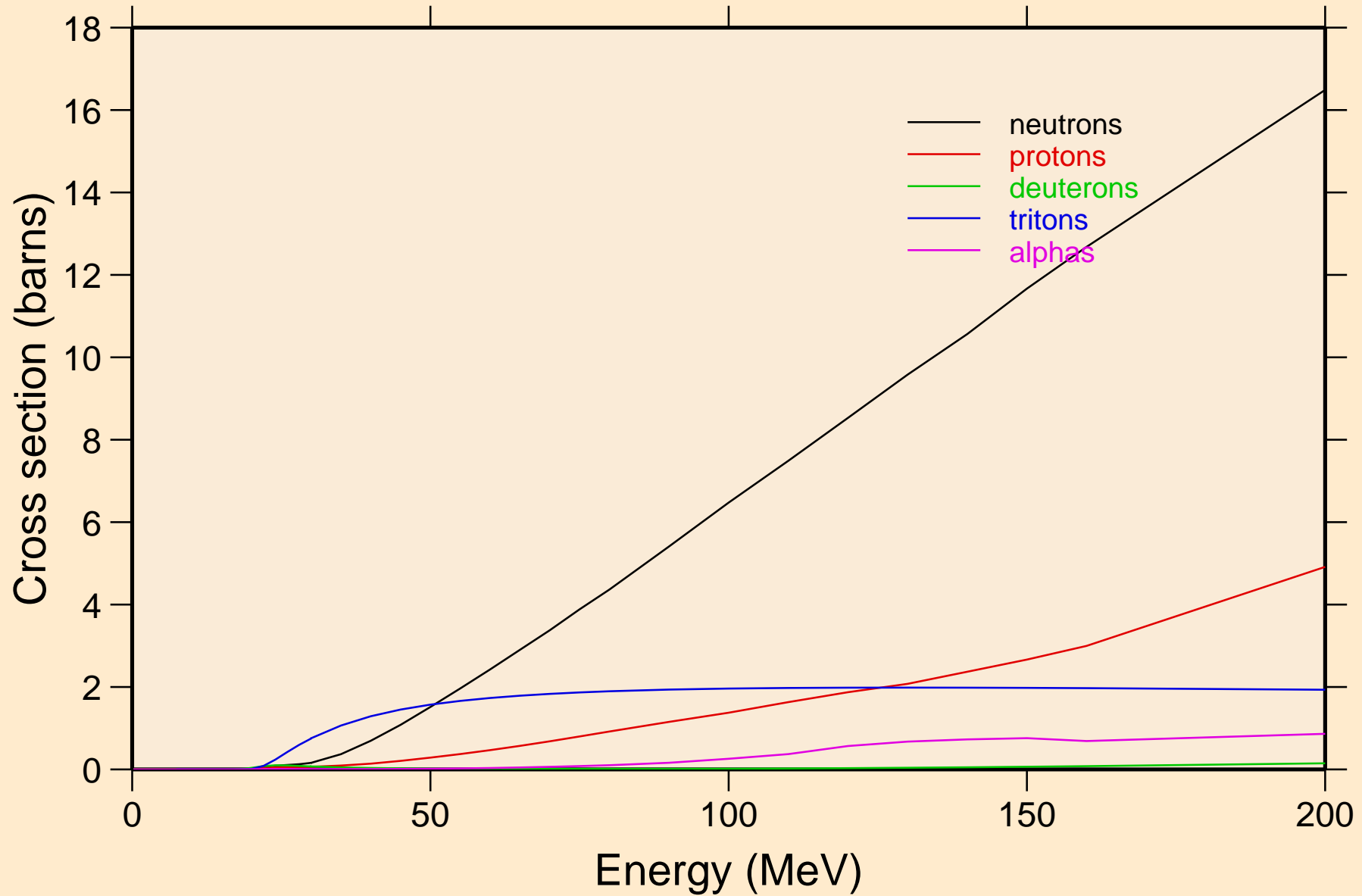

OS178 HELION ACER TENDL-2021 LIBRARY; T=0.K  
neutrons from (s,n)

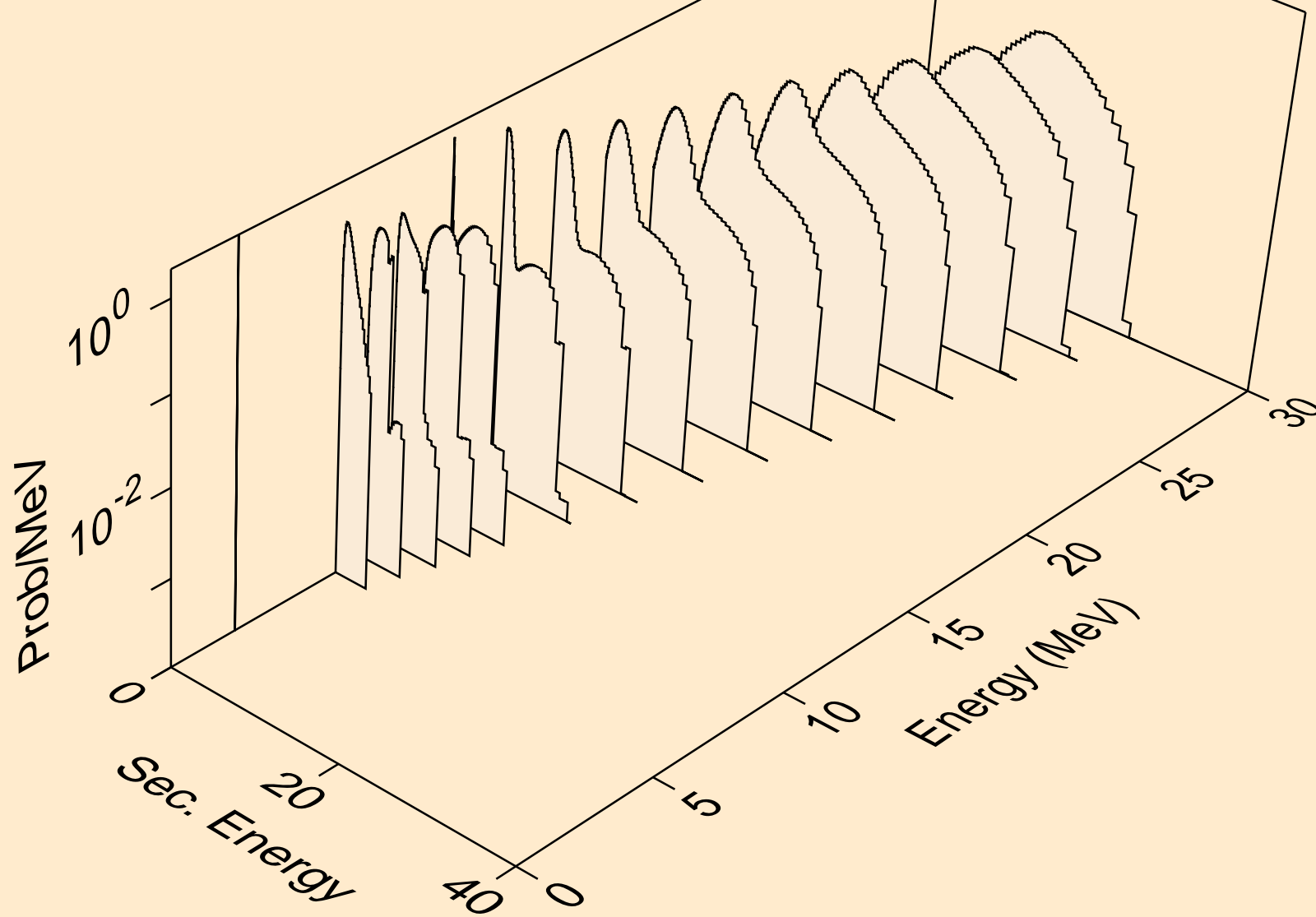

OS178 HELION ACER TENDL-2021 LIBRARY; T=0.K  
neutrons from (s,x)

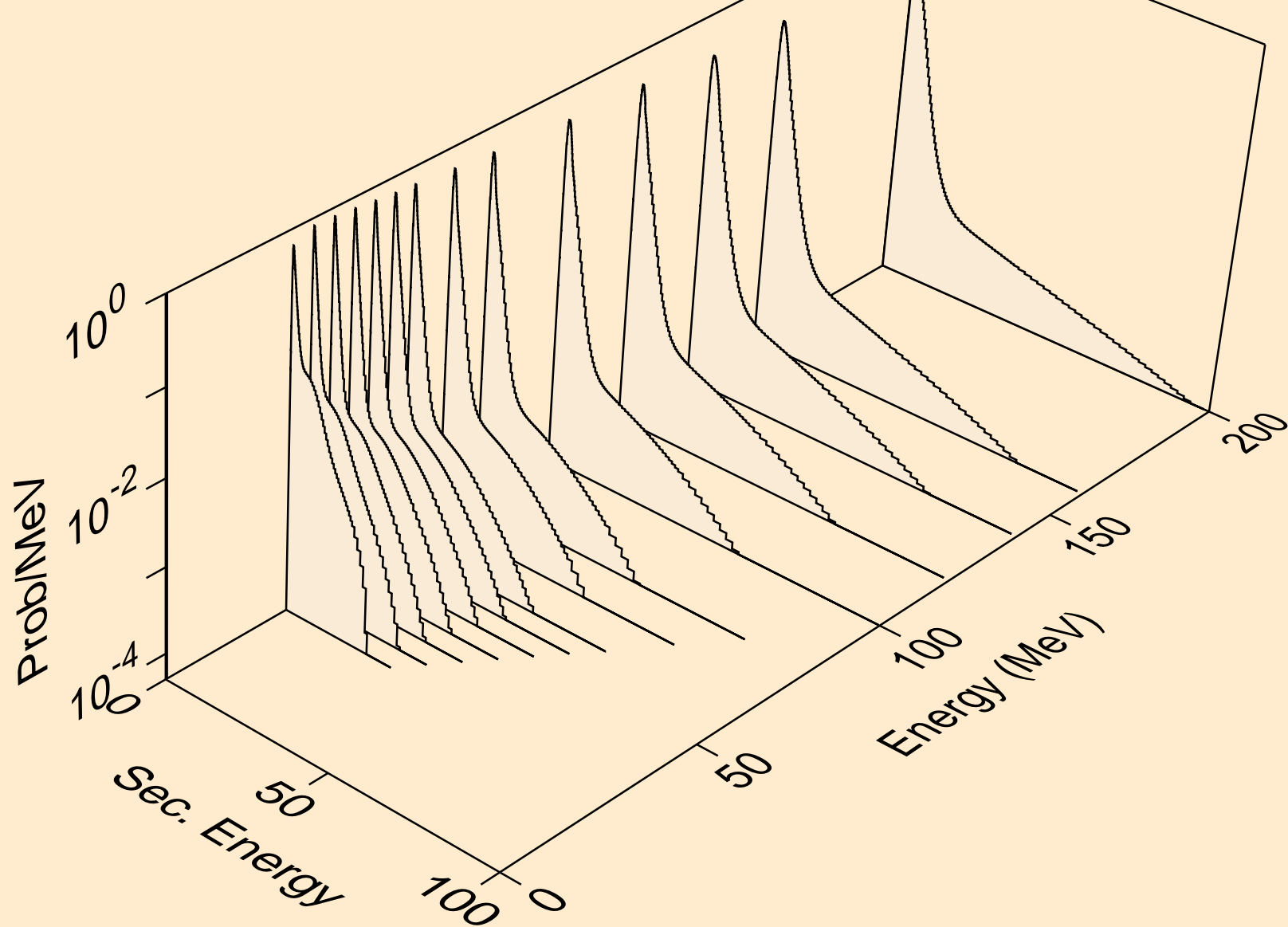

OS178 HELION ACER TENDL-2021 LIBRARY; T=0.K  
neutrons from (s,2nd)

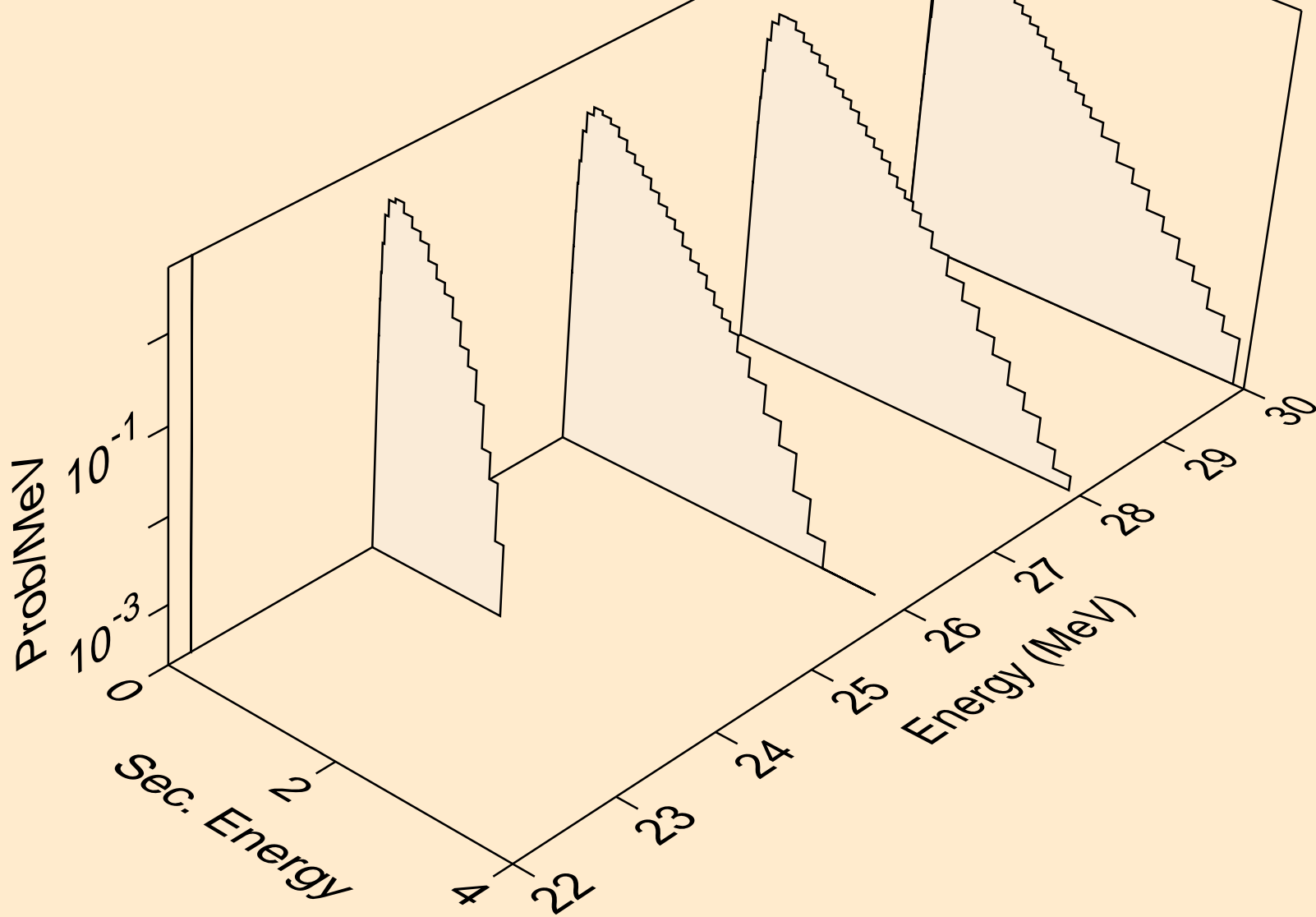

OS178 HELION ACER TENDL-2021 LIBRARY; T=0.K  
neutrons from (s,2n)

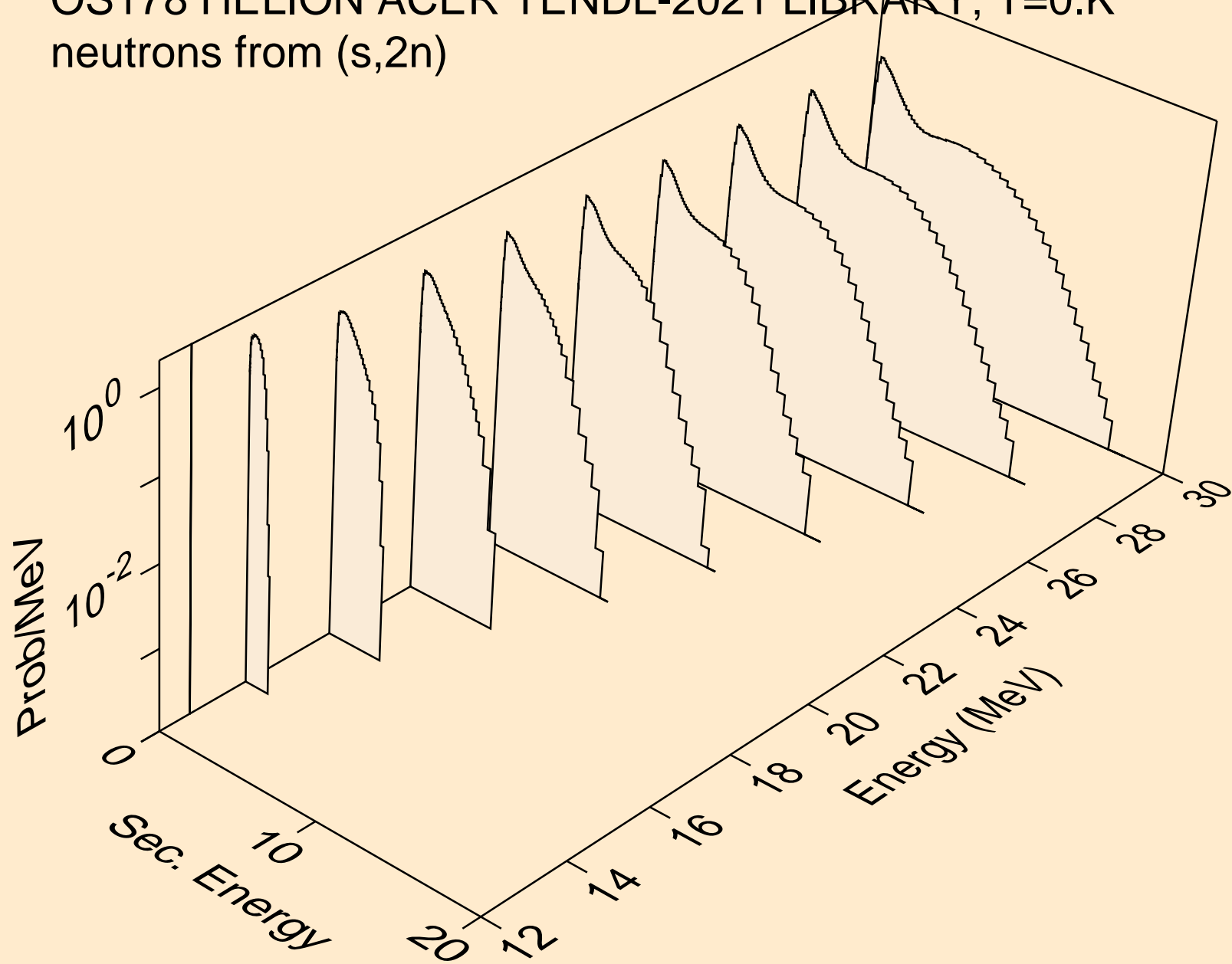

OS178 HELION ACER TENDL-2021 LIBRARY; T=0.K  
neutrons from (s,3n)

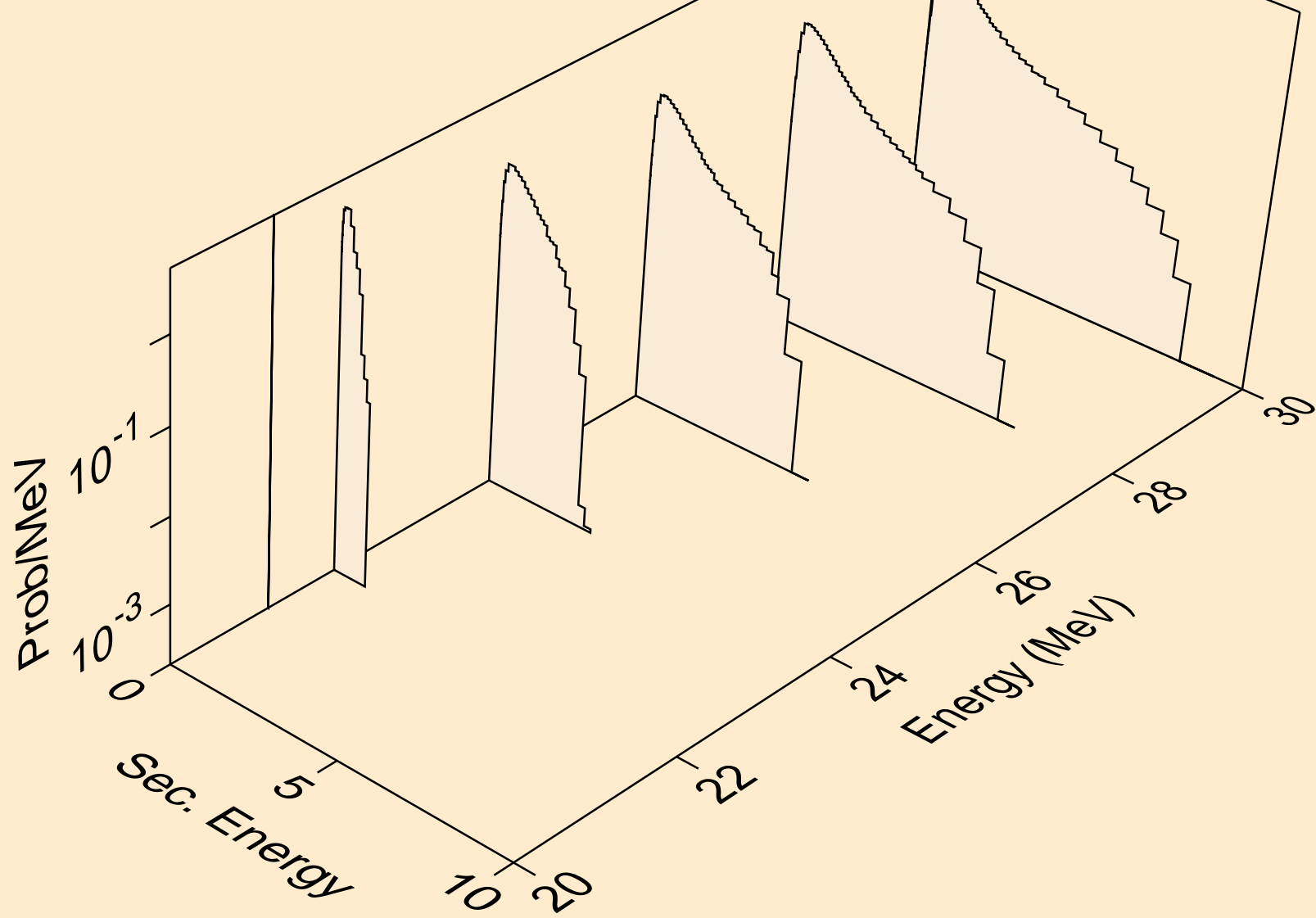

OS178 HELION ACER TENDL-2021 LIBRARY; T=0.K  
neutrons from (s,n\*)a

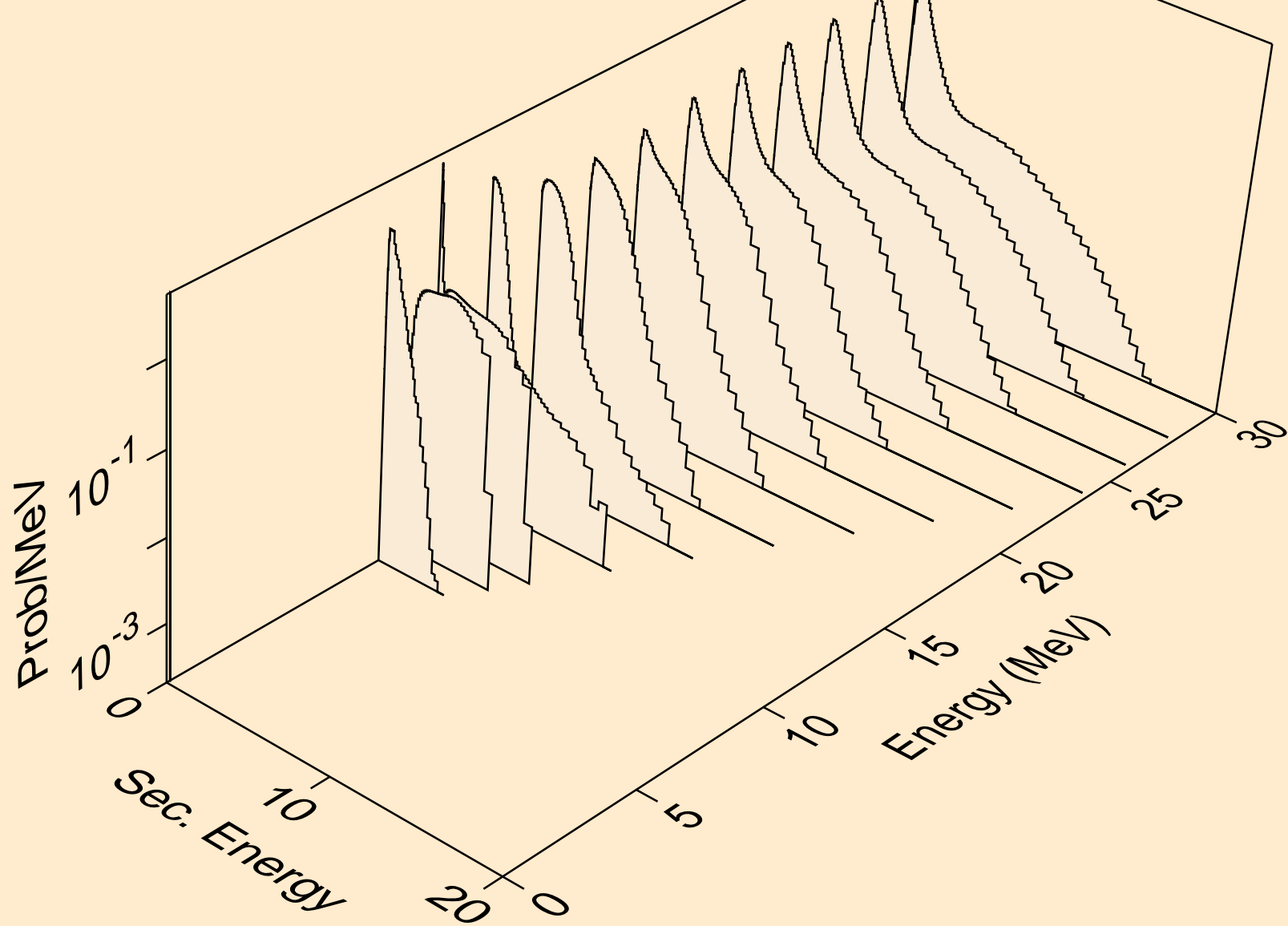

OS178 HELION ACER TENDL-2021 LIBRARY; T=0.K  
neutrons from (s,2n)a

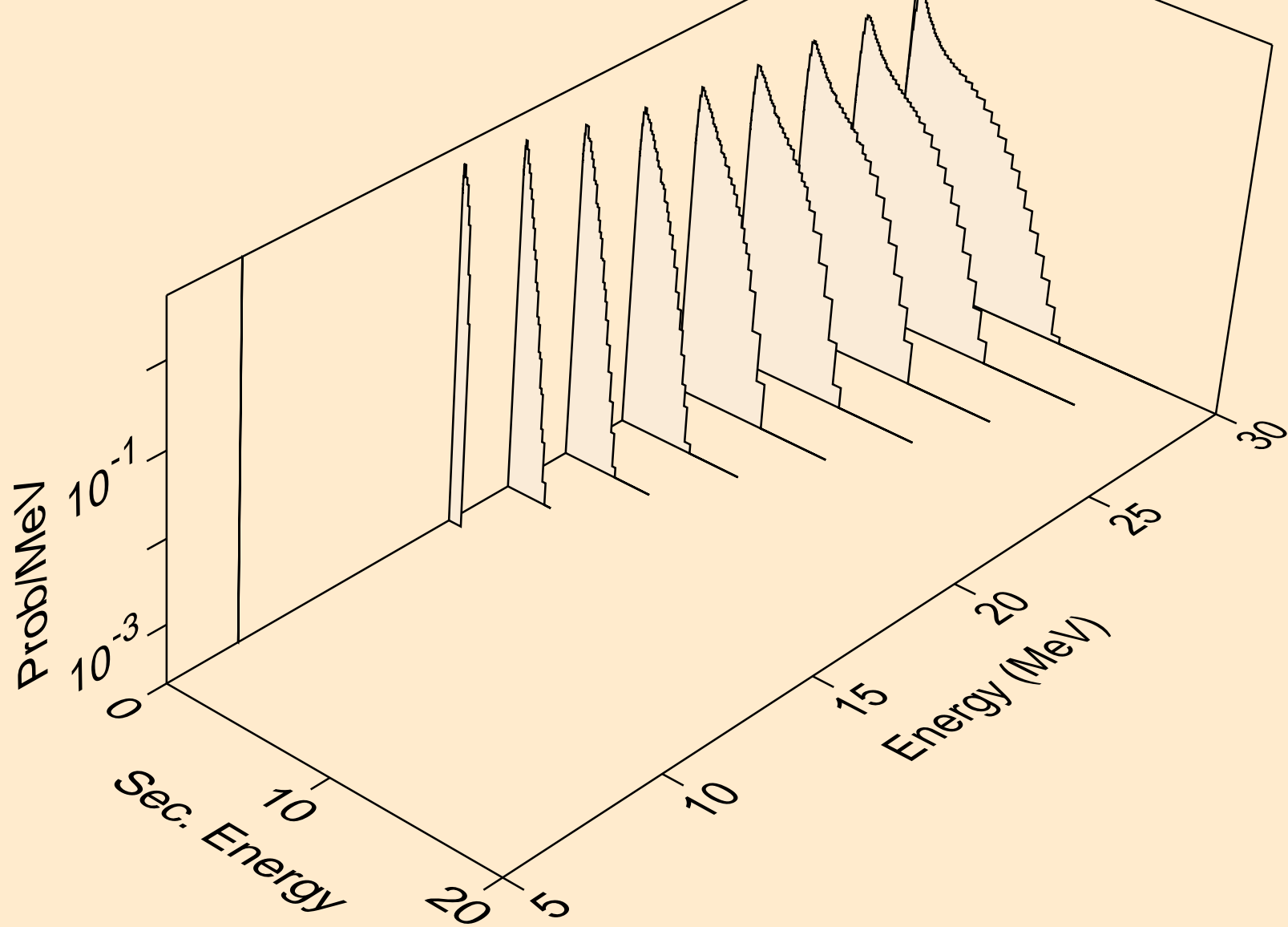



OS178 HELION ACER TENDL-2021 LIBRARY; T=0.K  
neutrons from (s,3n)a

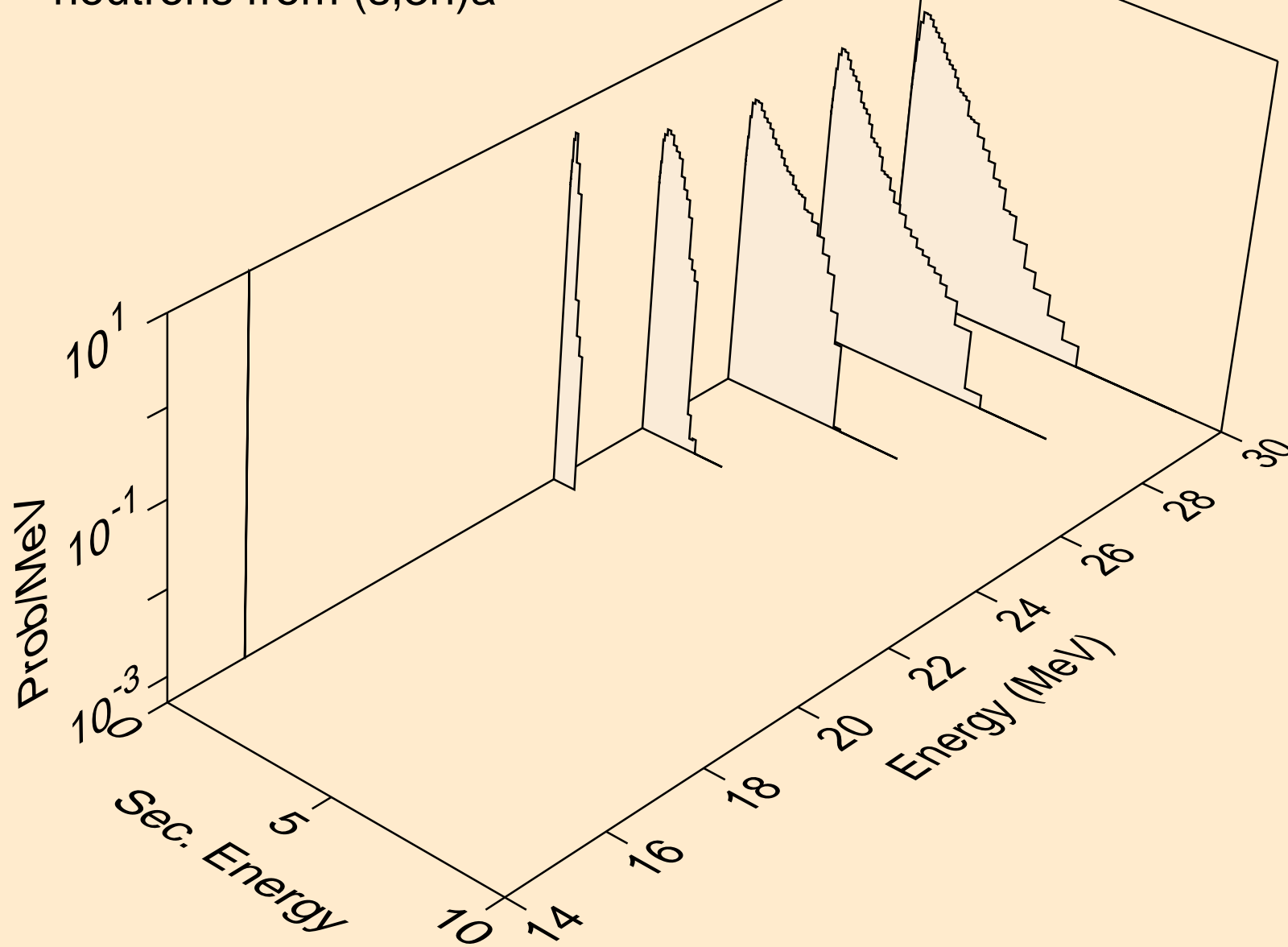

OS178 HELION ACER TENDL-2021 LIBRARY; T=0.K  
neutrons from (s,n\*)p

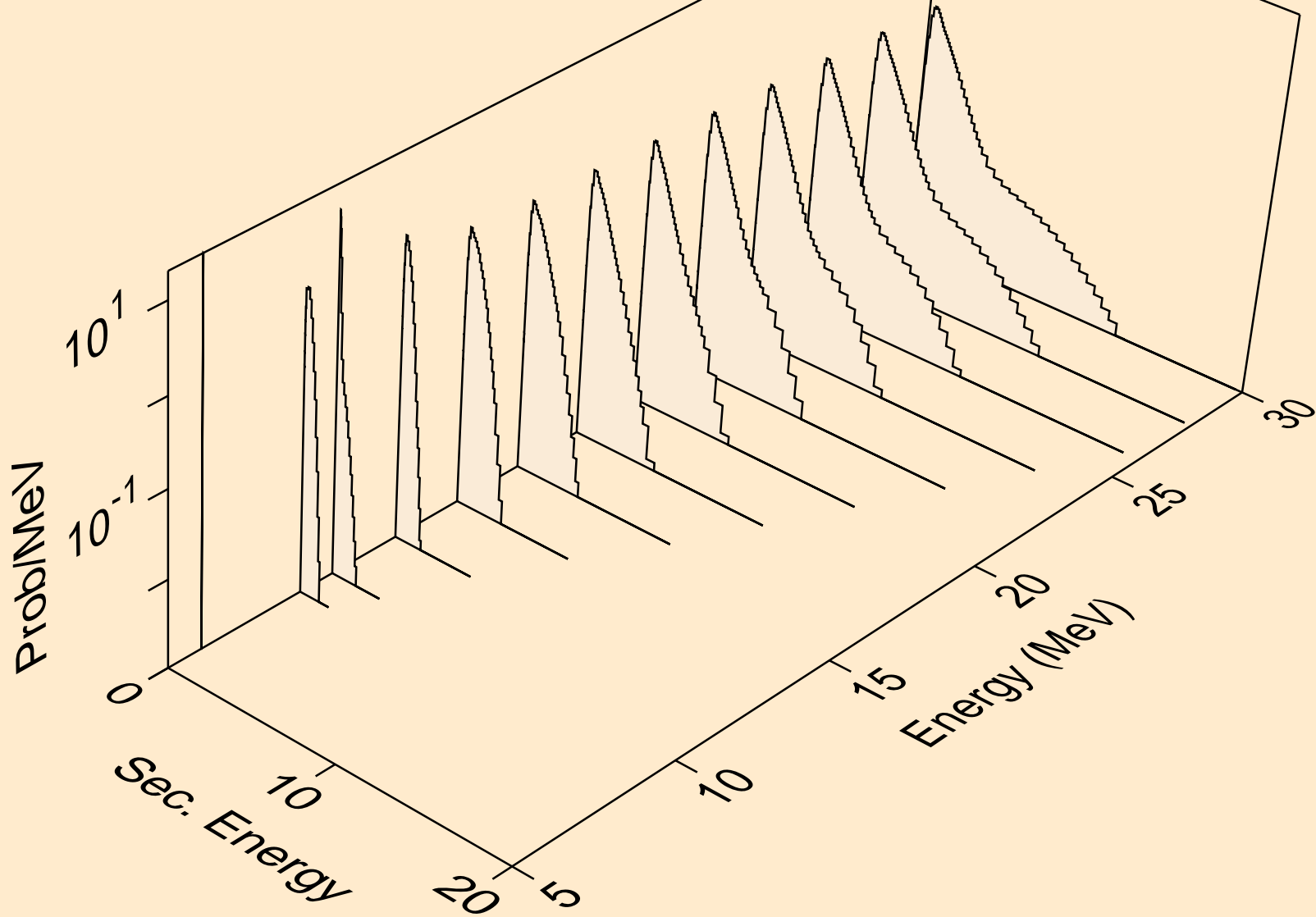

OS178 HELION ACER TENDL-2021 LIBRARY; T=0.K  
neutrons from (s,n\*)2a

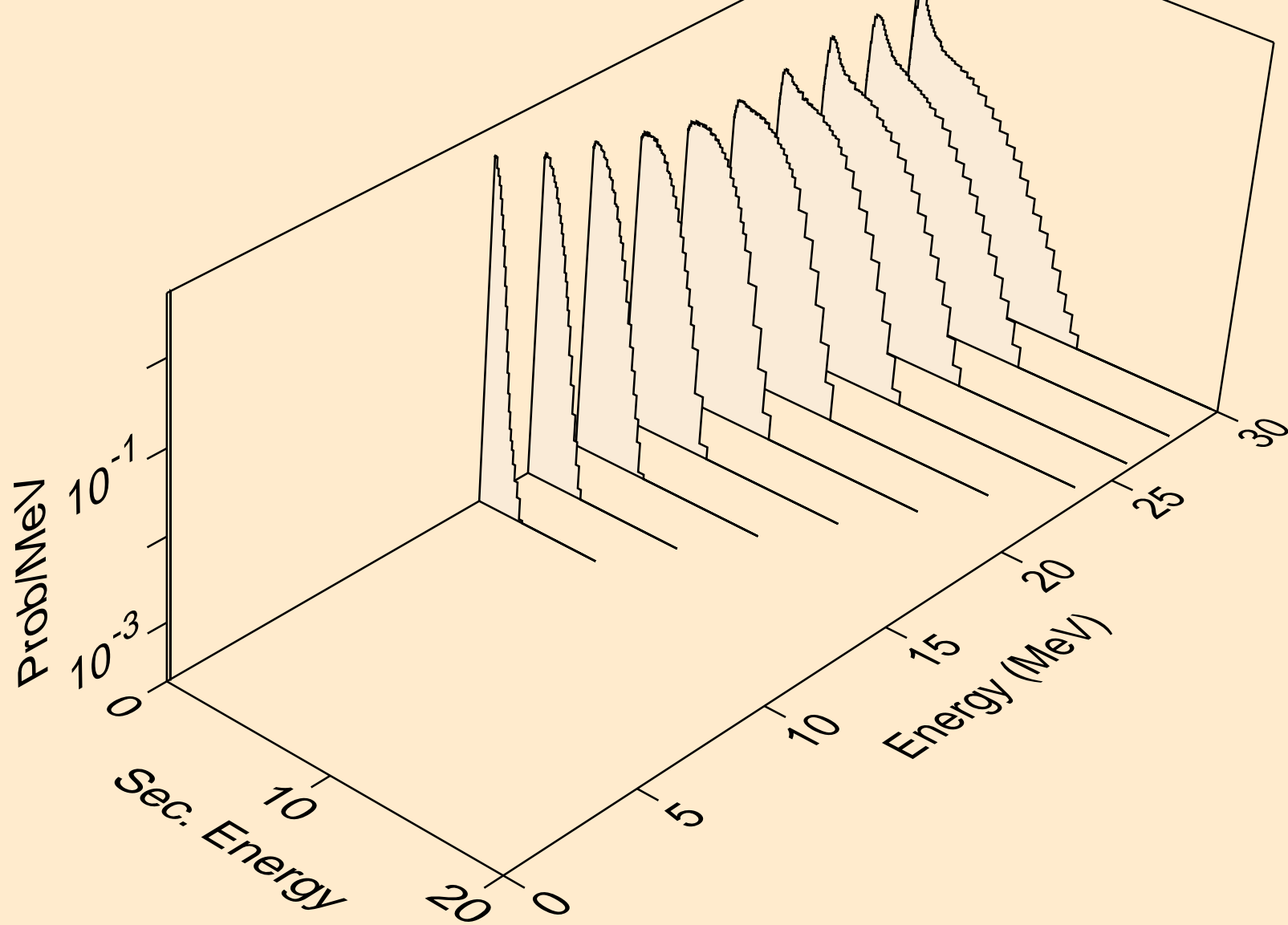

OS178 HELION ACER TENDL-2021 LIBRARY; T=0.K  
neutrons from (s,n\*)d

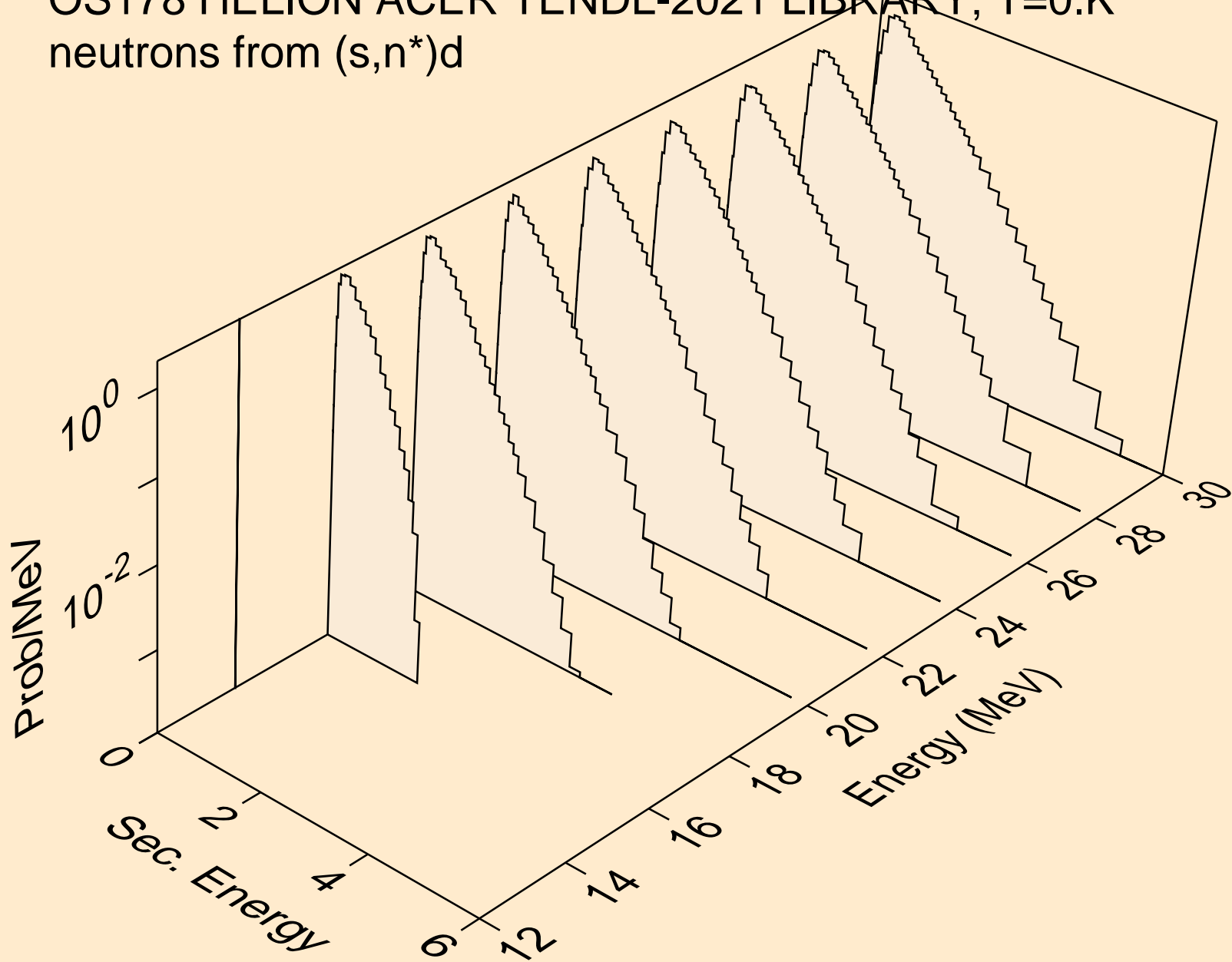

OS178 HELION ACER TENDL-2021 LIBRARY; T=0.K  
neutrons from (s,n\*)t

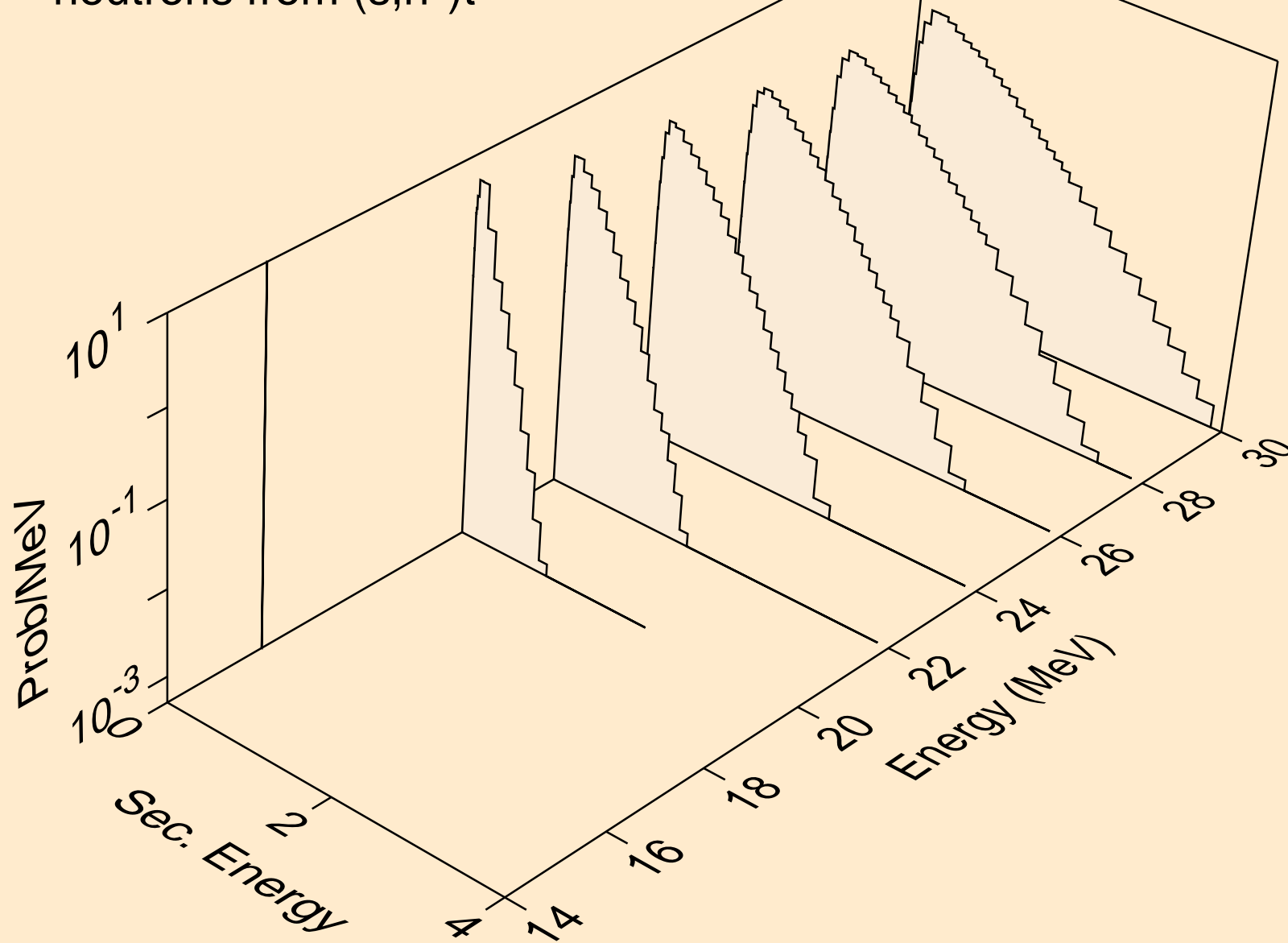

OS178 HELION ACER TENDL-2021 LIBRARY; T=0.K  
neutrons from (s,n\*)he3

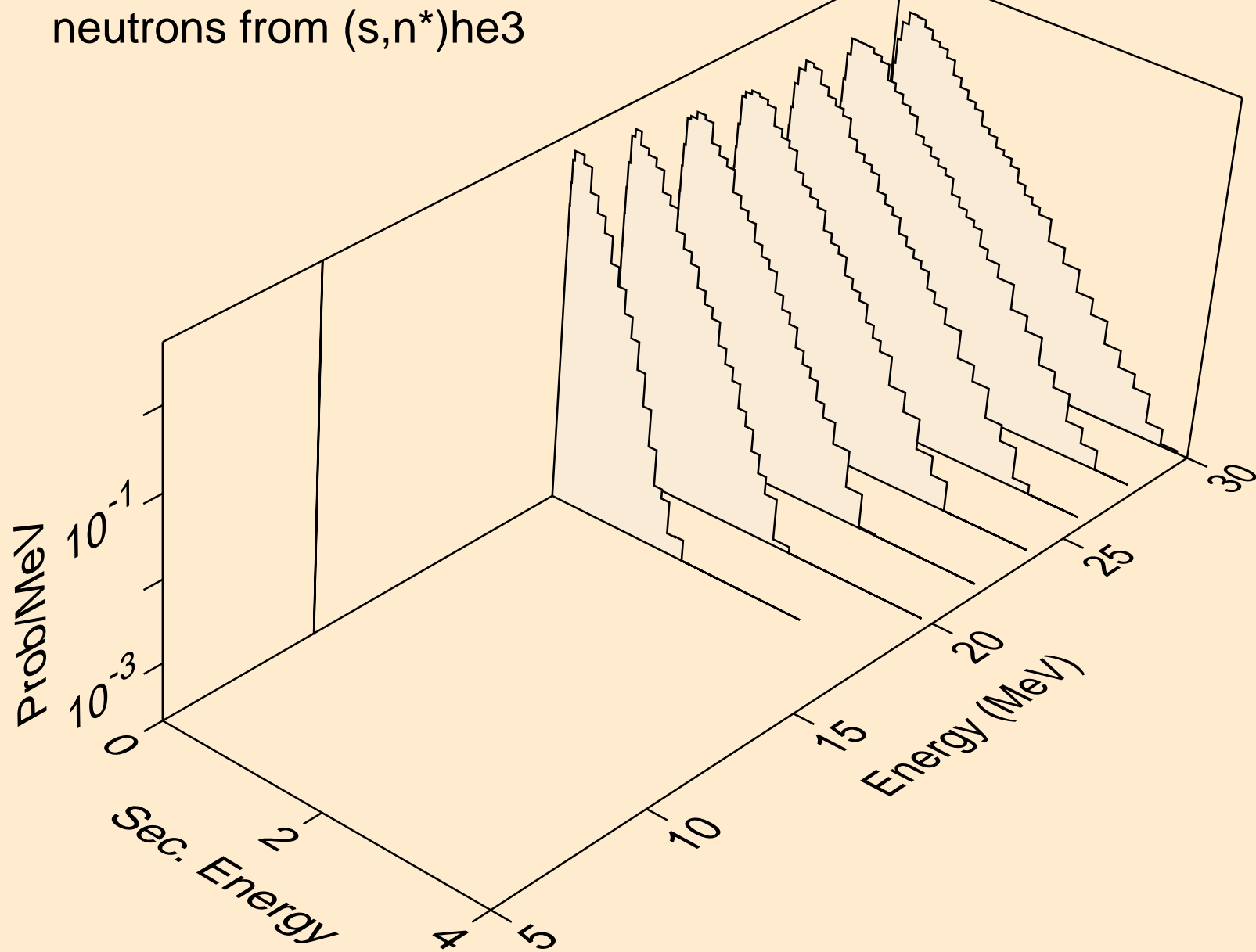

OS178 HELION ACER TENDL-2021 LIBRARY; T=0.K  
neutrons from (s,2np)

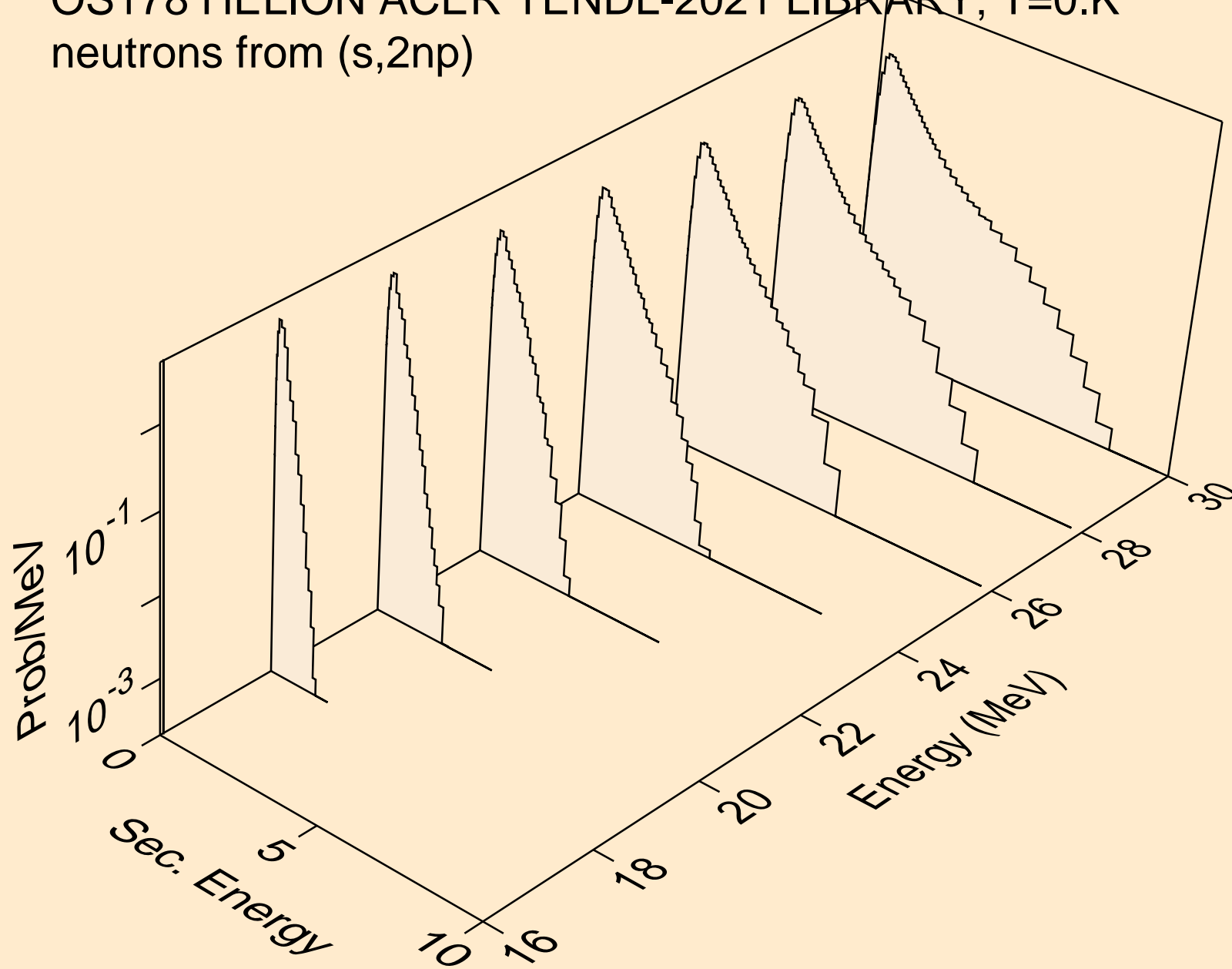

OS178 HELION ACER TENDL-2021 LIBRARY; T=0.K  
neutrons from (s,3np)

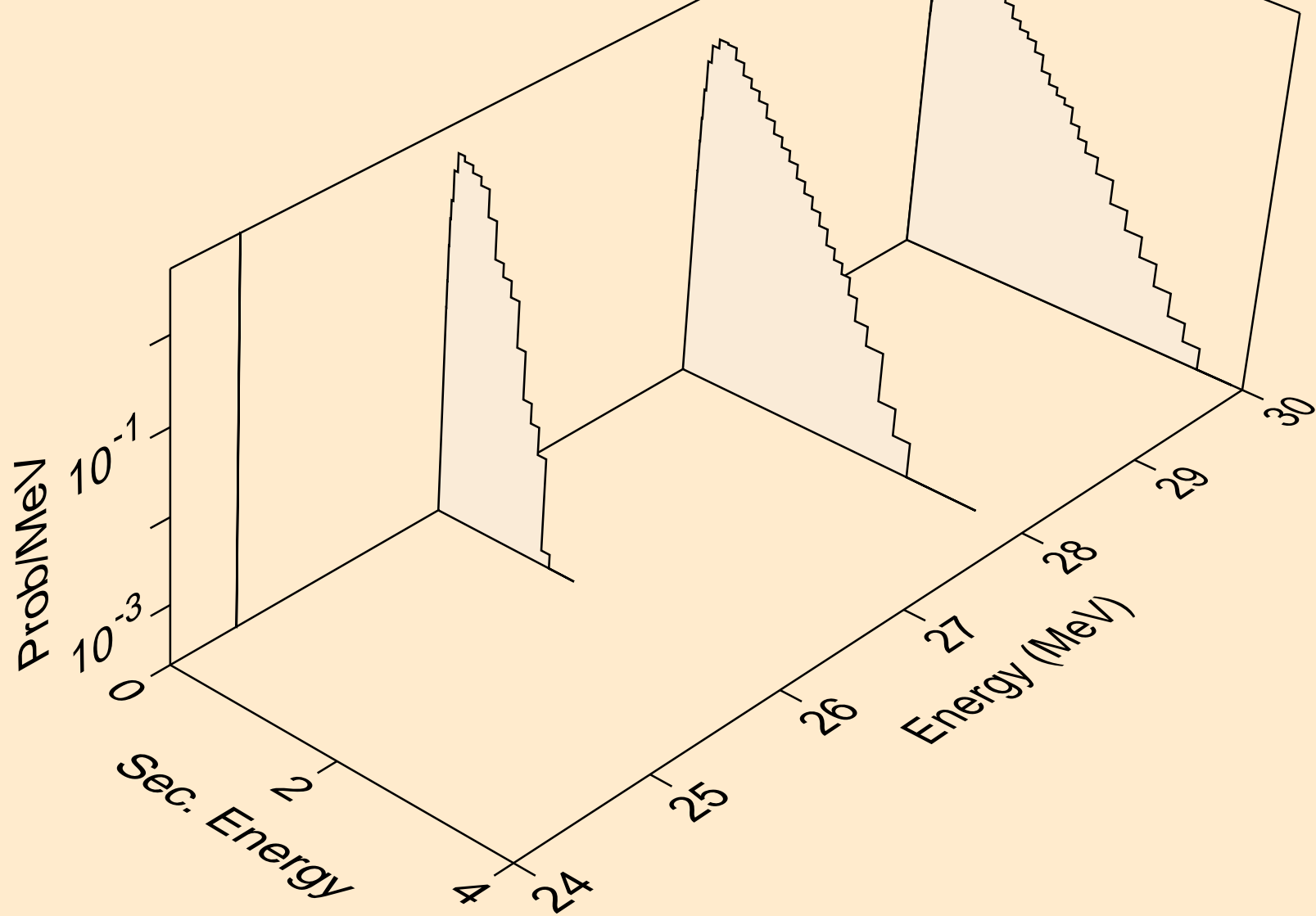



OS178 HELION ACER TENDL-2021 LIBRARY; T=0.K  
neutrons from (s,2np)

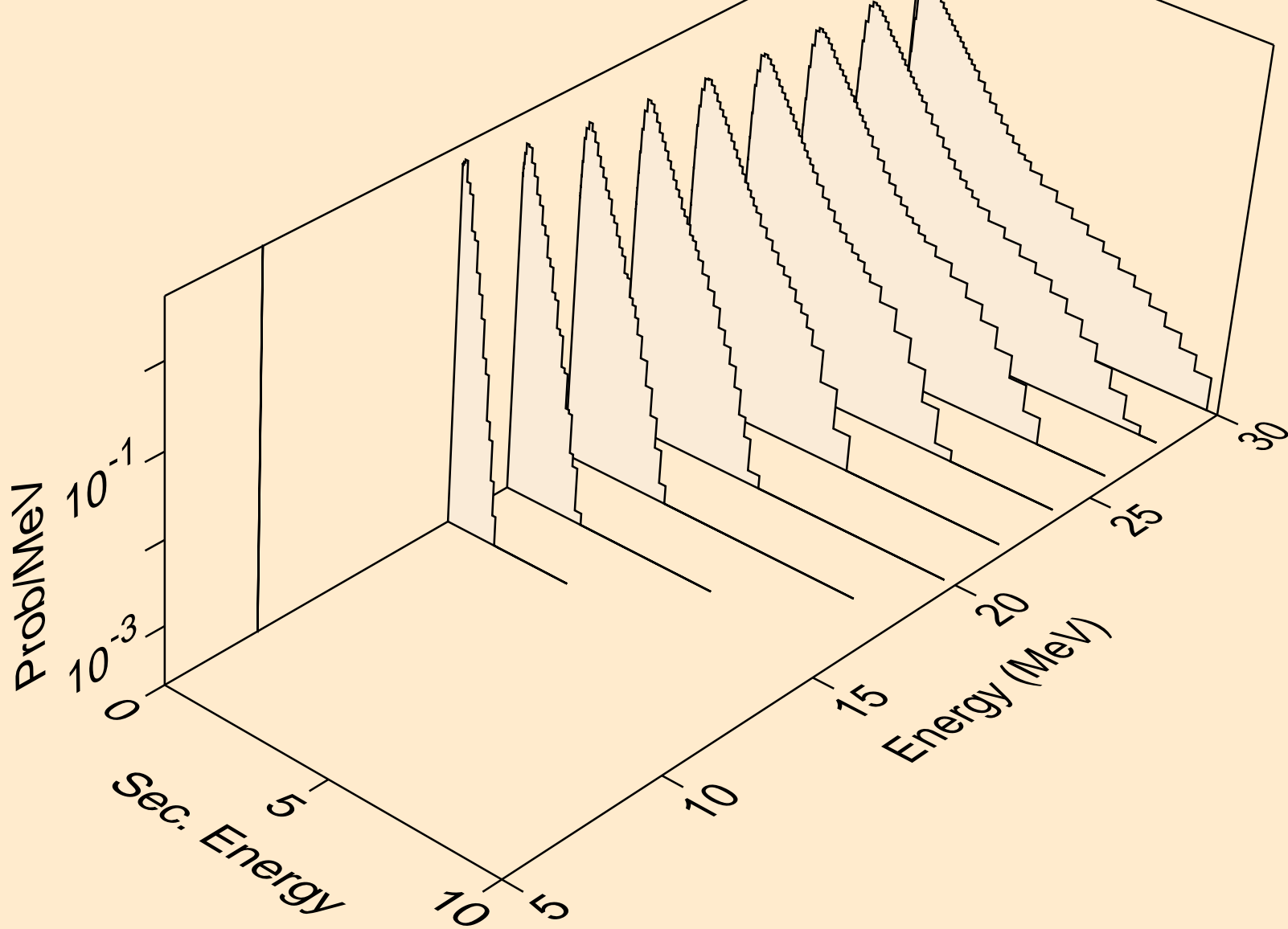

OS178 HELION ACER TENDL-2021 LIBRARY; T=0.K  
neutrons from (s,npa)

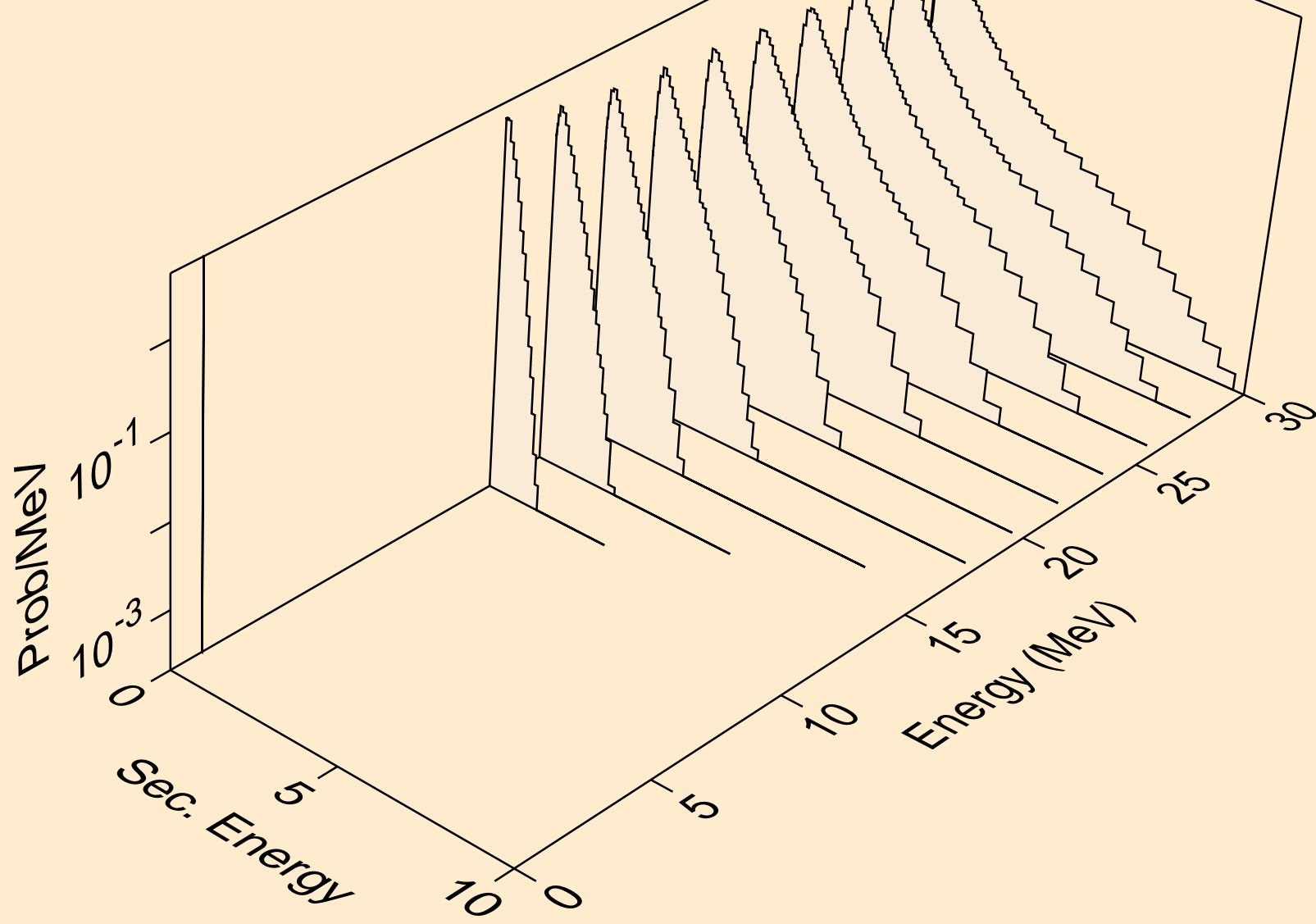

OS178 HELION ACER TENDL-2021 LIBRARY; T=0.K  
protons from (s,x)

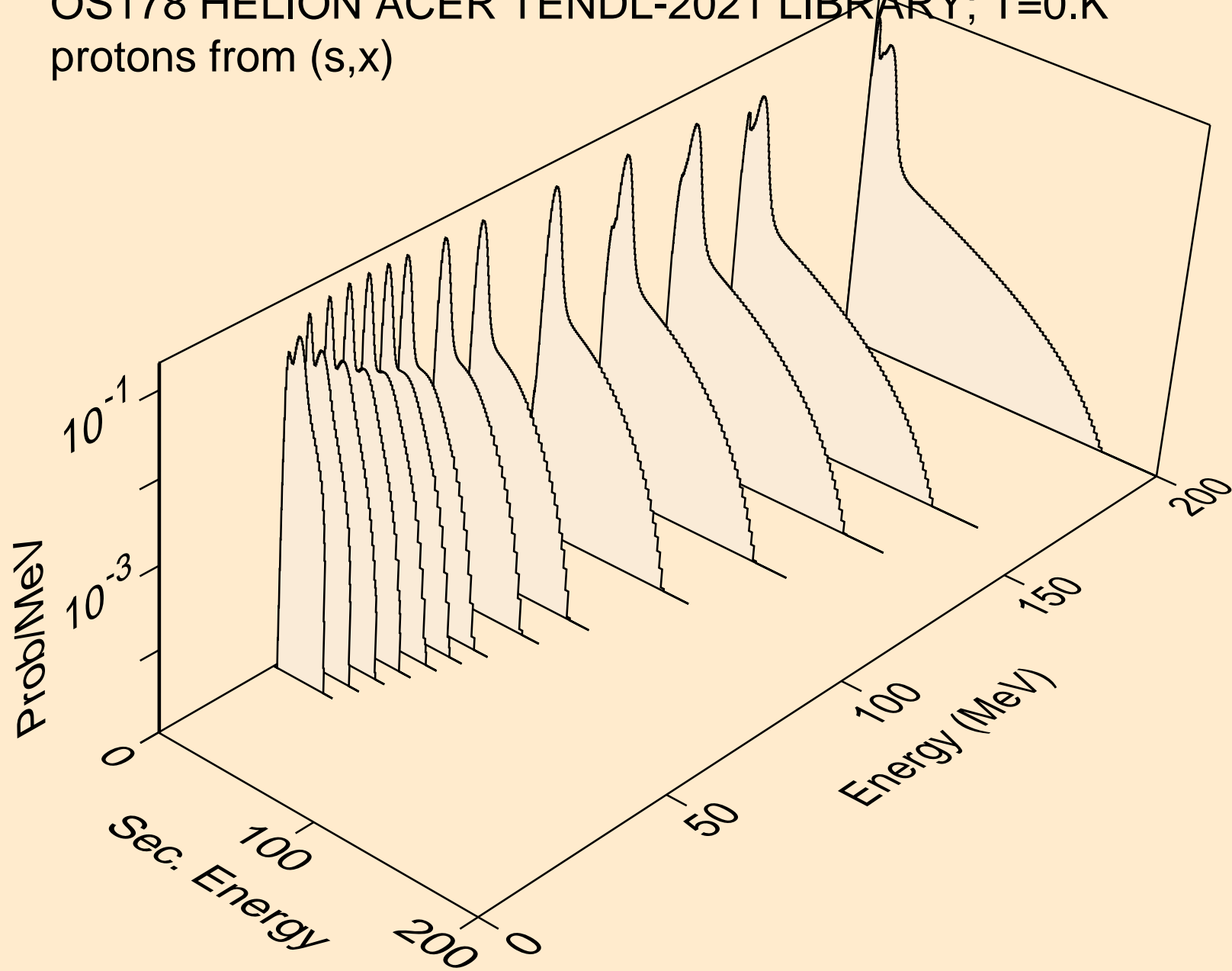

OS178 HELION ACER TENDL-2021 LIBRARY; T=0.K  
protons from (s,n\*)p

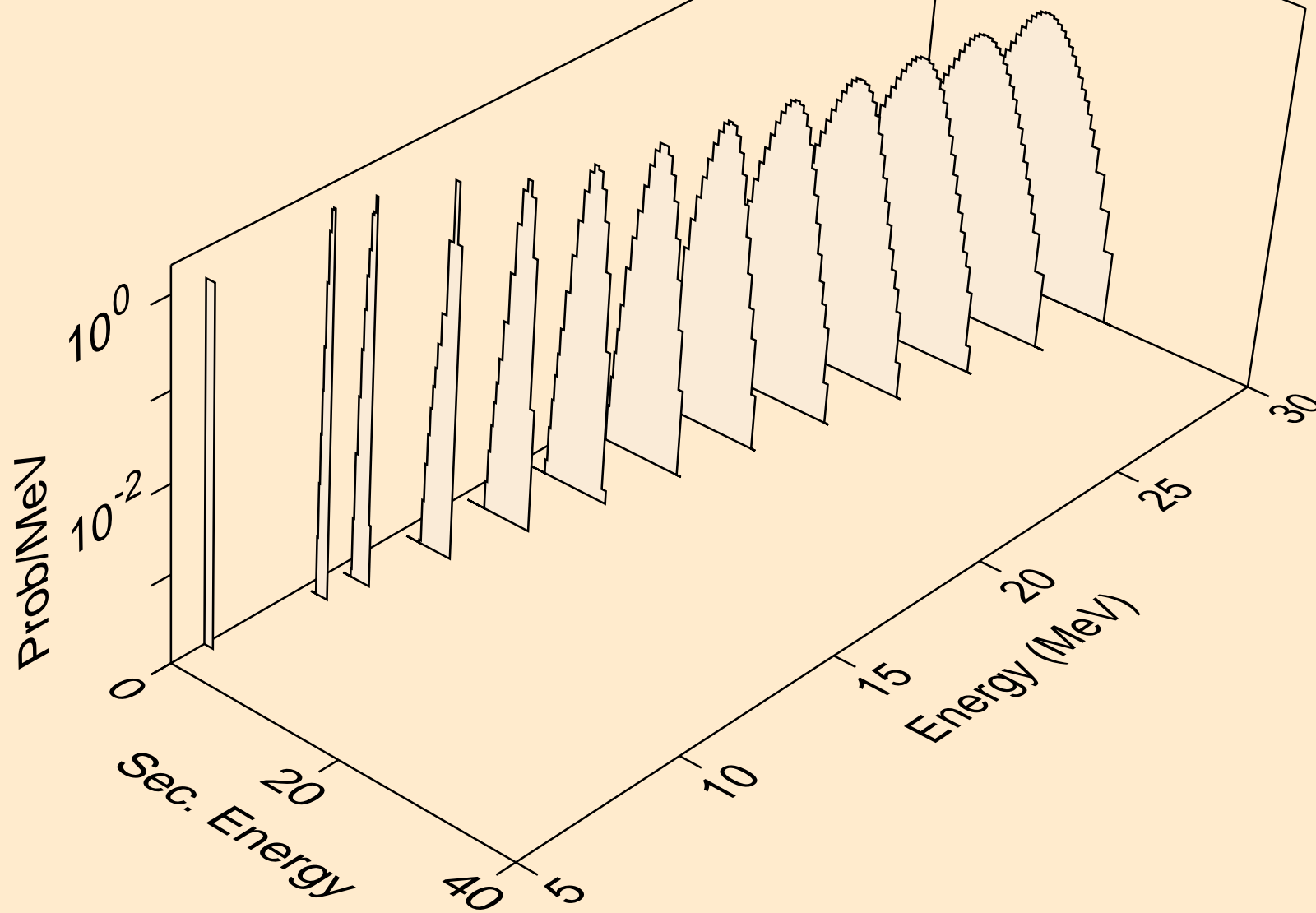

OS178 HELION ACER TENDL-2021 LIBRARY; T=0.K  
protons from (s,2np)

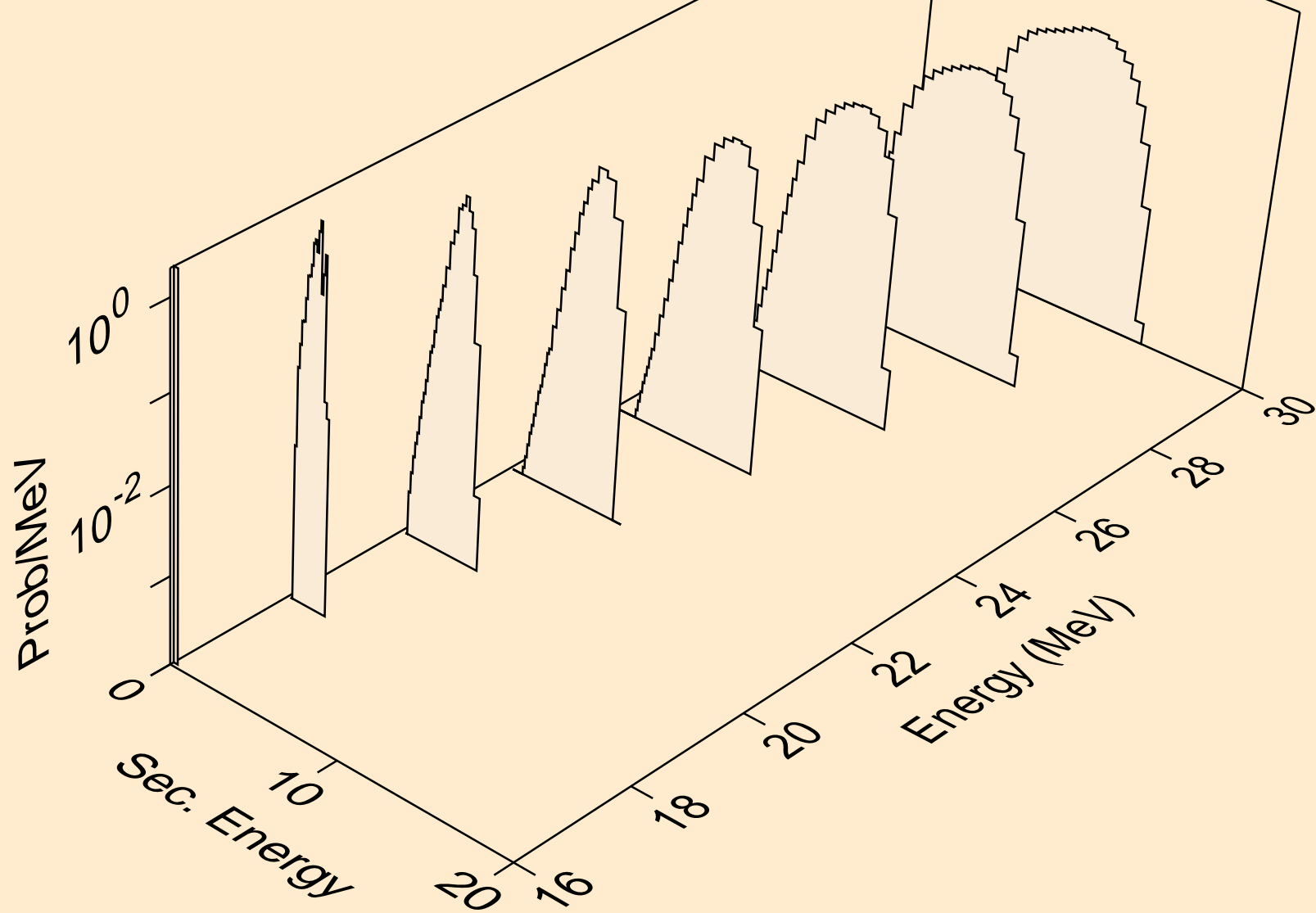

OS178 HELION ACER TENDL-2021 LIBRARY; T=0.K  
protons from (s,3np)

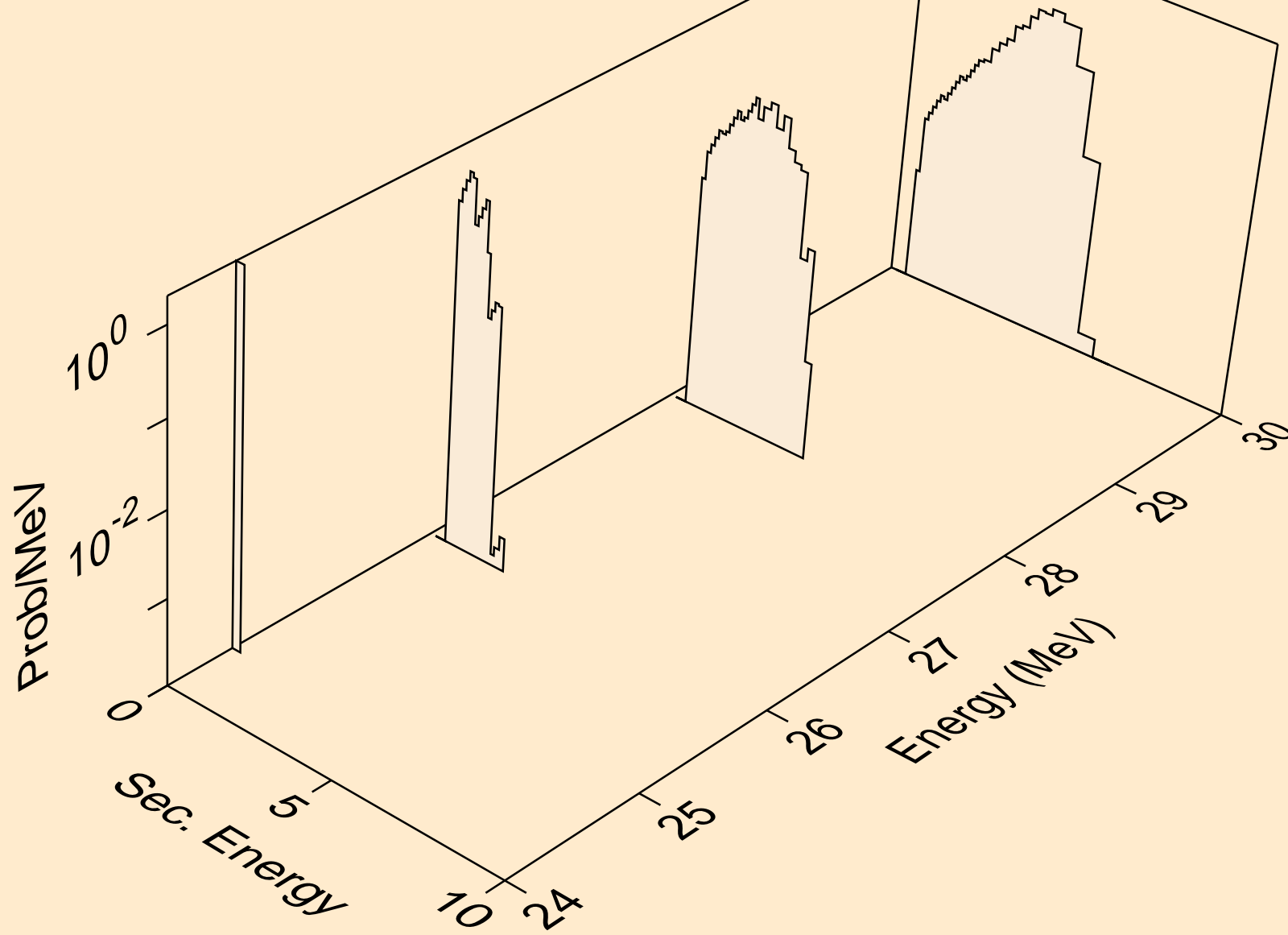

OS178 HELION ACER TENDL-2021 LIBRARY; T=0.K  
protons from (s,2np)

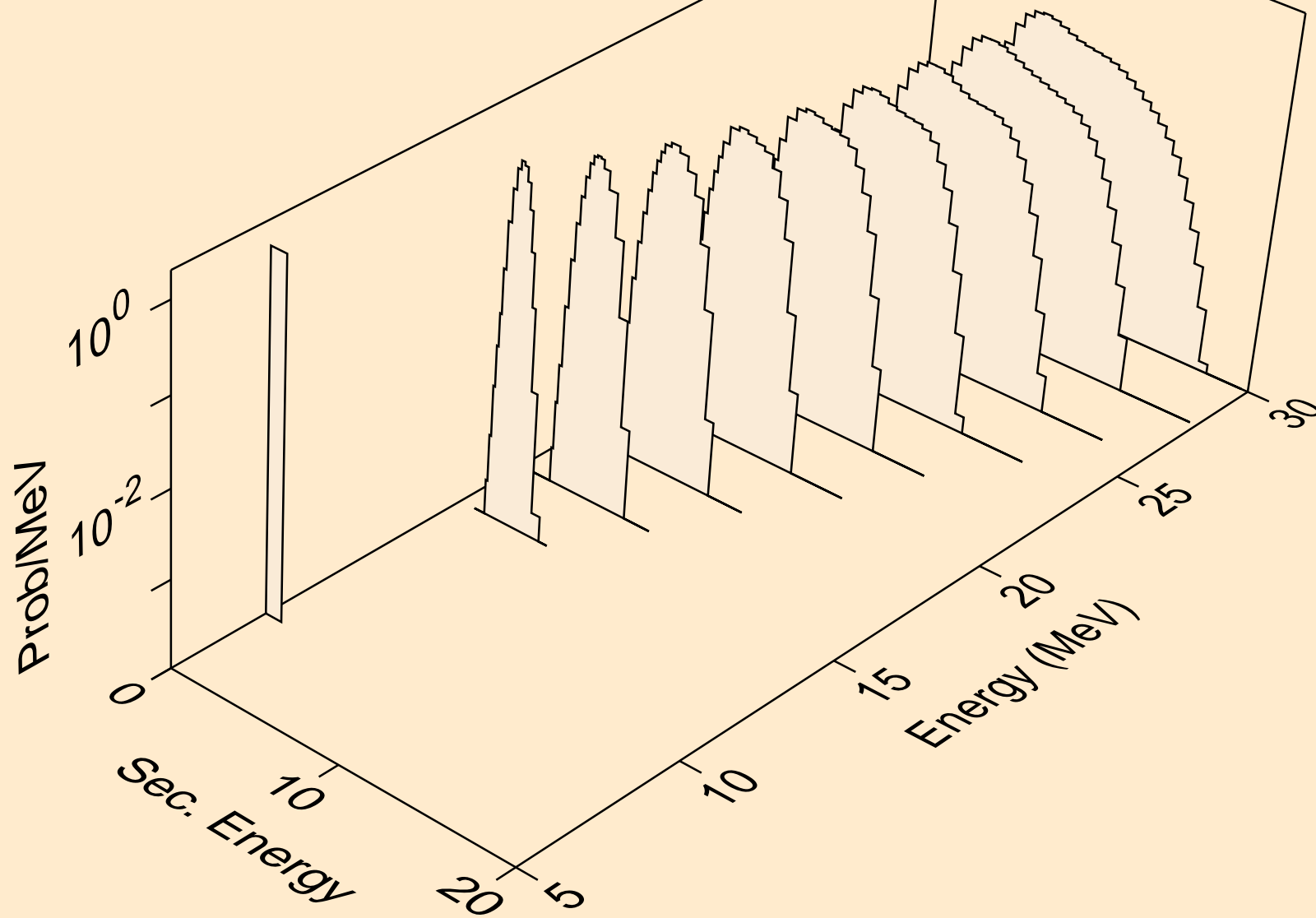

OS178 HELION ACER TENDL-2021 LIBRARY; T=0.K  
protons from (s,npa)

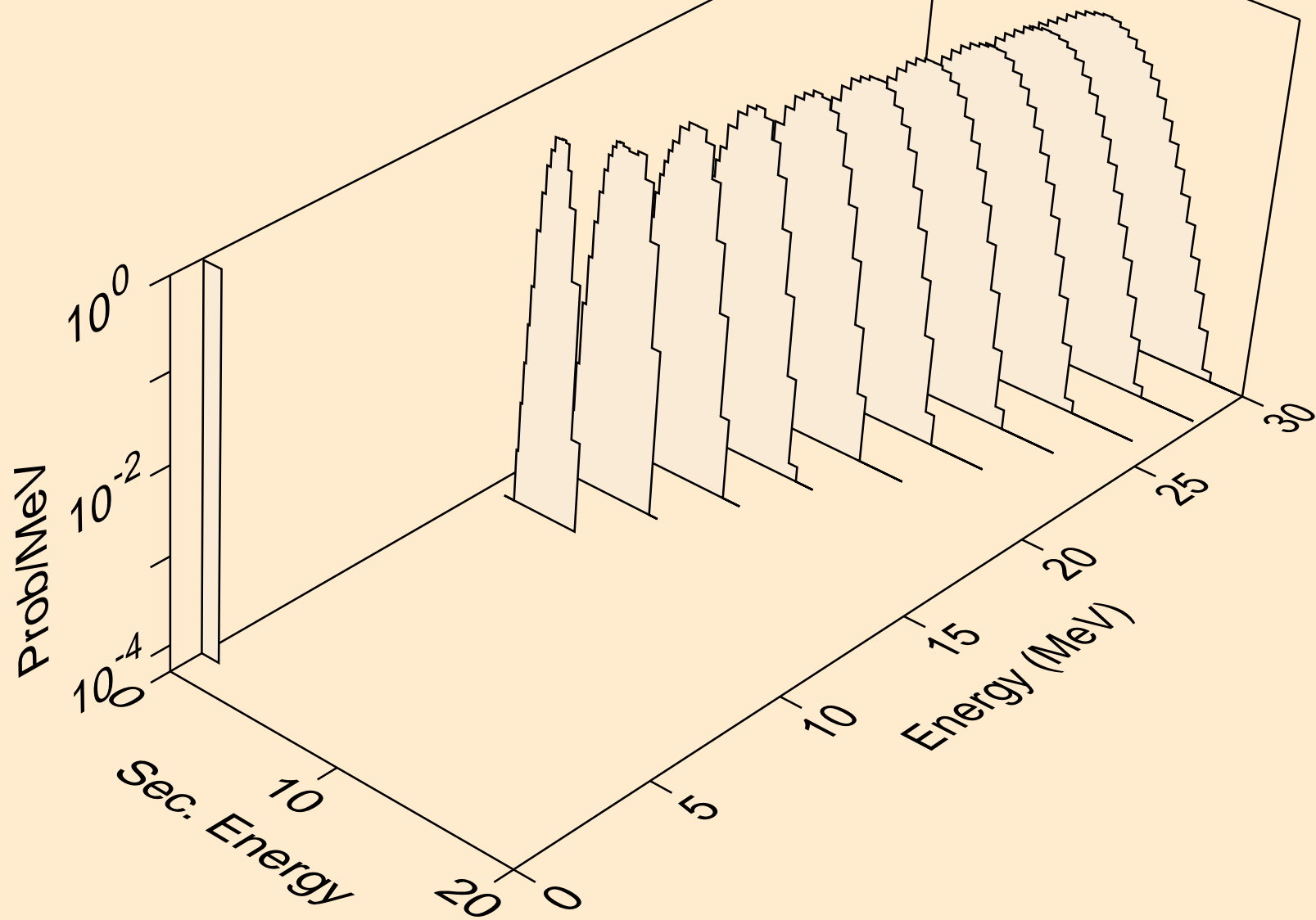



OS178 HELION ACER TENDL-2021 LIBRARY; T=0.K  
protons from (s,p)

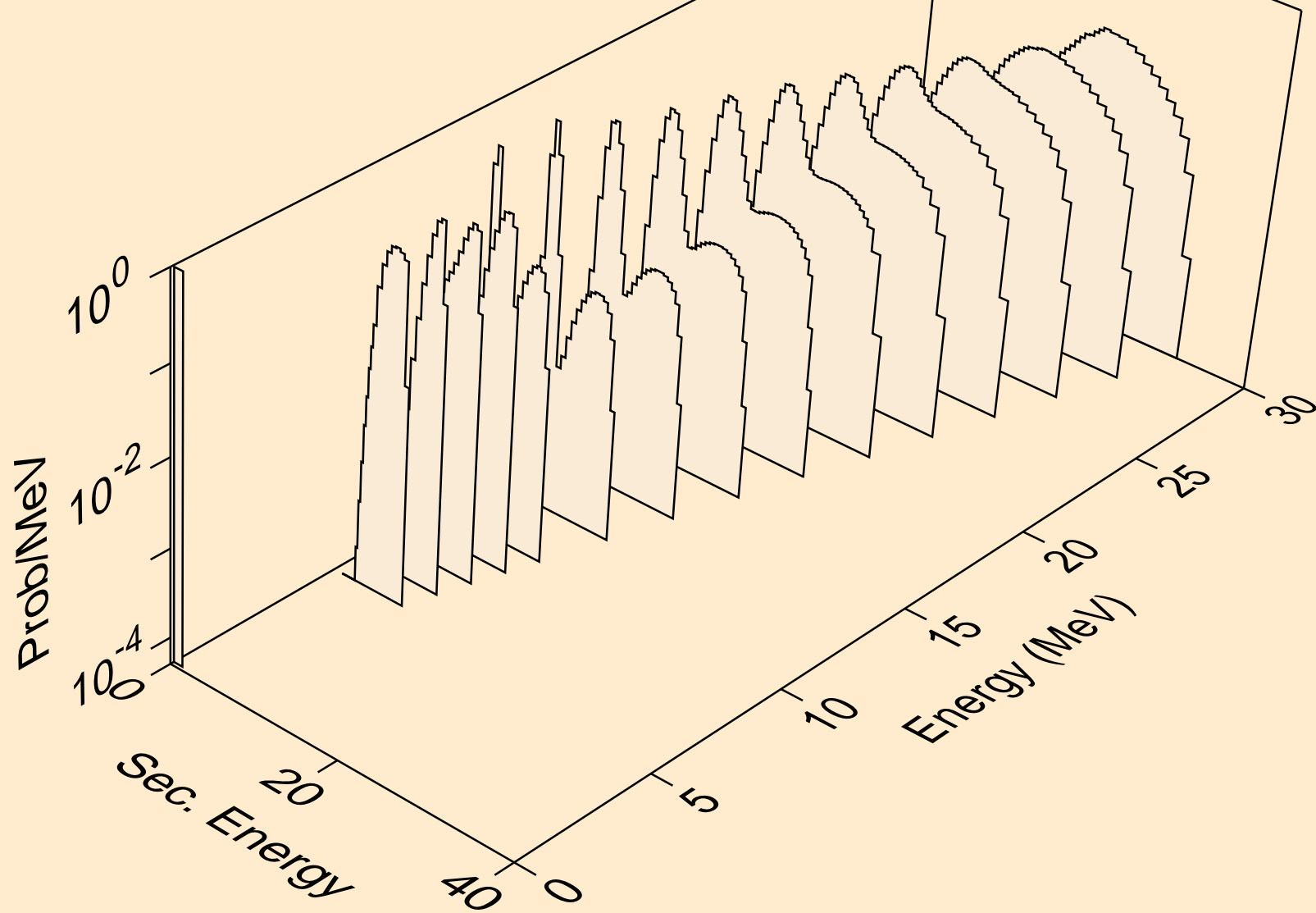

OS178 HELION ACER TENDL-2021 LIBRARY; T=0.K  
protons from (s,2p)

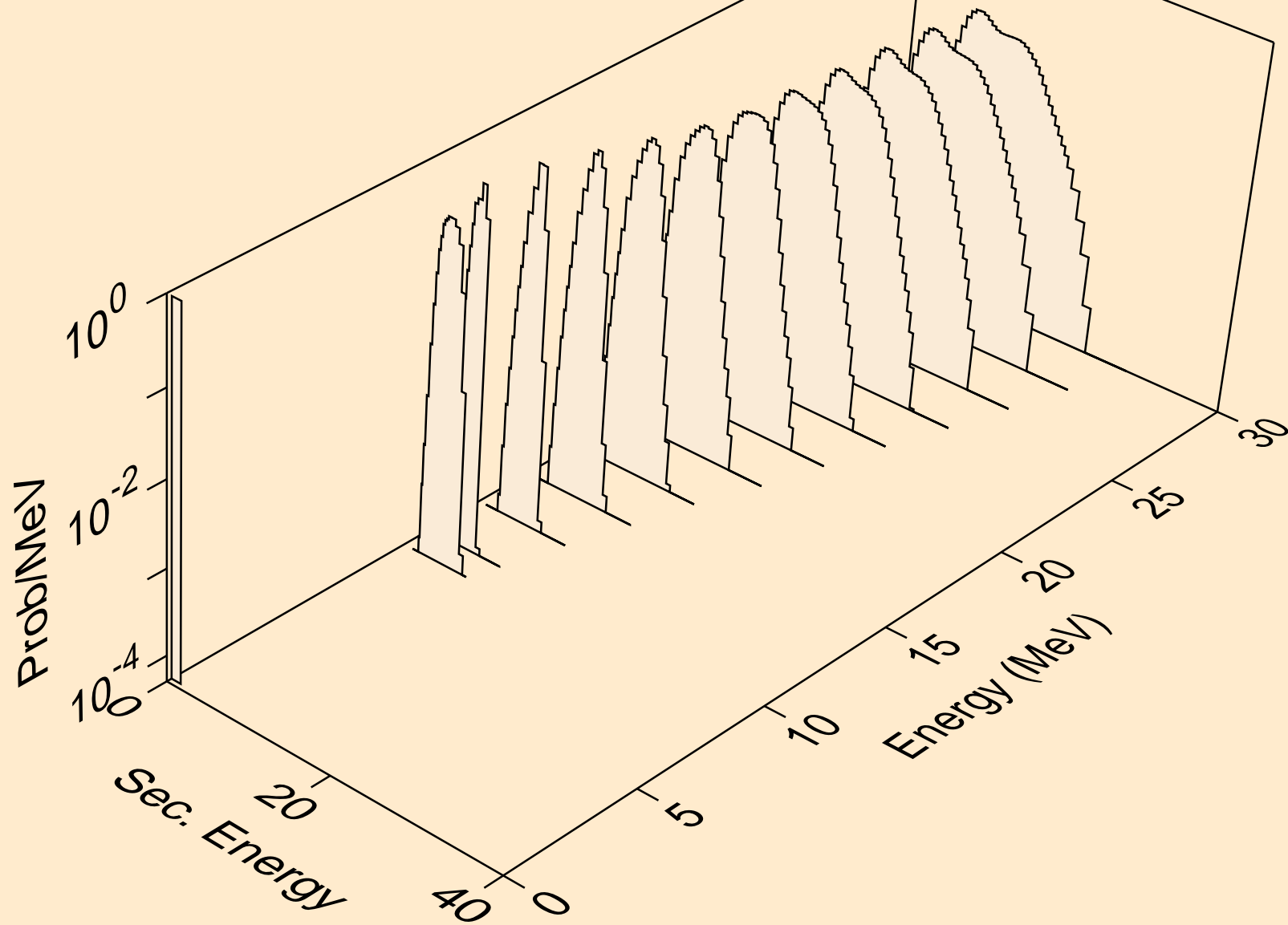

OS178 HELION ACER TENDL-2021 LIBRARY; T=0.K  
protons from (s,pa)

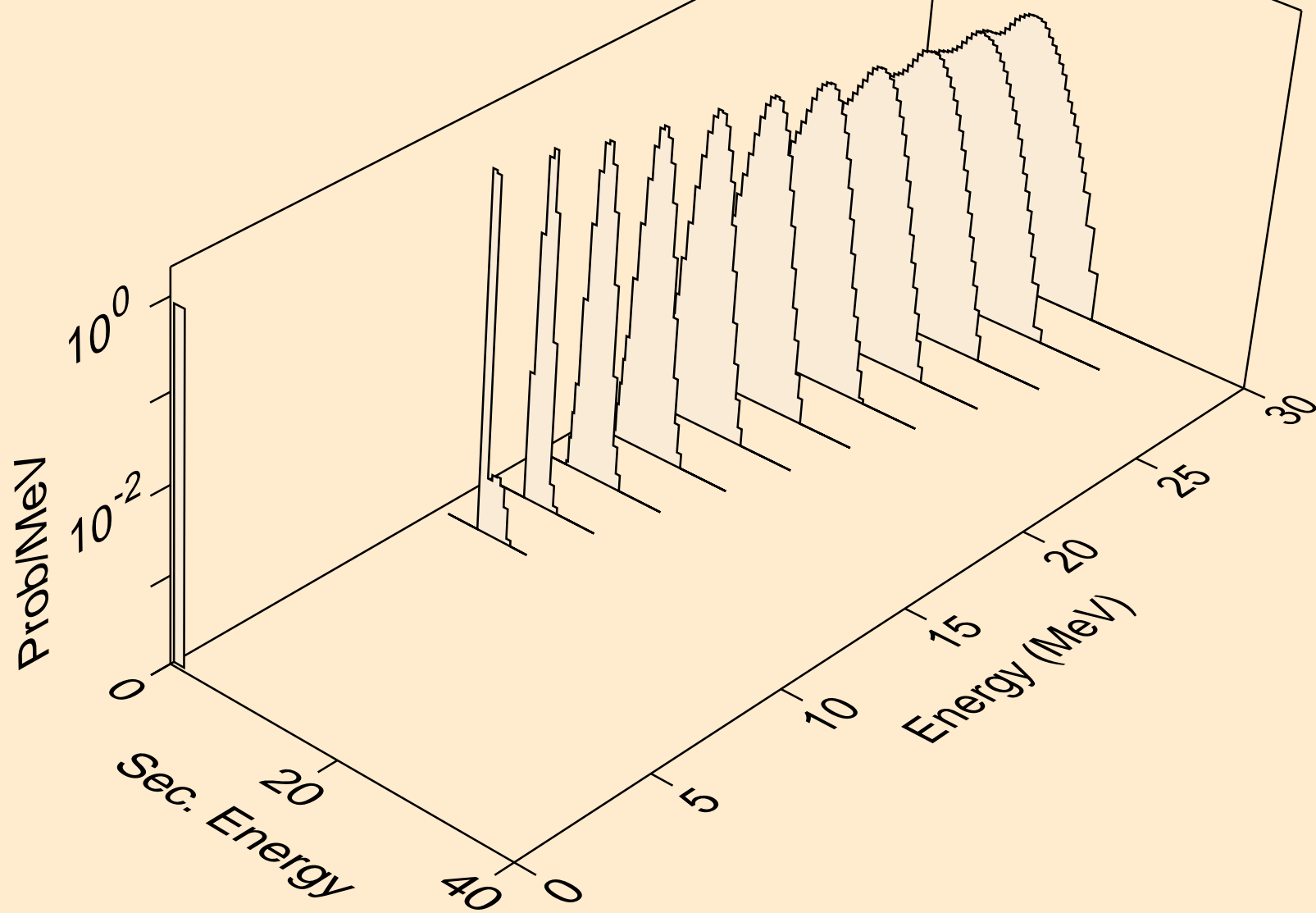

OS178 HELION ACER TENDL-2021 LIBRARY; T=0.K  
protons from (s,pd)

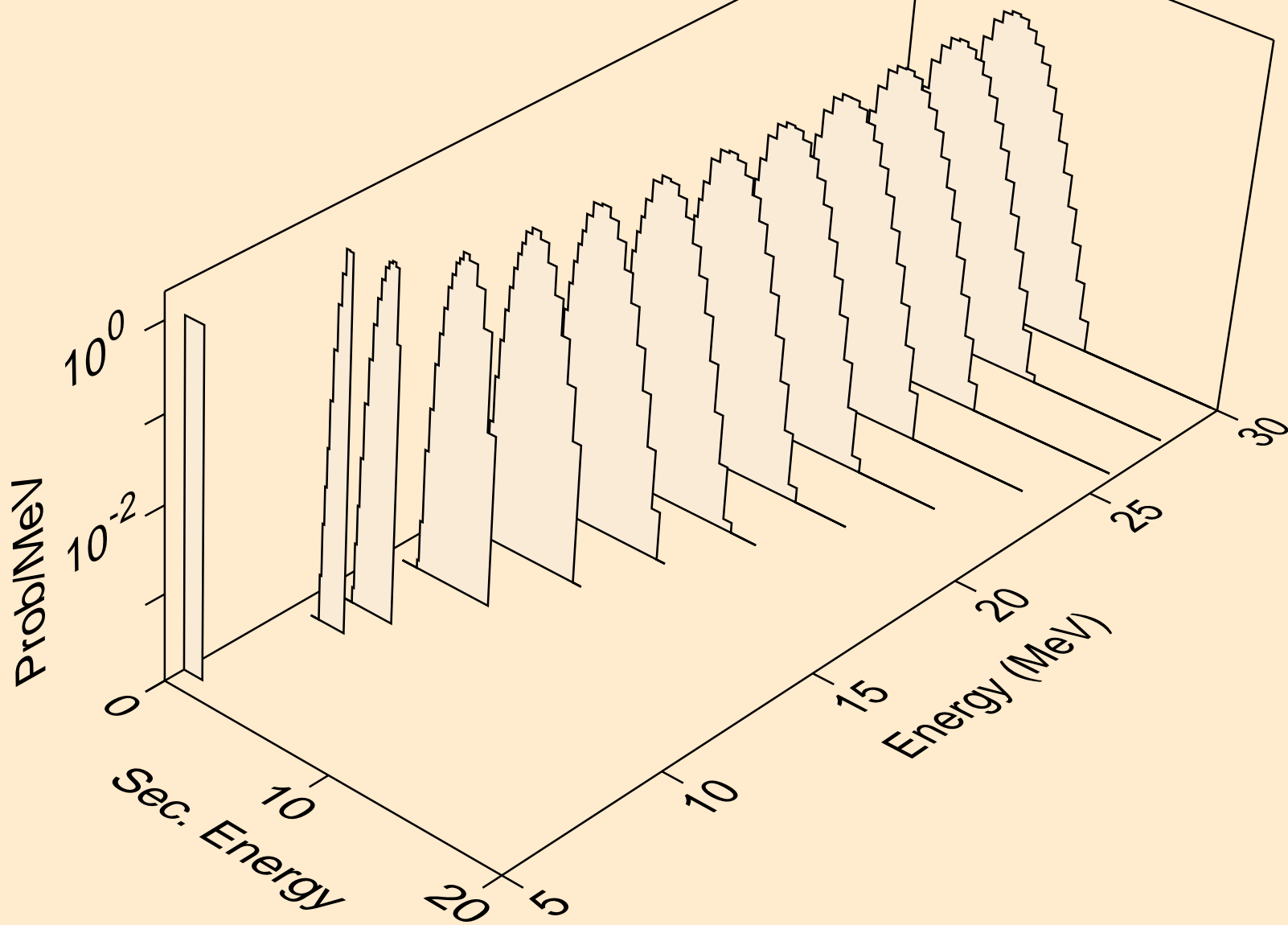

OS178 HELION ACER TENDL-2021 LIBRARY; T=0.K  
protons from (s,pt)

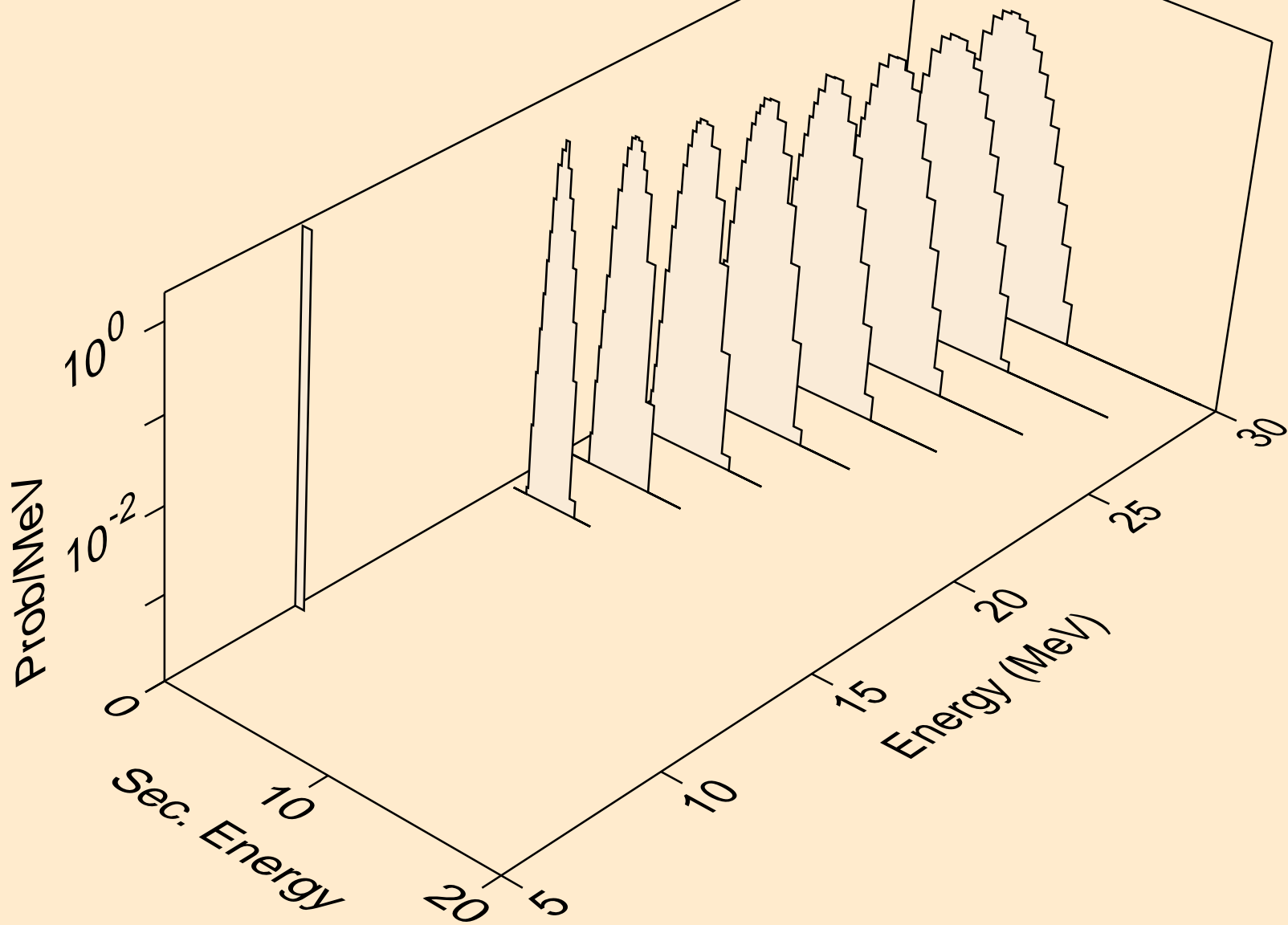

OS178 HELION ACER TENDL-2021 LIBRARY; T=0.K  
deuterons from (s,x)

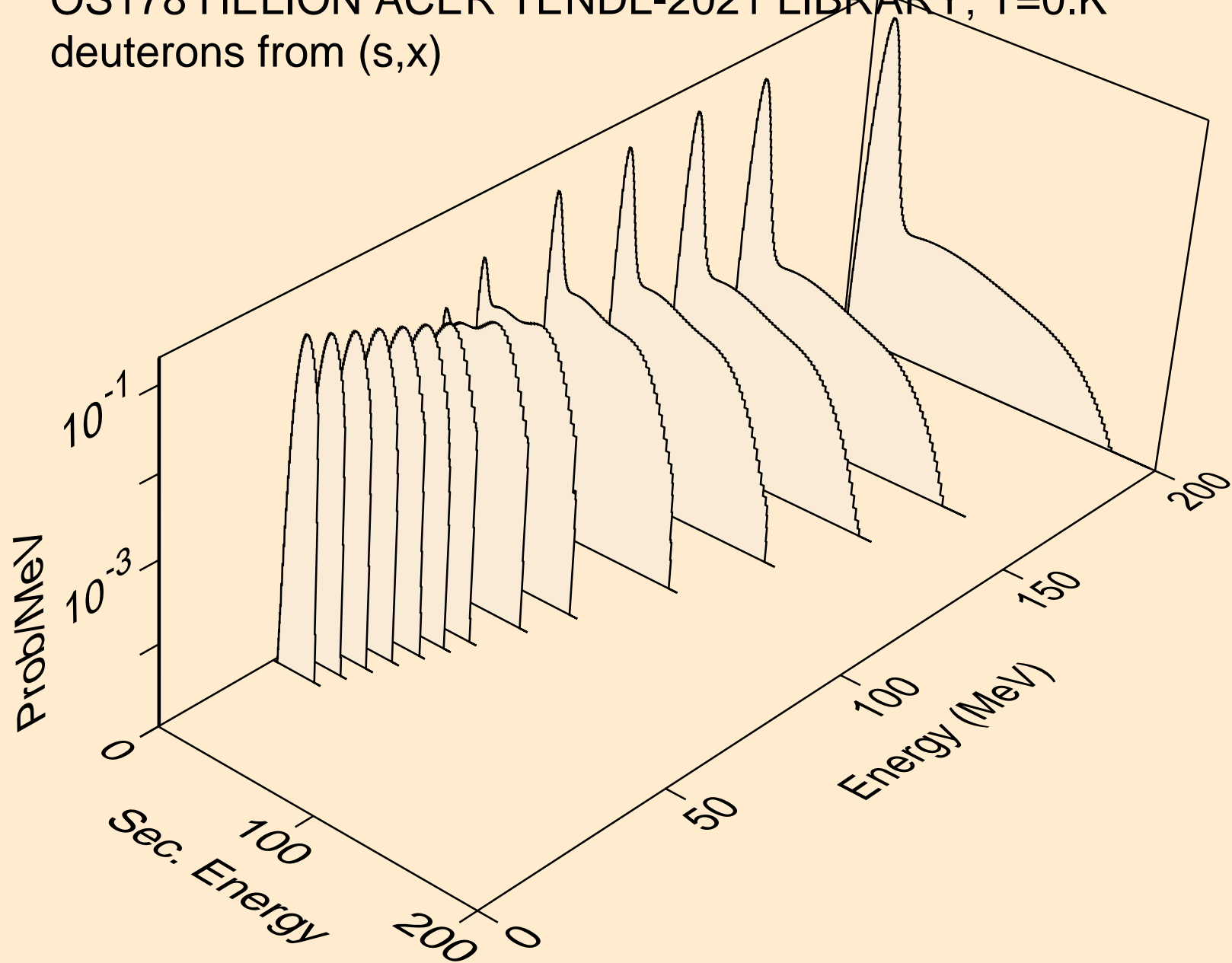

OS178 HELION ACER TENDL-2021 LIBRARY; T=0.K  
deuterons from (s,2nd)

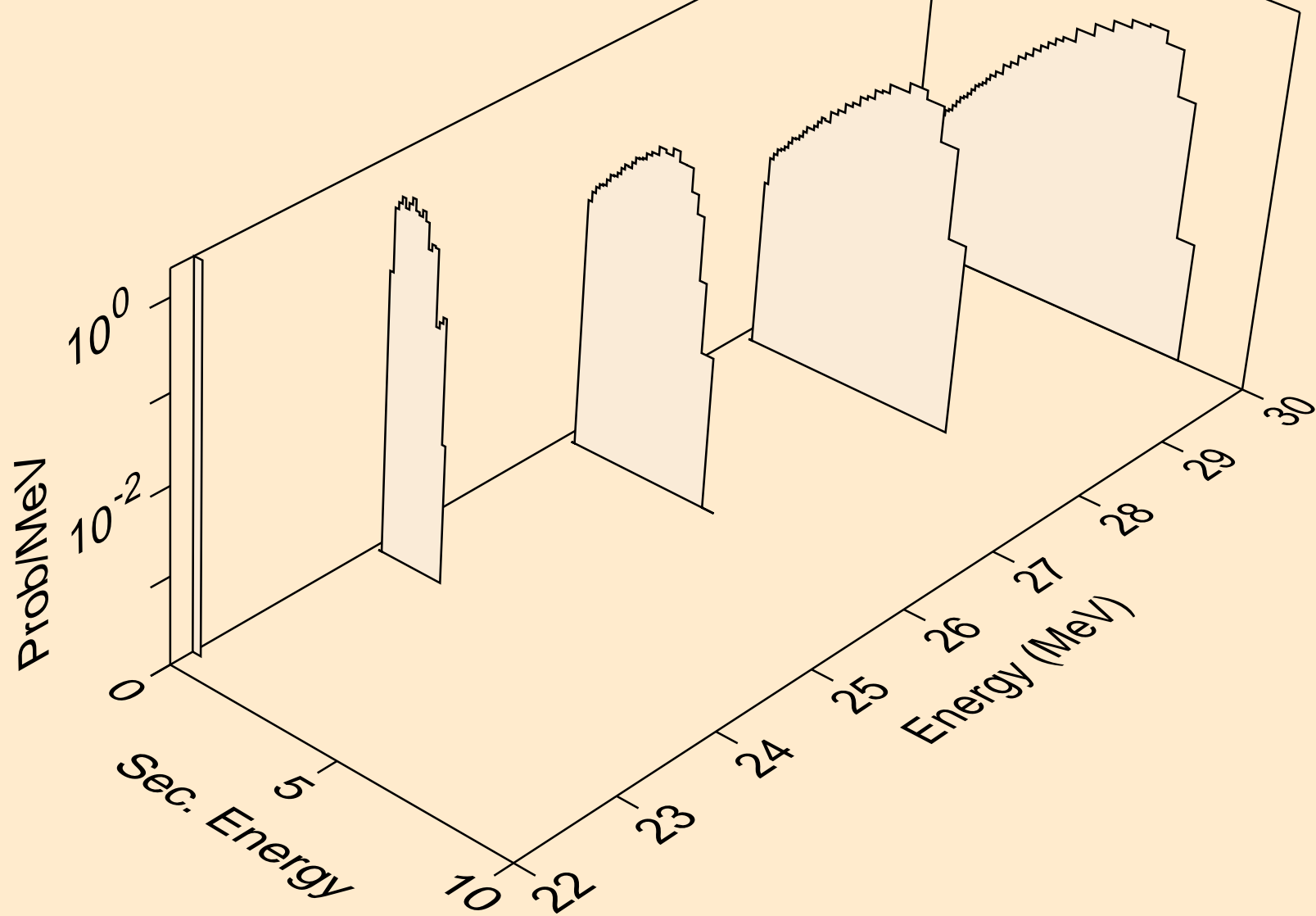

OS178 HELION ACER TENDL-2021 LIBRARY; T=0.K  
deuterons from (s,n\*)d

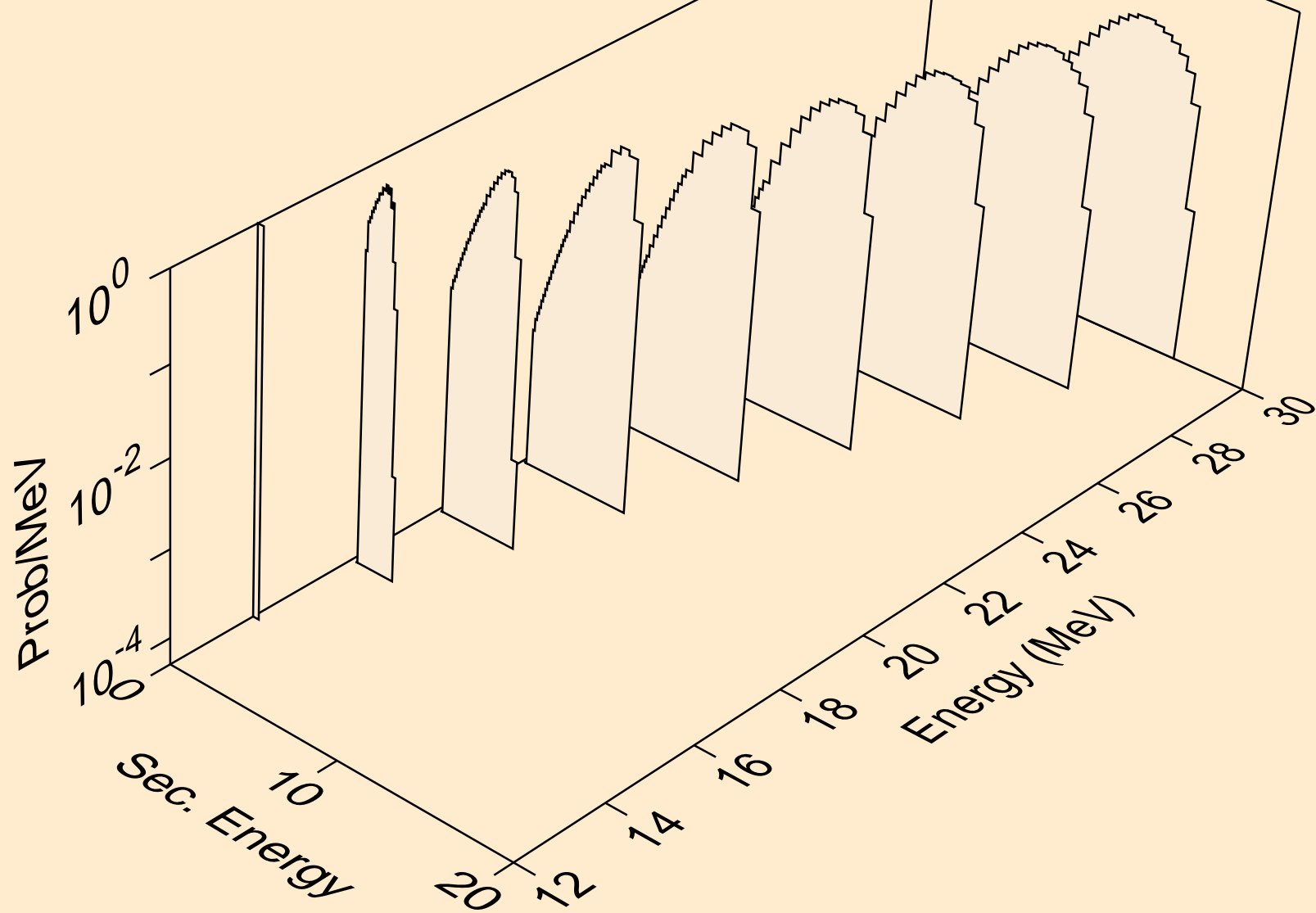



OS178 HELION ACER TENDL-2021 LIBRARY; T=0.K  
deuterons from (s,d)

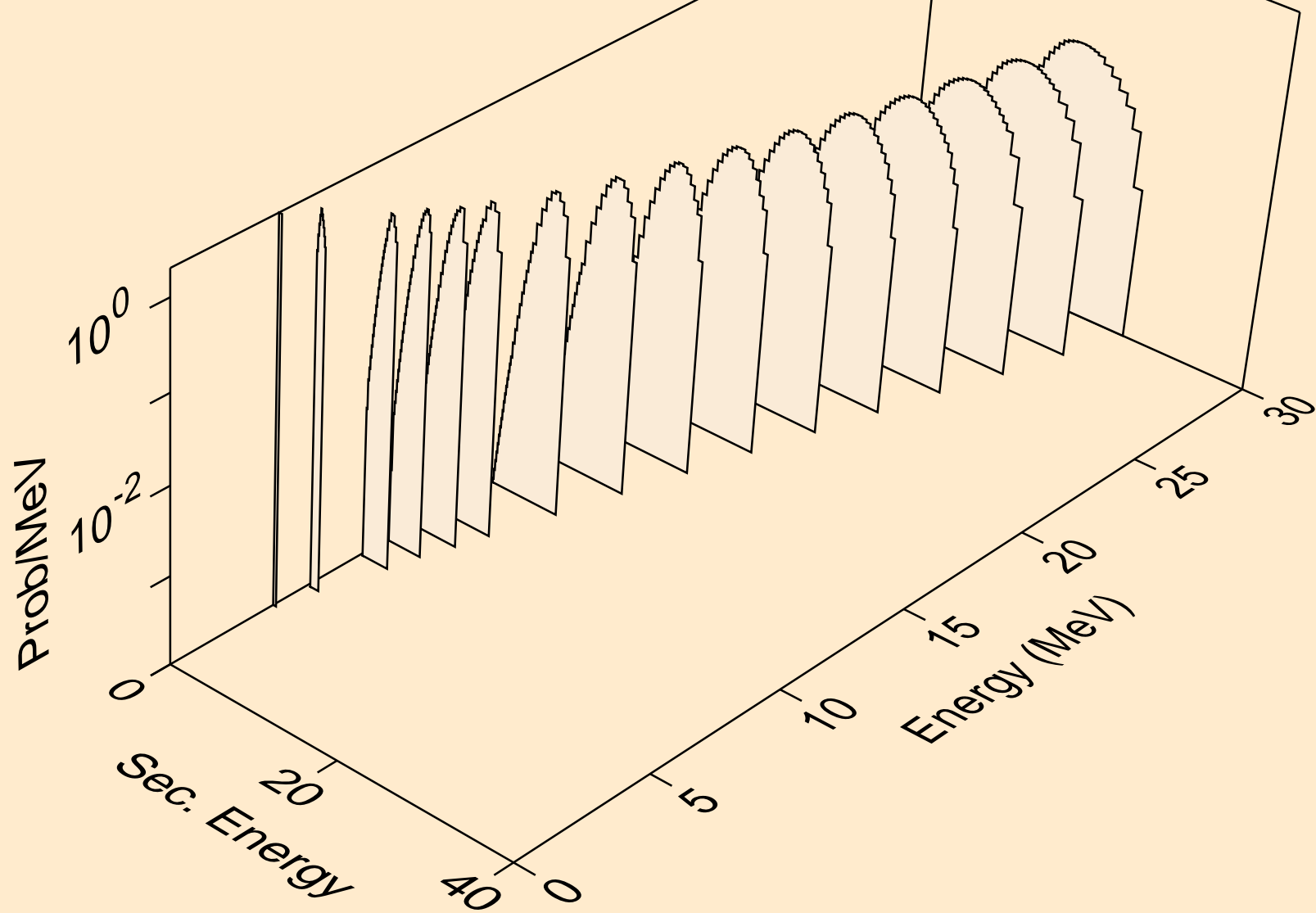

OS178 HELION ACER TENDL-2021 LIBRARY; T=0.K  
deuterons from (s,pd)

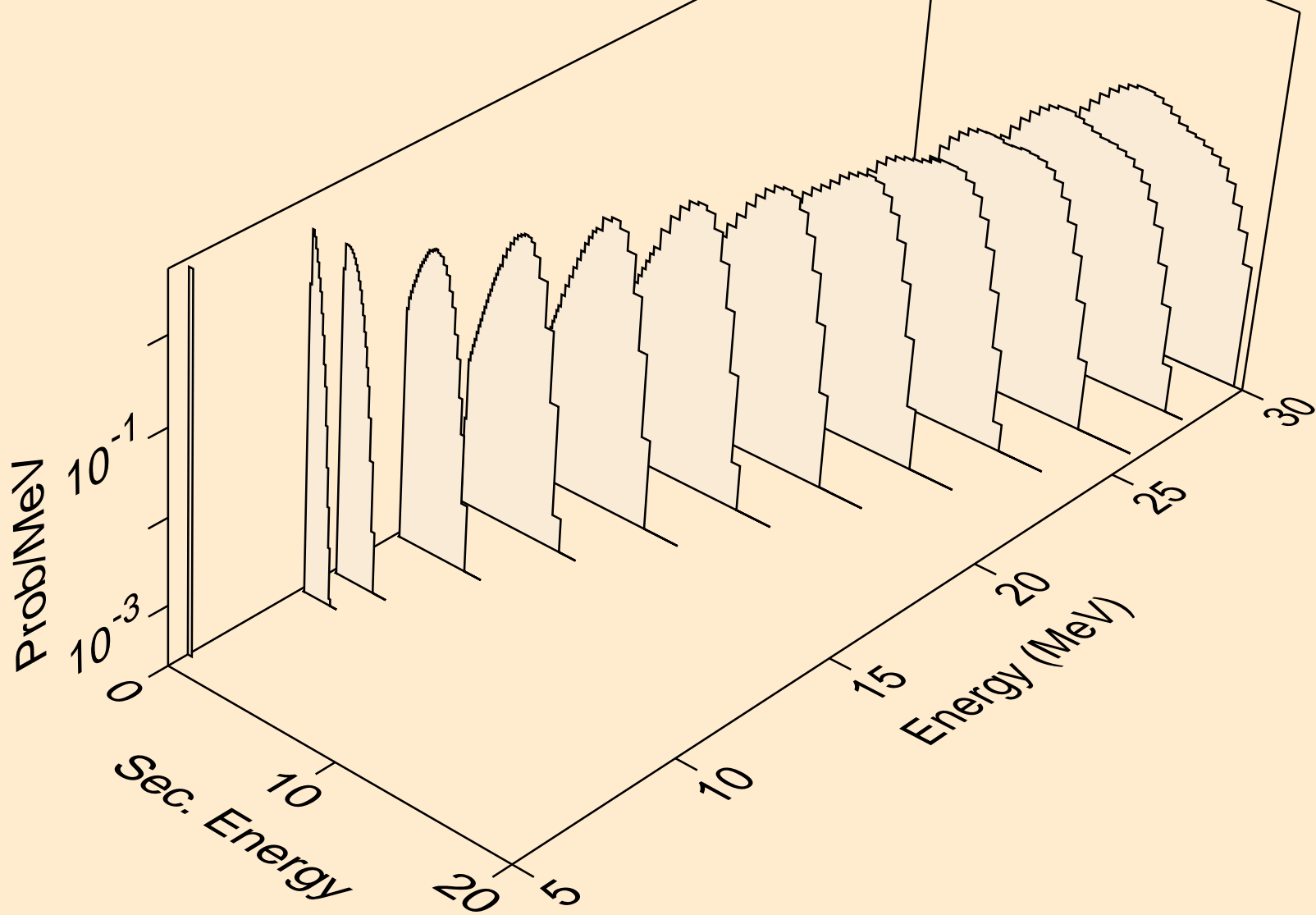

OS178 HELION ACER TENDL-2021 LIBRARY; T=0.K  
deuterons from (s,da)

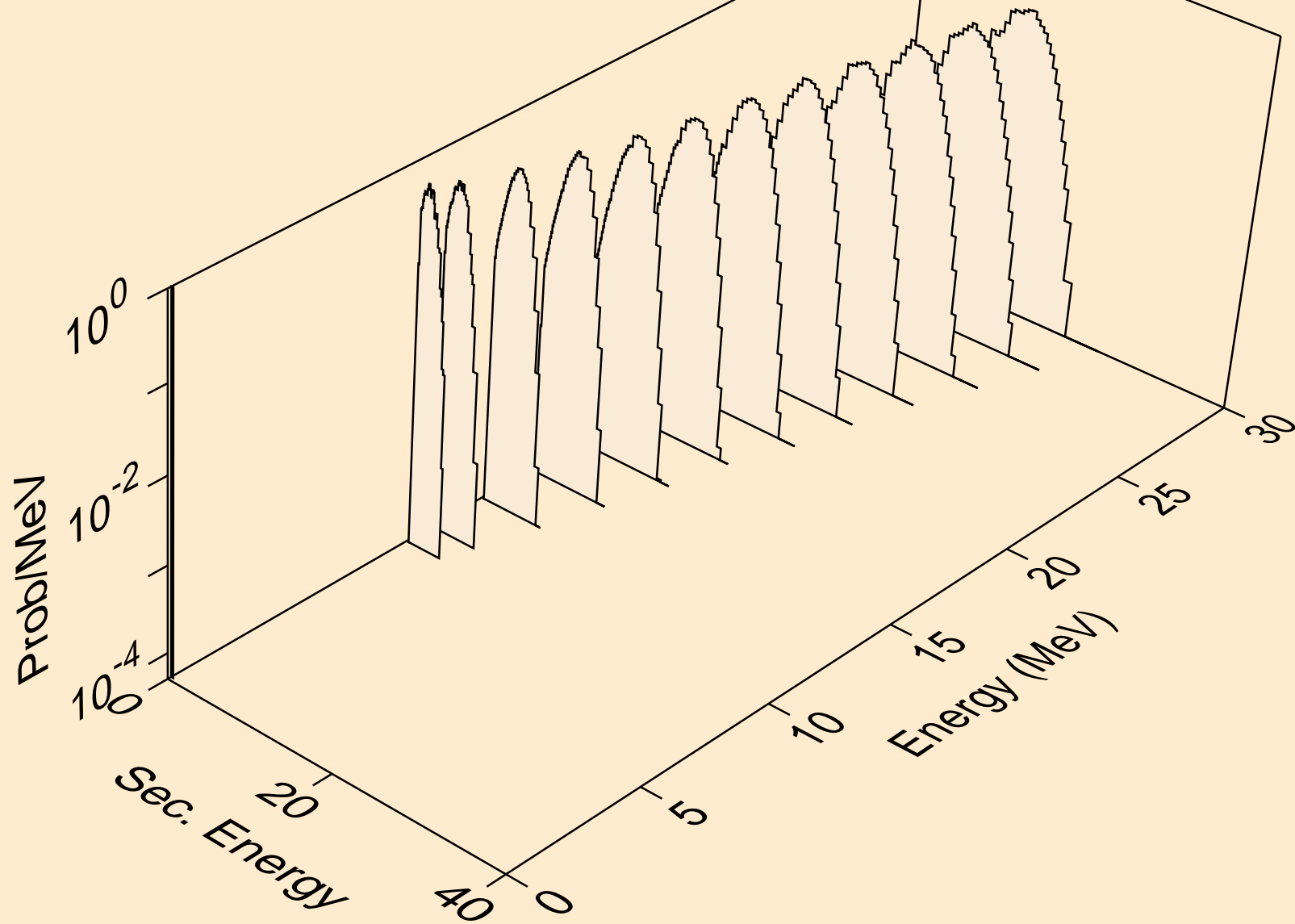

OS178 HELION ACER TENDL-2021 LIBRARY; T=0.K  
tritons from (s,x)

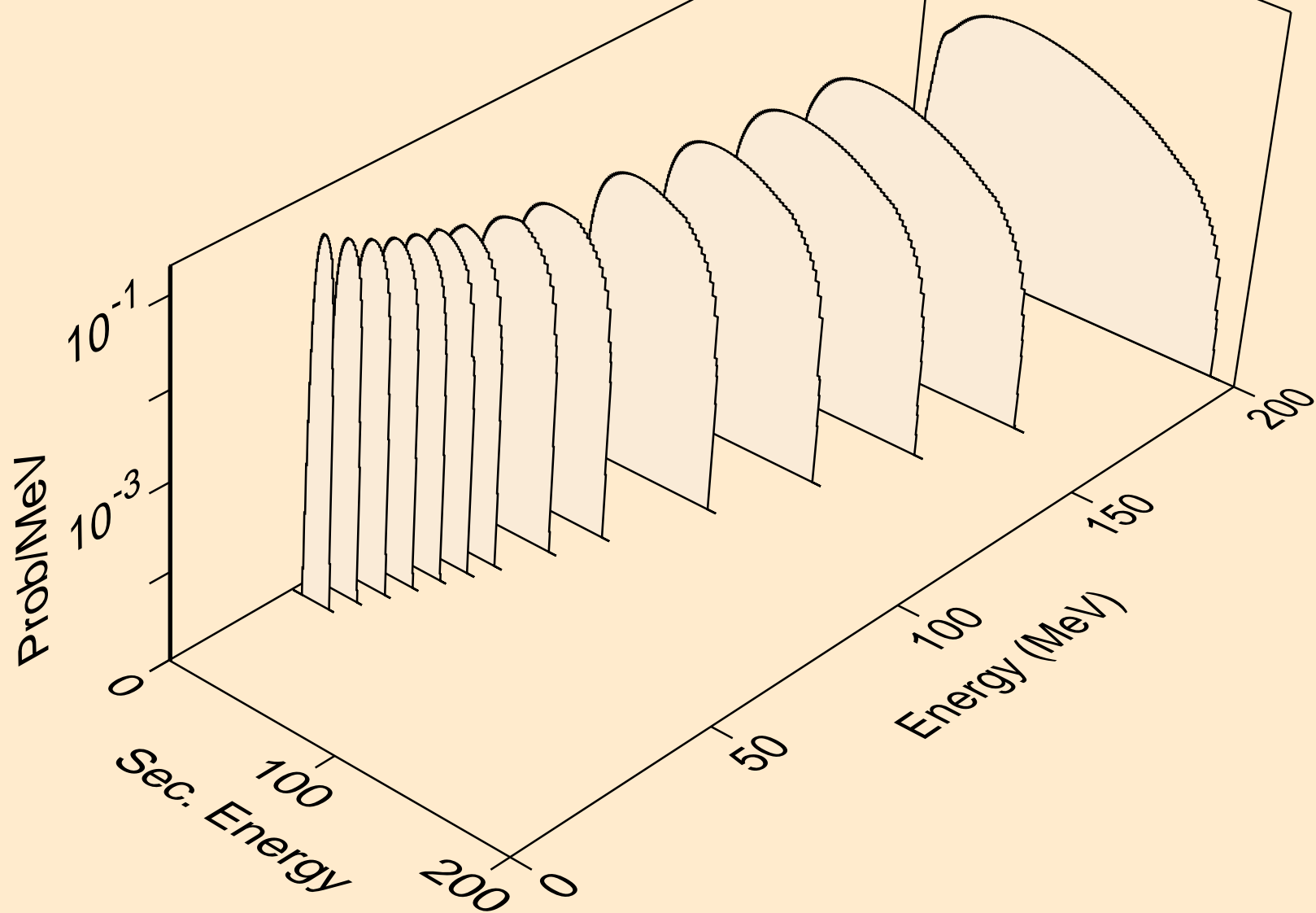

OS178 HELION ACER TENDL-2021 LIBRARY; T=0.K  
tritons from (s,n\*)t

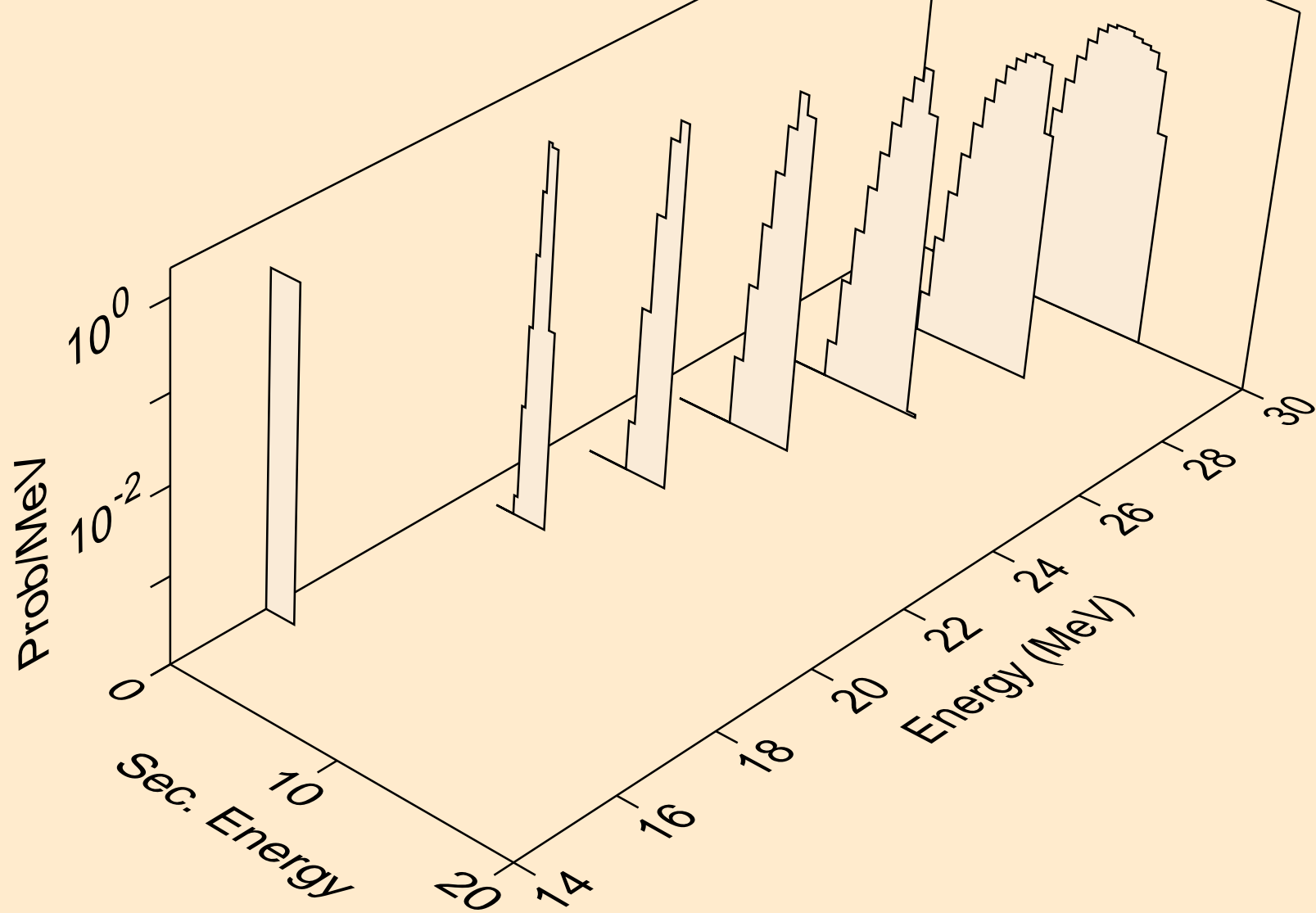

OS178 HELION ACER TENDL-2021 LIBRARY; T=0.K  
tritons from (s,t)

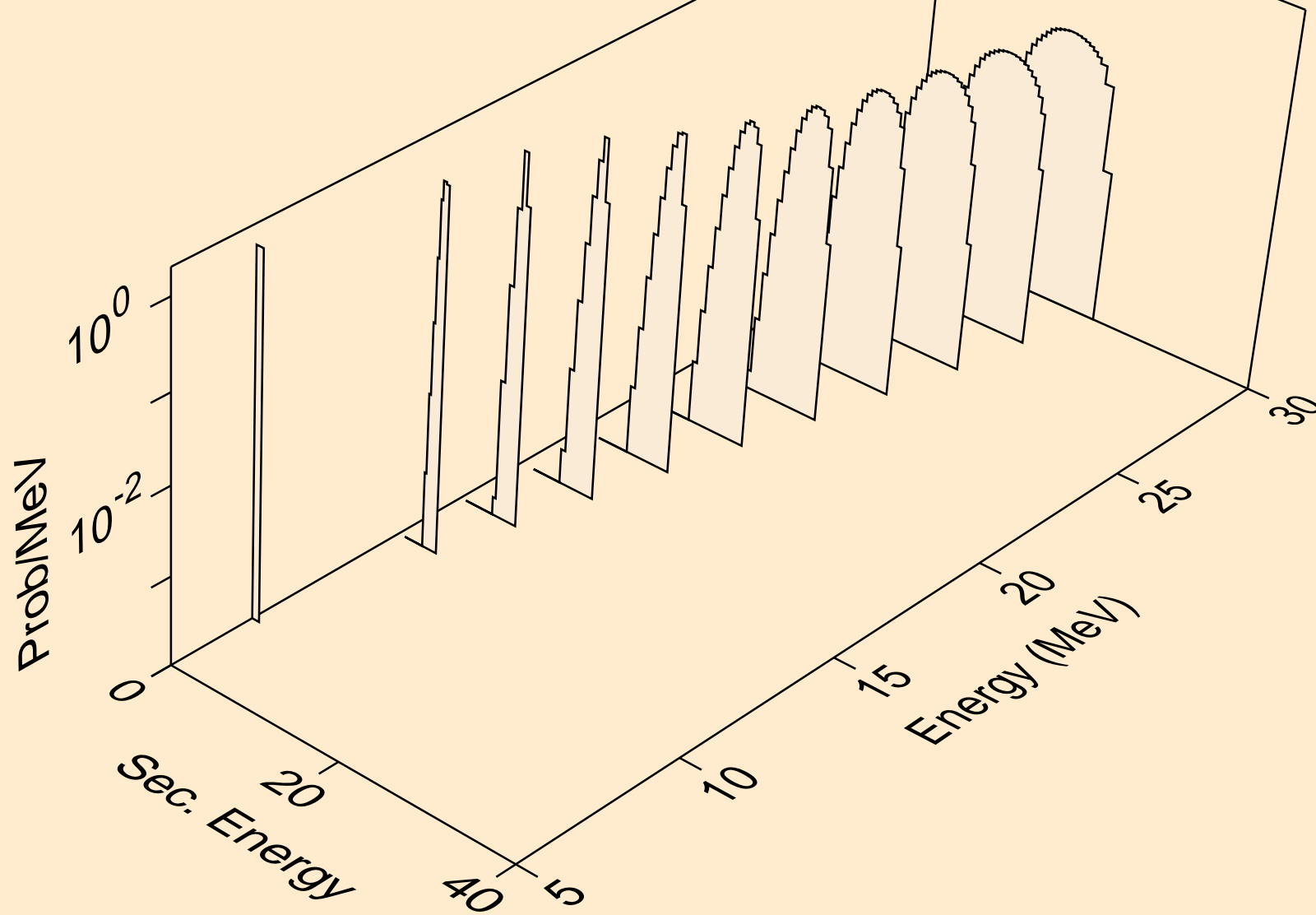

OS178 HELION ACER TENDL-2021 LIBRARY; T=0.K  
tritons from (s,pt)

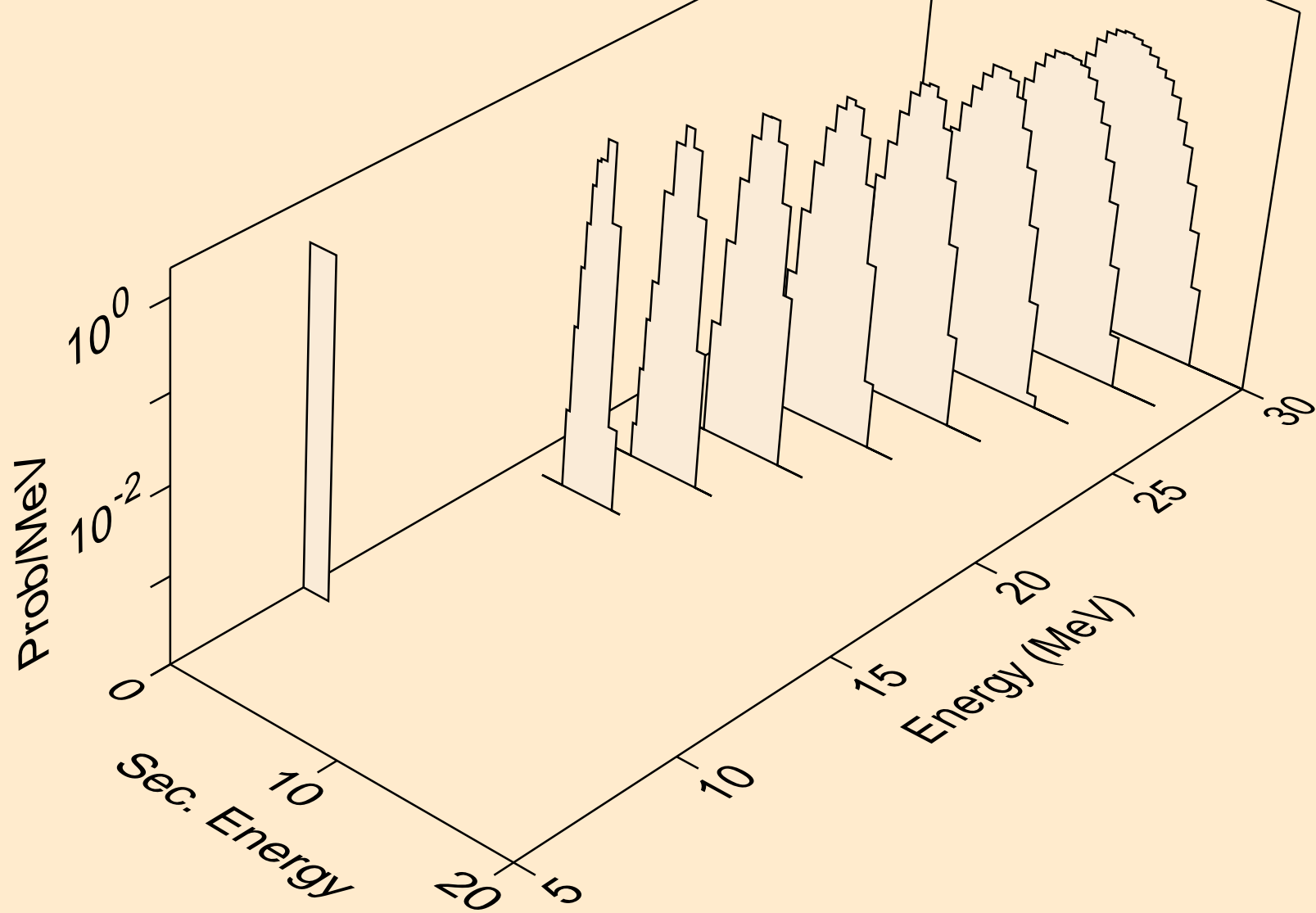

OS178 HELION ACER TENDL-2021 LIBRARY; T=0.K  
alphas from (s,x)

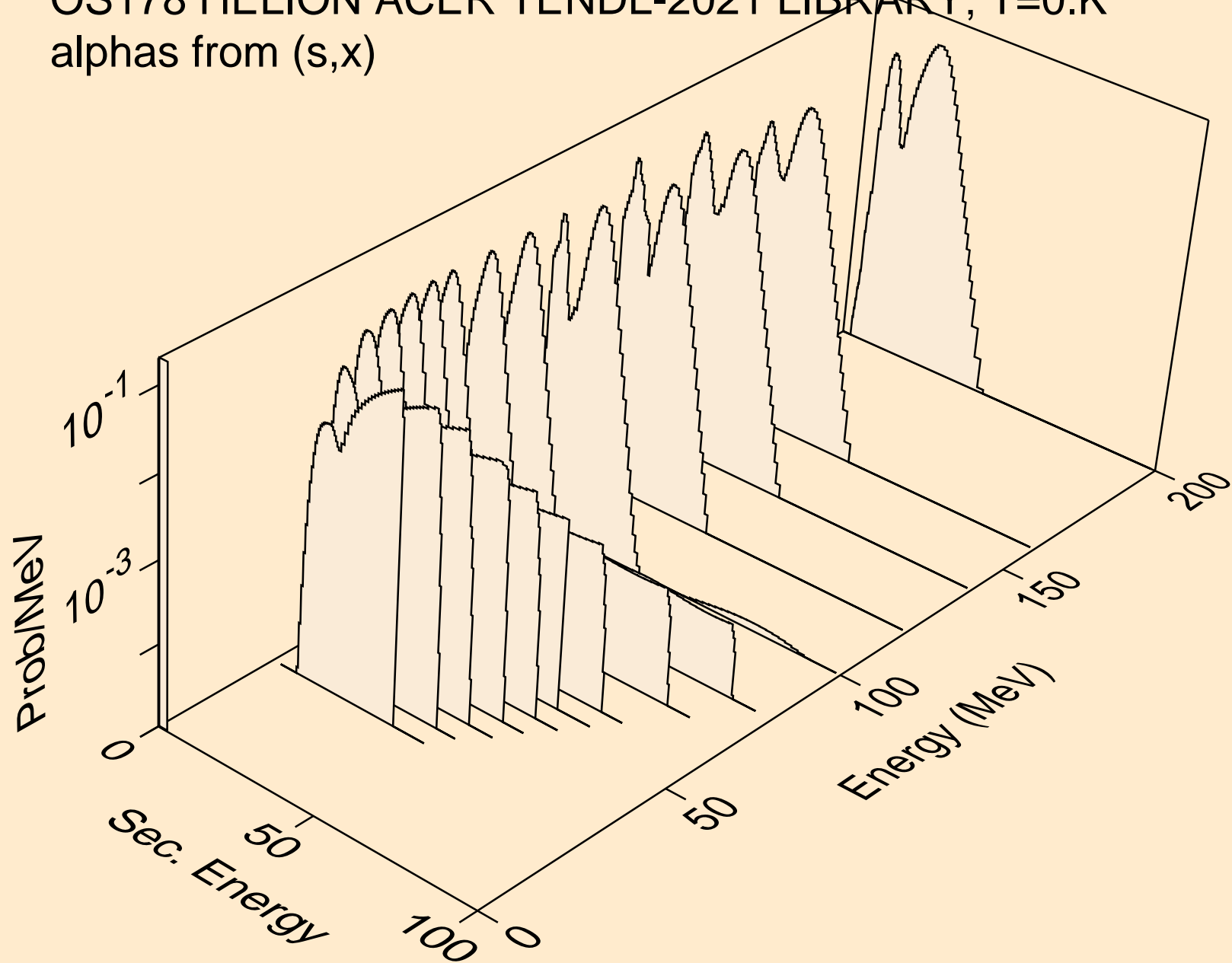



OS178 HELION ACER TENDL-2021 LIBRARY; T=0.K  
alphas from (s,n\*)a

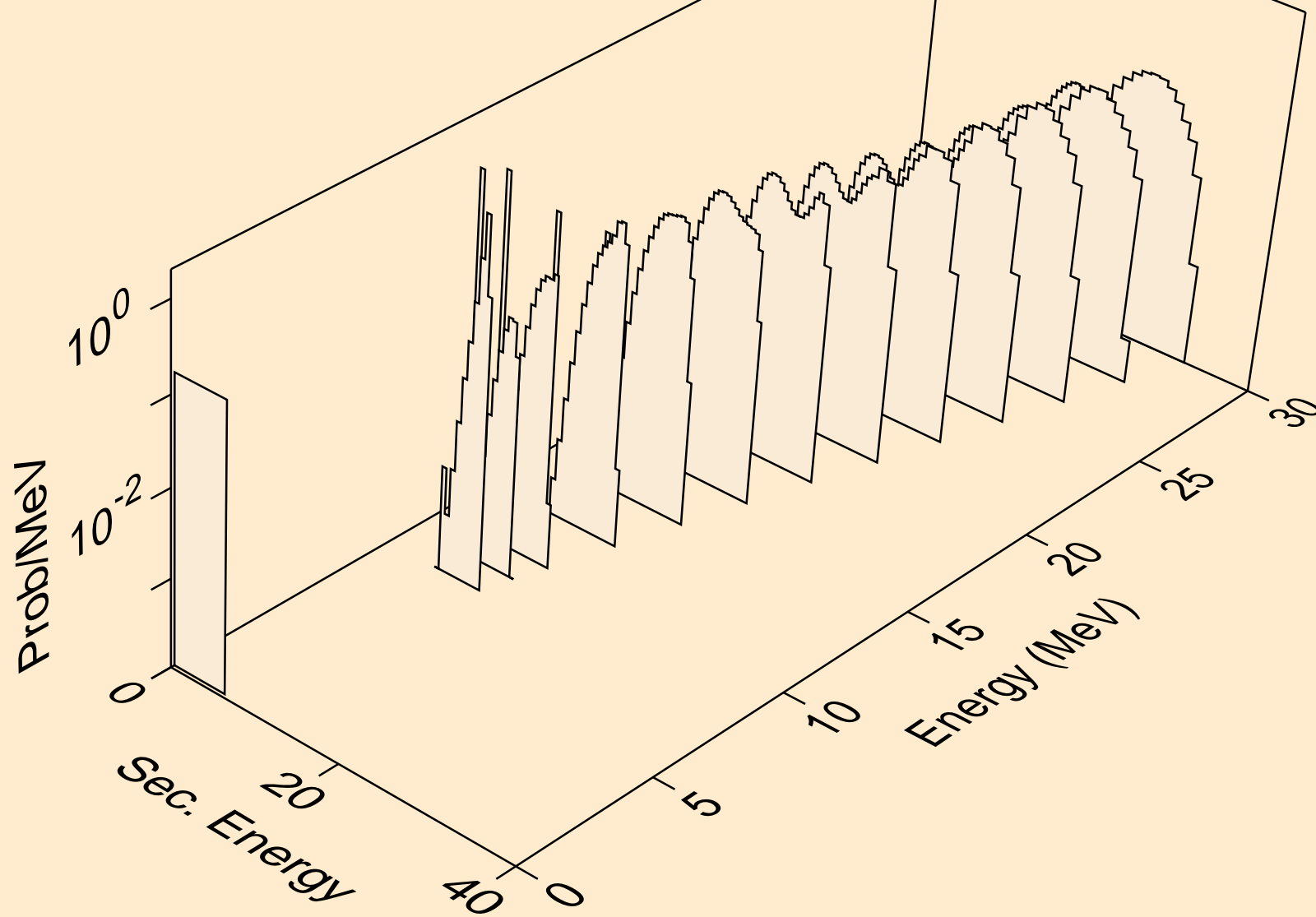

OS178 HELION ACER TENDL-2021 LIBRARY; T=0.K  
alphas from (s,2n)a

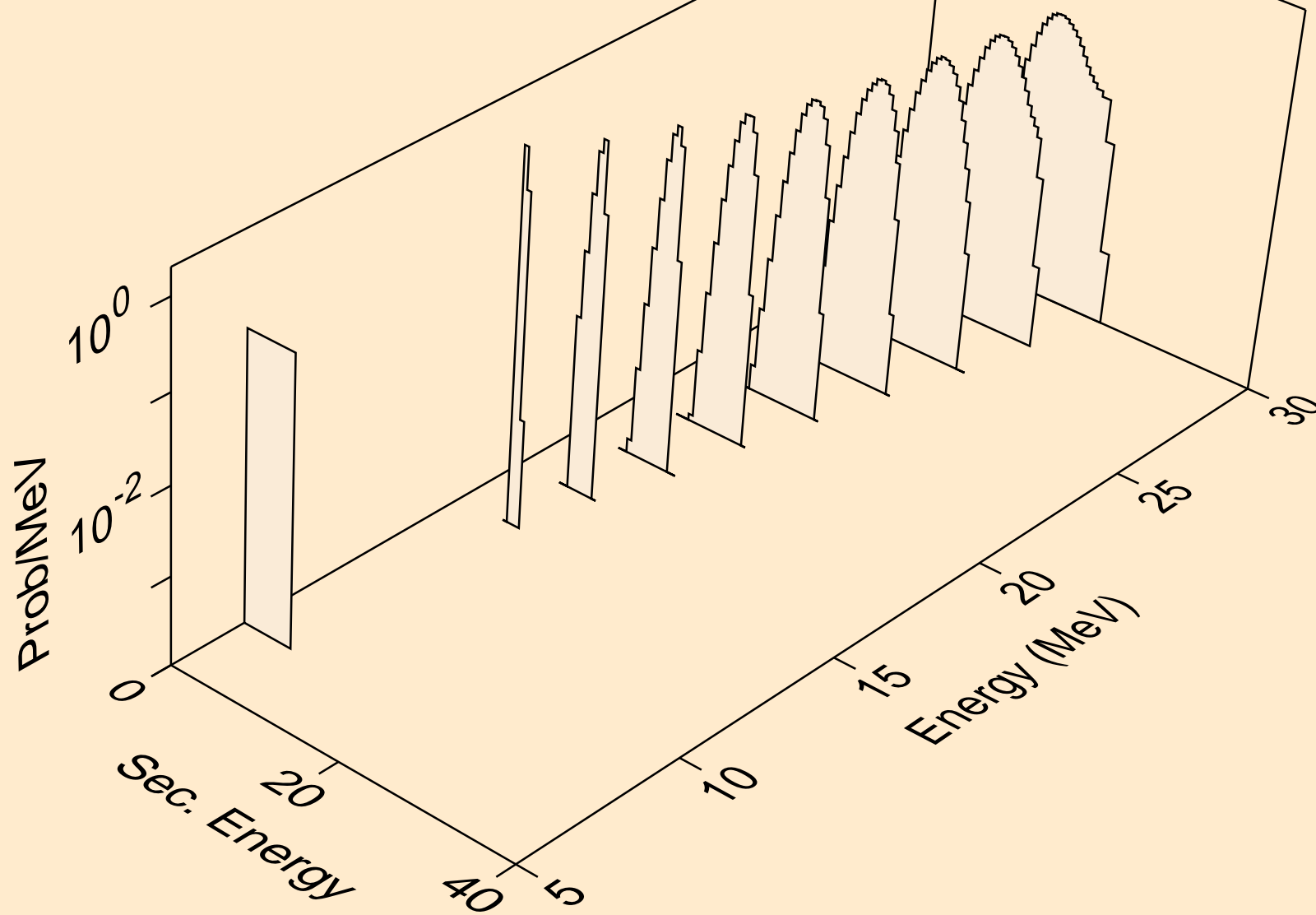

OS178 HELION ACER TENDL-2021 LIBRARY; T=0.K  
alphas from (s,3n)a

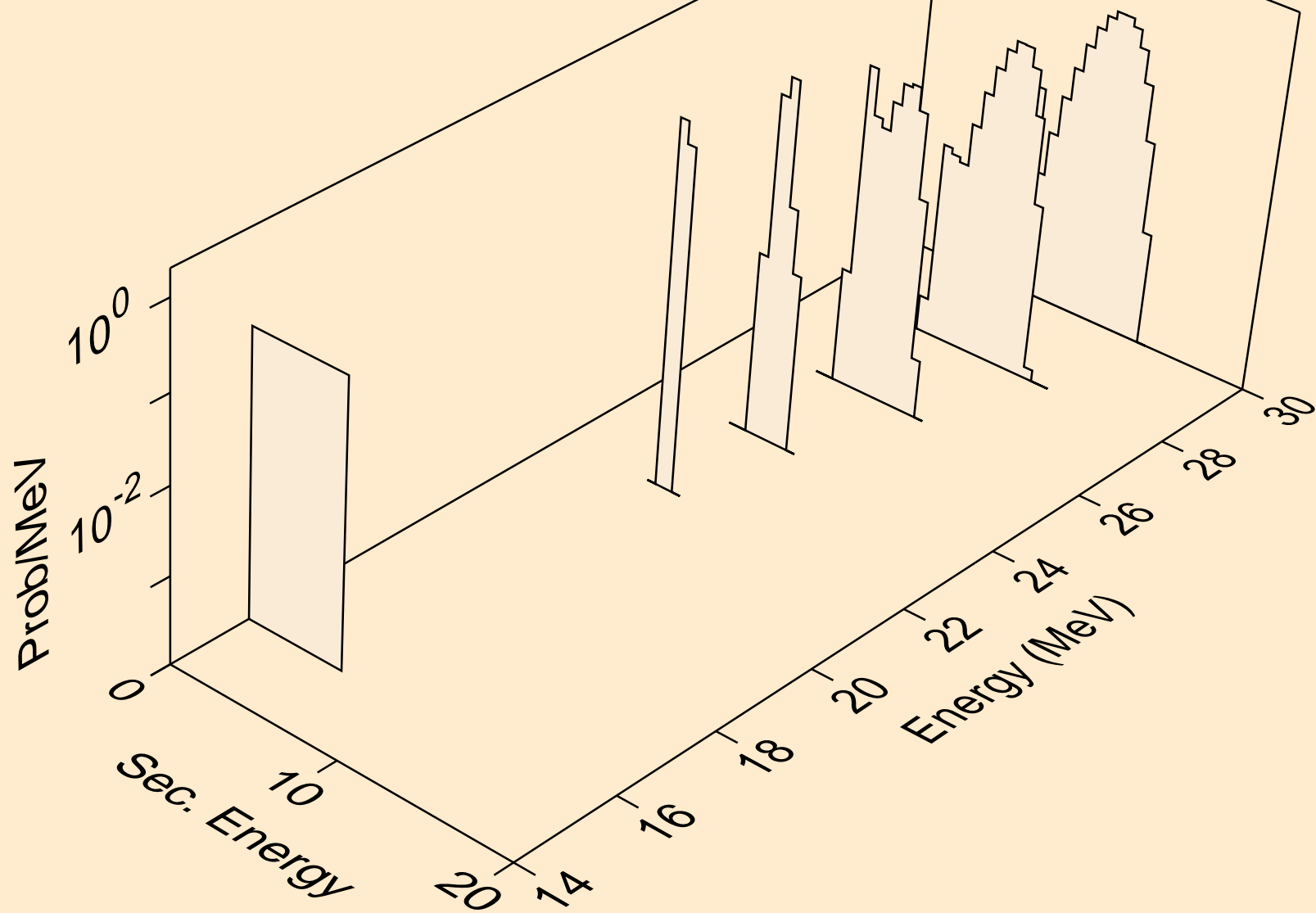

OS178 HELION ACER TENDL-2021 LIBRARY; T=0.K  
alphas from (s,n\*)2a

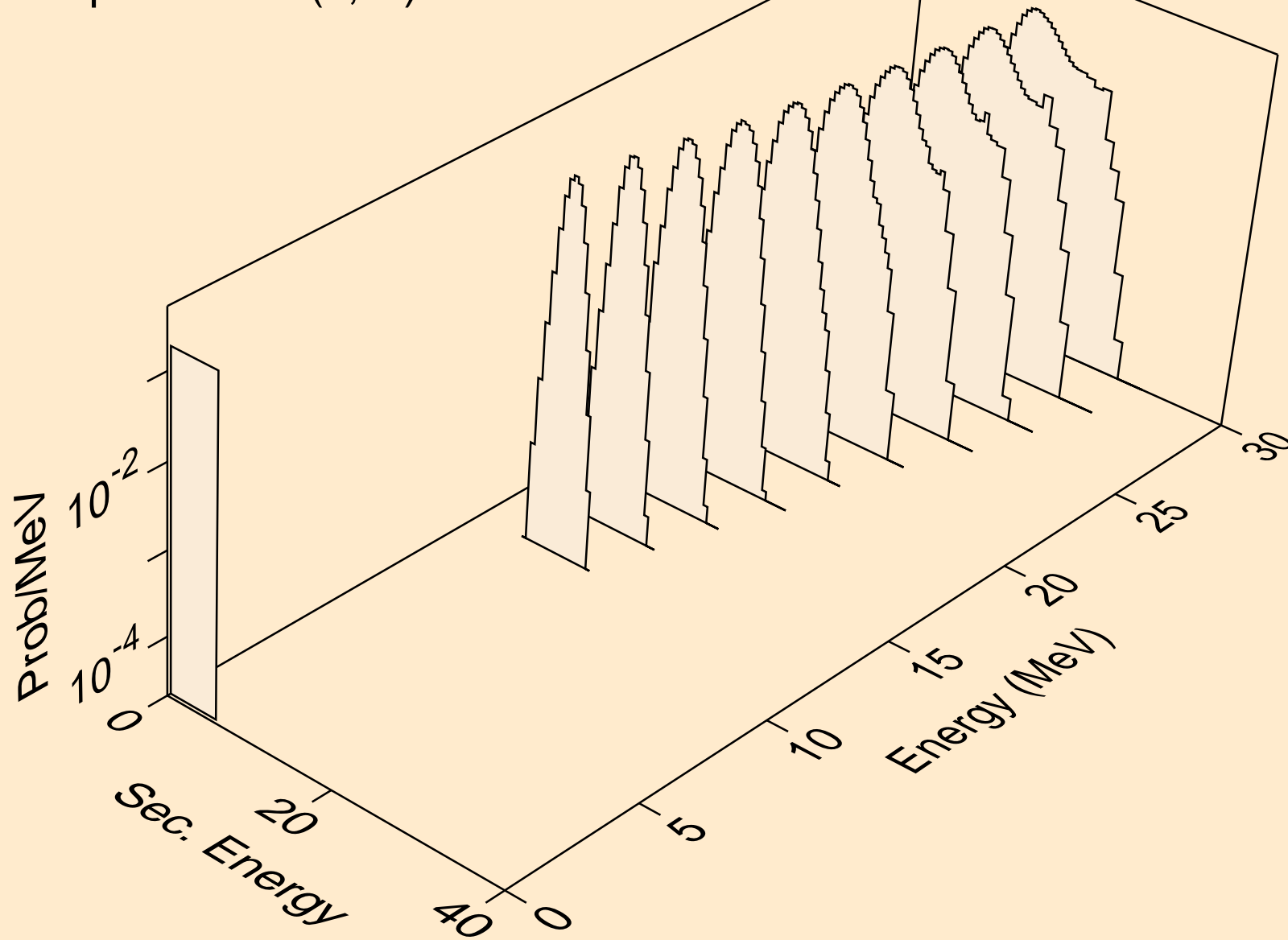

OS178 HELION ACER TENDL-2021 LIBRARY; T=0.K  
alphas from (s,npa)

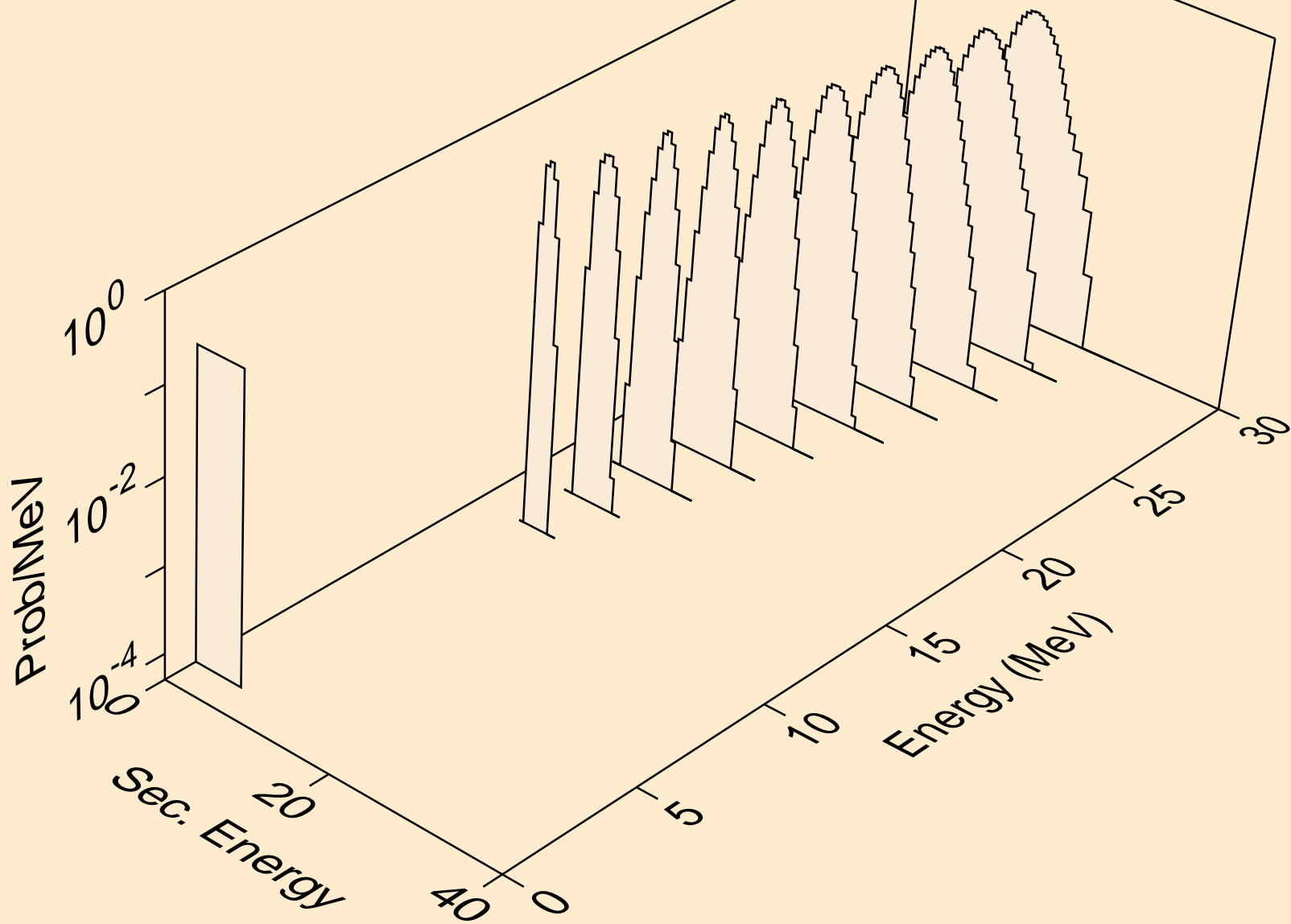

OS178 HELION ACER TENDL-2021 LIBRARY; T=0.K  
alphas from (s,a)

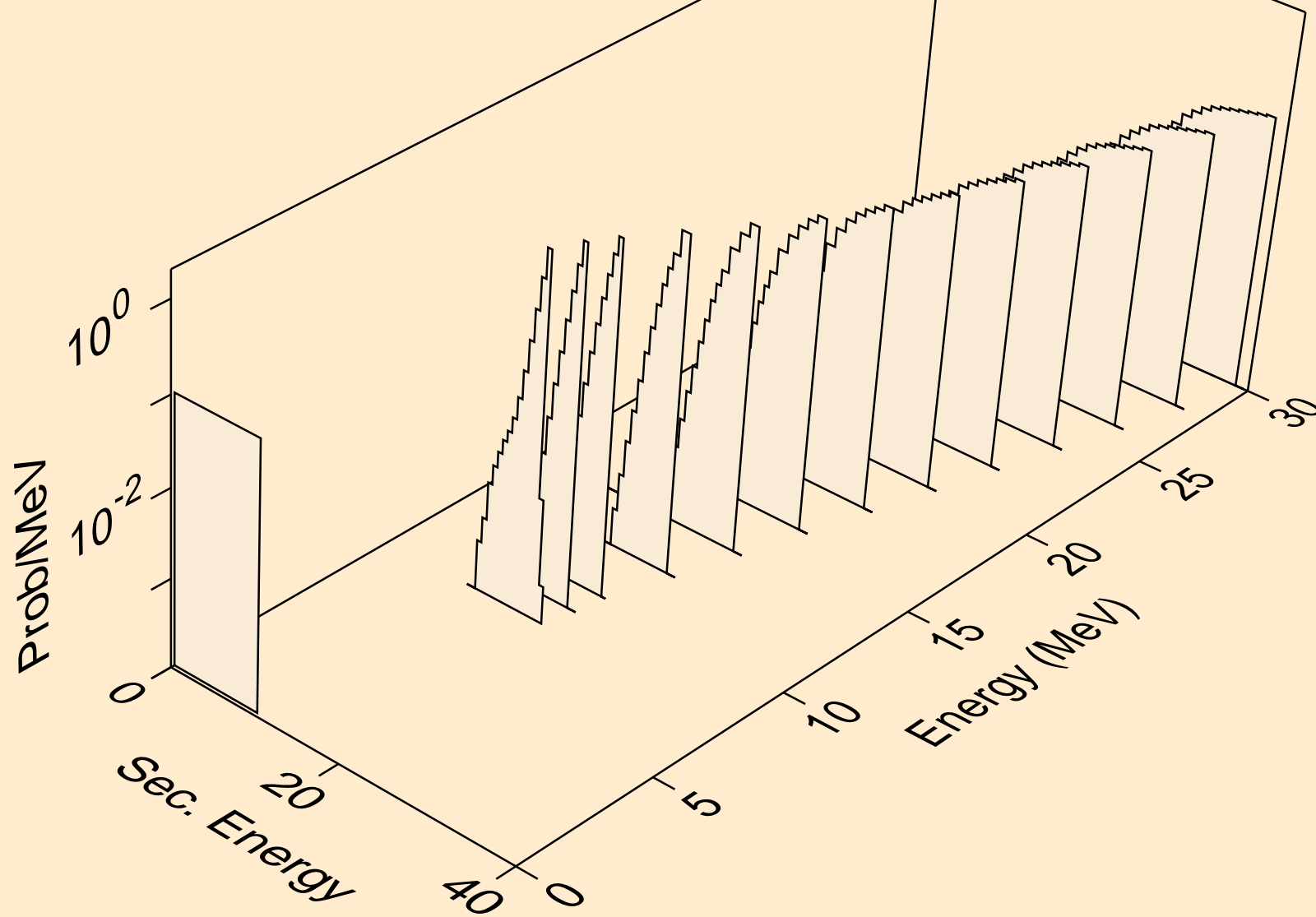

OS178 HELION ACER TENDL-2021 LIBRARY; T=0.K  
alphas from (s,2a)

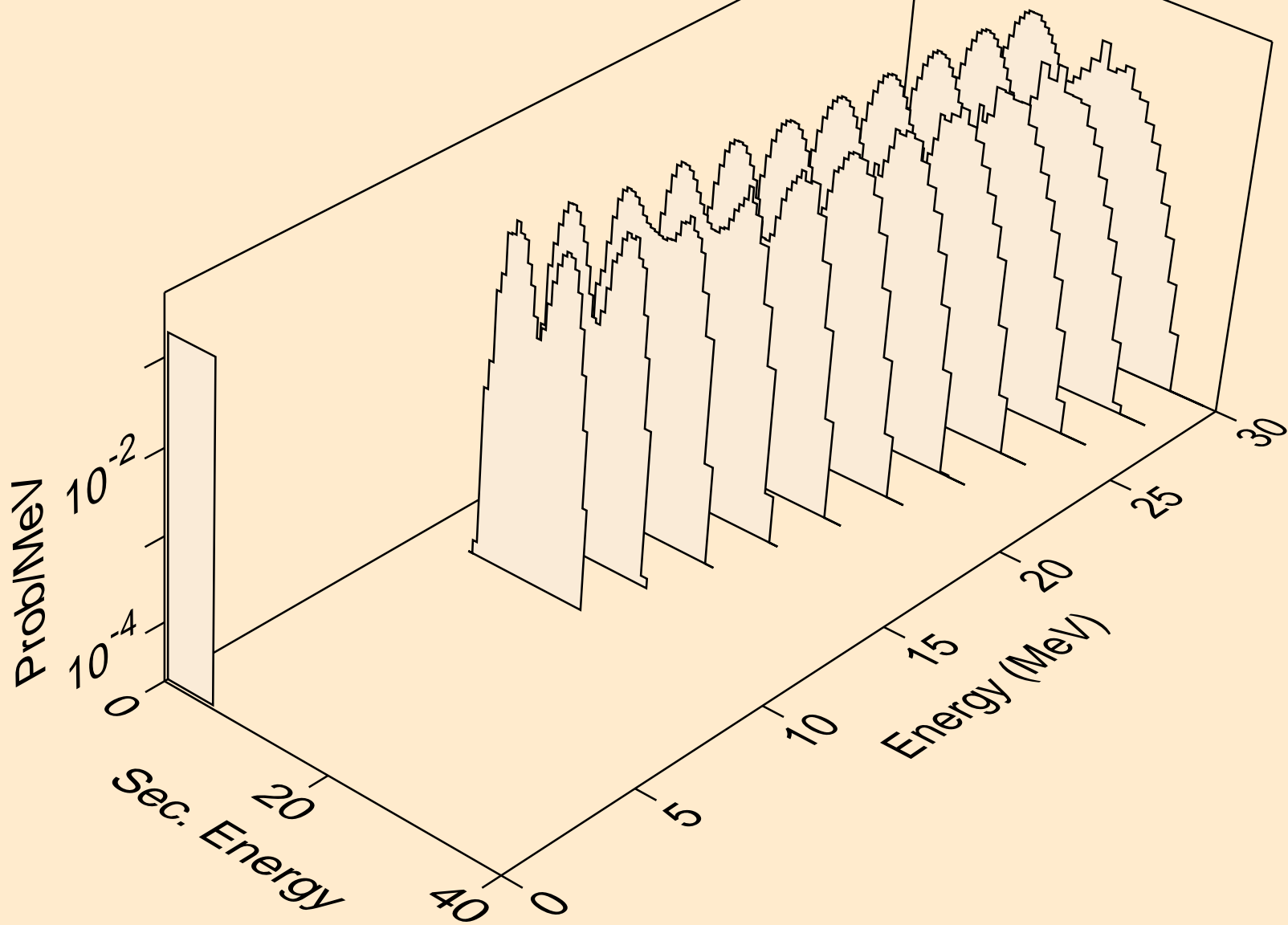

OS178 HELION ACER TENDL-2021 LIBRARY; T=0.K  
alphas from (s,pa)

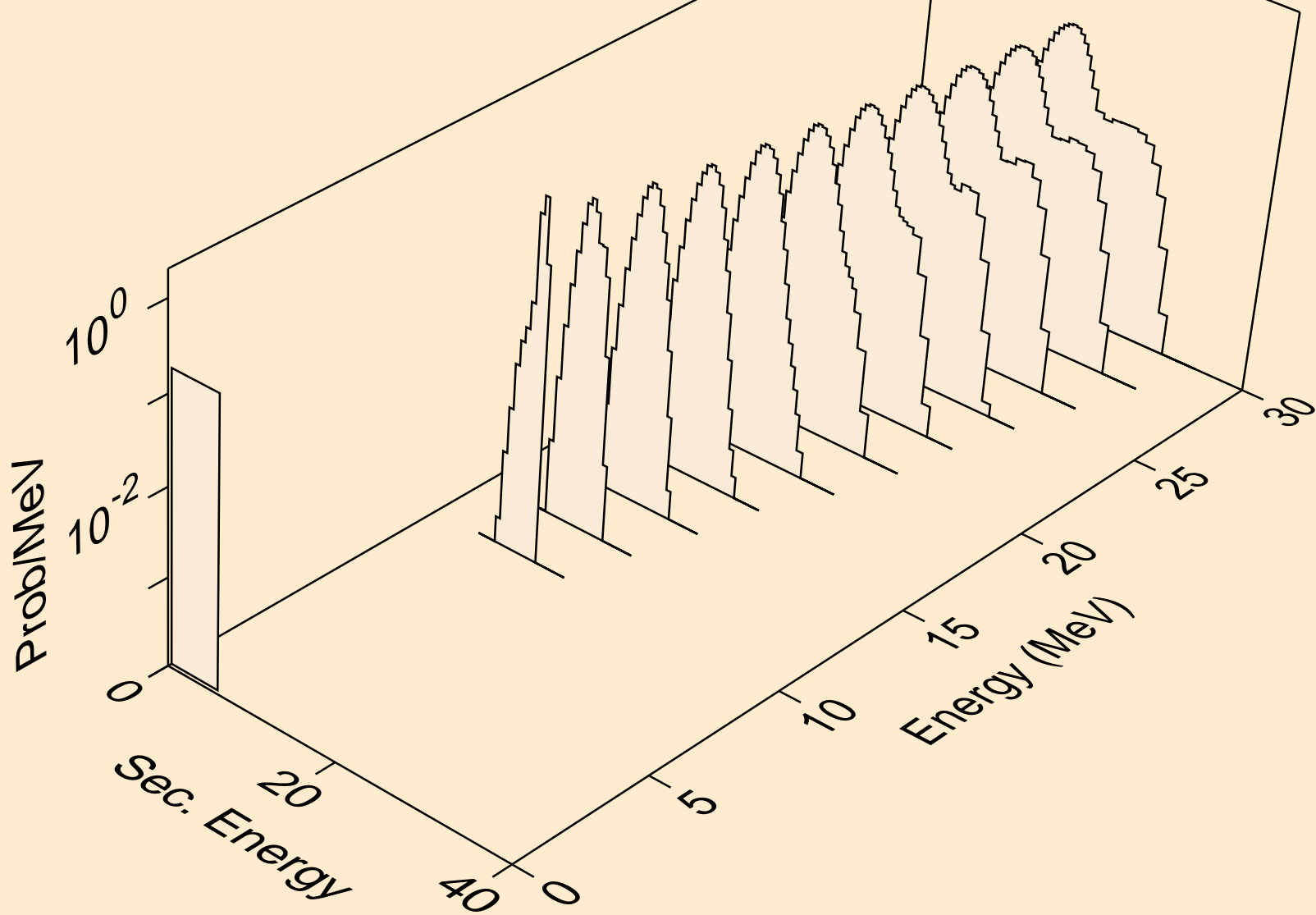



OS178 HELION ACER TENDL-2021 LIBRARY; T=0.K  
alphas from (s,da)

