

# OS179 HELION ACER TENDL-2021 LIBRARY; T=0.K

## Principal cross sections

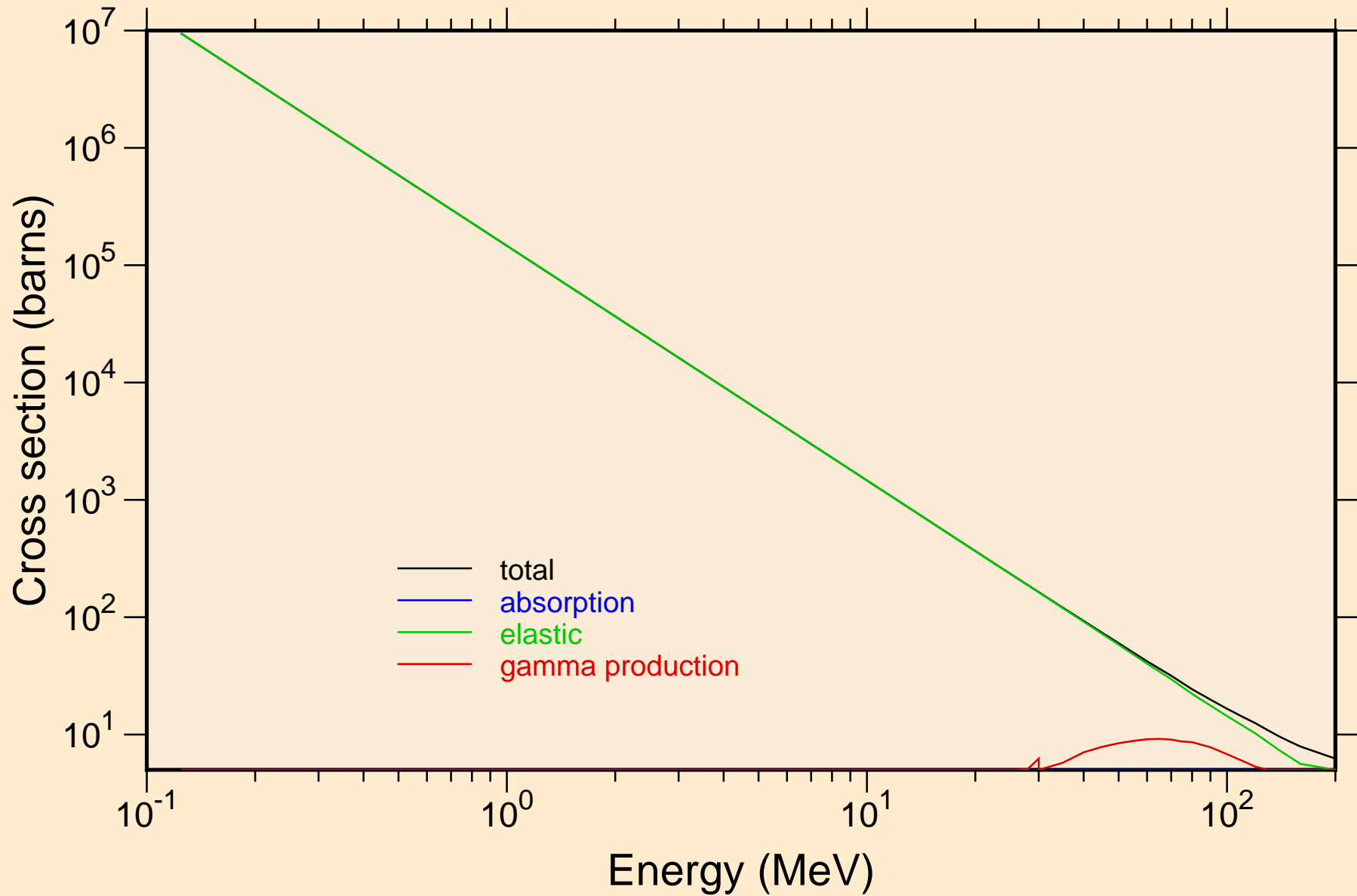

OS179 HELION ACER TENDL-2021 LIBRARY; T=0.K

Heating

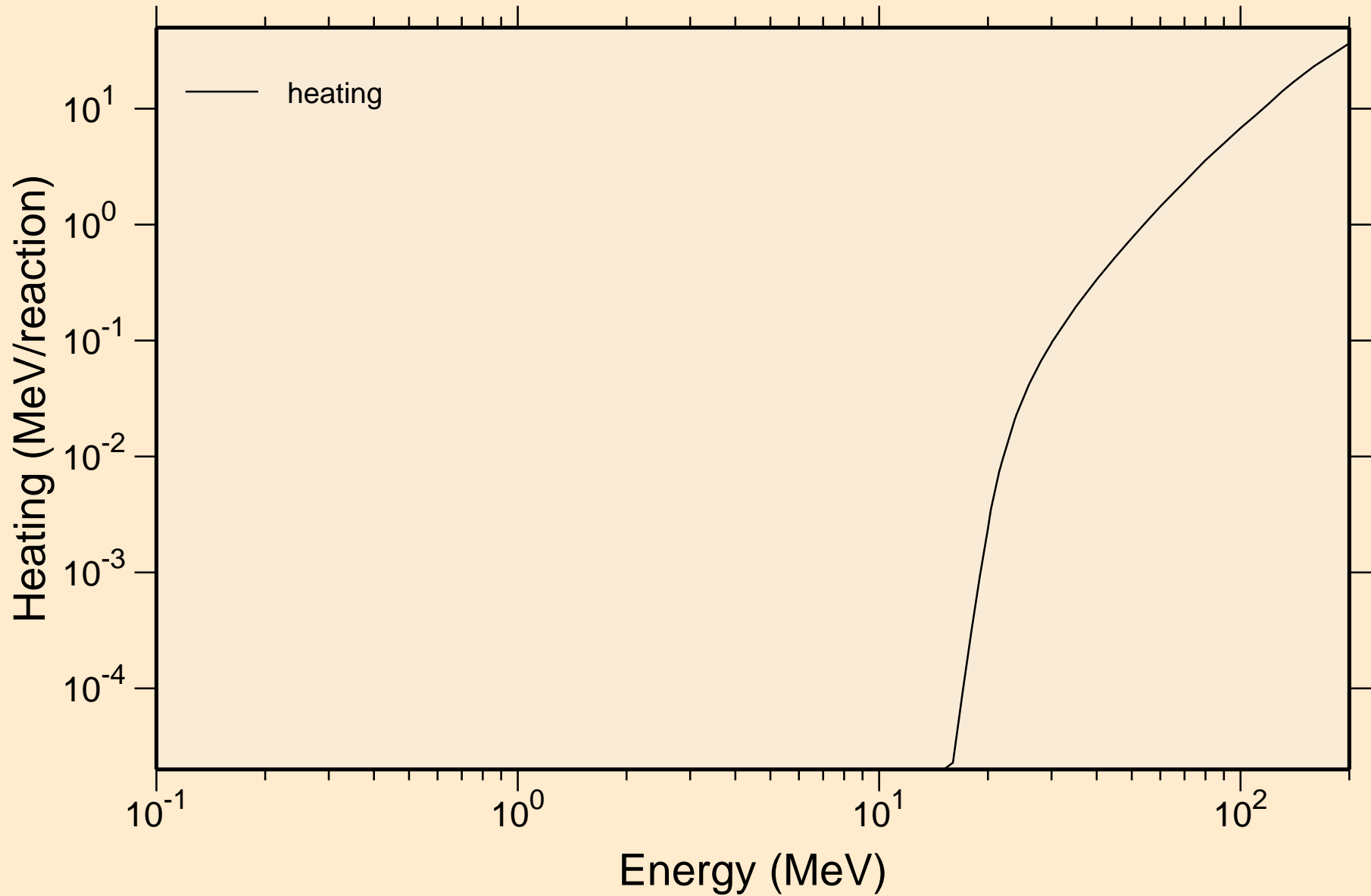

# OS179 HELION ACER TENDL-2021 LIBRARY; T=0.K

## Principal cross sections

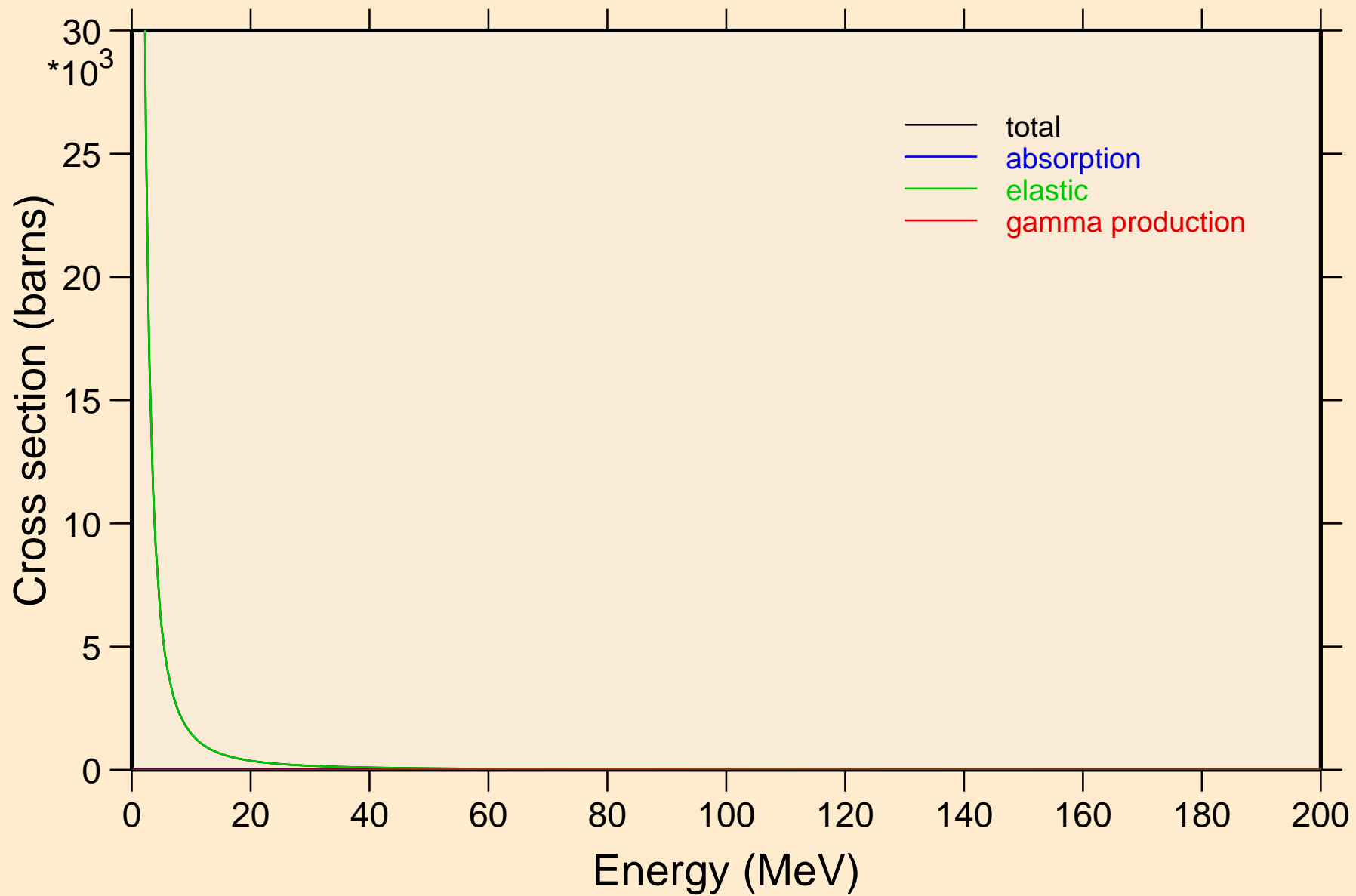

OS179 HELION ACER TENDL-2021 LIBRARY; T=0.K

Heating

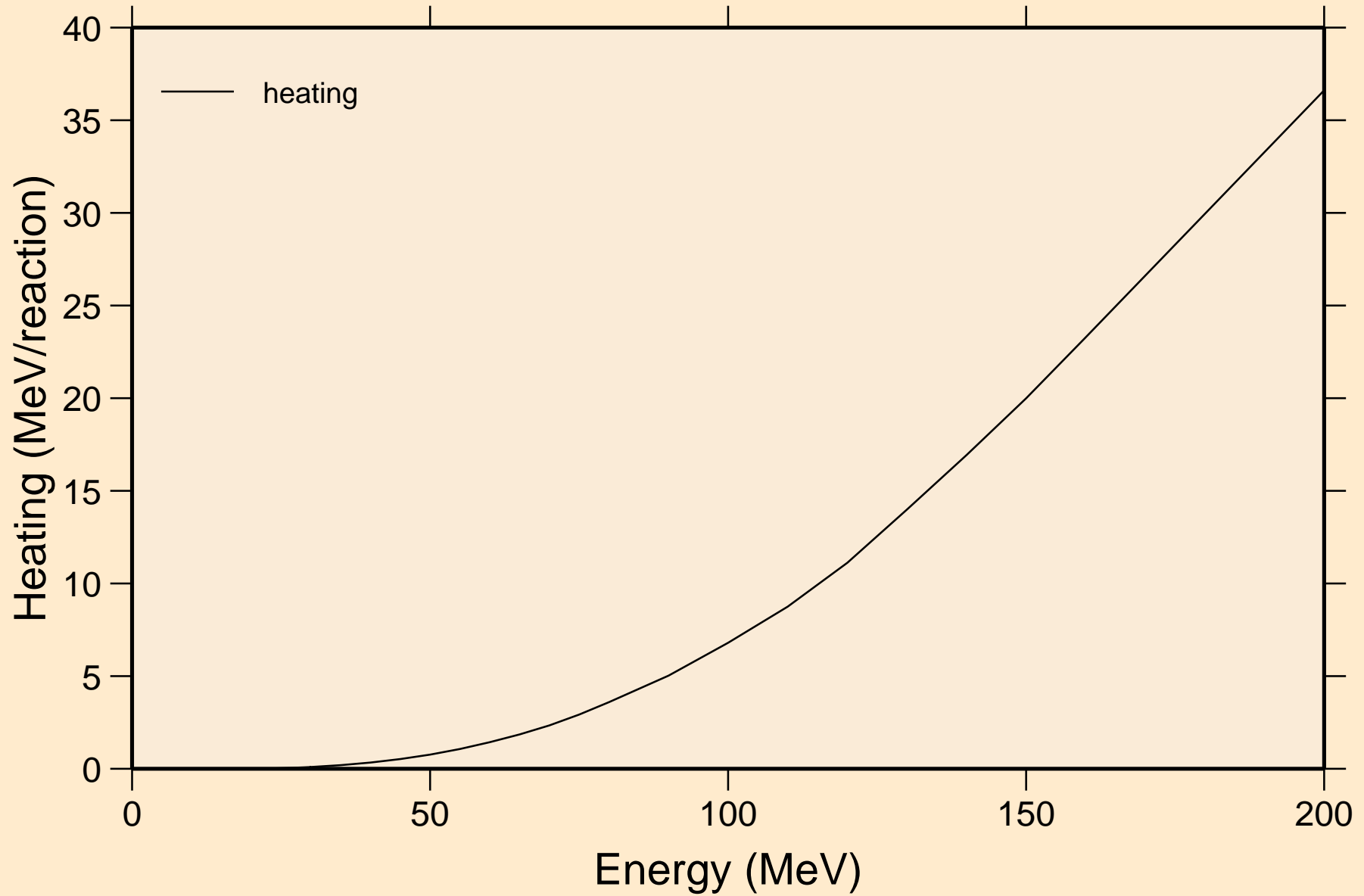

OS179 HELION ACER TENDL-2021 LIBRARY; T=0.K  
Threshold reactions

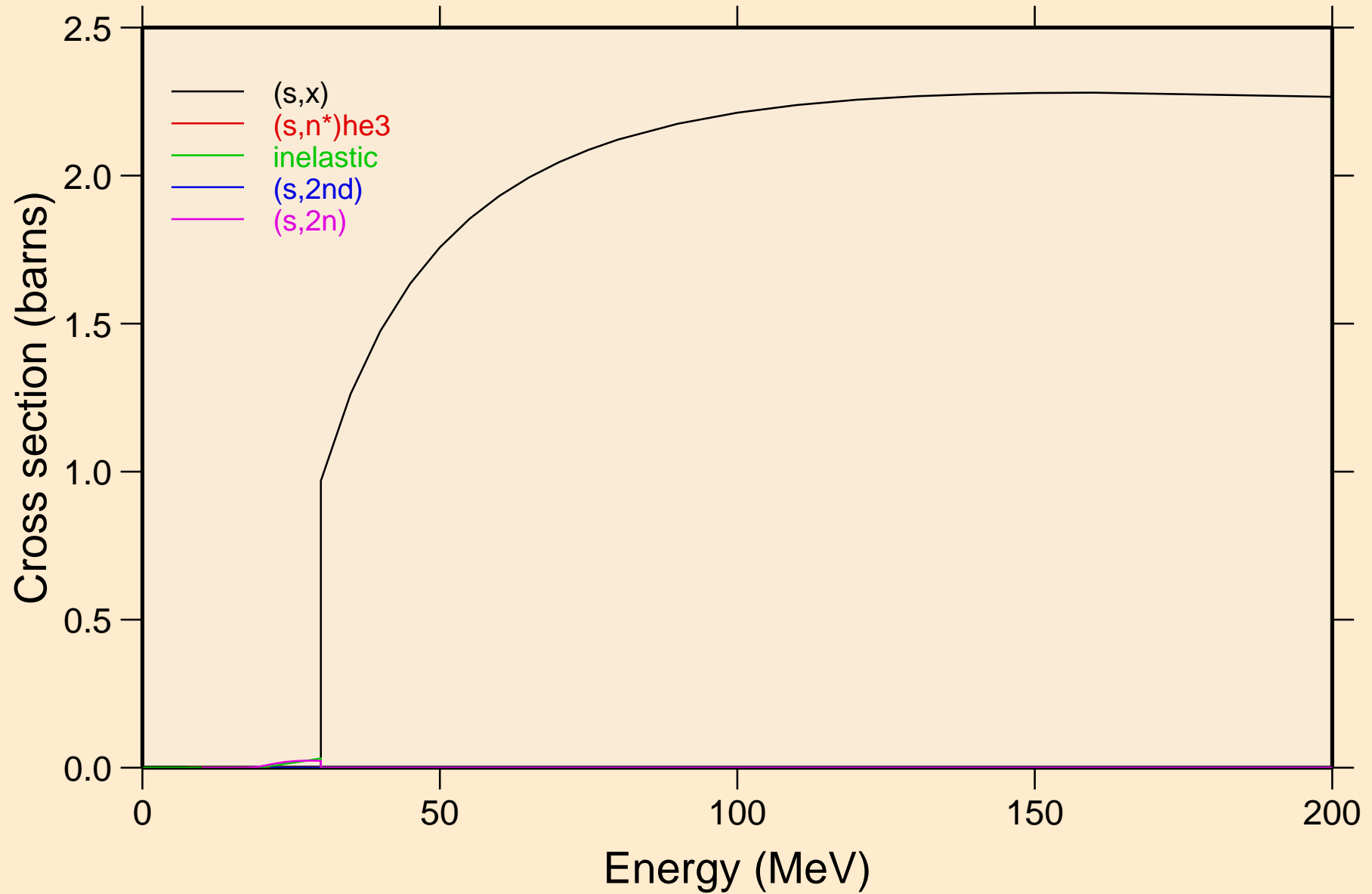

OS179 HELION ACER TENDL-2021 LIBRARY; T=0.K  
Threshold reactions

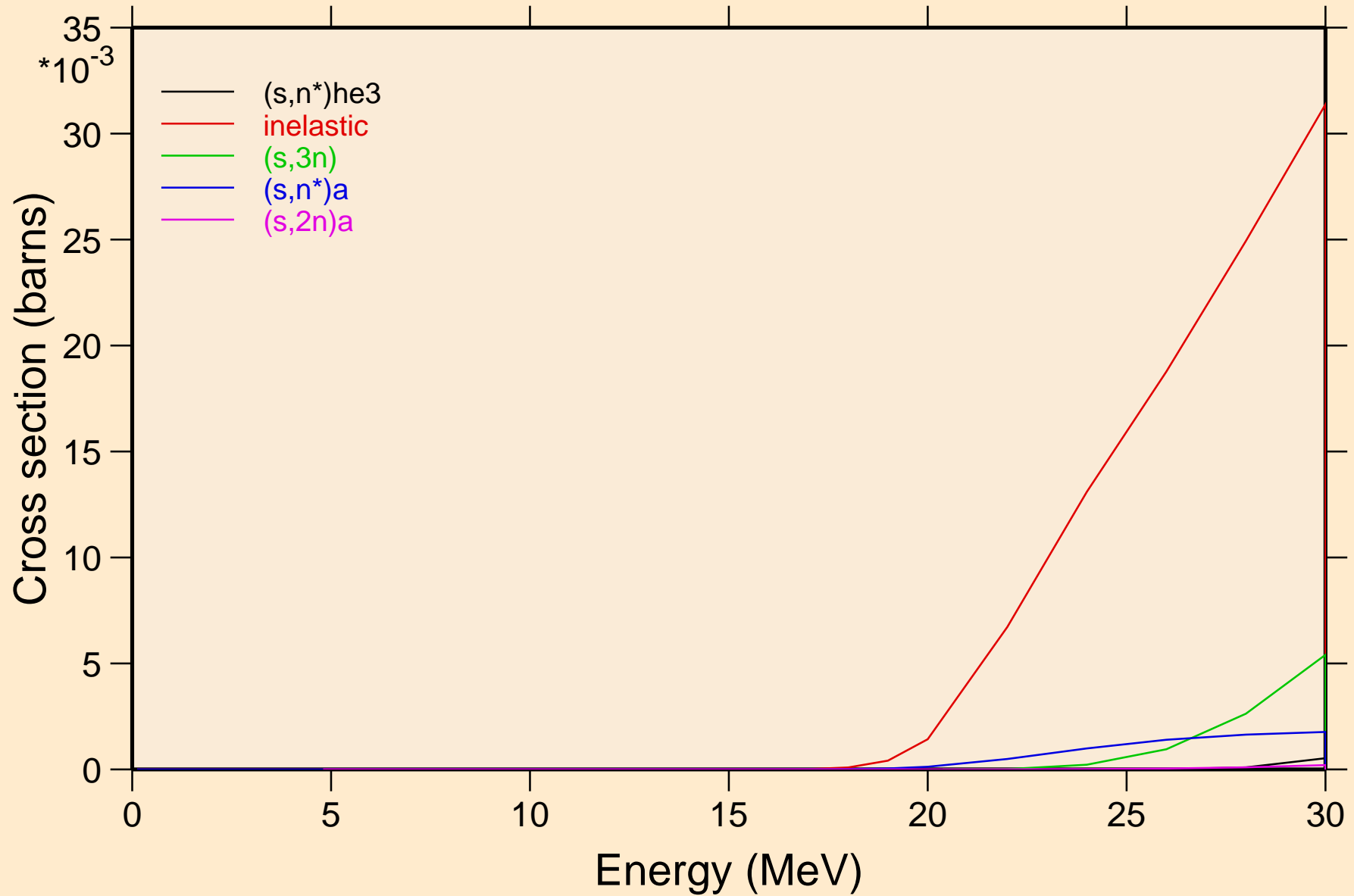

OS179 HELION ACER TENDL-2021 LIBRARY; T=0.K  
Threshold reactions

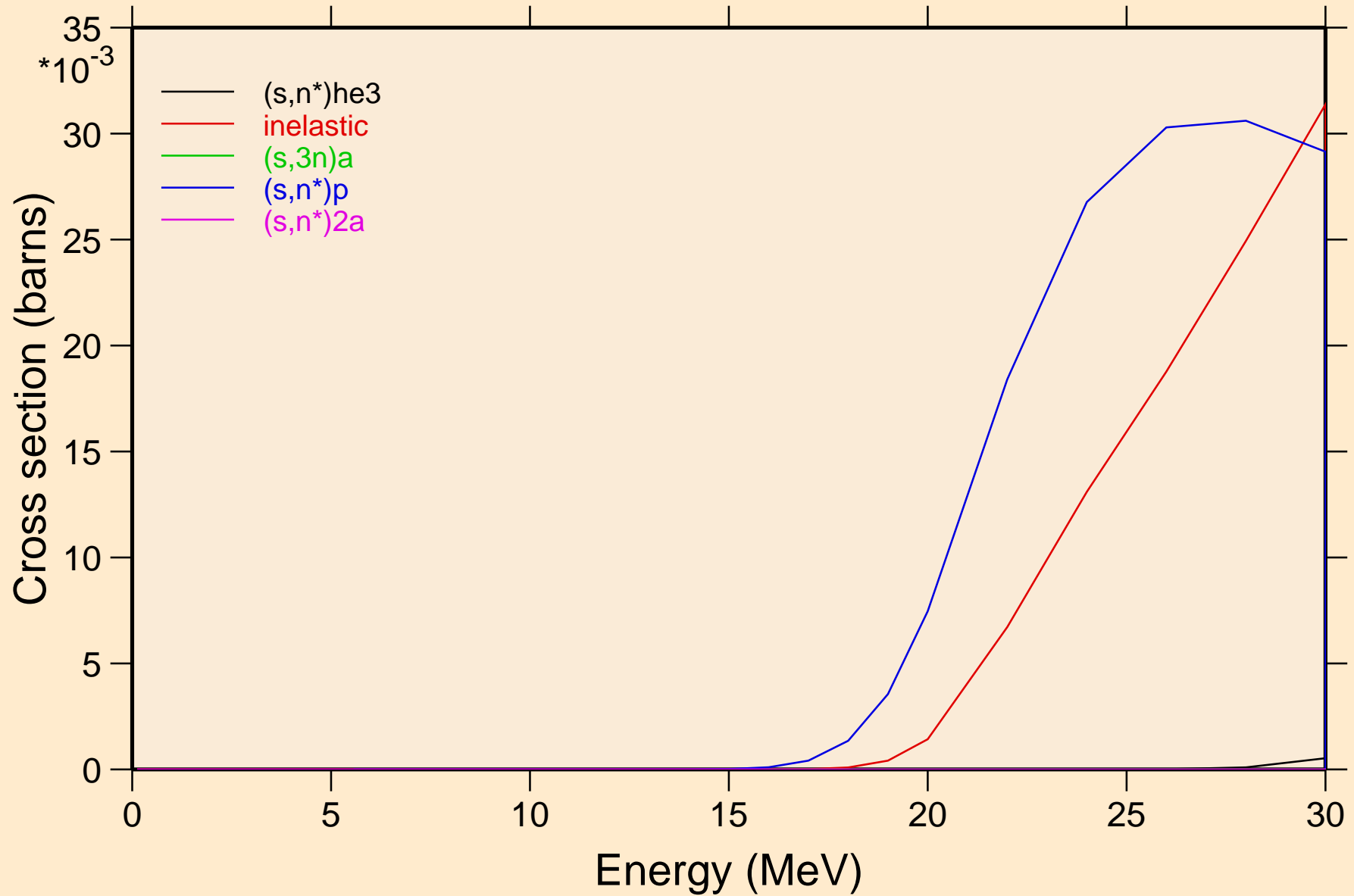

# OS179 HELION ACER TENDL-2021 LIBRARY; T=0.K

## Threshold reactions

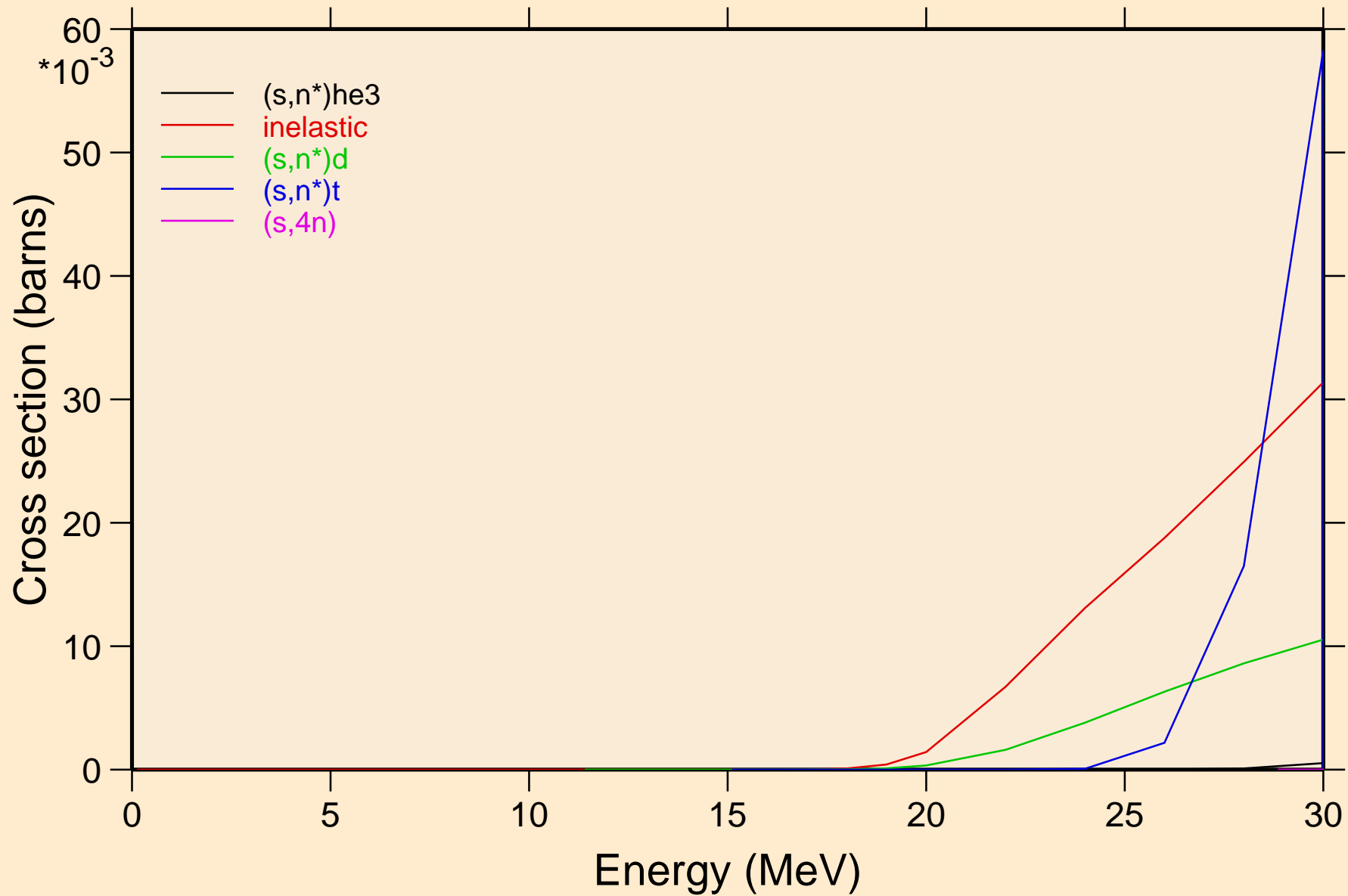



# OS179 HELION ACER TENDL-2021 LIBRARY; T=0.K

## Threshold reactions

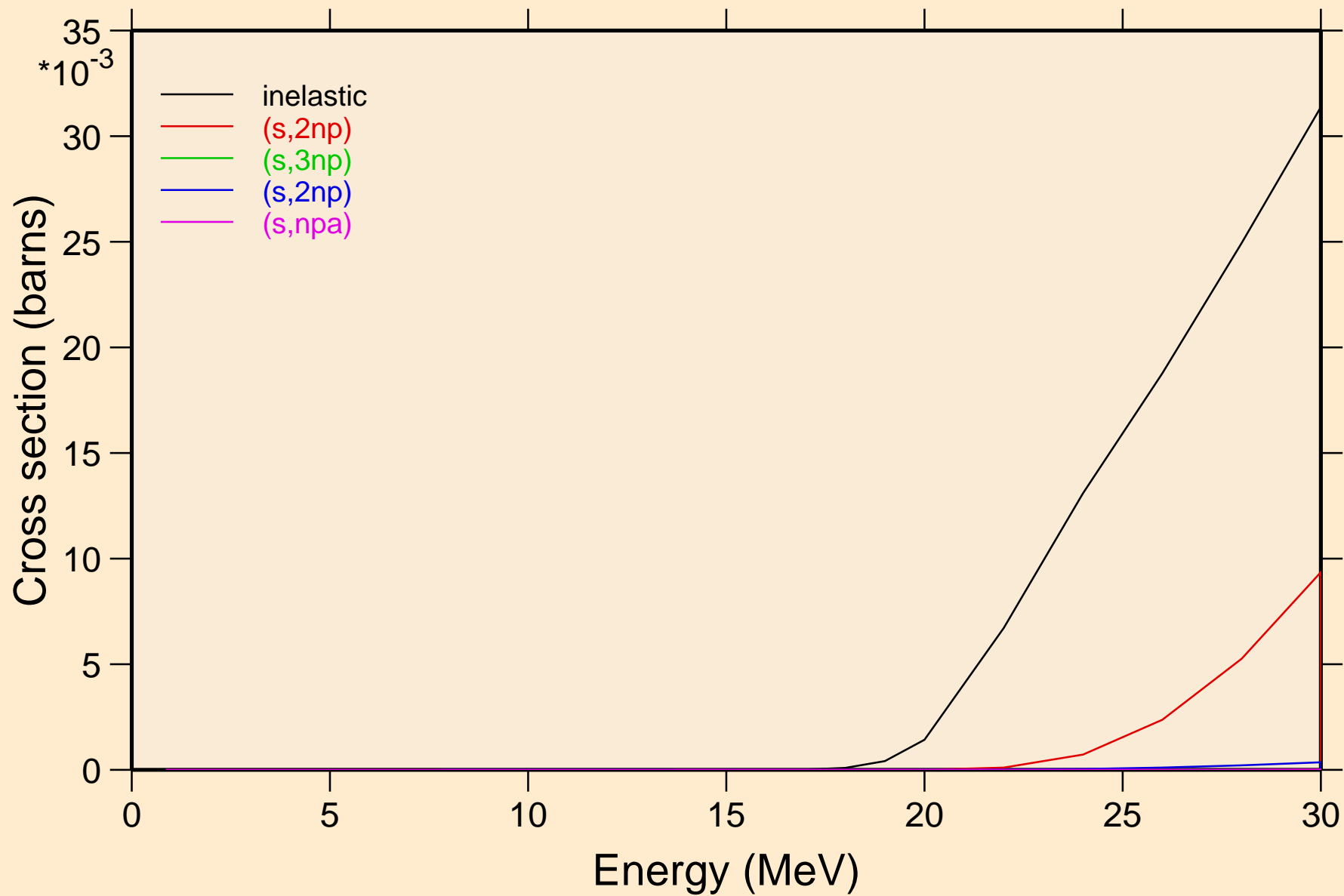

# OS179 HELION ACER TENDL-2021 LIBRARY; T=0.K

## Threshold reactions

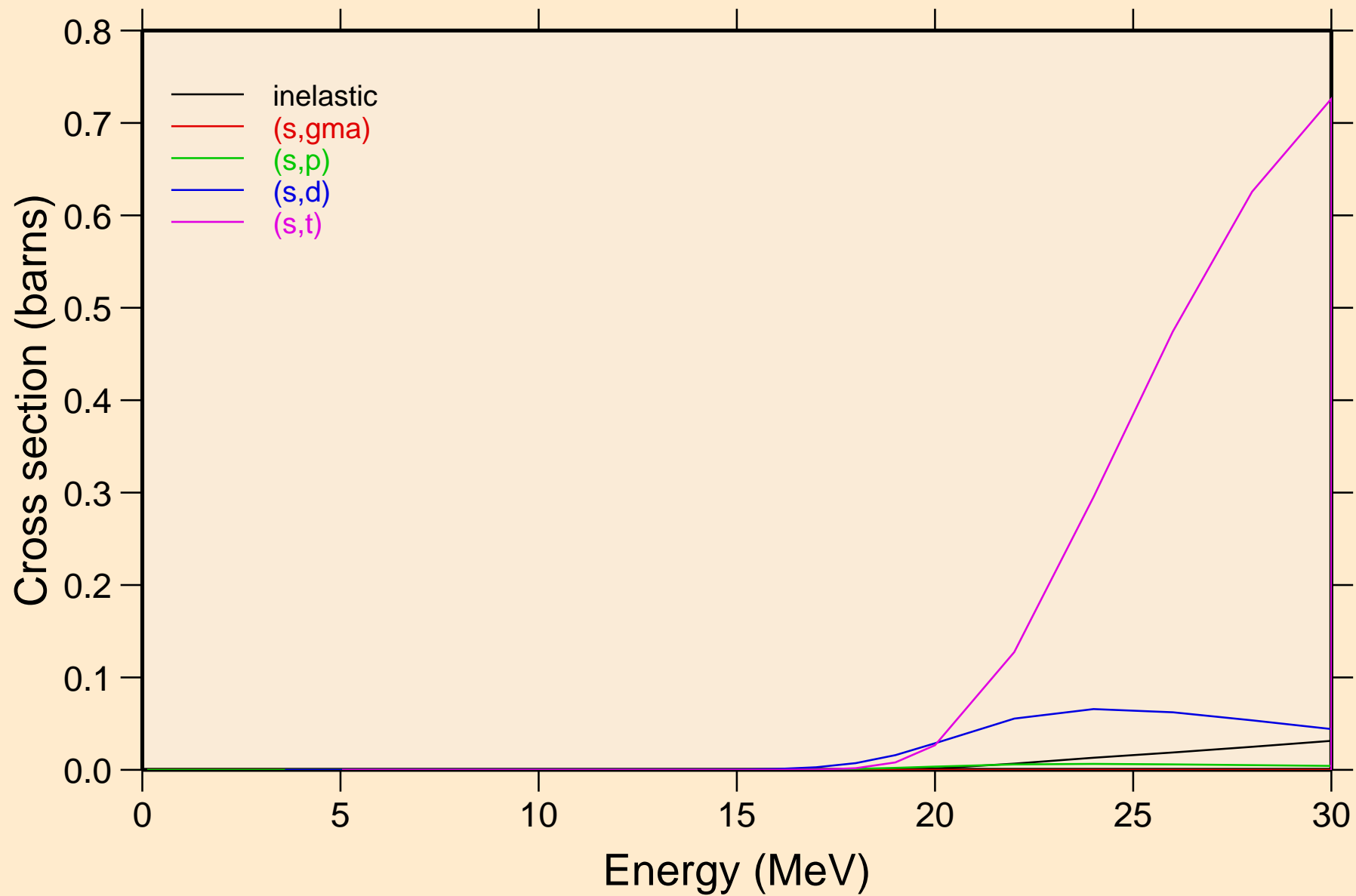

OS179 HELION ACER TENDL-2021 LIBRARY; T=0.K  
Threshold reactions

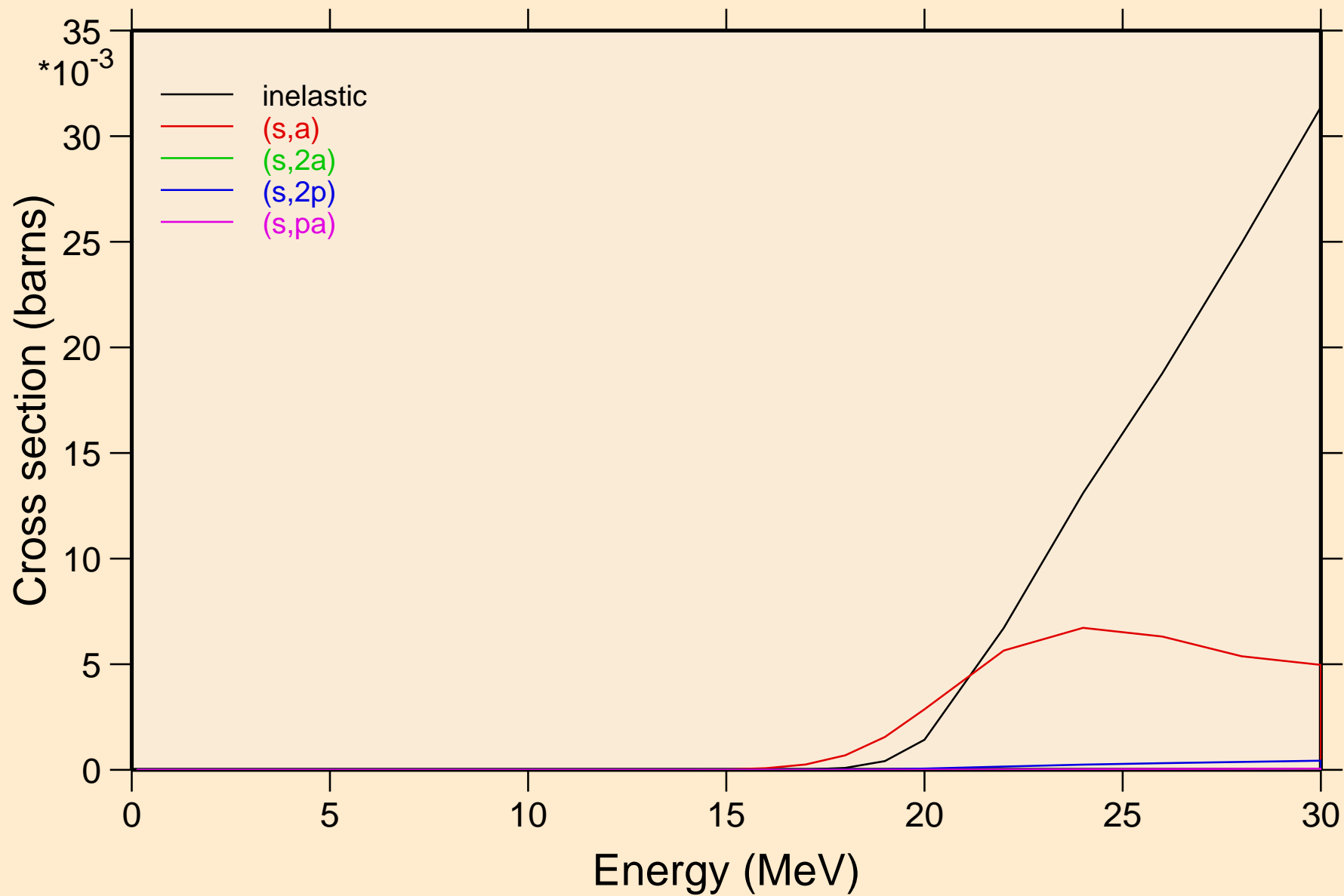

OS179 HELION ACER TENDL-2021 LIBRARY; T=0.K  
Threshold reactions

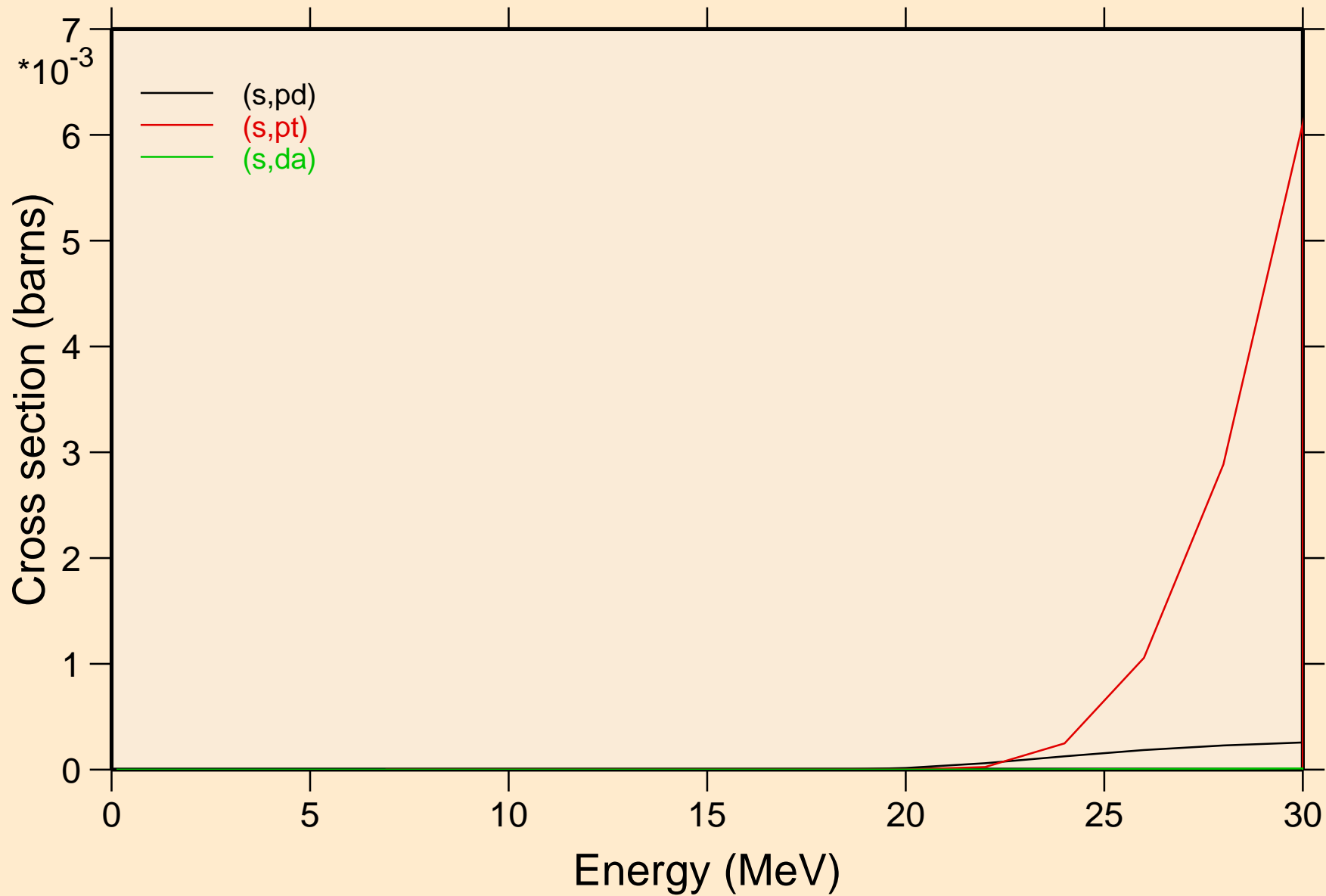

OS179 HELION ACER TENDL-2021 LIBRARY; T=0.K  
angular distribution for elastic

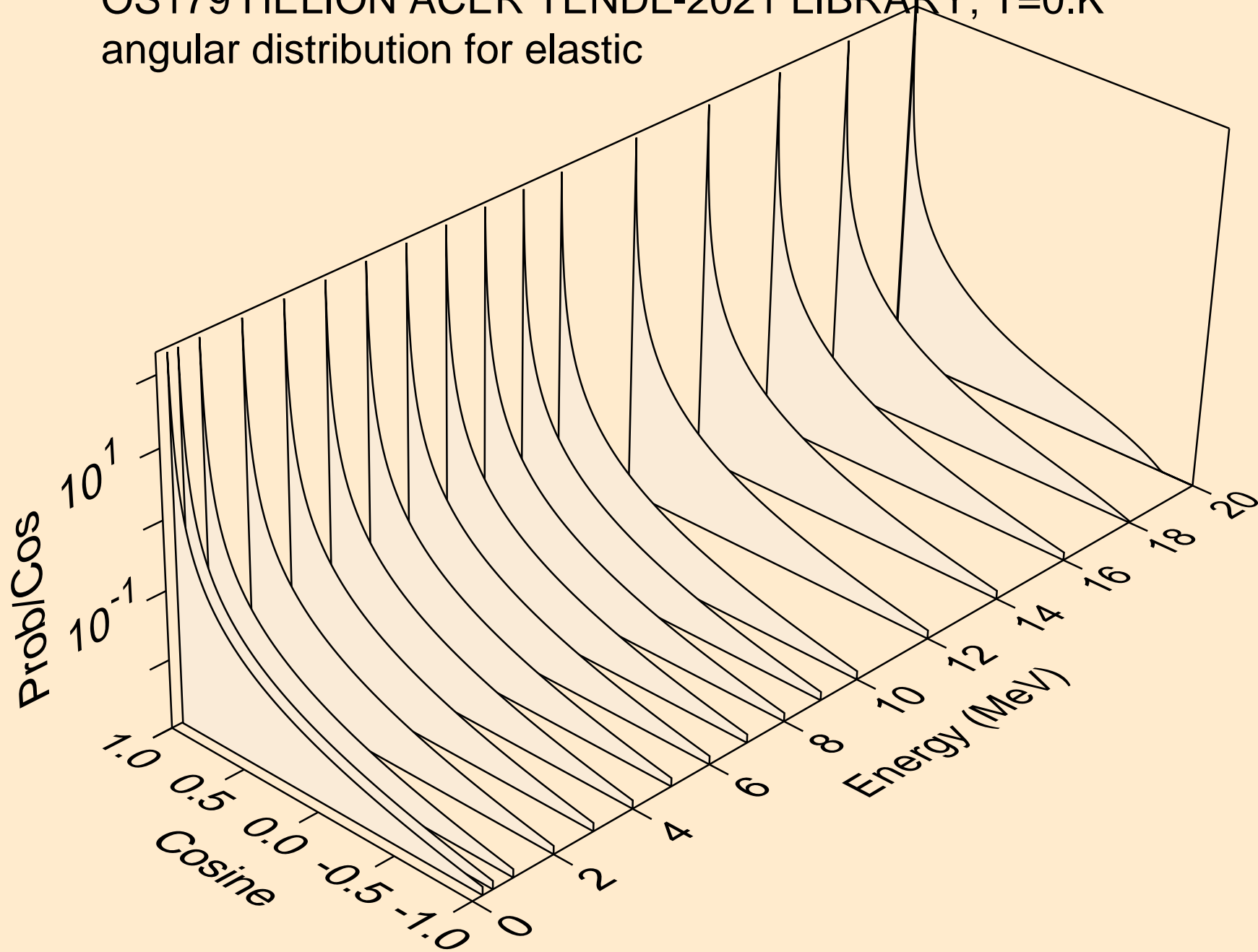

OS179 HELION ACER TENDL-2021 LIBRARY; T=0.K  
angular distribution for elastic

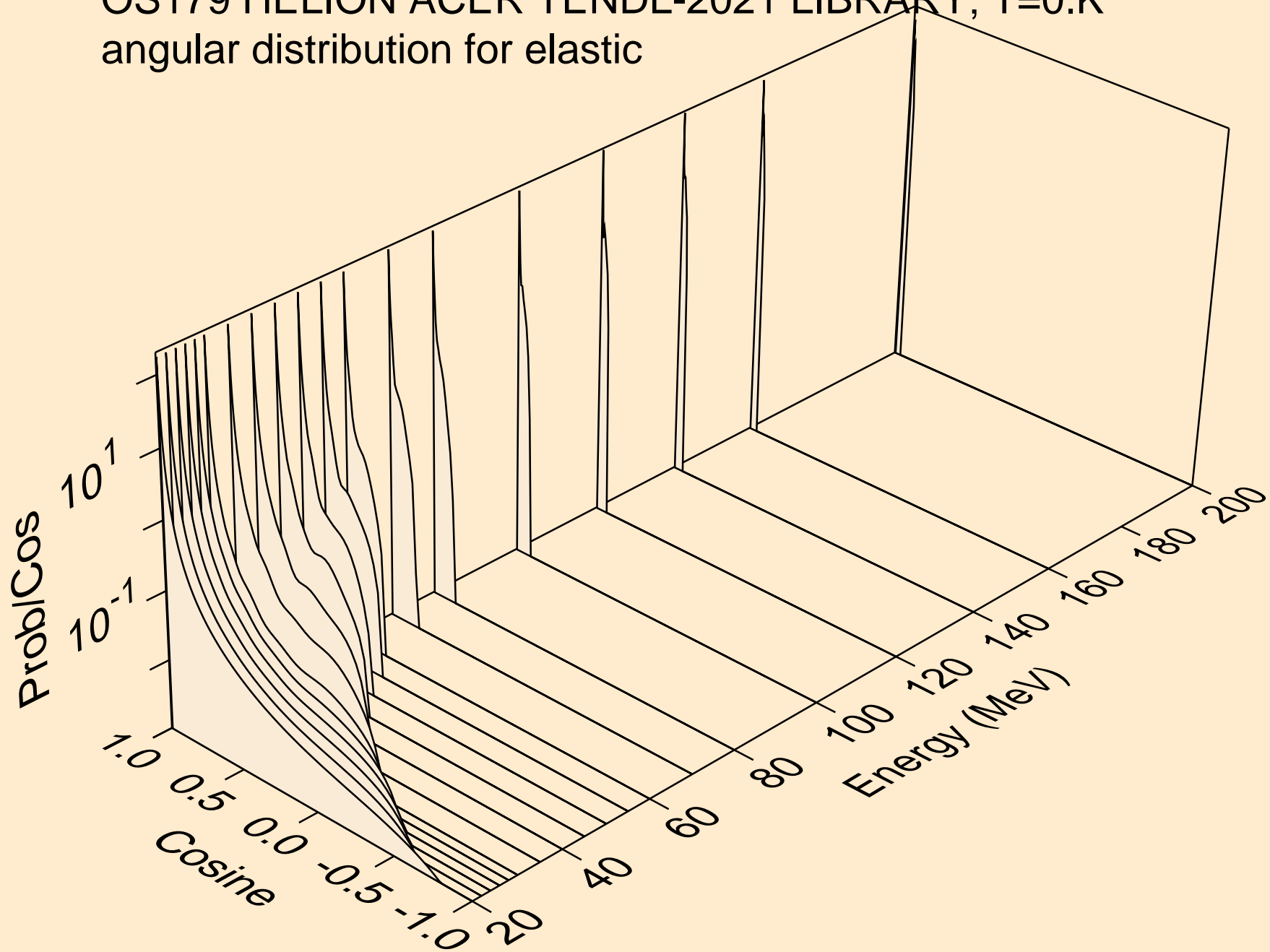

OS179 HELION ACER TENDL-2021 LIBRARY; T=0.K  
He-3 emission for (s,x)

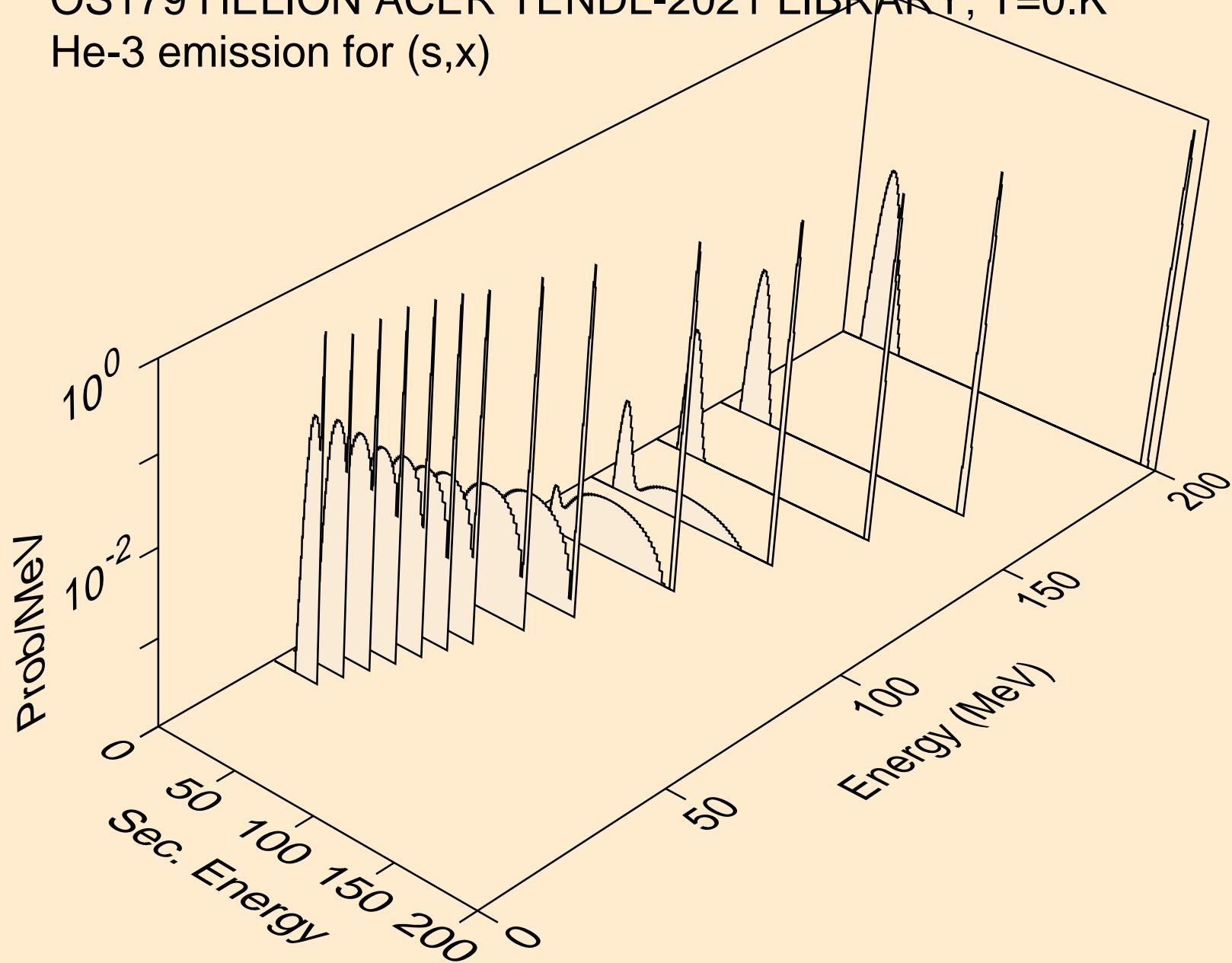

OS179 HELION ACER TENDL-2021 LIBRARY; T=0.K  
He-3 emission for (s,n\*)he3

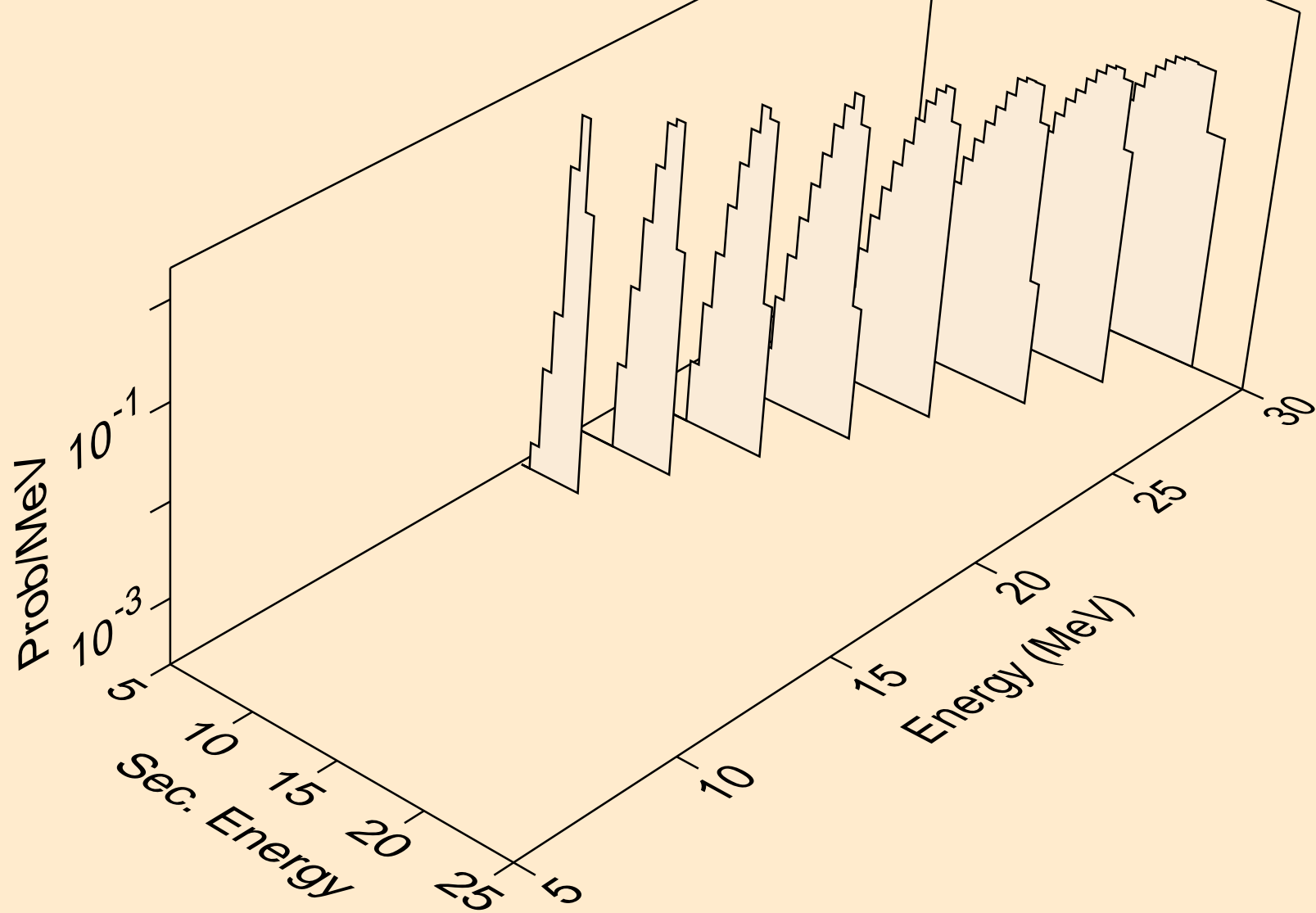



OS179 HELION ACER TENDL-2021 LIBRARY; T=0.K  
He-3 emission for inelastic

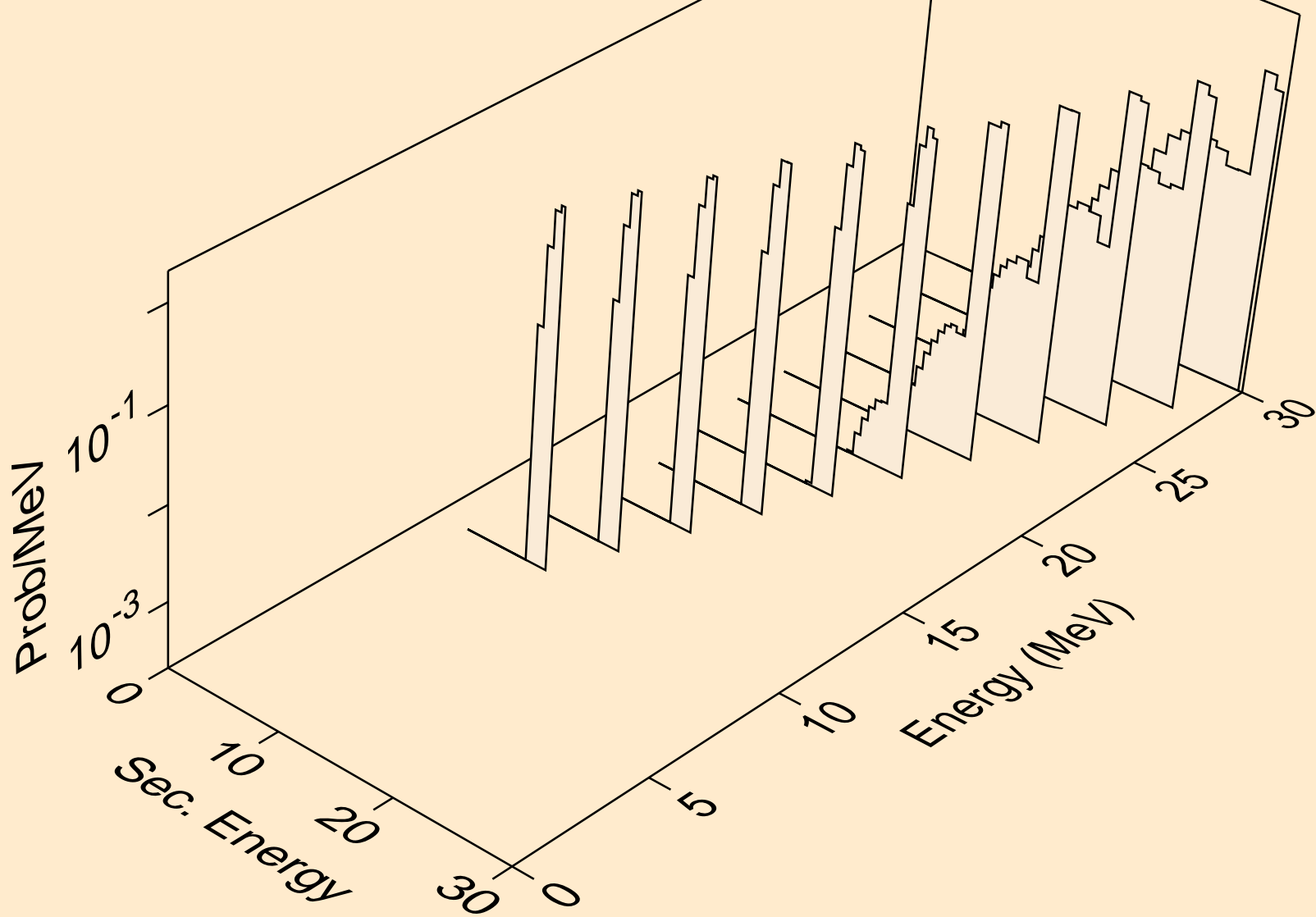

OS179 HELION ACER TENDL-2021 LIBRARY; T=0.K  
Photon emission for (z,n)

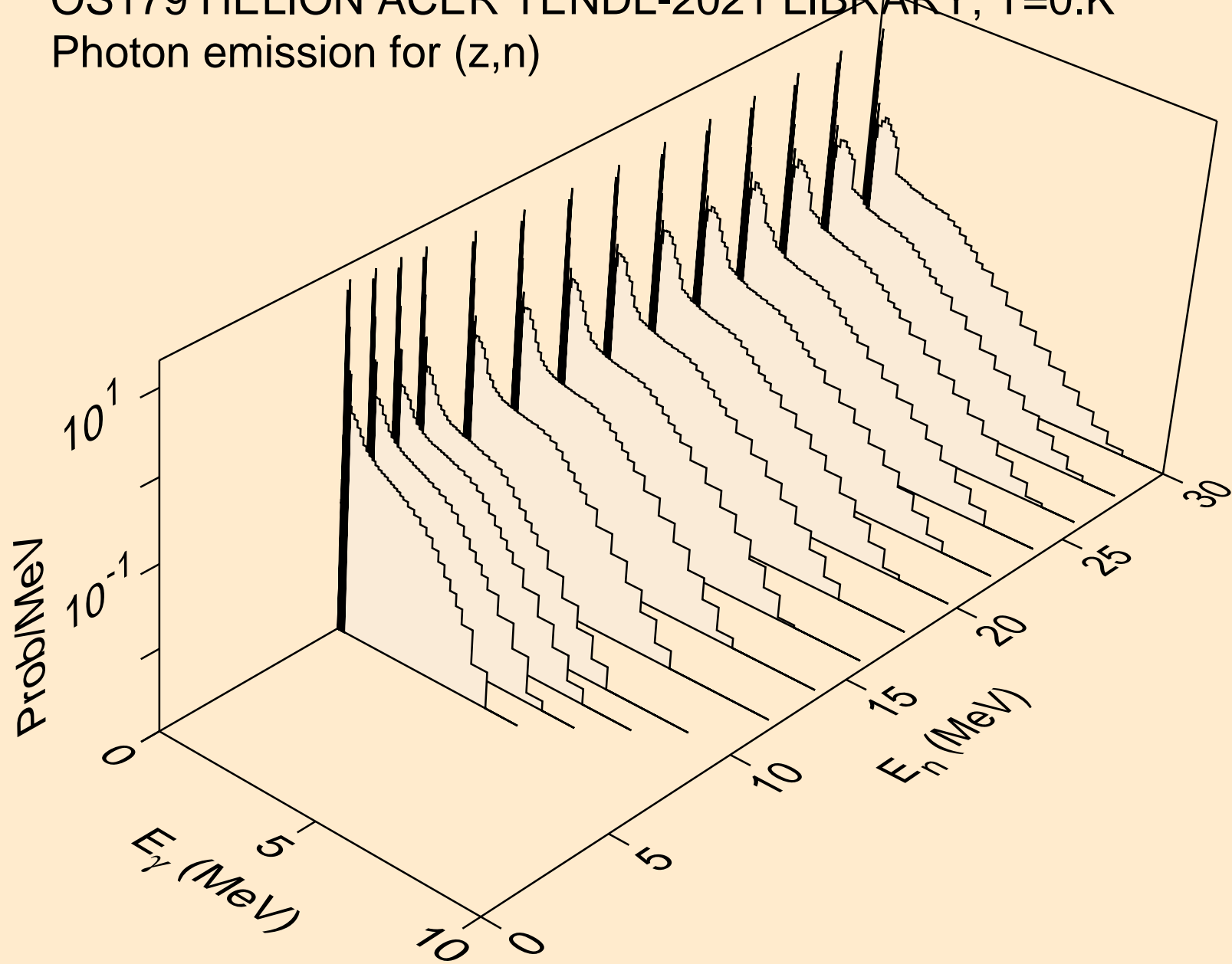

OS179 HELION ACER TENDL-2021 LIBRARY; T=0.K  
Photon emission for (n,x)

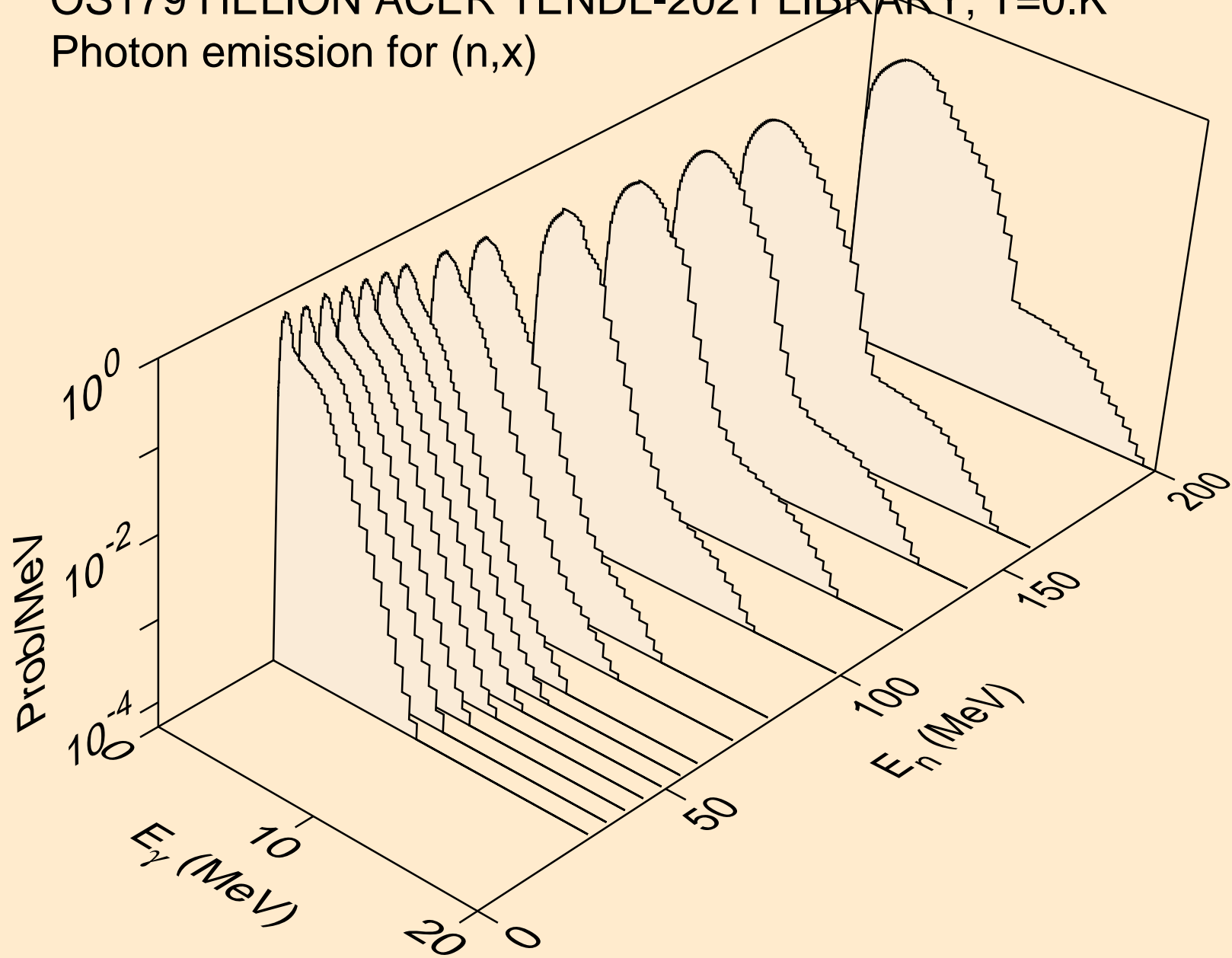

OS179 HELION ACER TENDL-2021 LIBRARY; T=0.K  
Photon emission for (n,2nd)

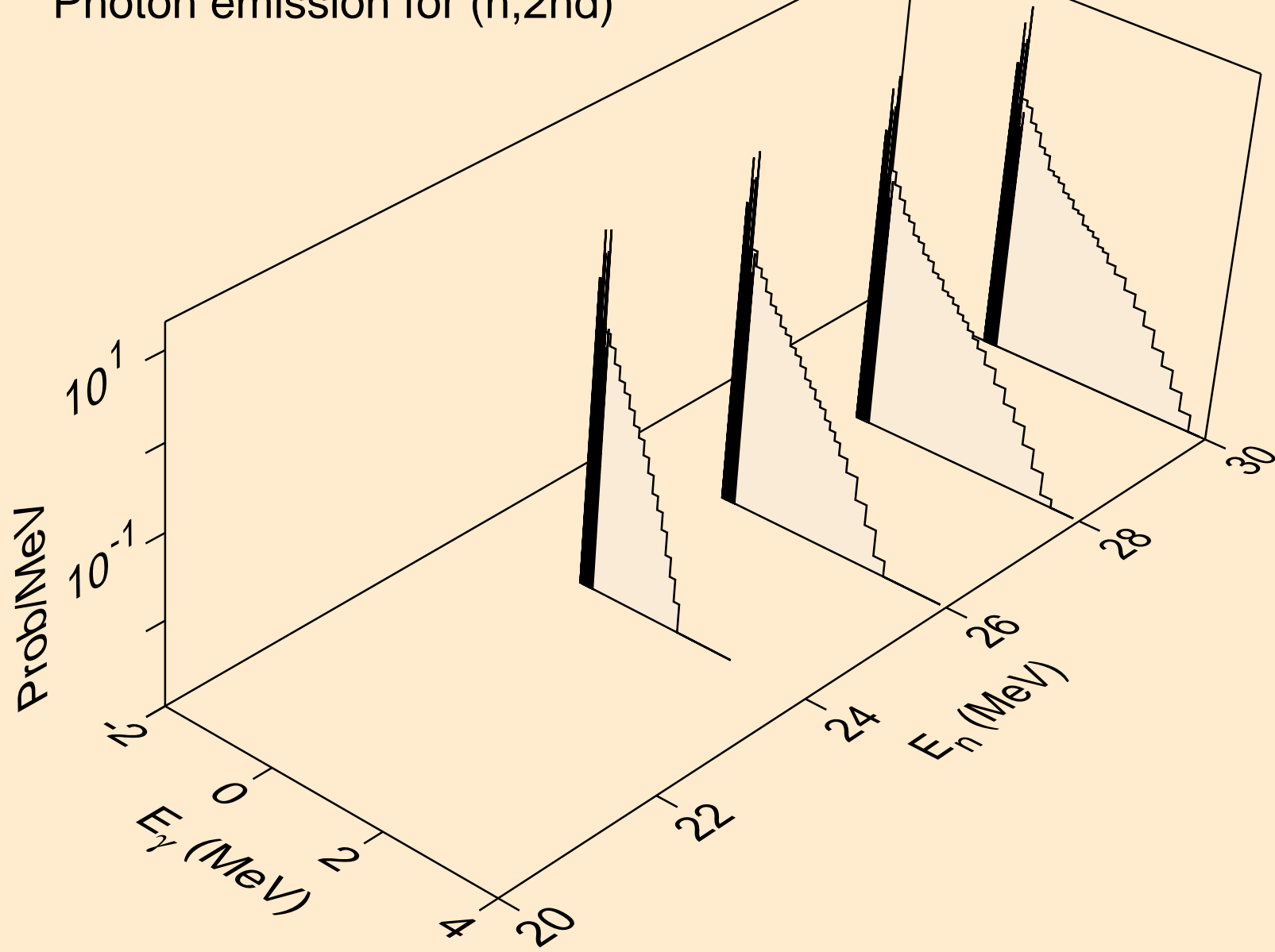

OS179 HELION ACER TENDL-2021 LIBRARY; T=0.K  
Photon emission for (n,2n)

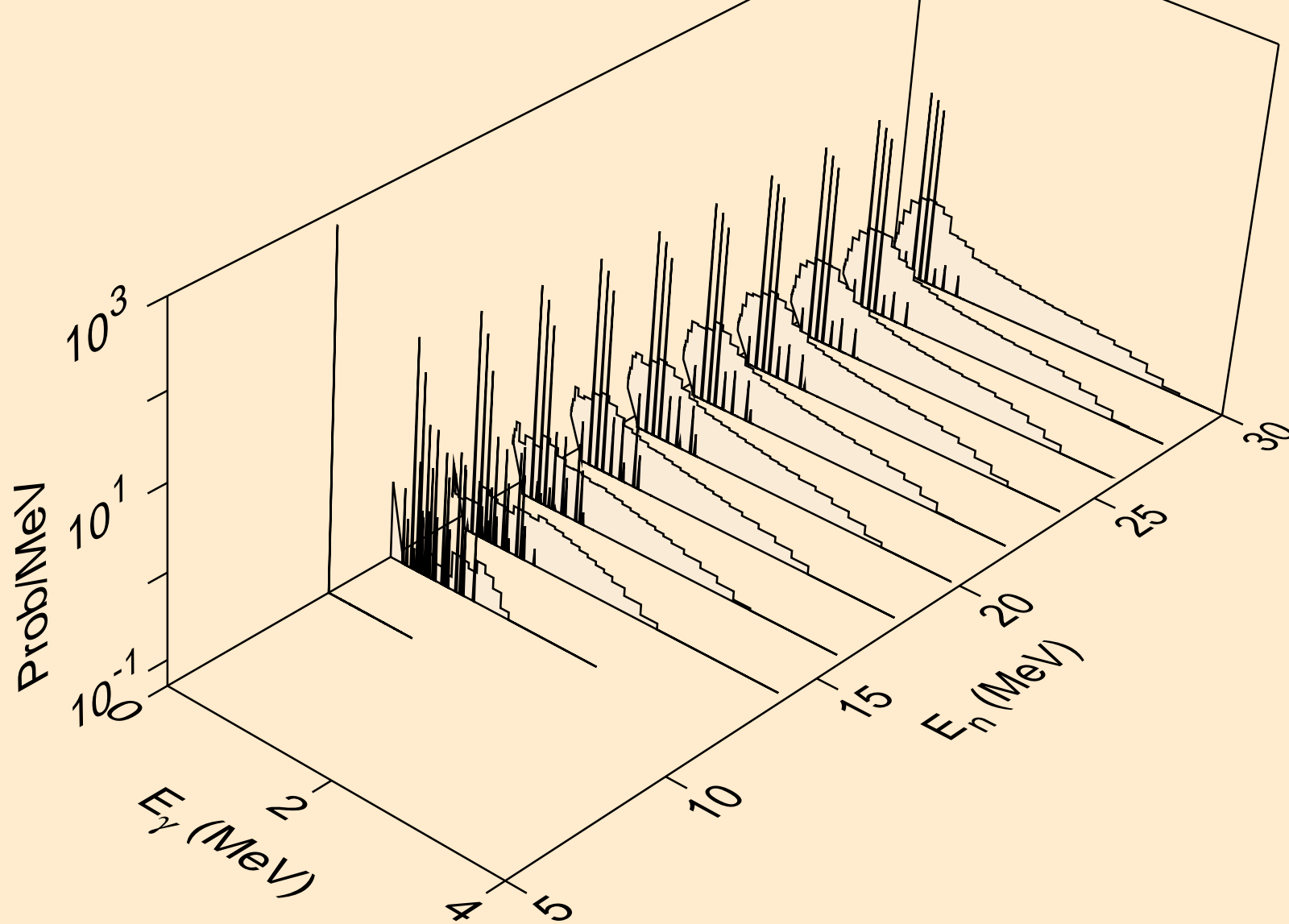

OS179 HELION ACER TENDL-2021 LIBRARY; T=0.K  
Photon emission for (n,3n)

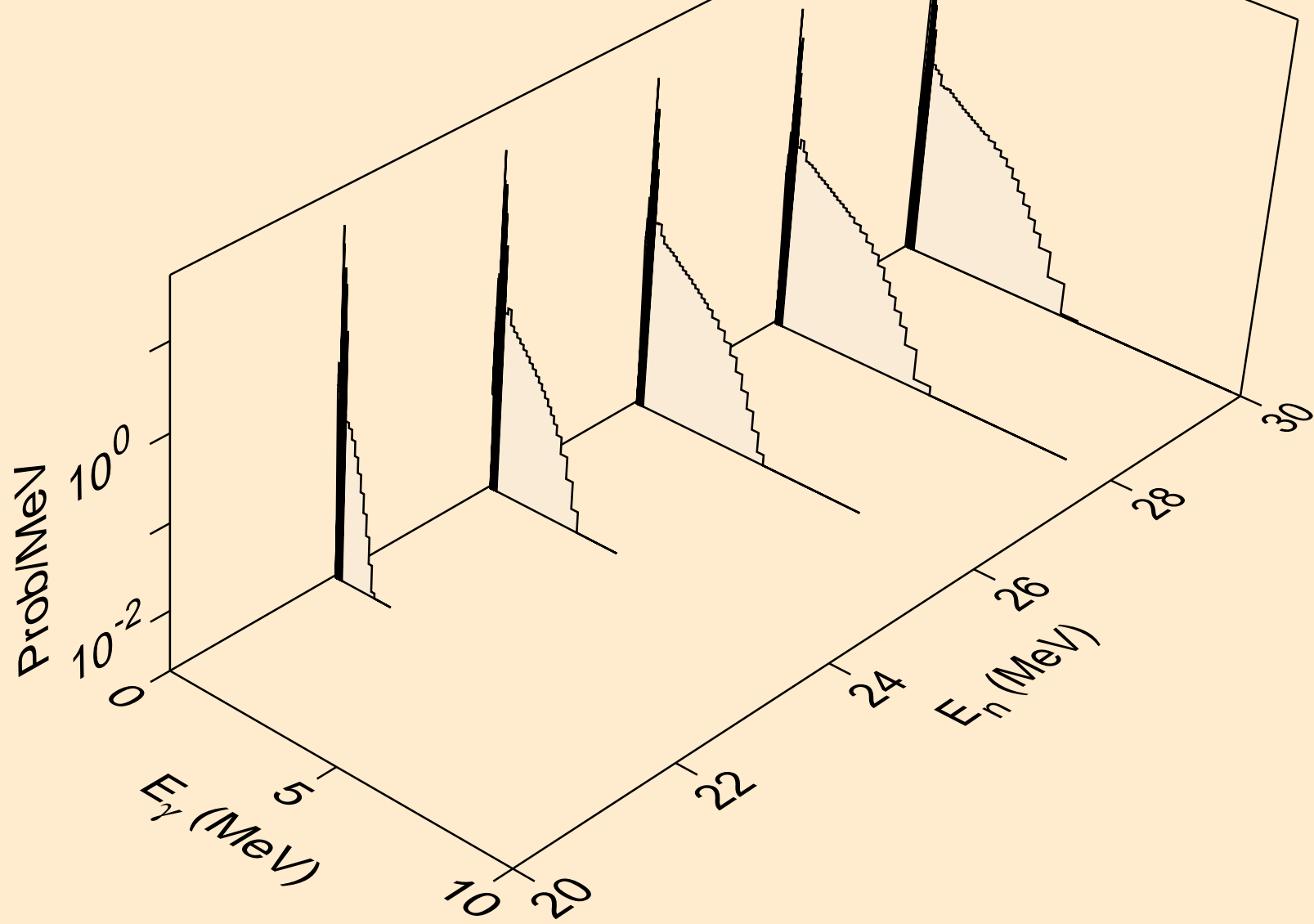

OS179 HELION ACER TENDL-2021 LIBRARY; T=0.K  
Photon emission for (n,n\*)a

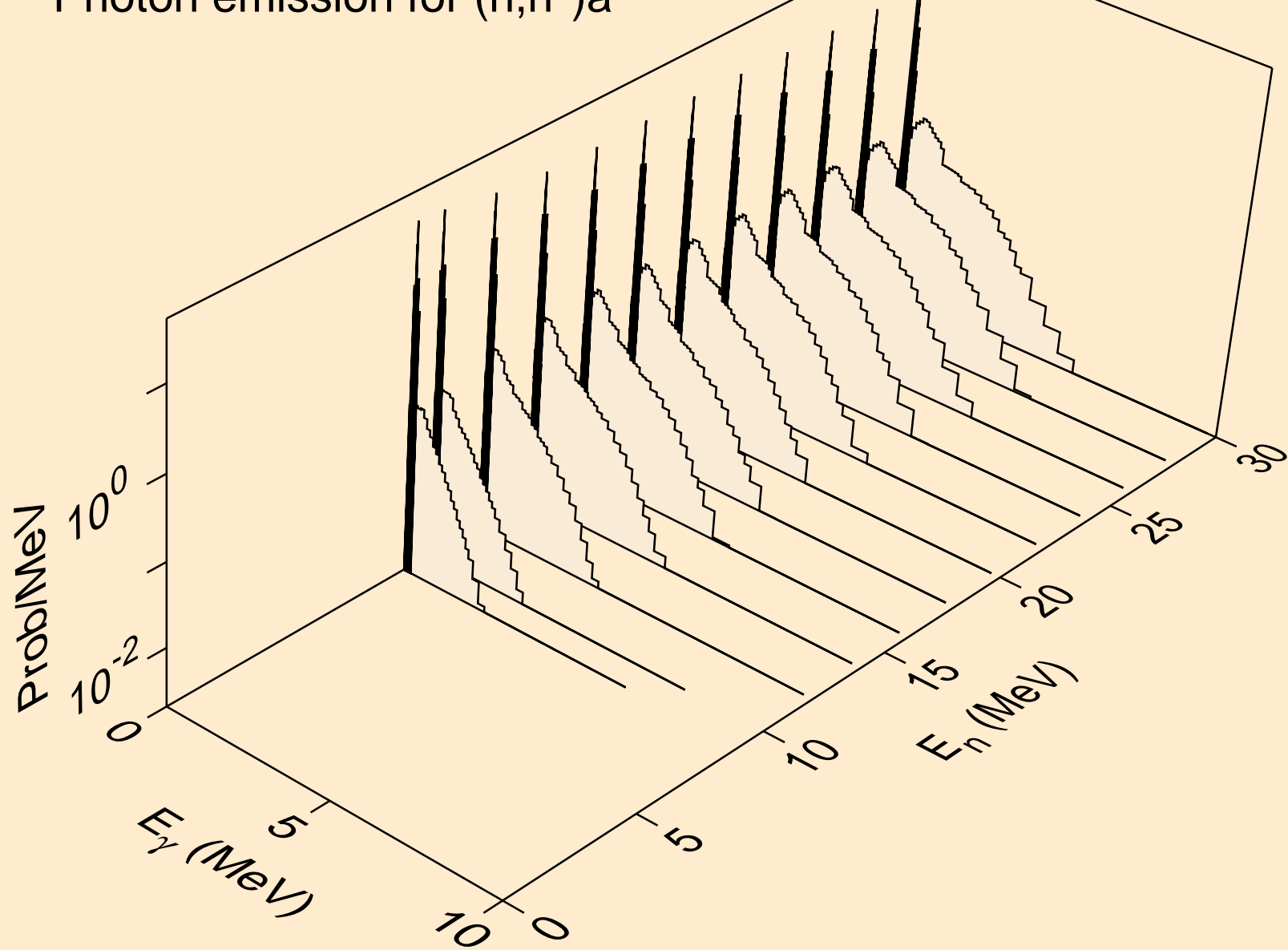

OS179 HELION ACER TENDL-2021 LIBRARY; T=0.K  
Photon emission for (n,2n)a

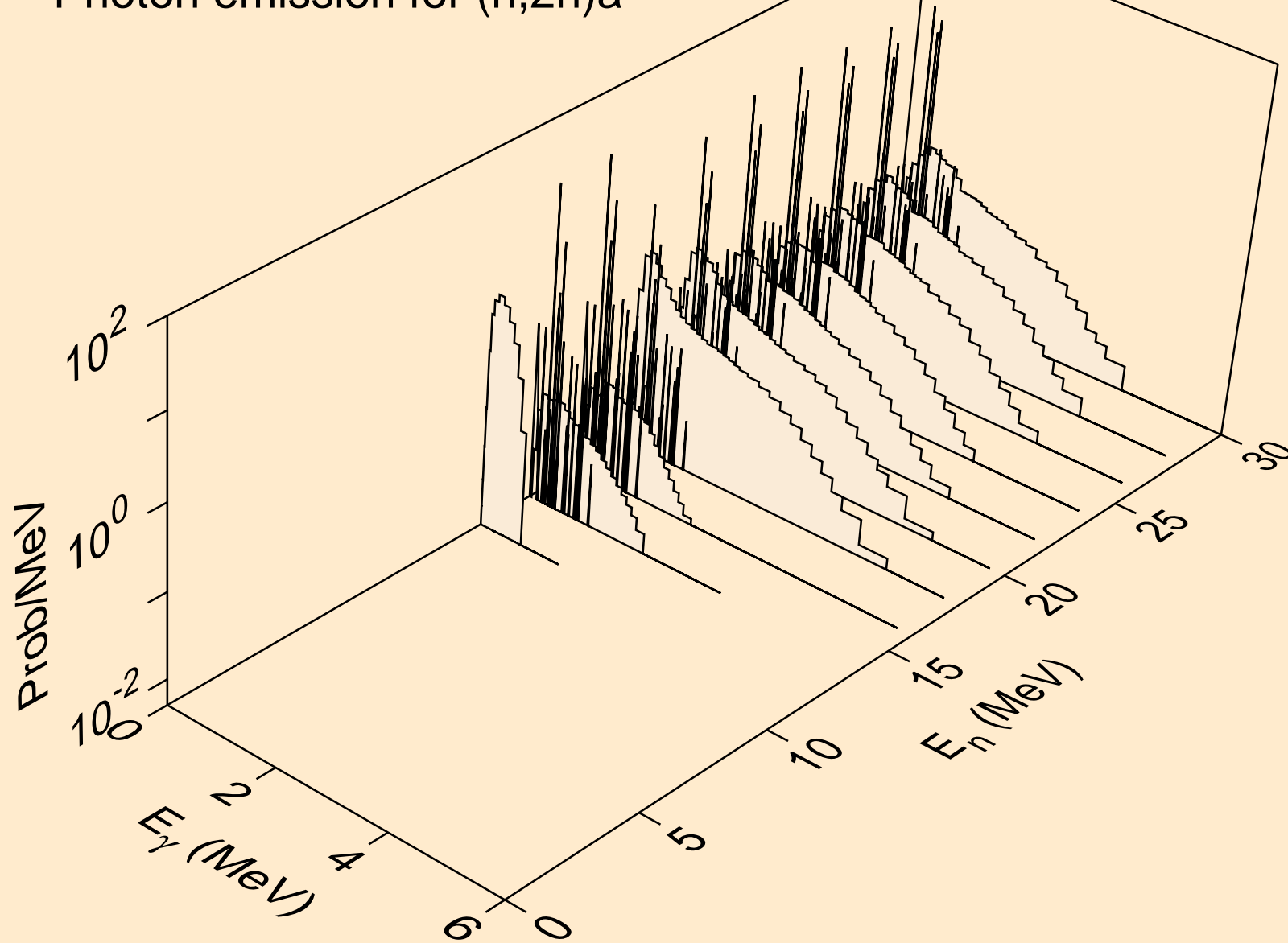



OS179 HELION ACER TENDL-2021 LIBRARY; T=0.K  
Photon emission for (n,3n)a

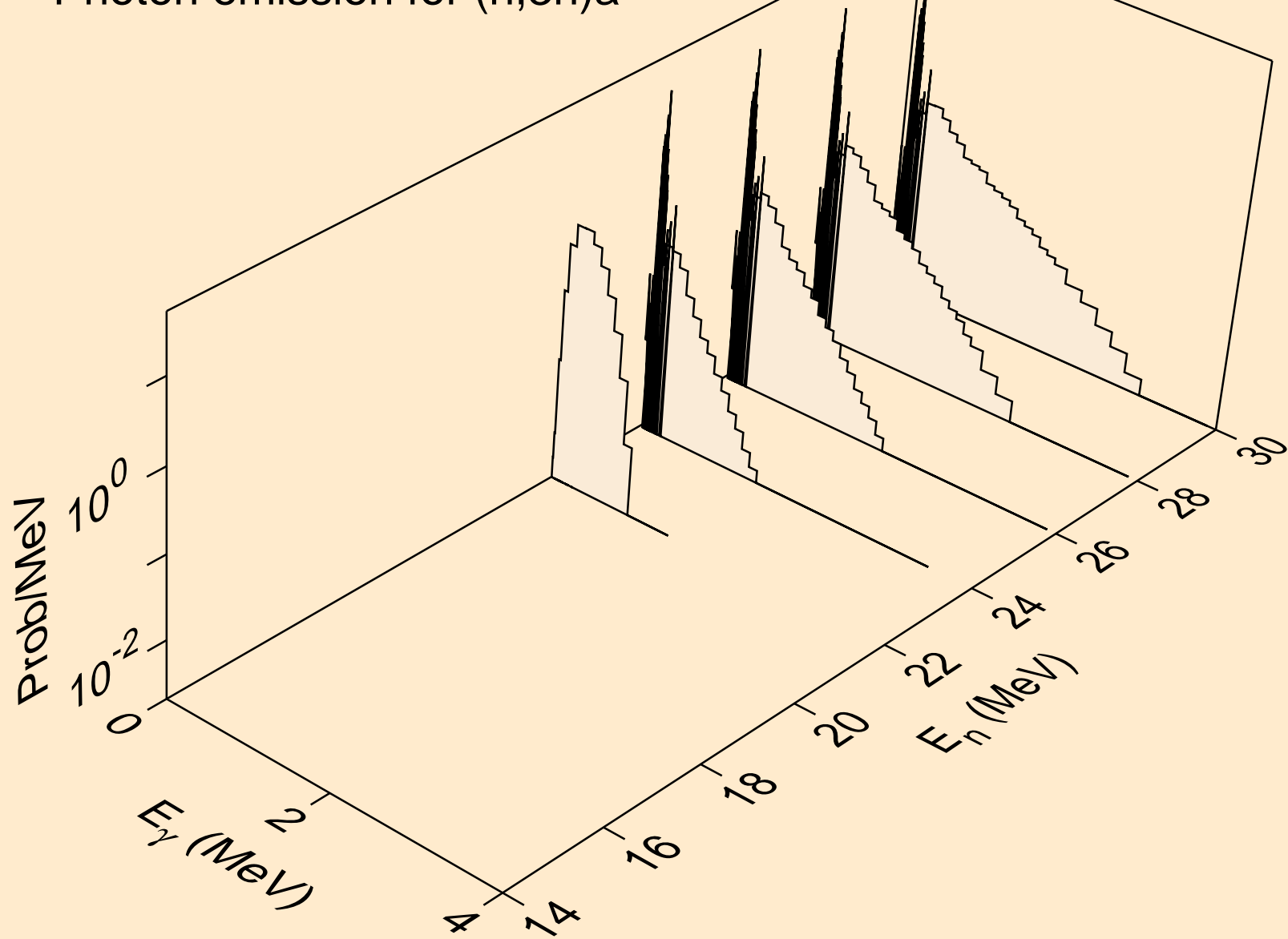

OS179 HELION ACER TENDL-2021 LIBRARY; T=0.K  
Photon emission for (n,n\*)p

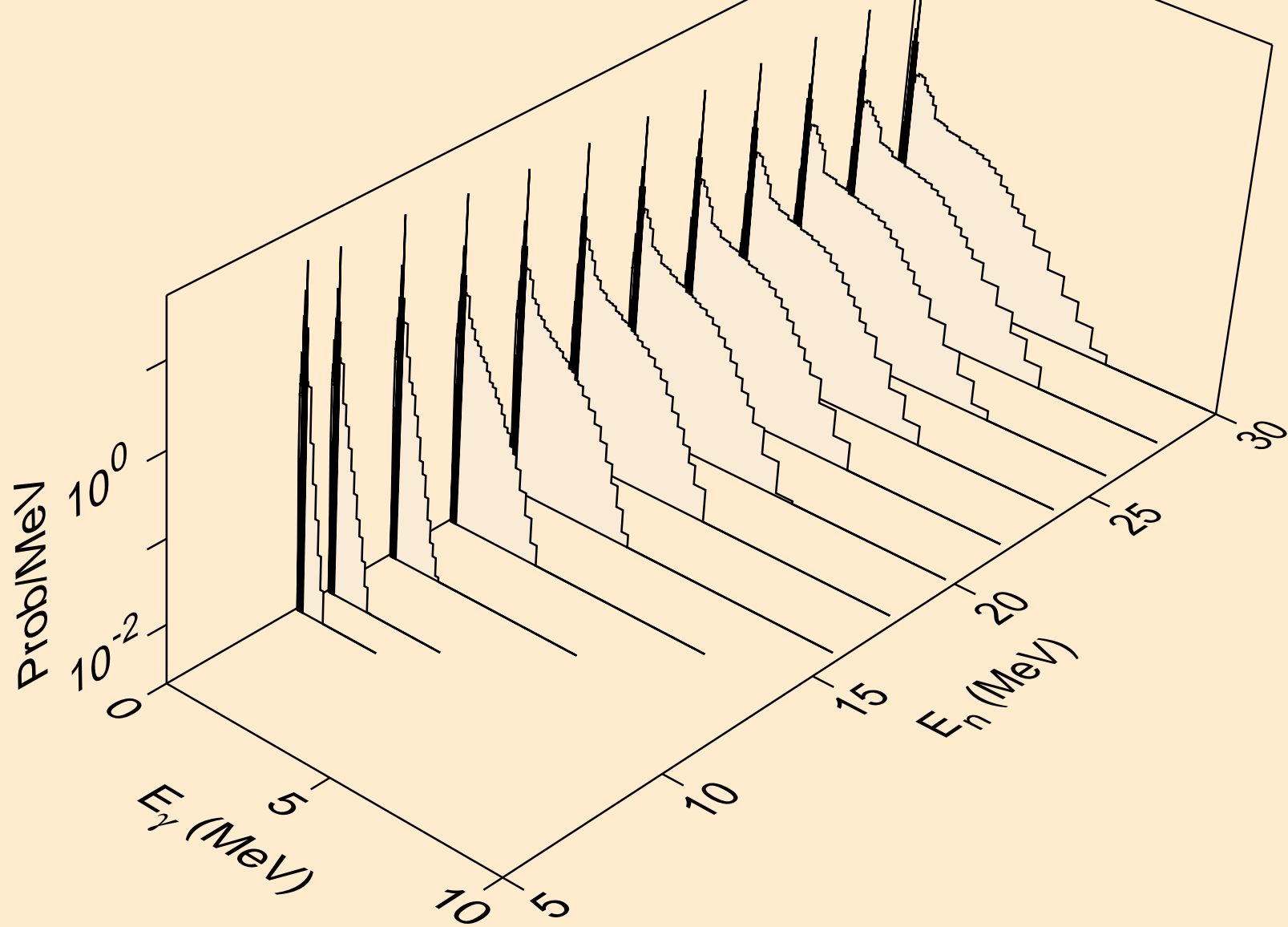

OS179 HELION ACER TENDL-2021 LIBRARY; T=0.K  
Photon emission for (n,n\*)2a

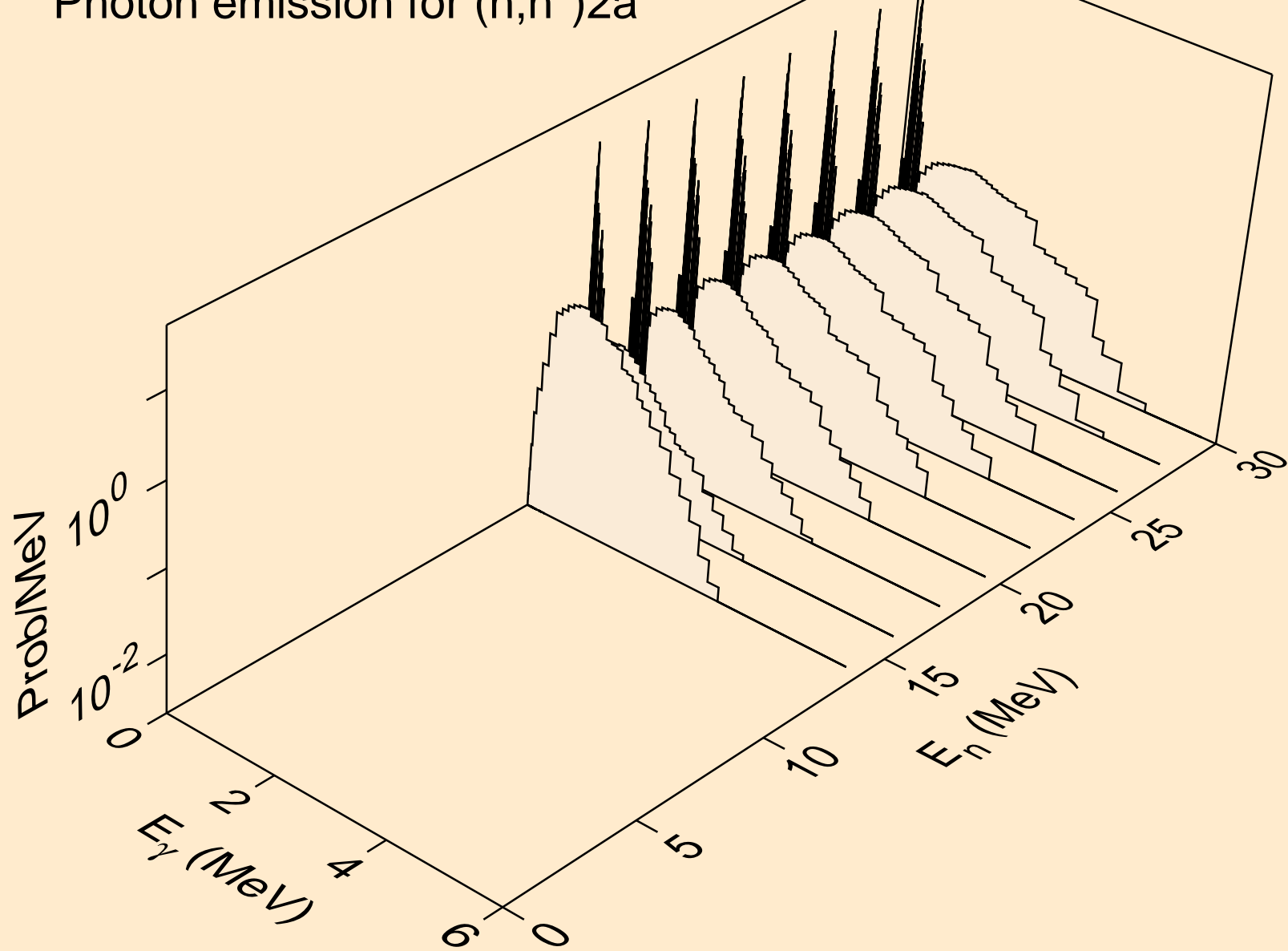

OS179 HELION ACER TENDL-2021 LIBRARY; T=0.K  
Photon emission for (n,n\*)d

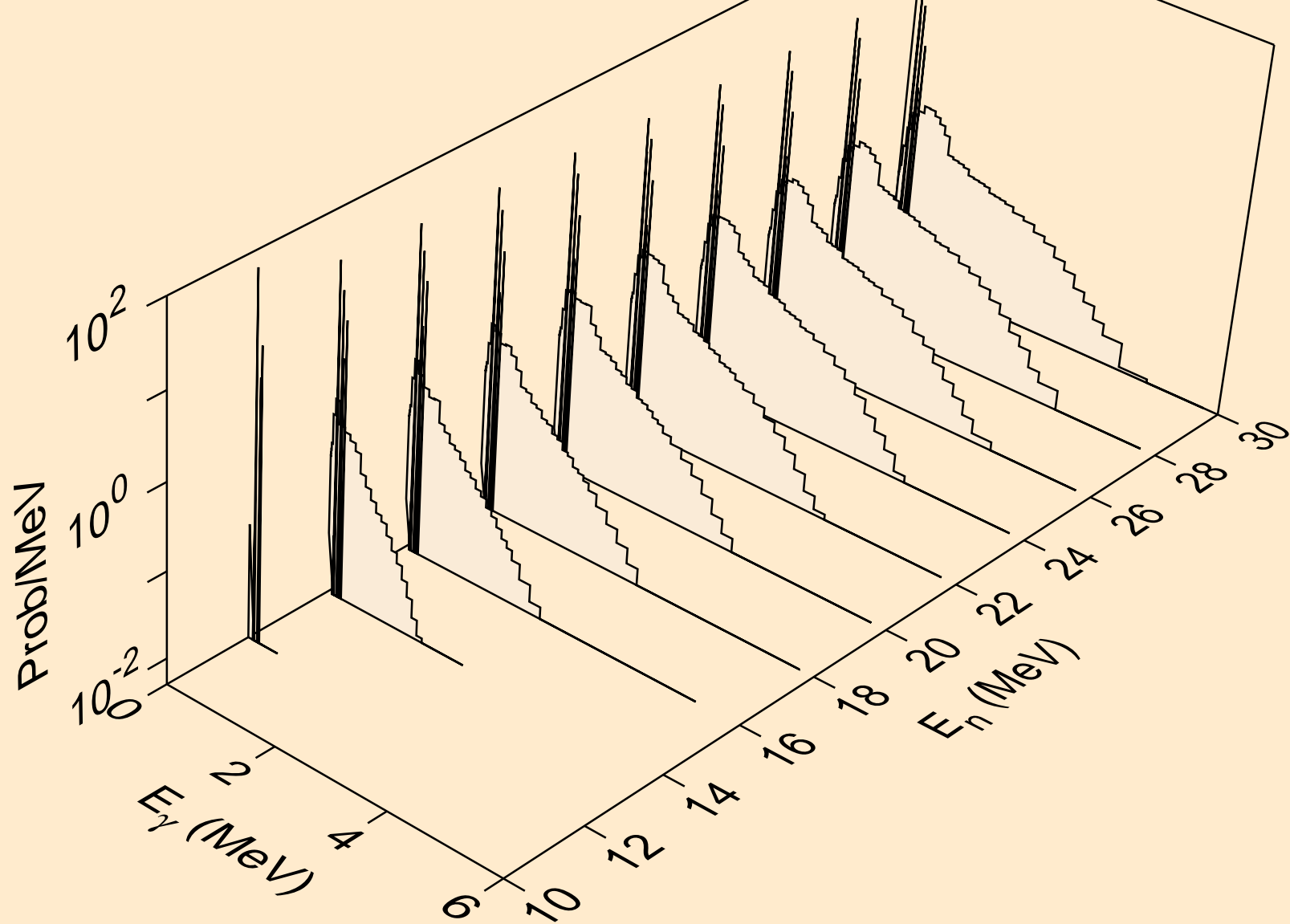

OS179 HELION ACER TENDL-2021 LIBRARY; T=0.K  
Photon emission for (n,n\*)t

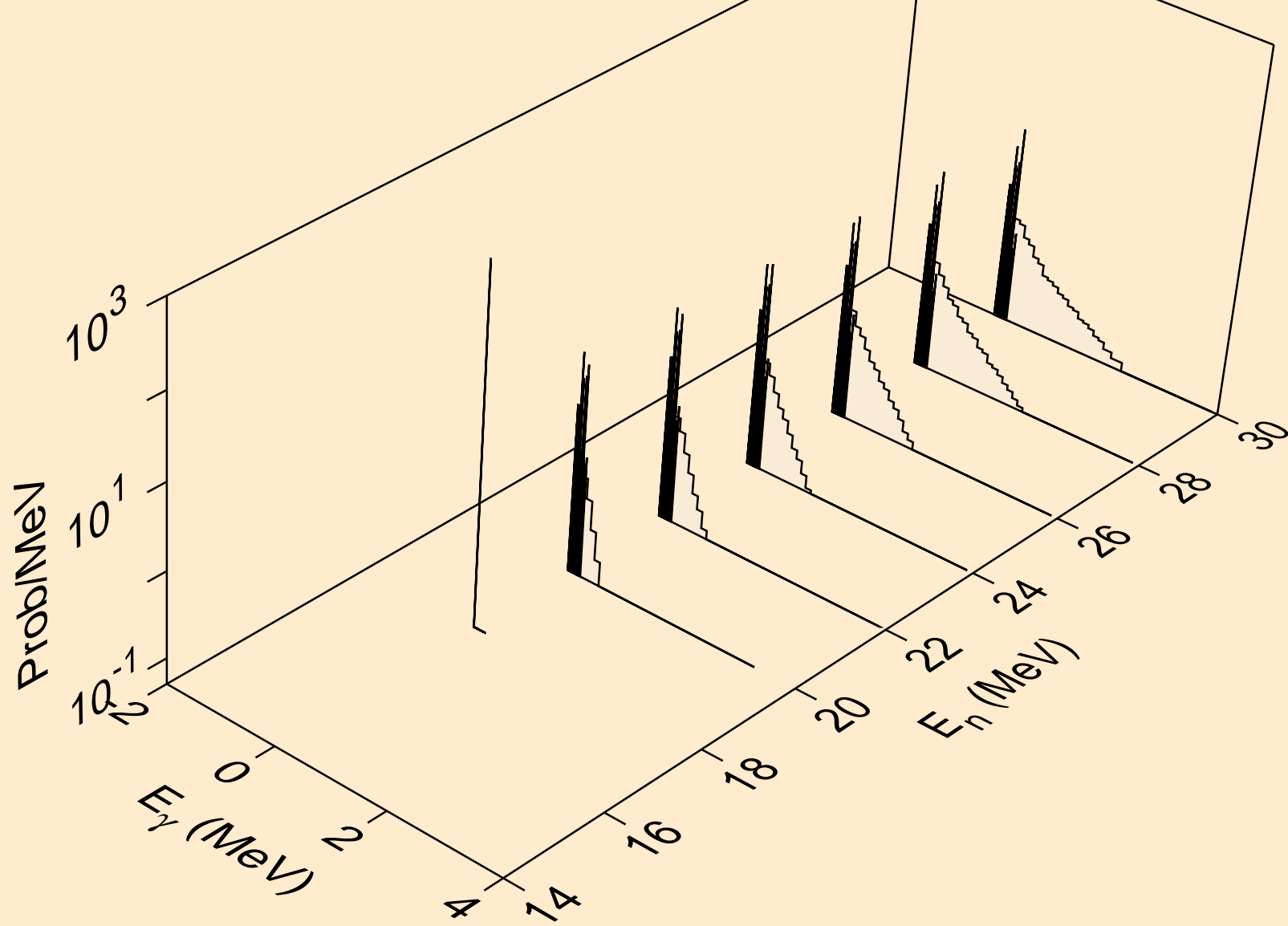

OS179 HELION ACER TENDL-2021 LIBRARY; T=0.K  
Photon emission for (n,n\*)he3

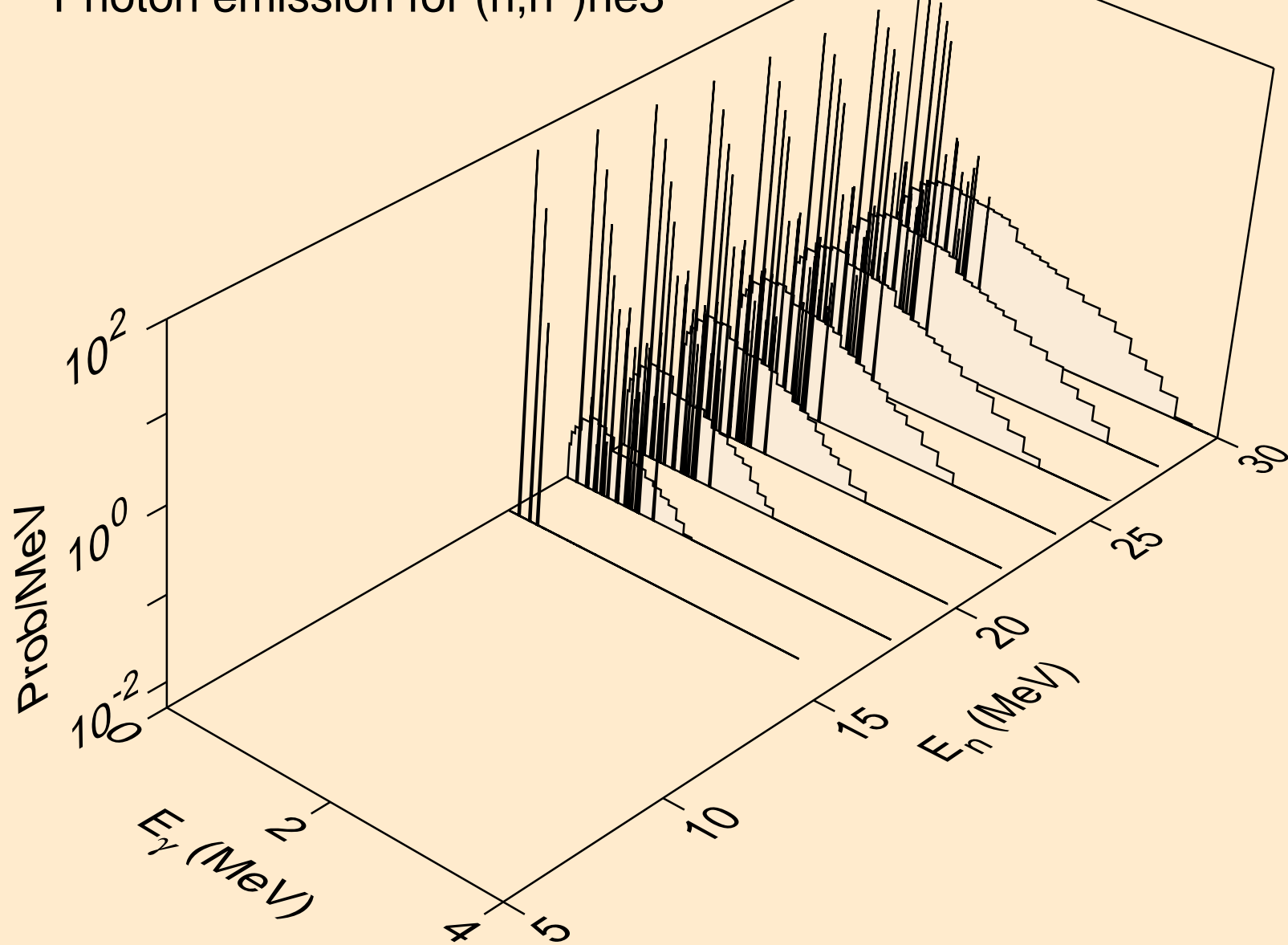

OS179 HELION ACER TENDL-2021 LIBRARY; T=0.K  
Photon emission for (n,4n)

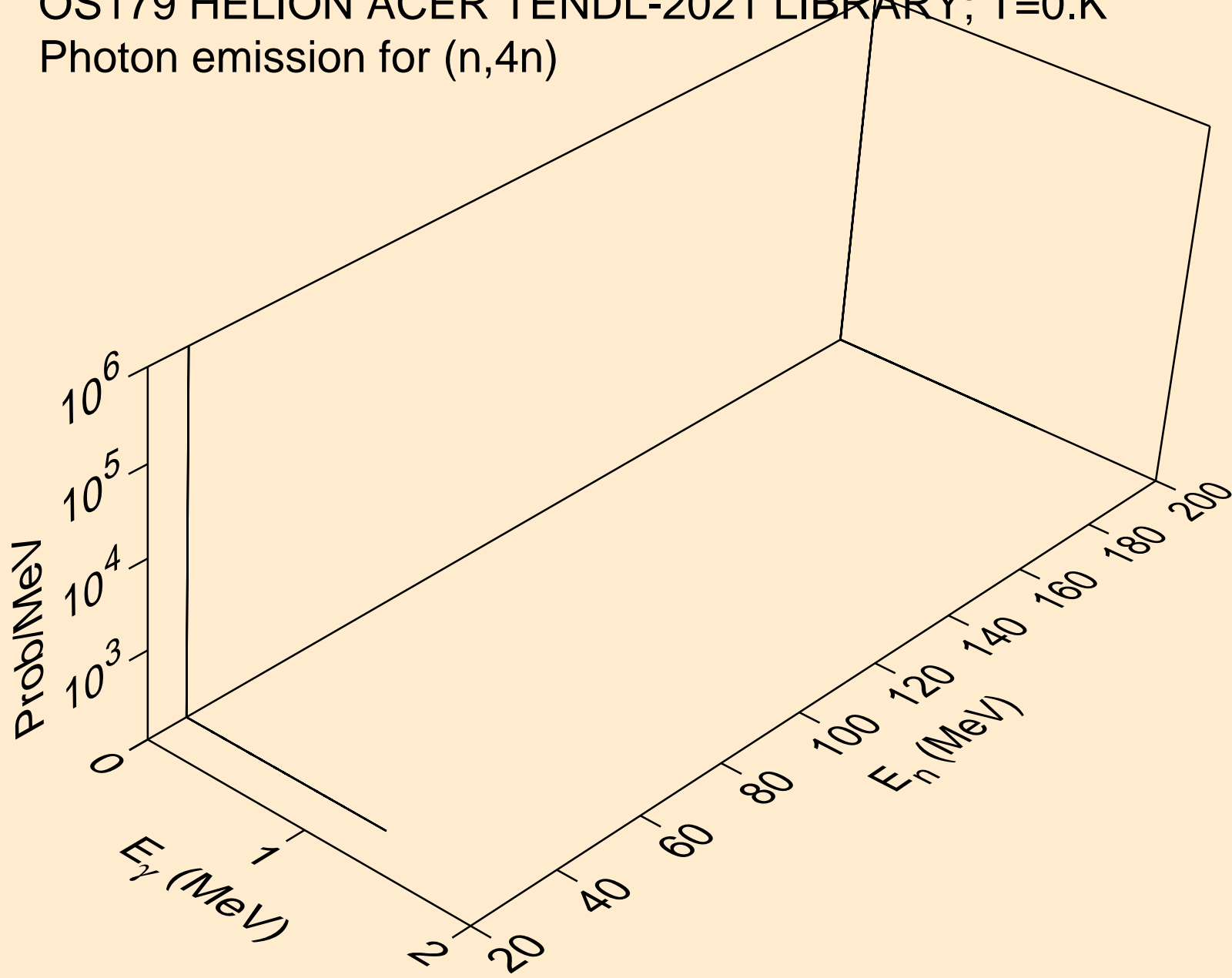

OS179 HELION ACER TENDL-2021 LIBRARY; T=0.K  
Photon emission for (n,2np)

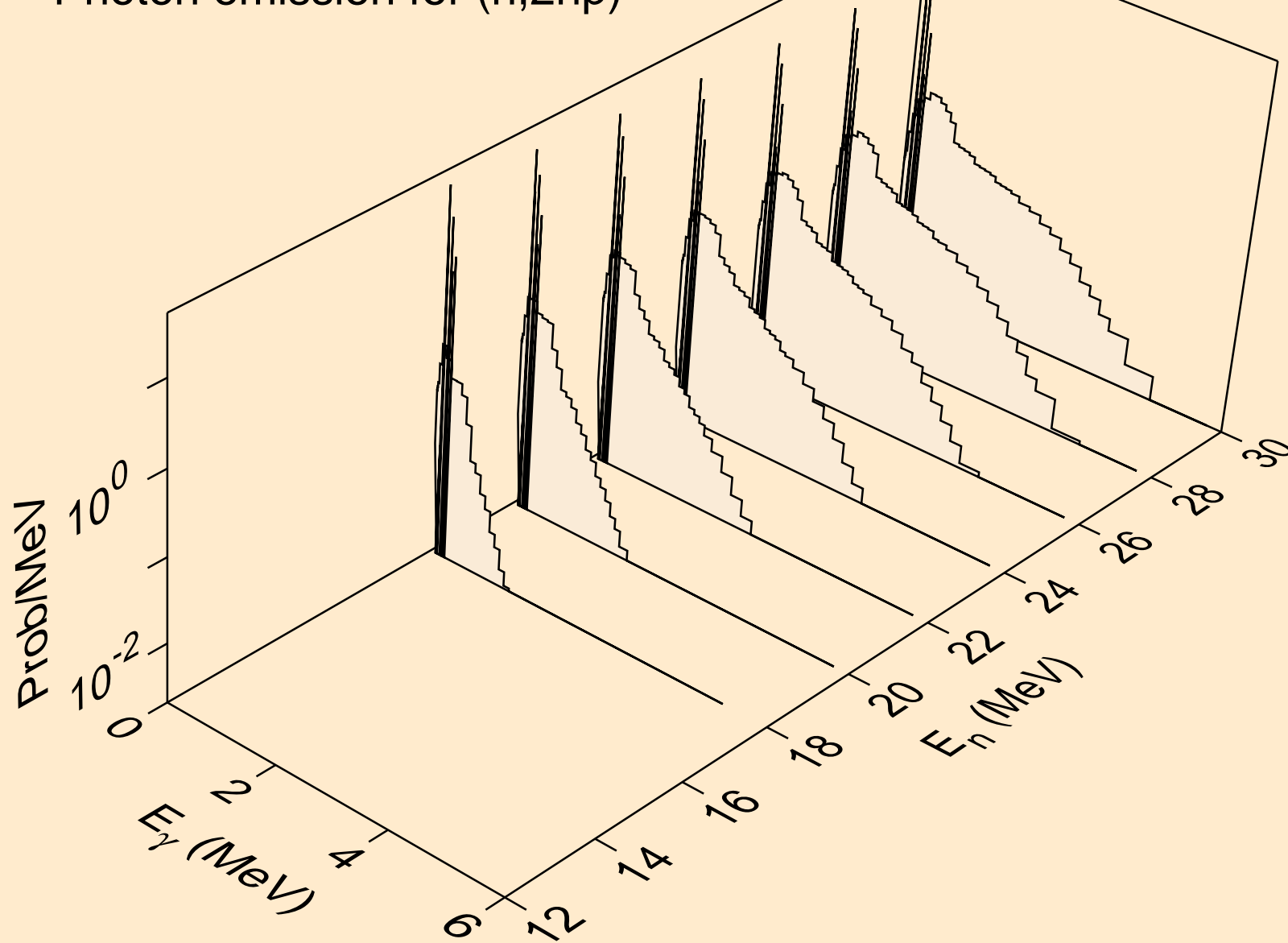



OS179 HELION ACER TENDL-2021 LIBRARY; T=0.K  
Photon emission for (n,3np)

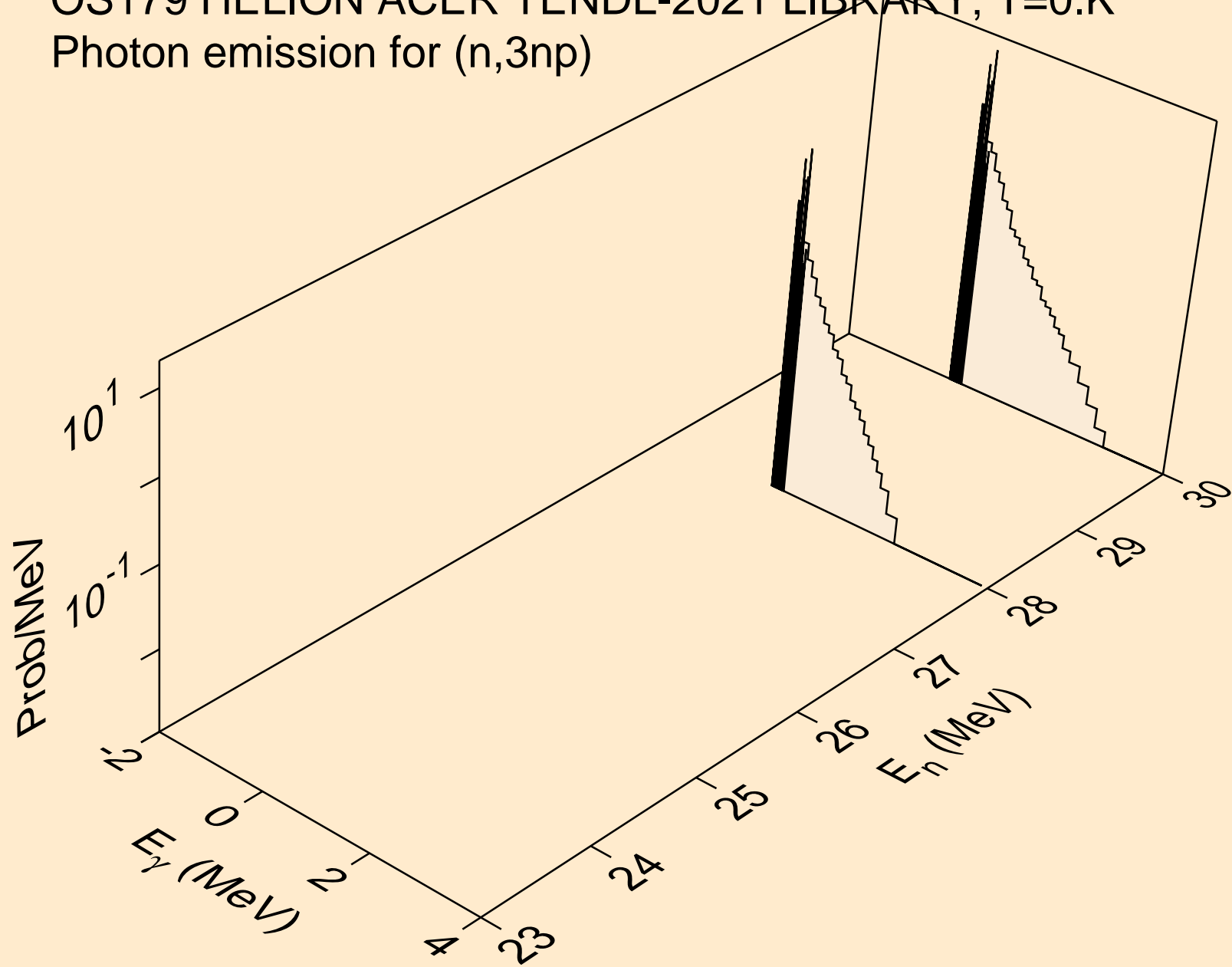

OS179 HELION ACER TENDL-2021 LIBRARY; T=0.K  
Photon emission for (n,2np)

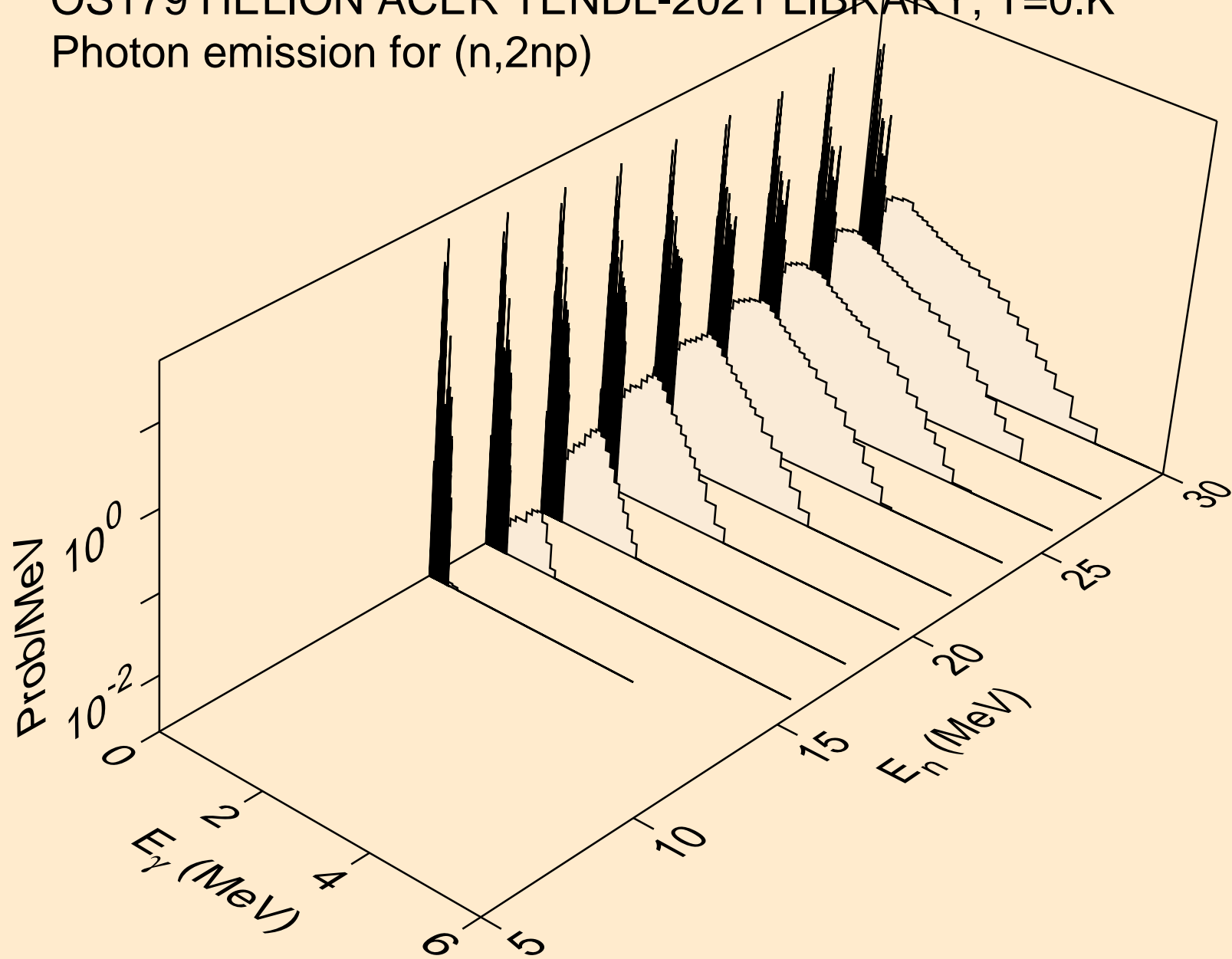

OS179 HELION ACER TENDL-2021 LIBRARY; T=0.K  
Photon emission for (n,npa)

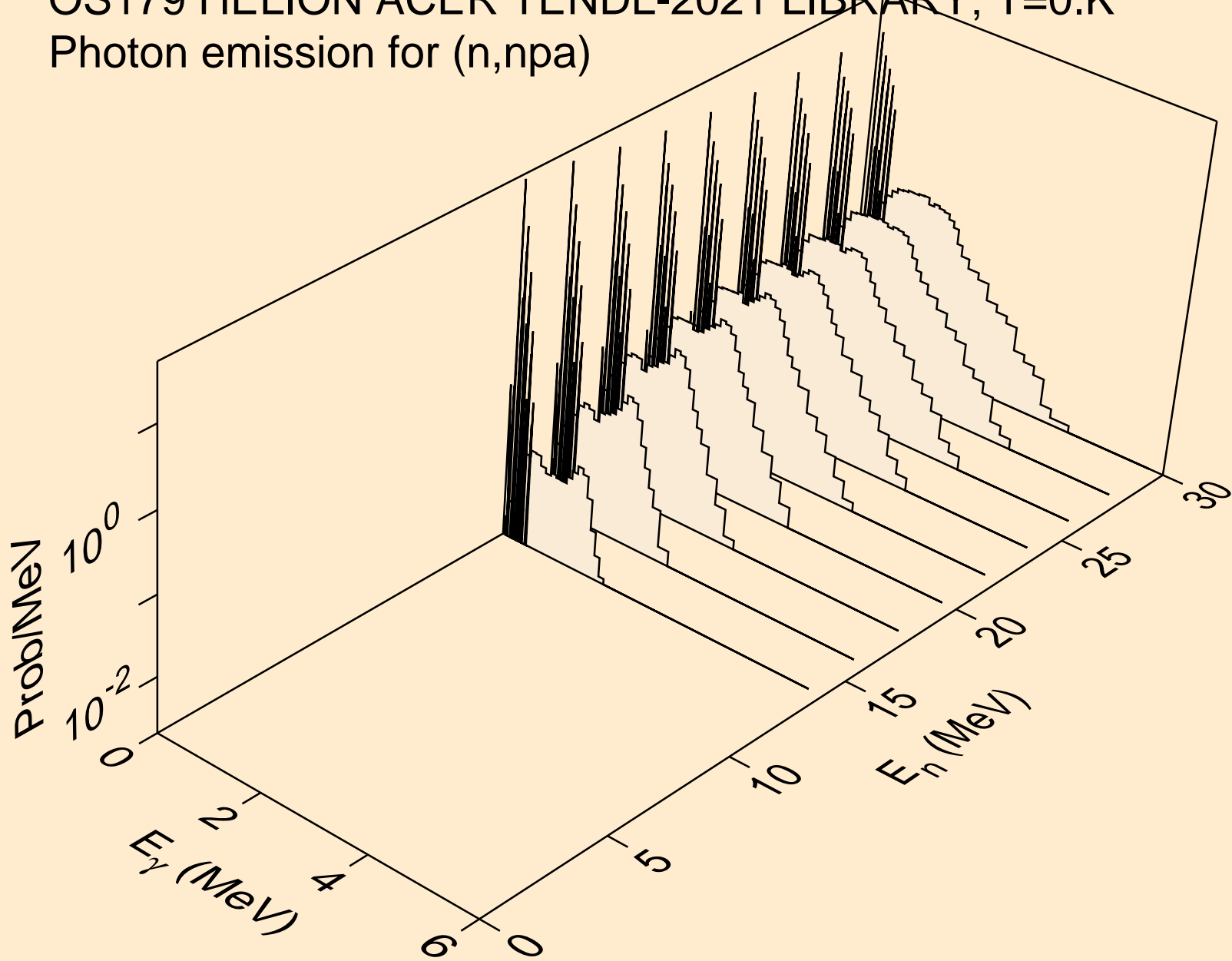

OS179 HELION ACER TENDL-2021 LIBRARY; T=0.K  
Photon emission for (n,gma)

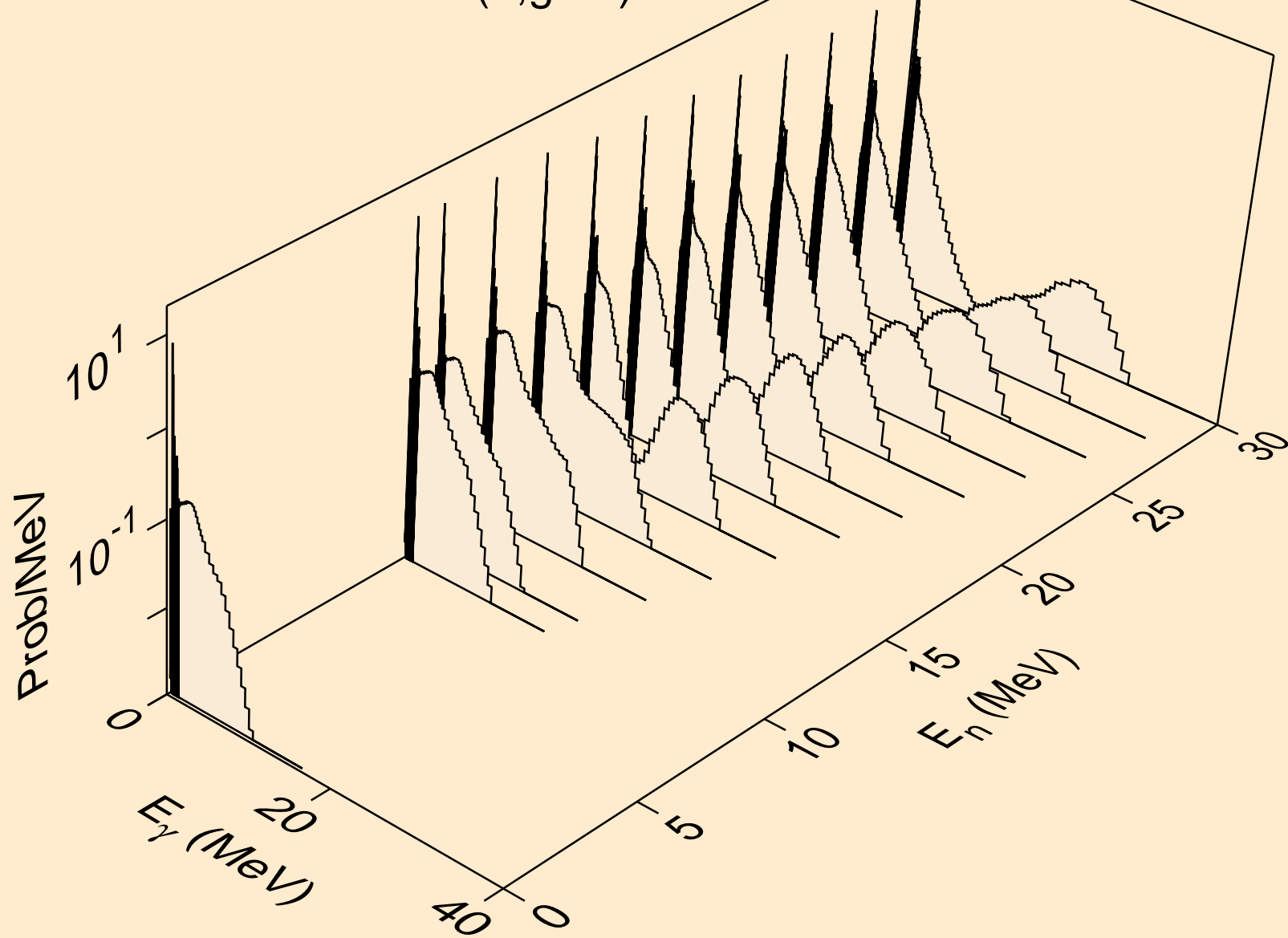

OS179 HELION ACER TENDL-2021 LIBRARY; T=0.K  
Photon emission for (n,p)

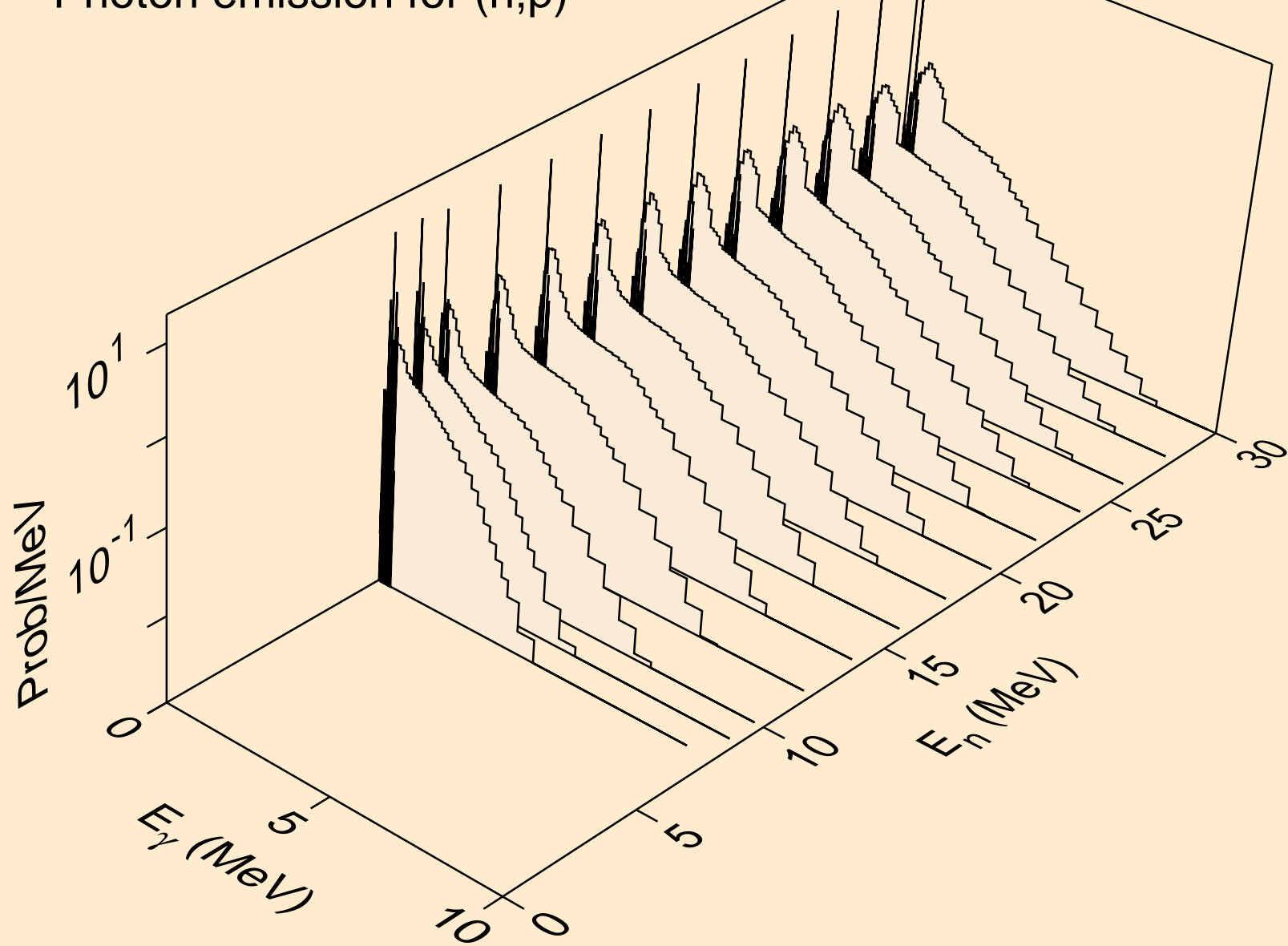

OS179 HELION ACER TENDL-2021 LIBRARY; T=0.K  
Photon emission for (n,d)

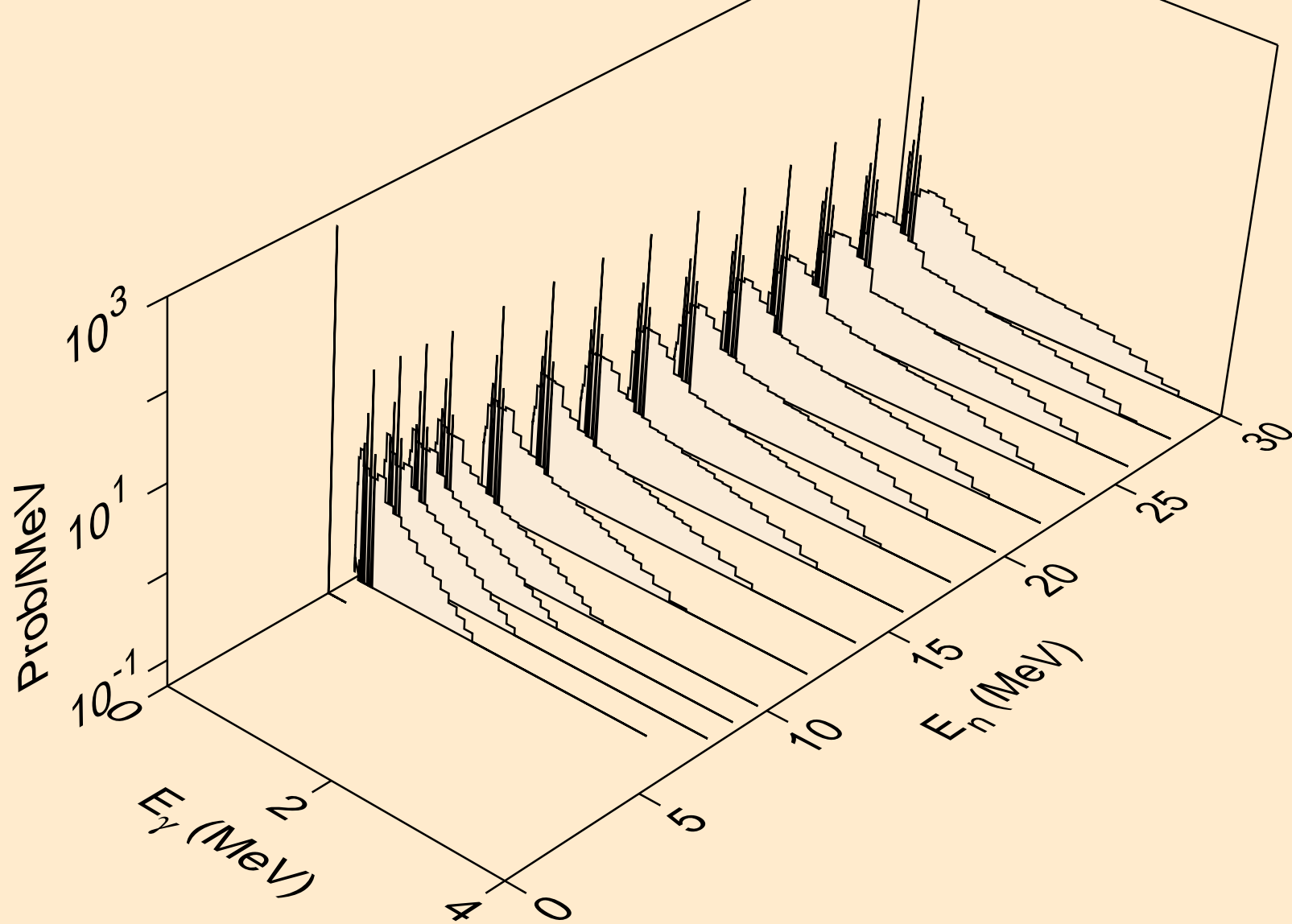

OS179 HELION ACER TENDL-2021 LIBRARY; T=0.K  
Photon emission for (n,t)

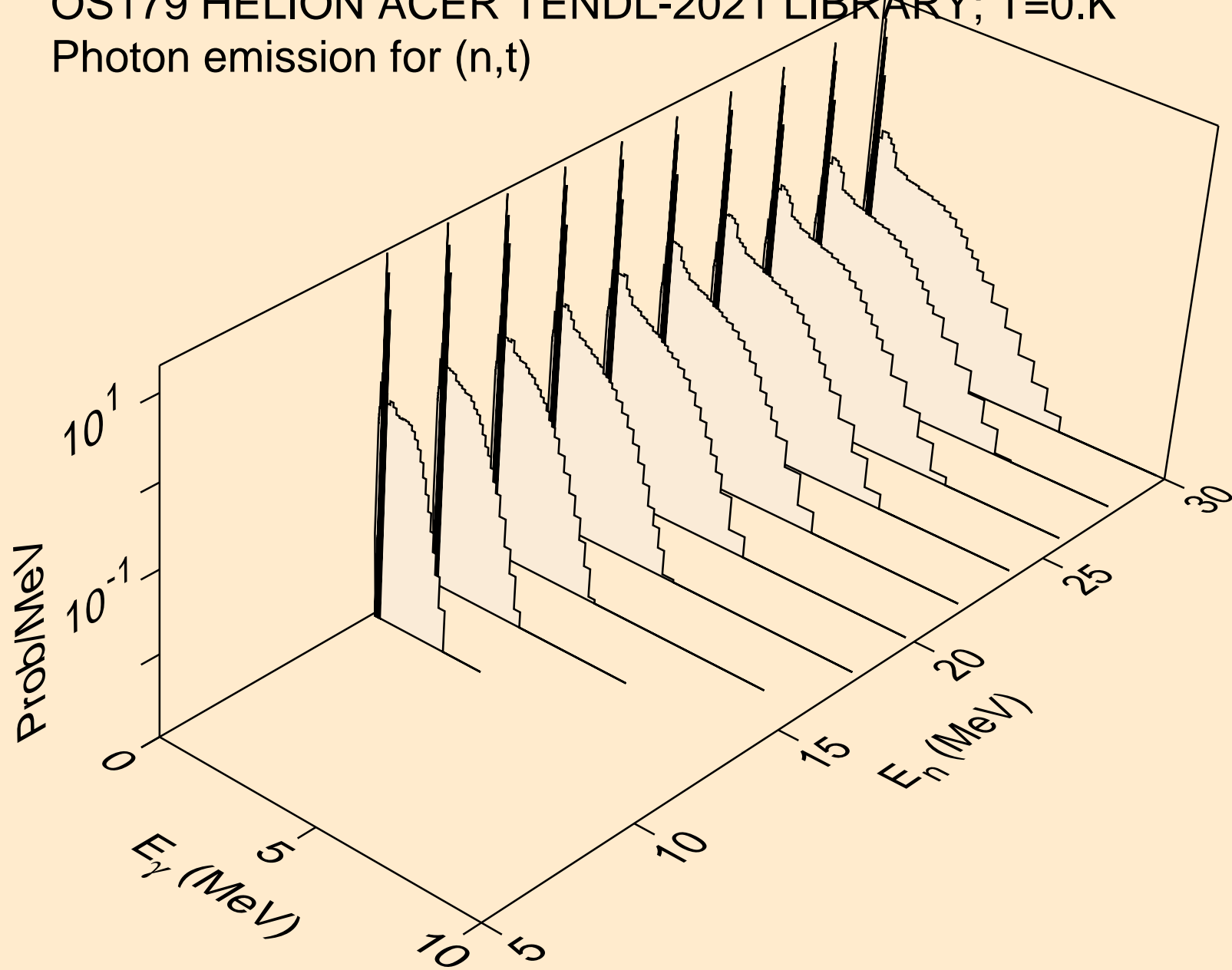

OS179 HELION ACER TENDL-2021 LIBRARY; T=0.K  
Photon emission for inelastic

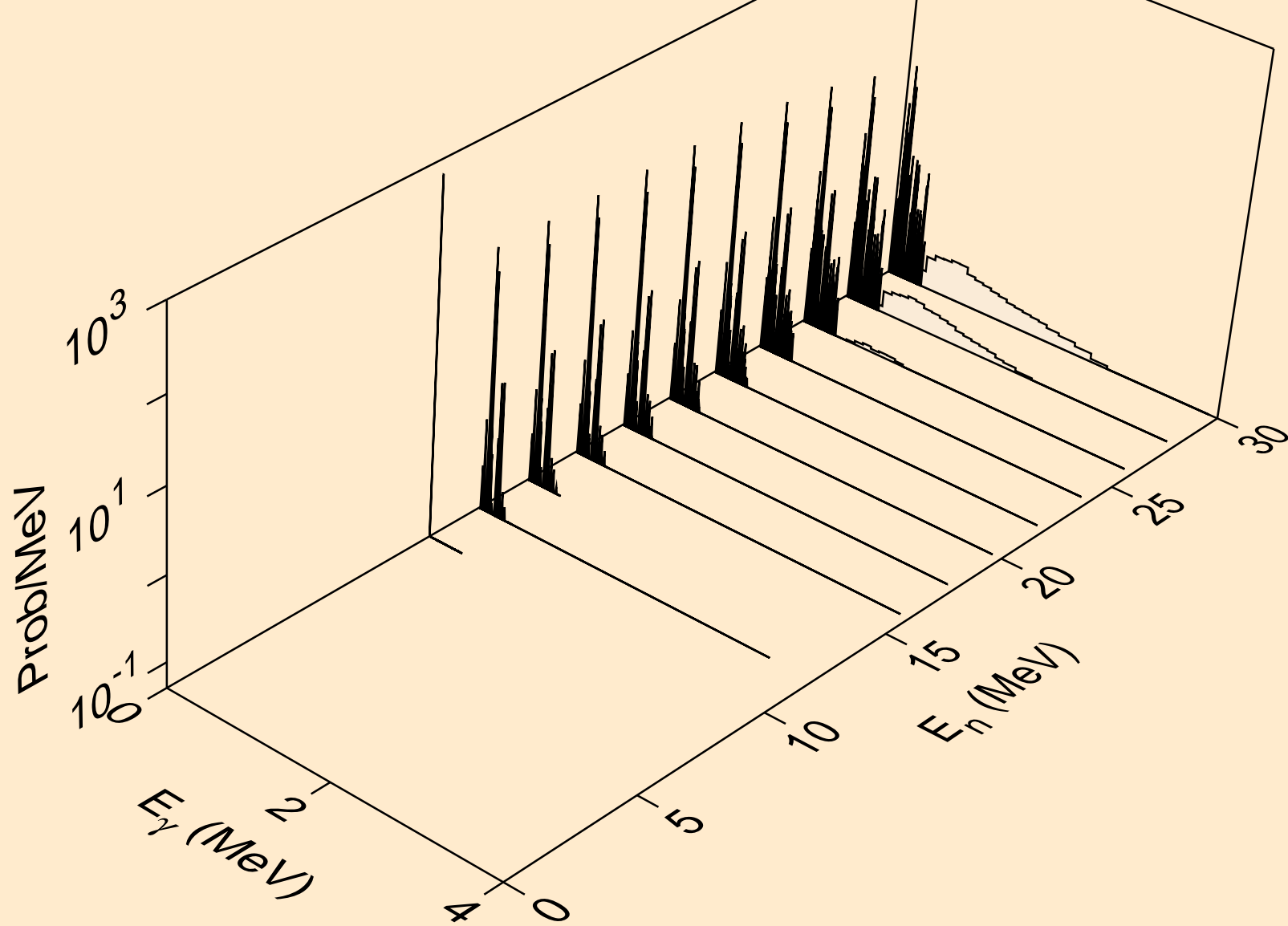



OS179 HELION ACER TENDL-2021 LIBRARY; T=0.K  
Photon emission for (n,a)

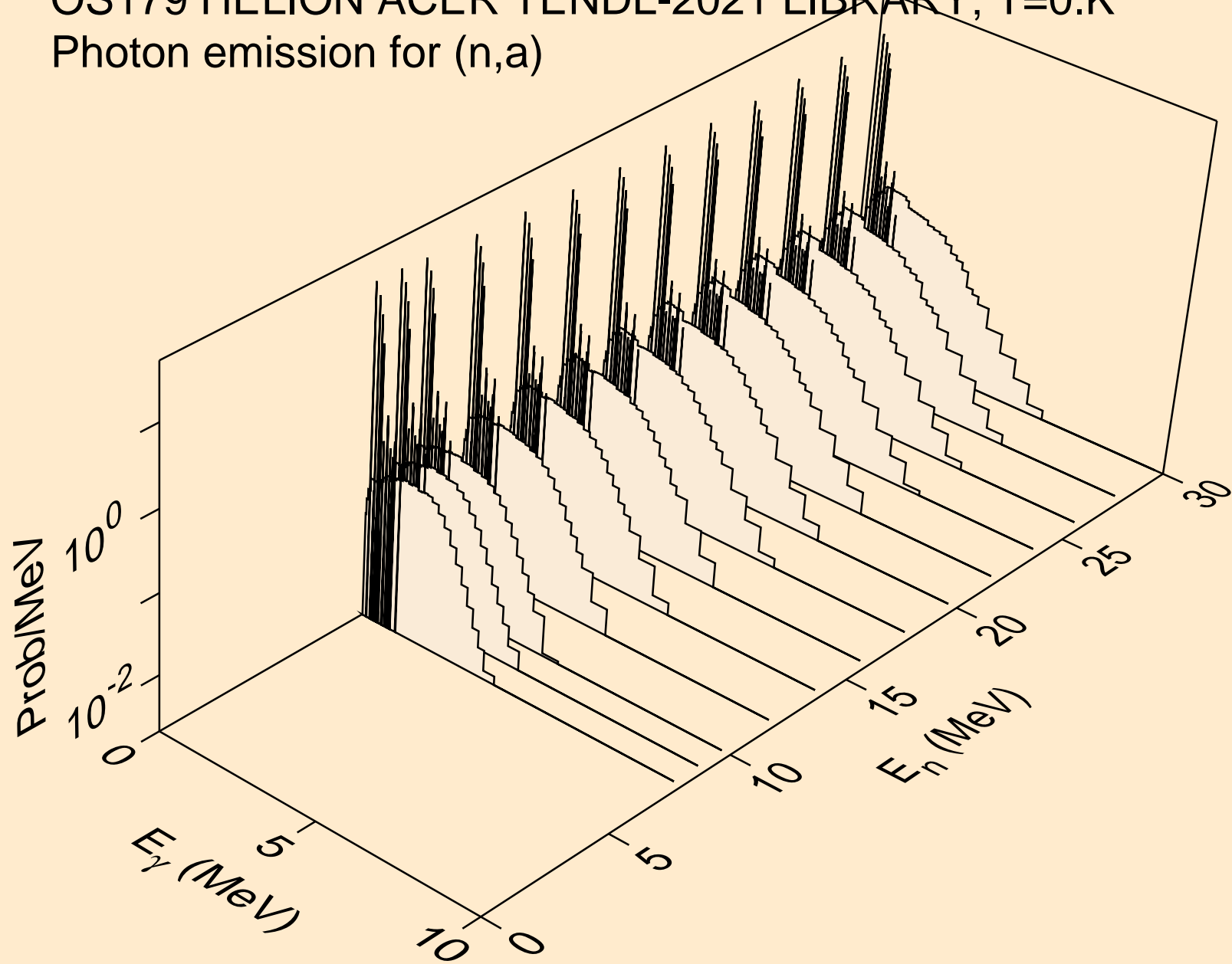

OS179 HELION ACER TENDL-2021 LIBRARY; T=0.K  
Photon emission for (n,2a)

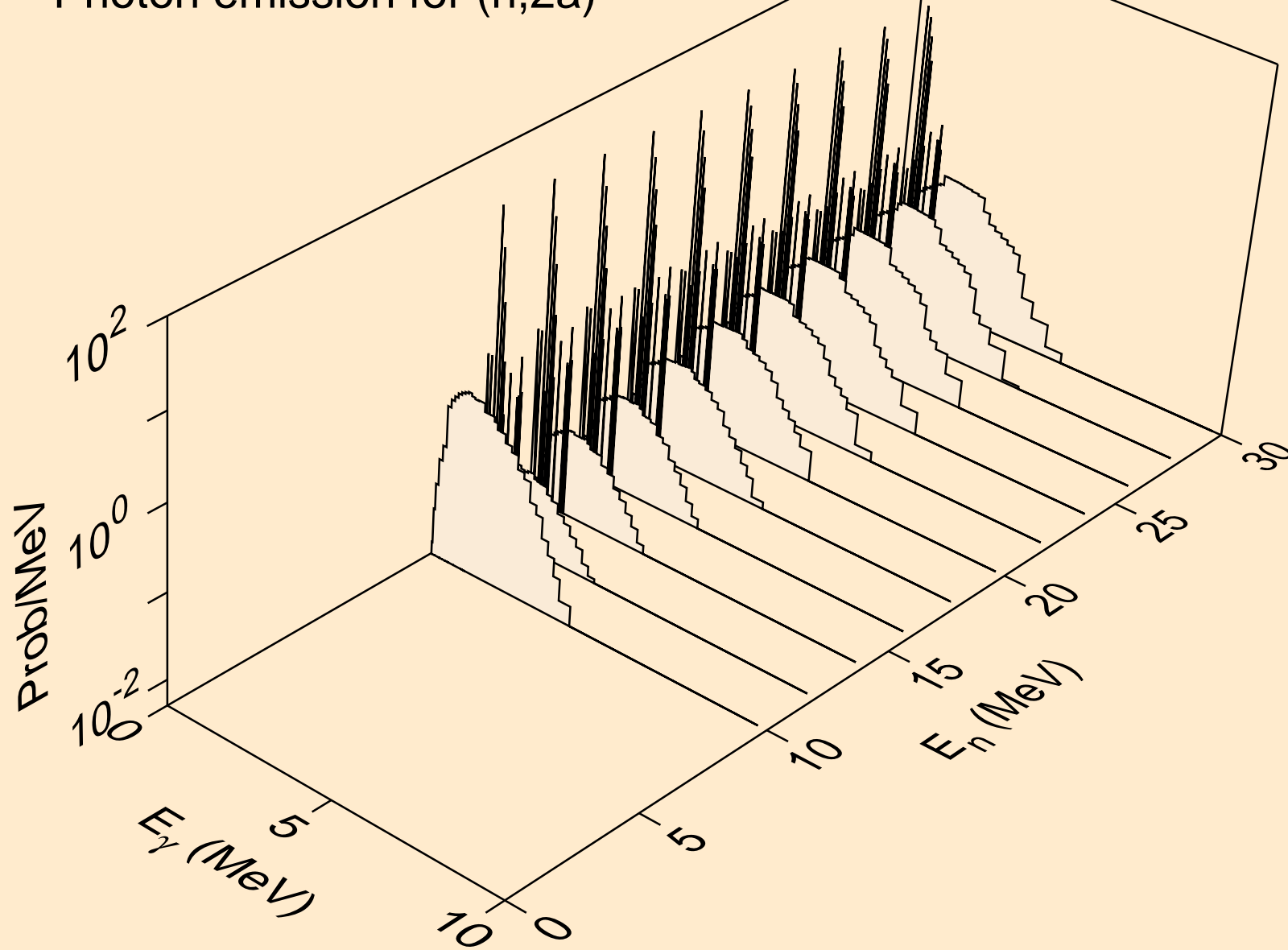

OS179 HELION ACER TENDL-2021 LIBRARY; T=0.K  
Photon emission for (n,2p)

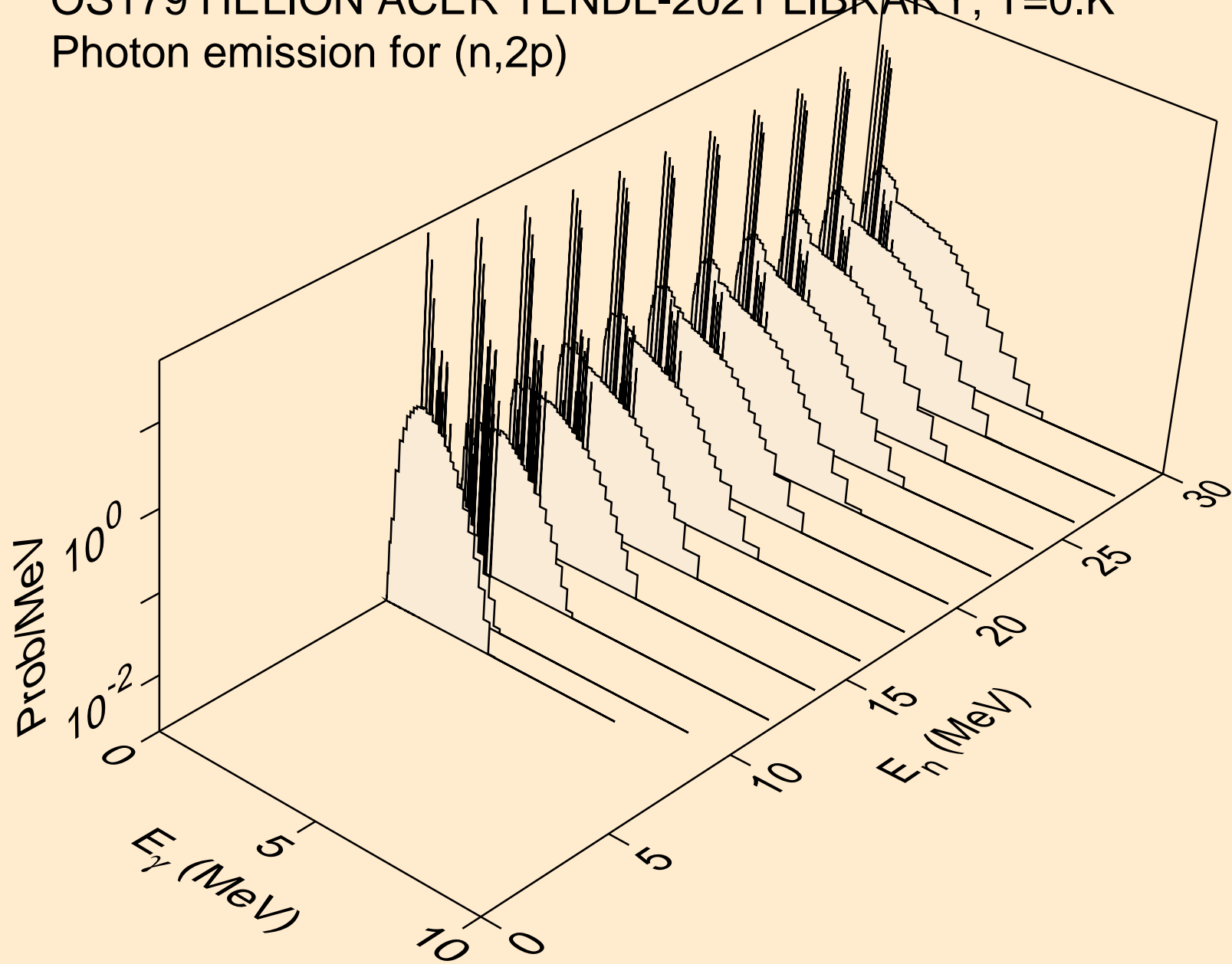

OS179 HELION ACER TENDL-2021 LIBRARY; T=0.K  
Photon emission for (n,p $\alpha$ )

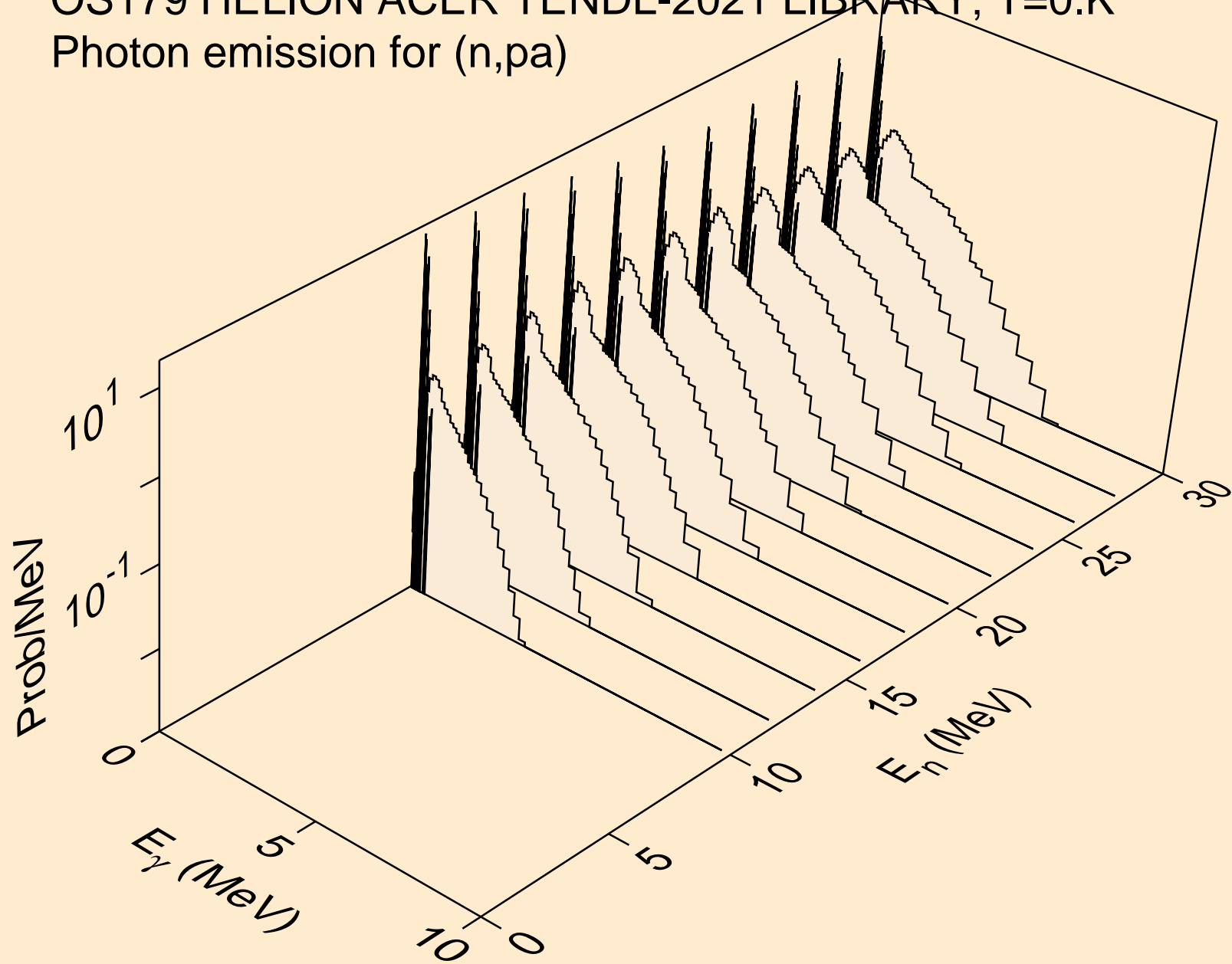

OS179 HELION ACER TENDL-2021 LIBRARY; T=0.K  
Photon emission for (n,pd)

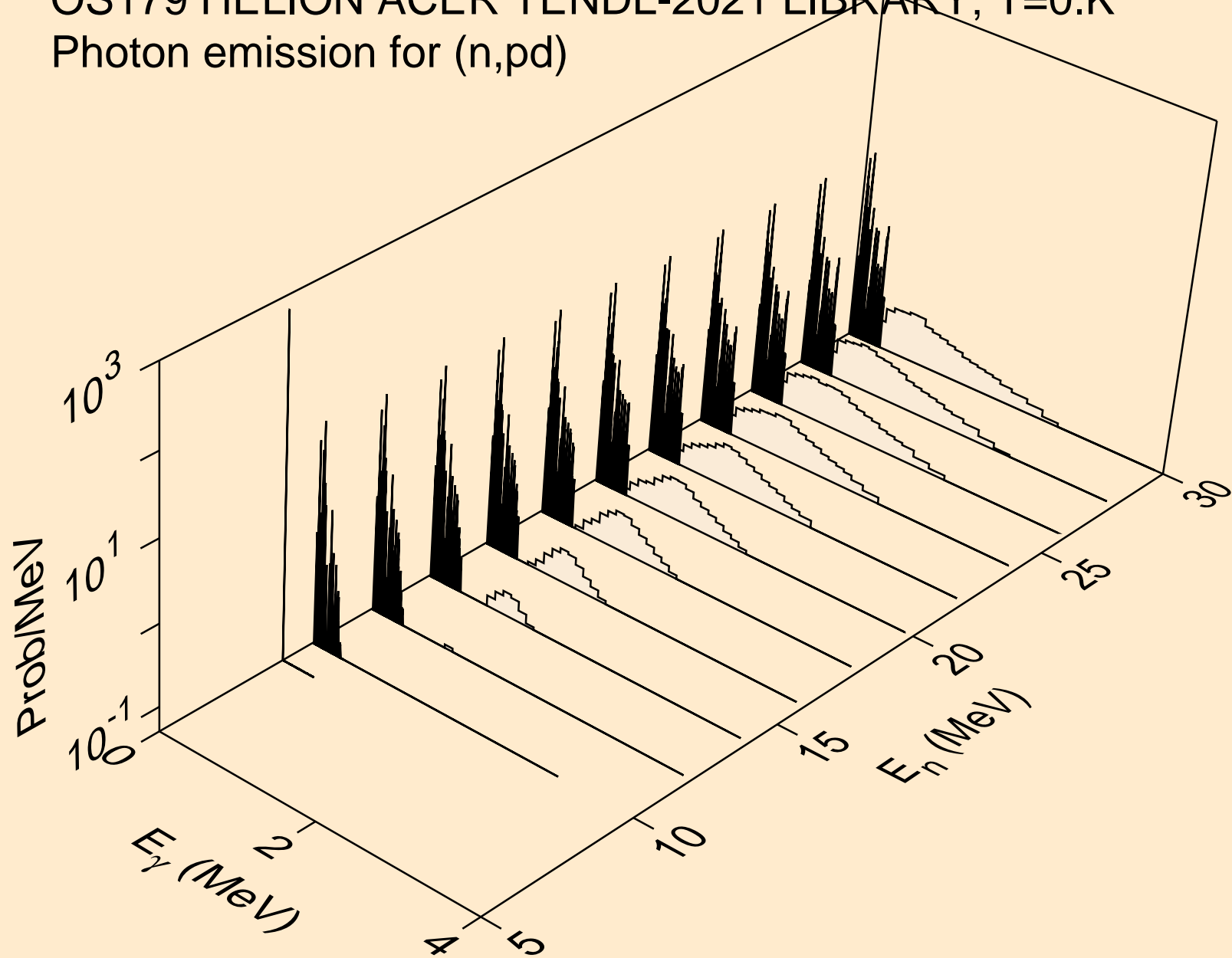

OS179 HELION ACER TENDL-2021 LIBRARY; T=0.K  
Photon emission for (n,pt)

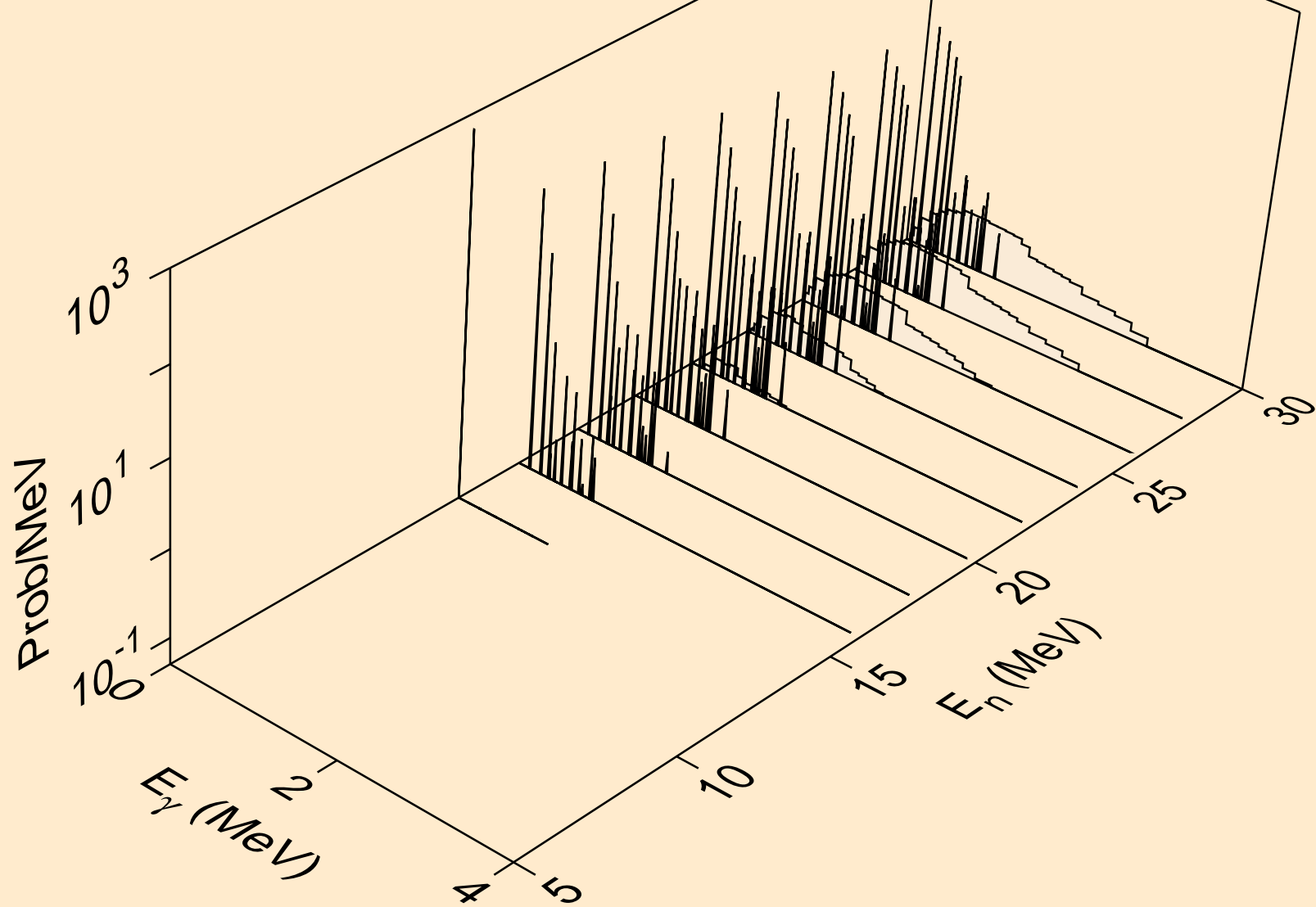

OS179 HELION ACER TENDL-2021 LIBRARY; T=0.K  
Photon emission for (n,da)

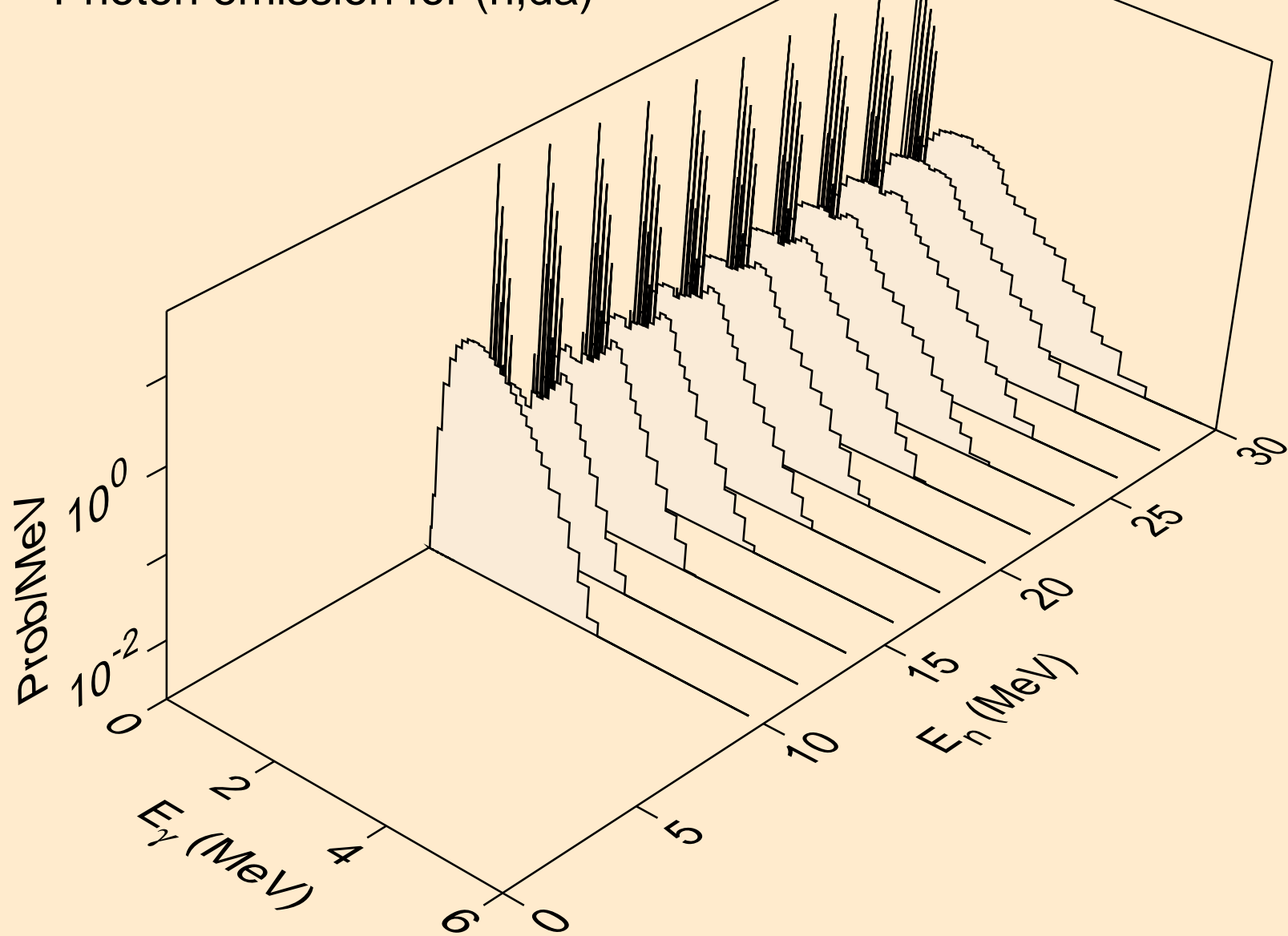

OS179 HELION ACER TENDL-2021 LIBRARY; T=0.K  
Particle heating contributions

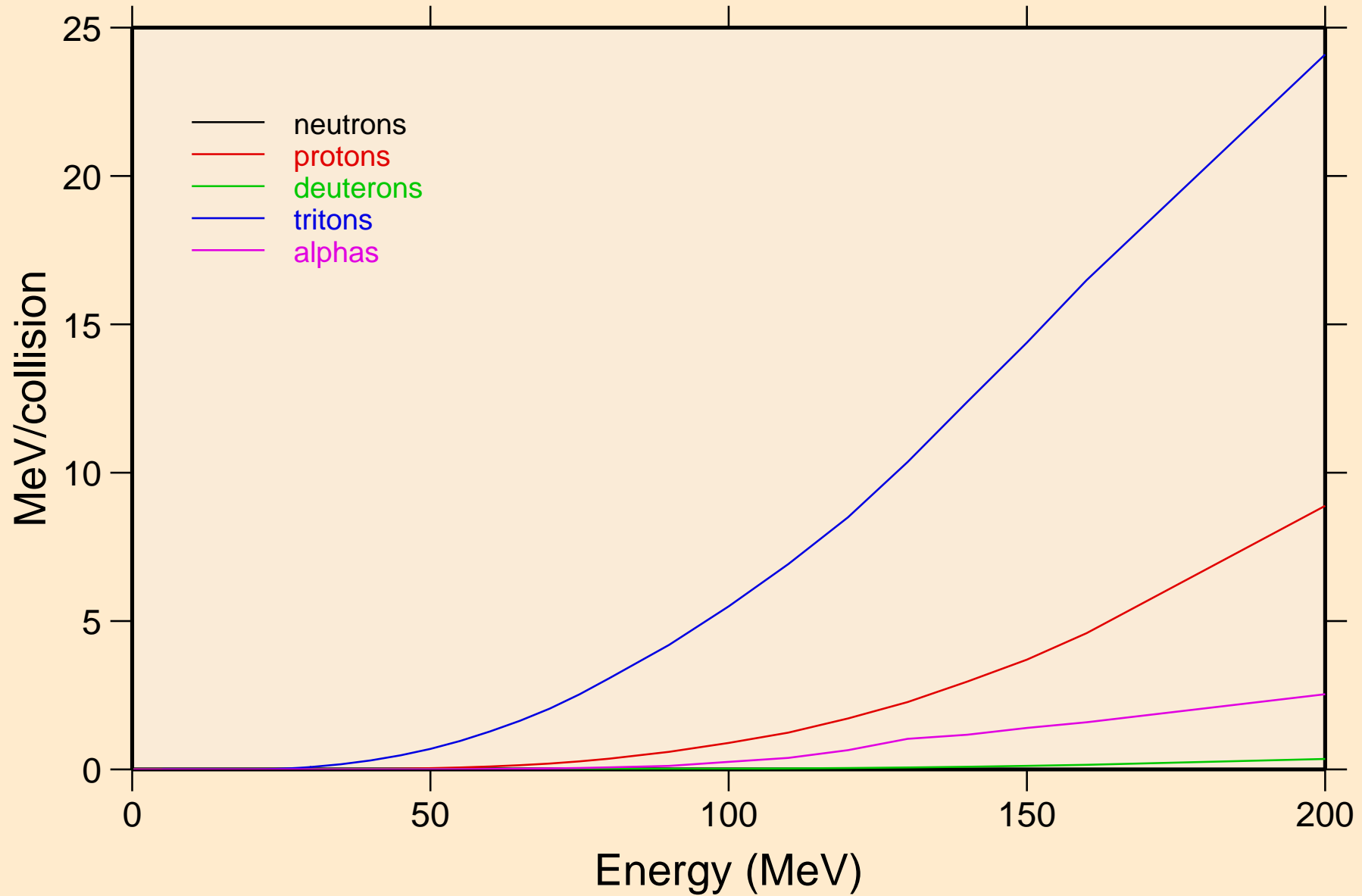



OS179 HELION ACER TENDL-2021 LIBRARY; T=0.K

Recoil Heating

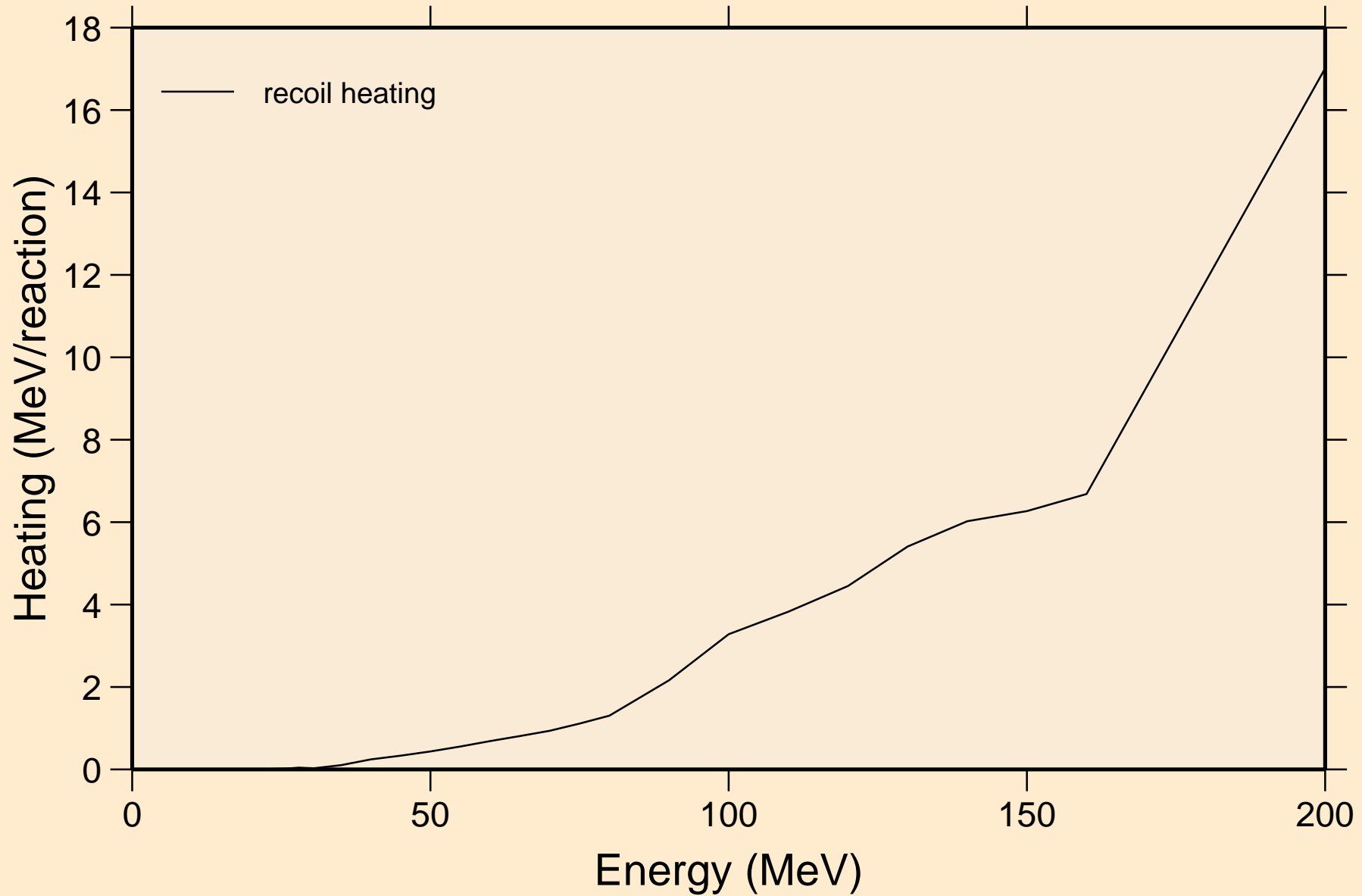

OS179 HELION ACER TENDL-2021 LIBRARY; T=0.K  
Particle production cross sections

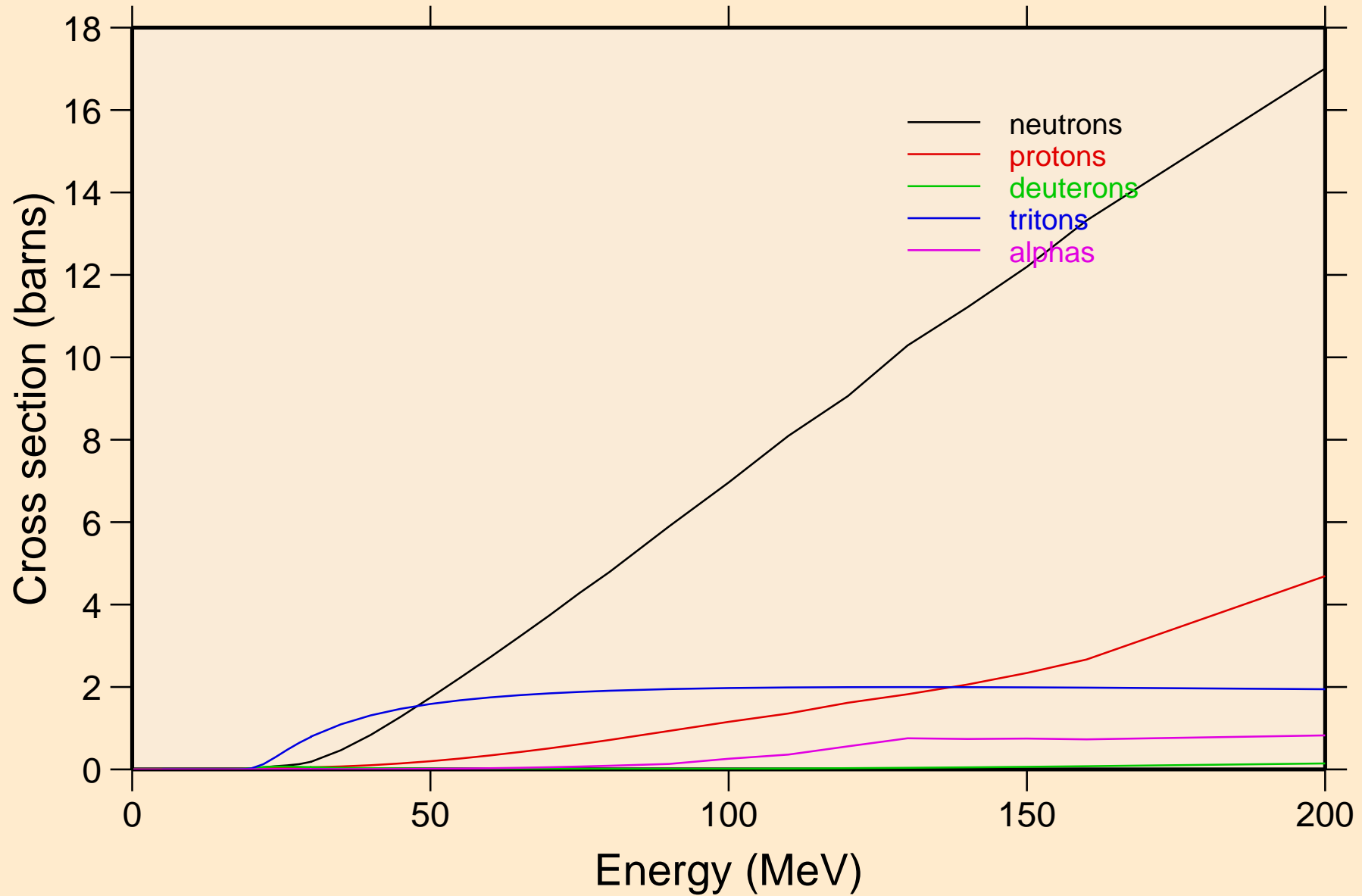

OS179 HELION ACER TENDL-2021 LIBRARY; T=0.K  
neutrons from (s,n)

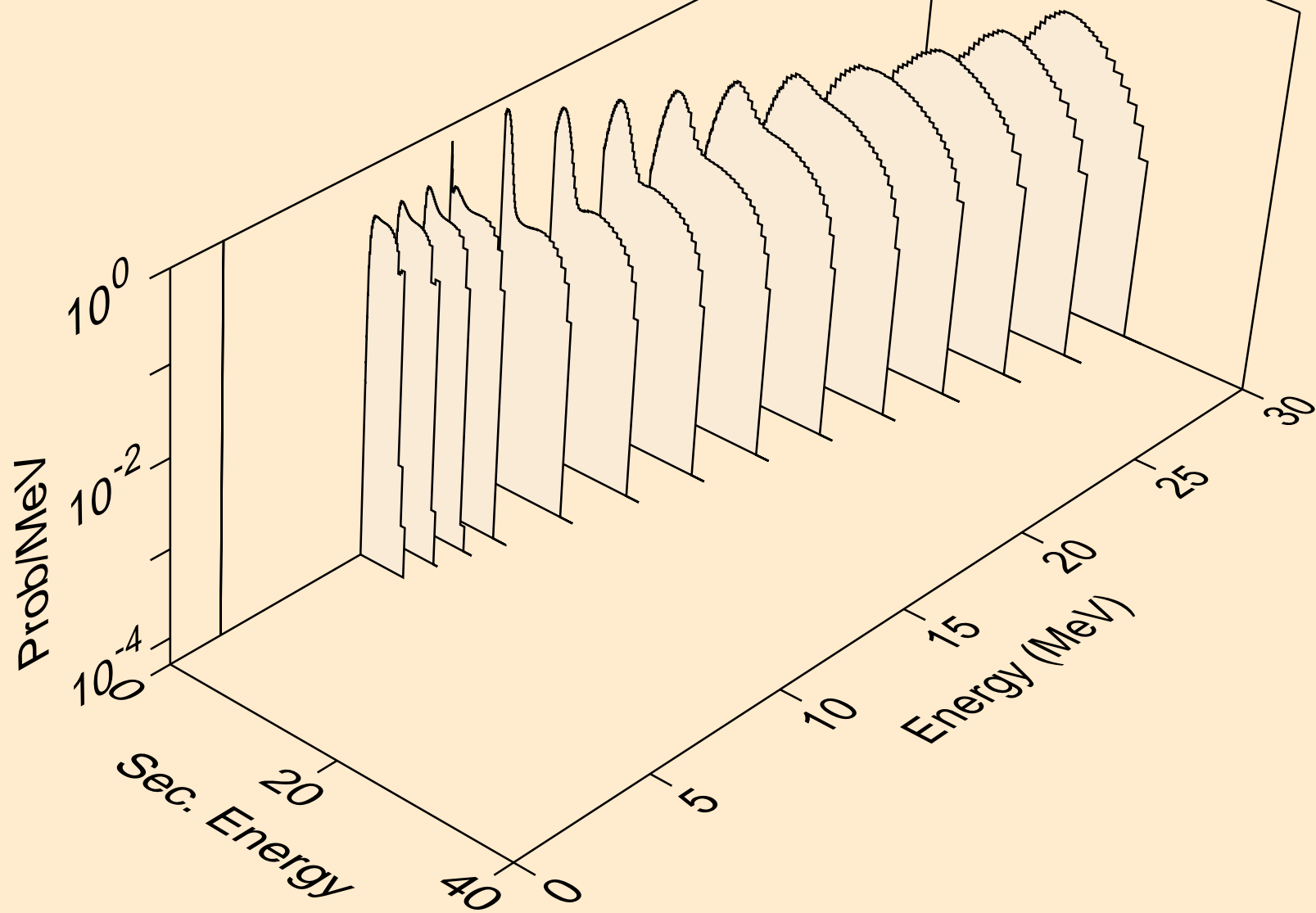

OS179 HELION ACER TENDL-2021 LIBRARY; T=0.K  
neutrons from (s,x)

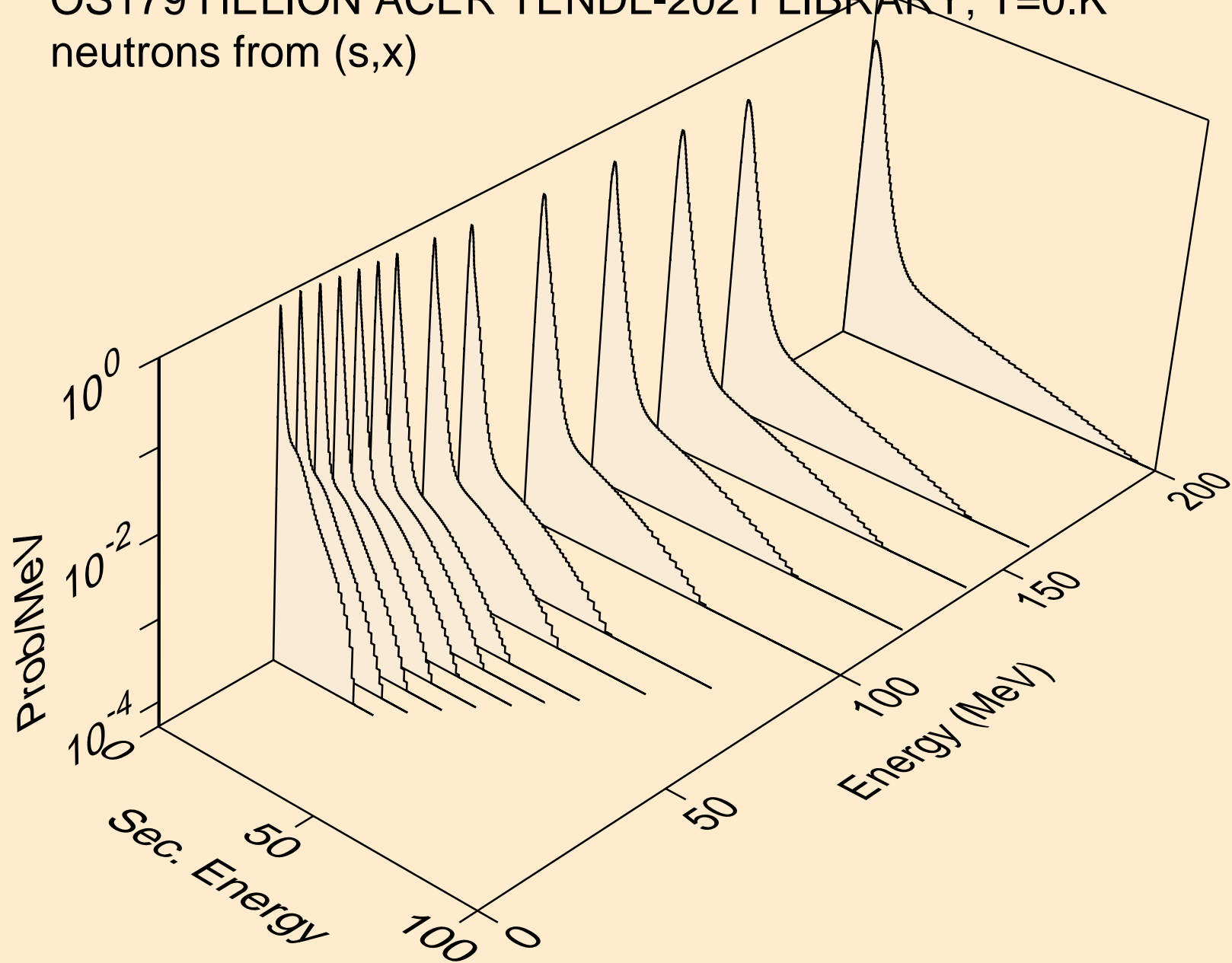

OS179 HELION ACER TENDL-2021 LIBRARY; T=0.K  
neutrons from (s,2nd)

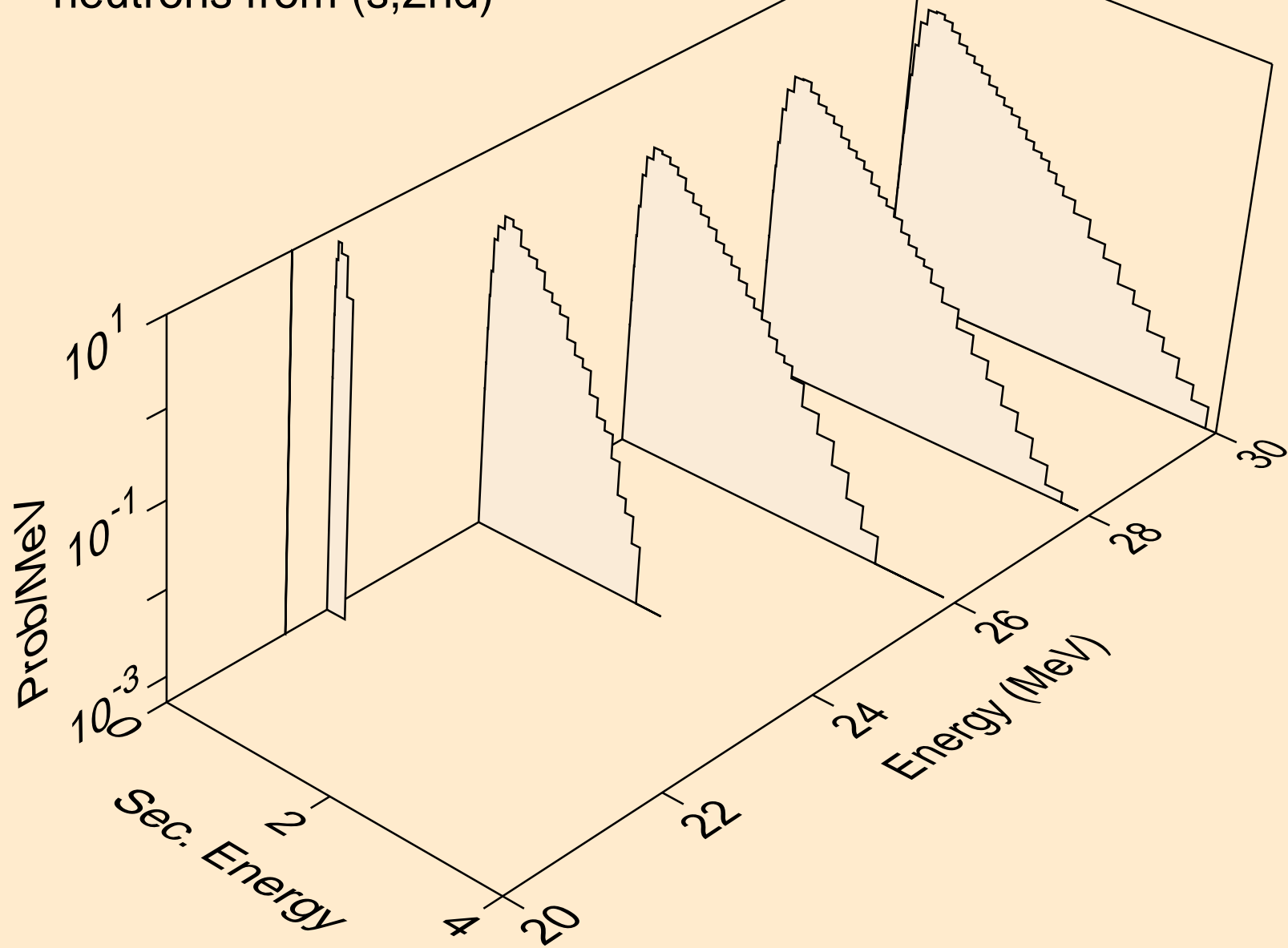

OS179 HELION ACER TENDL-2021 LIBRARY; T=0.K  
neutrons from (s,2n)

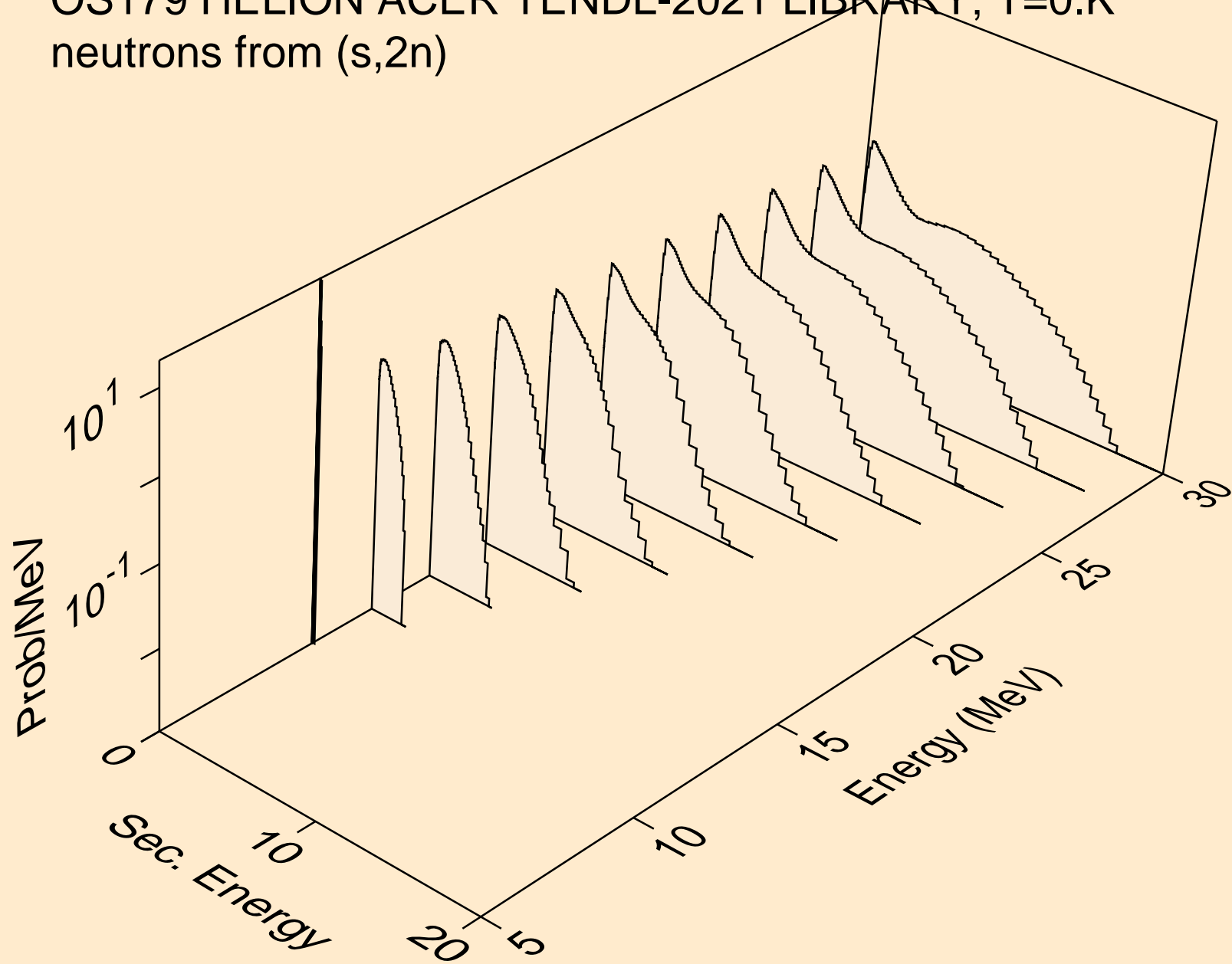

OS179 HELION ACER TENDL-2021 LIBRARY; T=0.K  
neutrons from (s,3n)

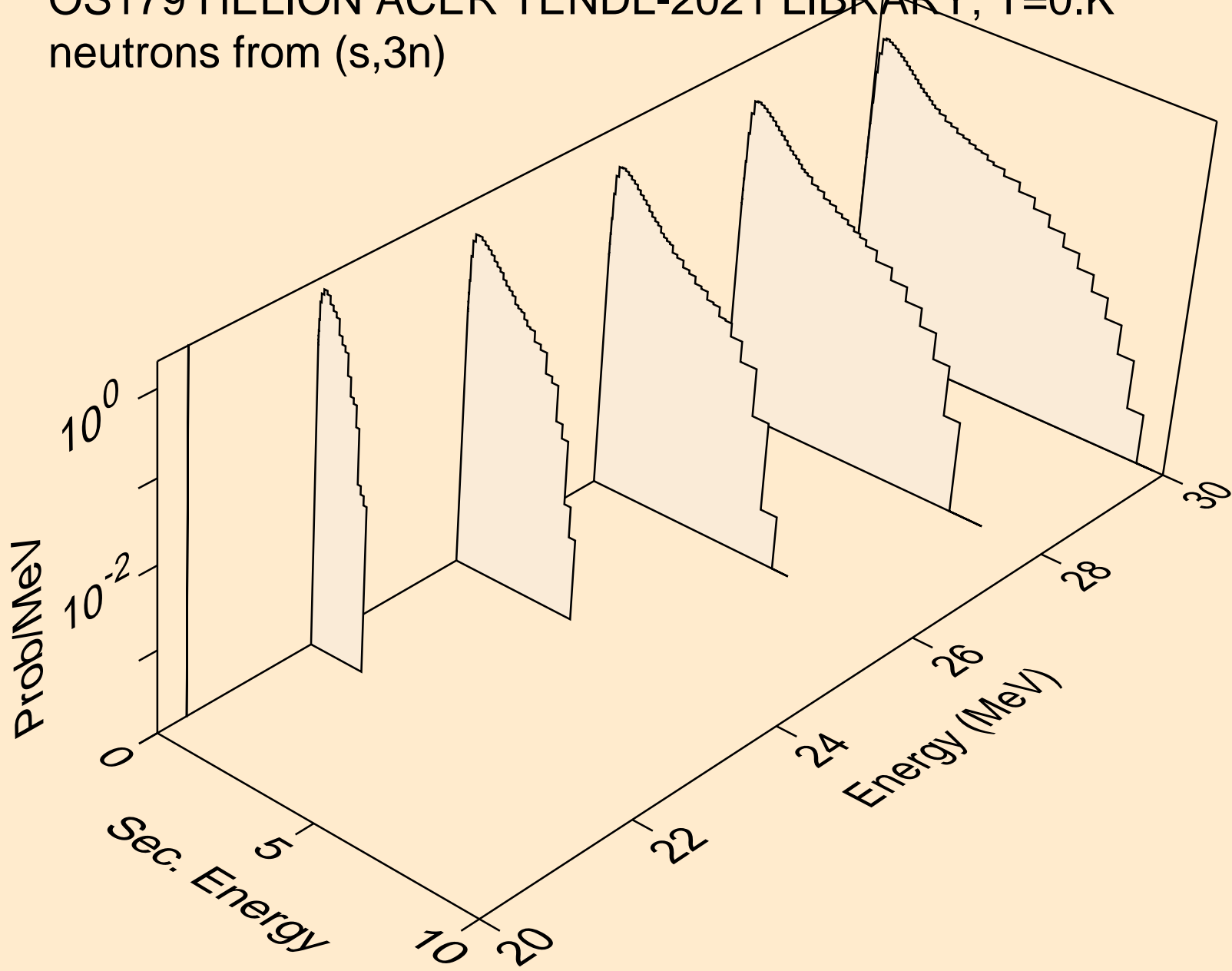

OS179 HELION ACER TENDL-2021 LIBRARY; T=0.K  
neutrons from (s,n\*)a

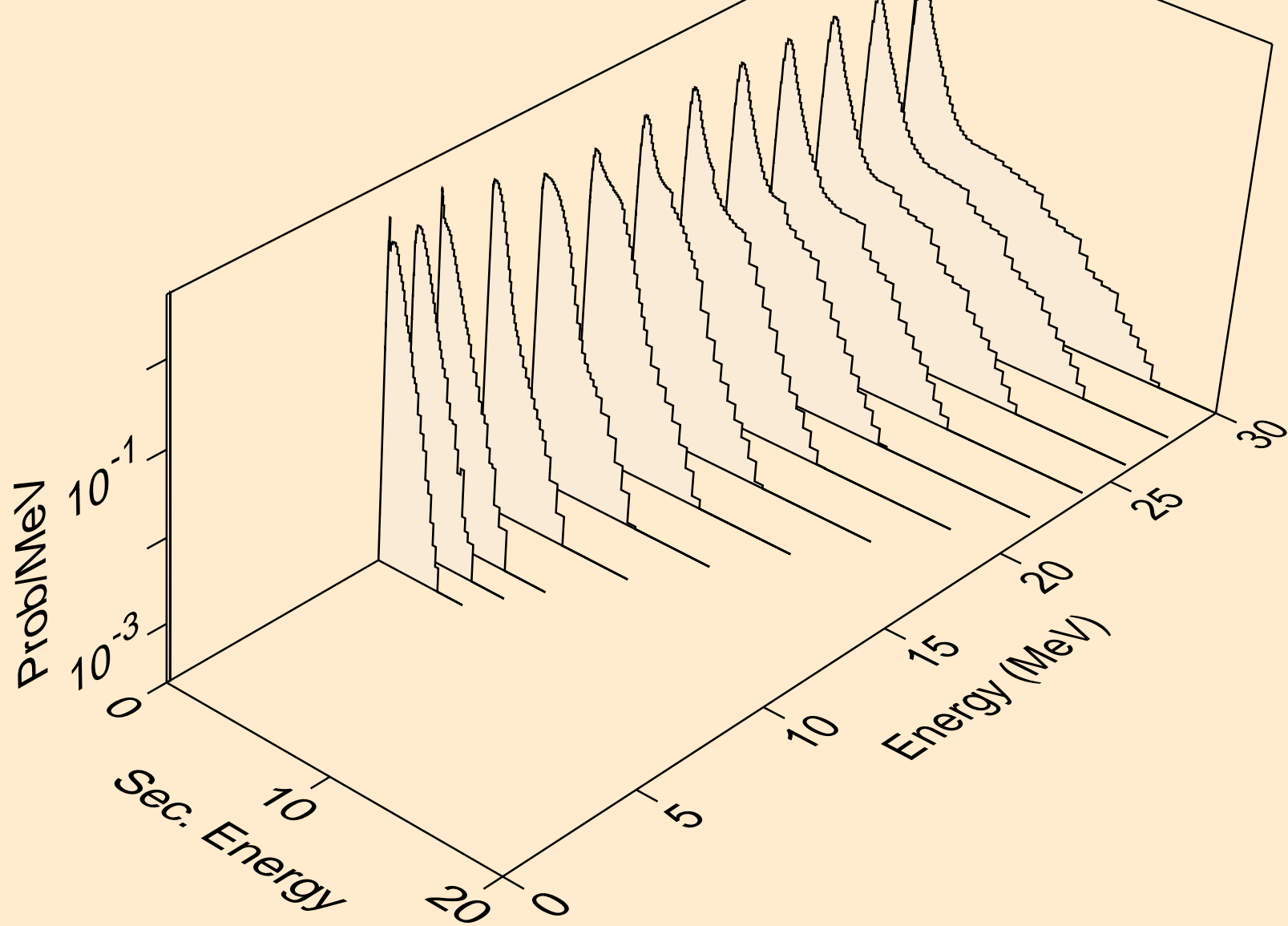



OS179 HELION ACER TENDL-2021 LIBRARY; T=0.K  
neutrons from (s,2n)a

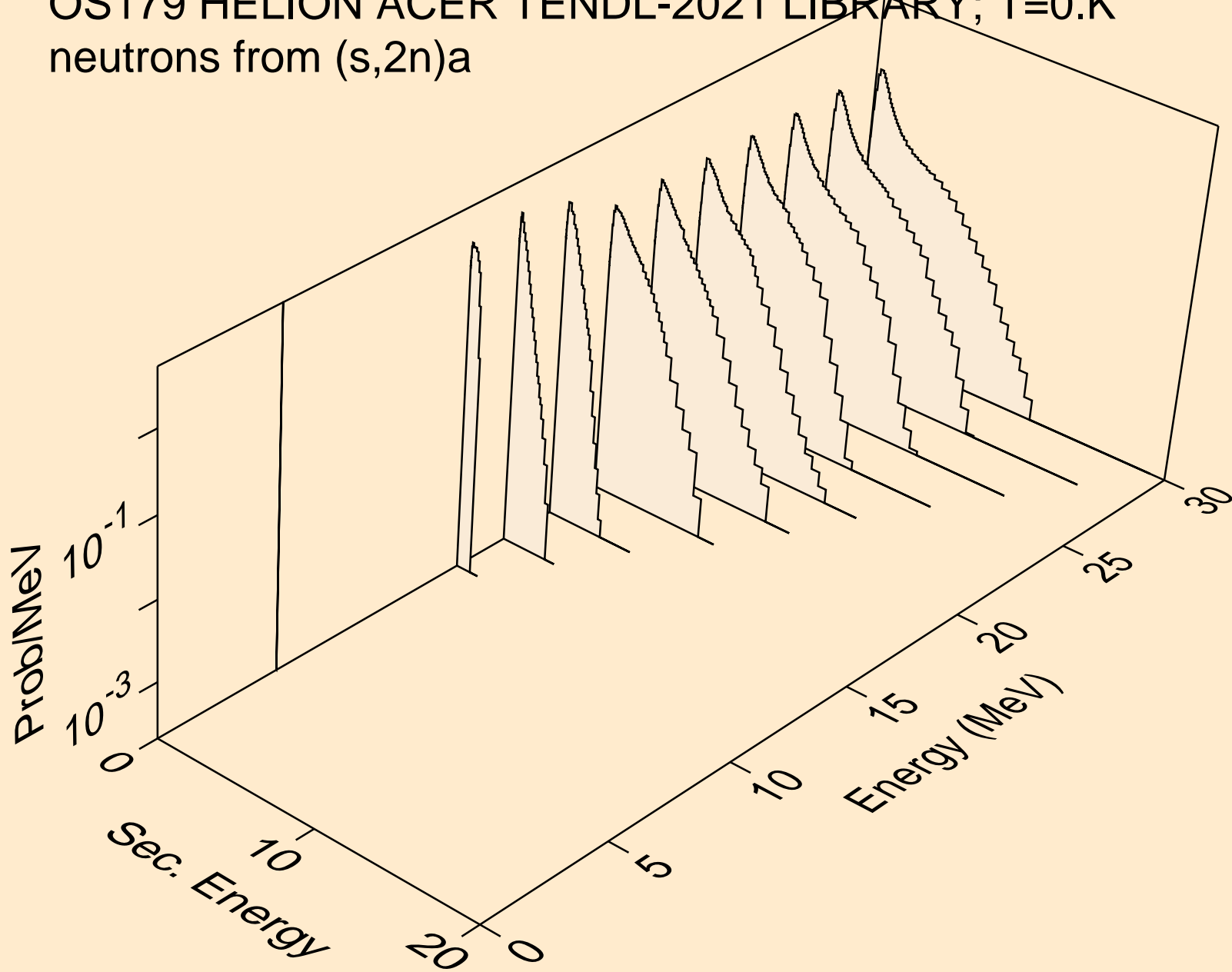

OS179 HELION ACER TENDL-2021 LIBRARY; T=0.K  
neutrons from (s,3n)a

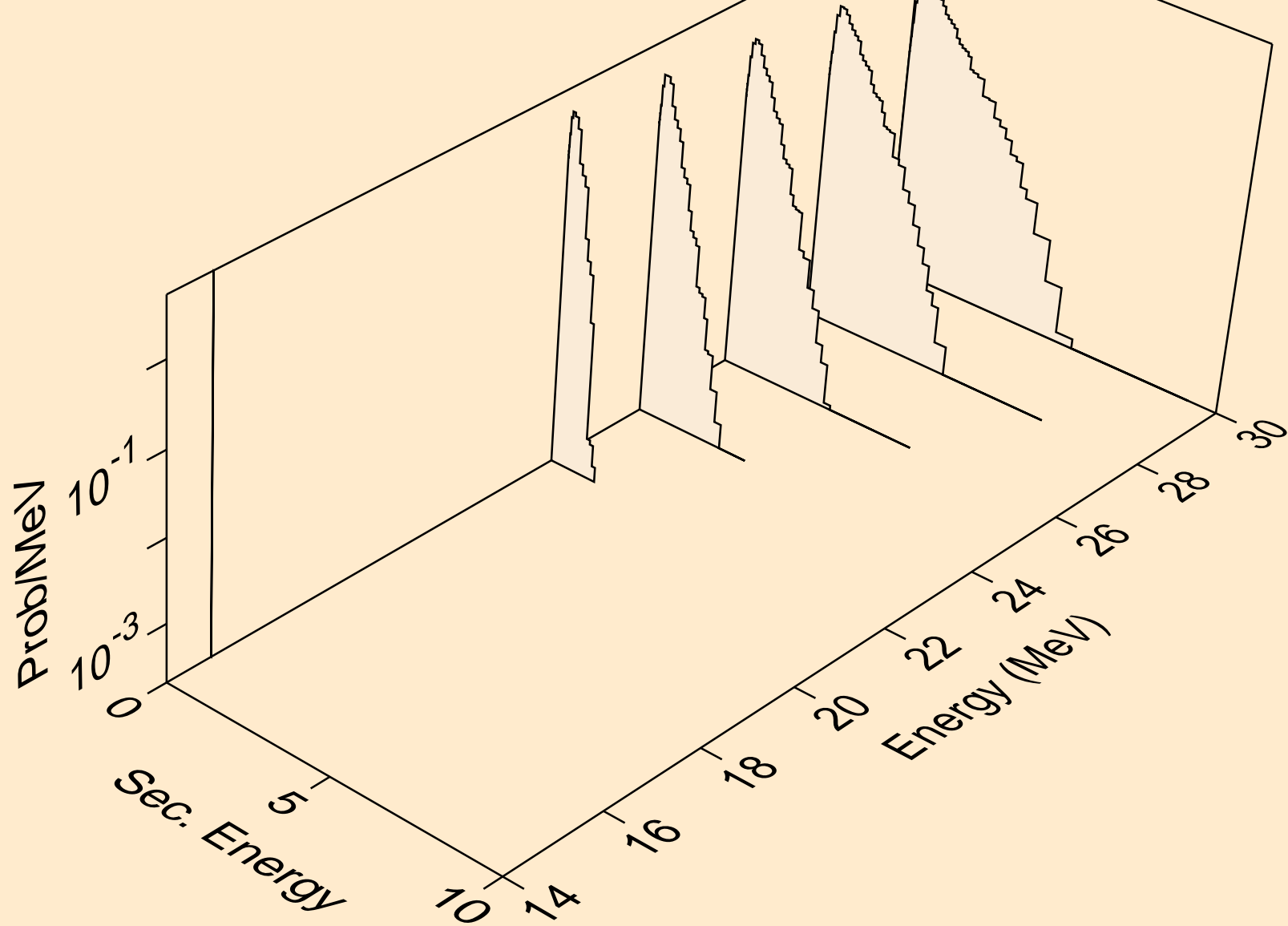

OS179 HELION ACER TENDL-2021 LIBRARY; T=0.K  
neutrons from (s,n\*)p

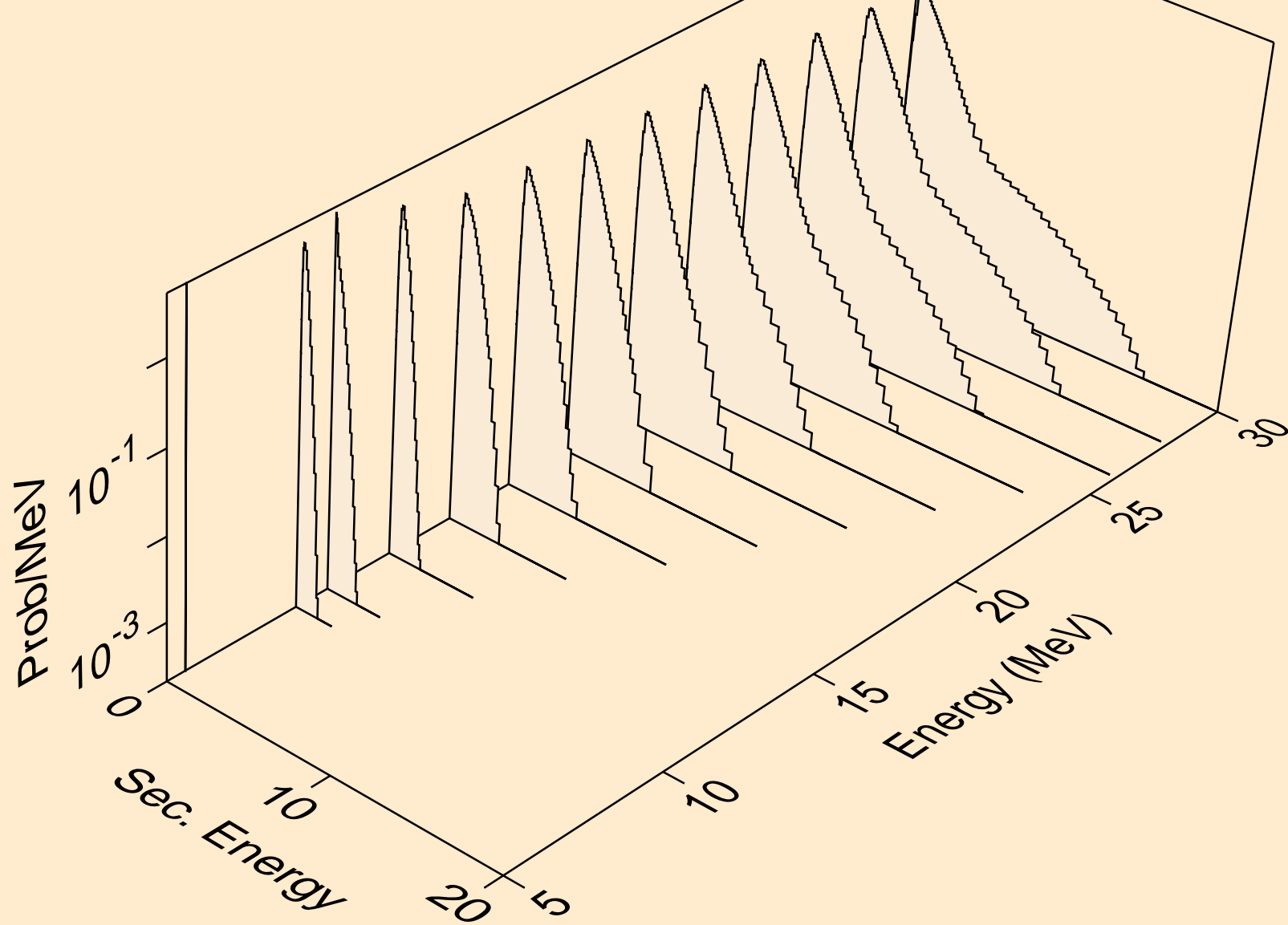

OS179 HELION ACER TENDL-2021 LIBRARY; T=0.K  
neutrons from (s,n\*)2a

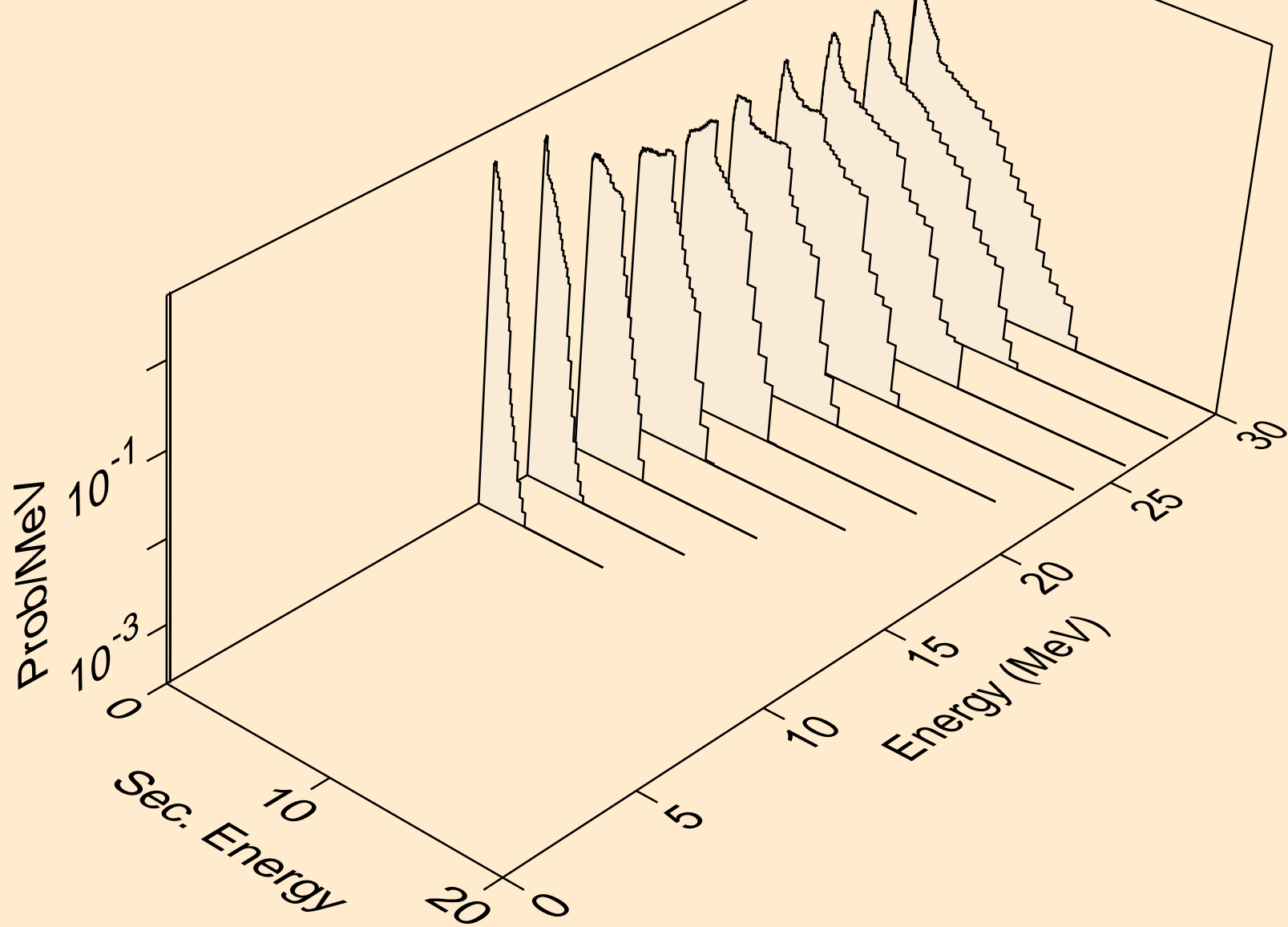

OS179 HELION ACER TENDL-2021 LIBRARY; T=0.K  
neutrons from (s,n\*)d

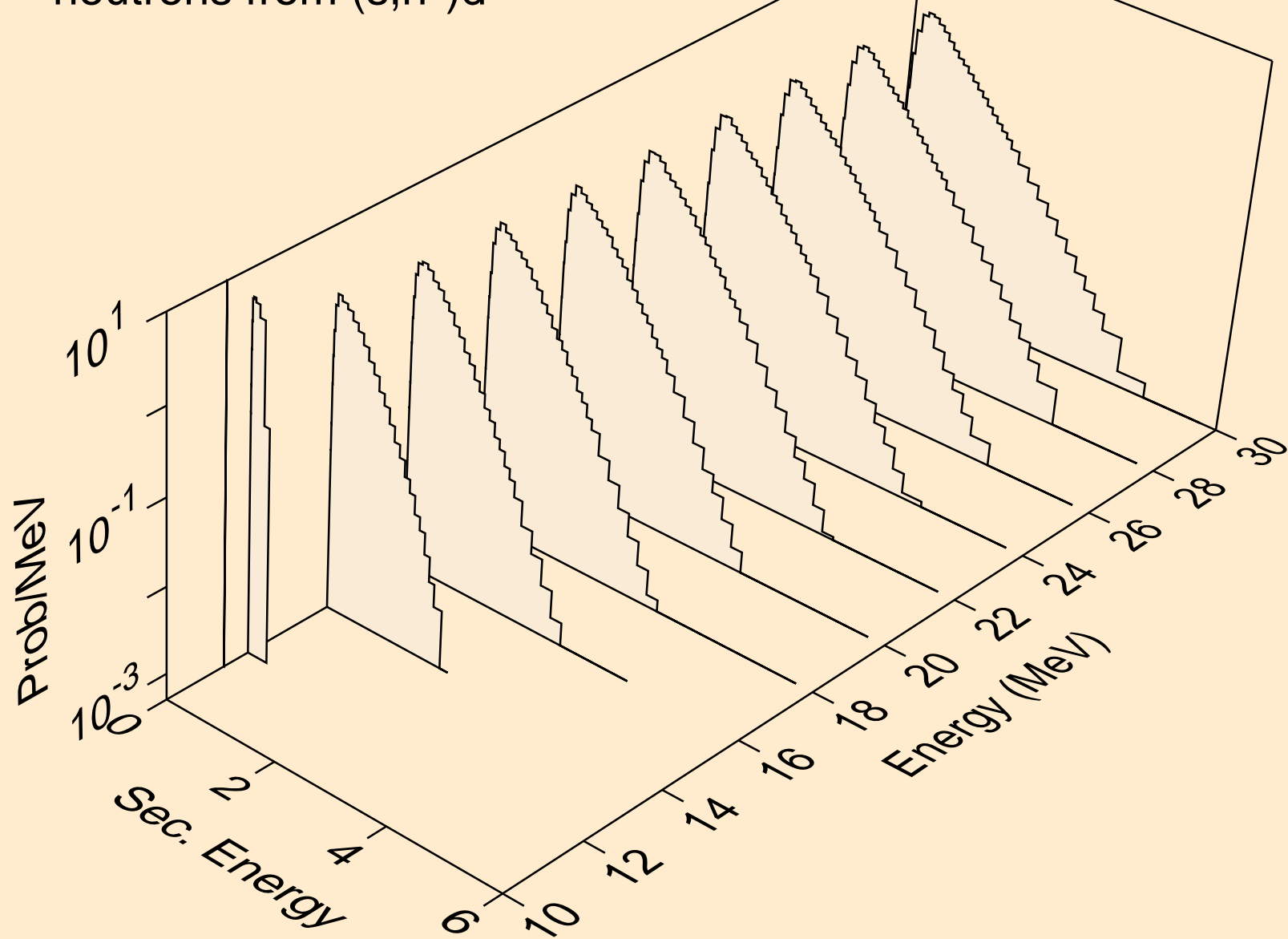

OS179 HELION ACER TENDL-2021 LIBRARY; T=0.K  
neutrons from (s,n\*)t

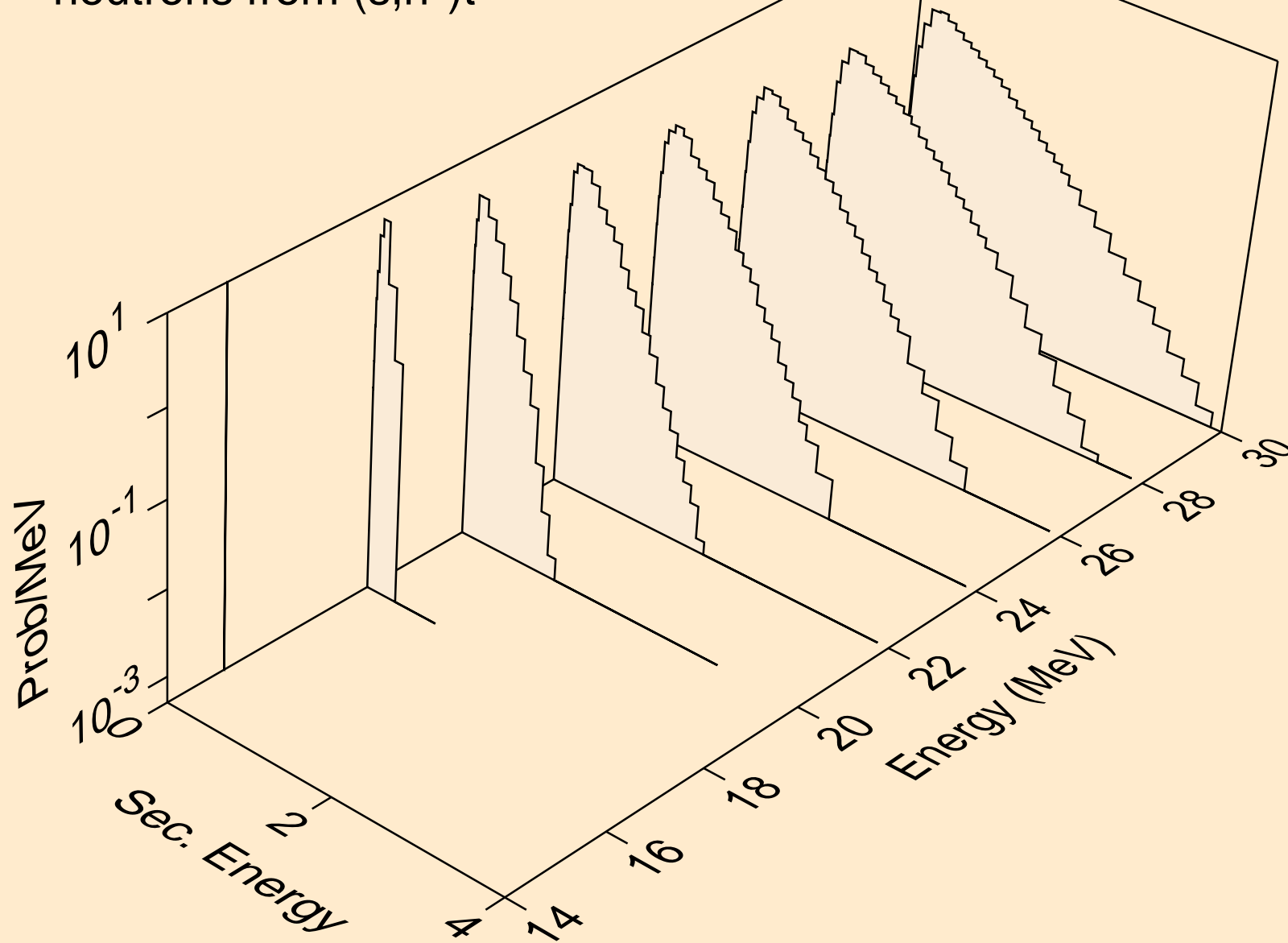

OS179 HELION ACER TENDL-2021 LIBRARY; T=0.K  
neutrons from (s,n\*)he3

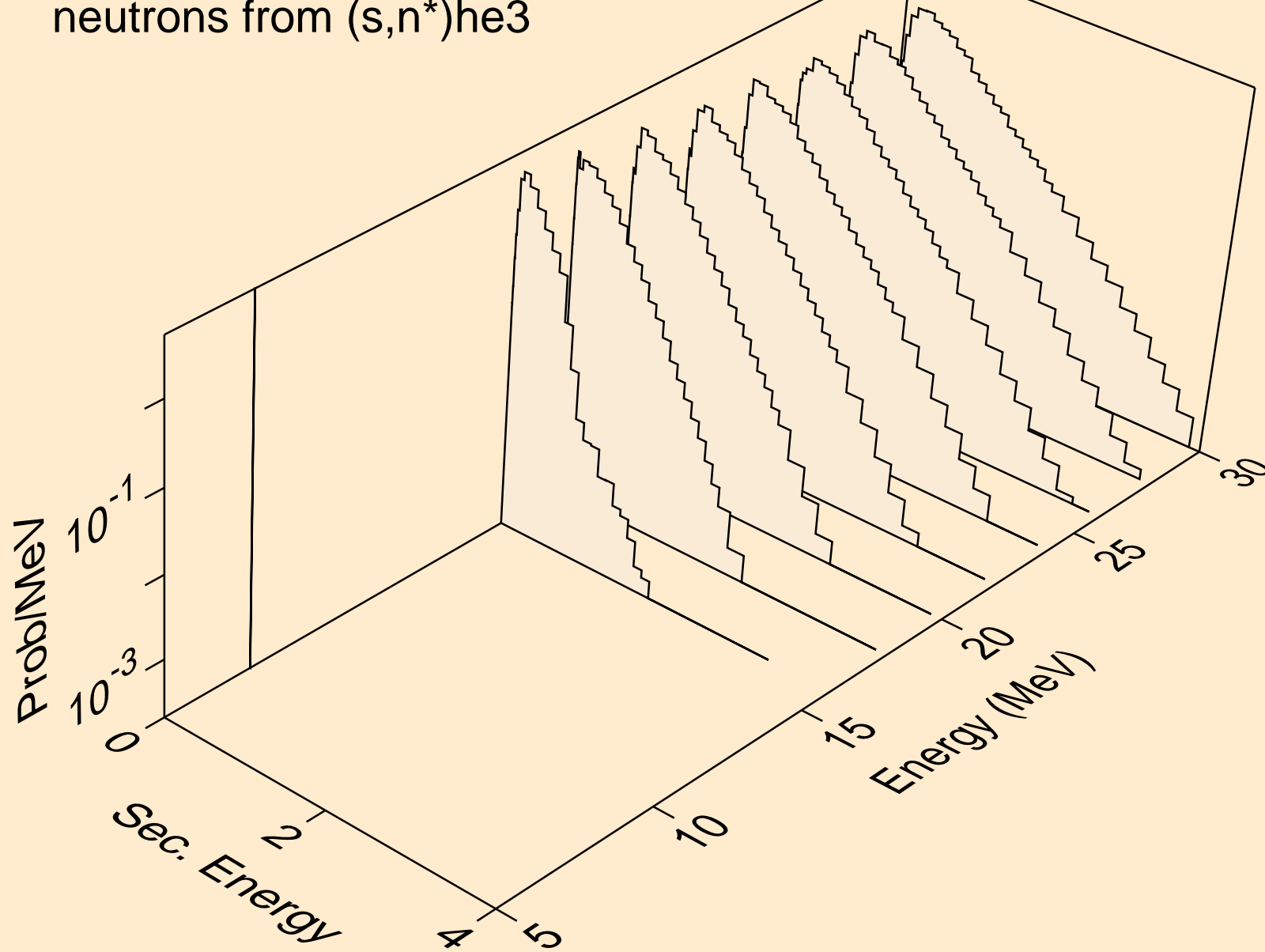

OS179 HELION ACER TENDL-2021 LIBRARY; T=0.K  
neutrons from (s,4n)

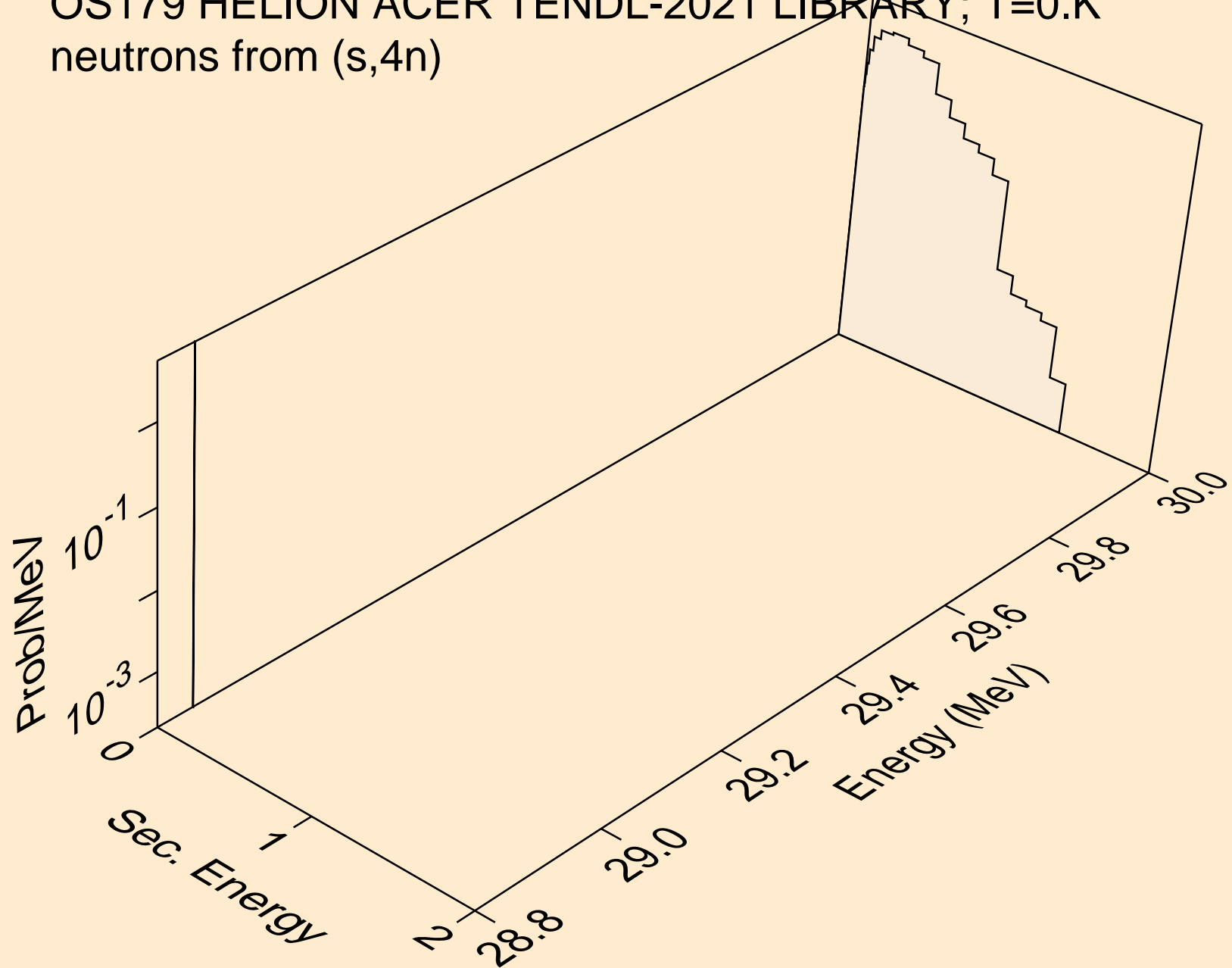



OS179 HELION ACER TENDL-2021 LIBRARY; T=0.K  
neutrons from (s,2np)

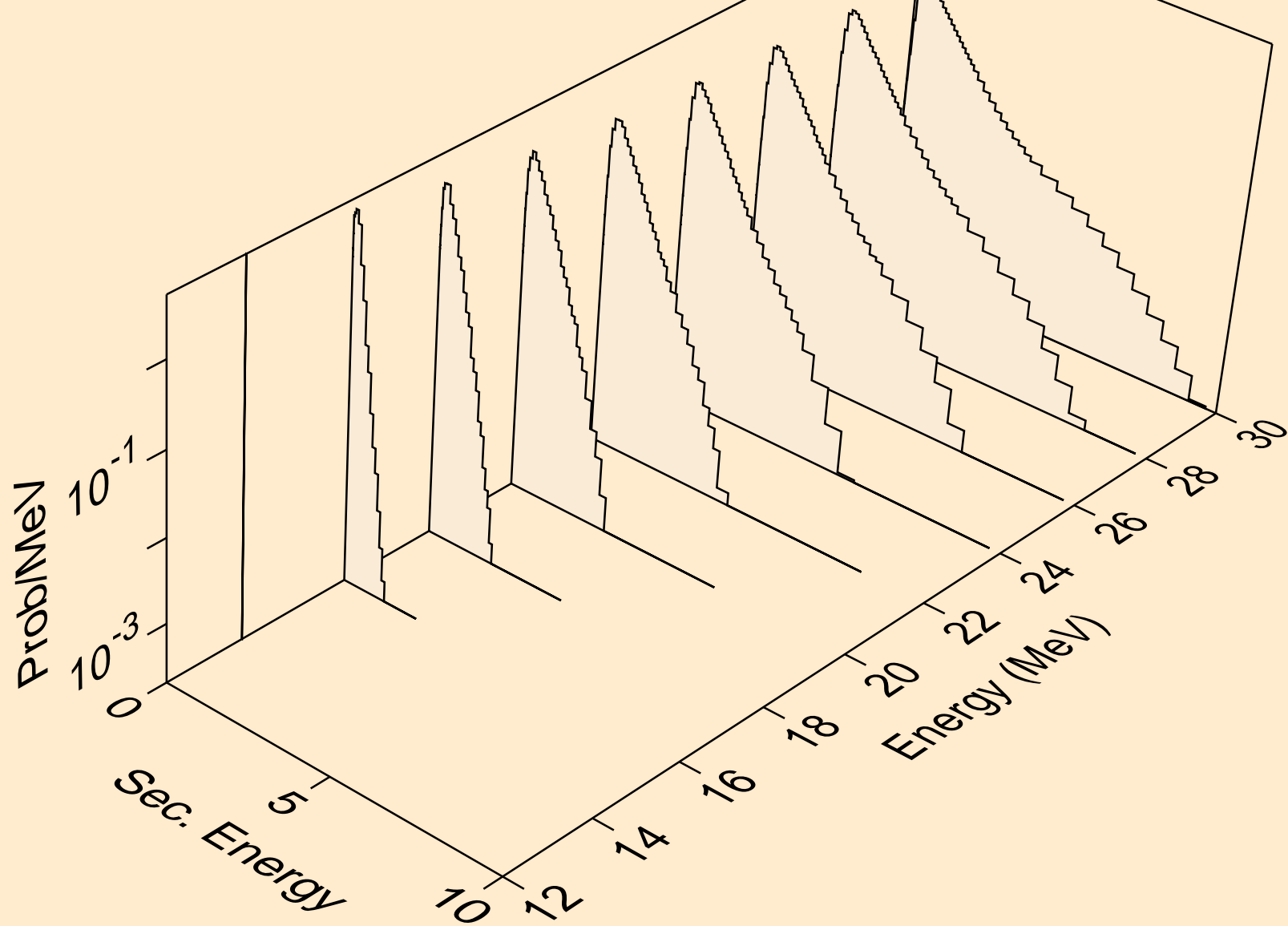

OS179 HELION ACER TENDL-2021 LIBRARY; T=0.K  
neutrons from (s,3np)

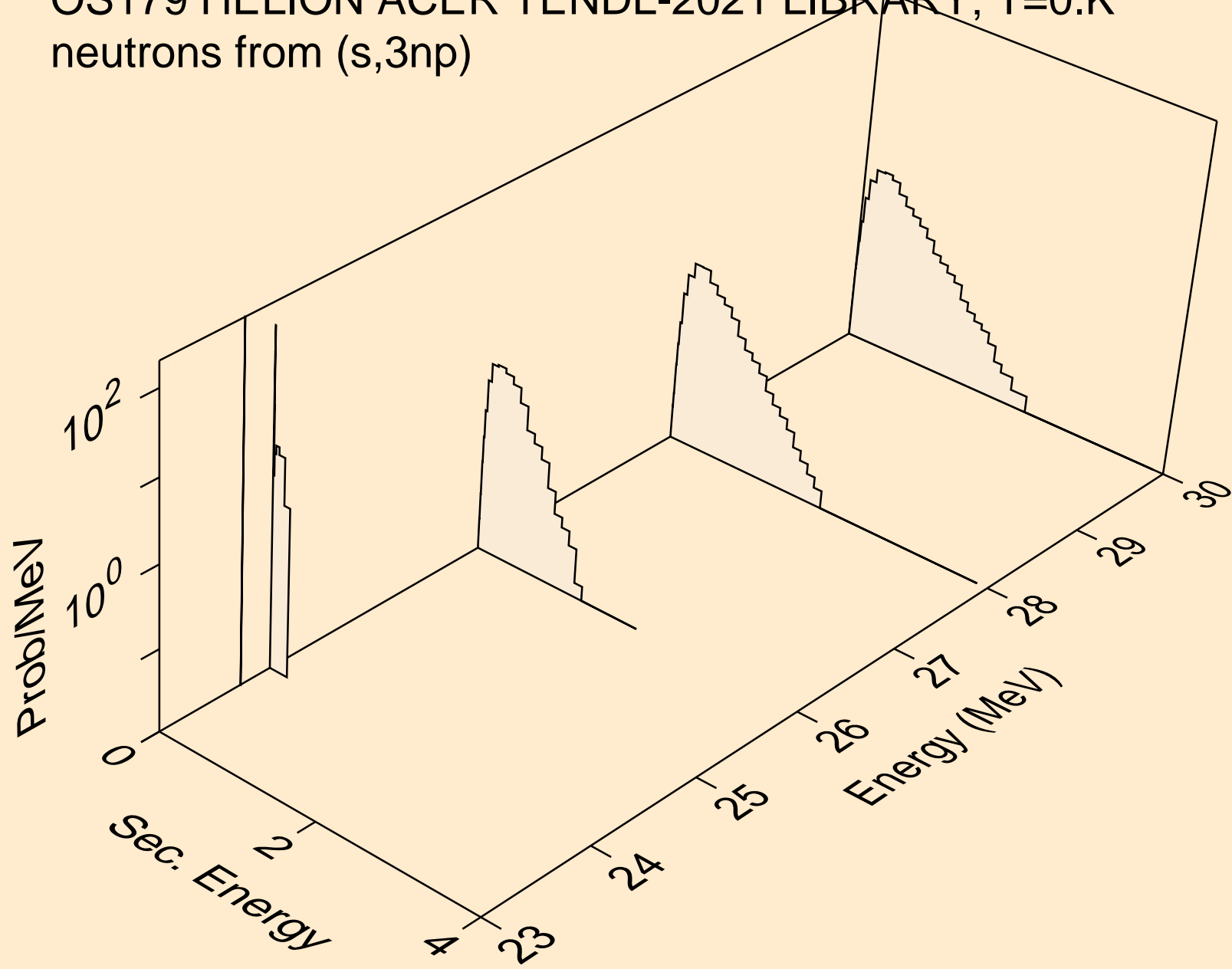

OS179 HELION ACER TENDL-2021 LIBRARY; T=0.K  
neutrons from (s,2np)

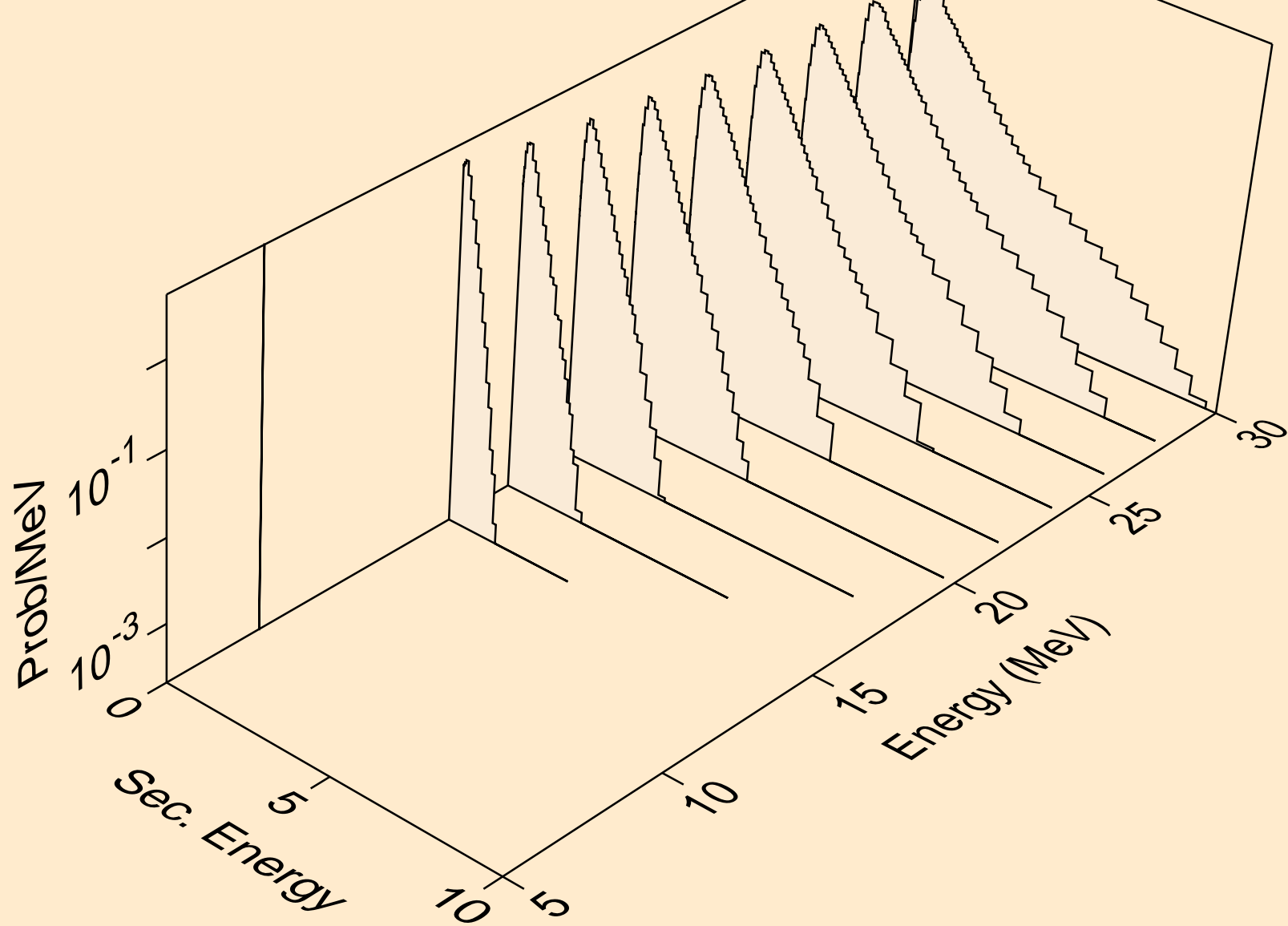

OS179 HELION ACER TENDL-2021 LIBRARY; T=0.K  
neutrons from (s,npa)

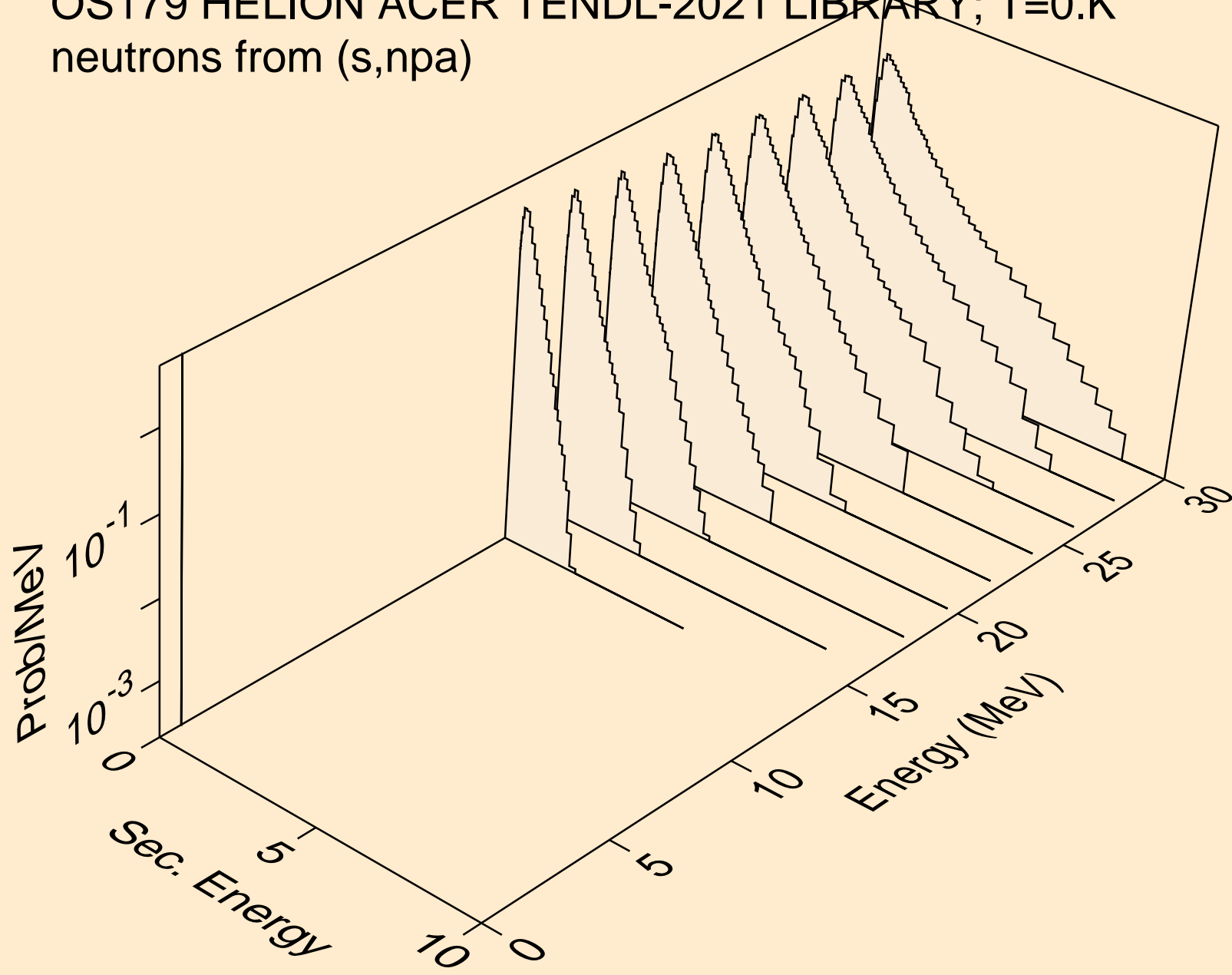

OS179 HELION ACER TENDL-2021 LIBRARY; T=0.K  
protons from (s,x)

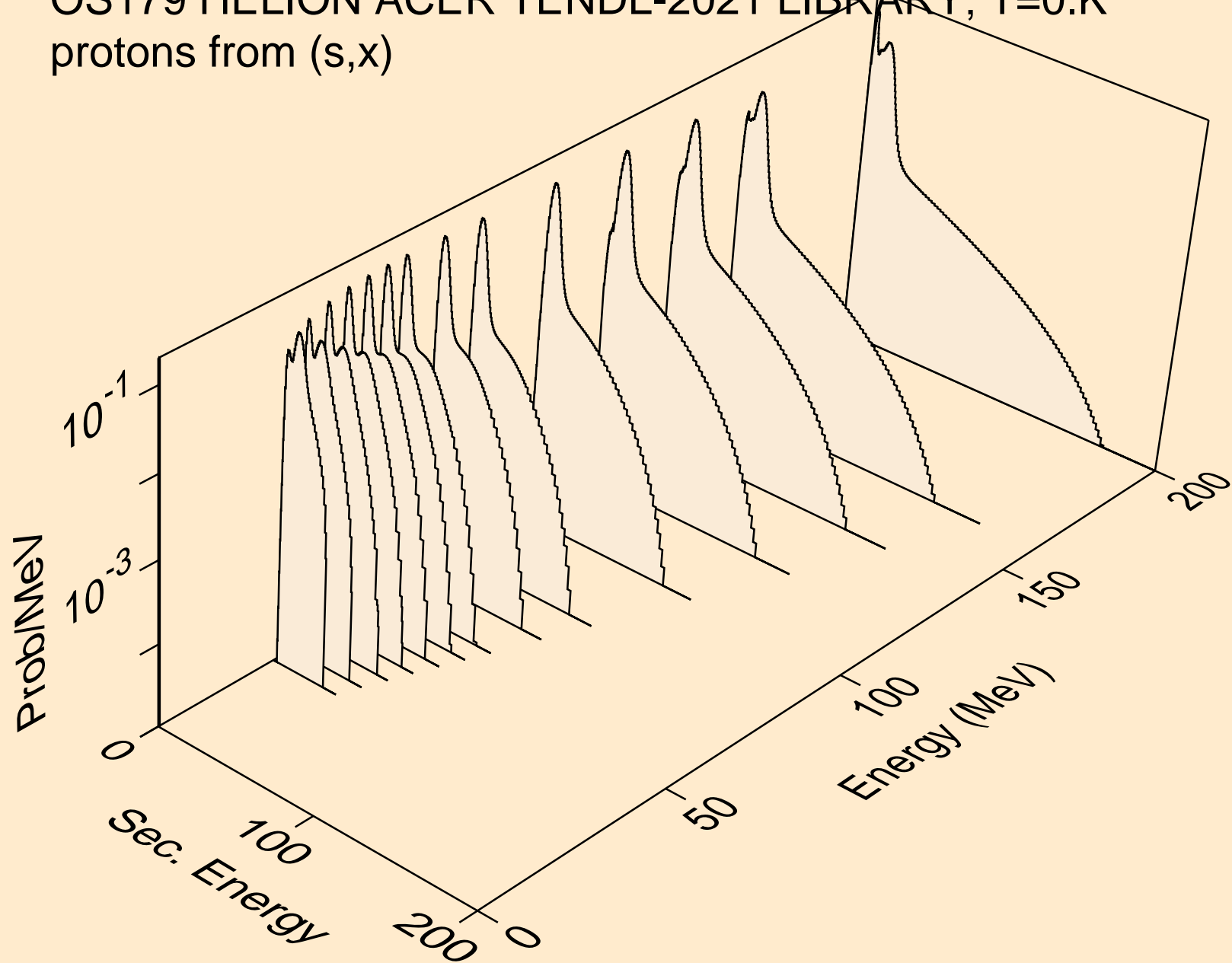

OS179 HELION ACER TENDL-2021 LIBRARY; T=0.K  
protons from (s,n\*)p

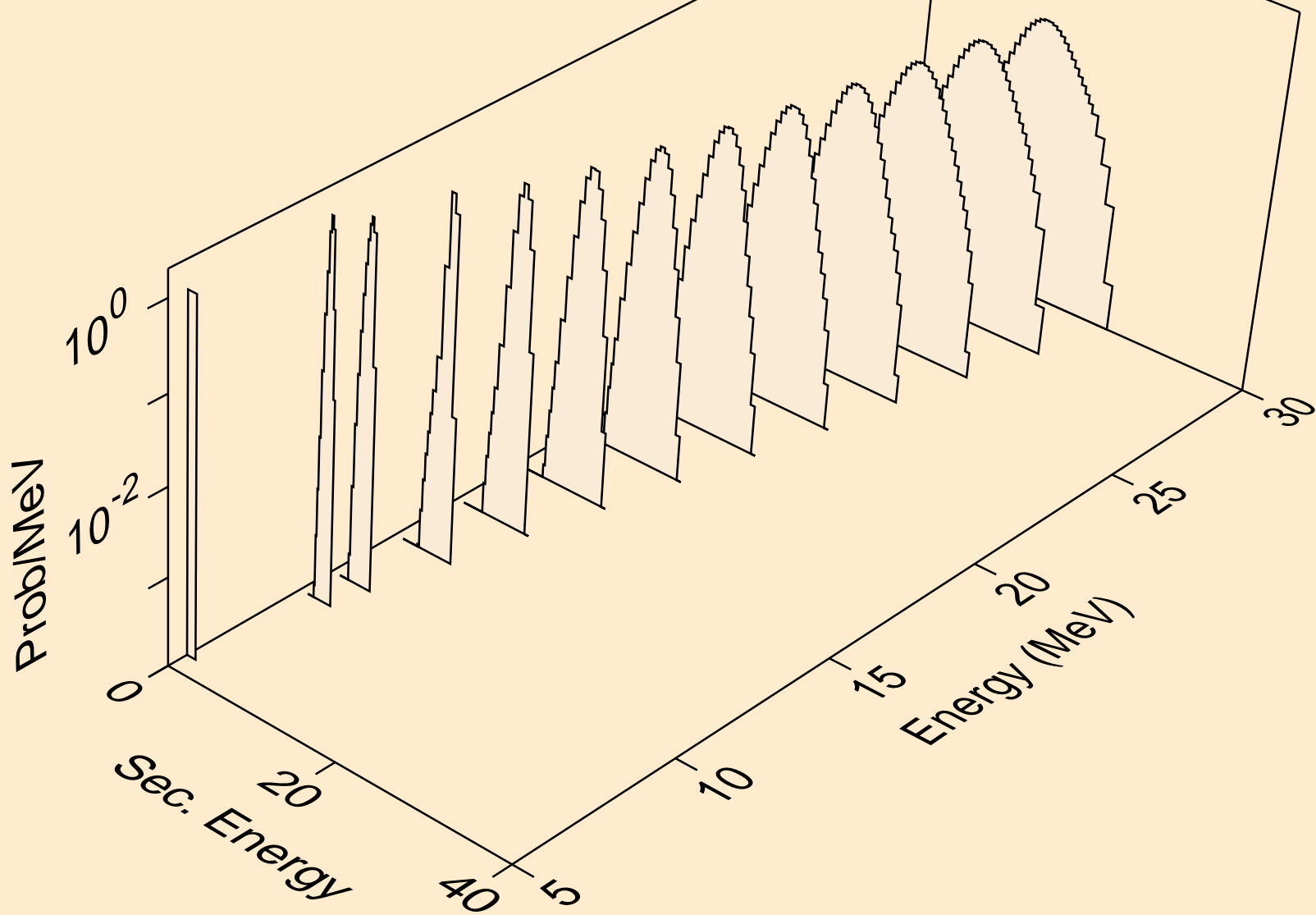

OS179 HELION ACER TENDL-2021 LIBRARY; T=0.K  
protons from (s,2np)

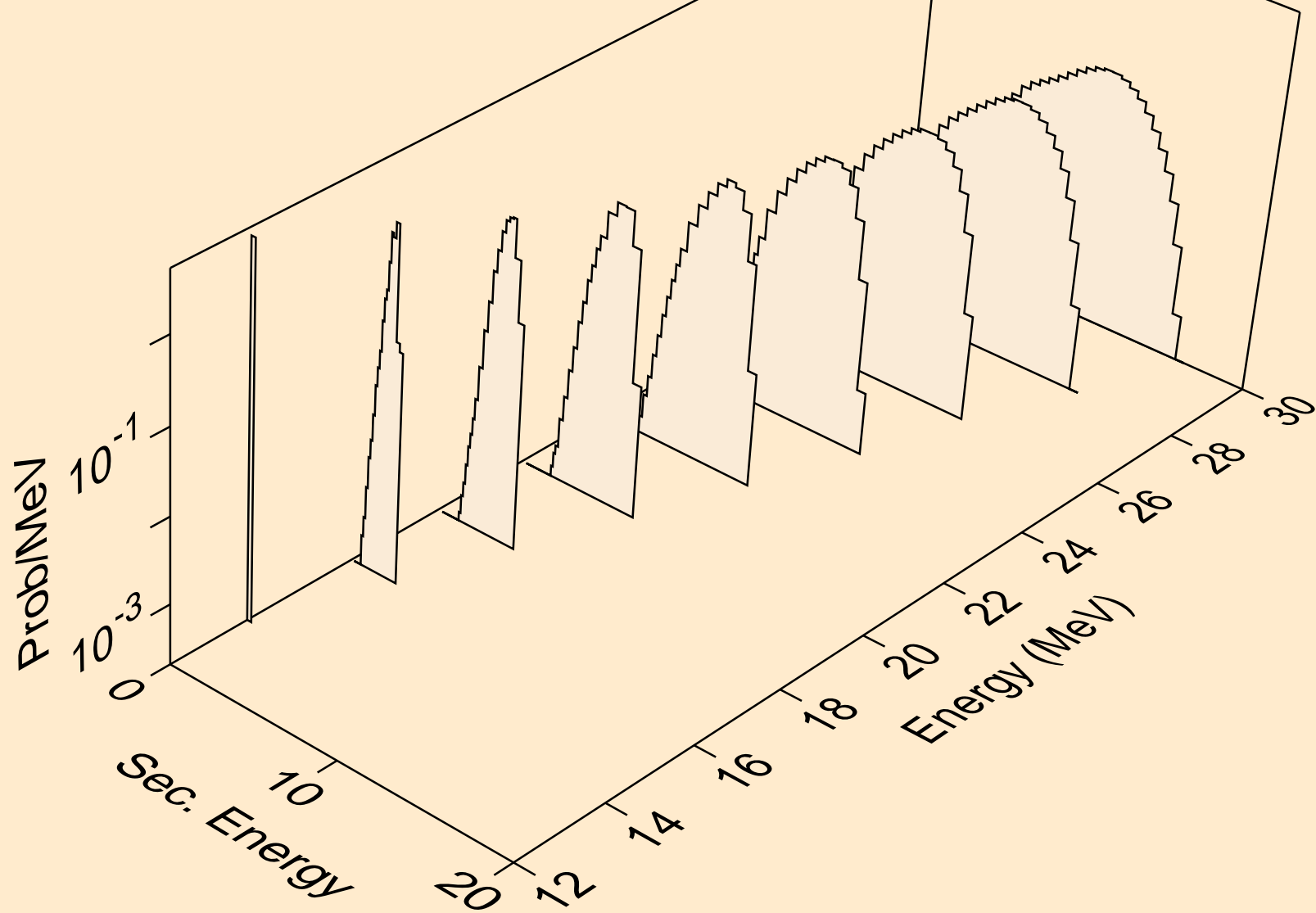

OS179 HELION ACER TENDL-2021 LIBRARY; T=0.K  
protons from (s,3np)

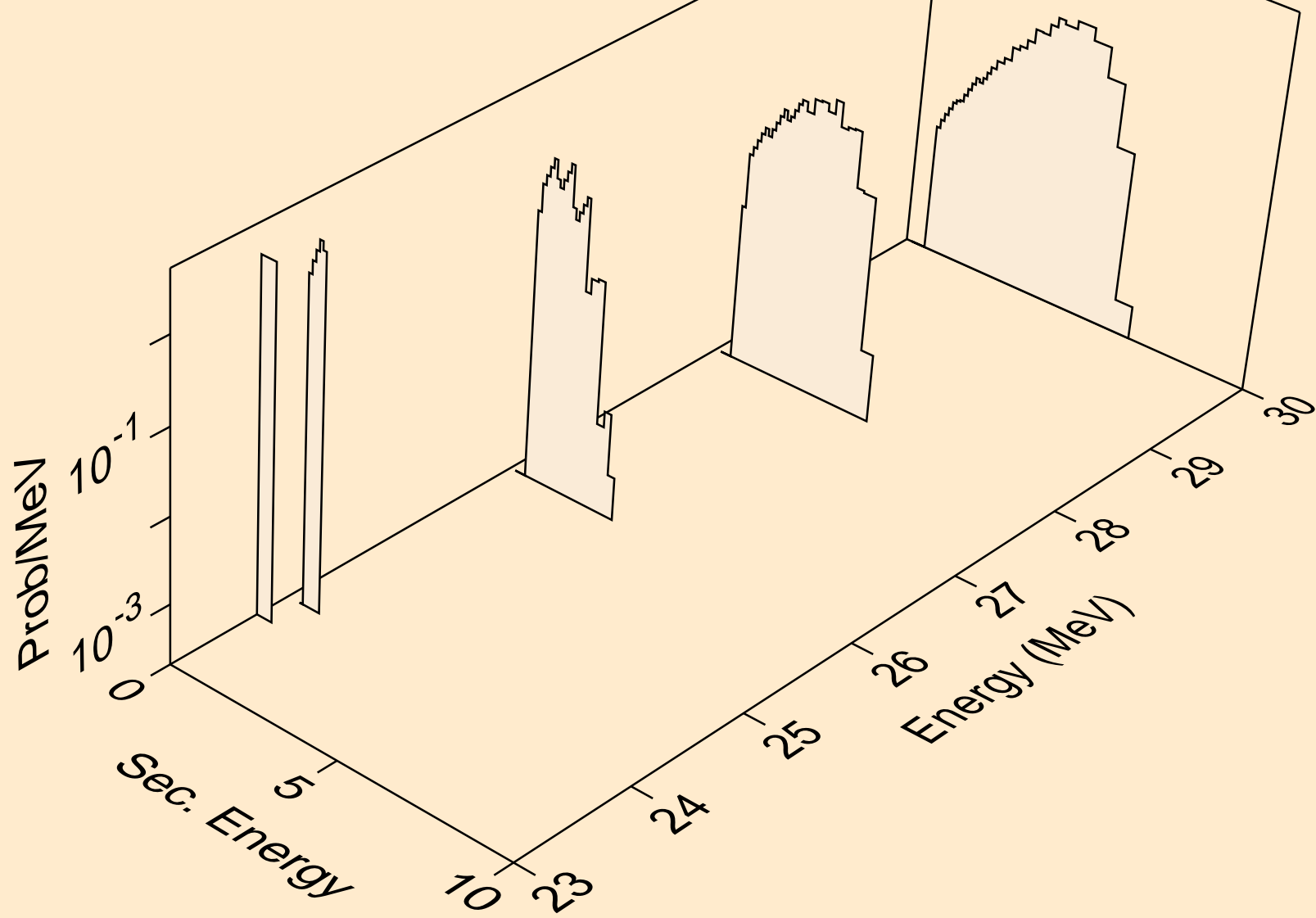



OS179 HELION ACER TENDL-2021 LIBRARY; T=0.K  
protons from (s,2np)

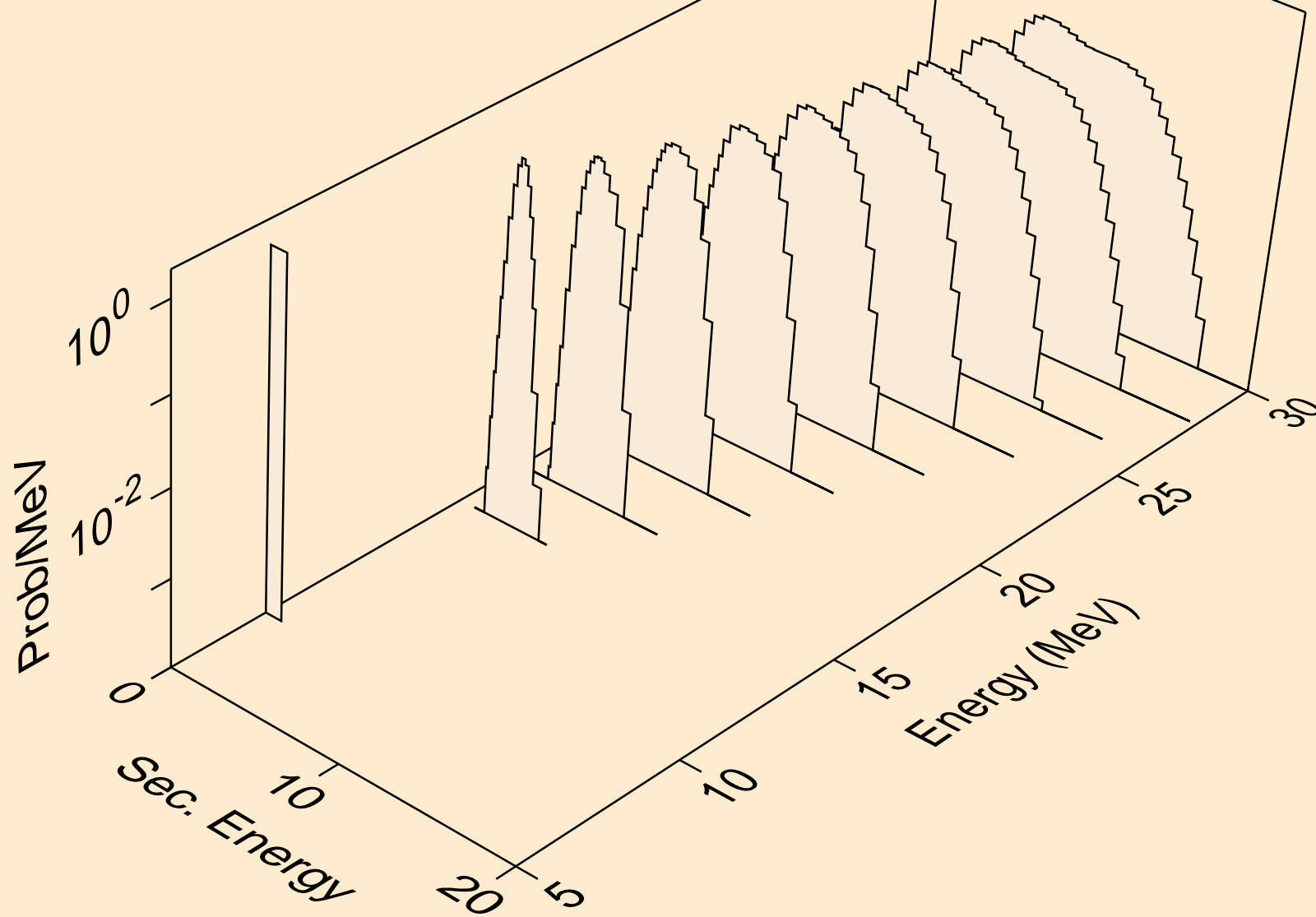

OS179 HELION ACER TENDL-2021 LIBRARY; T=0.K  
protons from (s,npa)

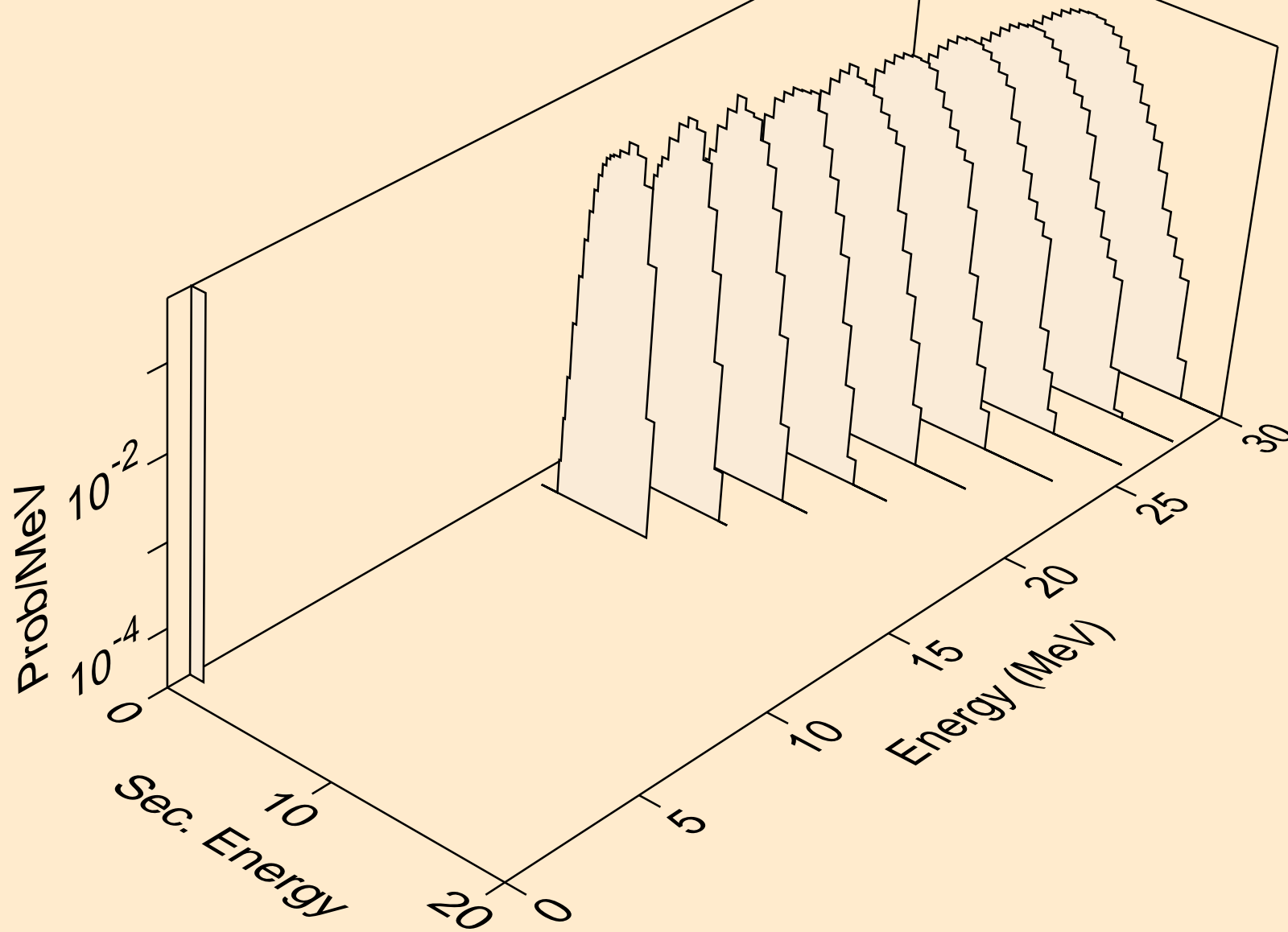

OS179 HELION ACER TENDL-2021 LIBRARY; T=0.K  
protons from (s,p)

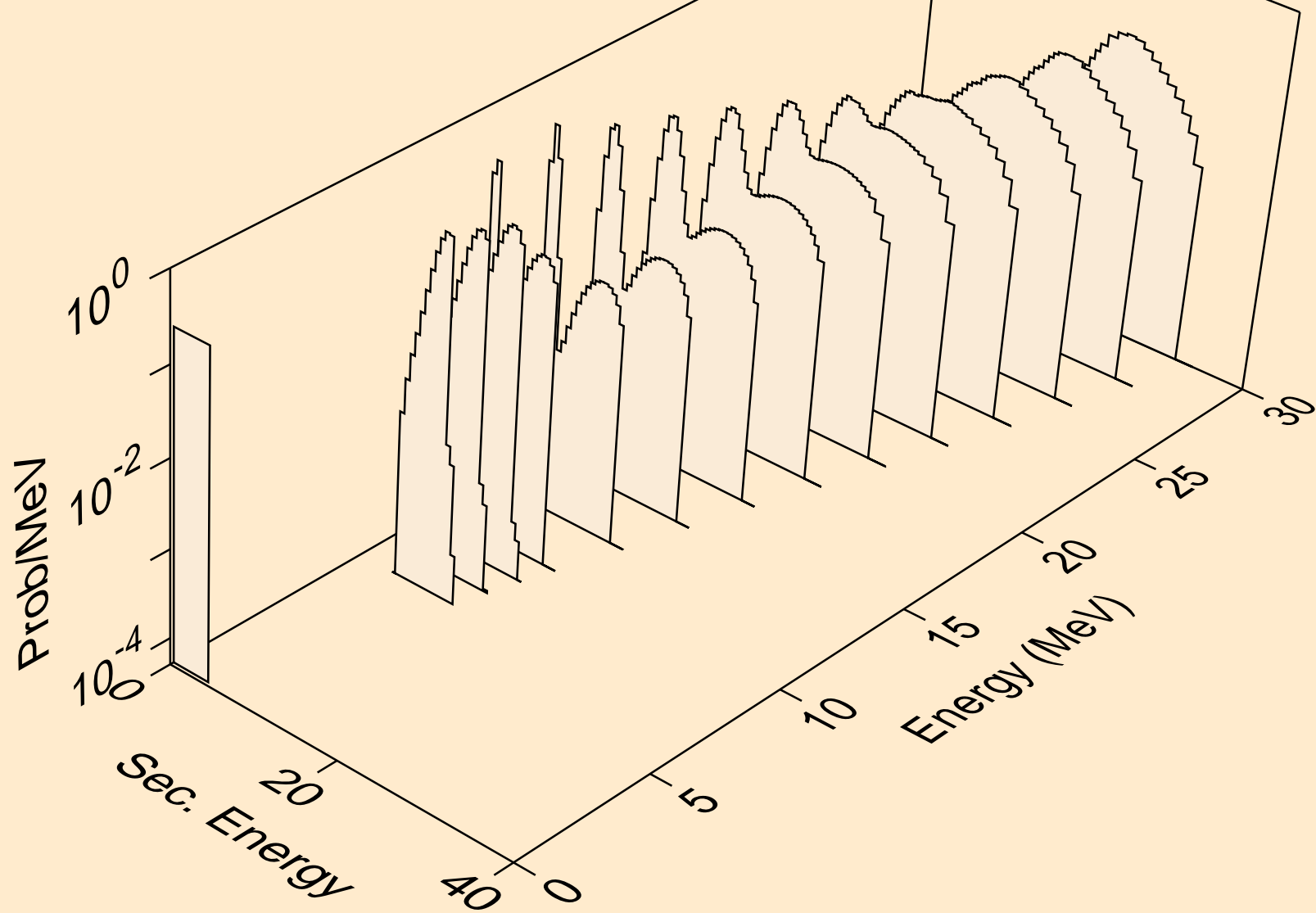

OS179 HELION ACER TENDL-2021 LIBRARY; T=0.K  
protons from (s,2p)

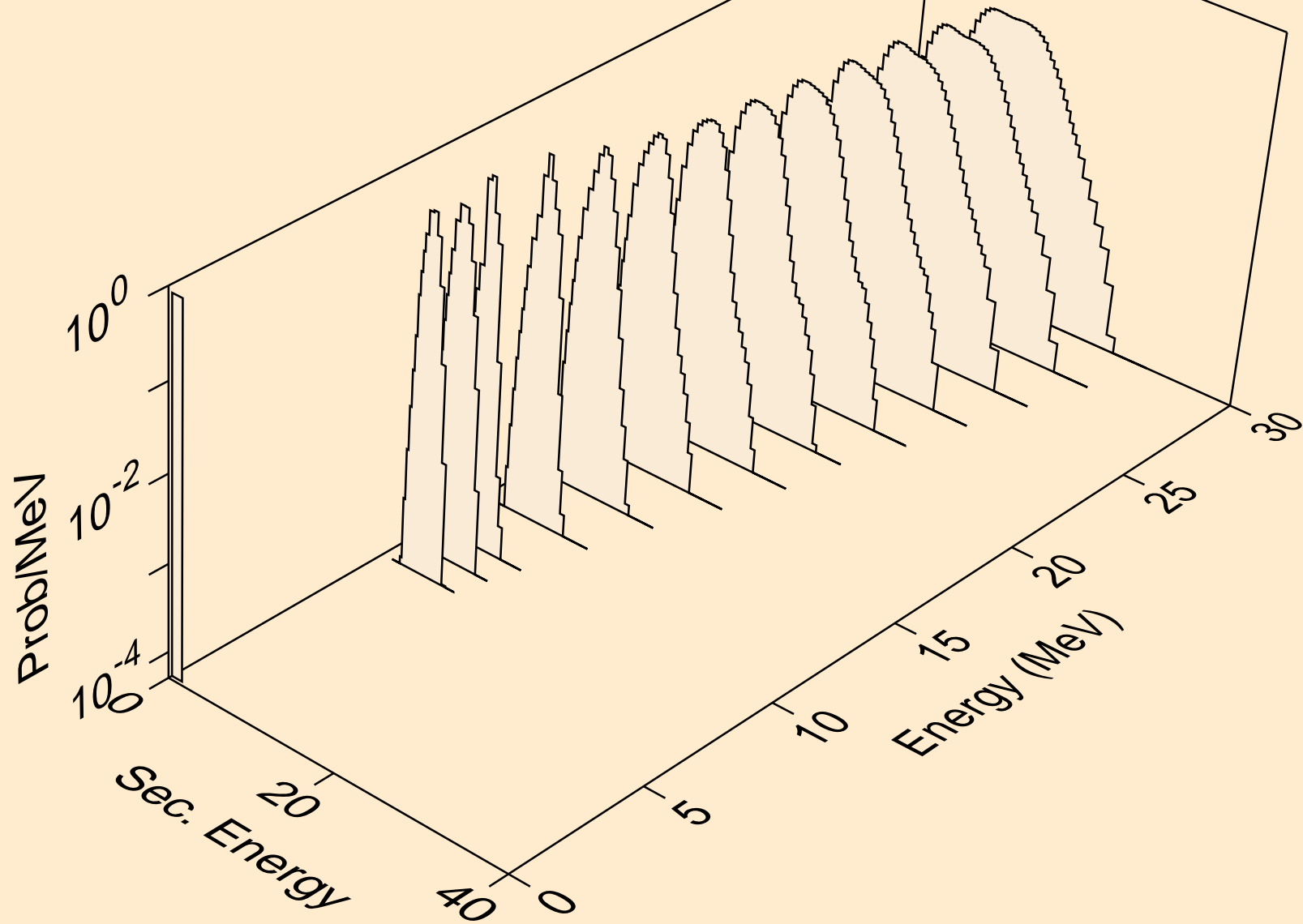

OS179 HELION ACER TENDL-2021 LIBRARY; T=0.K  
protons from (s,pa)

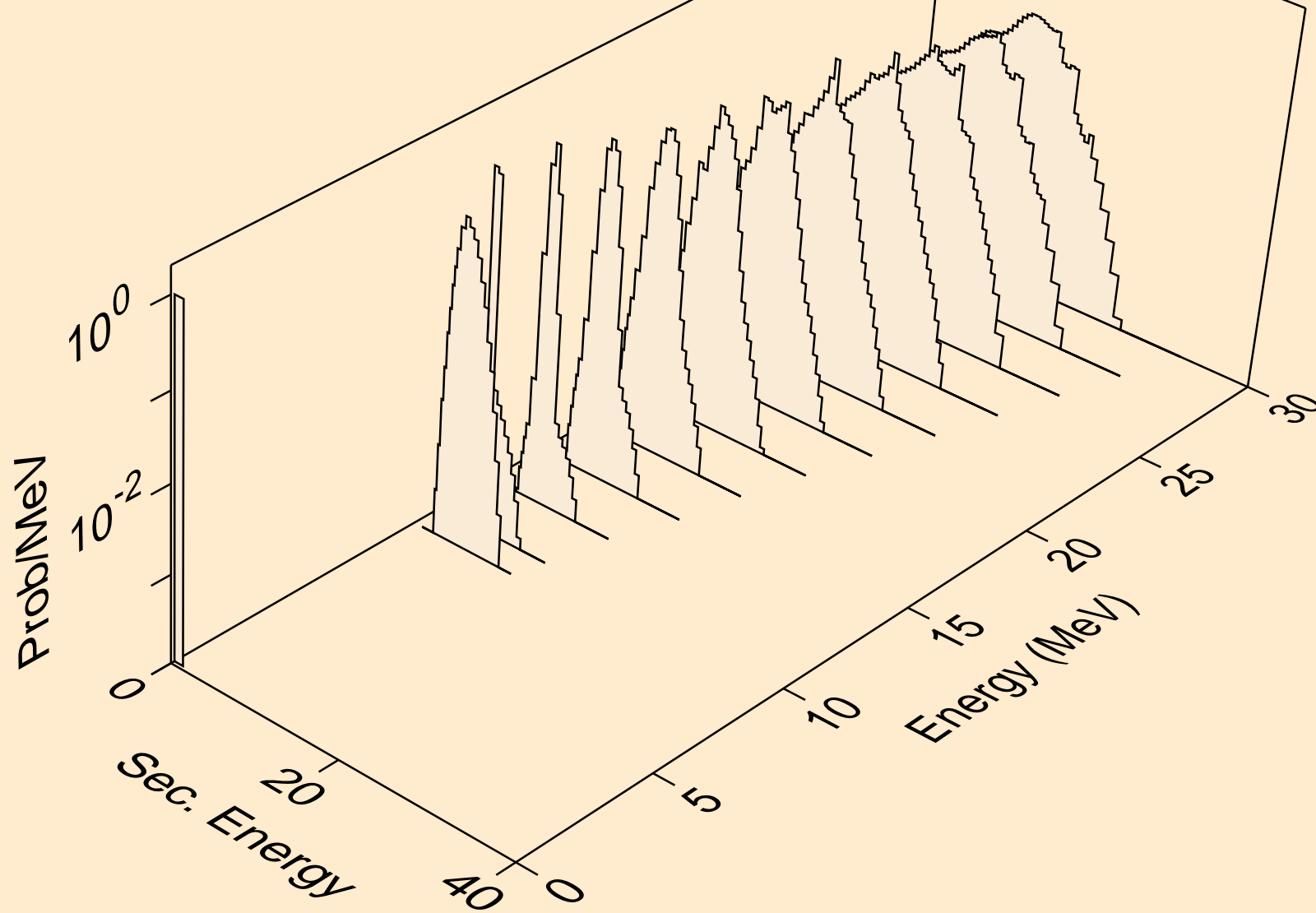

OS179 HELION ACER TENDL-2021 LIBRARY; T=0.K  
protons from (s,pd)

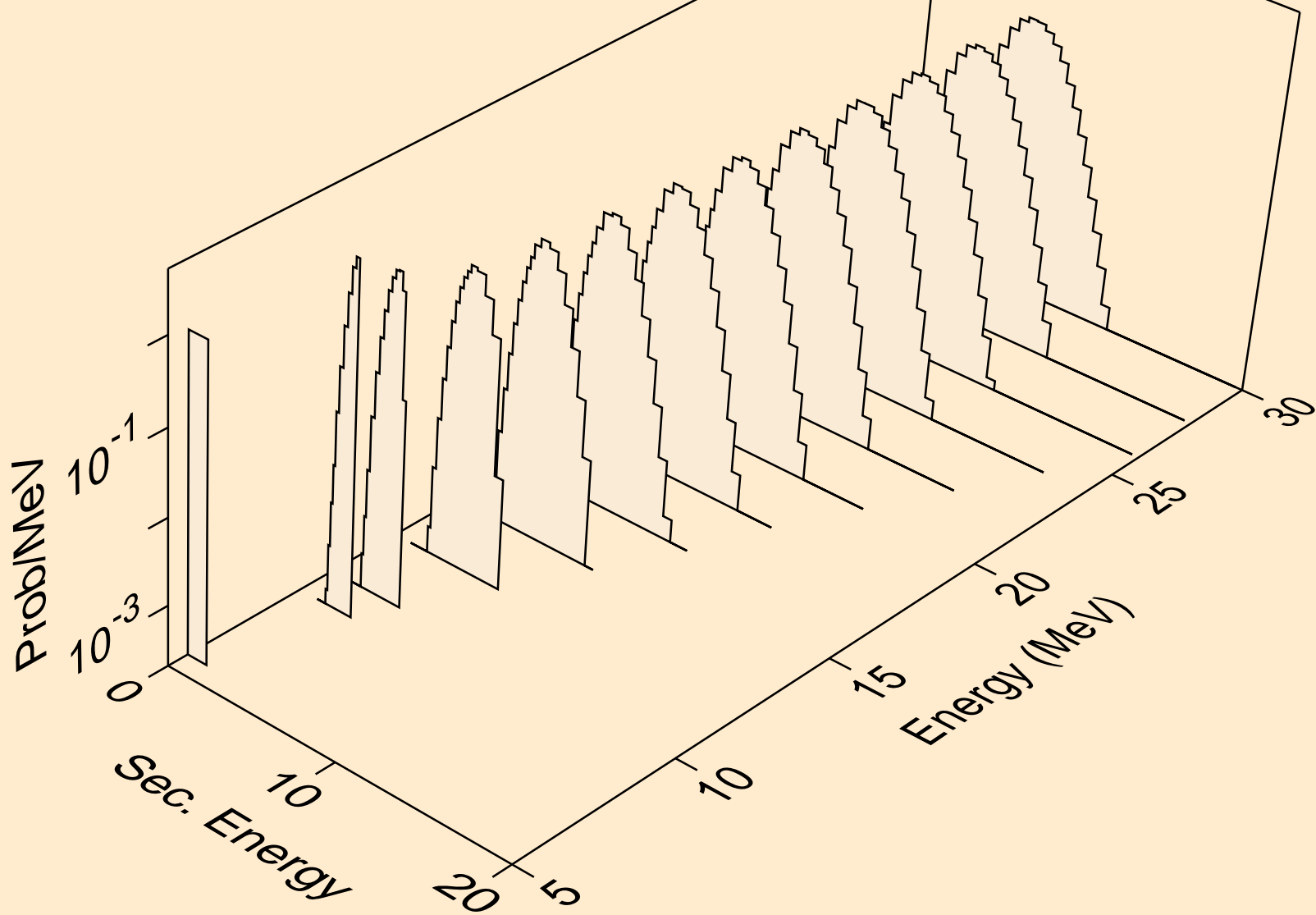

OS179 HELION ACER TENDL-2021 LIBRARY; T=0.K  
protons from (s,pt)

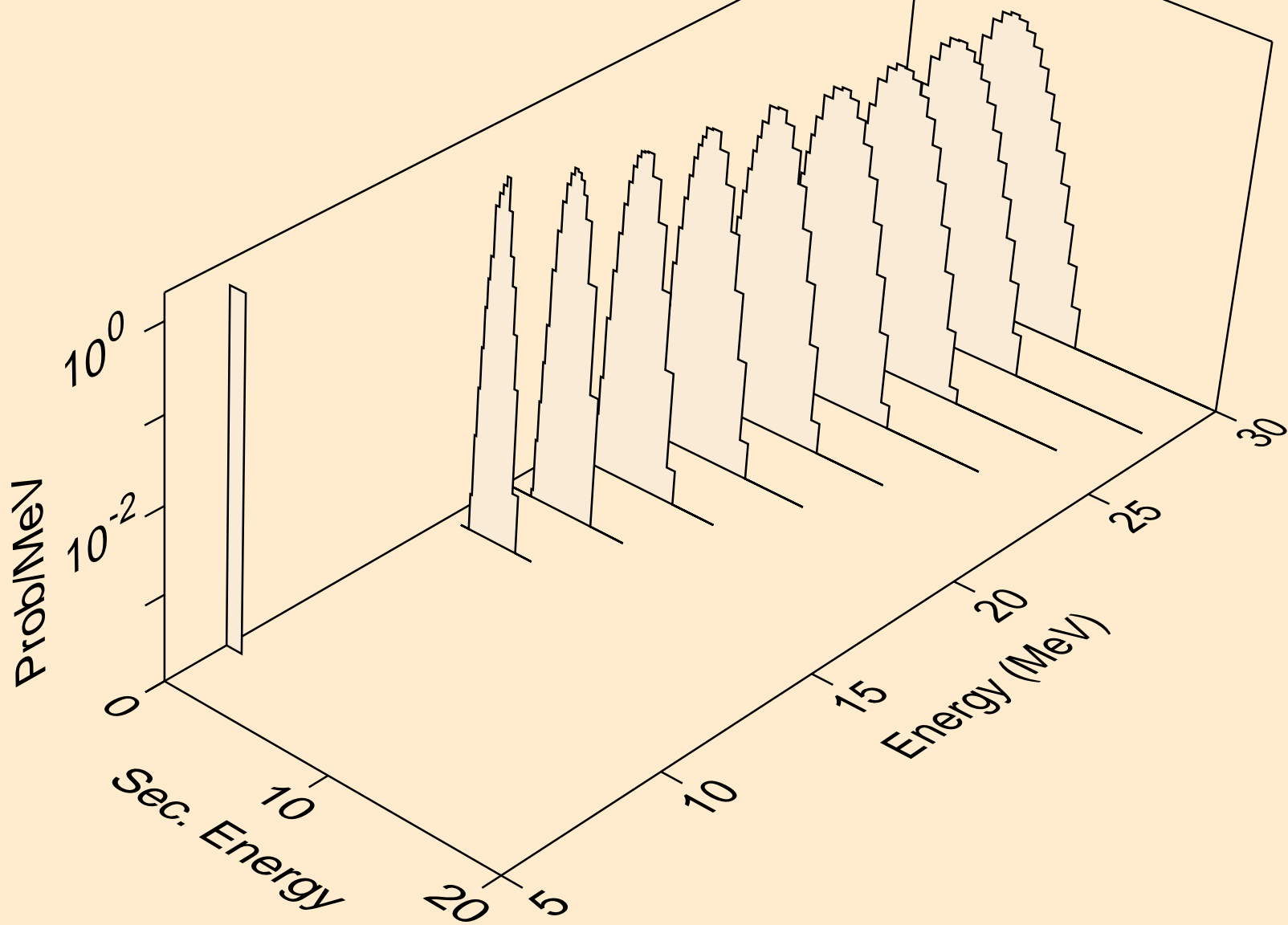

OS179 HELION ACER TENDL-2021 LIBRARY; T=0.K  
deuterons from (s,x)

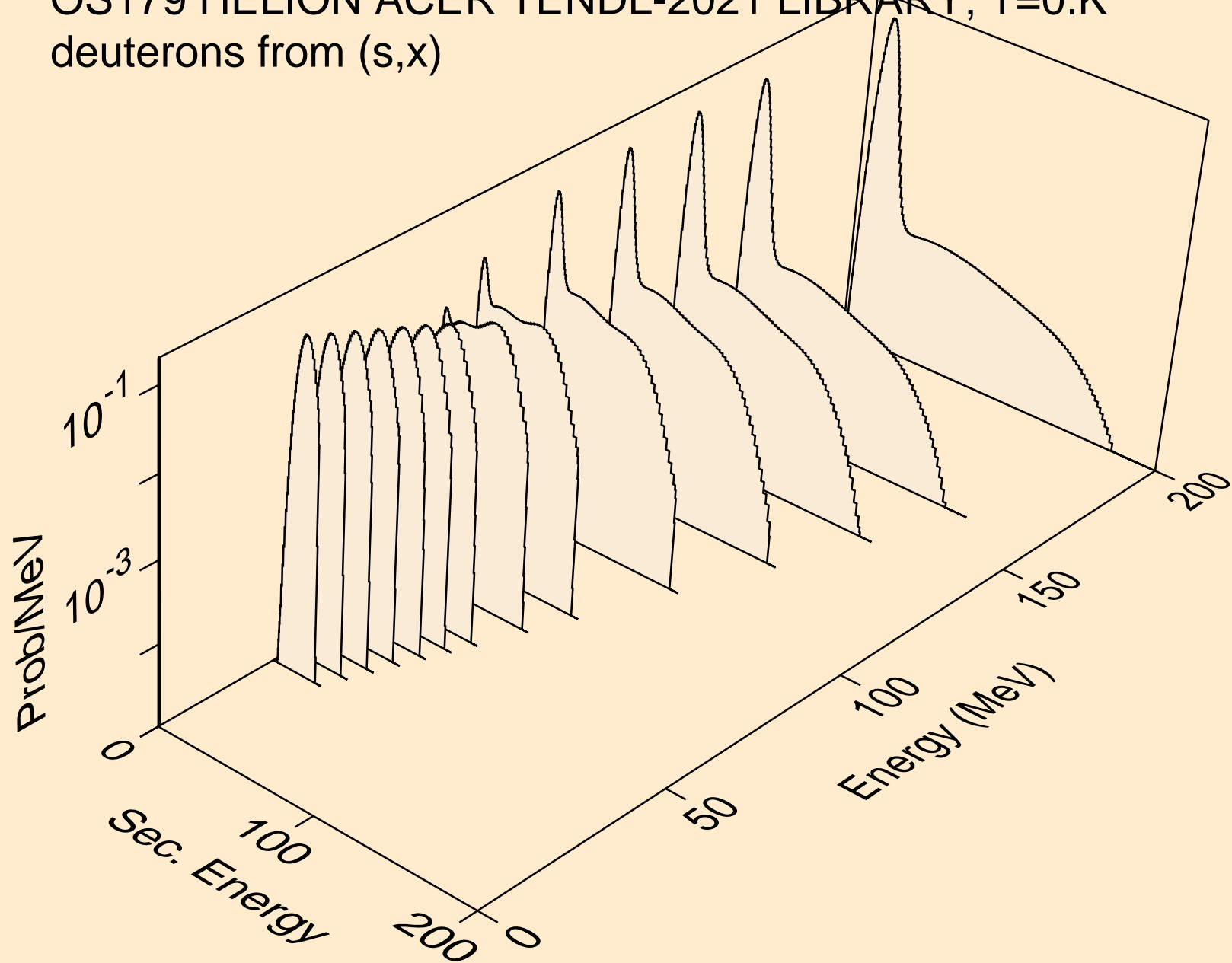



OS179 HELION ACER TENDL-2021 LIBRARY; T=0.K  
deuterons from (s,2nd)

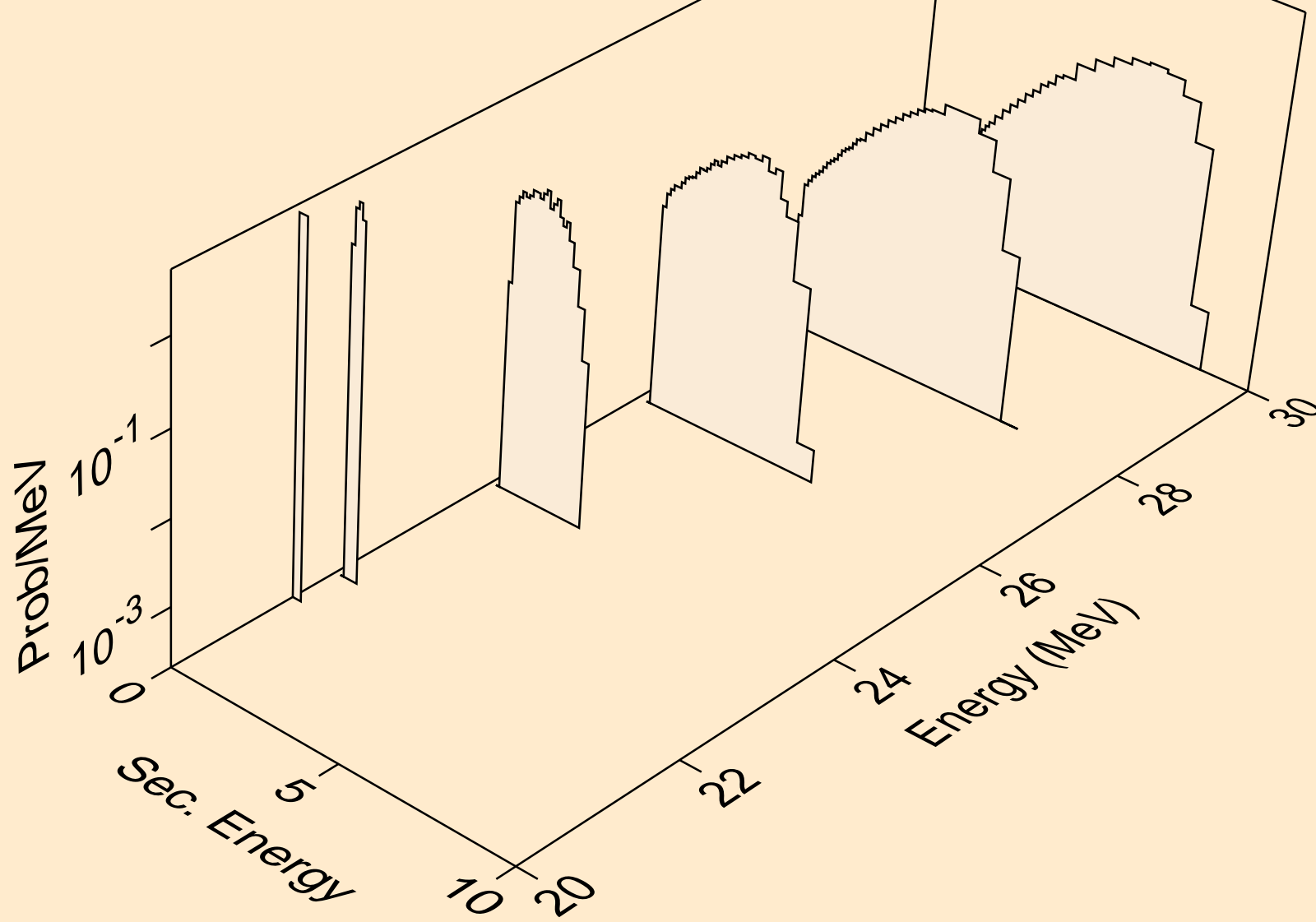

OS179 HELION ACER TENDL-2021 LIBRARY; T=0.K  
deuterons from (s,n\*)d

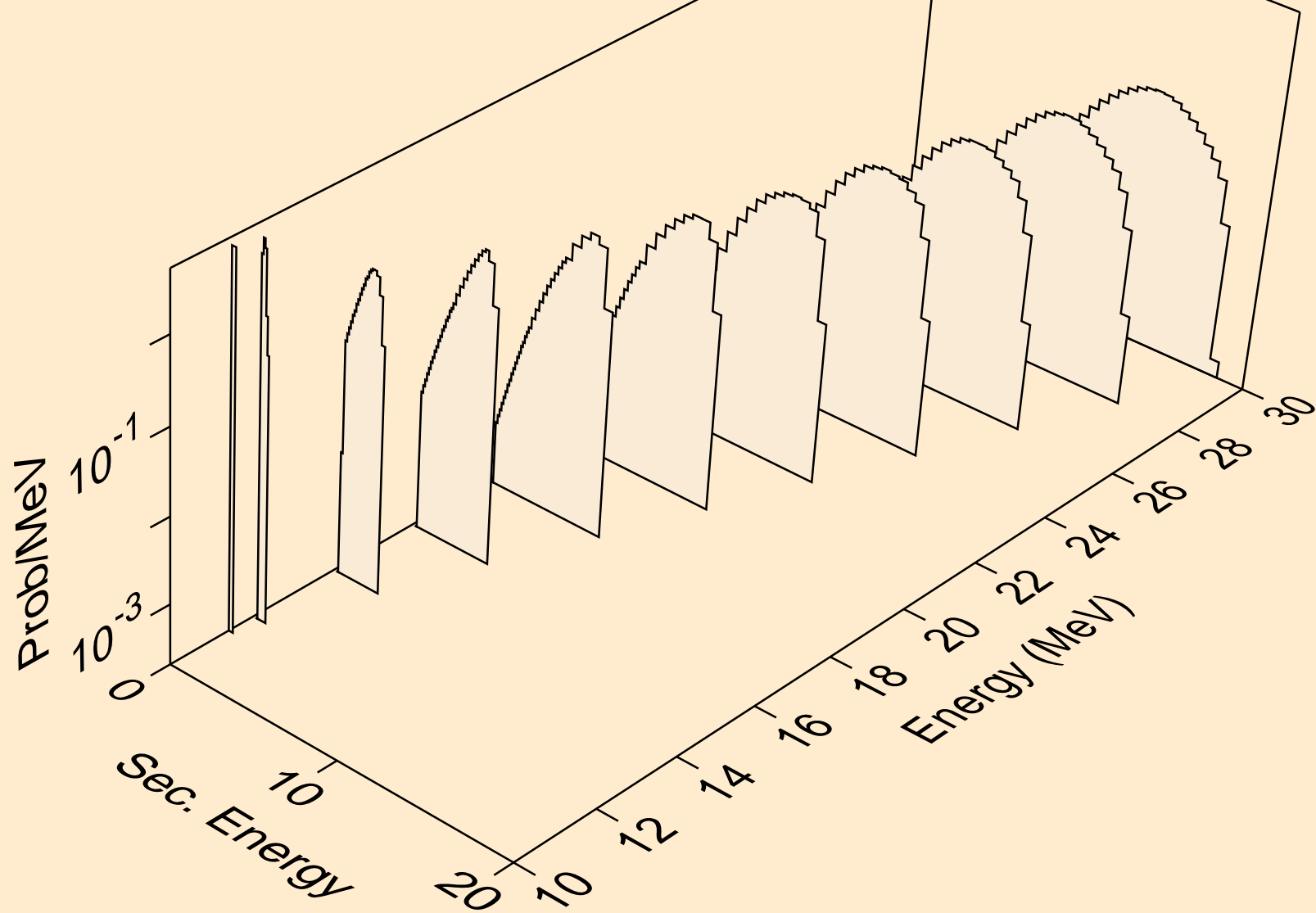

OS179 HELION ACER TENDL-2021 LIBRARY; T=0.K  
deuterons from (s,d)

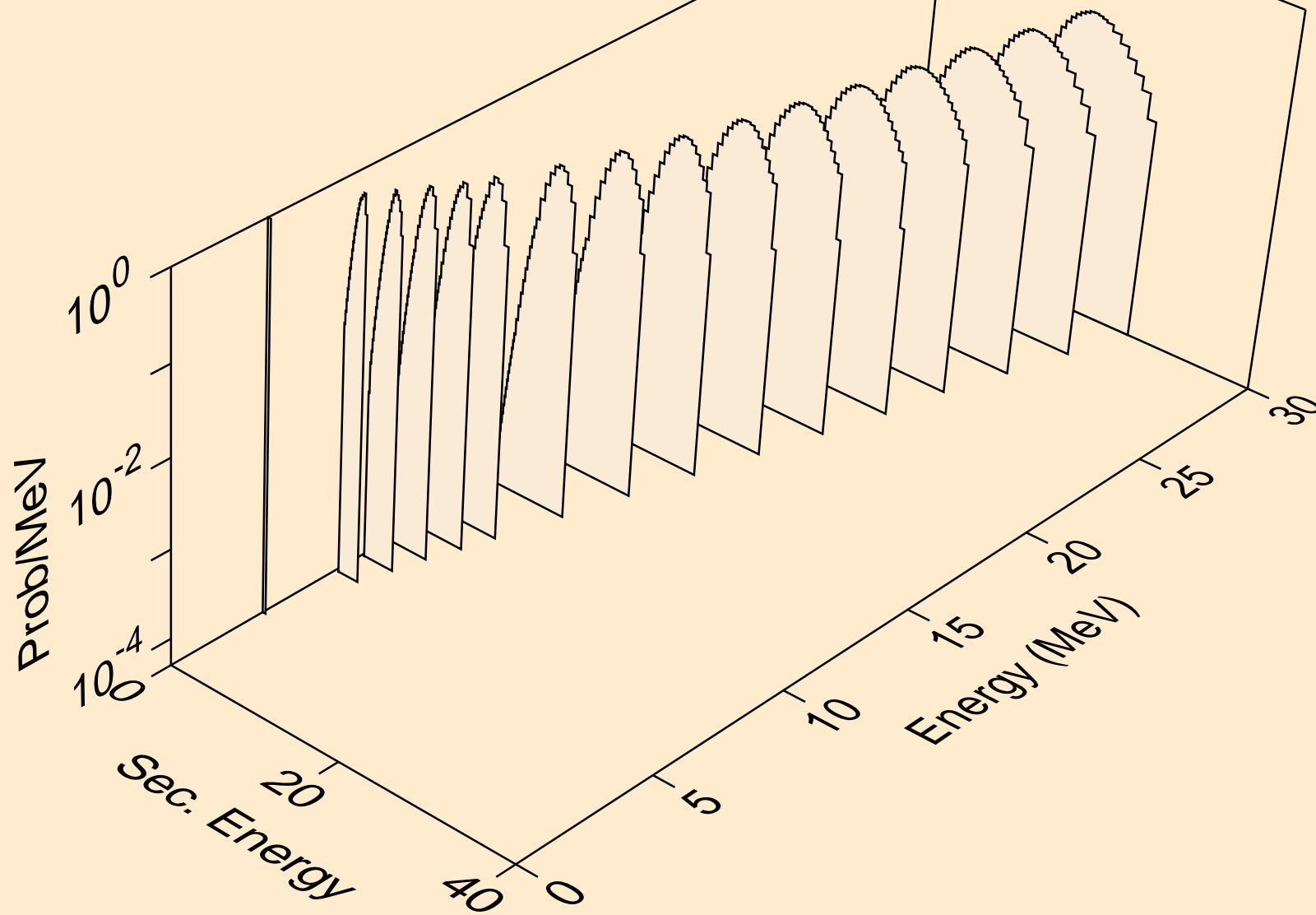

OS179 HELION ACER TENDL-2021 LIBRARY; T=0.K  
deuterons from (s,pd)

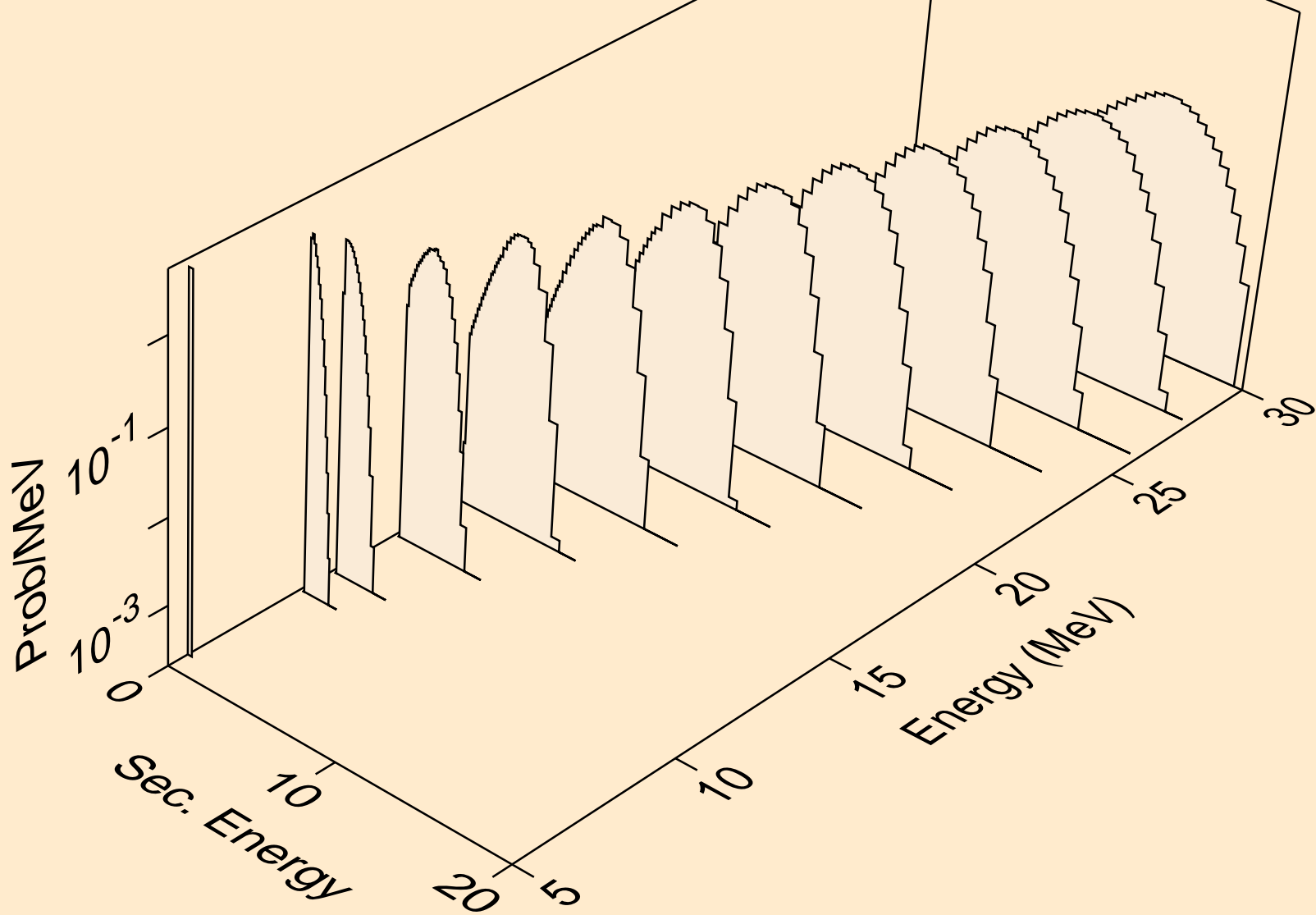

OS179 HELION ACER TENDL-2021 LIBRARY; T=0.K  
deuterons from (s,da)

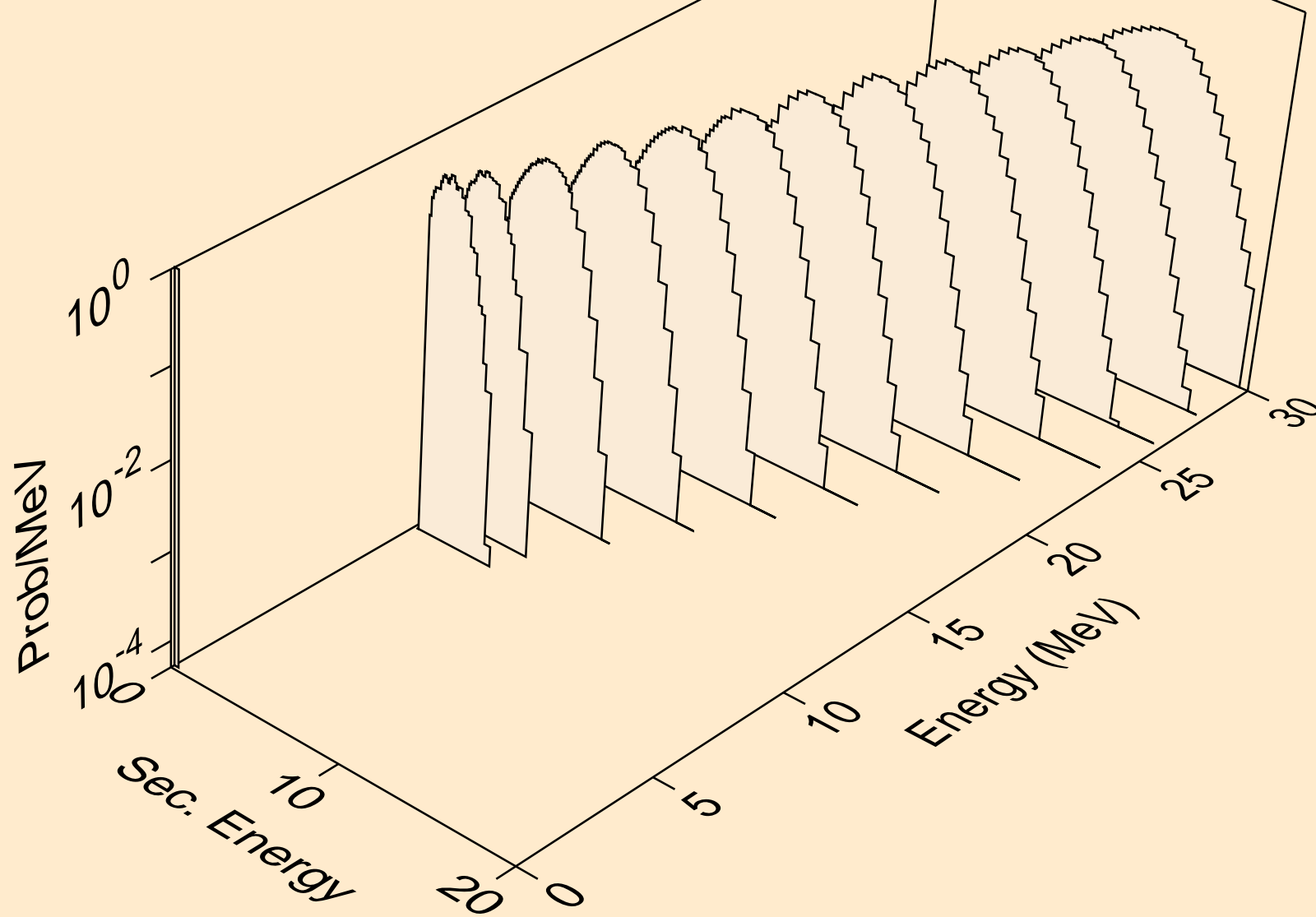

OS179 HELION ACER TENDL-2021 LIBRARY; T=0.K  
tritons from (s,x)

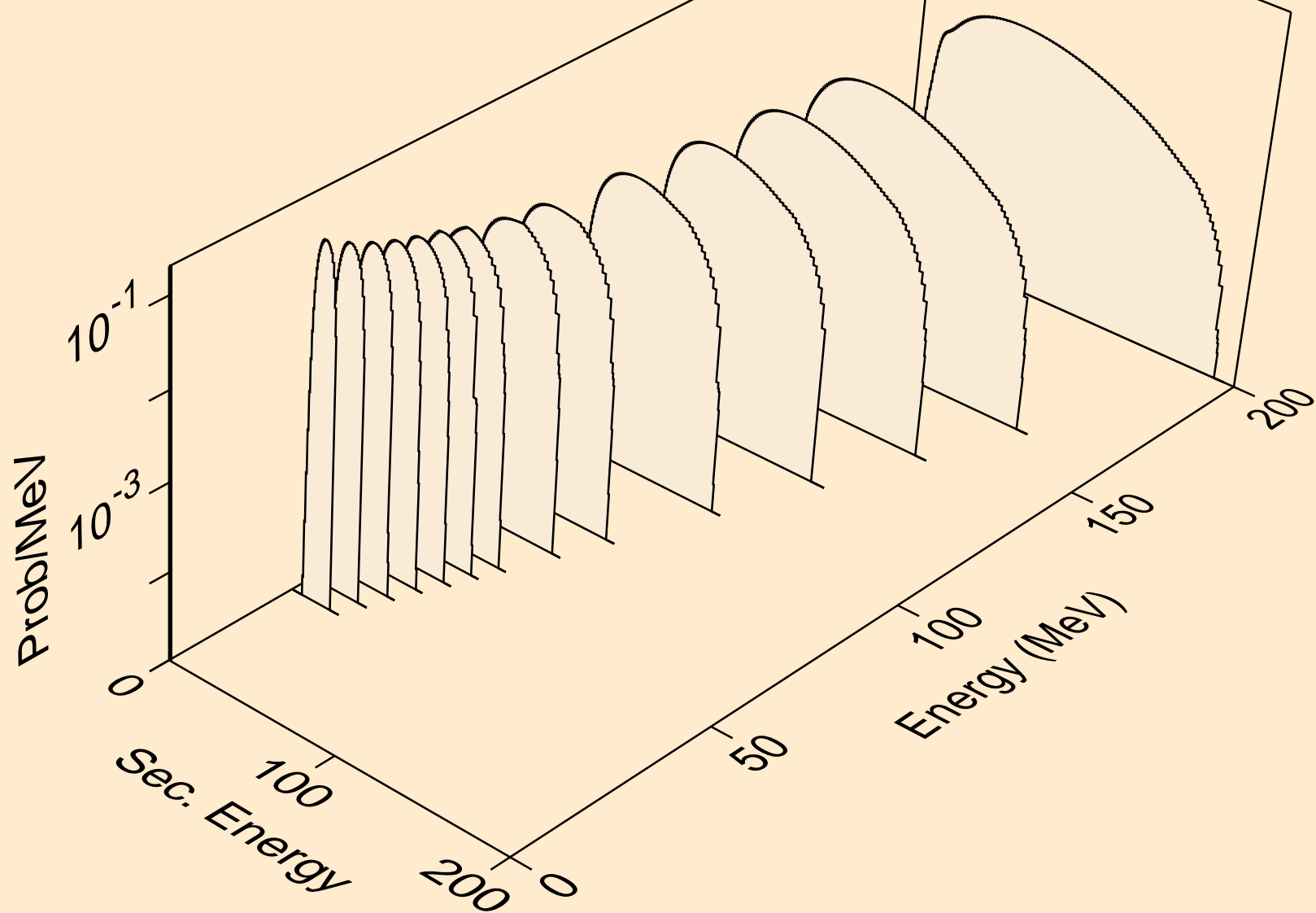

OS179 HELION ACER TENDL-2021 LIBRARY; T=0.K  
tritons from (s,n\*)t

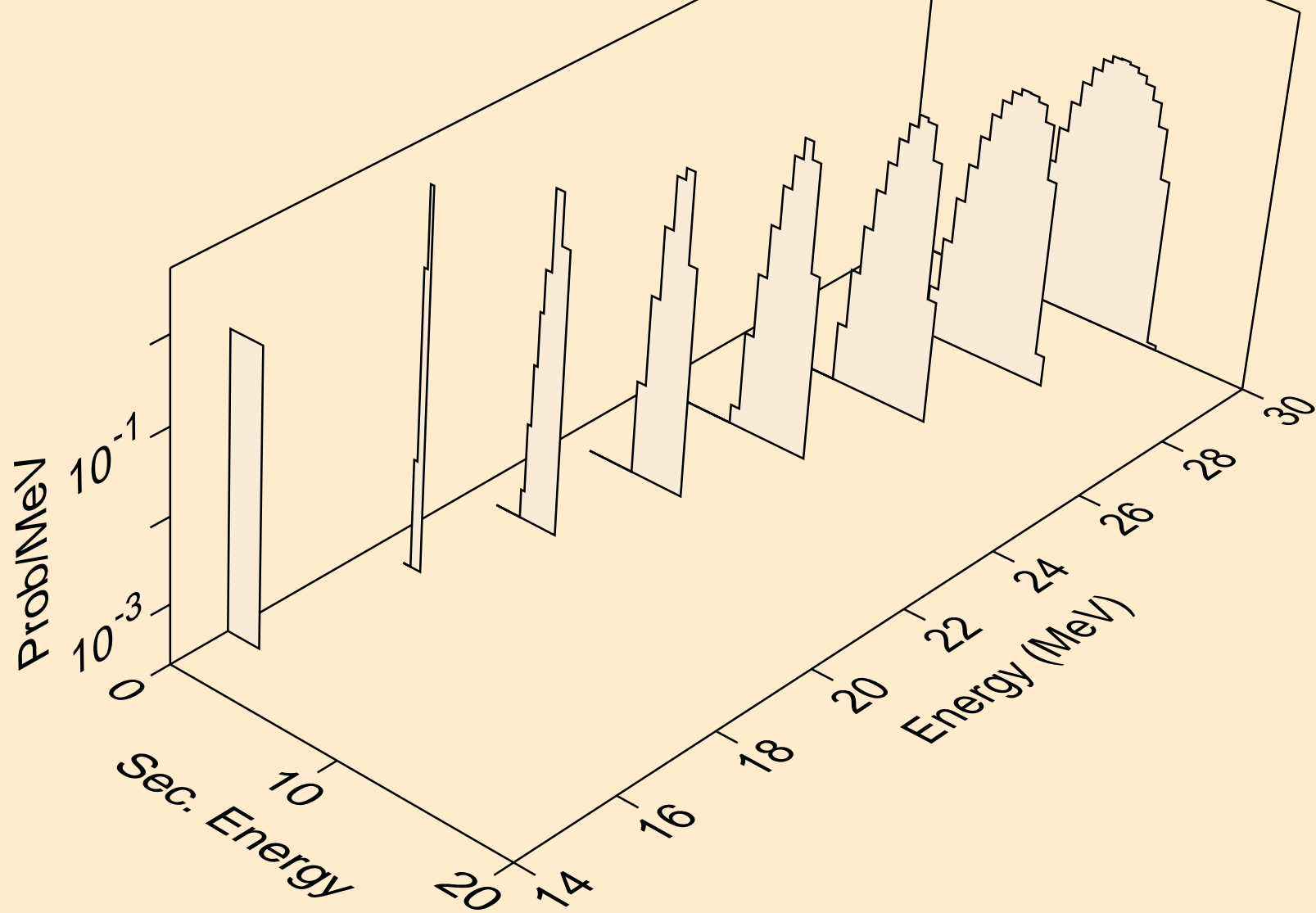

OS179 HELION ACER TENDL-2021 LIBRARY; T=0.K  
tritons from (s,t)

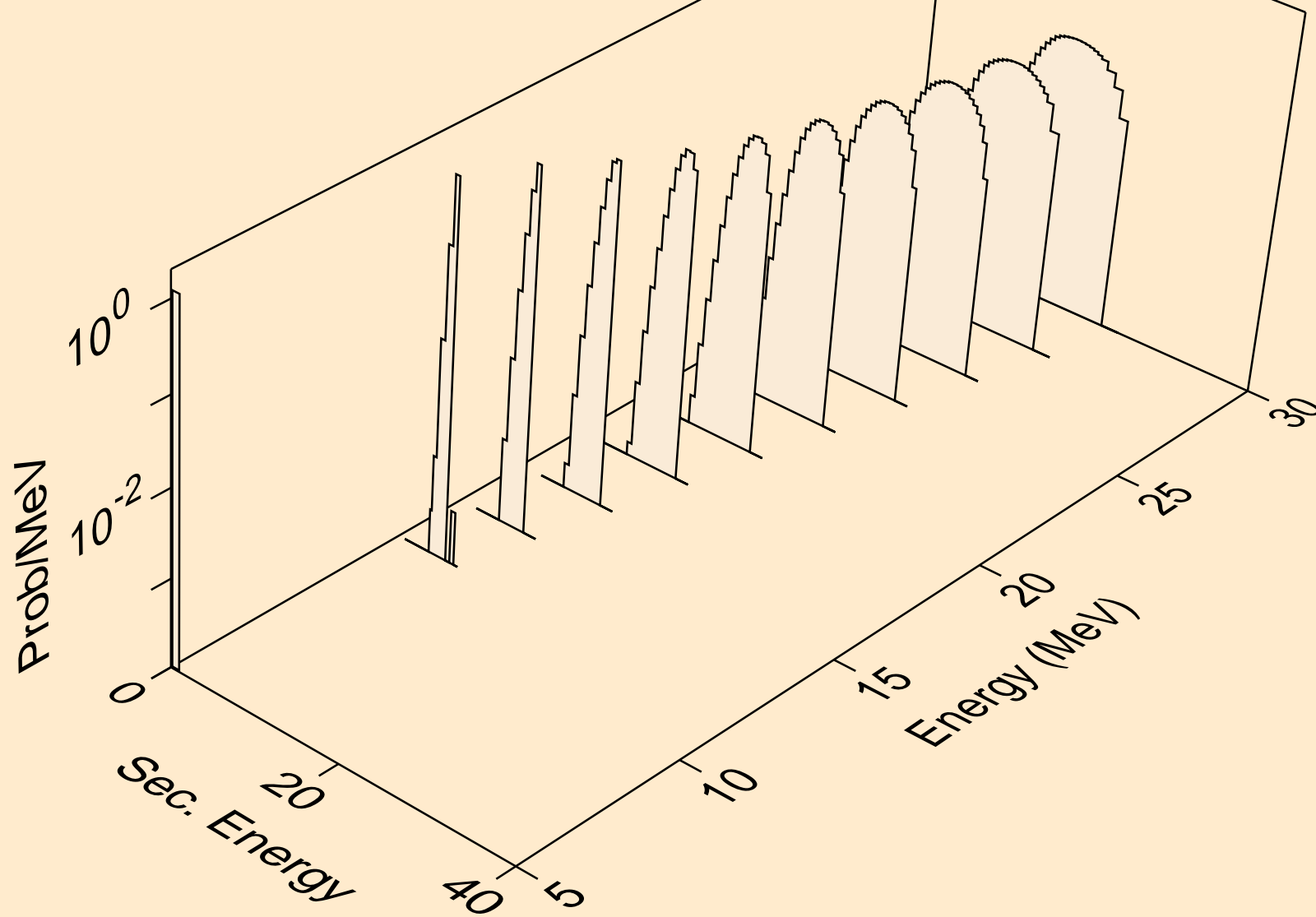



OS179 HELION ACER TENDL-2021 LIBRARY; T=0.K  
tritons from (s,pt)

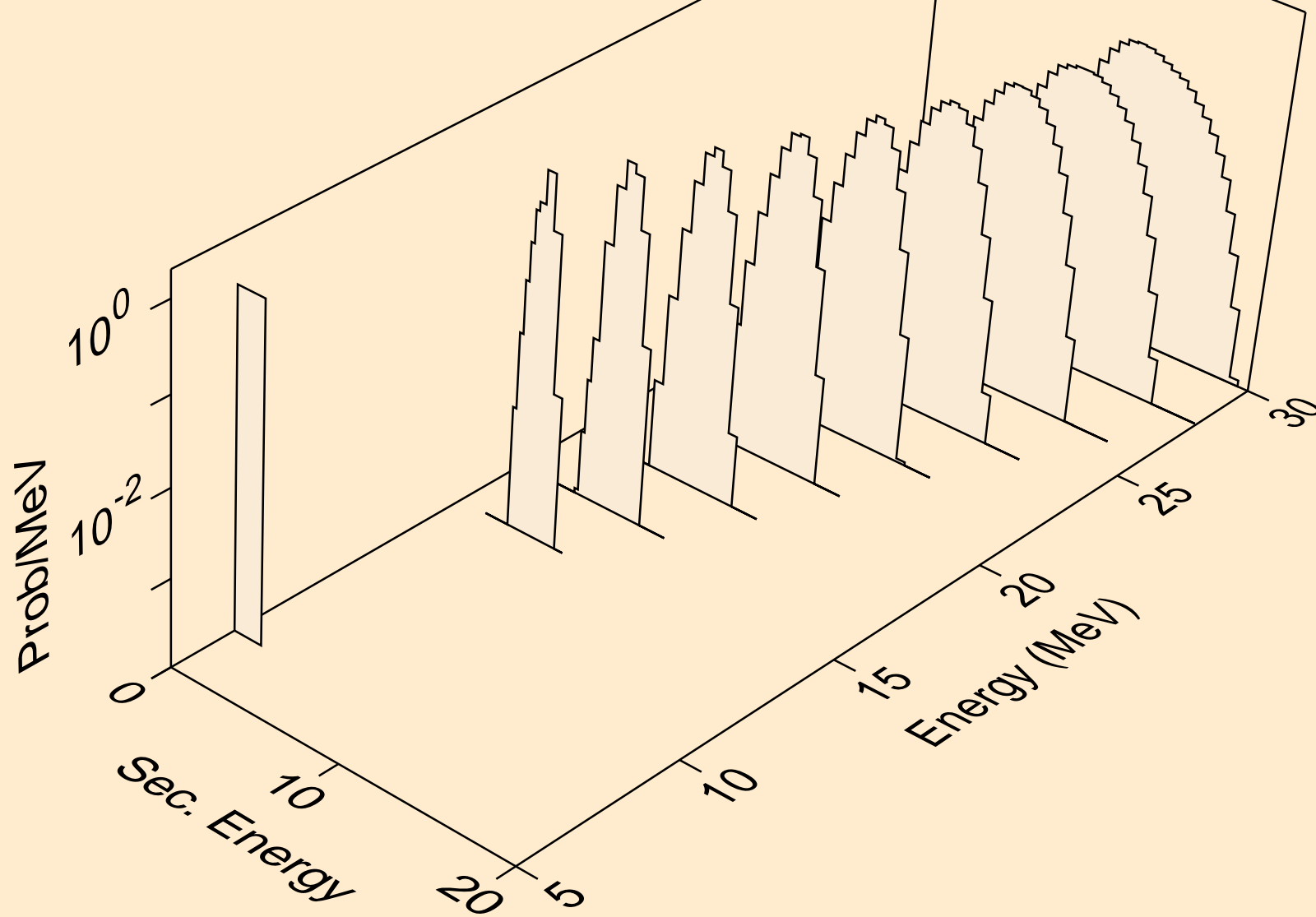

OS179 HELION ACER TENDL-2021 LIBRARY; T=0.K  
alphas from (s,x)

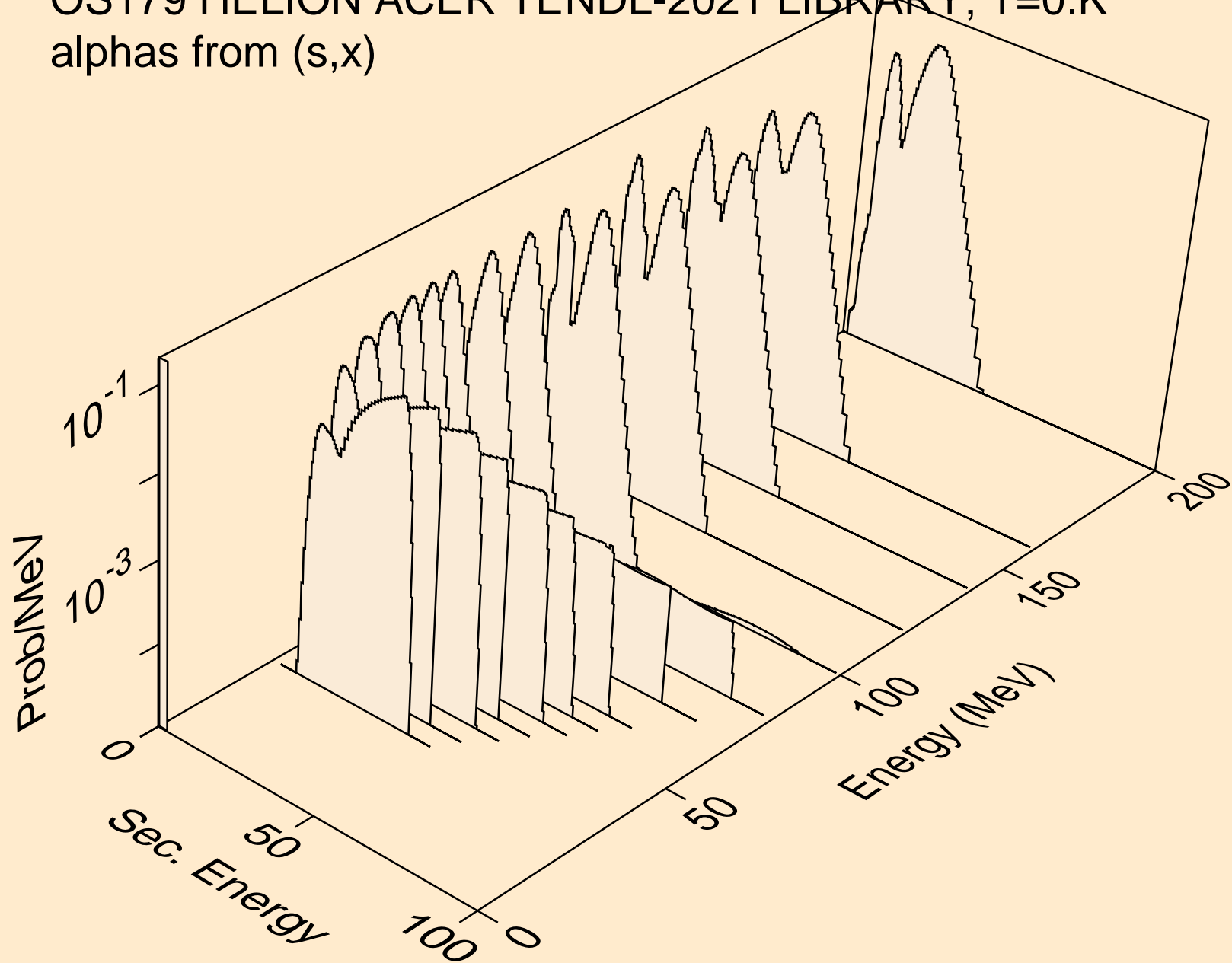

OS179 HELION ACER TENDL-2021 LIBRARY; T=0.K  
alphas from (s,n\*)a

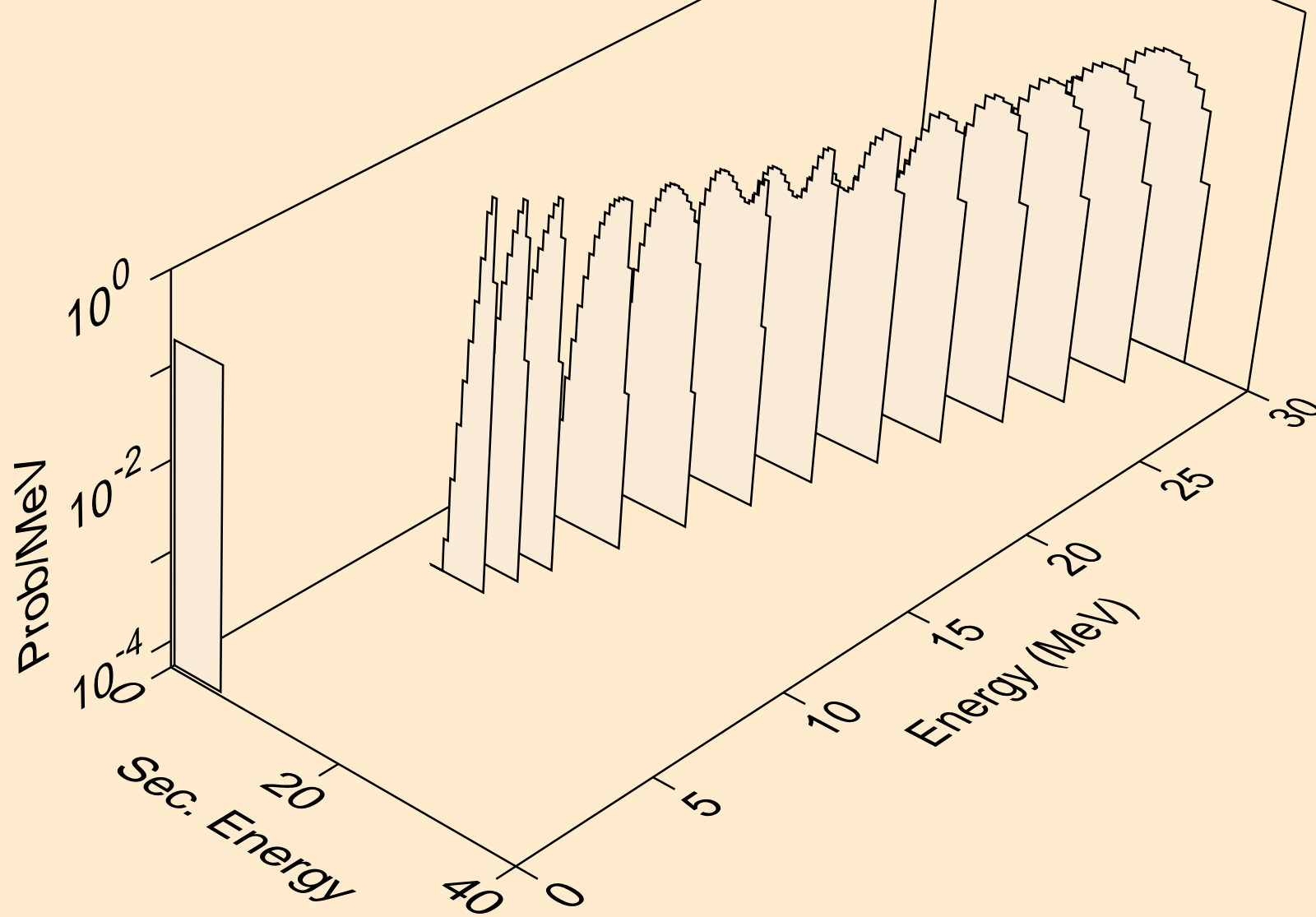

OS179 HELION ACER TENDL-2021 LIBRARY; T=0.K  
alphas from (s,2n)a

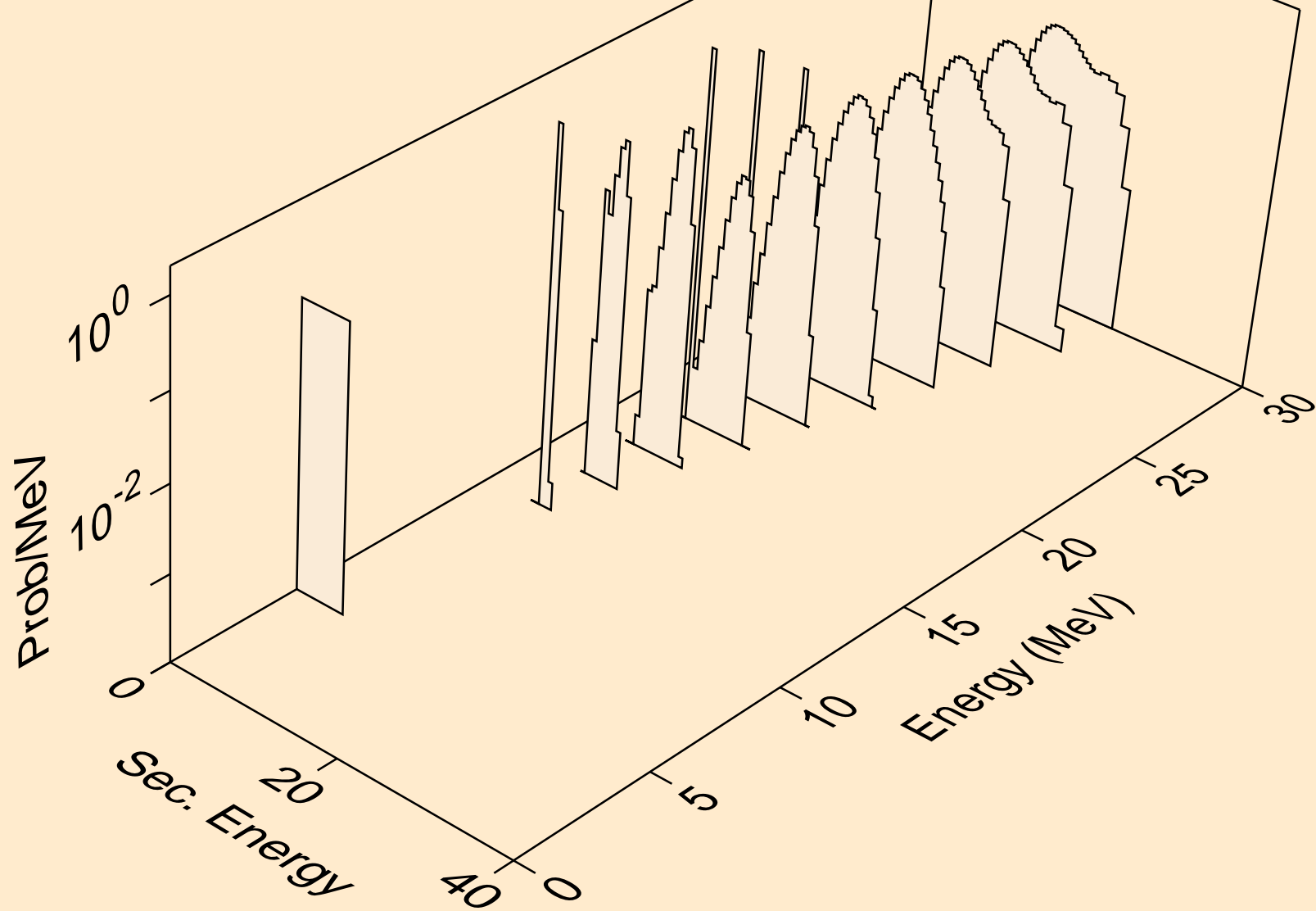

OS179 HELION ACER TENDL-2021 LIBRARY; T=0.K  
alphas from (s,3n)a

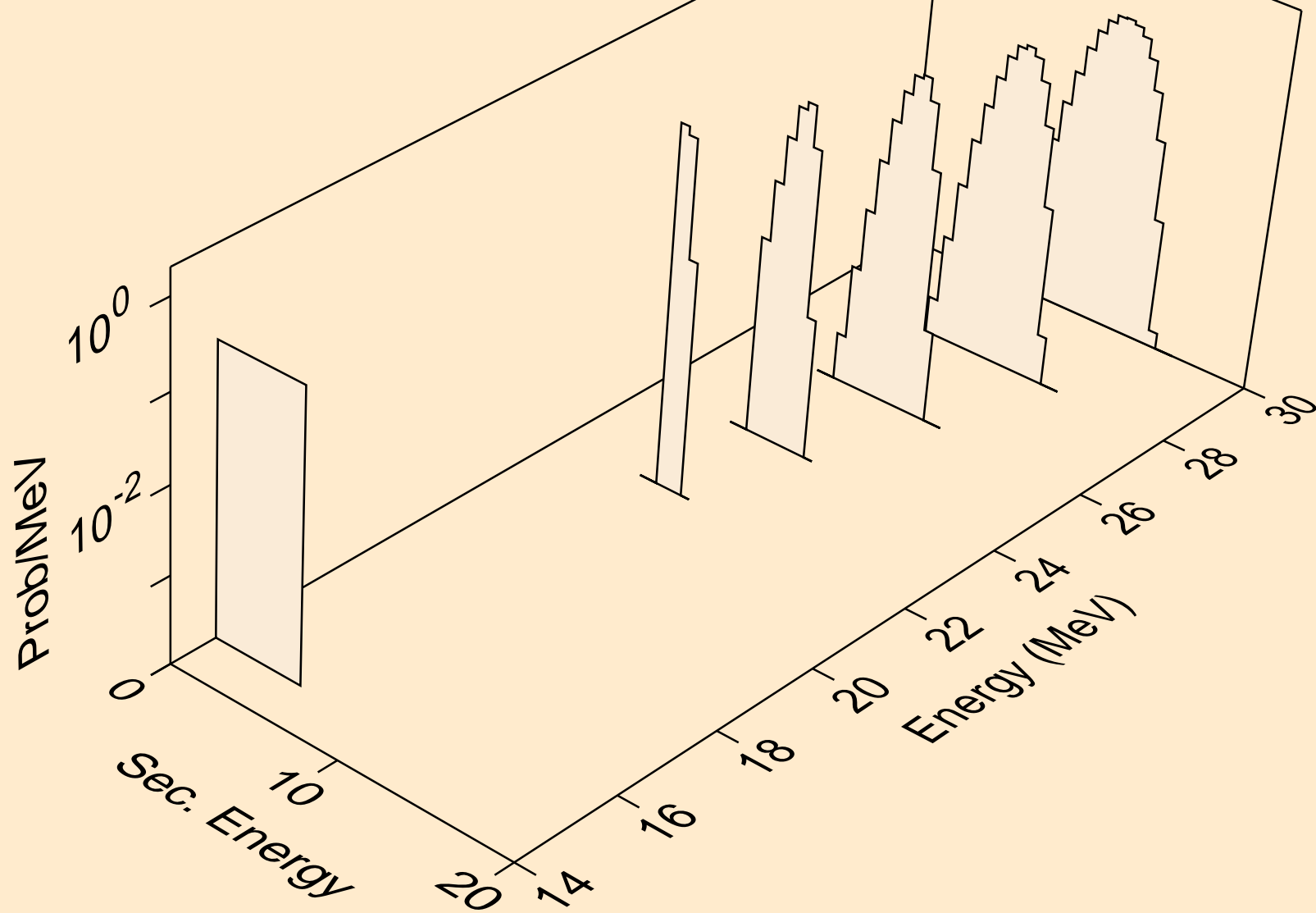

OS179 HELION ACER TENDL-2021 LIBRARY; T=0.K  
alphas from (s,n\*)2a

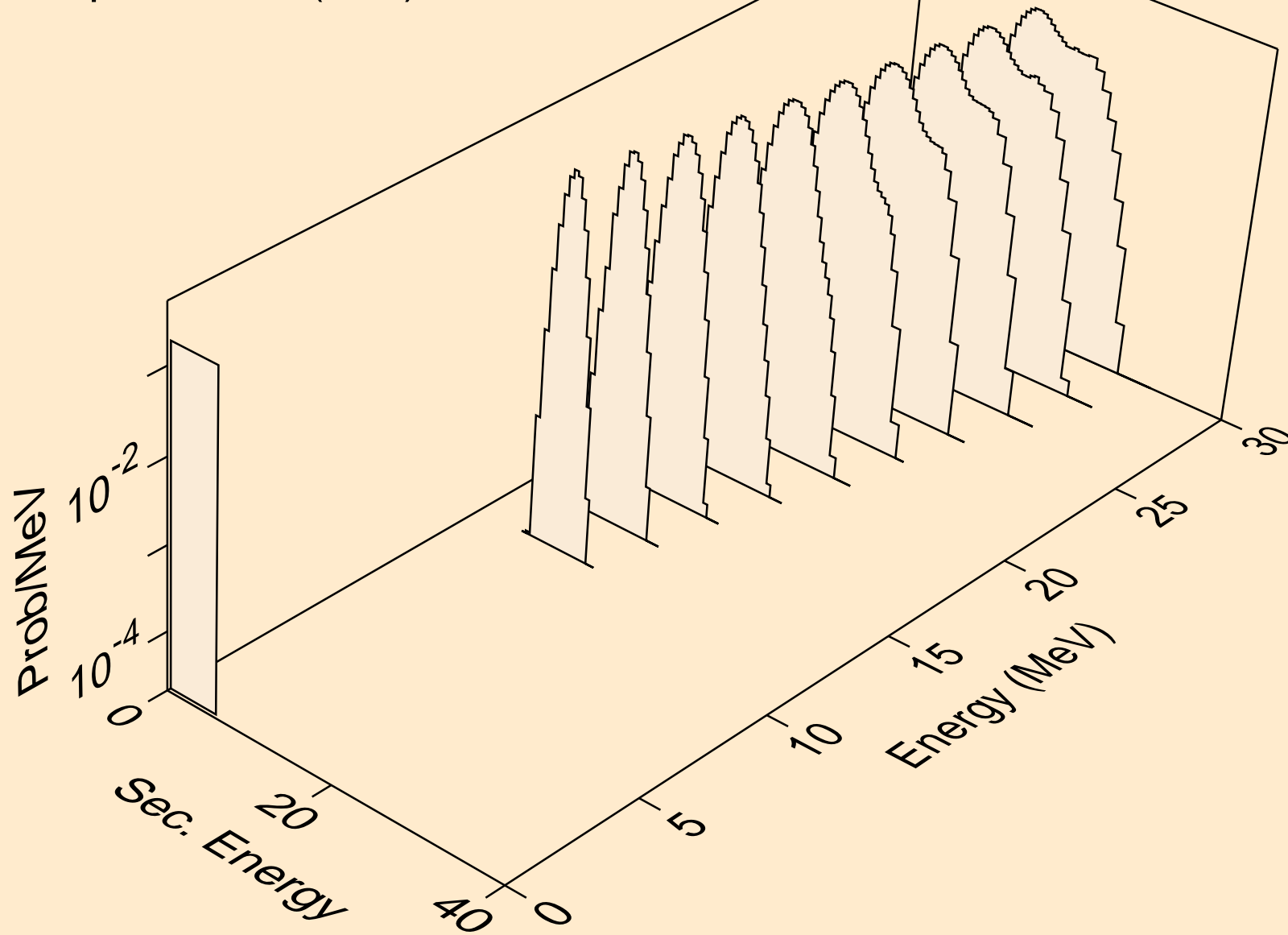

OS179 HELION ACER TENDL-2021 LIBRARY; T=0.K  
alphas from (s,npa)

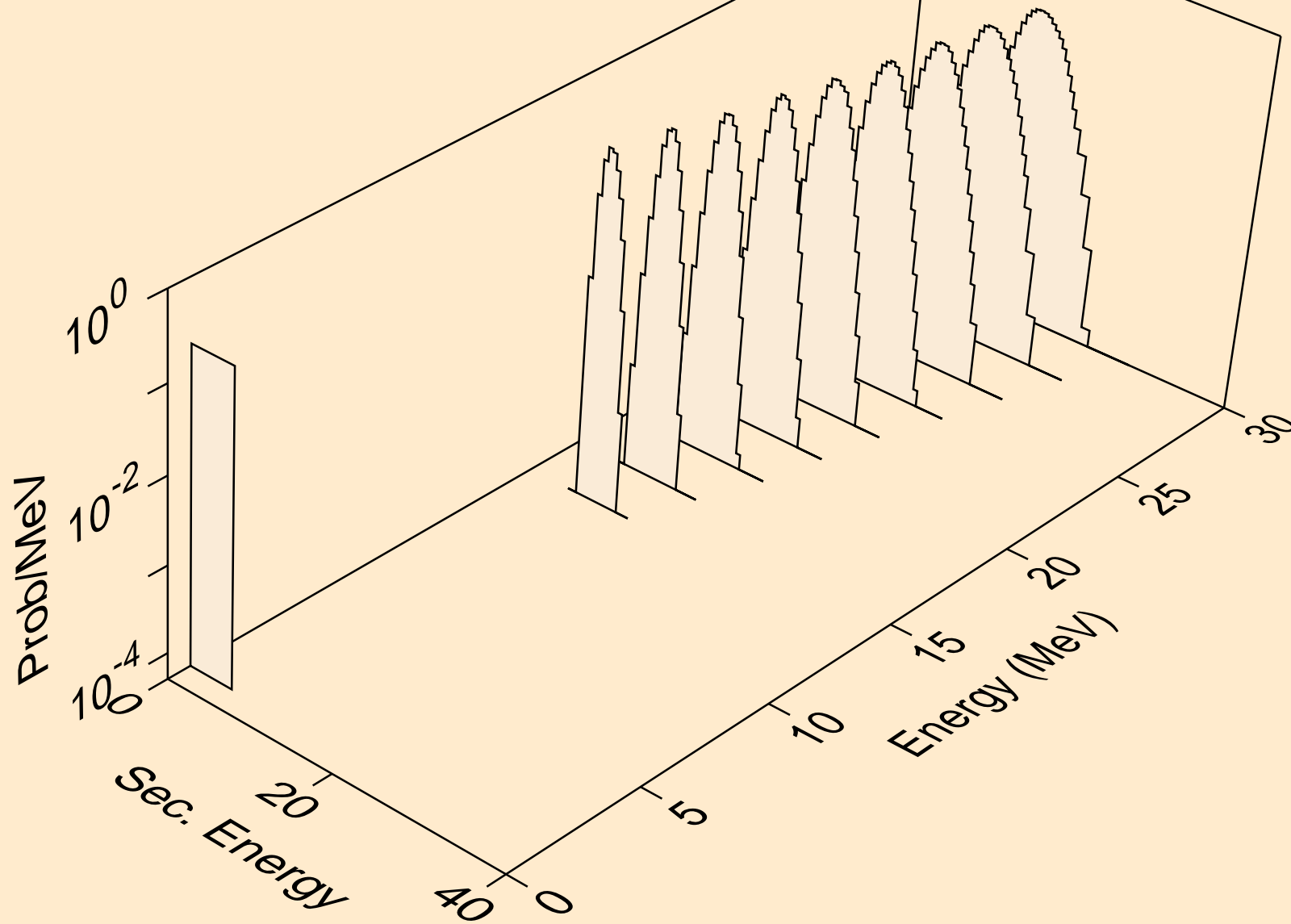

OS179 HELION ACER TENDL-2021 LIBRARY; T=0.K  
alphas from (s,a)

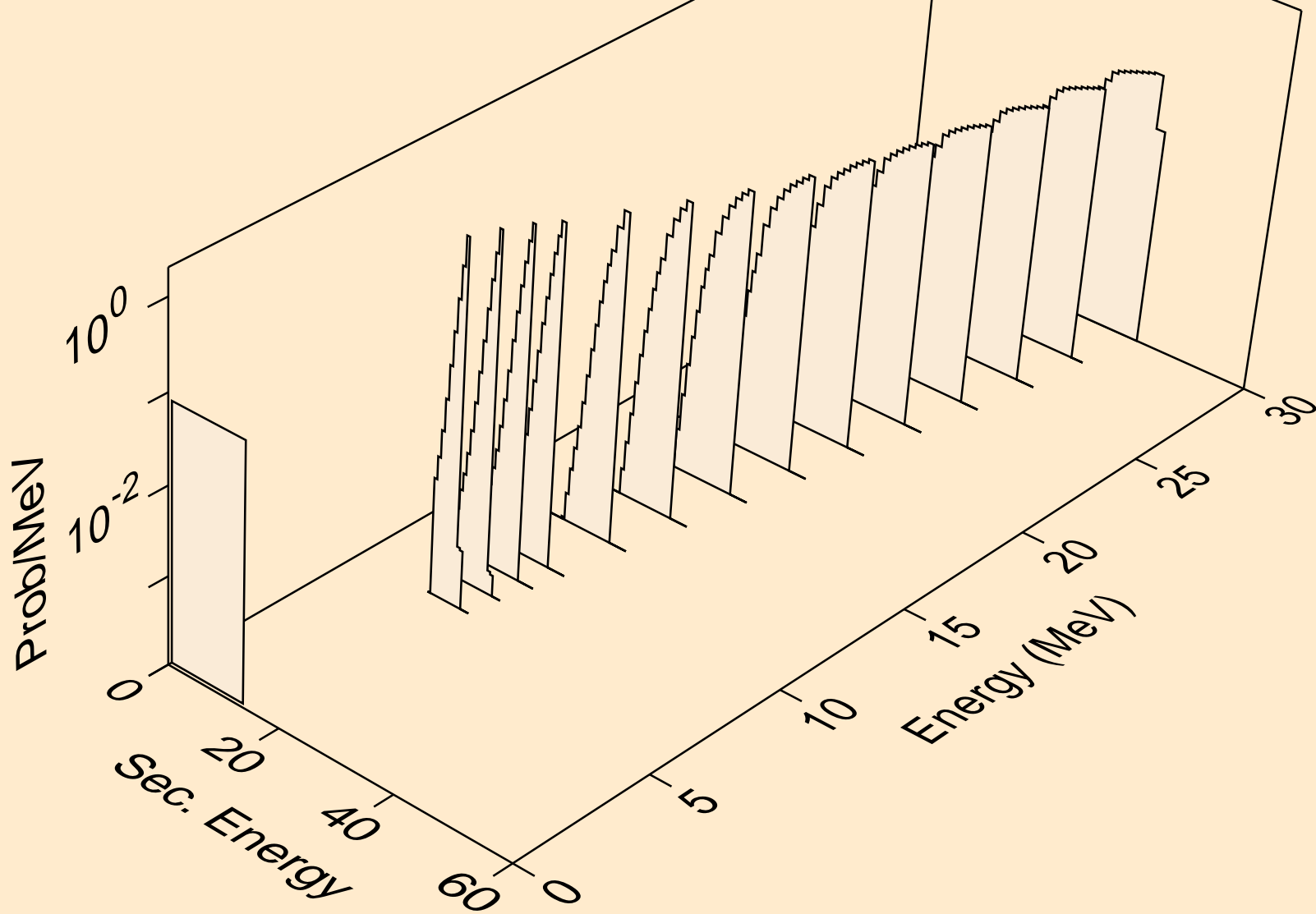



OS179 HELION ACER TENDL-2021 LIBRARY; T=0.K  
alphas from (s,2a)

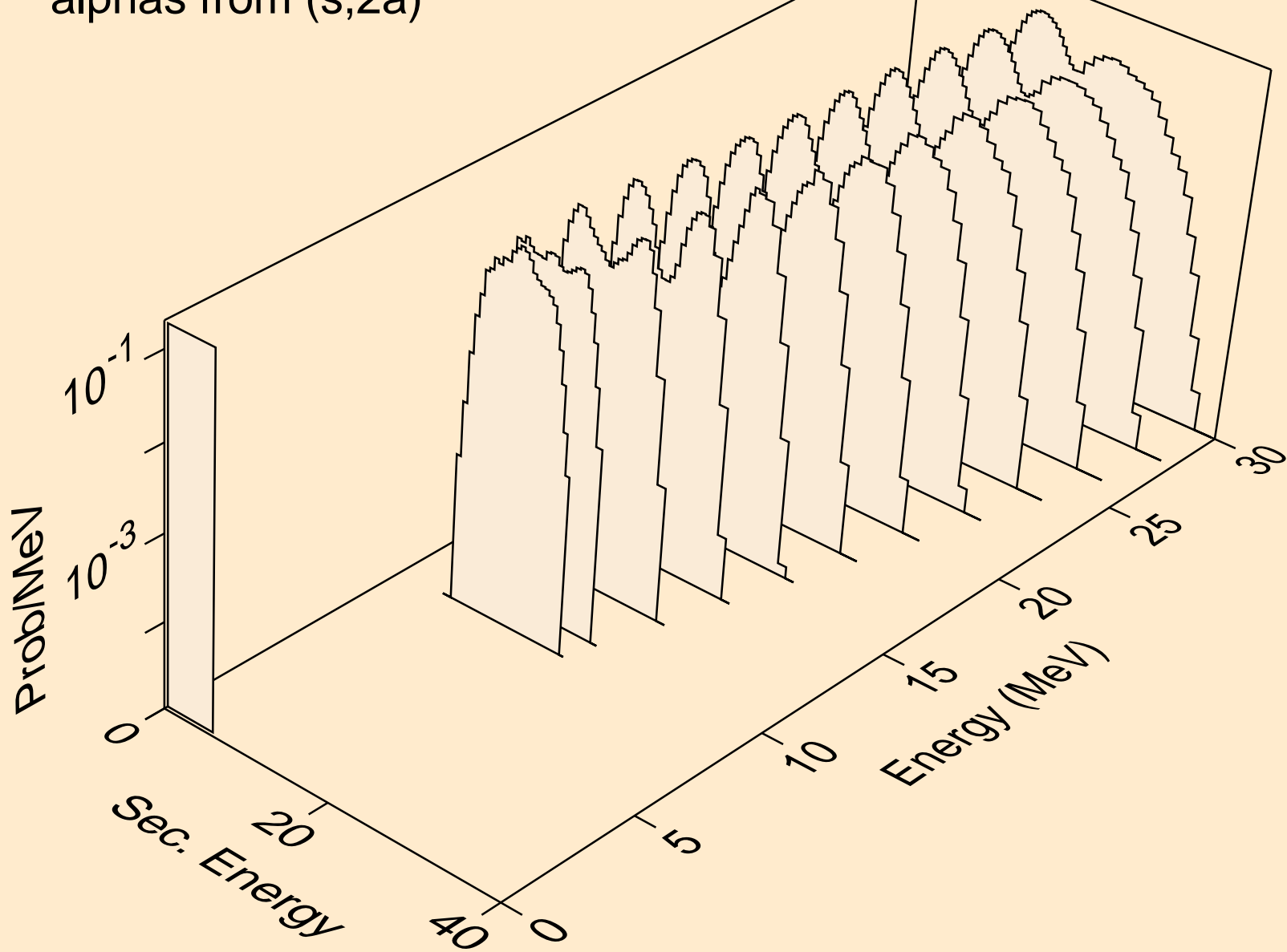

OS179 HELION ACER TENDL-2021 LIBRARY; T=0.K  
alphas from (s,pa)

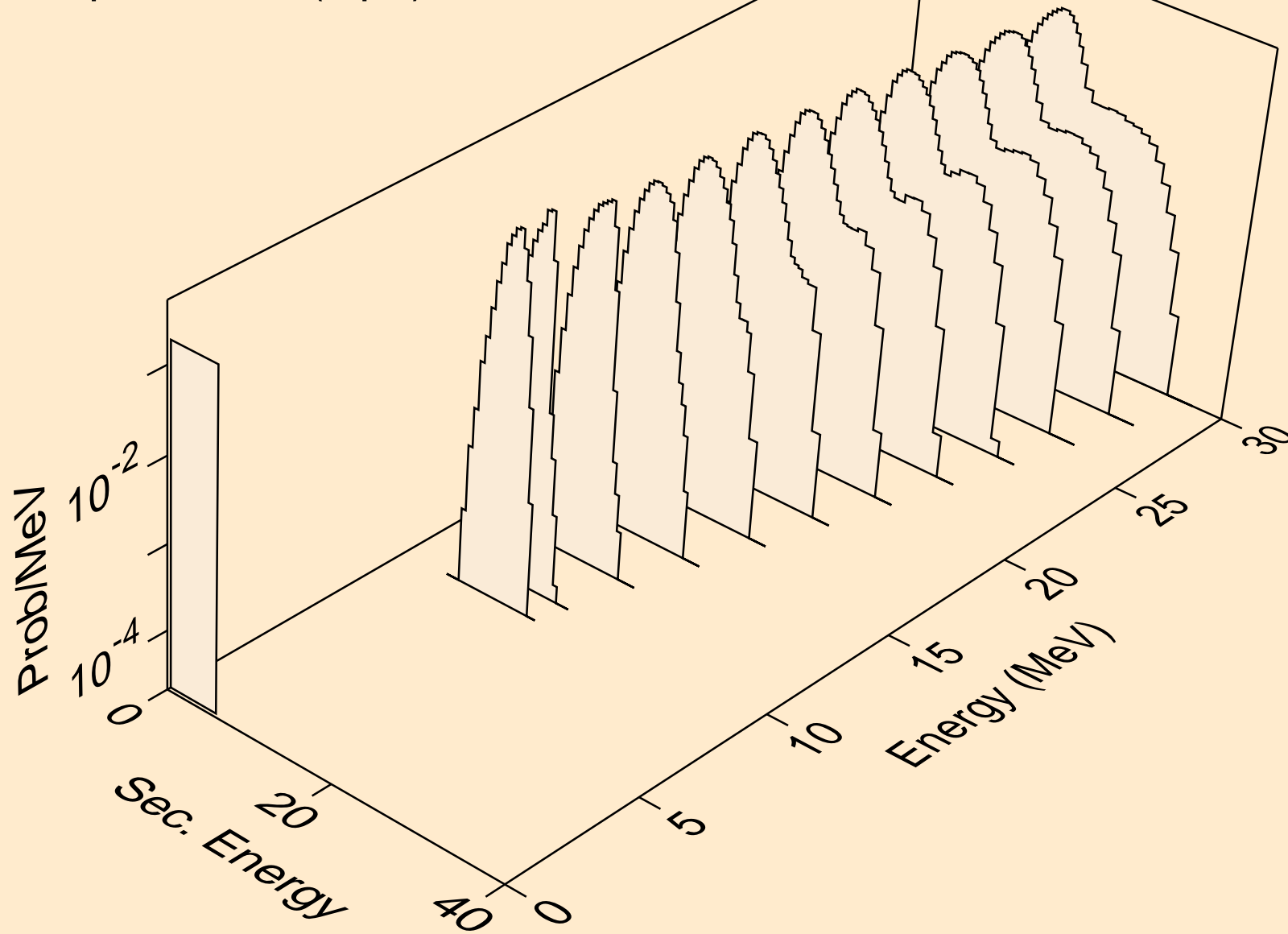

OS179 HELION ACER TENDL-2021 LIBRARY; T=0.K  
alphas from (s,da)

