

PA230 HELION ACER TENDL-2021 LIBRARY; T=0.K  
Principal cross sections

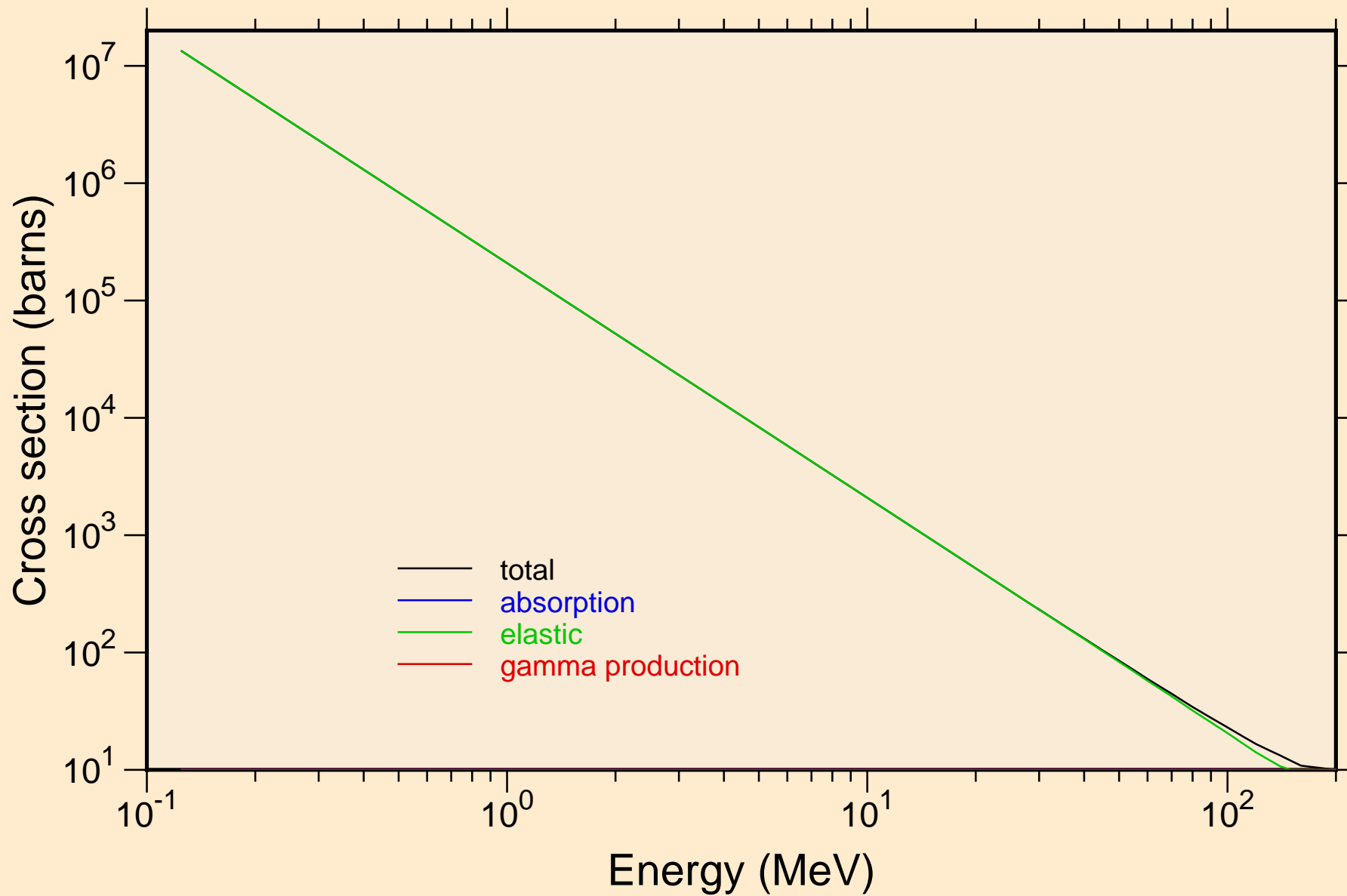

PA230 HELION ACER TENDL-2021 LIBRARY; T=0.K  
Heating

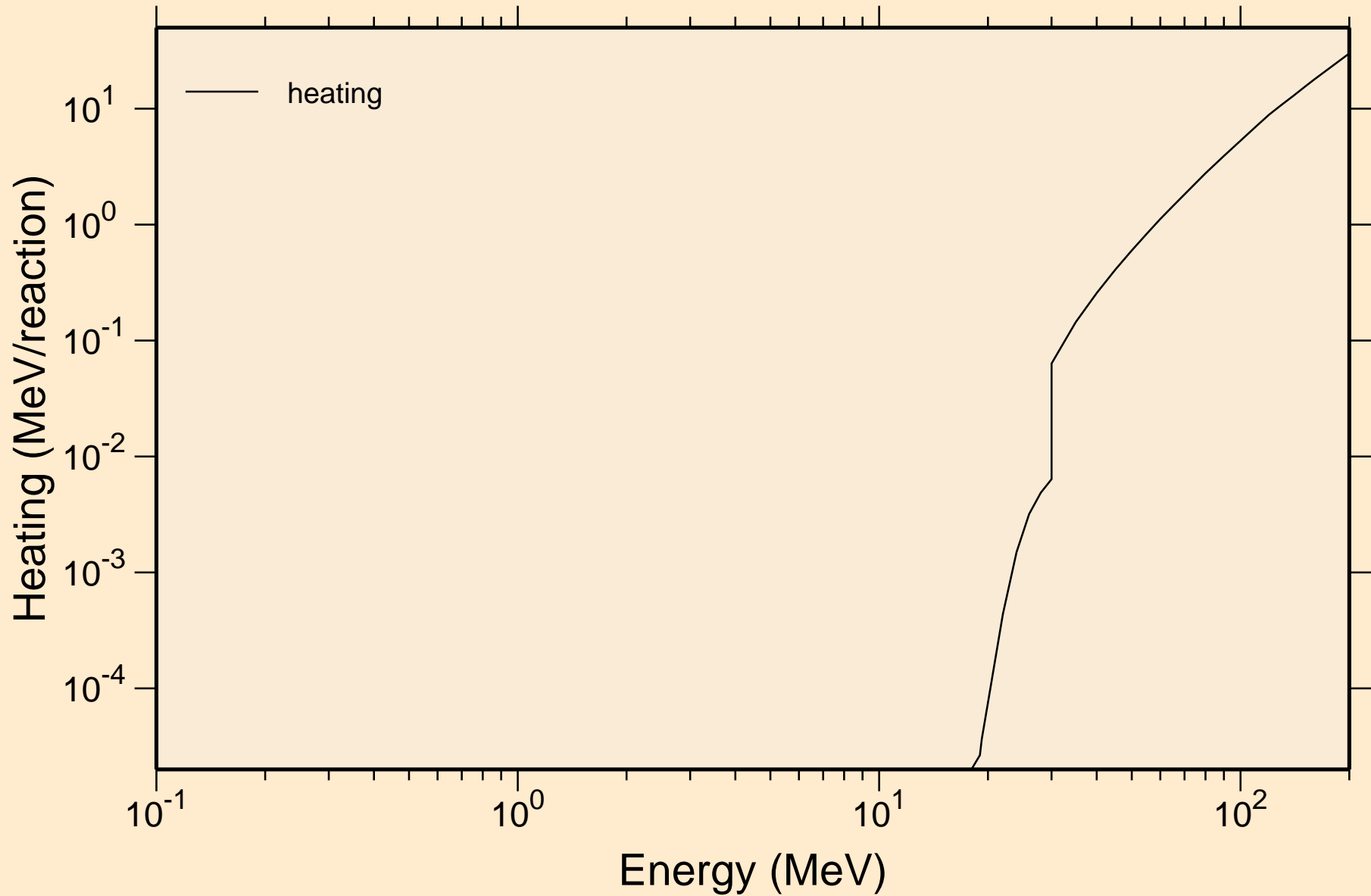

PA230 HELION ACER TENDL-2021 LIBRARY; T=0.K

Principal cross sections

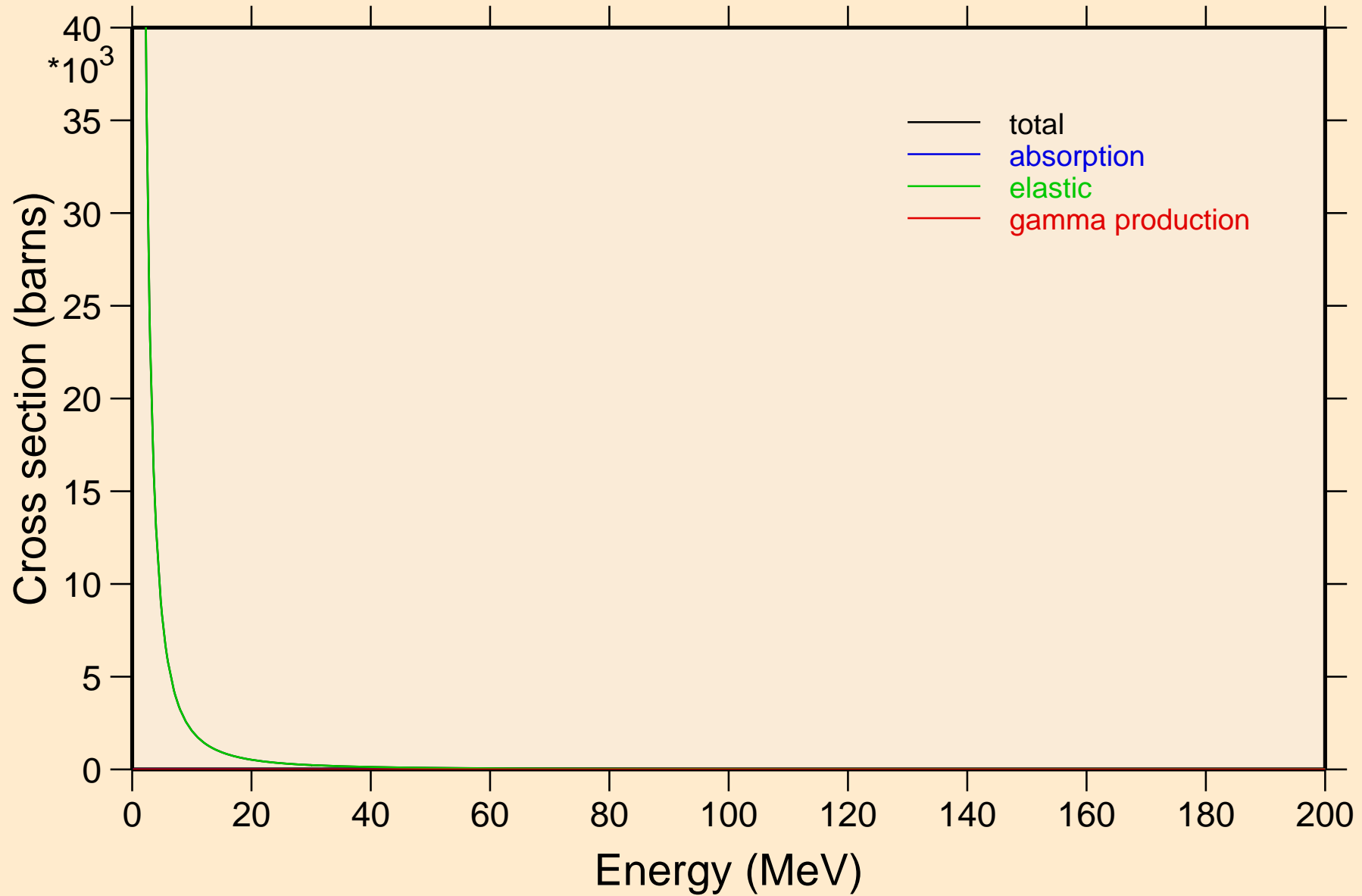

PA230 HELION ACER TENDL-2021 LIBRARY; T=0.K

Heating

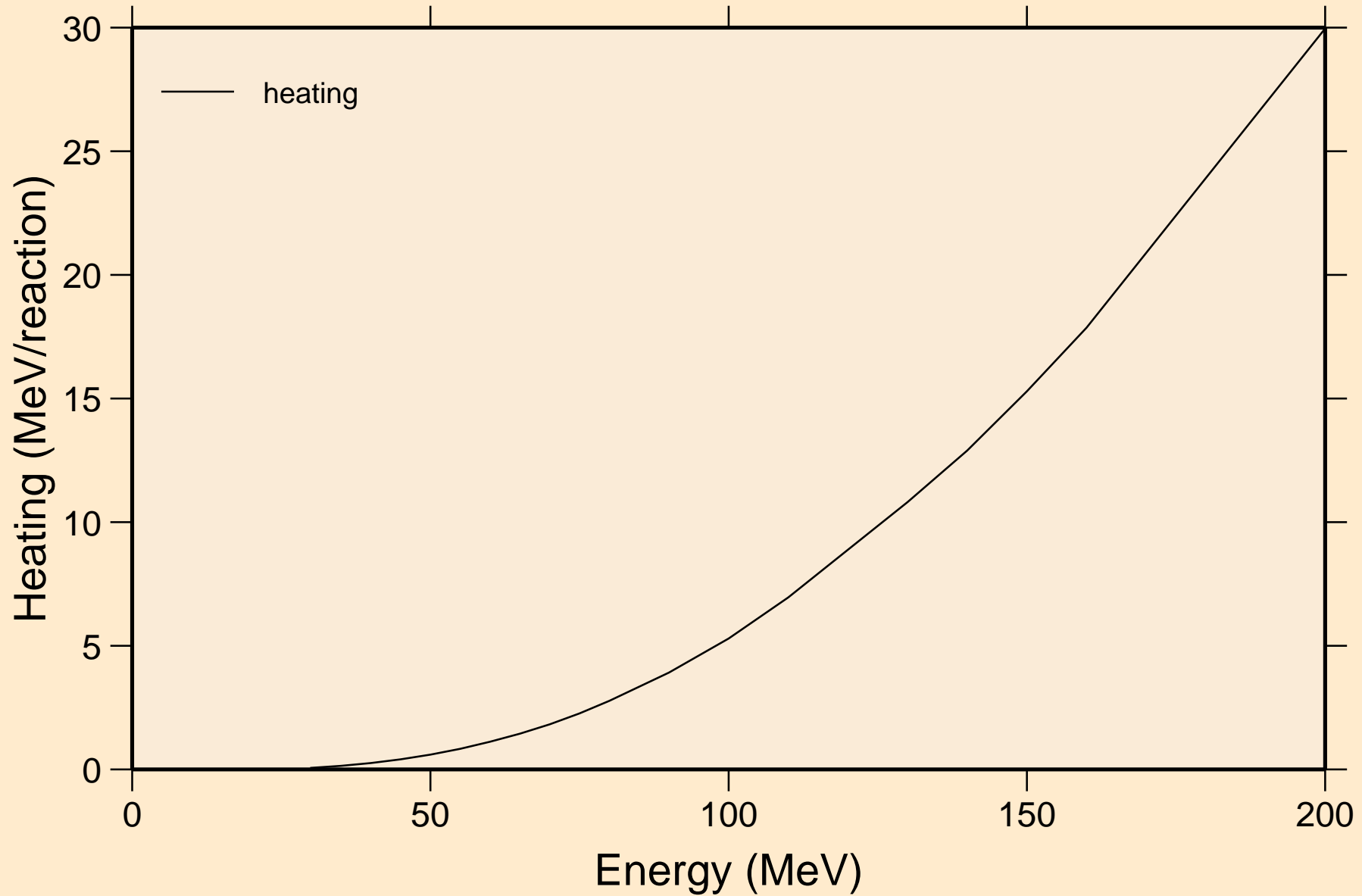

PA230 HELION ACER TENDL-2021 LIBRARY; T=0.K  
Threshold reactions

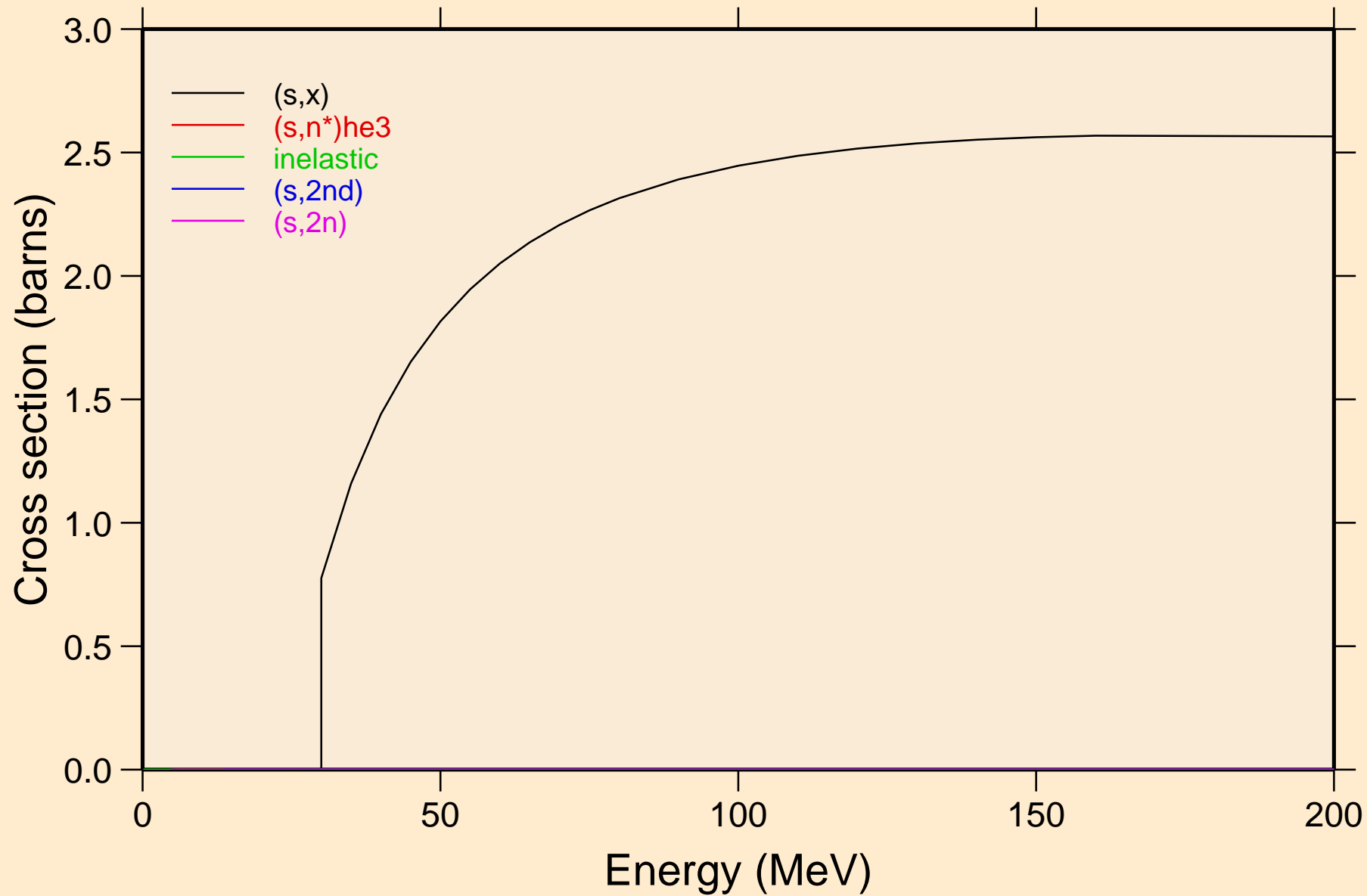

PA230 HELION ACER TENDL-2021 LIBRARY; T=0.K  
Threshold reactions

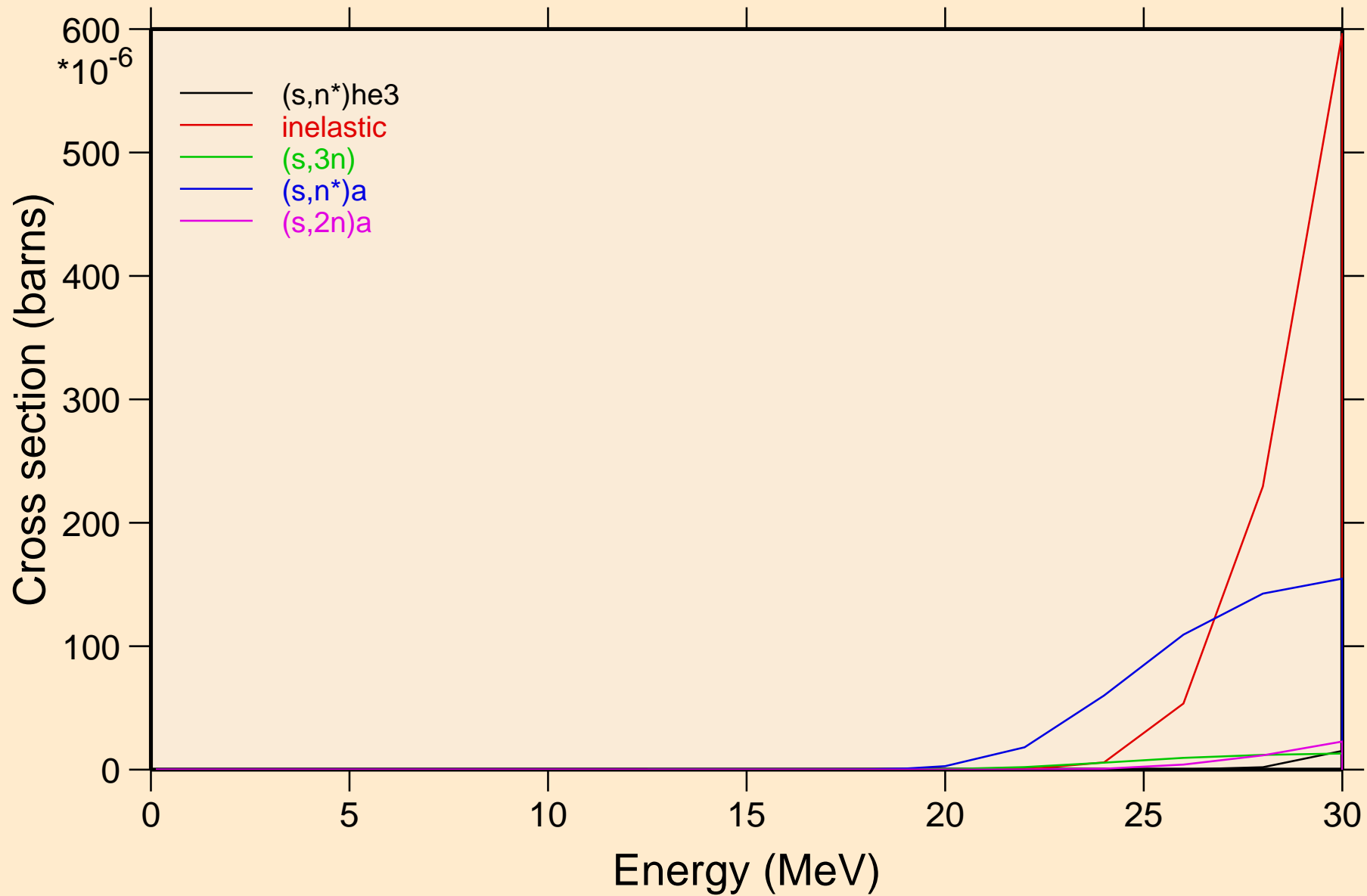

PA230 HELION ACER TENDL-2021 LIBRARY; T=0.K  
Threshold reactions

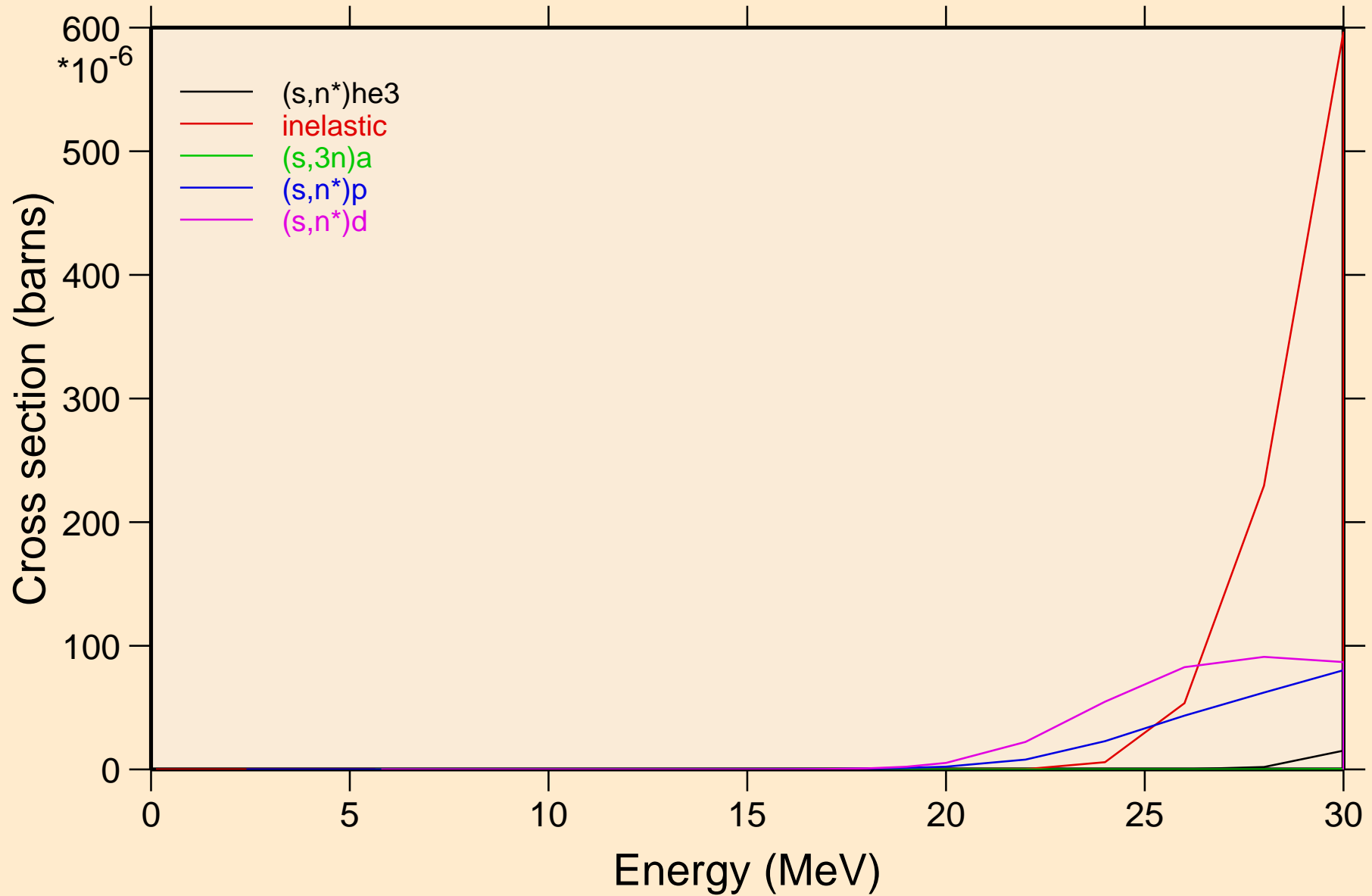

PA230 HELION ACER TENDL-2021 LIBRARY; T=0.K  
Threshold reactions

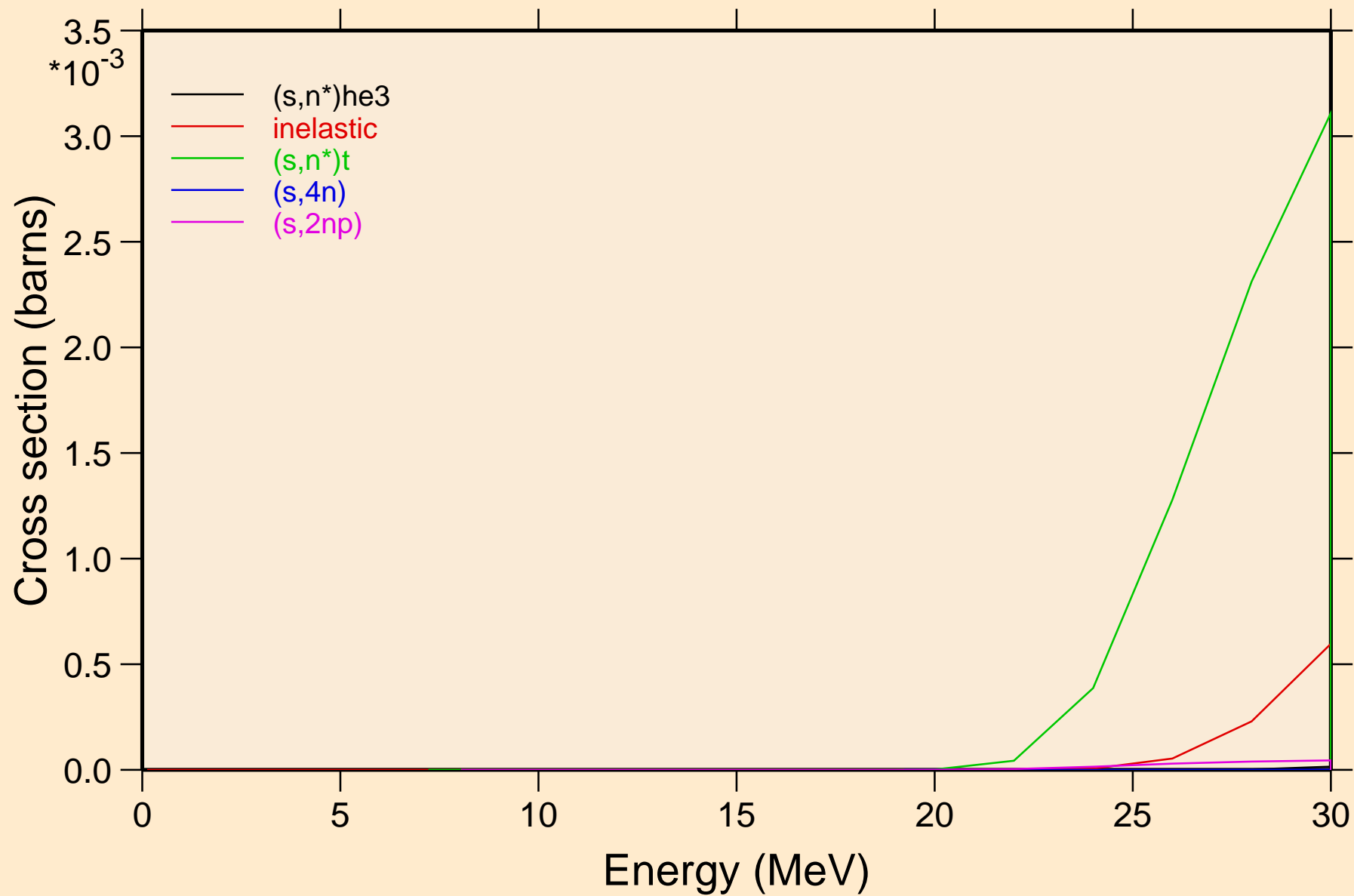



PA230 HELION ACER TENDL-2021 LIBRARY; T=0.K  
Threshold reactions

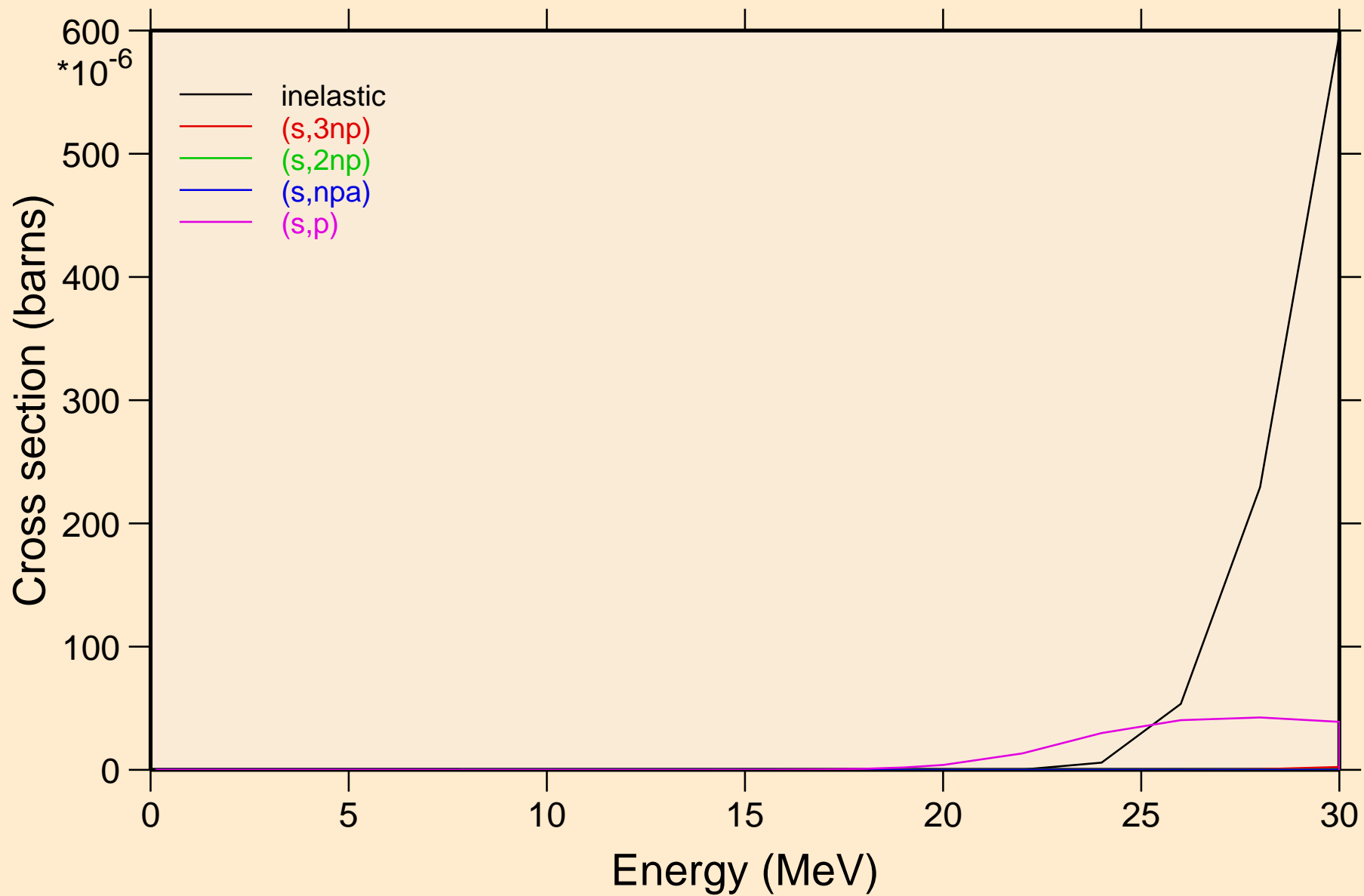

PA230 HELION ACER TENDL-2021 LIBRARY; T=0.K  
Threshold reactions

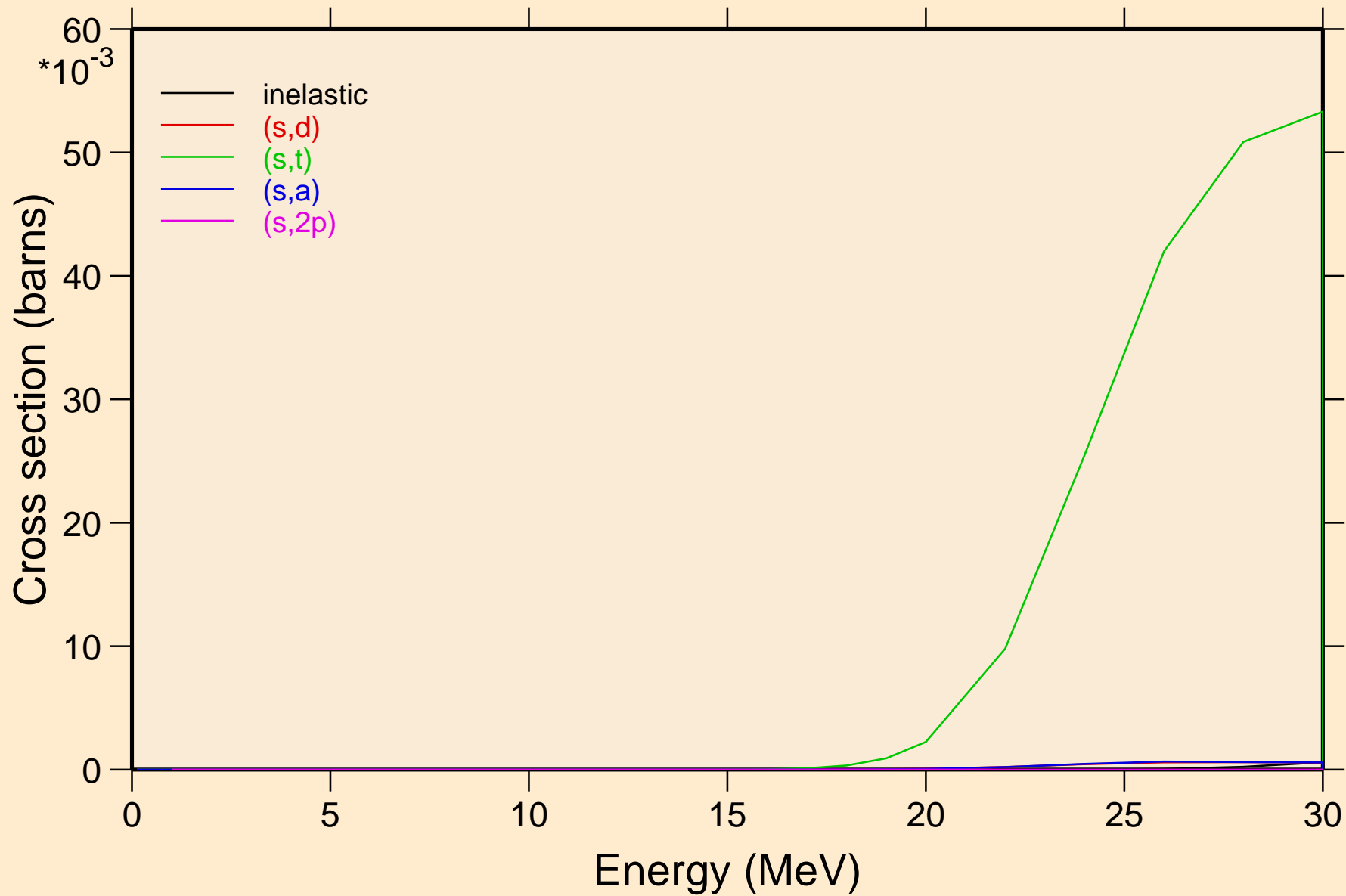

PA230 HELION ACER TENDL-2021 LIBRARY; T=0.K  
Threshold reactions

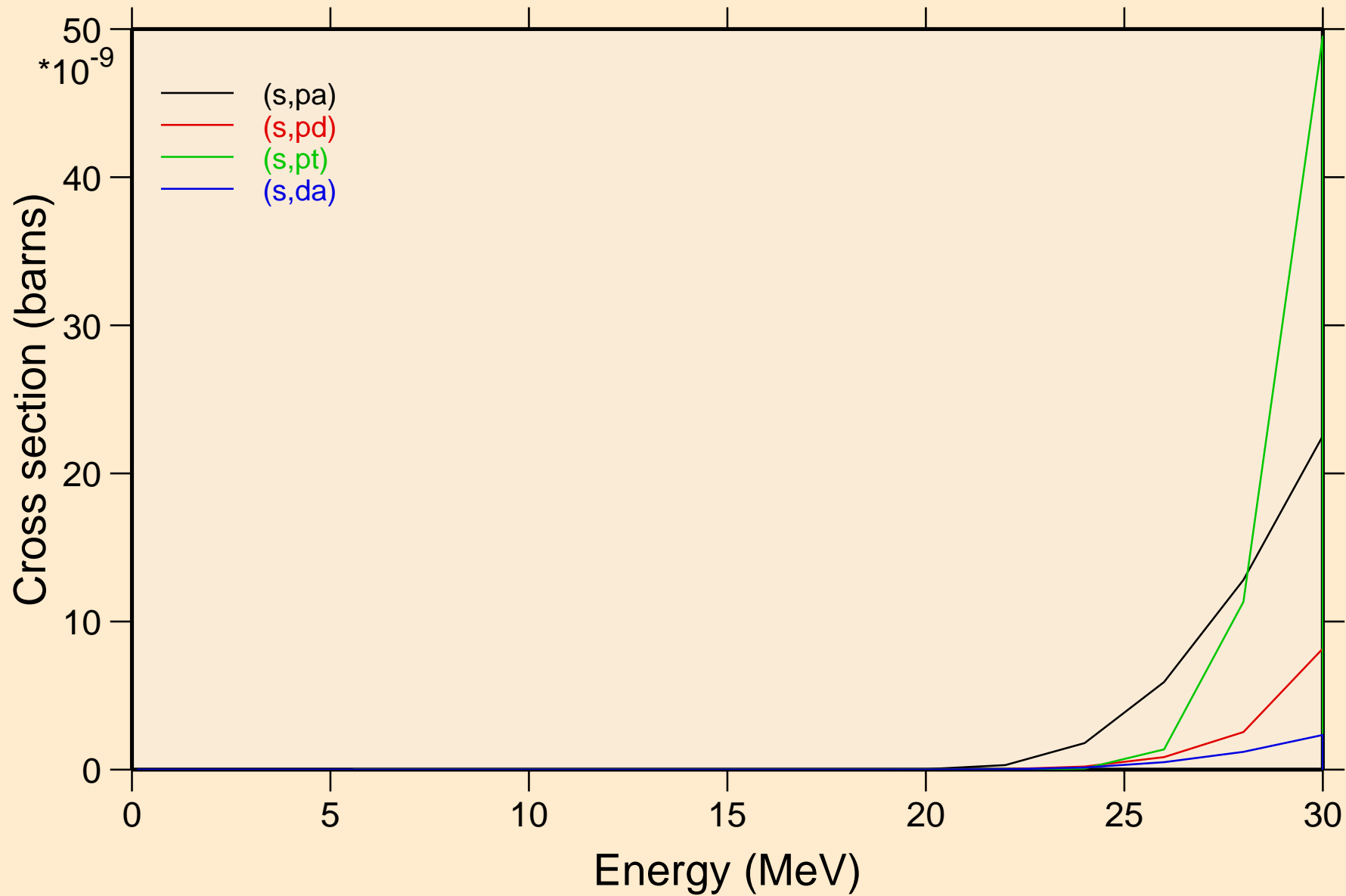

PA230 HELION ACER TENDL-2021 LIBRARY; T=0.K  
angular distribution for elastic

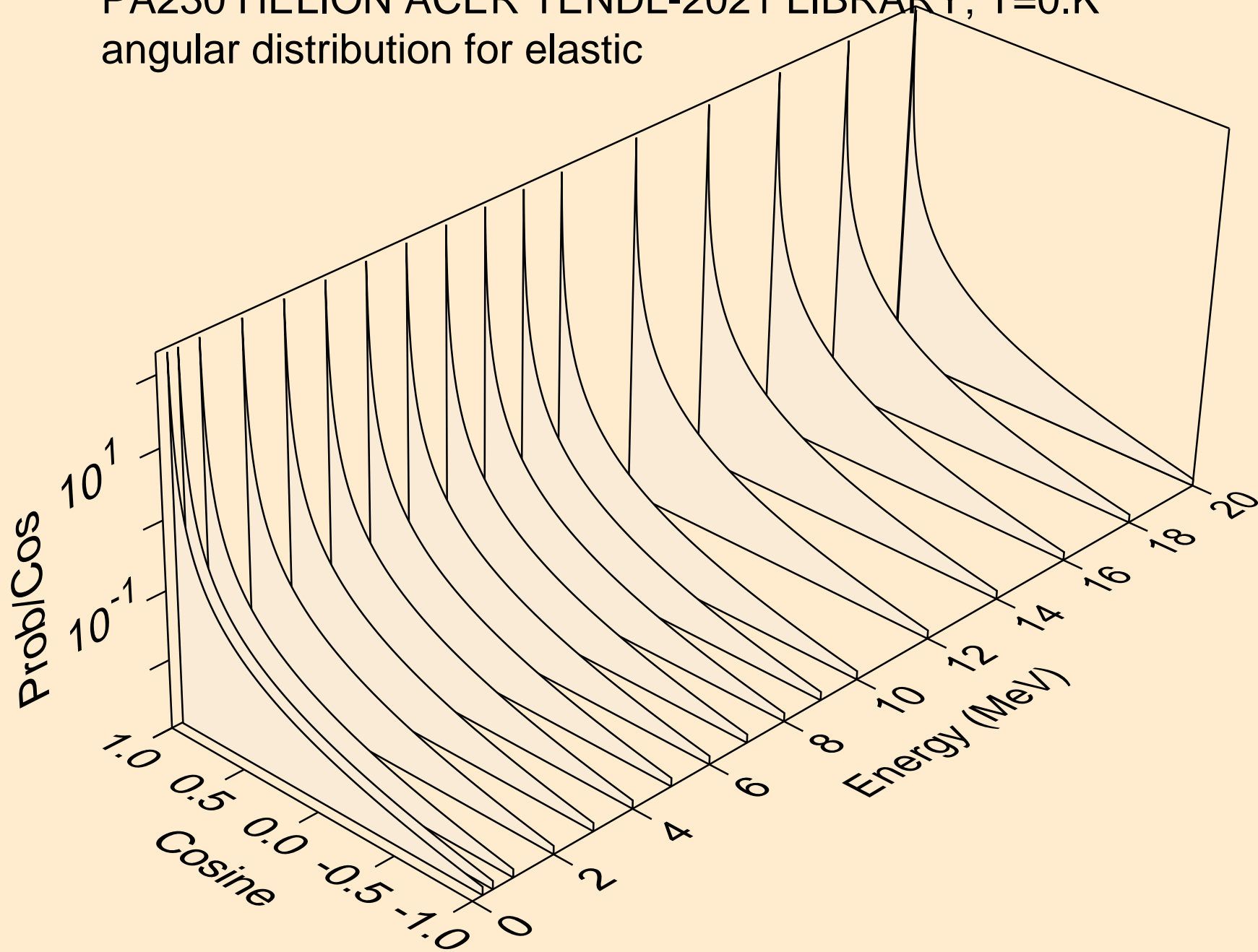

PA230 HELION ACER TENDL-2021 LIBRARY; T=0.K  
angular distribution for elastic

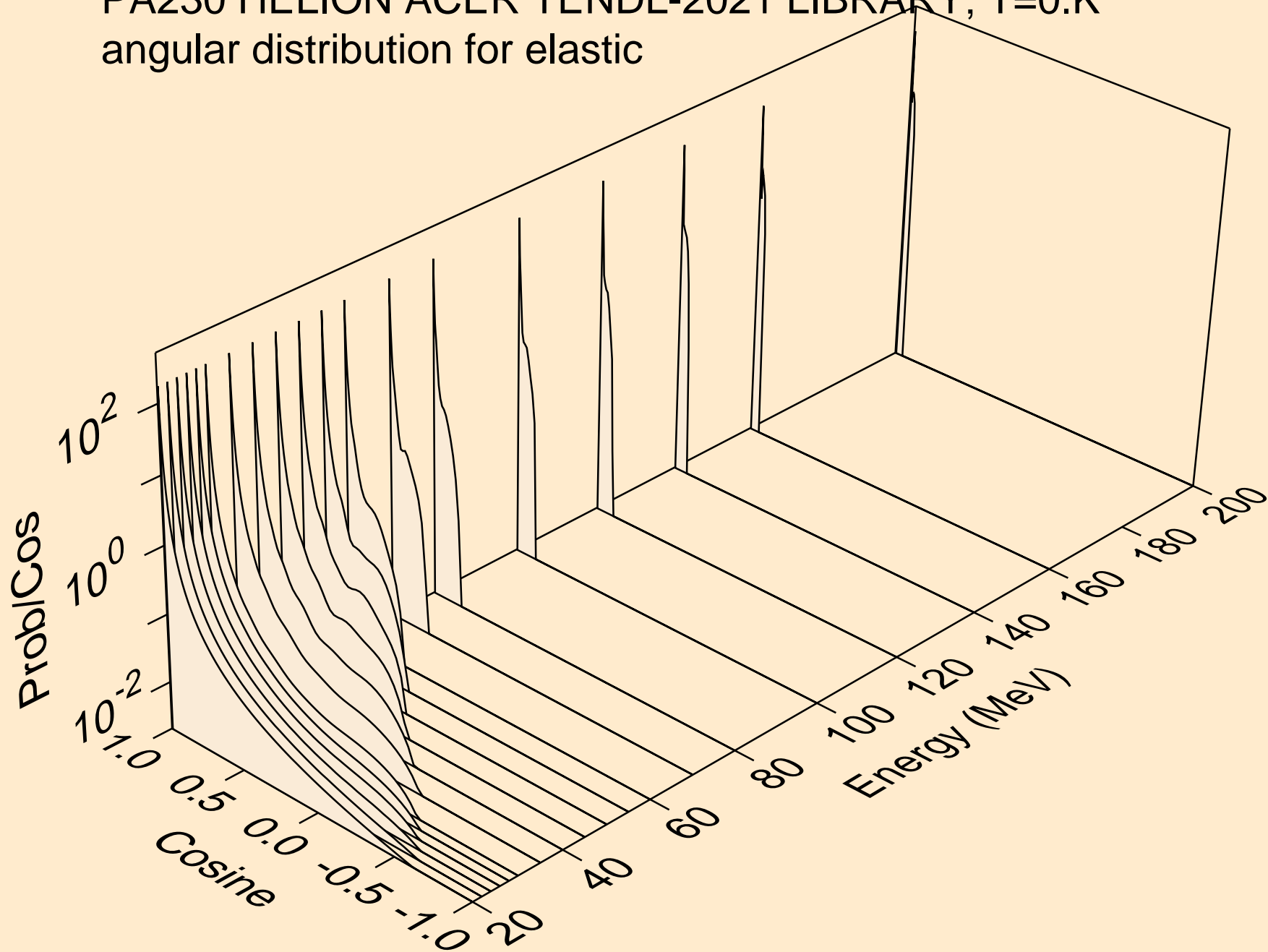

PA230 HELION ACER TENDL-2021 LIBRARY; T=0.K  
He-3 emission for (s,x)

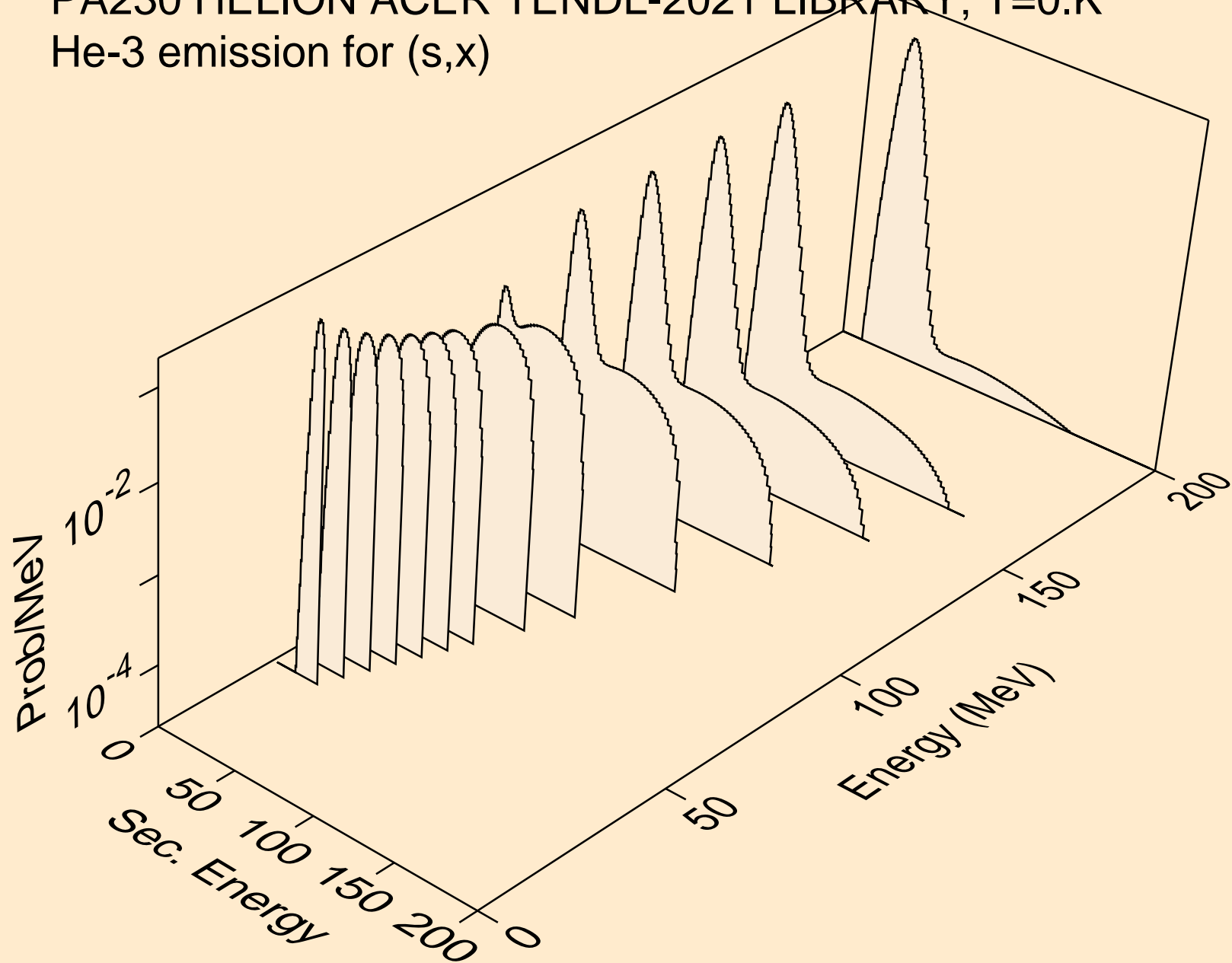

PA230 HELION ACER TENDL-2021 LIBRARY; T=0.K  
He-3 emission for (s,n\*)he3

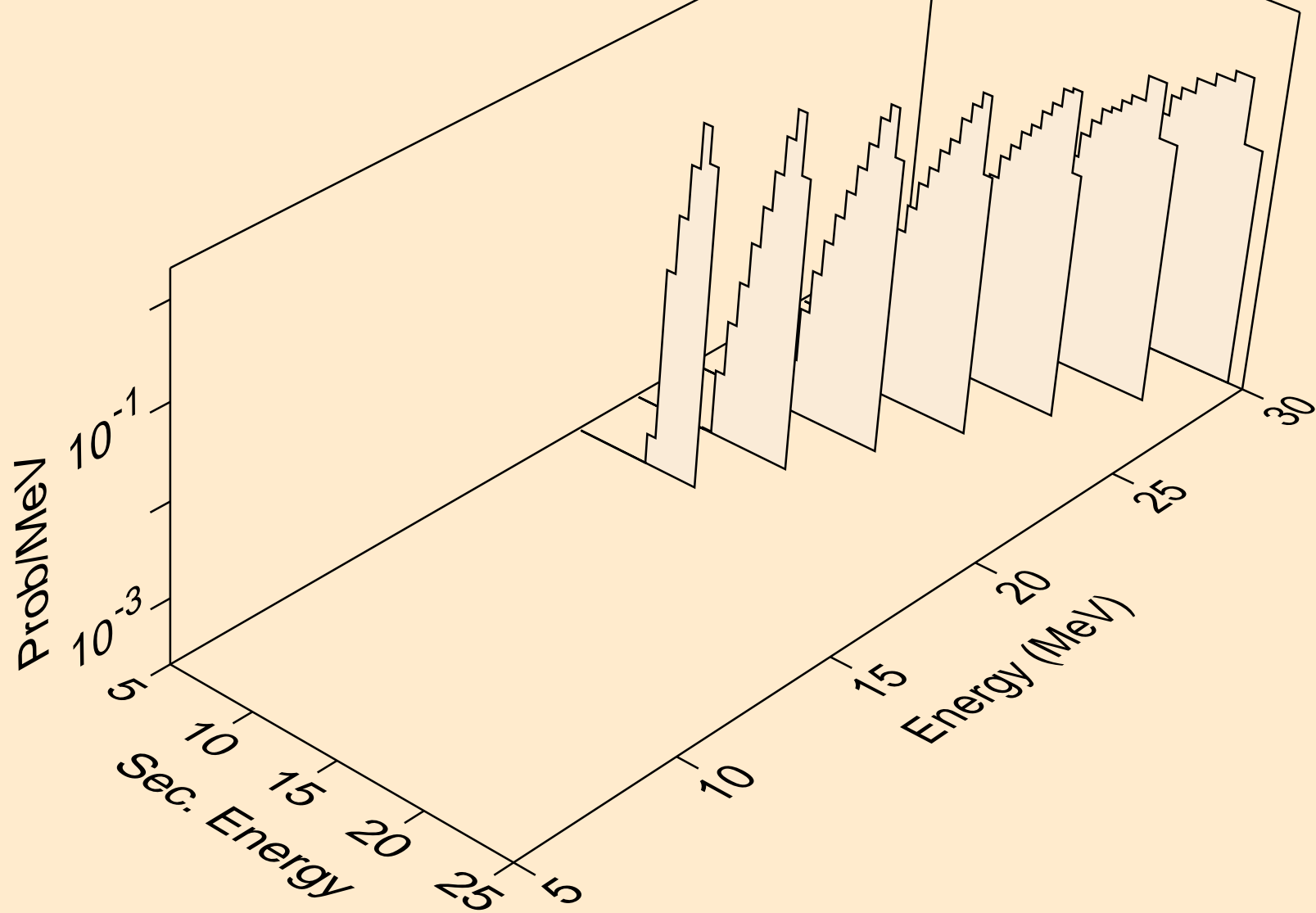

PA230 HELION ACER TENDL-2021 LIBRARY; T=0.K  
He-3 emission for inelastic

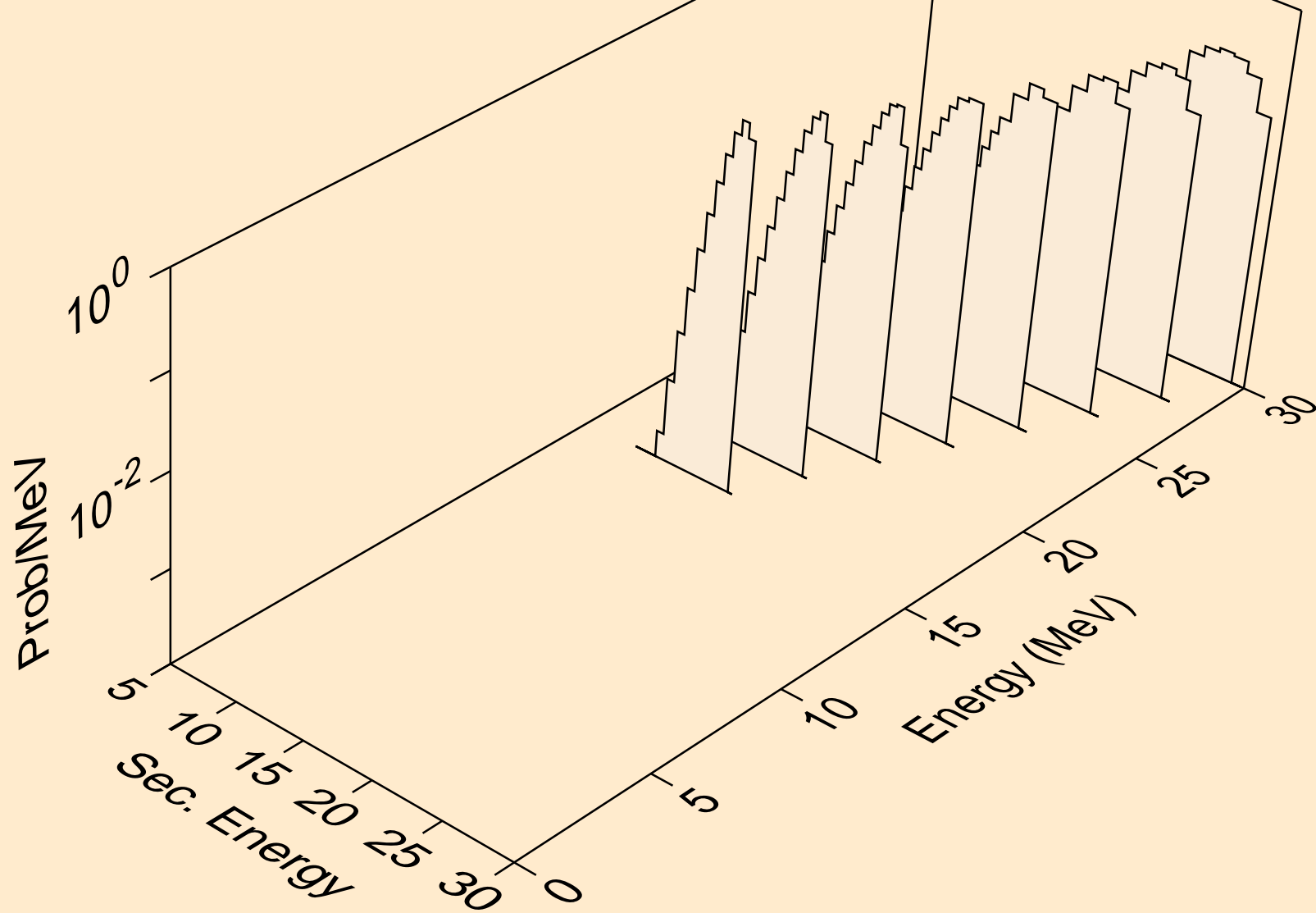



PA230 HELION ACER TENDL-2021 LIBRARY; T=0.K  
Photon emission for (z,n)

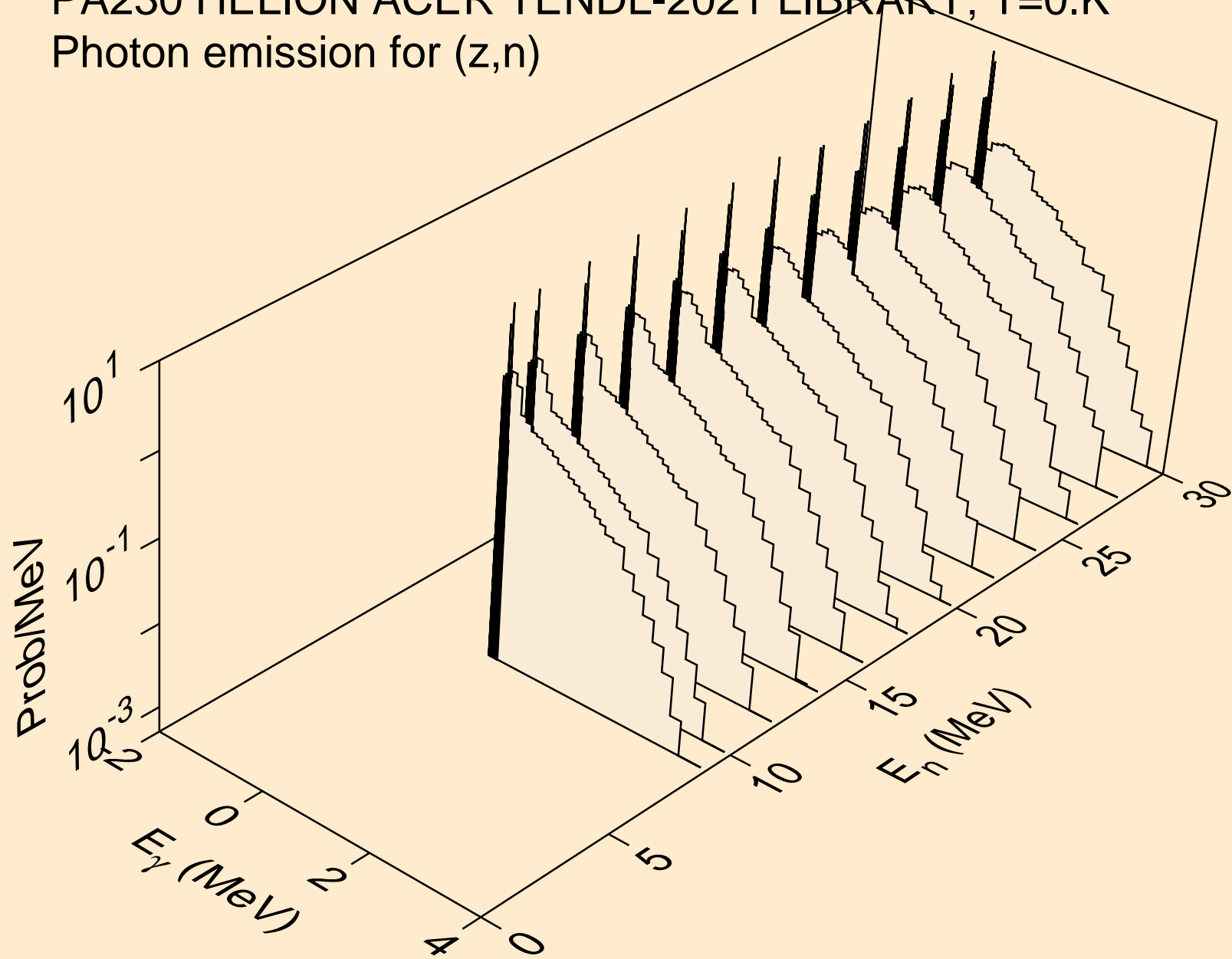

PA230 HELION ACER TENDL-2021 LIBRARY; T=0.K  
Photon emission for (n,x)

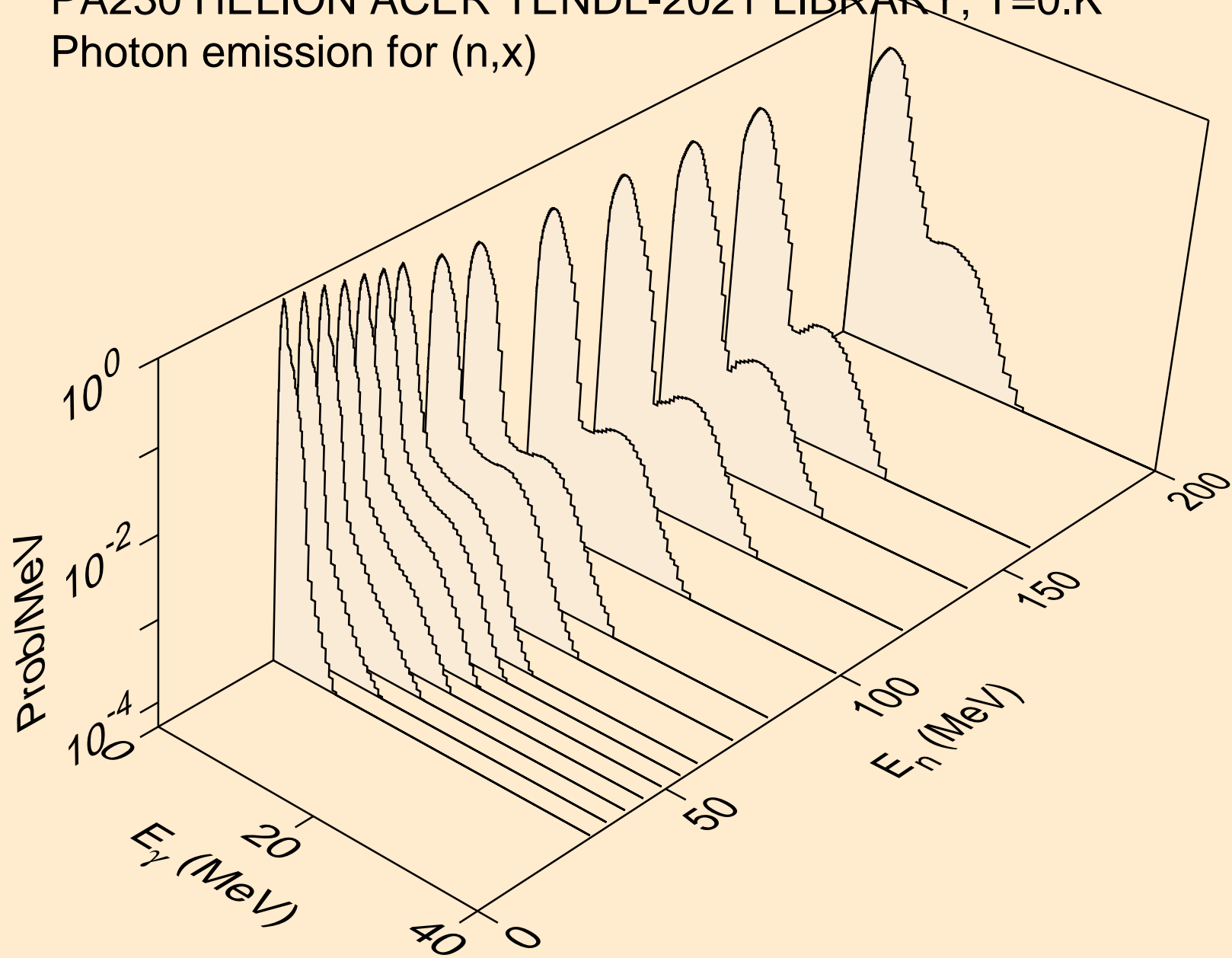

PA230 HELION ACER TENDL-2021 LIBRARY; T=0.K  
Photon emission for (n,2nd)

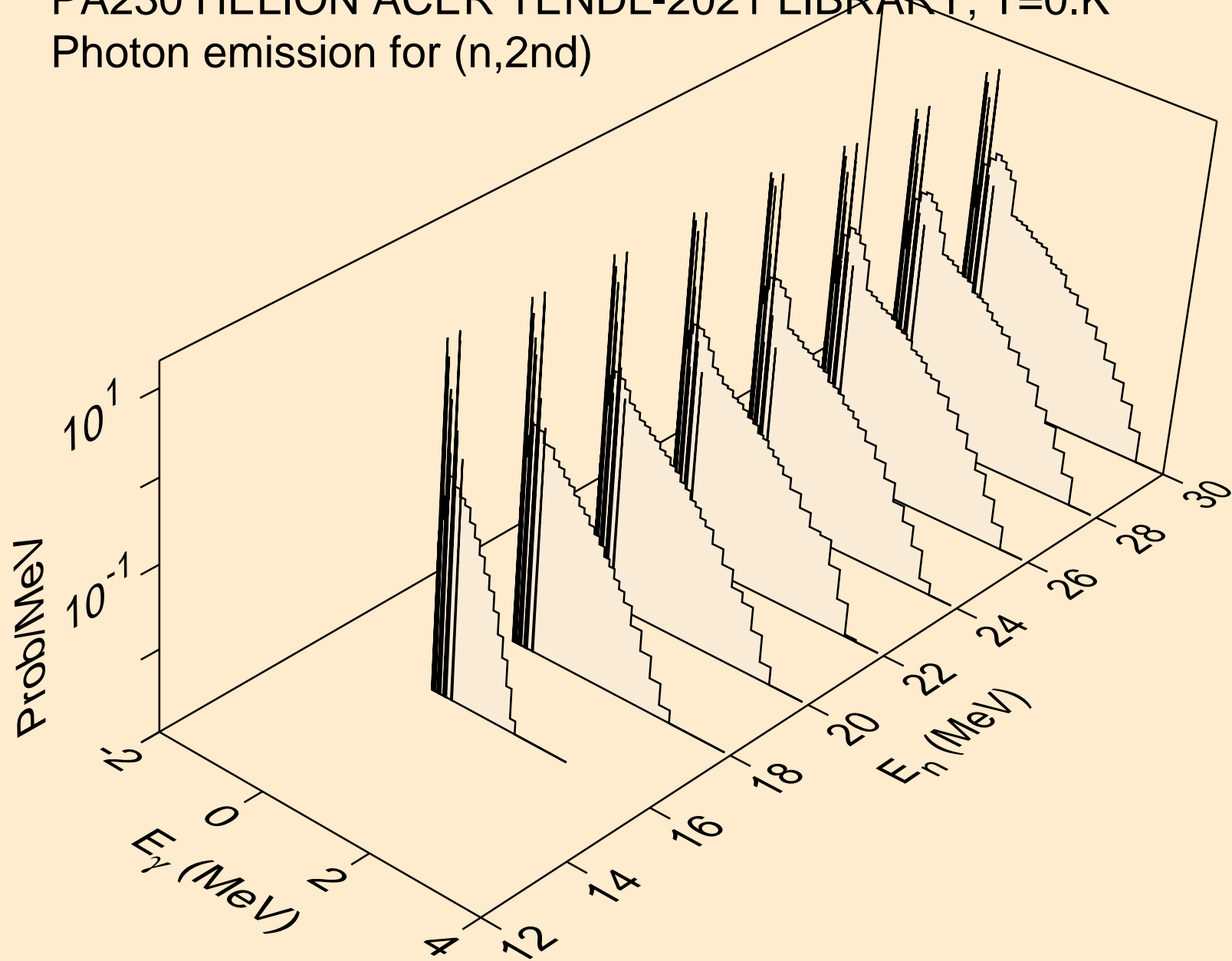

PA230 HELION ACER TENDL-2021 LIBRARY; T=0.K  
Photon emission for (n,2n)

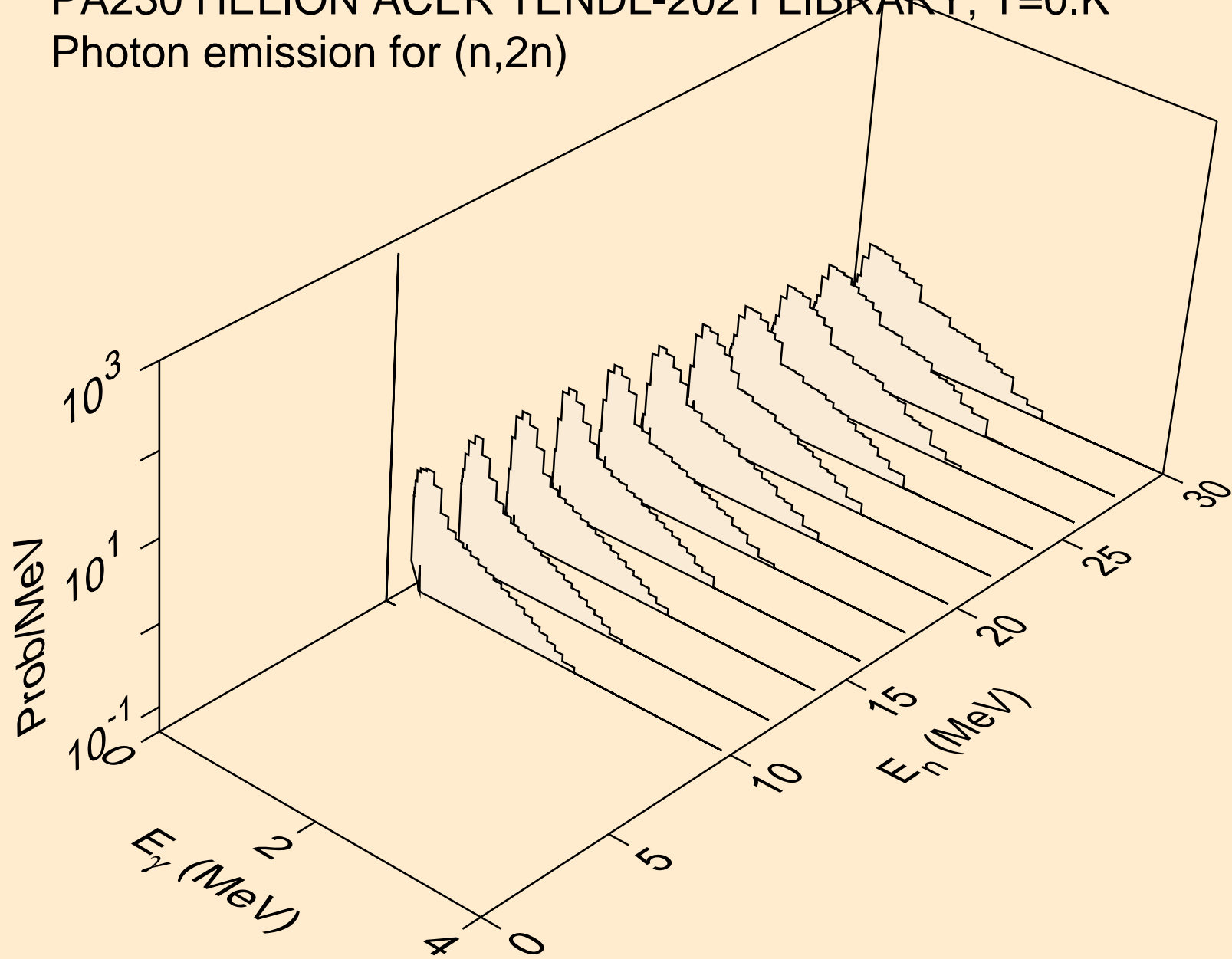

PA230 HELION ACER TENDL-2021 LIBRARY; T=0.K  
Photon emission for (n,3n)

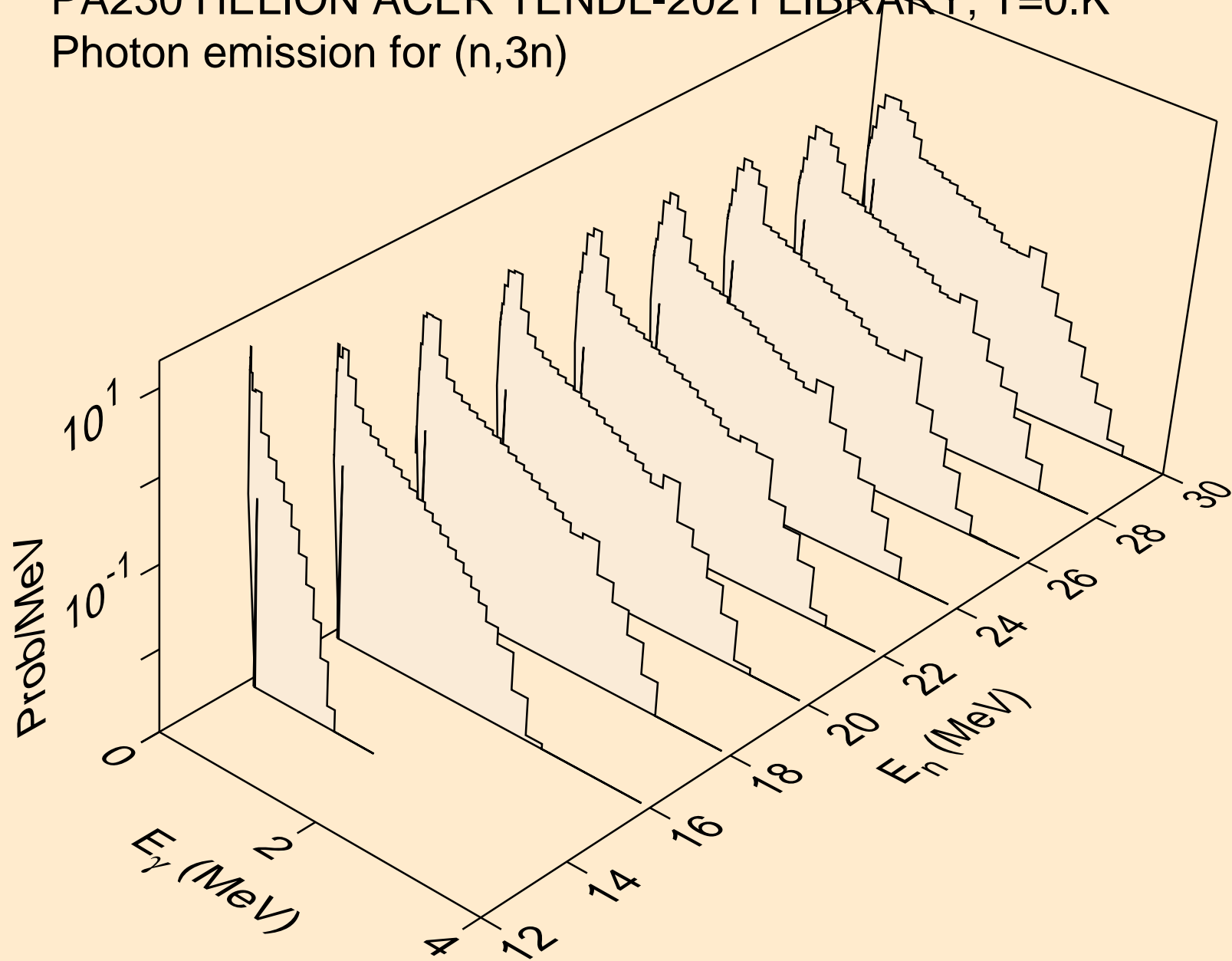

PA230 HELION ACER TENDL-2021 LIBRARY; T=0.K  
Photon emission for (n,n\*)a

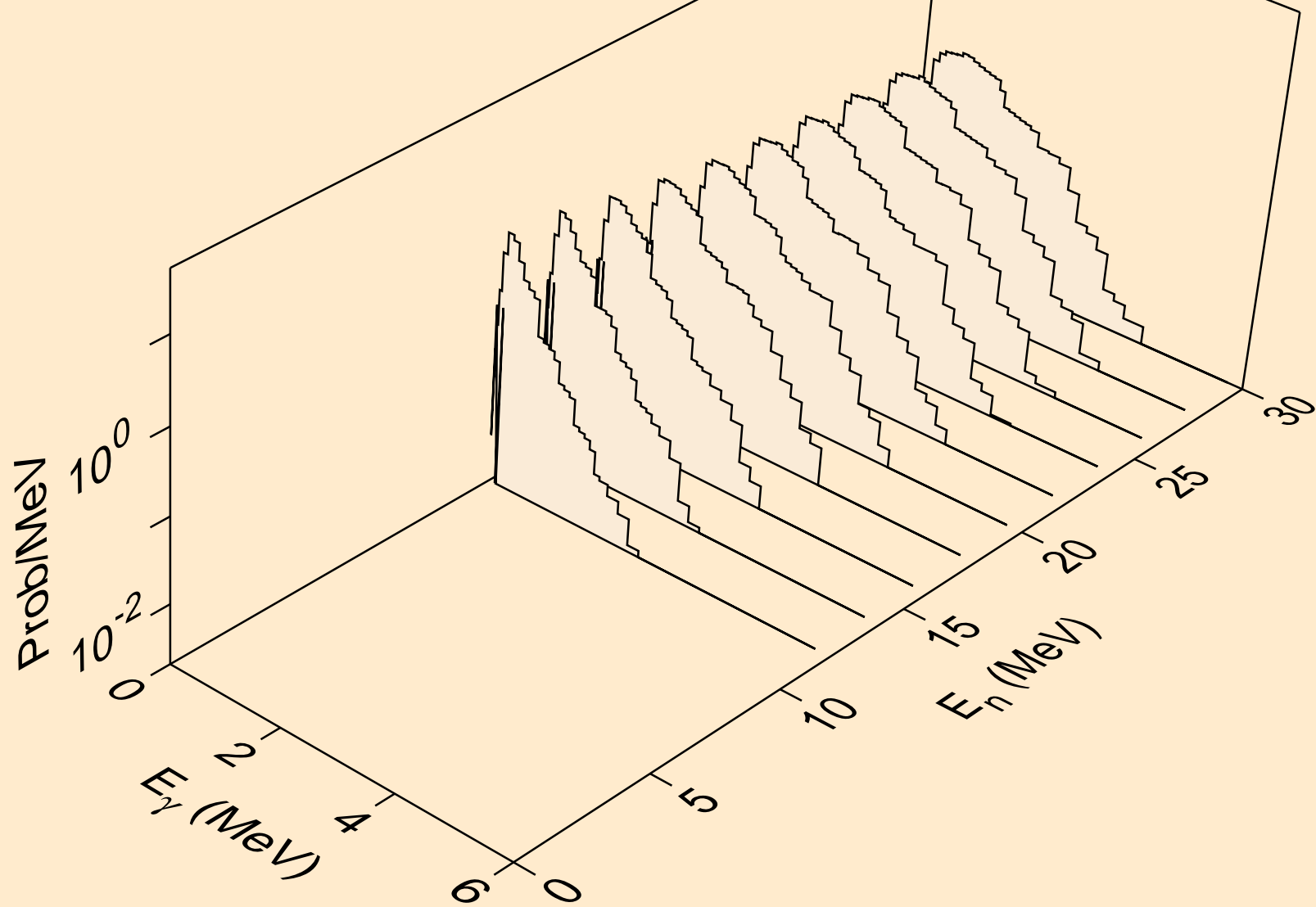

PA230 HELION ACER TENDL-2021 LIBRARY; T=0.K  
Photon emission for (n,2n)a

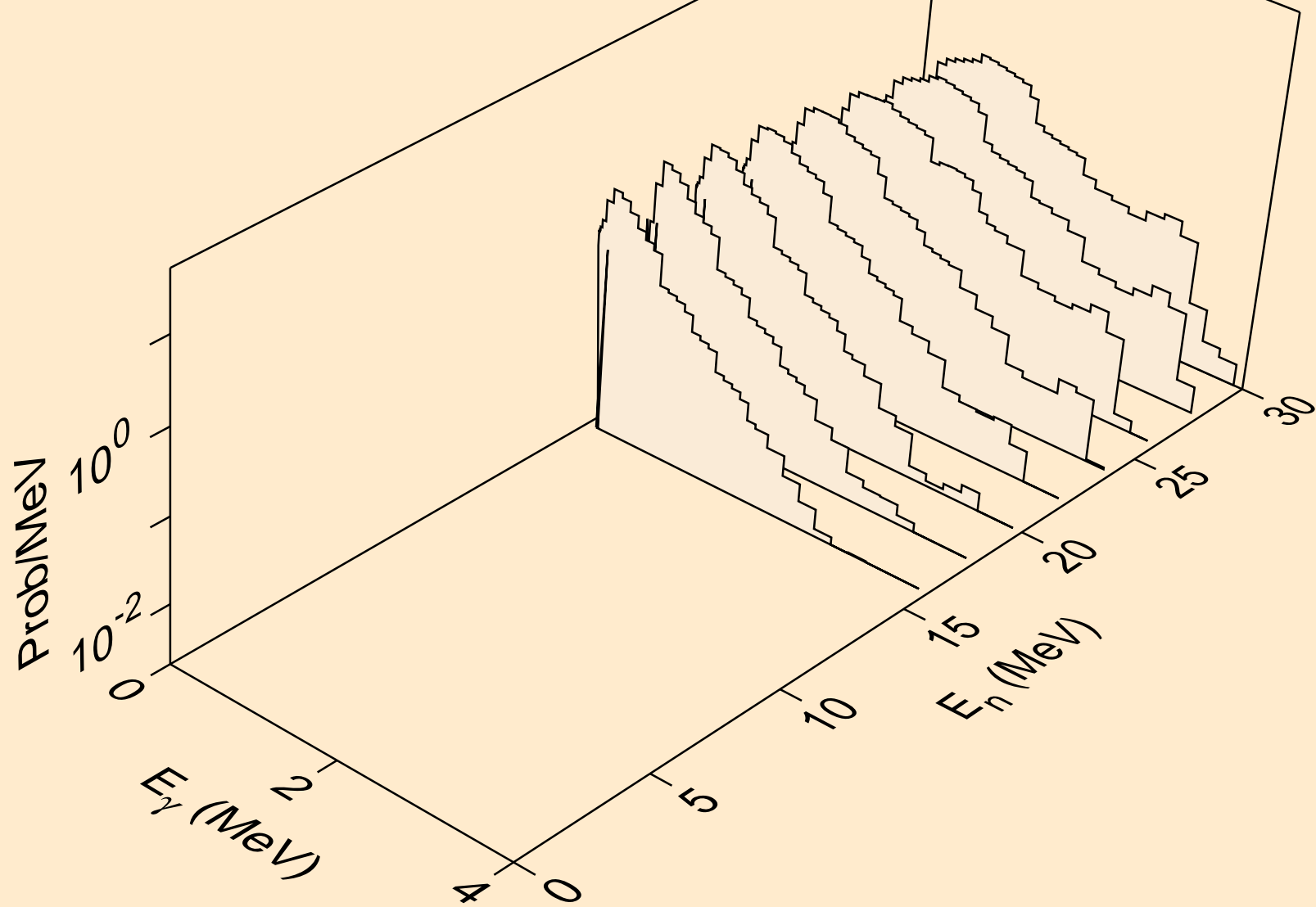

PA230 HELION ACER TENDL-2021 LIBRARY; T=0.K  
Photon emission for (n,3n)a

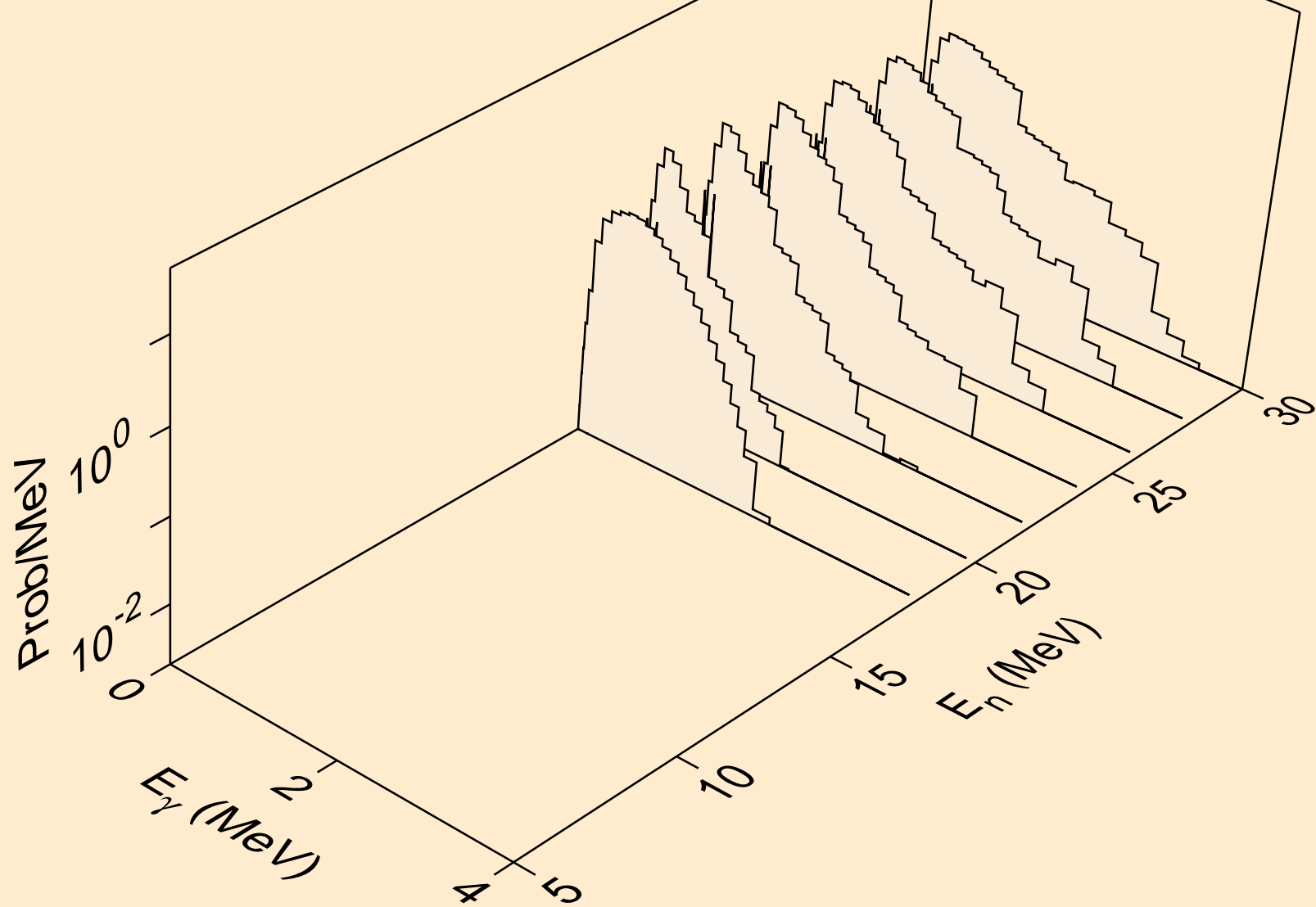



PA230 HELION ACER TENDL-2021 LIBRARY; T=0.K  
Photon emission for (n,n\*)p

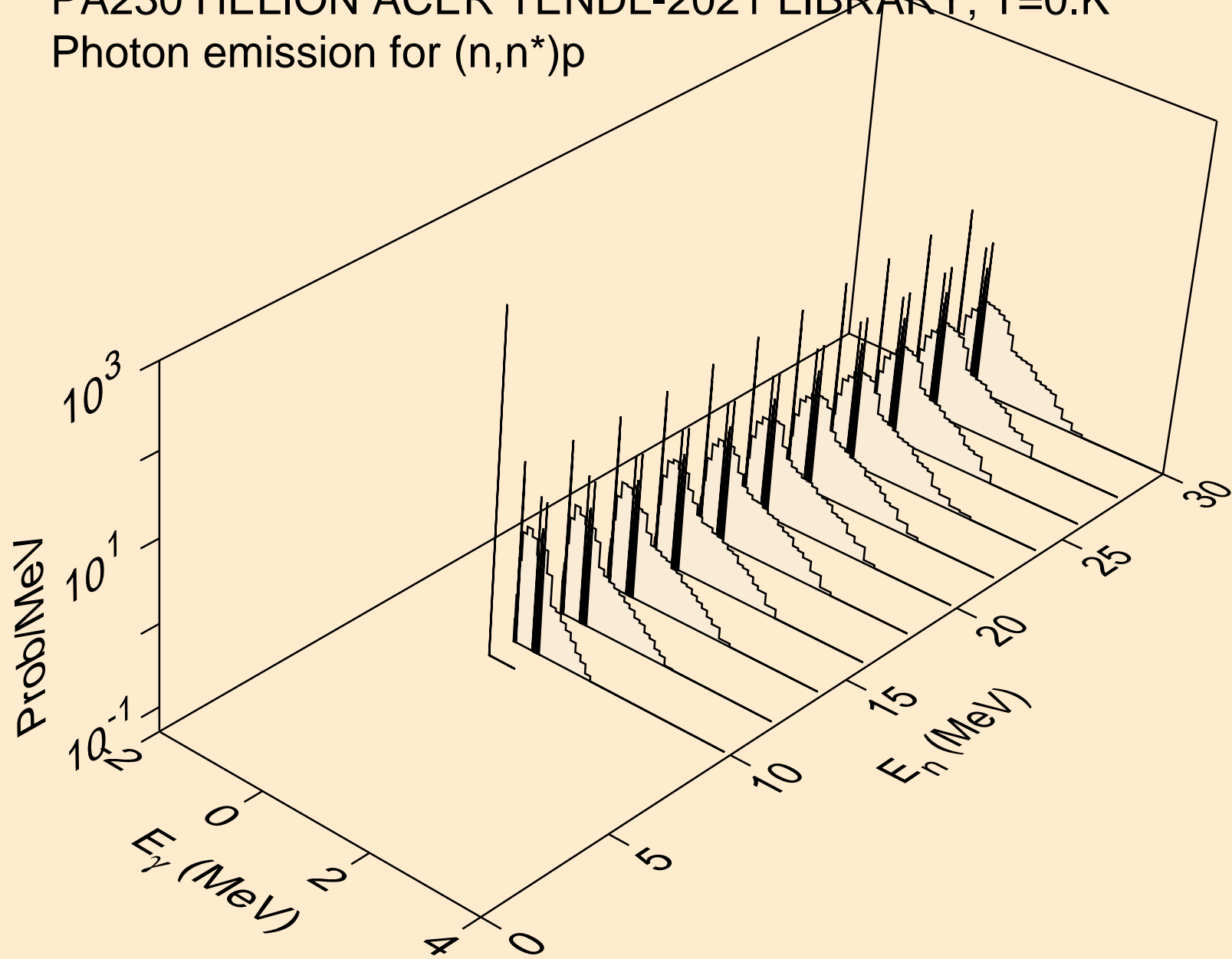

PA230 HELION ACER TENDL-2021 LIBRARY; T=0.K  
Photon emission for (n,n\*)d

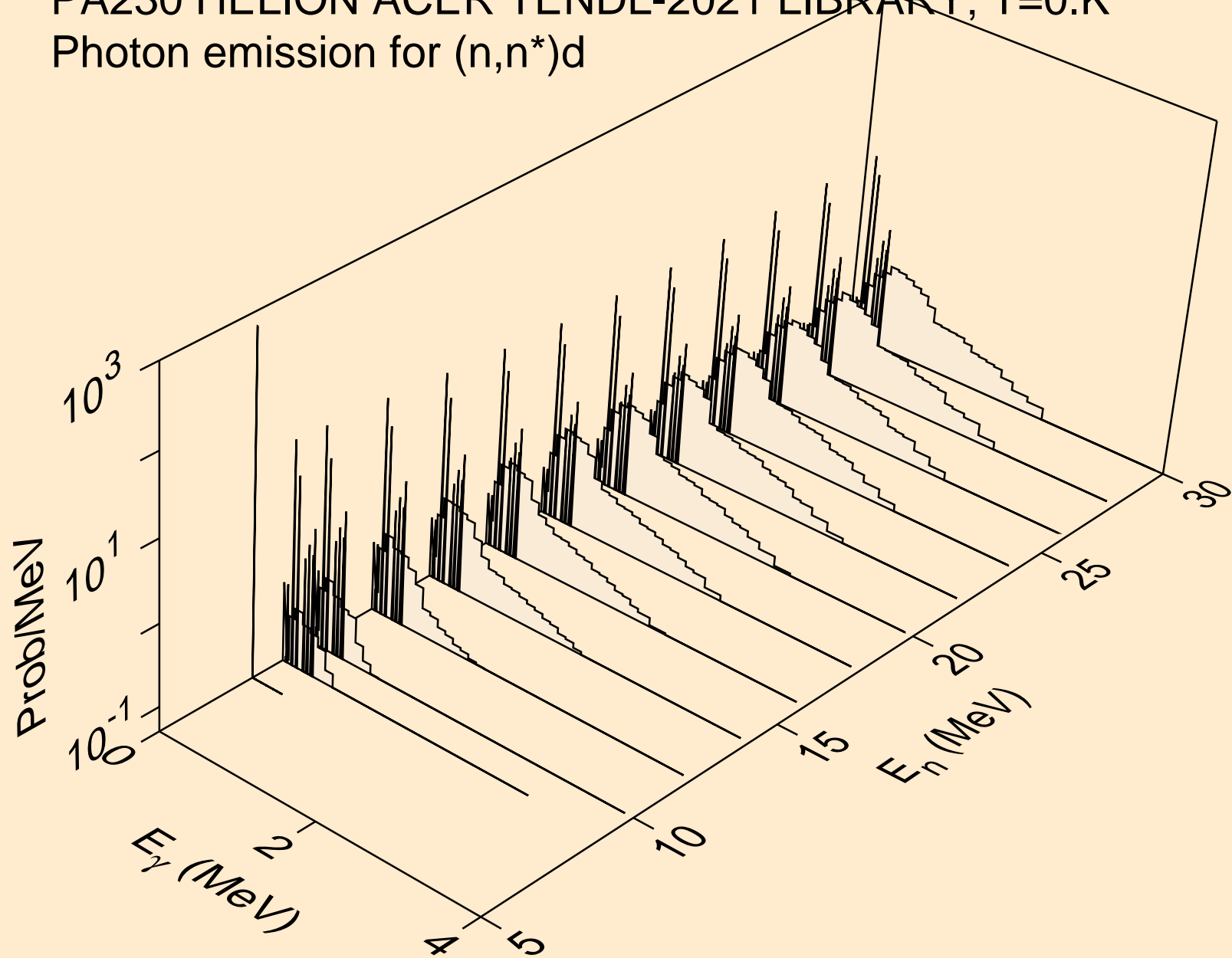

PA230 HELION ACER TENDL-2021 LIBRARY; T=0.K  
Photon emission for (n,n\*)t

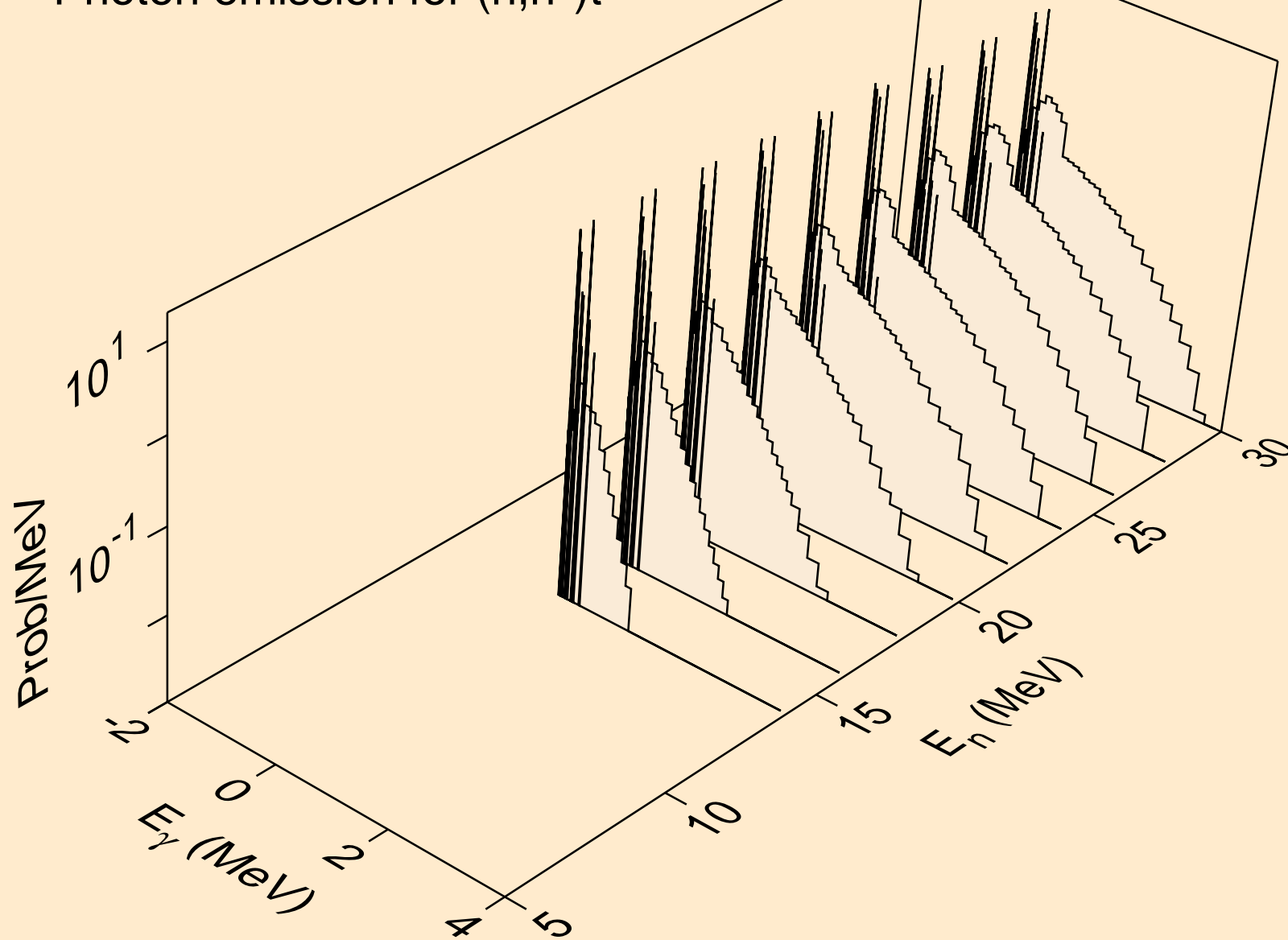

PA230 HELION ACER TENDL-2021 LIBRARY; T=0.K  
Photon emission for (n,n\*)he3

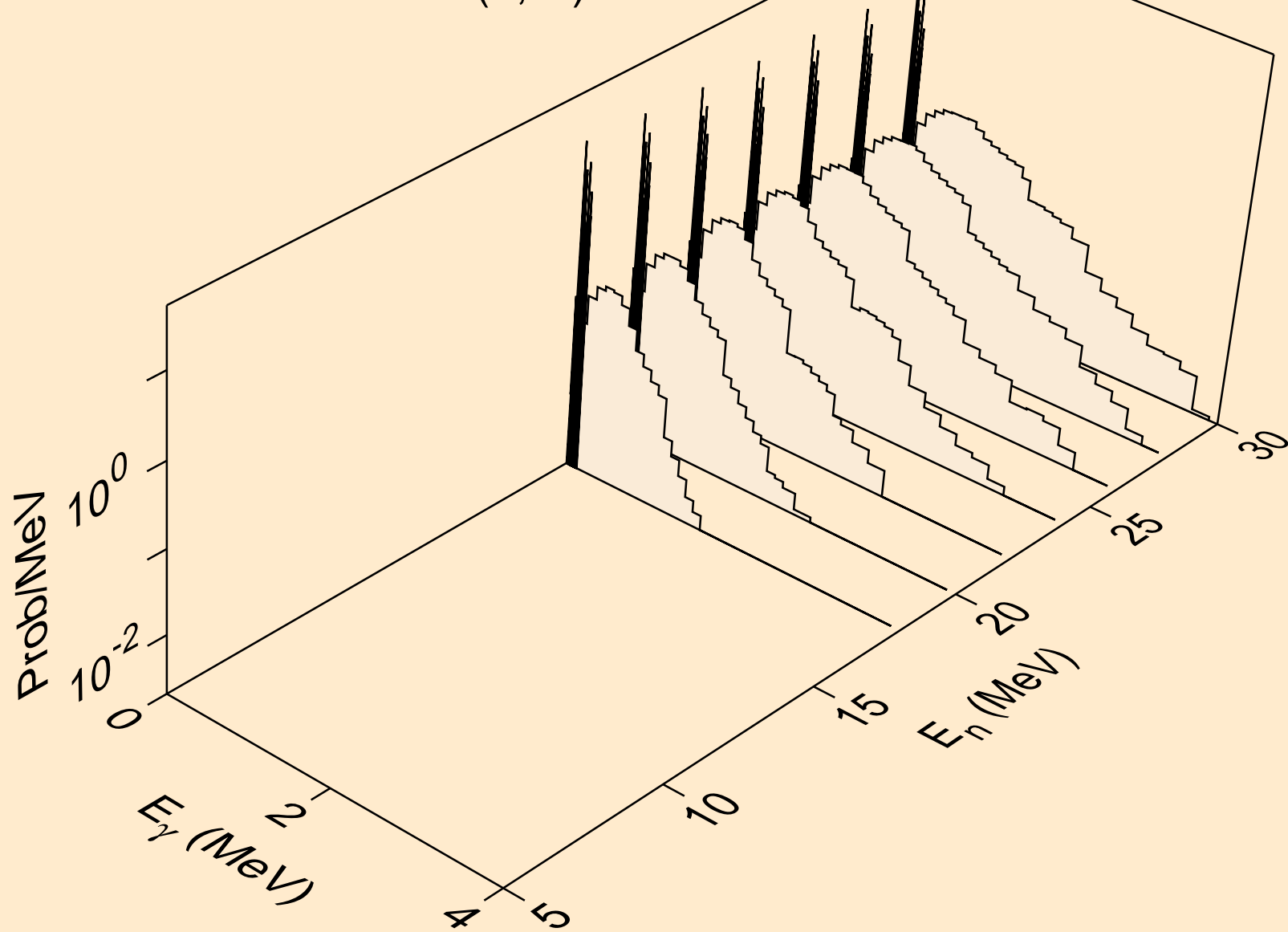

PA230 HELION ACER TENDL-2021 LIBRARY; T=0.K  
Photon emission for (n,4n)

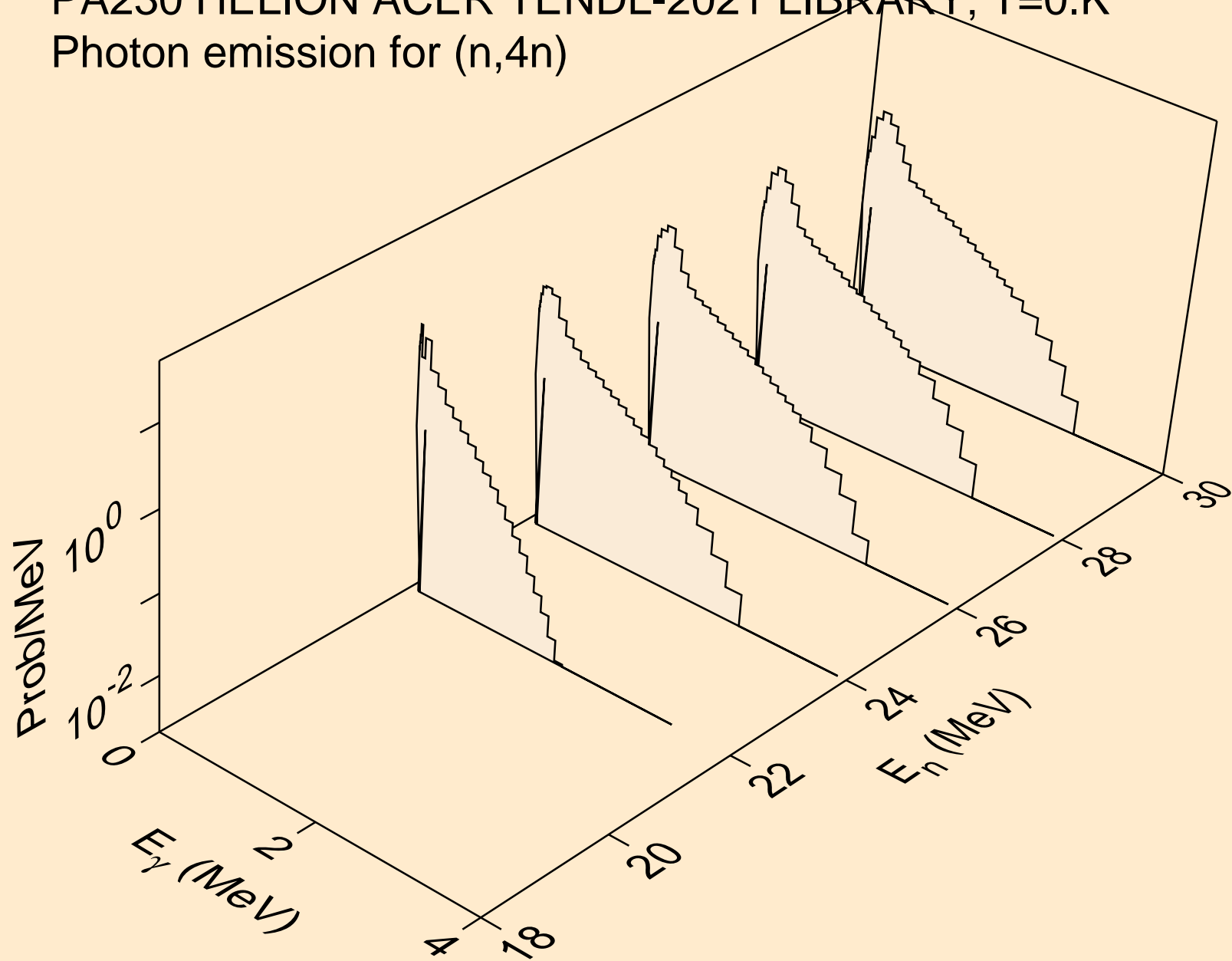

PA230 HELION ACER TENDL-2021 LIBRARY; T=0.K  
Photon emission for (n,2np)

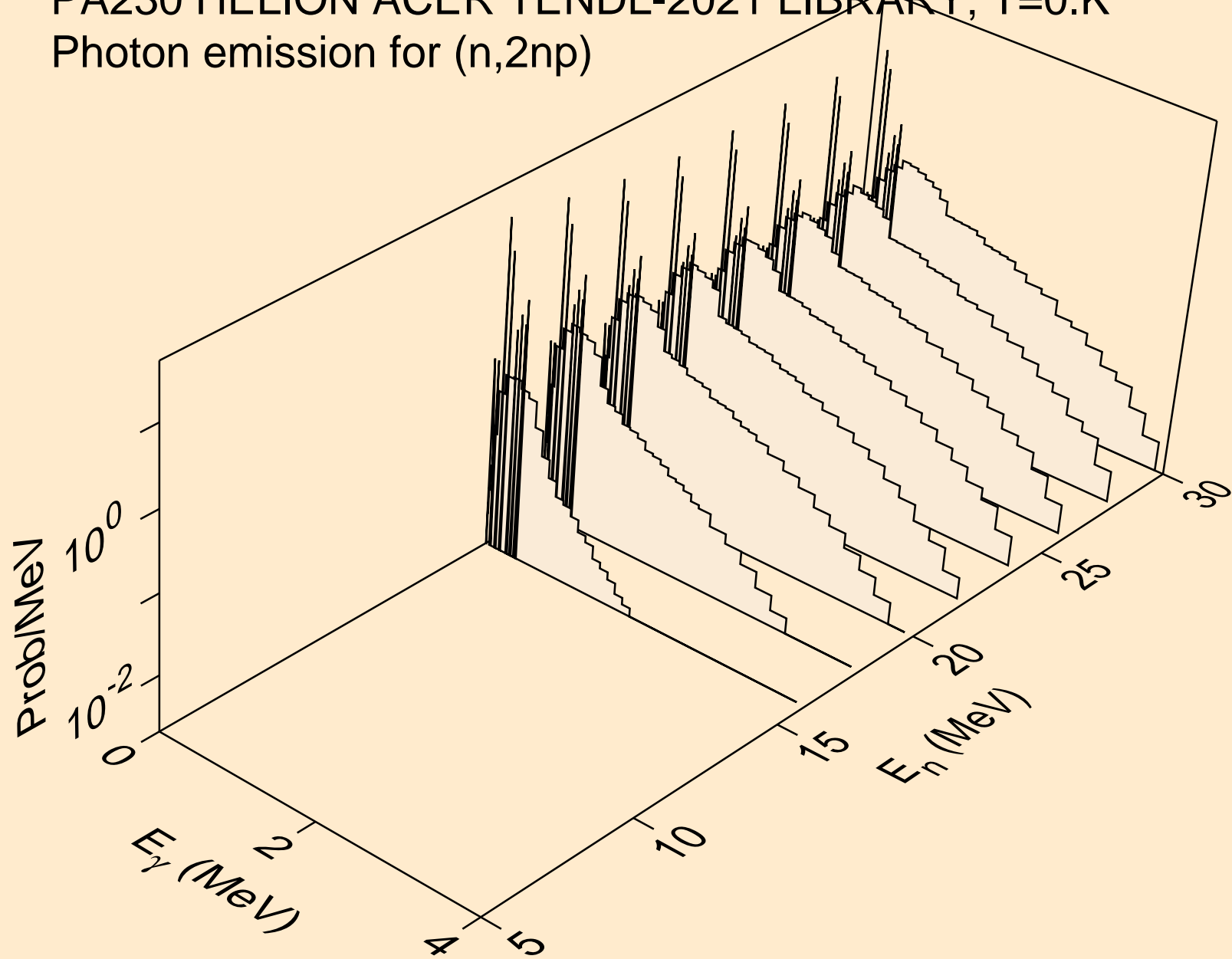

PA230 HELION ACER TENDL-2021 LIBRARY; T=0.K  
Photon emission for (n,3np)

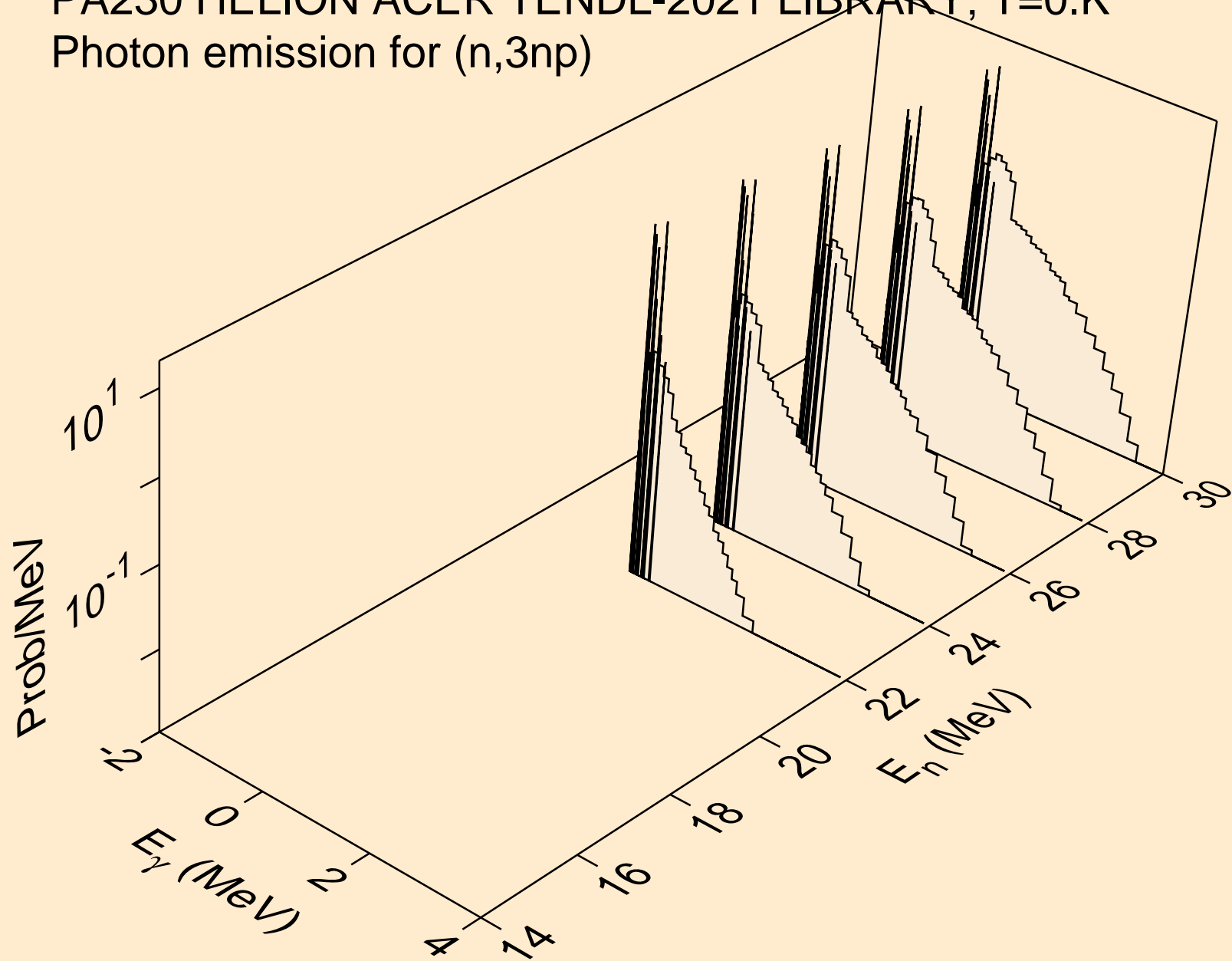

PA230 HELION ACER TENDL-2021 LIBRARY; T=0.K  
Photon emission for (n,2np)

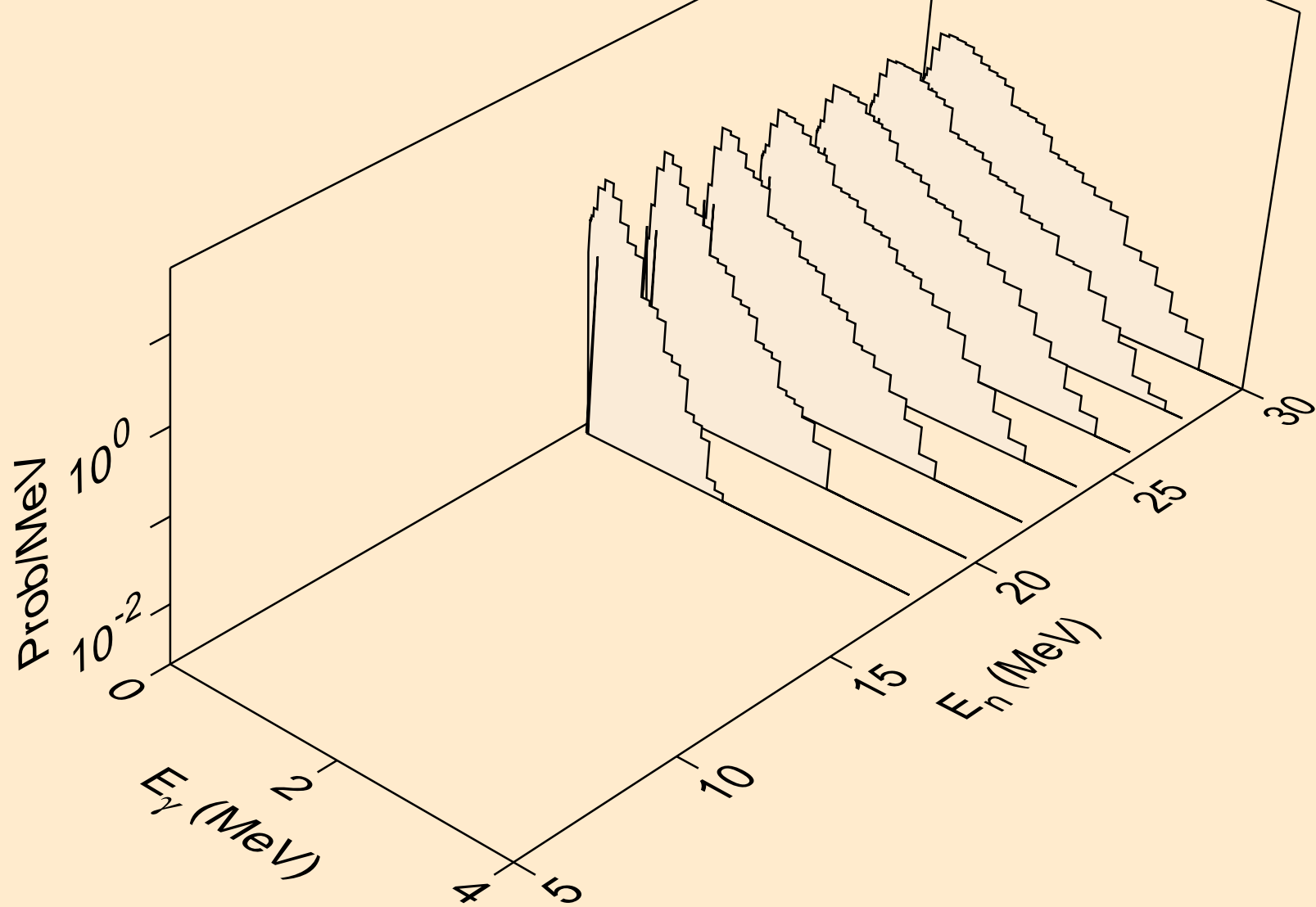



PA230 HELION ACER TENDL-2021 LIBRARY; T=0.K  
Photon emission for (n,npa)

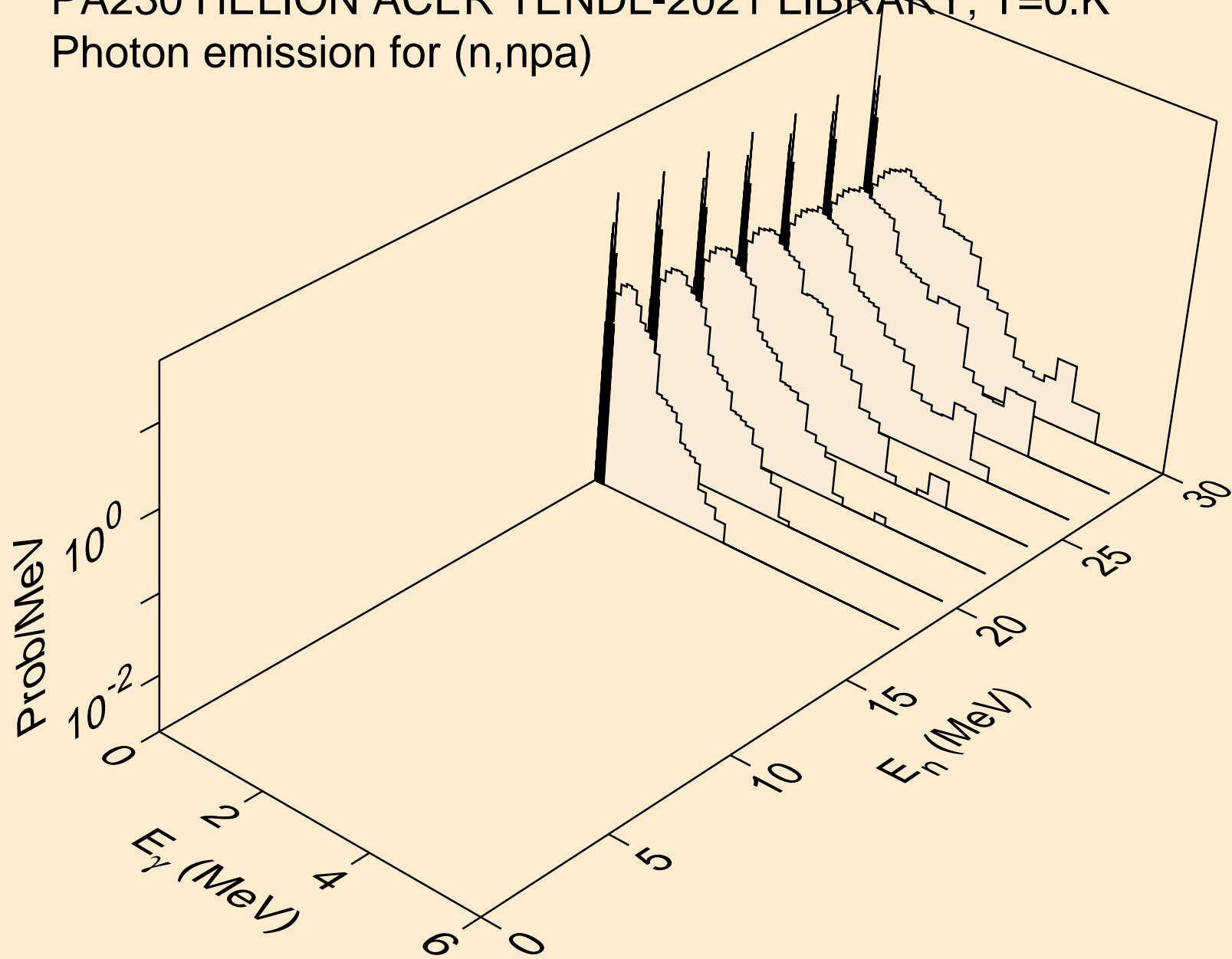

PA230 HELION ACER TENDL-2021 LIBRARY; T=0.K  
Photon emission for (n,p)

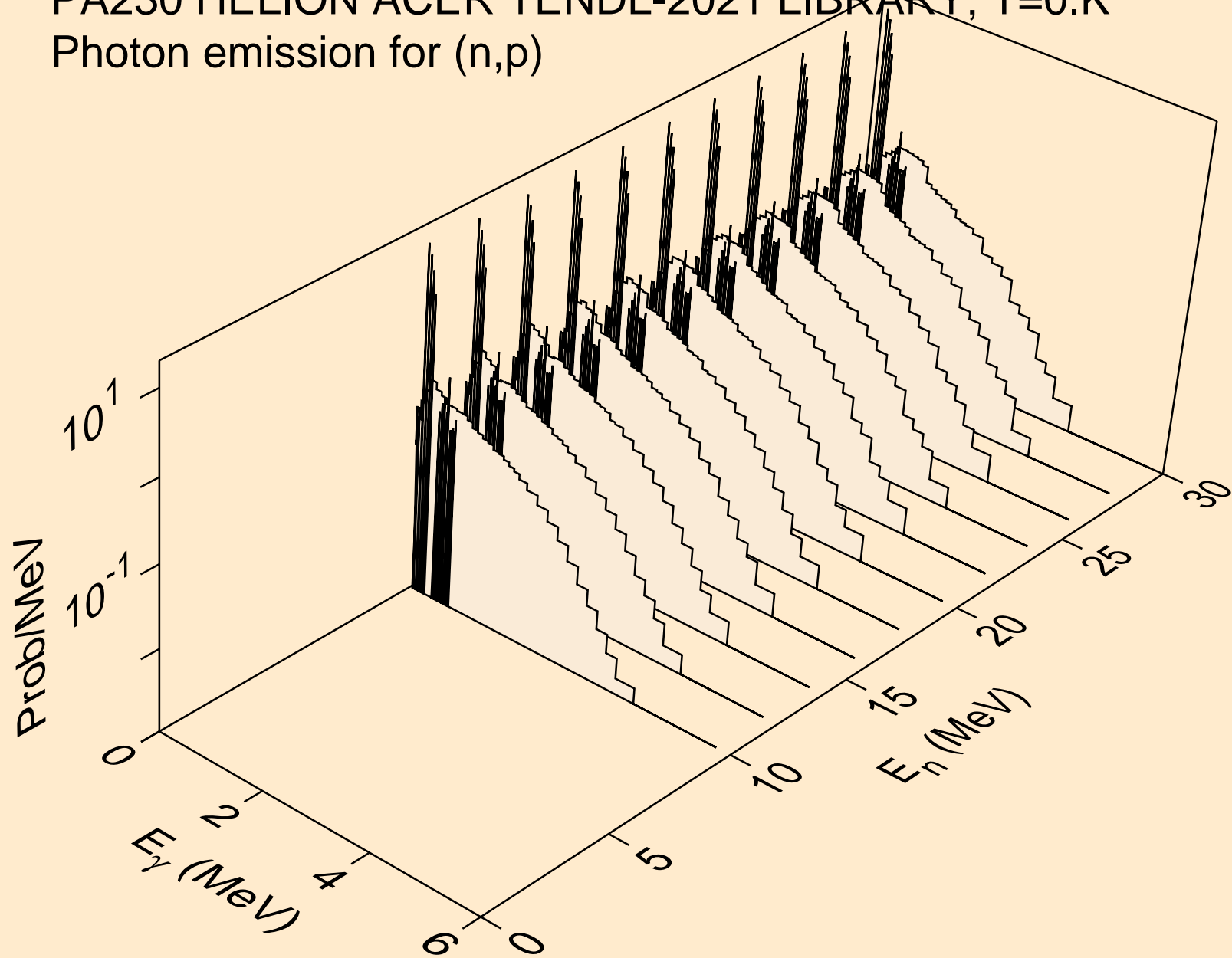

PA230 HELION ACER TENDL-2021 LIBRARY; T=0.K  
Photon emission for (n,d)

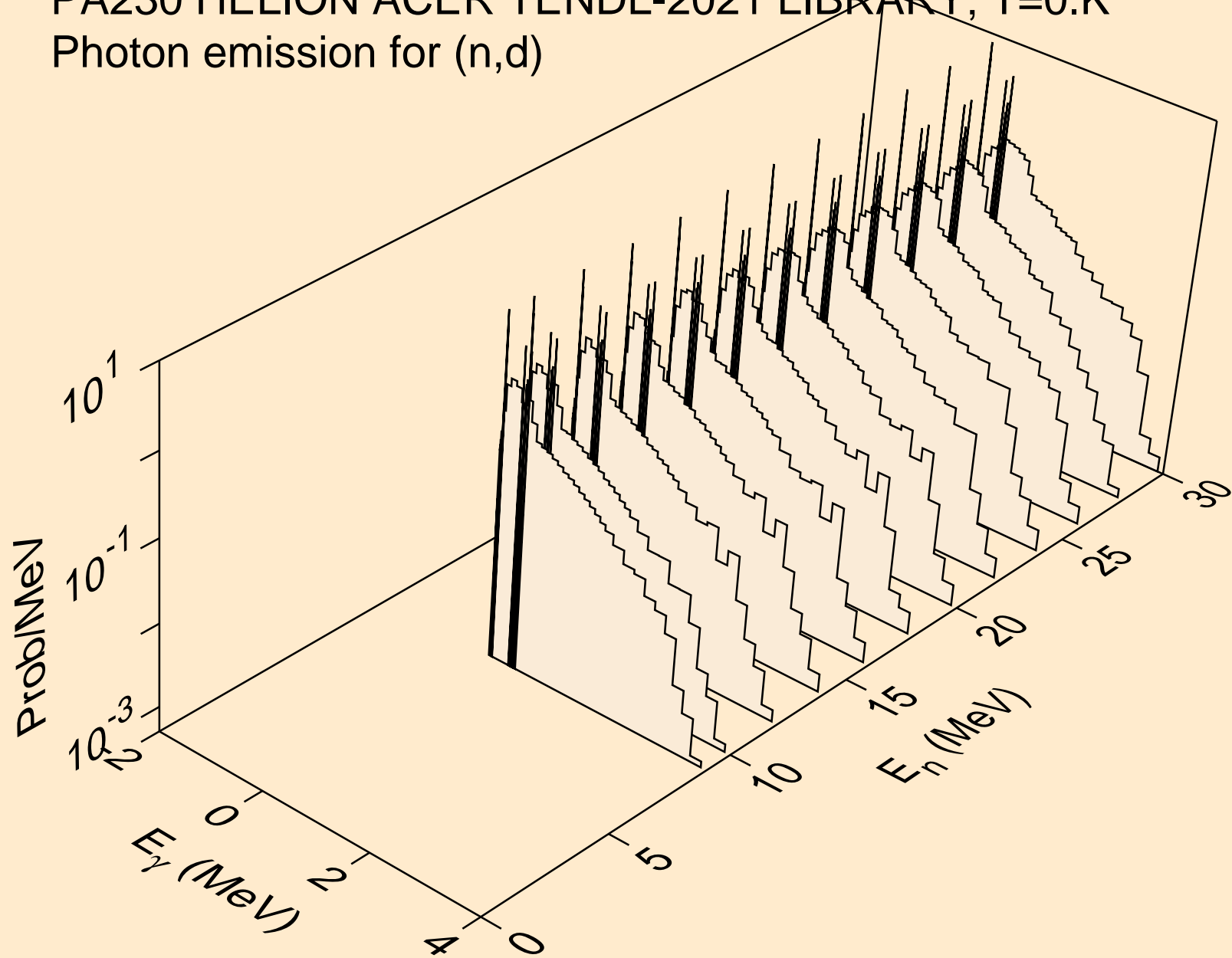

PA230 HELION ACER TENDL-2021 LIBRARY; T=0.K  
Photon emission for (n,t)

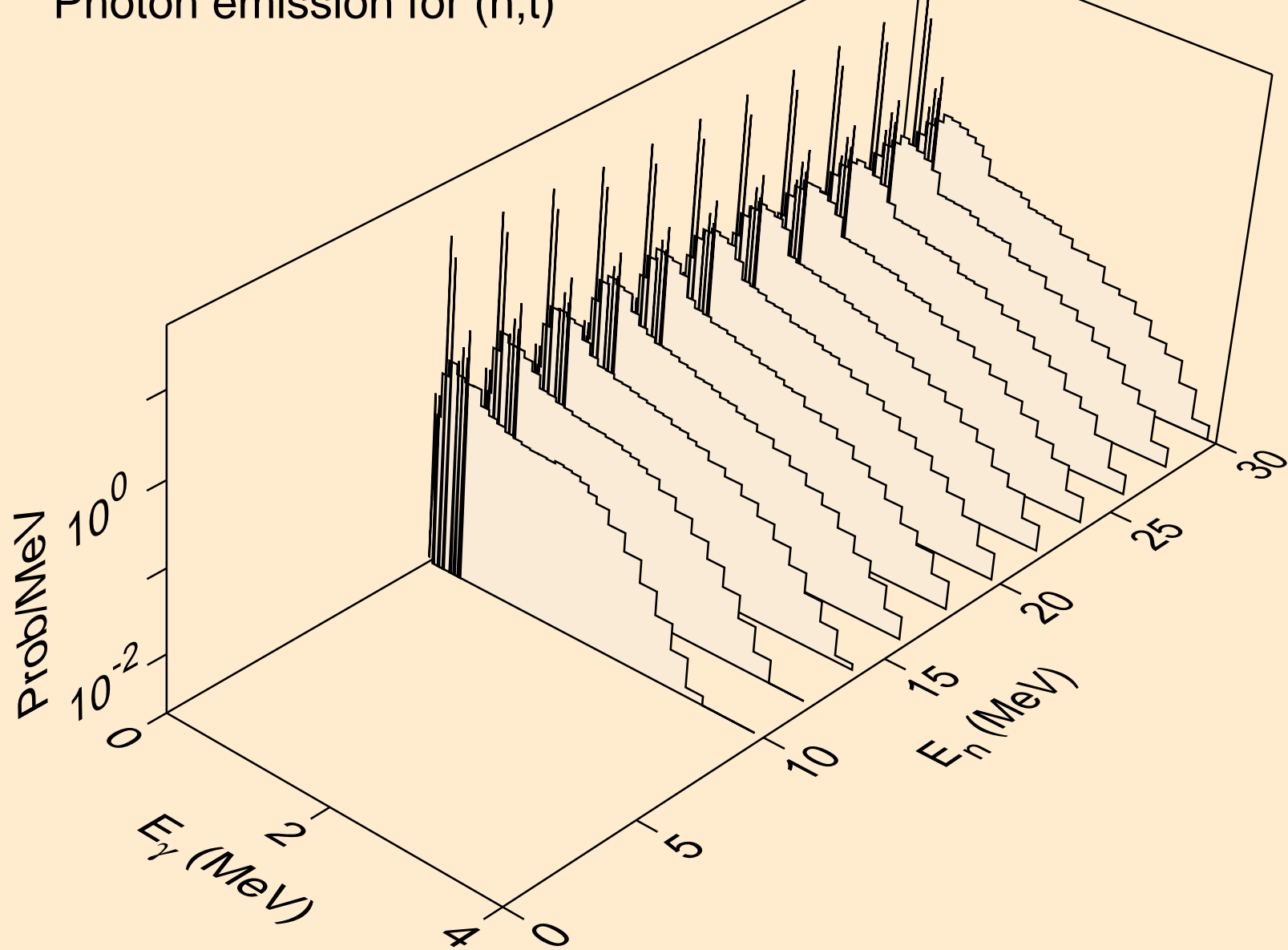

PA230 HELION ACER TENDL-2021 LIBRARY; T=0.K  
Photon emission for inelastic

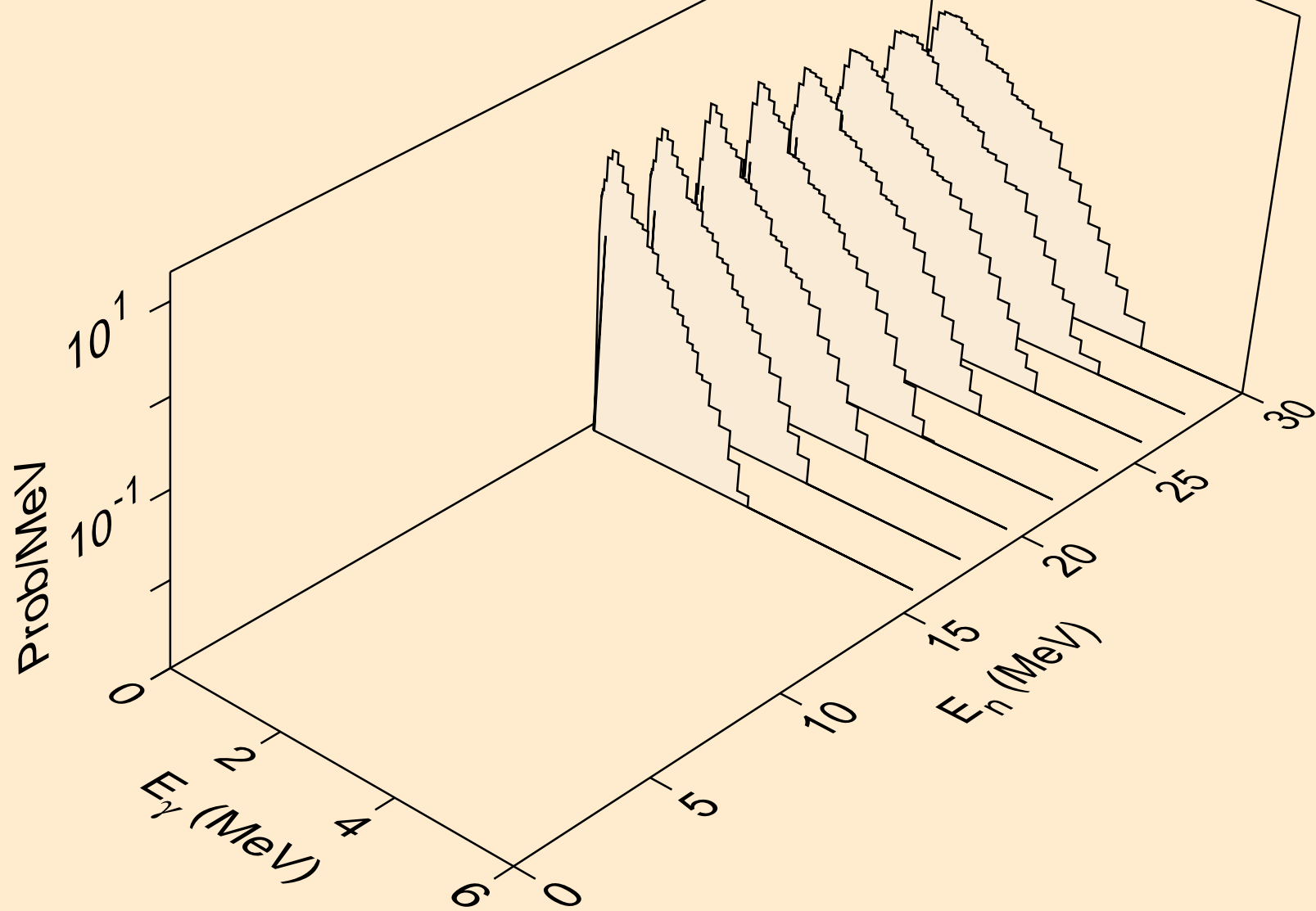

PA230 HELION ACER TENDL-2021 LIBRARY; T=0.K  
Photon emission for (n,a)

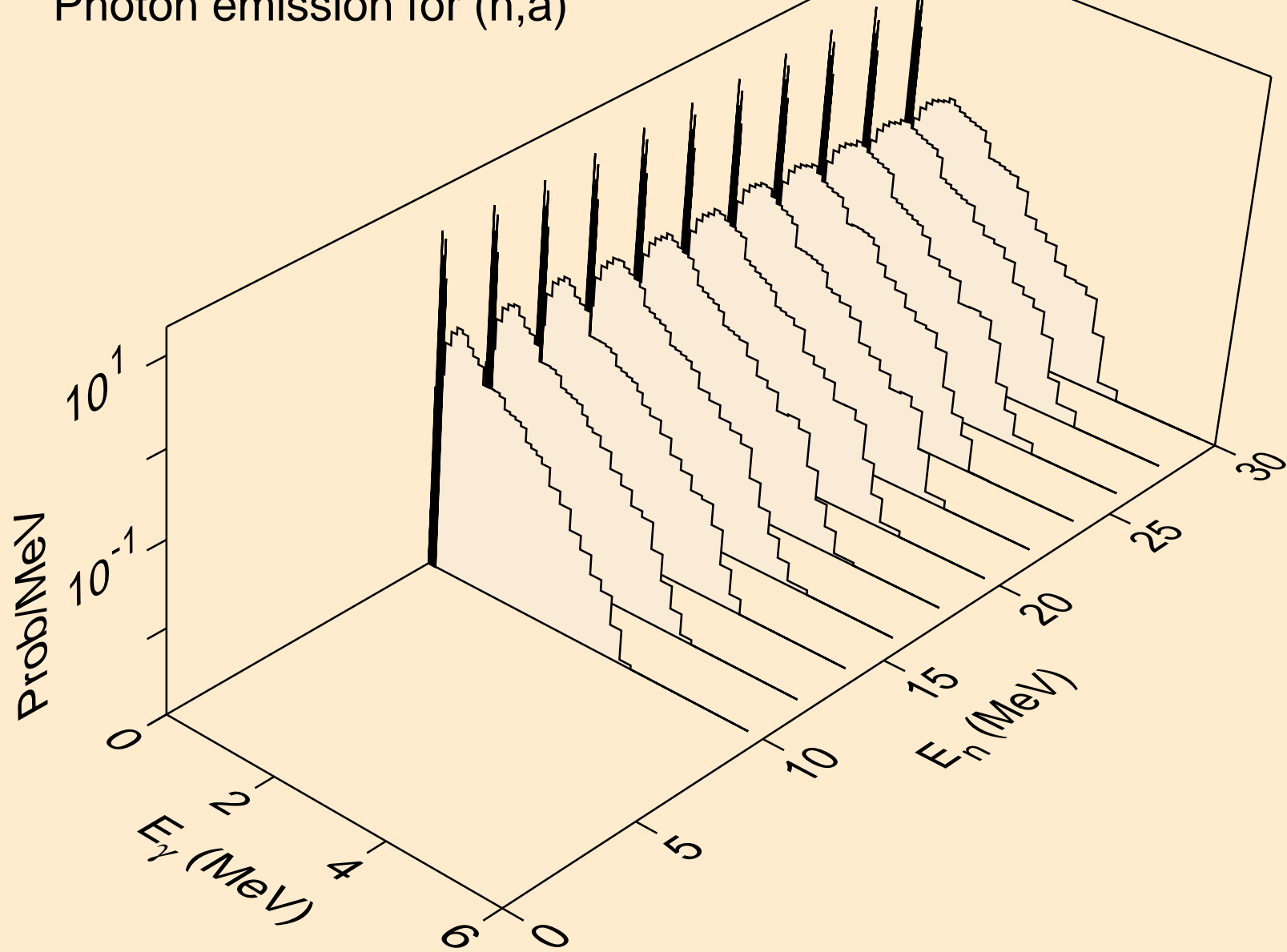

PA230 HELION ACER TENDL-2021 LIBRARY; T=0.K  
Photon emission for (n,2p)

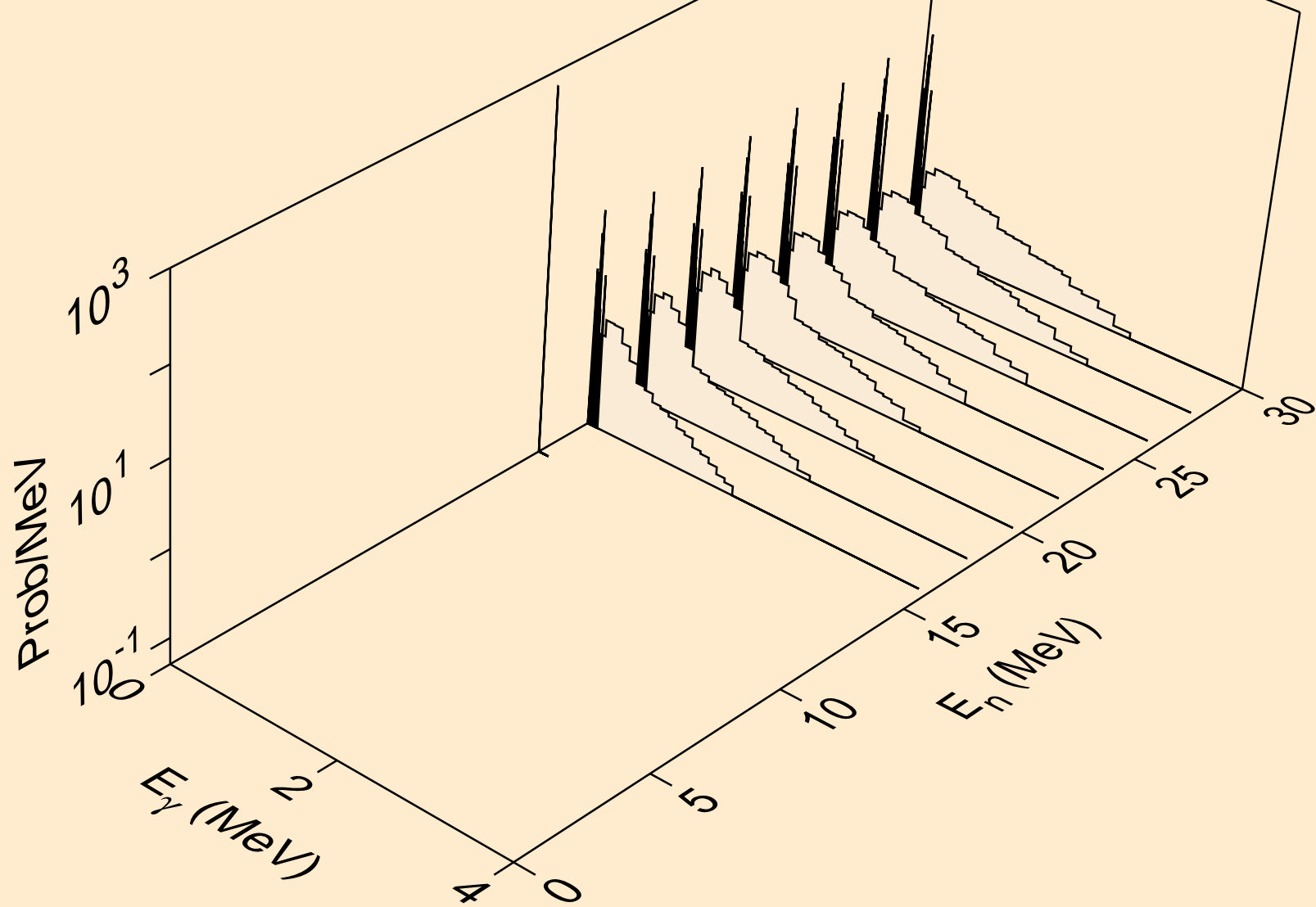

PA230 HELION ACER TENDL-2021 LIBRARY; T=0.K  
Photon emission for (n,pa)

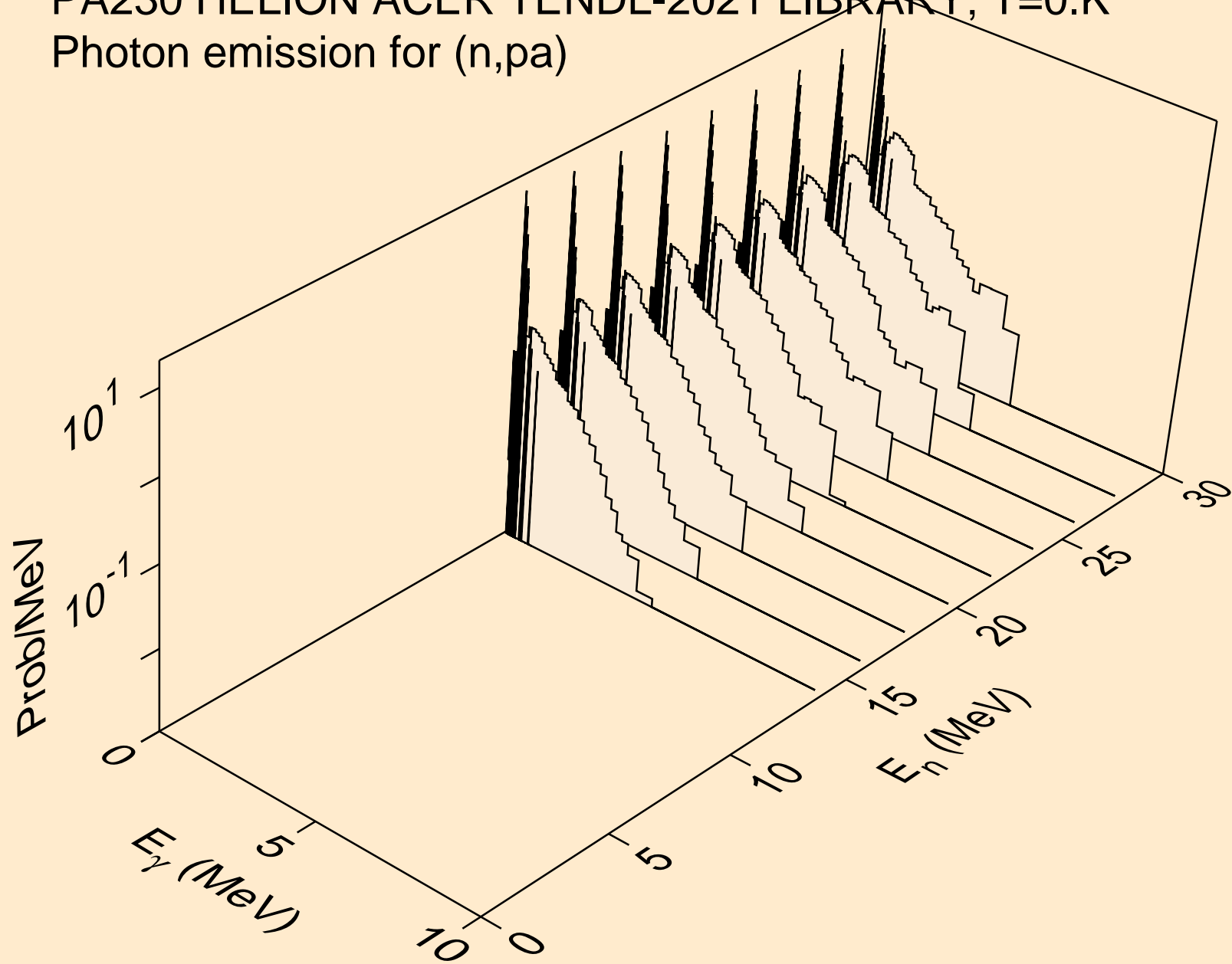



PA230 HELION ACER TENDL-2021 LIBRARY; T=0.K  
Photon emission for (n,pd)

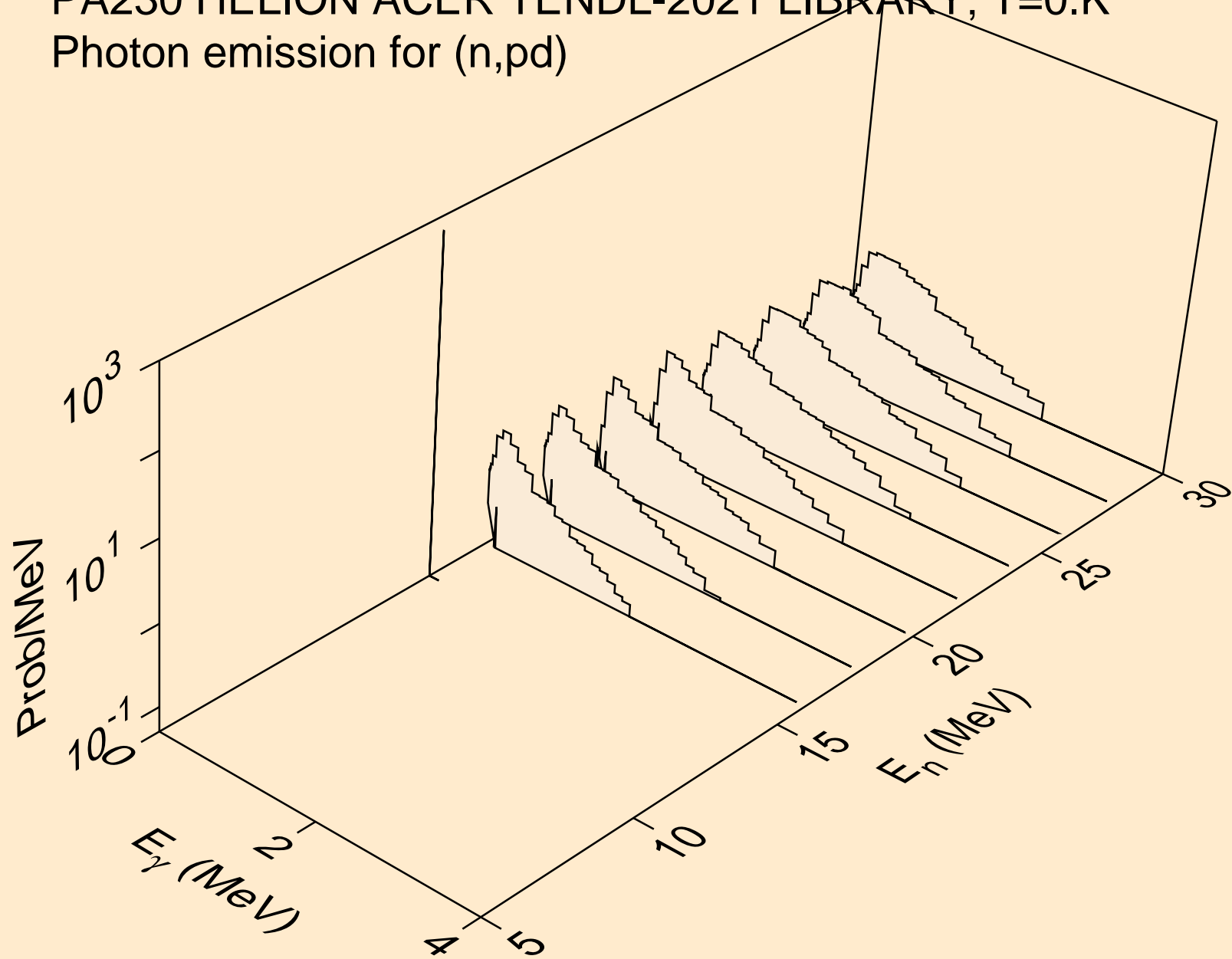

PA230 HELION ACER TENDL-2021 LIBRARY; T=0.K  
Photon emission for (n,pt)

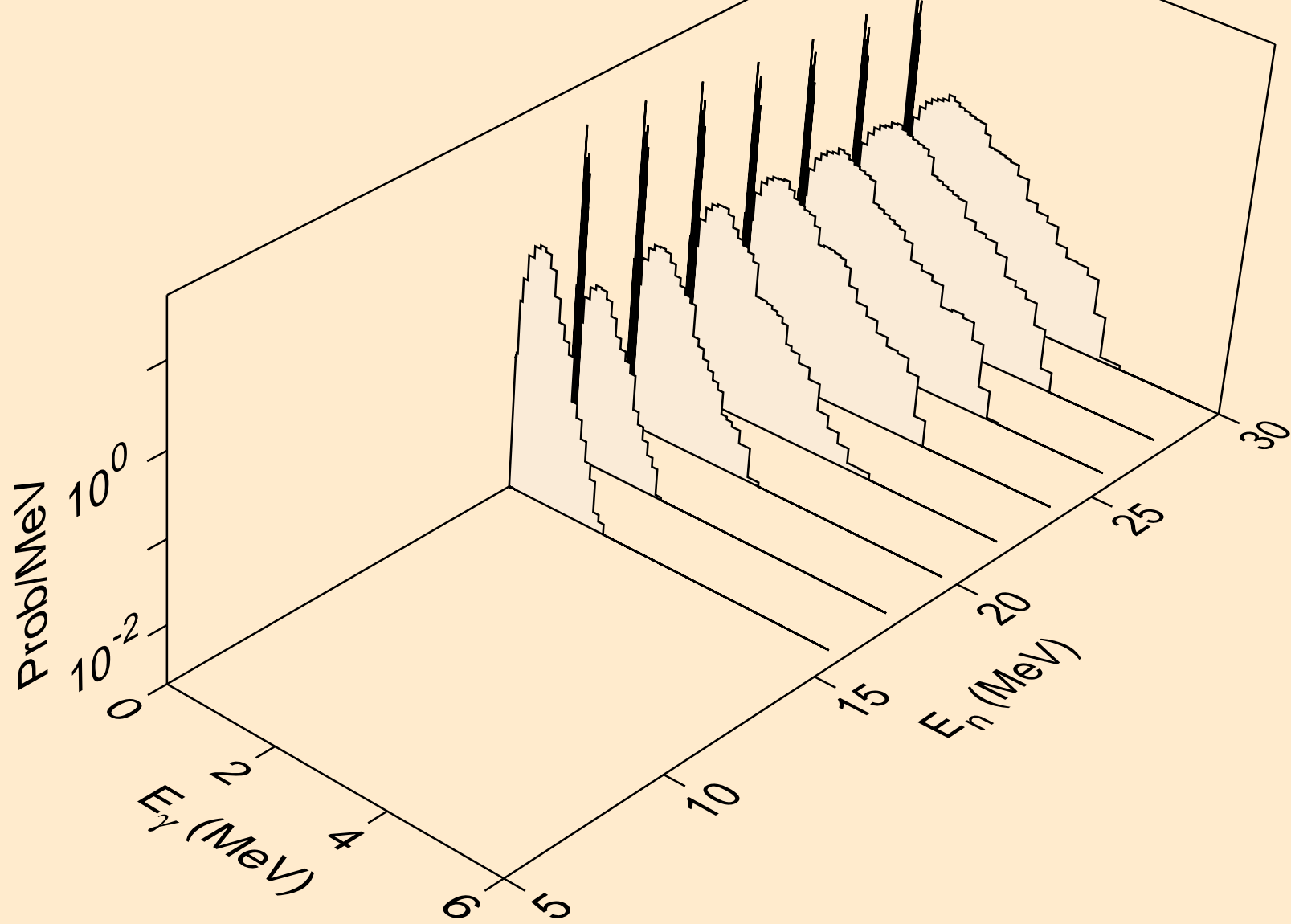

PA230 HELION ACER TENDL-2021 LIBRARY; T=0.K  
Photon emission for (n,da)

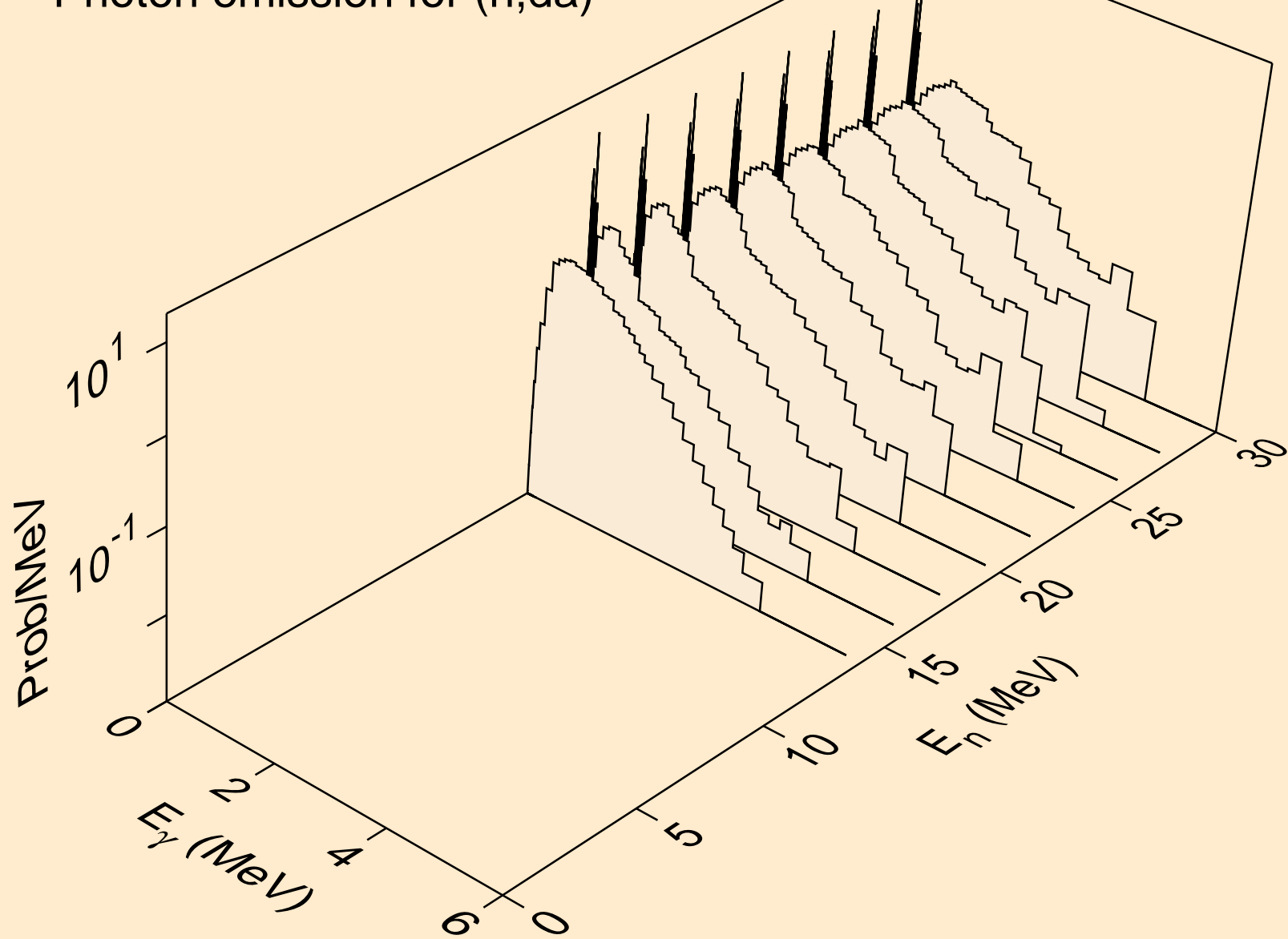

PA230 HELION ACER TENDL-2021 LIBRARY; T=0.K  
Particle heating contributions

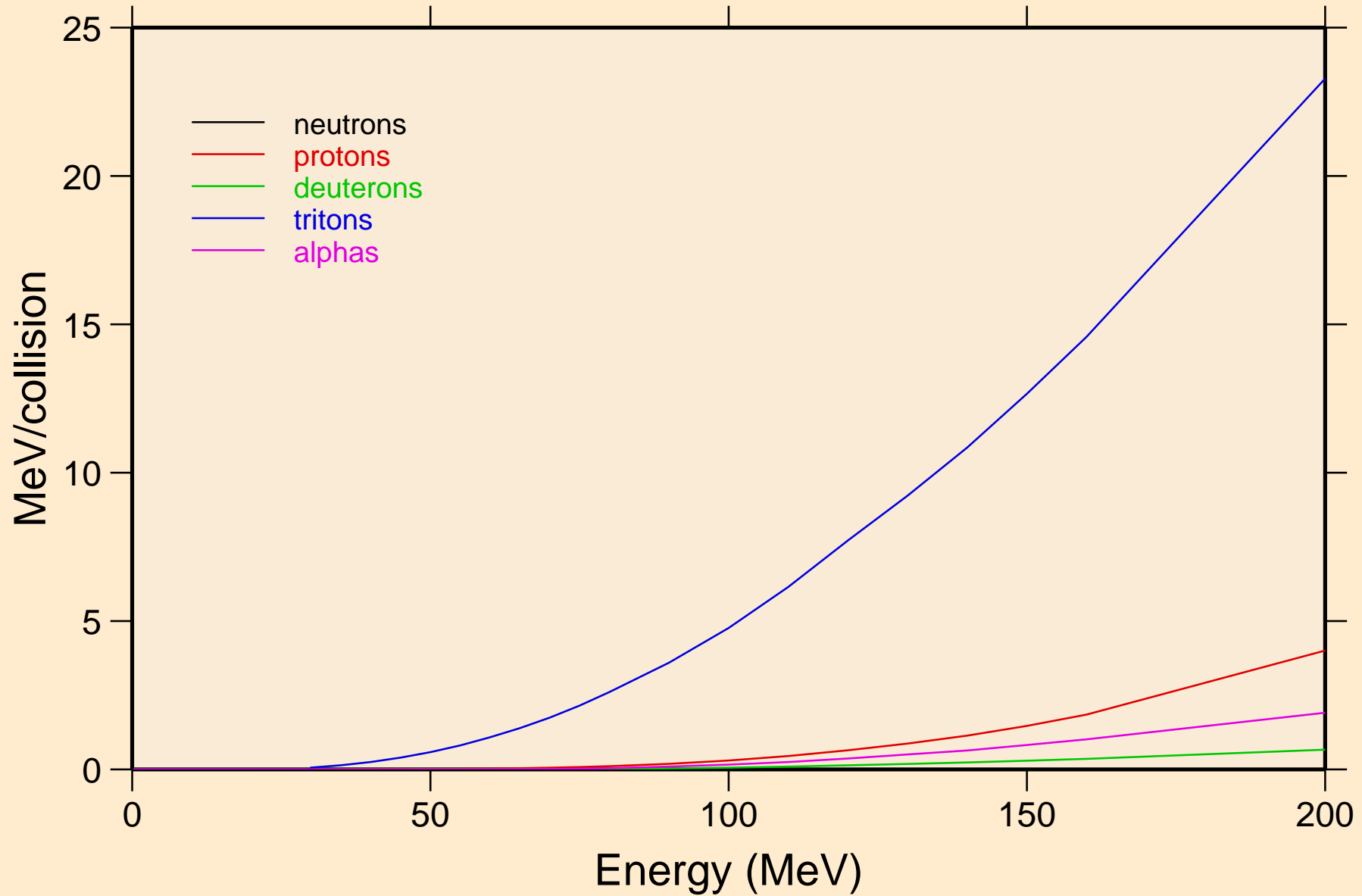

PA230 HELION ACER TENDL-2021 LIBRARY; T=0.K  
Recoil Heating

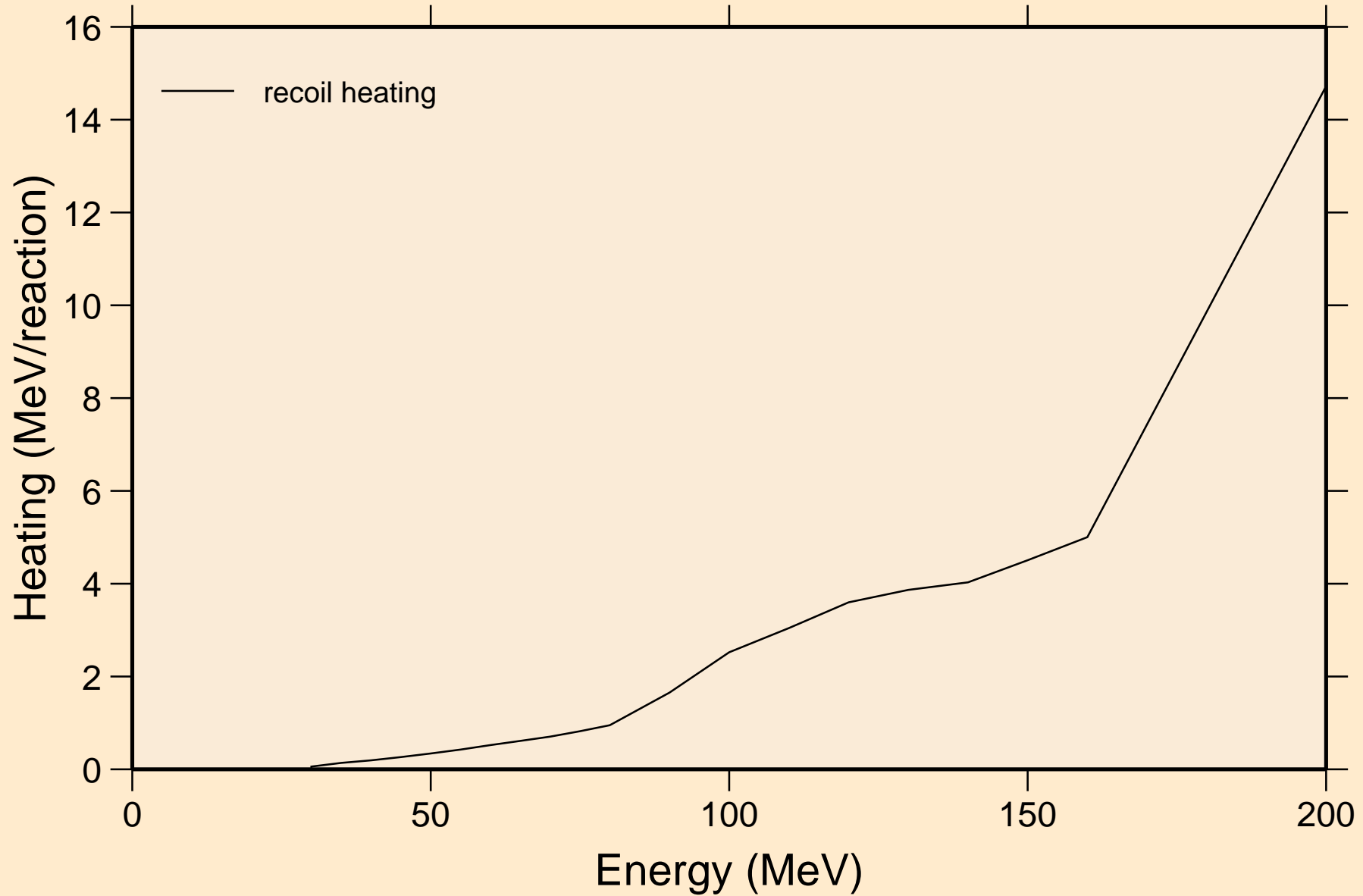

PA230 HELION ACER TENDL-2021 LIBRARY; T=0.K  
Particle production cross sections

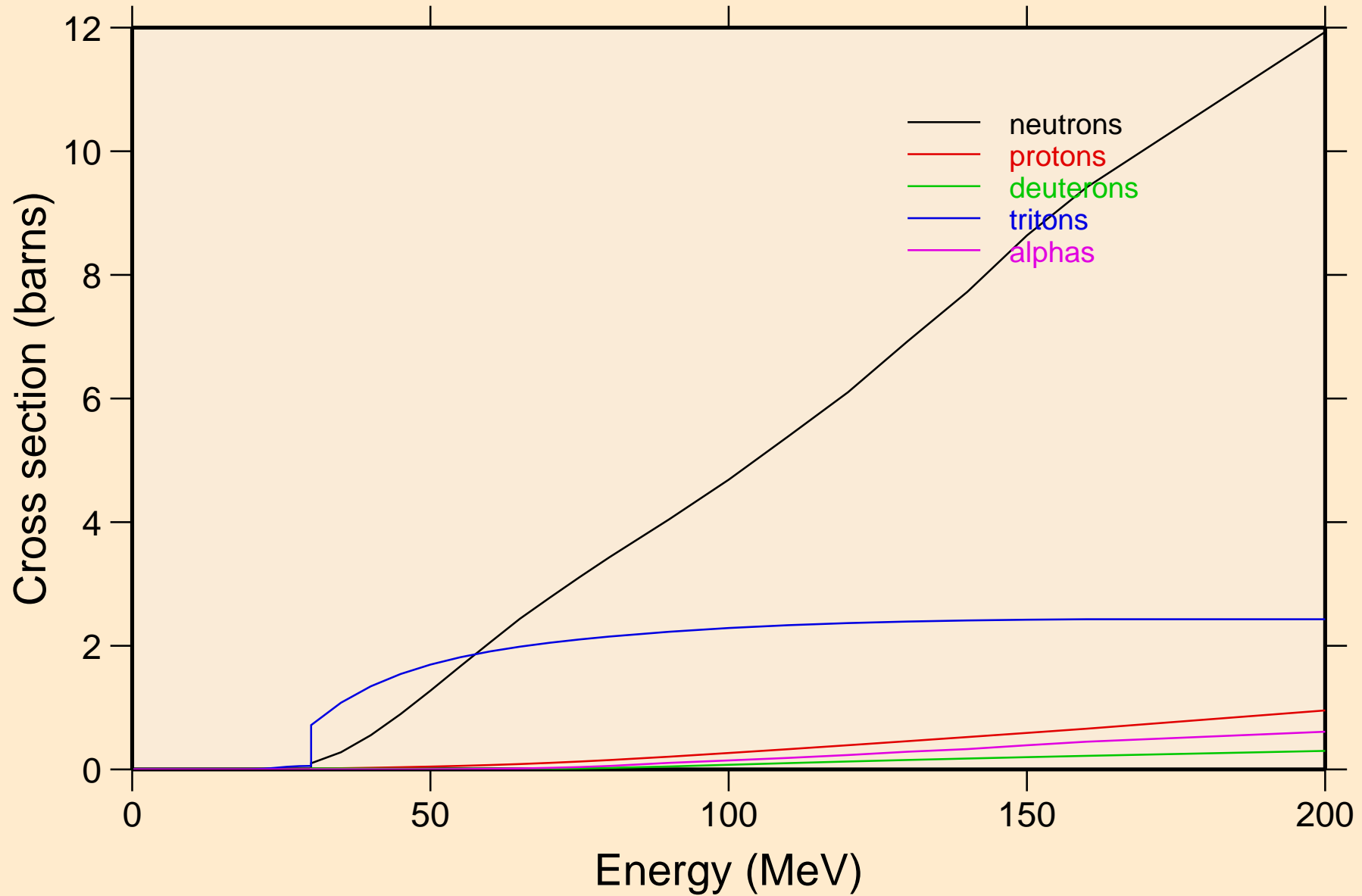

PA230 HELION ACER TENDL-2021 LIBRARY; T=0.K  
neutrons from (s,n)

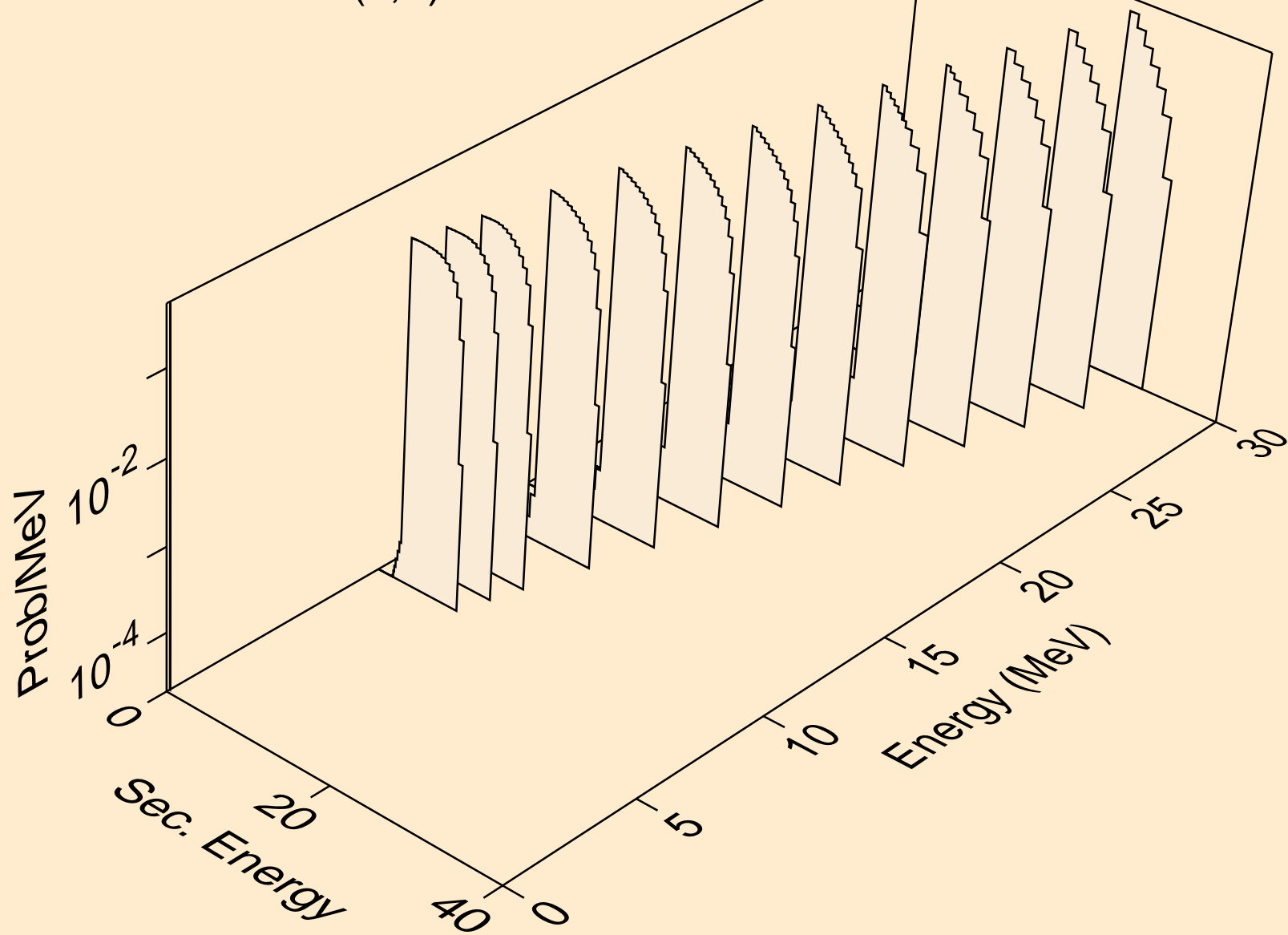

PA230 HELION ACER TENDL-2021 LIBRARY; T=0.K  
neutrons from (s,x)

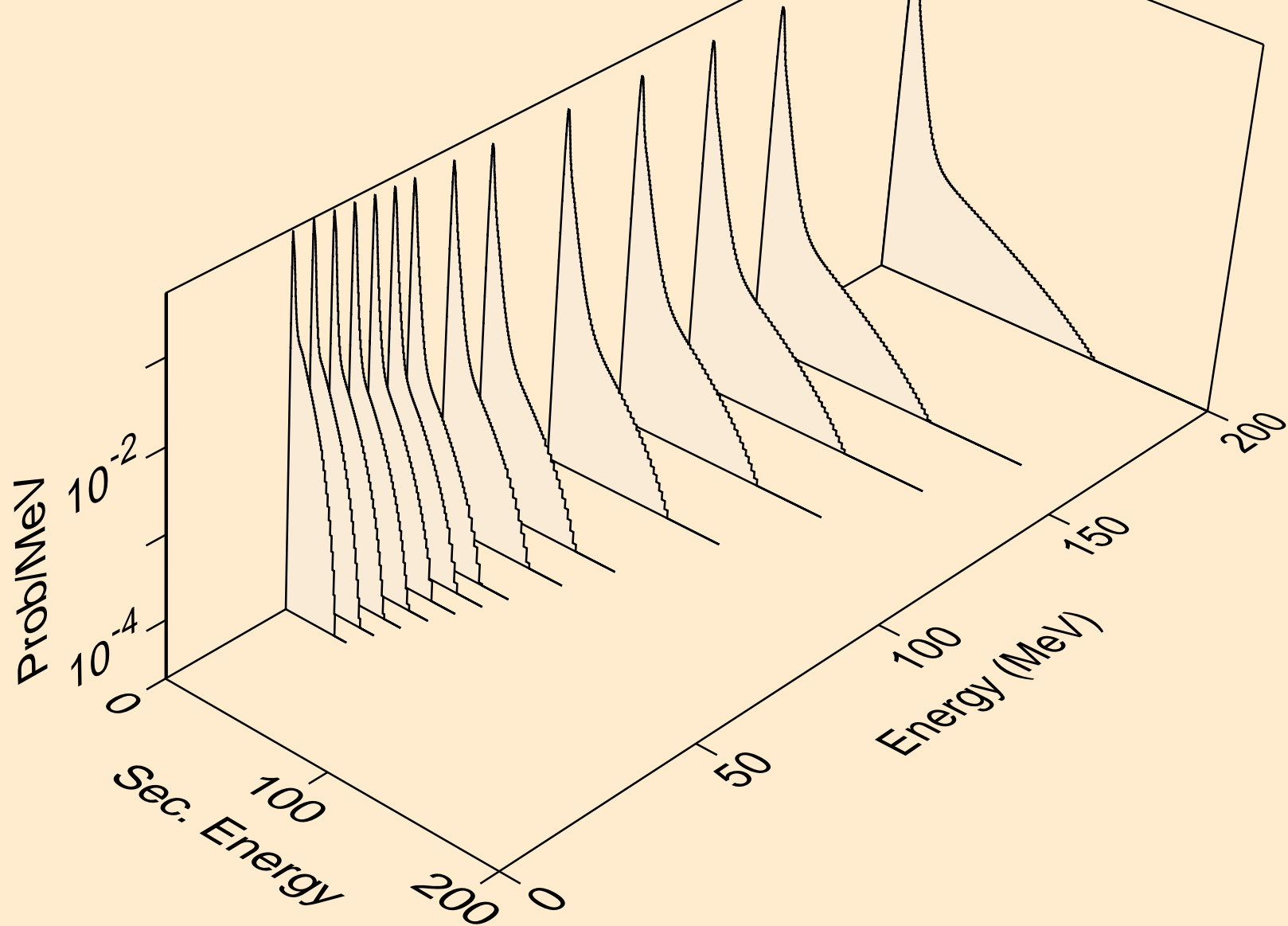



PA230 HELION ACER TENDL-2021 LIBRARY; T=0.K  
neutrons from (s,2nd)

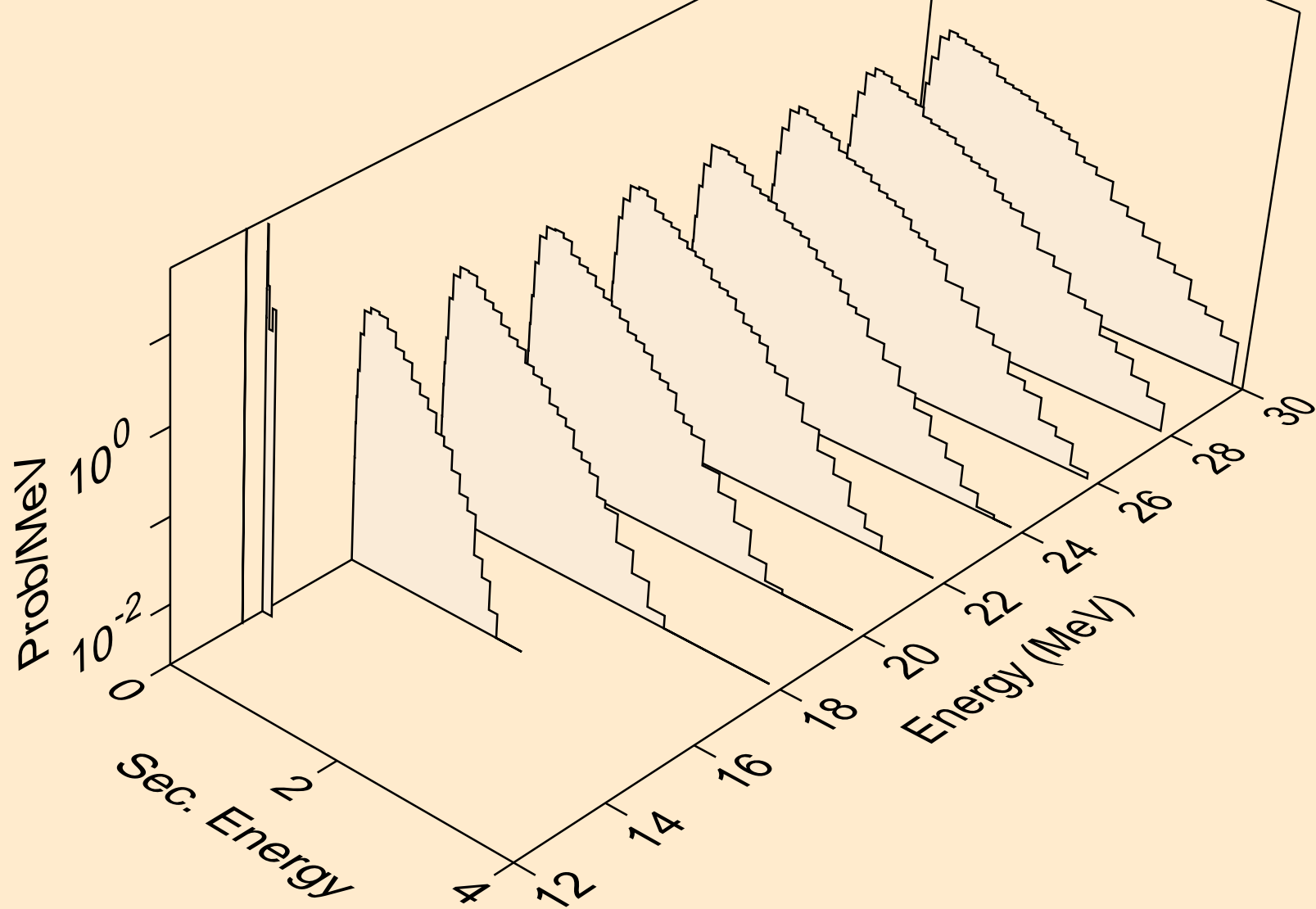

PA230 HELION ACER TENDL-2021 LIBRARY; T=0.K  
neutrons from (s,2n)

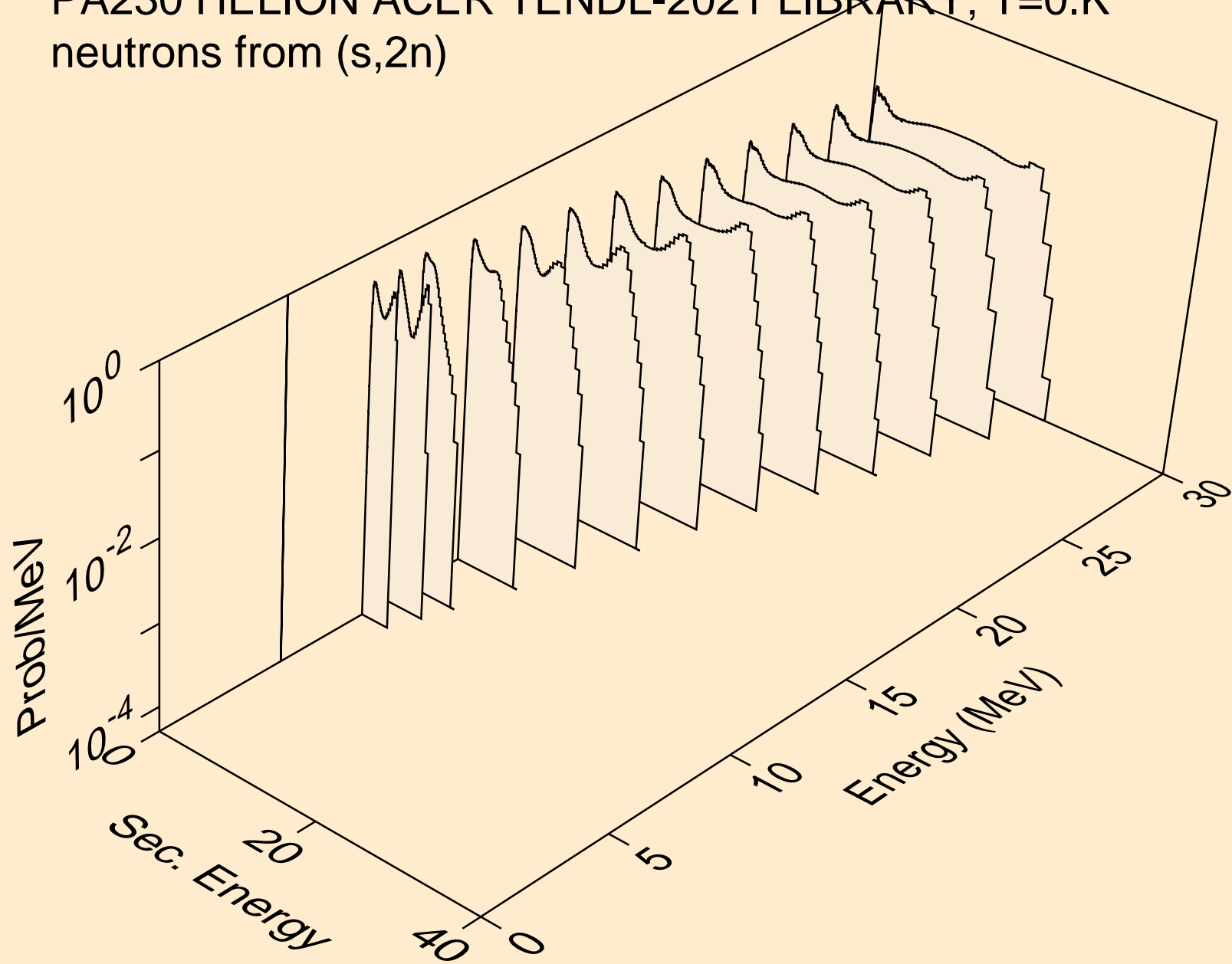

PA230 HELION ACER TENDL-2021 LIBRARY; T=0.K  
neutrons from (s,3n)

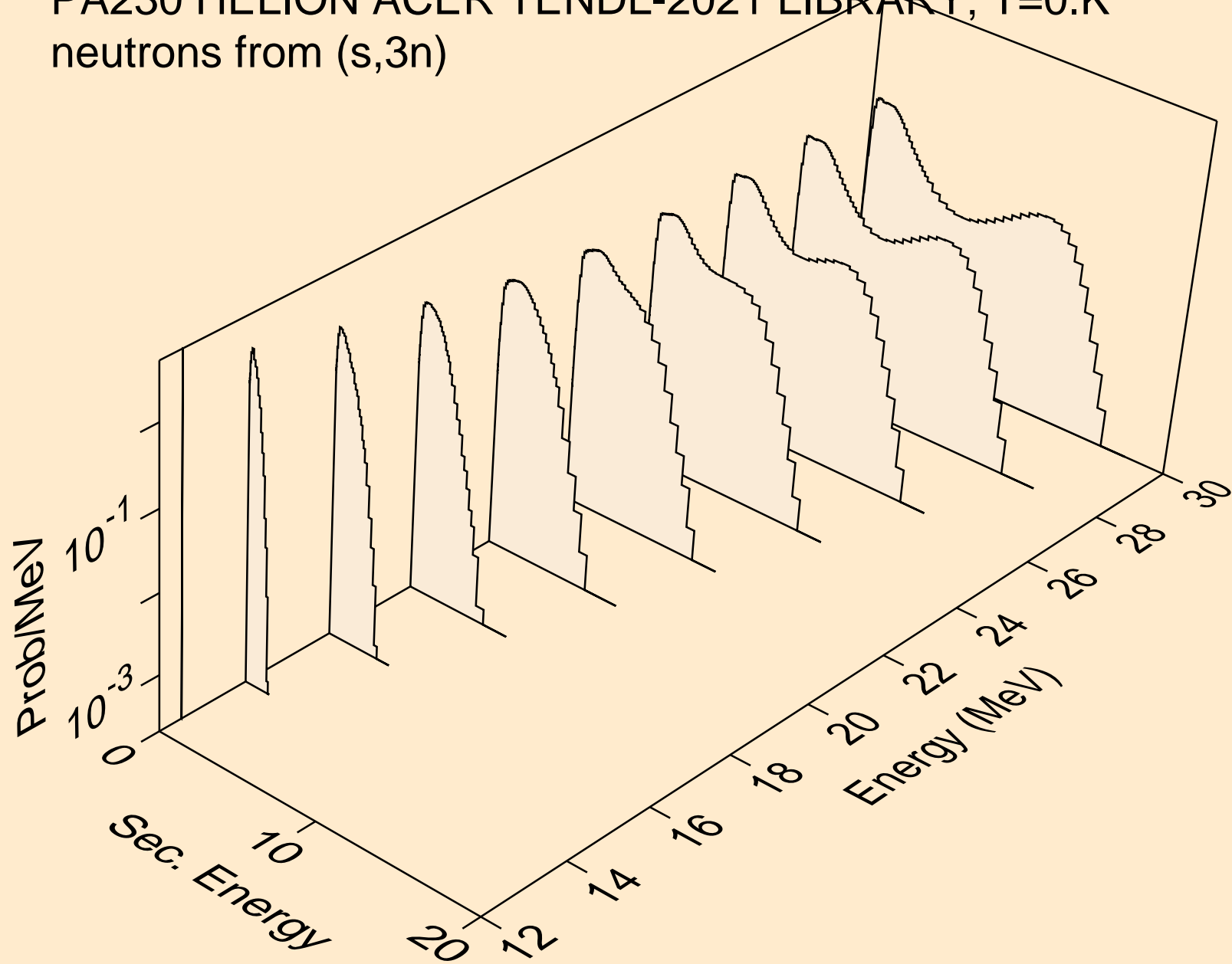

PA230 HELION ACER TENDL-2021 LIBRARY; T=0.K  
neutrons from (s,n\*)a

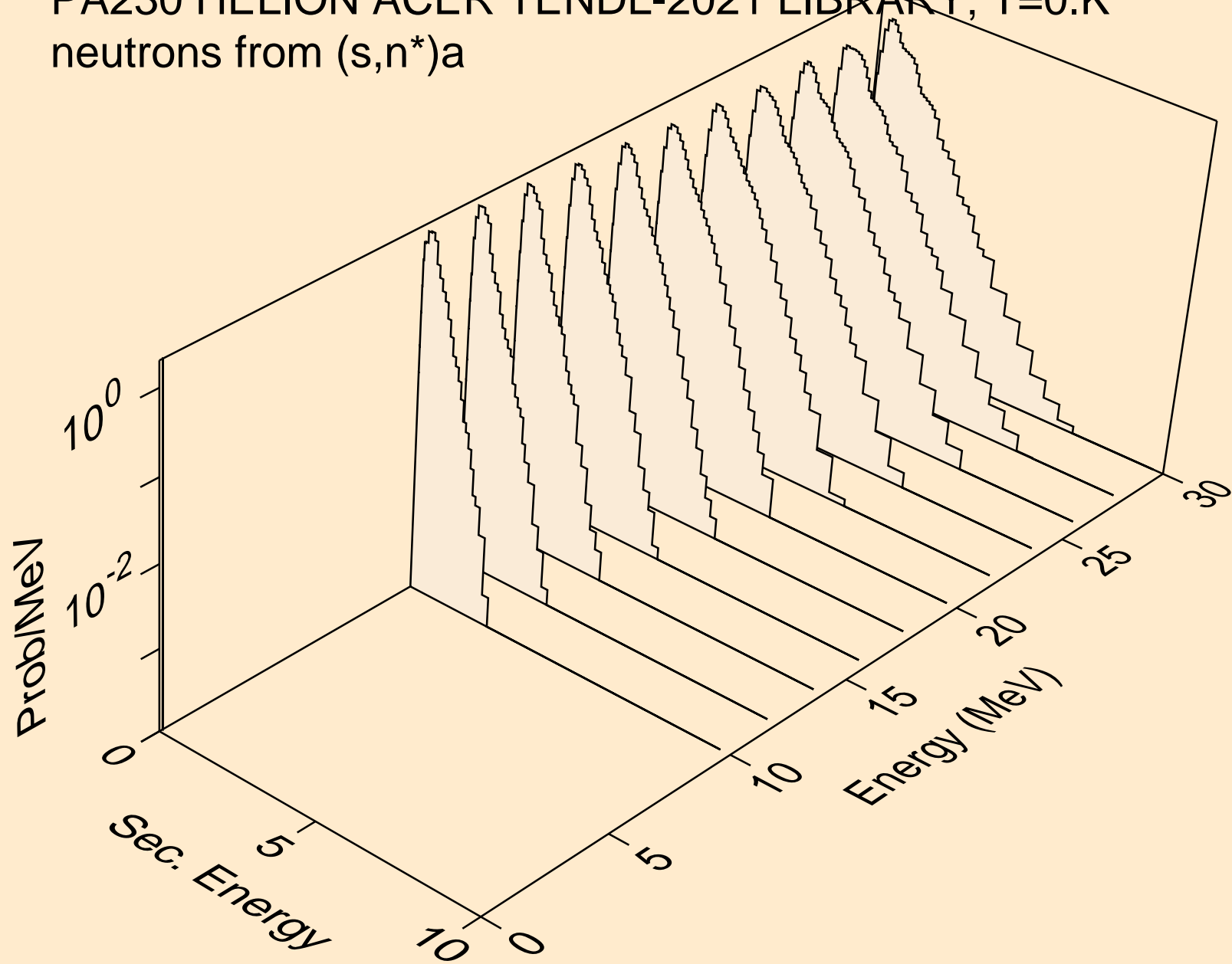

PA230 HELION ACER TENDL-2021 LIBRARY; T=0.K  
neutrons from (s,2n)a

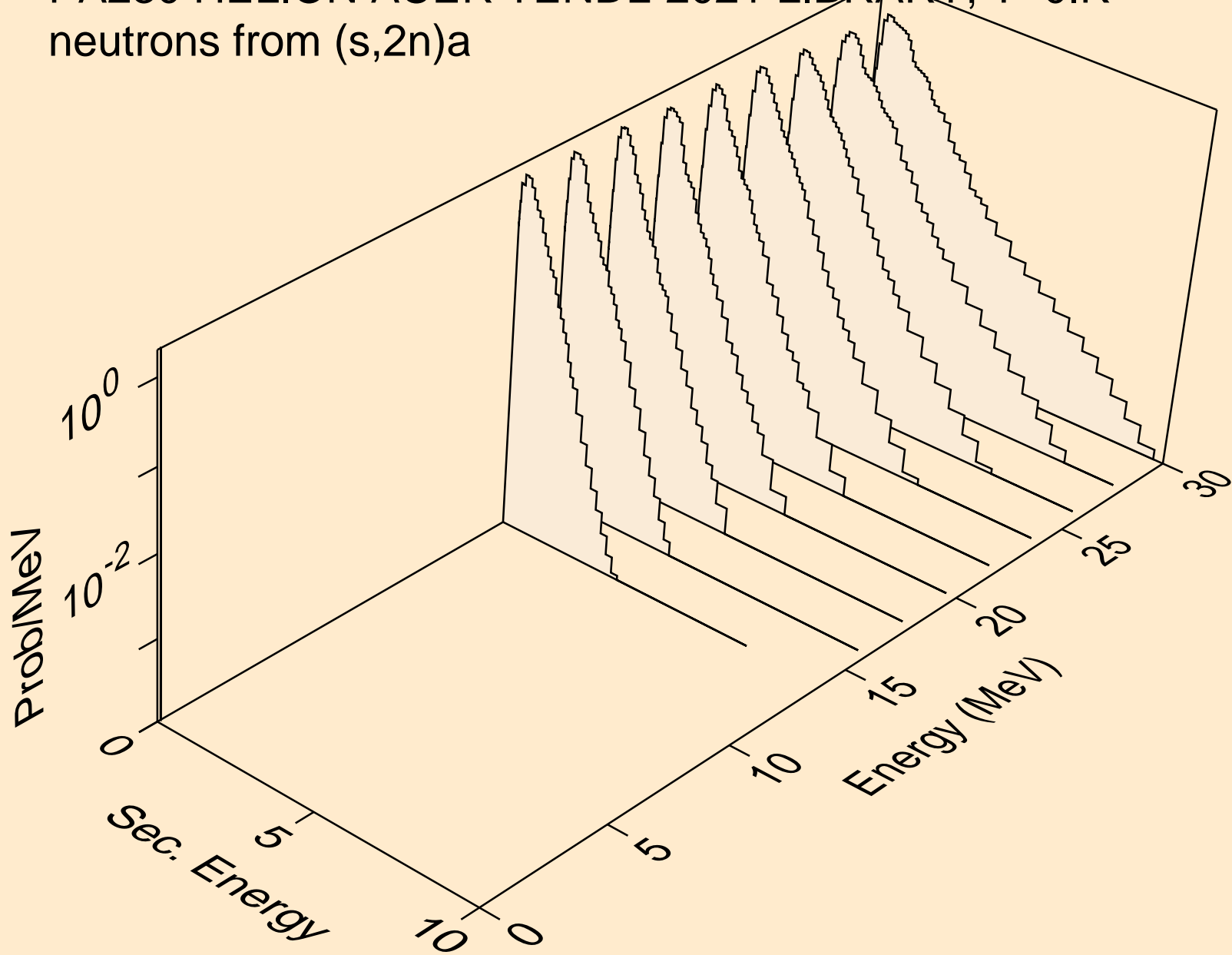

PA230 HELION ACER TENDL-2021 LIBRARY; T=0.K  
neutrons from (s,3n)a

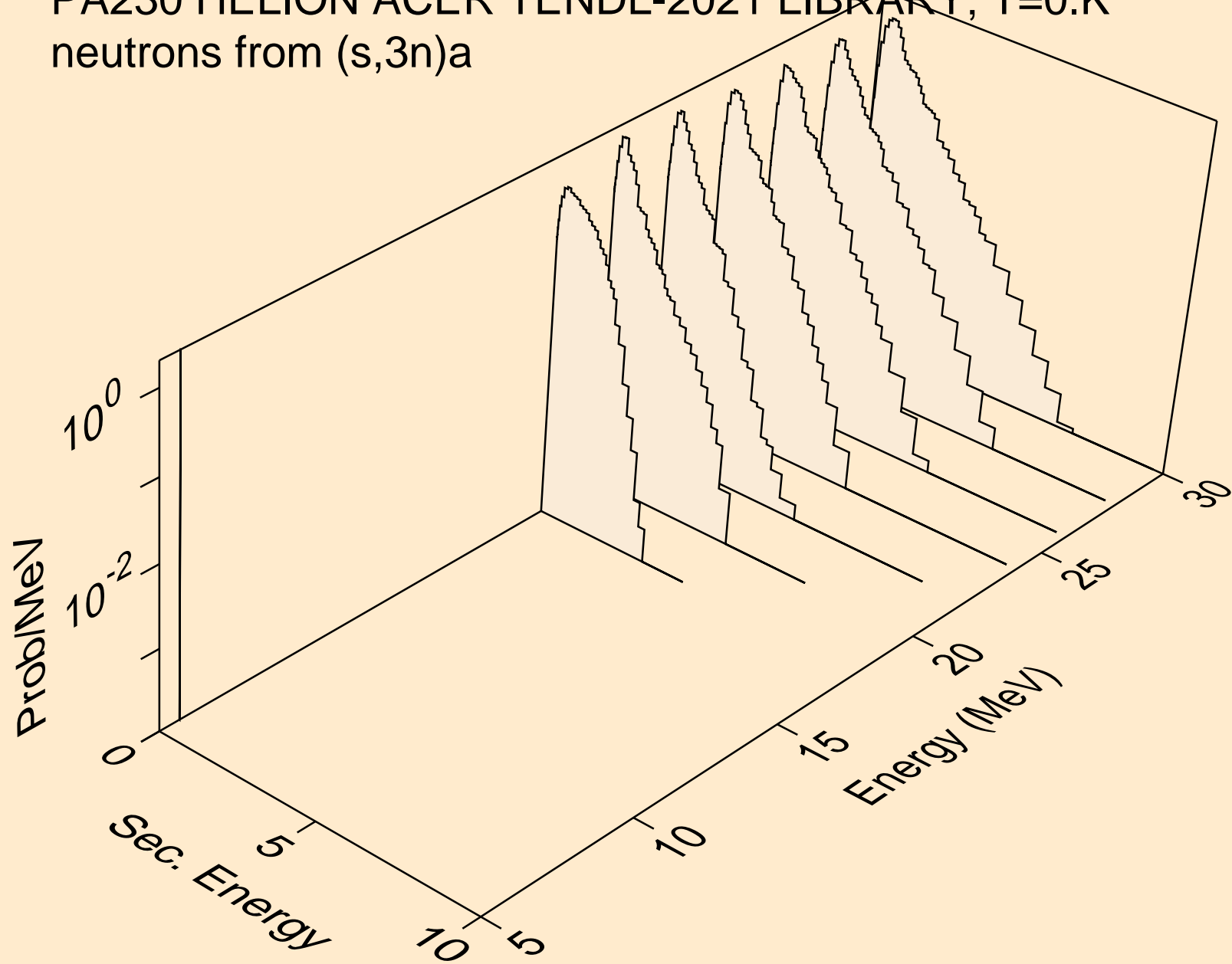

PA230 HELION ACER TENDL-2021 LIBRARY; T=0.K  
neutrons from (s,n\*)p

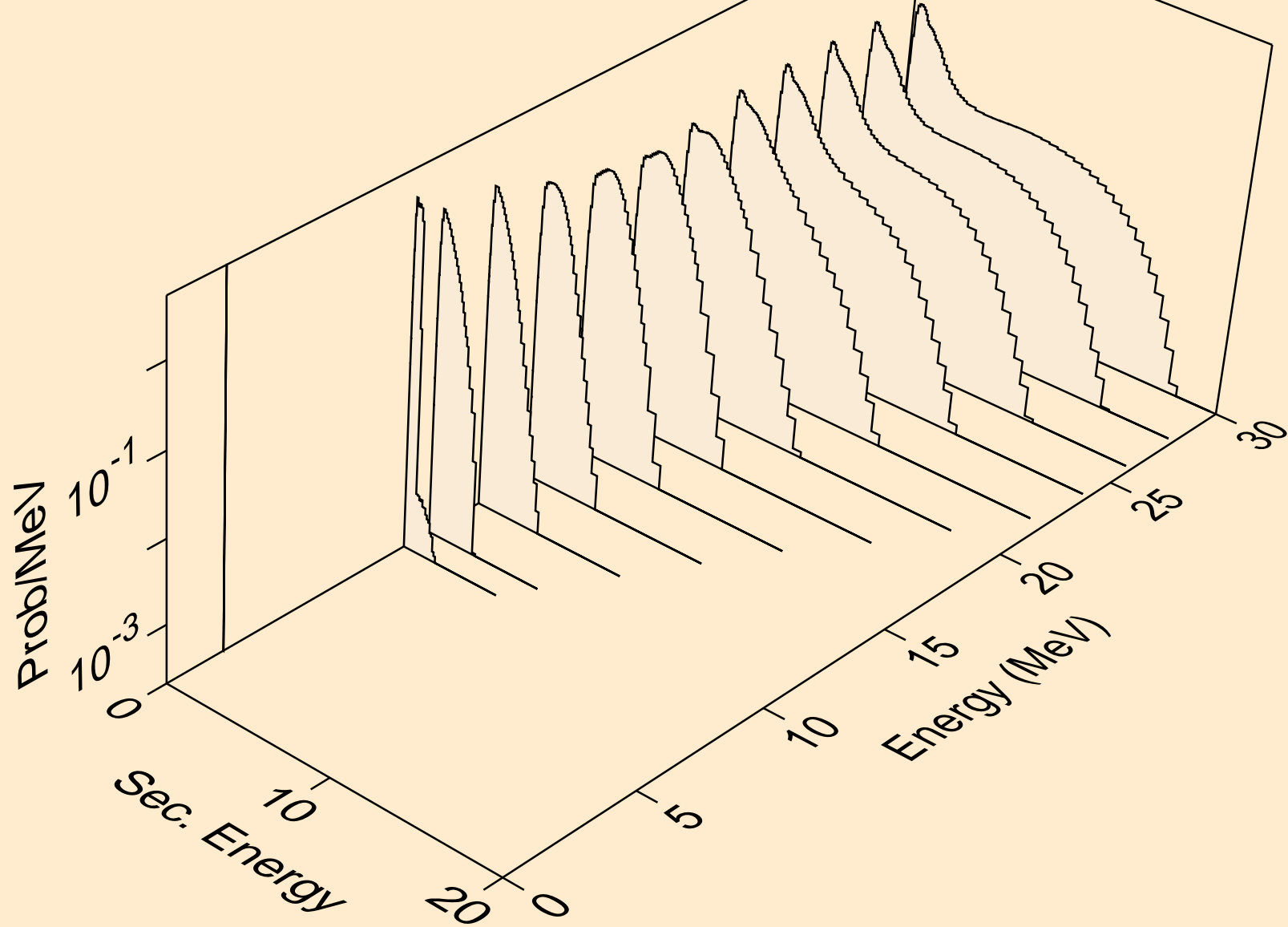

PA230 HELION ACER TENDL-2021 LIBRARY; T=0.K  
neutrons from (s,n\*)d

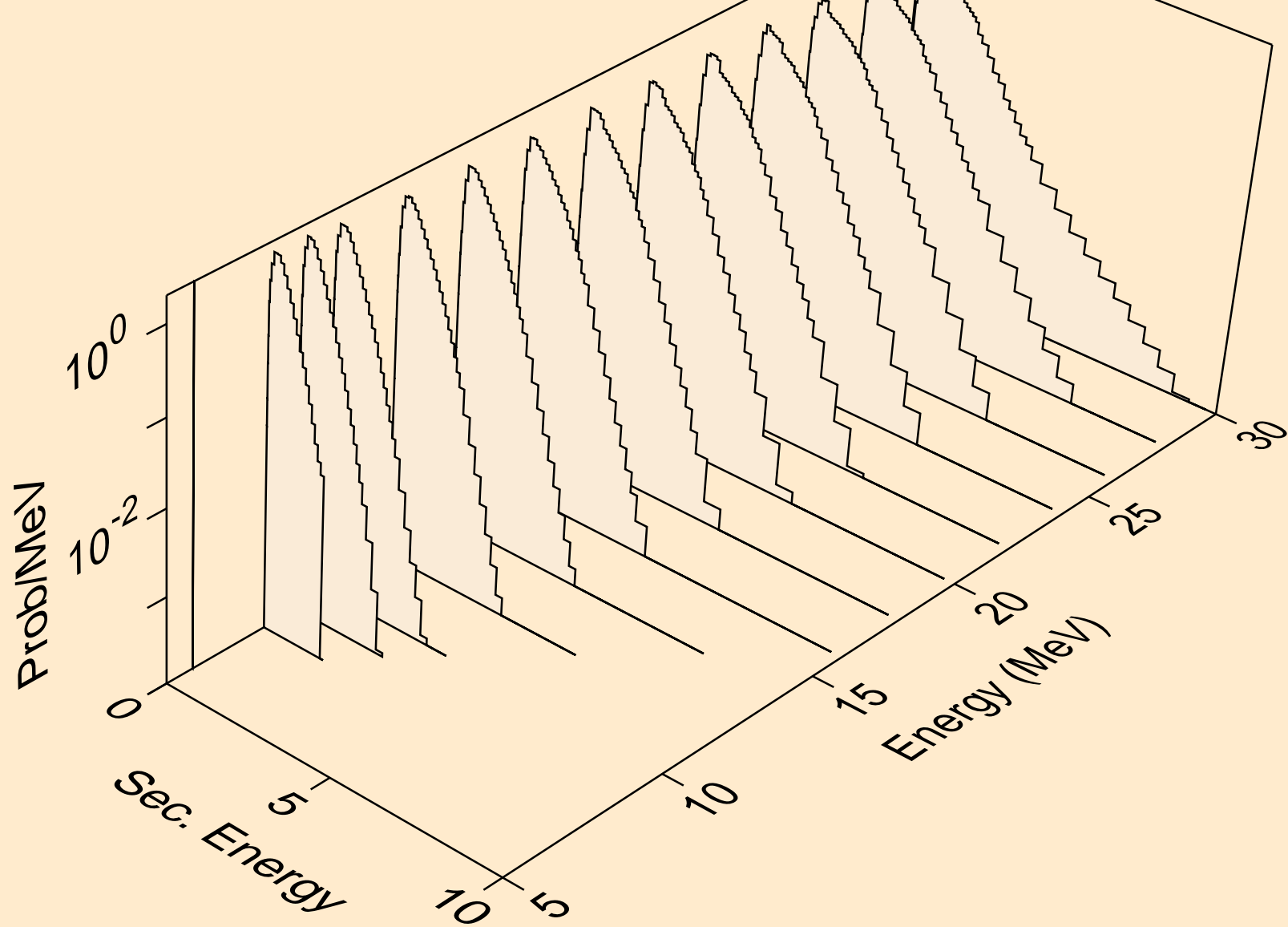



PA230 HELION ACER TENDL-2021 LIBRARY; T=0.K  
neutrons from (s,n\*)t

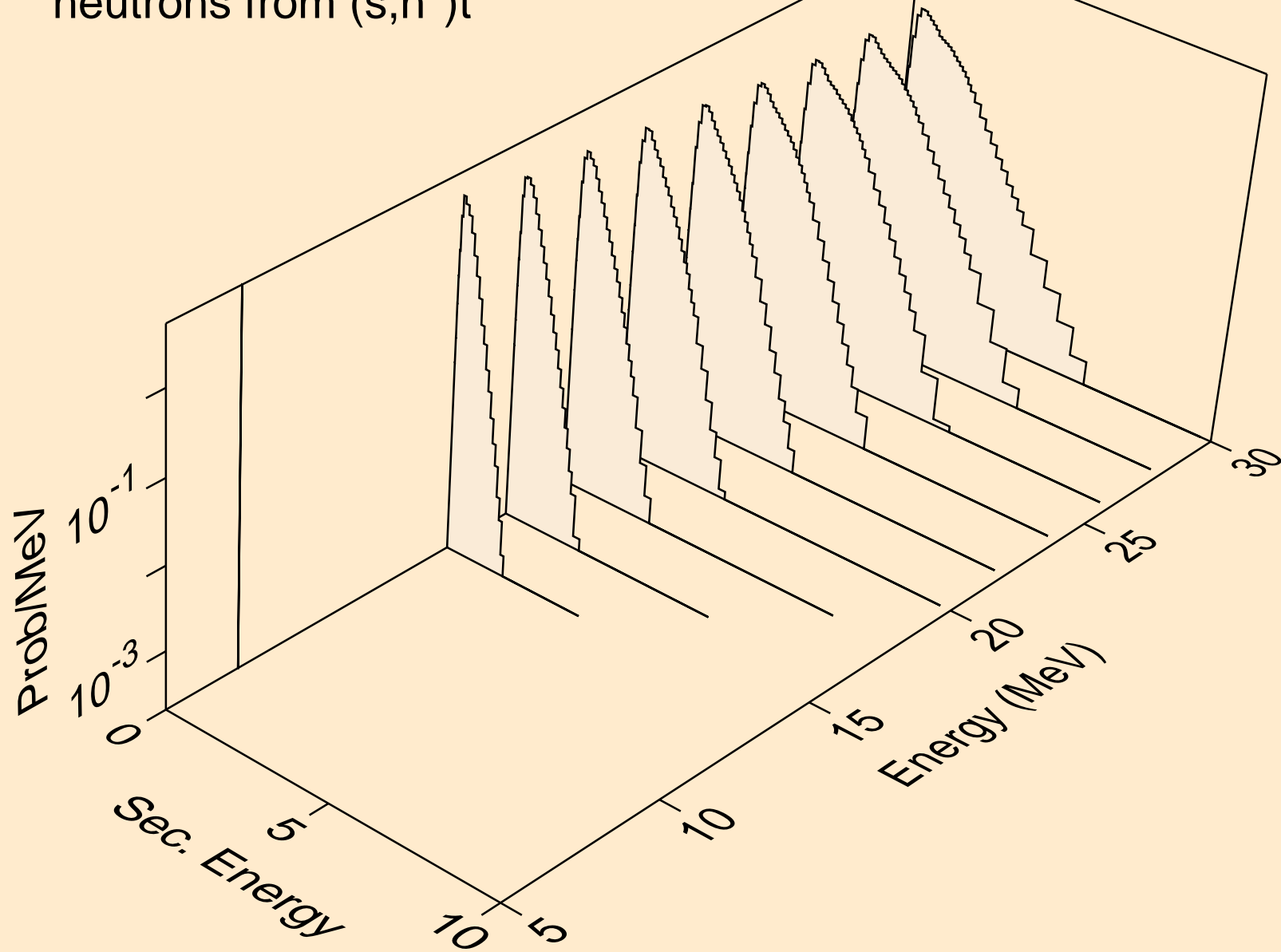

PA230 HELION ACER TENDL-2021 LIBRARY; T=0.K  
neutrons from (s,n\*)he3

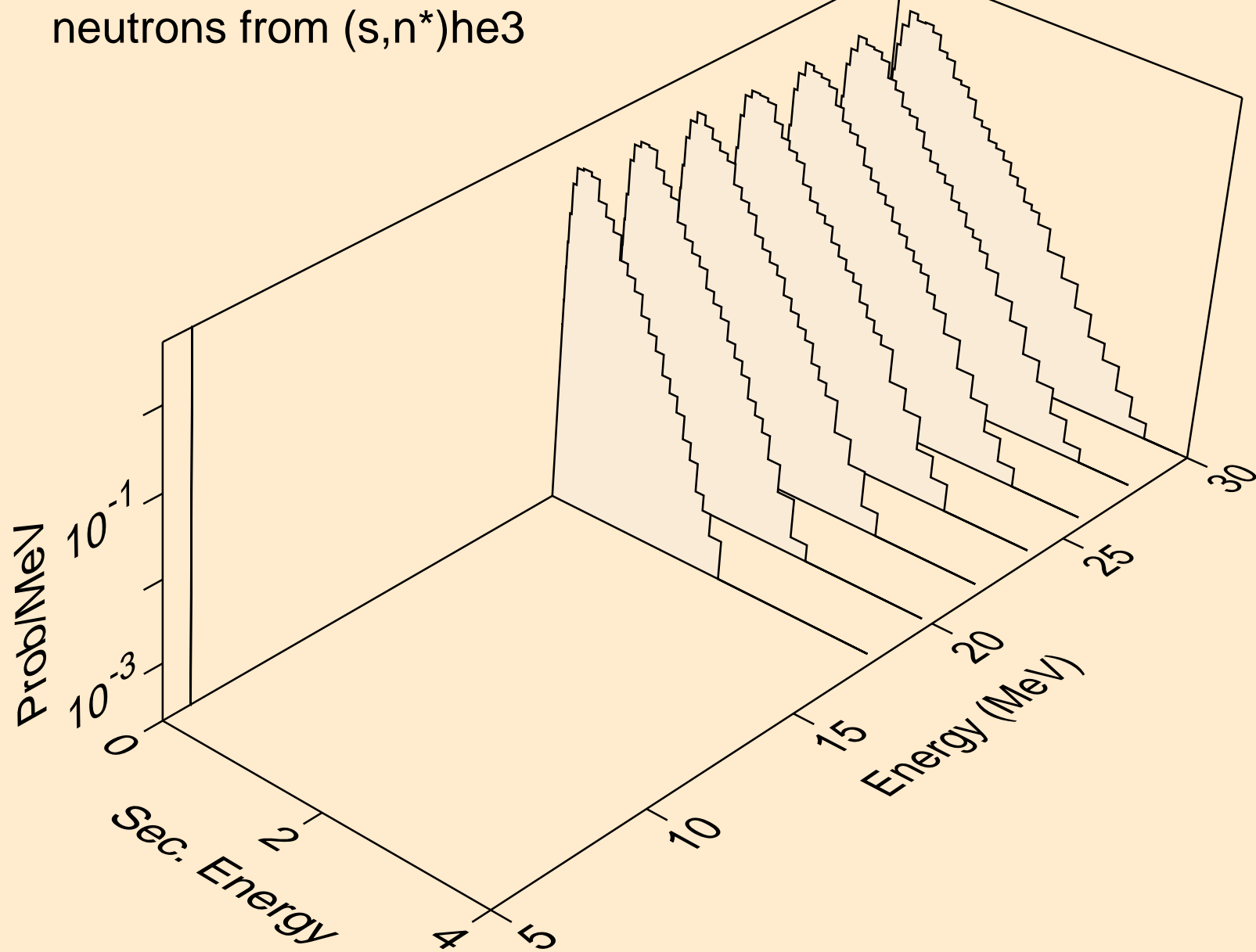

PA230 HELION ACER TENDL-2021 LIBRARY; T=0.K  
neutrons from (s,4n)

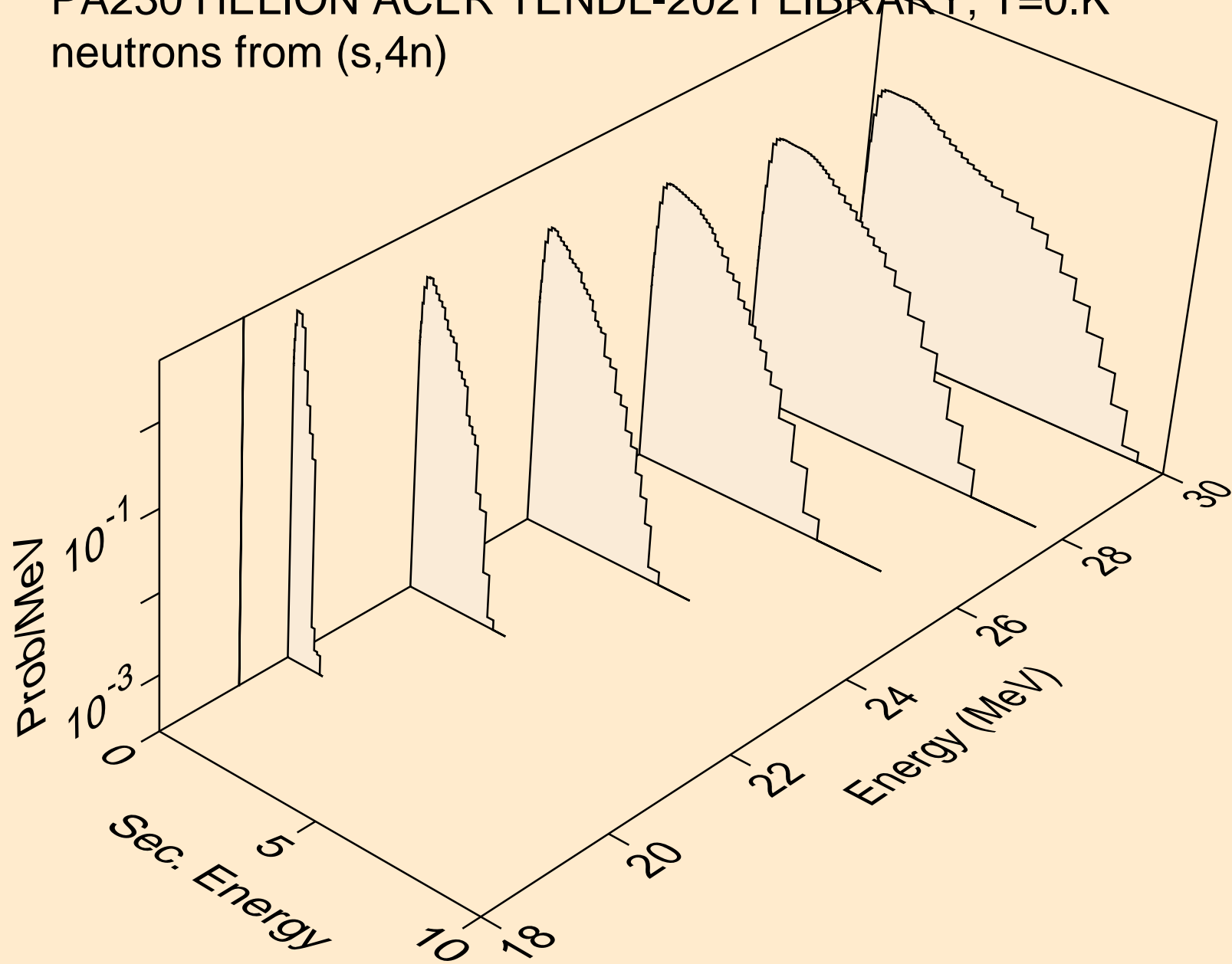

PA230 HELION ACER TENDL-2021 LIBRARY; T=0.K  
neutrons from (s,2np)

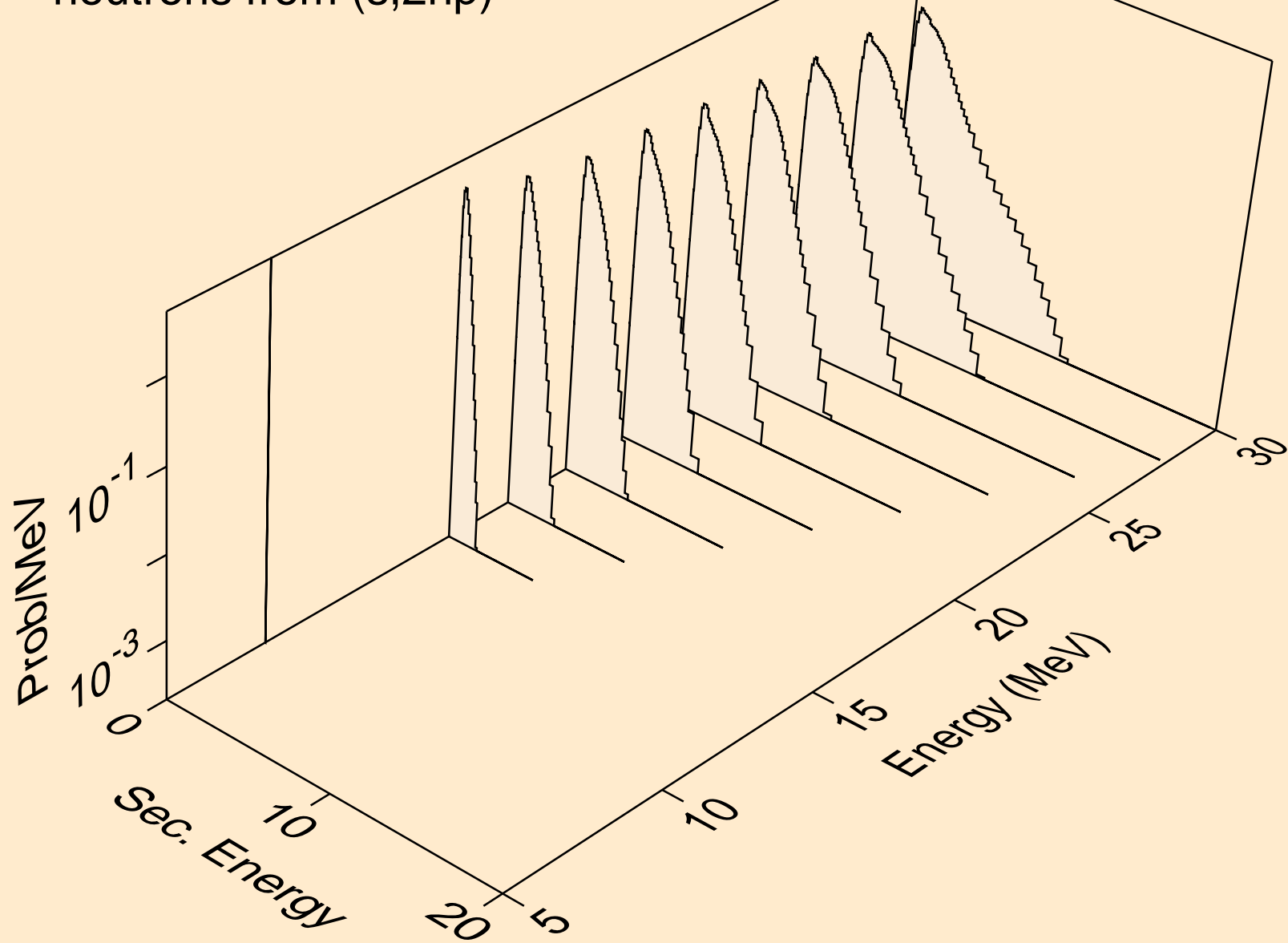

PA230 HELION ACER TENDL-2021 LIBRARY; T=0.K  
neutrons from (s,3np)

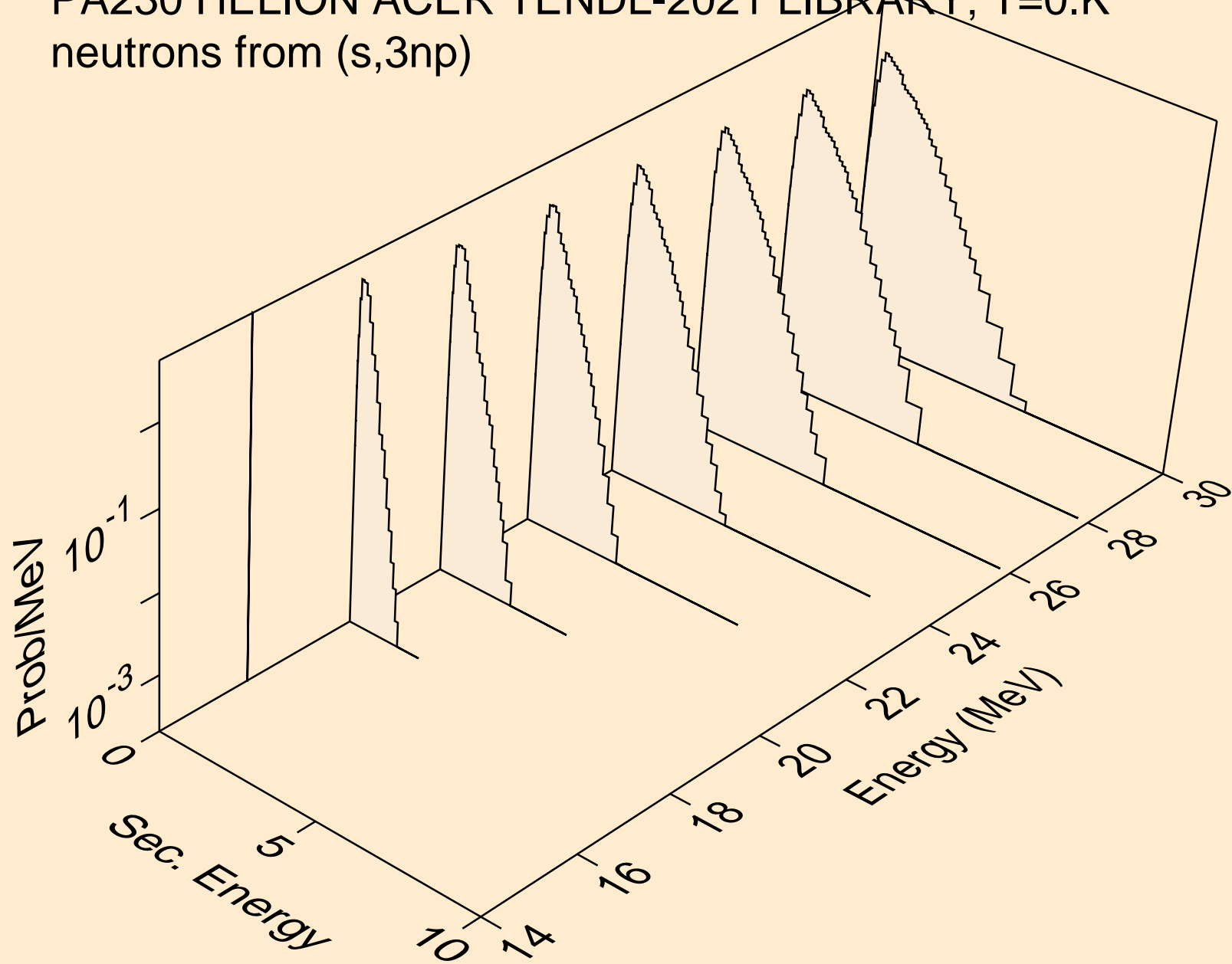

PA230 HELION ACER TENDL-2021 LIBRARY; T=0.K  
neutrons from (s,2np)

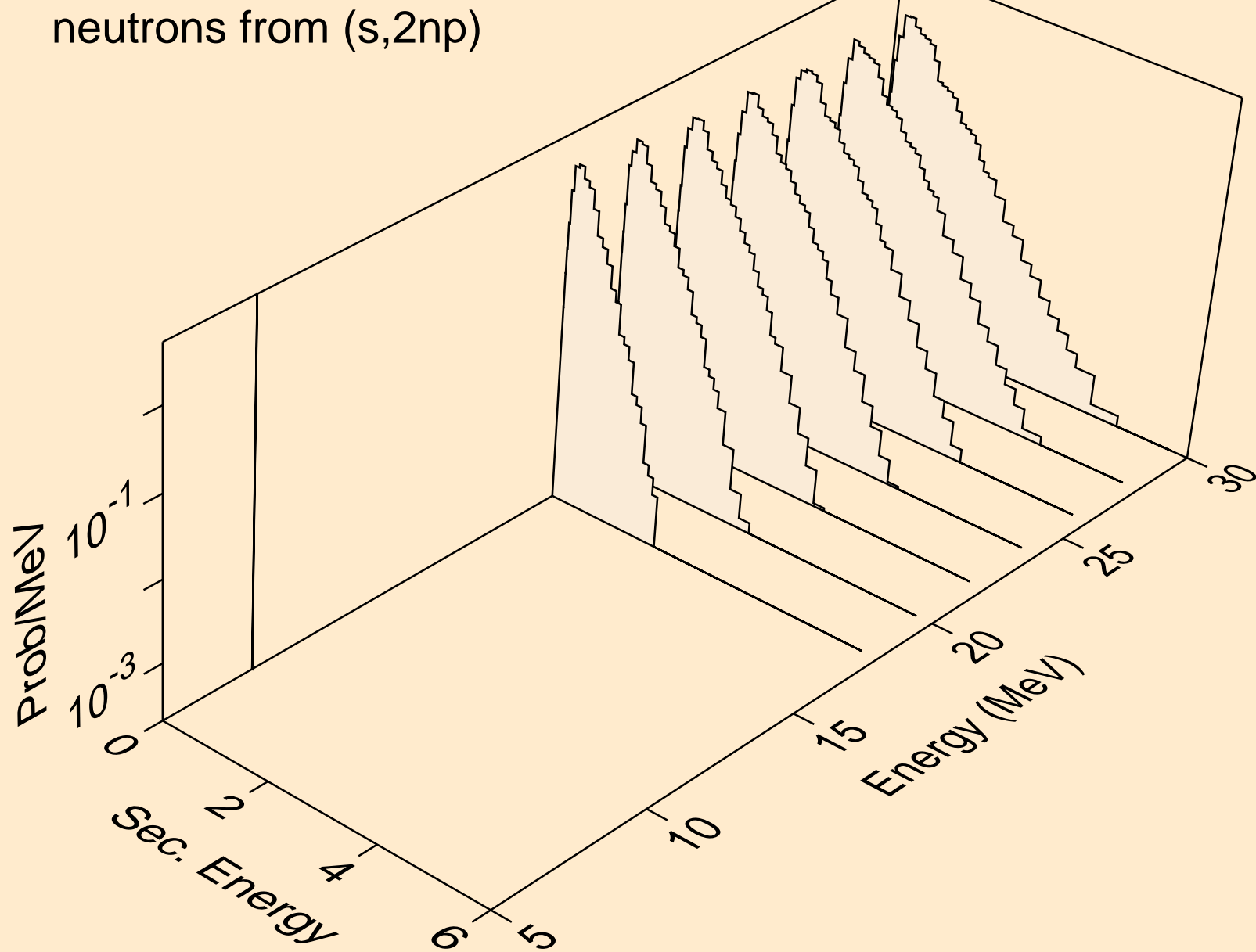

PA230 HELION ACER TENDL-2021 LIBRARY; T=0.K  
neutrons from (s,npa)

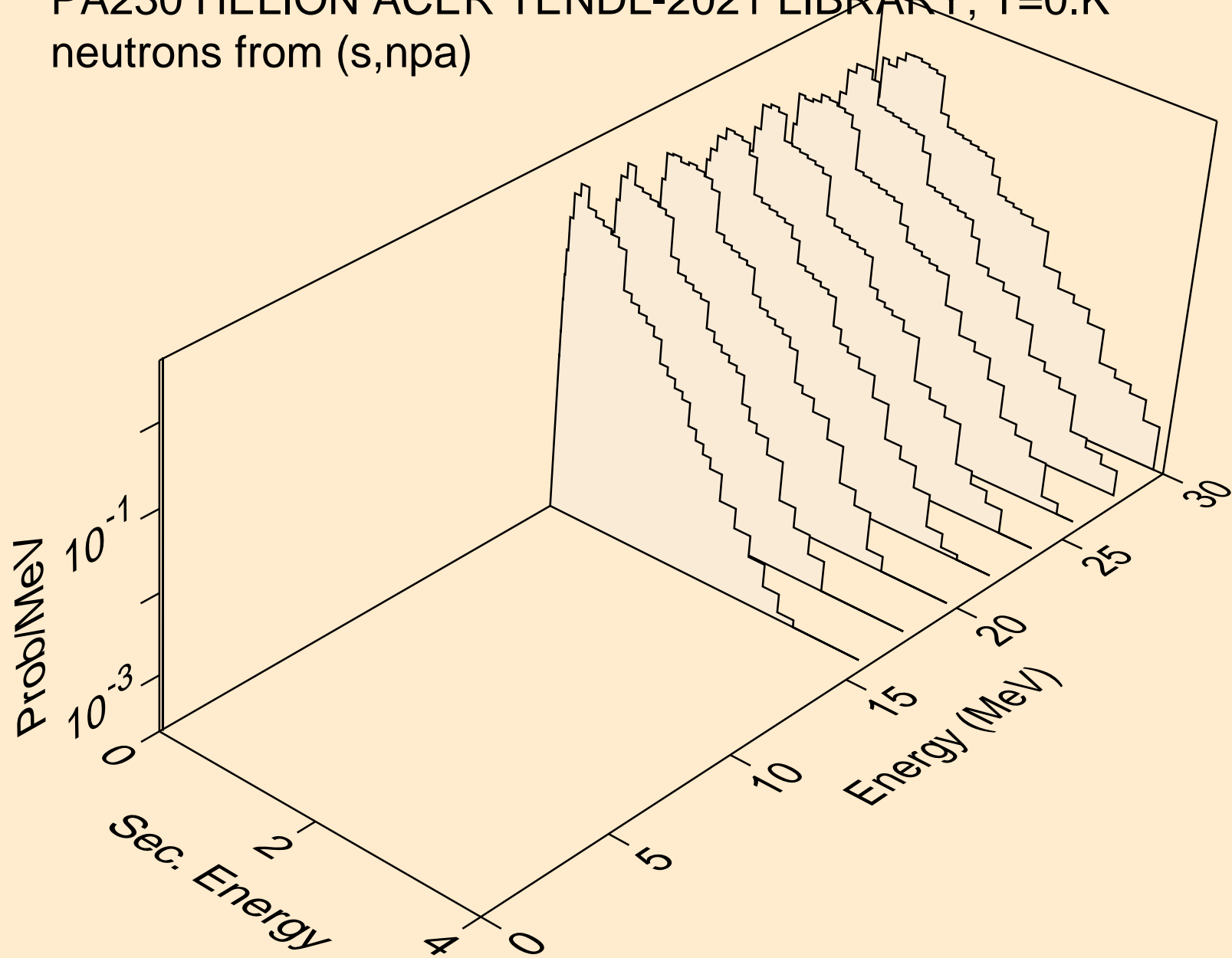

PA230 HELION ACER TENDL-2021 LIBRARY; T=0.K  
protons from (s,x)

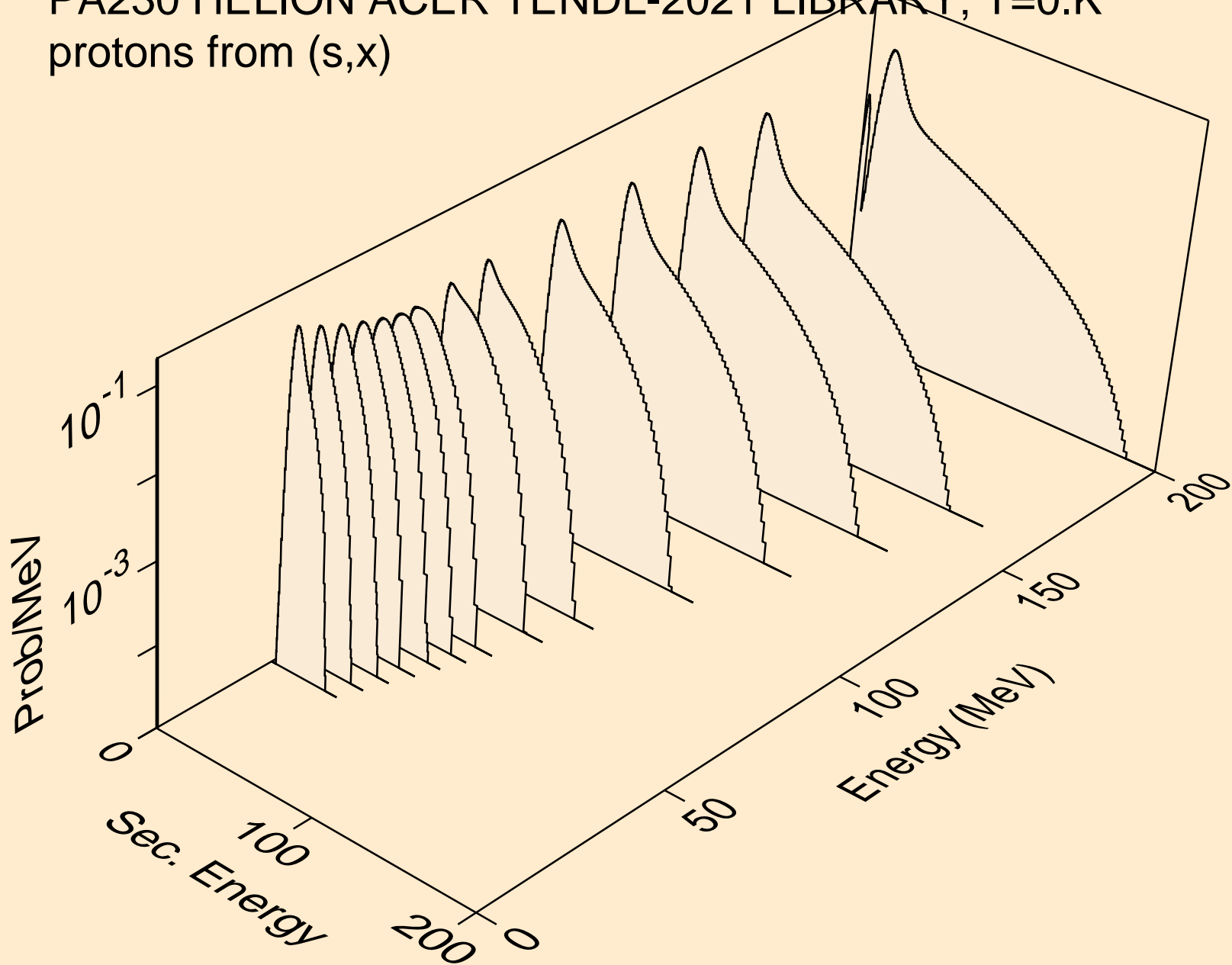



PA230 HELION ACER TENDL-2021 LIBRARY; T=0.K  
protons from (s,n\*)p

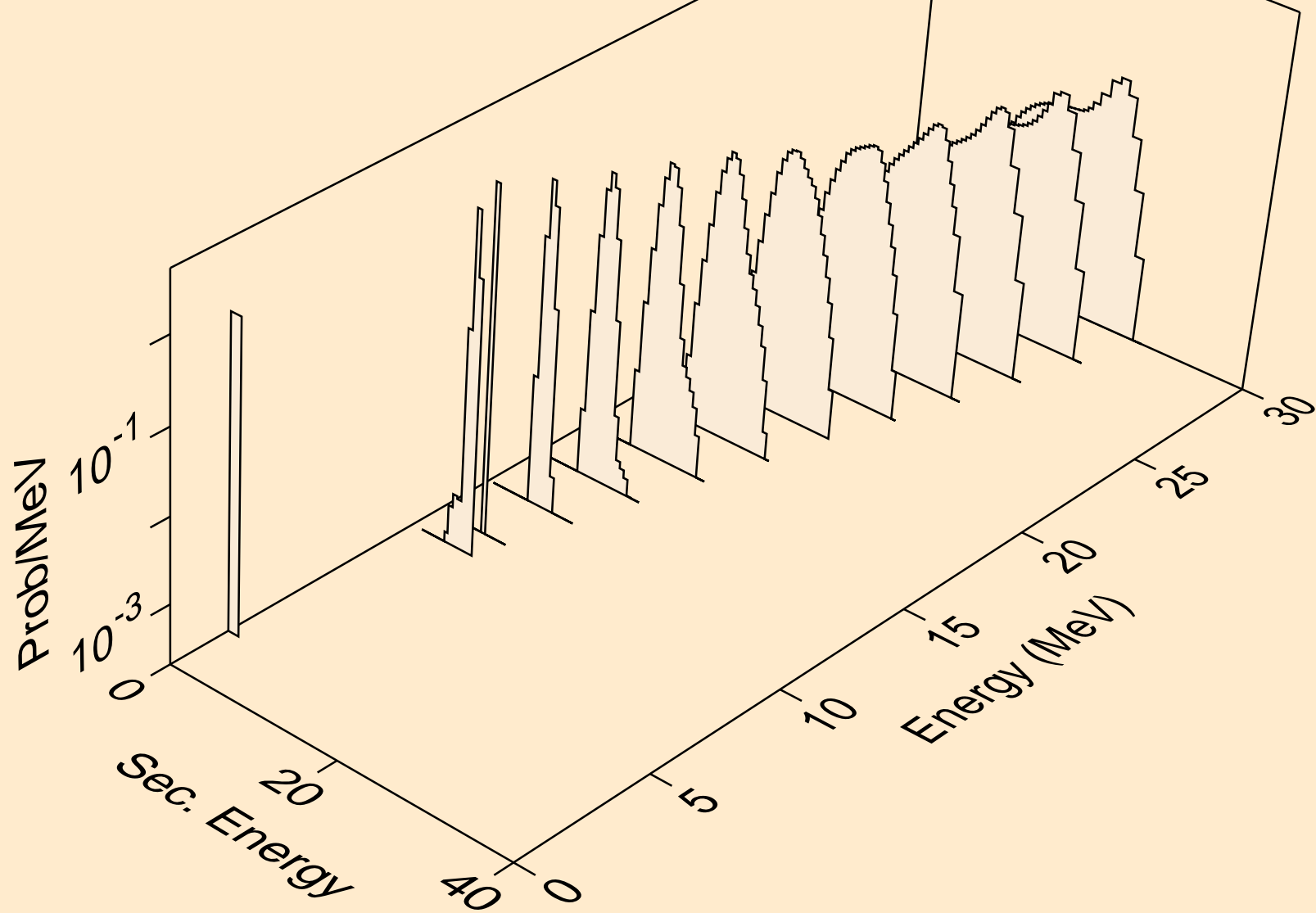

PA230 HELION ACER TENDL-2021 LIBRARY; T=0.K  
protons from (s,2np)

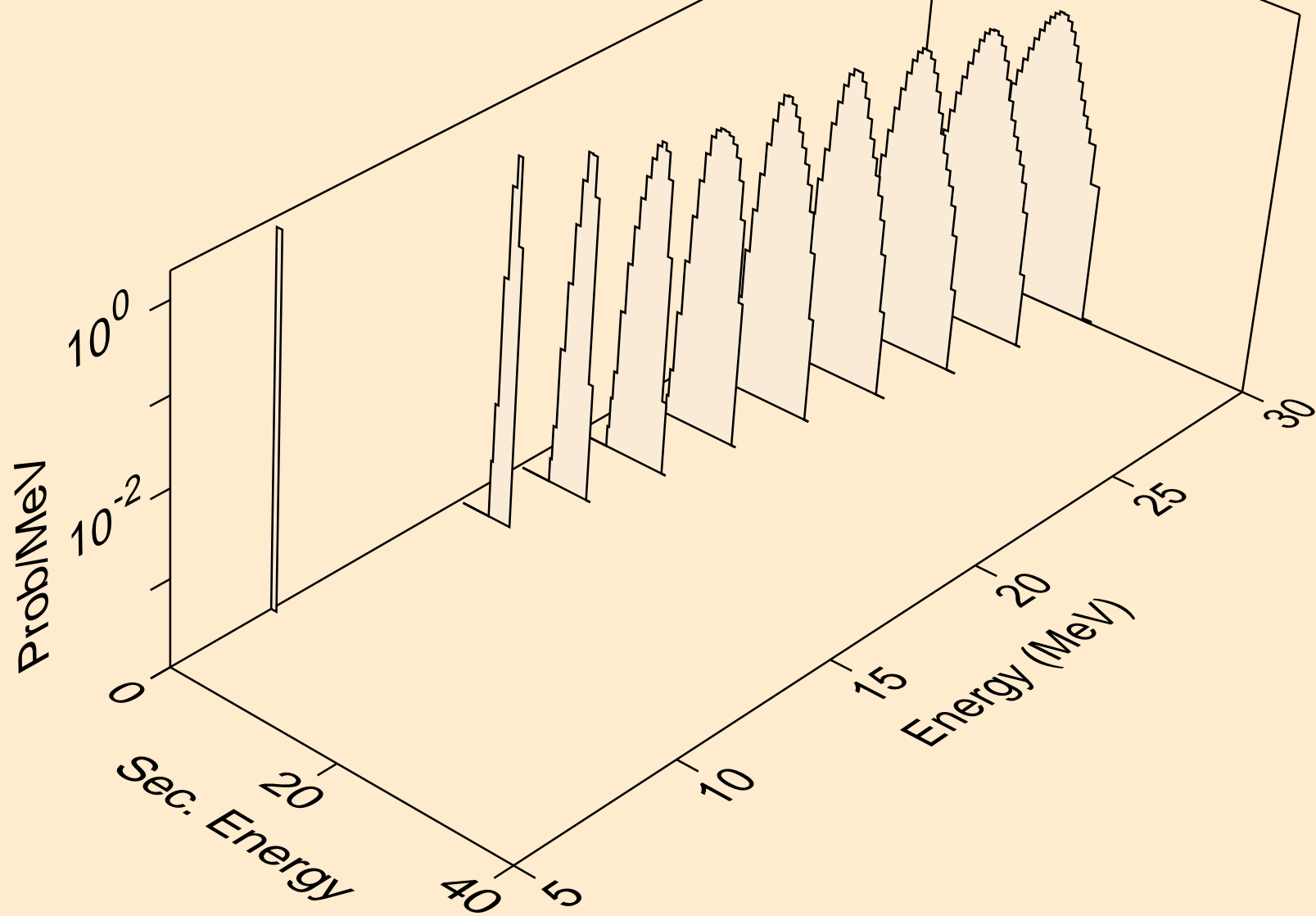

PA230 HELION ACER TENDL-2021 LIBRARY; T=0.K  
protons from (s,3np)

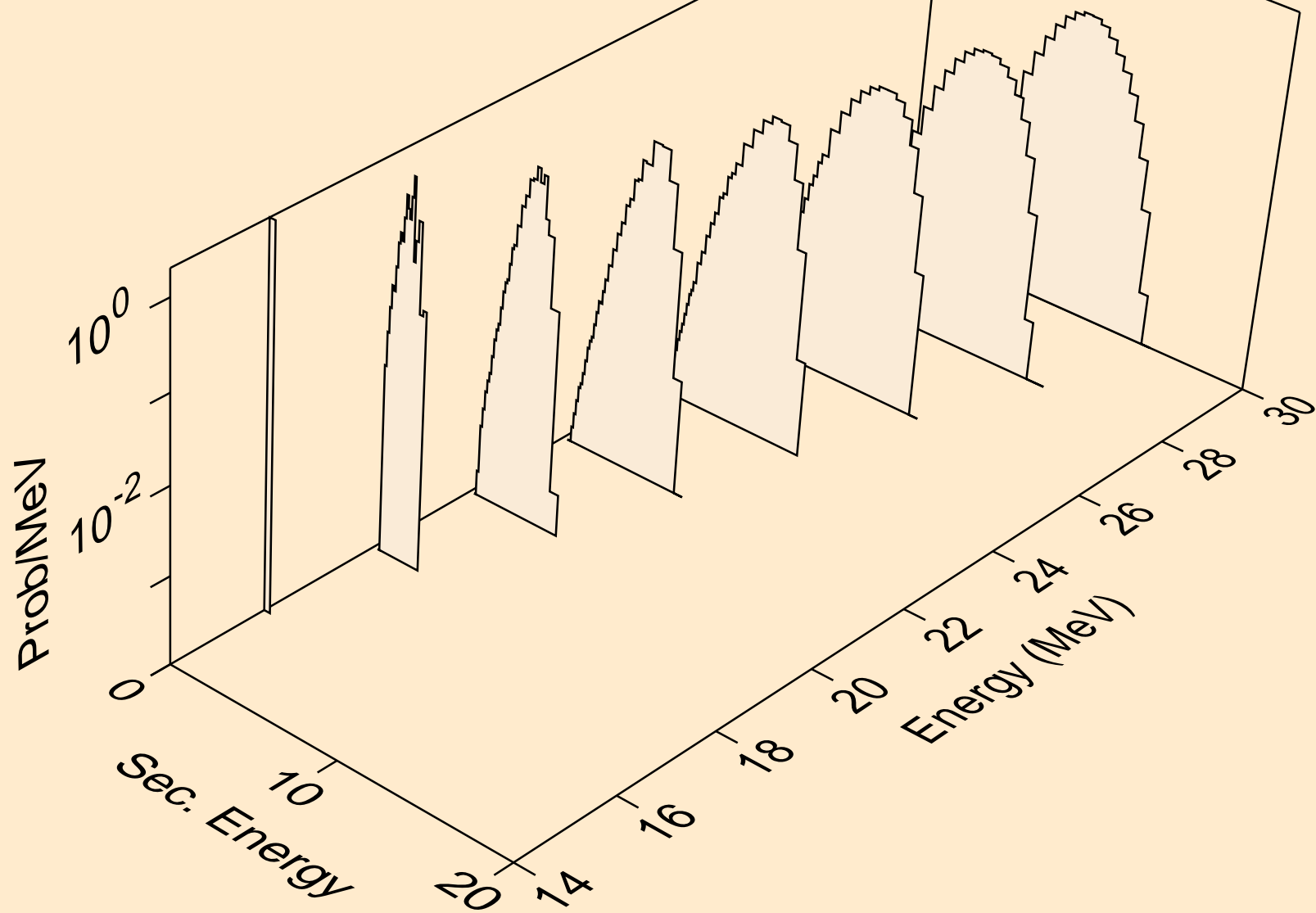

PA230 HELION ACER TENDL-2021 LIBRARY; T=0.K  
protons from (s,2np)

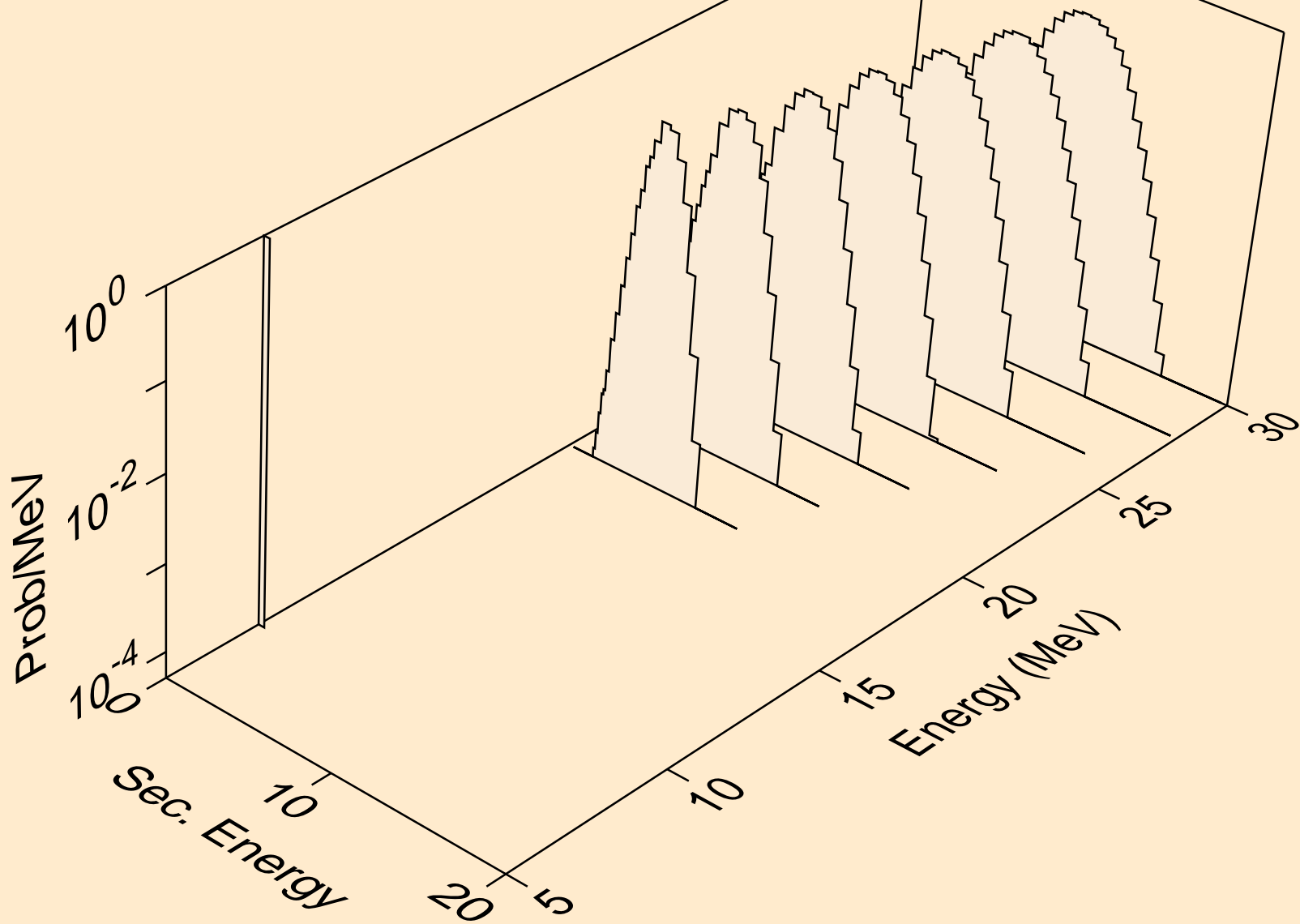

PA230 HELION ACER TENDL-2021 LIBRARY; T=0.K  
protons from (s,npa)

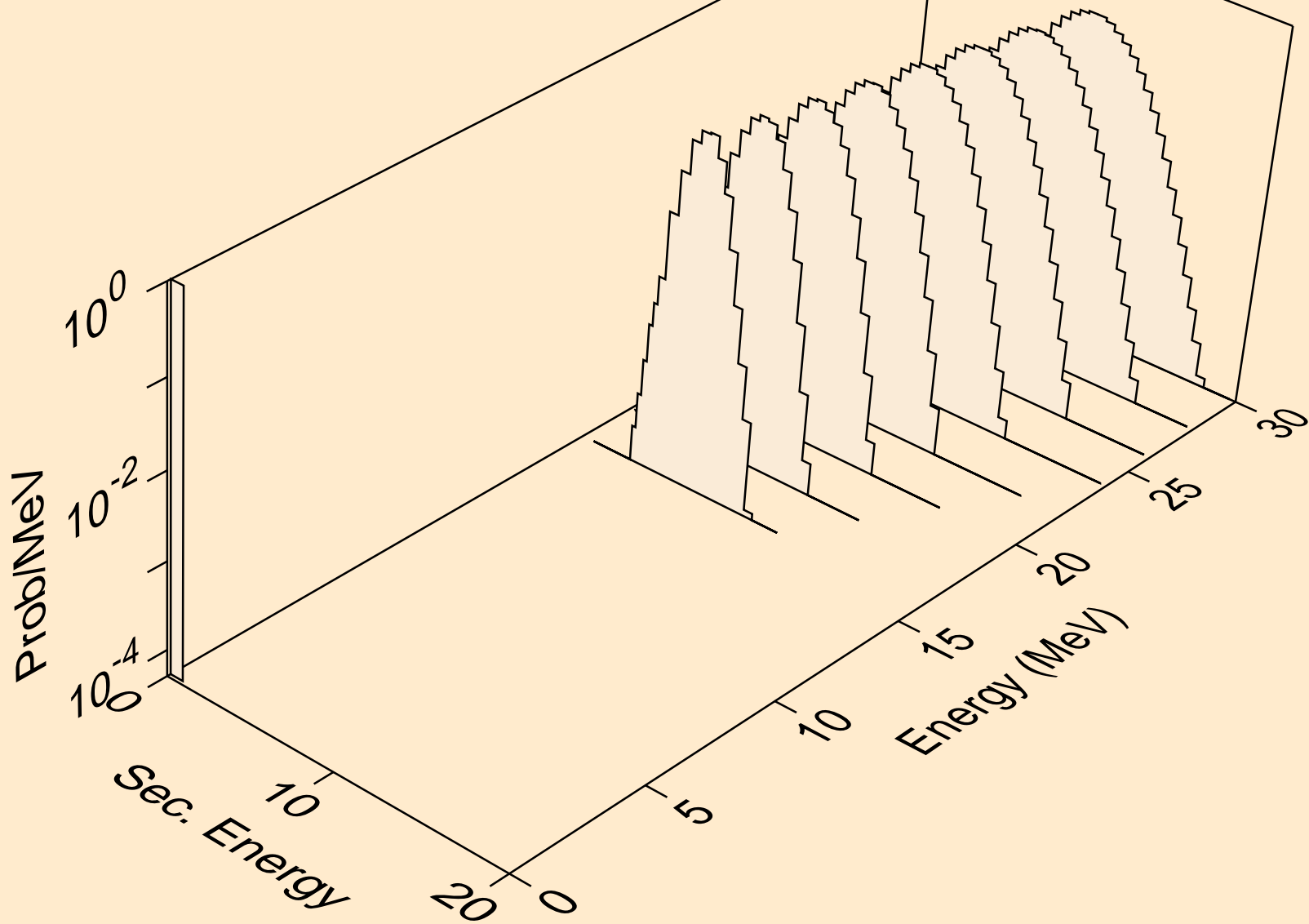

PA230 HELION ACER TENDL-2021 LIBRARY; T=0.K  
protons from (s,p)

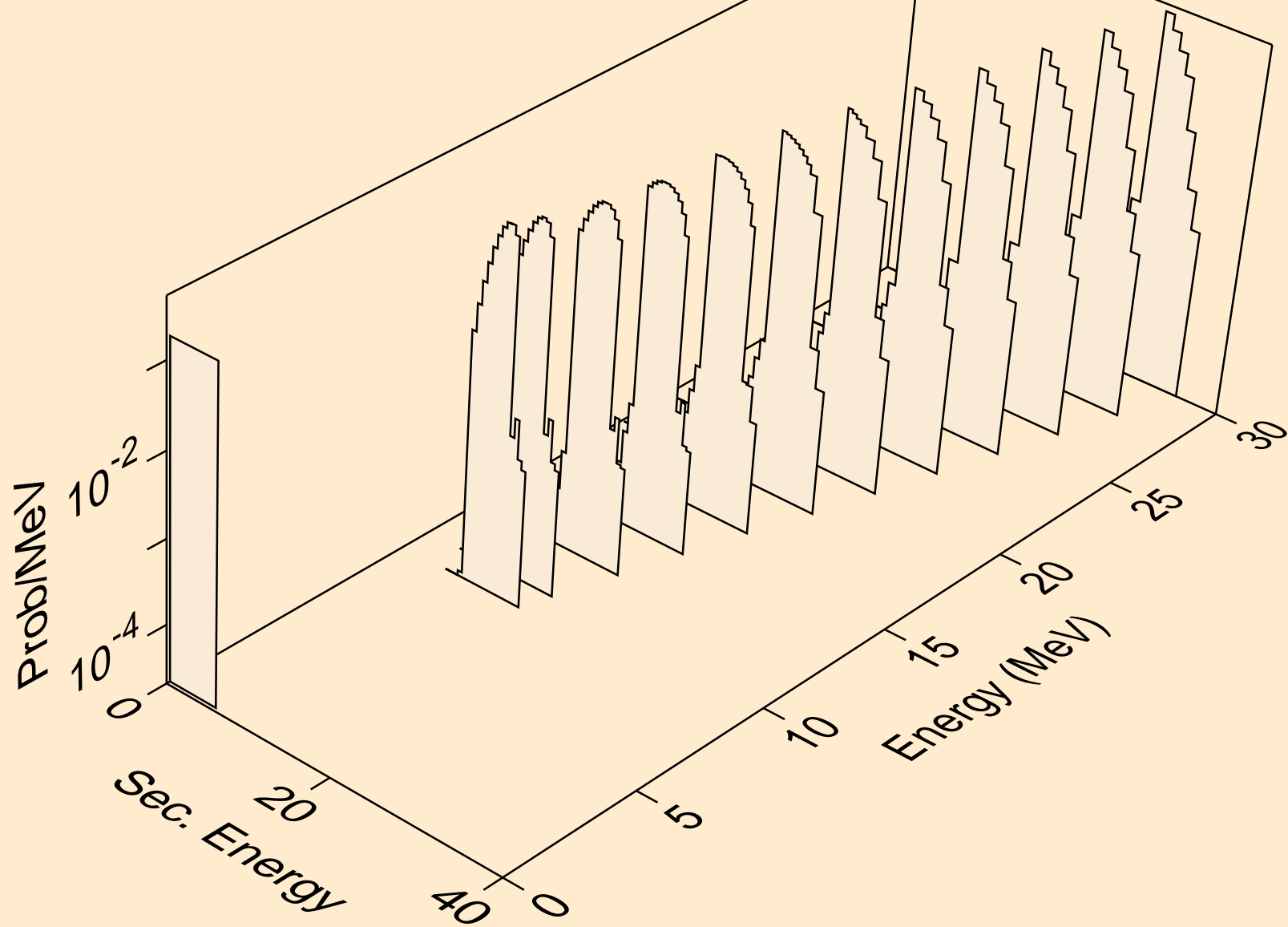

PA230 HELION ACER TENDL-2021 LIBRARY; T=0.K  
protons from (s,2p)

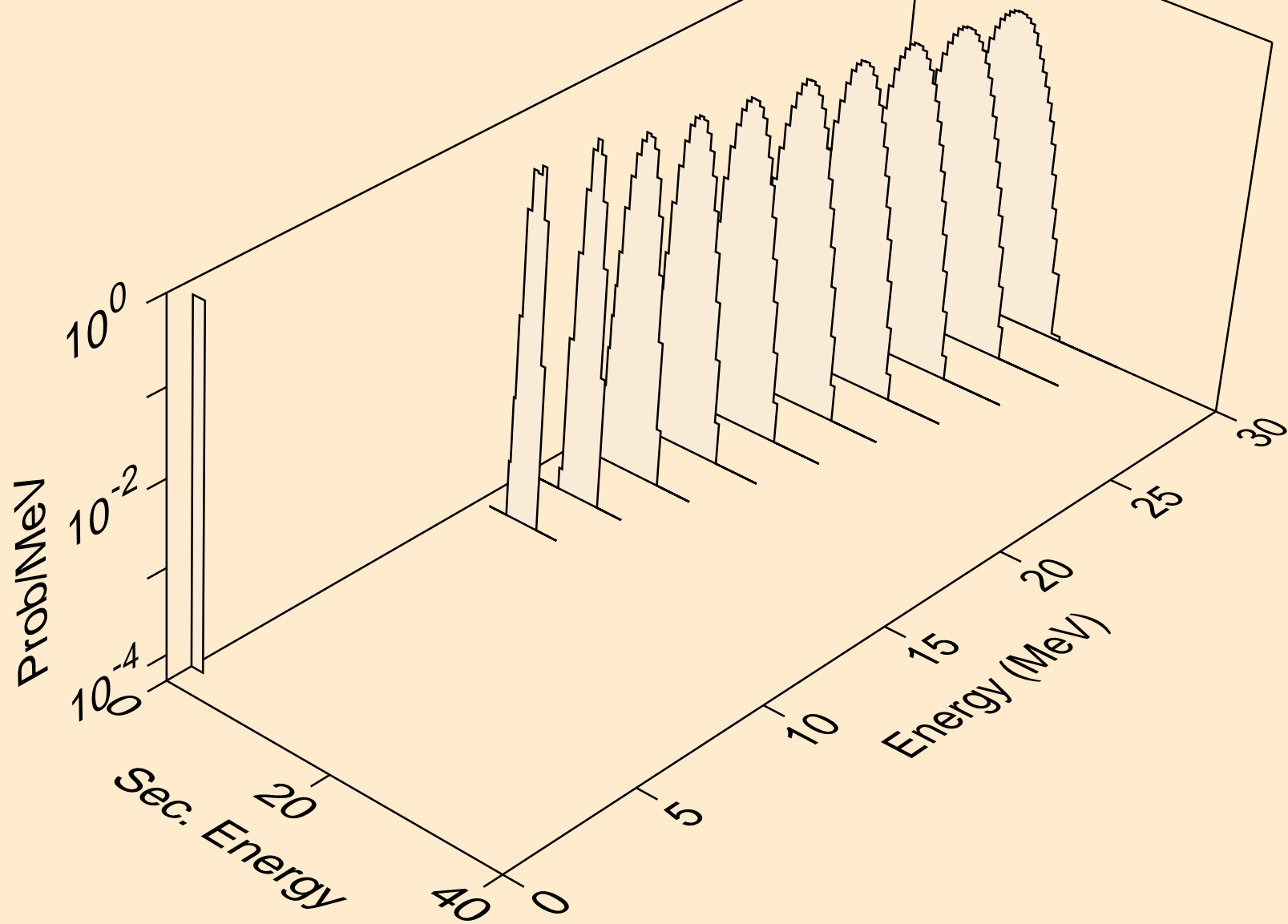

PA230 HELION ACER TENDL-2021 LIBRARY; T=0.K  
protons from (s,pa)

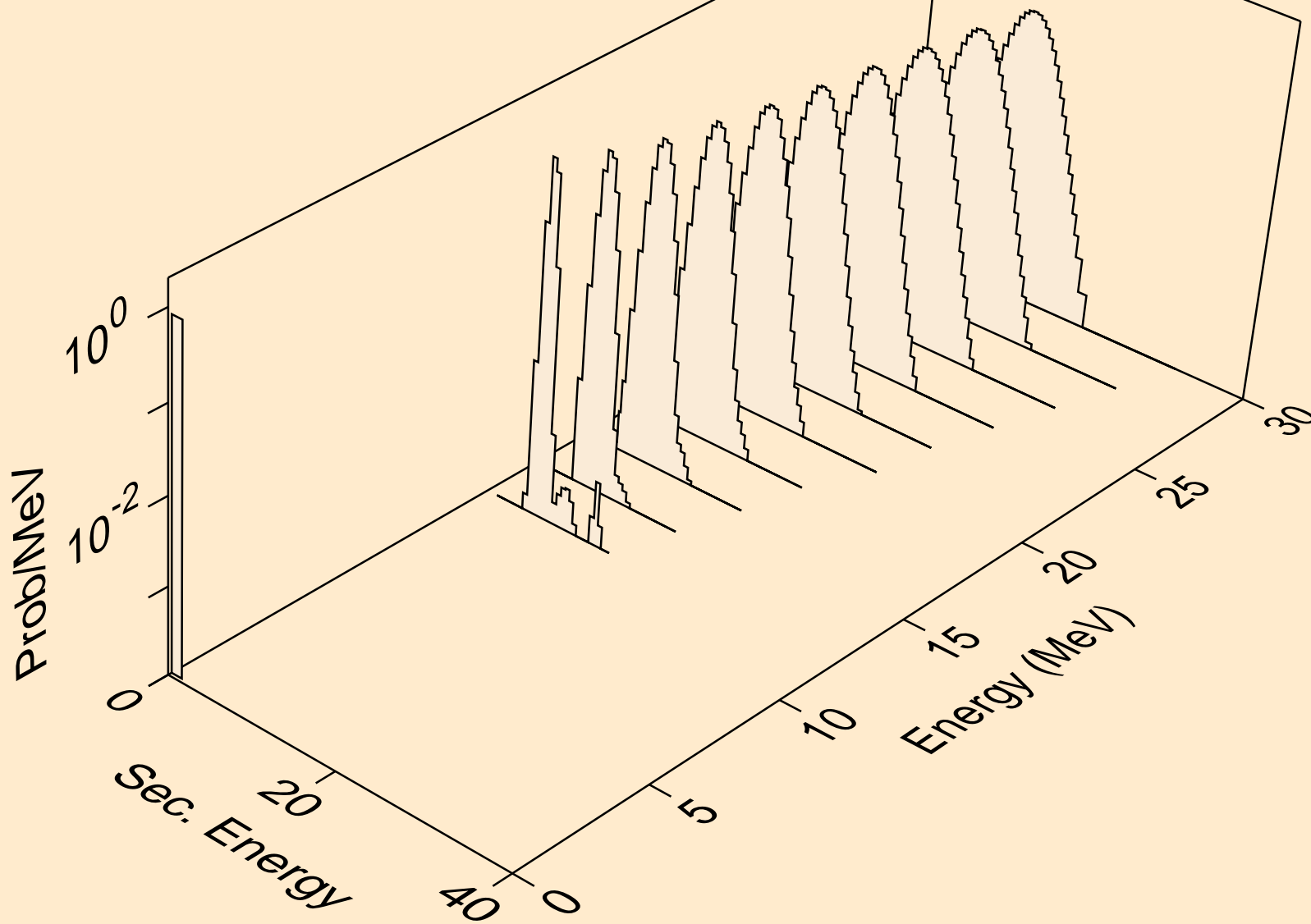



PA230 HELION ACER TENDL-2021 LIBRARY; T=0.K  
protons from (s,pd)

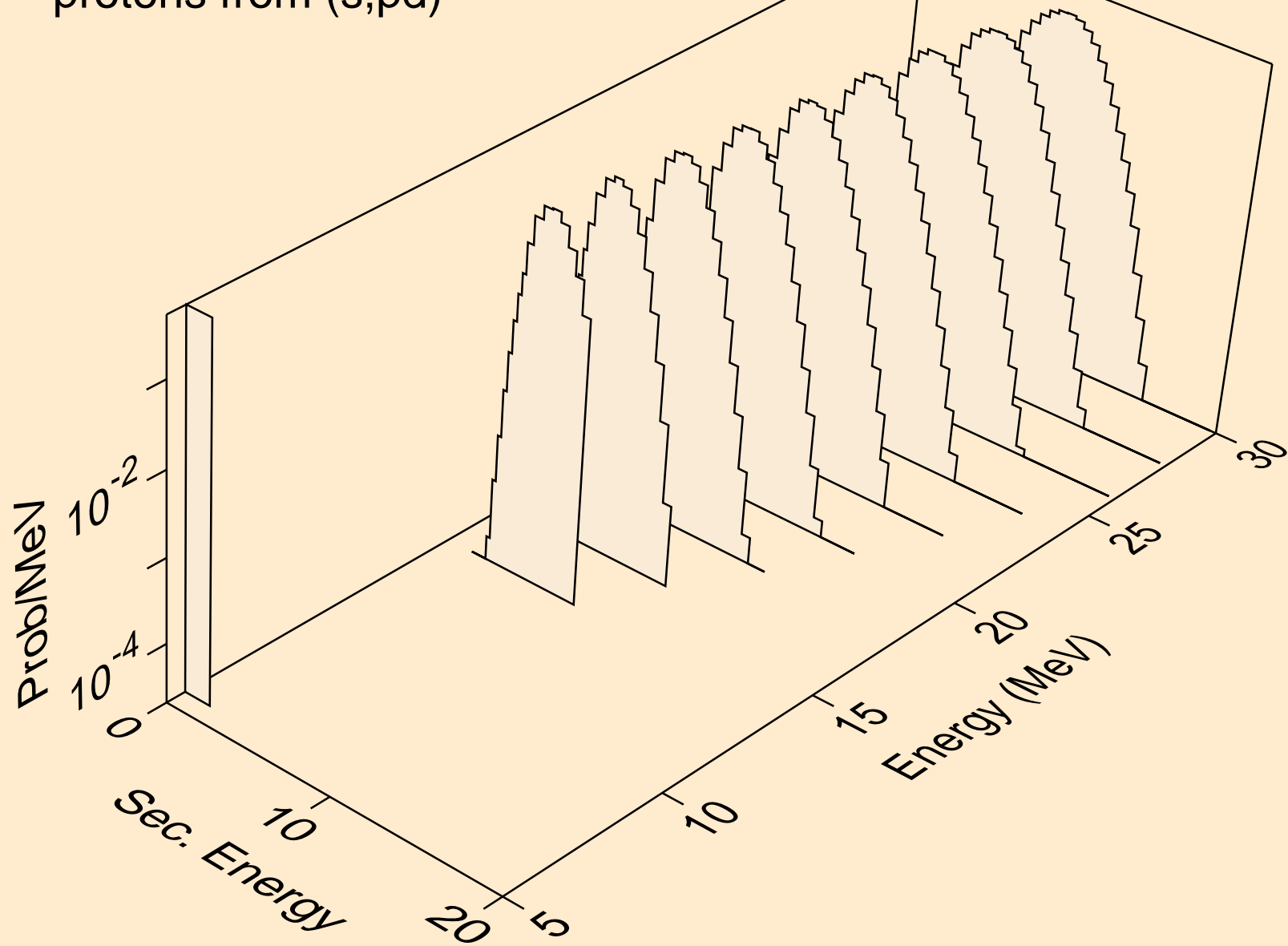

PA230 HELION ACER TENDL-2021 LIBRARY; T=0.K  
protons from (s,pt)

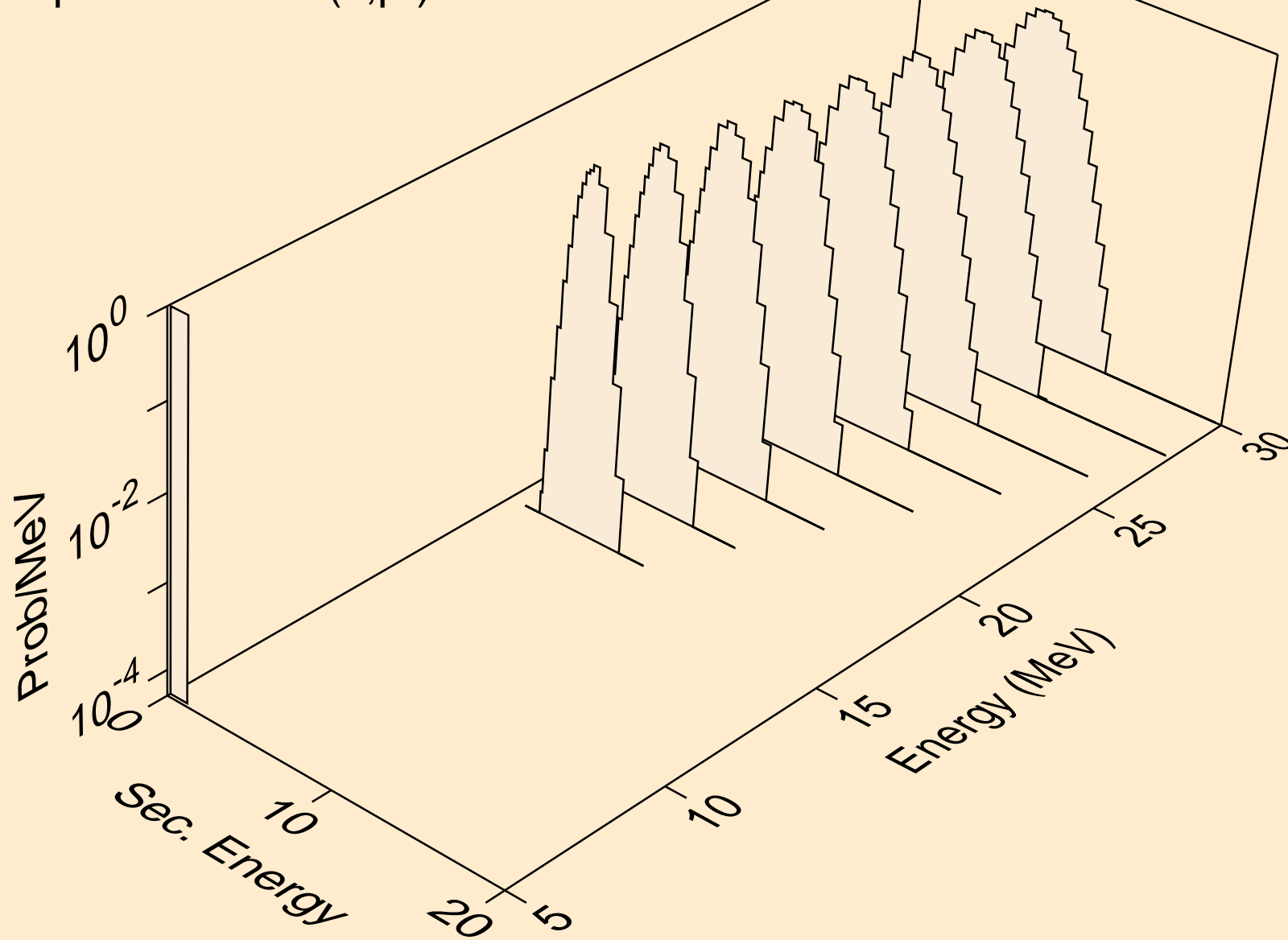

PA230 HELION ACER TENDL-2021 LIBRARY; T=0.K  
deuterons from (s,x)

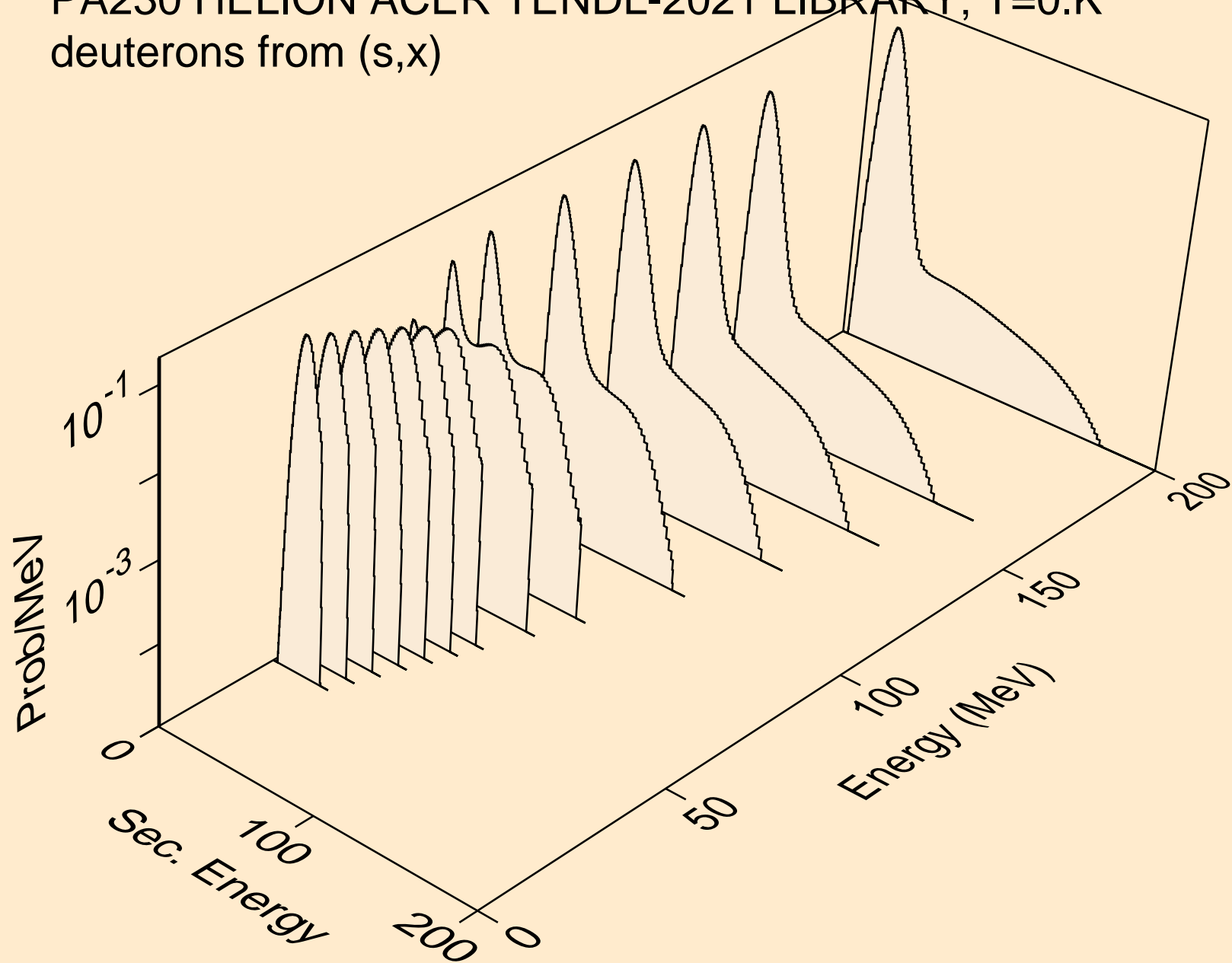

PA230 HELION ACER TENDL-2021 LIBRARY; T=0.K  
deuterons from (s,2nd)

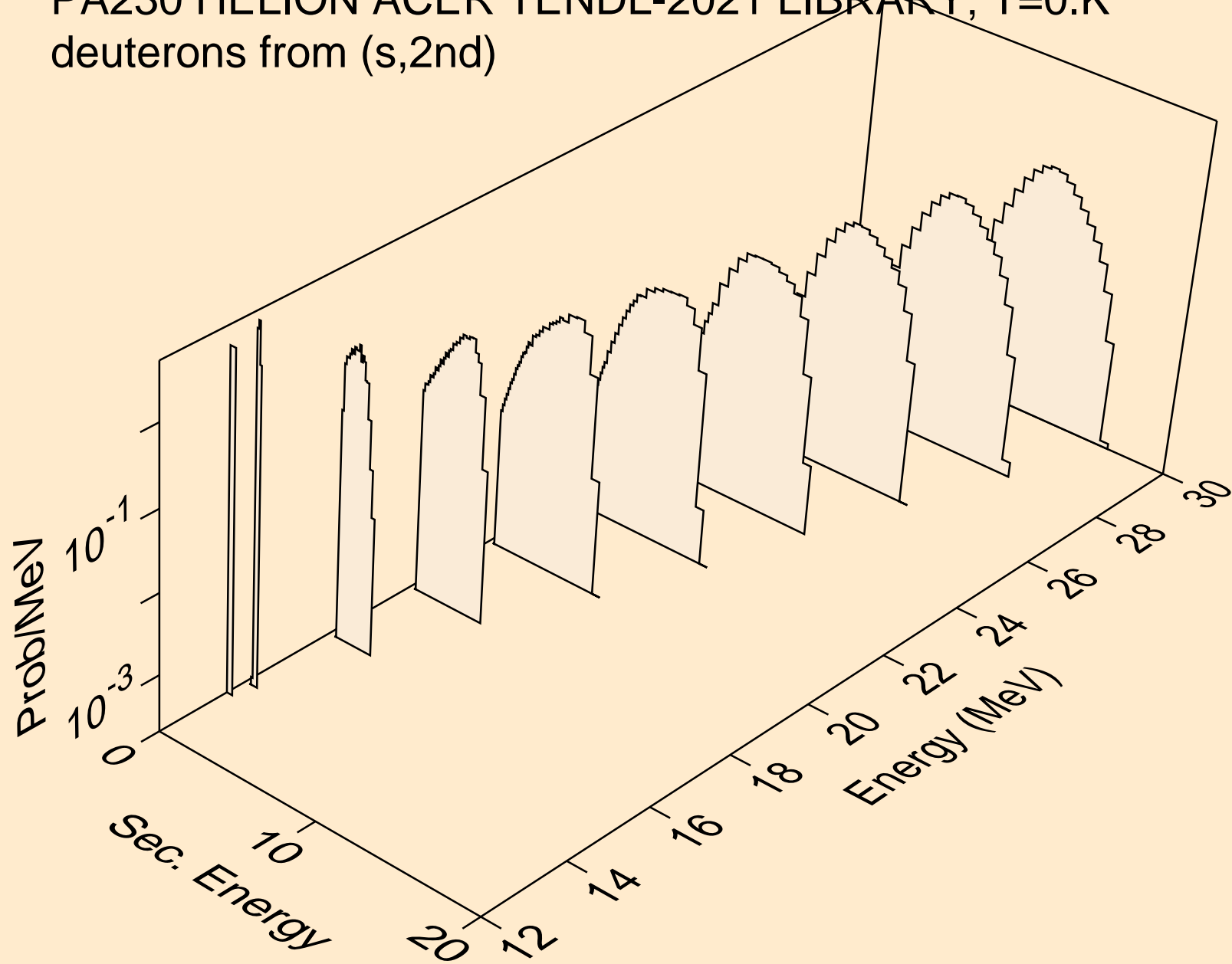

PA230 HELION ACER TENDL-2021 LIBRARY; T=0.K  
deuterons from (s,n\*)d

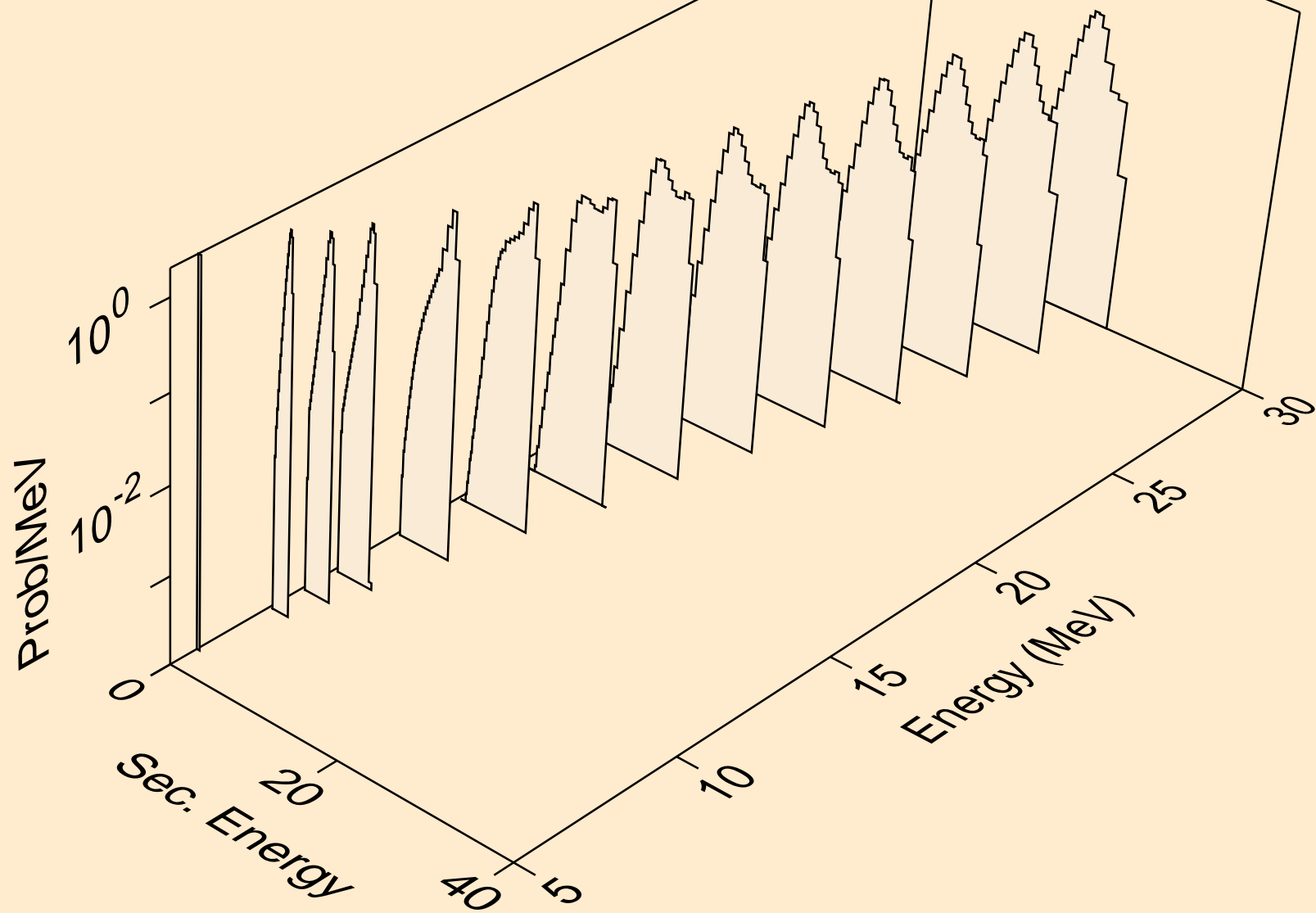

PA230 HELION ACER TENDL-2021 LIBRARY; T=0.K  
deuterons from (s,d)

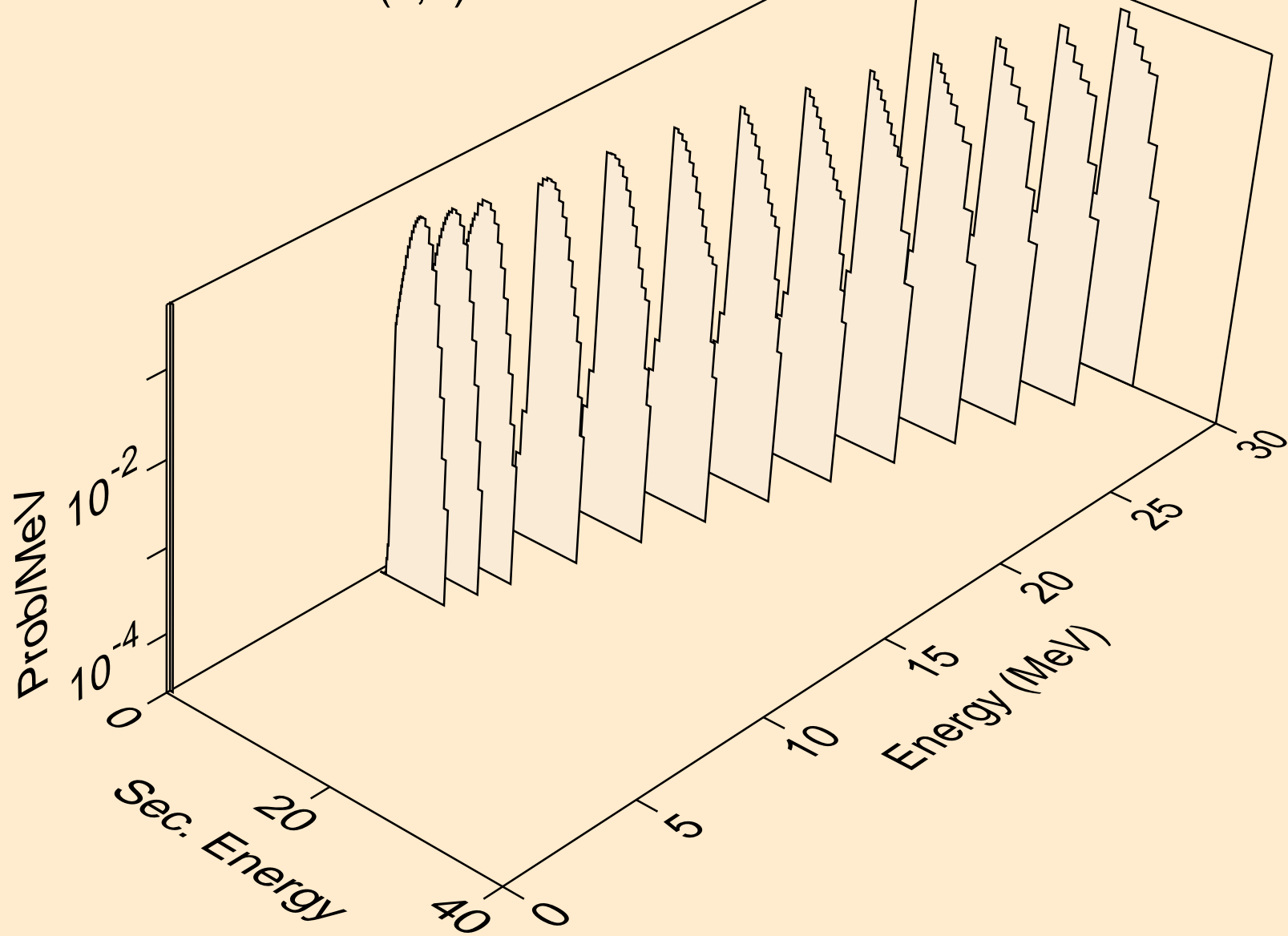

PA230 HELION ACER TENDL-2021 LIBRARY; T=0.K  
deuterons from (s,pd)

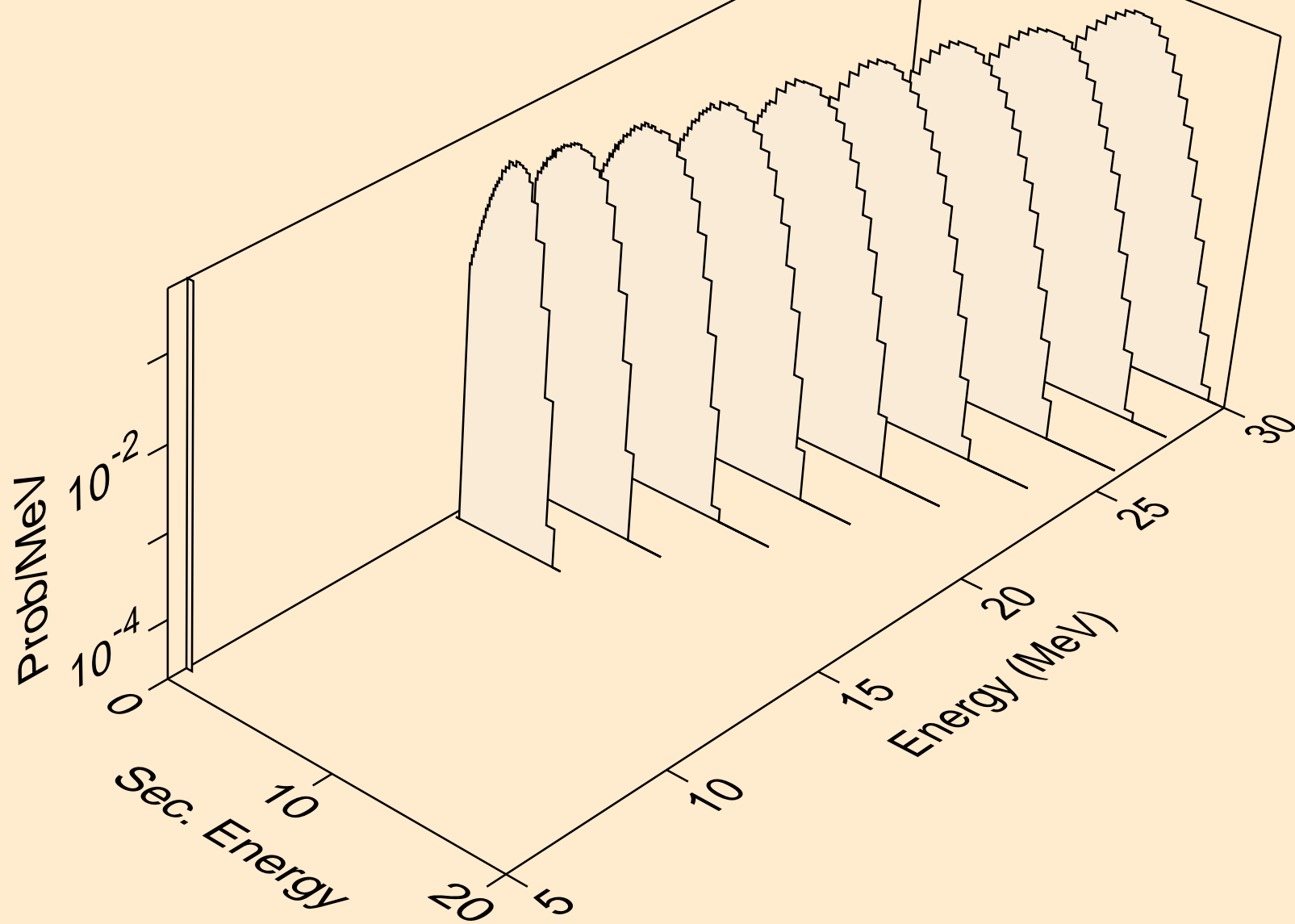

PA230 HELION ACER TENDL-2021 LIBRARY; T=0.K  
deuterons from (s,da)

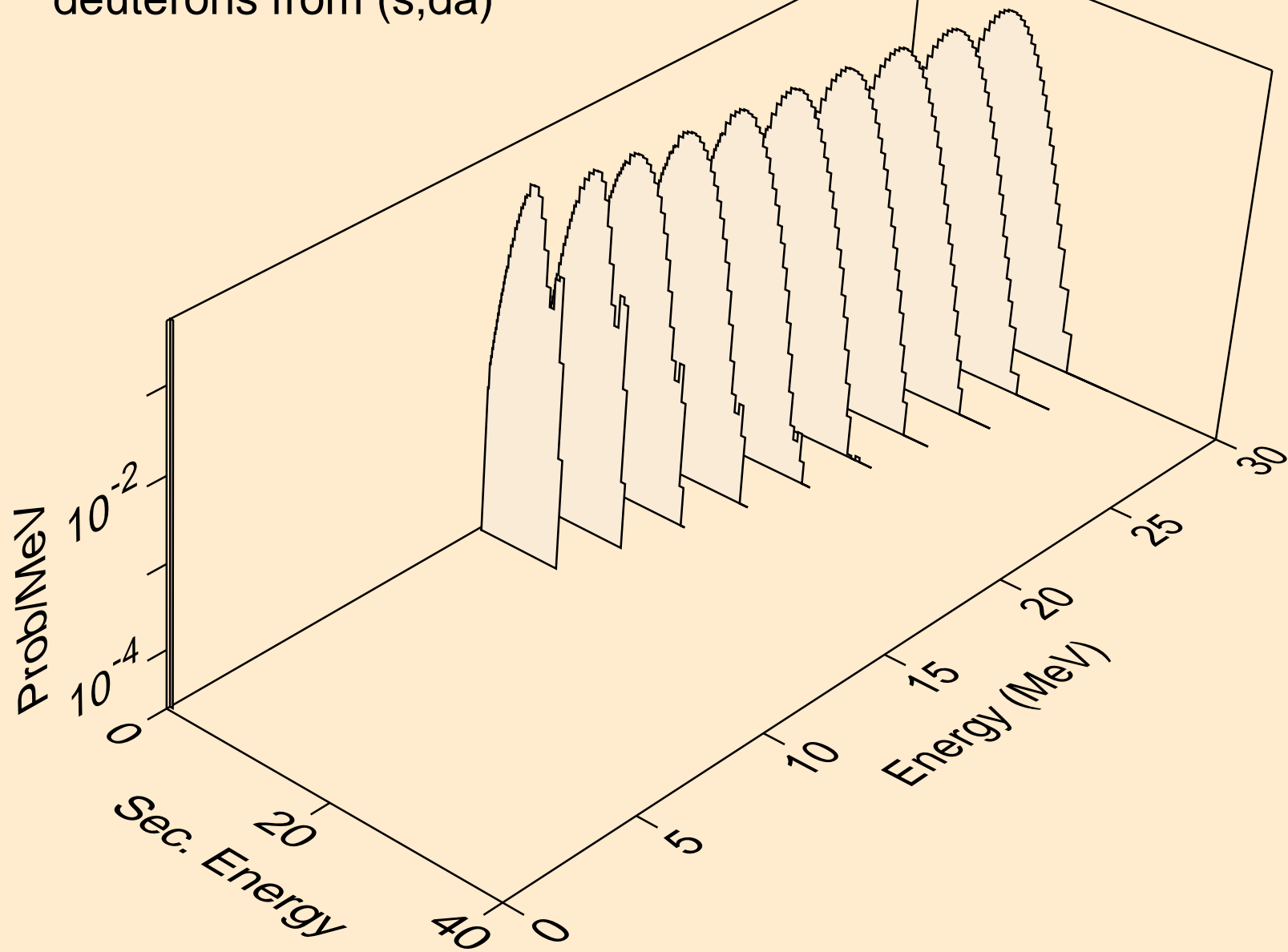



PA230 HELION ACER TENDL-2021 LIBRARY; T=0.K  
tritons from (s,x)

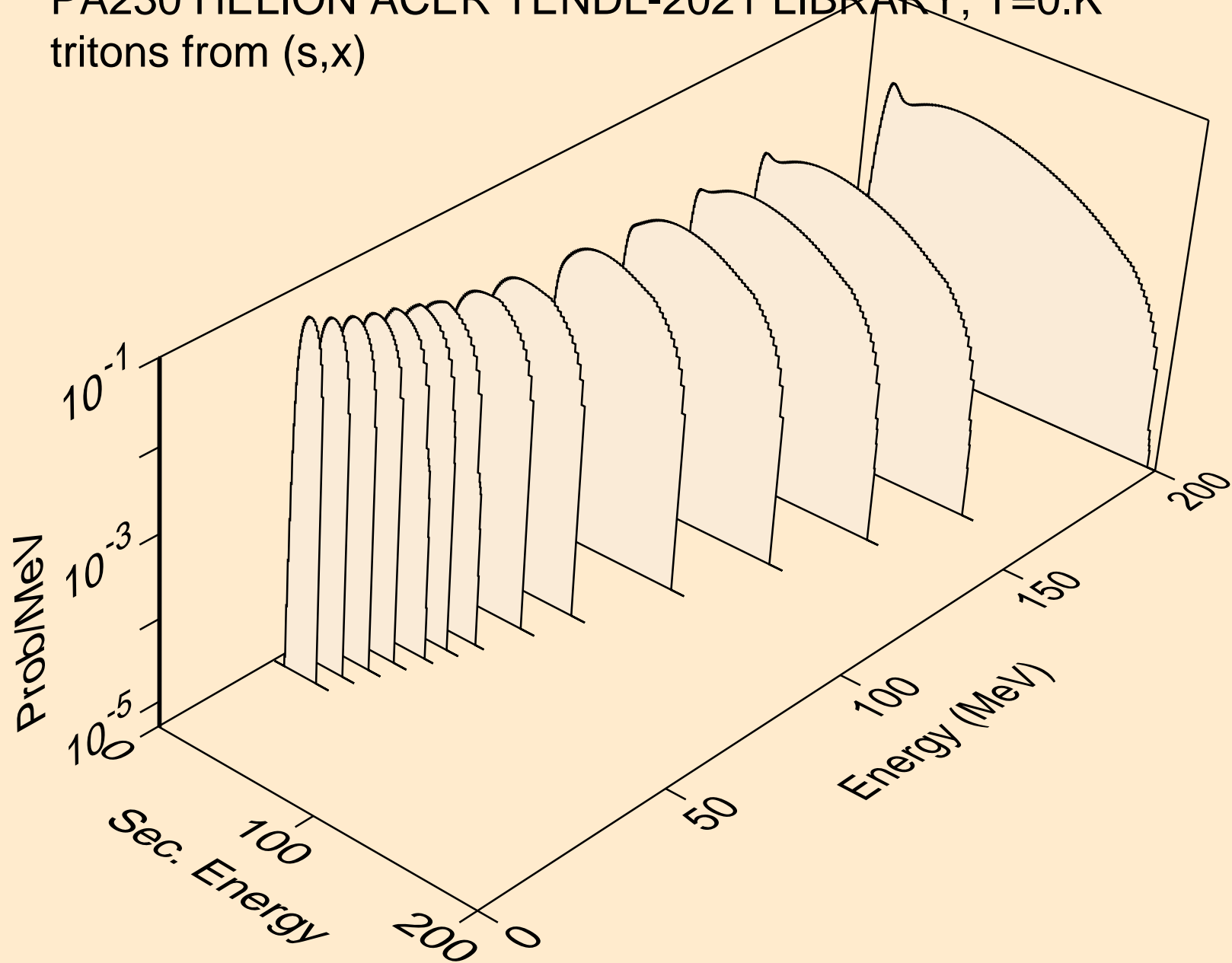

PA230 HELION ACER TENDL-2021 LIBRARY; T=0.K  
tritons from (s,n\*)t

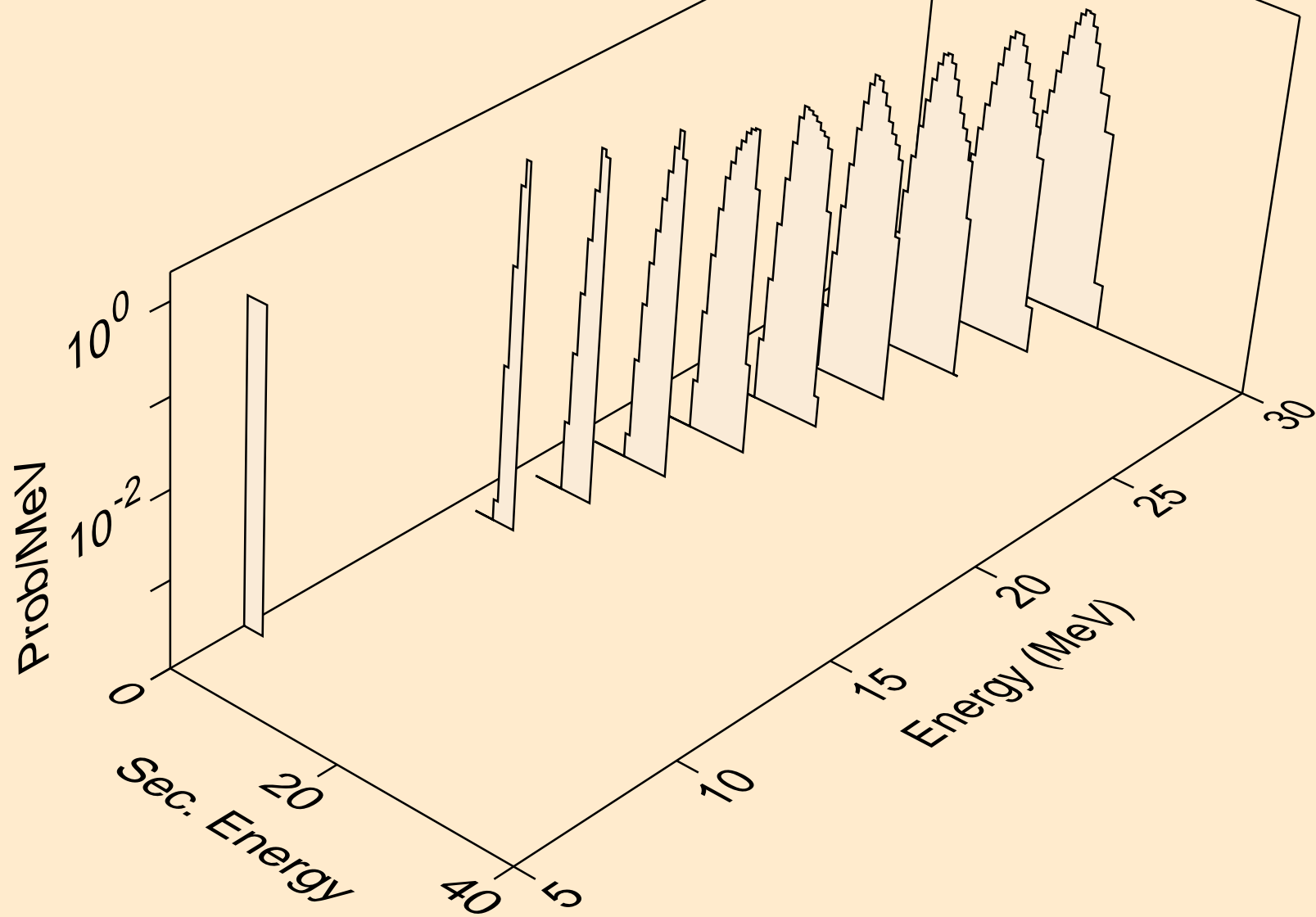

PA230 HELION ACER TENDL-2021 LIBRARY; T=0.K  
tritons from (s,t)

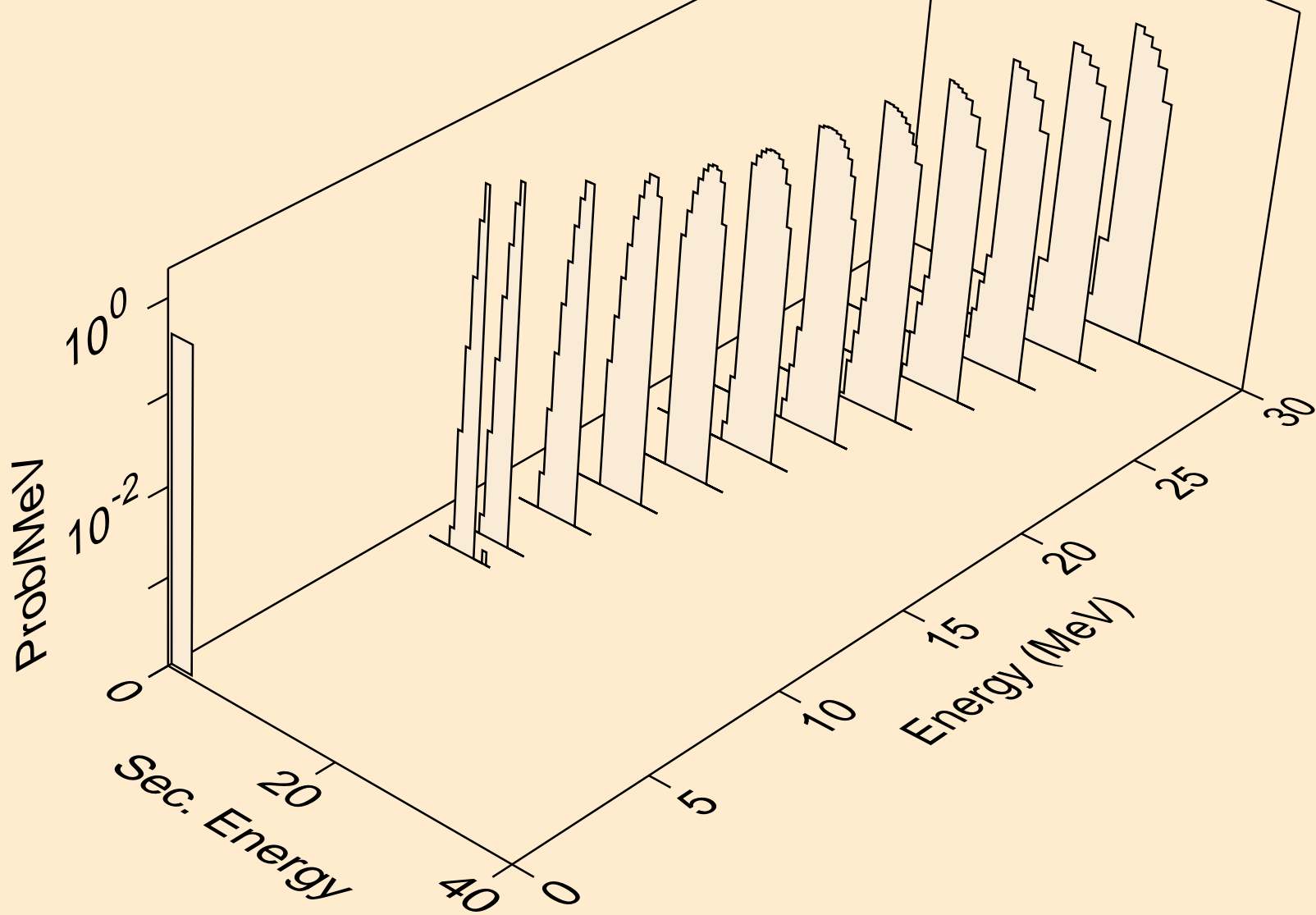

PA230 HELION ACER TENDL-2021 LIBRARY; T=0.K  
tritons from (s,pt)

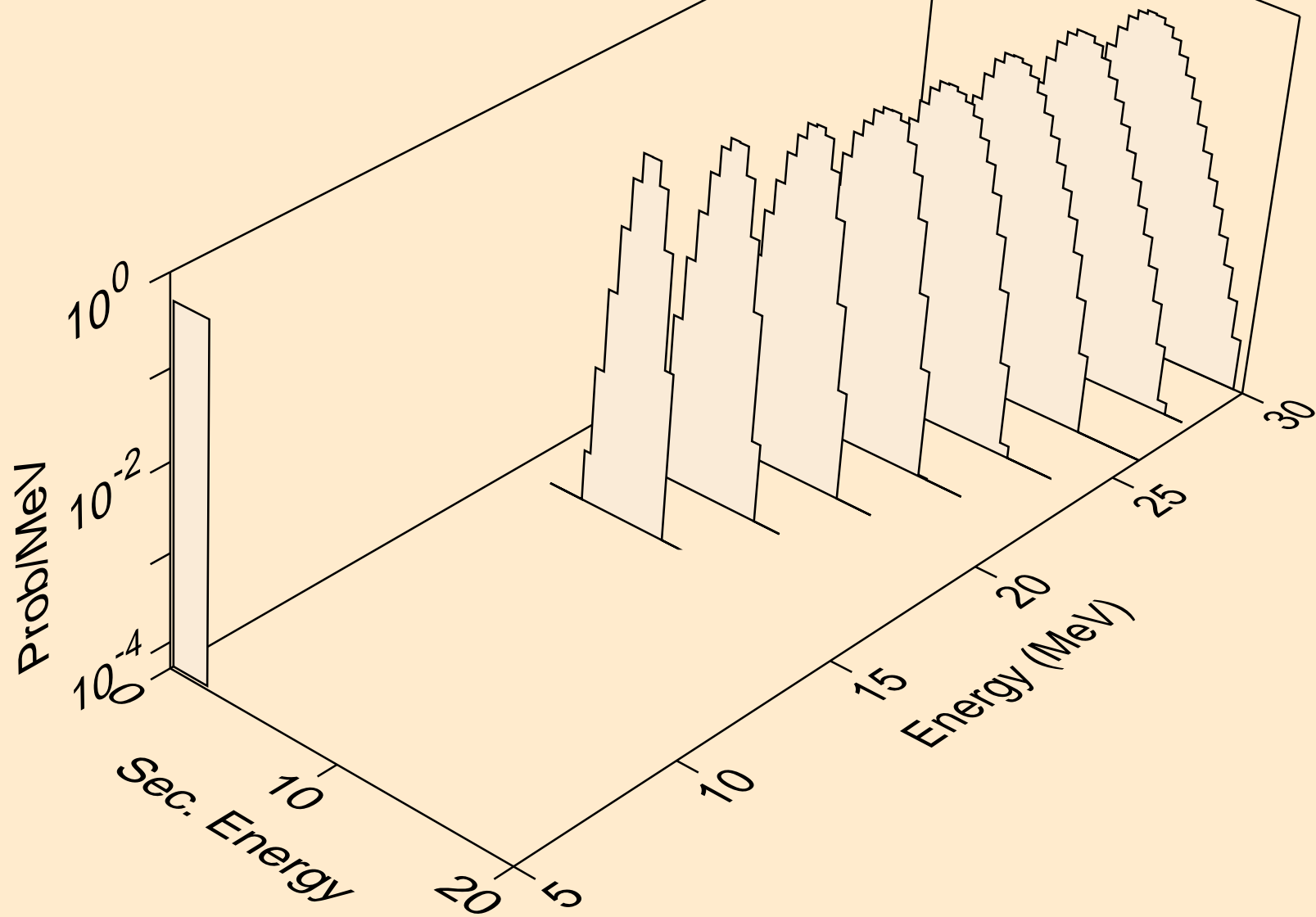

PA230 HELION ACER TENDL-2021 LIBRARY; T=0.K  
alphas from (s,x)

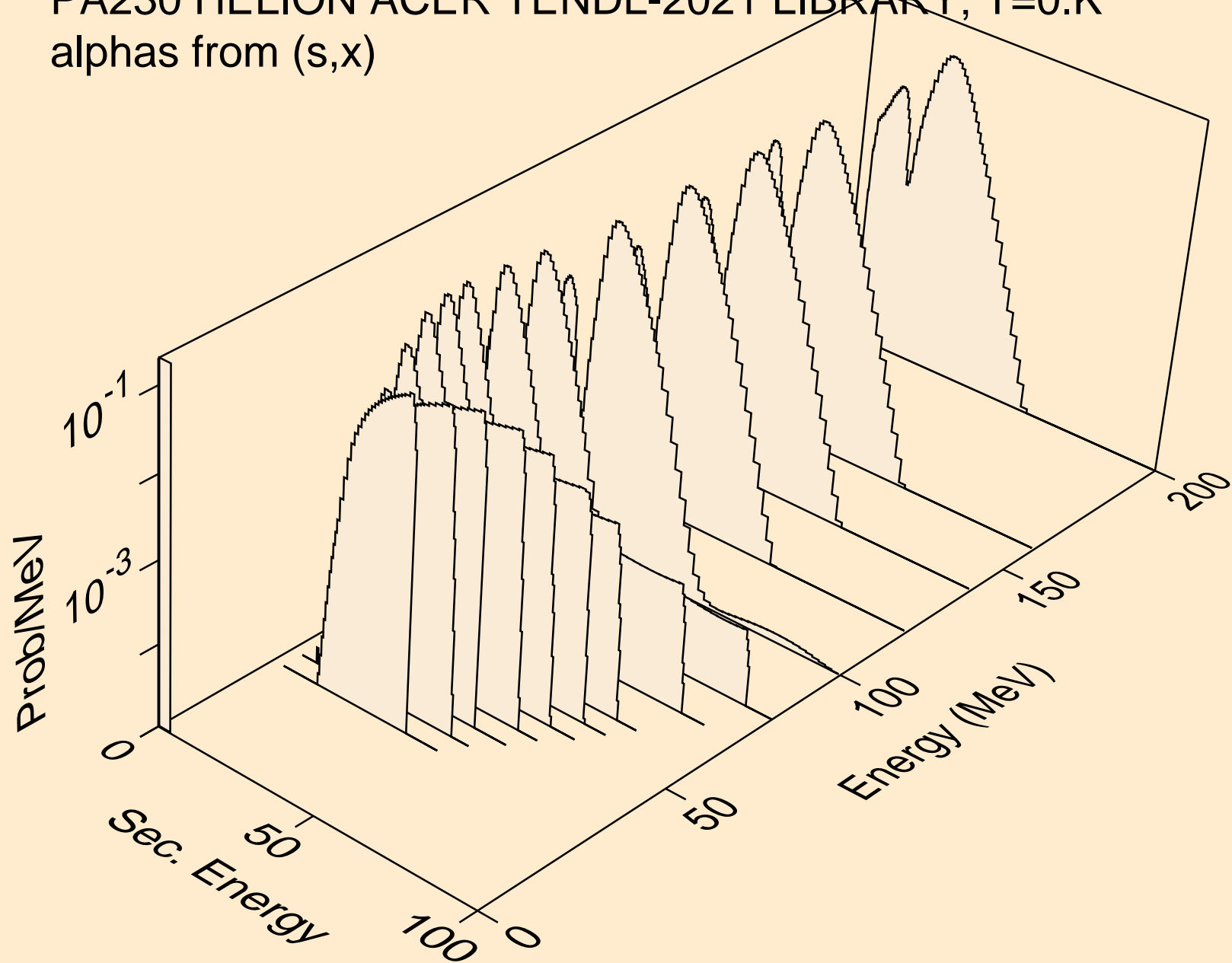

PA230 HELION ACER TENDL-2021 LIBRARY; T=0.K  
alphas from (s,n\*)a

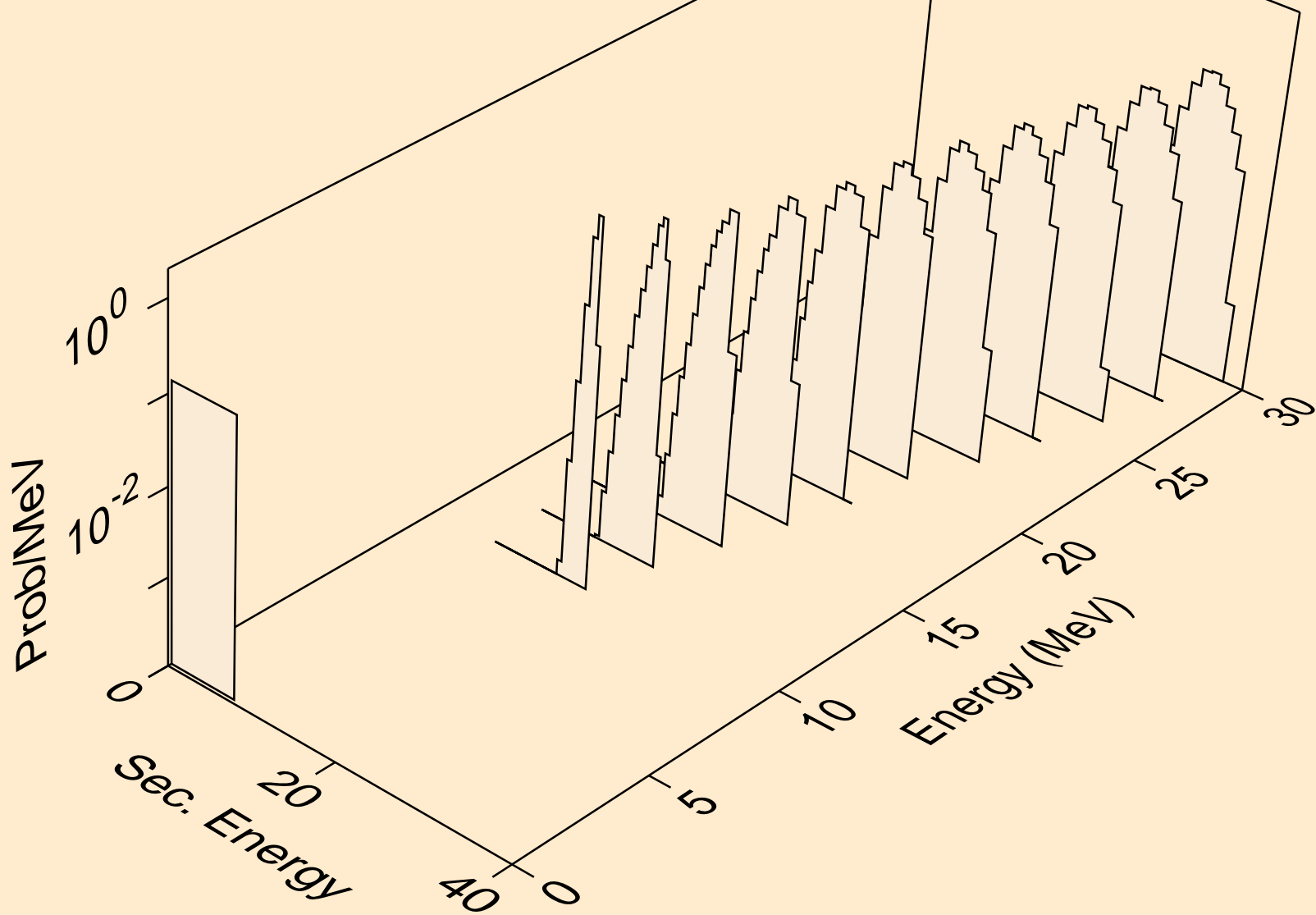

PA230 HELION ACER TENDL-2021 LIBRARY; T=0.K  
alphas from (s,2n)a

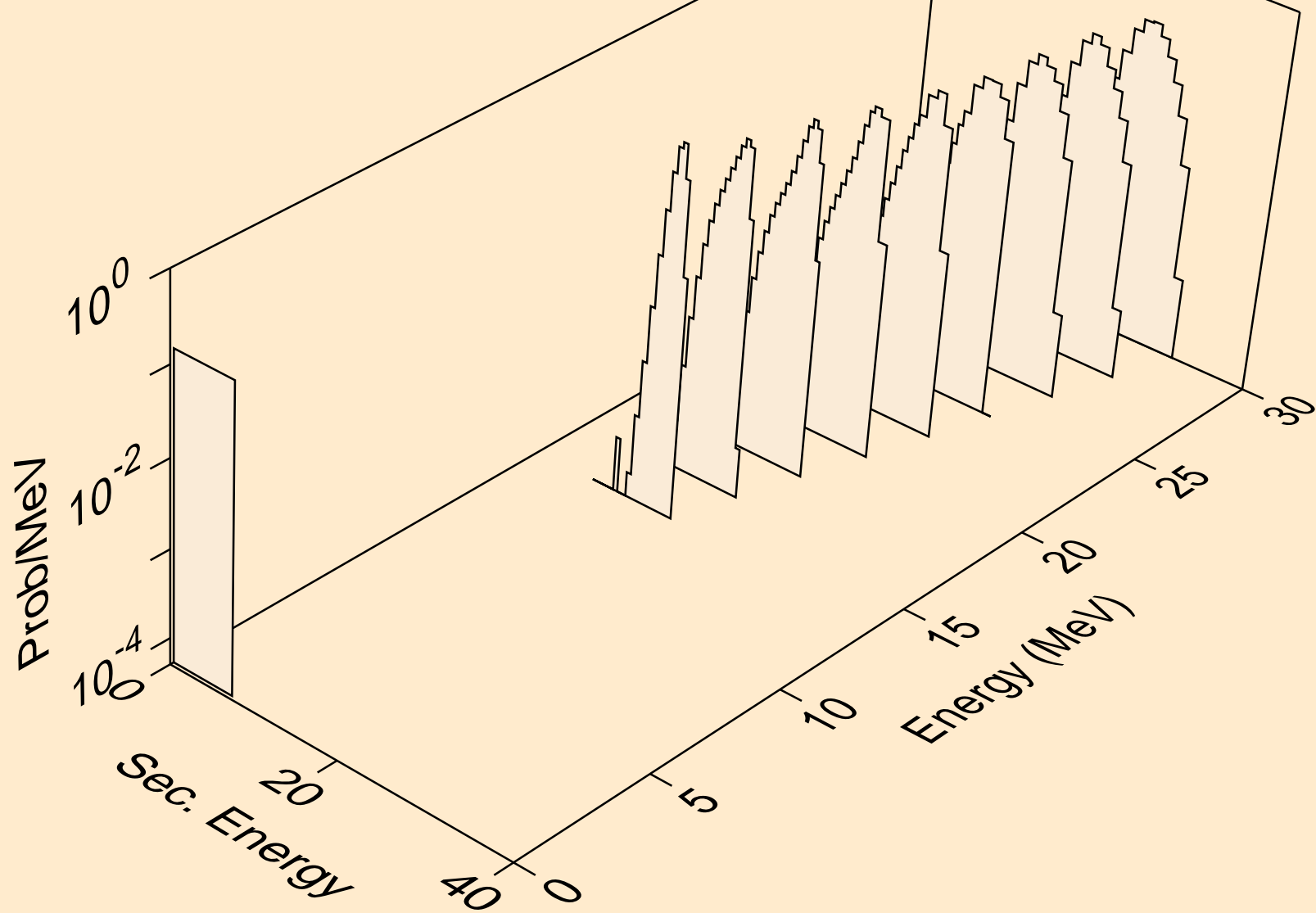

PA230 HELION ACER TENDL-2021 LIBRARY; T=0.K  
alphas from (s,3n)a

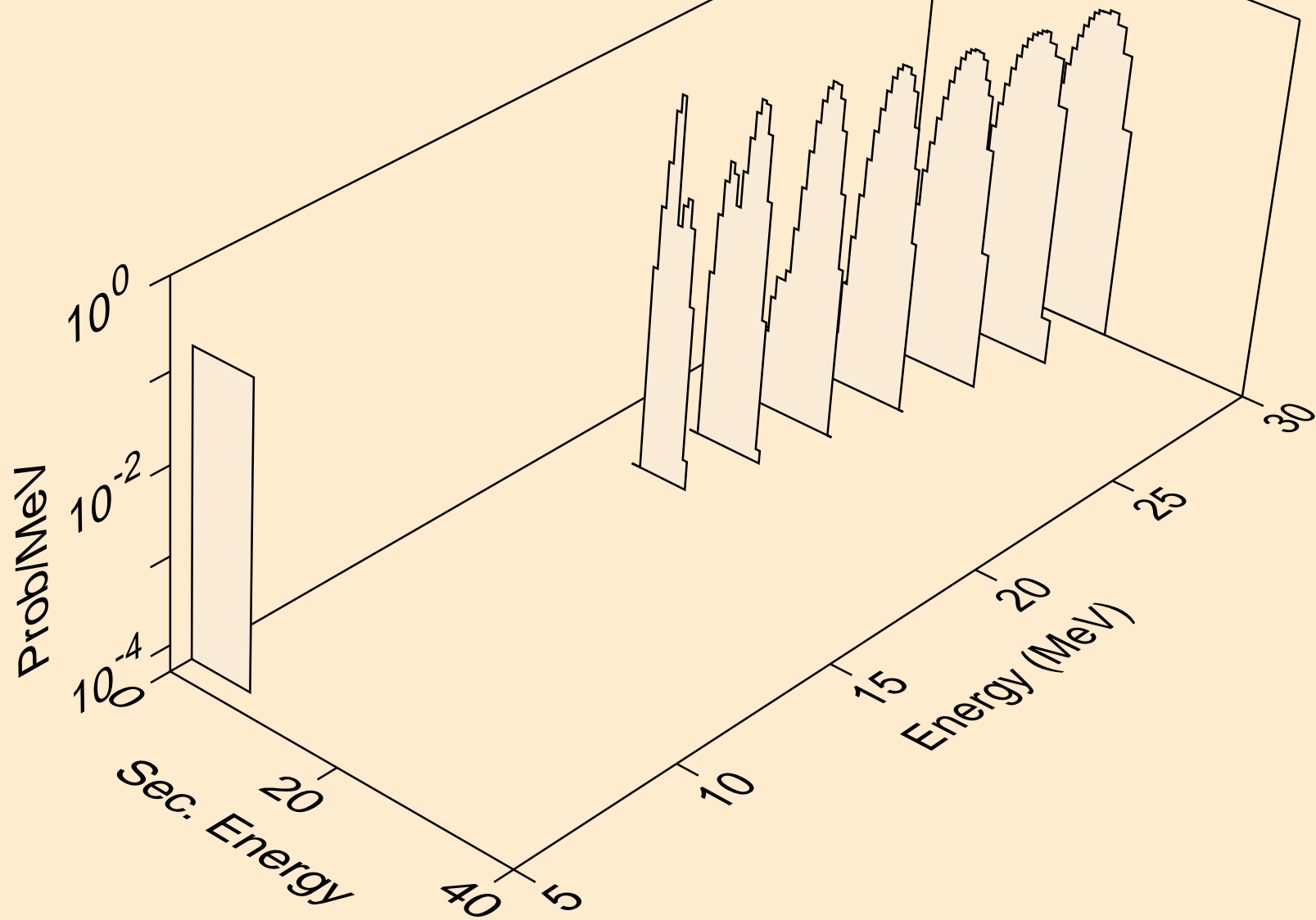



PA230 HELION ACER TENDL-2021 LIBRARY; T=0.K  
alphas from (s,npa)

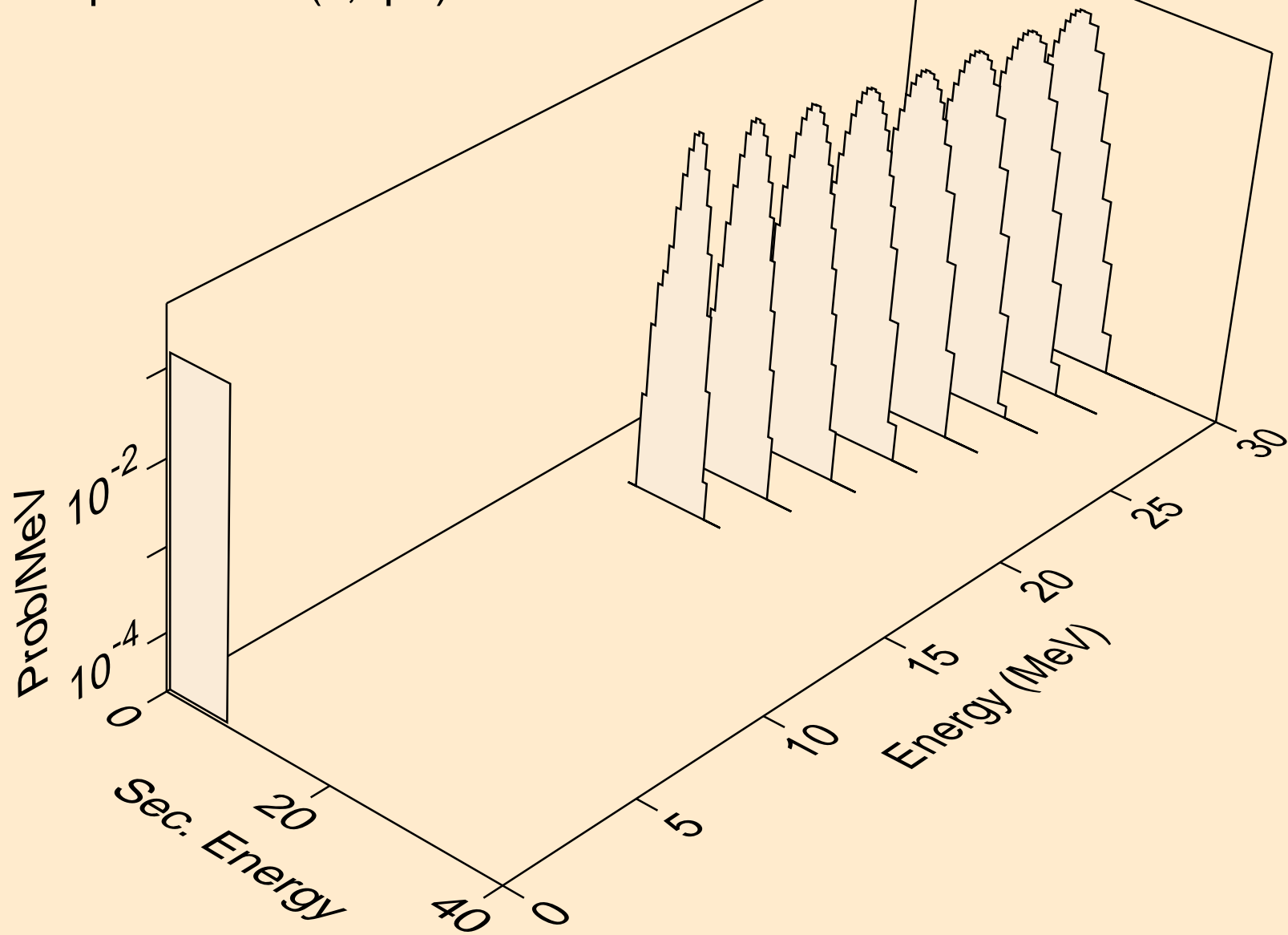

PA230 HELION ACER TENDL-2021 LIBRARY; T=0.K  
alphas from (s,a)

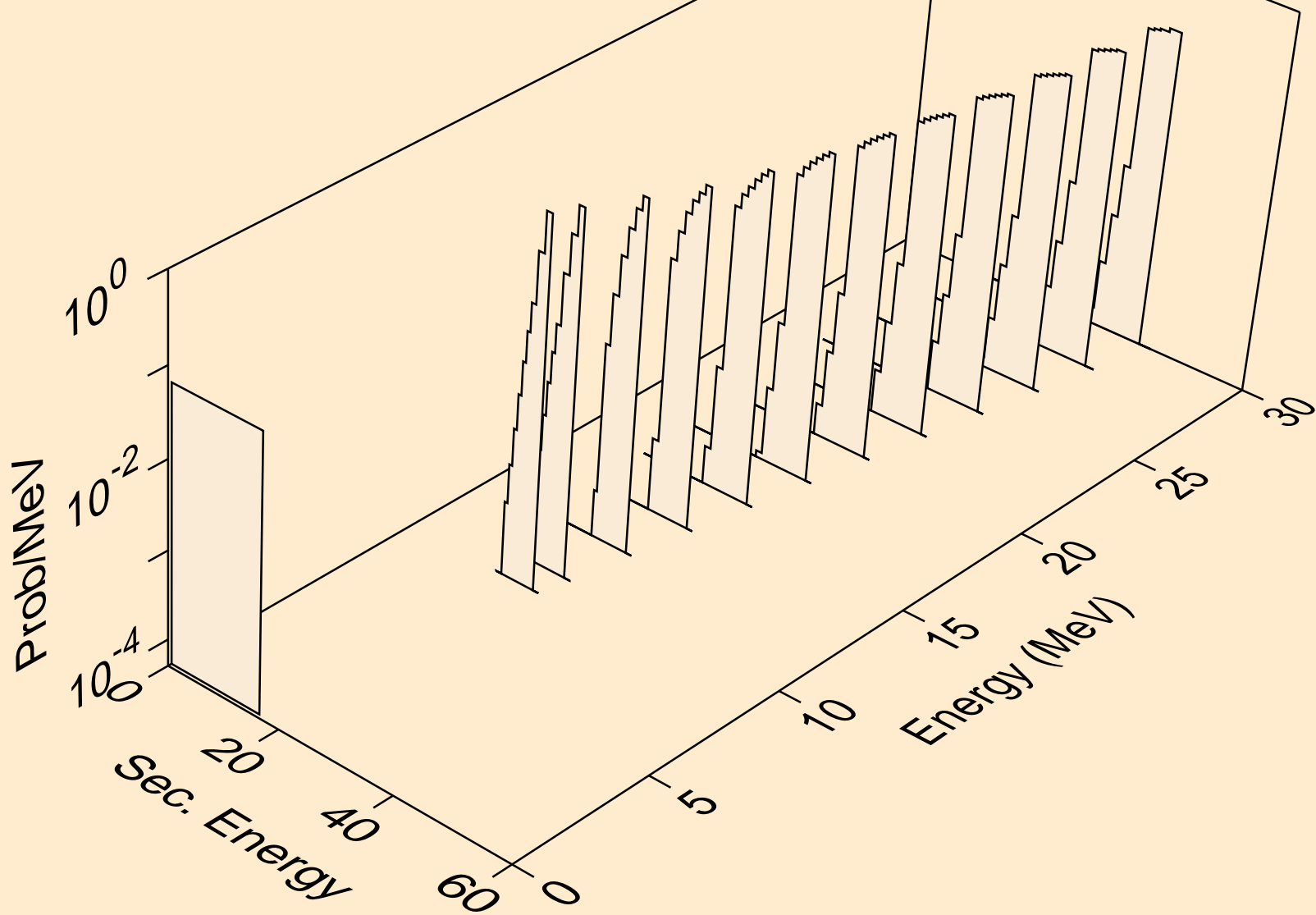

PA230 HELION ACER TENDL-2021 LIBRARY; T=0.K  
alphas from (s,pa)

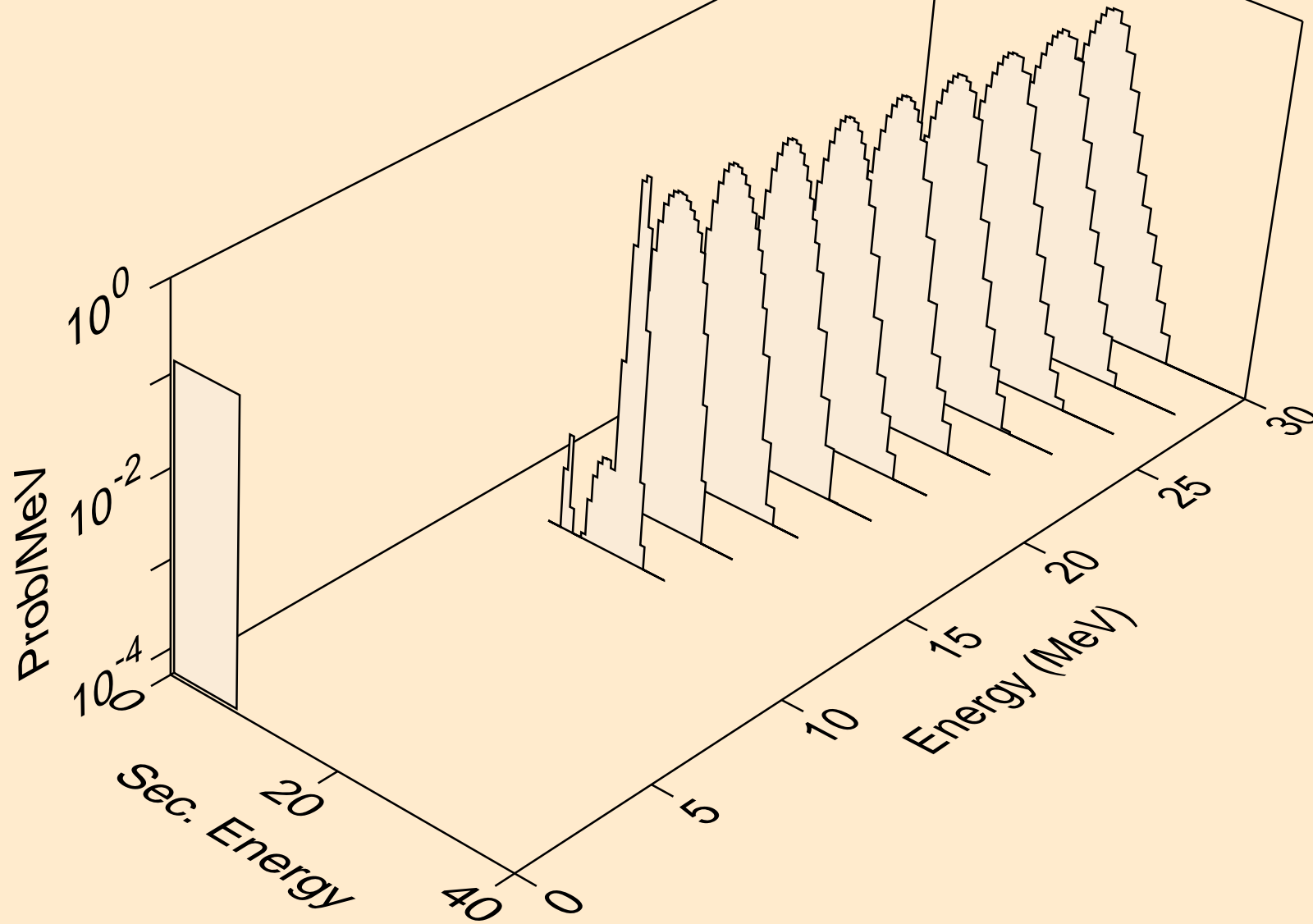

PA230 HELION ACER TENDL-2021 LIBRARY; T=0.K  
alphas from (s,da)

